

DB262 PROTON ACER TENDL-2021 LIBRARY; T=0.K
Principal cross sections

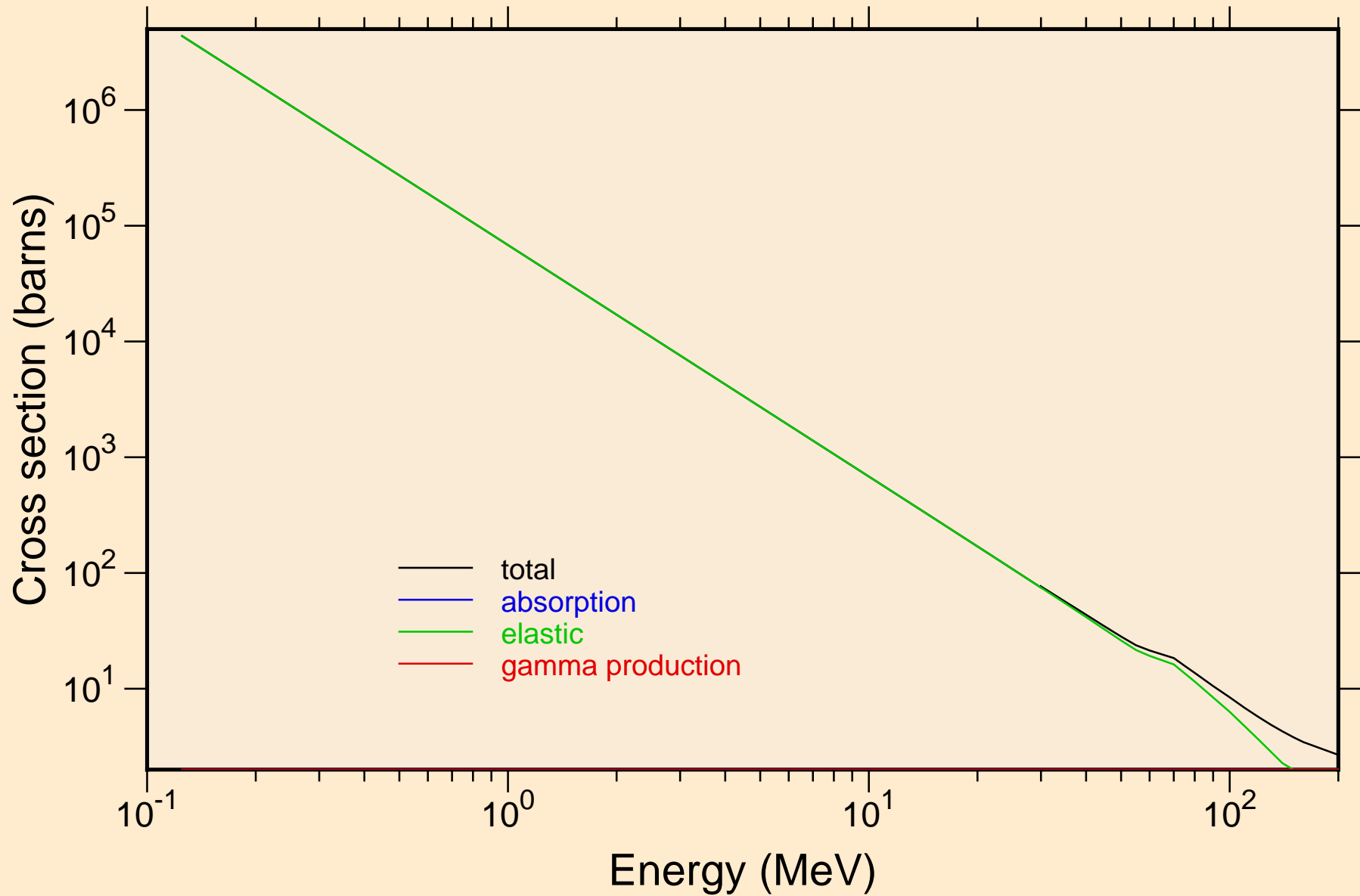

DB262 PROTON ACER TENDL-2021 LIBRARY; T=0.K

Heating

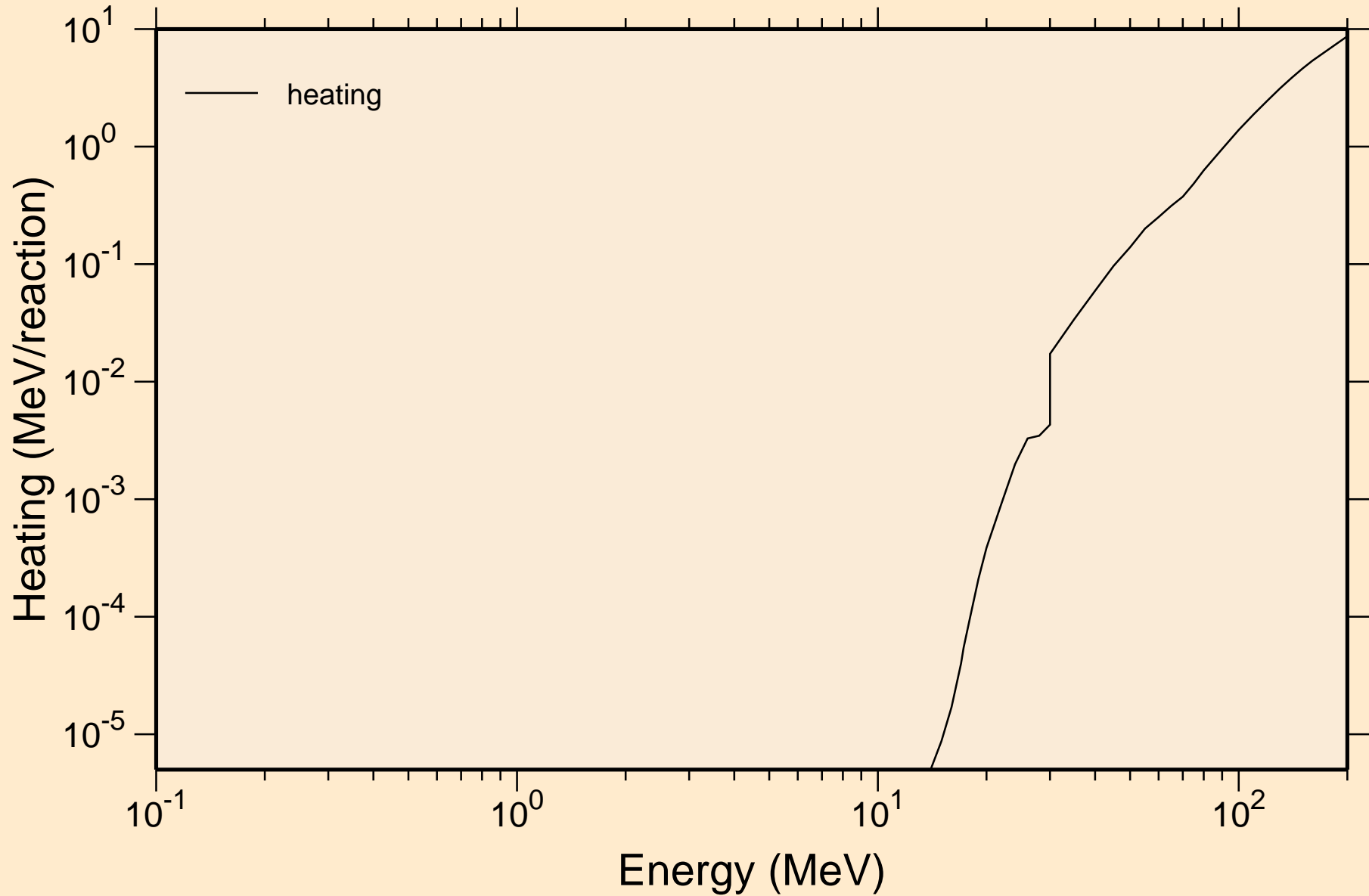

DB262 PROTON ACER TENDL-2021 LIBRARY; T=0.K

Principal cross sections

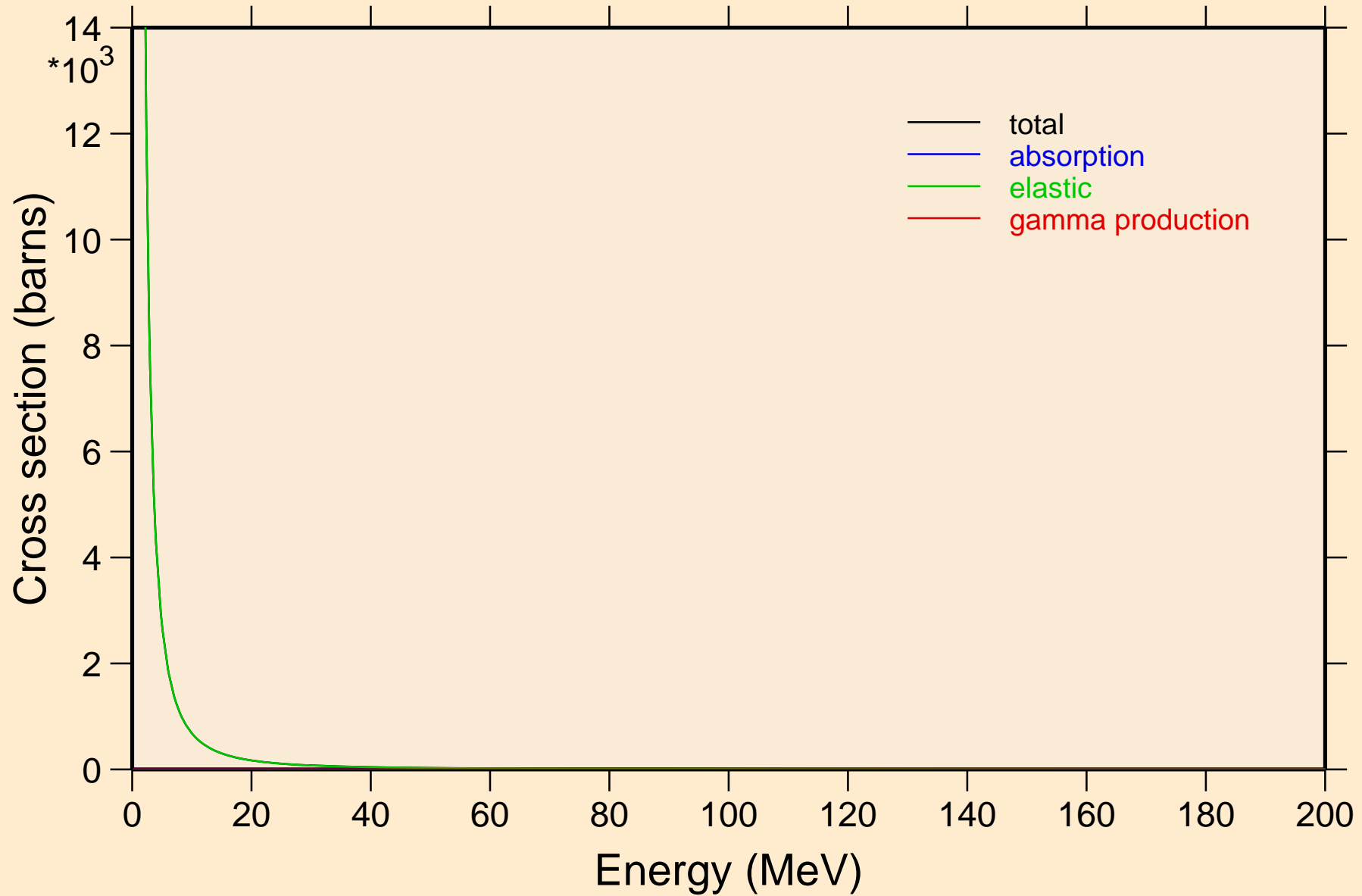

DB262 PROTON ACER TENDL-2021 LIBRARY; T=0.K

Heating

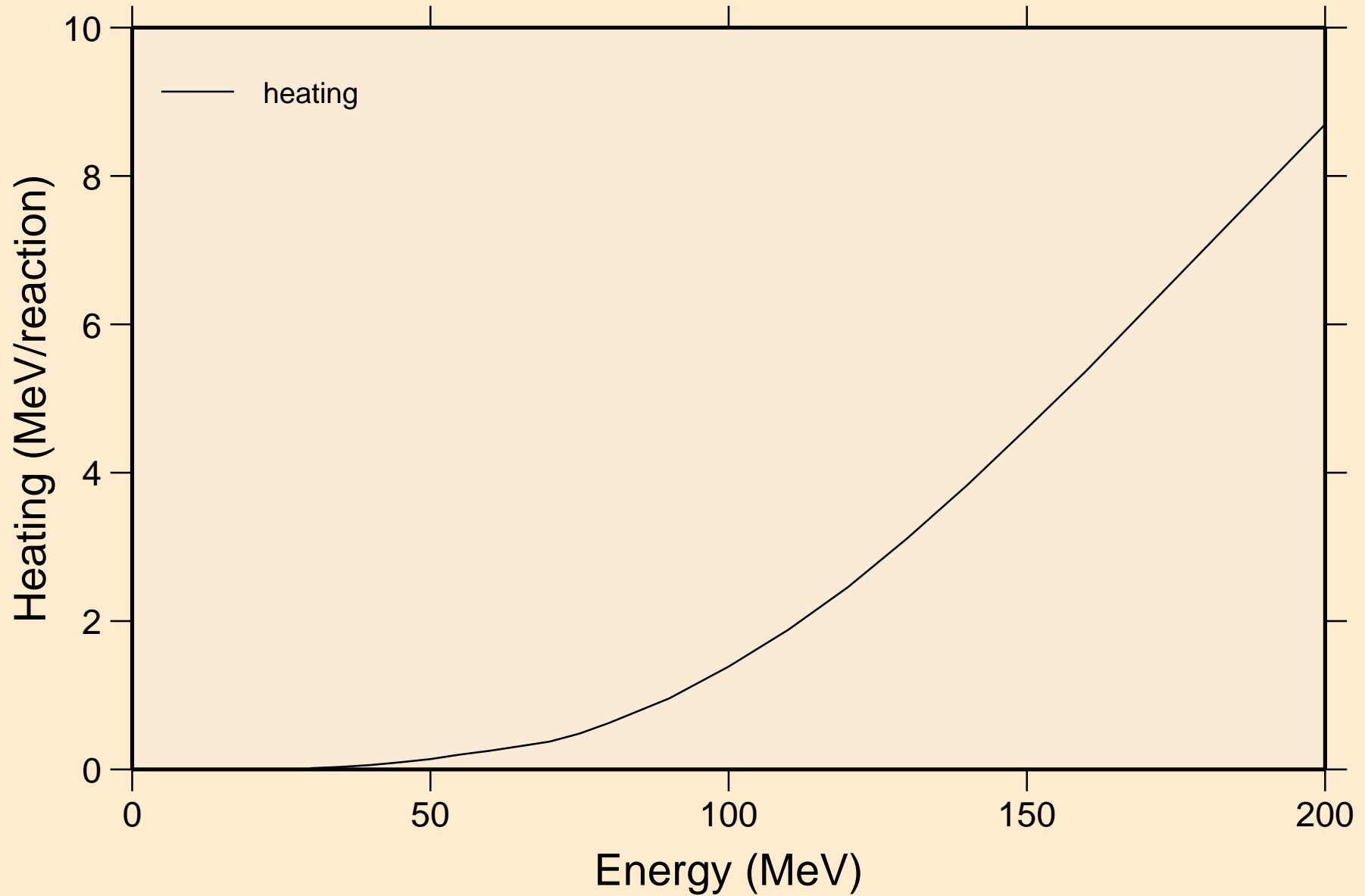

DB262 PROTON ACER TENDL-2021 LIBRARY; T=0.K
Threshold reactions

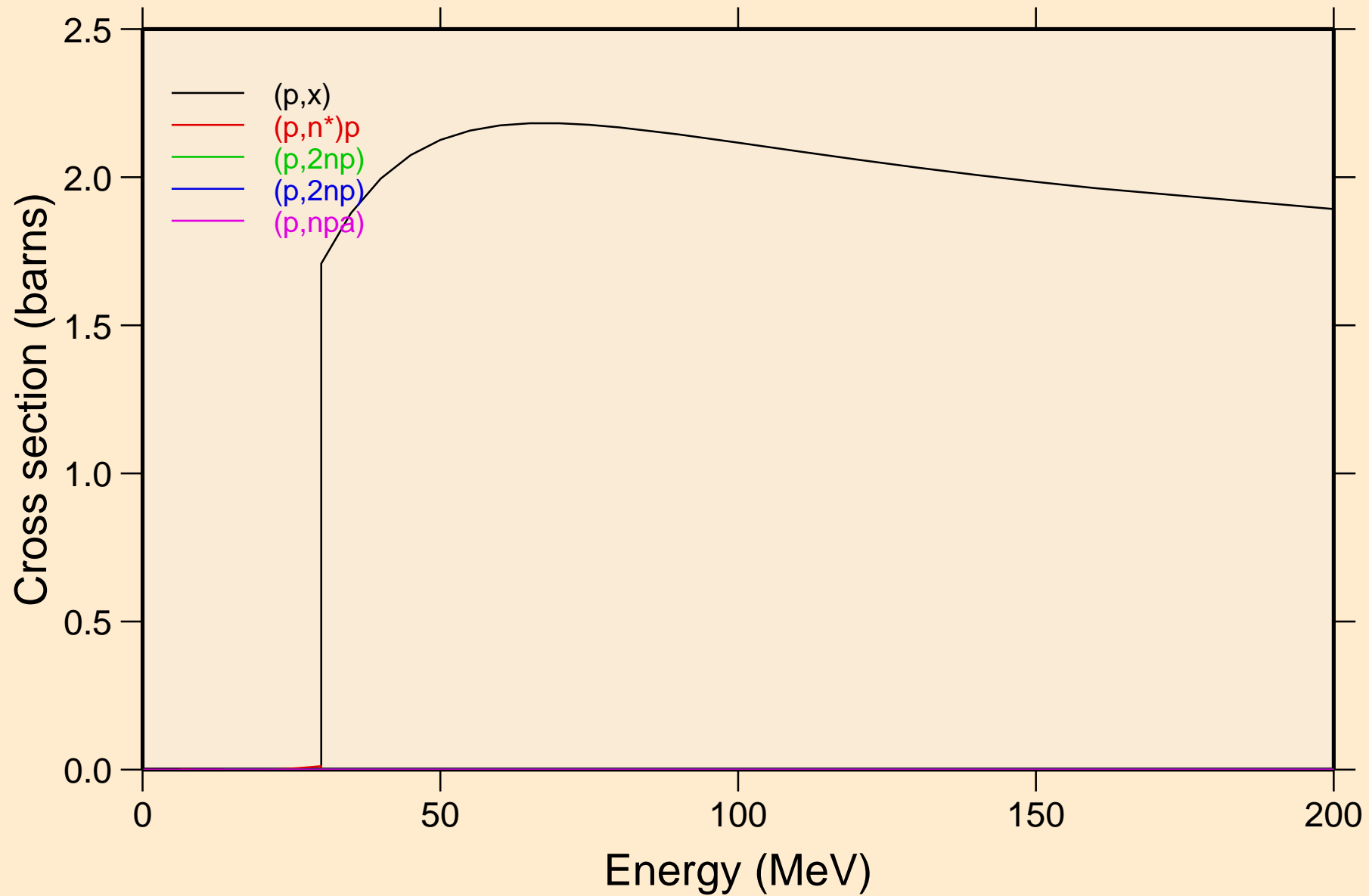

DB262 PROTON ACER TENDL-2021 LIBRARY; T=0.K
Threshold reactions

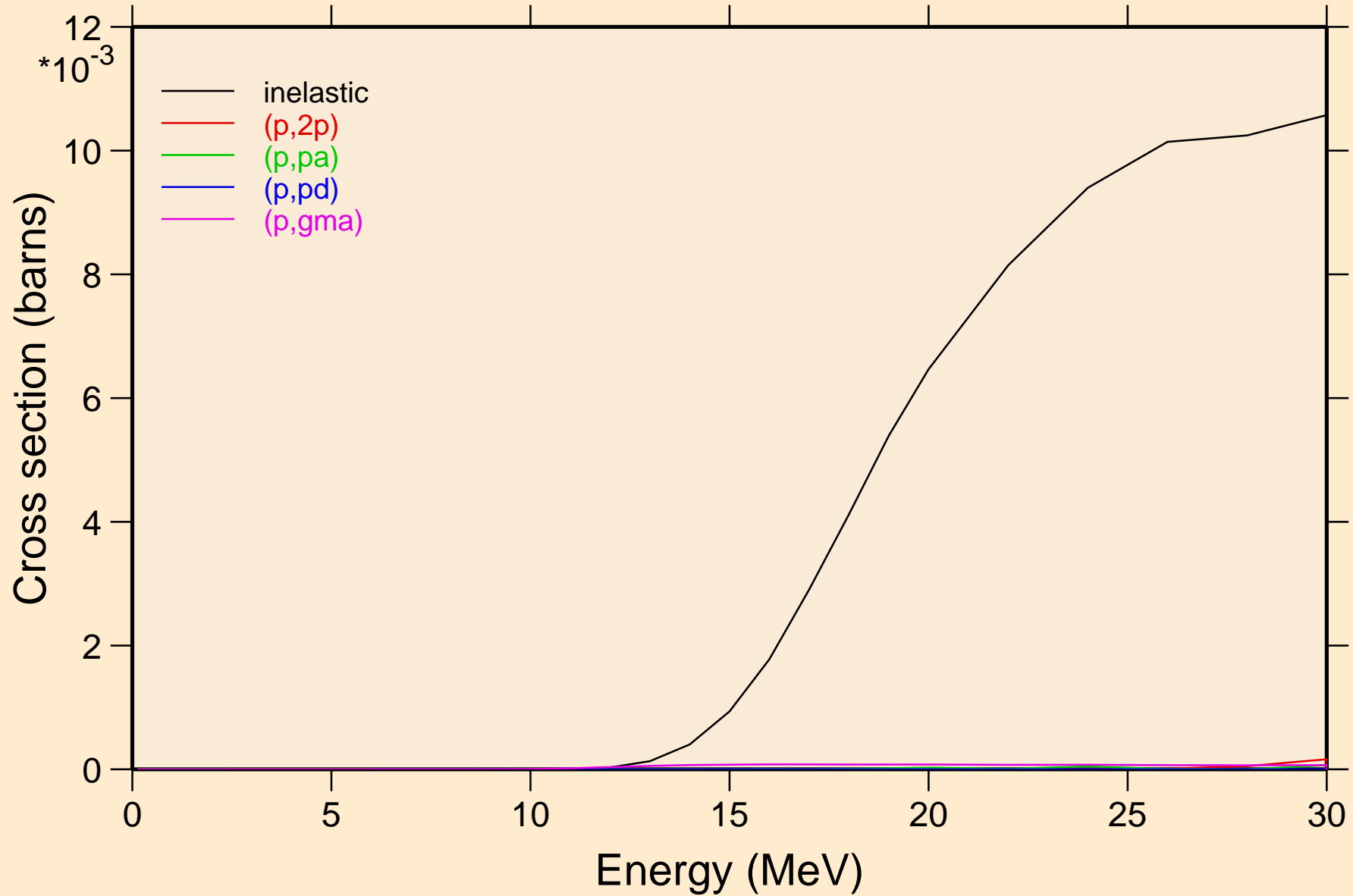

DB262 PROTON ACER TENDL-2021 LIBRARY; T=0.K
Threshold reactions

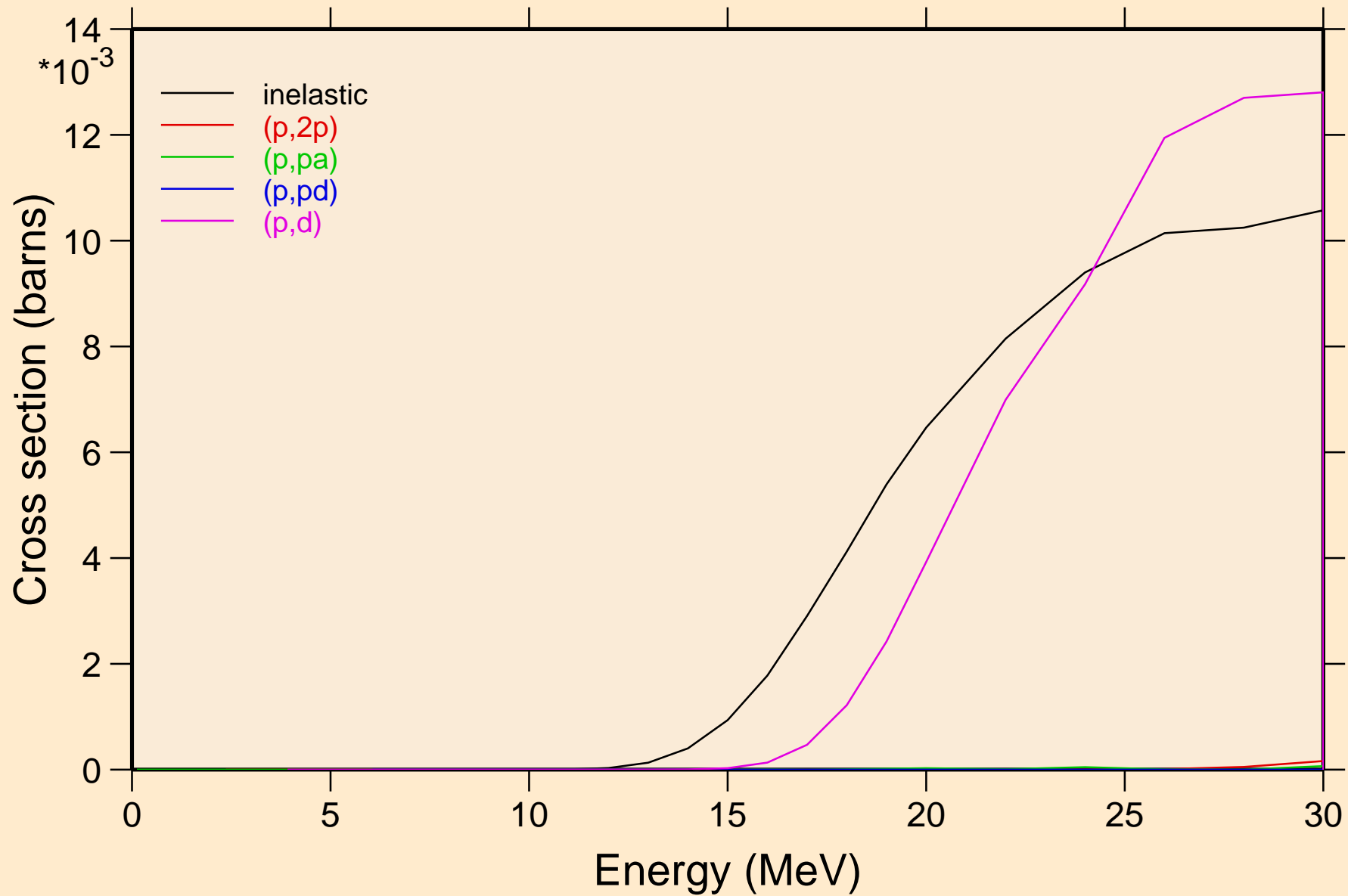

DB262 PROTON ACER TENDL-2021 LIBRARY; T=0.K

Threshold reactions

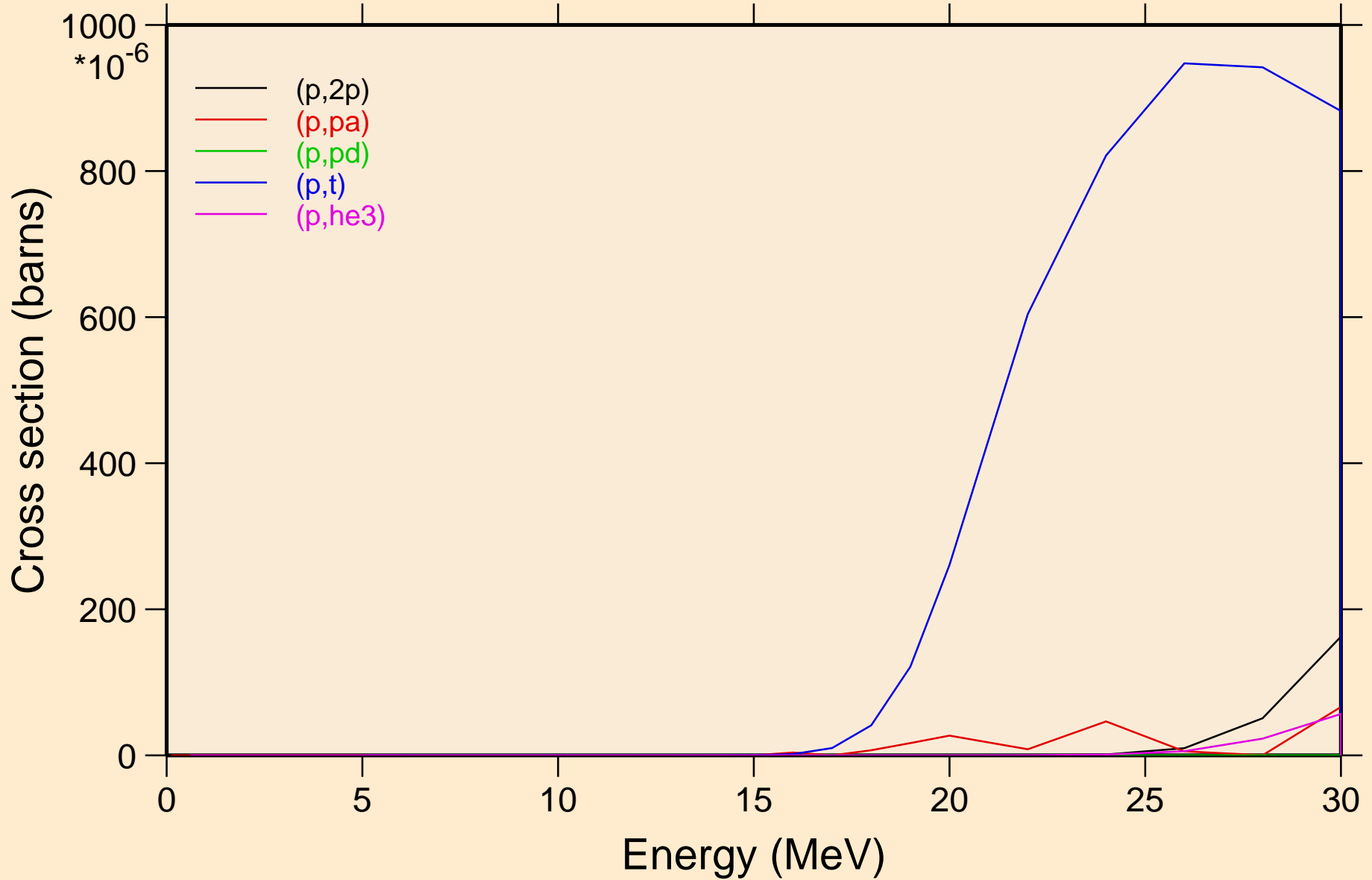

DB262 PROTON ACER TENDL-2021 LIBRARY; T=0.K
Threshold reactions

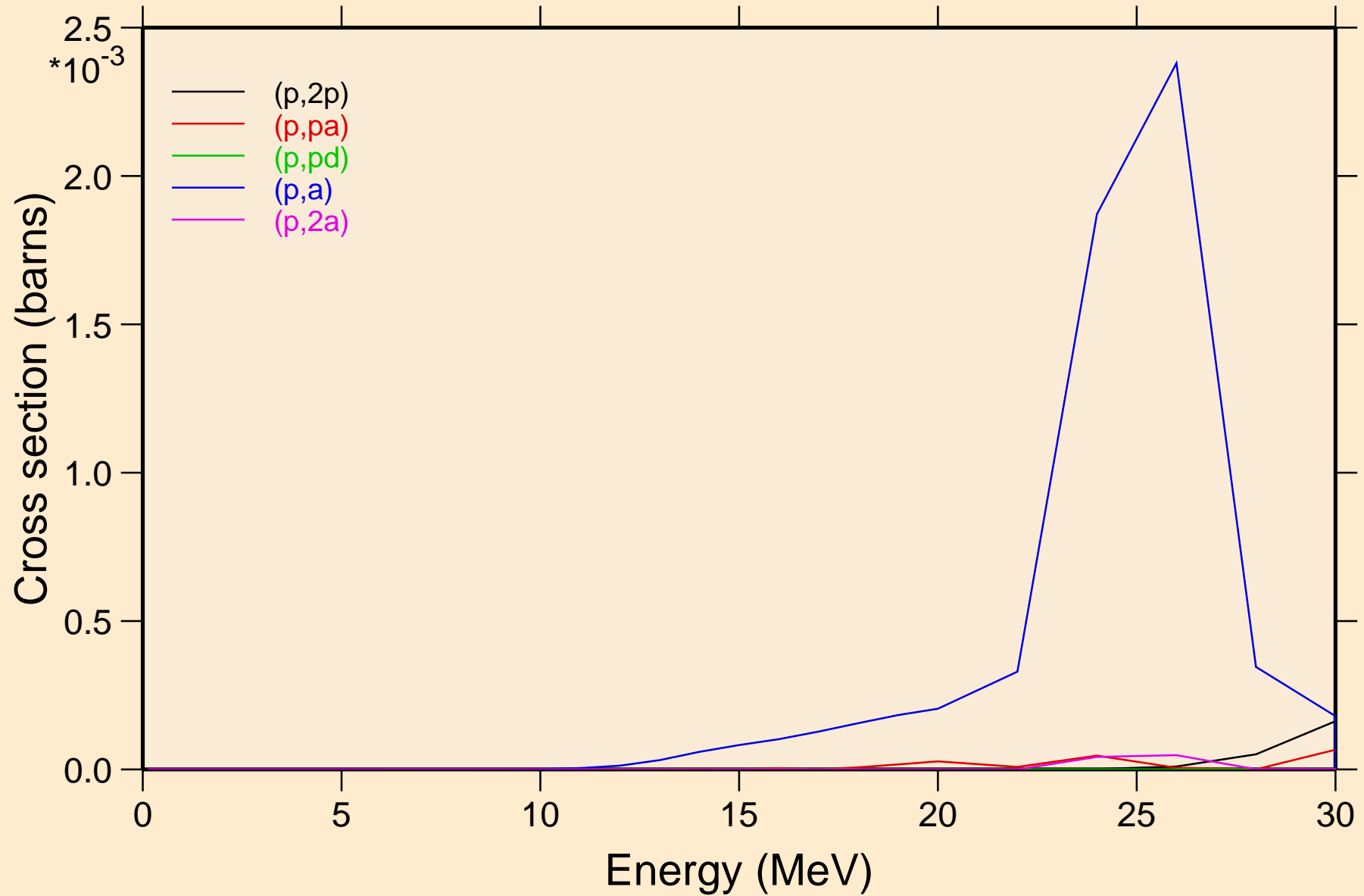

DB262 PROTON ACER TENDL-2021 LIBRARY; T=0.K
Threshold reactions

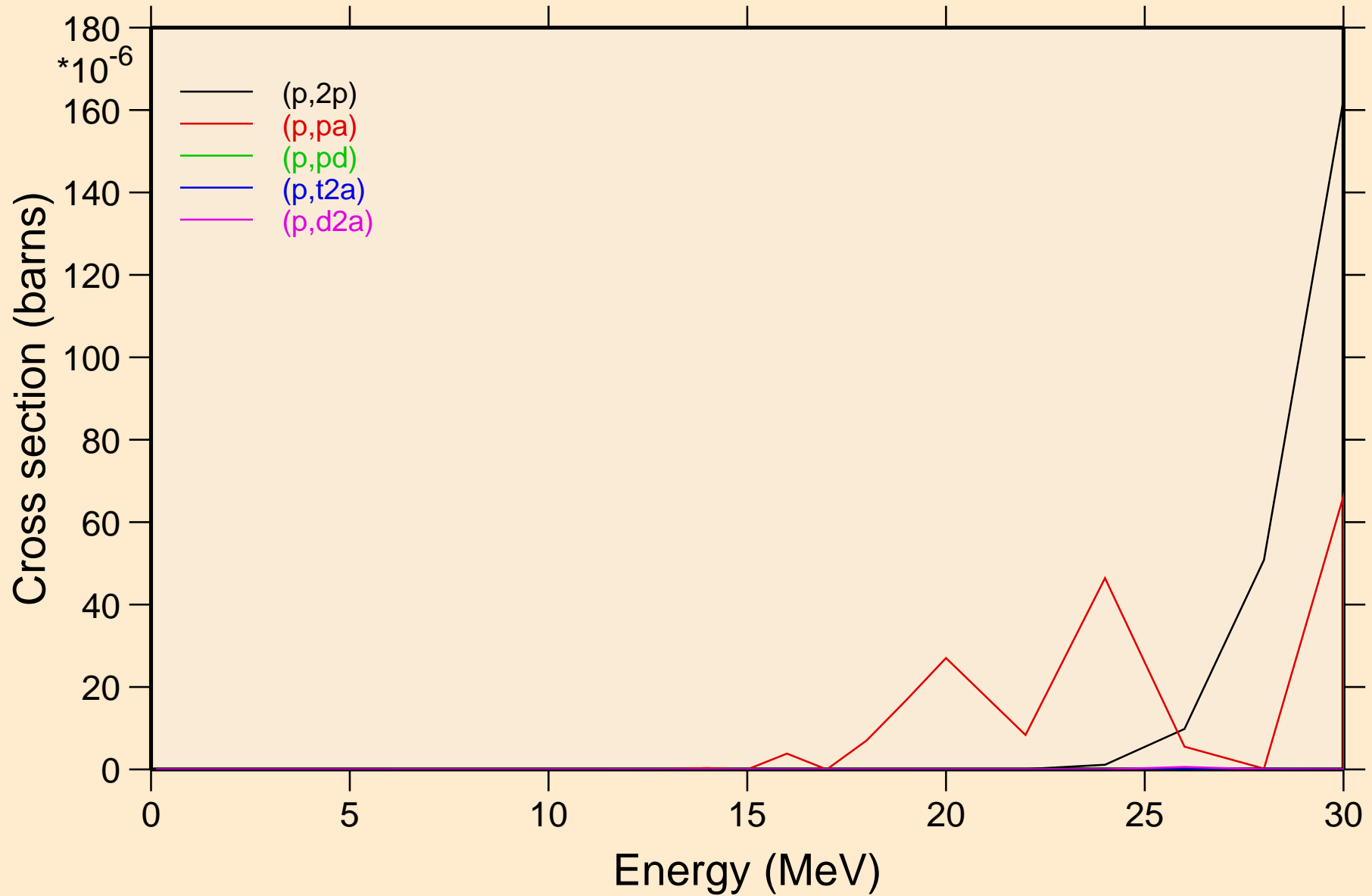

DB262 PROTON ACER TENDL-2021 LIBRARY; T=0.K
Threshold reactions

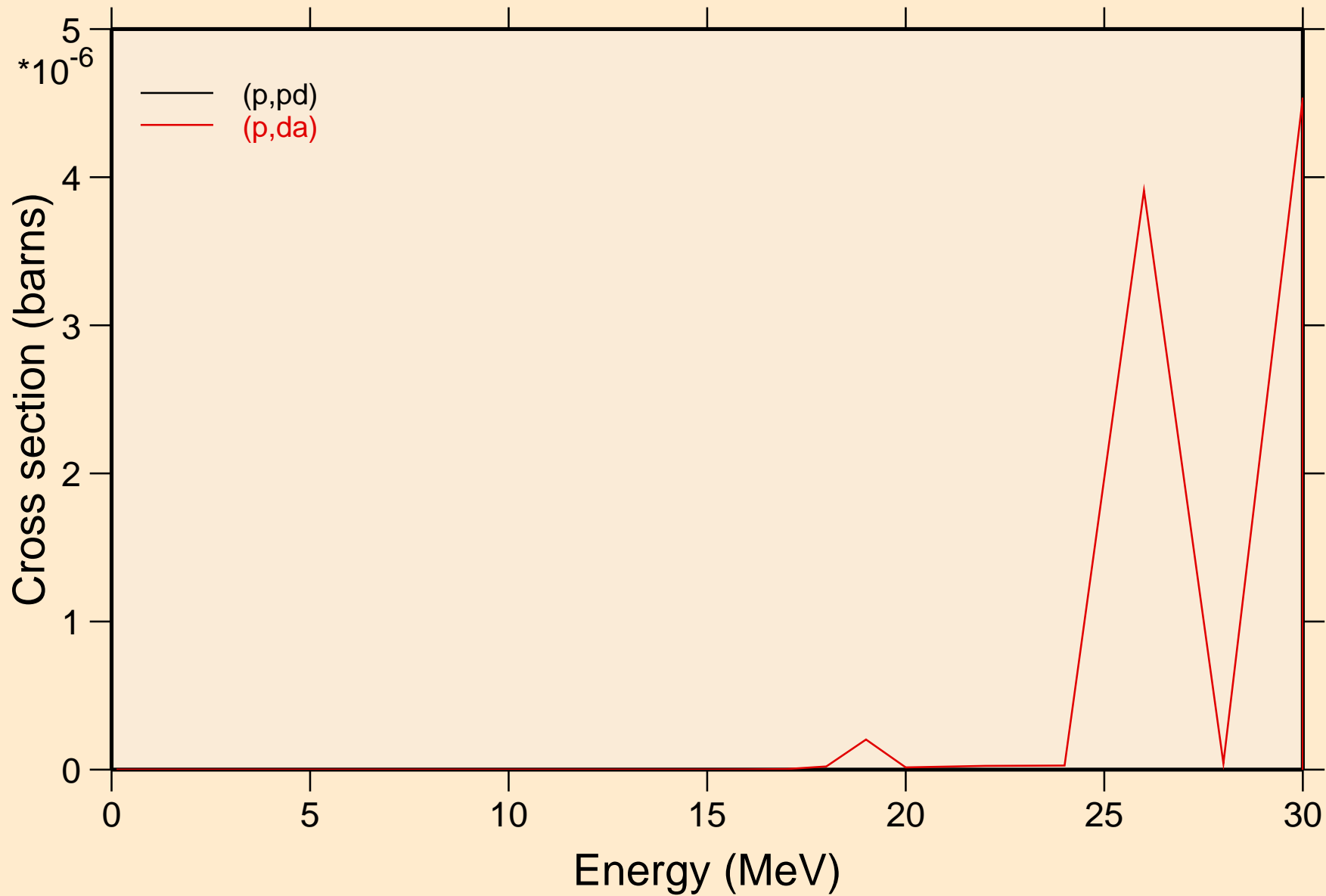

DB262 PROTON ACER TENDL-2021 LIBRARY; T=0.K
angular distribution for elastic

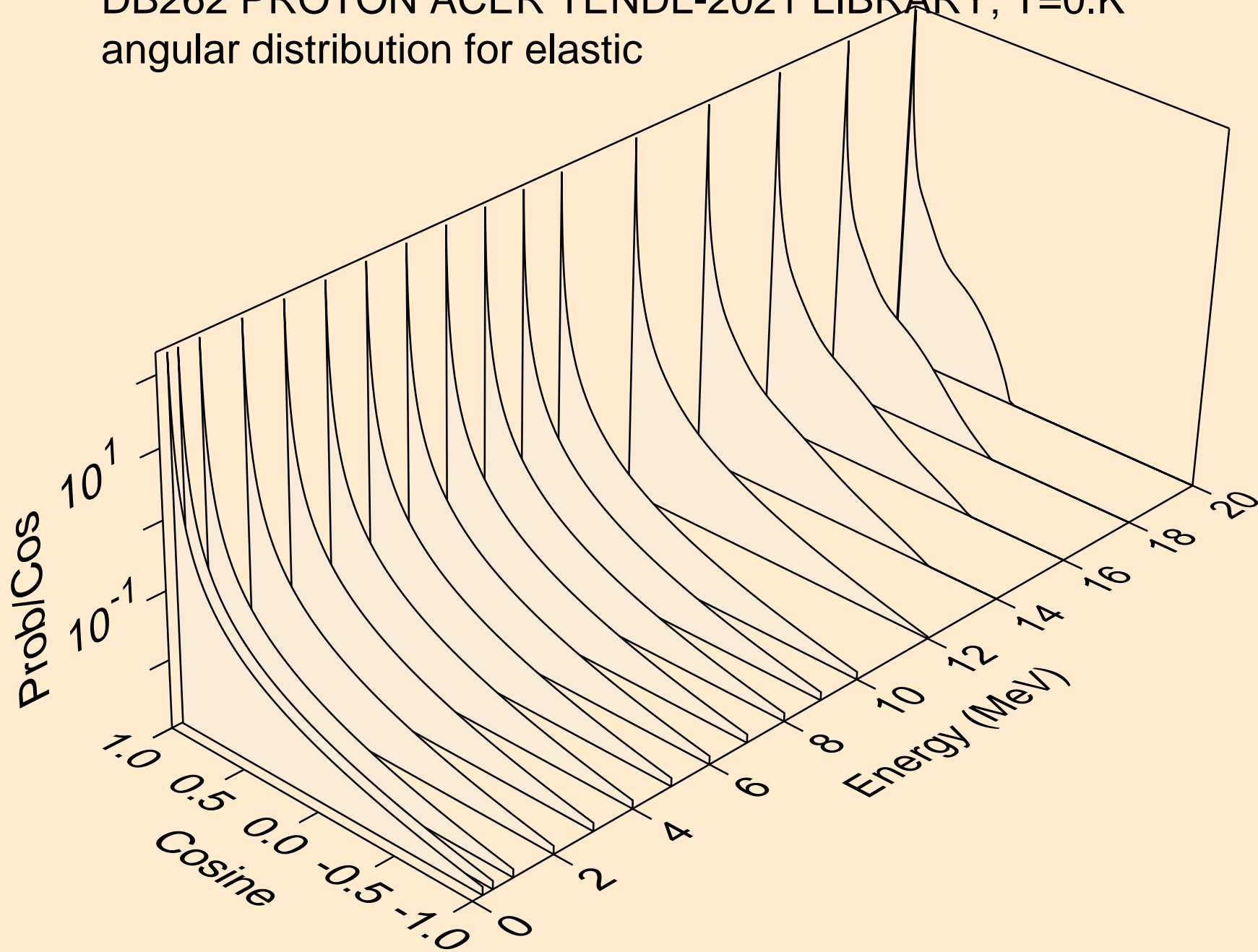

DB262 PROTON ACER TENDL-2021 LIBRARY; T=0.K
angular distribution for elastic

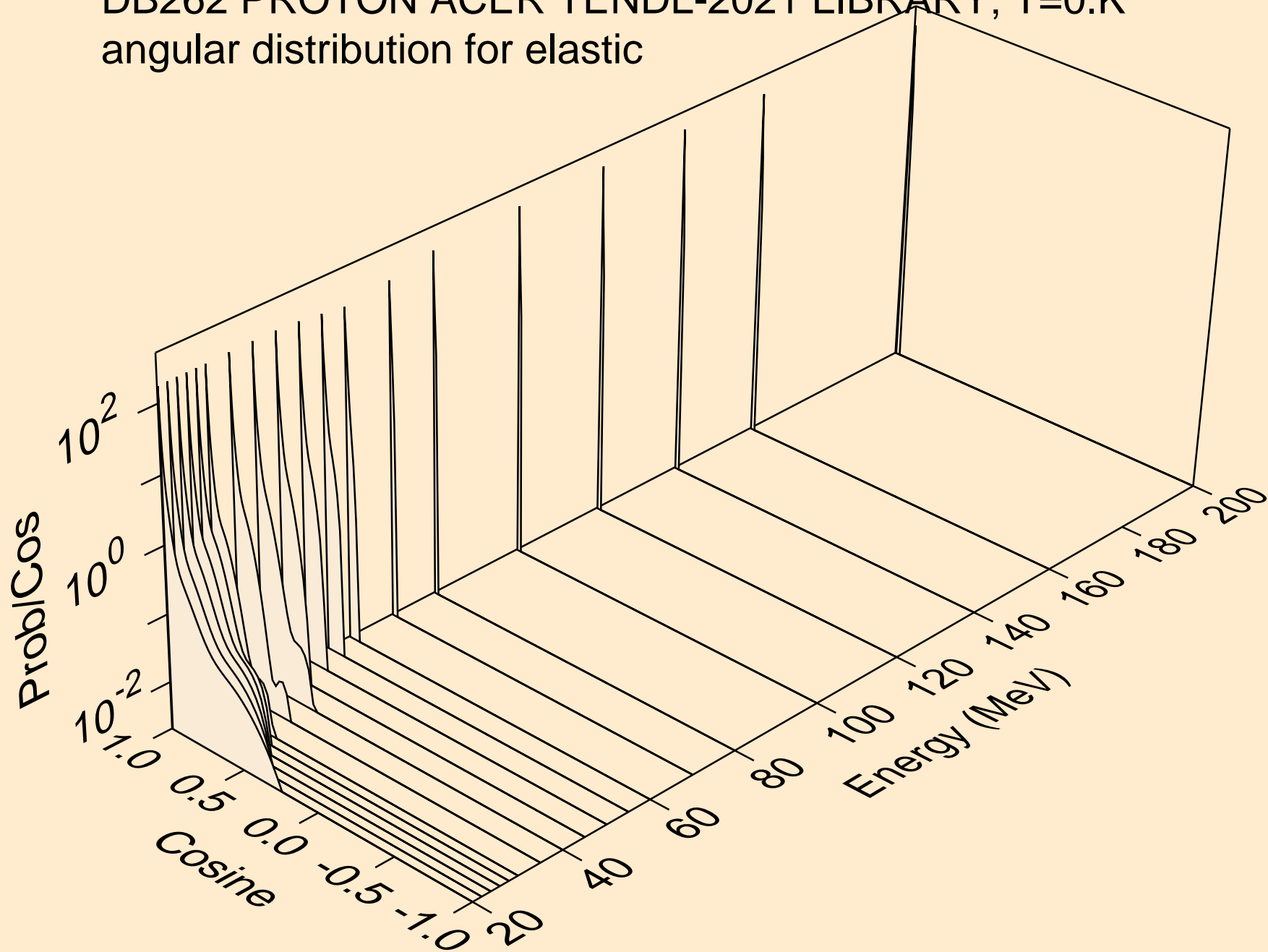

DB262 PROTON ACER TENDL-2021 LIBRARY; T=0.K
Proton emission for (p,x)

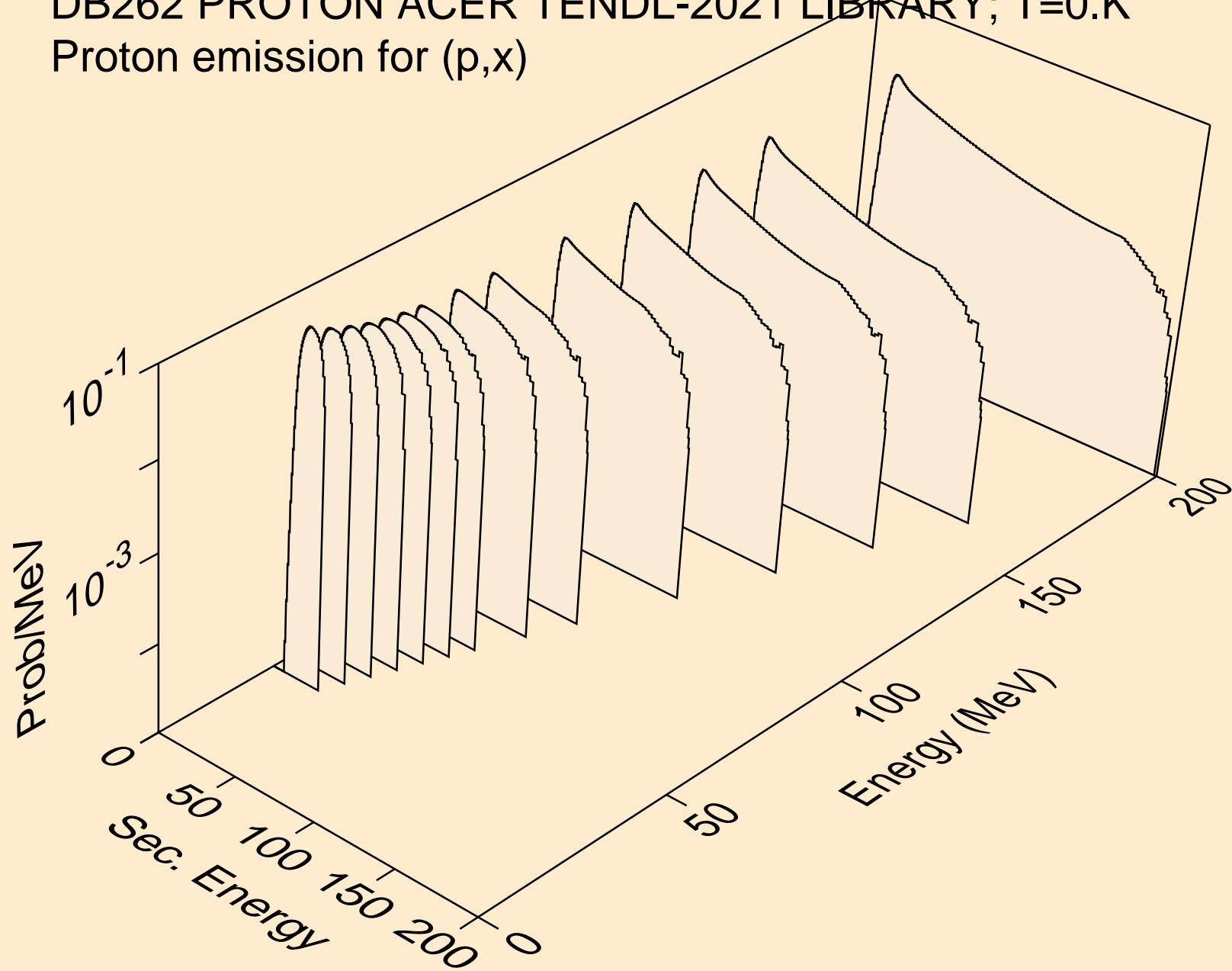

DB262 PROTON ACER TENDL-2021 LIBRARY; T=0.K
Proton emission for (p,n*)p

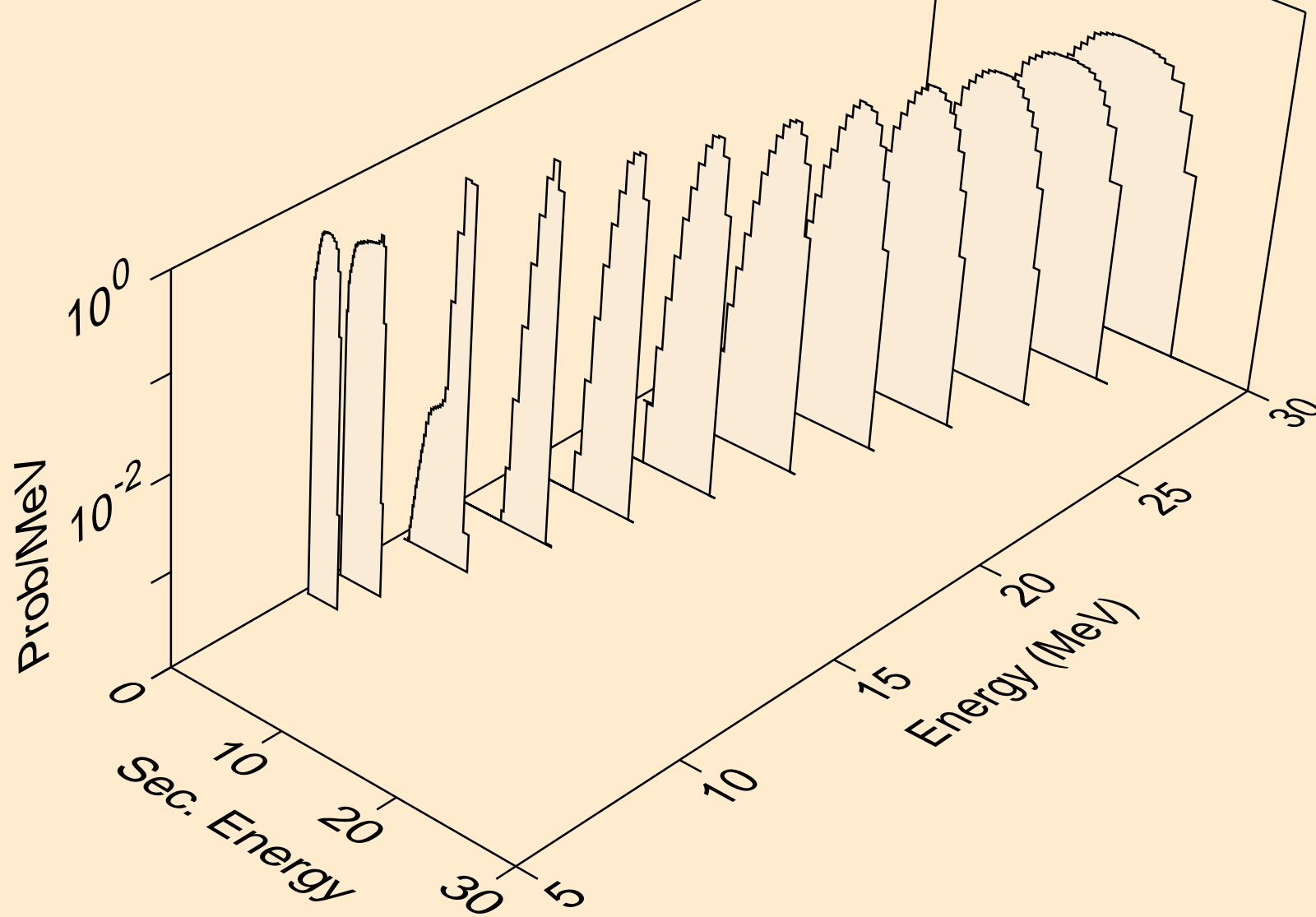

DB262 PROTON ACER TENDL-2021 LIBRARY; T=0.K
Proton emission for (p,2np)

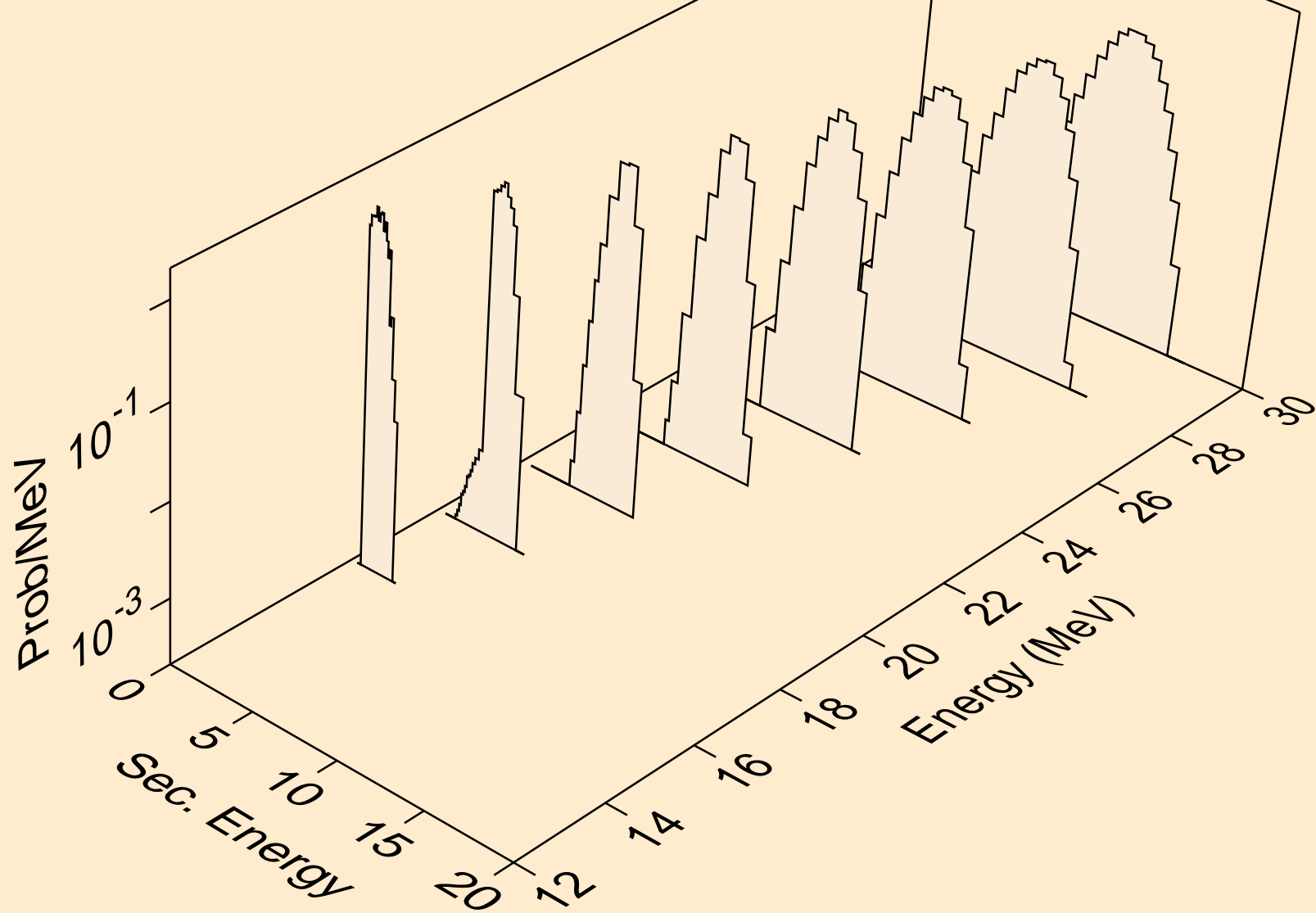

DB262 PROTON ACER TENDL-2021 LIBRARY; T=0.K
Proton emission for (p,2np)

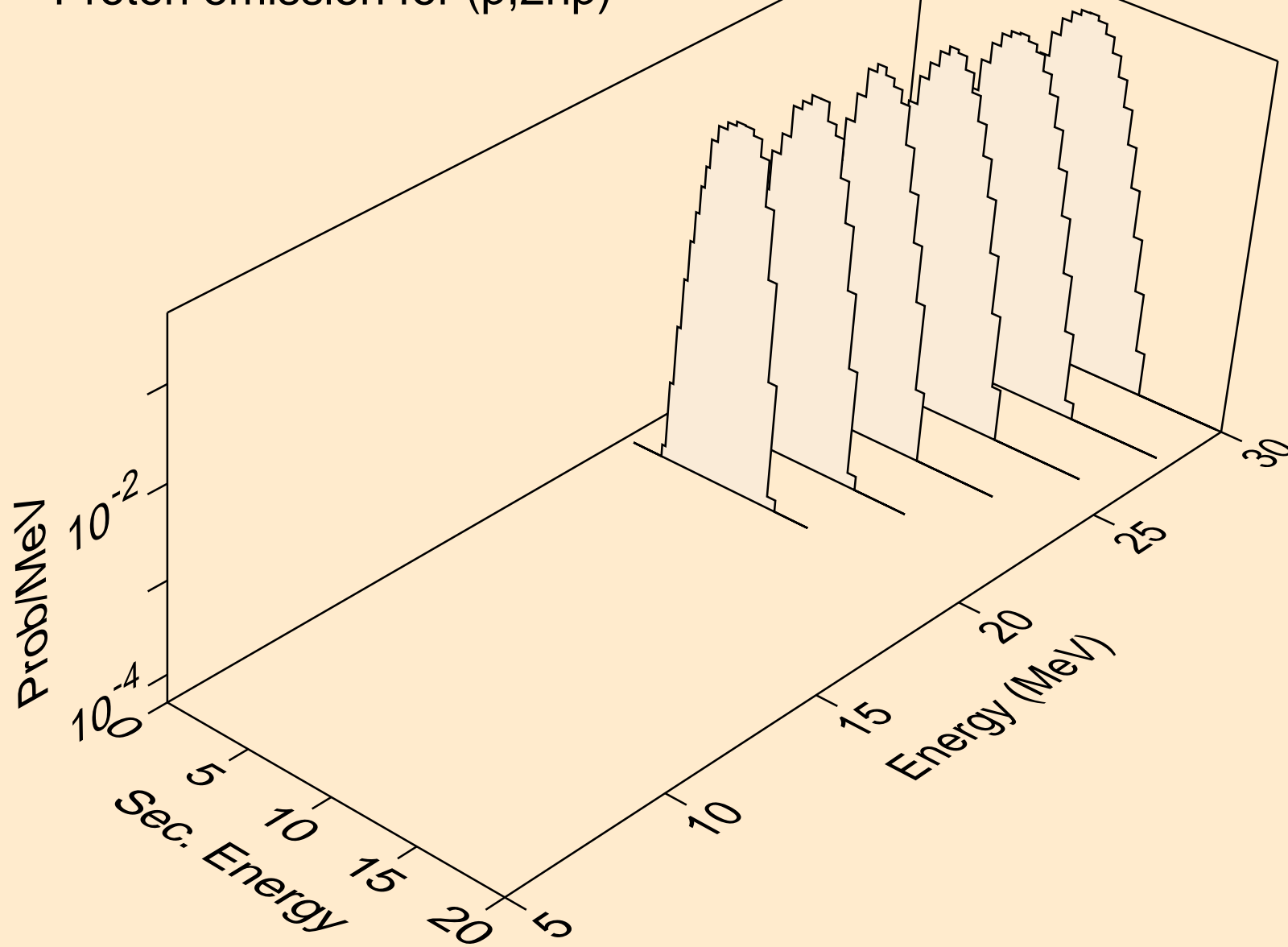

DB262 PROTON ACER TENDL-2021 LIBRARY; T=0.K
Proton emission for (p,npa)

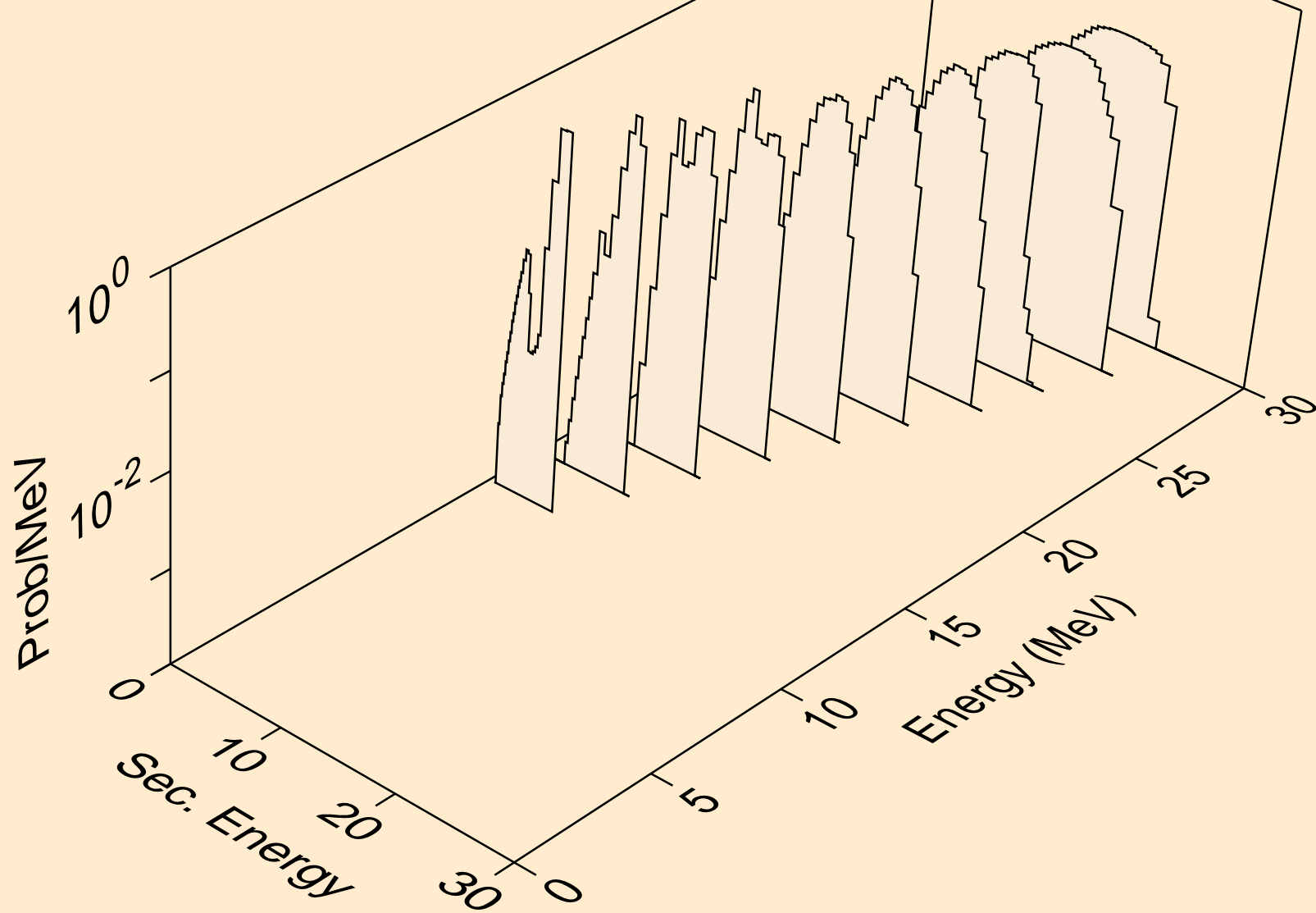

DB262 PROTON ACER TENDL-2021 LIBRARY; T=0.K
Proton emission for inelastic

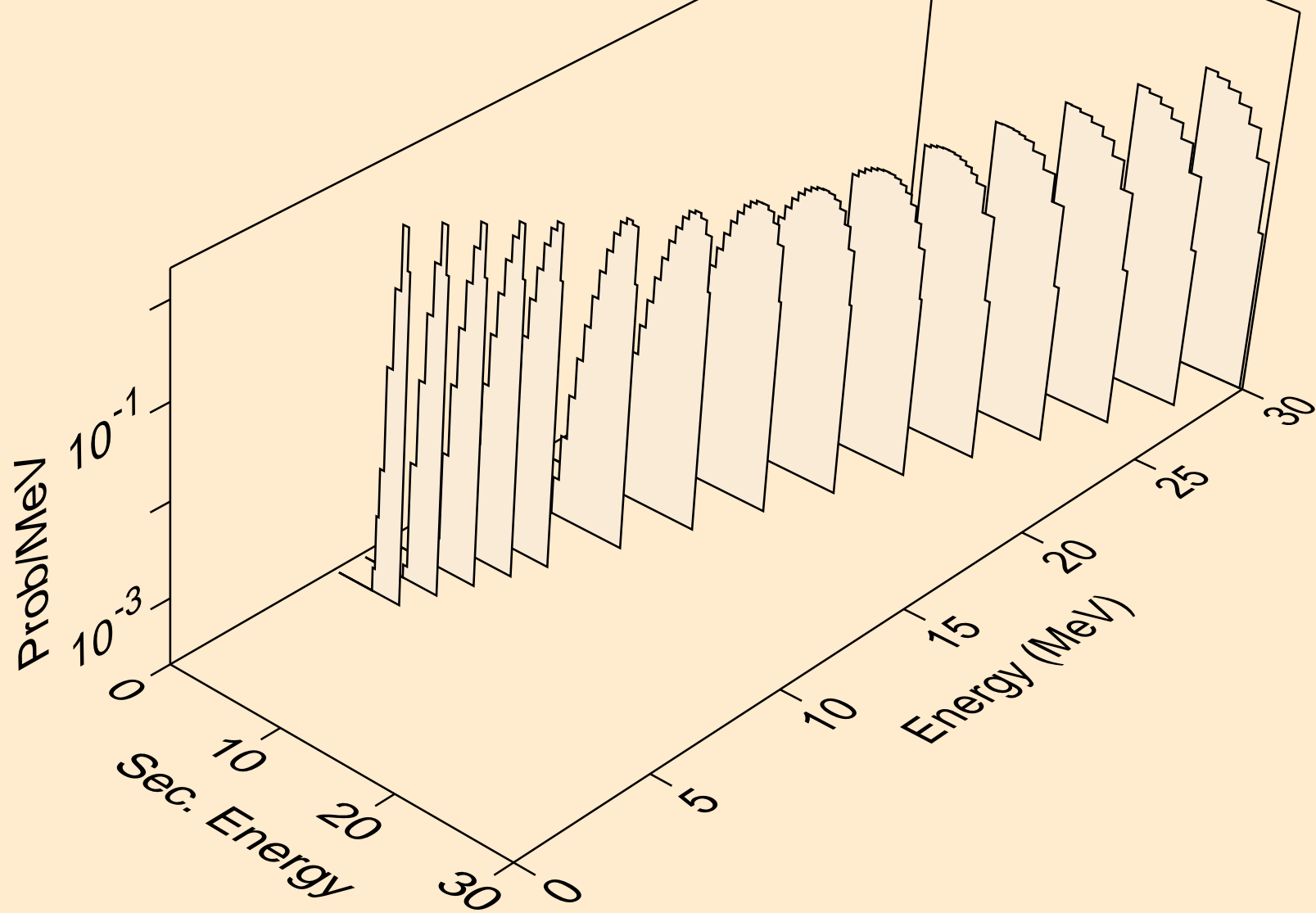

DB262 PROTON ACER TENDL-2021 LIBRARY; T=0.K
Proton emission for (p,2p)

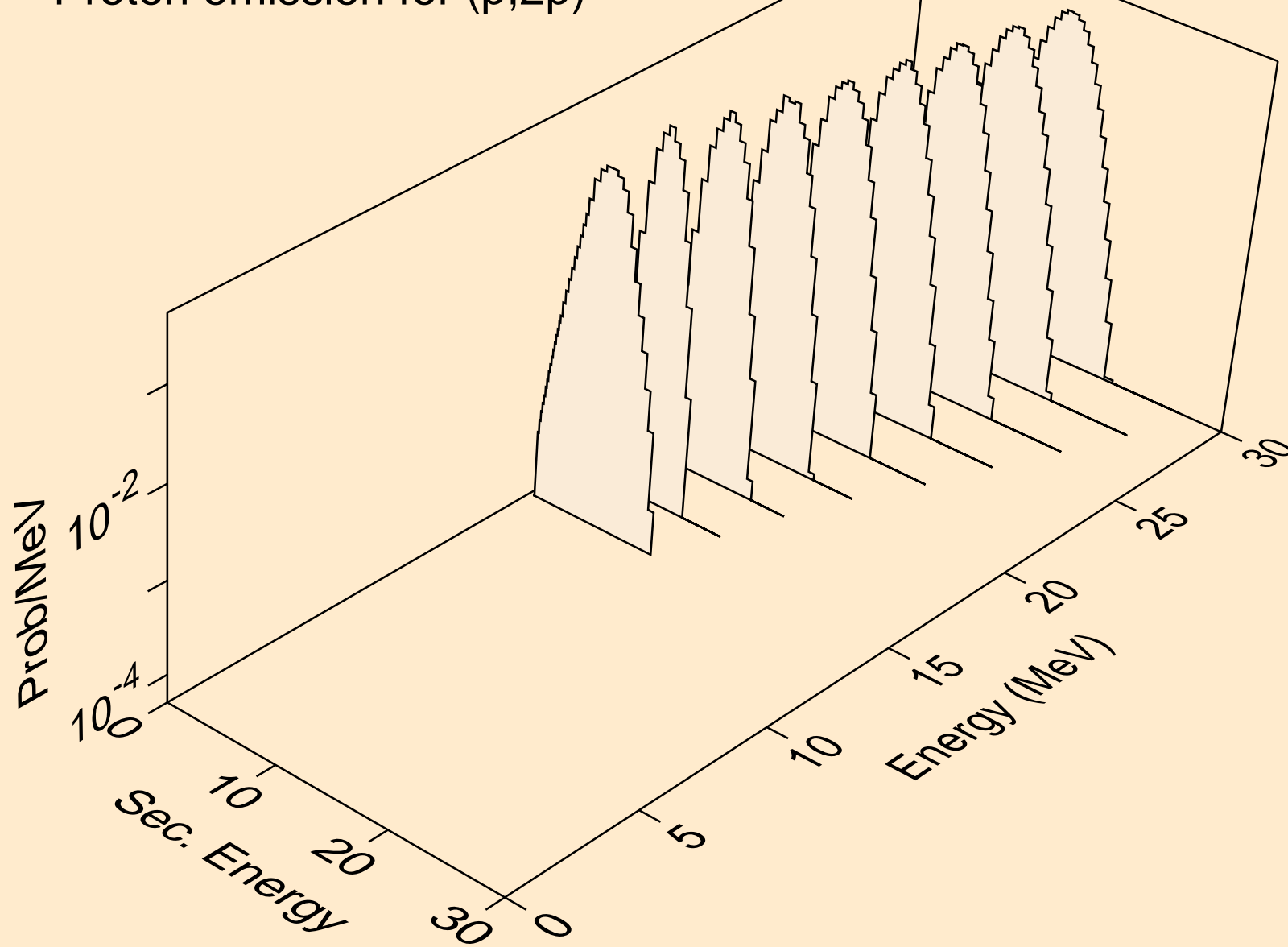

DB262 PROTON ACER TENDL-2021 LIBRARY; T=0.K
Proton emission for (p,pa)

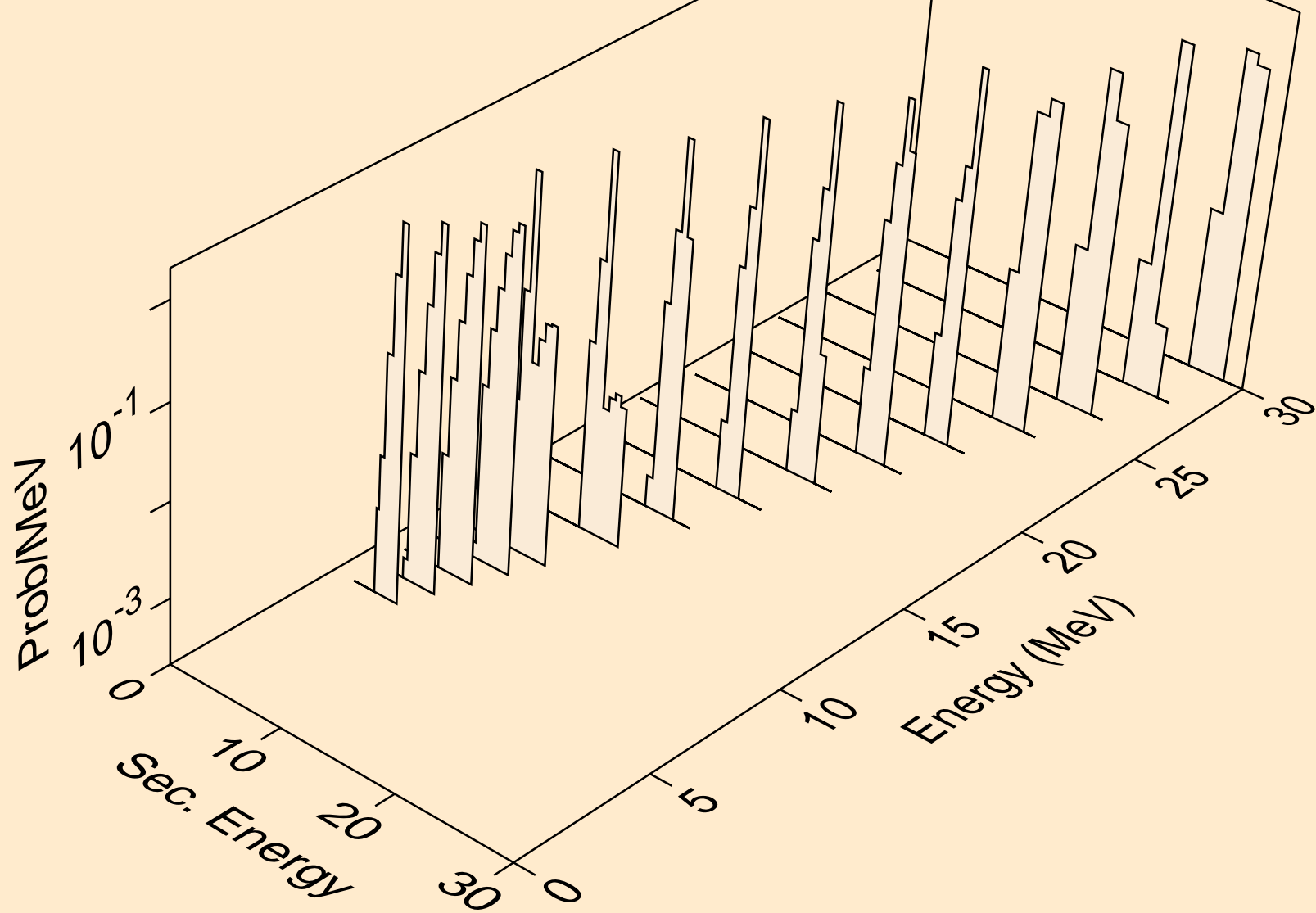

DB262 PROTON ACER TENDL-2021 LIBRARY; T=0.K
Proton emission for (p,pd)

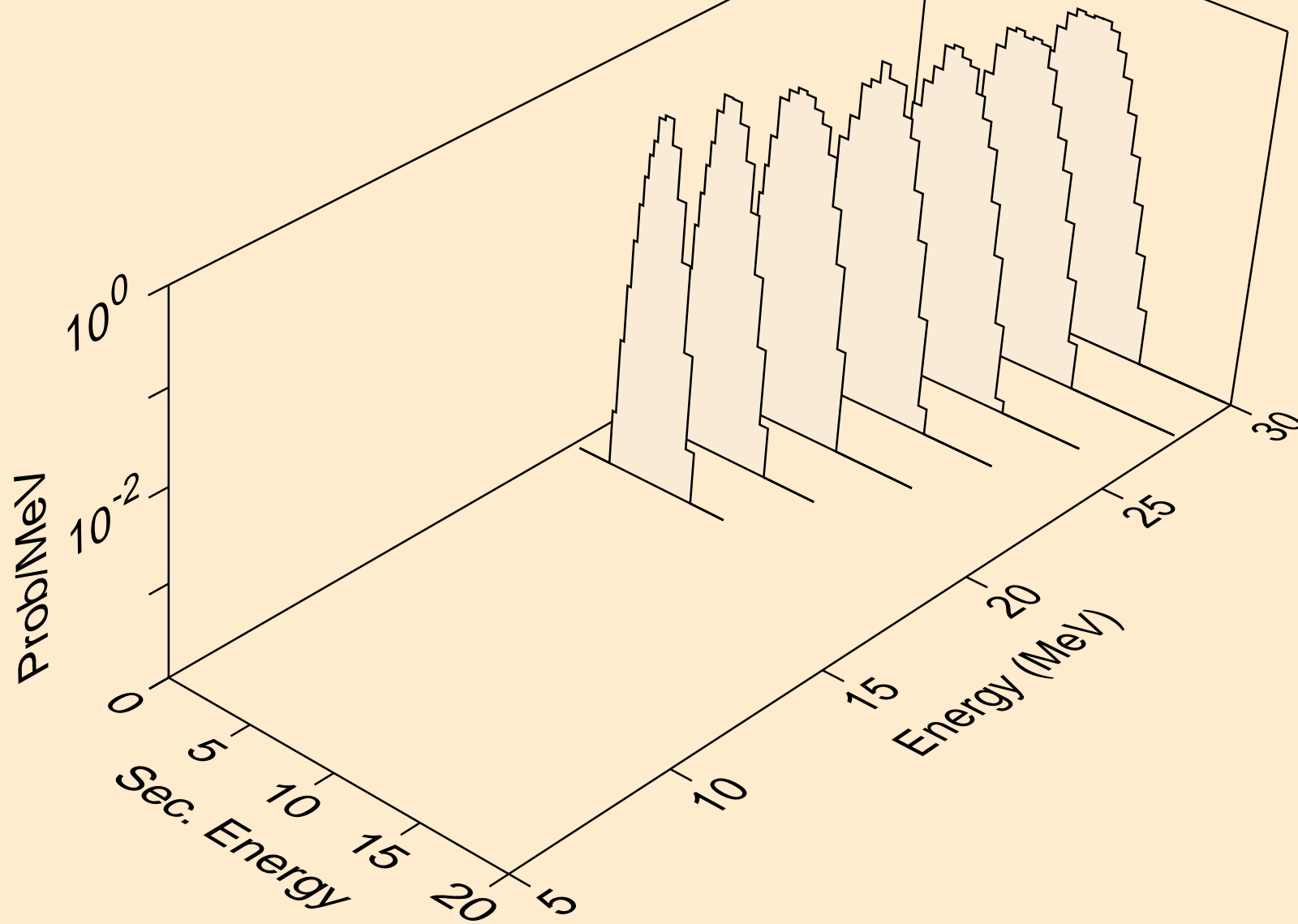

DB262 PROTON ACER TENDL-2021 LIBRARY; T=0.K
Photon emission for (z,n)

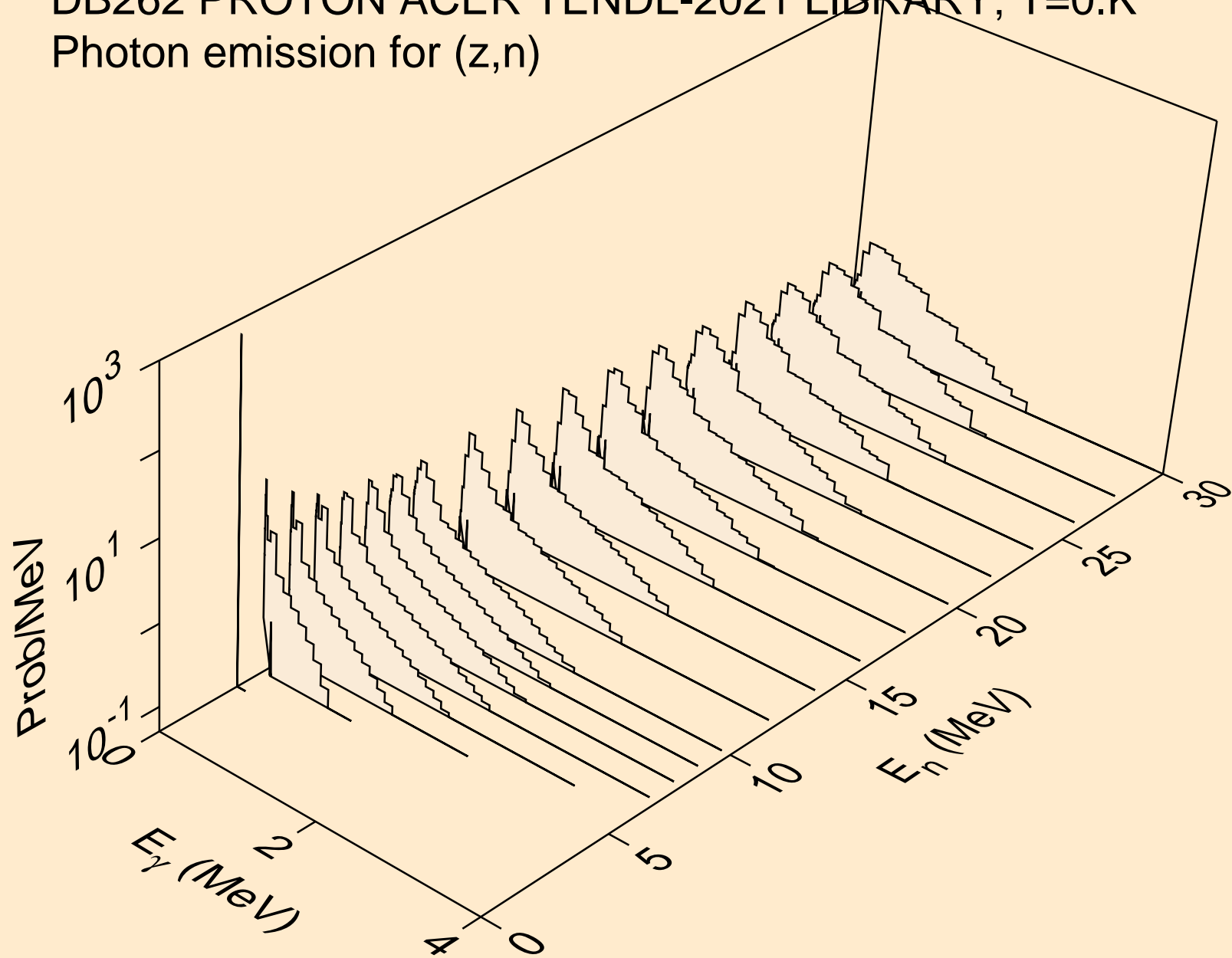

DB262 PROTON ACER TENDL-2021 LIBRARY; T=0.K
Photon emission for (n,x)

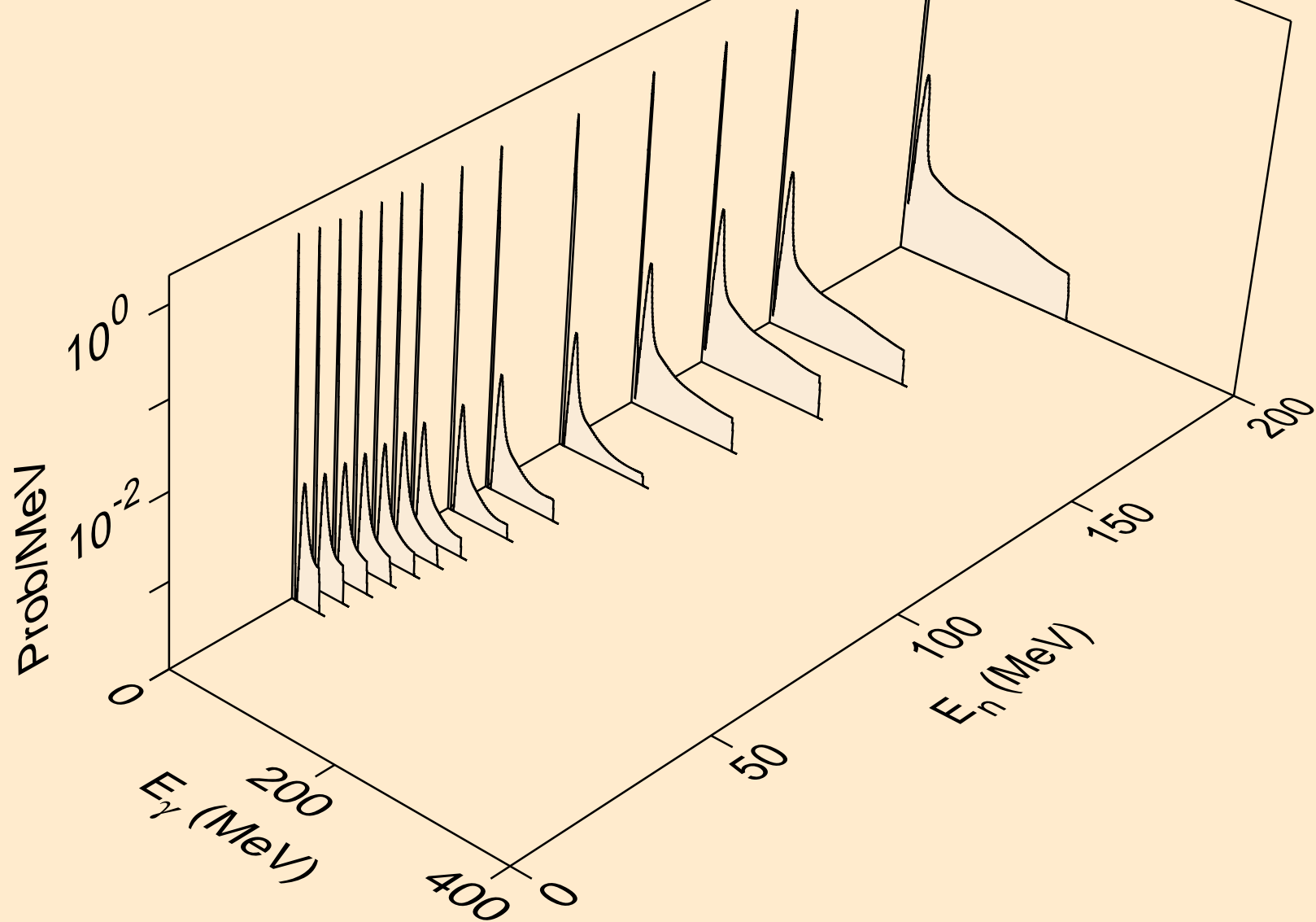

DB262 PROTON ACER TENDL-2021 LIBRARY; T=0.K
Photon emission for (n,2n)

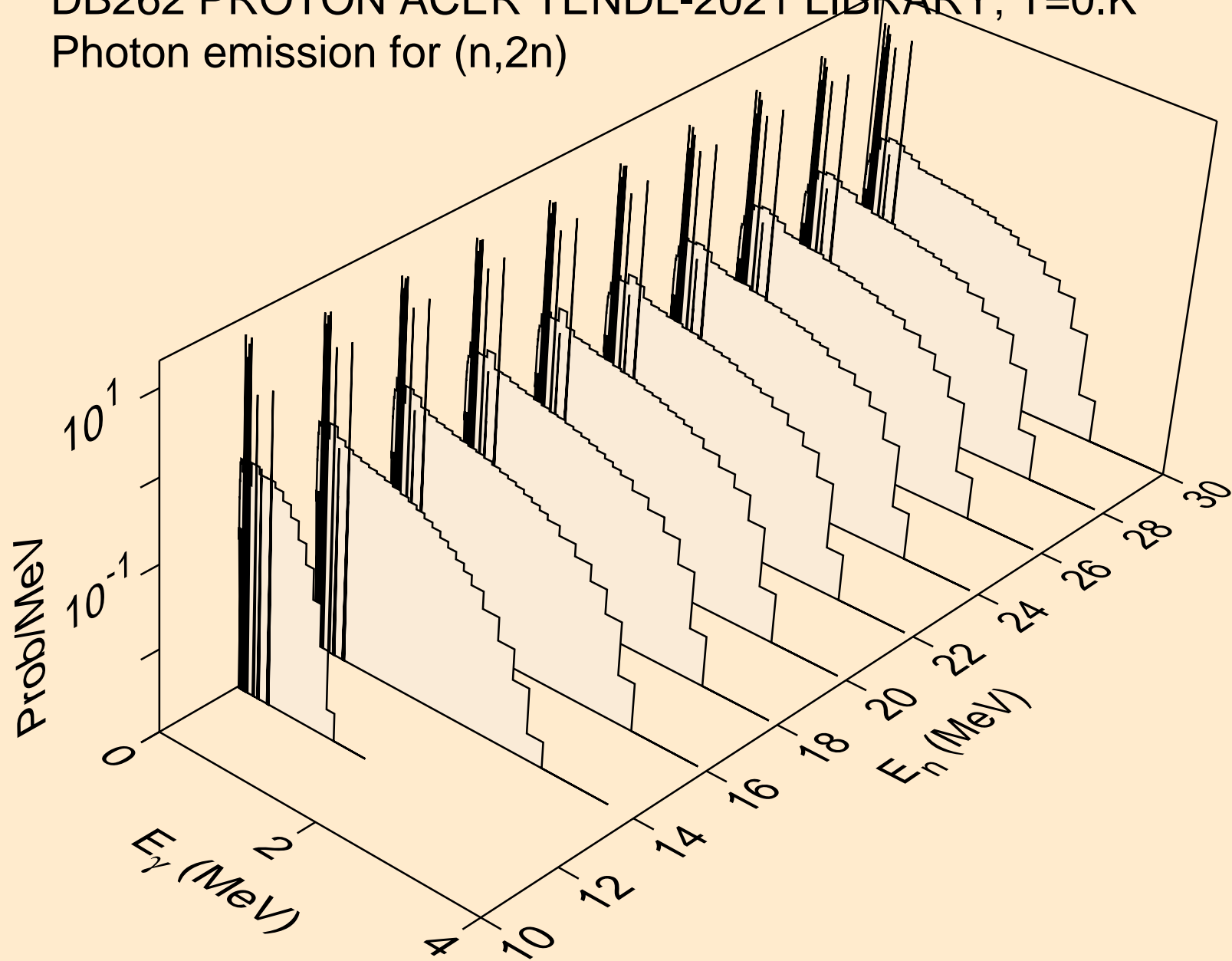

DB262 PROTON ACER TENDL-2021 LIBRARY; T=0.K
Photon emission for (n,3n)

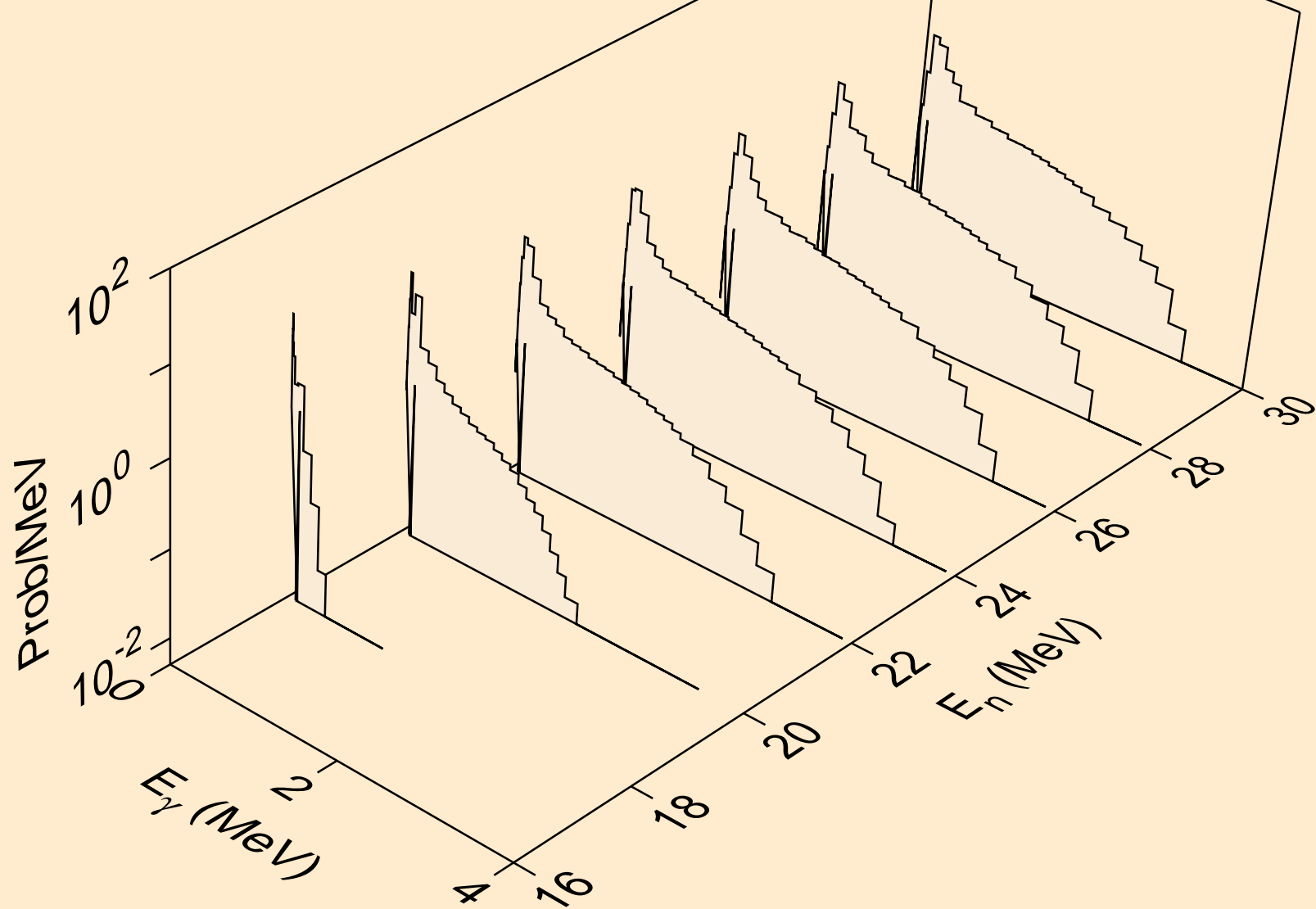

DB262 PROTON ACER TENDL-2021 LIBRARY; T=0.K
Photon emission for (n,n*)a

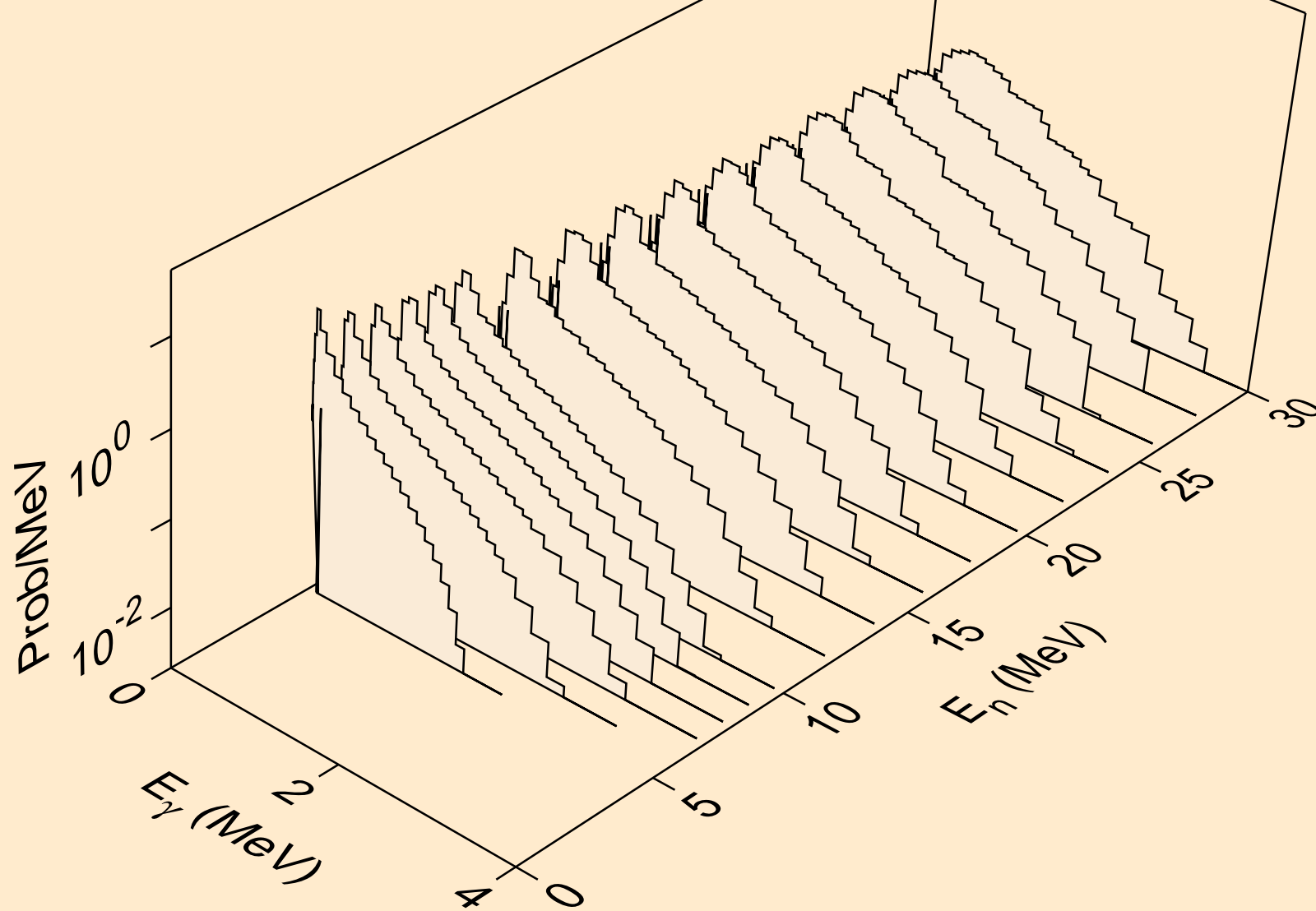

DB262 PROTON ACER TENDL-2021 LIBRARY; T=0.K
Photon emission for (n,2n) α

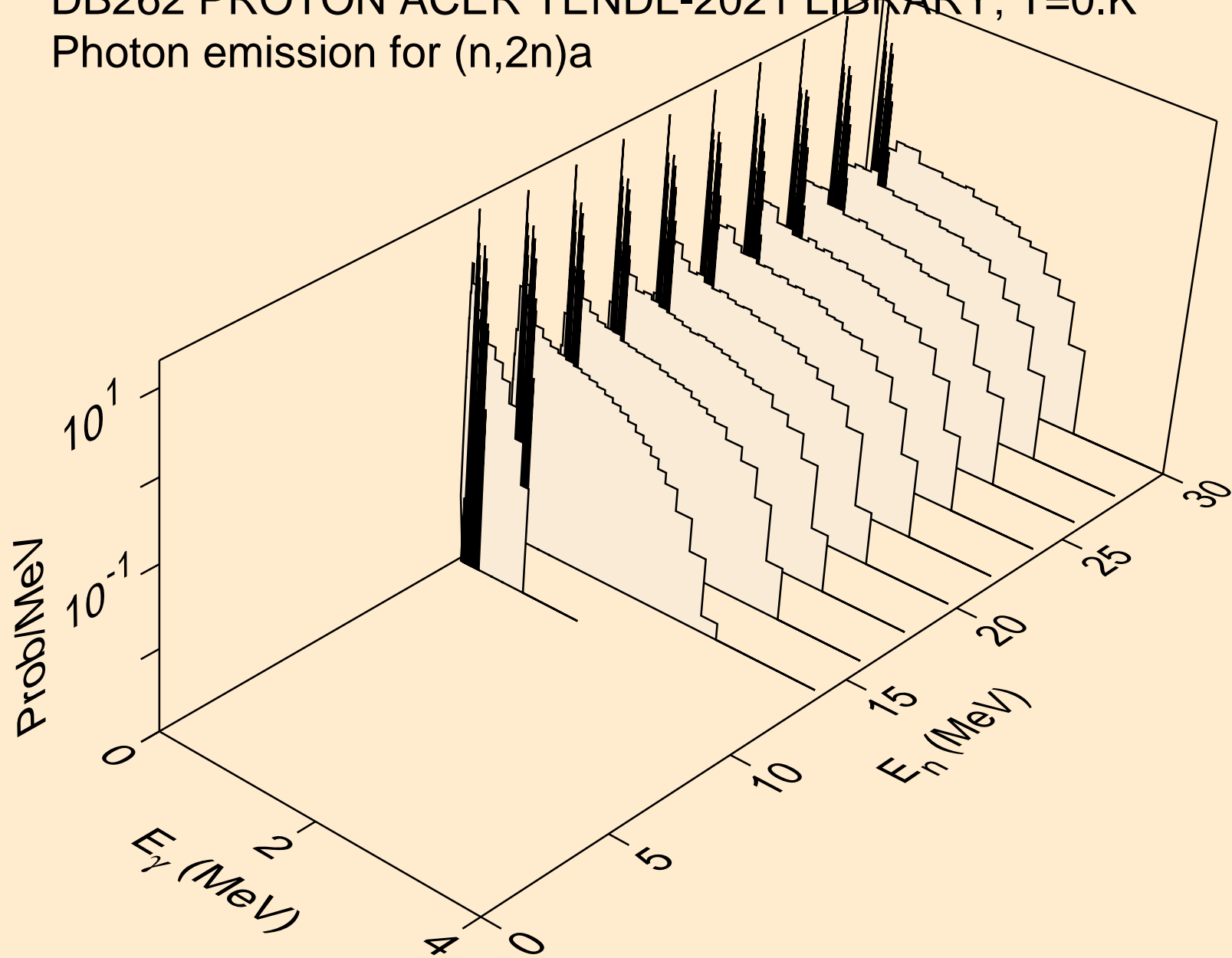

DB262 PROTON ACER TENDL-2021 LIBRARY; T=0.K
Photon emission for (n,3n)a

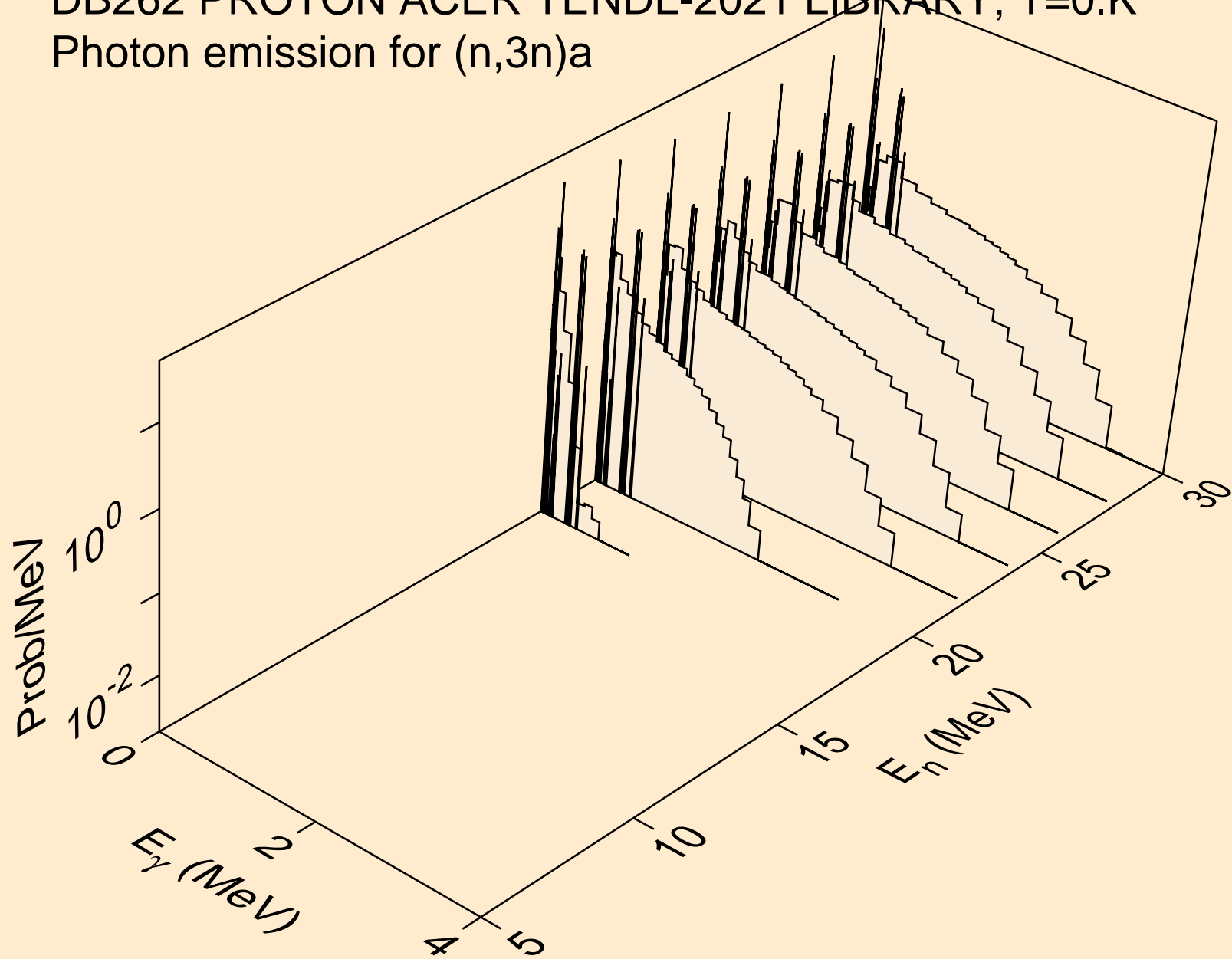

DB262 PROTON ACER TENDL-2021 LIBRARY; T=0.K
Photon emission for (n,n*)p

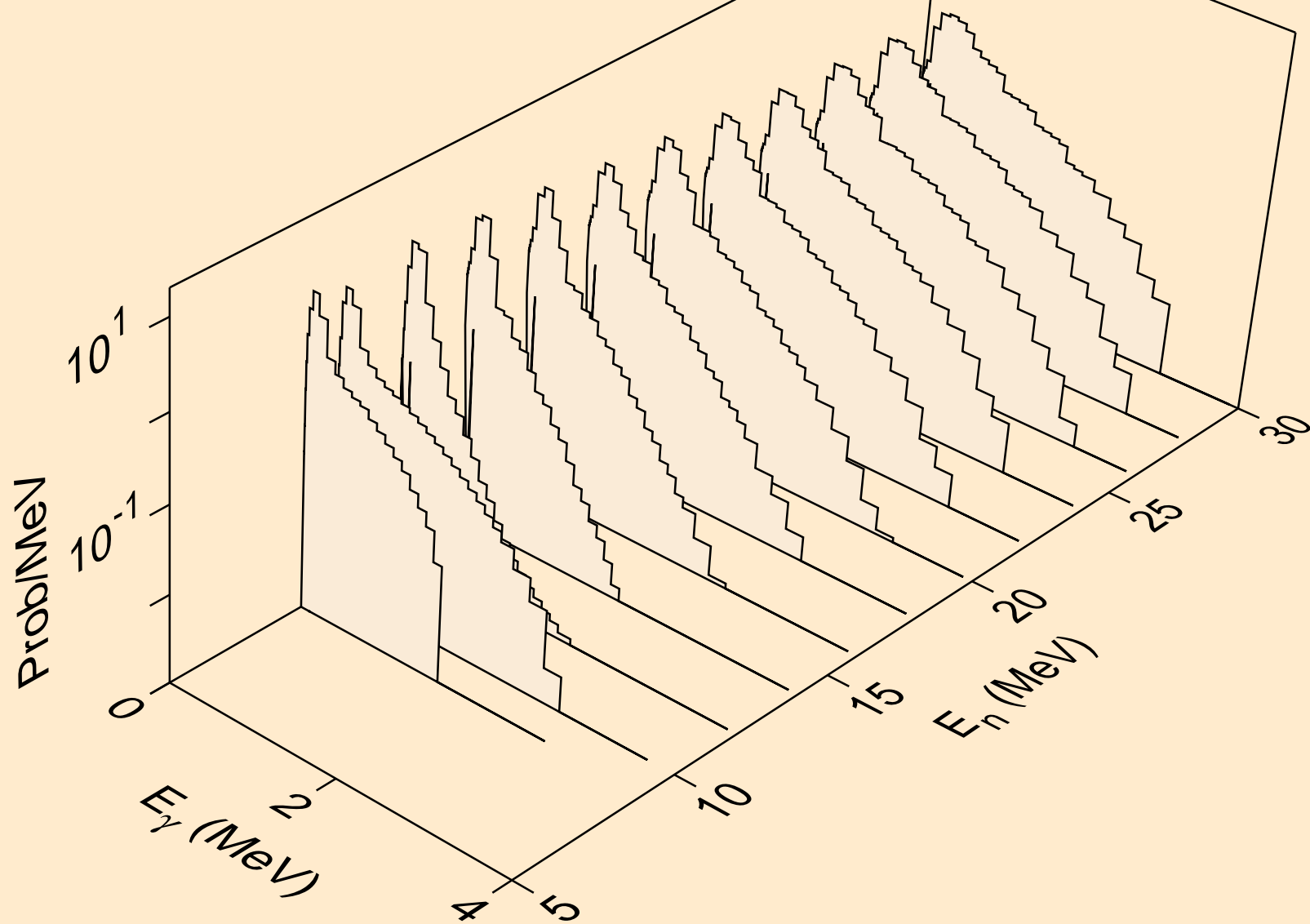

DB262 PROTON ACER TENDL-2021 LIBRARY; T=0.K
Photon emission for (n,n*)d

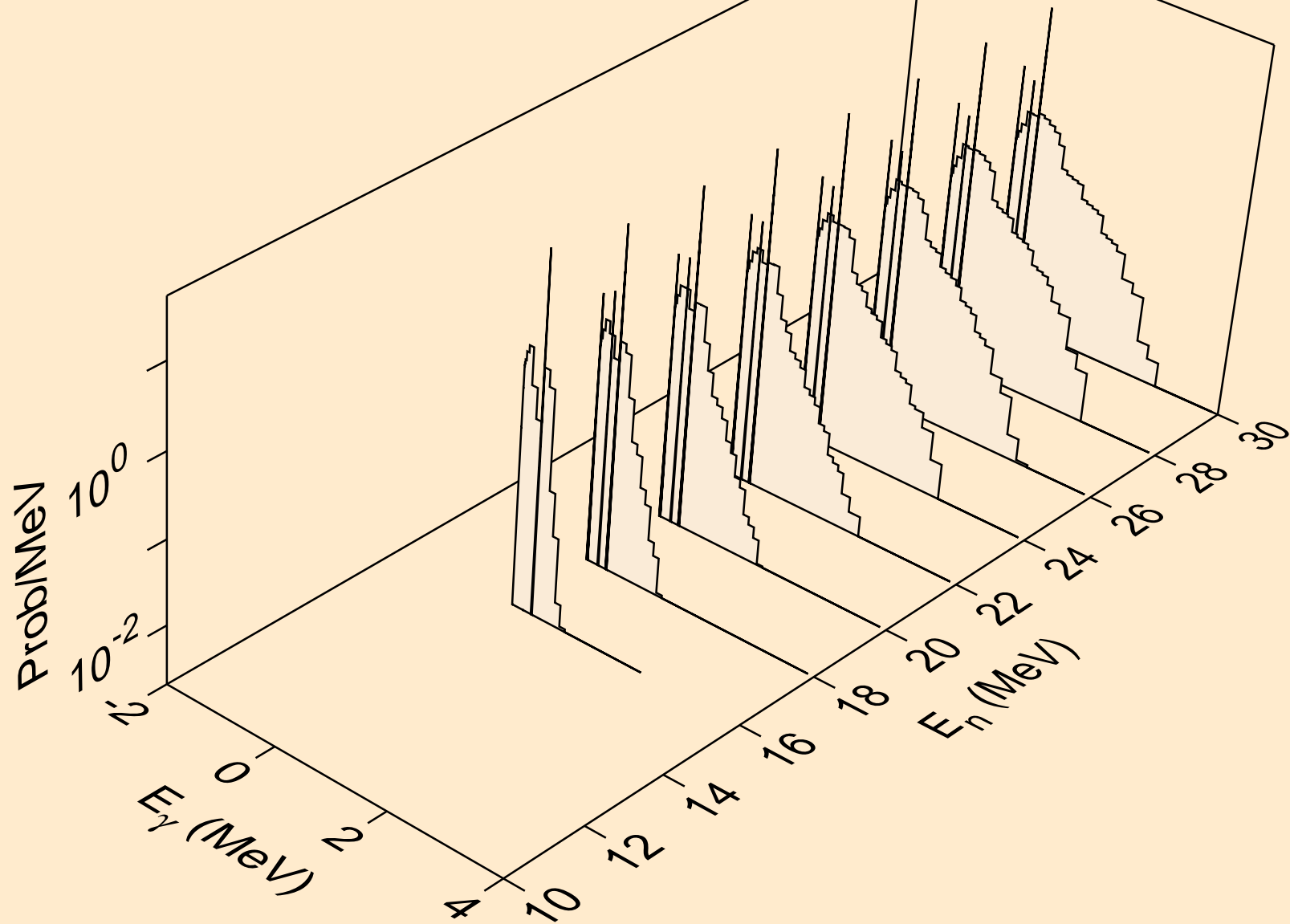

DB262 PROTON ACER TENDL-2021 LIBRARY; T=0.K
Photon emission for (n,n*)t

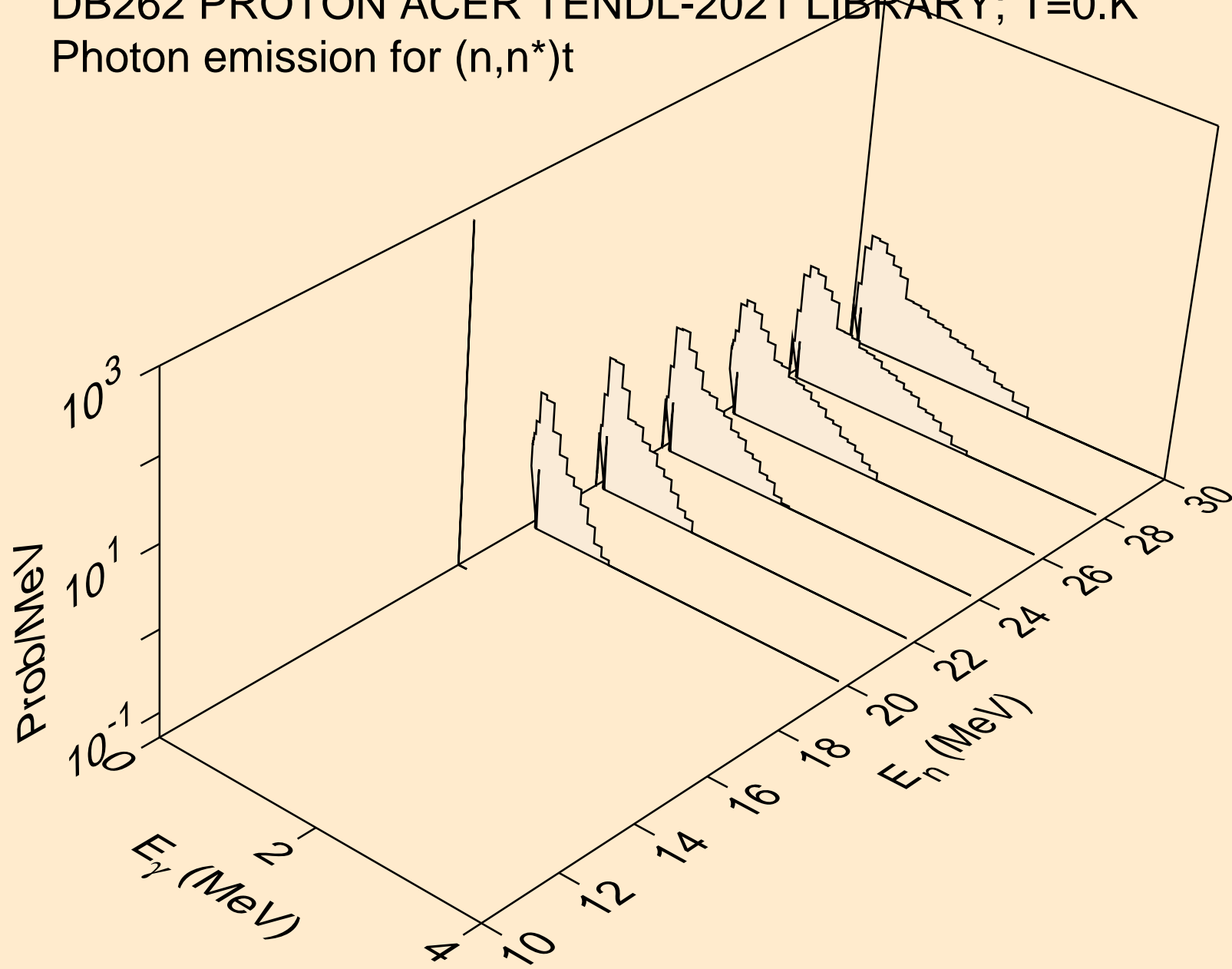

DB262 PROTON ACER TENDL-2021 LIBRARY; T=0.K
Photon emission for (n,2np)

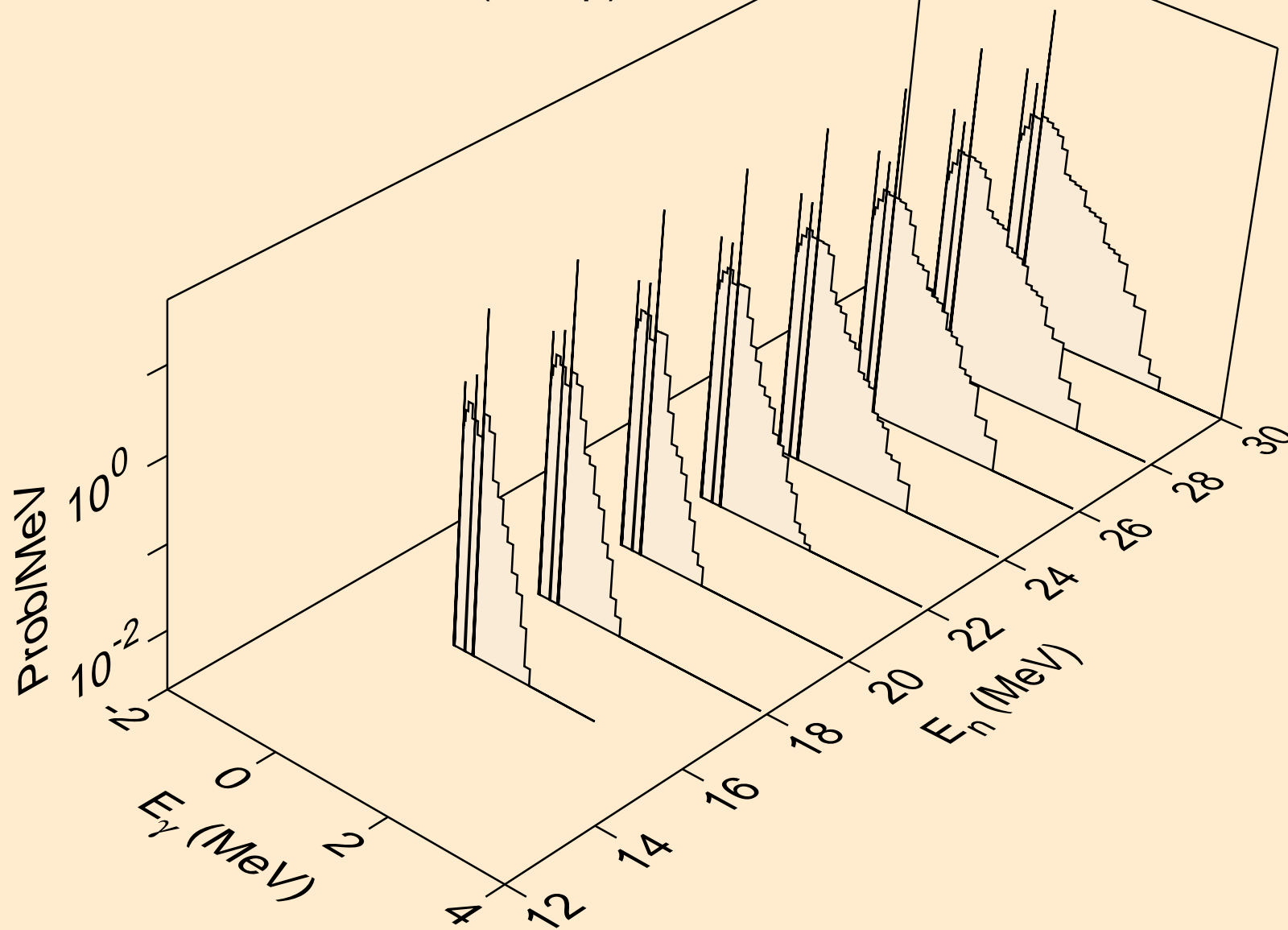

DB262 PROTON ACER TENDL-2021 LIBRARY; T=0.K
Photon emission for (n,2np)

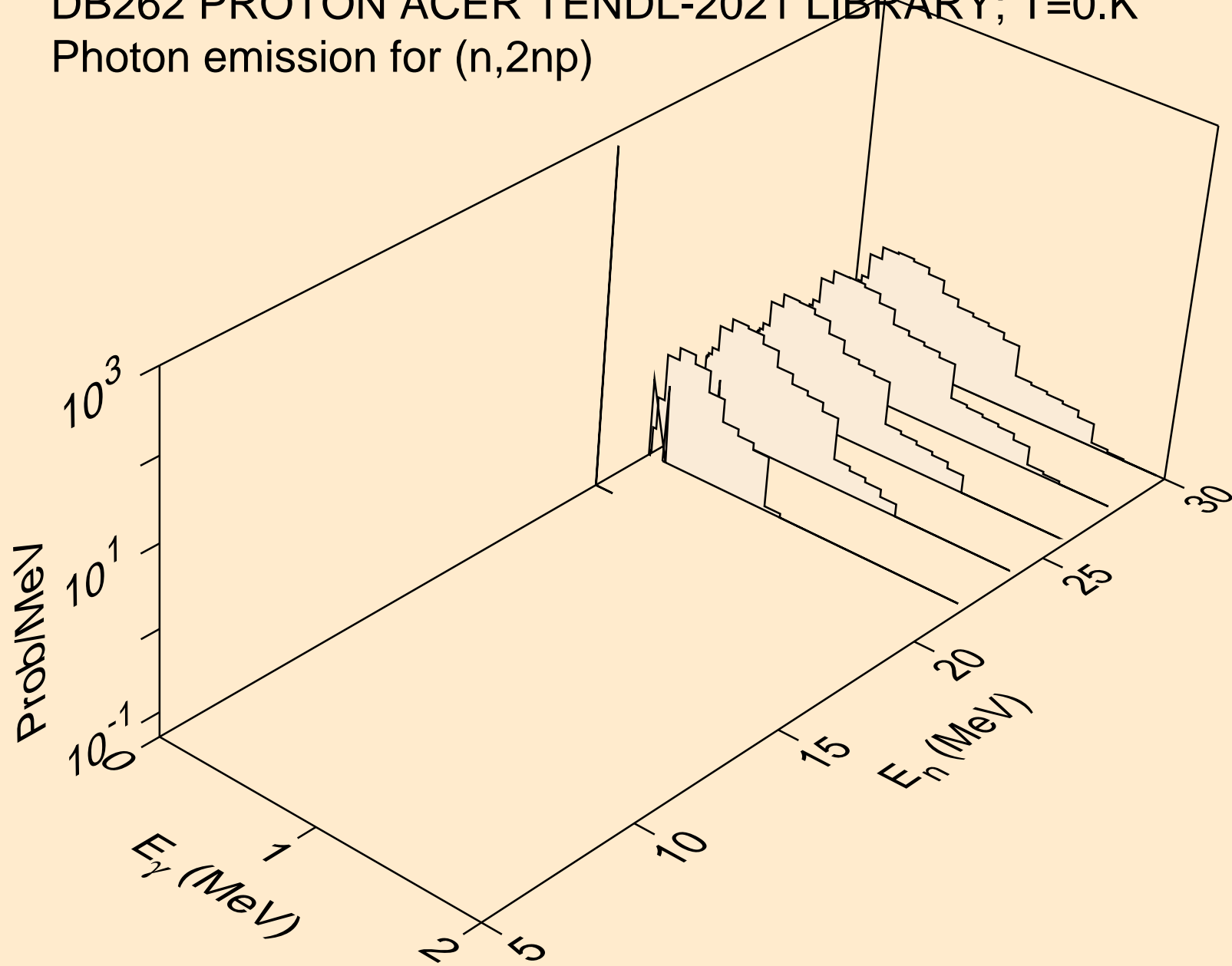

DB262 PROTON ACER TENDL-2021 LIBRARY; T=0.K
Photon emission for (n,npa)

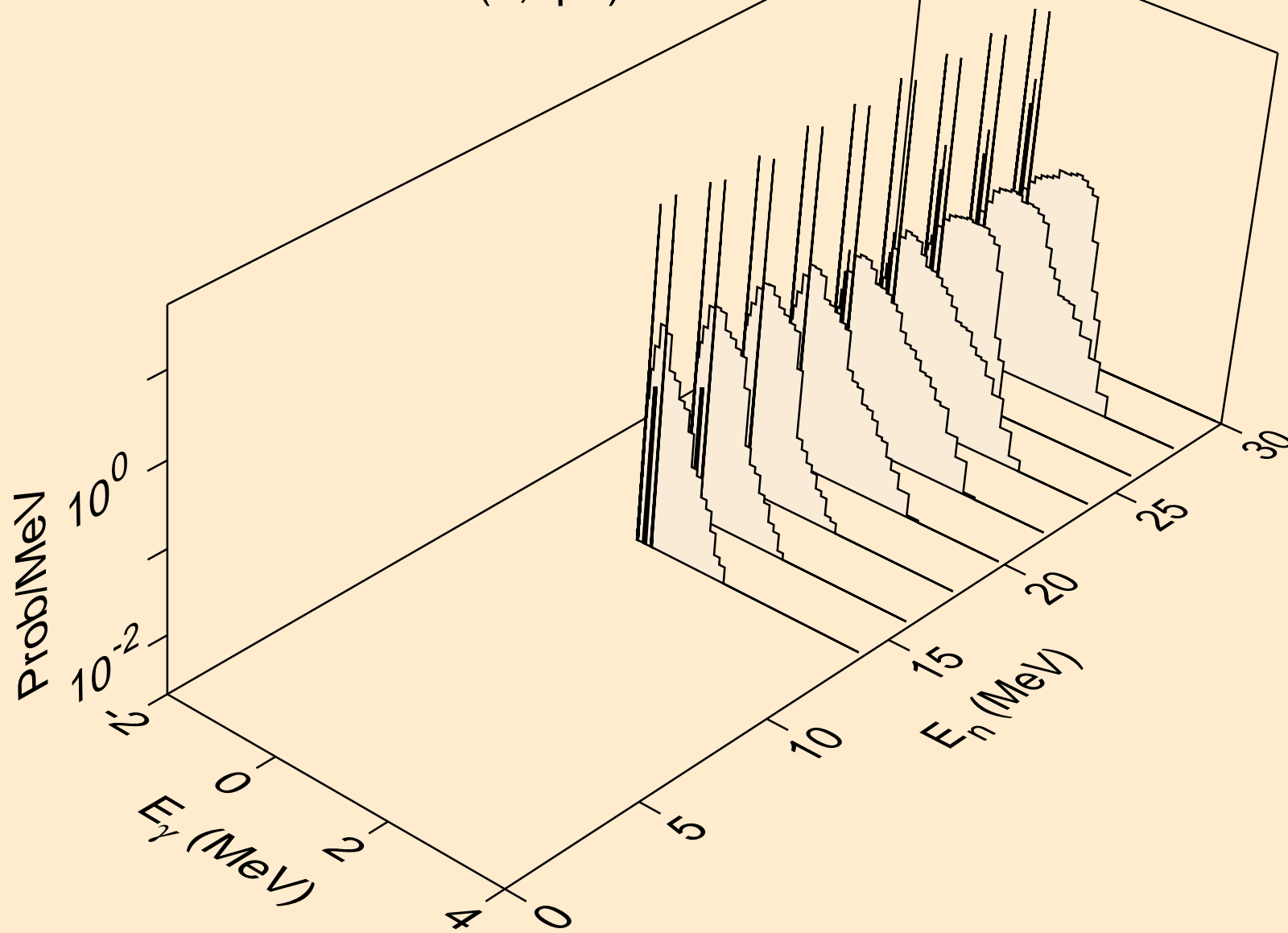

DB262 PROTON ACER TENDL-2021 LIBRARY; T=0.K
Photon emission for (n,gma)

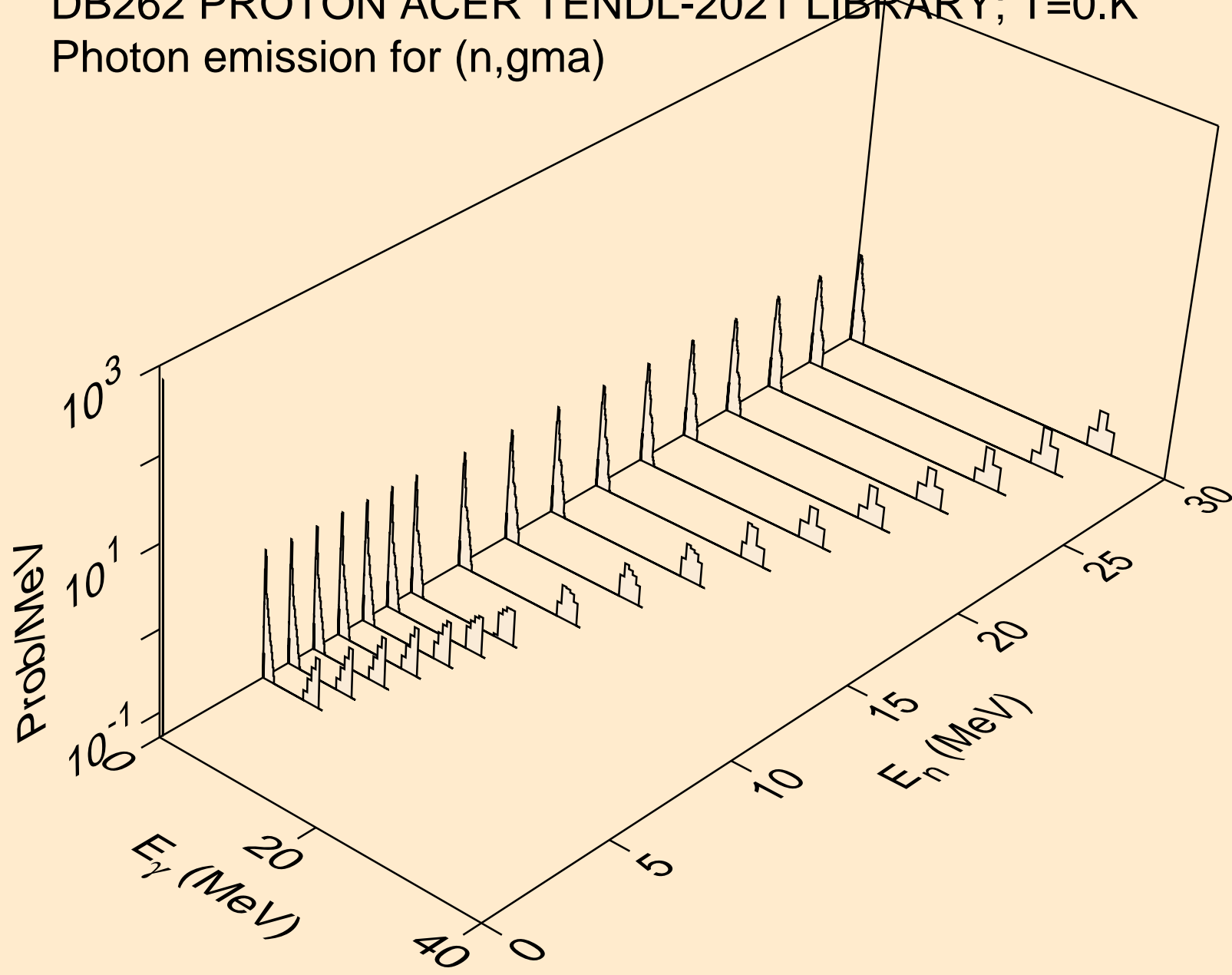

DB262 PROTON ACER TENDL-2021 LIBRARY; T=0.K
Photon emission for inelastic

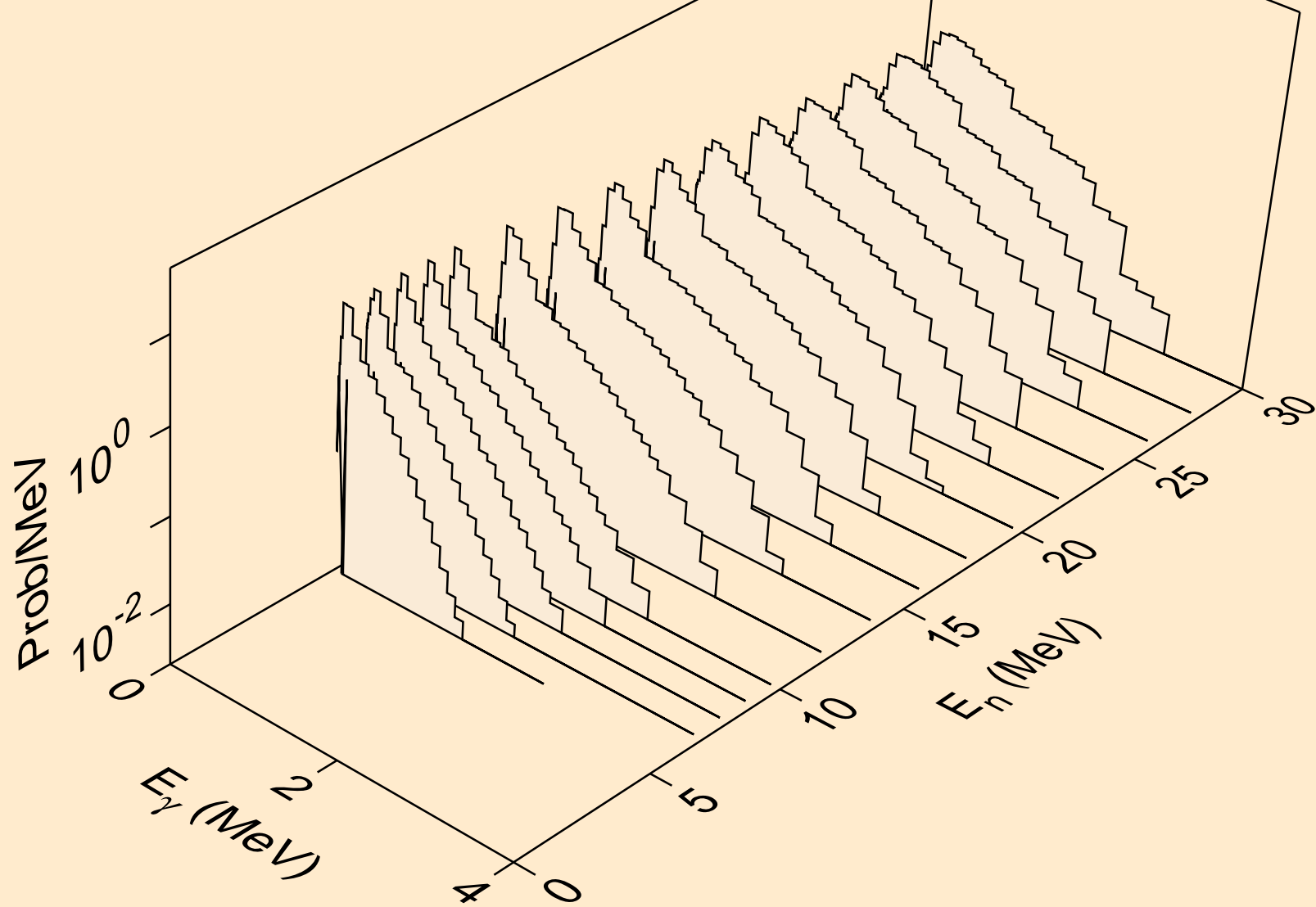

DB262 PROTON ACER TENDL-2021 LIBRARY; T=0.K
Photon emission for (n,d)

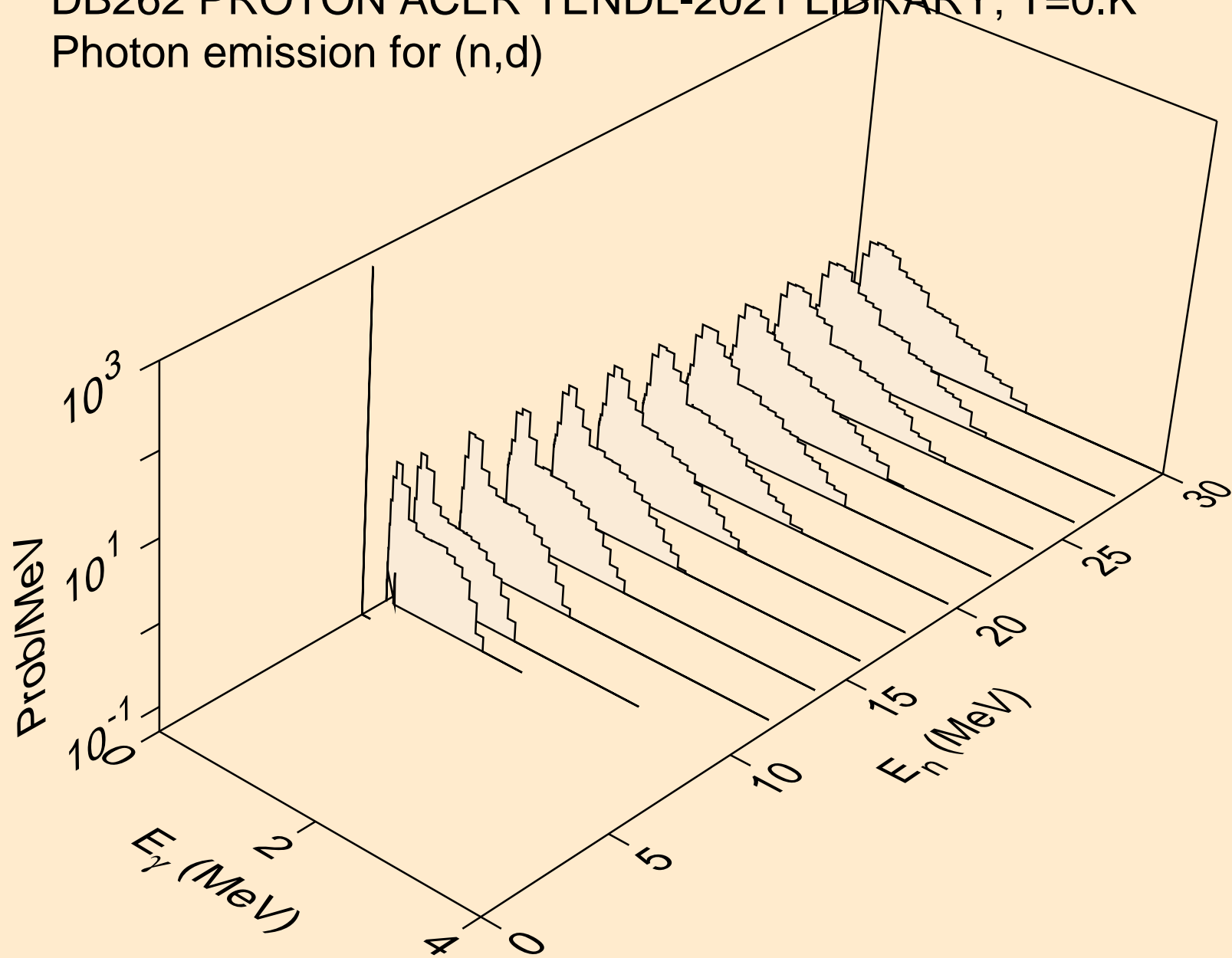

DB262 PROTON ACER TENDL-2021 LIBRARY; T=0.K
Photon emission for (n,t)

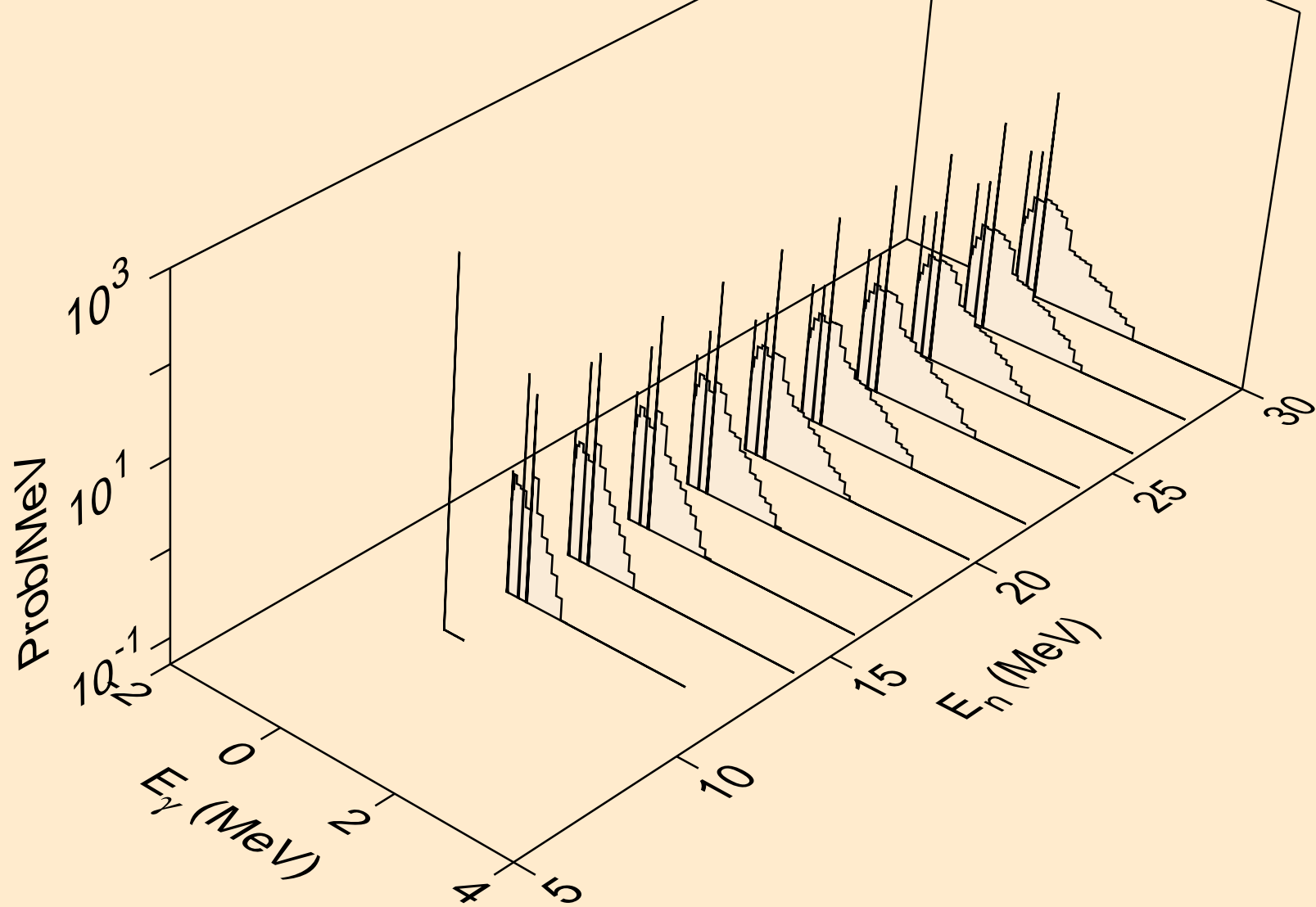

DB262 PROTON ACER TENDL-2021 LIBRARY; T=0.K
Photon emission for (n,he3)

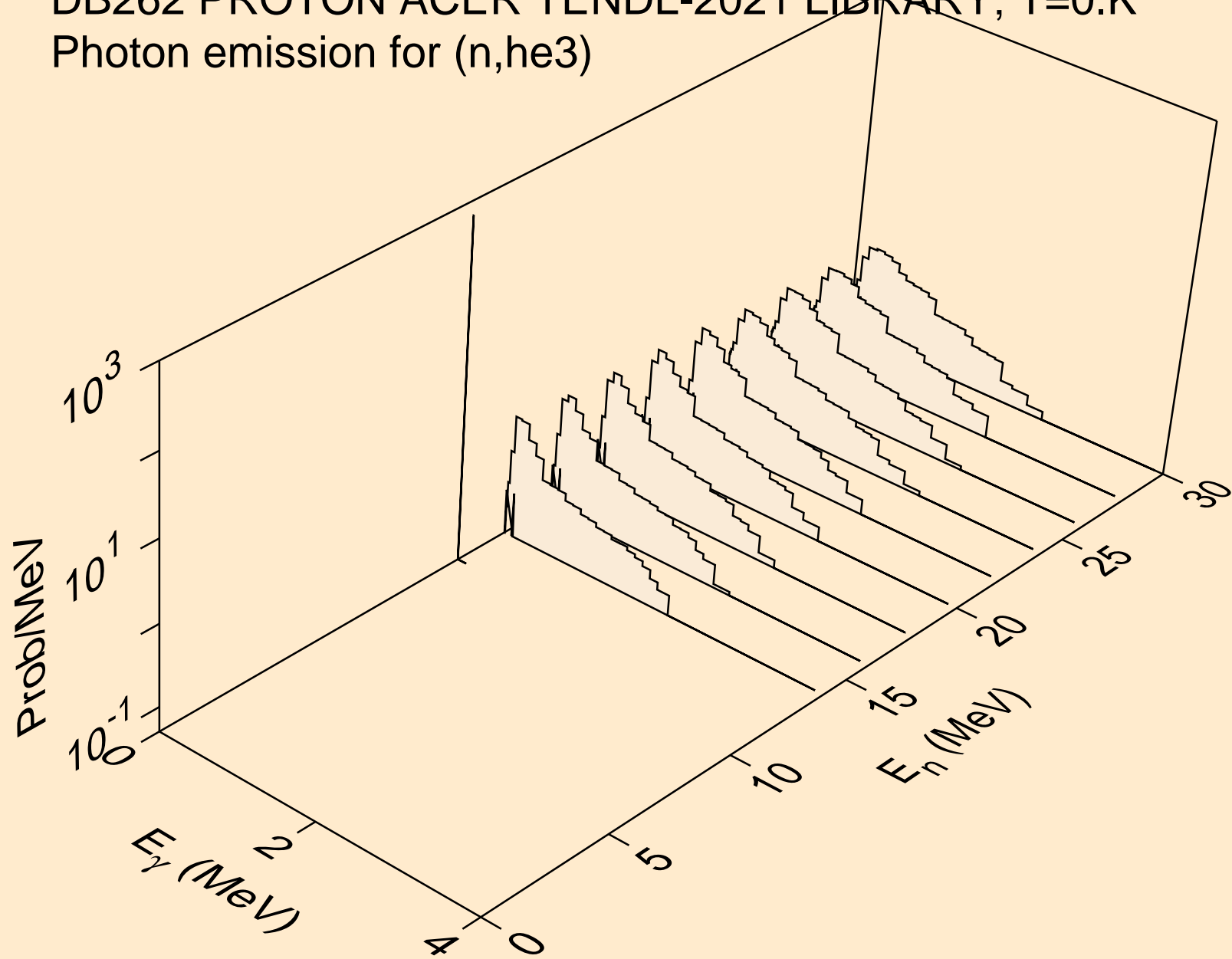

DB262 PROTON ACER TENDL-2021 LIBRARY; T=0.K
Photon emission for (n,a)

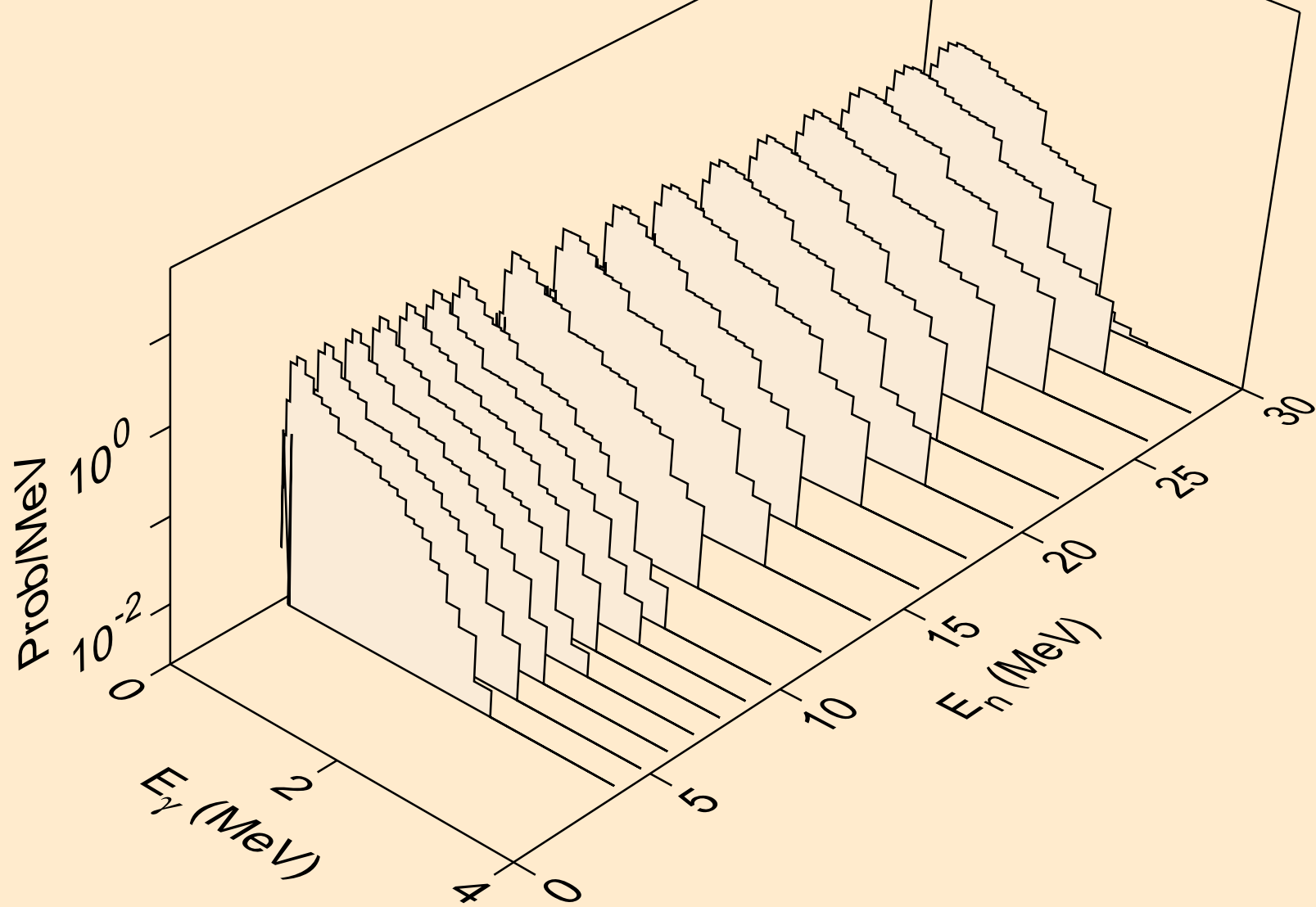

DB262 PROTON ACER TENDL-2021 LIBRARY; T=0.K
Photon emission for (n,2a)

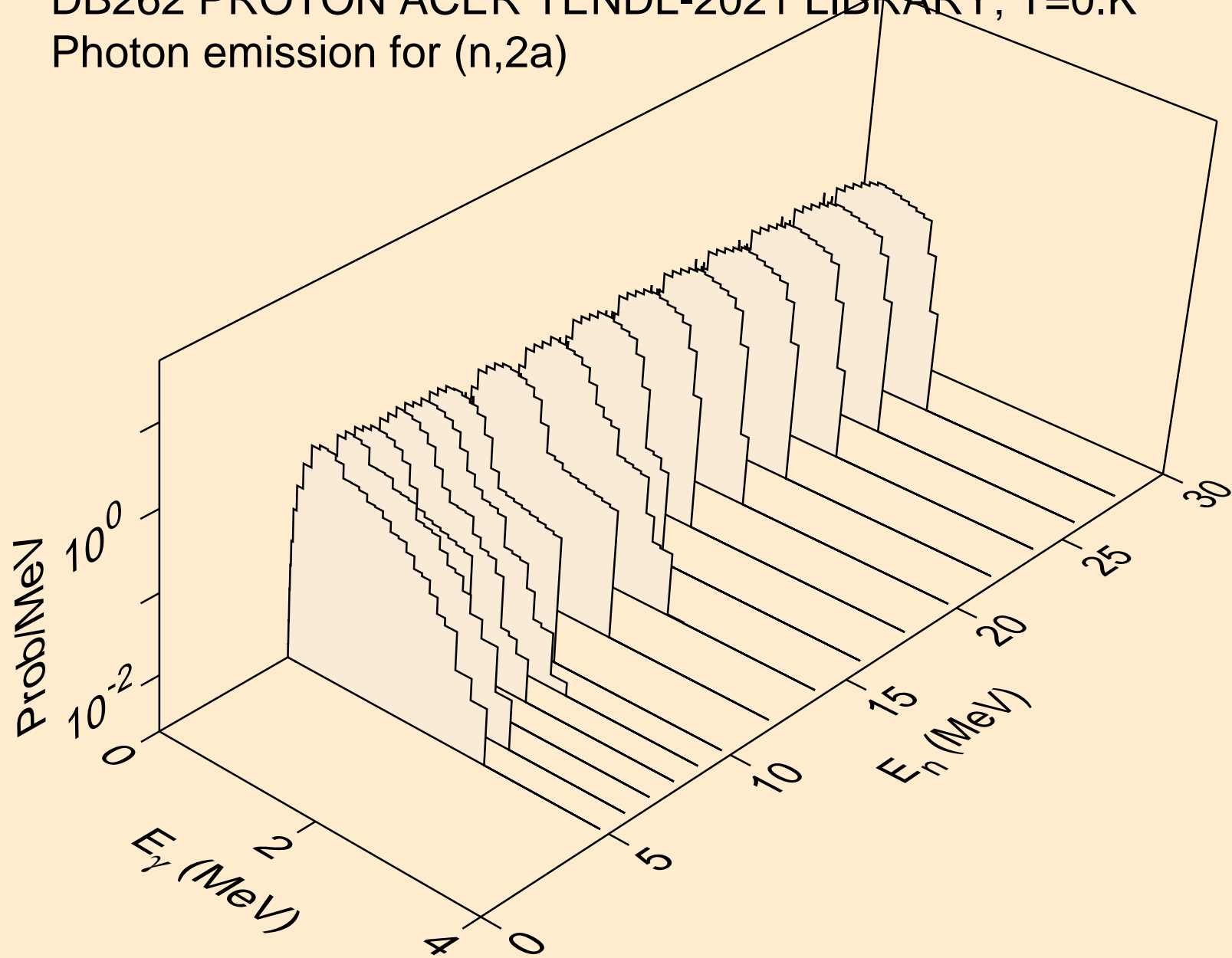

DB262 PROTON ACER TENDL-2021 LIBRARY; T=0.K
Photon emission for (n,2p)

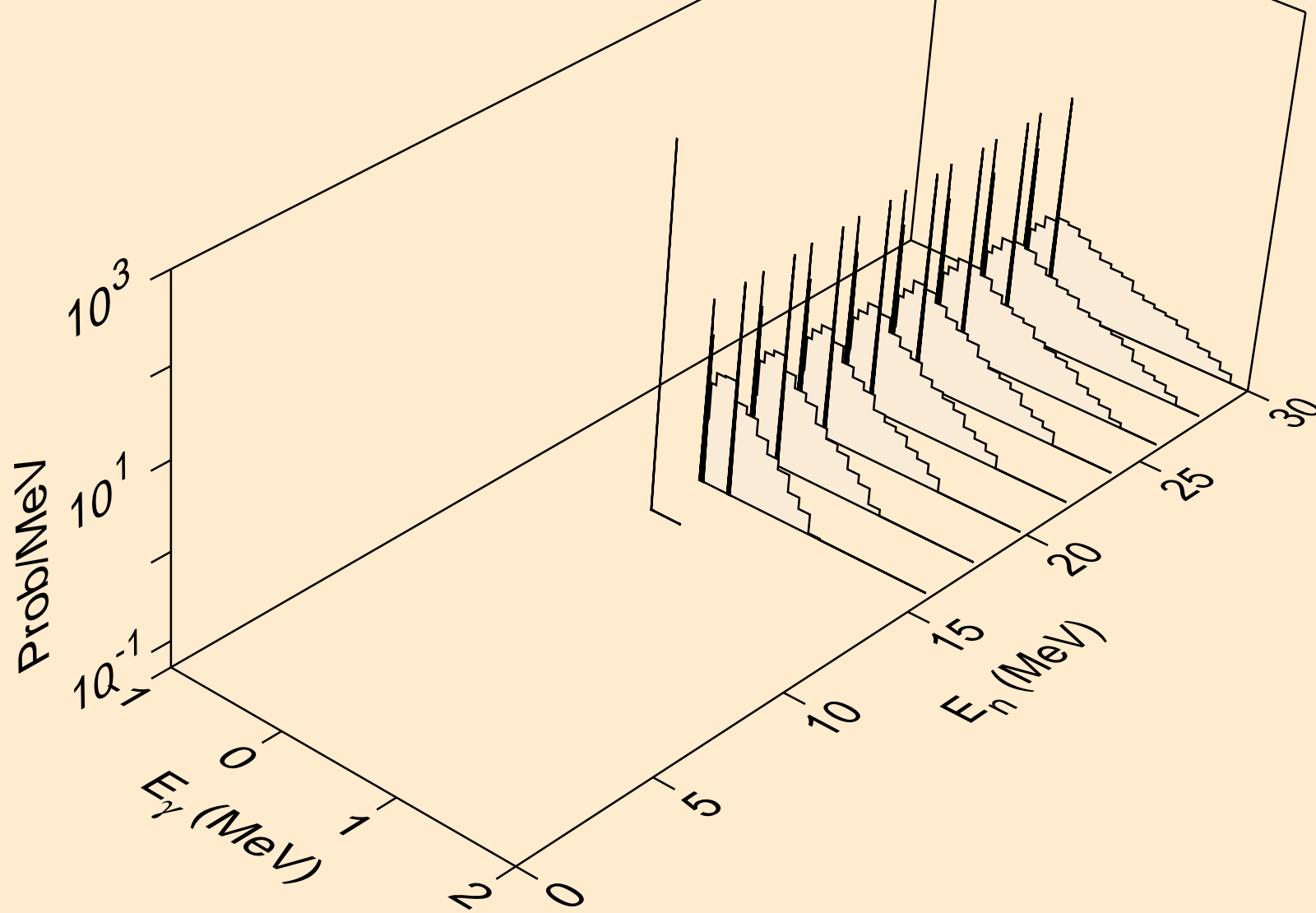

DB262 PROTON ACER TENDL-2021 LIBRARY; T=0.K
Photon emission for (n,pa)

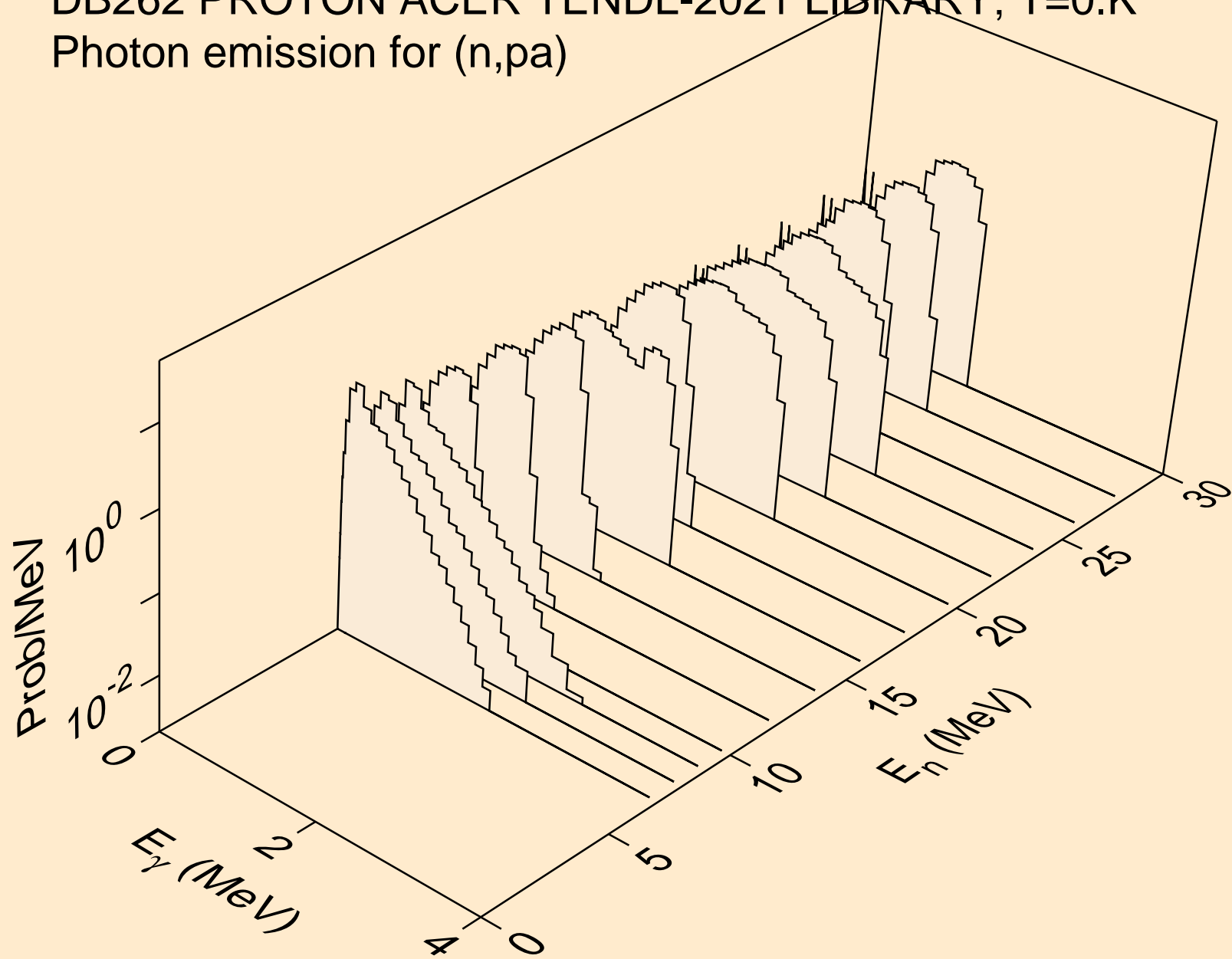

DB262 PROTON ACER TENDL-2021 LIBRARY; T=0.K
Photon emission for (n,t2a)

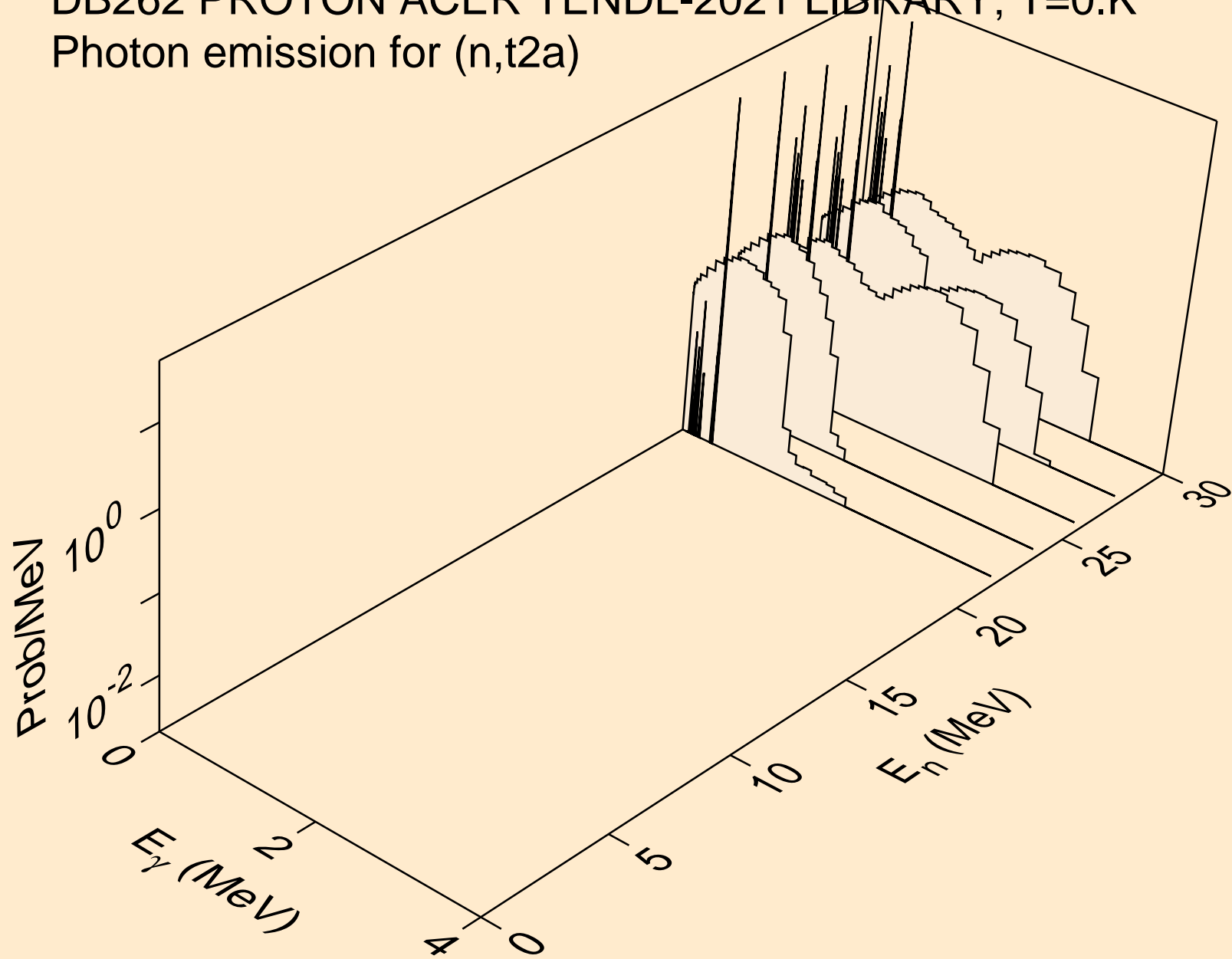

DB262 PROTON ACER TENDL-2021 LIBRARY; T=0.K
Photon emission for (n,d2a)

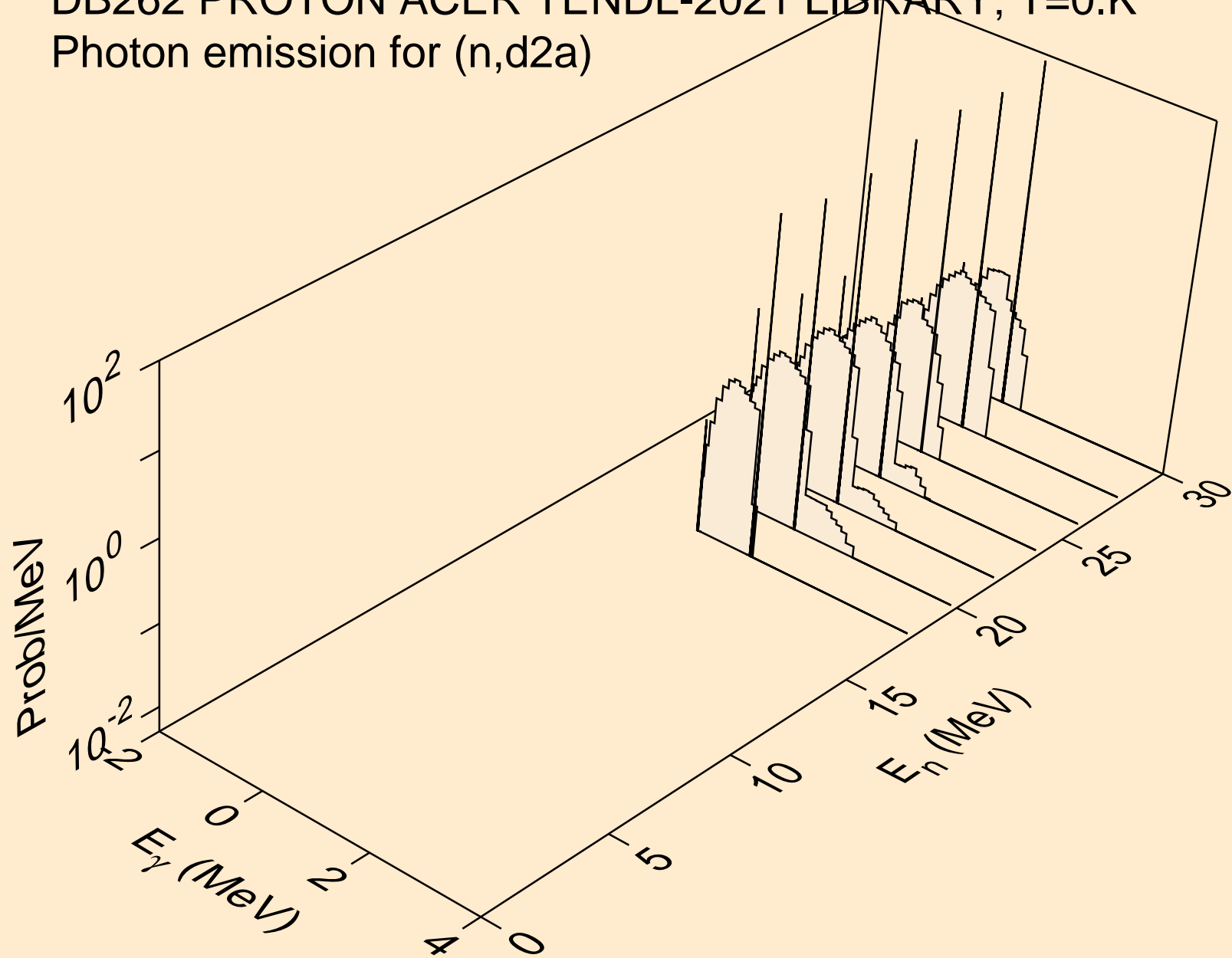

DB262 PROTON ACER TENDL-2021 LIBRARY; T=0.K
Photon emission for (n,pd)

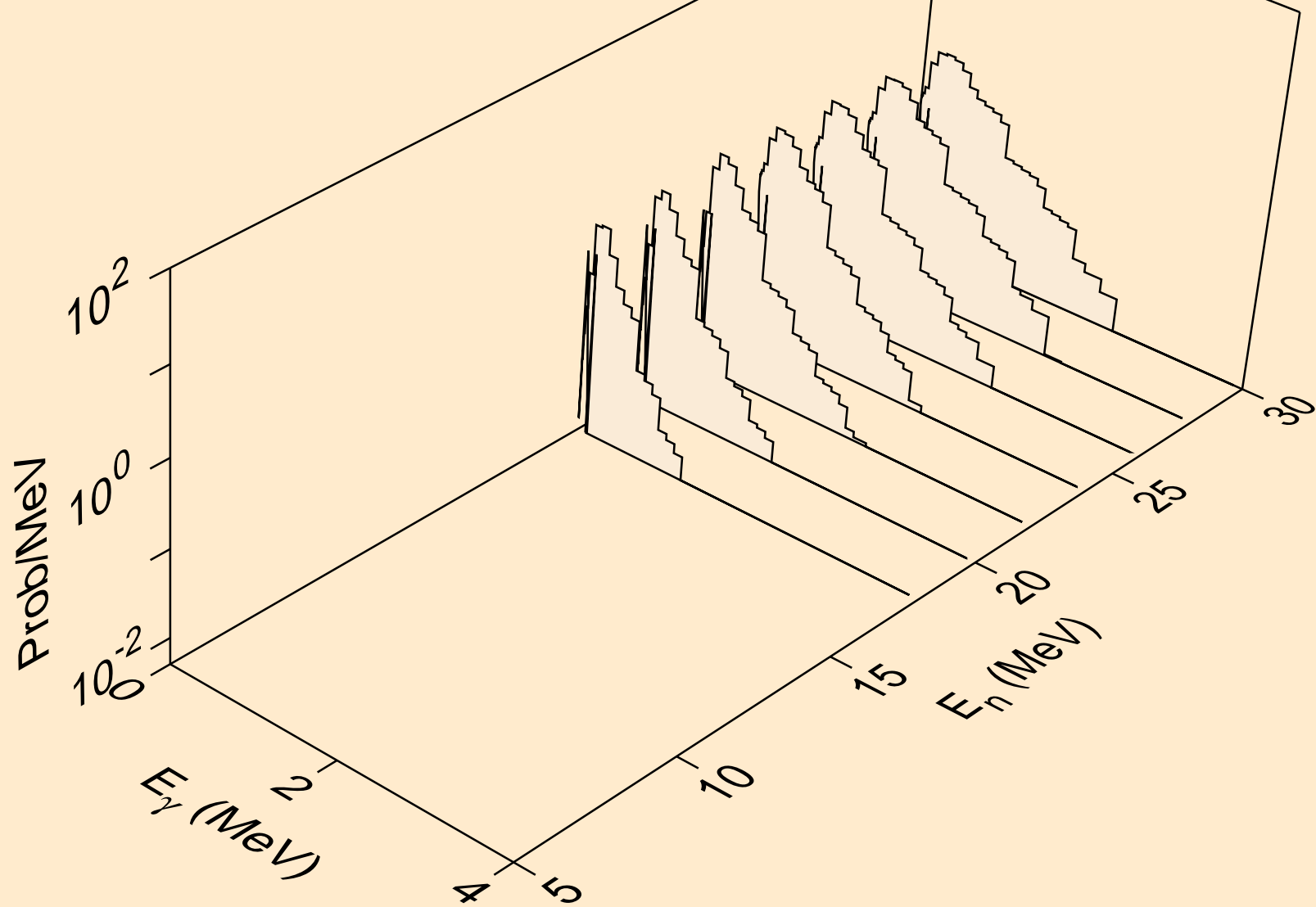

DB262 PROTON ACER TENDL-2021 LIBRARY; T=0.K
Photon emission for (n,da)

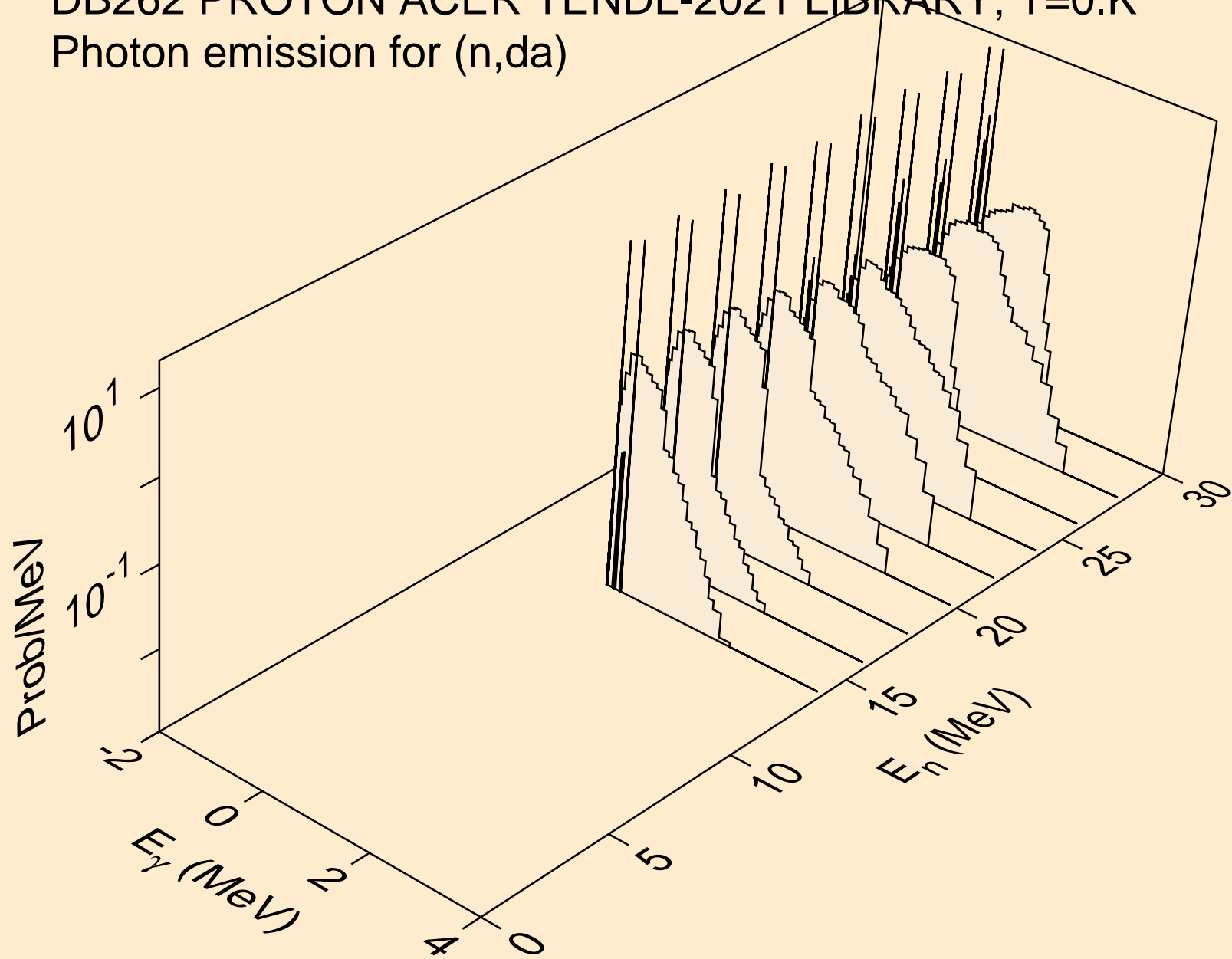

DB262 PROTON ACER TENDL-2021 LIBRARY; T=0.K
Particle heating contributions

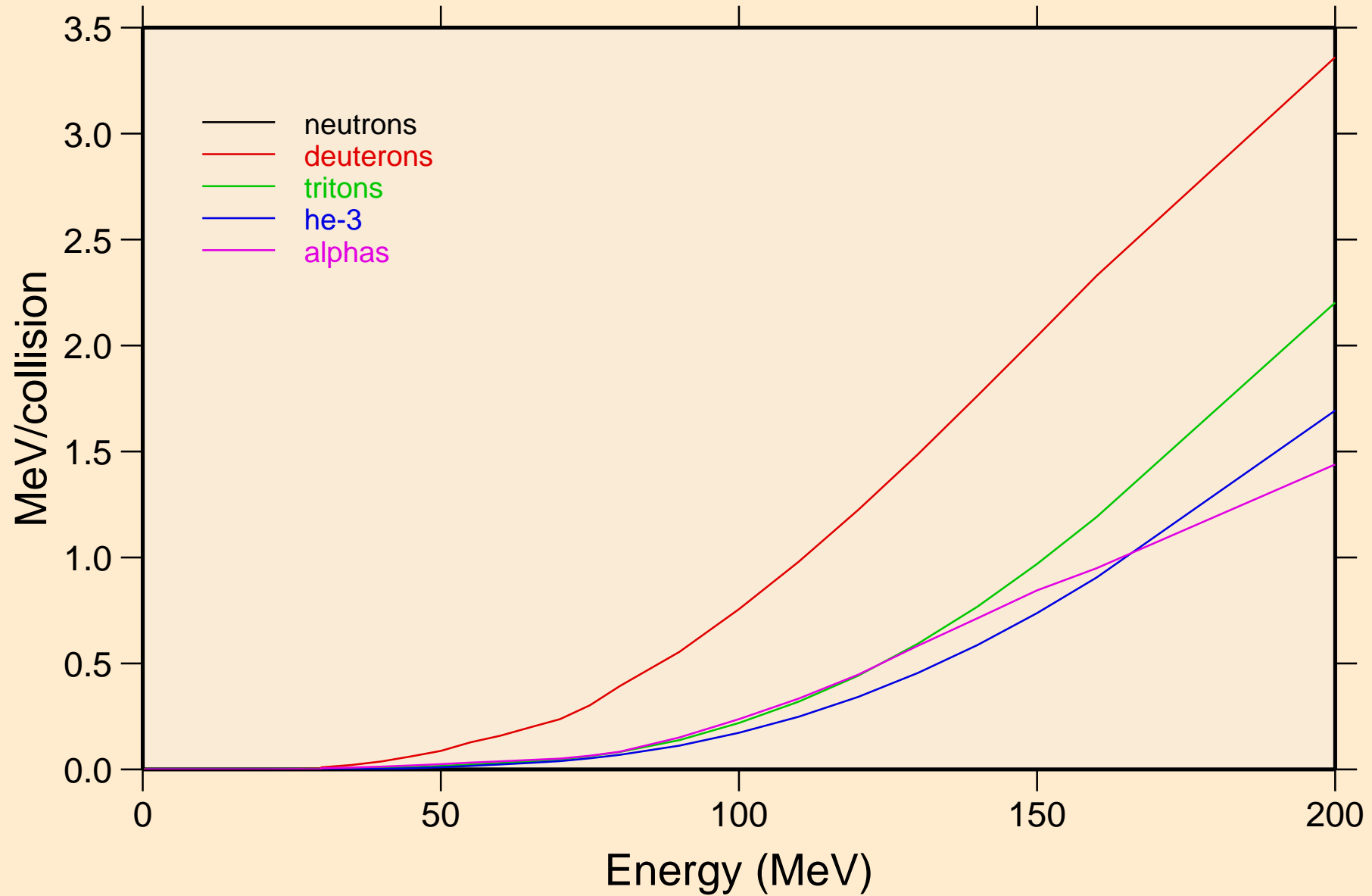

DB262 PROTON ACER TENDL-2021 LIBRARY; T=0.K
Recoil Heating

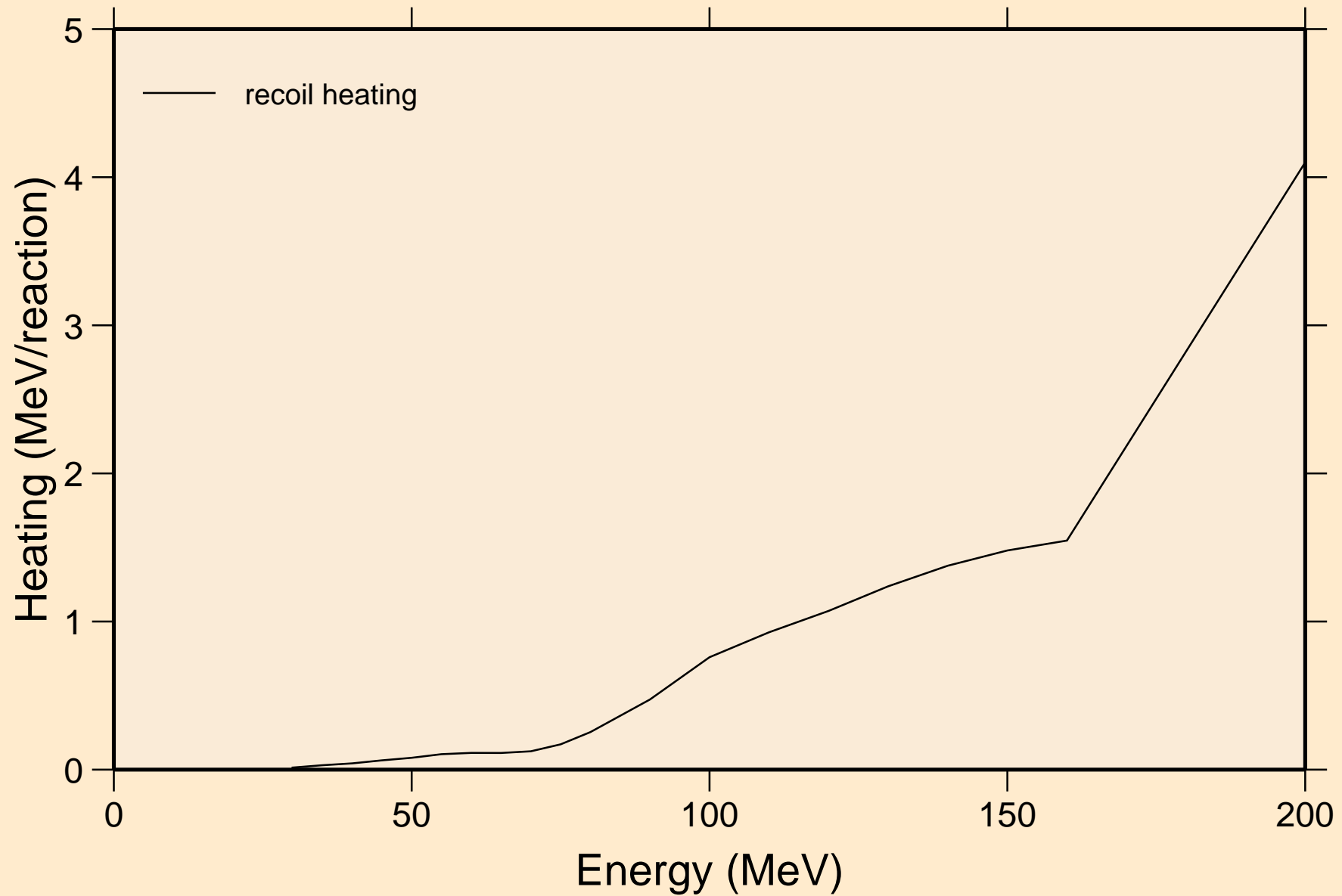

DB262 PROTON ACER TENDL-2021 LIBRARY; T=0.K
Particle production cross sections

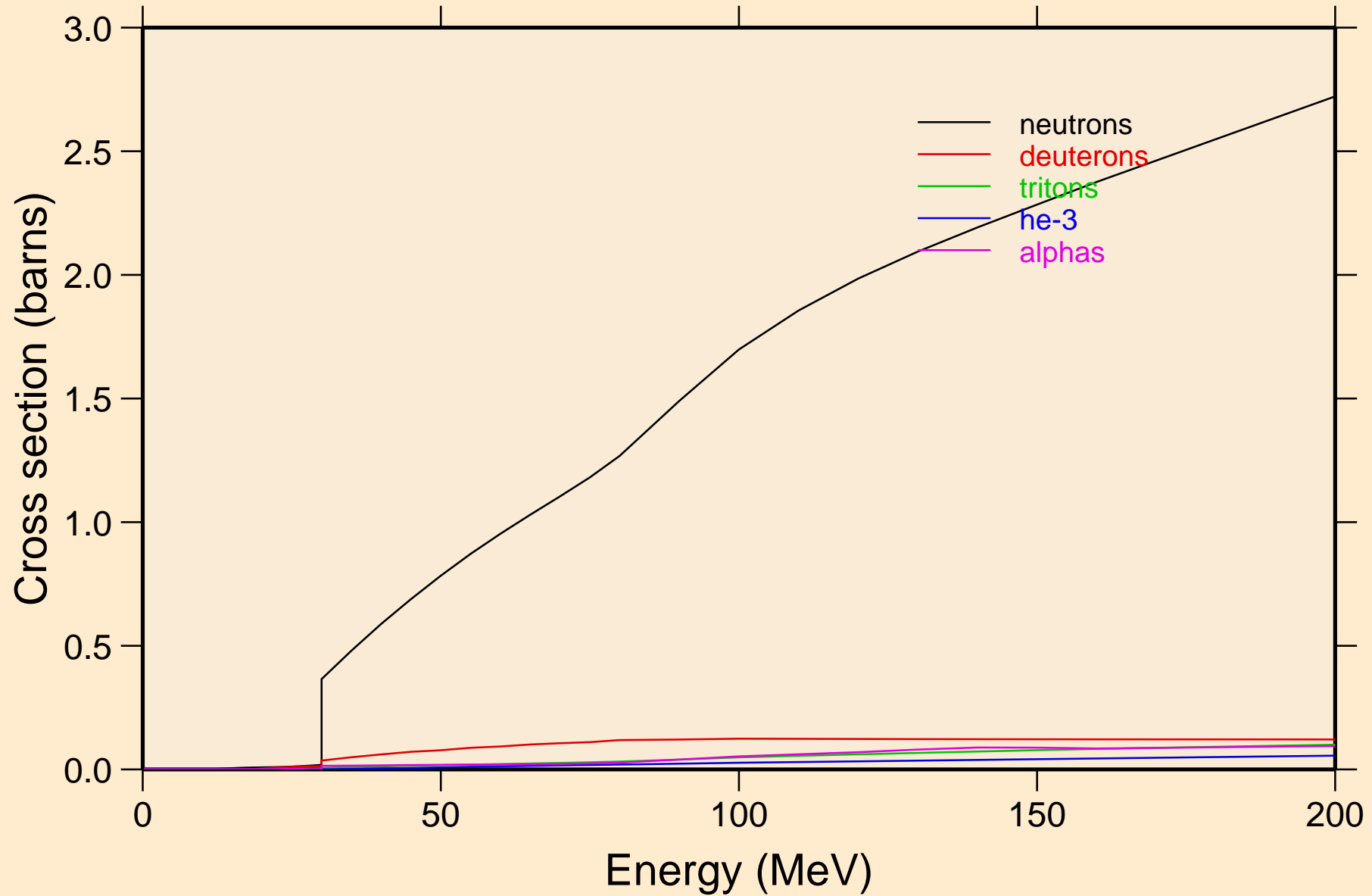

DB262 PROTON ACER TENDL-2021 LIBRARY; T=0.K
neutrons from (p,n)

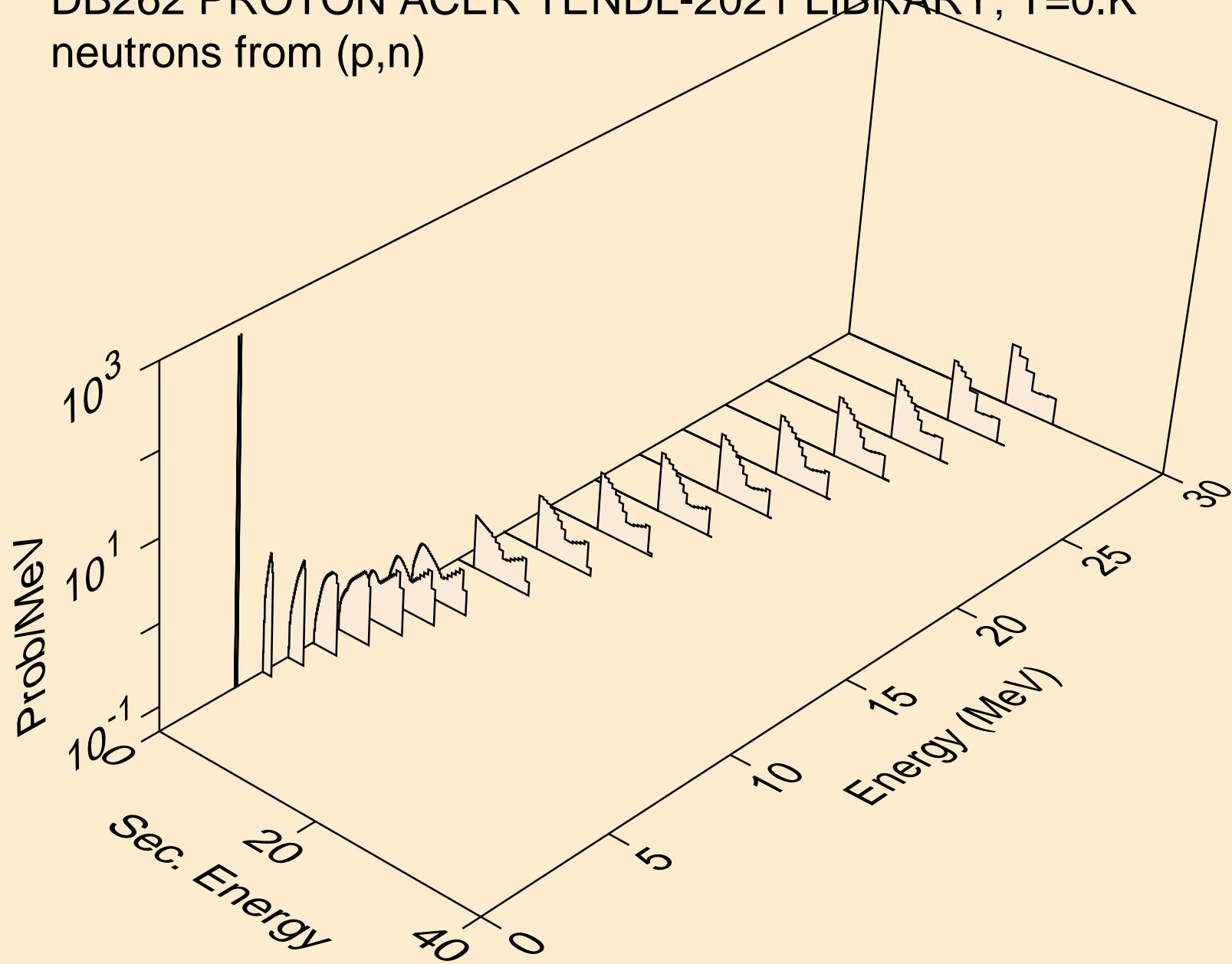

DB262 PROTON ACER TENDL-2021 LIBRARY; T=0.K
neutrons from (p,x)

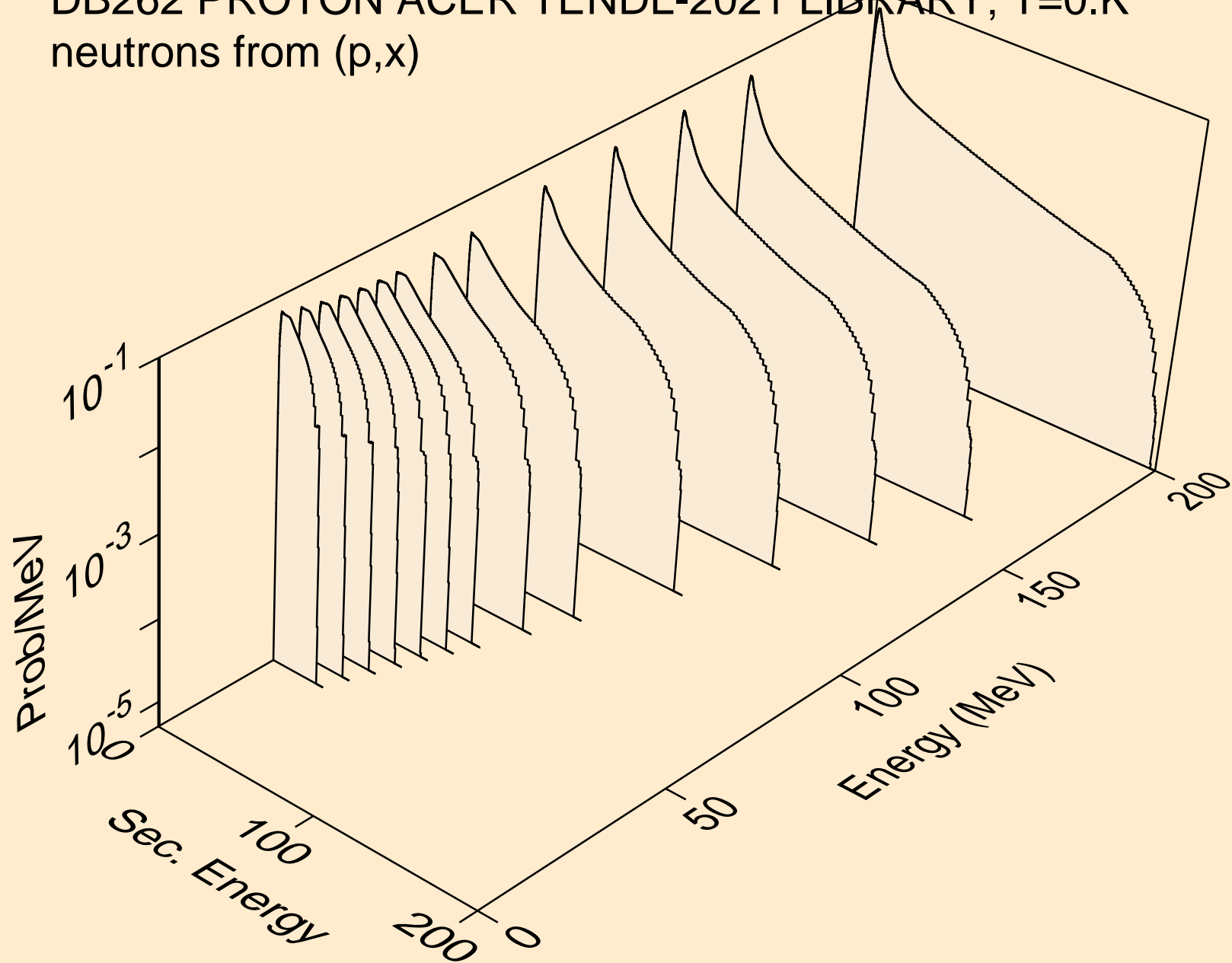

DB262 PROTON ACER TENDL-2021 LIBRARY; T=0.K
neutrons from (p,2n)

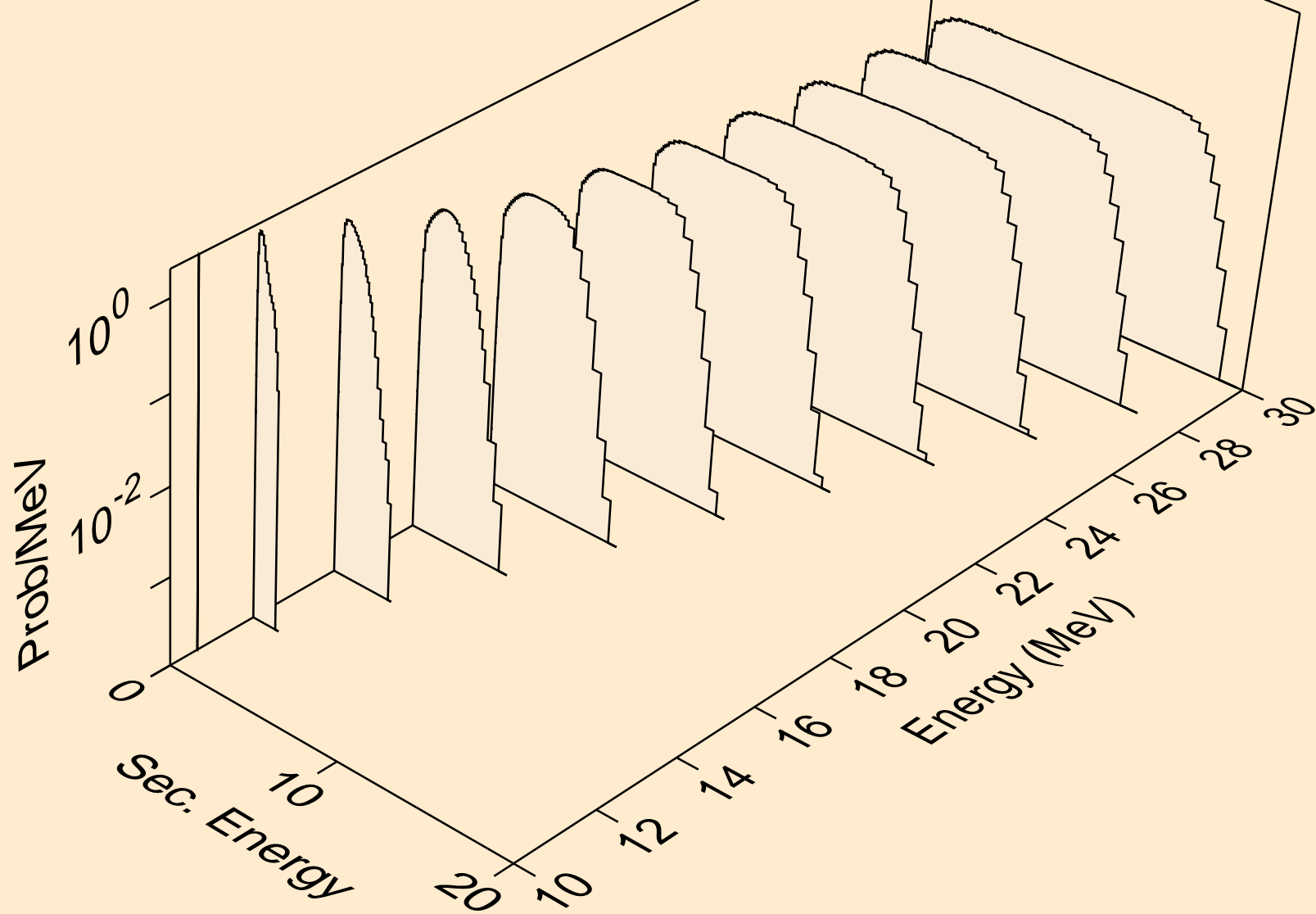

DB262 PROTON ACER TENDL-2021 LIBRARY; T=0.K
neutrons from (p,3n)

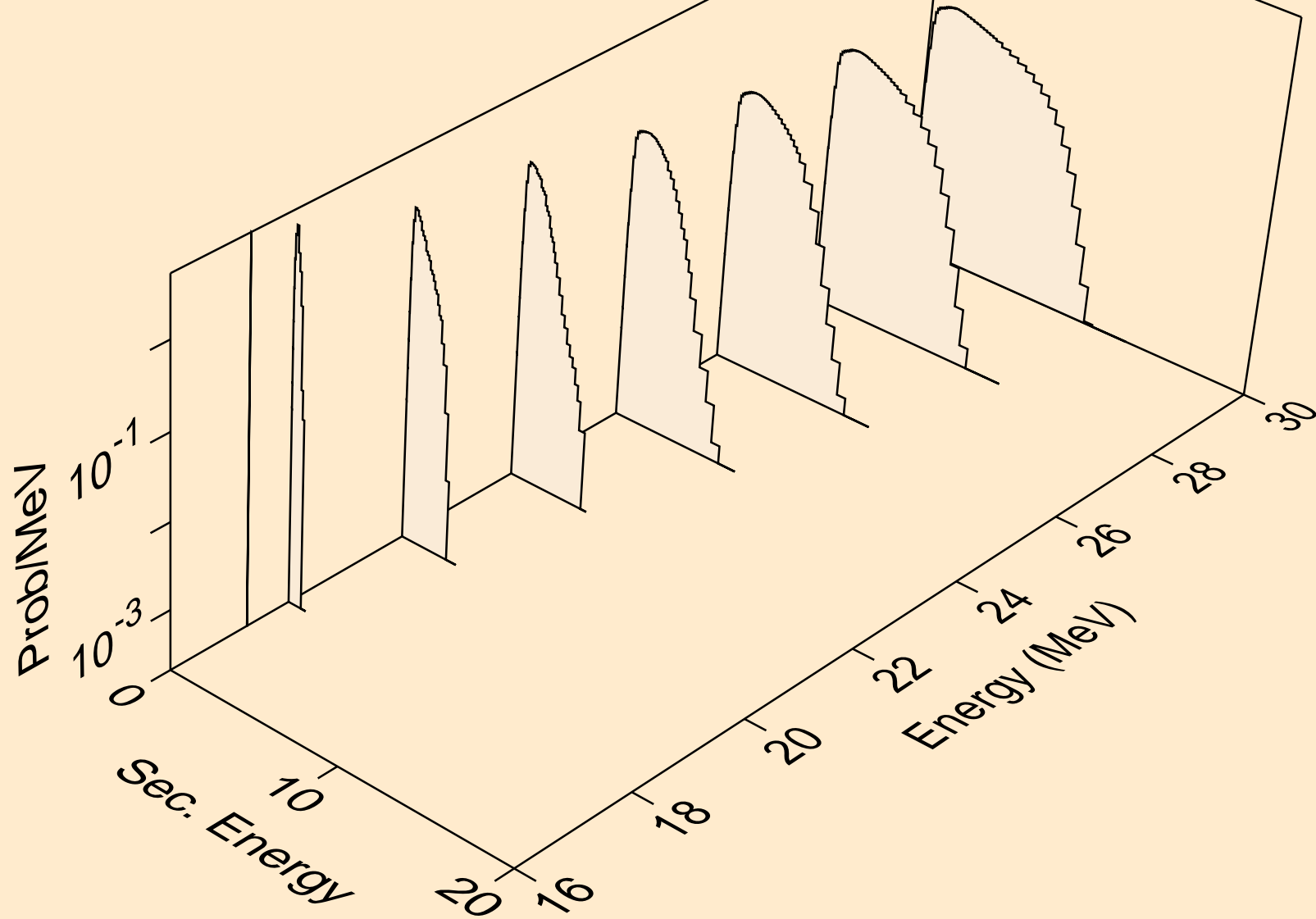

DB262 PROTON ACER TENDL-2021 LIBRARY; T=0.K
neutrons from (p,n*)a

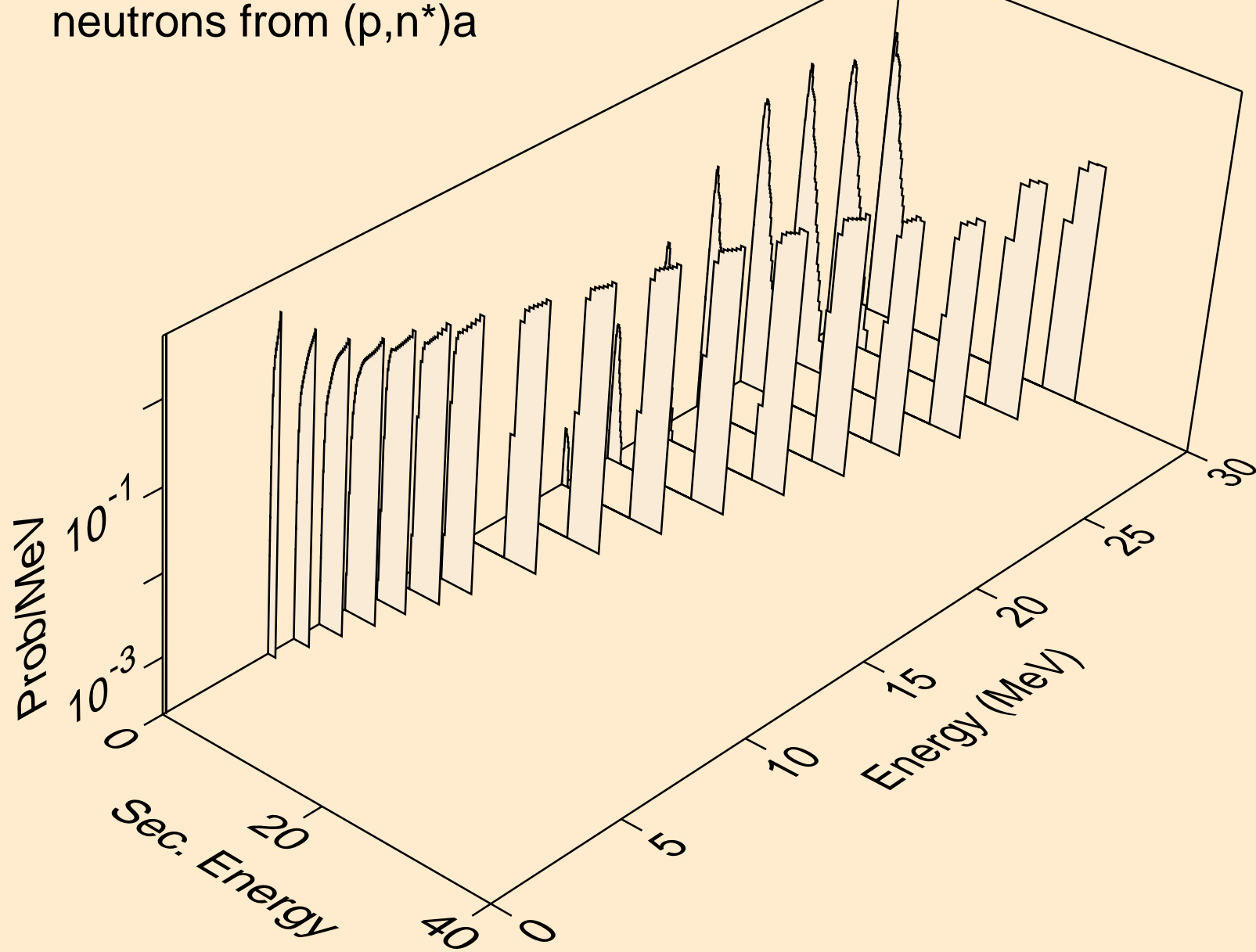

DB262 PROTON ACER TENDL-2021 LIBRARY; T=0.K
neutrons from (p,2n)a

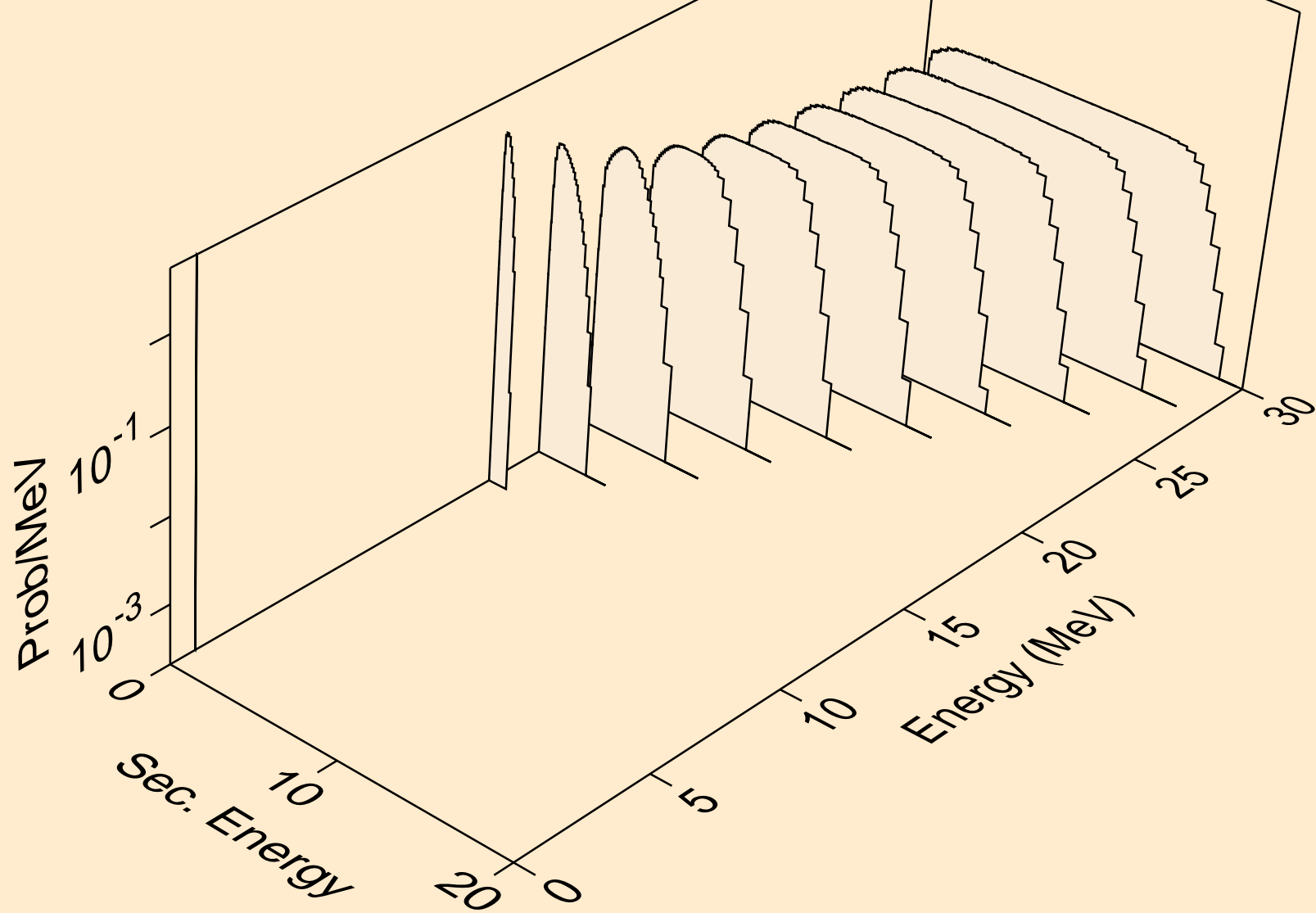

DB262 PROTON ACER TENDL-2021 LIBRARY; T=0.K
neutrons from (p,3n)a

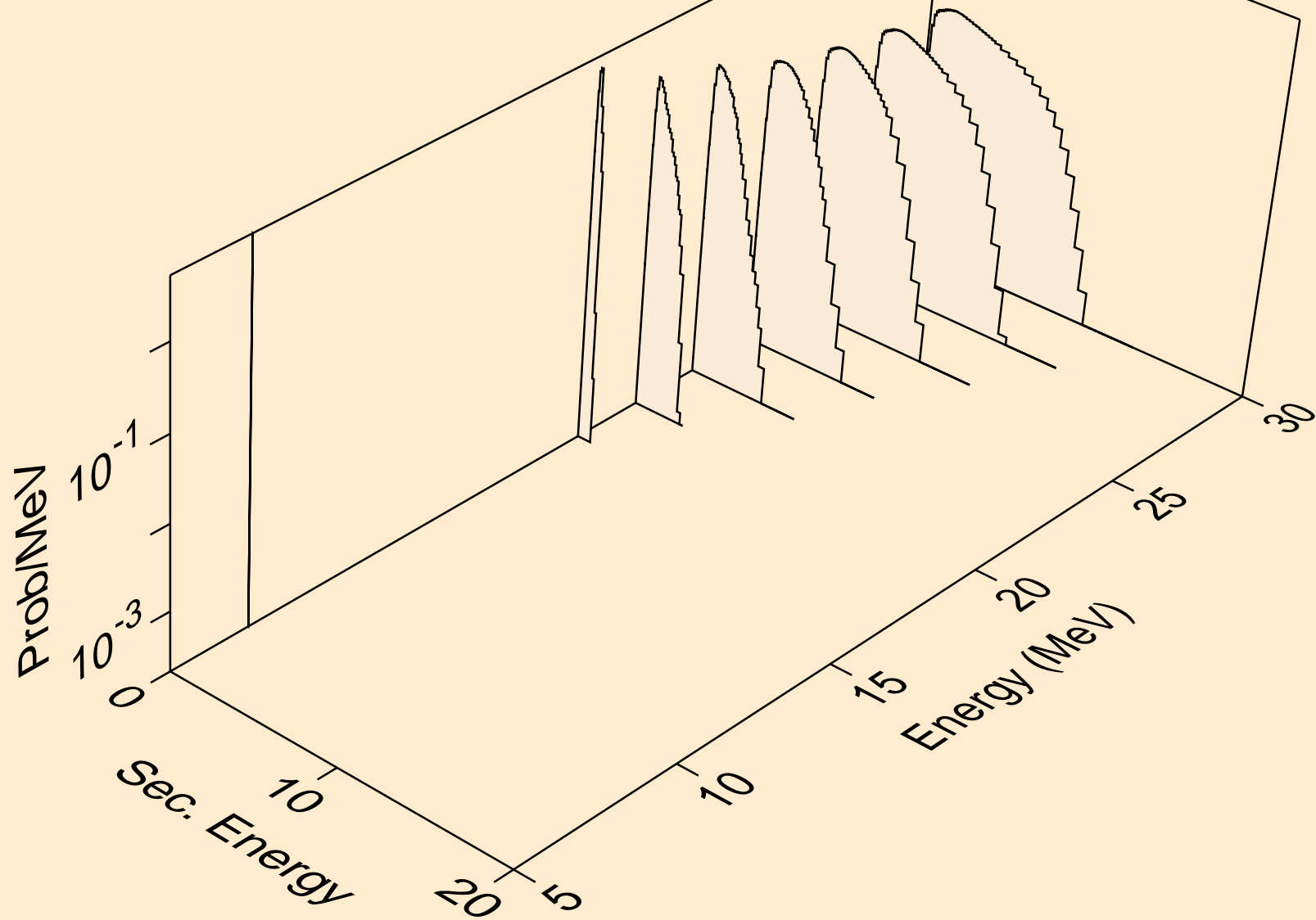

DB262 PROTON ACER TENDL-2021 LIBRARY; T=0.K
neutrons from (p,n*)p

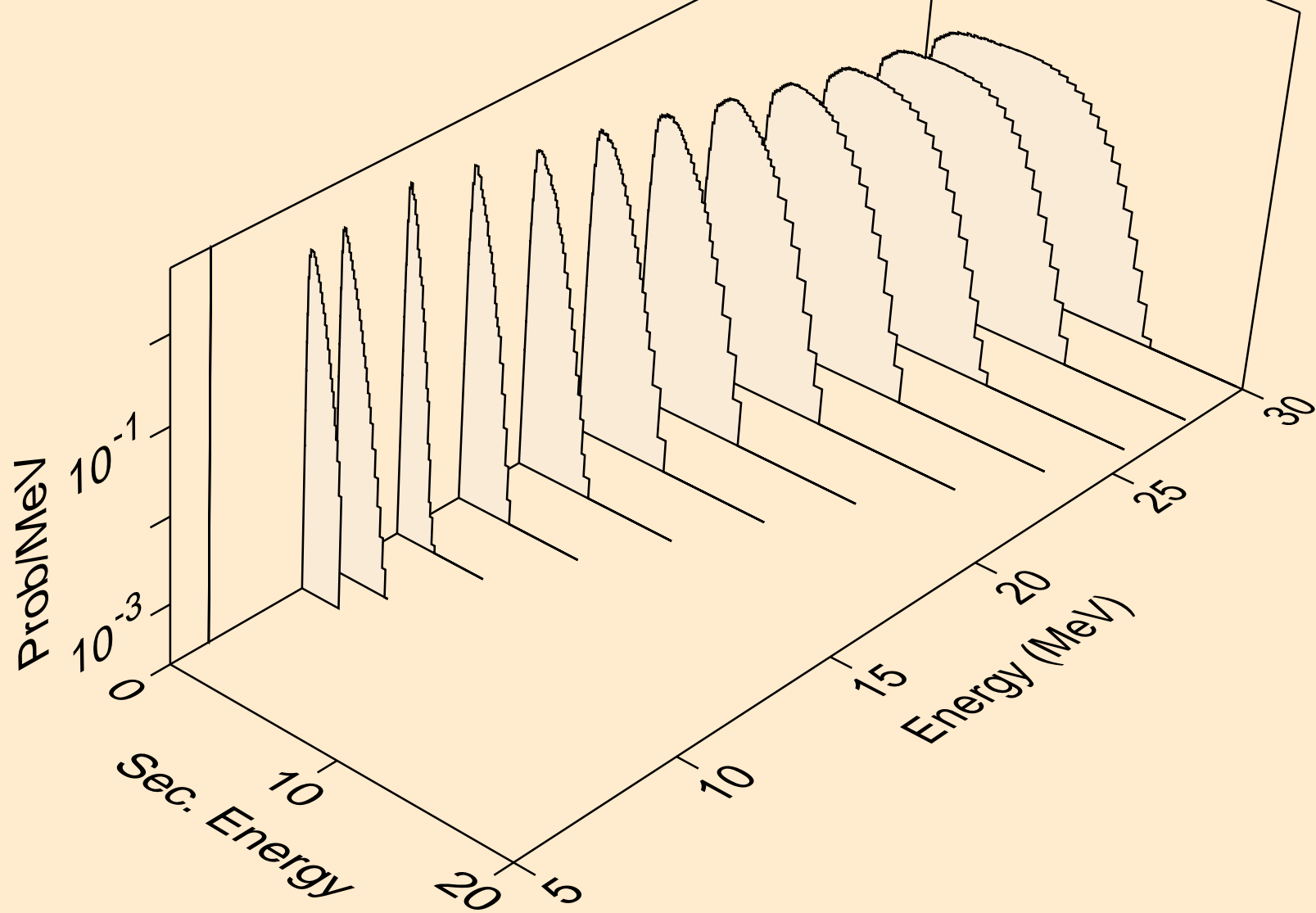

DB262 PROTON ACER TENDL-2021 LIBRARY; T=0.K
neutrons from (p,n*)d

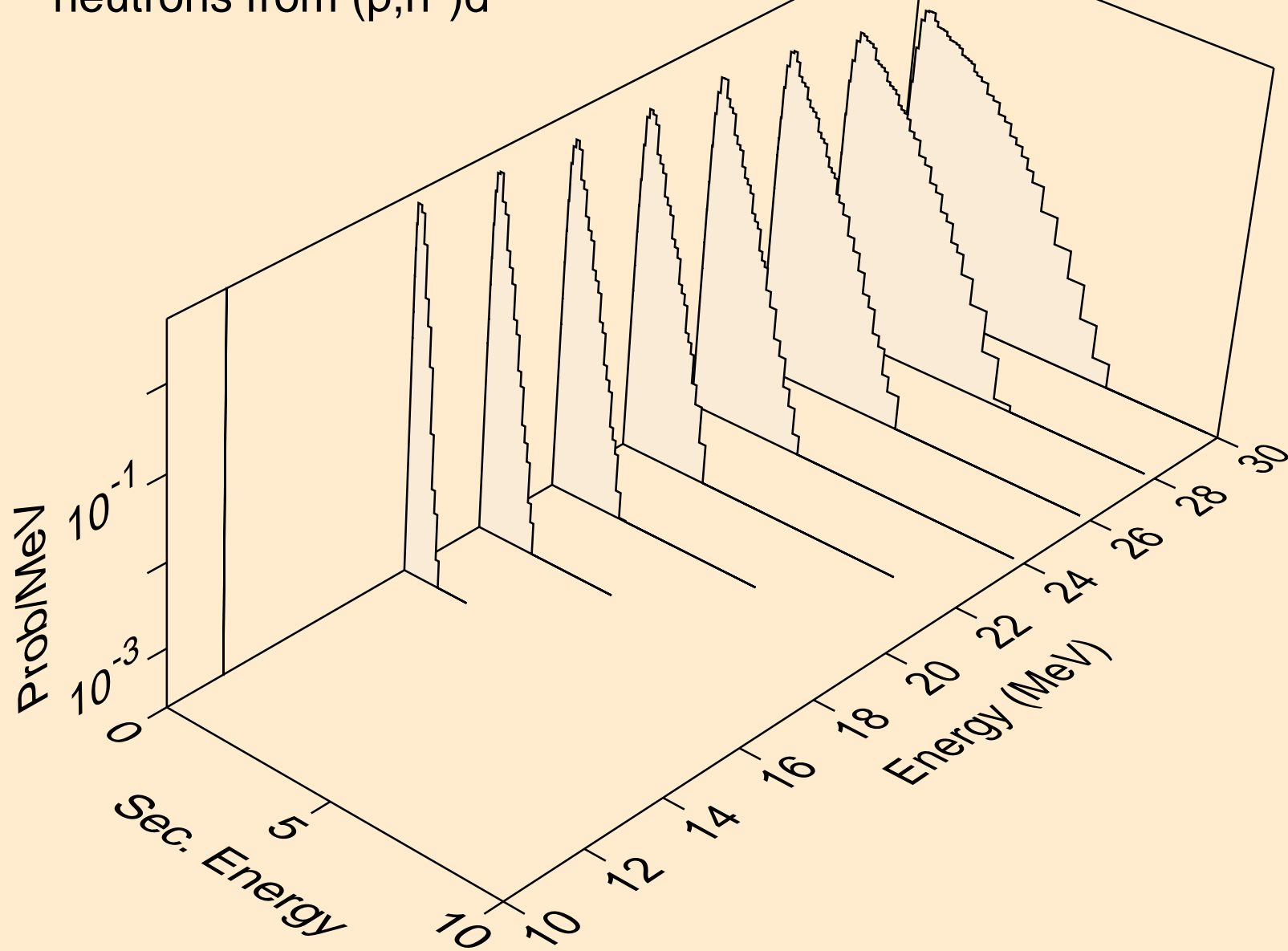

DB262 PROTON ACER TENDL-2021 LIBRARY; T=0.K
neutrons from (p,n*)t

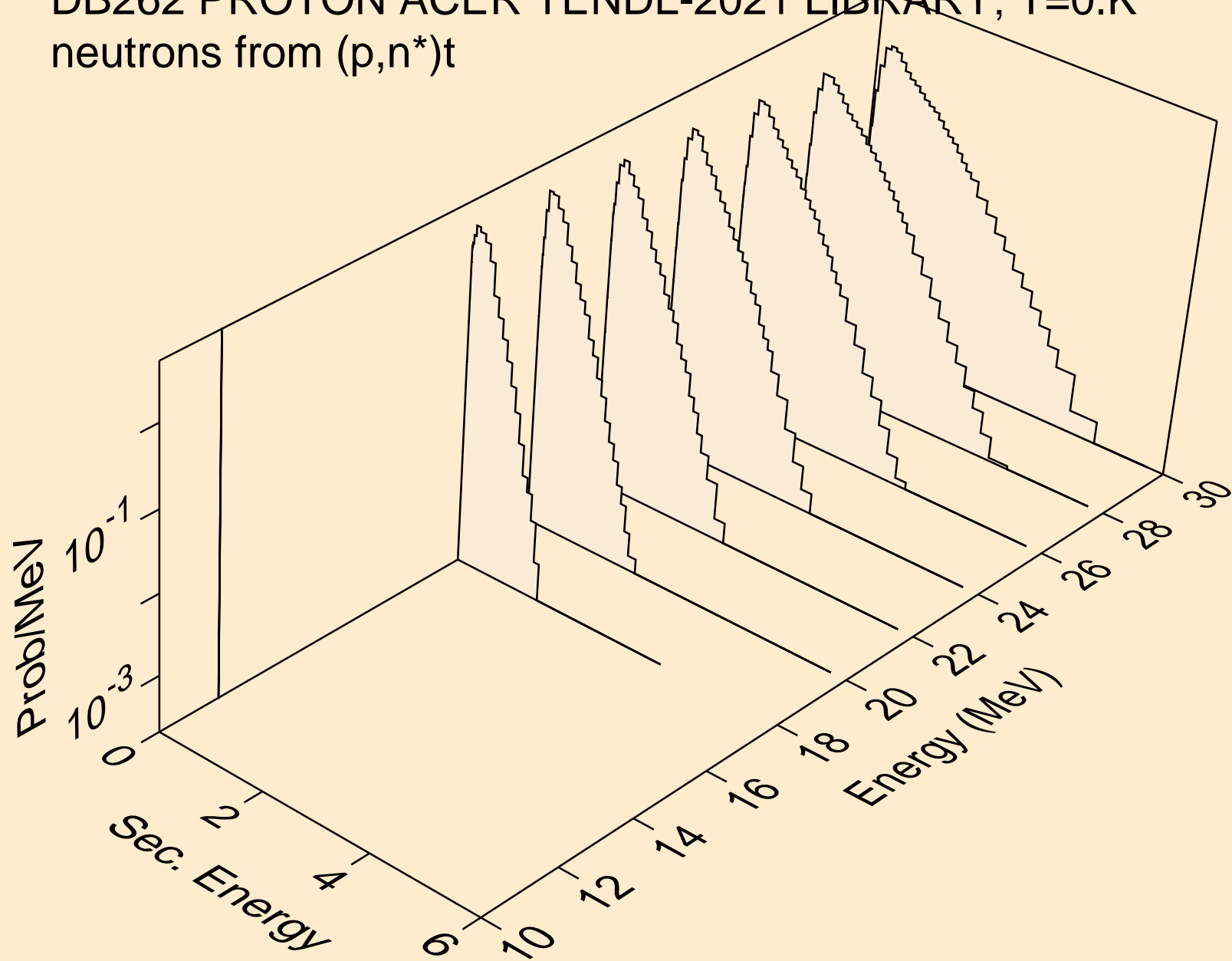

DB262 PROTON ACER TENDL-2021 LIBRARY; T=0.K
neutrons from (p,2np)

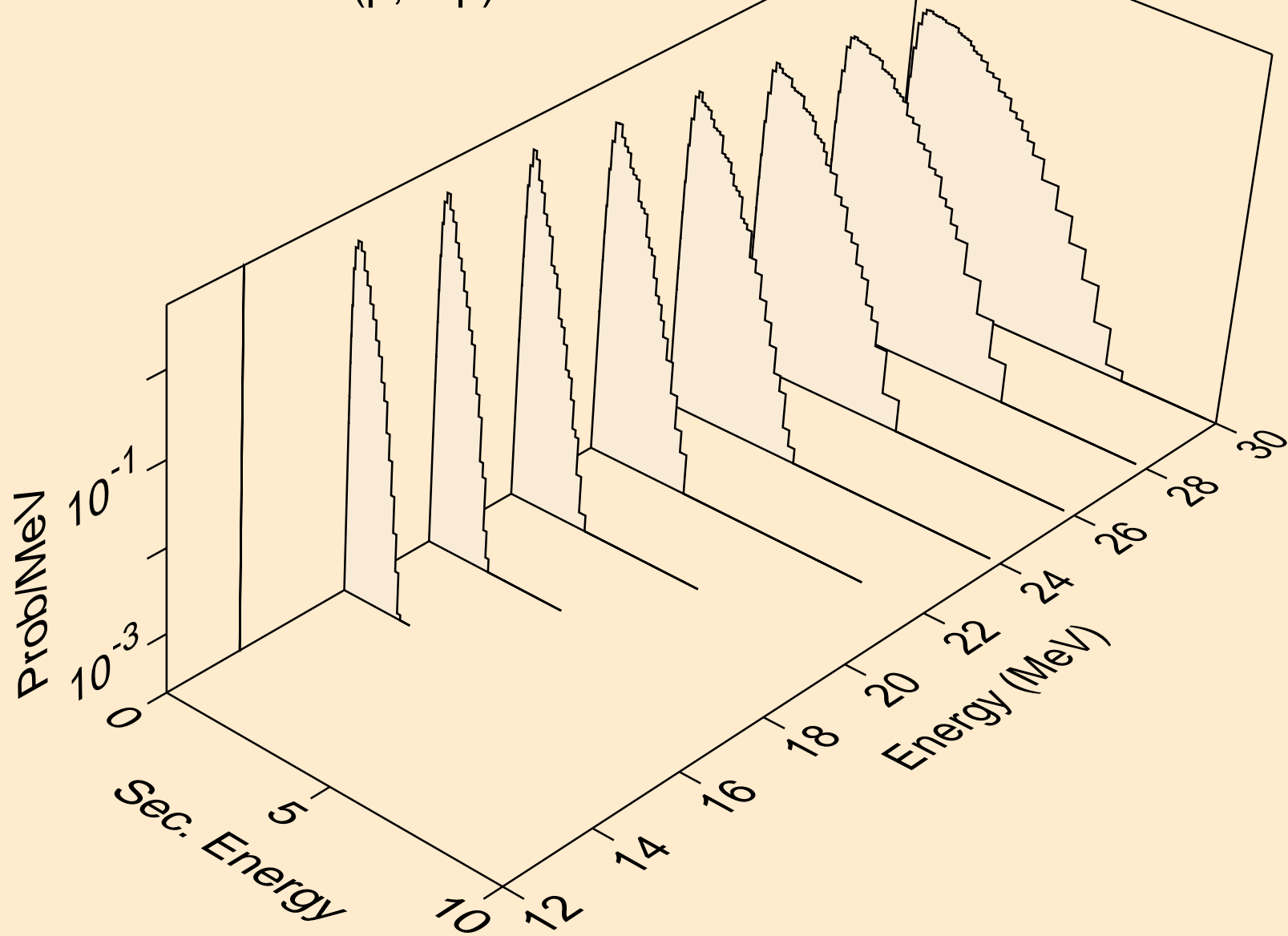

DB262 PROTON ACER TENDL-2021 LIBRARY; T=0.K
neutrons from (p,2np)

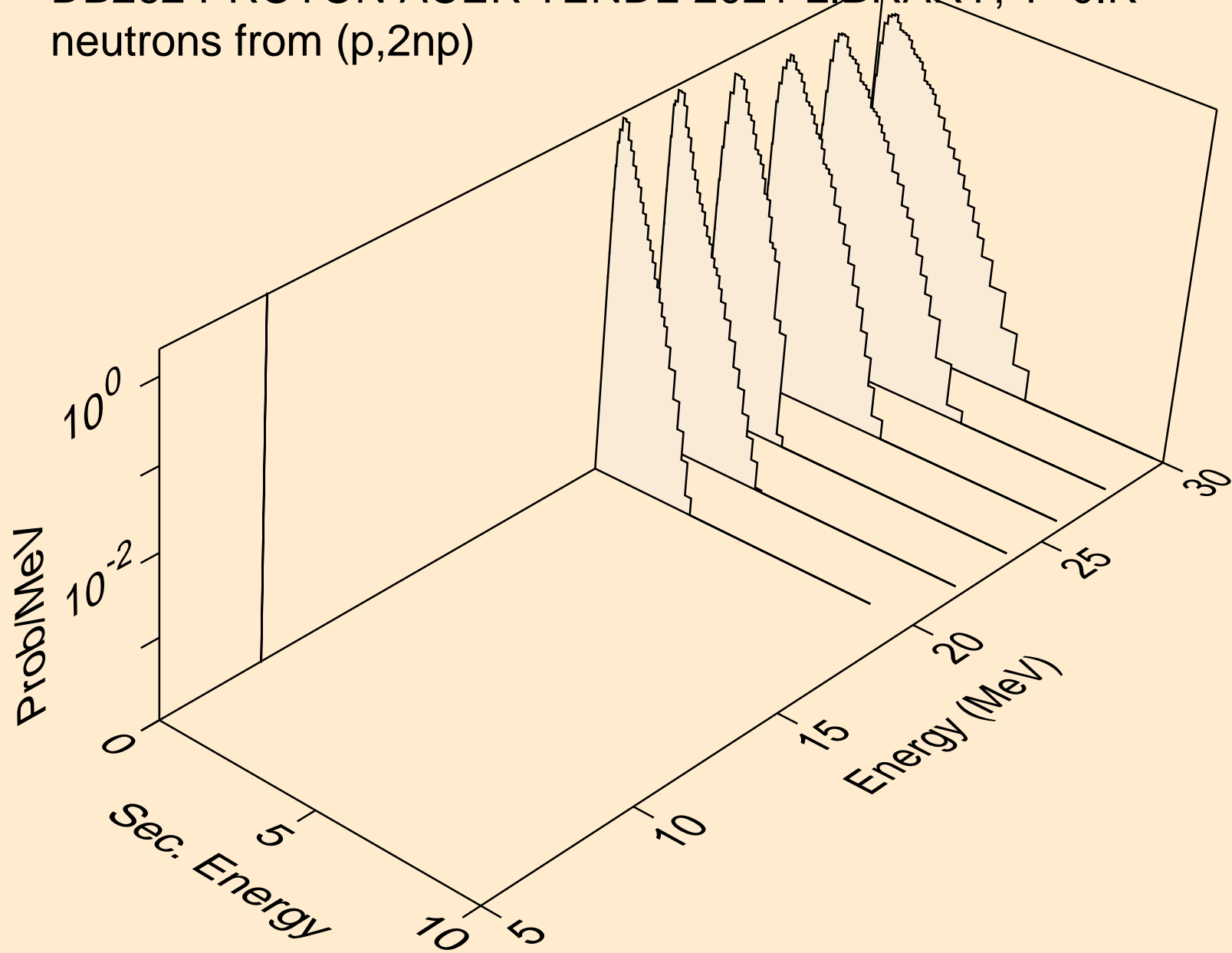

DB262 PROTON ACER TENDL-2021 LIBRARY; T=0.K
neutrons from (p,npa)

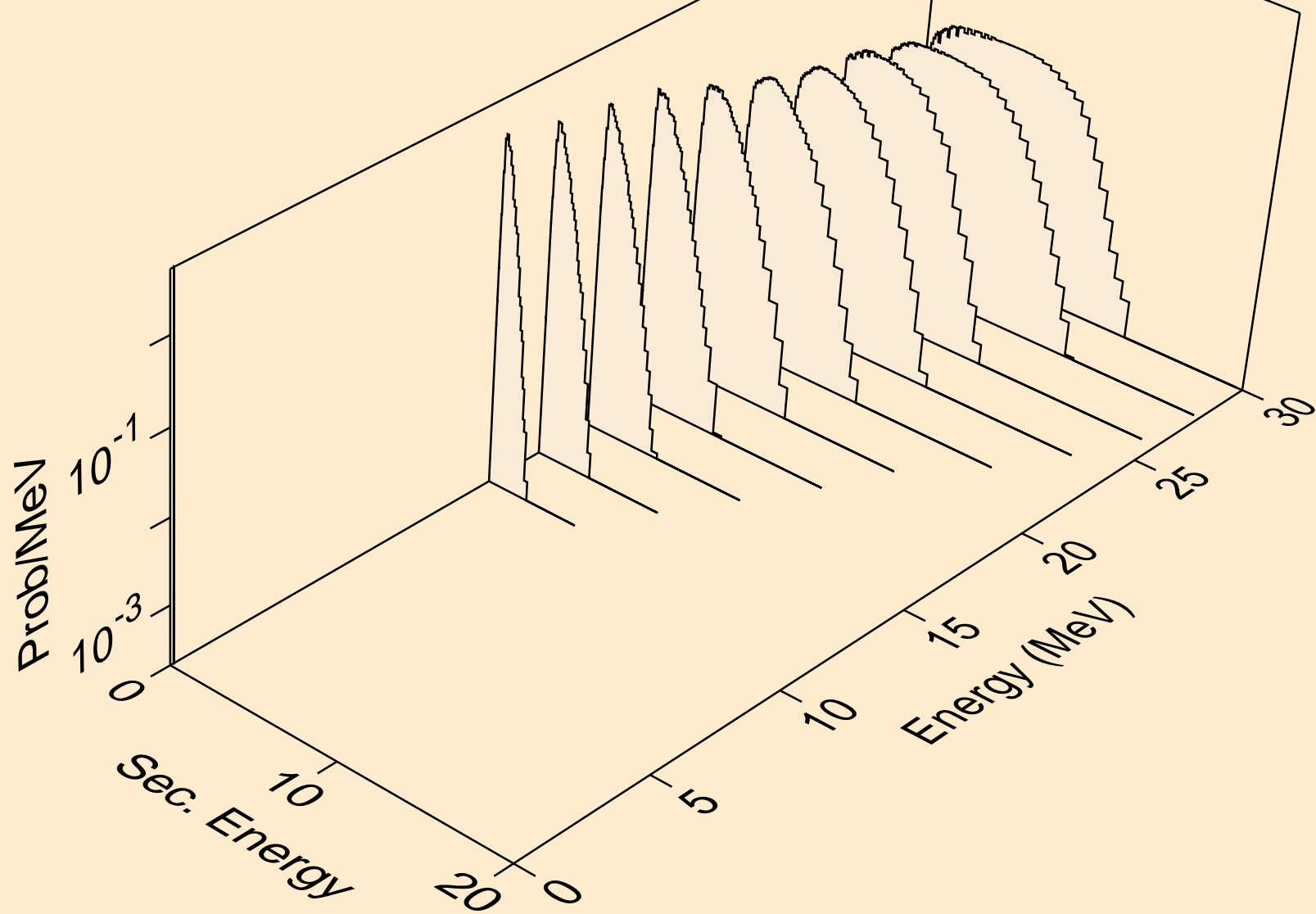

DB262 PROTON ACER TENDL-2021 LIBRARY; T=0.K
deuterons from (p,x)

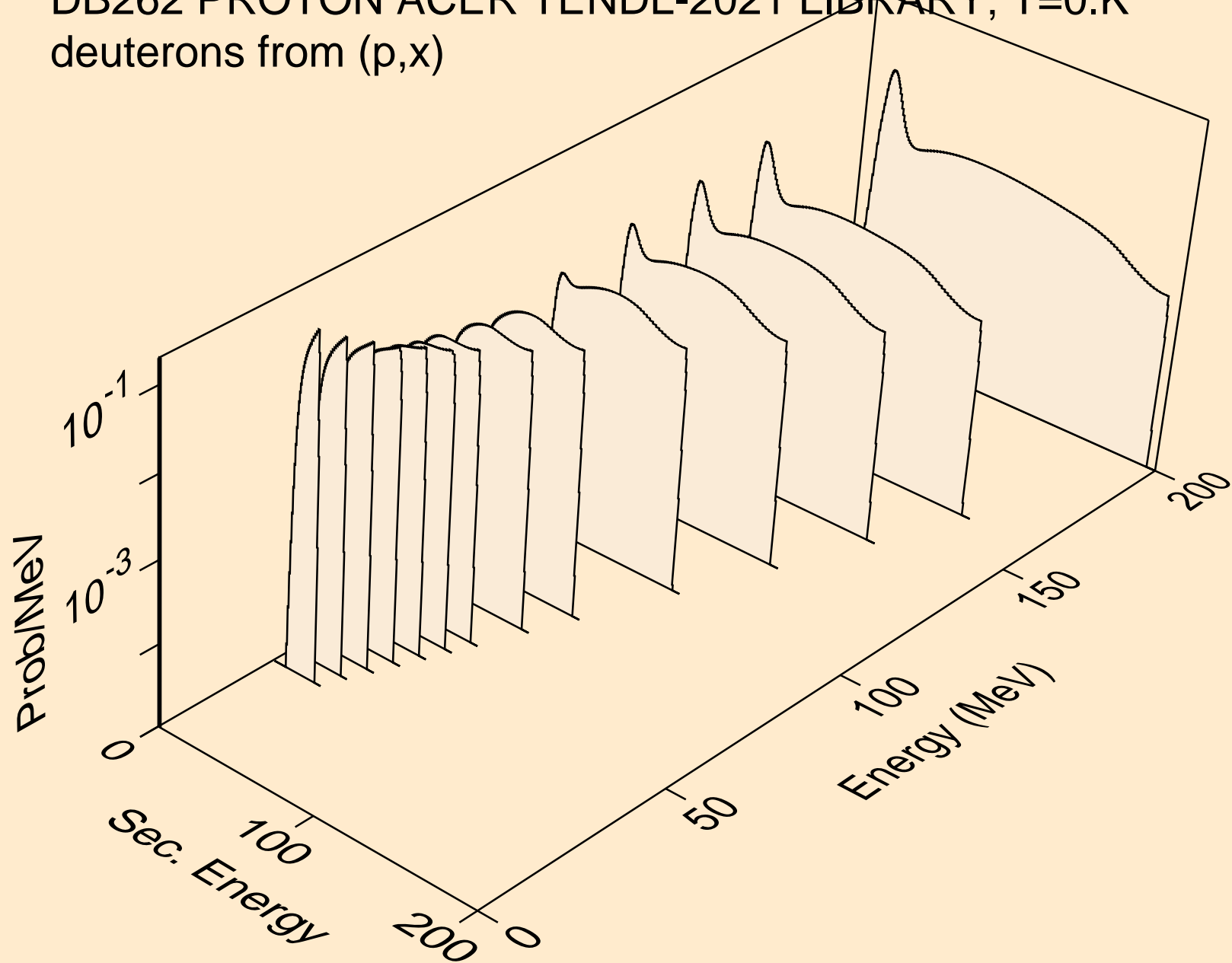

DB262 PROTON ACER TENDL-2021 LIBRARY; T=0.K
deuterons from (p,n*)d

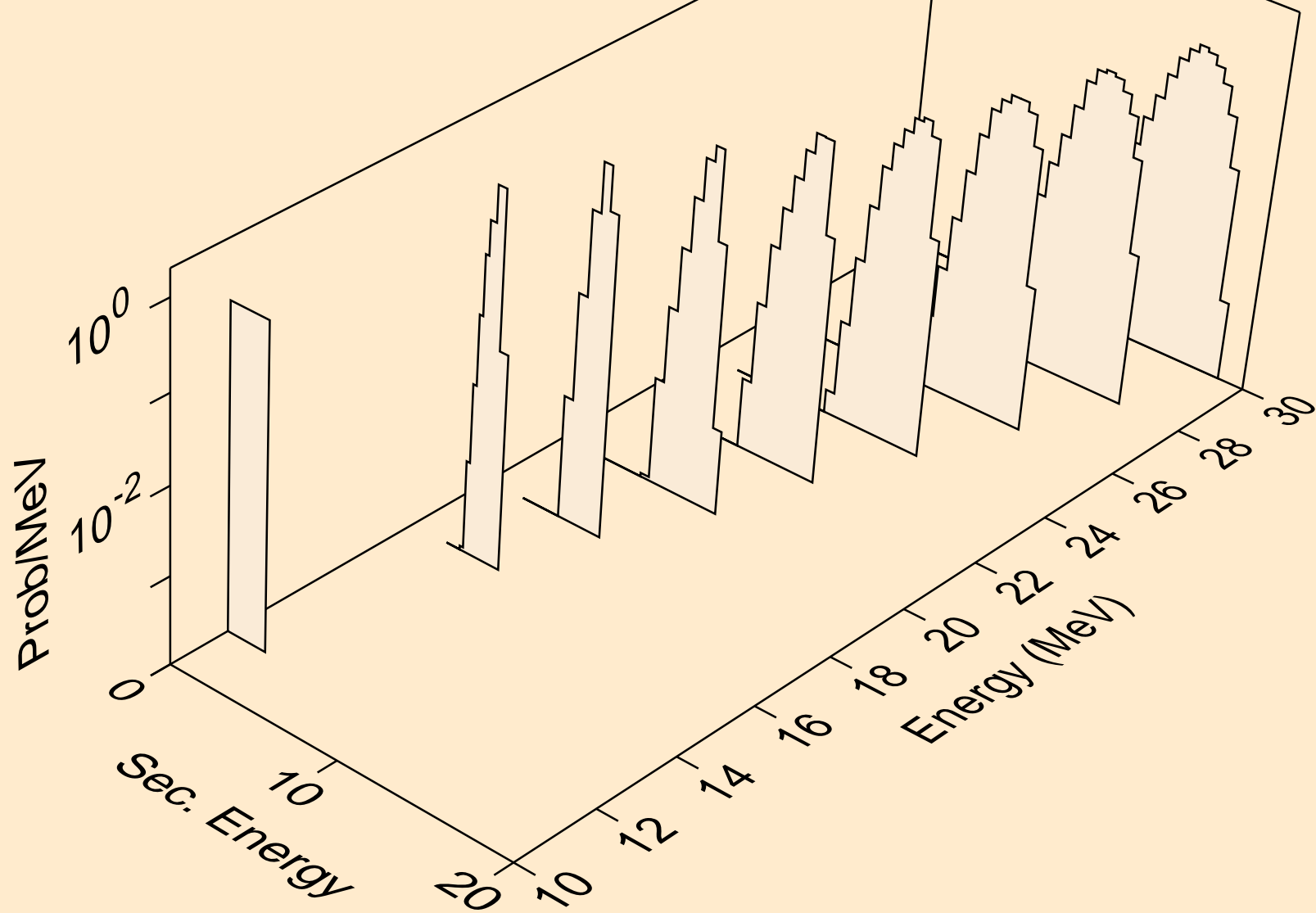

DB262 PROTON ACER TENDL-2021 LIBRARY; T=0.K
deuterons from (p,d)

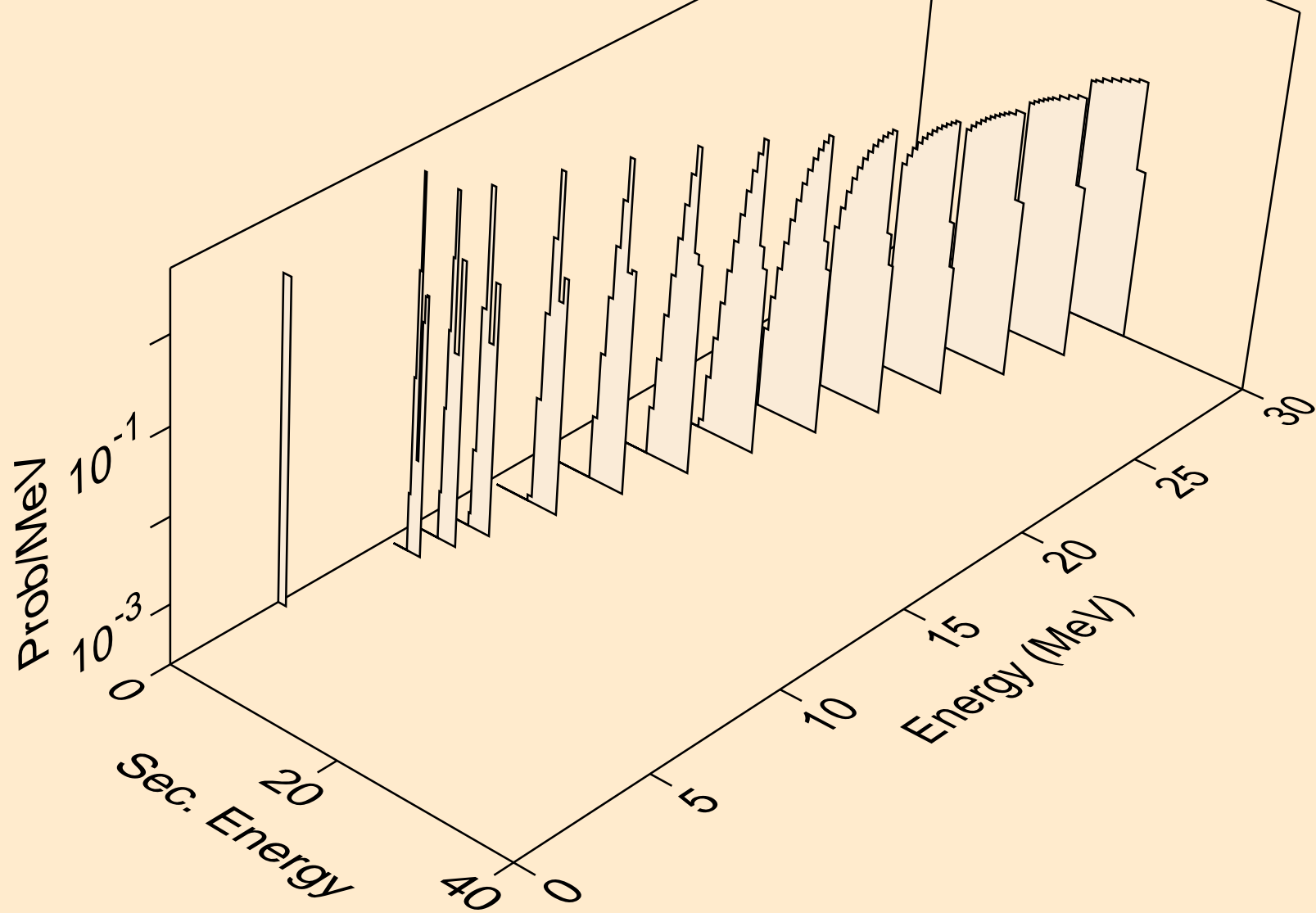

DB262 PROTON ACER TENDL-2021 LIBRARY; T=0.K
deuterons from (p,d2a)

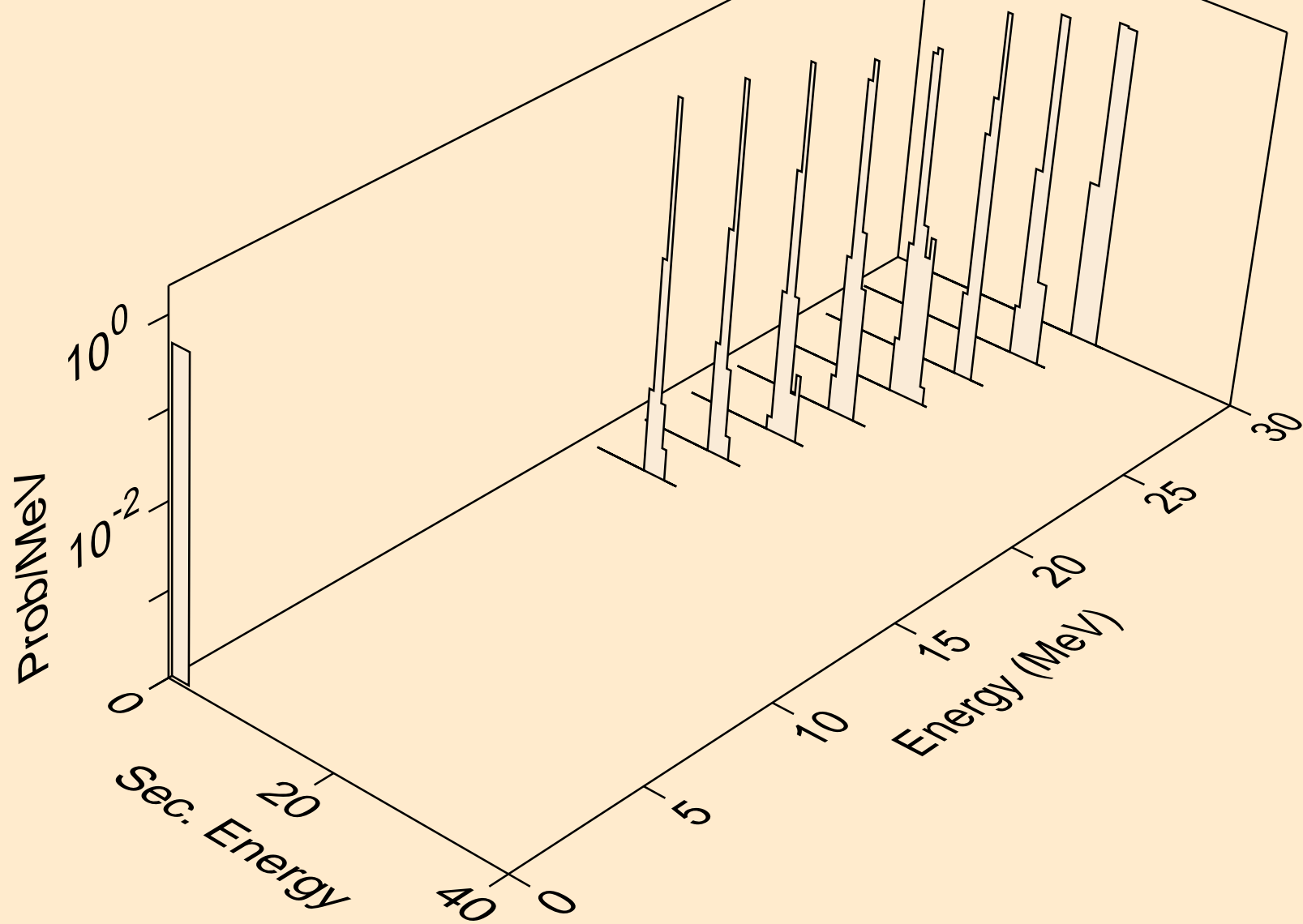

DB262 PROTON ACER TENDL-2021 LIBRARY; T=0.K
deuterons from (p,pd)

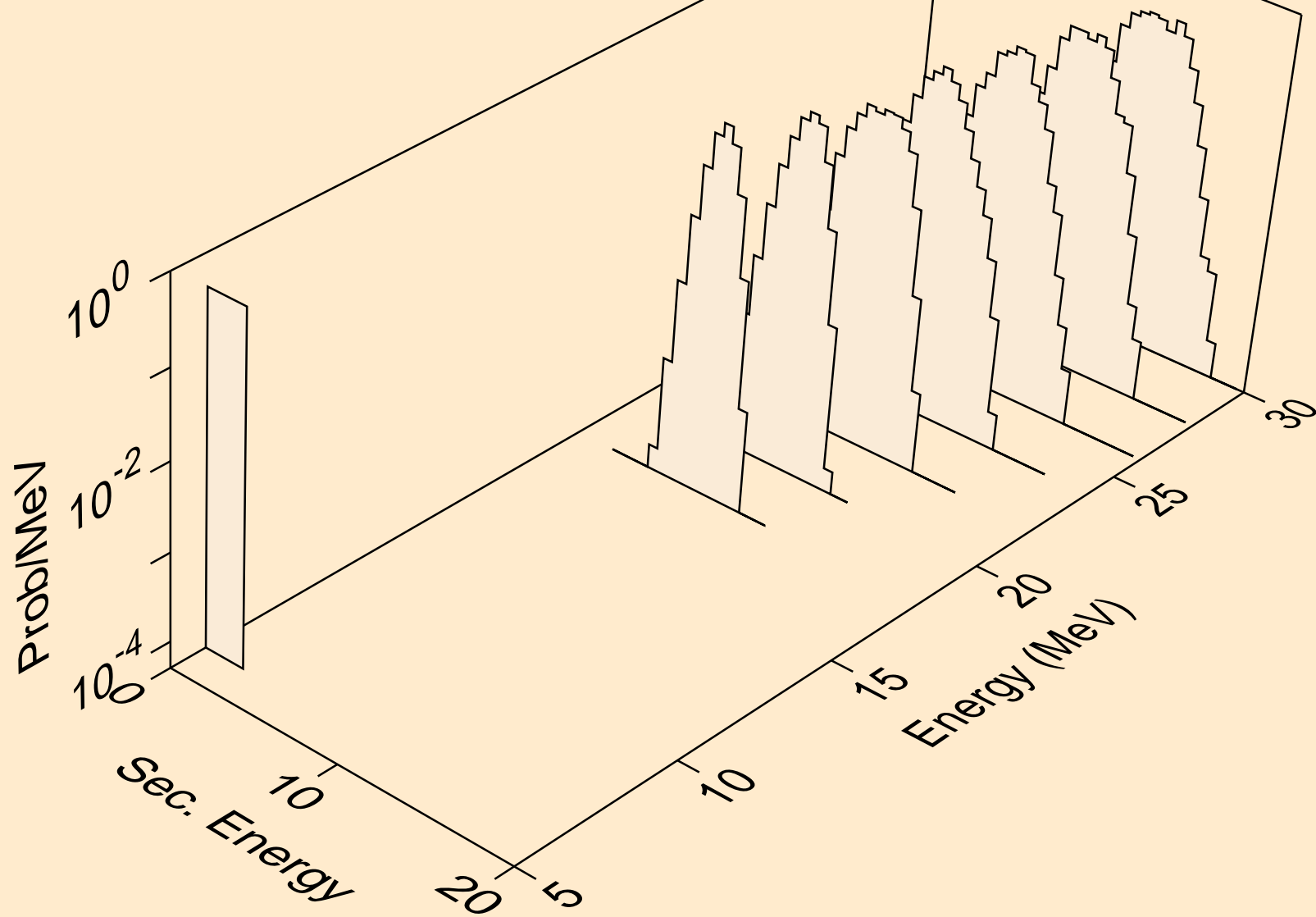

DB262 PROTON ACER TENDL-2021 LIBRARY; T=0.K
deuterons from (p,da)

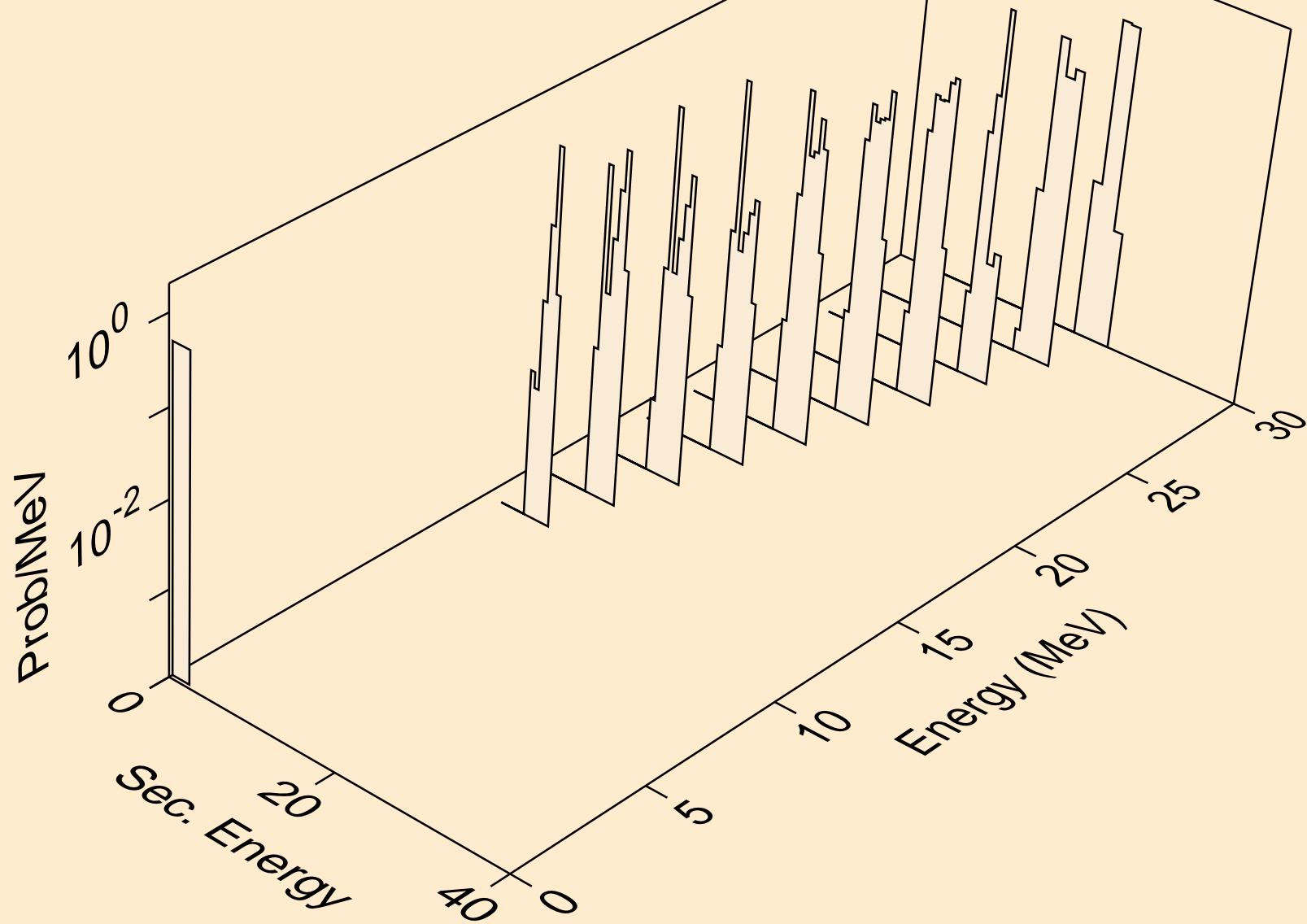

DB262 PROTON ACER TENDL-2021 LIBRARY; T=0.K
tritons from (p,x)

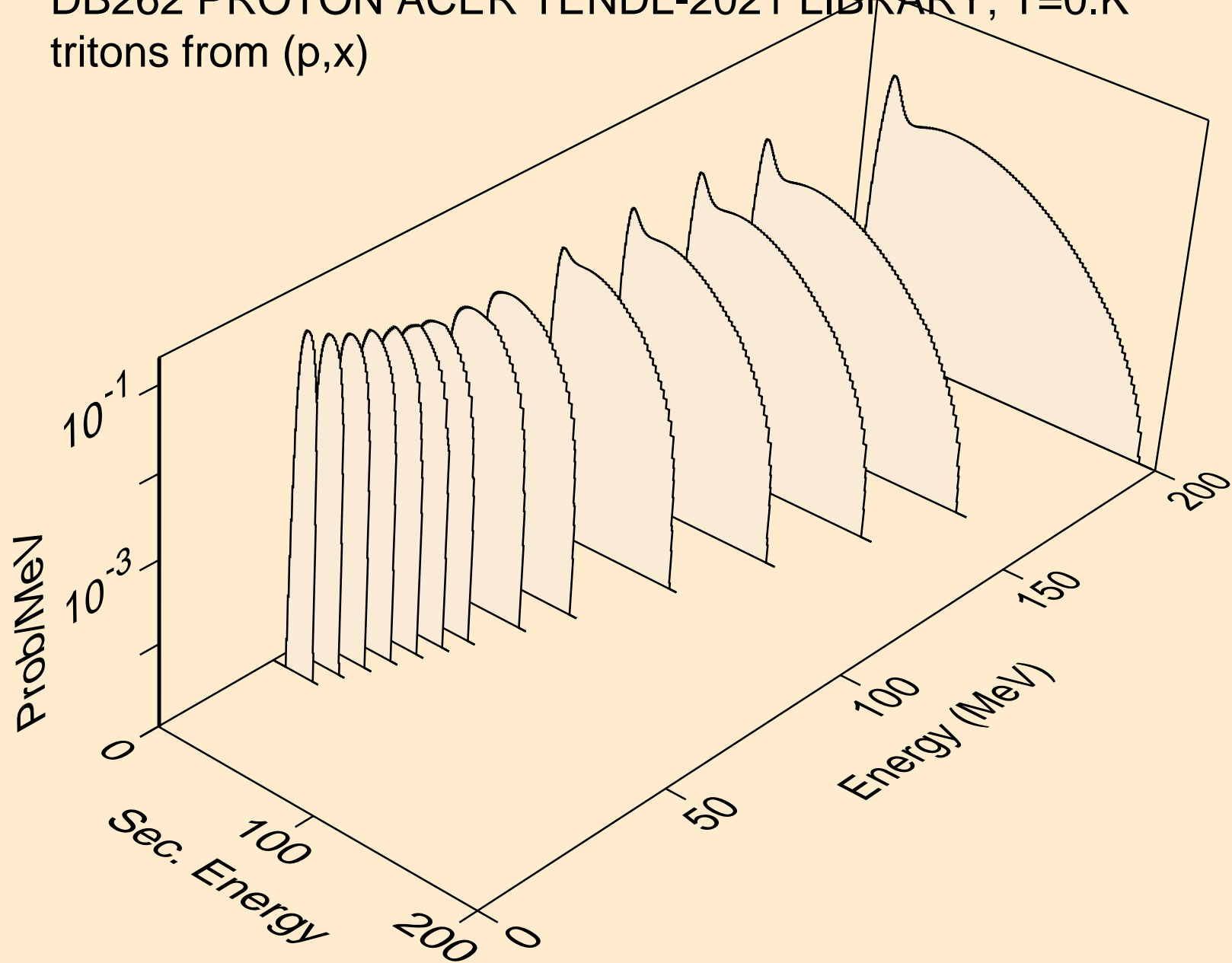

DB262 PROTON ACER TENDL-2021 LIBRARY; T=0.K
tritons from (p,n*)t

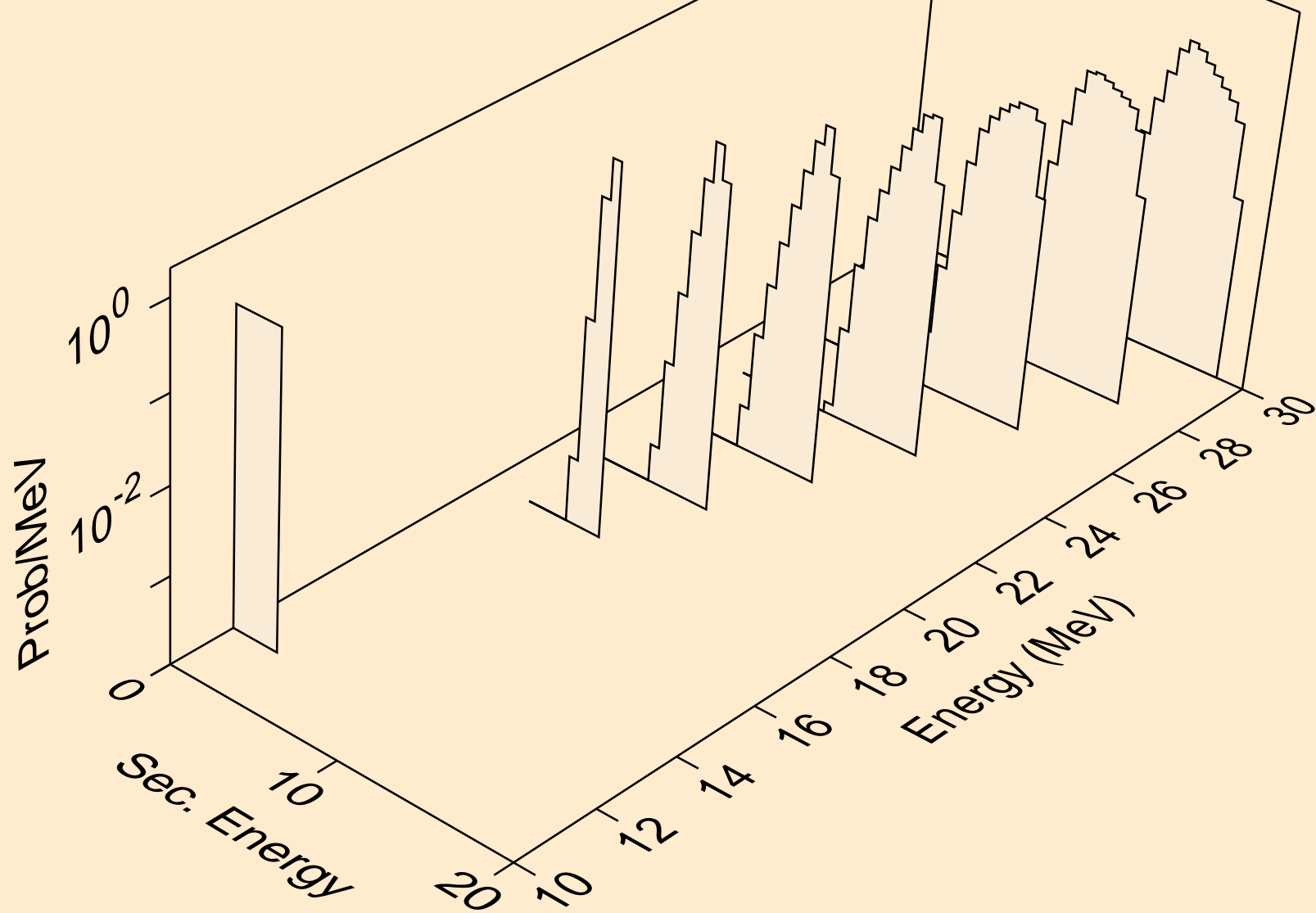

DB262 PROTON ACER TENDL-2021 LIBRARY; T=0.K
tritons from (p,t)

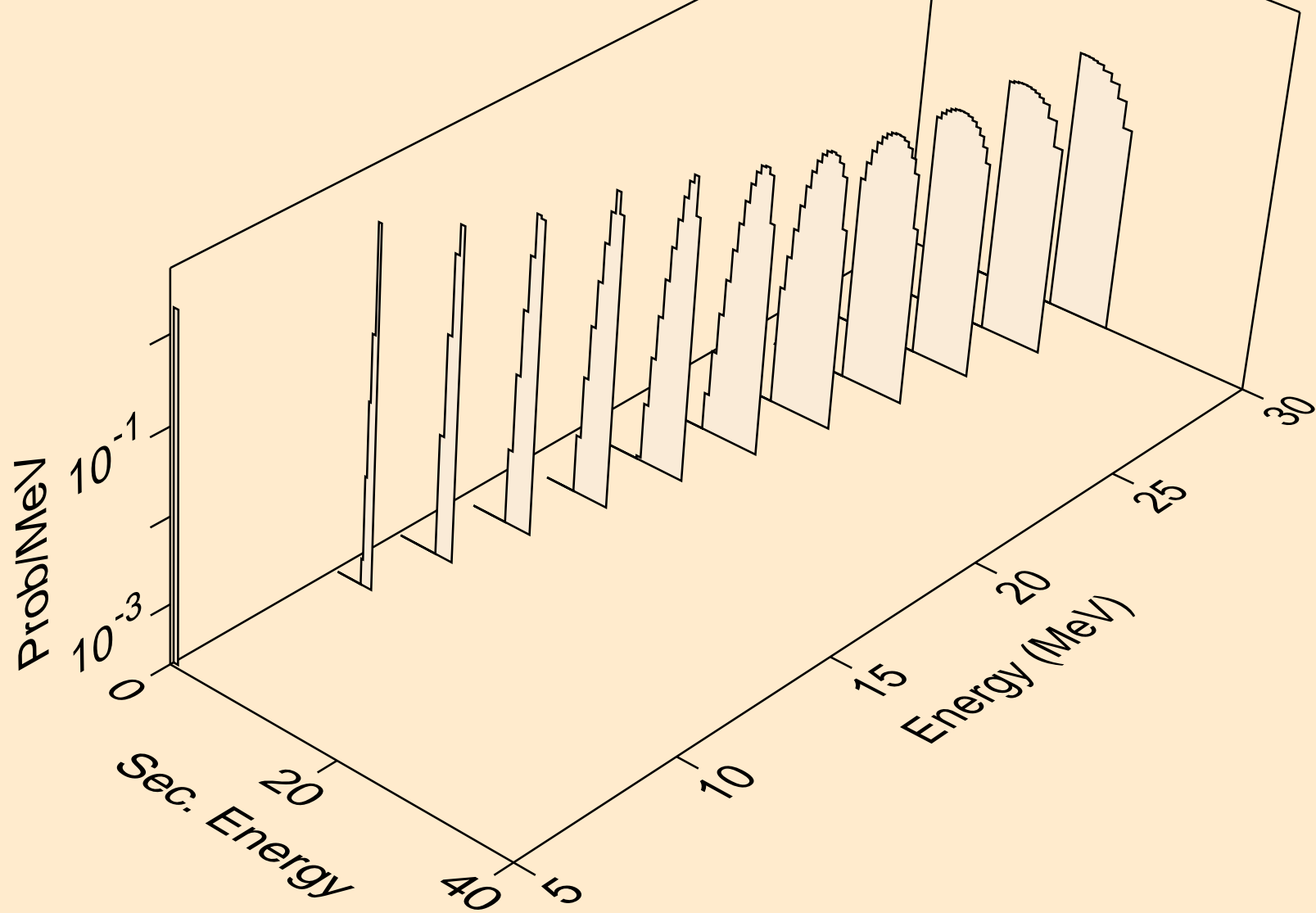

DB262 PROTON ACER TENDL-2021 LIBRARY; T=0.K
tritons from (p,t2a)

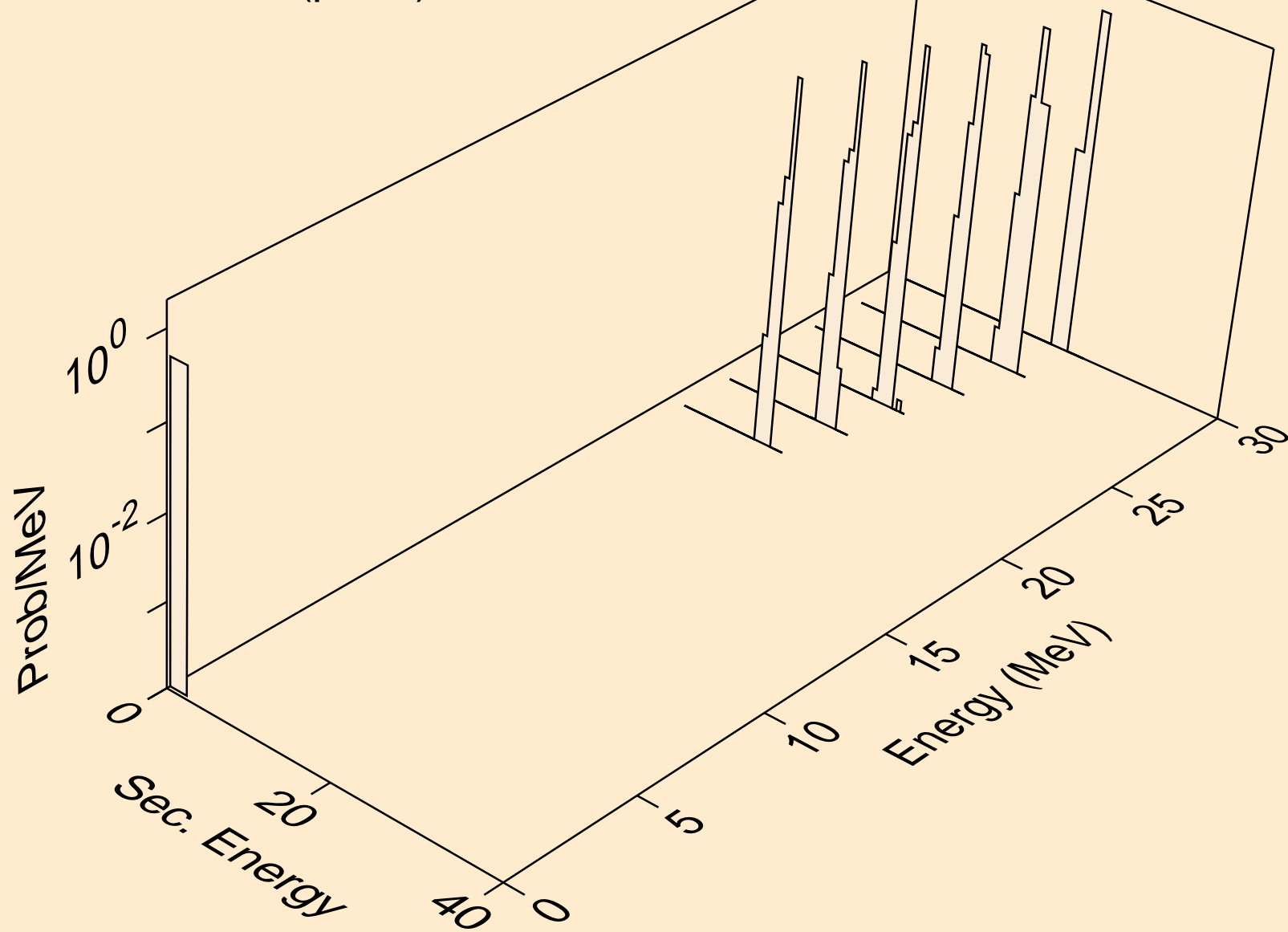

DB262 PROTON ACER TENDL-2021 LIBRARY; T=0.K
he3s from (p,x)

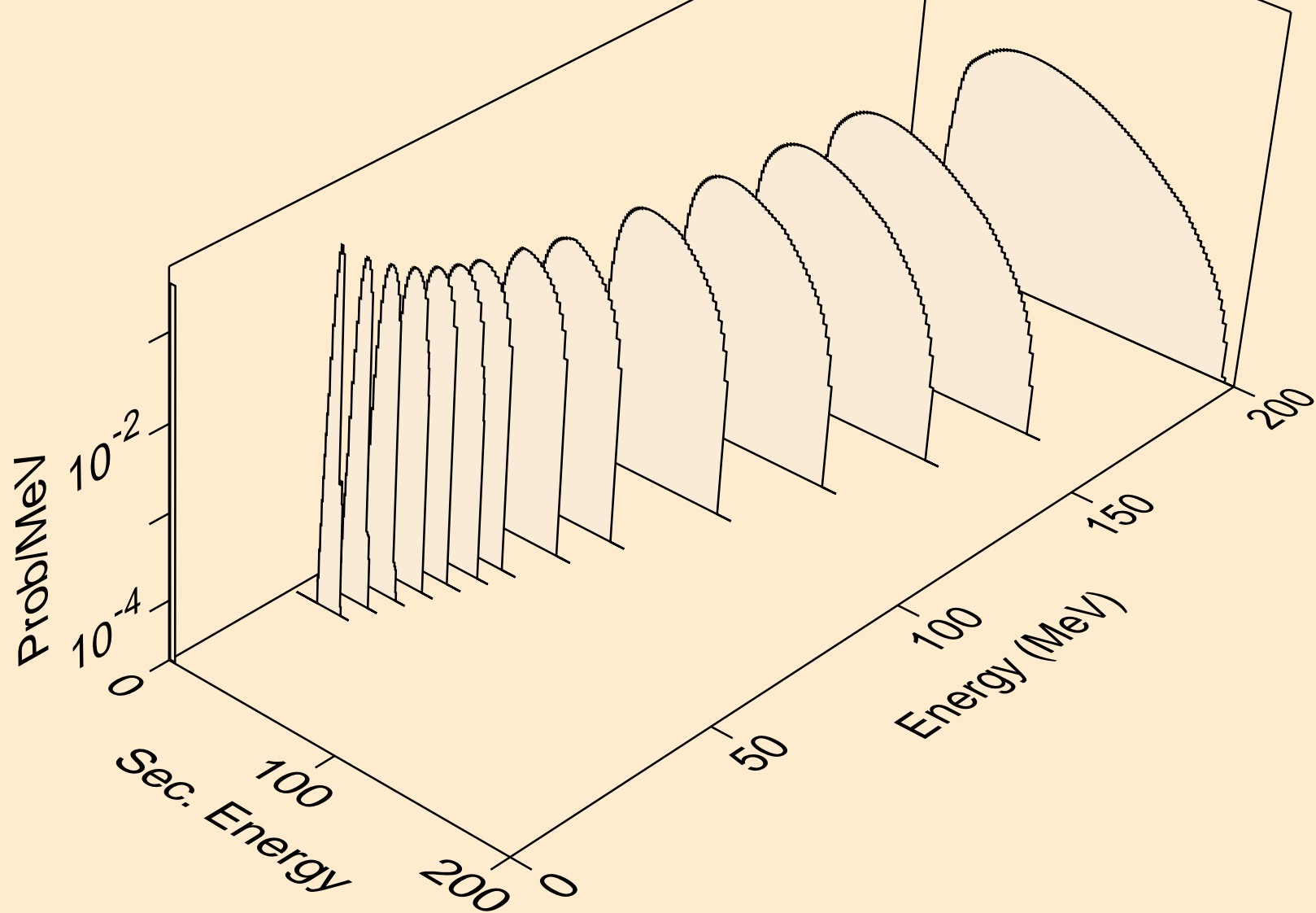

DB262 PROTON ACER TENDL-2021 LIBRARY; T=0.K
he3s from (p,he3)

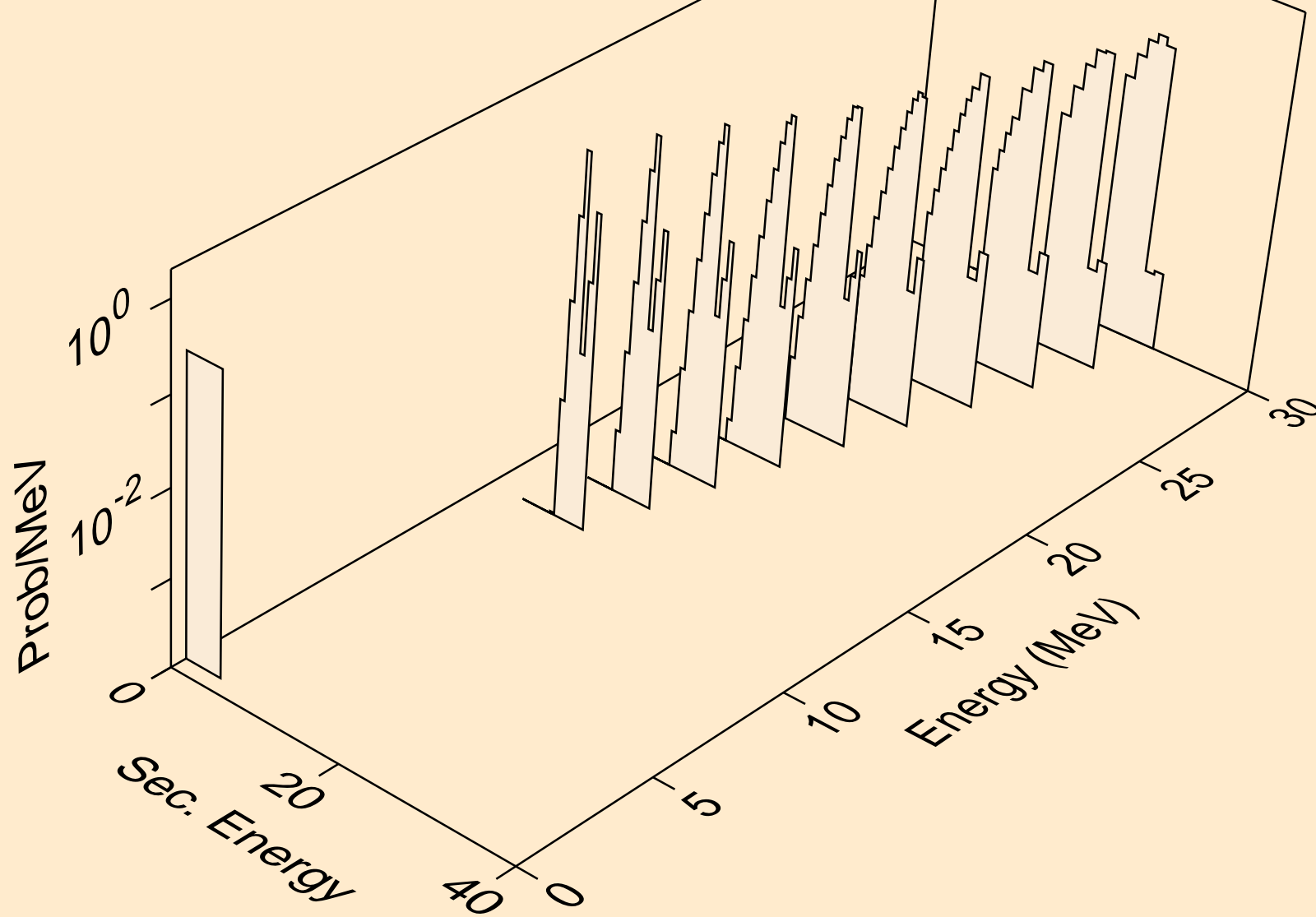

DB262 PROTON ACER TENDL-2021 LIBRARY; T=0.K
alphas from (p,x)

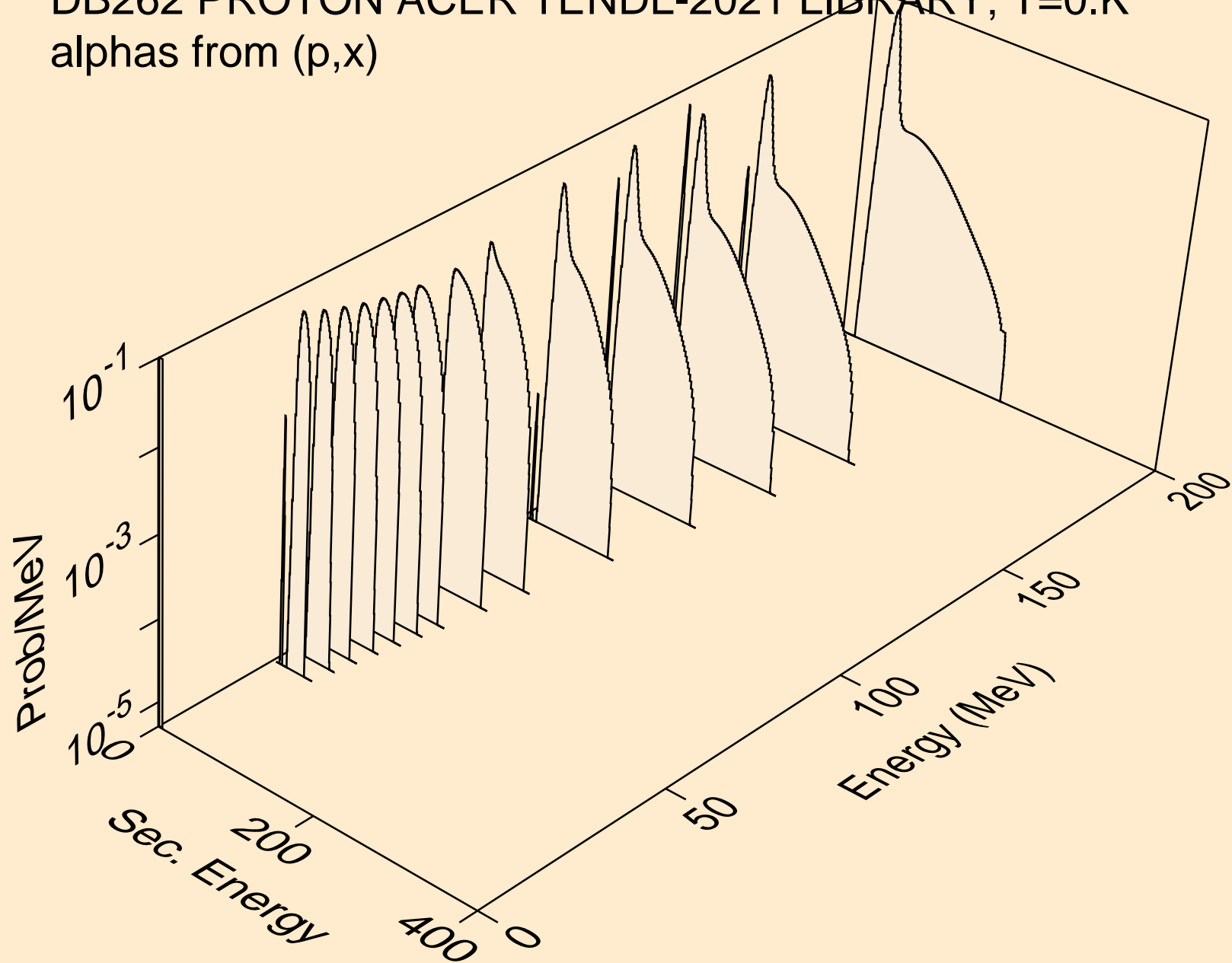

DB262 PROTON ACER TENDL-2021 LIBRARY; T=0.K
alphas from (p,n*)a

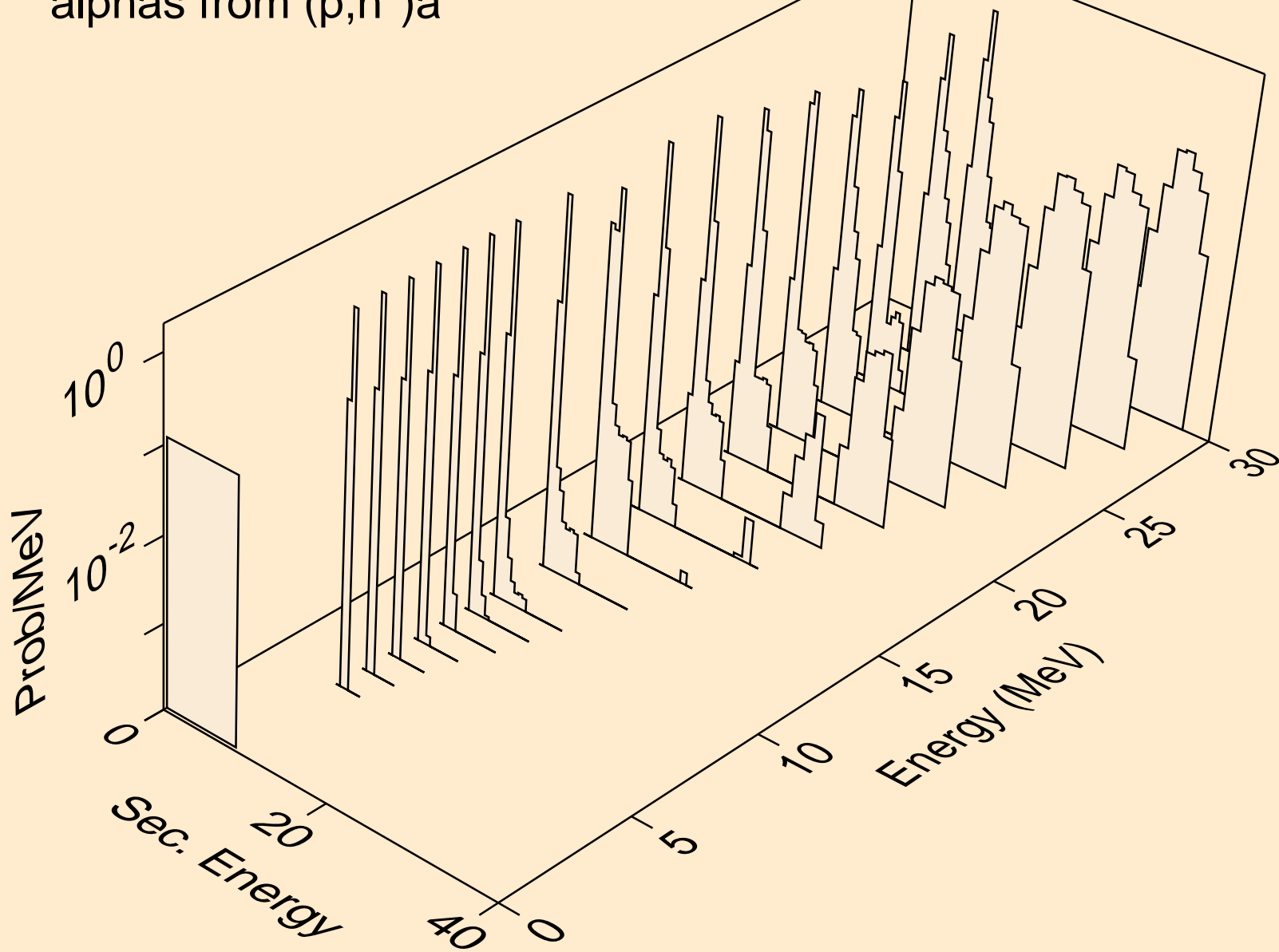

DB262 PROTON ACER TENDL-2021 LIBRARY; T=0.K
alphas from (p,2n)a

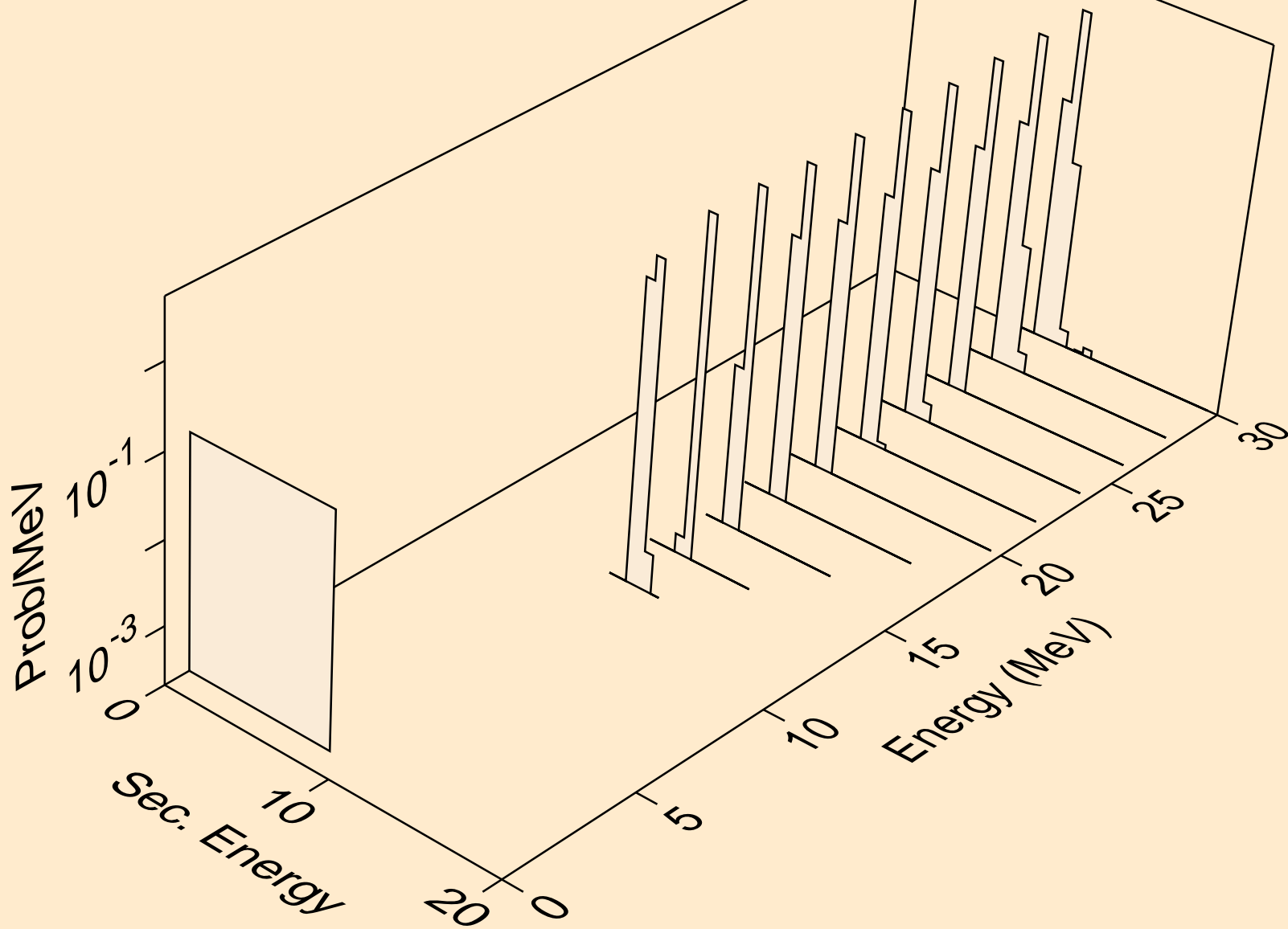

DB262 PROTON ACER TENDL-2021 LIBRARY; T=0.K
alphas from (p,3n)a

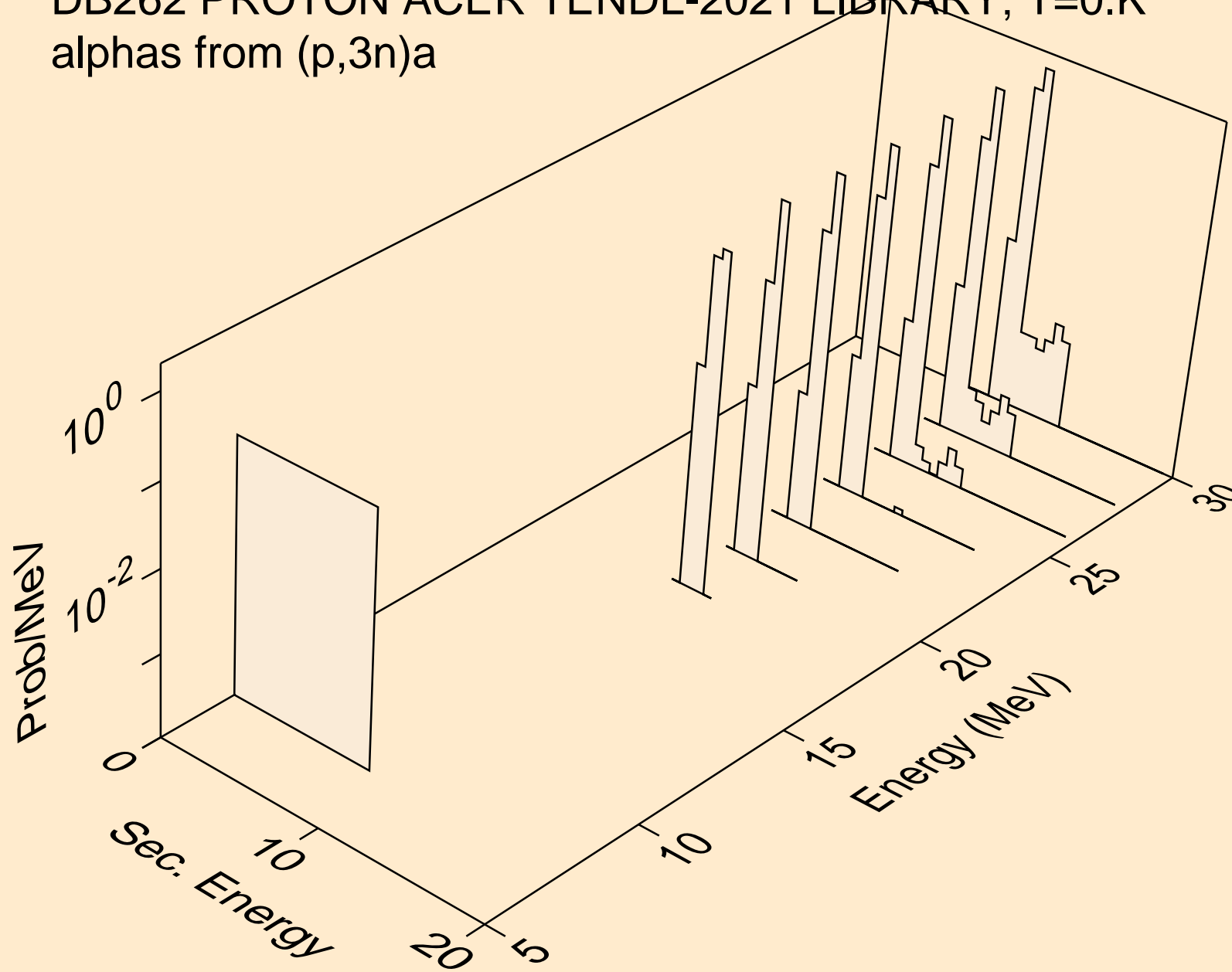

DB262 PROTON ACER TENDL-2021 LIBRARY; T=0.K
alphas from (p,npa)

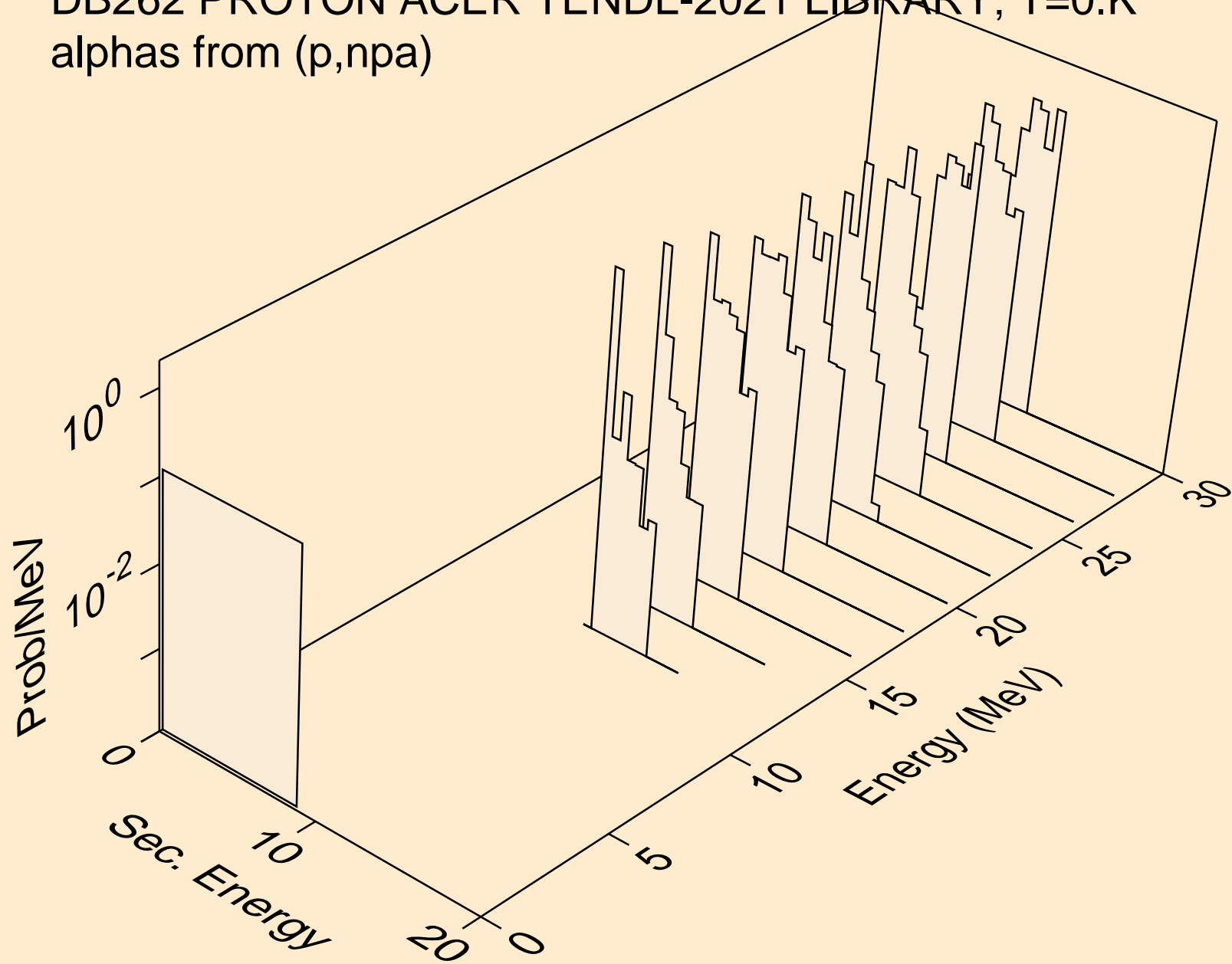

DB262 PROTON ACER TENDL-2021 LIBRARY; T=0.K
alphas from (p,a)

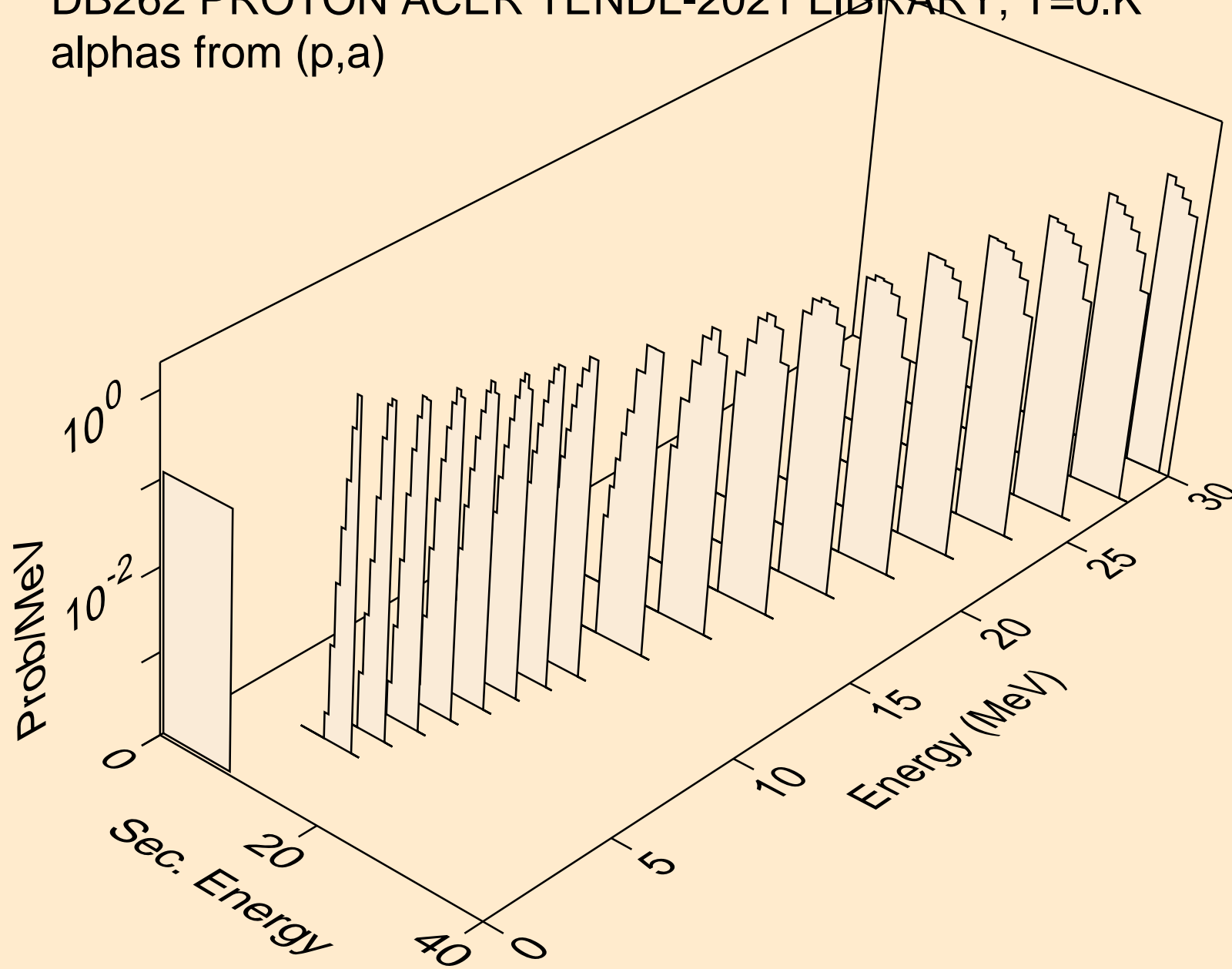

DB262 PROTON ACER TENDL-2021 LIBRARY; T=0.K
alphas from (p,2a)

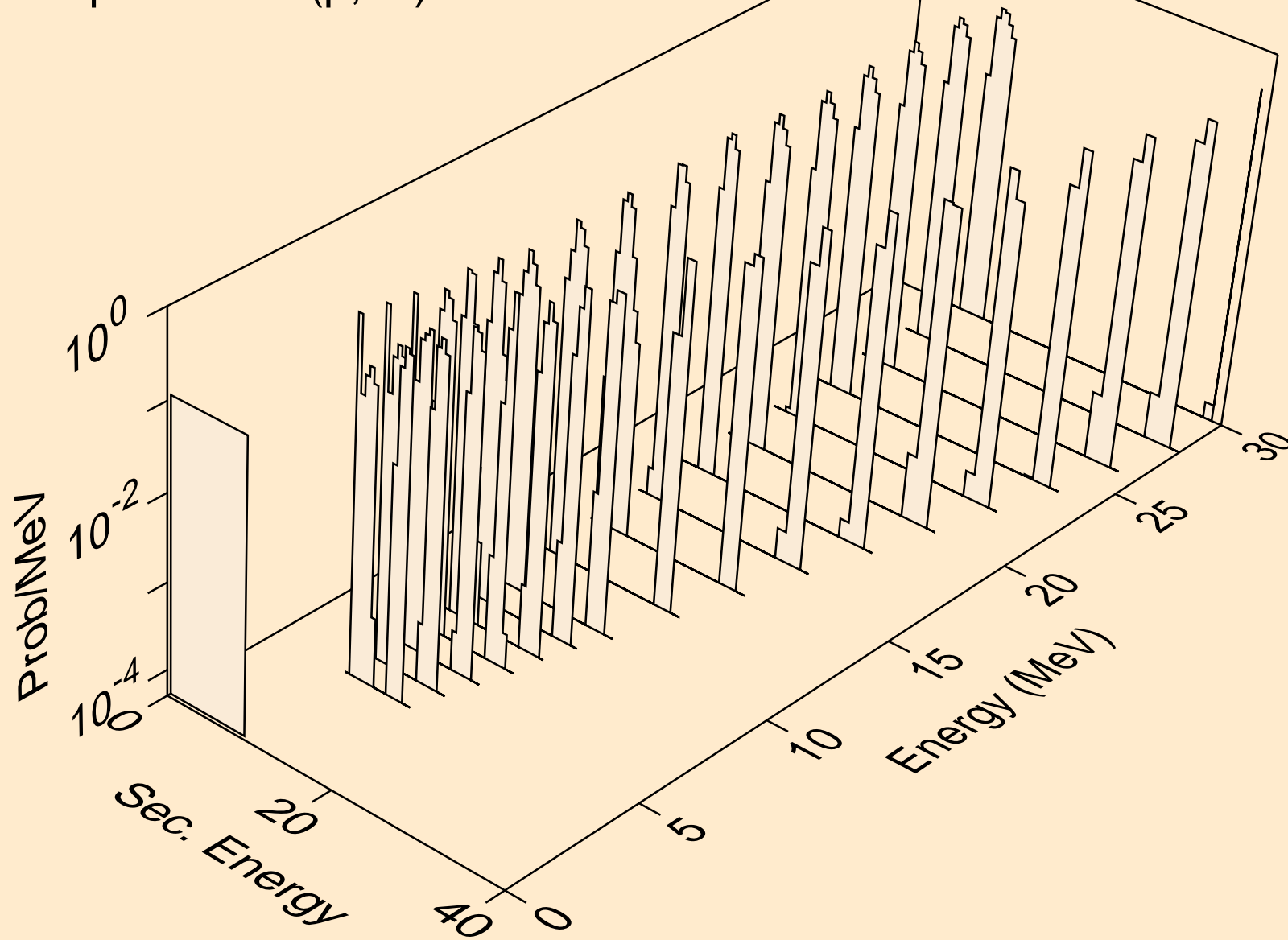

DB262 PROTON ACER TENDL-2021 LIBRARY; T=0.K
alphas from (p,pa)

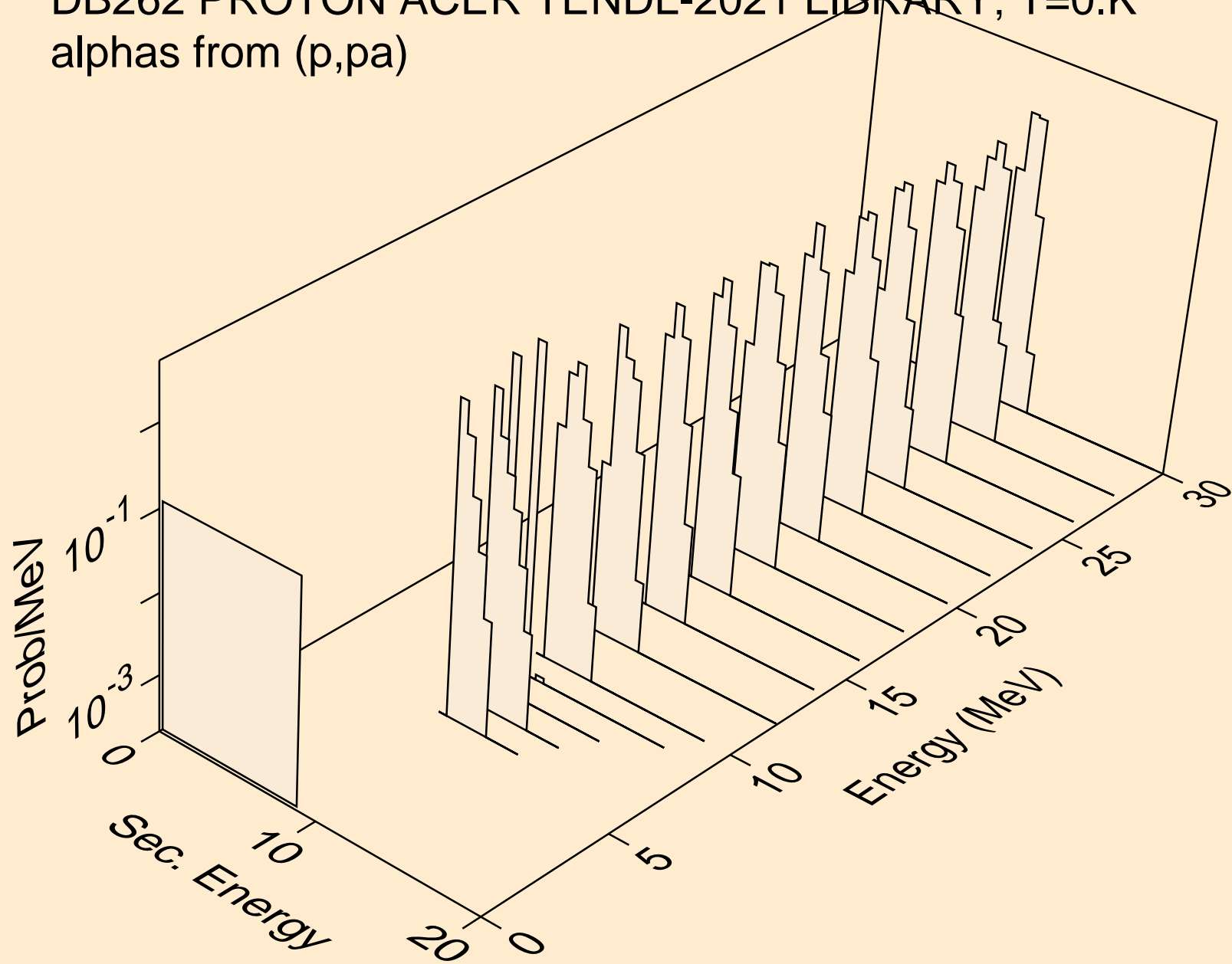

DB262 PROTON ACER TENDL-2021 LIBRARY; T=0.K
alphas from (p,t2a)

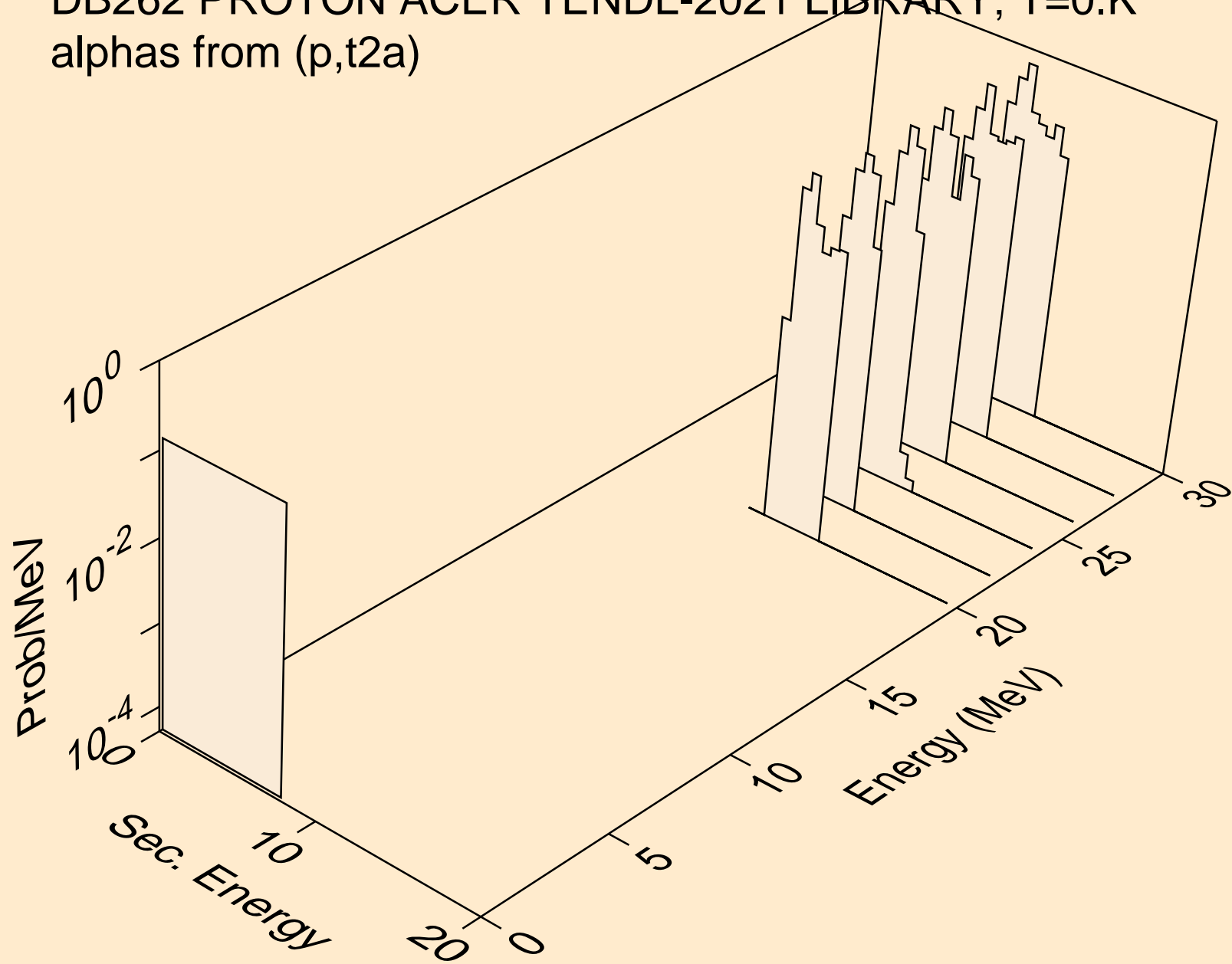

DB262 PROTON ACER TENDL-2021 LIBRARY; T=0.K
alphas from (p,d2a)

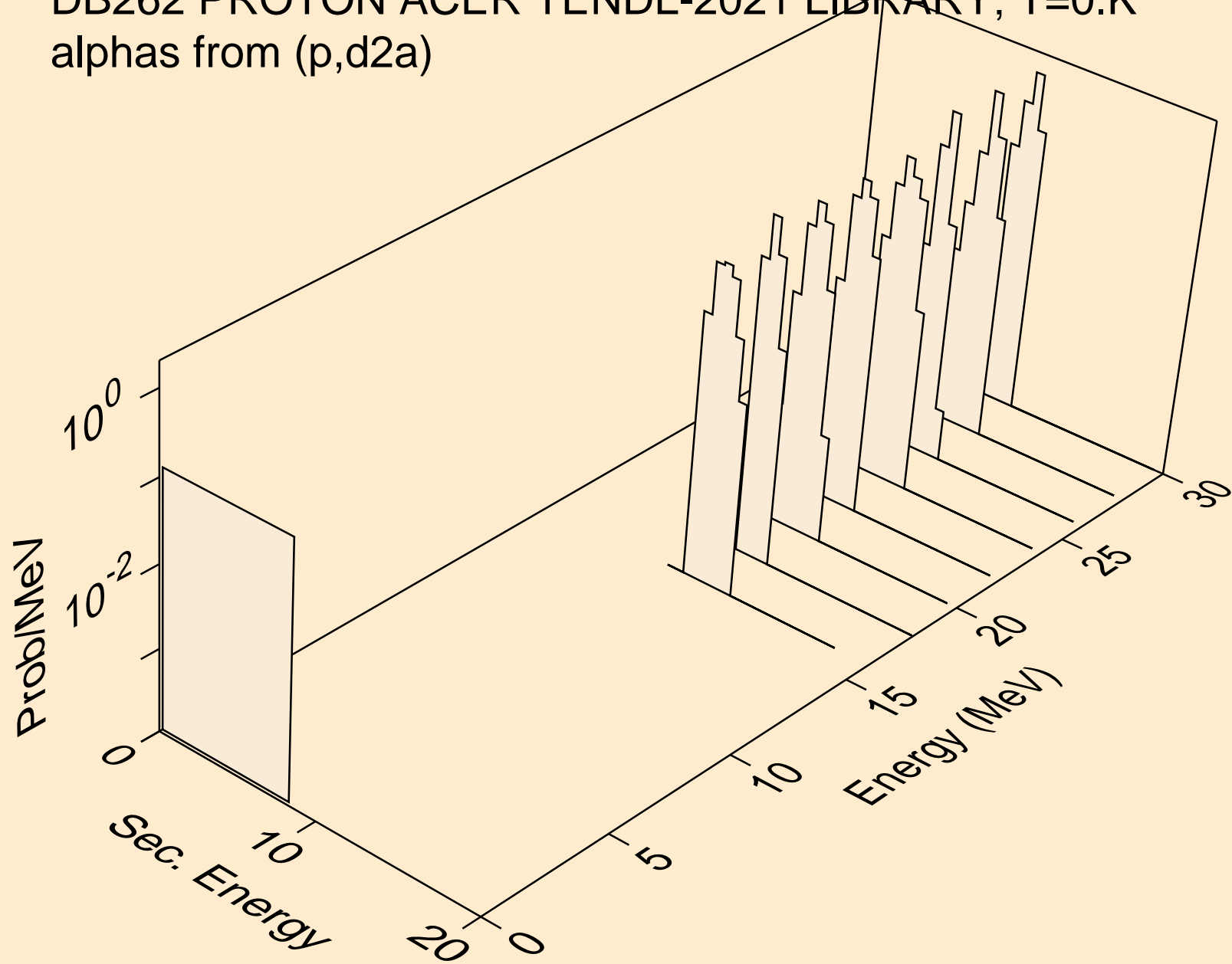

DB262 PROTON ACER TENDL-2021 LIBRARY; T=0.K
alphas from (p,da)

