

DB265 PROTON ACER TENDL-2021 LIBRARY; T=0.K  
Principal cross sections

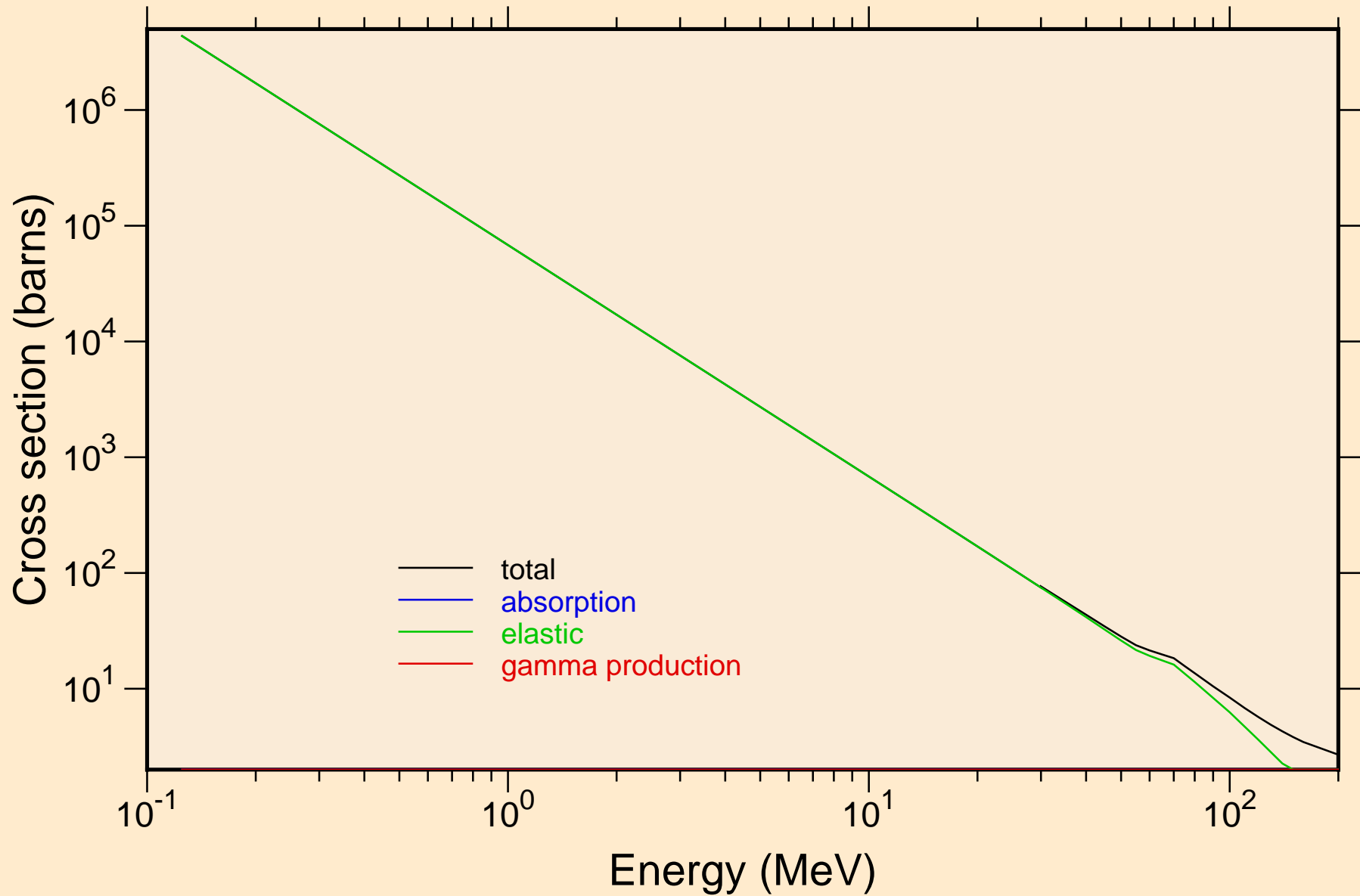

# DB265 PROTON ACER TENDL-2021 LIBRARY; T=0.K

## Heating

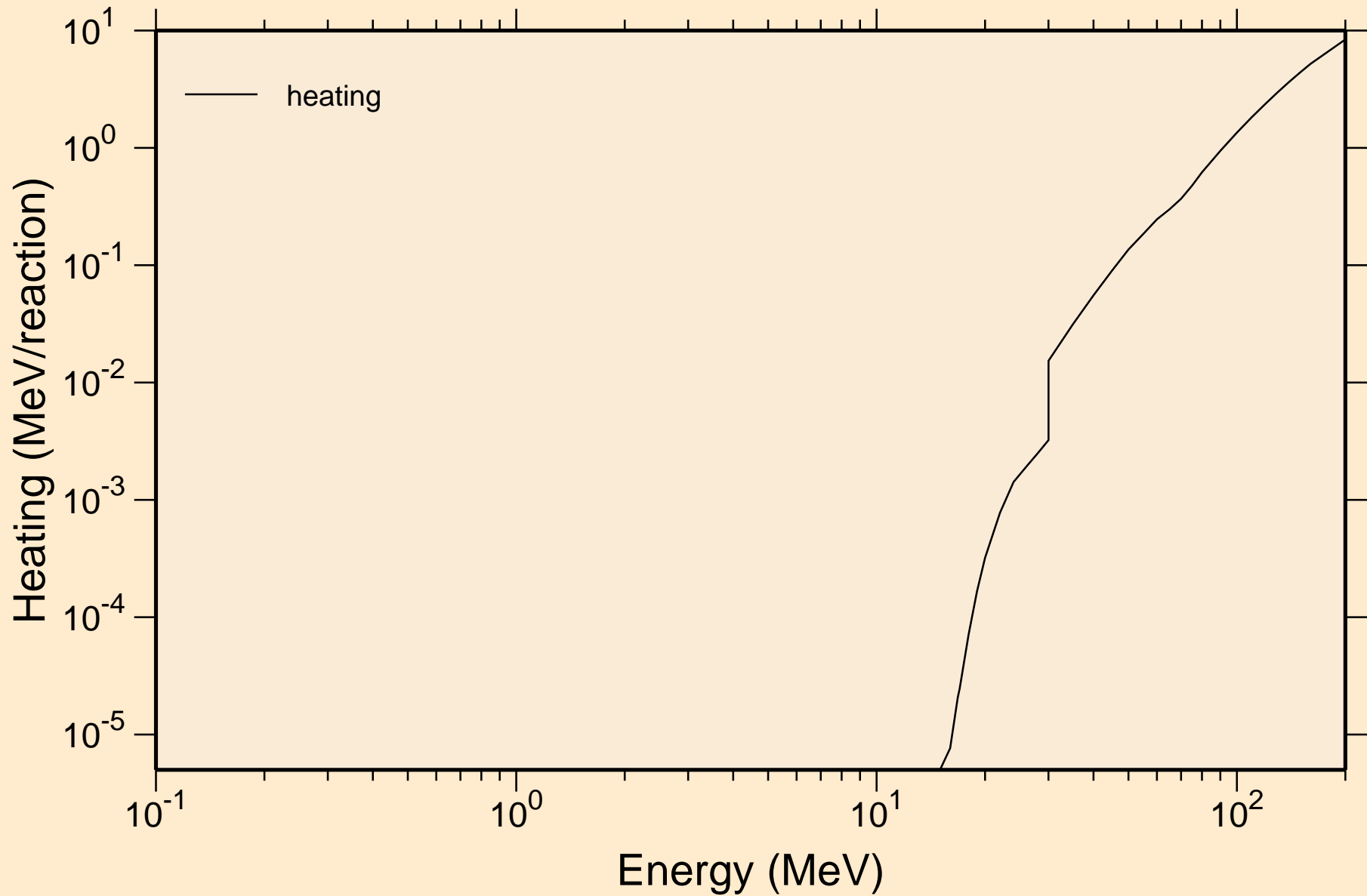

# DB265 PROTON ACER TENDL-2021 LIBRARY; T=0.K

## Principal cross sections

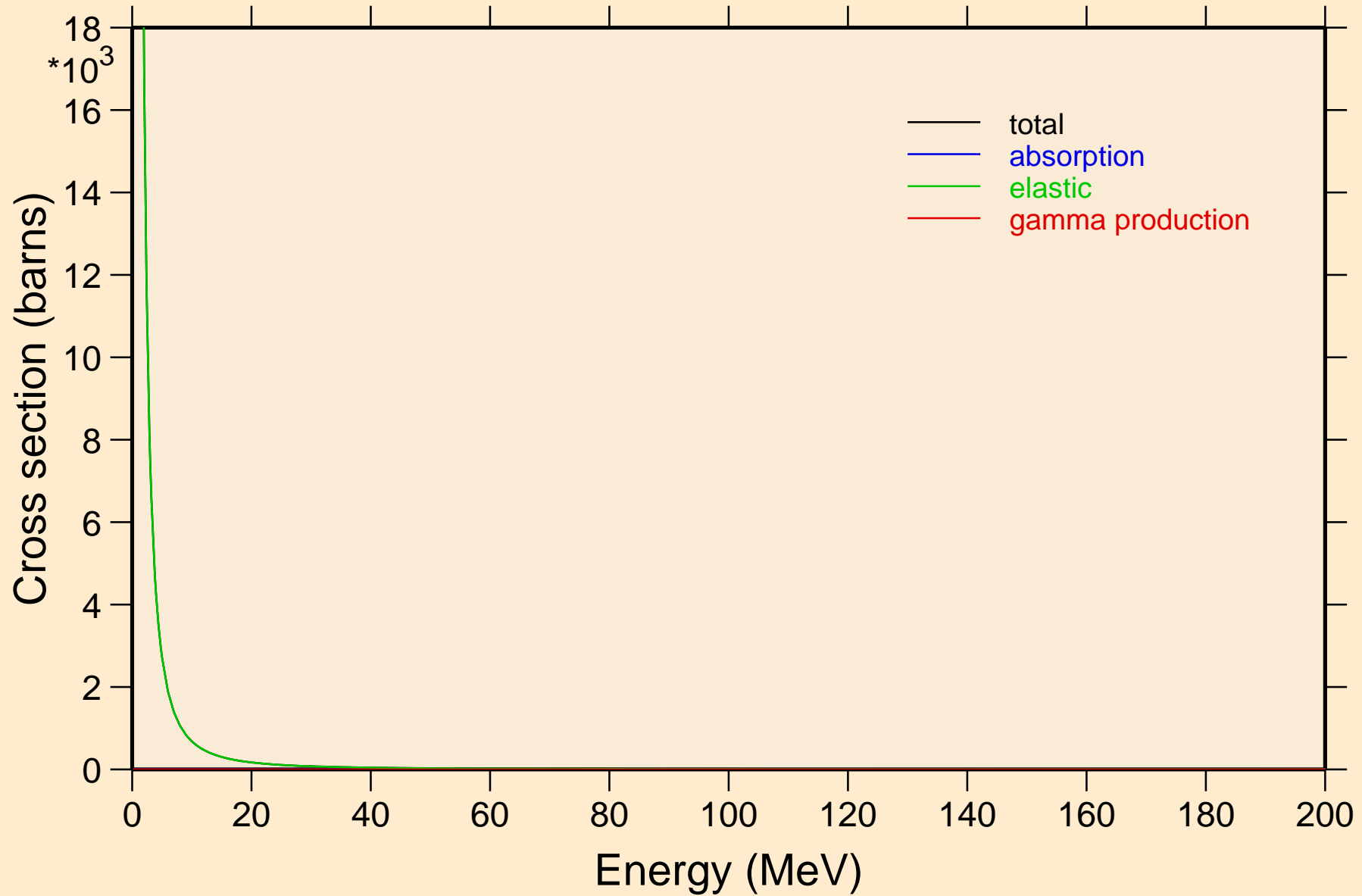

DB265 PROTON ACER TENDL-2021 LIBRARY; T=0.K

Heating

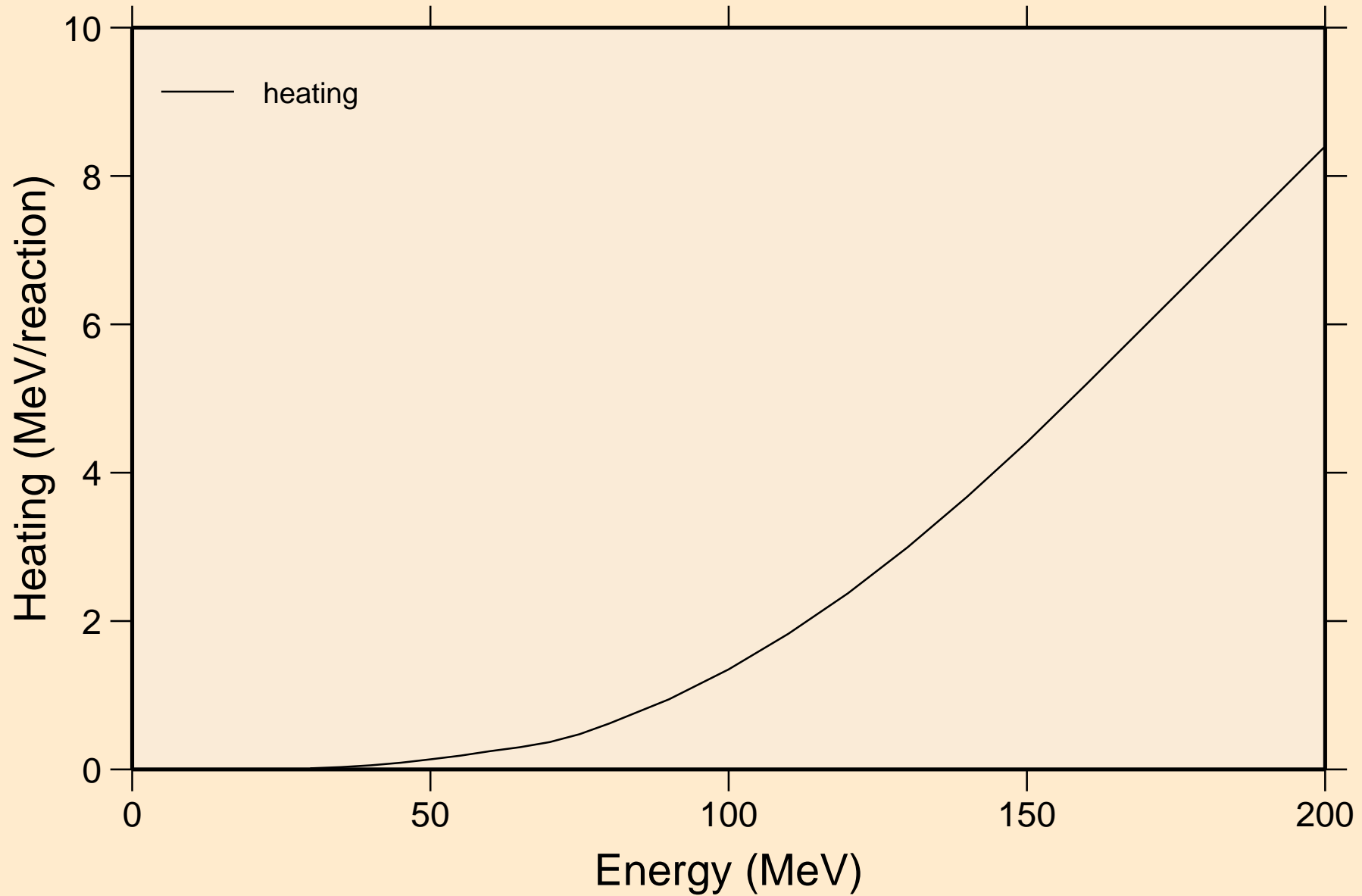

DB265 PROTON ACER TENDL-2021 LIBRARY; T=0.K  
Threshold reactions

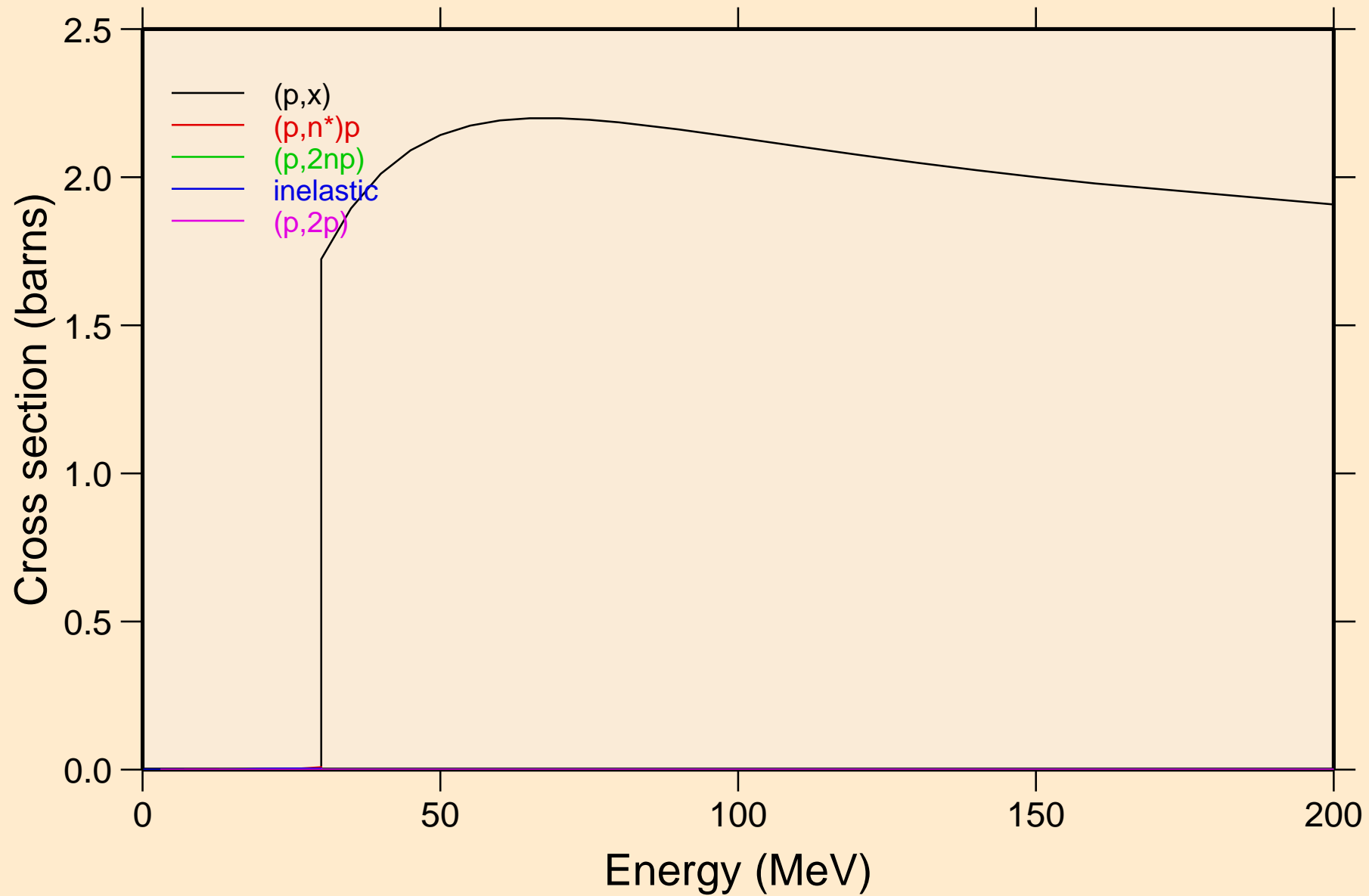

DB265 PROTON ACER TENDL-2021 LIBRARY; T=0.K  
angular distribution for elastic

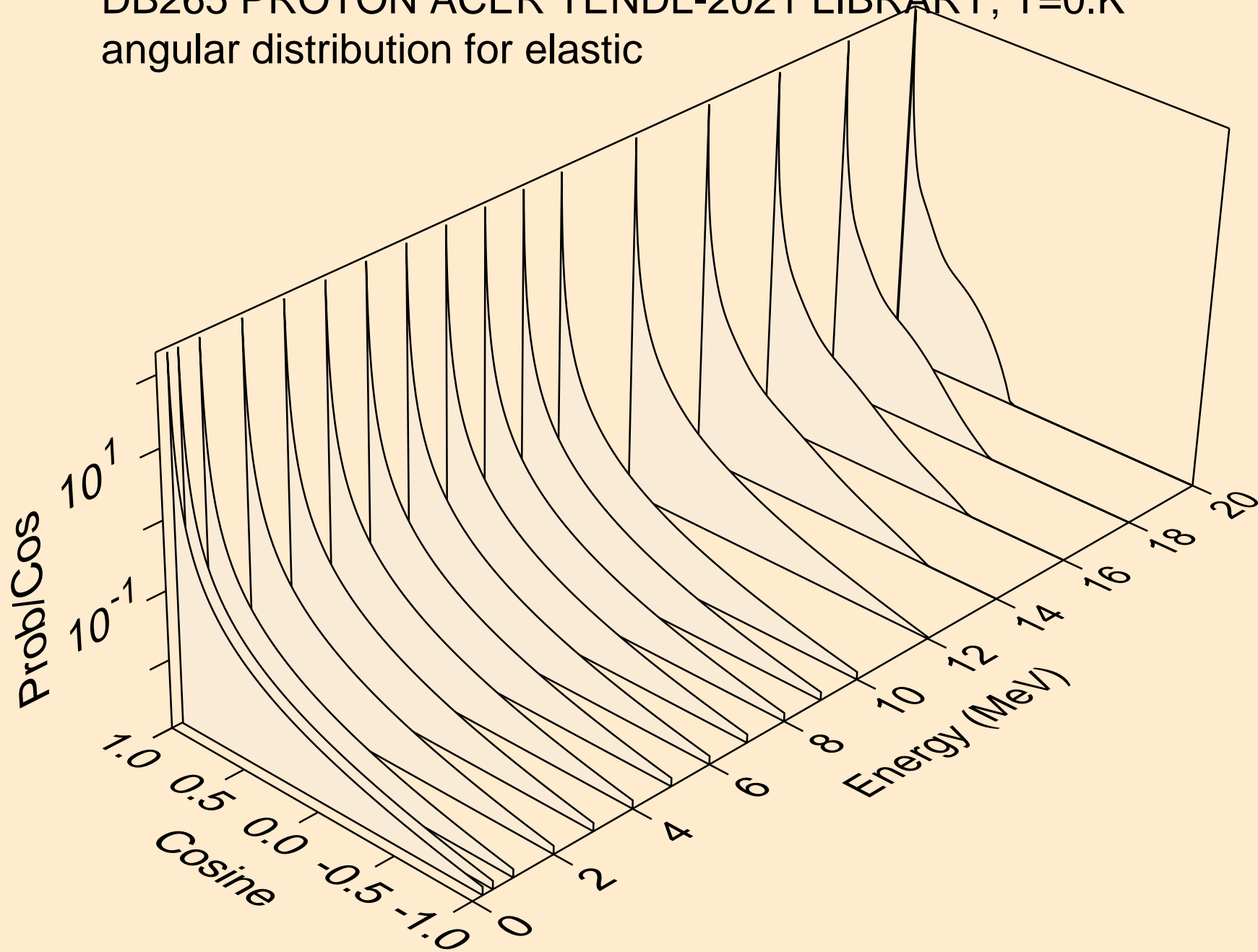

DB265 PROTON ACER TENDL-2021 LIBRARY; T=0.K  
angular distribution for elastic

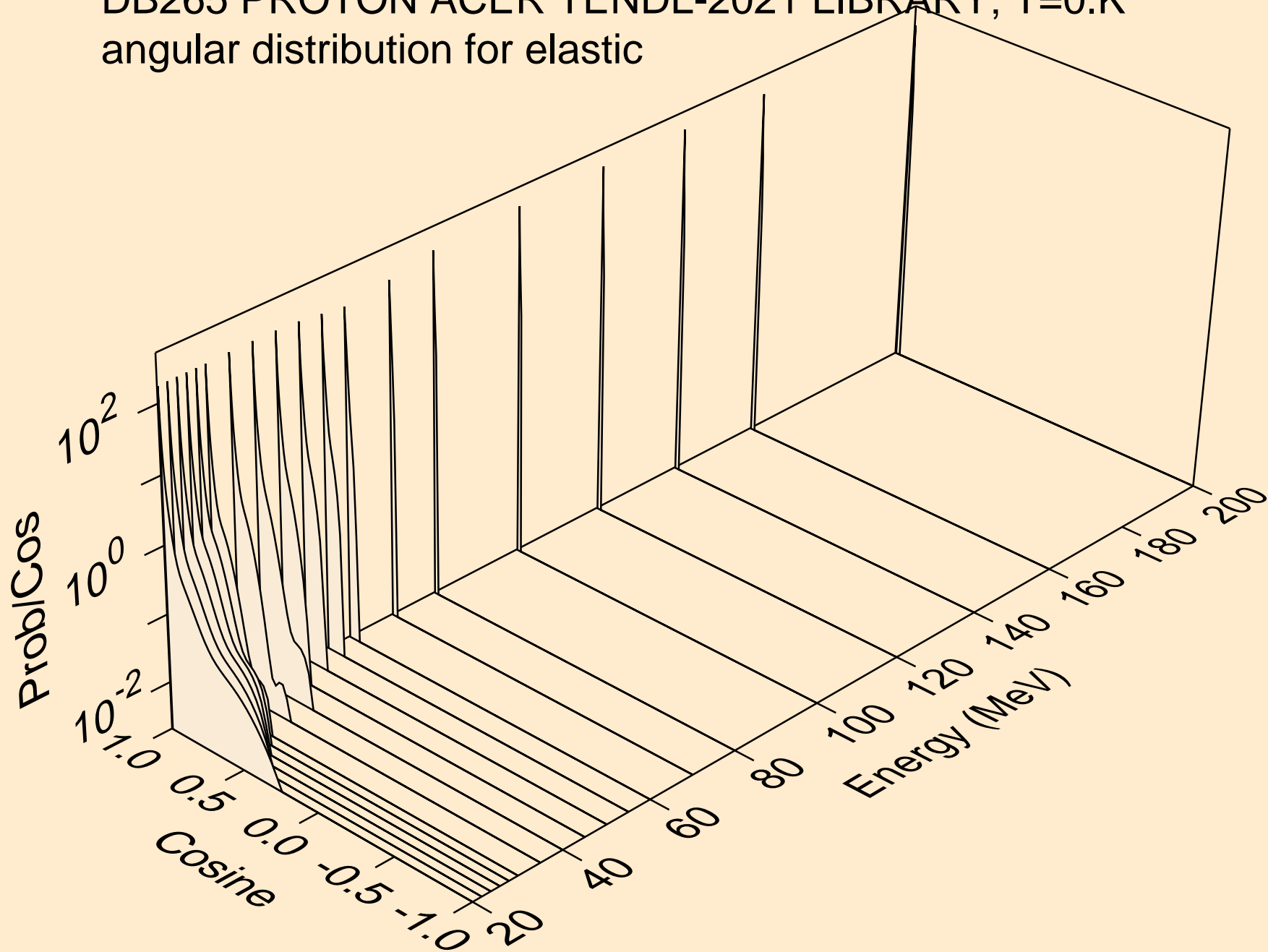

DB265 PROTON ACER TENDL-2021 LIBRARY; T=0.K  
Proton emission for (p,x)

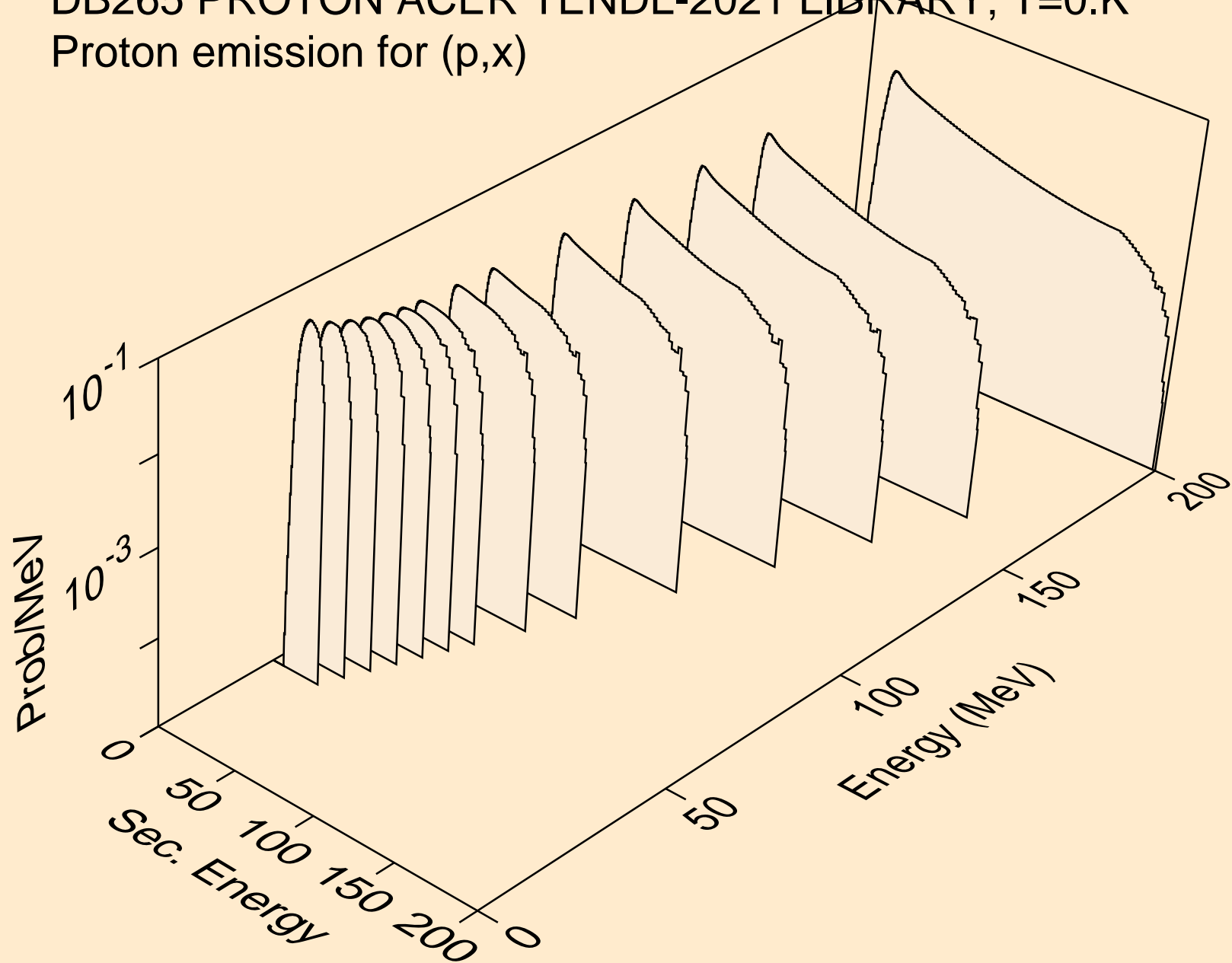



DB265 PROTON ACER TENDL-2021 LIBRARY; T=0.K  
Proton emission for (p,n\*)p

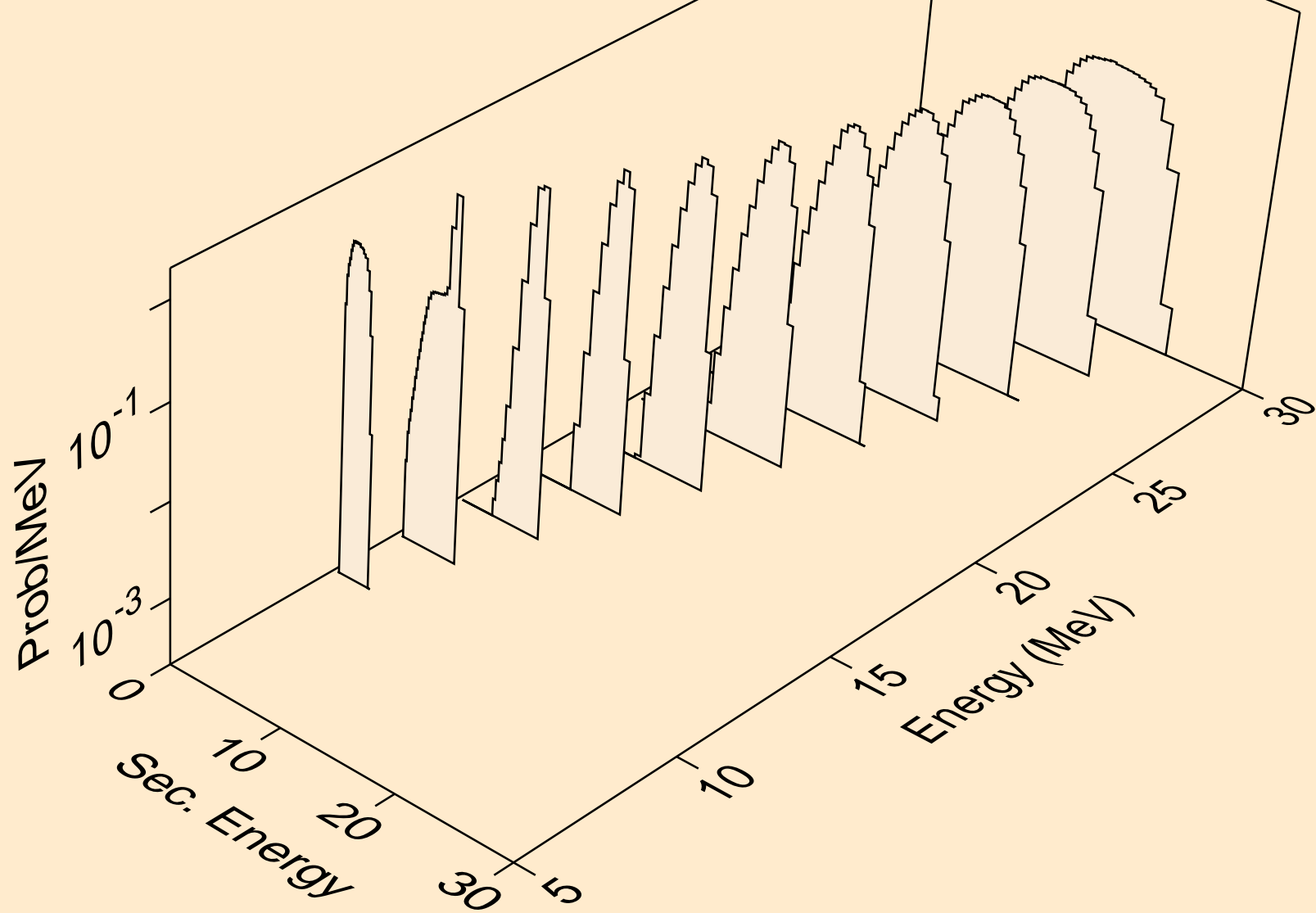

DB265 PROTON ACER TENDL-2021 LIBRARY; T=0.K  
Proton emission for (p,2np)

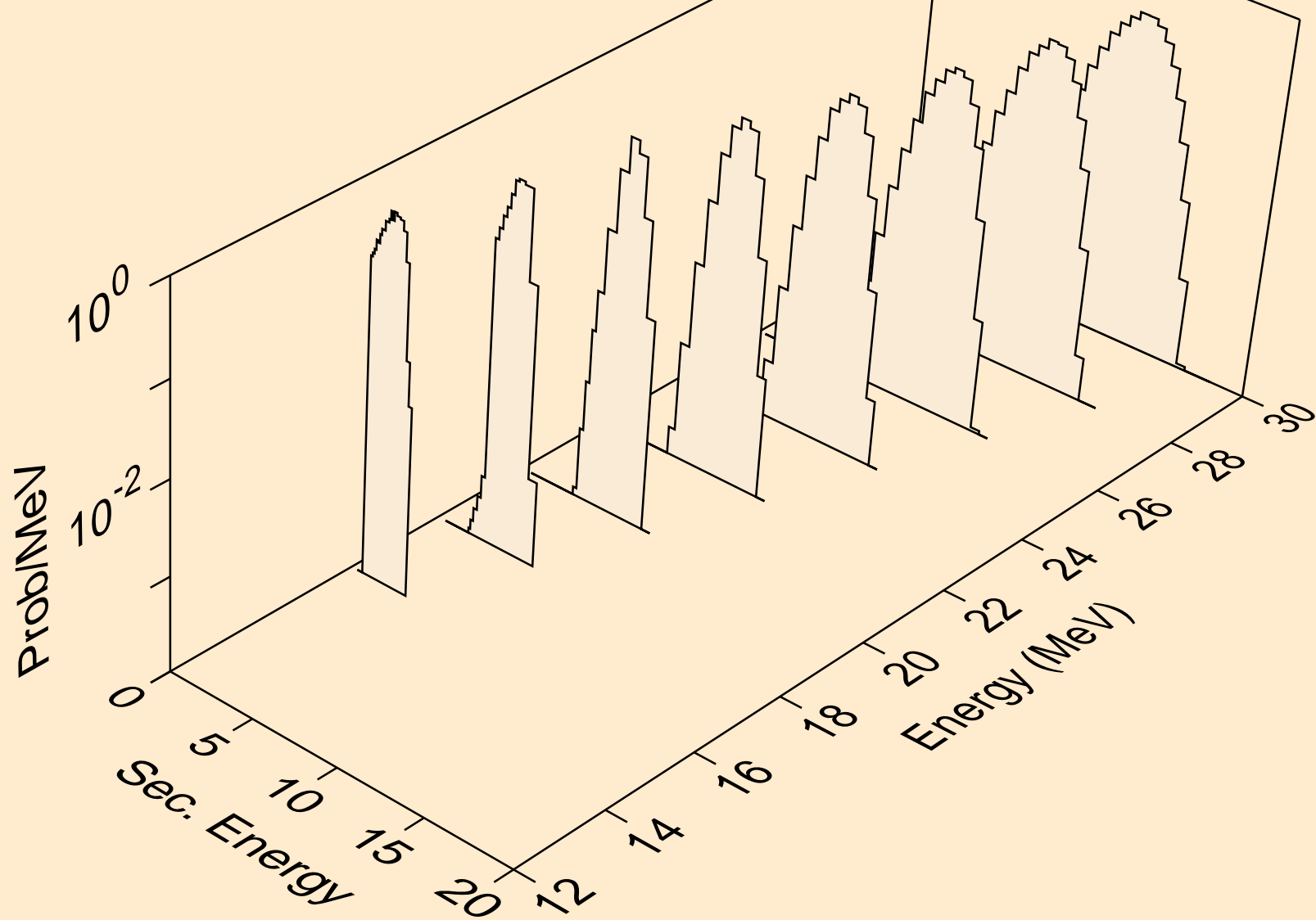

DB265 PROTON ACER TENDL-2021 LIBRARY; T=0.K  
Proton emission for inelastic

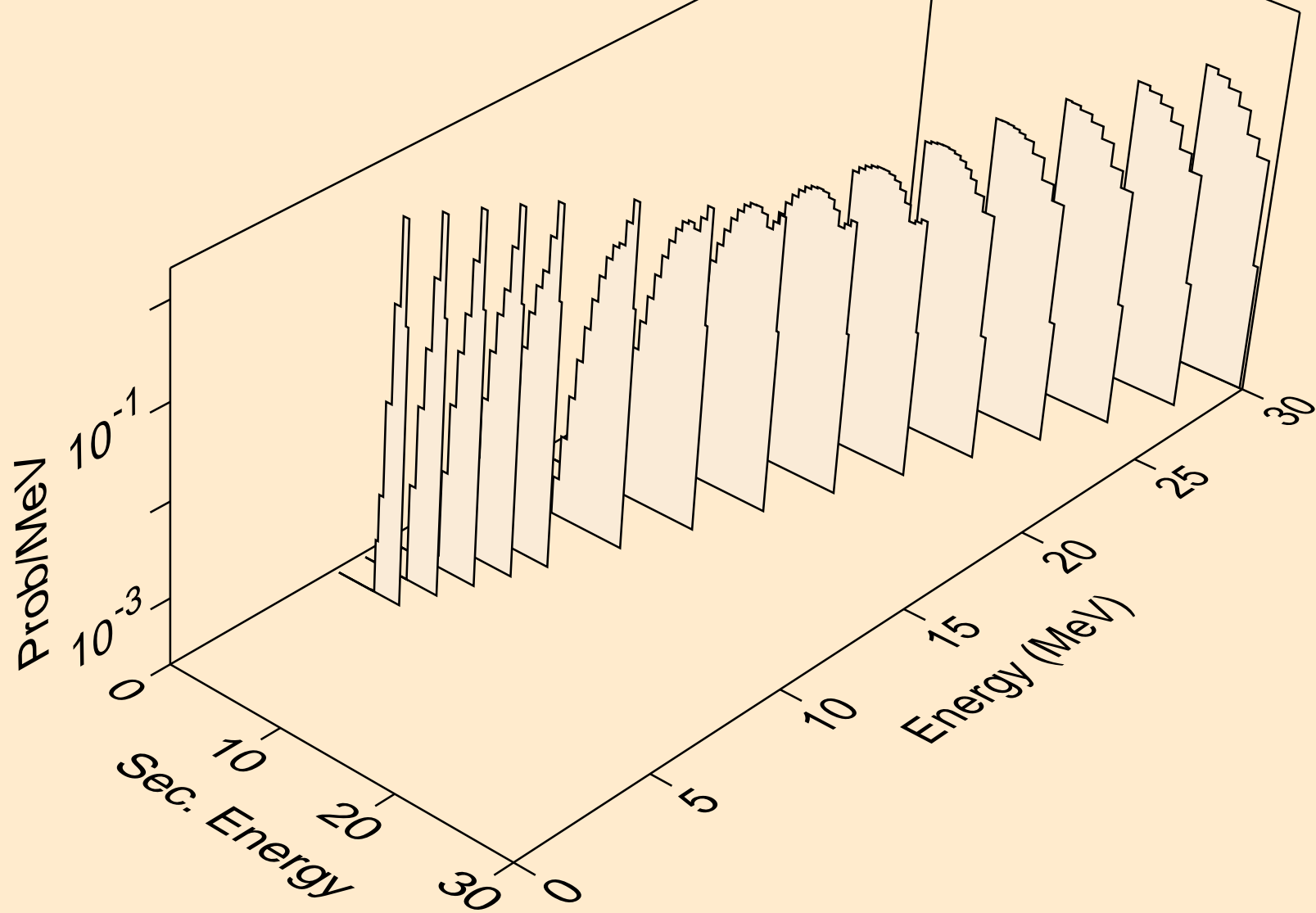

DB265 PROTON ACER TENDL-2021 LIBRARY; T=0.K  
Proton emission for (p,2p)

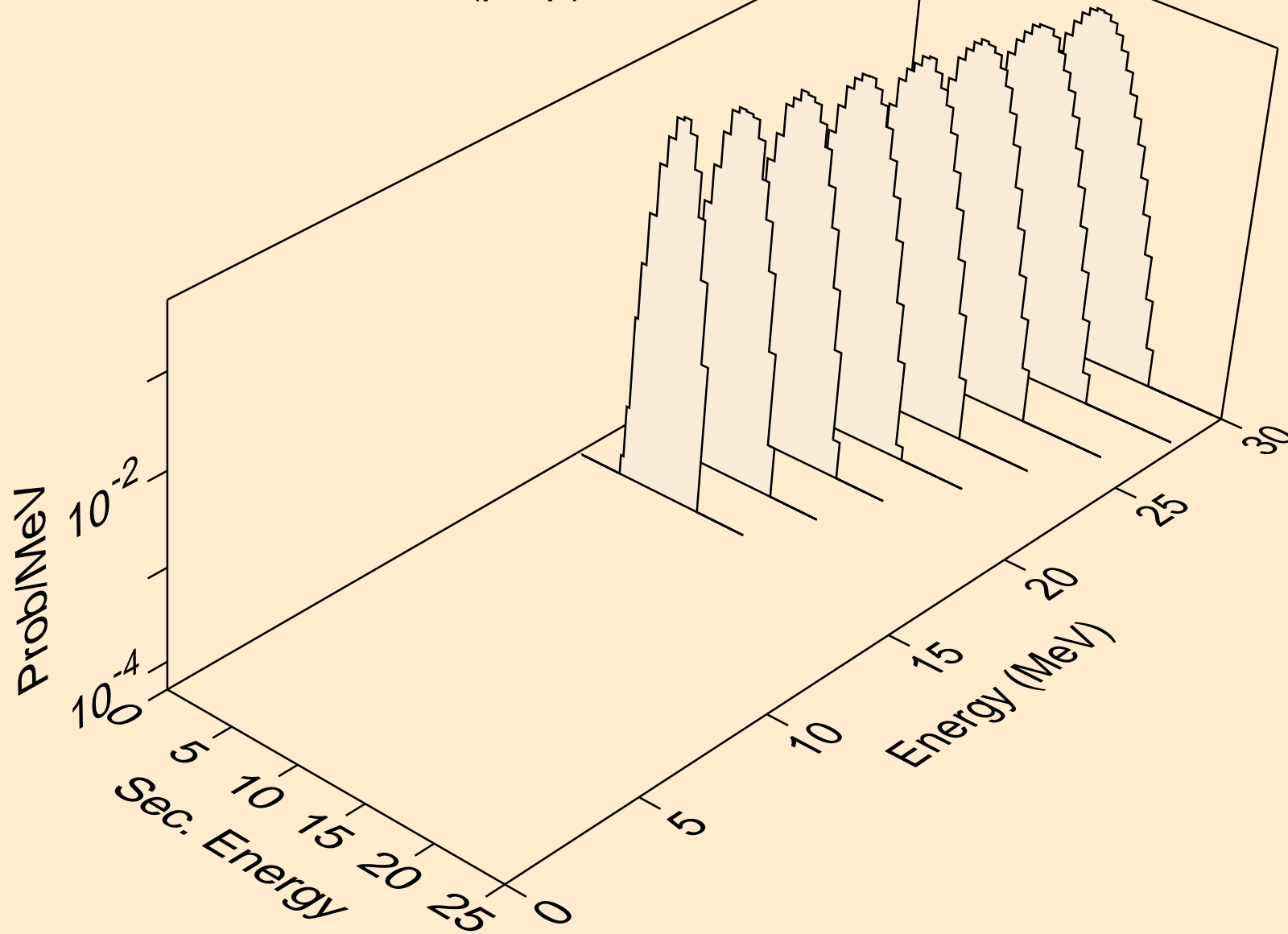

DB265 PROTON ACER TENDL-2021 LIBRARY; T=0.K  
Photon emission for (z,n)

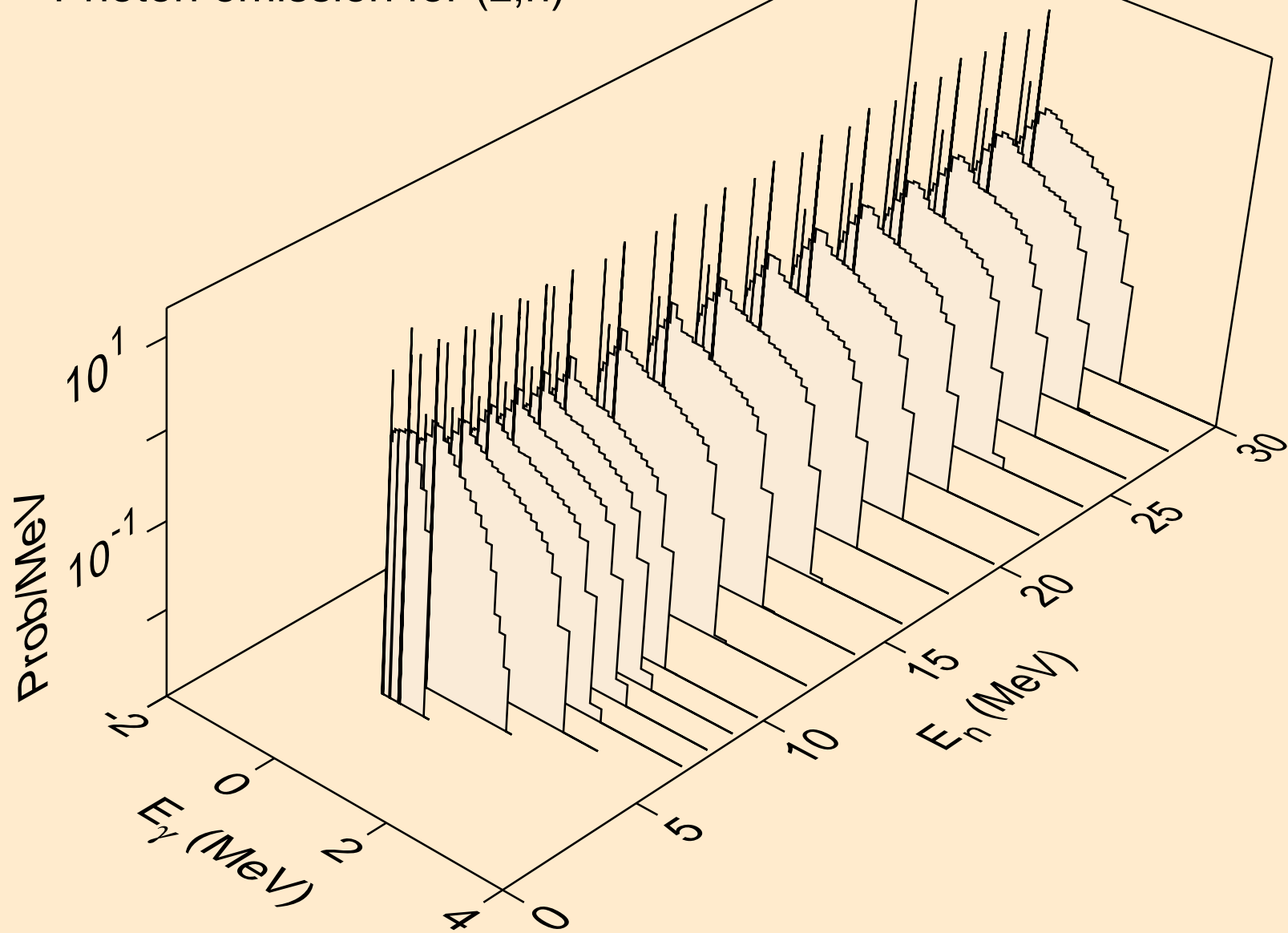

DB265 PROTON ACER TENDL-2021 LIBRARY; T=0.K  
Photon emission for (n,x)

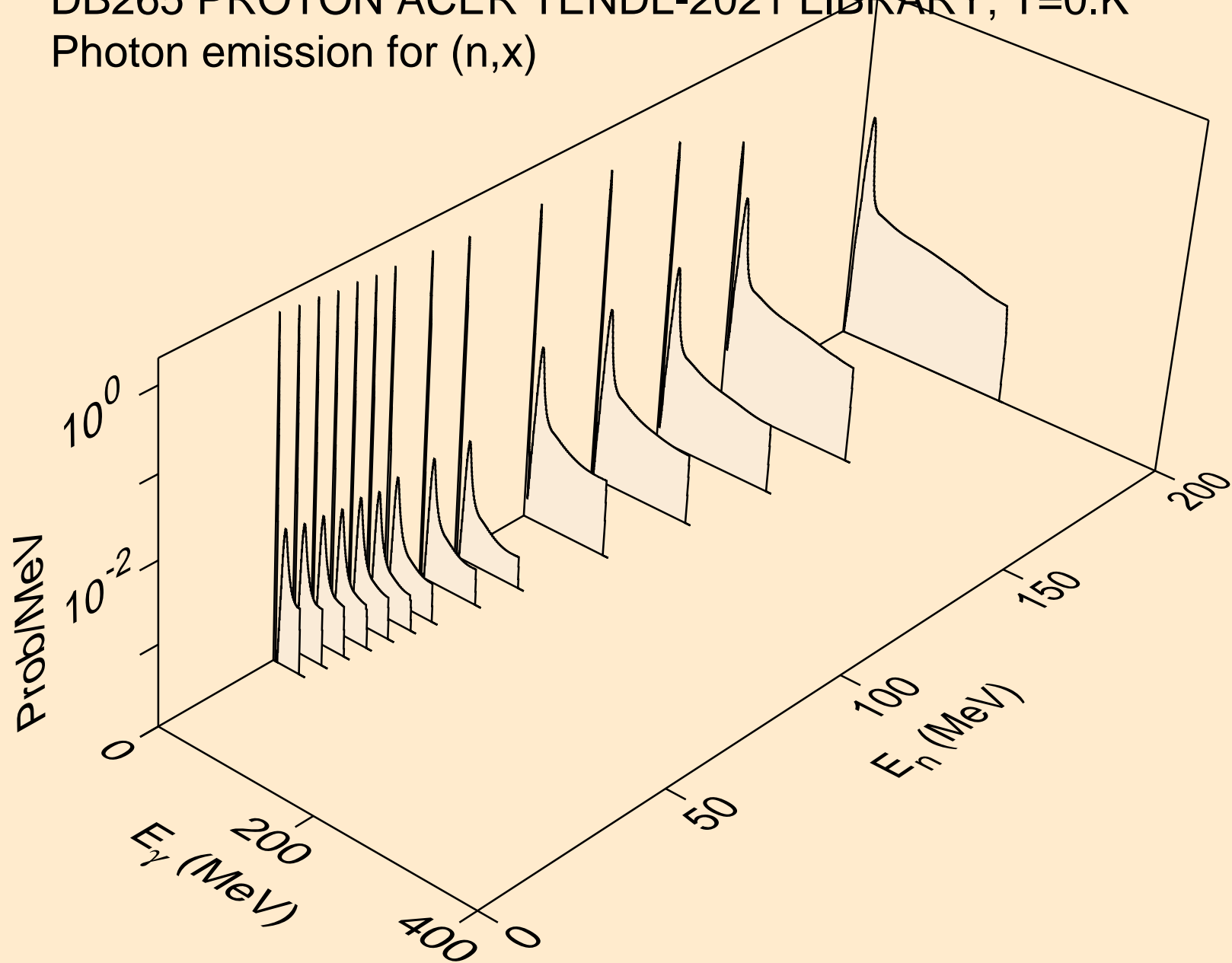

DB265 PROTON ACER TENDL-2021 LIBRARY; T=0.K  
Photon emission for (n,2n)

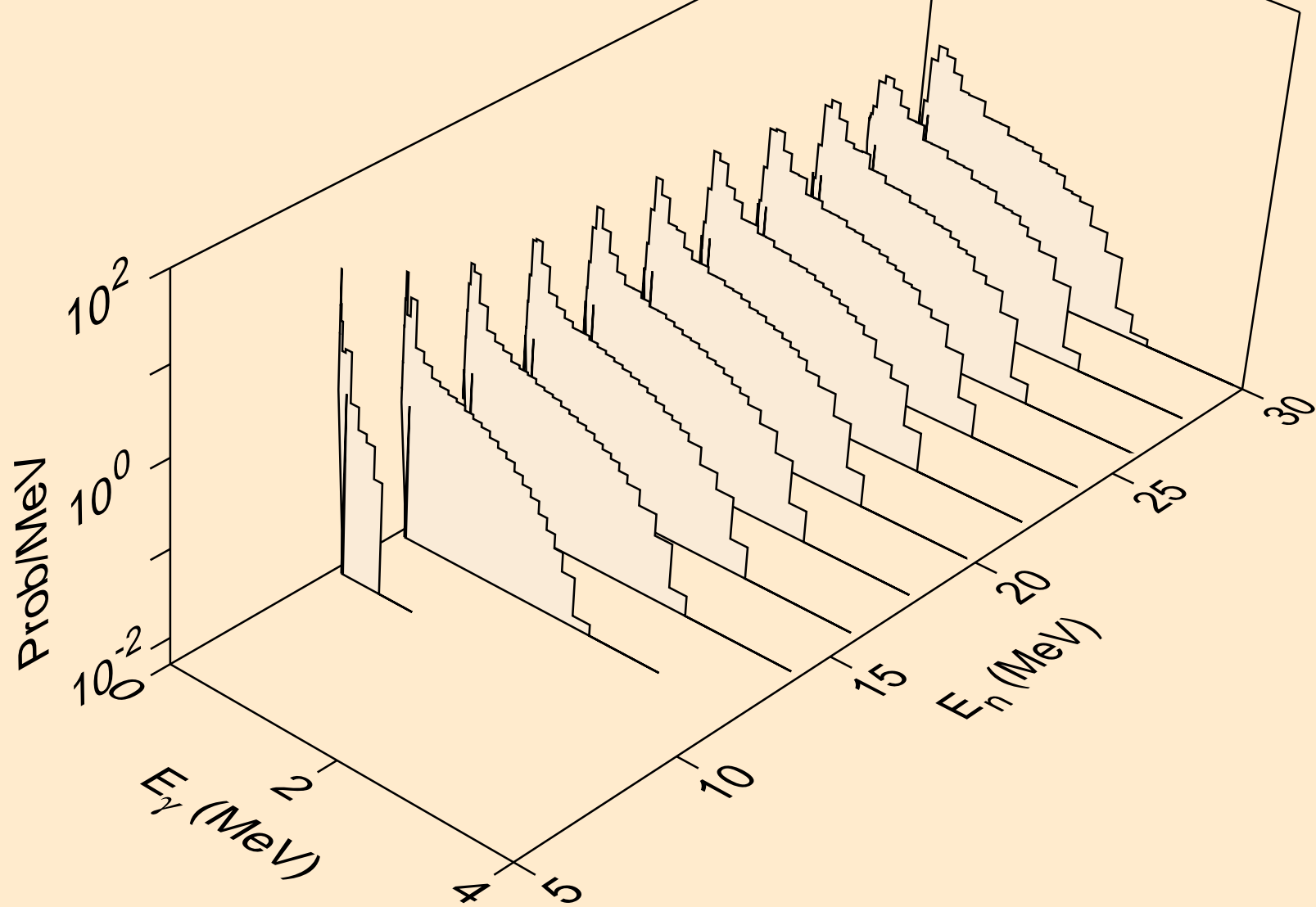

DB265 PROTON ACER TENDL-2021 LIBRARY; T=0.K  
Photon emission for (n,3n)

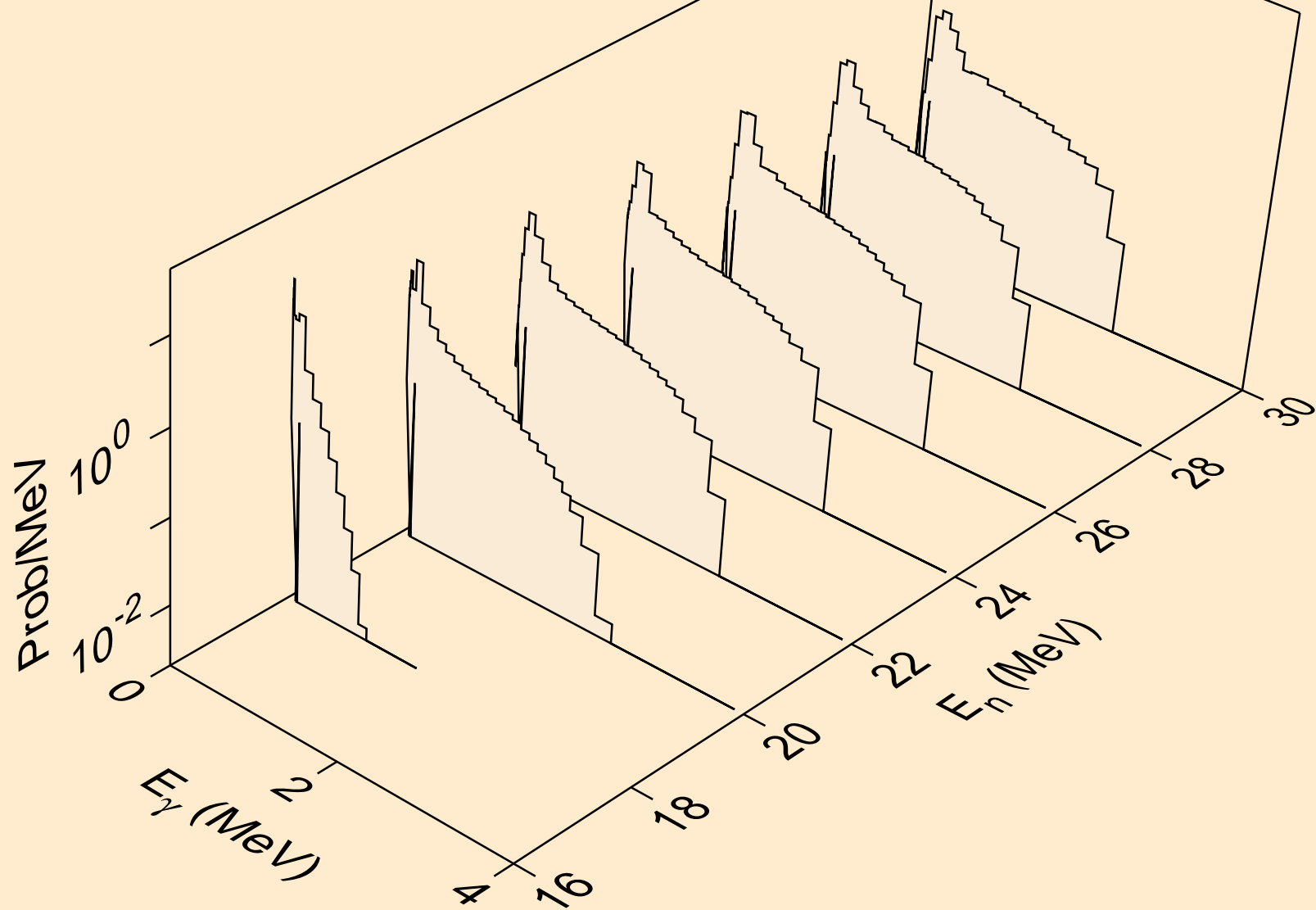



DB265 PROTON ACER TENDL-2021 LIBRARY; T=0.K  
Photon emission for (n,n\*)a

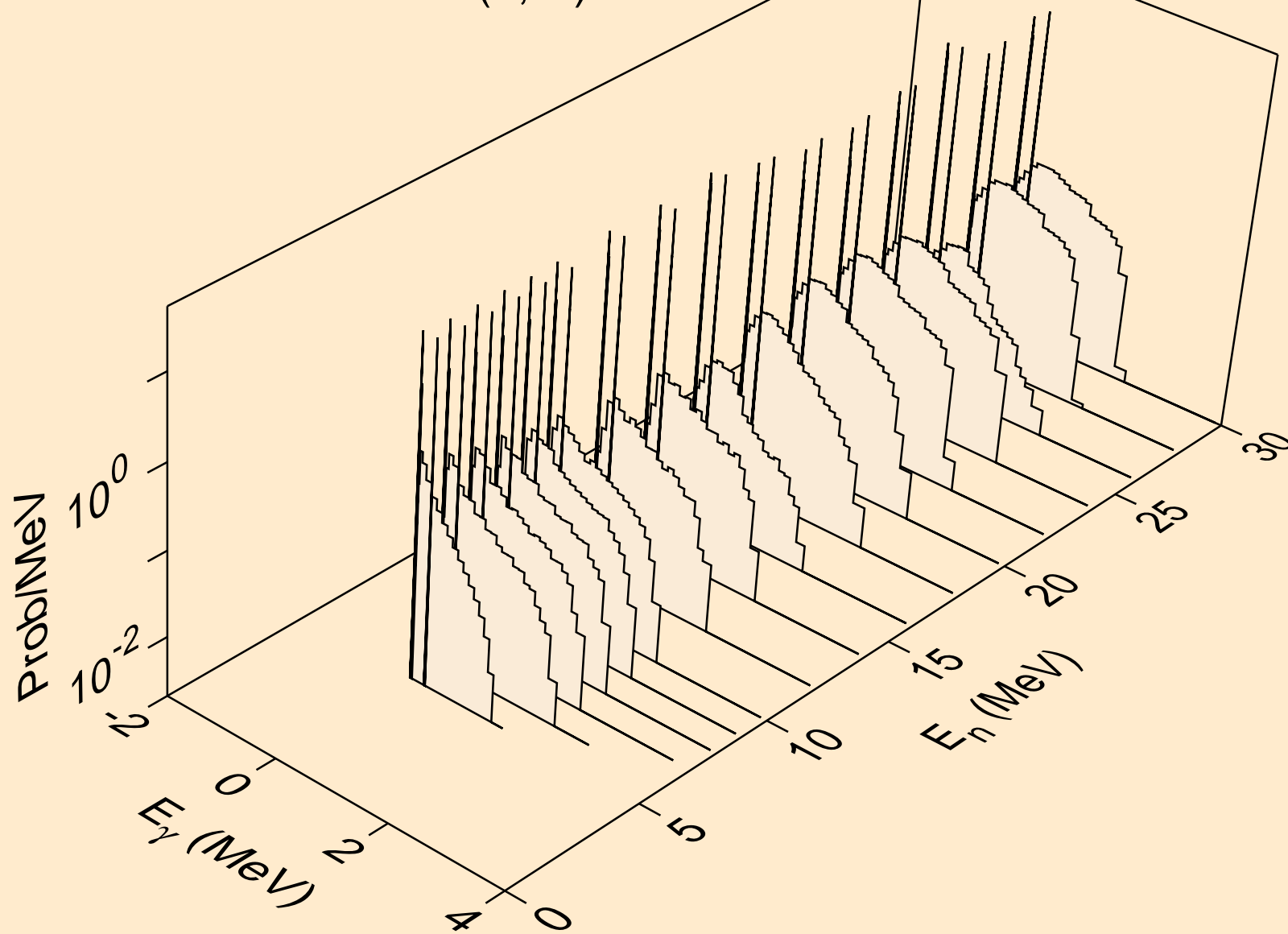

DB265 PROTON ACER TENDL-2021 LIBRARY; T=0.K  
Photon emission for (n,2n)a

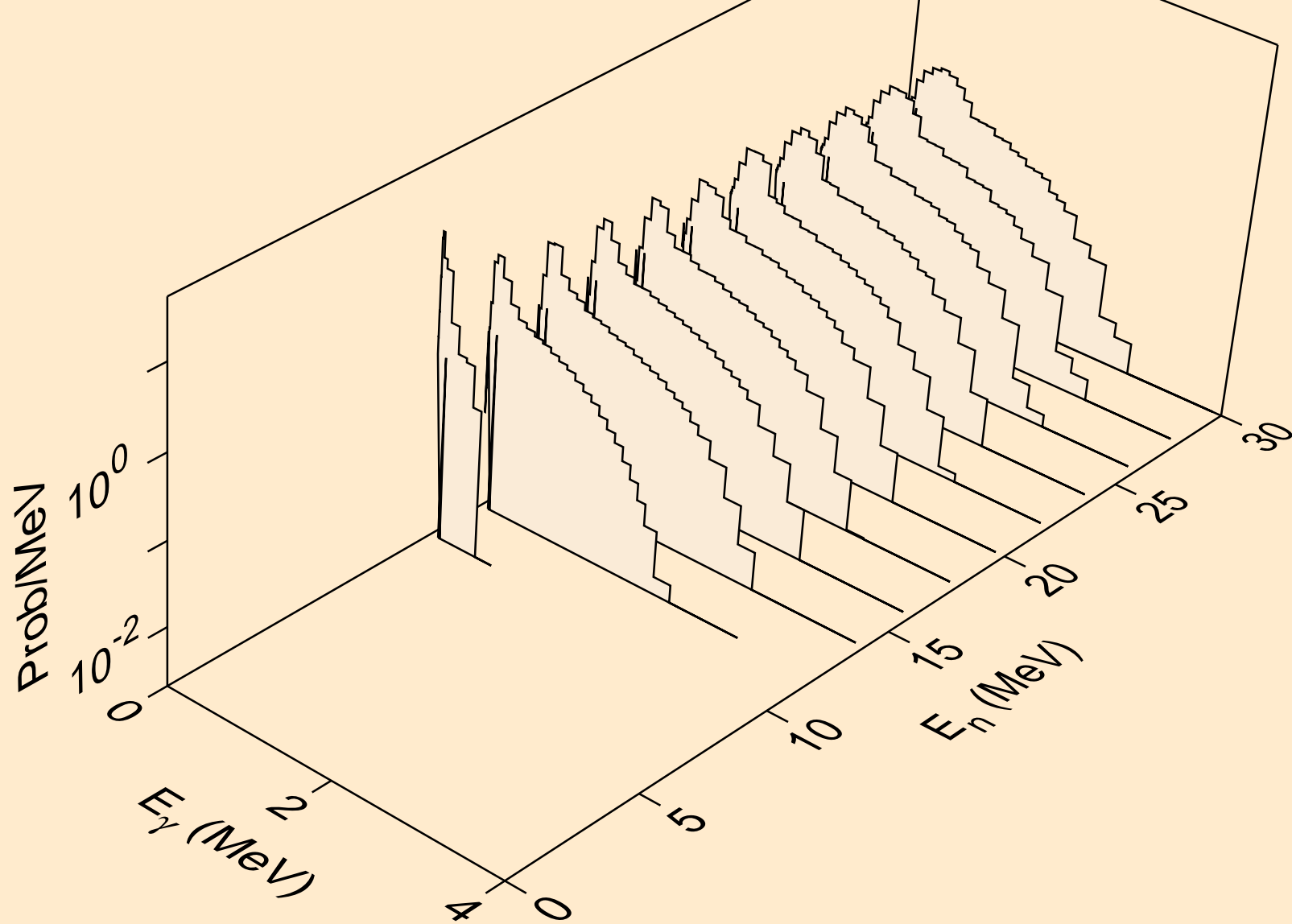

DB265 PROTON ACER TENDL-2021 LIBRARY; T=0.K  
Photon emission for (n,n\*)p

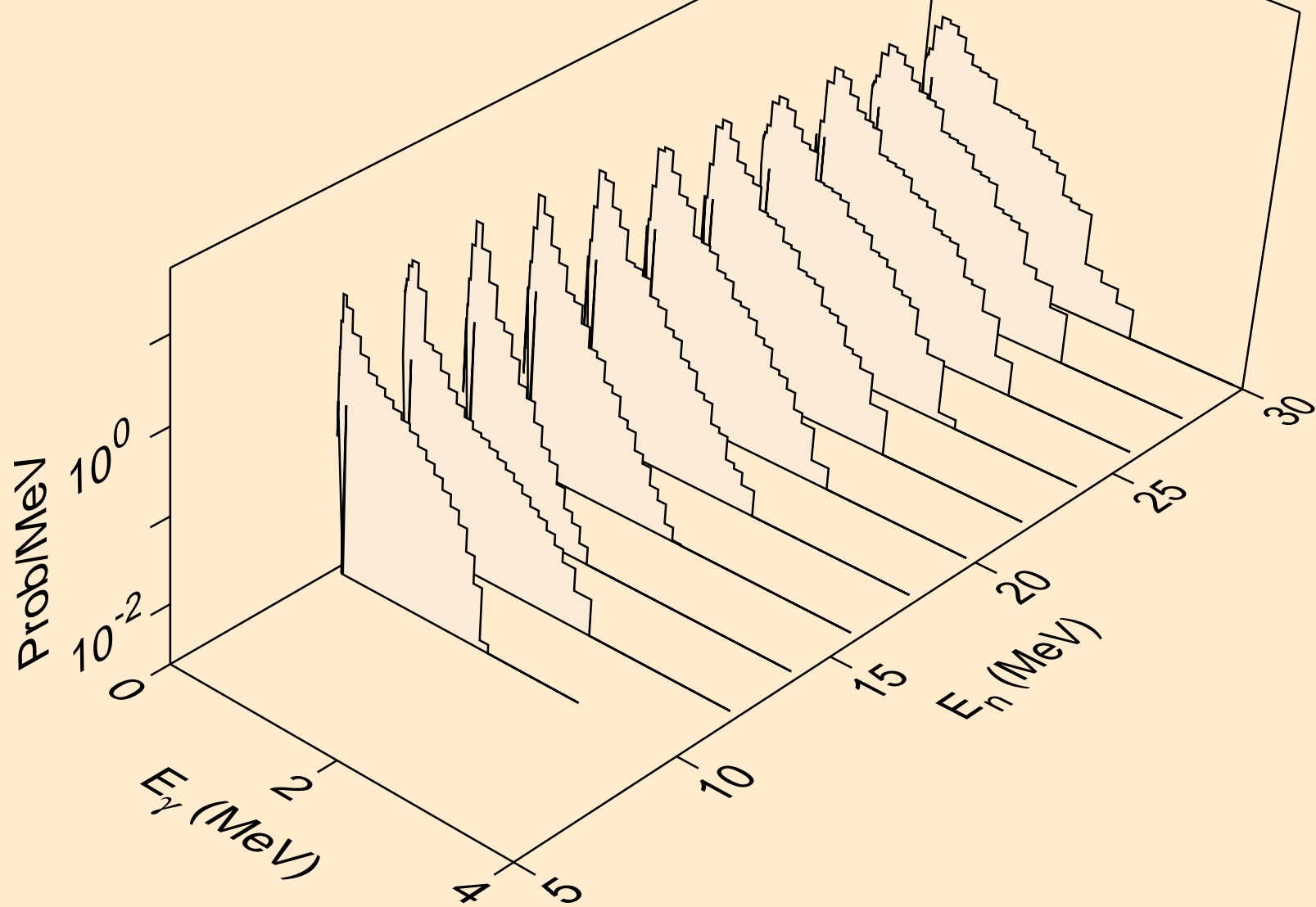

DB265 PROTON ACER TENDL-2021 LIBRARY; T=0.K  
Photon emission for (n,n\*)d

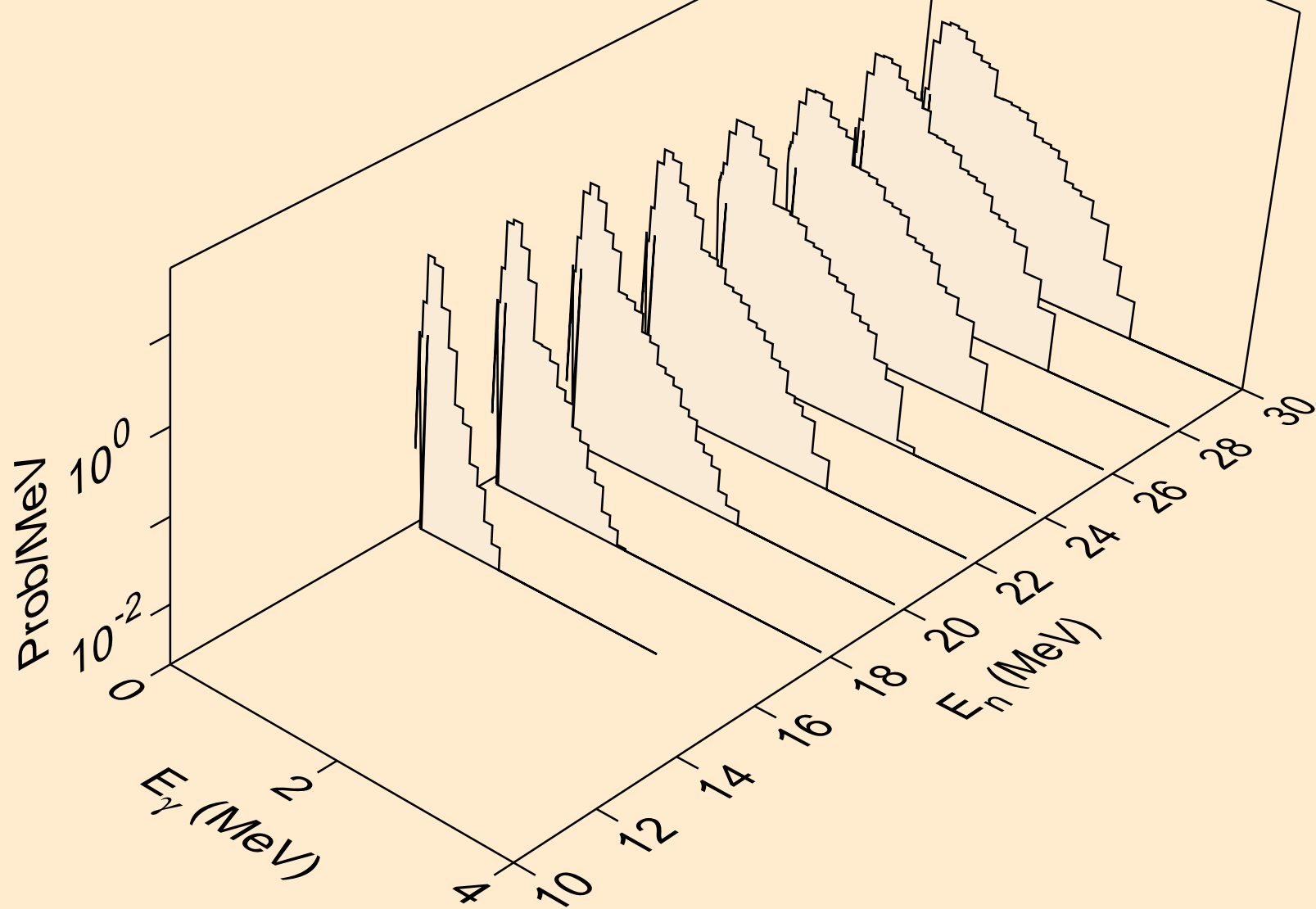

DB265 PROTON ACER TENDL-2021 LIBRARY; T=0.K  
Photon emission for (n,n\*)t

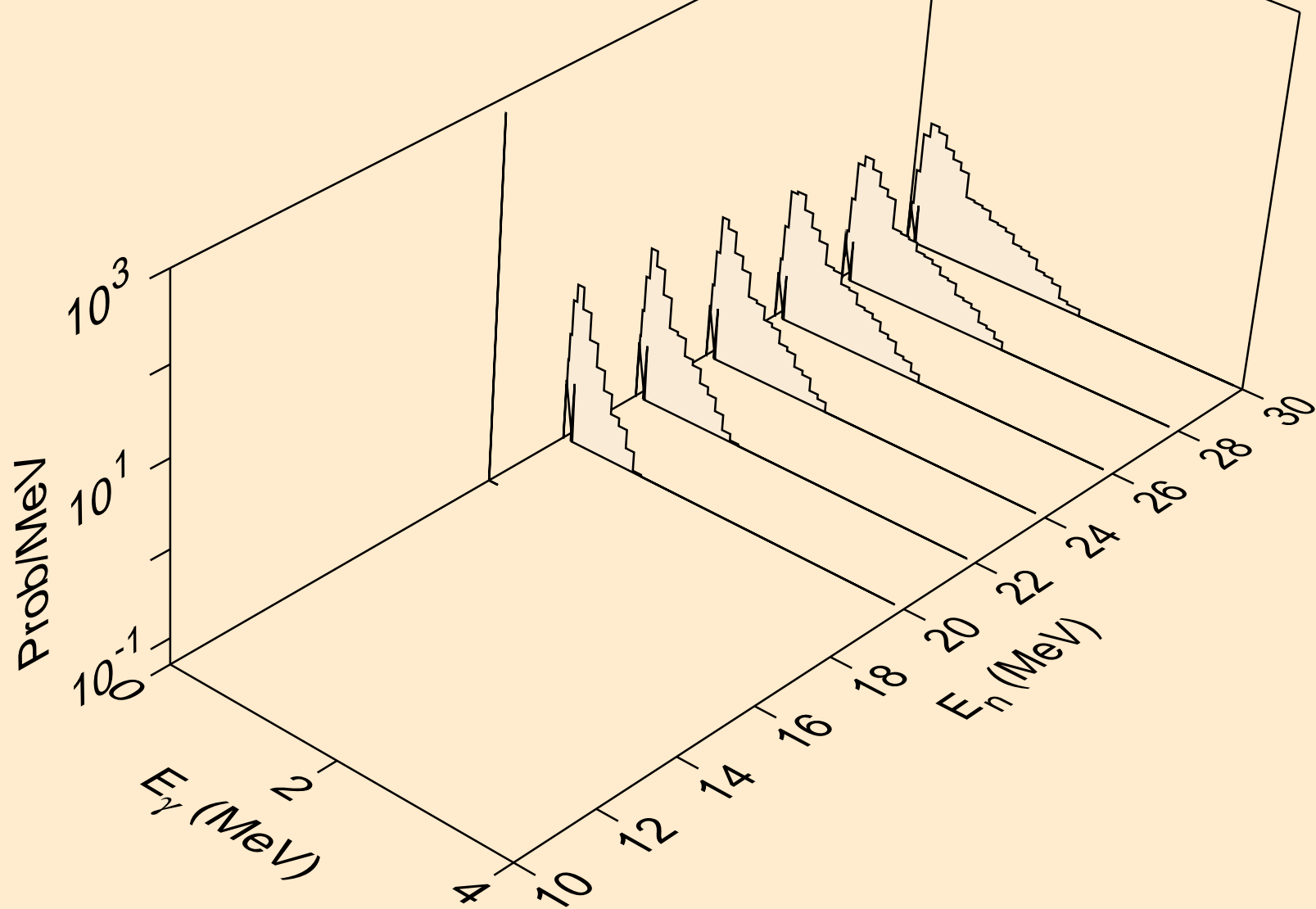

DB265 PROTON ACER TENDL-2021 LIBRARY; T=0.K  
Photon emission for (n,2np)

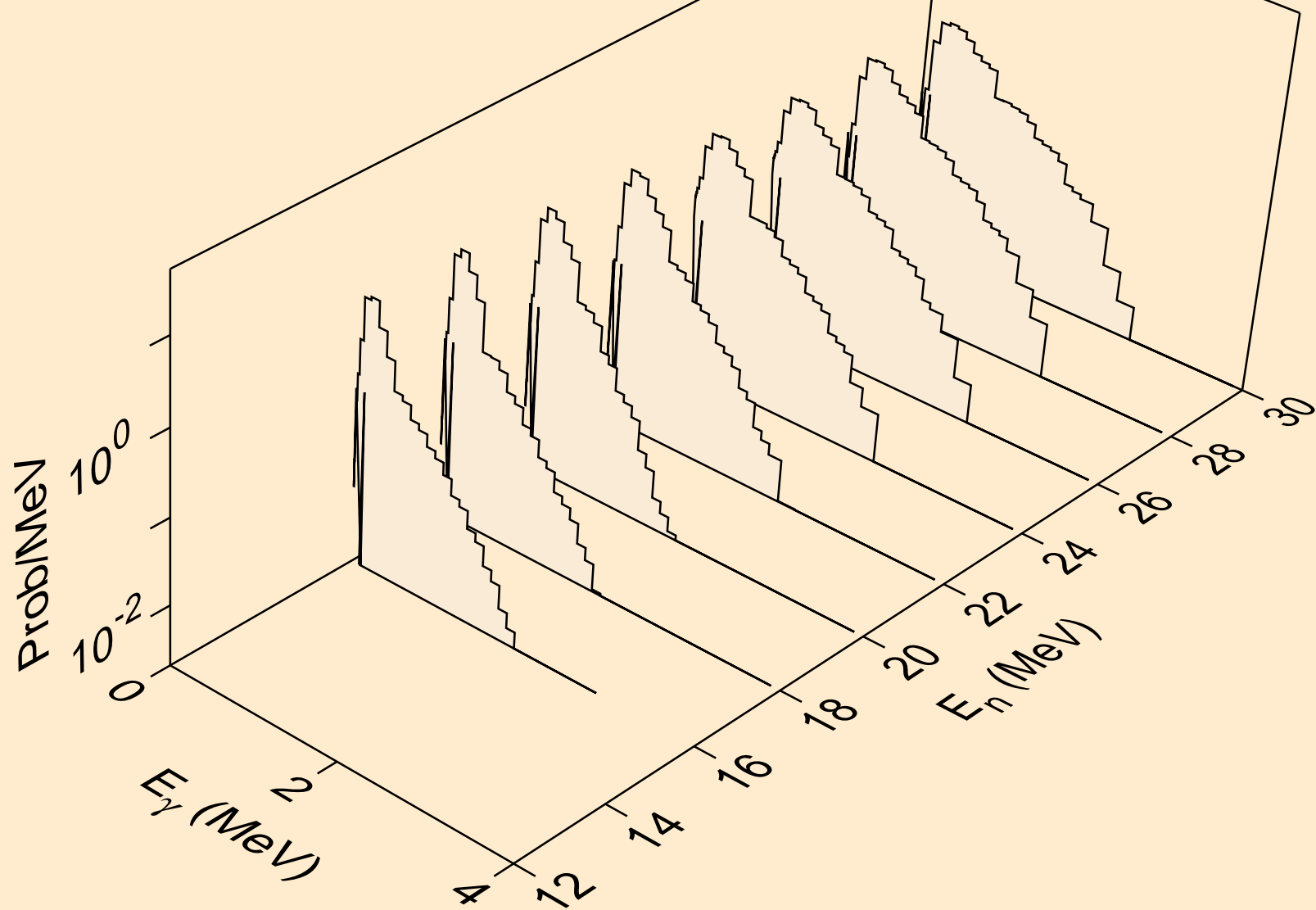

DB265 PROTON ACER TENDL-2021 LIBRARY; T=0.K  
Photon emission for (n,gma)

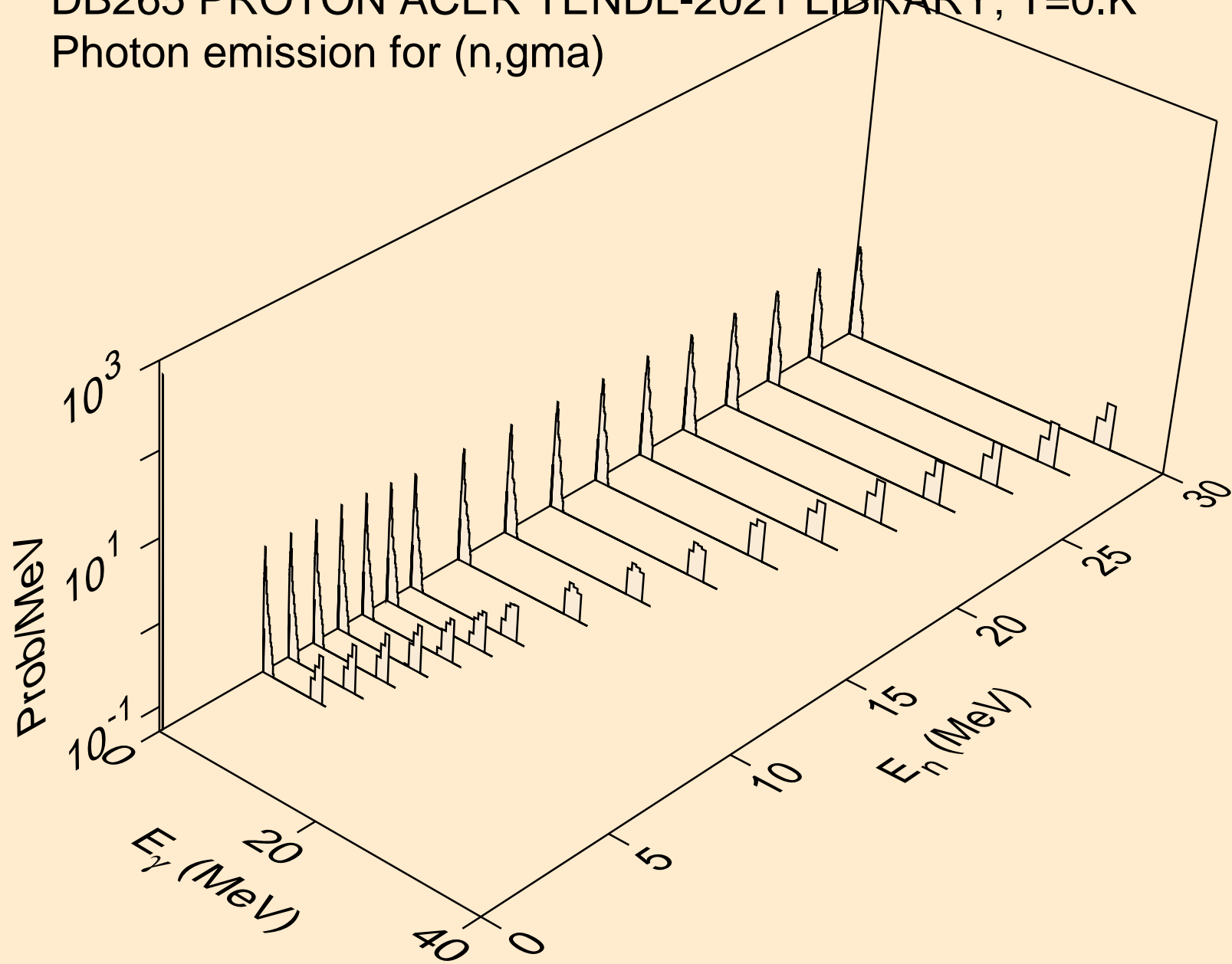

DB265 PROTON ACER TENDL-2021 LIBRARY; T=0.K  
Photon emission for inelastic

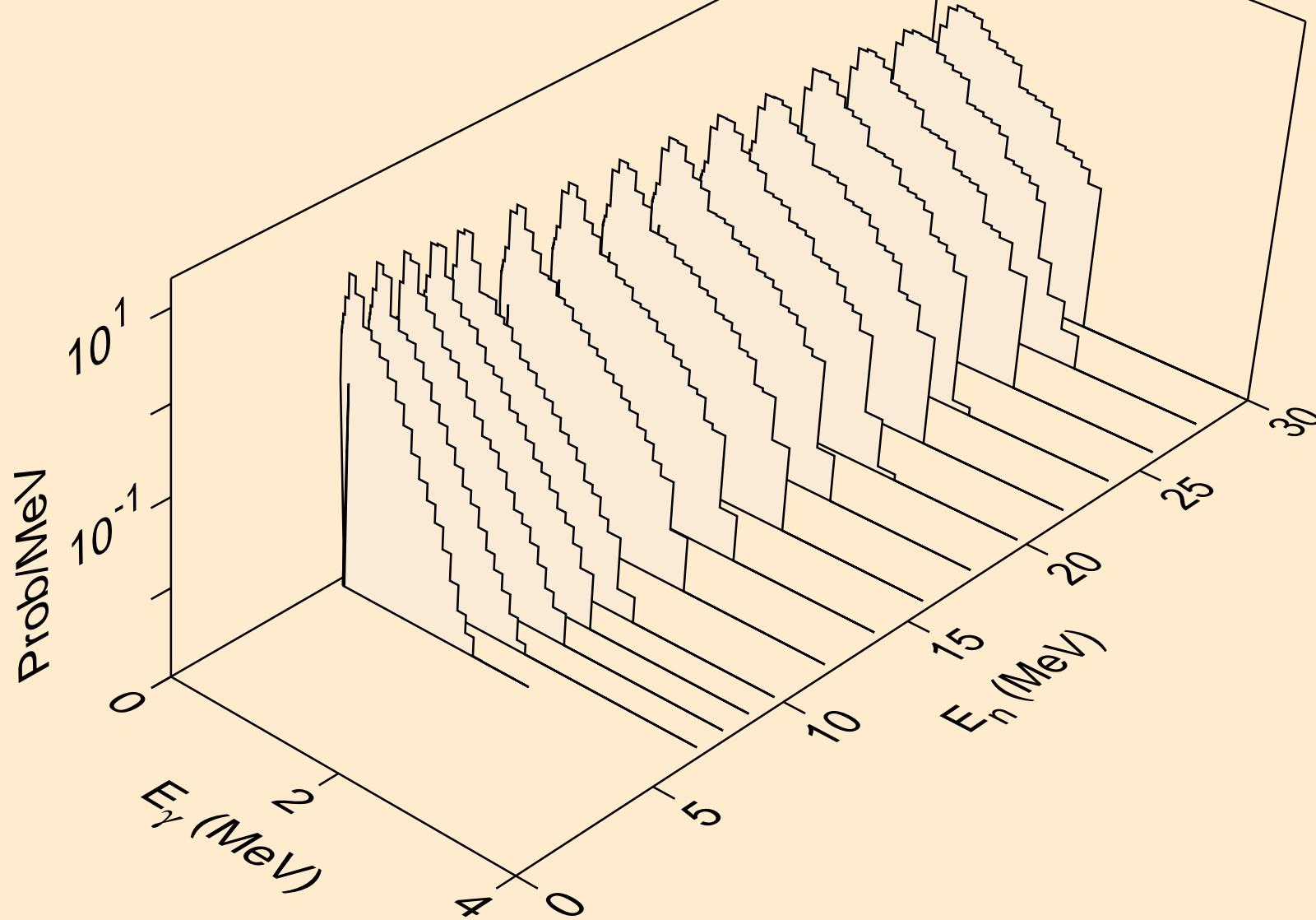



DB265 PROTON ACER TENDL-2021 LIBRARY; T=0.K  
Photon emission for (n,d)

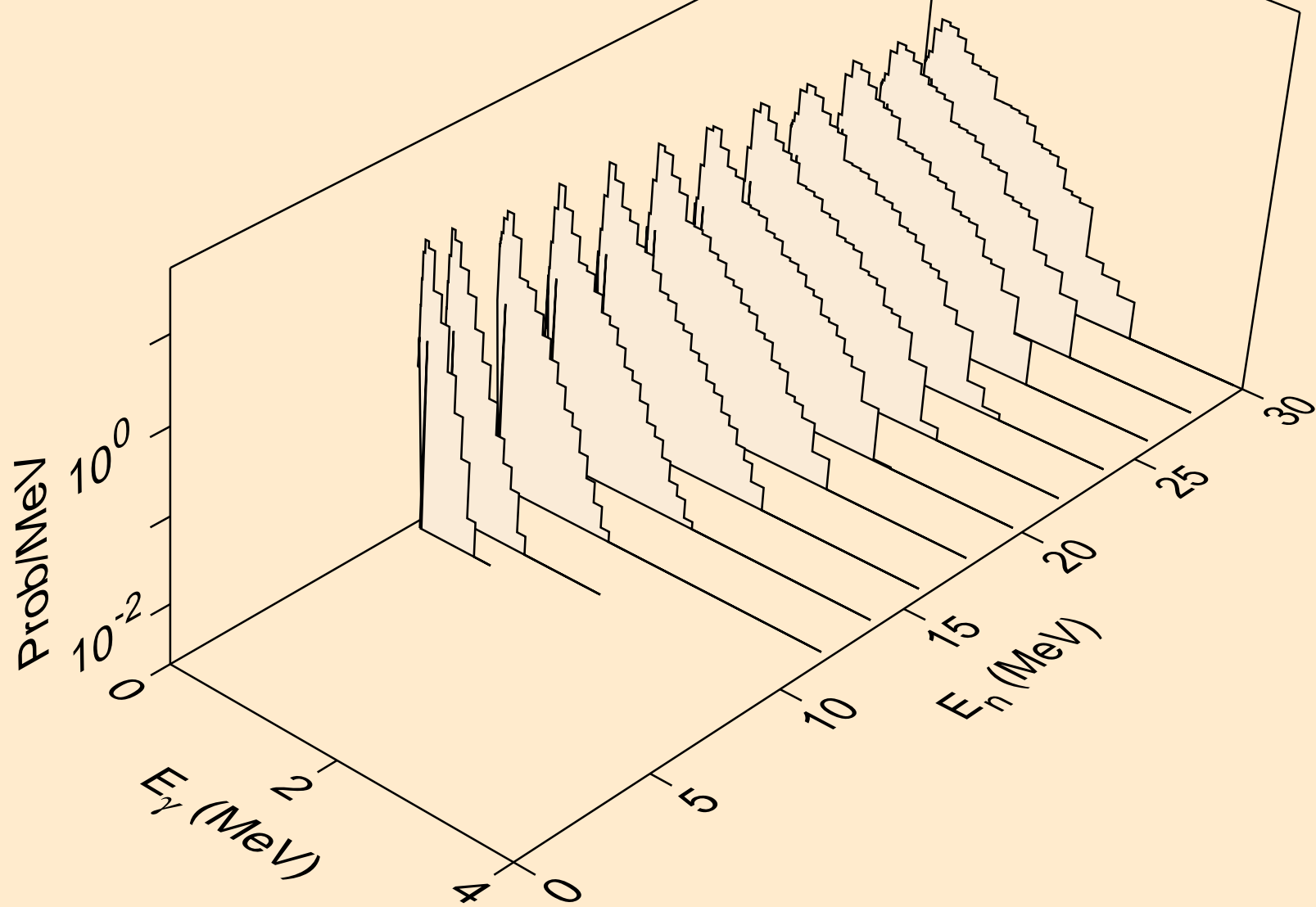

DB265 PROTON ACER TENDL-2021 LIBRARY; T=0.K  
Photon emission for (n,t)

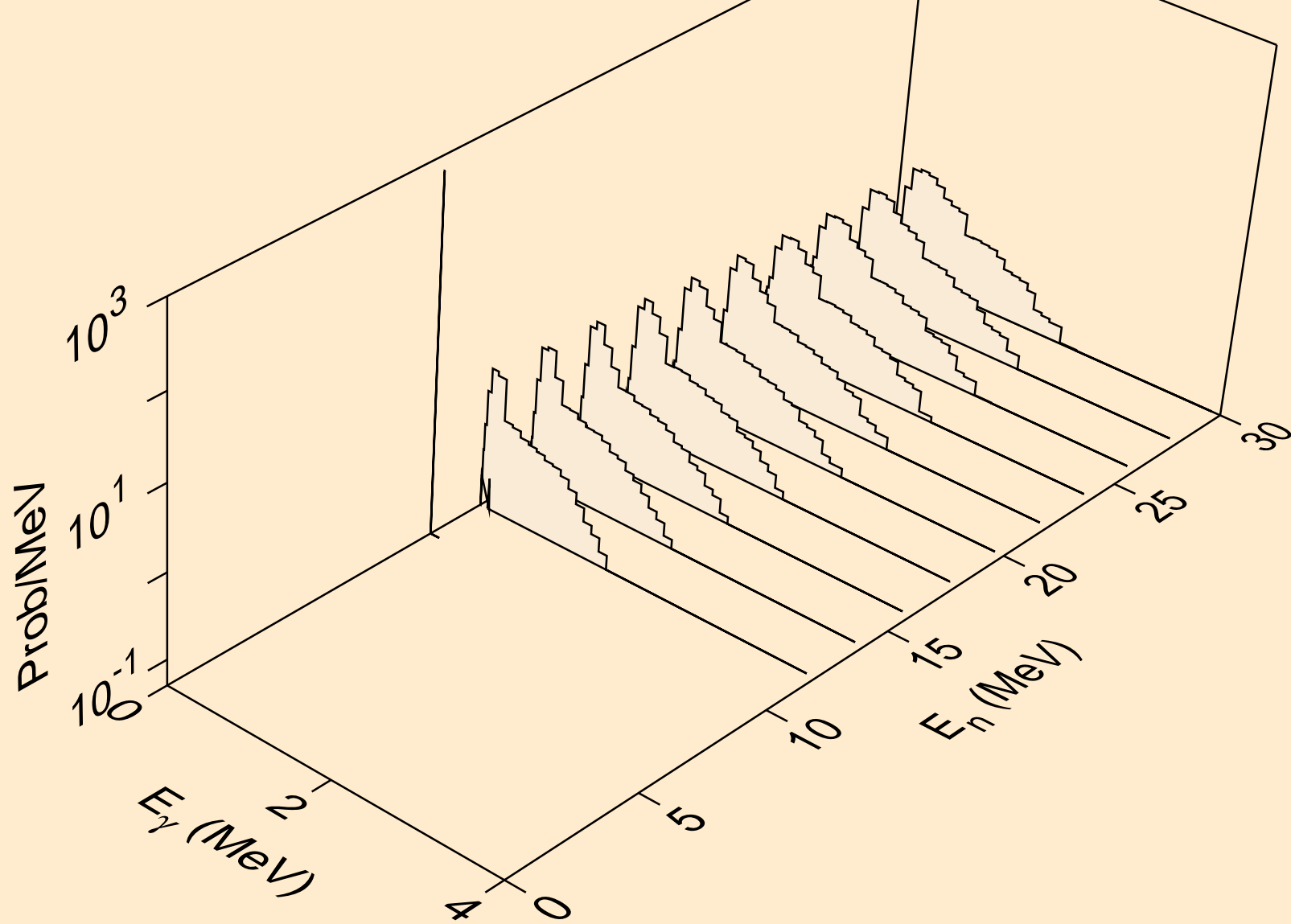

DB265 PROTON ACER TENDL-2021 LIBRARY; T=0.K  
Photon emission for (n,he3)

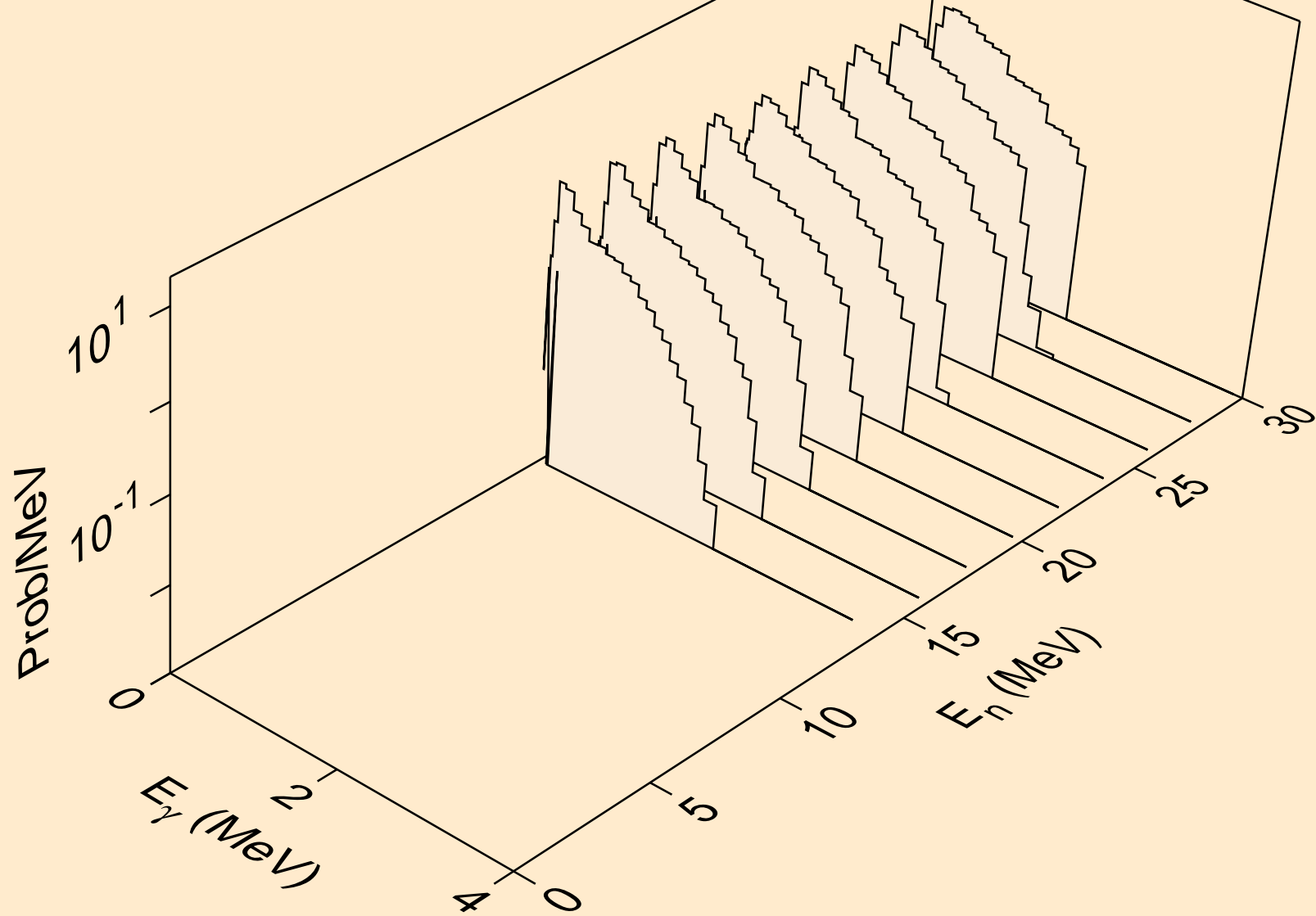

DB265 PROTON ACER TENDL-2021 LIBRARY; T=0.K  
Photon emission for (n,a)

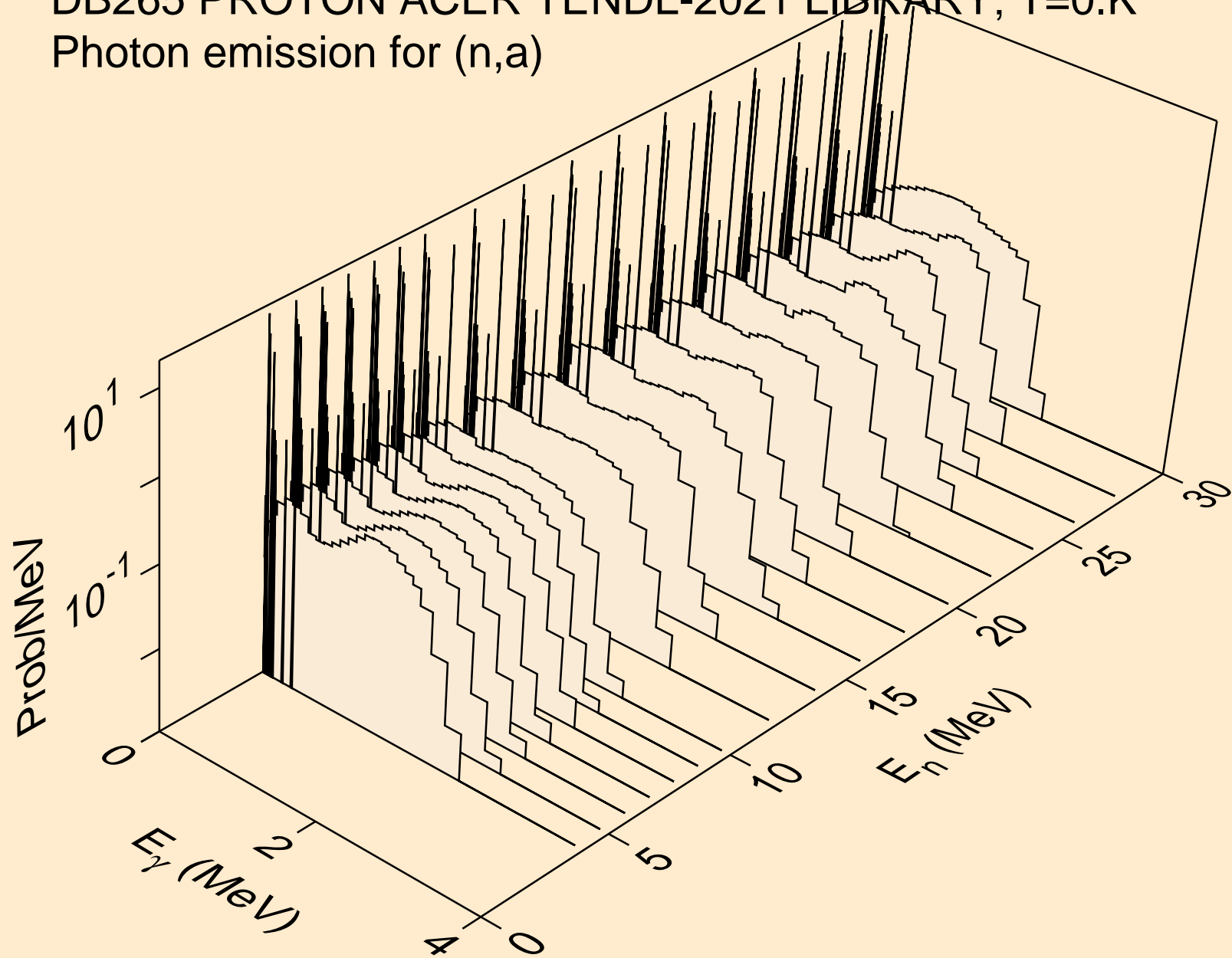

DB265 PROTON ACER TENDL-2021 LIBRARY; T=0.K  
Photon emission for (n,2p)

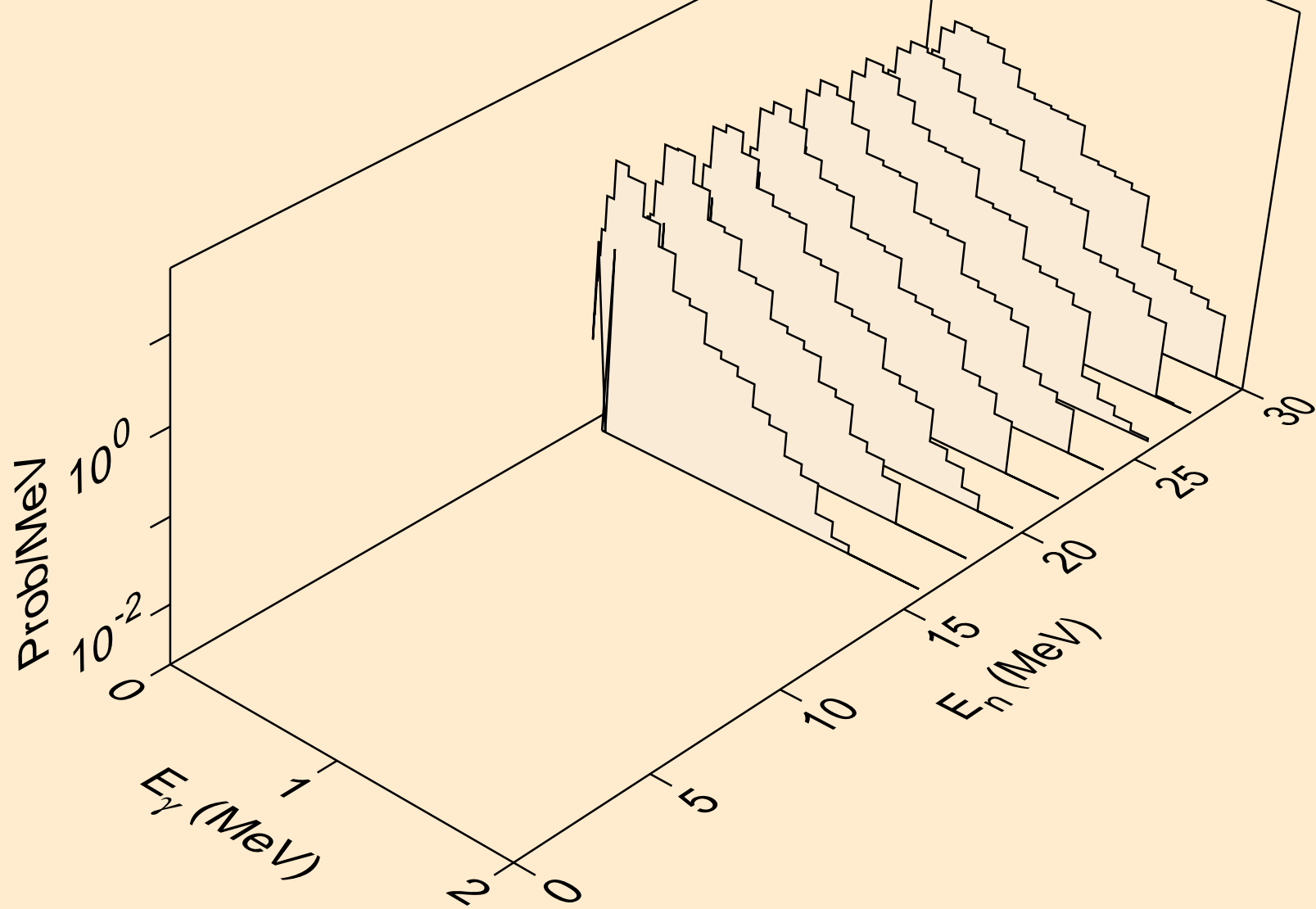

DB265 PROTON ACER TENDL-2021 LIBRARY; T=0.K  
Particle heating contributions

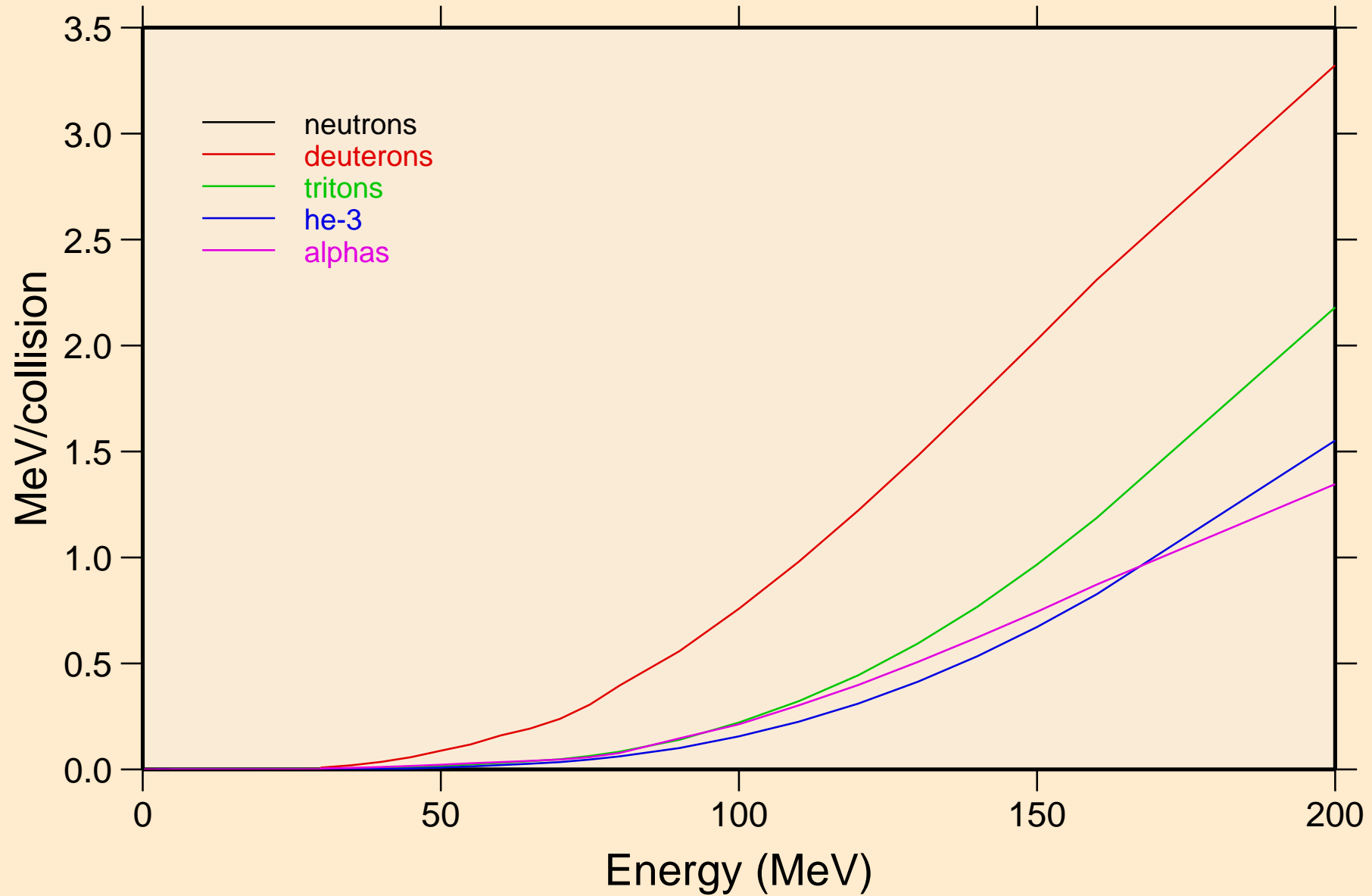

DB265 PROTON ACER TENDL-2021 LIBRARY; T=0.K  
Recoil Heating

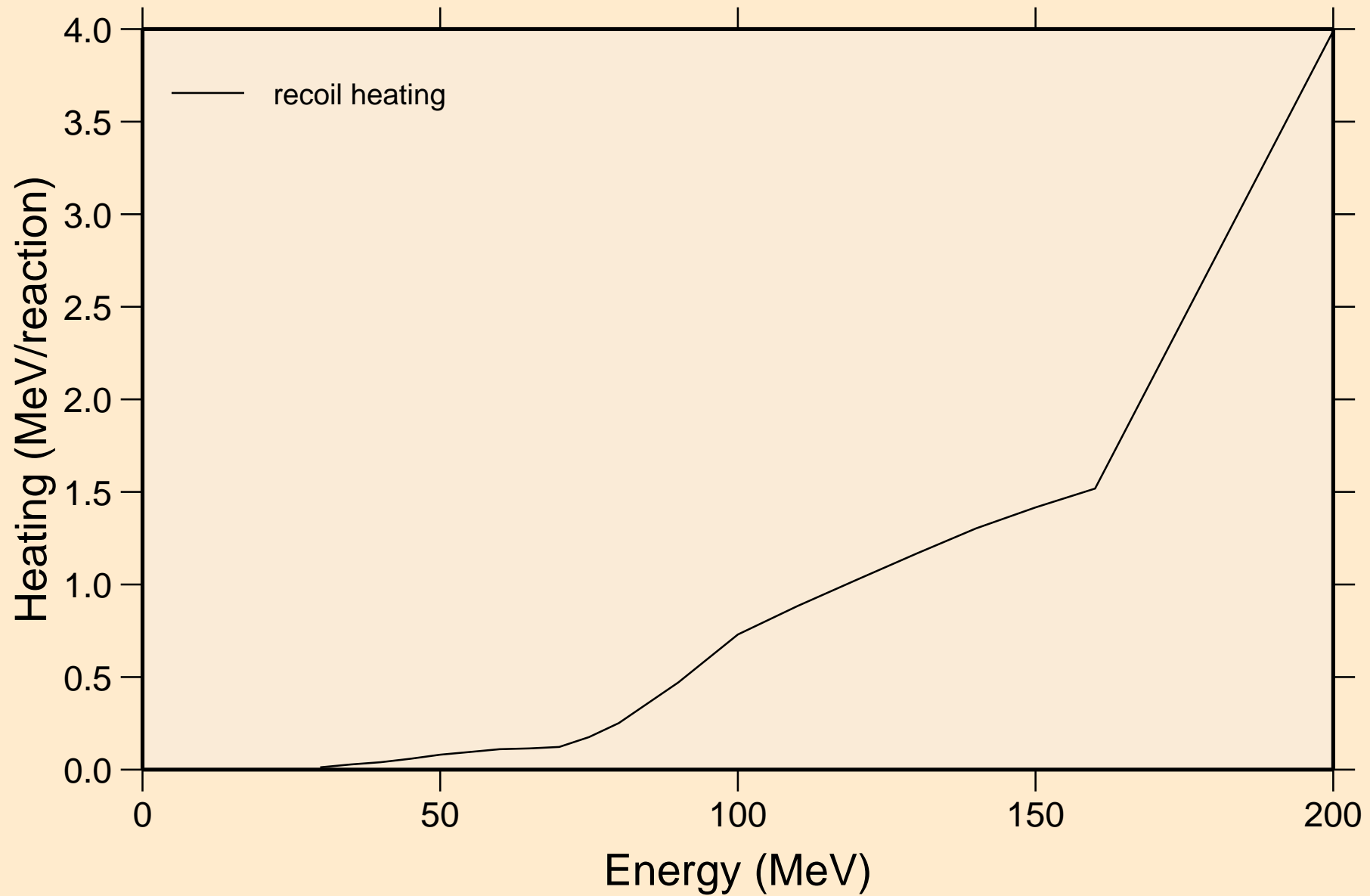

DB265 PROTON ACER TENDL-2021 LIBRARY; T=0.K  
Particle production cross sections

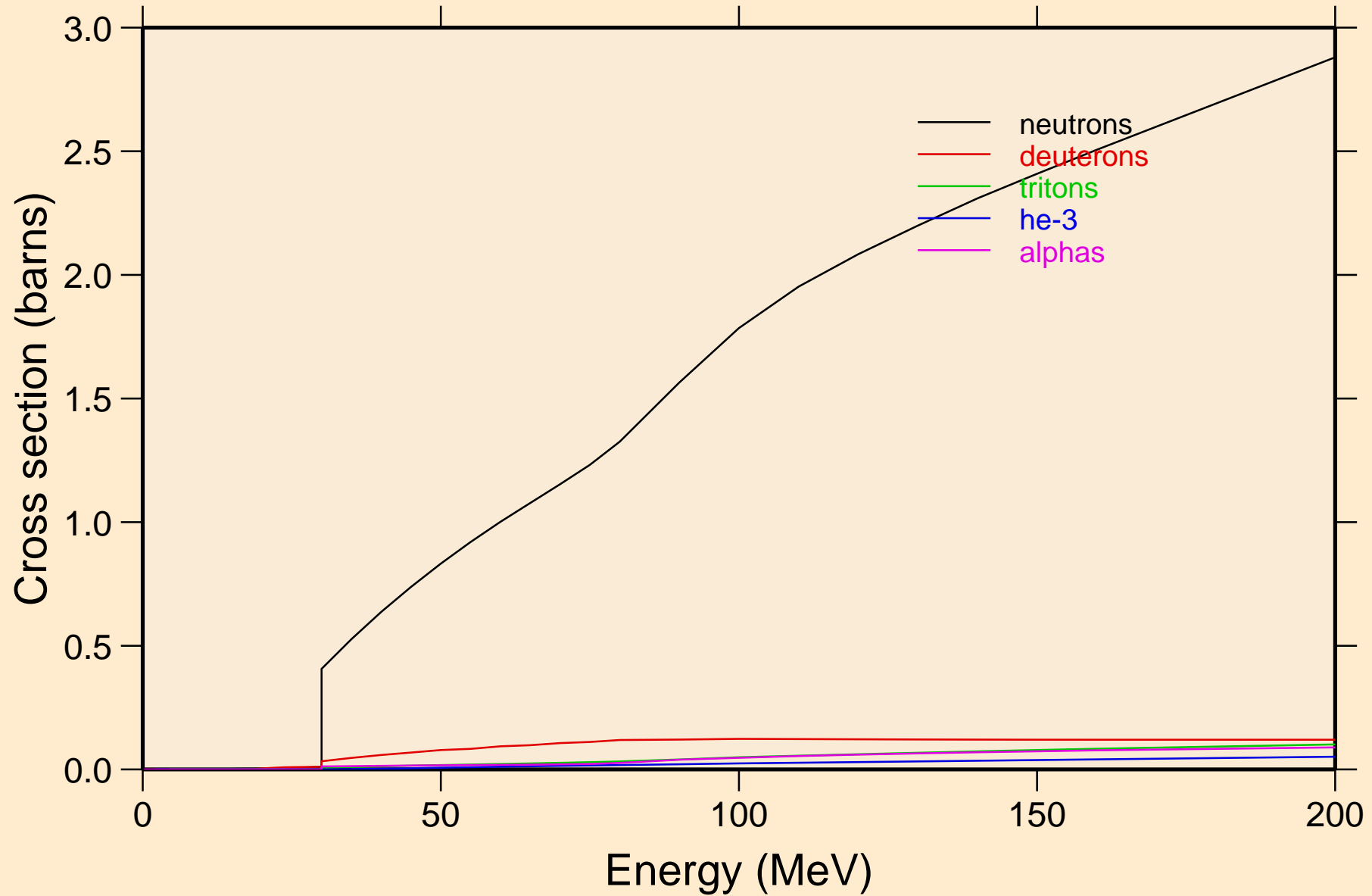



DB265 PROTON ACER TENDL-2021 LIBRARY; T=0.K  
neutrons from (p,n)

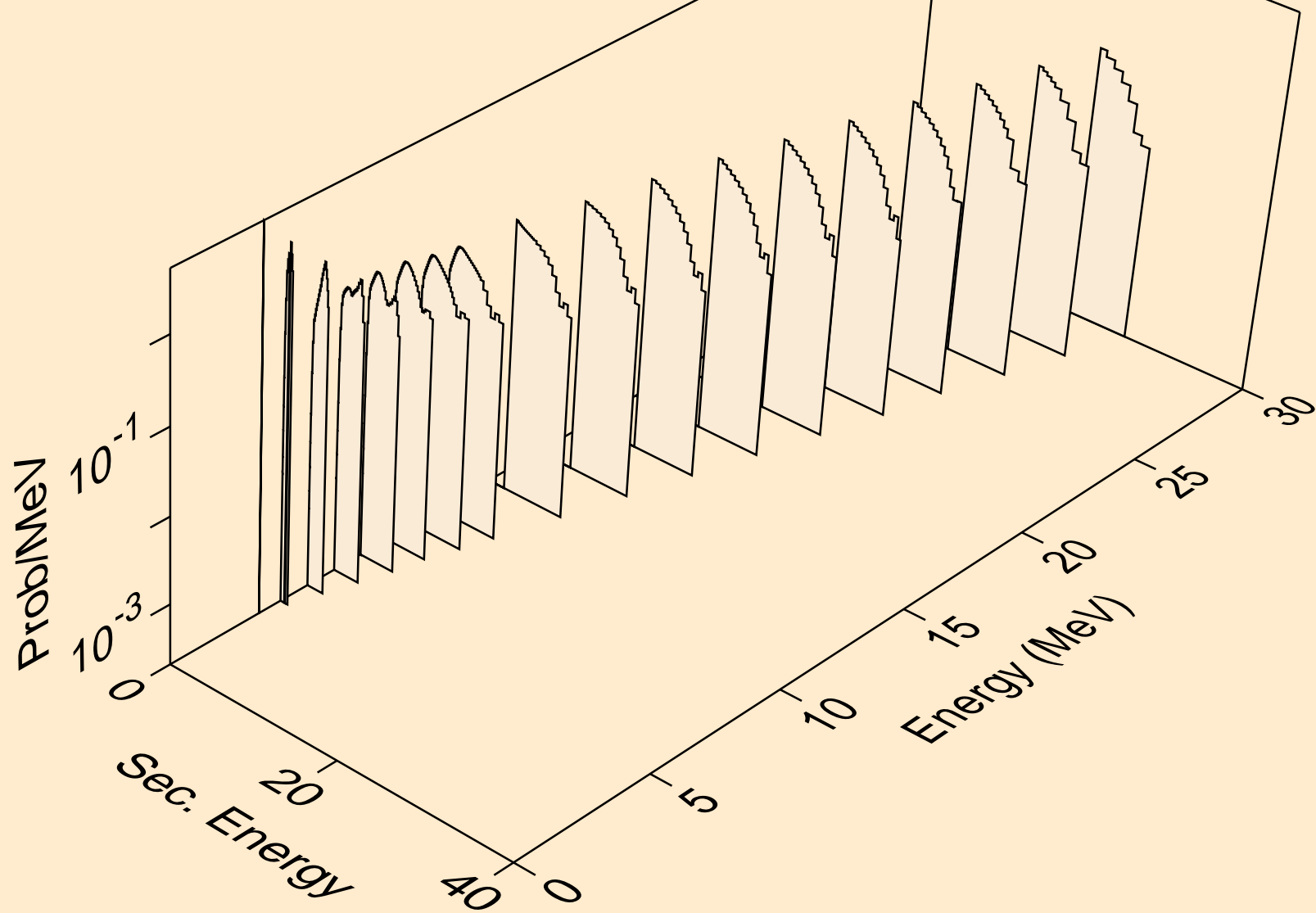

DB265 PROTON ACER TENDL-2021 LIBRARY; T=0.K  
neutrons from (p,x)

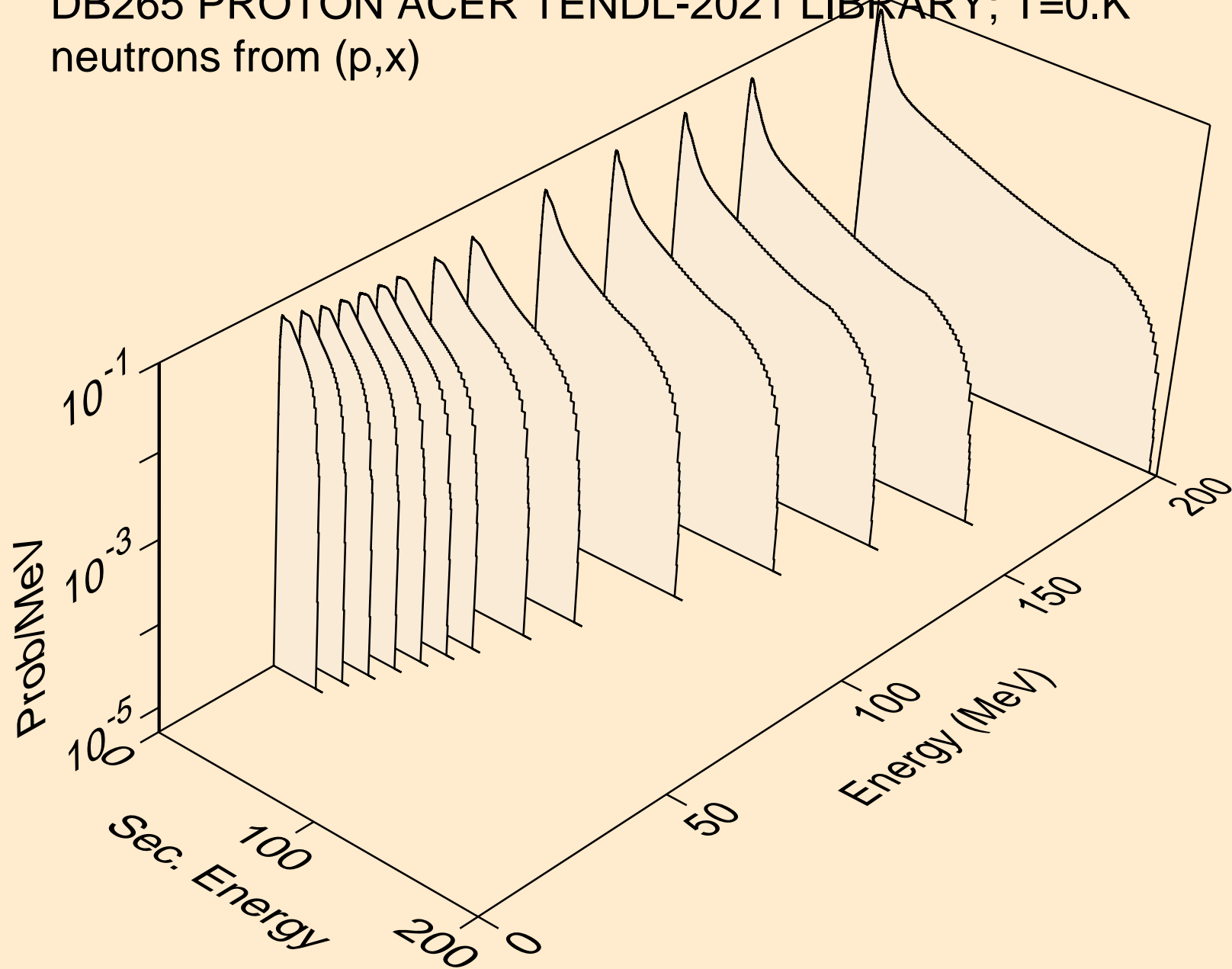

DB265 PROTON ACER TENDL-2021 LIBRARY; T=0.K  
neutrons from (p,2n)

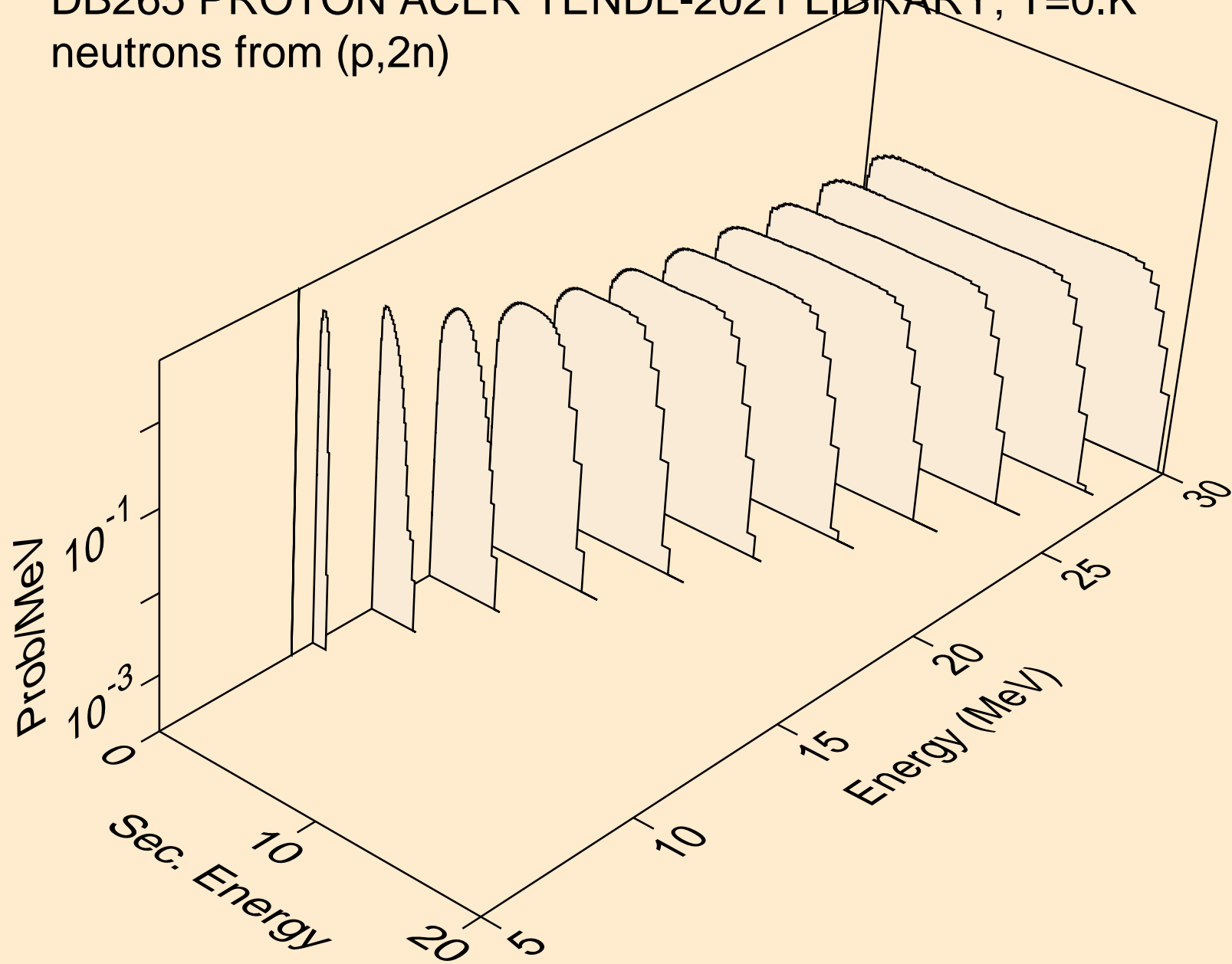

DB265 PROTON ACER TENDL-2021 LIBRARY; T=0.K  
neutrons from (p,3n)

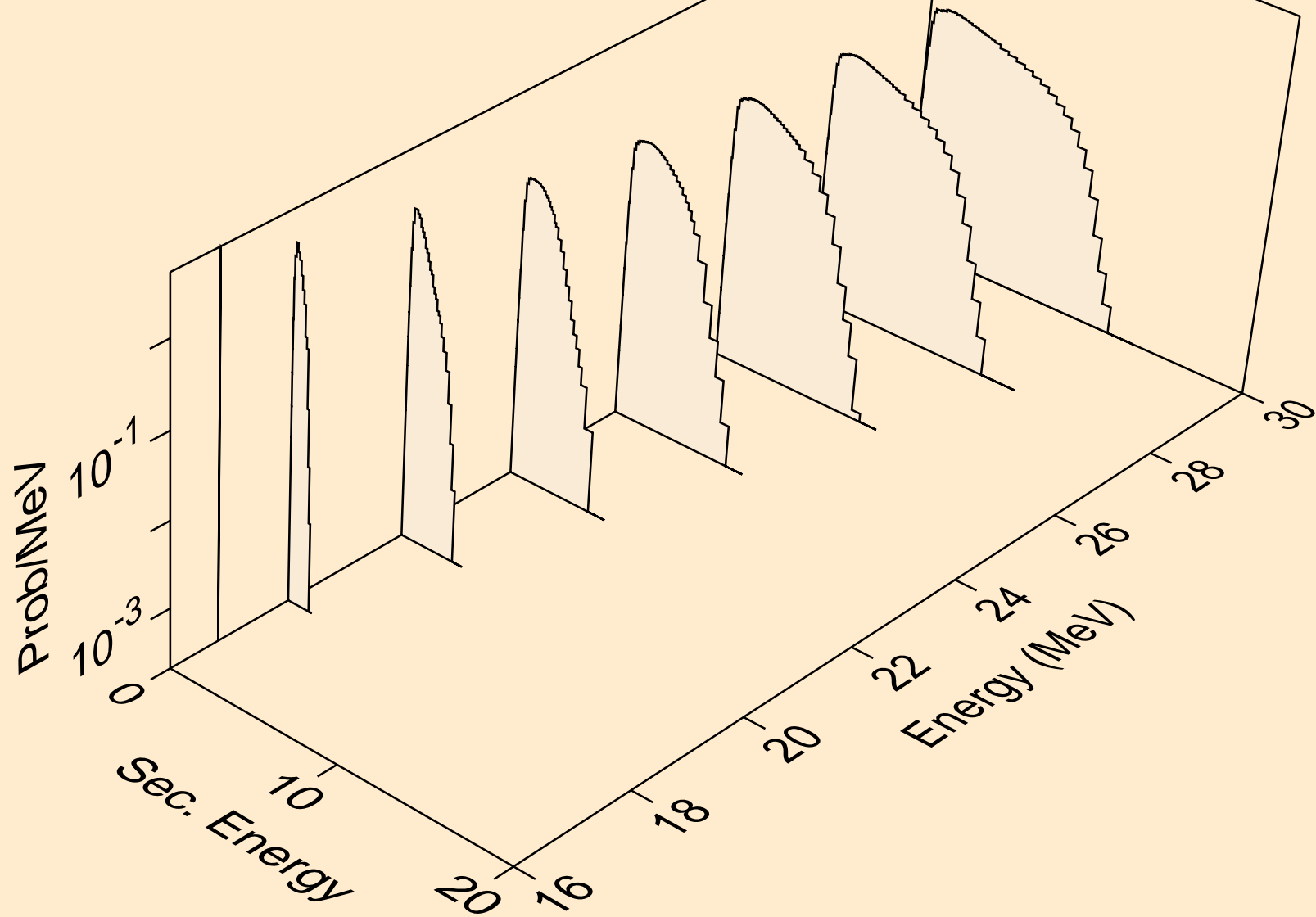

DB265 PROTON ACER TENDL-2021 LIBRARY; T=0.K  
neutrons from (p,n\*)a

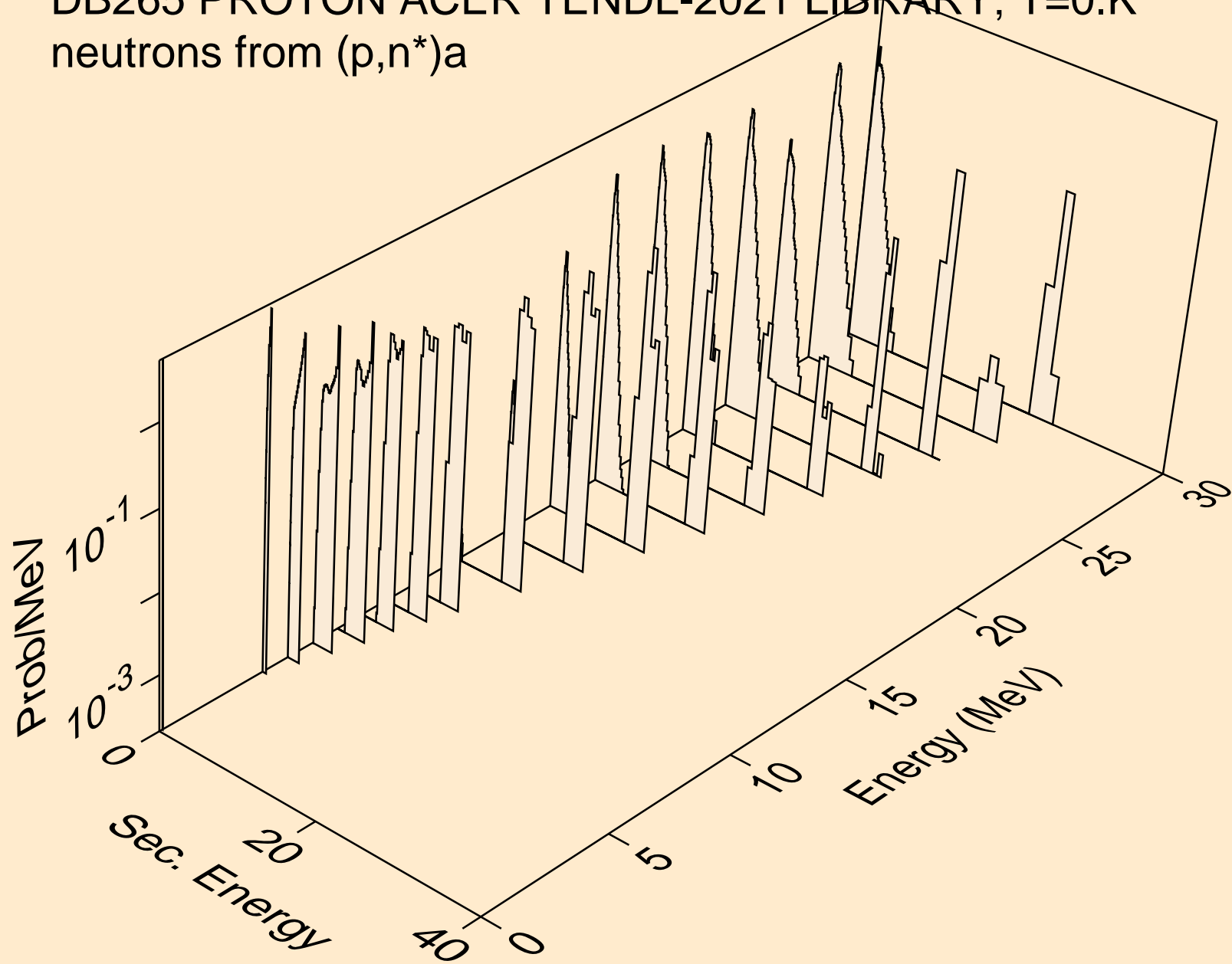

DB265 PROTON ACER TENDL-2021 LIBRARY; T=0.K  
neutrons from (p,2n)a

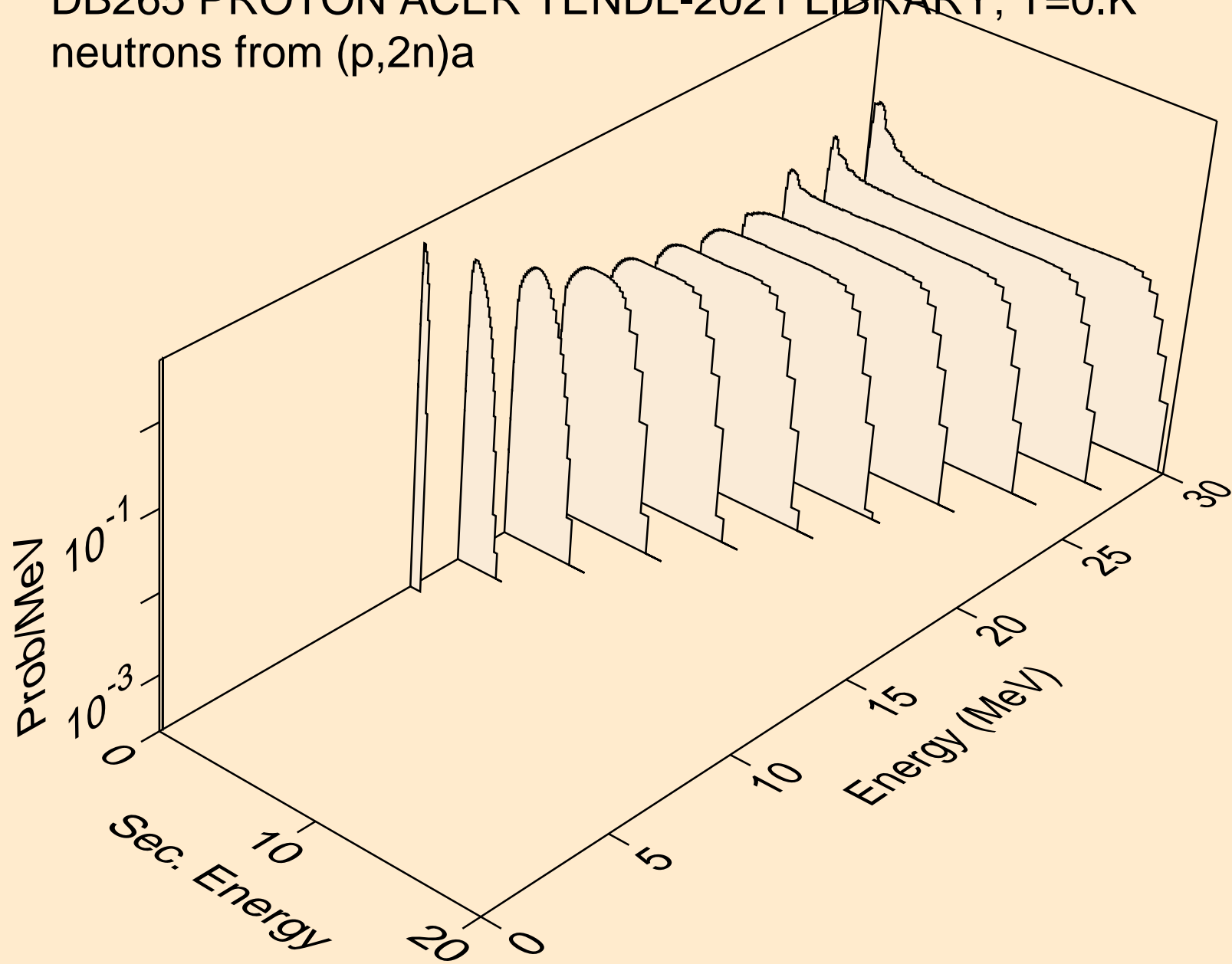

DB265 PROTON ACER TENDL-2021 LIBRARY; T=0.K  
neutrons from (p,n\*)p

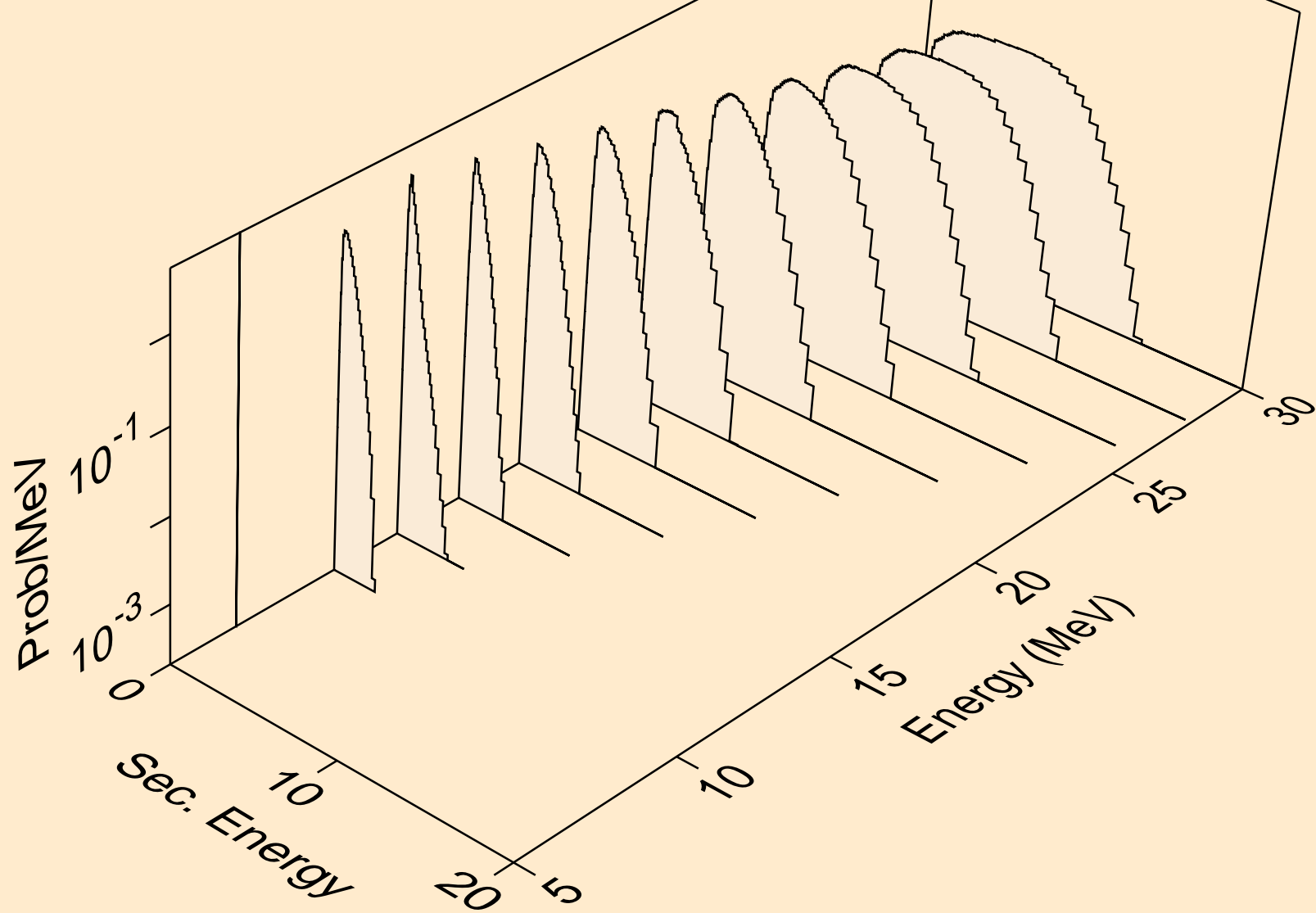

DB265 PROTON ACER TENDL-2021 LIBRARY; T=0.K  
neutrons from (p,n\*)d

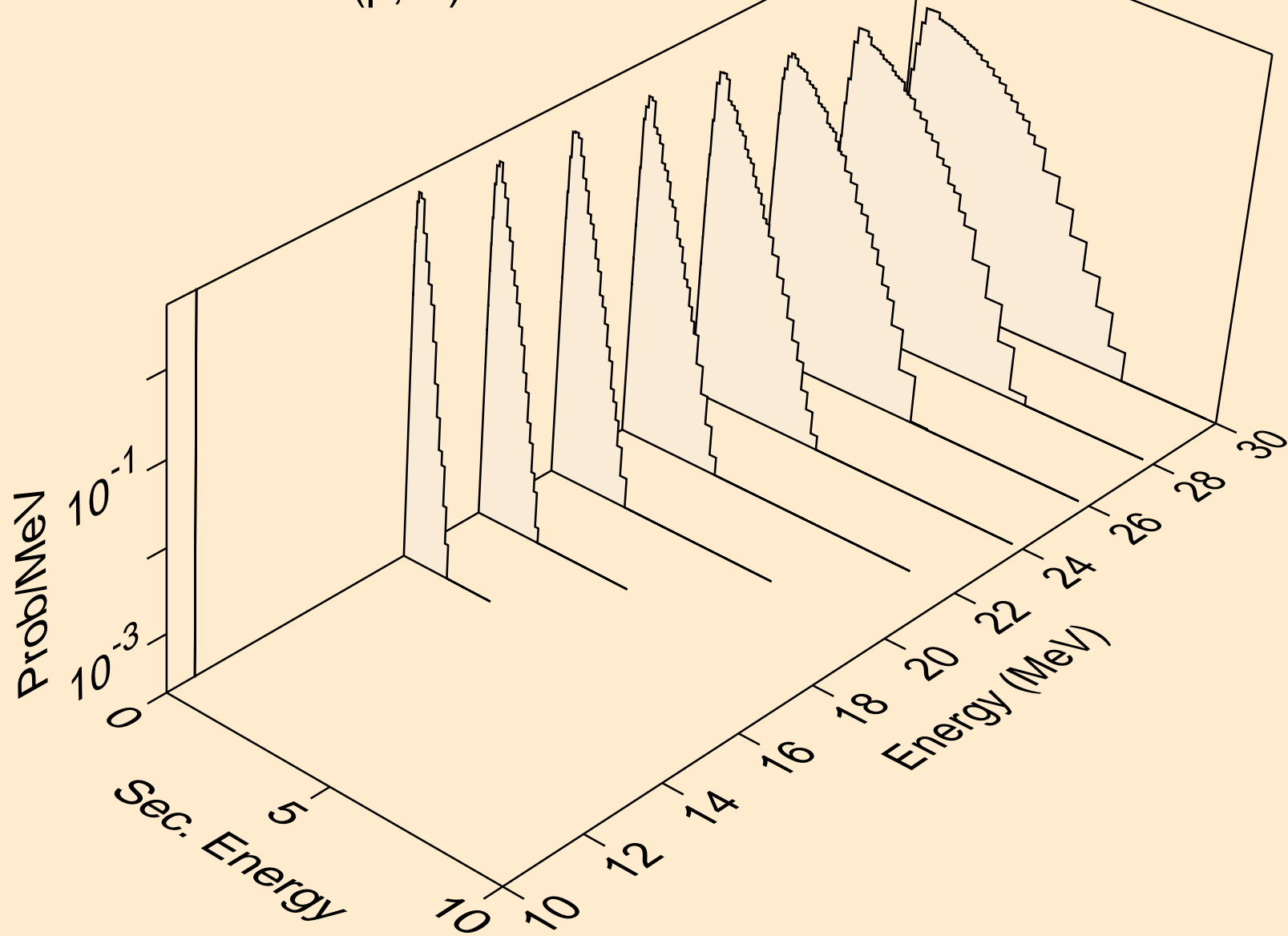



DB265 PROTON ACER TENDL-2021 LIBRARY; T=0.K  
neutrons from (p,n\*)t

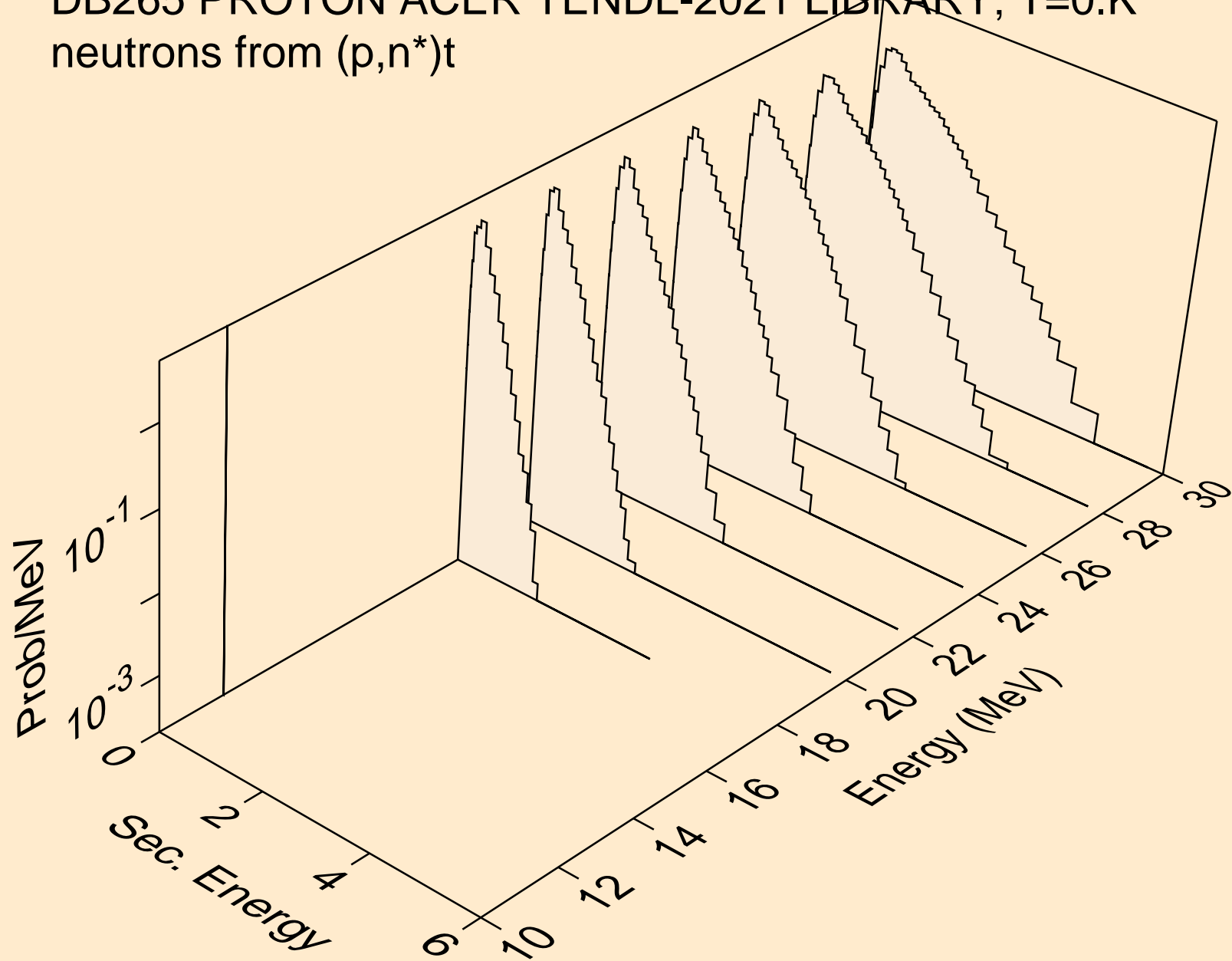

DB265 PROTON ACER TENDL-2021 LIBRARY; T=0.K  
neutrons from (p,2np)

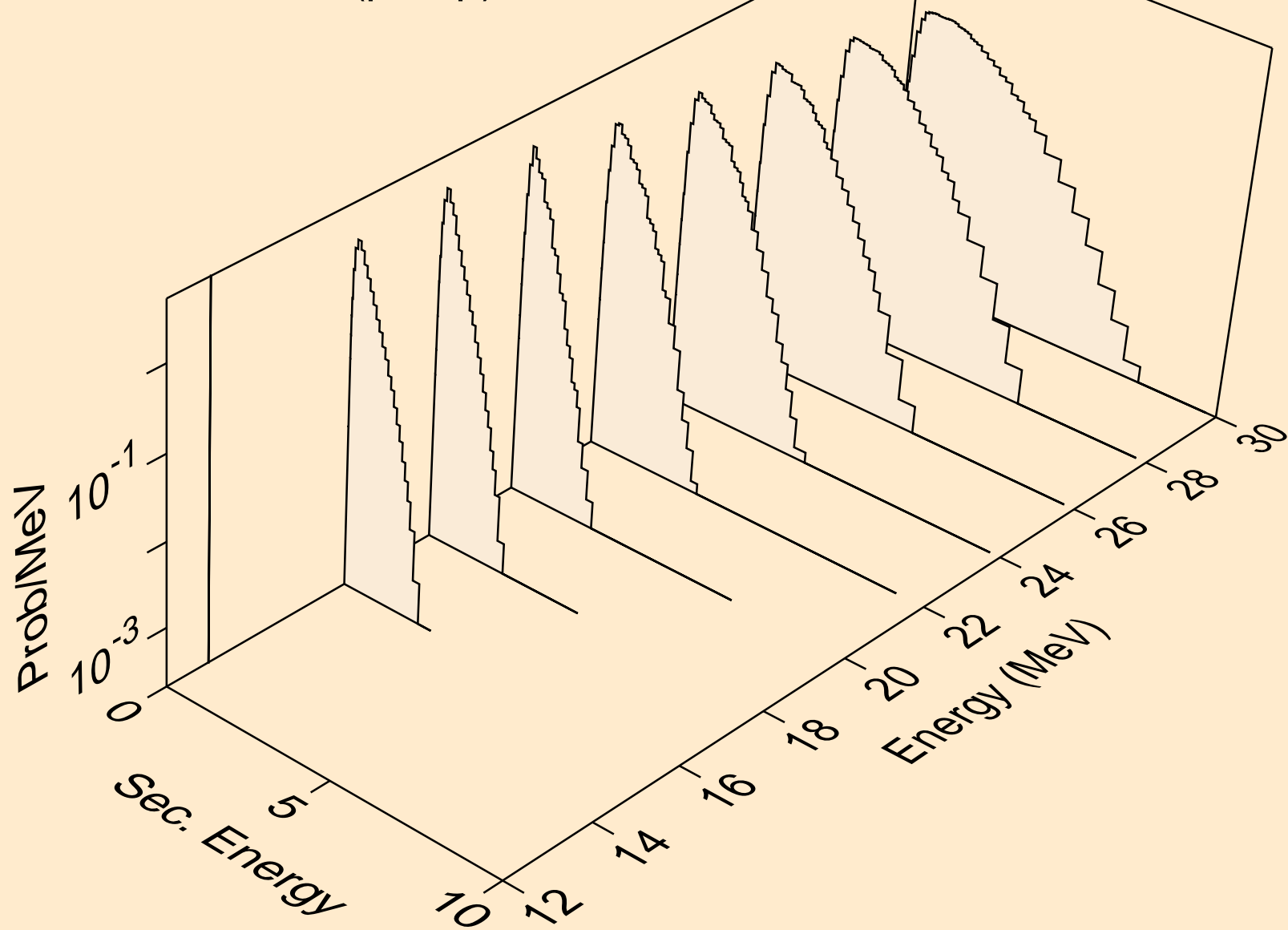

DB265 PROTON ACER TENDL-2021 LIBRARY; T=0.K  
deuterons from (p,x)

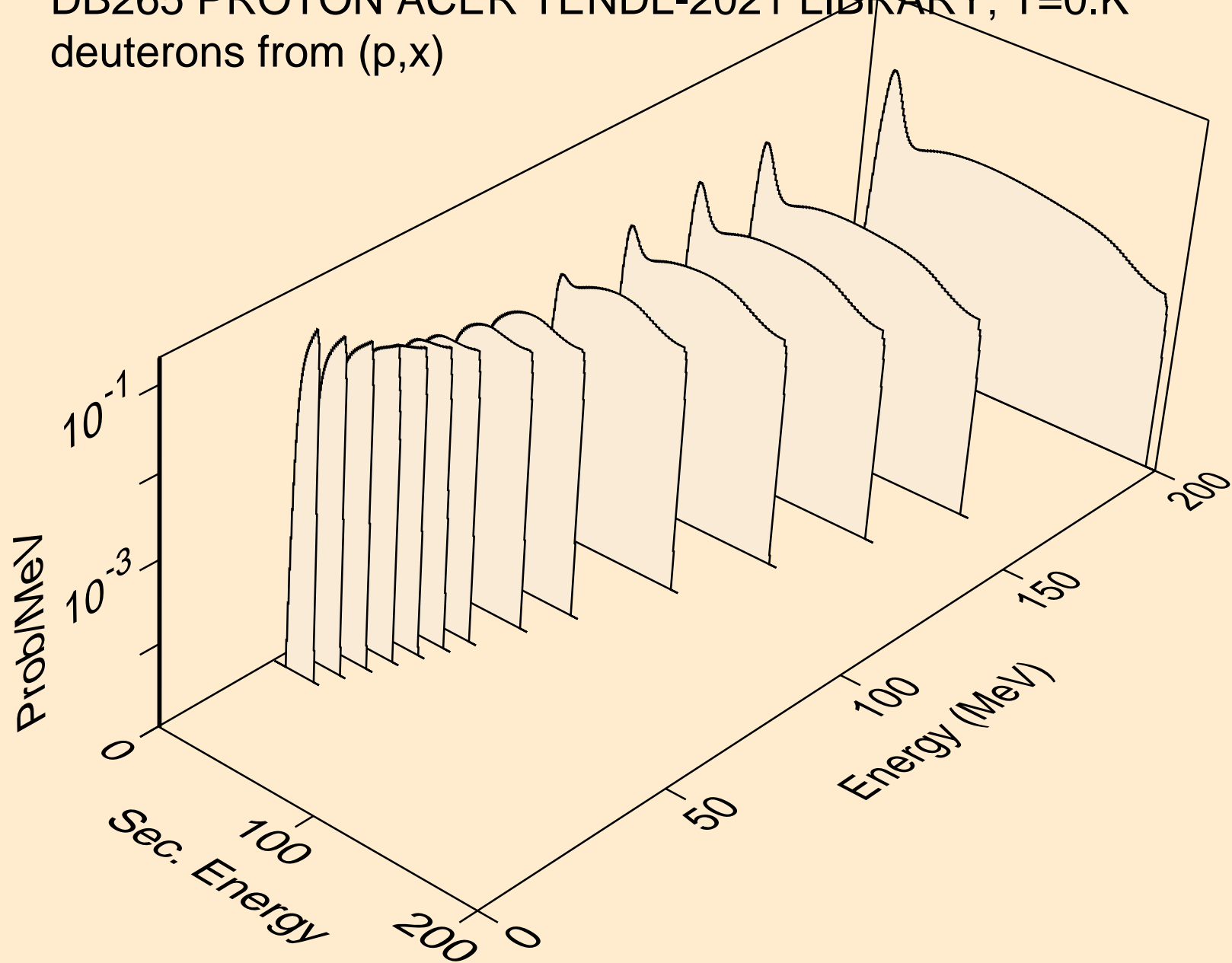

DB265 PROTON ACER TENDL-2021 LIBRARY; T=0.K  
deuterons from (p,n\*)d

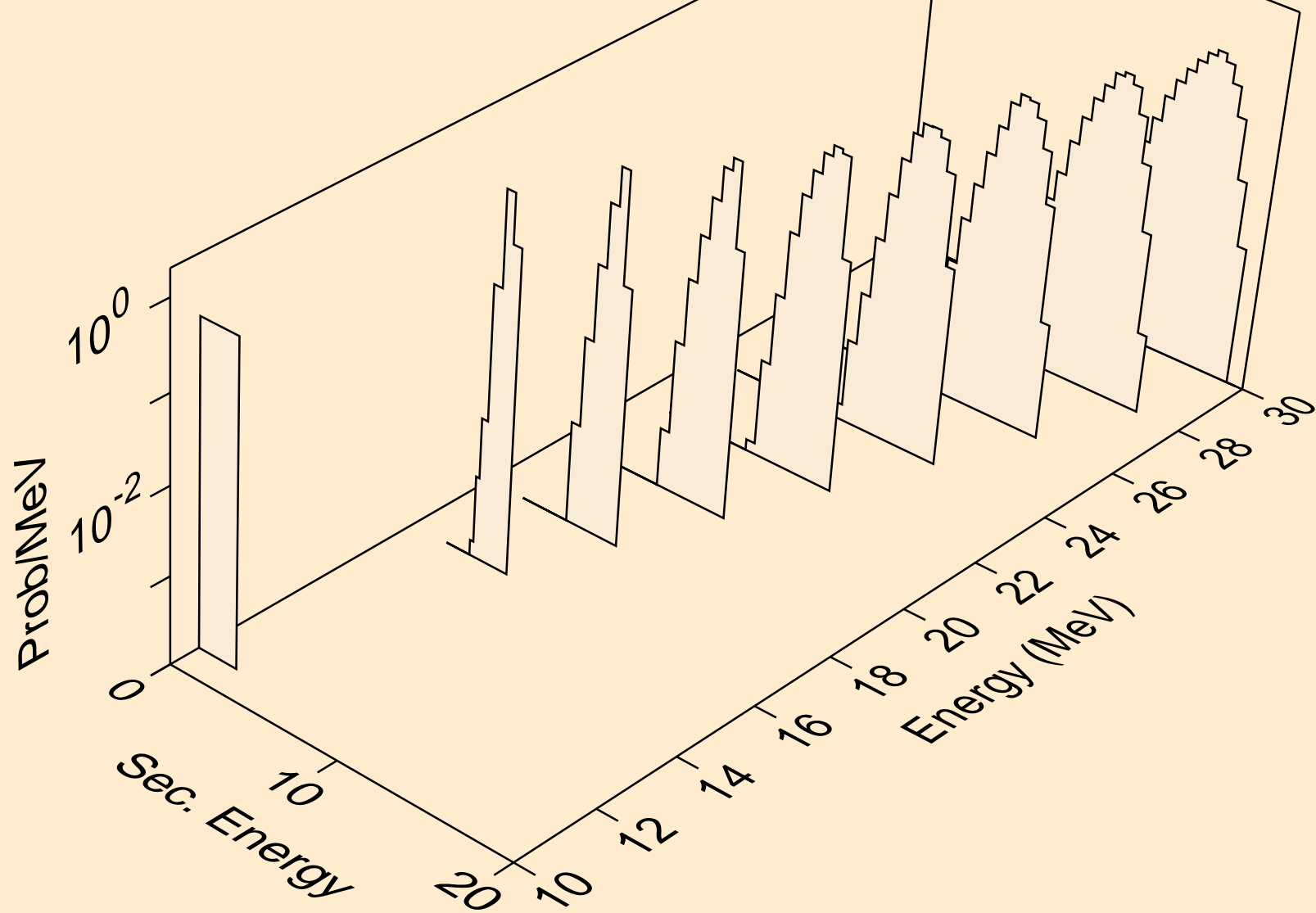

DB265 PROTON ACER TENDL-2021 LIBRARY; T=0.K  
deuterons from (p,d)

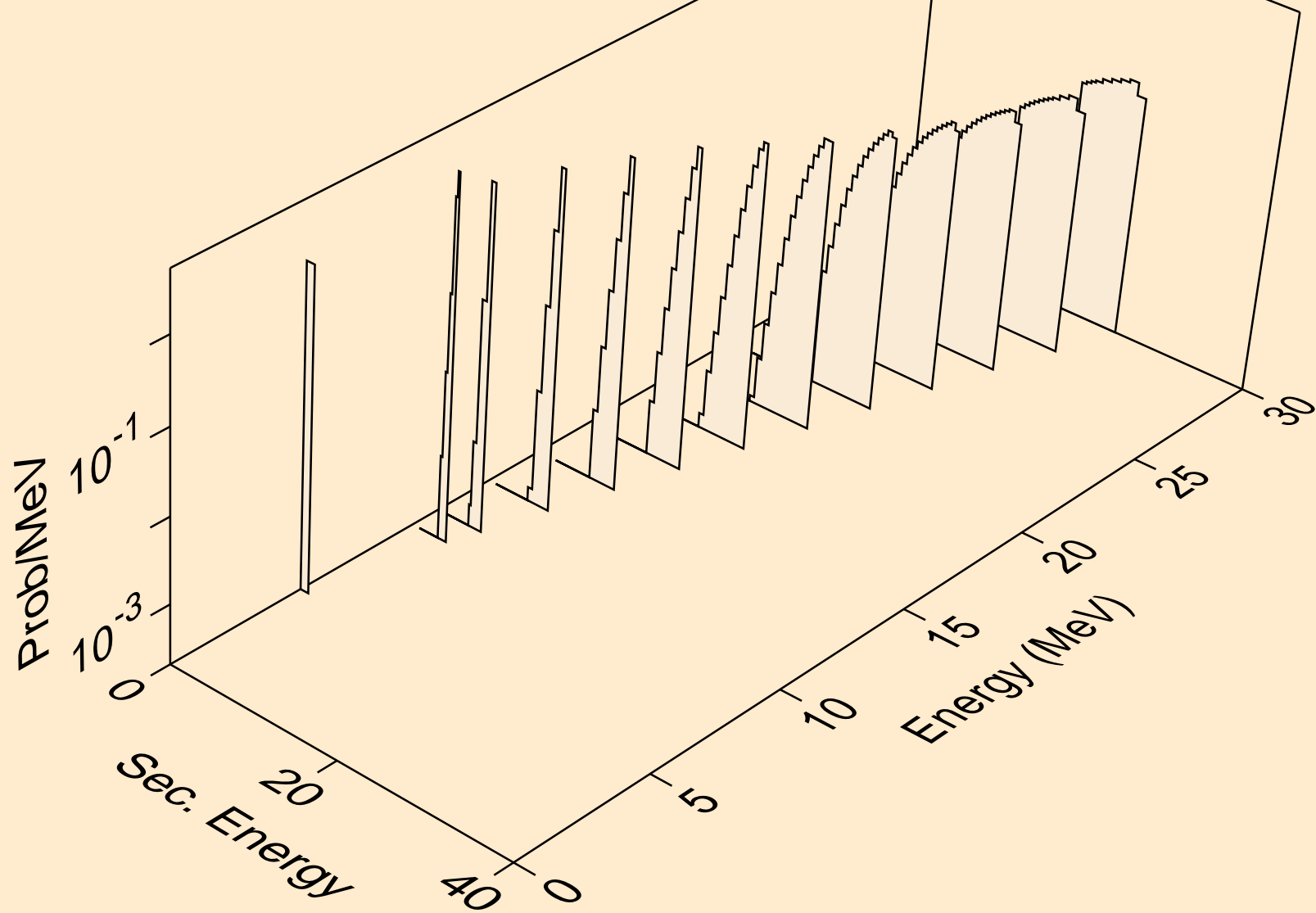

DB265 PROTON ACER TENDL-2021 LIBRARY; T=0.K  
tritons from (p,x)

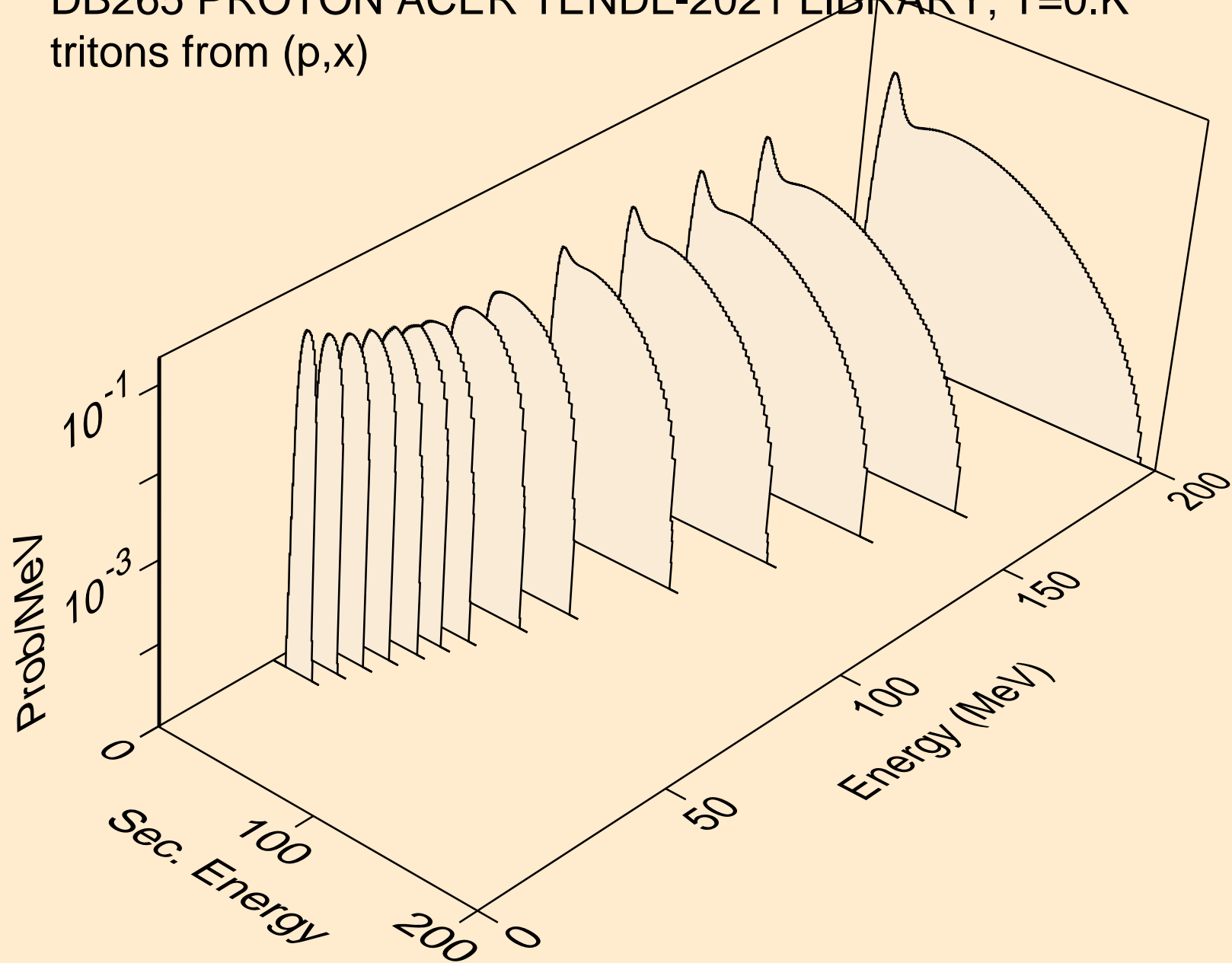

# DB265 PROTON ACER TENDL-2021 LIBRARY; T=0.K

tritons from (p,n\*)t

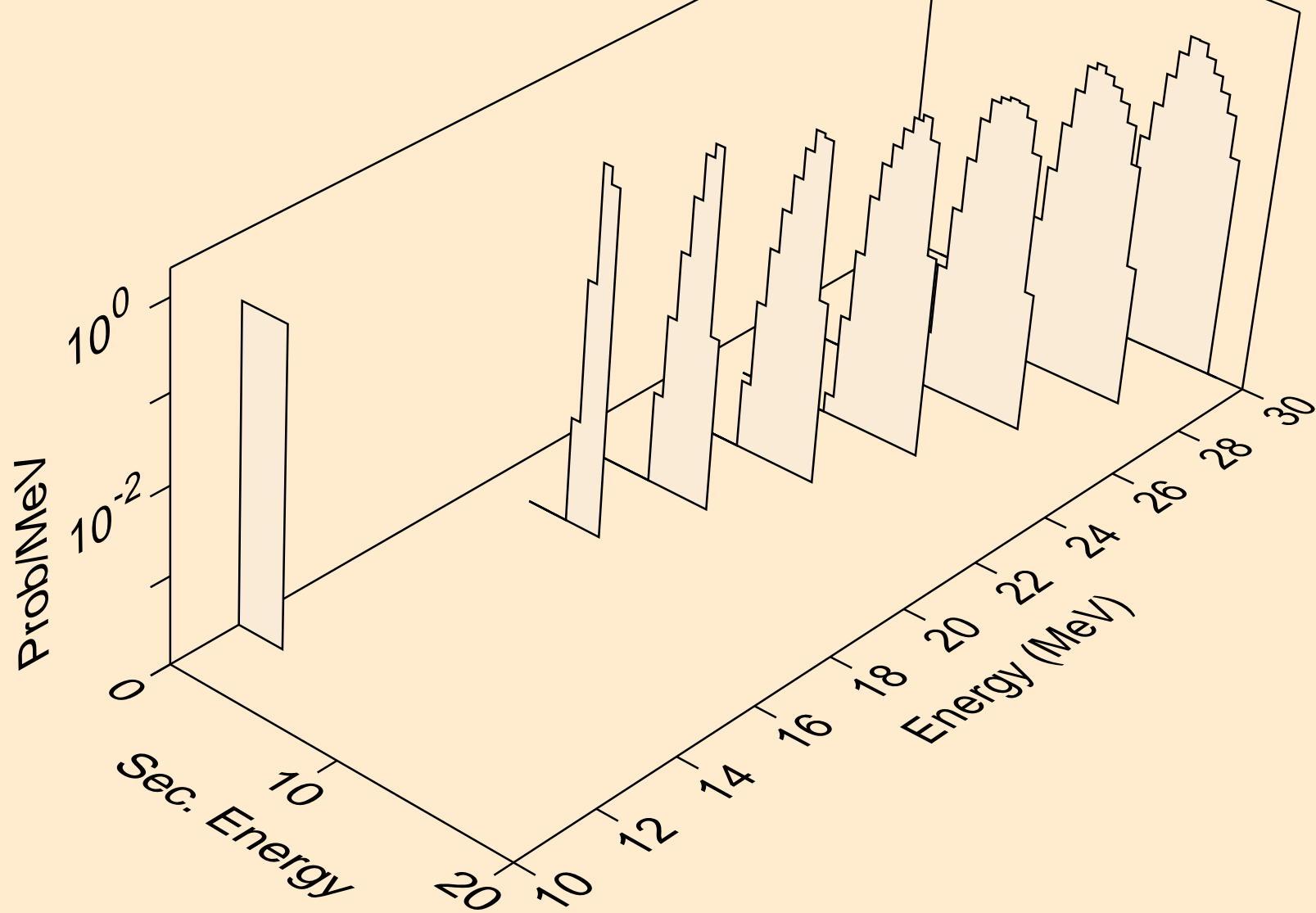

DB265 PROTON ACER TENDL-2021 LIBRARY; T=0.K  
tritons from (p,t)

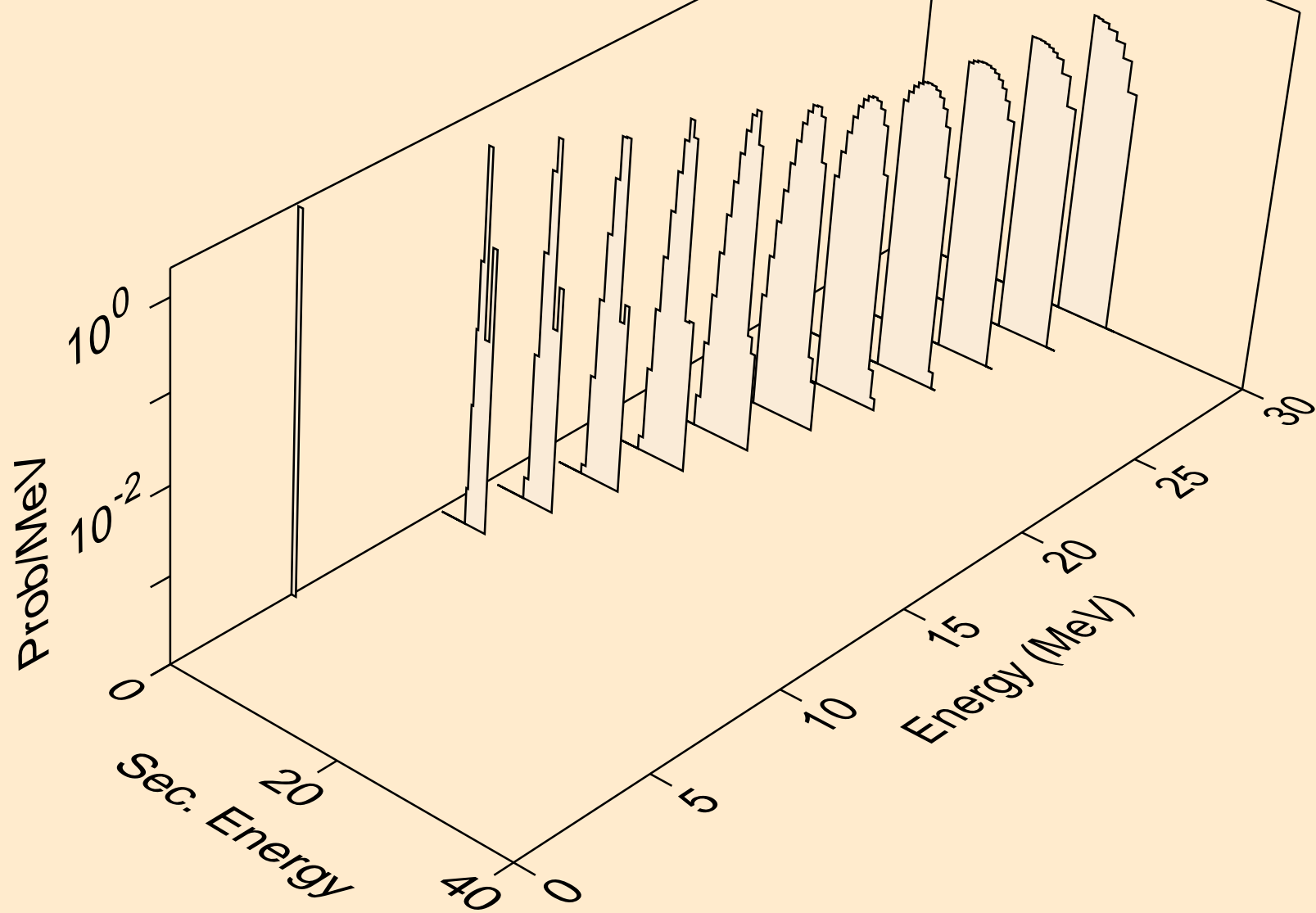



DB265 PROTON ACER TENDL-2021 LIBRARY; T=0.K  
he3s from (p,x)

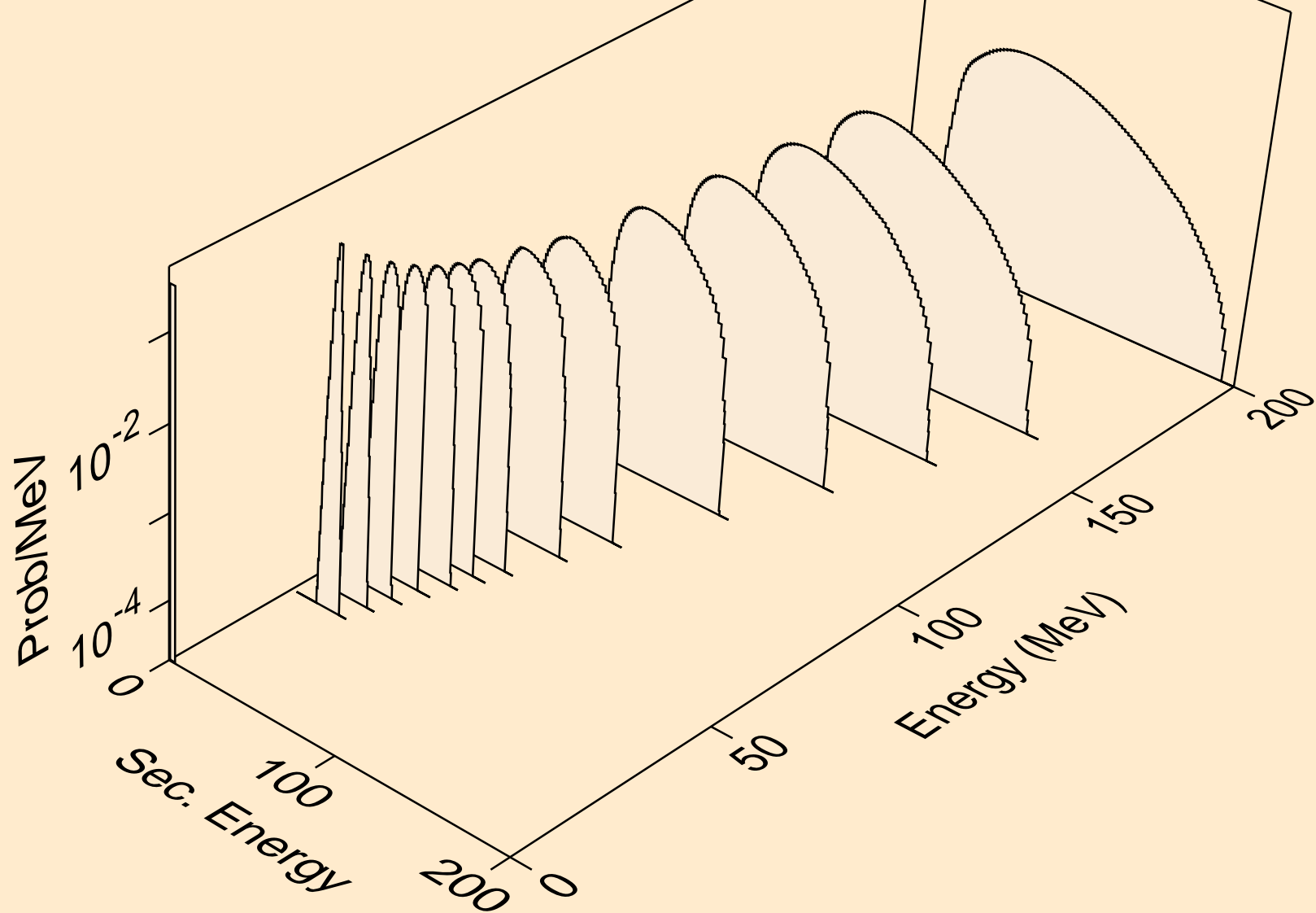

DB265 PROTON ACER TENDL-2021 LIBRARY; T=0.K  
he3s from (p,he3)

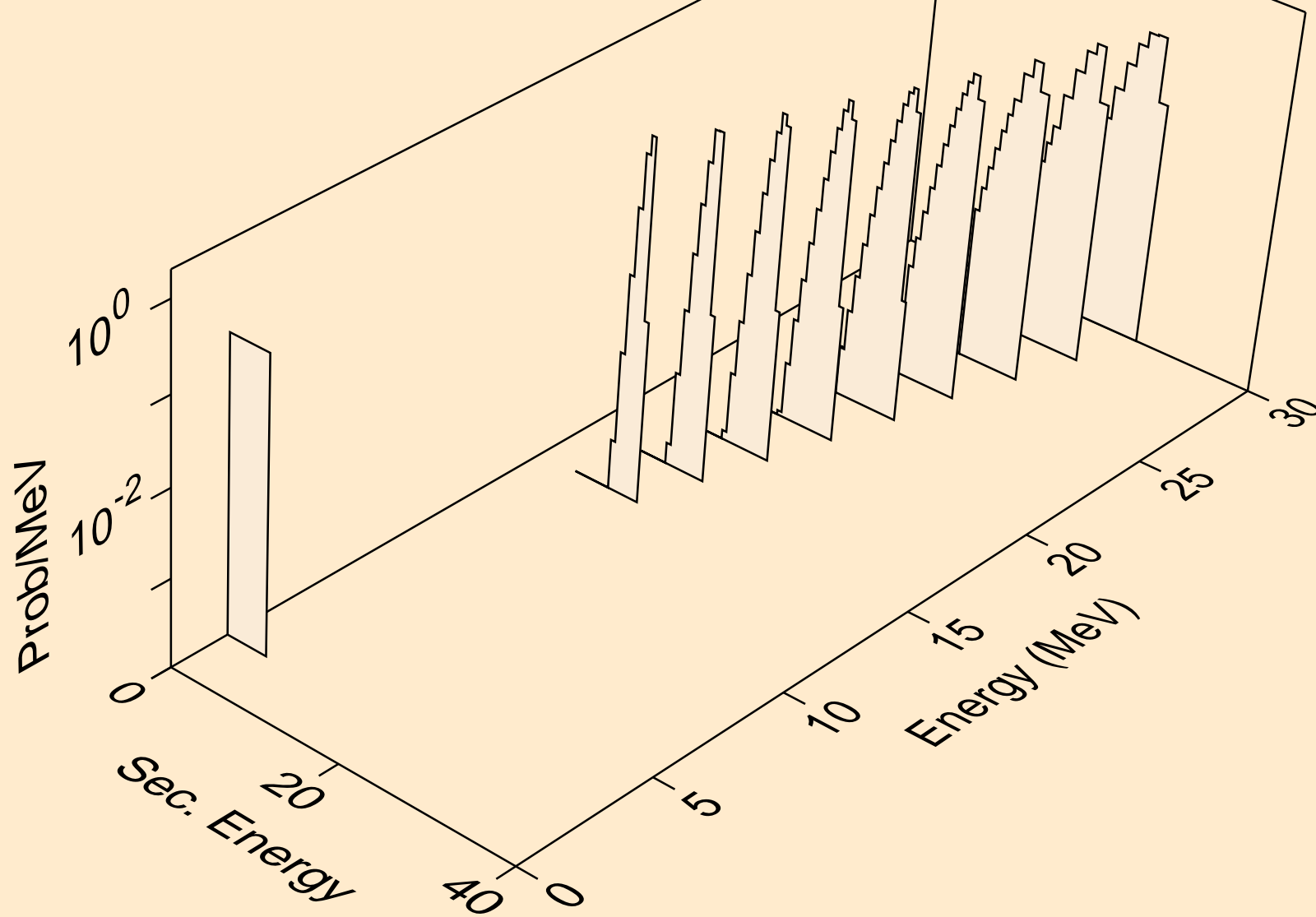

DB265 PROTON ACER TENDL-2021 LIBRARY; T=0.K  
alphas from (p,x)

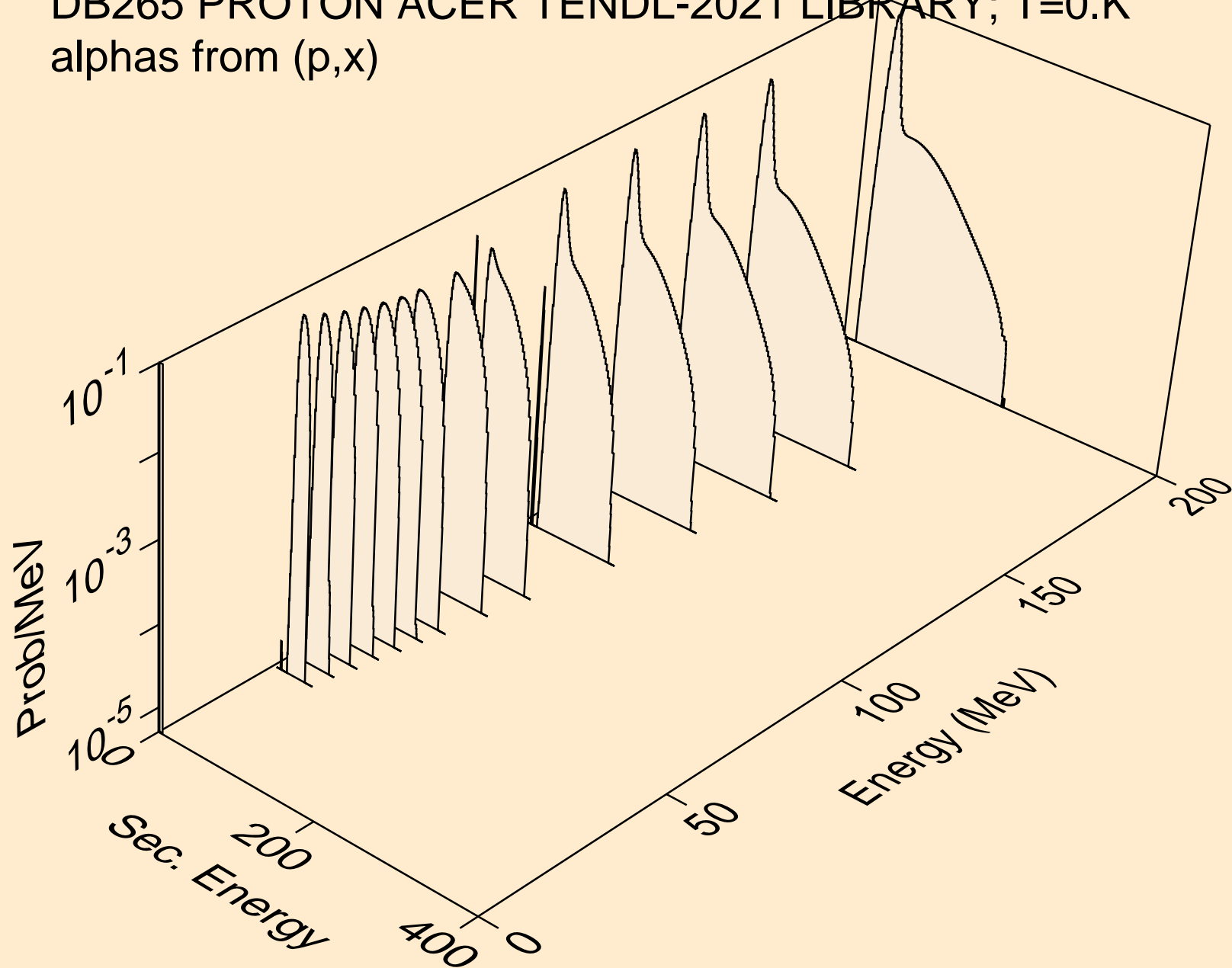

DB265 PROTON ACER TENDL-2021 LIBRARY; T=0.K  
alphas from (p,n\*)a

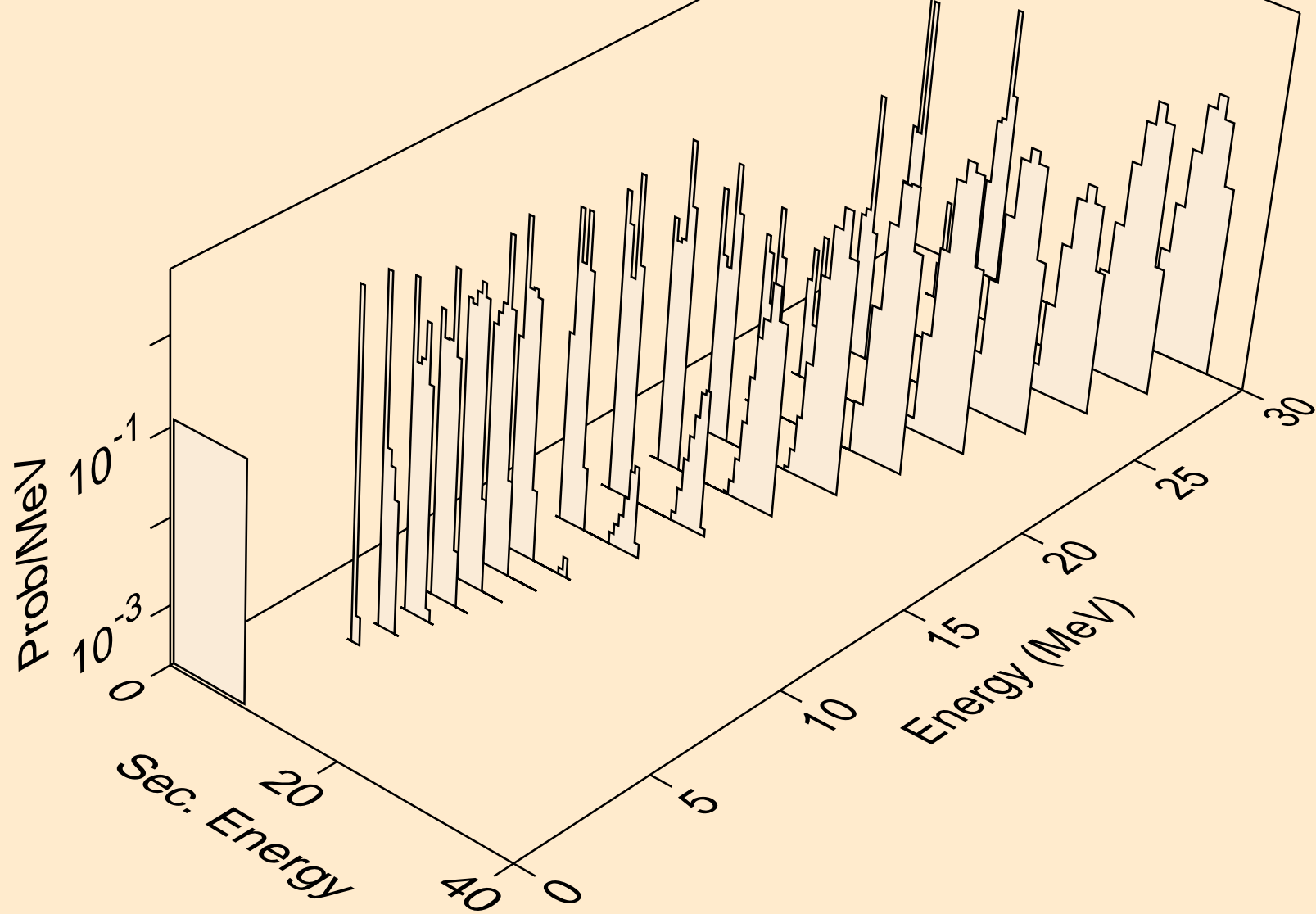

DB265 PROTON ACER TENDL-2021 LIBRARY; T=0.K  
alphas from (p,2n)a

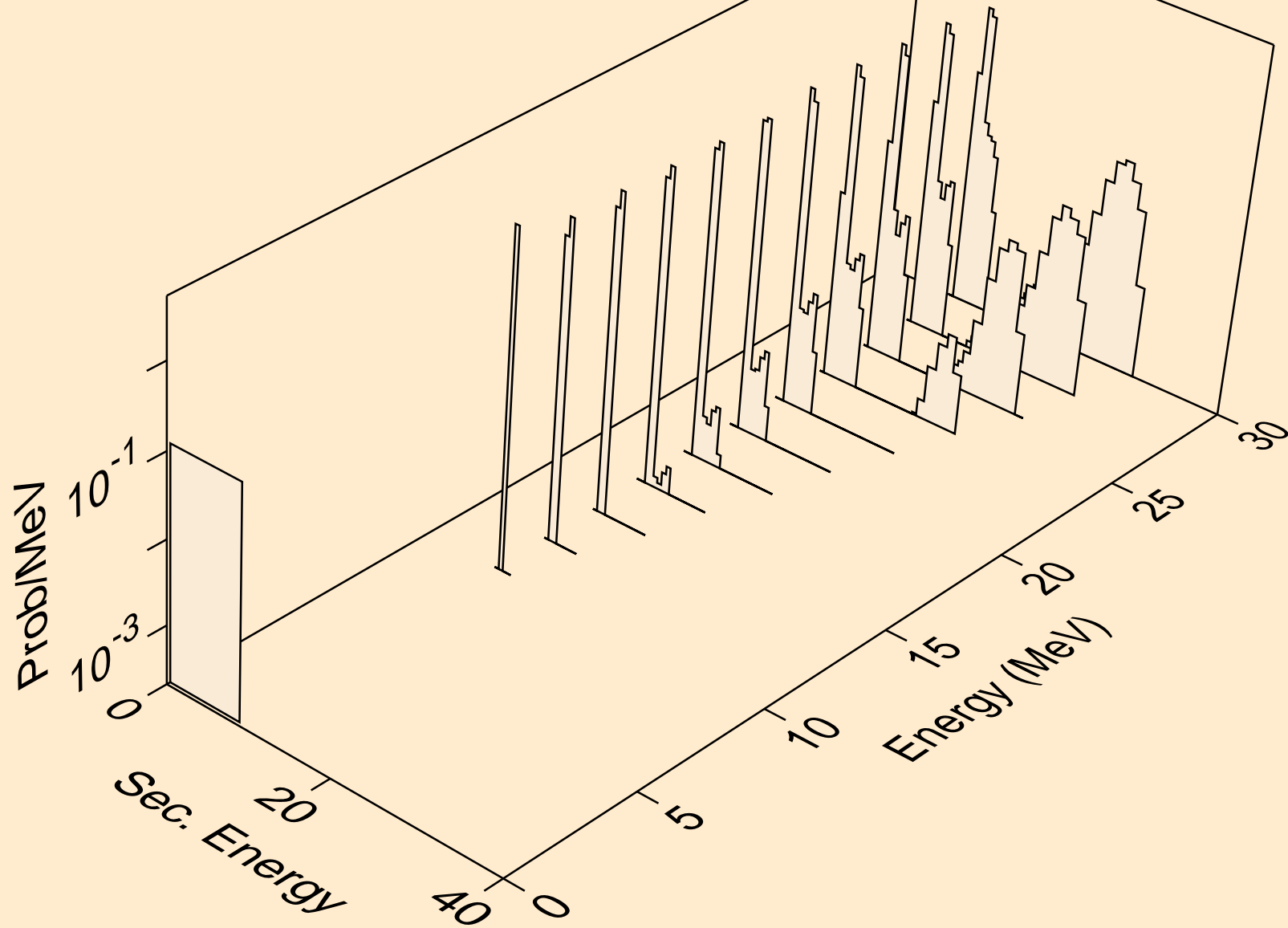

DB265 PROTON ACER TENDL-2021 LIBRARY; T=0.K  
alphas from (p,a)

