

DS281 PROTON ACER TENDL-2021 LIBRARY; T=0.K
Principal cross sections

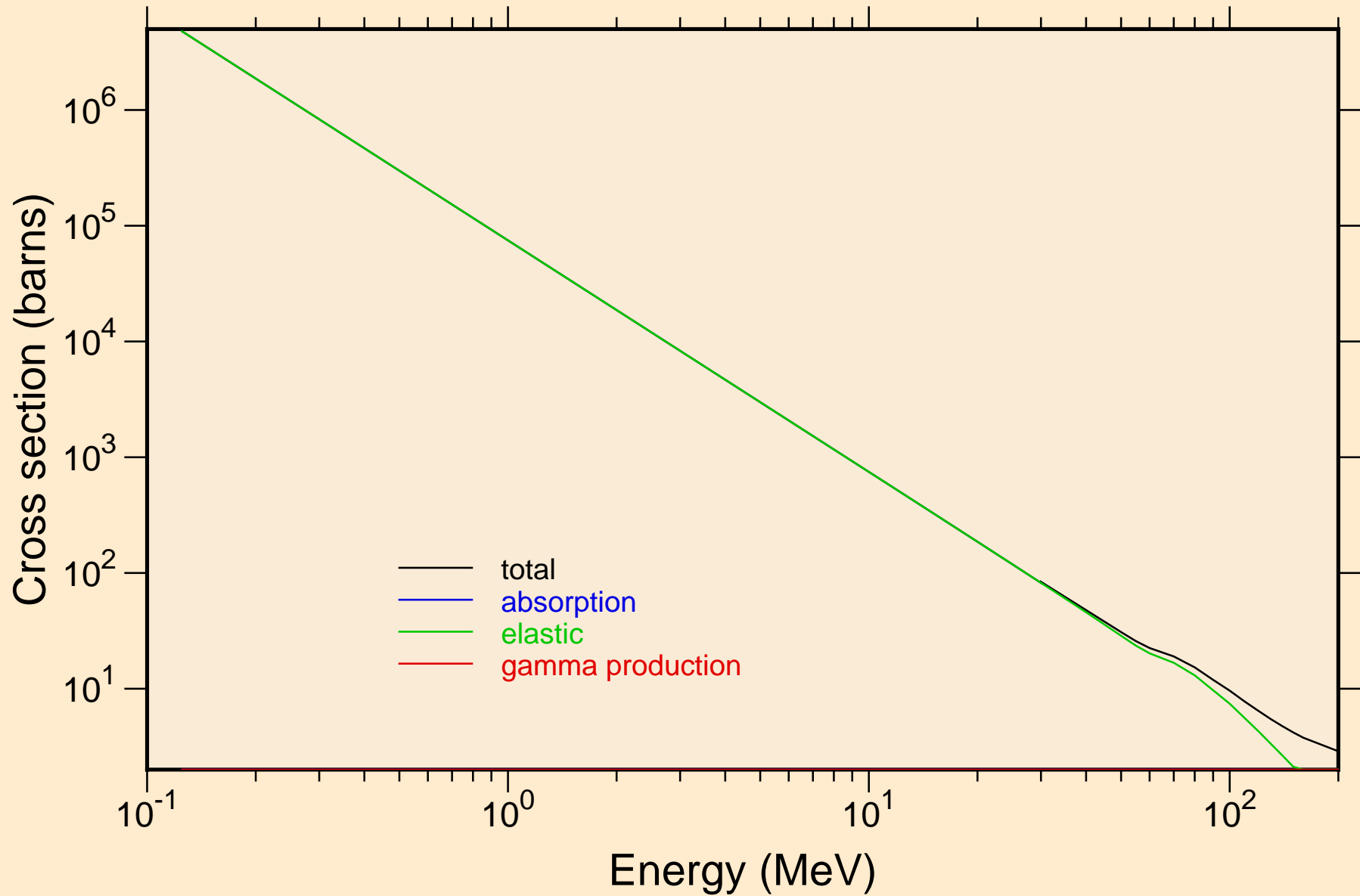

DS281 PROTON ACER TENDL-2021 LIBRARY; T=0.K

Heating

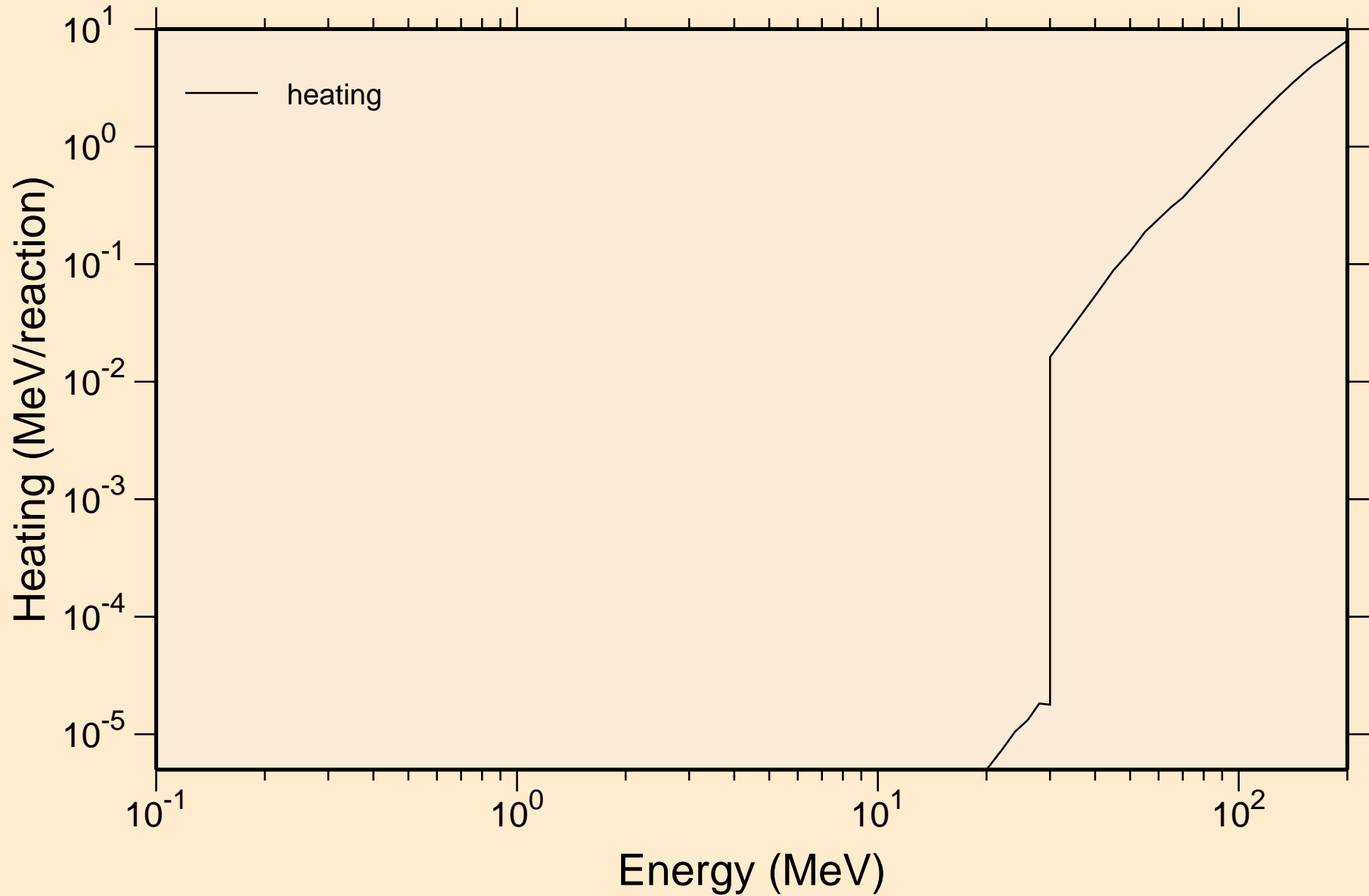

DS281 PROTON ACER TENDL-2021 LIBRARY; T=0.K

Principal cross sections

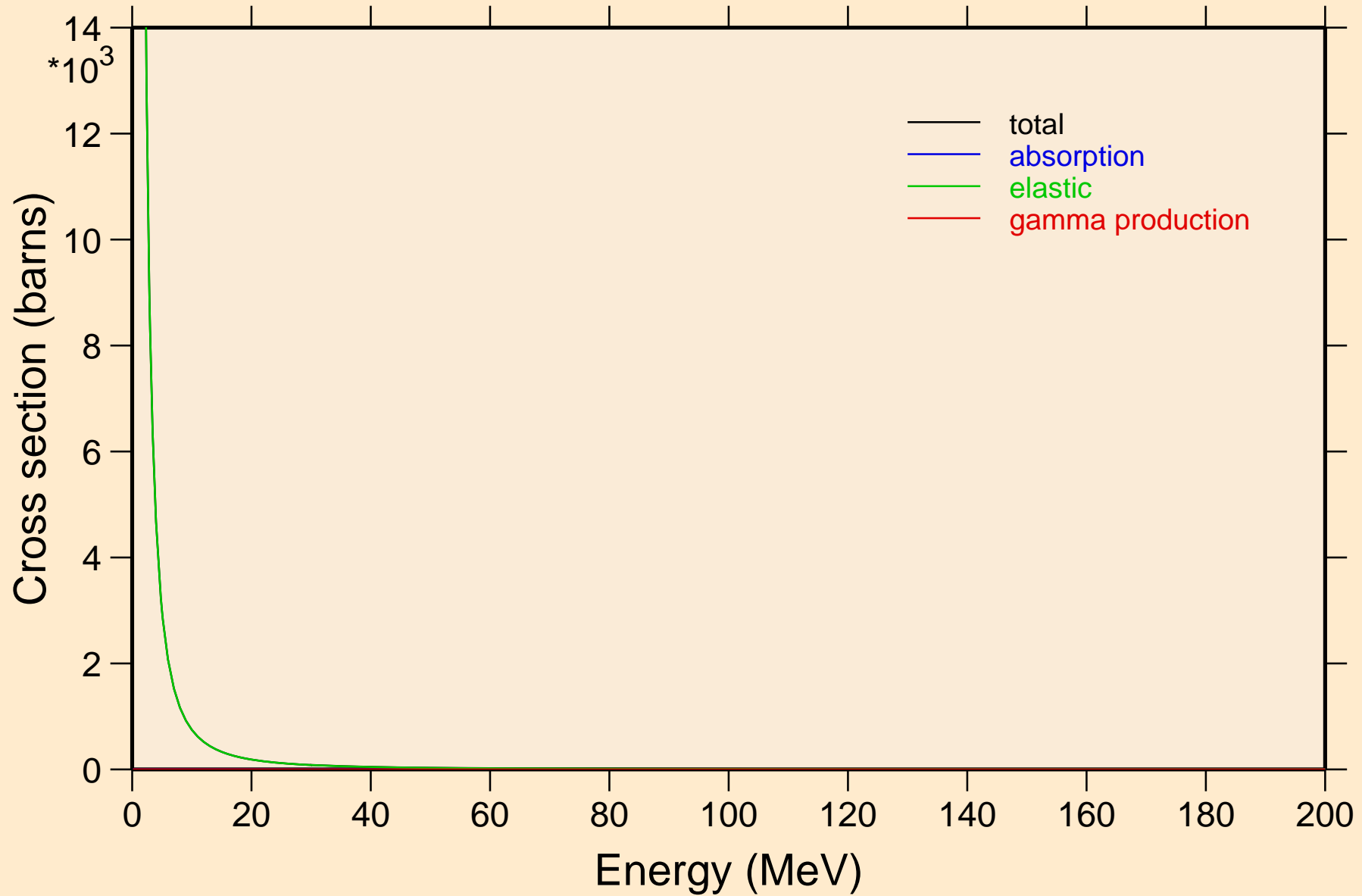

DS281 PROTON ACER TENDL-2021 LIBRARY; T=0.K

Heating

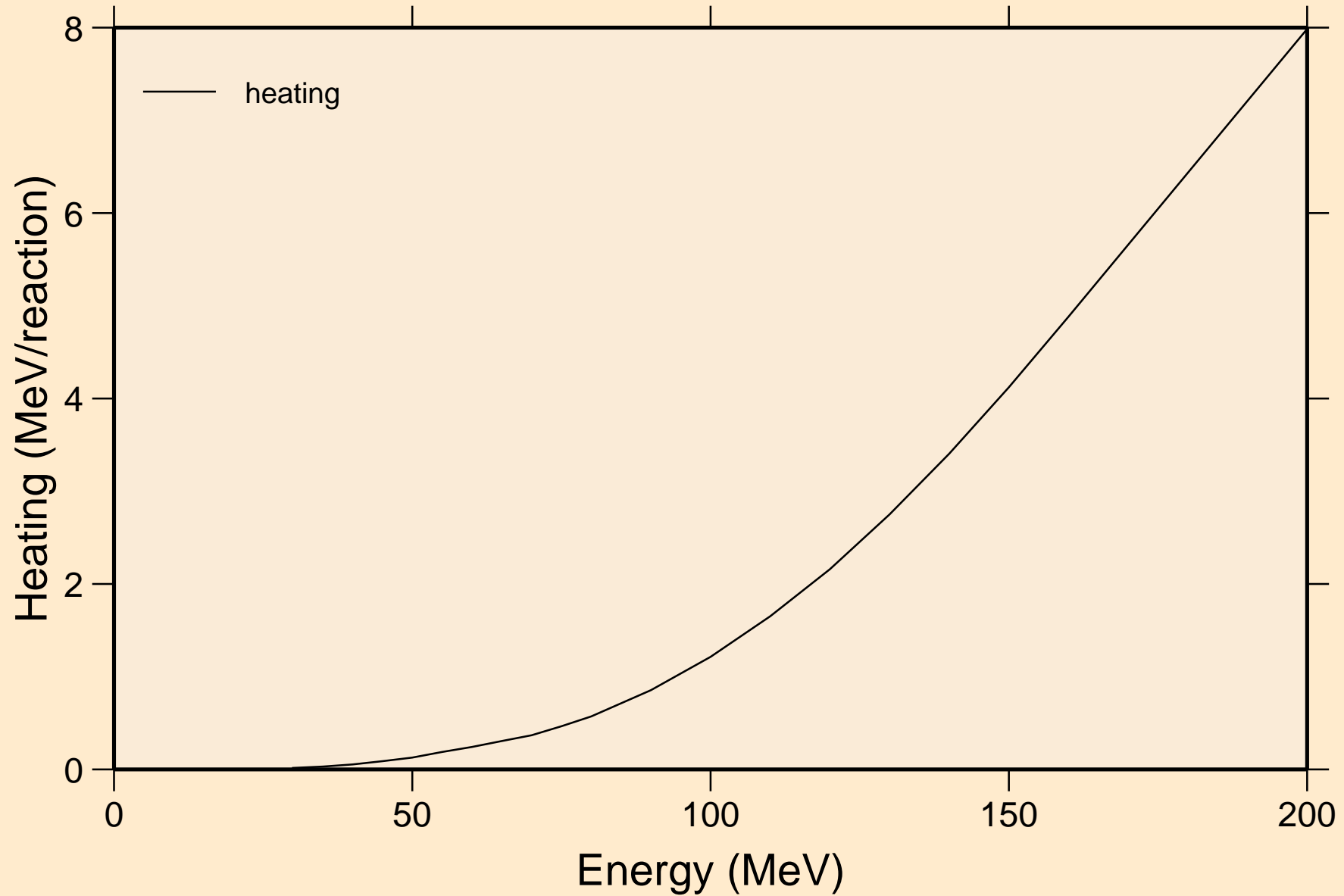

DS281 PROTON ACER TENDL-2021 LIBRARY; T=0.K
Threshold reactions

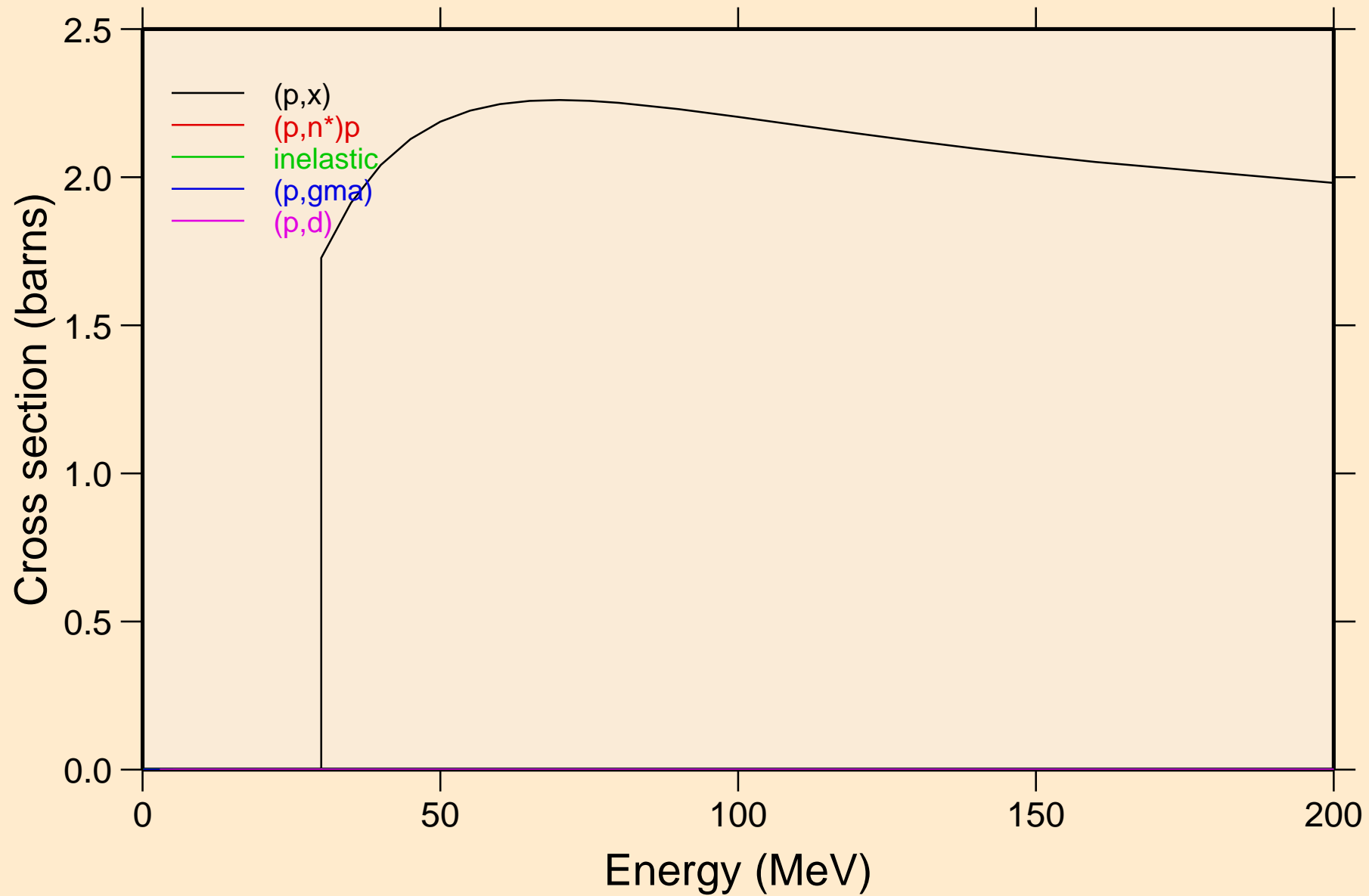

DS281 PROTON ACER TENDL-2021 LIBRARY; T=0.K
Threshold reactions

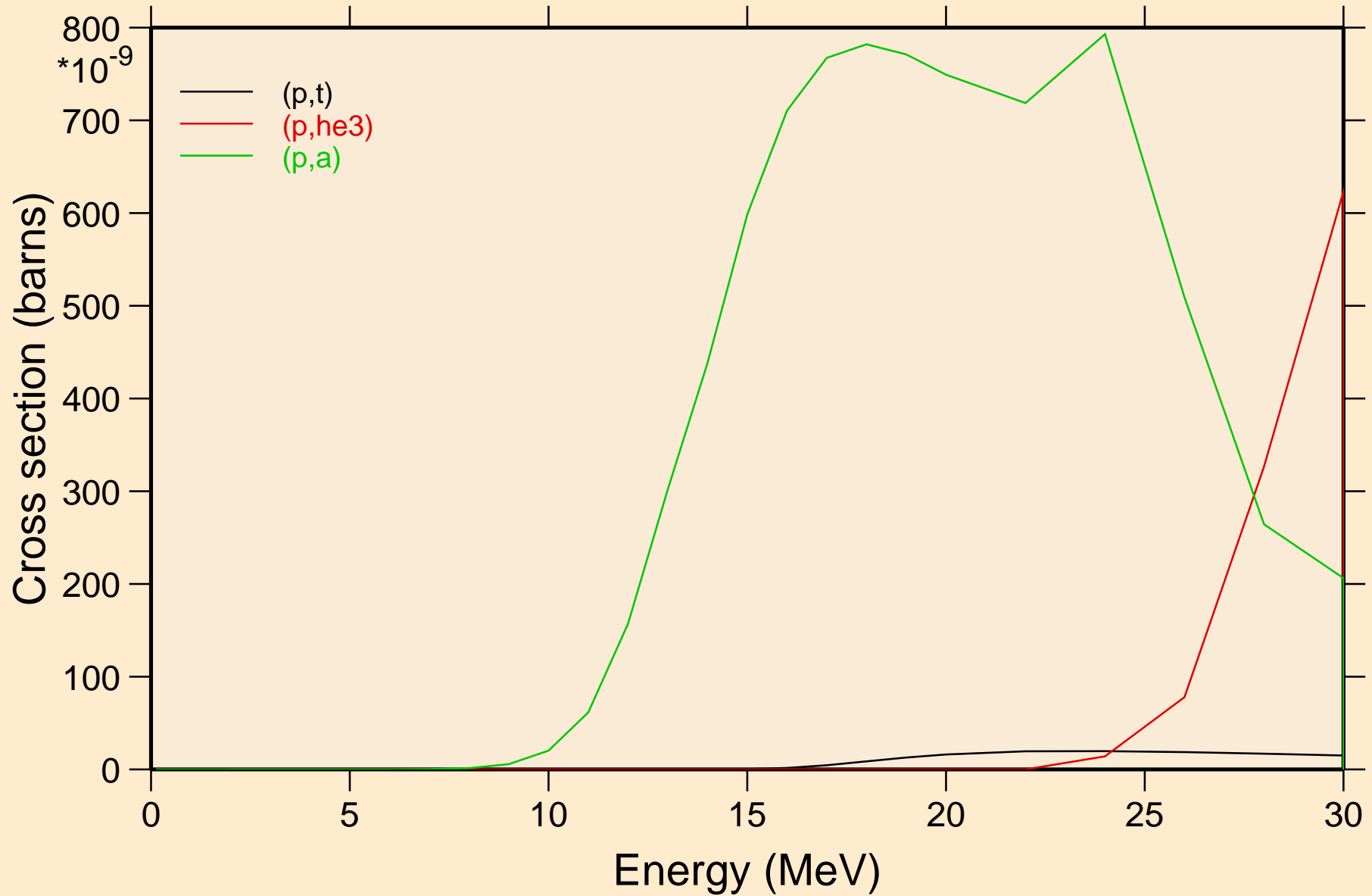

DS281 PROTON ACER TENDL-2021 LIBRARY; T=0.K
angular distribution for elastic

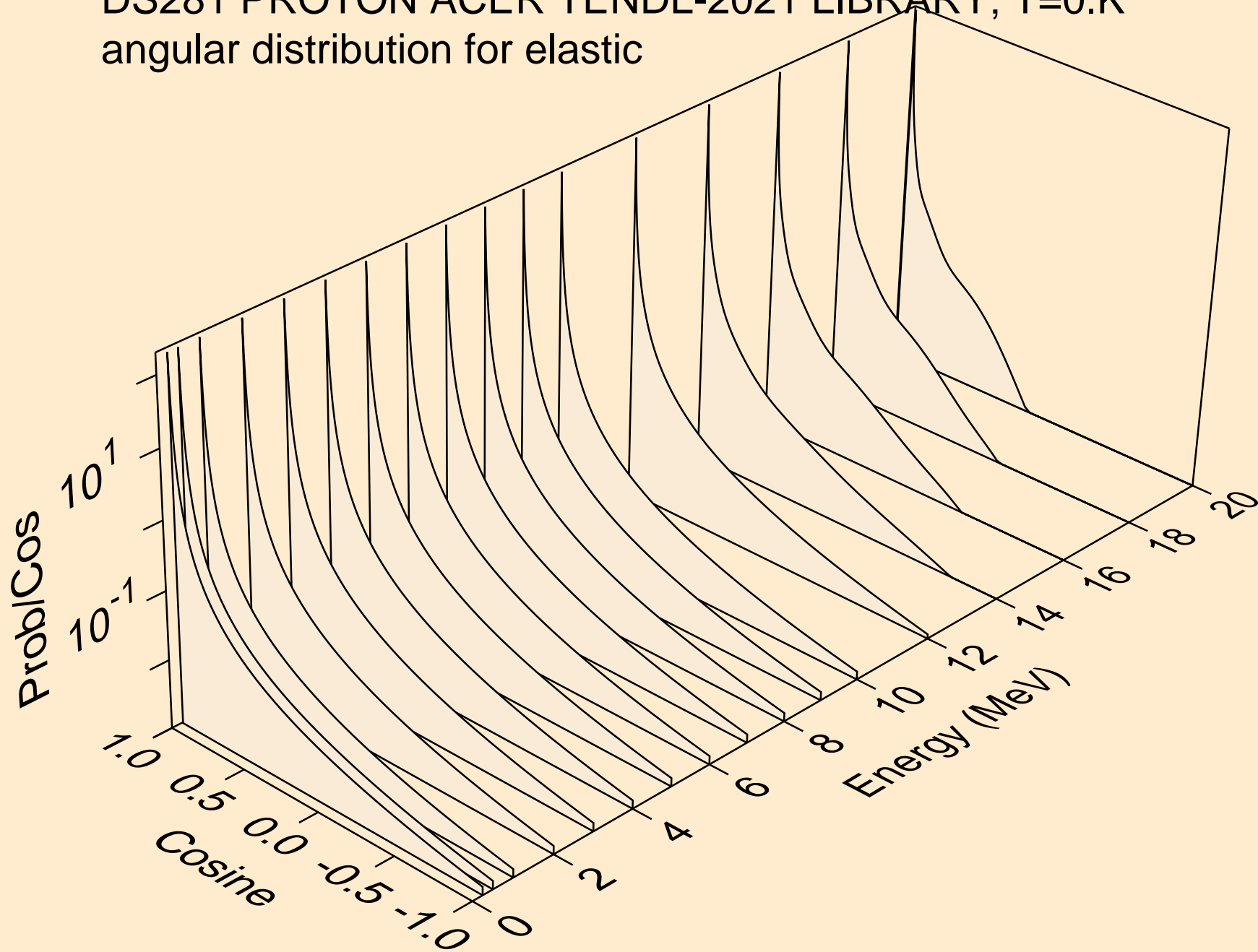

DS281 PROTON ACER TENDL-2021 LIBRARY; T=0.K
angular distribution for elastic

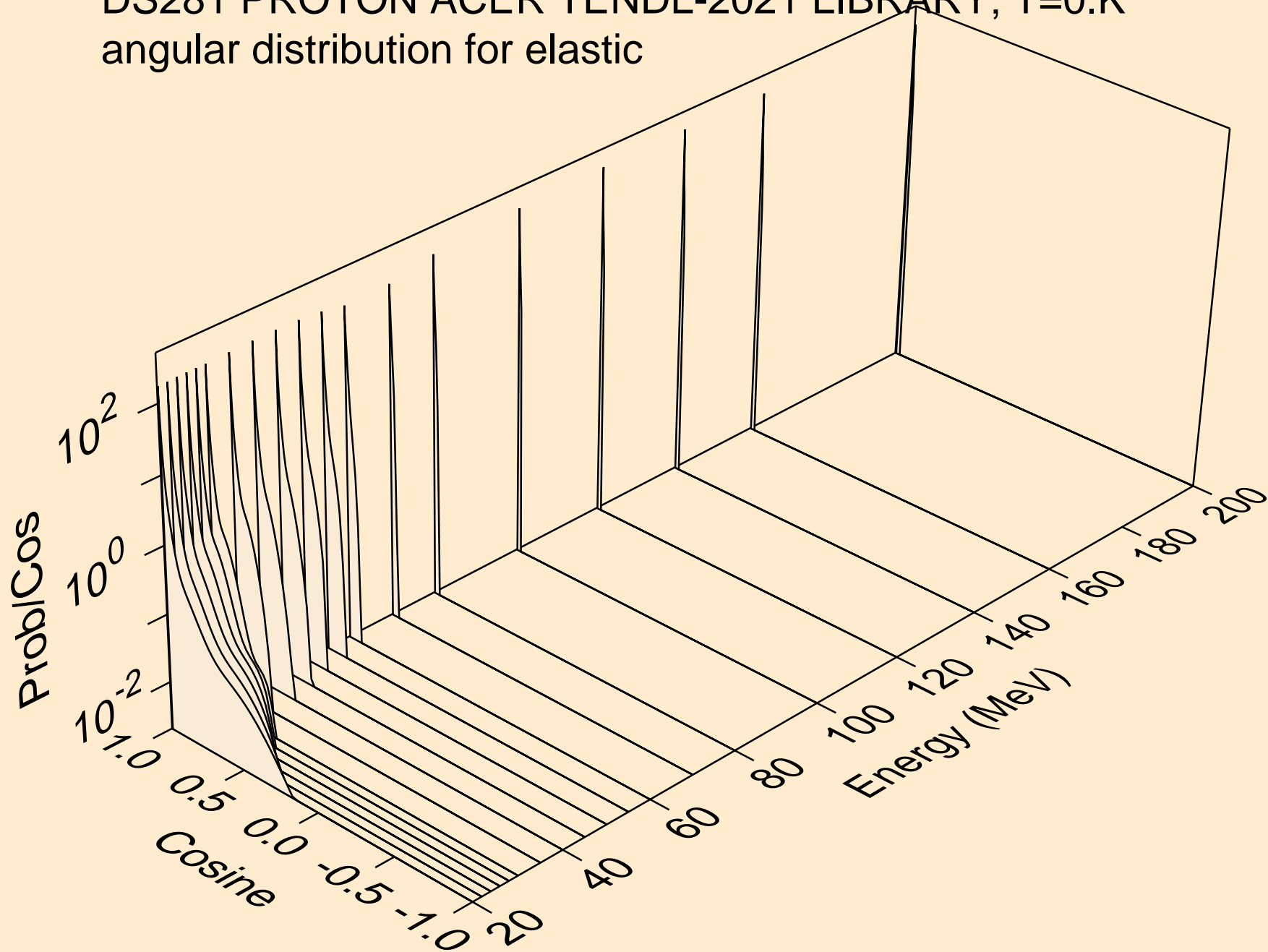

DS281 PROTON ACER TENDL-2021 LIBRARY; T=0.K
Proton emission for (p,x)

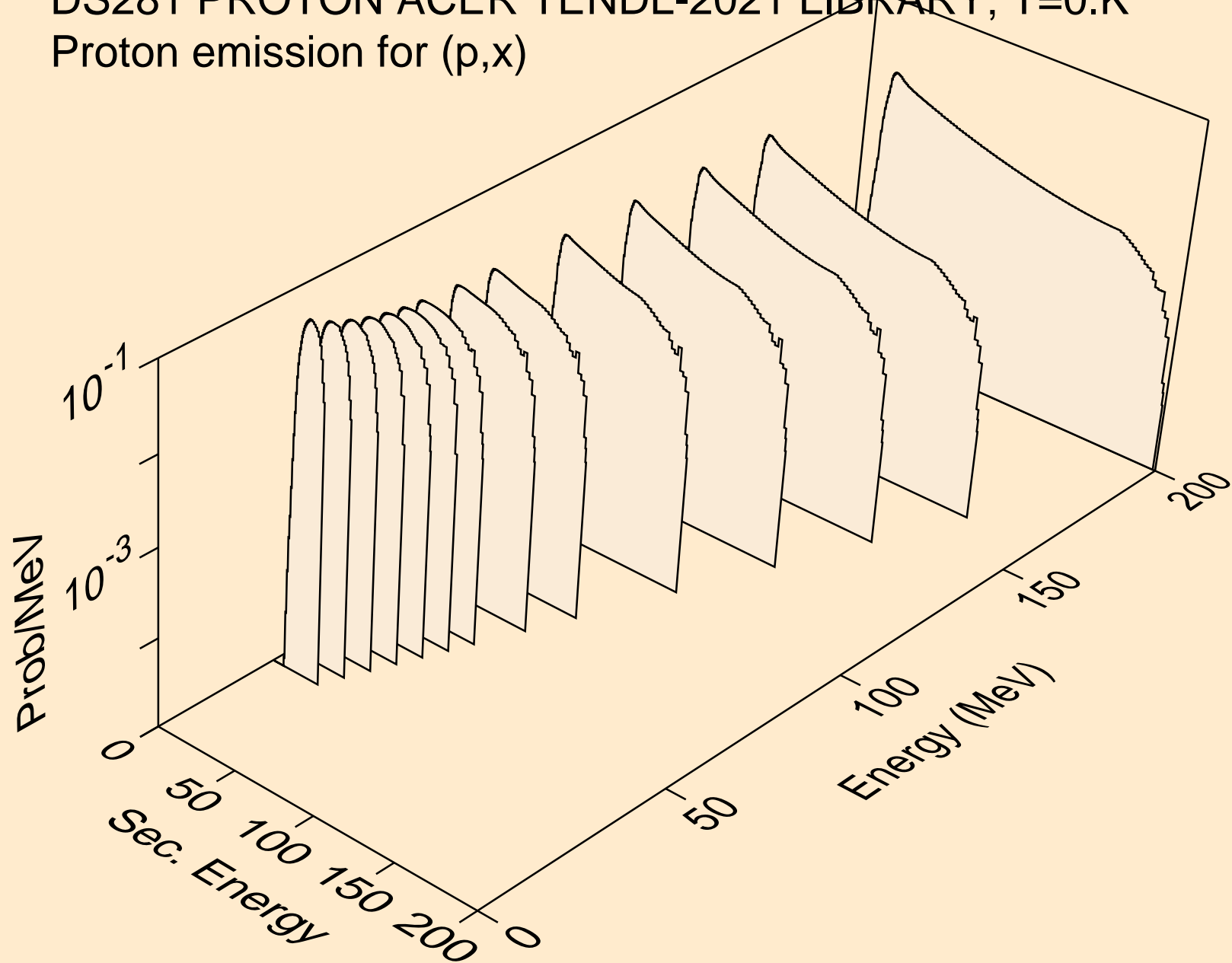

DS281 PROTON ACER TENDL-2021 LIBRARY; T=0.K
Proton emission for (p,n*)p

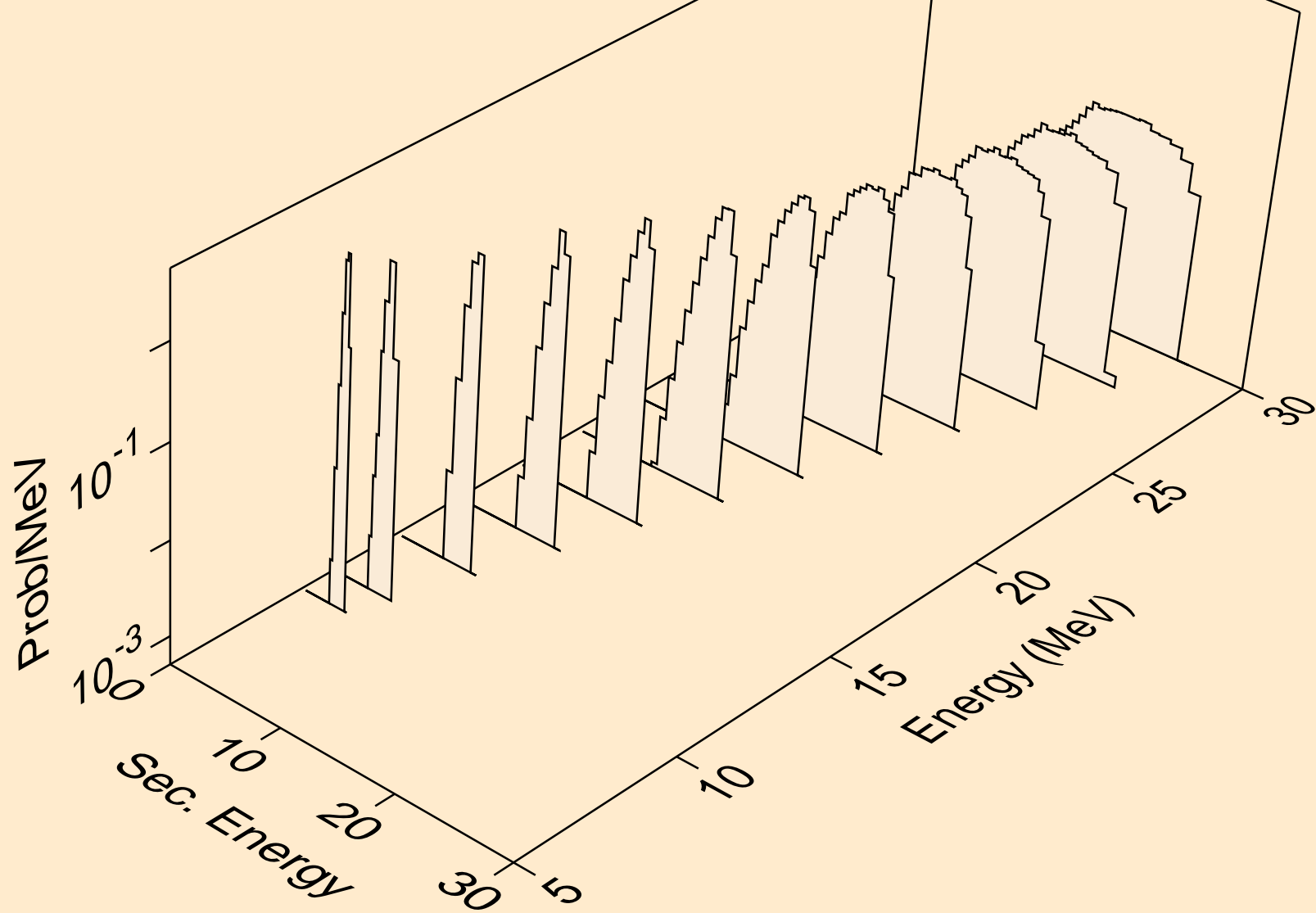

DS281 PROTON ACER TENDL-2021 LIBRARY; T=0.K
Proton emission for inelastic

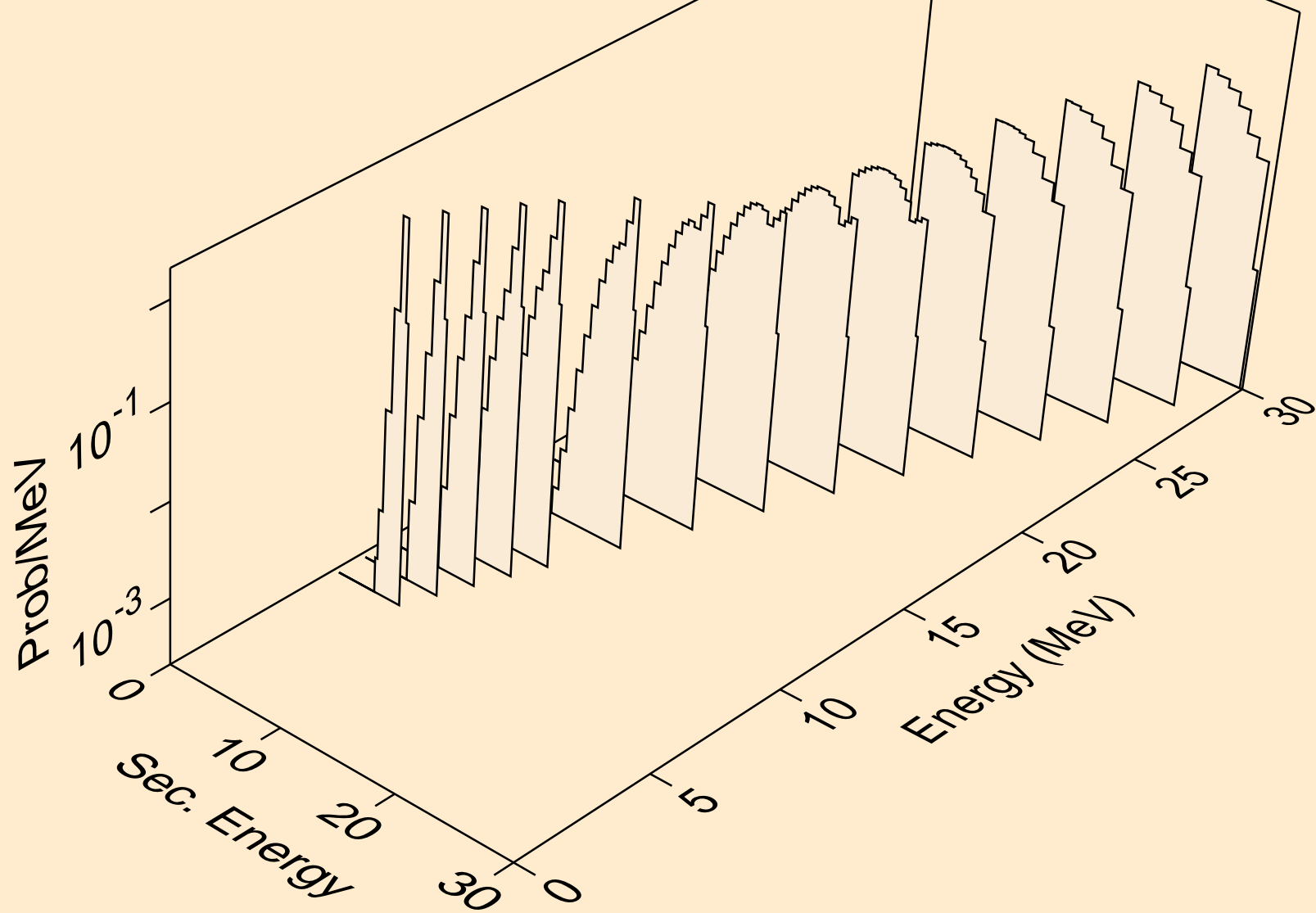

DS281 PROTON ACER TENDL-2021 LIBRARY; T=0.K
Photon emission for (z,n)

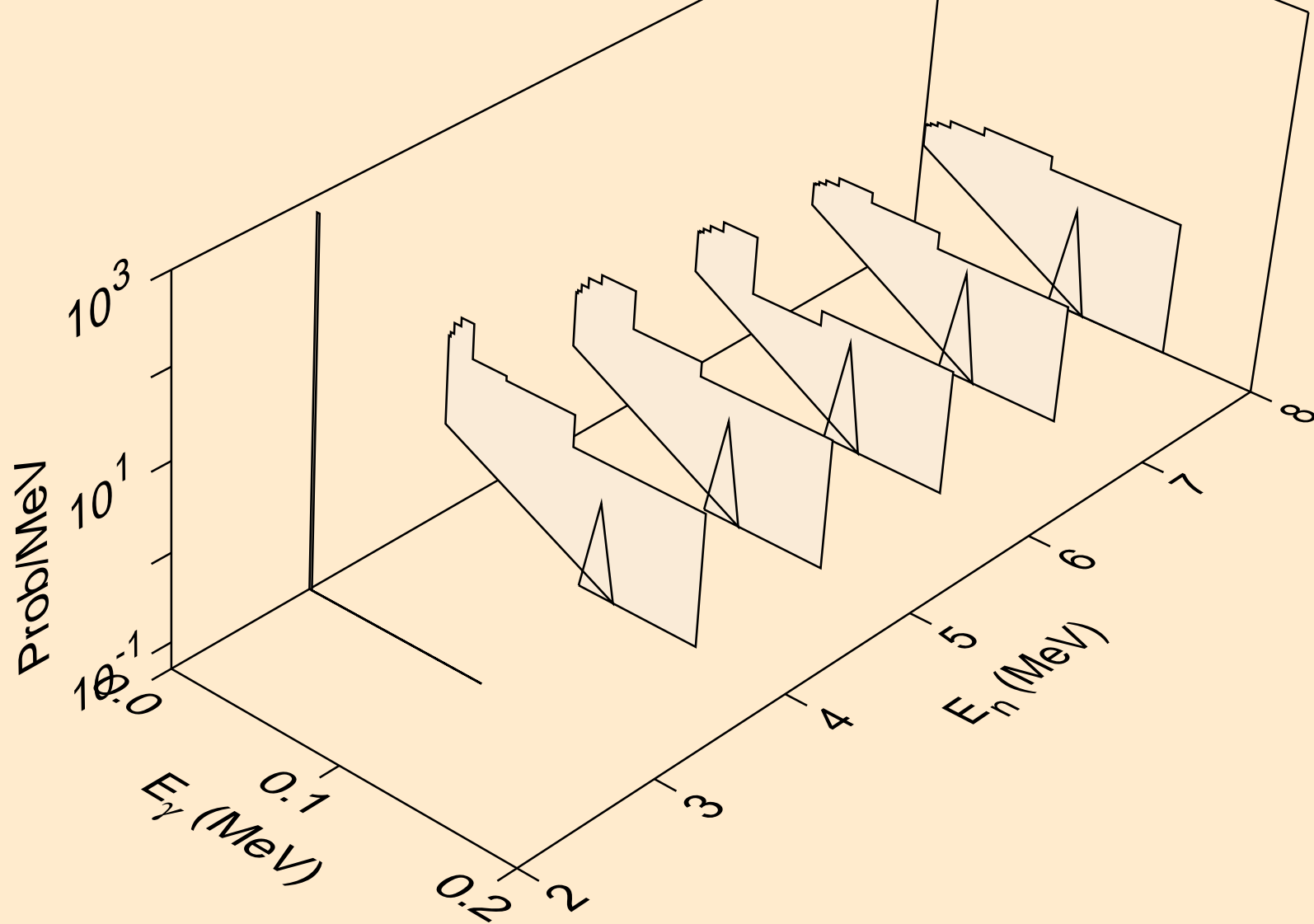

DS281 PROTON ACER TENDL-2021 LIBRARY; T=0.K
Photon emission for (n,x)

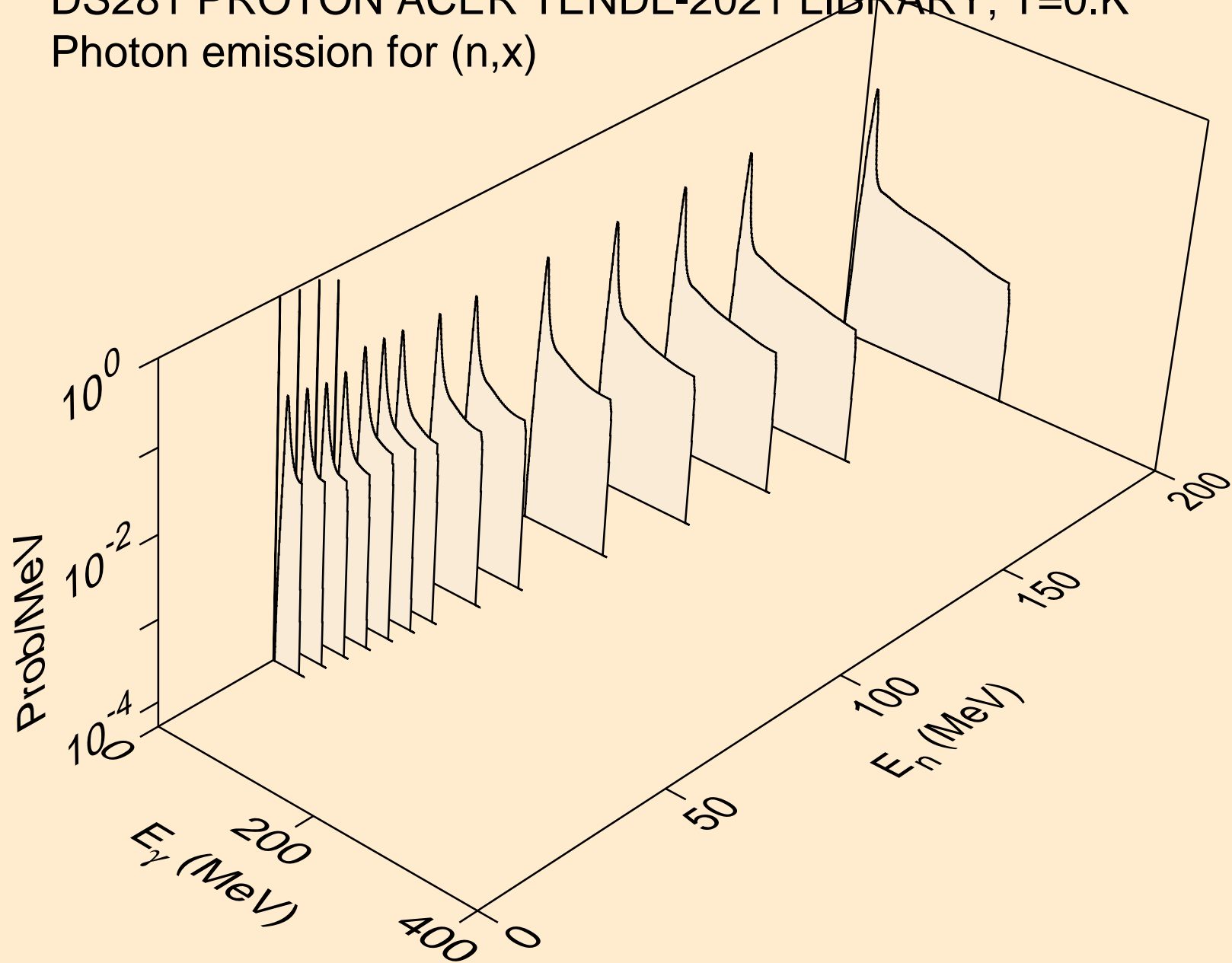

DS281 PROTON ACER TENDL-2021 LIBRARY; T=0.K
Photon emission for (n,n*)p

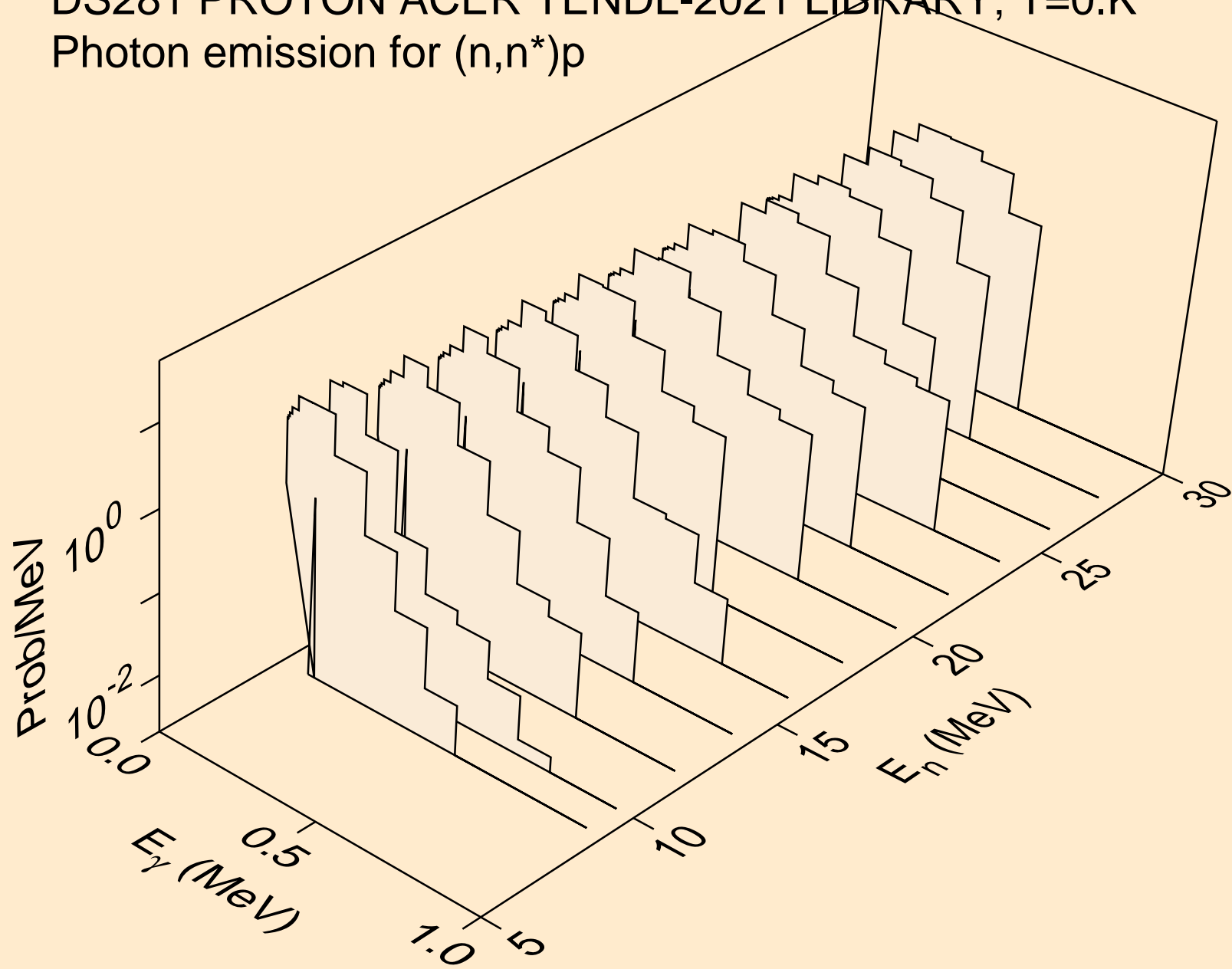

DS281 PROTON ACER TENDL-2021 LIBRARY; T=0.K
Photon emission for (n,gma)

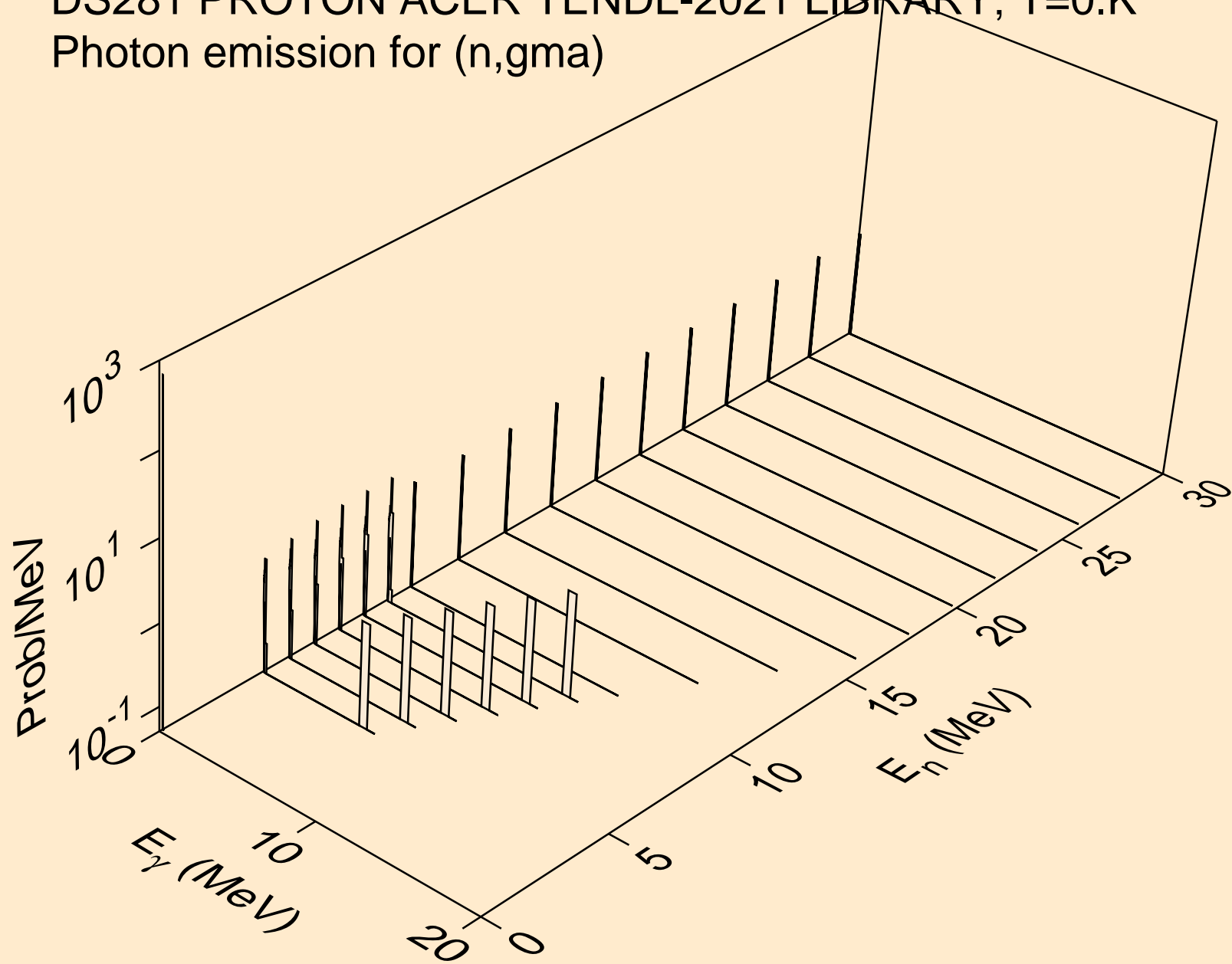

DS281 PROTON ACER TENDL-2021 LIBRARY; T=0.K
Photon emission for inelastic

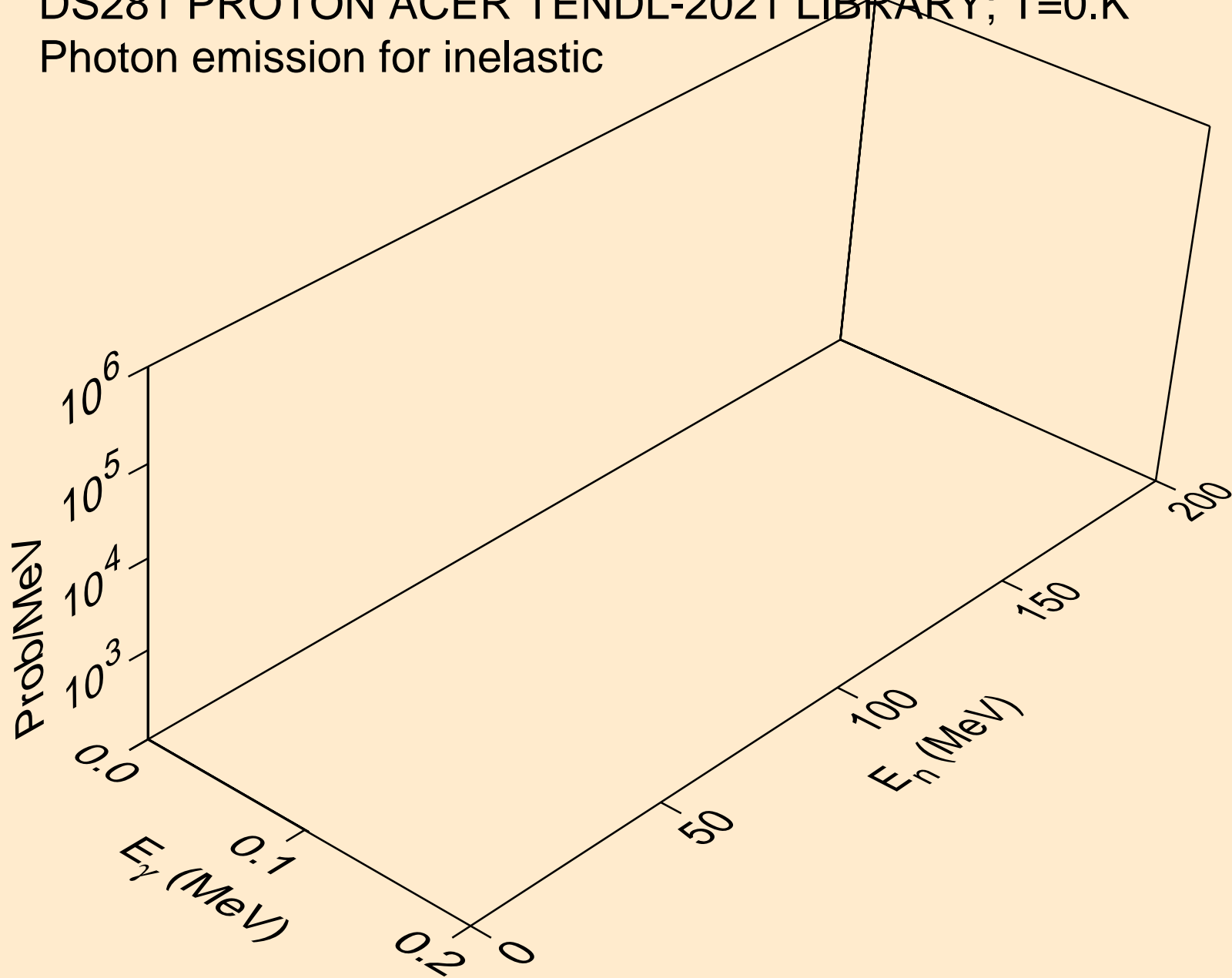

DS281 PROTON ACER TENDL-2021 LIBRARY; T=0.K
Photon emission for (n,d)

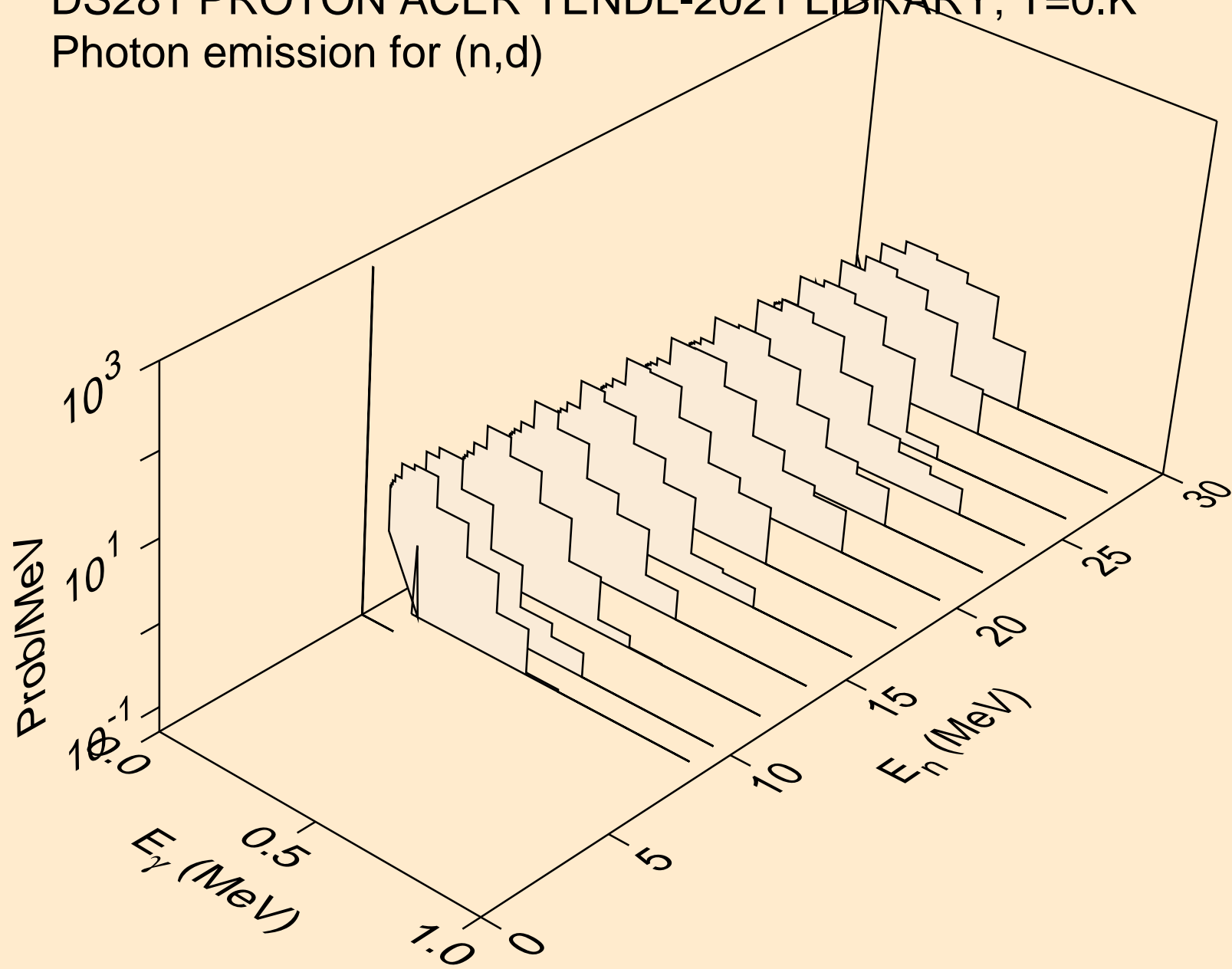

DS281 PROTON ACER TENDL-2021 LIBRARY; T=0.K
Photon emission for (n,t)

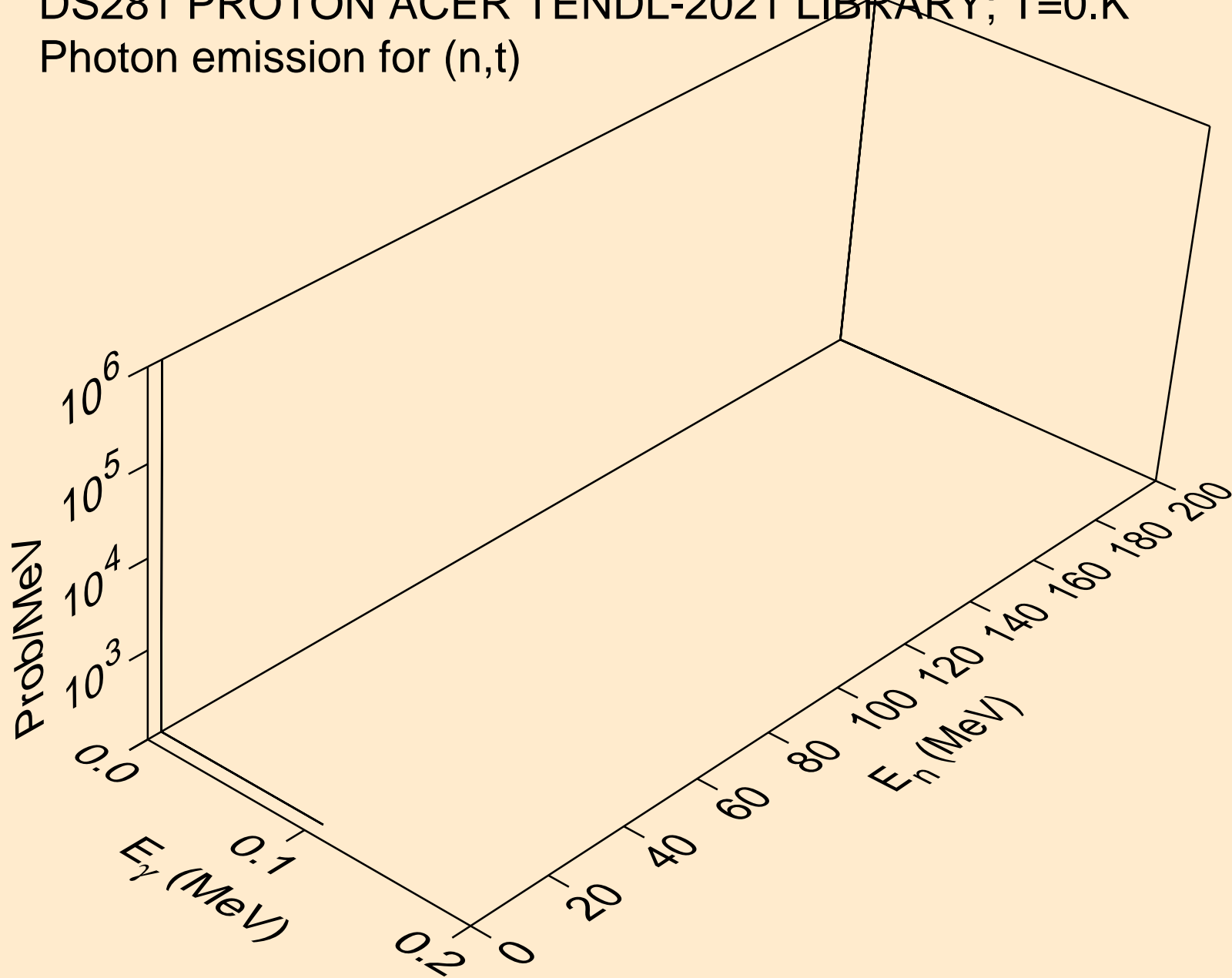

DS281 PROTON ACER TENDL-2021 LIBRARY; T=0.K
Photon emission for (n,he3)

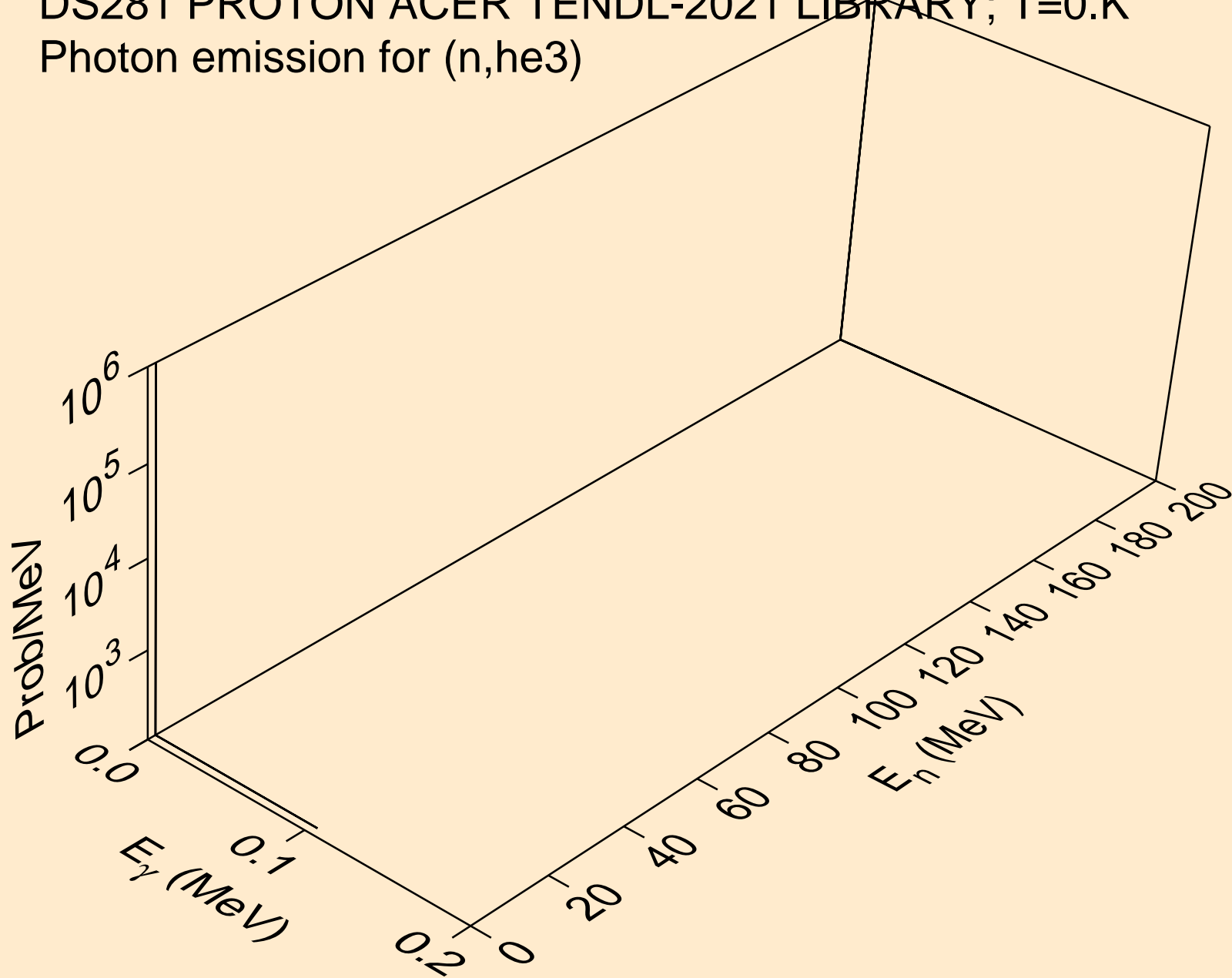

DS281 PROTON ACER TENDL-2021 LIBRARY; T=0.K
Photon emission for (n,a)

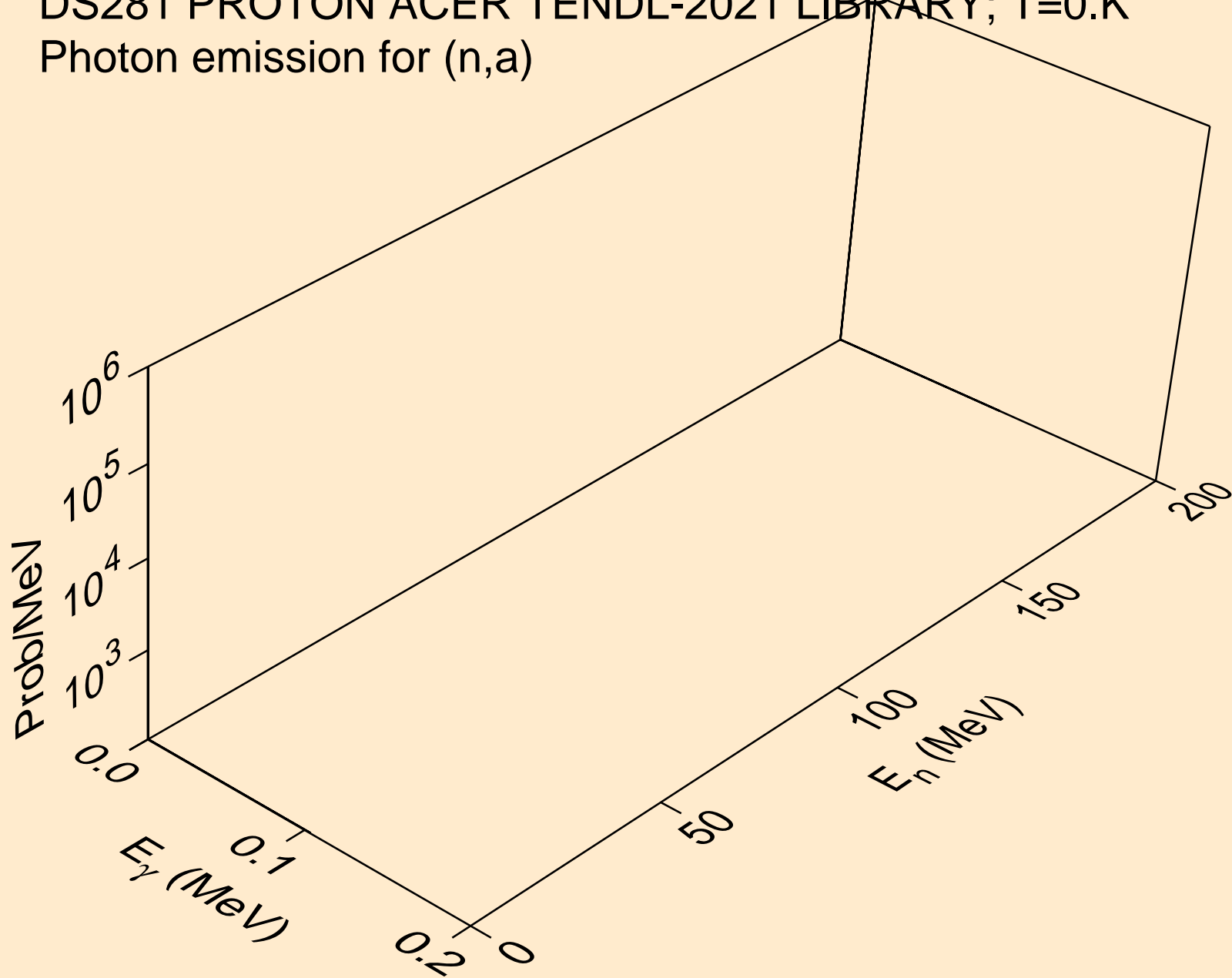

DS281 PROTON ACER TENDL-2021 LIBRARY; T=0.K
Particle heating contributions

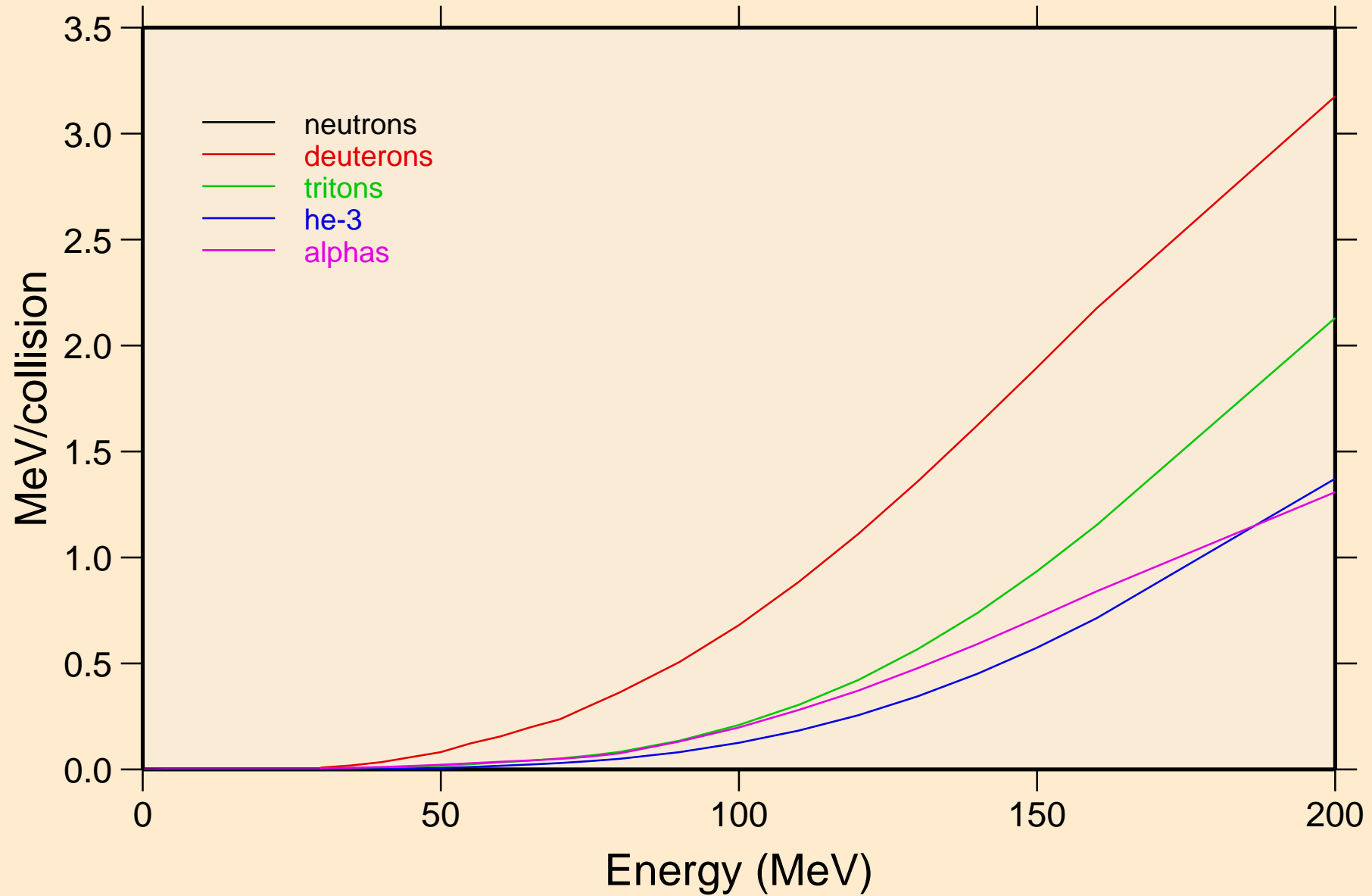

DS281 PROTON ACER TENDL-2021 LIBRARY; T=0.K
Recoil Heating

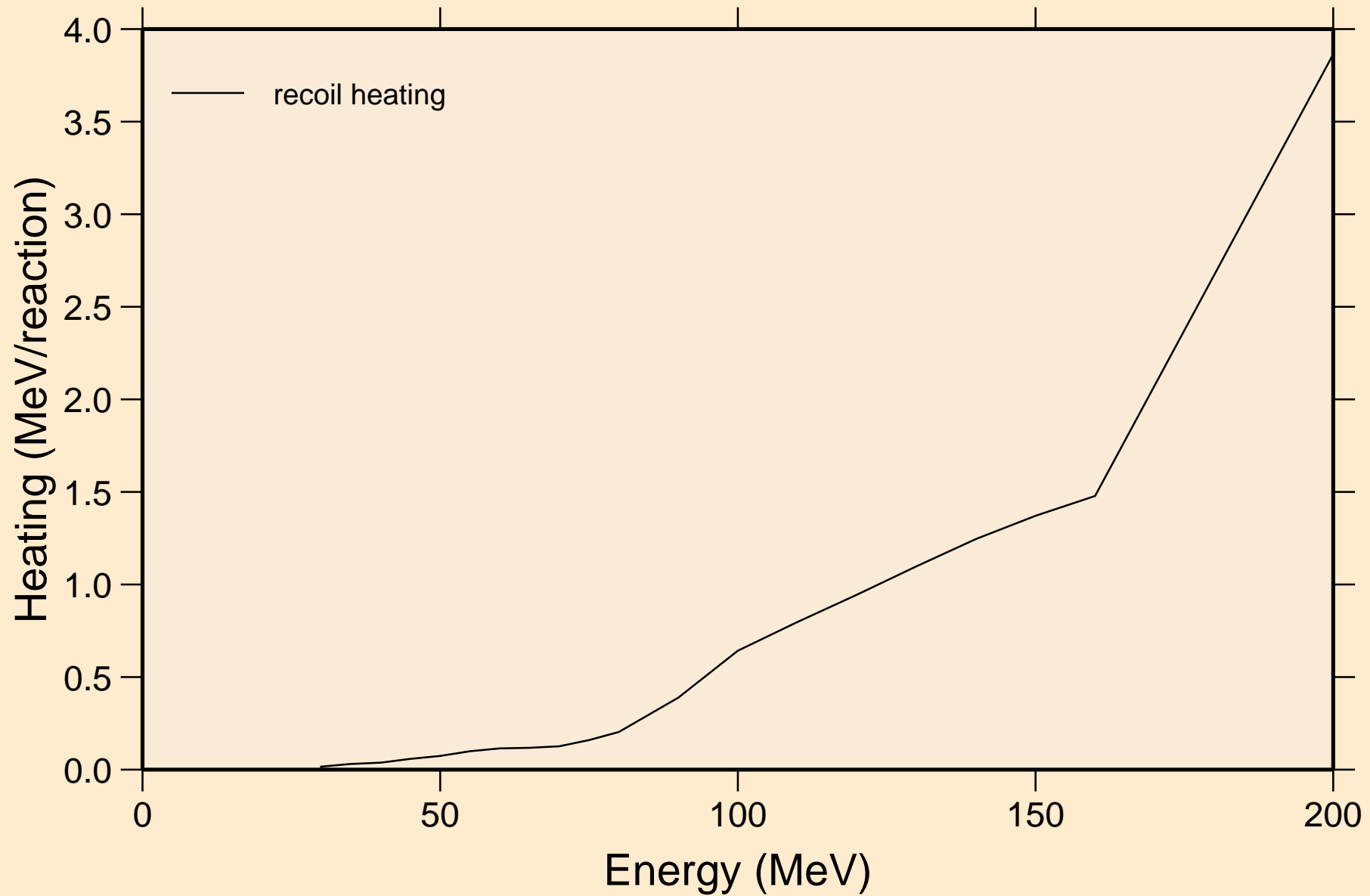

DS281 PROTON ACER TENDL-2021 LIBRARY; T=0.K
Particle production cross sections

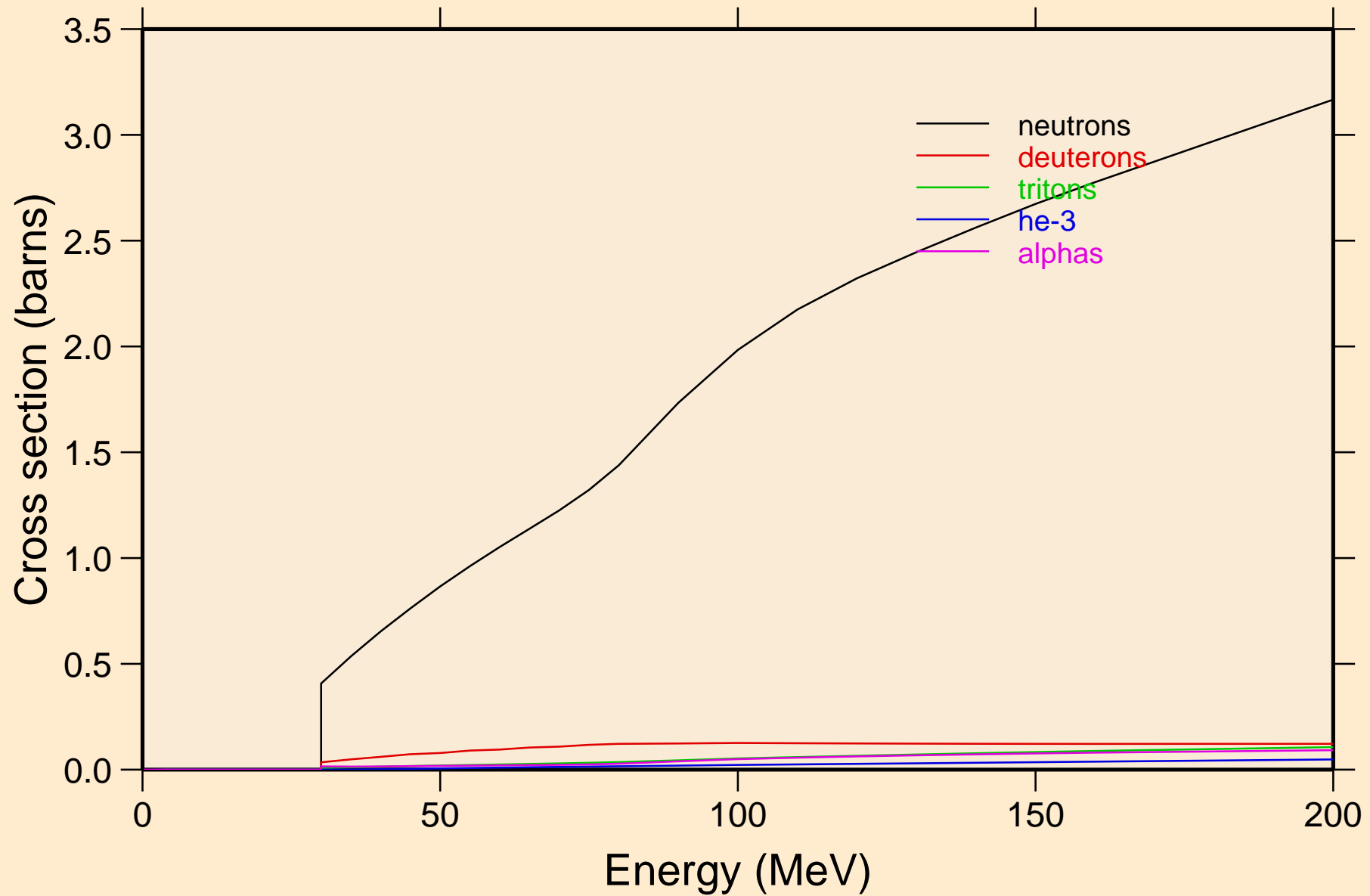

DS281 PROTON ACER TENDL-2021 LIBRARY; T=0.K
neutrons from (p,n)

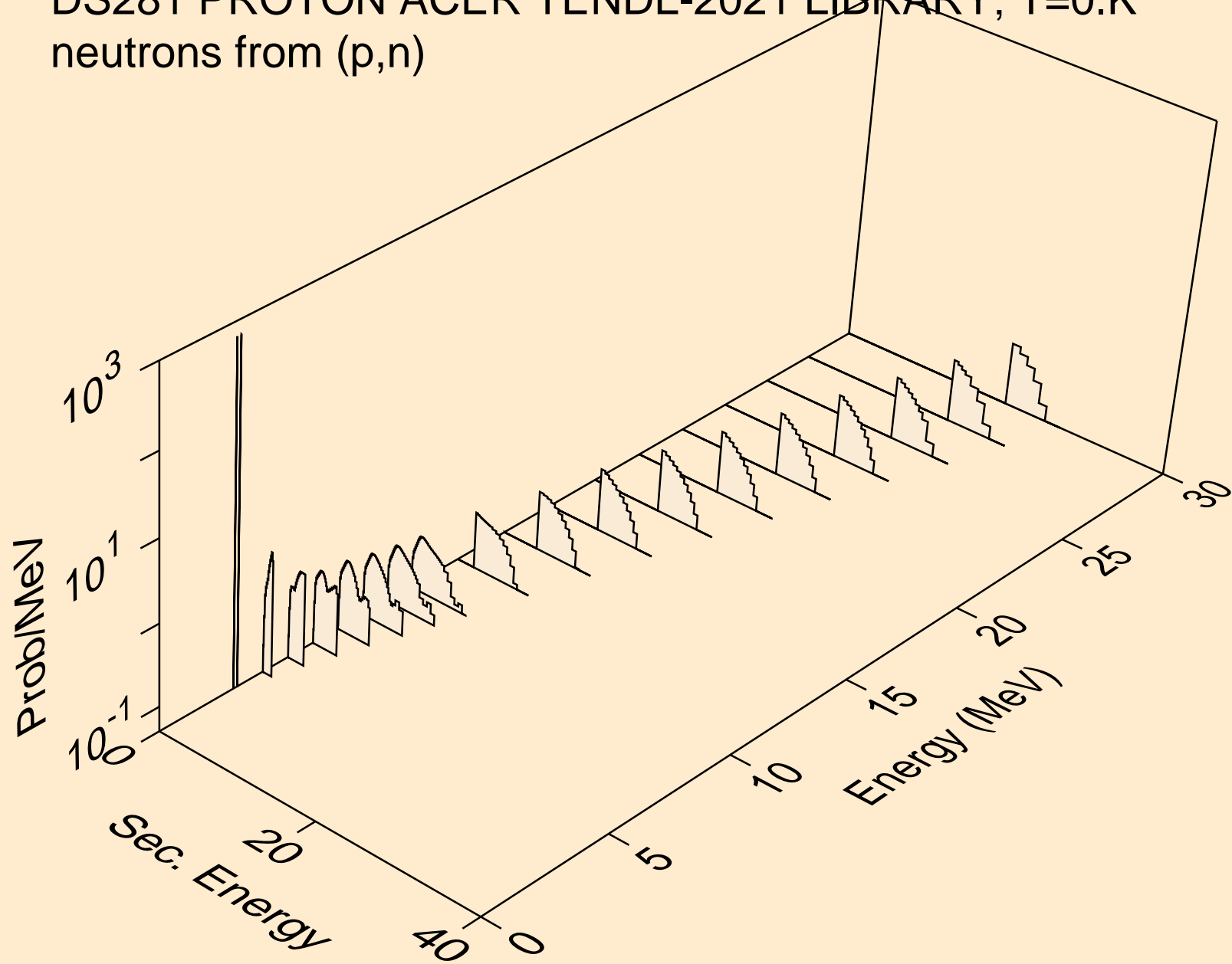

DS281 PROTON ACER TENDL-2021 LIBRARY; T=0.K
neutrons from (p,x)

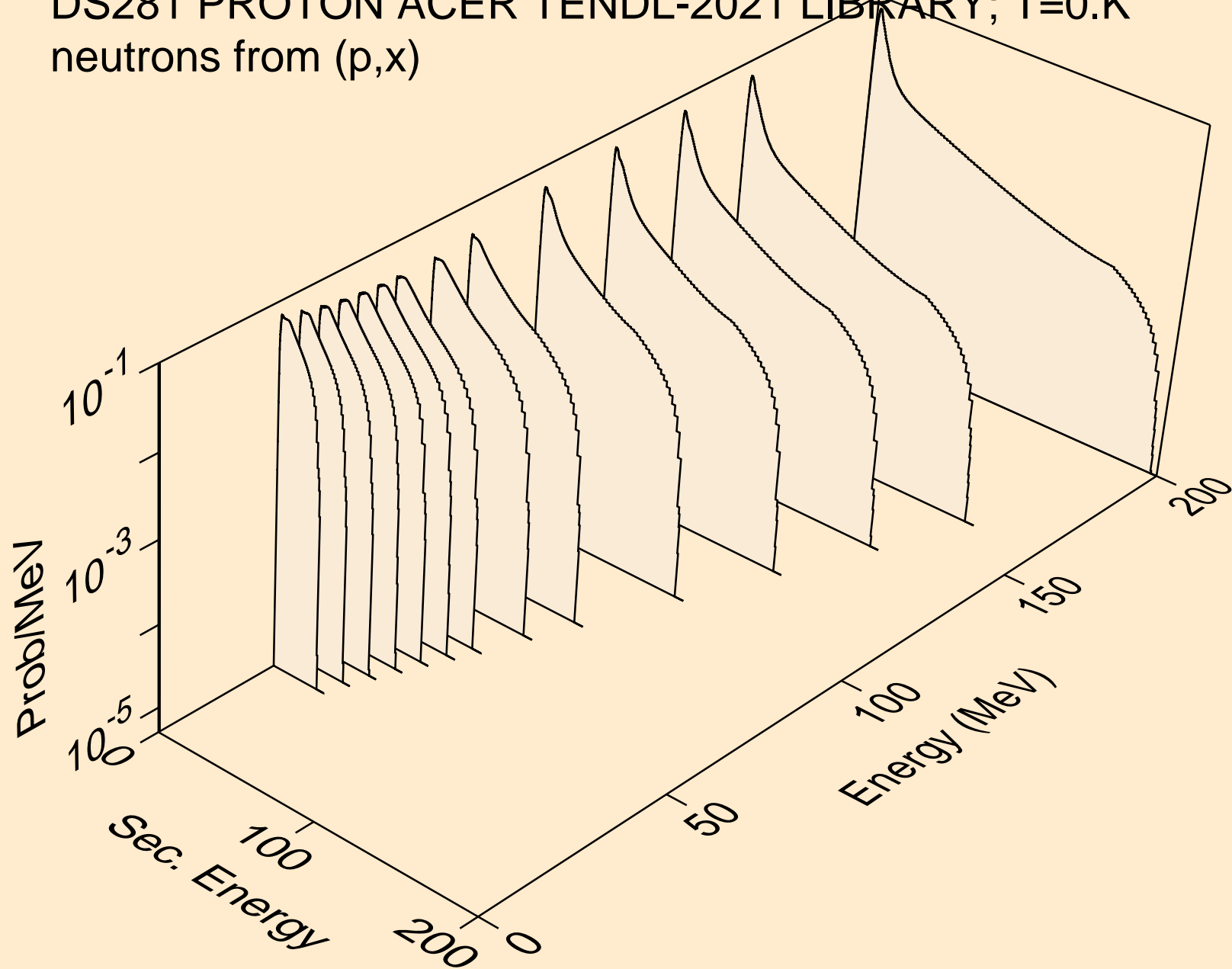

DS281 PROTON ACER TENDL-2021 LIBRARY; T=0.K
neutrons from (p,n*)p

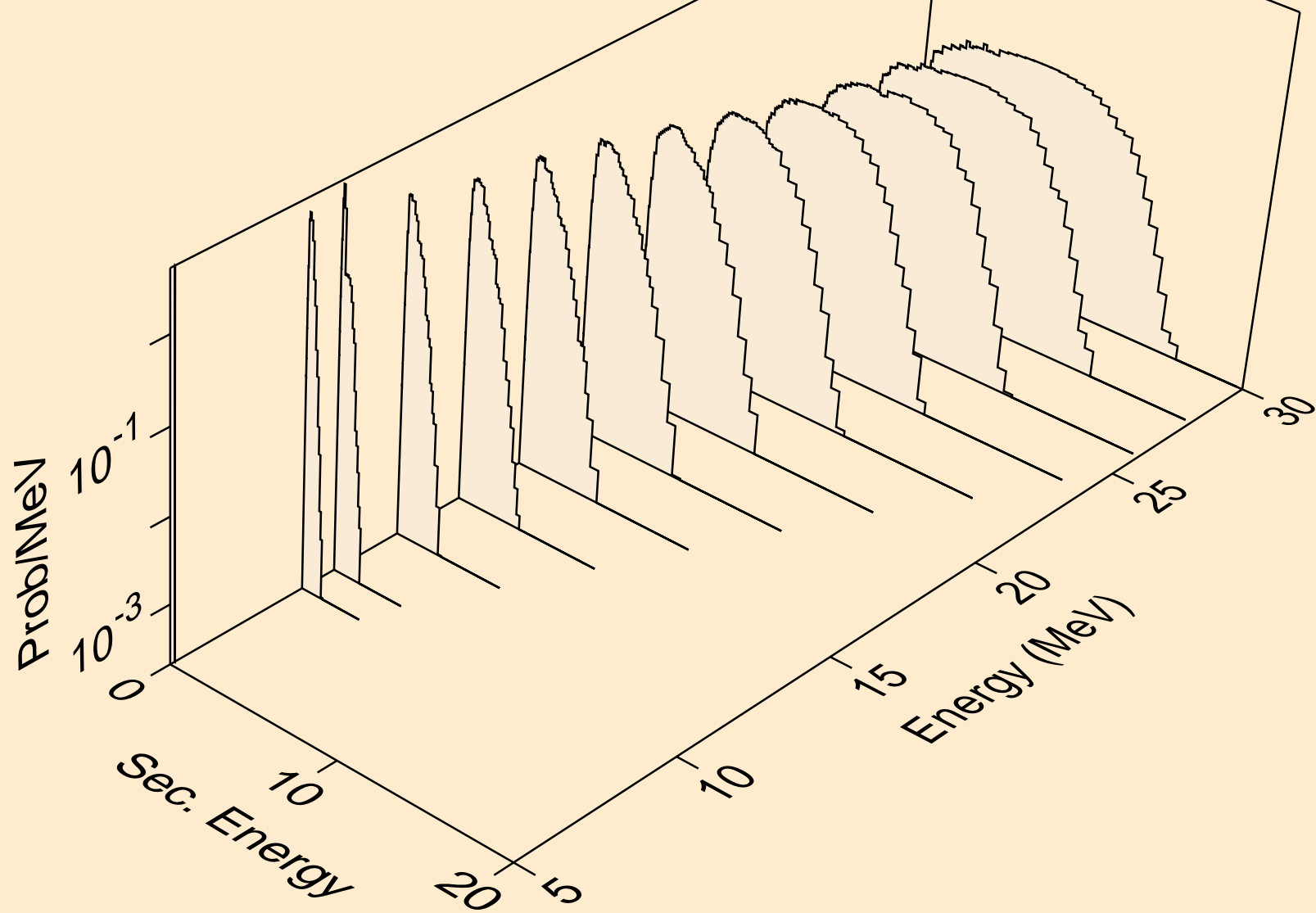

DS281 PROTON ACER TENDL-2021 LIBRARY; T=0.K
deuterons from (p,x)

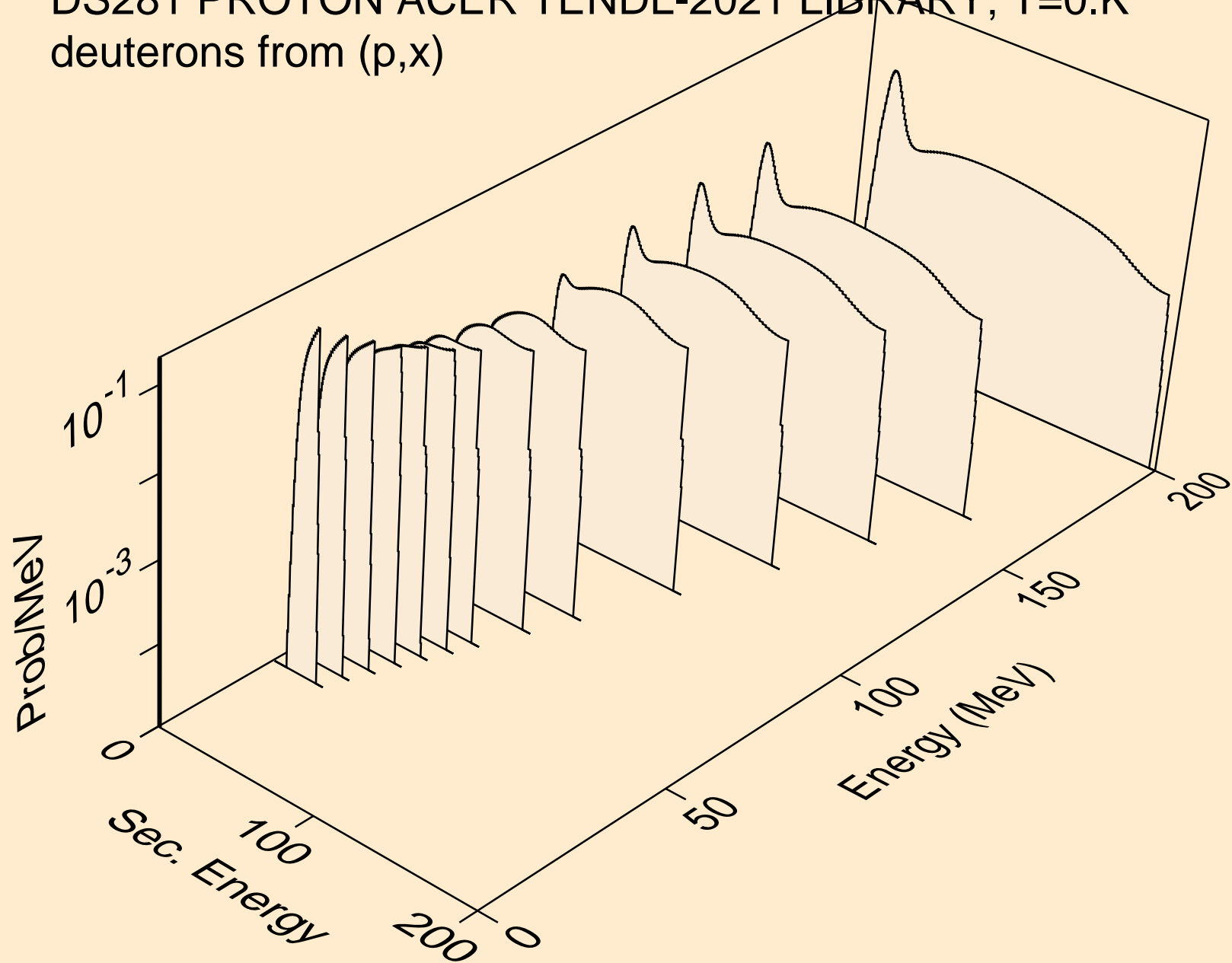

DS281 PROTON ACER TENDL-2021 LIBRARY; T=0.K
deuterons from (p,d)

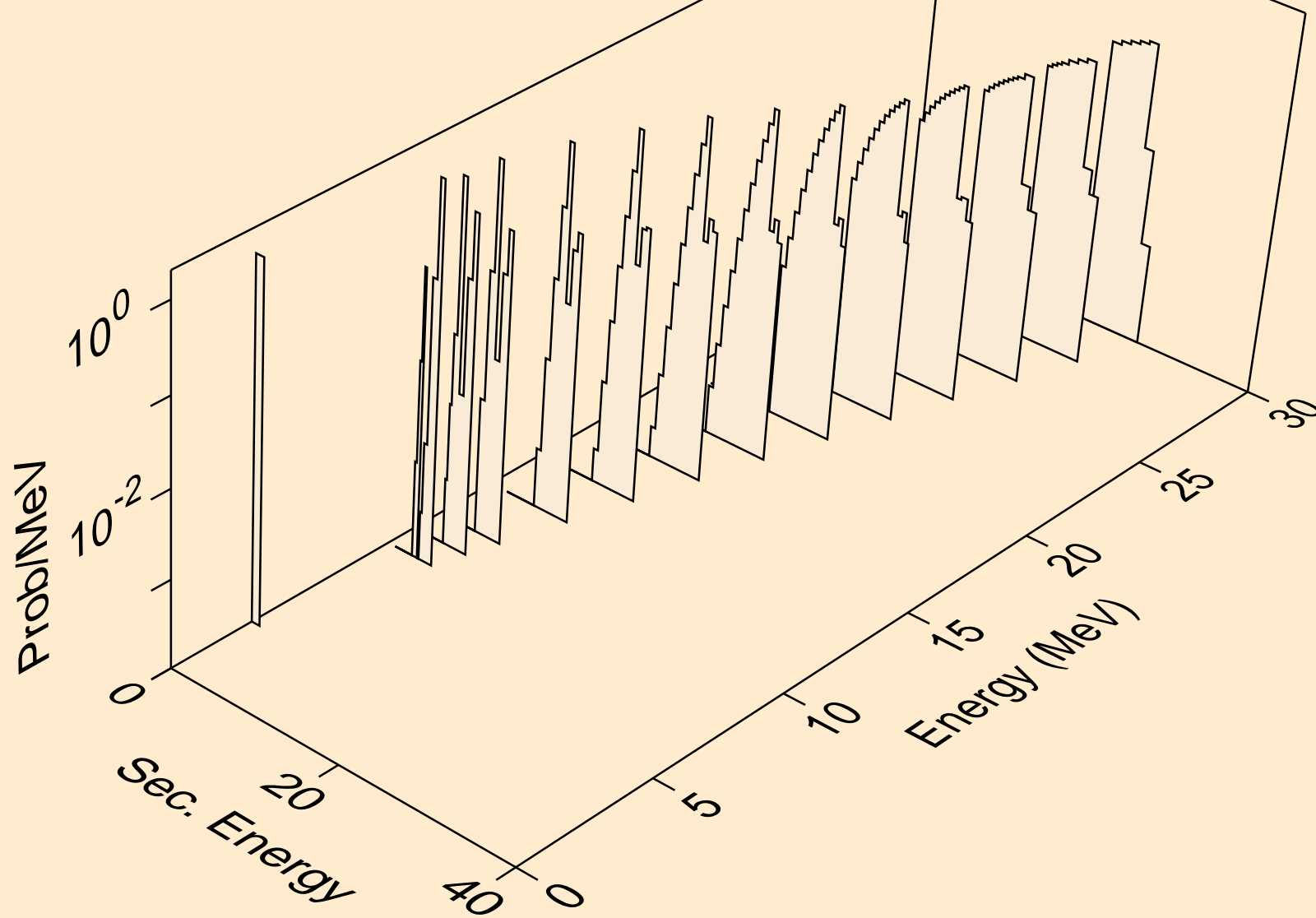

DS281 PROTON ACER TENDL-2021 LIBRARY; T=0.K
tritons from (p,x)

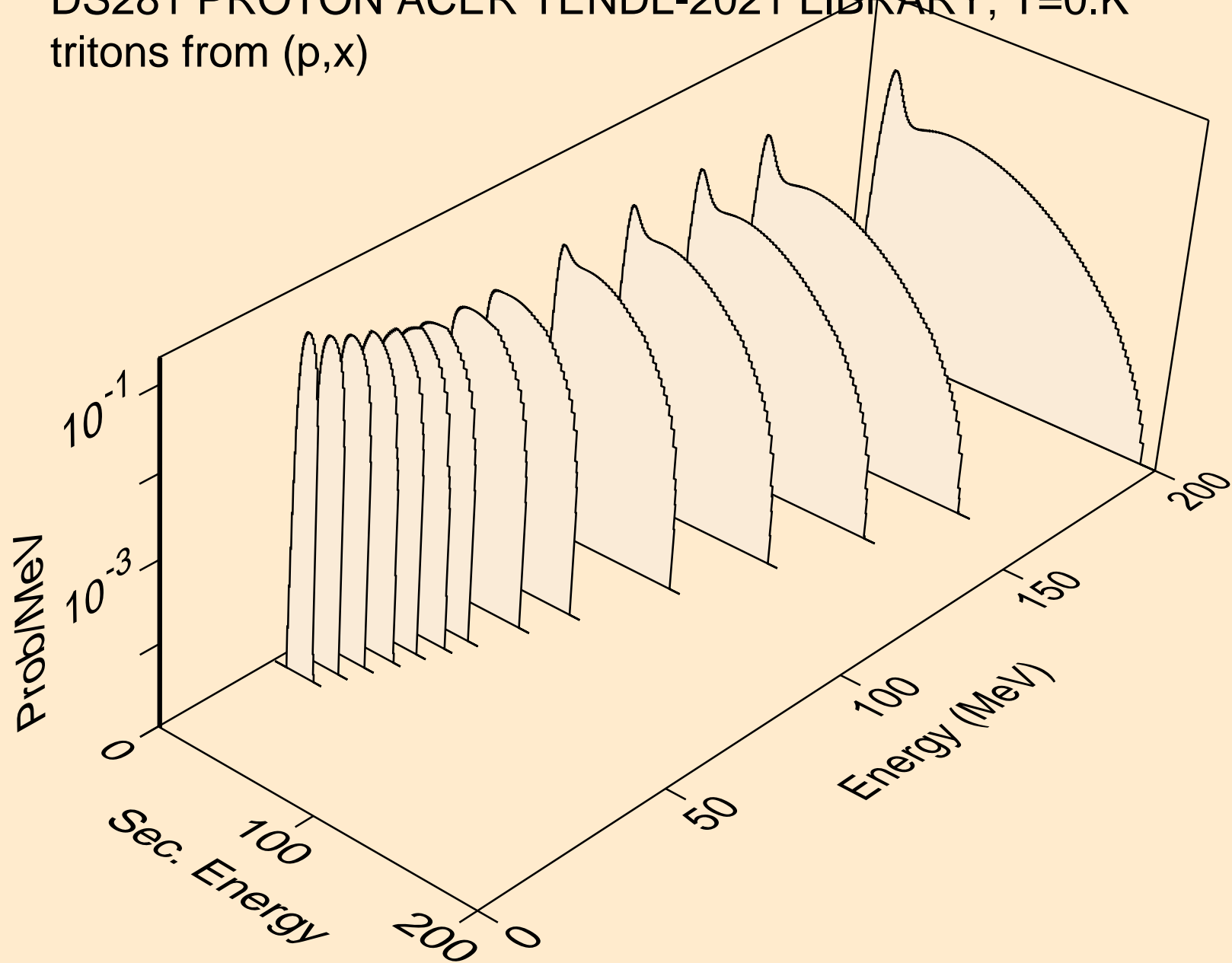

DS281 PROTON ACER TENDL-2021 LIBRARY; T=0.K
tritons from (p,t)

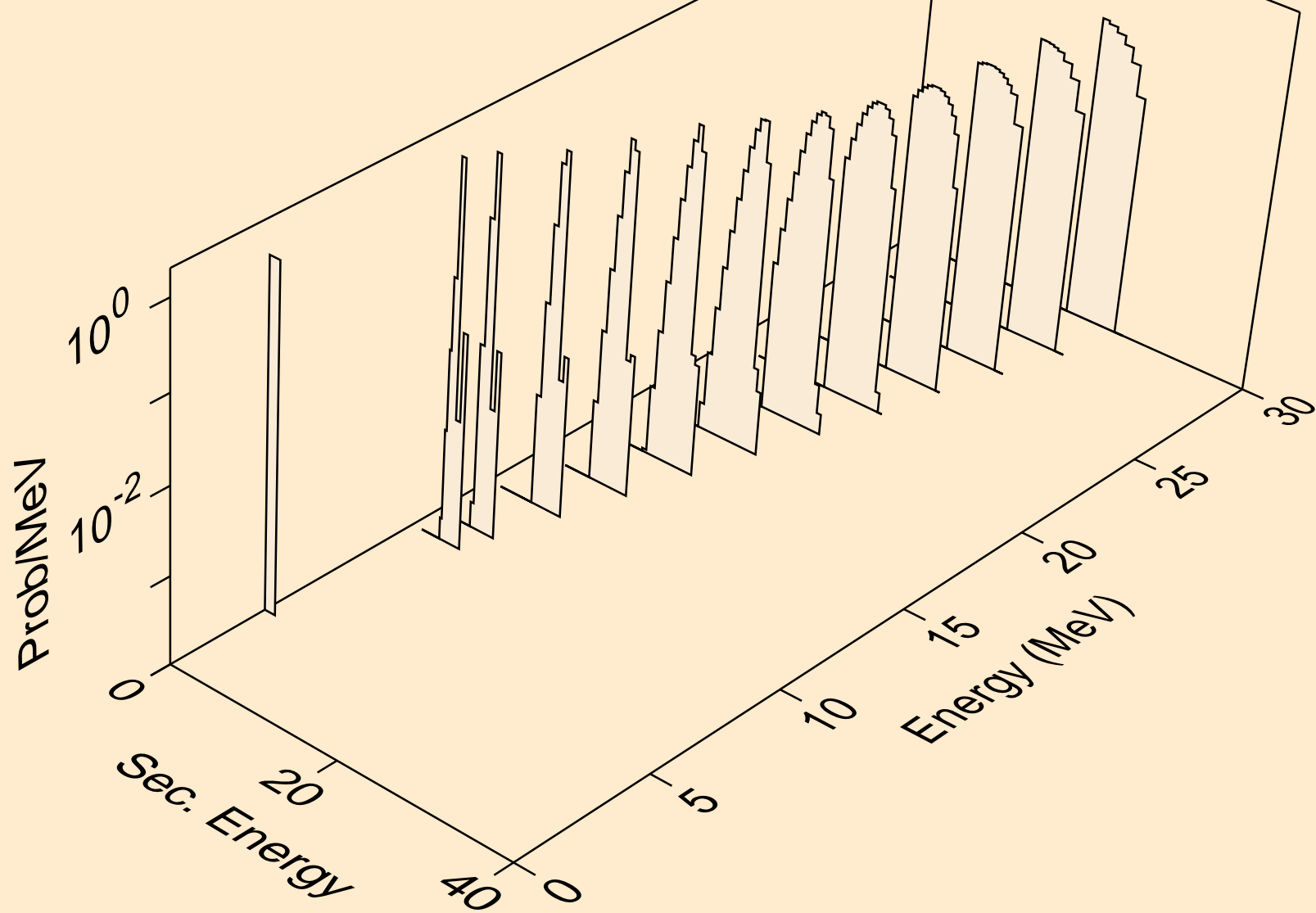

DS281 PROTON ACER TENDL-2021 LIBRARY; T=0.K
he3s from (p,x)

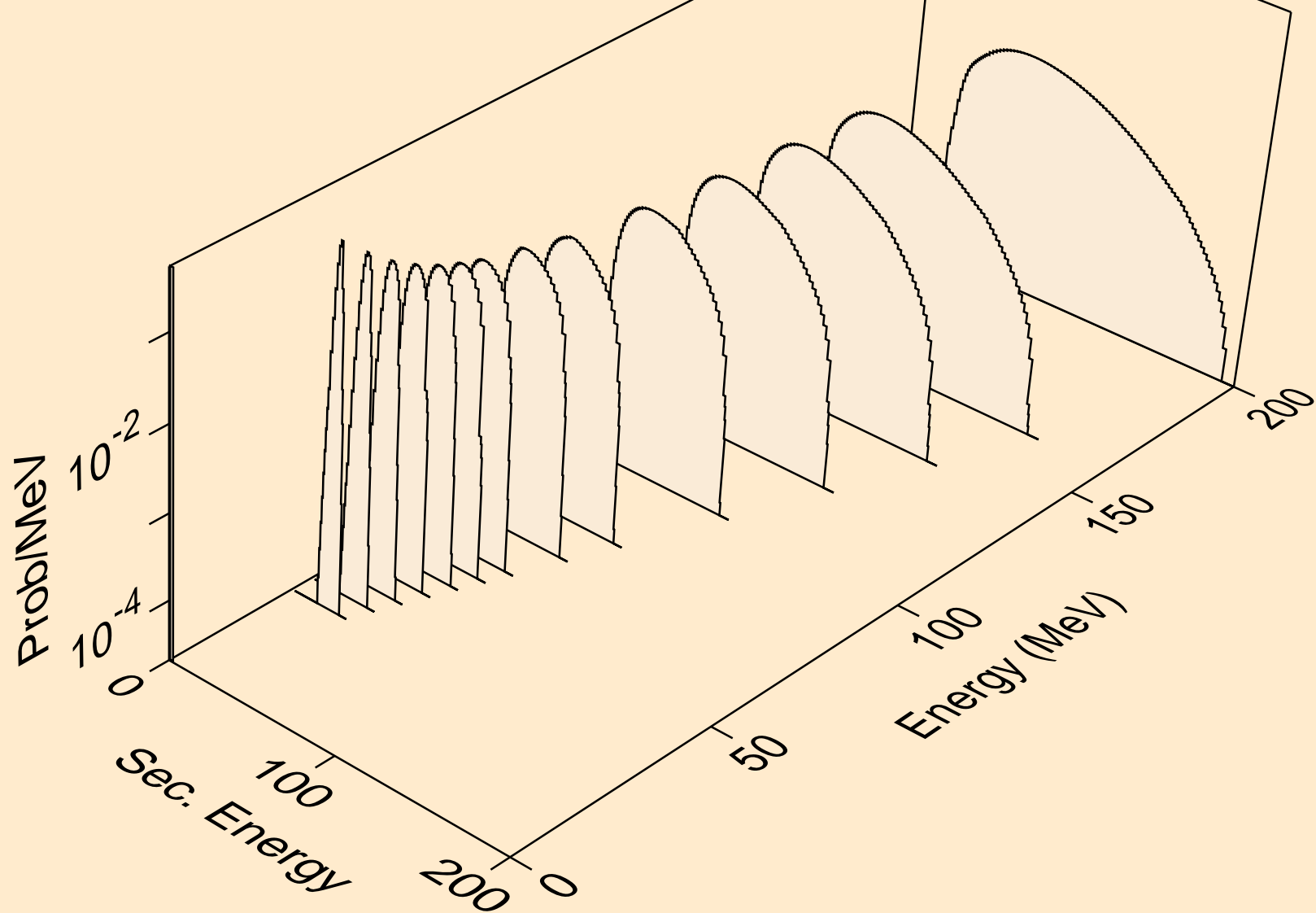

DS281 PROTON ACER TENDL-2021 LIBRARY; T=0.K
he3s from (p,he3)

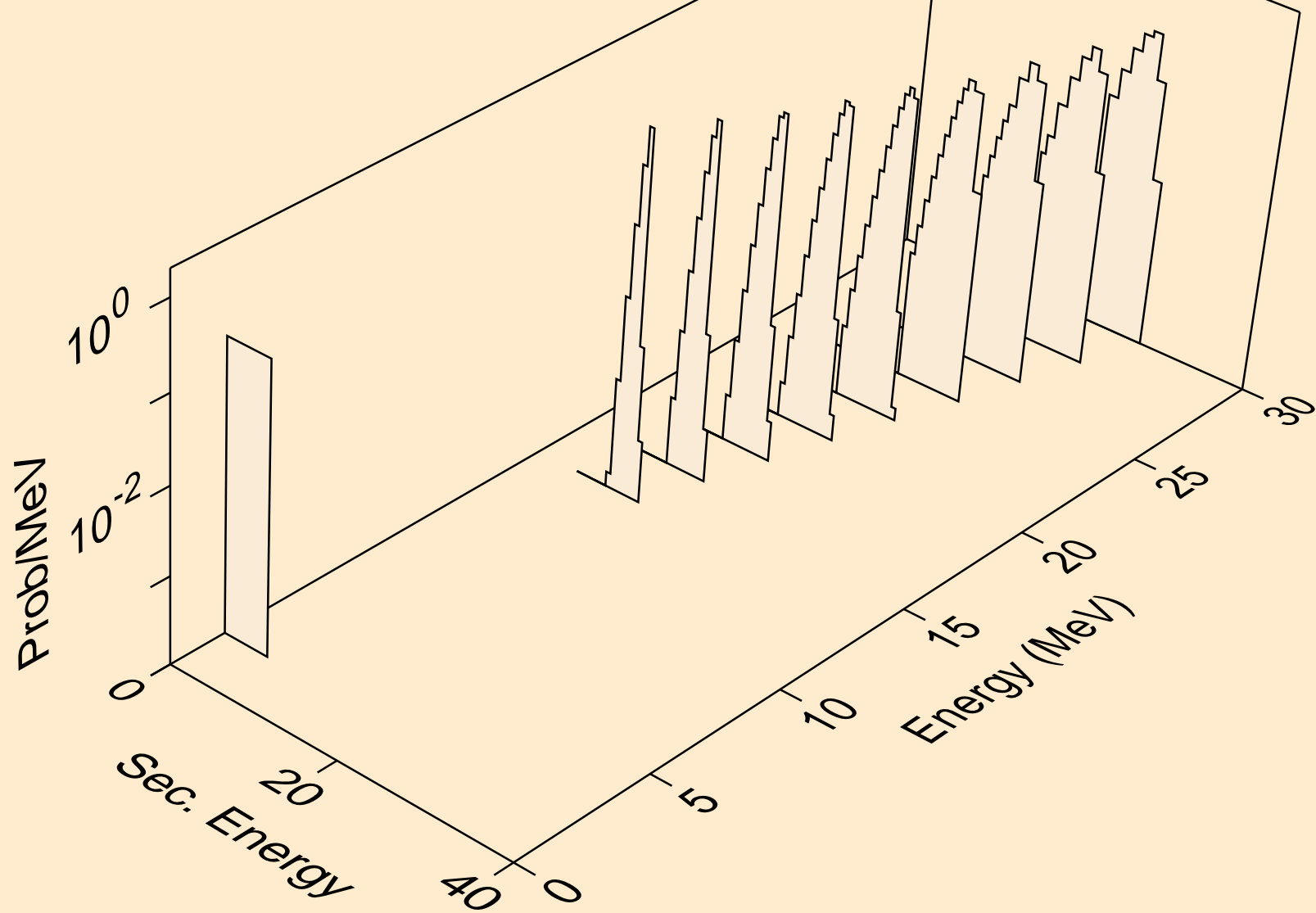

DS281 PROTON ACER TENDL-2021 LIBRARY; T=0.K
alphas from (p,x)

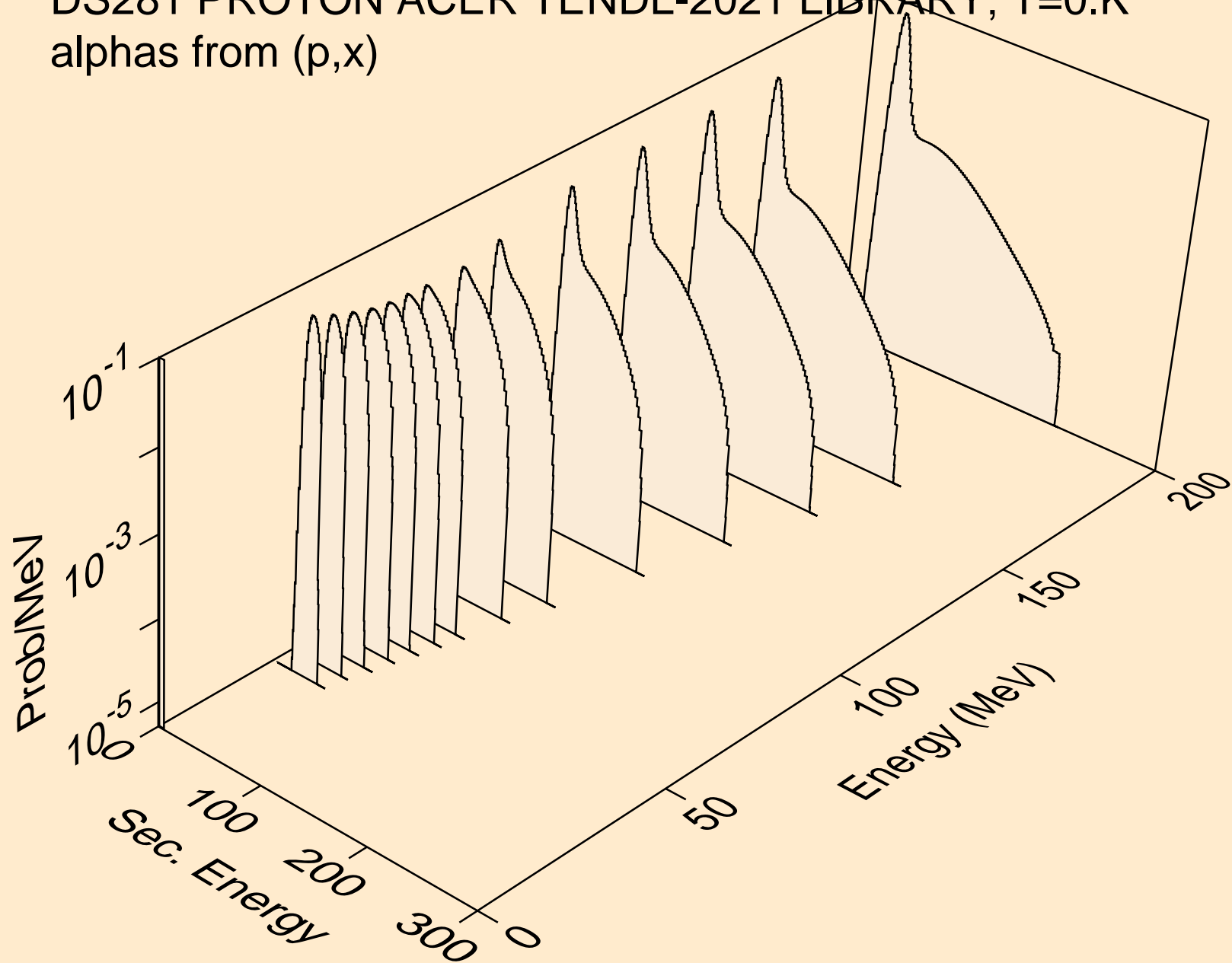

DS281 PROTON ACER TENDL-2021 LIBRARY; T=0.K
alphas from (p,a)

