

DY170 PROTON ACER TENDL-2021 LIBRARY; T=0.K  
Principal cross sections

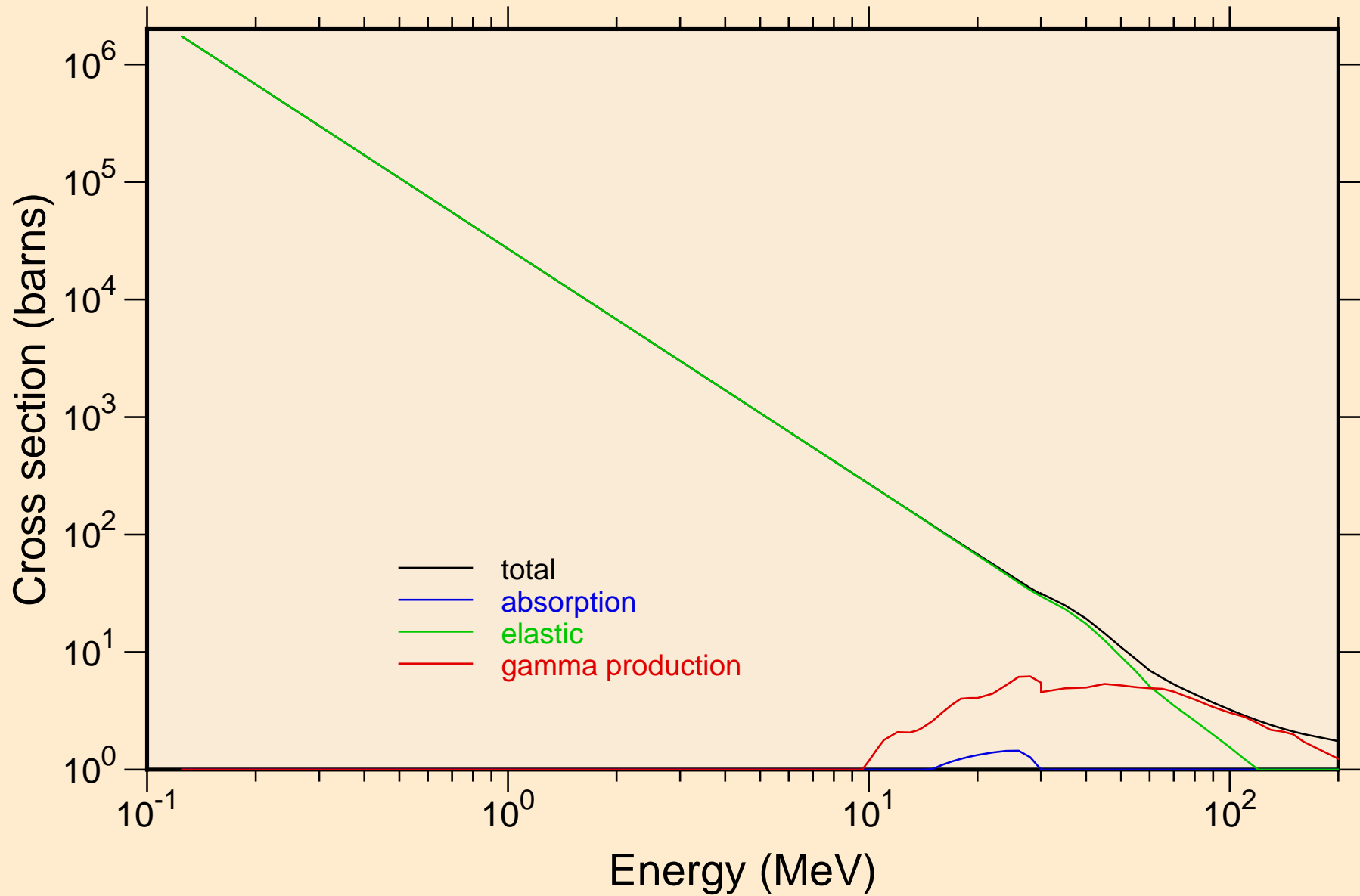

DY170 PROTON ACER TENDL-2021 LIBRARY; T=0.K

Heating

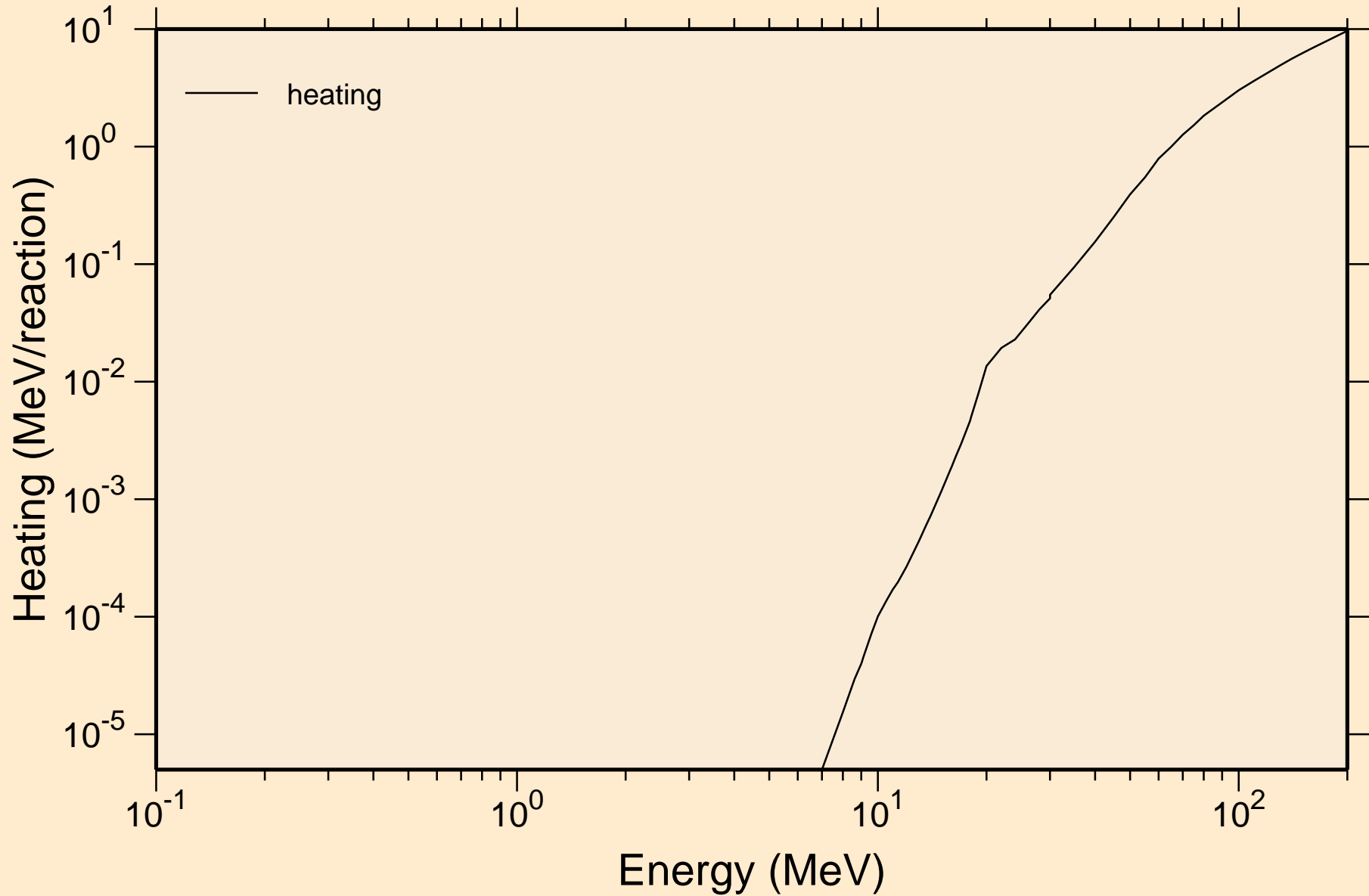

# DY170 PROTON ACER TENDL-2021 LIBRARY; T=0.K

## Principal cross sections

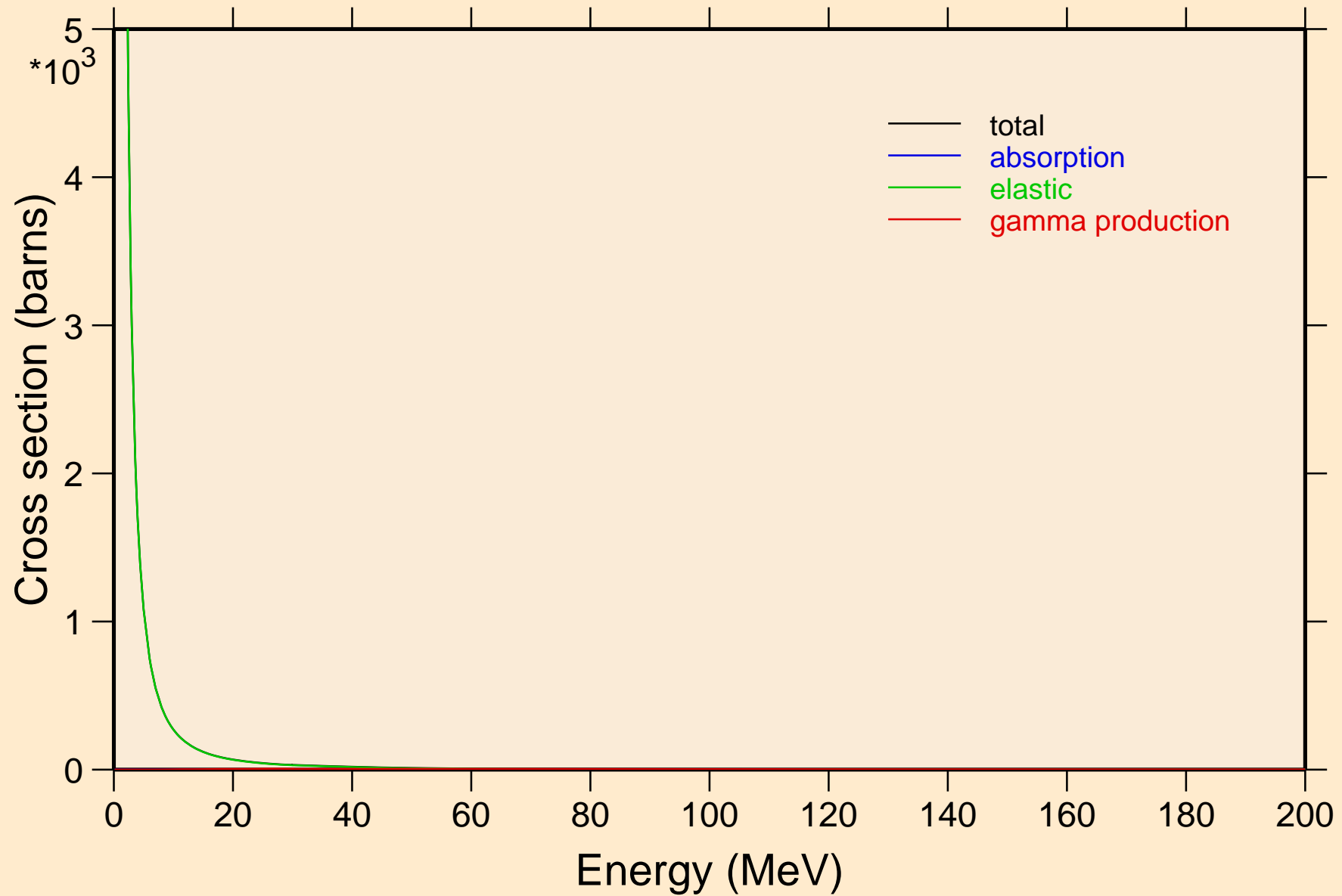

DY170 PROTON ACER TENDL-2021 LIBRARY; T=0.K

Heating

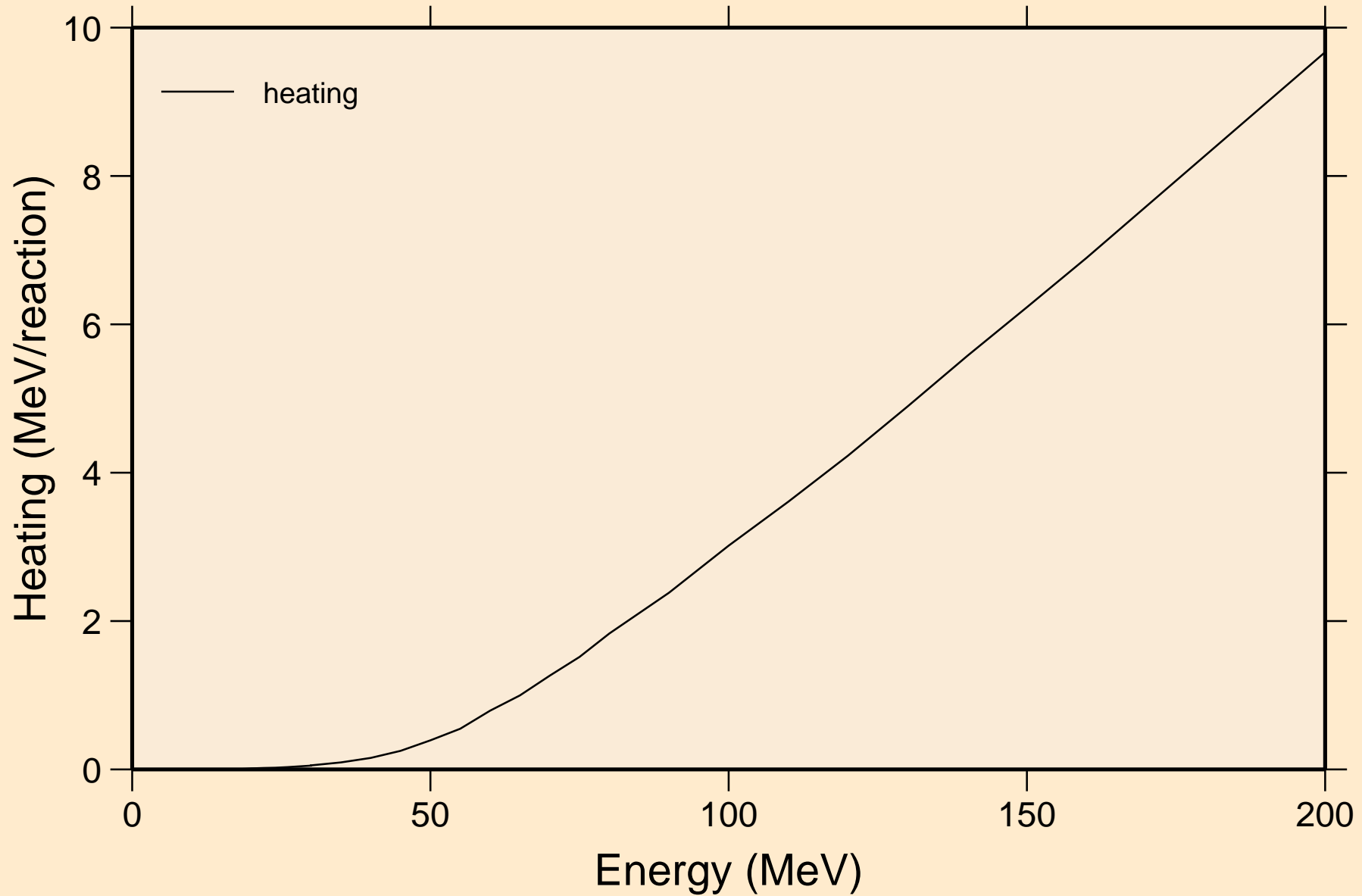

# DY170 PROTON ACER TENDL-2021 LIBRARY; T=0.K

## Threshold reactions

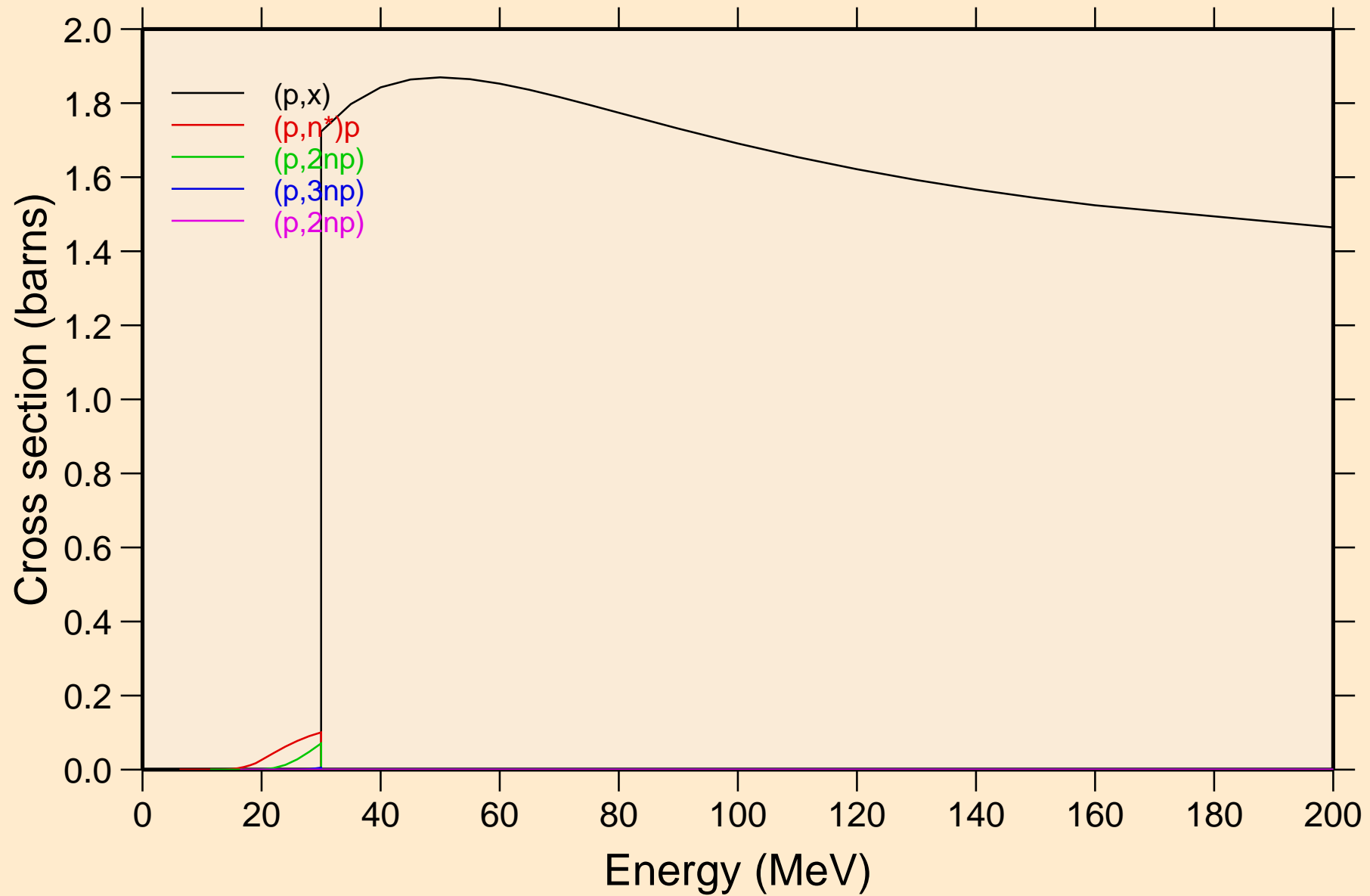

DY170 PROTON ACER TENDL-2021 LIBRARY; T=0.K  
Threshold reactions

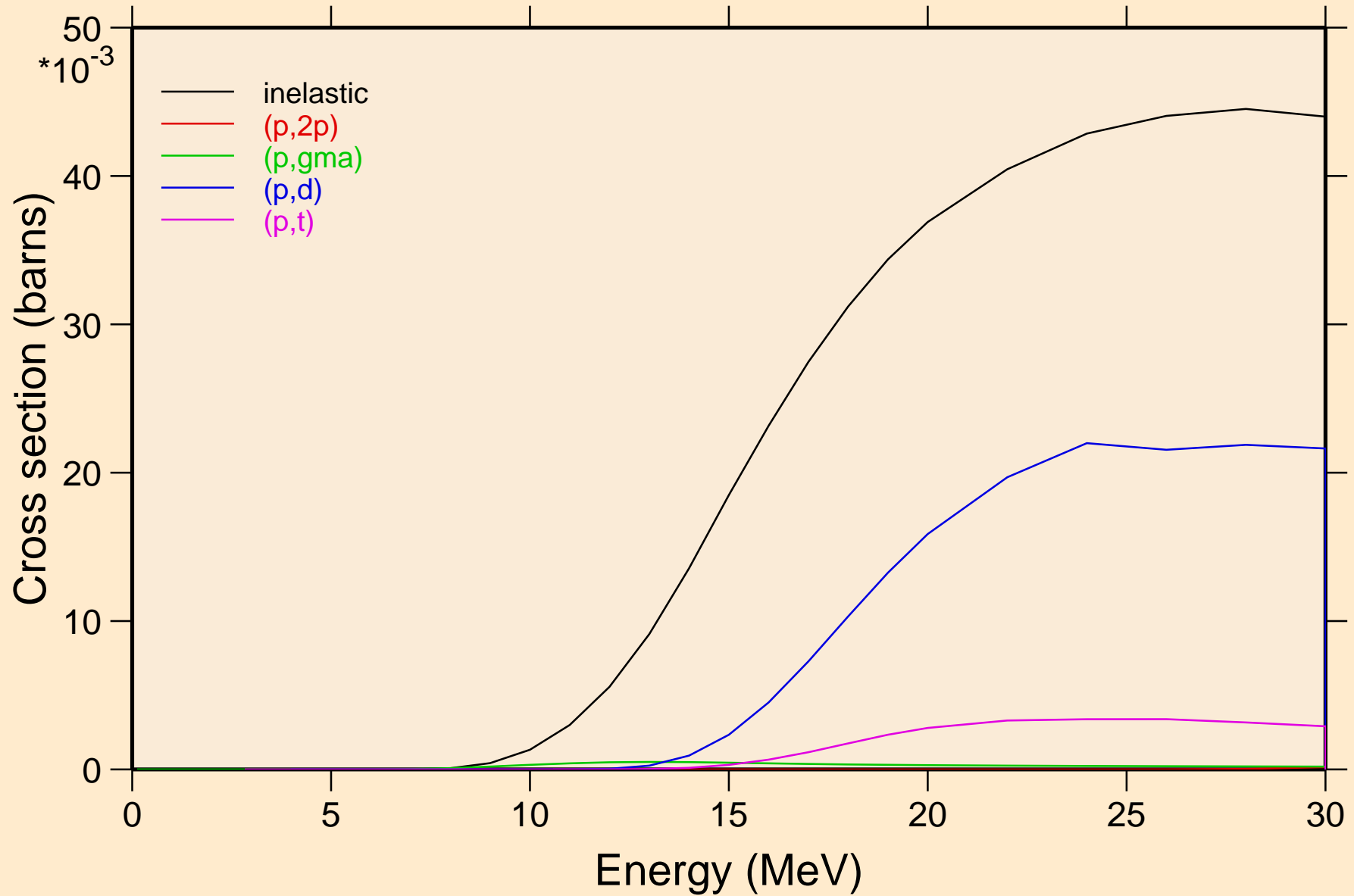

DY170 PROTON ACER TENDL-2021 LIBRARY; T=0.K  
Threshold reactions

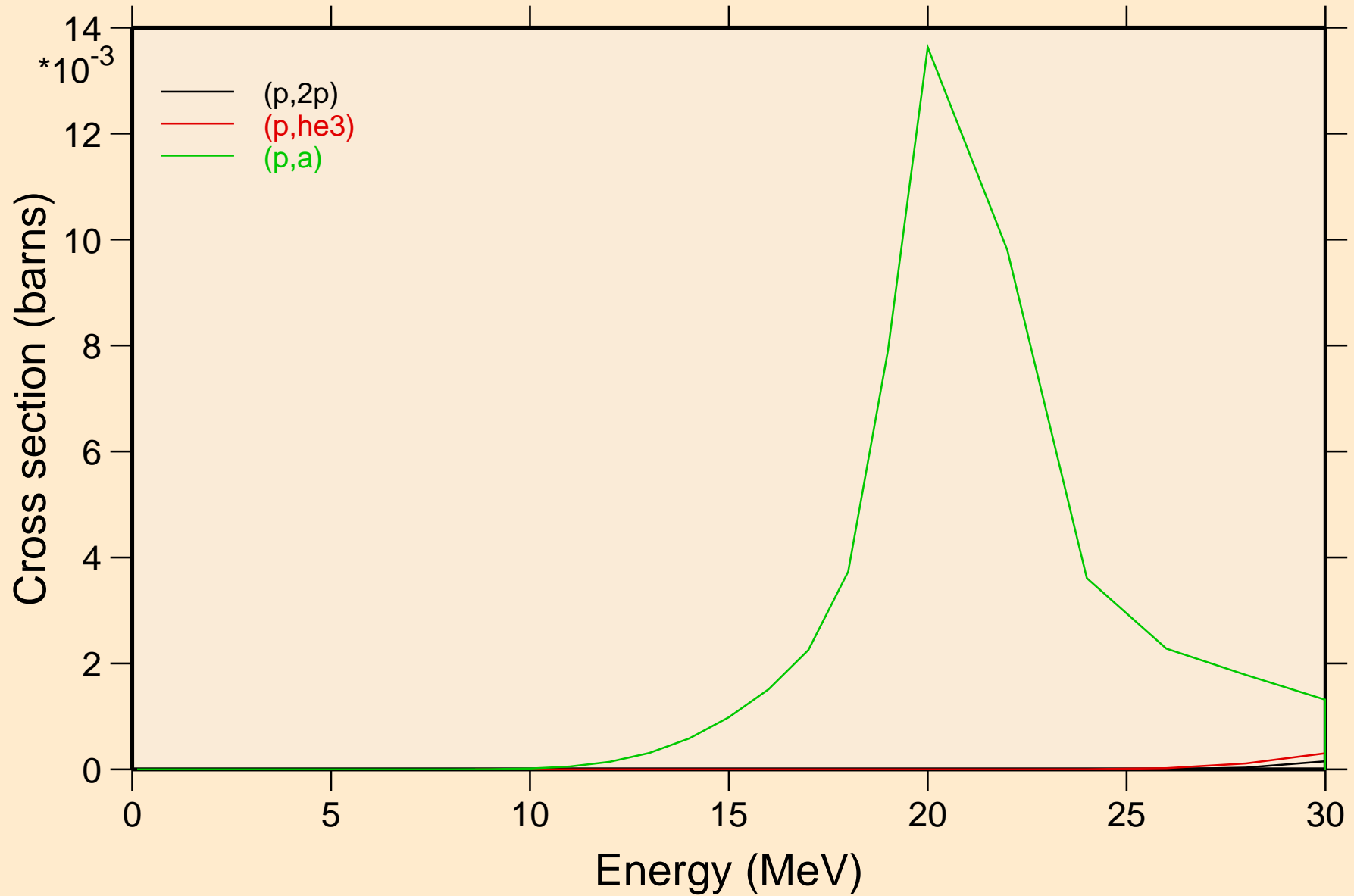

DY170 PROTON ACER TENDL-2021 LIBRARY; T=0.K  
Threshold reactions

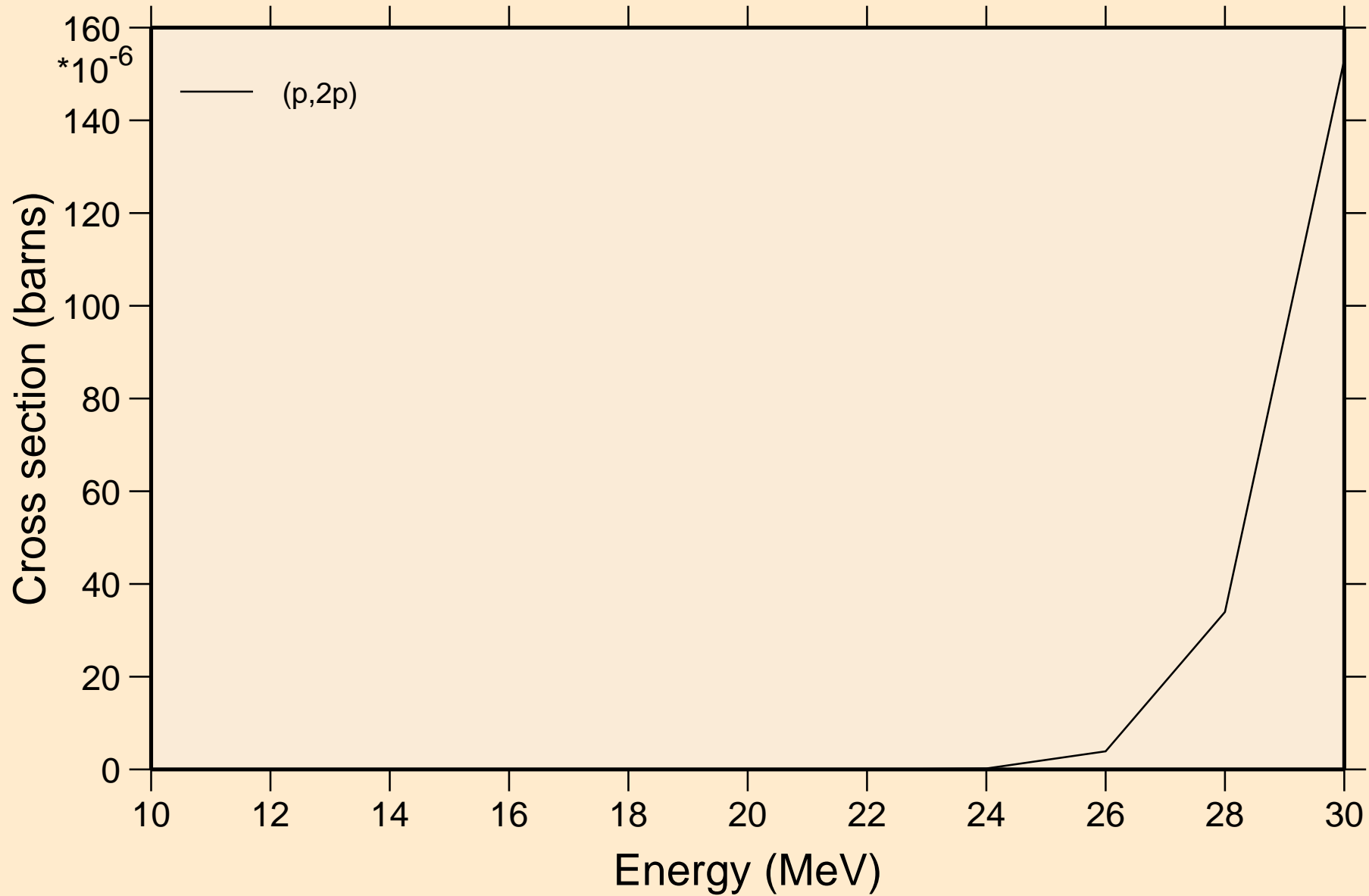



DY170 PROTON ACER TENDL-2021 LIBRARY; T=0.K  
angular distribution for elastic

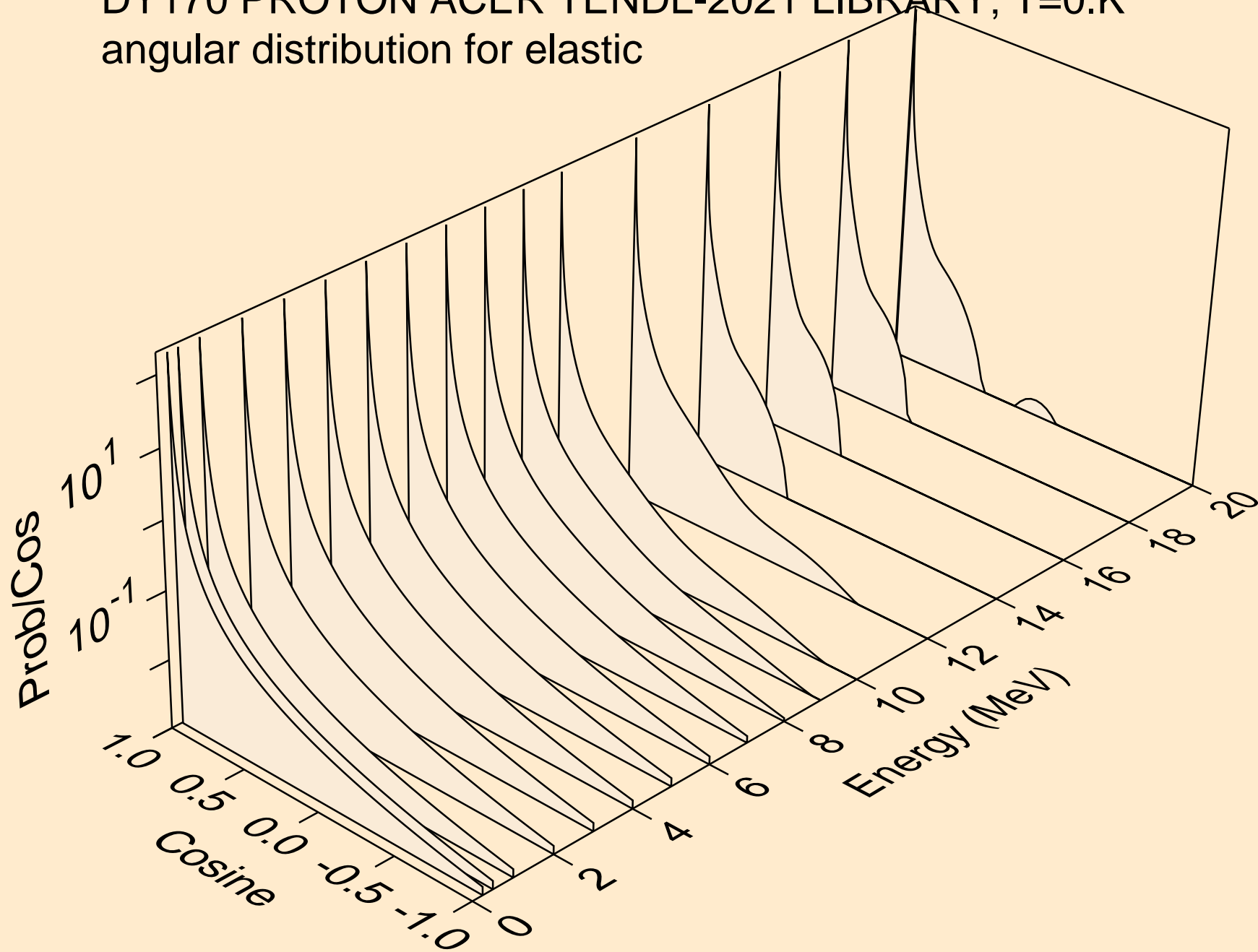

DY170 PROTON ACER TENDL-2021 LIBRARY; T=0.K  
angular distribution for elastic

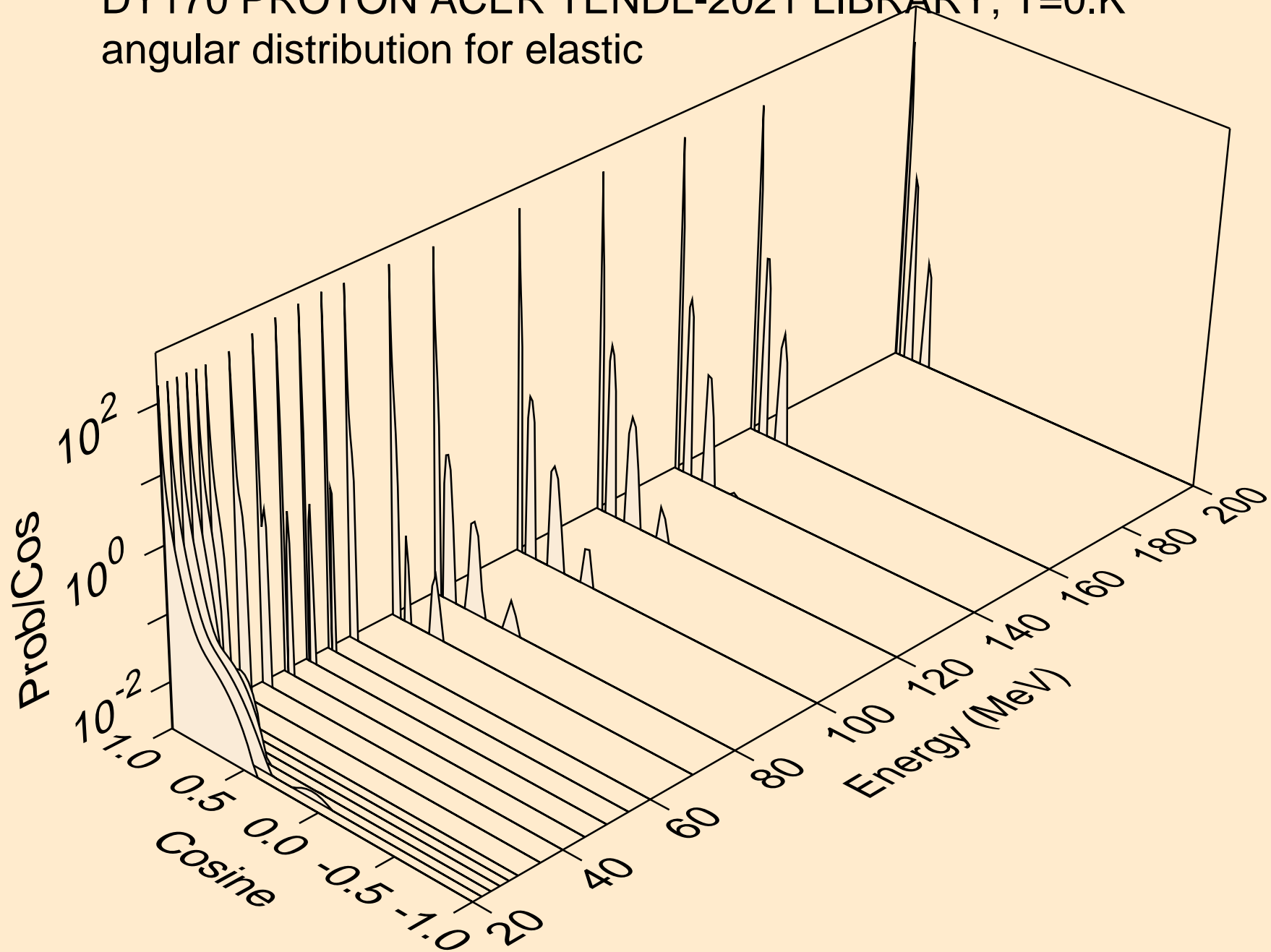

DY170 PROTON ACER TENDL-2021 LIBRARY; T=0.K  
Proton emission for (p,x)

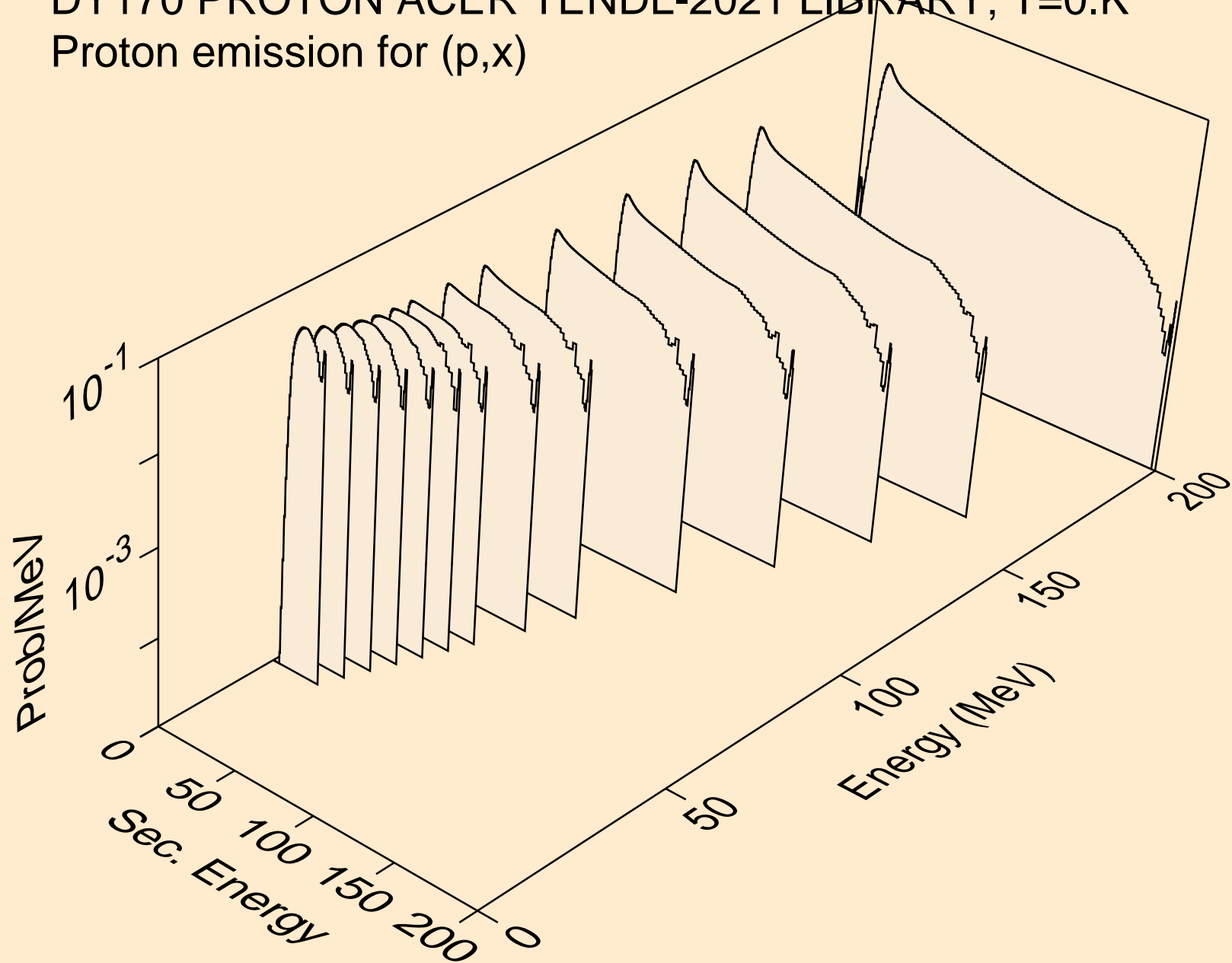

DY170 PROTON ACER TENDL-2021 LIBRARY; T=0.K  
Proton emission for (p,n\*)p

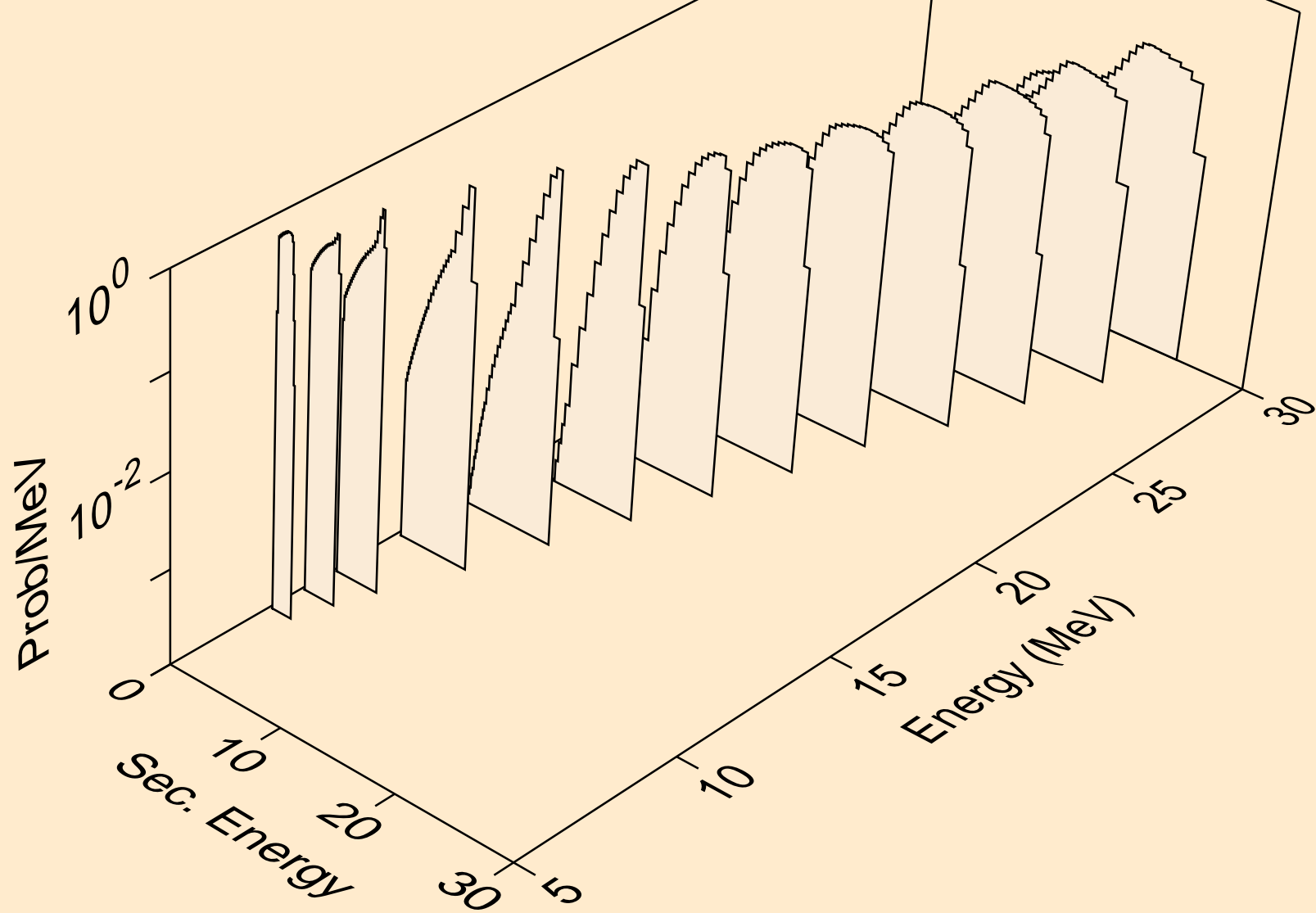

DY170 PROTON ACER TENDL-2021 LIBRARY; T=0.K  
Proton emission for (p,2np)

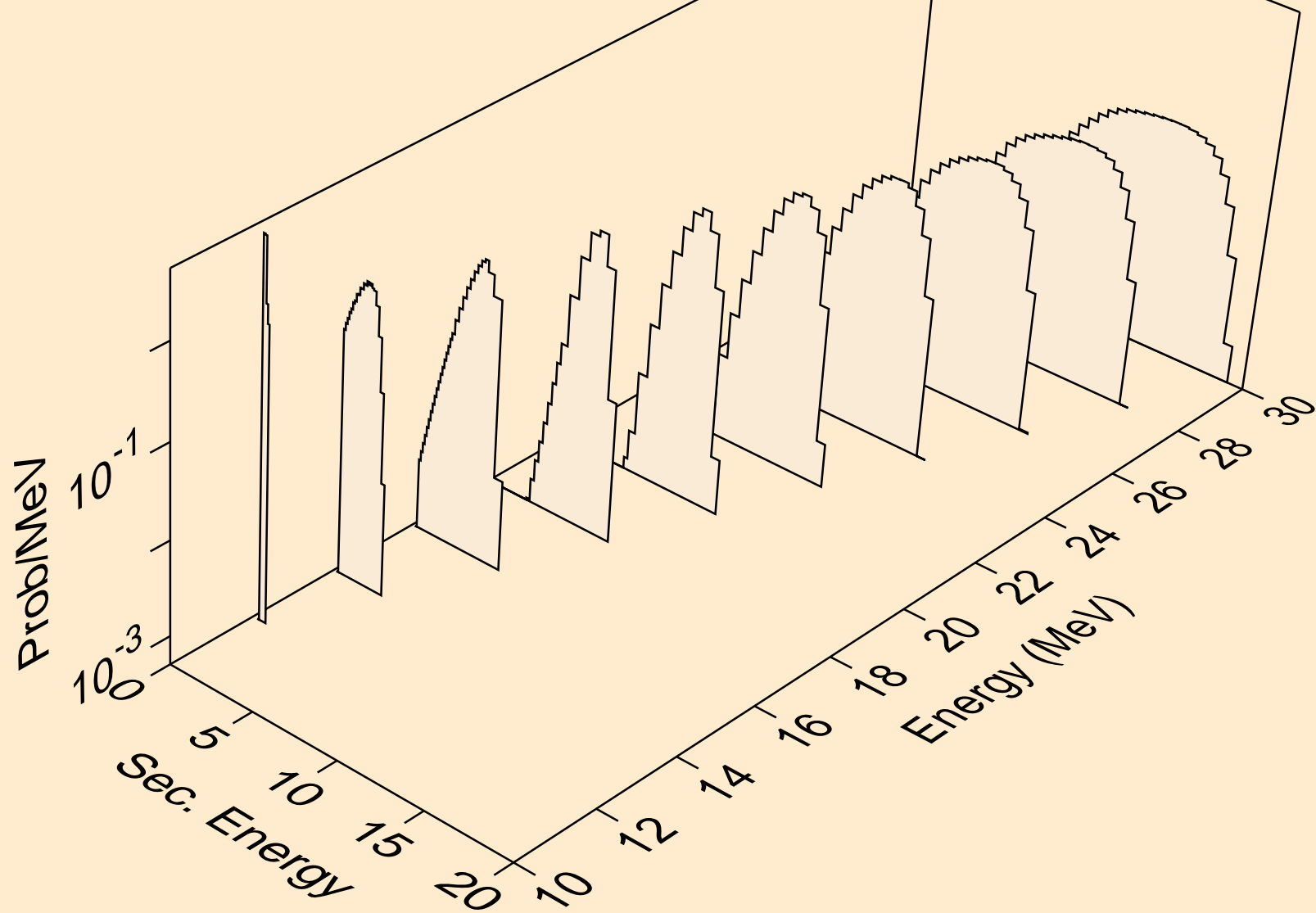

DY170 PROTON ACER TENDL-2021 LIBRARY; T=0.K  
Proton emission for (p,3np)

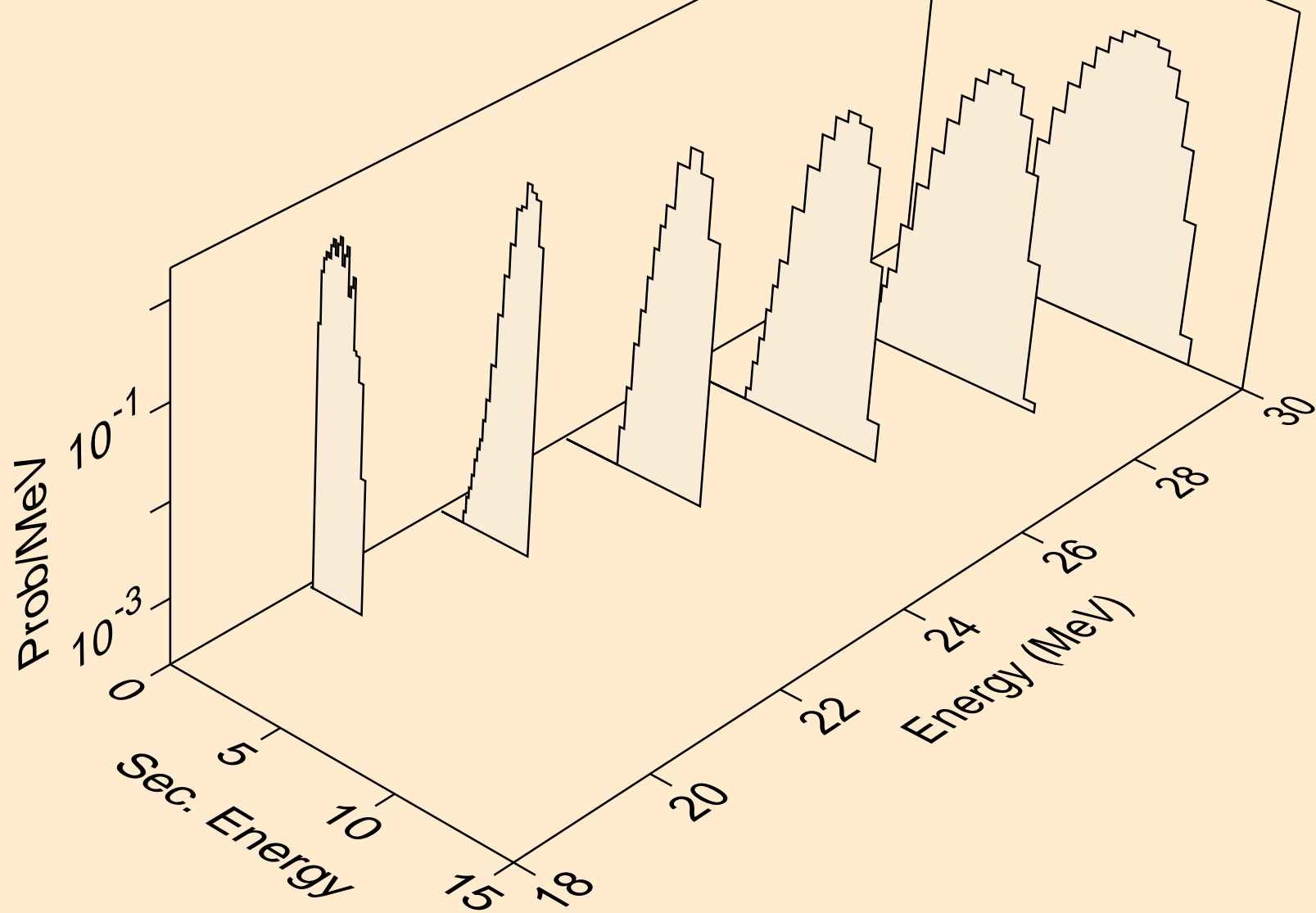

DY170 PROTON ACER TENDL-2021 LIBRARY; T=0.K  
Proton emission for (p,2np)

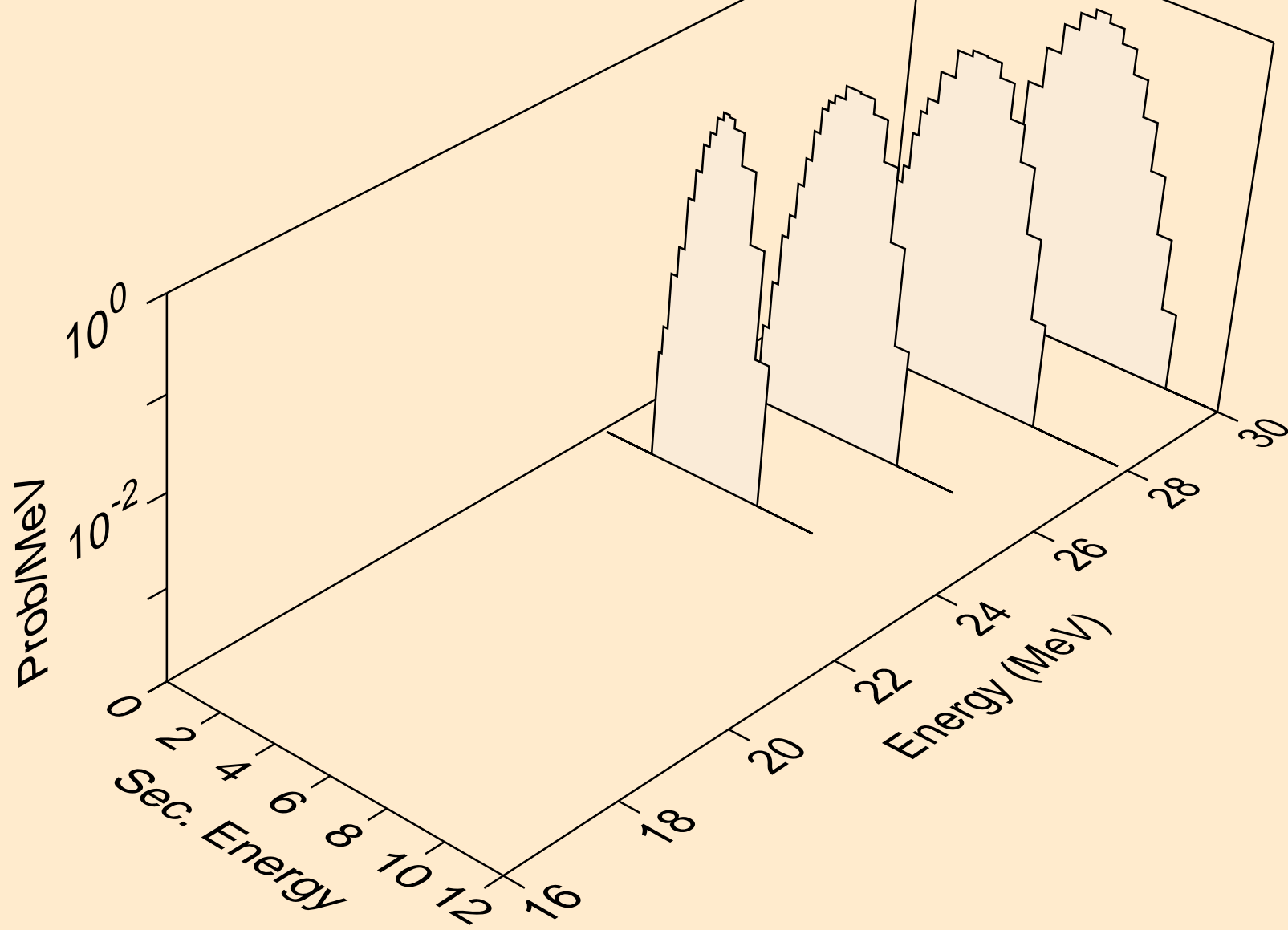

DY170 PROTON ACER TENDL-2021 LIBRARY; T=0.K  
Proton emission for inelastic

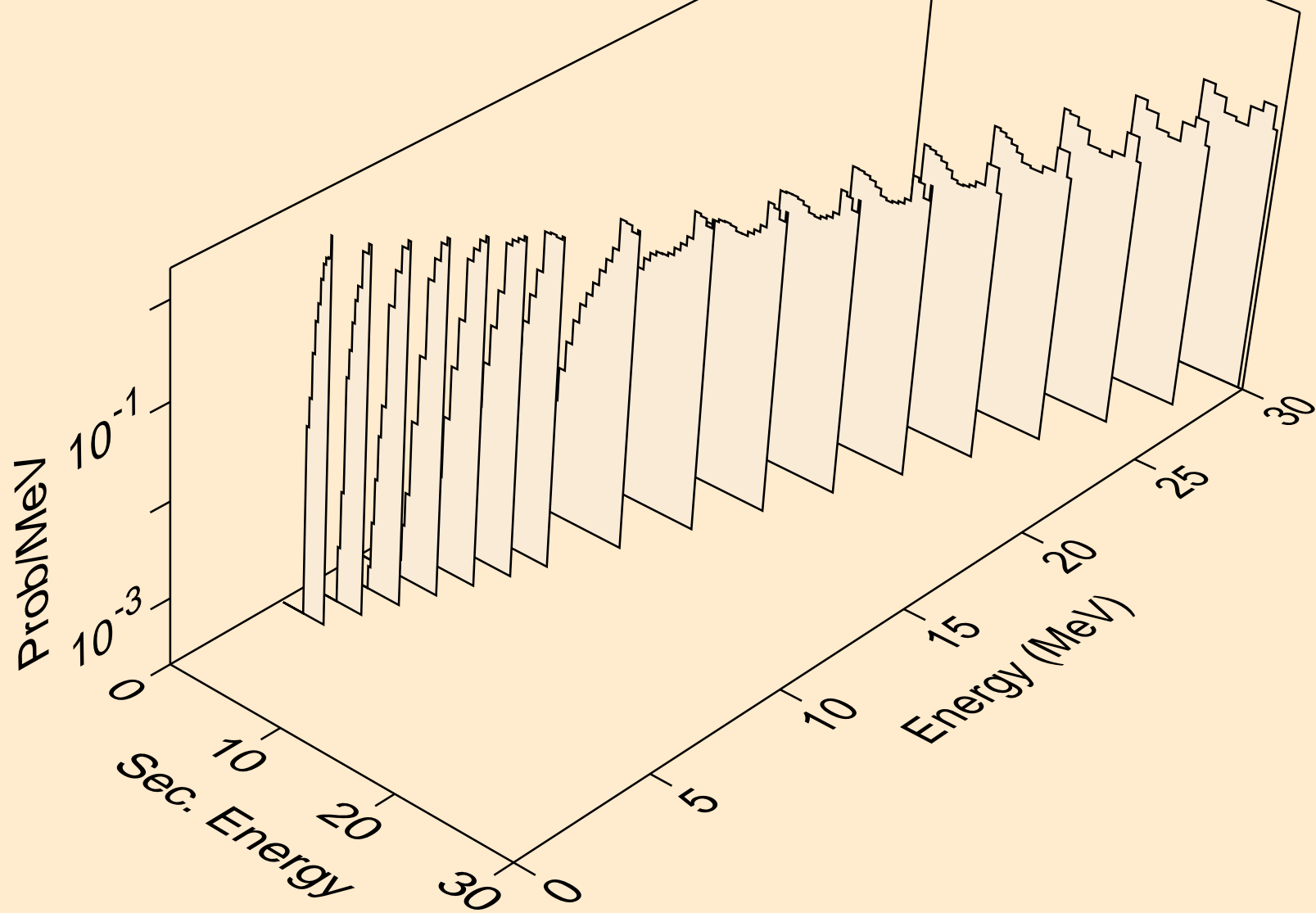



DY170 PROTON ACER TENDL-2021 LIBRARY; T=0.K  
Proton emission for (p,2p)

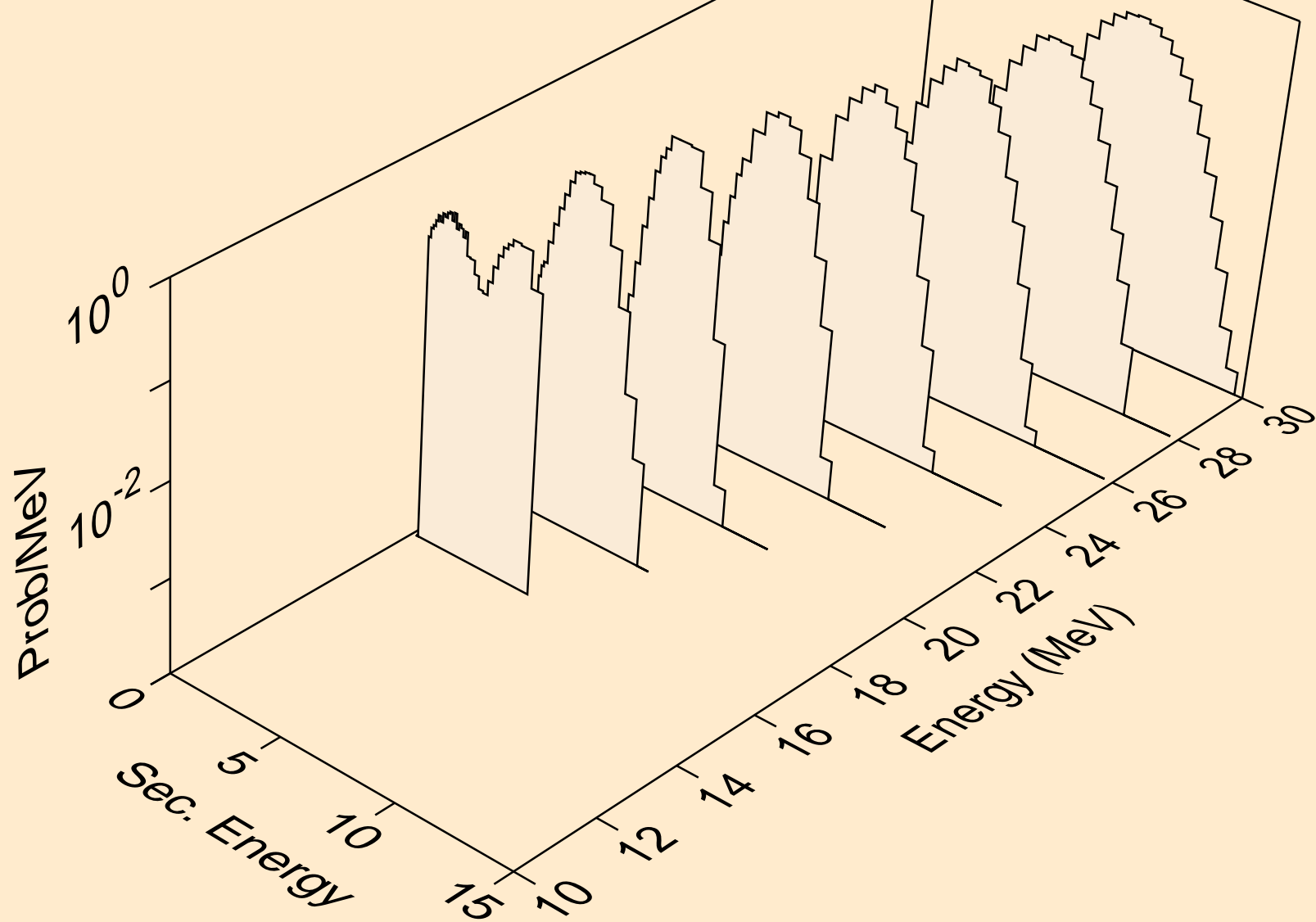

DY170 PROTON ACER TENDL-2021 LIBRARY; T=0.K  
Photon emission for (z,n)

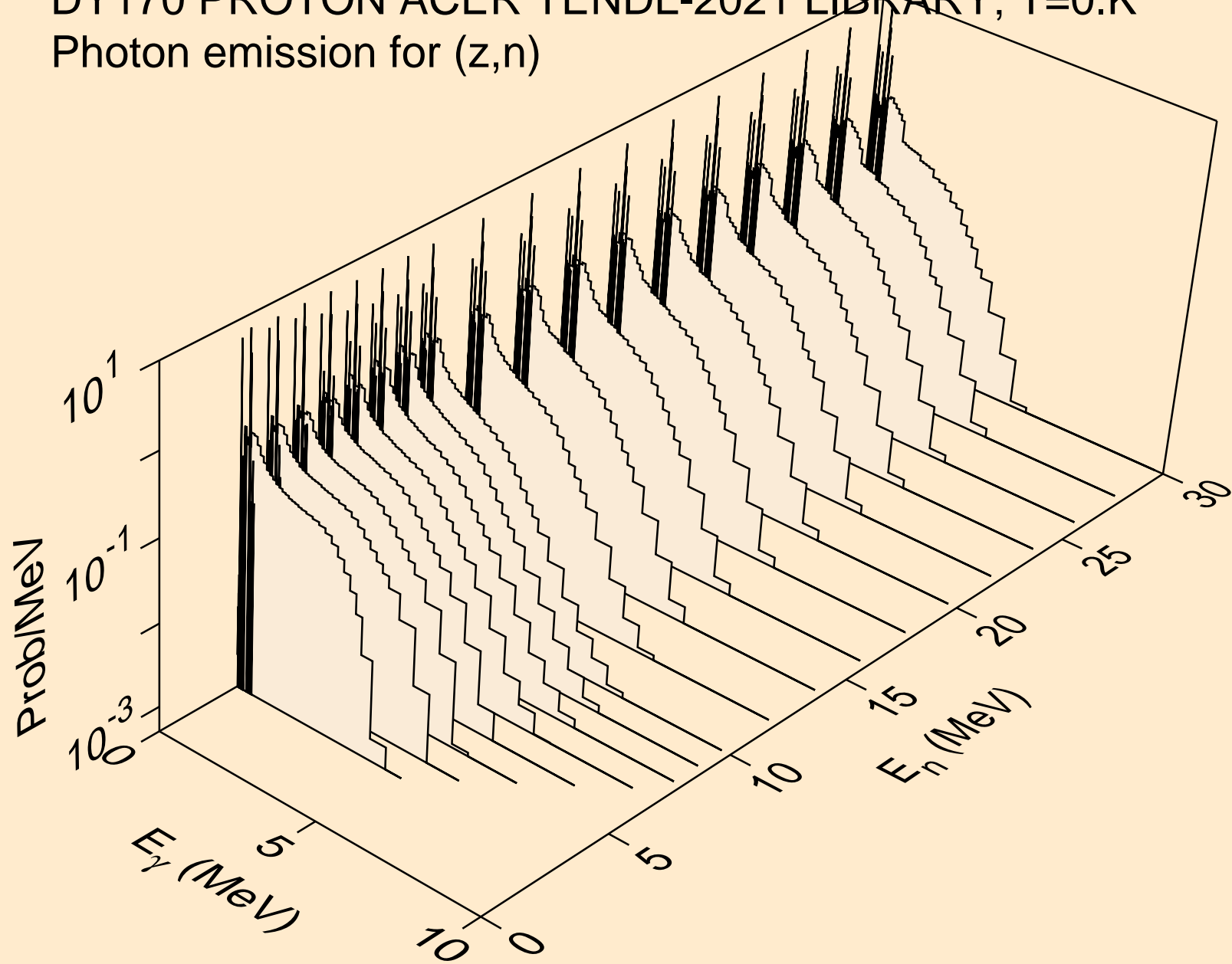

DY170 PROTON ACER TENDL-2021 LIBRARY; T=0.K  
Photon emission for (n,x)

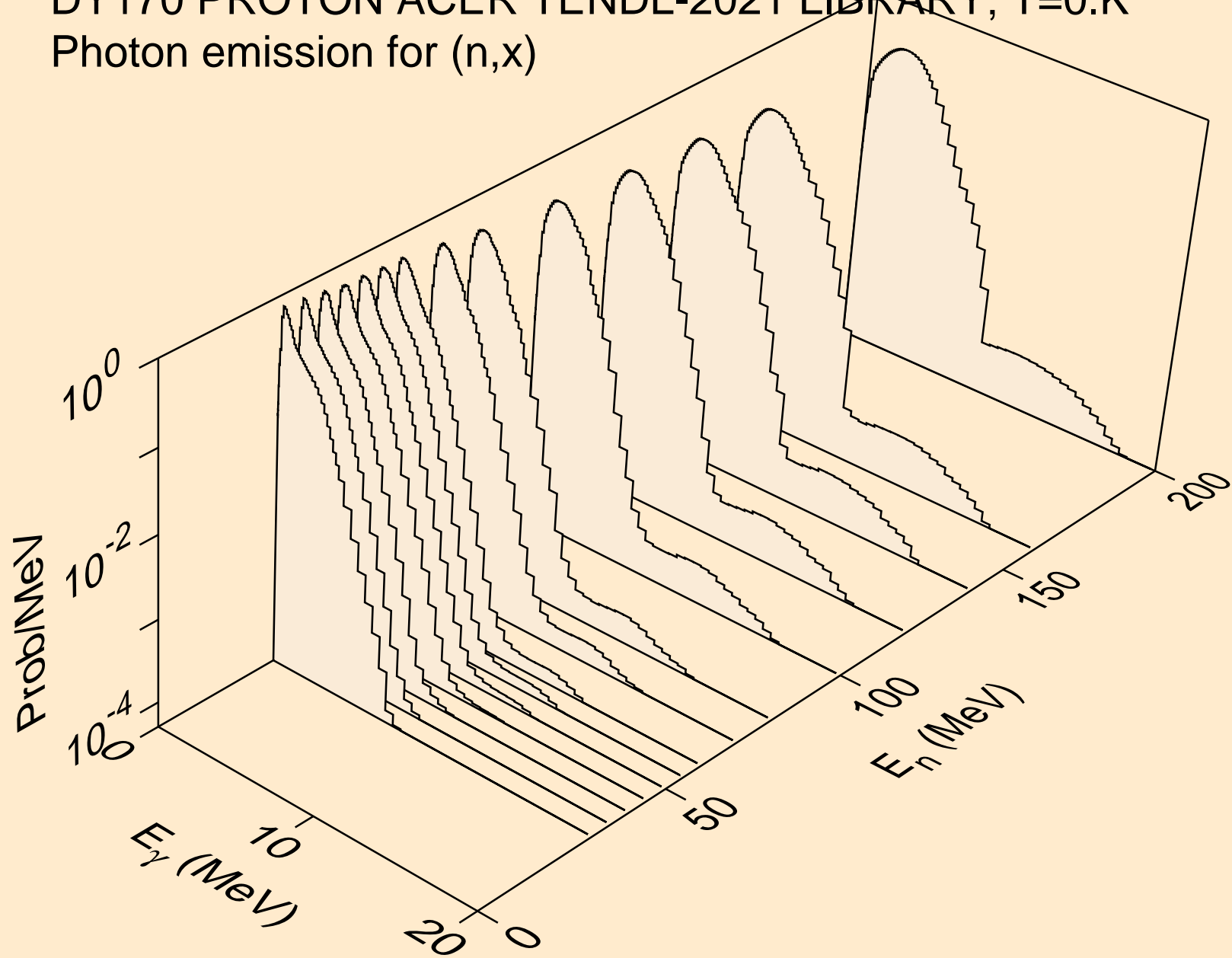

DY170 PROTON ACER TENDL-2021 LIBRARY; T=0.K  
Photon emission for (n,2nd)

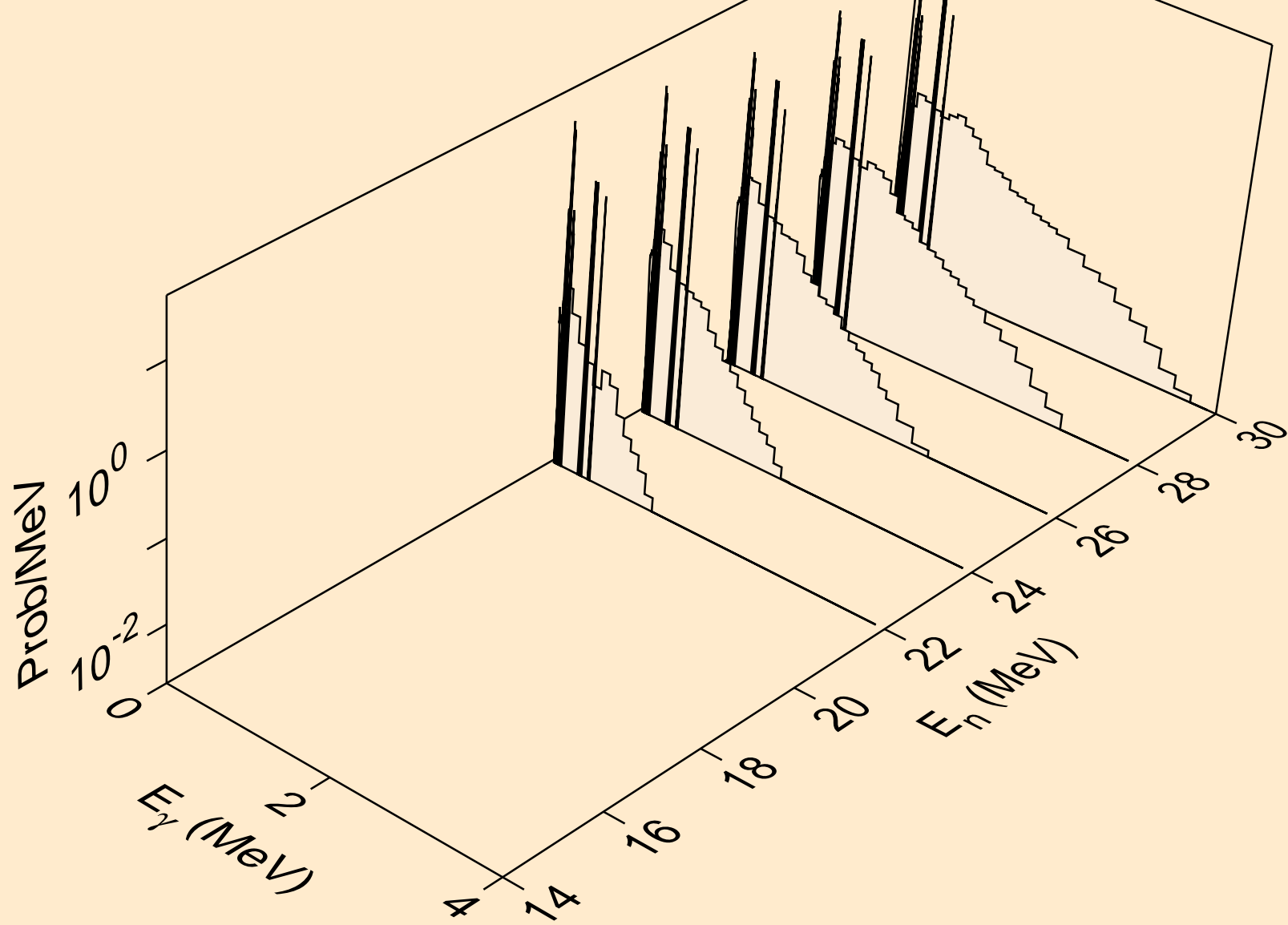

DY170 PROTON ACER TENDL-2021 LIBRARY; T=0.K  
Photon emission for (n,2n)

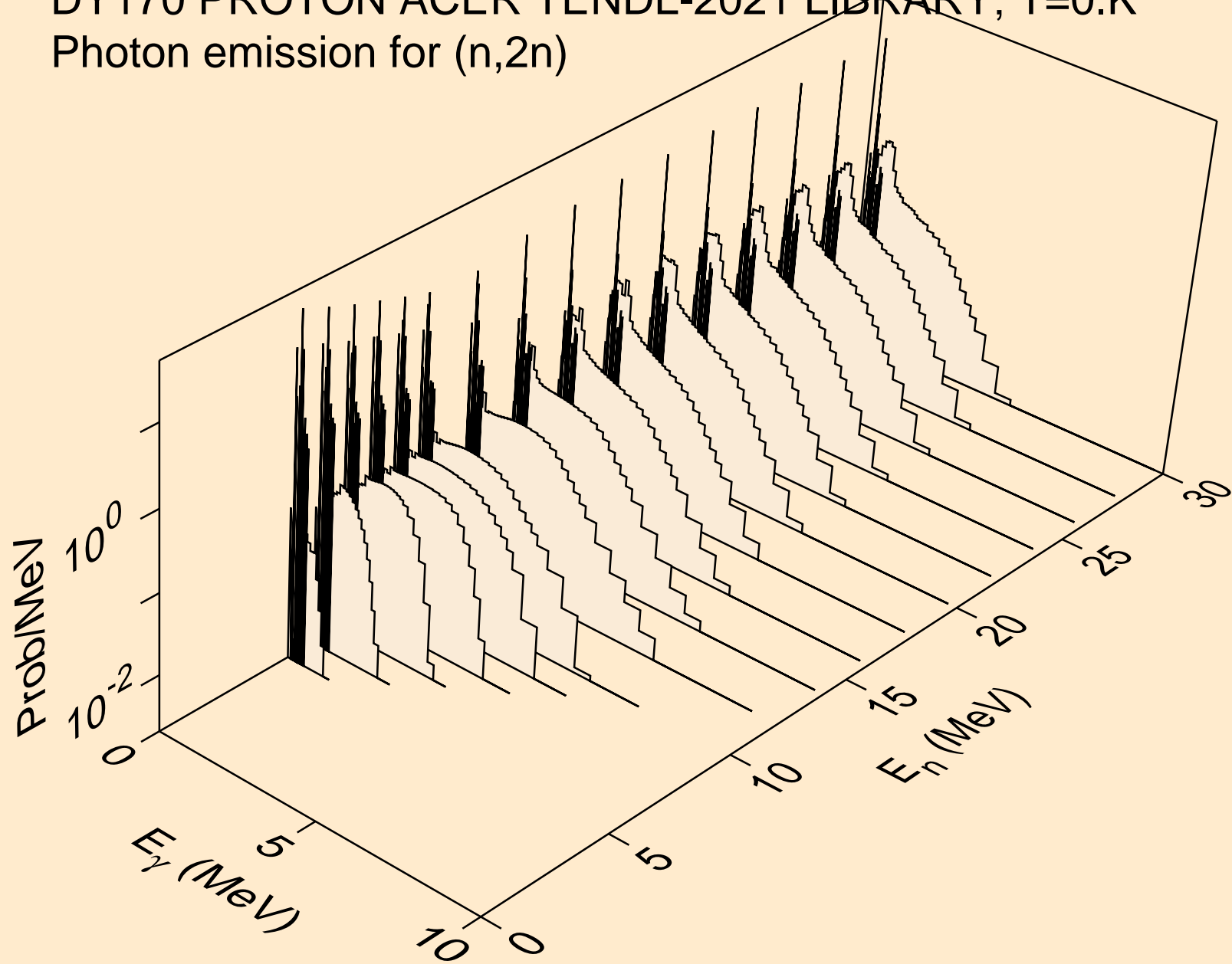

DY170 PROTON ACER TENDL-2021 LIBRARY; T=0.K  
Photon emission for (n,3n)

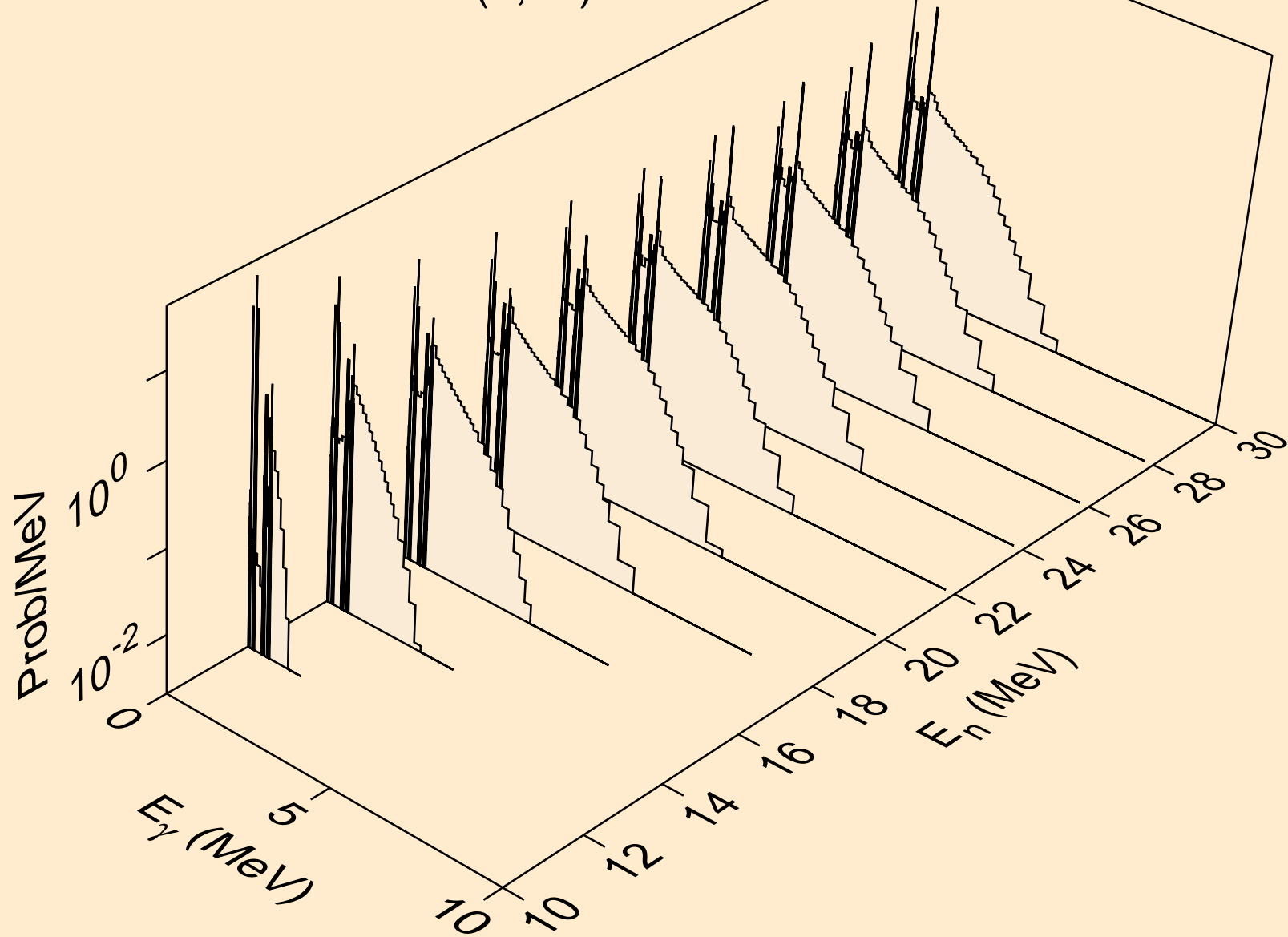

DY170 PROTON ACER TENDL-2021 LIBRARY; T=0.K  
Photon emission for (n,n\*)a

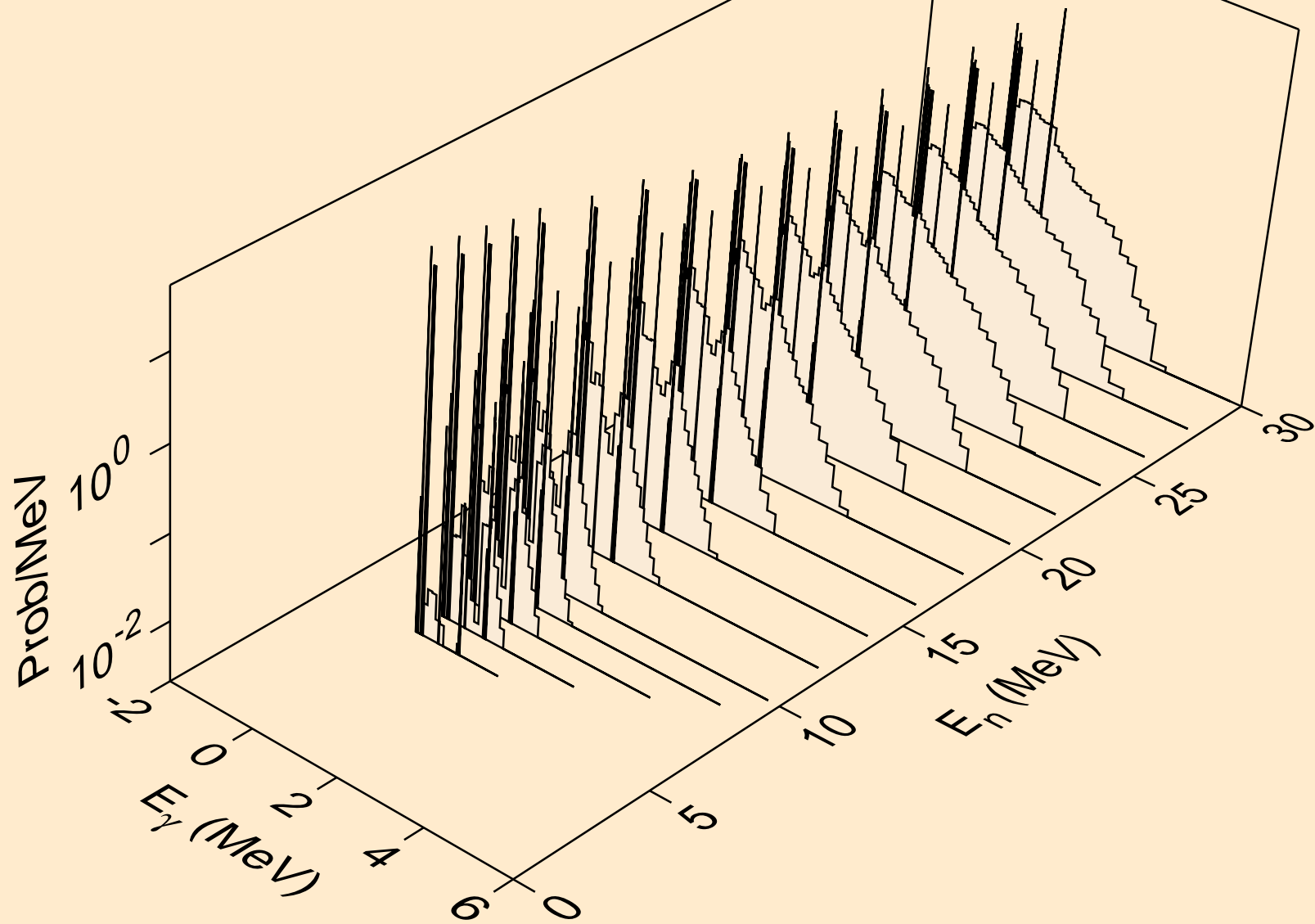

DY170 PROTON ACER TENDL-2021 LIBRARY; T=0.K  
Photon emission for (n,2n)a

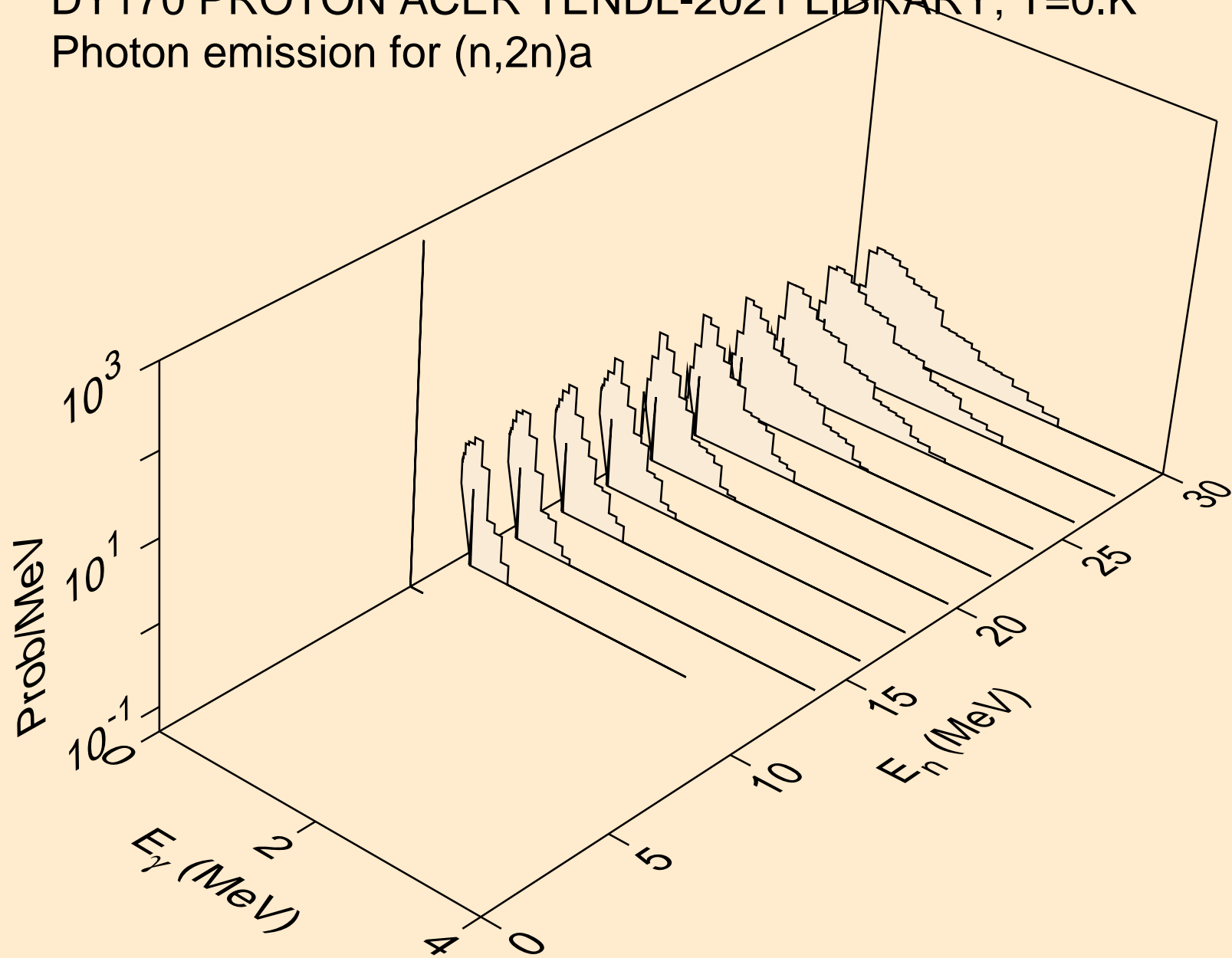



DY170 PROTON ACER TENDL-2021 LIBRARY; T=0.K  
Photon emission for (n,3n)a

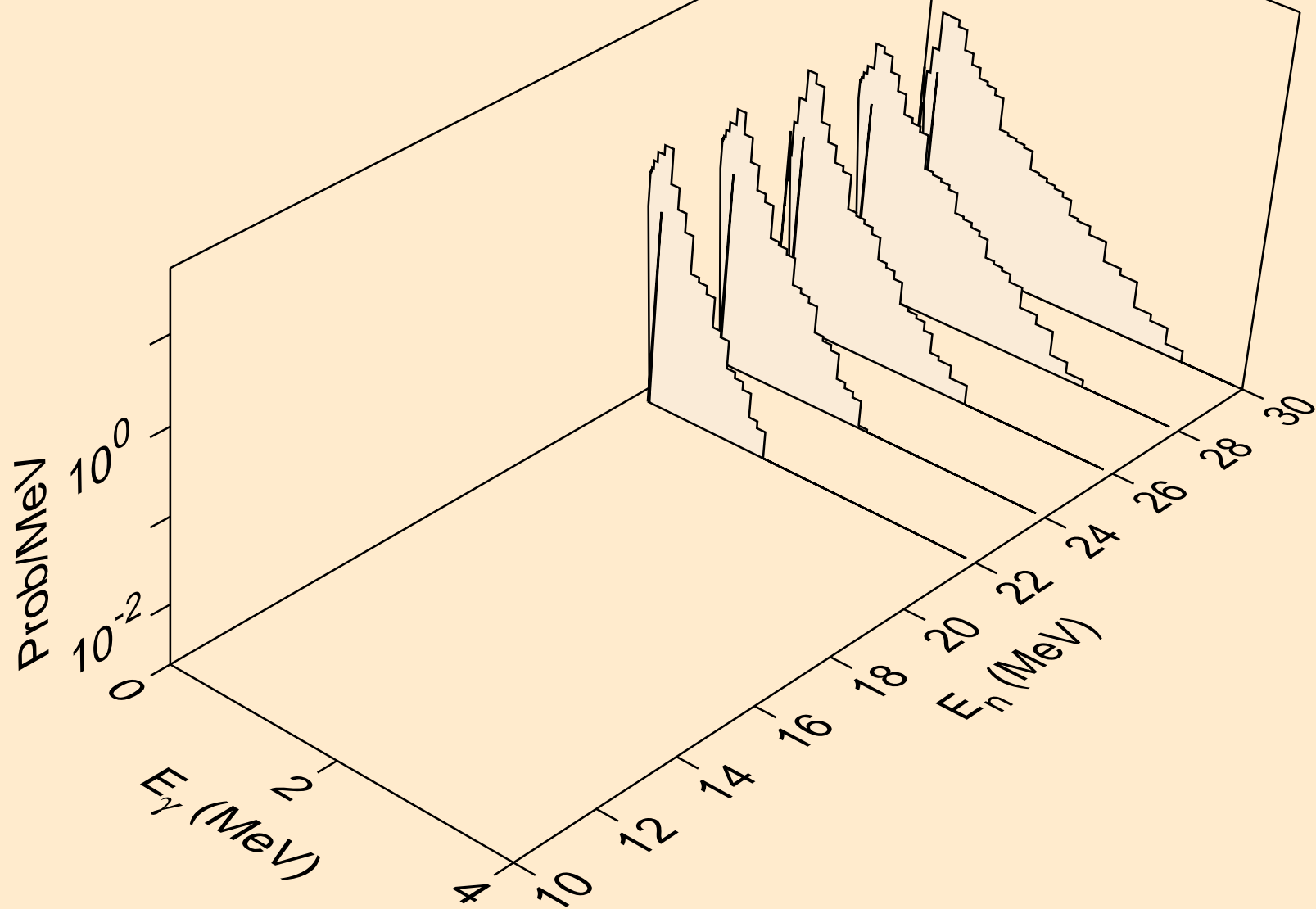

DY170 PROTON ACER TENDL-2021 LIBRARY; T=0.K  
Photon emission for (n,n\*)p

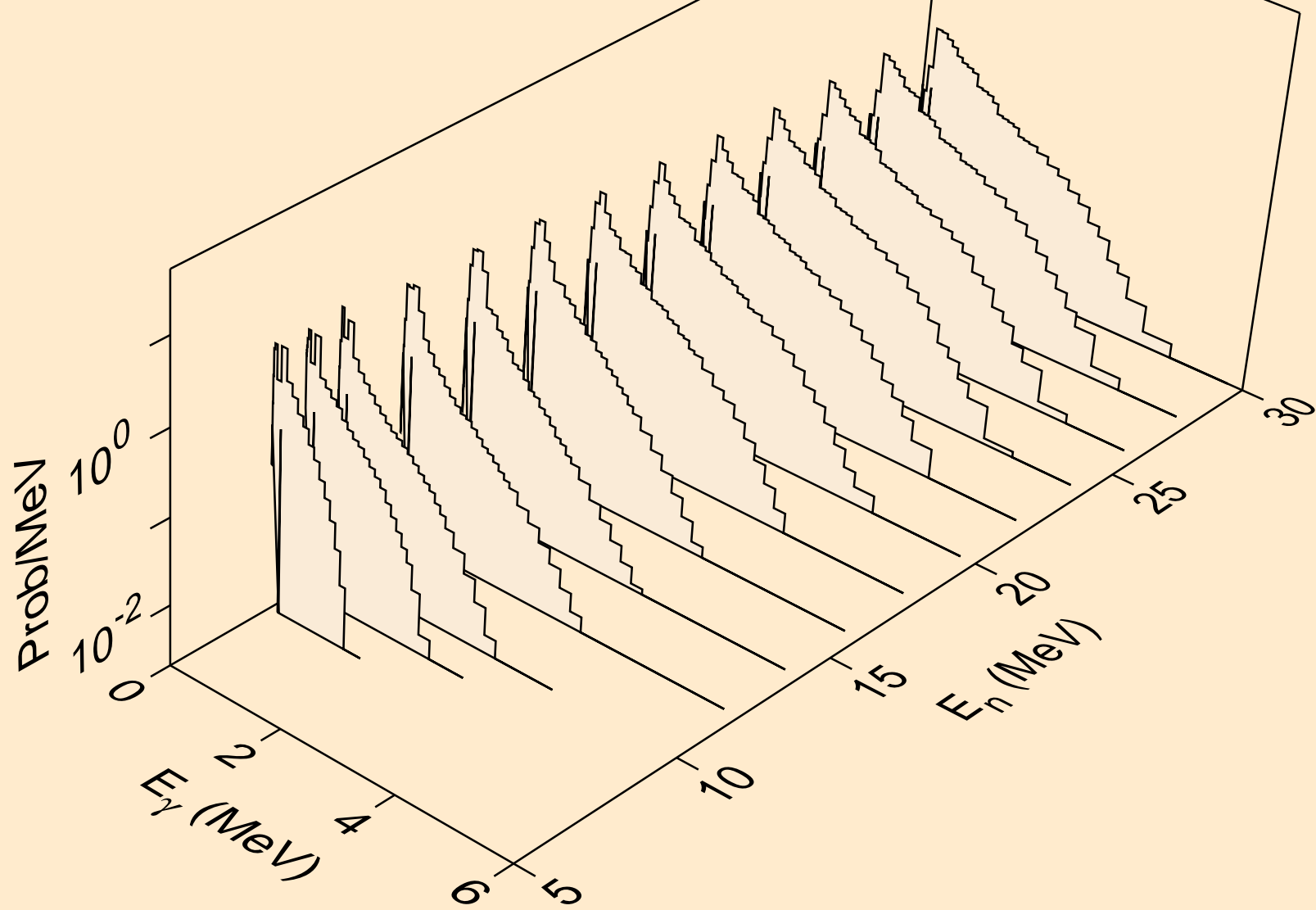

DY170 PROTON ACER TENDL-2021 LIBRARY; T=0.K  
Photon emission for (n,n\*)d

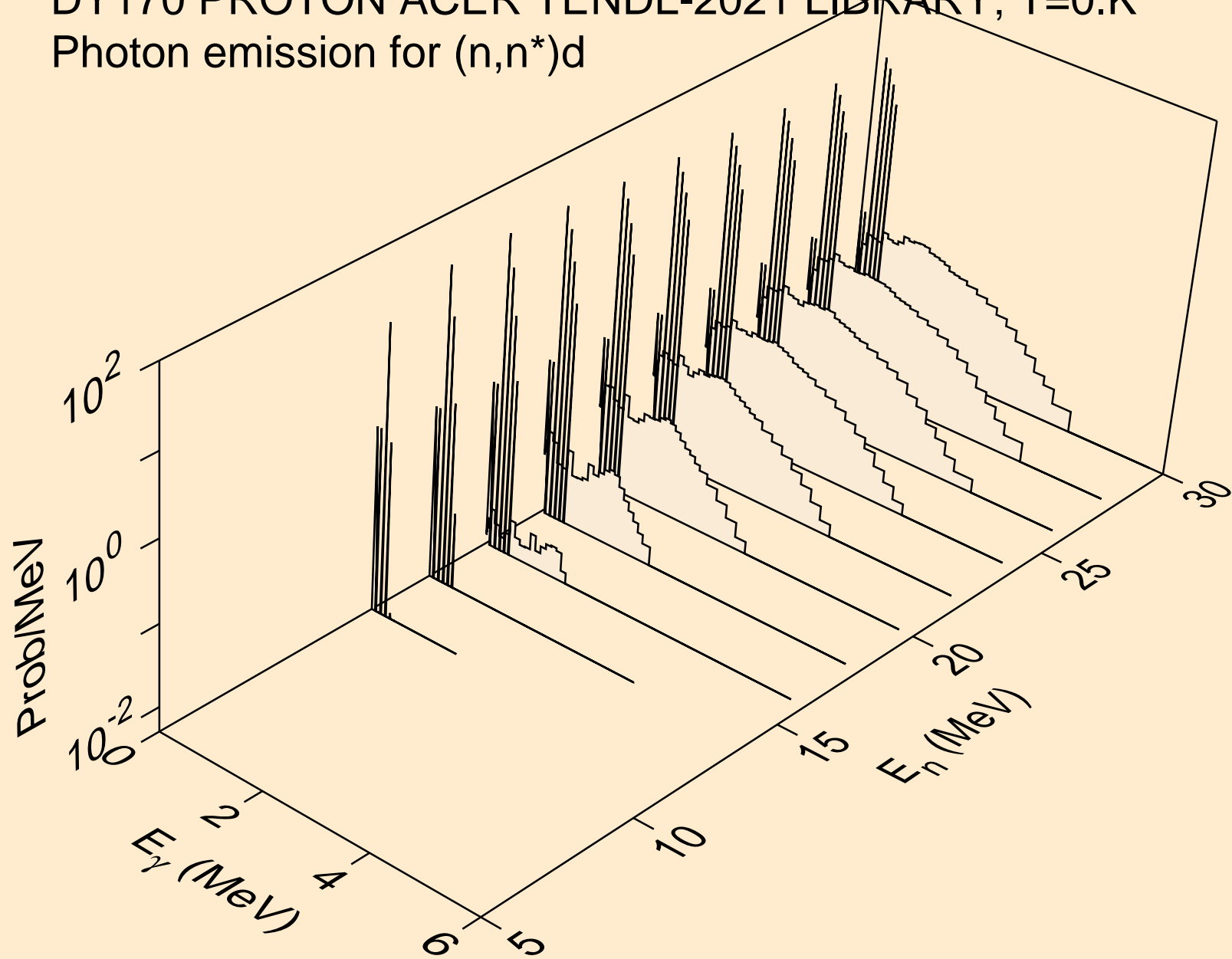

DY170 PROTON ACER TENDL-2021 LIBRARY; T=0.K  
Photon emission for (n,n\*)t

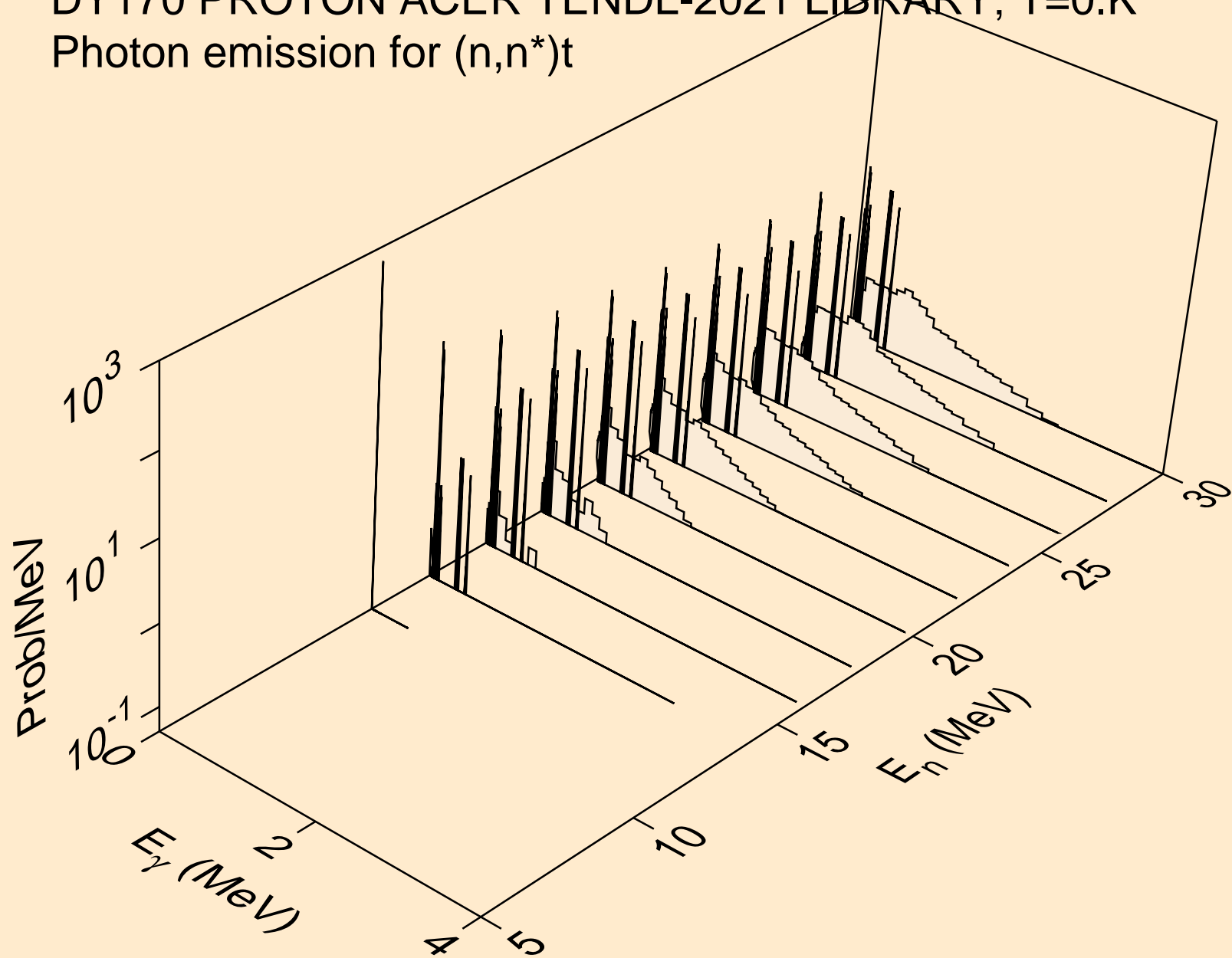

DY170 PROTON ACER TENDL-2021 LIBRARY; T=0.K  
Photon emission for (n,n\*)he3

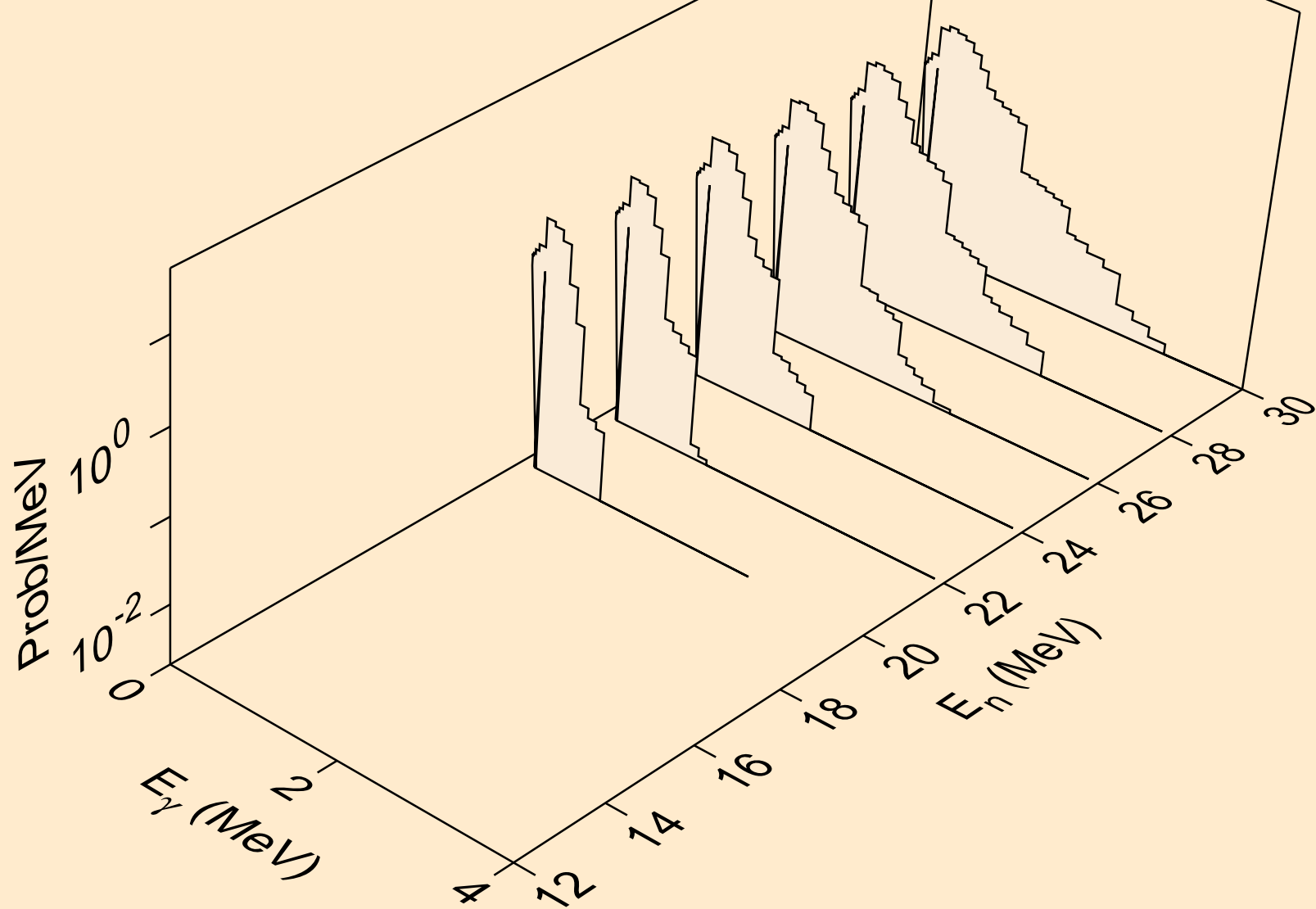

DY170 PROTON ACER TENDL-2021 LIBRARY; T=0.K  
Photon emission for (n,4n)

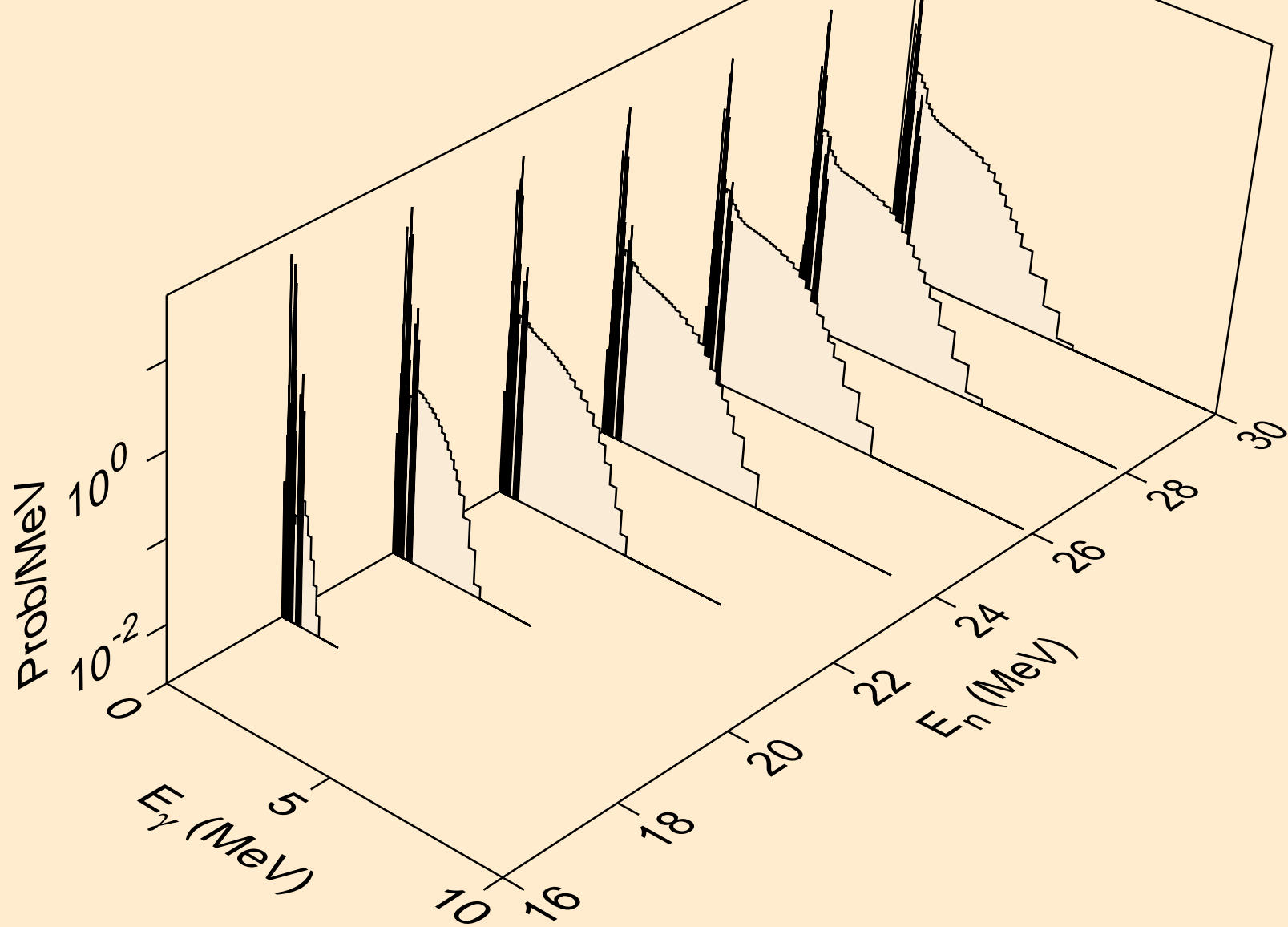

DY170 PROTON ACER TENDL-2021 LIBRARY; T=0.K  
Photon emission for (n,2np)

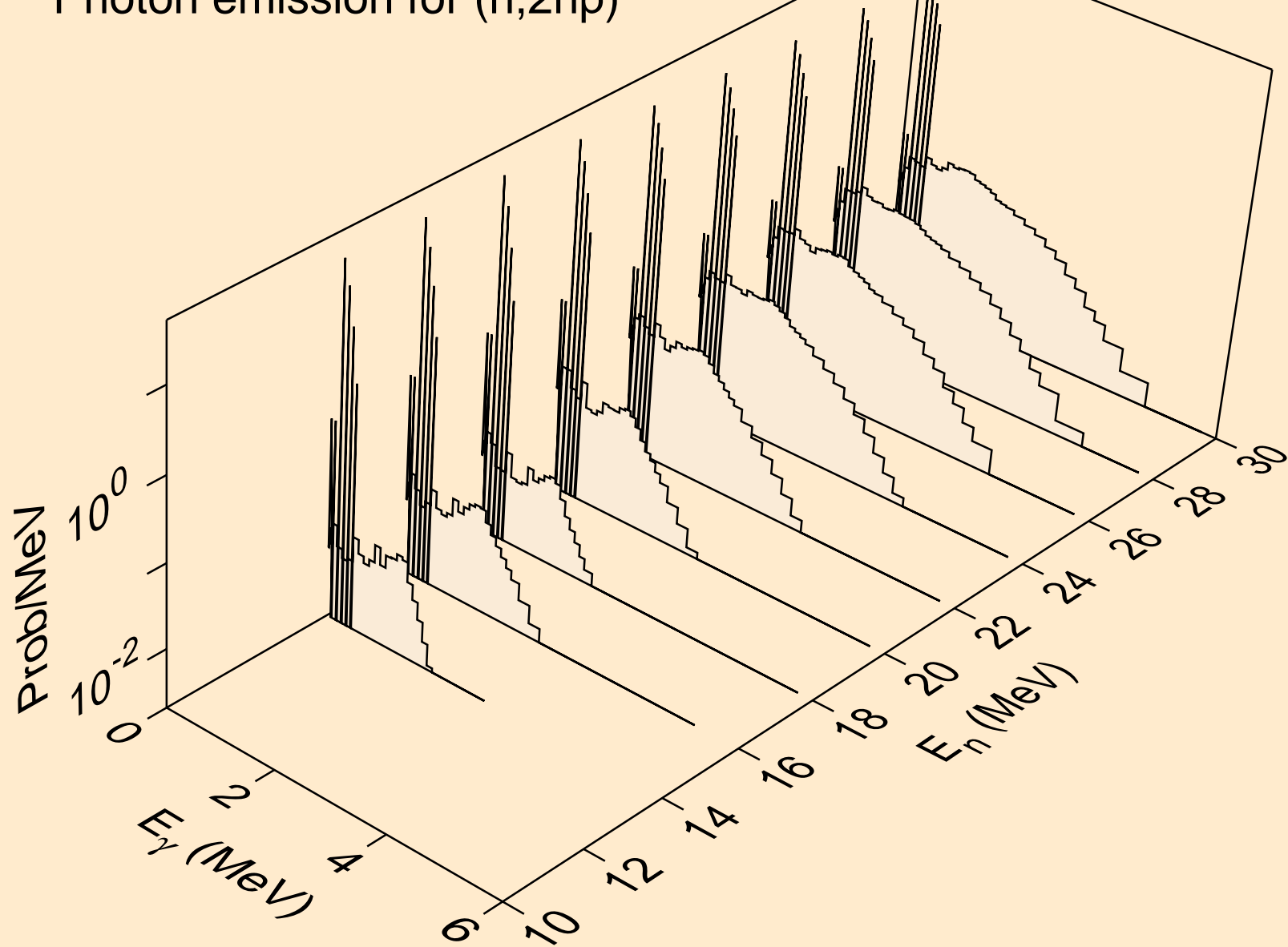

DY170 PROTON ACER TENDL-2021 LIBRARY; T=0.K  
Photon emission for (n,3np)

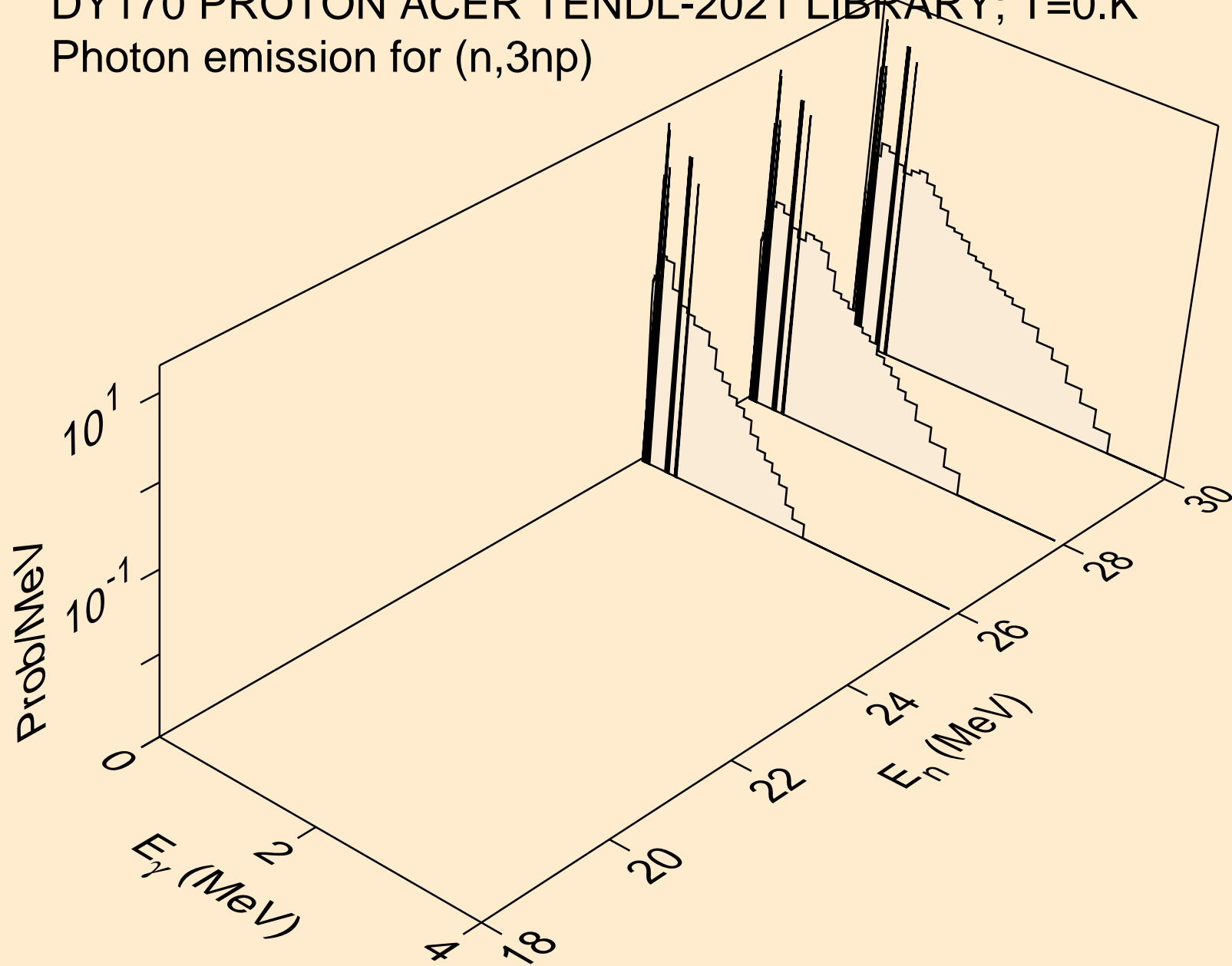



DY170 PROTON ACER TENDL-2021 LIBRARY; T=0.K  
Photon emission for (n,2np)

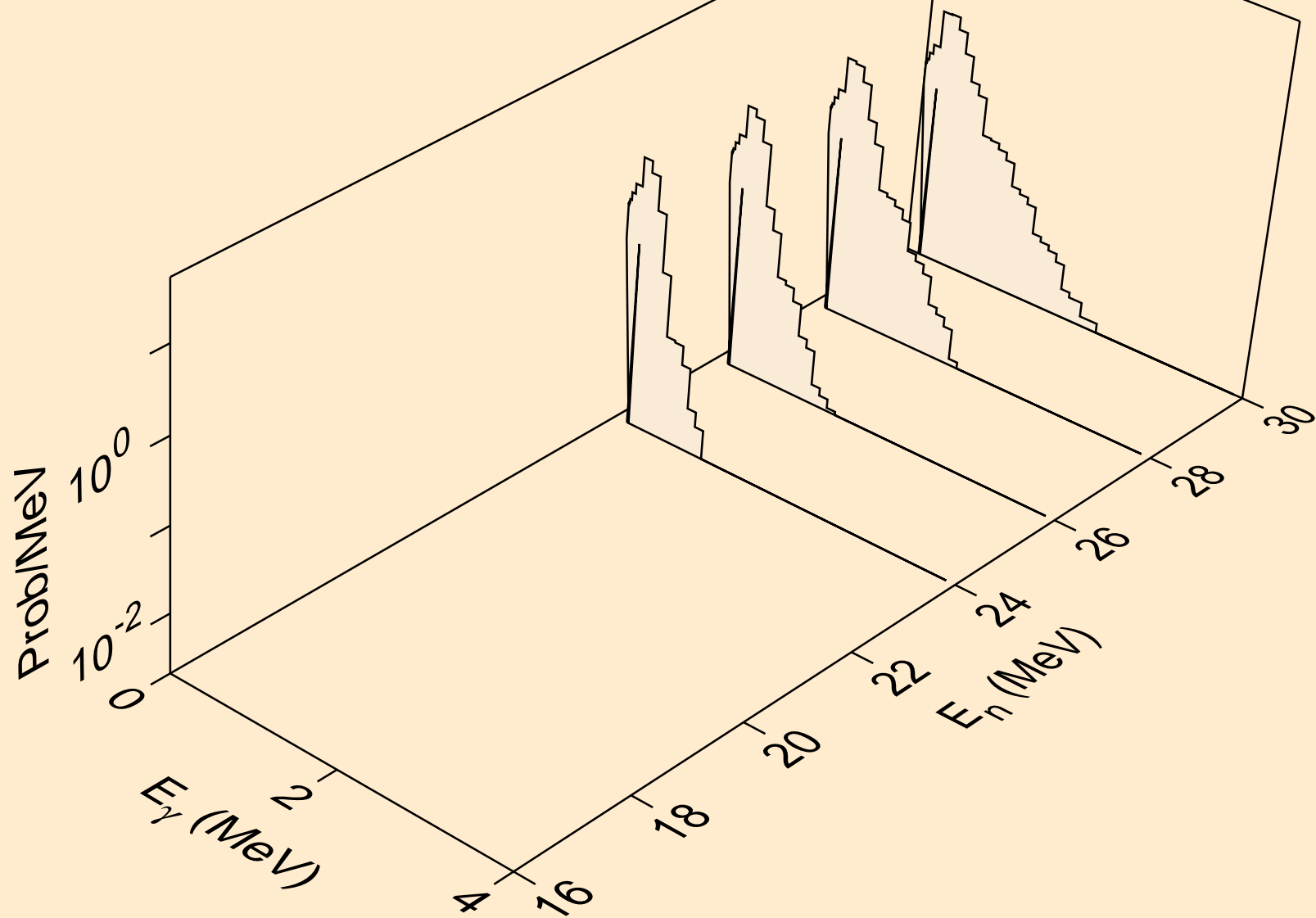

DY170 PROTON ACER TENDL-2021 LIBRARY; T=0.K  
Photon emission for (n,gma)

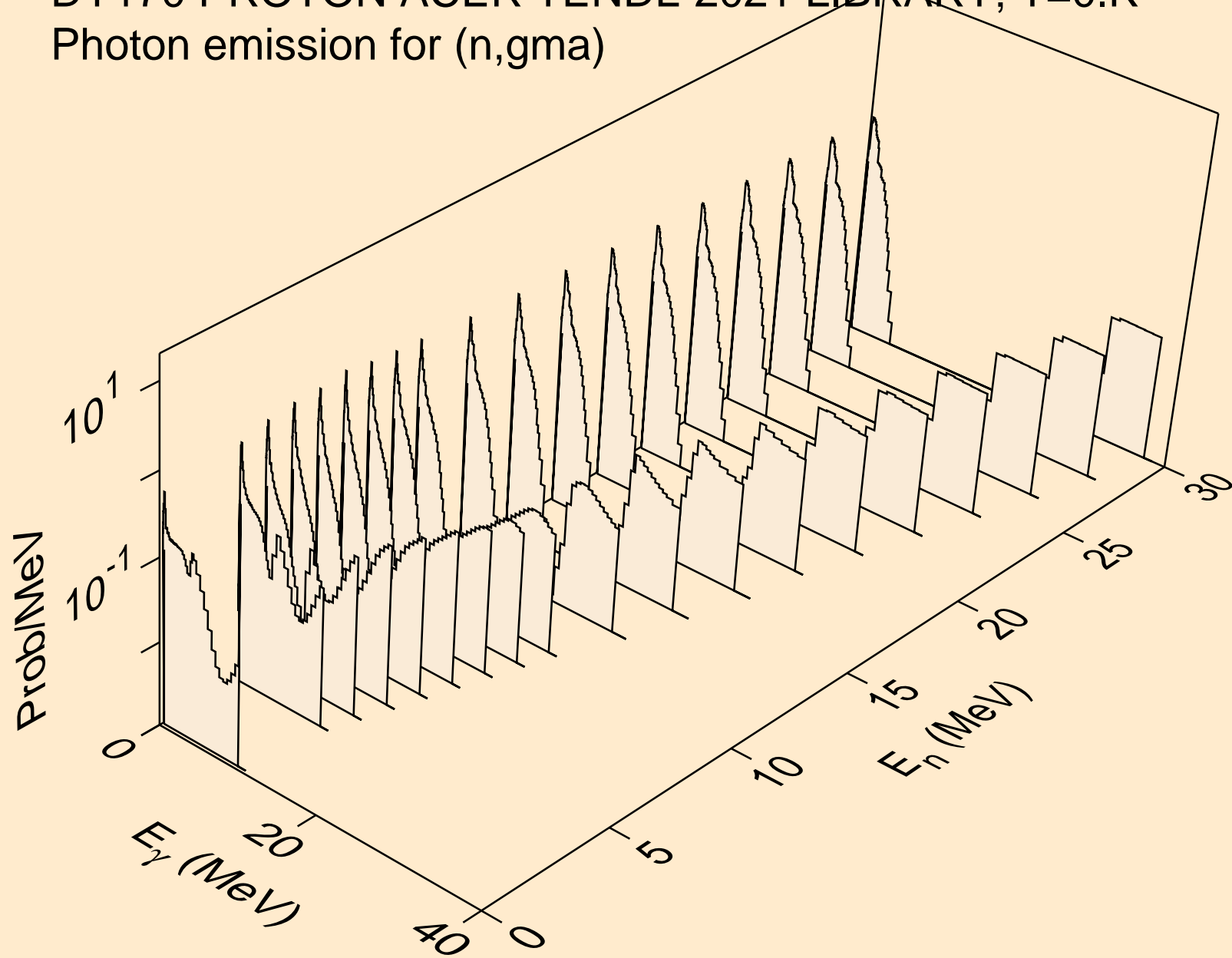

DY170 PROTON ACER TENDL-2021 LIBRARY; T=0.K  
Photon emission for inelastic

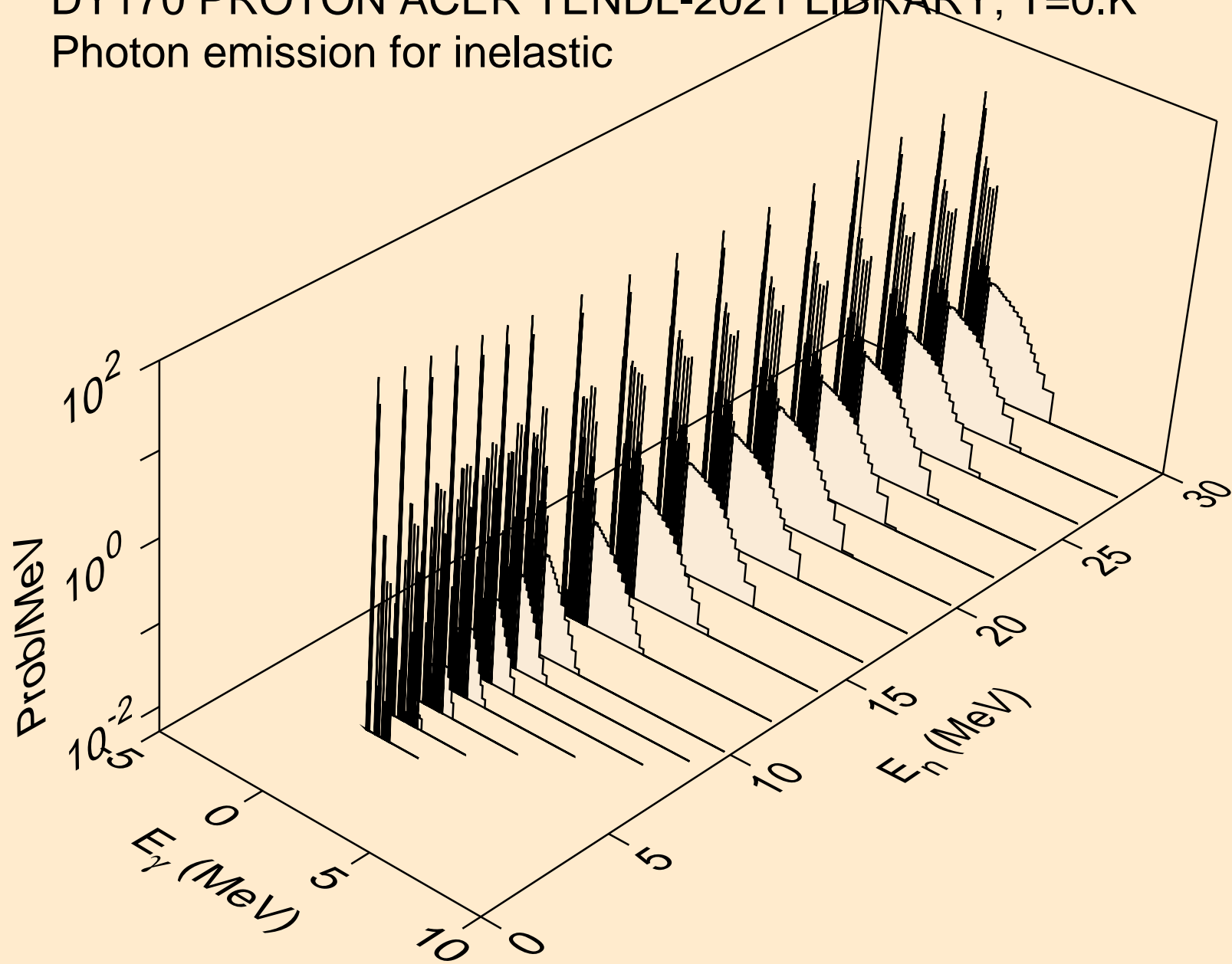

DY170 PROTON ACER TENDL-2021 LIBRARY; T=0.K  
Photon emission for (n,d)

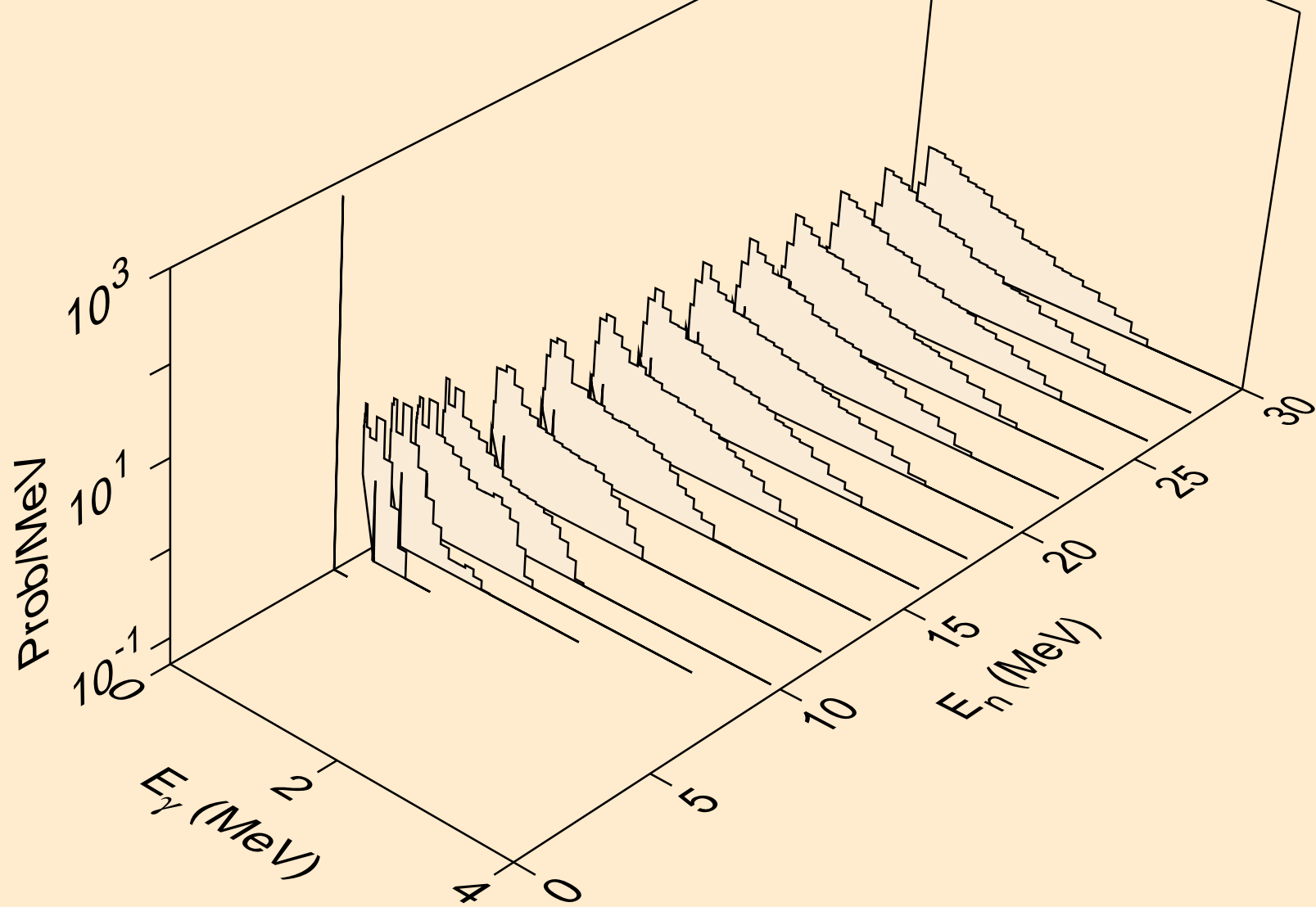

DY170 PROTON ACER TENDL-2021 LIBRARY; T=0.K  
Photon emission for (n,t)

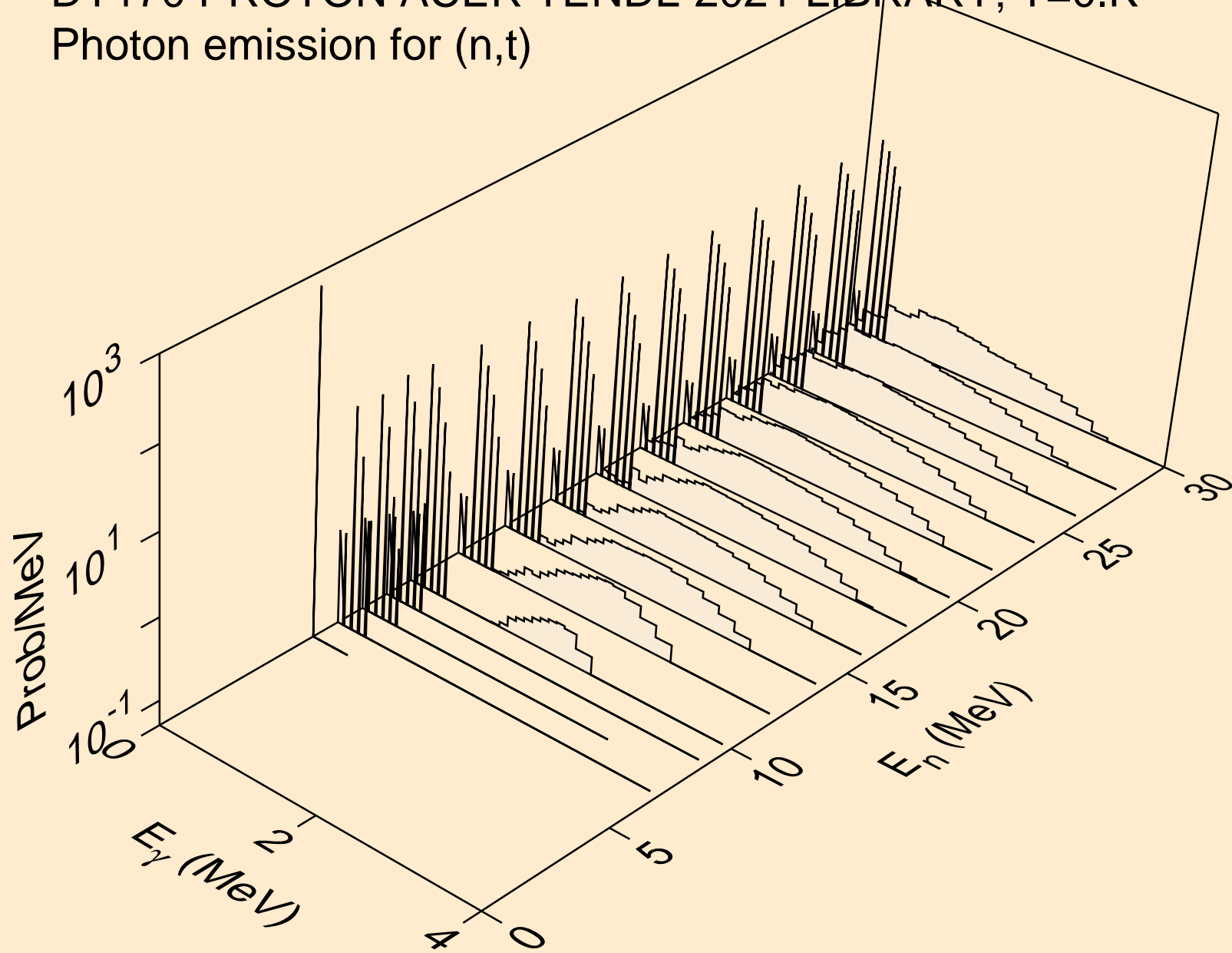

DY170 PROTON ACER TENDL-2021 LIBRARY; T=0.K  
Photon emission for (n,he3)

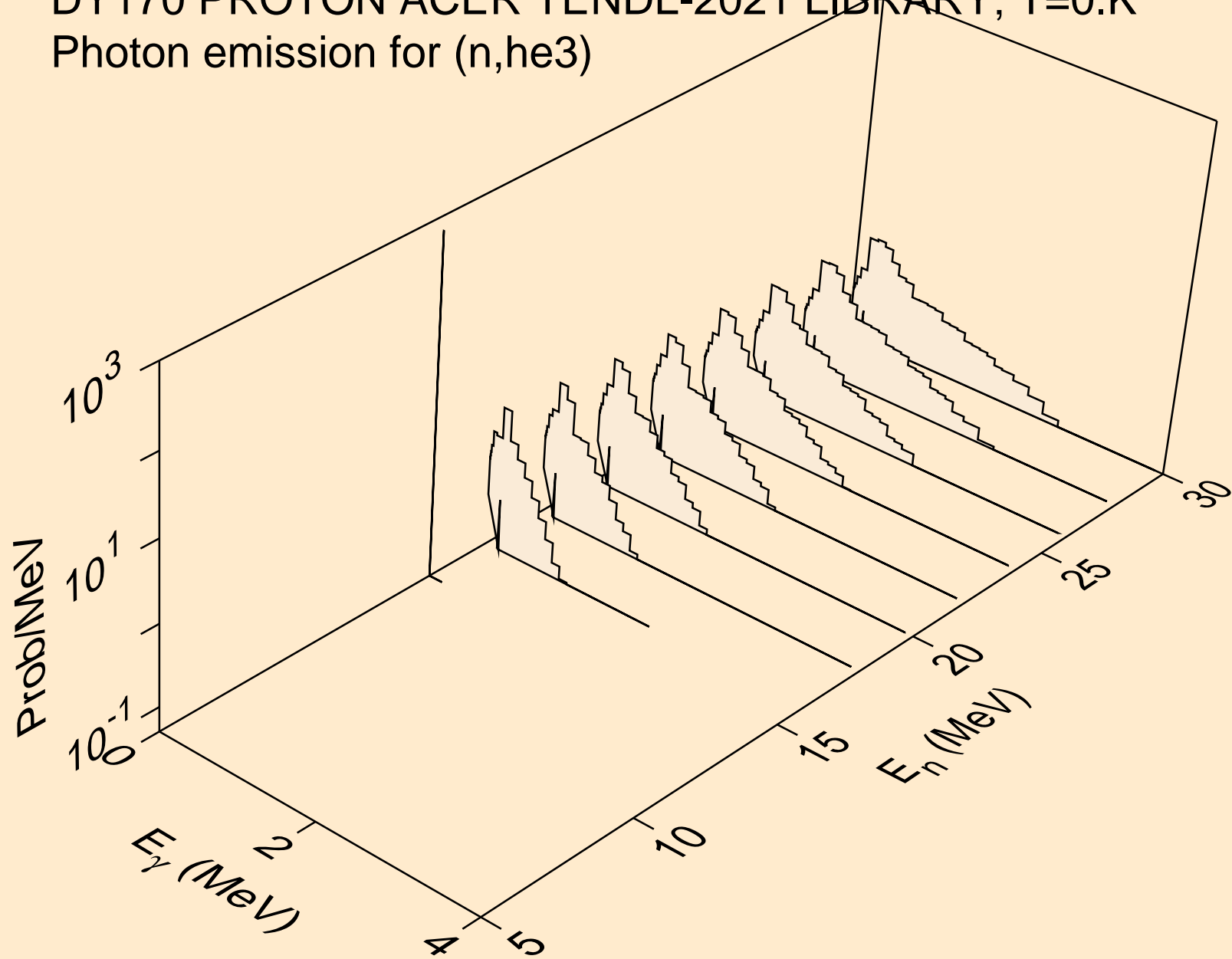

DY170 PROTON ACER TENDL-2021 LIBRARY; T=0.K  
Photon emission for (n,a)

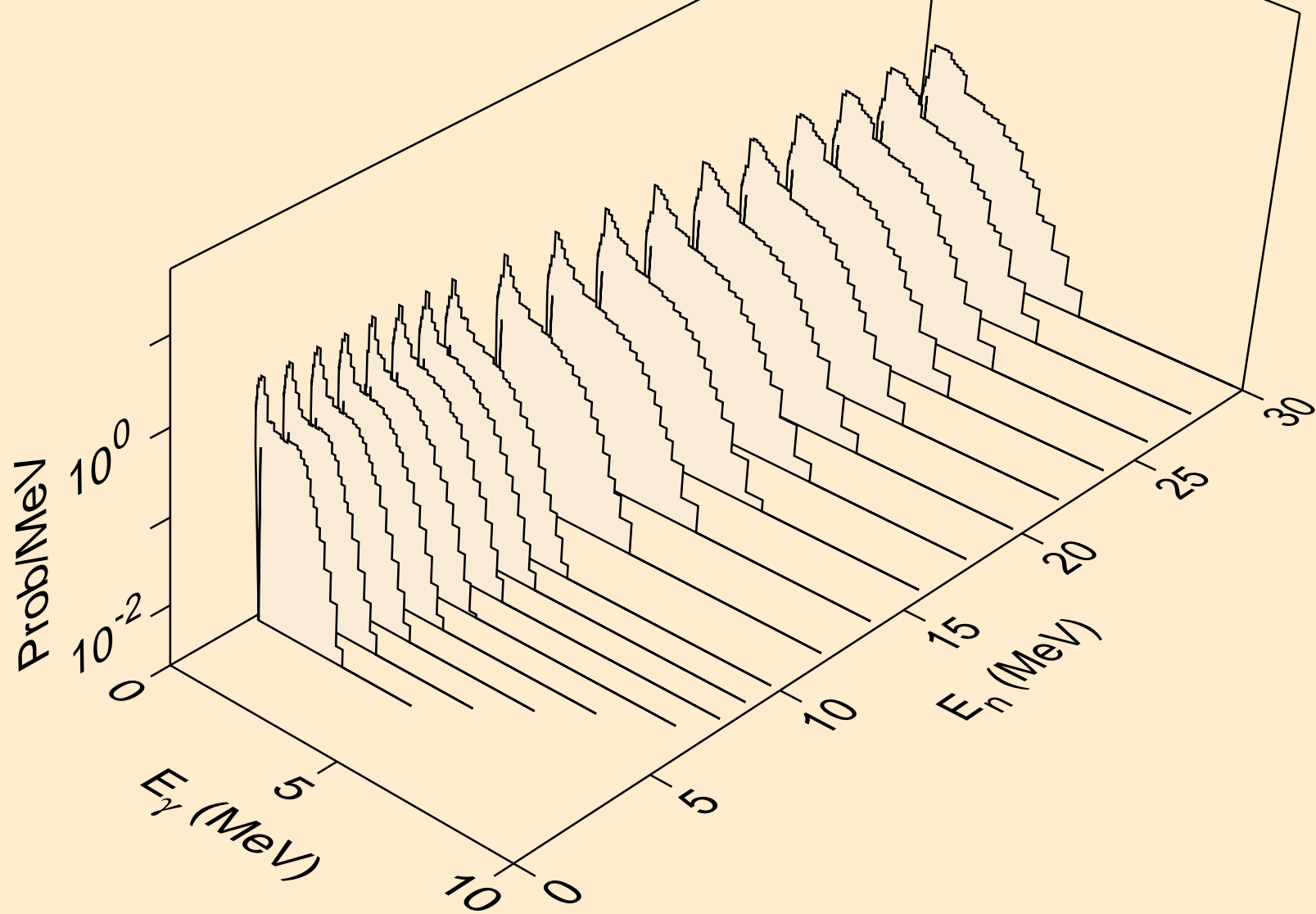

DY170 PROTON ACER TENDL-2021 LIBRARY; T=0.K  
Photon emission for (n,2p)

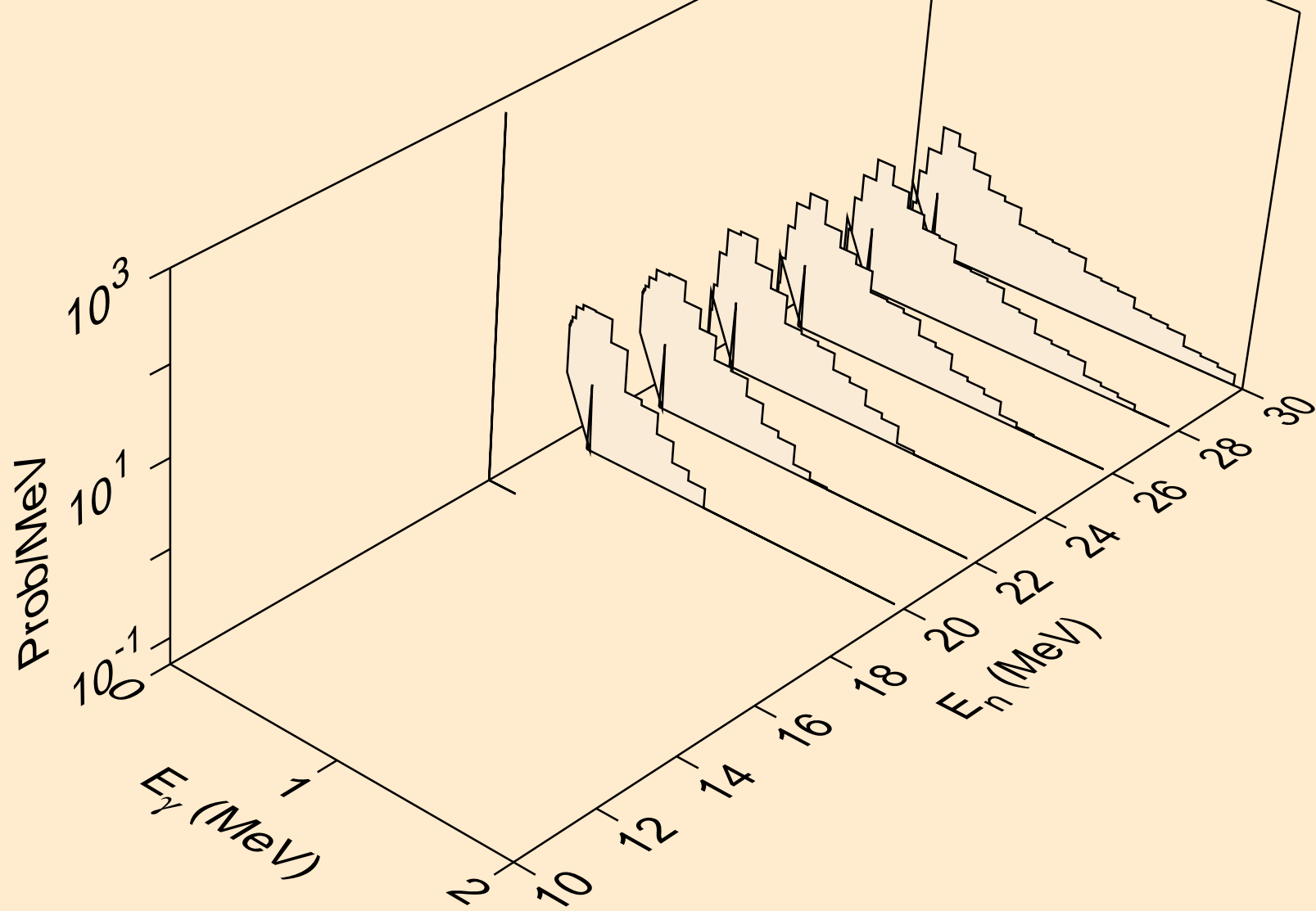



DY170 PROTON ACER TENDL-2021 LIBRARY; T=0.K  
Particle heating contributions

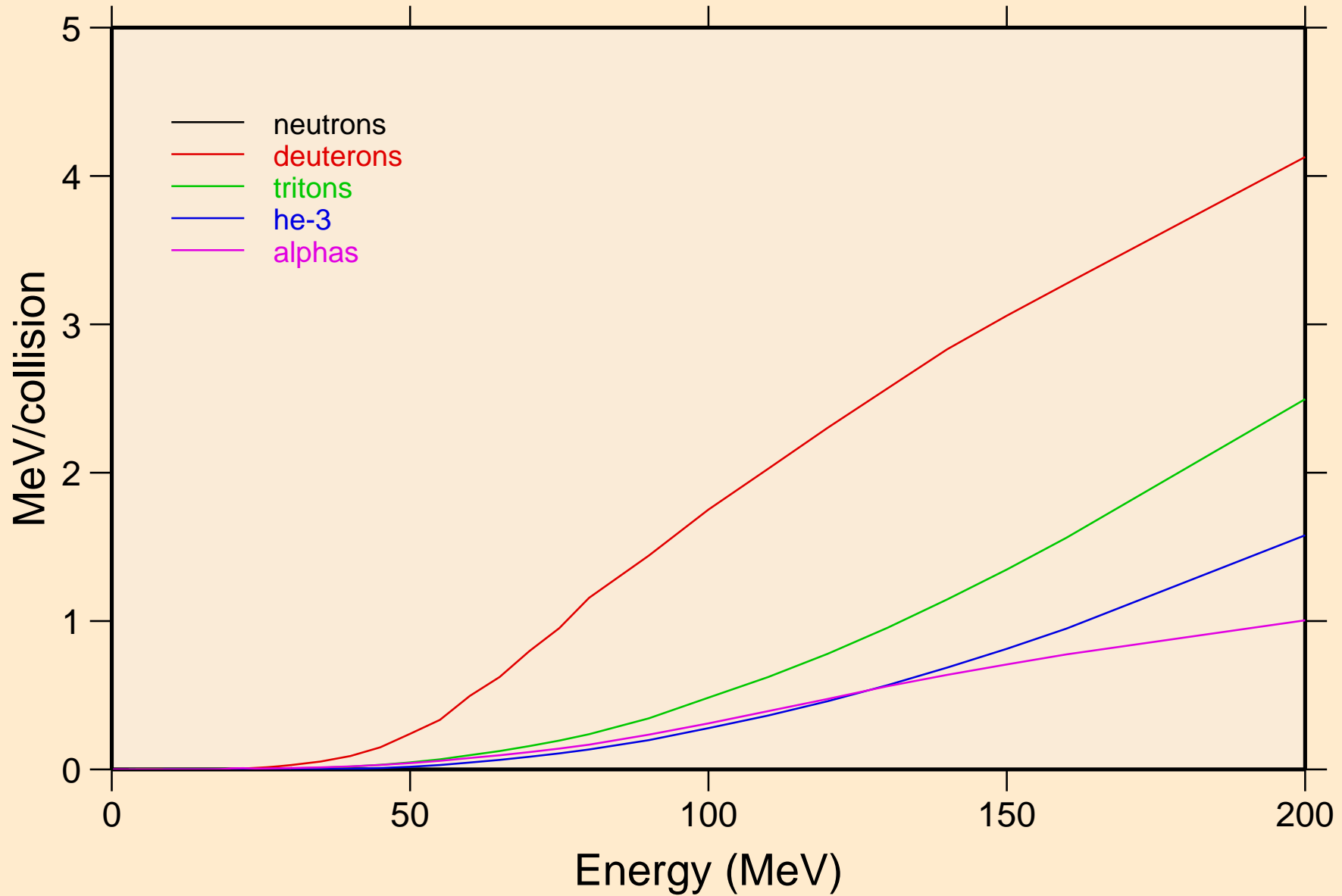

DY170 PROTON ACER TENDL-2021 LIBRARY; T=0.K  
Recoil Heating

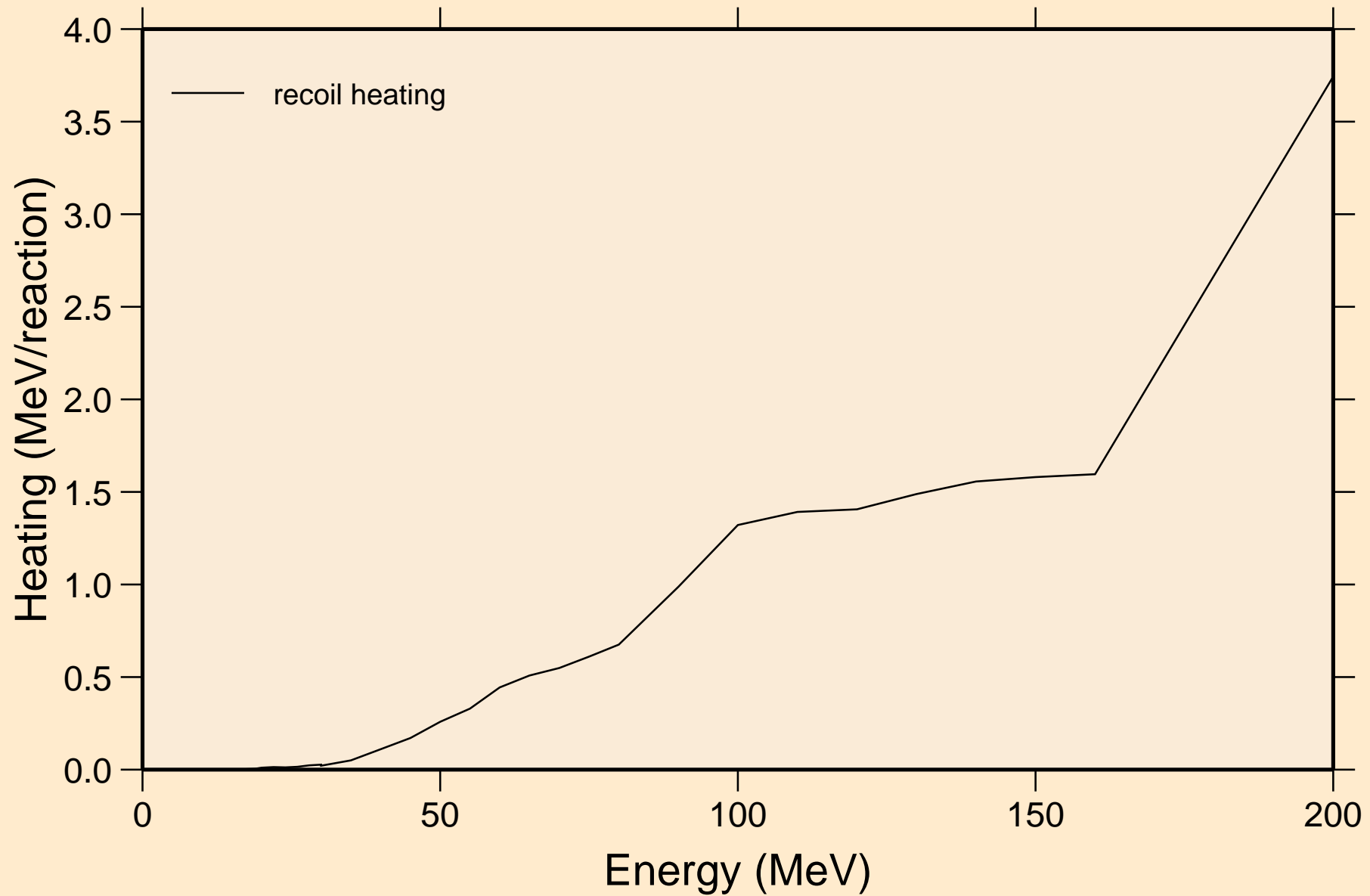

DY170 PROTON ACER TENDL-2021 LIBRARY; T=0.K  
Particle production cross sections

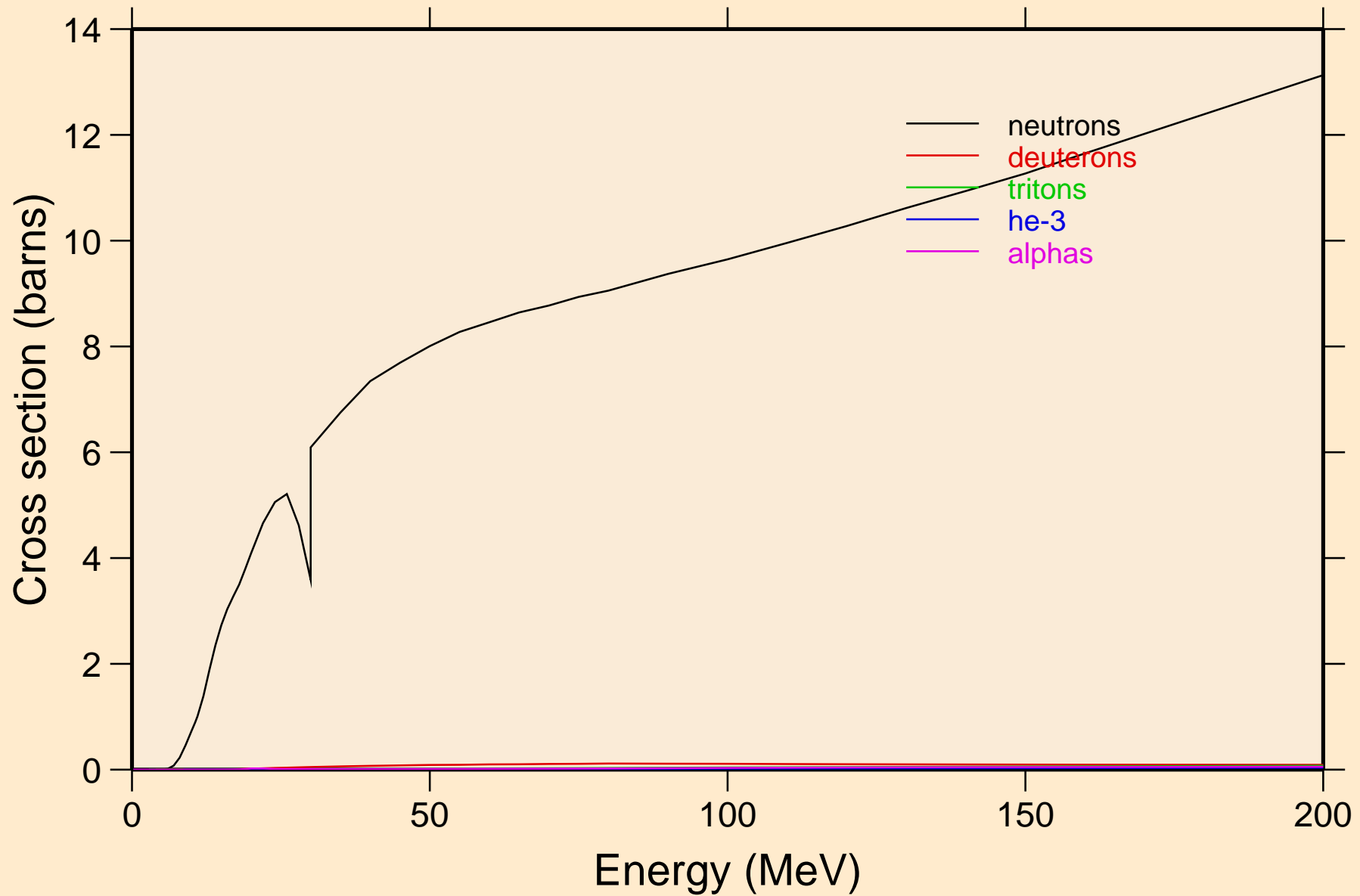

DY170 PROTON ACER TENDL-2021 LIBRARY; T=0.K  
neutrons from (p,n)

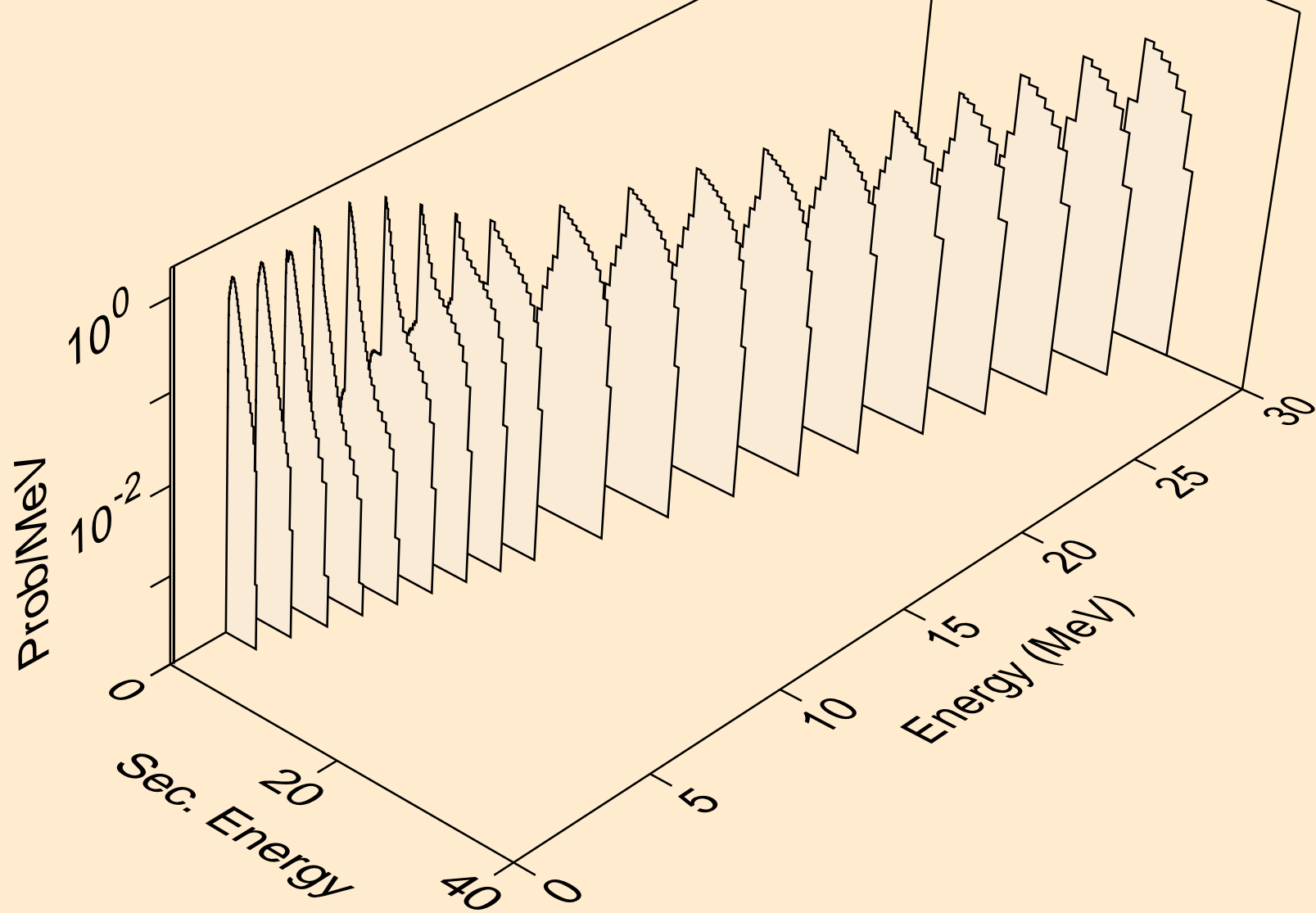

DY170 PROTON ACER TENDL-2021 LIBRARY; T=0.K  
neutrons from (p,x)

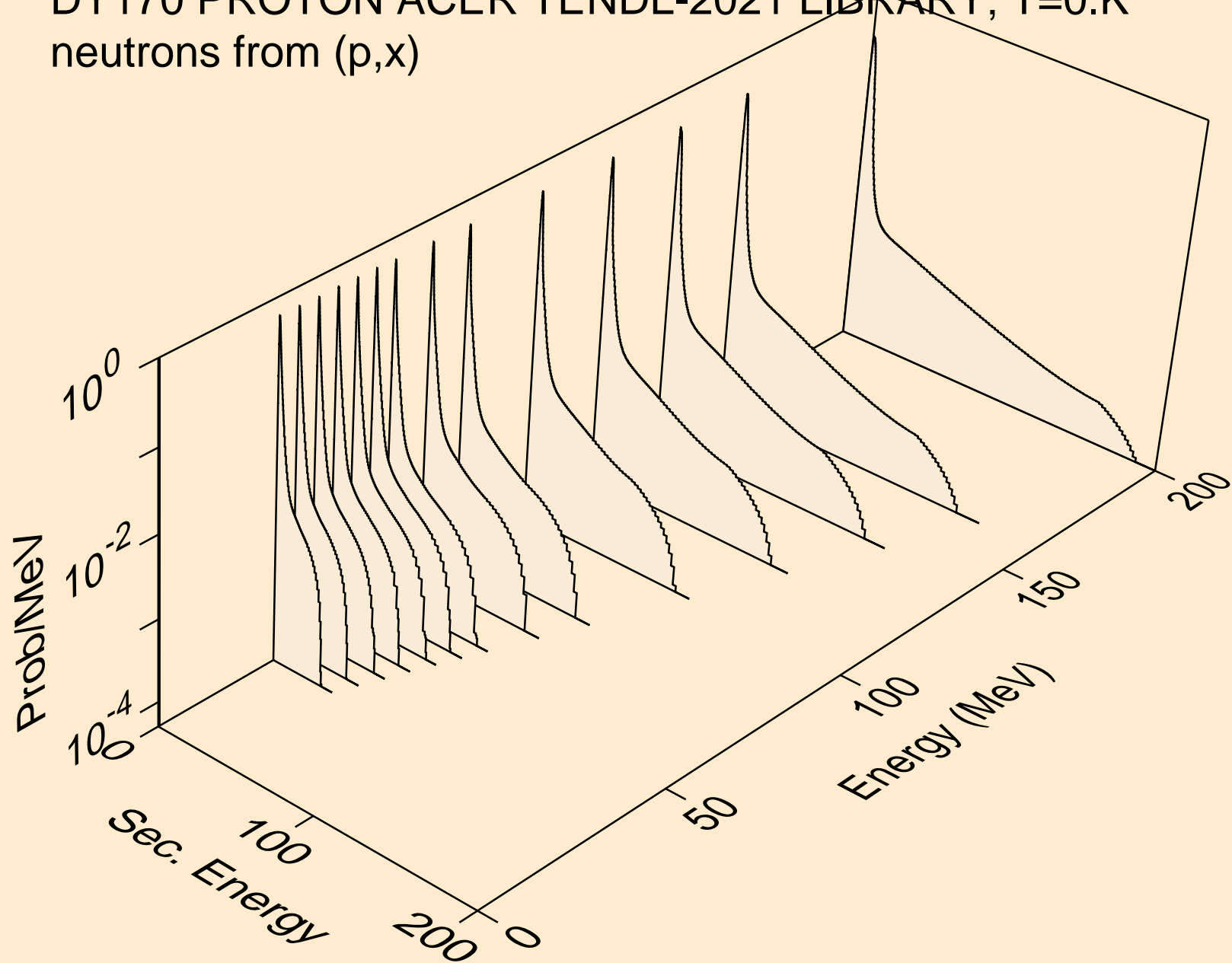

DY170 PROTON ACER TENDL-2021 LIBRARY; T=0.K  
neutrons from (p,2nd)

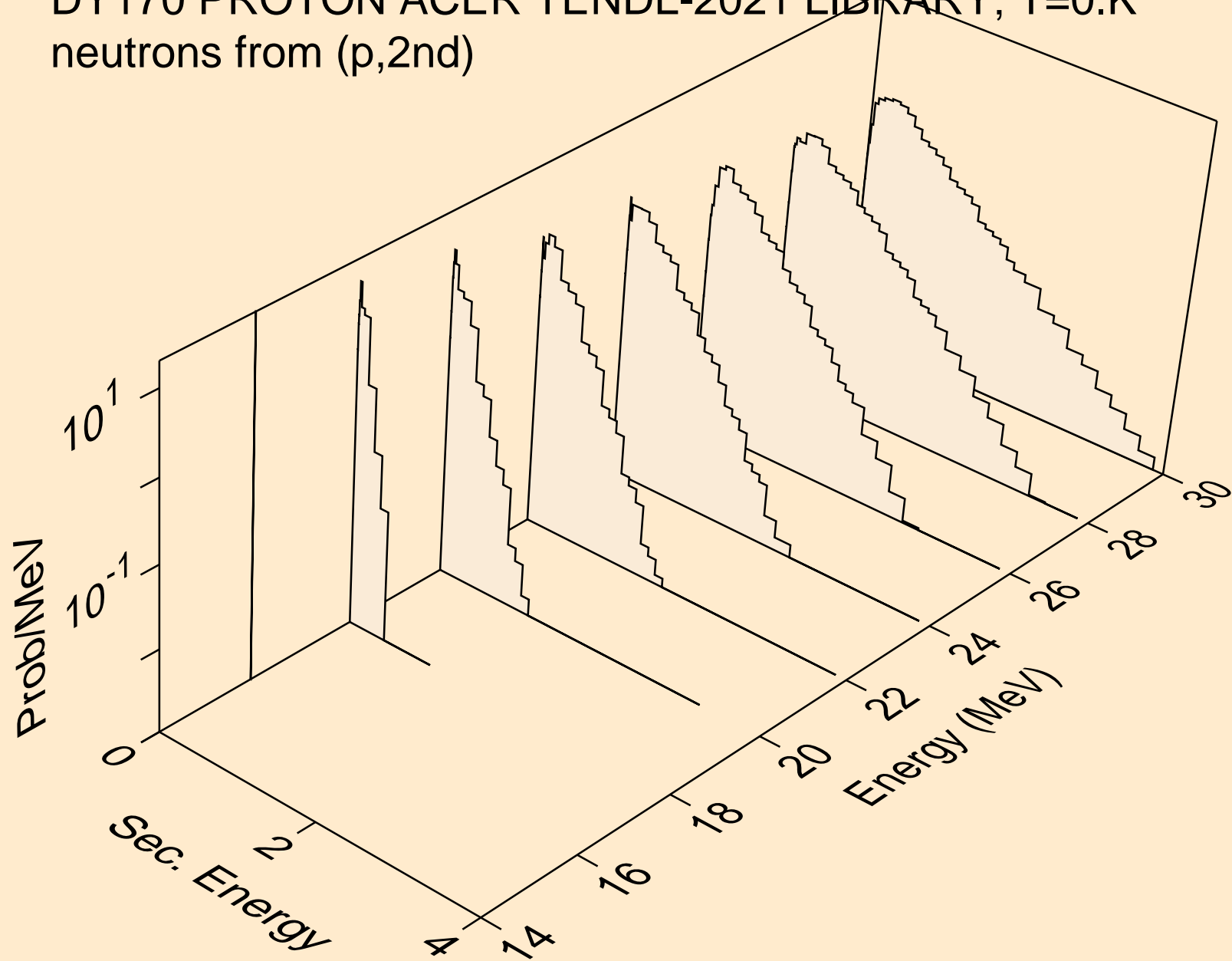

DY170 PROTON ACER TENDL-2021 LIBRARY; T=0.K  
neutrons from (p,2n)

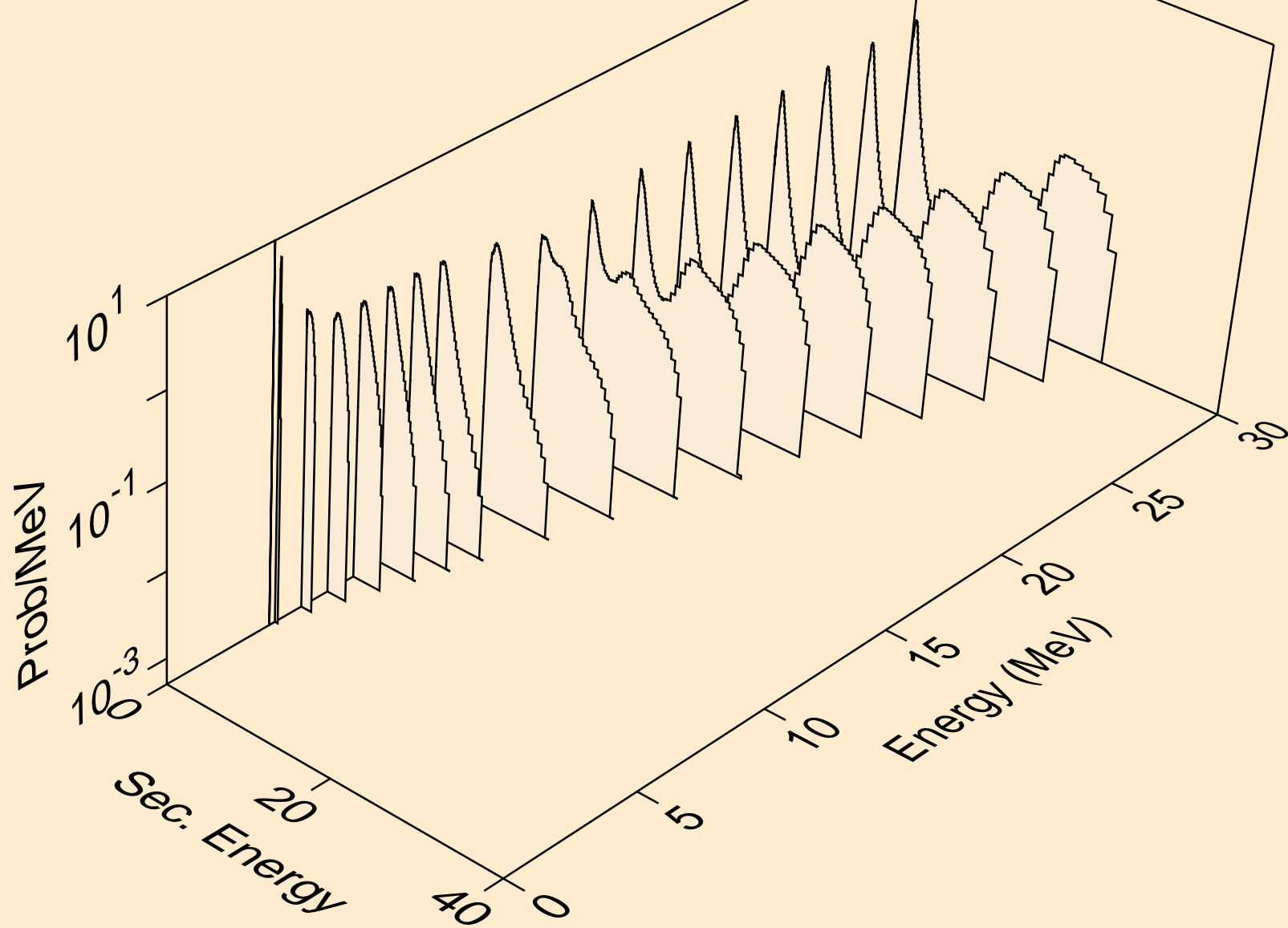

DY170 PROTON ACER TENDL-2021 LIBRARY; T=0.K  
neutrons from (p,3n)

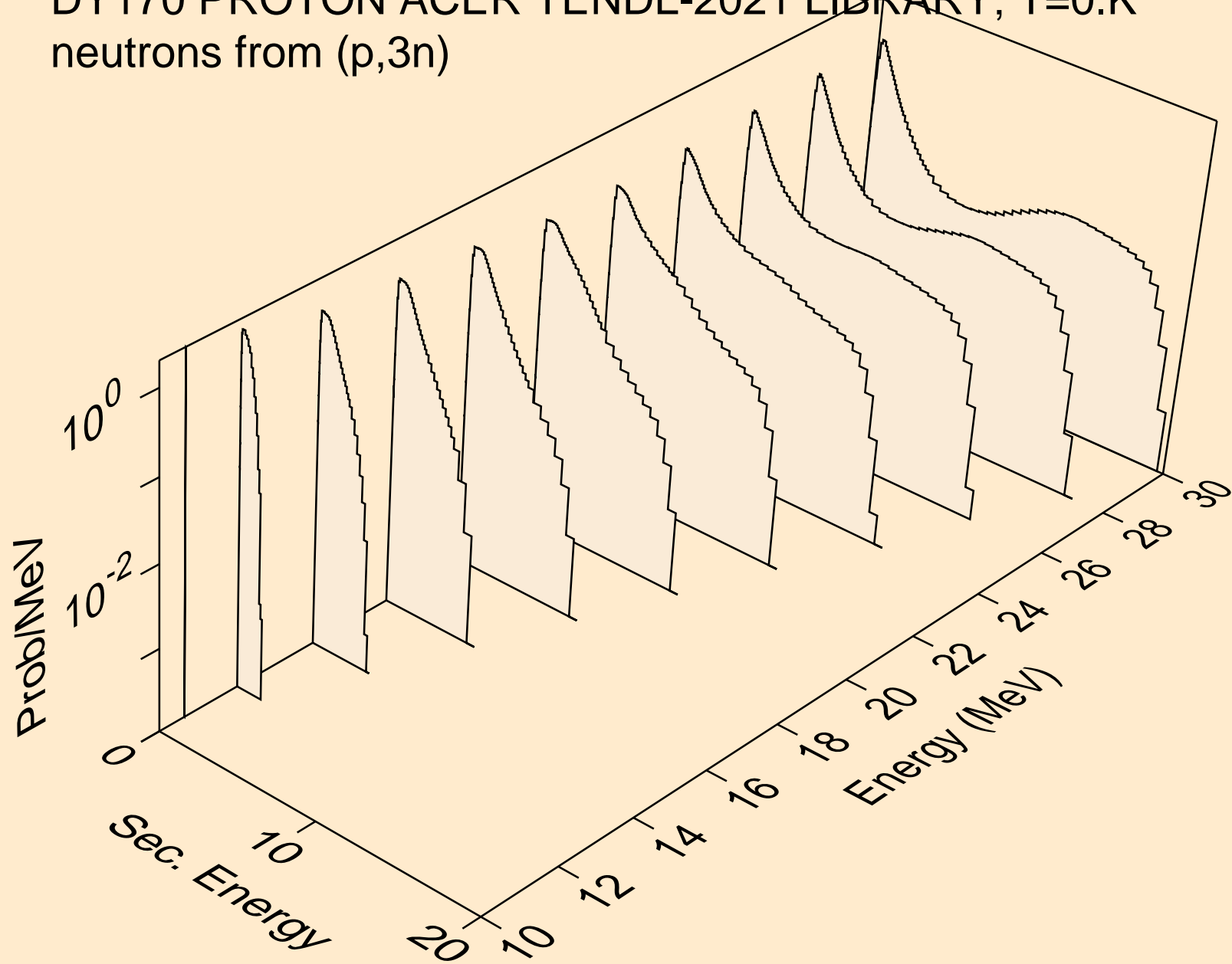



DY170 PROTON ACER TENDL-2021 LIBRARY; T=0.K  
neutrons from (p,n\*)a

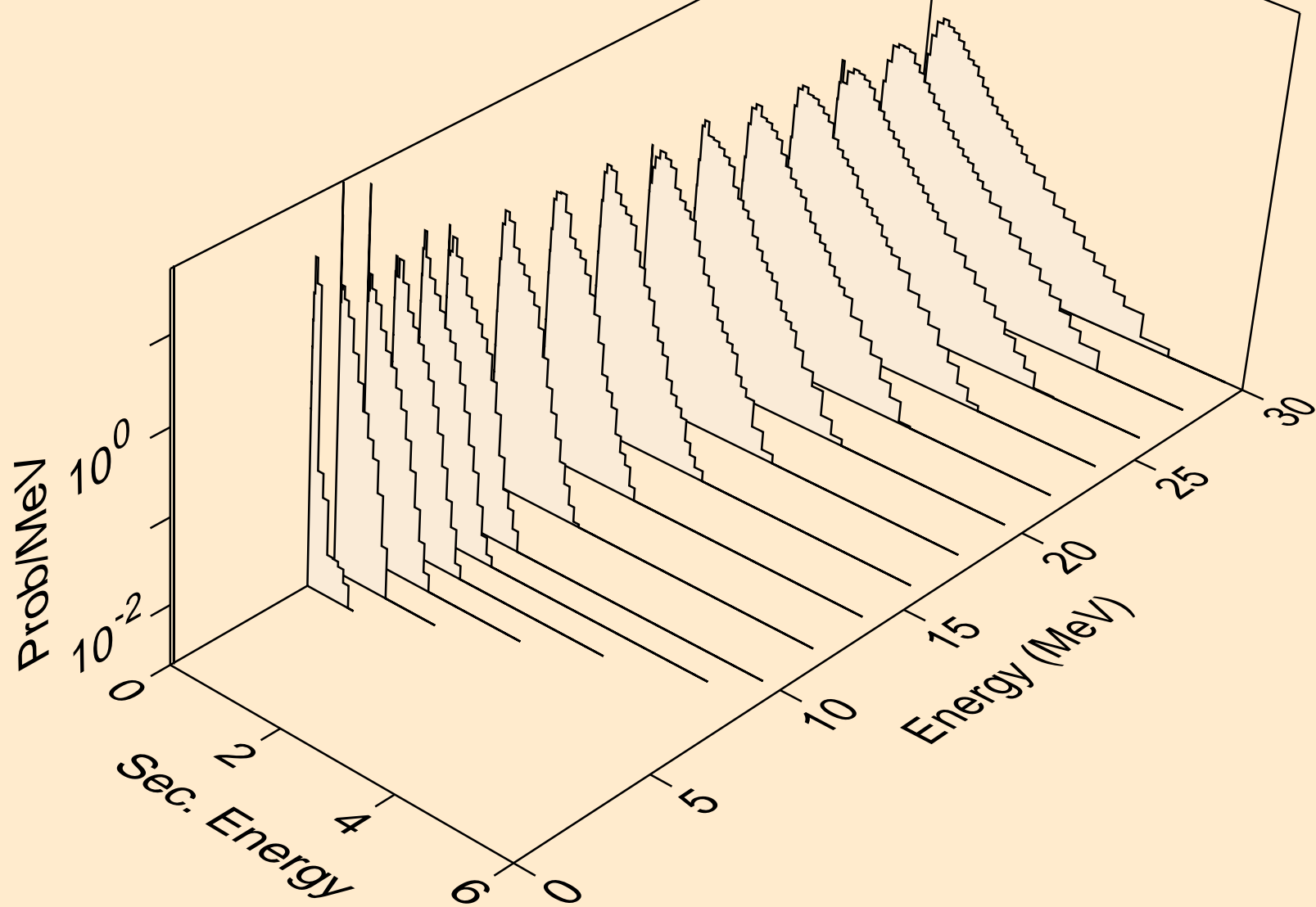

DY170 PROTON ACER TENDL-2021 LIBRARY; T=0.K  
neutrons from (p,2n)a

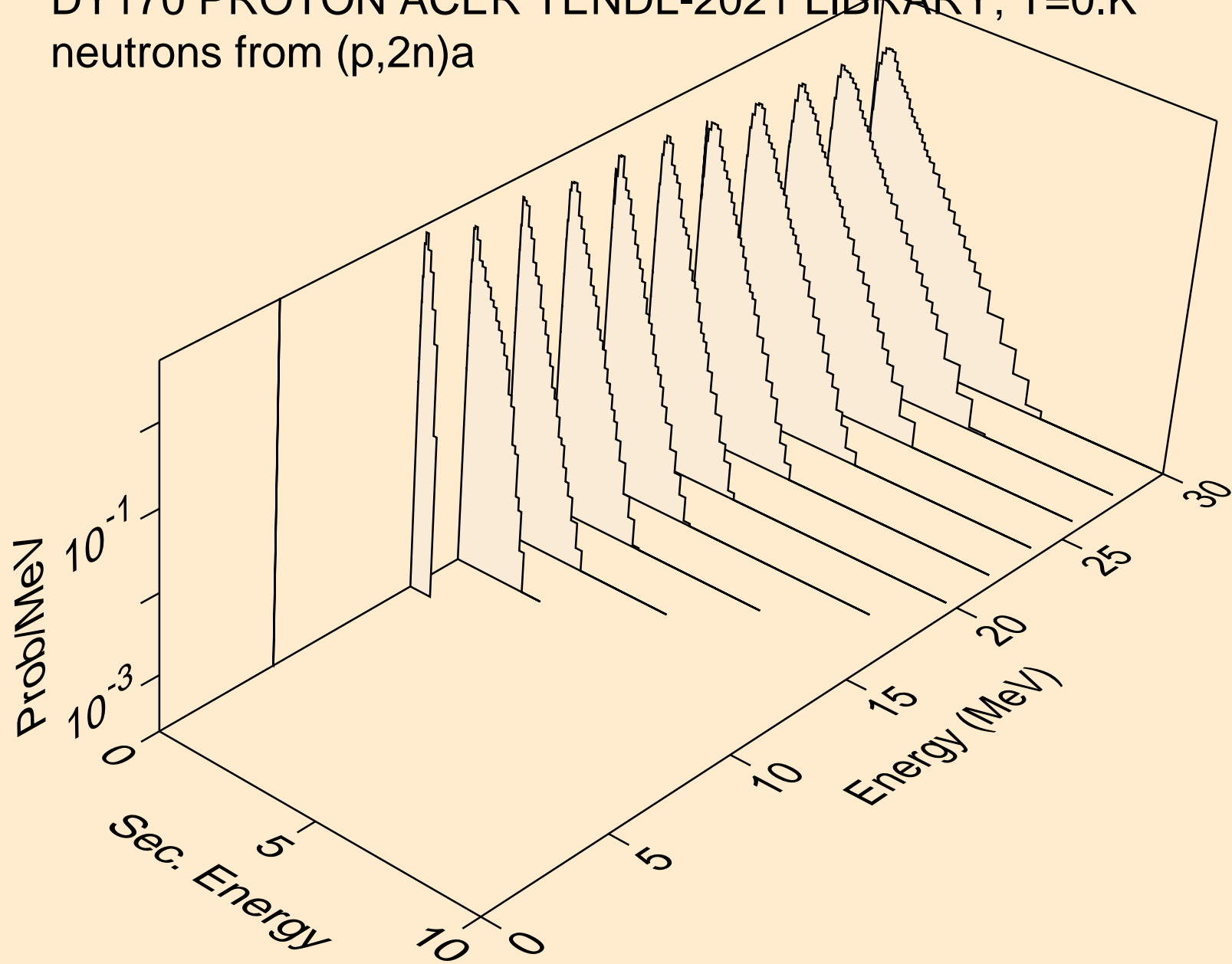

DY170 PROTON ACER TENDL-2021 LIBRARY; T=0.K  
neutrons from (p,3n)a

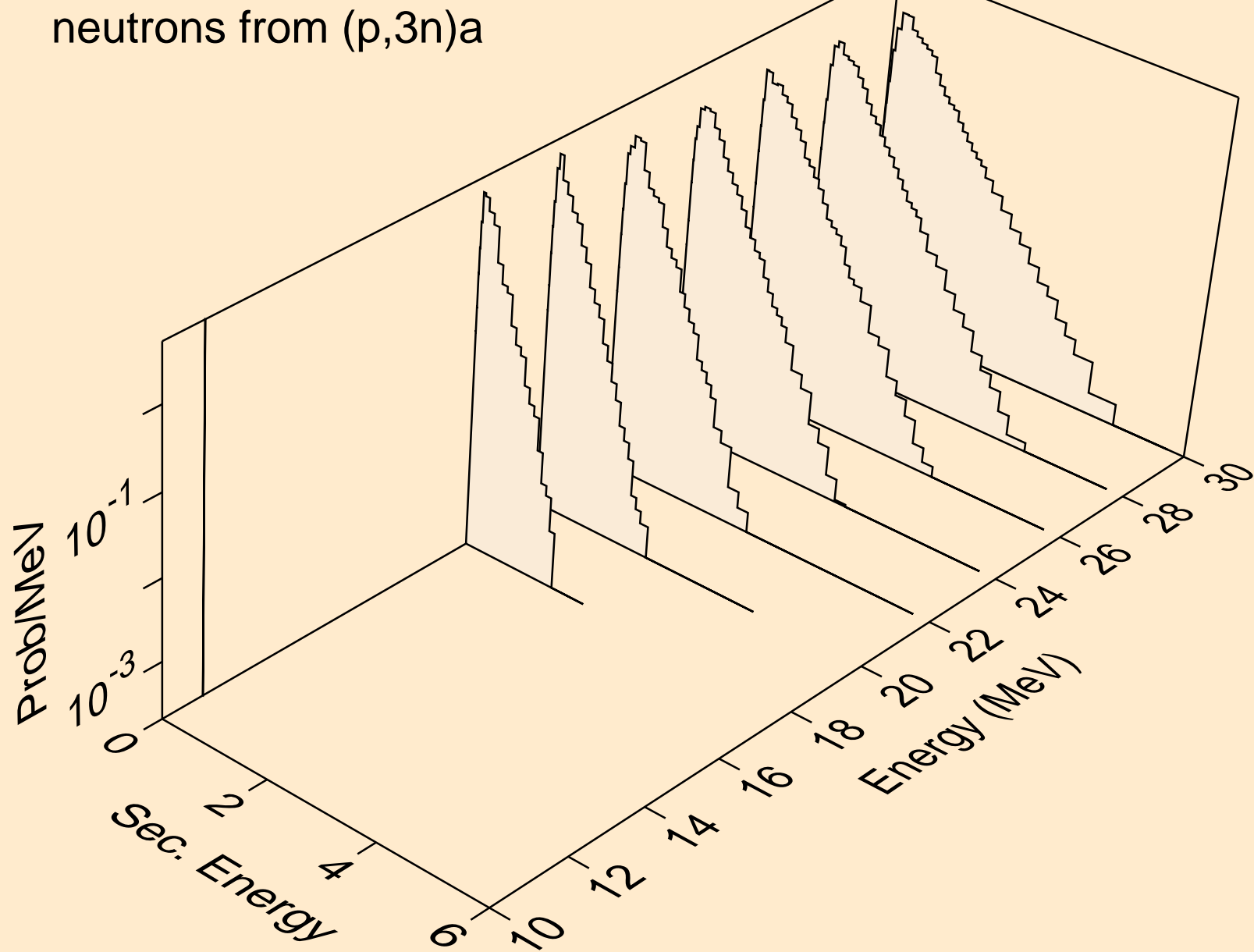

DY170 PROTON ACER TENDL-2021 LIBRARY; T=0.K  
neutrons from (p,n\*)p

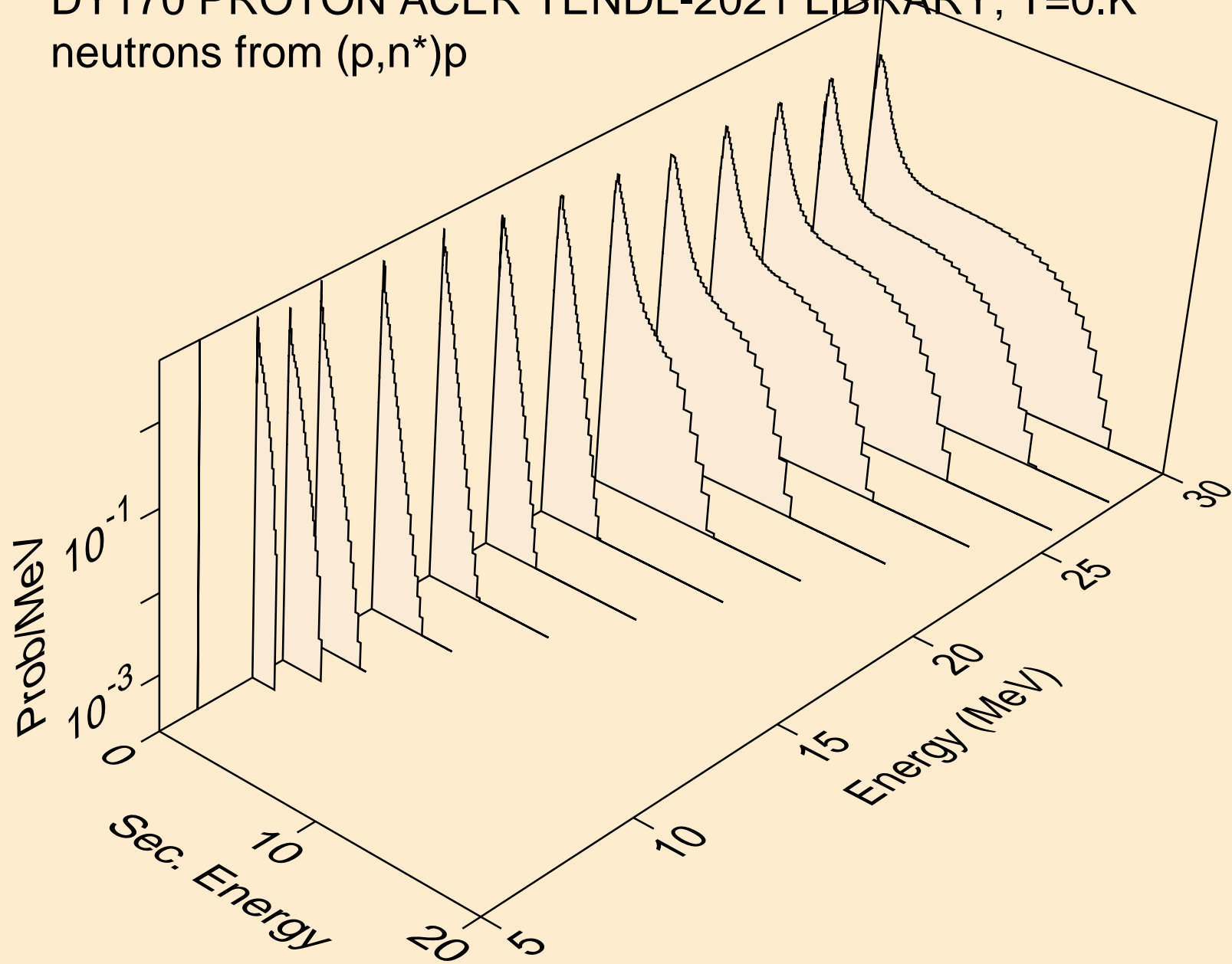

DY170 PROTON ACER TENDL-2021 LIBRARY; T=0.K  
neutrons from (p,n\*)d

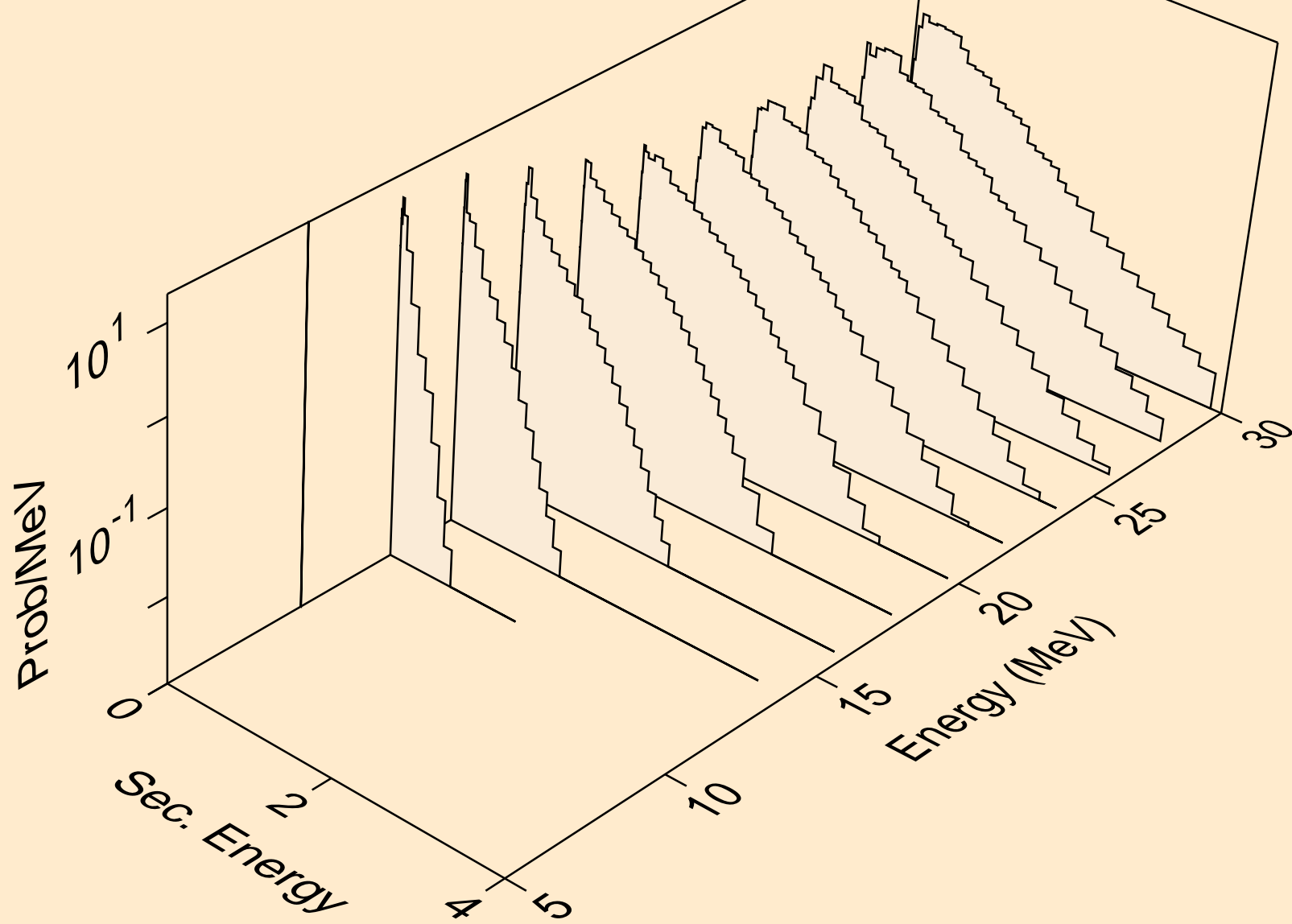

DY170 PROTON ACER TENDL-2021 LIBRARY; T=0.K  
neutrons from (p,n\*)t

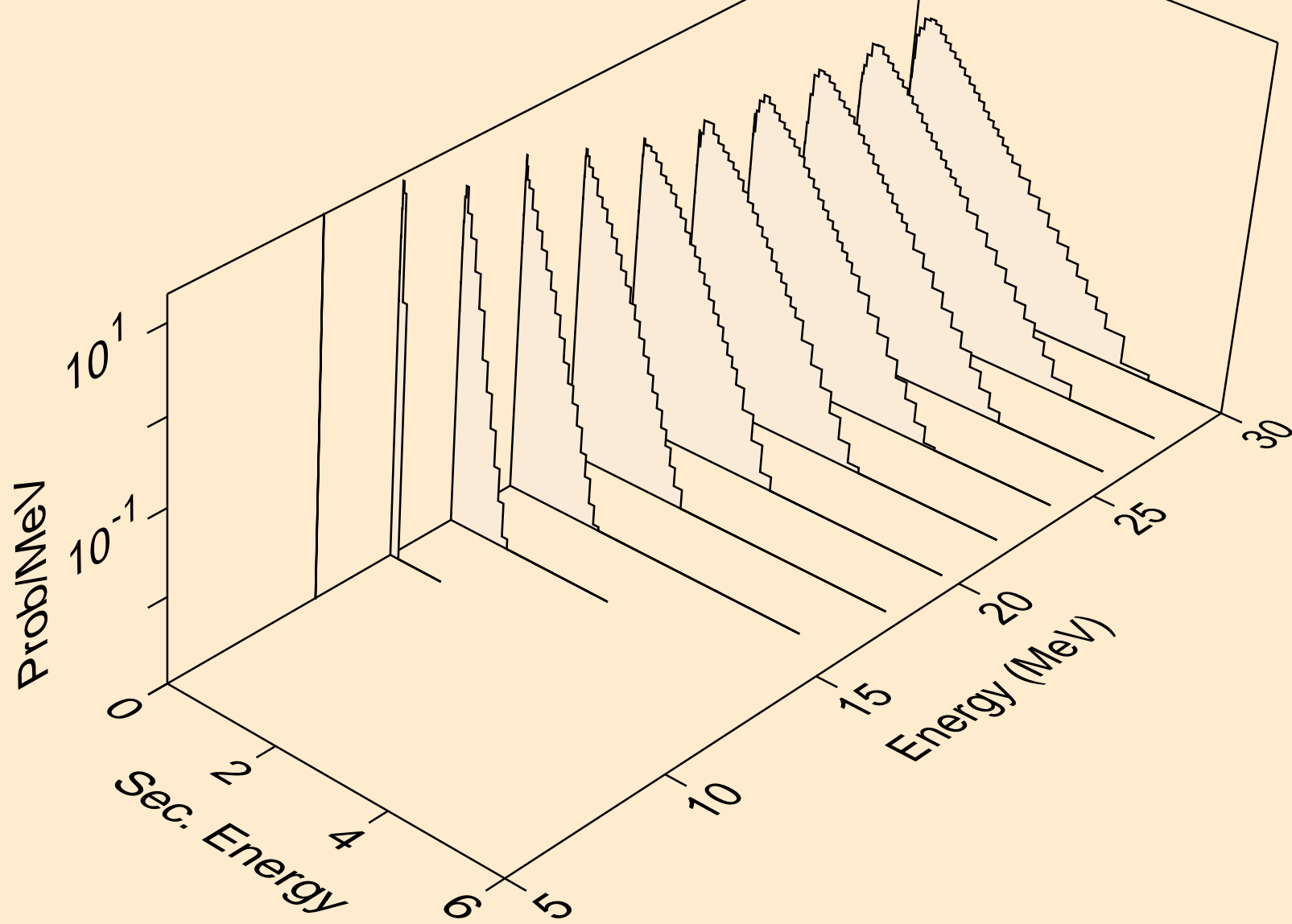

DY170 PROTON ACER TENDL-2021 LIBRARY; T=0.K  
neutrons from (p,n\*)he3

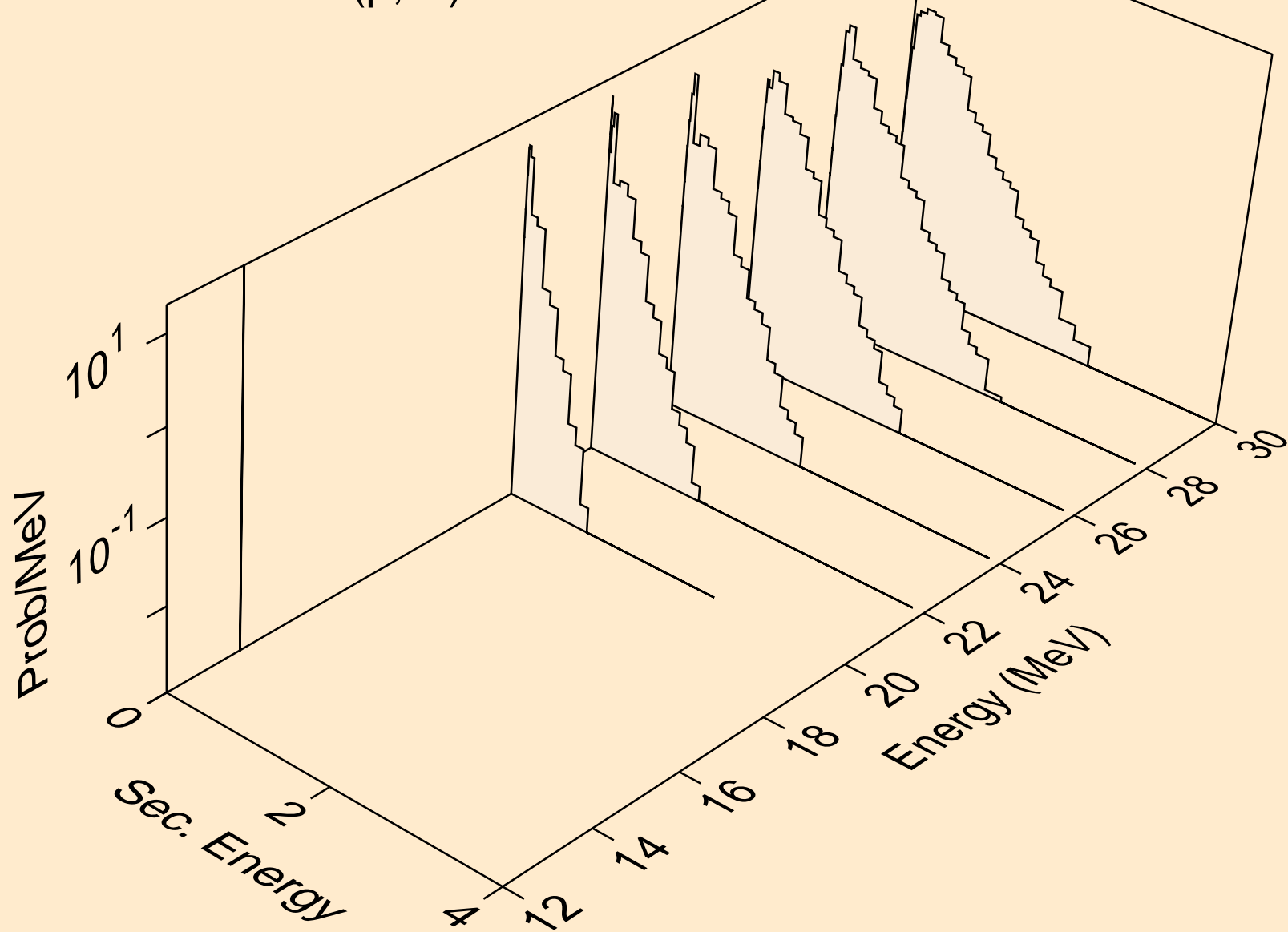

DY170 PROTON ACER TENDL-2021 LIBRARY; T=0.K  
neutrons from (p,4n)

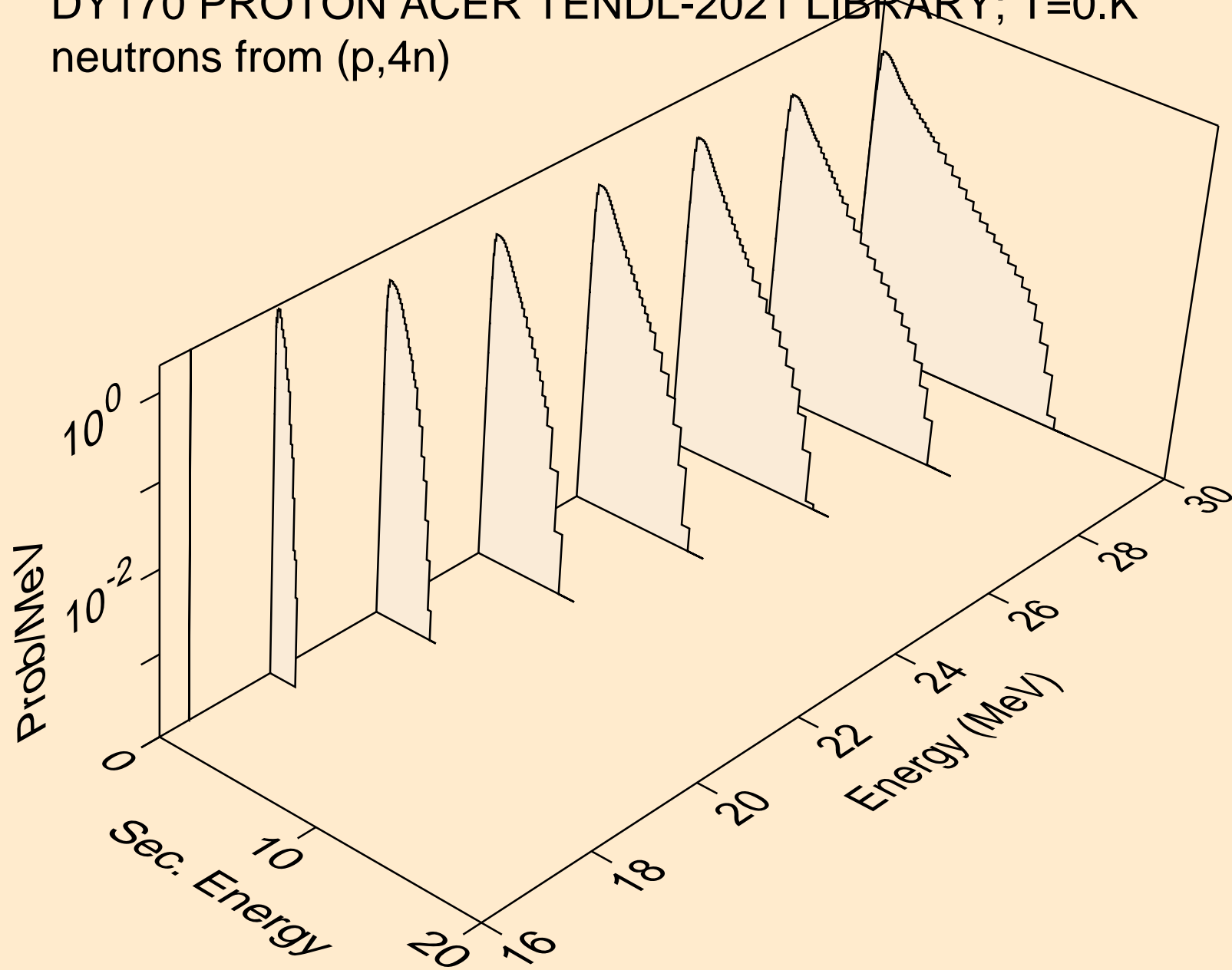



DY170 PROTON ACER TENDL-2021 LIBRARY; T=0.K  
neutrons from (p,2np)

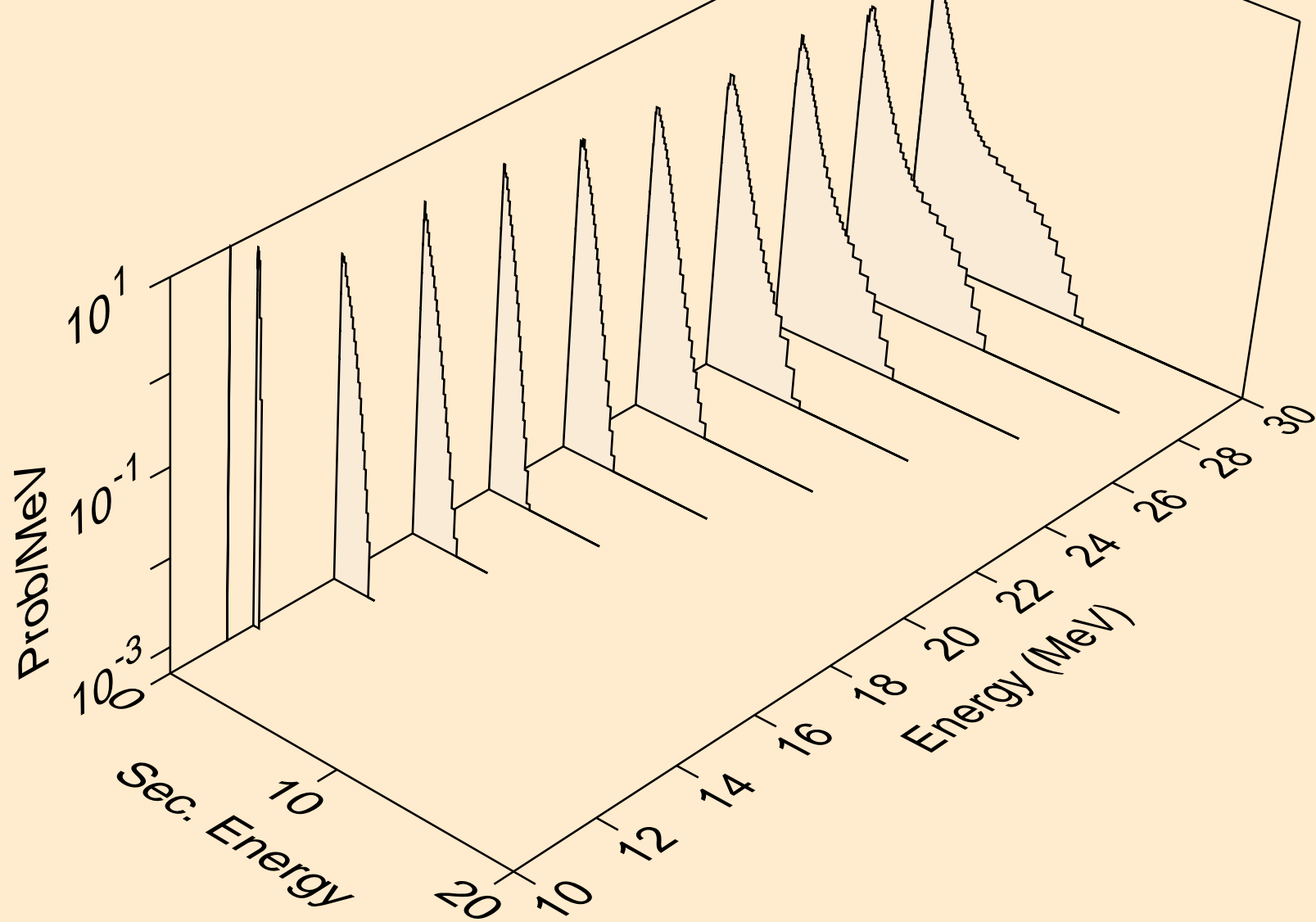

DY170 PROTON ACER TENDL-2021 LIBRARY; T=0.K  
neutrons from (p,3np)

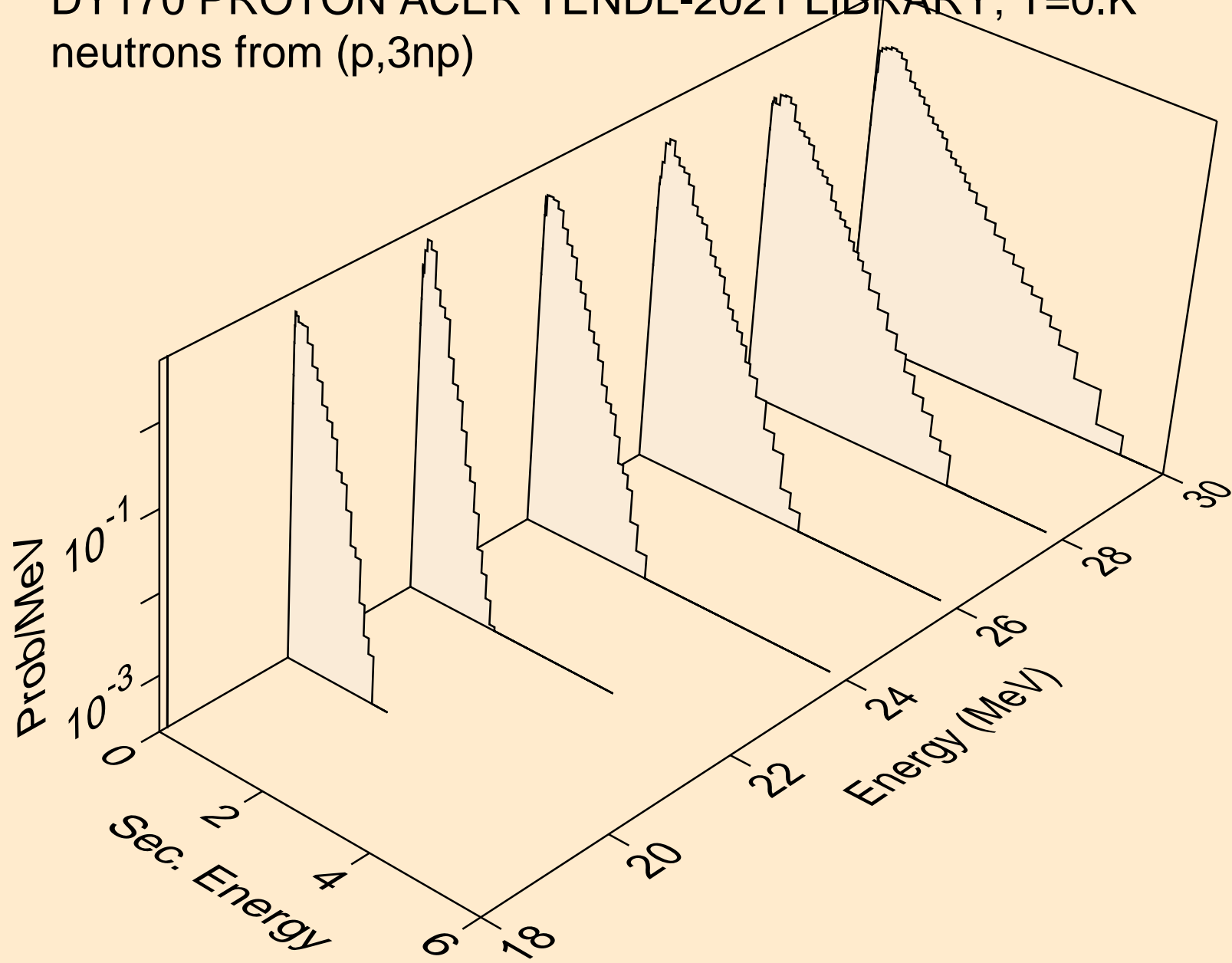

DY170 PROTON ACER TENDL-2021 LIBRARY; T=0.K  
neutrons from (p,2np)

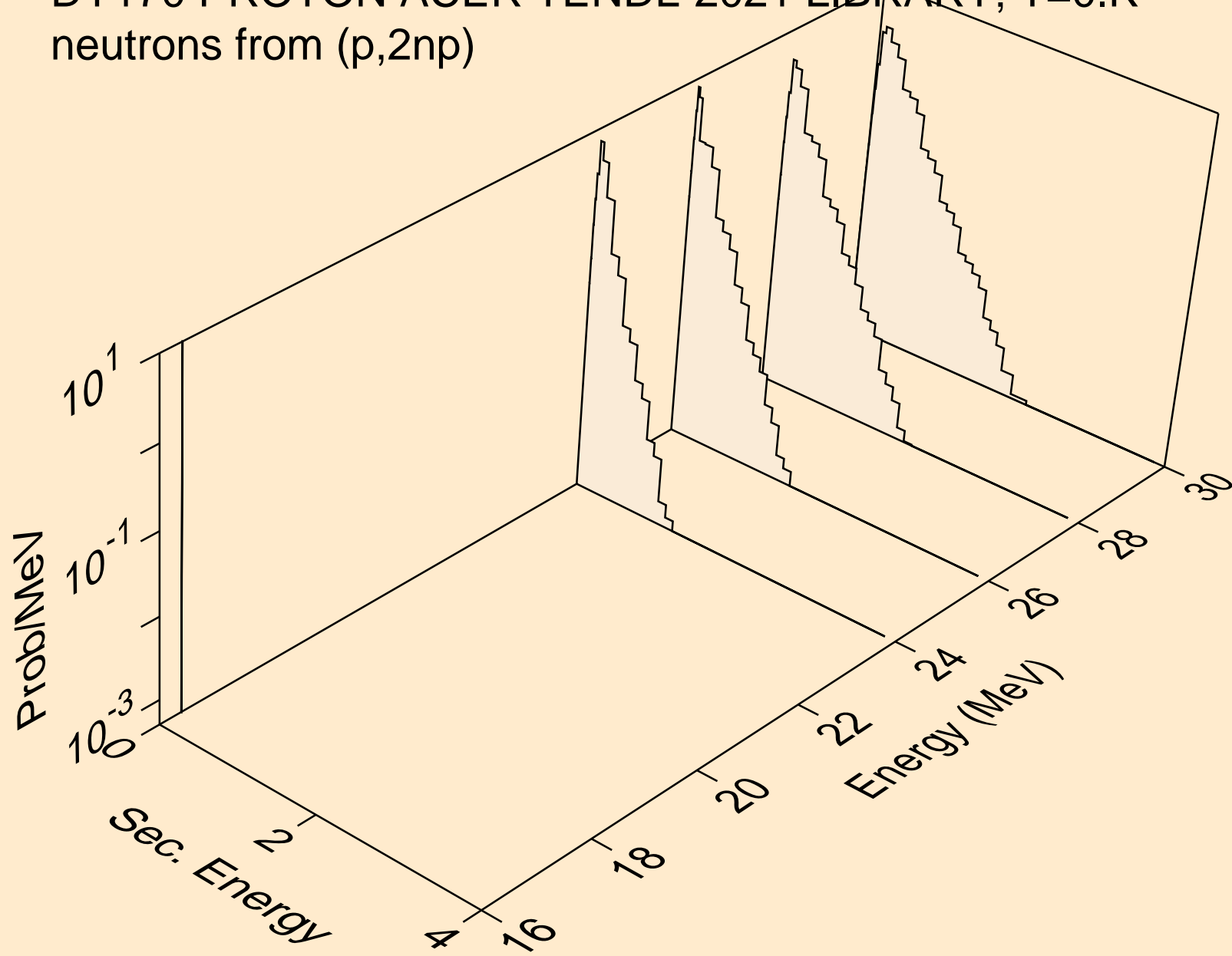

DY170 PROTON ACER TENDL-2021 LIBRARY; T=0.K  
deuterons from (p,x)

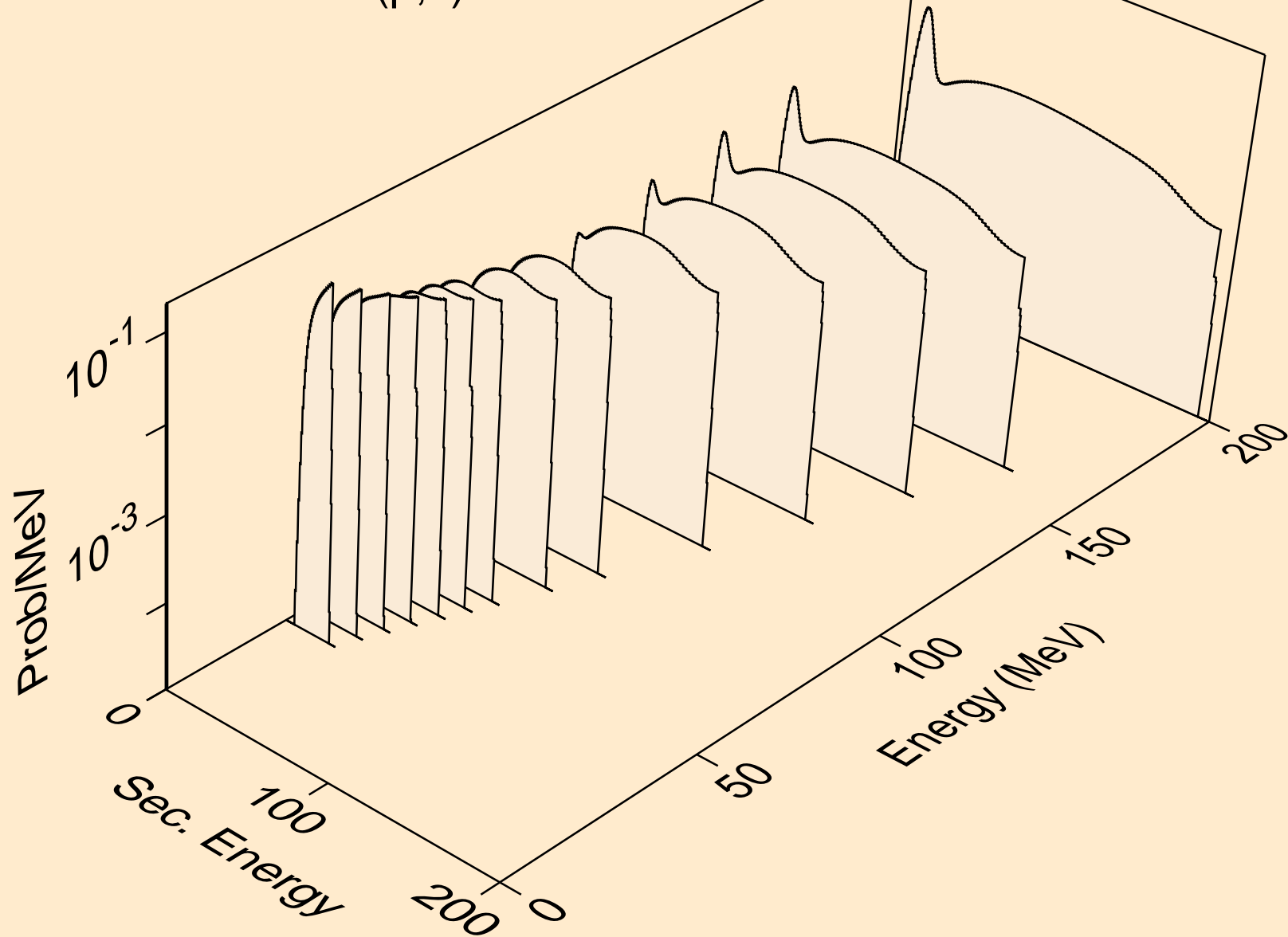

DY170 PROTON ACER TENDL-2021 LIBRARY; T=0.K  
deuterons from (p,2nd)

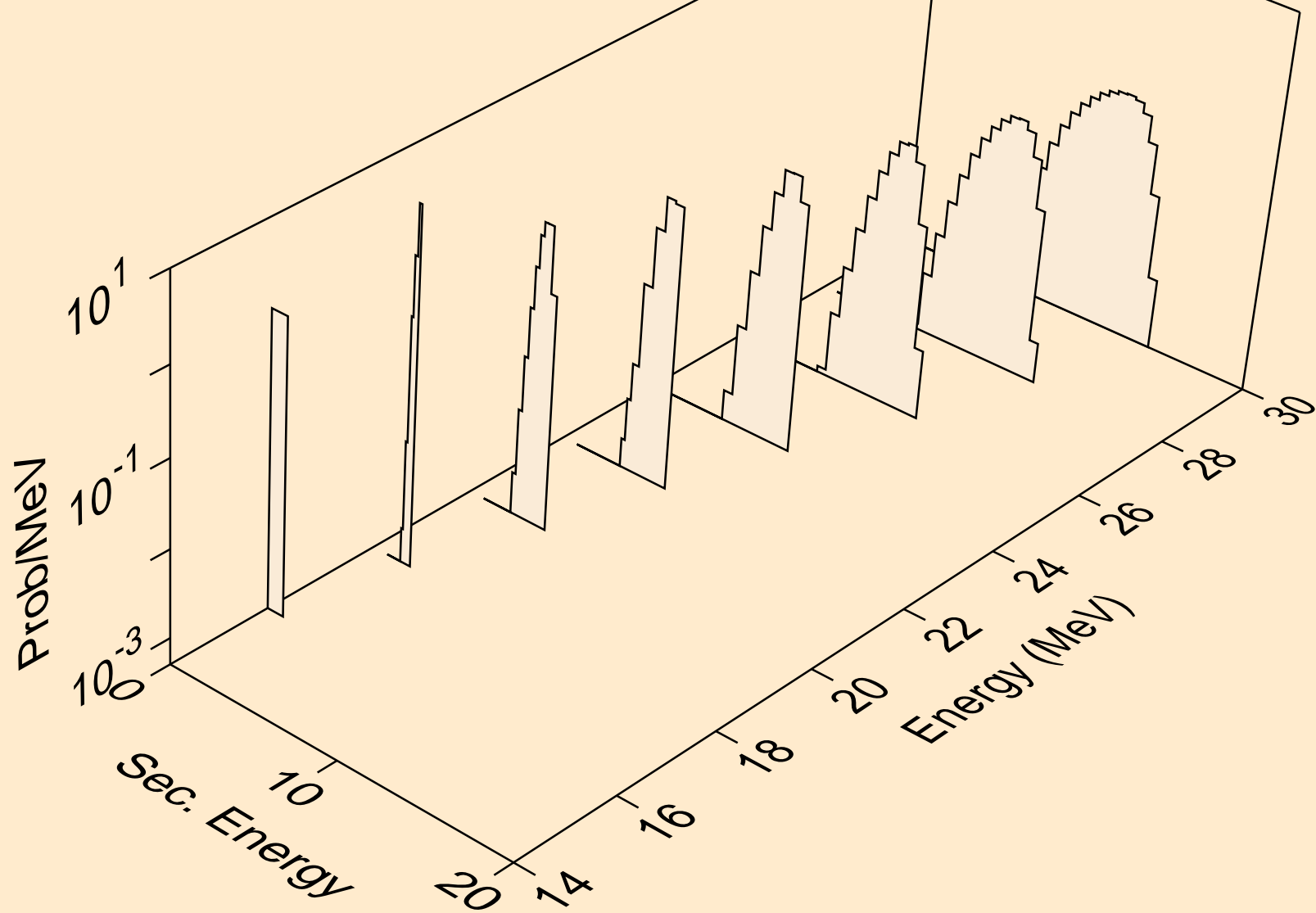

DY170 PROTON ACER TENDL-2021 LIBRARY; T=0.K  
deuterons from (p,n\*)d

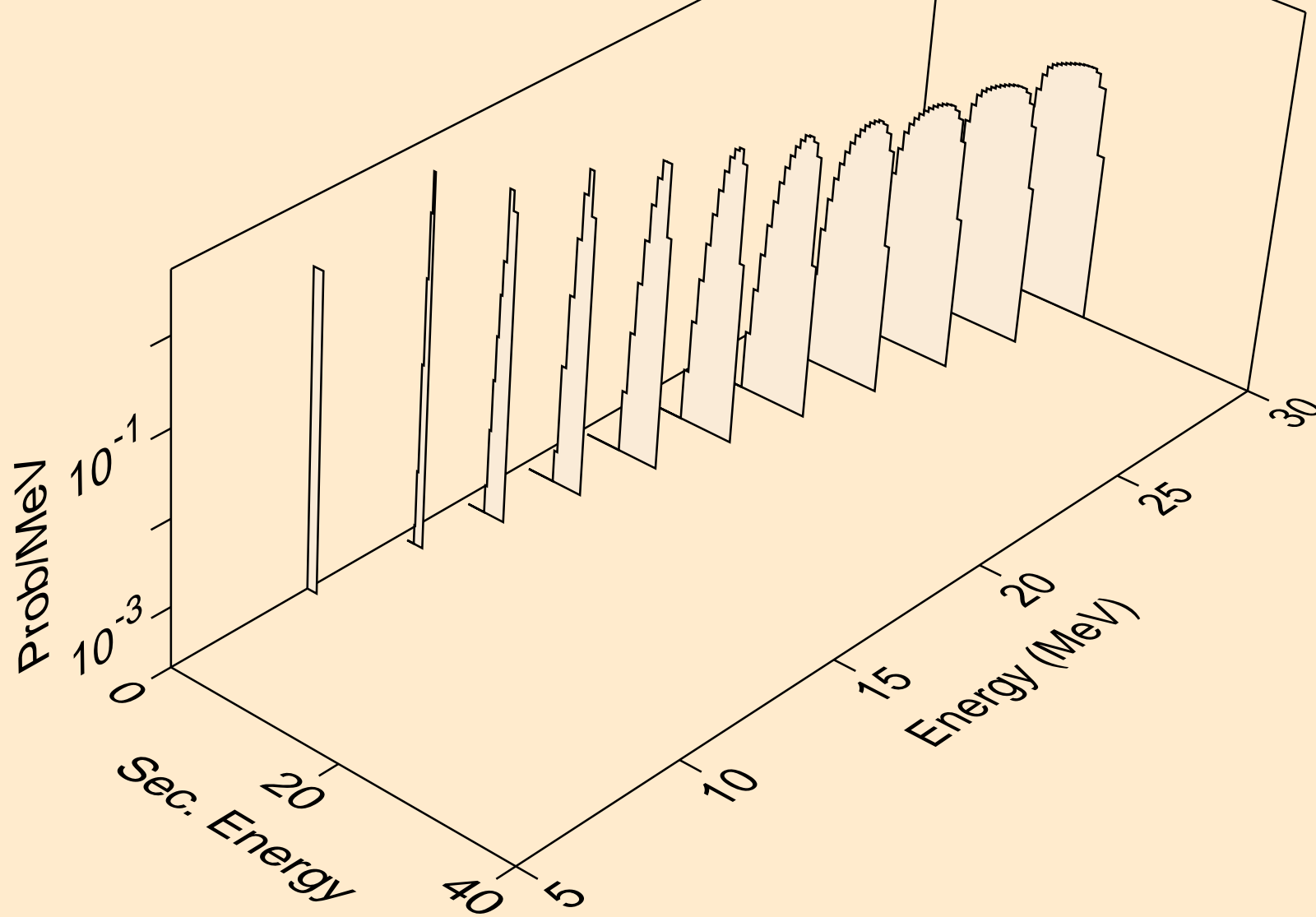

DY170 PROTON ACER TENDL-2021 LIBRARY; T=0.K  
deuterons from (p,d)

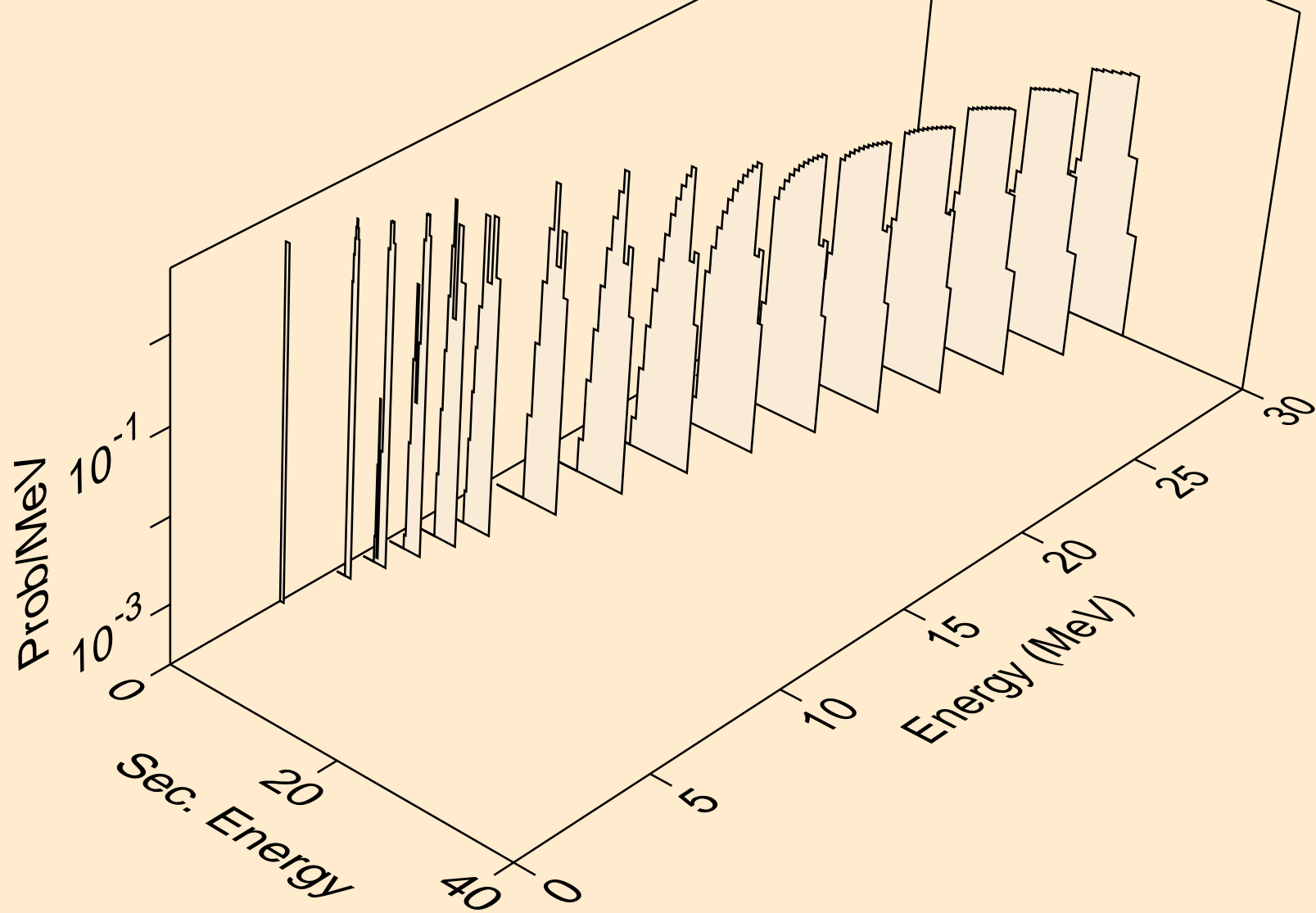

DY170 PROTON ACER TENDL-2021 LIBRARY; T=0.K  
tritons from (p,x)

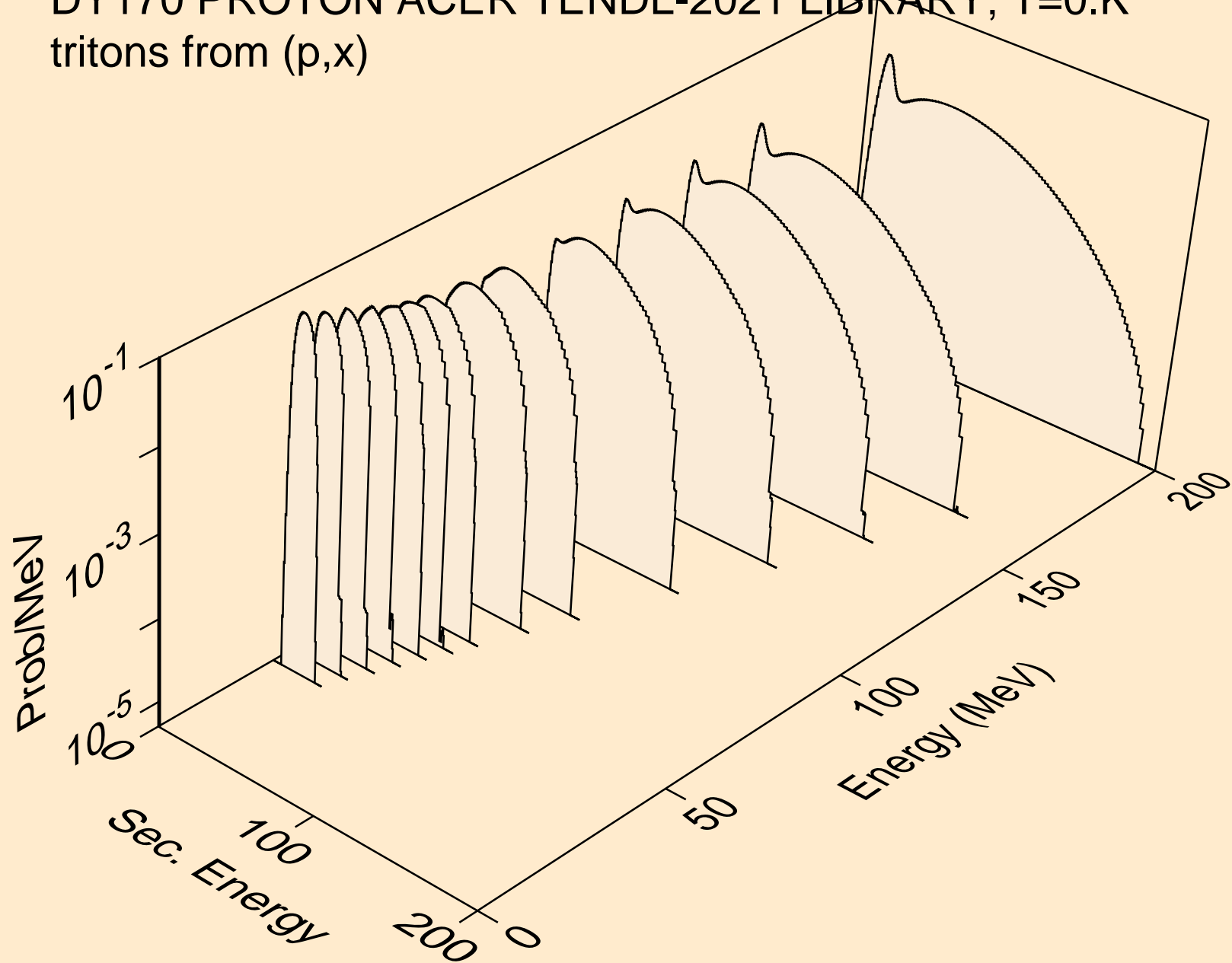



DY170 PROTON ACER TENDL-2021 LIBRARY; T=0.K  
tritons from (p,n\*)t

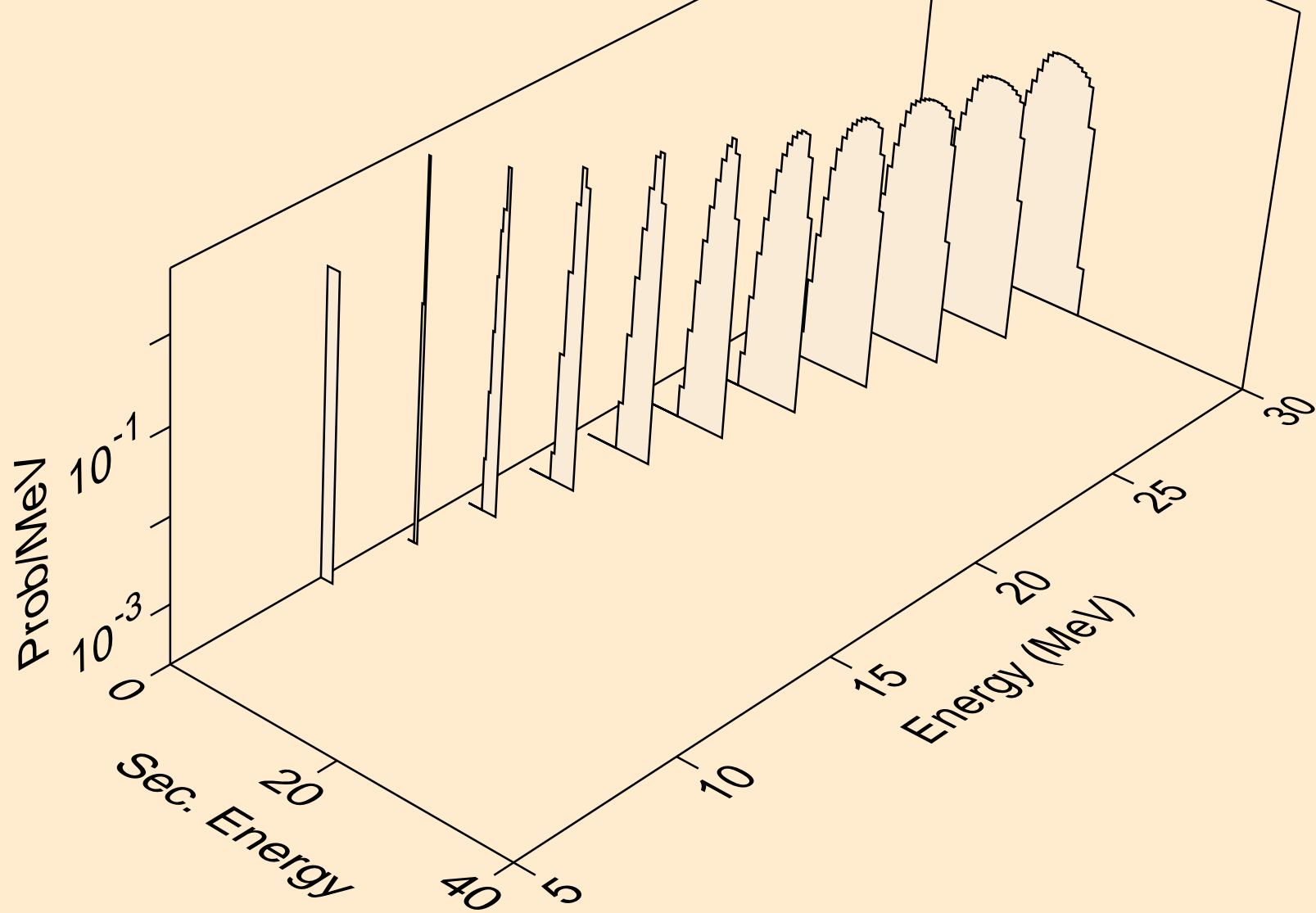

DY170 PROTON ACER TENDL-2021 LIBRARY; T=0.K  
tritons from (p,t)

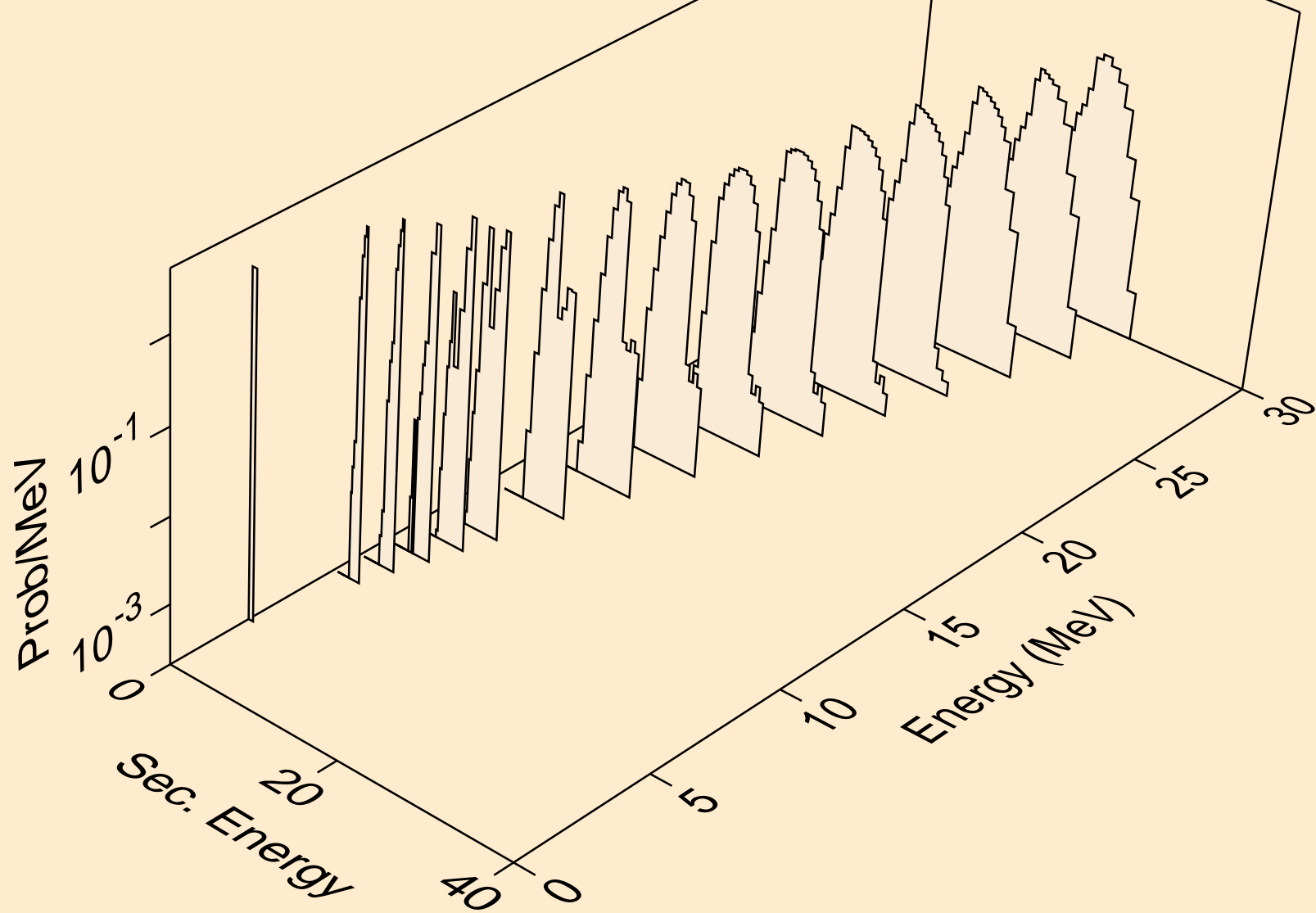

DY170 PROTON ACER TENDL-2021 LIBRARY; T=0.K  
he3s from (p,x)

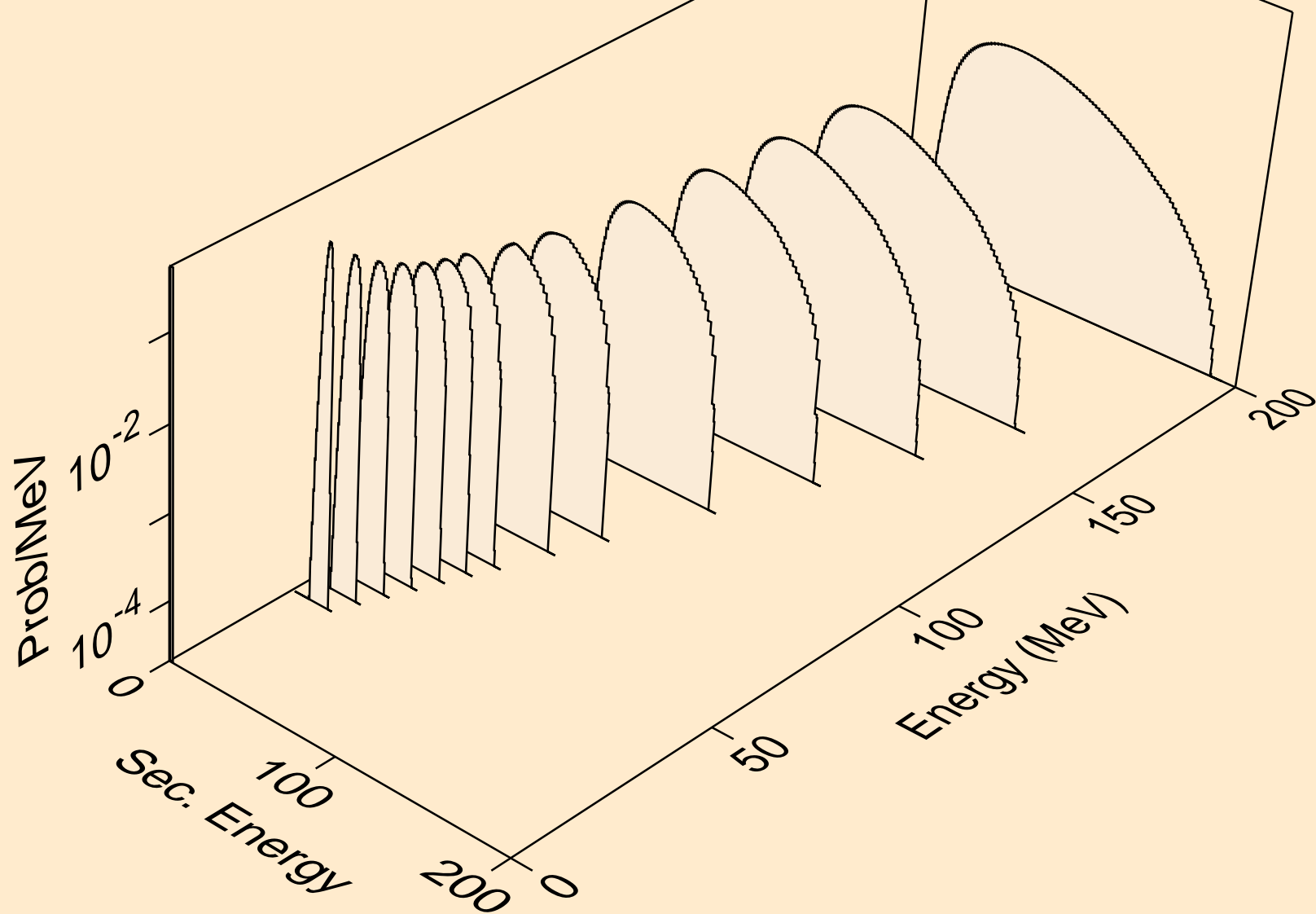

DY170 PROTON ACER TENDL-2021 LIBRARY; T=0.K  
he3s from (p,n\*)he3

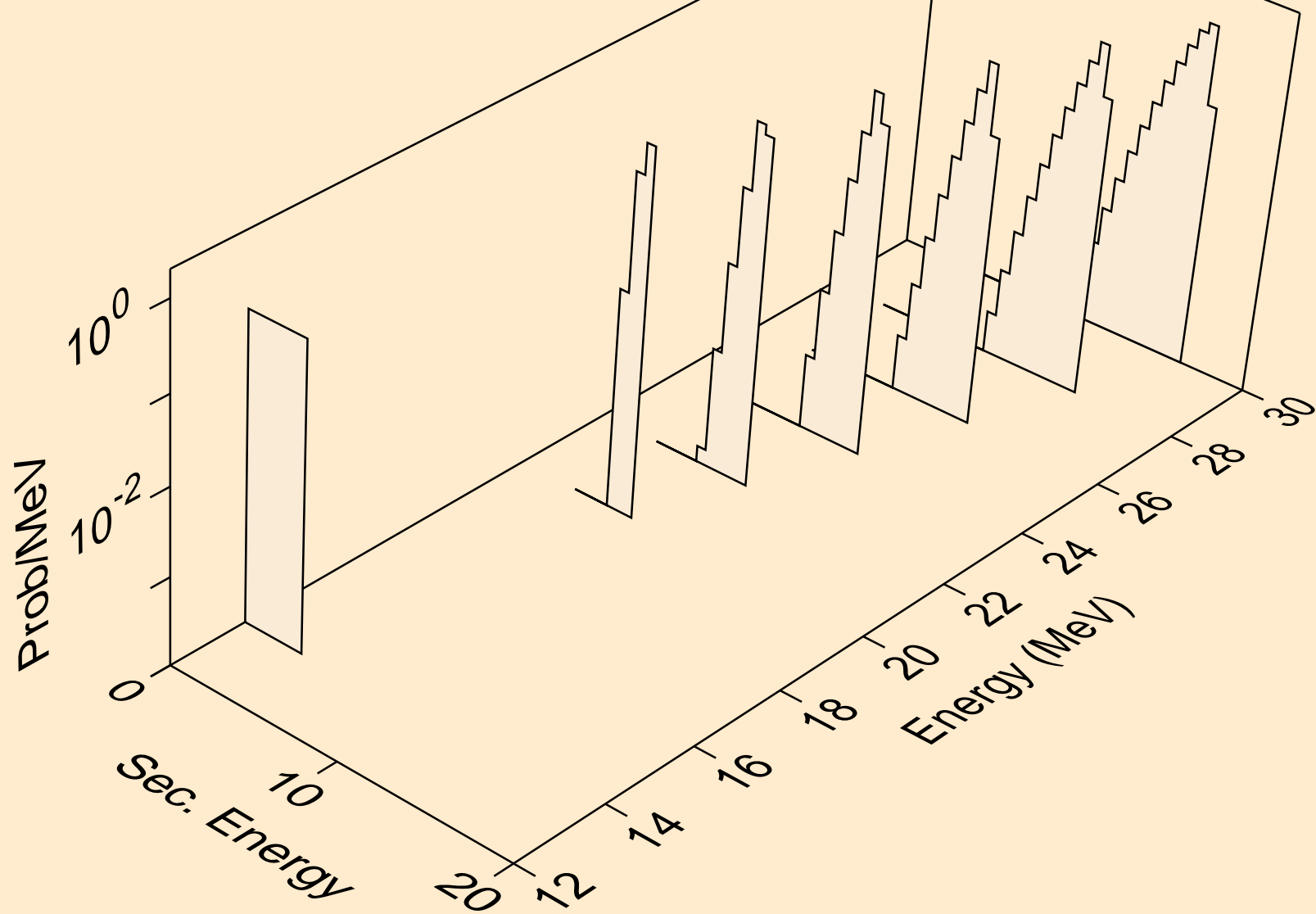

DY170 PROTON ACER TENDL-2021 LIBRARY; T=0.K  
he3s from (p,he3)

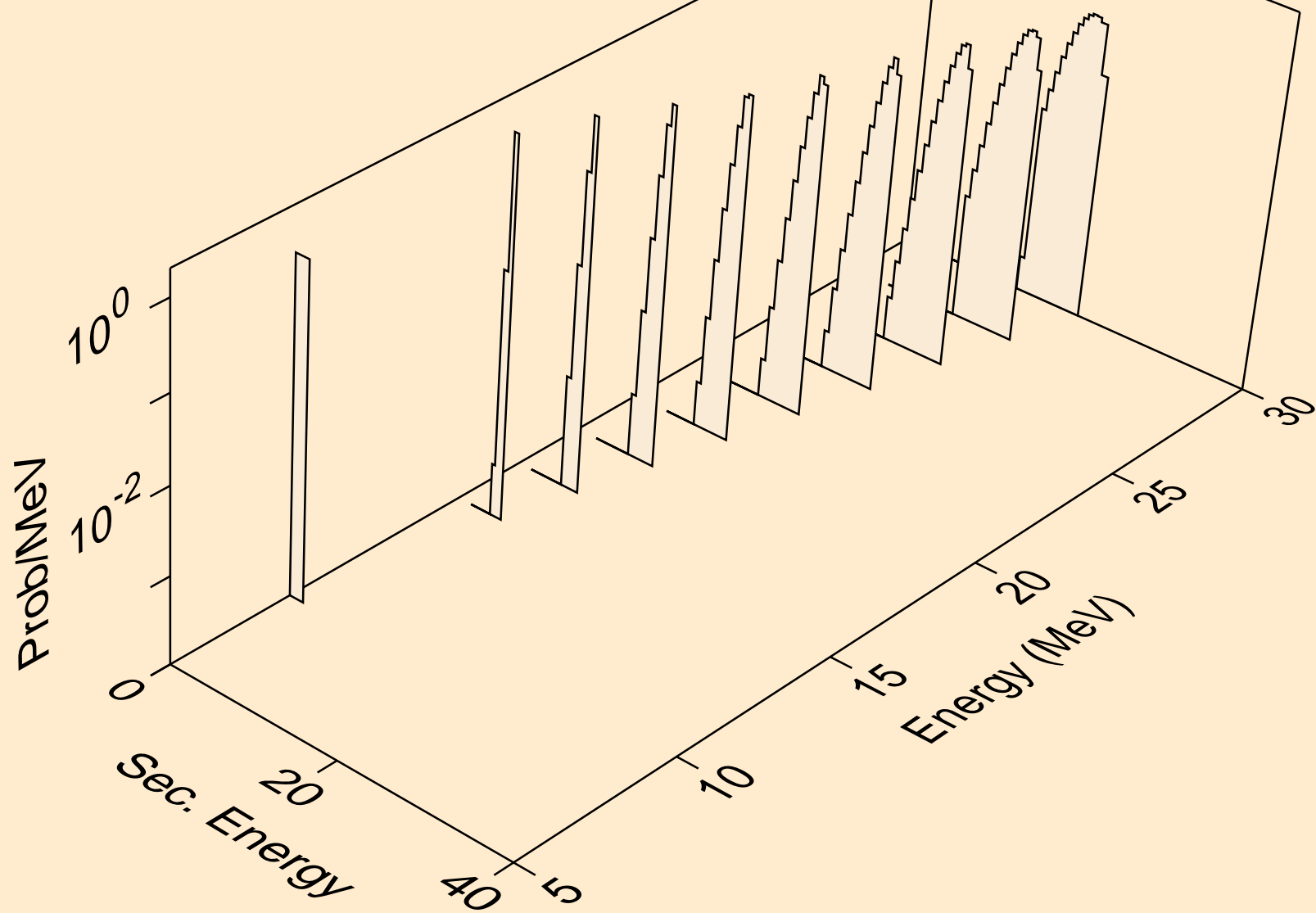

DY170 PROTON ACER TENDL-2021 LIBRARY; T=0.K  
alphas from (p,x)

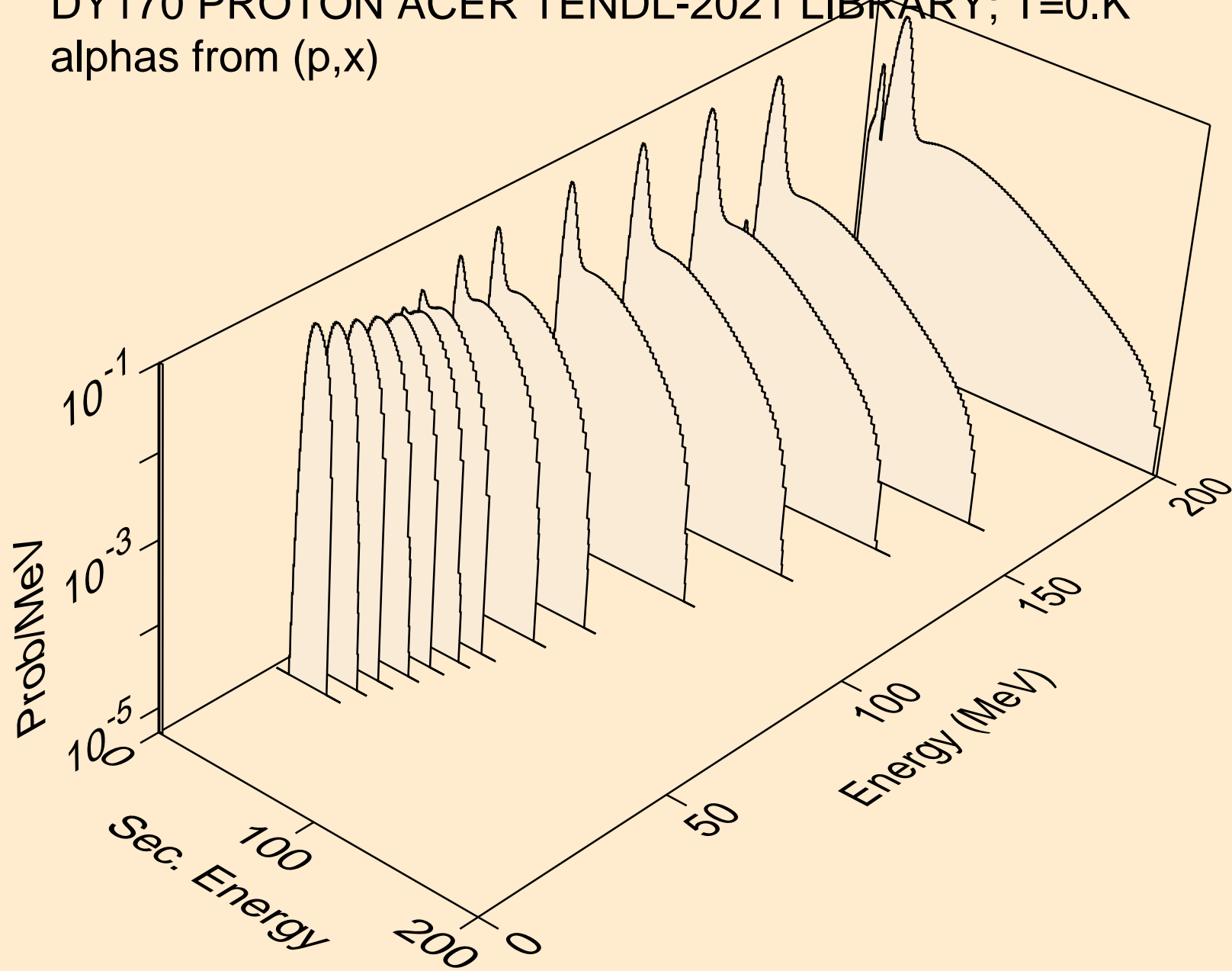

DY170 PROTON ACER TENDL-2021 LIBRARY; T=0.K  
alphas from (p,n\*)a

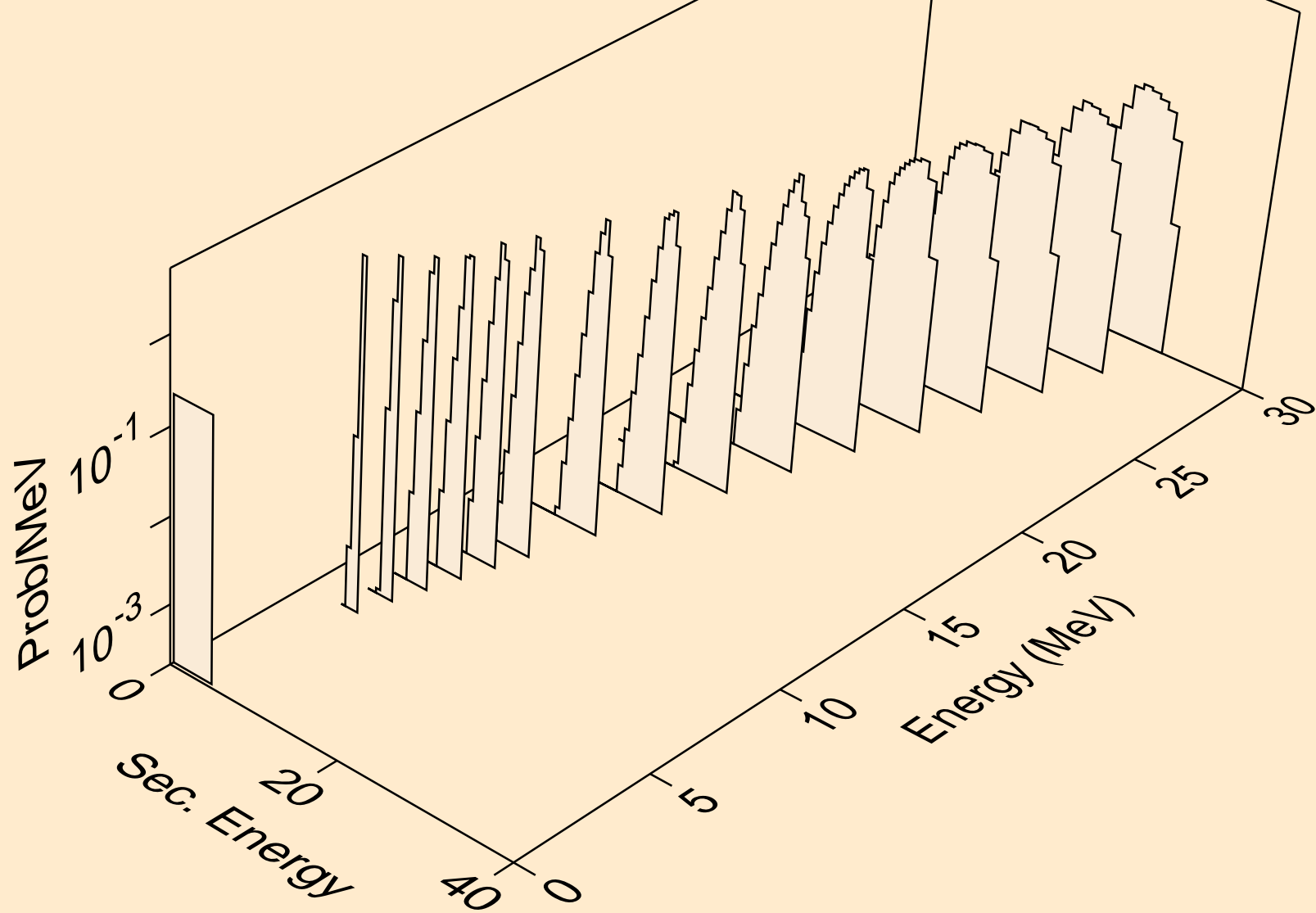

DY170 PROTON ACER TENDL-2021 LIBRARY; T=0.K  
alphas from (p,2n)a

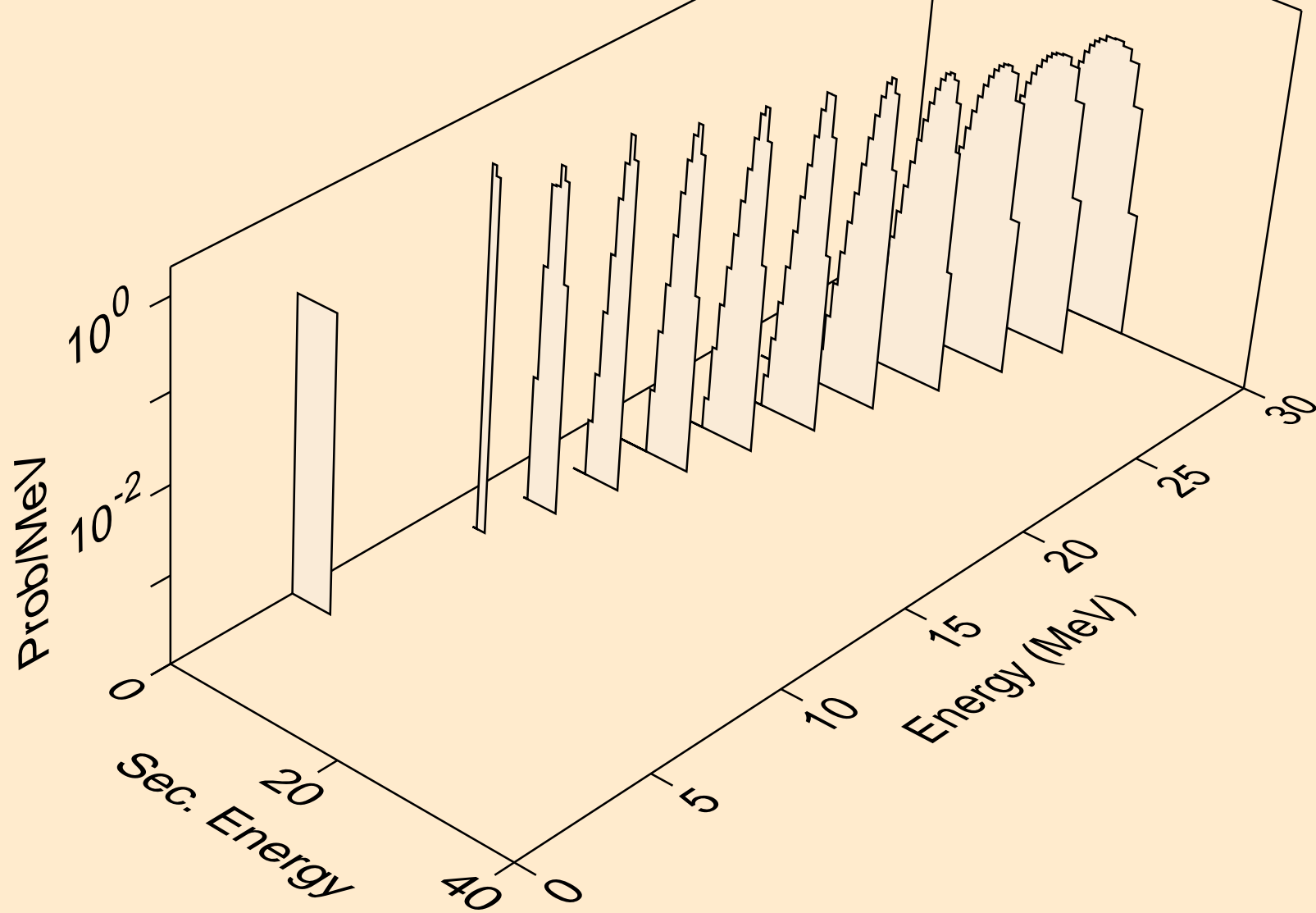



DY170 PROTON ACER TENDL-2021 LIBRARY; T=0.K  
alphas from (p,3n)a

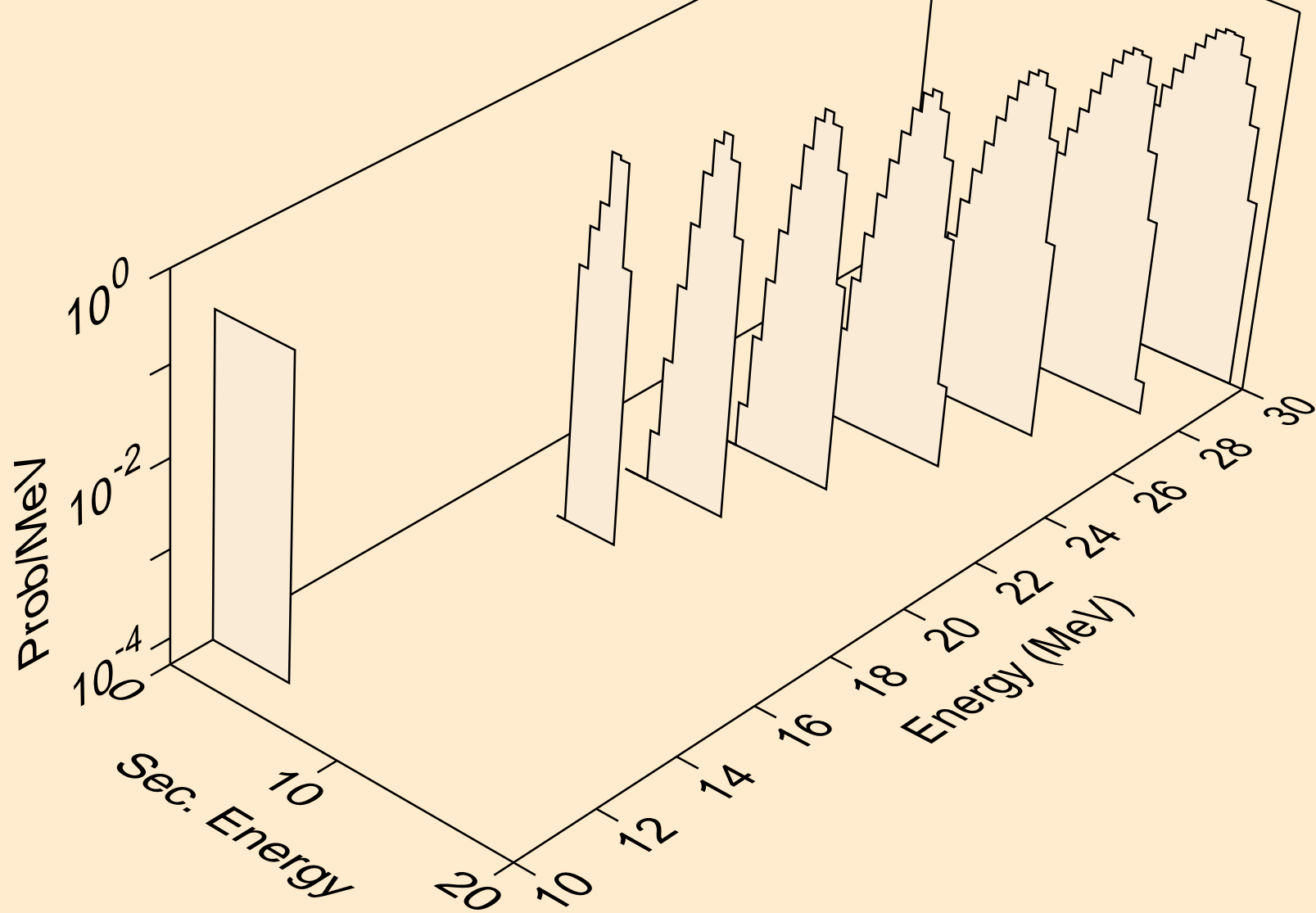

DY170 PROTON ACER TENDL-2021 LIBRARY; T=0.K  
alphas from (p,a)

