

ES250 PROTON ACER TENDL-2021 LIBRARY; T=0.K

Principal cross sections

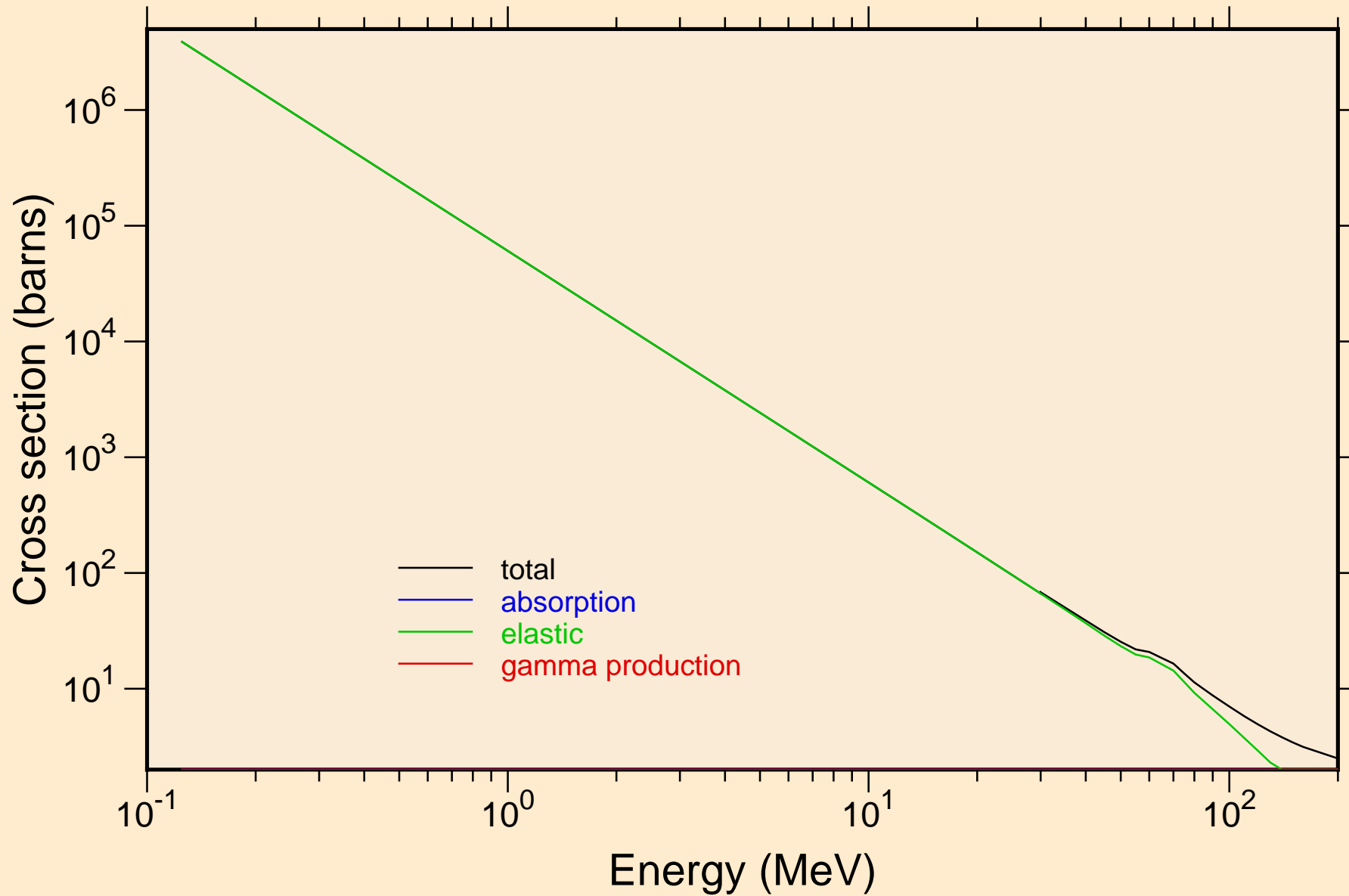

ES250 PROTON ACER TENDL-2021 LIBRARY; T=0.K

Heating

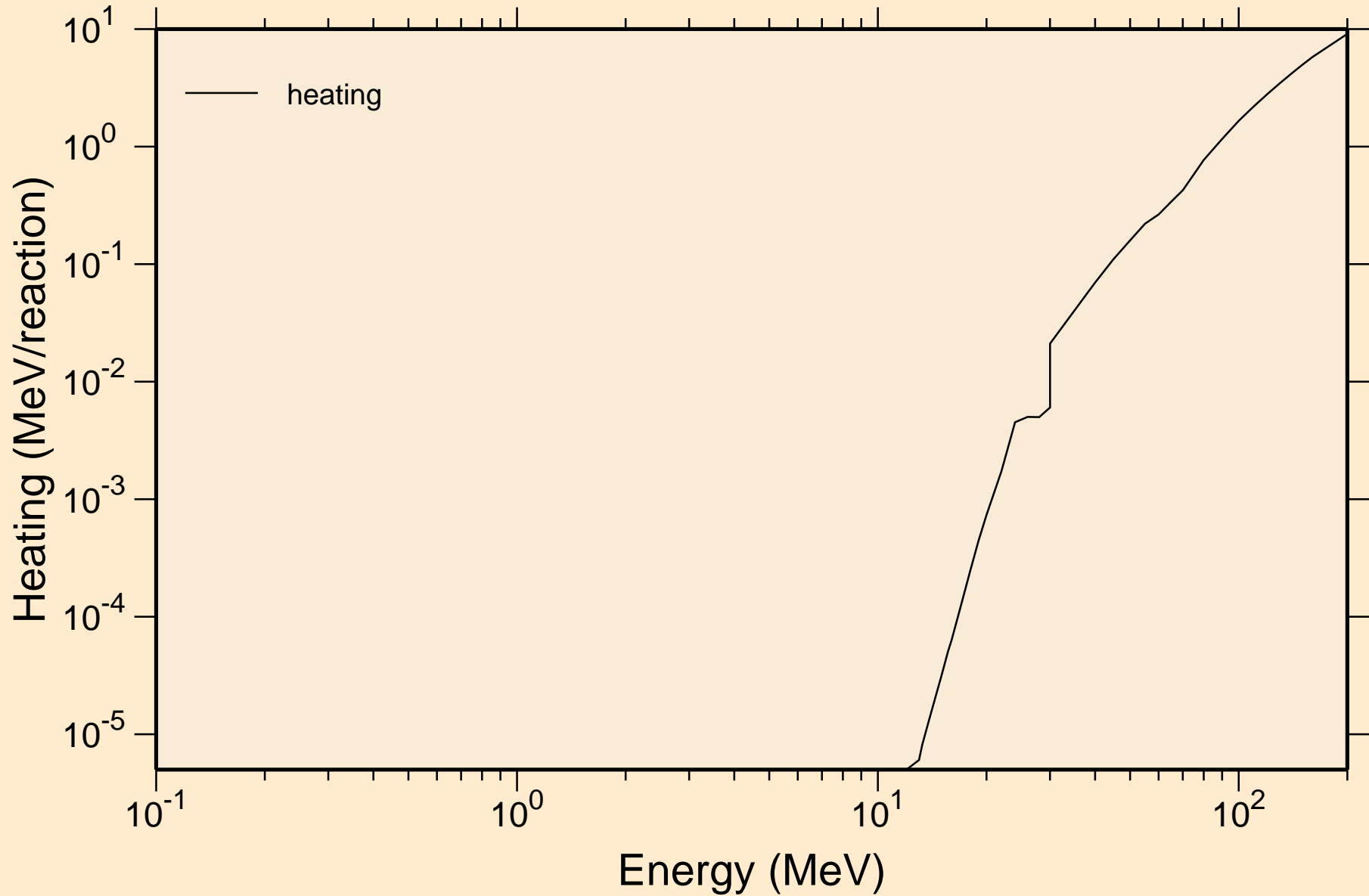

ES250 PROTON ACER TENDL-2021 LIBRARY; T=0.K

Principal cross sections

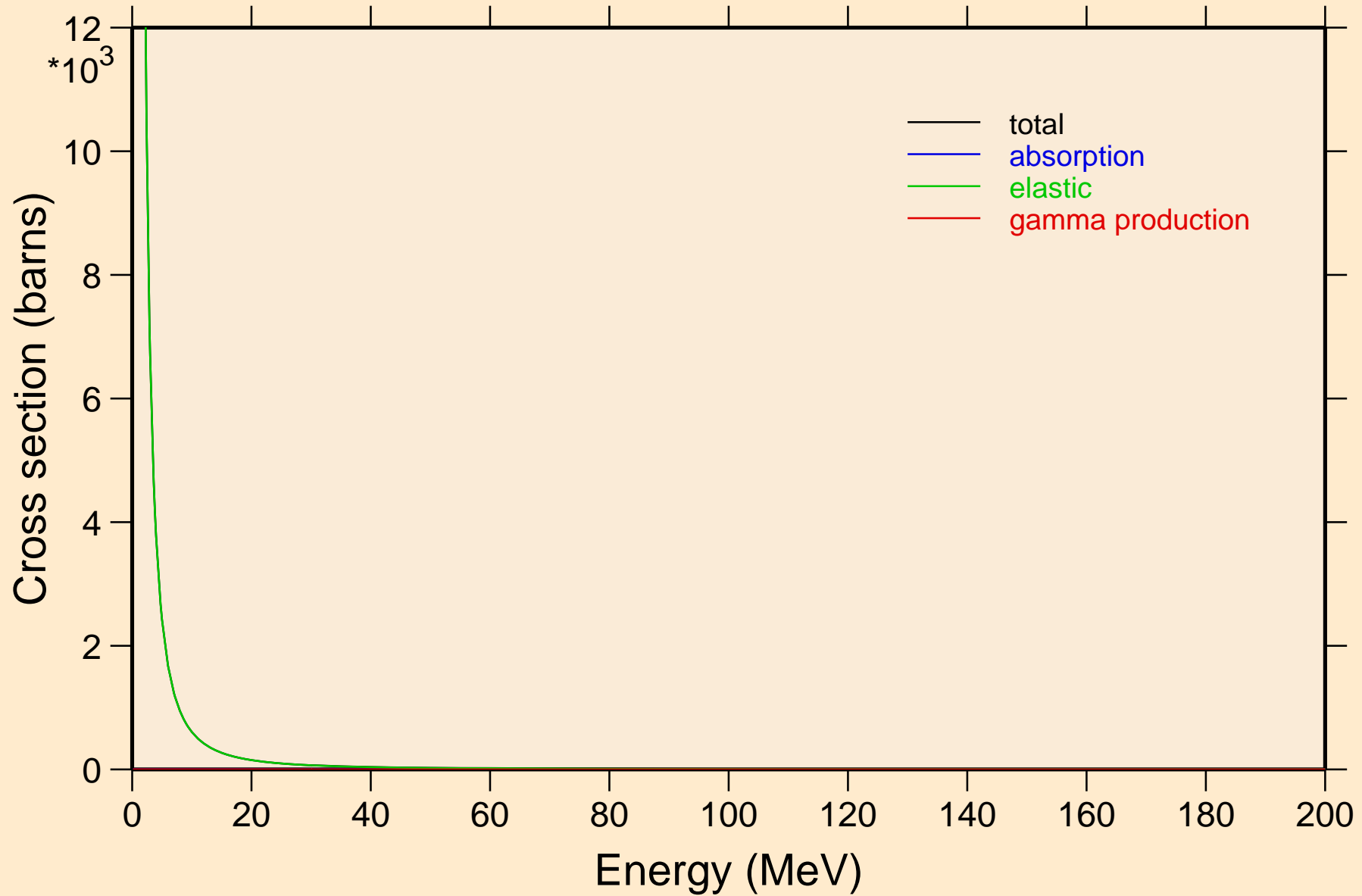

ES250 PROTON ACER TENDL-2021 LIBRARY; T=0.K

Heating

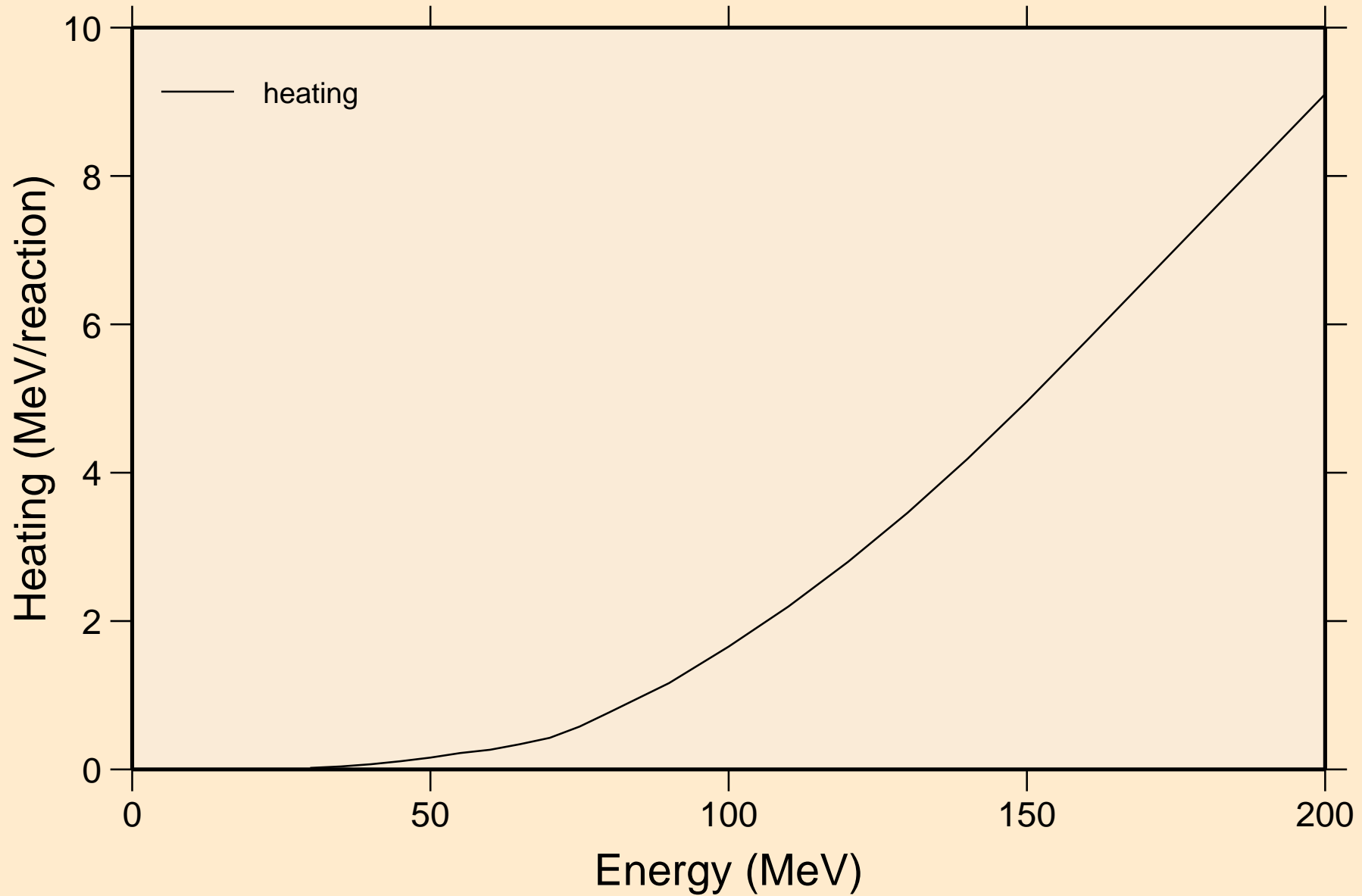

ES250 PROTON ACER TENDL-2021 LIBRARY; T=0.K

Threshold reactions

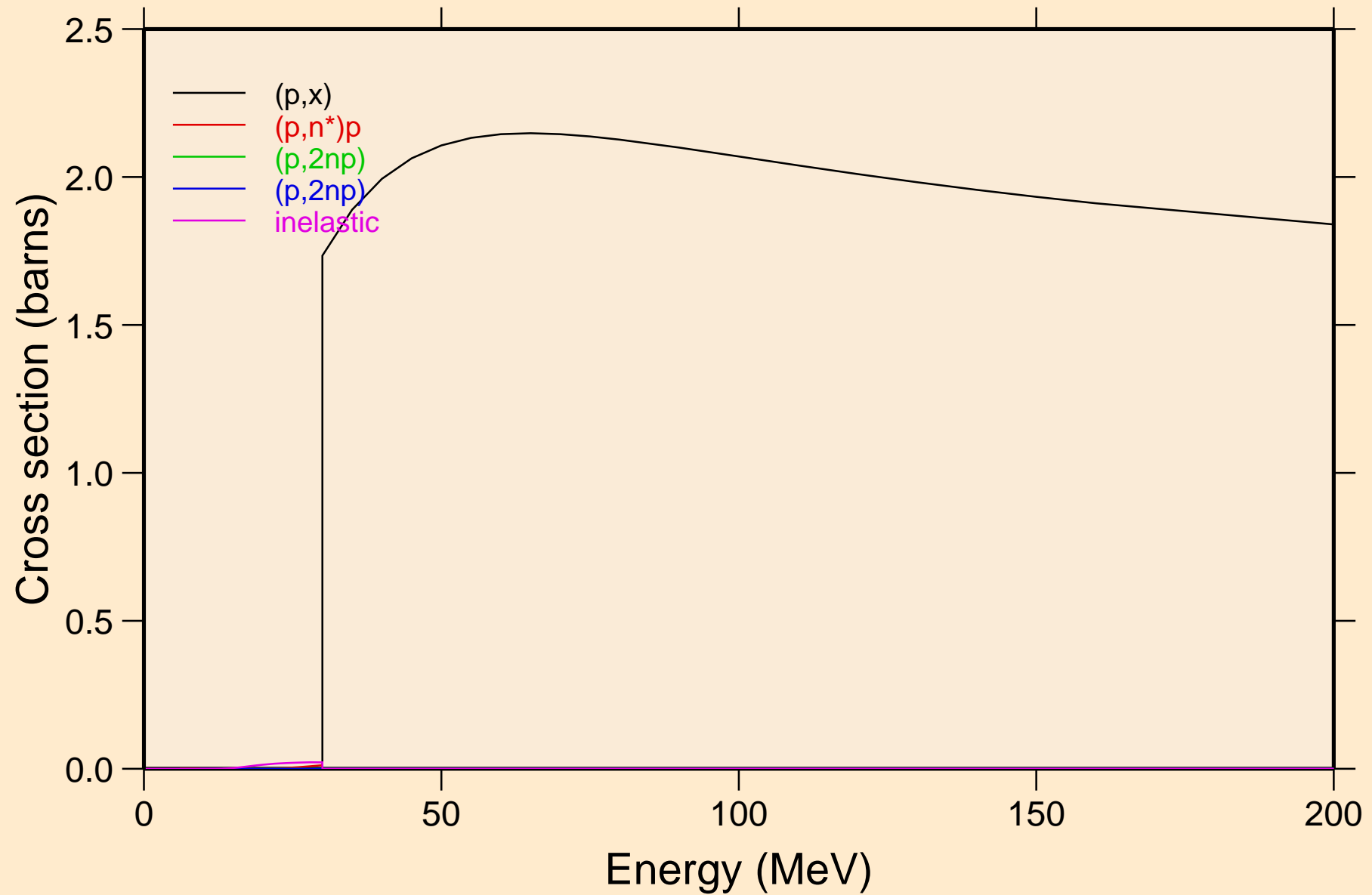

ES250 PROTON ACER TENDL-2021 LIBRARY; T=0.K

Threshold reactions

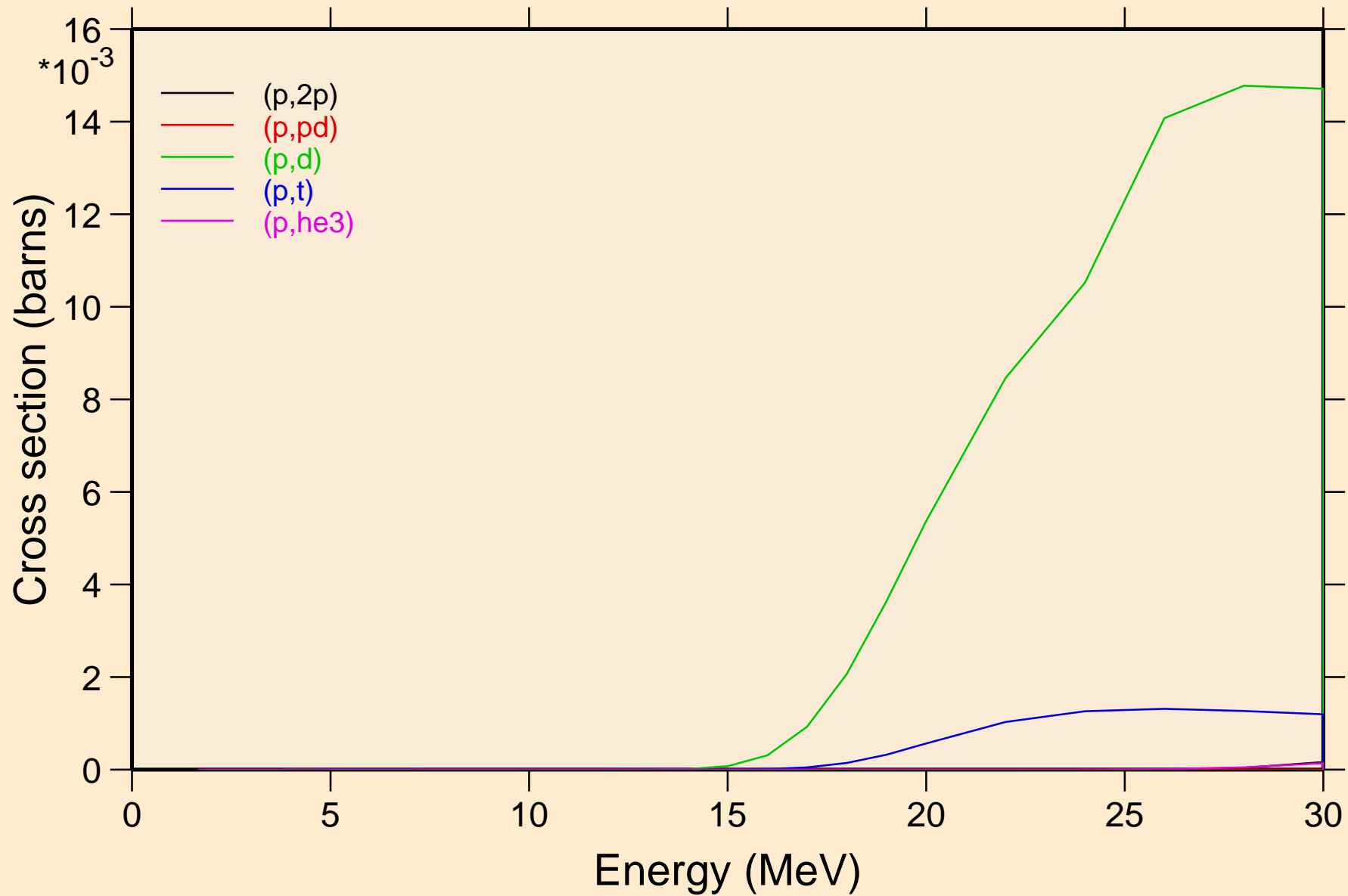

ES250 PROTON ACER TENDL-2021 LIBRARY; T=0.K
Threshold reactions

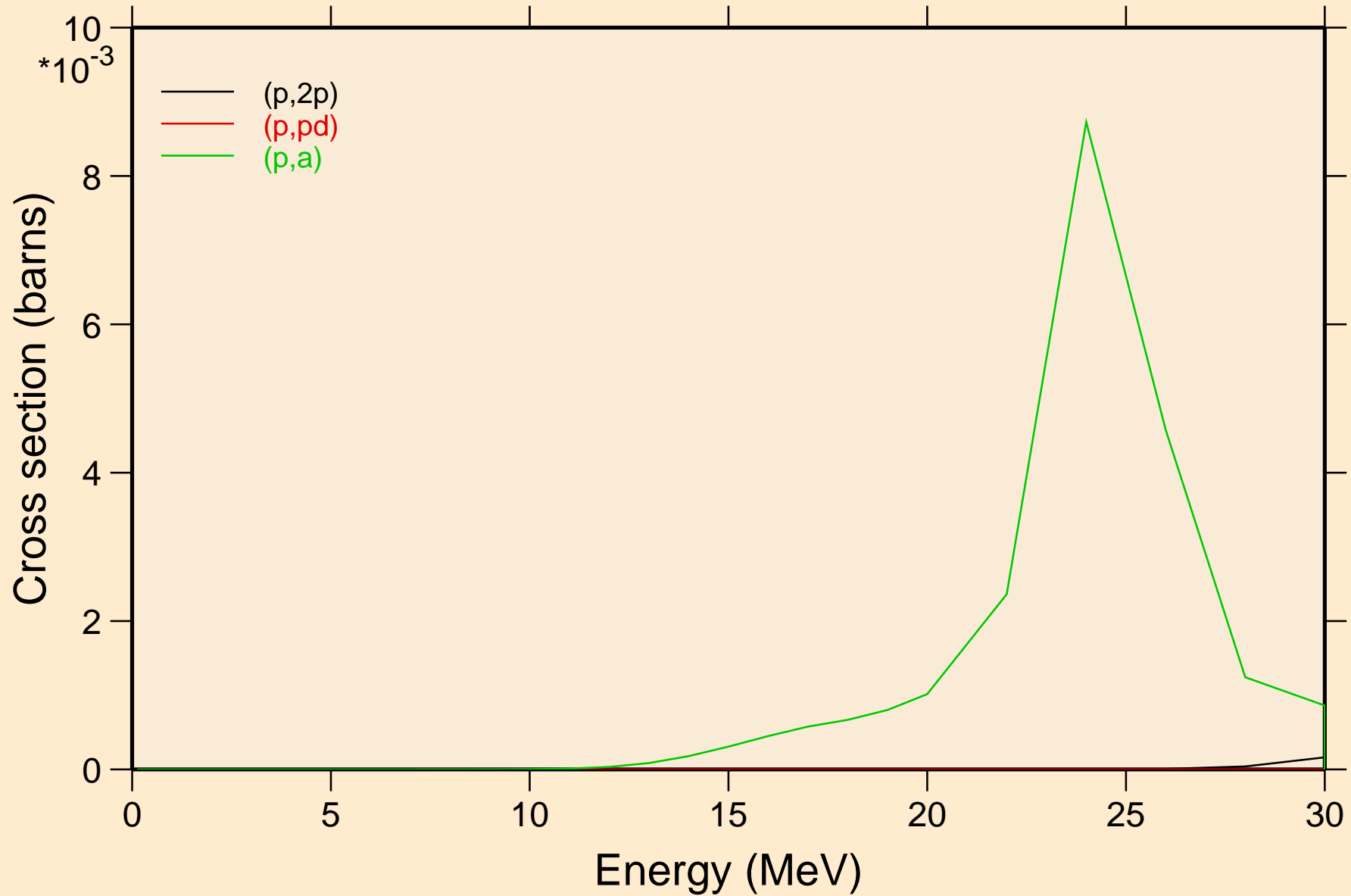

ES250 PROTON ACER TENDL-2021 LIBRARY; T=0.K
Threshold reactions

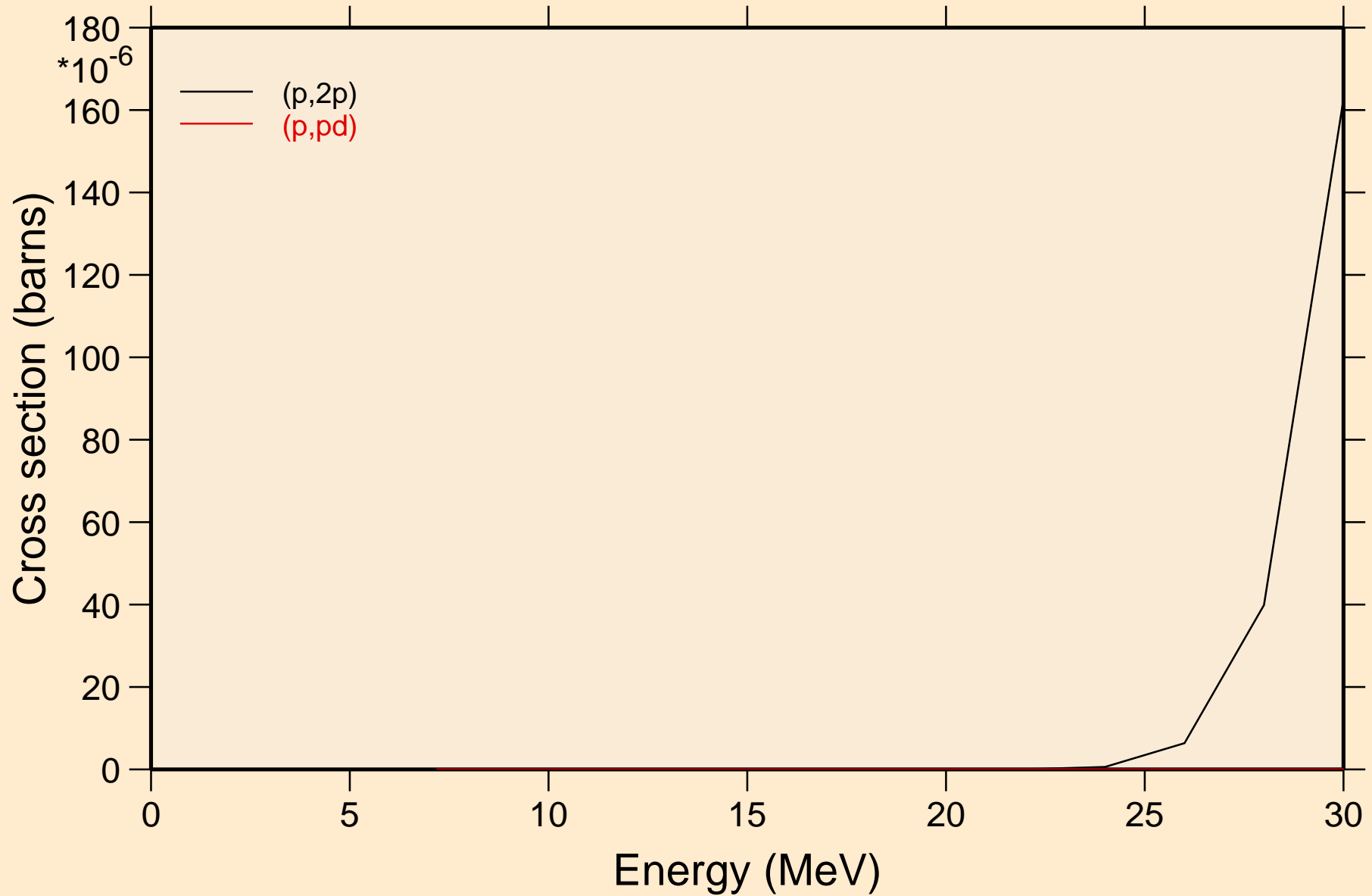

ES250 PROTON ACER TENDL-2021 LIBRARY; T=0.K
angular distribution for elastic

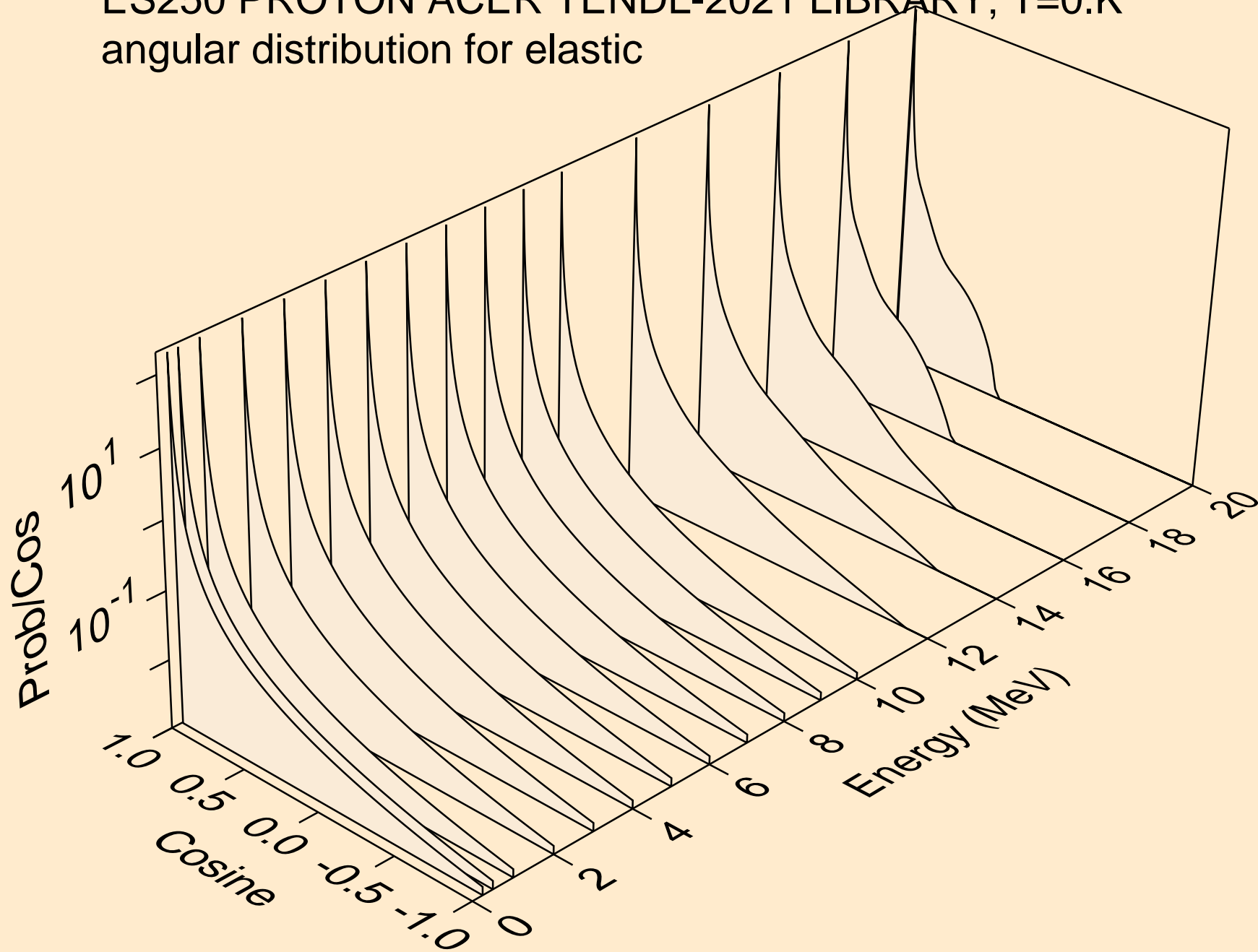

ES250 PROTON ACER TENDL-2021 LIBRARY; T=0.K
angular distribution for elastic

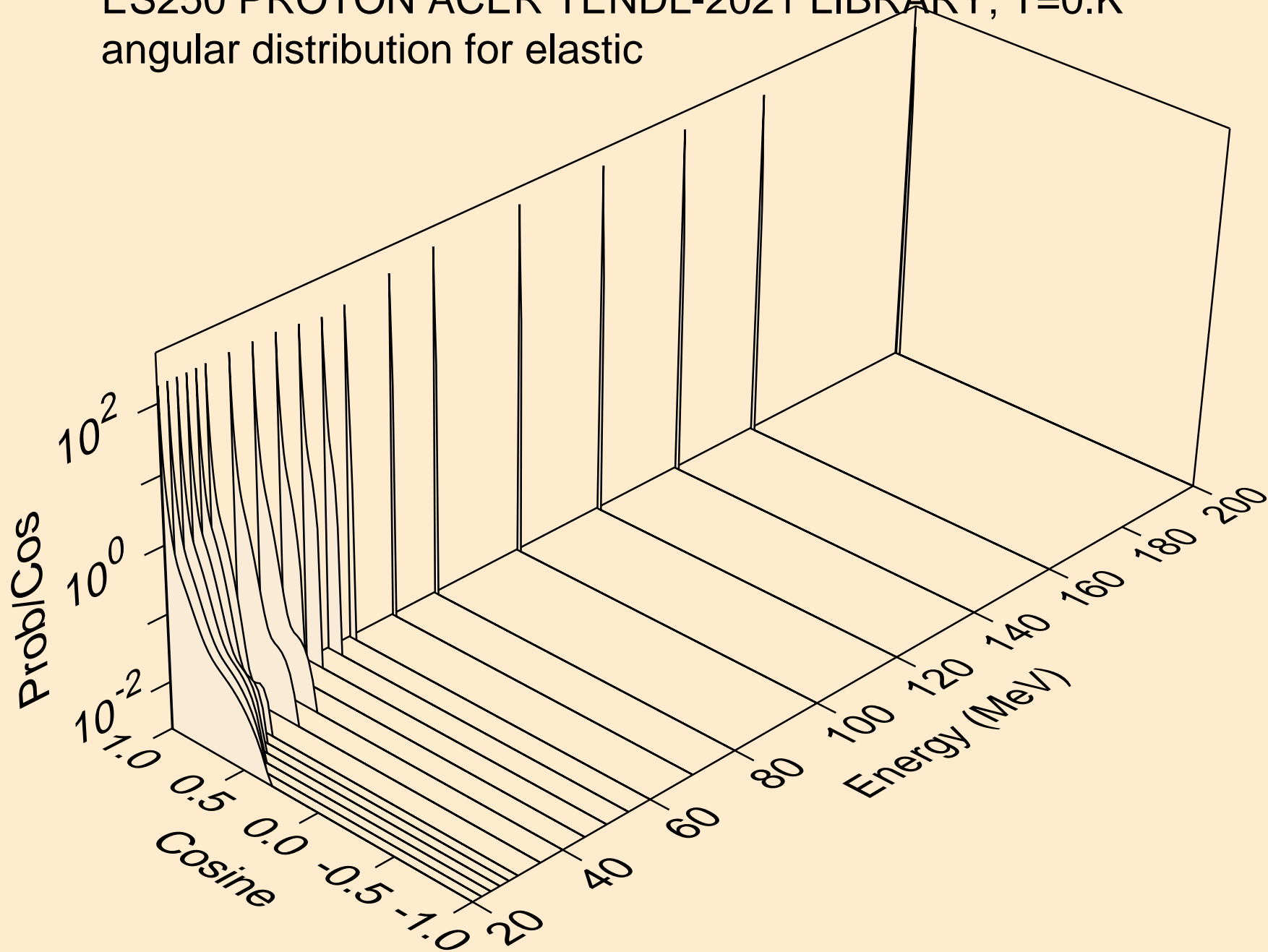

ES250 PROTON ACER TENDL-2021 LIBRARY; T=0.K
Proton emission for (p,x)

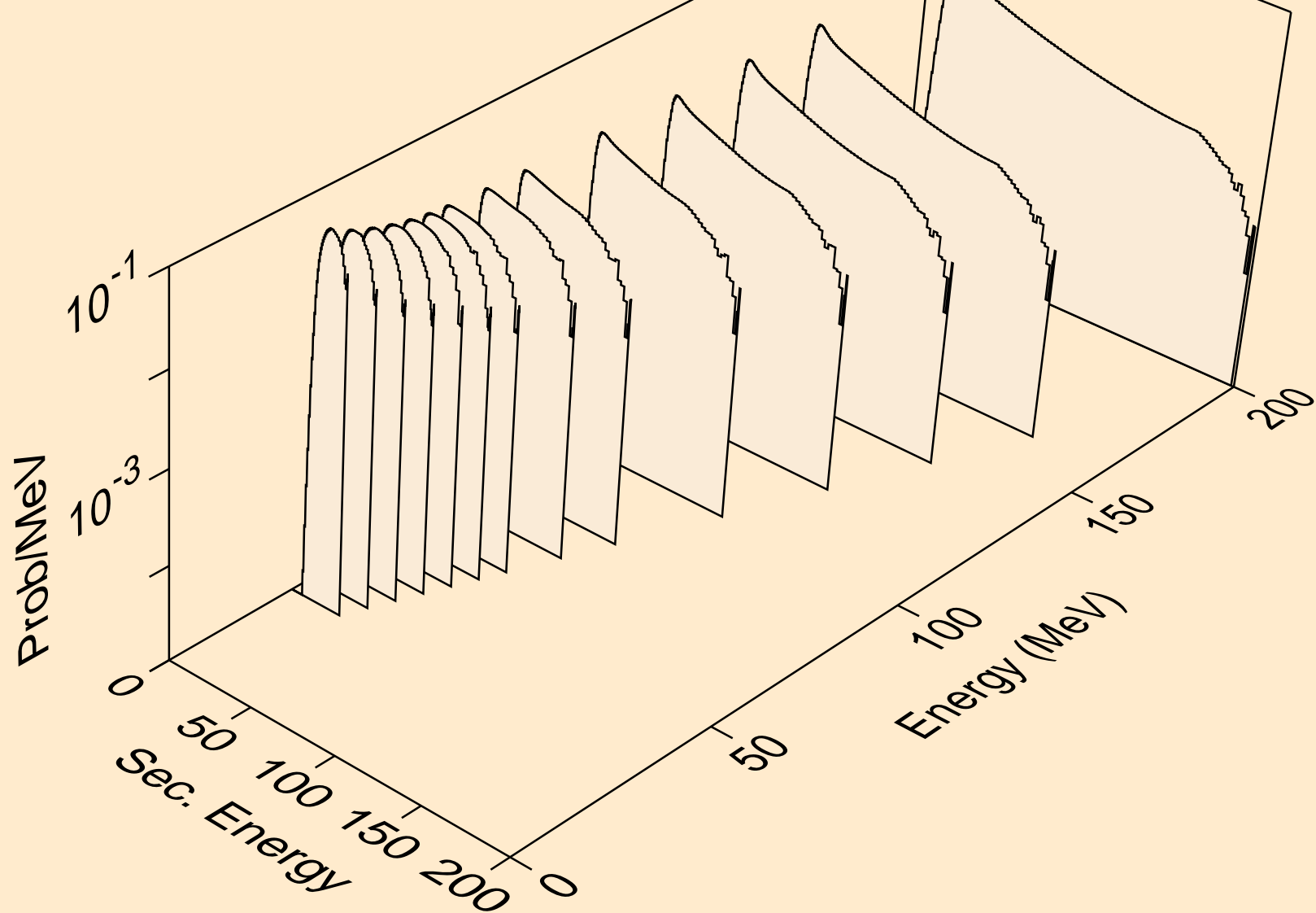

ES250 PROTON ACER TENDL-2021 LIBRARY; T=0.K
Proton emission for (p,n*)p

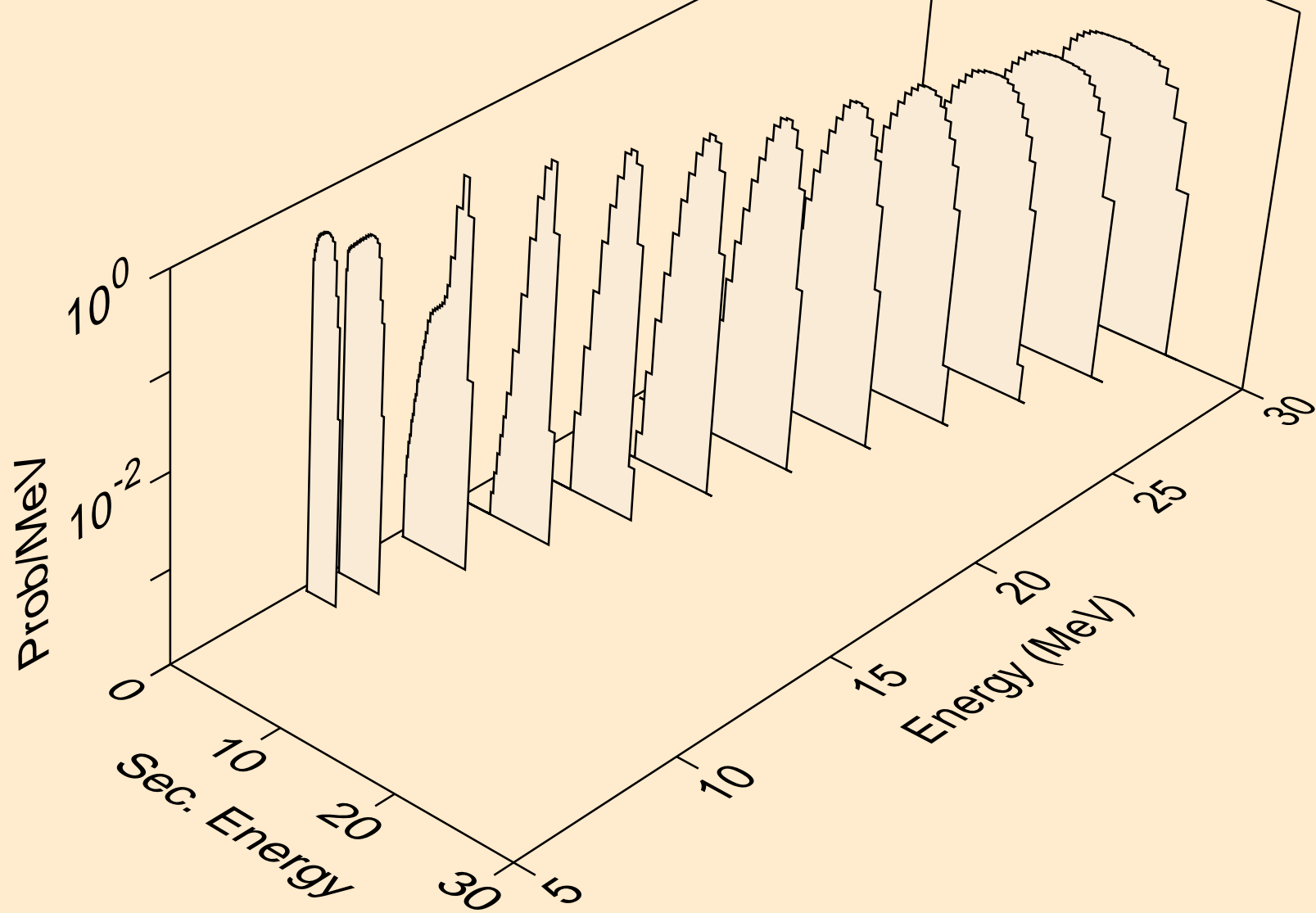

ES250 PROTON ACER TENDL-2021 LIBRARY; T=0.K
Proton emission for (p,2np)

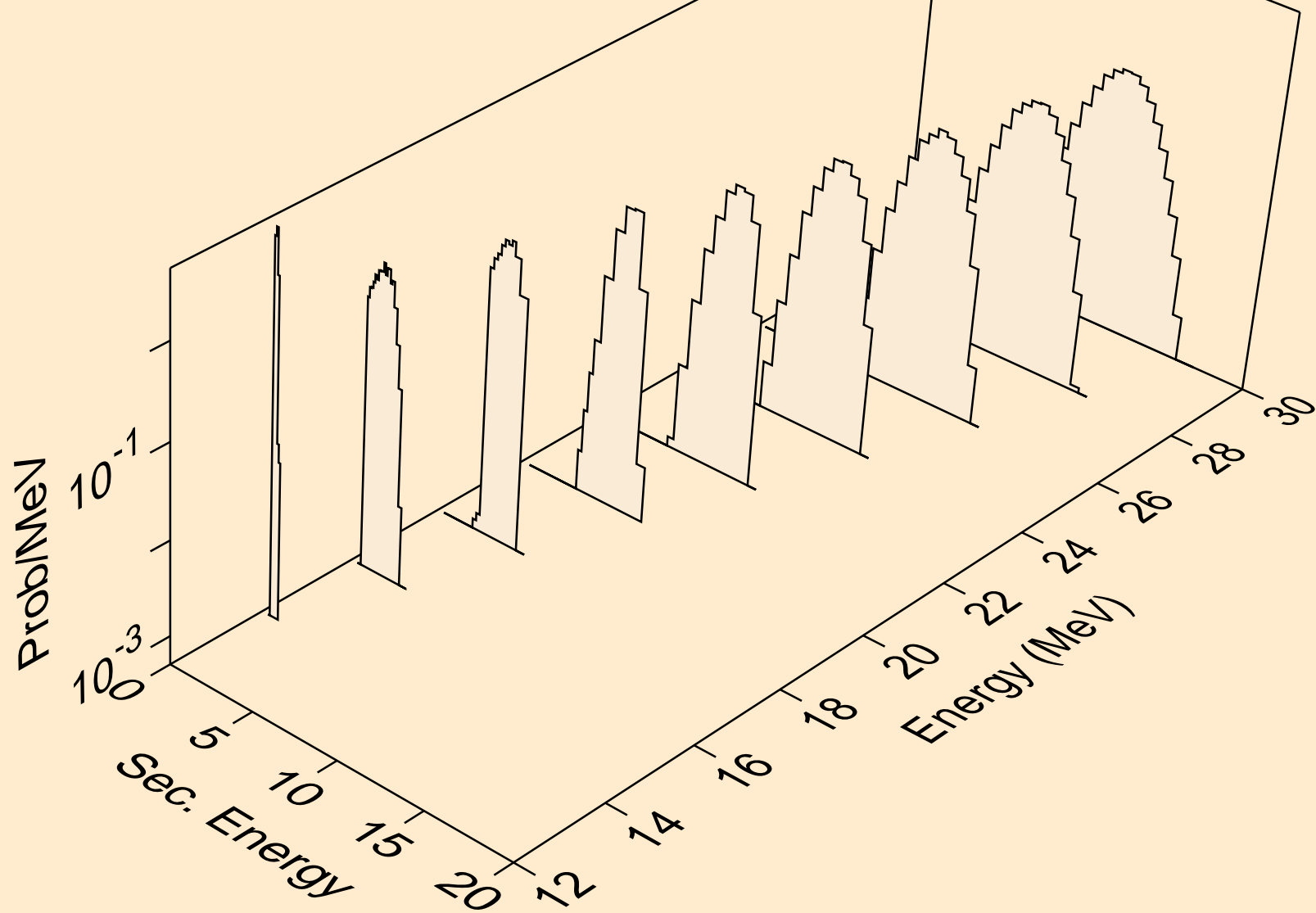

ES250 PROTON ACER TENDL-2021 LIBRARY; T=0.K
Proton emission for (p,2np)

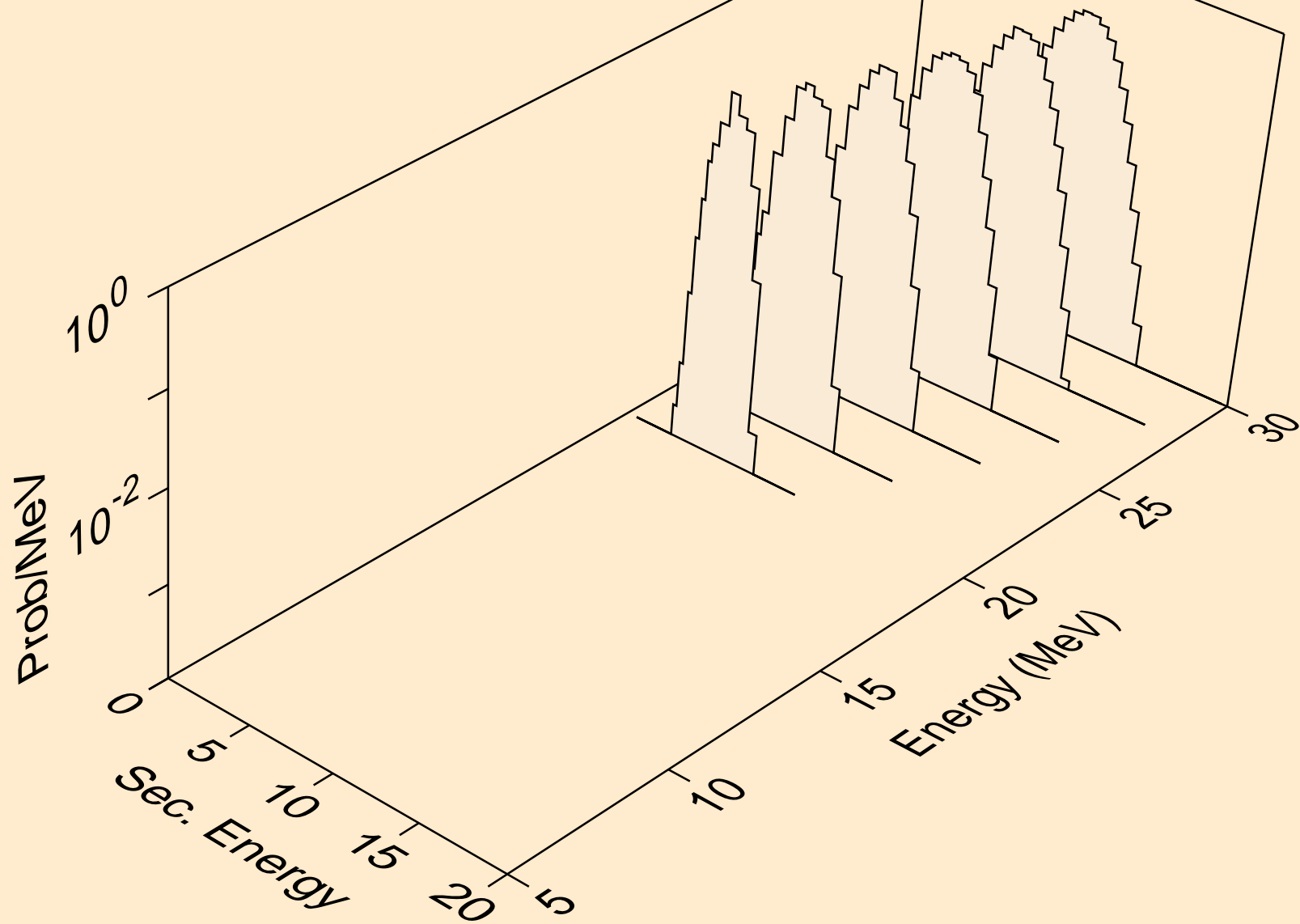

ES250 PROTON ACER TENDL-2021 LIBRARY; T=0.K
Proton emission for inelastic

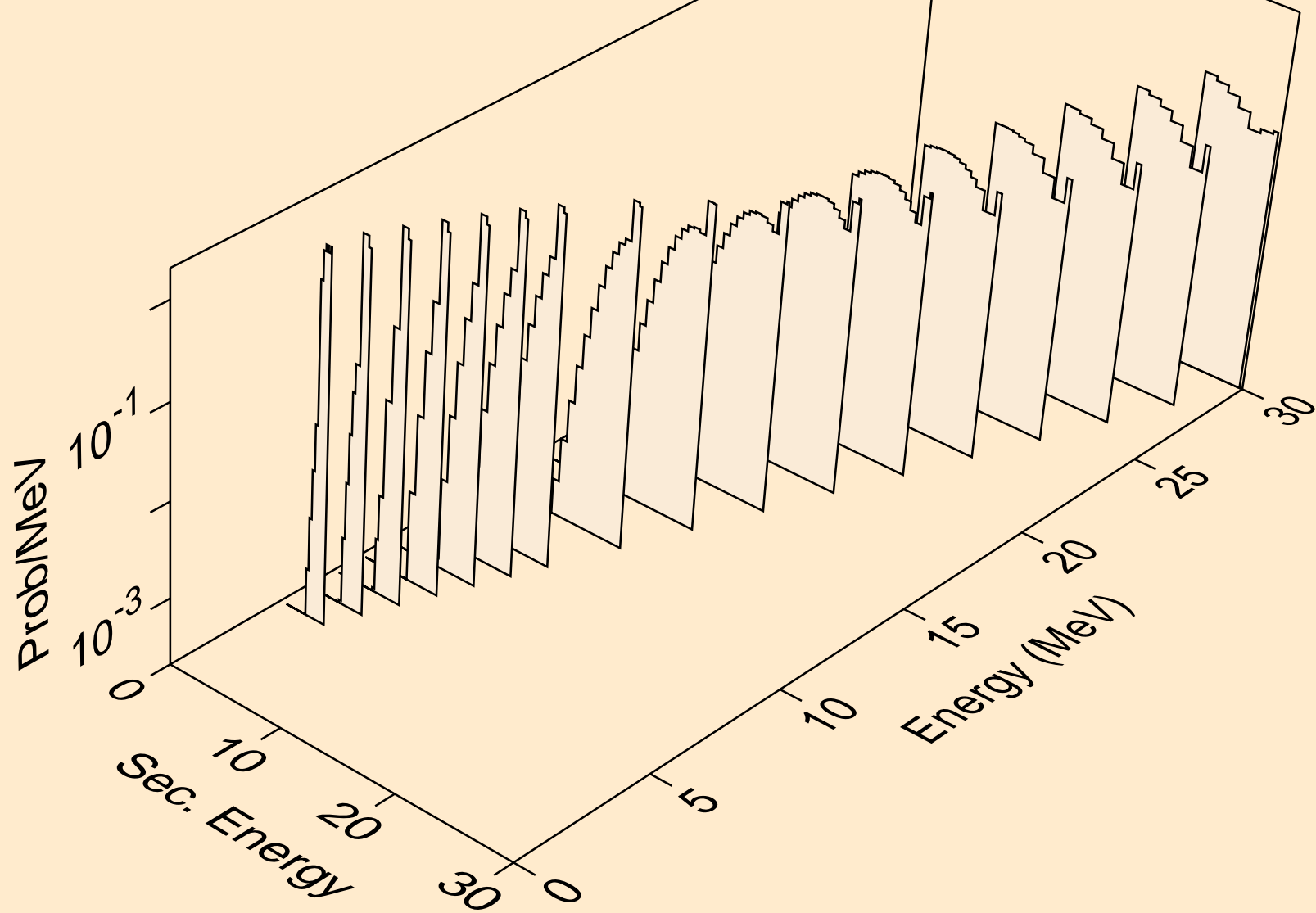

ES250 PROTON ACER TENDL-2021 LIBRARY; T=0.K
Proton emission for (p,2p)

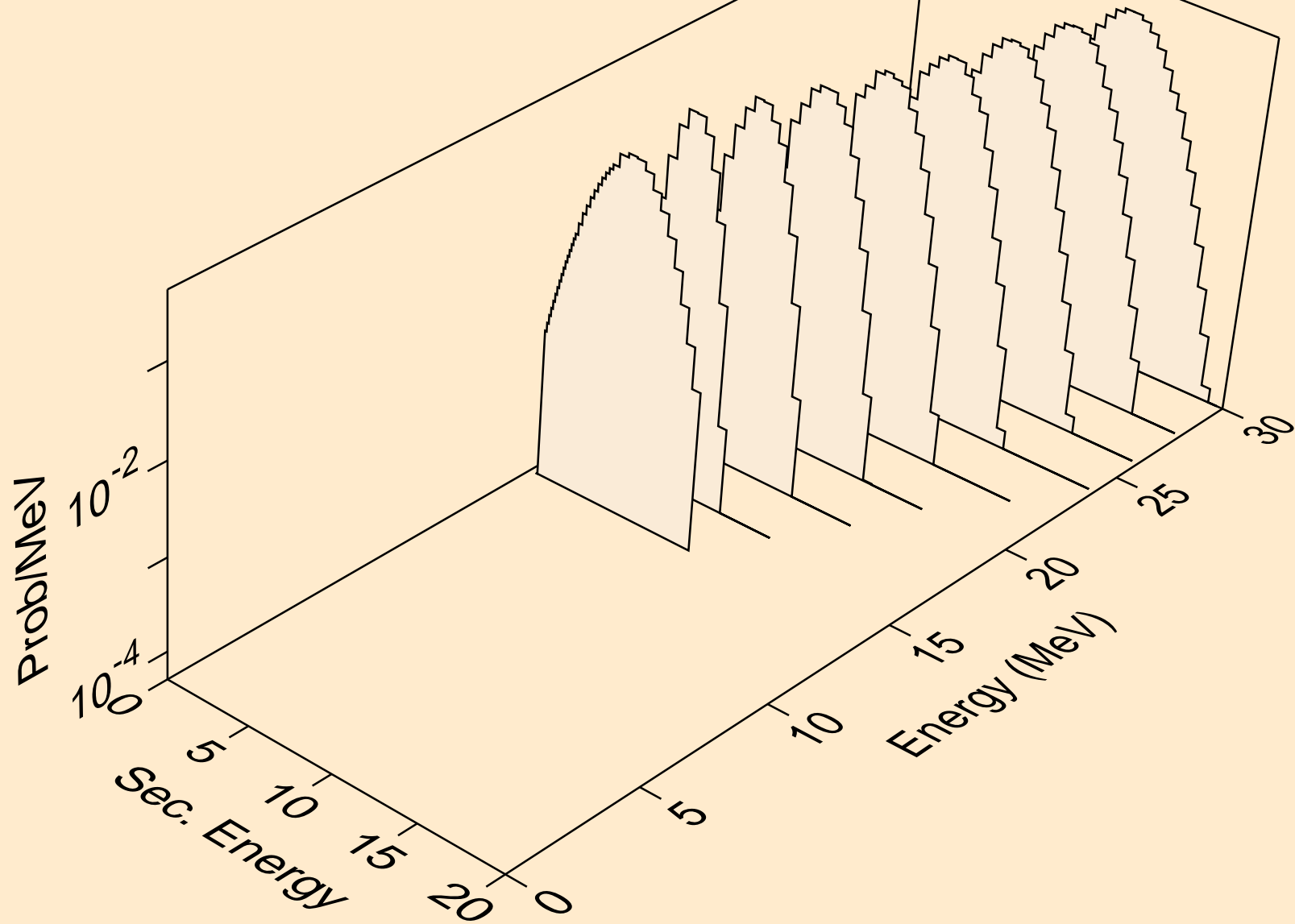

ES250 PROTON ACER TENDL-2021 LIBRARY; T=0.K
Proton emission for (p,pd)

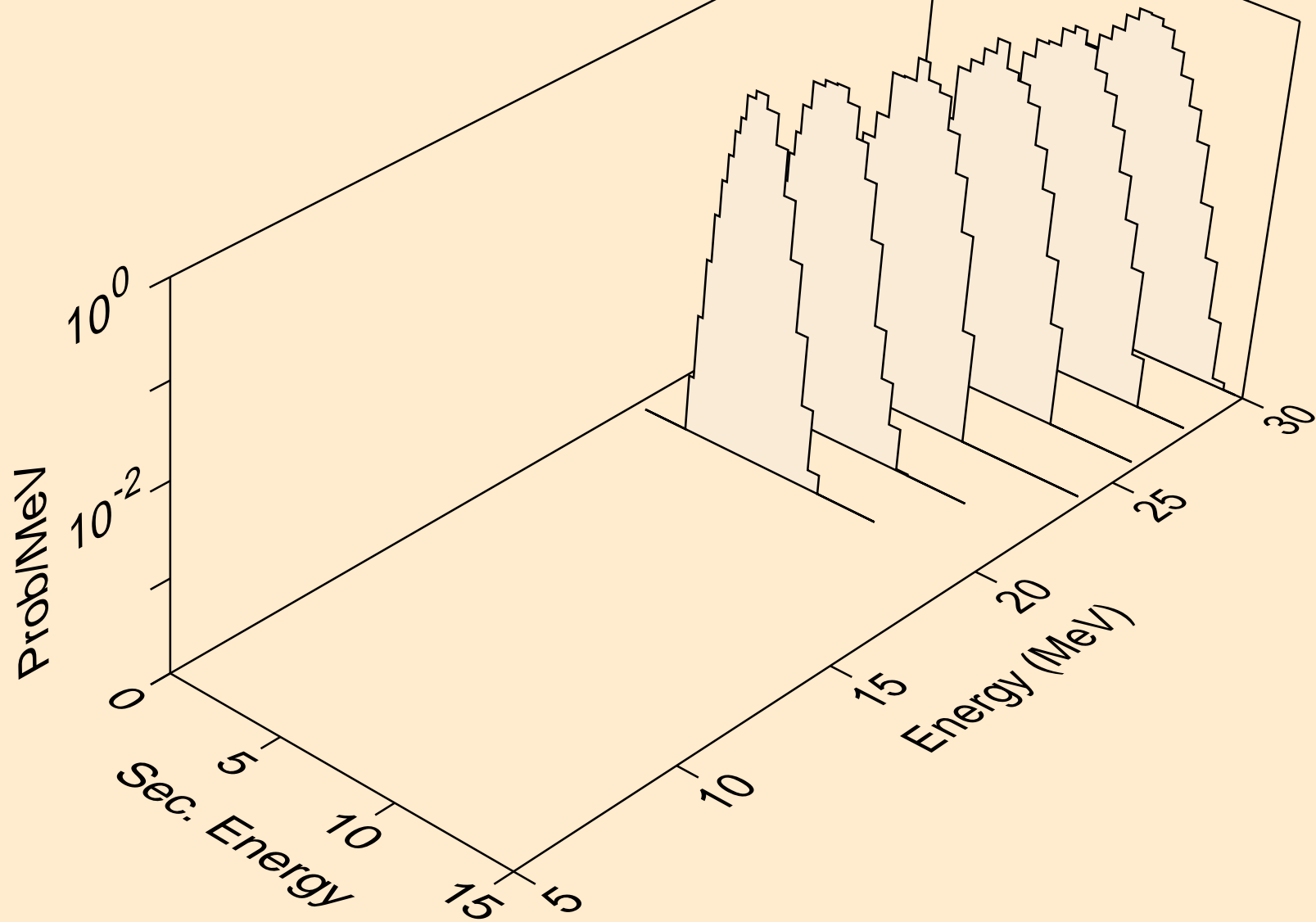

ES250 PROTON ACER TENDL-2021 LIBRARY; T=0.K
Photon emission for (z,n)

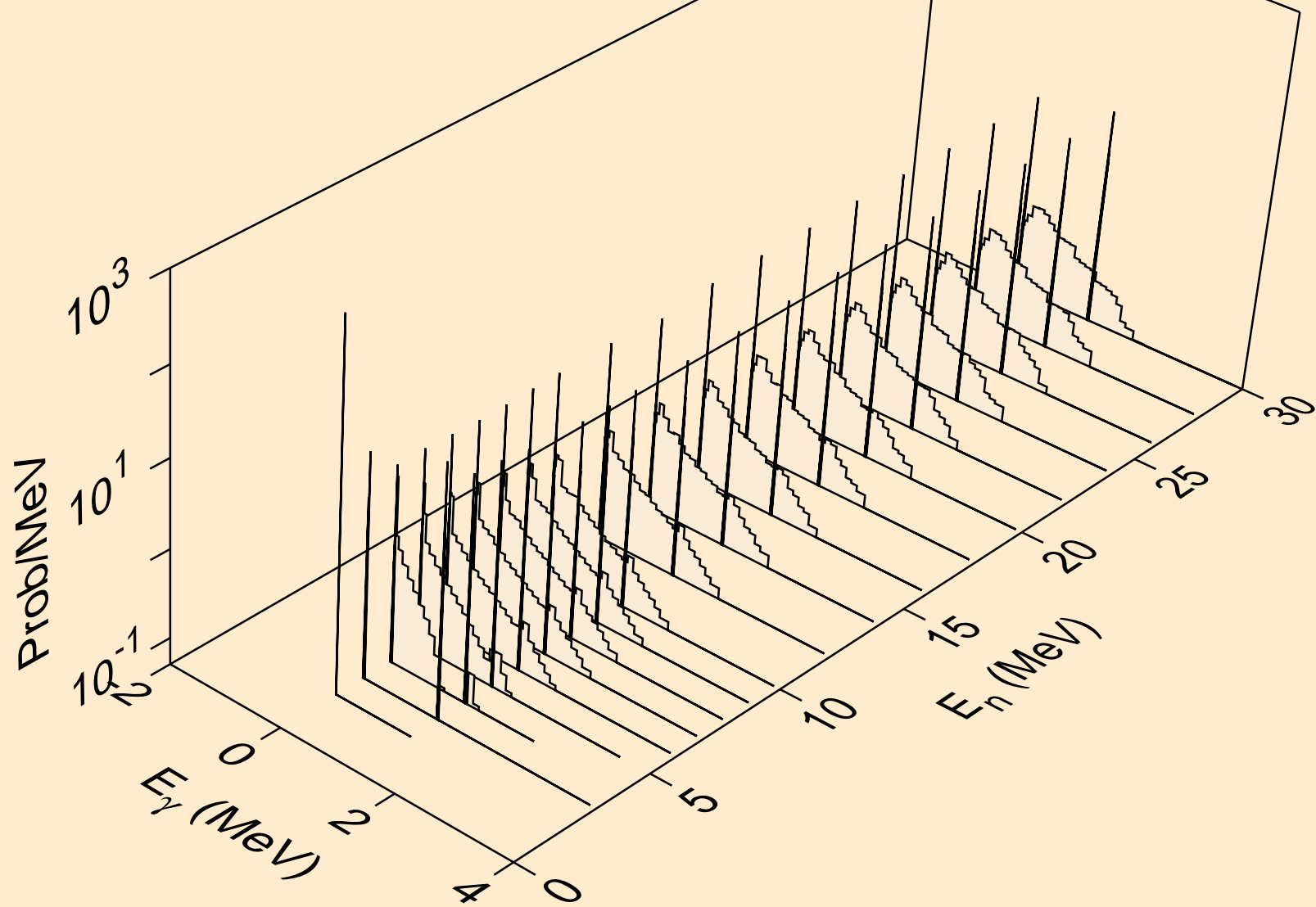

ES250 PROTON ACER TENDL-2021 LIBRARY; T=0.K
Photon emission for (n,x)

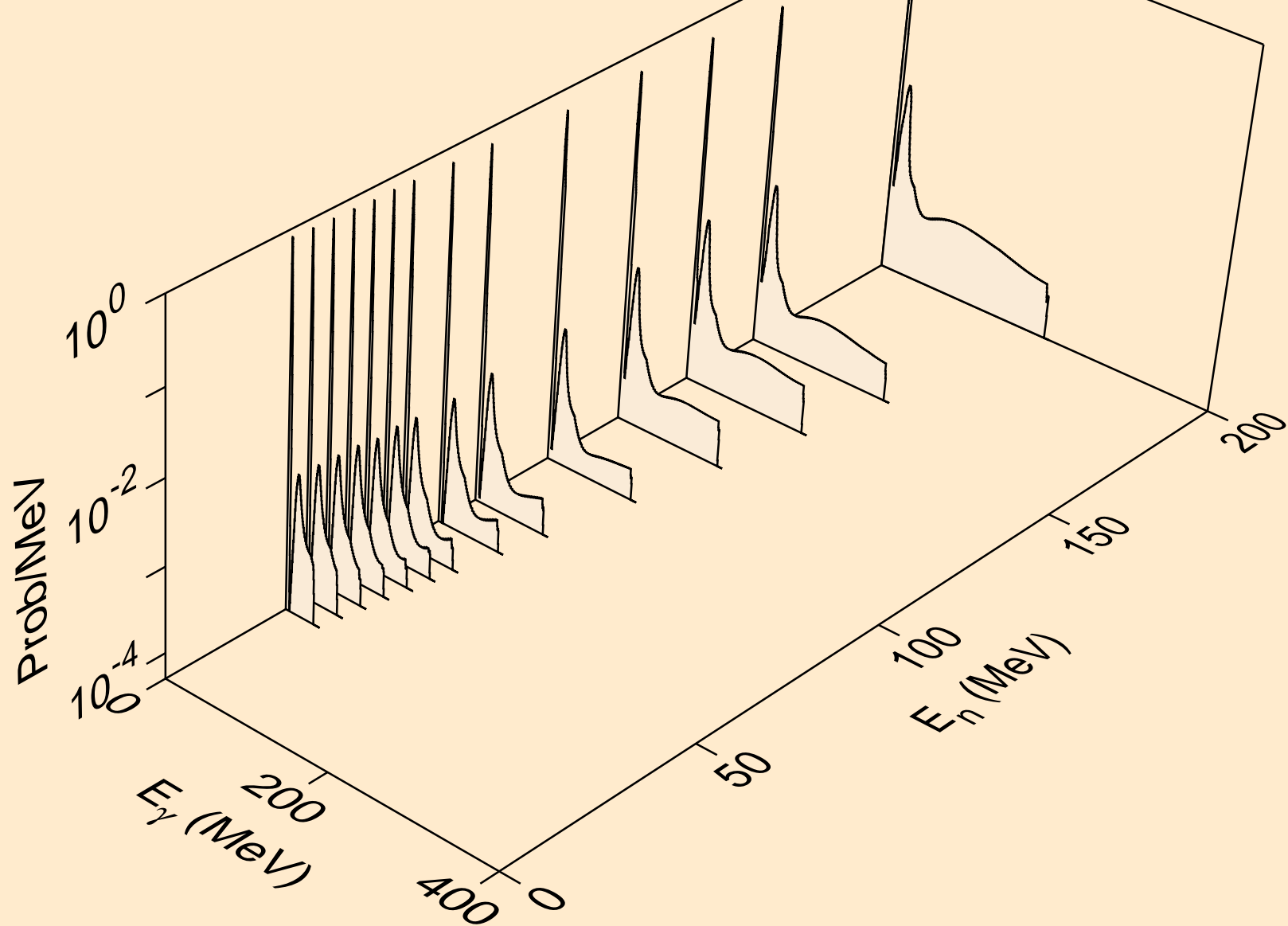

ES250 PROTON ACER TENDL-2021 LIBRARY; T=0.K
Photon emission for (n,2n)

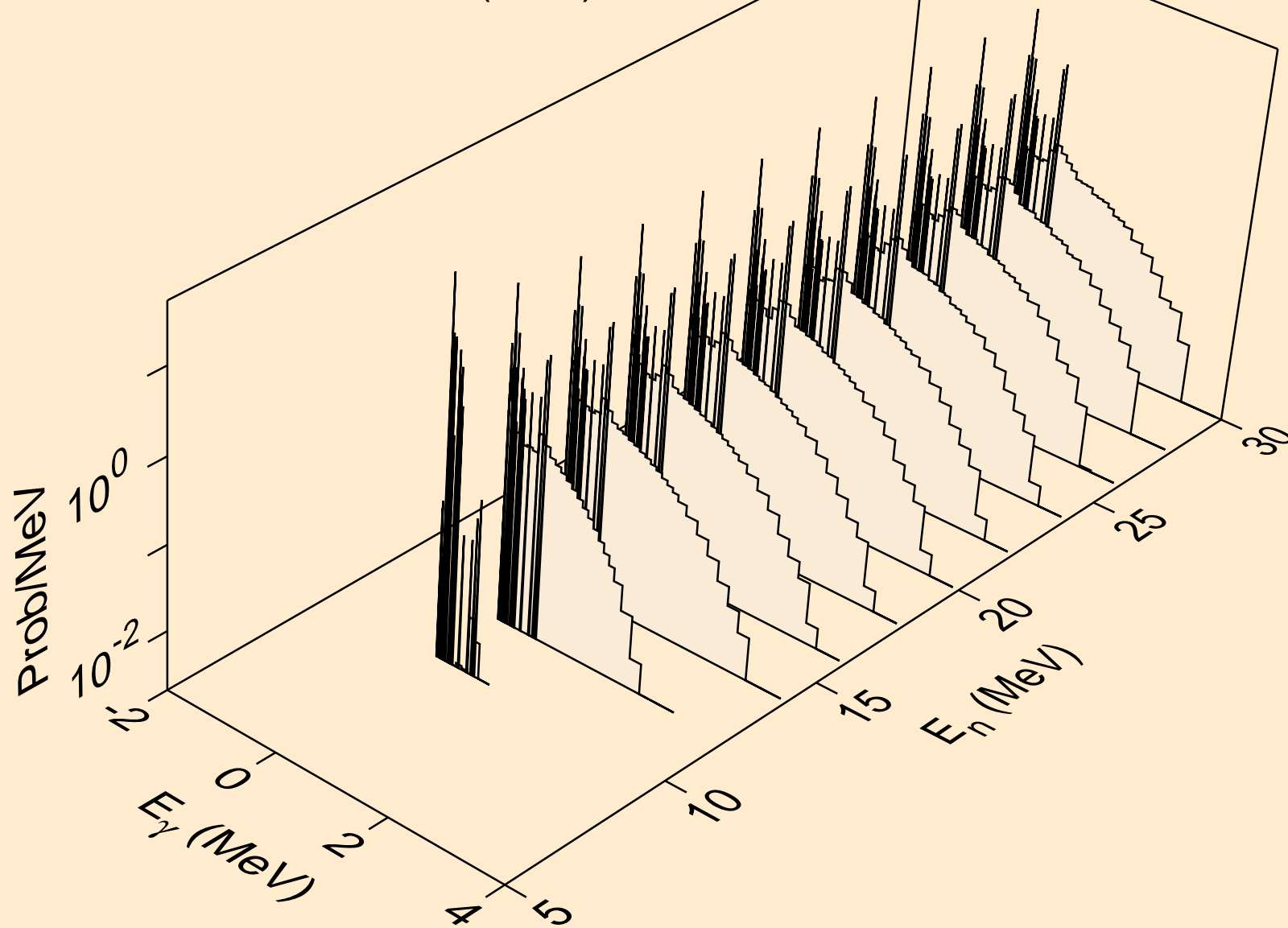

ES250 PROTON ACER TENDL-2021 LIBRARY; T=0.K
Photon emission for (n,3n)

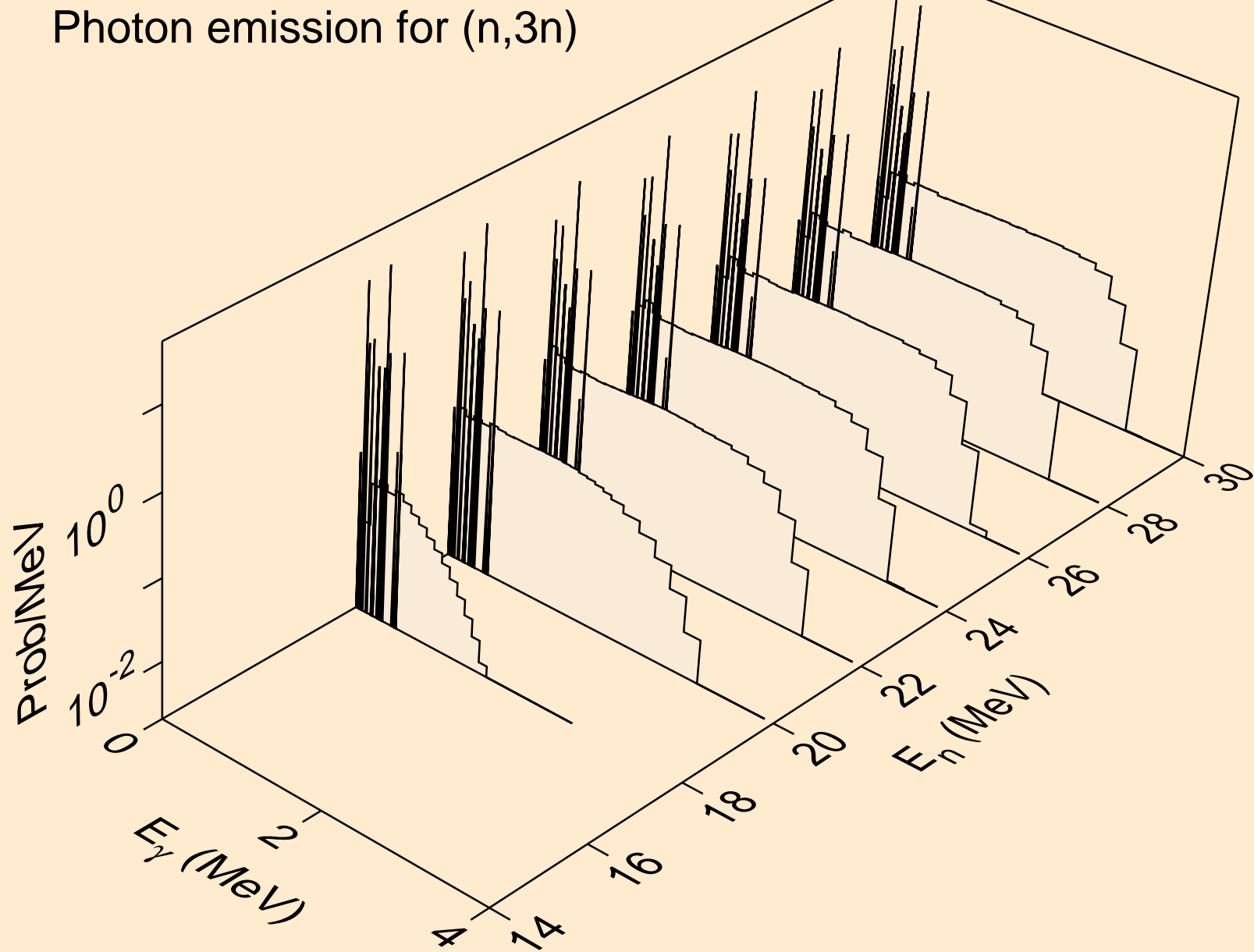

ES250 PROTON ACER TENDL-2021 LIBRARY; T=0.K
Photon emission for (n,n*)a

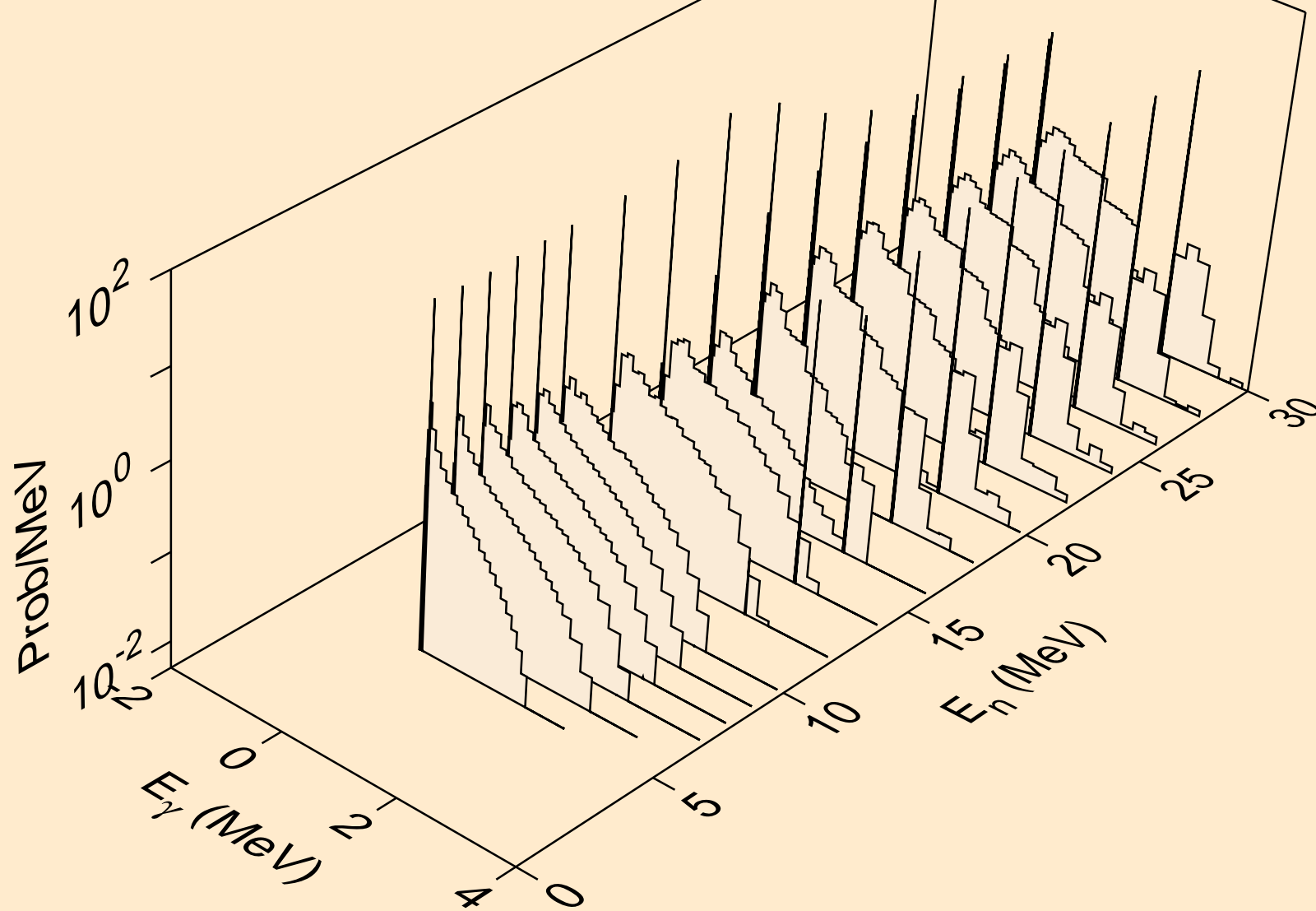

ES250 PROTON ACER TENDL-2021 LIBRARY; T=0.K
Photon emission for (n,2n) α

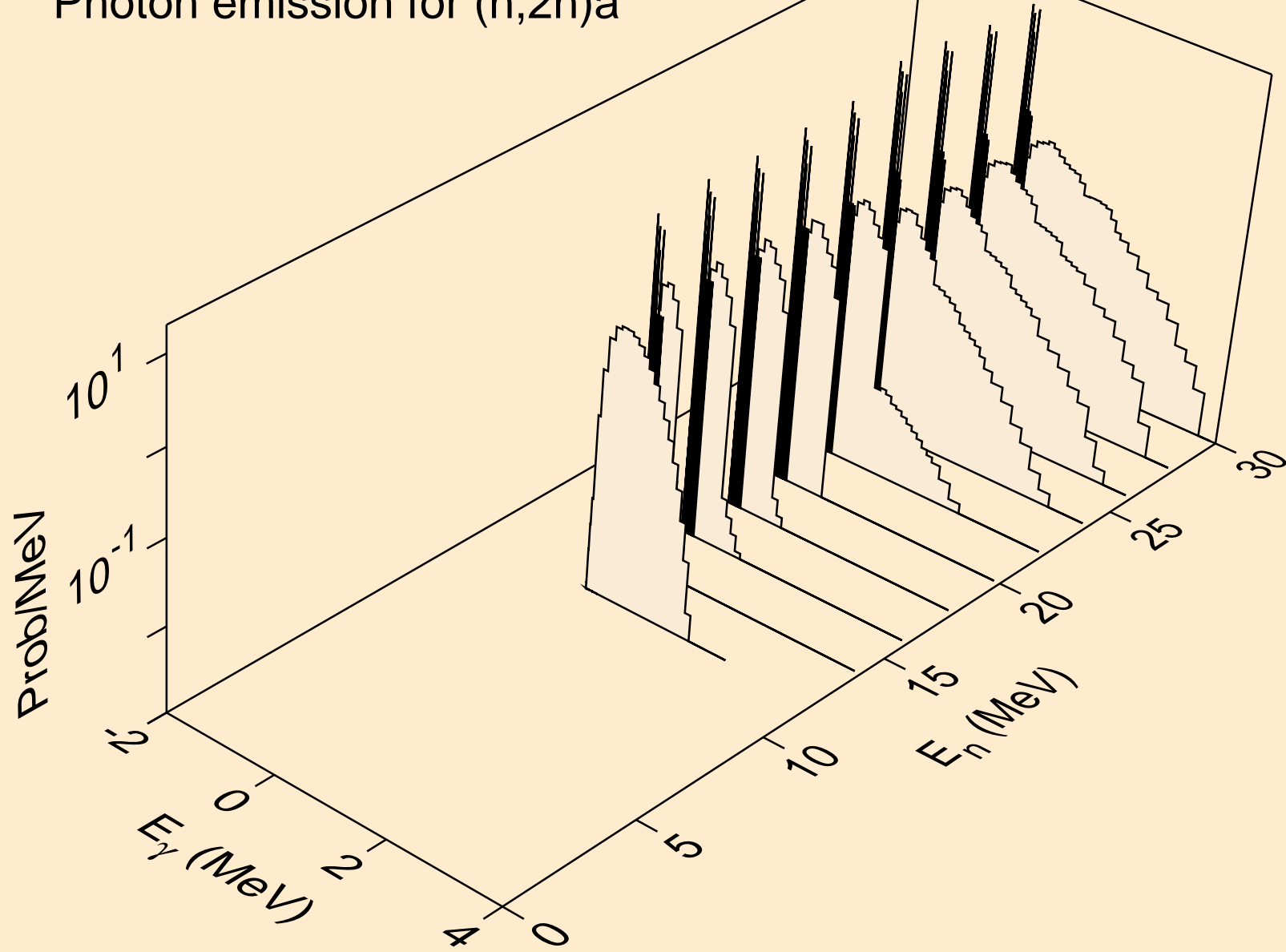

ES250 PROTON ACER TENDL-2021 LIBRARY; T=0.K
Photon emission for (n,n*)p

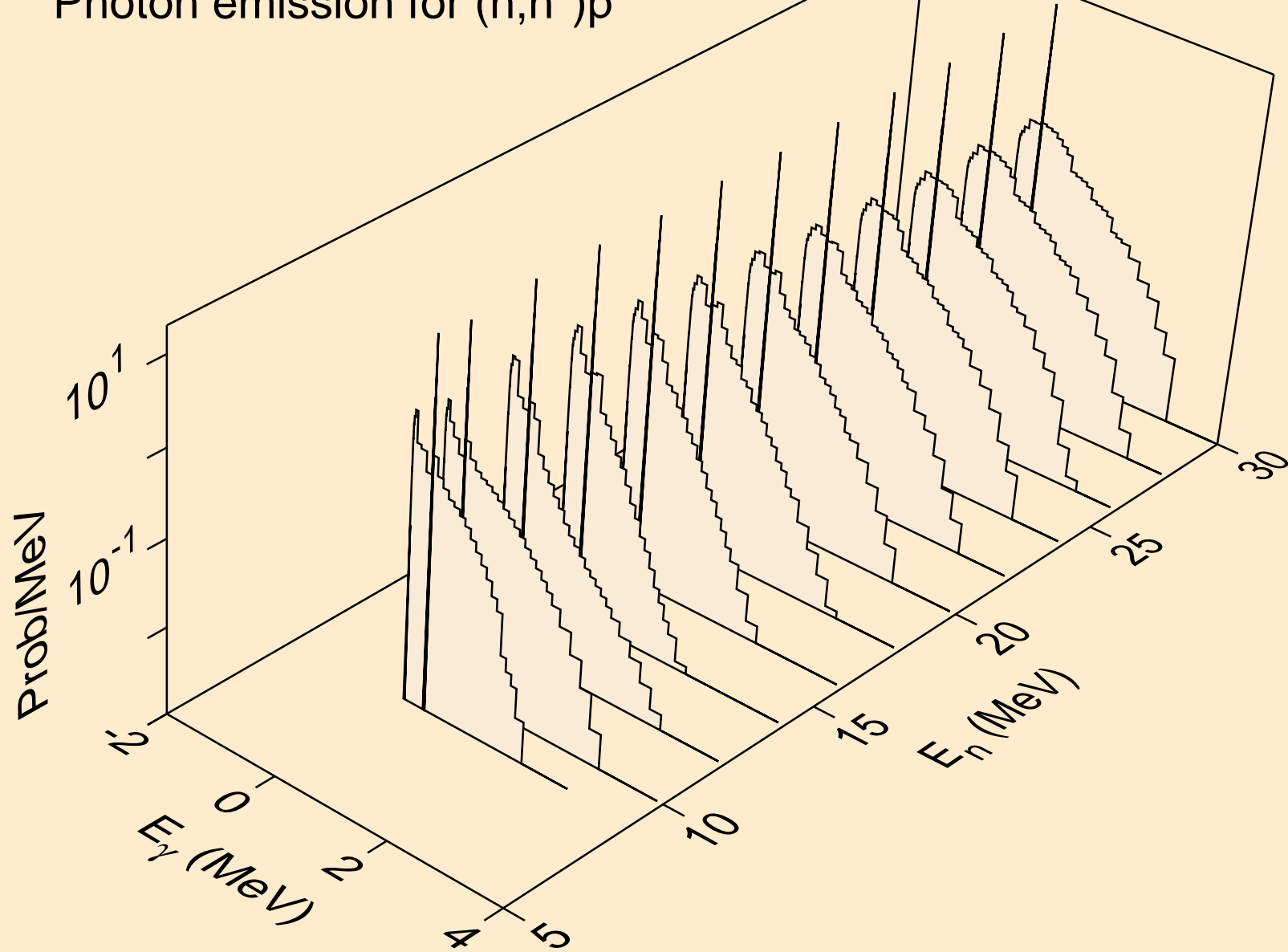

ES250 PROTON ACER TENDL-2021 LIBRARY; T=0.K
Photon emission for (n,n*)2a

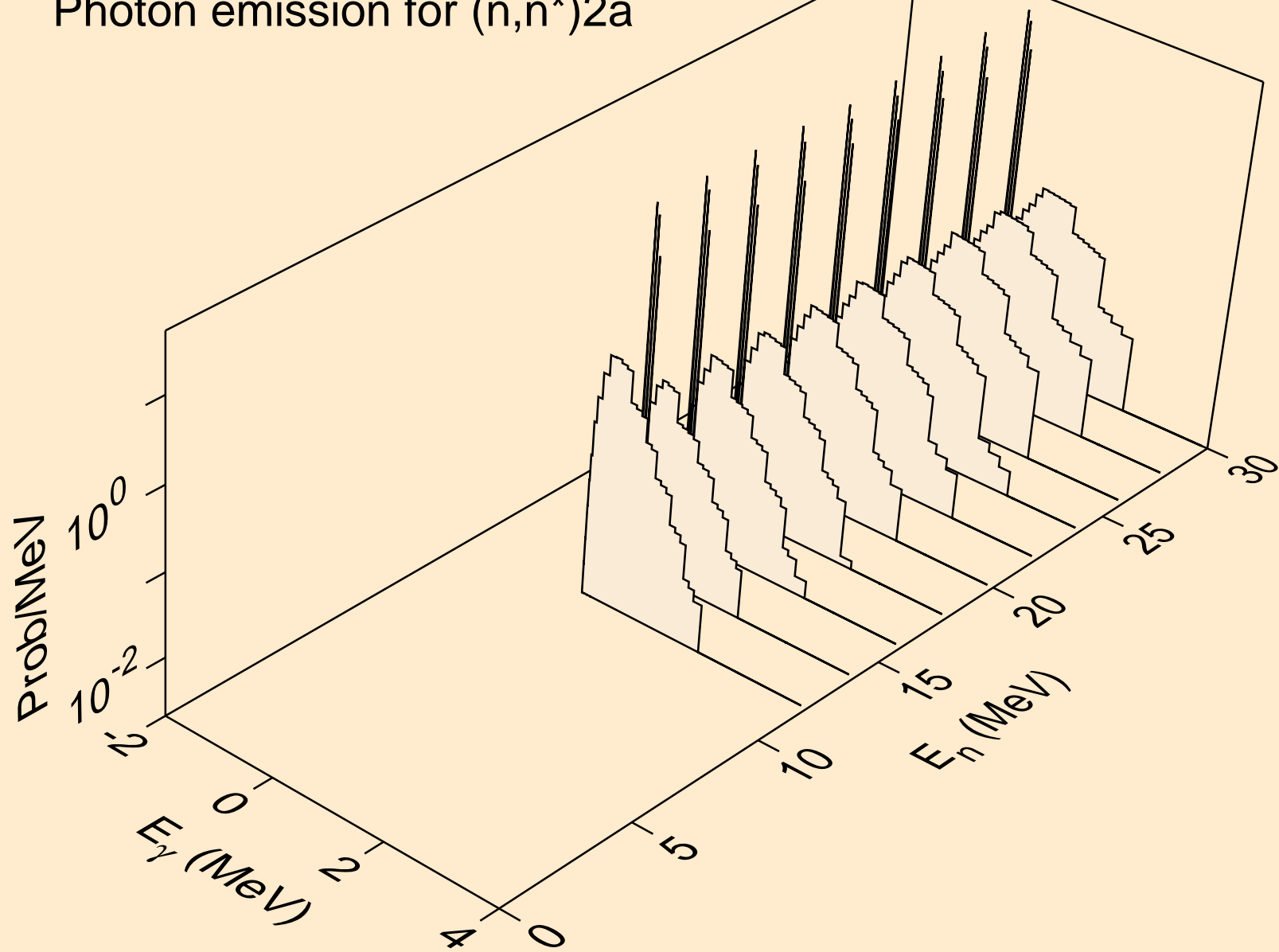

ES250 PROTON ACER TENDL-2021 LIBRARY; T=0.K
Photon emission for (n,n*)d

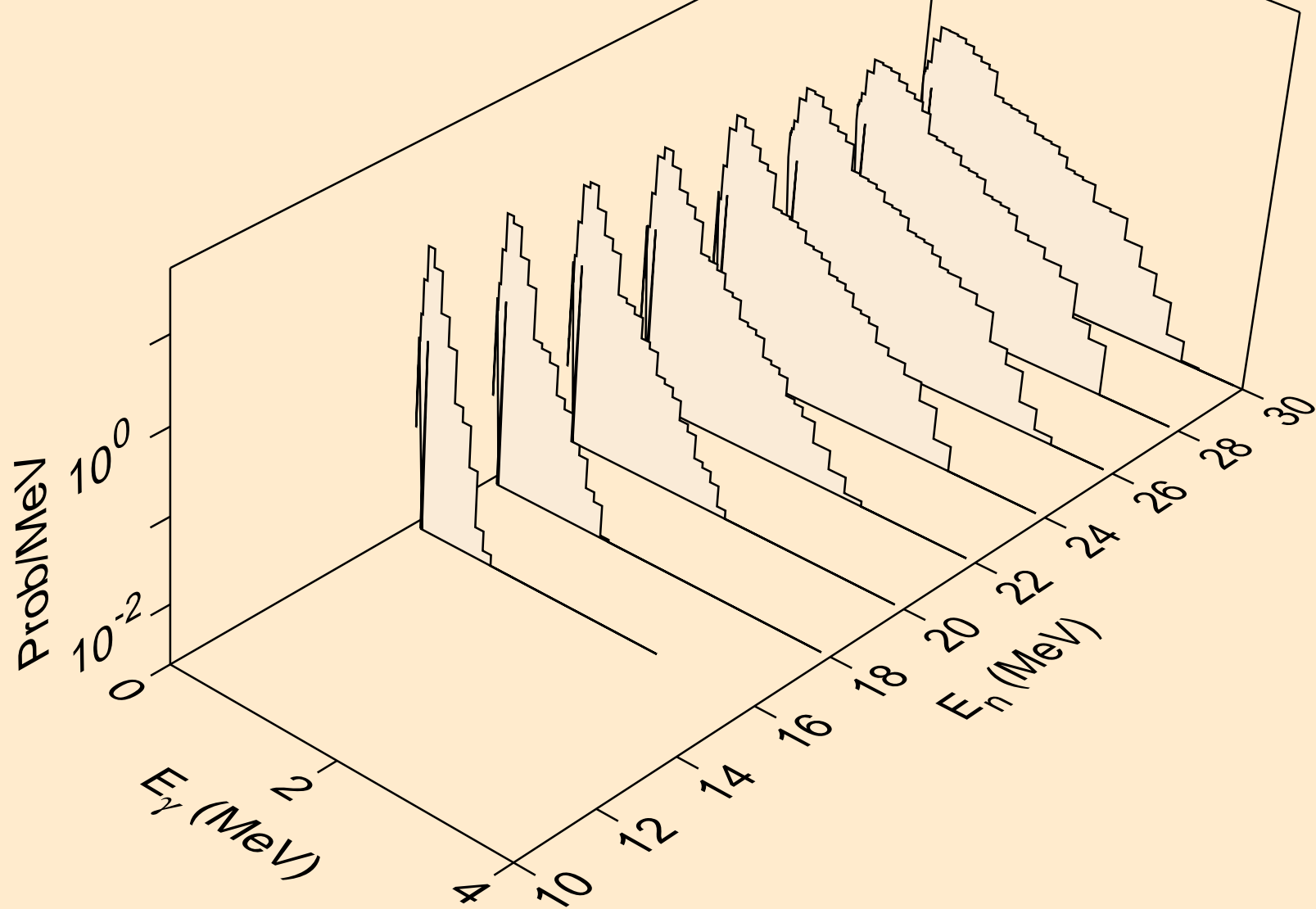

ES250 PROTON ACER TENDL-2021 LIBRARY; T=0.K
Photon emission for (n,n*)t

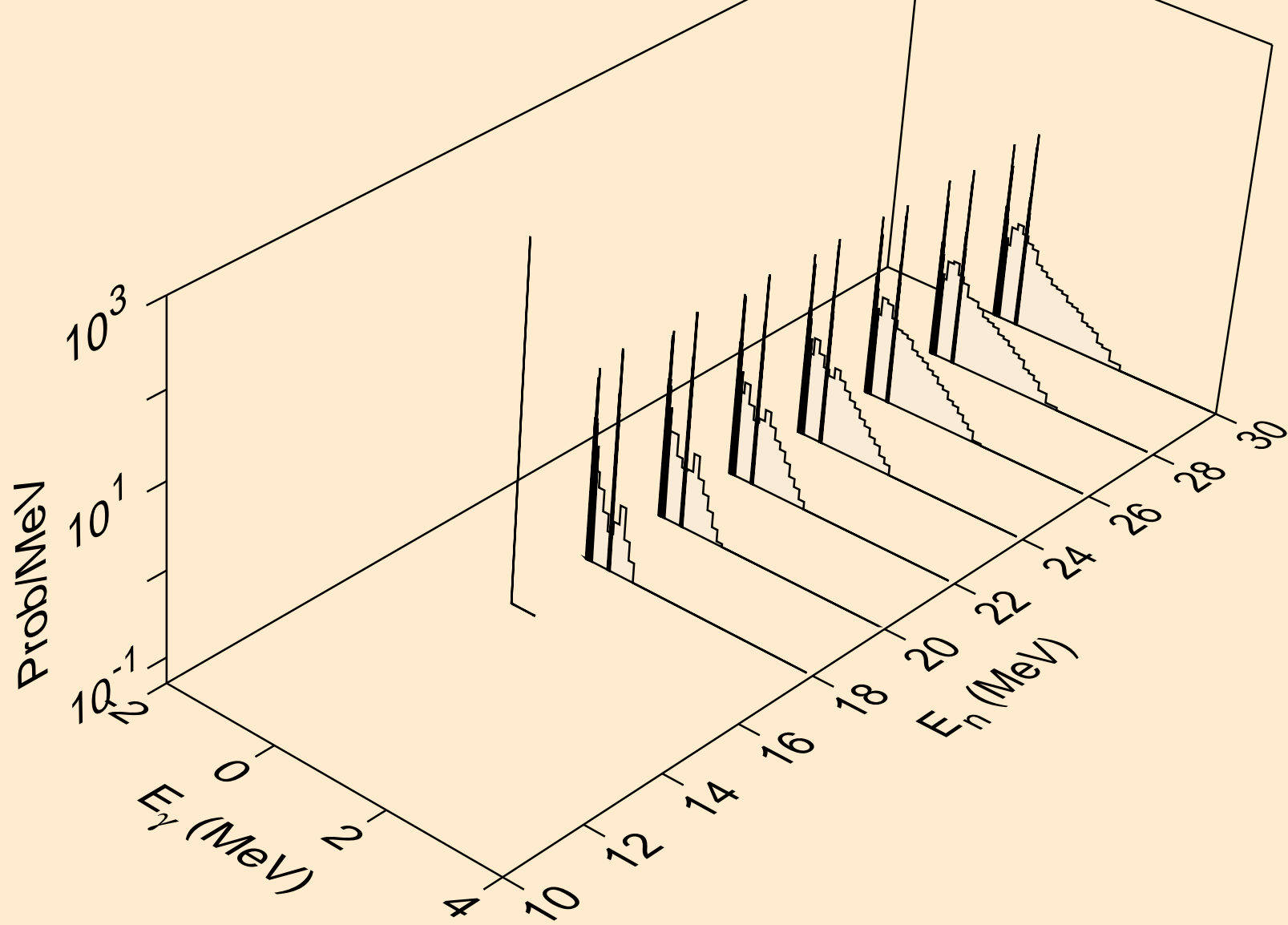

ES250 PROTON ACER TENDL-2021 LIBRARY; T=0.K
Photon emission for (n,n*)he3

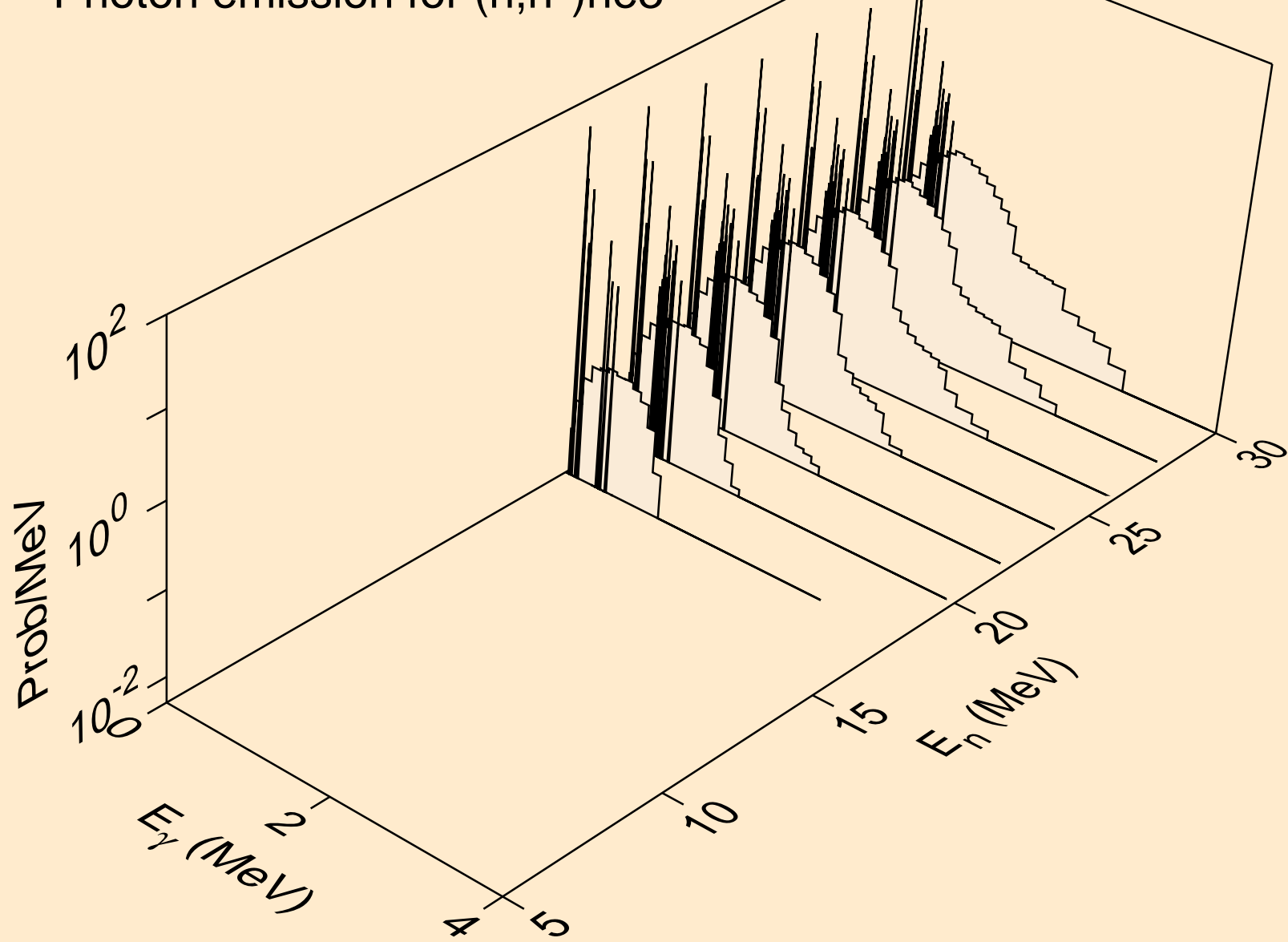

ES250 PROTON ACER TENDL-2021 LIBRARY; T=0.K
Photon emission for (n,2np)

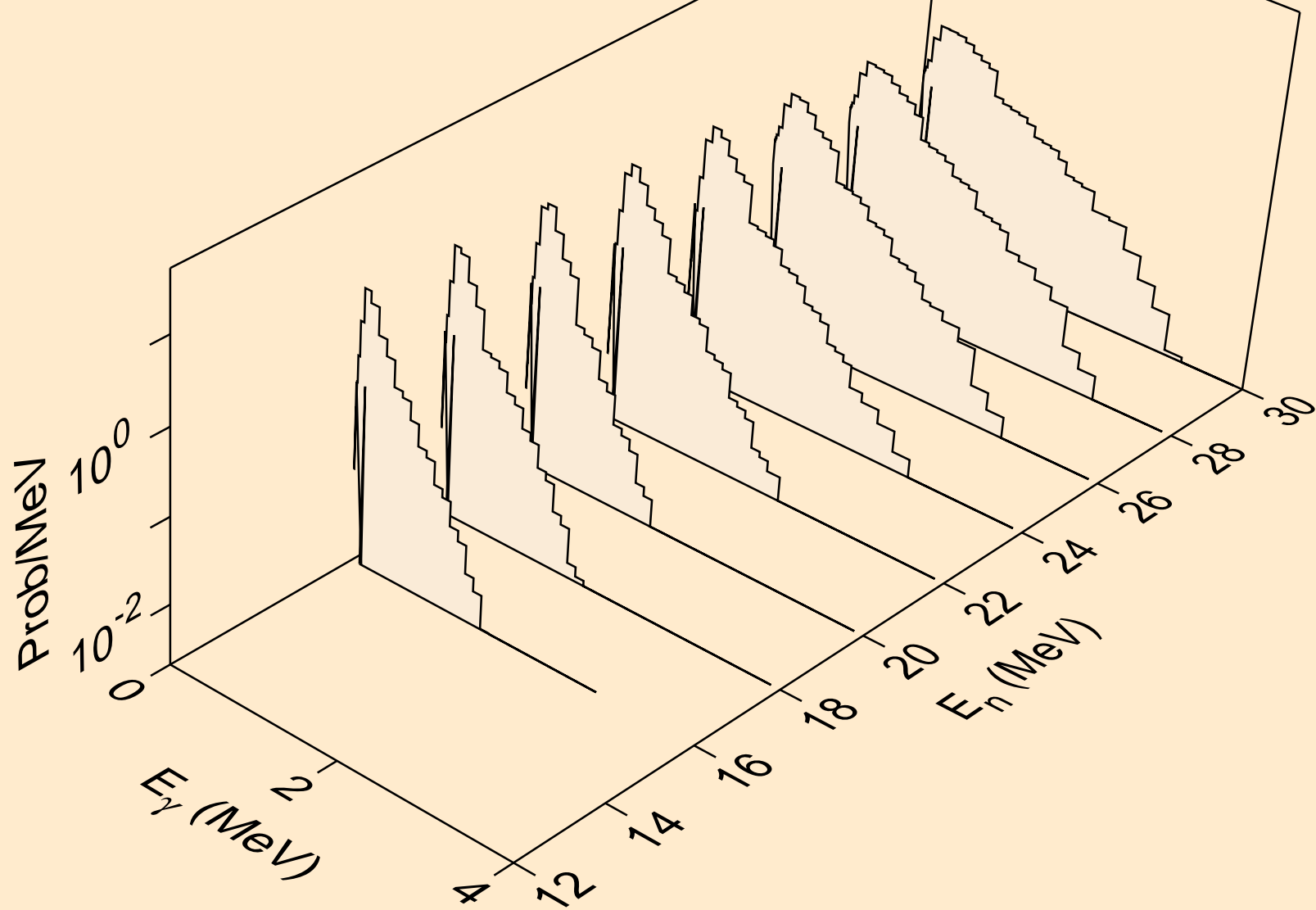

ES250 PROTON ACER TENDL-2021 LIBRARY; T=0.K
Photon emission for (n,2np)

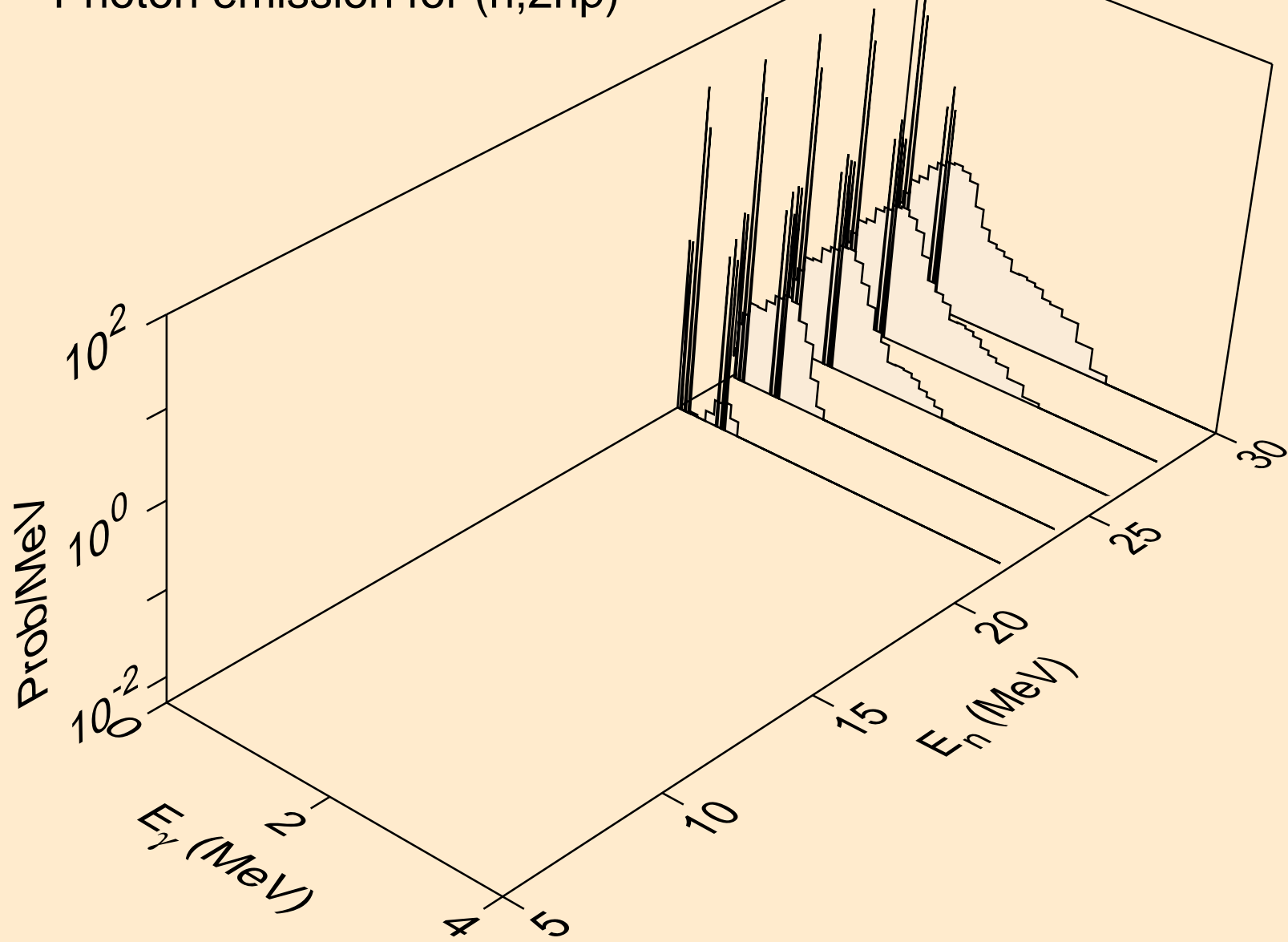

ES250 PROTON ACER TENDL-2021 LIBRARY; T=0.K
Photon emission for (n,gma)

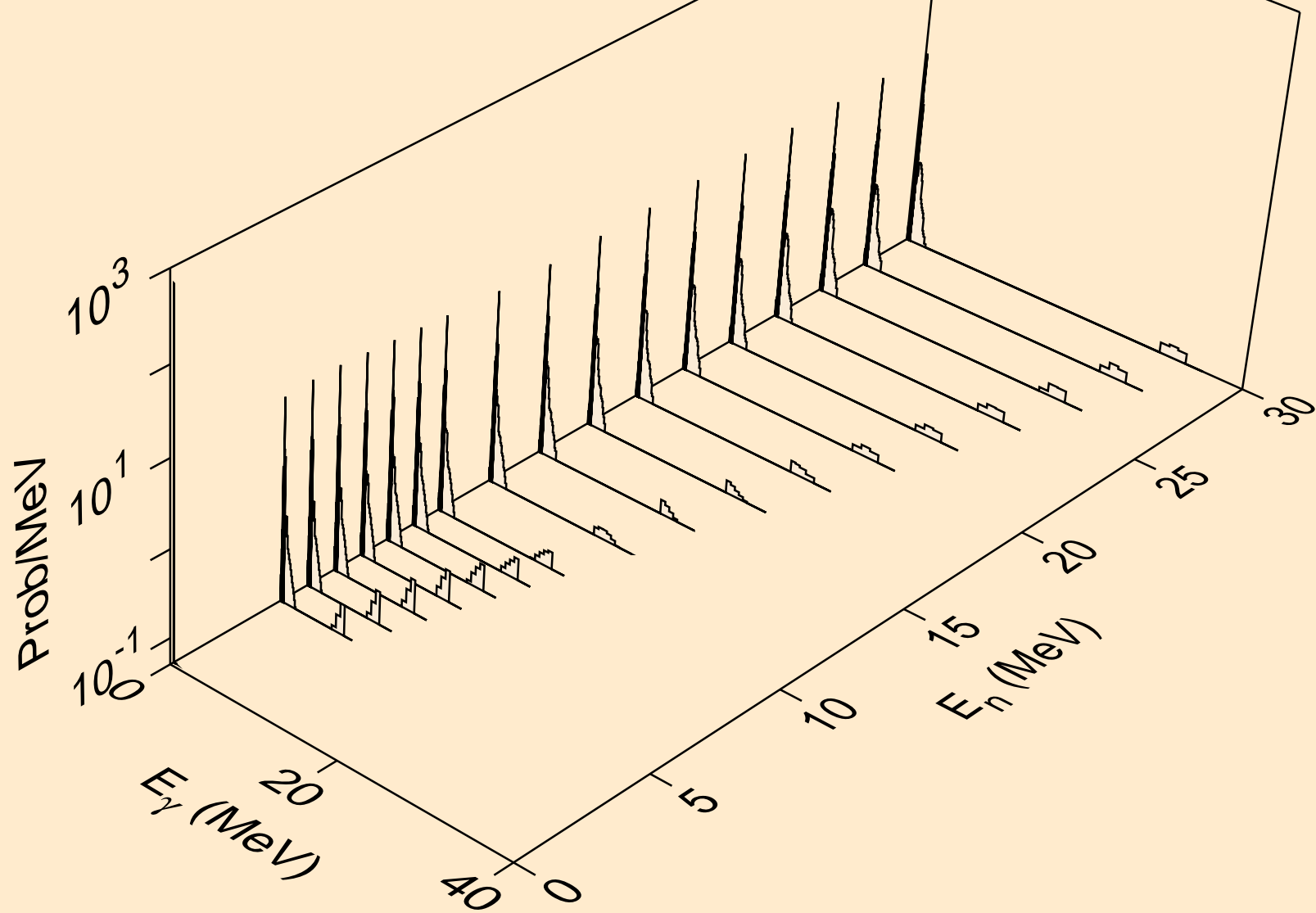

ES250 PROTON ACER TENDL-2021 LIBRARY; T=0.K
Photon emission for inelastic

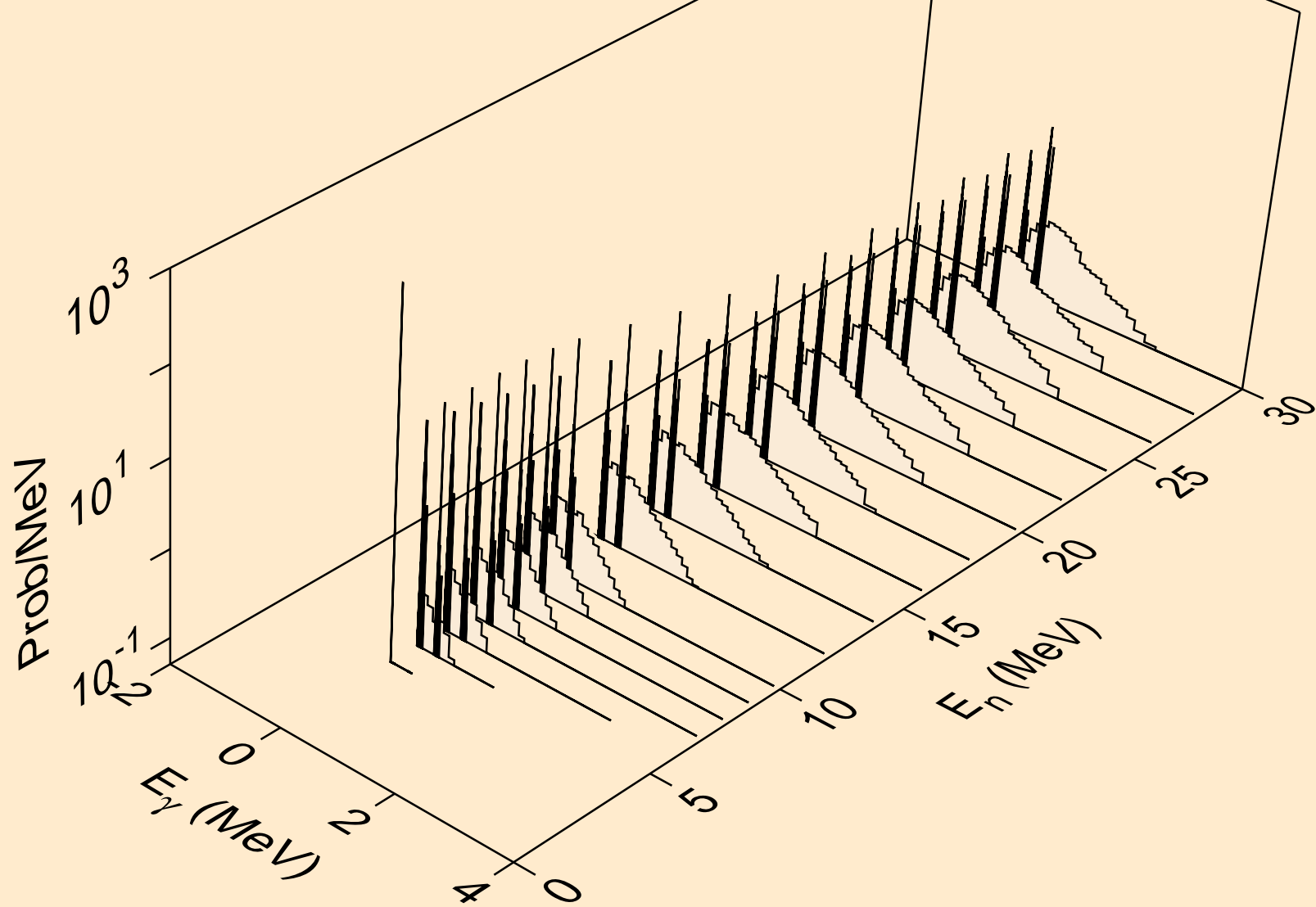

ES250 PROTON ACER TENDL-2021 LIBRARY; T=0.K
Photon emission for (n,d)

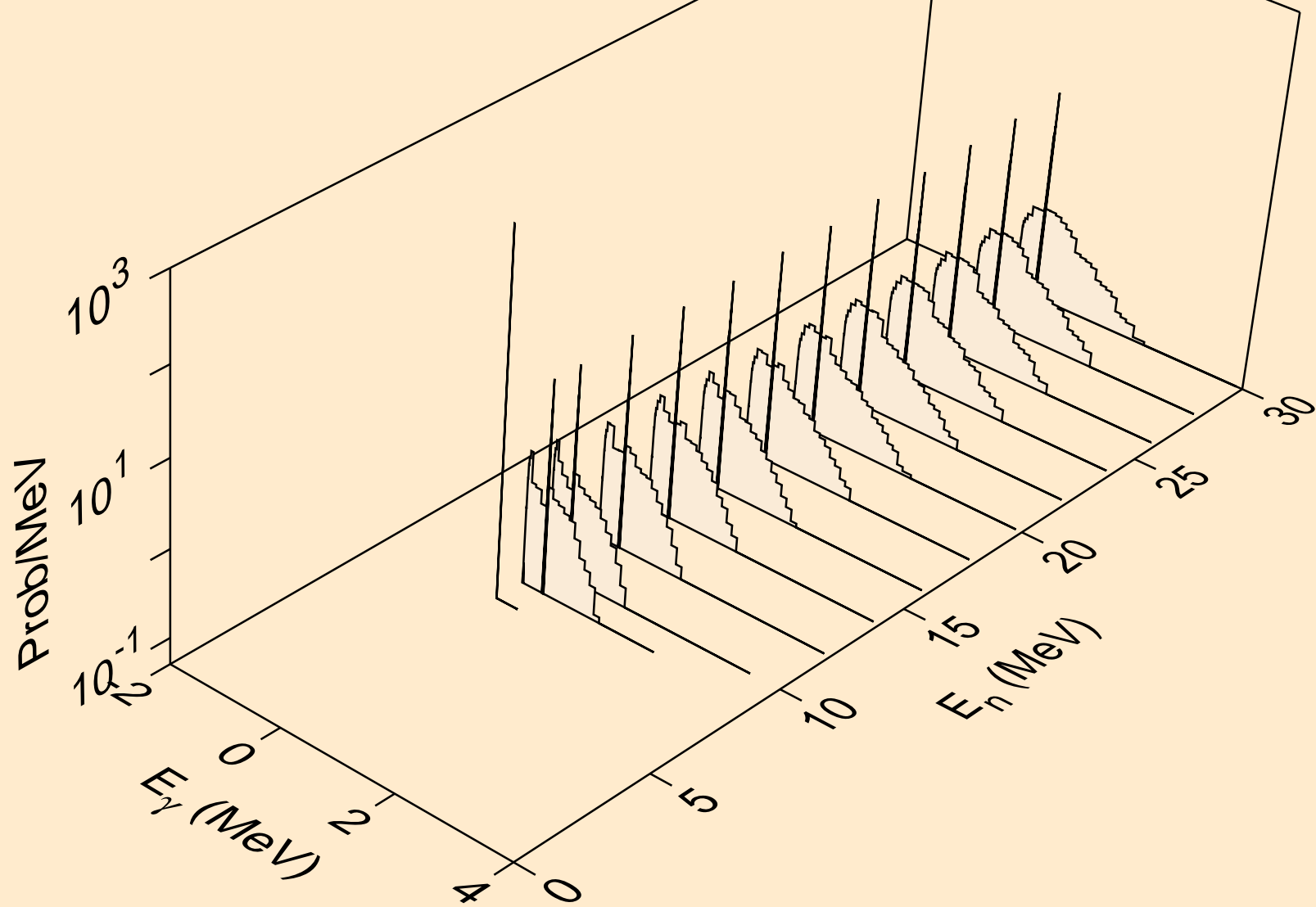

ES250 PROTON ACER TENDL-2021 LIBRARY; T=0.K
Photon emission for (n,t)

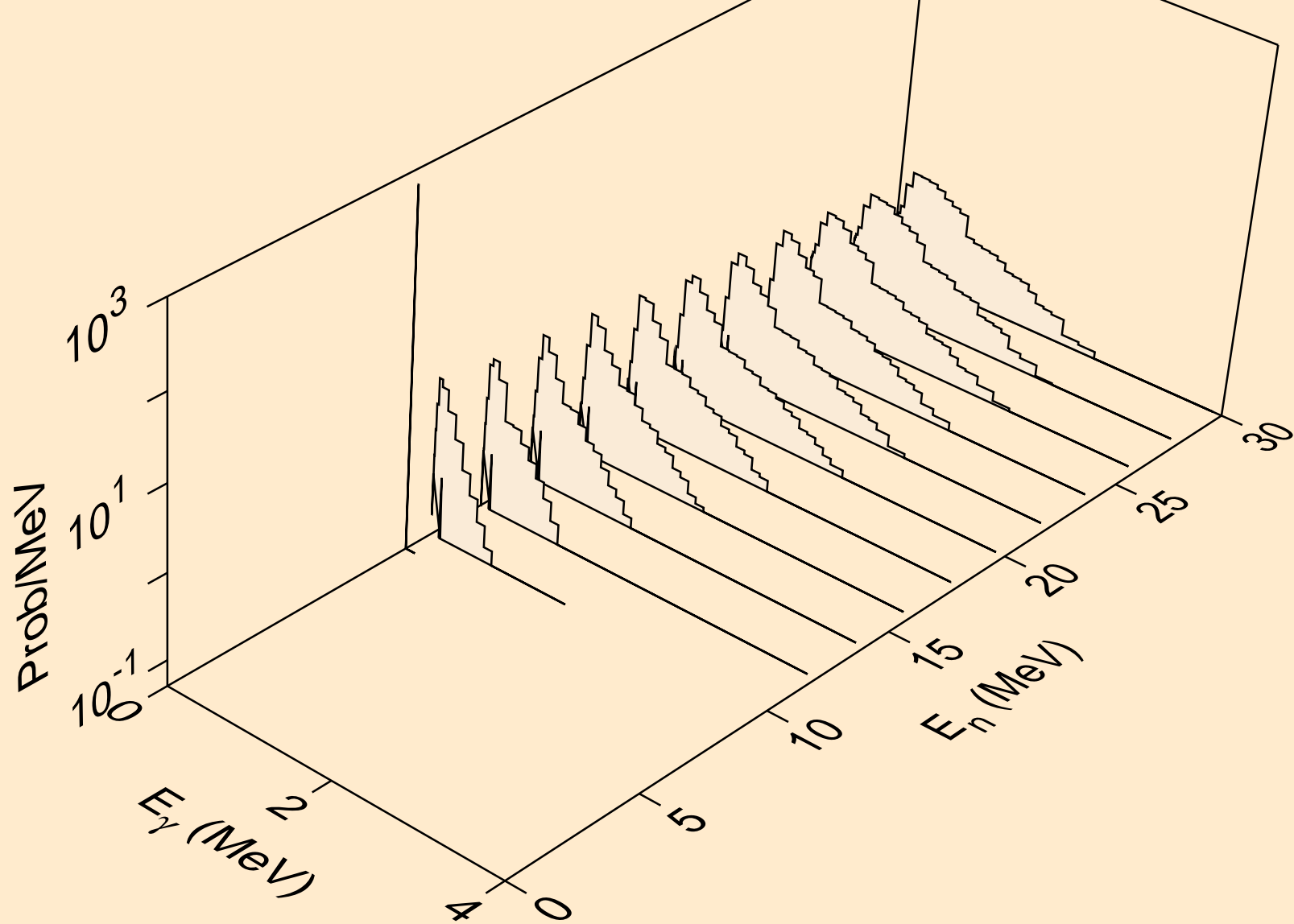

ES250 PROTON ACER TENDL-2021 LIBRARY; T=0.K
Photon emission for (n,he3)

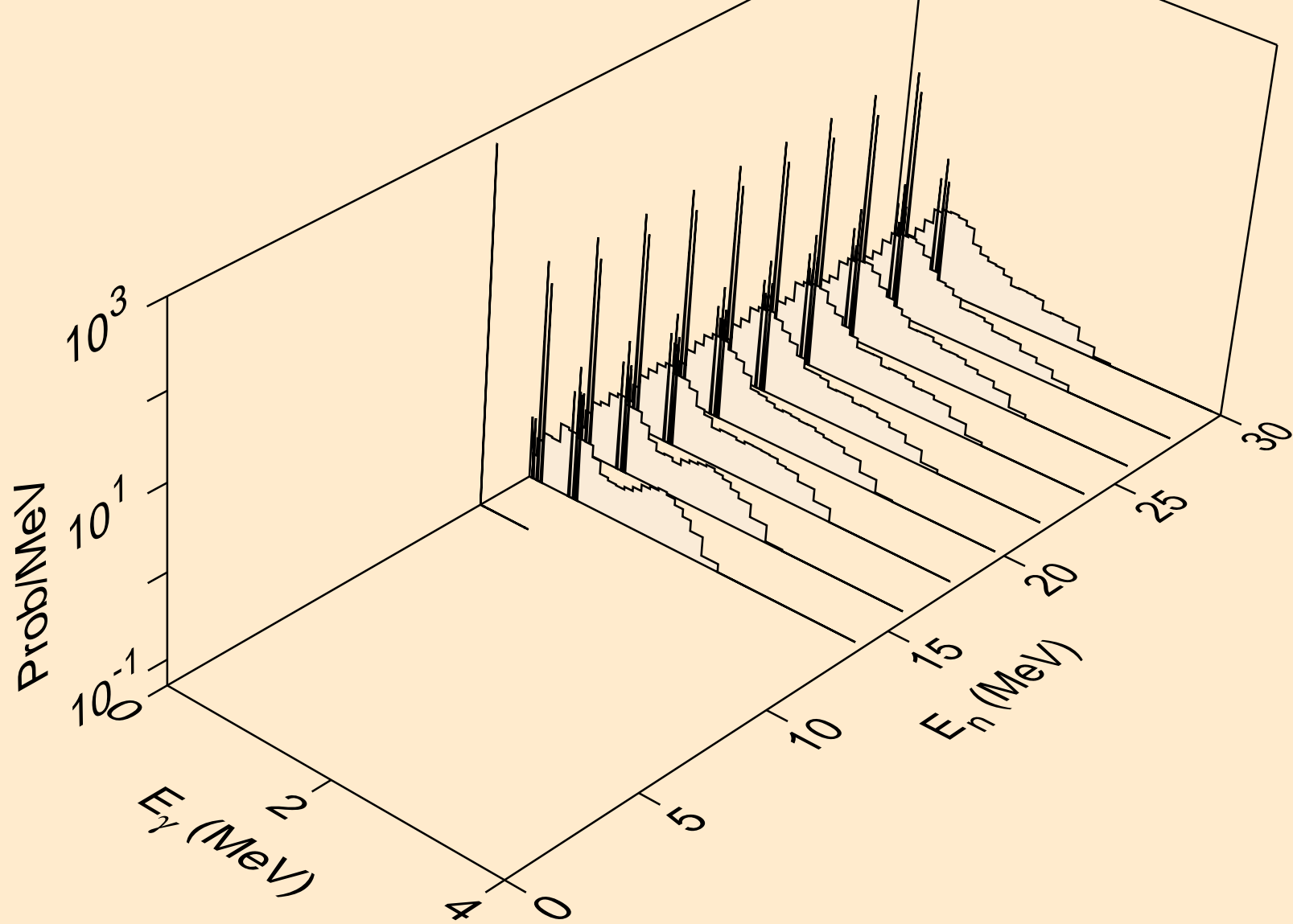

ES250 PROTON ACER TENDL-2021 LIBRARY; T=0.K
Photon emission for (n,a)

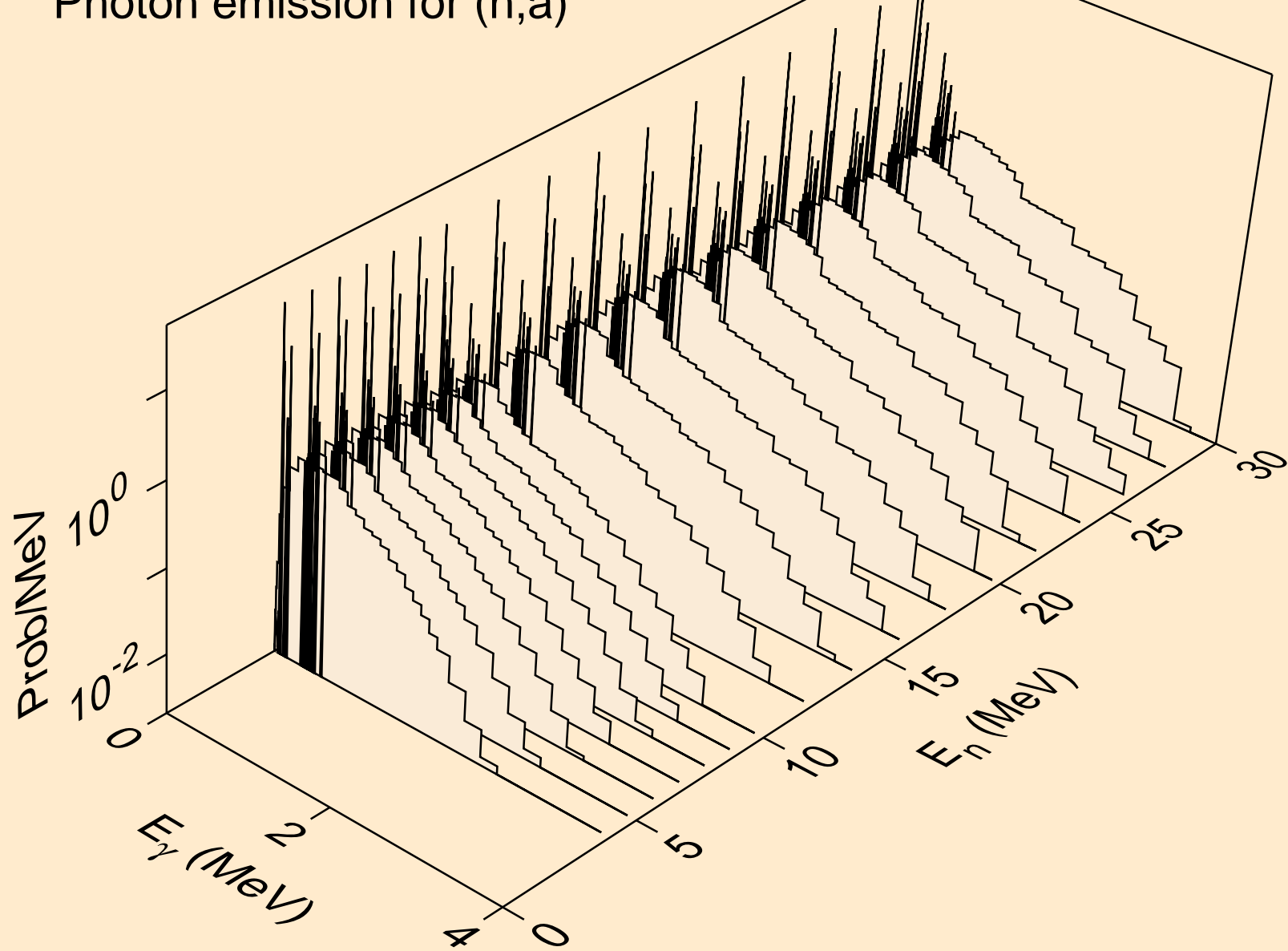

ES250 PROTON ACER TENDL-2021 LIBRARY; T=0.K
Photon emission for (n,2p)

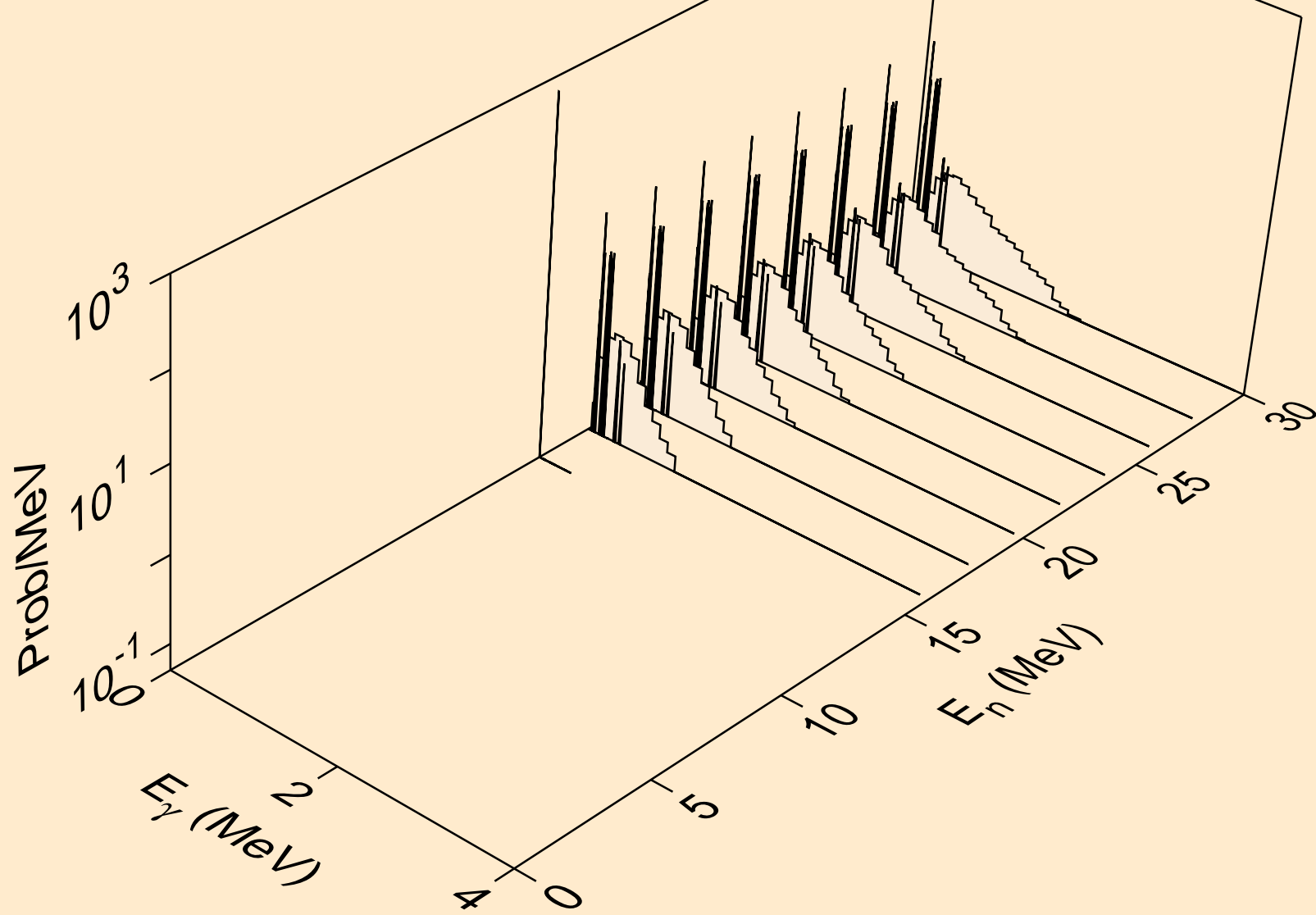

ES250 PROTON ACER TENDL-2021 LIBRARY; T=0.K
Photon emission for (n,pd)

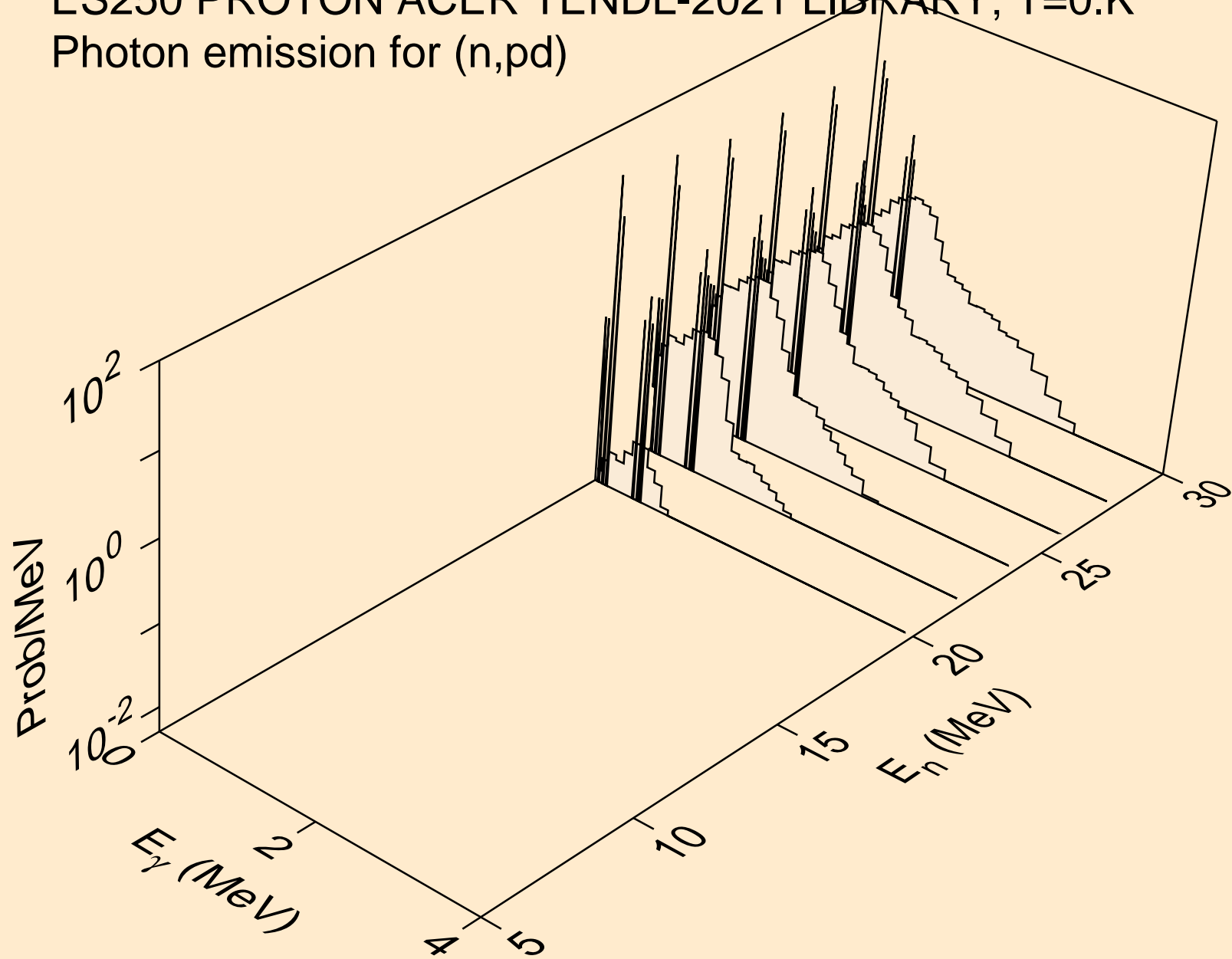

ES250 PROTON ACER TENDL-2021 LIBRARY; T=0.K

Particle heating contributions

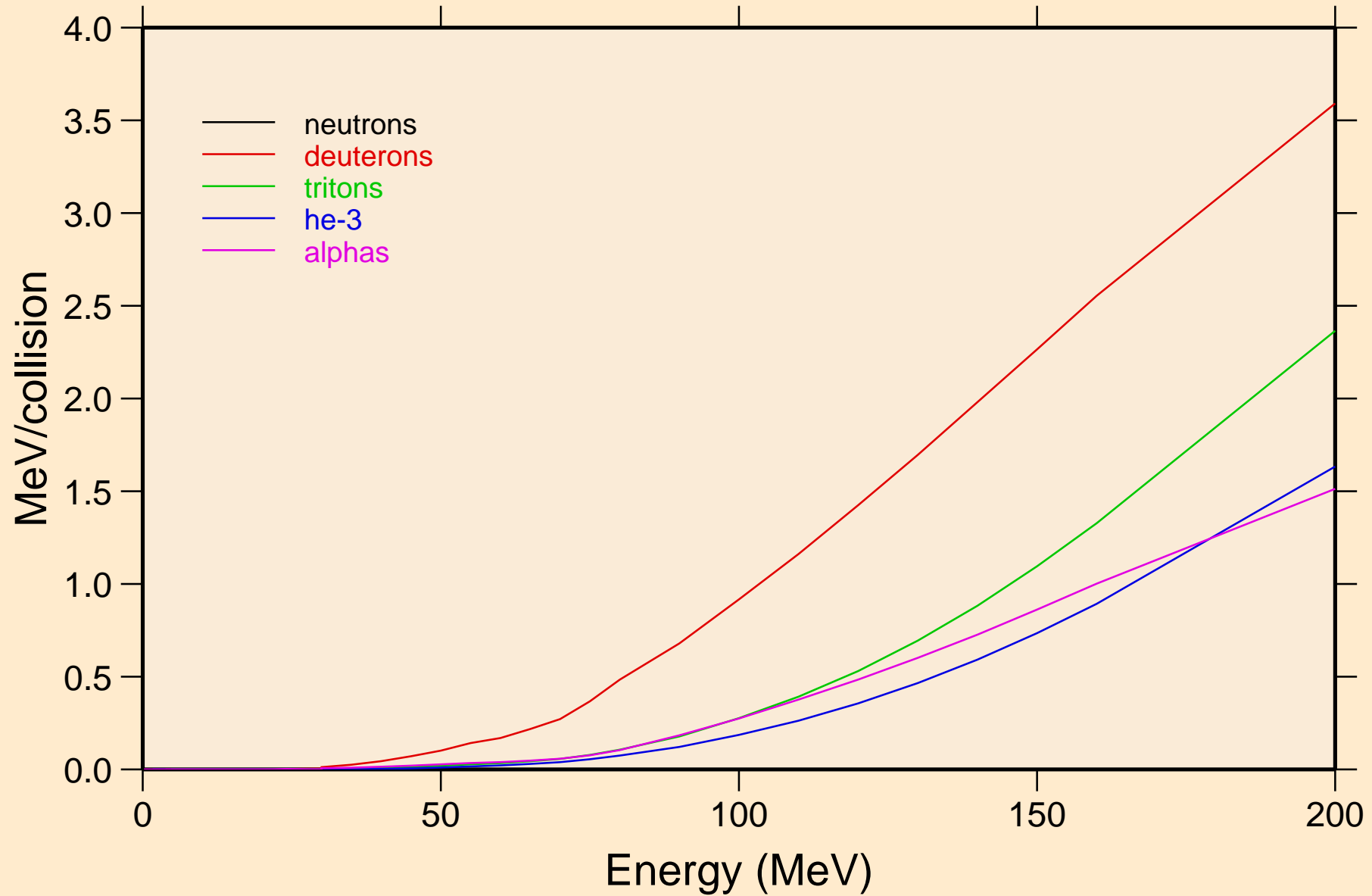

ES250 PROTON ACER TENDL-2021 LIBRARY; T=0.K

Recoil Heating

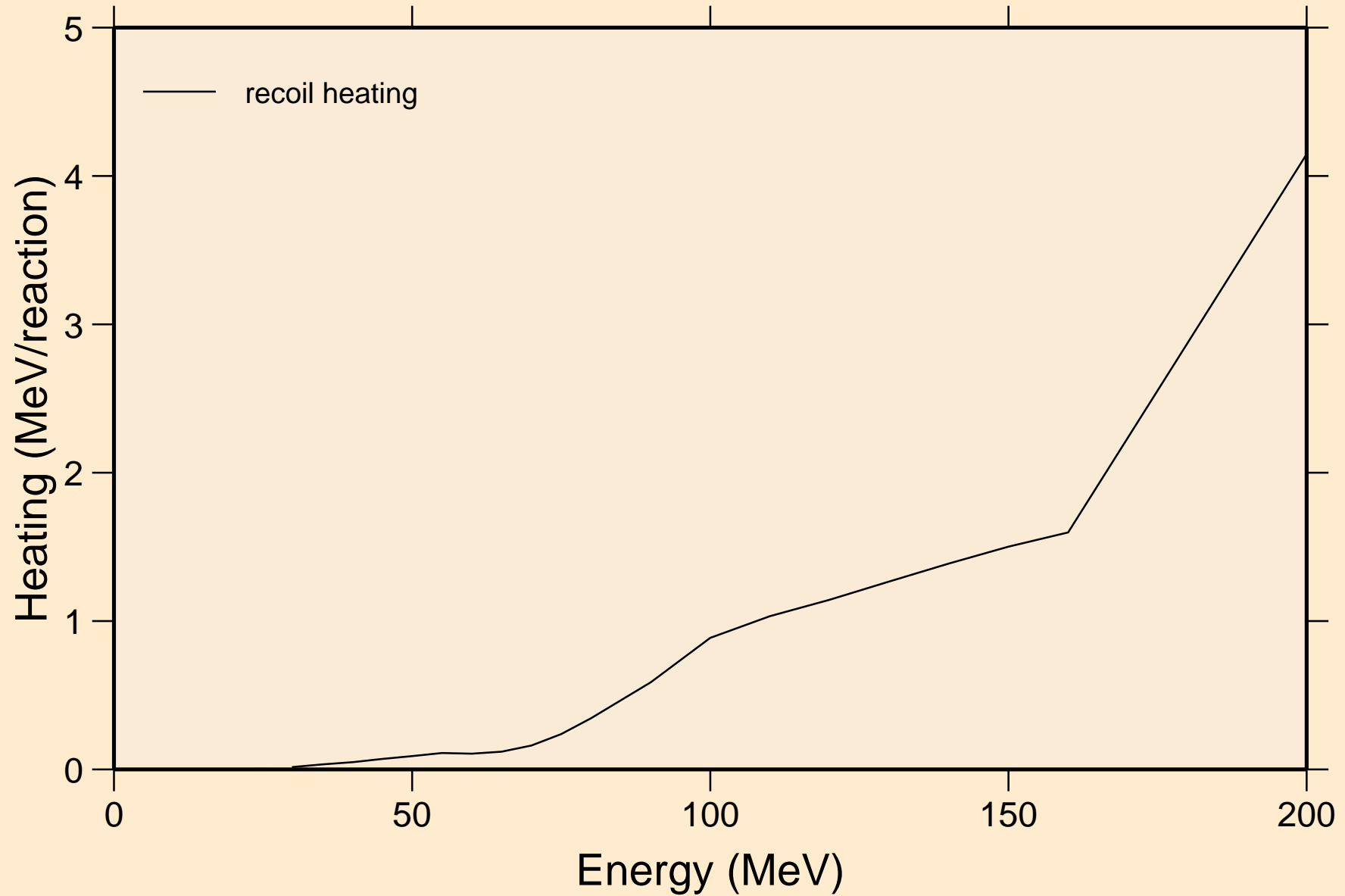

ES250 PROTON ACER TENDL-2021 LIBRARY; T=0.K
Particle production cross sections

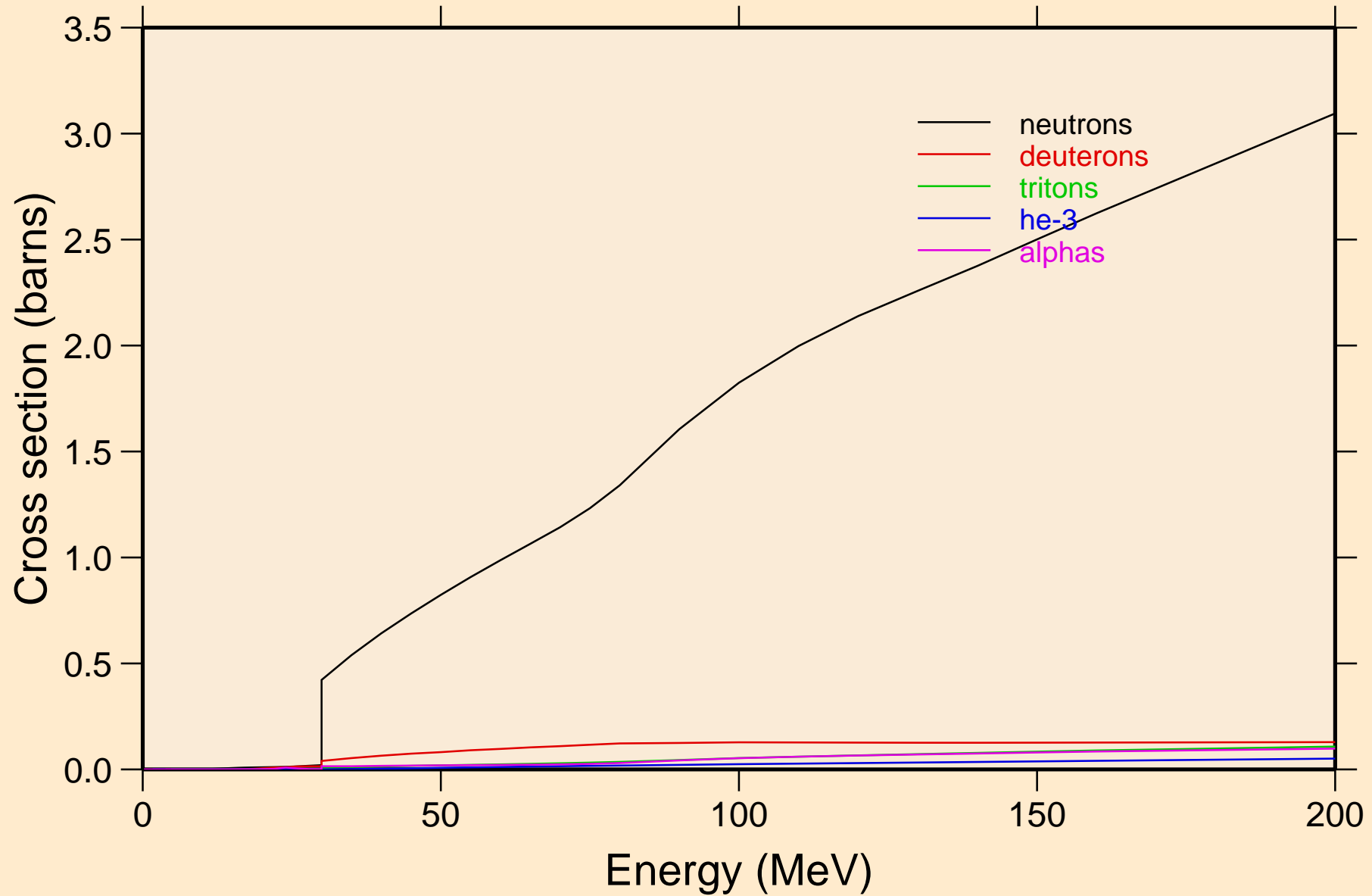

ES250 PROTON ACER TENDL-2021 LIBRARY; T=0.K
neutrons from (p,n)

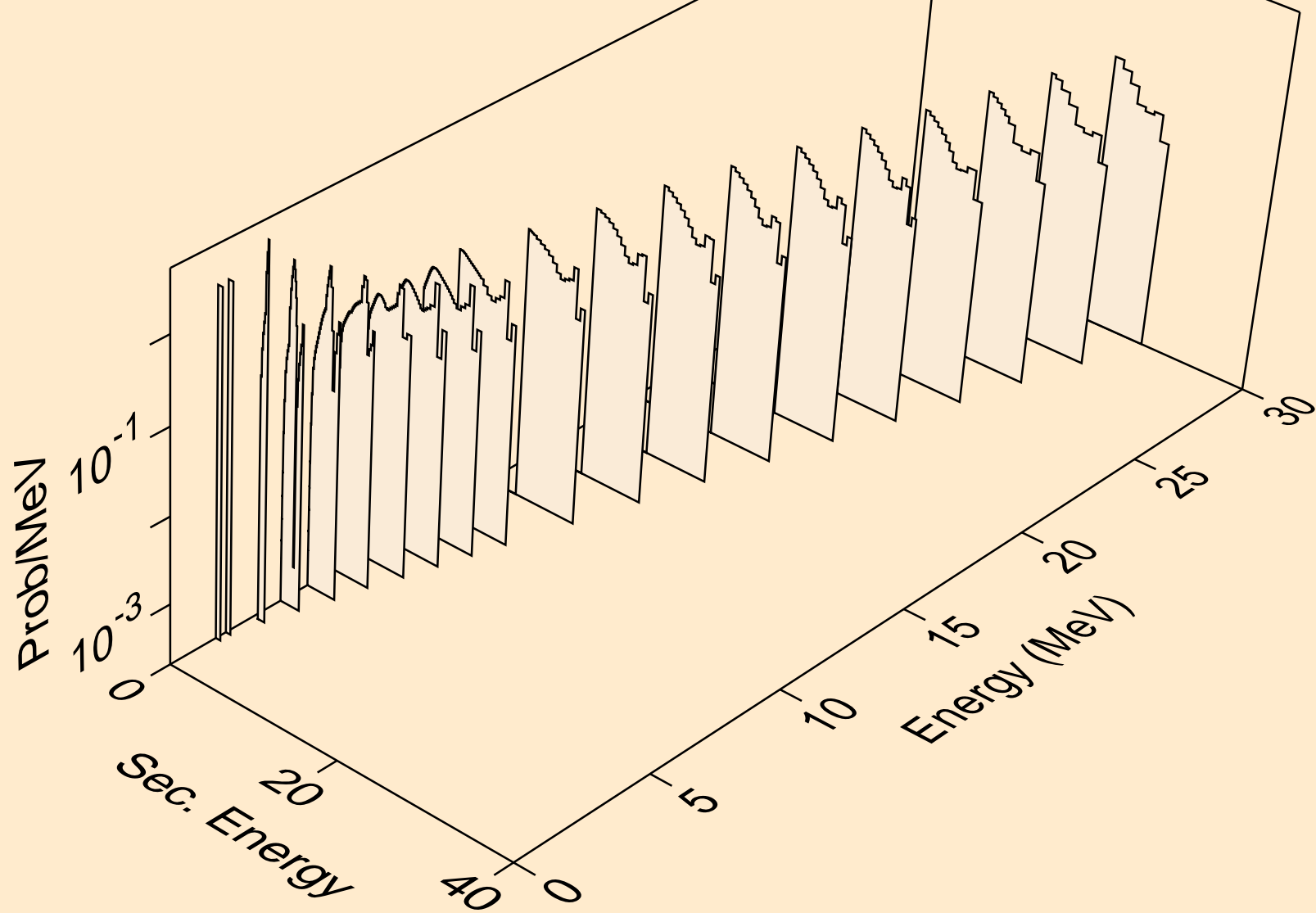

ES250 PROTON ACER TENDL-2021 LIBRARY; T=0.K
neutrons from (p,x)

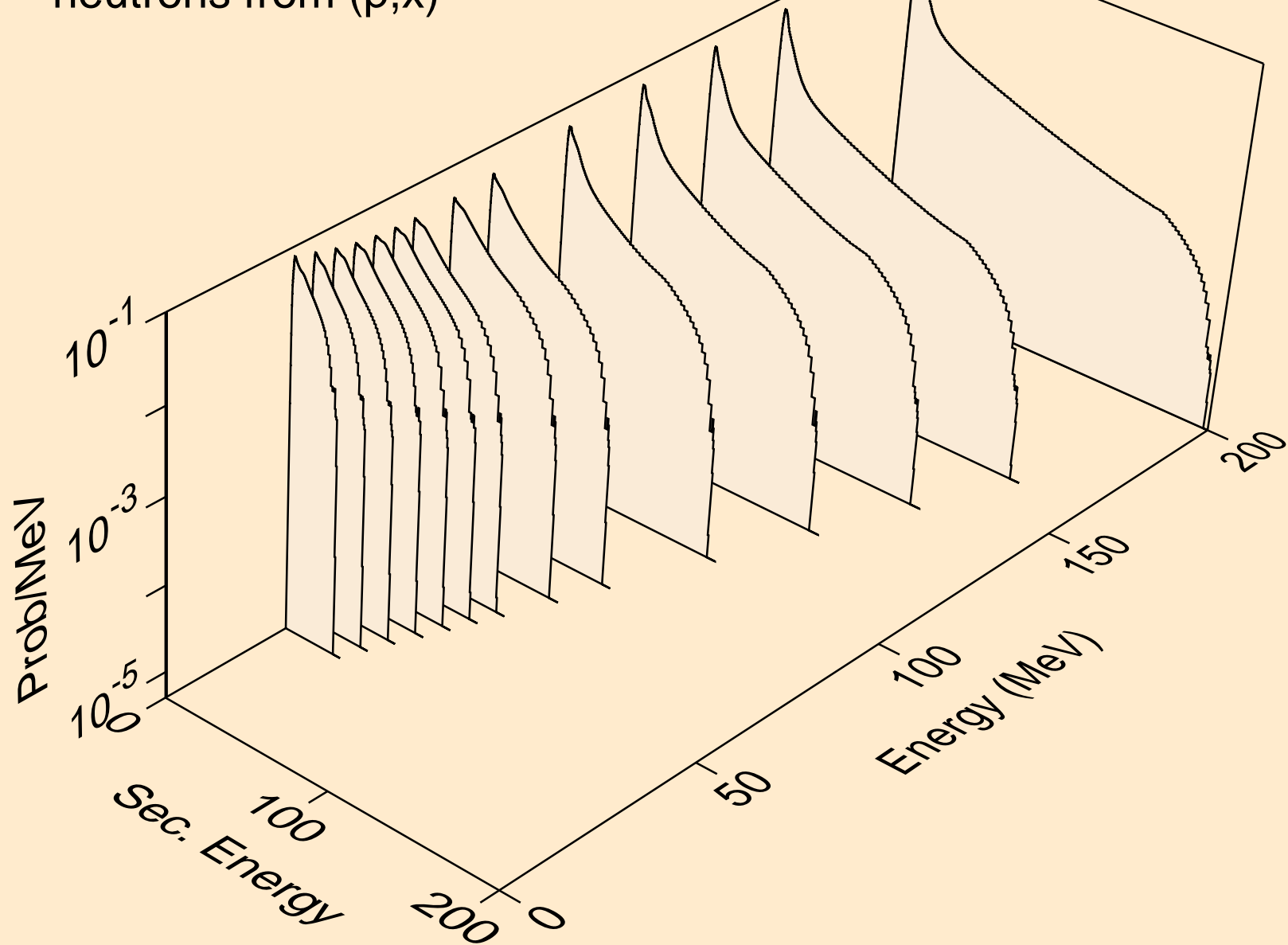

ES250 PROTON ACER TENDL-2021 LIBRARY; T=0.K
neutrons from (p,2n)

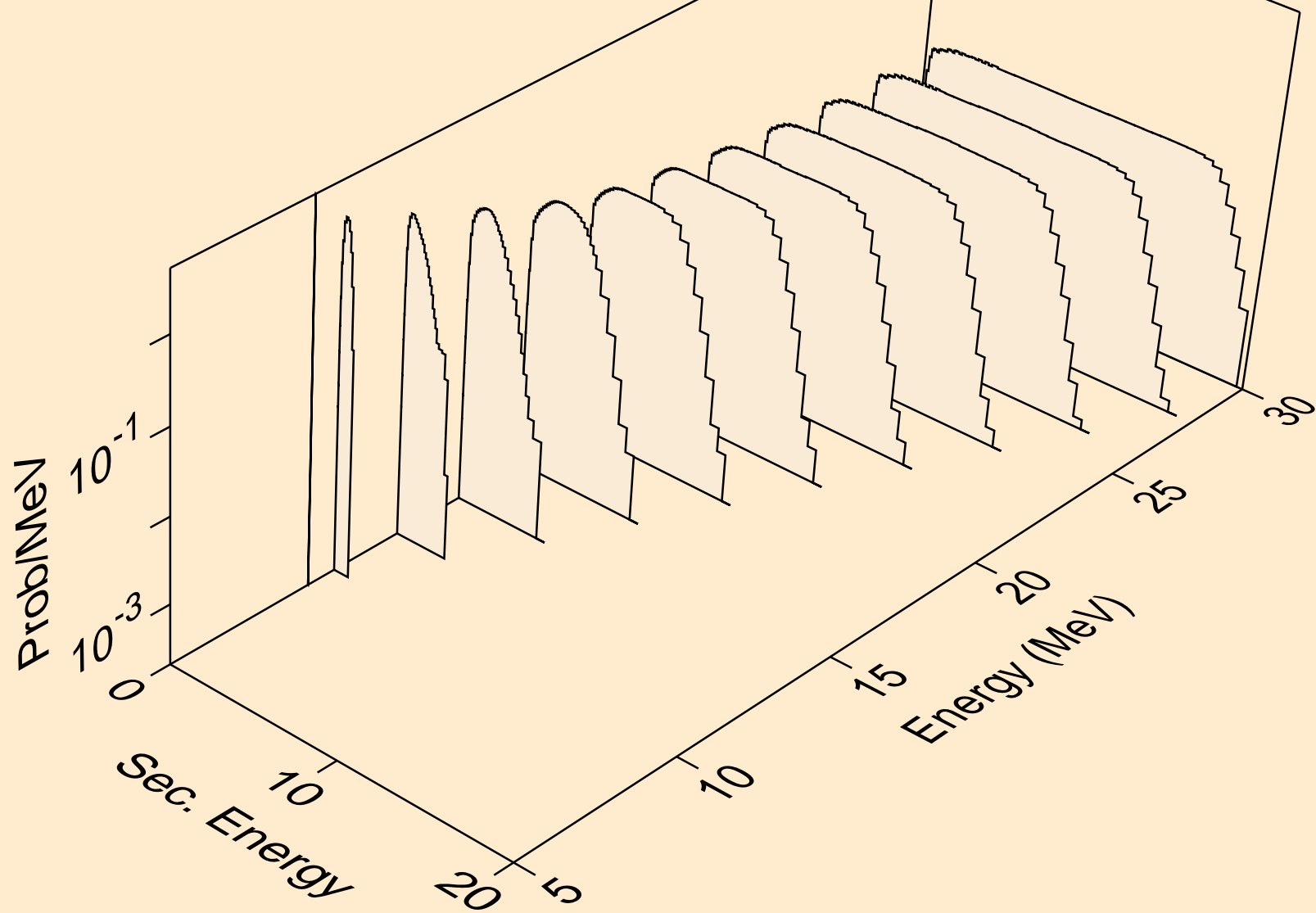

ES250 PROTON ACER TENDL-2021 LIBRARY; T=0.K
neutrons from (p,3n)

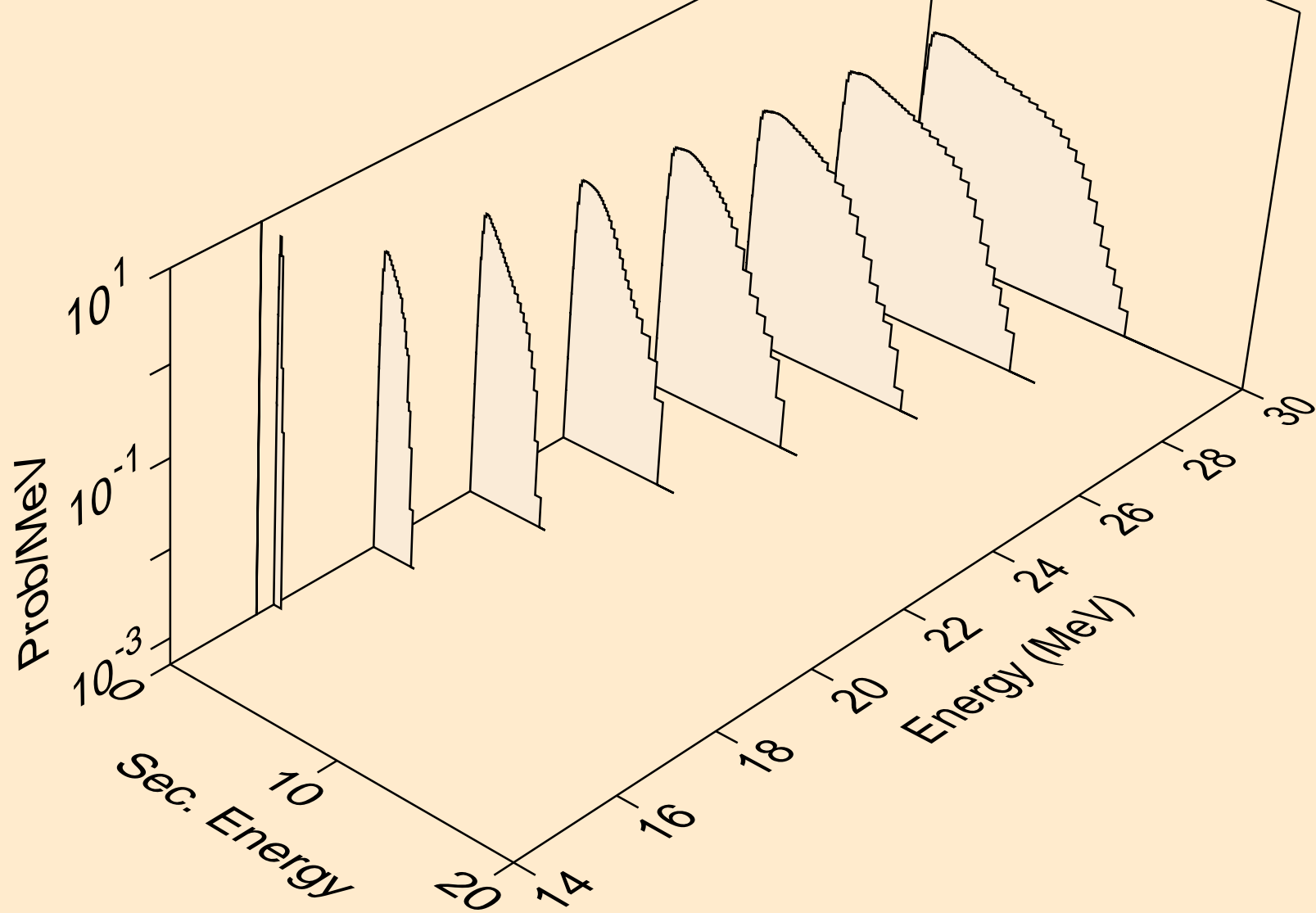

ES250 PROTON ACER TENDL-2021 LIBRARY; T=0.K
neutrons from (p,n*)a

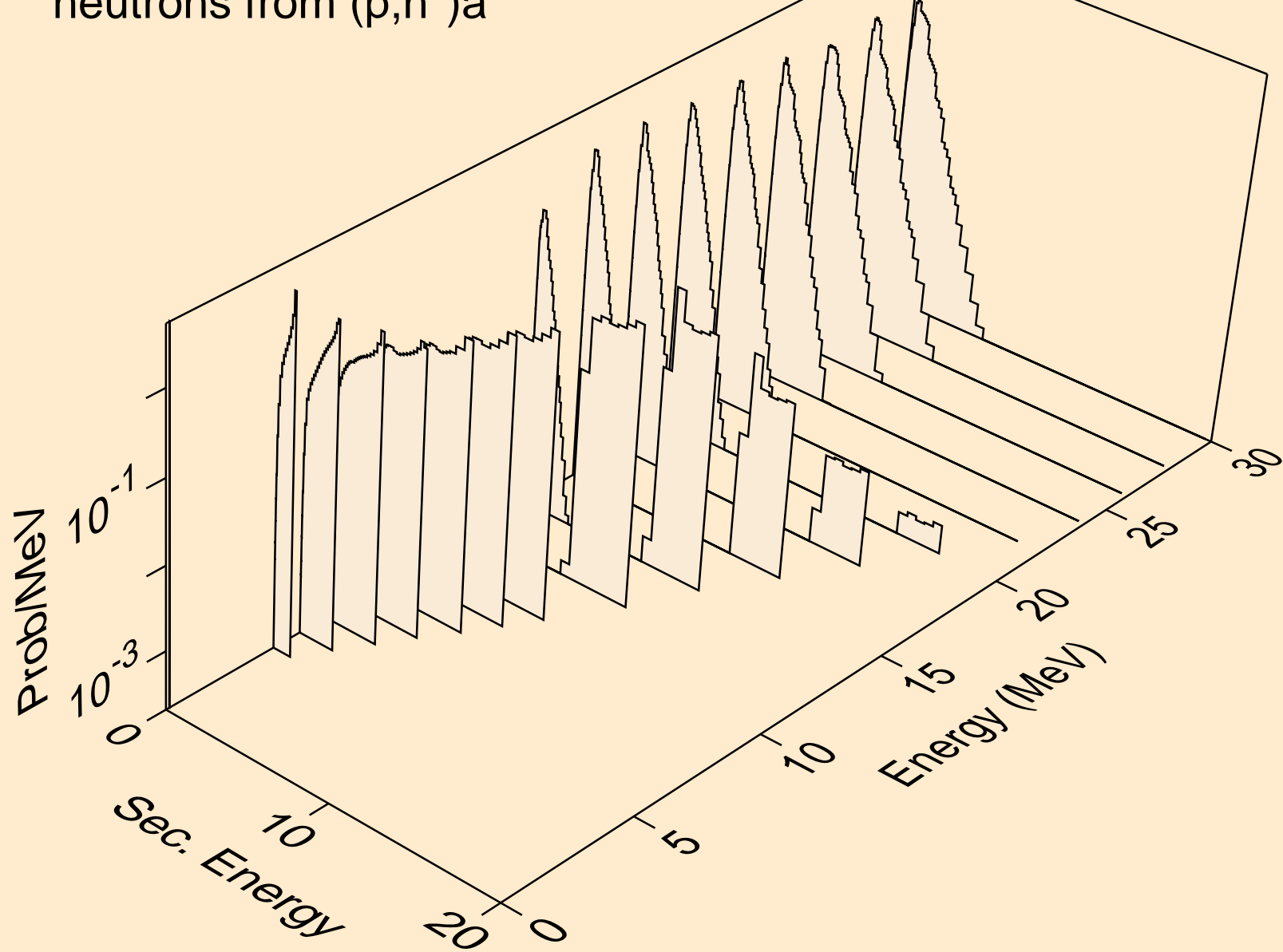

ES250 PROTON ACER TENDL-2021 LIBRARY; T=0.K
neutrons from (p,2n)a

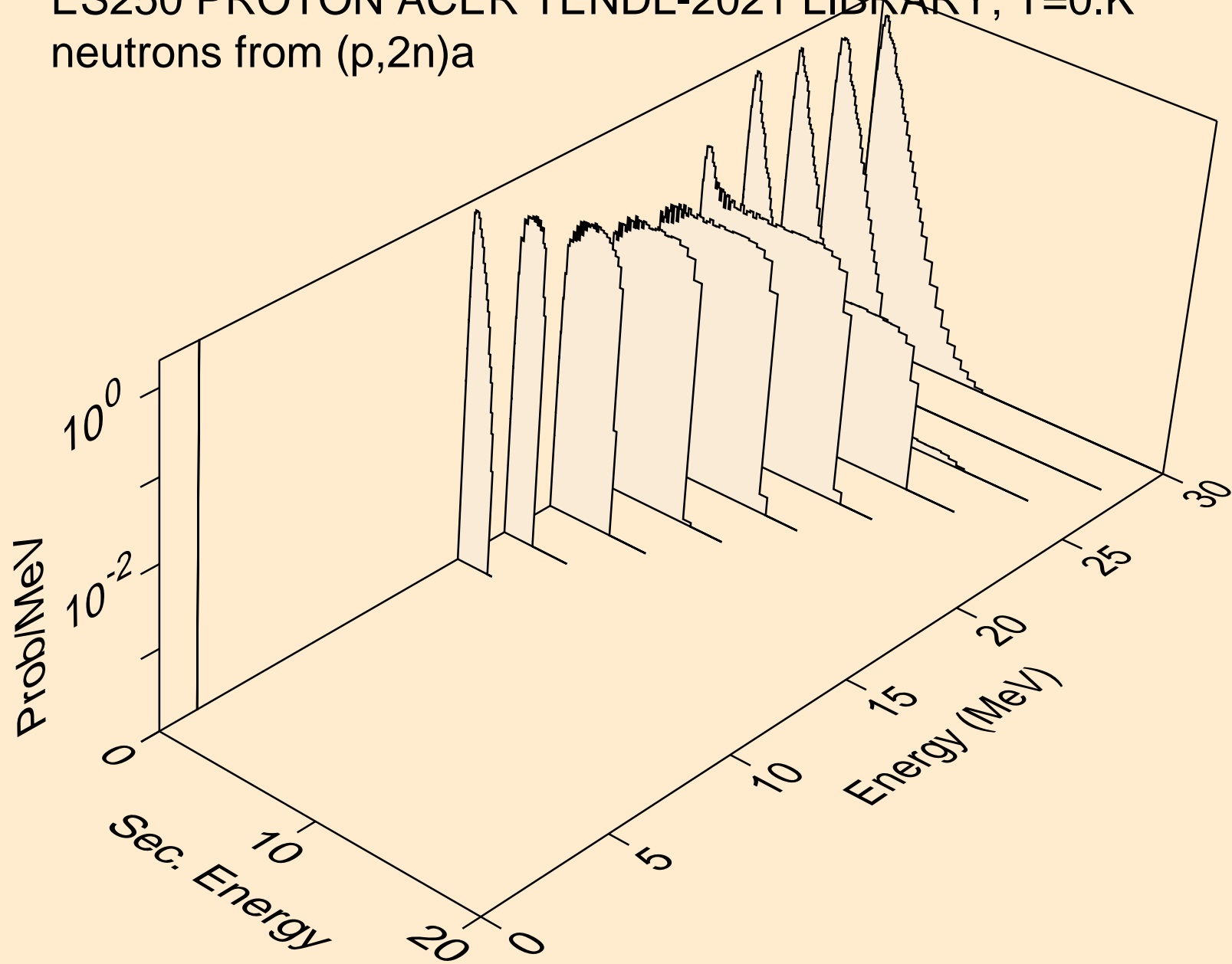

ES250 PROTON ACER TENDL-2021 LIBRARY; T=0.K
neutrons from (p,n*)p

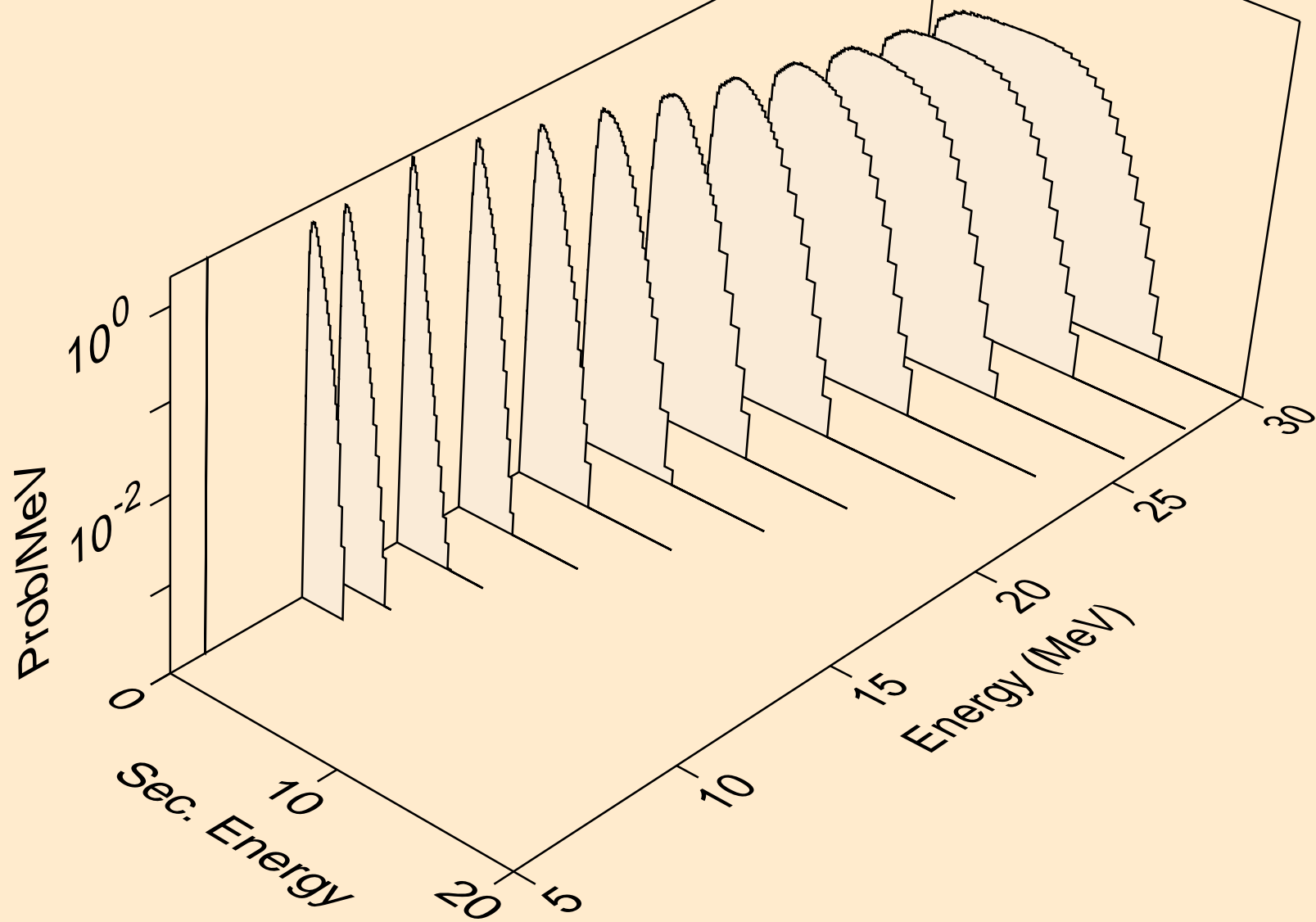

ES250 PROTON ACER TENDL-2021 LIBRARY; T=0.K
neutrons from (p,n*)2a

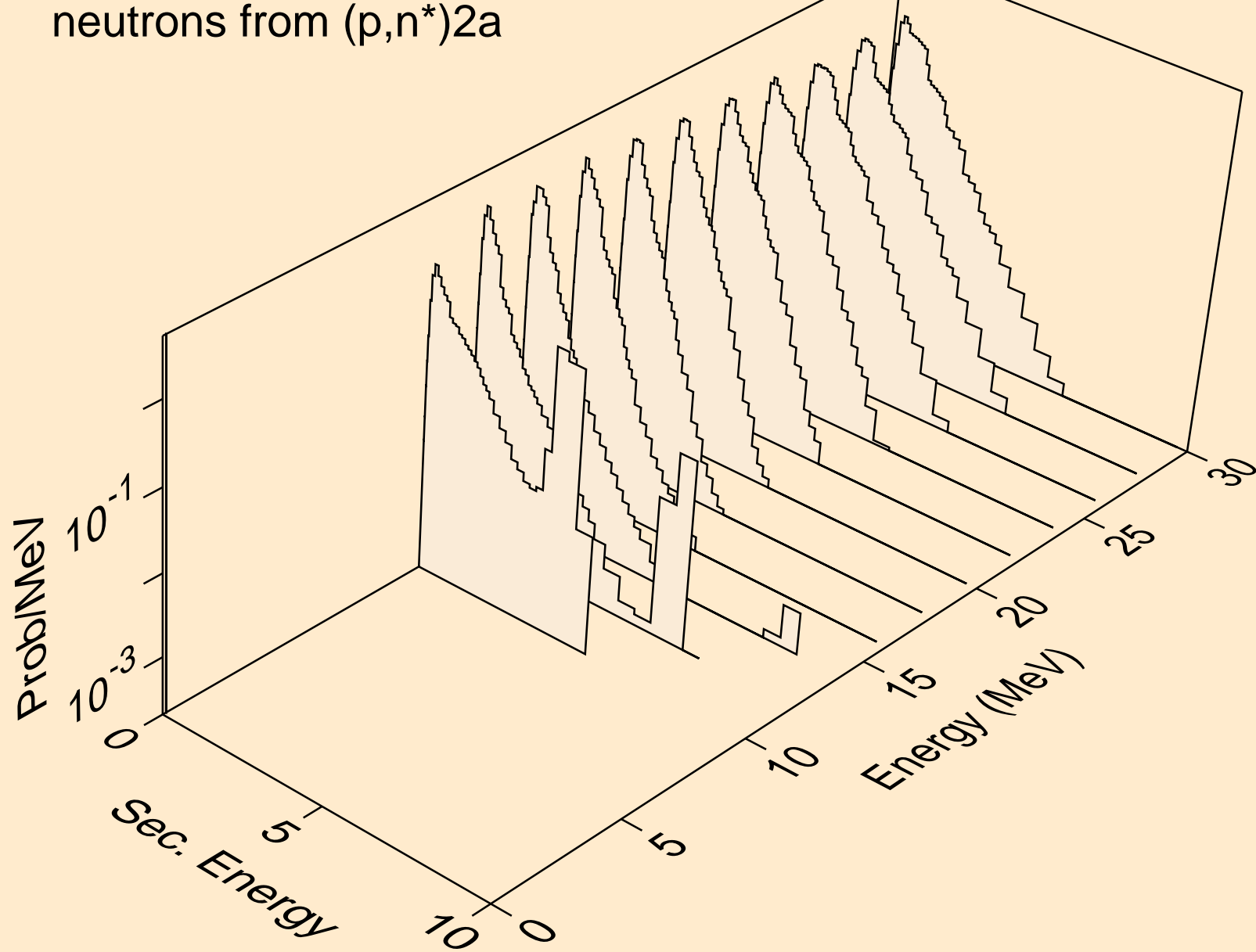

ES250 PROTON ACER TENDL-2021 LIBRARY; T=0.K
neutrons from (p,n*)d

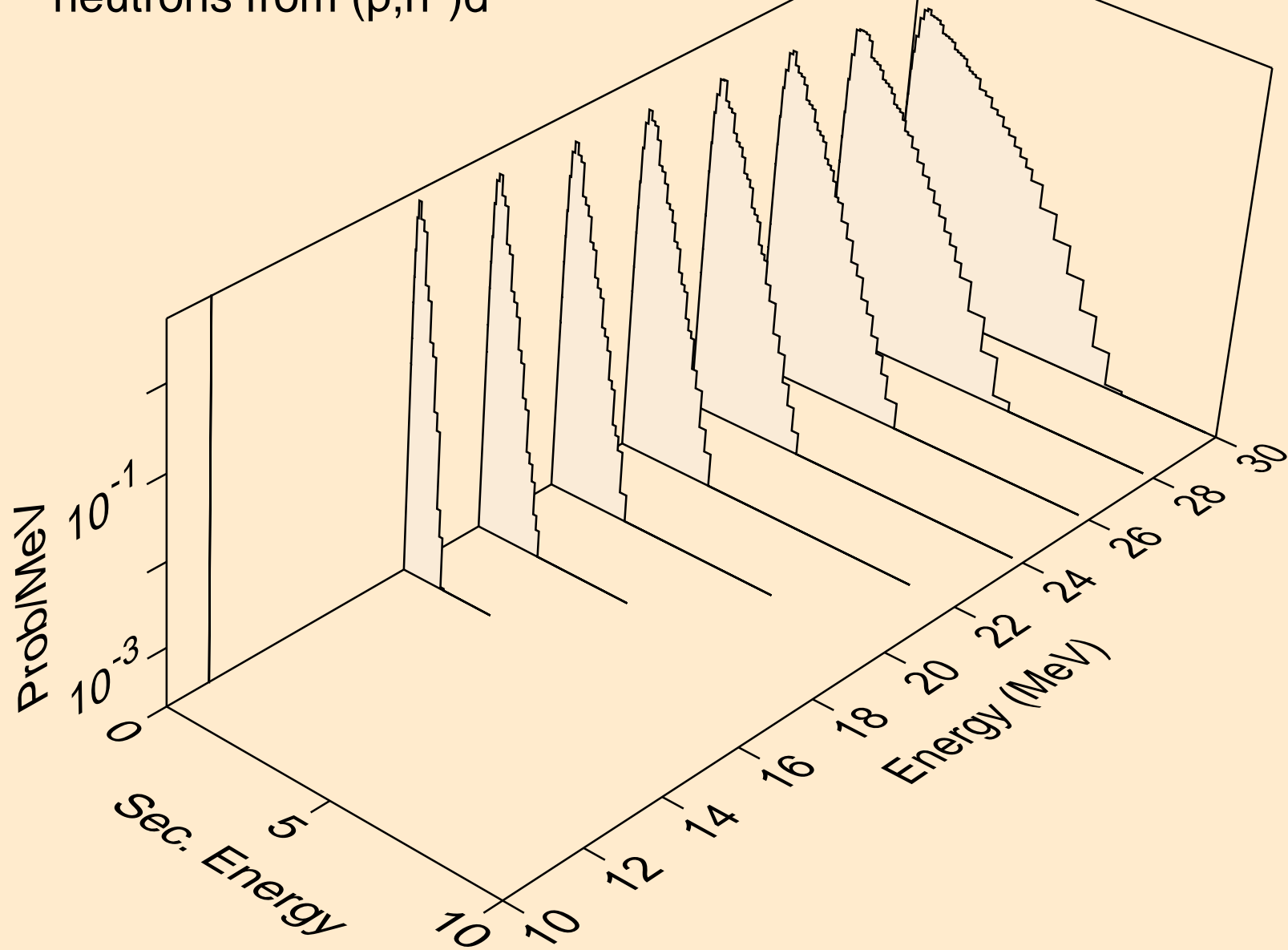

ES250 PROTON ACER TENDL-2021 LIBRARY; T=0.K
neutrons from (p,n*)t

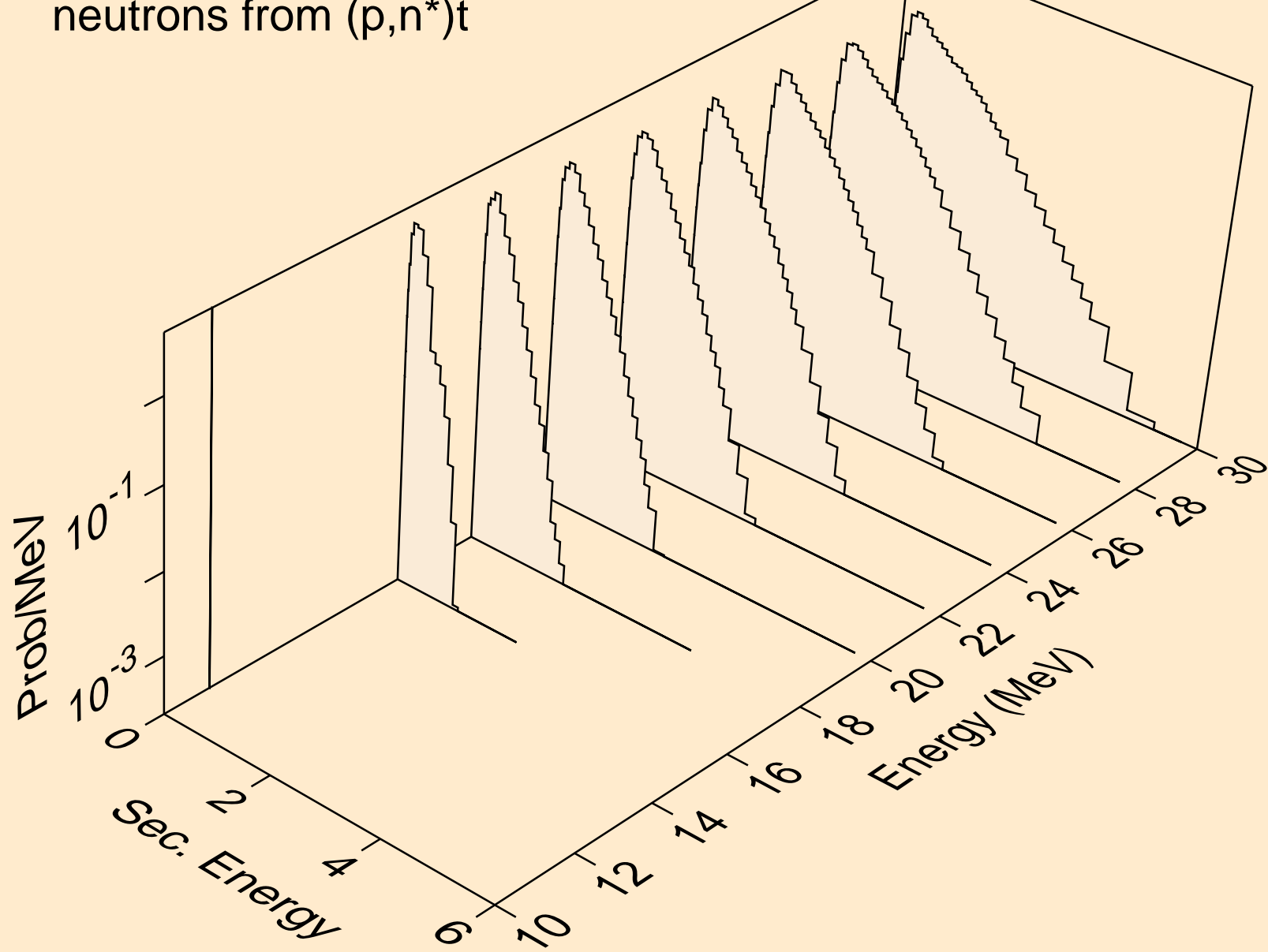

ES250 PROTON ACER TENDL-2021 LIBRARY; T=0.K
neutrons from (p,n*)he3

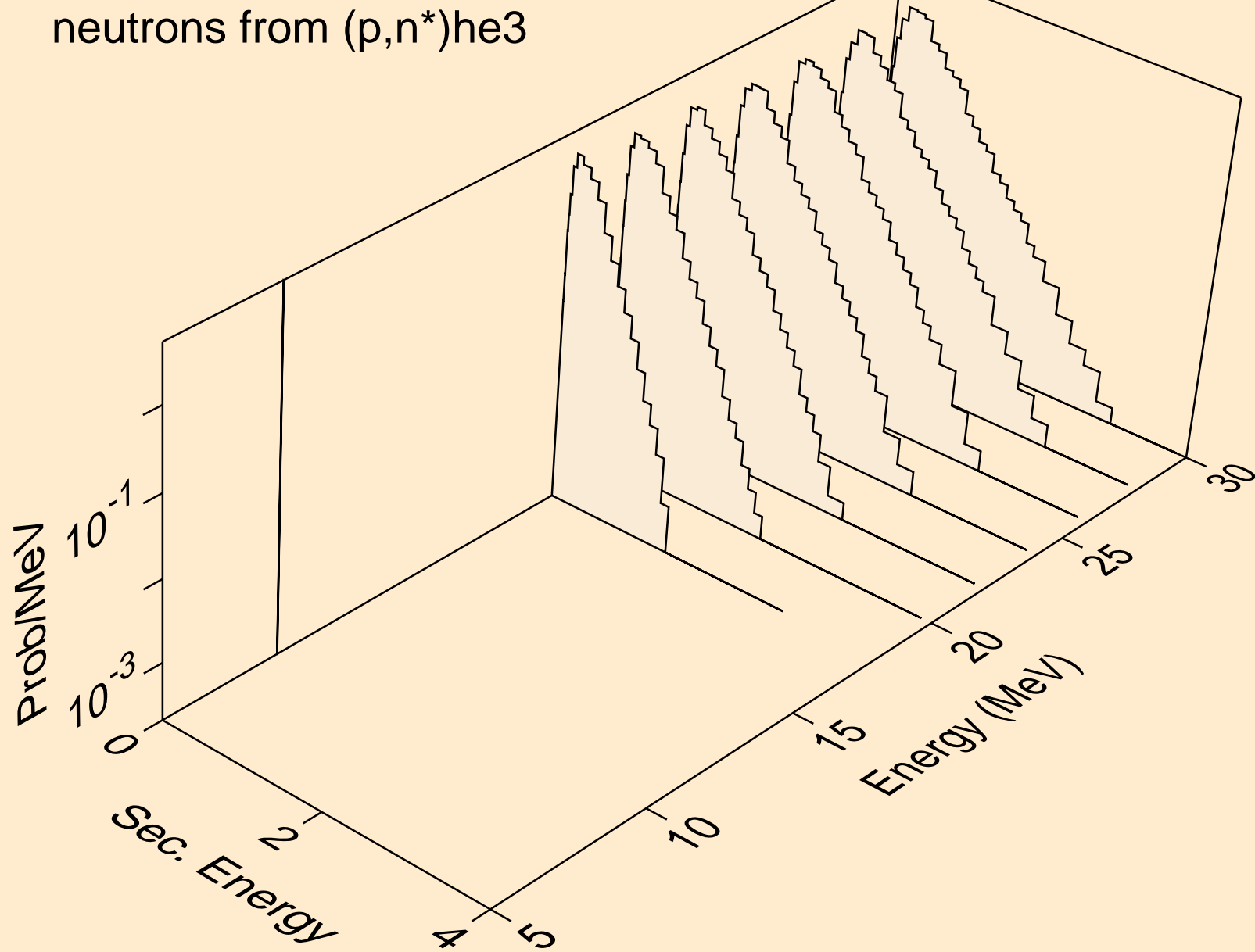

ES250 PROTON ACER TENDL-2021 LIBRARY; T=0.K
neutrons from (p,2np)

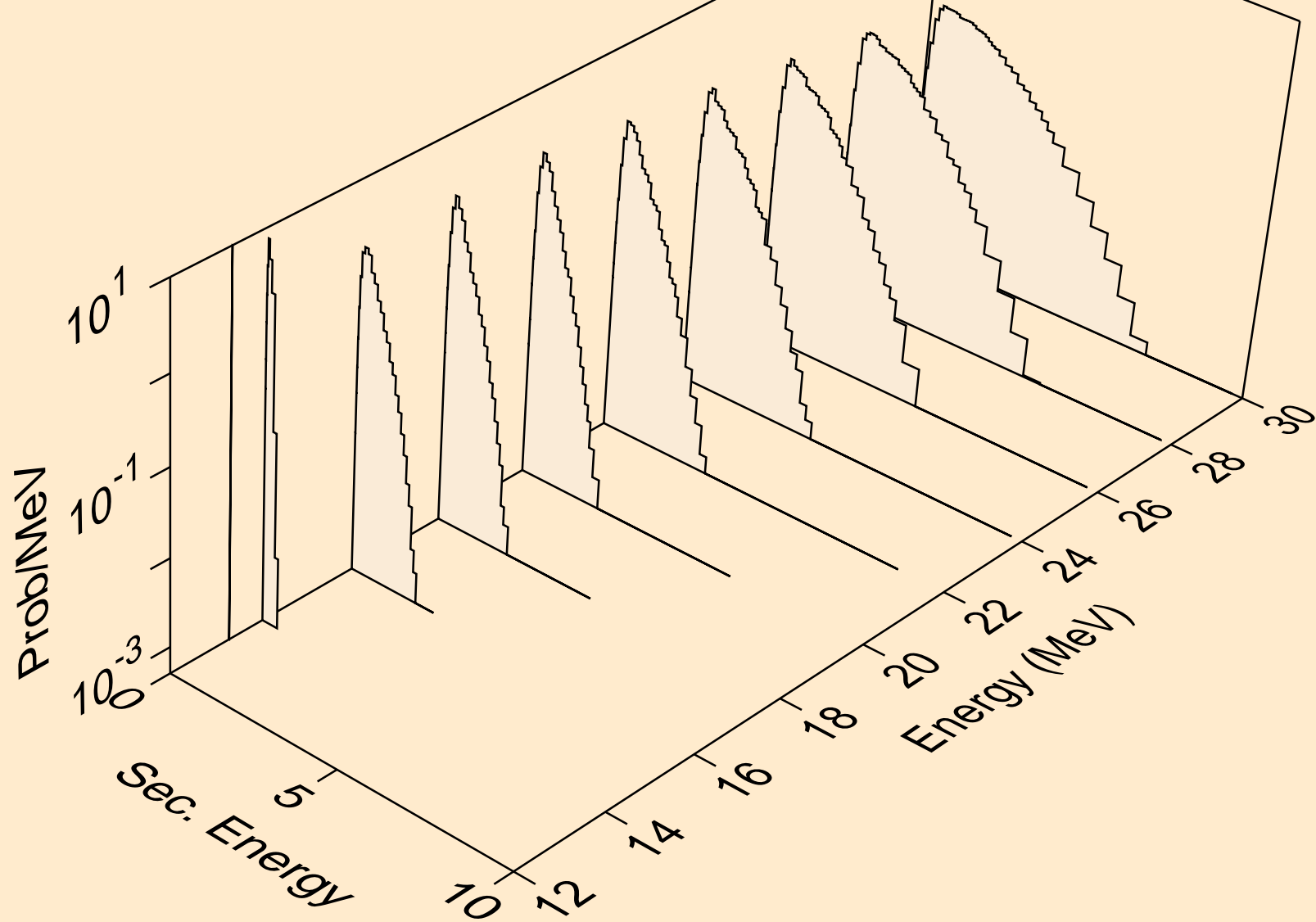

ES250 PROTON ACER TENDL-2021 LIBRARY; T=0.K
neutrons from (p,2np)

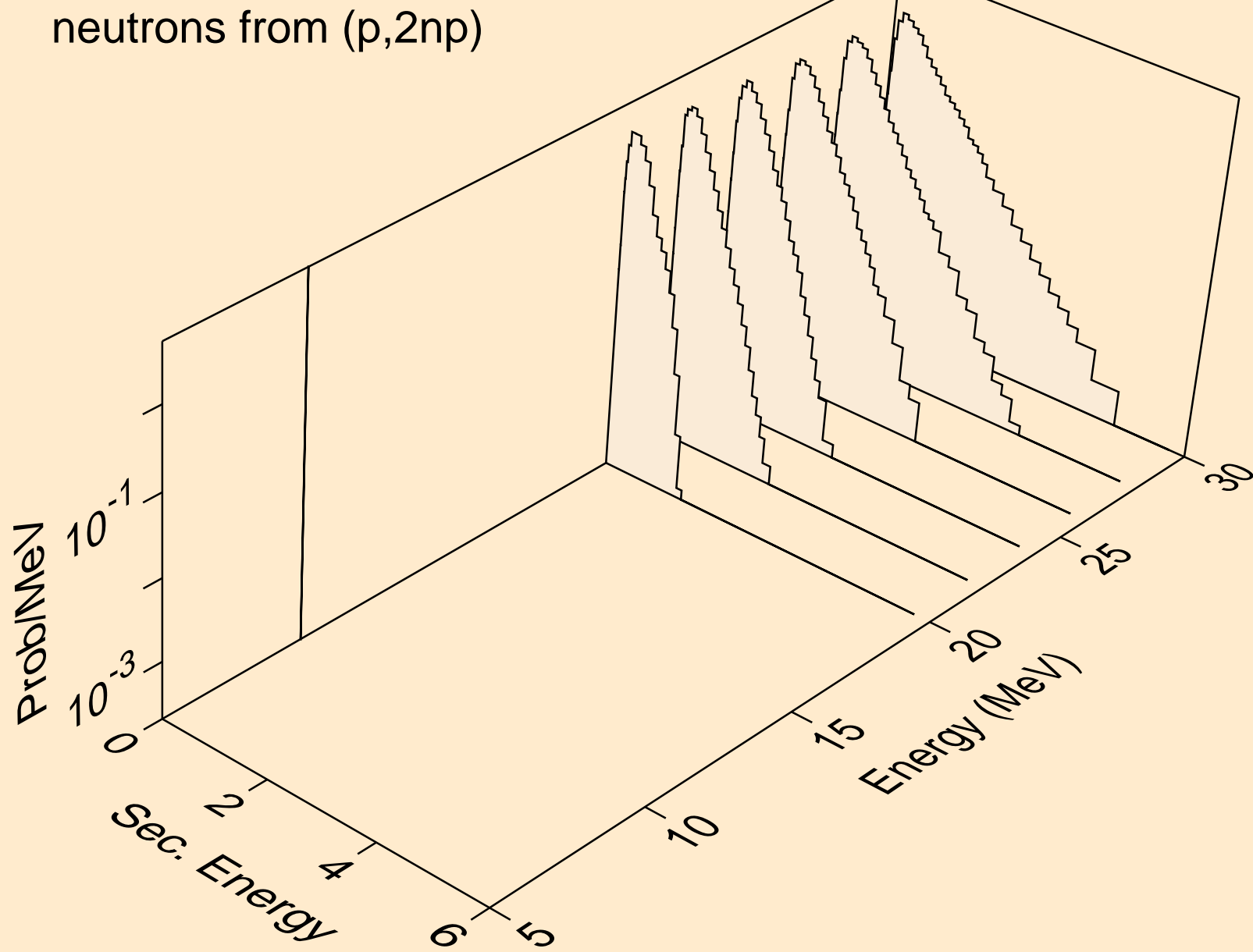

ES250 PROTON ACER TENDL-2021 LIBRARY; T=0.K
deuterons from (p,x)

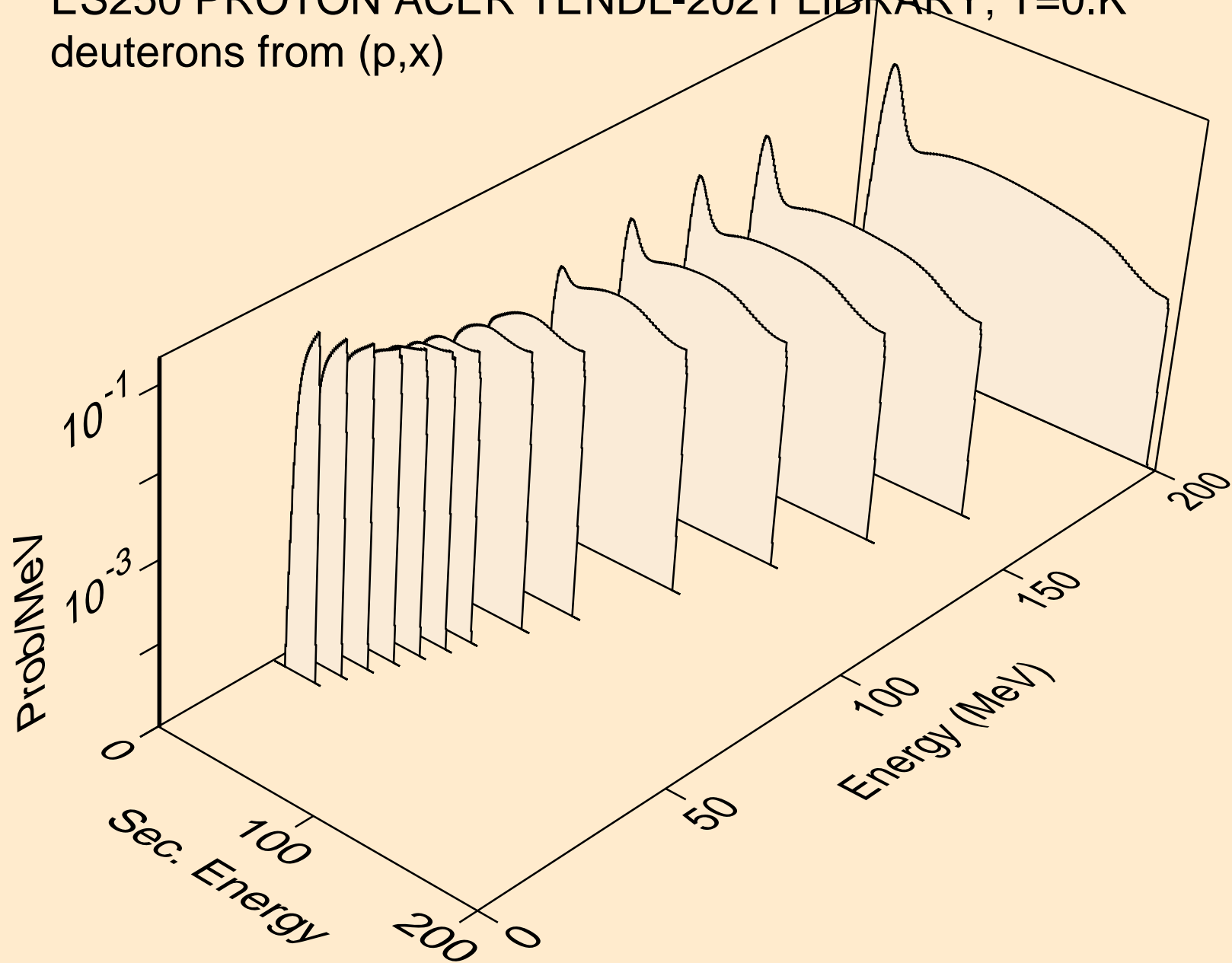

ES250 PROTON ACER TENDL-2021 LIBRARY; T=0.K
deuterons from (p,n*)d

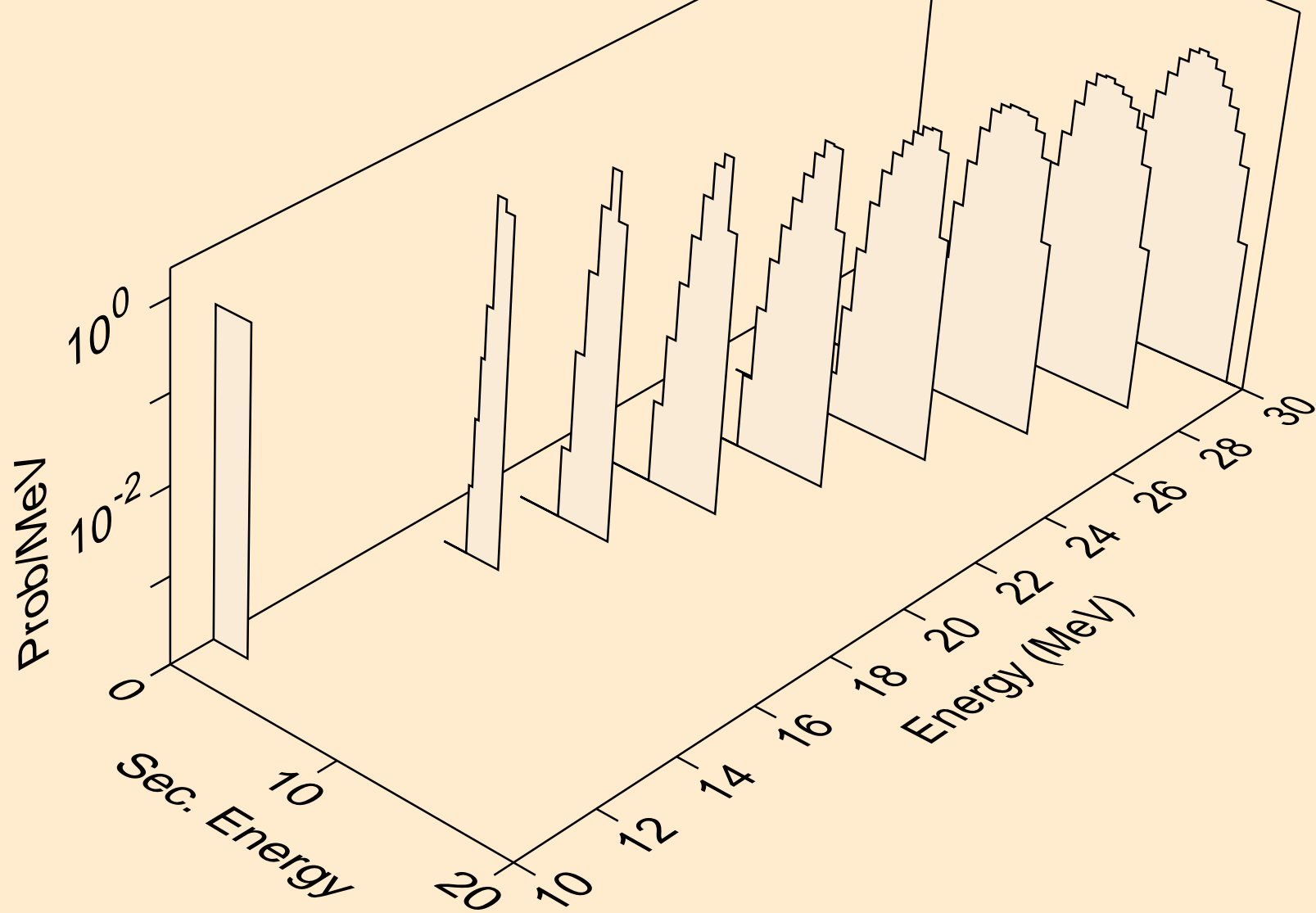

ES250 PROTON ACER TENDL-2021 LIBRARY; T=0.K
deuterons from (p,d)

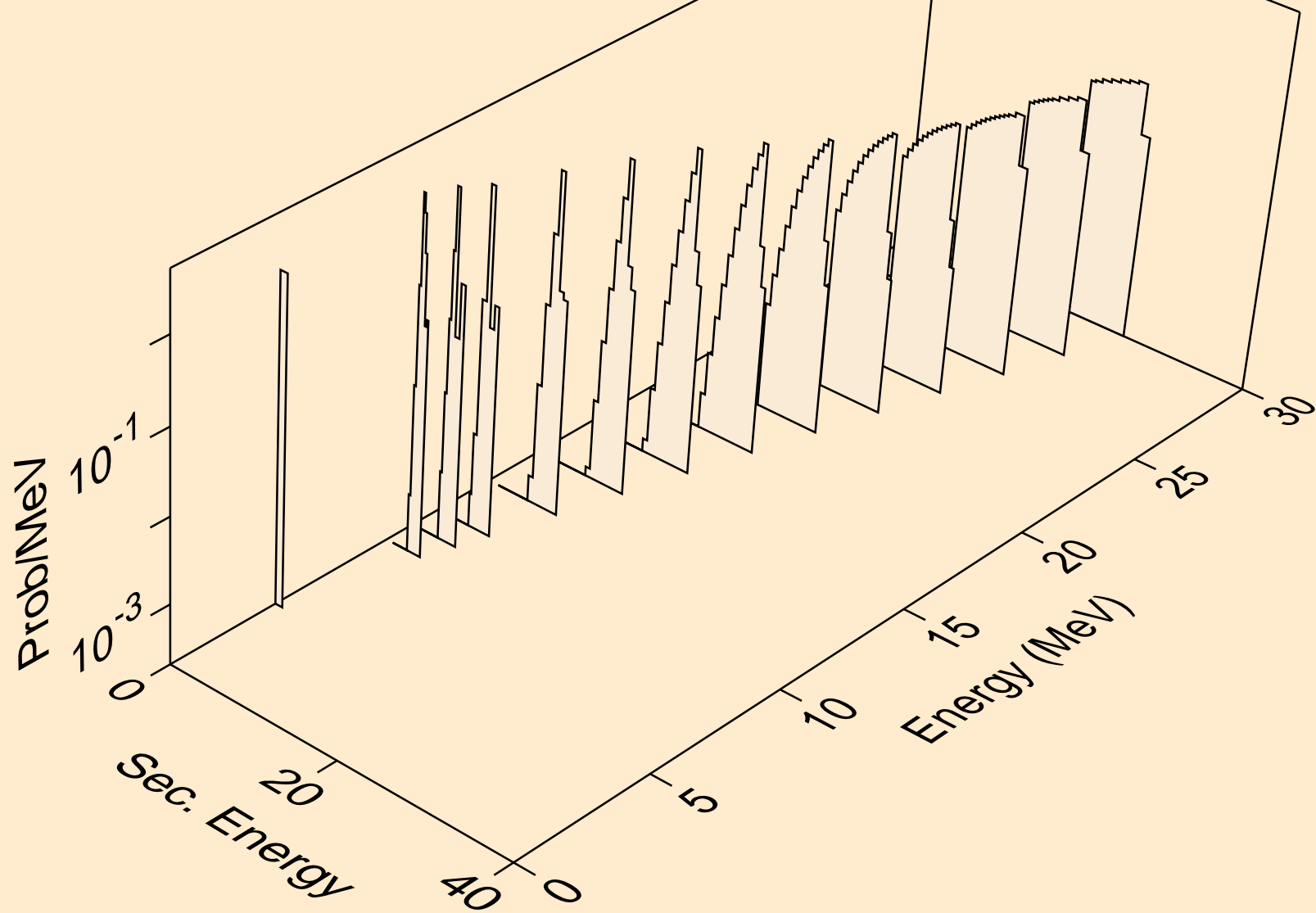

ES250 PROTON ACER TENDL-2021 LIBRARY; T=0.K
deuterons from (p,pd)

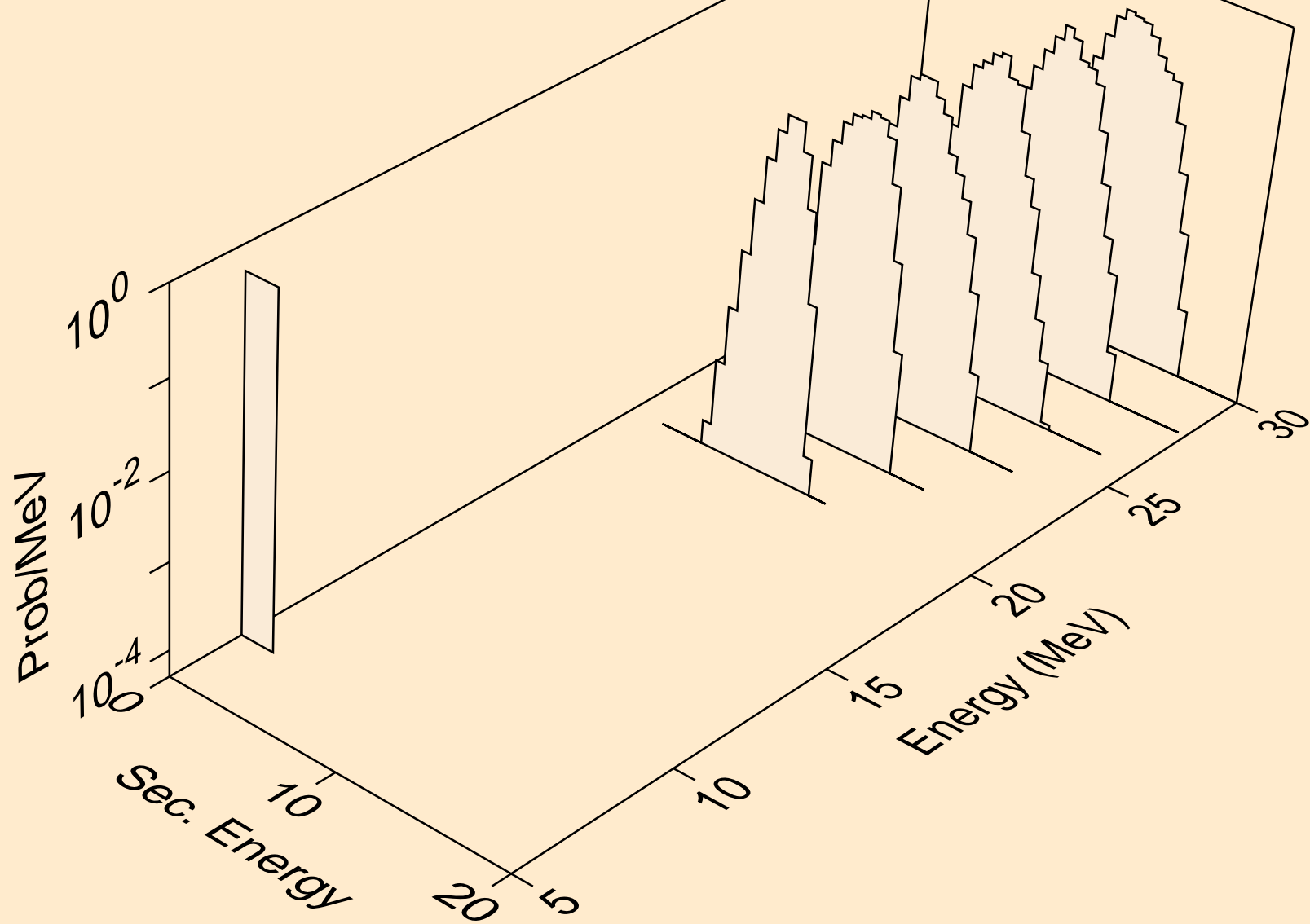

ES250 PROTON ACER TENDL-2021 LIBRARY; T=0.K
tritons from (p,x)

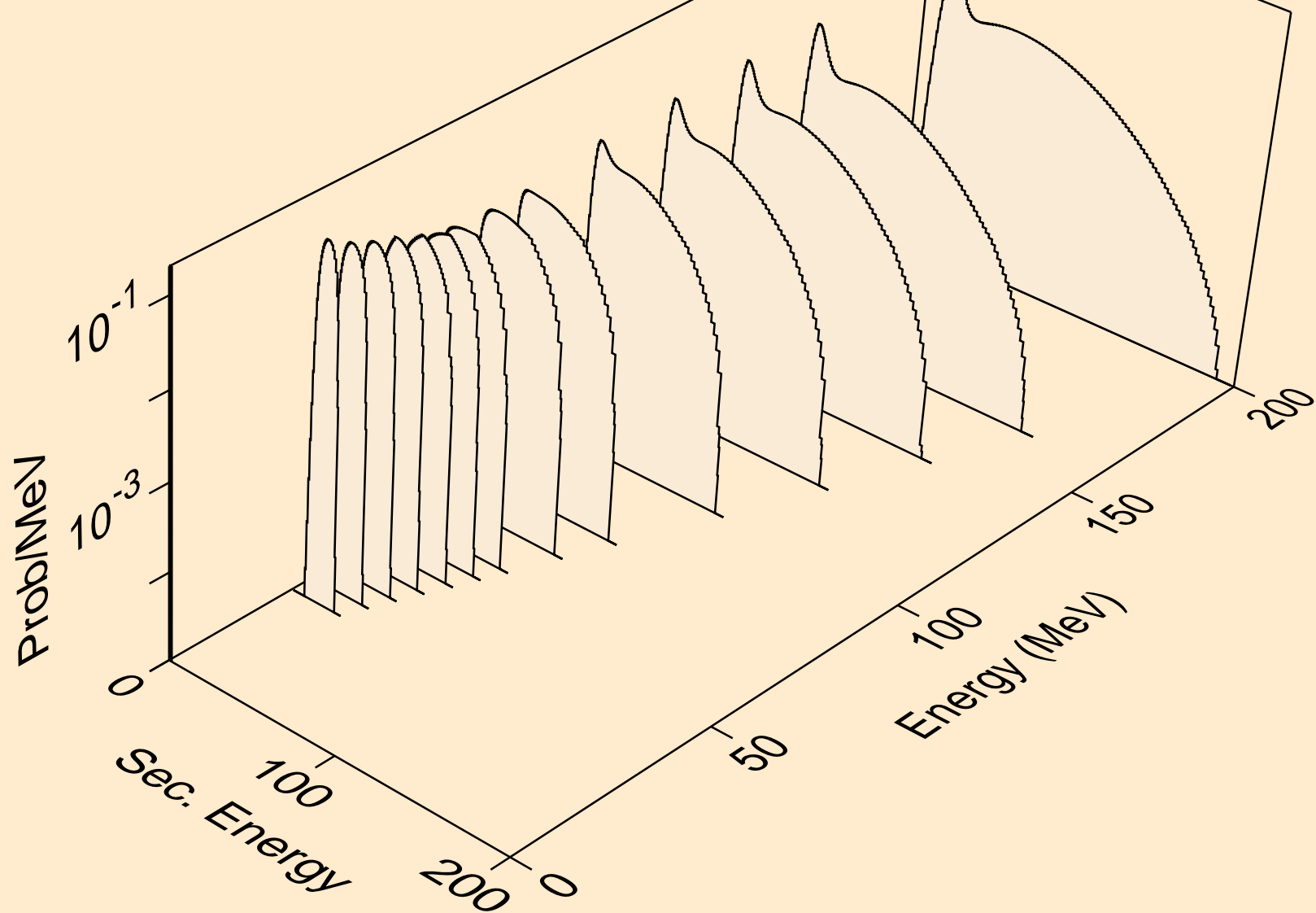

ES250 PROTON ACER TENDL-2021 LIBRARY; T=0.K
tritons from (p,n*)t

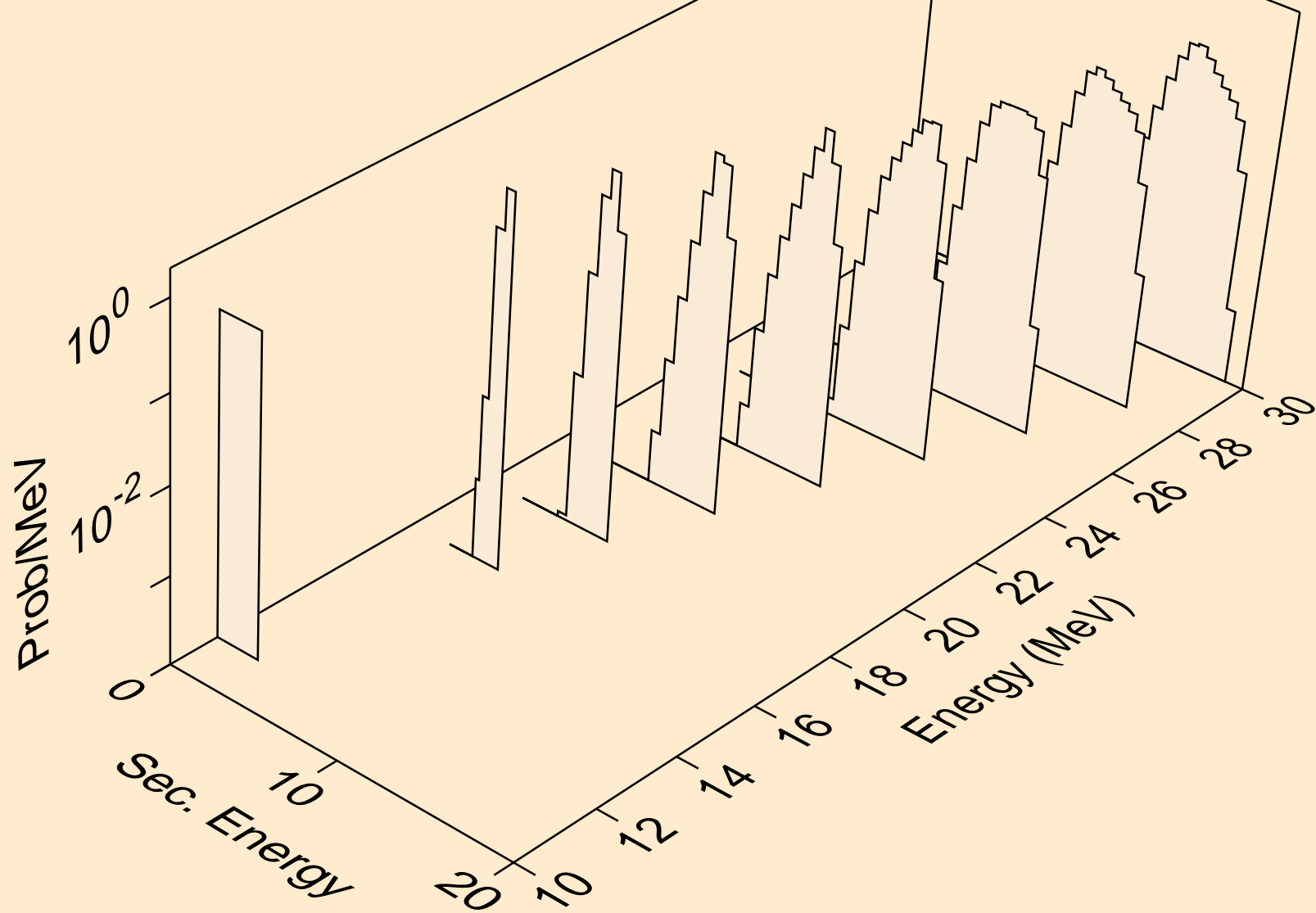

ES250 PROTON ACER TENDL-2021 LIBRARY; T=0.K
tritons from (p,t)

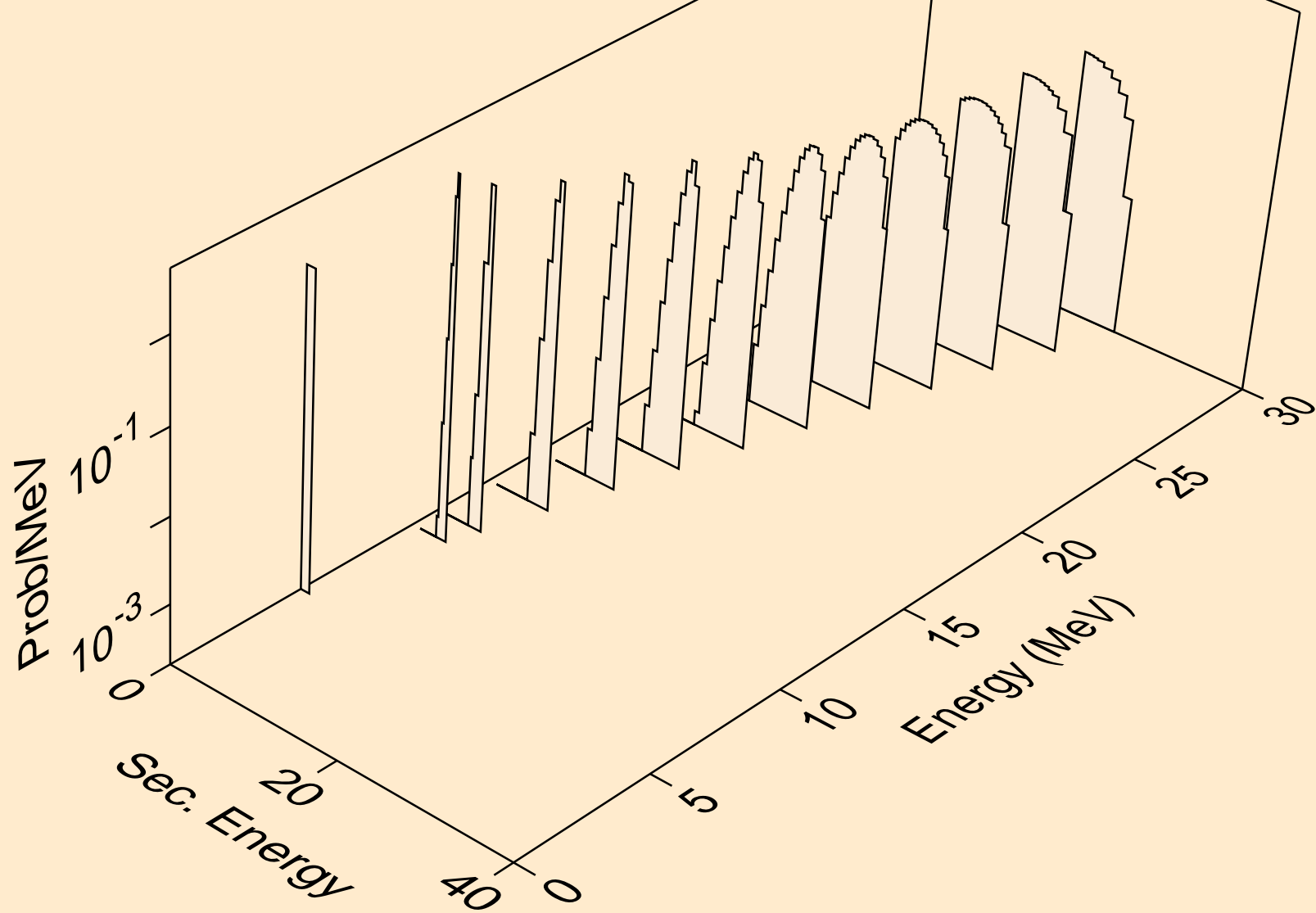

ES250 PROTON ACER TENDL-2021 LIBRARY; T=0.K
he3s from (p,x)

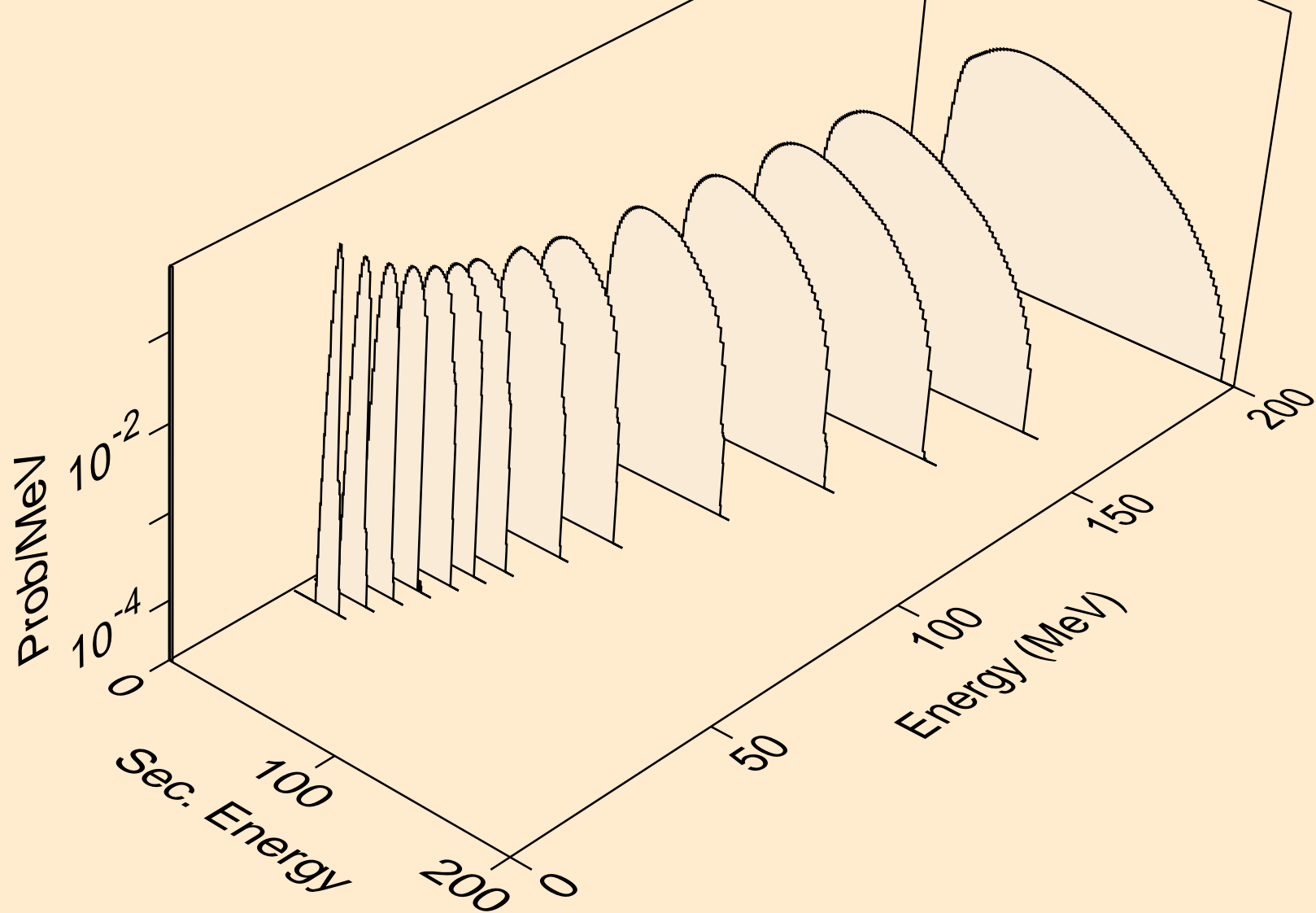

ES250 PROTON ACER TENDL-2021 LIBRARY; T=0.K
he3s from (p,n*)he3

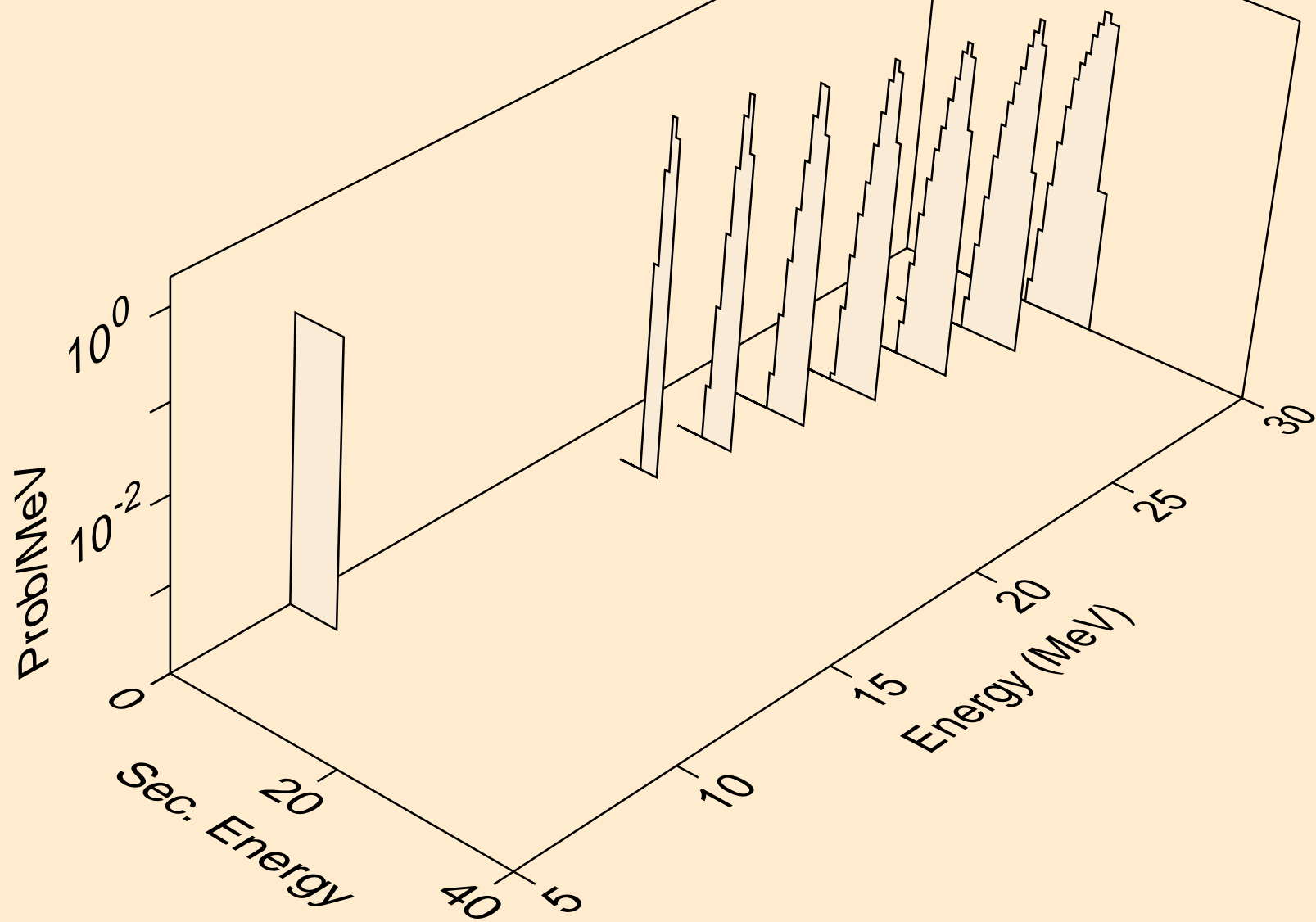

ES250 PROTON ACER TENDL-2021 LIBRARY; T=0.K
he3s from (p,he3)

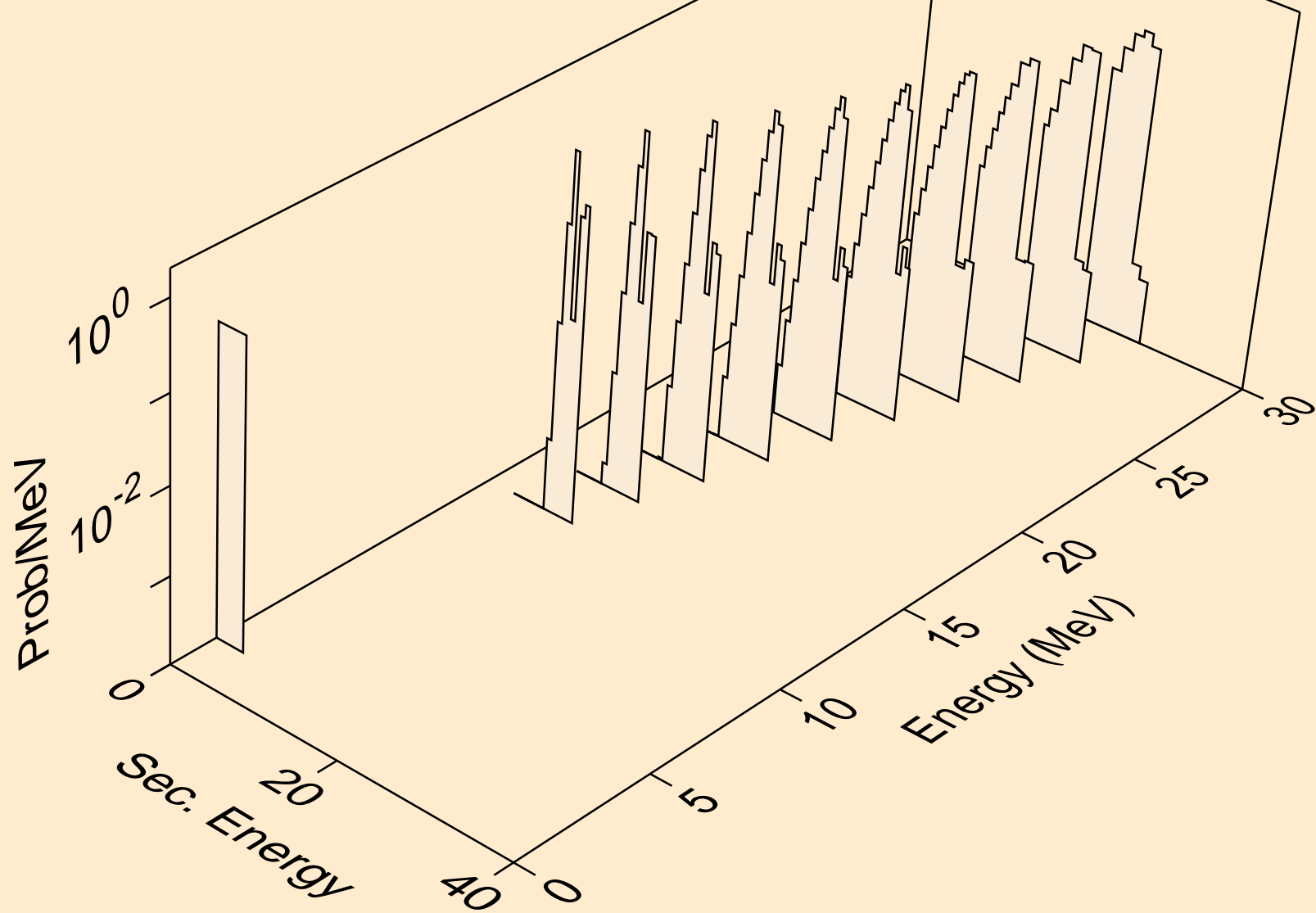

ES250 PROTON ACER TENDL-2021 LIBRARY; T=0.K
alphas from (p,x)

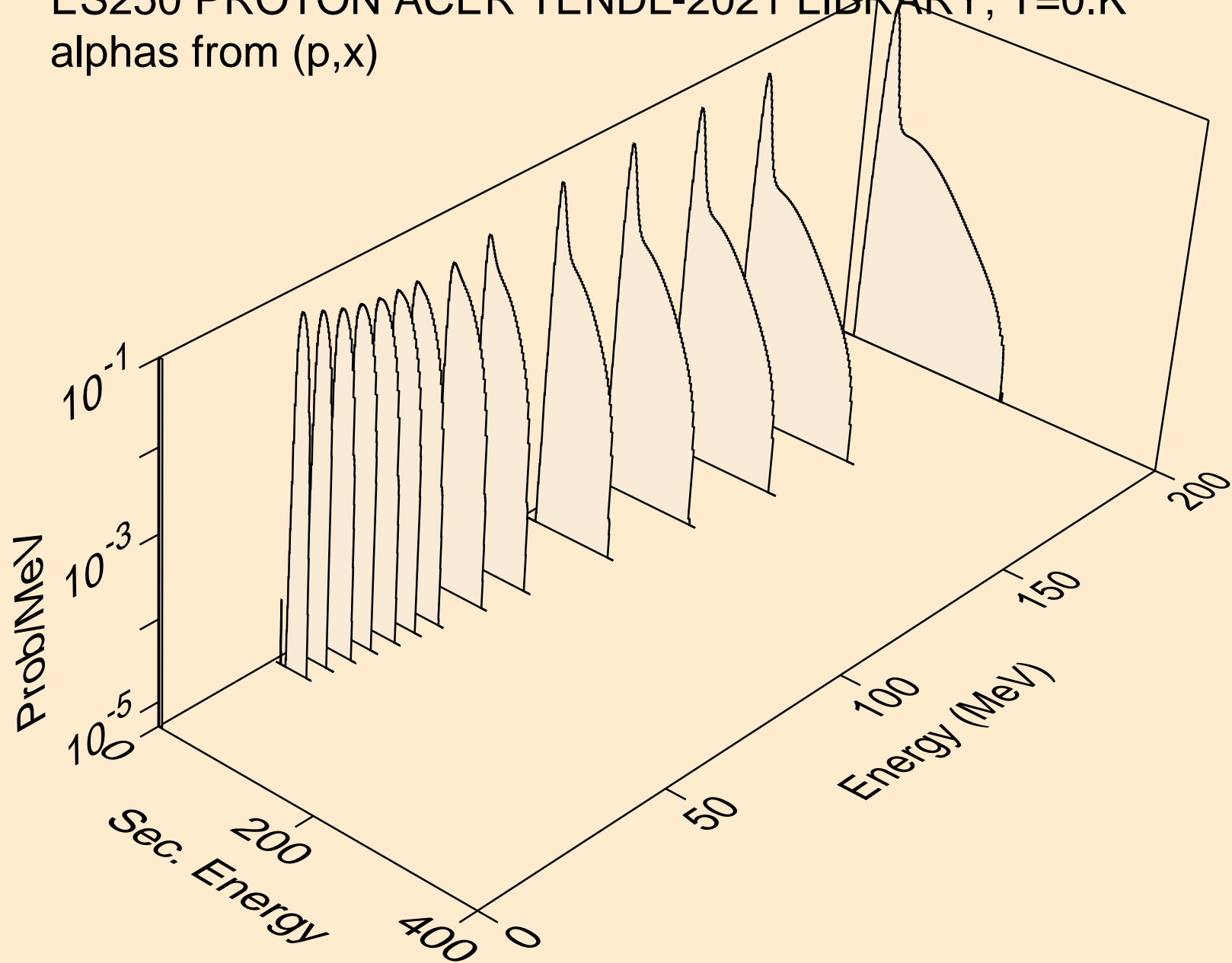

ES250 PROTON ACER TENDL-2021 LIBRARY; T=0.K
alphas from (p,n*)a

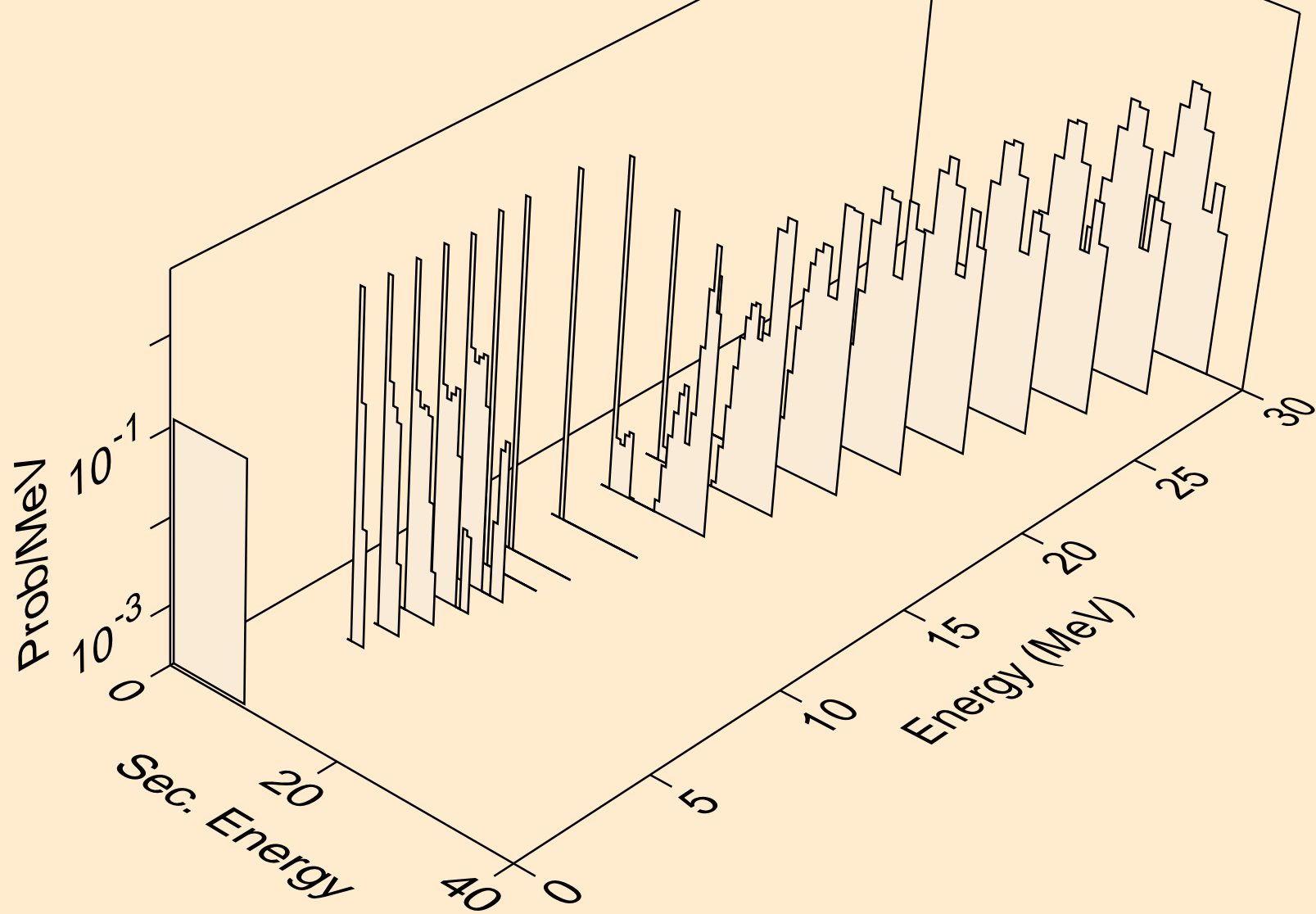

ES250 PROTON ACER TENDL-2021 LIBRARY; T=0.K
alphas from (p,2n)a

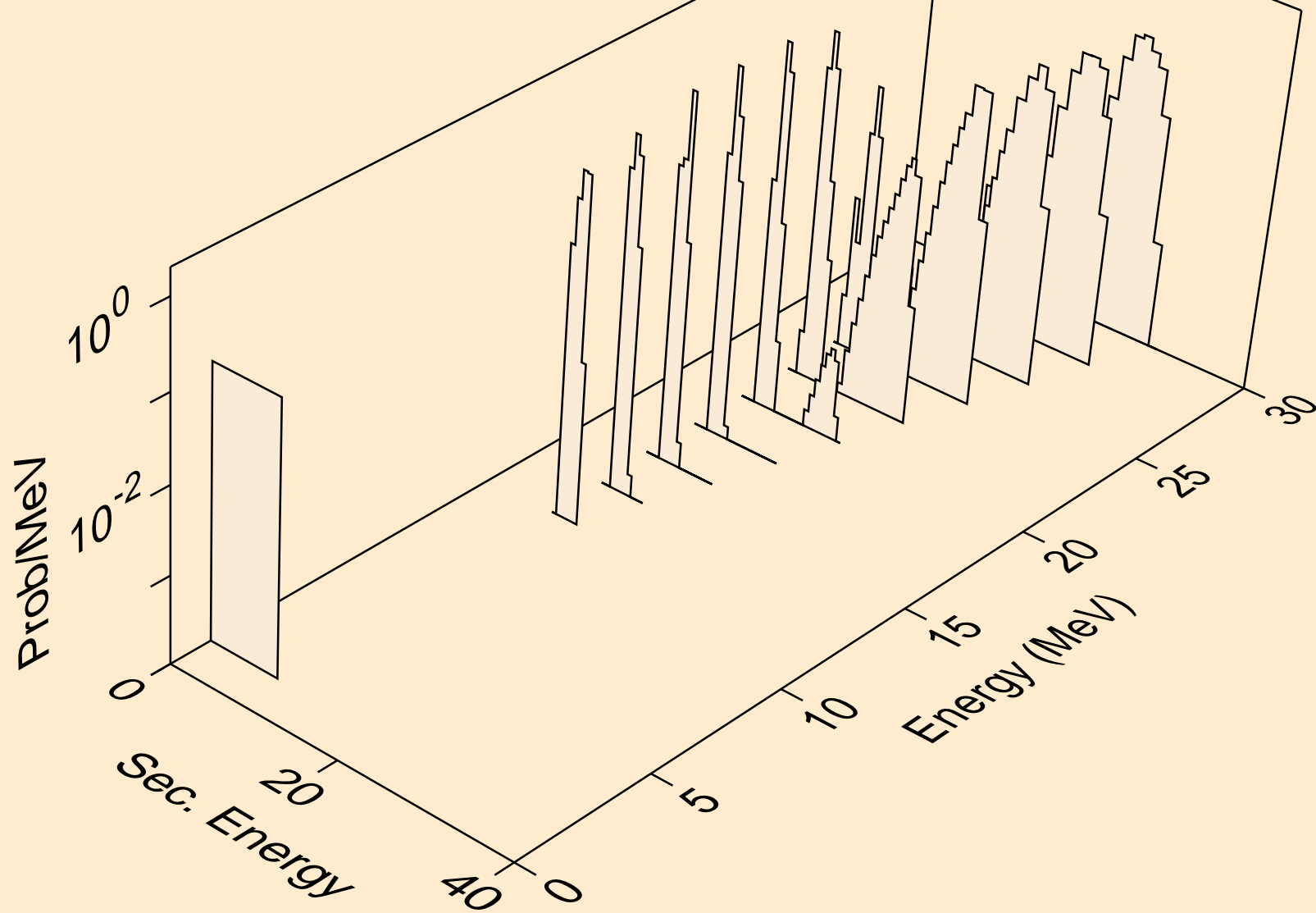

ES250 PROTON ACER TENDL-2021 LIBRARY; T=0.K
alphas from (p,n*)2a

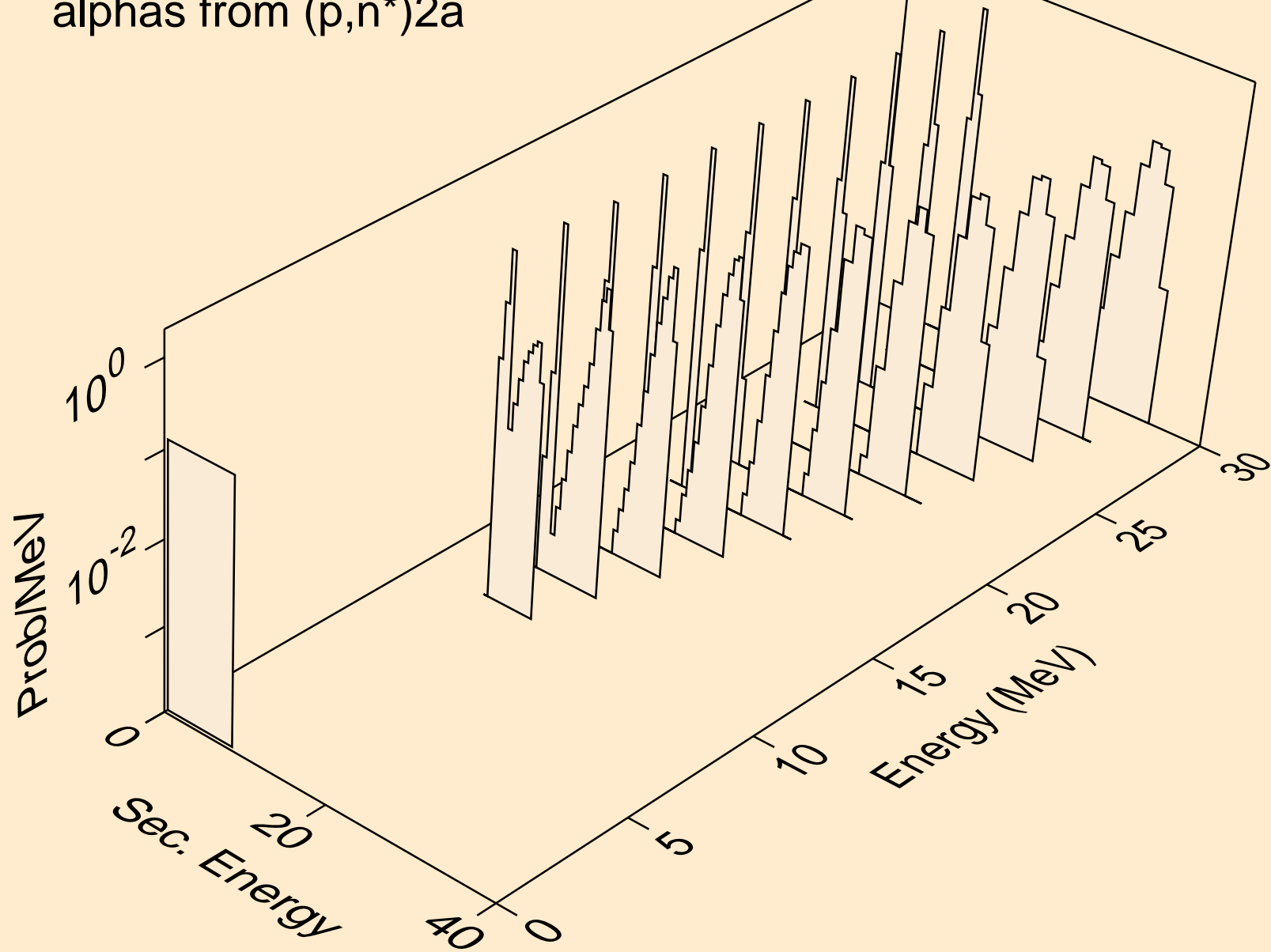

ES250 PROTON ACER TENDL-2021 LIBRARY; T=0.K
alphas from (p,a)

