

# EU163 PROTON ACER TENDL-2021 LIBRARY; T=0.K

## Principal cross sections

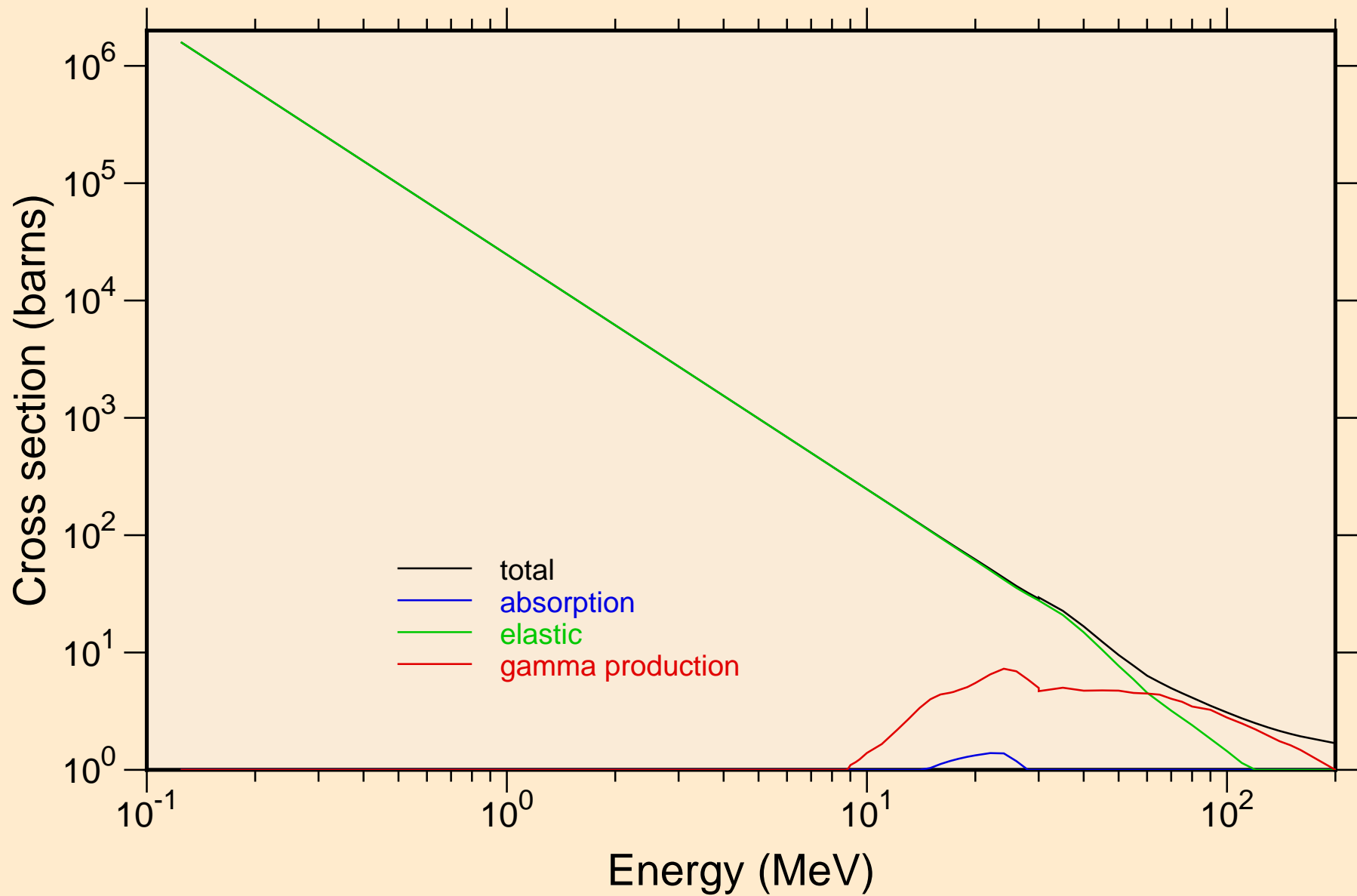

# EU163 PROTON ACER TENDL-2021 LIBRARY; T=0.K

## Heating

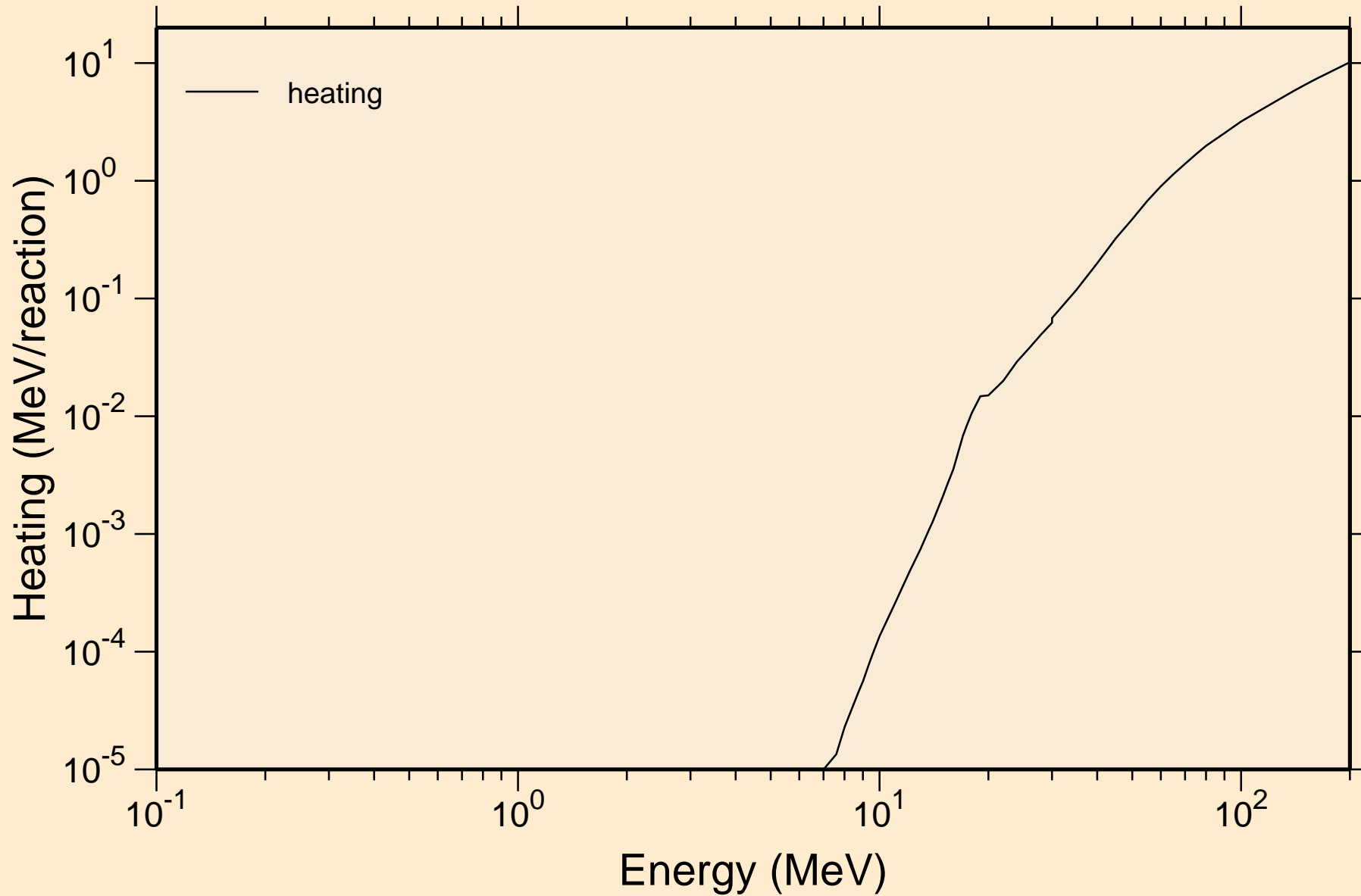

# EU163 PROTON ACER TENDL-2021 LIBRARY; T=0.K

## Principal cross sections

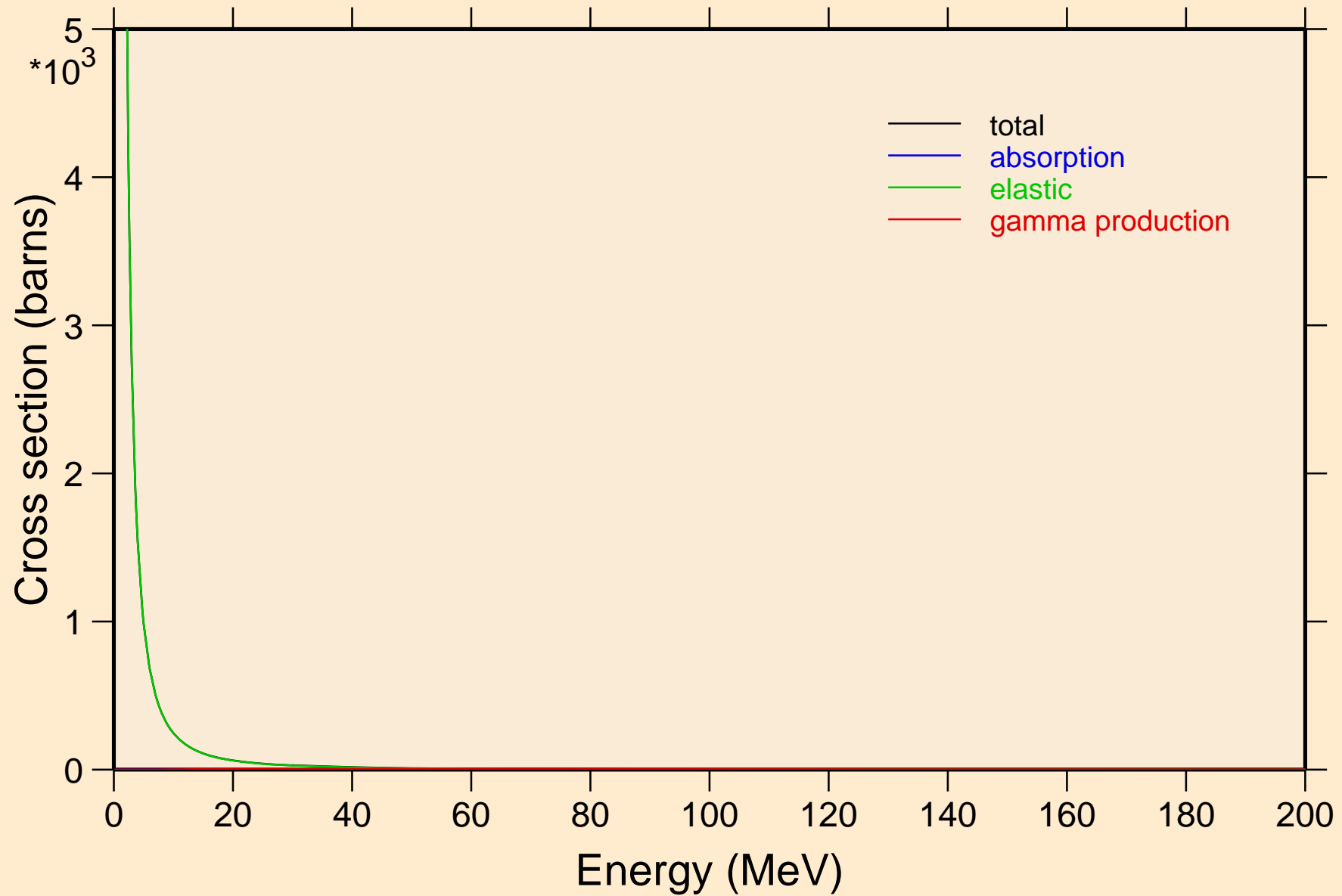

EU163 PROTON ACER TENDL-2021 LIBRARY; T=0.K

Heating

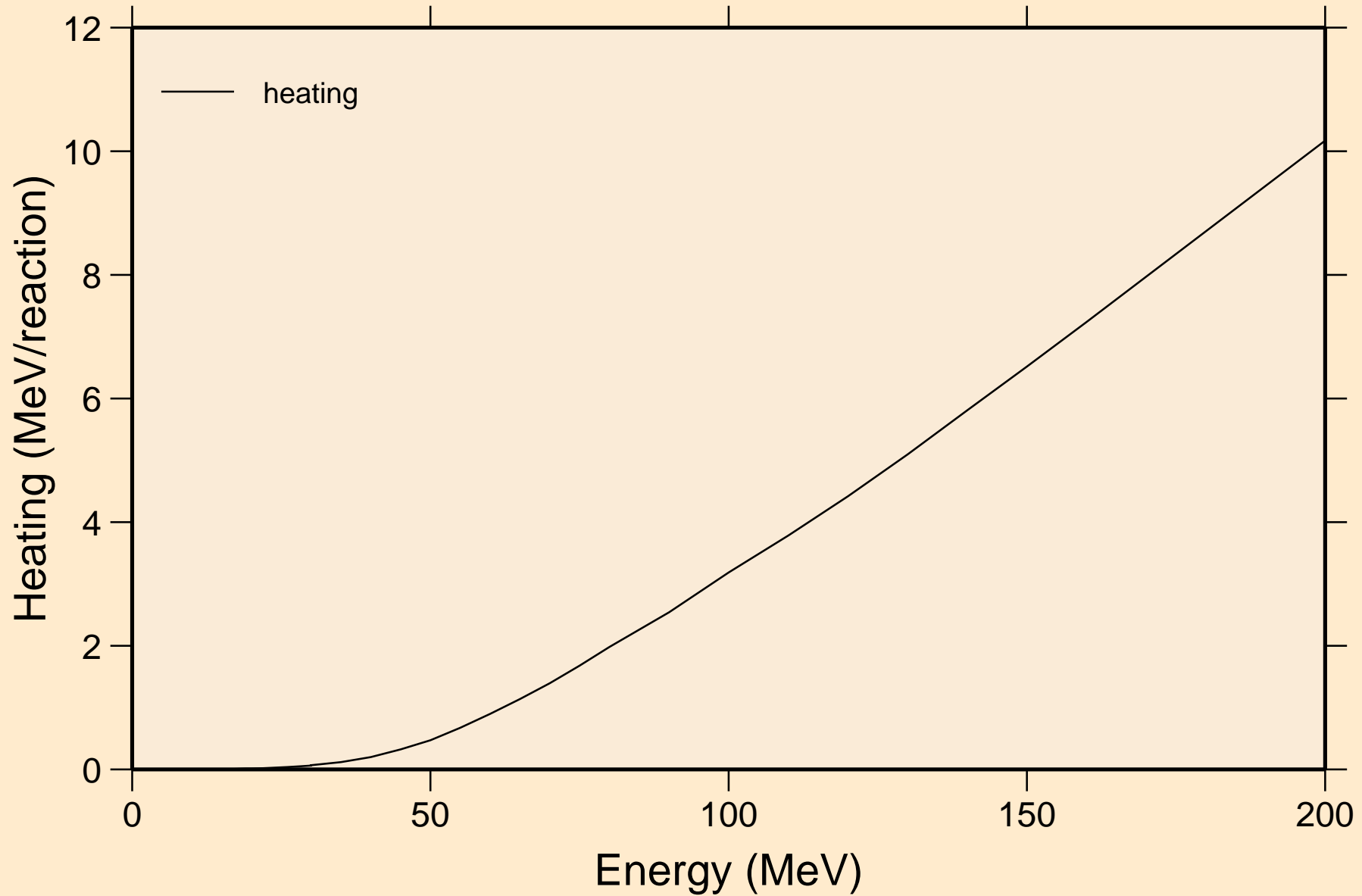

# EU163 PROTON ACER TENDL-2021 LIBRARY; T=0.K

## Threshold reactions

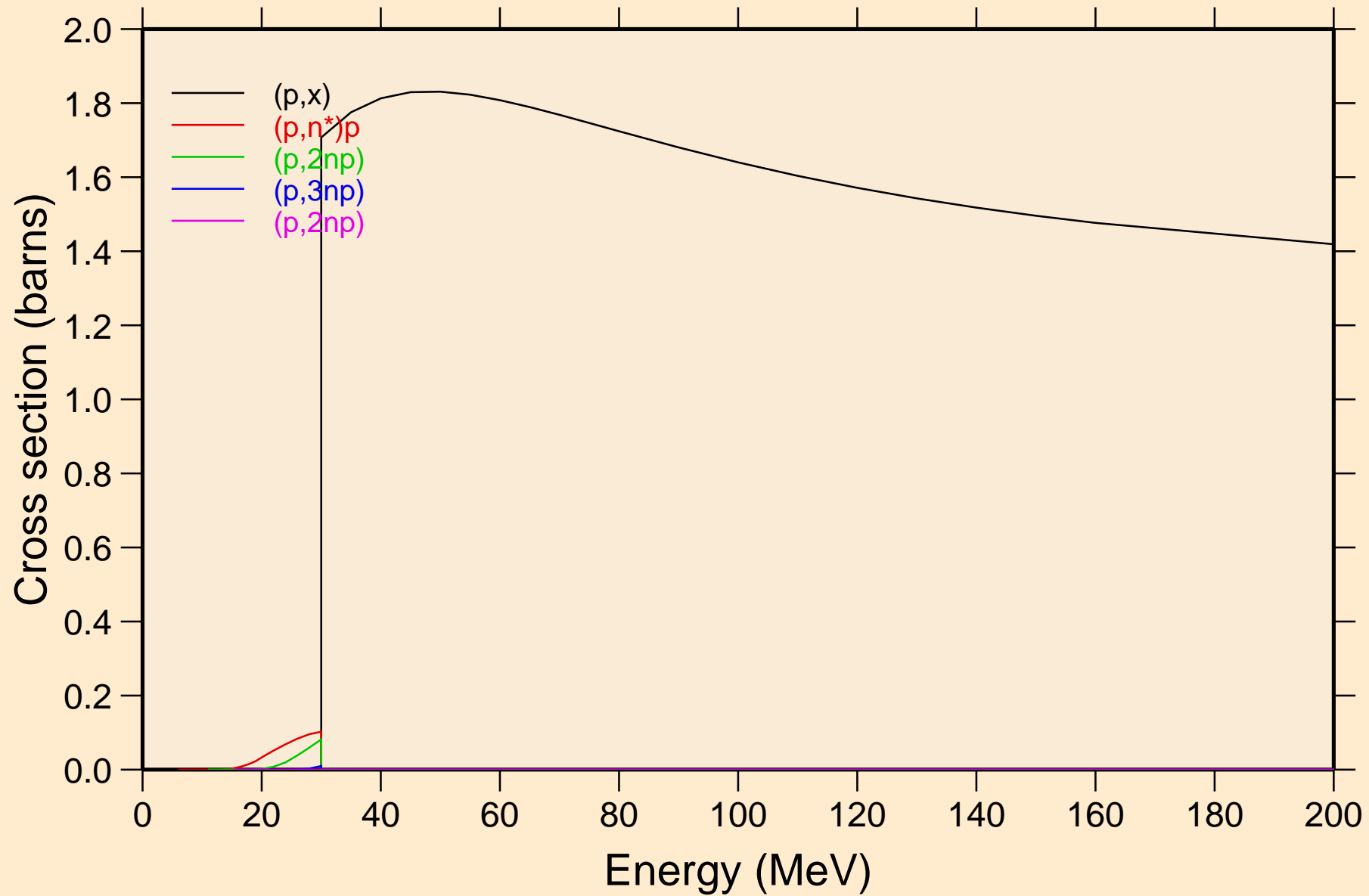

# EU163 PROTON ACER TENDL-2021 LIBRARY; T=0.K

## Threshold reactions

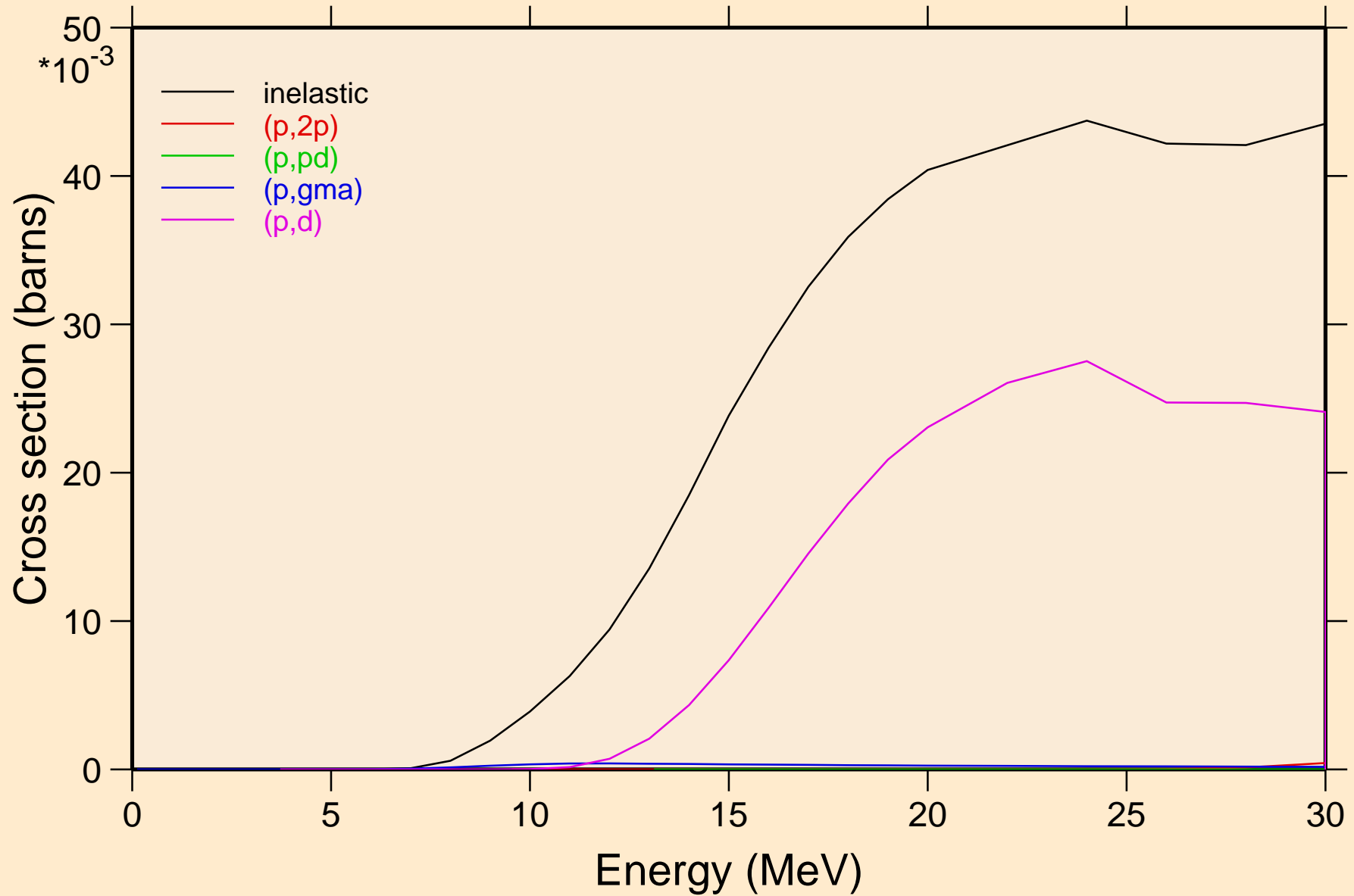

# EU163 PROTON ACER TENDL-2021 LIBRARY; T=0.K

## Threshold reactions

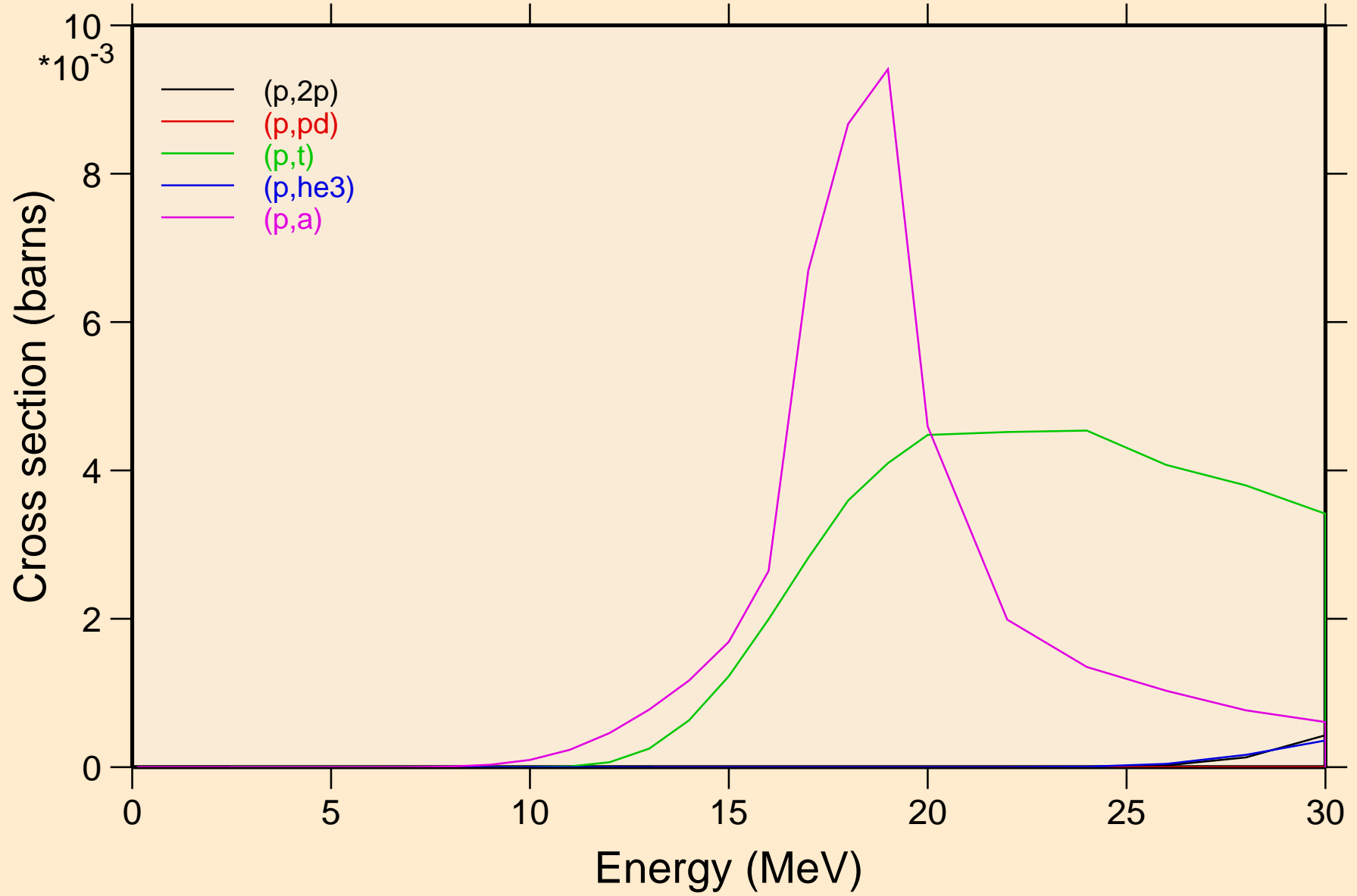

EU163 PROTON ACER TENDL-2021 LIBRARY; T=0.K  
Threshold reactions

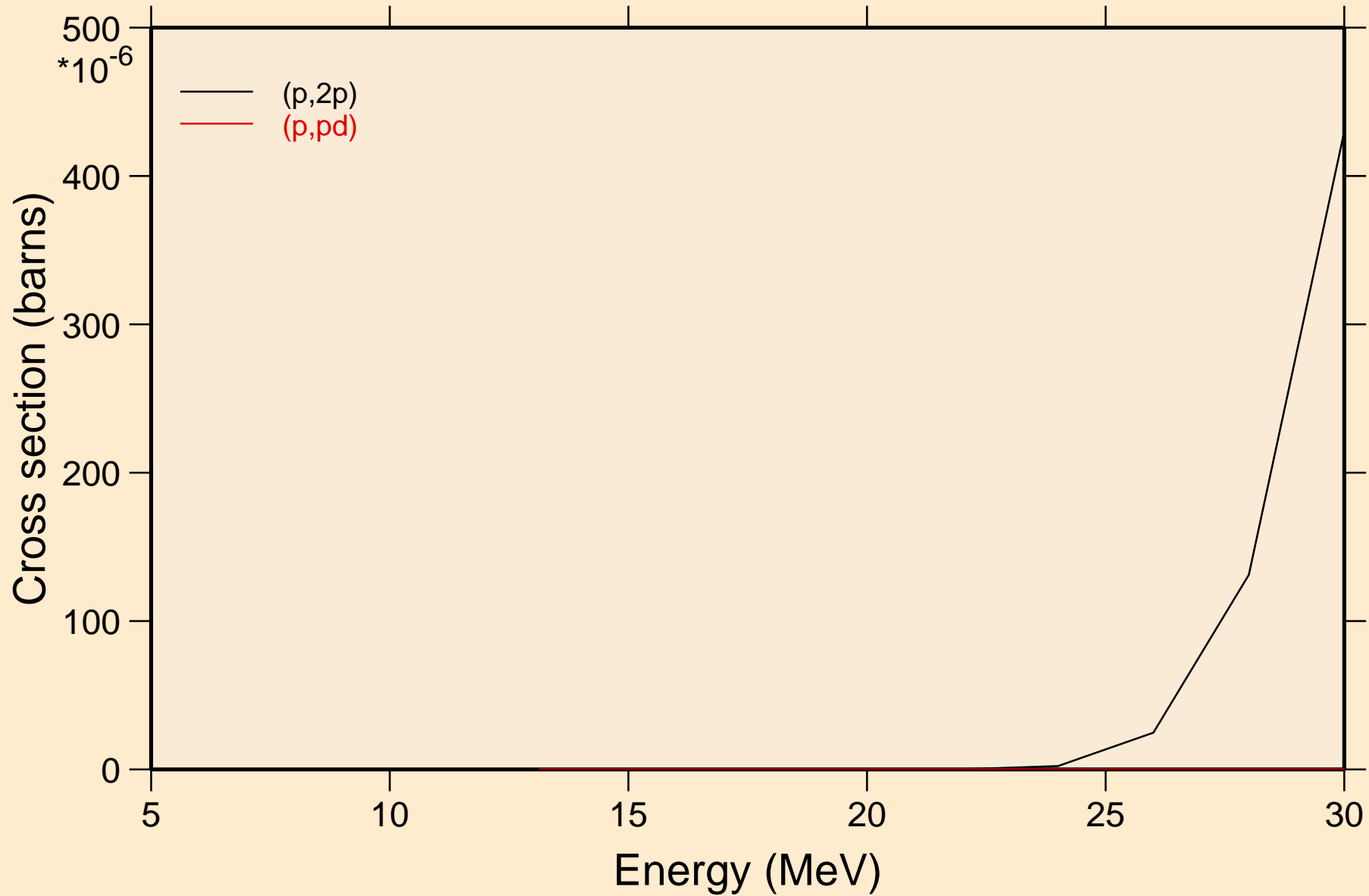



EU163 PROTON ACER TENDL-2021 LIBRARY; T=0.K  
angular distribution for elastic

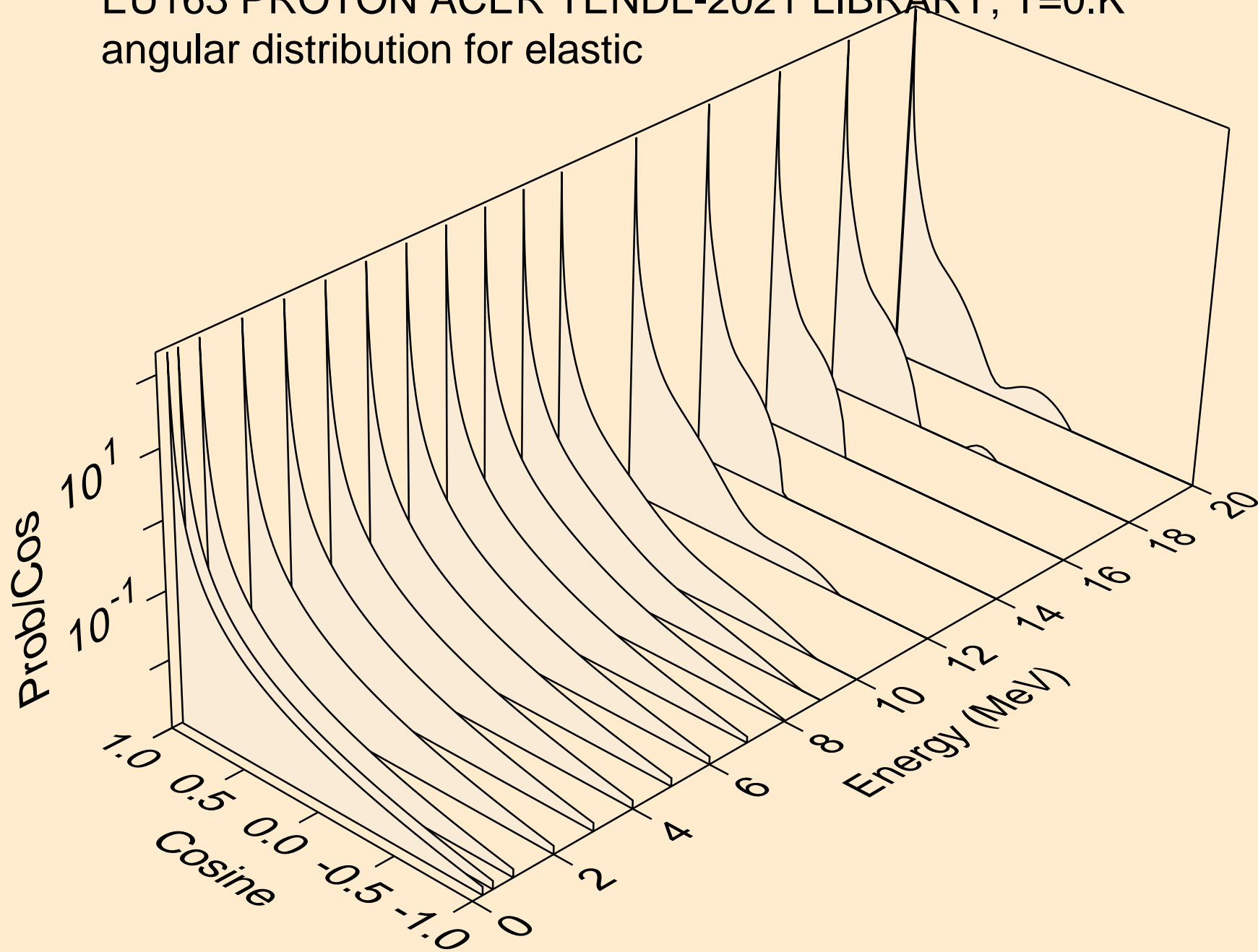

EU163 PROTON ACER TENDL-2021 LIBRARY; T=0.K  
angular distribution for elastic

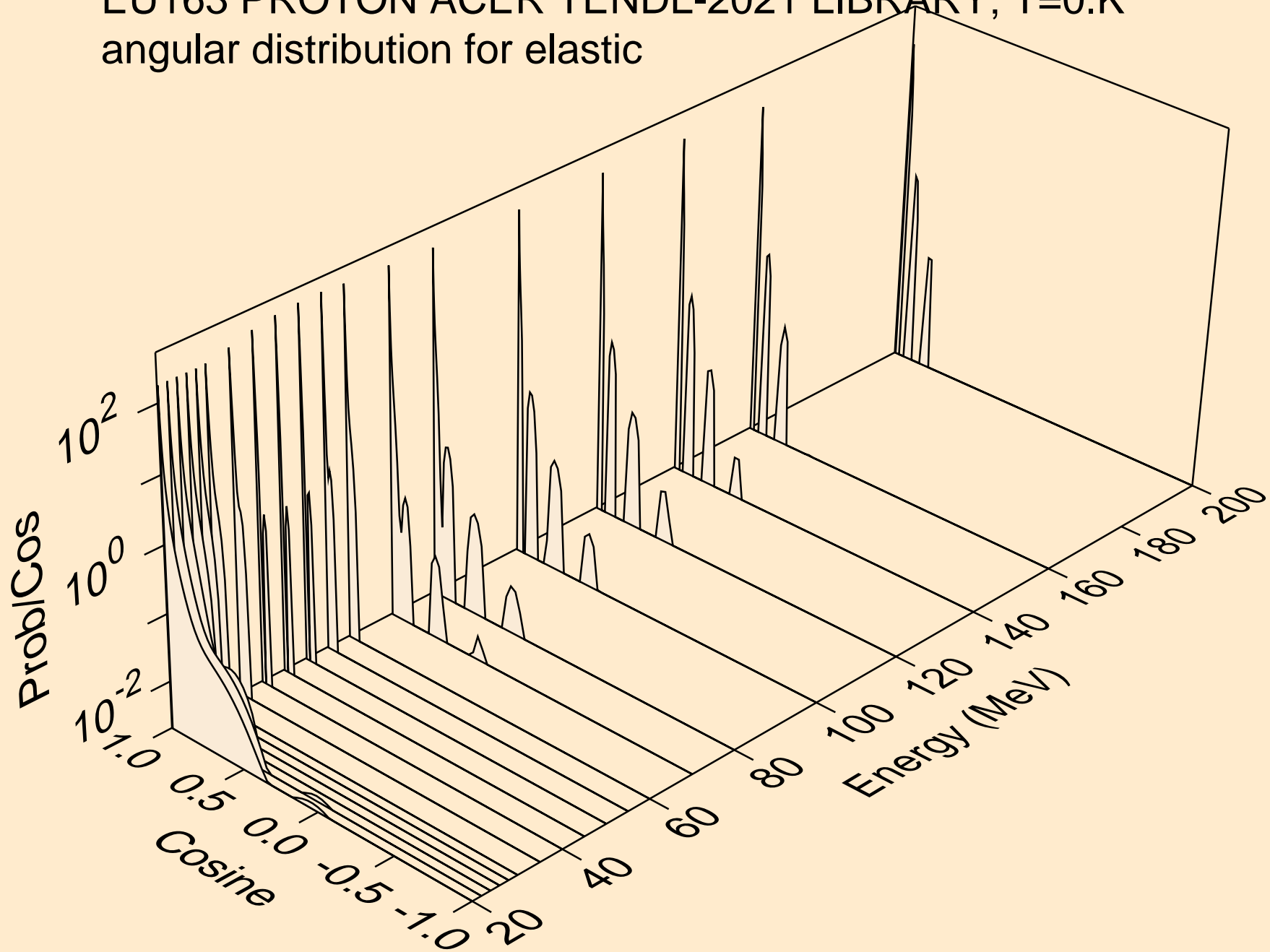

EU163 PROTON ACER TENDL-2021 LIBRARY; T=0.K  
Proton emission for (p,x)

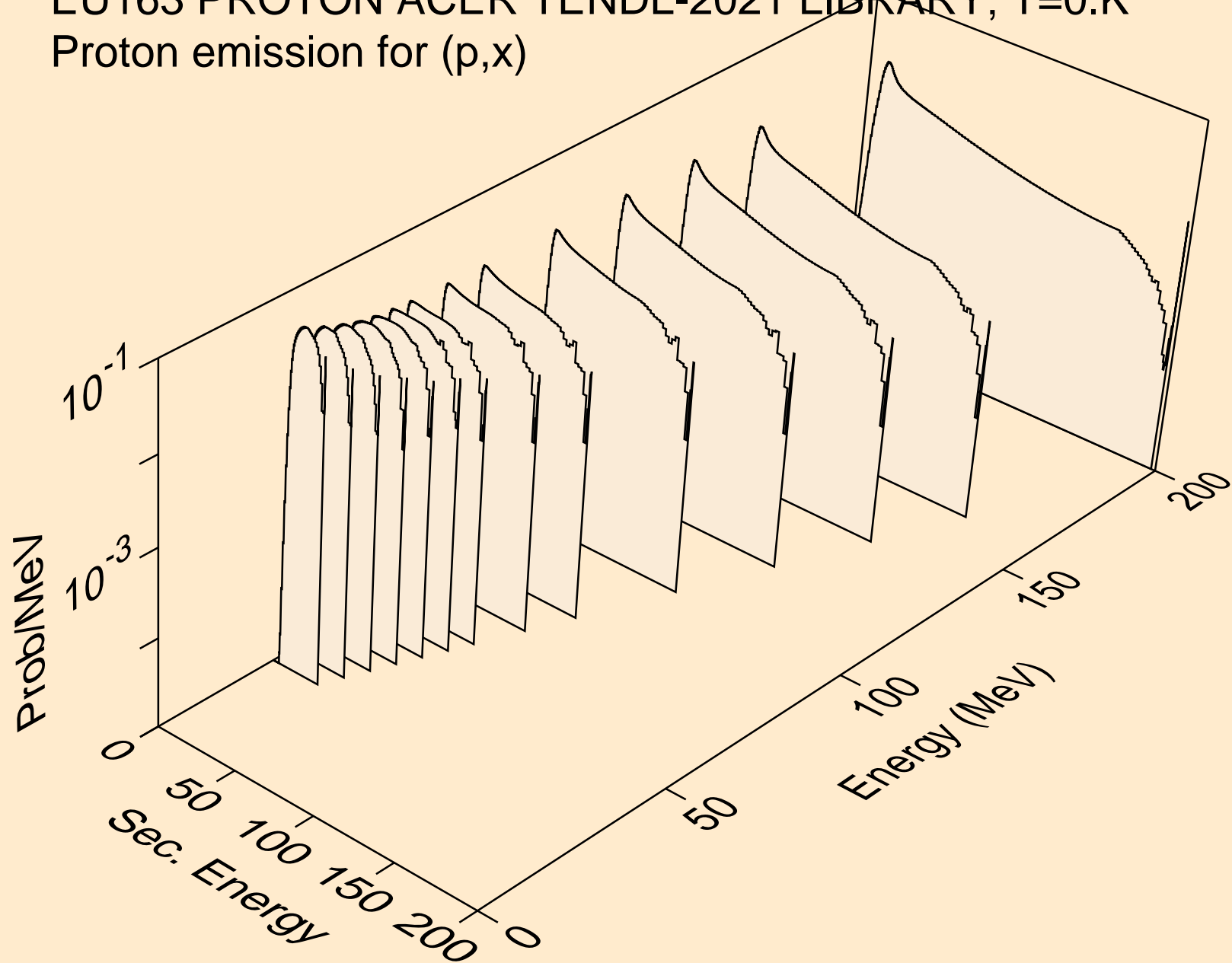

EU163 PROTON ACER TENDL-2021 LIBRARY; T=0.K  
Proton emission for (p,n\*)p

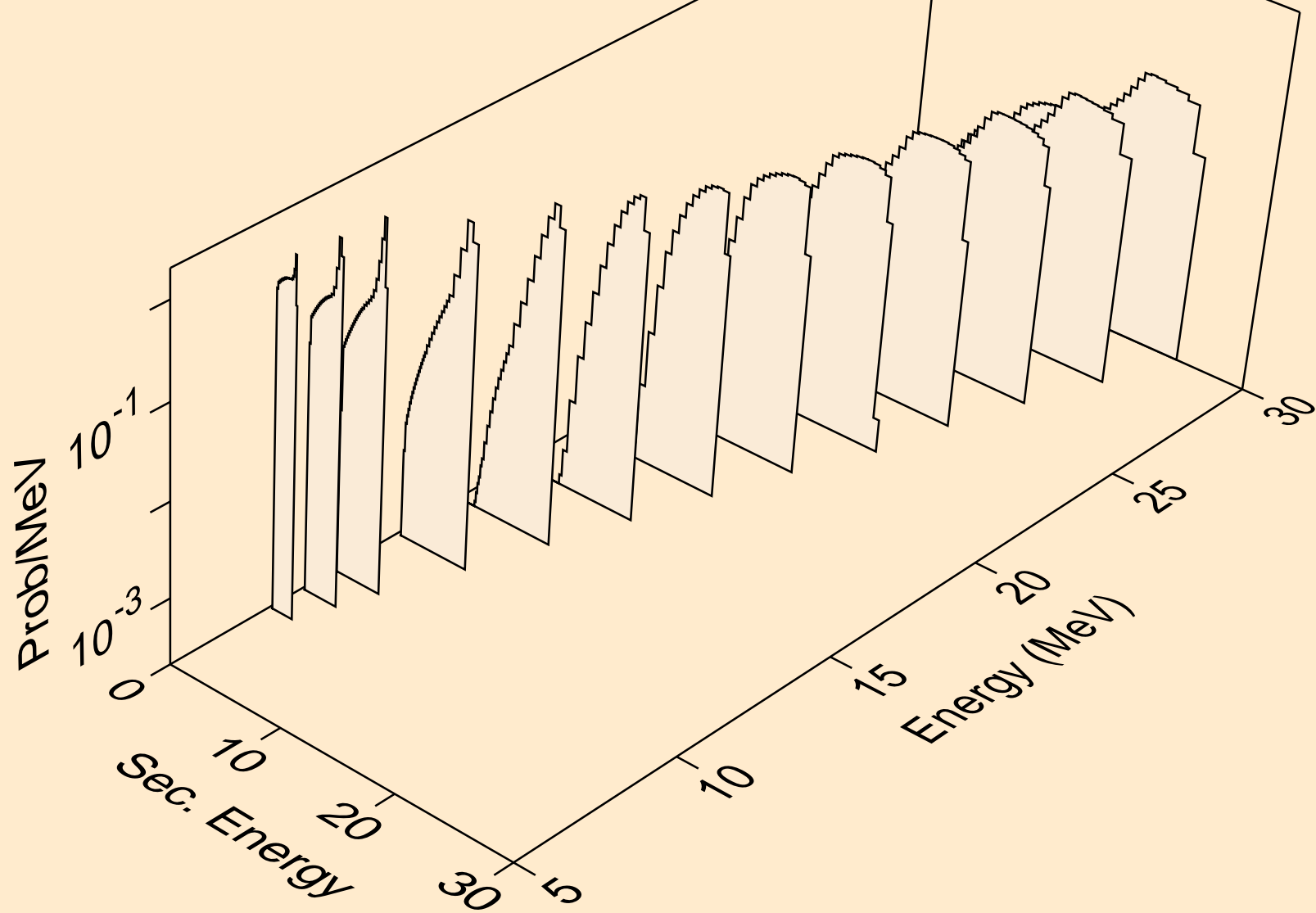

EU163 PROTON ACER TENDL-2021 LIBRARY; T=0.K  
Proton emission for (p,2np)

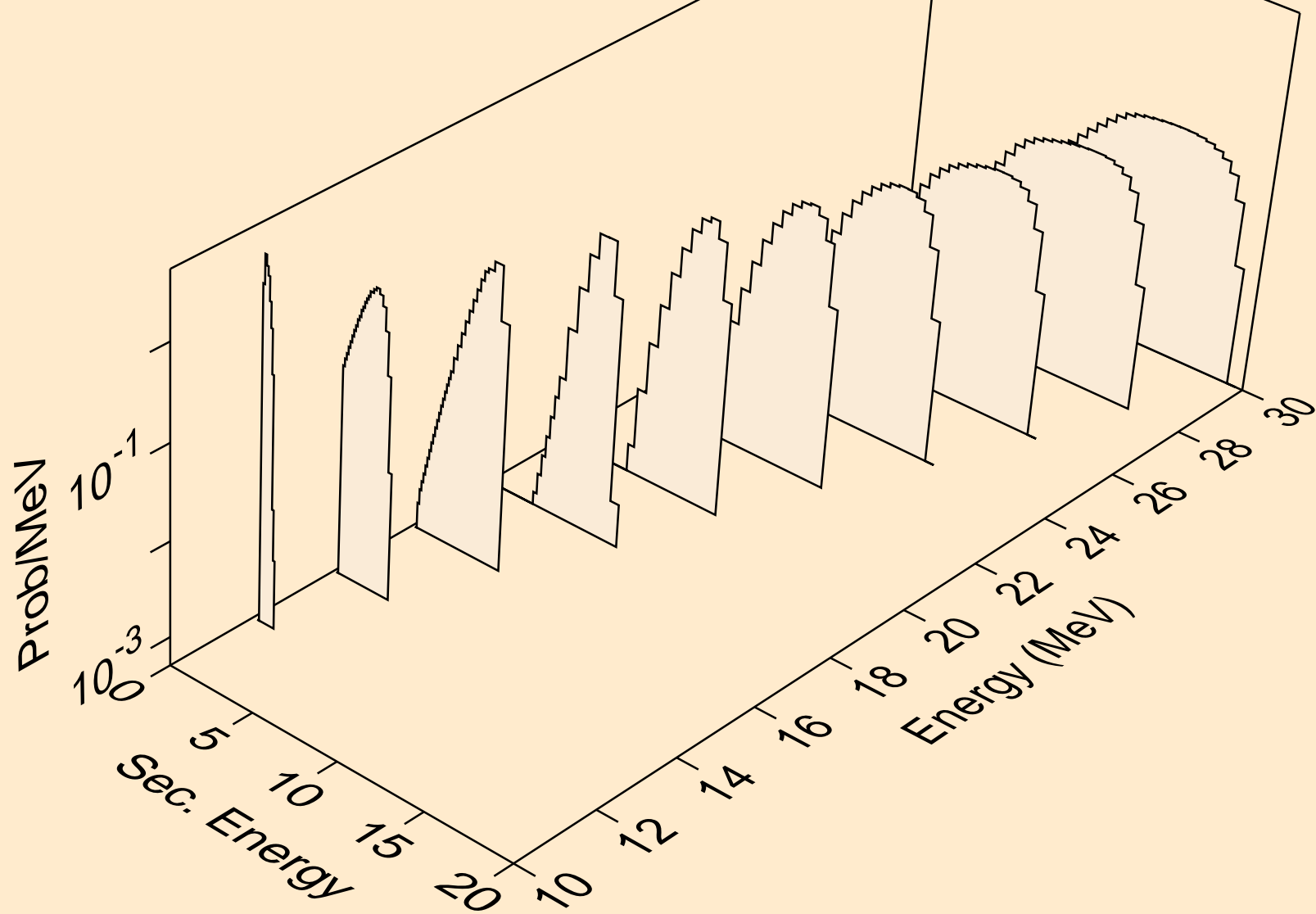

EU163 PROTON ACER TENDL-2021 LIBRARY; T=0.K  
Proton emission for (p,3np)

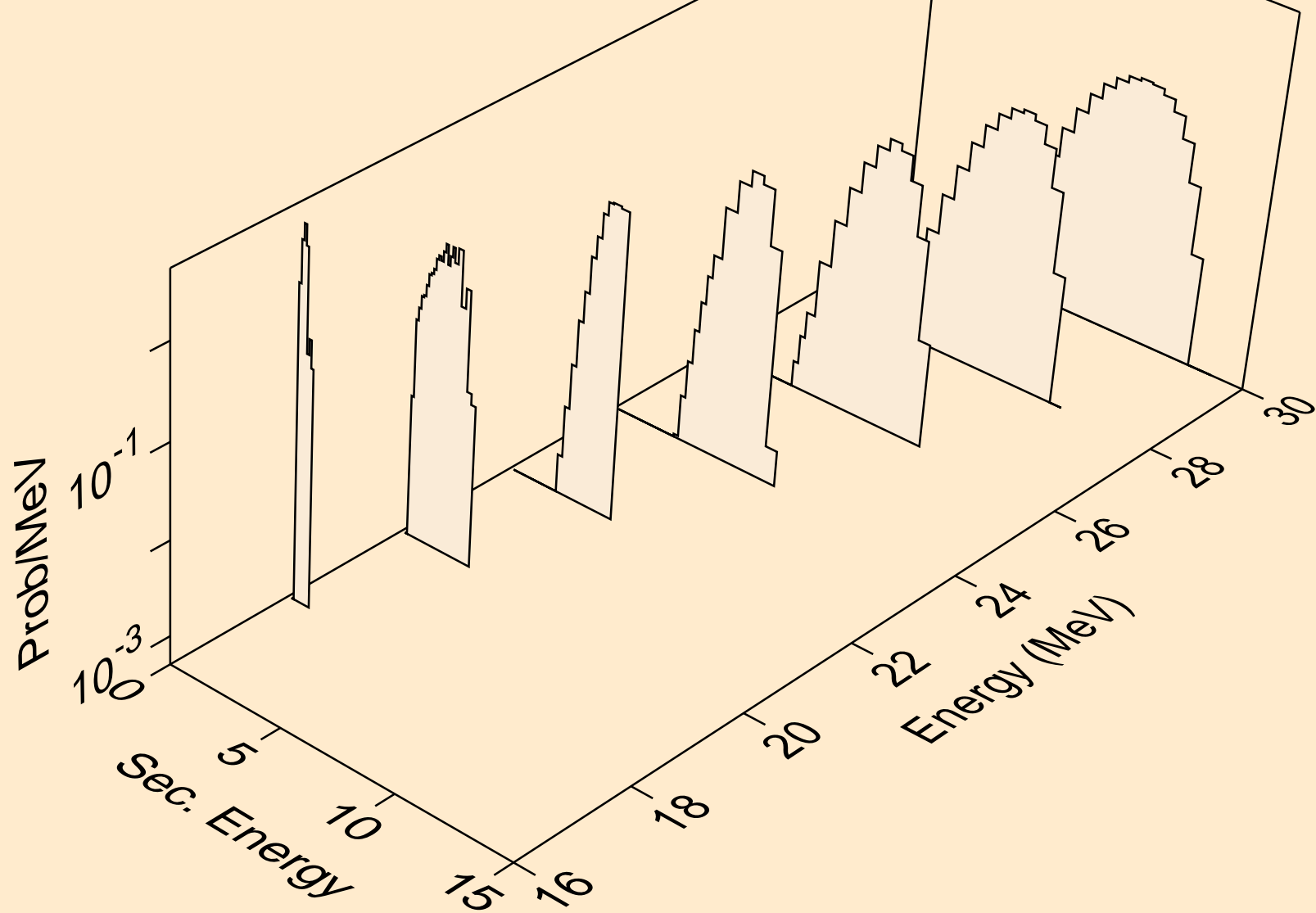

EU163 PROTON ACER TENDL-2021 LIBRARY; T=0.K  
Proton emission for (p,2np)

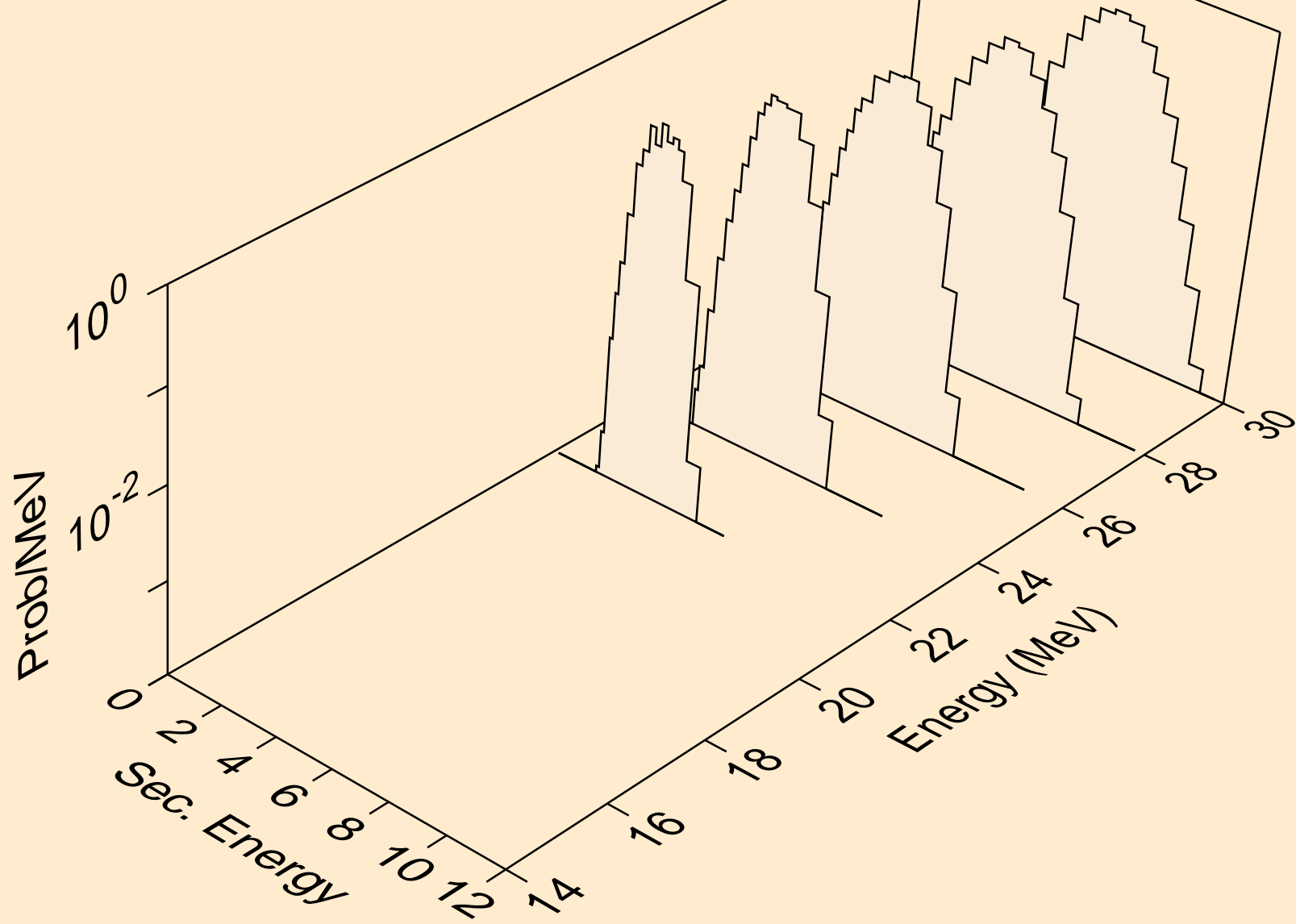

EU163 PROTON ACER TENDL-2021 LIBRARY; T=0.K  
Proton emission for inelastic

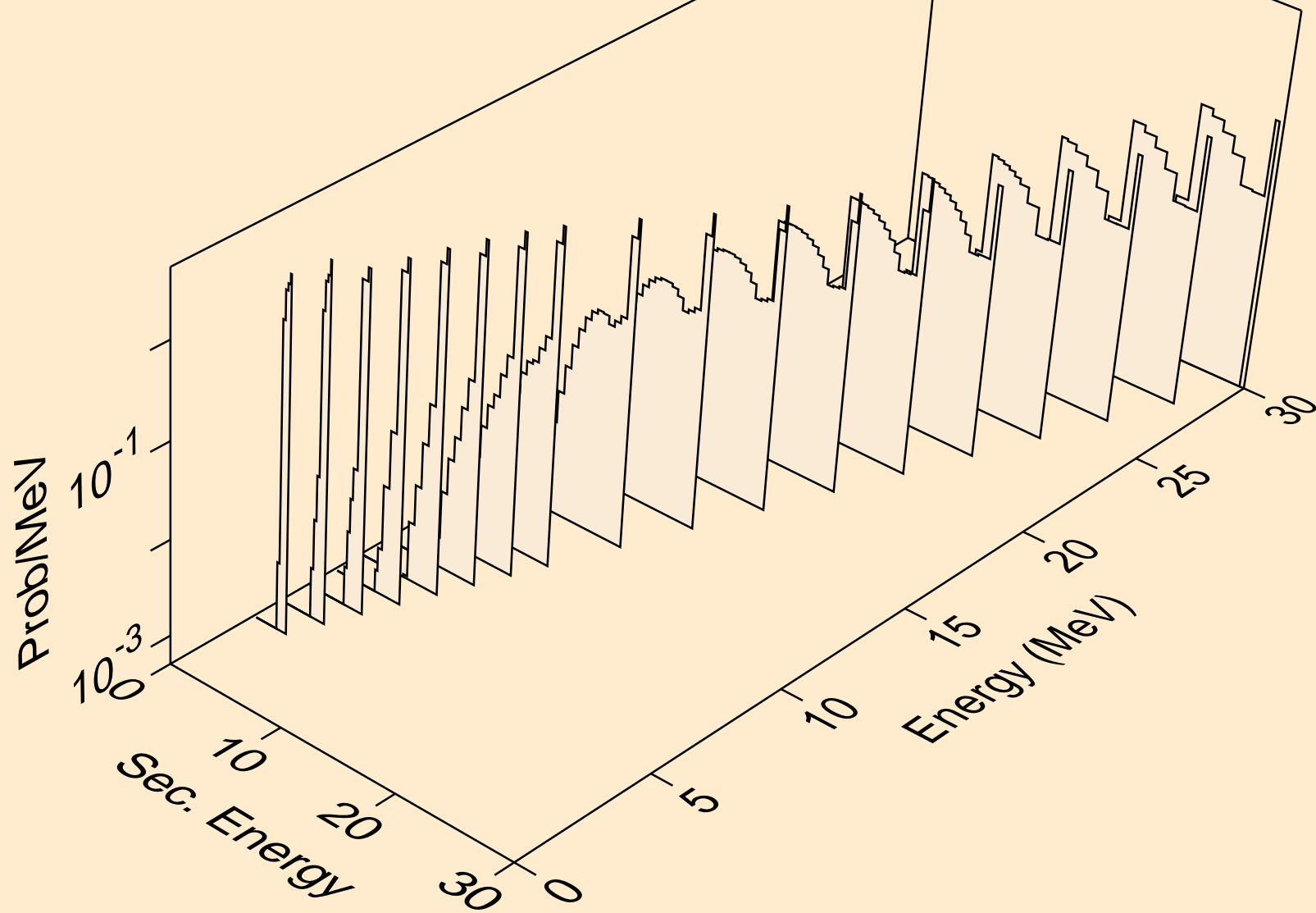



EU163 PROTON ACER TENDL-2021 LIBRARY; T=0.K  
Proton emission for (p,2p)

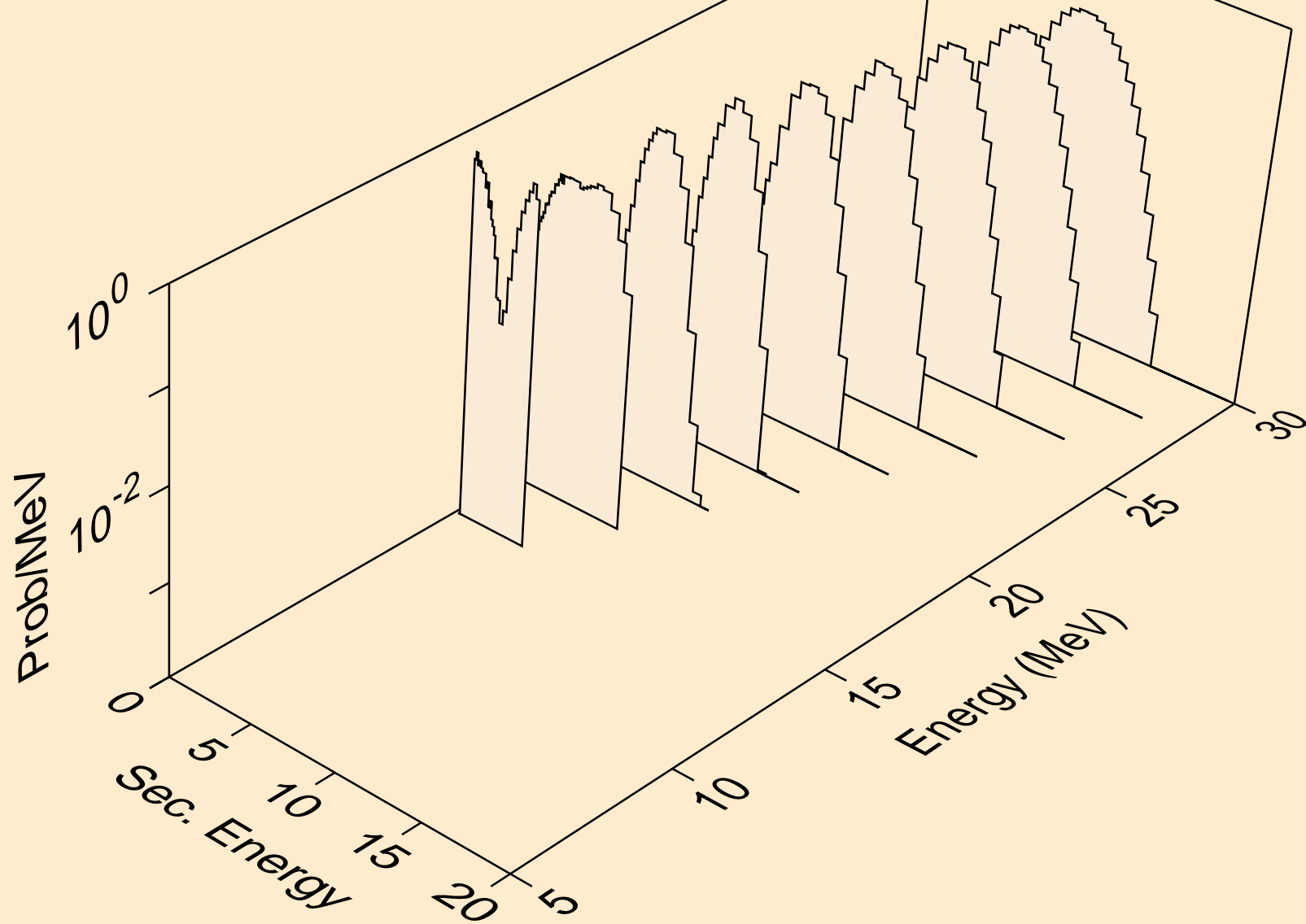

EU163 PROTON ACER TENDL-2021 LIBRARY; T=0.K  
Proton emission for (p,pd)

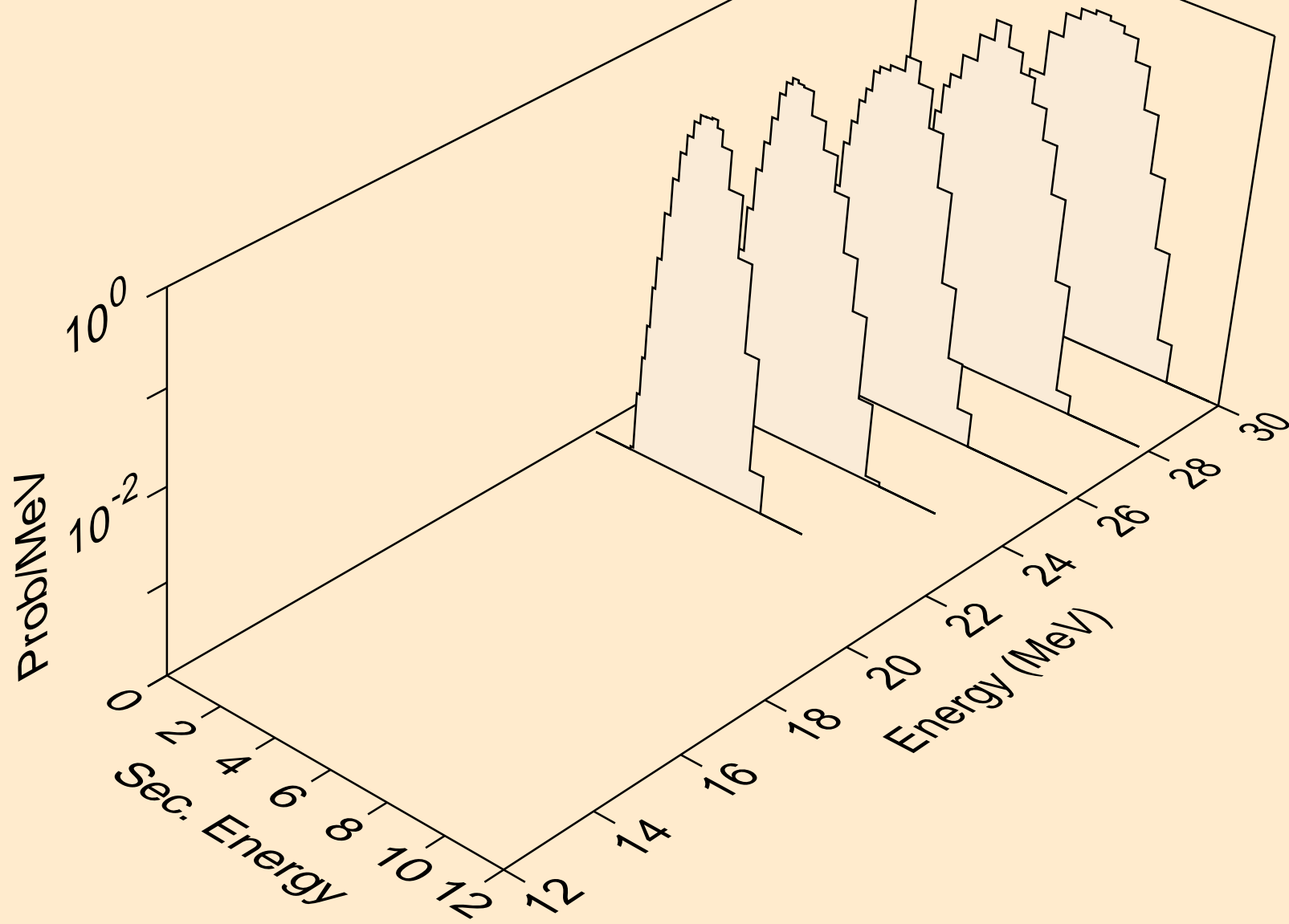

EU163 PROTON ACER TENDL-2021 LIBRARY; T=0.K  
Photon emission for (z,n)

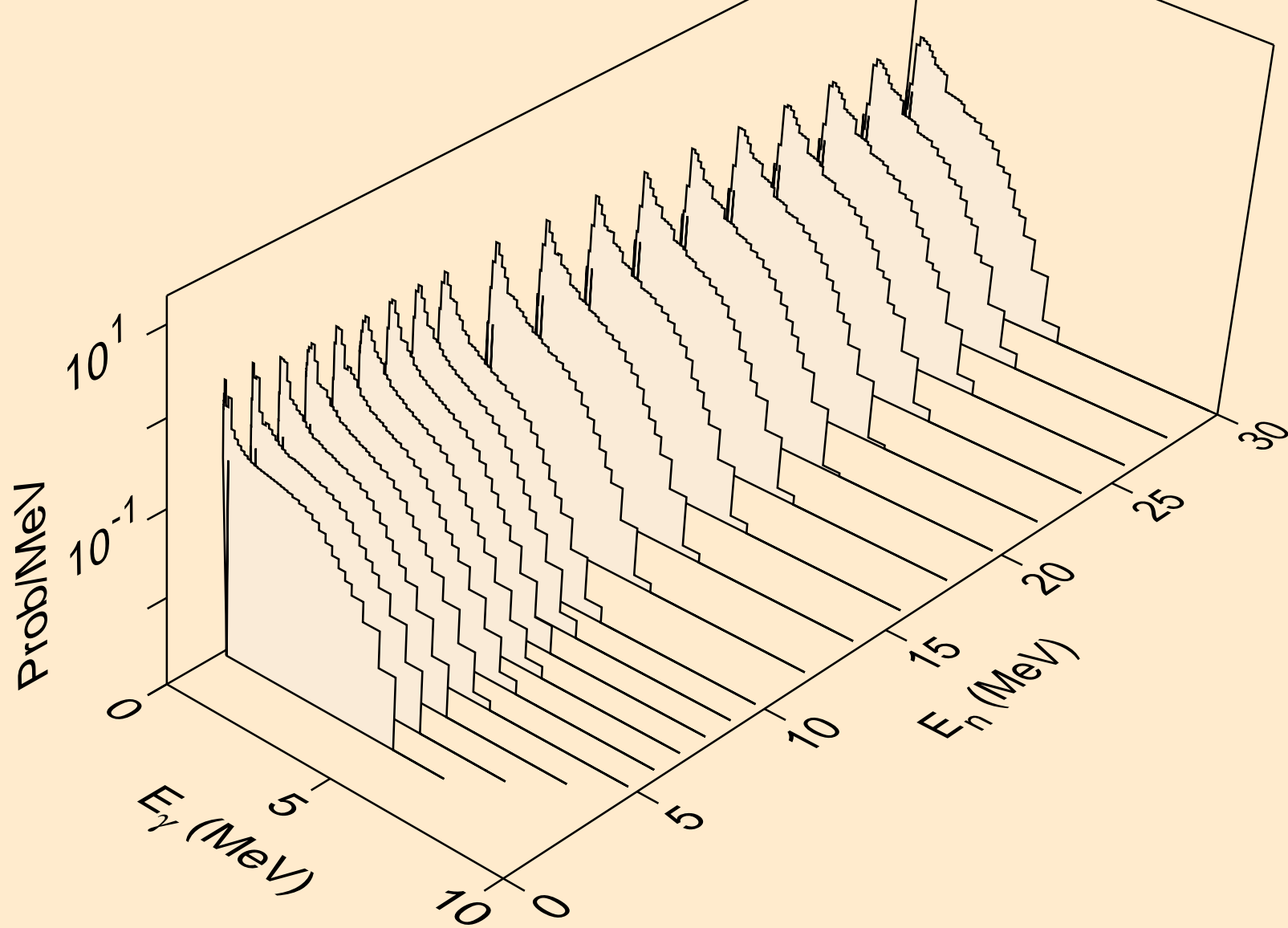

EU163 PROTON ACER TENDL-2021 LIBRARY; T=0.K  
Photon emission for (n,x)

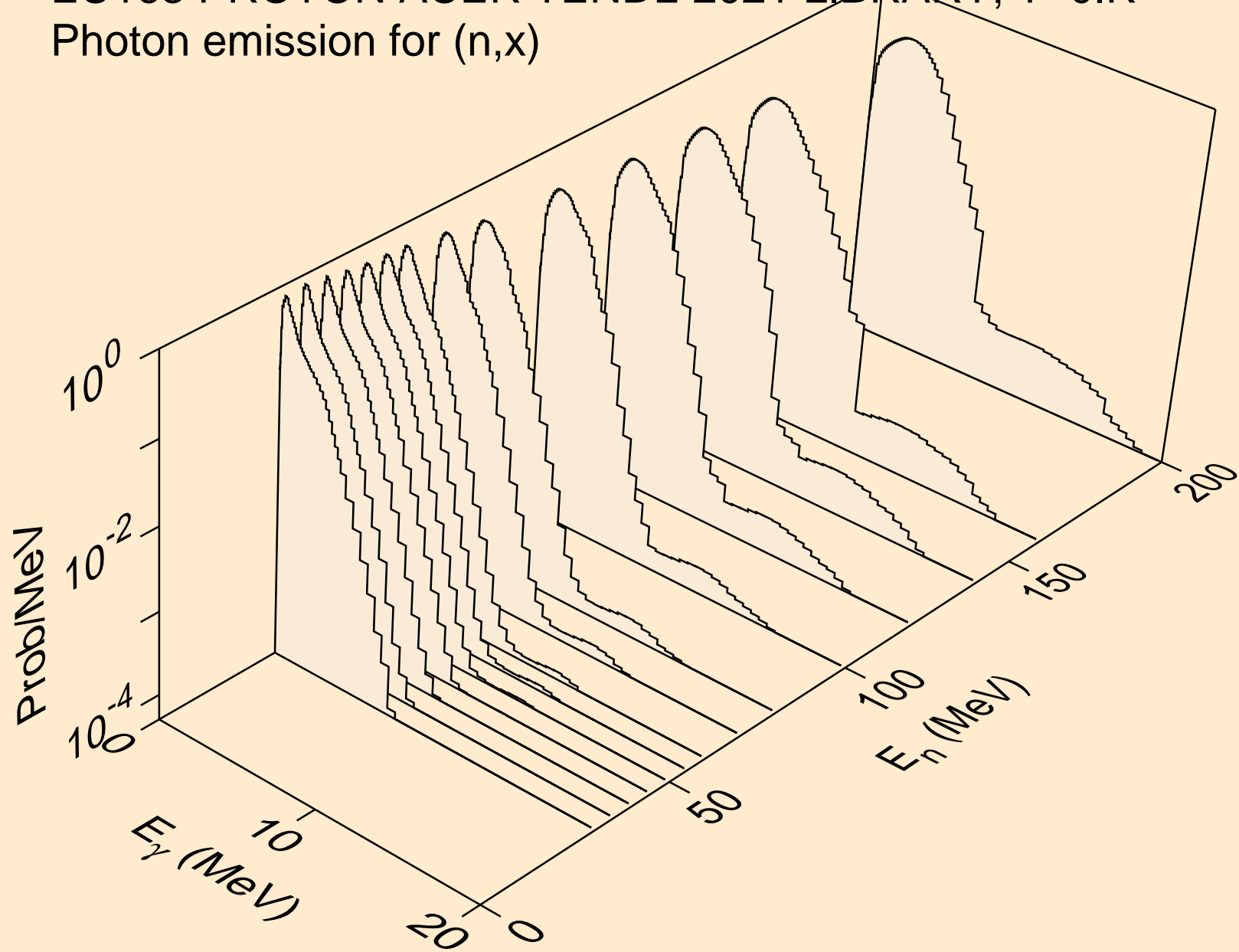

EU163 PROTON ACER TENDL-2021 LIBRARY; T=0.K  
Photon emission for (n,2nd)

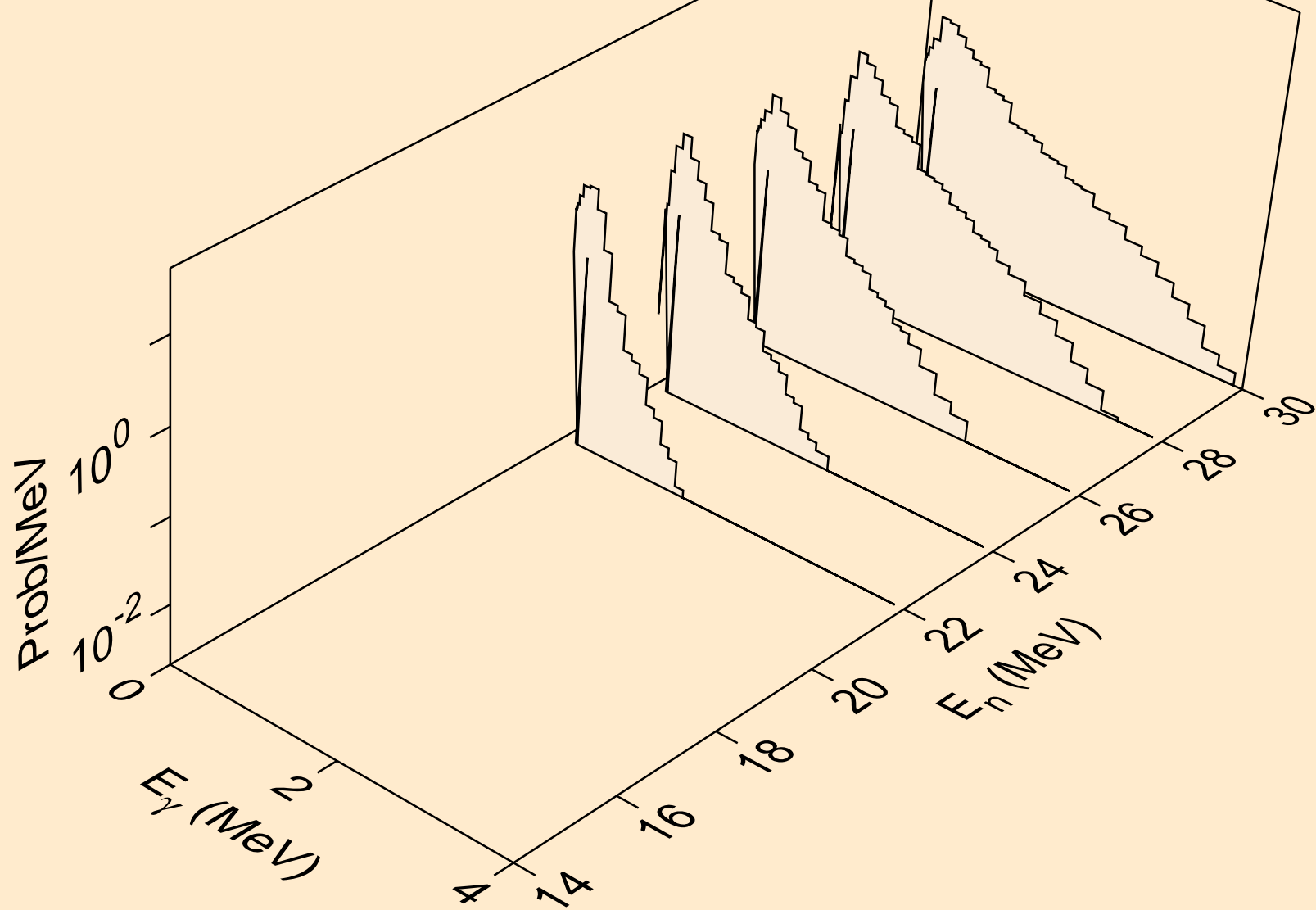

EU163 PROTON ACER TENDL-2021 LIBRARY; T=0.K  
Photon emission for (n,2n)

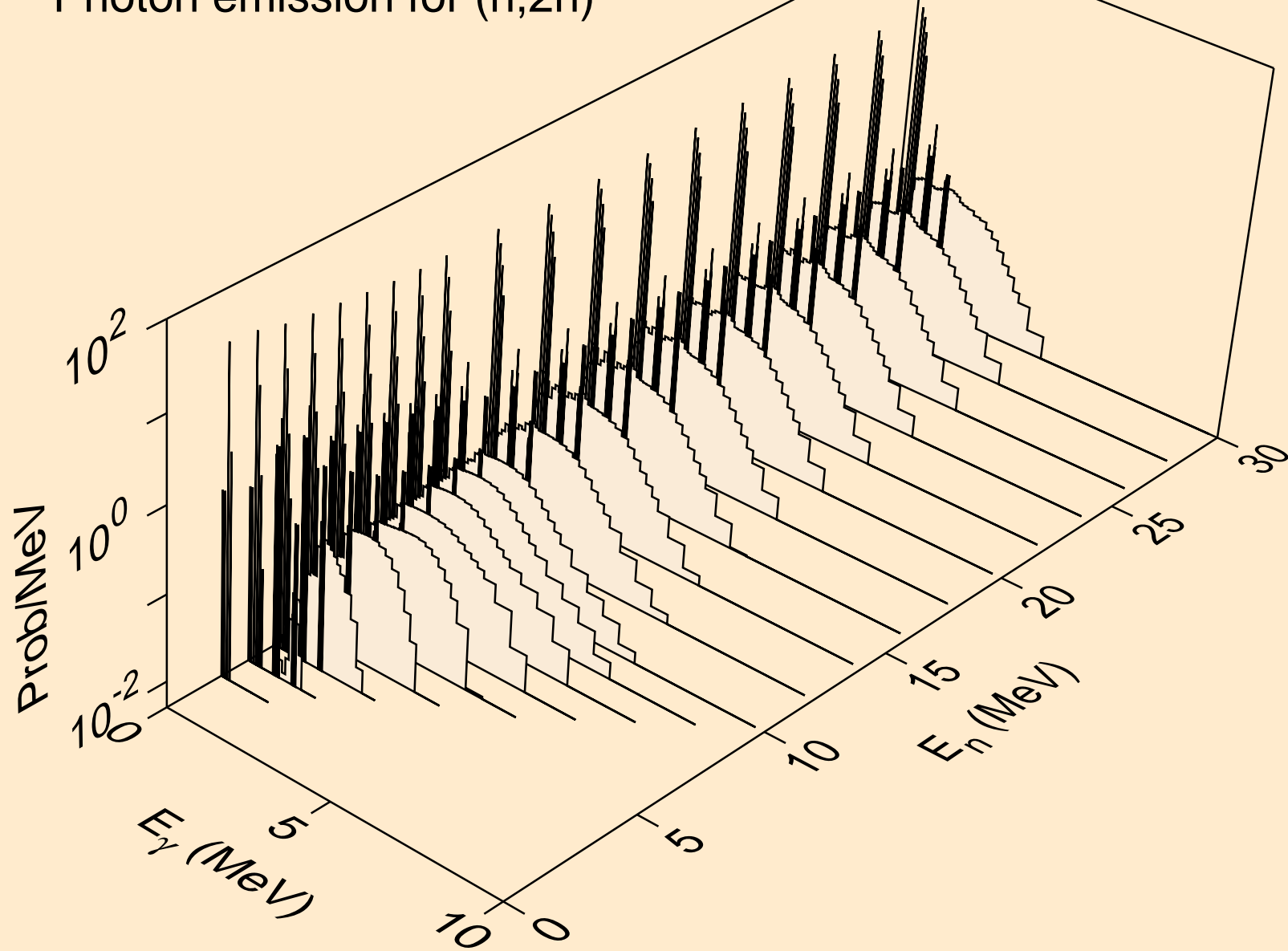

EU163 PROTON ACER TENDL-2021 LIBRARY; T=0.K  
Photon emission for (n,3n)

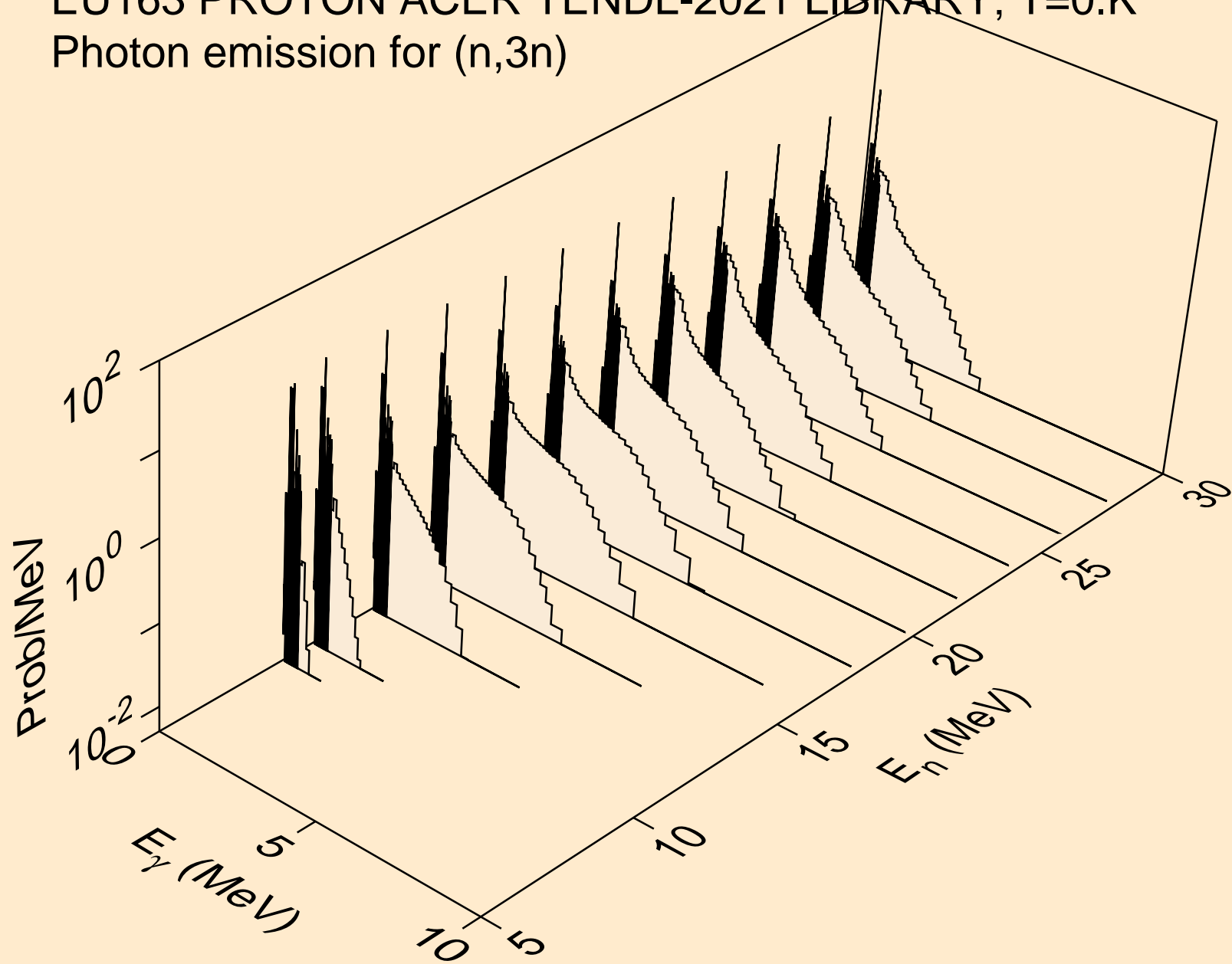

EU163 PROTON ACER TENDL-2021 LIBRARY; T=0.K  
Photon emission for (n,n\*)a

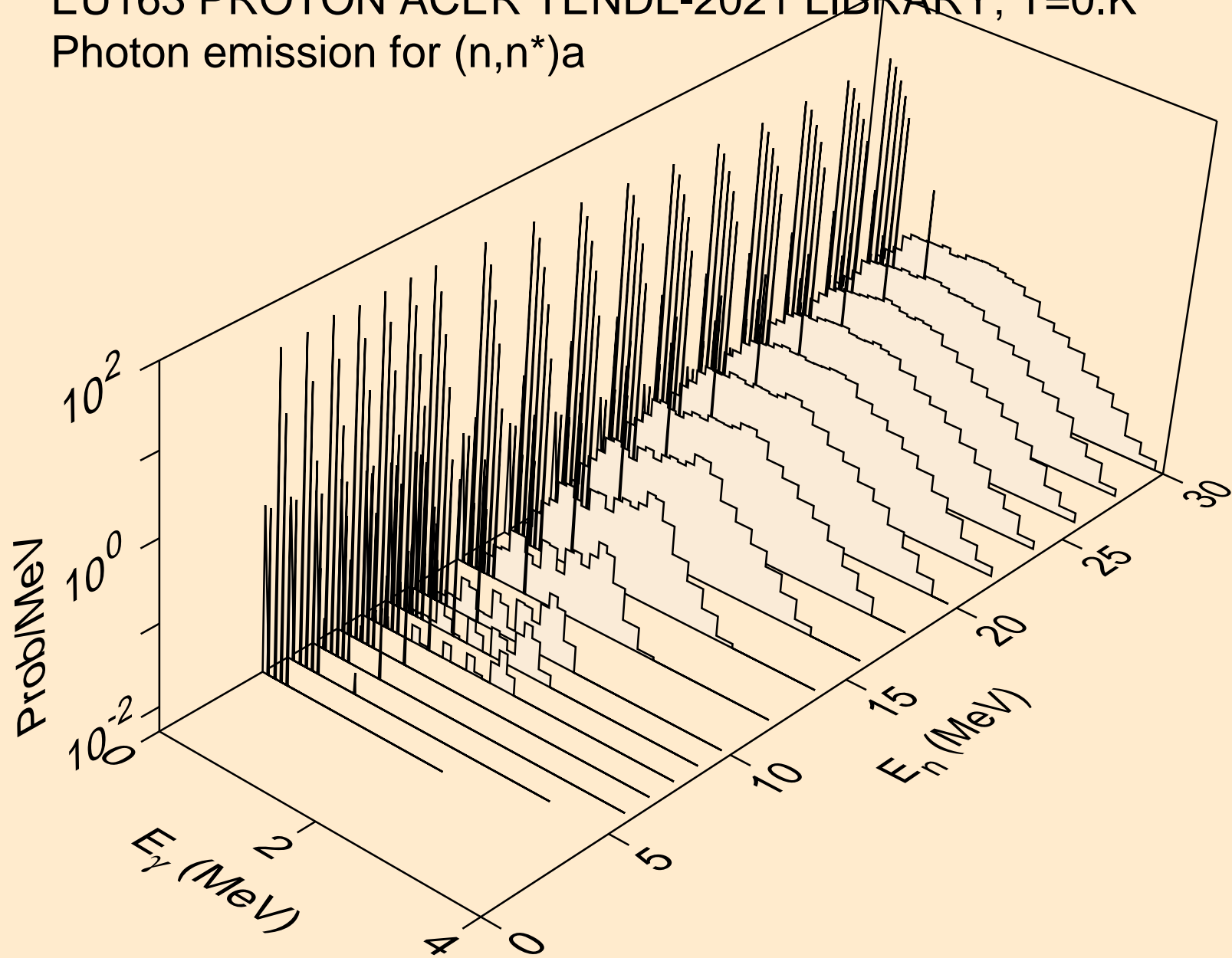



EU163 PROTON ACER TENDL-2021 LIBRARY; T=0.K  
Photon emission for (n,2n)a

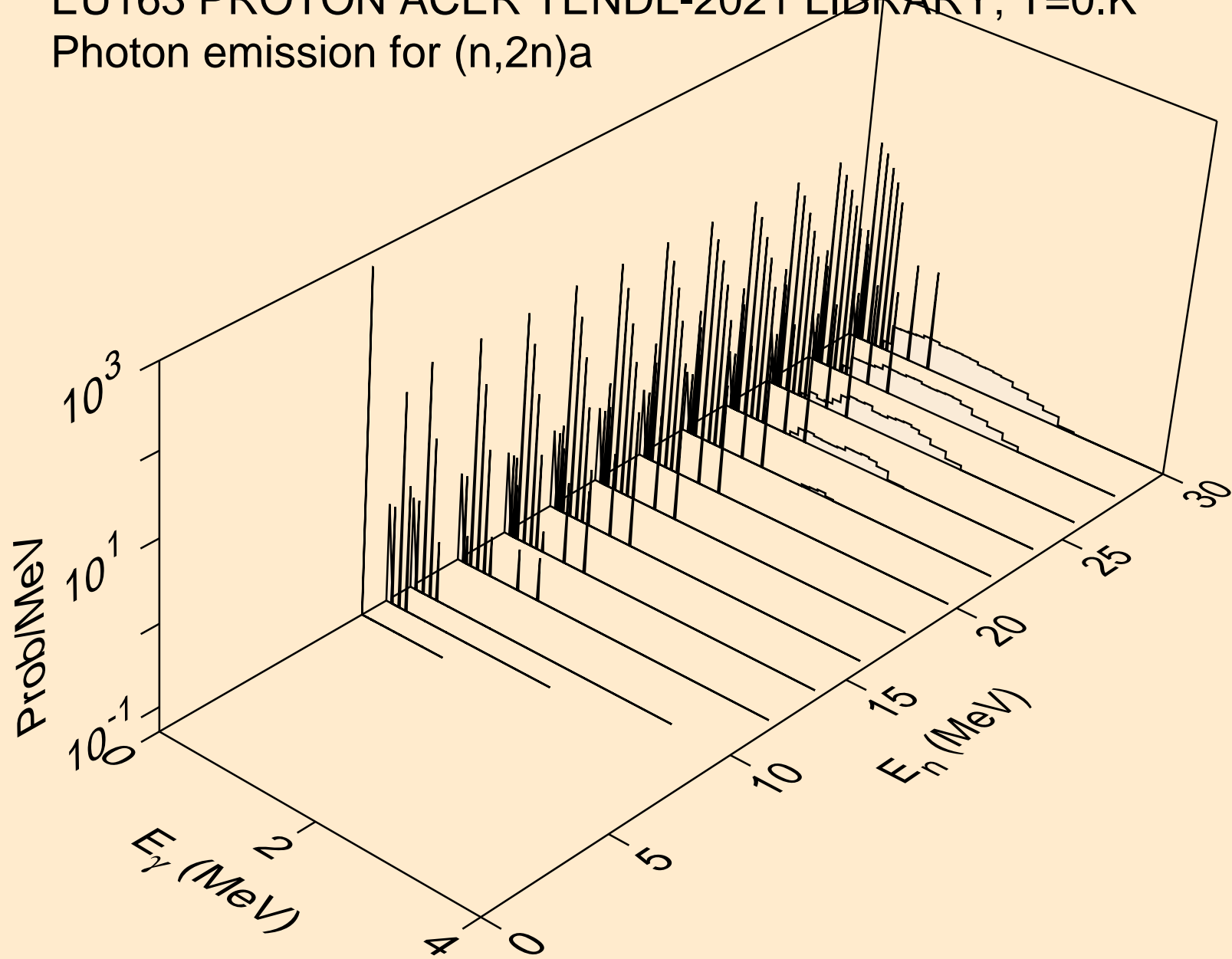

EU163 PROTON ACER TENDL-2021 LIBRARY; T=0.K  
Photon emission for (n,3n)a

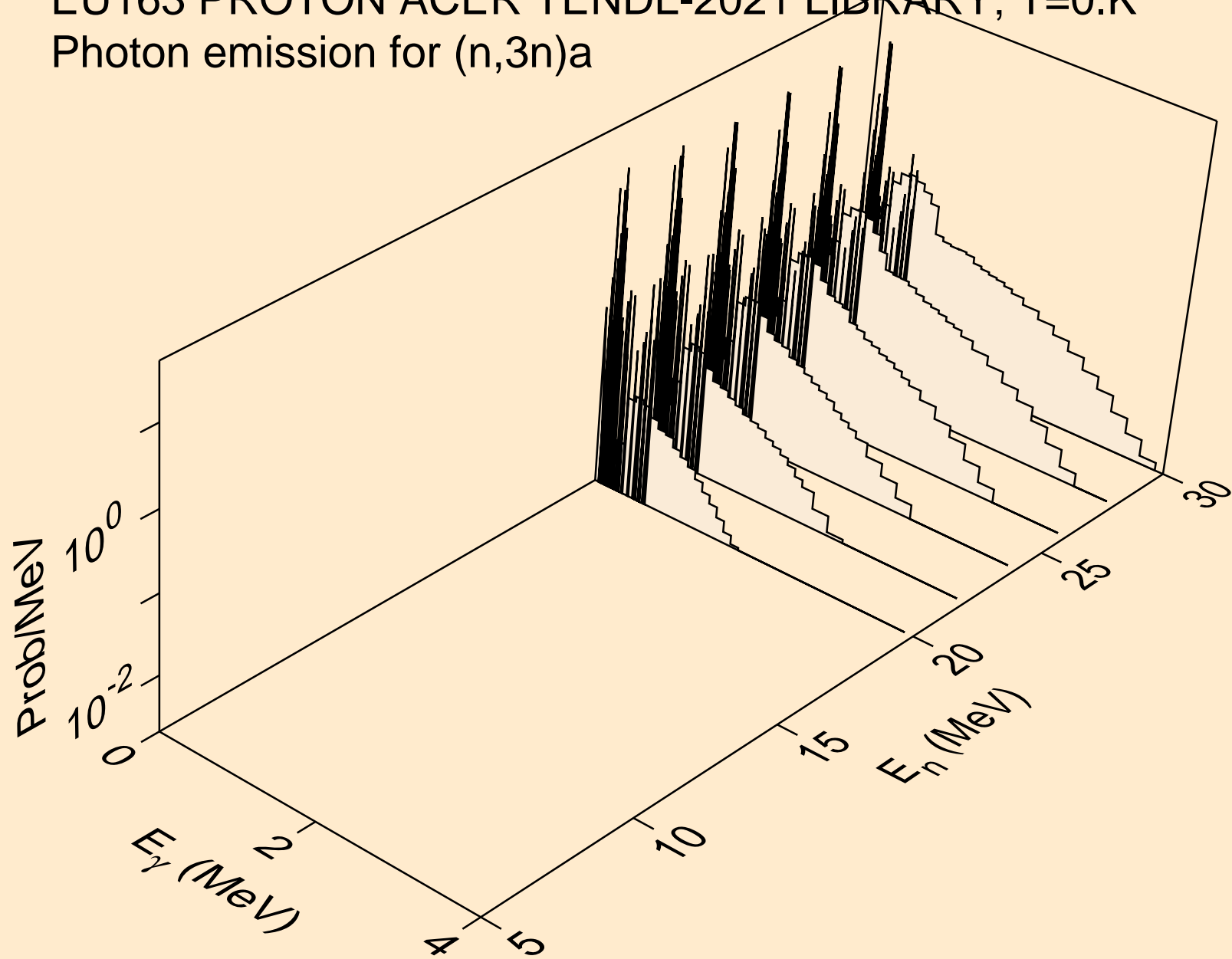

EU163 PROTON ACER TENDL-2021 LIBRARY; T=0.K  
Photon emission for (n,n\*)p

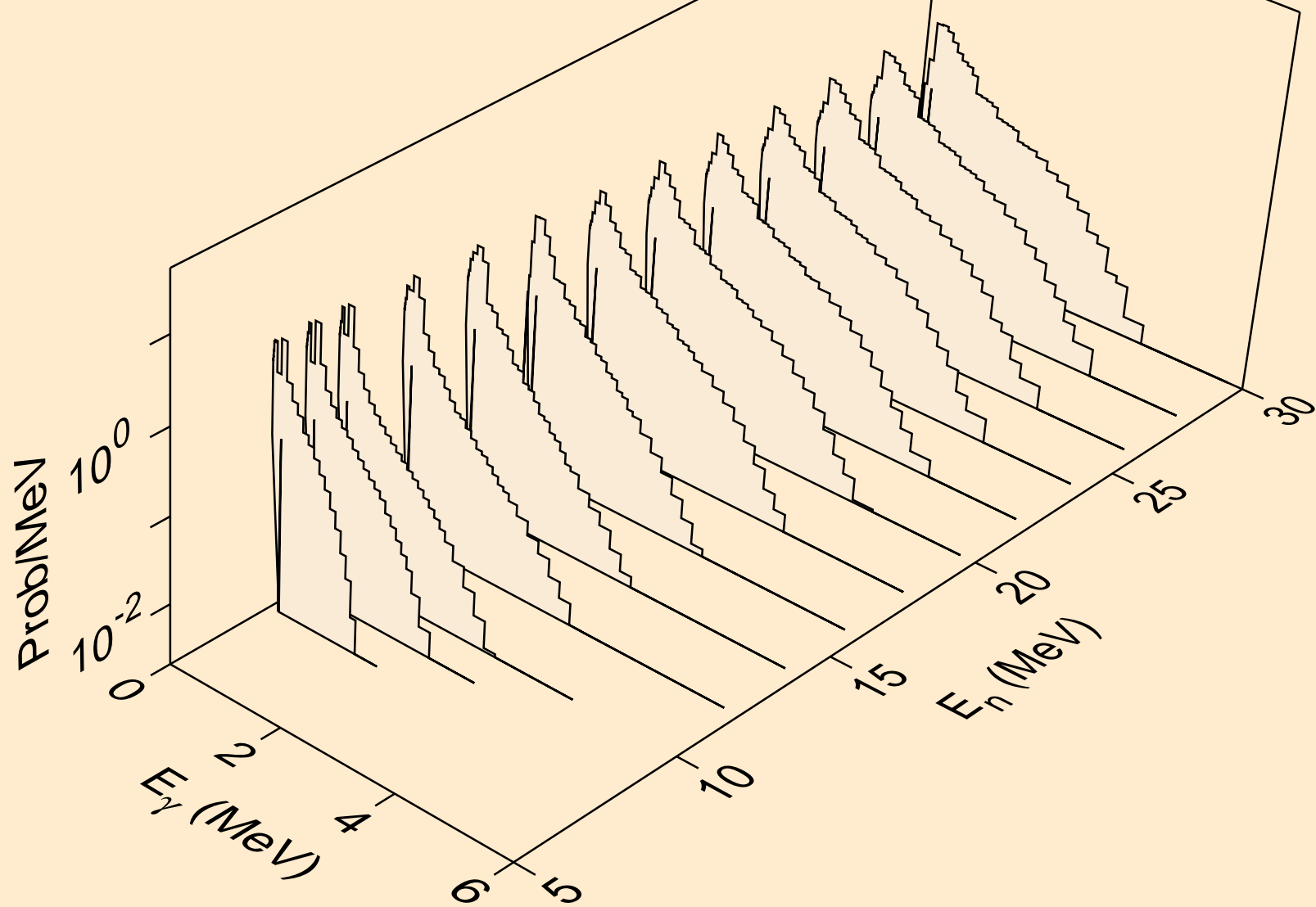

EU163 PROTON ACER TENDL-2021 LIBRARY; T=0.K  
Photon emission for (n,n\*)d

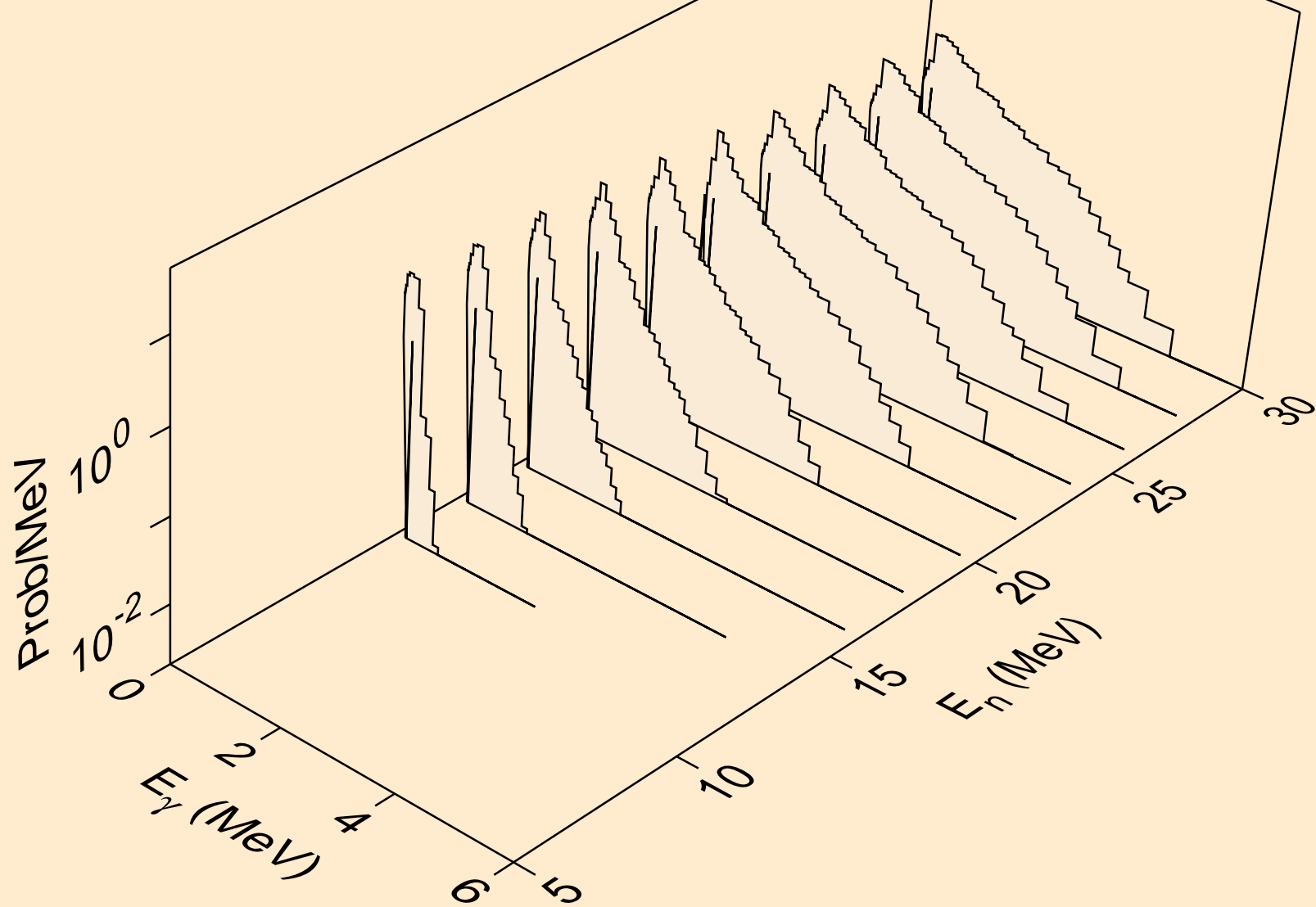

EU163 PROTON ACER TENDL-2021 LIBRARY; T=0.K  
Photon emission for (n,n\*)t

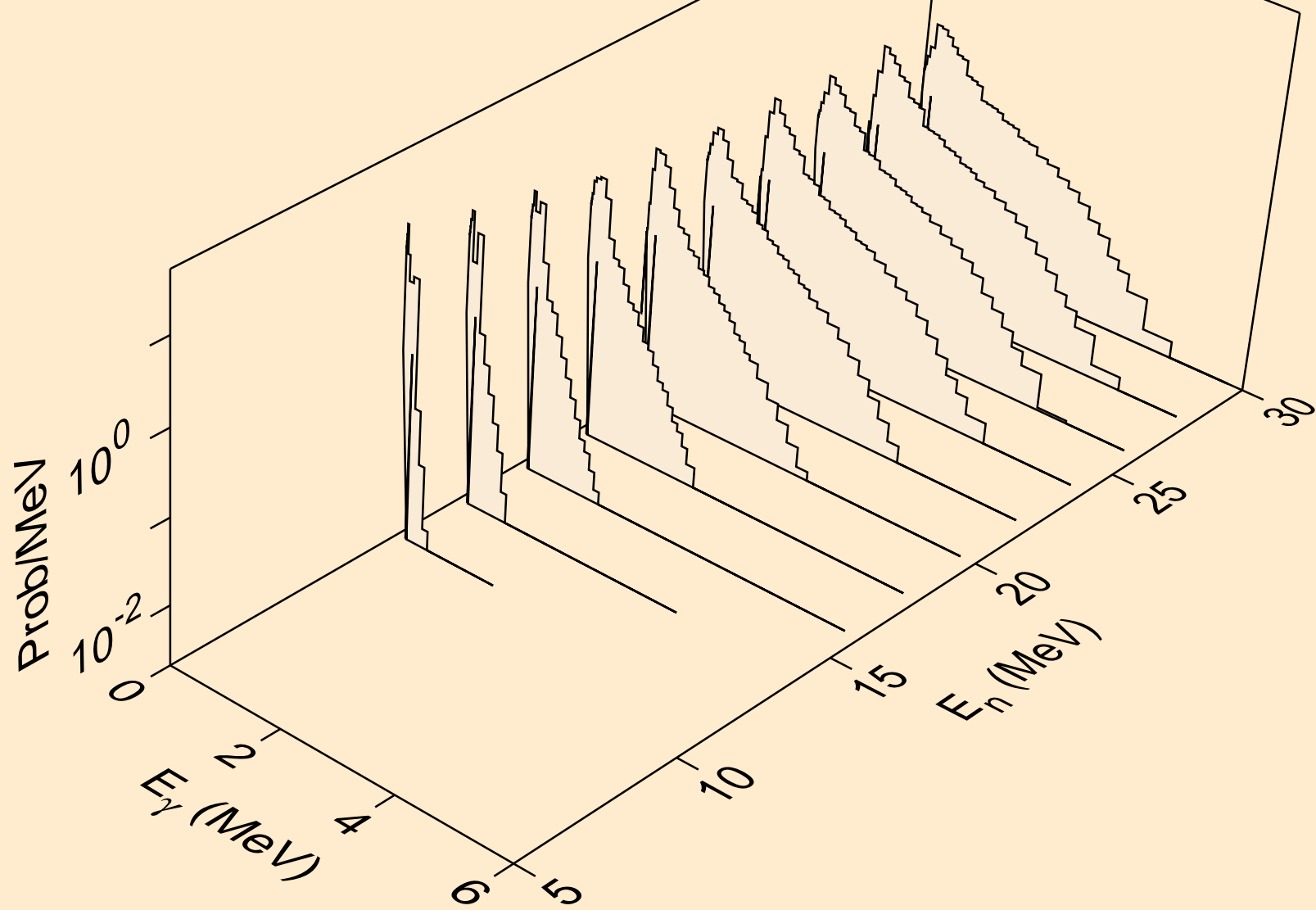

EU163 PROTON ACER TENDL-2021 LIBRARY; T=0.K  
Photon emission for (n,n\*)he3

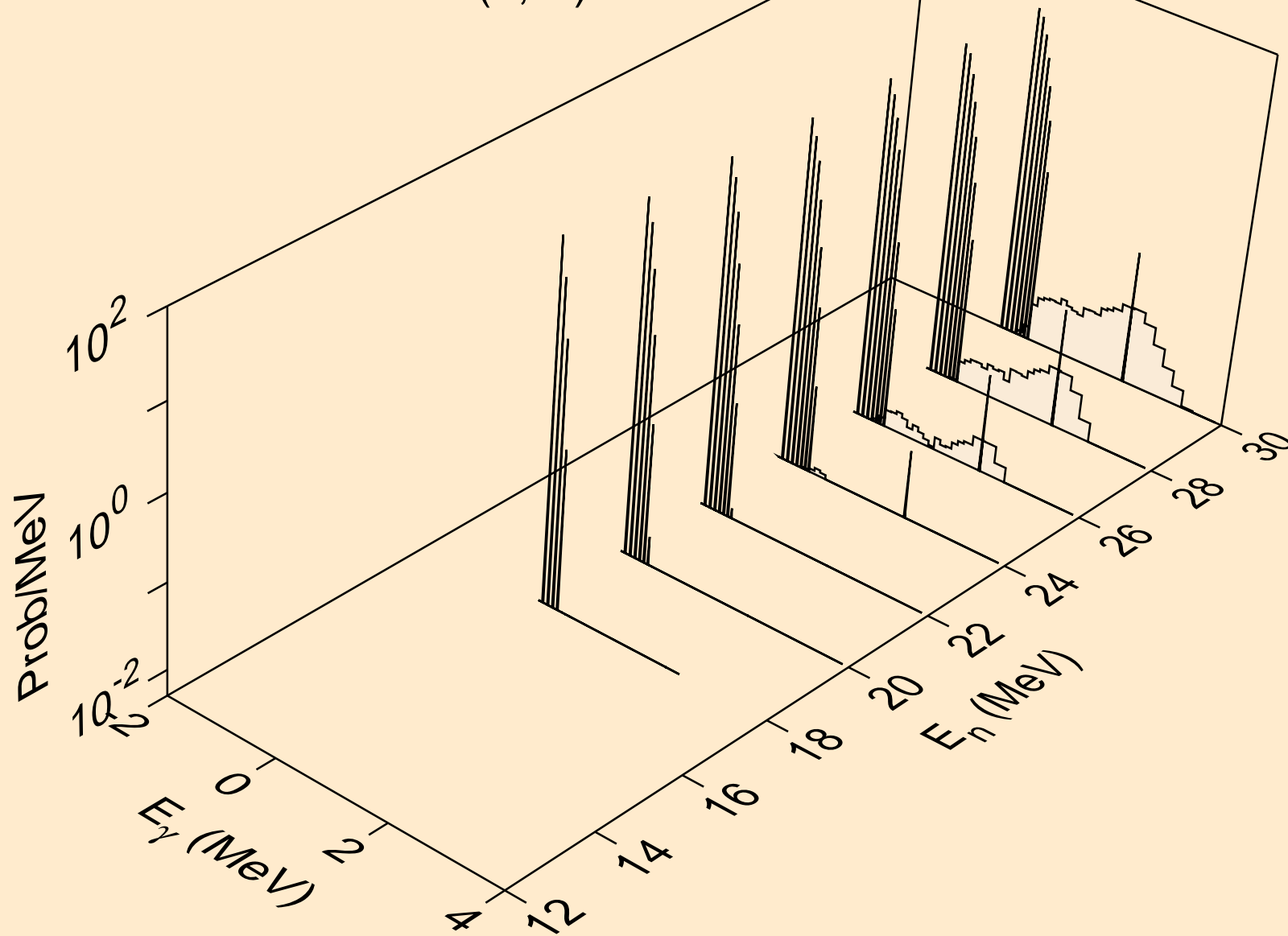

EU163 PROTON ACER TENDL-2021 LIBRARY; T=0.K  
Photon emission for (n,4n)

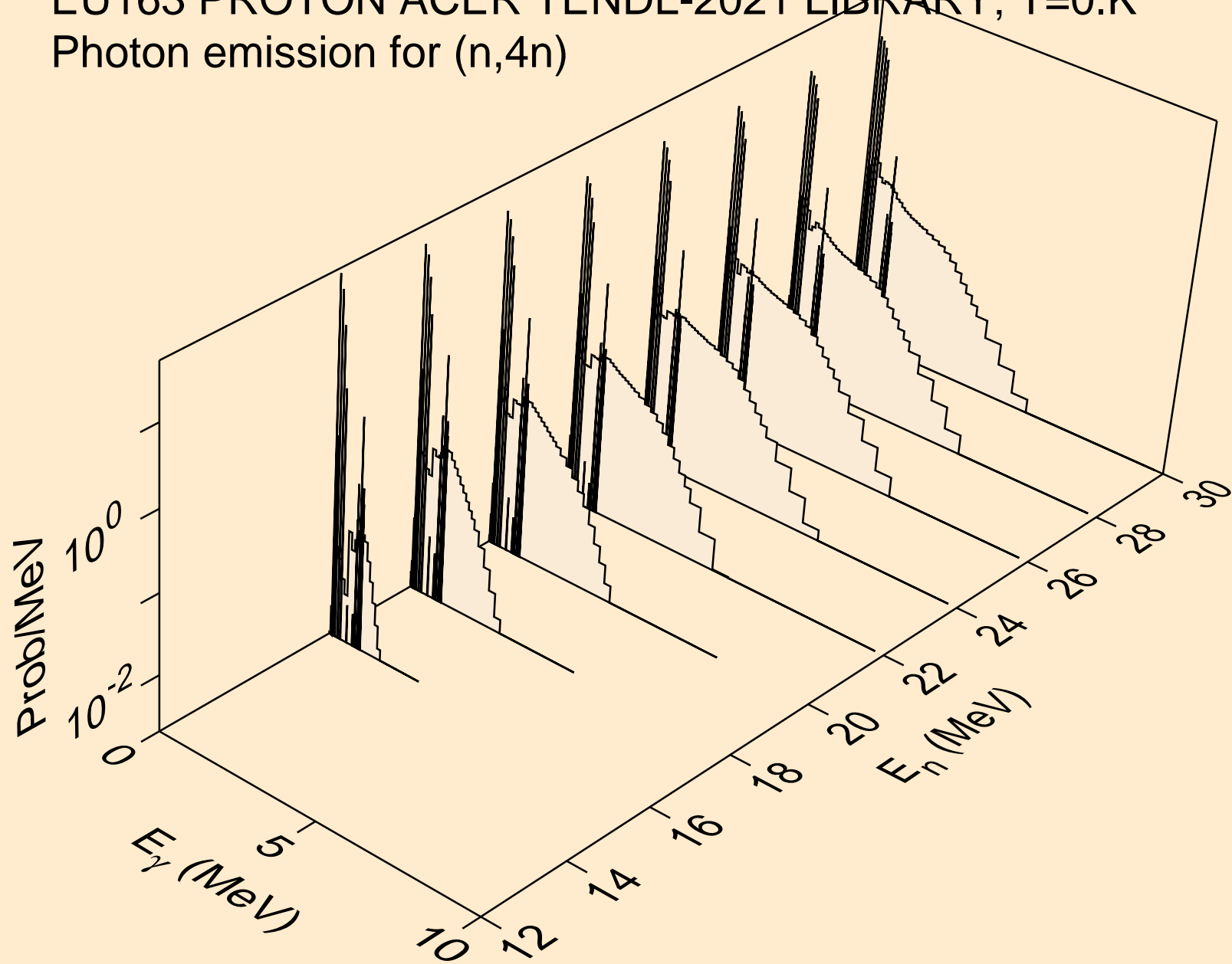

EU163 PROTON ACER TENDL-2021 LIBRARY; T=0.K  
Photon emission for (n,2np)

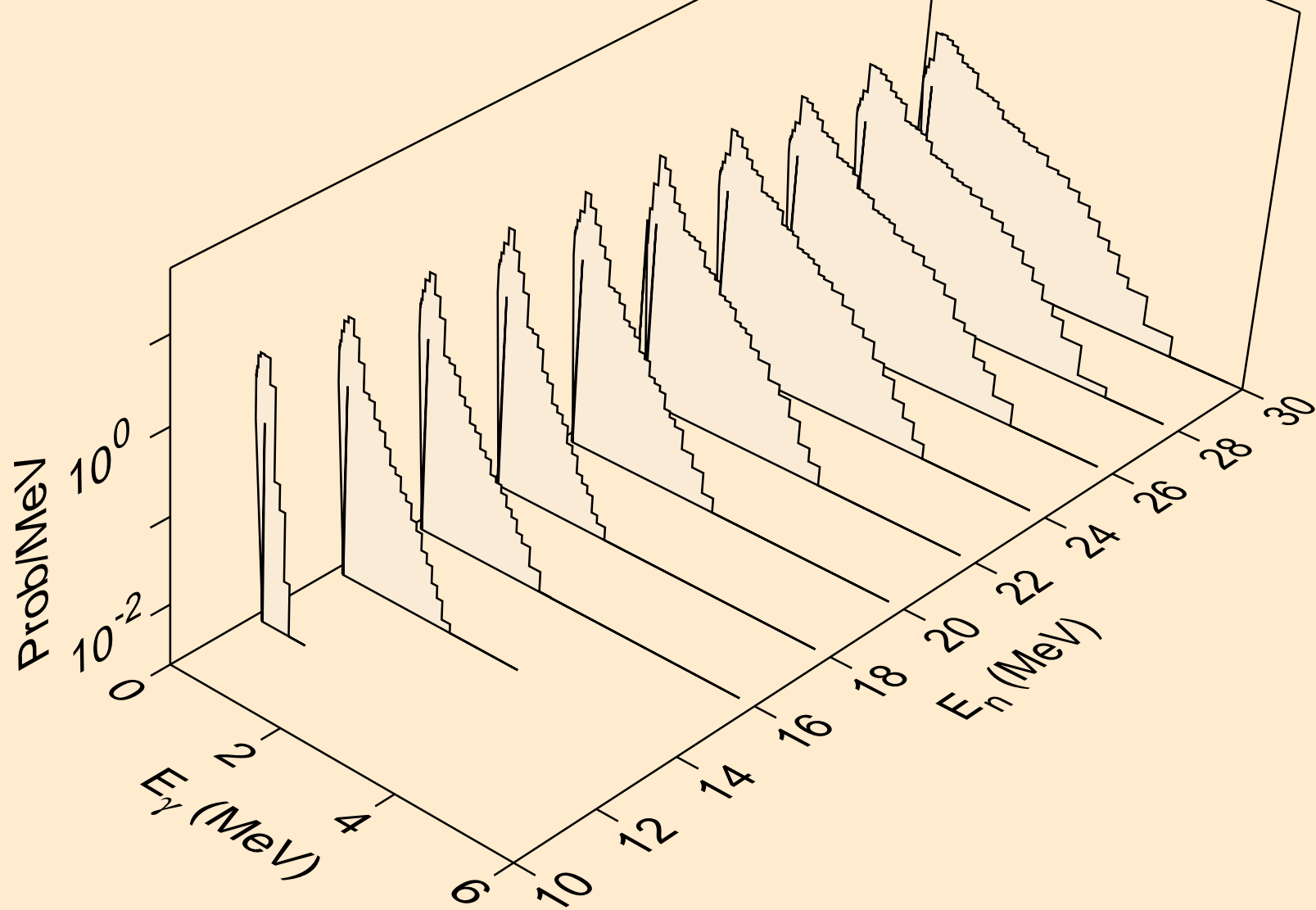



EU163 PROTON ACER TENDL-2021 LIBRARY; T=0.K  
Photon emission for (n,3np)

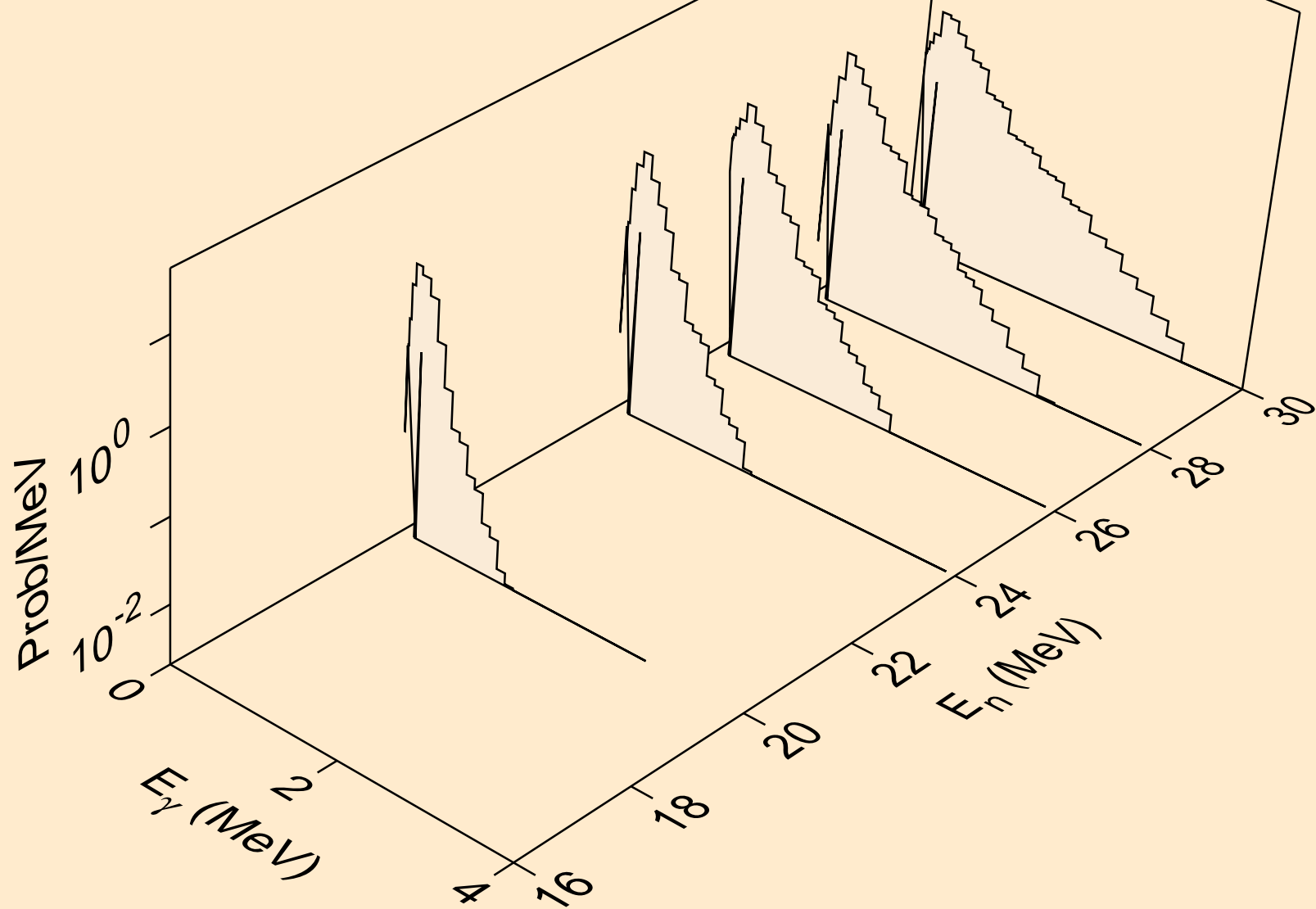

EU163 PROTON ACER TENDL-2021 LIBRARY; T=0.K  
Photon emission for (n,2np)

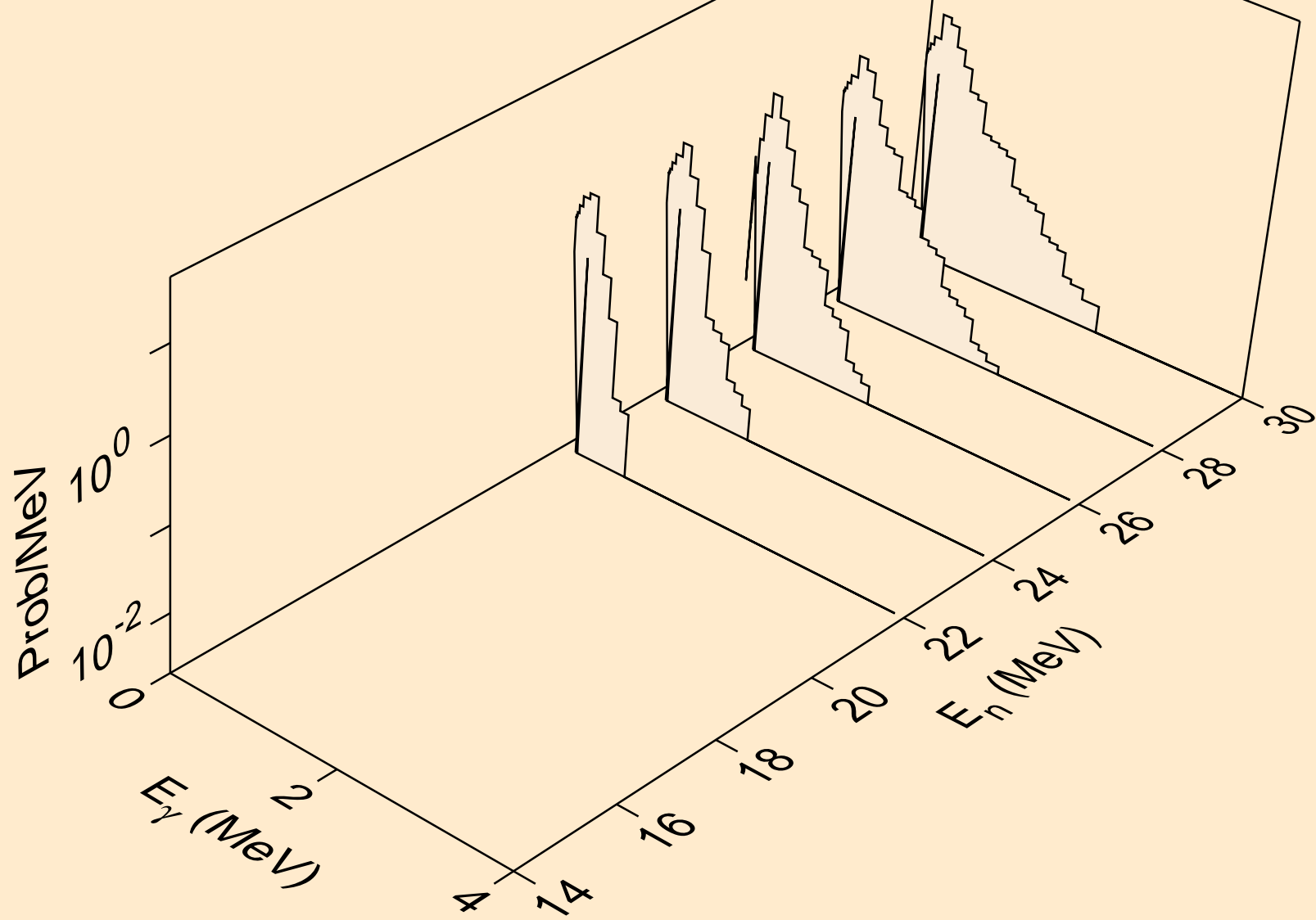

EU163 PROTON ACER TENDL-2021 LIBRARY; T=0.K  
Photon emission for (n,gma)

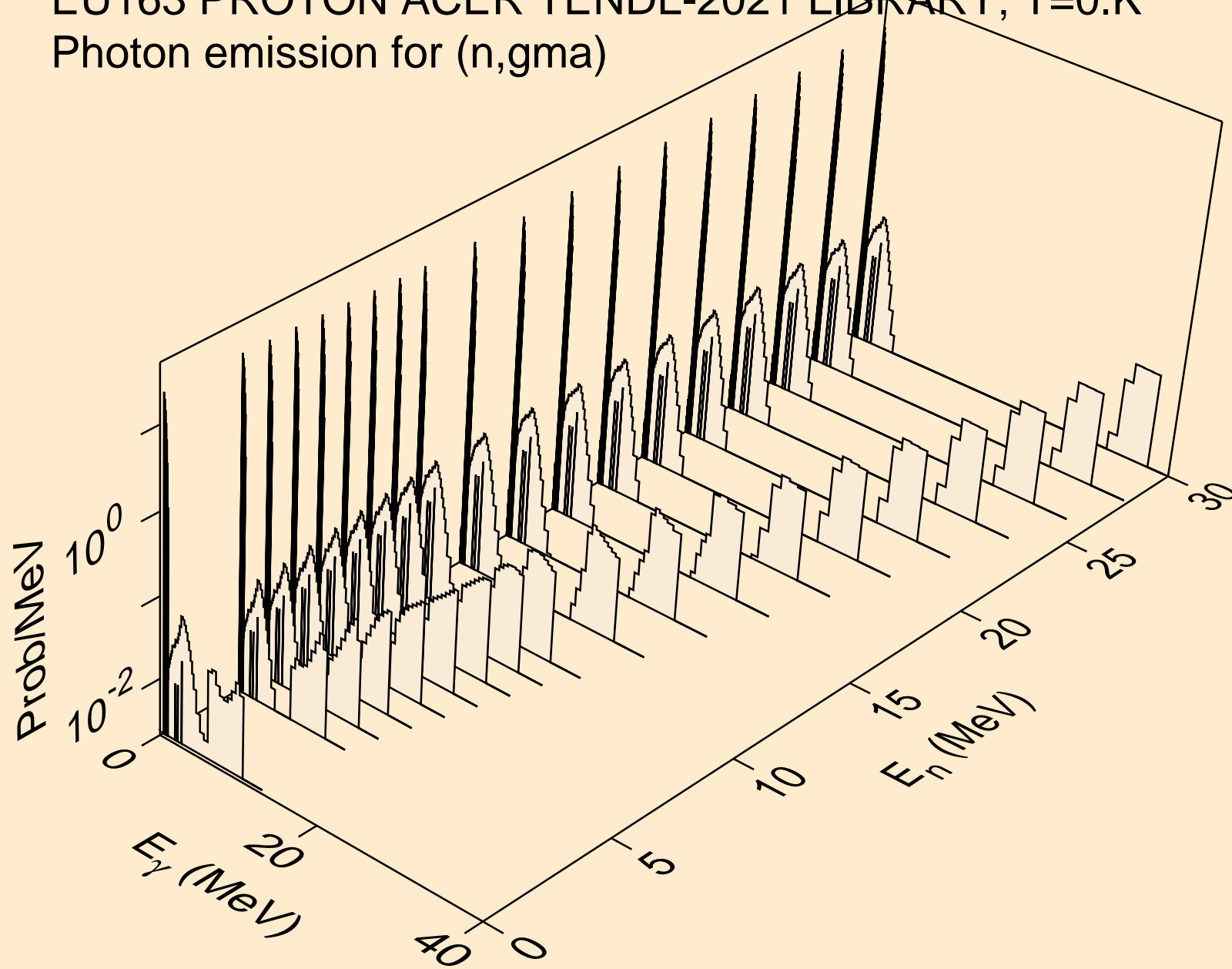

EU163 PROTON ACER TENDL-2021 LIBRARY; T=0.K  
Photon emission for inelastic

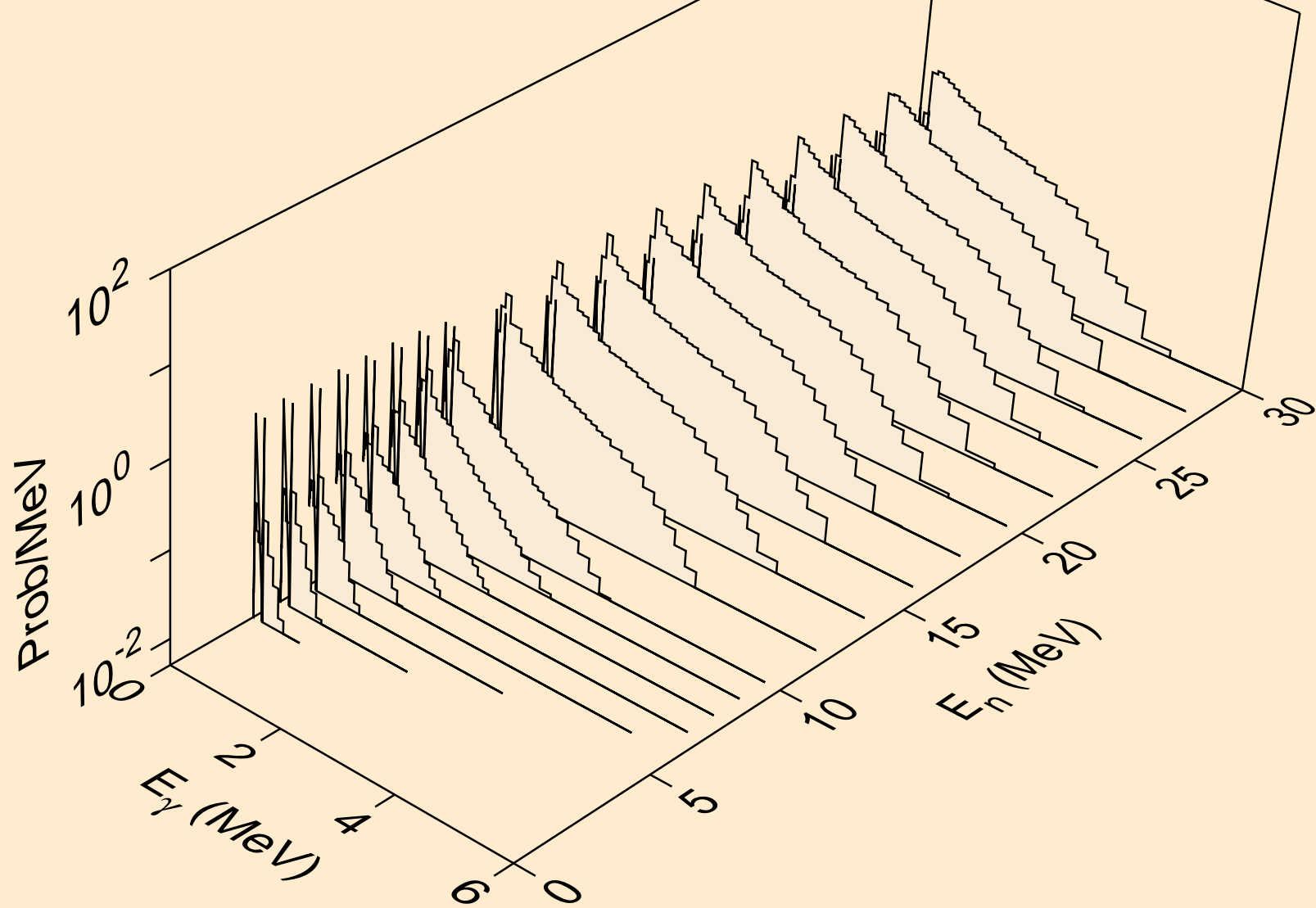

EU163 PROTON ACER TENDL-2021 LIBRARY; T=0.K  
Photon emission for (n,d)

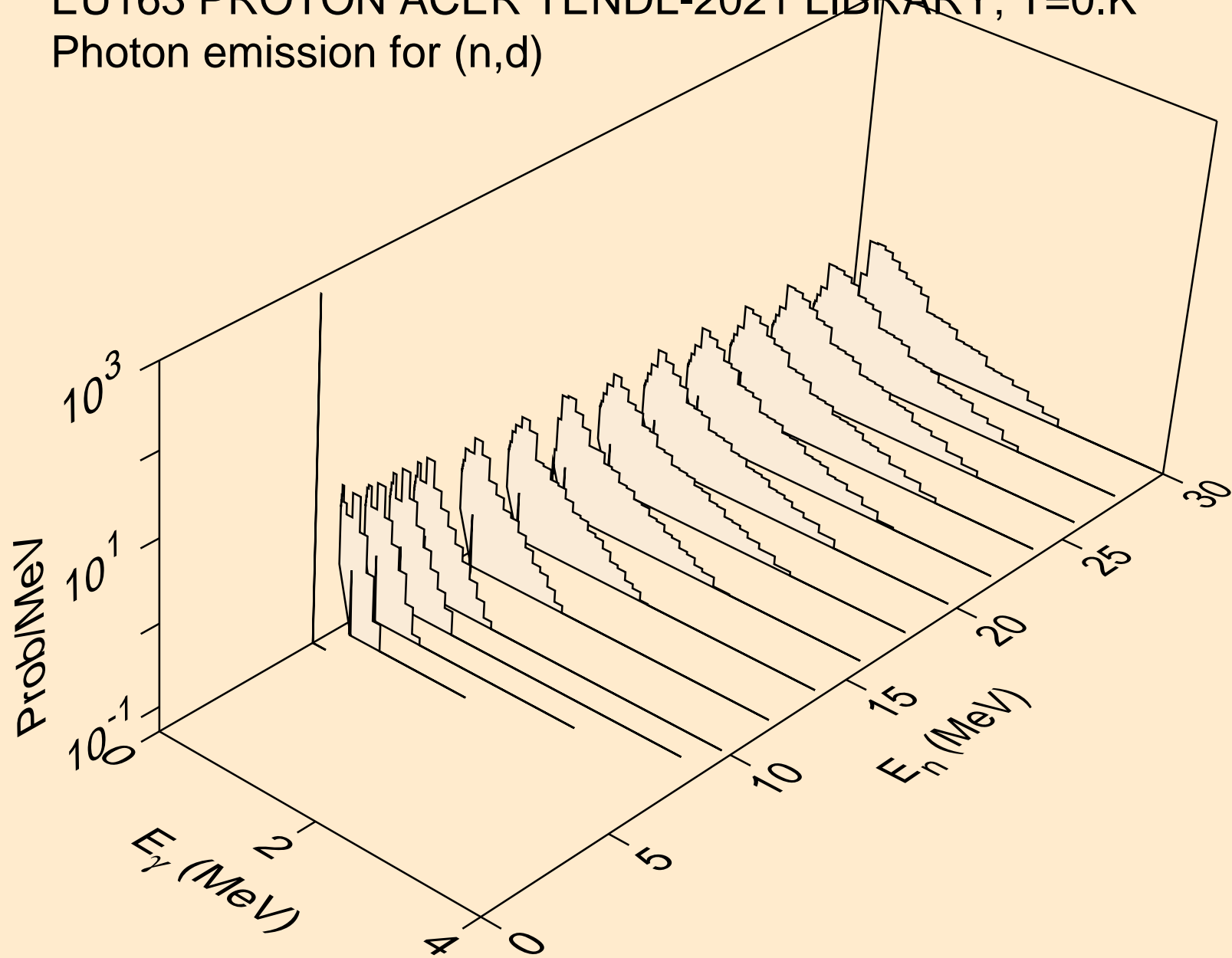

EU163 PROTON ACER TENDL-2021 LIBRARY; T=0.K  
Photon emission for (n,t)

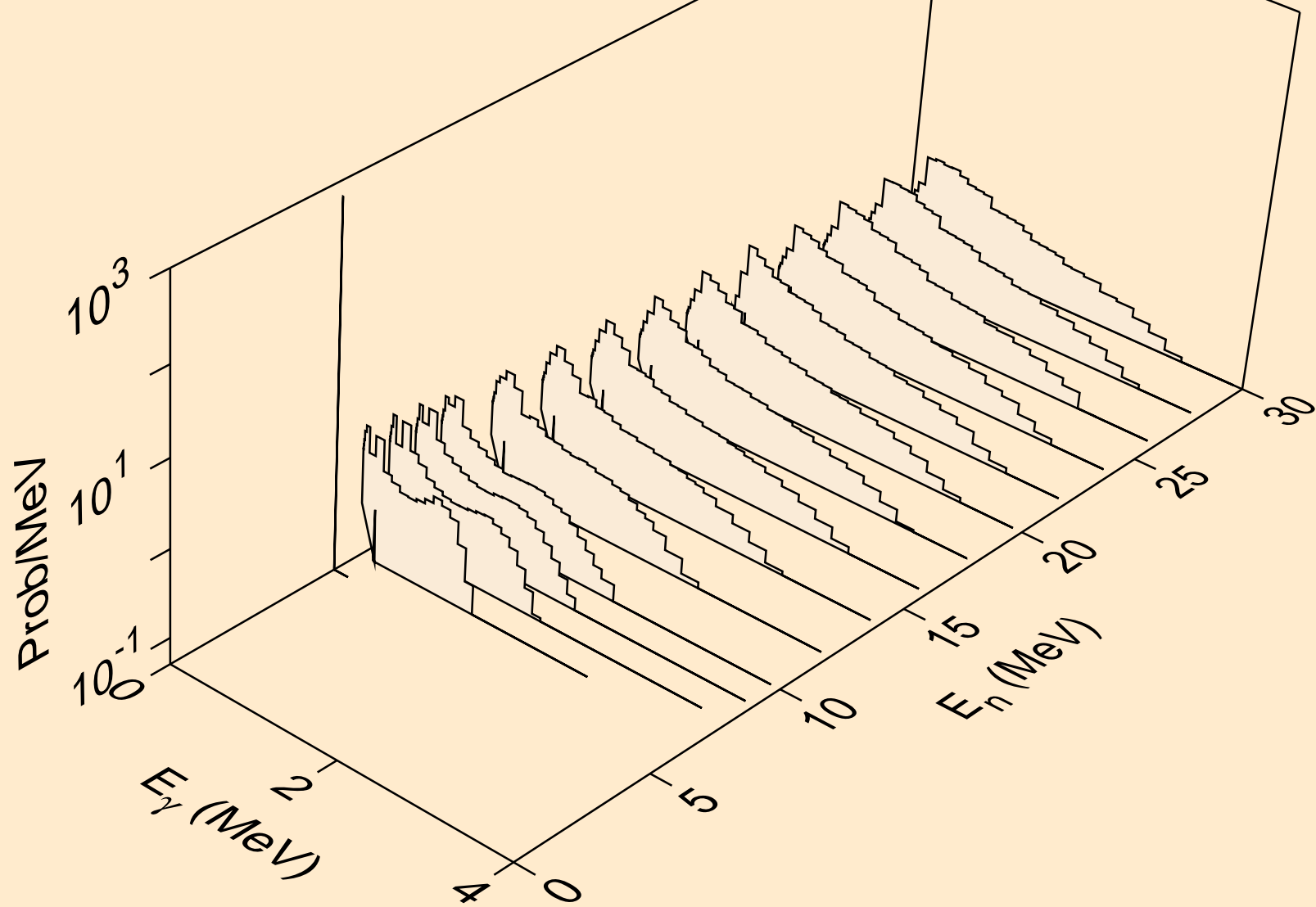

EU163 PROTON ACER TENDL-2021 LIBRARY; T=0.K  
Photon emission for (n,he3)

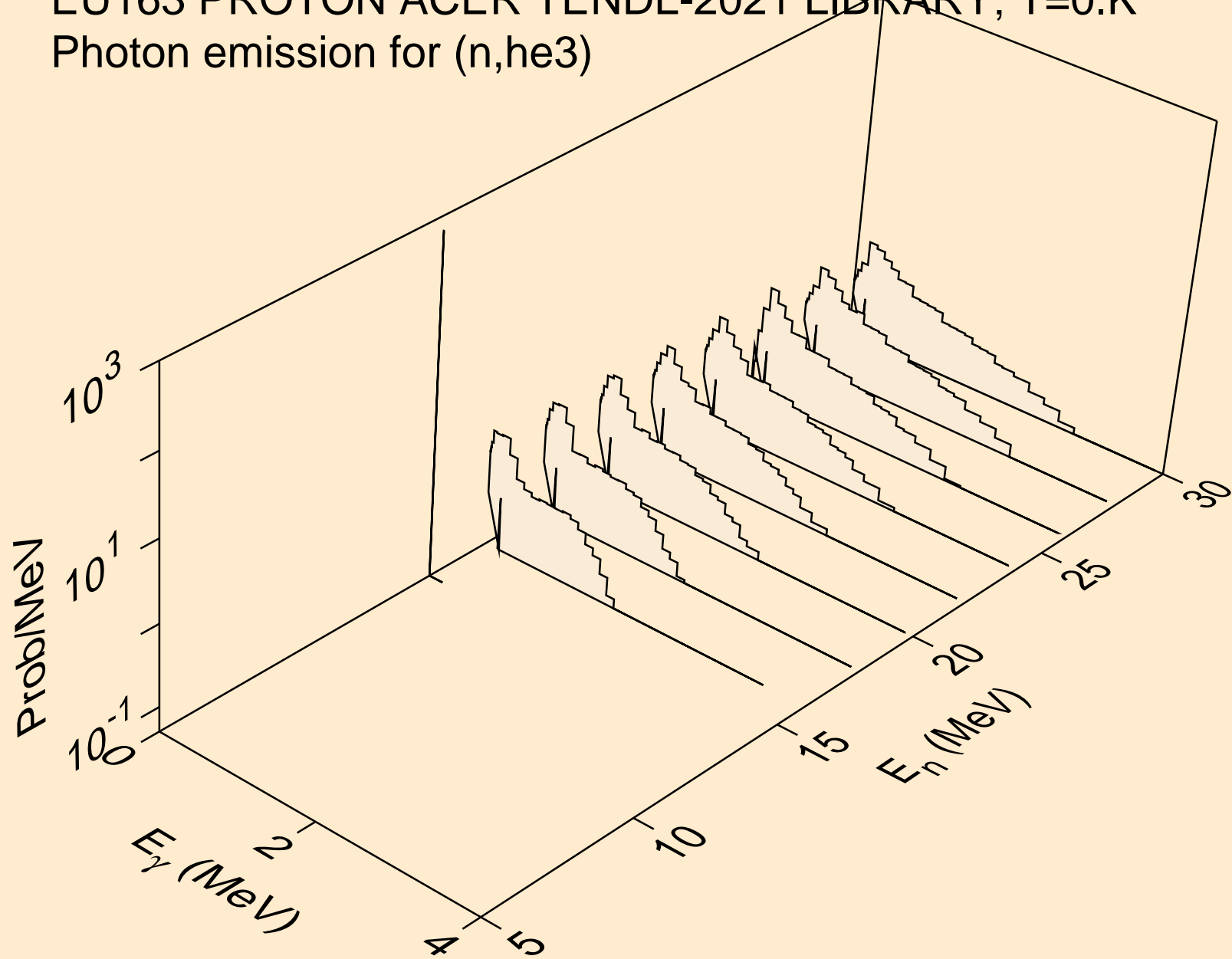

EU163 PROTON ACER TENDL-2021 LIBRARY; T=0.K  
Photon emission for (n,a)

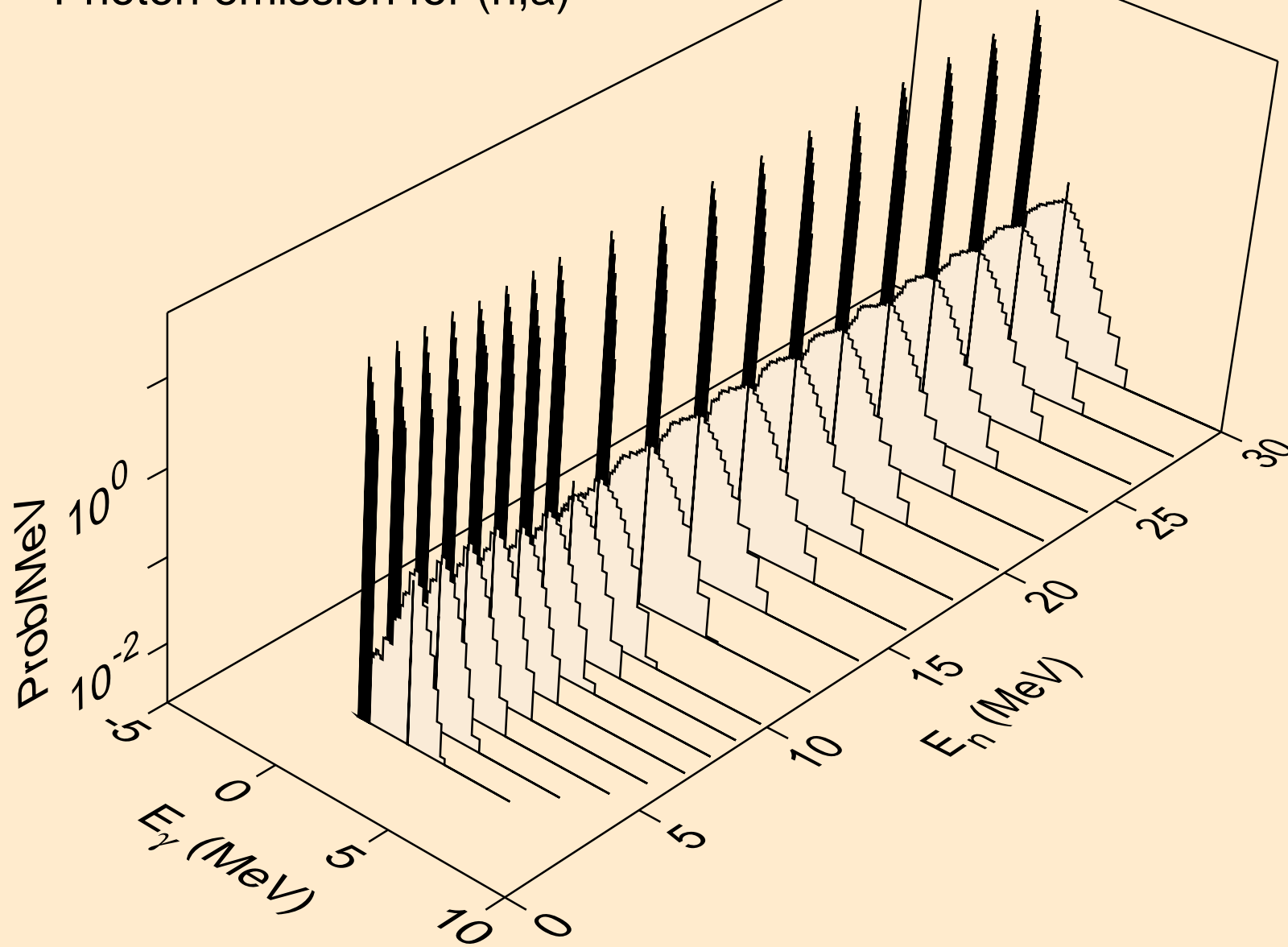



EU163 PROTON ACER TENDL-2021 LIBRARY; T=0.K  
Photon emission for (n,2p)

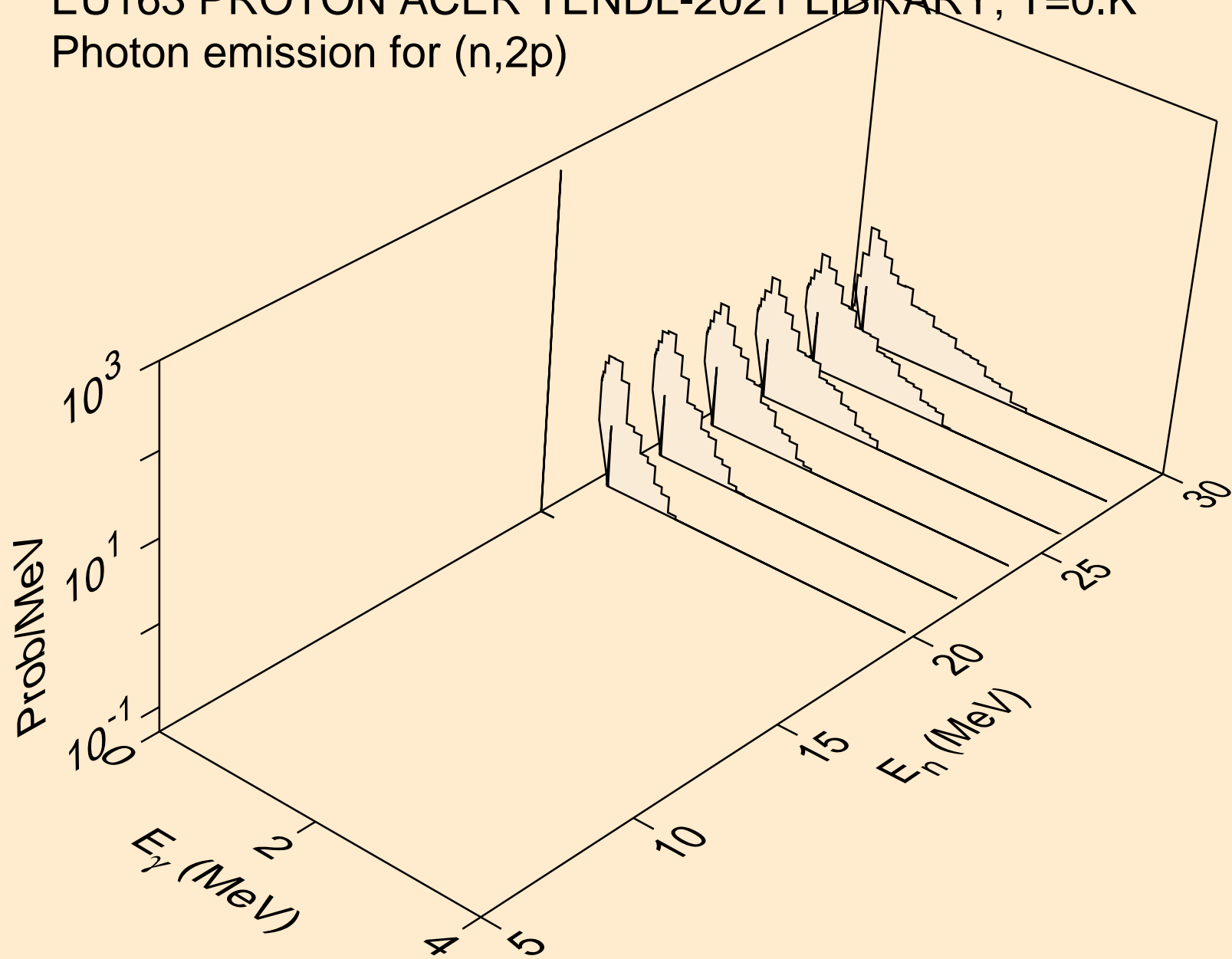

EU163 PROTON ACER TENDL-2021 LIBRARY; T=0.K  
Photon emission for (n,pd)

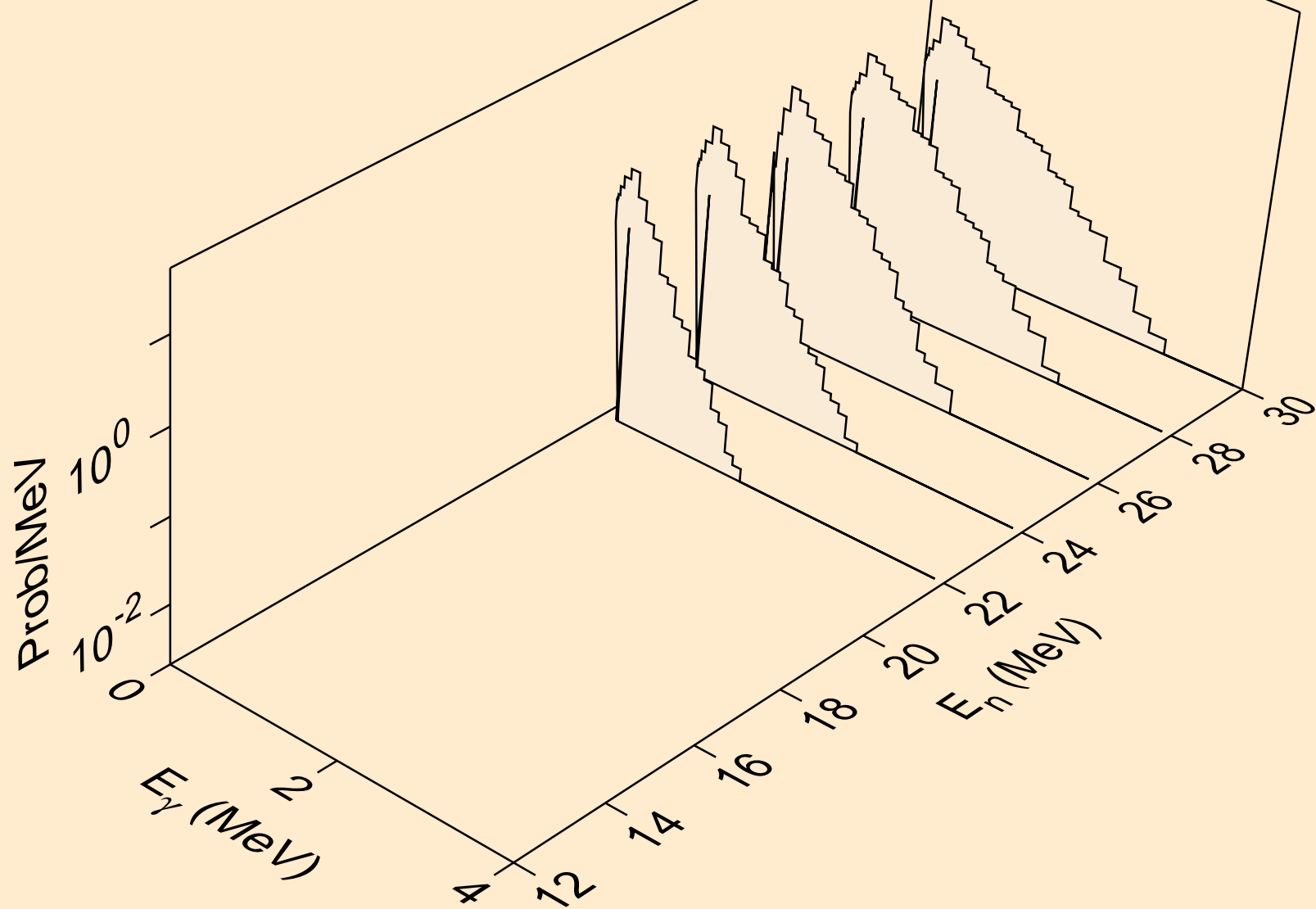

EU163 PROTON ACER TENDL-2021 LIBRARY; T=0.K  
Particle heating contributions

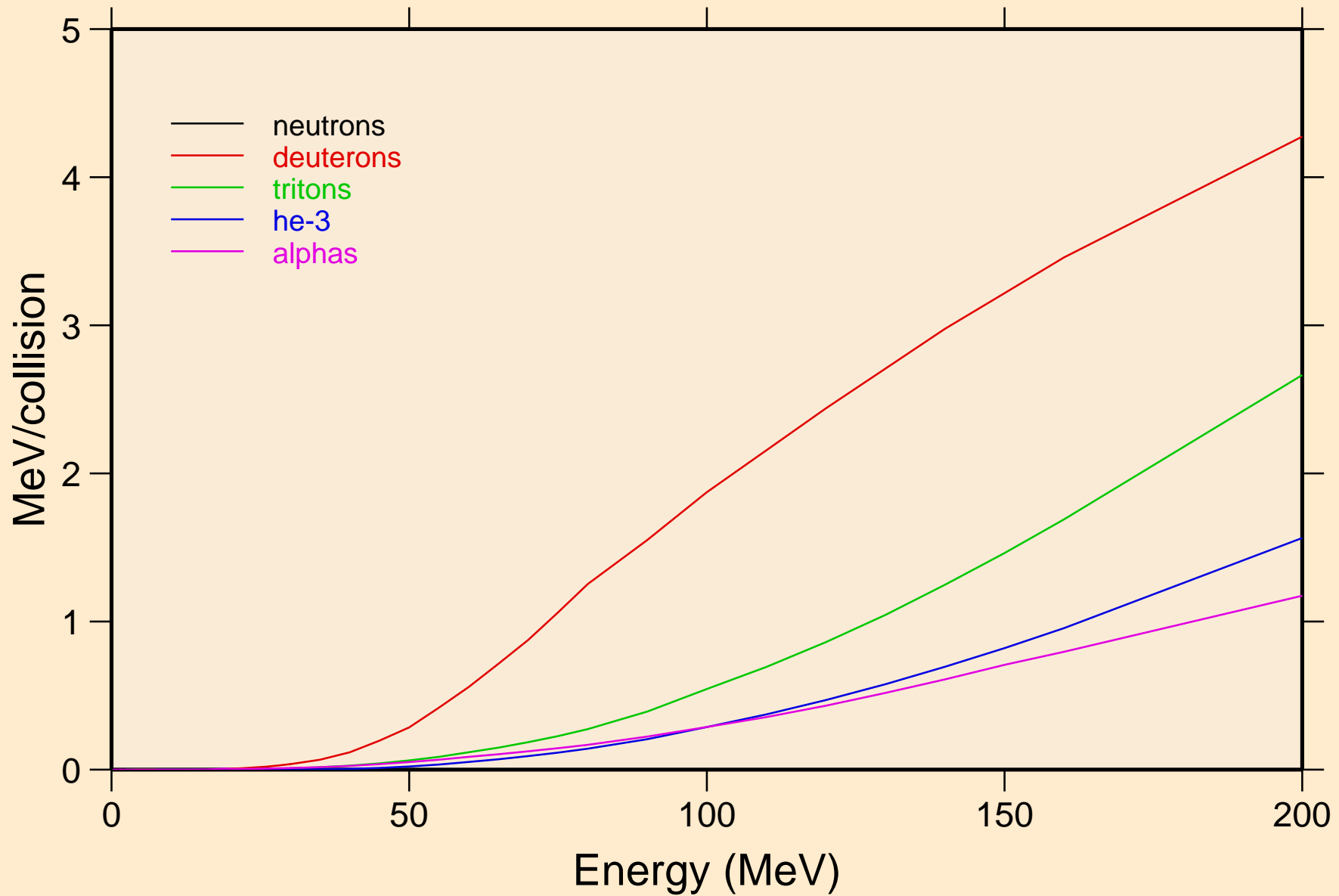

EU163 PROTON ACER TENDL-2021 LIBRARY; T=0.K  
Recoil Heating

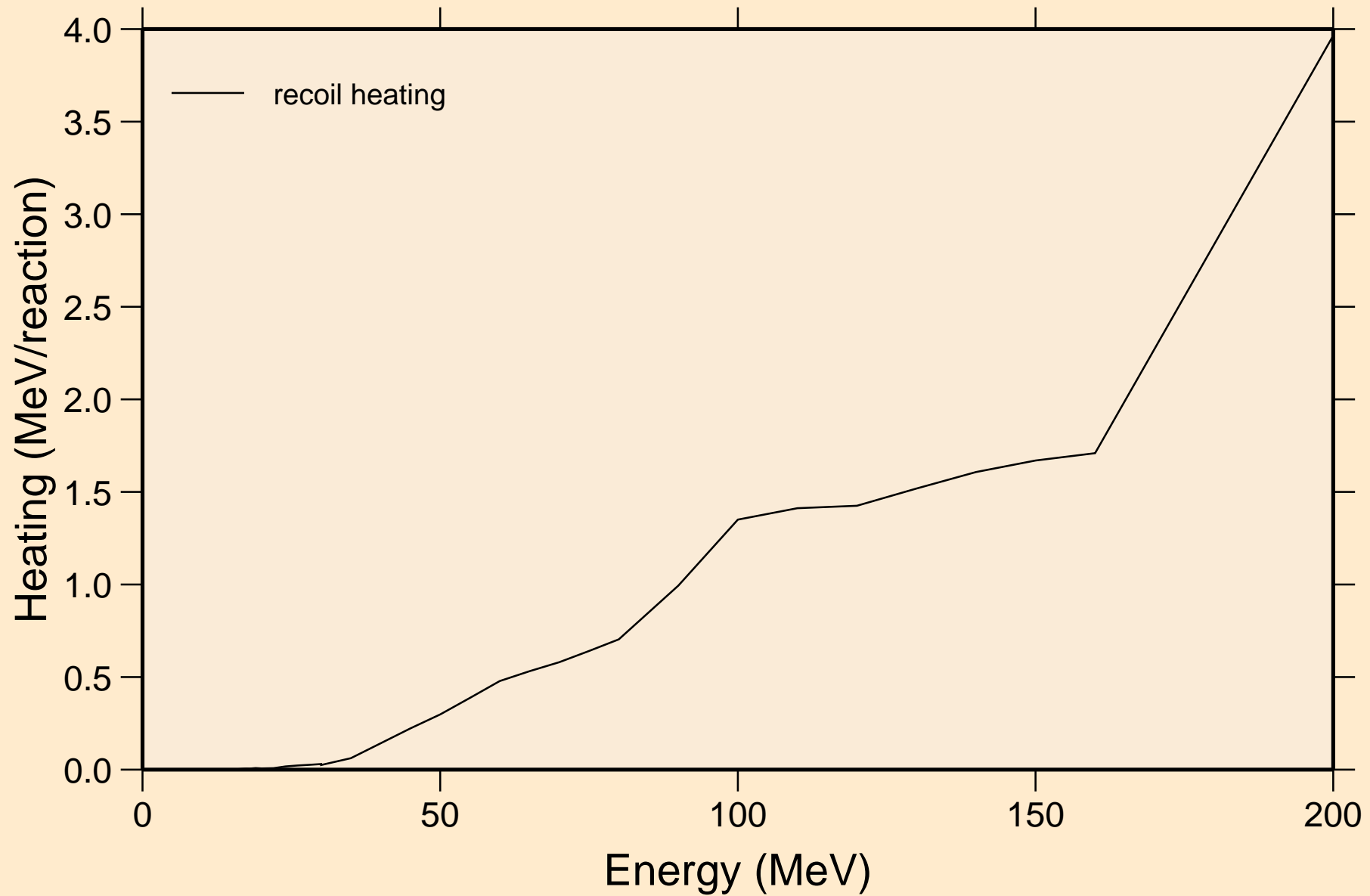

# EU163 PROTON ACER TENDL-2021 LIBRARY; T=0.K

## Particle production cross sections

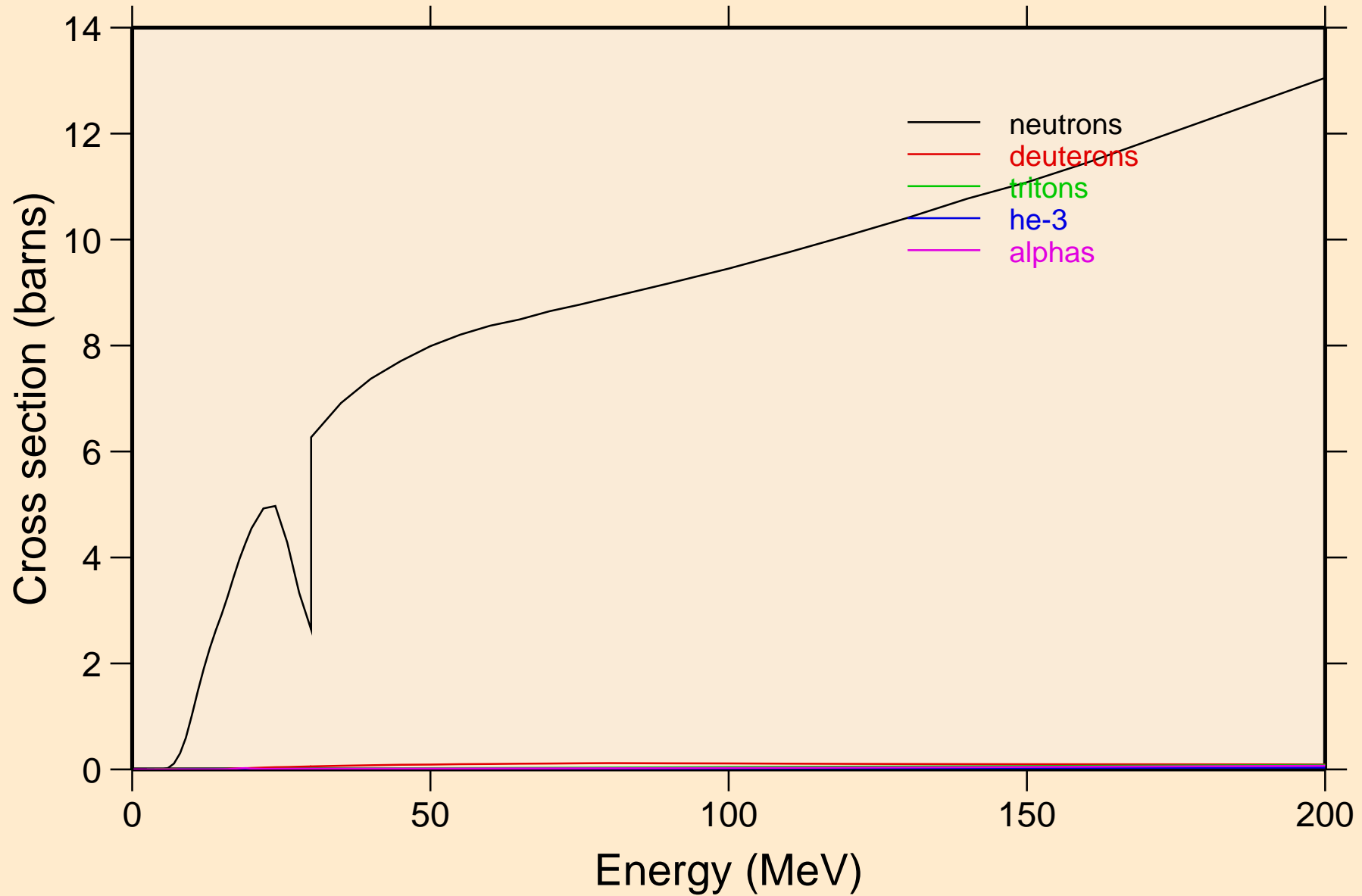

EU163 PROTON ACER TENDL-2021 LIBRARY; T=0.K  
neutrons from (p,n)

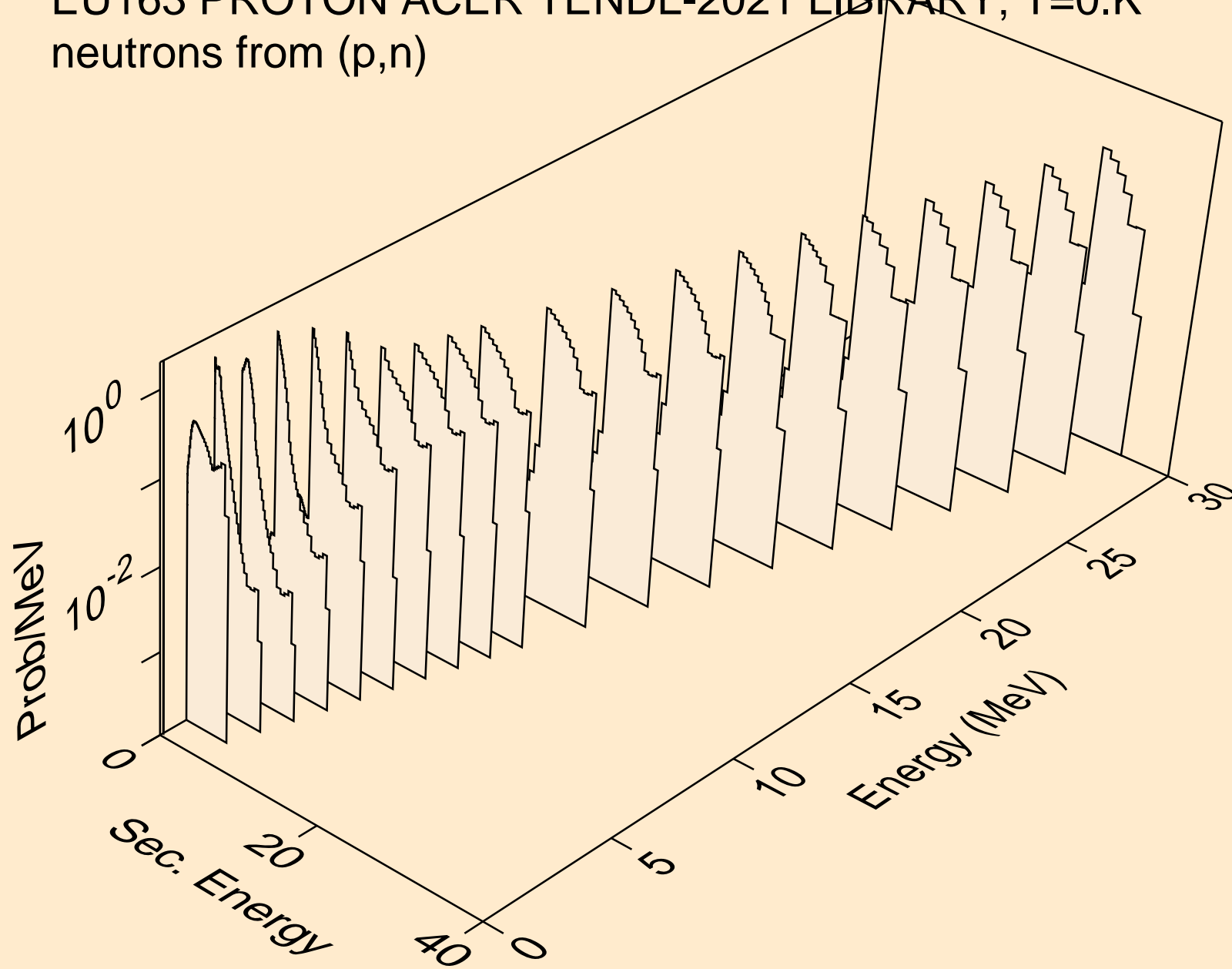

EU163 PROTON ACER TENDL-2021 LIBRARY; T=0.K  
neutrons from (p,x)

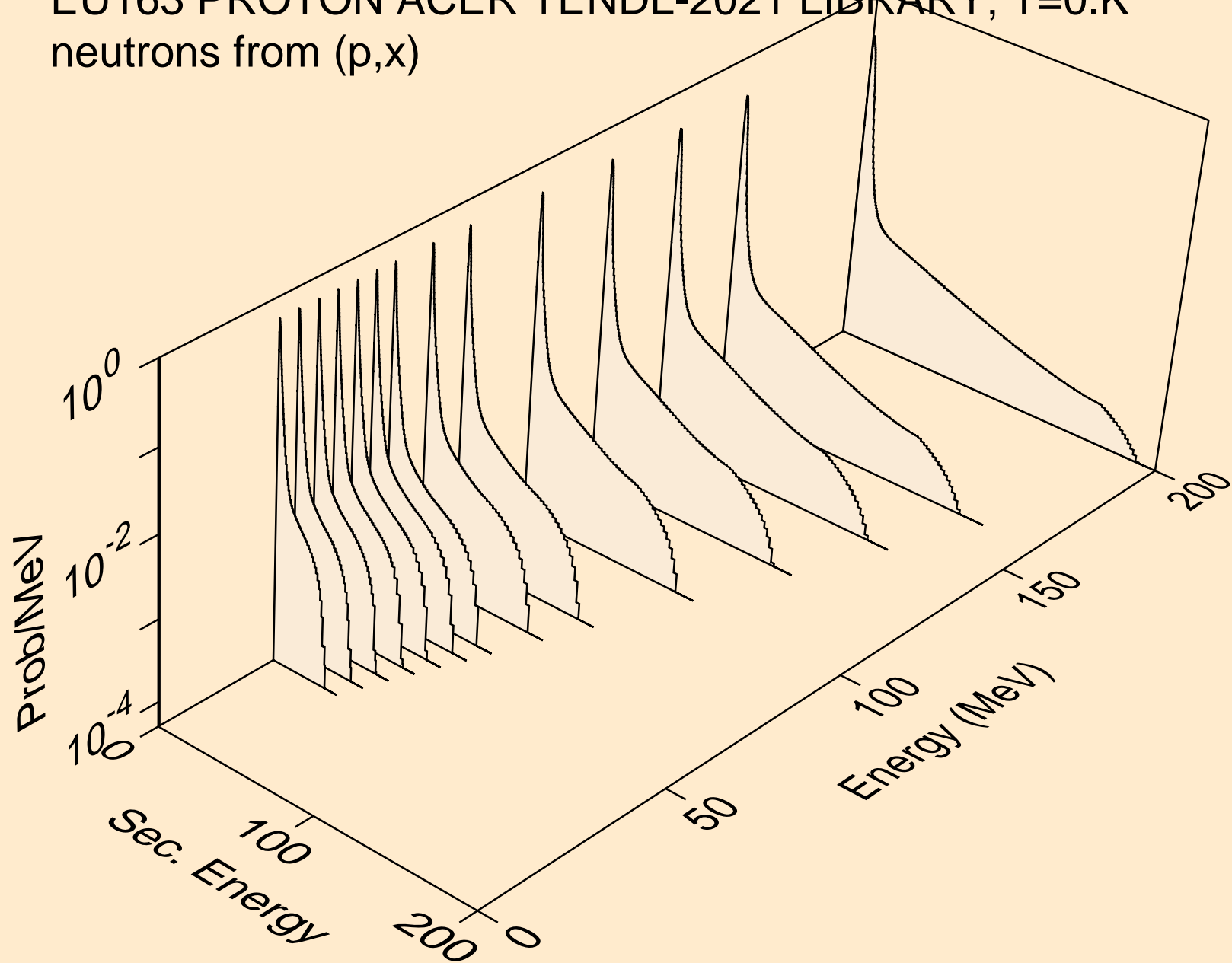

EU163 PROTON ACER TENDL-2021 LIBRARY; T=0.K  
neutrons from (p,2nd)

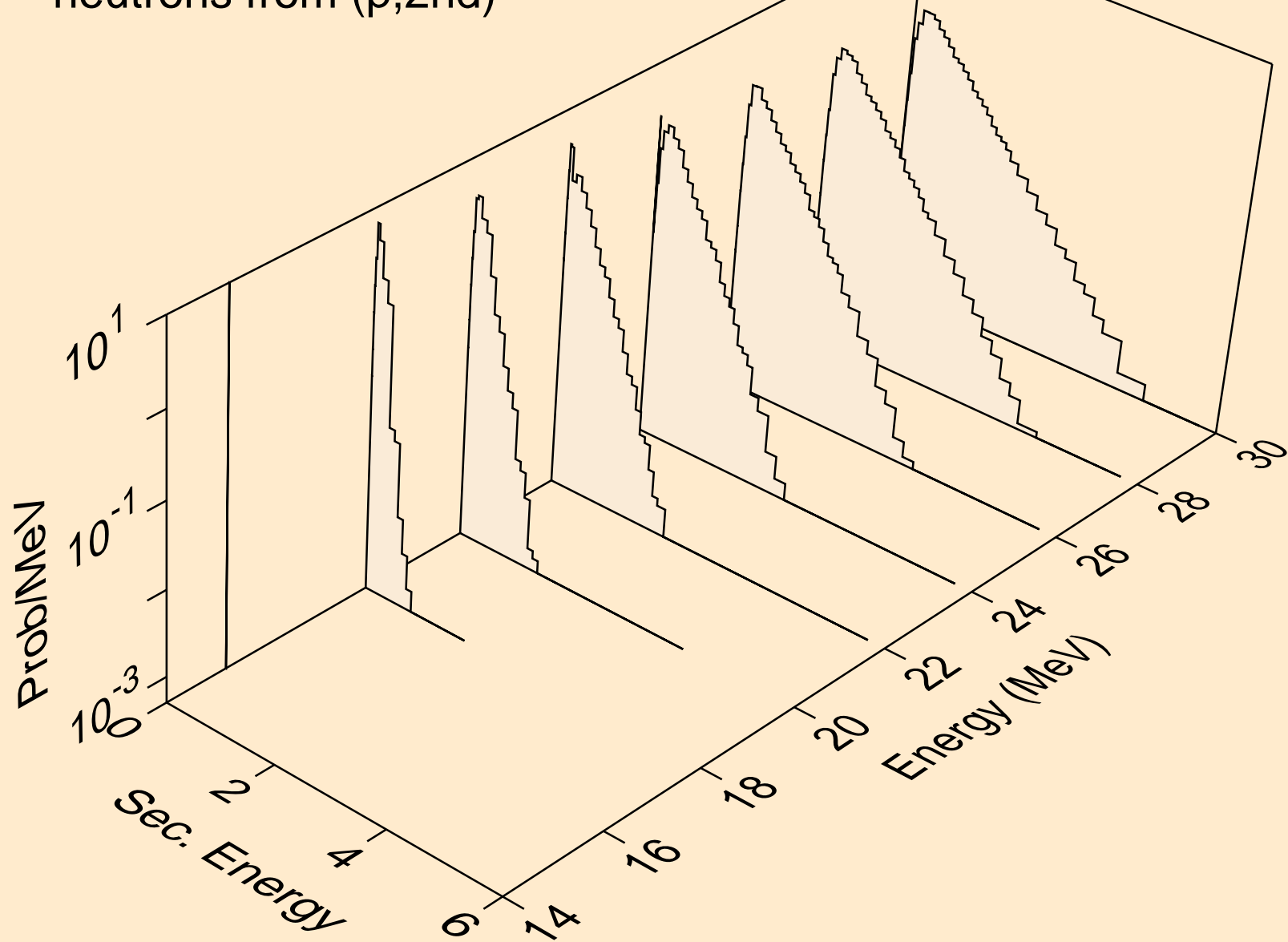



EU163 PROTON ACER TENDL-2021 LIBRARY; T=0.K  
neutrons from (p,2n)

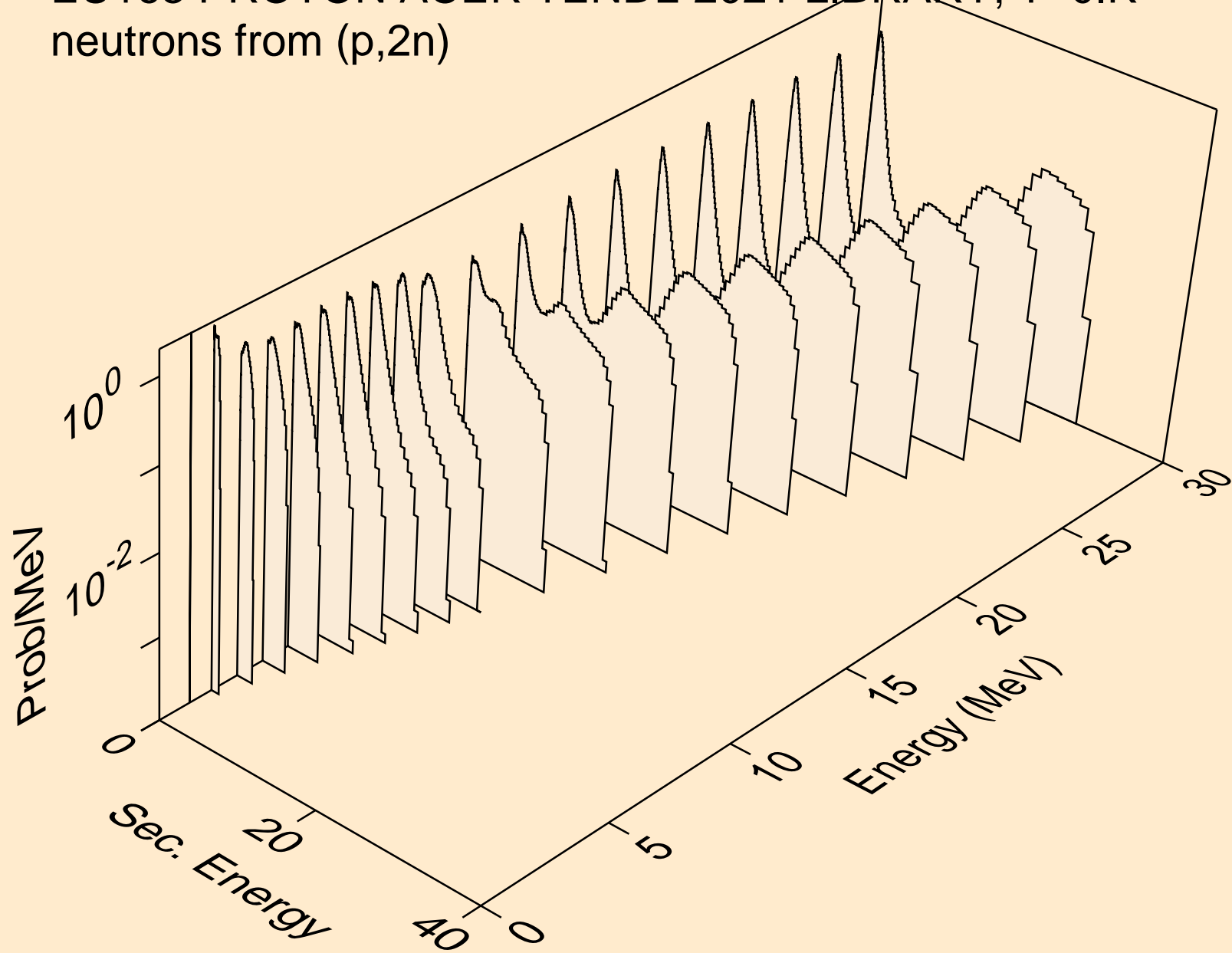

EU163 PROTON ACER TENDL-2021 LIBRARY; T=0.K  
neutrons from (p,3n)

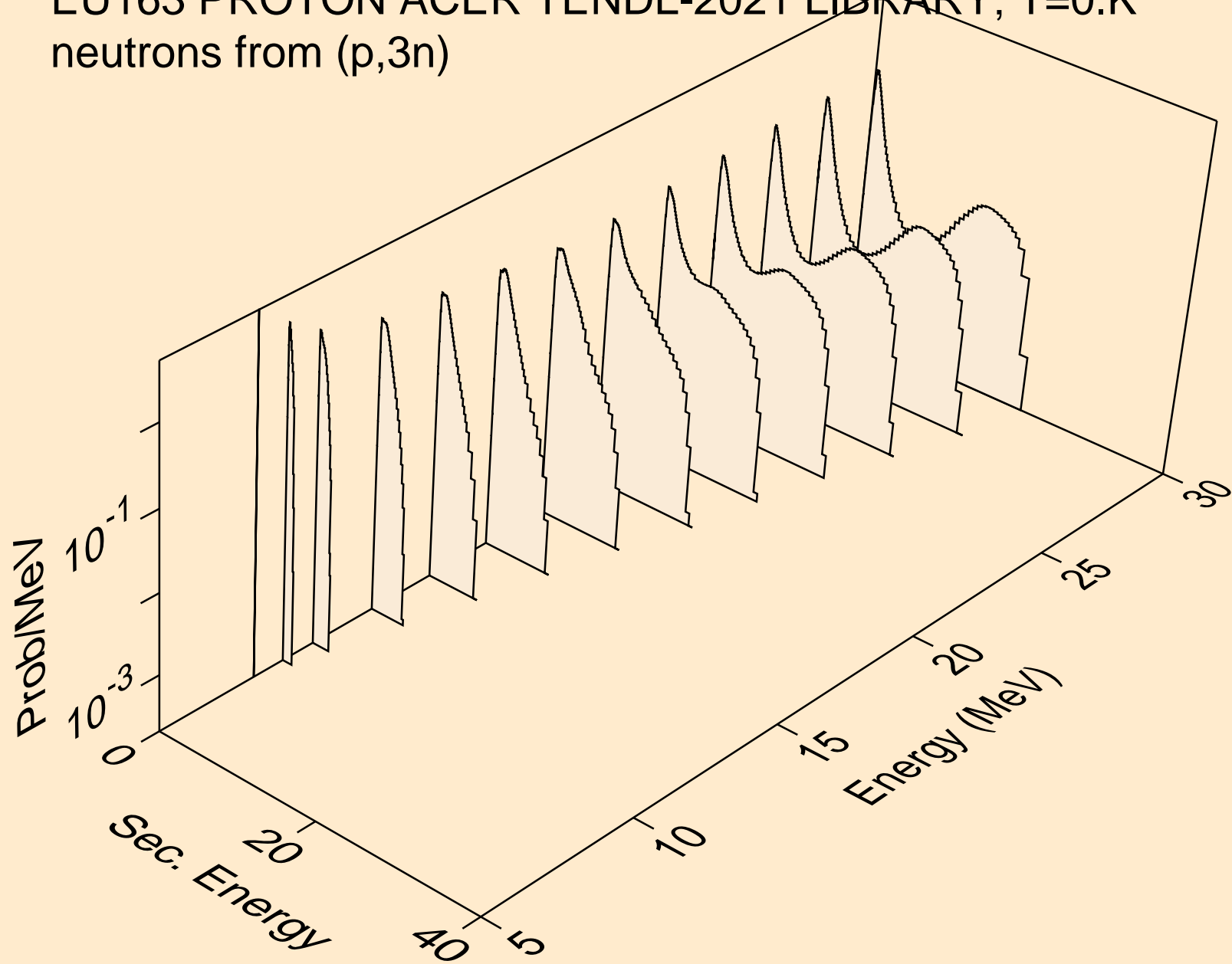

EU163 PROTON ACER TENDL-2021 LIBRARY; T=0.K  
neutrons from (p,n\*)a

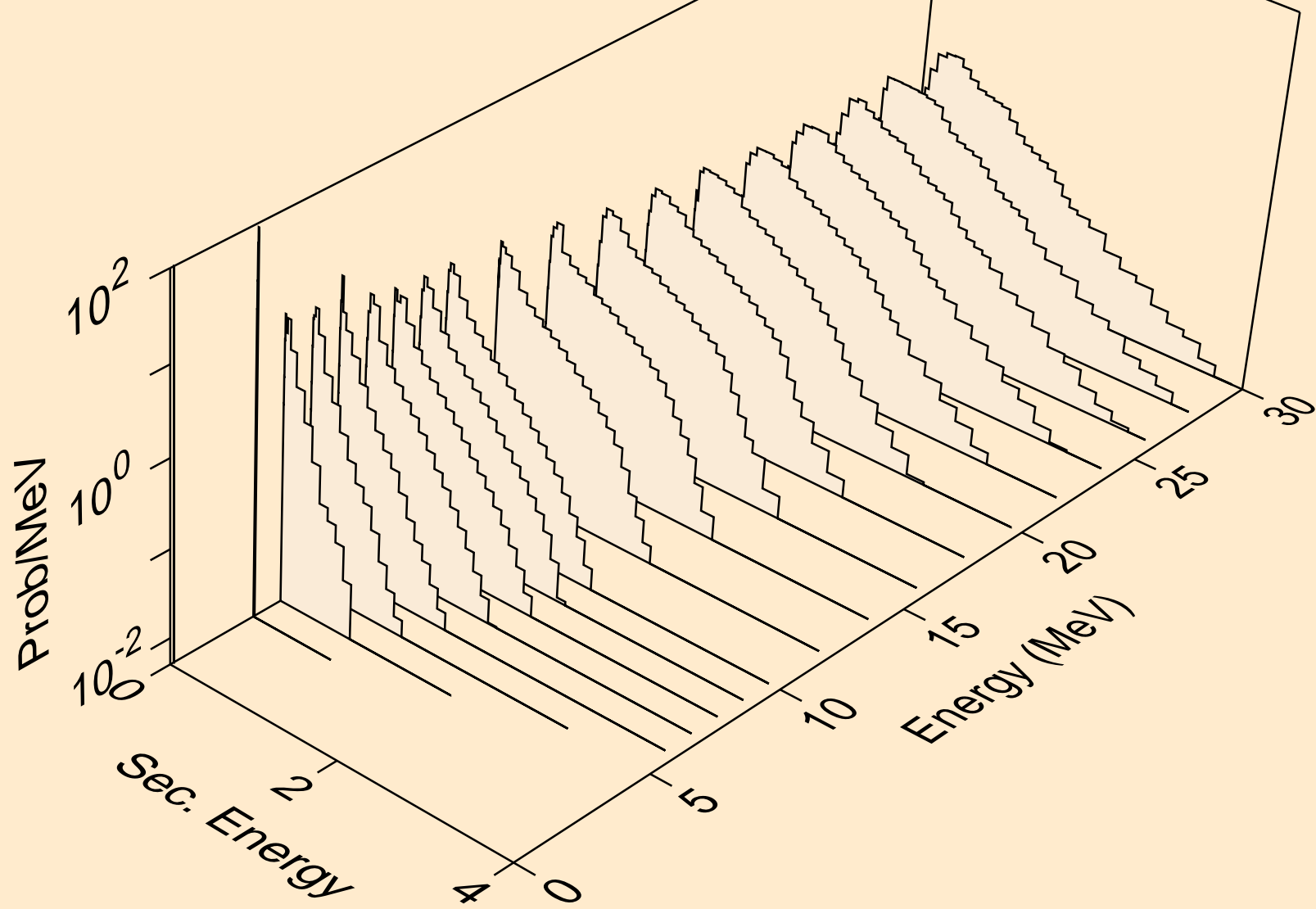

EU163 PROTON ACER TENDL-2021 LIBRARY; T=0.K  
neutrons from (p,2n)a

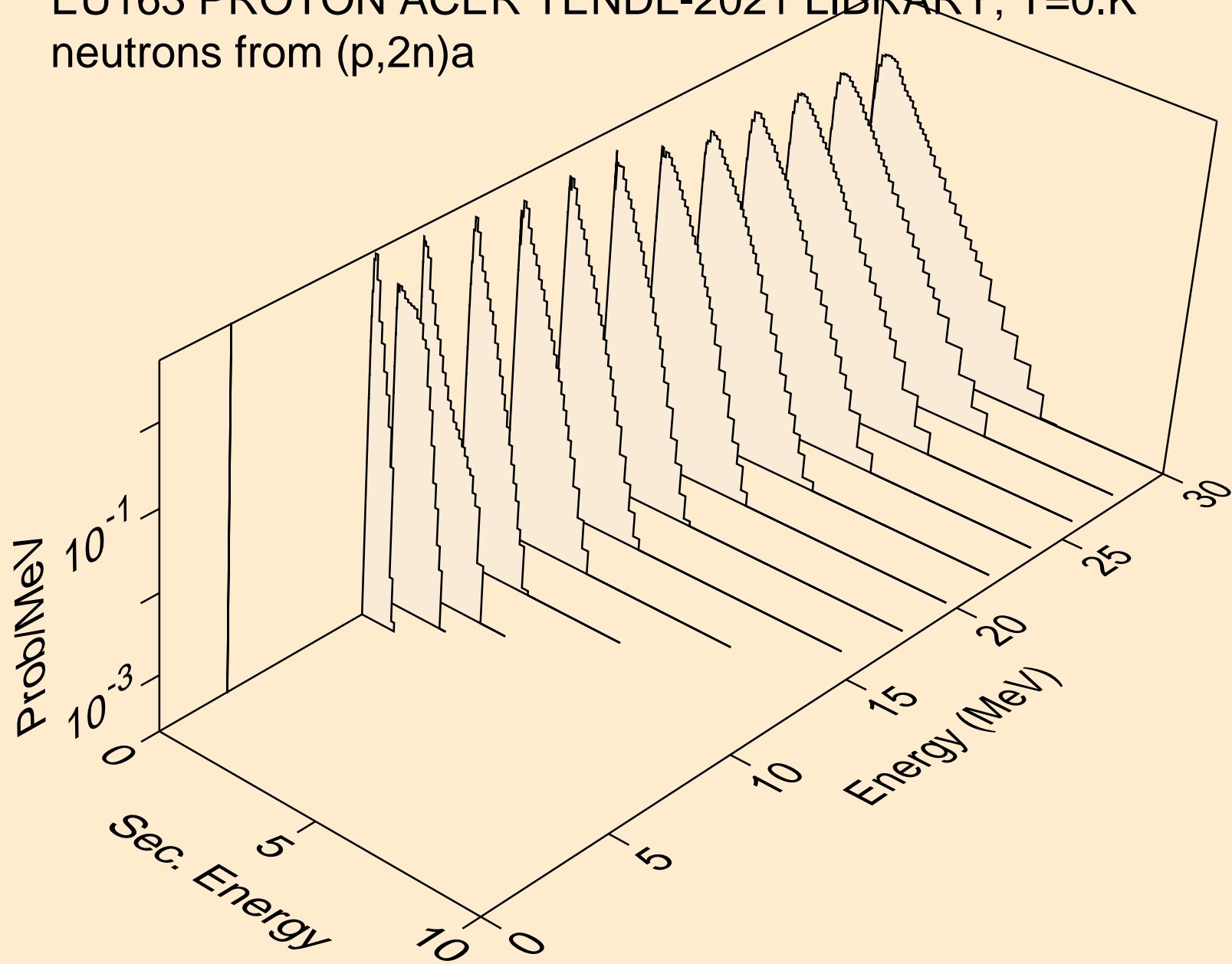

EU163 PROTON ACER TENDL-2021 LIBRARY; T=0.K  
neutrons from (p,3n)a

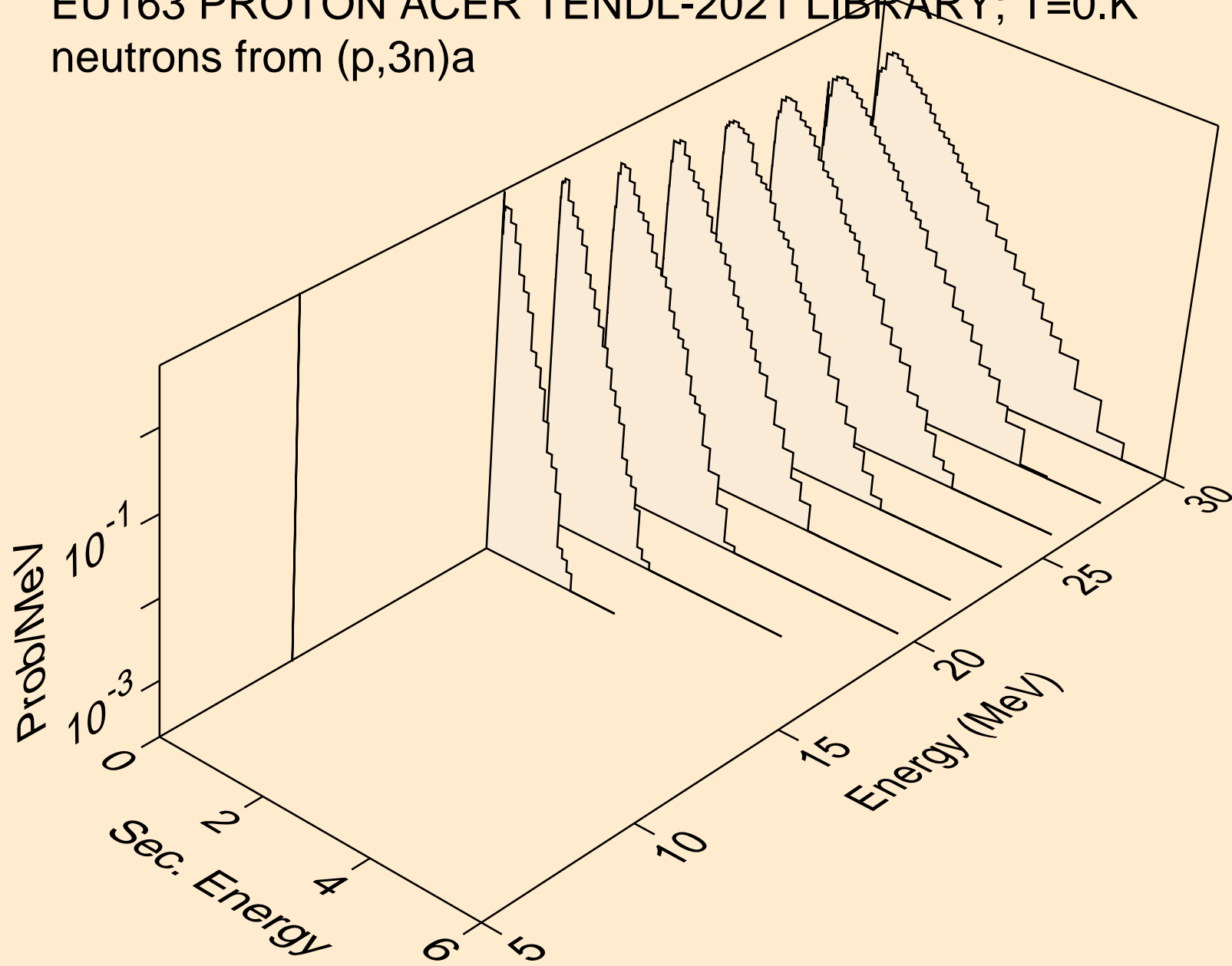

EU163 PROTON ACER TENDL-2021 LIBRARY; T=0.K  
neutrons from (p,n\*)p

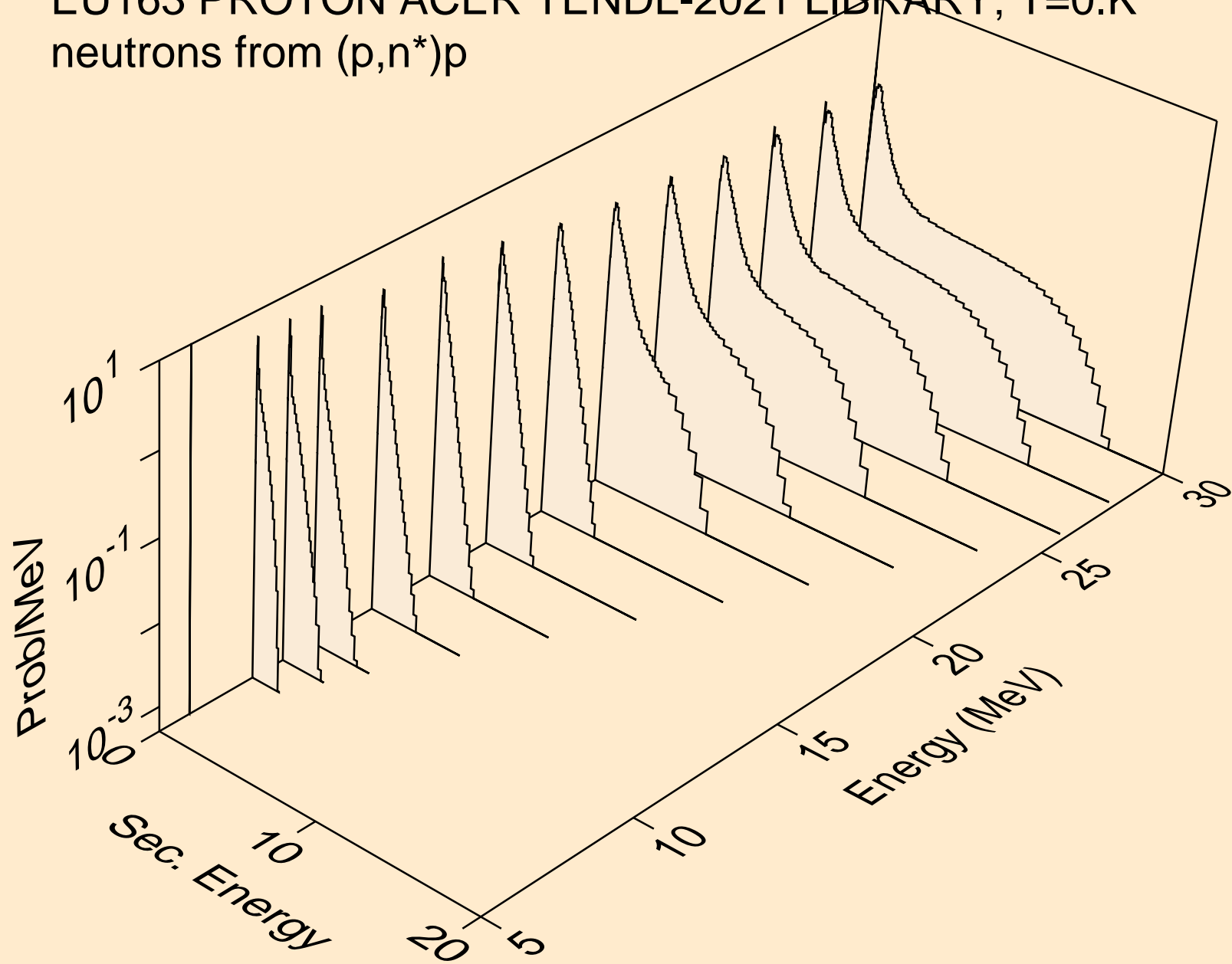

EU163 PROTON ACER TENDL-2021 LIBRARY; T=0.K  
neutrons from (p,n\*)d

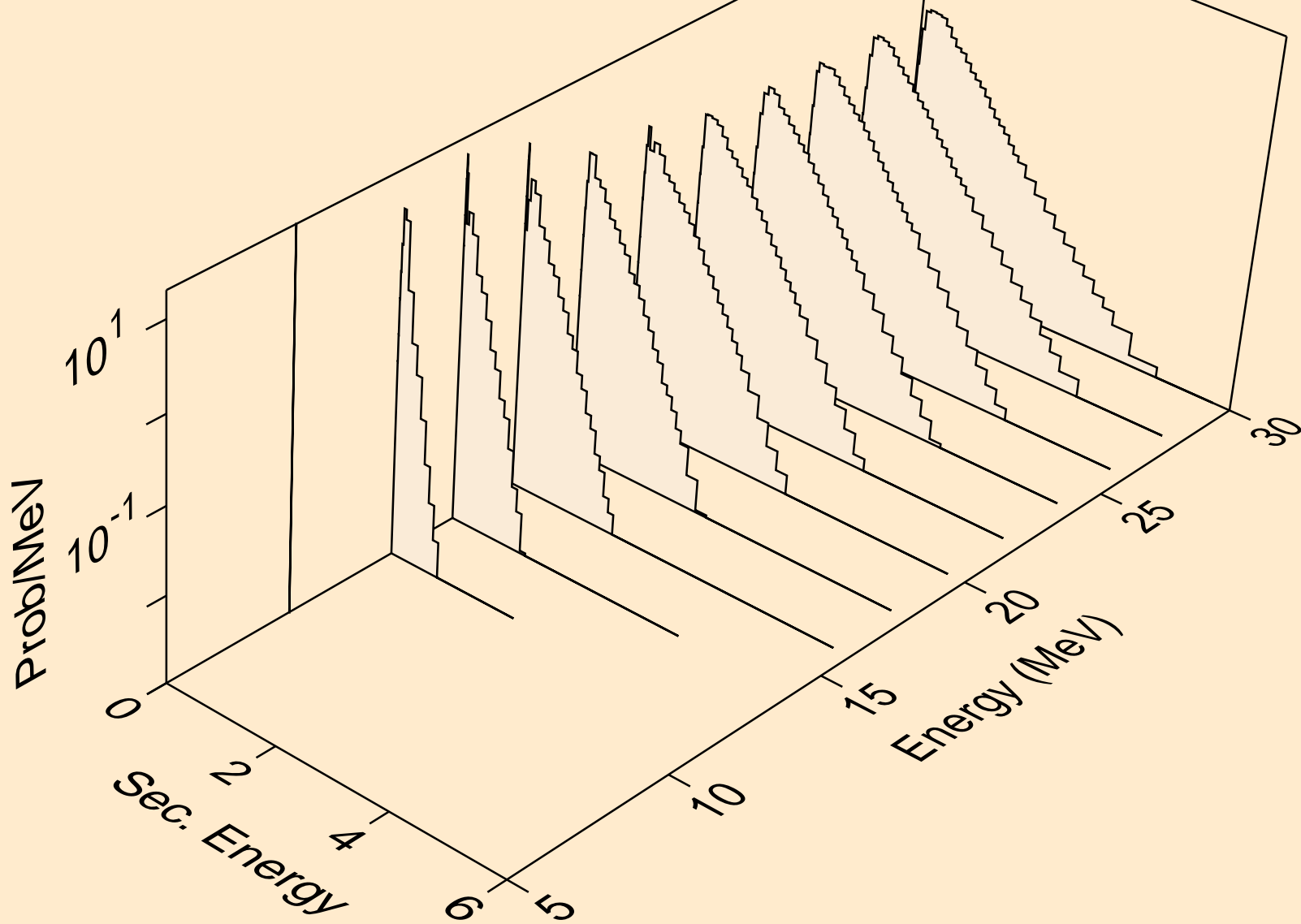

EU163 PROTON ACER TENDL-2021 LIBRARY; T=0.K  
neutrons from (p,n\*)t

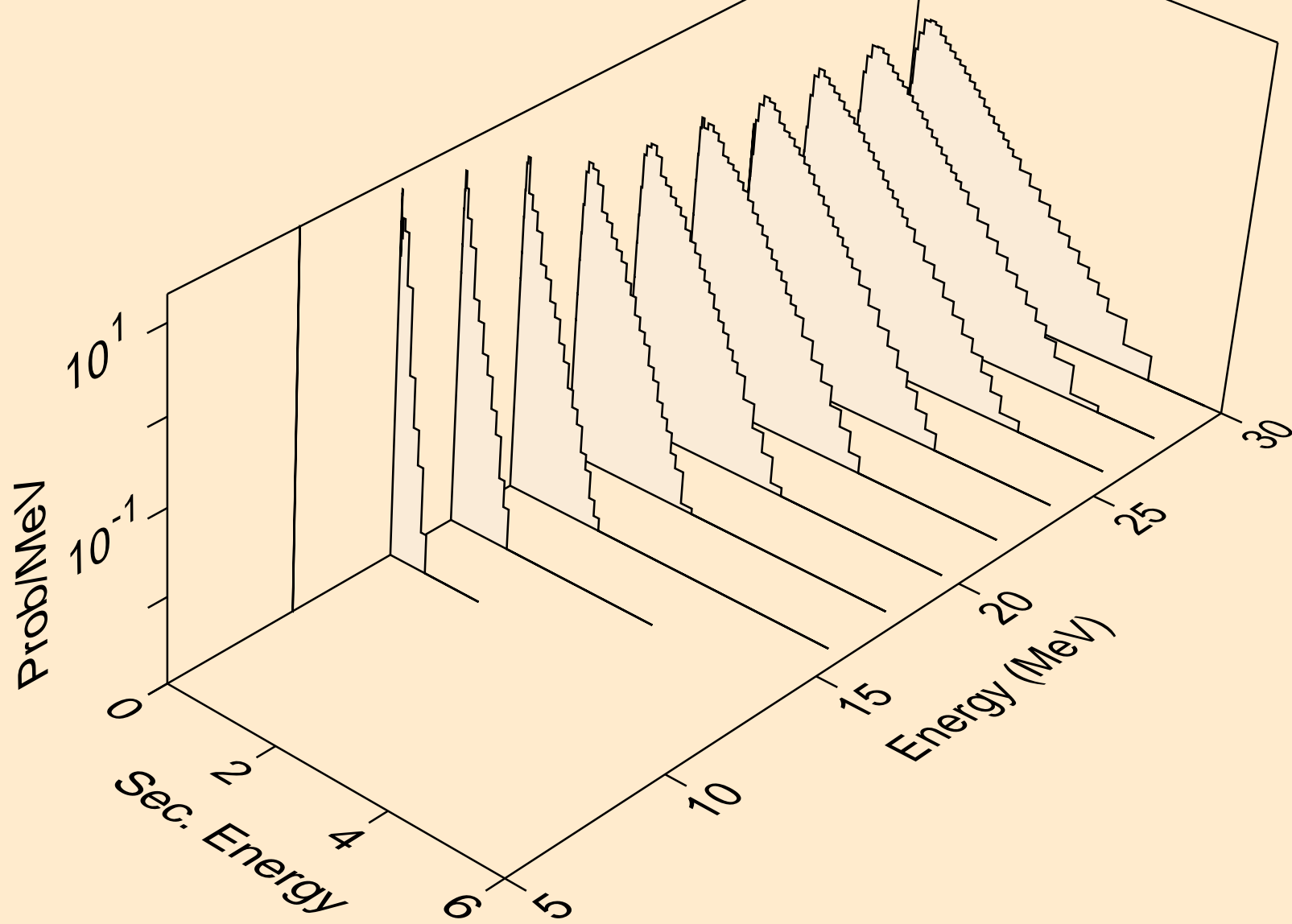



EU163 PROTON ACER TENDL-2021 LIBRARY; T=0.K  
neutrons from (p,n\*)he3

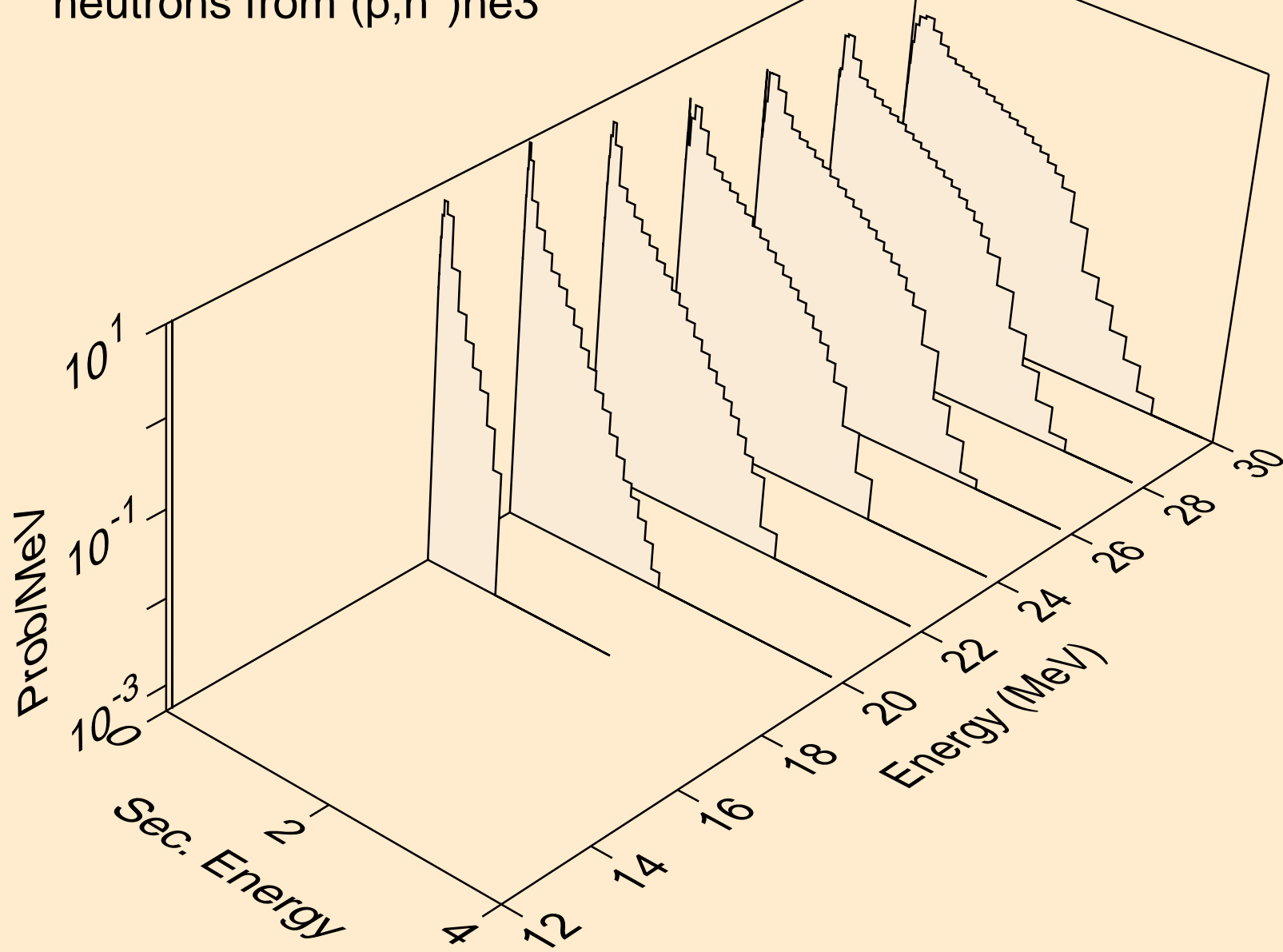

EU163 PROTON ACER TENDL-2021 LIBRARY; T=0.K  
neutrons from (p,4n)

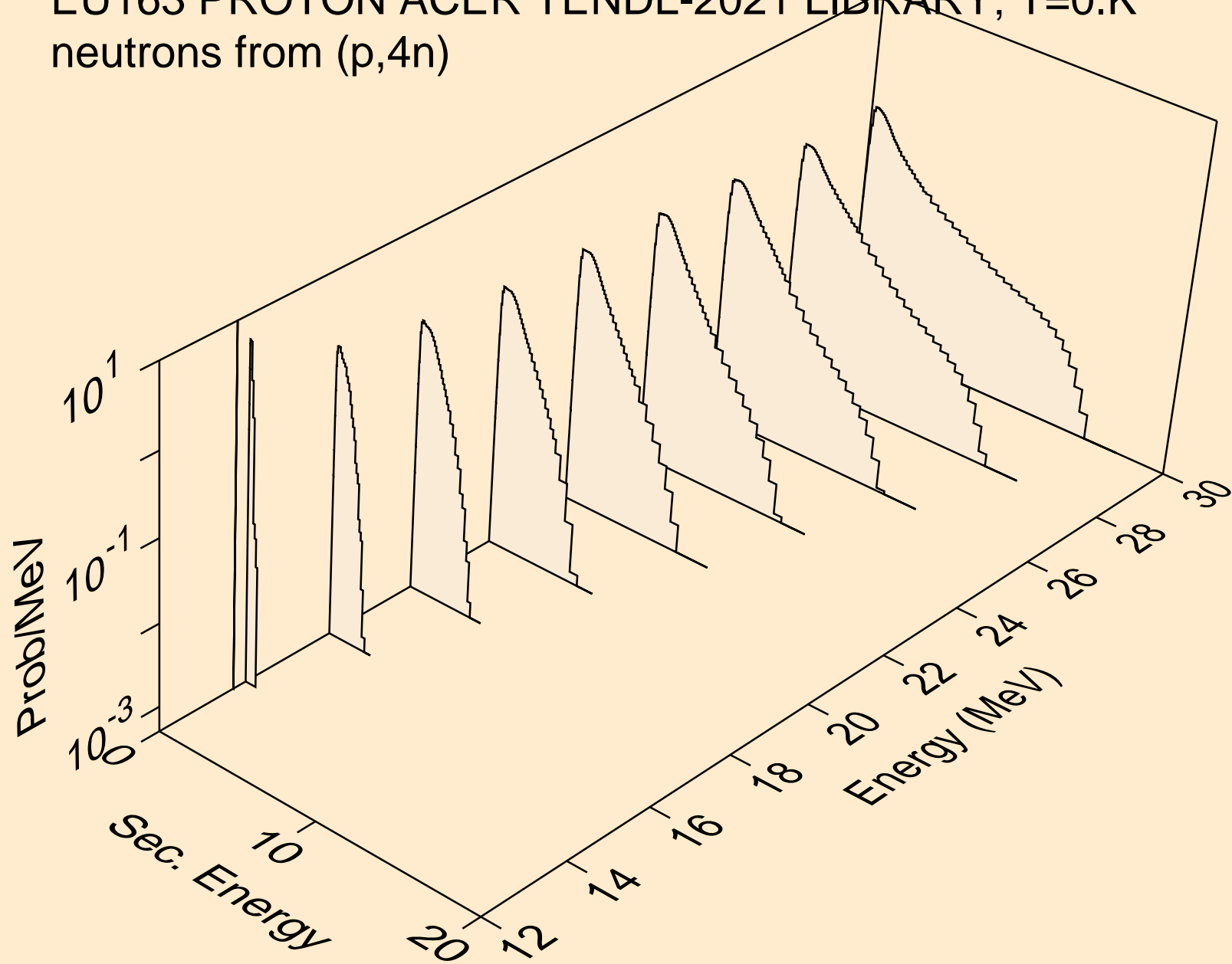

EU163 PROTON ACER TENDL-2021 LIBRARY; T=0.K  
neutrons from (p,2np)

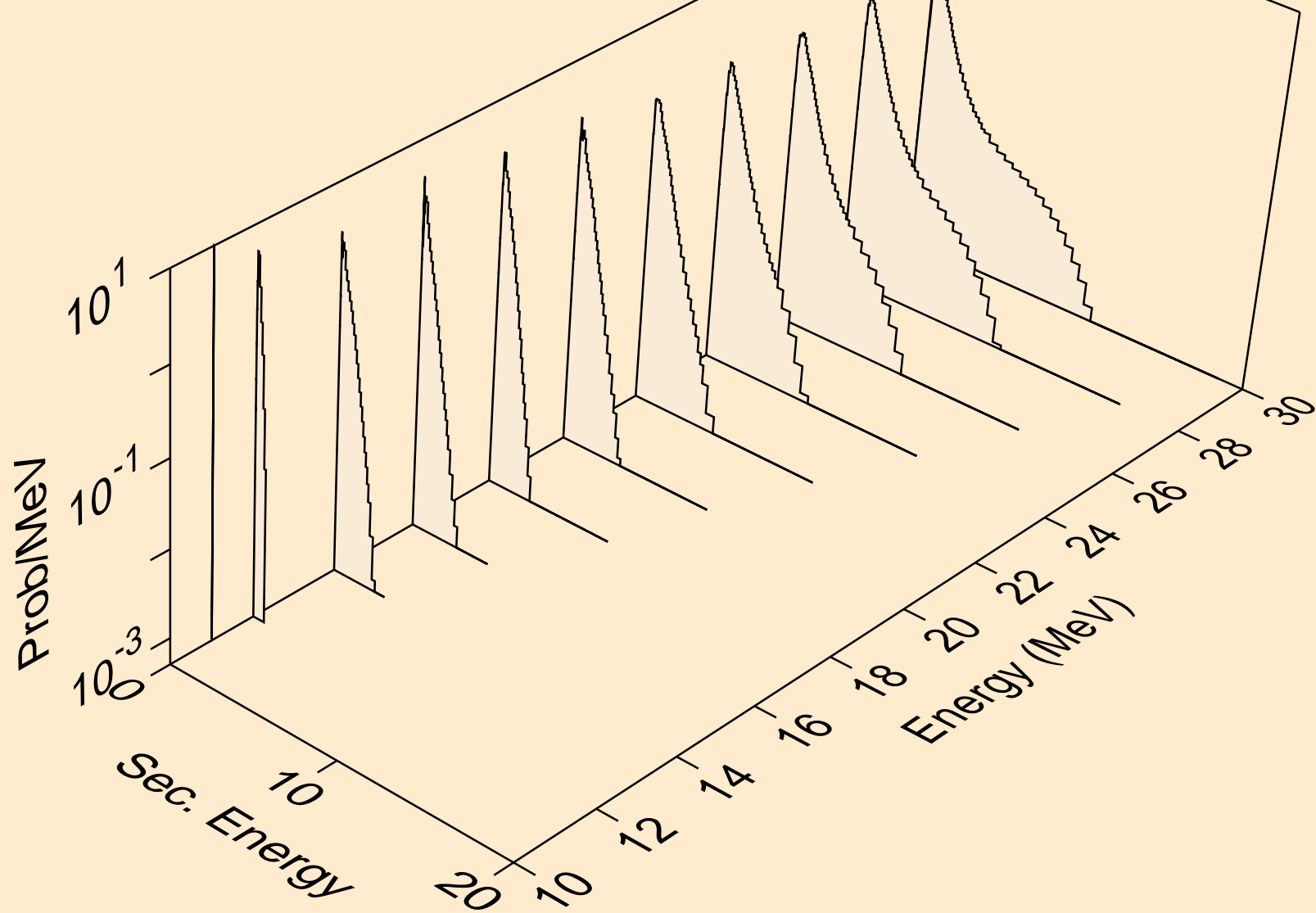

EU163 PROTON ACER TENDL-2021 LIBRARY; T=0.K  
neutrons from (p,3np)

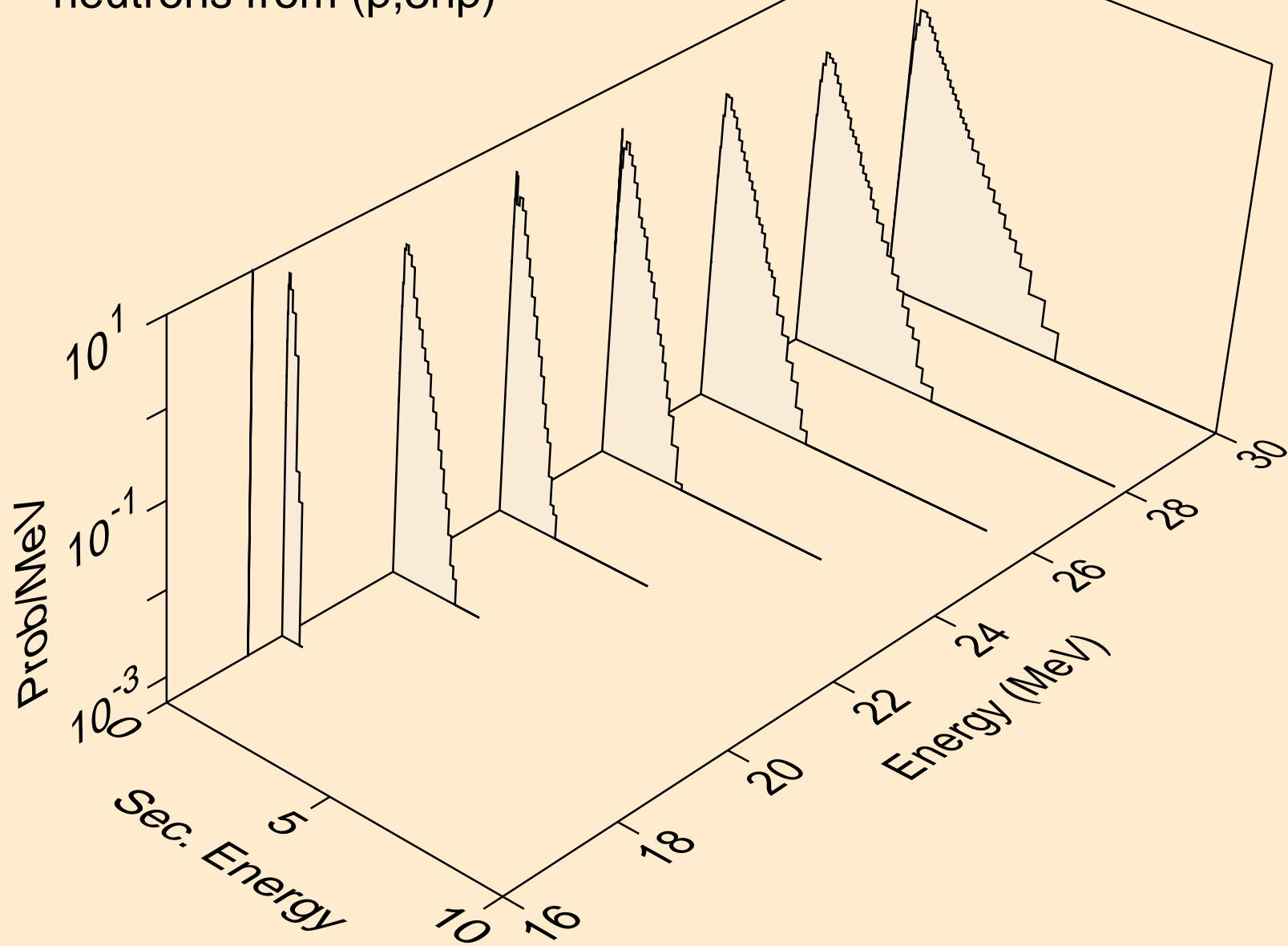

EU163 PROTON ACER TENDL-2021 LIBRARY; T=0.K  
neutrons from (p,2np)

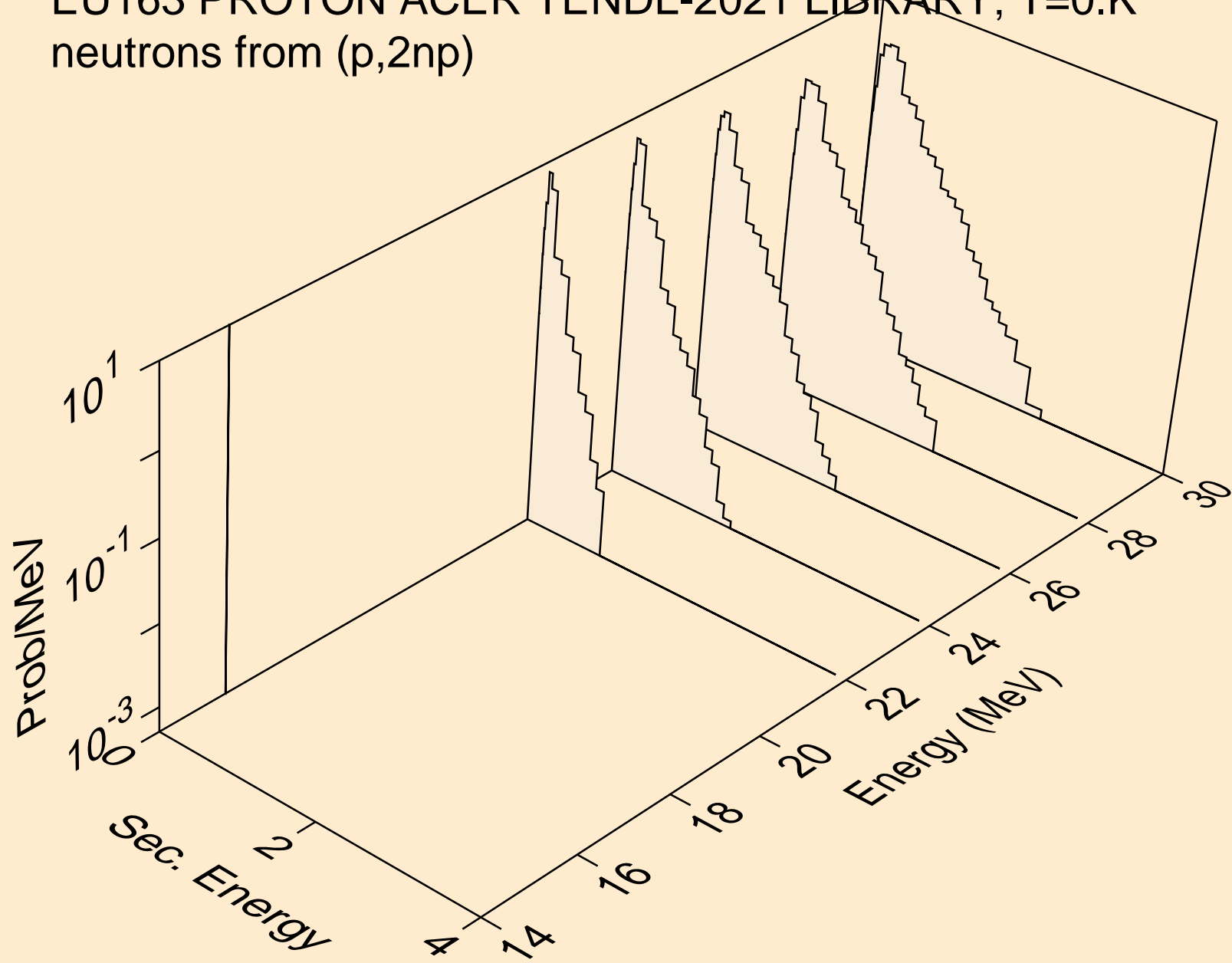

EU163 PROTON ACER TENDL-2021 LIBRARY; T=0.K  
deuterons from (p,x)

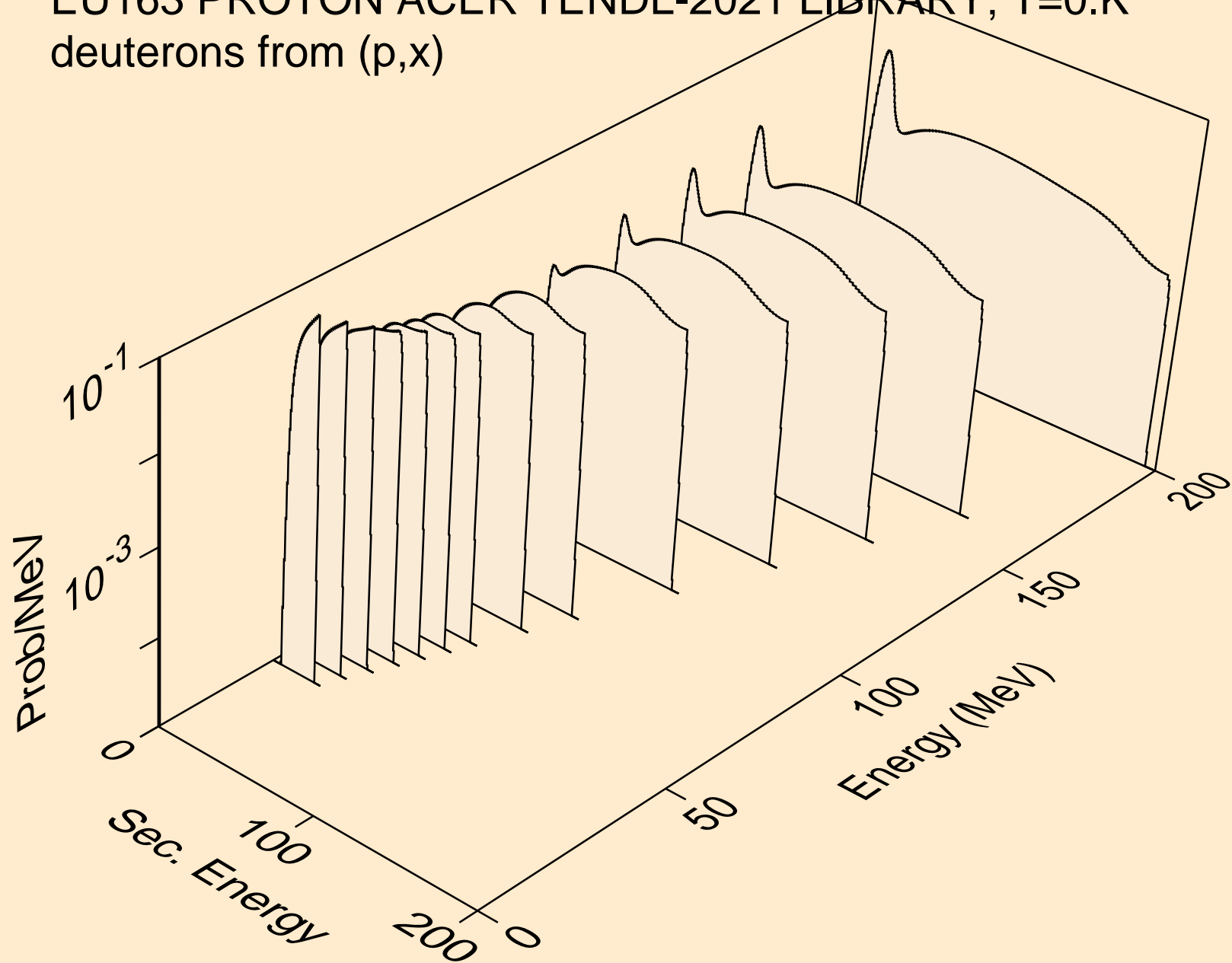

EU163 PROTON ACER TENDL-2021 LIBRARY; T=0.K  
deuterons from (p,2nd)

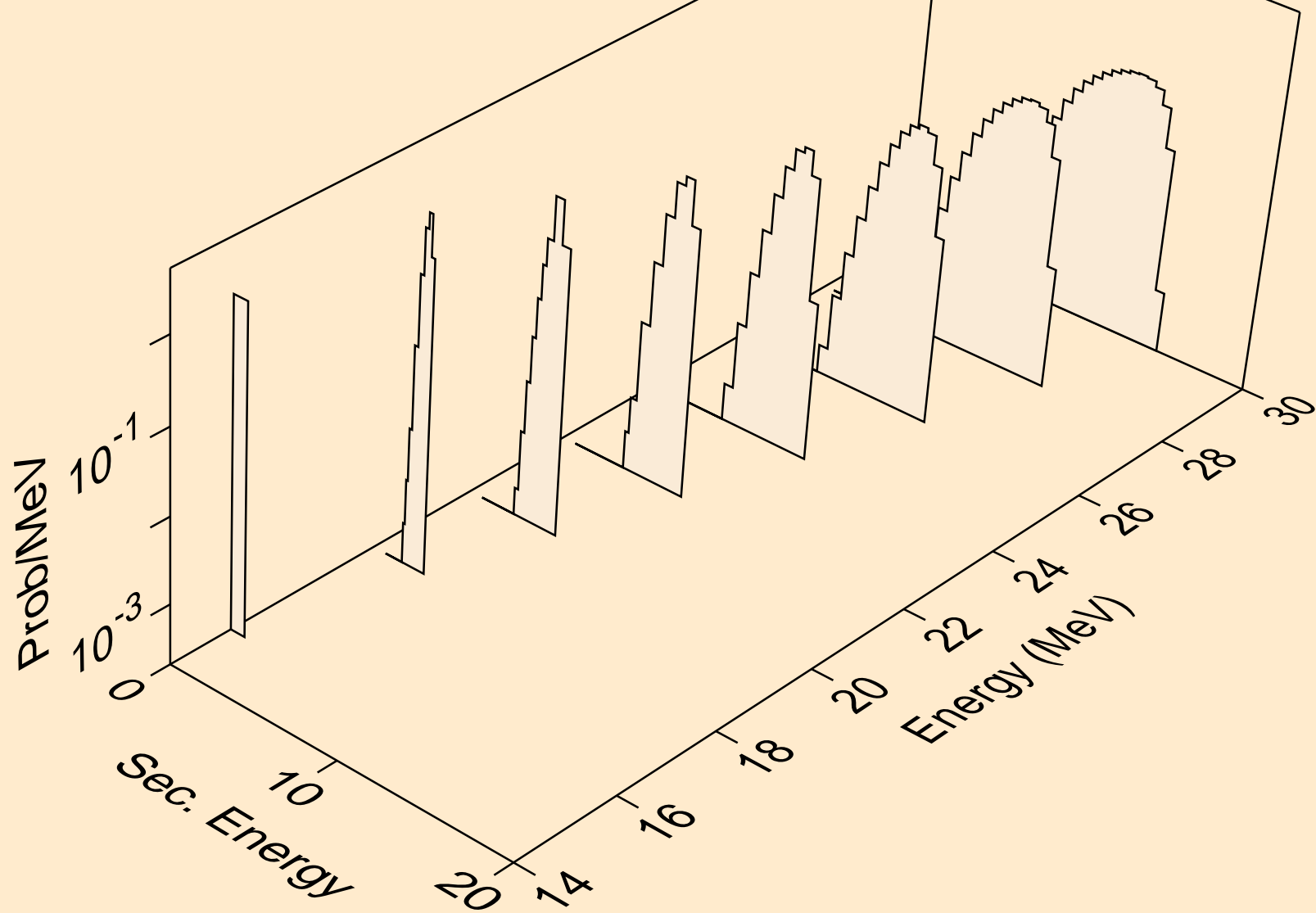

EU163 PROTON ACER TENDL-2021 LIBRARY; T=0.K  
deuterons from (p,n\*)d

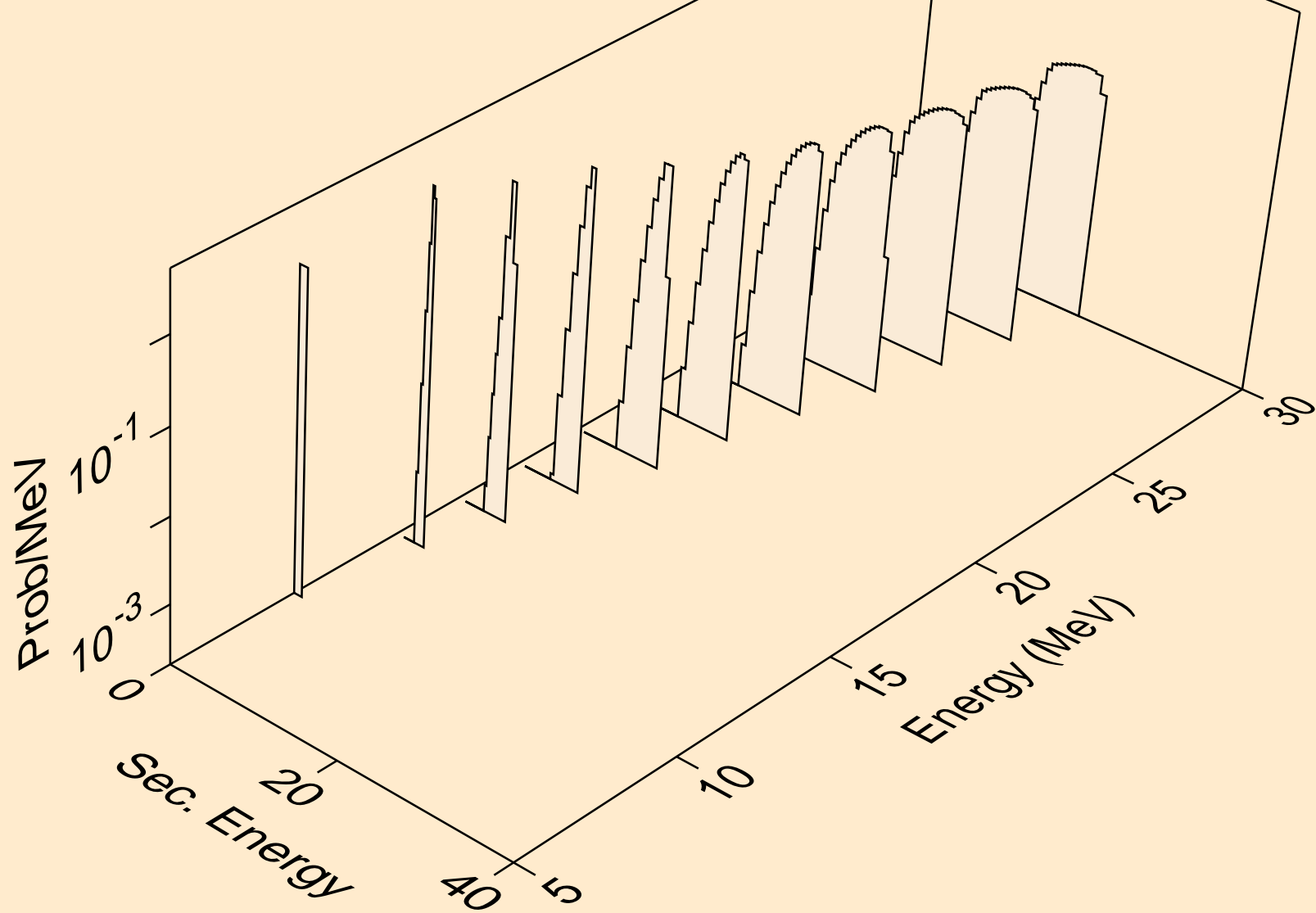



EU163 PROTON ACER TENDL-2021 LIBRARY; T=0.K  
deuterons from (p,d)

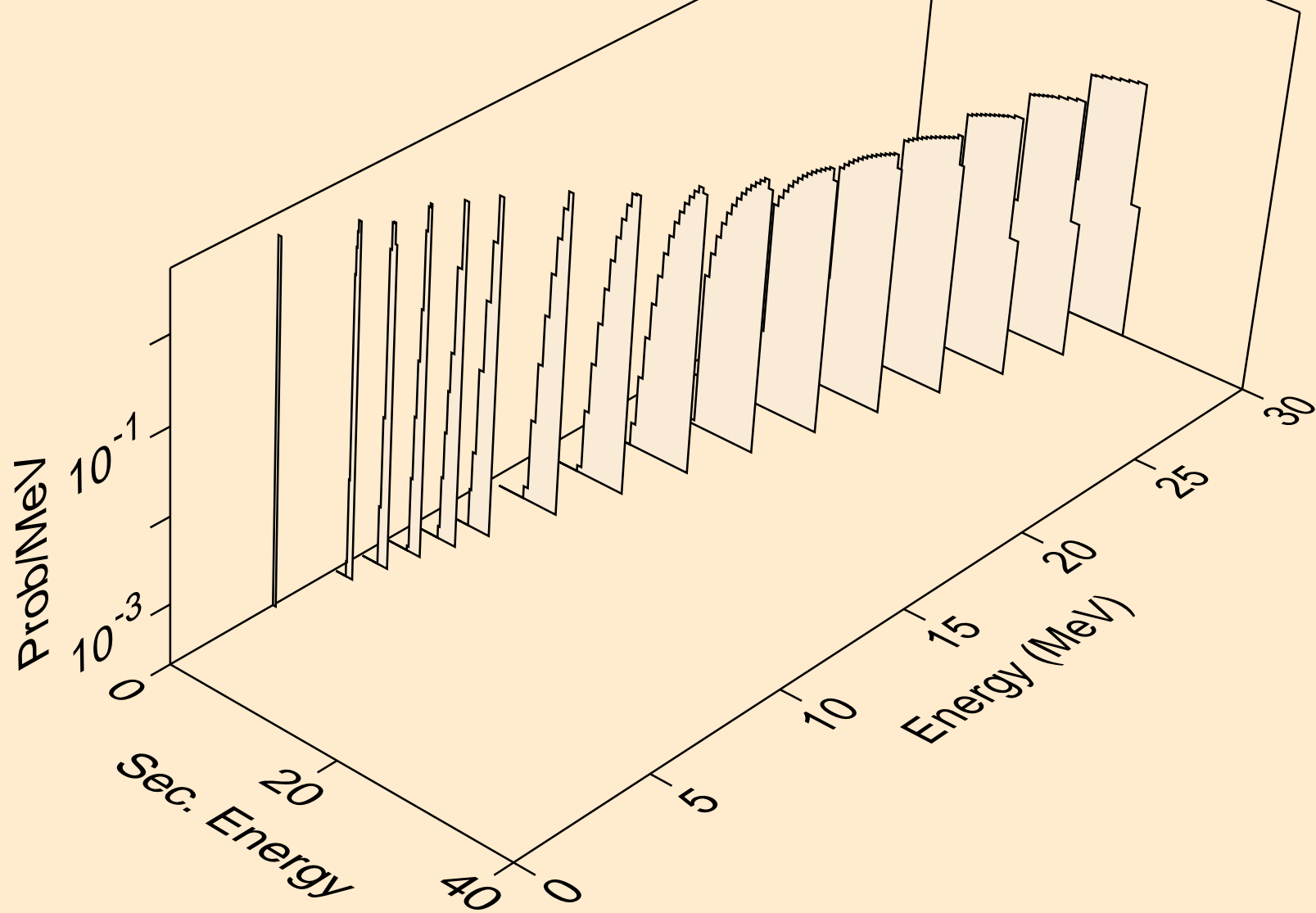

EU163 PROTON ACER TENDL-2021 LIBRARY; T=0.K  
deuterons from (p,pd)

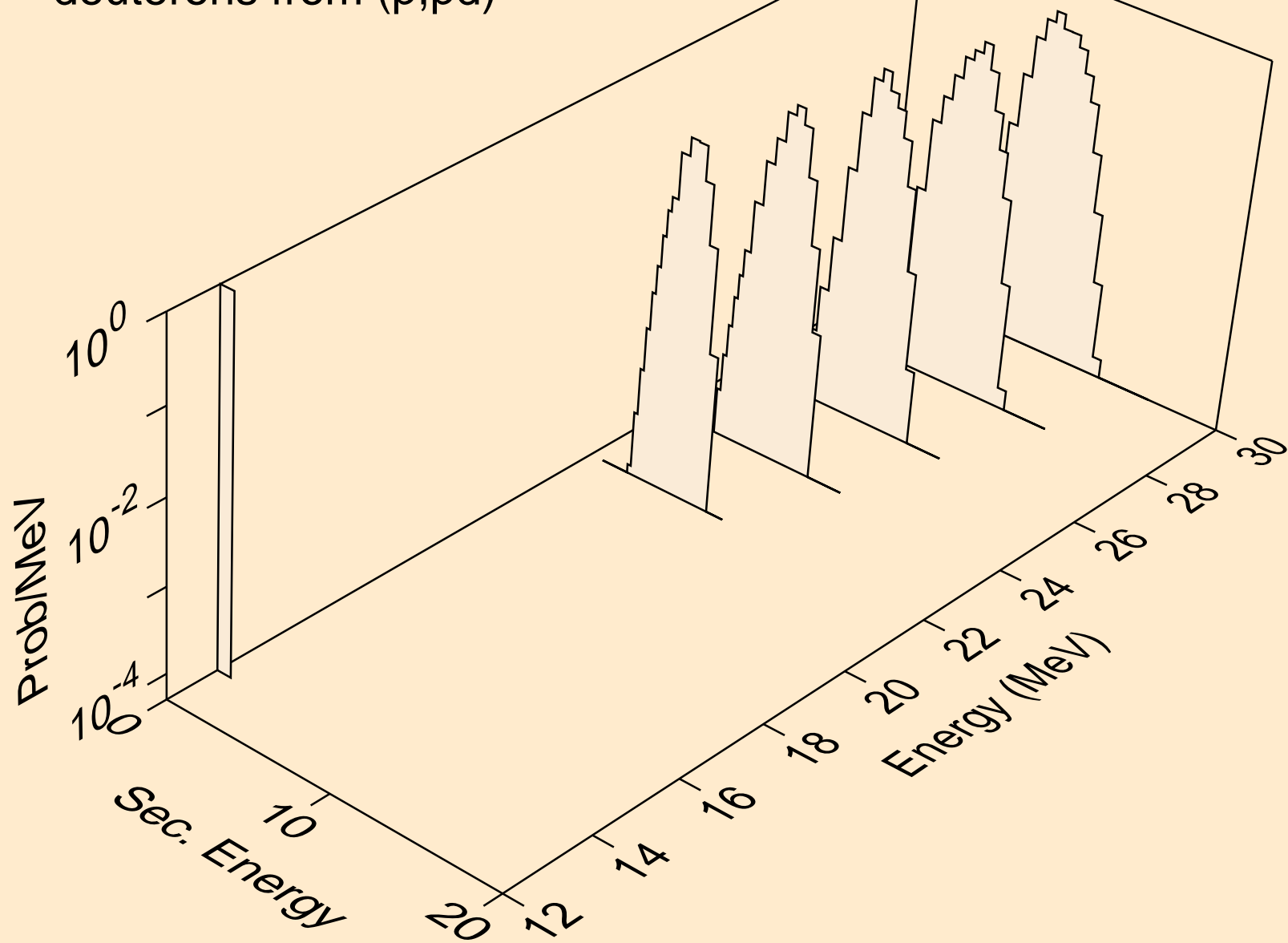

EU163 PROTON ACER TENDL-2021 LIBRARY; T=0.K  
tritons from (p,x)

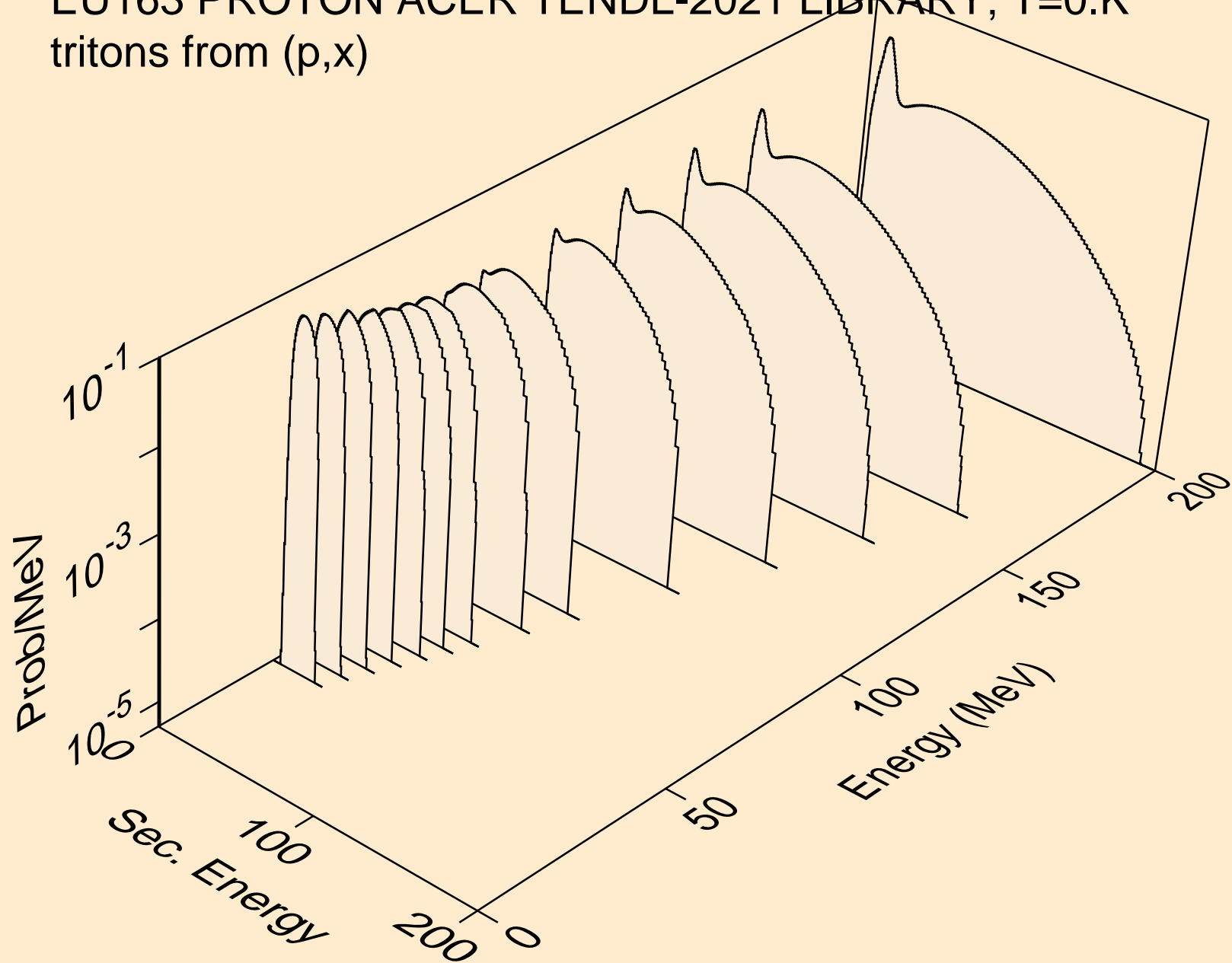

EU163 PROTON ACER TENDL-2021 LIBRARY; T=0.K  
tritons from (p,n\*)t

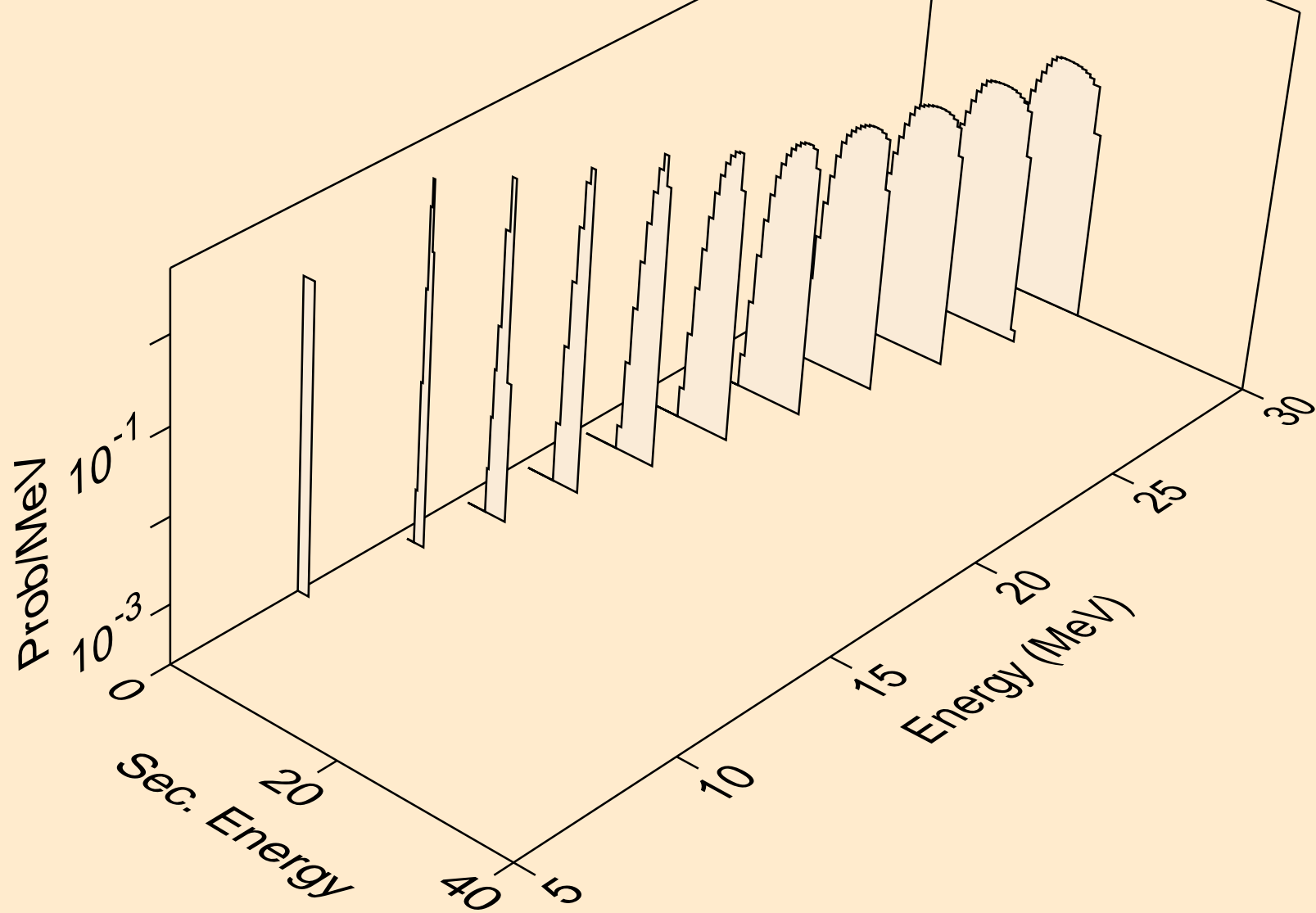

EU163 PROTON ACER TENDL-2021 LIBRARY; T=0.K  
tritons from (p,t)

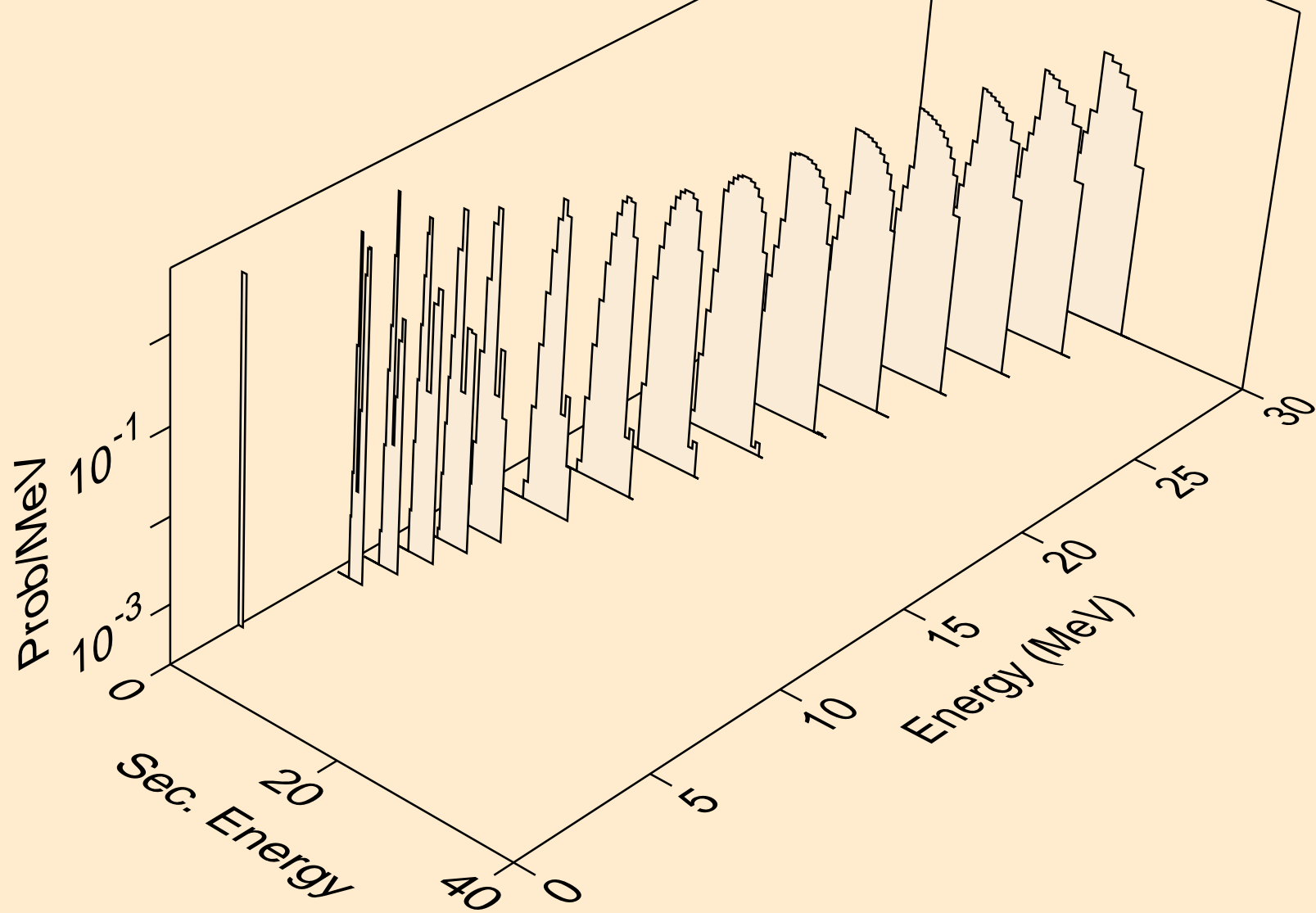

EU163 PROTON ACER TENDL-2021 LIBRARY; T=0.K  
he3s from (p,x)

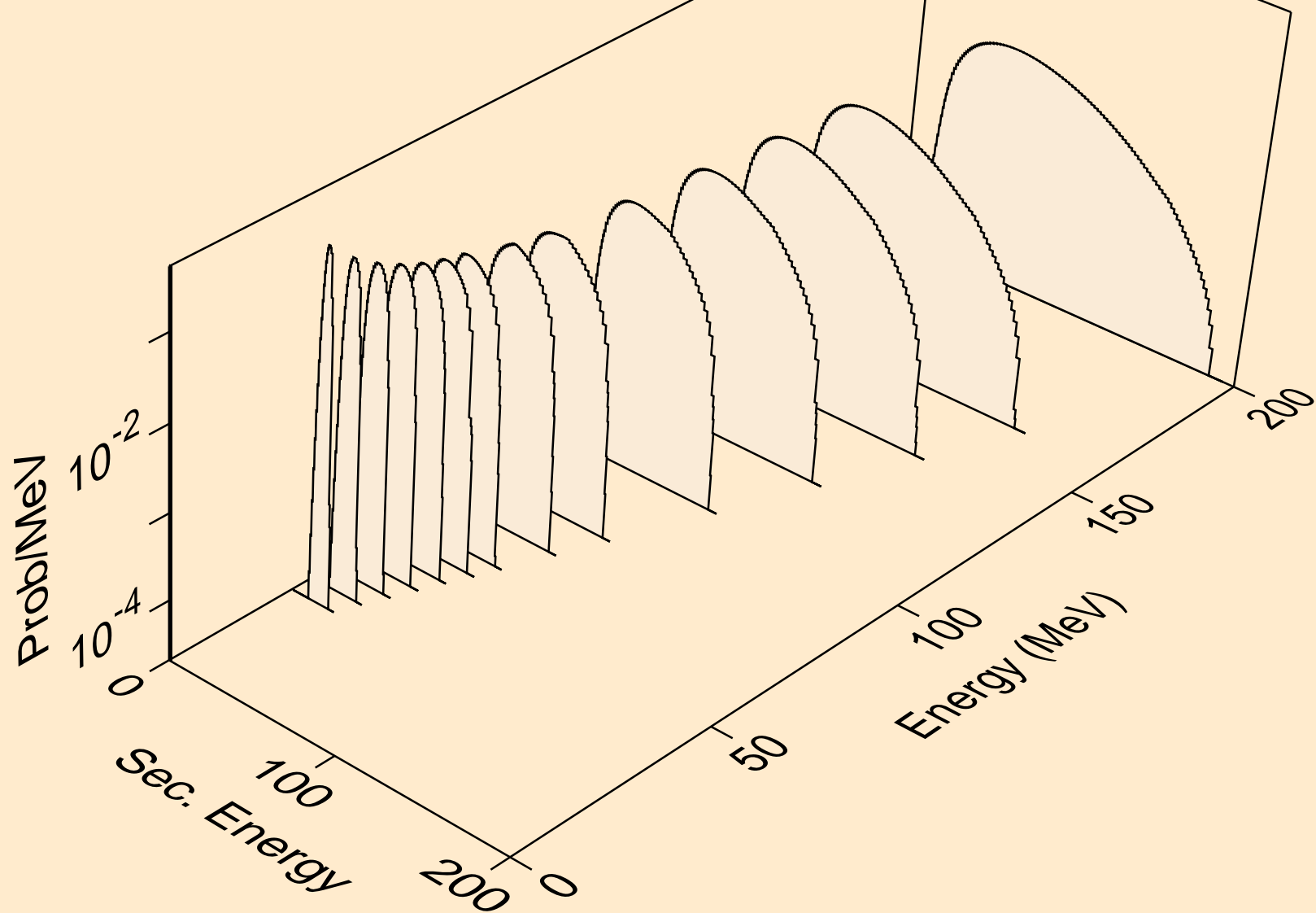

EU163 PROTON ACER TENDL-2021 LIBRARY; T=0.K  
he3s from (p,n\*)he3

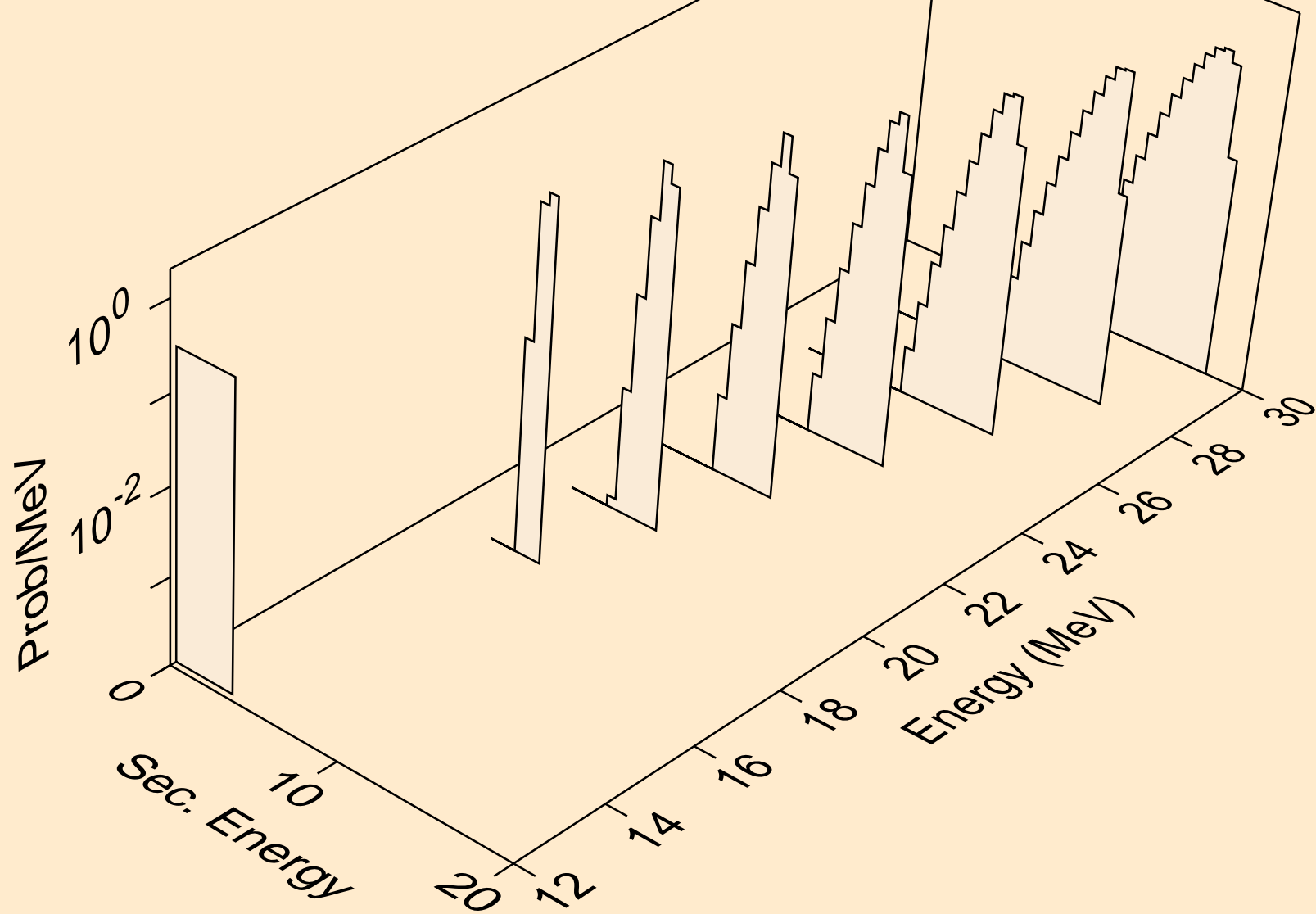

EU163 PROTON ACER TENDL-2021 LIBRARY; T=0.K  
he3s from (p,he3)

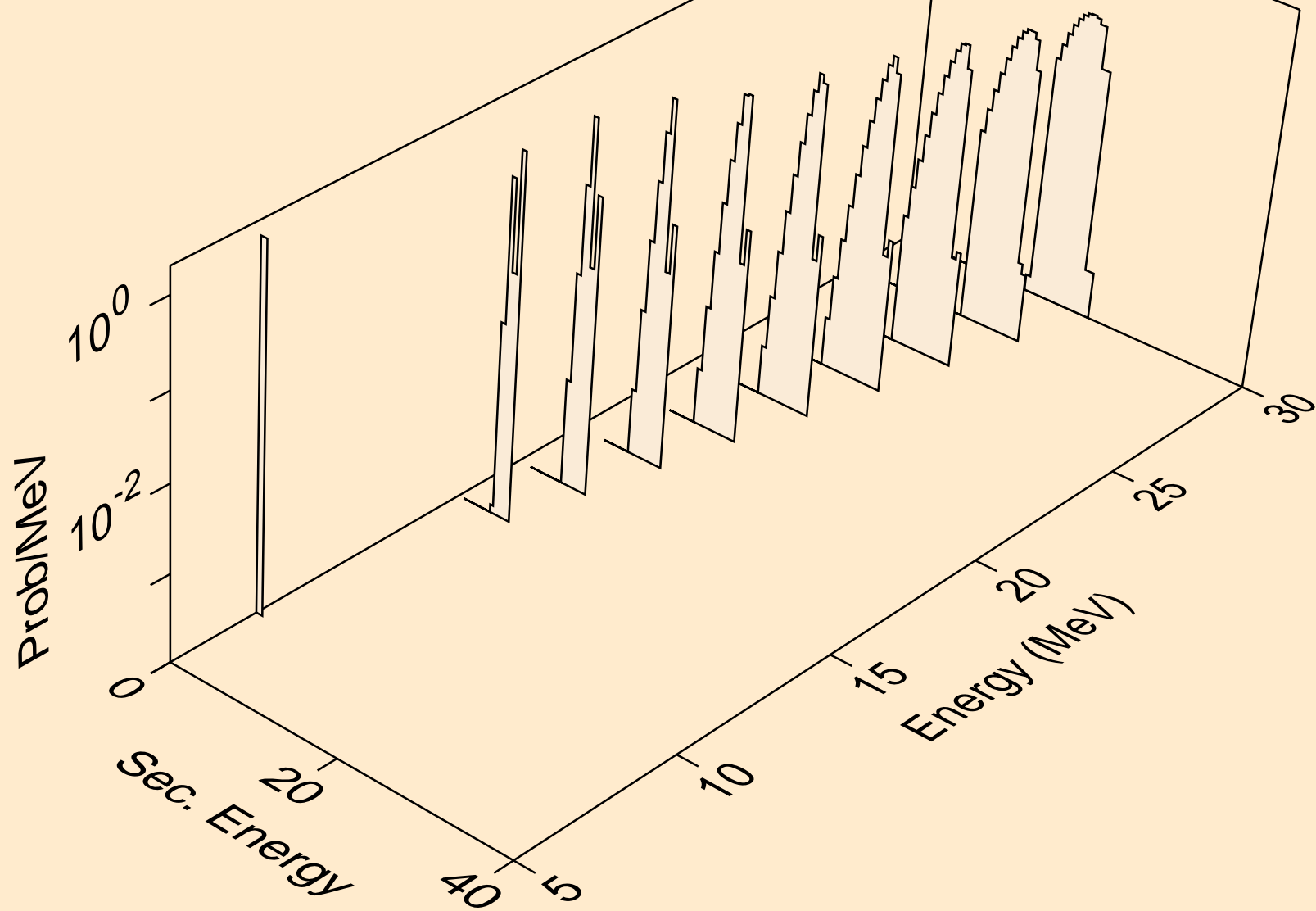



EU163 PROTON ACER TENDL-2021 LIBRARY; T=0.K  
alphas from (p,x)

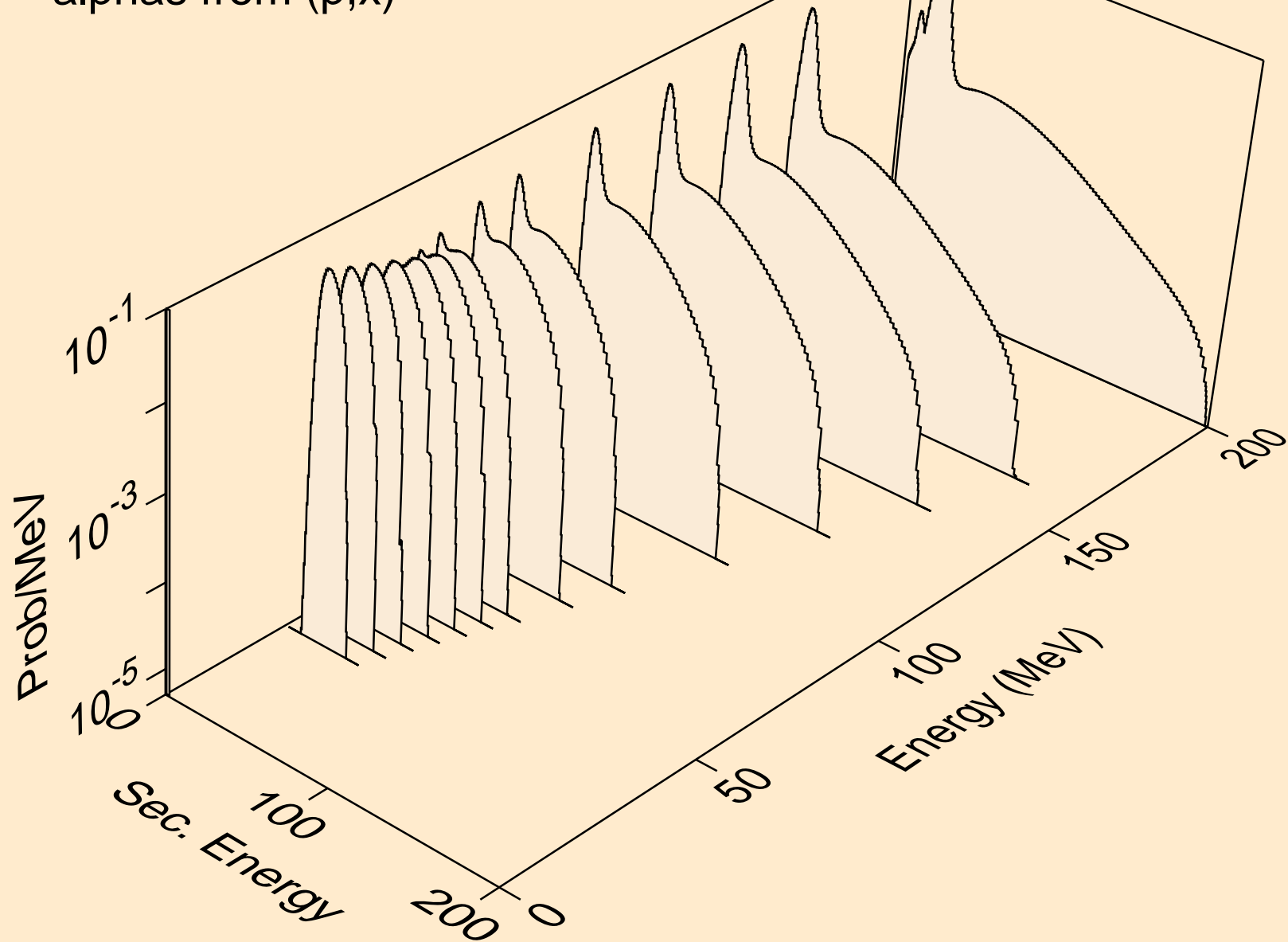

EU163 PROTON ACER TENDL-2021 LIBRARY; T=0.K  
alphas from (p,n\*)a

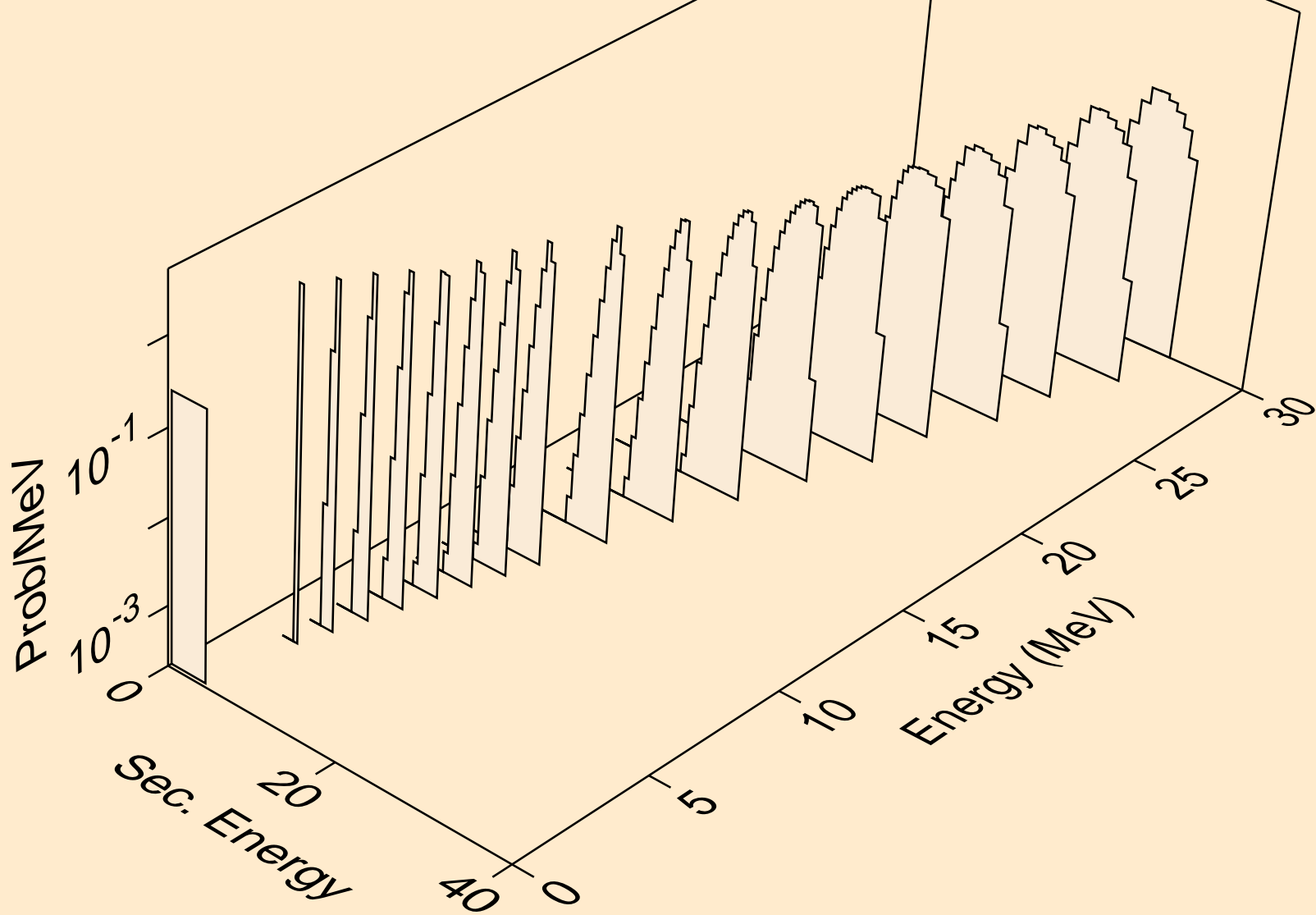

EU163 PROTON ACER TENDL-2021 LIBRARY; T=0.K  
alphas from (p,2n)a

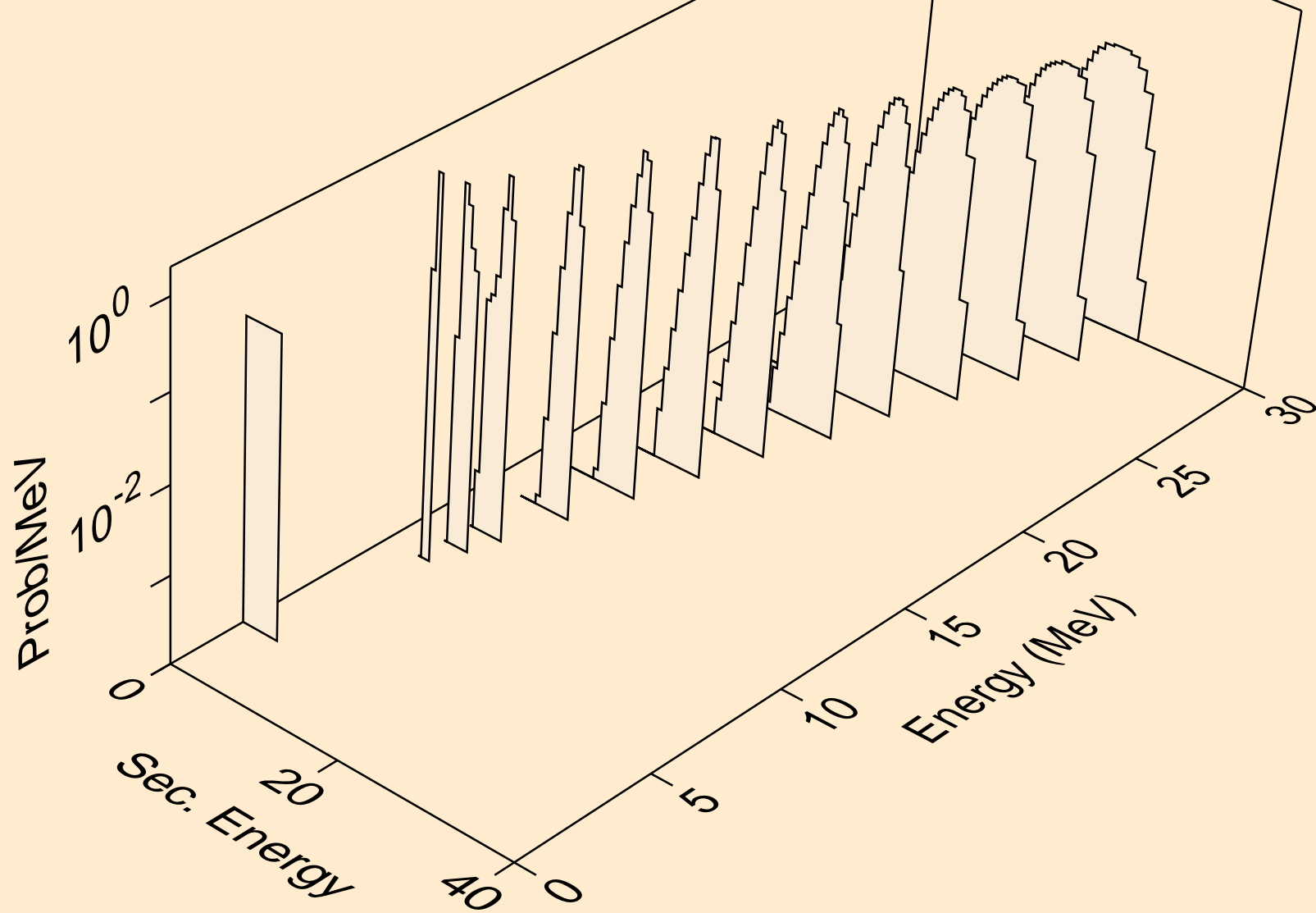

EU163 PROTON ACER TENDL-2021 LIBRARY; T=0.K  
alphas from (p,3n)a

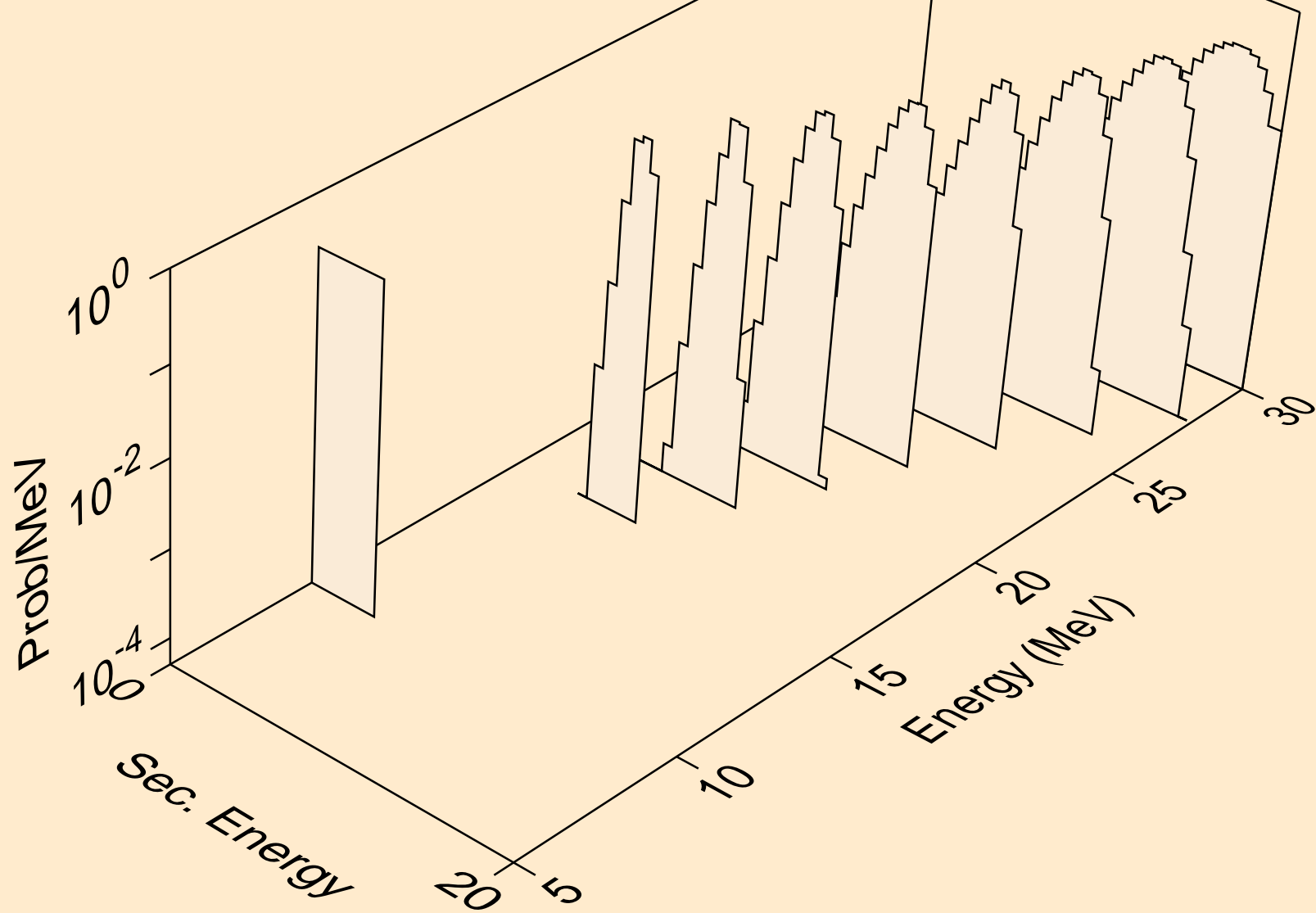

EU163 PROTON ACER TENDL-2021 LIBRARY; T=0.K  
alphas from (p,a)

