

FE052 PROTON ACER TENDL-2021 LIBRARY; T=0.K

Principal cross sections

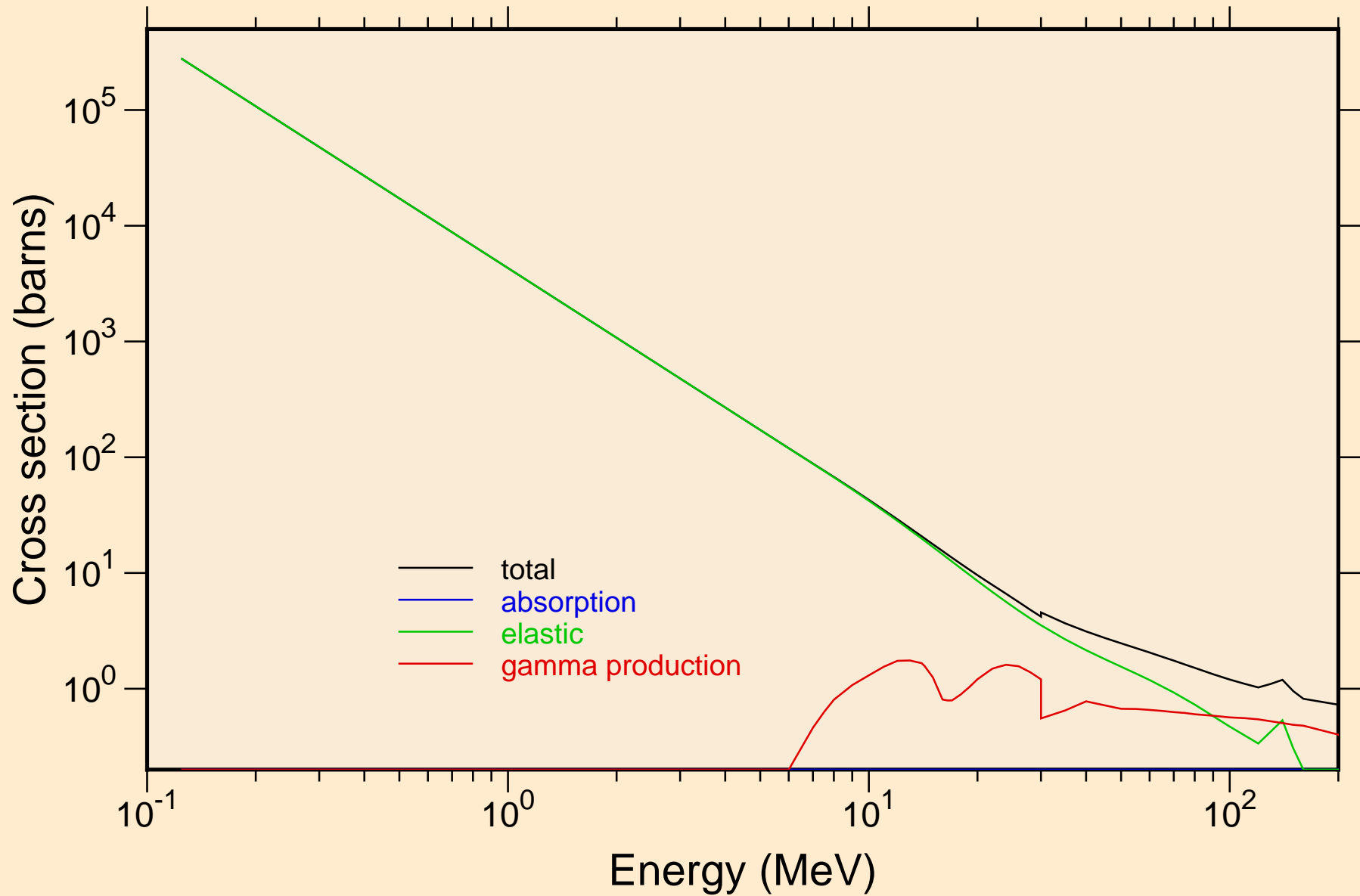

FE052 PROTON ACER TENDL-2021 LIBRARY; T=0.K

Heating

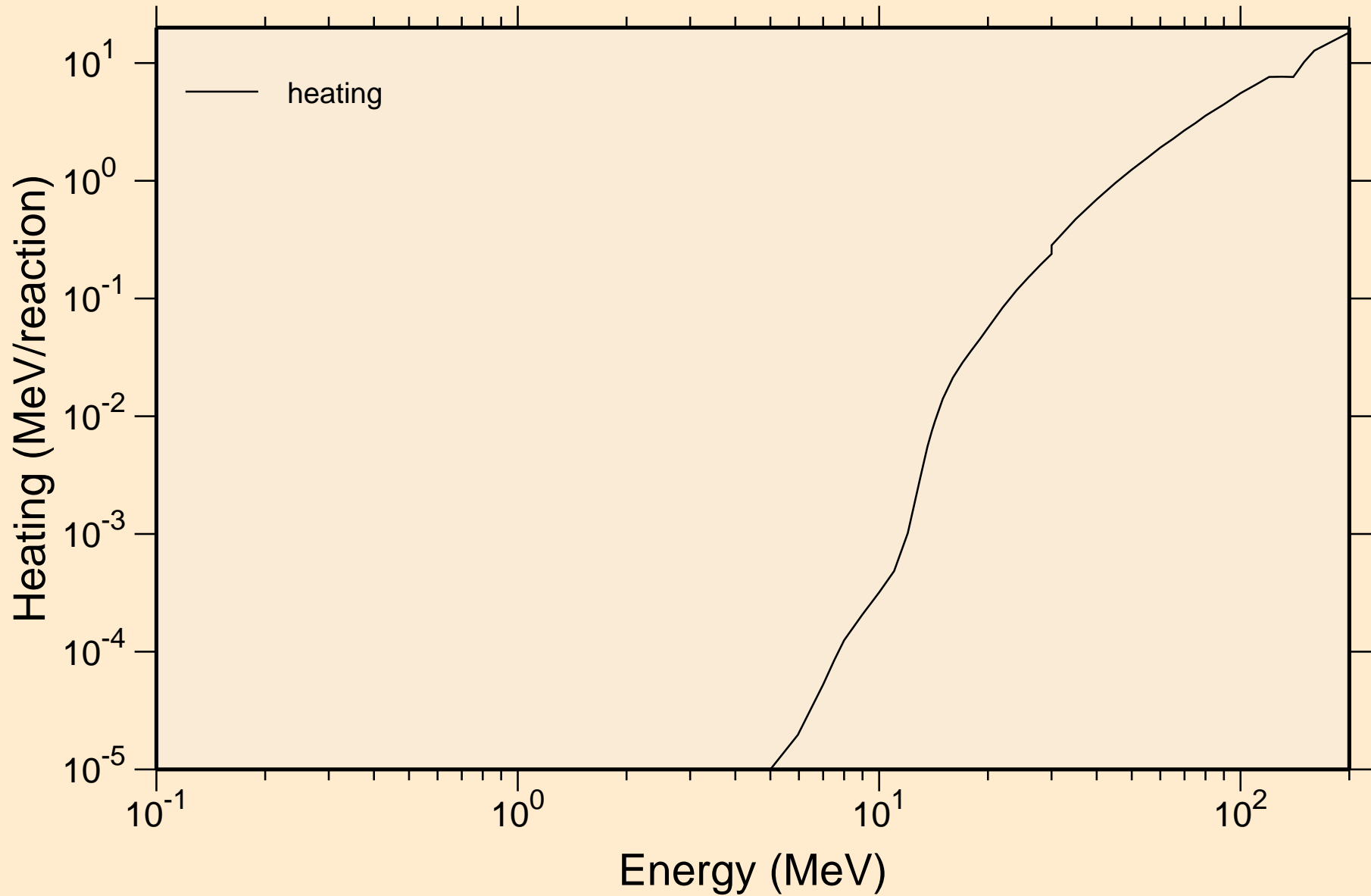

FE052 PROTON ACER TENDL-2021 LIBRARY; T=0.K

Principal cross sections

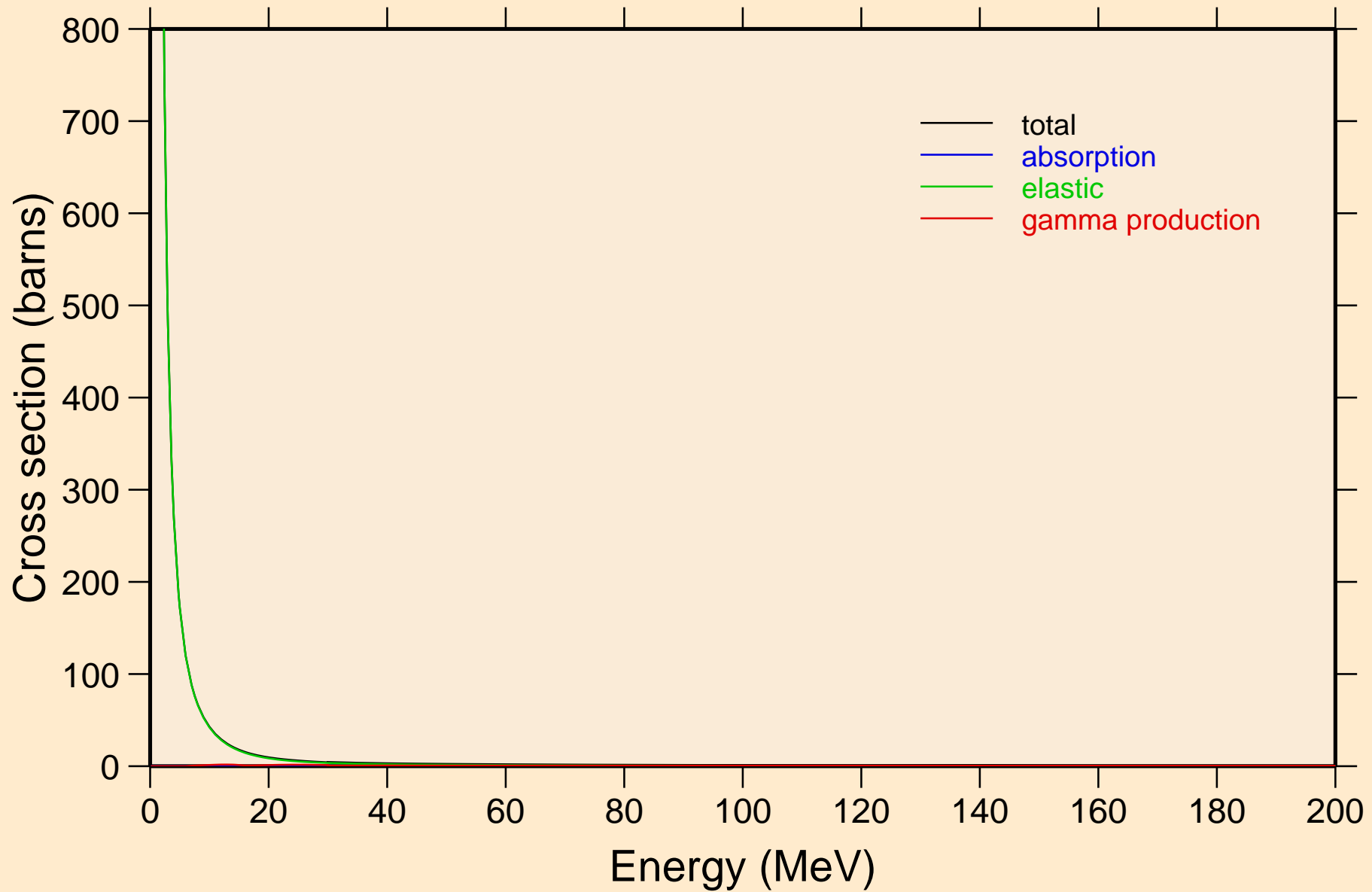

FE052 PROTON ACER TENDL-2021 LIBRARY; T=0.K

Heating

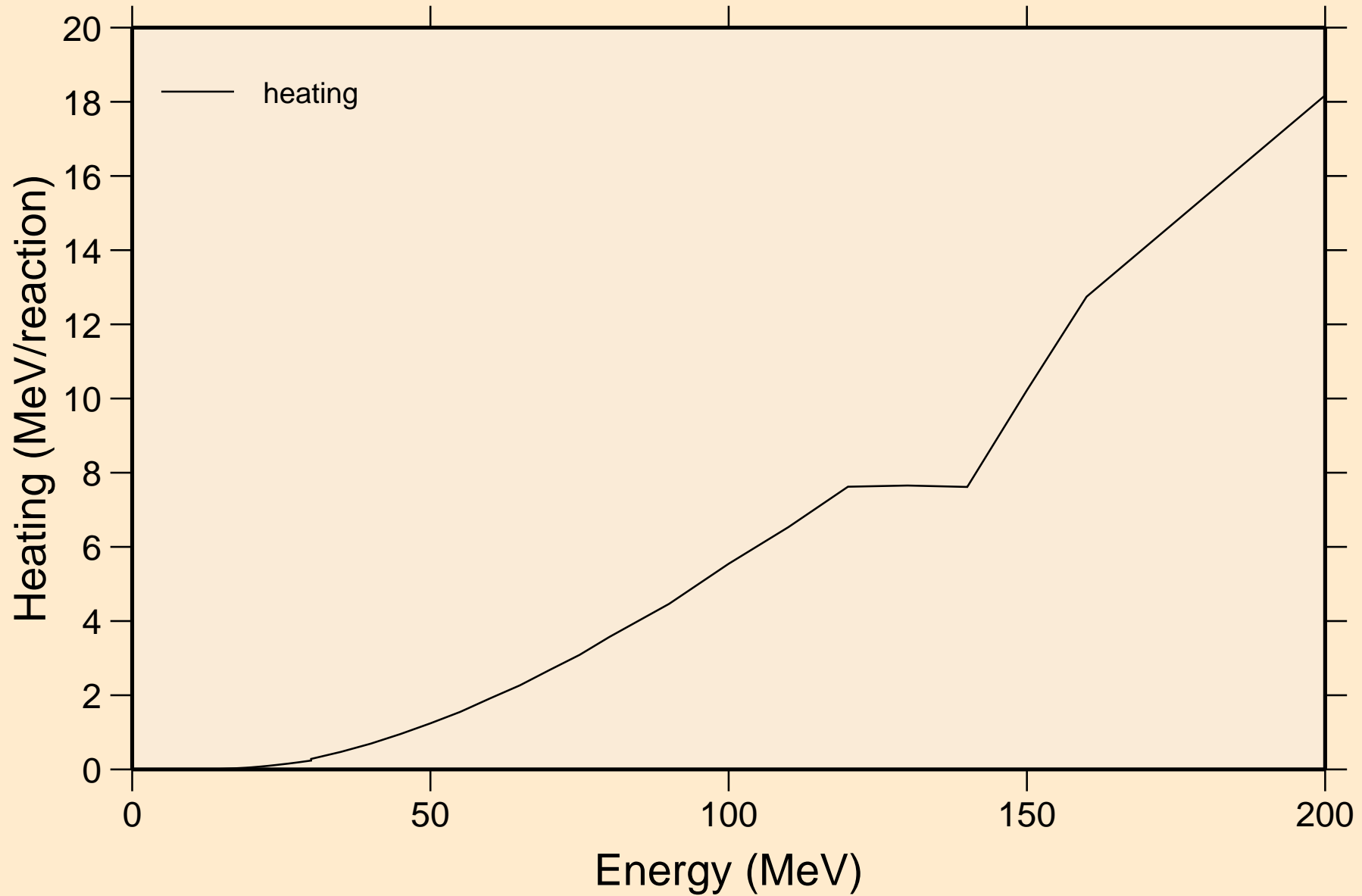

FE052 PROTON ACER TENDL-2021 LIBRARY; T=0.K

Threshold reactions

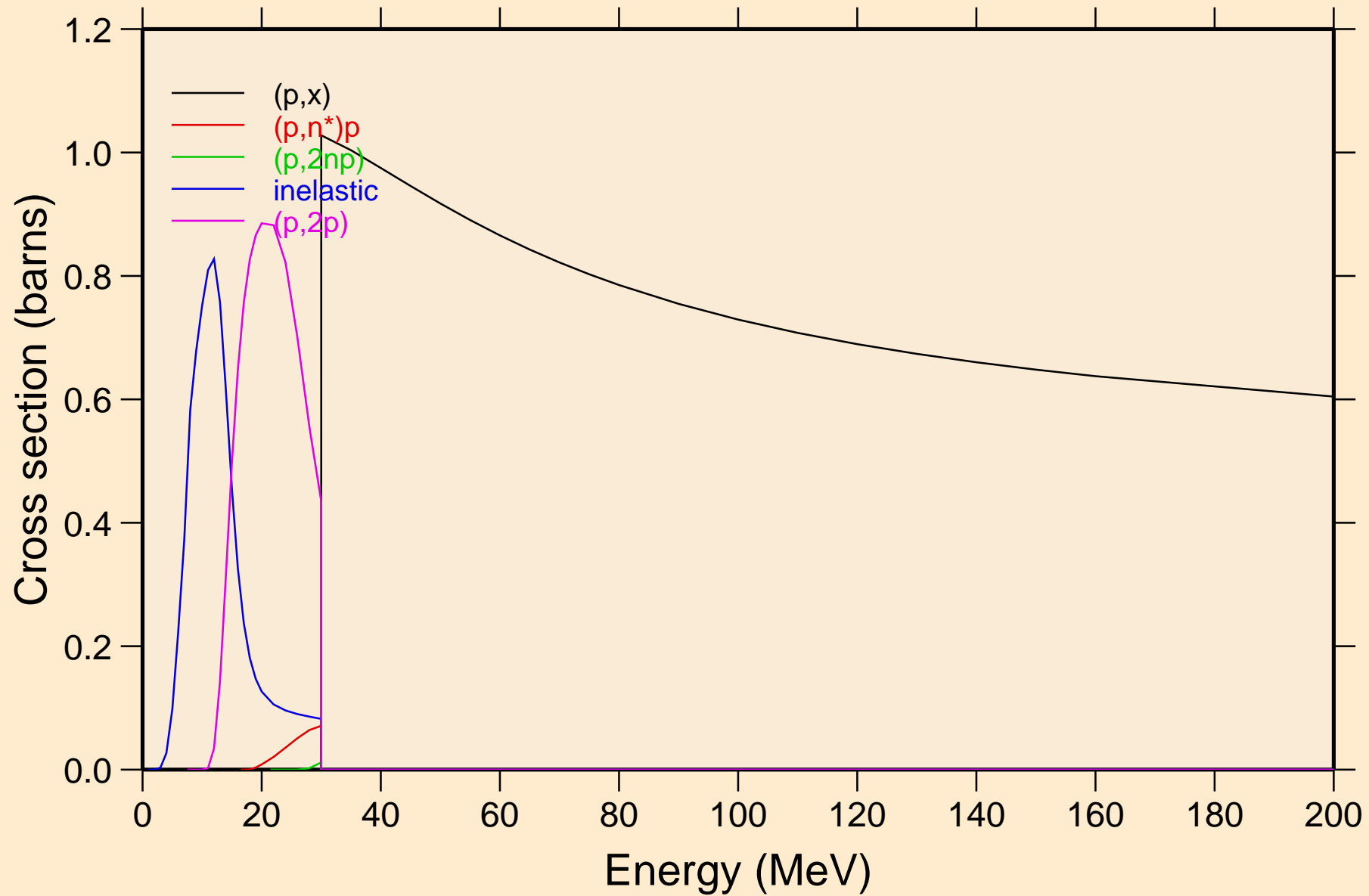

FE052 PROTON ACER TENDL-2021 LIBRARY; T=0.K
Threshold reactions

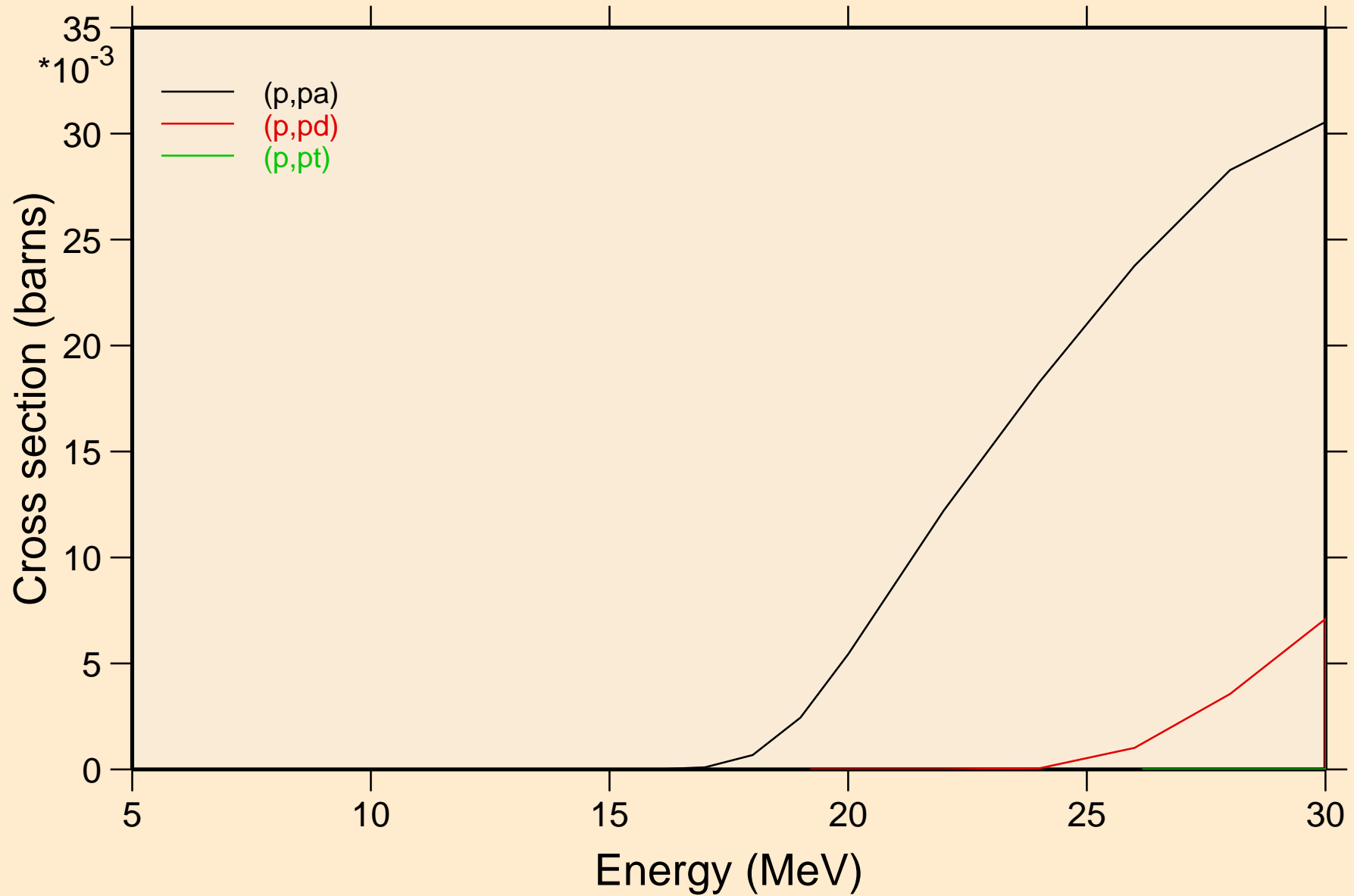

FE052 PROTON ACER TENDL-2021 LIBRARY; T=0.K
angular distribution for elastic

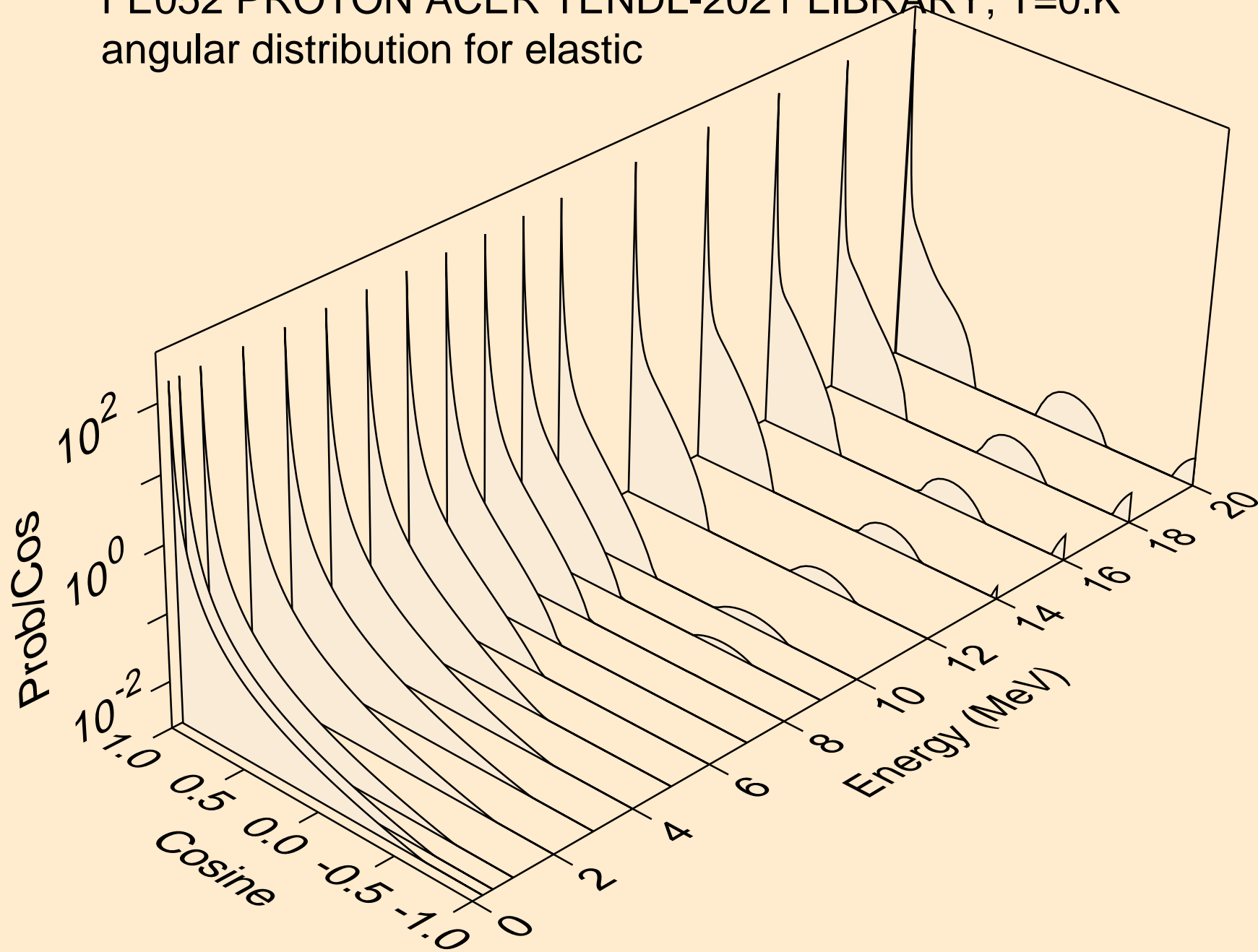

FE052 PROTON ACER TENDL-2021 LIBRARY; T=0.K
angular distribution for elastic

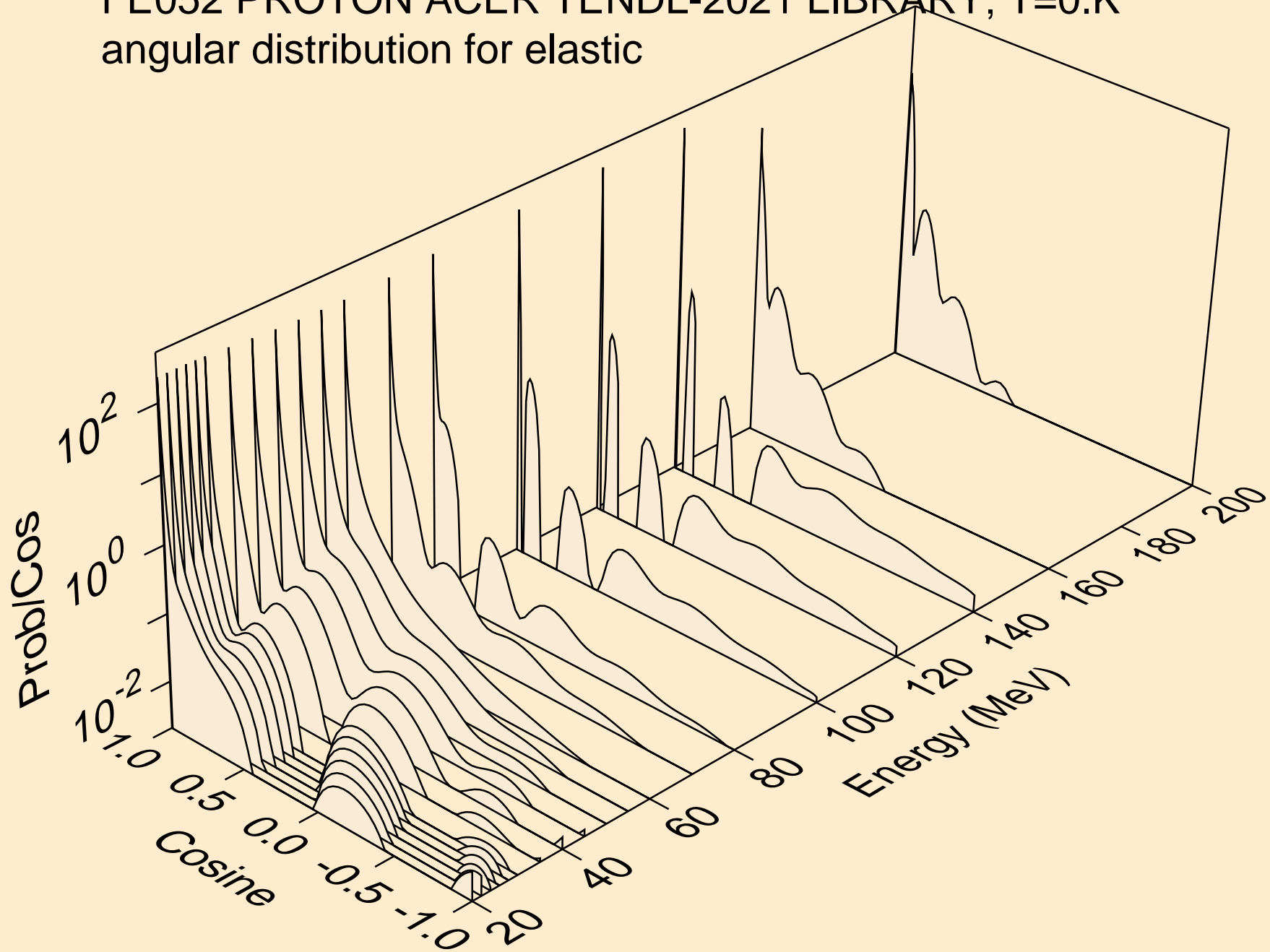

FE052 PROTON ACER TENDL-2021 LIBRARY; T=0.K
Proton emission for (p,x)

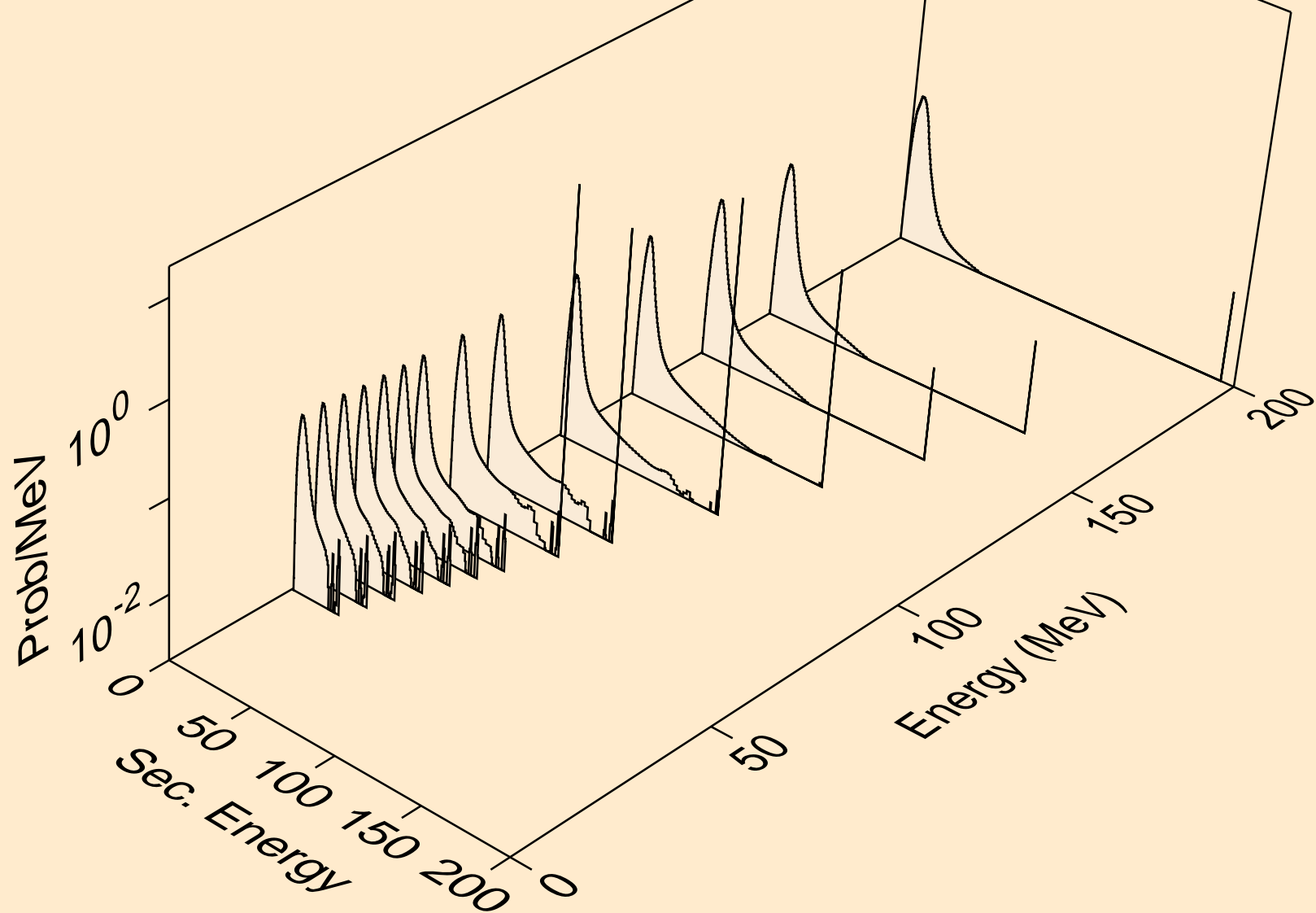

FE052 PROTON ACER TENDL-2021 LIBRARY; T=0.K
Proton emission for (p,n*)p

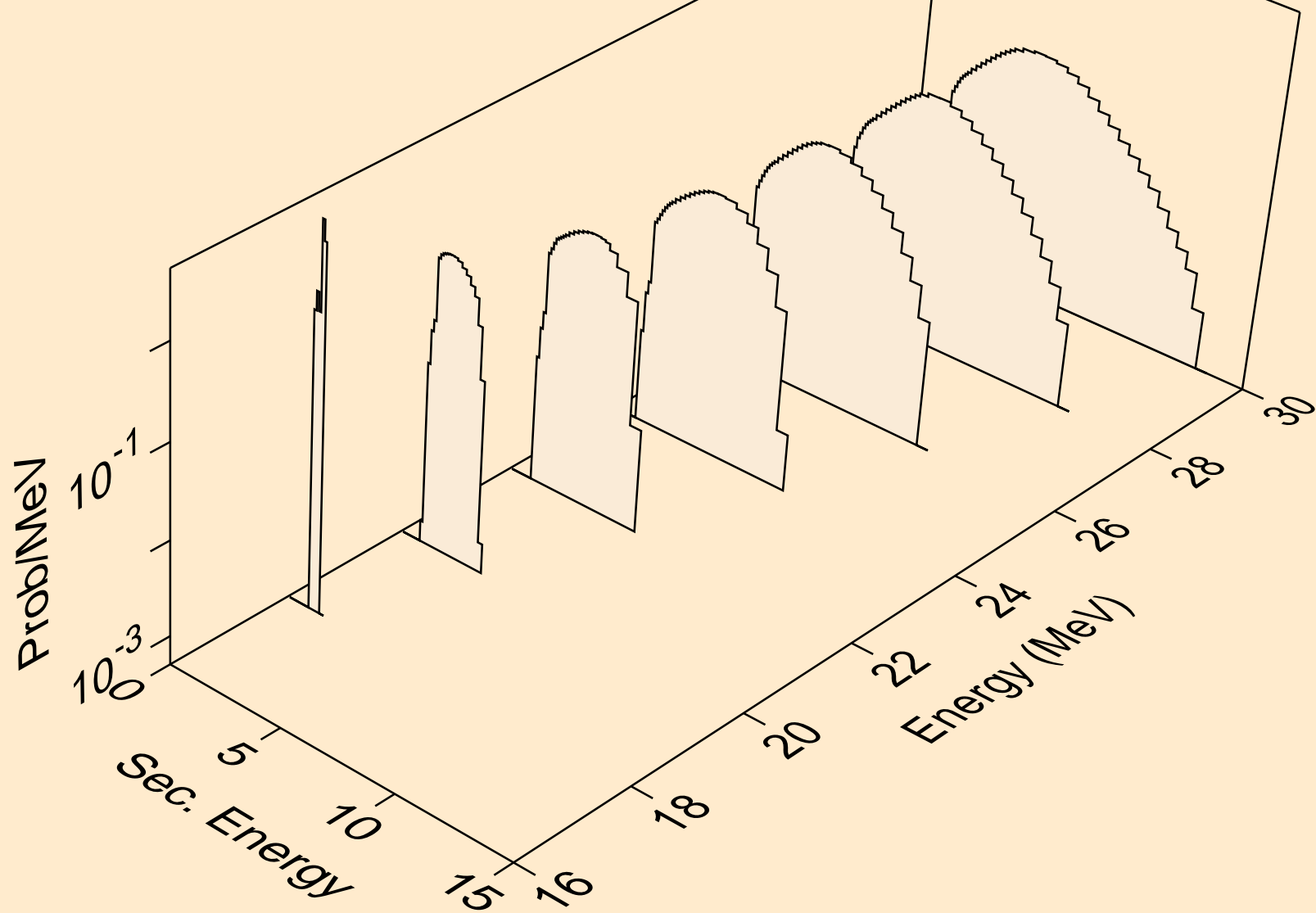

FE052 PROTON ACER TENDL-2021 LIBRARY; T=0.K
Proton emission for (p,2np)

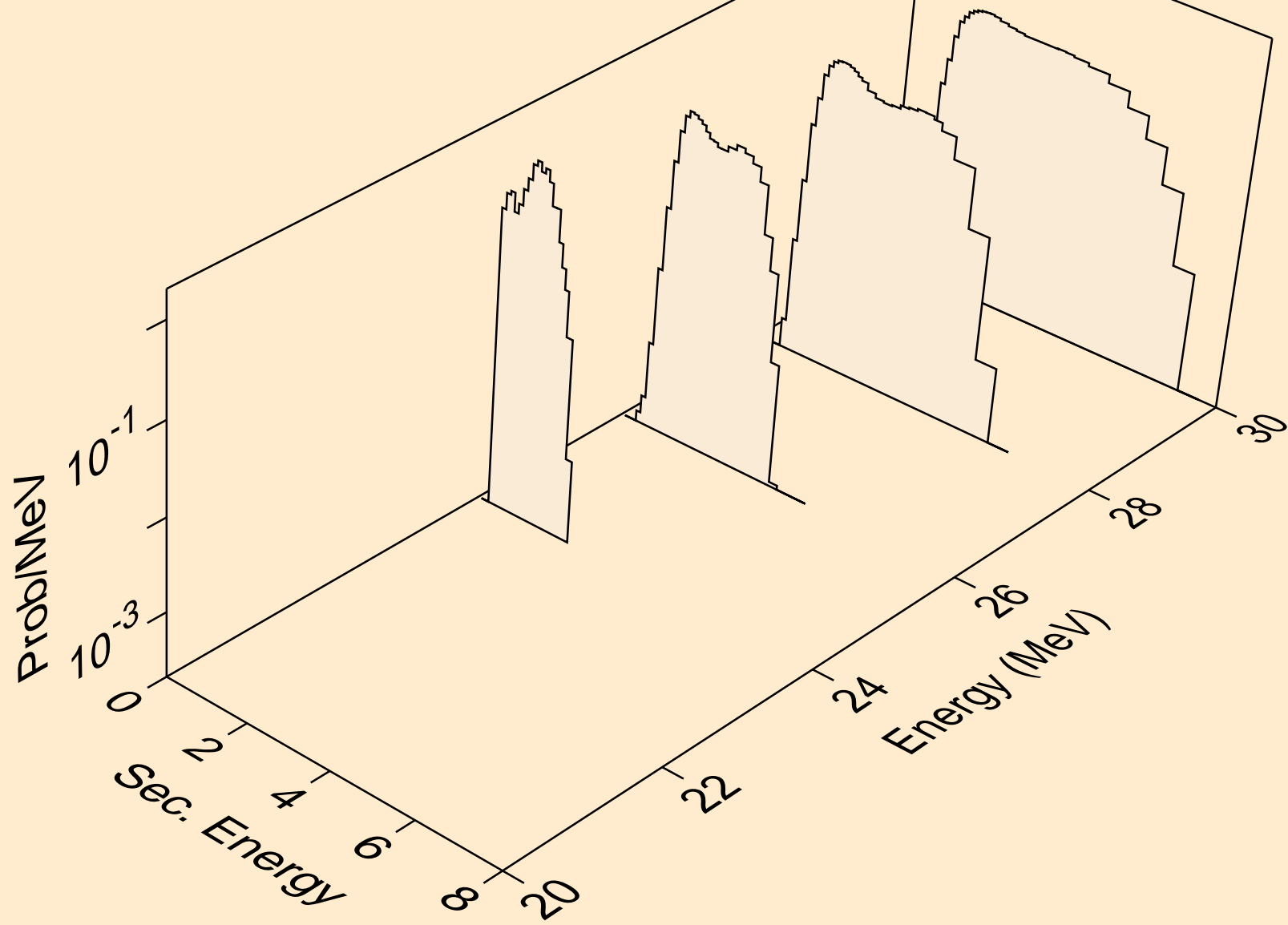

FE052 PROTON ACER TENDL-2021 LIBRARY; T=0.K
Proton emission for inelastic

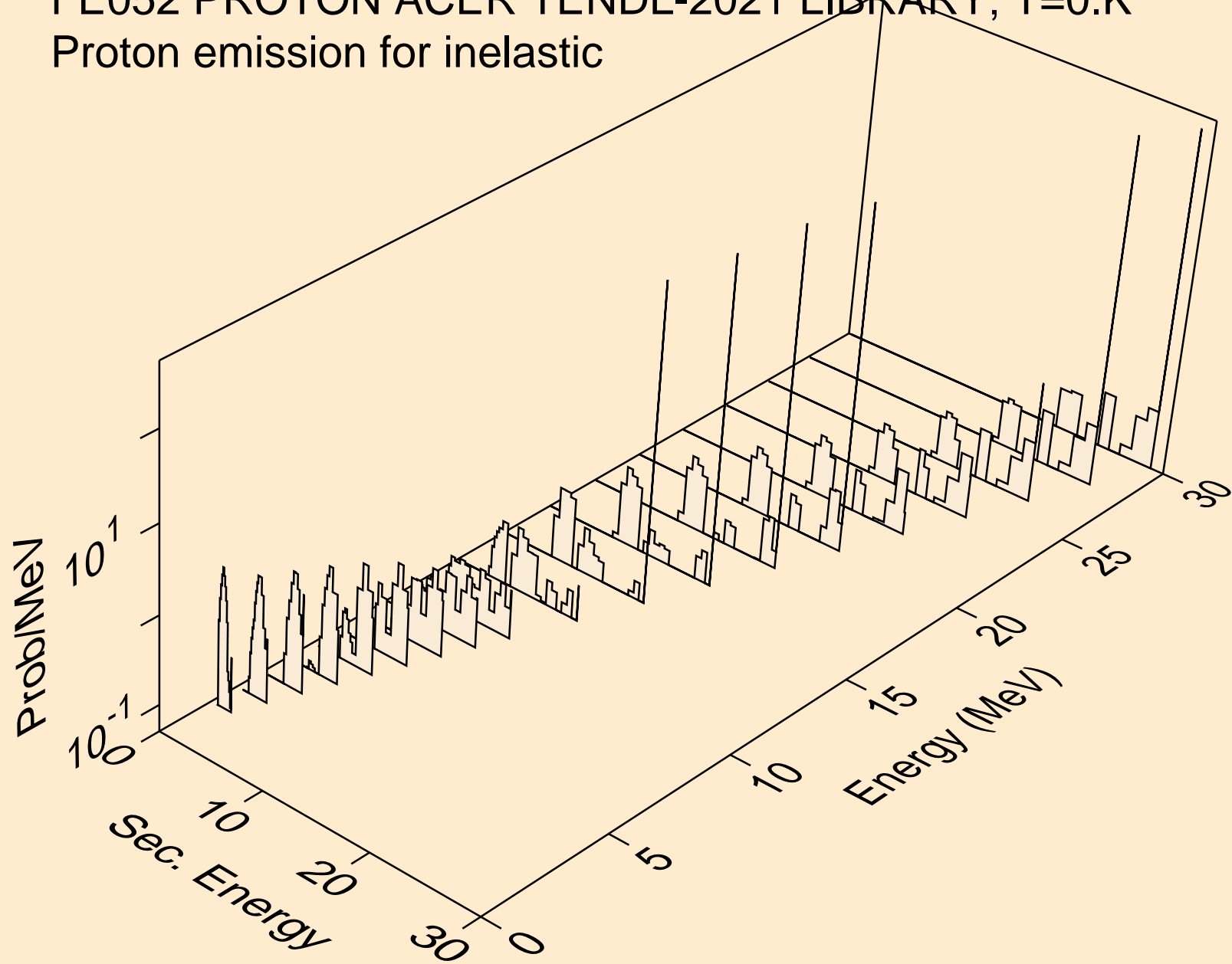

FE052 PROTON ACER TENDL-2021 LIBRARY; T=0.K
Proton emission for (p,2p)

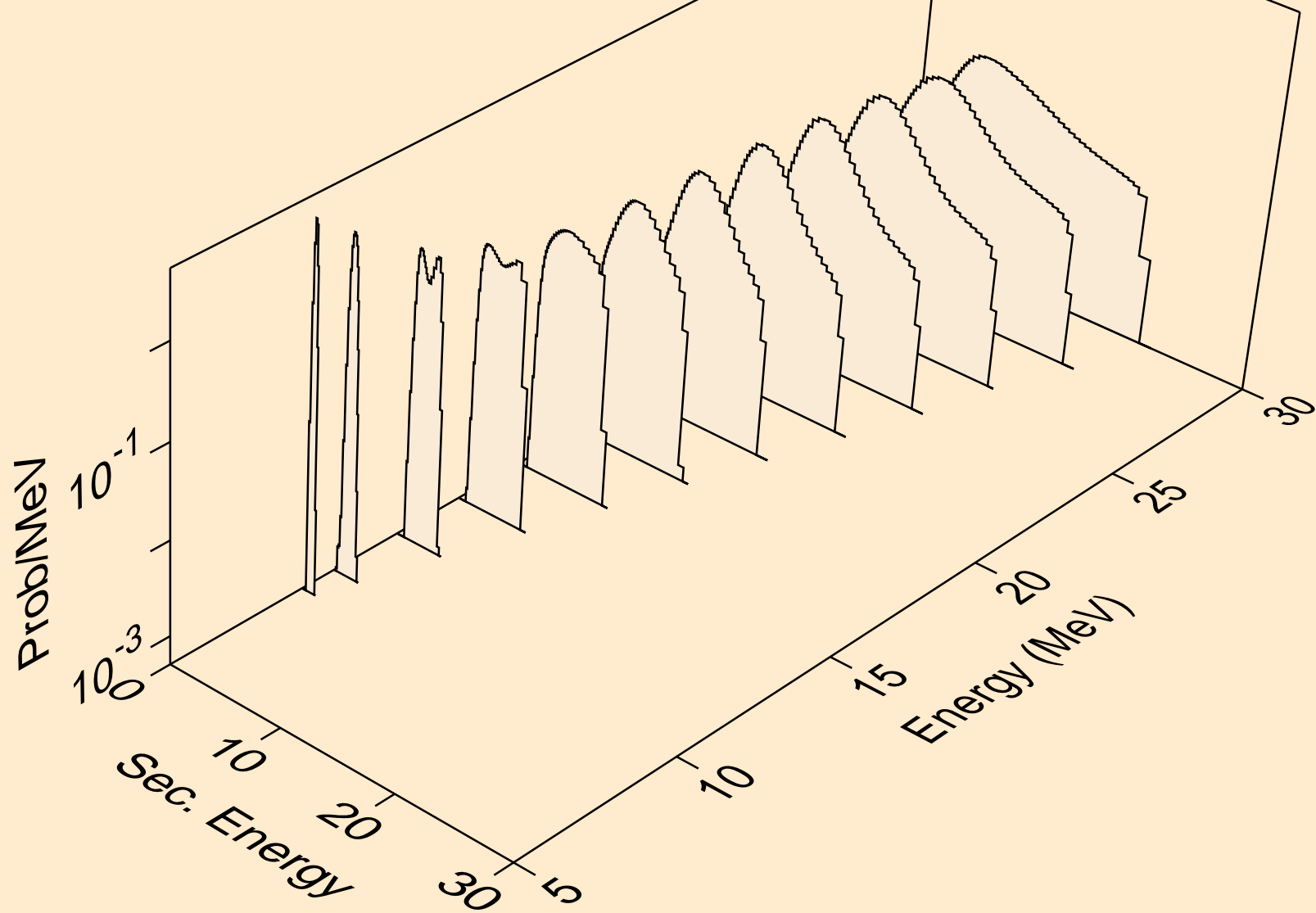

FE052 PROTON ACER TENDL-2021 LIBRARY; T=0.K
Proton emission for (p,pa)

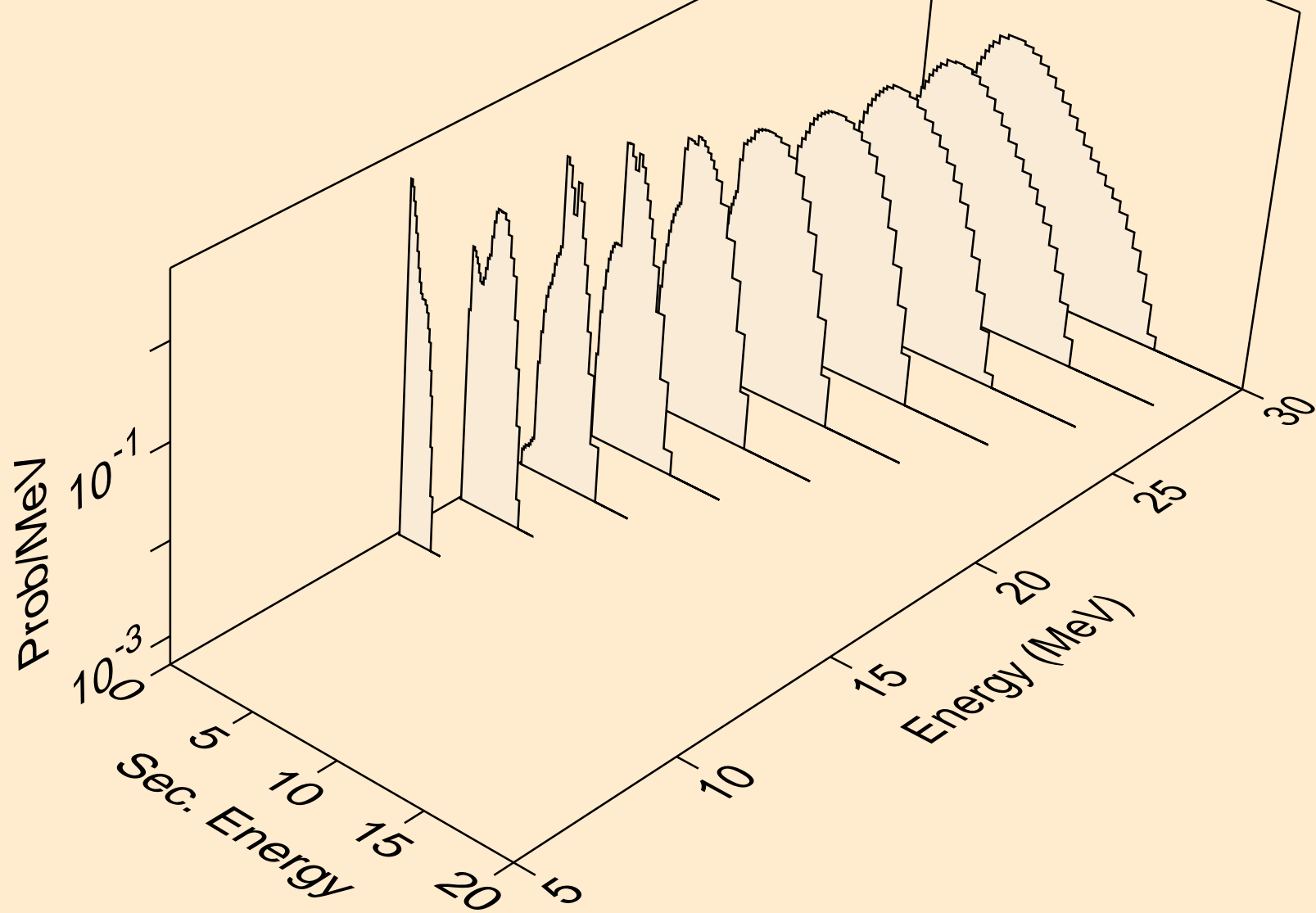

FE052 PROTON ACER TENDL-2021 LIBRARY; T=0.K
Proton emission for (p,pd)

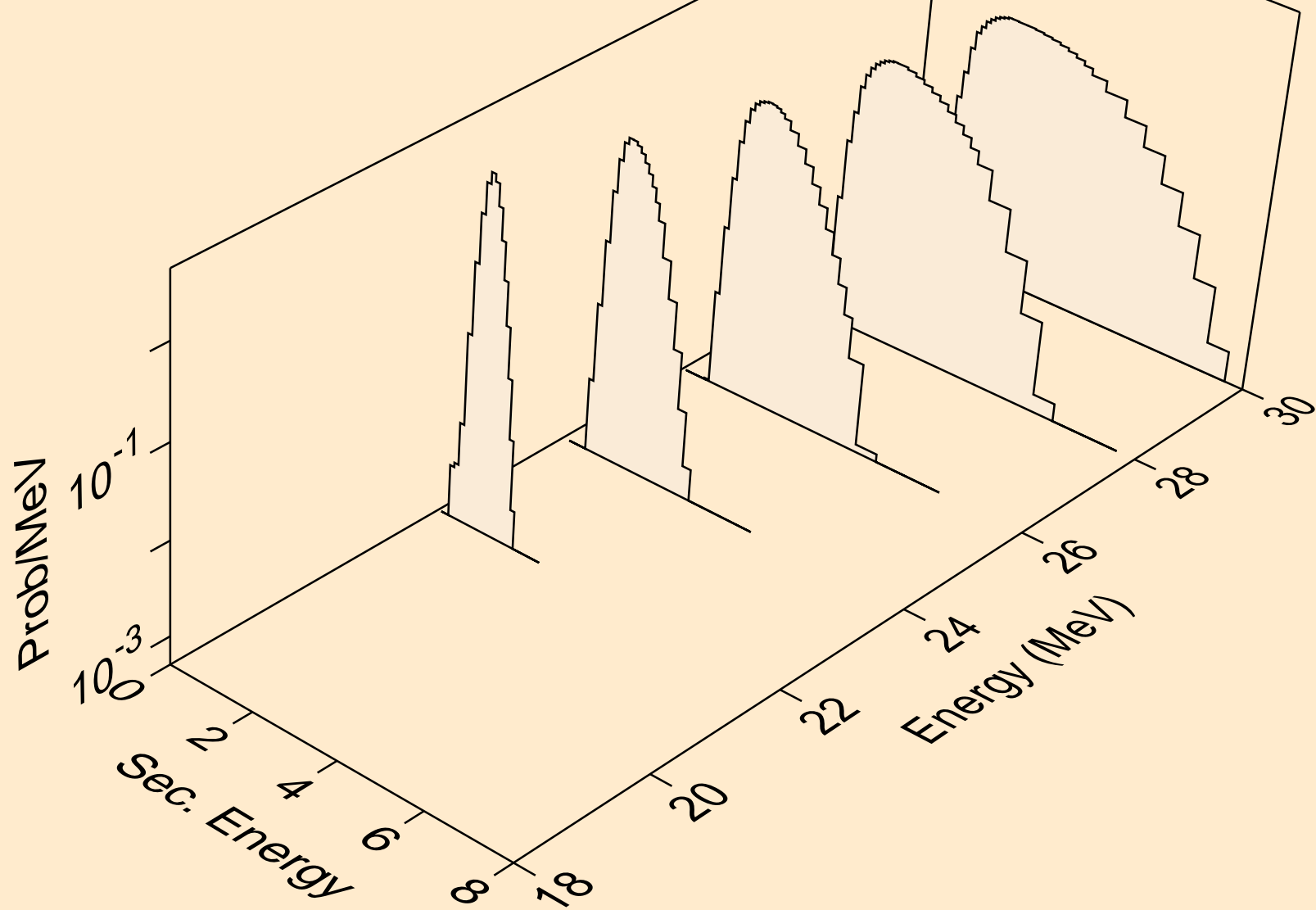

FE052 PROTON ACER TENDL-2021 LIBRARY; T=0.K
Proton emission for (p,pt)

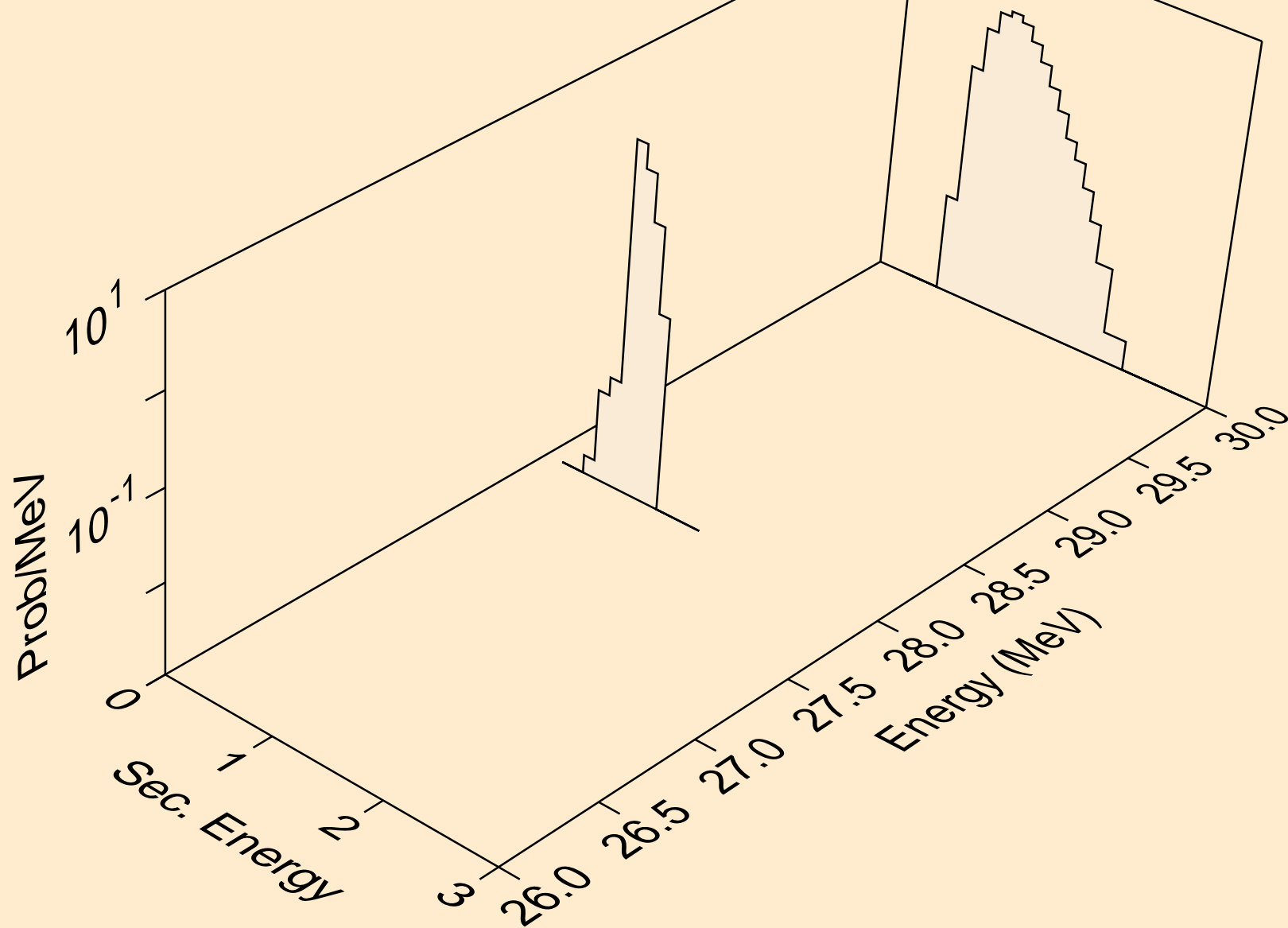

FE052 PROTON ACER TENDL-2021 LIBRARY; T=0.K
Photon emission for (z,n)

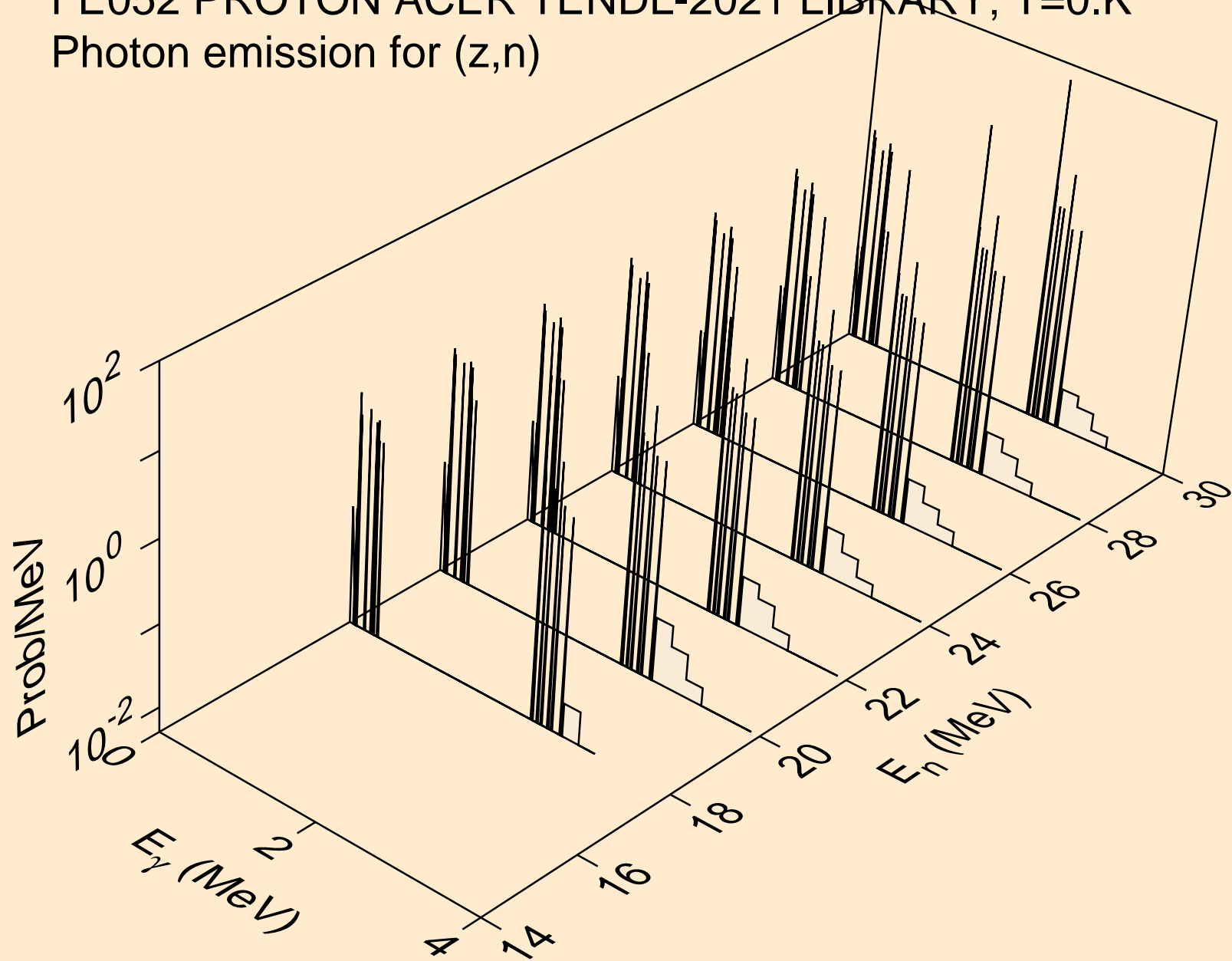

FE052 PROTON ACER TENDL-2021 LIBRARY; T=0.K
Photon emission for (n,x)

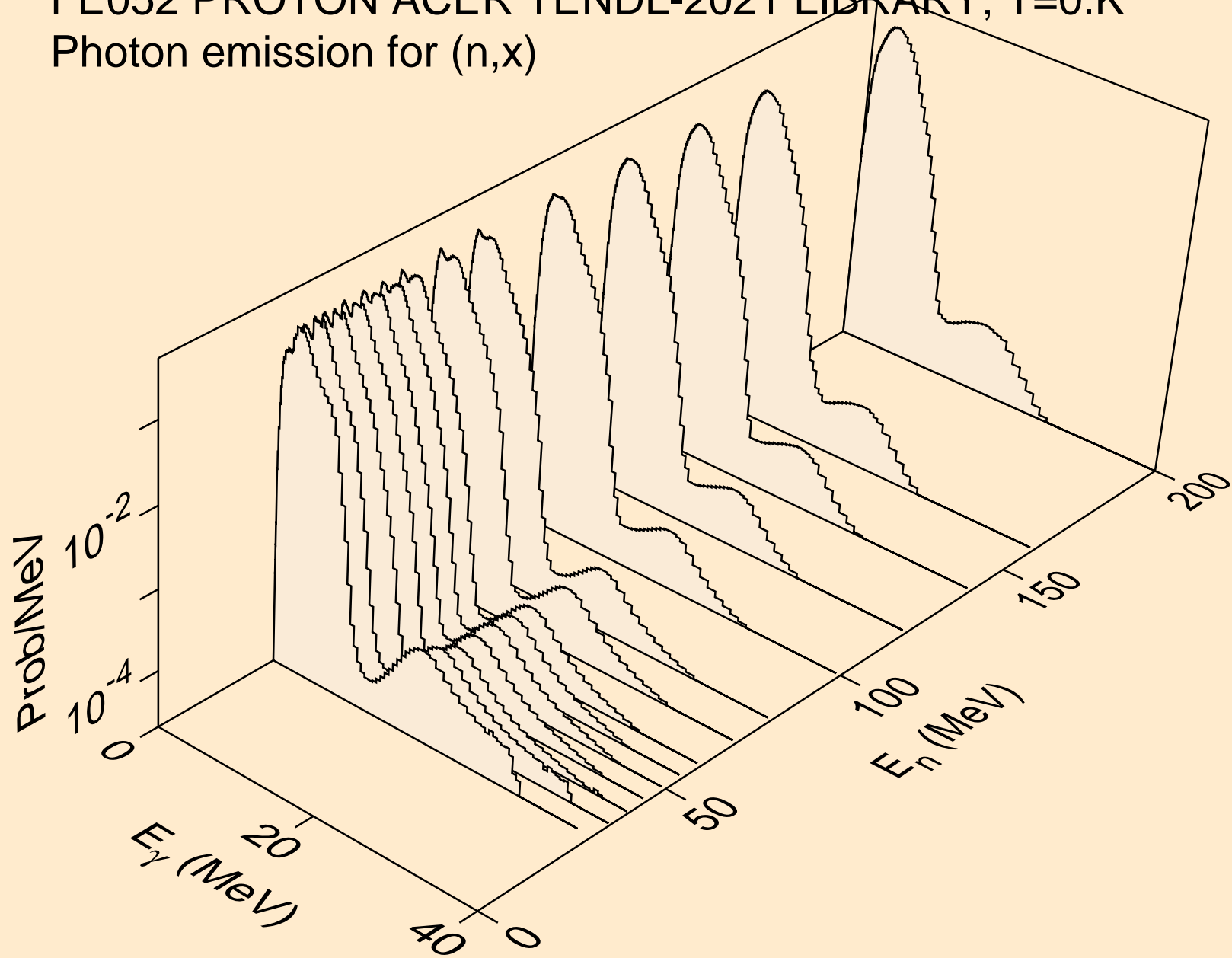

FE052 PROTON ACER TENDL-2021 LIBRARY; T=0.K
Photon emission for (n,n*)a

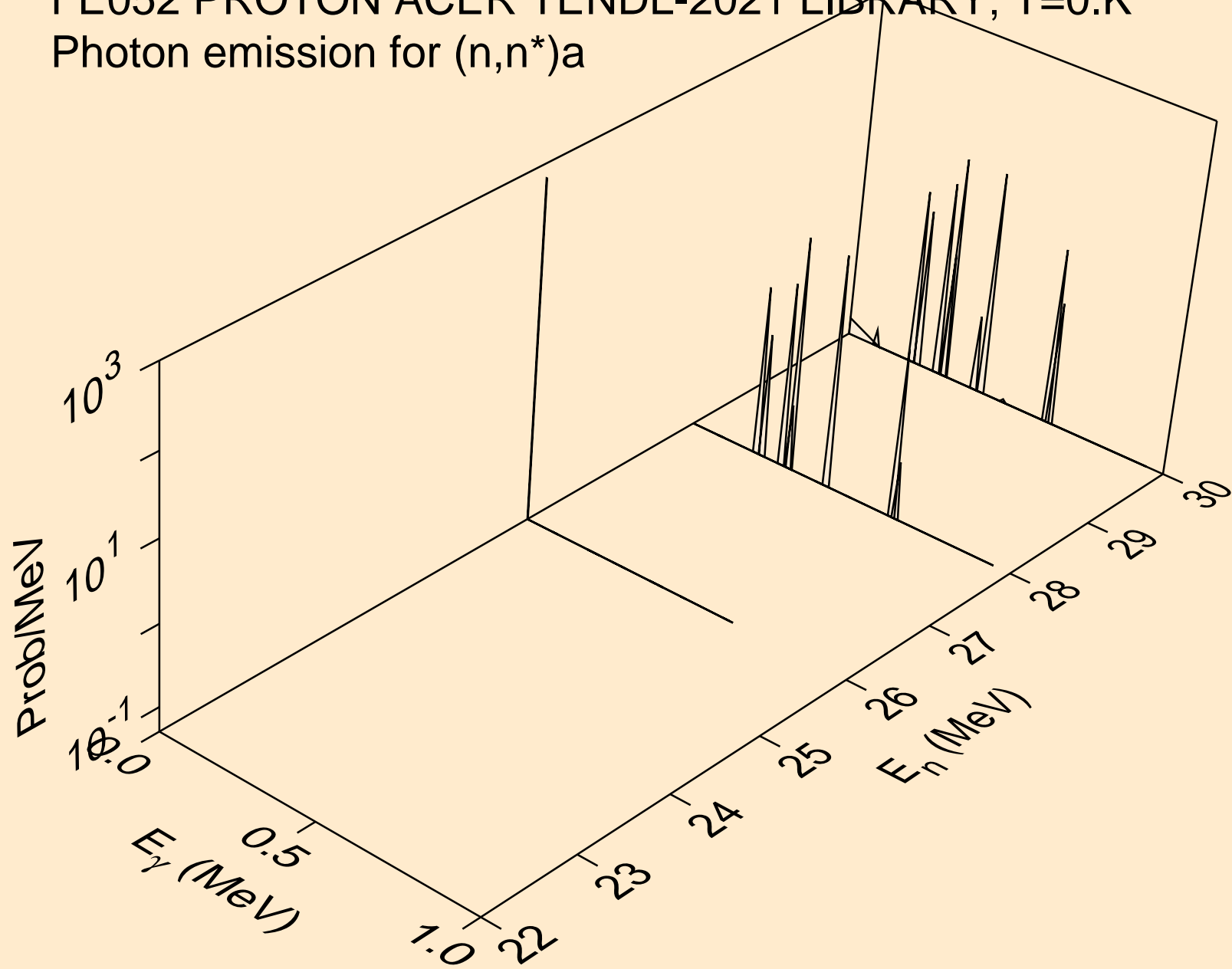

FE052 PROTON ACER TENDL-2021 LIBRARY; T=0.K
Photon emission for (n,n*)p

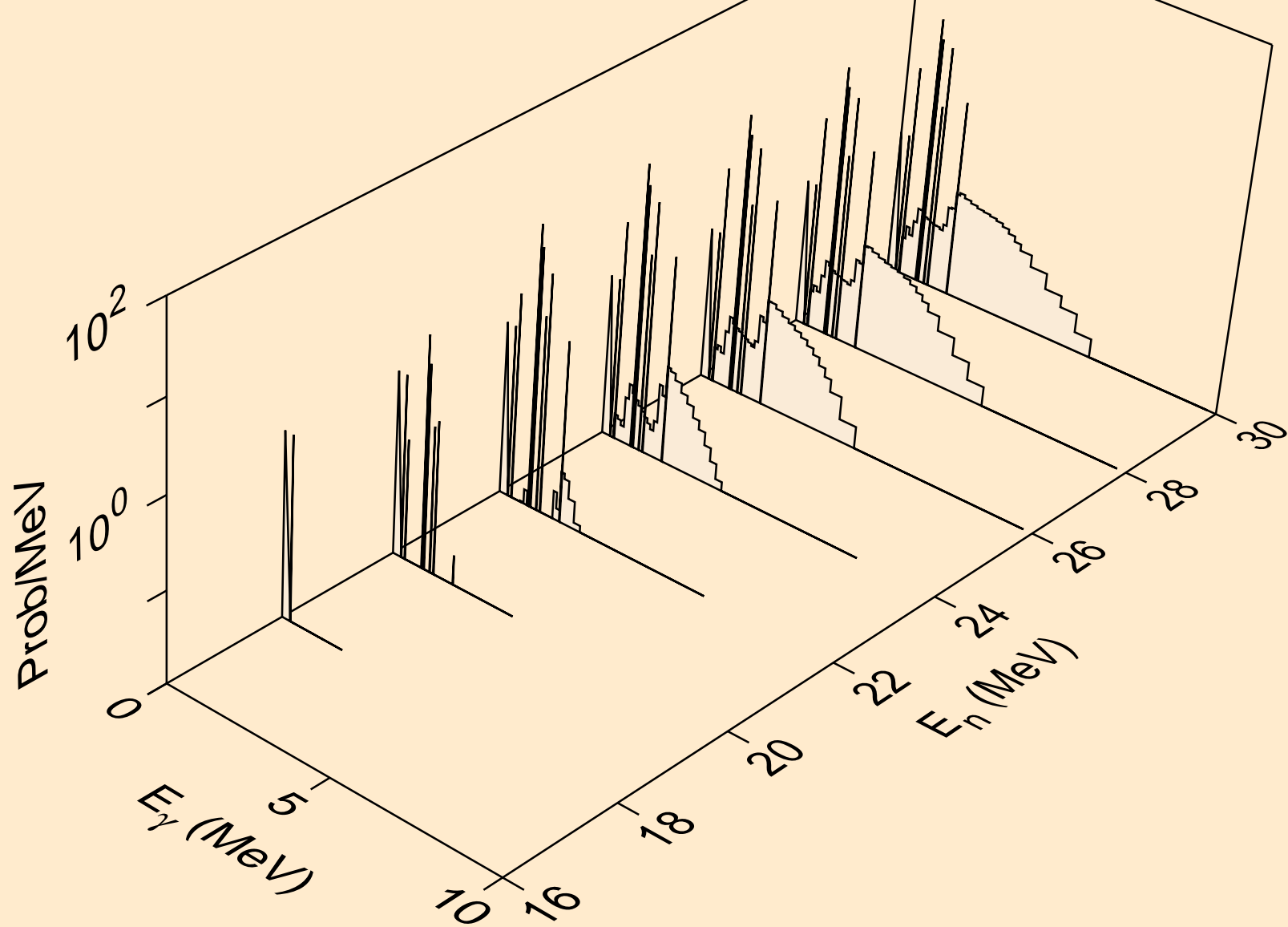

FE052 PROTON ACER TENDL-2021 LIBRARY; T=0.K
Photon emission for (n,2np)

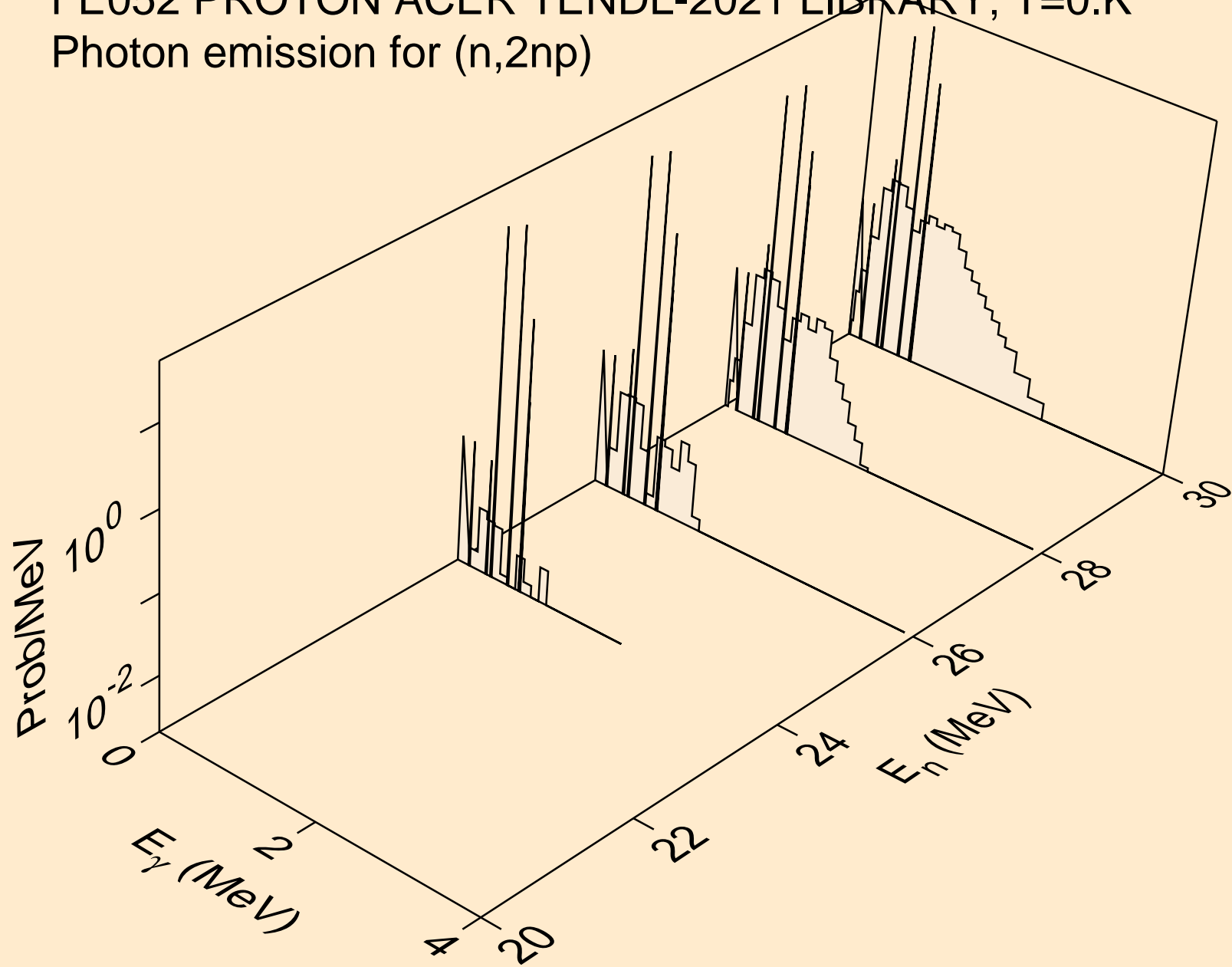

FE052 PROTON ACER TENDL-2021 LIBRARY; T=0.K
Photon emission for (n,gma)

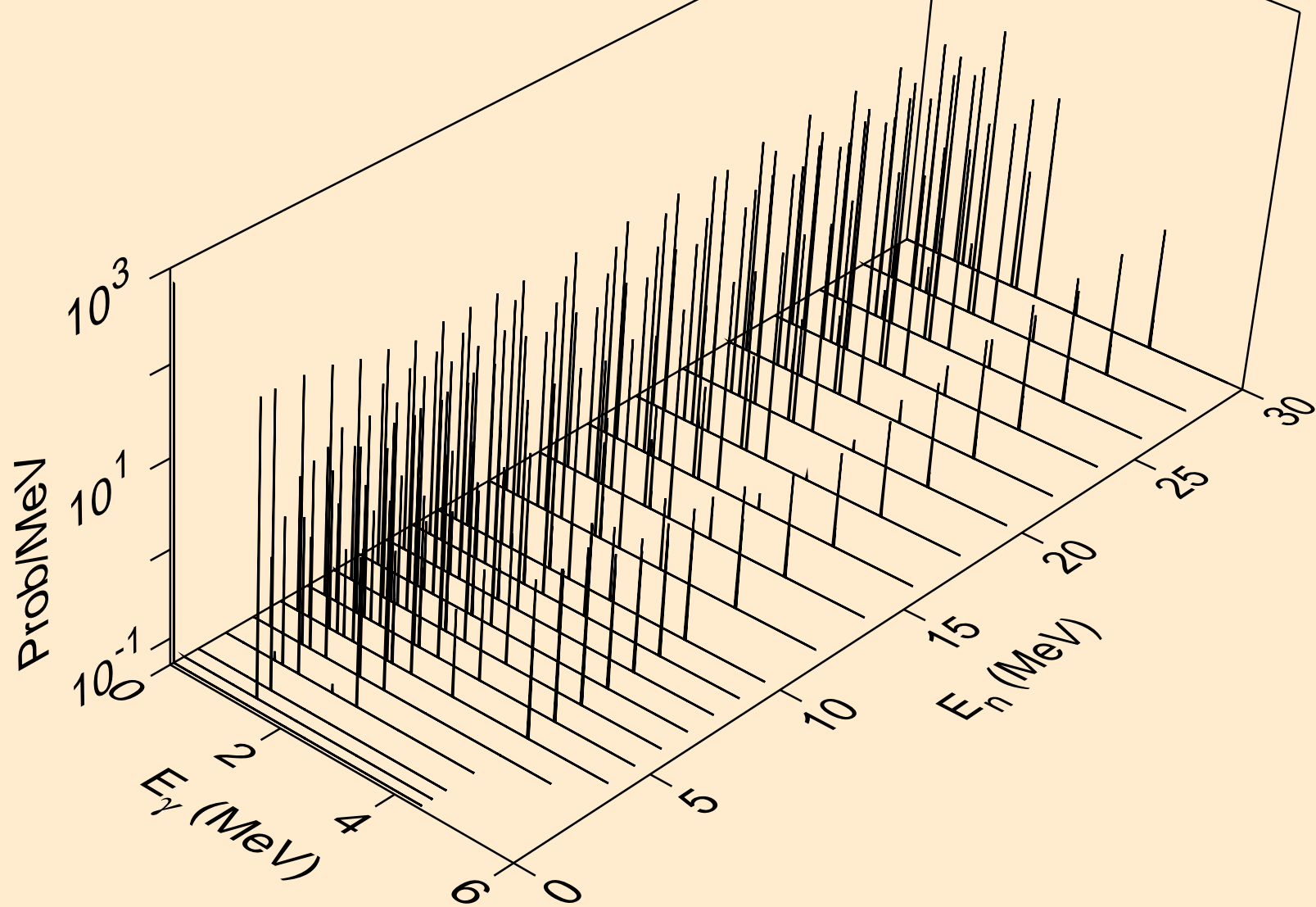

FE052 PROTON ACER TENDL-2021 LIBRARY; T=0.K
Photon emission for inelastic

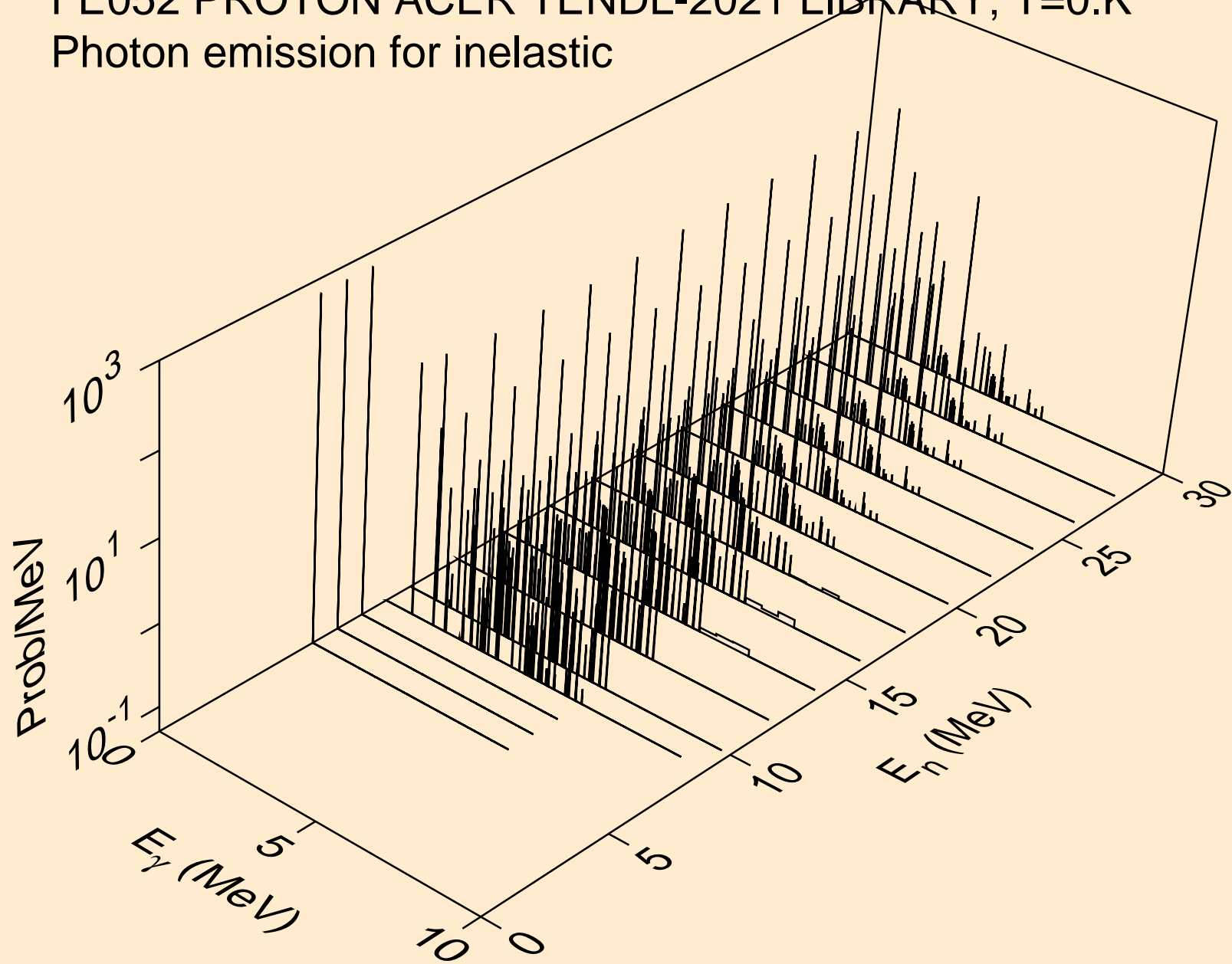

FE052 PROTON ACER TENDL-2021 LIBRARY; T=0.K
Photon emission for (n,d)

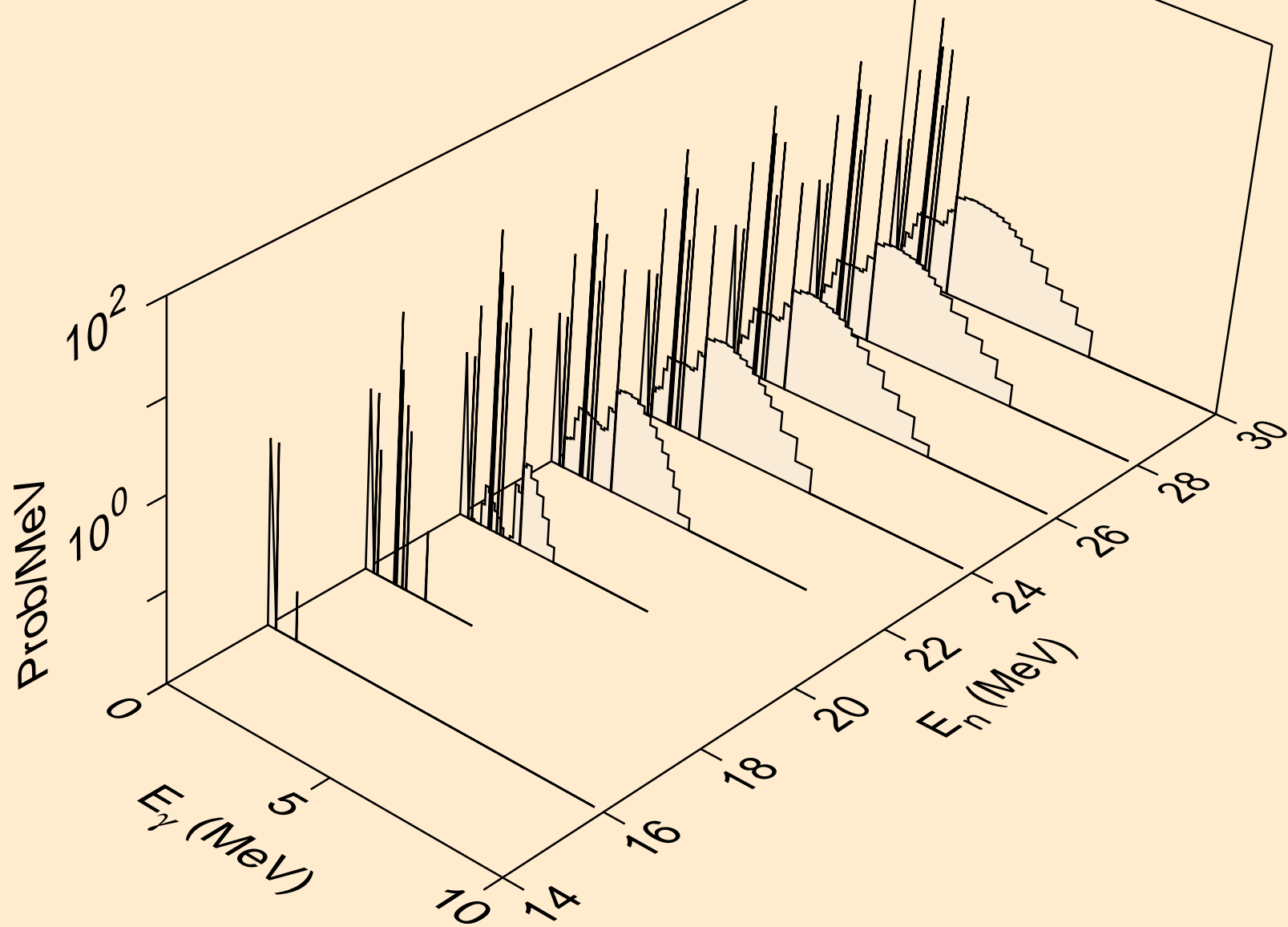

FE052 PROTON ACER TENDL-2021 LIBRARY; T=0.K
Photon emission for (n,t)

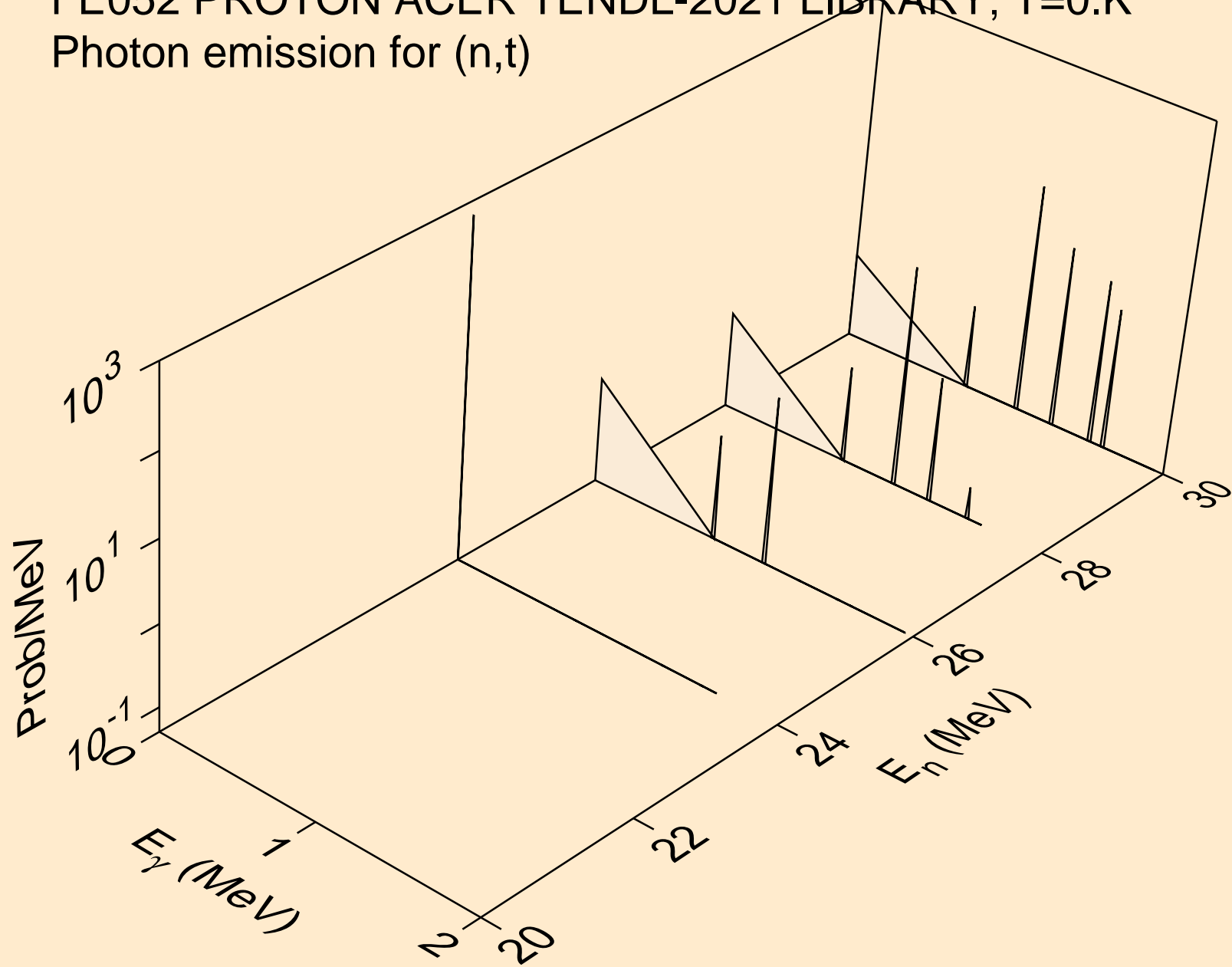

FE052 PROTON ACER TENDL-2021 LIBRARY; T=0.K
Photon emission for (n,he3)

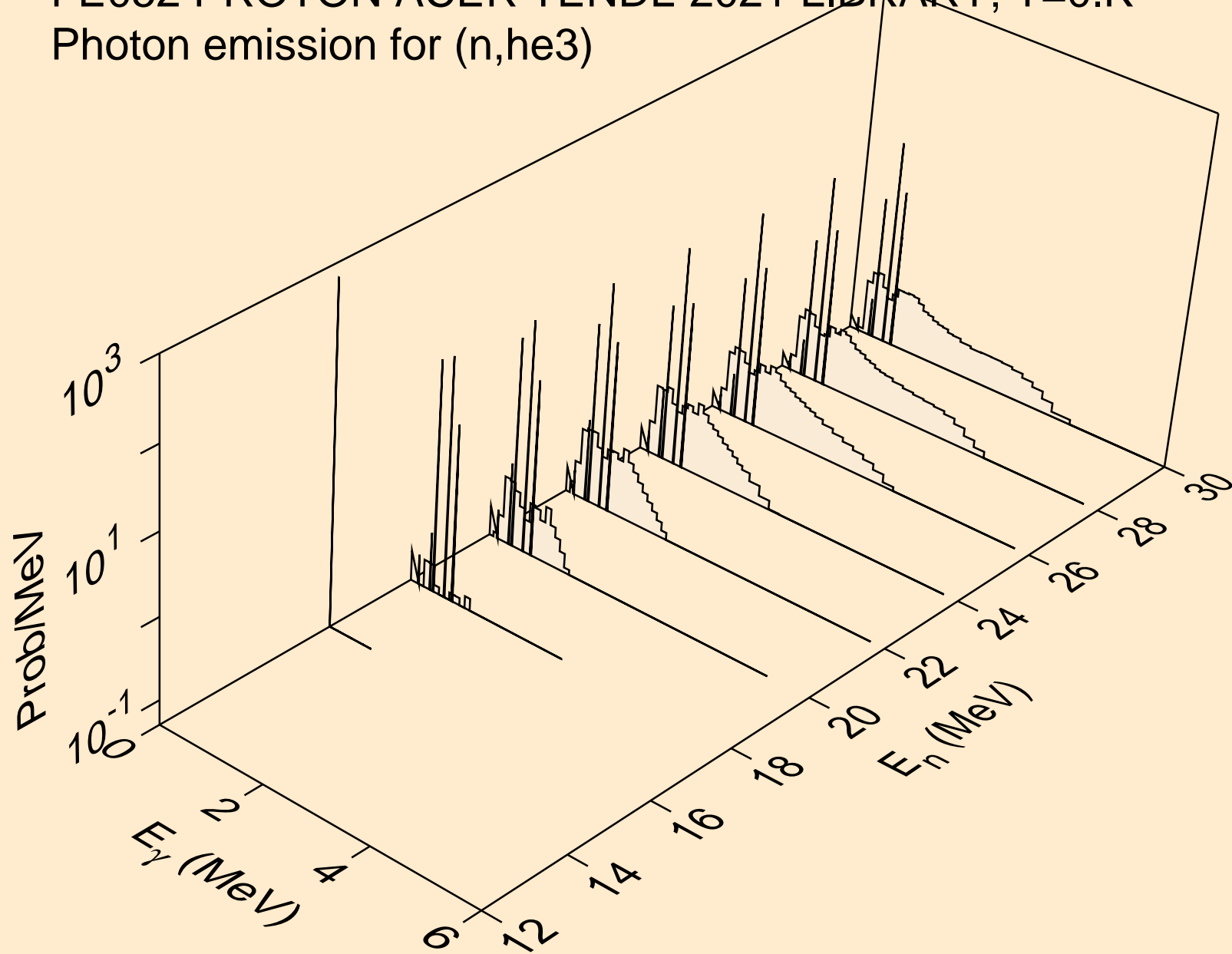

FE052 PROTON ACER TENDL-2021 LIBRARY; T=0.K
Photon emission for (n,a)

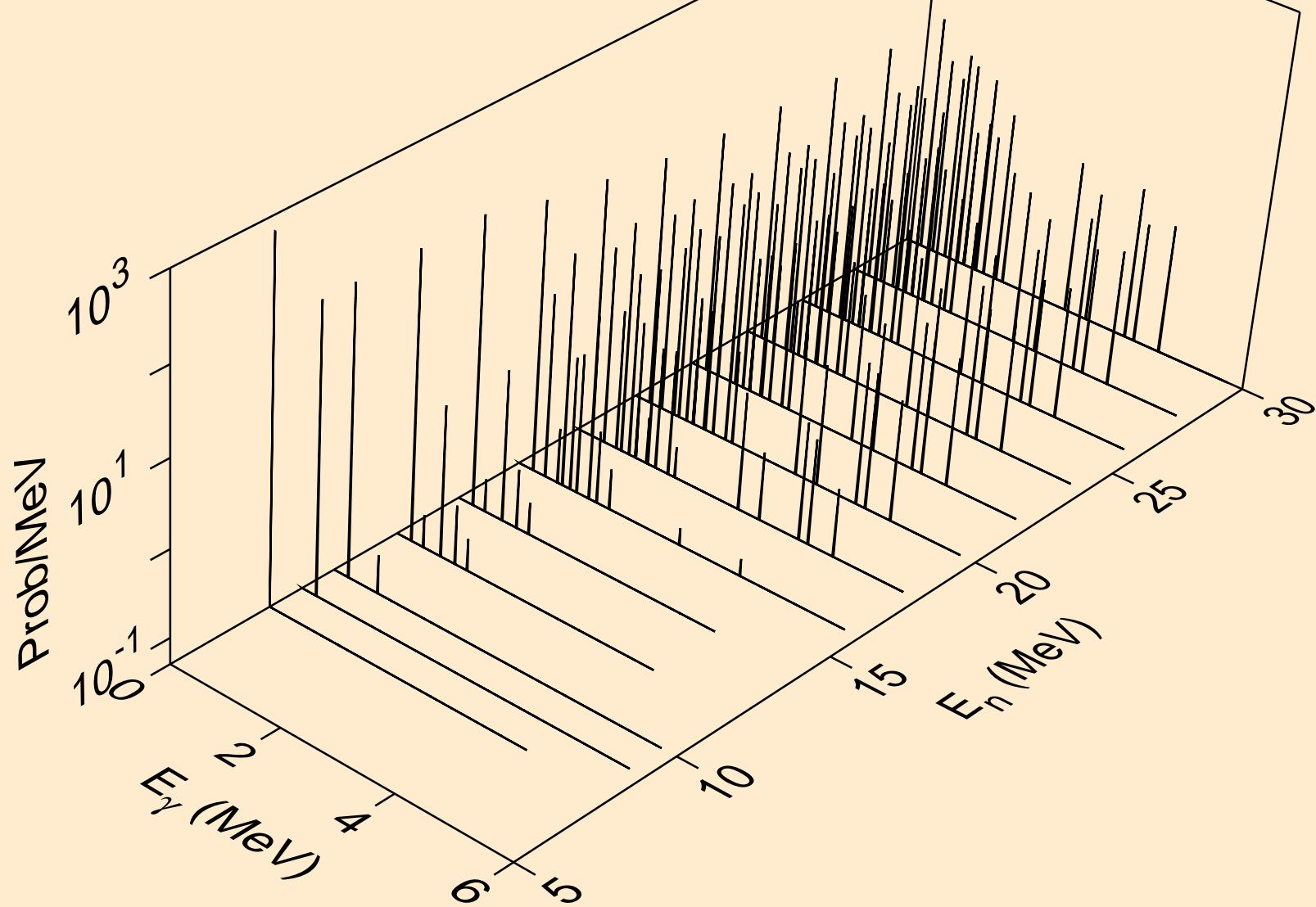

FE052 PROTON ACER TENDL-2021 LIBRARY; T=0.K
Photon emission for (n,2a)

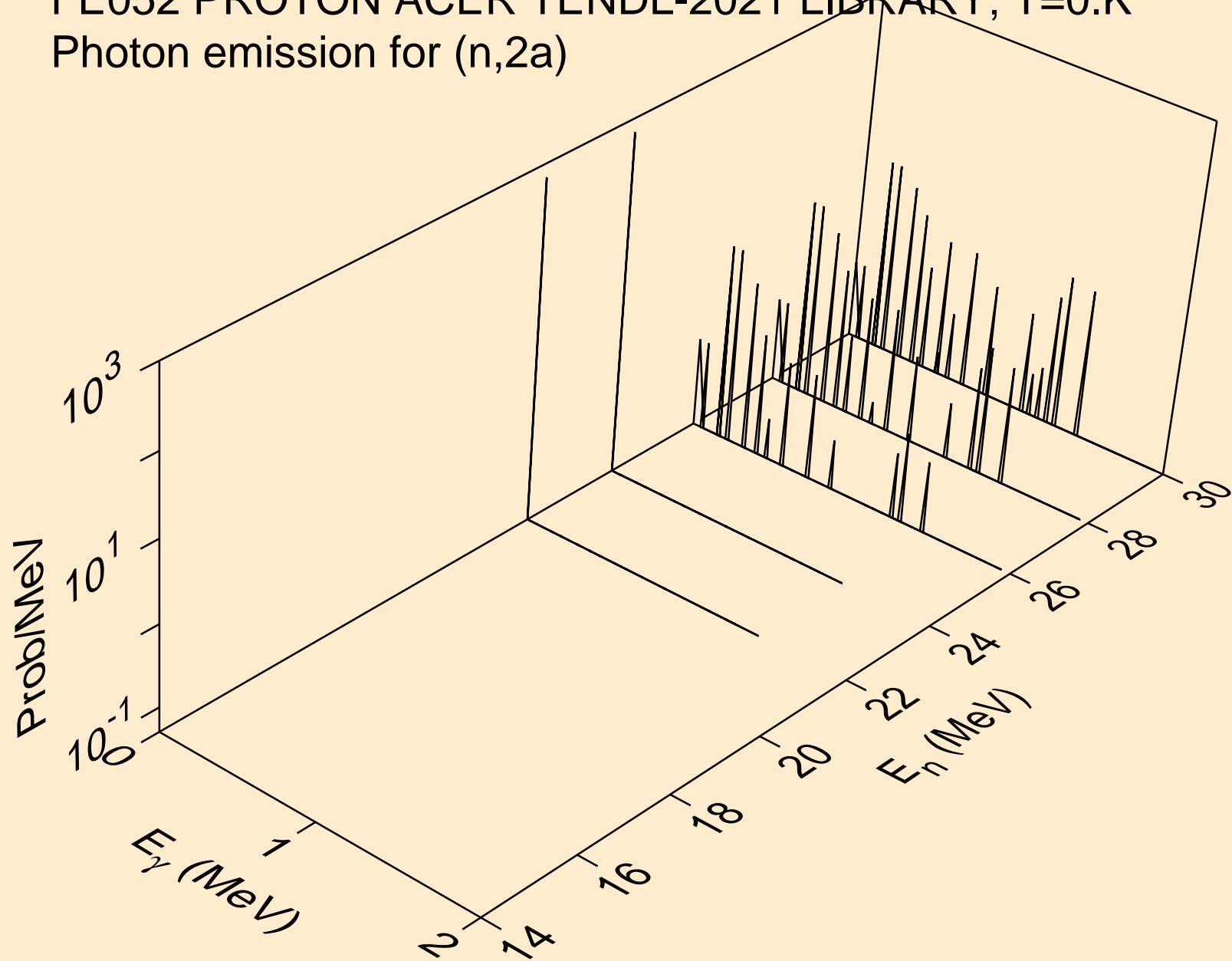

FE052 PROTON ACER TENDL-2021 LIBRARY; T=0.K
Photon emission for (n,2p)

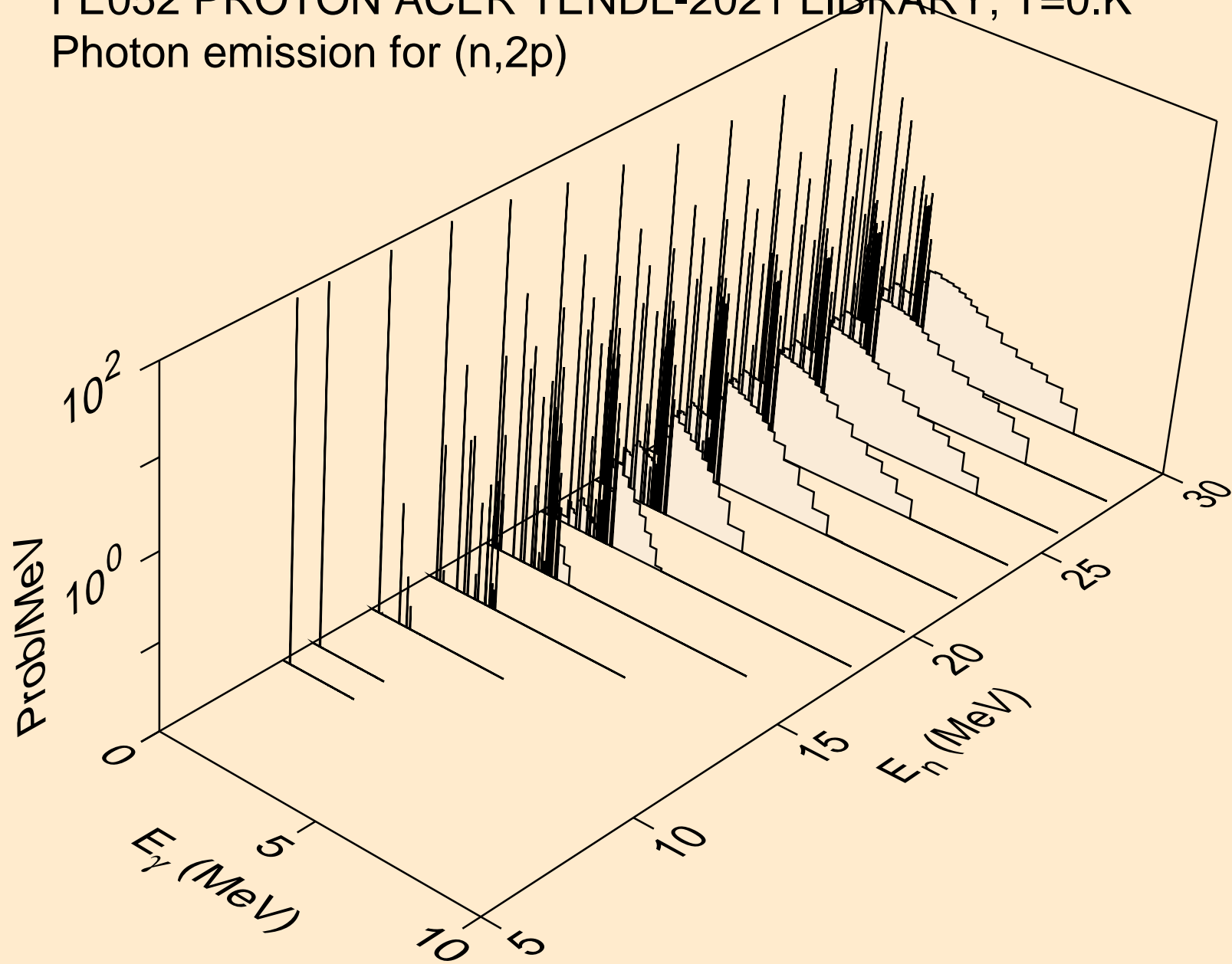

FE052 PROTON ACER TENDL-2021 LIBRARY; T=0.K
Photon emission for (n,pa)

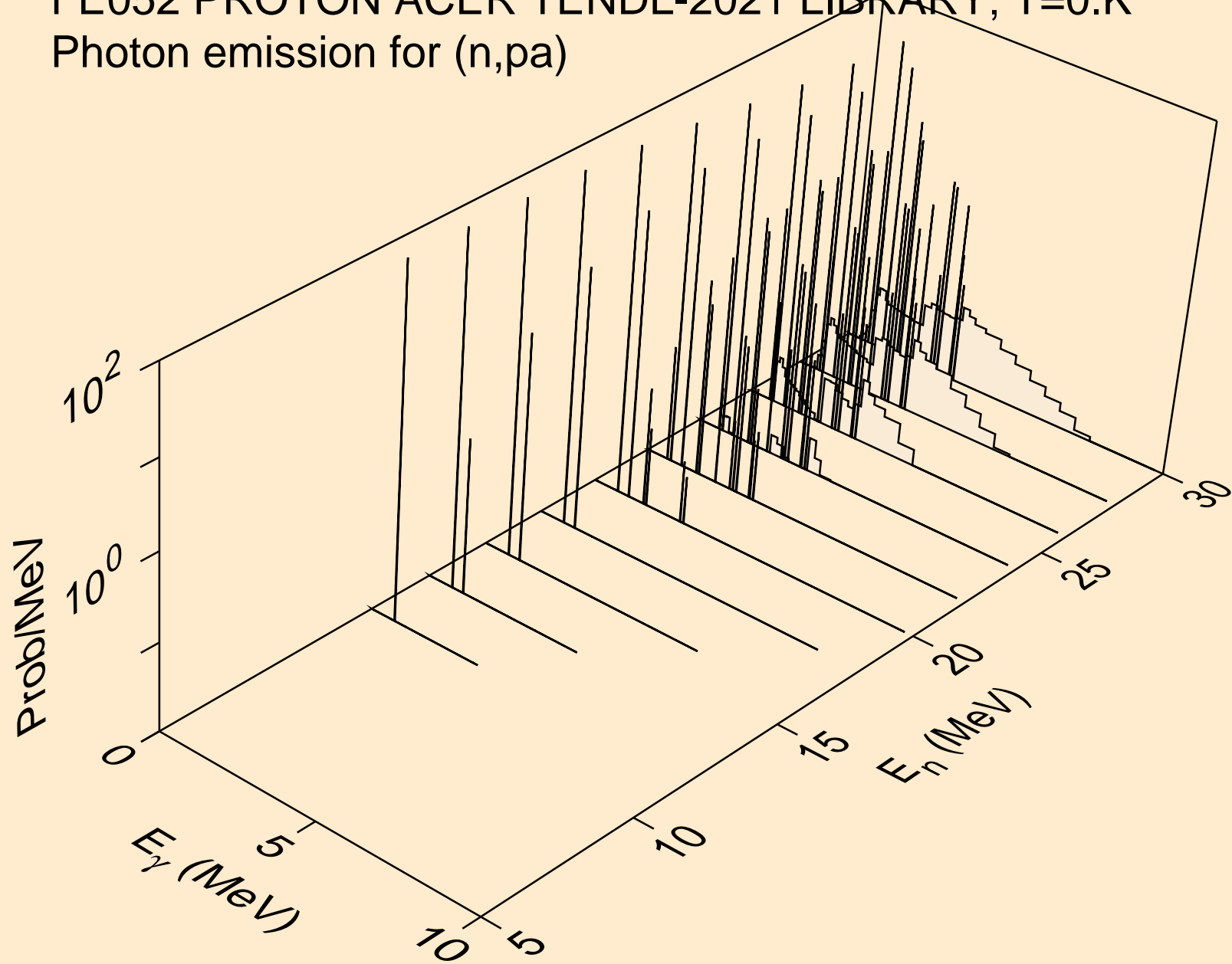

FE052 PROTON ACER TENDL-2021 LIBRARY; T=0.K
Photon emission for (n,pd)

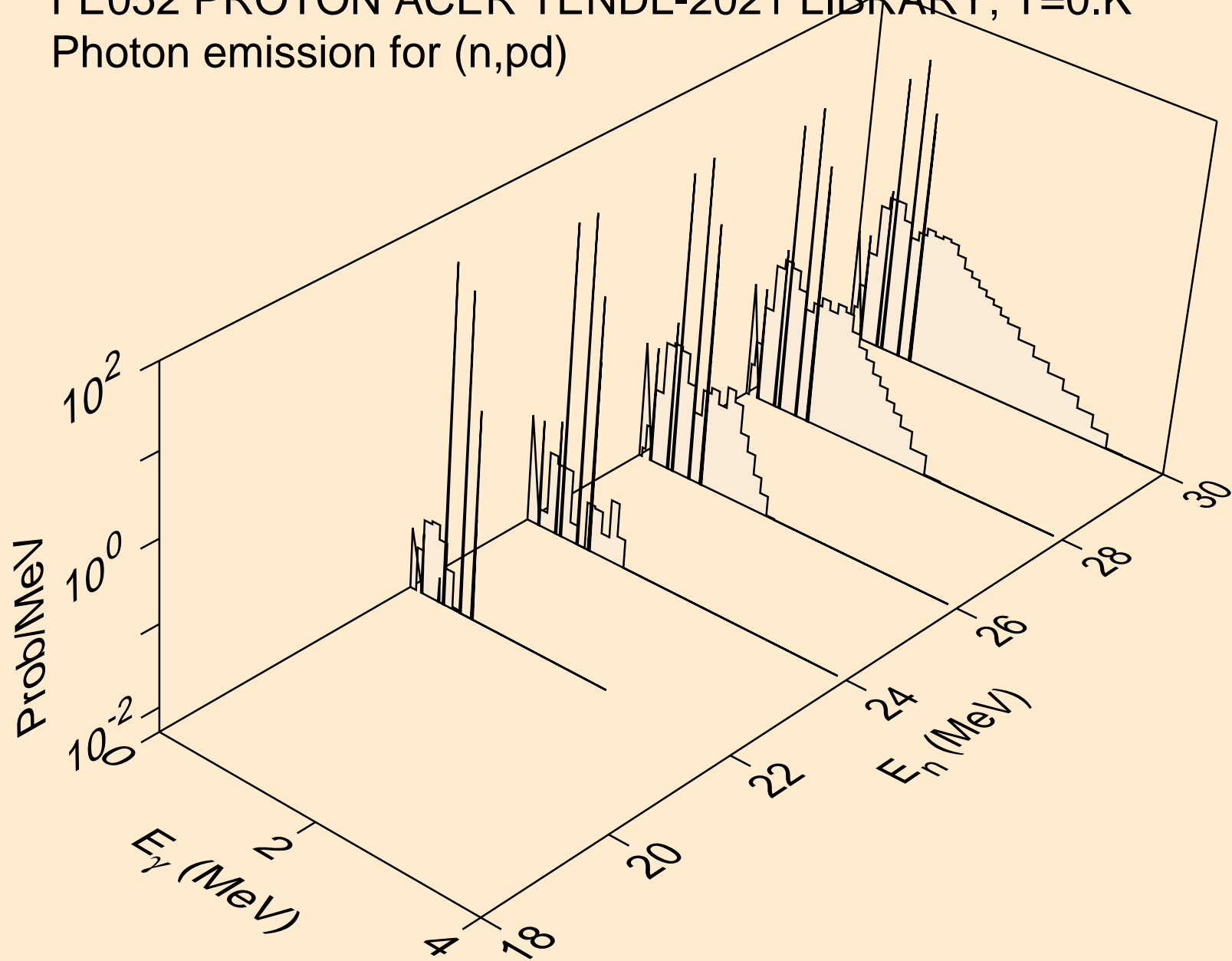

FE052 PROTON ACER TENDL-2021 LIBRARY; T=0.K
Photon emission for (n,pt)

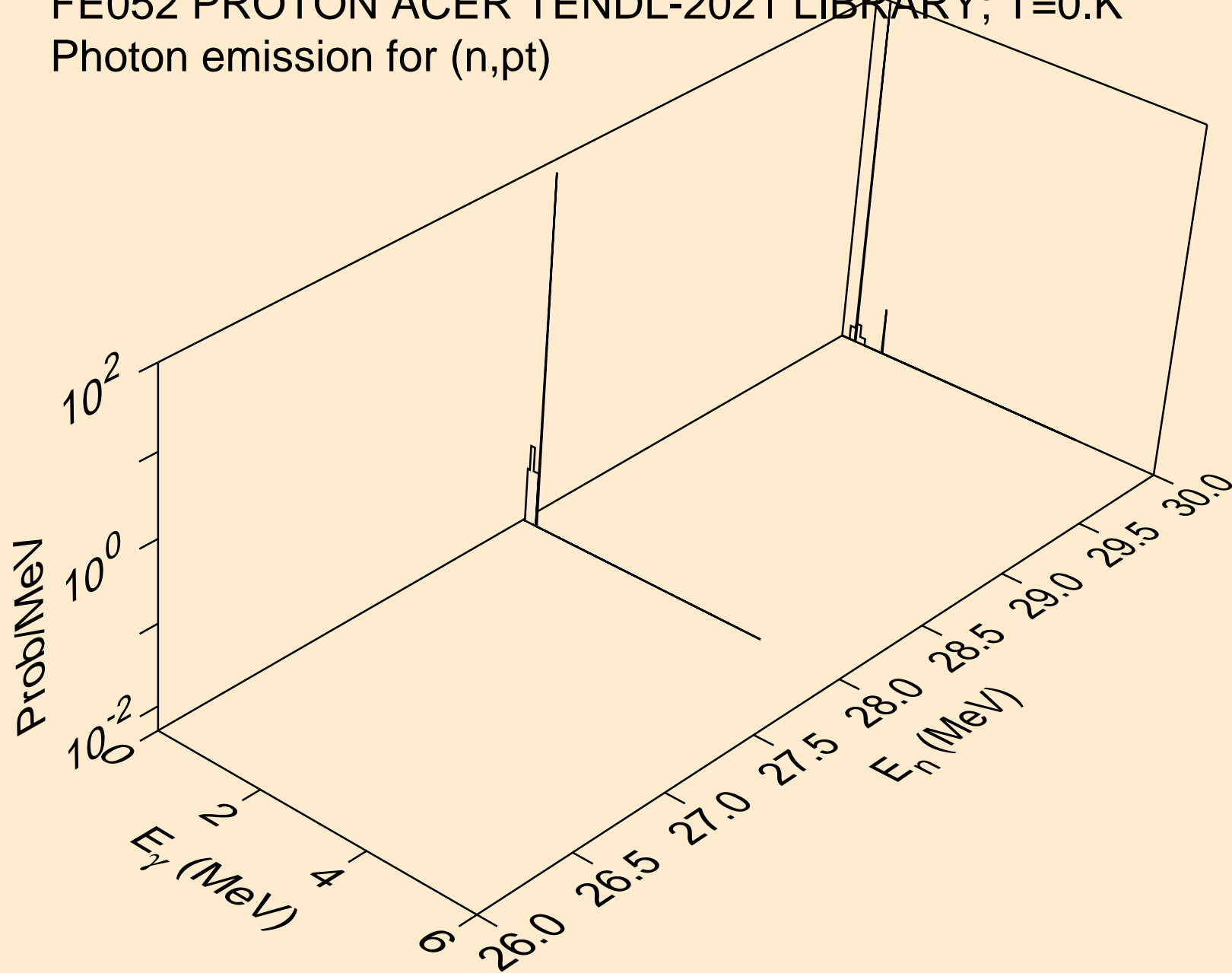

FE052 PROTON ACER TENDL-2021 LIBRARY; T=0.K
Particle heating contributions

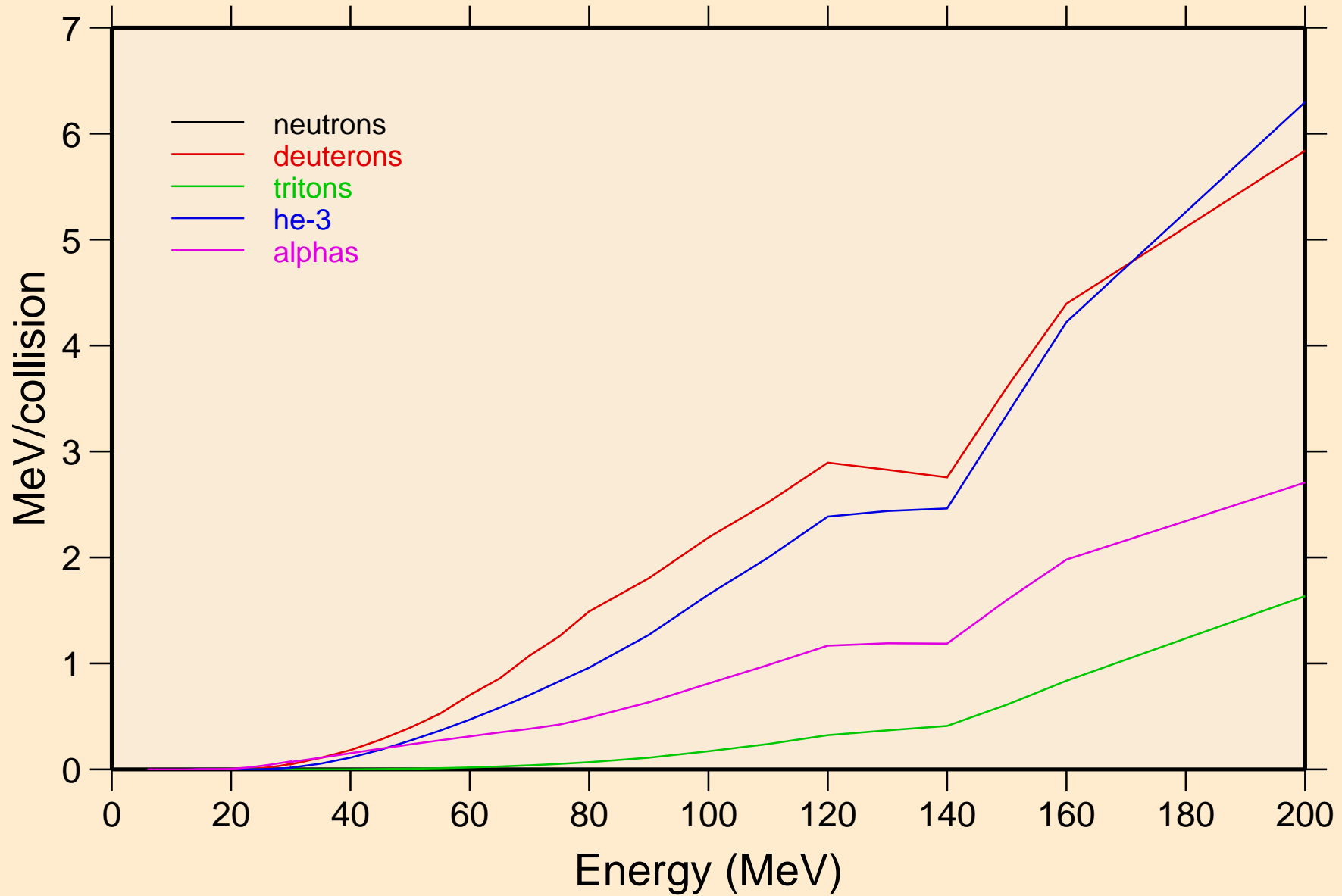

FE052 PROTON ACER TENDL-2021 LIBRARY; T=0.K

Recoil Heating

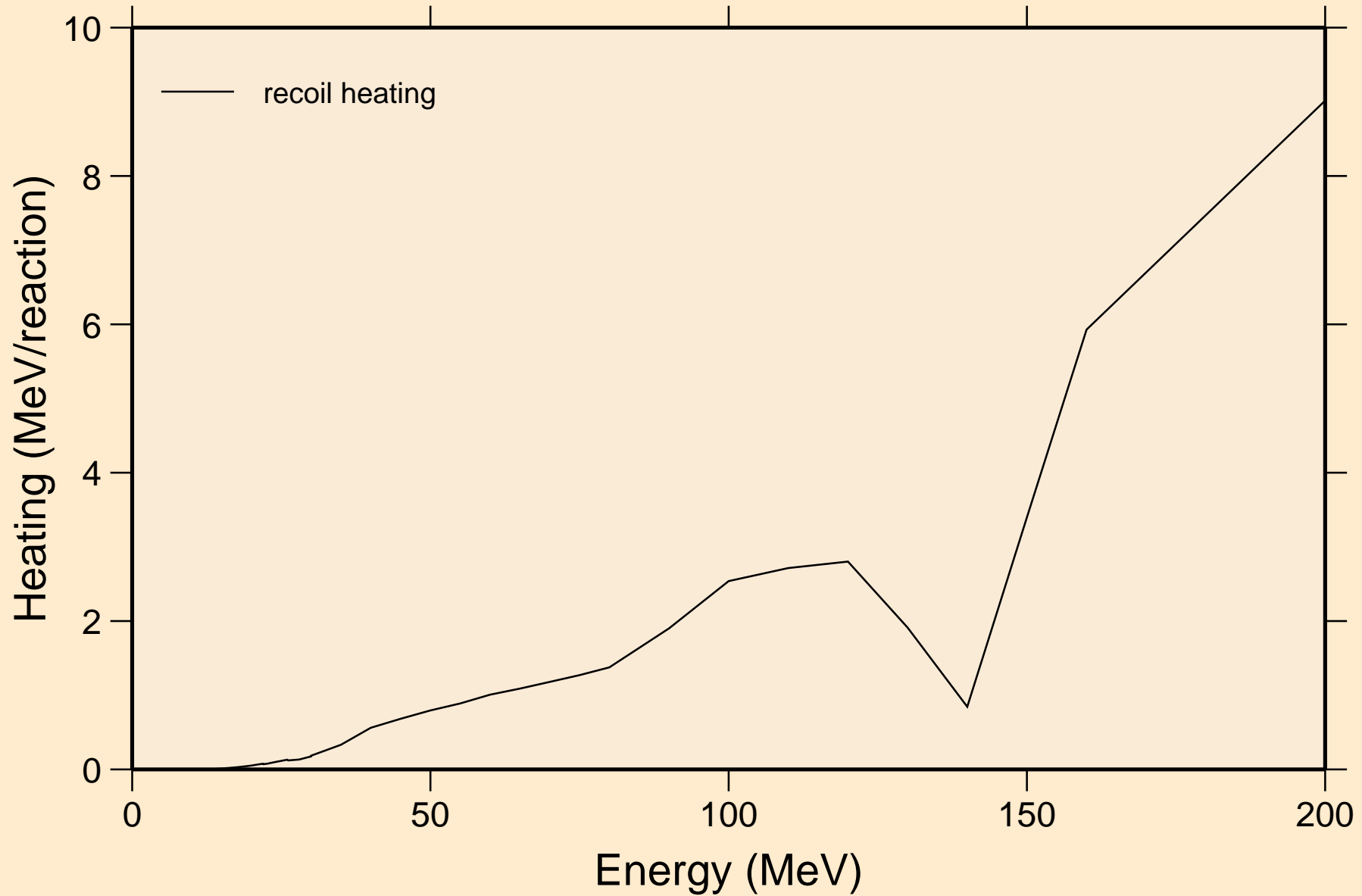

FE052 PROTON ACER TENDL-2021 LIBRARY; T=0.K
Particle production cross sections

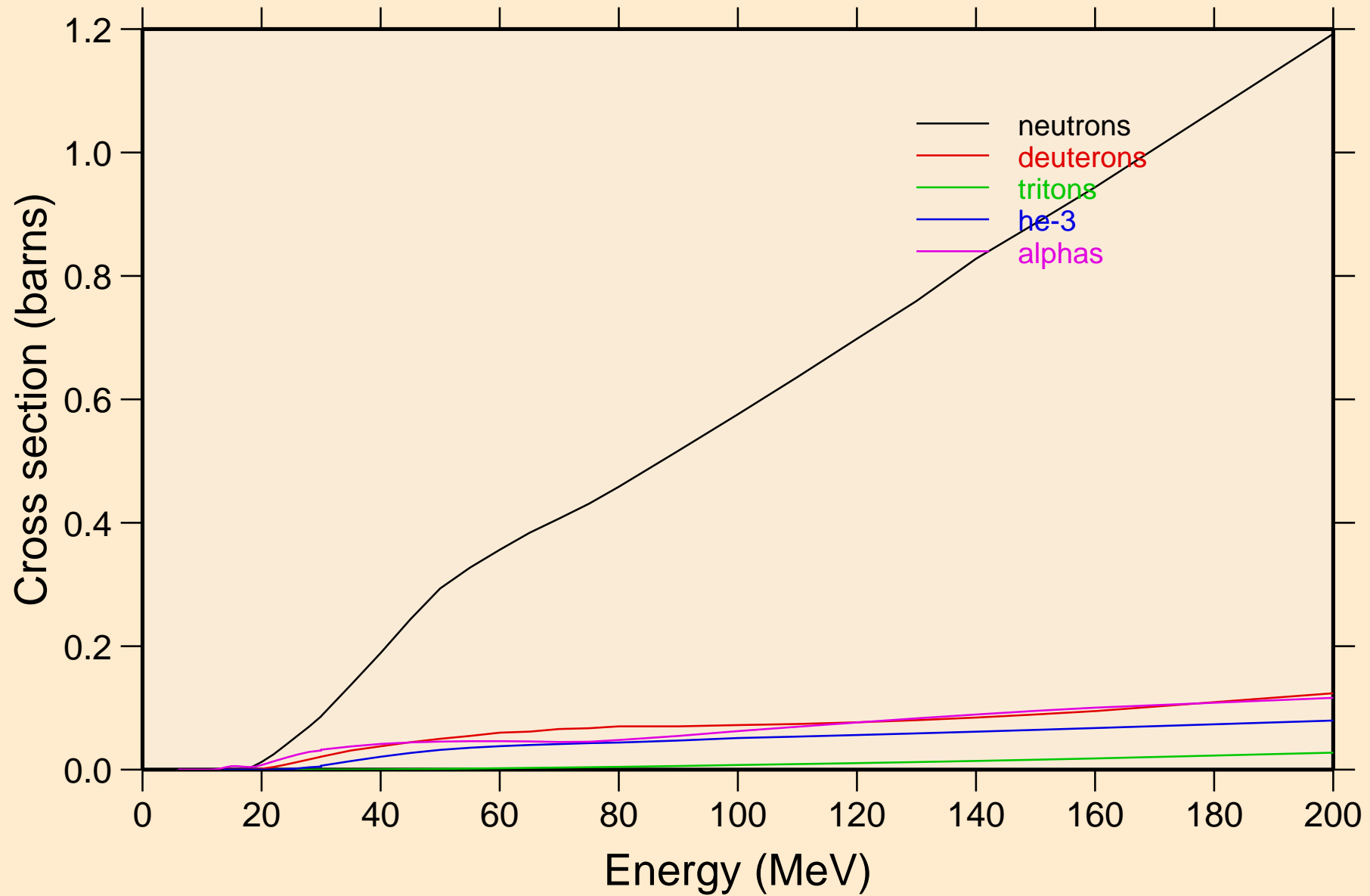

FE052 PROTON ACER TENDL-2021 LIBRARY; T=0.K
neutrons from (p,n)

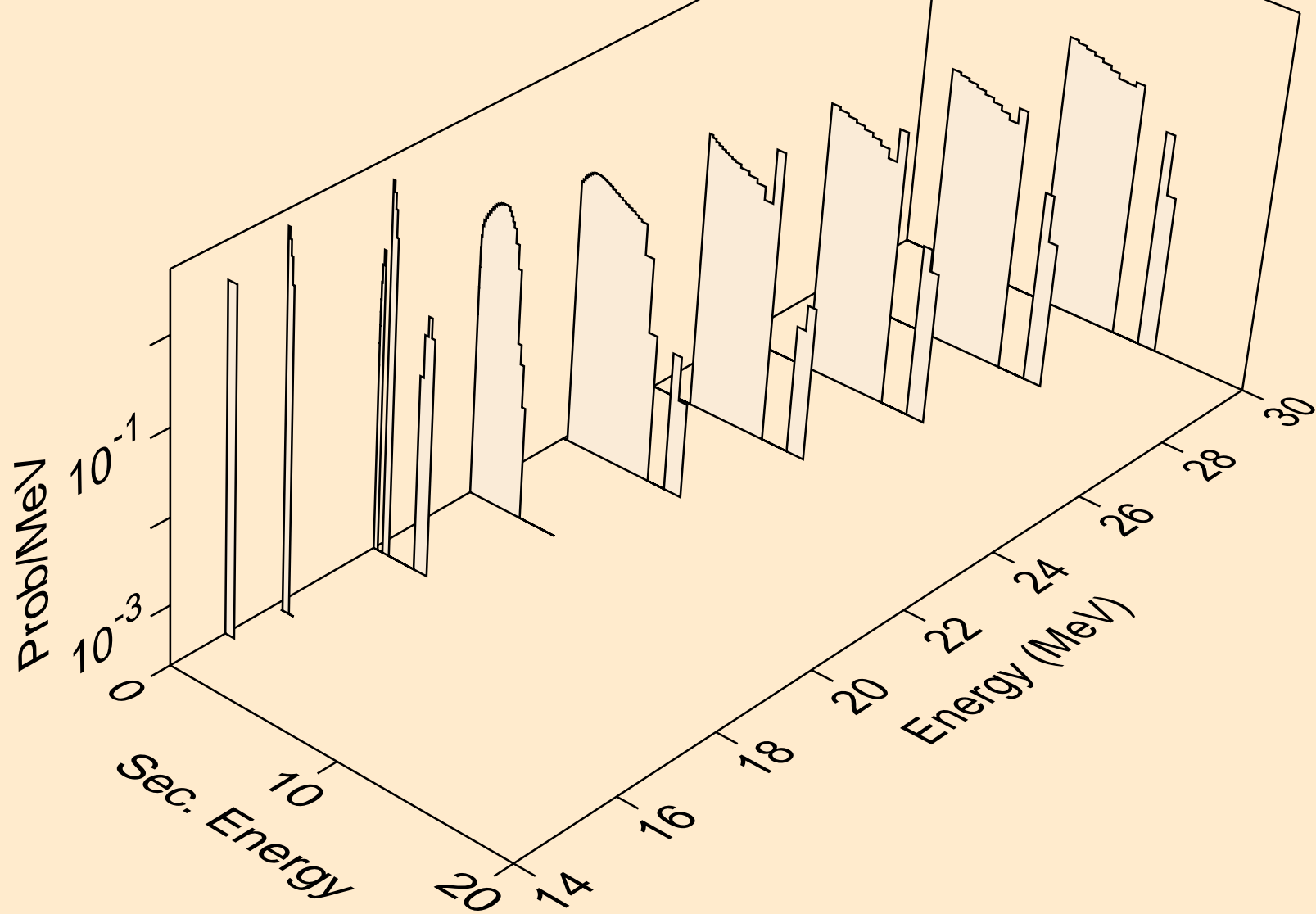

FE052 PROTON ACER TENDL-2021 LIBRARY; T=0.K
neutrons from (p,x)

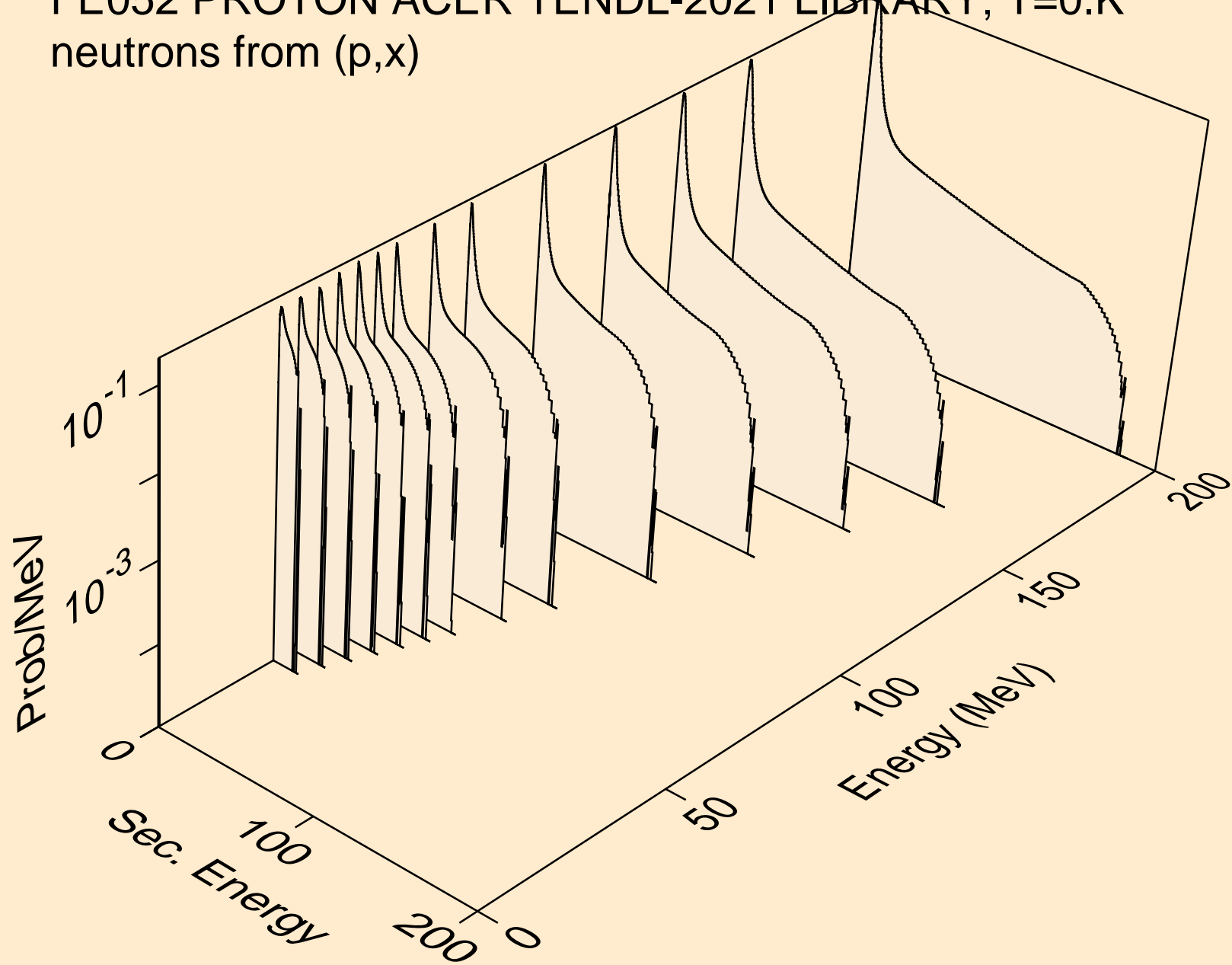

FE052 PROTON ACER TENDL-2021 LIBRARY; T=0.K
neutrons from (p,n*)a

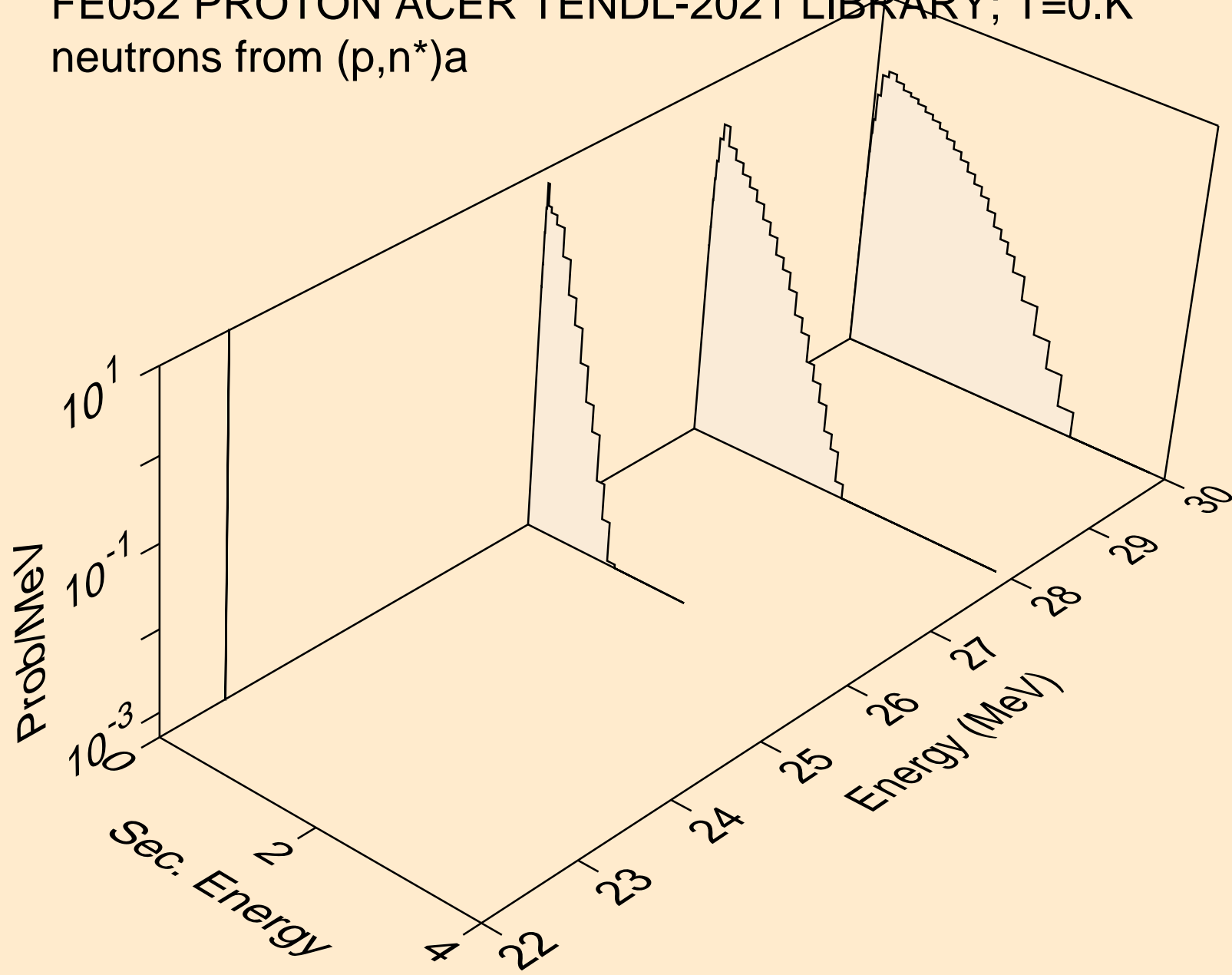

FE052 PROTON ACER TENDL-2021 LIBRARY; T=0.K
neutrons from (p,n*)p

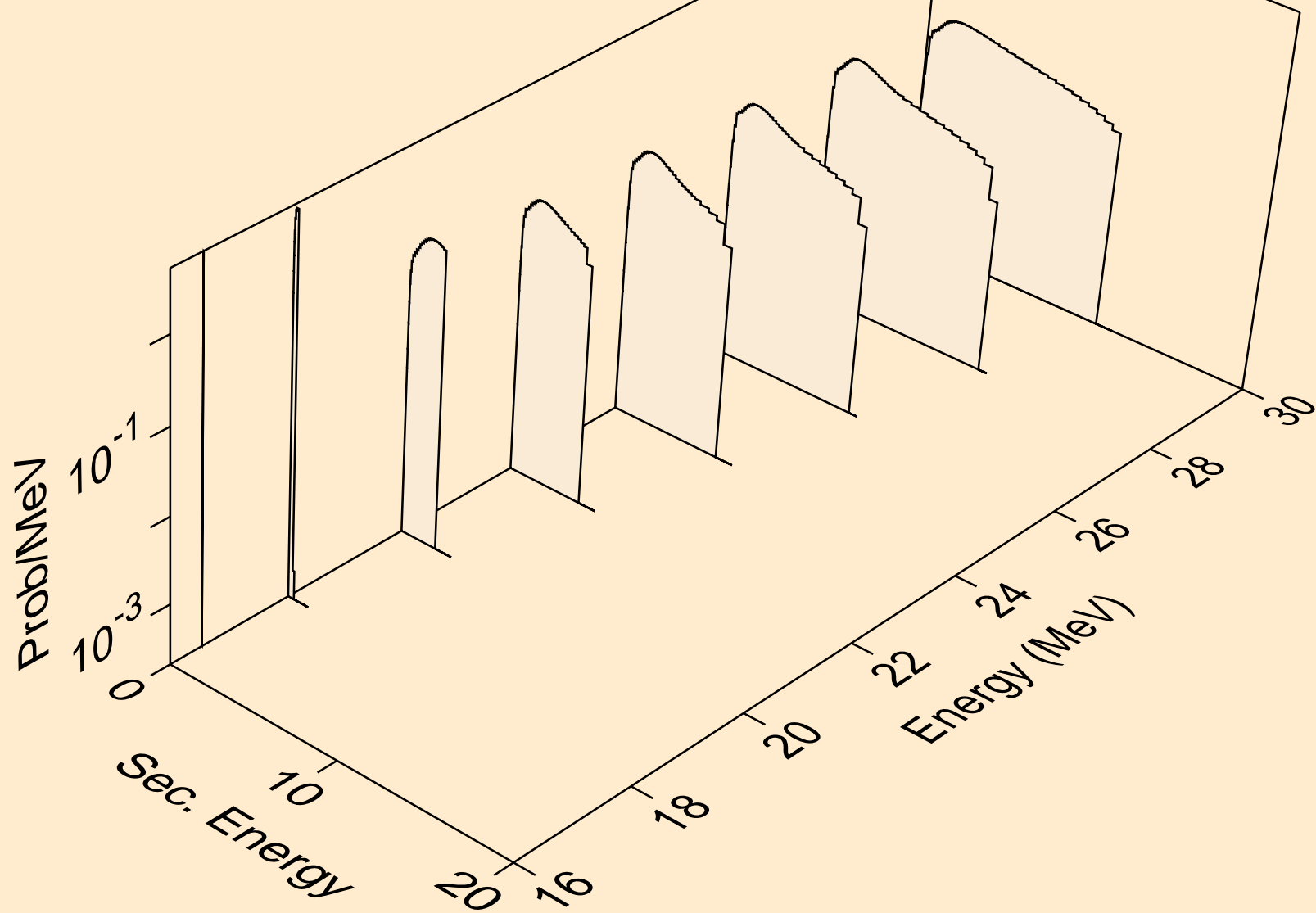

FE052 PROTON ACER TENDL-2021 LIBRARY; T=0.K
neutrons from (p,2np)

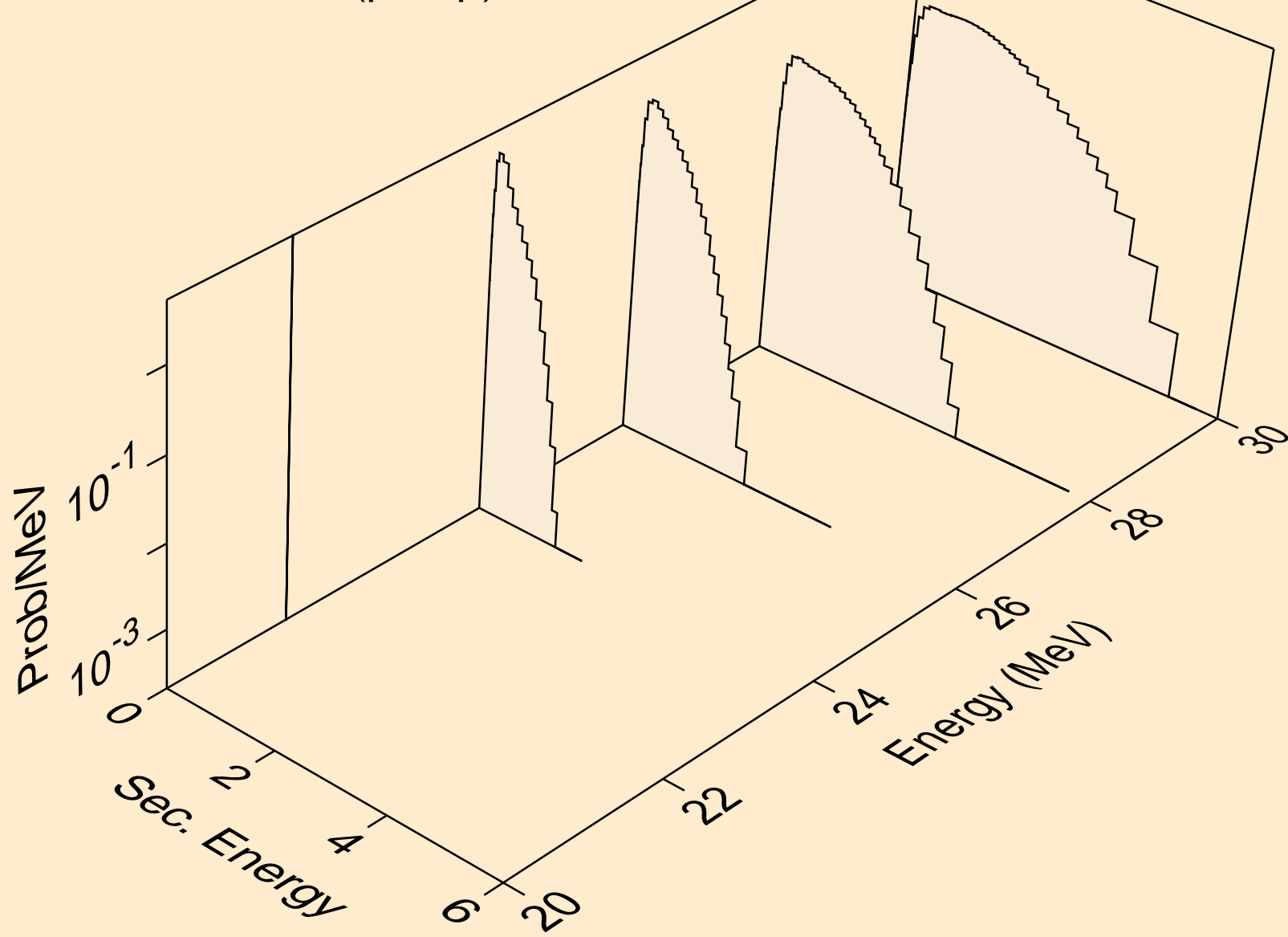

FE052 PROTON ACER TENDL-2021 LIBRARY; T=0.K
deuterons from (p,x)

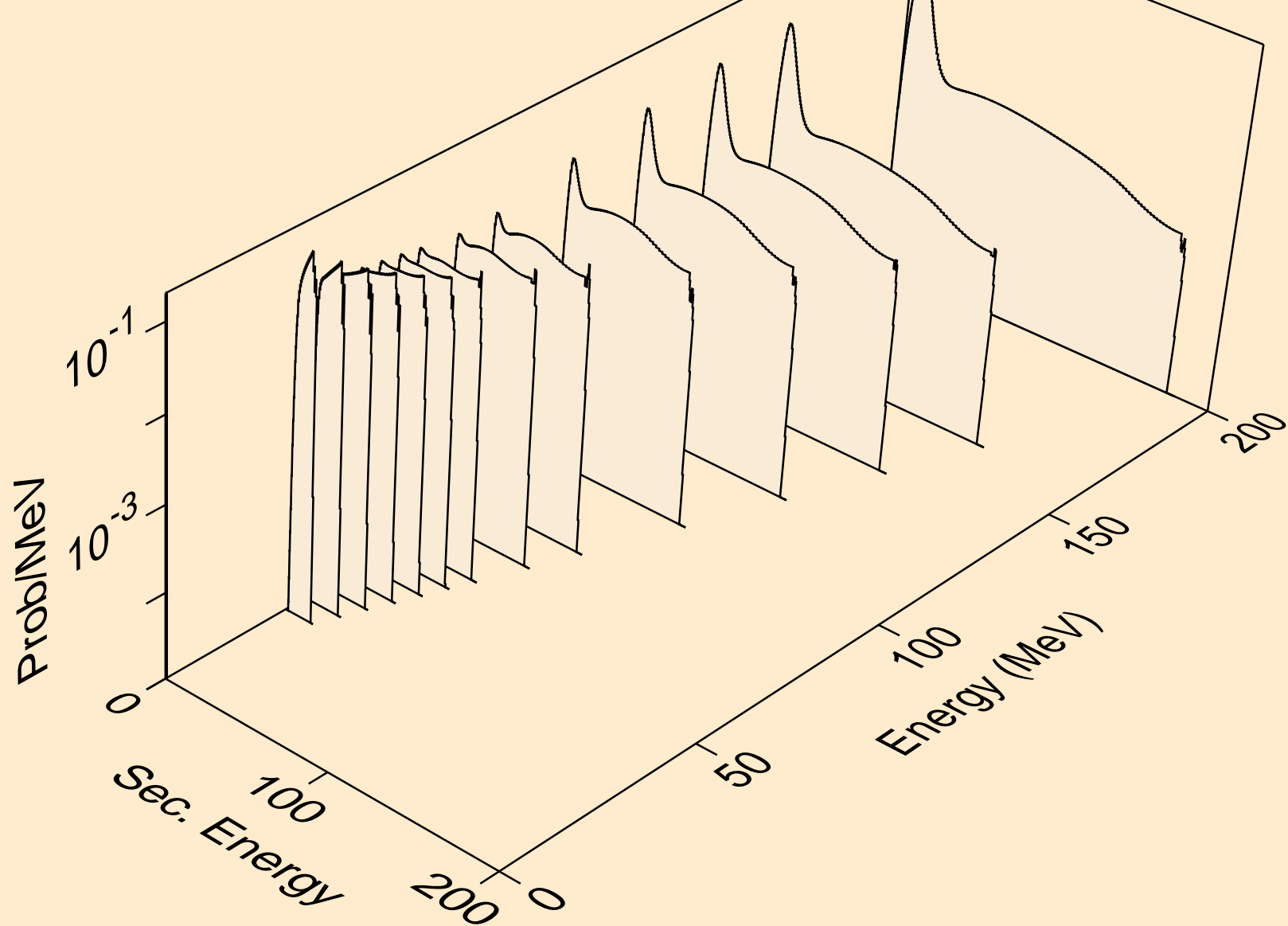

FE052 PROTON ACER TENDL-2021 LIBRARY; T=0.K
deuterons from (p,d)

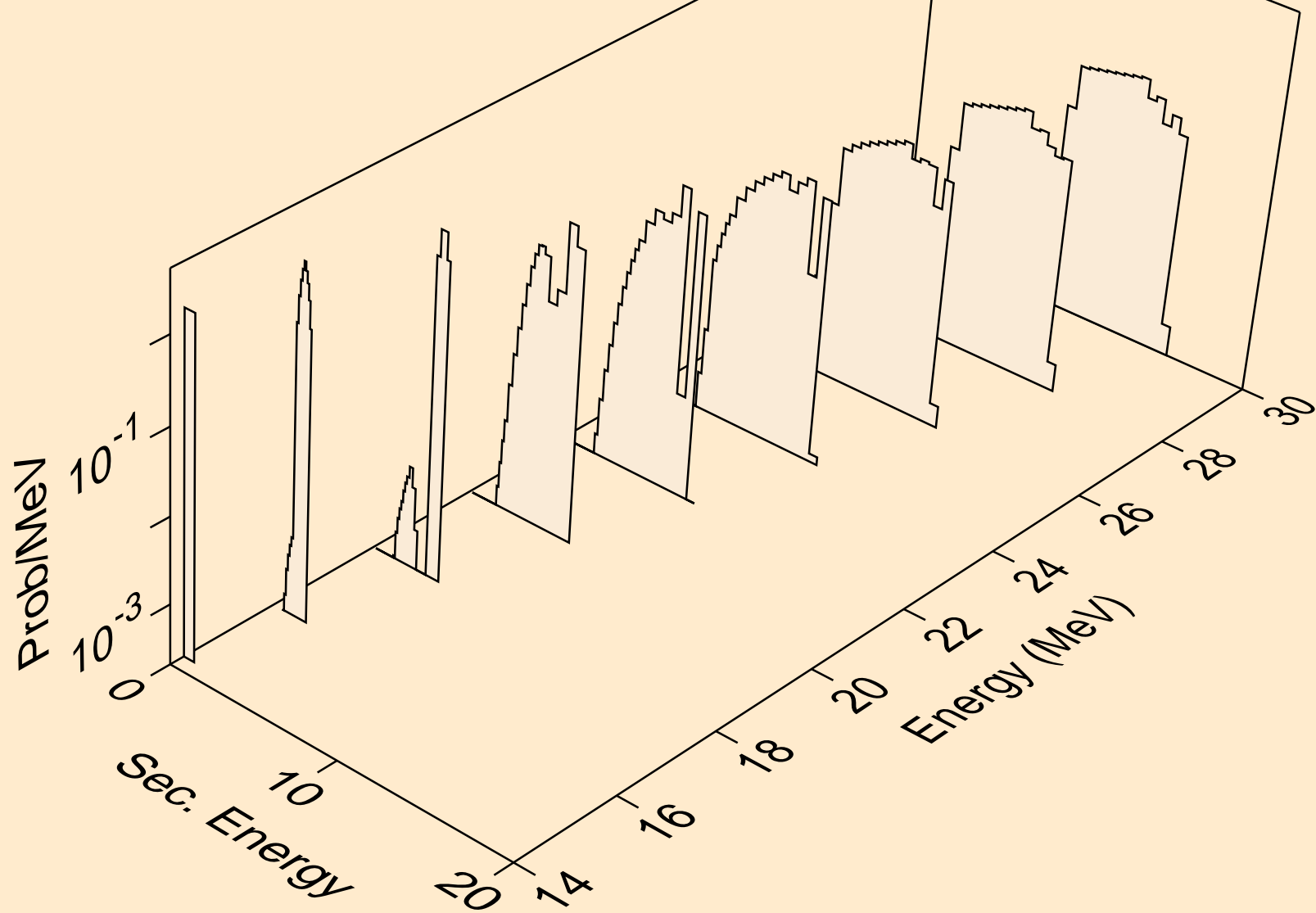

FE052 PROTON ACER TENDL-2021 LIBRARY; T=0.K
deuterons from (p,pd)

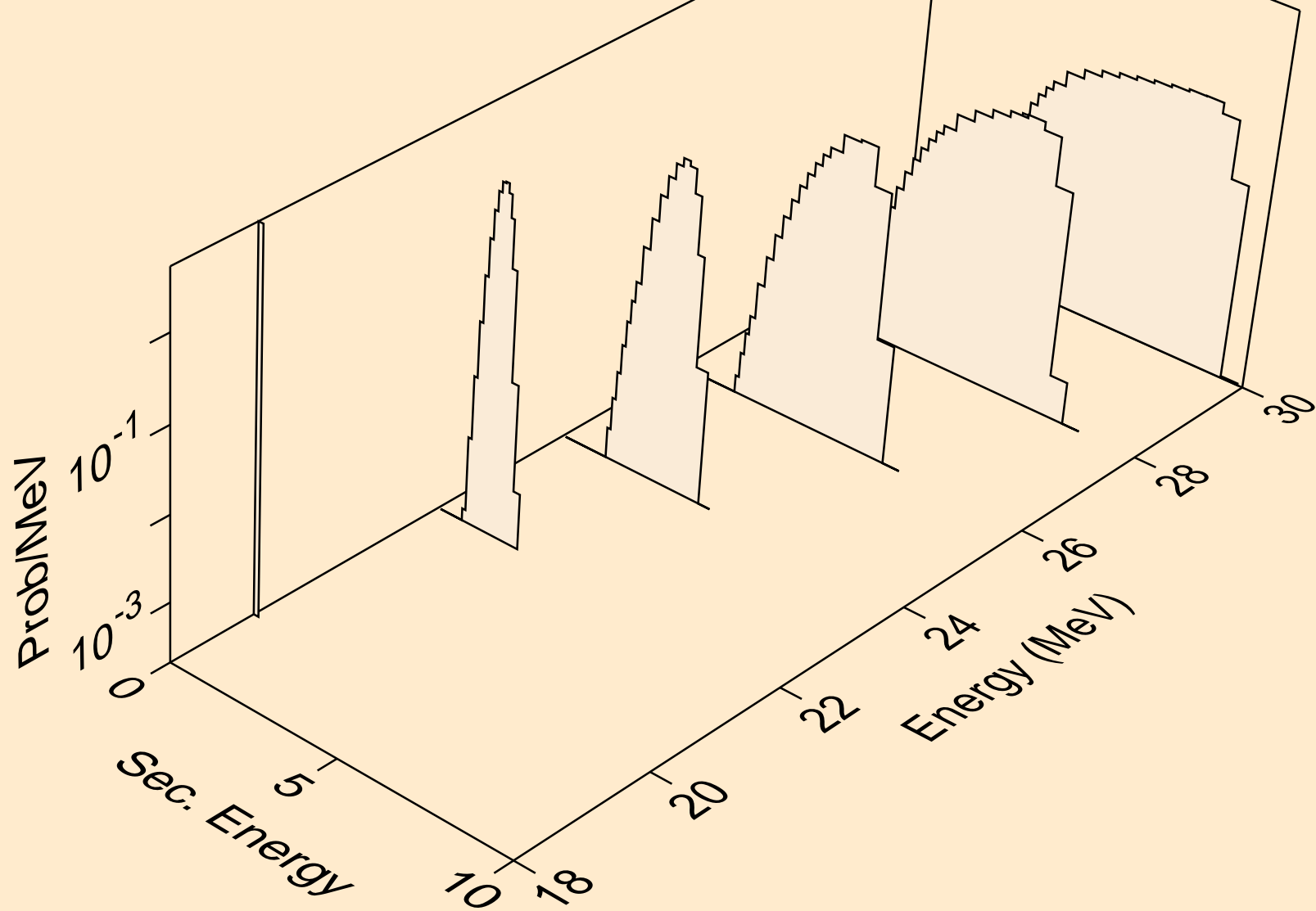

FE052 PROTON ACER TENDL-2021 LIBRARY; T=0.K
tritons from (p,x)

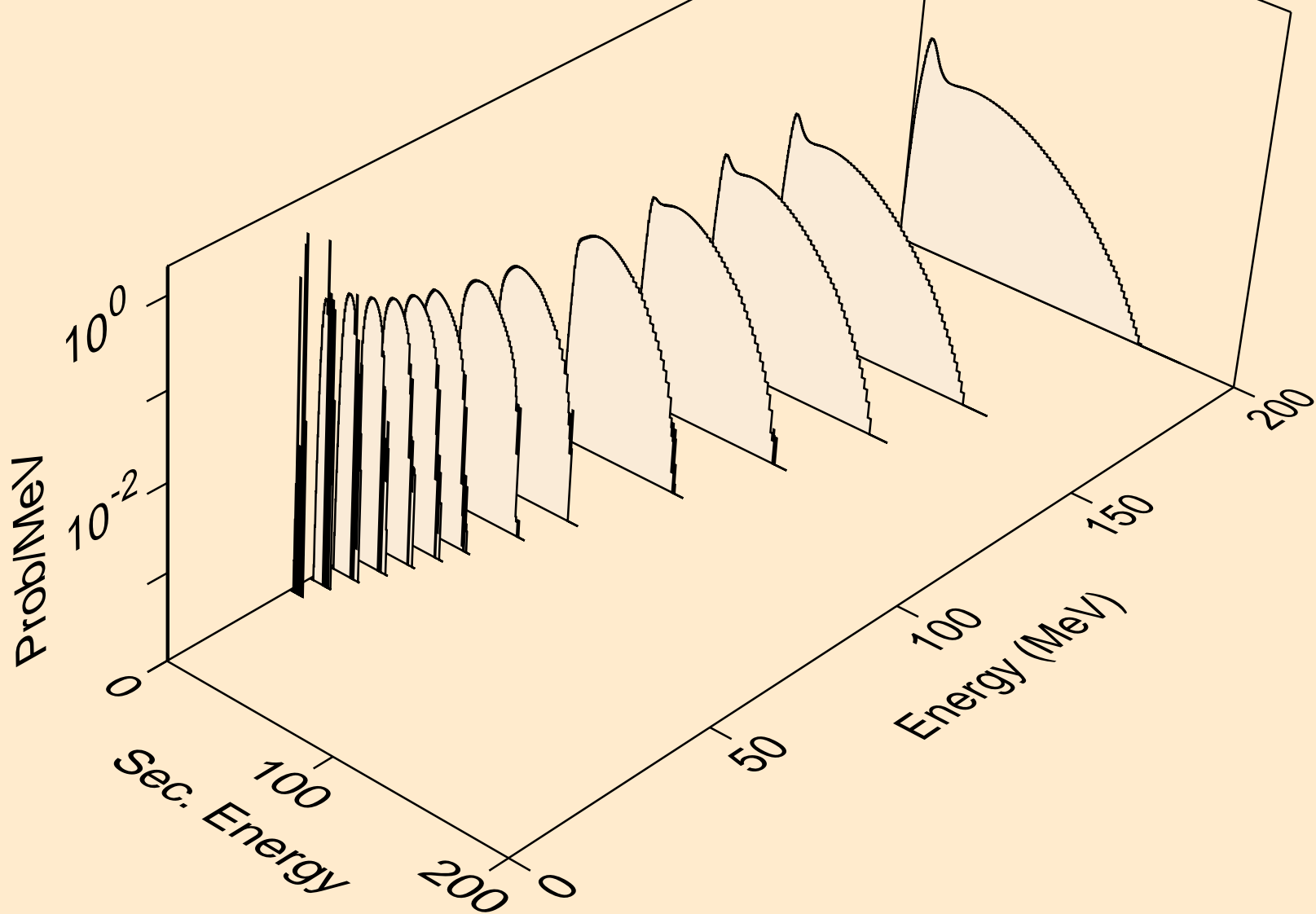

FE052 PROTON ACER TENDL-2021 LIBRARY; T=0.K
tritons from (p,t)

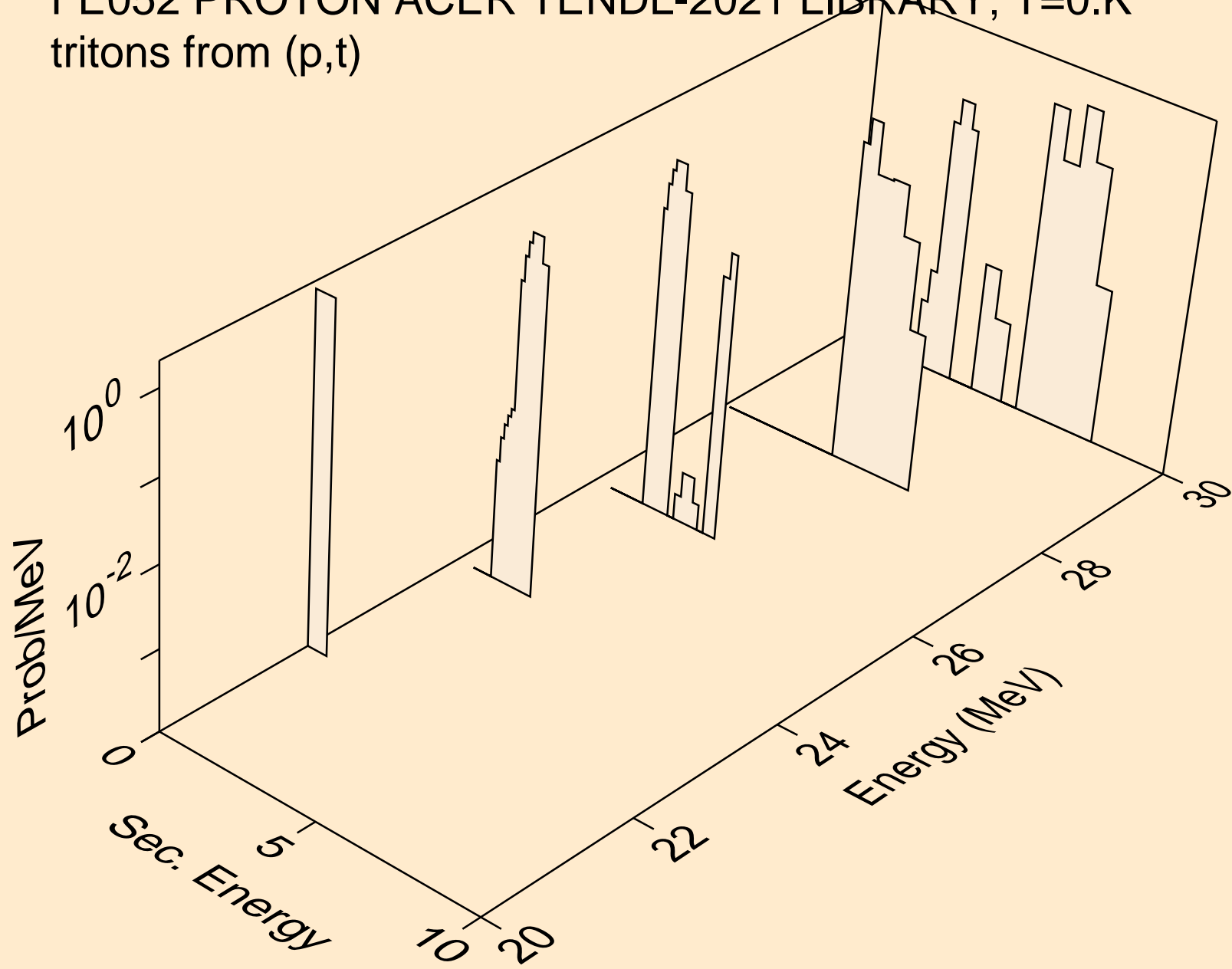

FE052 PROTON ACER TENDL-2021 LIBRARY; T=0.K
tritons from (p,pt)

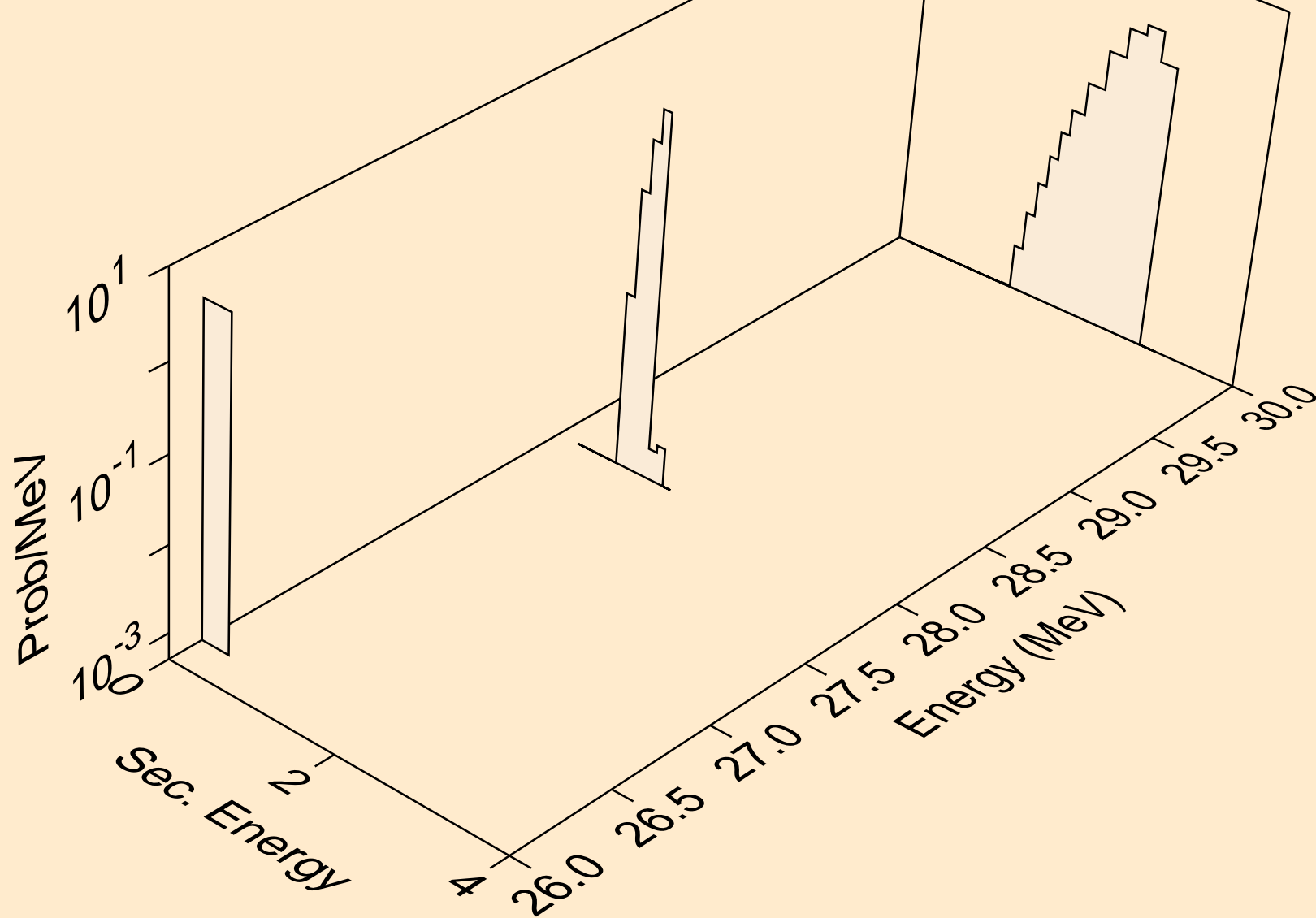

FE052 PROTON ACER TENDL-2021 LIBRARY; T=0.K
he3s from (p,x)

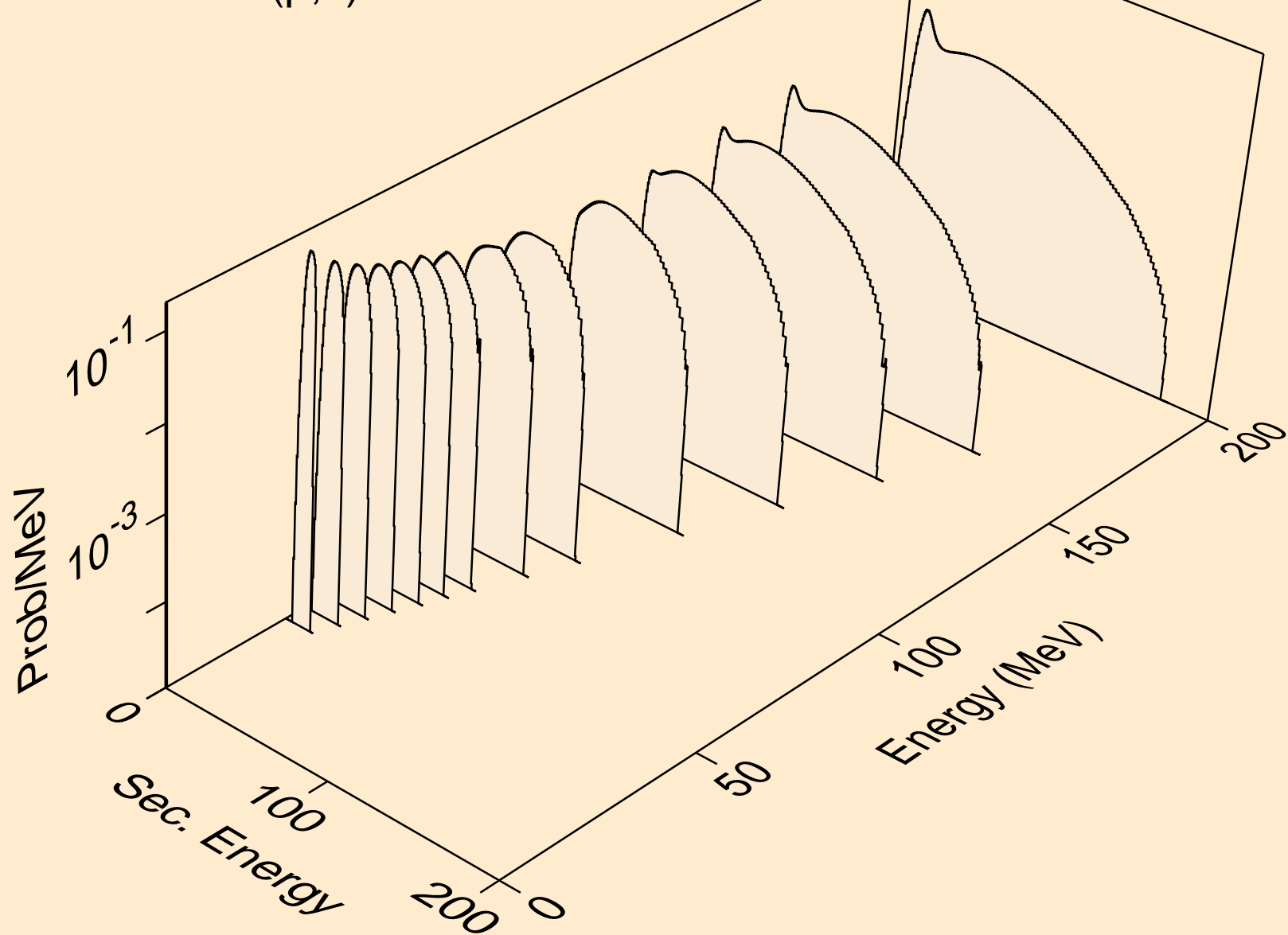

FE052 PROTON ACER TENDL-2021 LIBRARY; T=0.K
he3s from (p,he3)

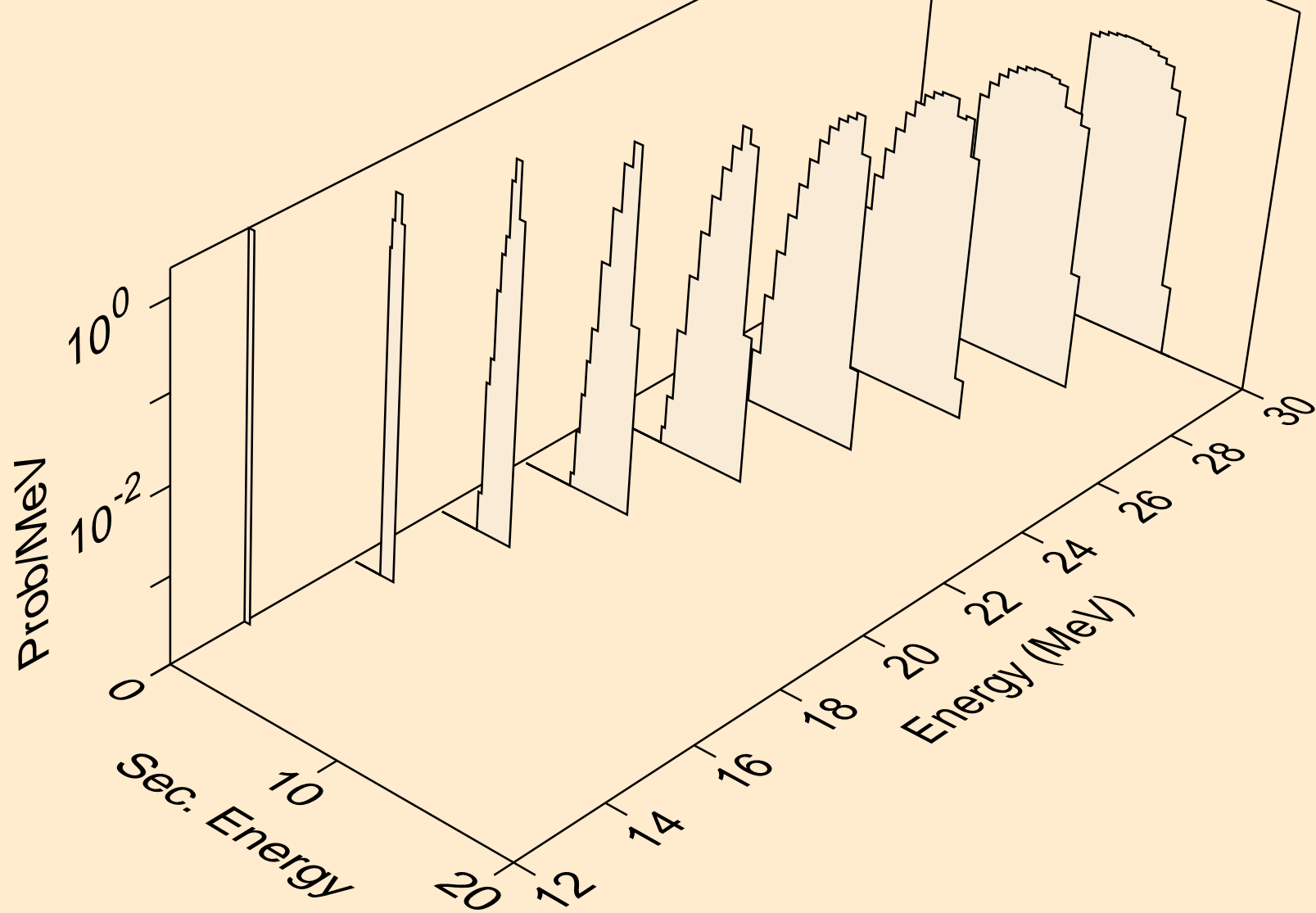

FE052 PROTON ACER TENDL-2021 LIBRARY; T=0.K
alphas from (p,x)

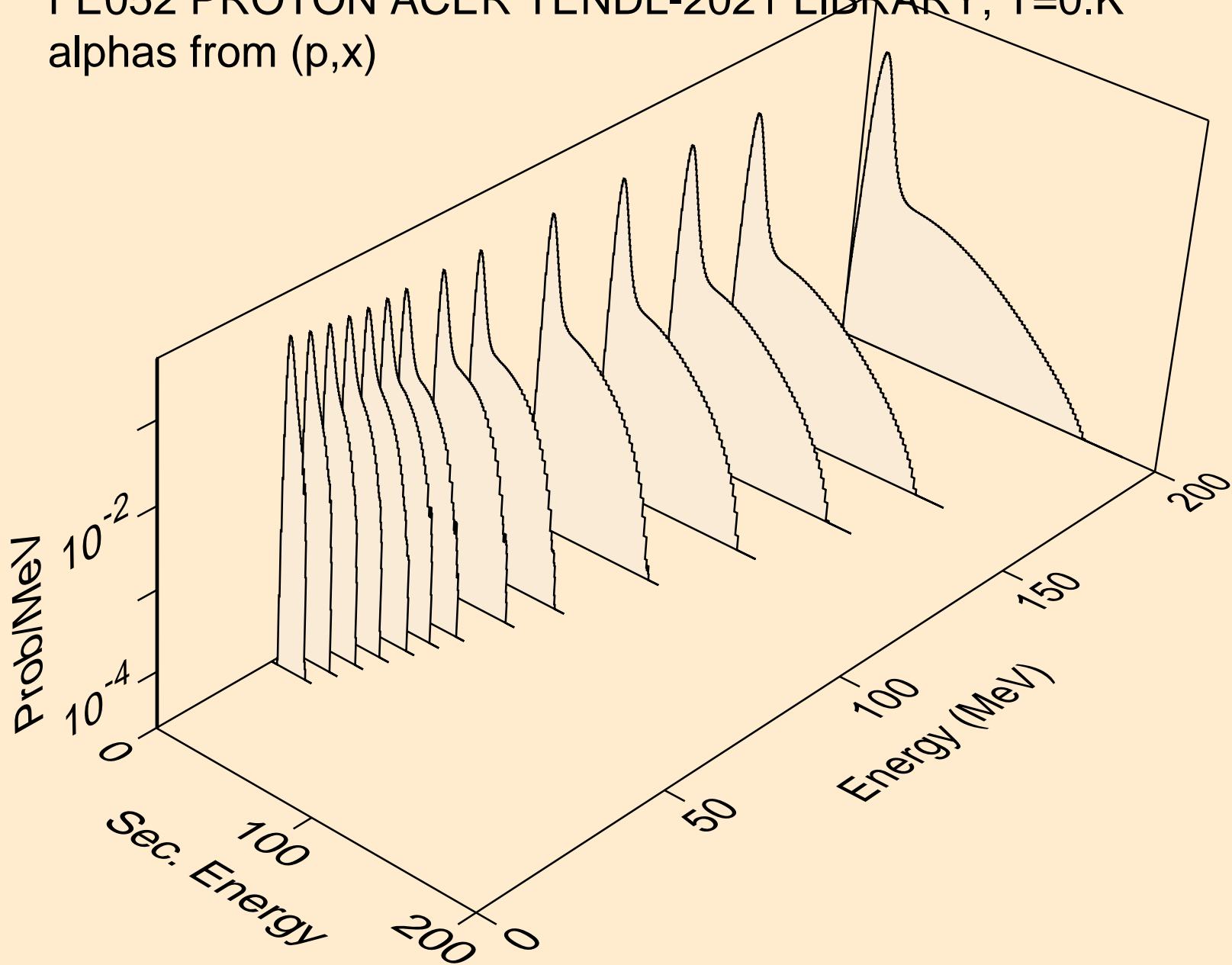

FE052 PROTON ACER TENDL-2021 LIBRARY; T=0.K
alphas from (p,n*)a

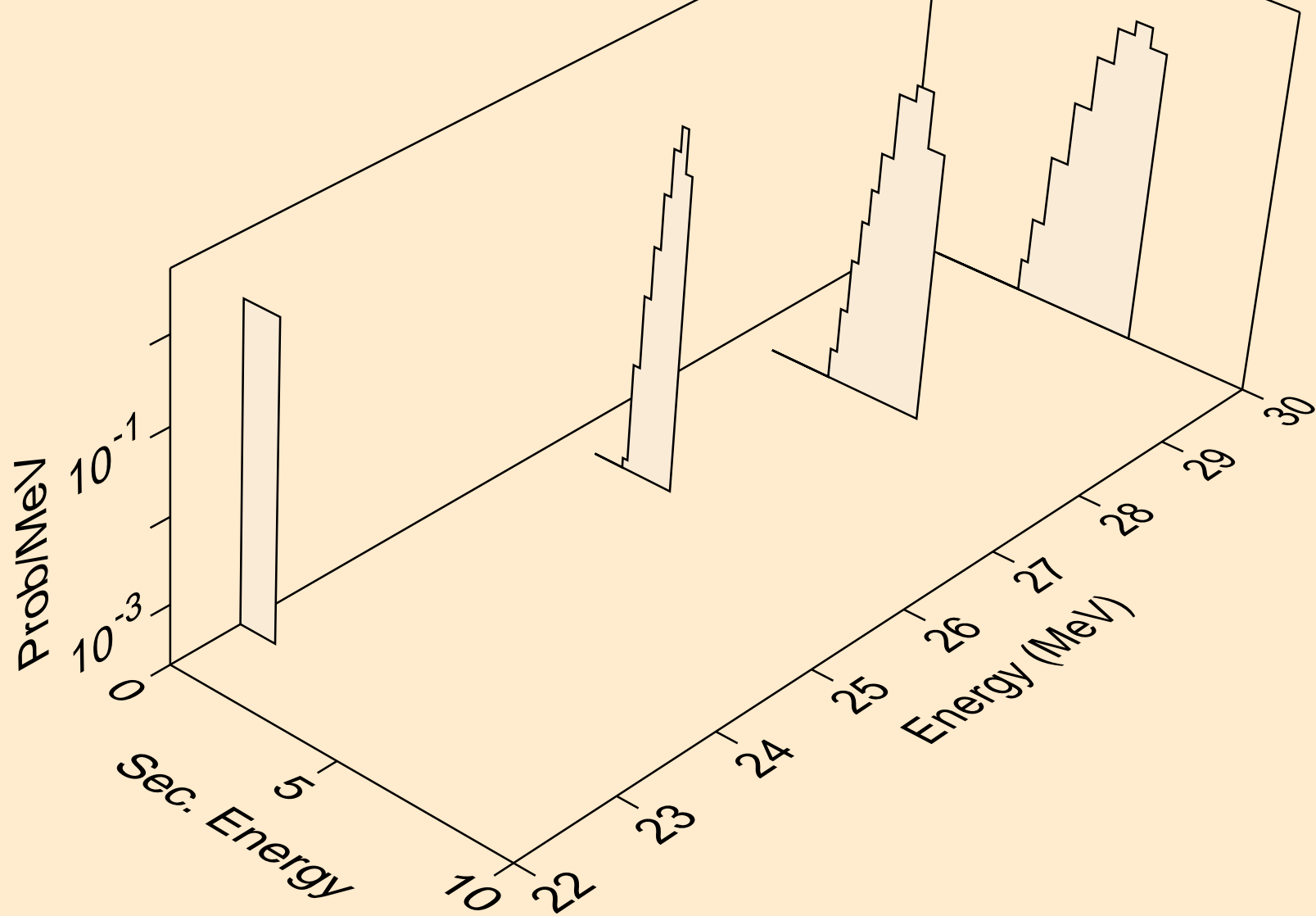

FE052 PROTON ACER TENDL-2021 LIBRARY; T=0.K
alphas from (p,a)

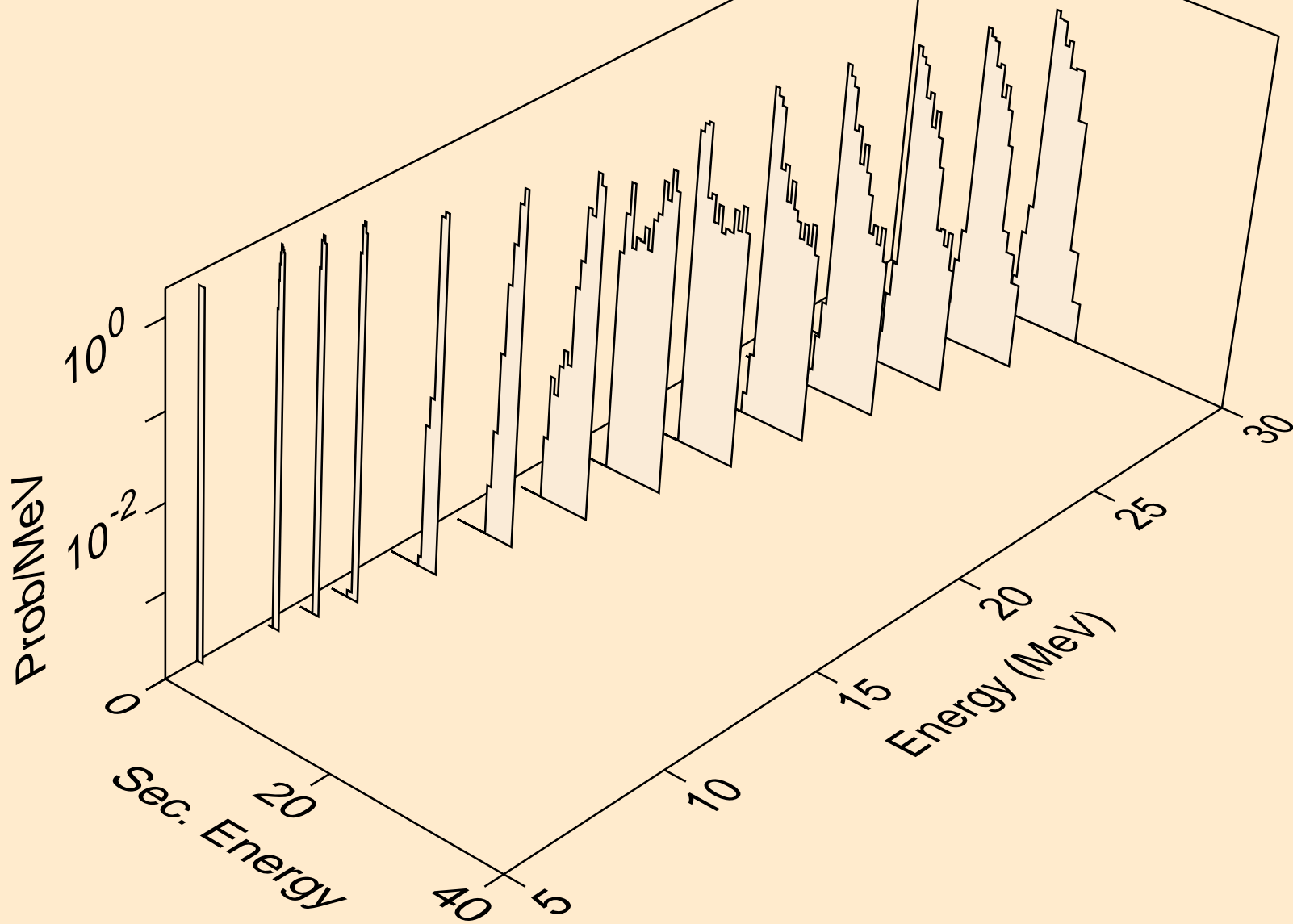

FE052 PROTON ACER TENDL-2021 LIBRARY; T=0.K
alphas from (p,2a)

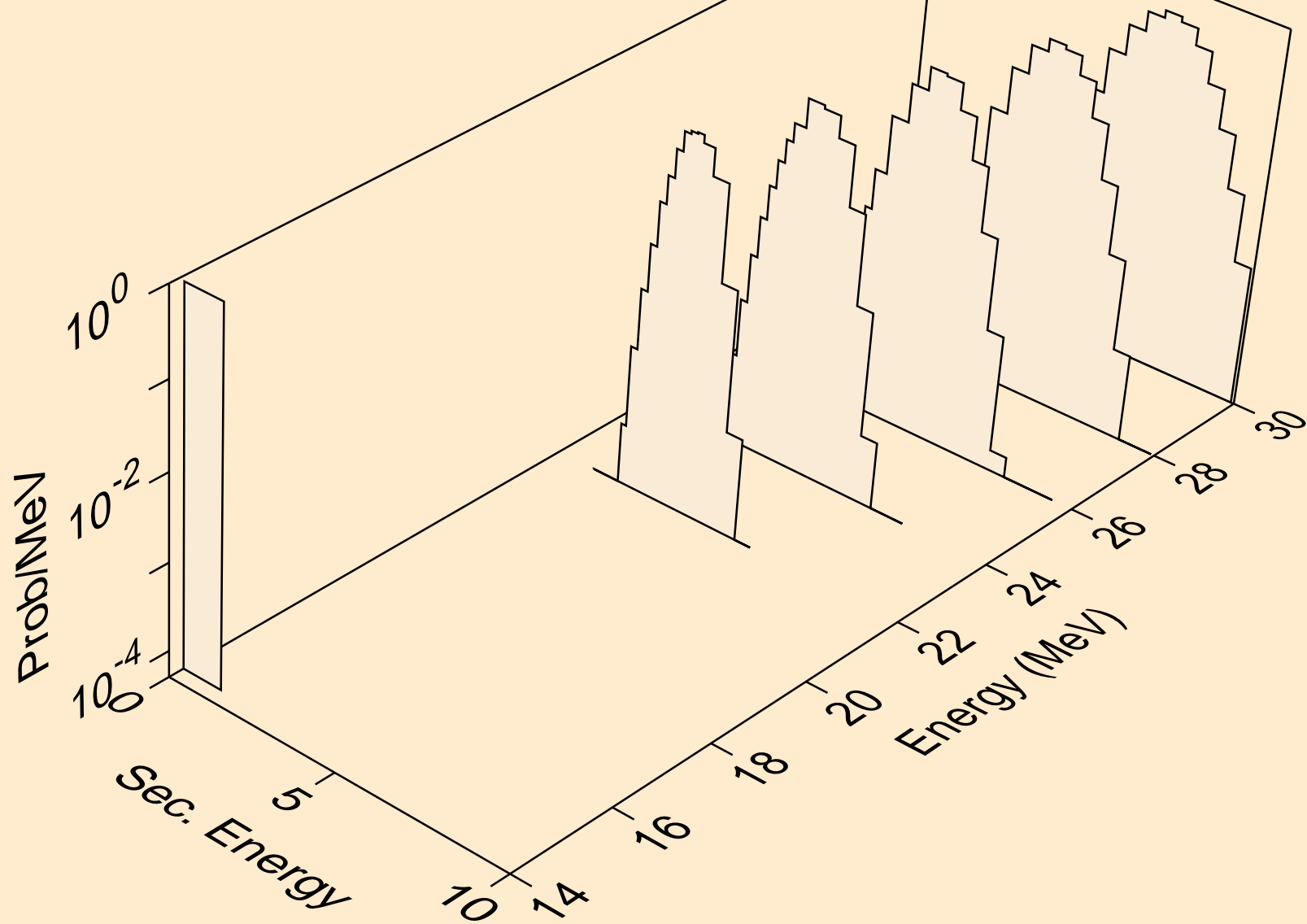

FE052 PROTON ACER TENDL-2021 LIBRARY; T=0.K
alphas from (p,pa)

