

FE053 PROTON ACER TENDL-2021 LIBRARY; T=0.K

Principal cross sections

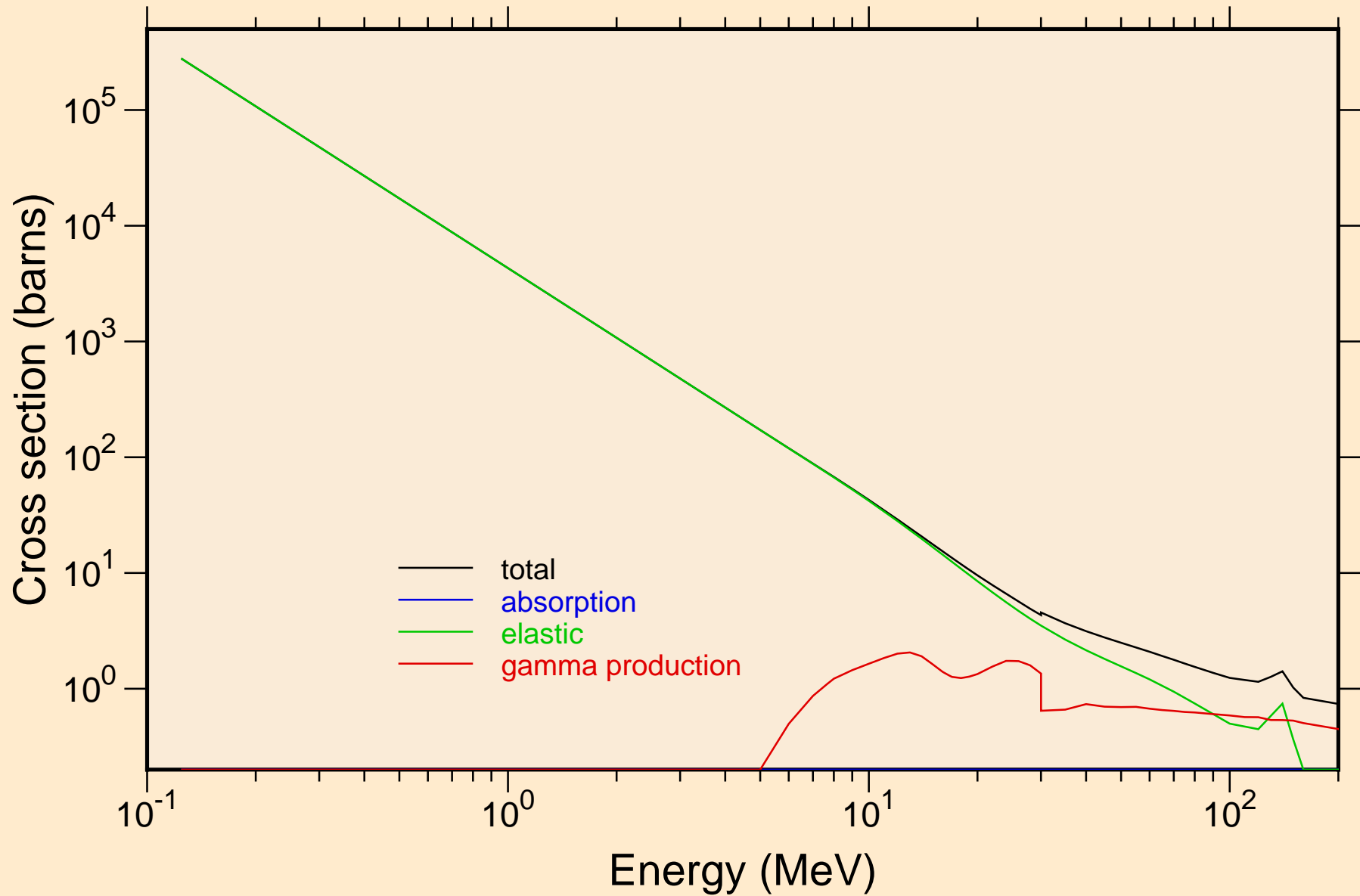

FE053 PROTON ACER TENDL-2021 LIBRARY; T=0.K

Heating

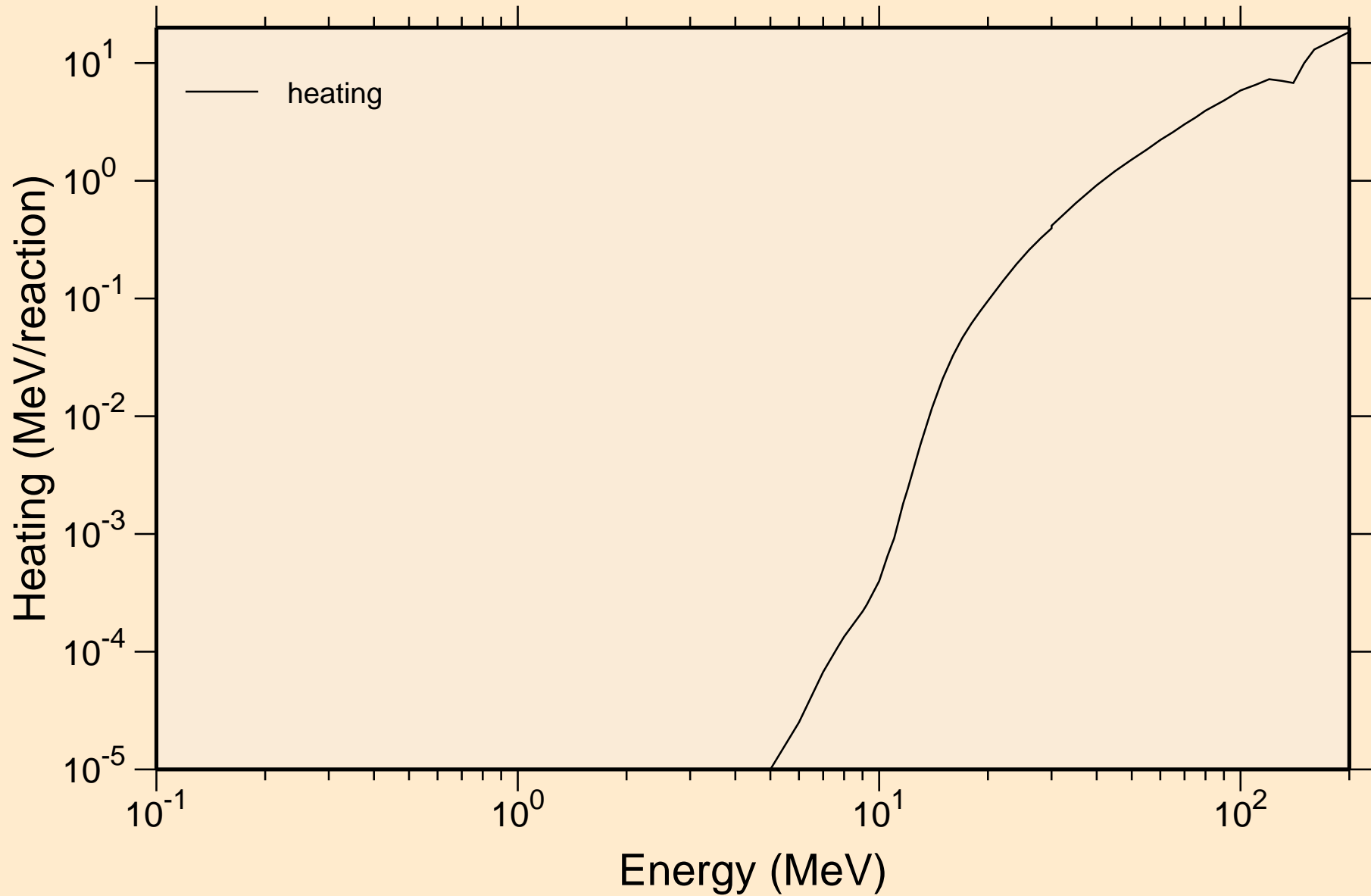

FE053 PROTON ACER TENDL-2021 LIBRARY; T=0.K

Principal cross sections

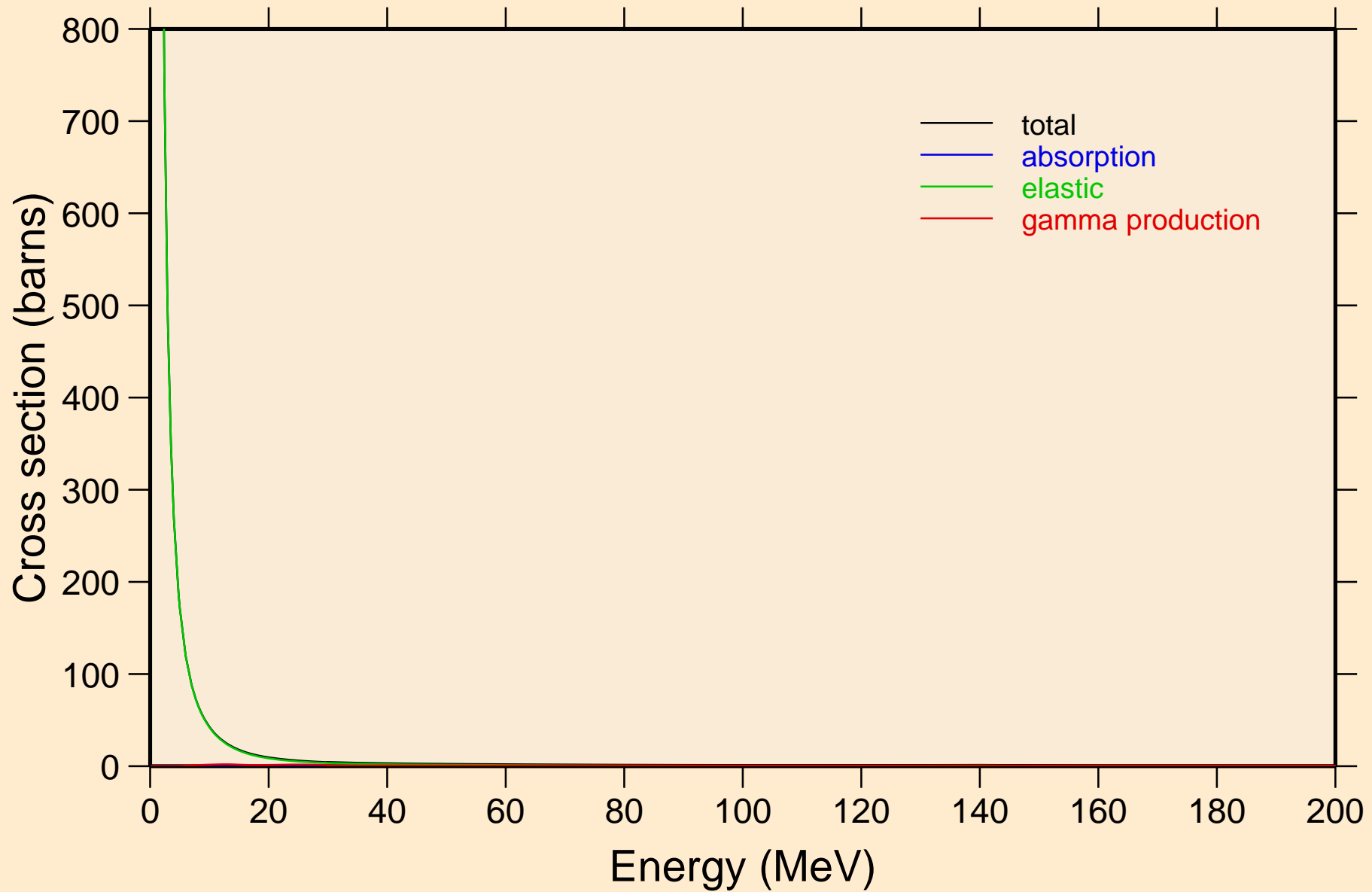

FE053 PROTON ACER TENDL-2021 LIBRARY; T=0.K

Heating

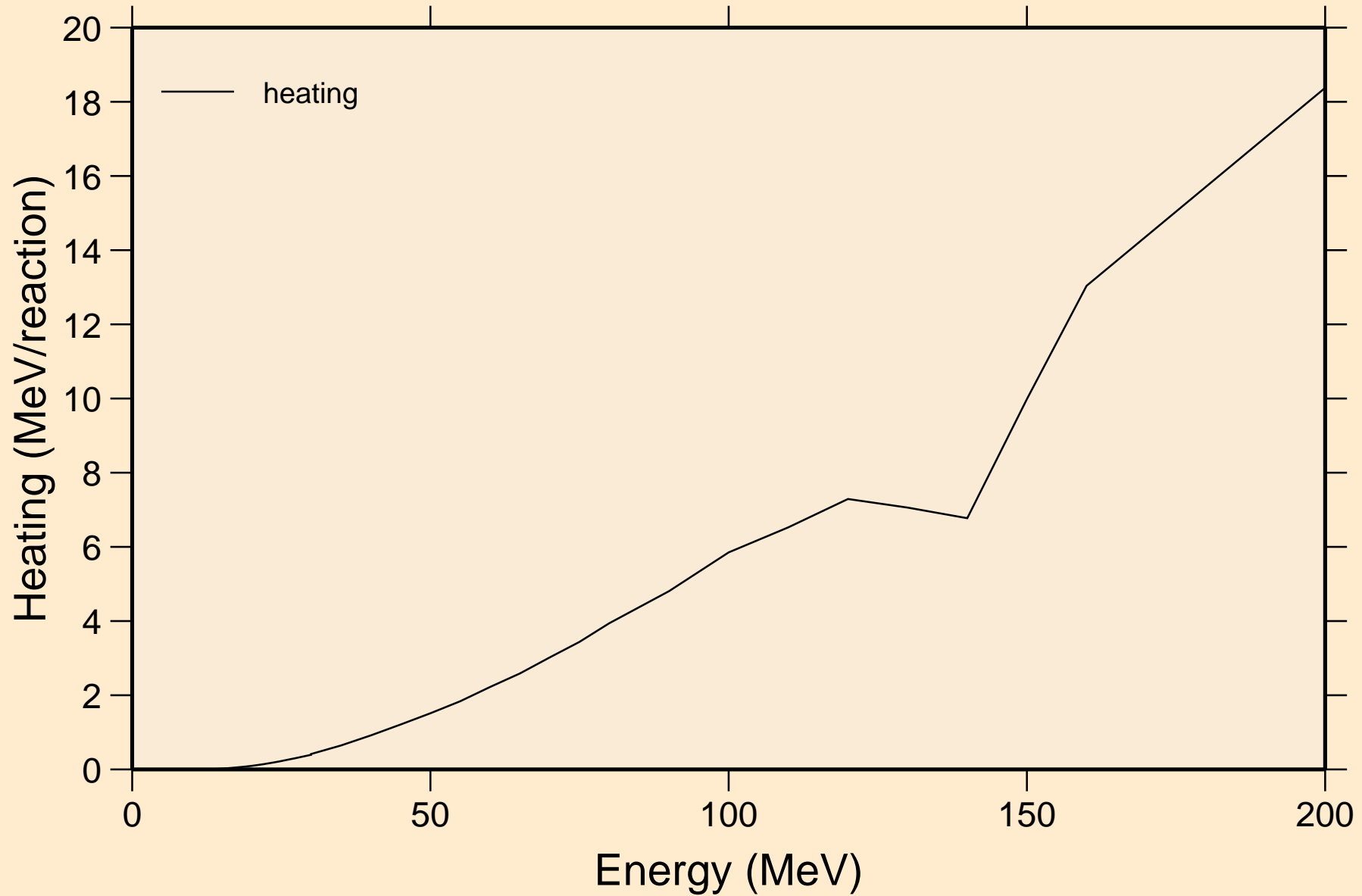

FE053 PROTON ACER TENDL-2021 LIBRARY; T=0.K

Threshold reactions

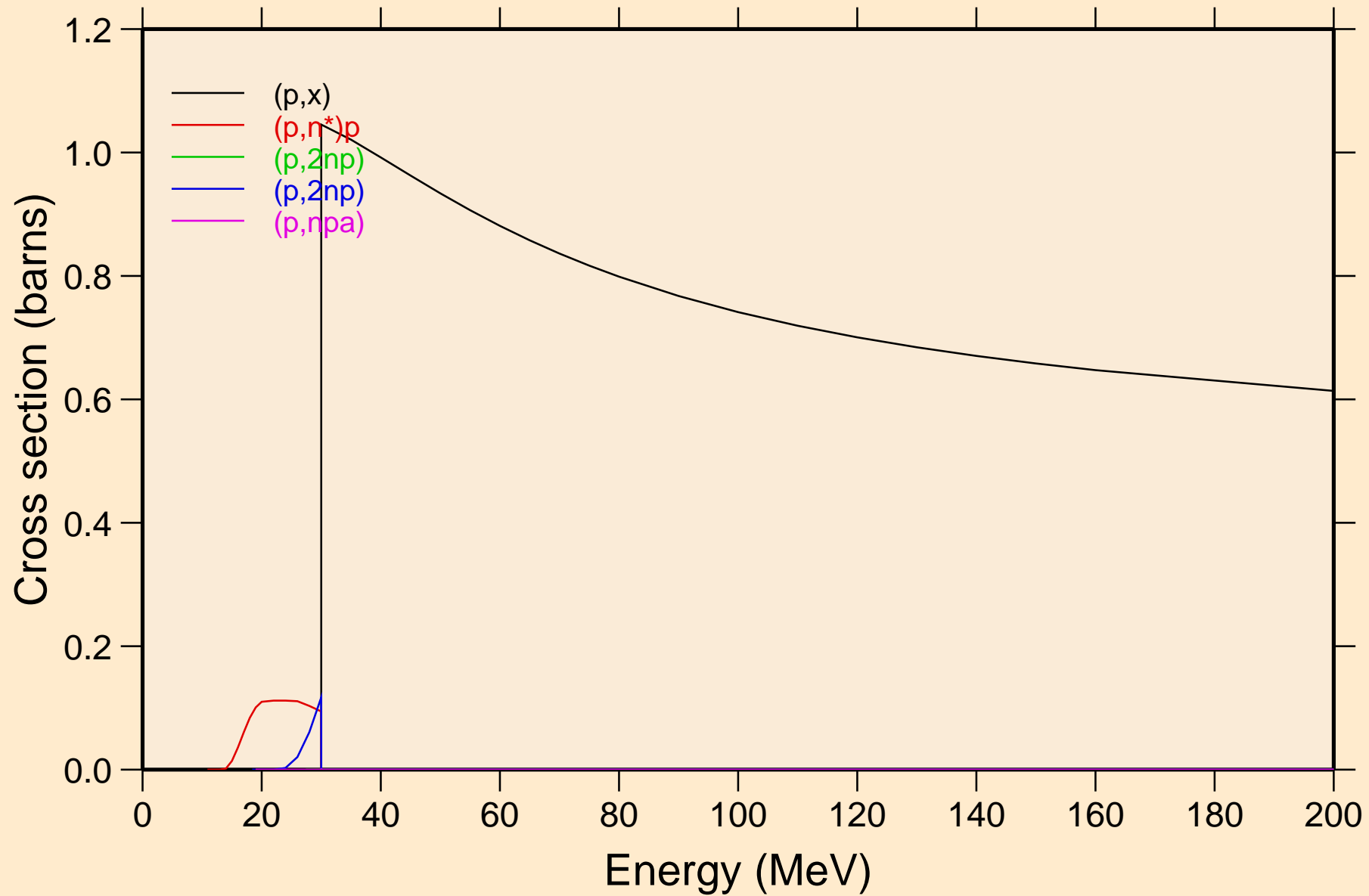

FE053 PROTON ACER TENDL-2021 LIBRARY; T=0.K
Threshold reactions

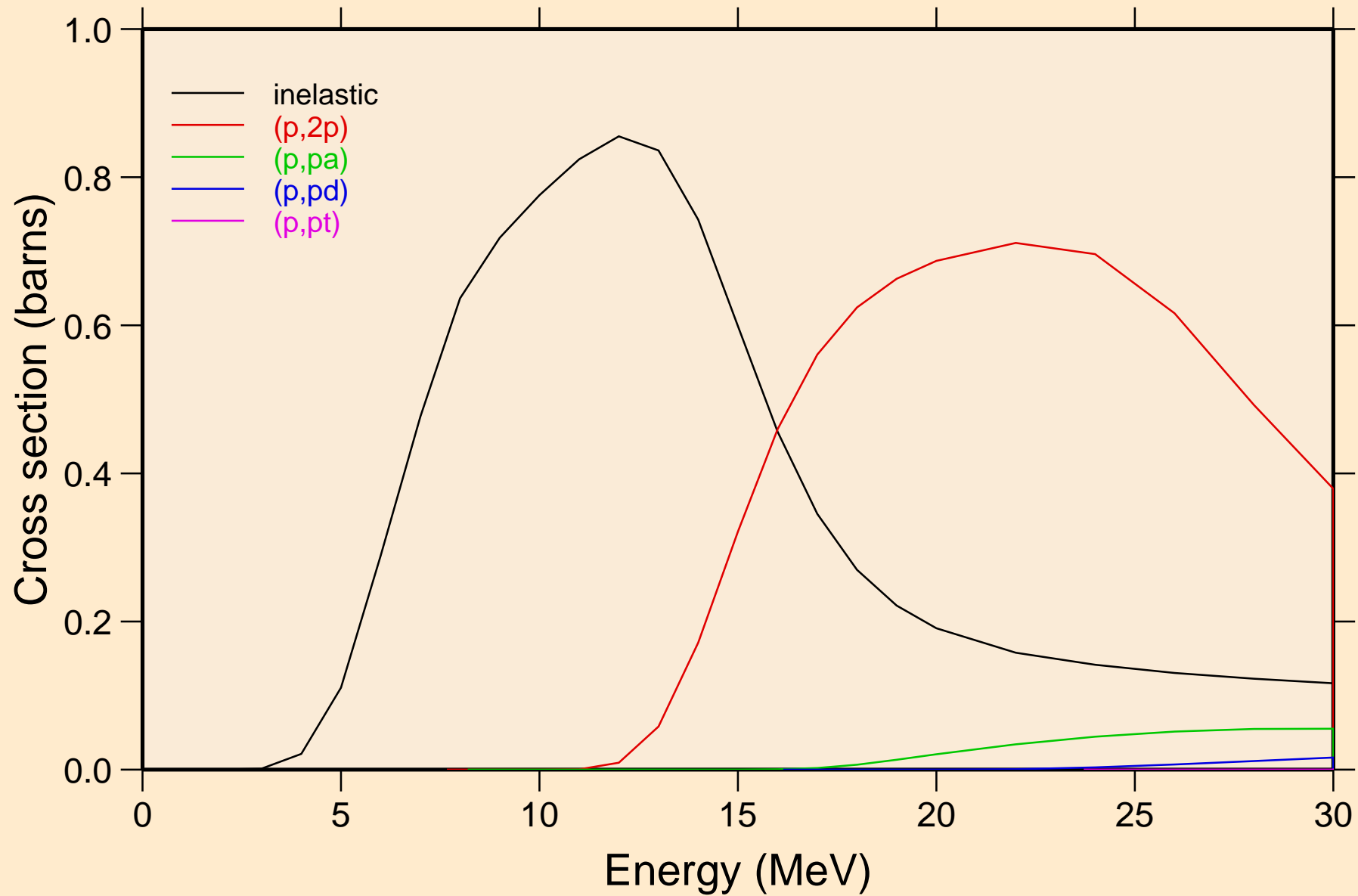

FE053 PROTON ACER TENDL-2021 LIBRARY; T=0.K
Threshold reactions

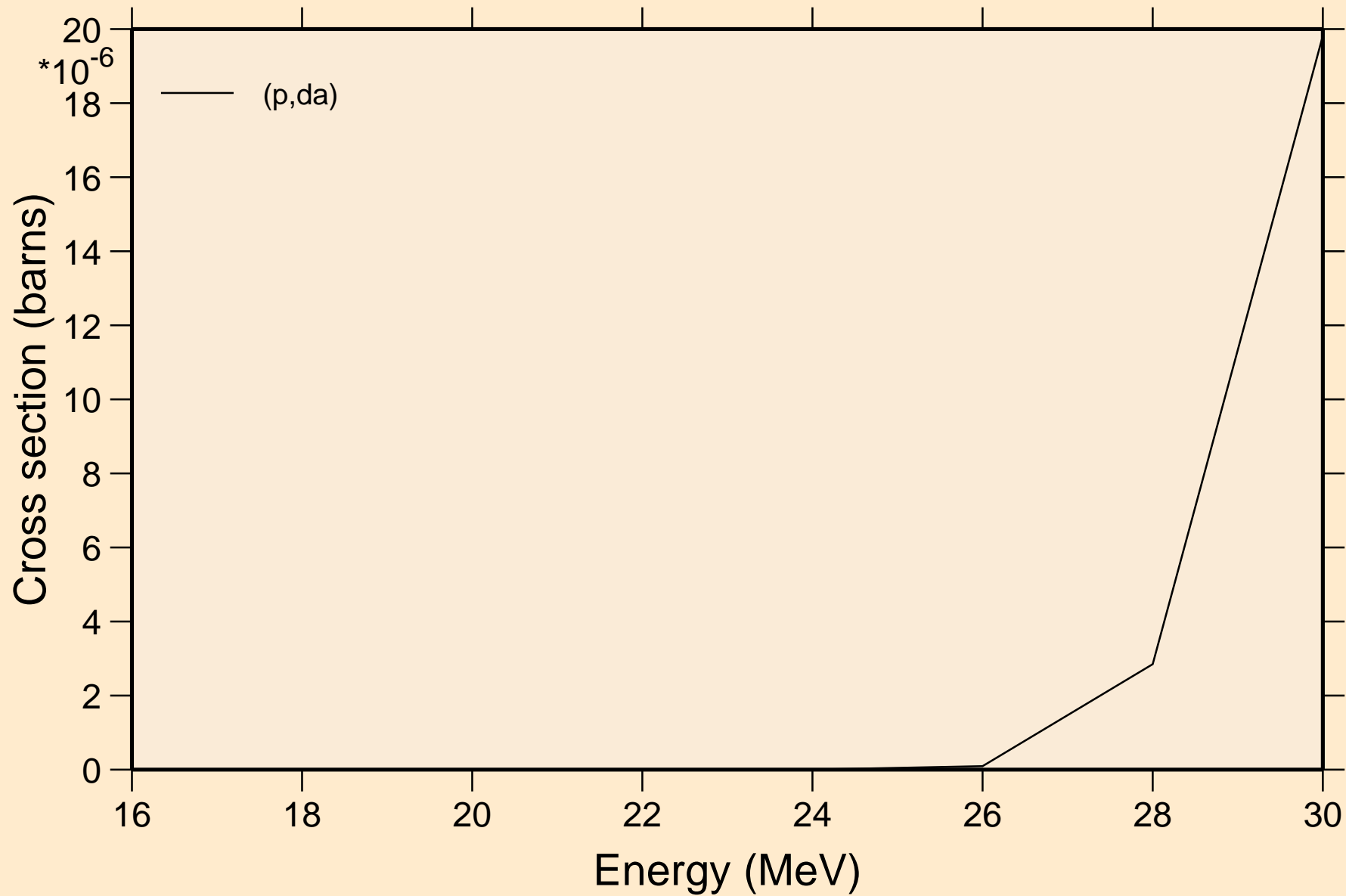

FE053 PROTON ACER TENDL-2021 LIBRARY; T=0.K
angular distribution for elastic

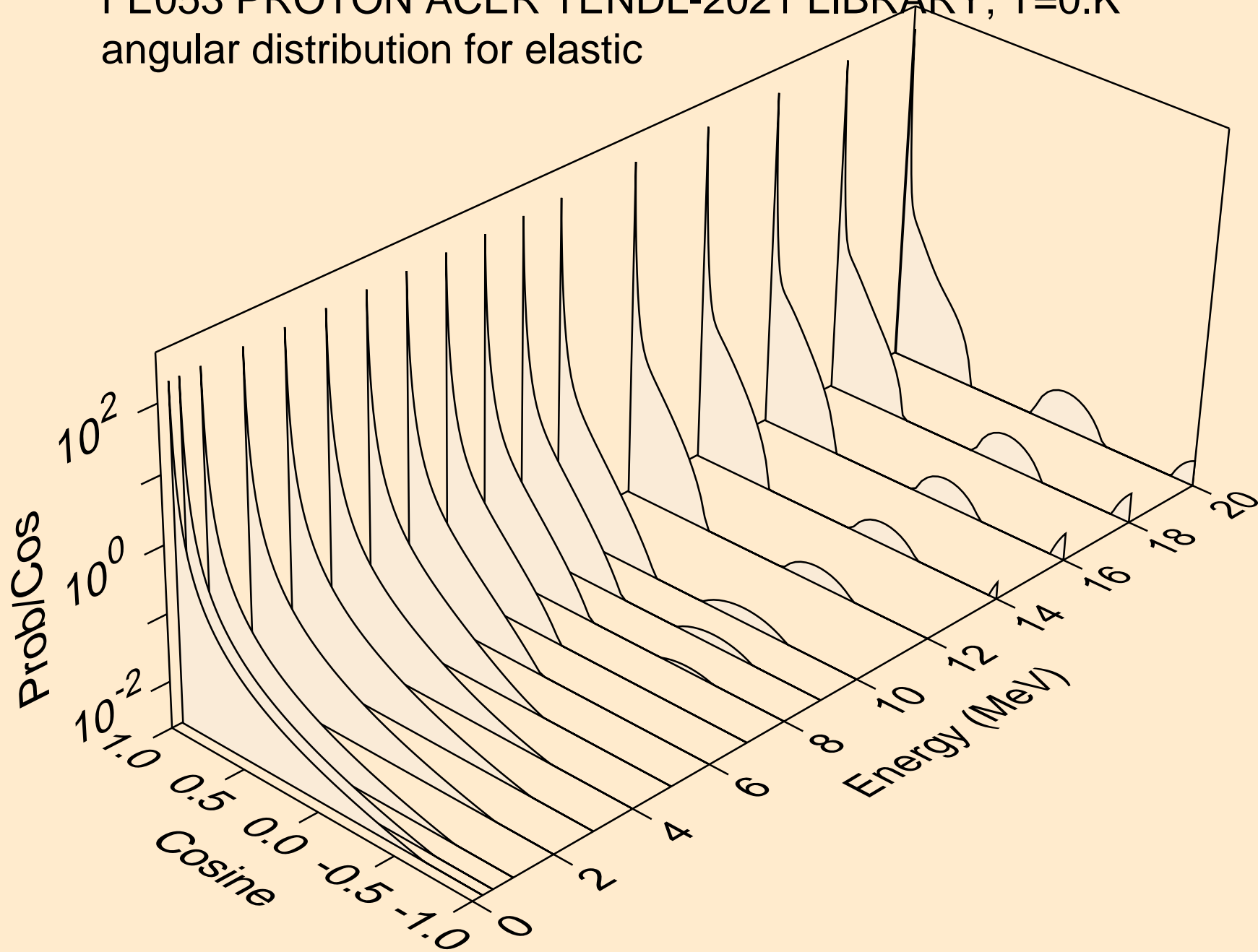

FE053 PROTON ACER TENDL-2021 LIBRARY; T=0.K
angular distribution for elastic

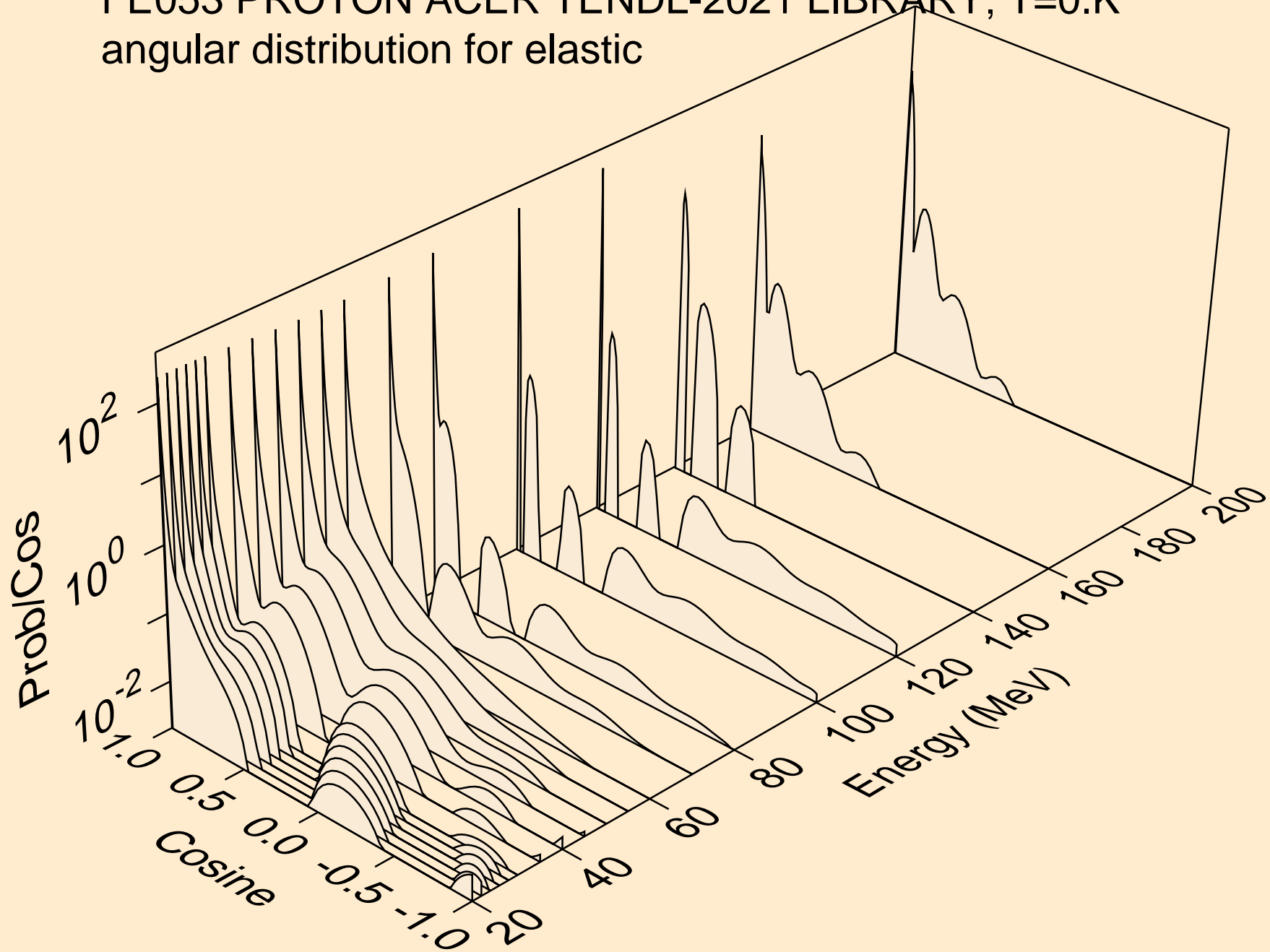

FE053 PROTON ACER TENDL-2021 LIBRARY; T=0.K
Proton emission for (p,x)

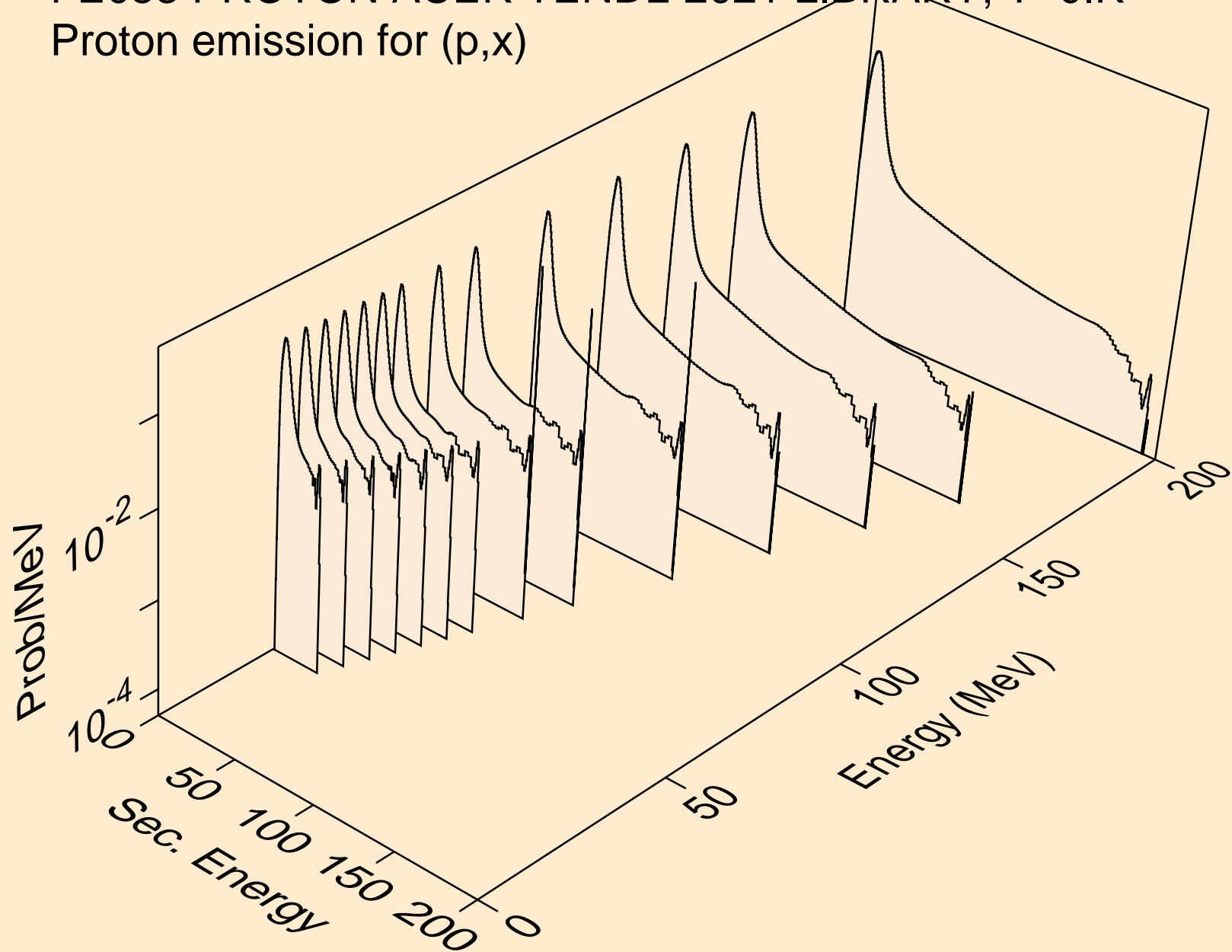

FE053 PROTON ACER TENDL-2021 LIBRARY; T=0.K
Proton emission for (p,n*)p

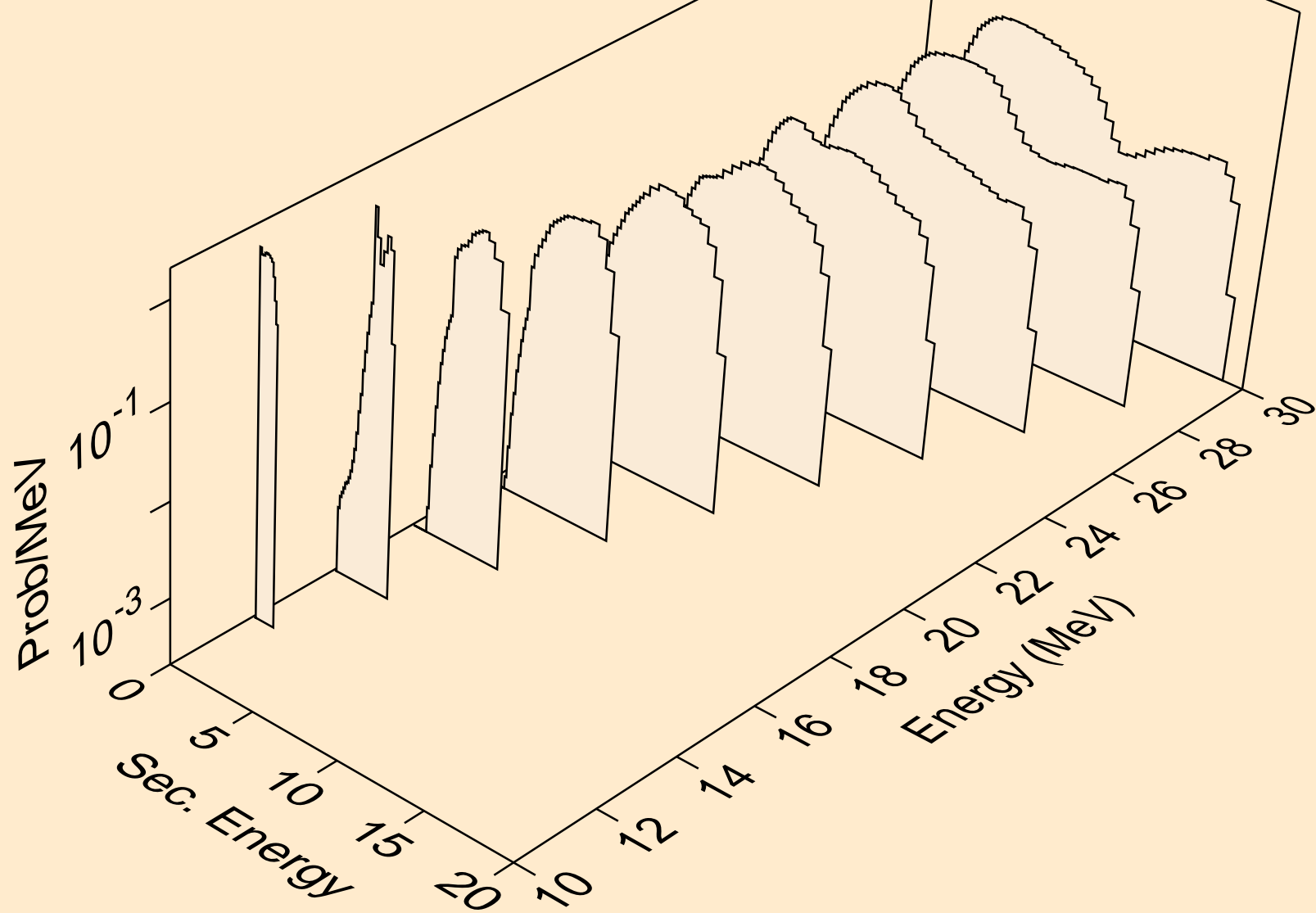

FE053 PROTON ACER TENDL-2021 LIBRARY; T=0.K
Proton emission for (p,2np)

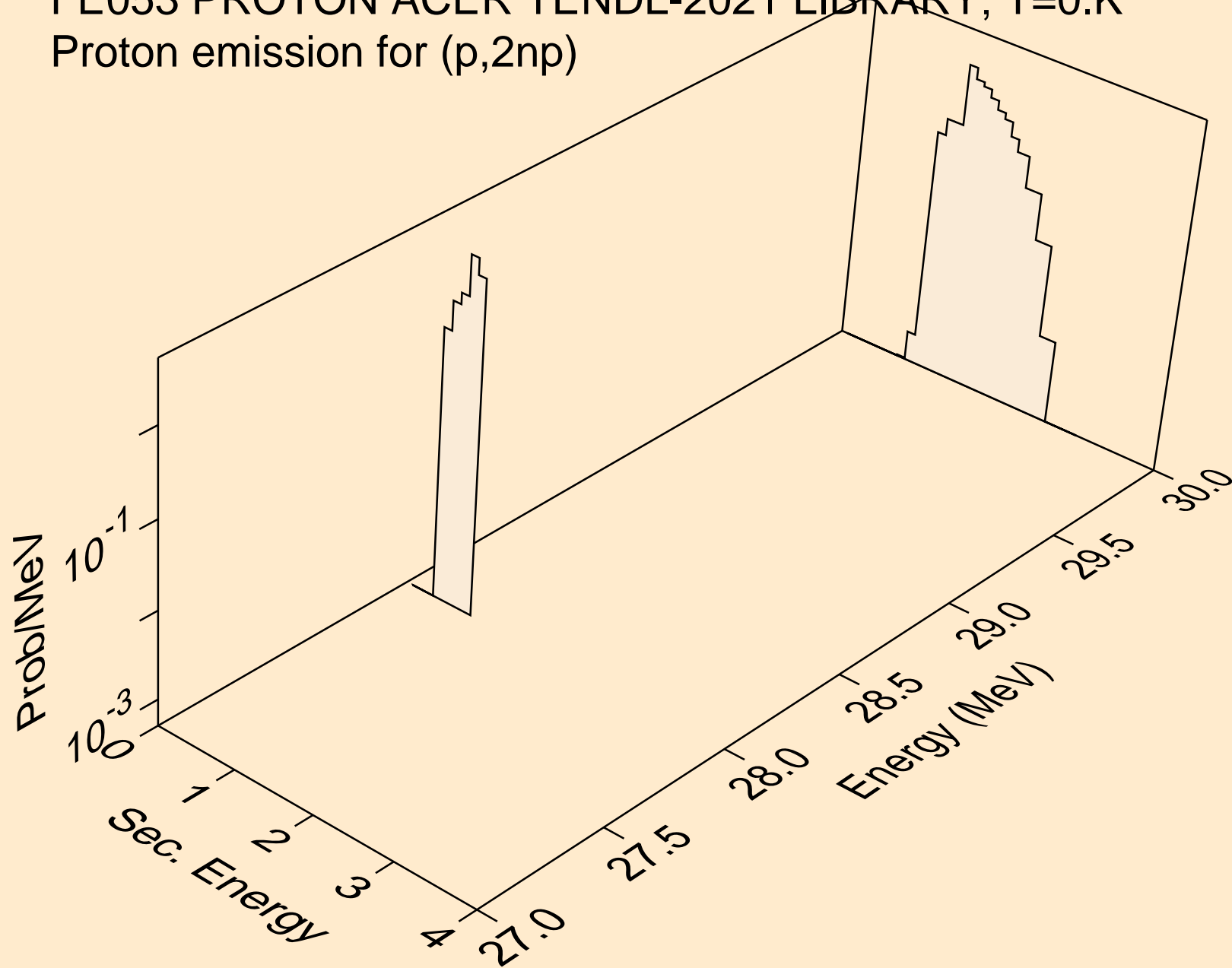

FE053 PROTON ACER TENDL-2021 LIBRARY; T=0.K
Proton emission for (p,2np)

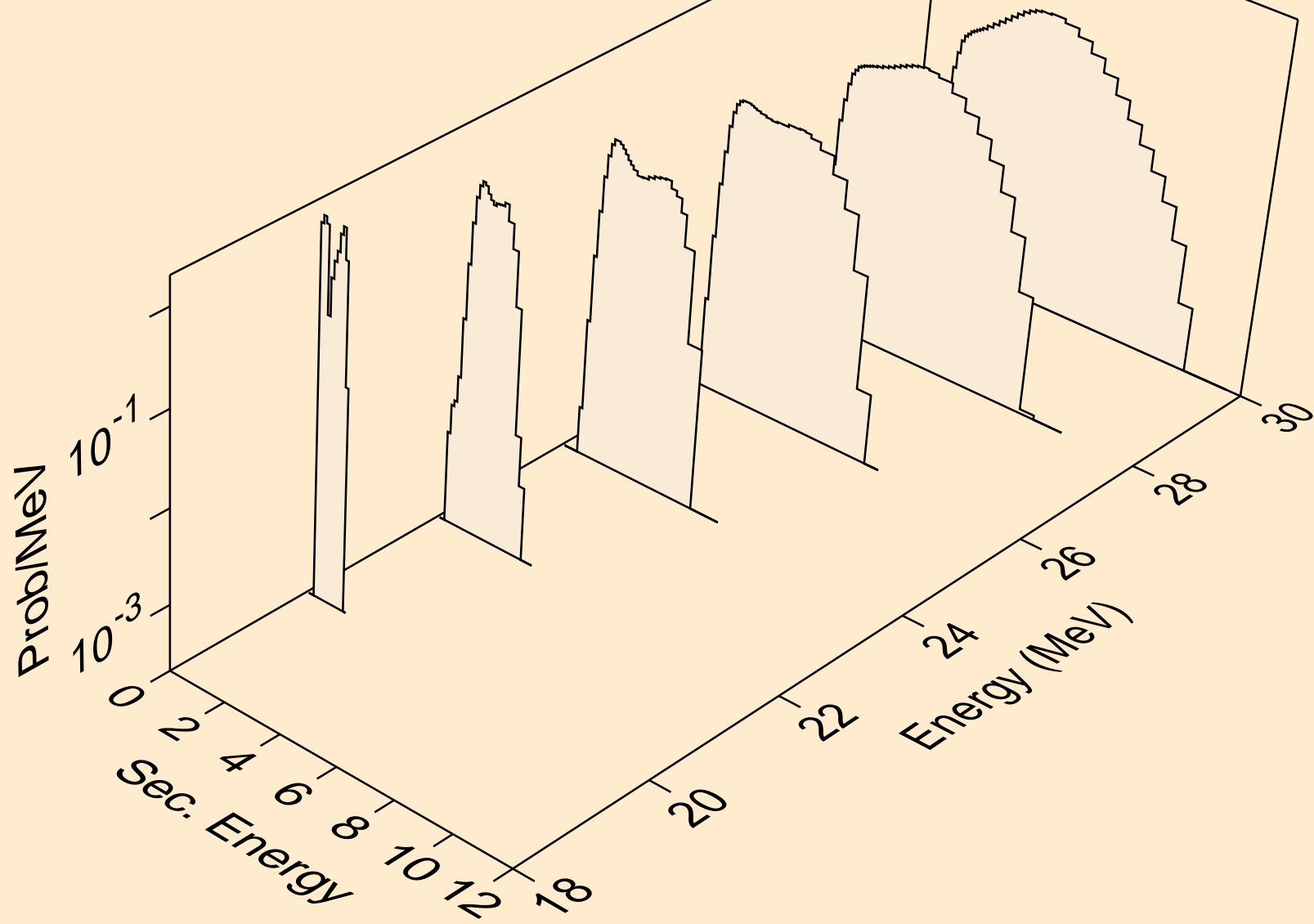

FE053 PROTON ACER TENDL-2021 LIBRARY; T=0.K
Proton emission for (p,npa)

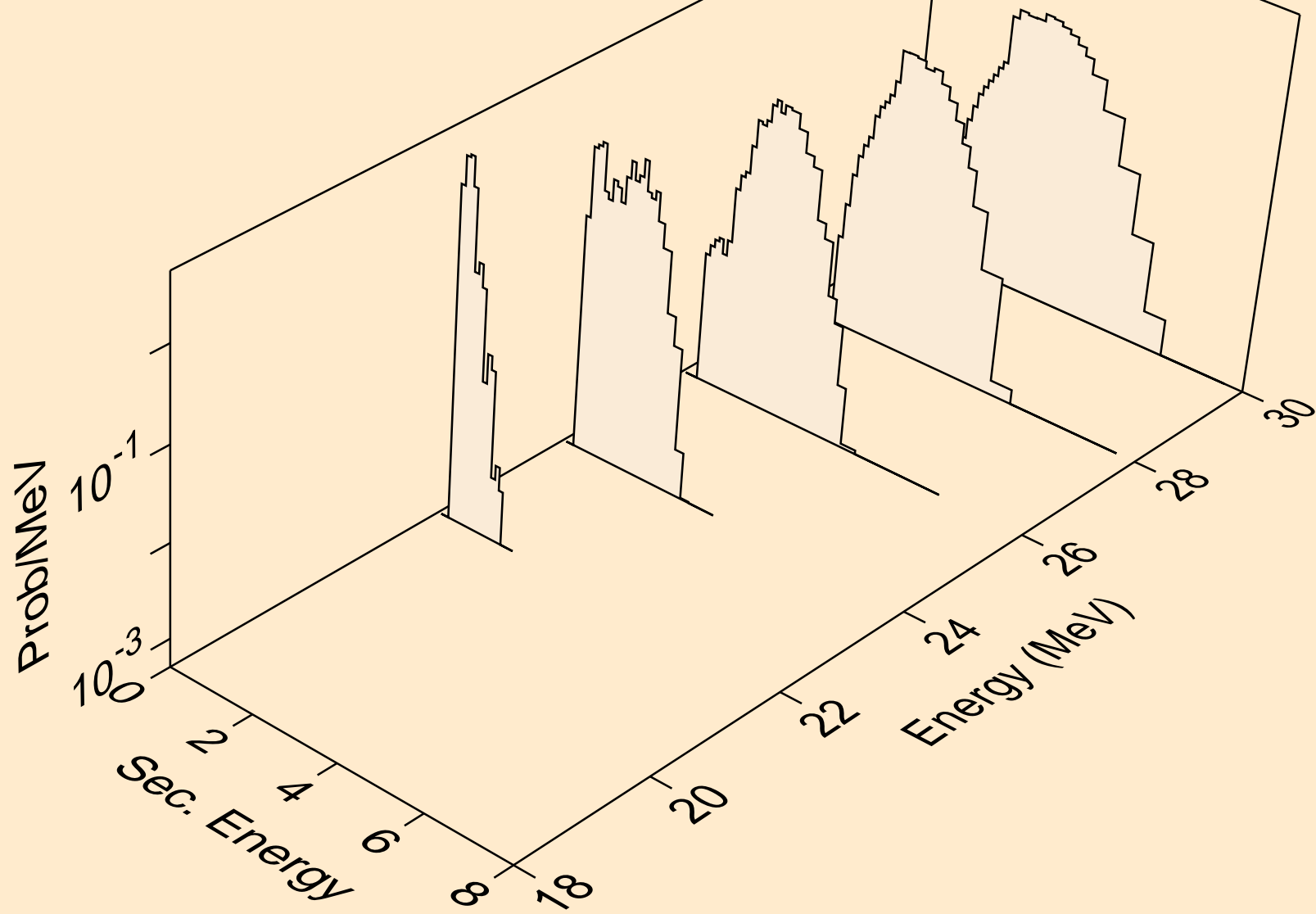

FE053 PROTON ACER TENDL-2021 LIBRARY; T=0.K
Proton emission for inelastic

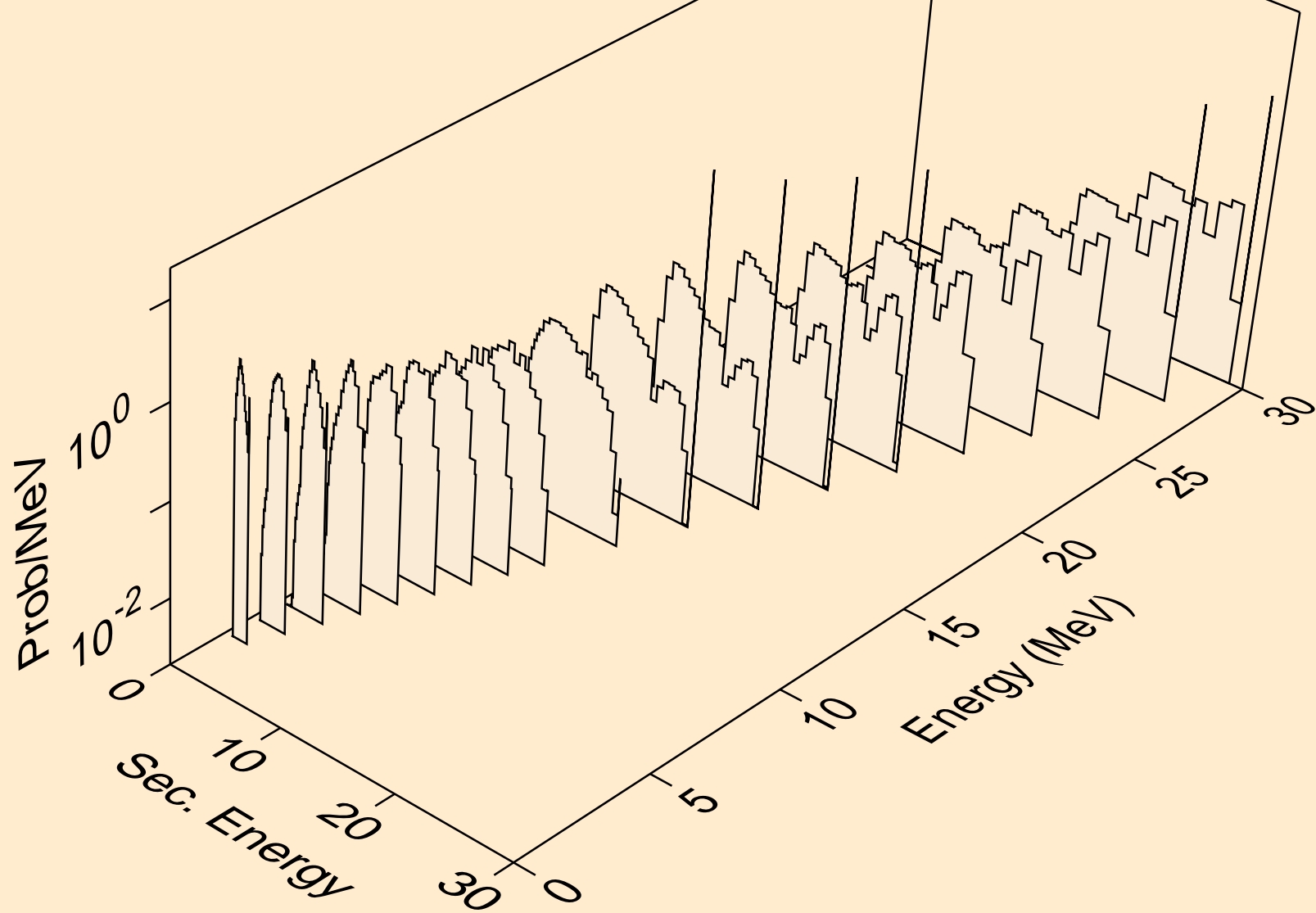

FE053 PROTON ACER TENDL-2021 LIBRARY; T=0.K
Proton emission for (p,2p)

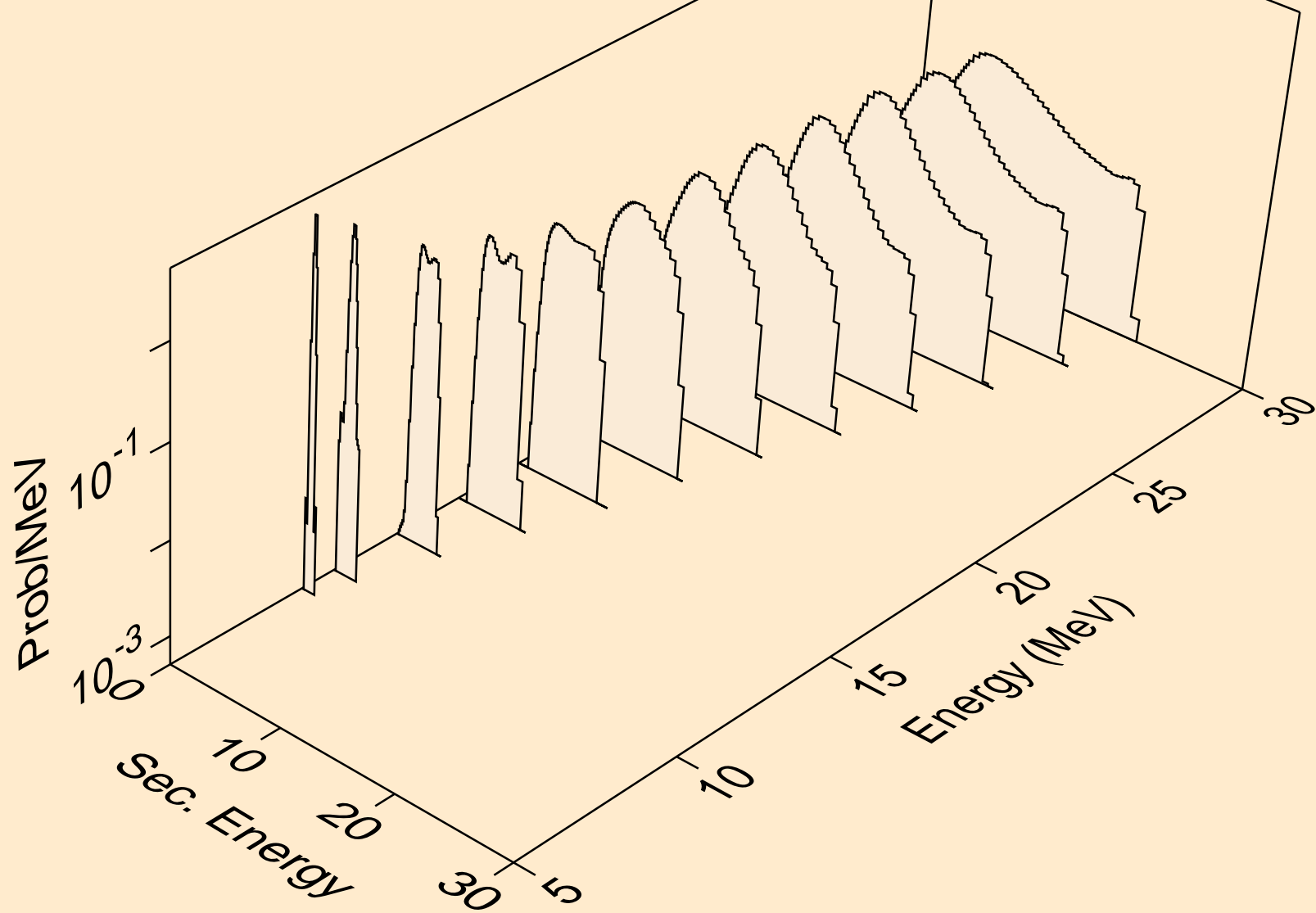

FE053 PROTON ACER TENDL-2021 LIBRARY; T=0.K
Proton emission for (p,pa)

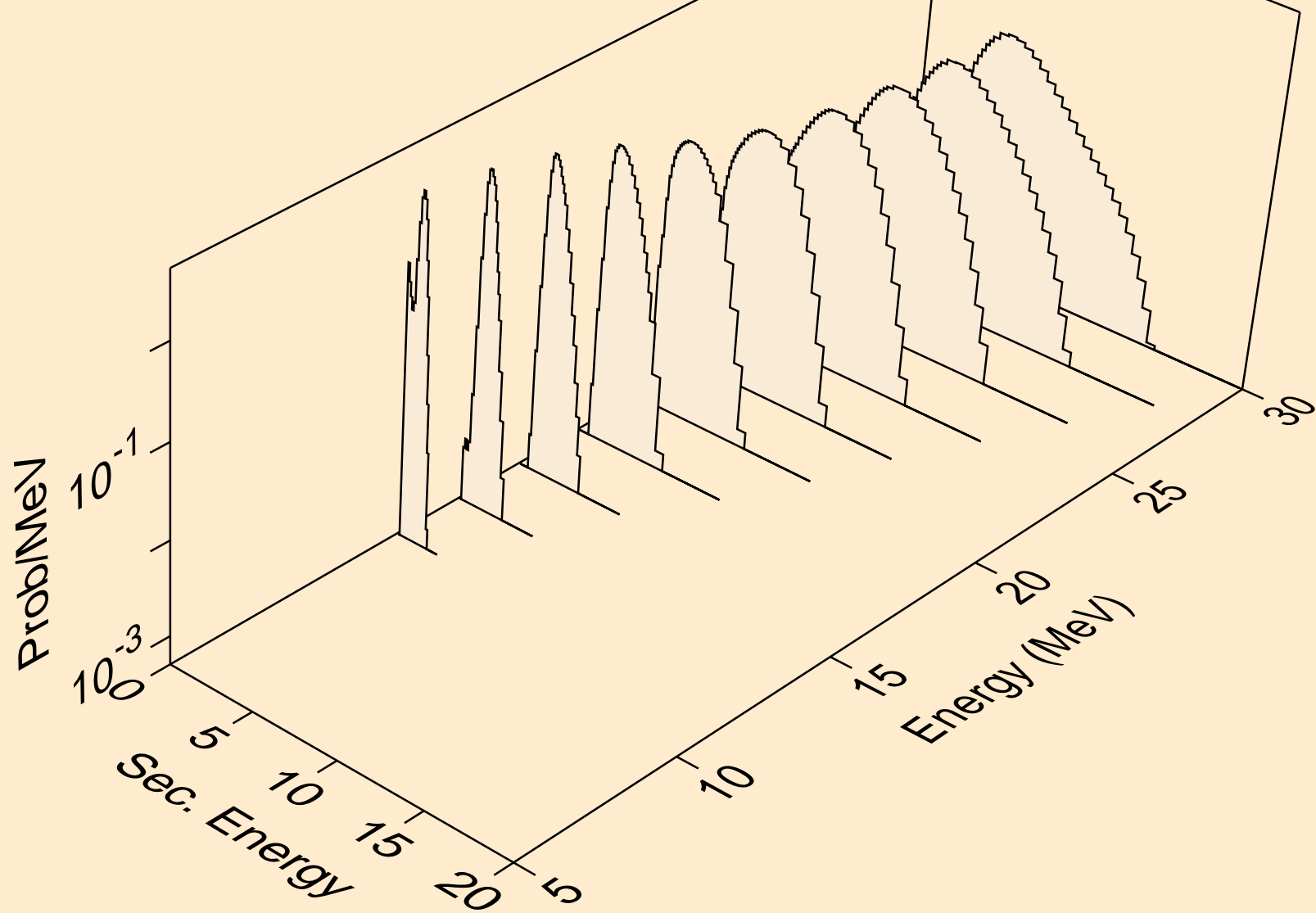

FE053 PROTON ACER TENDL-2021 LIBRARY; T=0.K
Proton emission for (p,pd)

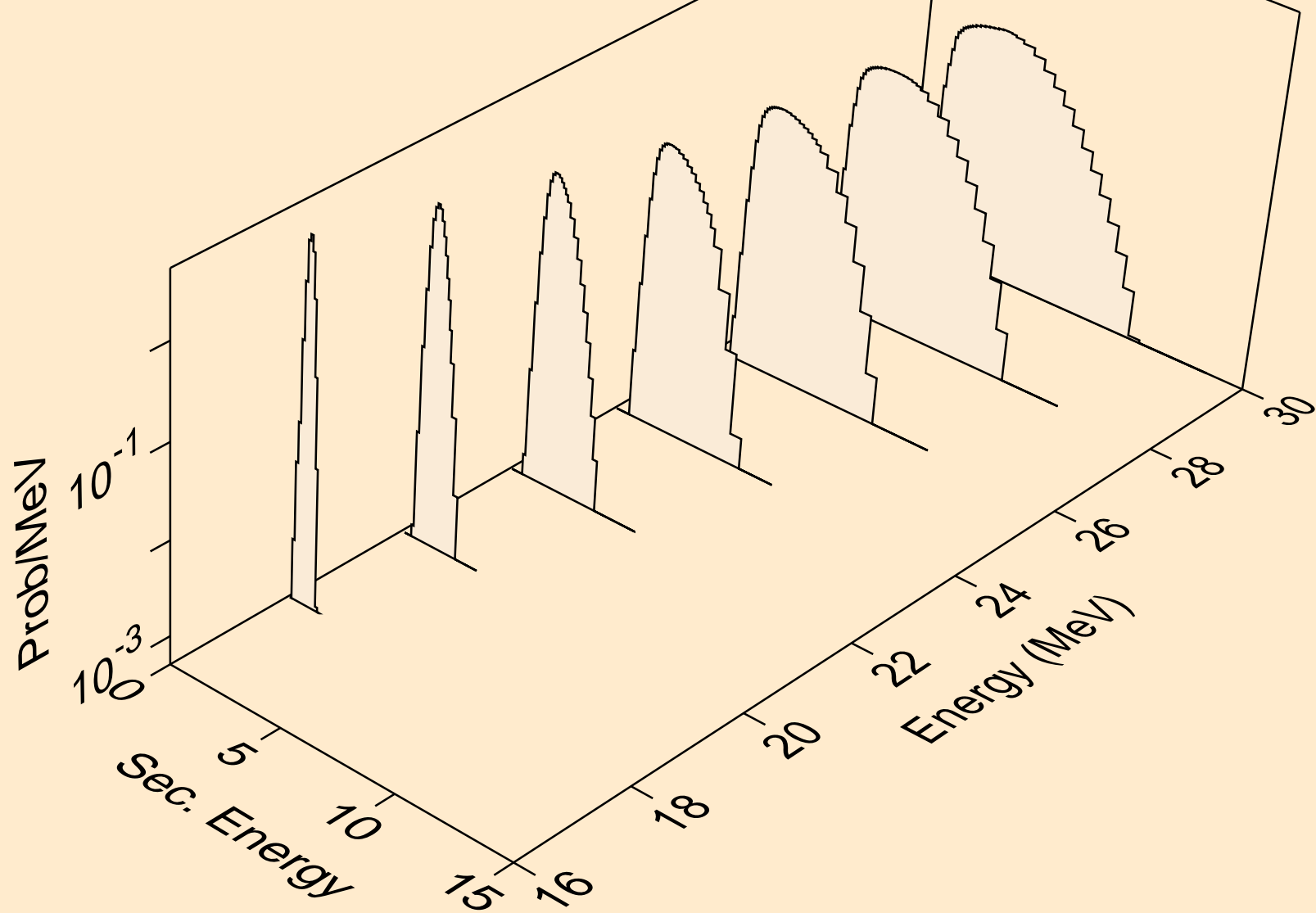

FE053 PROTON ACER TENDL-2021 LIBRARY; T=0.K
Proton emission for (p,pt)

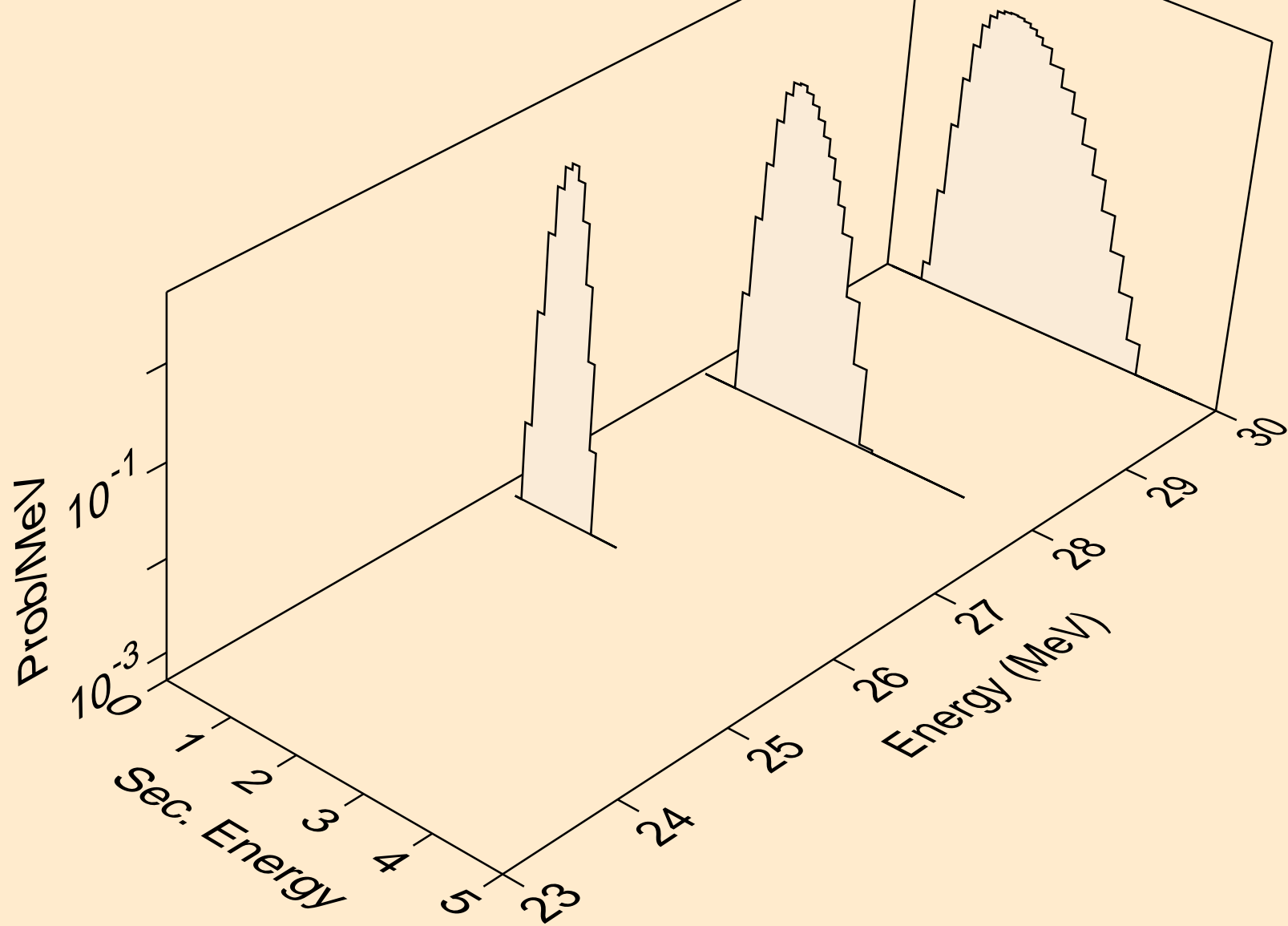

FE053 PROTON ACER TENDL-2021 LIBRARY; T=0.K
Photon emission for (z,n)

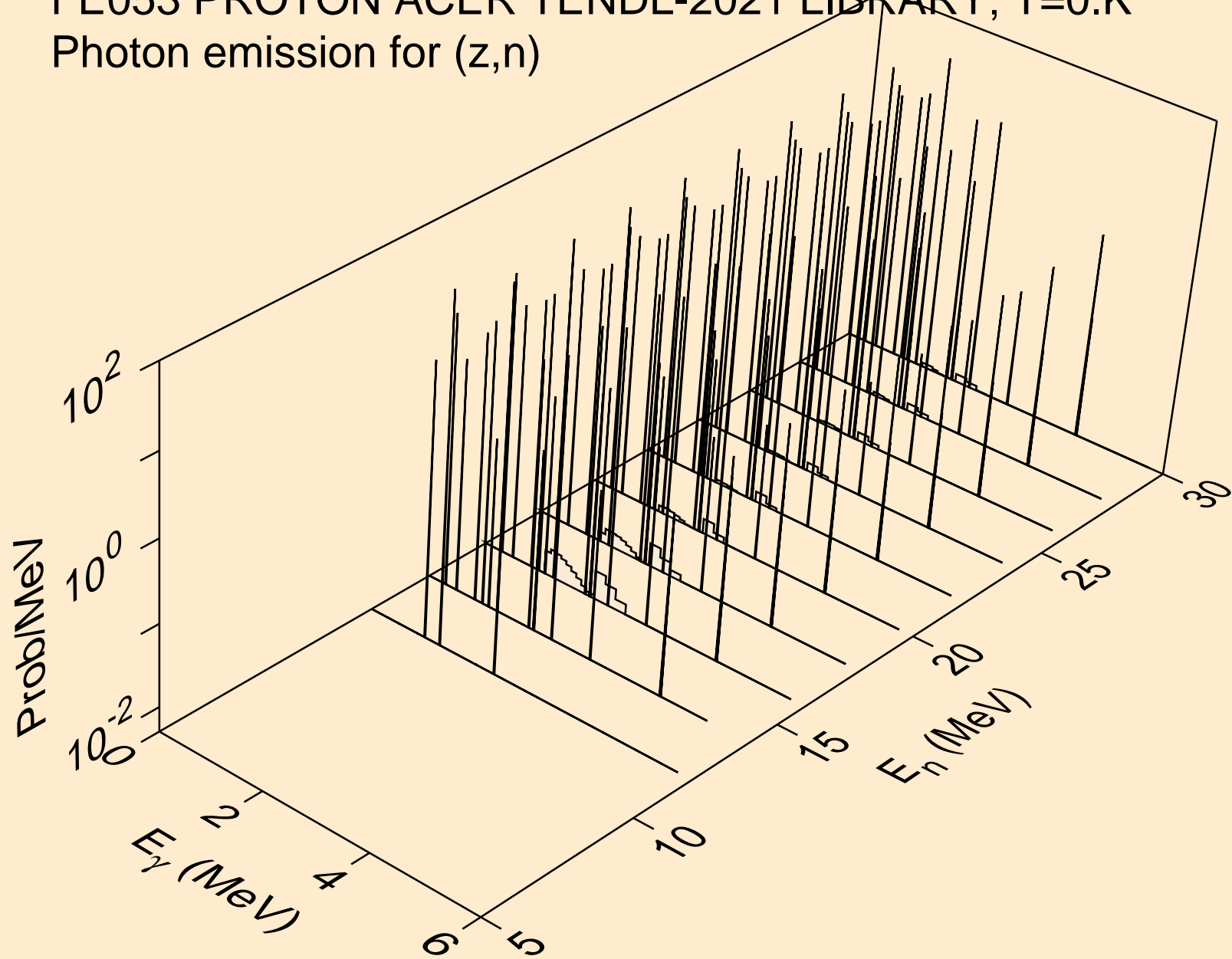

FE053 PROTON ACER TENDL-2021 LIBRARY; T=0.K
Photon emission for (n,x)

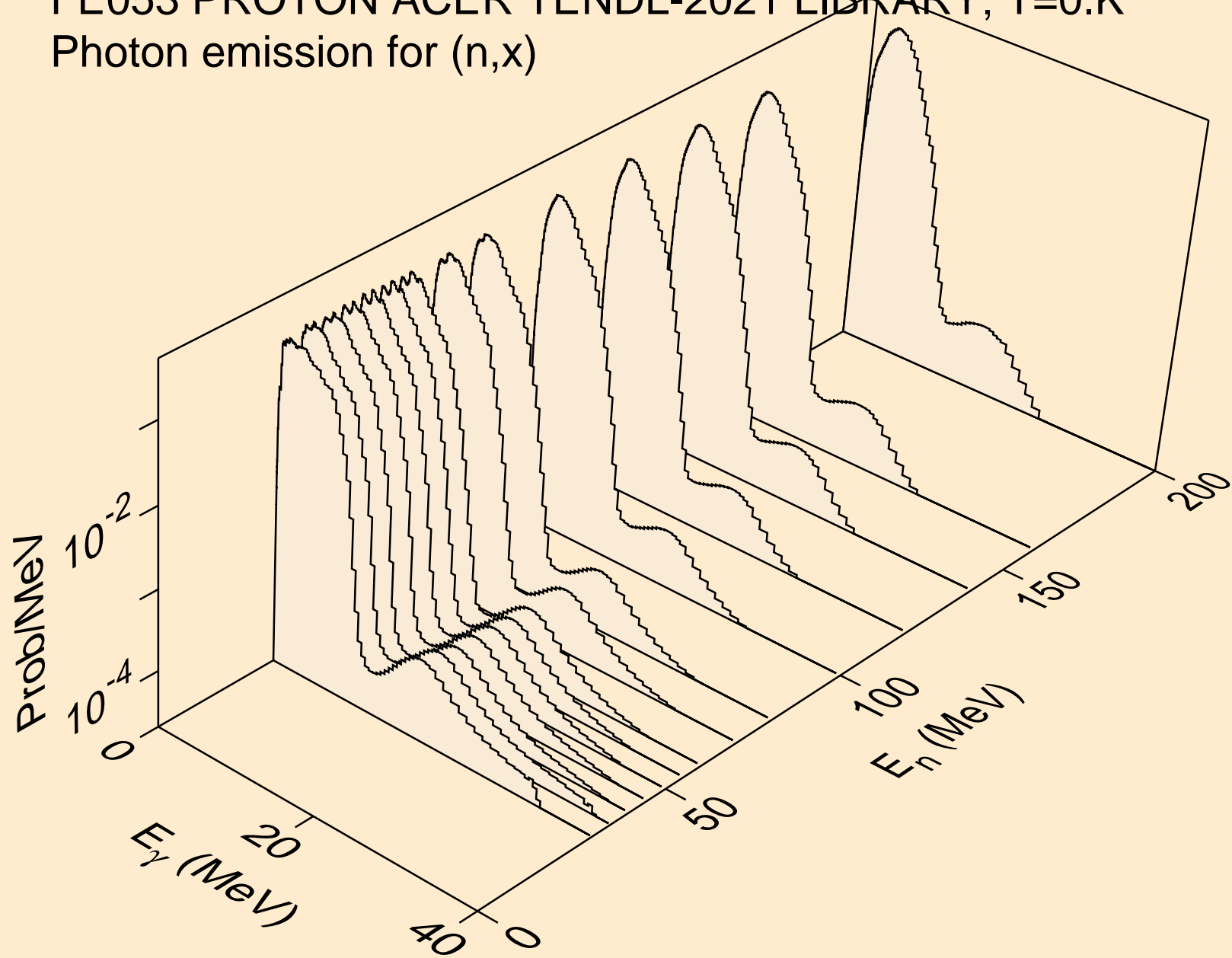

FE053 PROTON ACER TENDL-2021 LIBRARY; T=0.K
Photon emission for (n,2n)

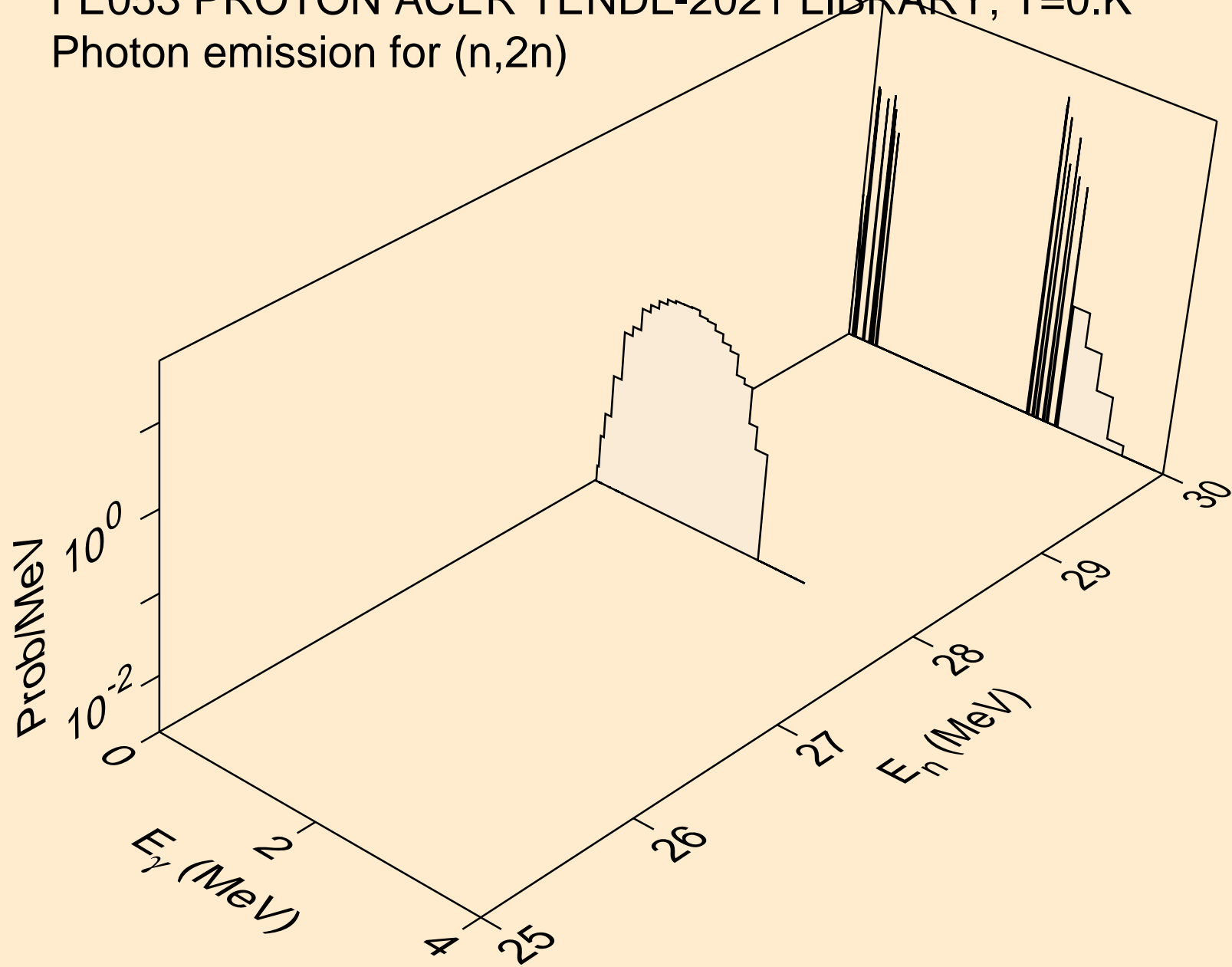

FE053 PROTON ACER TENDL-2021 LIBRARY; T=0.K
Photon emission for (n,n*)a

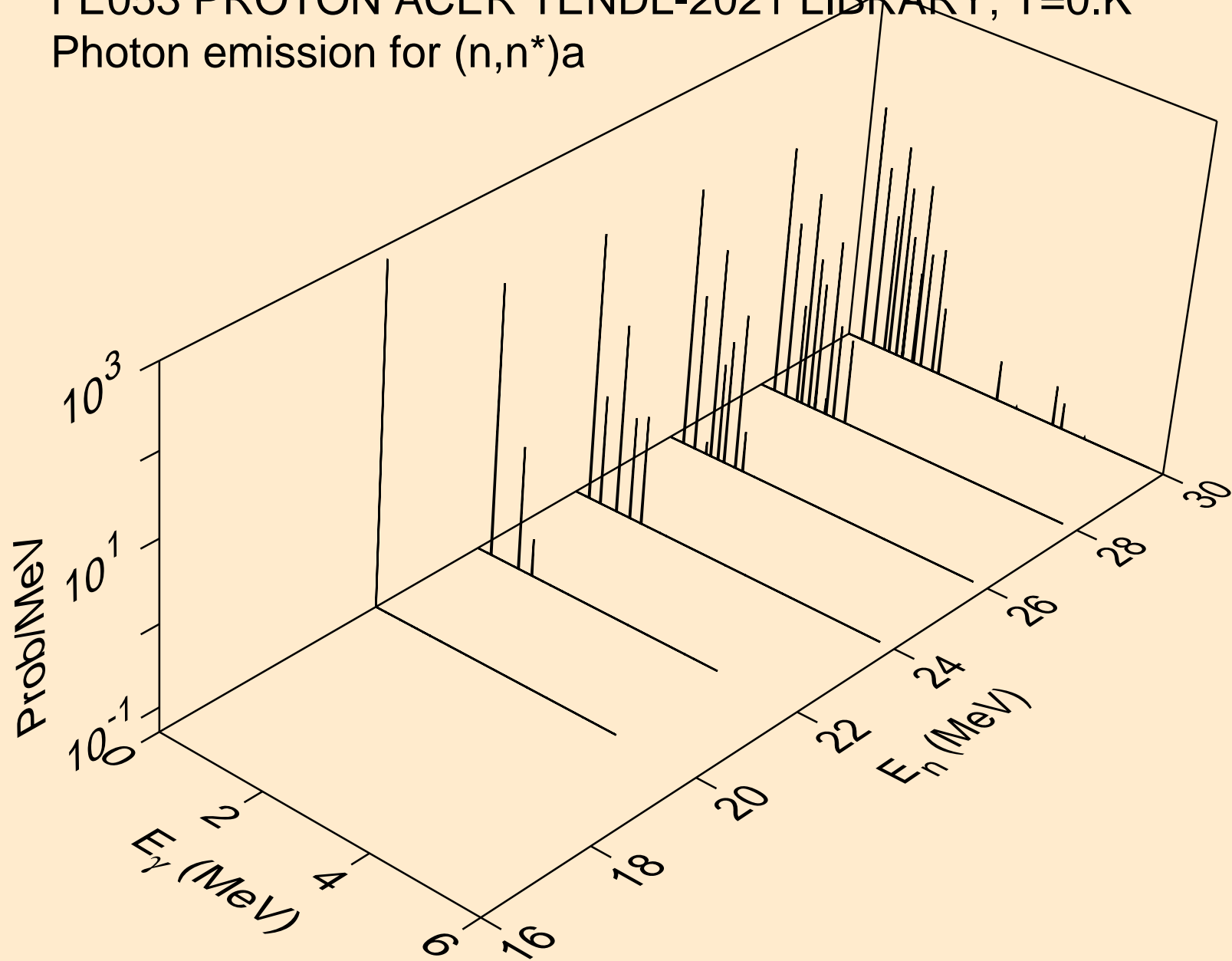

FE053 PROTON ACER TENDL-2021 LIBRARY; T=0.K
Photon emission for (n,n*)p

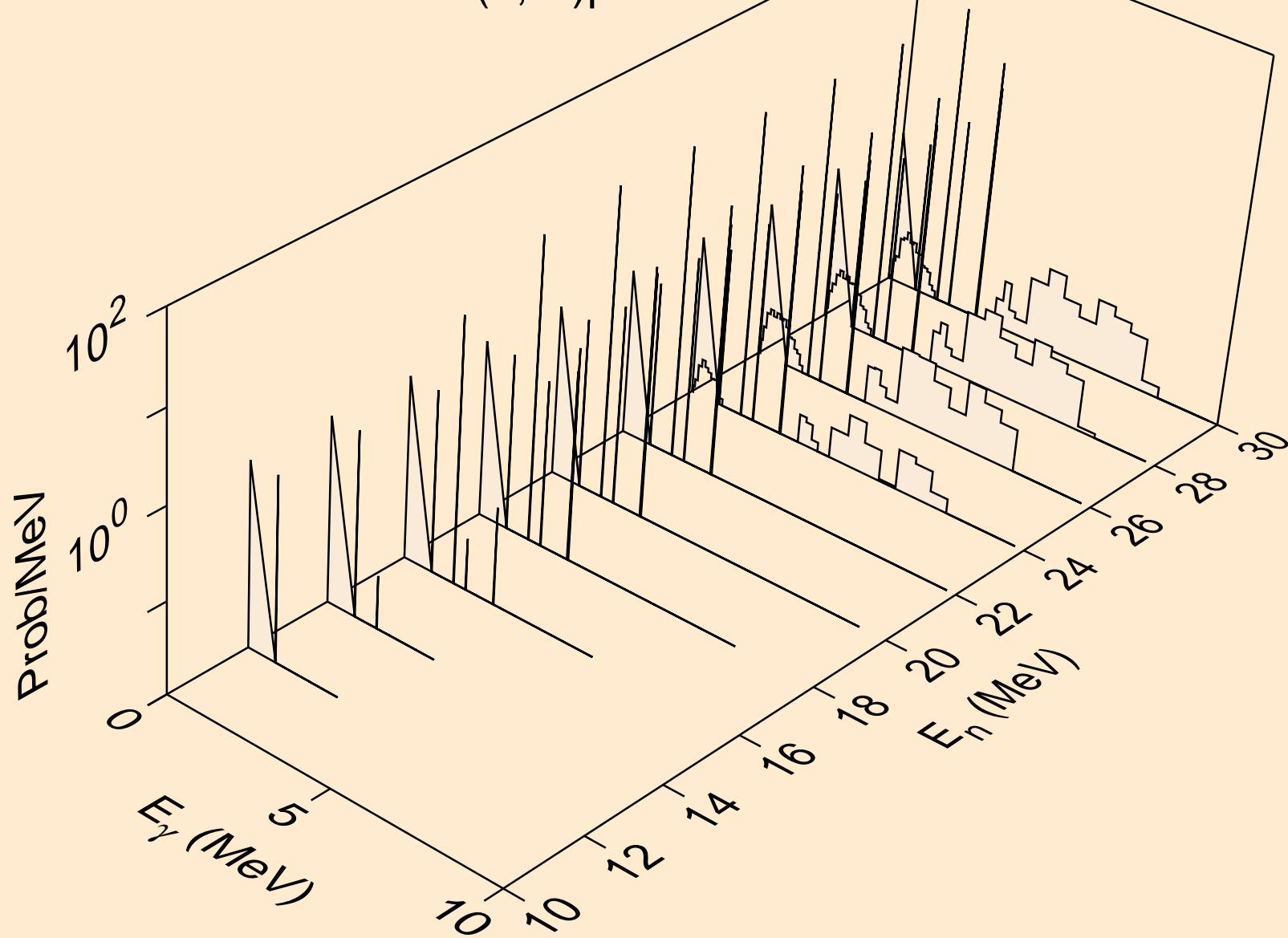

FE053 PROTON ACER TENDL-2021 LIBRARY; T=0.K
Photon emission for (n,n*)d

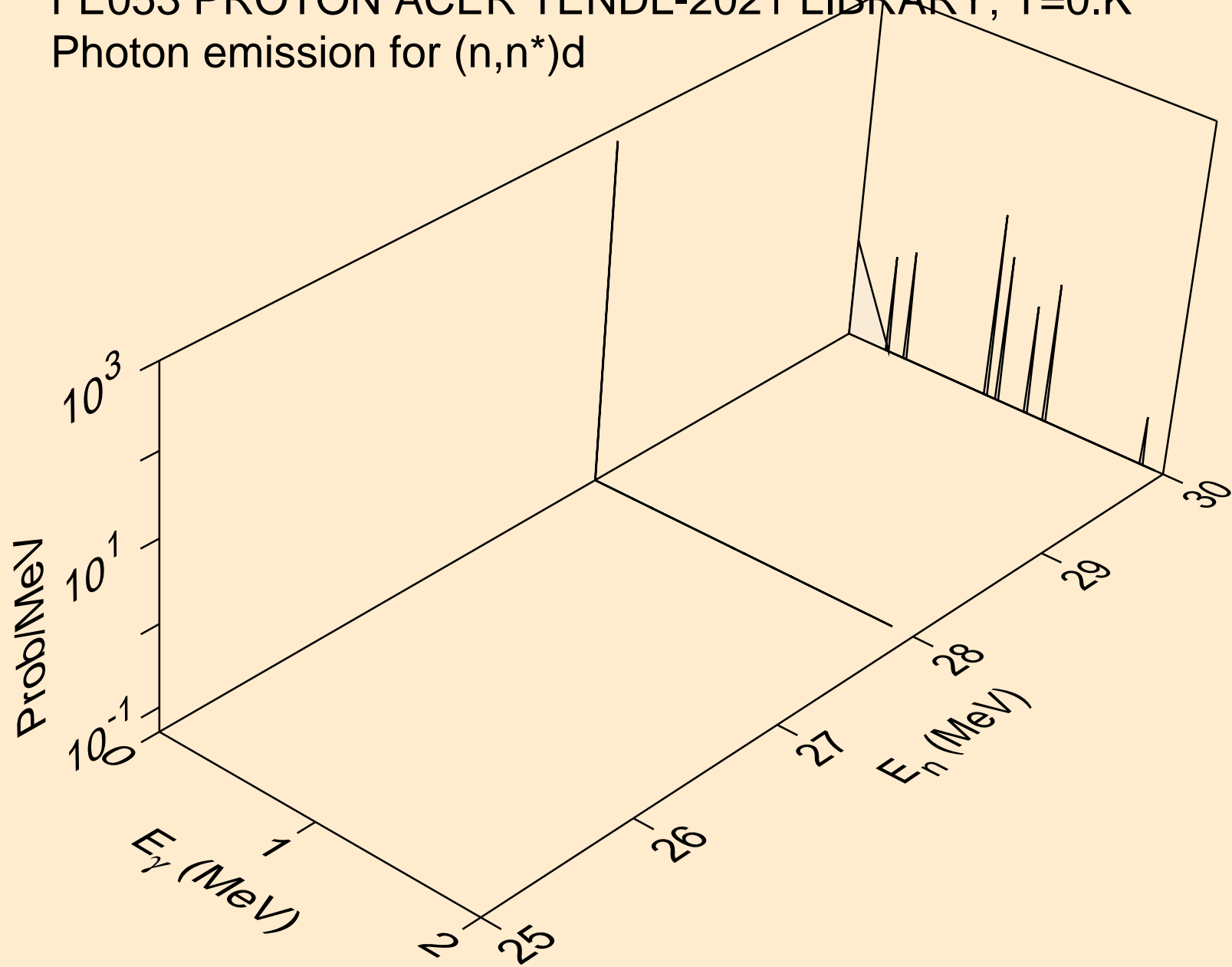

FE053 PROTON ACER TENDL-2021 LIBRARY; T=0.K
Photon emission for (n,n*)he3

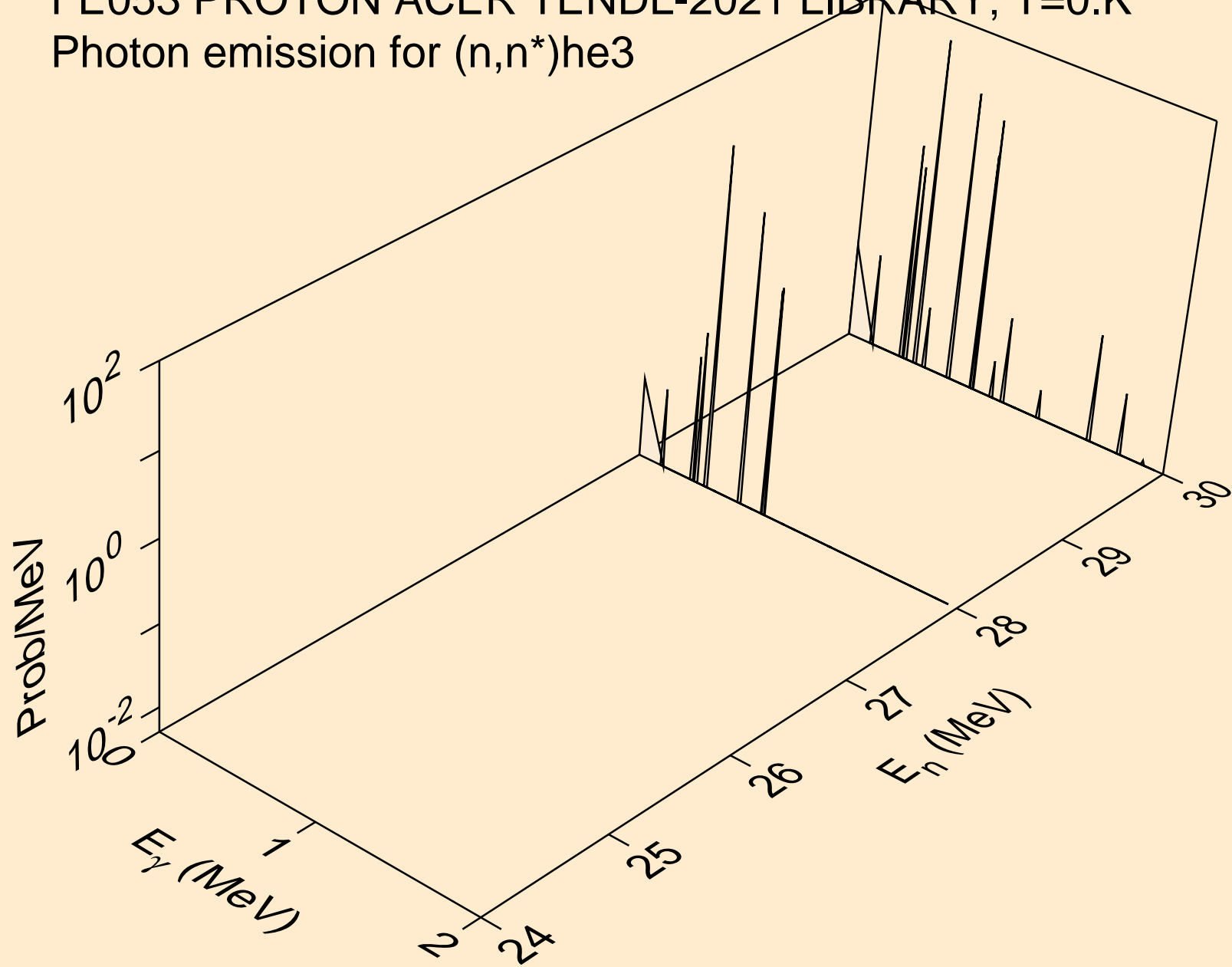

FE053 PROTON ACER TENDL-2021 LIBRARY; T=0.K
Photon emission for (n,2np)

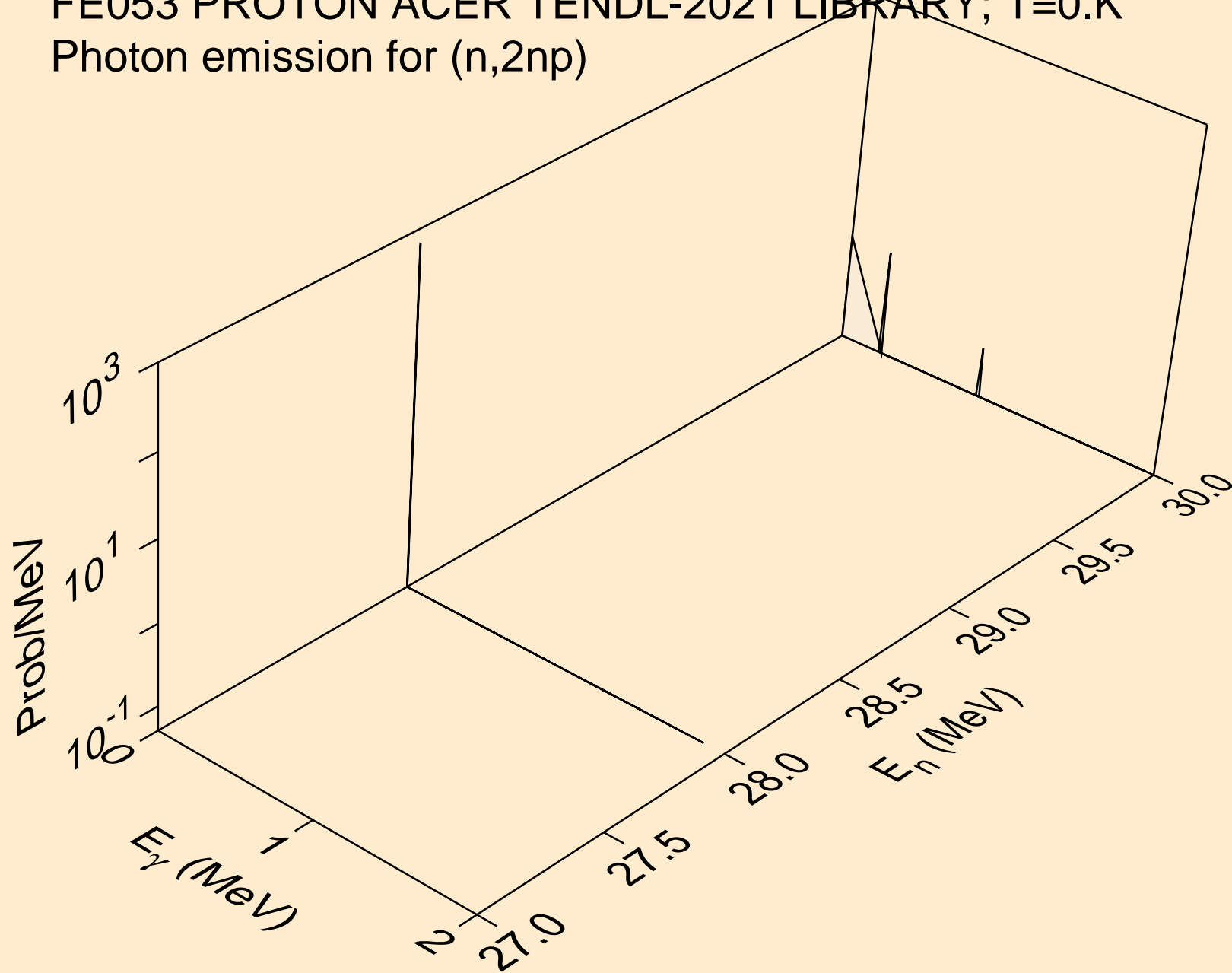

FE053 PROTON ACER TENDL-2021 LIBRARY; T=0.K
Photon emission for (n,2np)

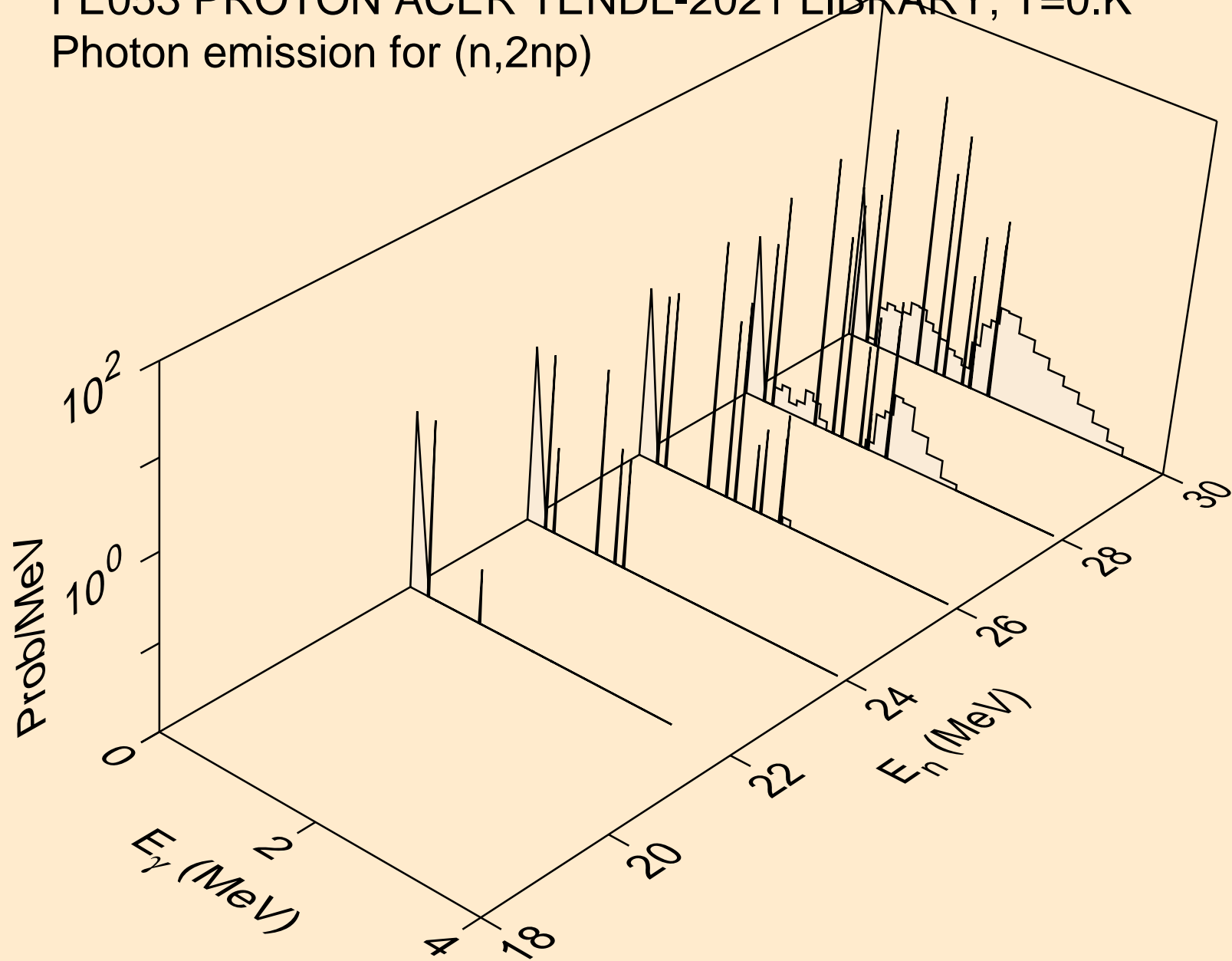

FE053 PROTON ACER TENDL-2021 LIBRARY; T=0.K
Photon emission for (n,npa)

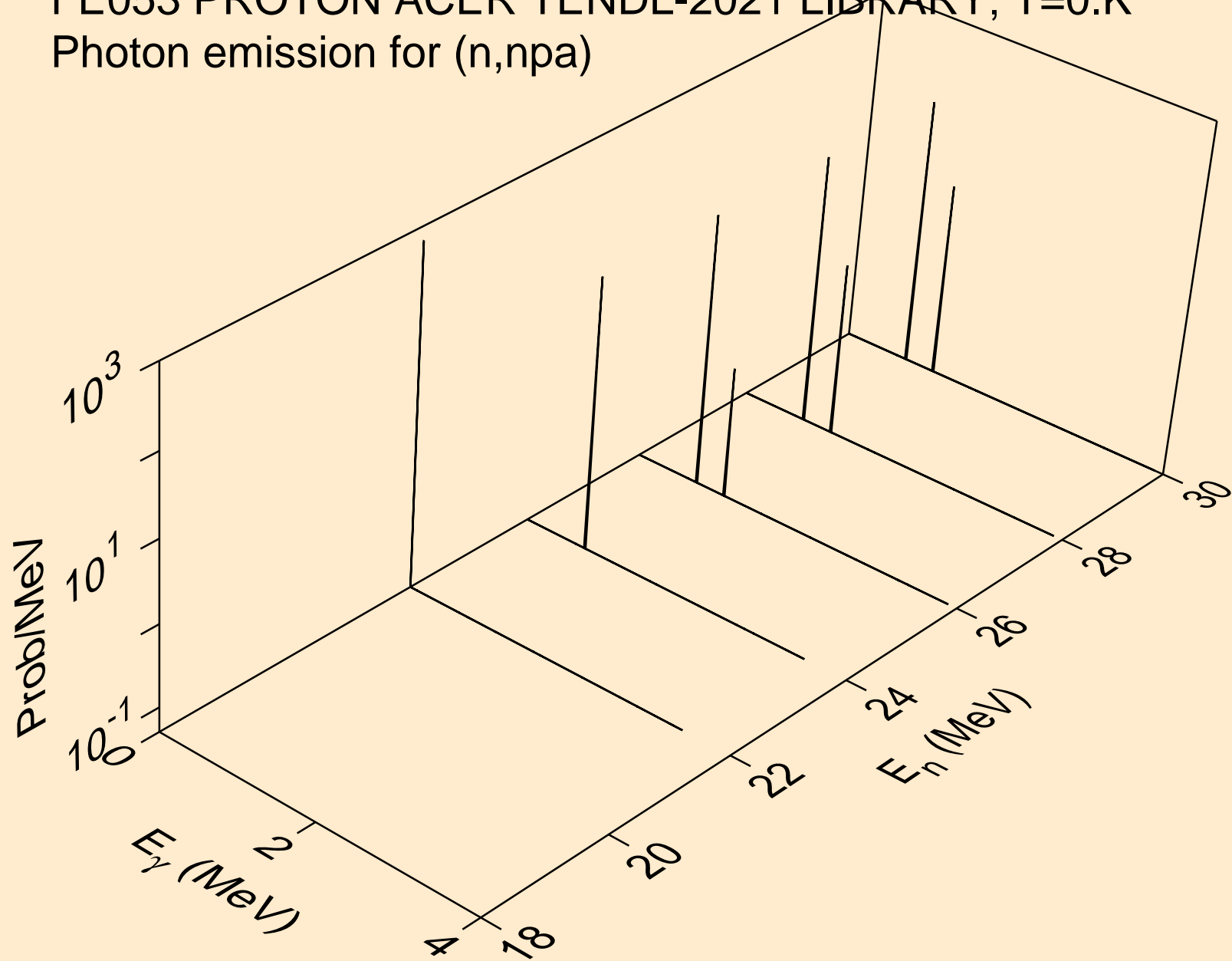

FE053 PROTON ACER TENDL-2021 LIBRARY; T=0.K
Photon emission for (n,gma)

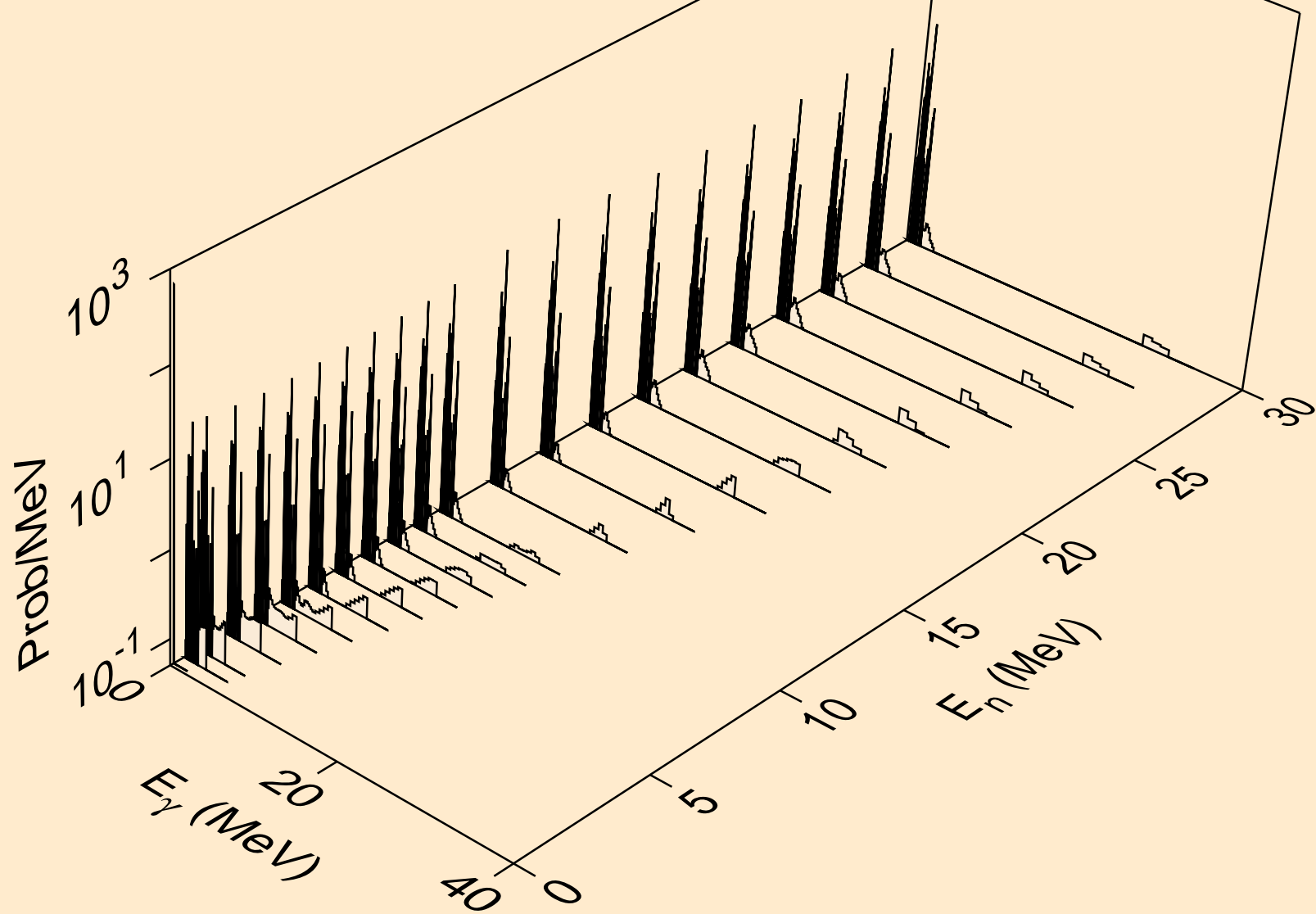

FE053 PROTON ACER TENDL-2021 LIBRARY; T=0.K
Photon emission for inelastic

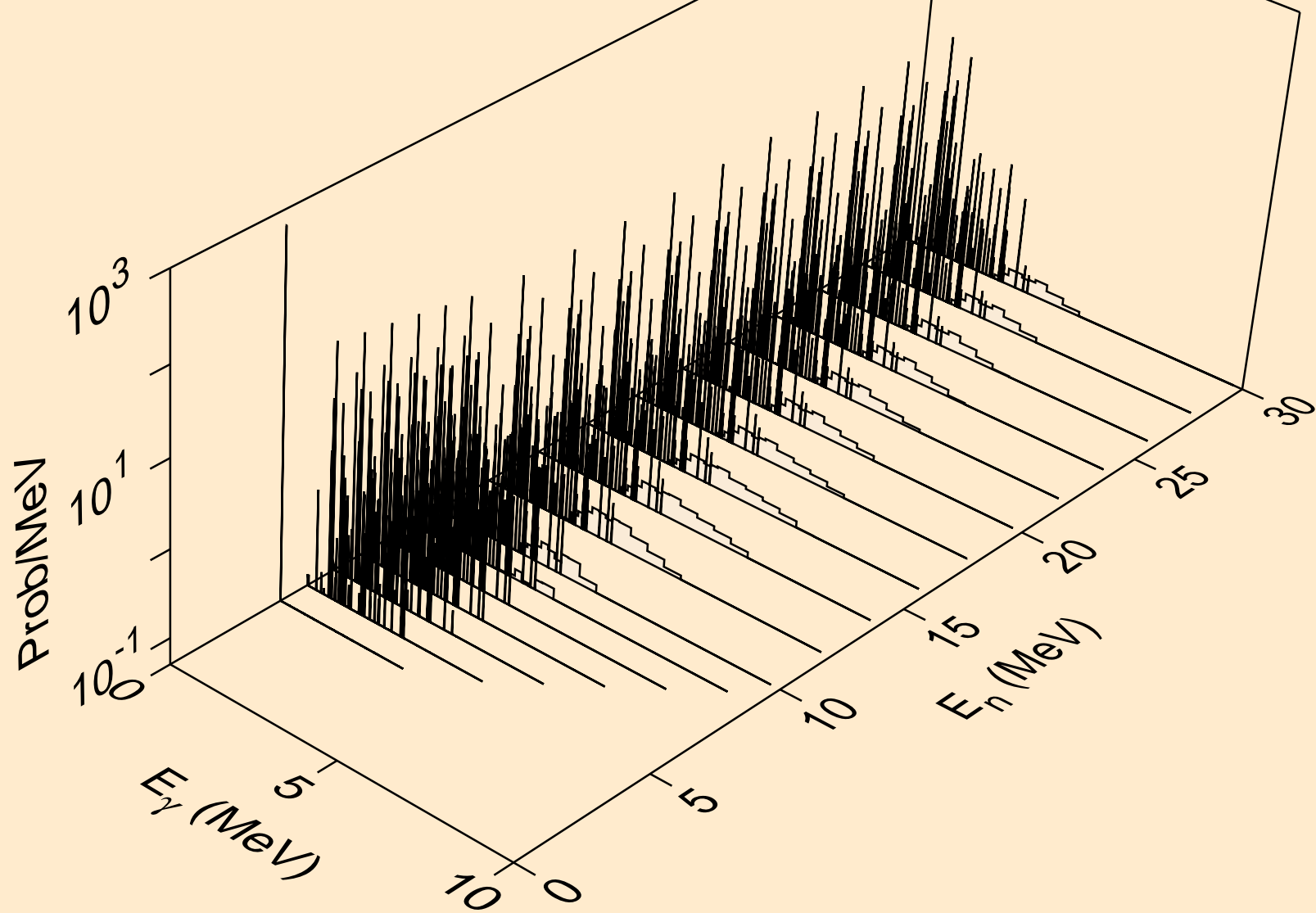

FE053 PROTON ACER TENDL-2021 LIBRARY; T=0.K
Photon emission for (n,d)

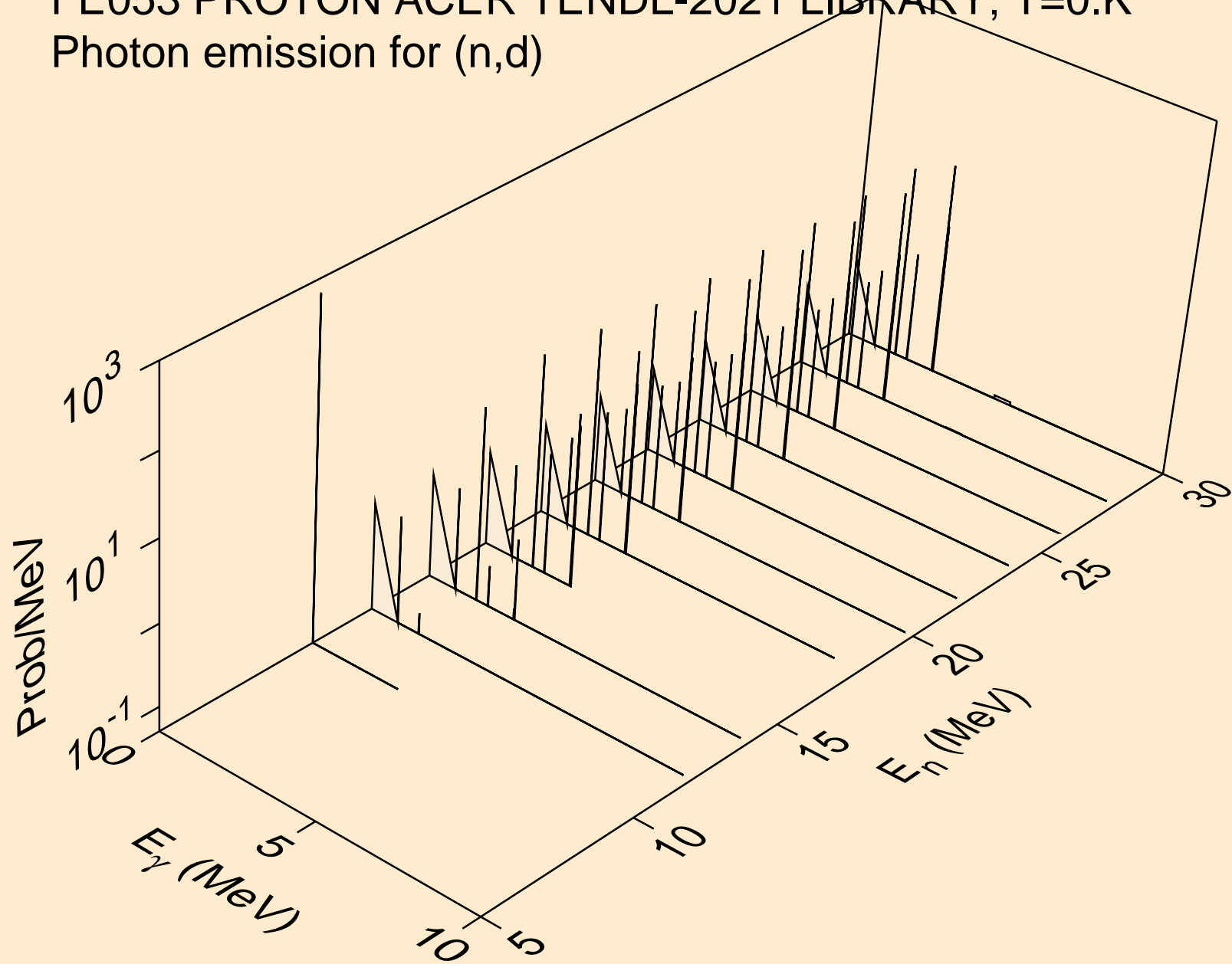

FE053 PROTON ACER TENDL-2021 LIBRARY; T=0.K
Photon emission for (n,t)

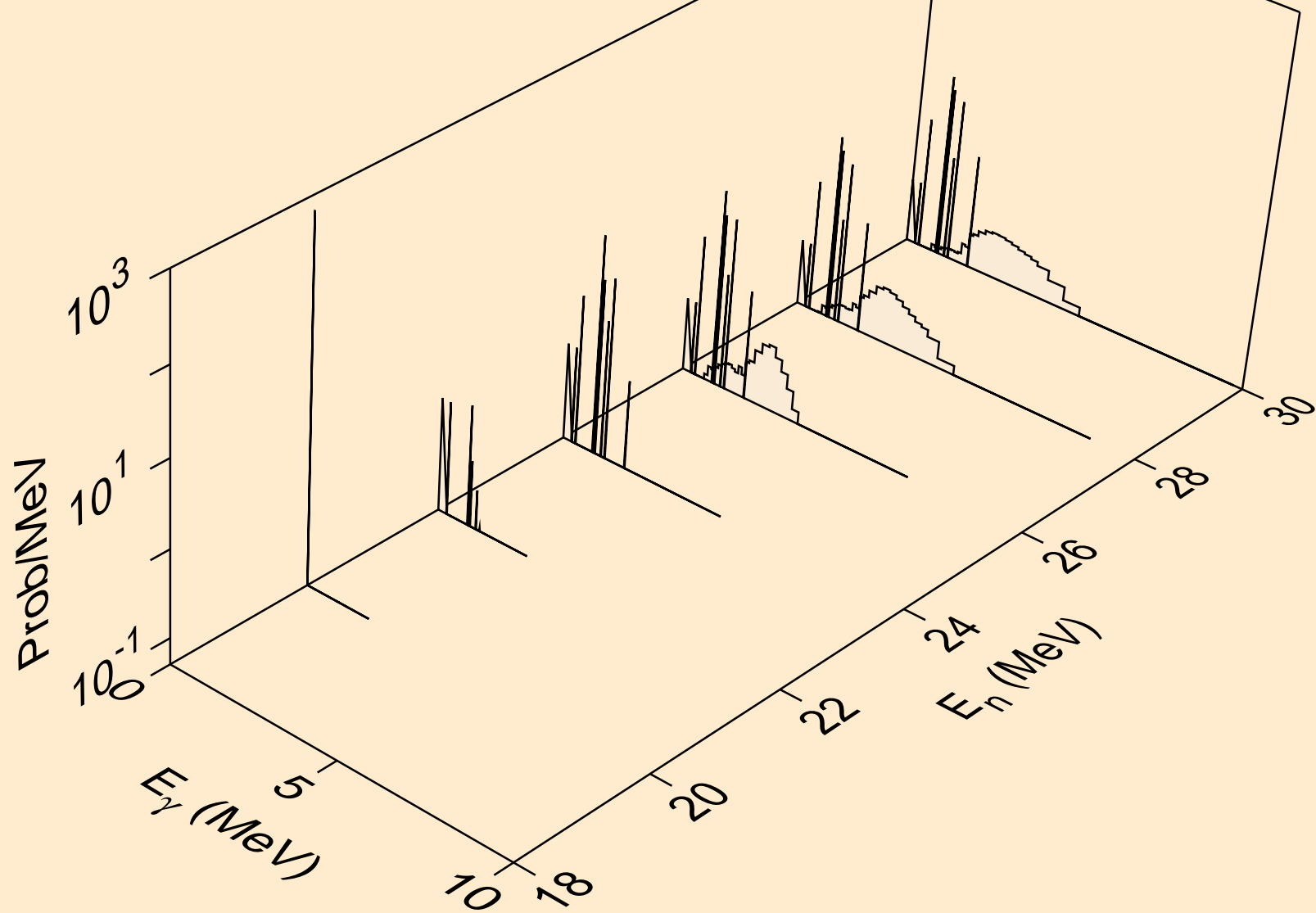

FE053 PROTON ACER TENDL-2021 LIBRARY; T=0.K
Photon emission for (n,he3)

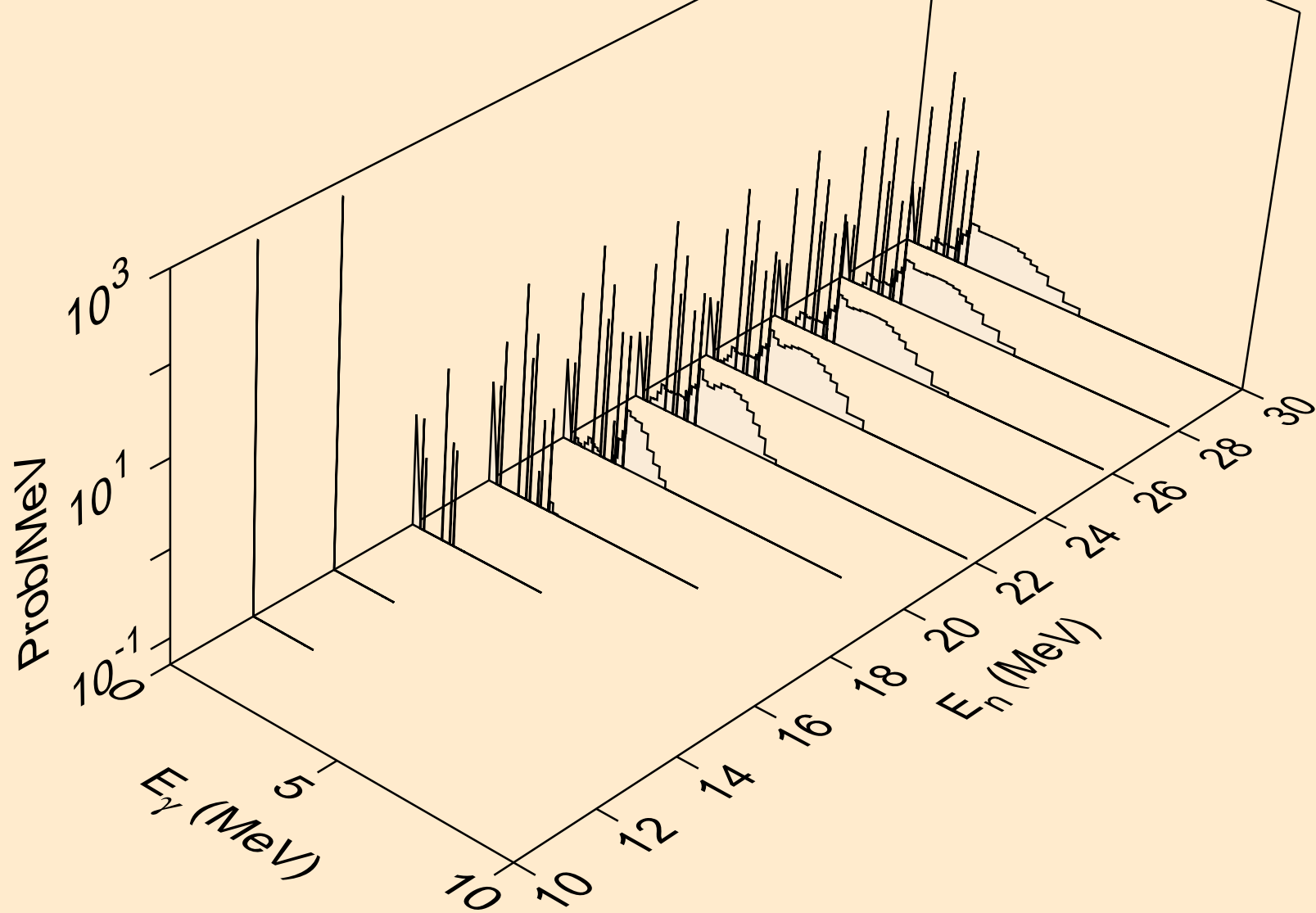

FE053 PROTON ACER TENDL-2021 LIBRARY; T=0.K
Photon emission for (n,a)

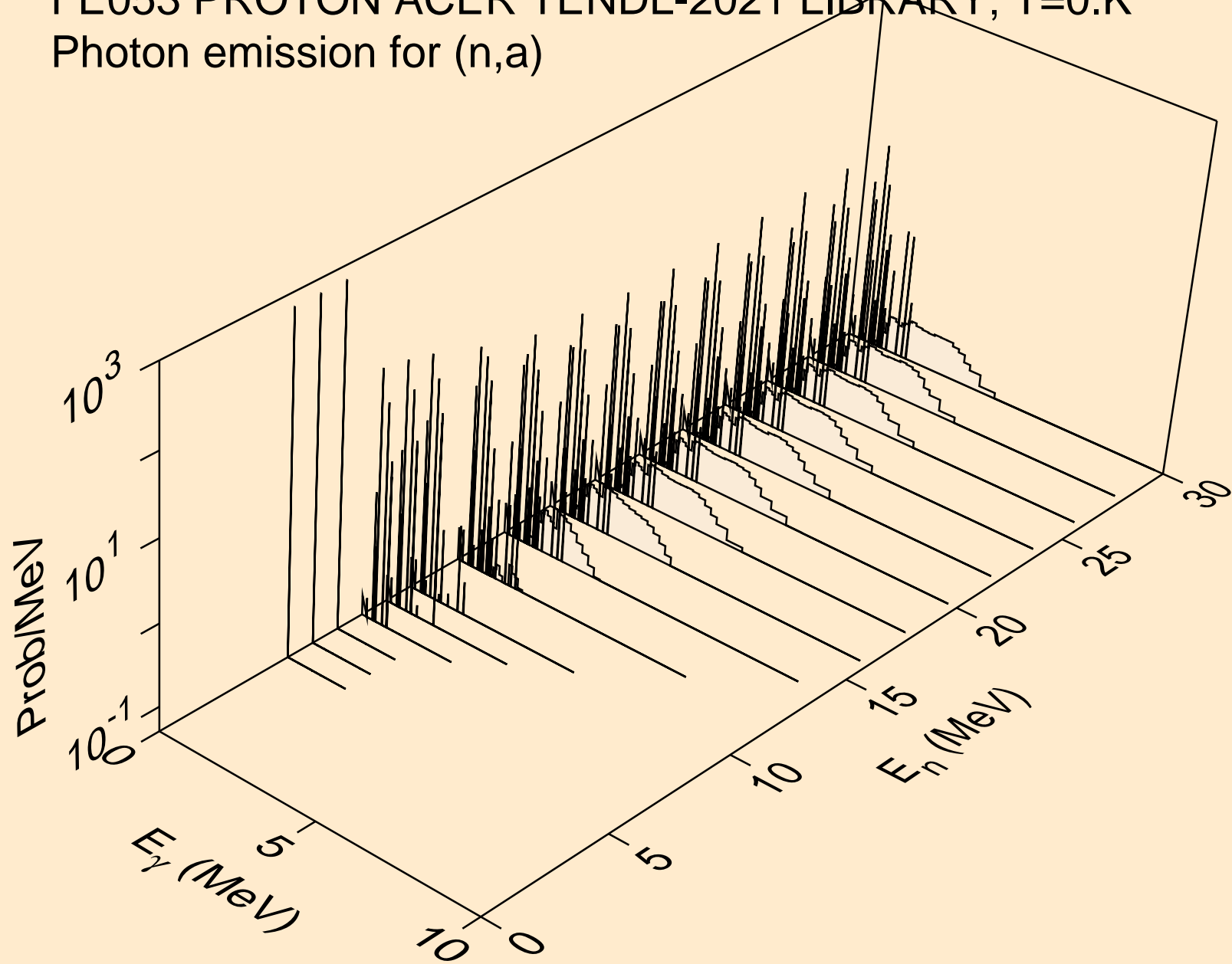

FE053 PROTON ACER TENDL-2021 LIBRARY; T=0.K
Photon emission for (n,2a)

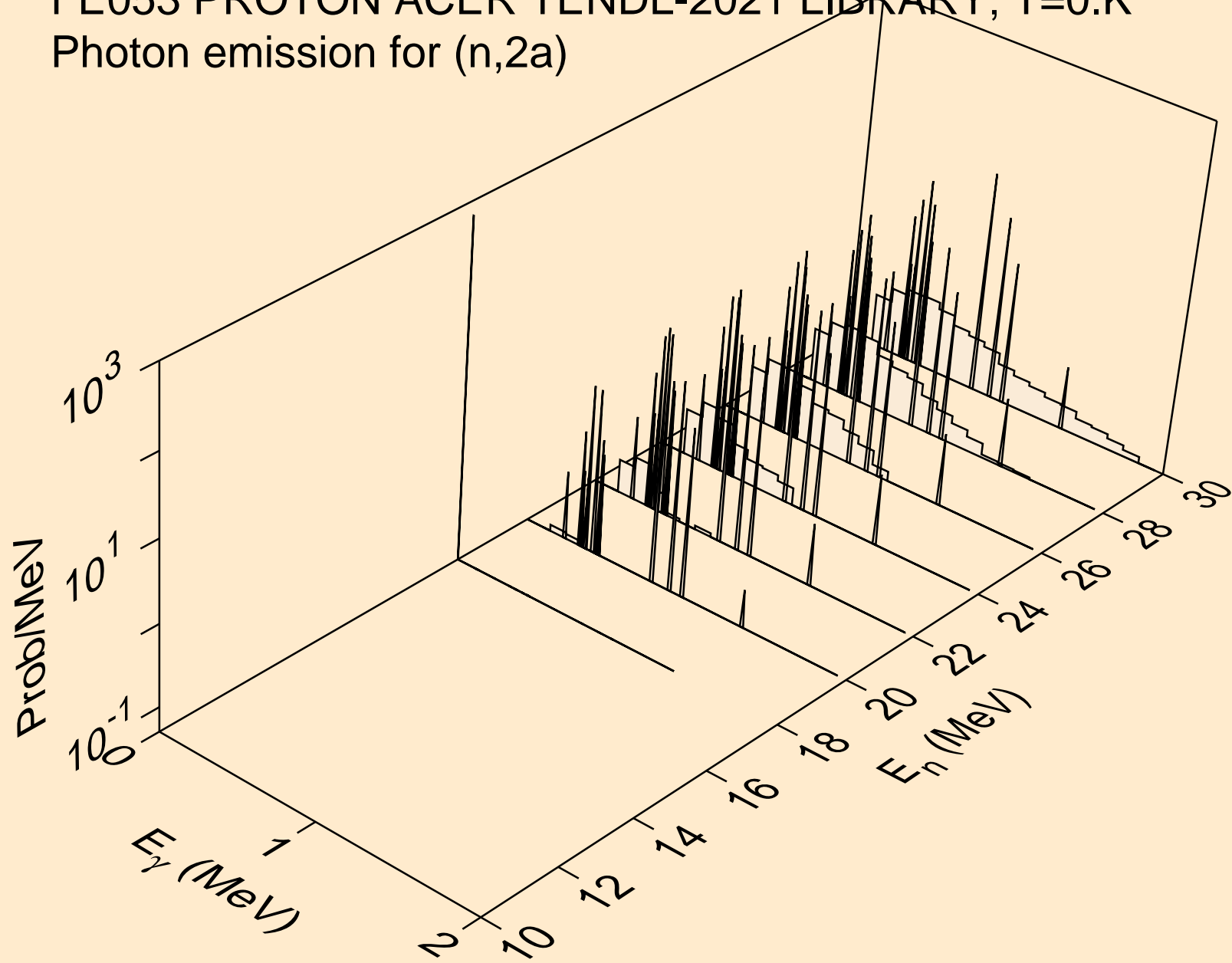

FE053 PROTON ACER TENDL-2021 LIBRARY; T=0.K
Photon emission for (n,2p)

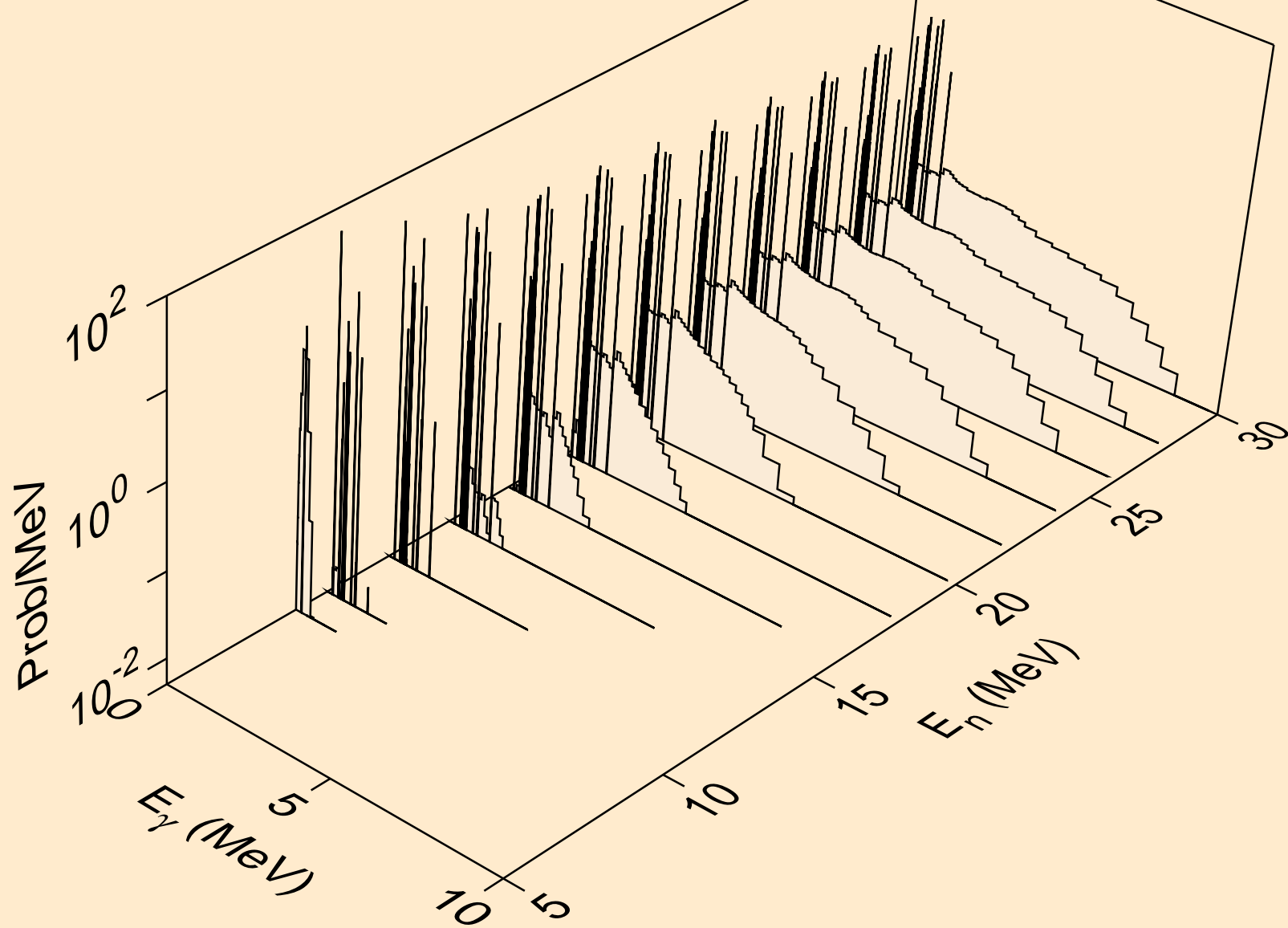

FE053 PROTON ACER TENDL-2021 LIBRARY; T=0.K
Photon emission for (n,p)

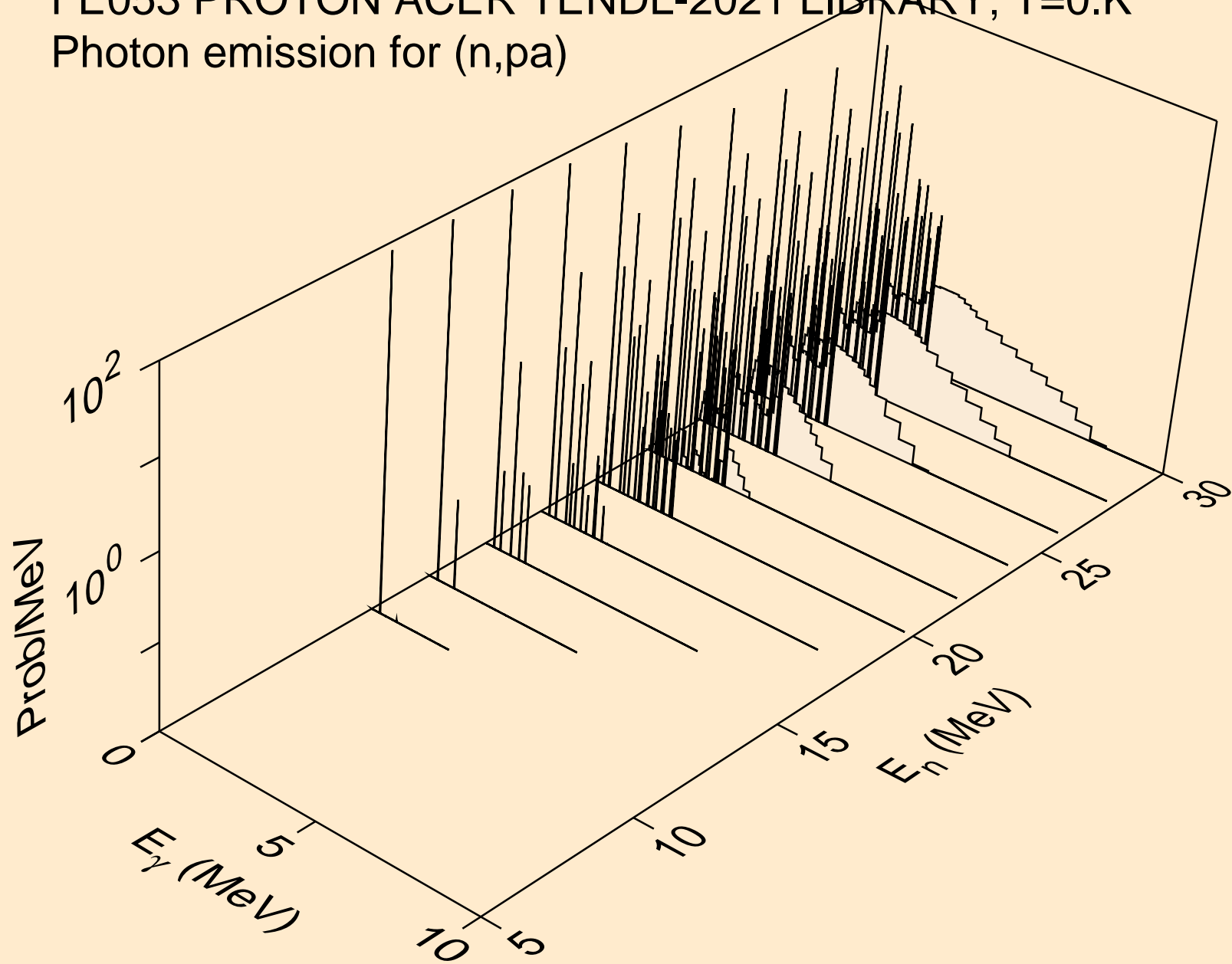

FE053 PROTON ACER TENDL-2021 LIBRARY; T=0.K
Photon emission for (n,pd)

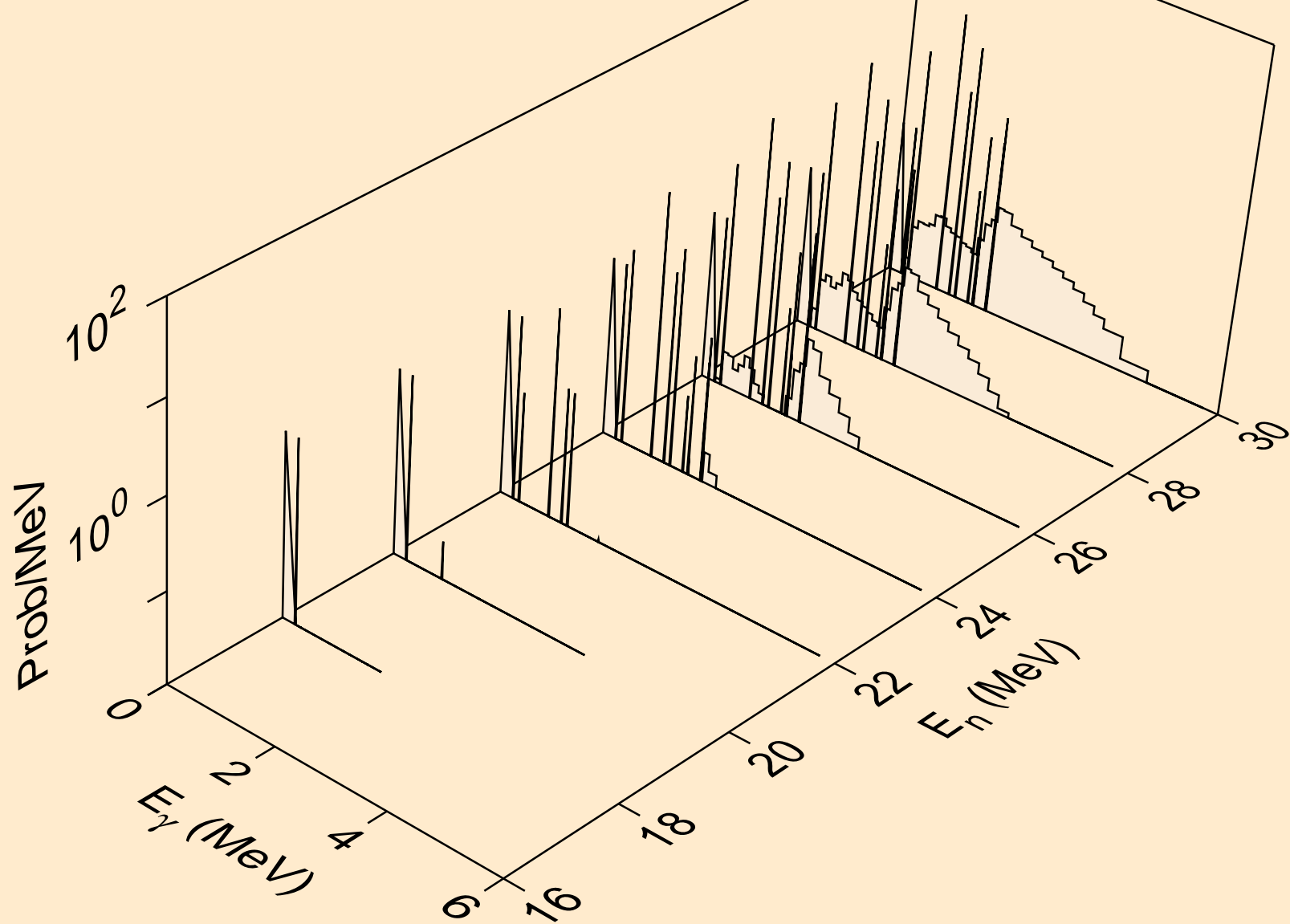

FE053 PROTON ACER TENDL-2021 LIBRARY; T=0.K
Photon emission for (n,pt)

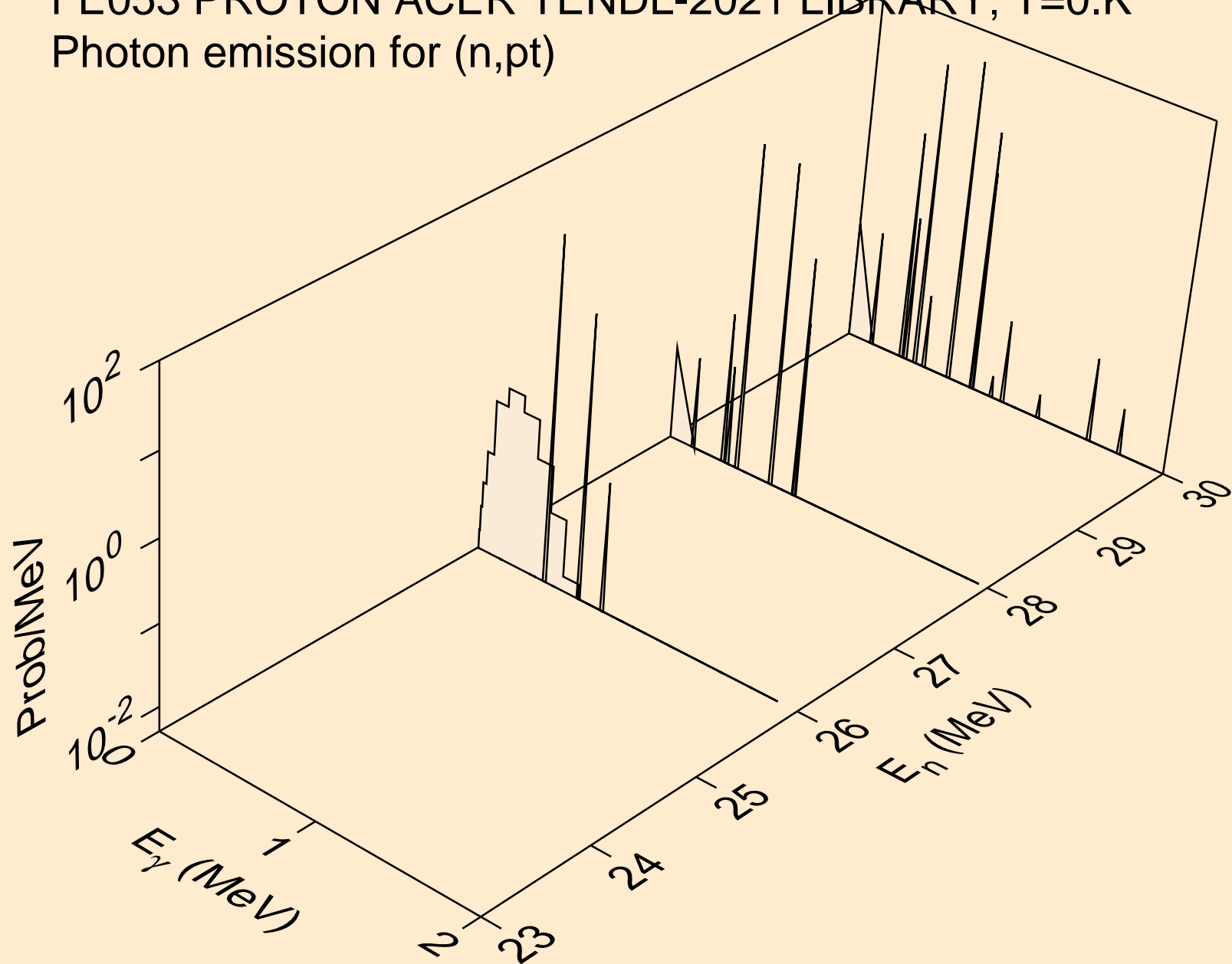

FE053 PROTON ACER TENDL-2021 LIBRARY; T=0.K
Photon emission for (n,da)

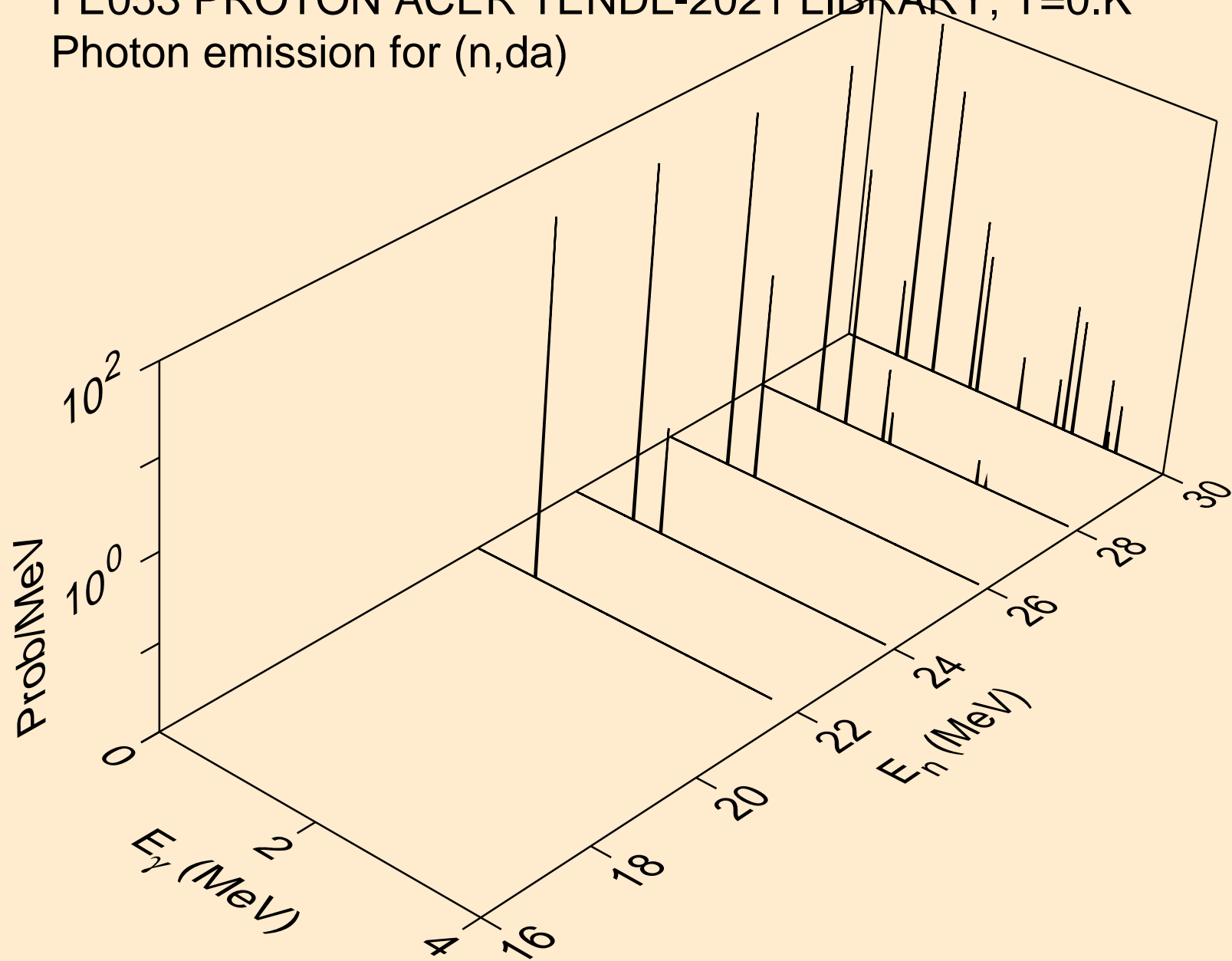

FE053 PROTON ACER TENDL-2021 LIBRARY; T=0.K
Particle heating contributions

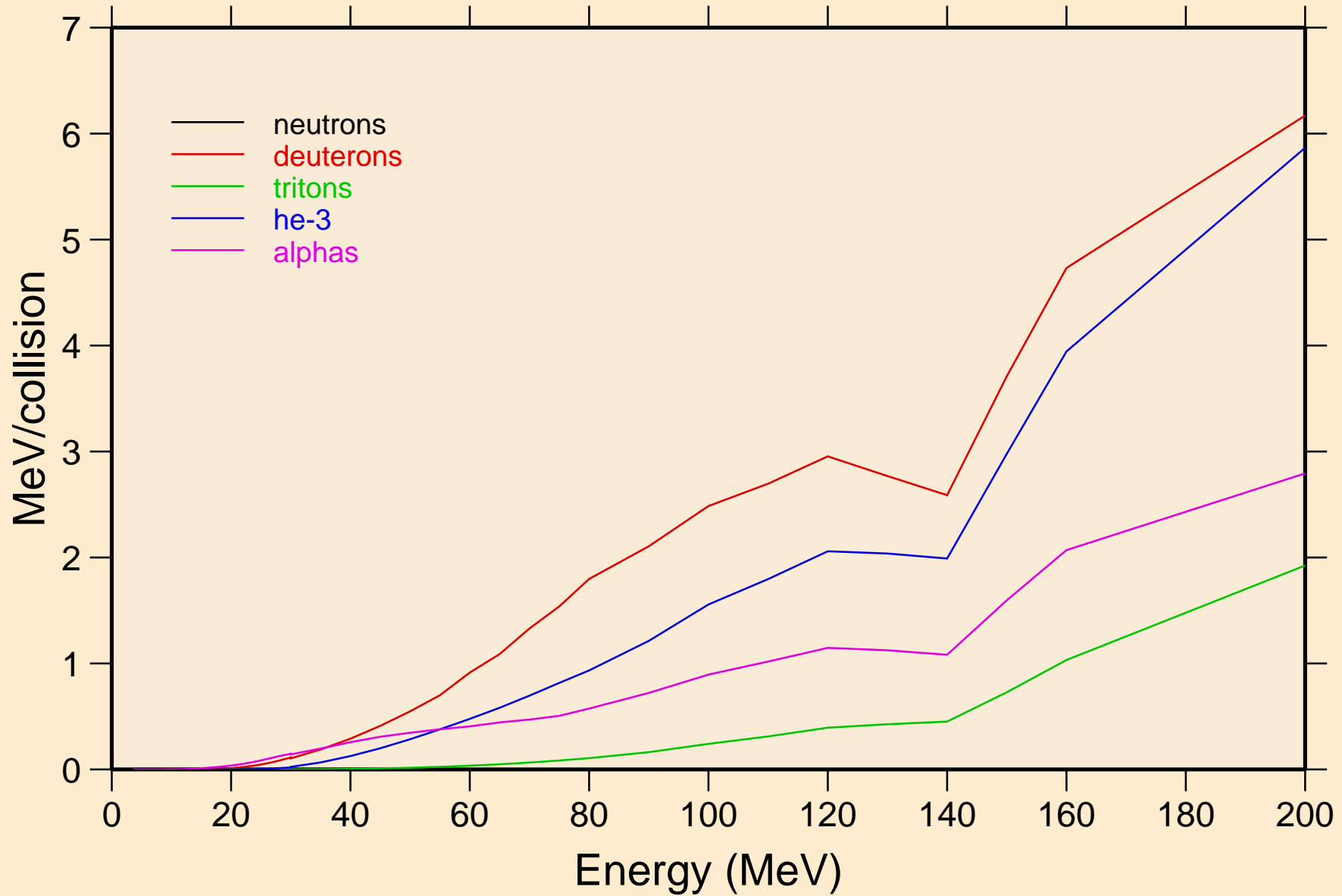

FE053 PROTON ACER TENDL-2021 LIBRARY; T=0.K

Recoil Heating

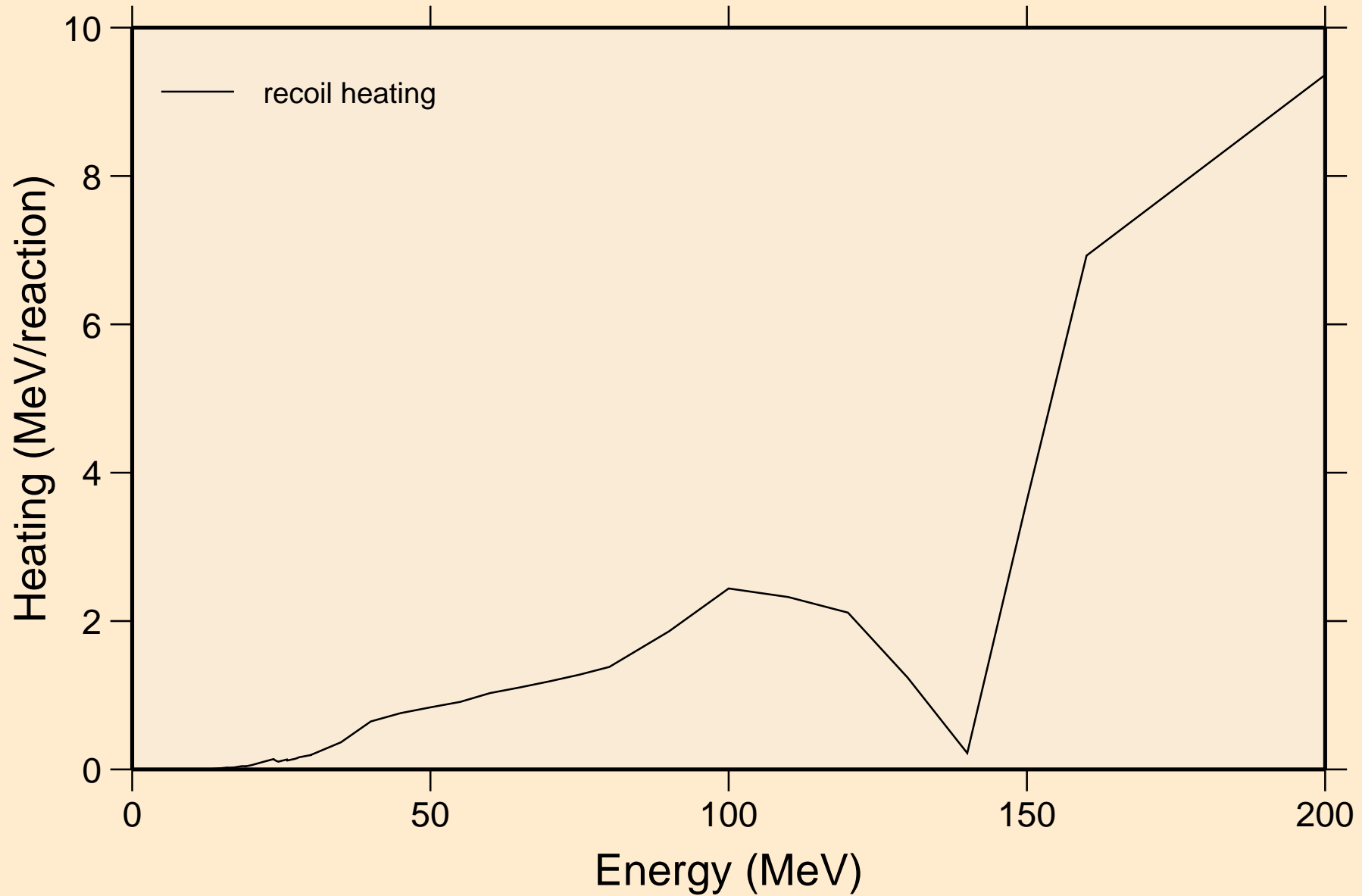

FE053 PROTON ACER TENDL-2021 LIBRARY; T=0.K
Particle production cross sections

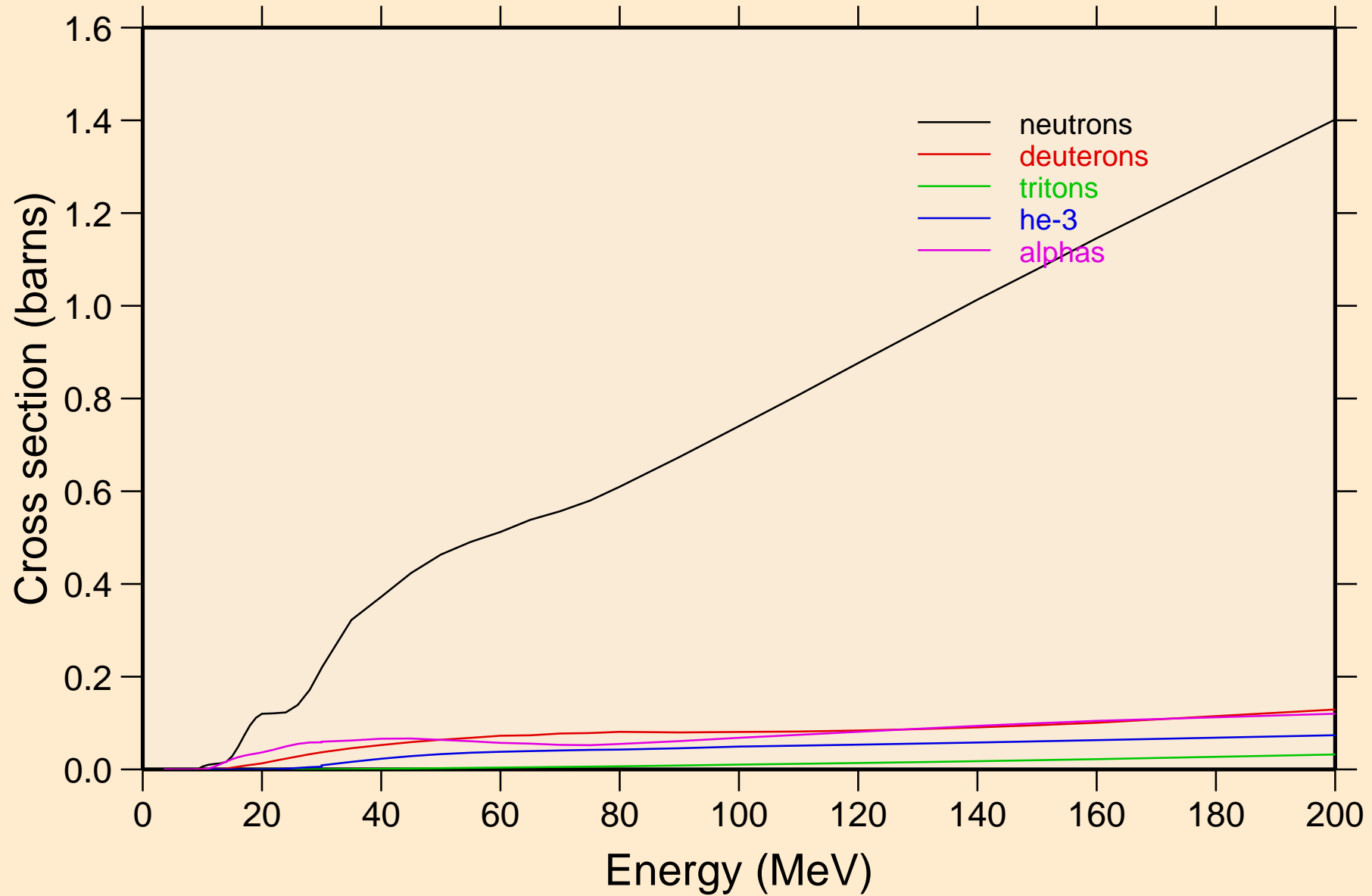

FE053 PROTON ACER TENDL-2021 LIBRARY; T=0.K
neutrons from (p,n)

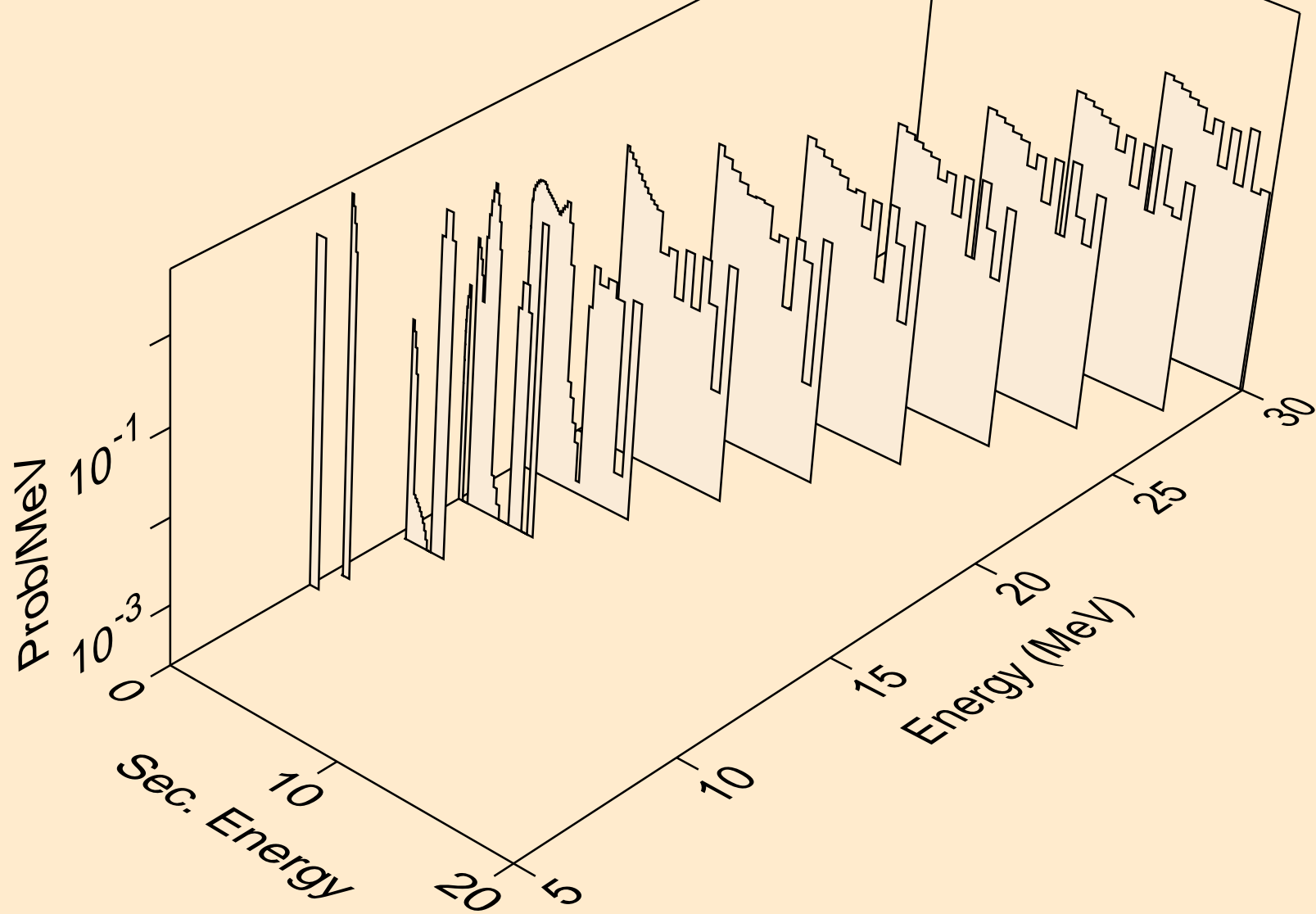

FE053 PROTON ACER TENDL-2021 LIBRARY; T=0.K
neutrons from (p,x)

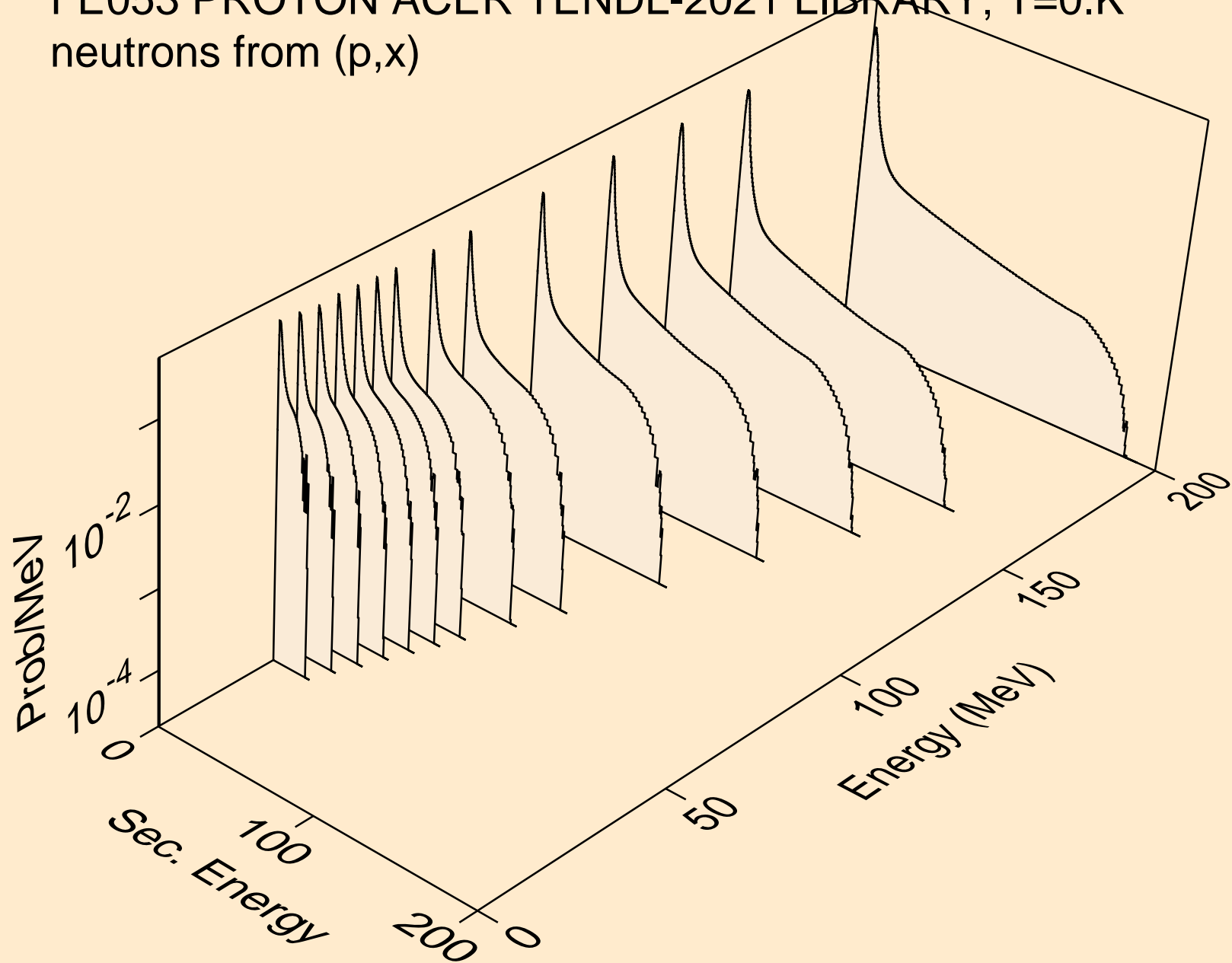

FE053 PROTON ACER TENDL-2021 LIBRARY; T=0.K
neutrons from (p,2n)

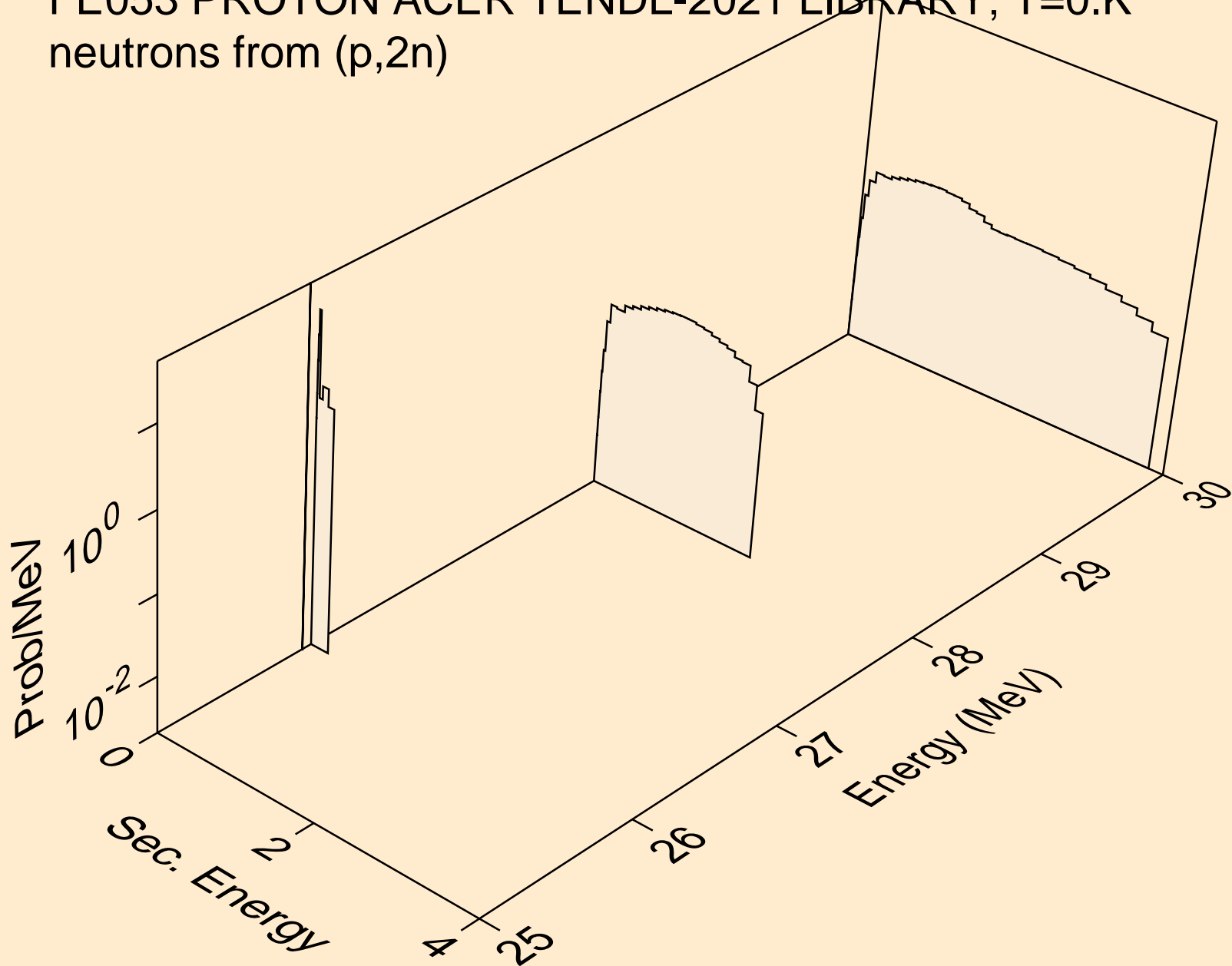

FE053 PROTON ACER TENDL-2021 LIBRARY; T=0.K
neutrons from (p,n*)a

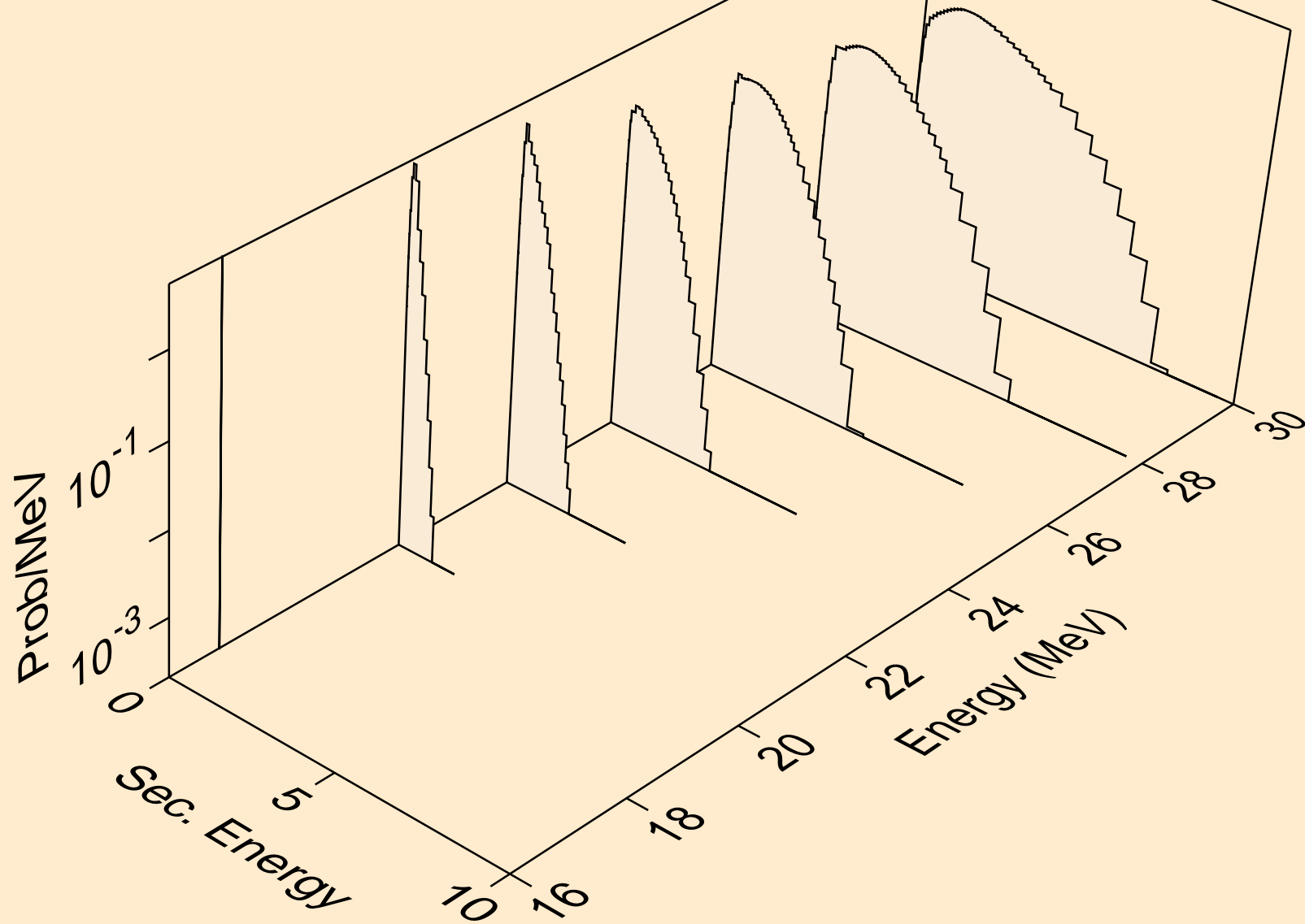

FE053 PROTON ACER TENDL-2021 LIBRARY; T=0.K
neutrons from (p,n*)p

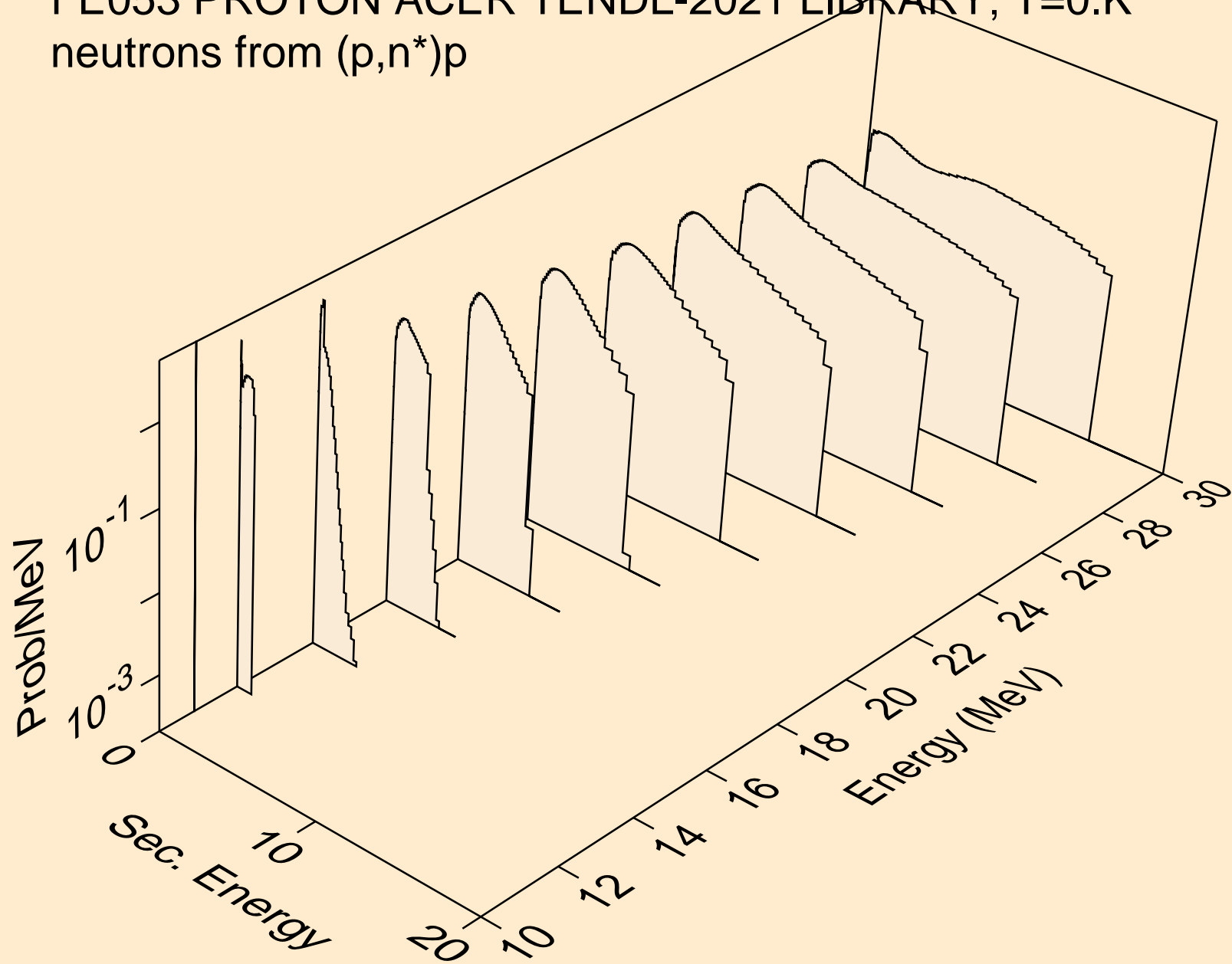

FE053 PROTON ACER TENDL-2021 LIBRARY; T=0.K
neutrons from (p,n*)d

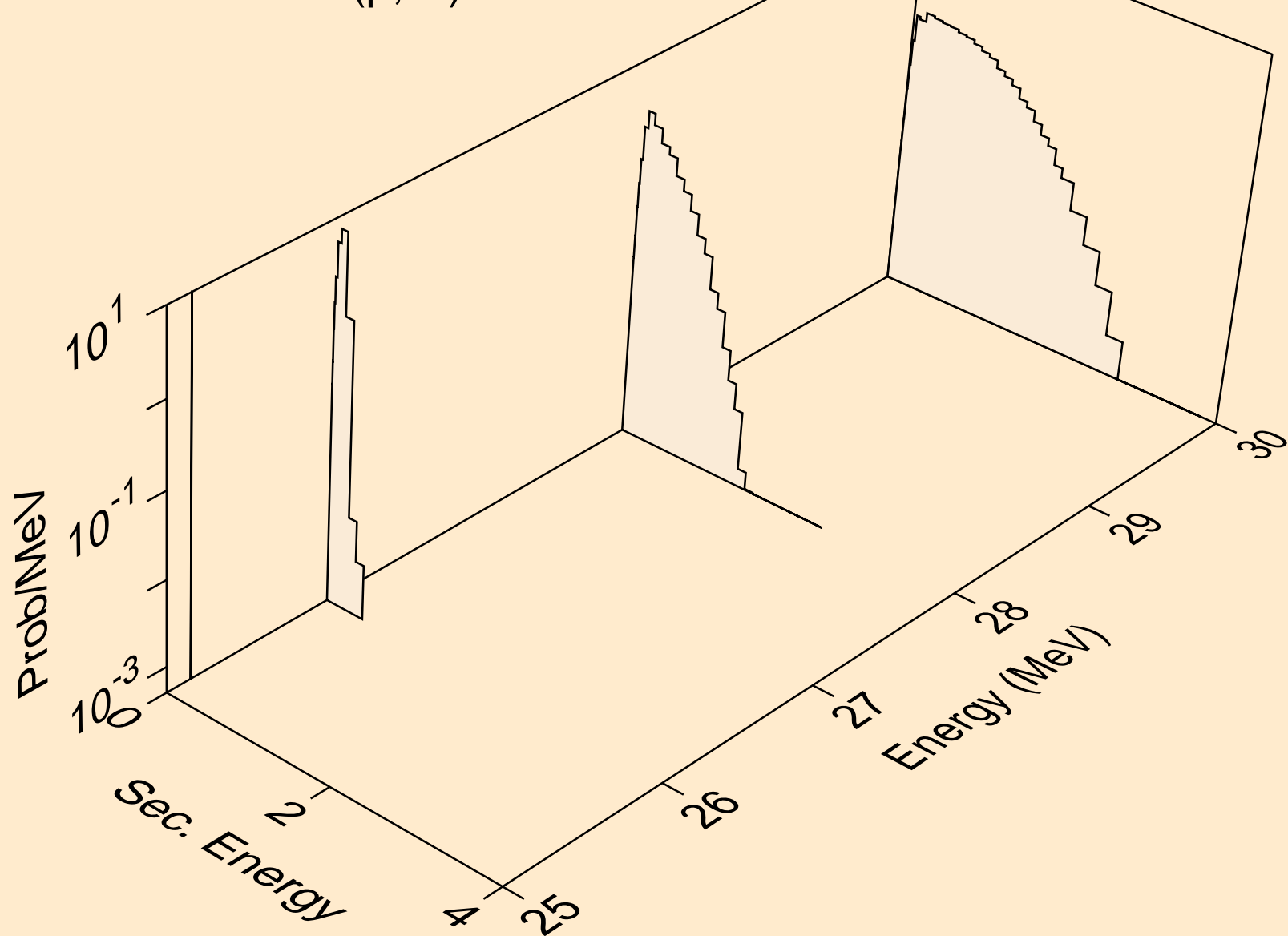

FE053 PROTON ACER TENDL-2021 LIBRARY; T=0.K
neutrons from (p,n*)he3

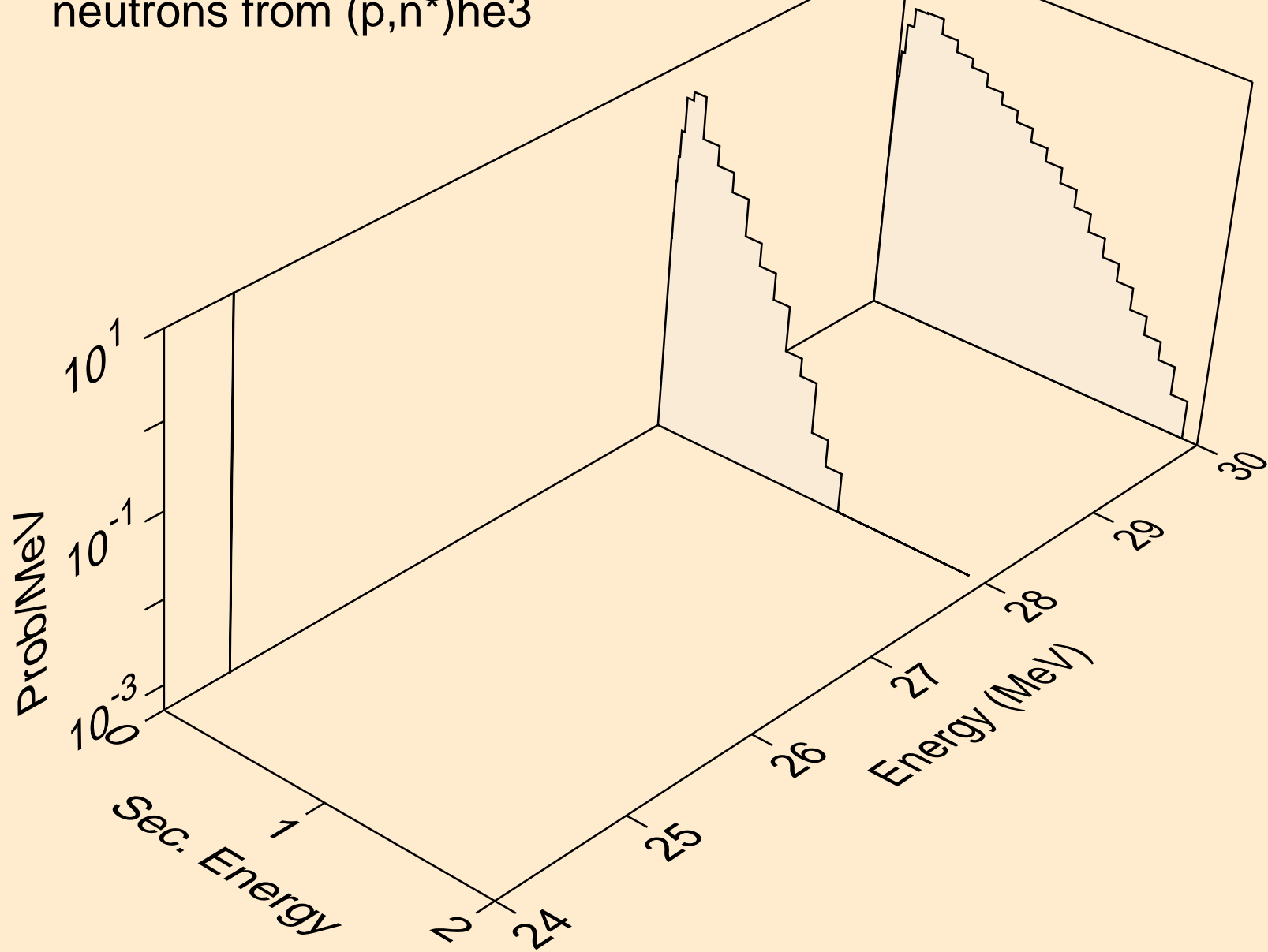

FE053 PROTON ACER TENDL-2021 LIBRARY; T=0.K
neutrons from (p,2np)

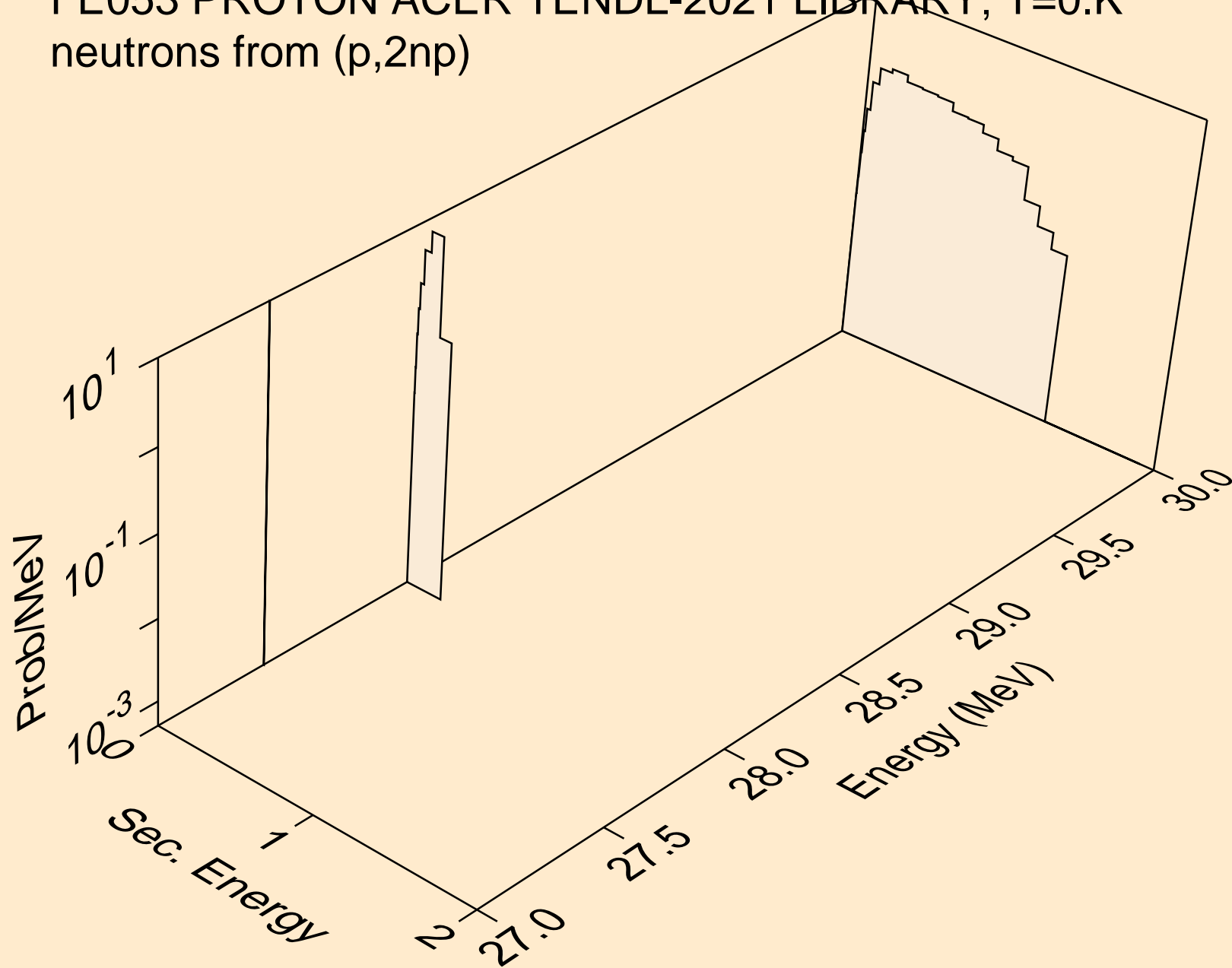

FE053 PROTON ACER TENDL-2021 LIBRARY; T=0.K
neutrons from (p,2np)

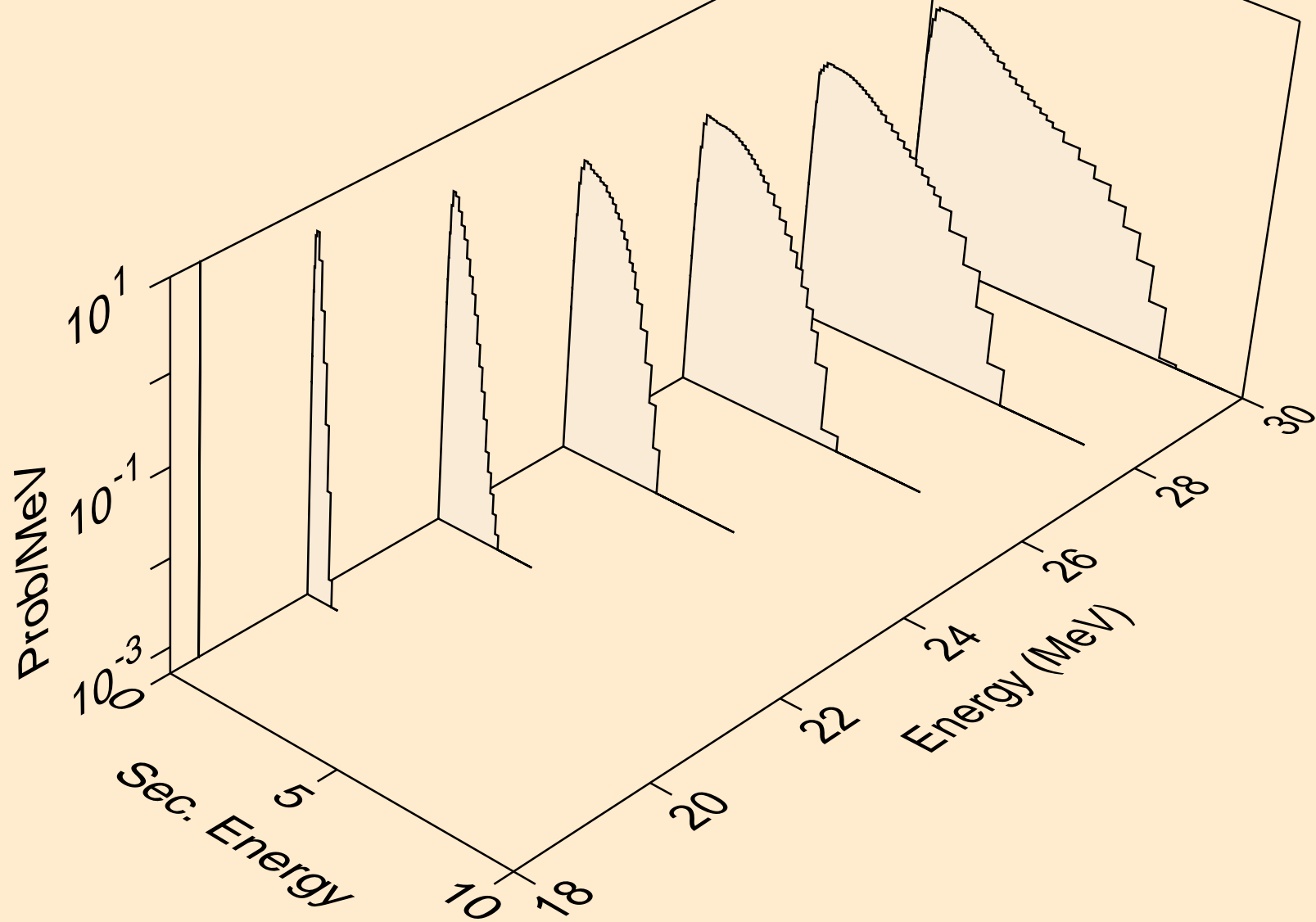

FE053 PROTON ACER TENDL-2021 LIBRARY; T=0.K
neutrons from (p,npa)

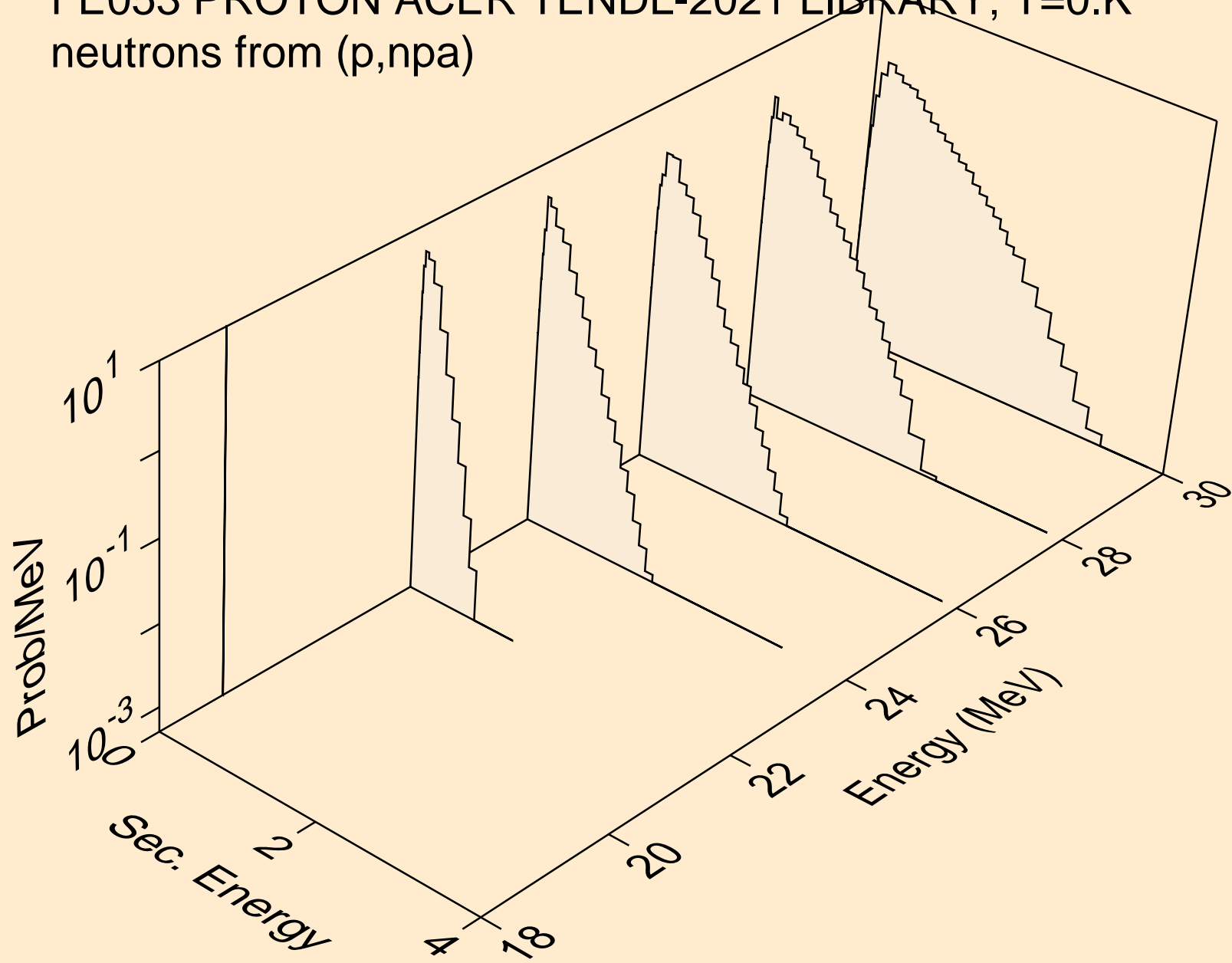

FE053 PROTON ACER TENDL-2021 LIBRARY; T=0.K
deuterons from (p,x)

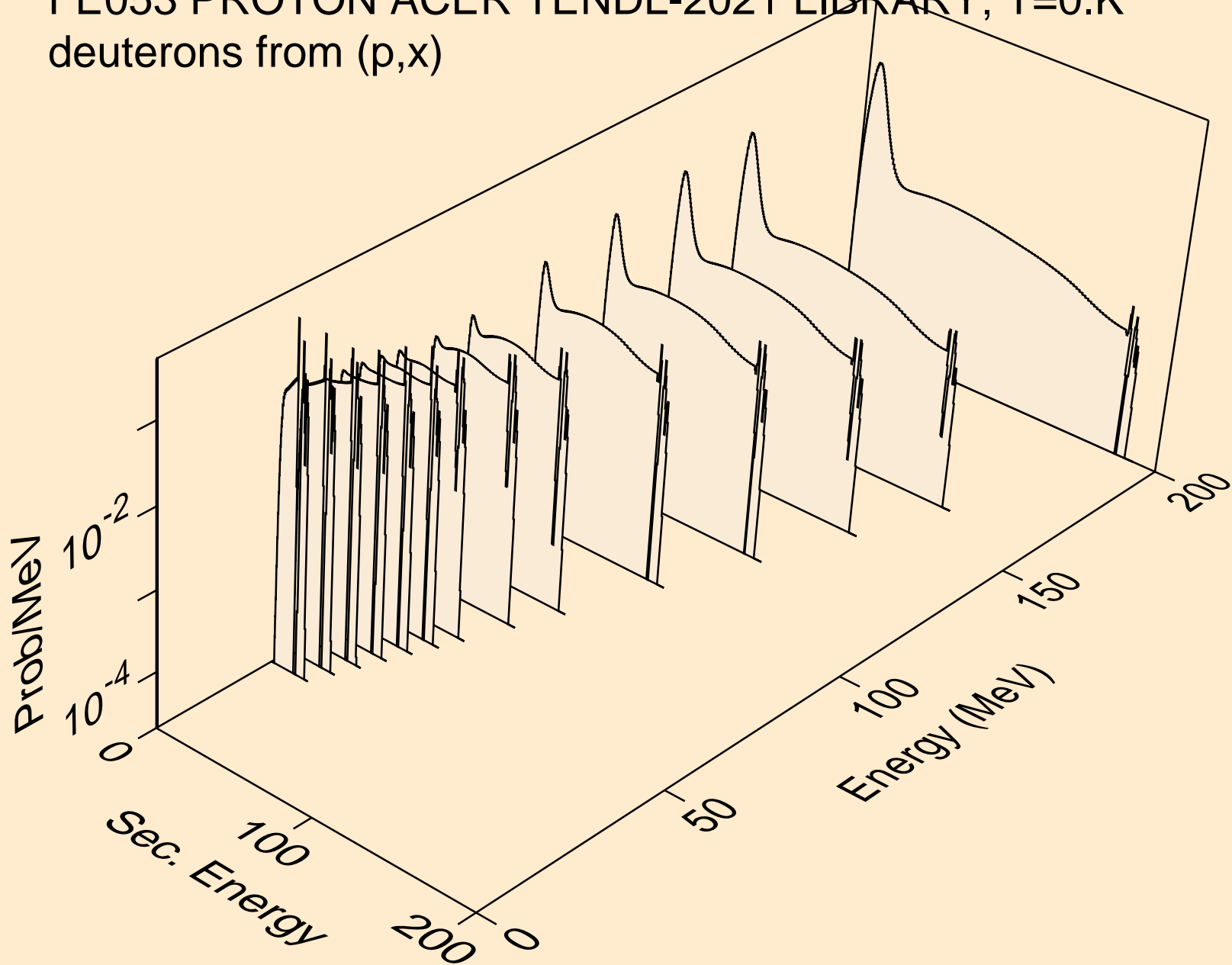

FE053 PROTON ACER TENDL-2021 LIBRARY; T=0.K
deuterons from (p,n*)d

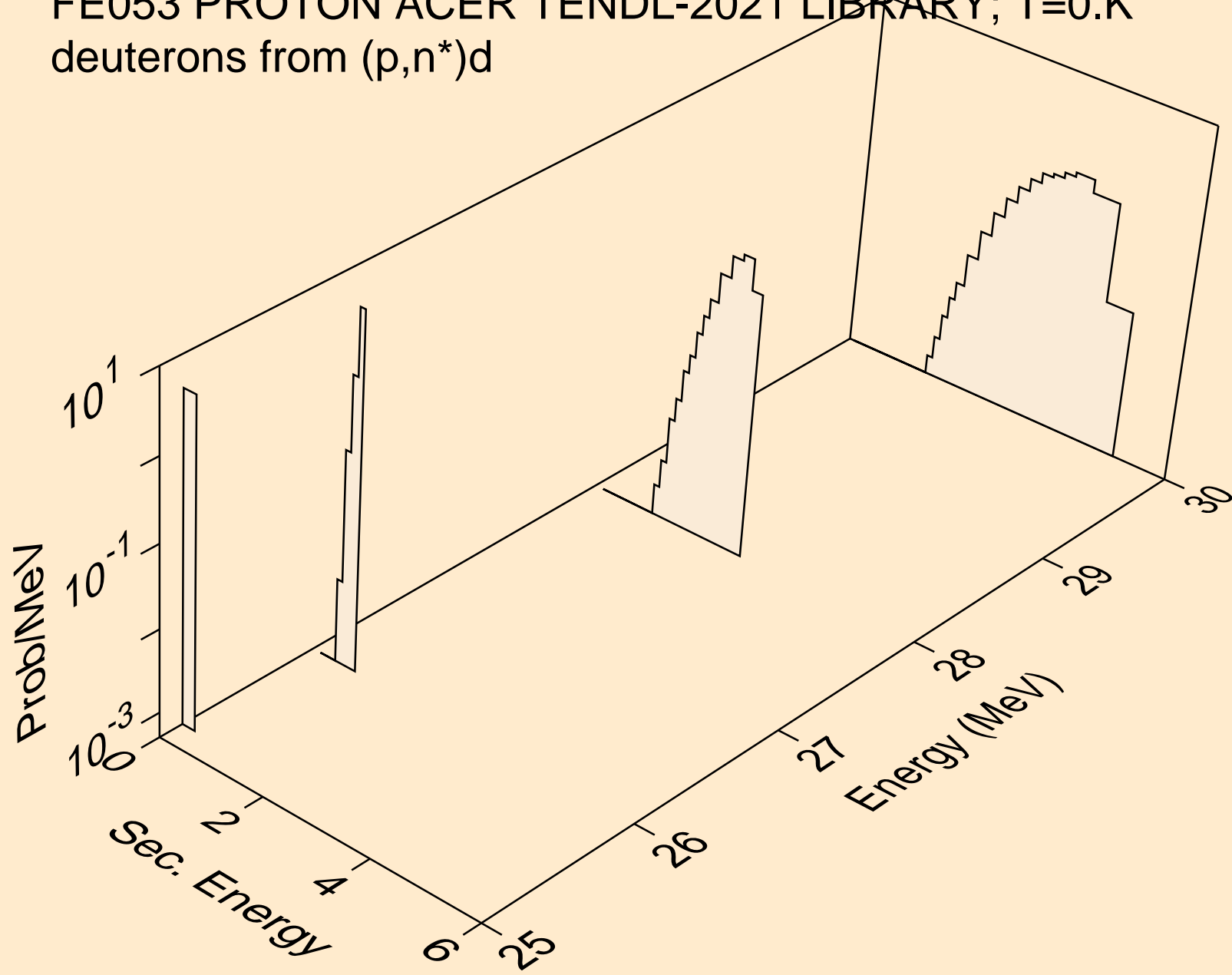

FE053 PROTON ACER TENDL-2021 LIBRARY; T=0.K
deuterons from (p,d)

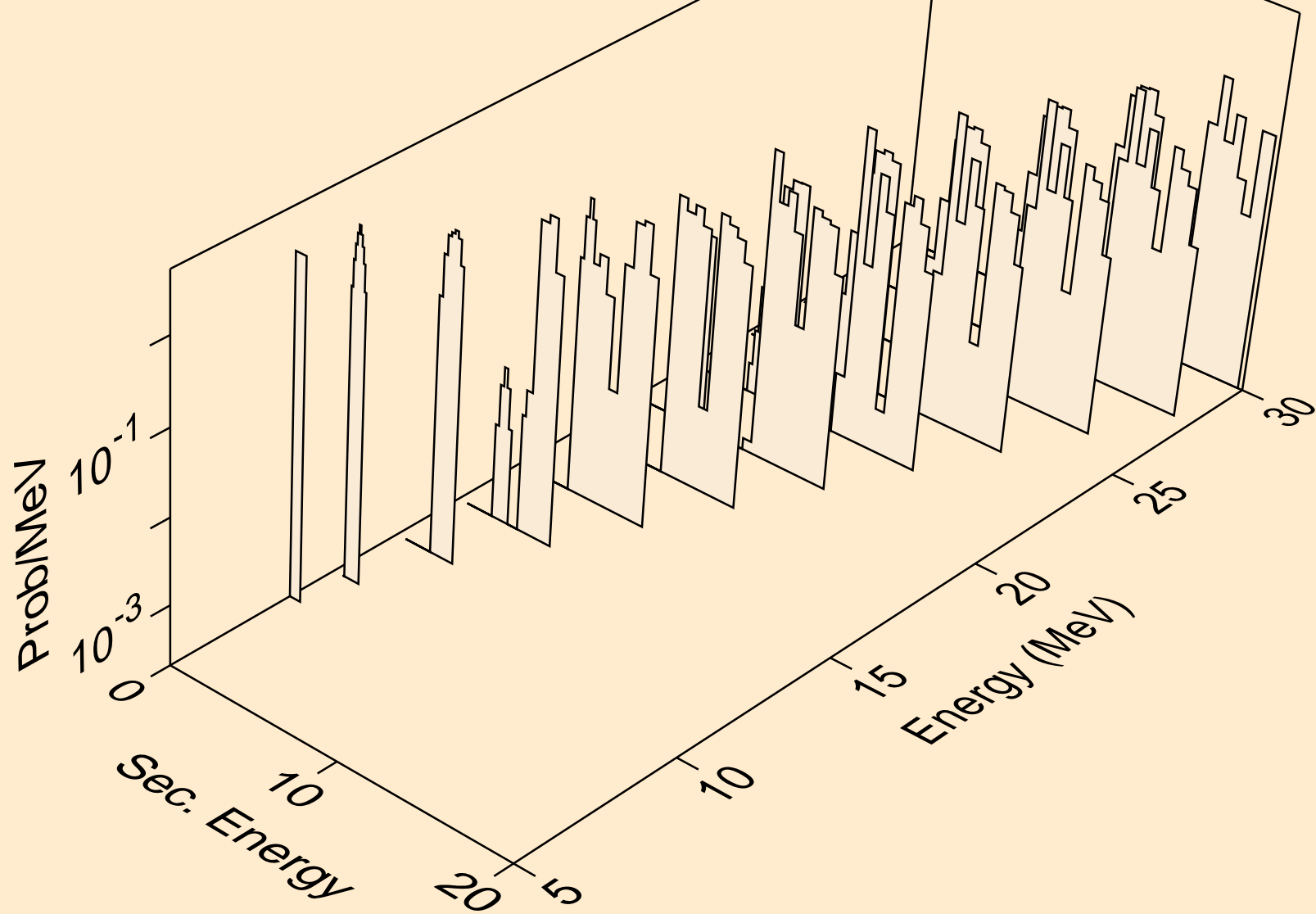

FE053 PROTON ACER TENDL-2021 LIBRARY; T=0.K
deuterons from (p,pd)

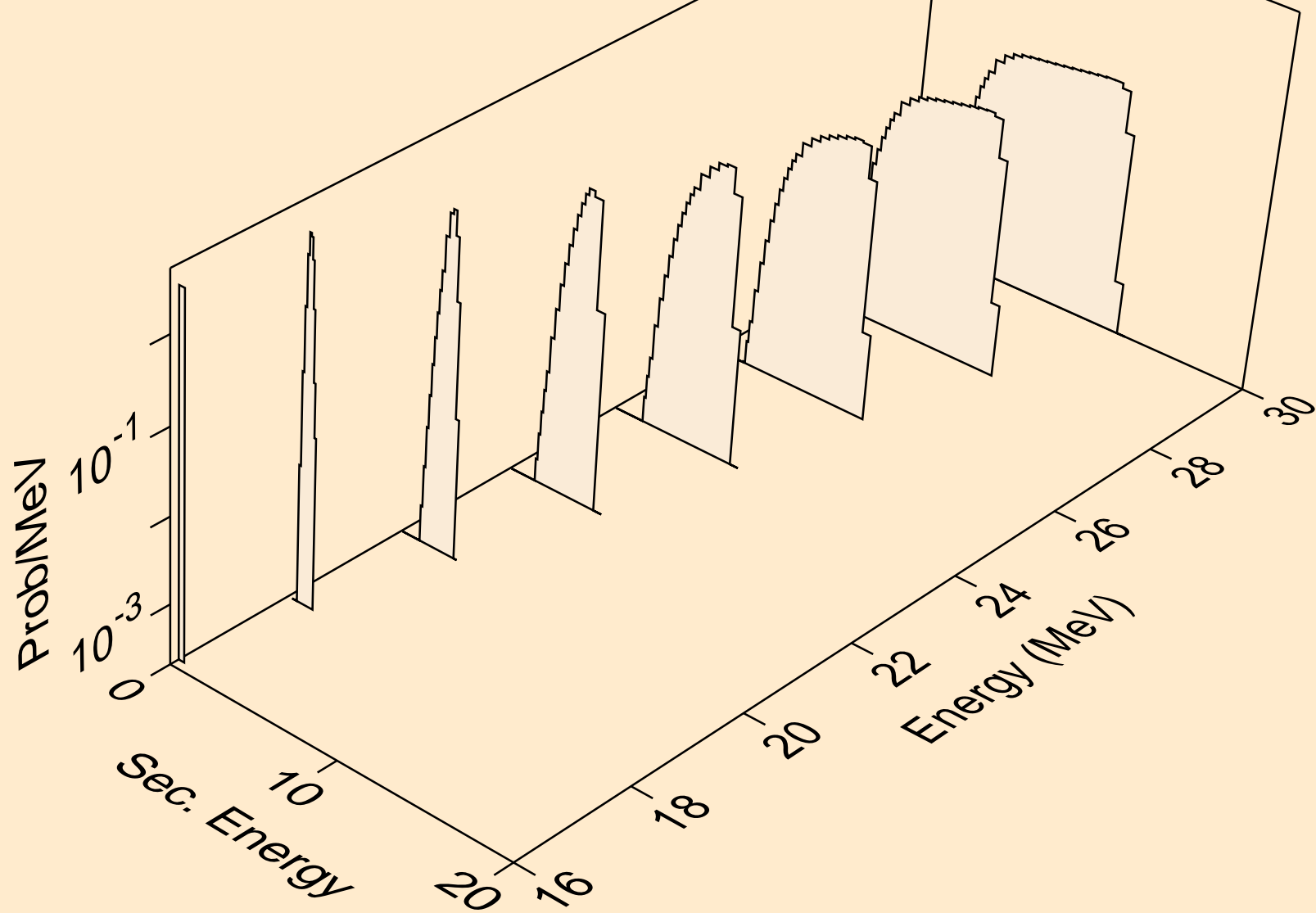

FE053 PROTON ACER TENDL-2021 LIBRARY; T=0.K
deuterons from (p,da)

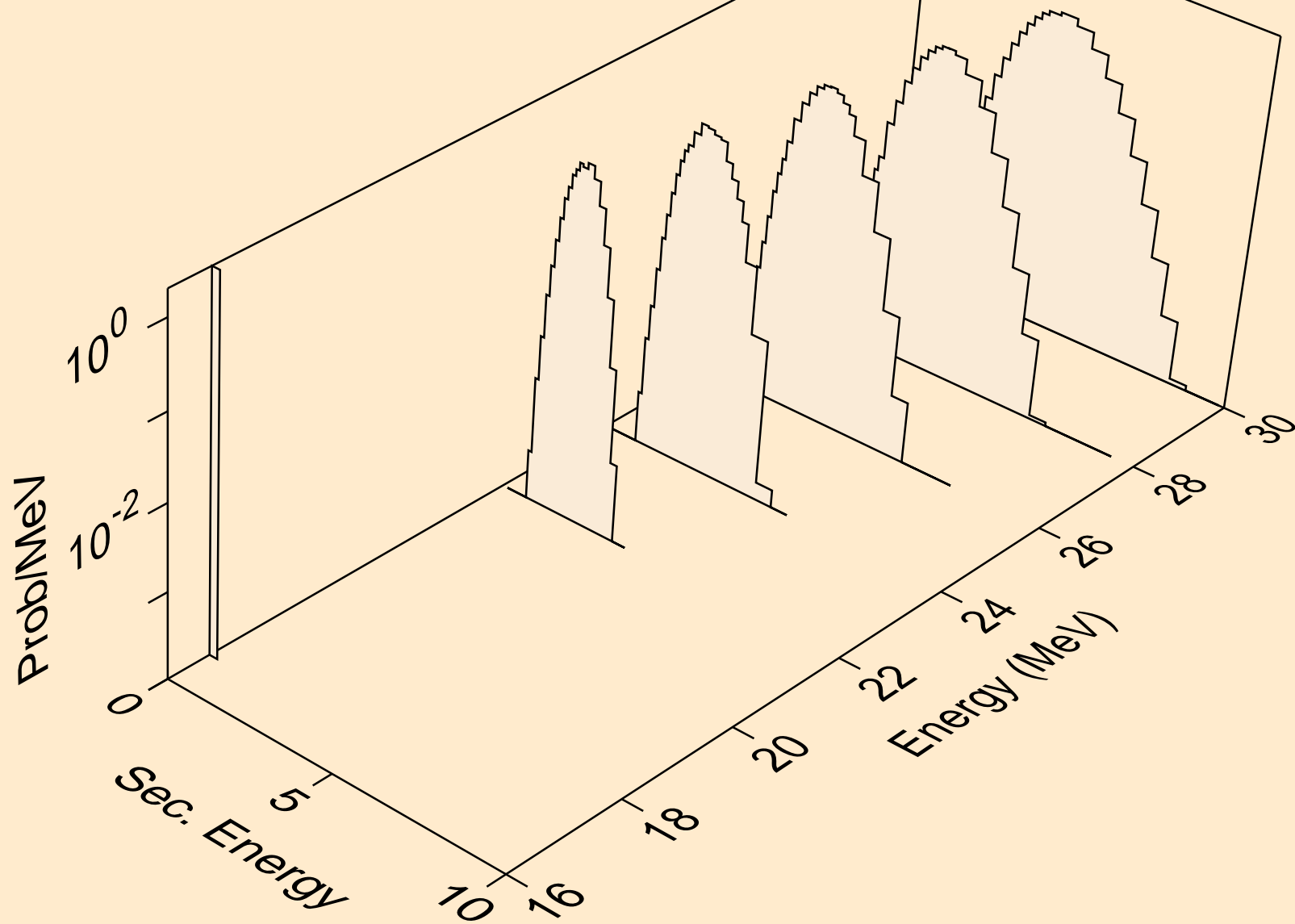

FE053 PROTON ACER TENDL-2021 LIBRARY; T=0.K
tritons from (p,x)

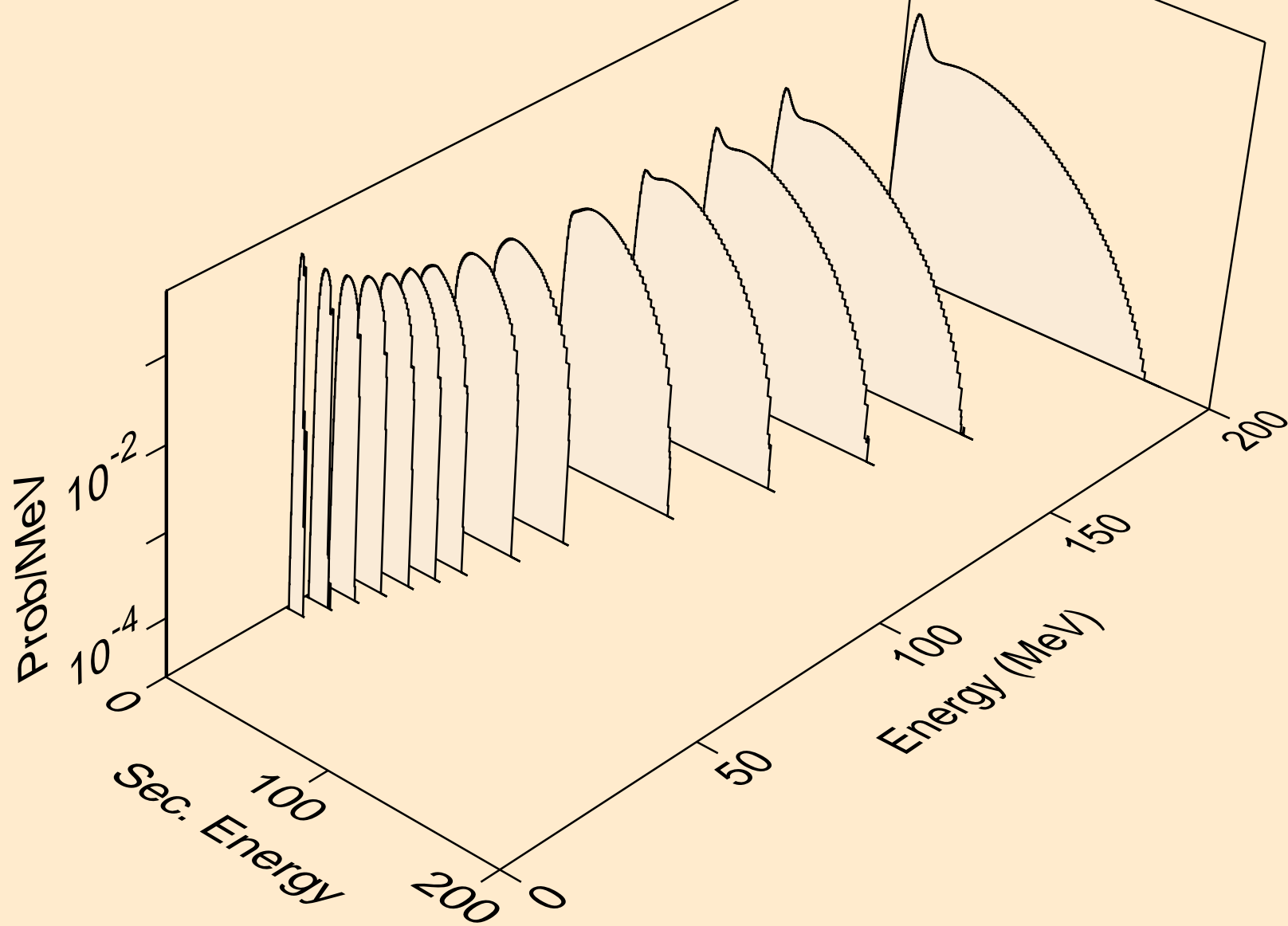

FE053 PROTON ACER TENDL-2021 LIBRARY; T=0.K
tritons from (p,t)

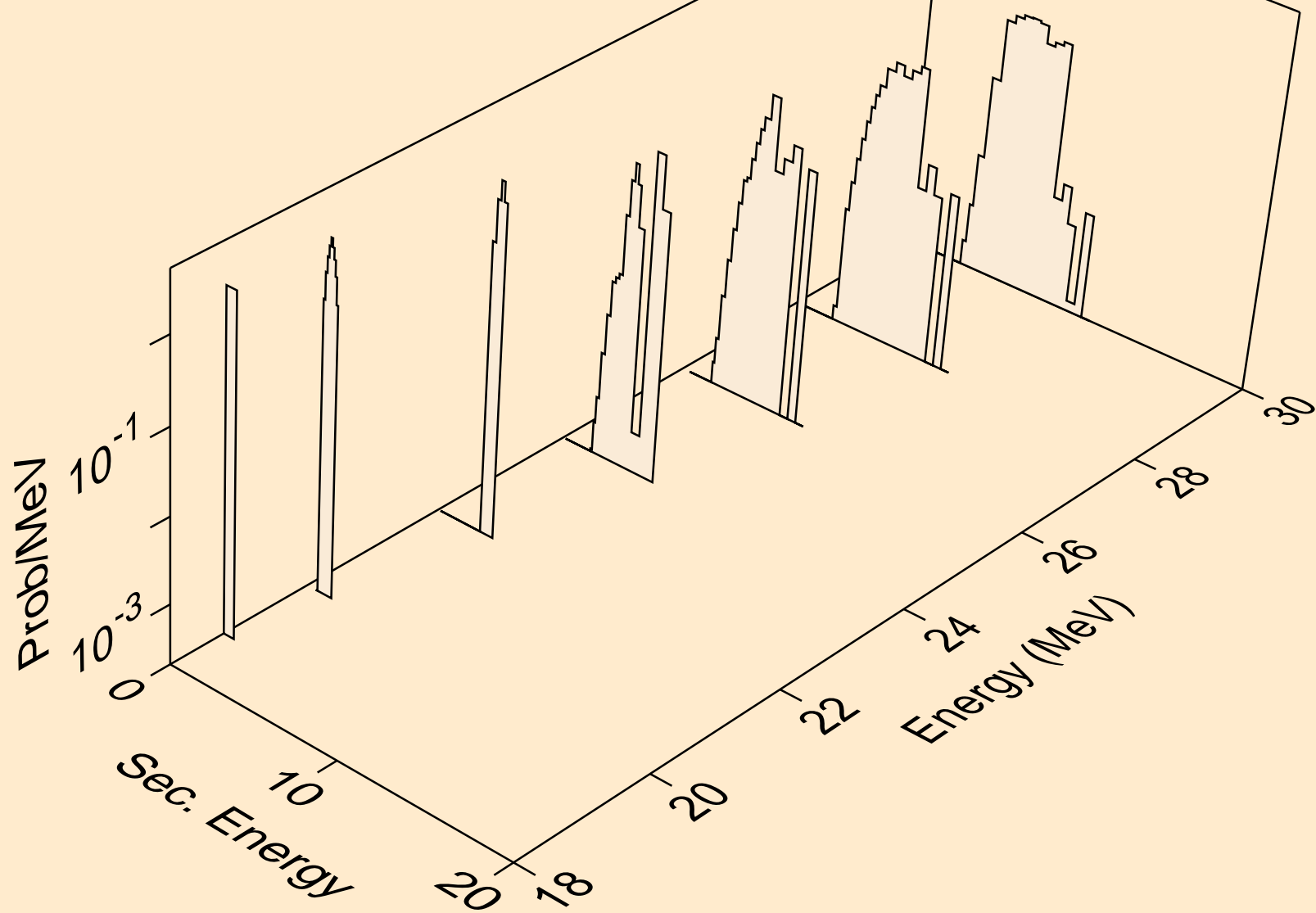

FE053 PROTON ACER TENDL-2021 LIBRARY; T=0.K
tritons from (p,pt)

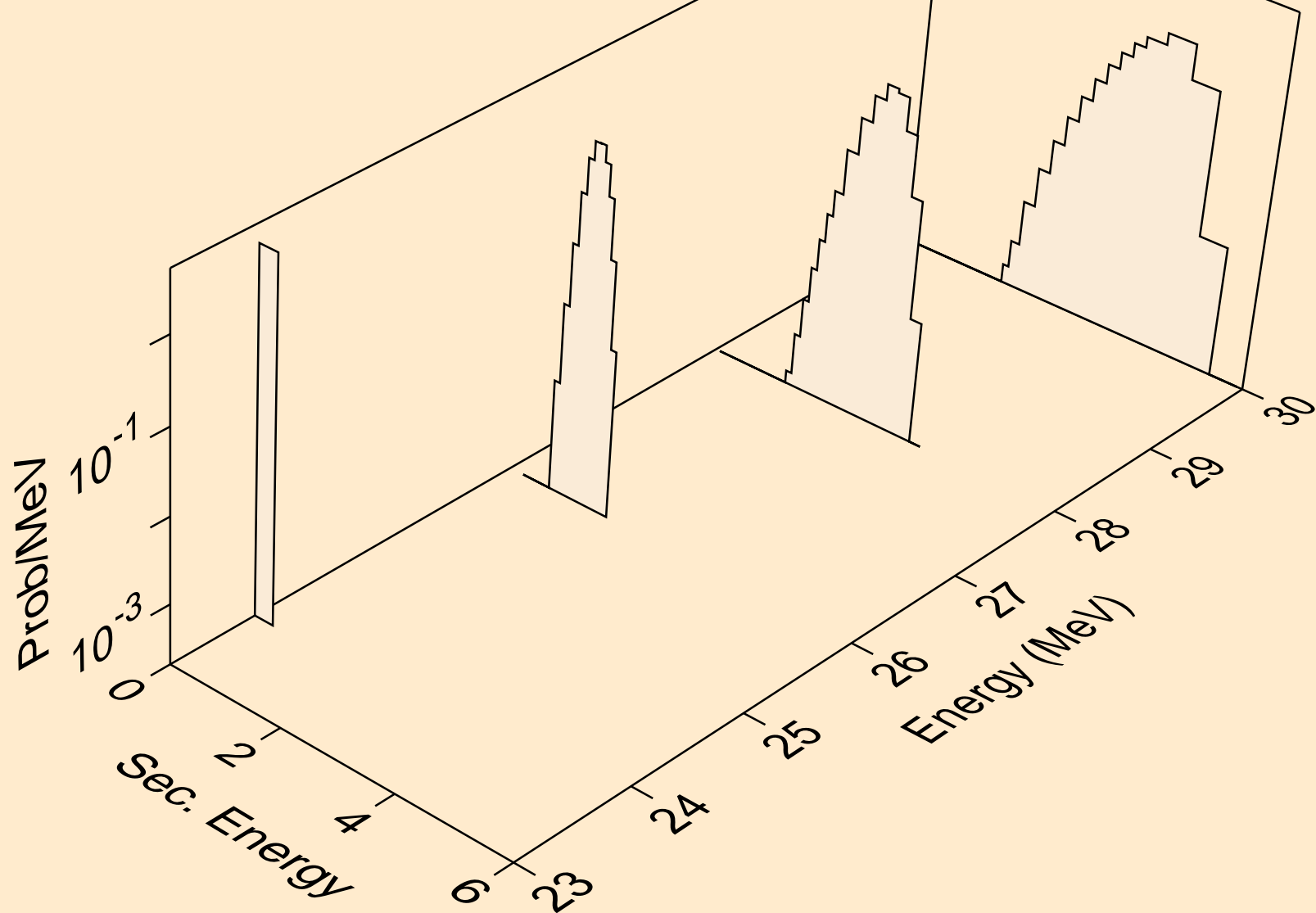

FE053 PROTON ACER TENDL-2021 LIBRARY; T=0.K
he3s from (p,x)

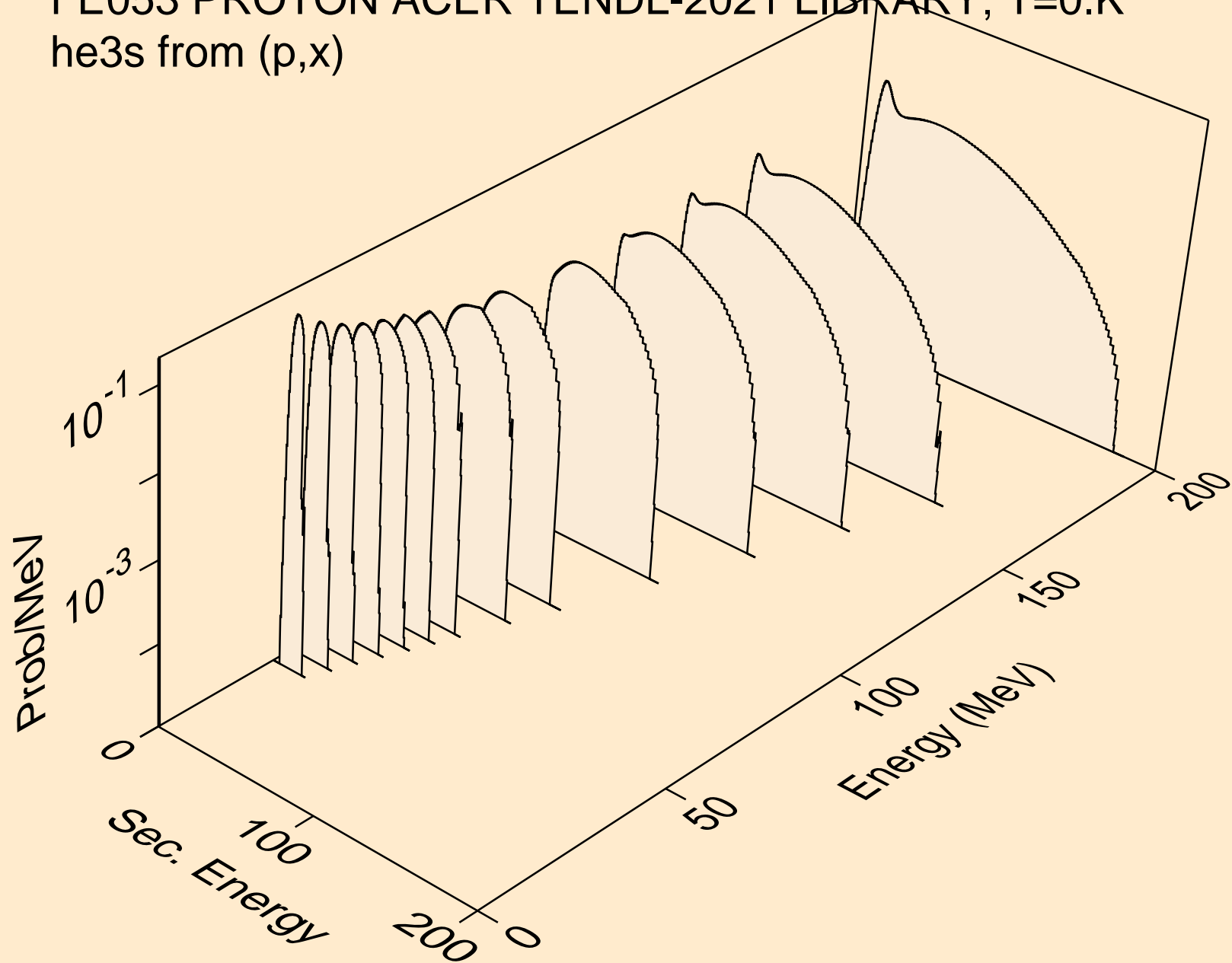

FE053 PROTON ACER TENDL-2021 LIBRARY; T=0.K
he3s from (p,n*)he3

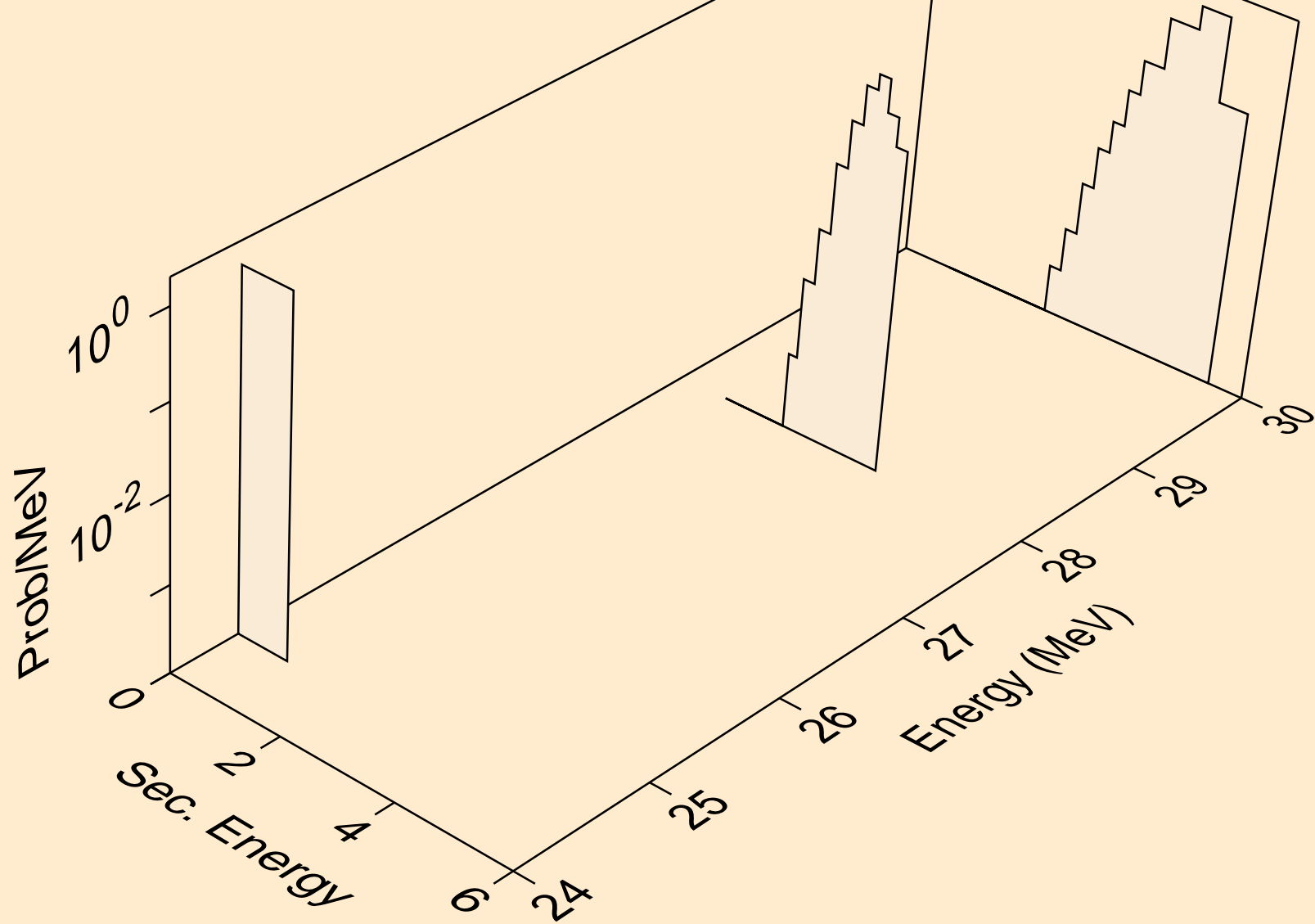

FE053 PROTON ACER TENDL-2021 LIBRARY; T=0.K
he3s from (p,he3)

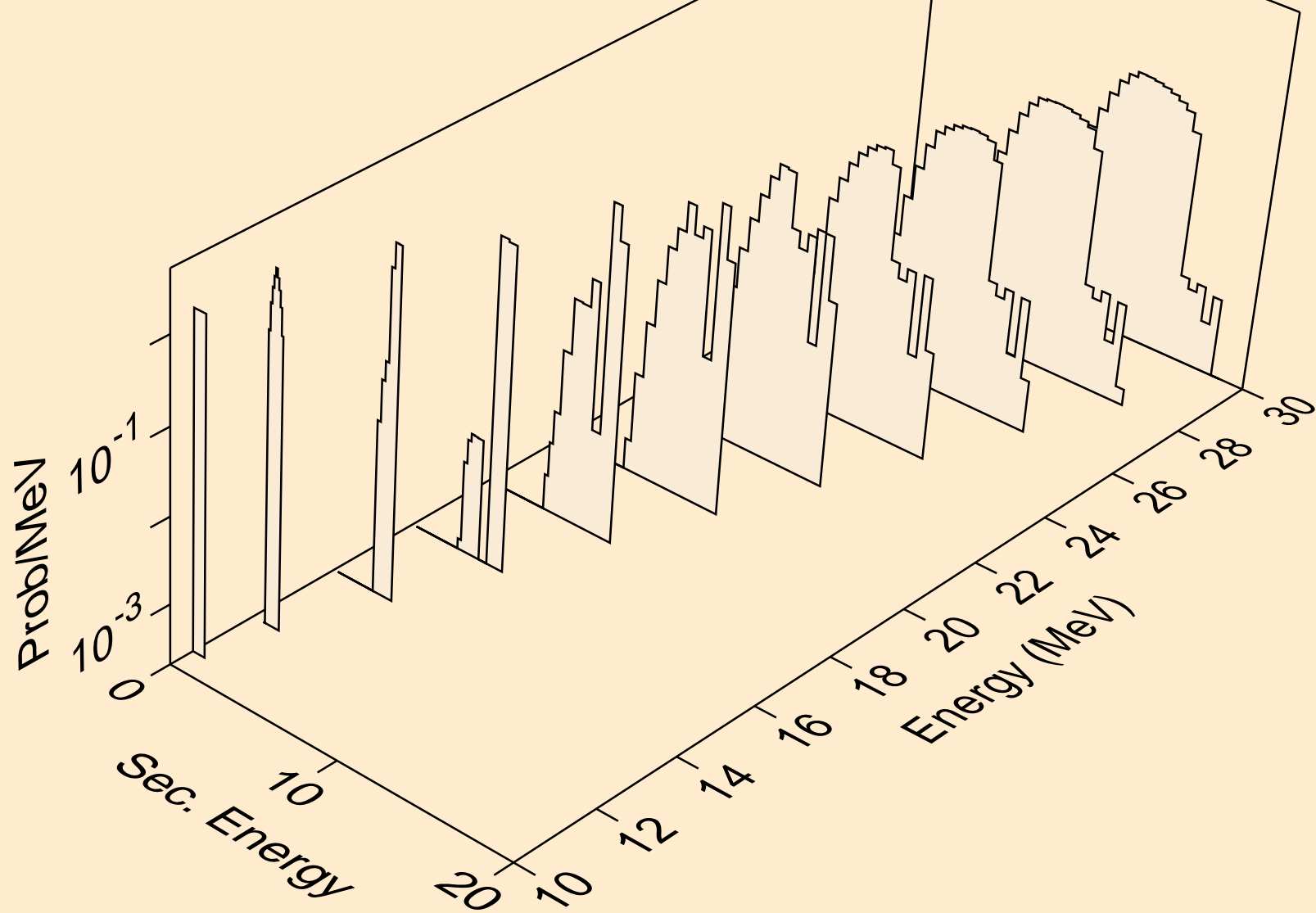

FE053 PROTON ACER TENDL-2021 LIBRARY; T=0.K
alphas from (p,x)

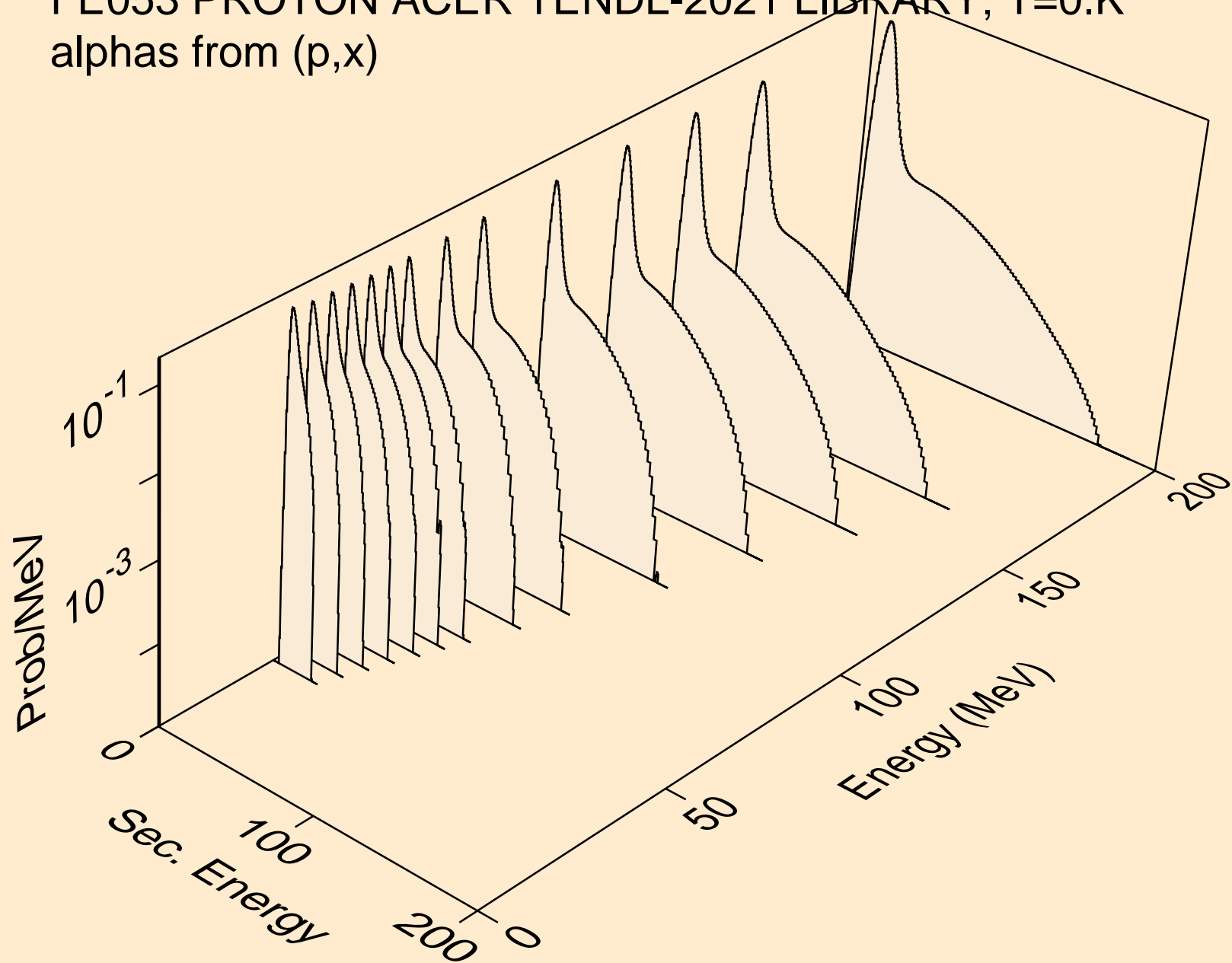

FE053 PROTON ACER TENDL-2021 LIBRARY; T=0.K
alphas from (p,n*)a

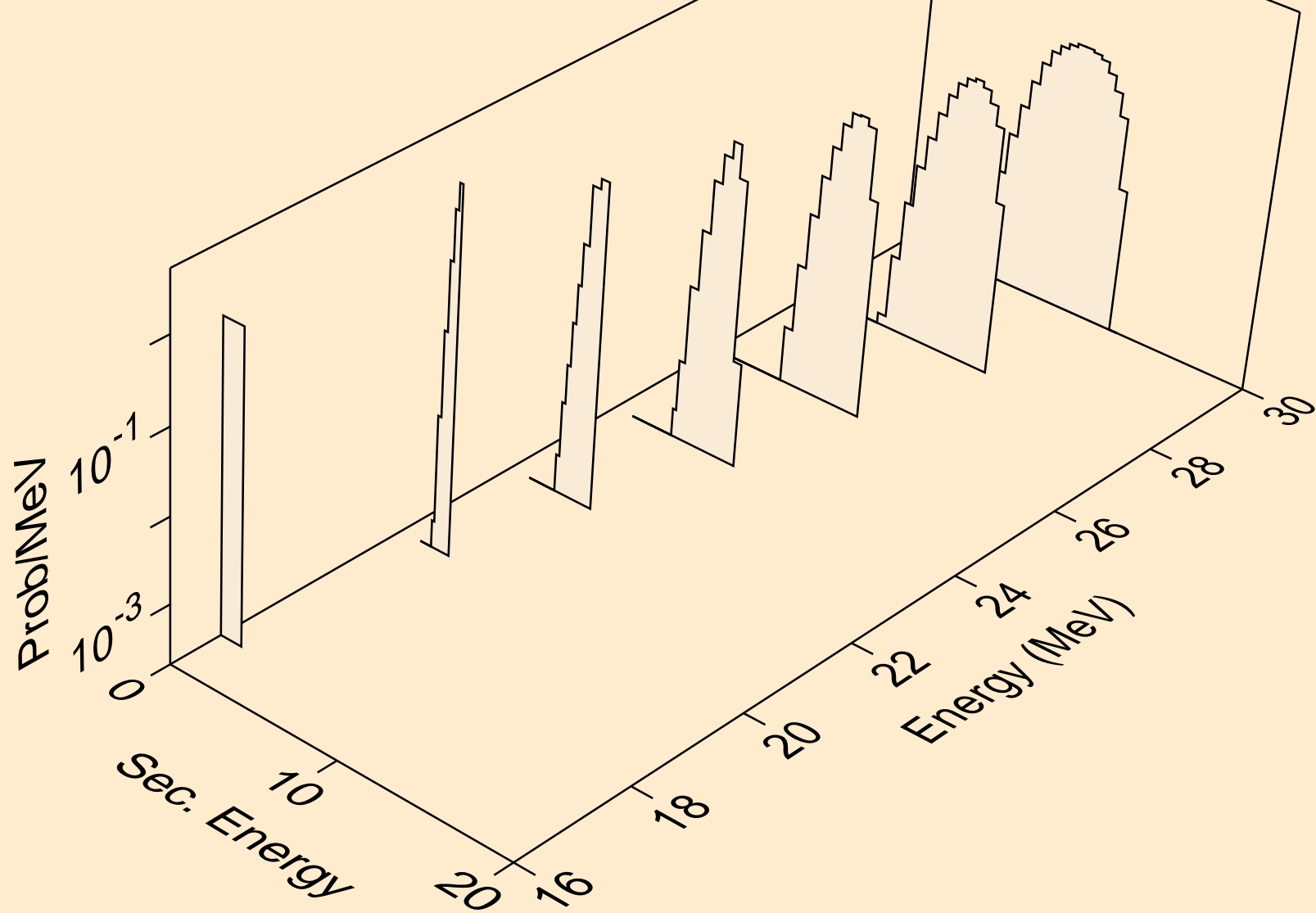

FE053 PROTON ACER TENDL-2021 LIBRARY; T=0.K
alphas from (p,npa)

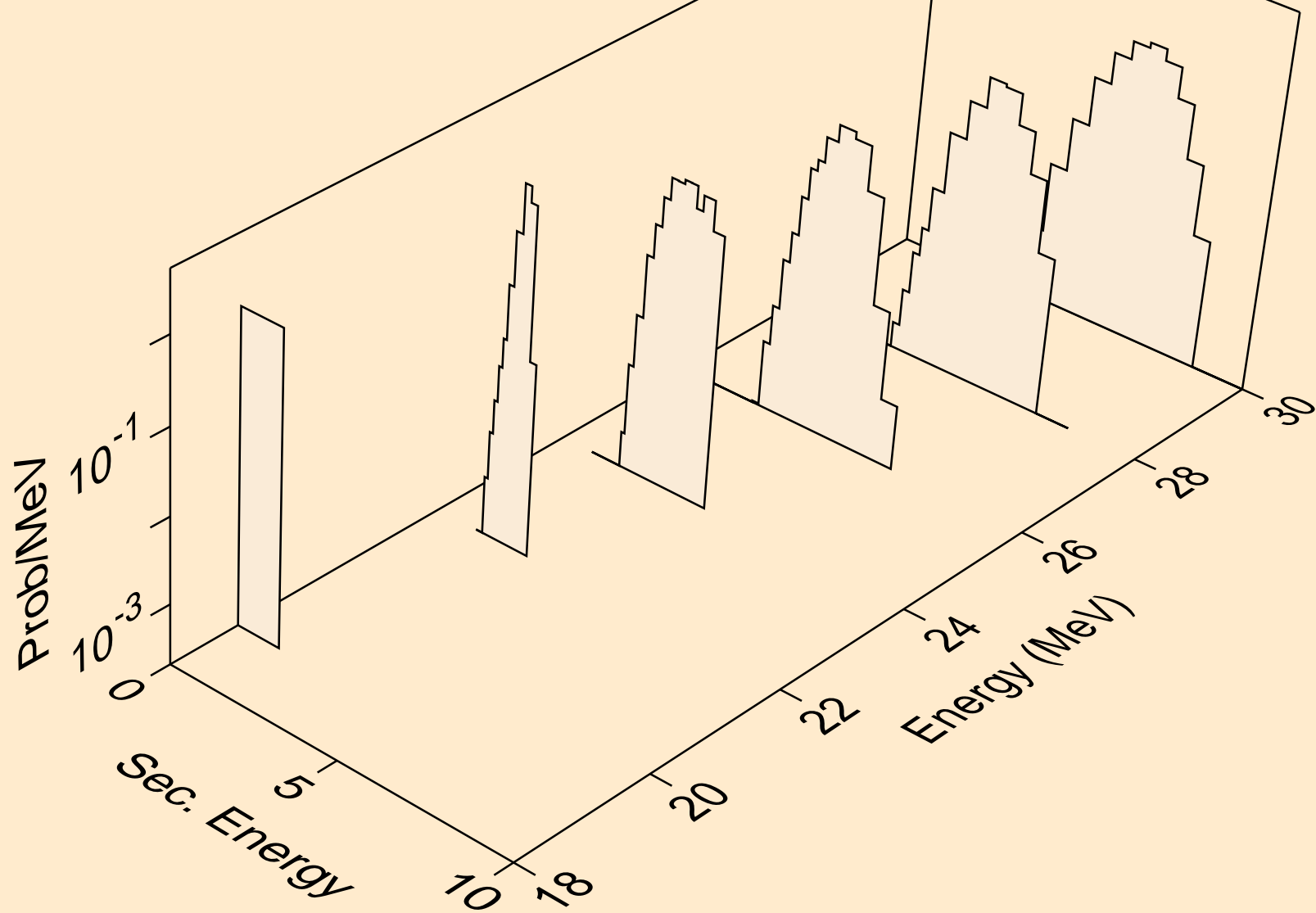

FE053 PROTON ACER TENDL-2021 LIBRARY; T=0.K
alphas from (p,a)

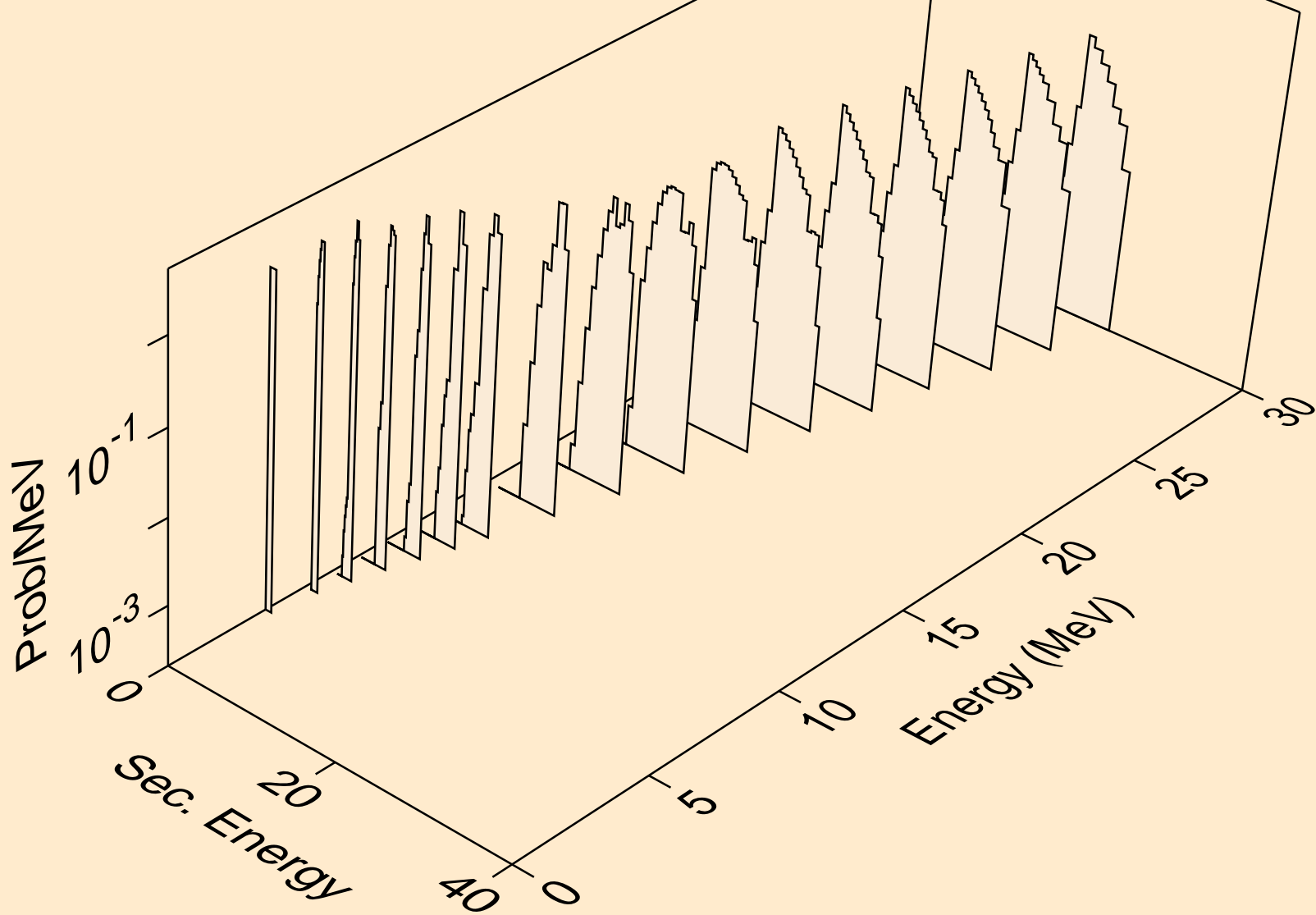

FE053 PROTON ACER TENDL-2021 LIBRARY; T=0.K
alphas from (p,2a)

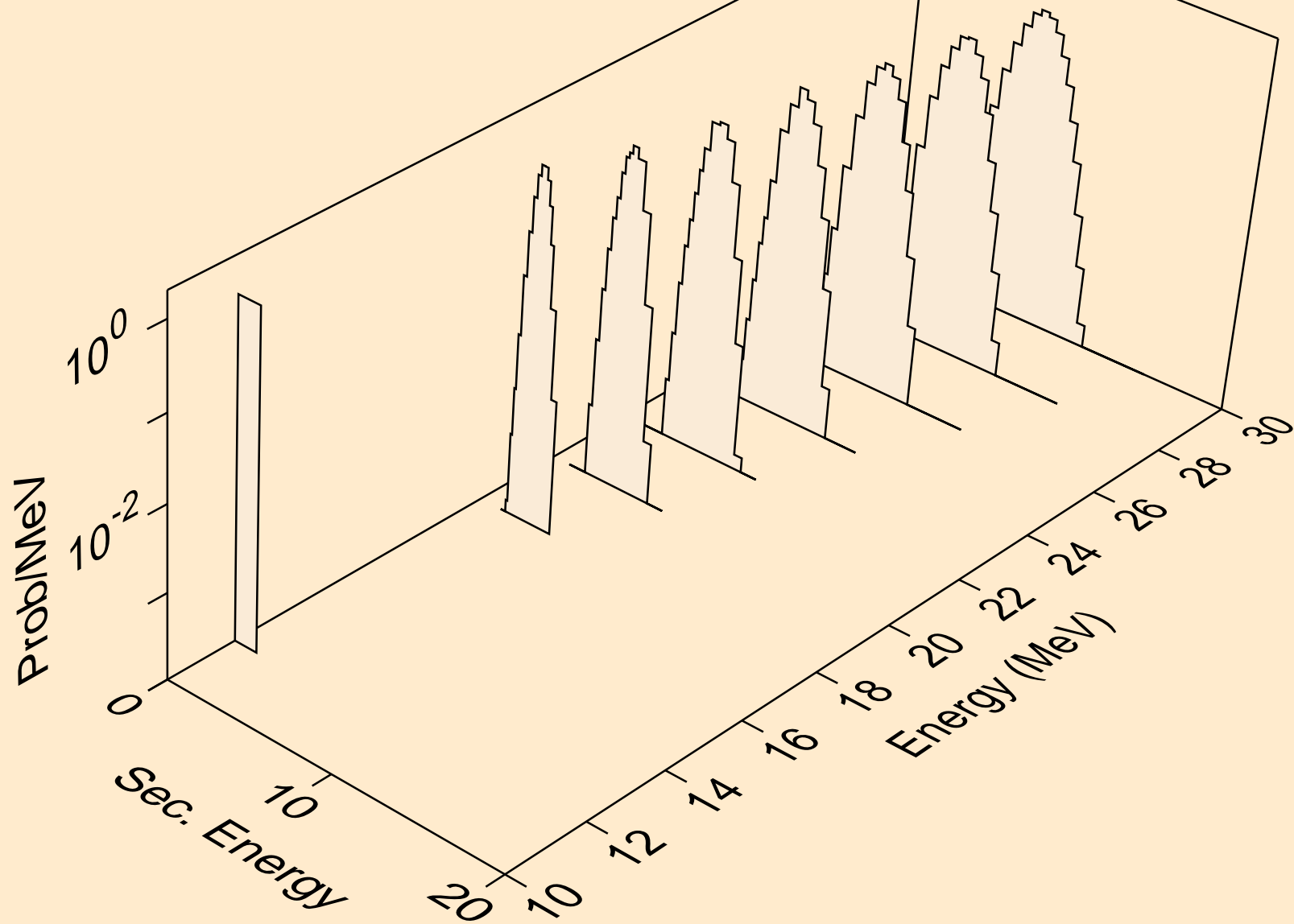

FE053 PROTON ACER TENDL-2021 LIBRARY; T=0.K
alphas from (p,pa)

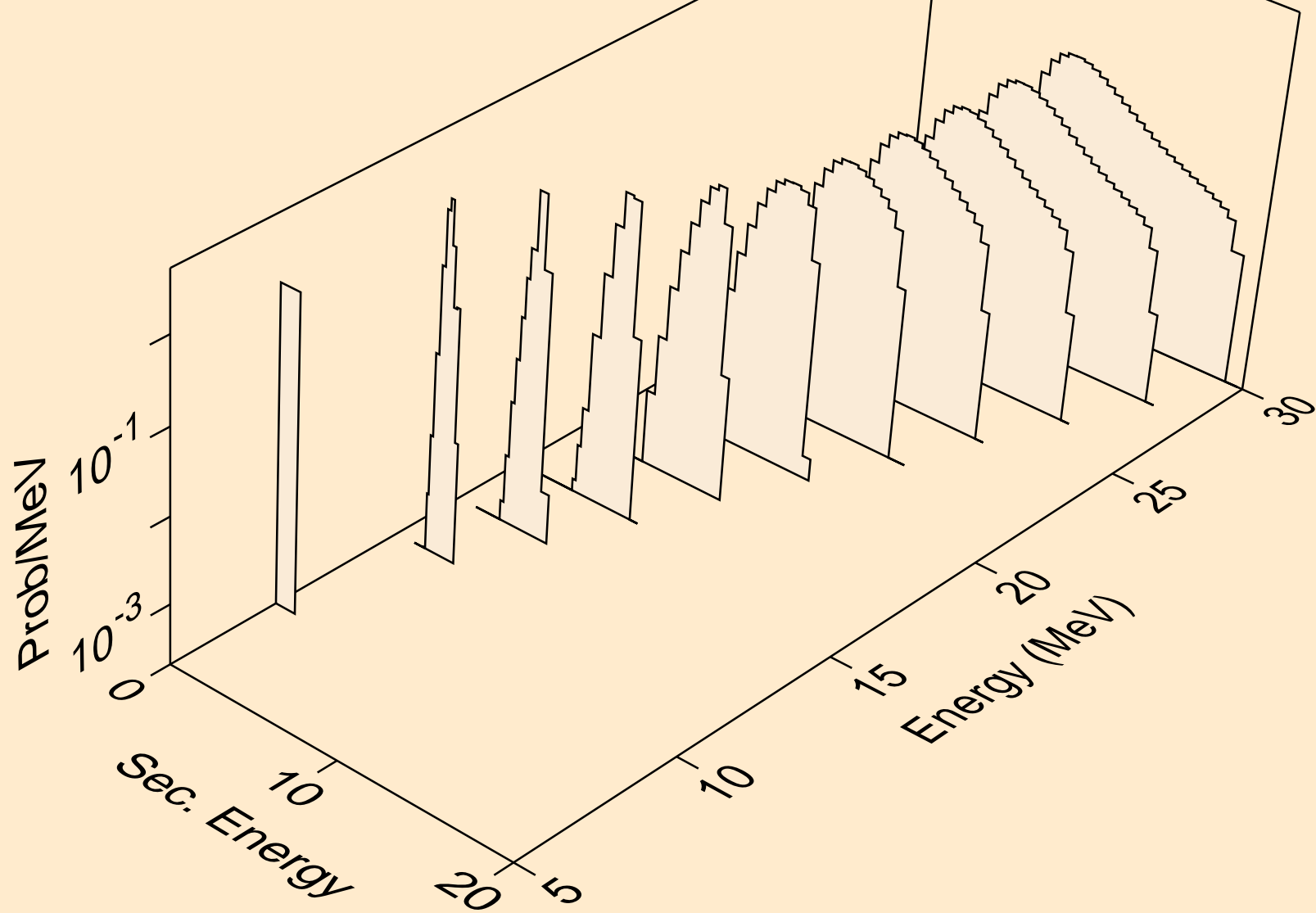

FE053 PROTON ACER TENDL-2021 LIBRARY; T=0.K
alphas from (p,da)

