

FM260 PROTON ACER TENDL-2021 LIBRARY; T=0.K
Principal cross sections

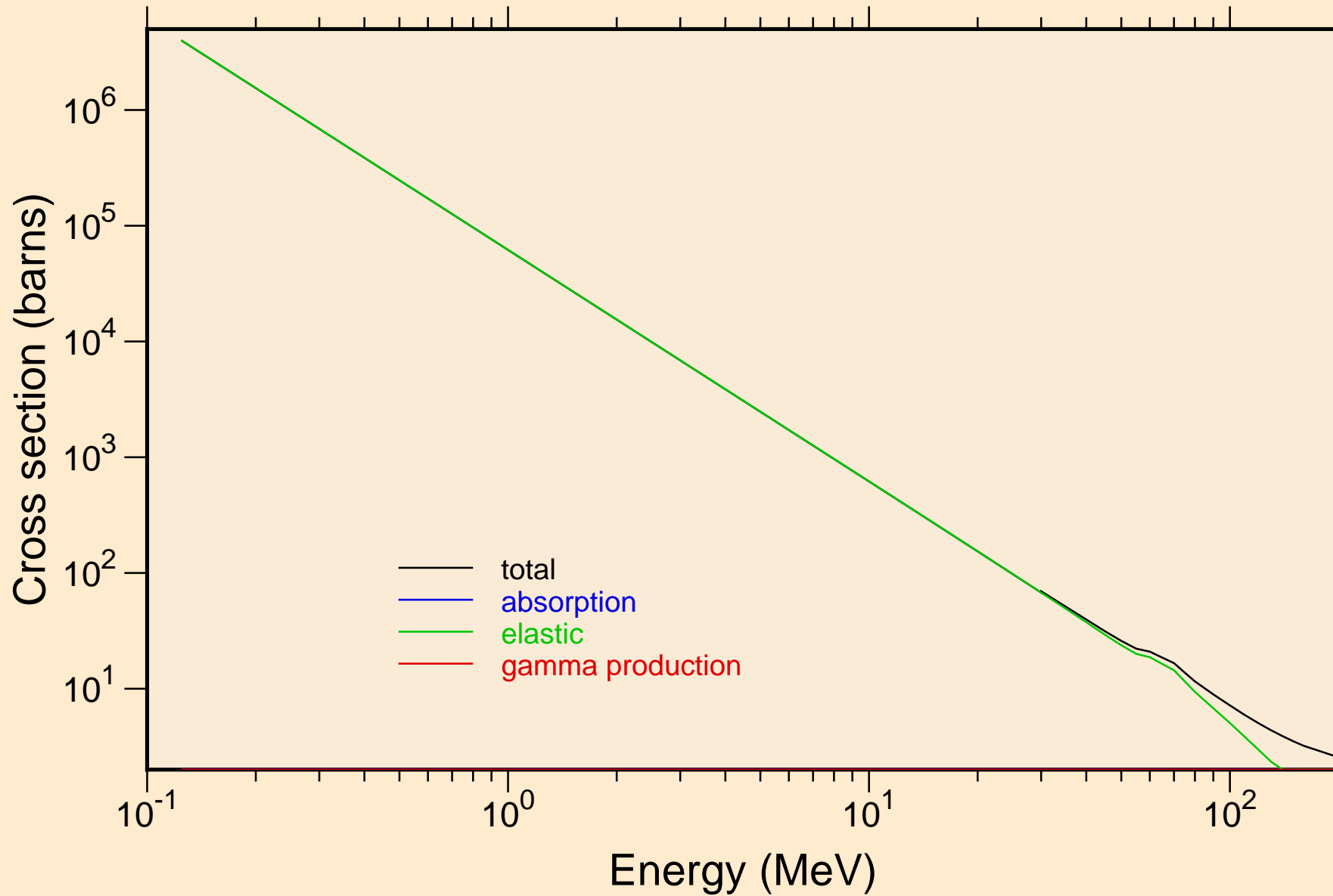

FM260 PROTON ACER TENDL-2021 LIBRARY; T=0.K

Heating

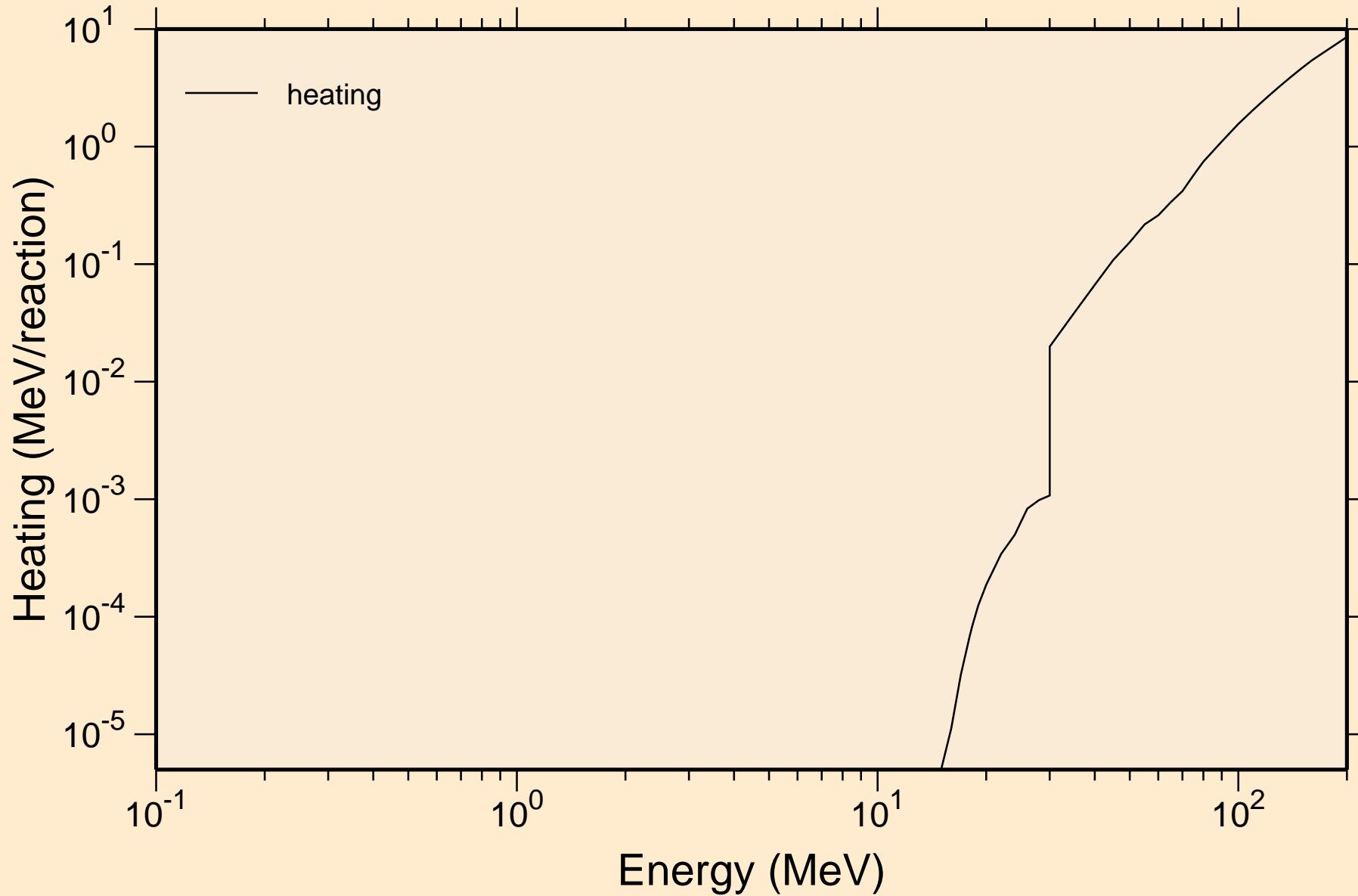

FM260 PROTON ACER TENDL-2021 LIBRARY; T=0.K
Principal cross sections

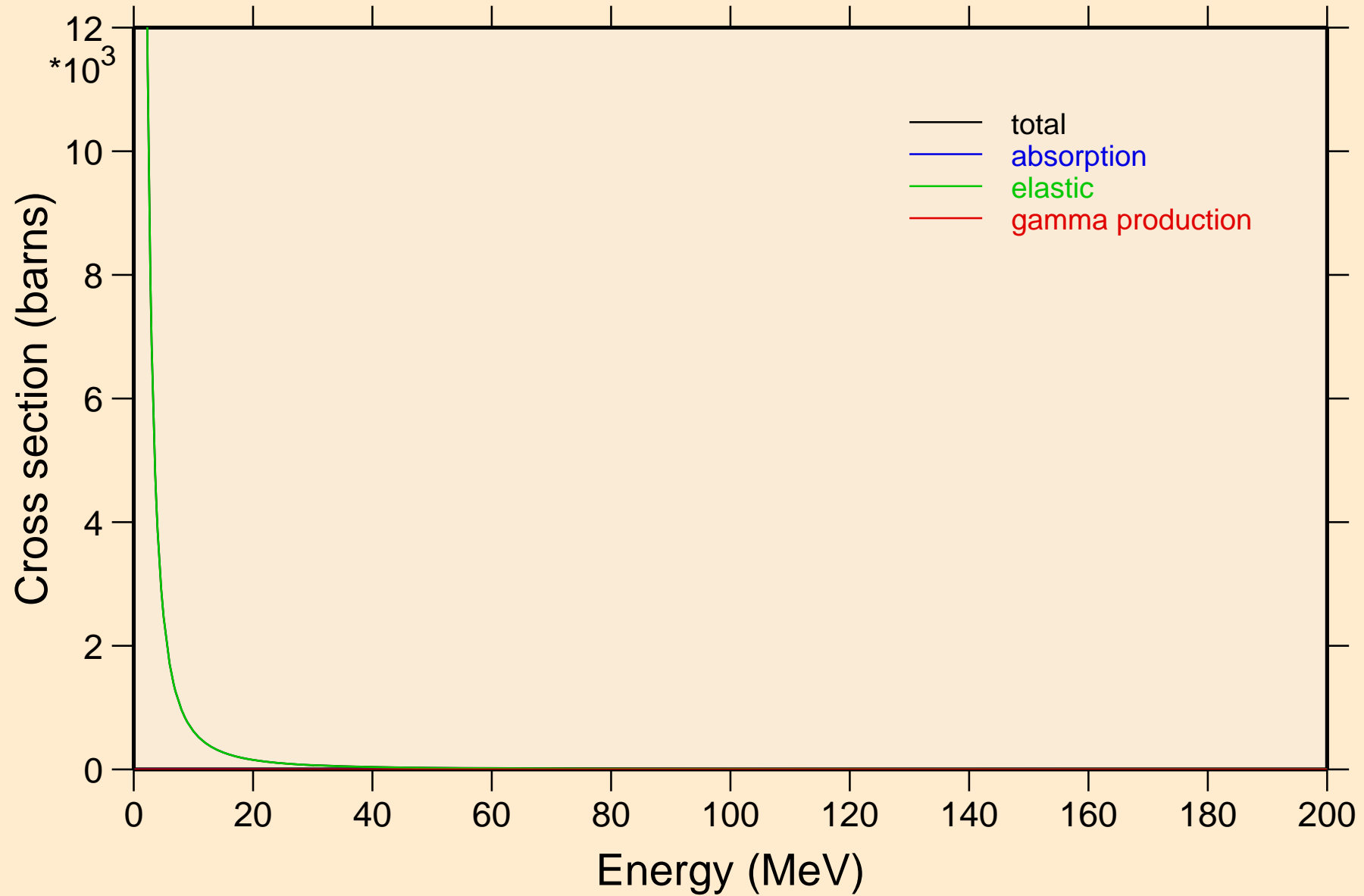

FM260 PROTON ACER TENDL-2021 LIBRARY; T=0.K

Heating

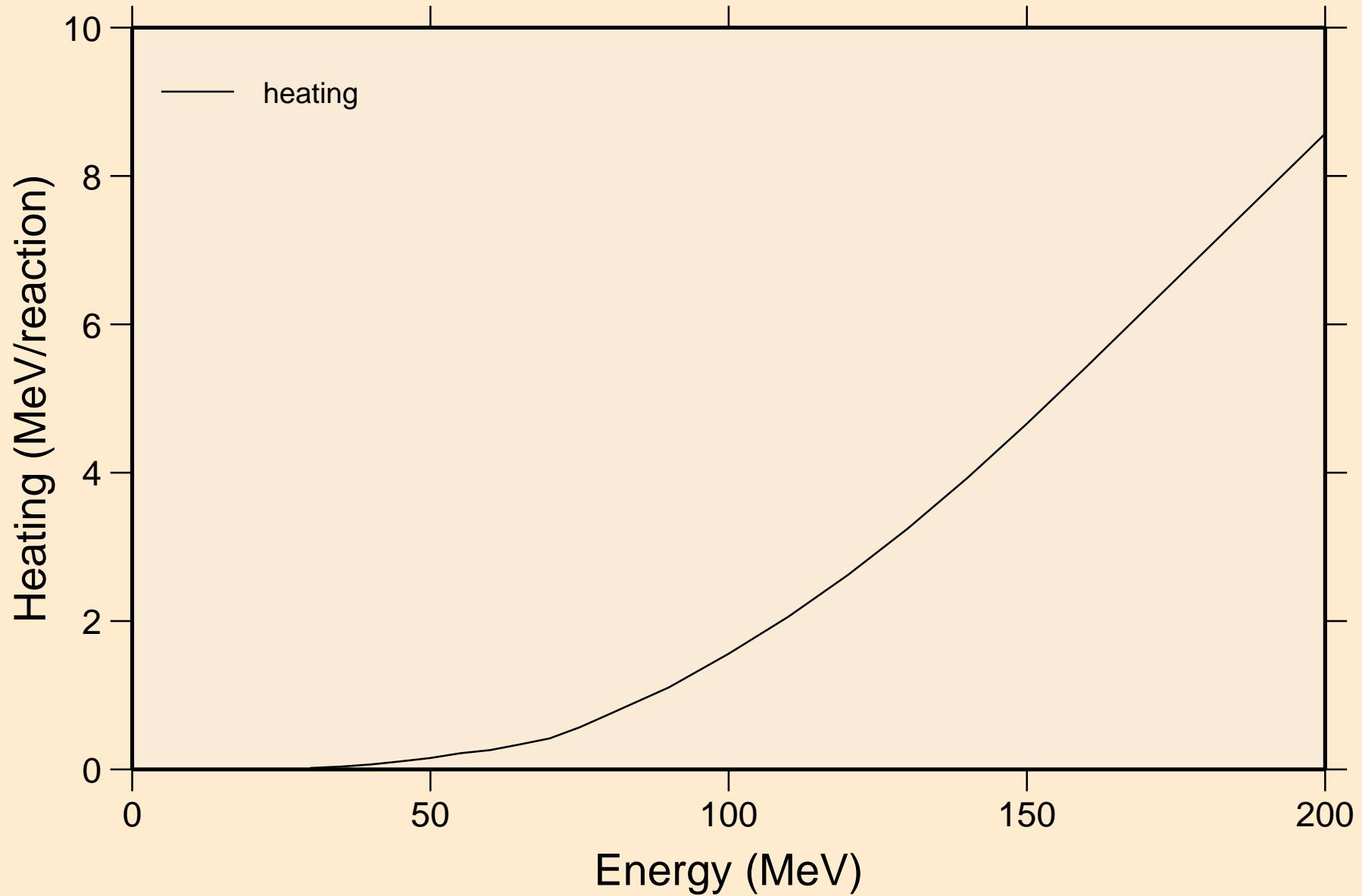

FM260 PROTON ACER TENDL-2021 LIBRARY; T=0.K

Threshold reactions

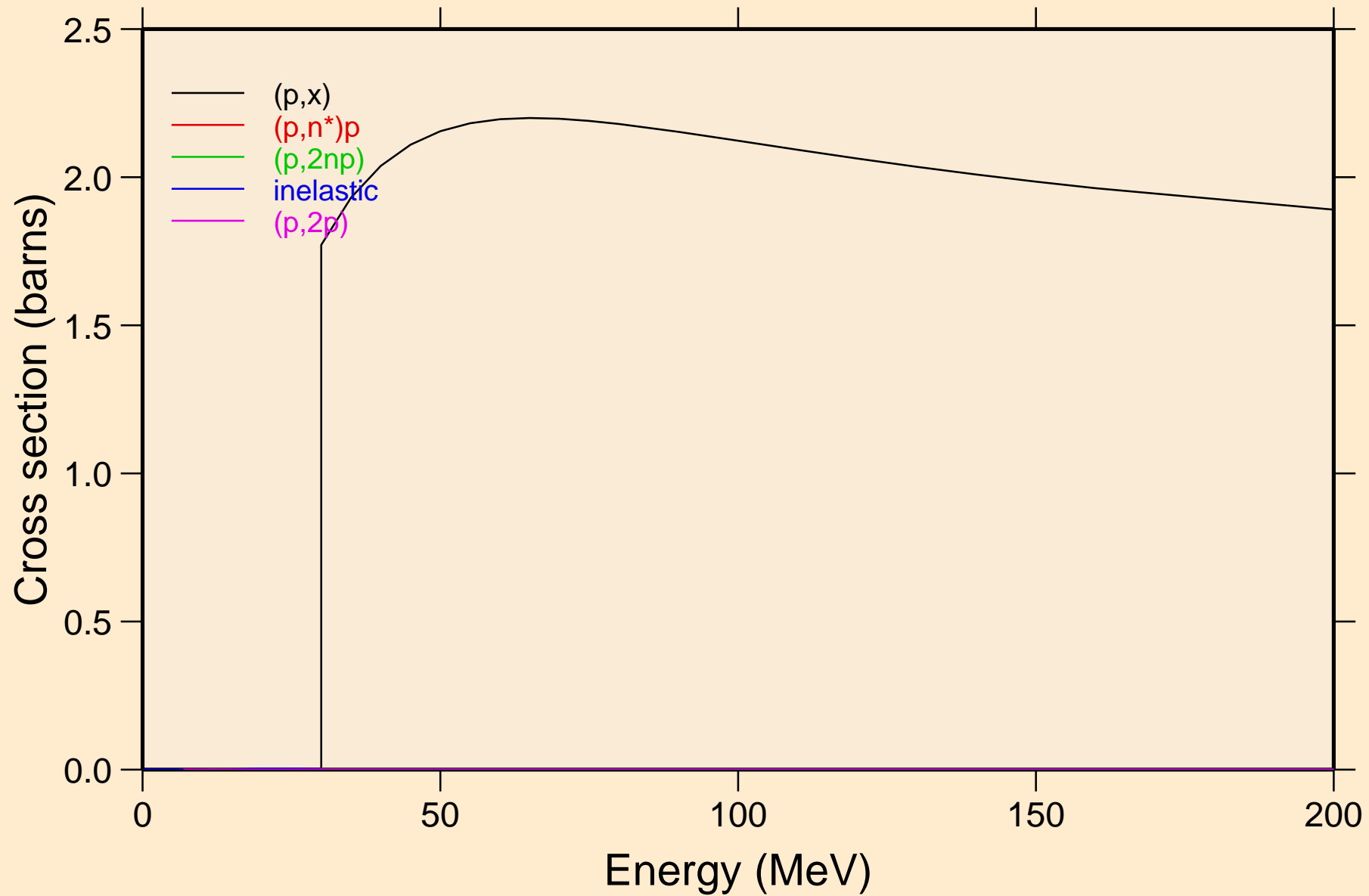

FM260 PROTON ACER TENDL-2021 LIBRARY; T=0.K
angular distribution for elastic

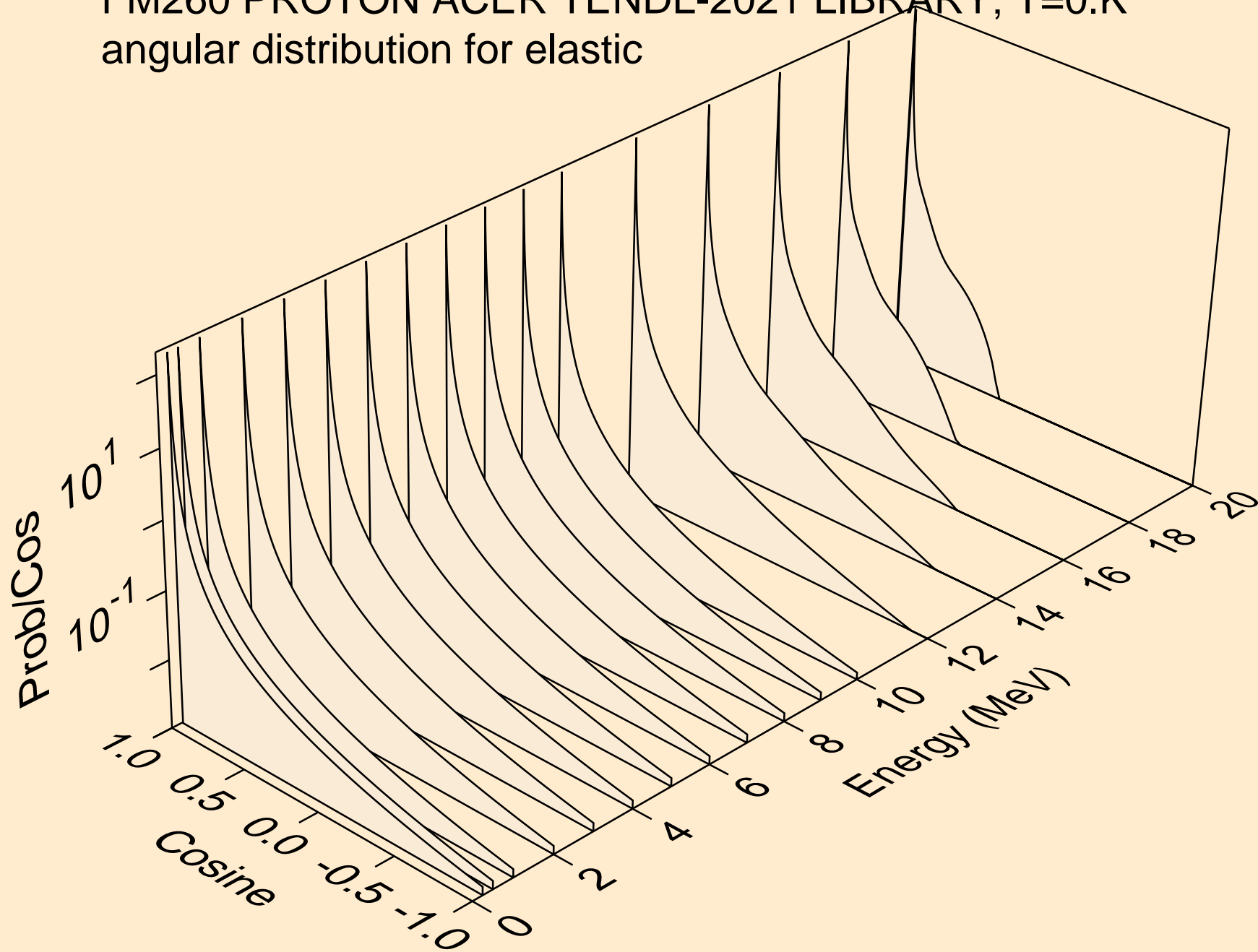

FM260 PROTON ACER TENDL-2021 LIBRARY; T=0.K
angular distribution for elastic

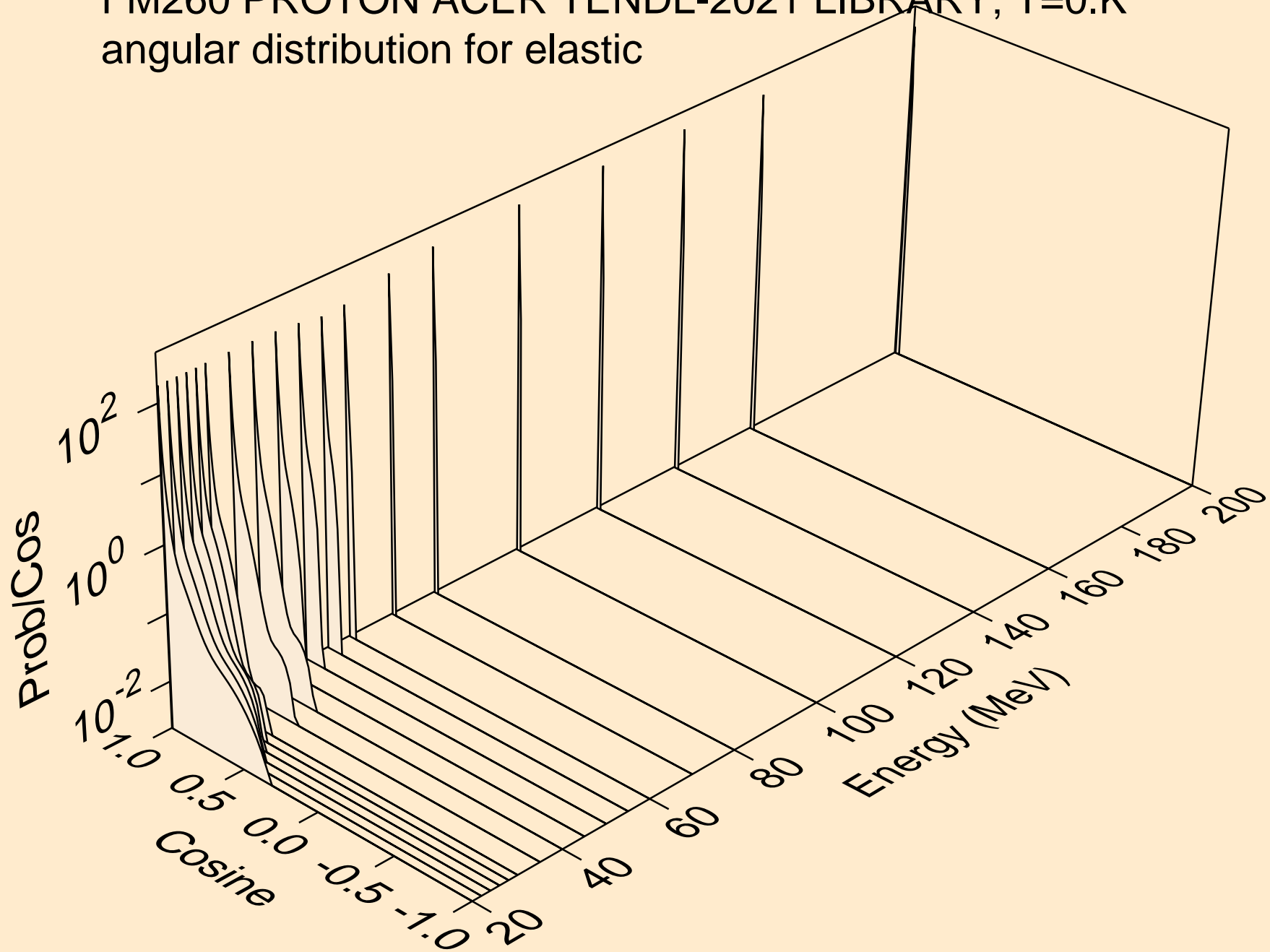

FM260 PROTON ACER TENDL-2021 LIBRARY; T=0.K
Proton emission for (p,x)

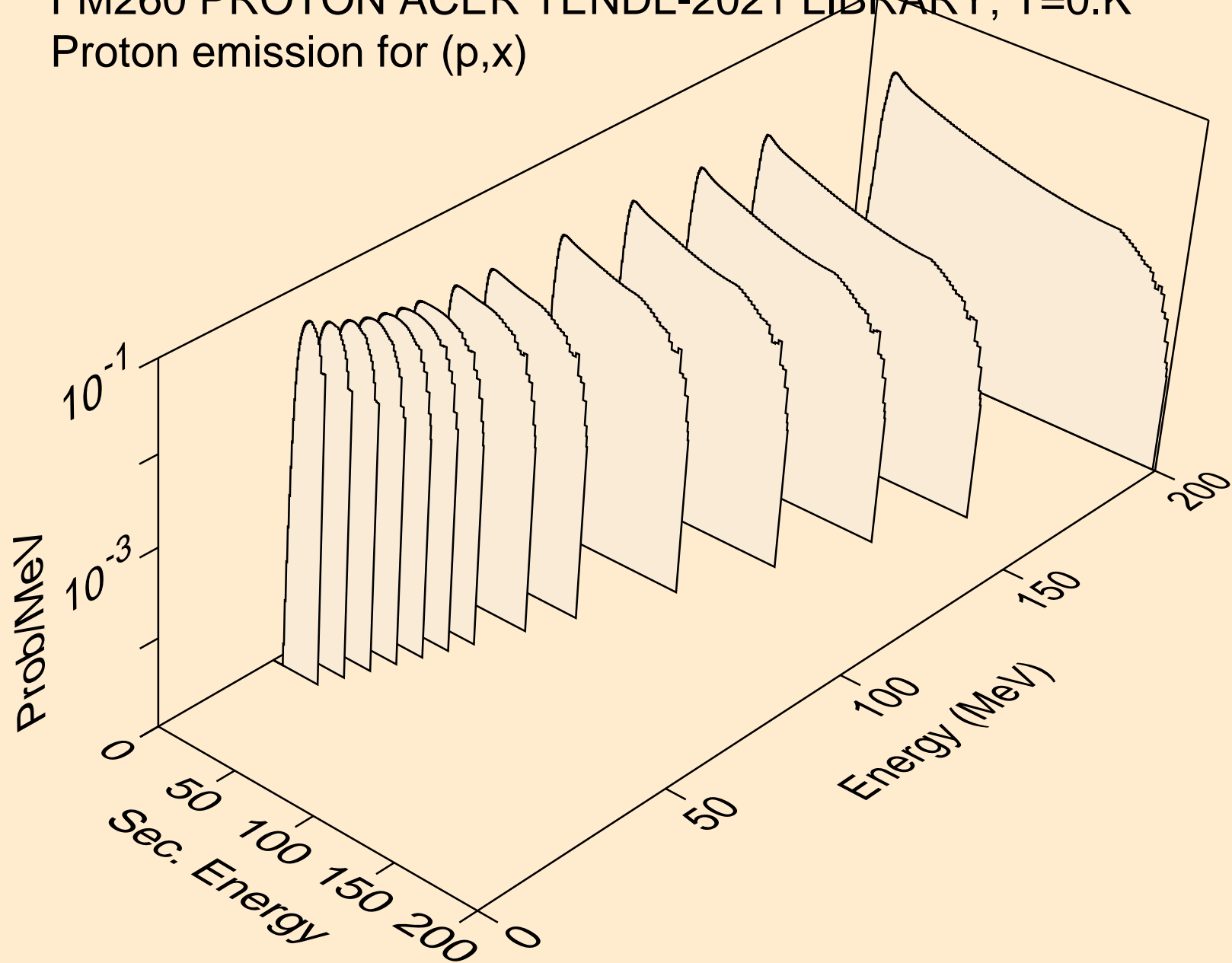

FM260 PROTON ACER TENDL-2021 LIBRARY; T=0.K
Proton emission for (p,n*)p

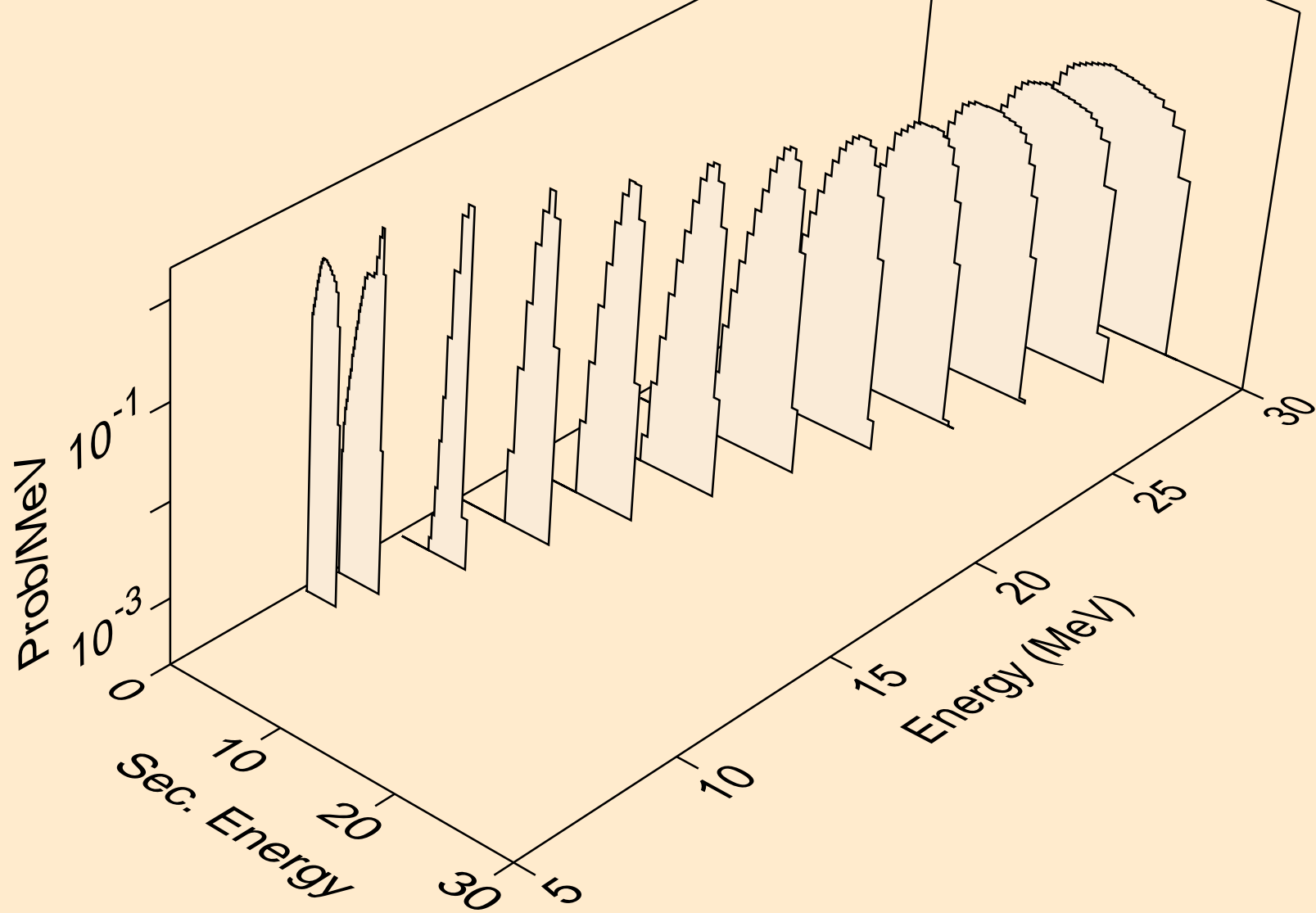

FM260 PROTON ACER TENDL-2021 LIBRARY; T=0.K
Proton emission for (p,2np)

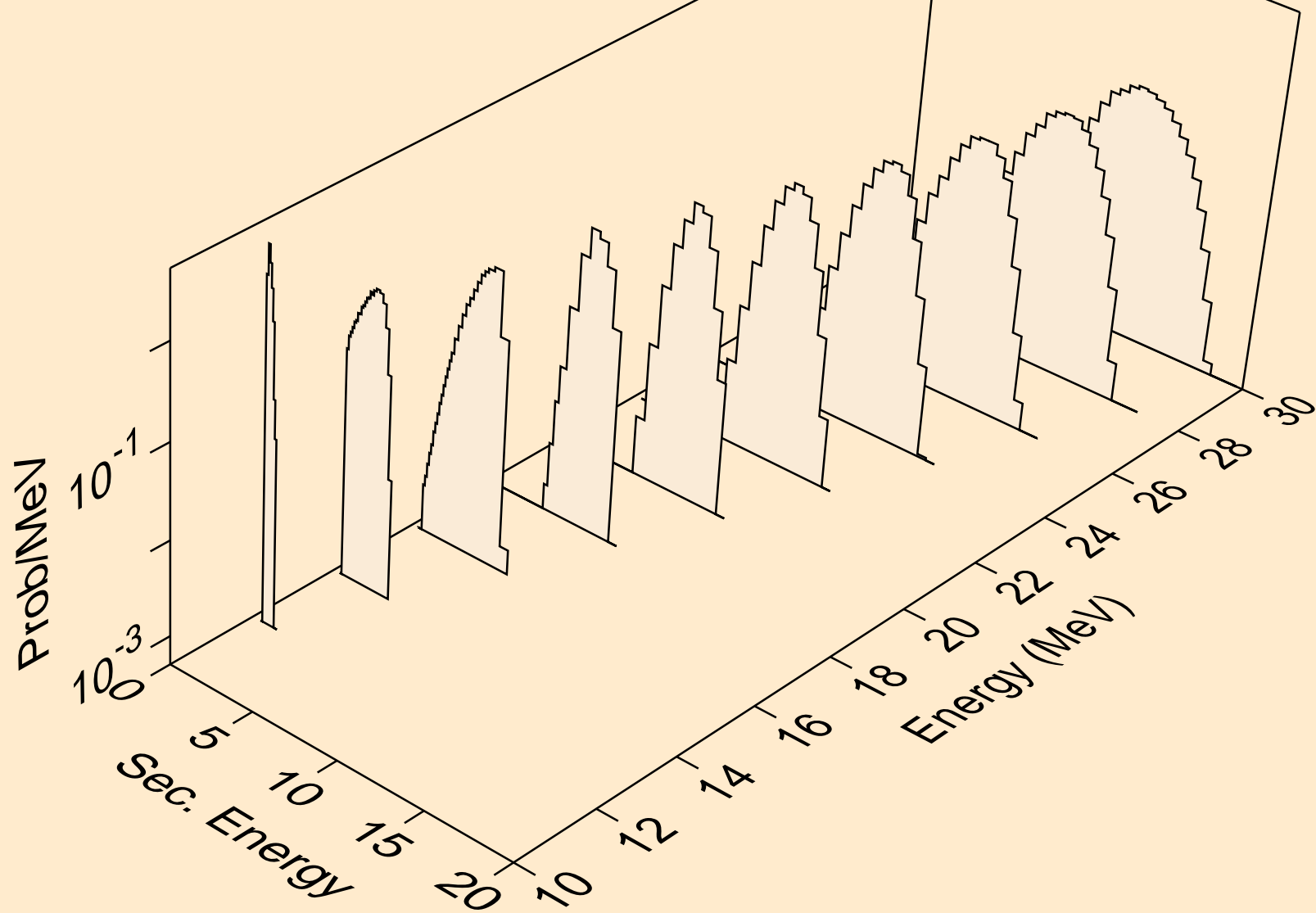

FM260 PROTON ACER TENDL-2021 LIBRARY; T=0.K
Proton emission for inelastic

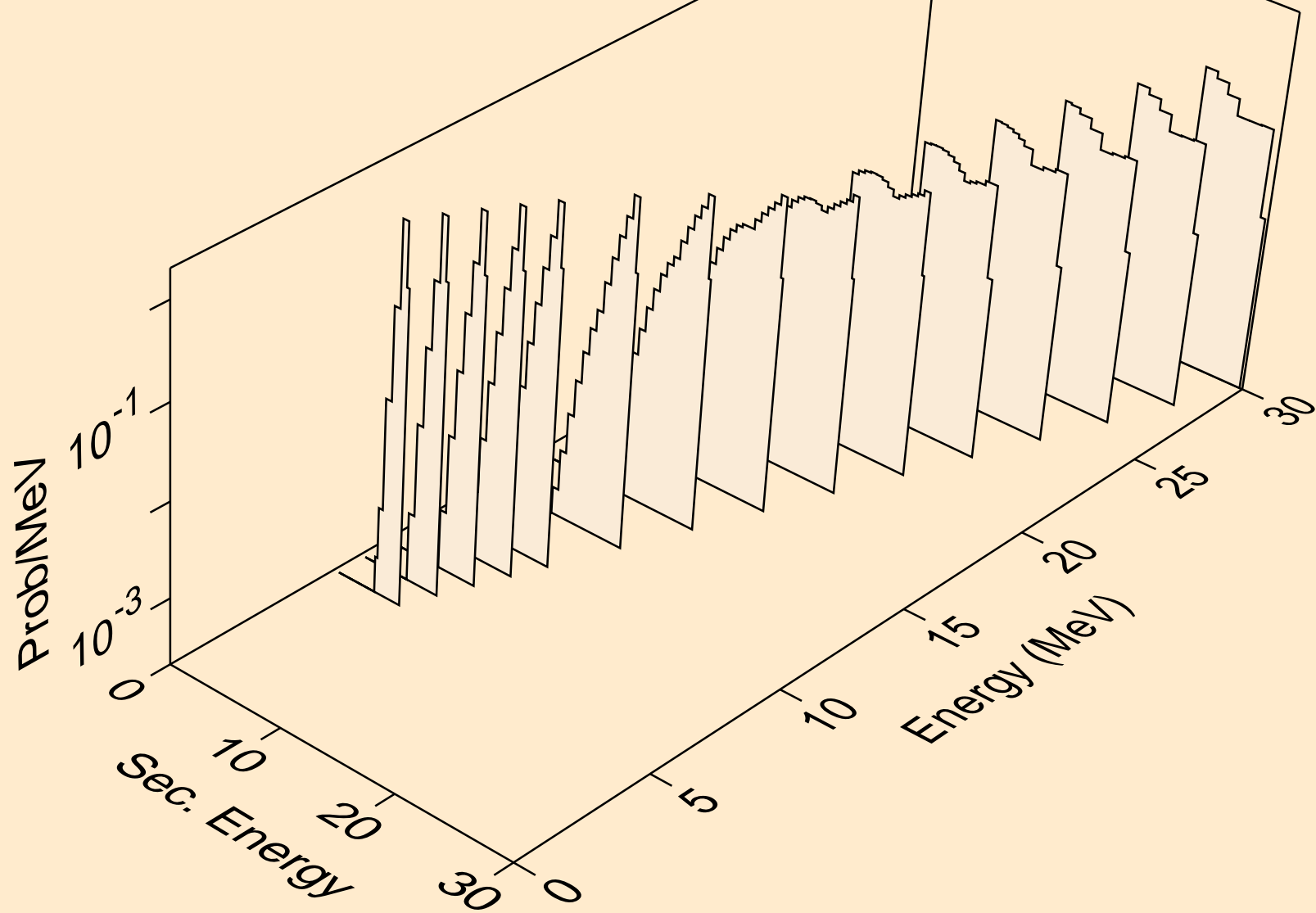

FM260 PROTON ACER TENDL-2021 LIBRARY; T=0.K
Proton emission for (p,2p)

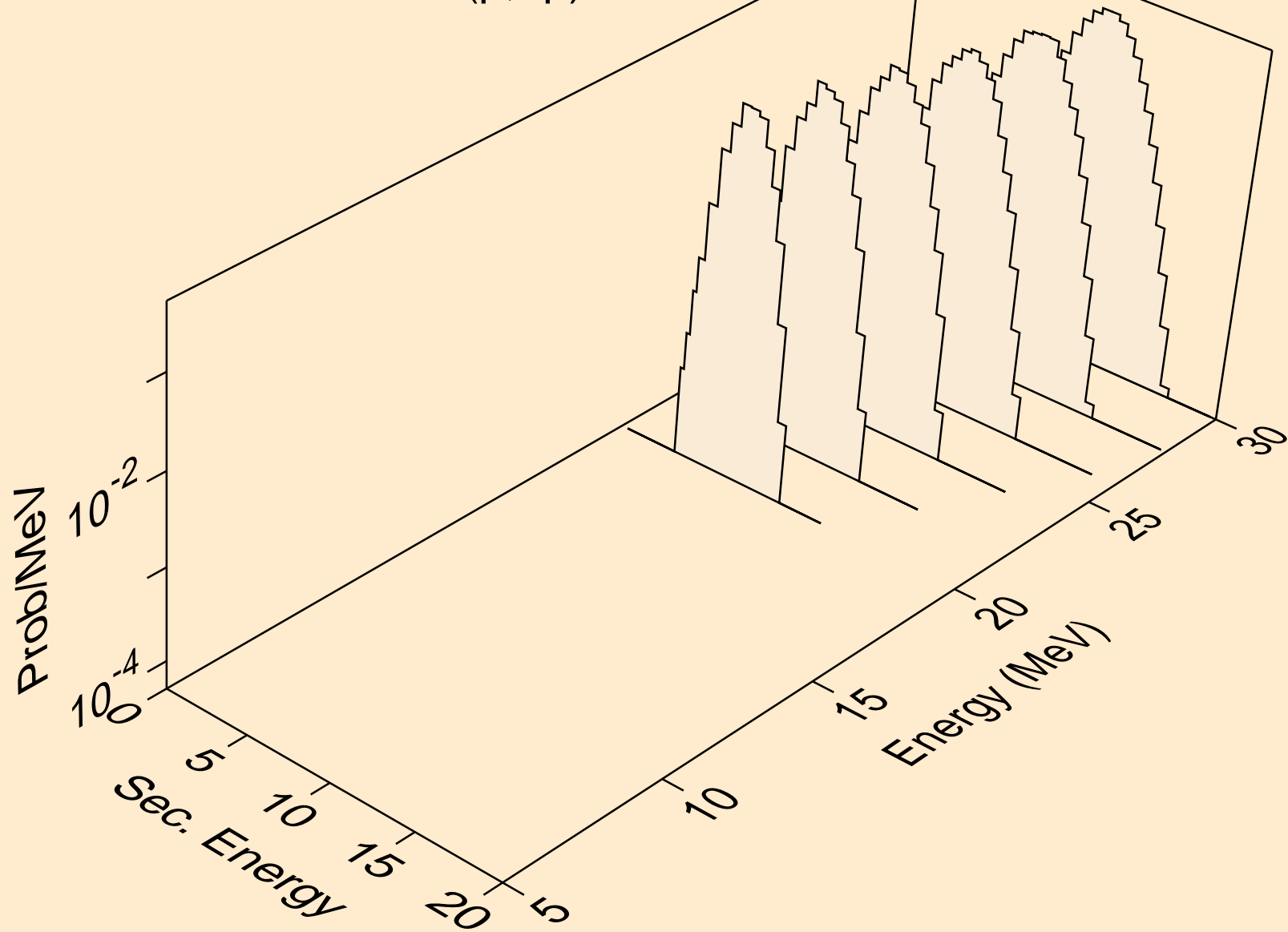

FM260 PROTON ACER TENDL-2021 LIBRARY; T=0.K
Photon emission for (z,n)

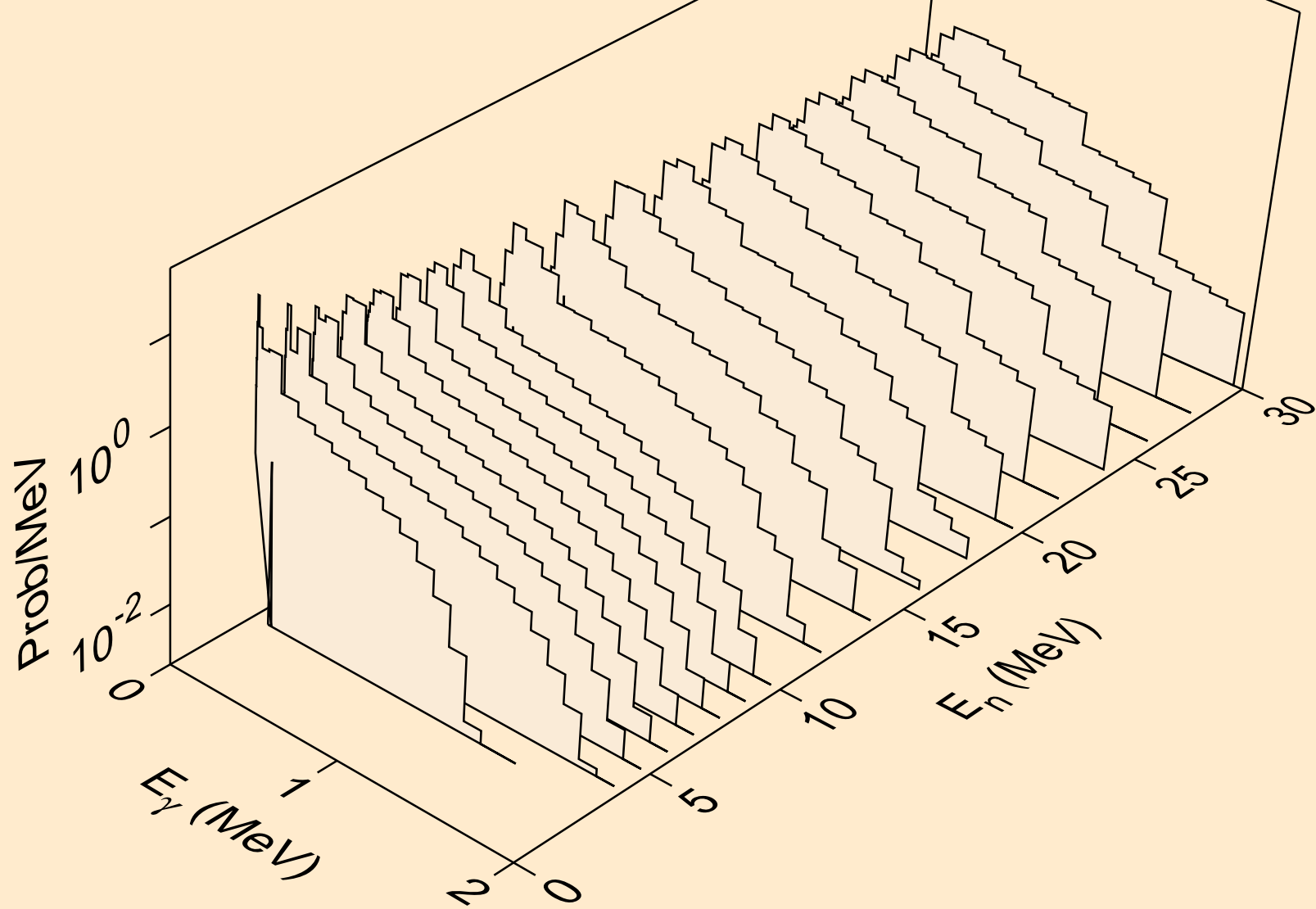

FM260 PROTON ACER TENDL-2021 LIBRARY; T=0.K
Photon emission for (n,x)

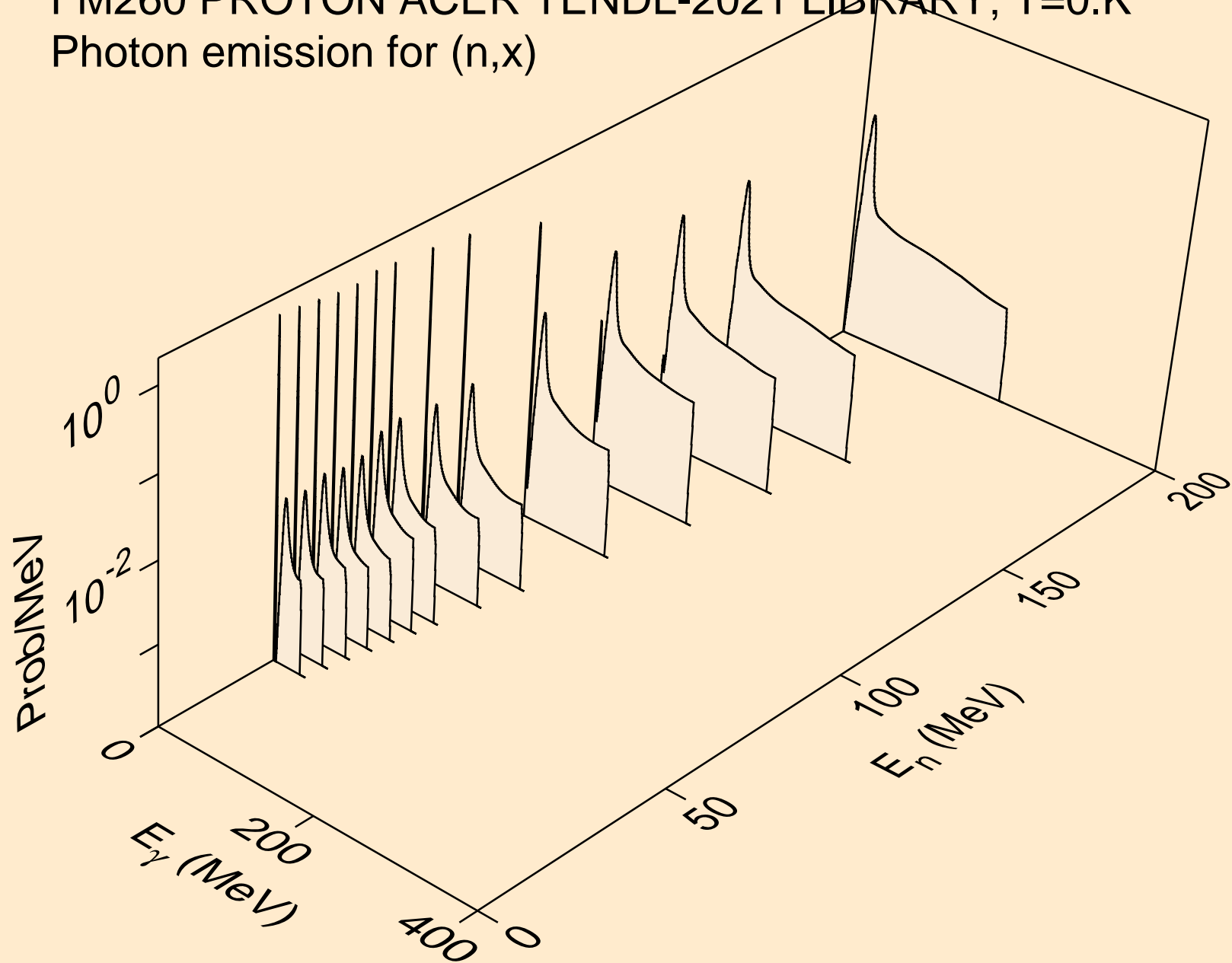

FM260 PROTON ACER TENDL-2021 LIBRARY; T=0.K
Photon emission for (n,2n)

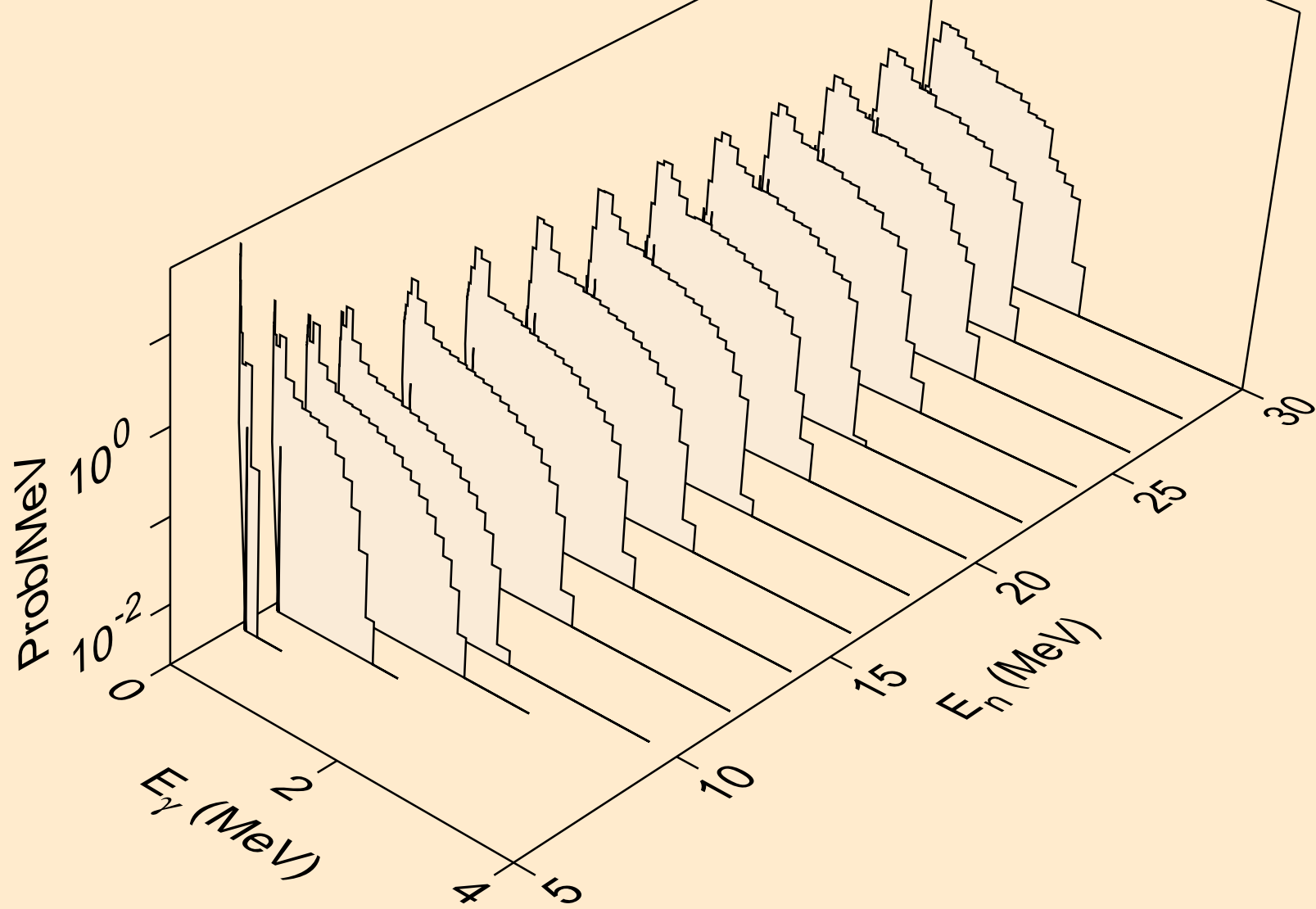

FM260 PROTON ACER TENDL-2021 LIBRARY; T=0.K
Photon emission for (n,3n)

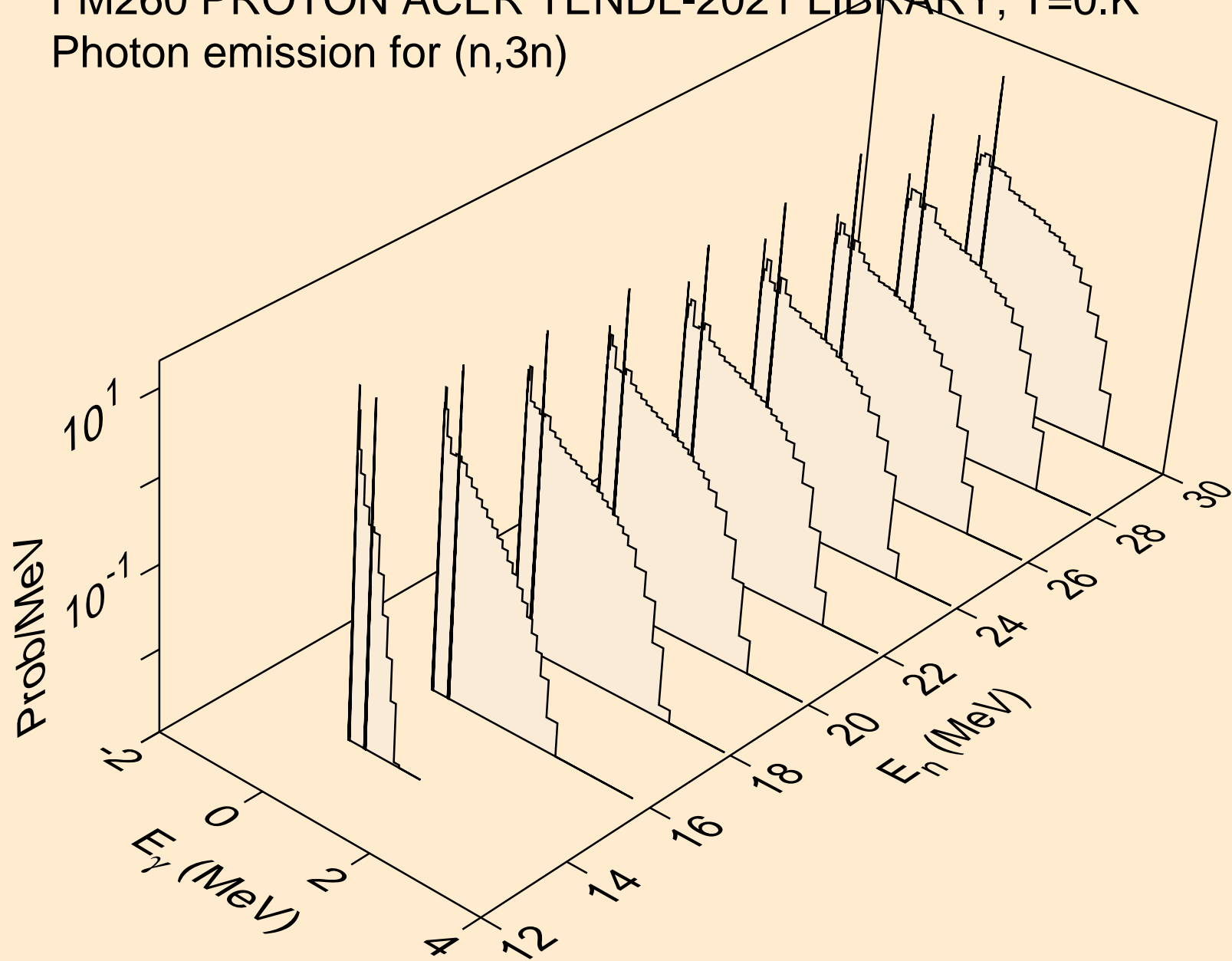

FM260 PROTON ACER TENDL-2021 LIBRARY; T=0.K
Photon emission for (n,n*)a

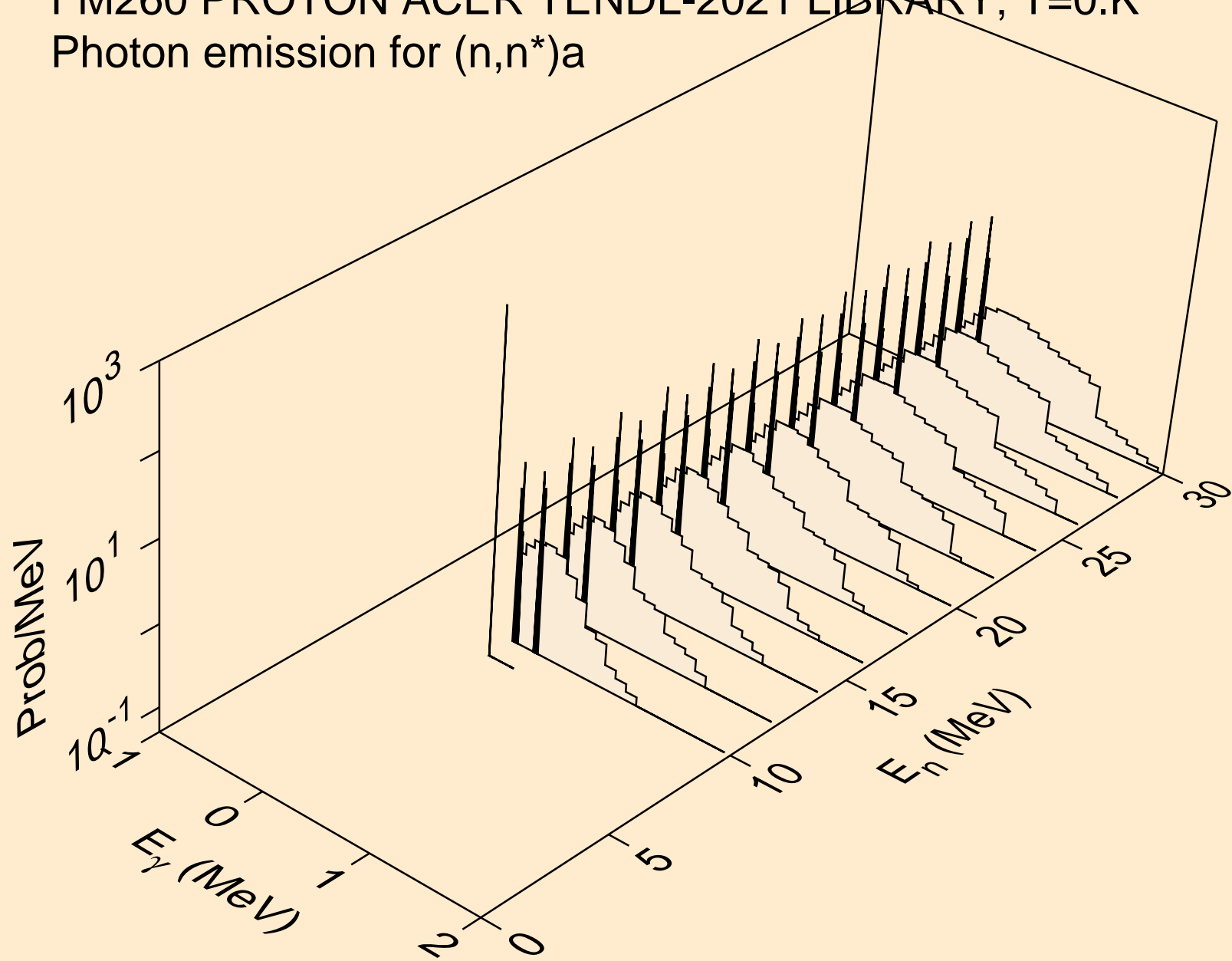

FM260 PROTON ACER TENDL-2021 LIBRARY; T=0.K
Photon emission for (n,n*)p

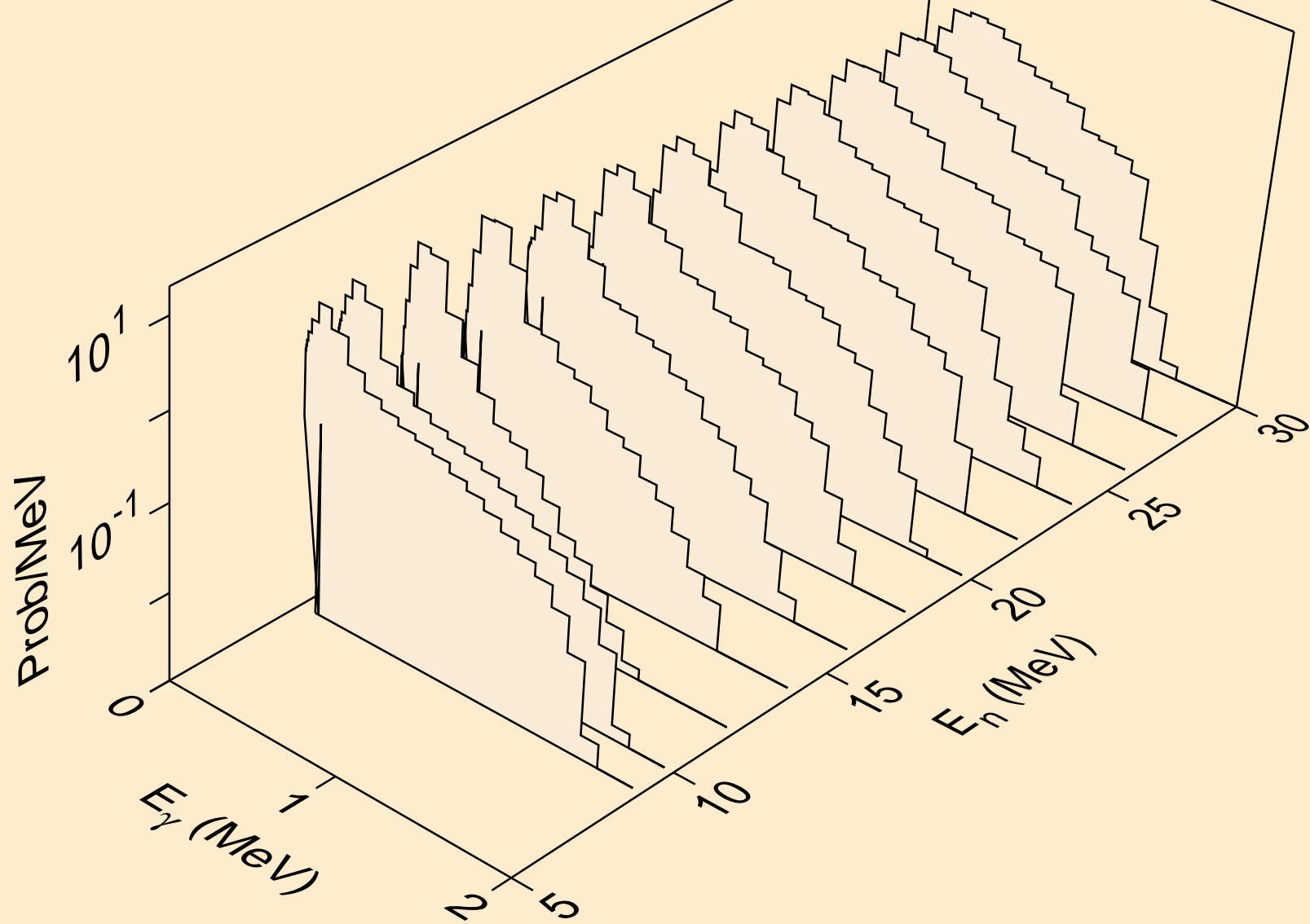

FM260 PROTON ACER TENDL-2021 LIBRARY; T=0.K
Photon emission for (n,n*)d

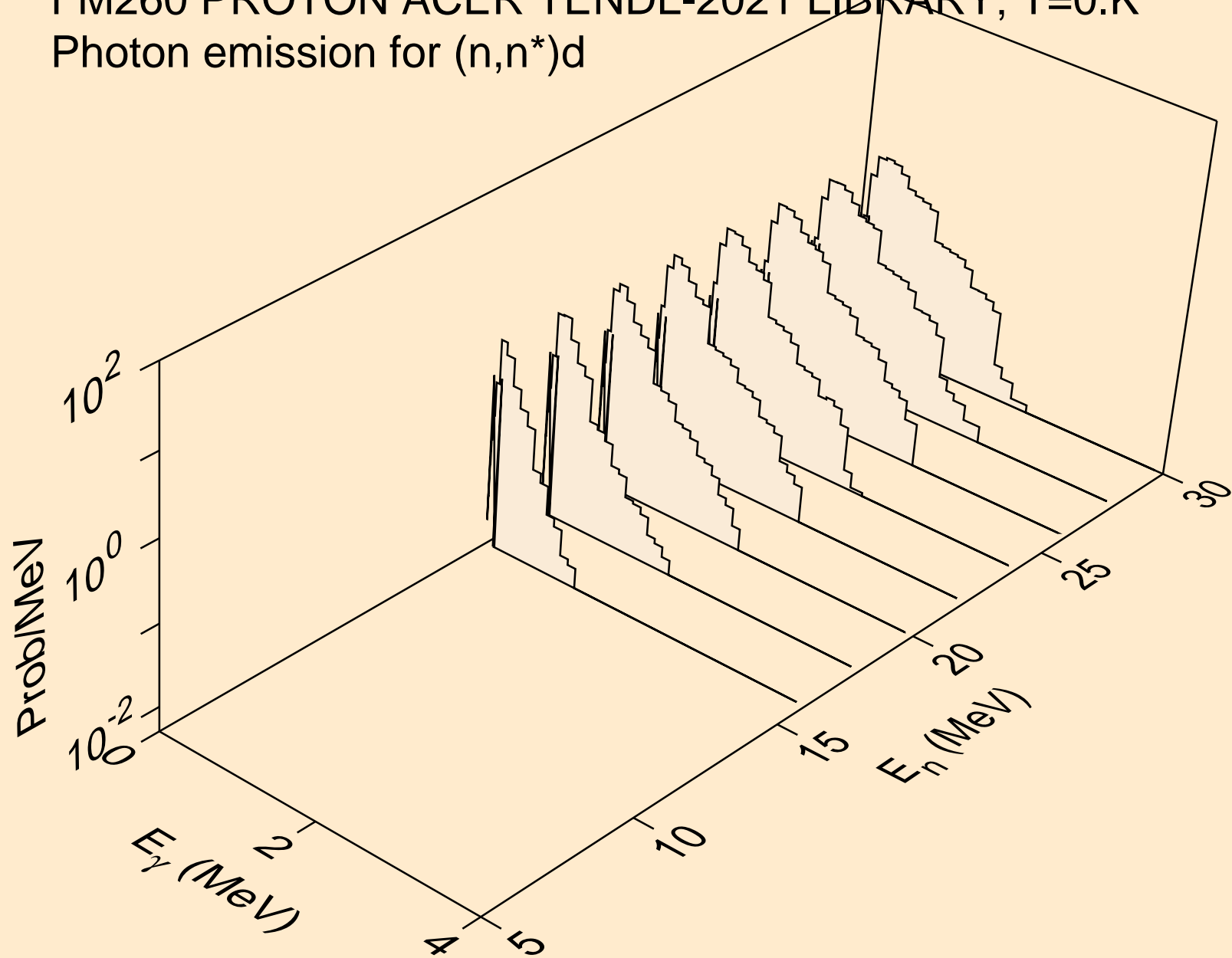

FM260 PROTON ACER TENDL-2021 LIBRARY; T=0.K
Photon emission for (n,n*)t

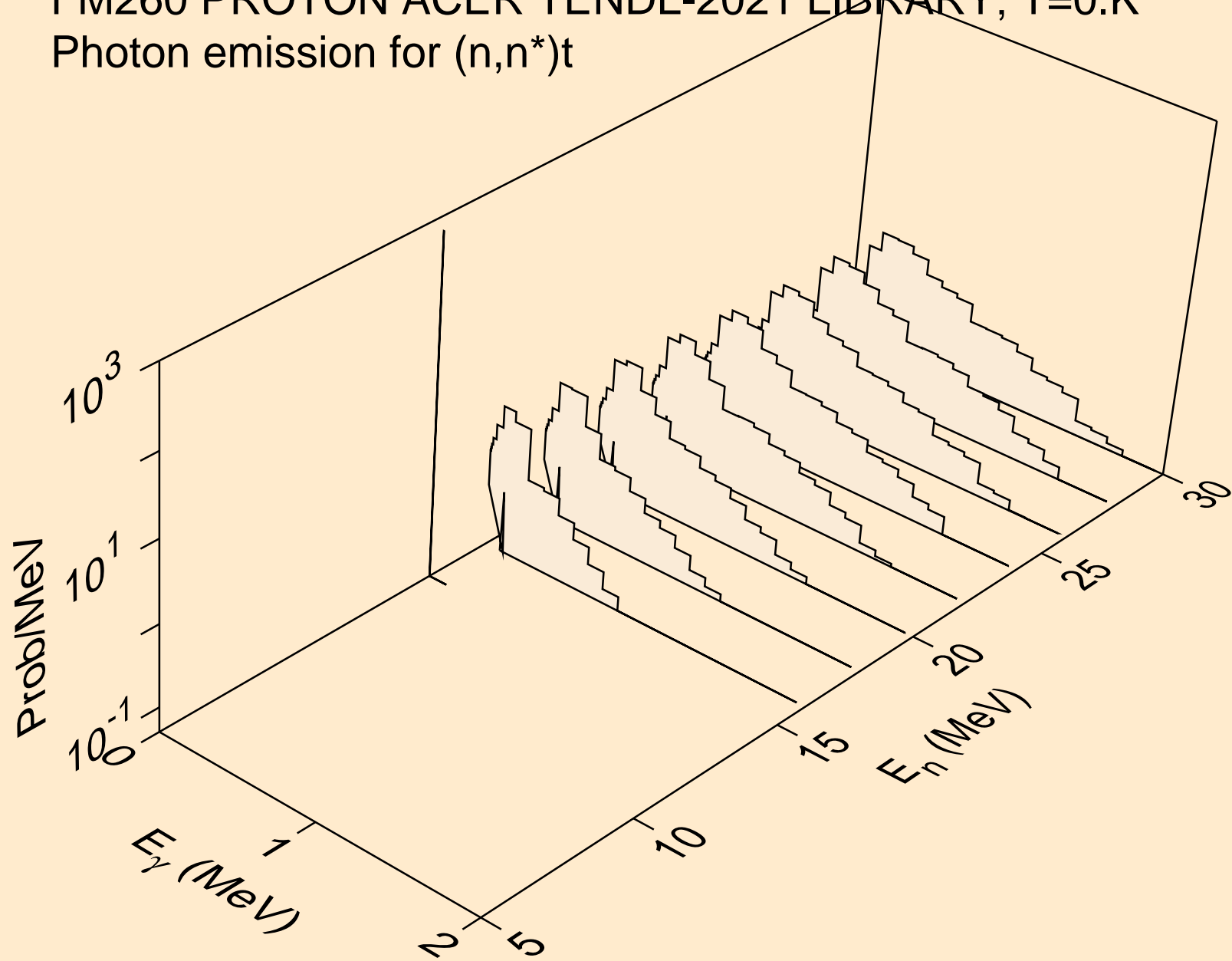

FM260 PROTON ACER TENDL-2021 LIBRARY; T=0.K
Photon emission for (n,4n)

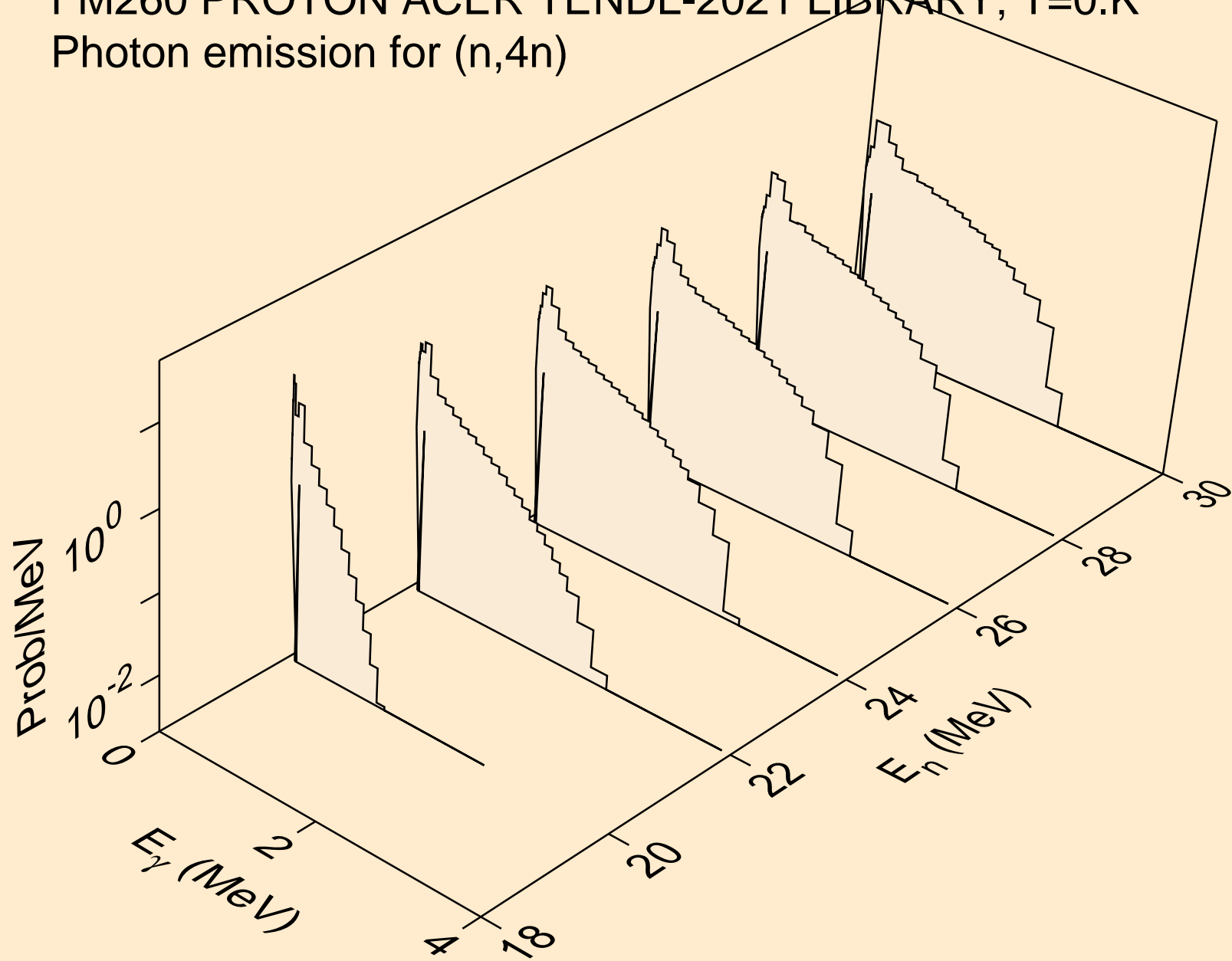

FM260 PROTON ACER TENDL-2021 LIBRARY; T=0.K
Photon emission for (n,2np)

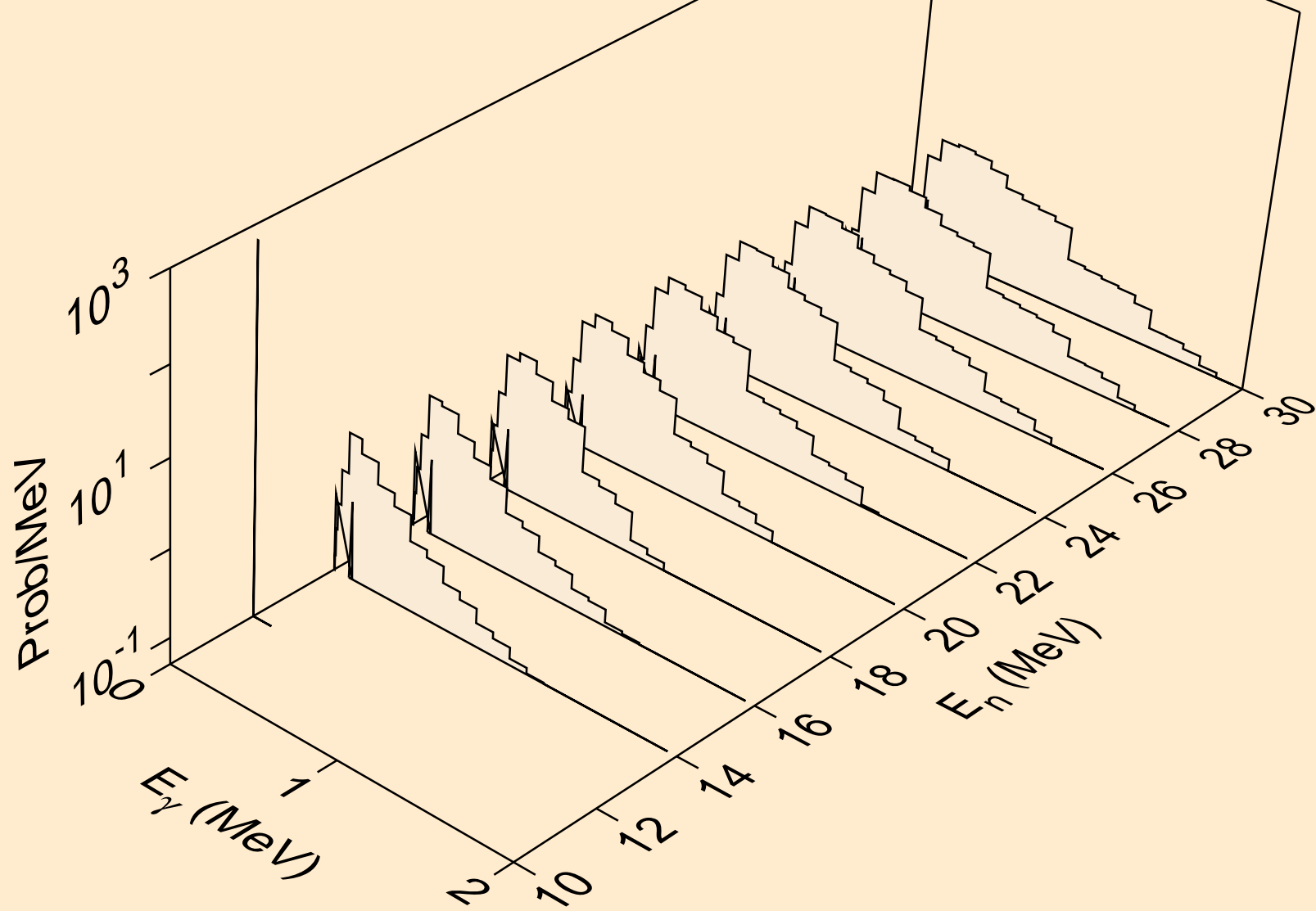

FM260 PROTON ACER TENDL-2021 LIBRARY; T=0.K
Photon emission for (n,gma)

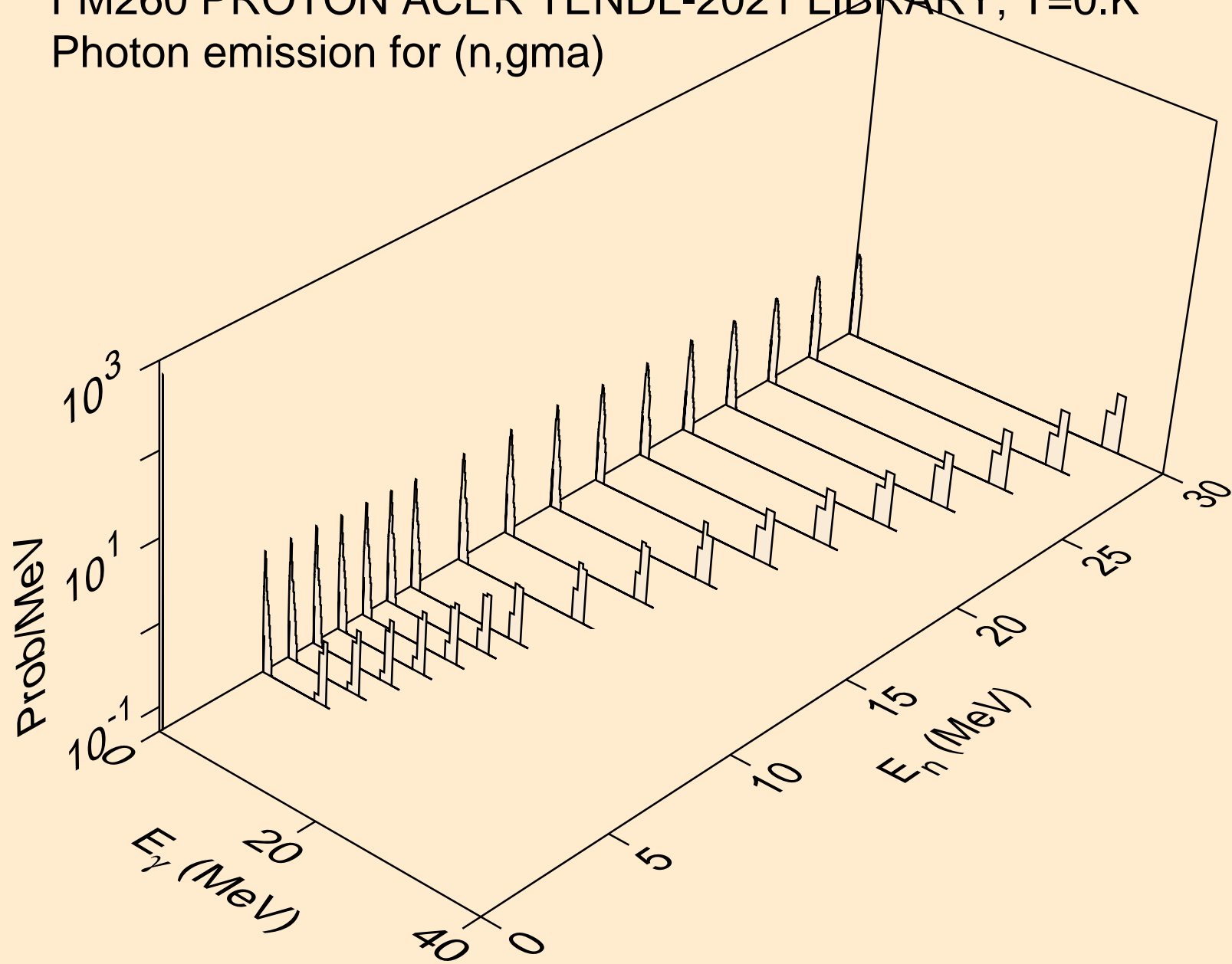

FM260 PROTON ACER TENDL-2021 LIBRARY; T=0.K
Photon emission for inelastic

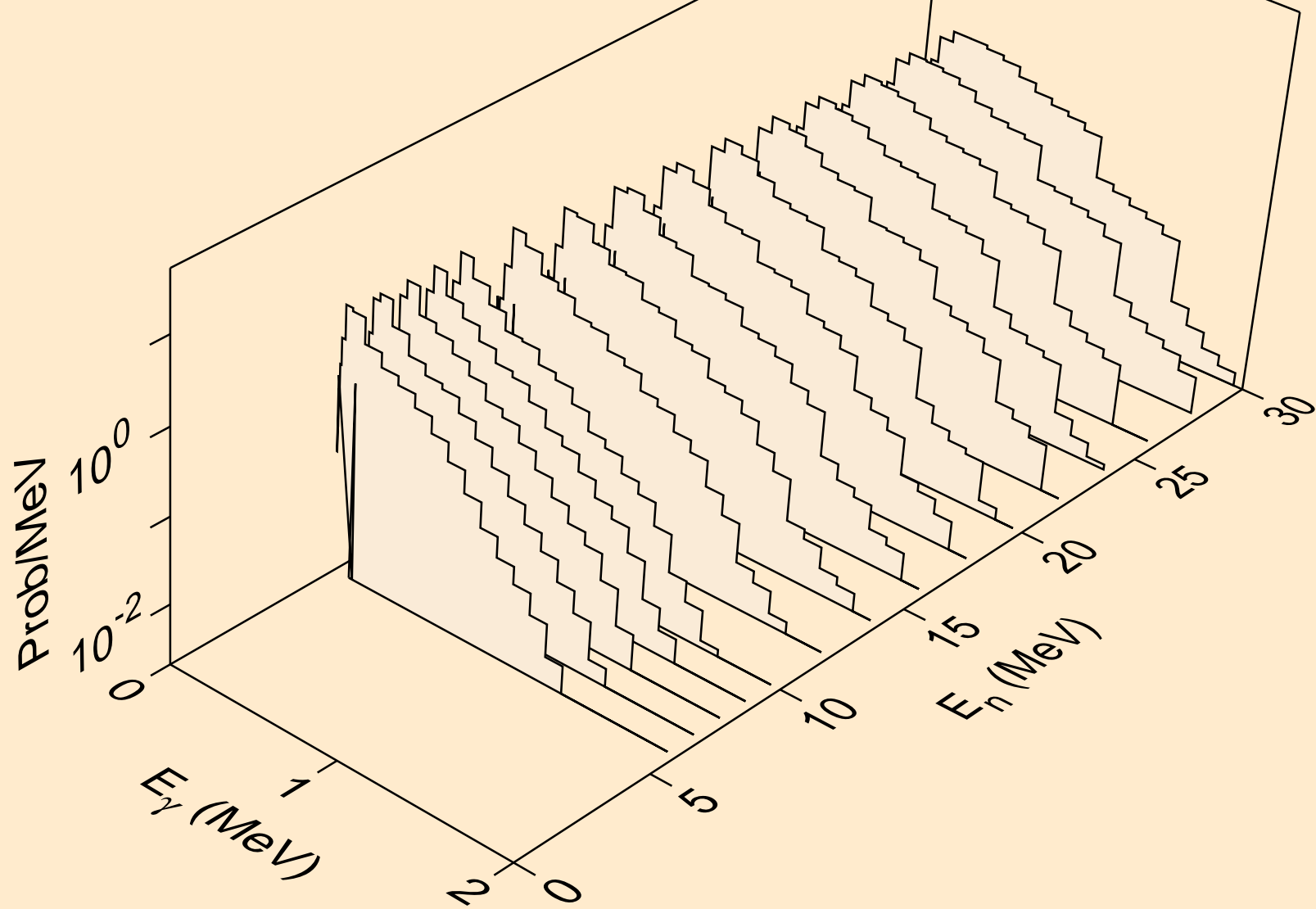

FM260 PROTON ACER TENDL-2021 LIBRARY; T=0.K
Photon emission for (n,d)

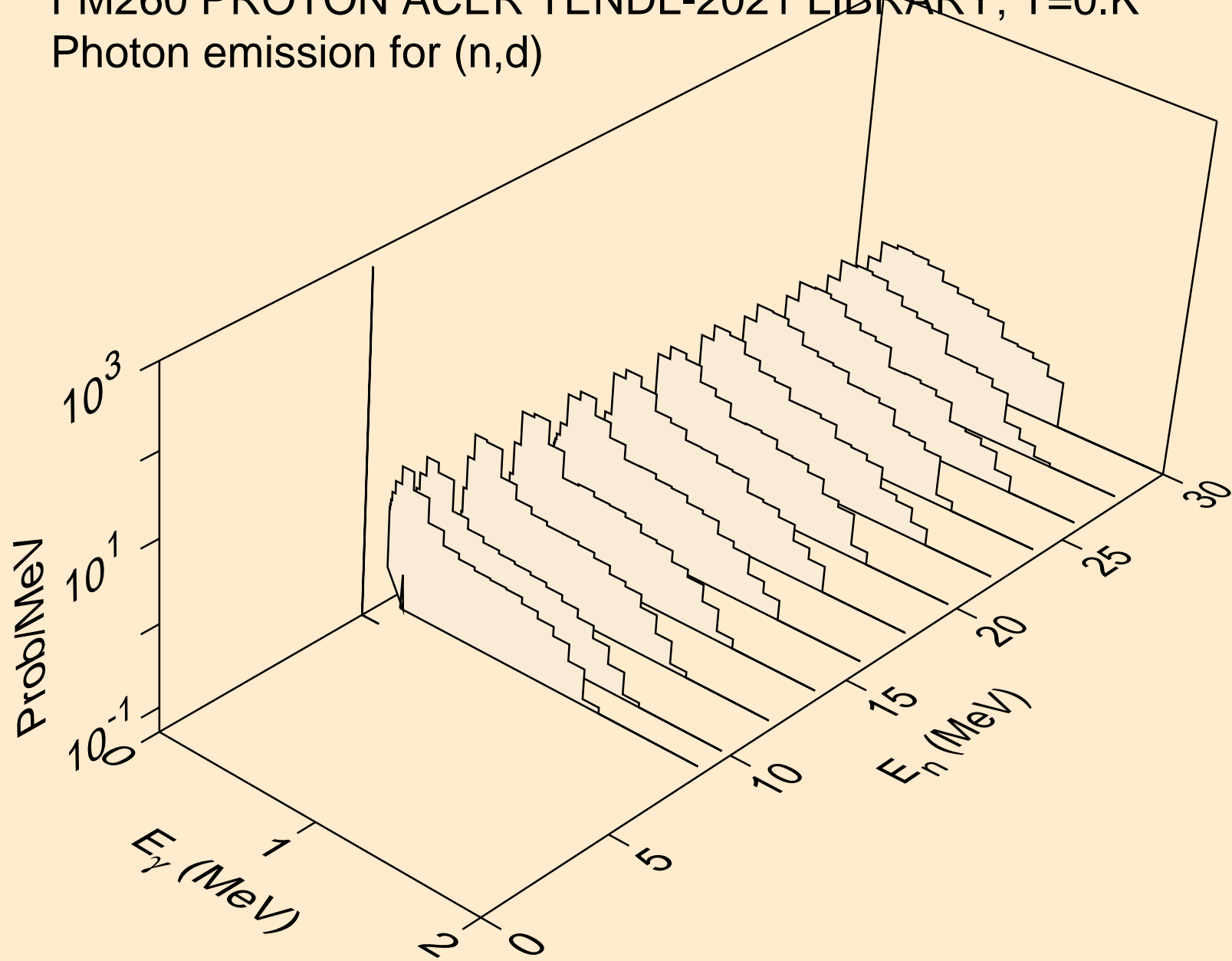

FM260 PROTON ACER TENDL-2021 LIBRARY; T=0.K
Photon emission for (n,t)

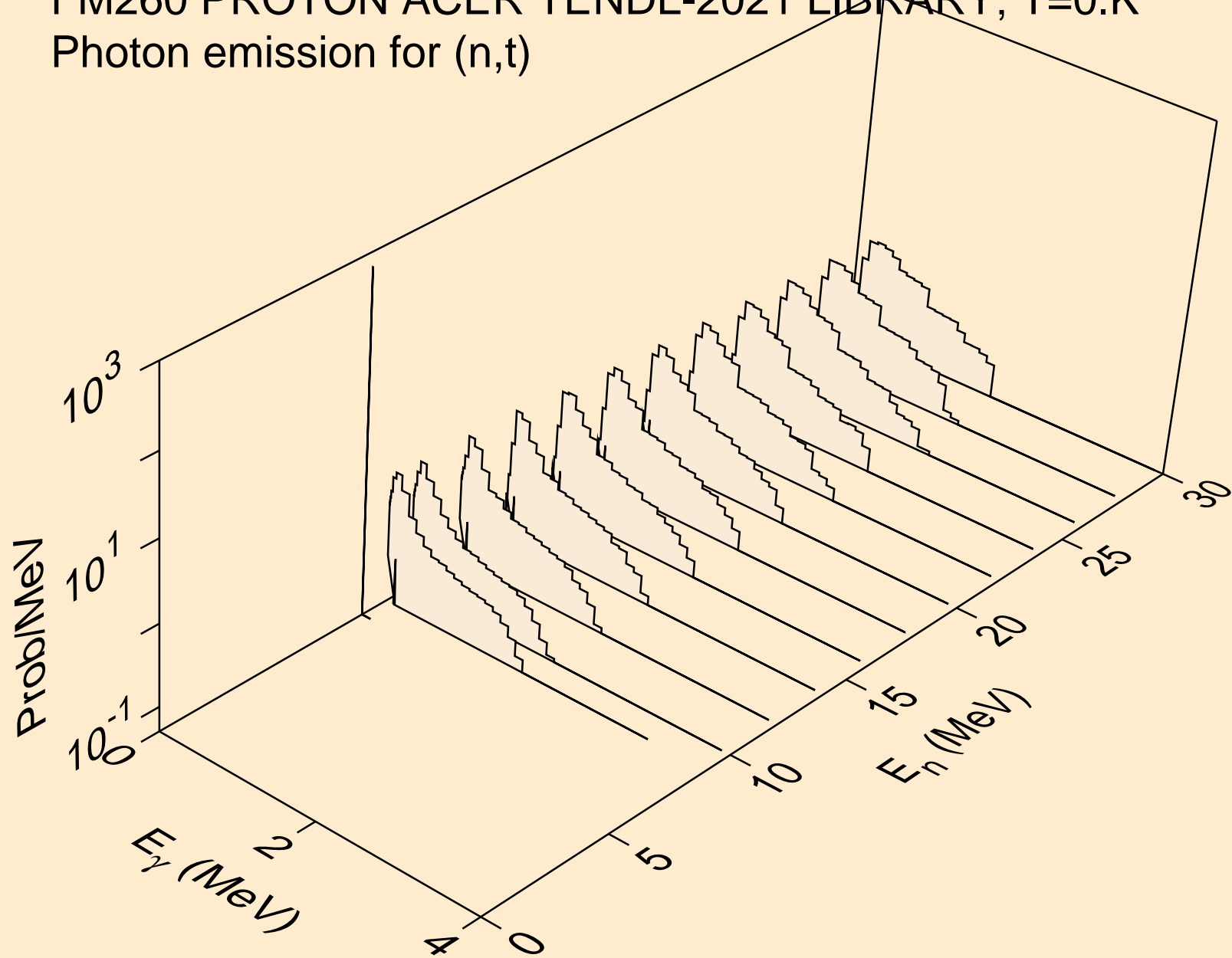

FM260 PROTON ACER TENDL-2021 LIBRARY; T=0.K
Photon emission for (n,he3)

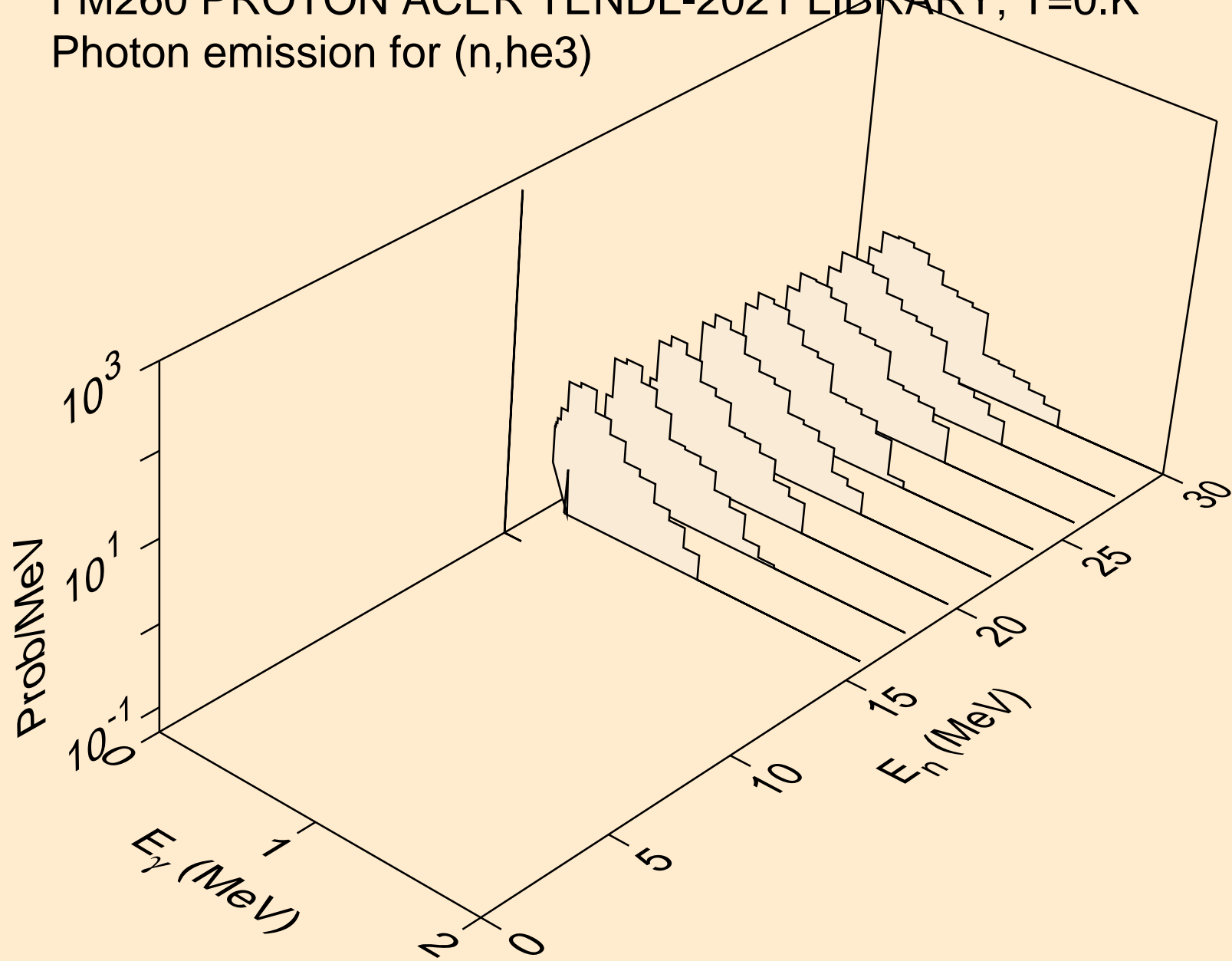

FM260 PROTON ACER TENDL-2021 LIBRARY; T=0.K
Photon emission for (n,a)

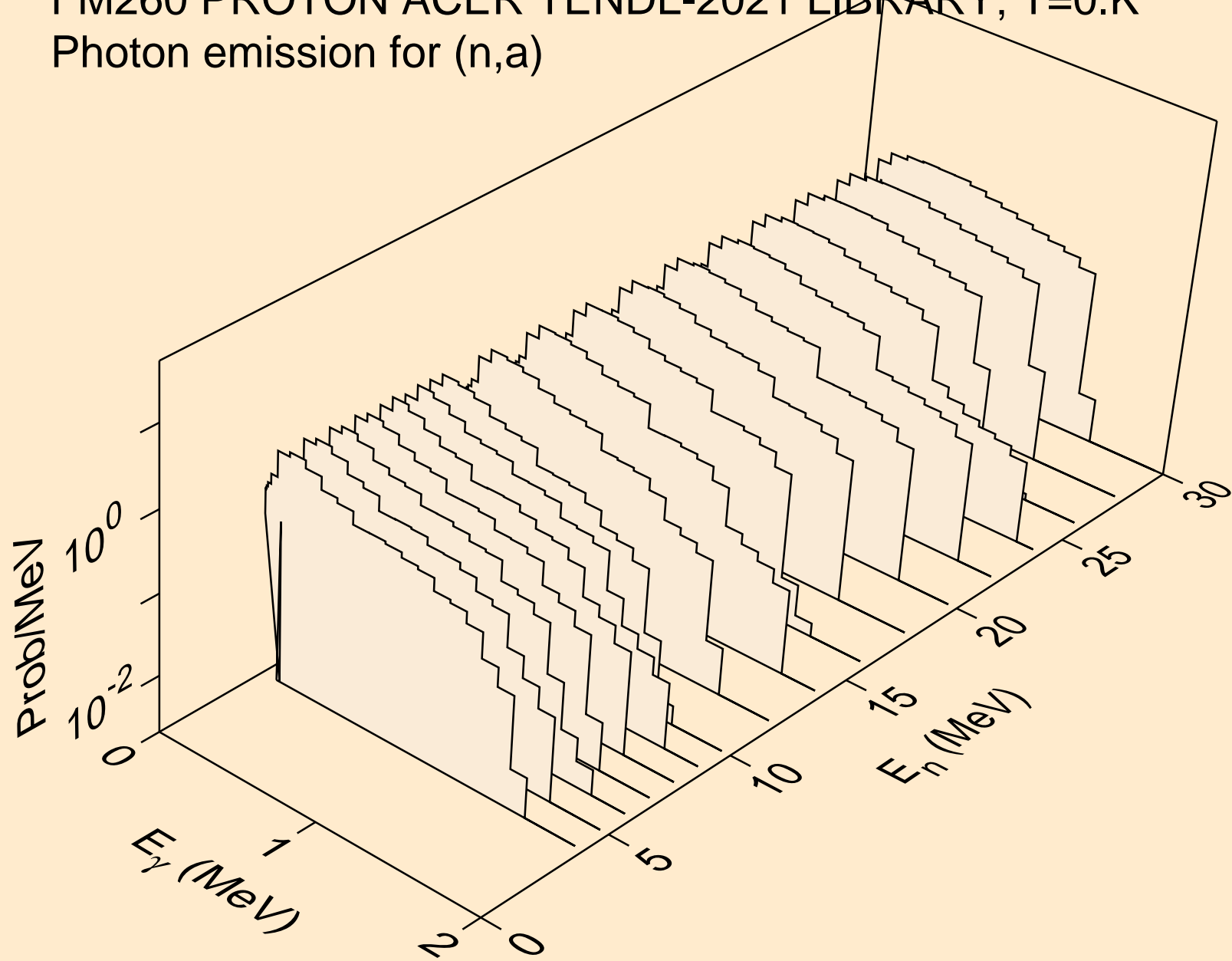

FM260 PROTON ACER TENDL-2021 LIBRARY; T=0.K
Photon emission for (n,2p)

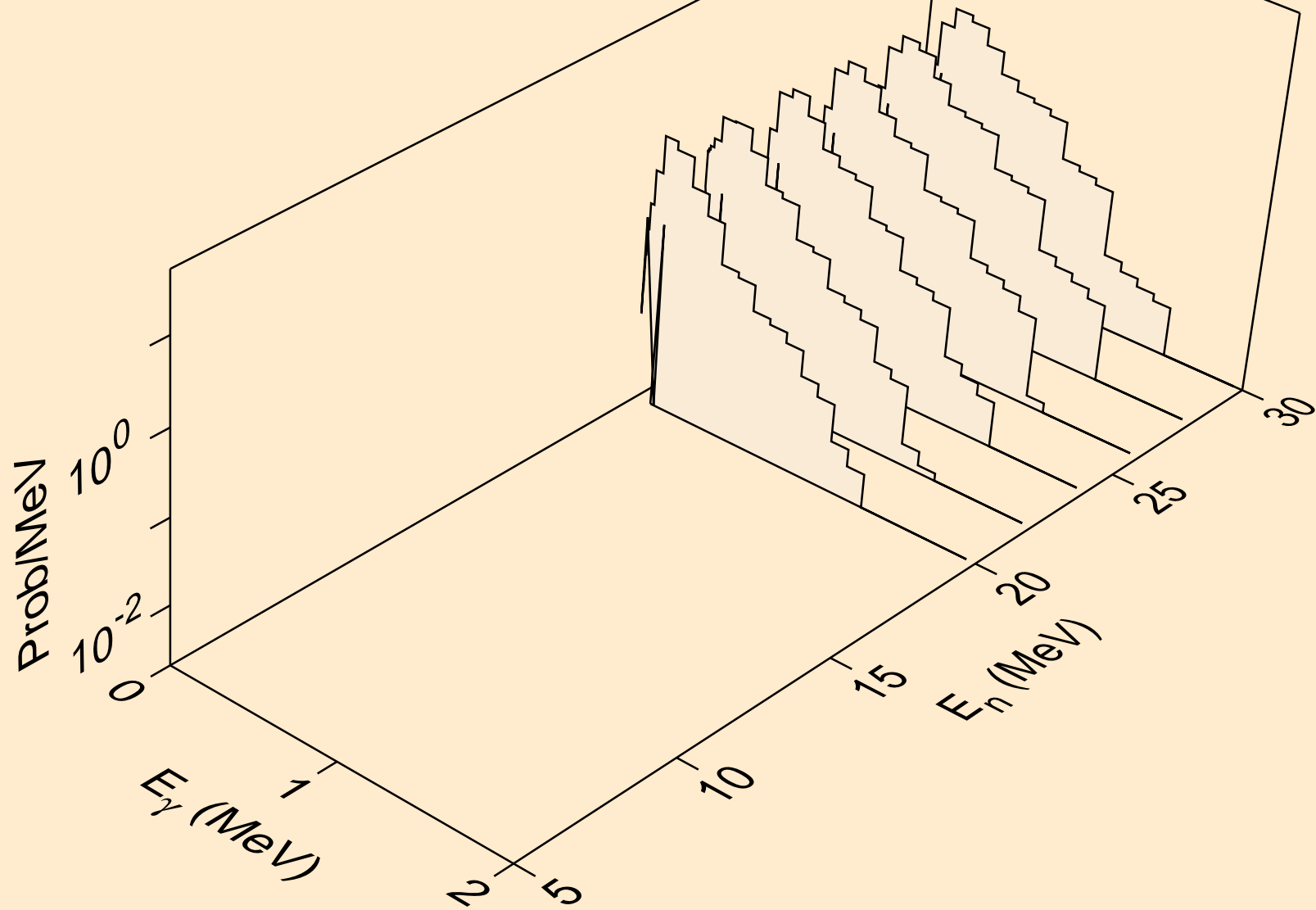

FM260 PROTON ACER TENDL-2021 LIBRARY; T=0.K

Particle heating contributions

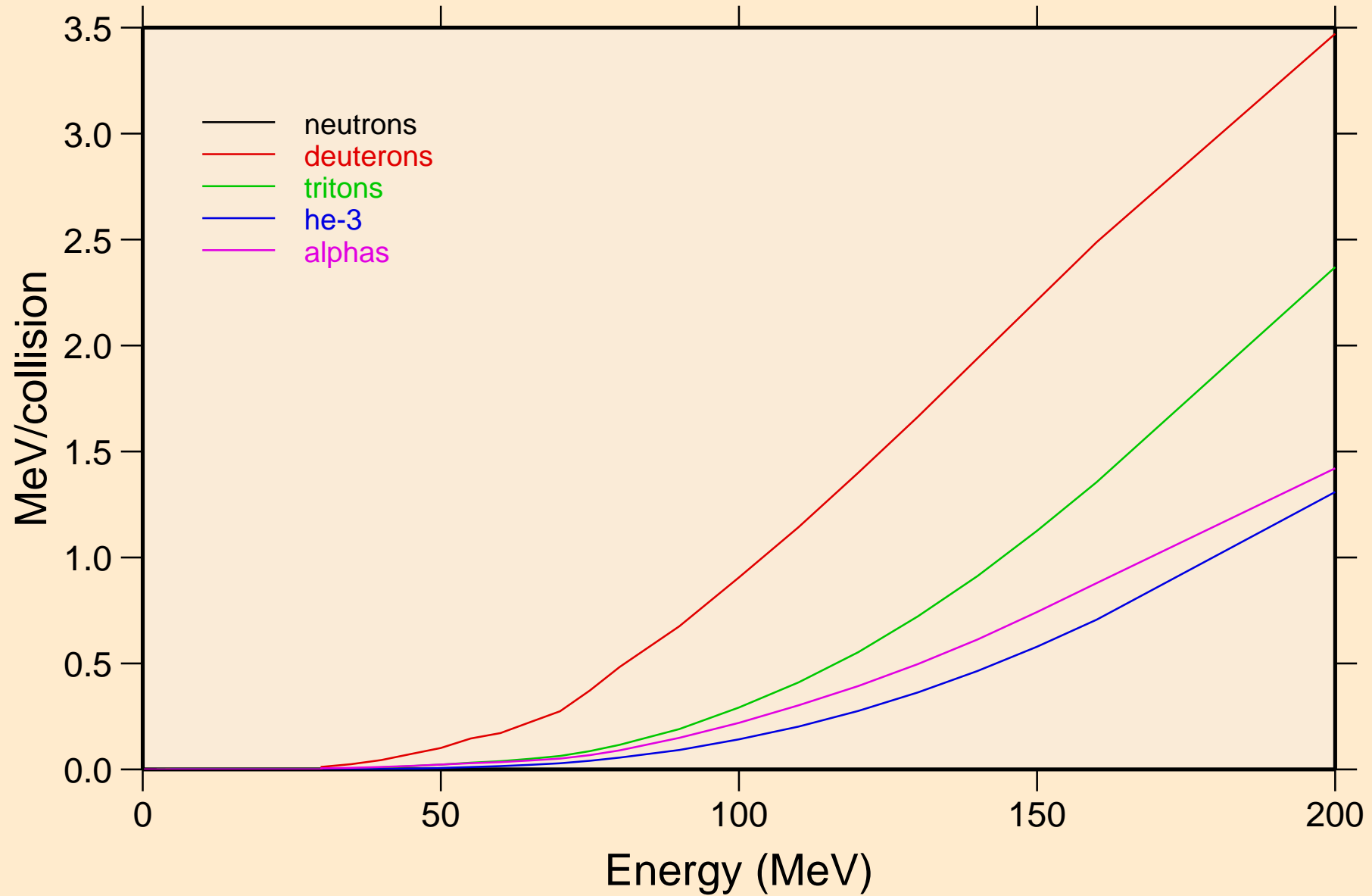

FM260 PROTON ACER TENDL-2021 LIBRARY; T=0.K

Recoil Heating

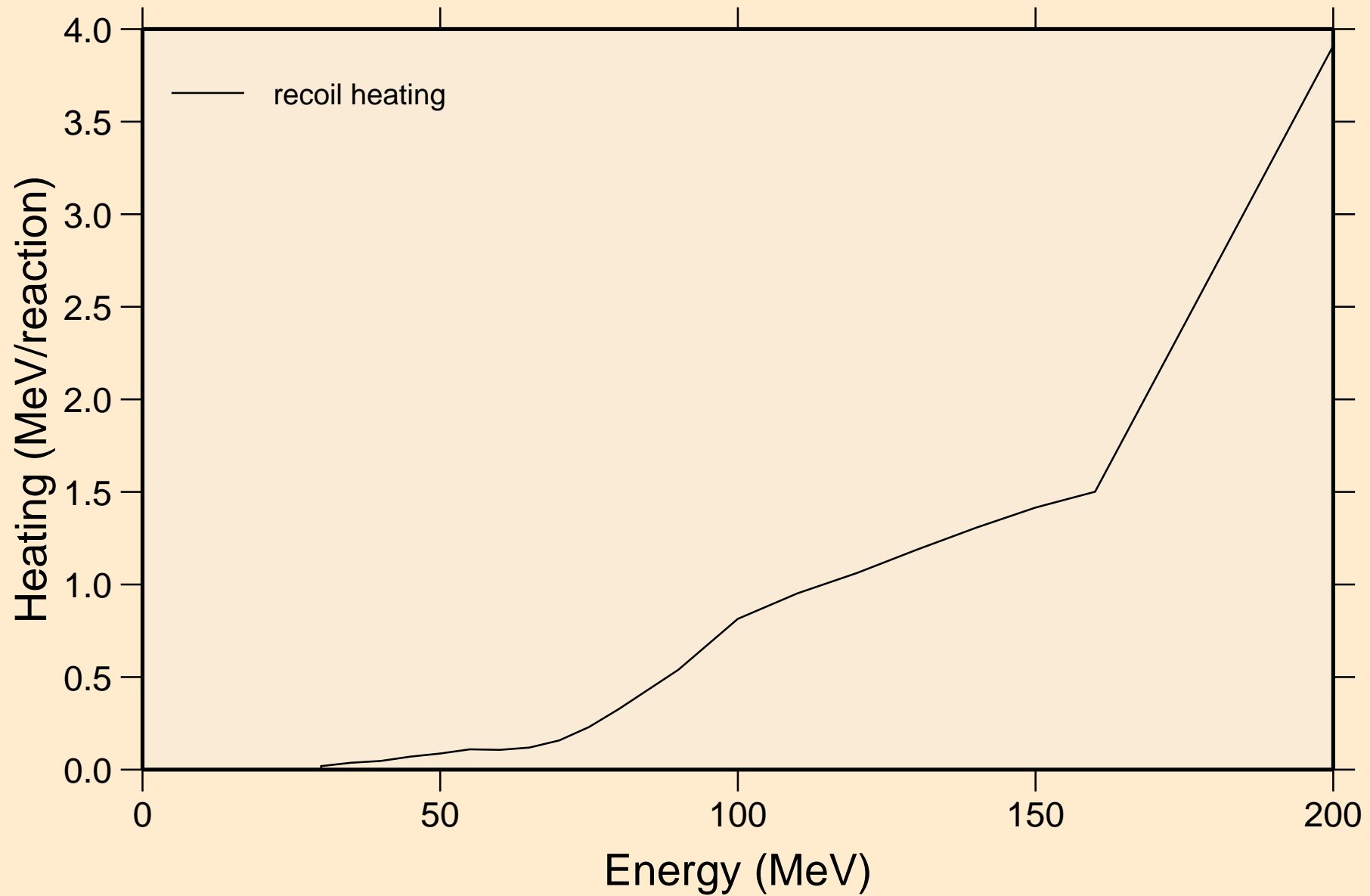

FM260 PROTON ACER TENDL-2021 LIBRARY; T=0.K
Particle production cross sections

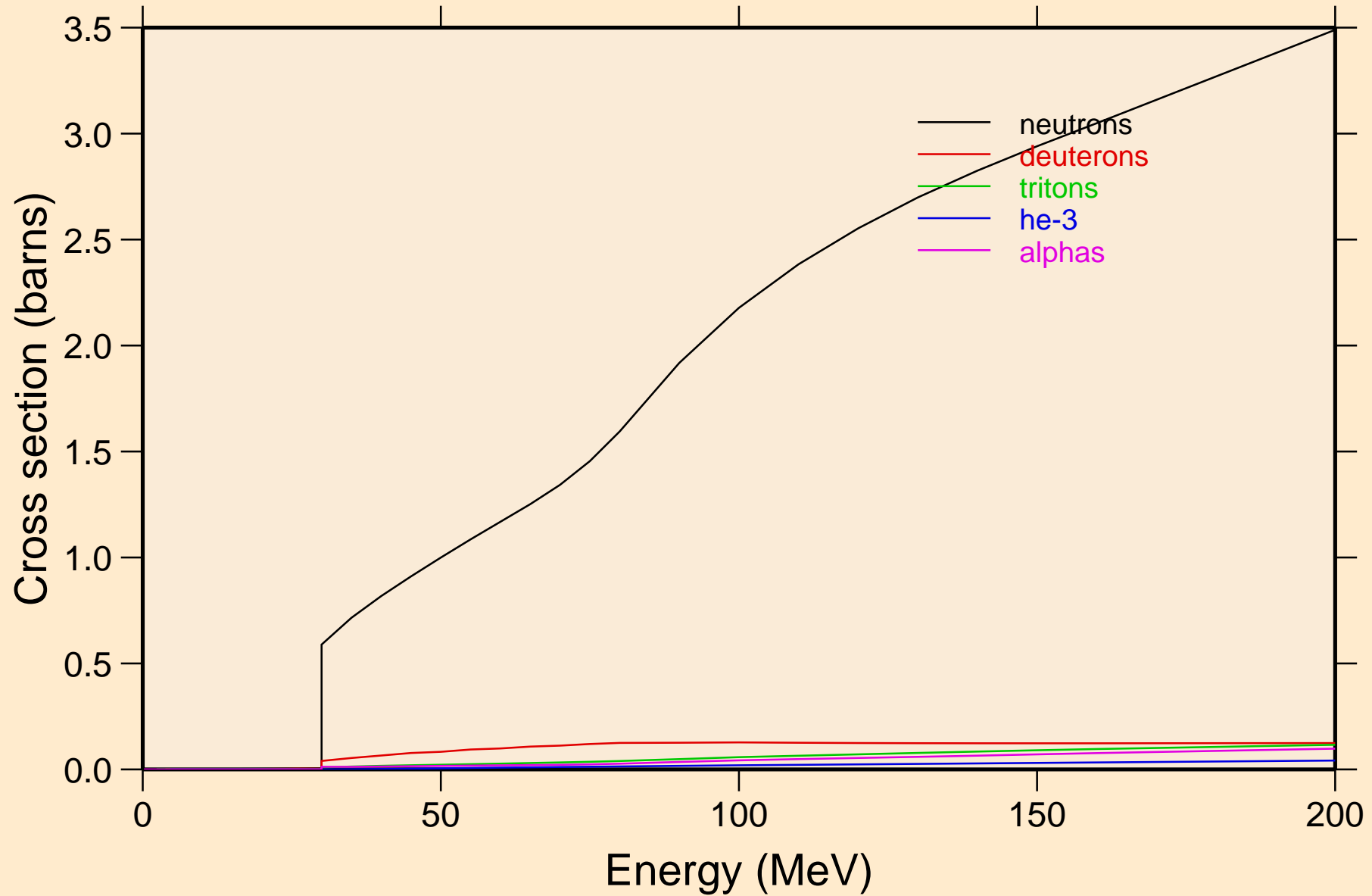

FM260 PROTON ACER TENDL-2021 LIBRARY; T=0.K
neutrons from (p,n)

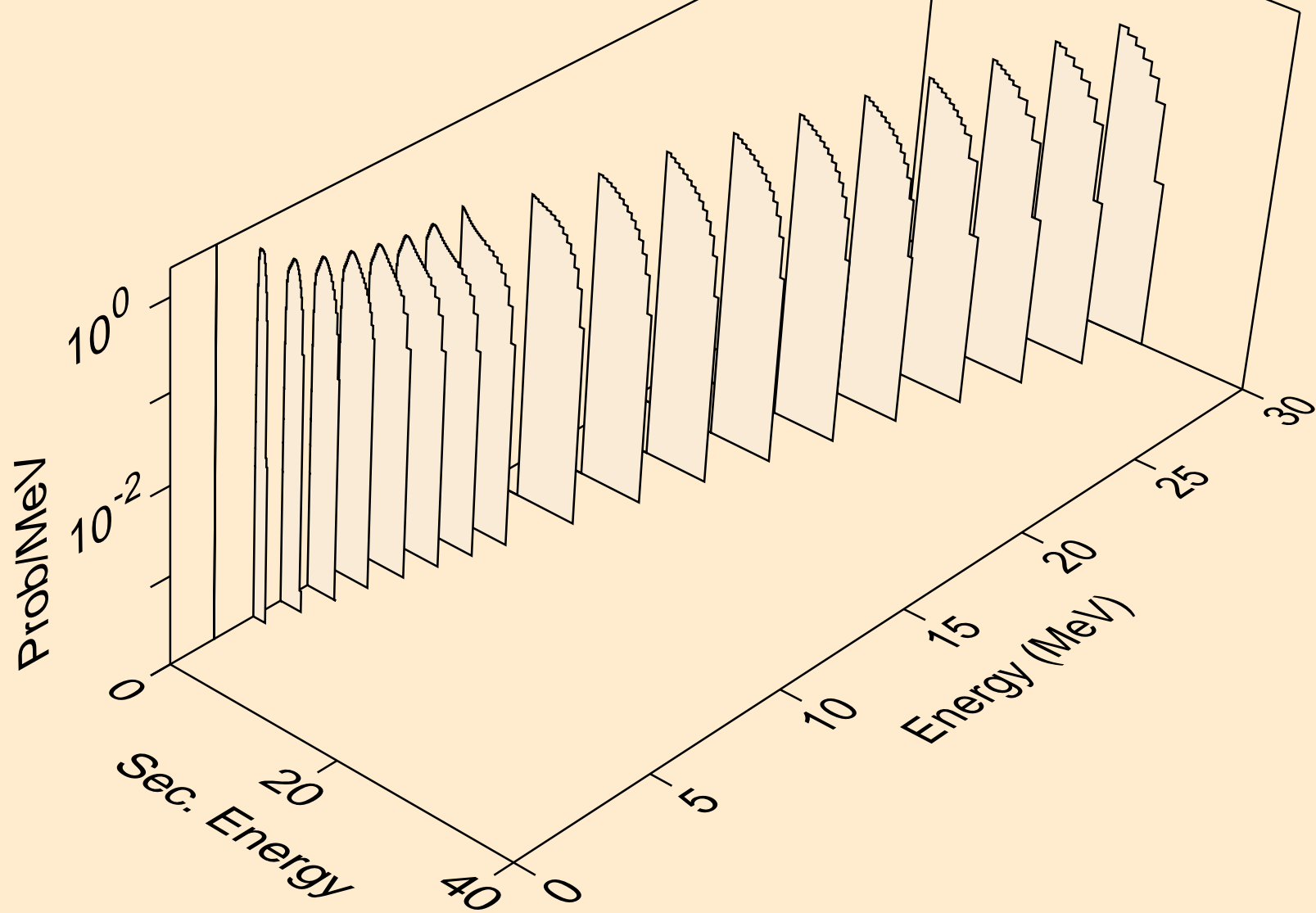

FM260 PROTON ACER TENDL-2021 LIBRARY; T=0.K
neutrons from (p,x)

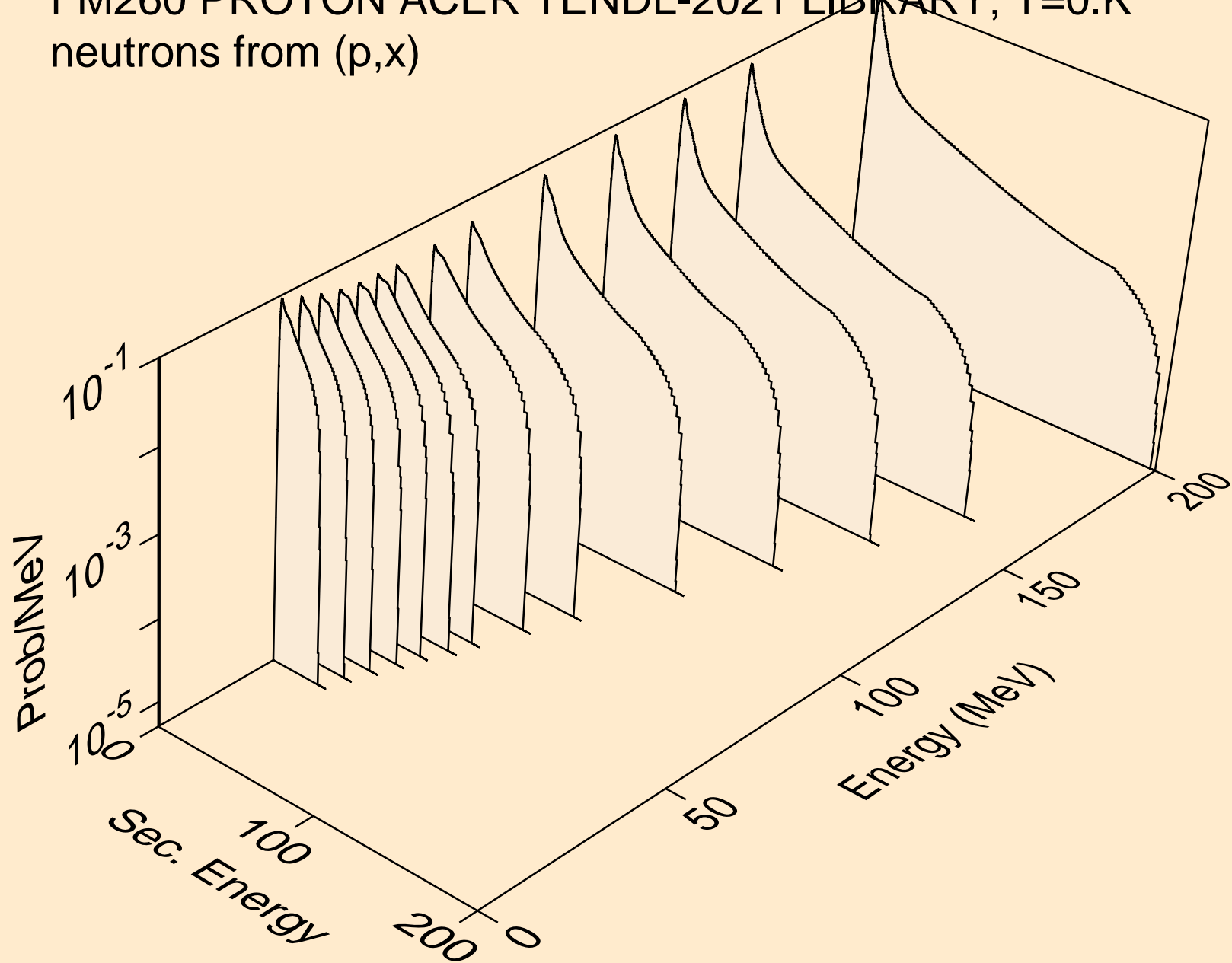

FM260 PROTON ACER TENDL-2021 LIBRARY; T=0.K
neutrons from (p,2n)

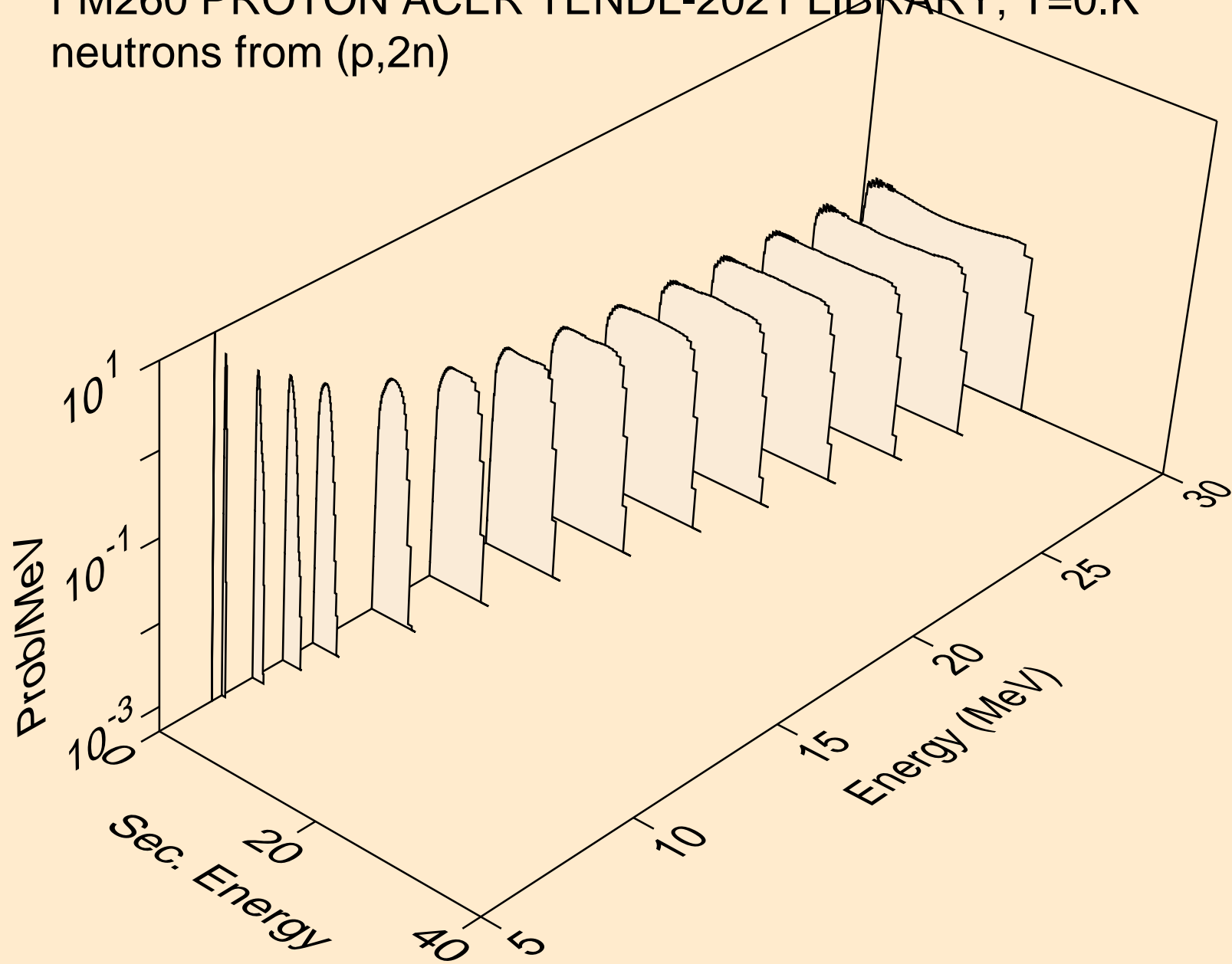

FM260 PROTON ACER TENDL-2021 LIBRARY; T=0.K
neutrons from (p,3n)

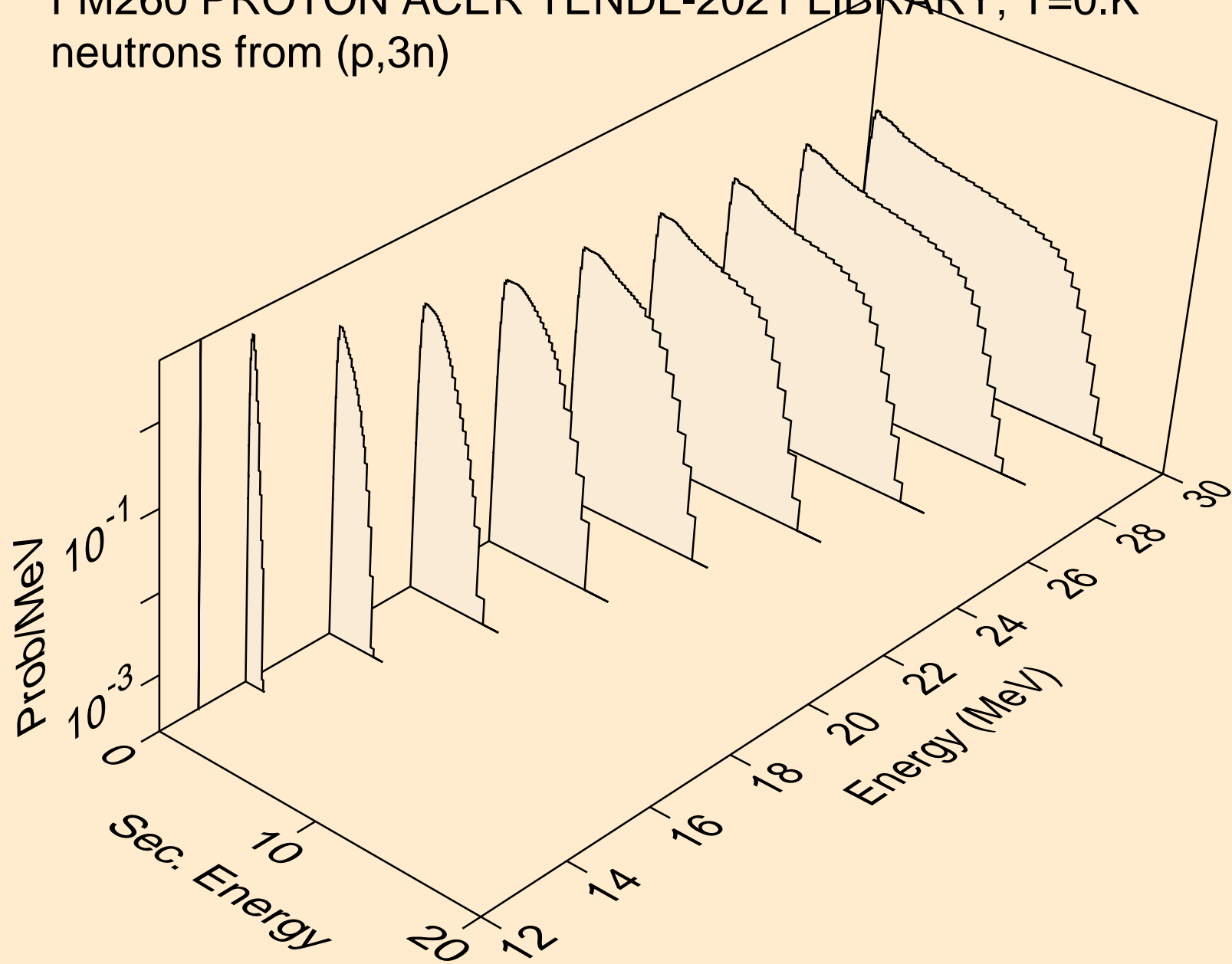

FM260 PROTON ACER TENDL-2021 LIBRARY; T=0.K
neutrons from (p,n*)a

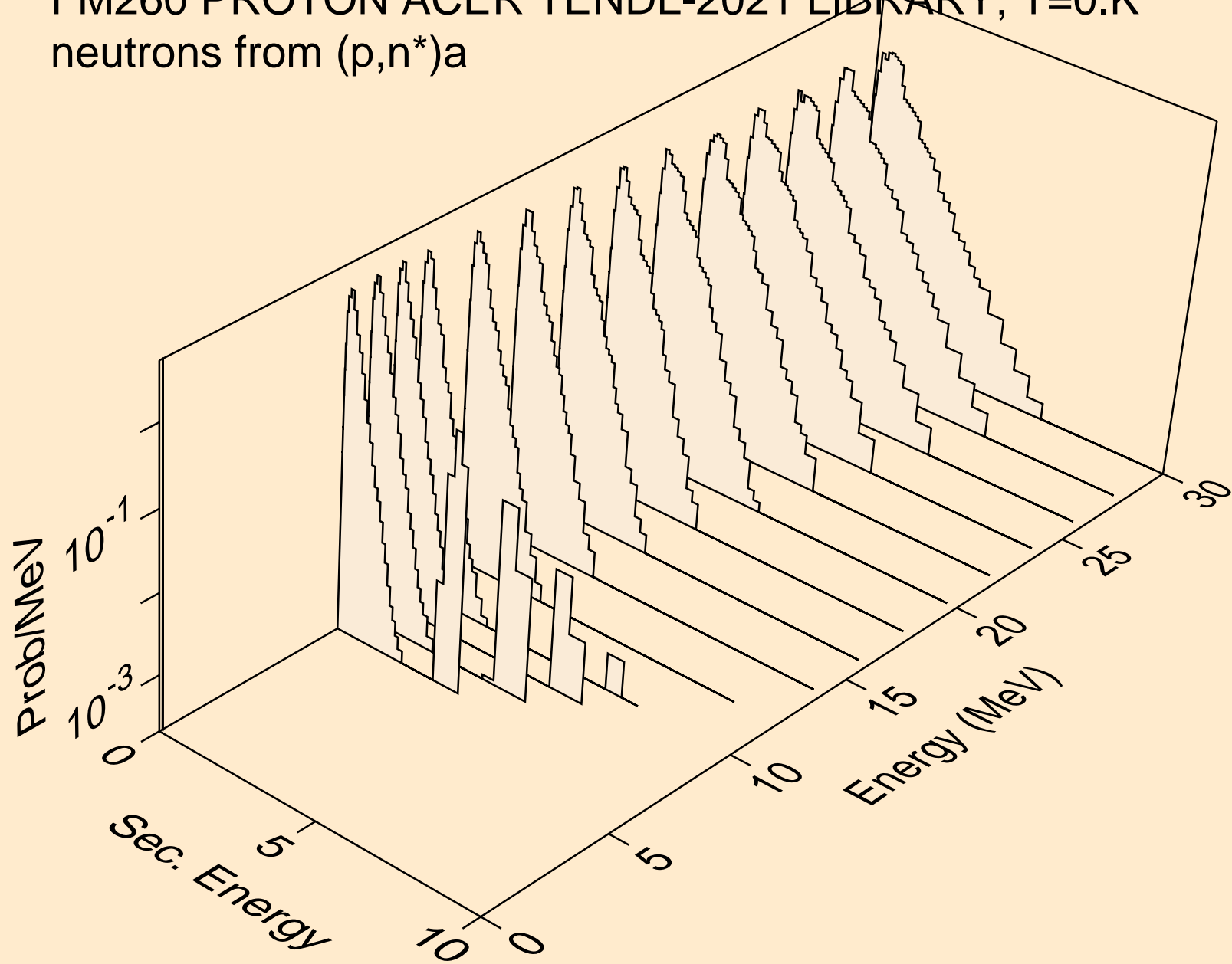

FM260 PROTON ACER TENDL-2021 LIBRARY; T=0.K
neutrons from (p,n*)p

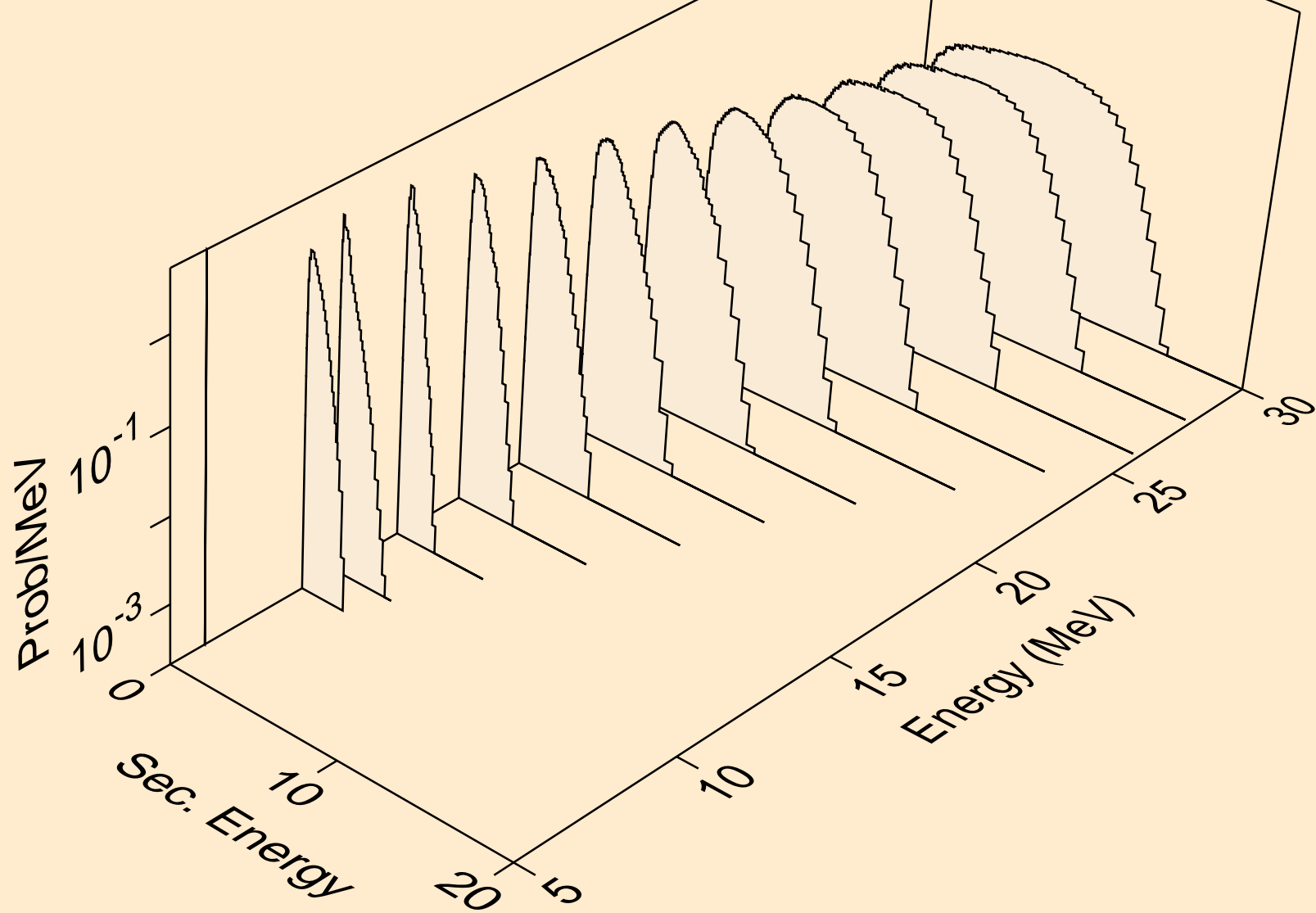

FM260 PROTON ACER TENDL-2021 LIBRARY; T=0.K
neutrons from (p,n*)d

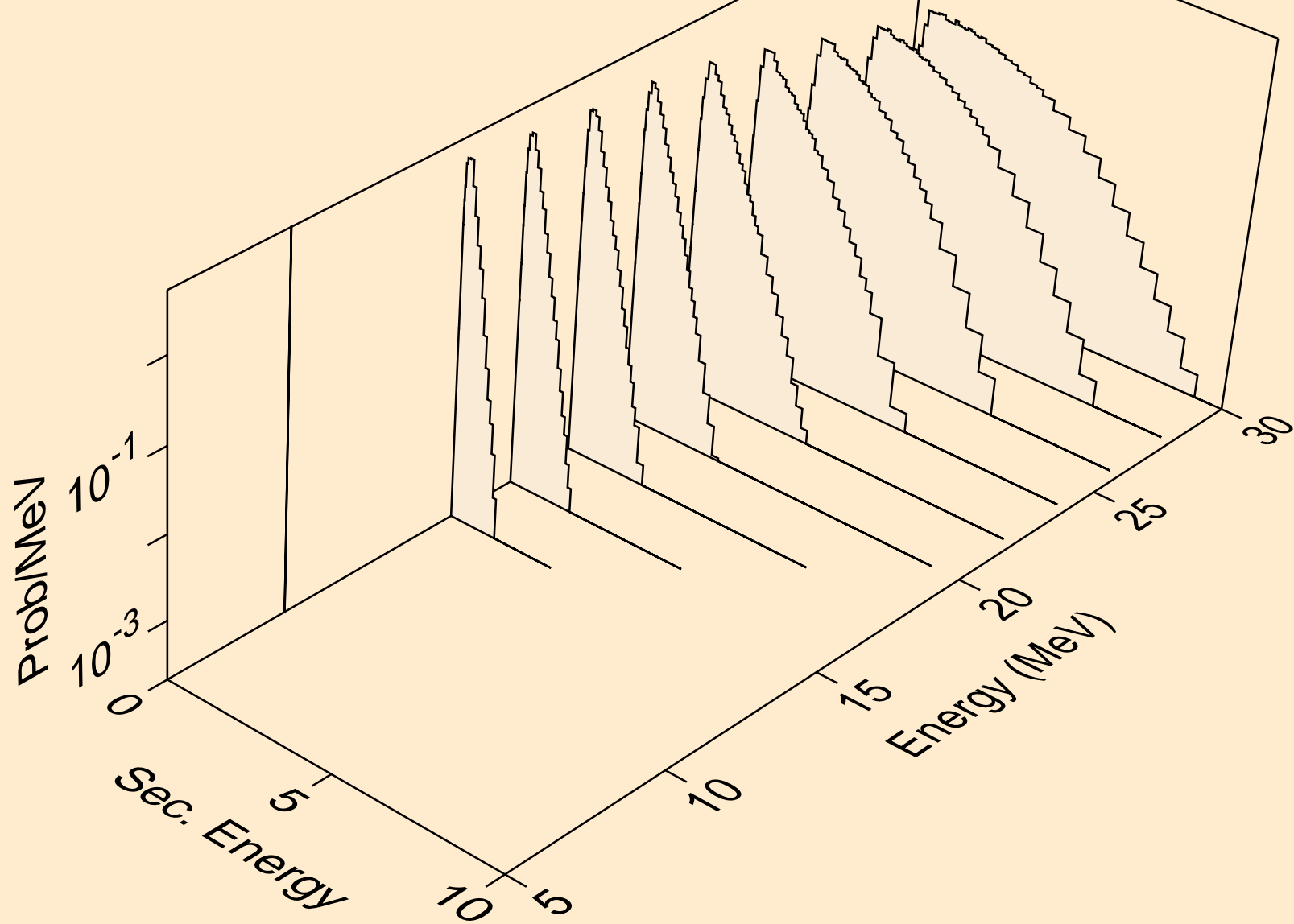

FM260 PROTON ACER TENDL-2021 LIBRARY; T=0.K
neutrons from (p,n*)t

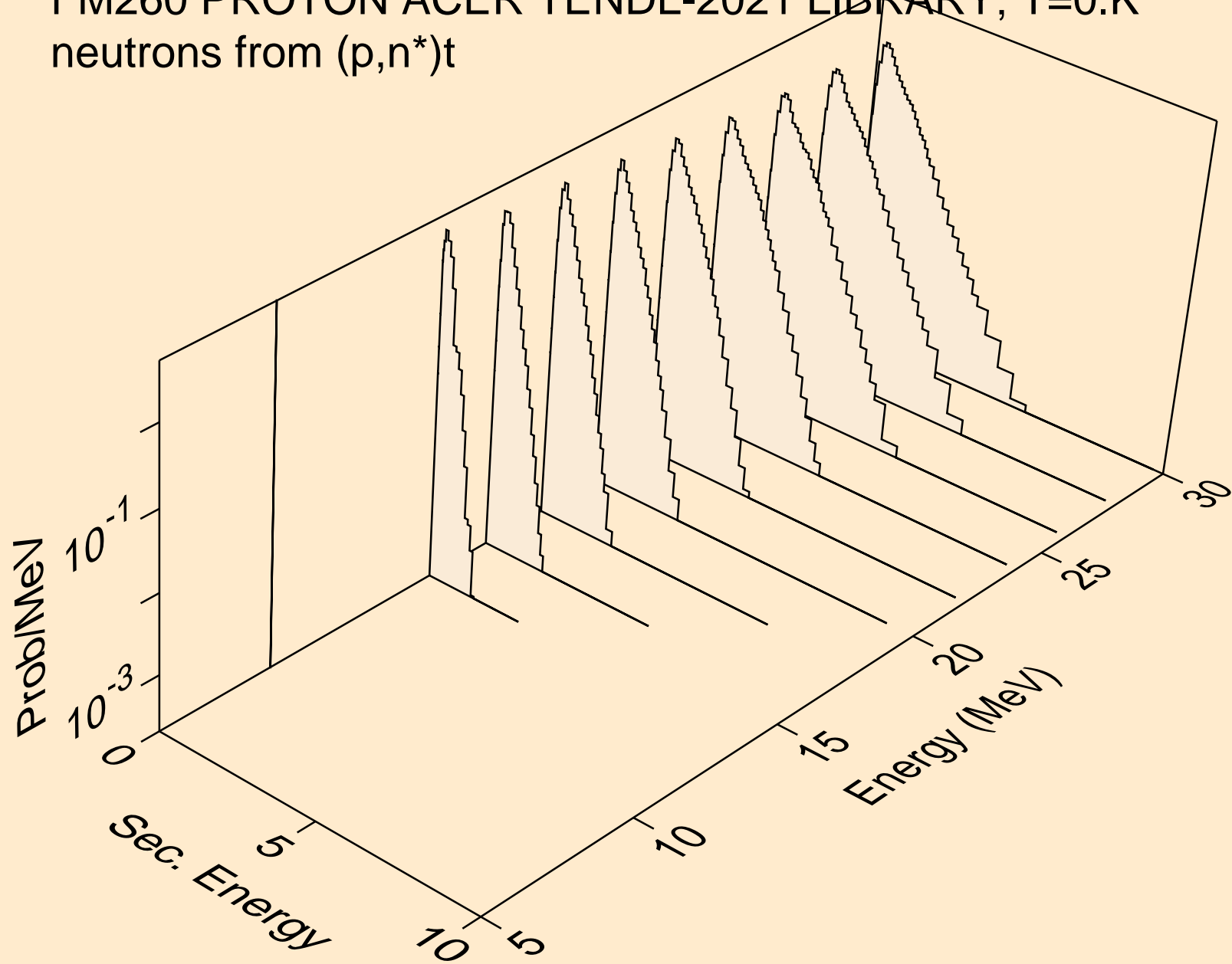

FM260 PROTON ACER TENDL-2021 LIBRARY; T=0.K
neutrons from (p,4n)

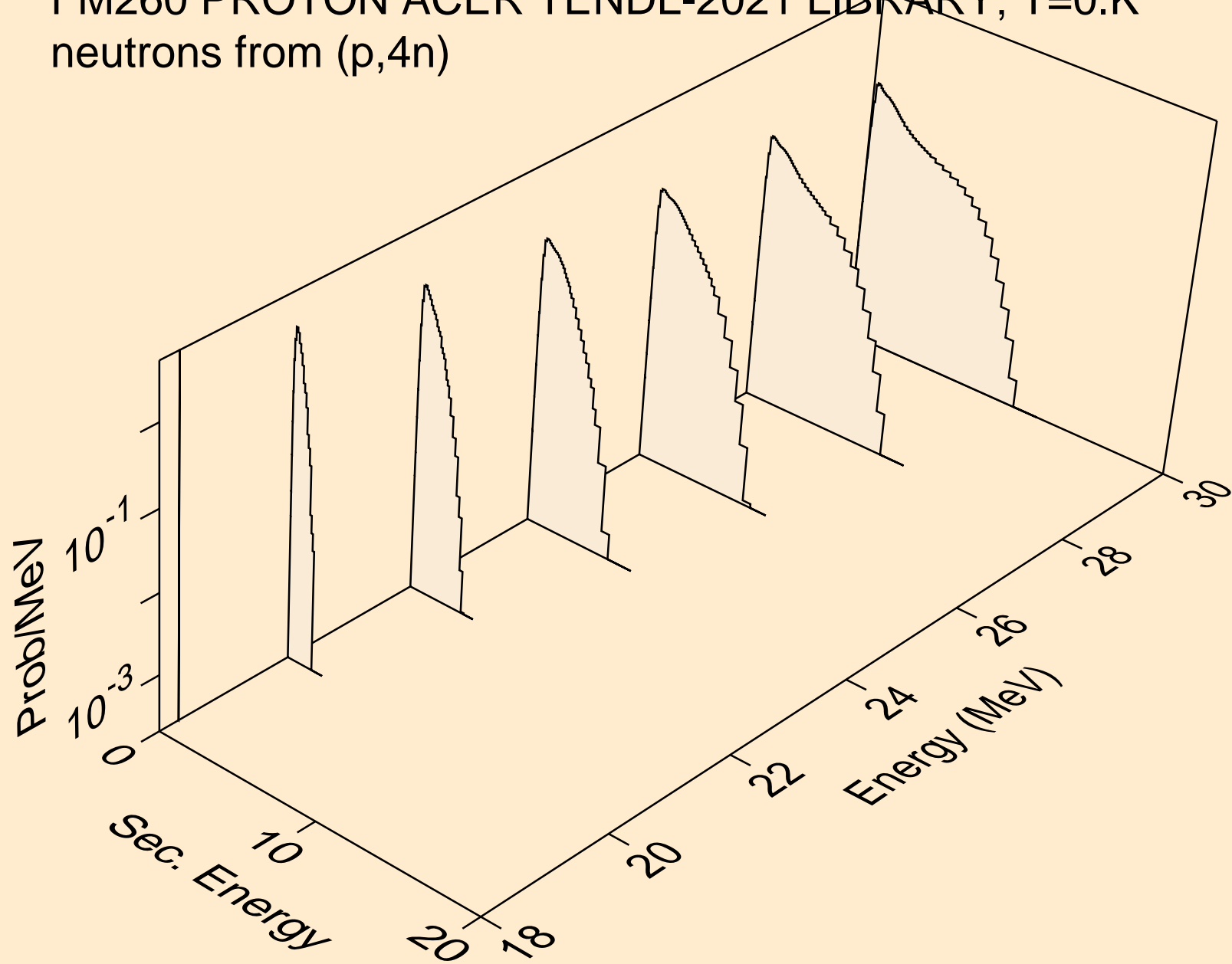

FM260 PROTON ACER TENDL-2021 LIBRARY; T=0.K
neutrons from (p,2np)

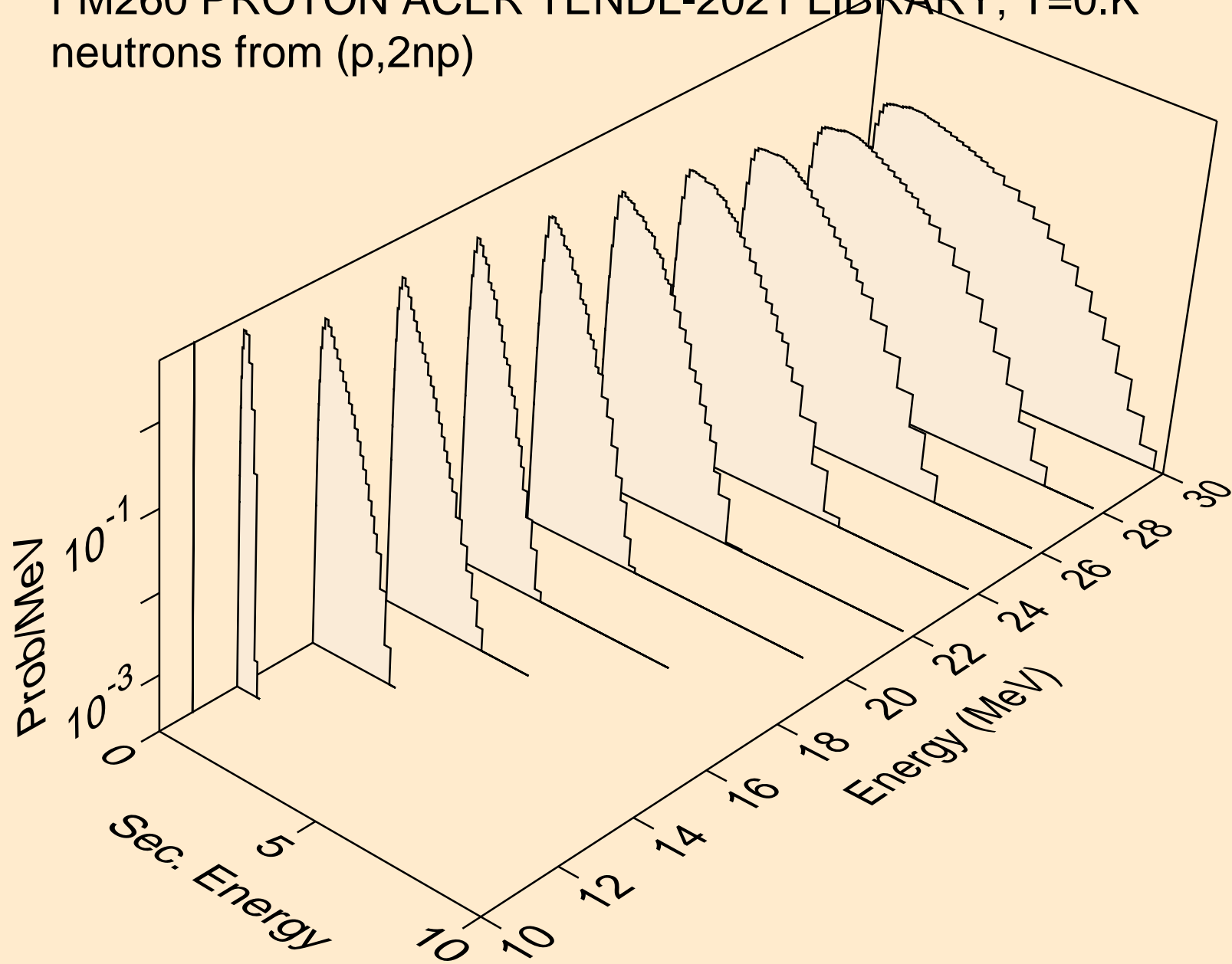

FM260 PROTON ACER TENDL-2021 LIBRARY; T=0.K
deuterons from (p,x)

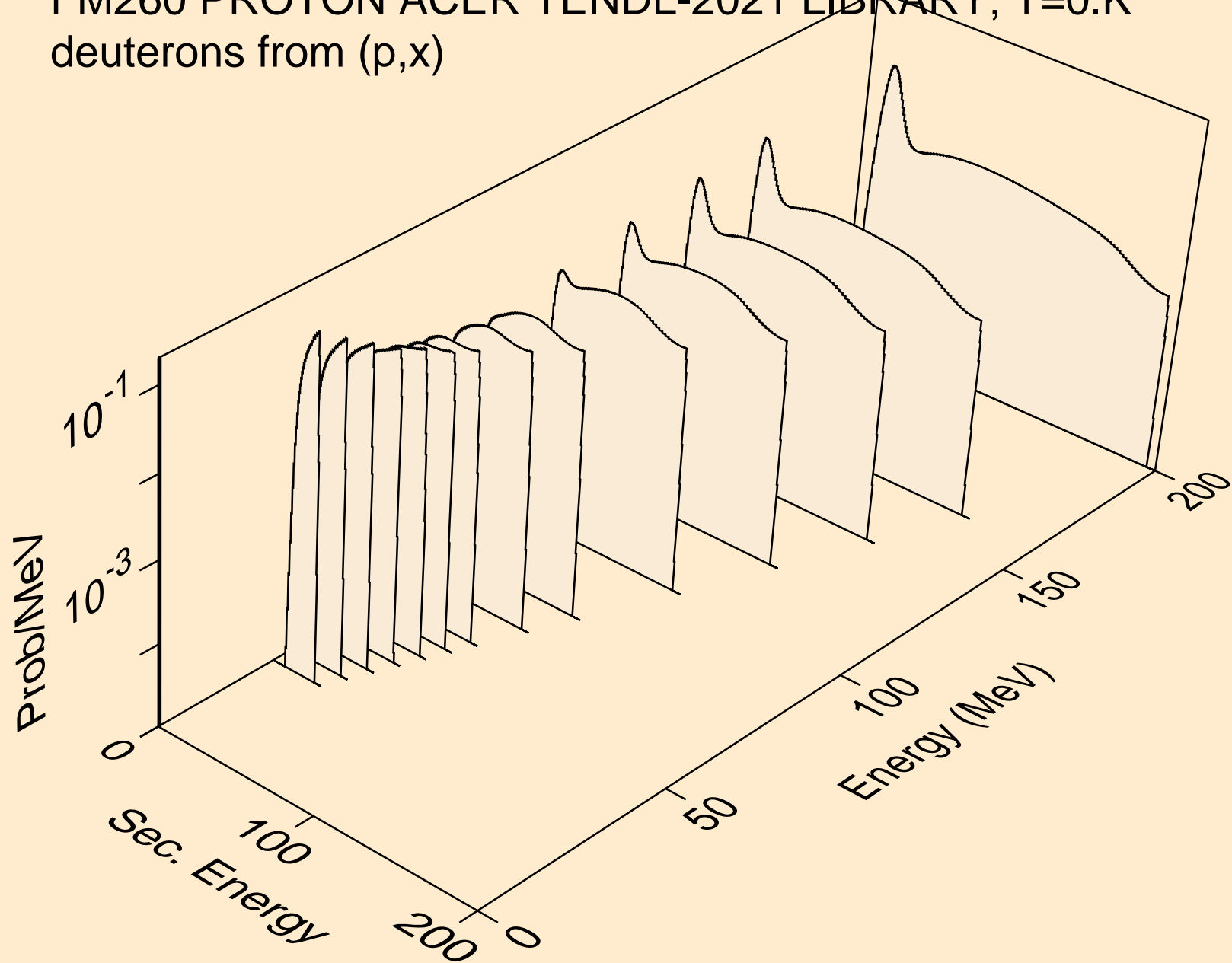

FM260 PROTON ACER TENDL-2021 LIBRARY; T=0.K
deuterons from (p,n*)d

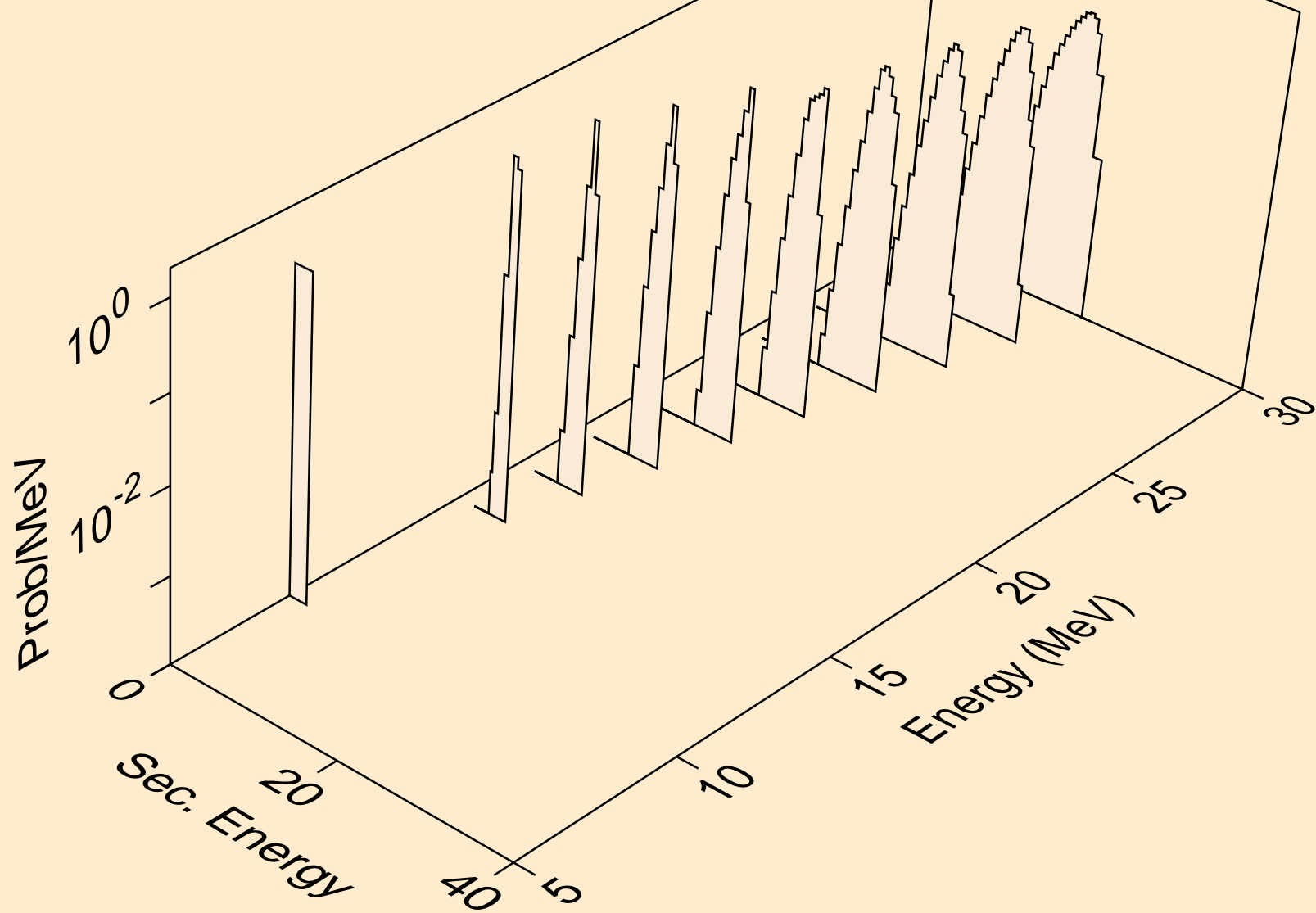

FM260 PROTON ACER TENDL-2021 LIBRARY; T=0.K
deuterons from (p,d)

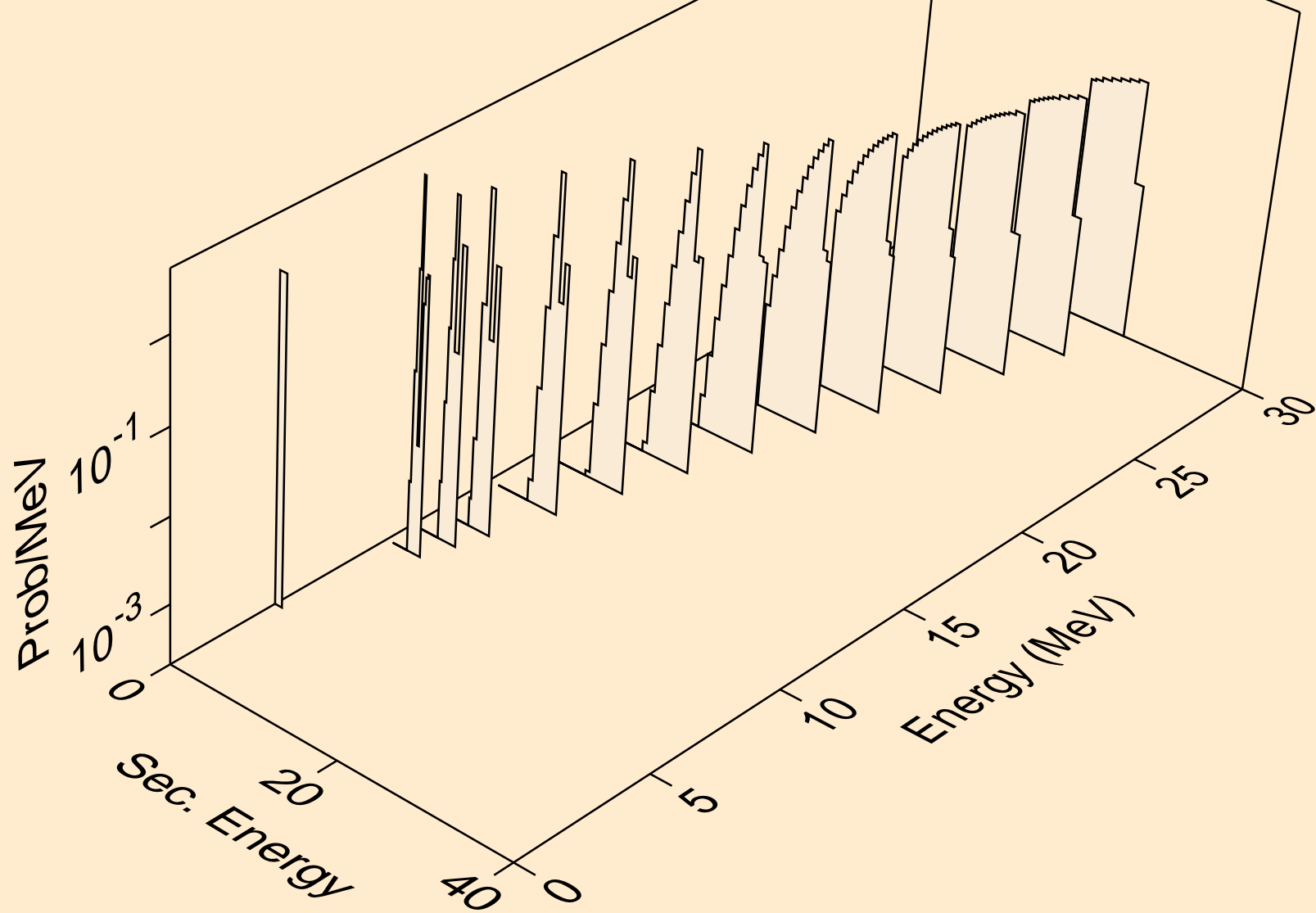

FM260 PROTON ACER TENDL-2021 LIBRARY; T=0.K
tritons from (p,x)

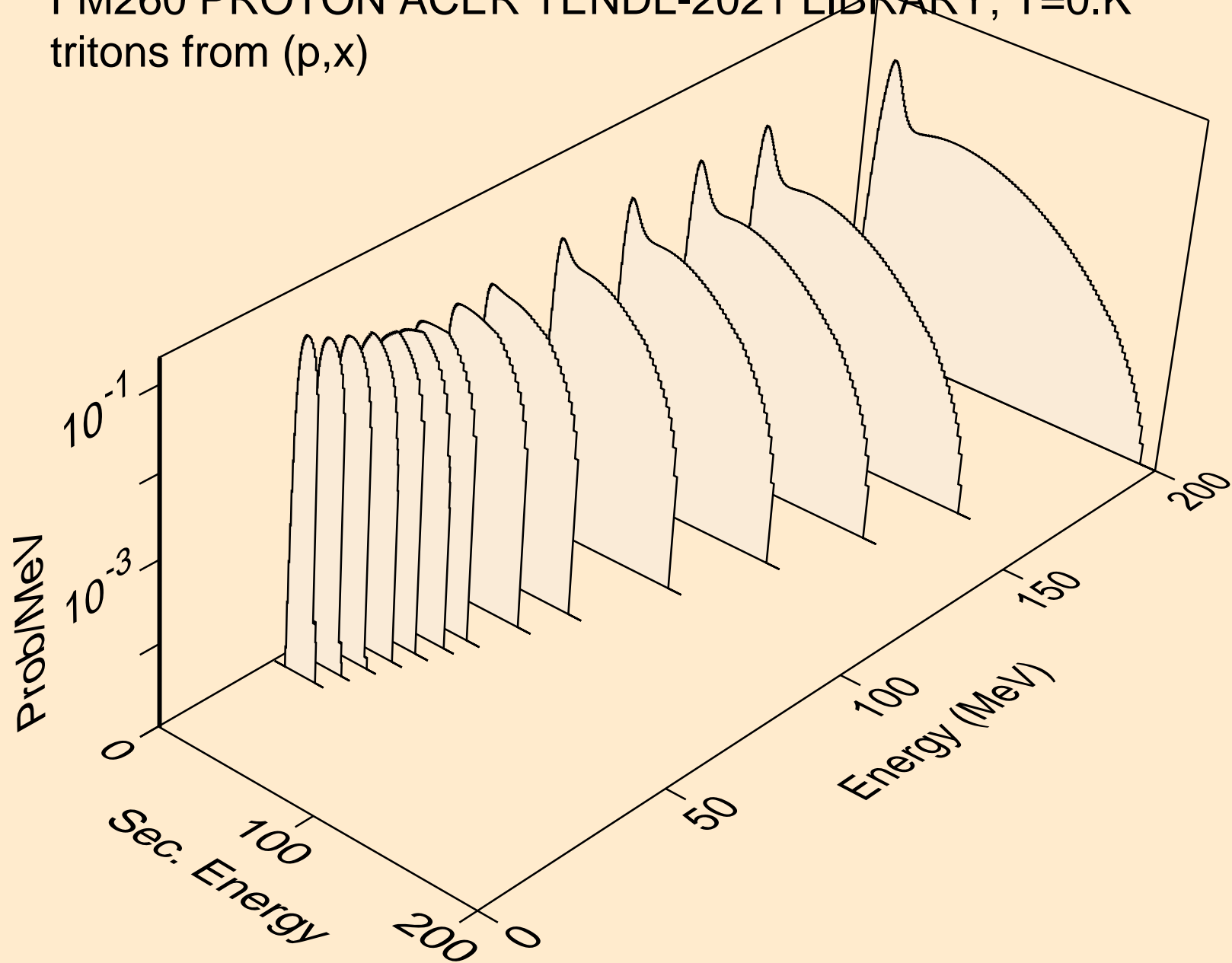

FM260 PROTON ACER TENDL-2021 LIBRARY; T=0.K
tritons from (p,n*)t

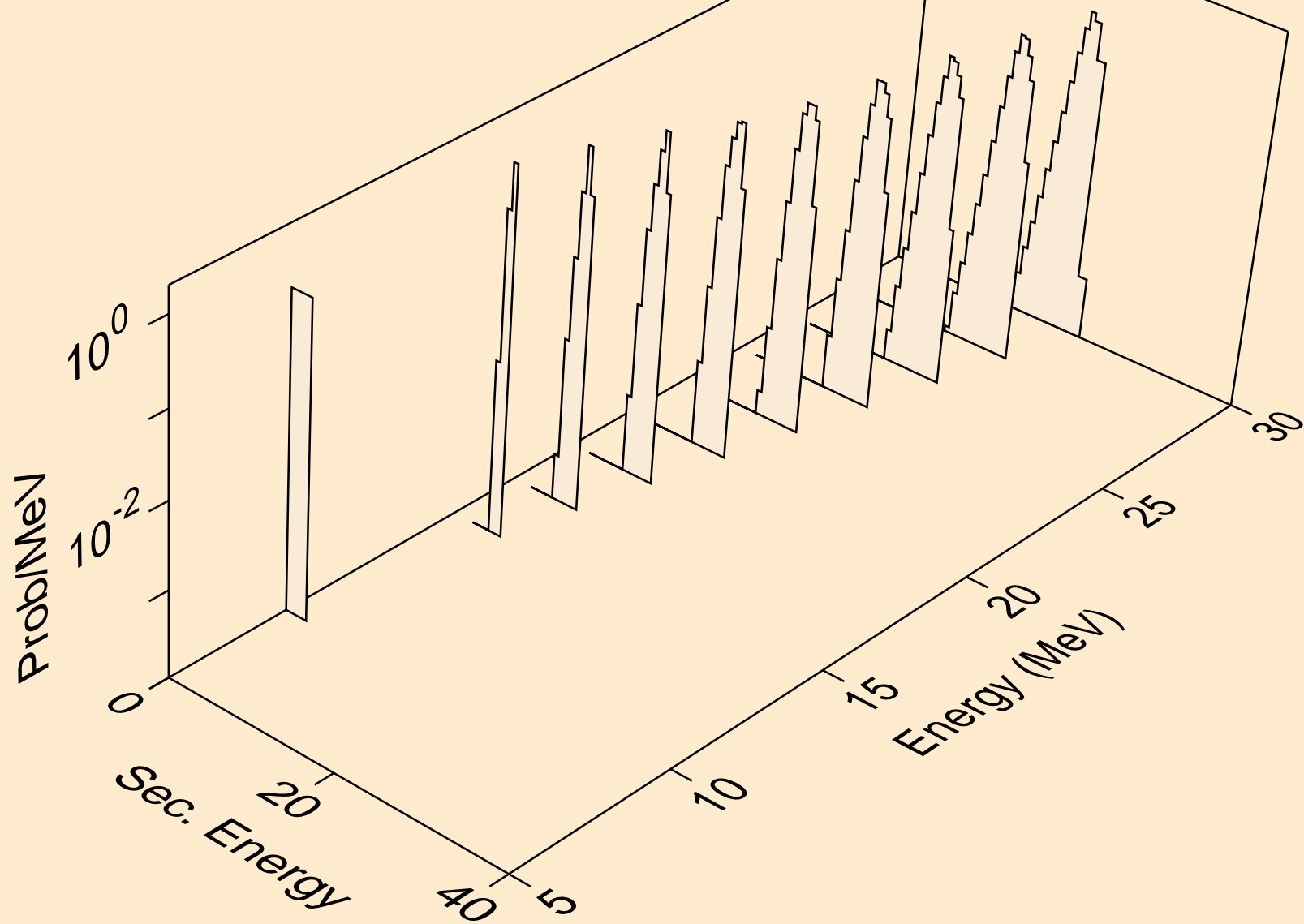

FM260 PROTON ACER TENDL-2021 LIBRARY; T=0.K
tritons from (p,t)

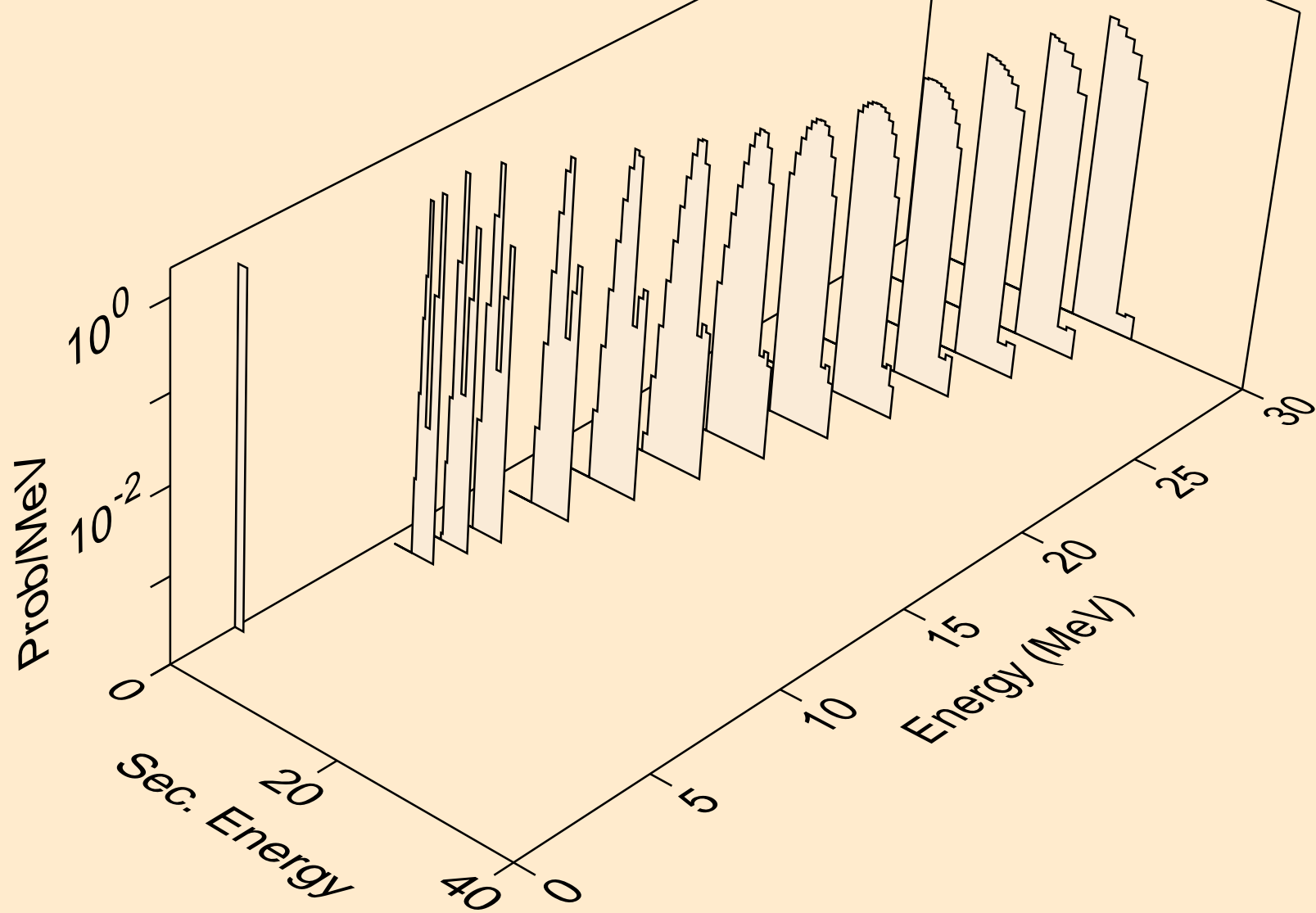

FM260 PROTON ACER TENDL-2021 LIBRARY; T=0.K
he3s from (p,x)

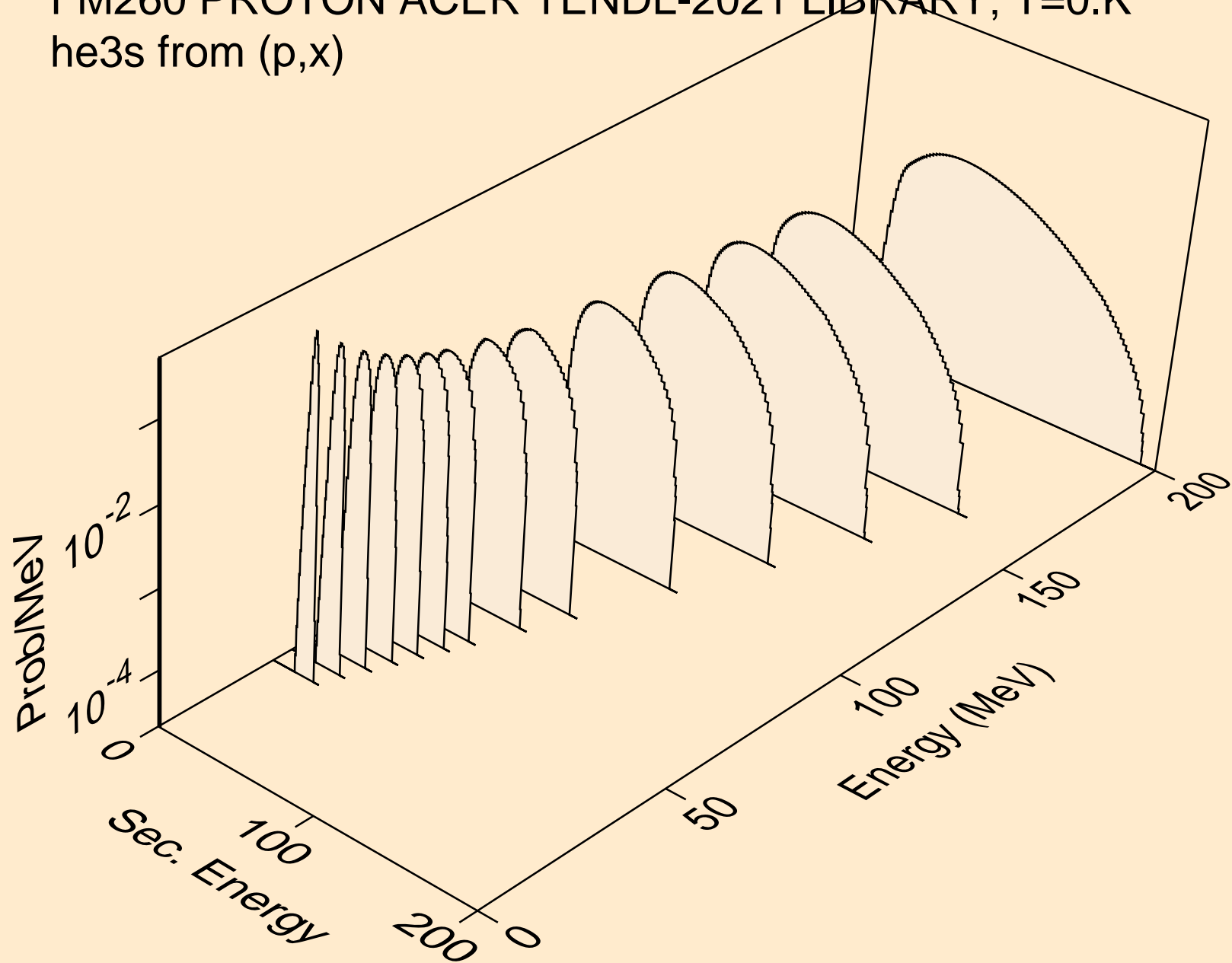

FM260 PROTON ACER TENDL-2021 LIBRARY; T=0.K
he3s from (p,he3)

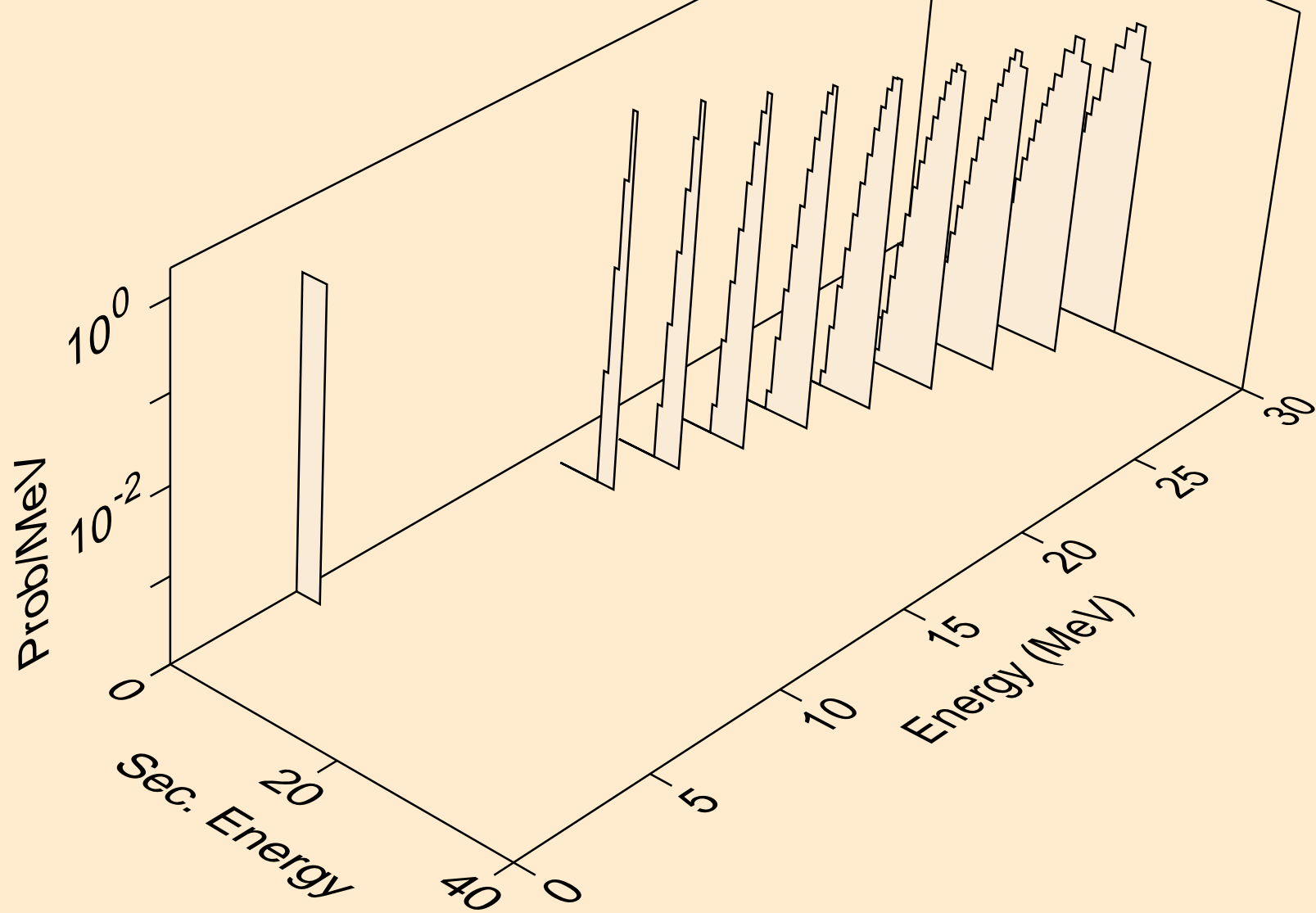

FM260 PROTON ACER TENDL-2021 LIBRARY; T=0.K
alphas from (p,x)

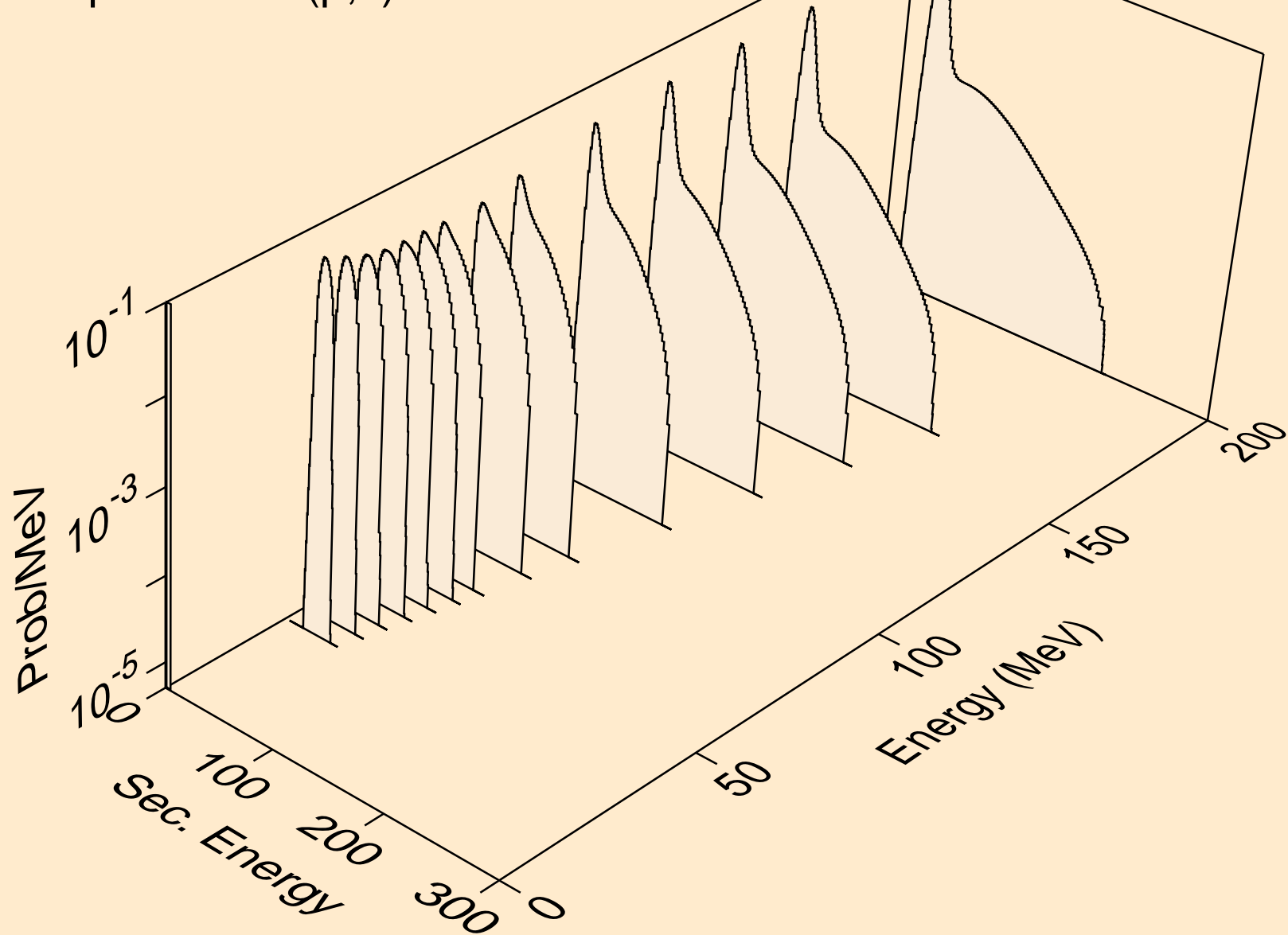

FM260 PROTON ACER TENDL-2021 LIBRARY; T=0.K
alphas from (p,n*)a

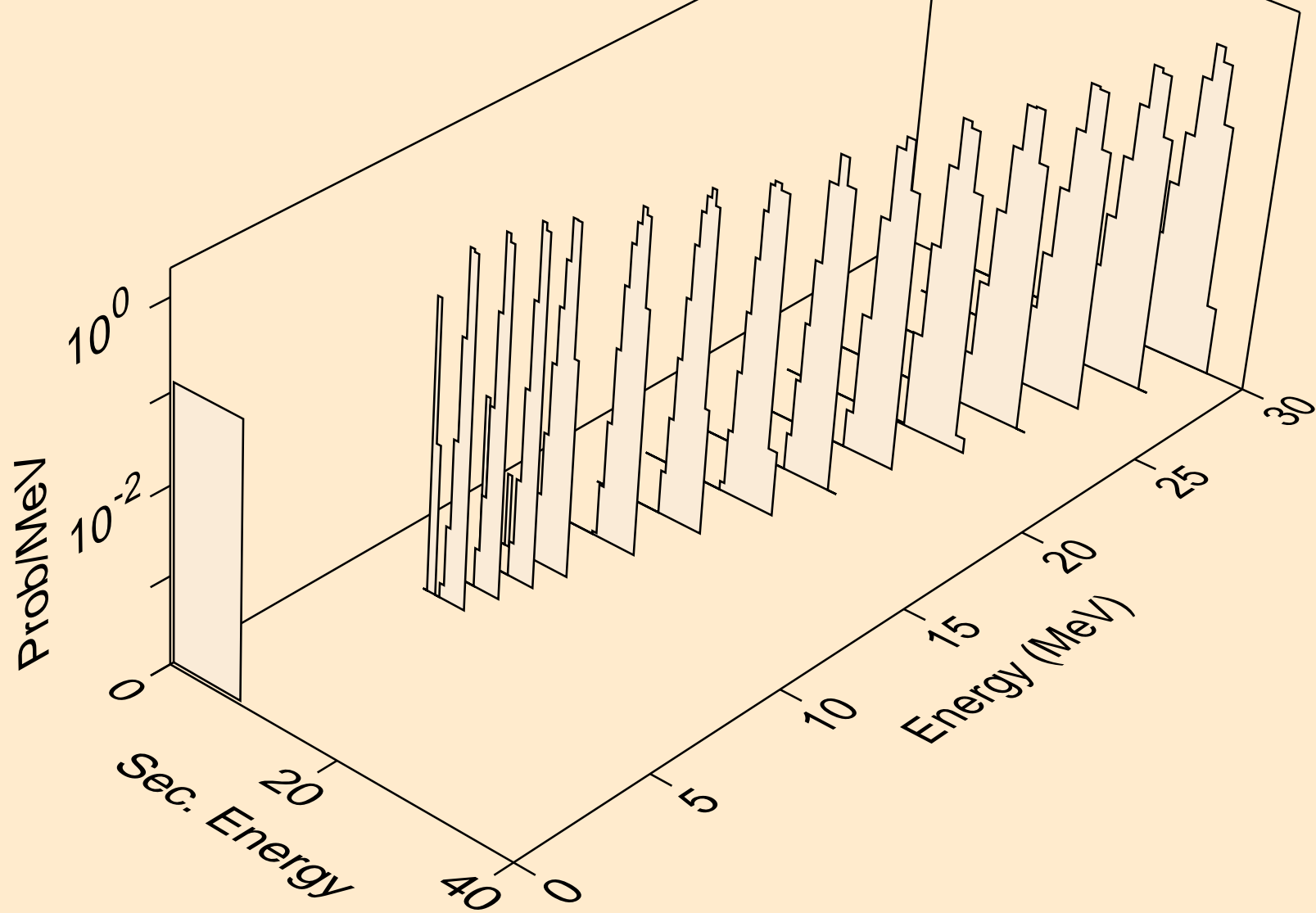

FM260 PROTON ACER TENDL-2021 LIBRARY; T=0.K
alphas from (p,a)

