

FR205 PROTON ACER TENDL-2021 LIBRARY; T=0.K  
Principal cross sections

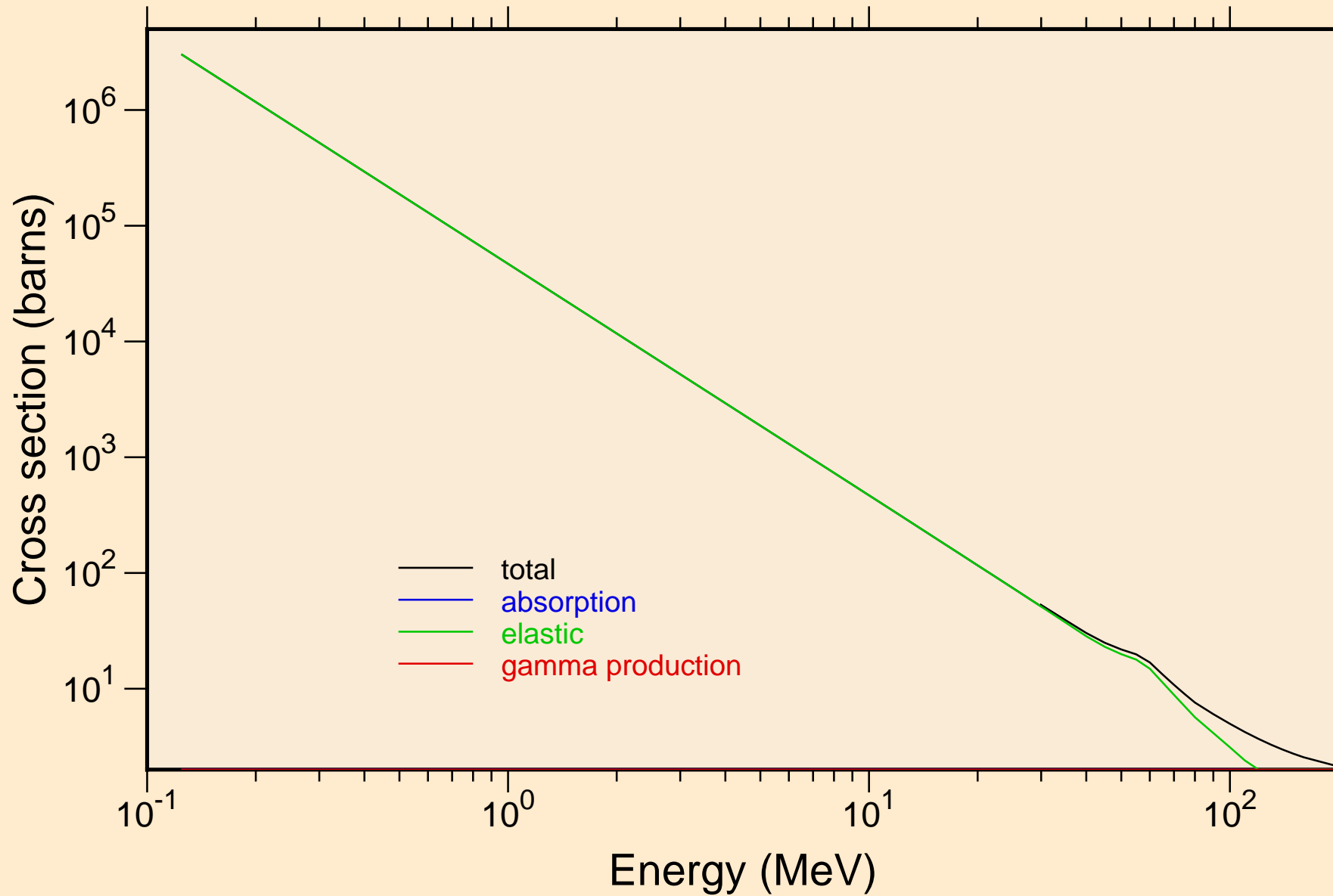

# FR205 PROTON ACER TENDL-2021 LIBRARY; T=0.K

## Heating

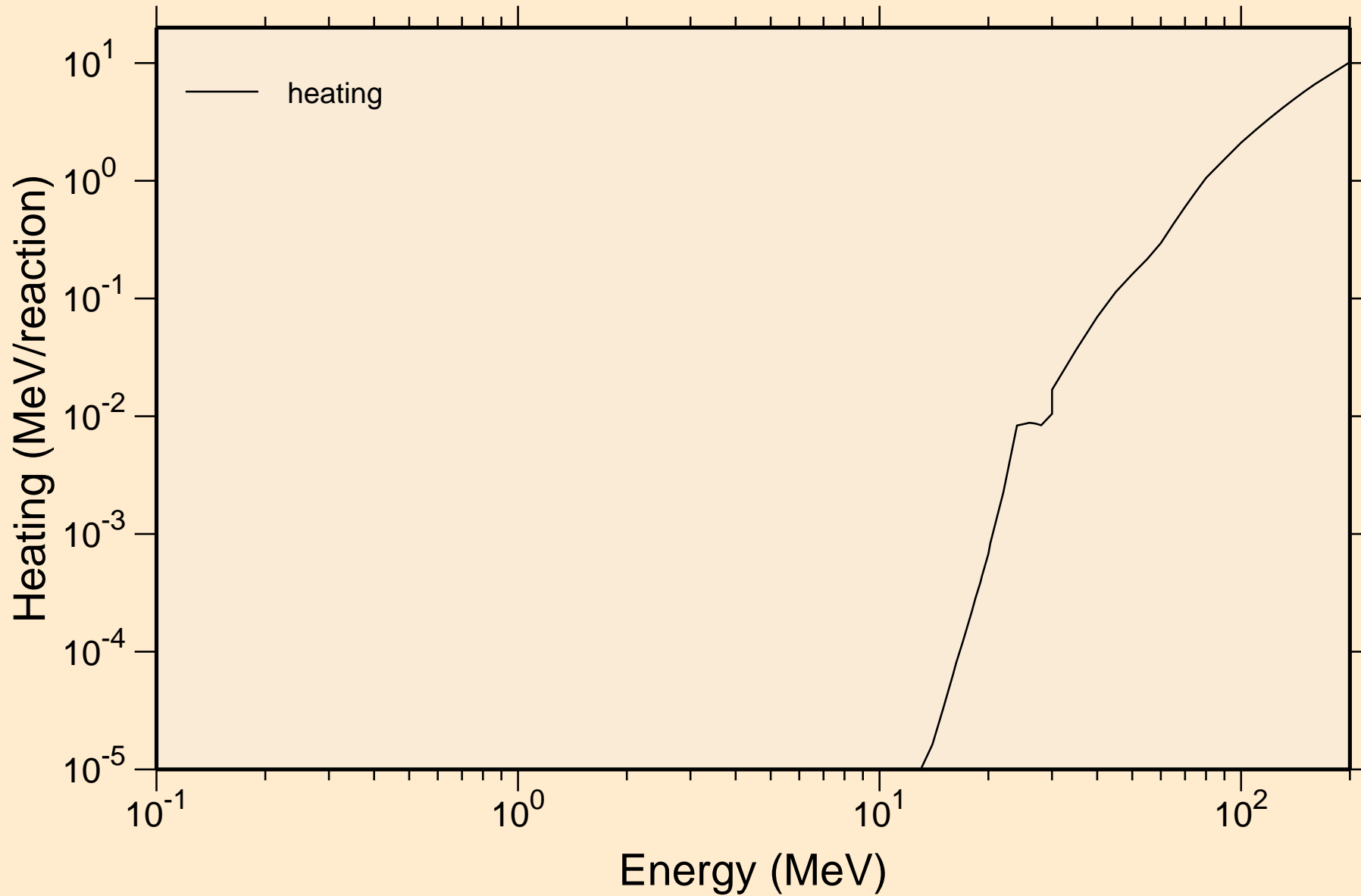

# FR205 PROTON ACER TENDL-2021 LIBRARY; T=0.K

## Principal cross sections

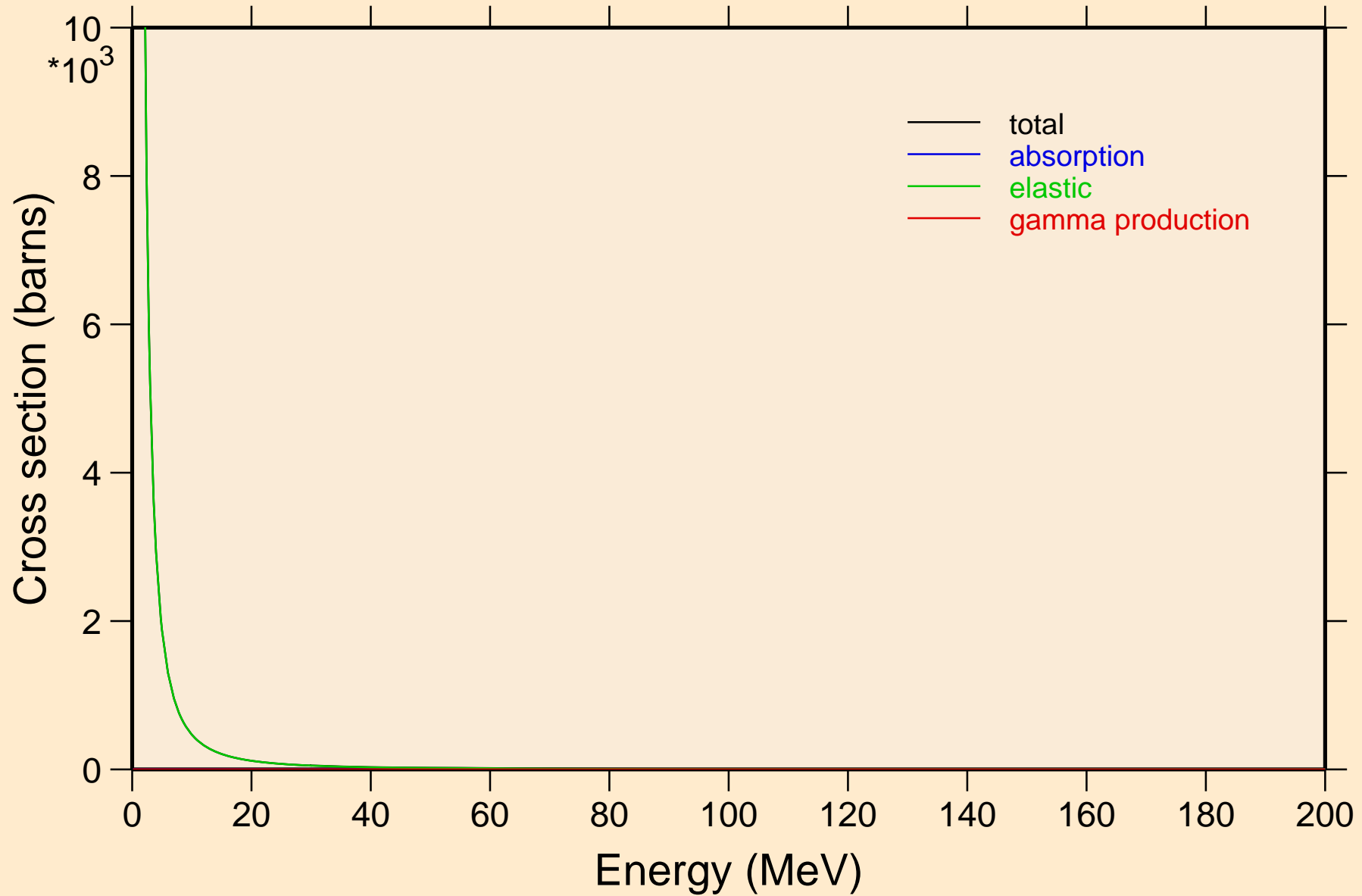

FR205 PROTON ACER TENDL-2021 LIBRARY; T=0.K

Heating

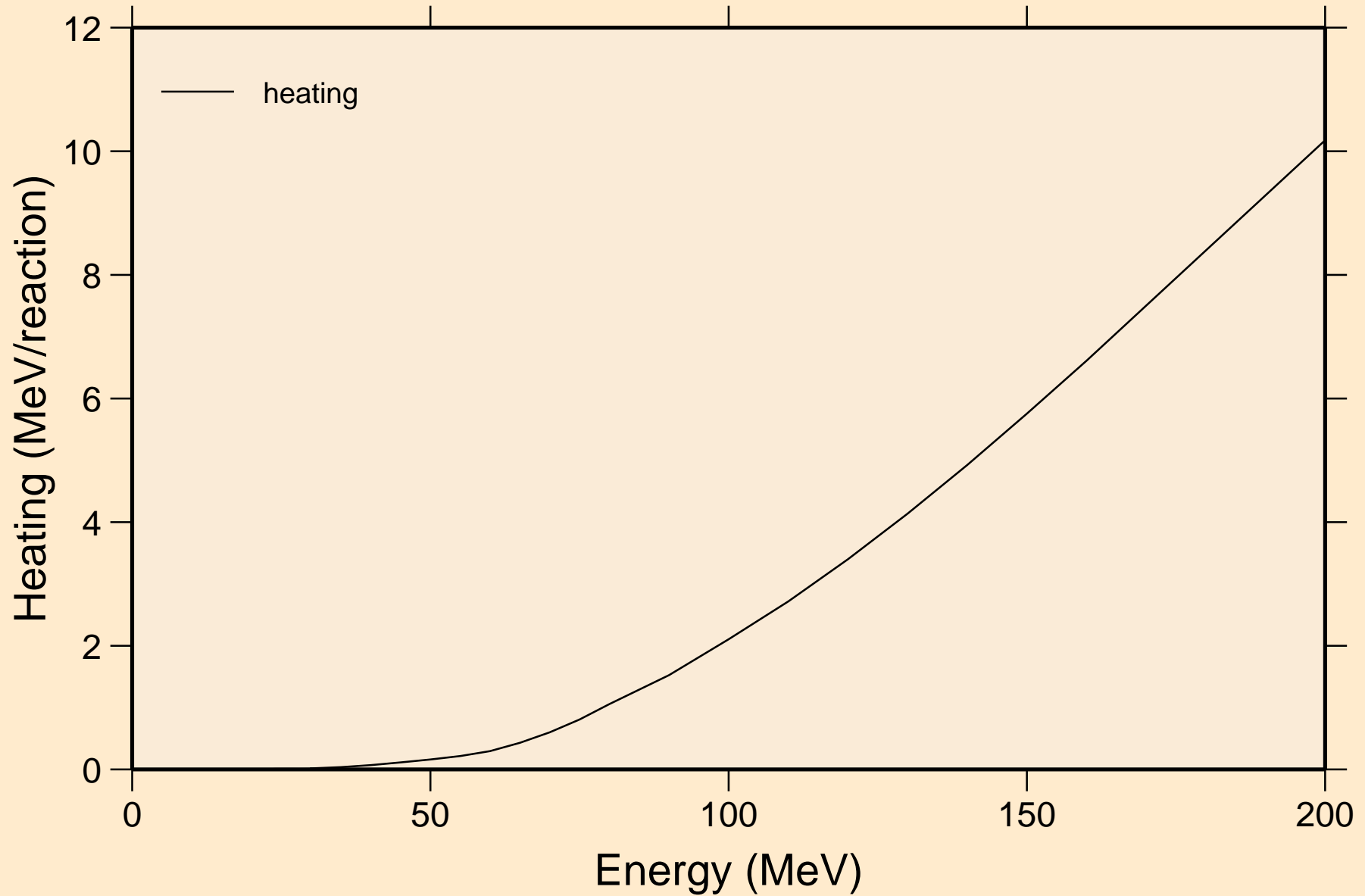

# FR205 PROTON ACER TENDL-2021 LIBRARY; T=0.K

## Threshold reactions

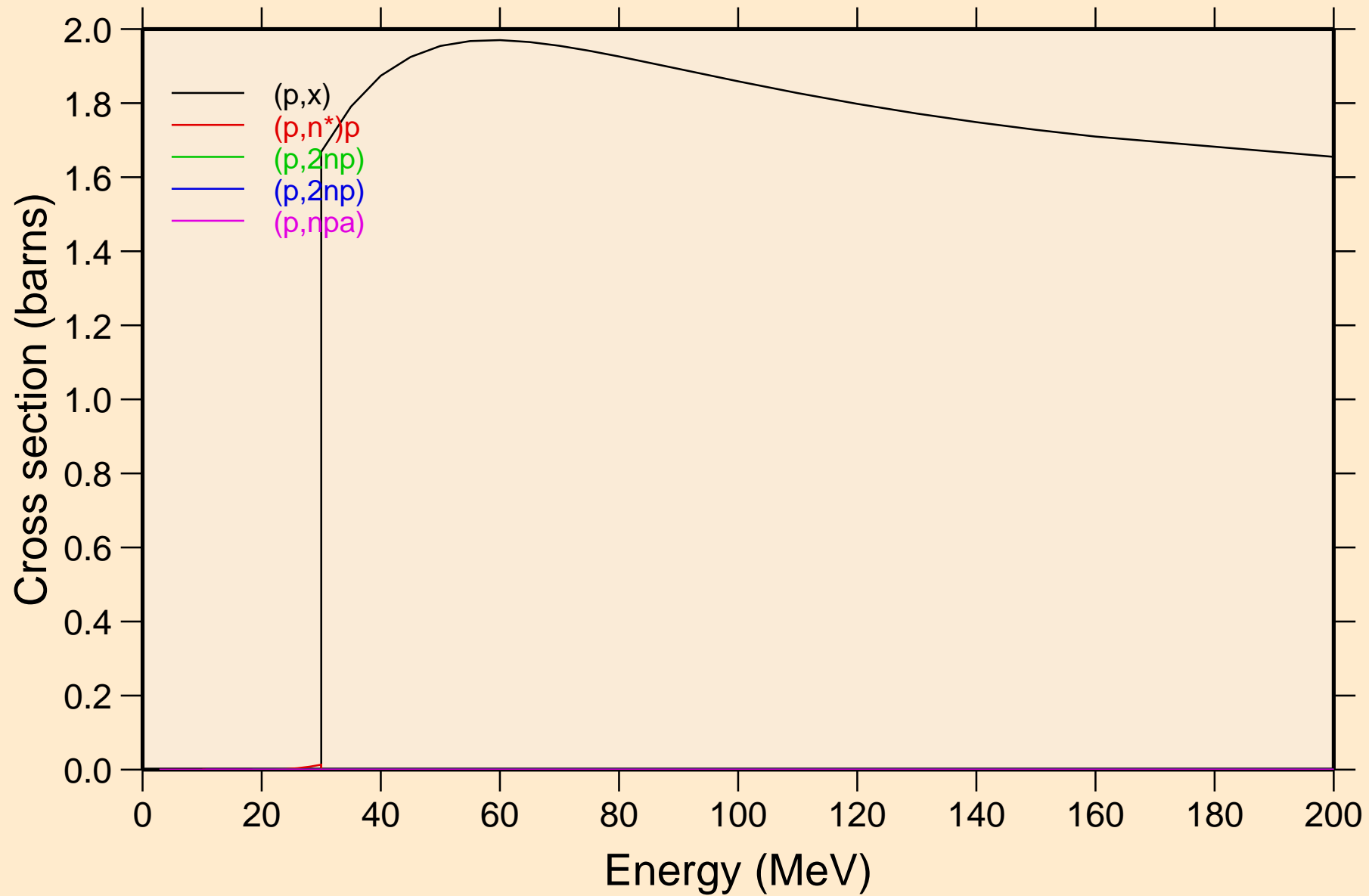

FR205 PROTON ACER TENDL-2021 LIBRARY; T=0.K  
Threshold reactions

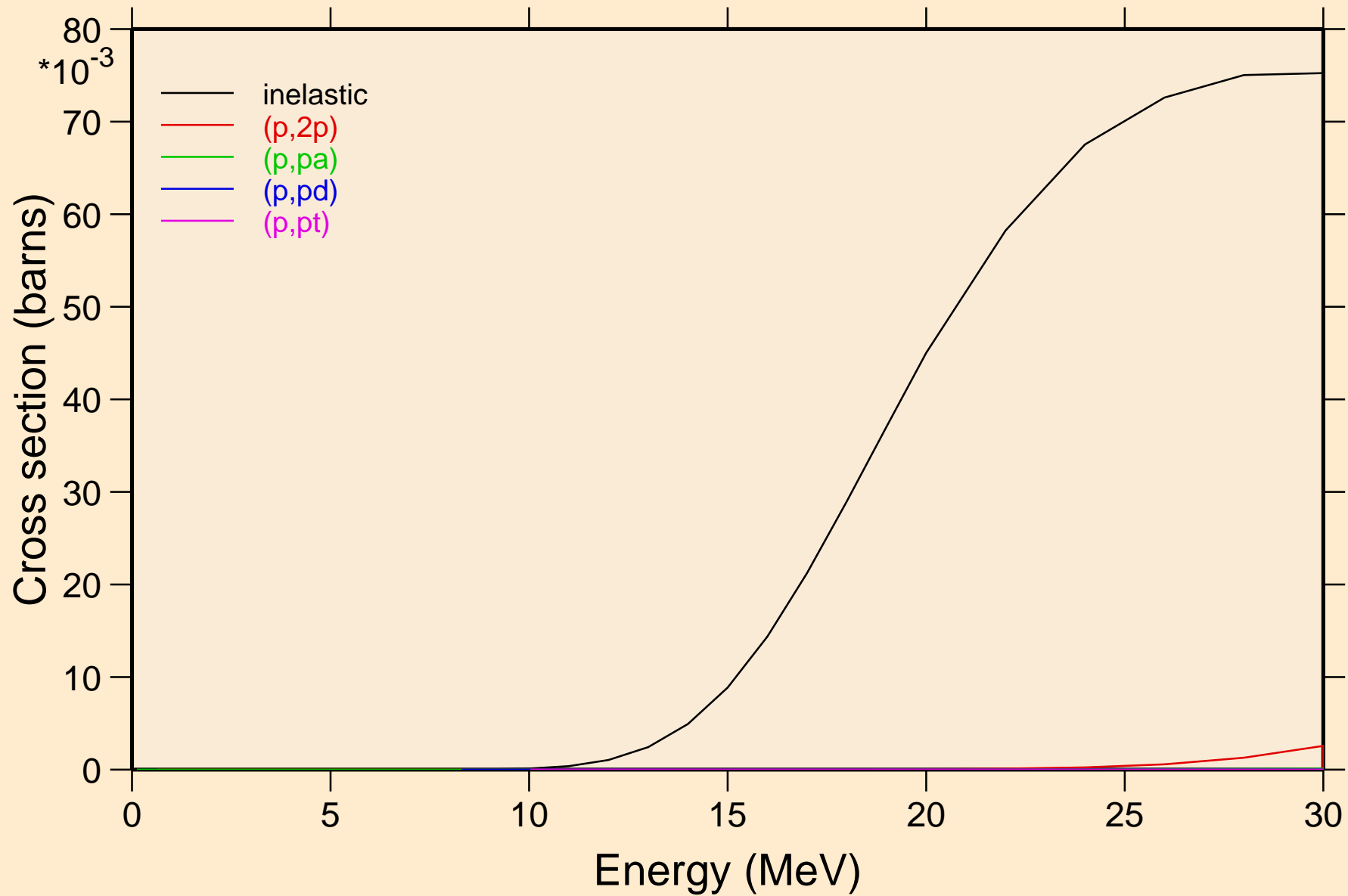

FR205 PROTON ACER TENDL-2021 LIBRARY; T=0.K  
Threshold reactions

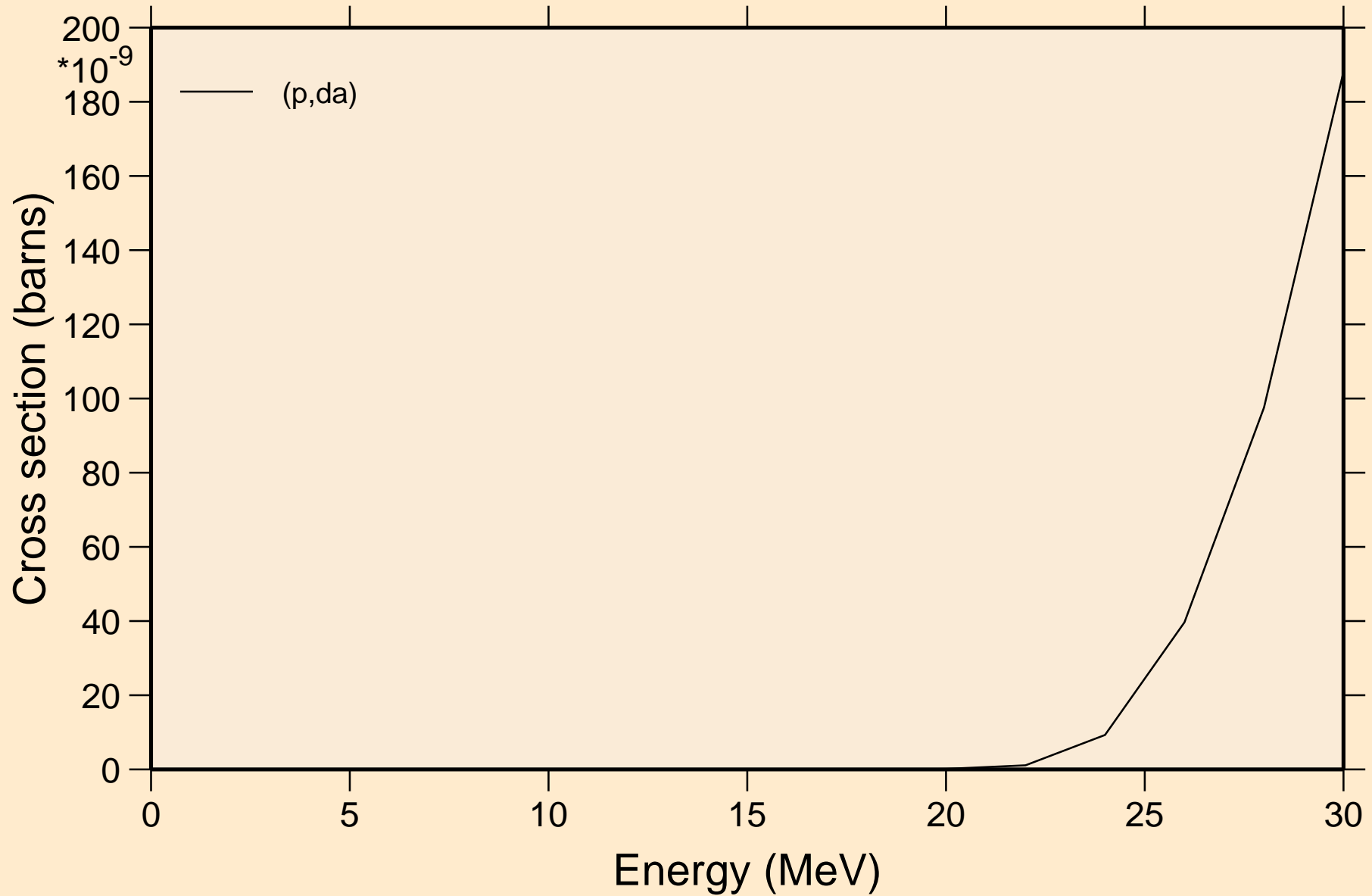

FR205 PROTON ACER TENDL-2021 LIBRARY; T=0.K  
angular distribution for elastic

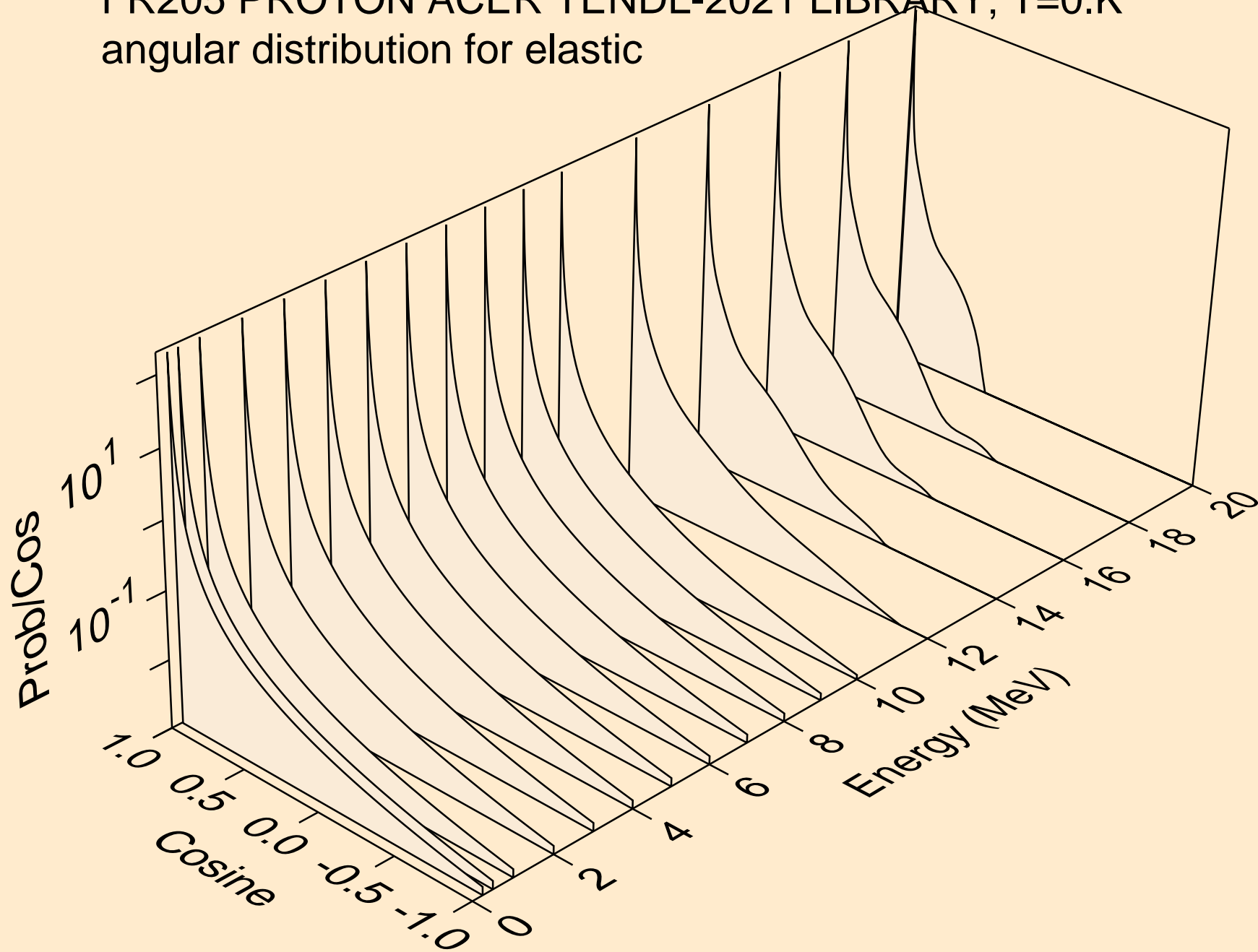



FR205 PROTON ACER TENDL-2021 LIBRARY; T=0.K  
angular distribution for elastic

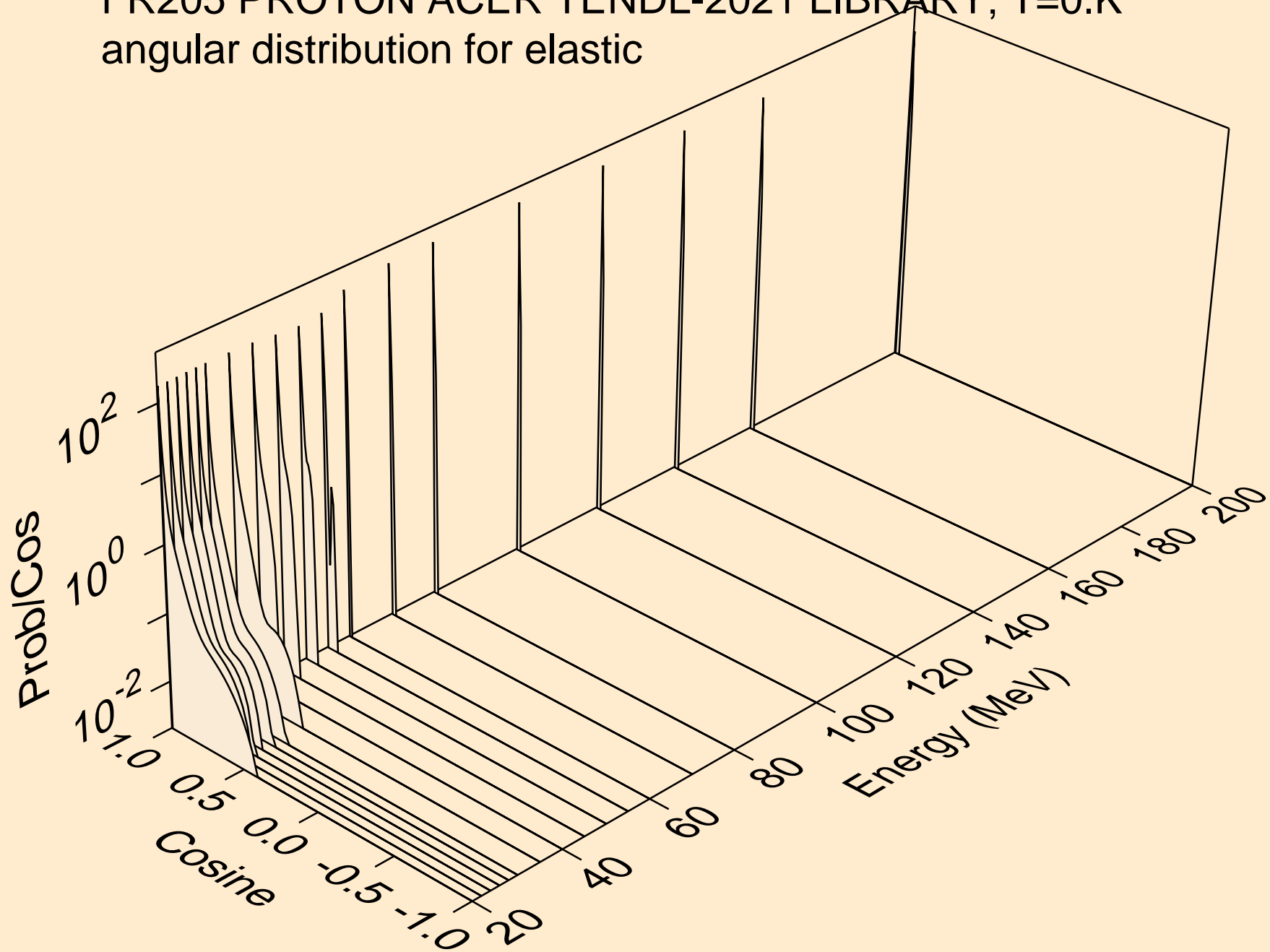

FR205 PROTON ACER TENDL-2021 LIBRARY; T=0.K  
Proton emission for (p,x)

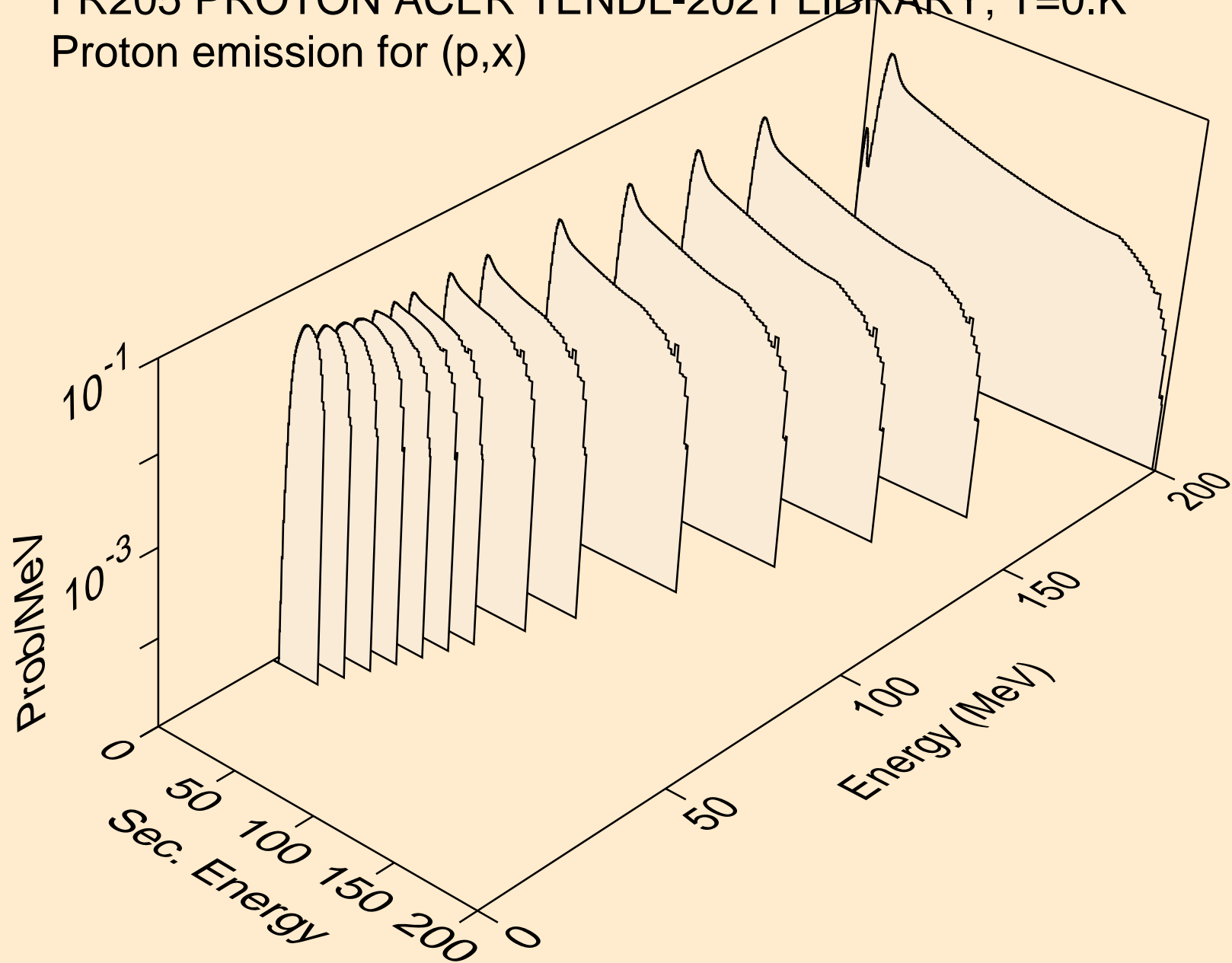

FR205 PROTON ACER TENDL-2021 LIBRARY; T=0.K  
Proton emission for (p,n\*)p

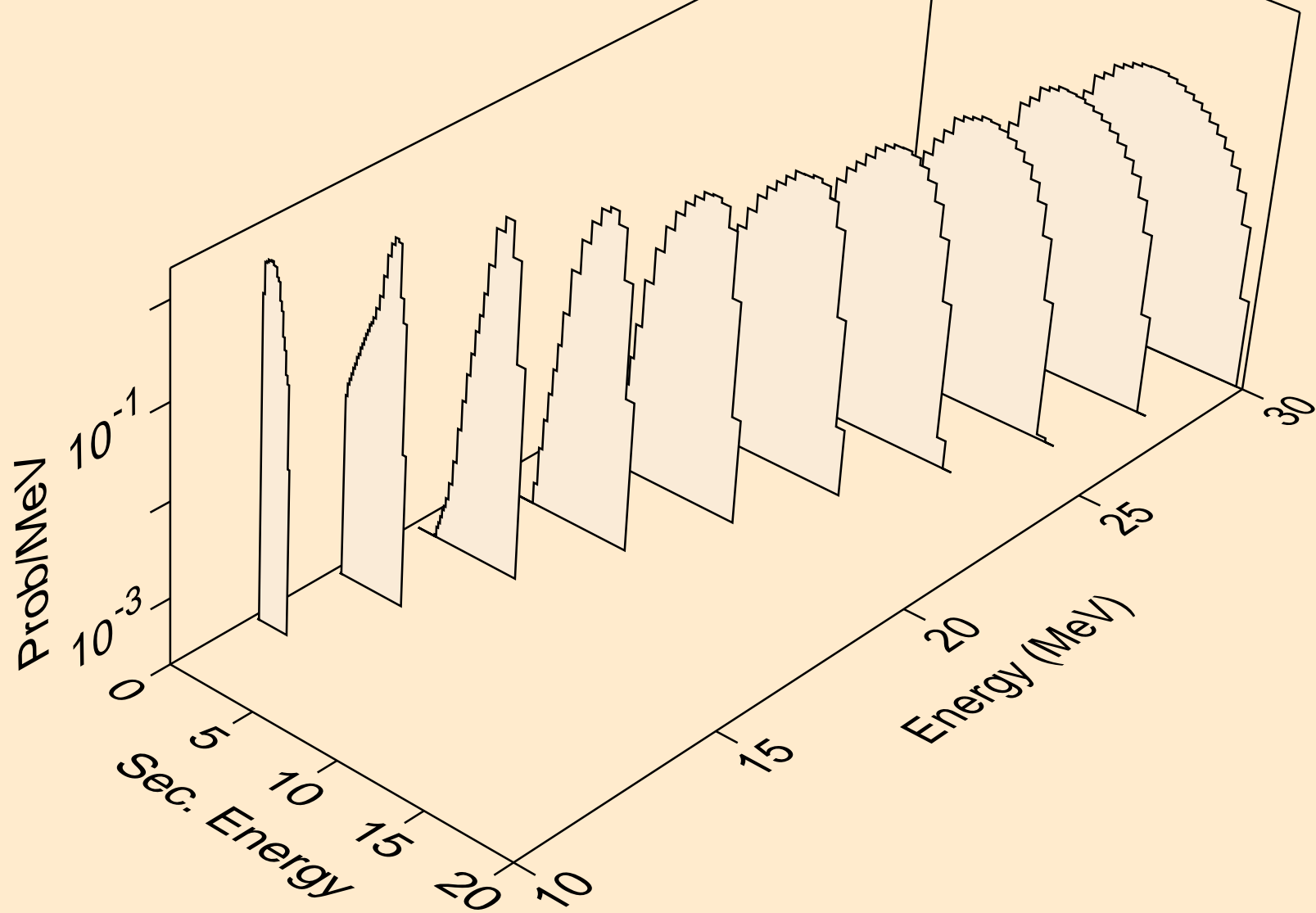

FR205 PROTON ACER TENDL-2021 LIBRARY; T=0.K  
Proton emission for (p,2np)

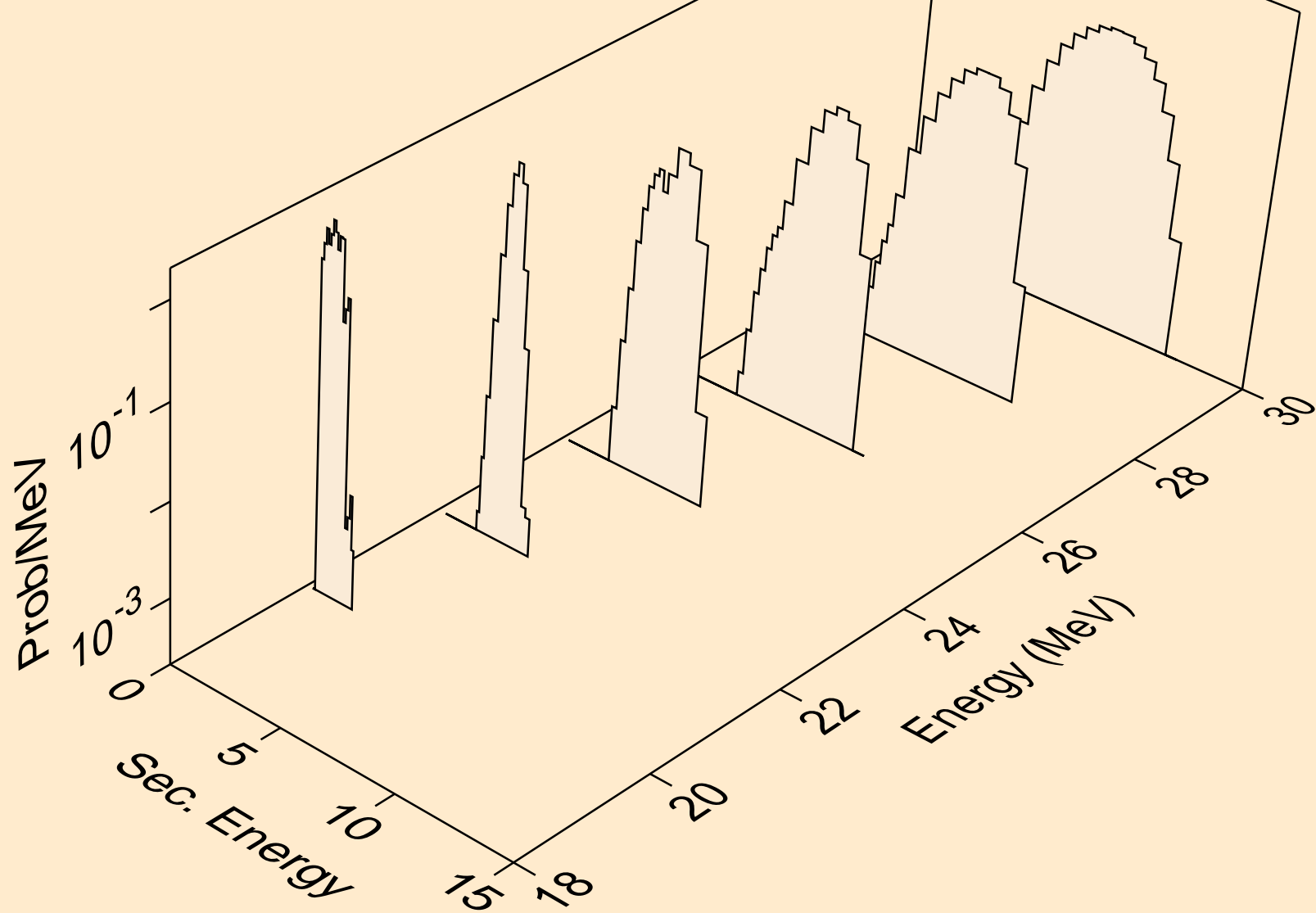

FR205 PROTON ACER TENDL-2021 LIBRARY; T=0.K  
Proton emission for (p,2np)

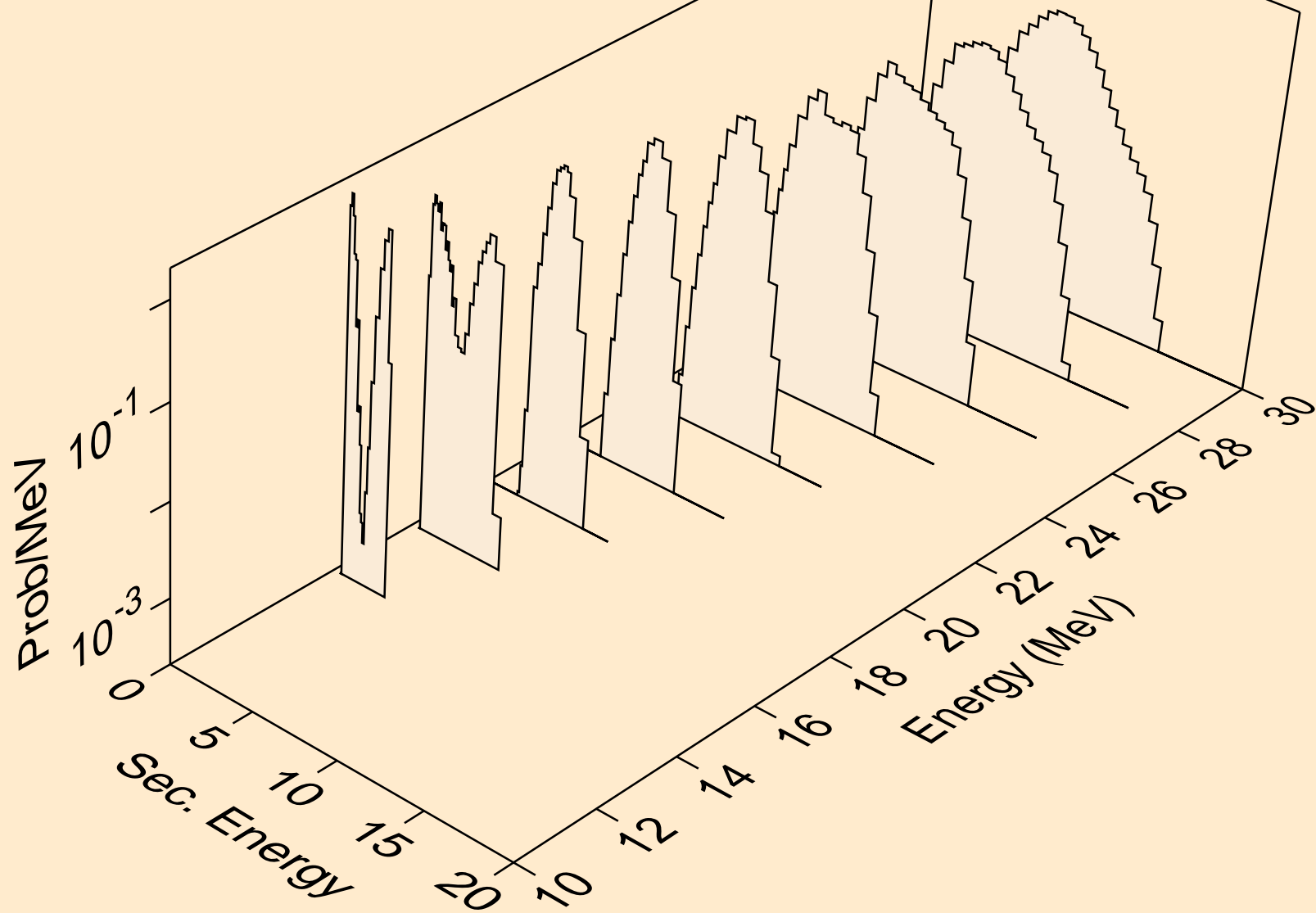

FR205 PROTON ACER TENDL-2021 LIBRARY; T=0.K  
Proton emission for (p,npa)

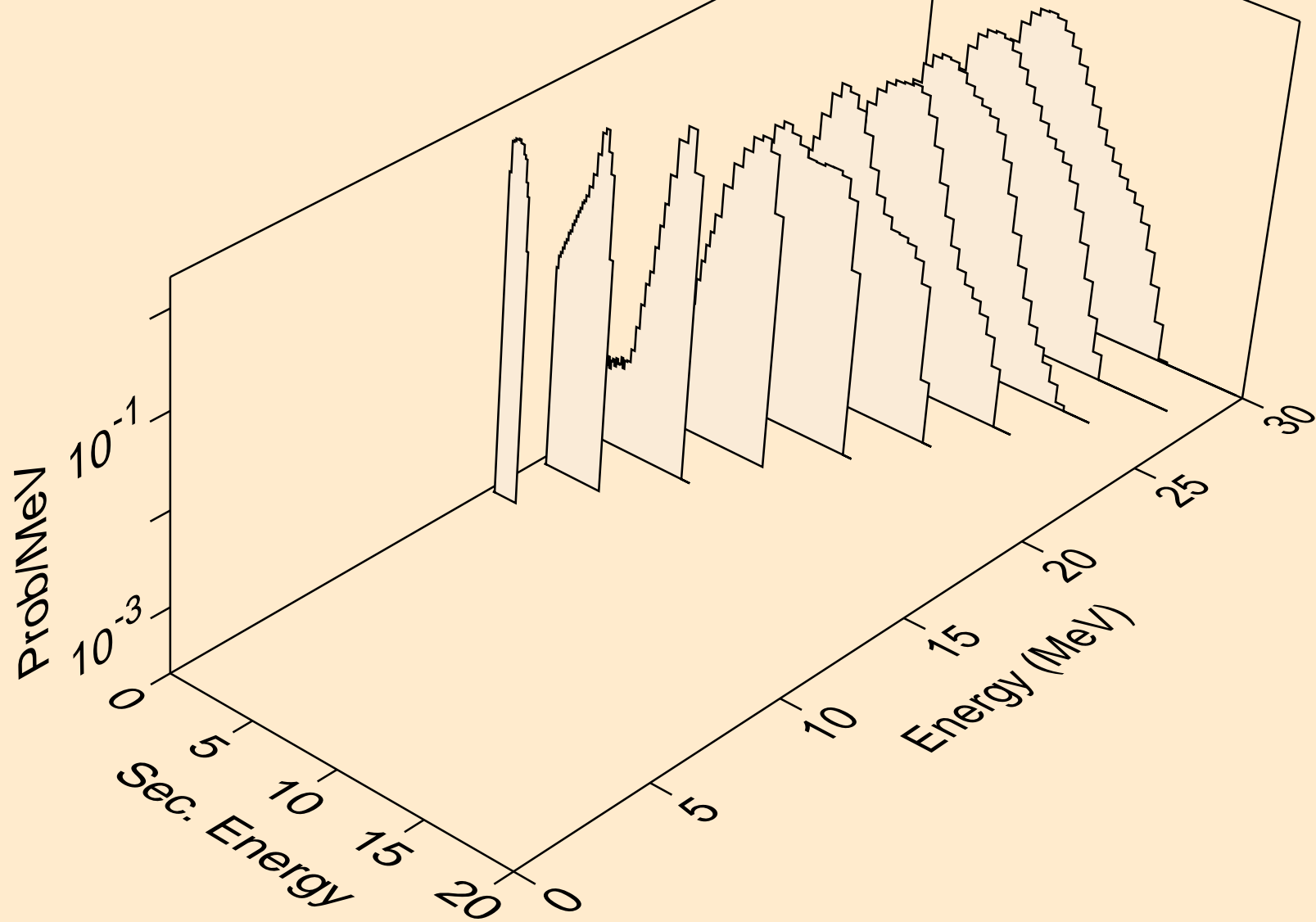

FR205 PROTON ACER TENDL-2021 LIBRARY; T=0.K  
Proton emission for inelastic

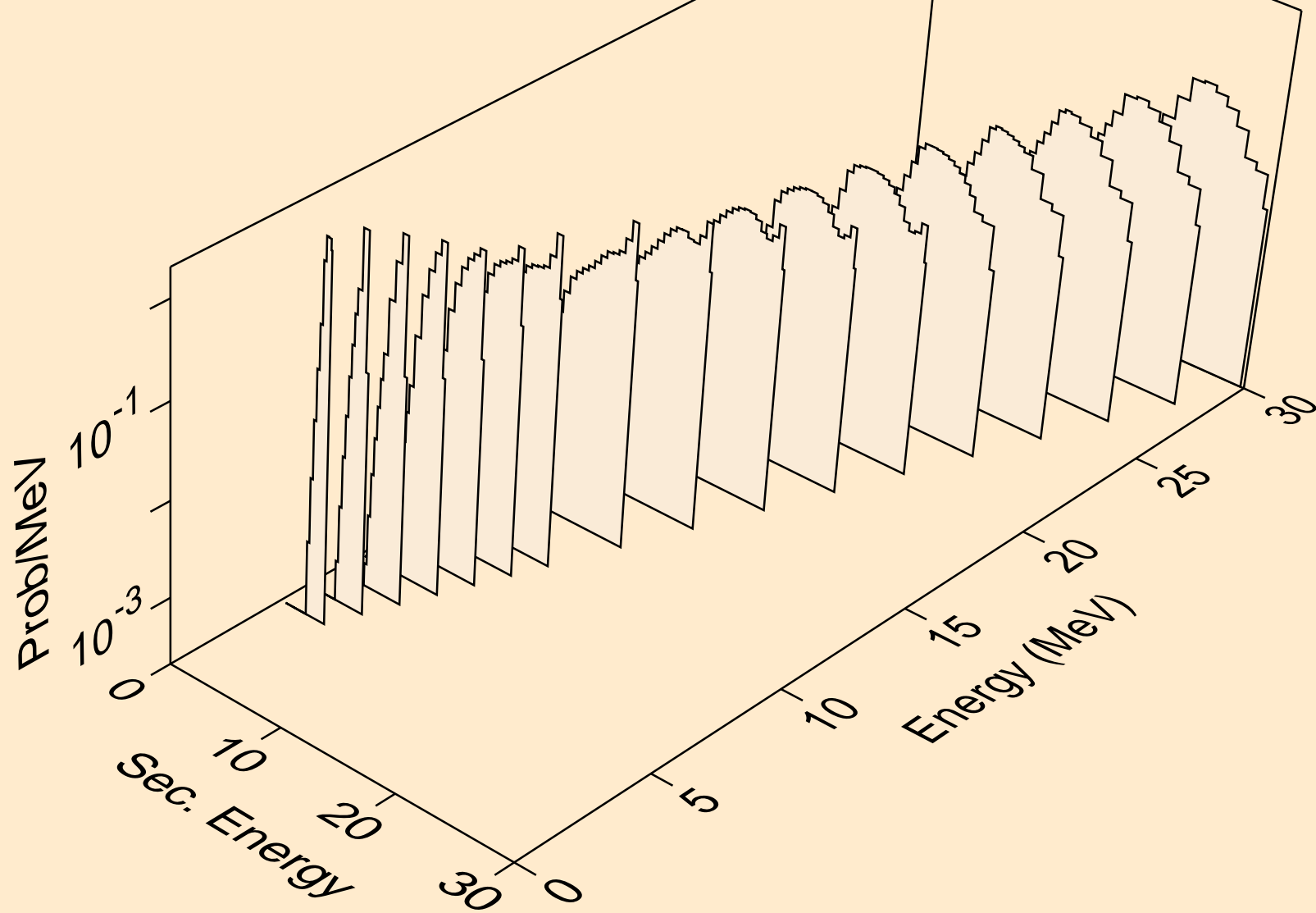

FR205 PROTON ACER TENDL-2021 LIBRARY; T=0.K  
Proton emission for (p,2p)

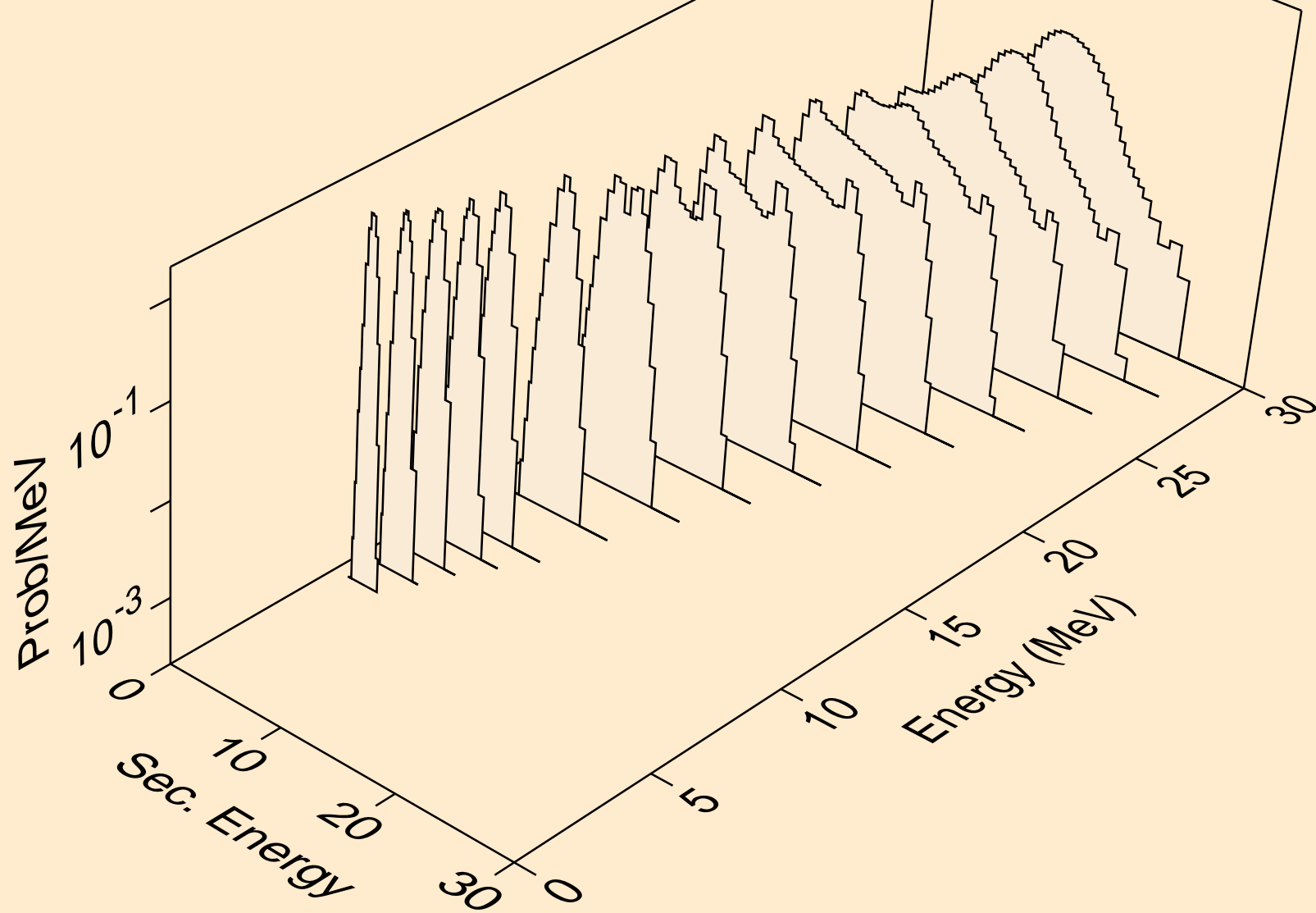



FR205 PROTON ACER TENDL-2021 LIBRARY; T=0.K  
Proton emission for (p,pa)

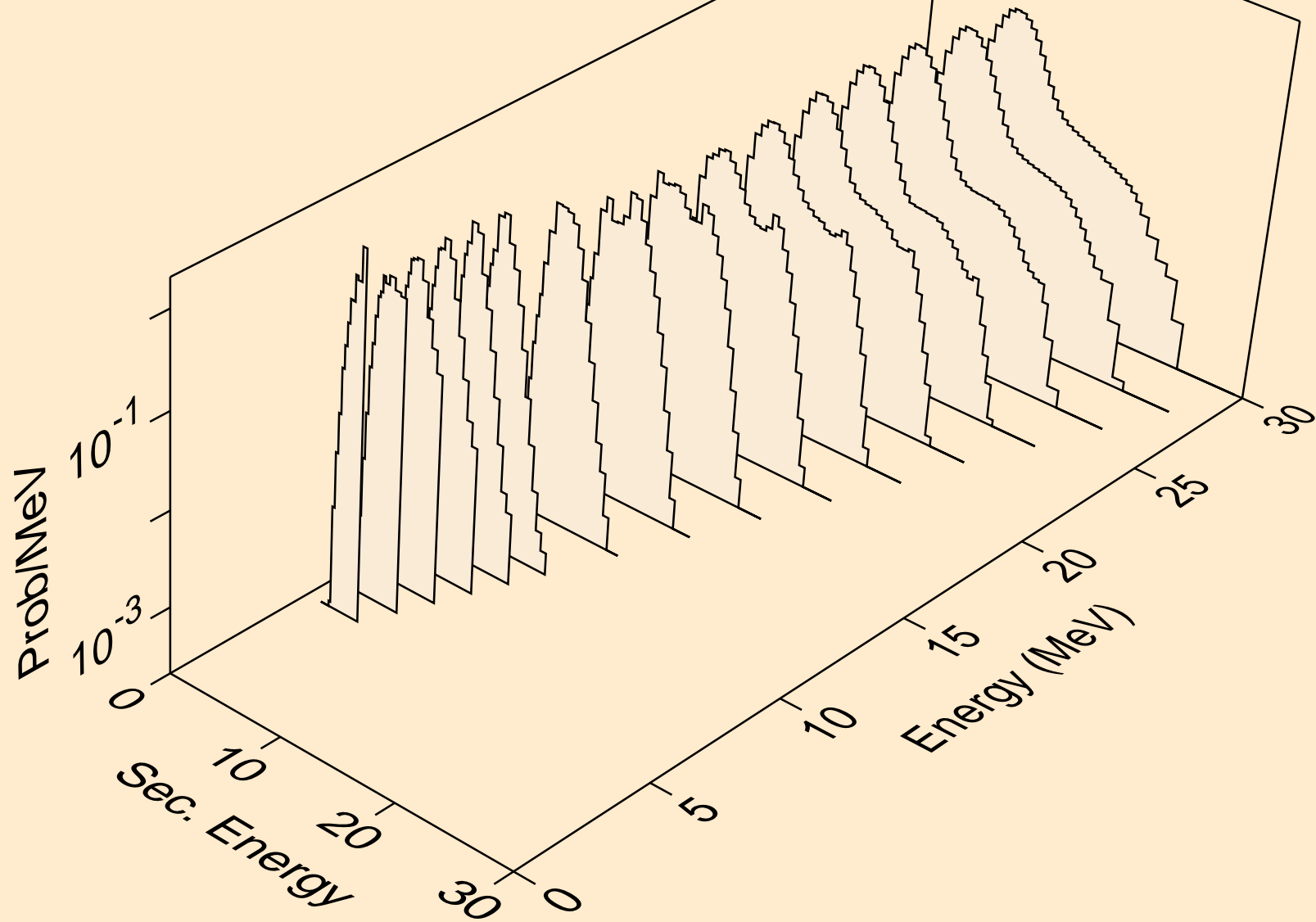

FR205 PROTON ACER TENDL-2021 LIBRARY; T=0.K  
Proton emission for (p,pd)

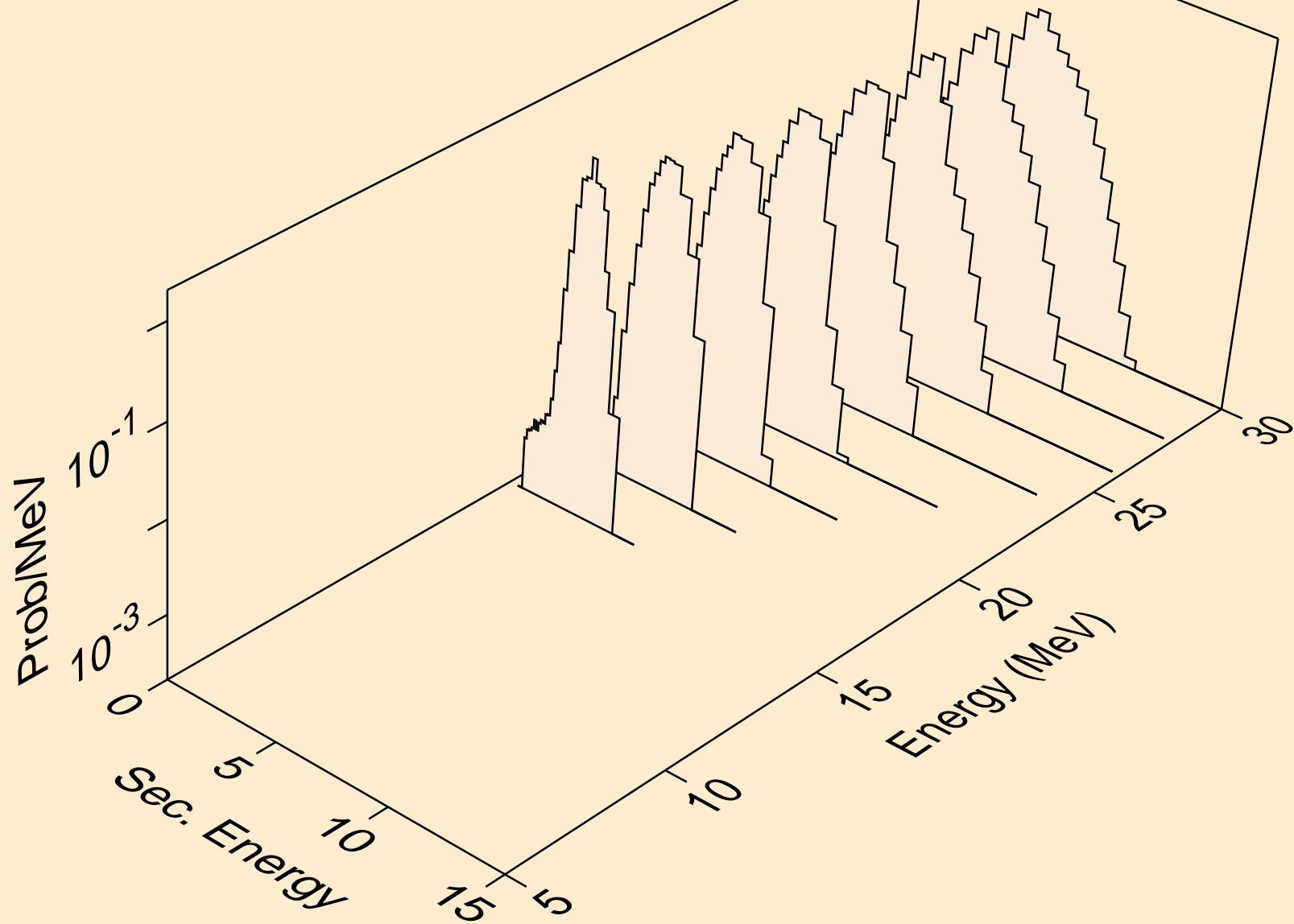

FR205 PROTON ACER TENDL-2021 LIBRARY; T=0.K  
Proton emission for (p,pt)

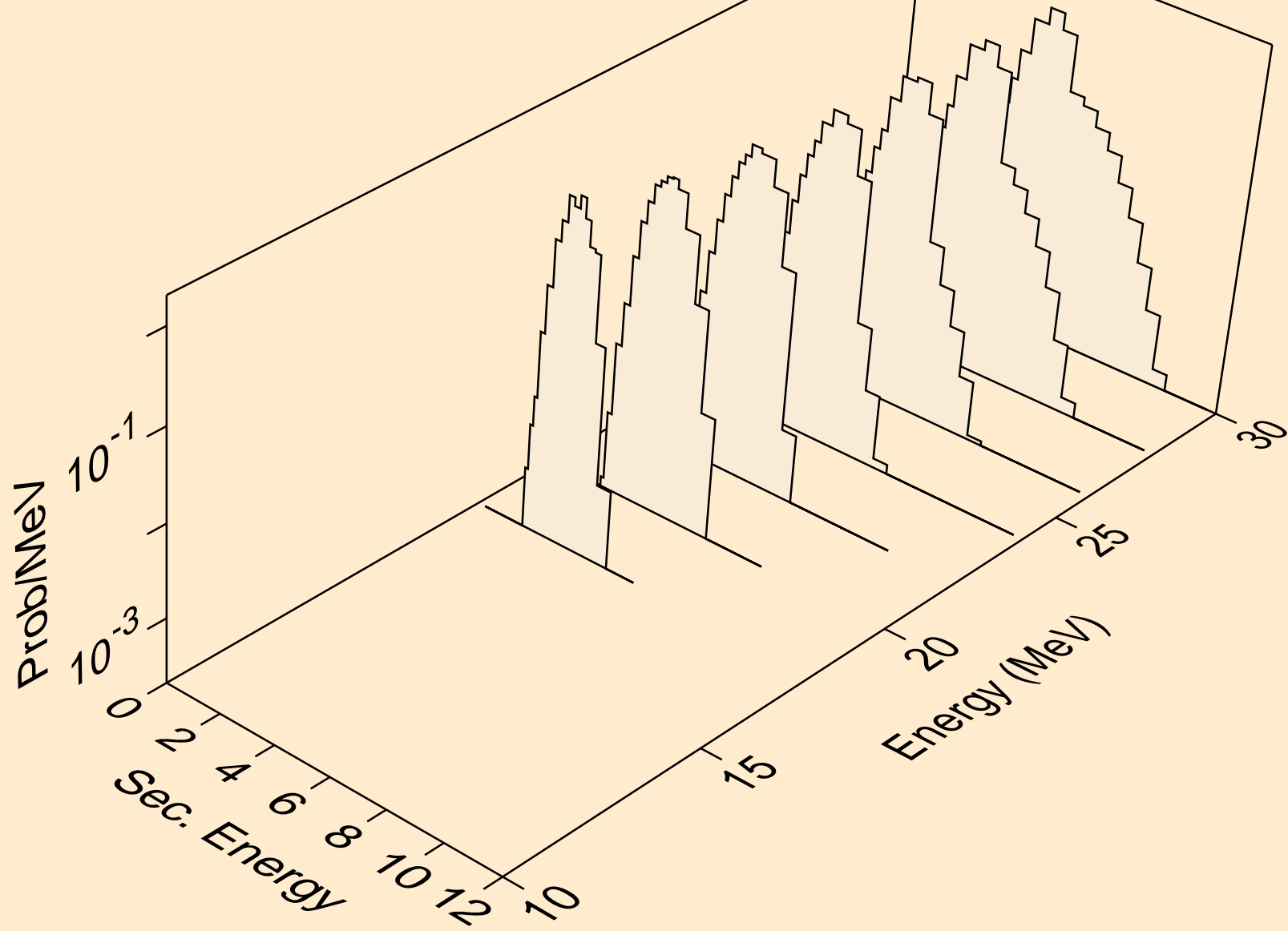

FR205 PROTON ACER TENDL-2021 LIBRARY; T=0.K  
Photon emission for (z,n)

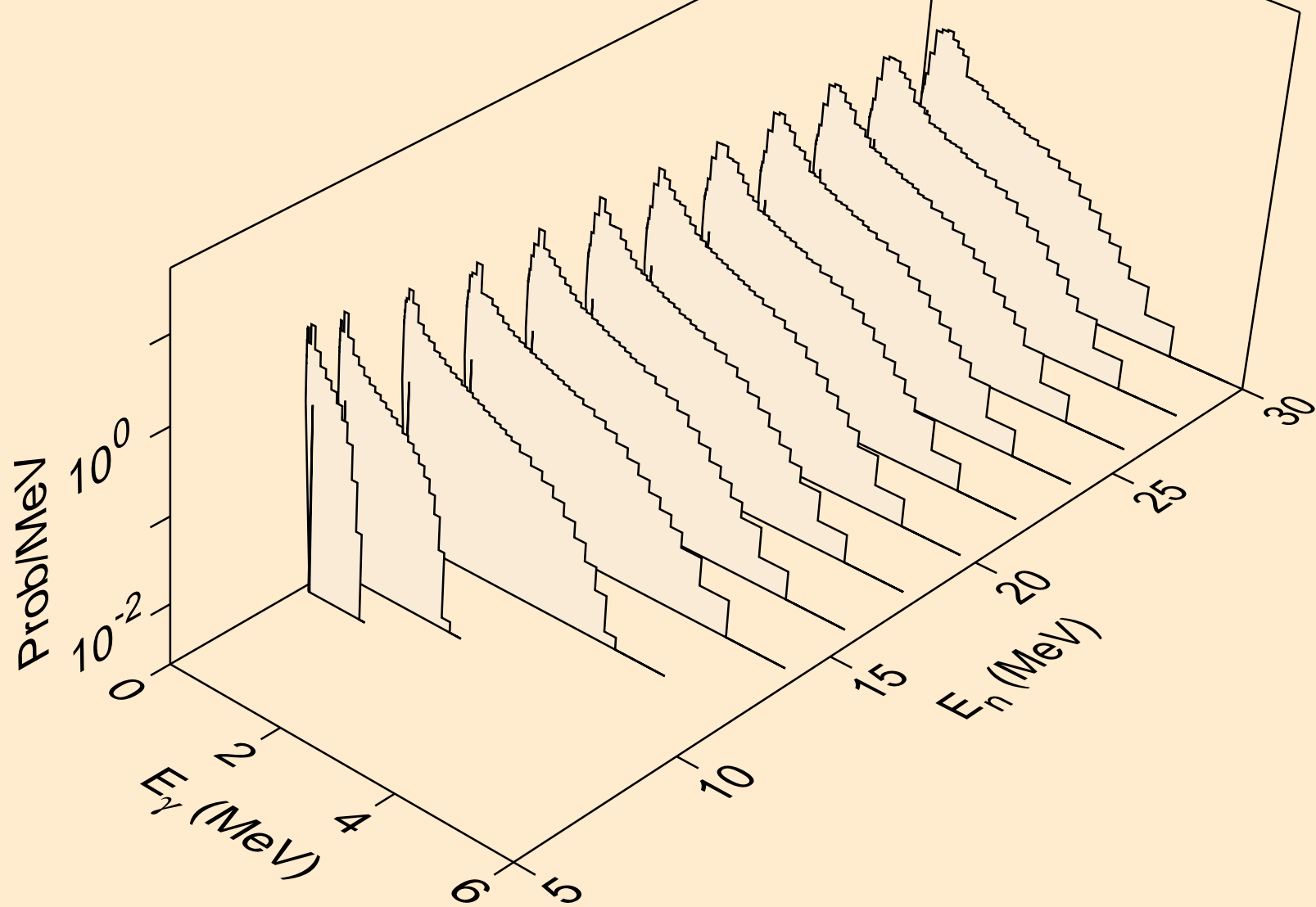

FR205 PROTON ACER TENDL-2021 LIBRARY; T=0.K  
Photon emission for (n,x)

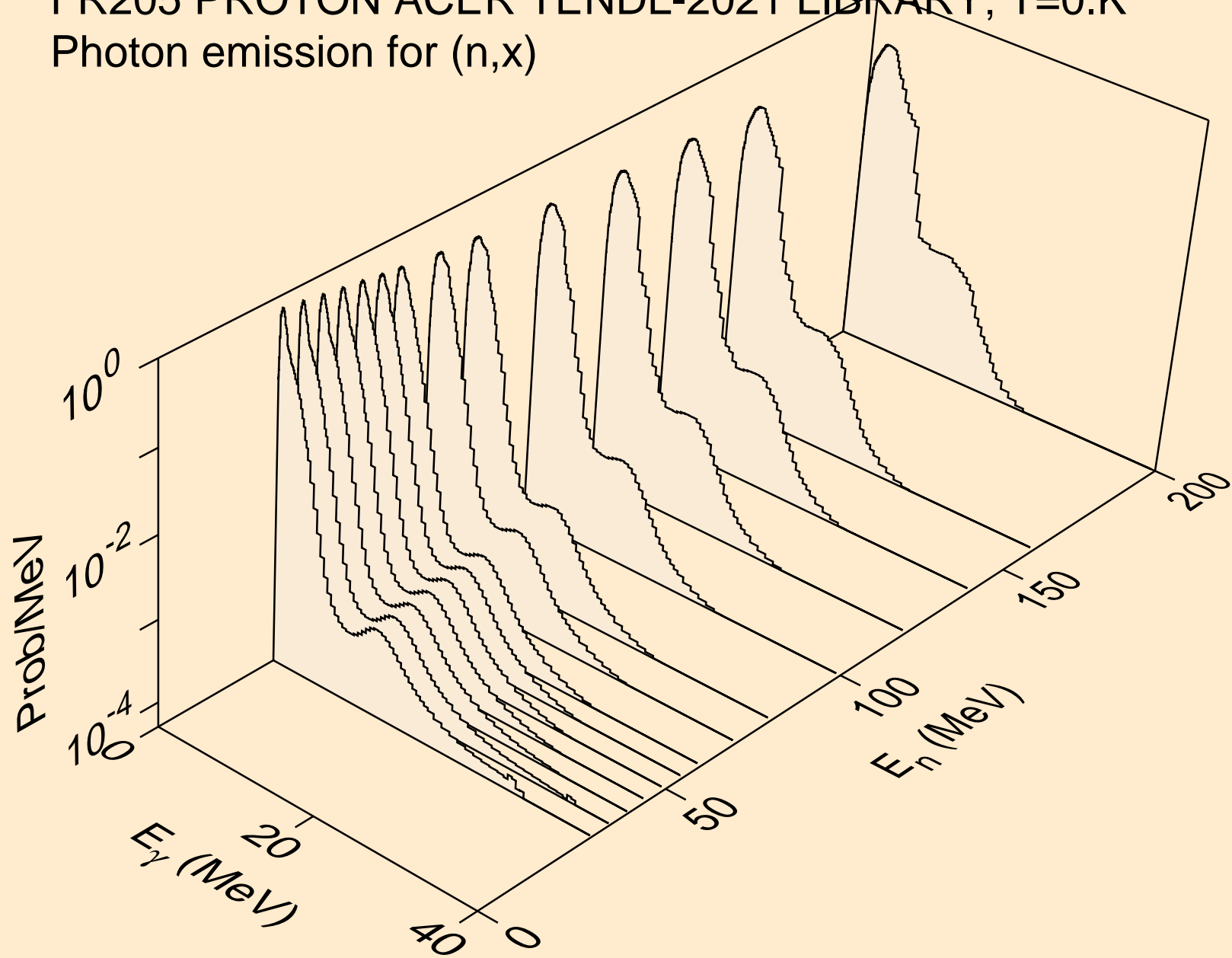

FR205 PROTON ACER TENDL-2021 LIBRARY; T=0.K  
Photon emission for (n,2n)

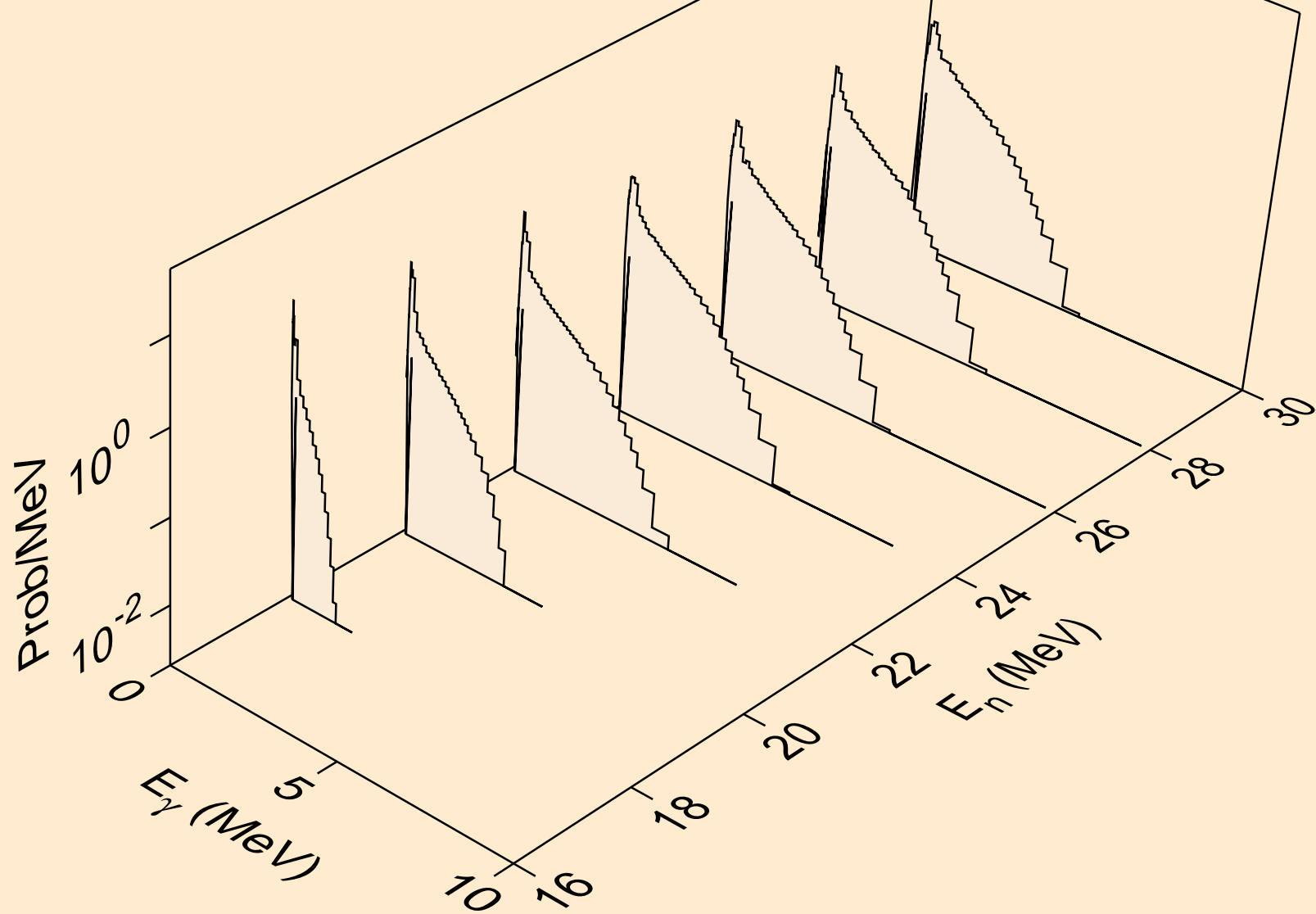

FR205 PROTON ACER TENDL-2021 LIBRARY; T=0.K  
Photon emission for (n,3n)

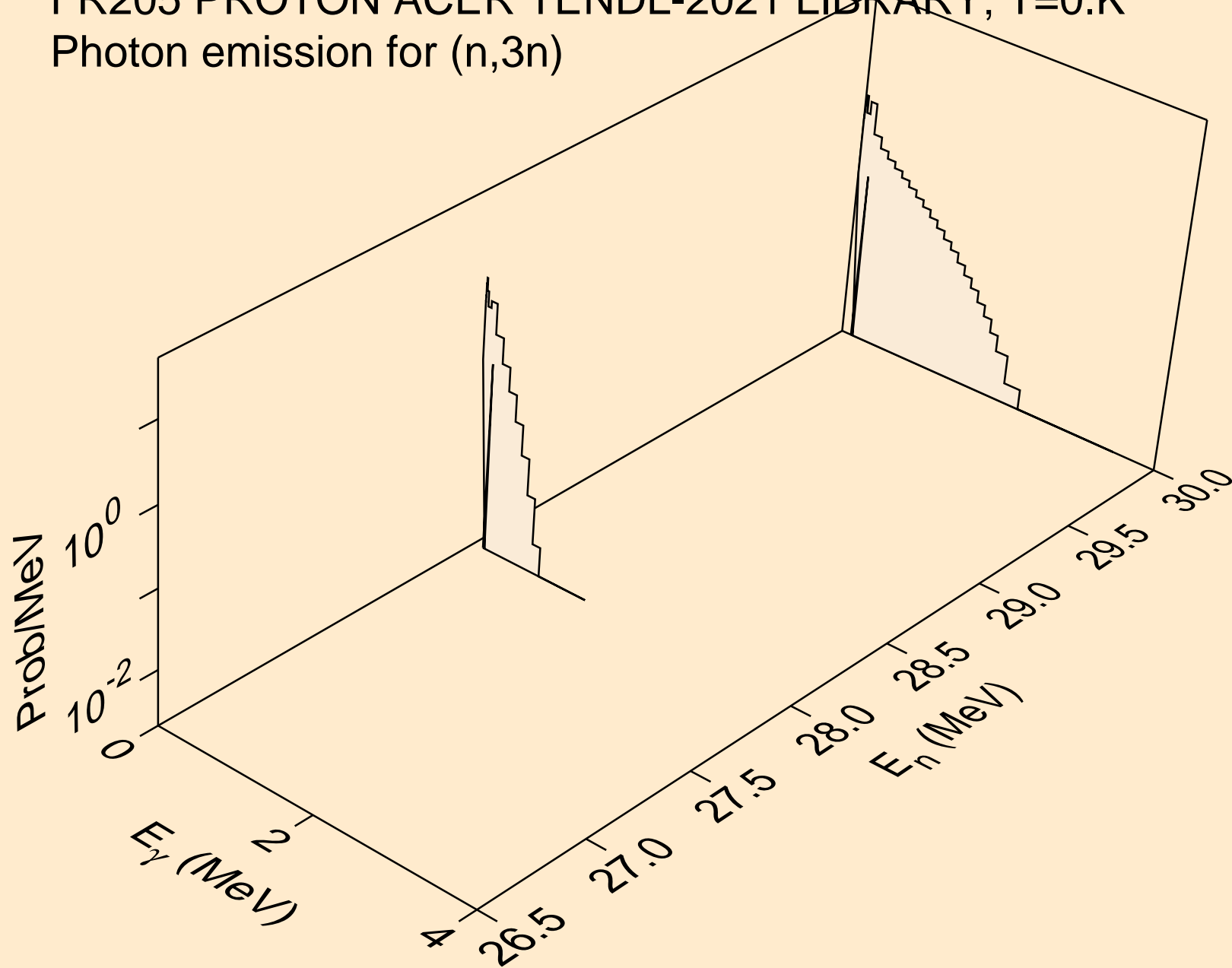

FR205 PROTON ACER TENDL-2021 LIBRARY; T=0.K  
Photon emission for (n,n\*)a

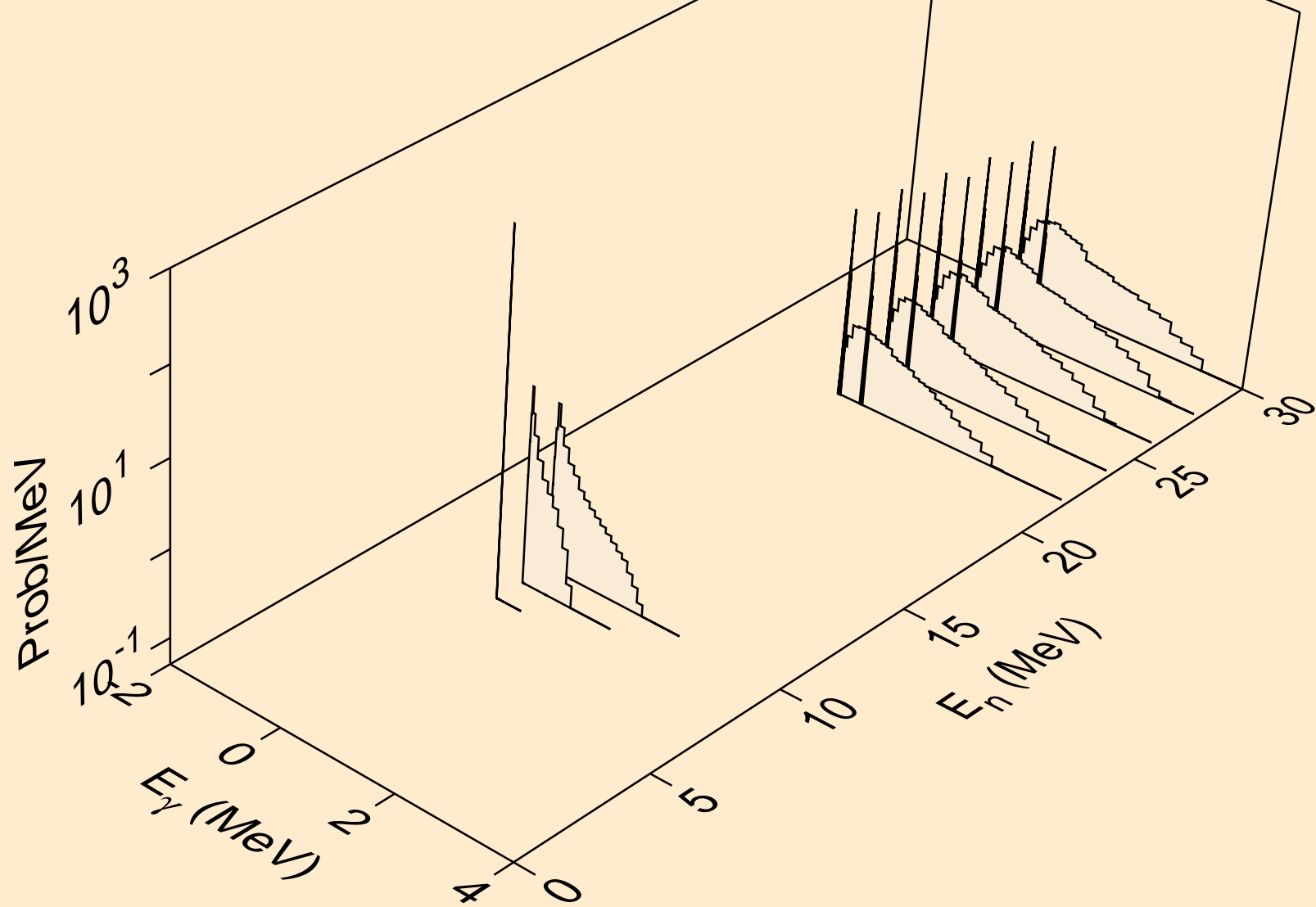



FR205 PROTON ACER TENDL-2021 LIBRARY; T=0.K  
Photon emission for (n,2n)a

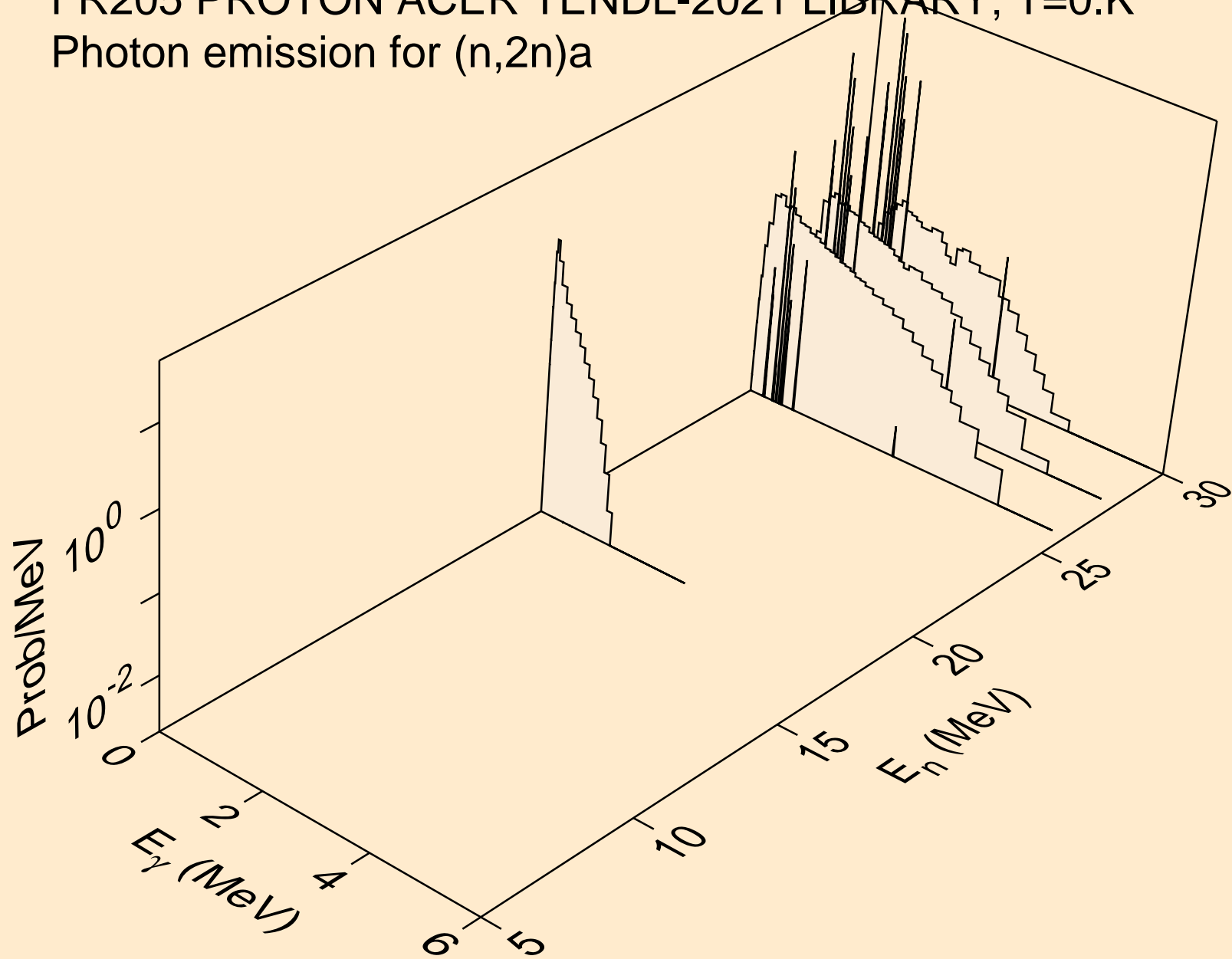

FR205 PROTON ACER TENDL-2021 LIBRARY; T=0.K  
Photon emission for (n,3n)a

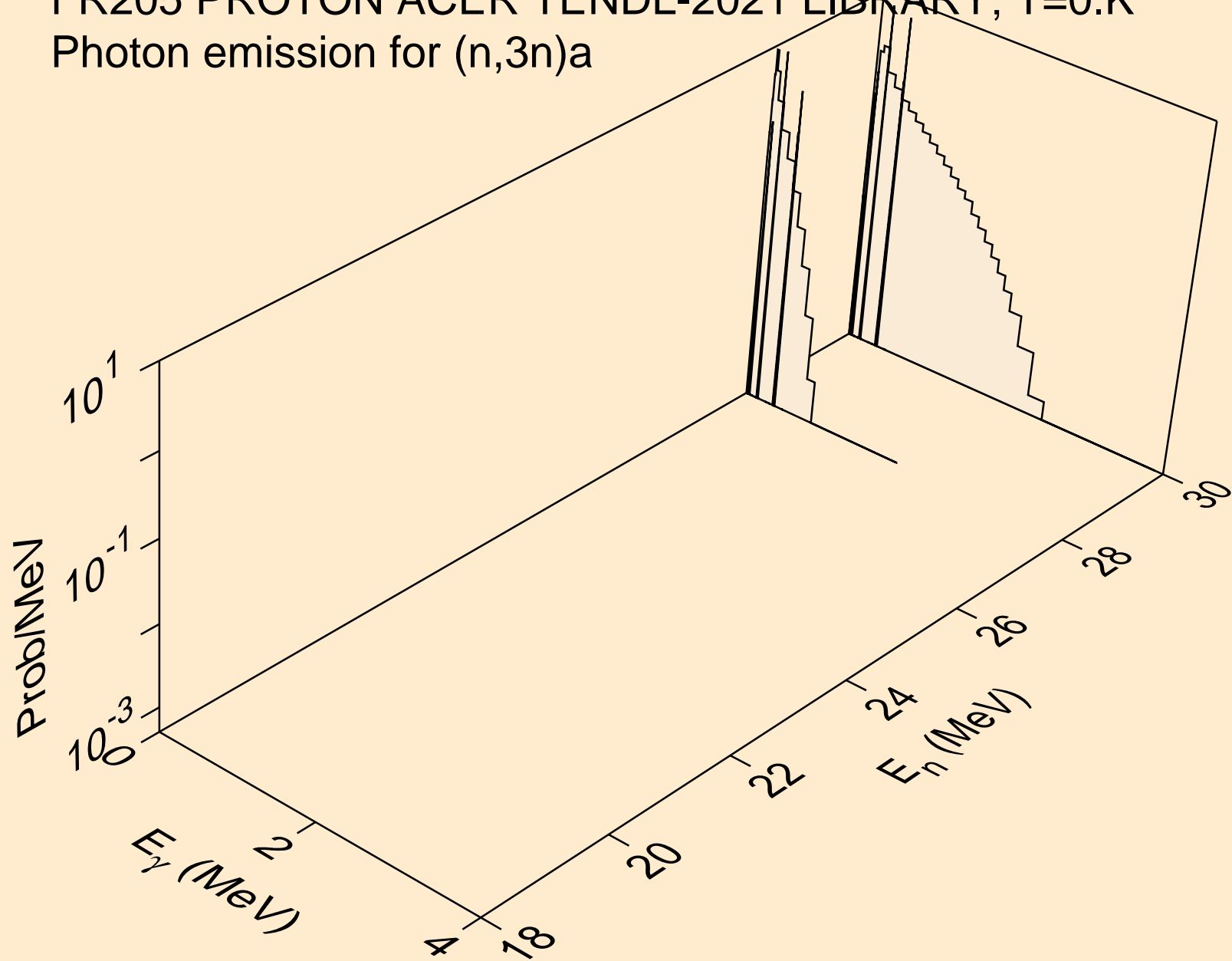

FR205 PROTON ACER TENDL-2021 LIBRARY; T=0.K  
Photon emission for (n,n\*)p

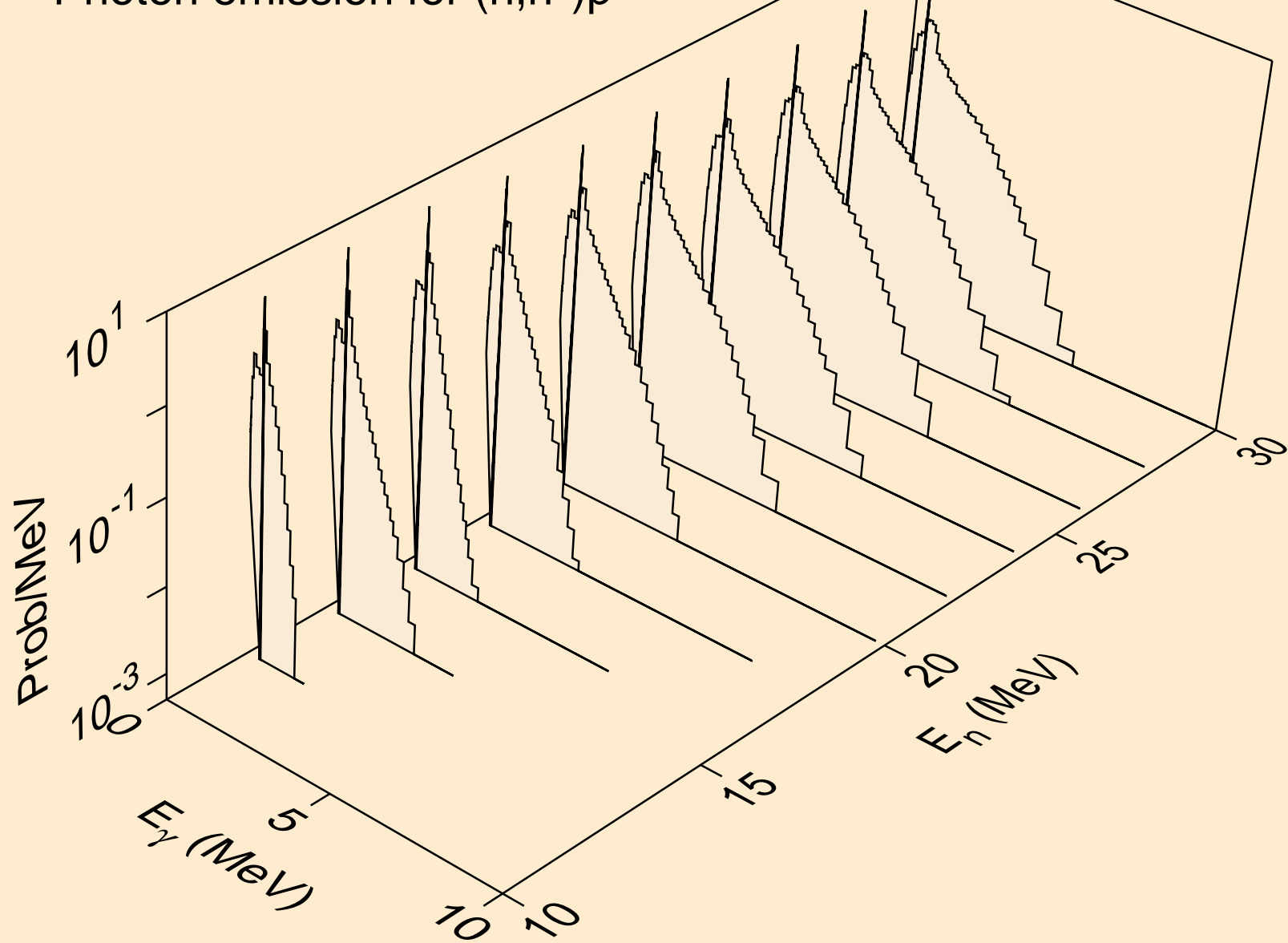

FR205 PROTON ACER TENDL-2021 LIBRARY; T=0.K  
Photon emission for (n,n\*)2a

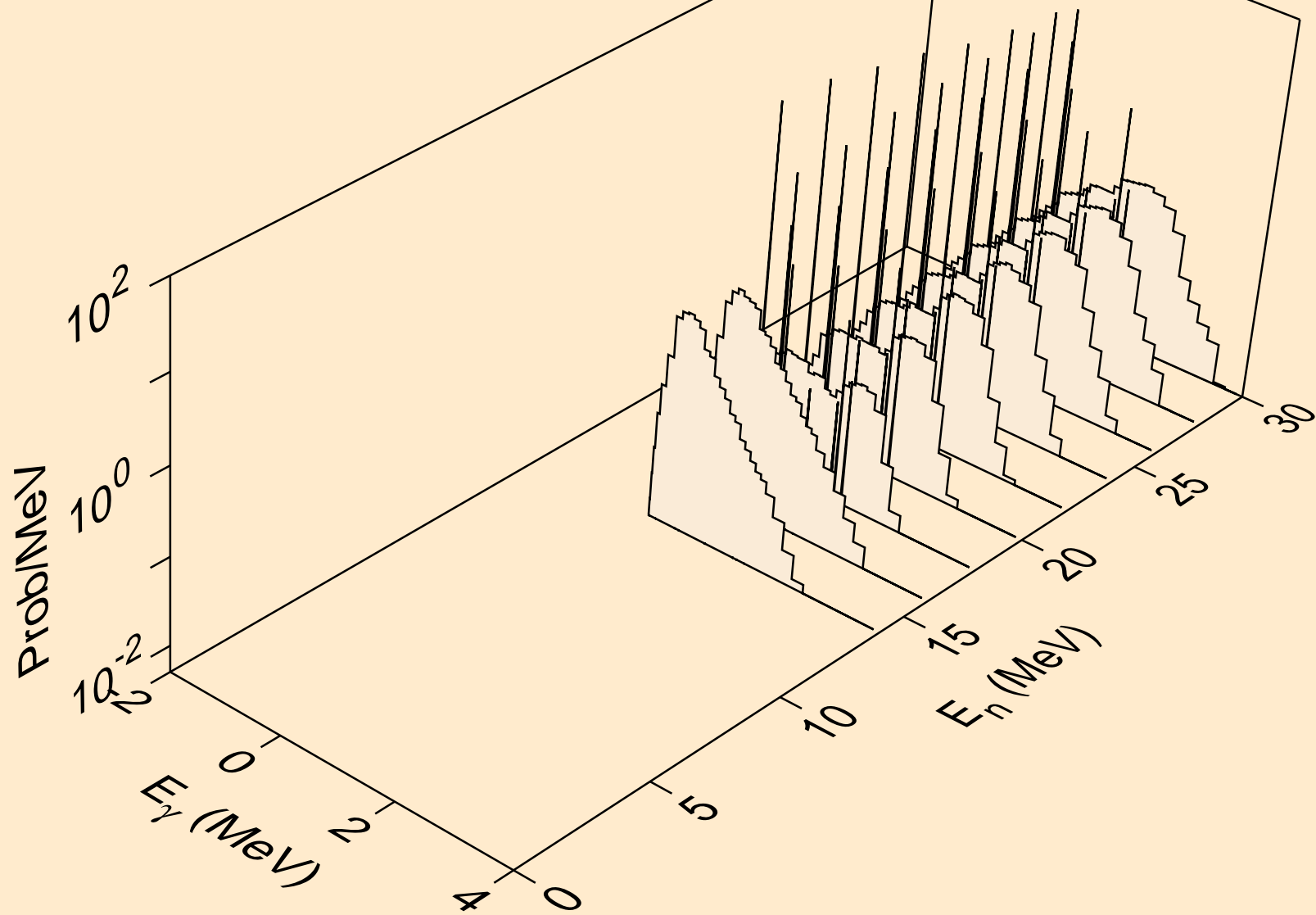

FR205 PROTON ACER TENDL-2021 LIBRARY; T=0.K  
Photon emission for (n,n\*)d

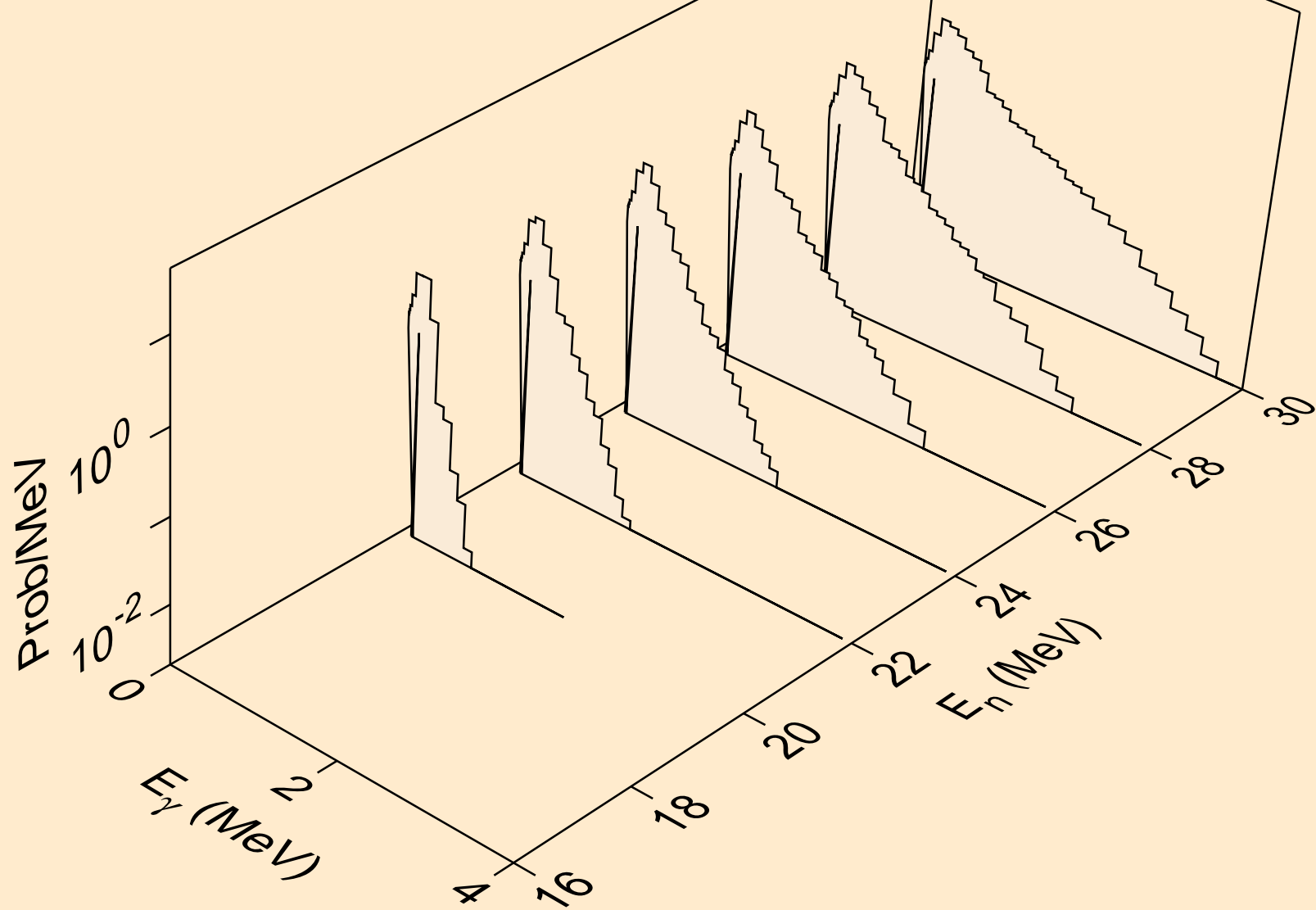

FR205 PROTON ACER TENDL-2021 LIBRARY; T=0.K  
Photon emission for (n,n\*)t

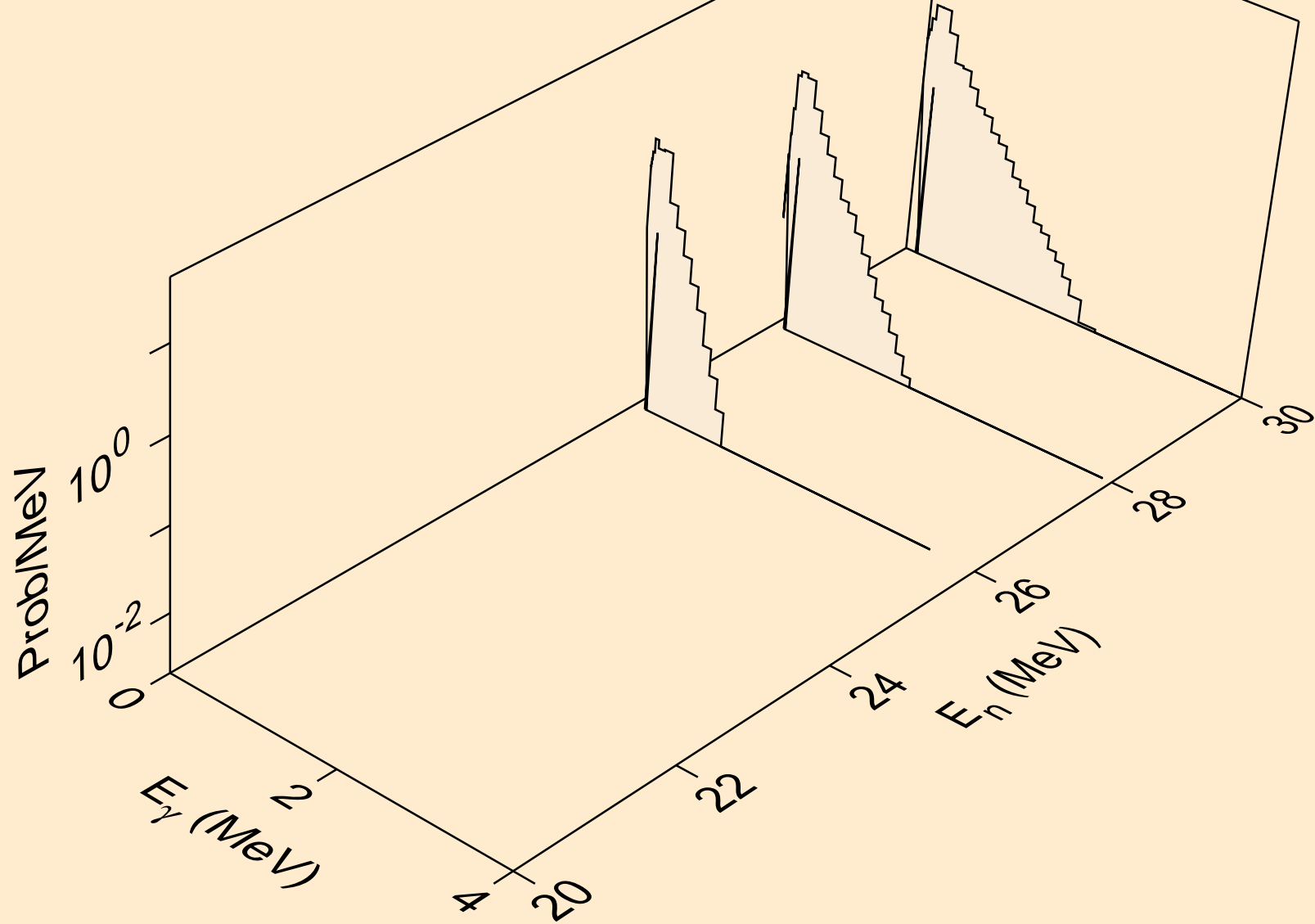

FR205 PROTON ACER TENDL-2021 LIBRARY; T=0.K  
Photon emission for (n,n\*)he3

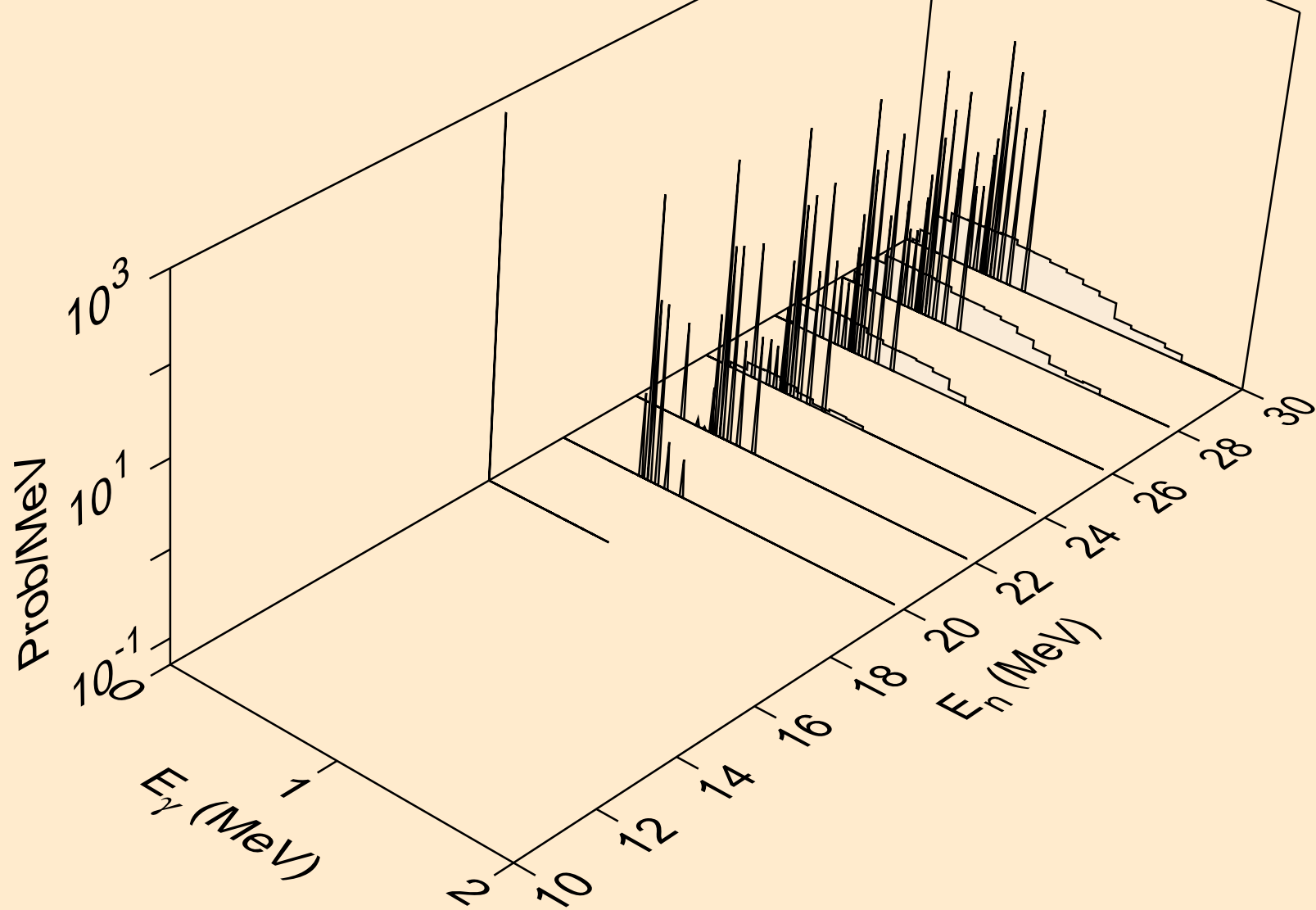

FR205 PROTON ACER TENDL-2021 LIBRARY; T=0.K  
Photon emission for (n,2np)

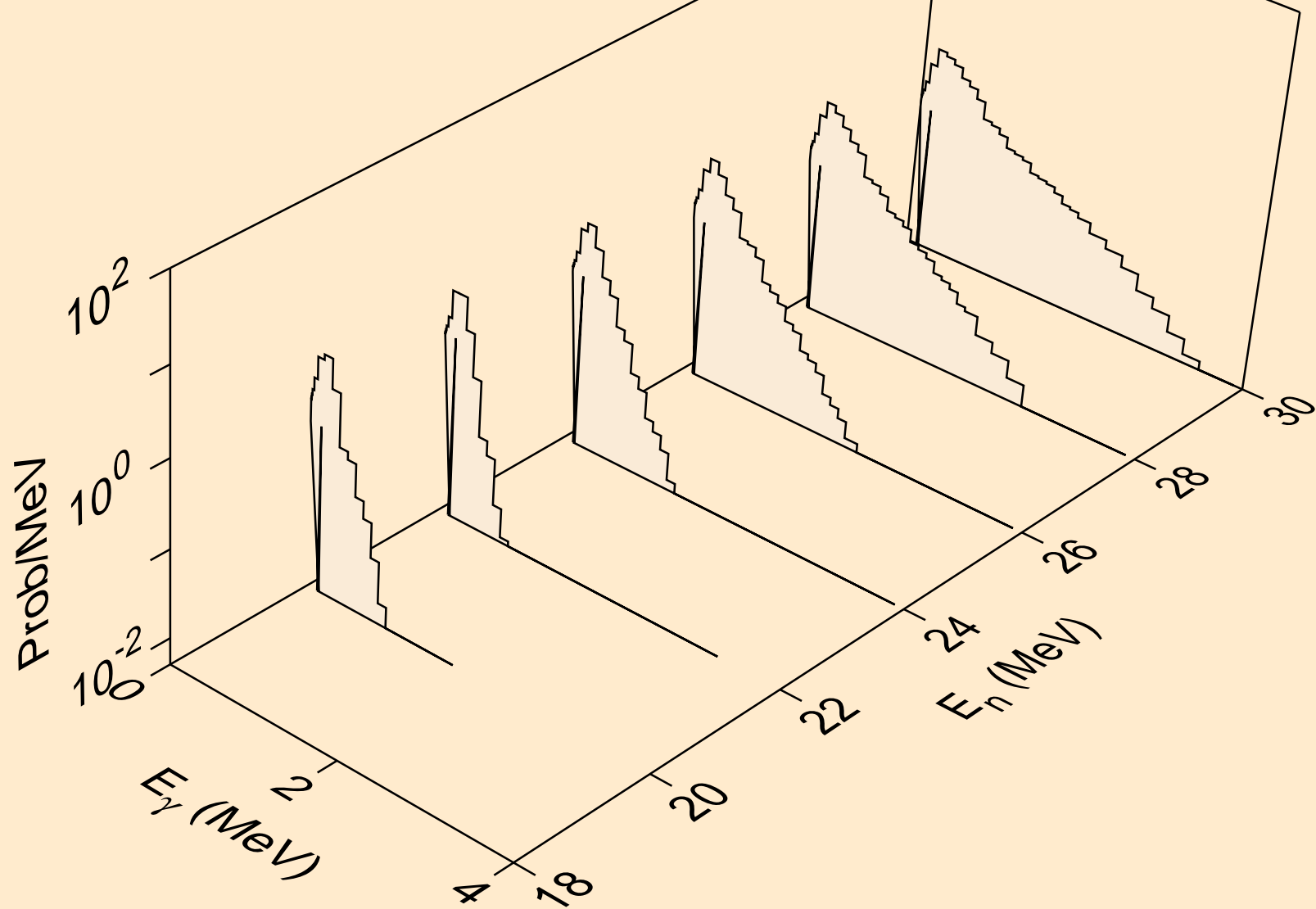



FR205 PROTON ACER TENDL-2021 LIBRARY; T=0.K  
Photon emission for (n,2np)

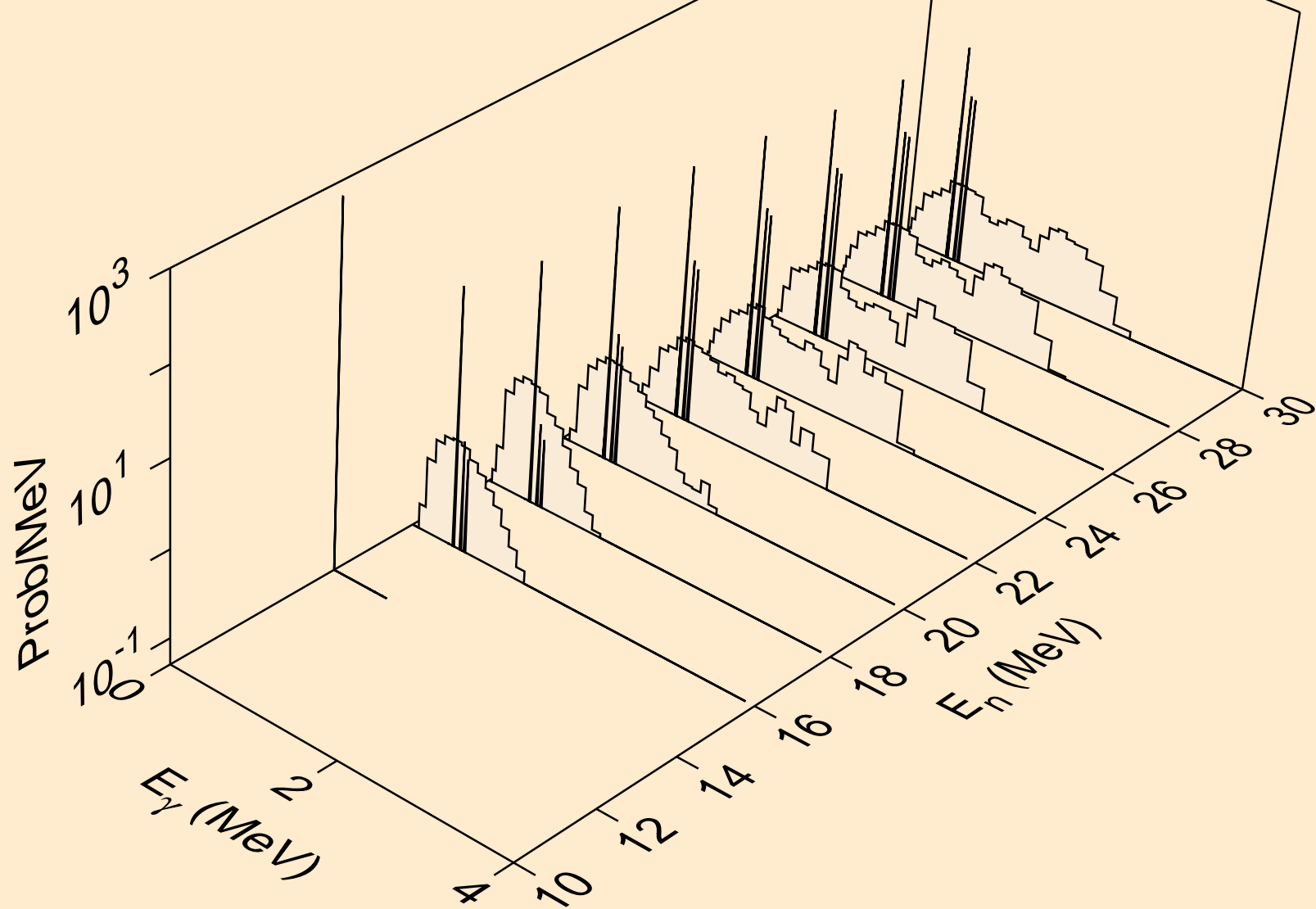

FR205 PROTON ACER TENDL-2021 LIBRARY; T=0.K  
Photon emission for (n,npa)

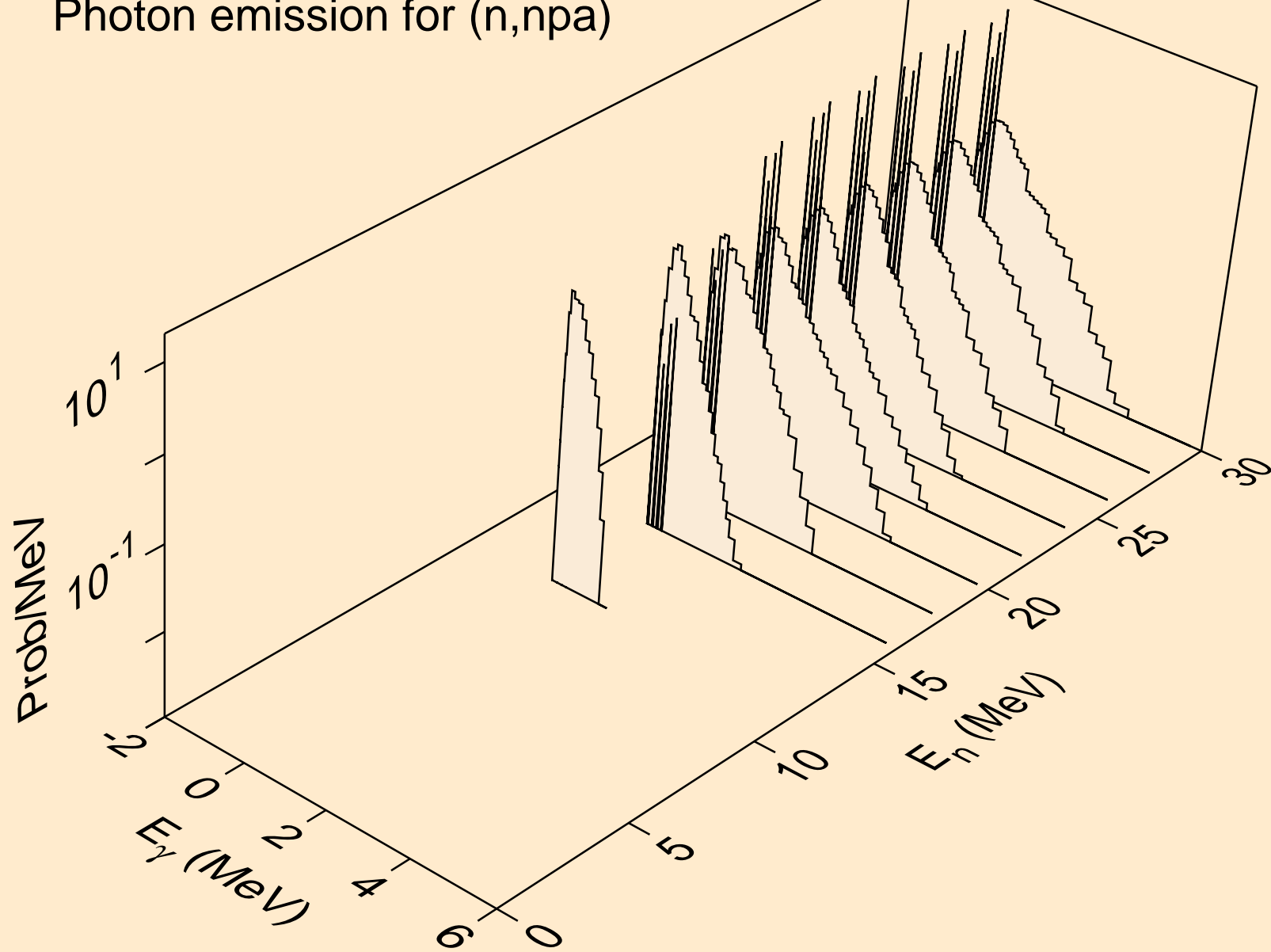

FR205 PROTON ACER TENDL-2021 LIBRARY; T=0.K  
Photon emission for (n,gma)

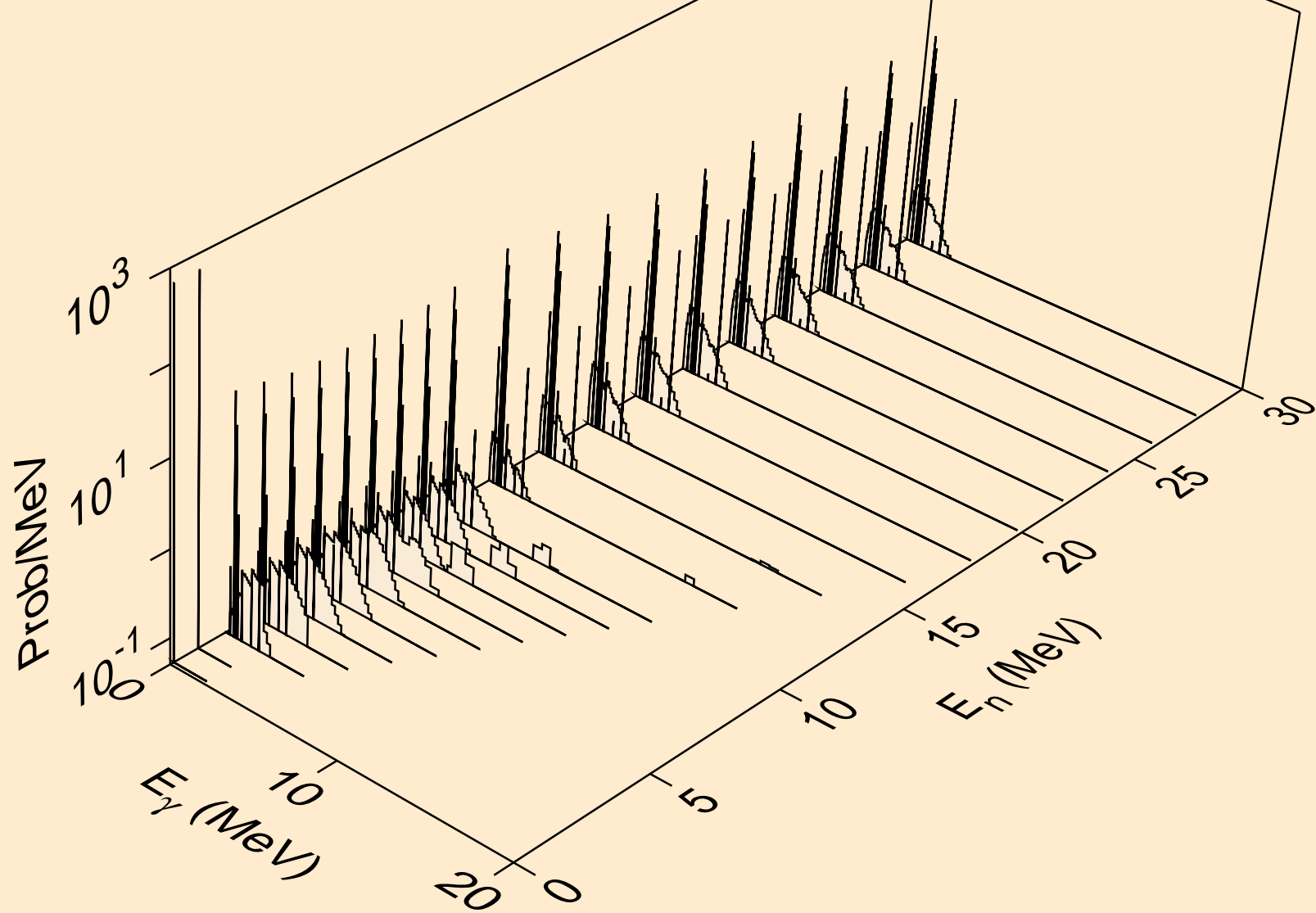

FR205 PROTON ACER TENDL-2021 LIBRARY; T=0.K  
Photon emission for inelastic

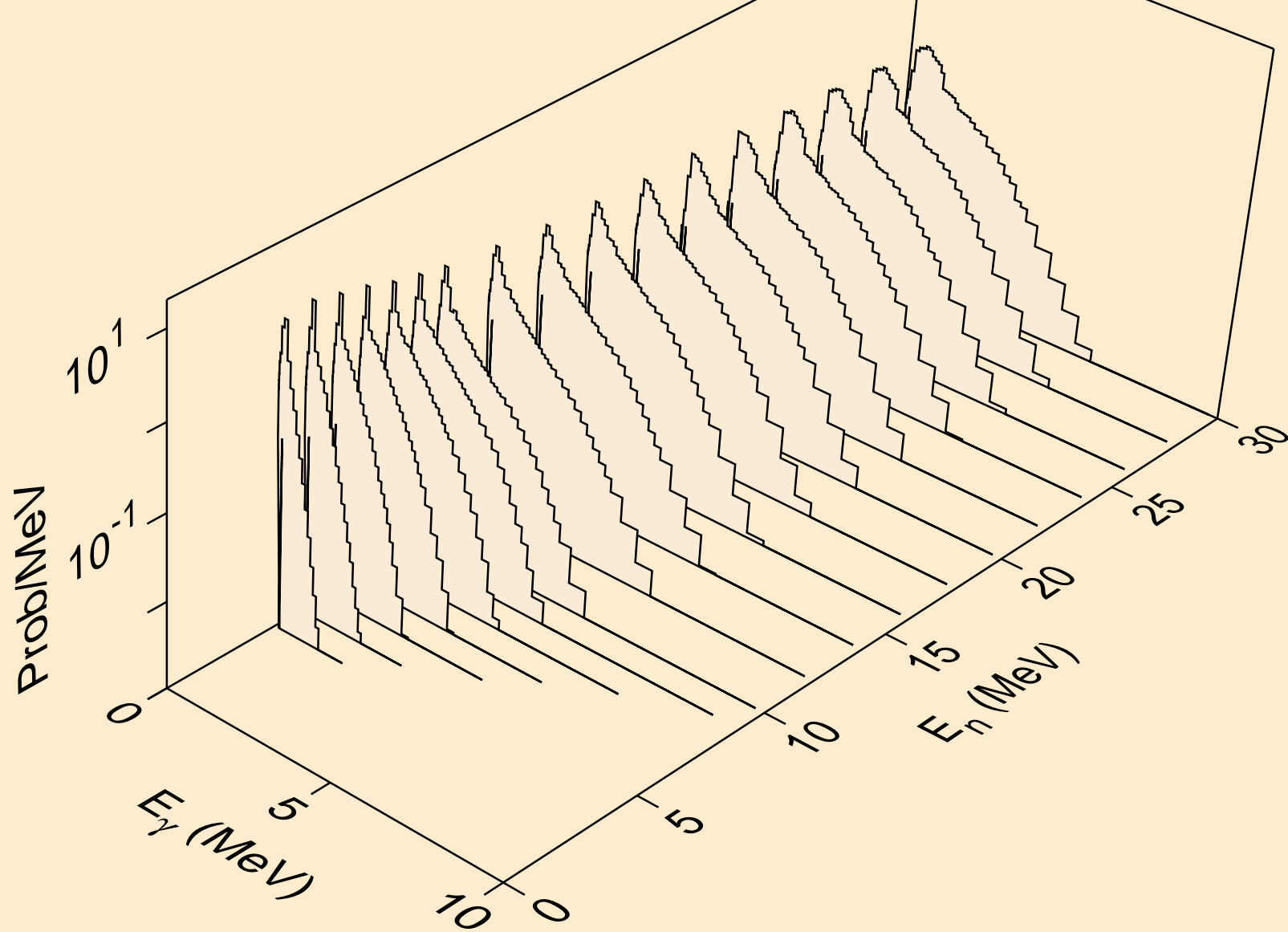

FR205 PROTON ACER TENDL-2021 LIBRARY; T=0.K  
Photon emission for (n,d)

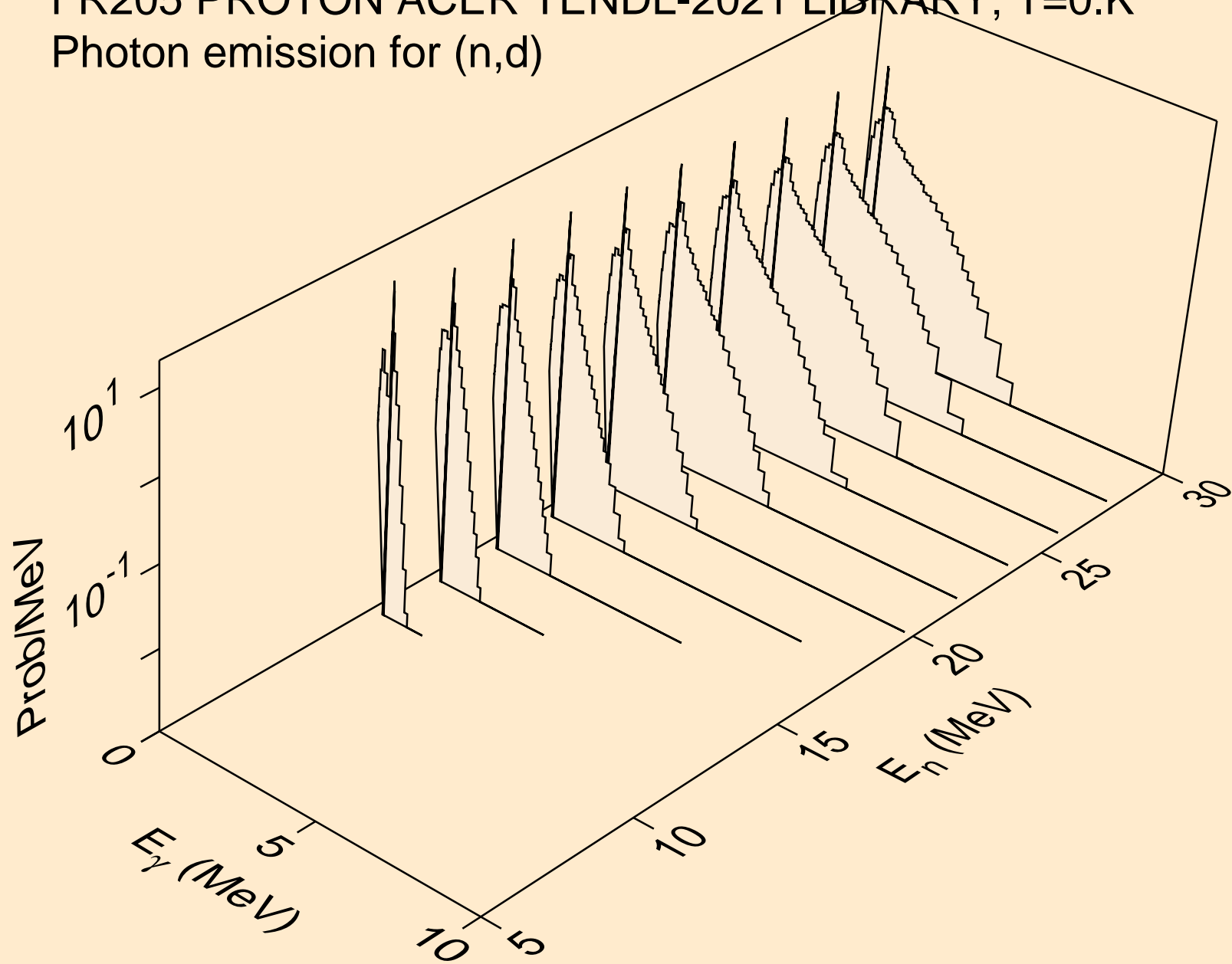

FR205 PROTON ACER TENDL-2021 LIBRARY; T=0.K  
Photon emission for (n,t)

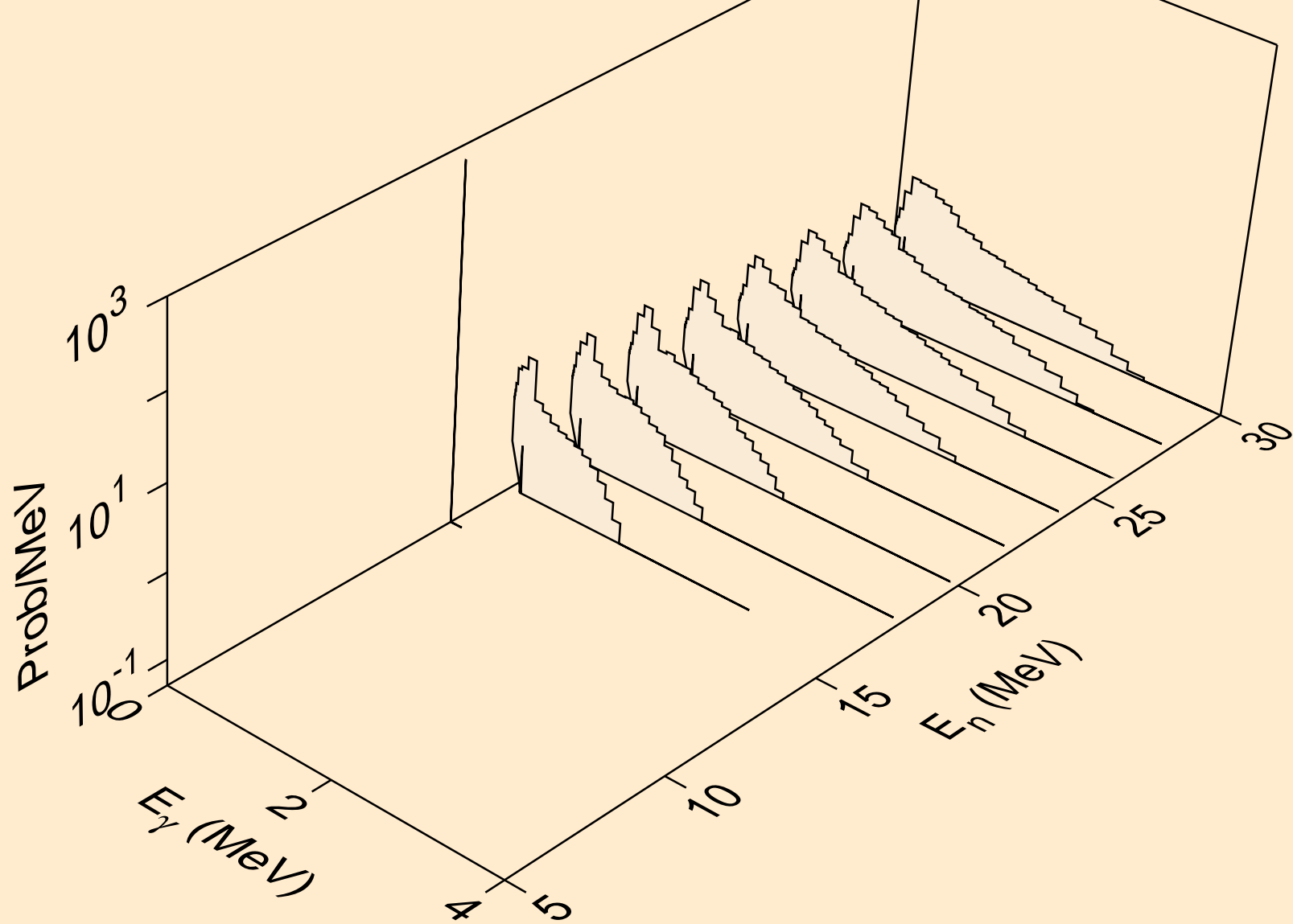

FR205 PROTON ACER TENDL-2021 LIBRARY; T=0.K  
Photon emission for (n,he3)

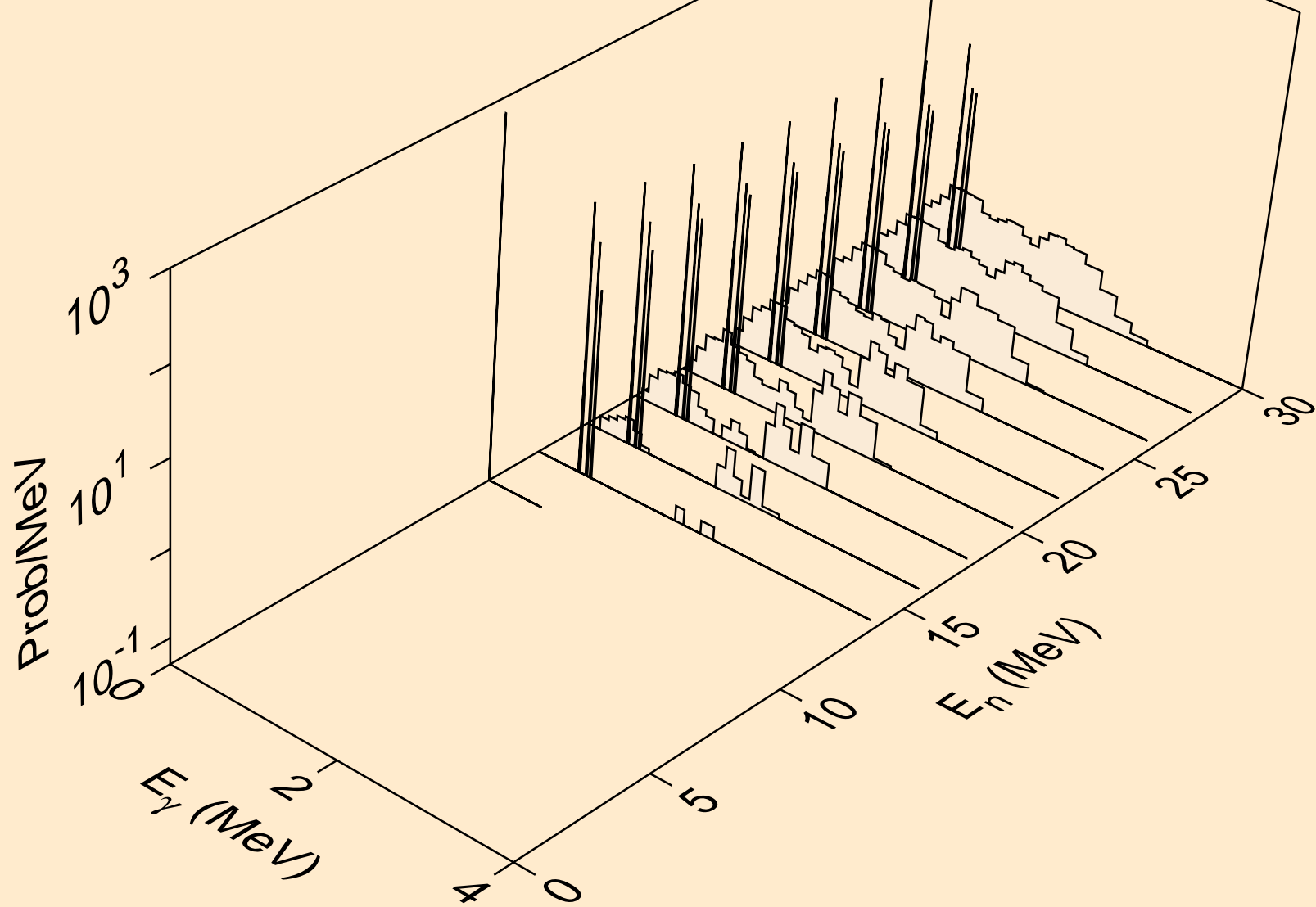

FR205 PROTON ACER TENDL-2021 LIBRARY; T=0.K  
Photon emission for (n,a)

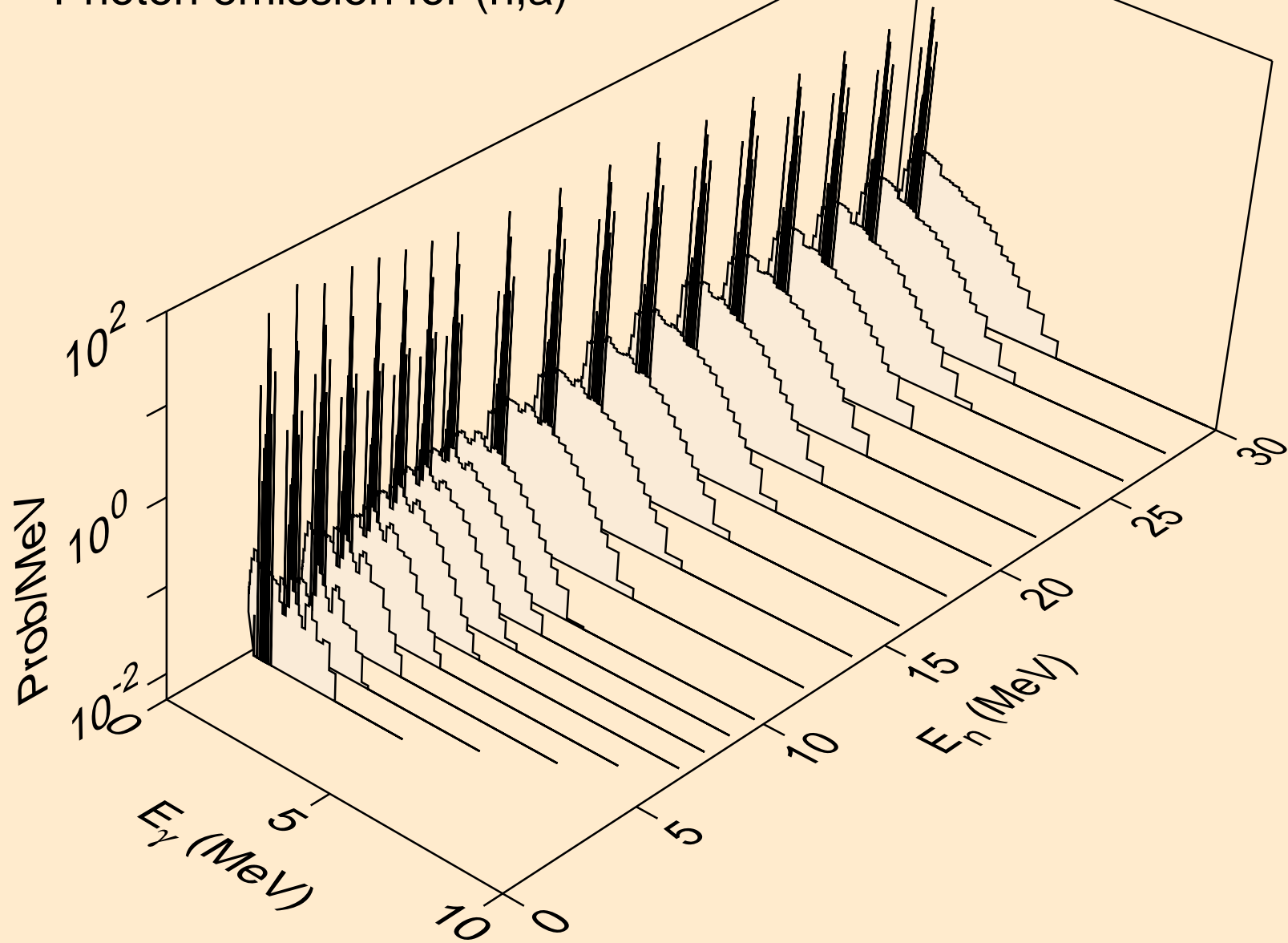



FR205 PROTON ACER TENDL-2021 LIBRARY; T=0.K  
Photon emission for (n,2a)

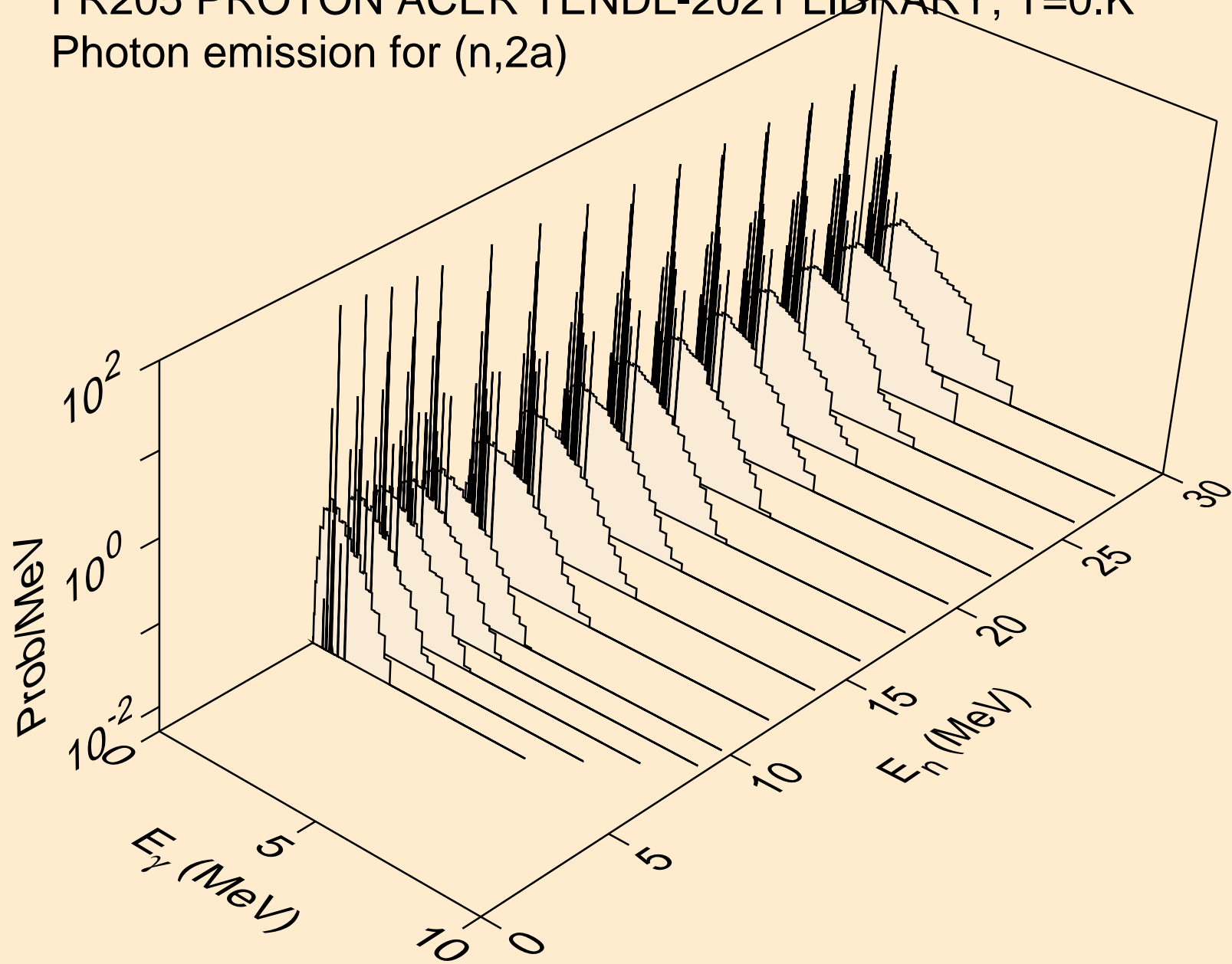

FR205 PROTON ACER TENDL-2021 LIBRARY; T=0.K  
Photon emission for (n,2p)

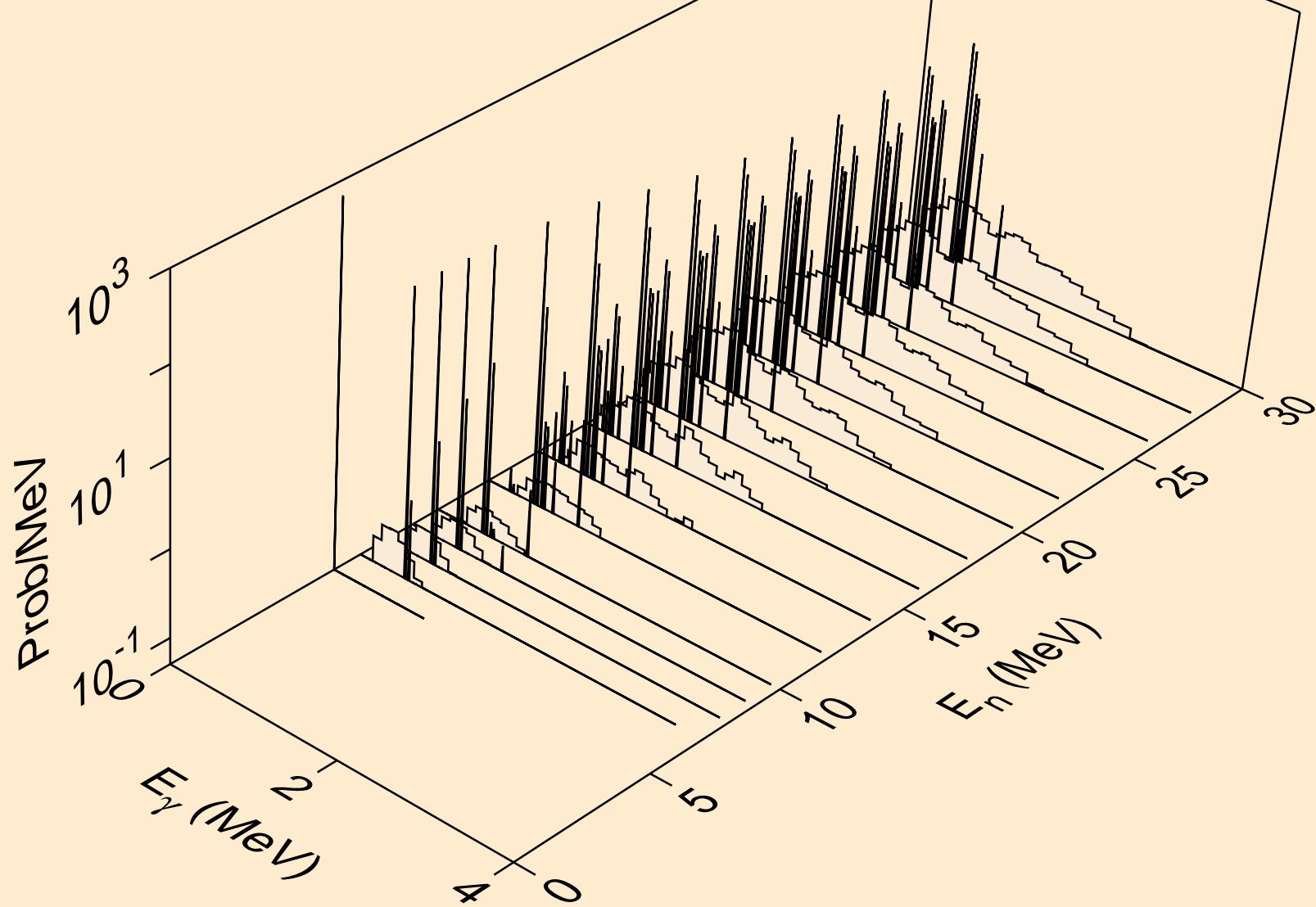

FR205 PROTON ACER TENDL-2021 LIBRARY; T=0.K  
Photon emission for (n,pa)

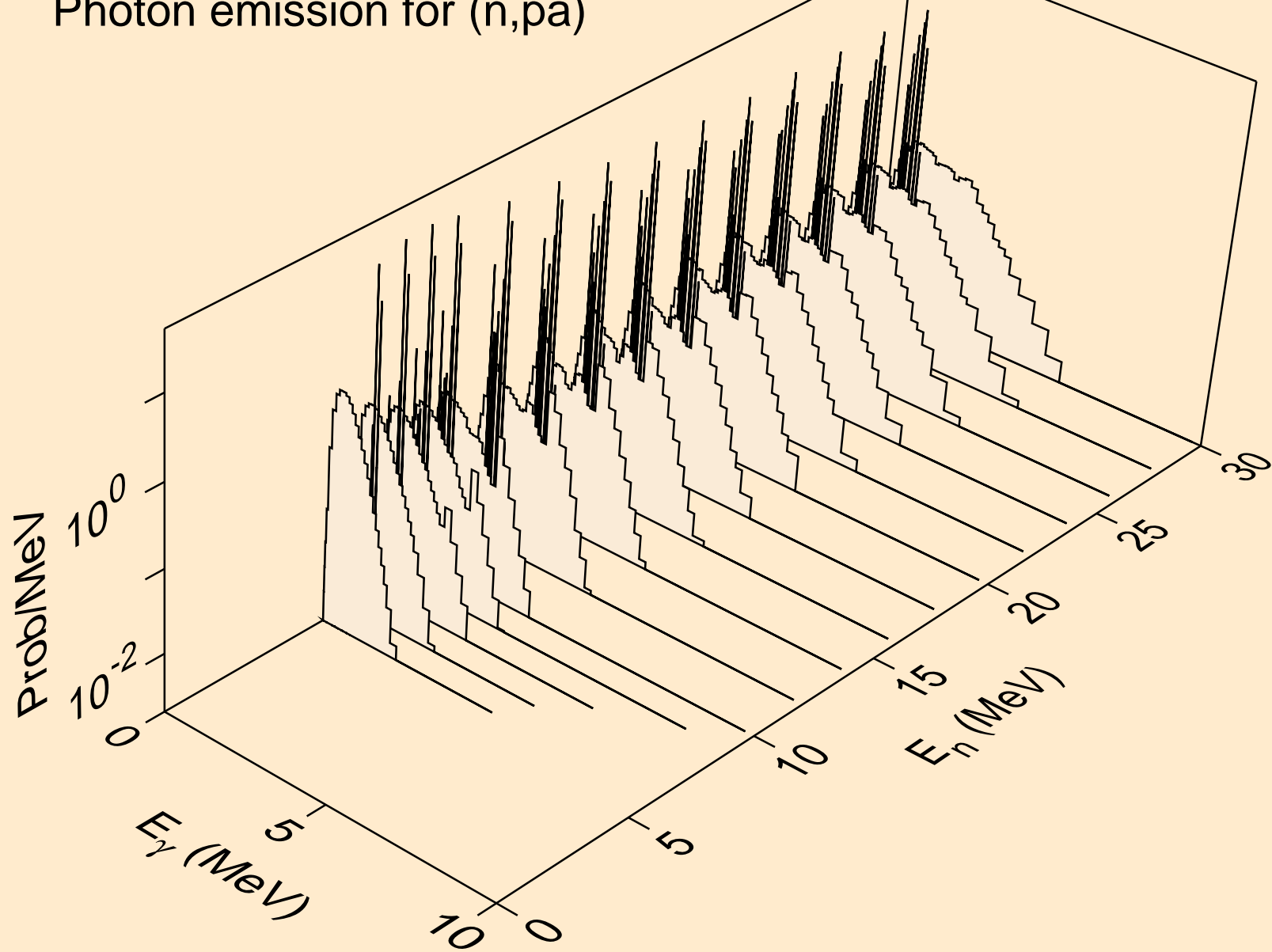

FR205 PROTON ACER TENDL-2021 LIBRARY; T=0.K  
Photon emission for (n,pd)

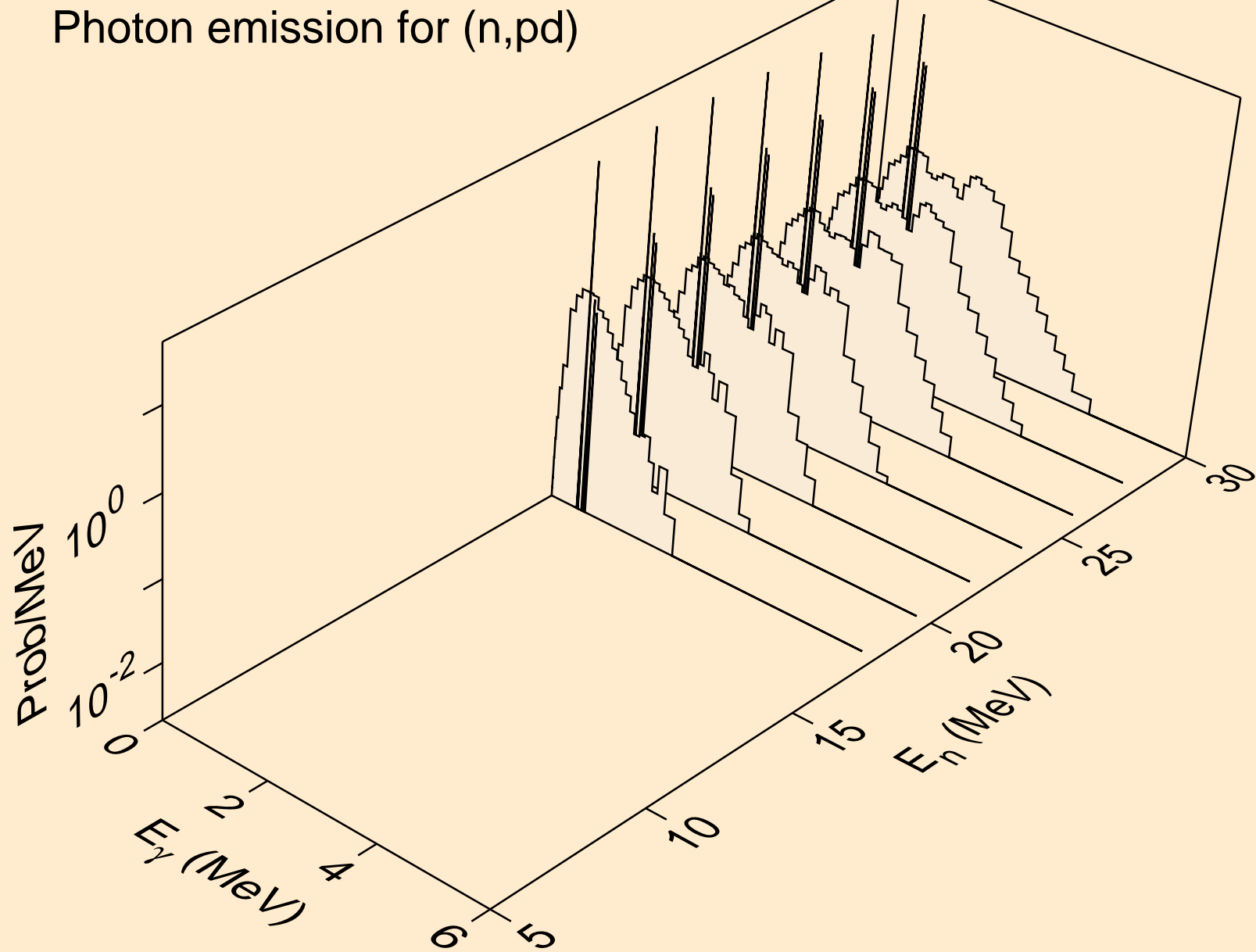

FR205 PROTON ACER TENDL-2021 LIBRARY; T=0.K  
Photon emission for (n,pt)

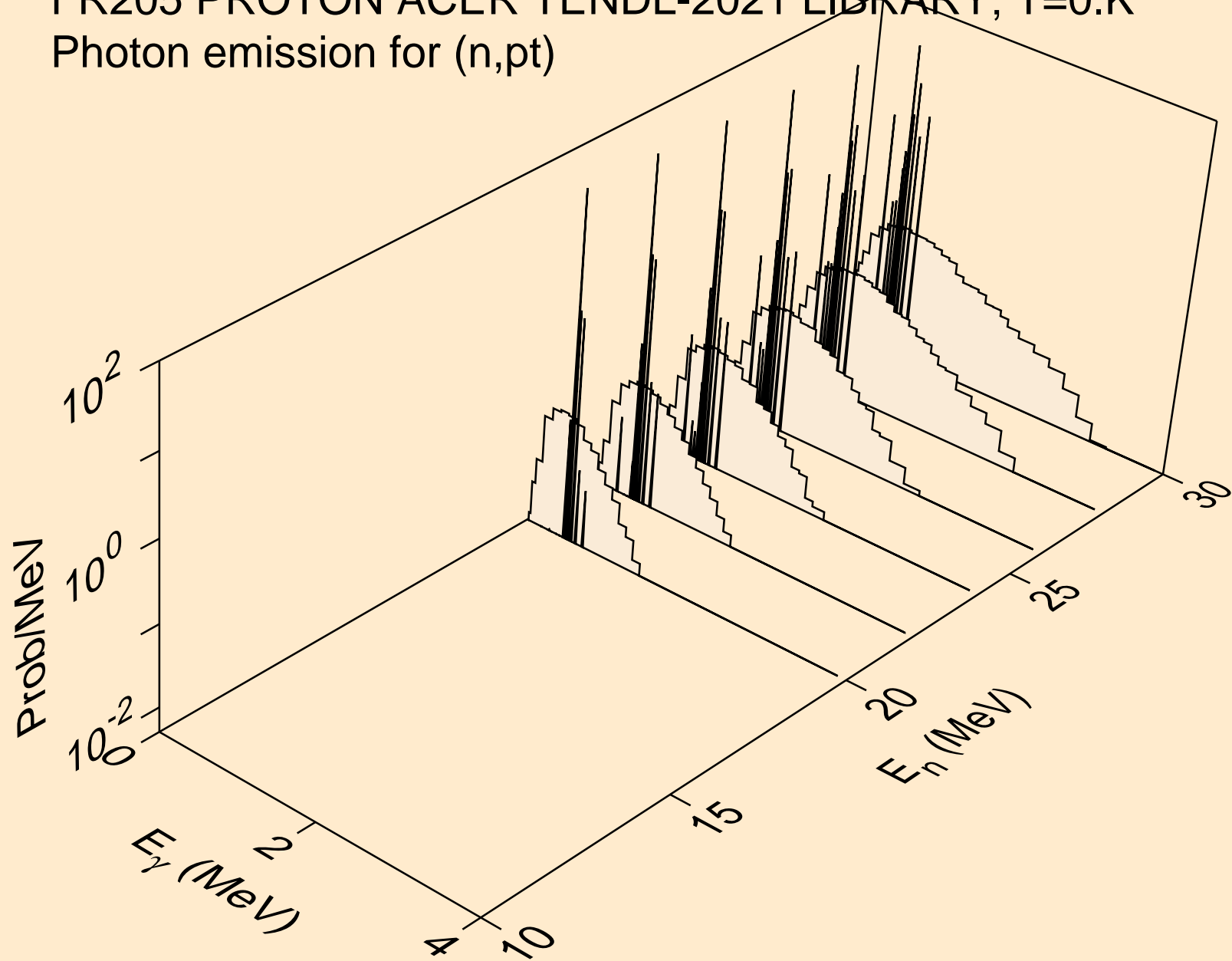

FR205 PROTON ACER TENDL-2021 LIBRARY; T=0.K  
Photon emission for (n,da)

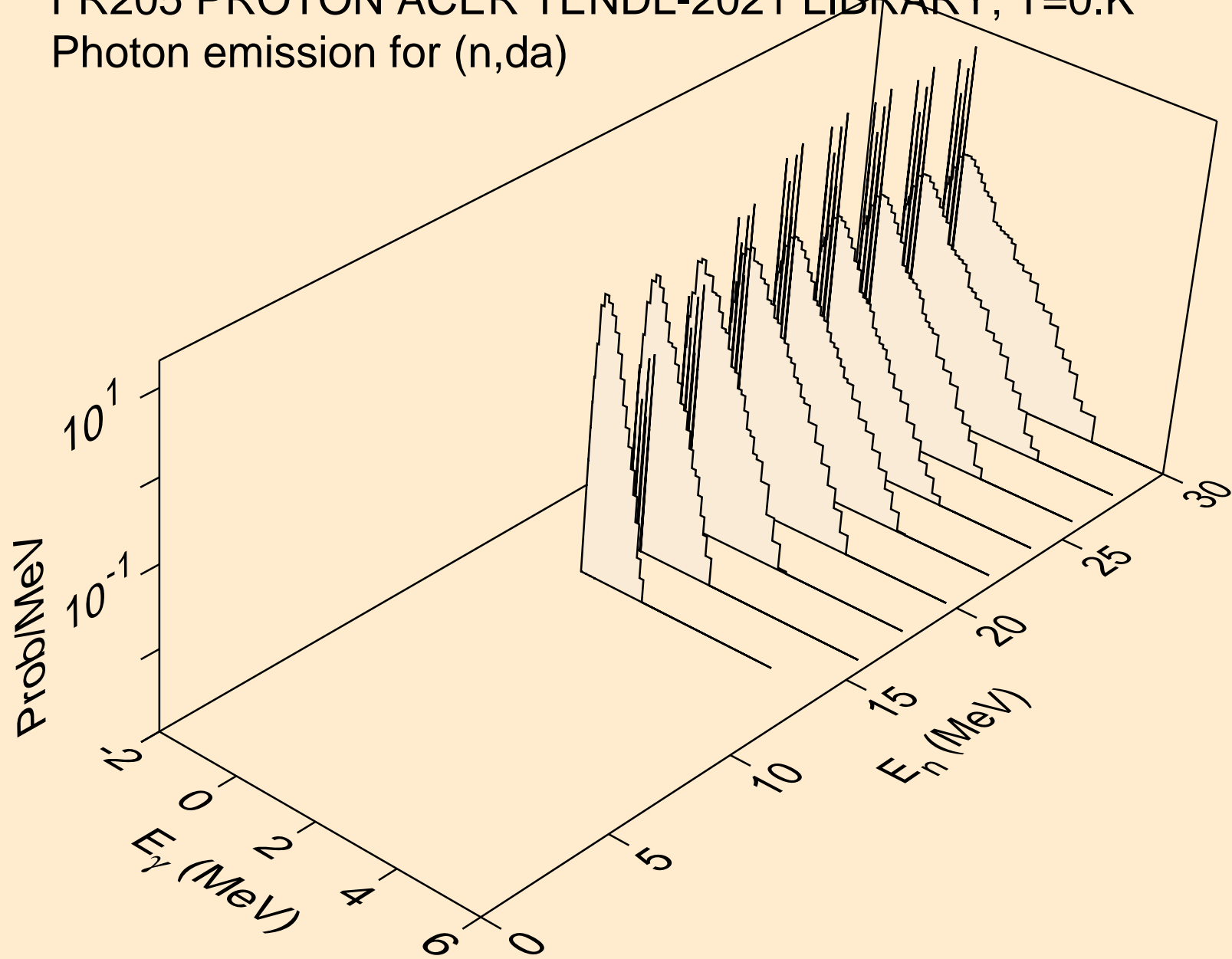

FR205 PROTON ACER TENDL-2021 LIBRARY; T=0.K  
Particle heating contributions

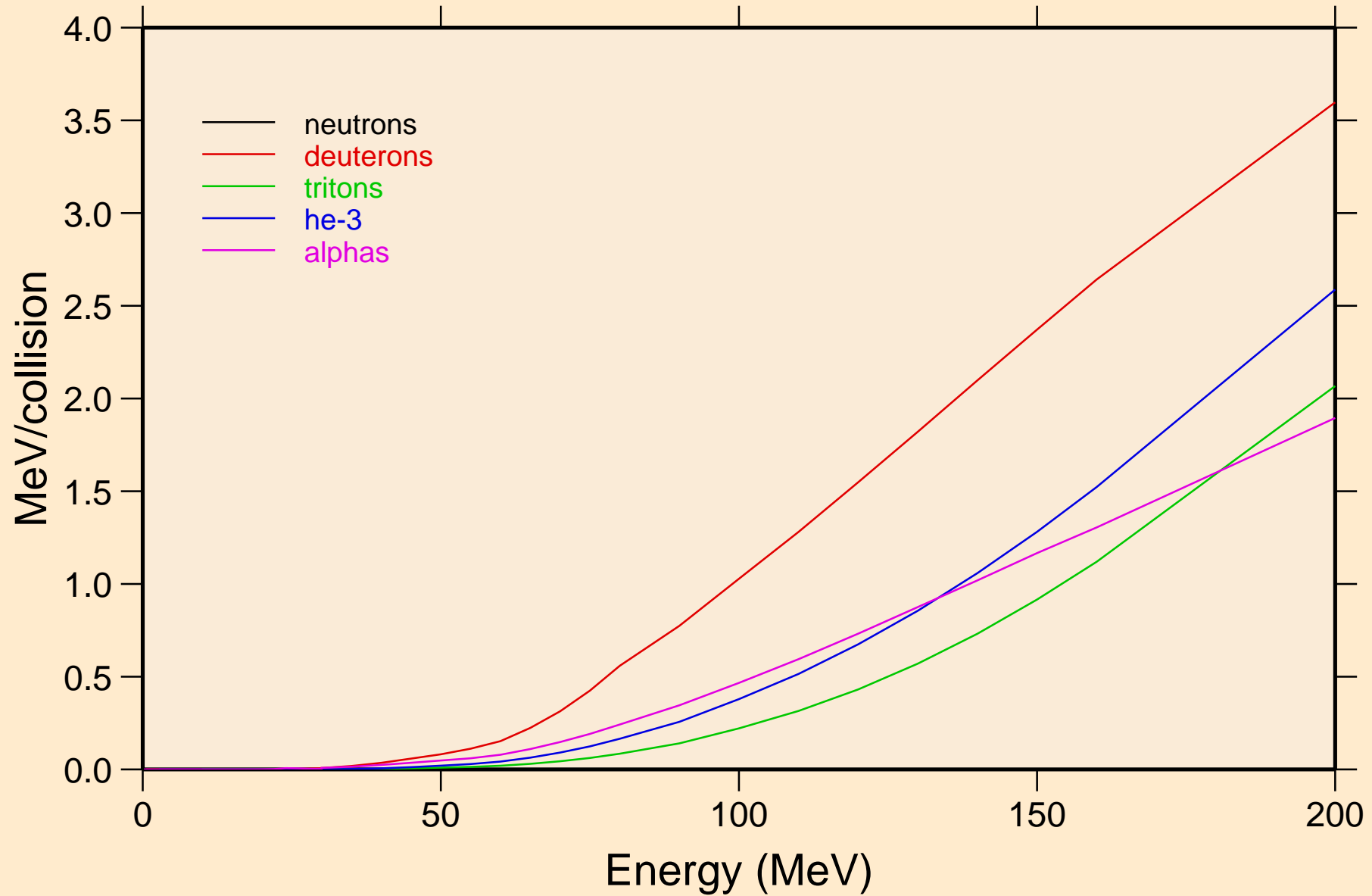

FR205 PROTON ACER TENDL-2021 LIBRARY; T=0.K  
Recoil Heating

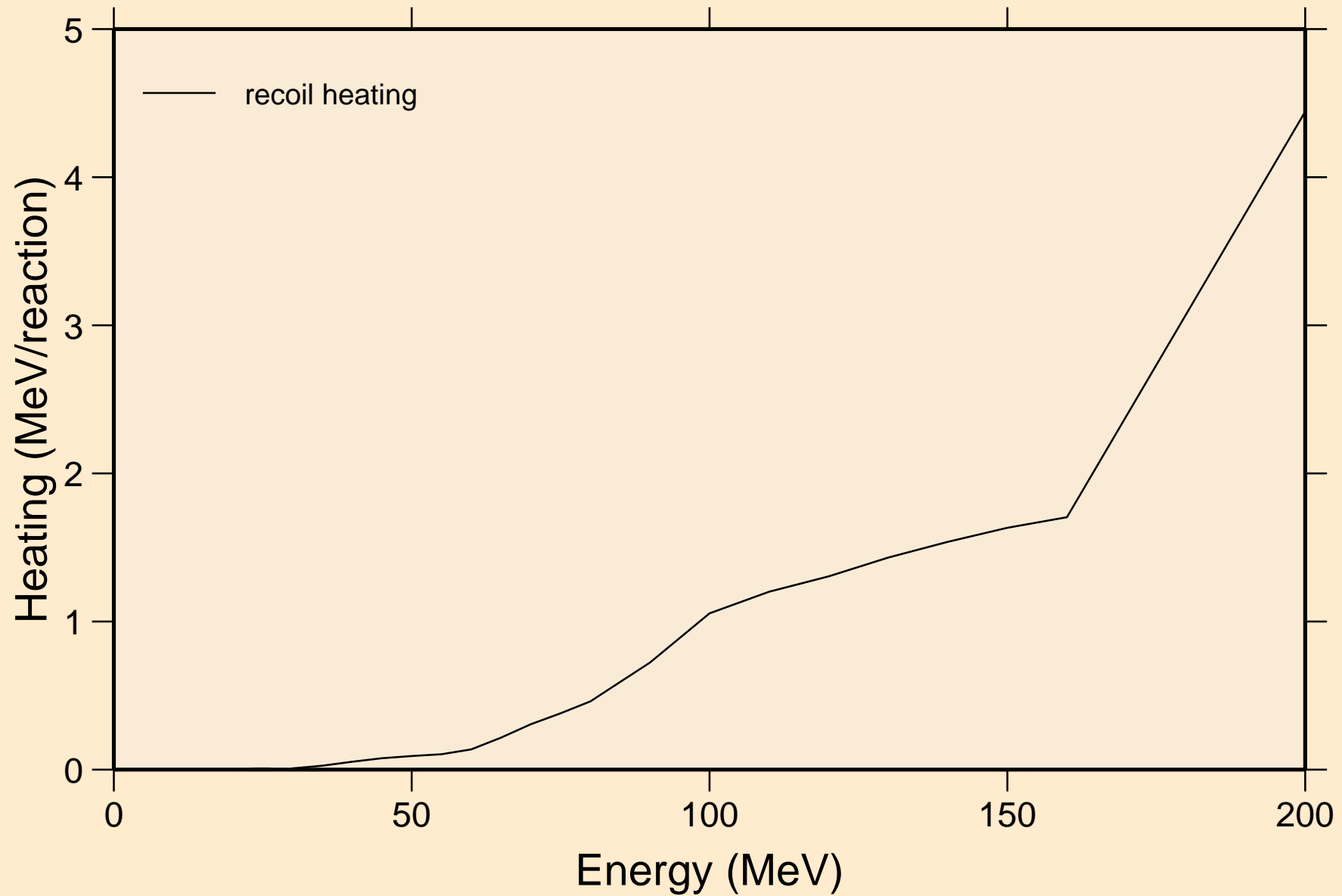



FR205 PROTON ACER TENDL-2021 LIBRARY; T=0.K  
Particle production cross sections

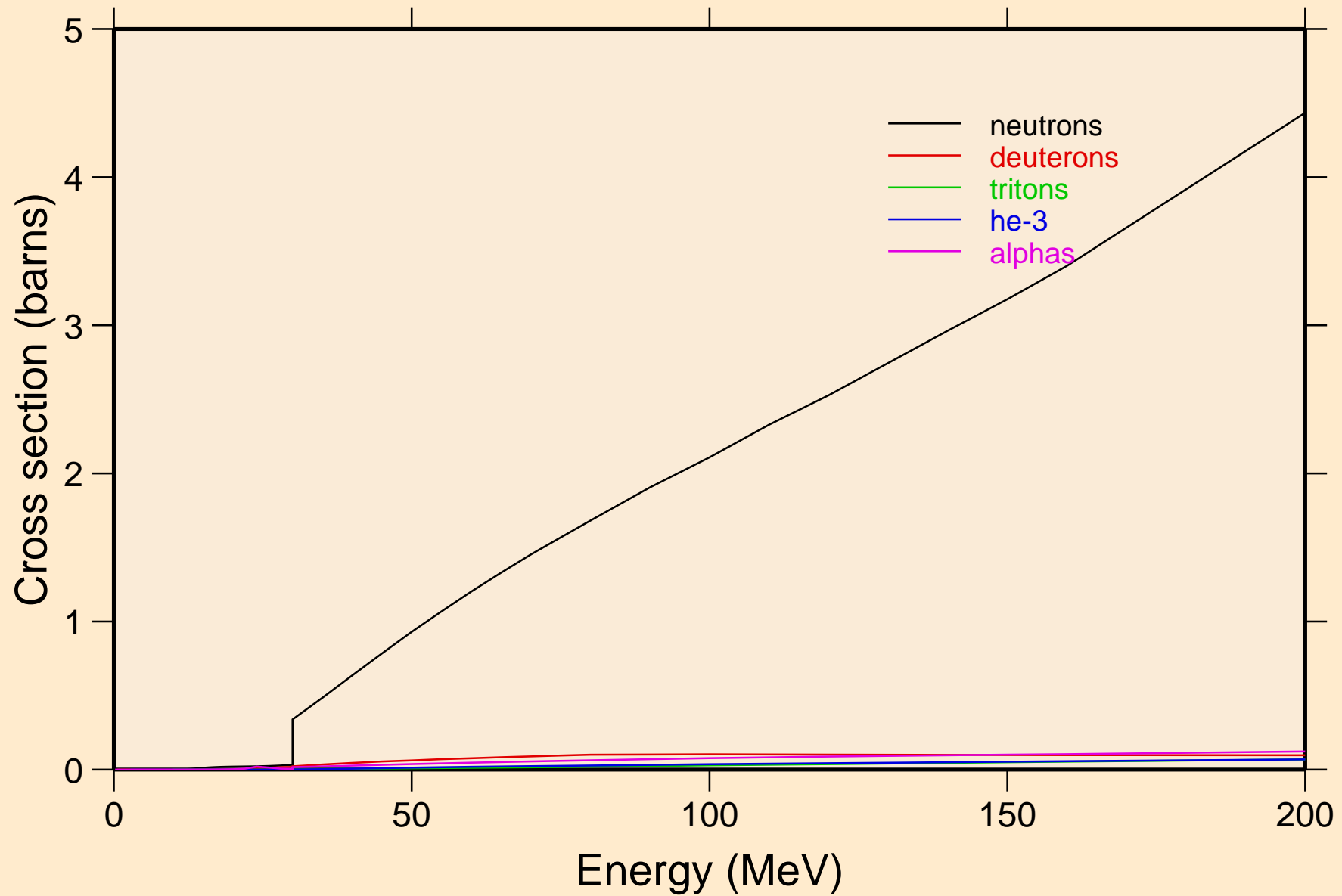

FR205 PROTON ACER TENDL-2021 LIBRARY; T=0.K  
neutrons from (p,n)

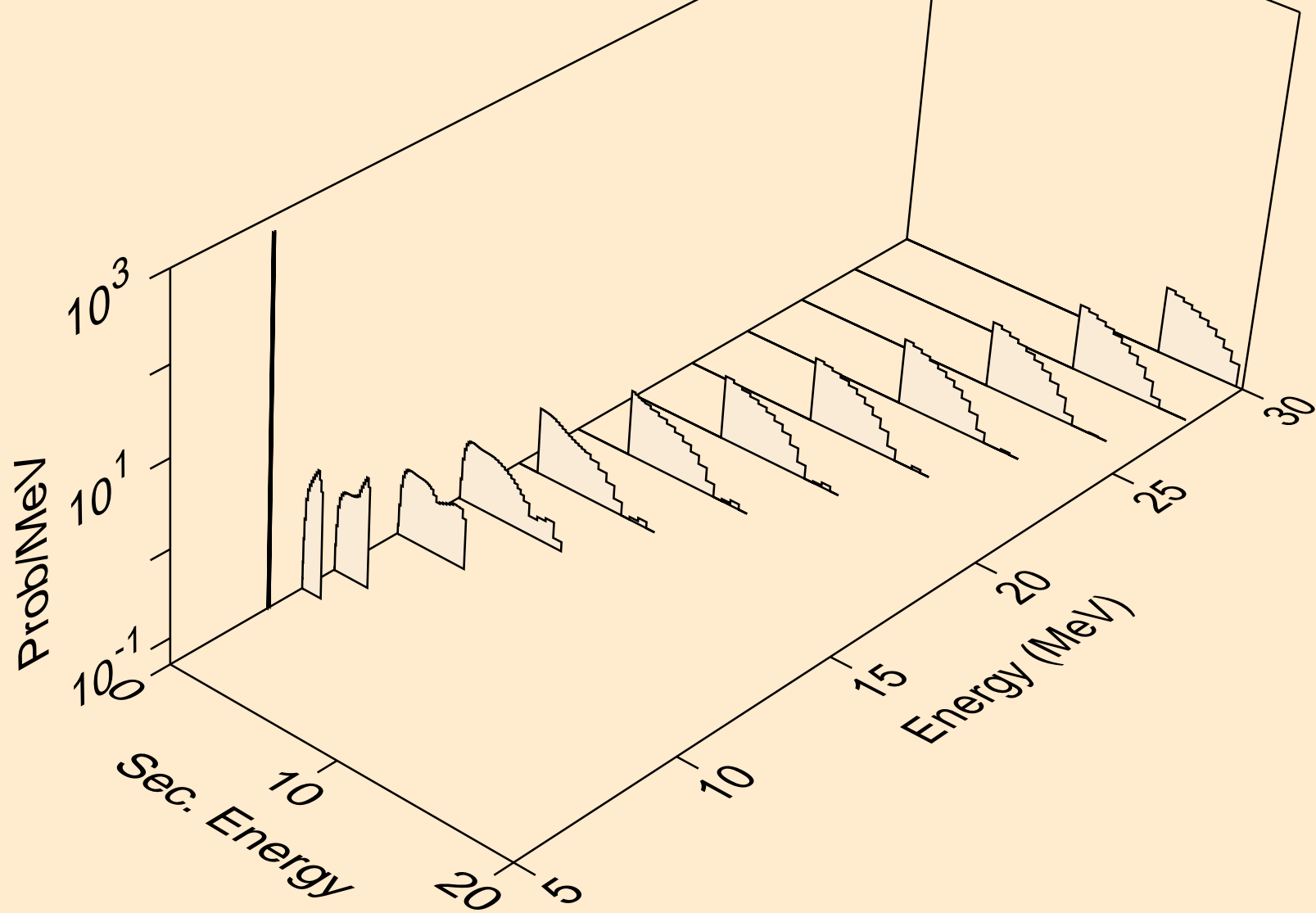

FR205 PROTON ACER TENDL-2021 LIBRARY; T=0.K  
neutrons from (p,x)

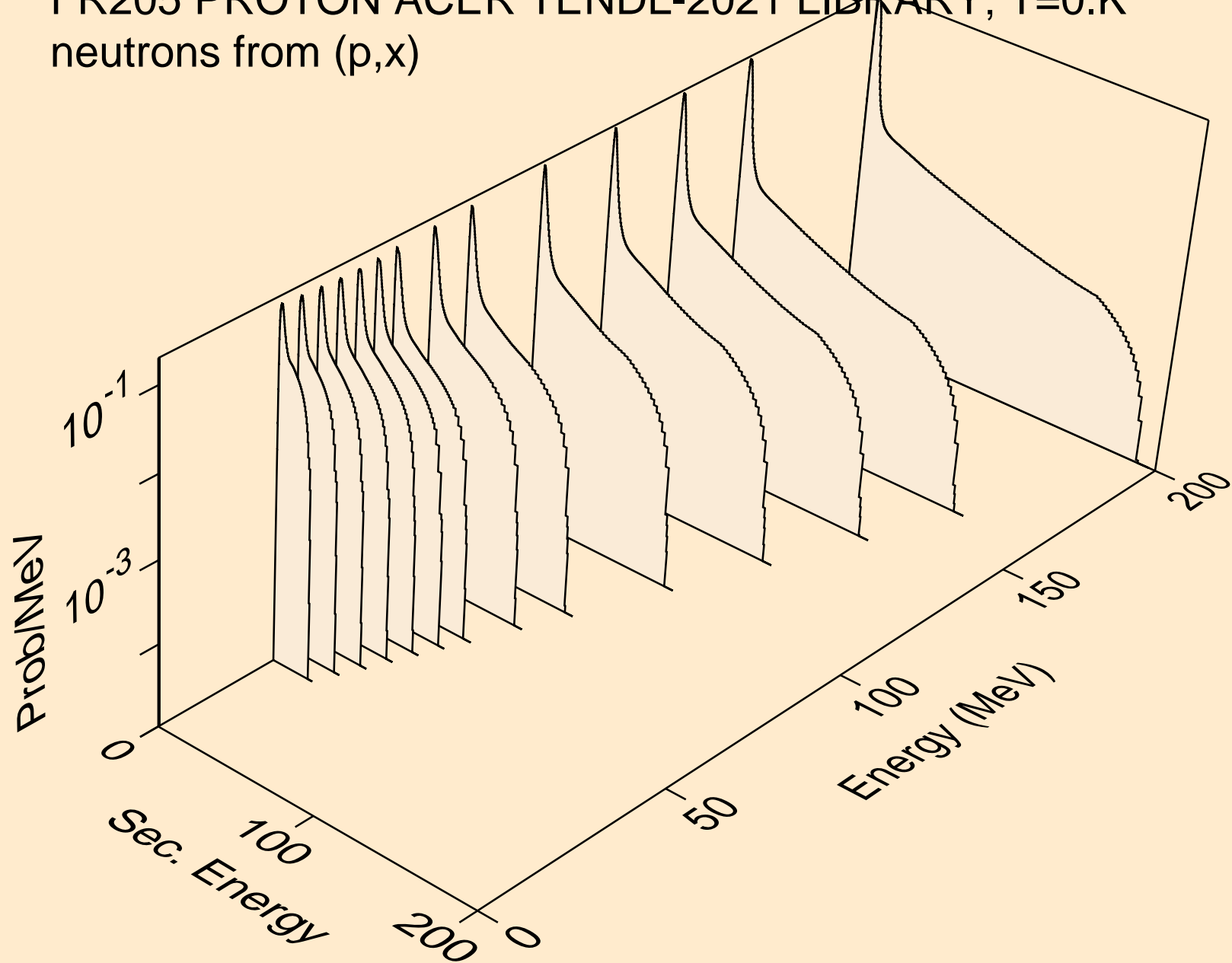

FR205 PROTON ACER TENDL-2021 LIBRARY; T=0.K  
neutrons from (p,2n)

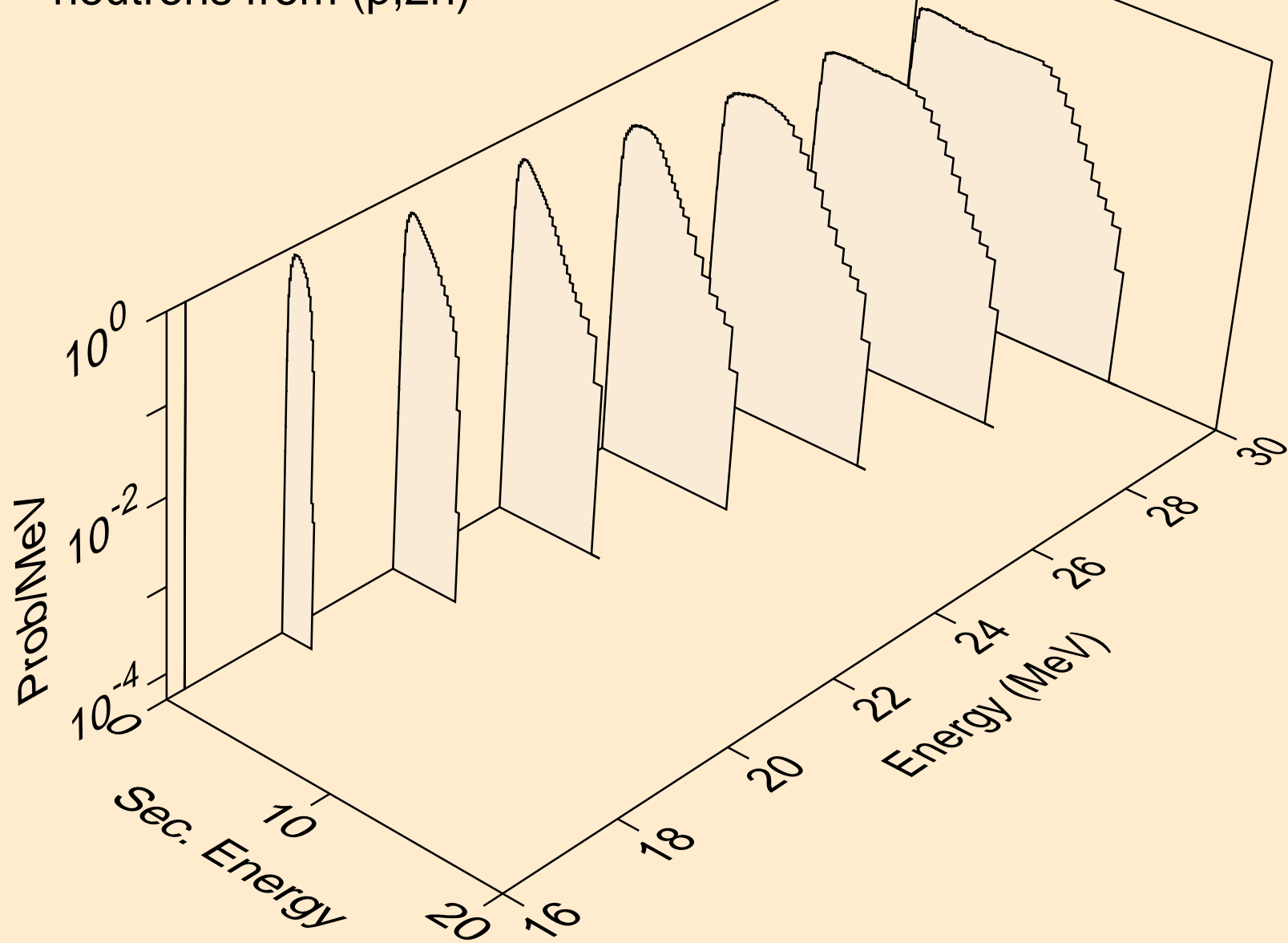

FR205 PROTON ACER TENDL-2021 LIBRARY; T=0.K  
neutrons from (p,3n)

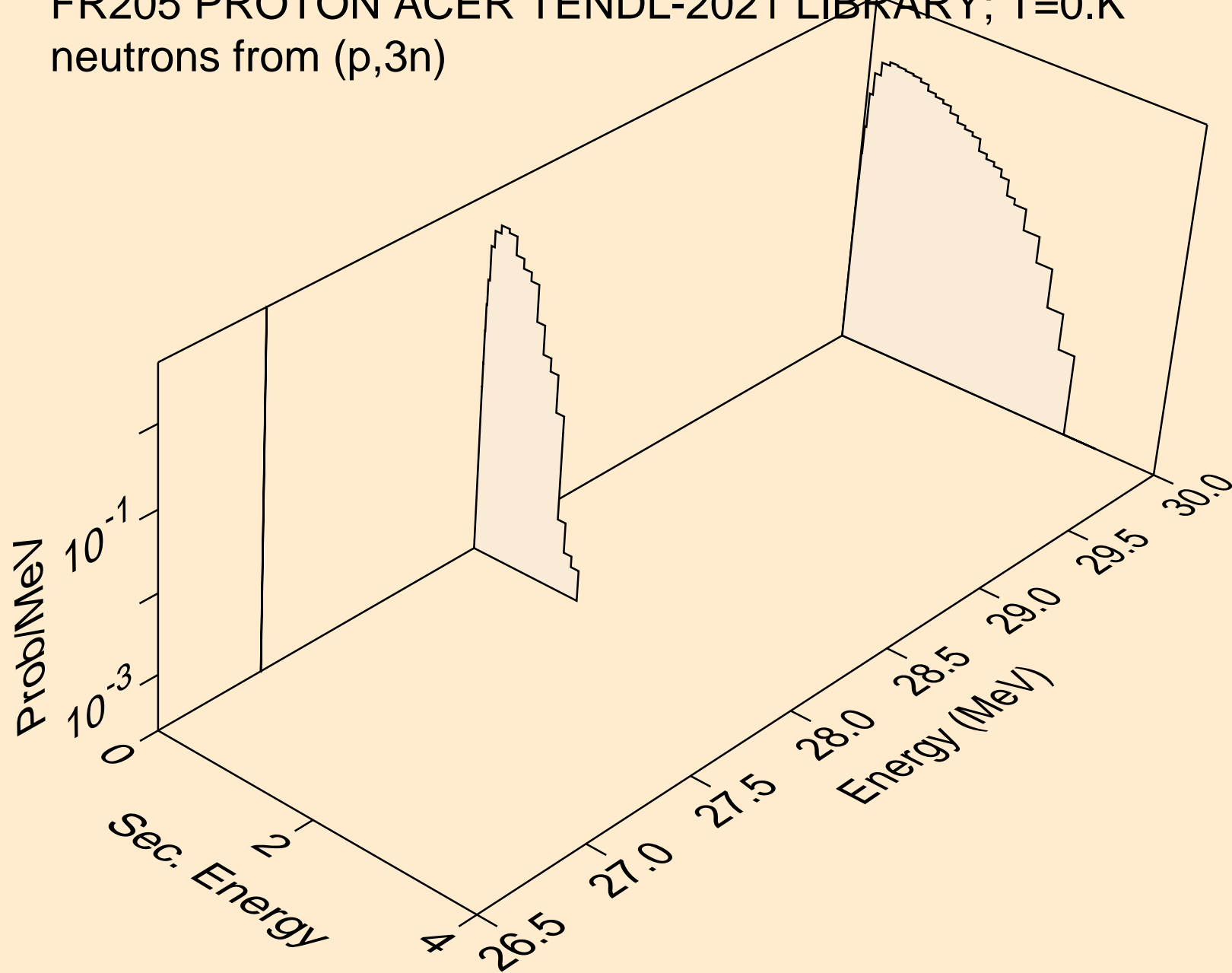

FR205 PROTON ACER TENDL-2021 LIBRARY; T=0.K  
neutrons from (p,n\*)a

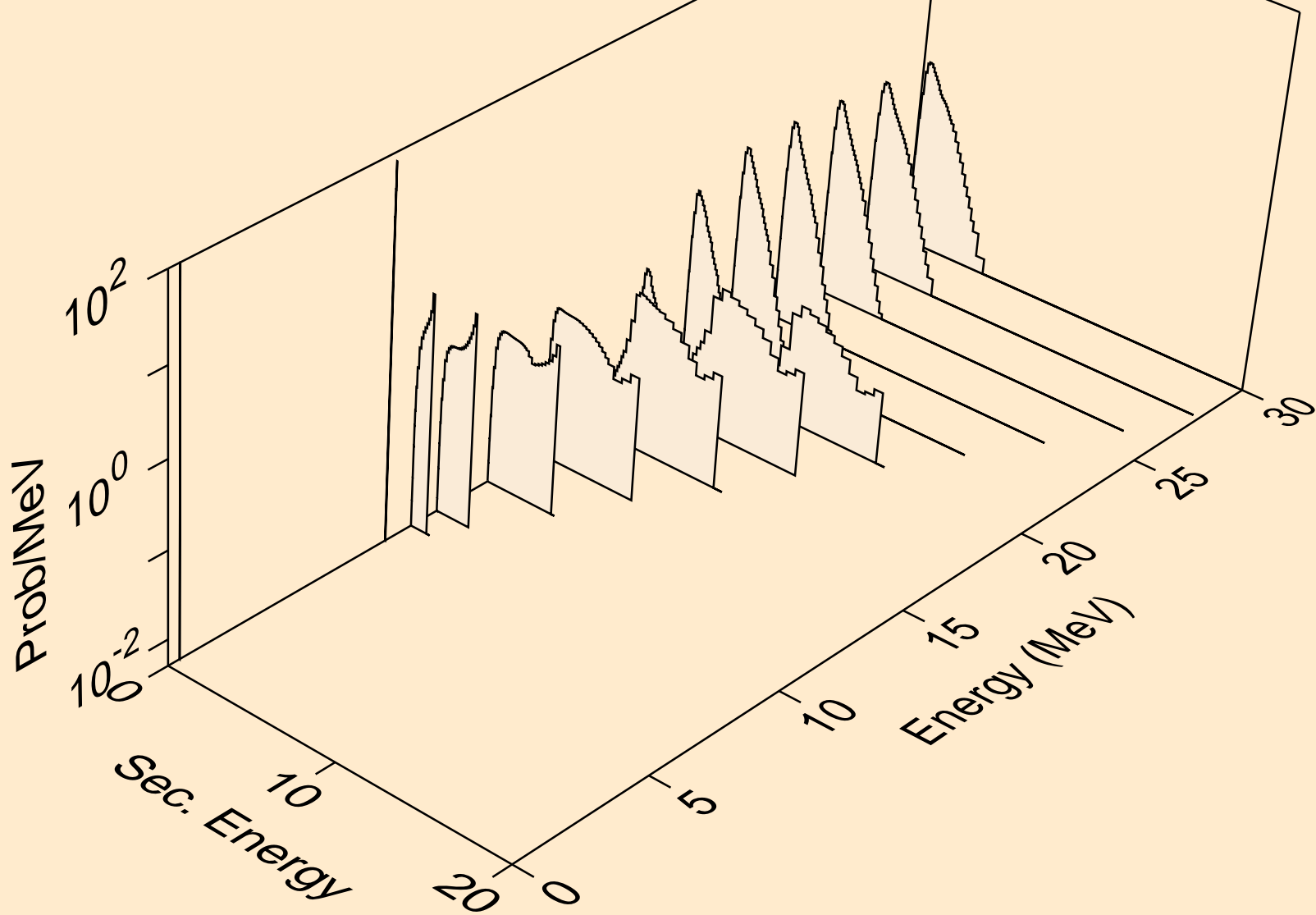

FR205 PROTON ACER TENDL-2021 LIBRARY; T=0.K  
neutrons from (p,2n)a

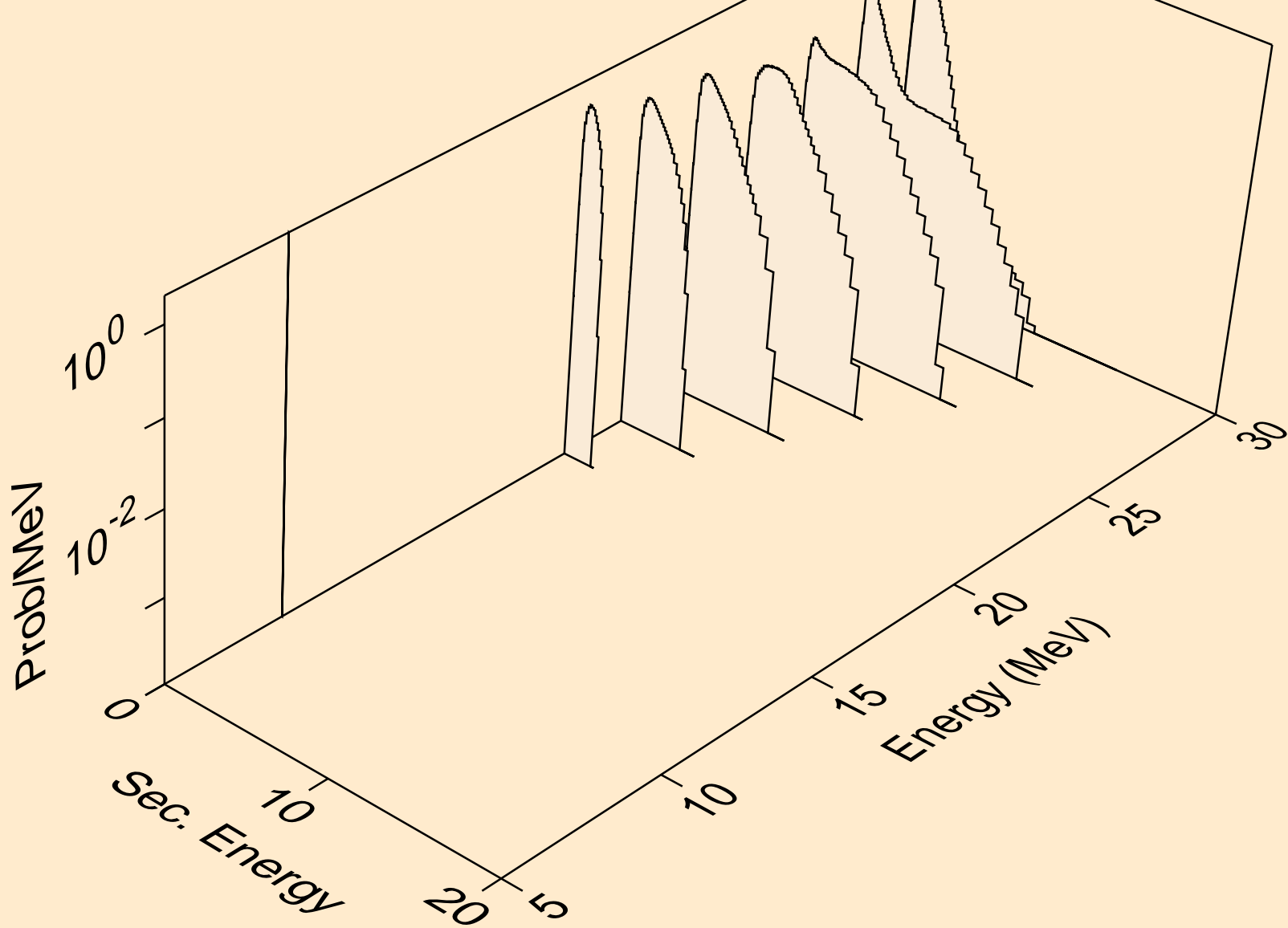

FR205 PROTON ACER TENDL-2021 LIBRARY; T=0.K  
neutrons from (p,3n)a

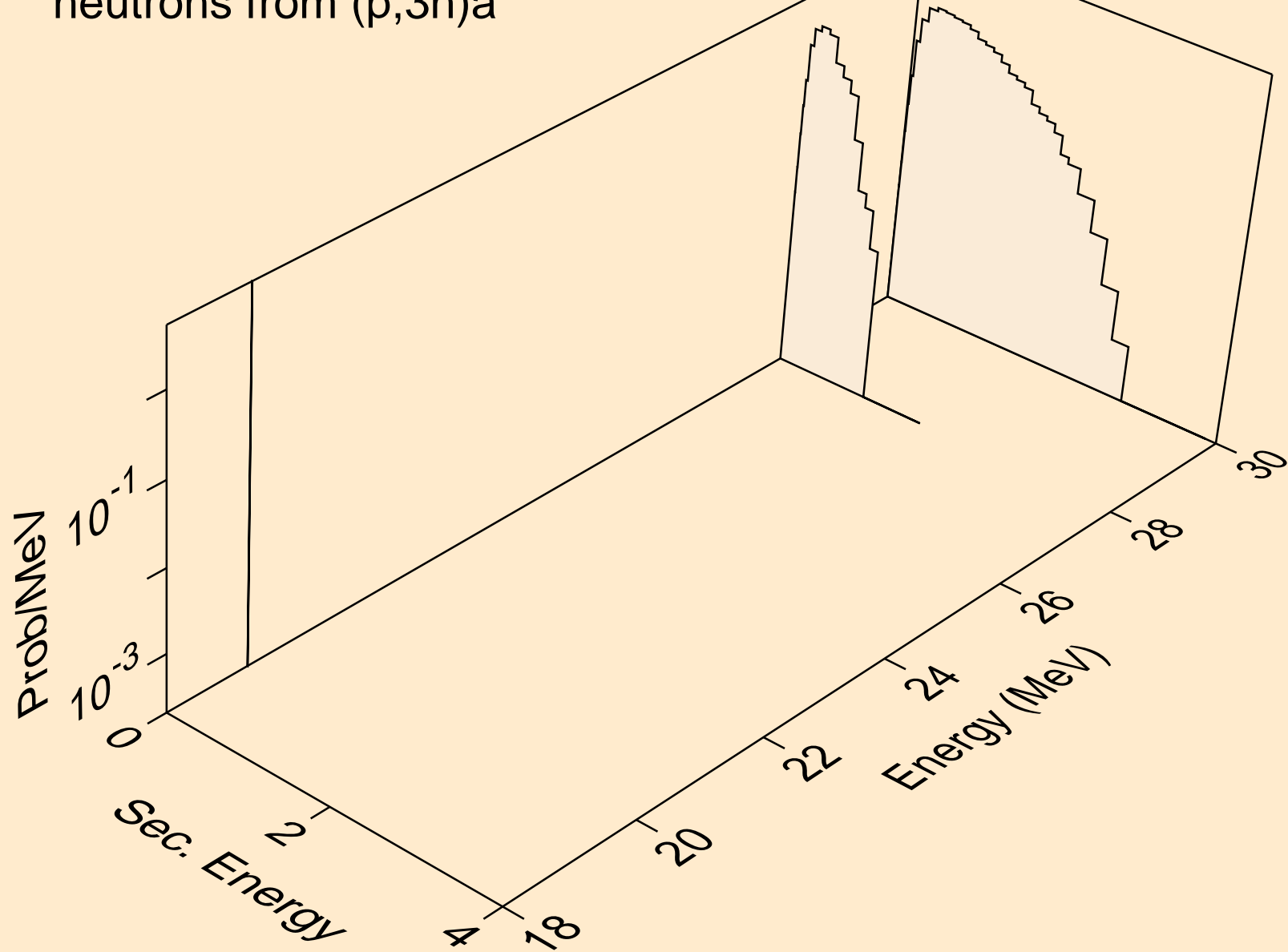



FR205 PROTON ACER TENDL-2021 LIBRARY; T=0.K  
neutrons from (p,n\*)p

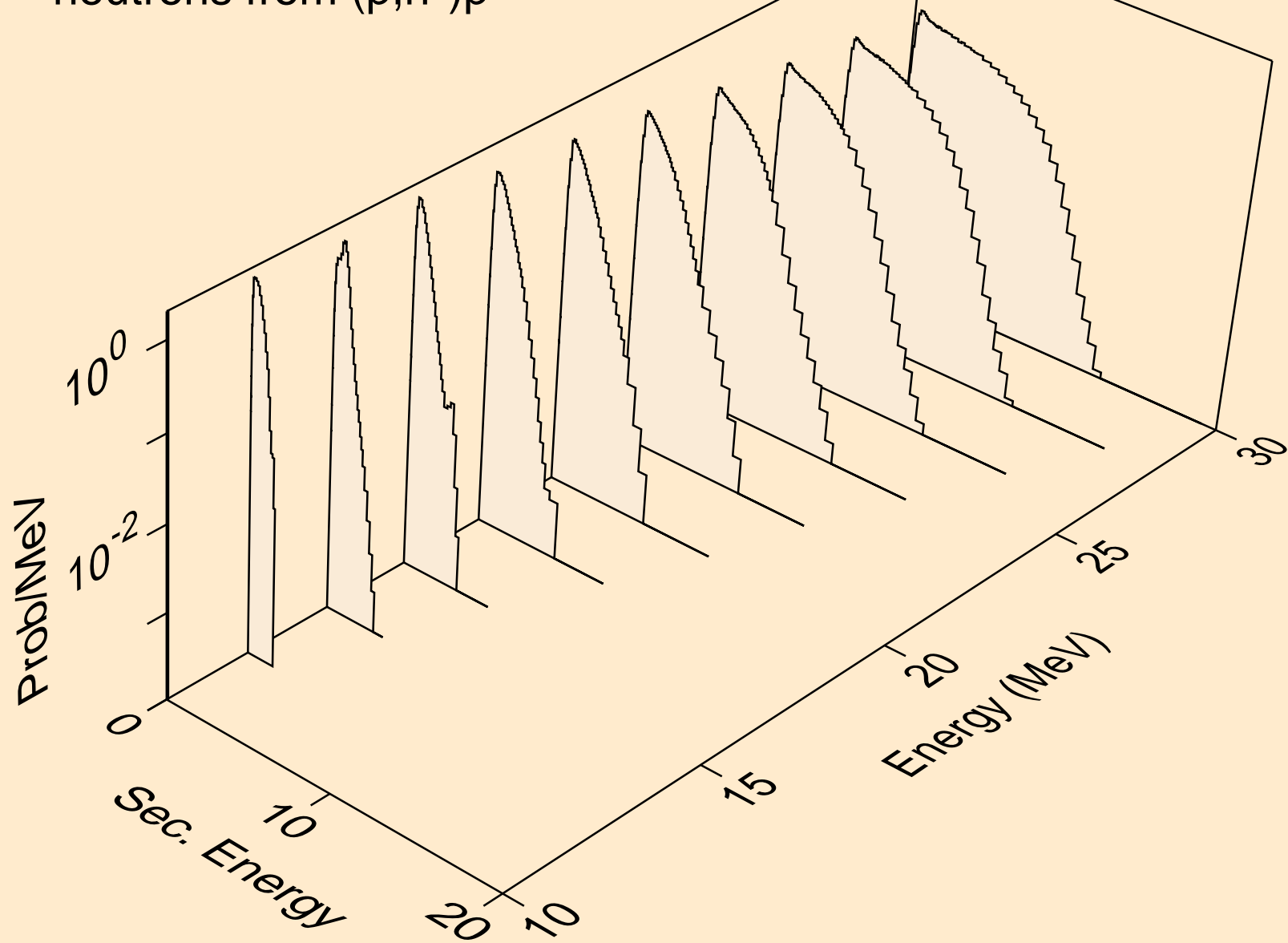

FR205 PROTON ACER TENDL-2021 LIBRARY; T=0.K  
neutrons from (p,n\*)2a

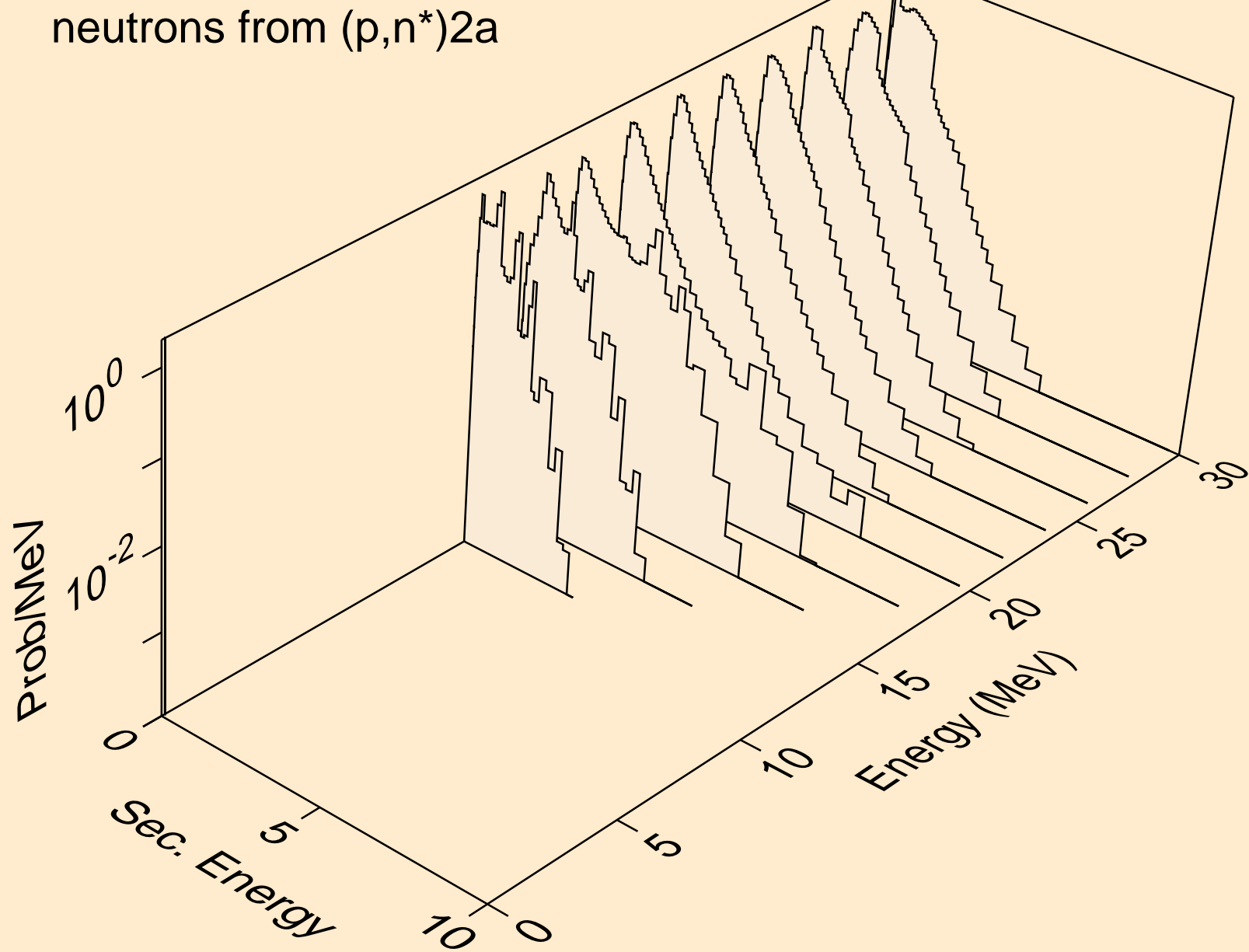

FR205 PROTON ACER TENDL-2021 LIBRARY; T=0.K  
neutrons from (p,n\*)d

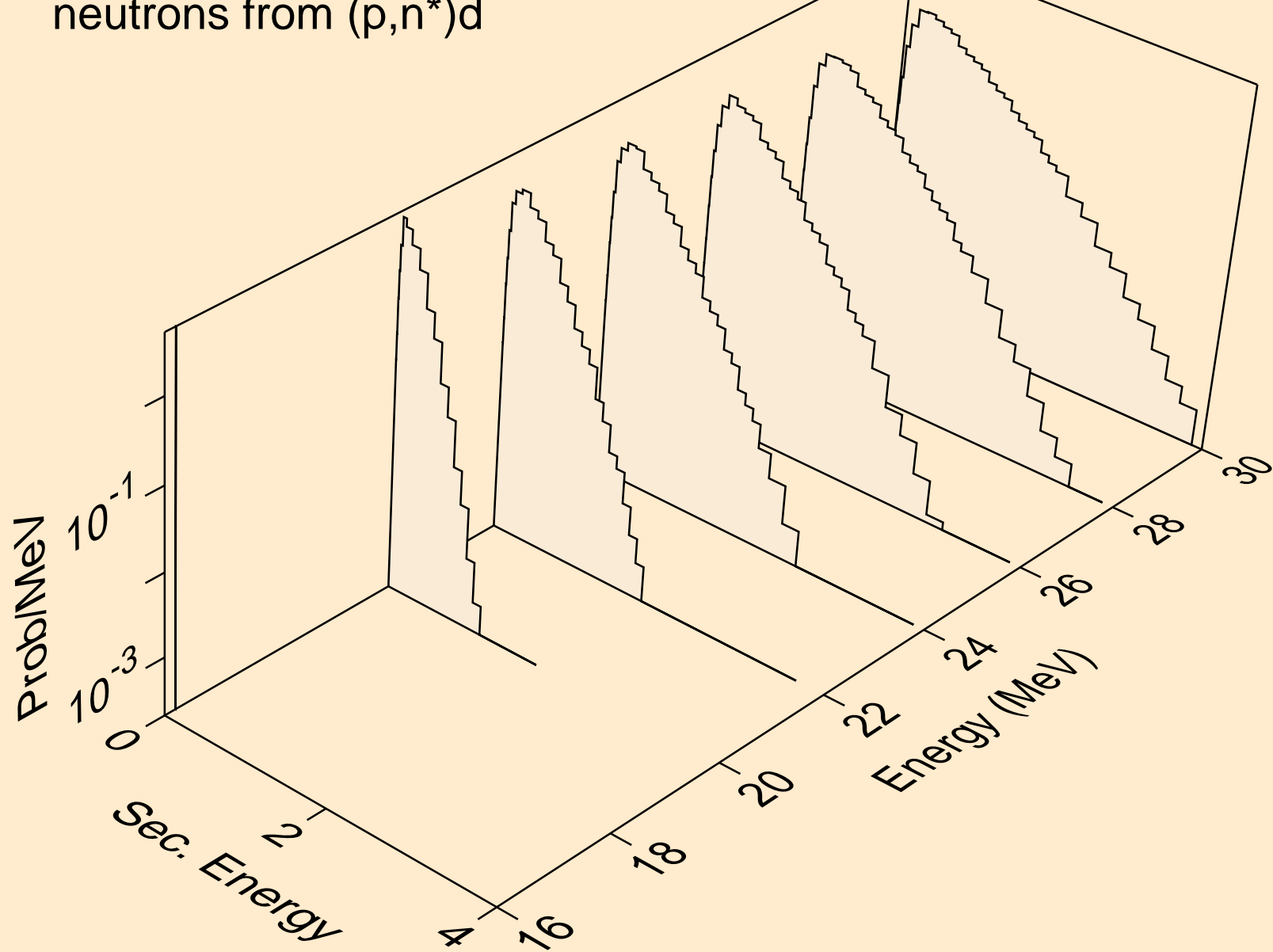

FR205 PROTON ACER TENDL-2021 LIBRARY; T=0.K  
neutrons from (p,n\*)t

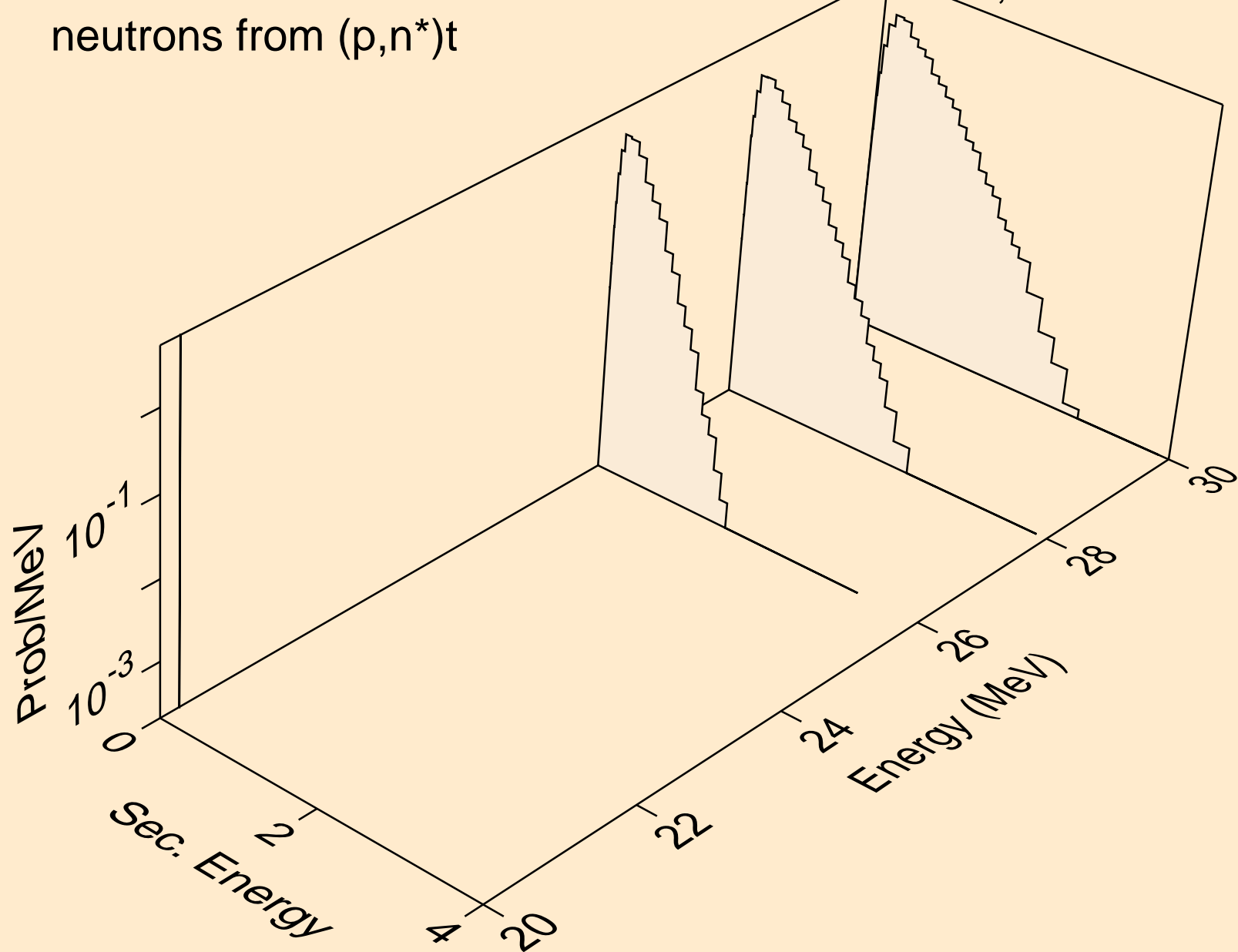

FR205 PROTON ACER TENDL-2021 LIBRARY; T=0.K  
neutrons from (p,n\*)he3

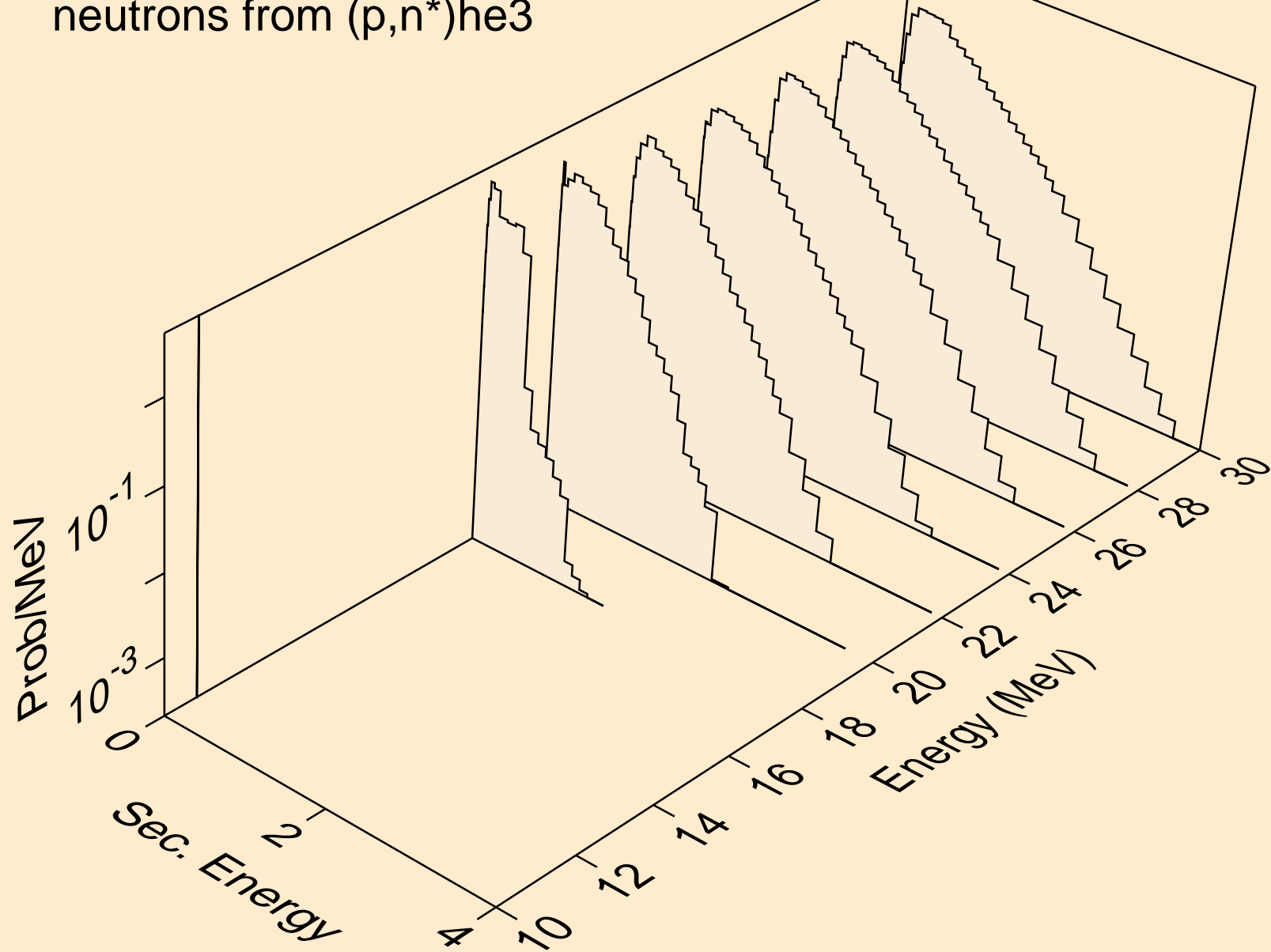

FR205 PROTON ACER TENDL-2021 LIBRARY; T=0.K  
neutrons from (p,2np)

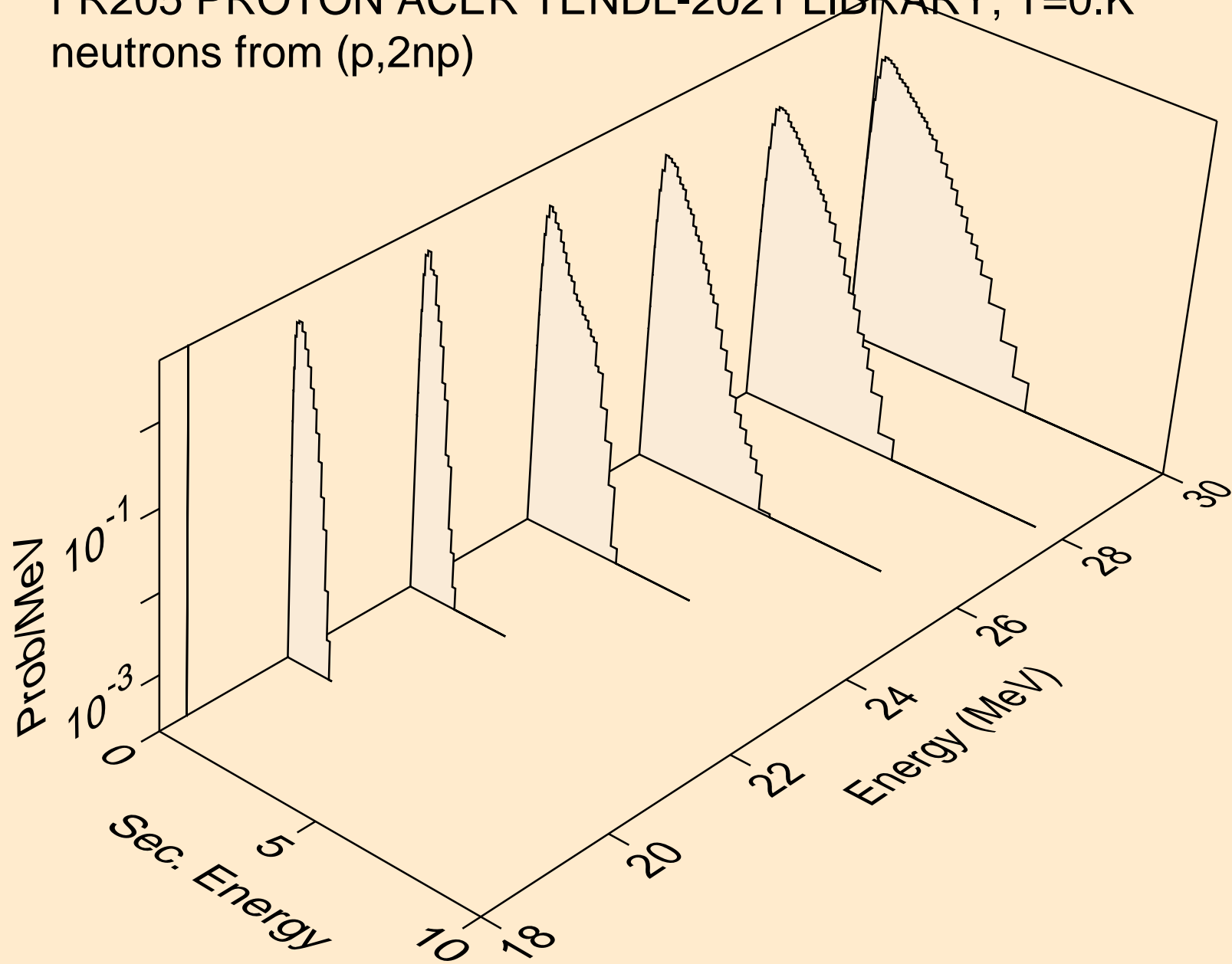

FR205 PROTON ACER TENDL-2021 LIBRARY; T=0.K  
neutrons from (p,2np)

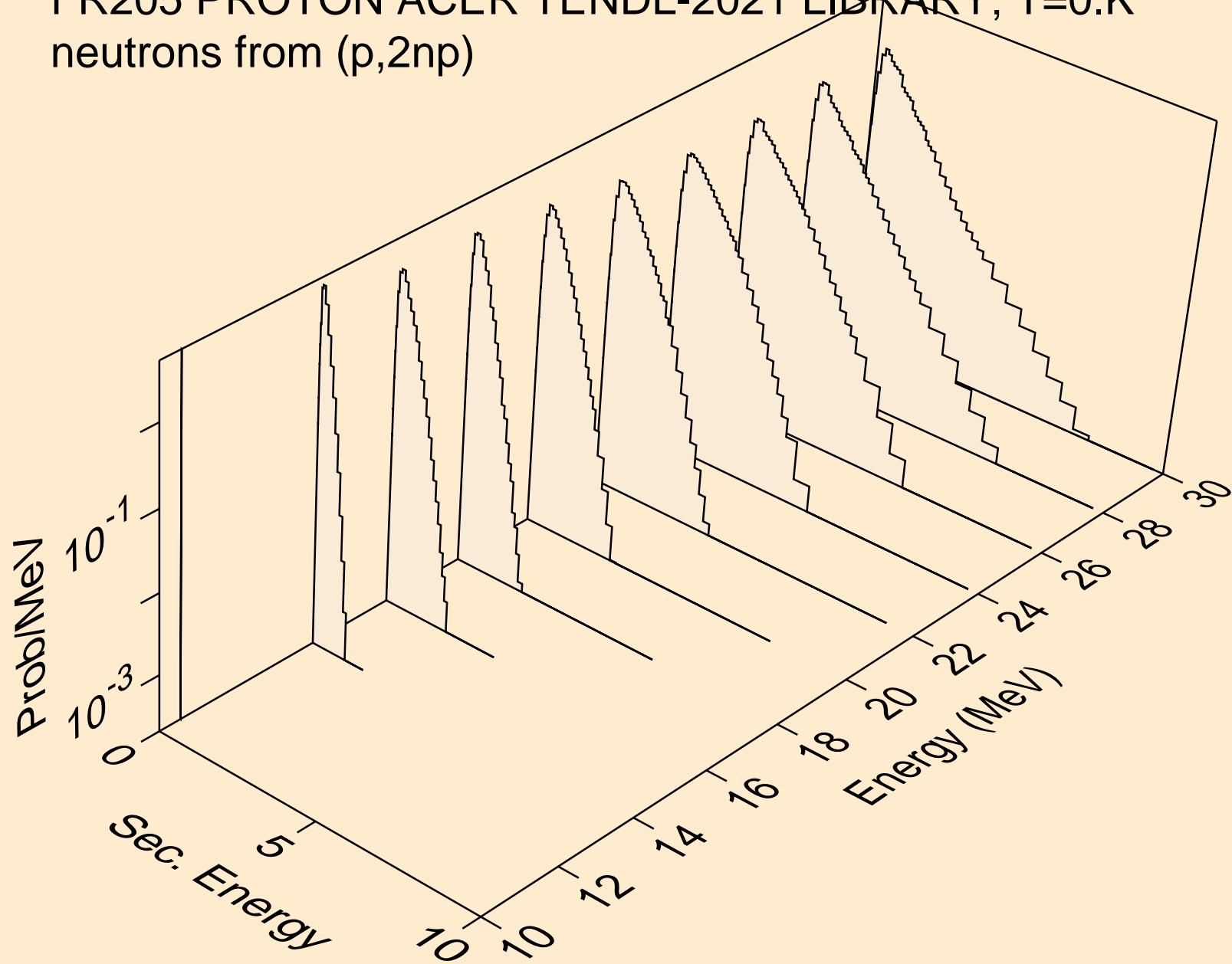

FR205 PROTON ACER TENDL-2021 LIBRARY; T=0.K  
neutrons from (p,npa)

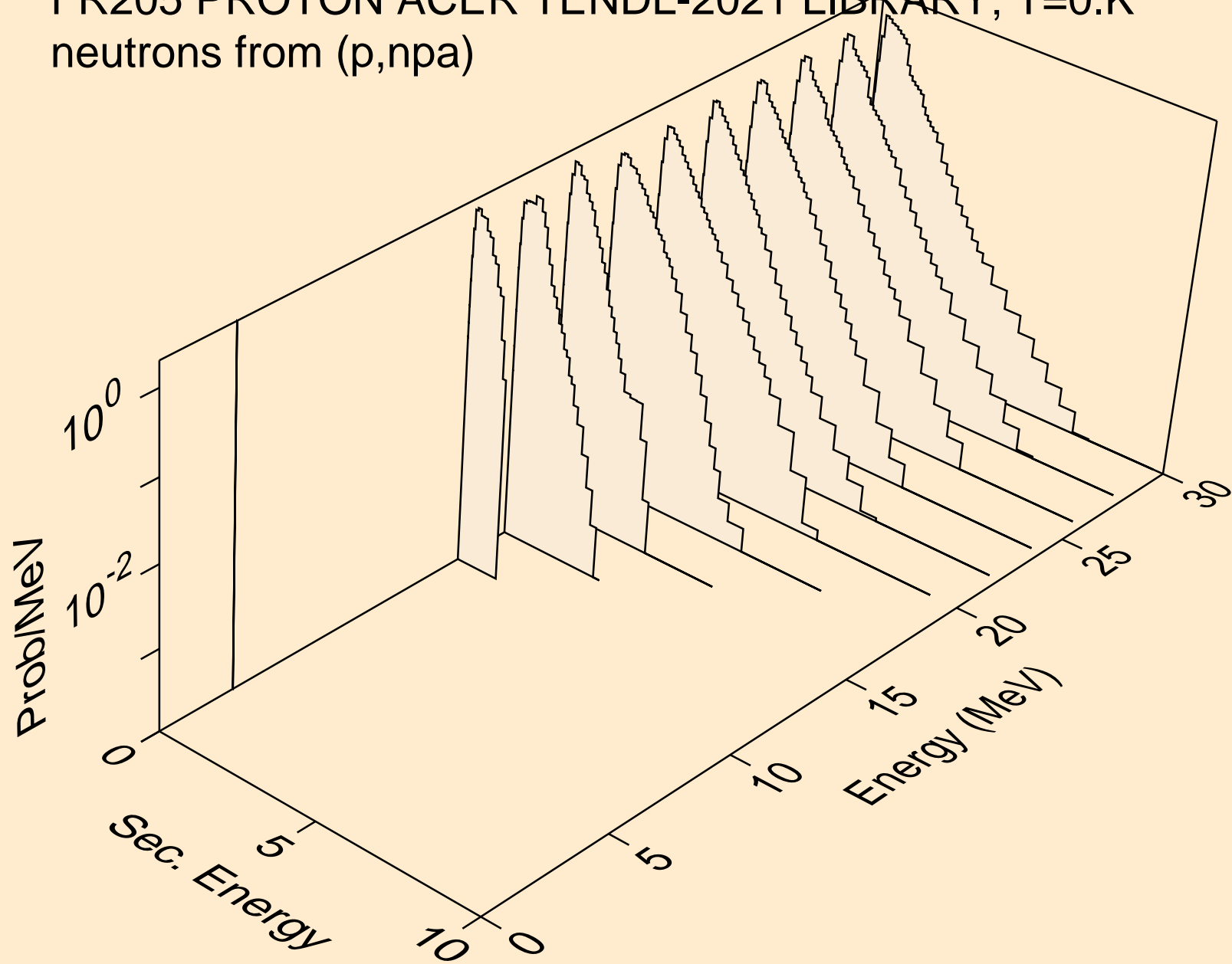



FR205 PROTON ACER TENDL-2021 LIBRARY; T=0.K  
deuterons from (p,x)

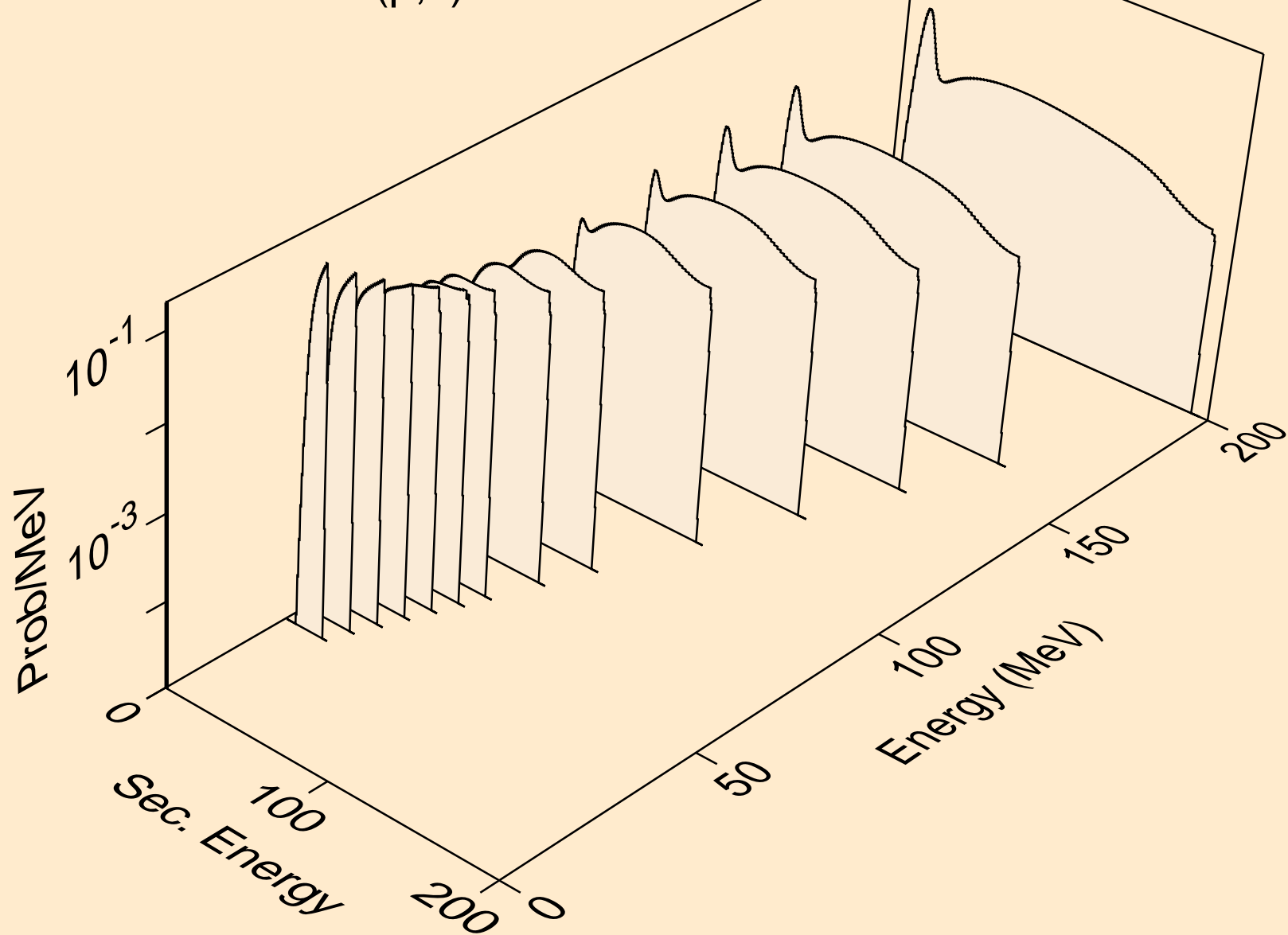

FR205 PROTON ACER TENDL-2021 LIBRARY; T=0.K  
deuterons from (p,n\*)d

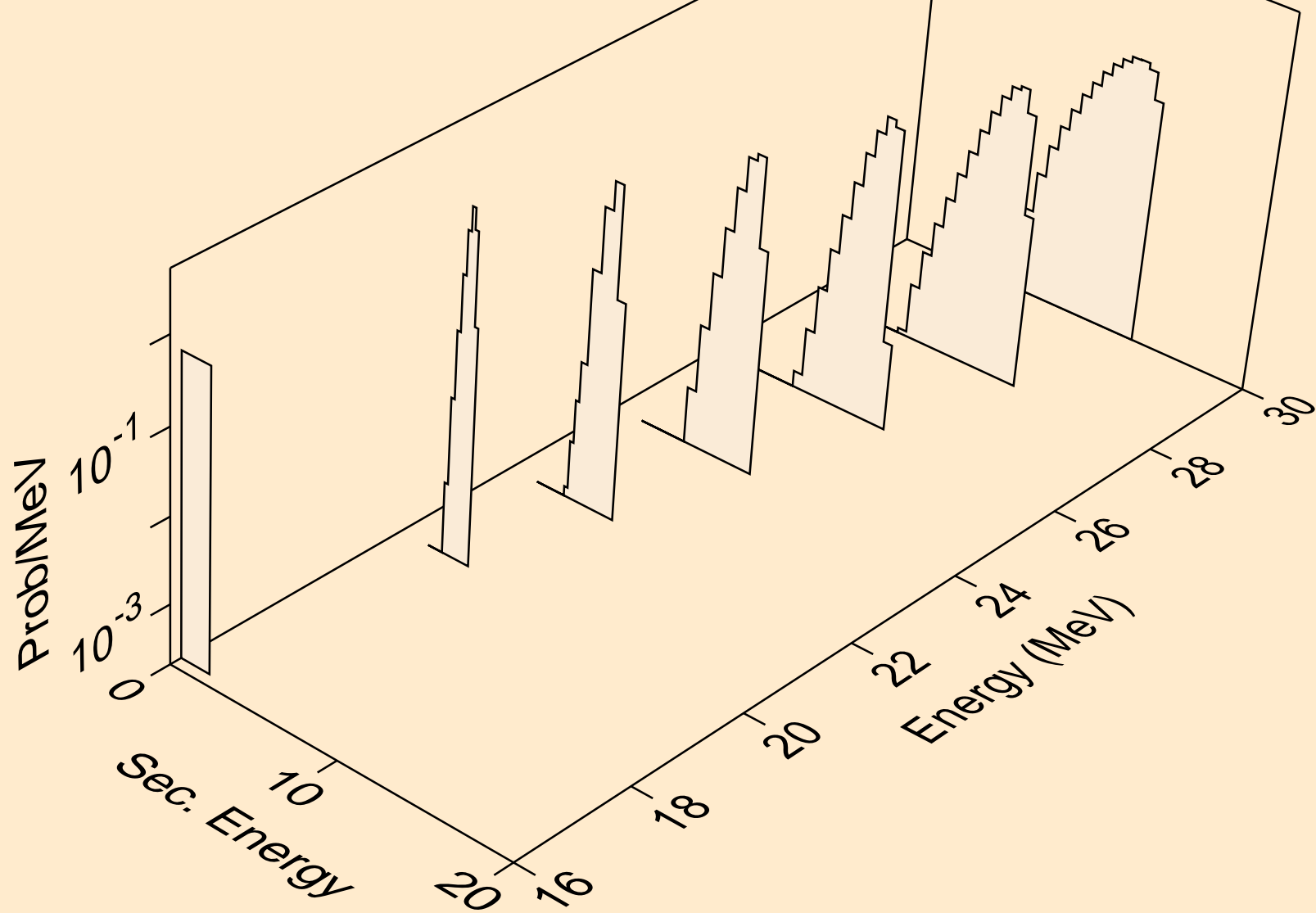

FR205 PROTON ACER TENDL-2021 LIBRARY; T=0.K  
deuterons from (p,d)

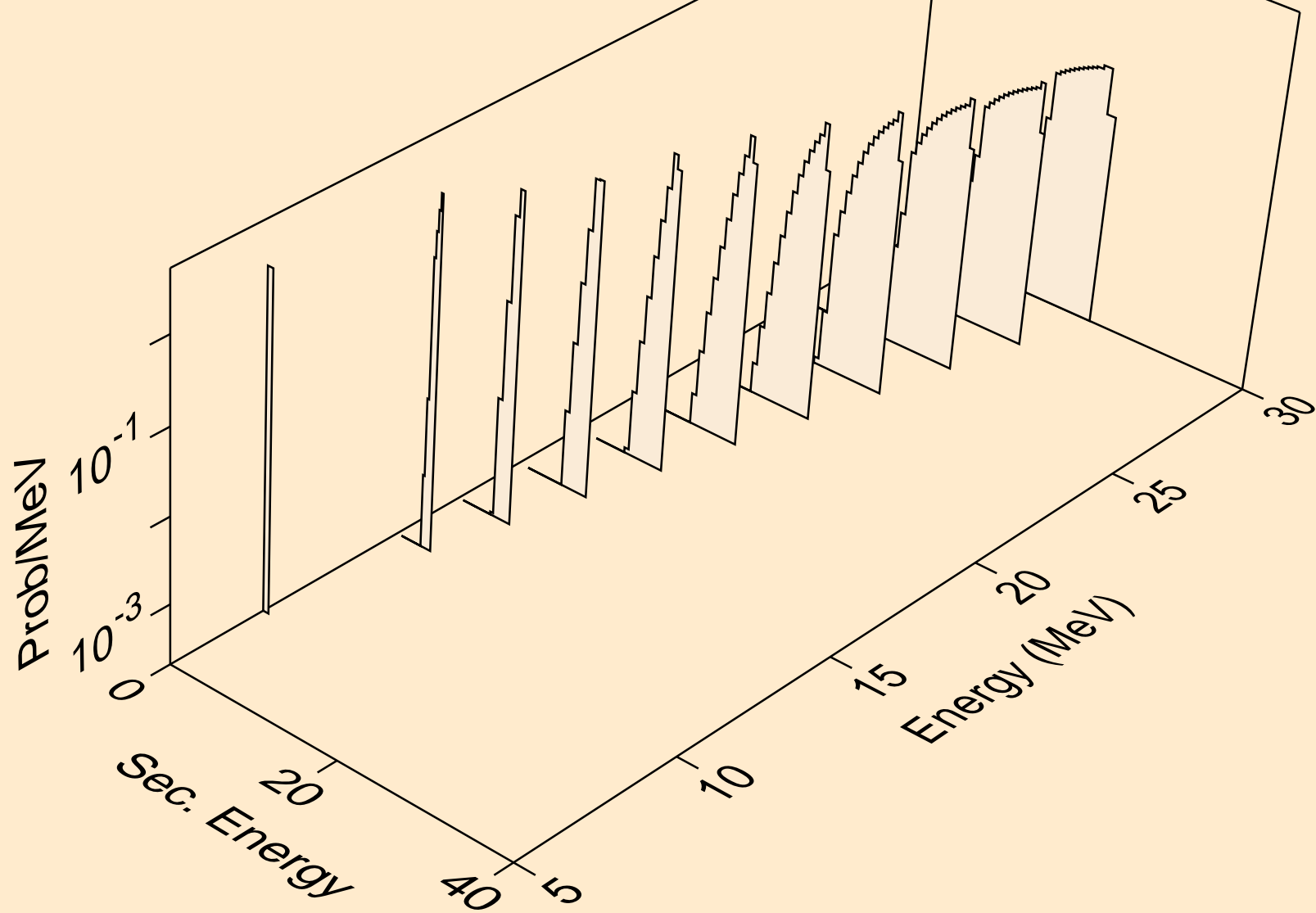

FR205 PROTON ACER TENDL-2021 LIBRARY; T=0.K  
deuterons from (p,pd)

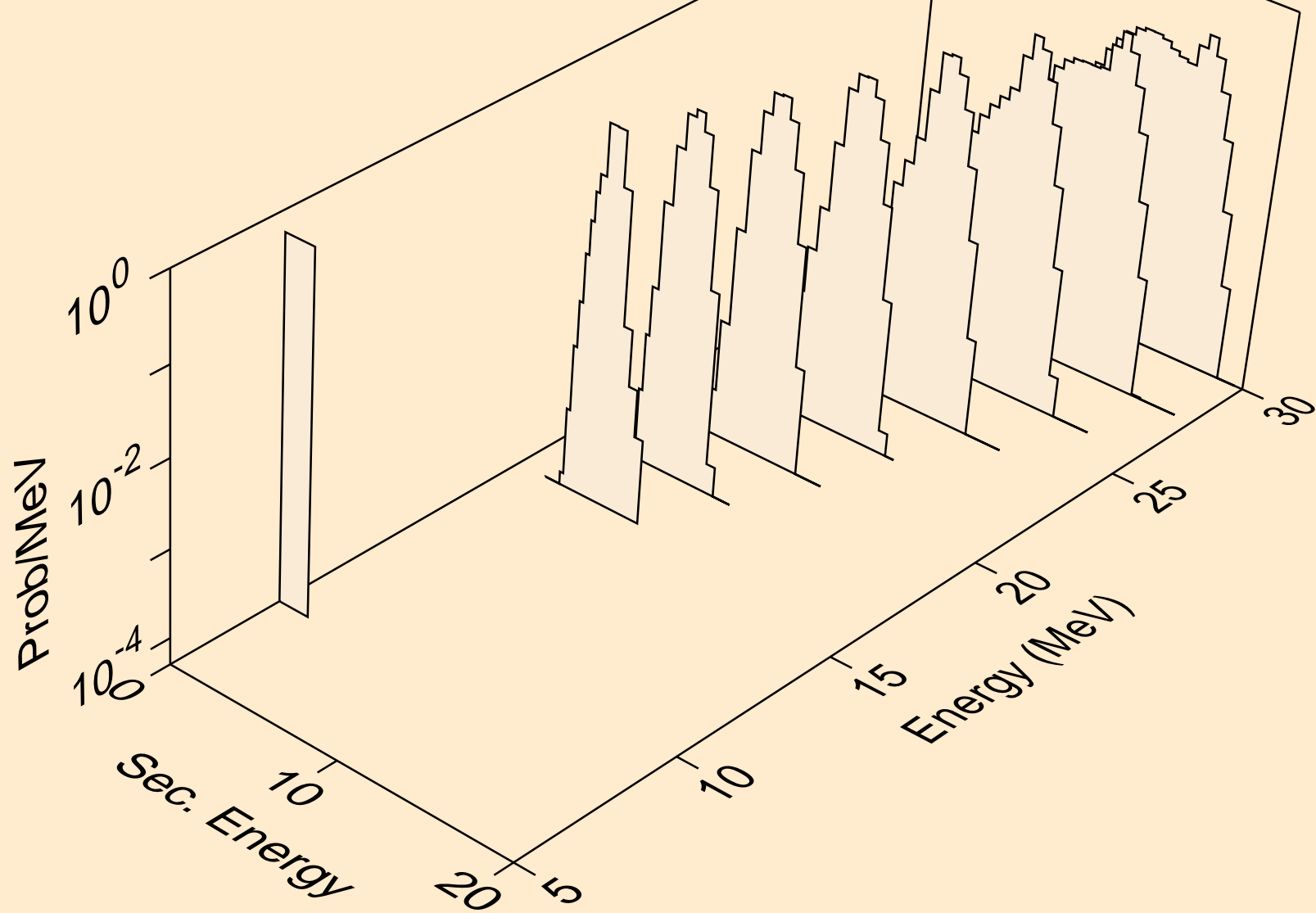

FR205 PROTON ACER TENDL-2021 LIBRARY; T=0.K  
deuterons from (p,da)

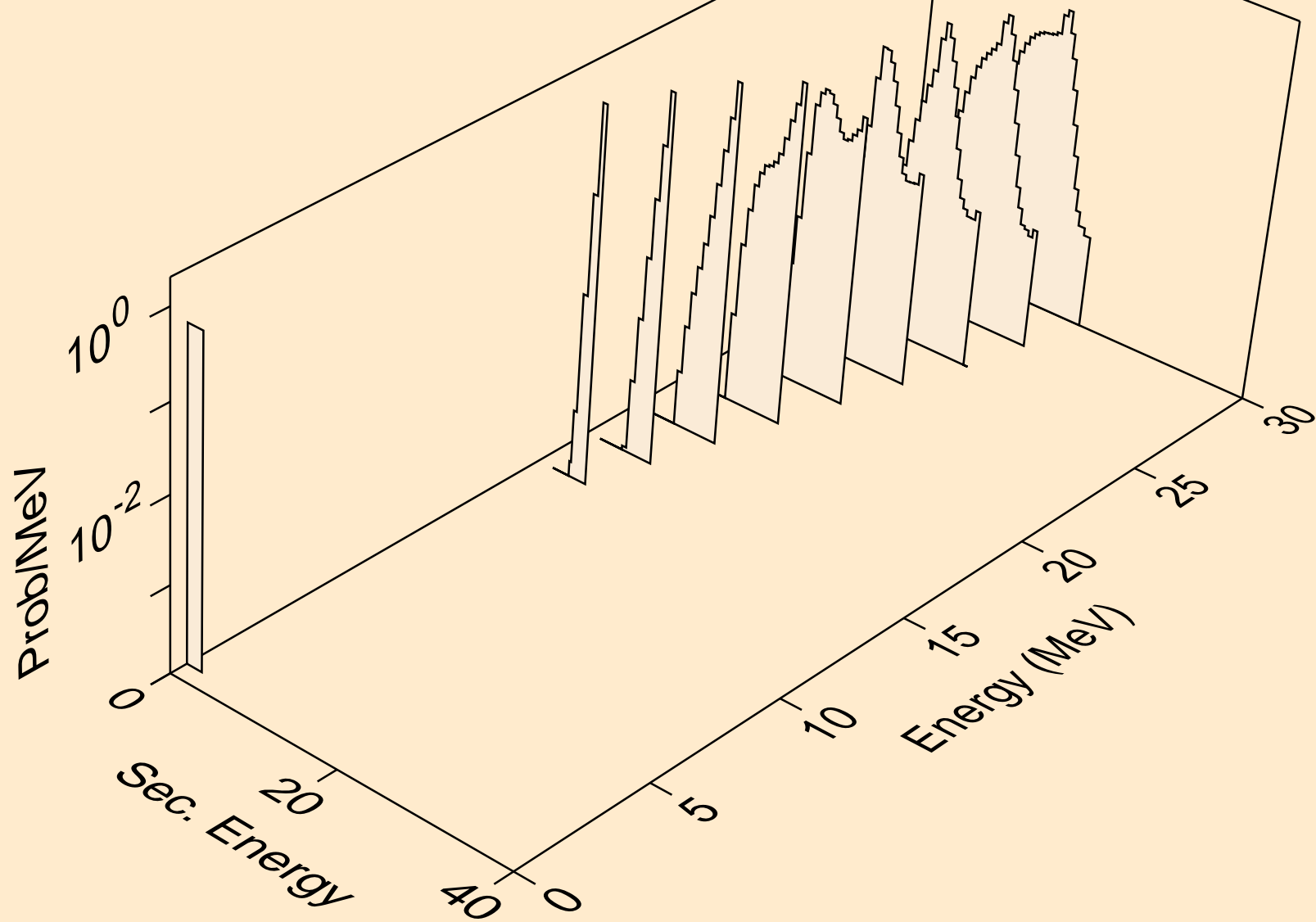

FR205 PROTON ACER TENDL-2021 LIBRARY; T=0.K  
tritons from (p,x)

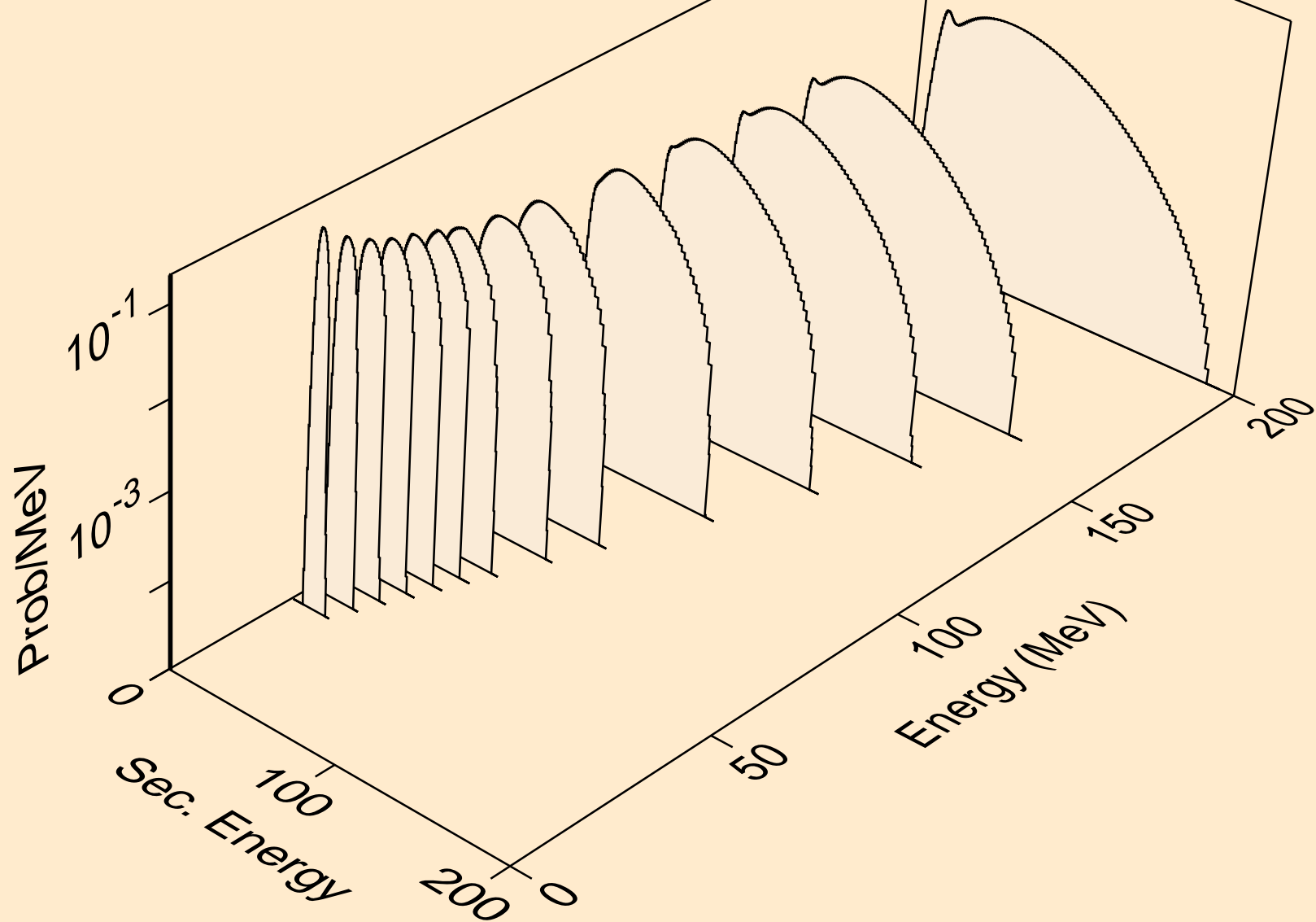

FR205 PROTON ACER TENDL-2021 LIBRARY; T=0.K  
tritons from (p,n\*)t

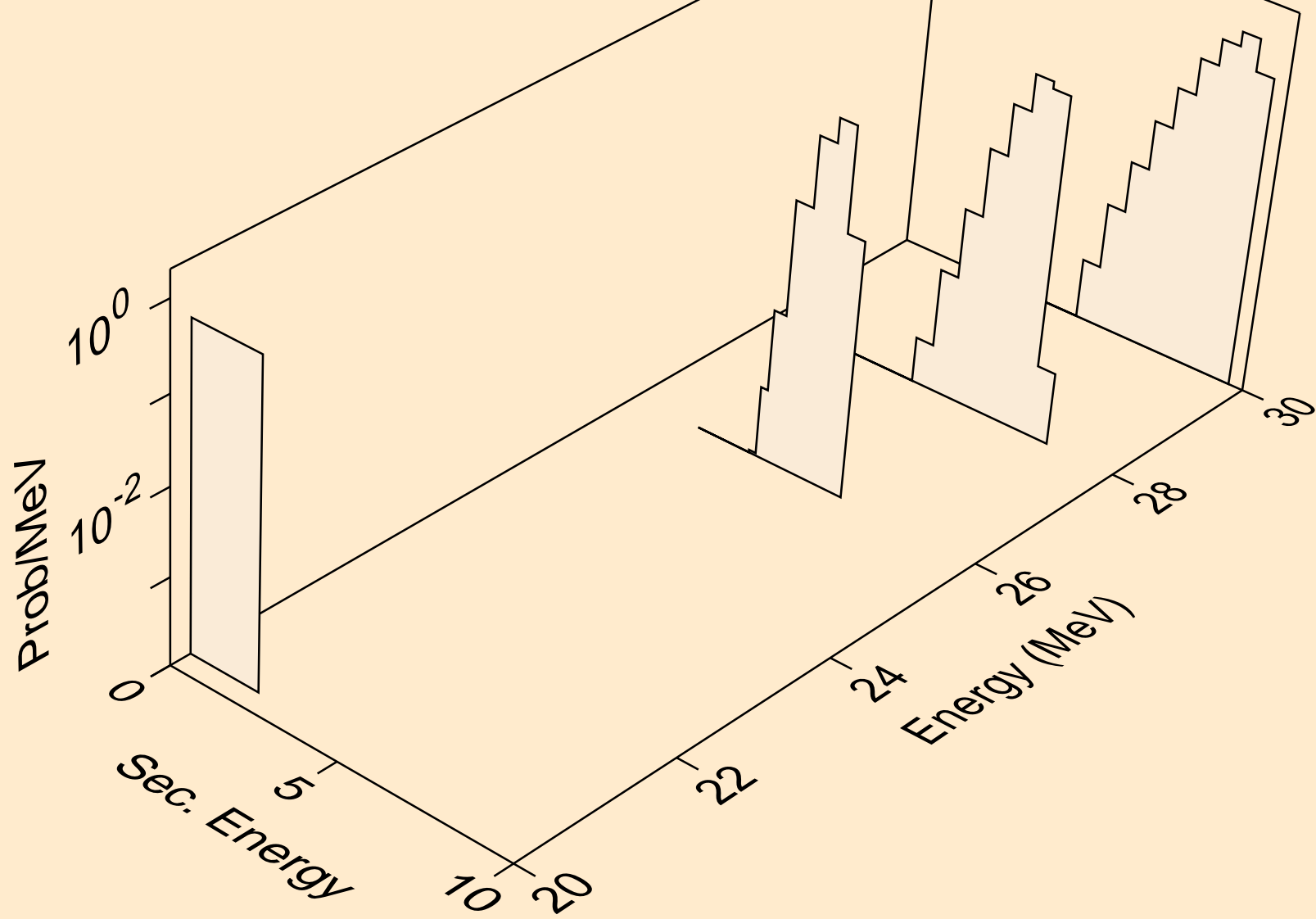

FR205 PROTON ACER TENDL-2021 LIBRARY; T=0.K  
tritons from (p,t)

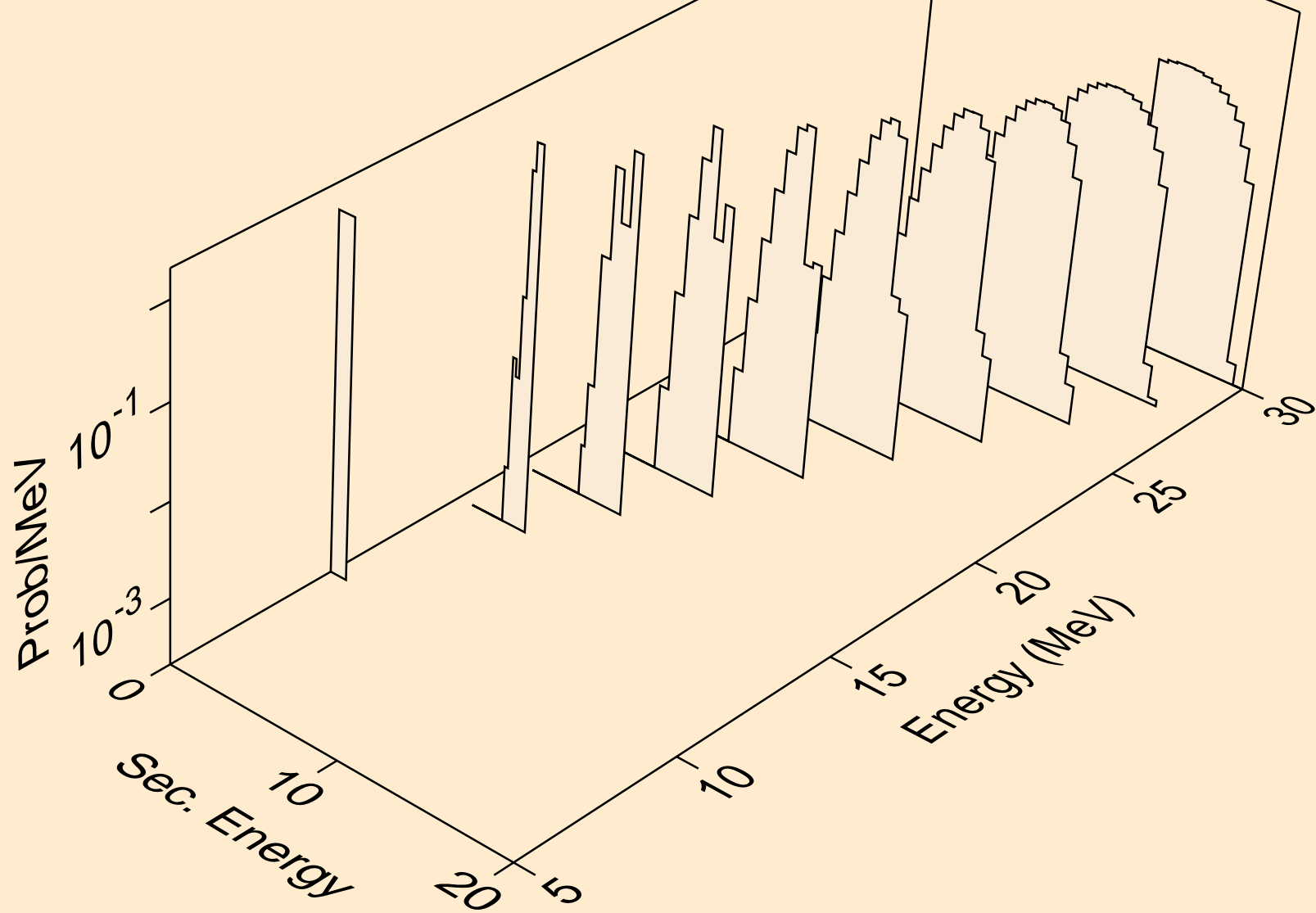



FR205 PROTON ACER TENDL-2021 LIBRARY; T=0.K  
tritons from (p,pt)

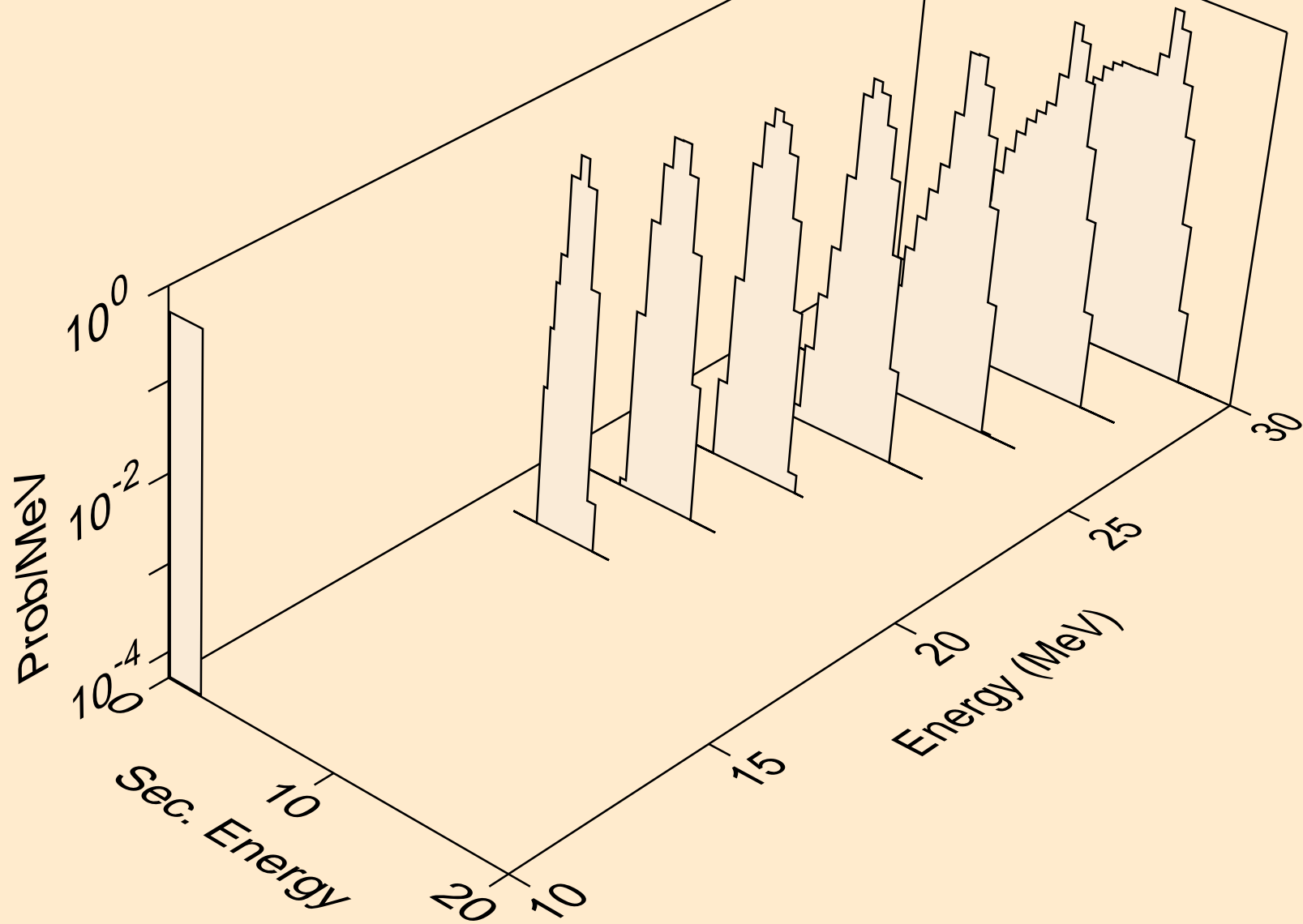

FR205 PROTON ACER TENDL-2021 LIBRARY; T=0.K  
he3s from (p,x)

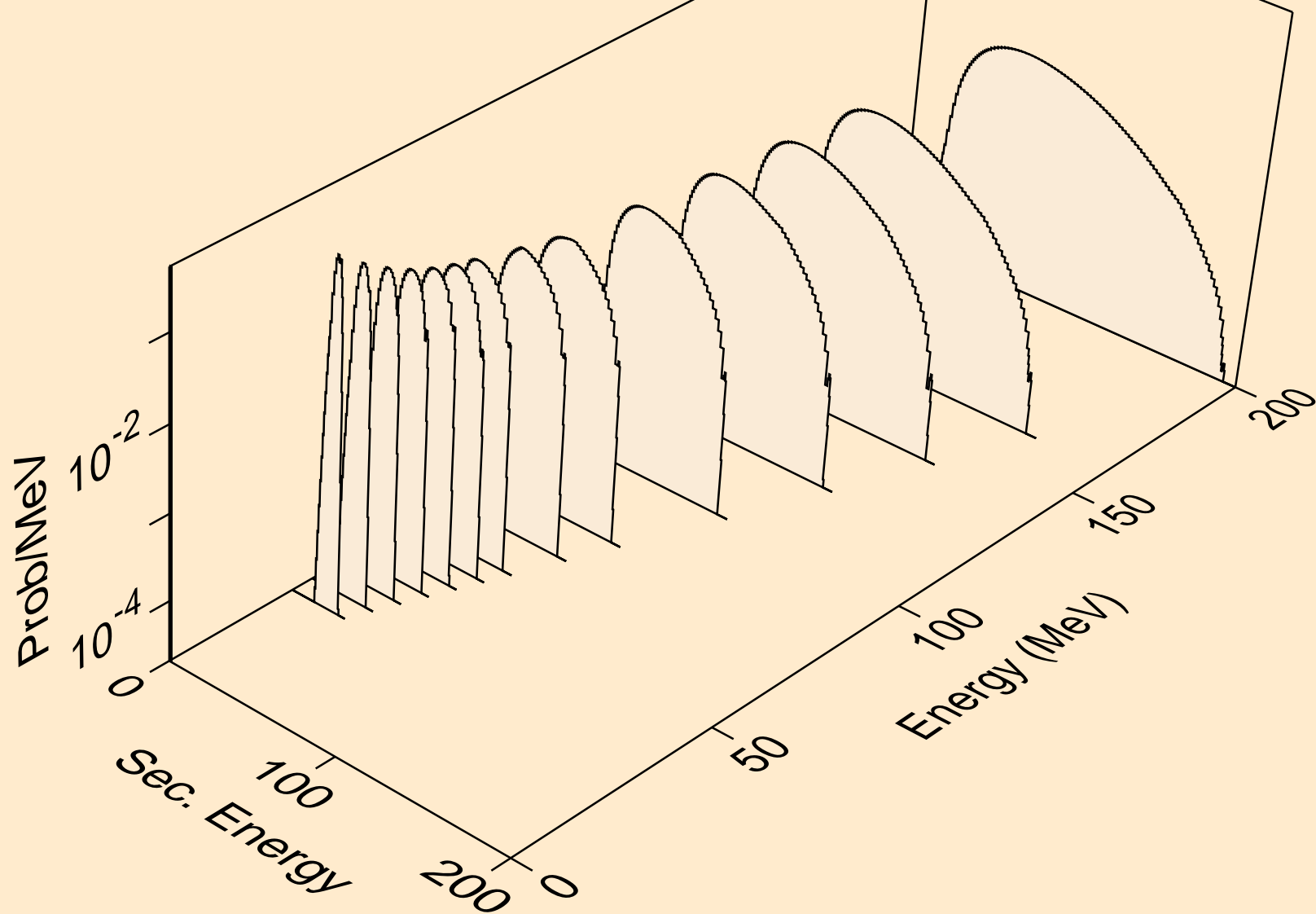

FR205 PROTON ACER TENDL-2021 LIBRARY; T=0.K  
he3s from (p,n\*)he3

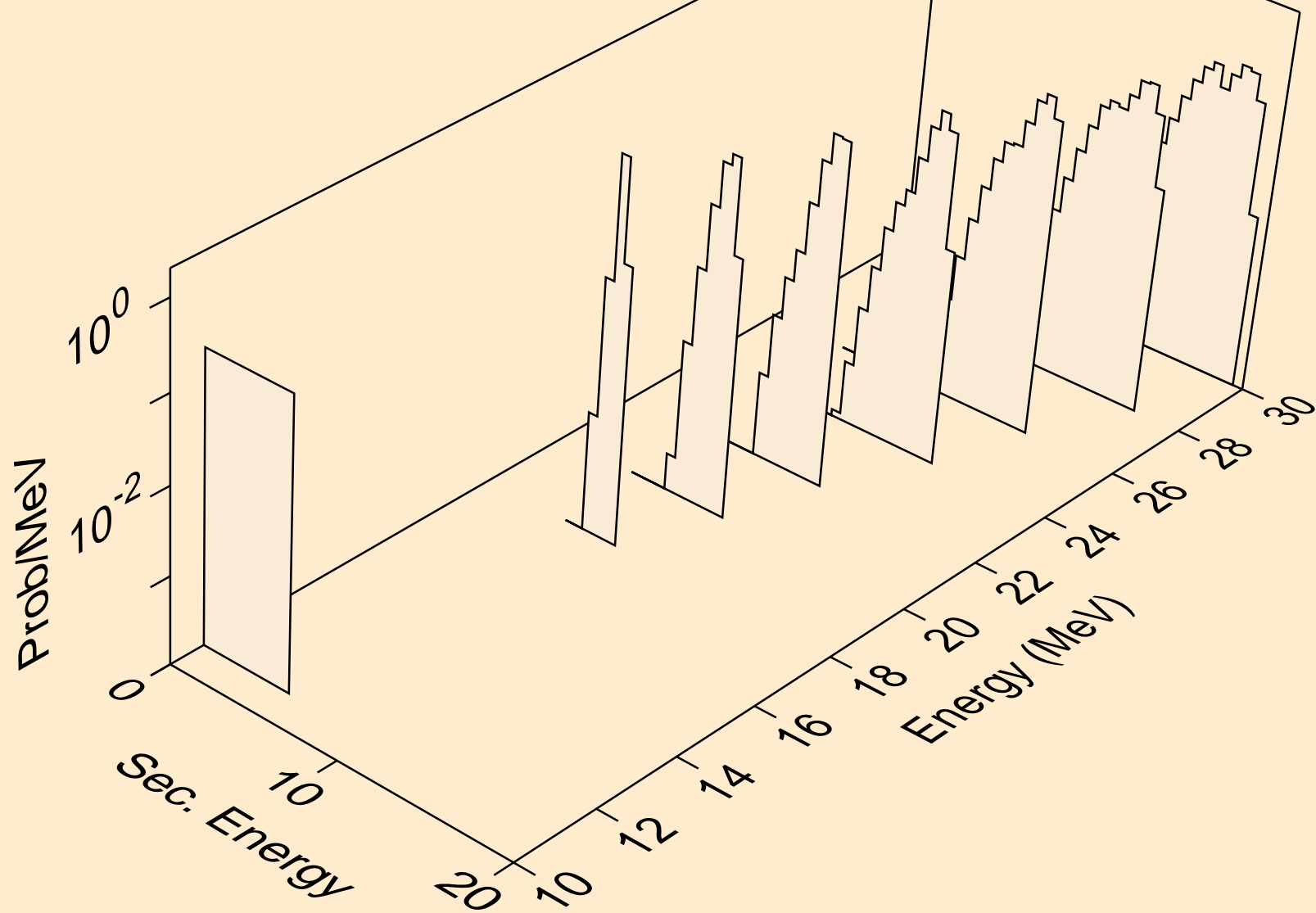

FR205 PROTON ACER TENDL-2021 LIBRARY; T=0.K  
he3s from (p,he3)

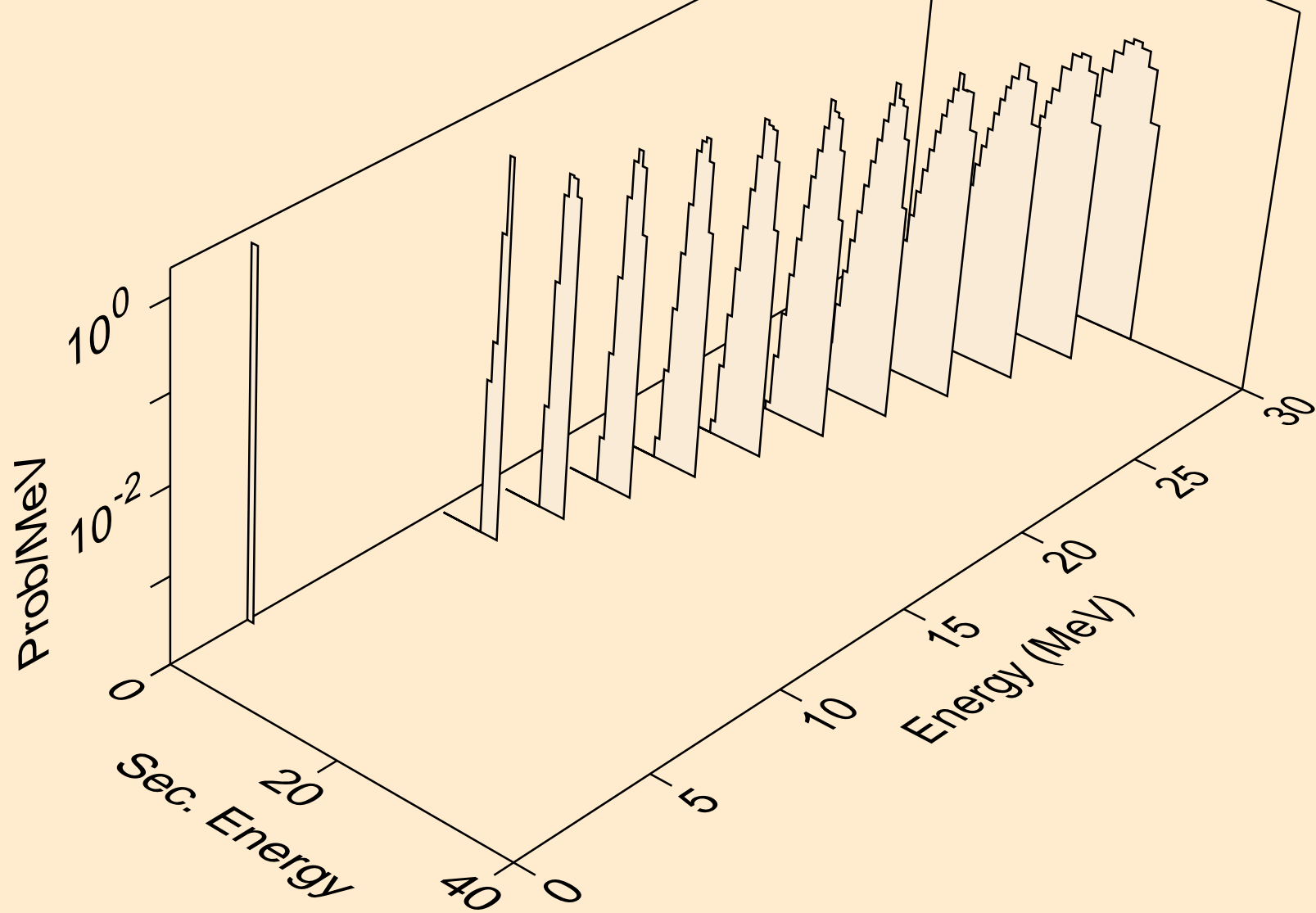

FR205 PROTON ACER TENDL-2021 LIBRARY; T=0.K  
alphas from (p,x)

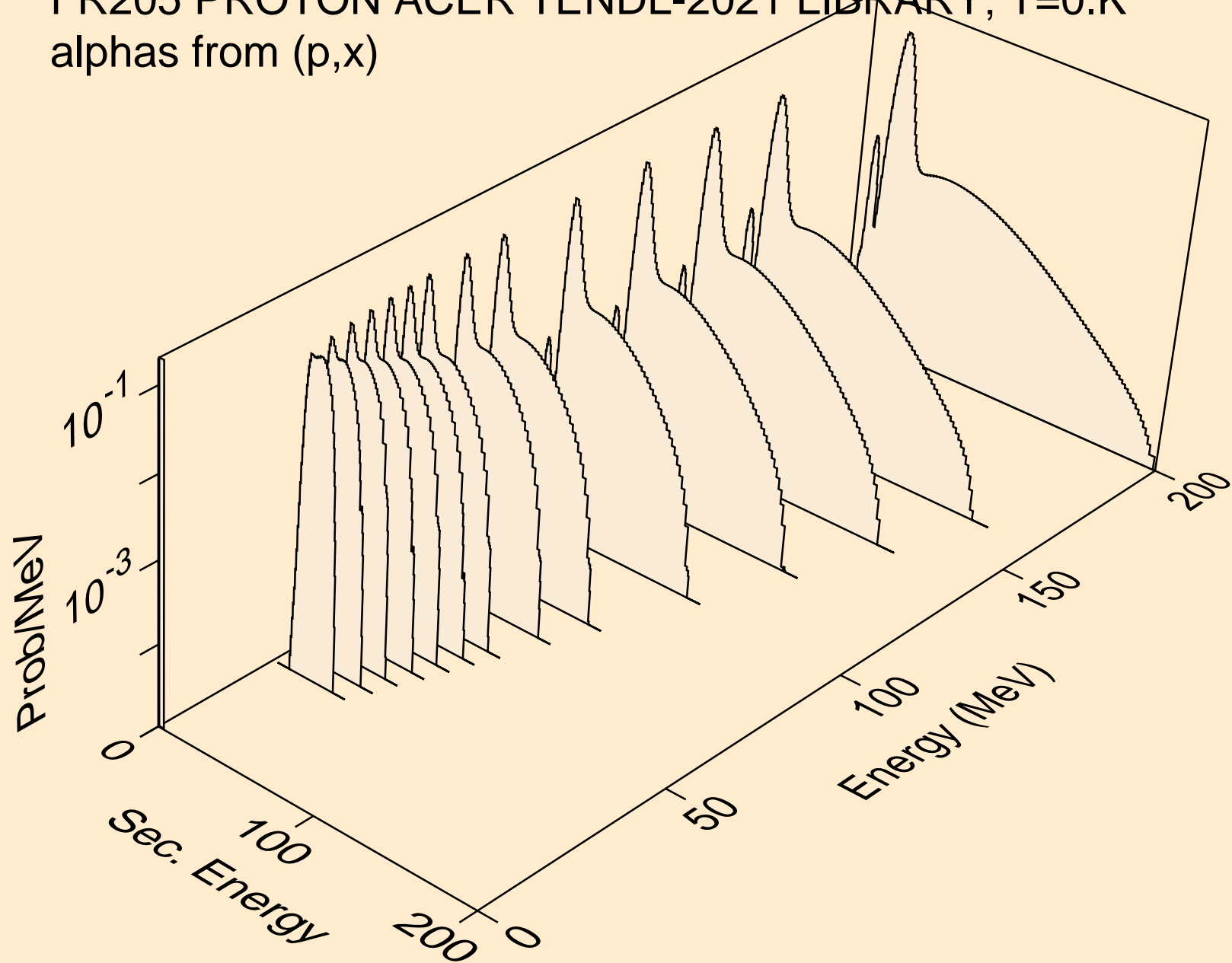

FR205 PROTON ACER TENDL-2021 LIBRARY; T=0.K  
alphas from (p,n\*)a

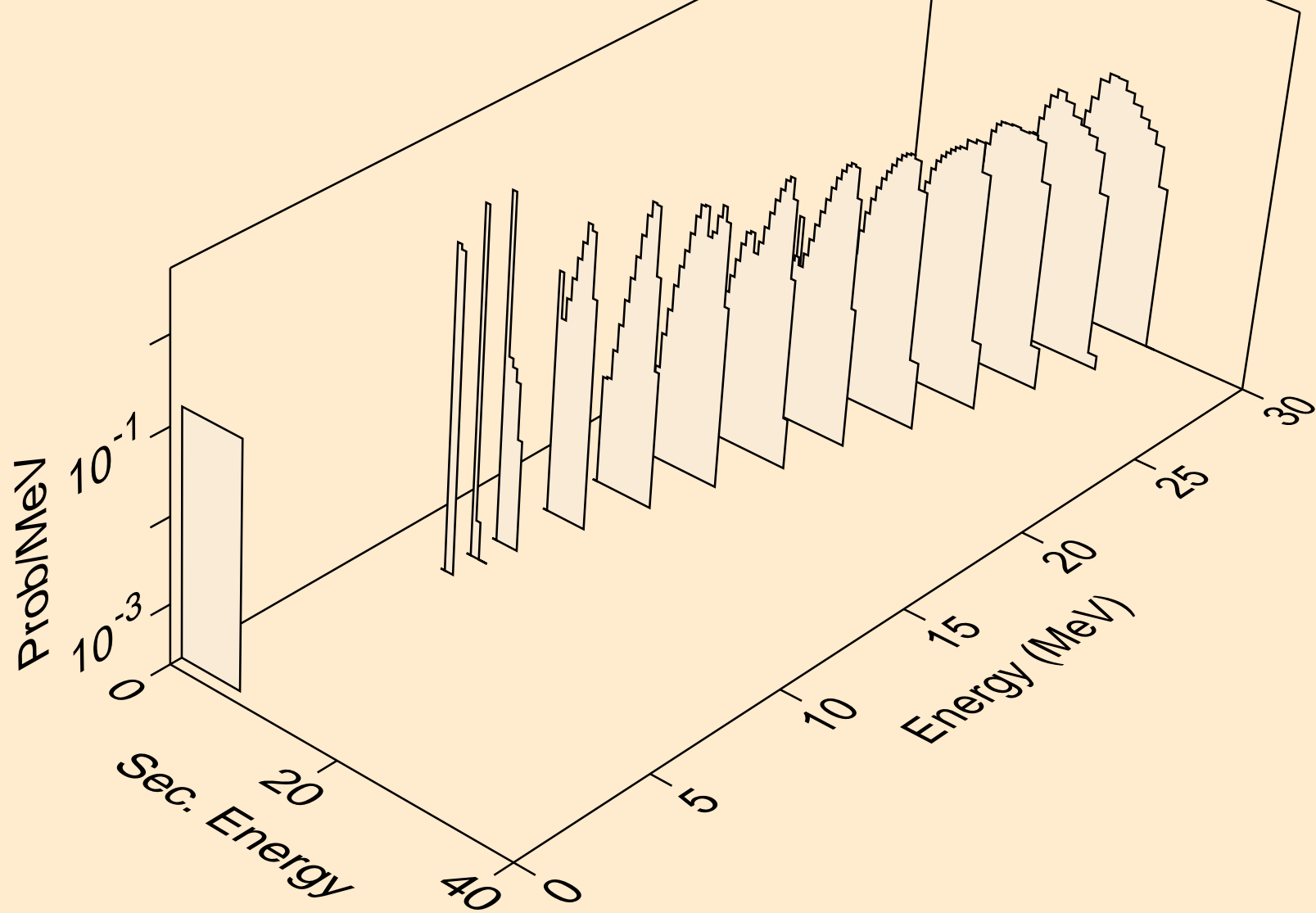

FR205 PROTON ACER TENDL-2021 LIBRARY; T=0.K  
alphas from (p,2n)a

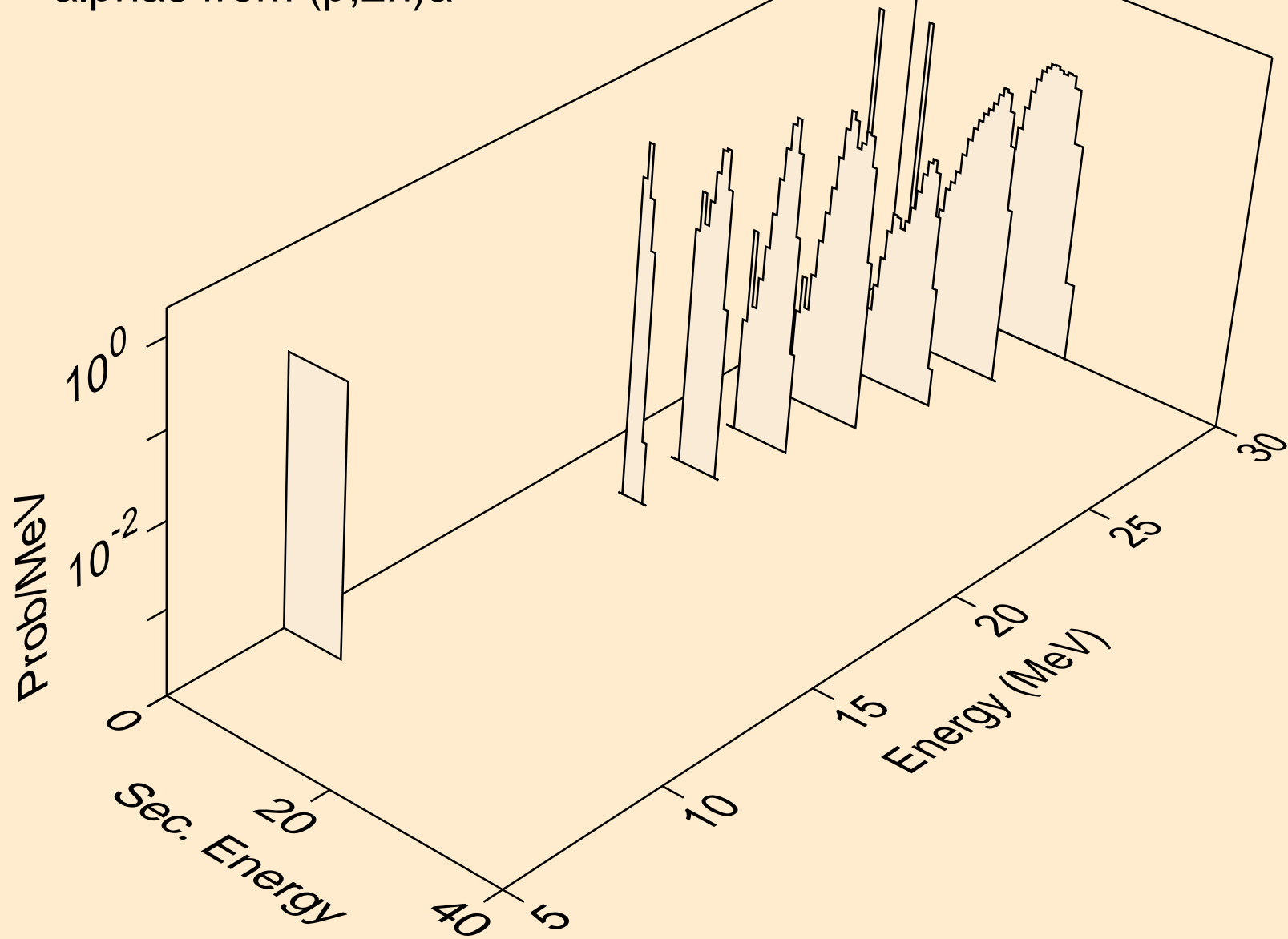

FR205 PROTON ACER TENDL-2021 LIBRARY; T=0.K  
alphas from (p,3n)a

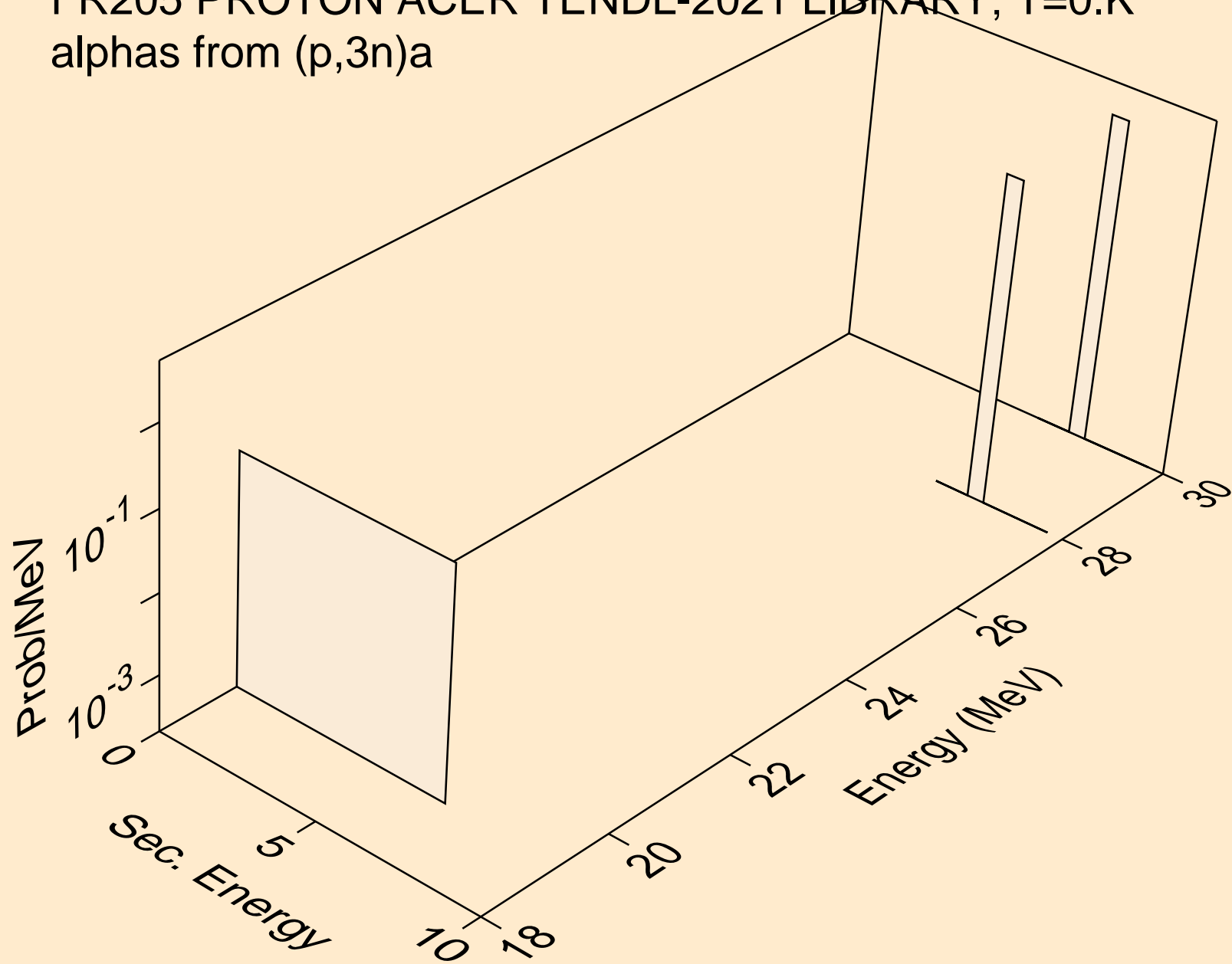



FR205 PROTON ACER TENDL-2021 LIBRARY; T=0.K  
alphas from (p,n\*)2a

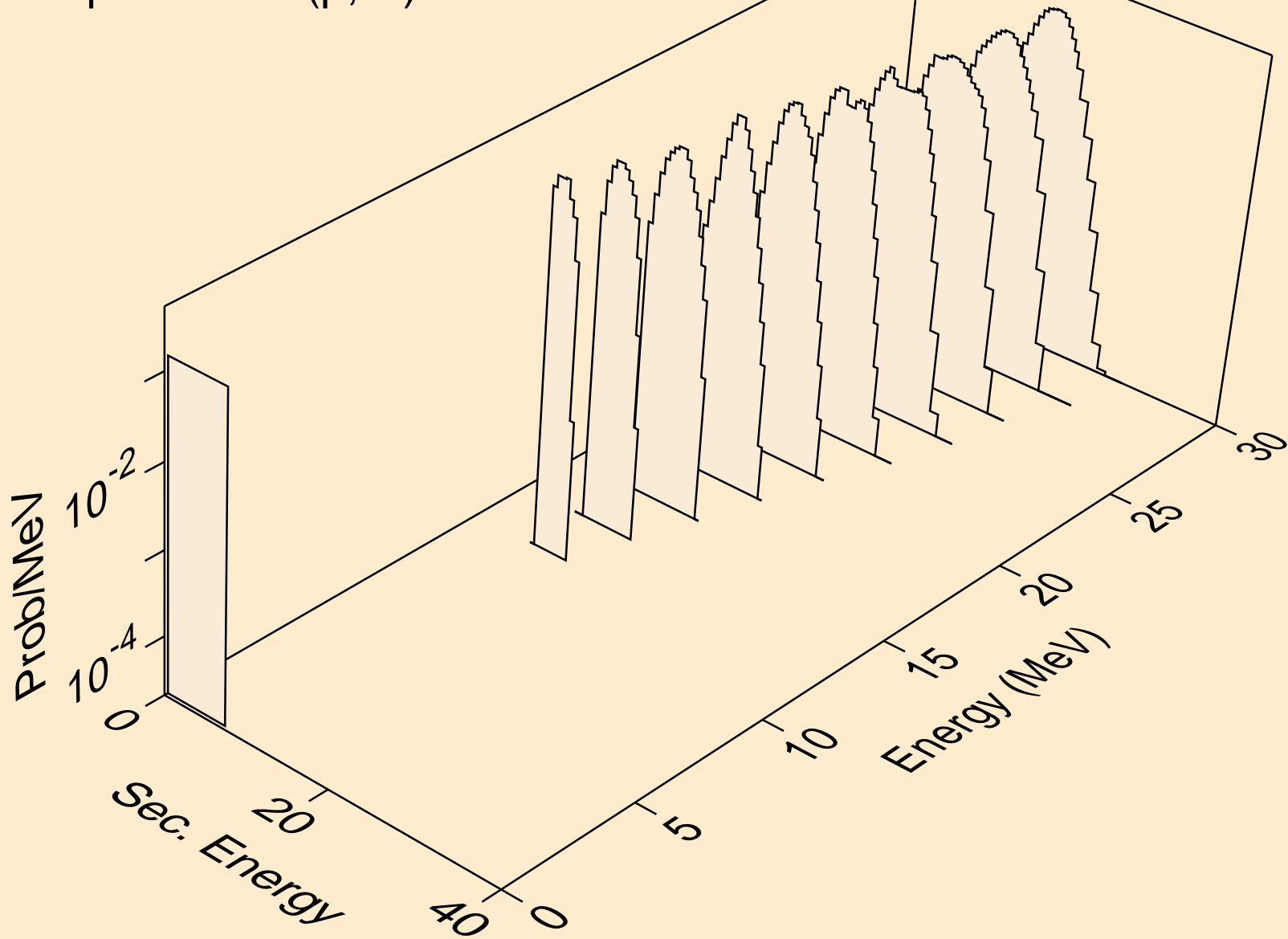

FR205 PROTON ACER TENDL-2021 LIBRARY; T=0.K  
alphas from (p,npa)

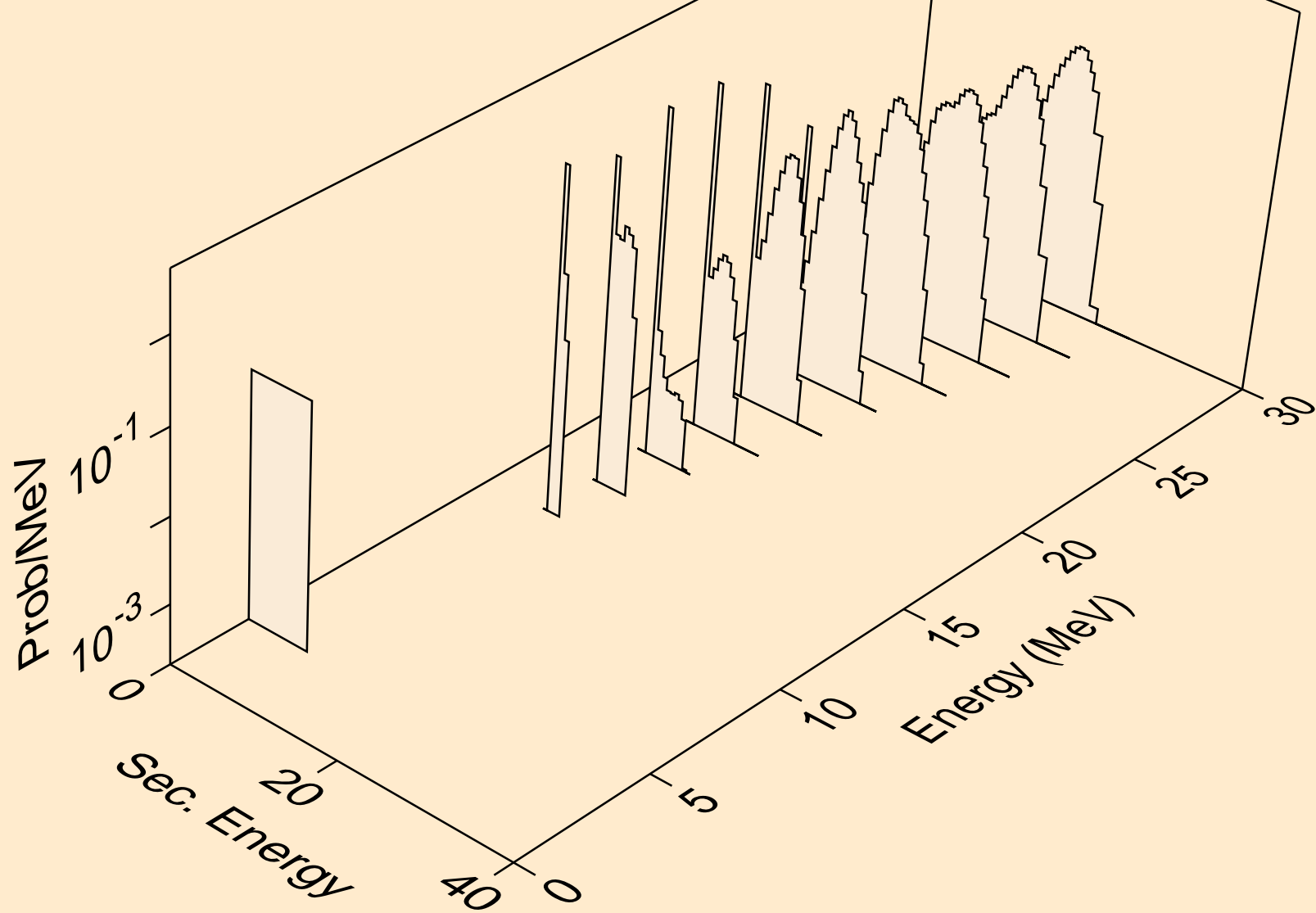

FR205 PROTON ACER TENDL-2021 LIBRARY; T=0.K  
alphas from (p,a)

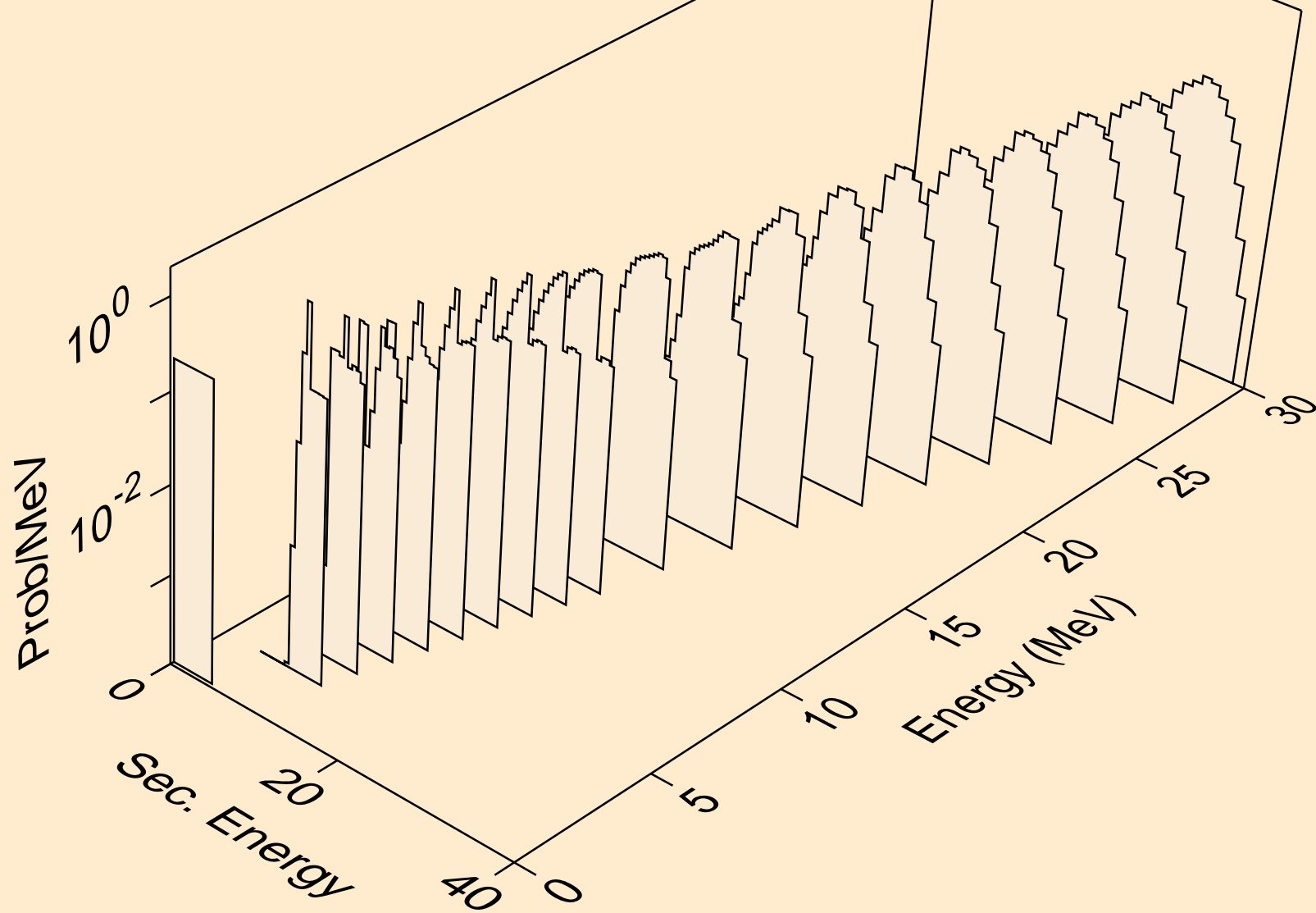

FR205 PROTON ACER TENDL-2021 LIBRARY; T=0.K  
alphas from (p,2a)

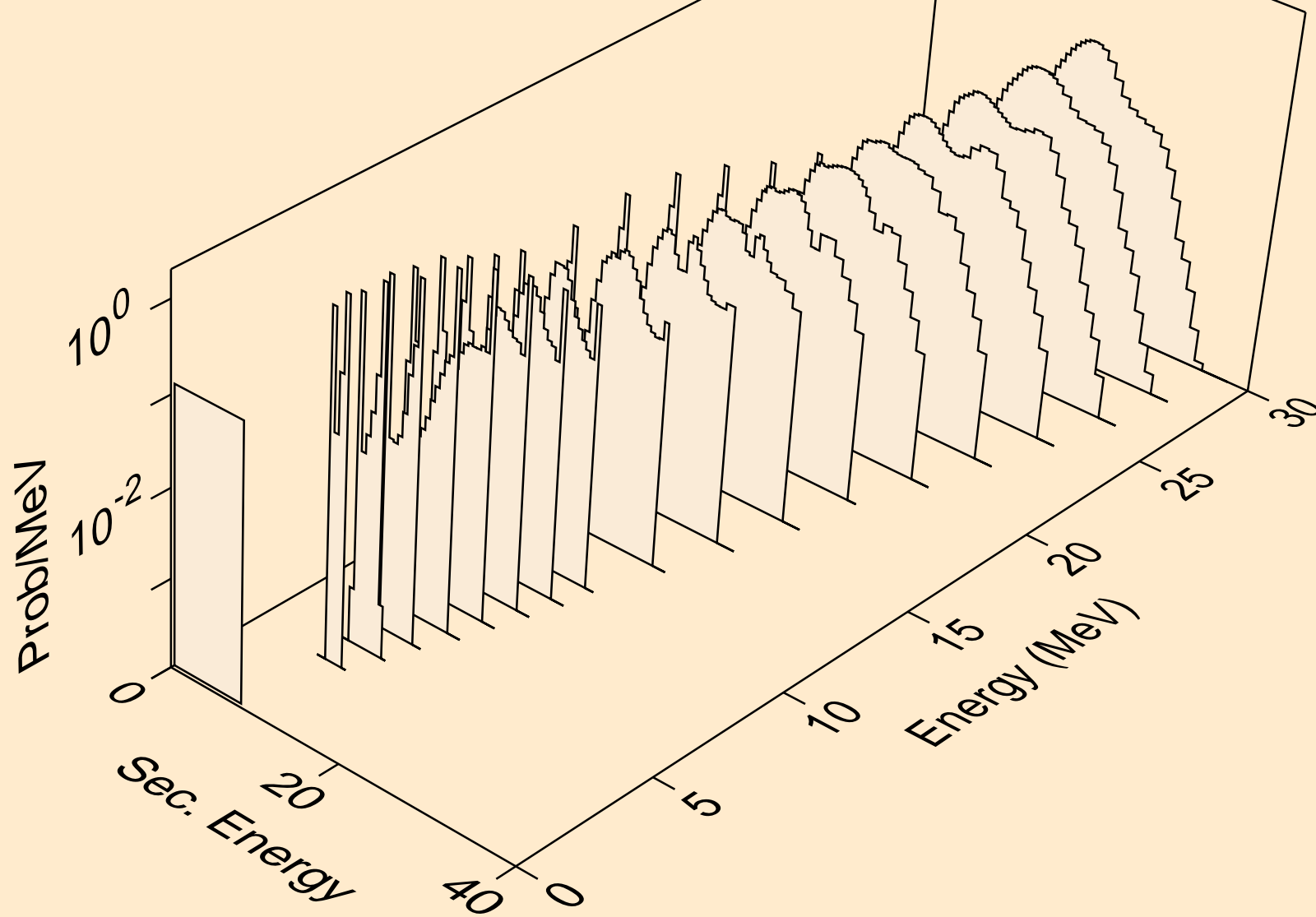

FR205 PROTON ACER TENDL-2021 LIBRARY; T=0.K  
alphas from (p,pa)

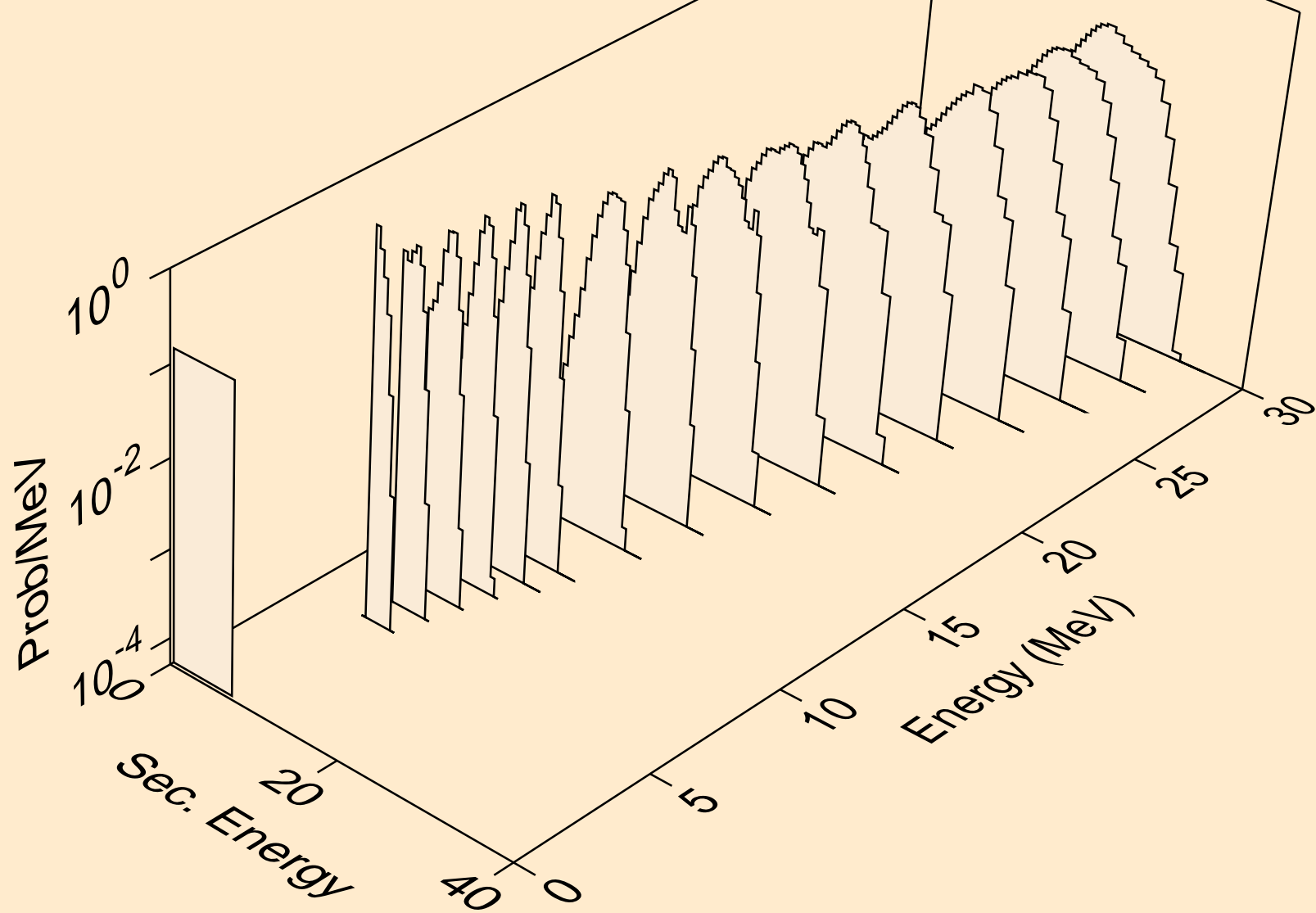

FR205 PROTON ACER TENDL-2021 LIBRARY; T=0.K  
alphas from (p,da)

