

# GD146 PROTON ACER TENDL-2021 LIBRARY; T=0.K

## Principal cross sections

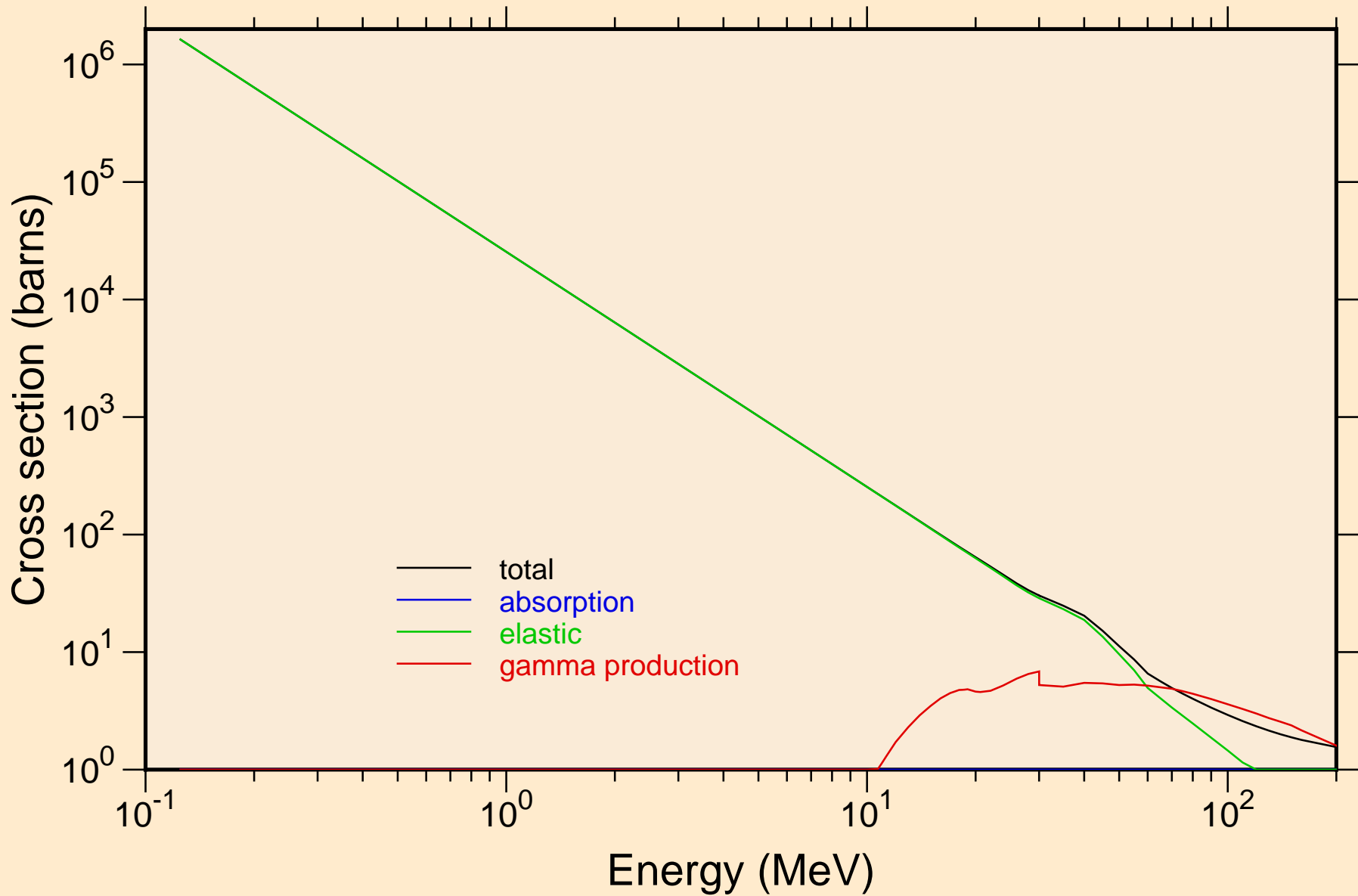

GD146 PROTON ACER TENDL-2021 LIBRARY; T=0.K  
Heating

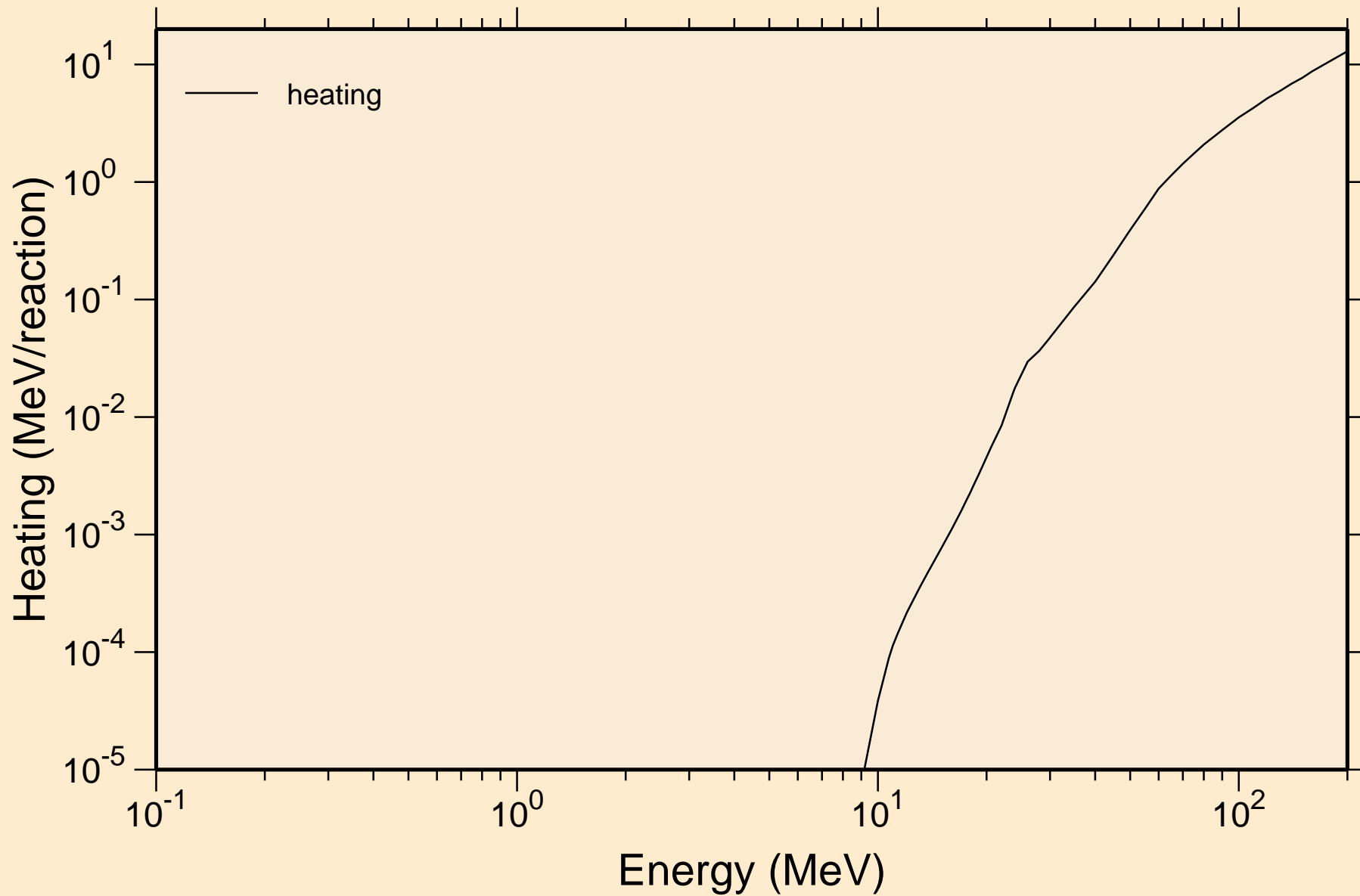

# GD146 PROTON ACER TENDL-2021 LIBRARY; T=0.K

## Principal cross sections

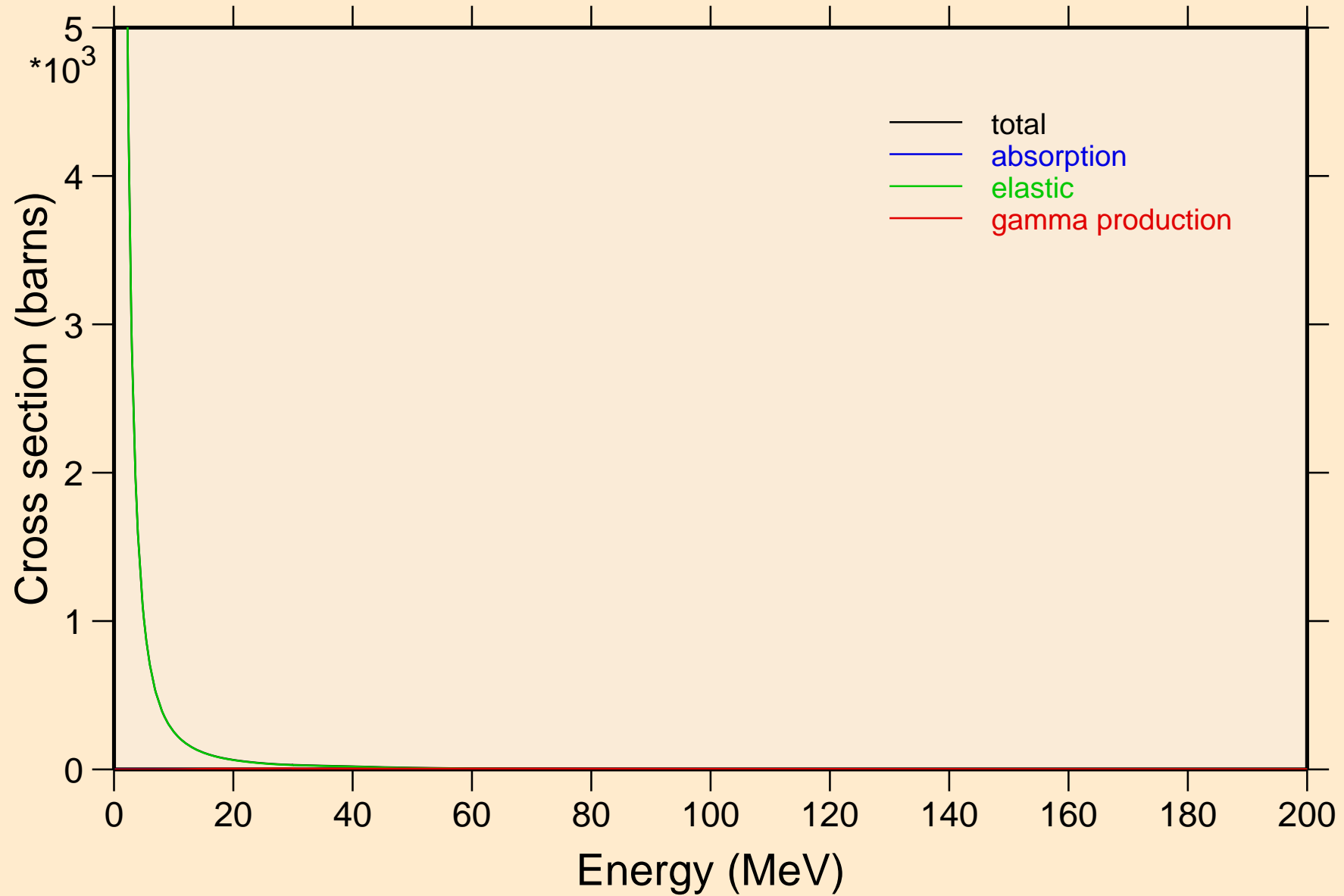

# GD146 PROTON ACER TENDL-2021 LIBRARY; T=0.K

## Heating

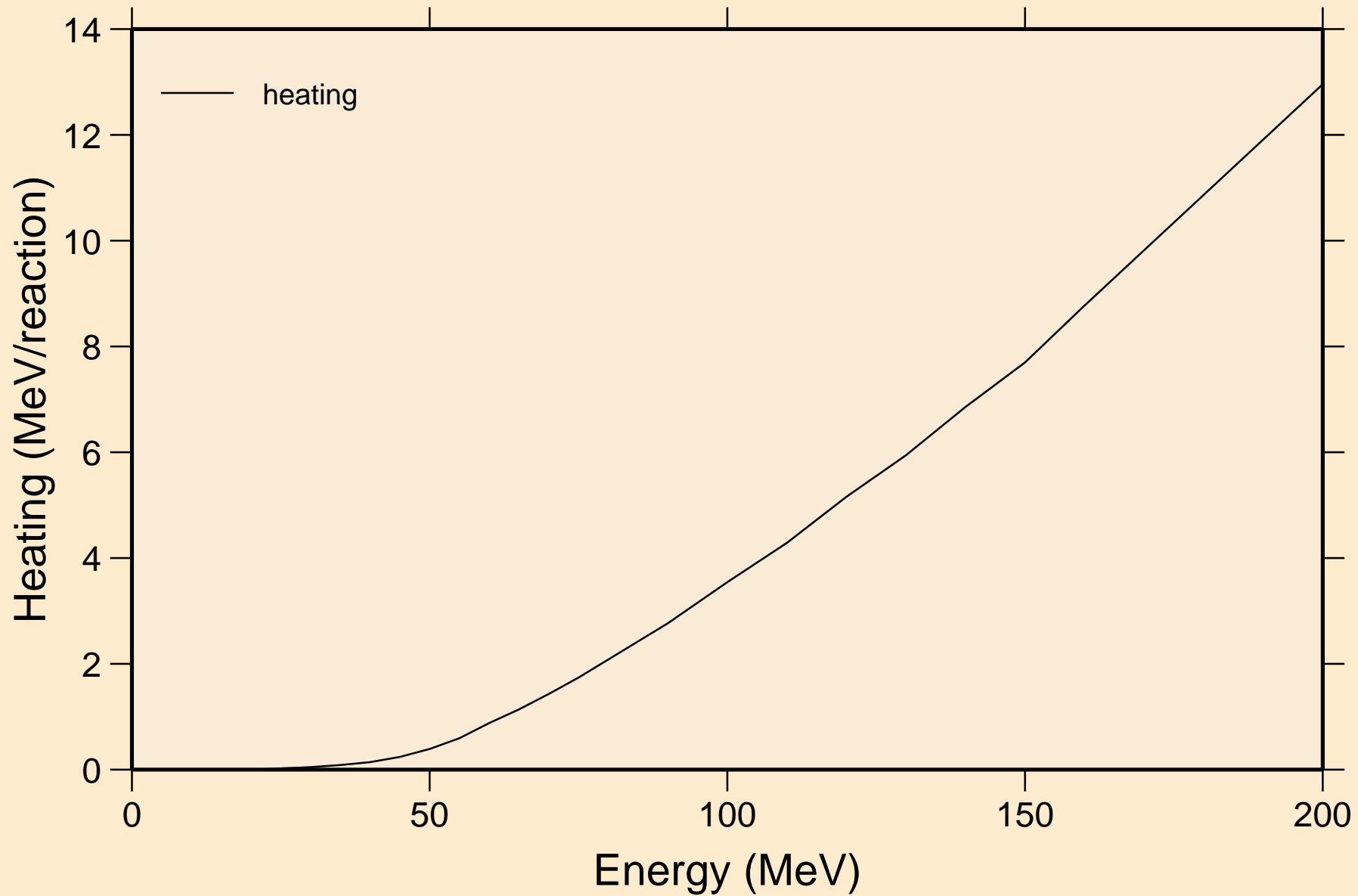

# GD146 PROTON ACER TENDL-2021 LIBRARY; T=0.K

## Threshold reactions

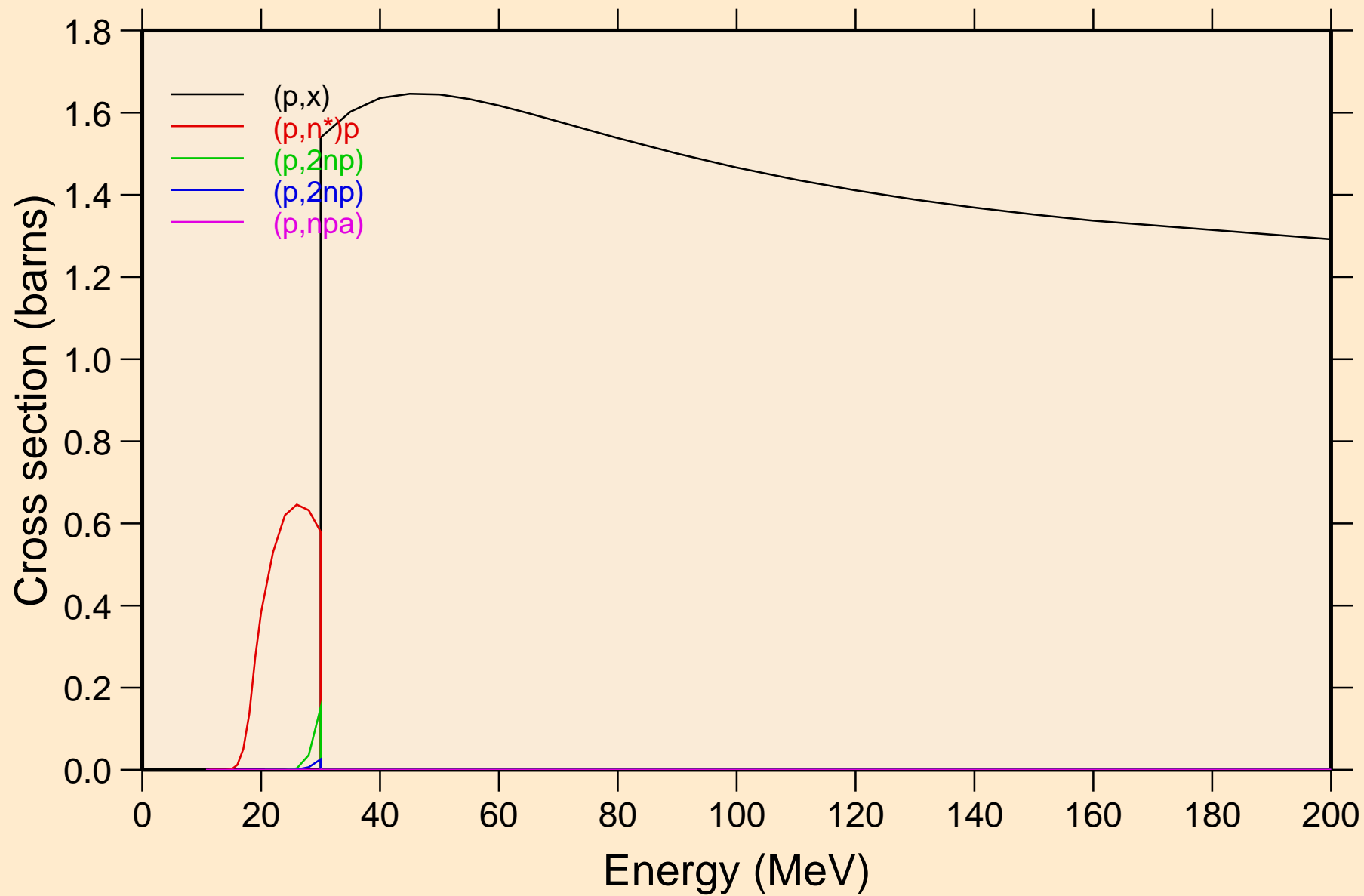

# GD146 PROTON ACER TENDL-2021 LIBRARY; T=0.K

## Threshold reactions

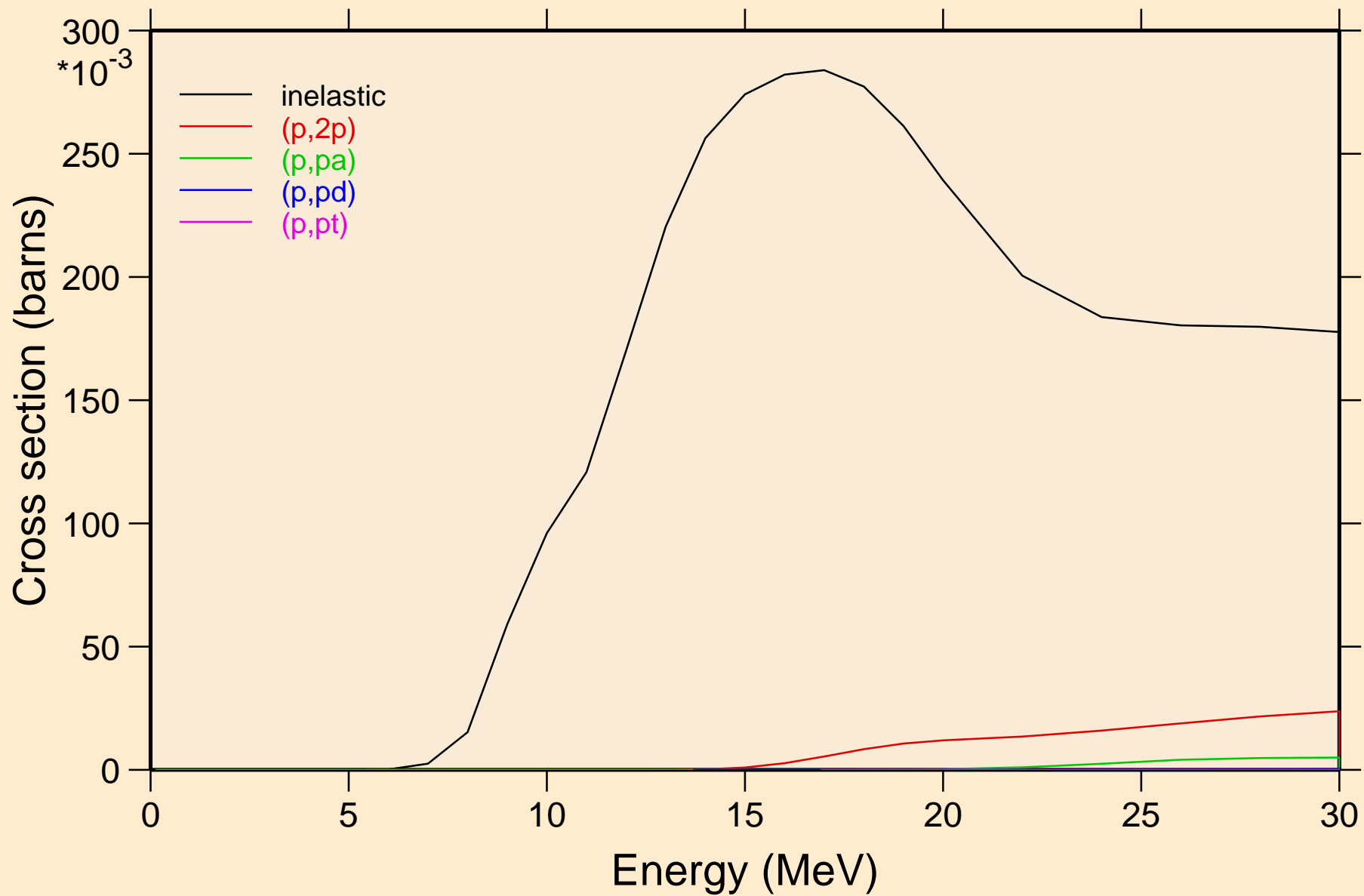

GD146 PROTON ACER TENDL-2021 LIBRARY; T=0.K  
Threshold reactions

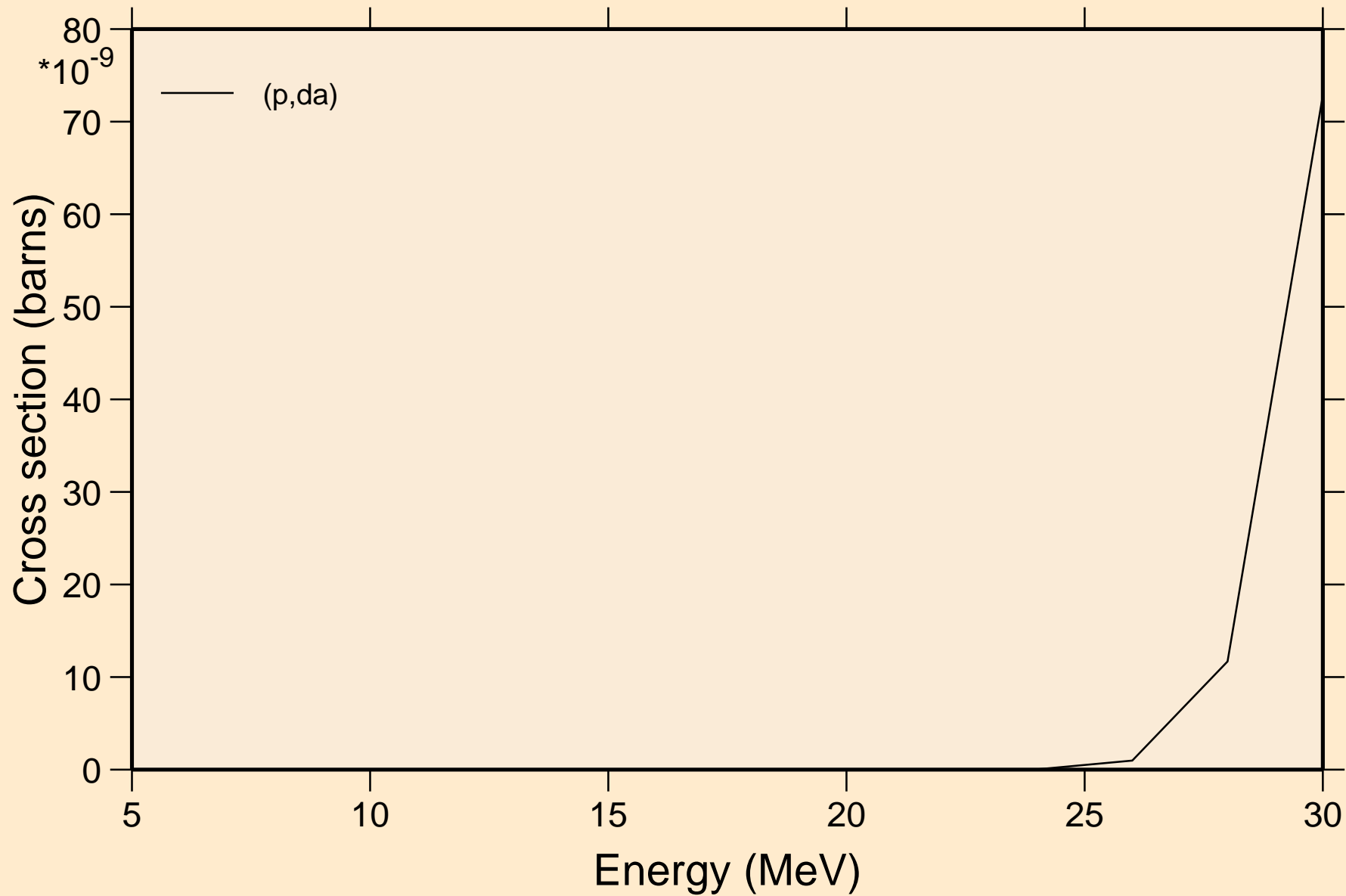

GD146 PROTON ACER TENDL-2021 LIBRARY; T=0.K  
angular distribution for elastic

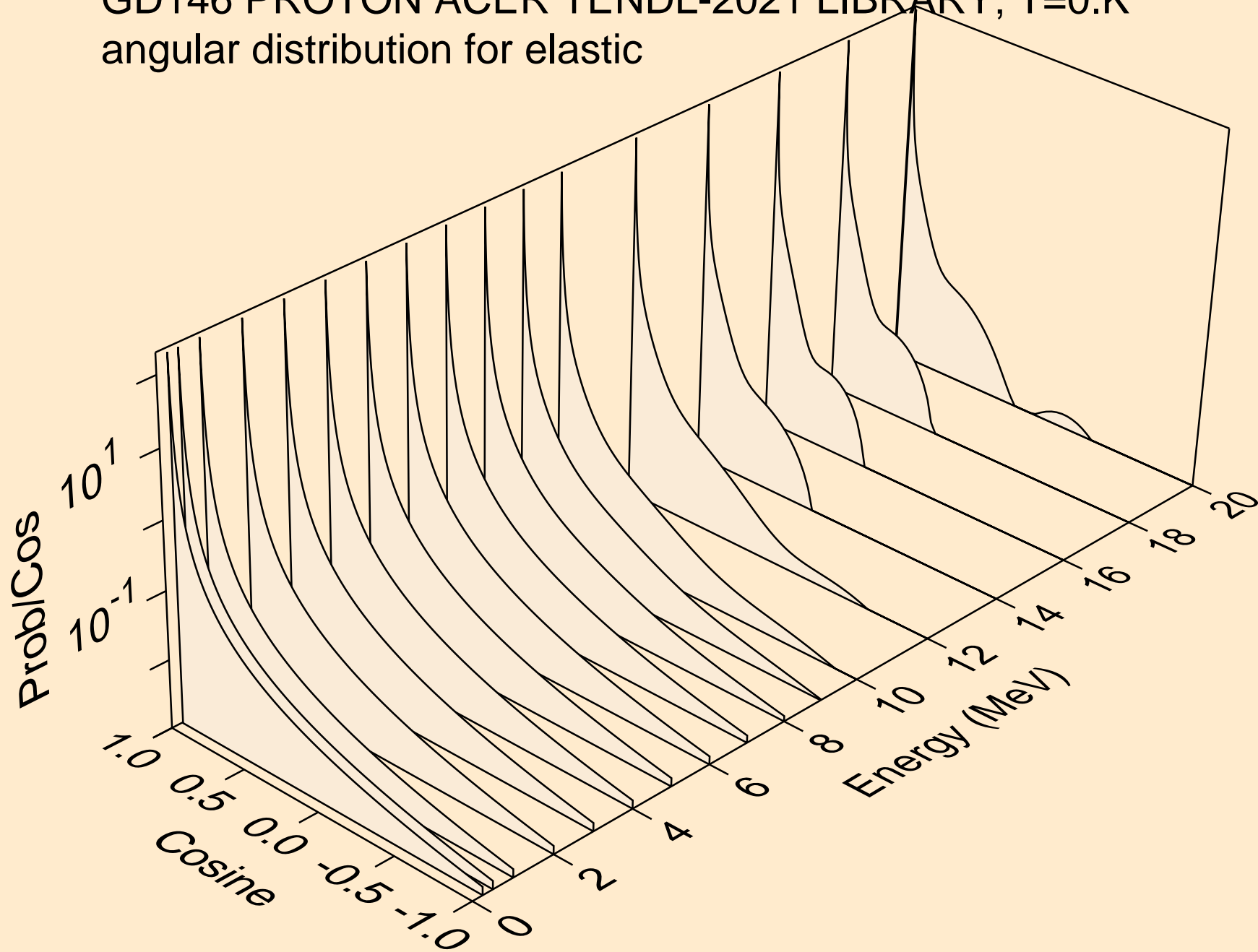



GD146 PROTON ACER TENDL-2021 LIBRARY; T=0.K  
angular distribution for elastic

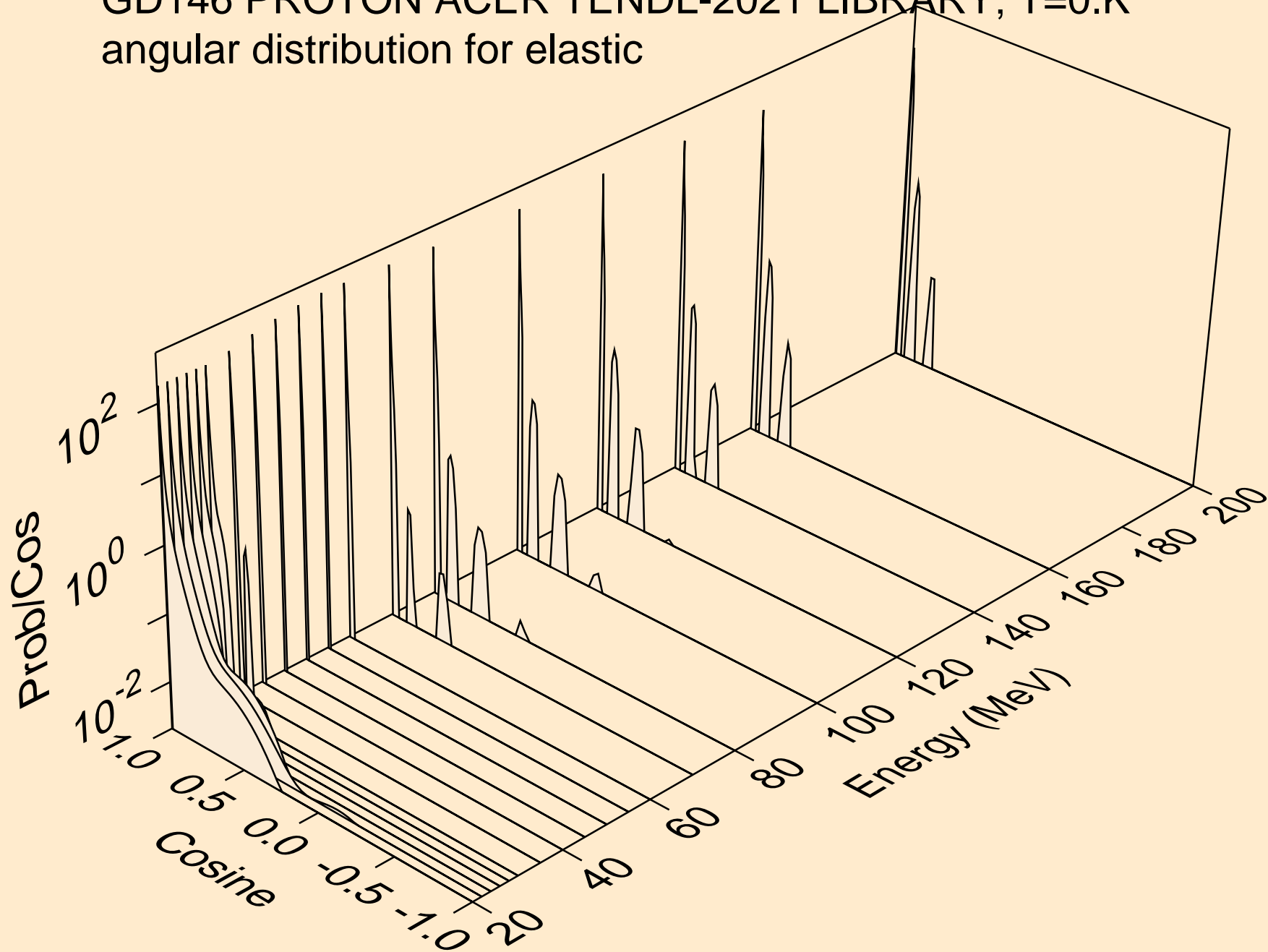

GD146 PROTON ACER TENDL-2021 LIBRARY; T=0.K  
Proton emission for (p,x)

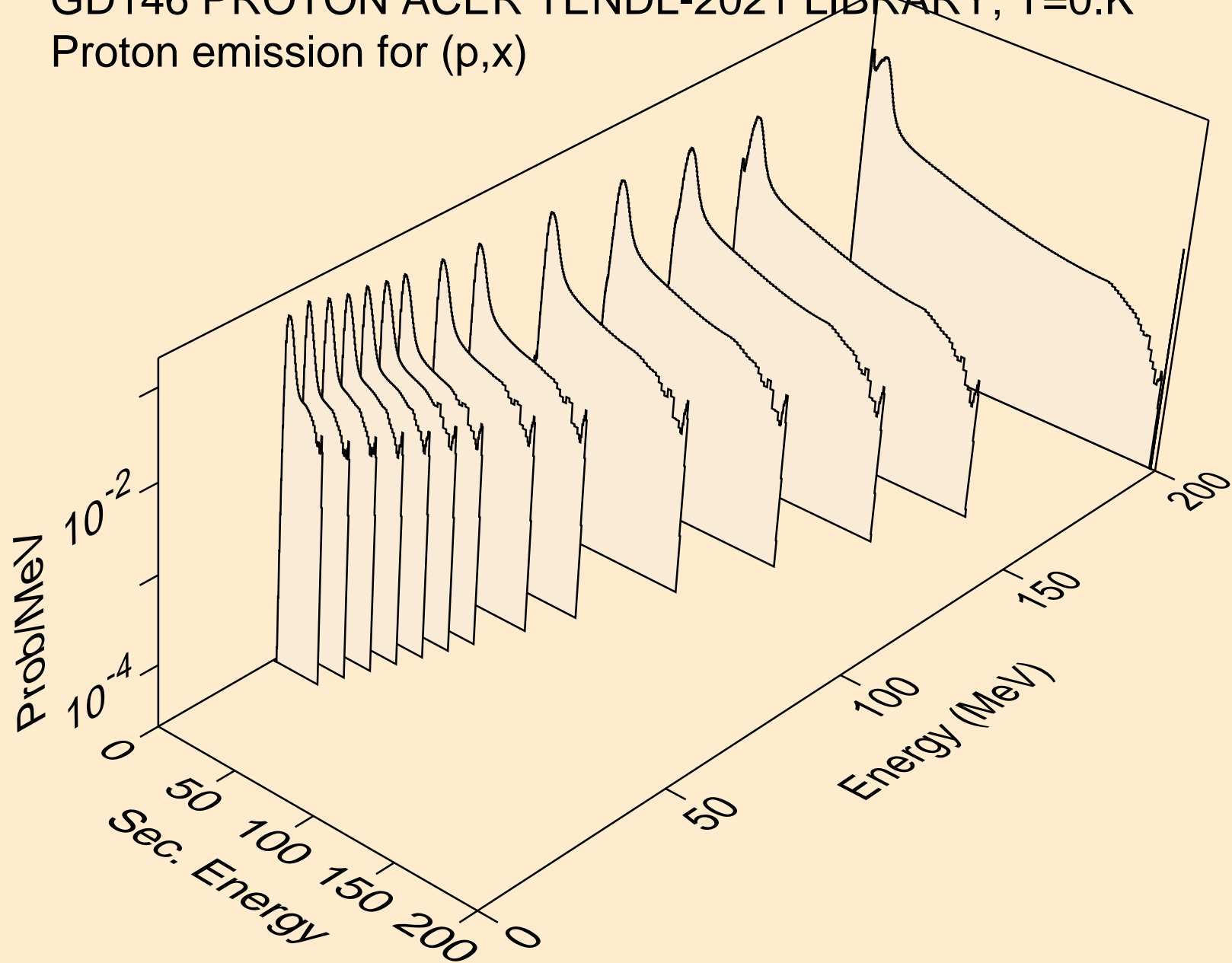

GD146 PROTON ACER TENDL-2021 LIBRARY; T=0.K  
Proton emission for (p,n\*)p

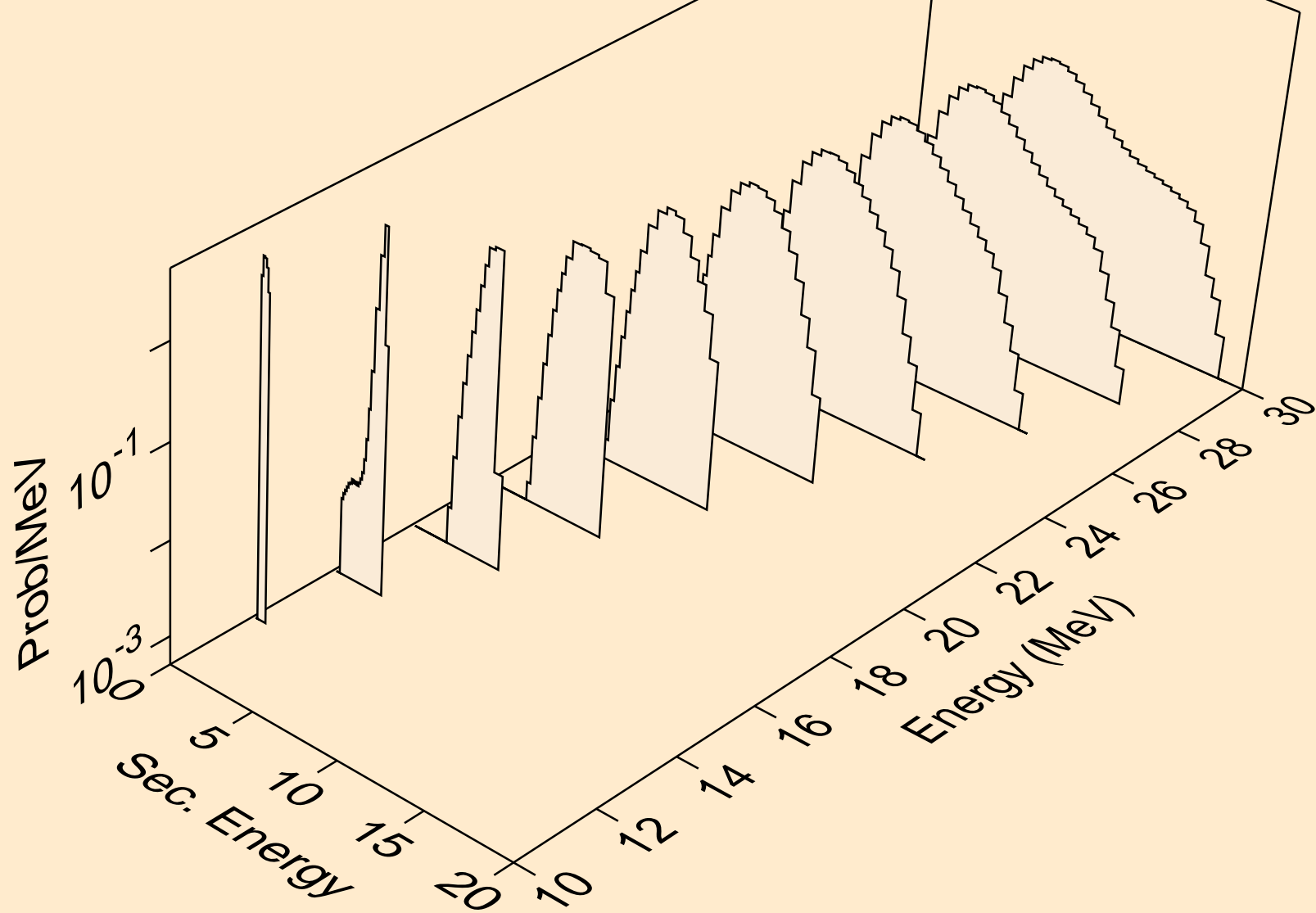

GD146 PROTON ACER TENDL-2021 LIBRARY; T=0.K  
Proton emission for (p,2np)

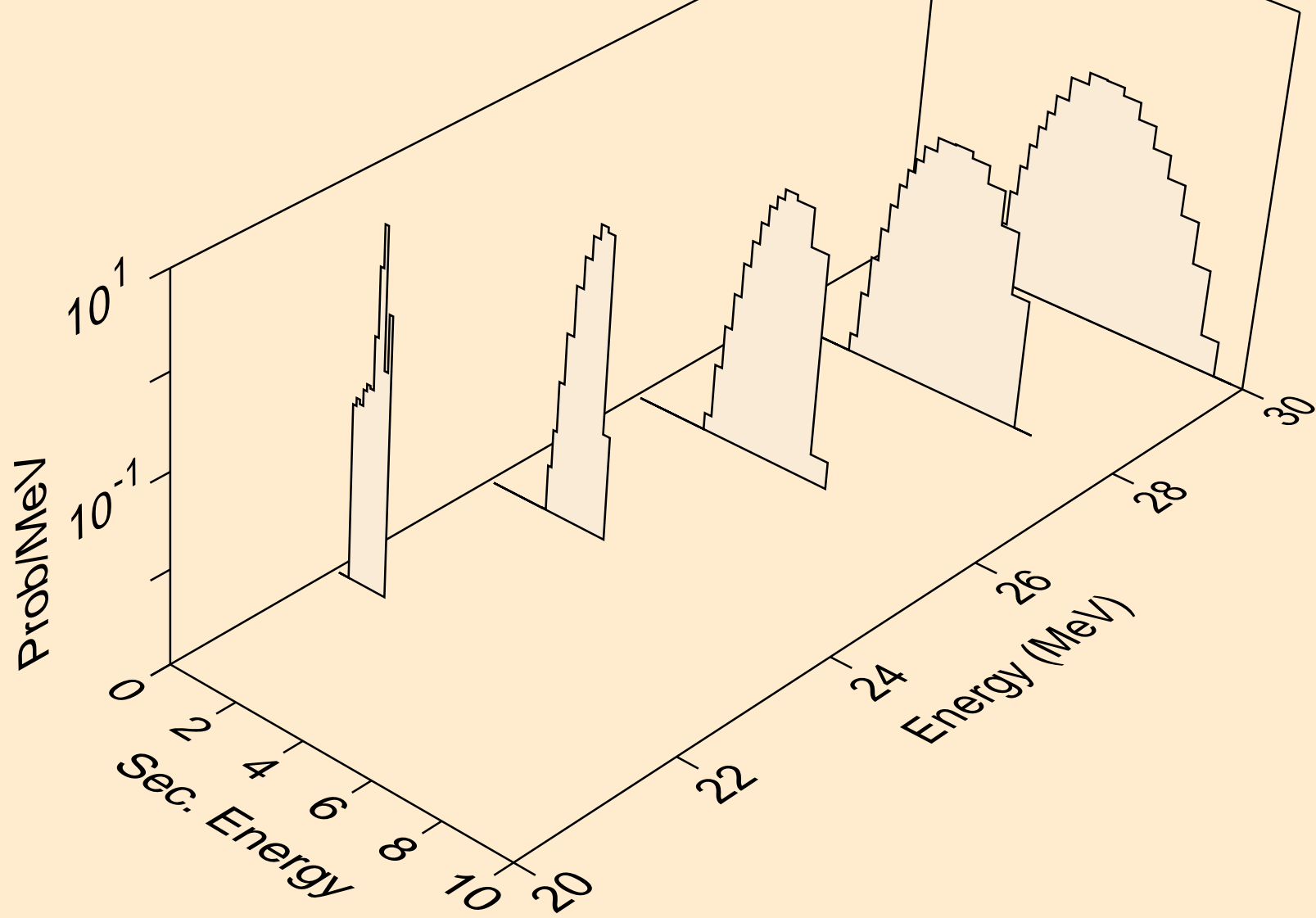

GD146 PROTON ACER TENDL-2021 LIBRARY; T=0.K  
Proton emission for (p,2np)

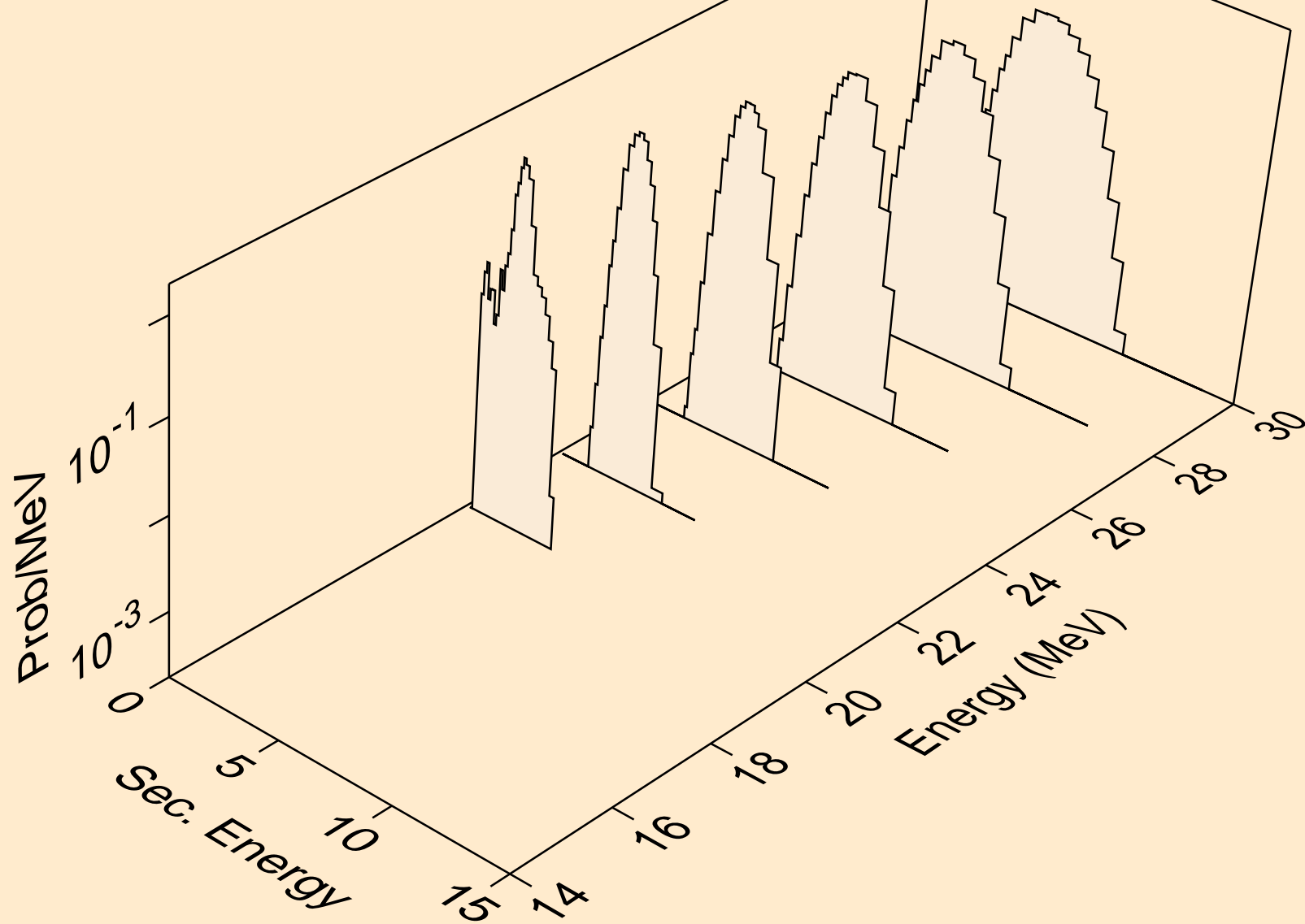

GD146 PROTON ACER TENDL-2021 LIBRARY; T=0.K  
Proton emission for (p,npa)

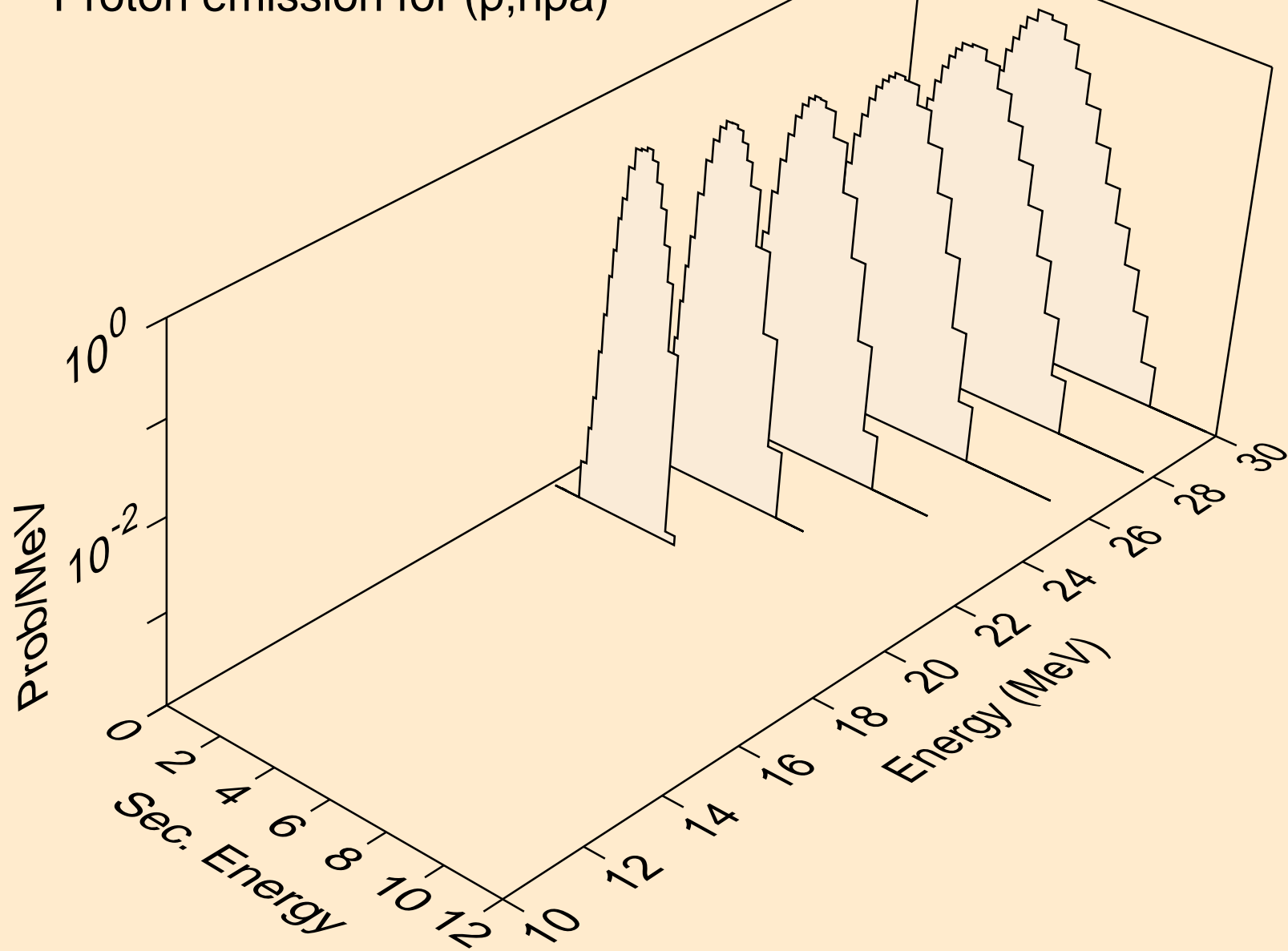

GD146 PROTON ACER TENDL-2021 LIBRARY; T=0.K  
Proton emission for inelastic

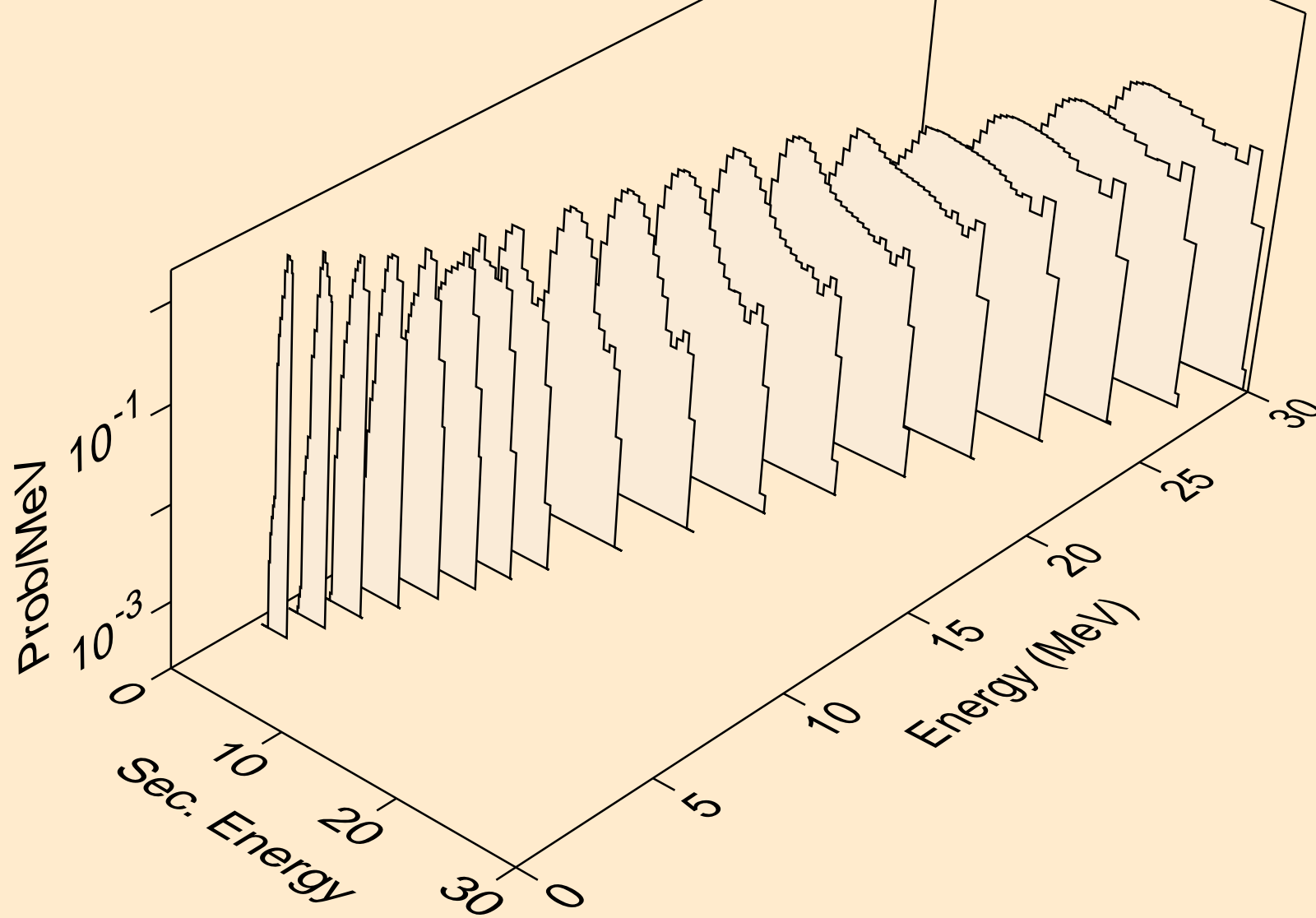

GD146 PROTON ACER TENDL-2021 LIBRARY; T=0.K  
Proton emission for (p,2p)

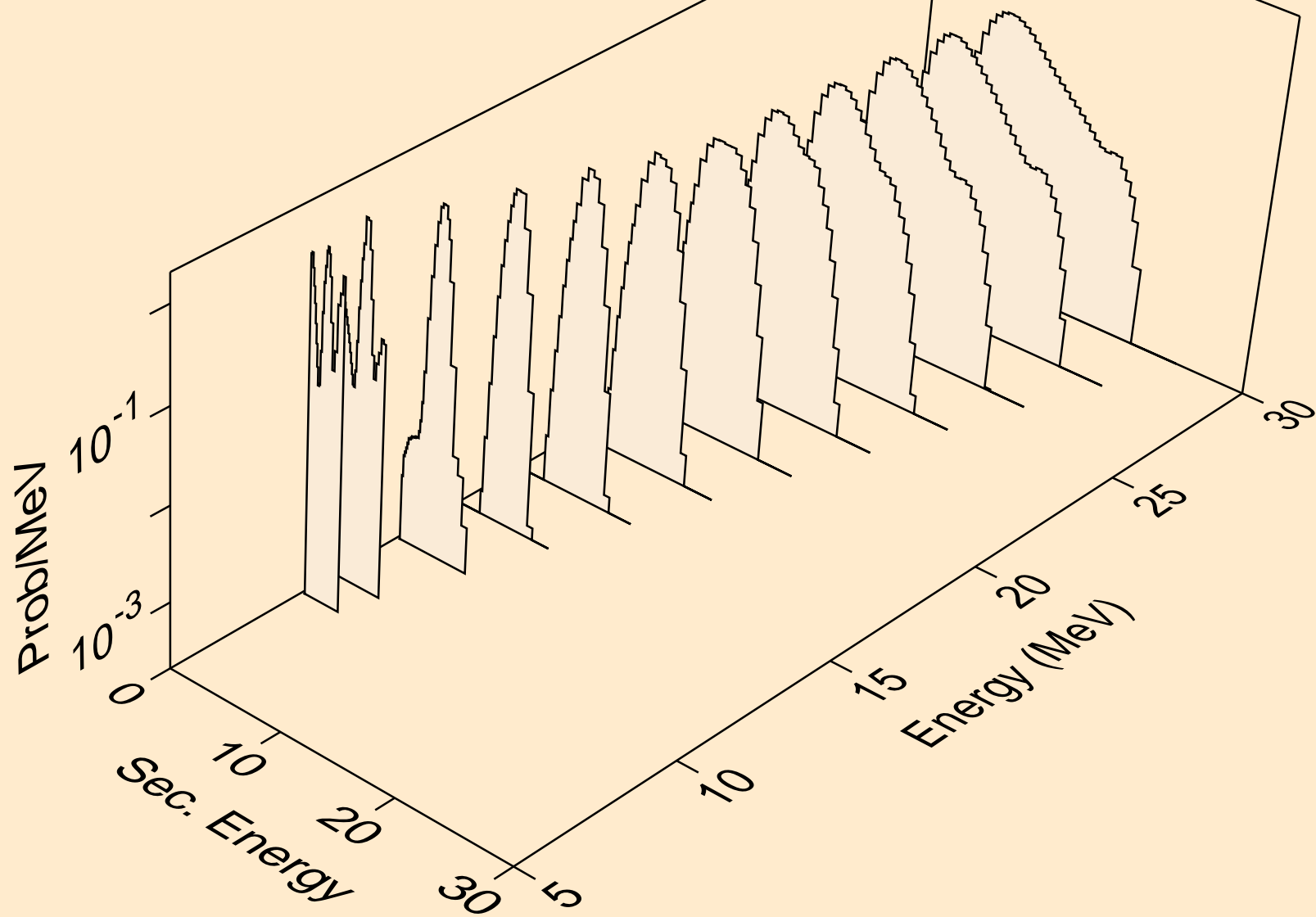



GD146 PROTON ACER TENDL-2021 LIBRARY; T=0.K  
Proton emission for (p,pa)

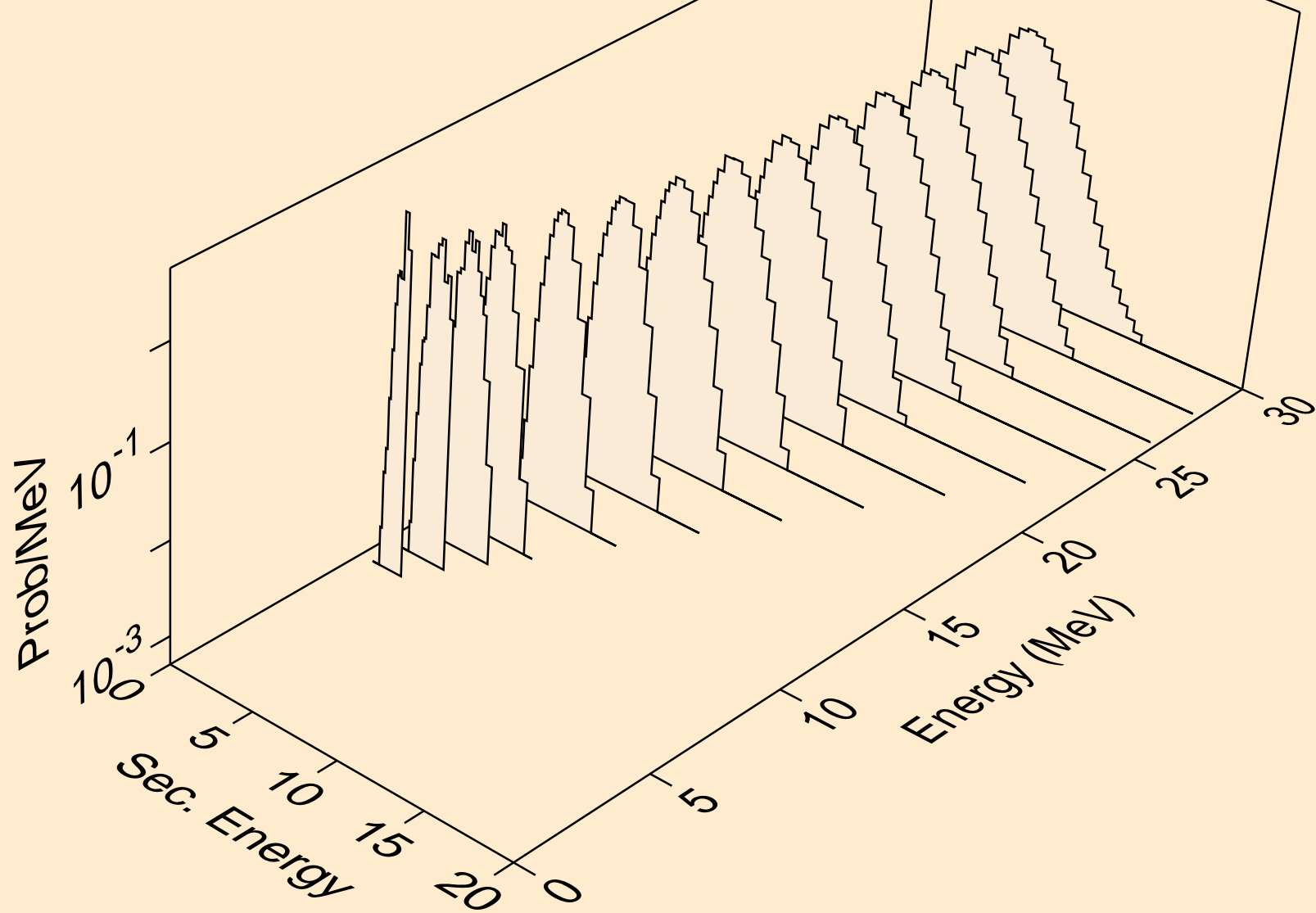

GD146 PROTON ACER TENDL-2021 LIBRARY; T=0.K  
Proton emission for (p,pd)

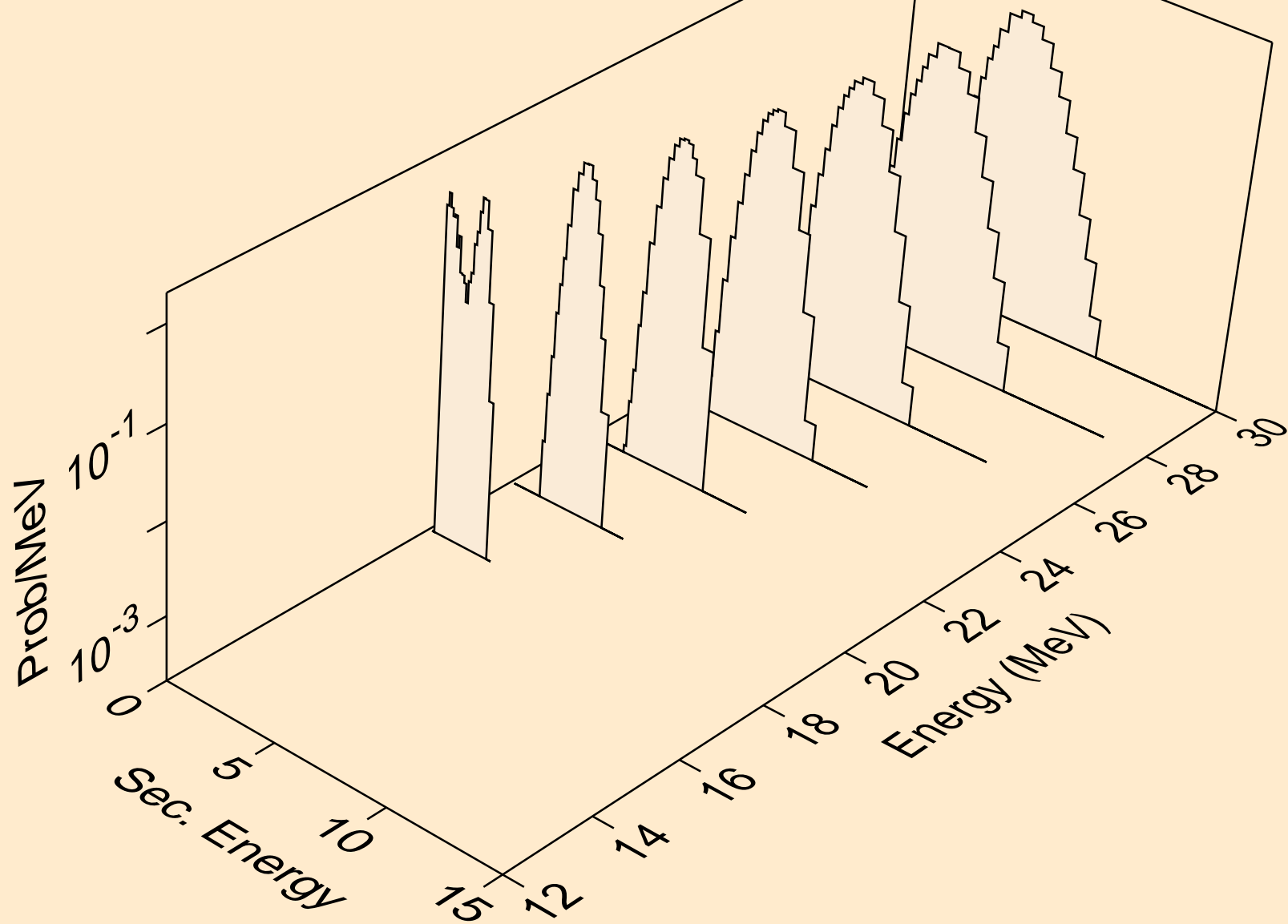

GD146 PROTON ACER TENDL-2021 LIBRARY; T=0.K  
Proton emission for (p,pt)

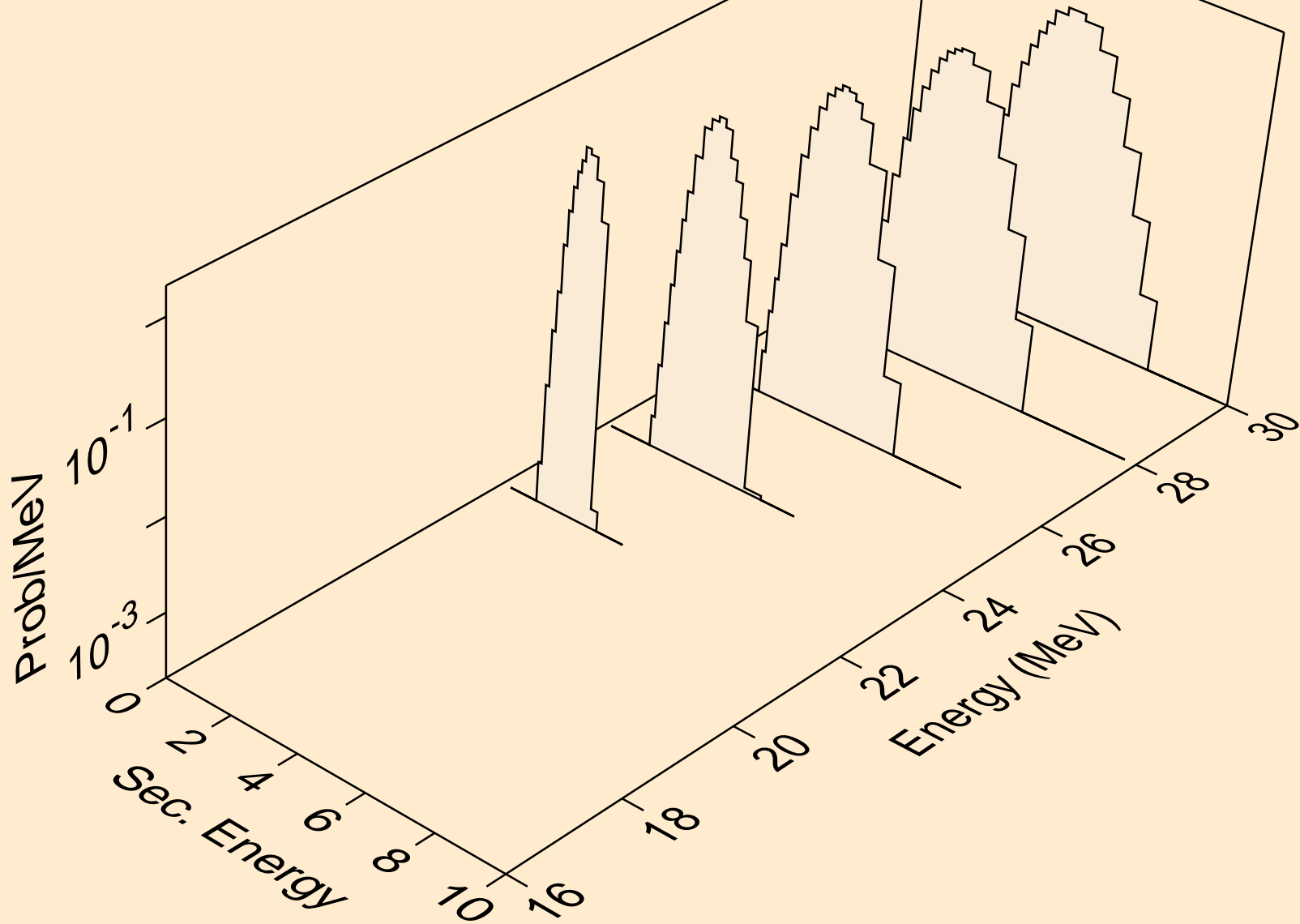

GD146 PROTON ACER TENDL-2021 LIBRARY; T=0.K  
Photon emission for (z,n)

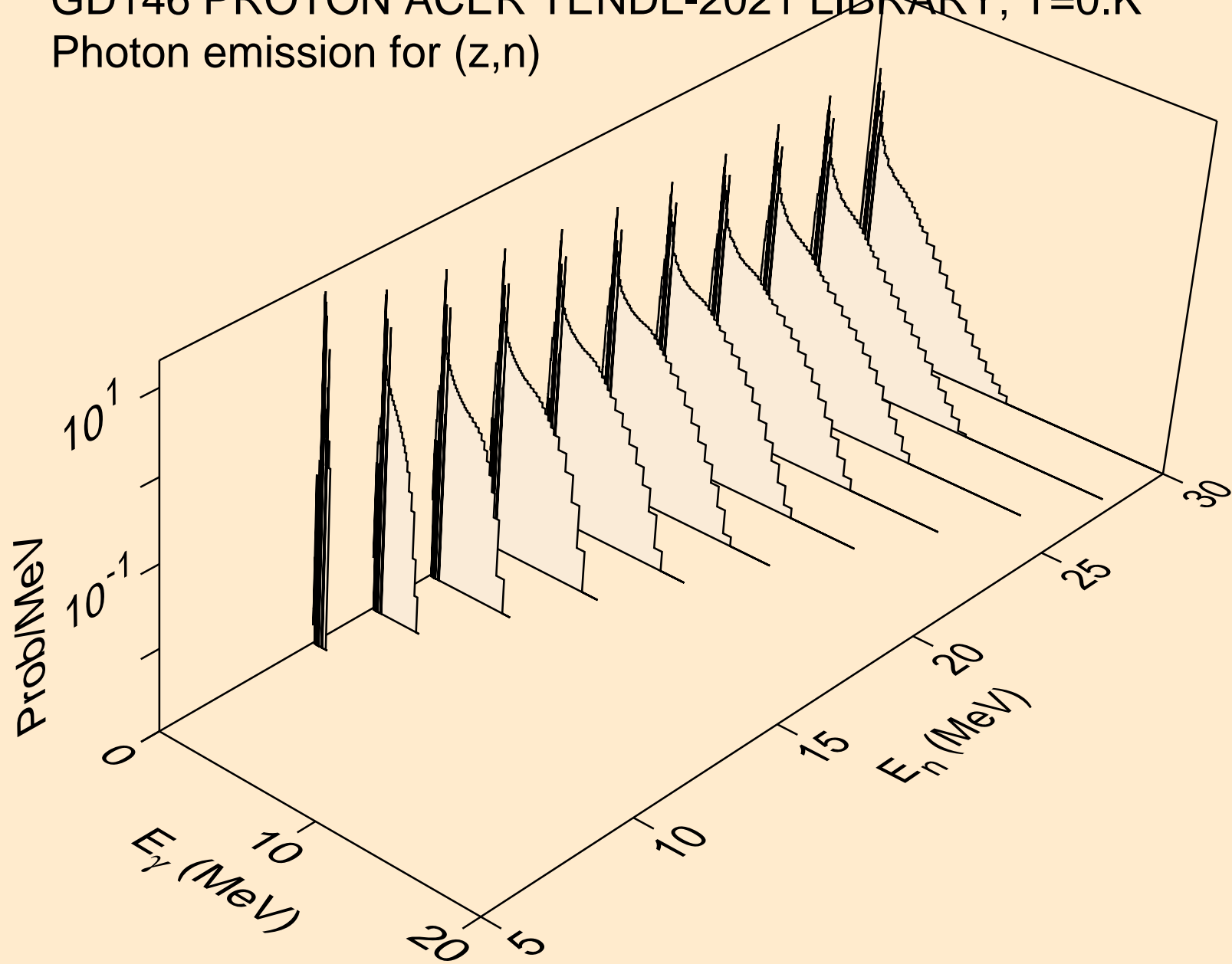

GD146 PROTON ACER TENDL-2021 LIBRARY; T=0.K  
Photon emission for (n,x)

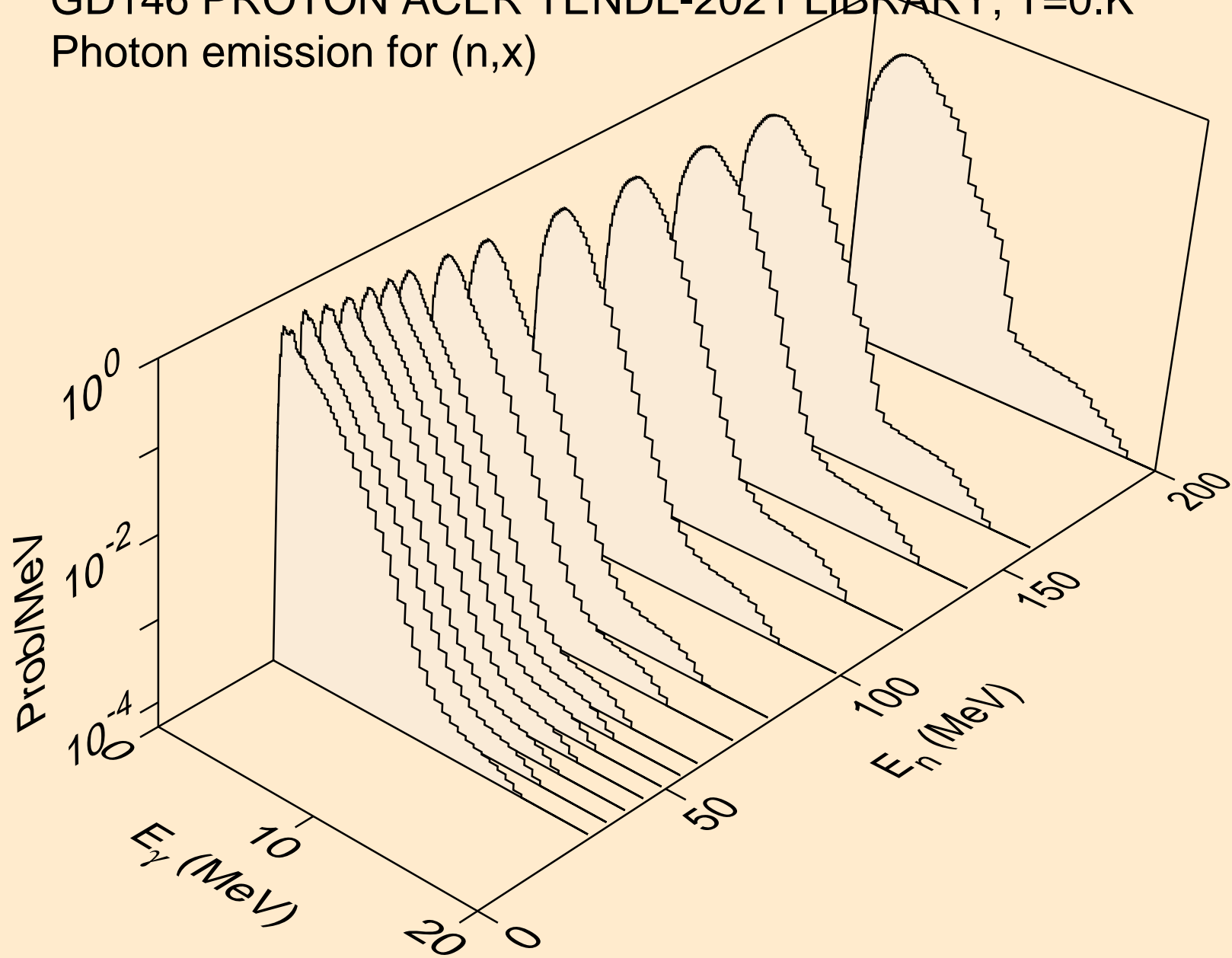

GD146 PROTON ACER TENDL-2021 LIBRARY; T=0.K  
Photon emission for (n,2n)

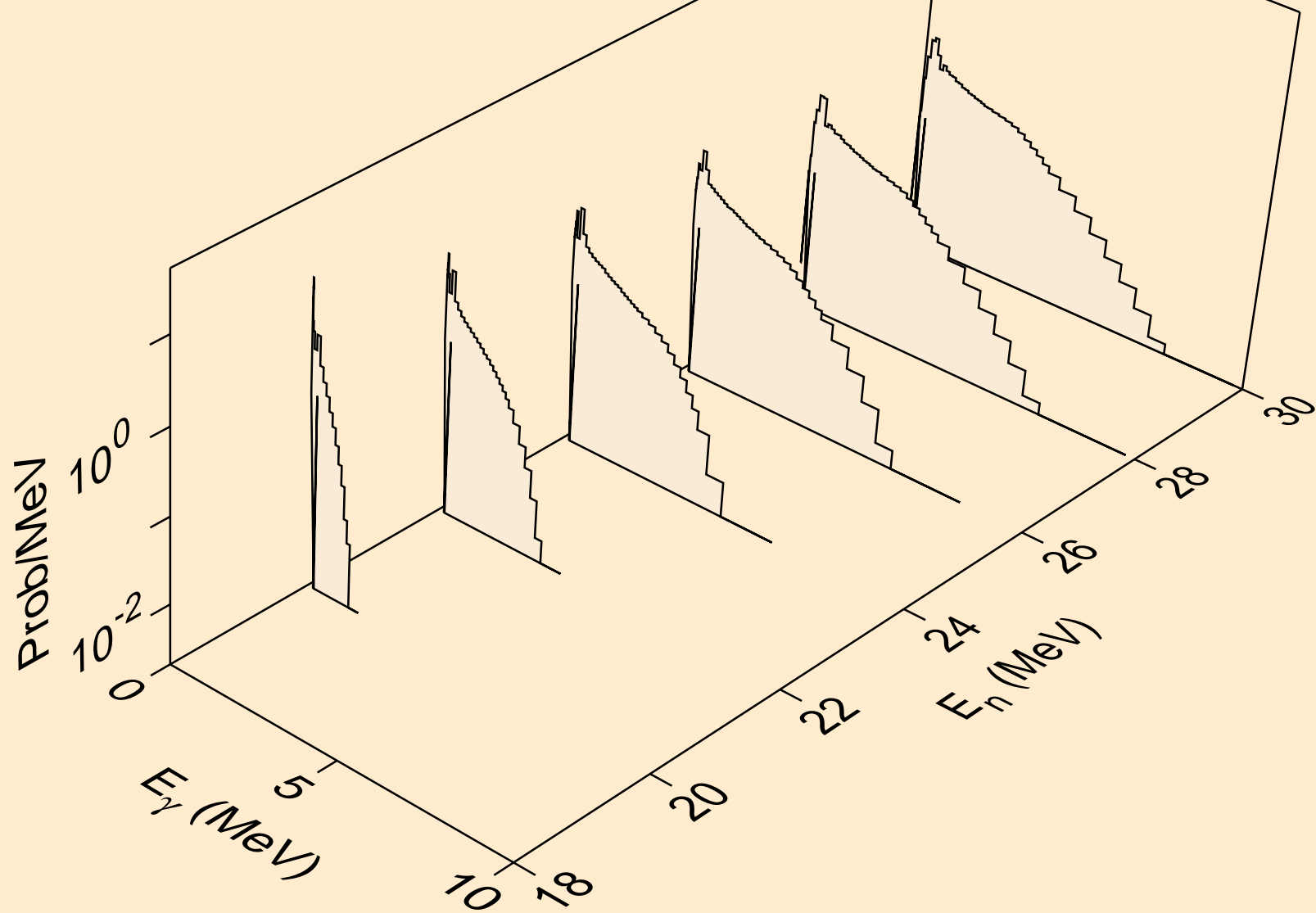

GD146 PROTON ACER TENDL-2021 LIBRARY; T=0.K  
Photon emission for (n,n\*)a

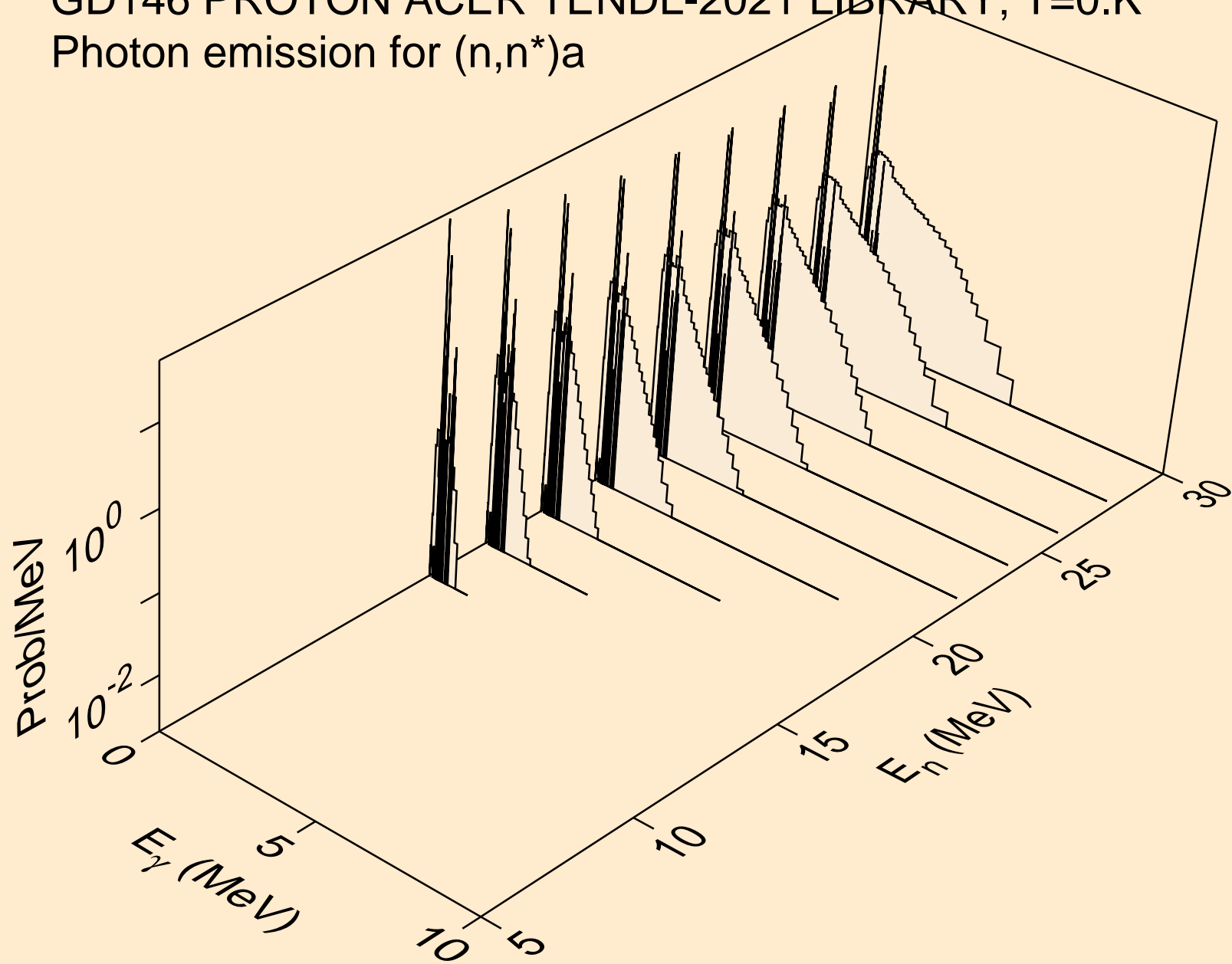

GD146 PROTON ACER TENDL-2021 LIBRARY; T=0.K  
Photon emission for (n,2n)a

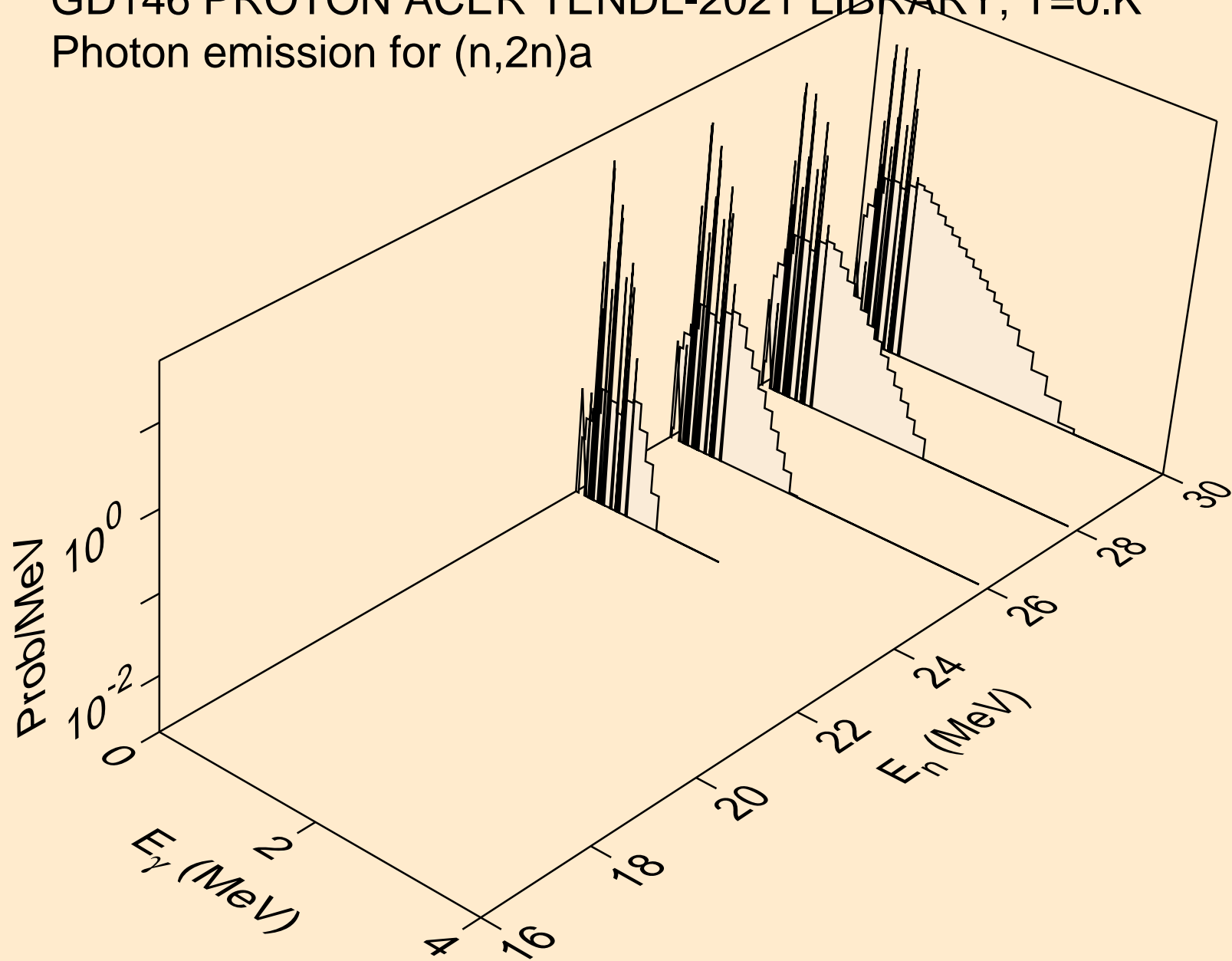



GD146 PROTON ACER TENDL-2021 LIBRARY; T=0.K  
Photon emission for (n,n\*)p

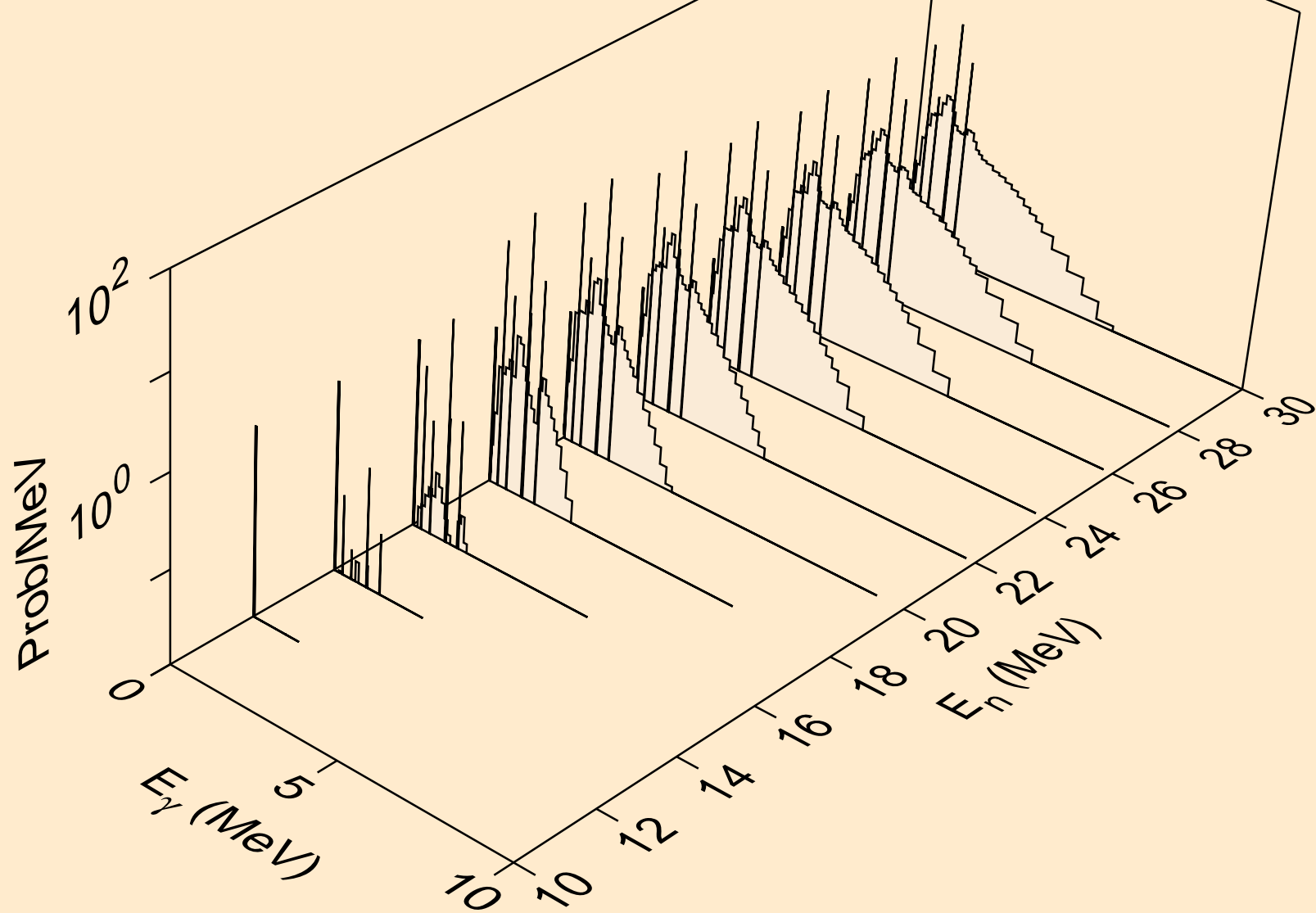

GD146 PROTON ACER TENDL-2021 LIBRARY; T=0.K  
Photon emission for (n,n\*)2a

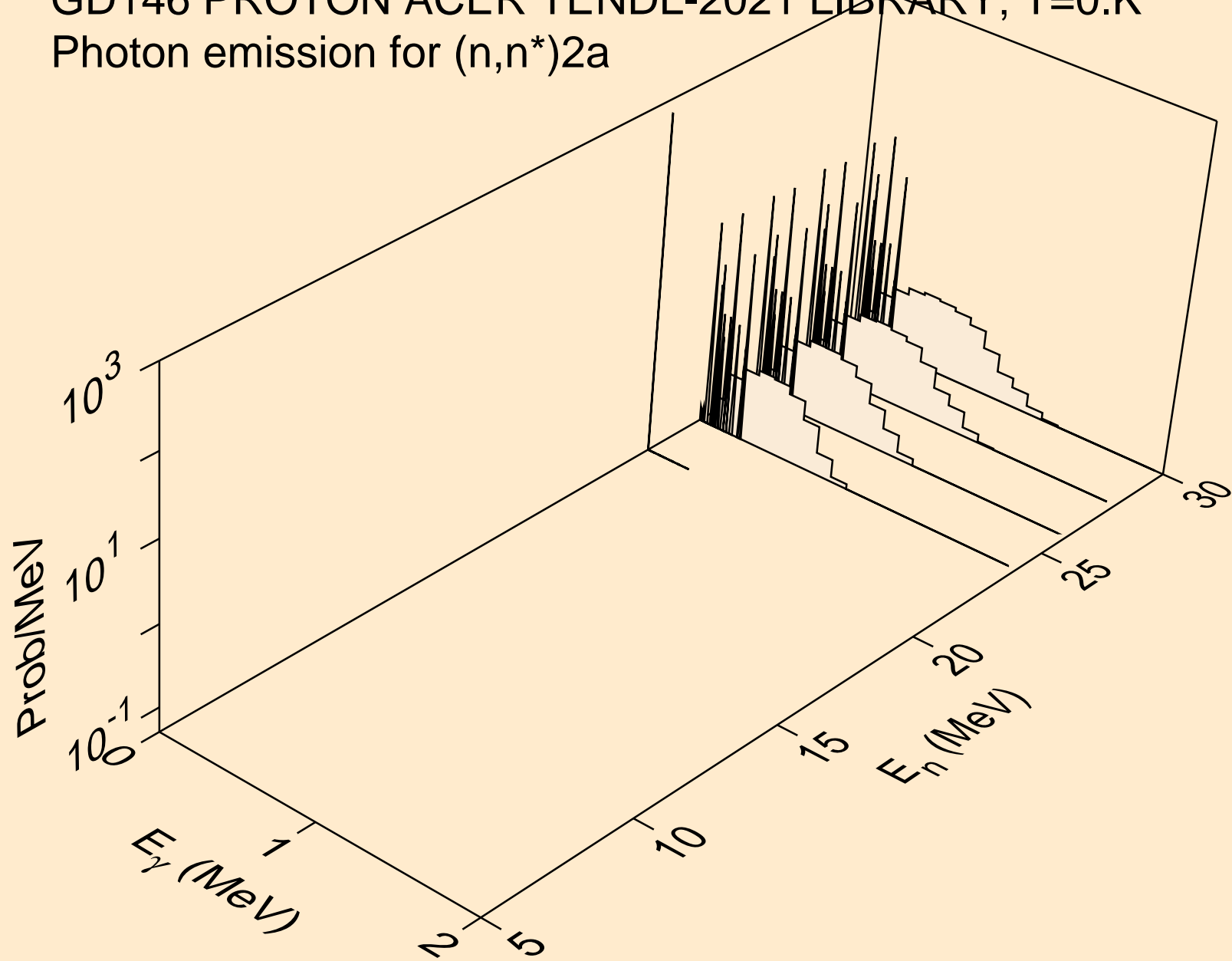

GD146 PROTON ACER TENDL-2021 LIBRARY; T=0.K  
Photon emission for (n,n\*)d

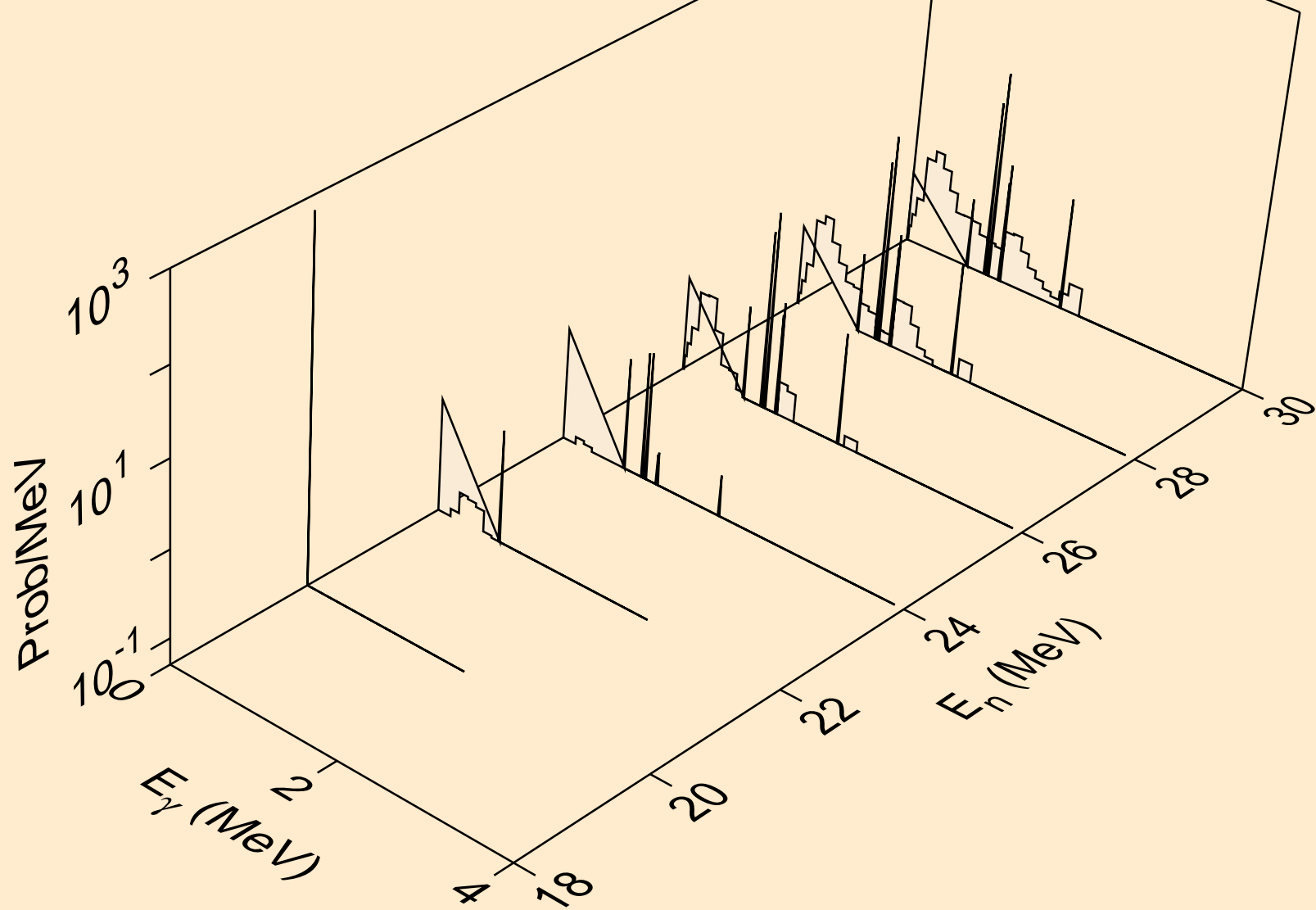

GD146 PROTON ACER TENDL-2021 LIBRARY; T=0.K  
Photon emission for (n,n\*)t

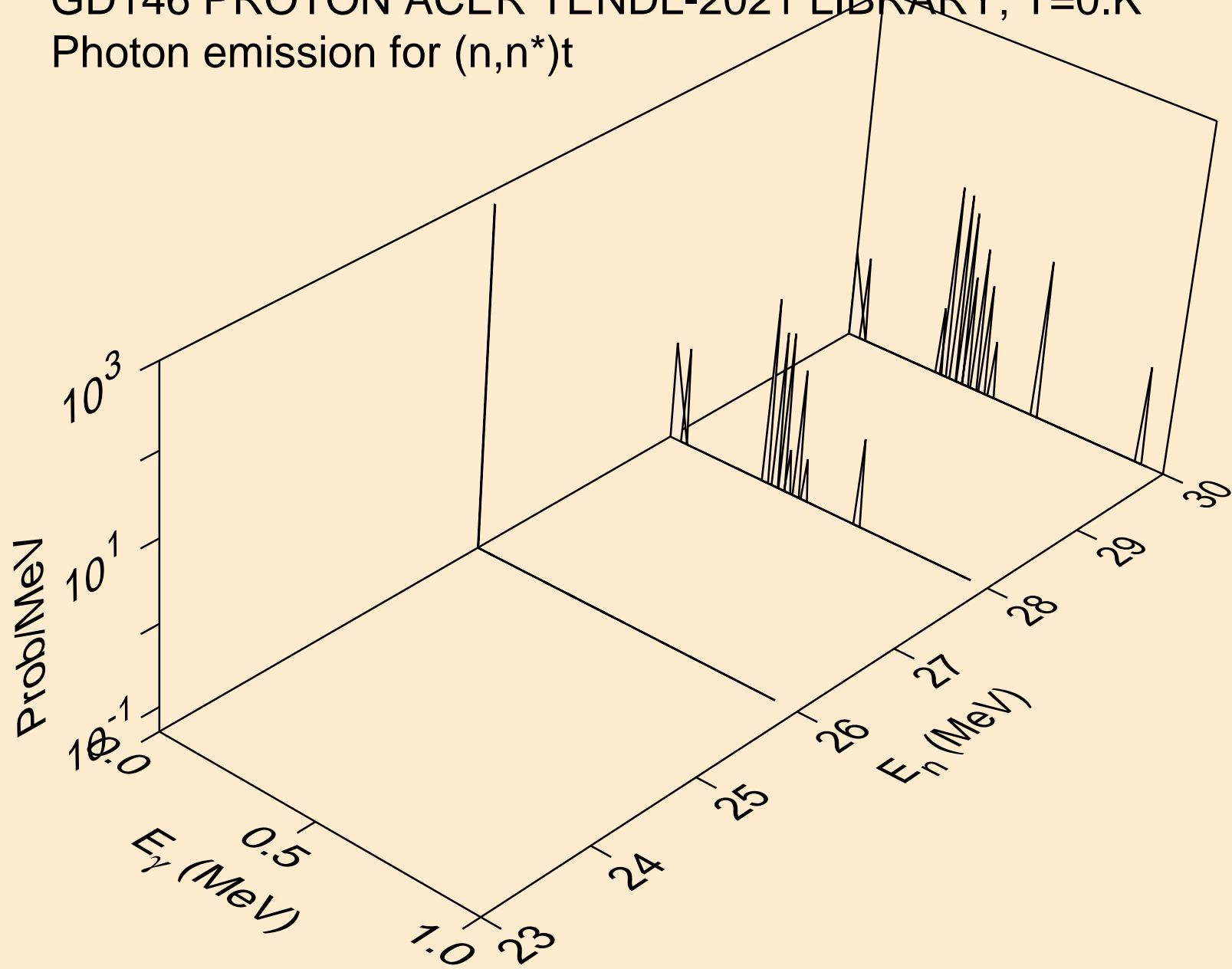

GD146 PROTON ACER TENDL-2021 LIBRARY; T=0.K  
Photon emission for (n,n\*)he3

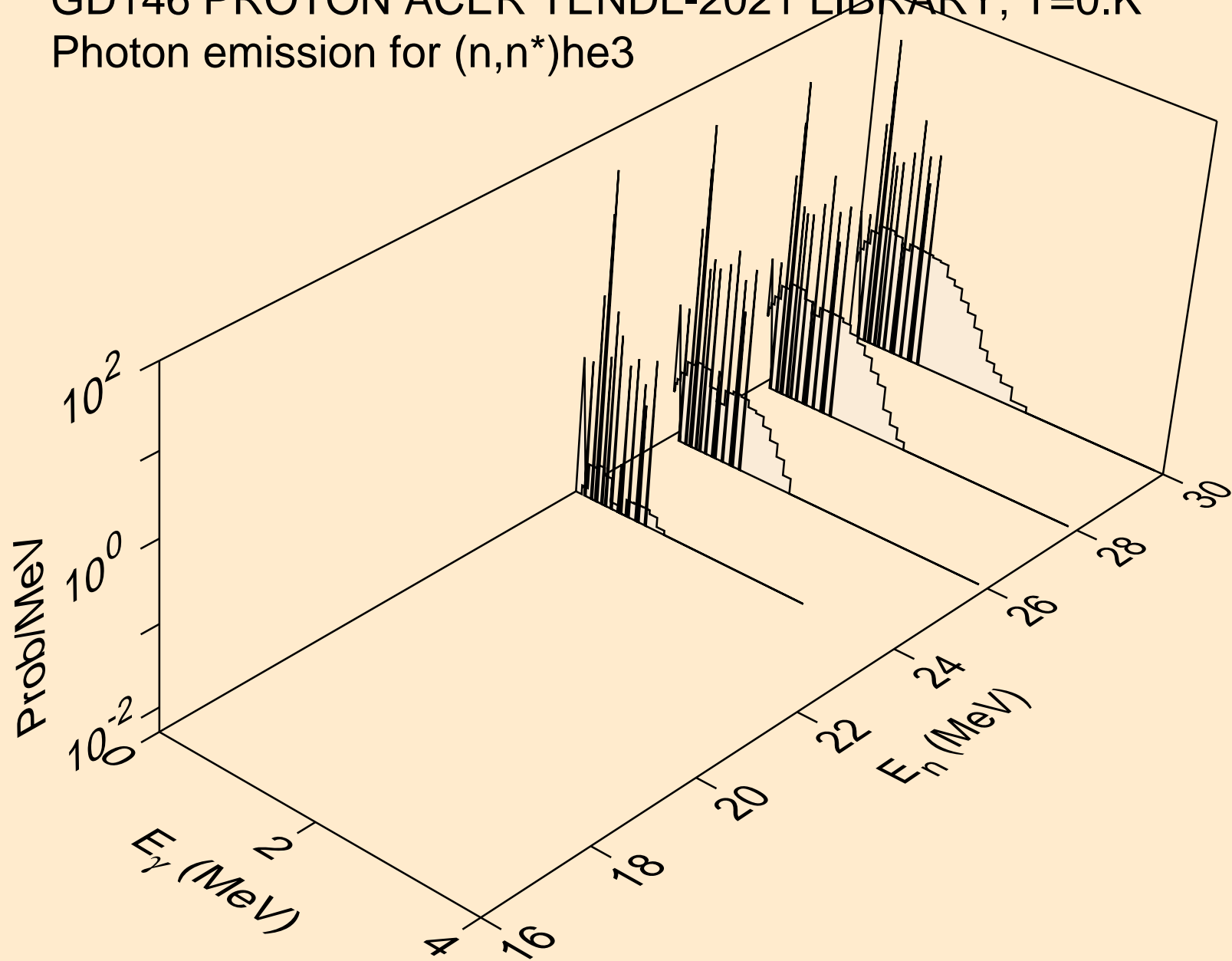

GD146 PROTON ACER TENDL-2021 LIBRARY; T=0.K  
Photon emission for (n,2np)

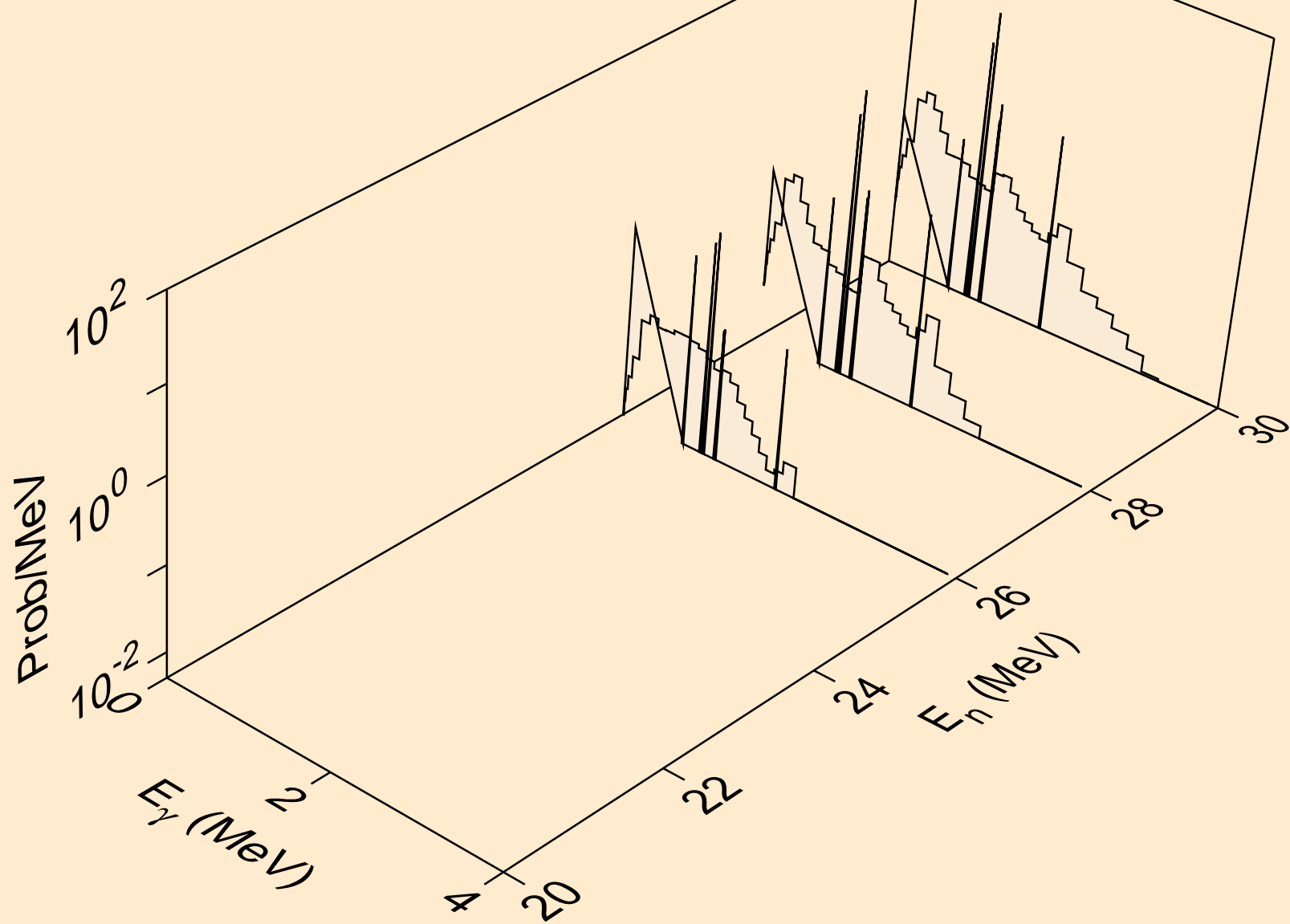

GD146 PROTON ACER TENDL-2021 LIBRARY; T=0.K  
Photon emission for (n,2np)

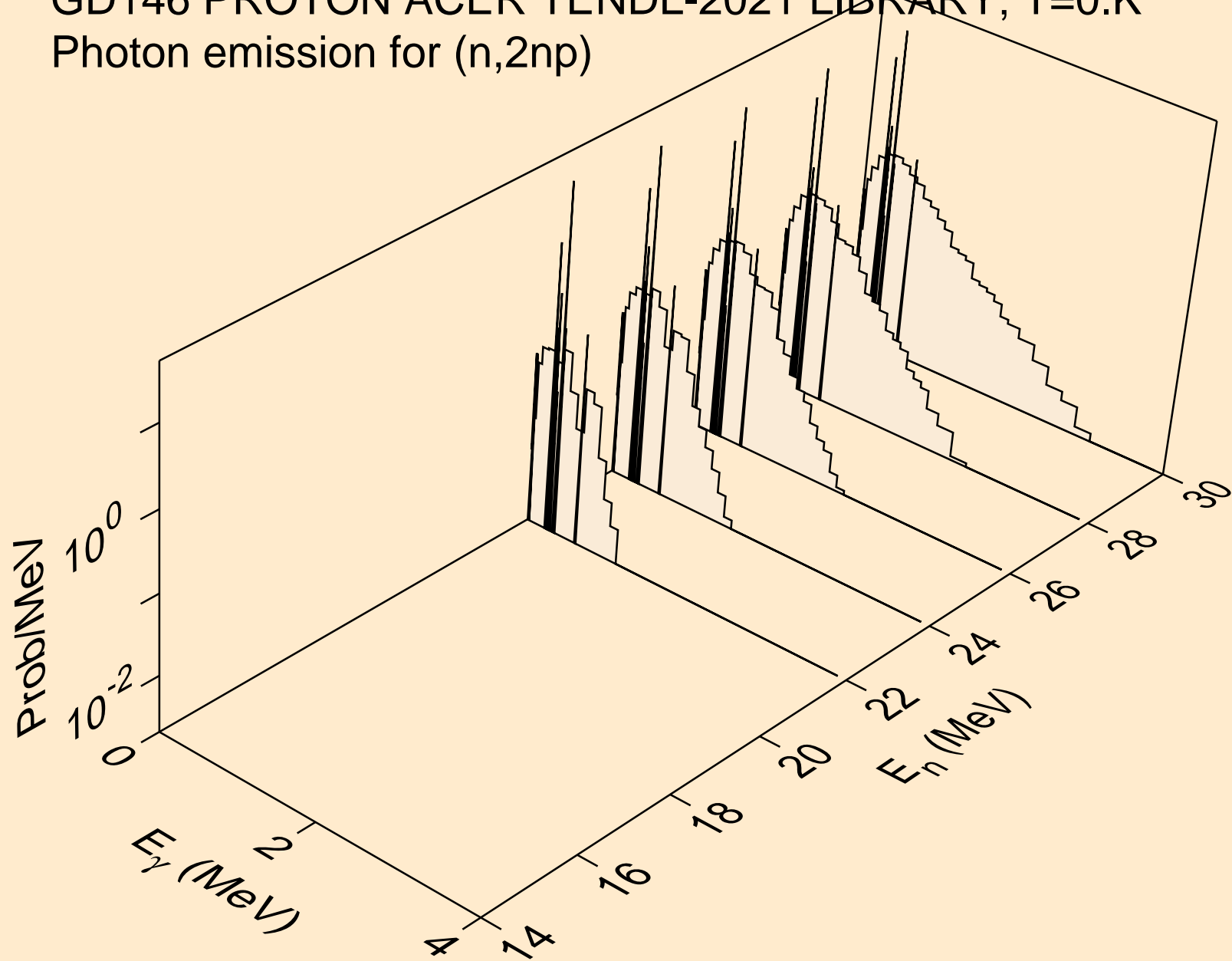

GD146 PROTON ACER TENDL-2021 LIBRARY; T=0.K  
Photon emission for (n,npa)

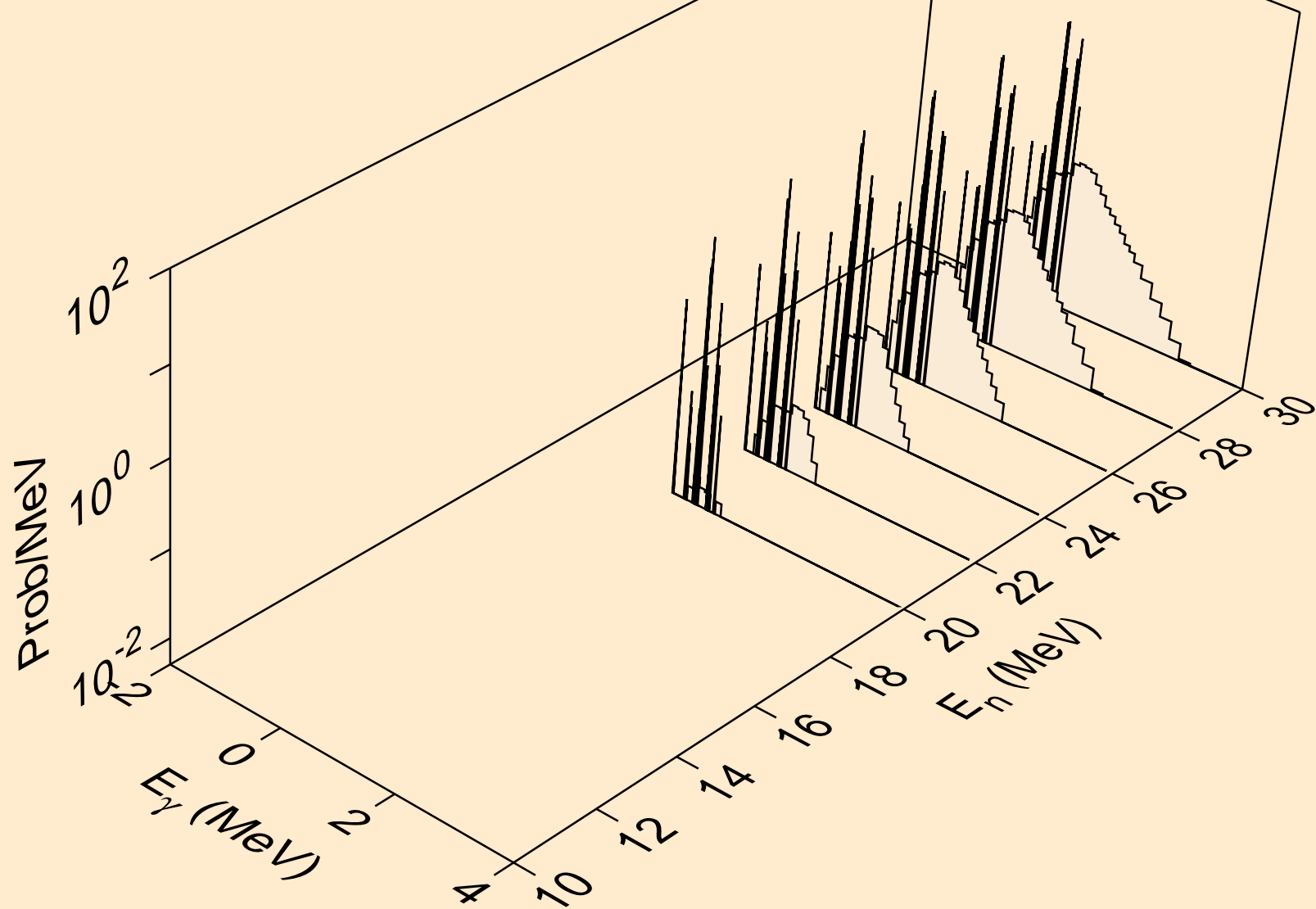



GD146 PROTON ACER TENDL-2021 LIBRARY; T=0.K  
Photon emission for (n,gma)

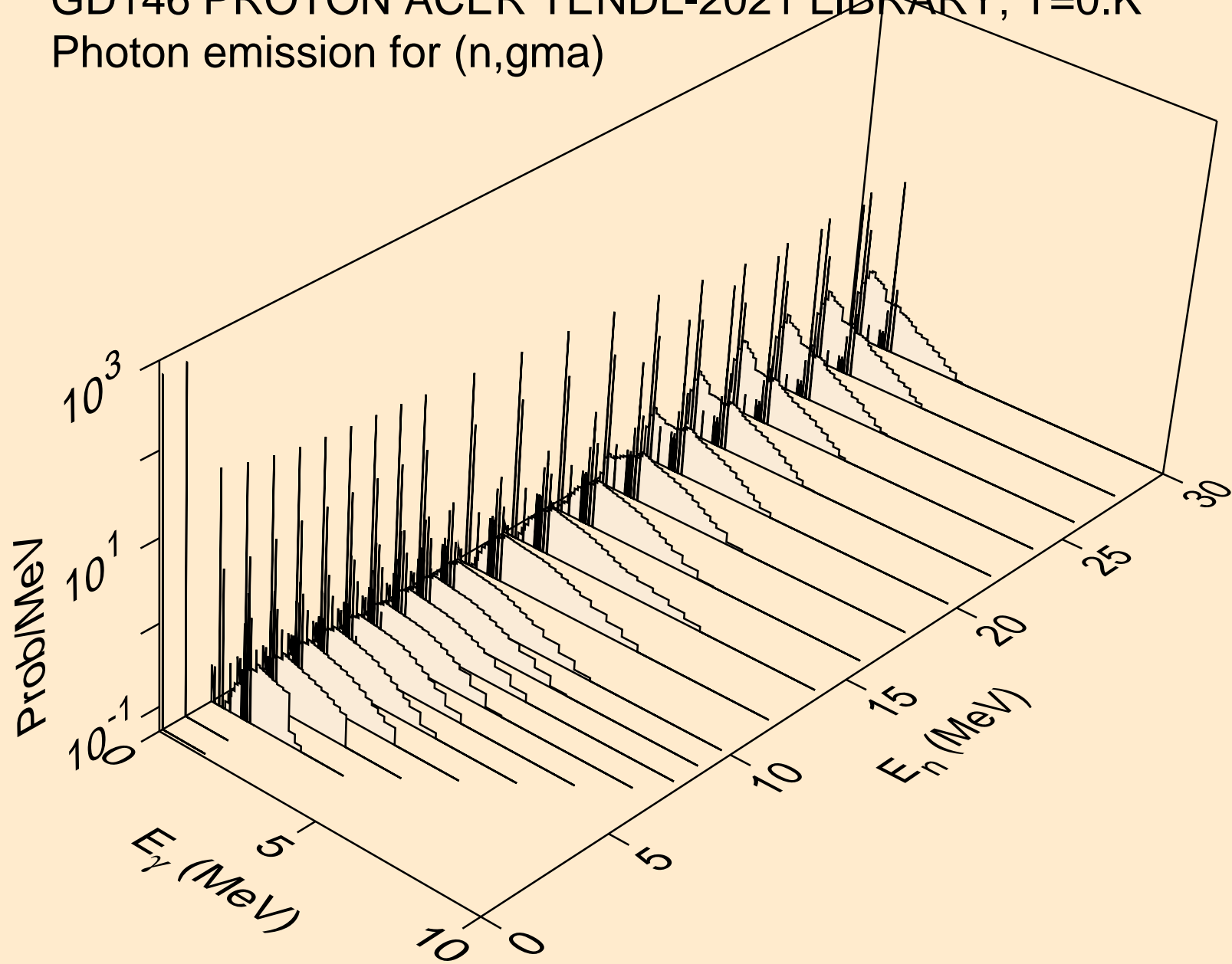

GD146 PROTON ACER TENDL-2021 LIBRARY; T=0.K  
Photon emission for inelastic

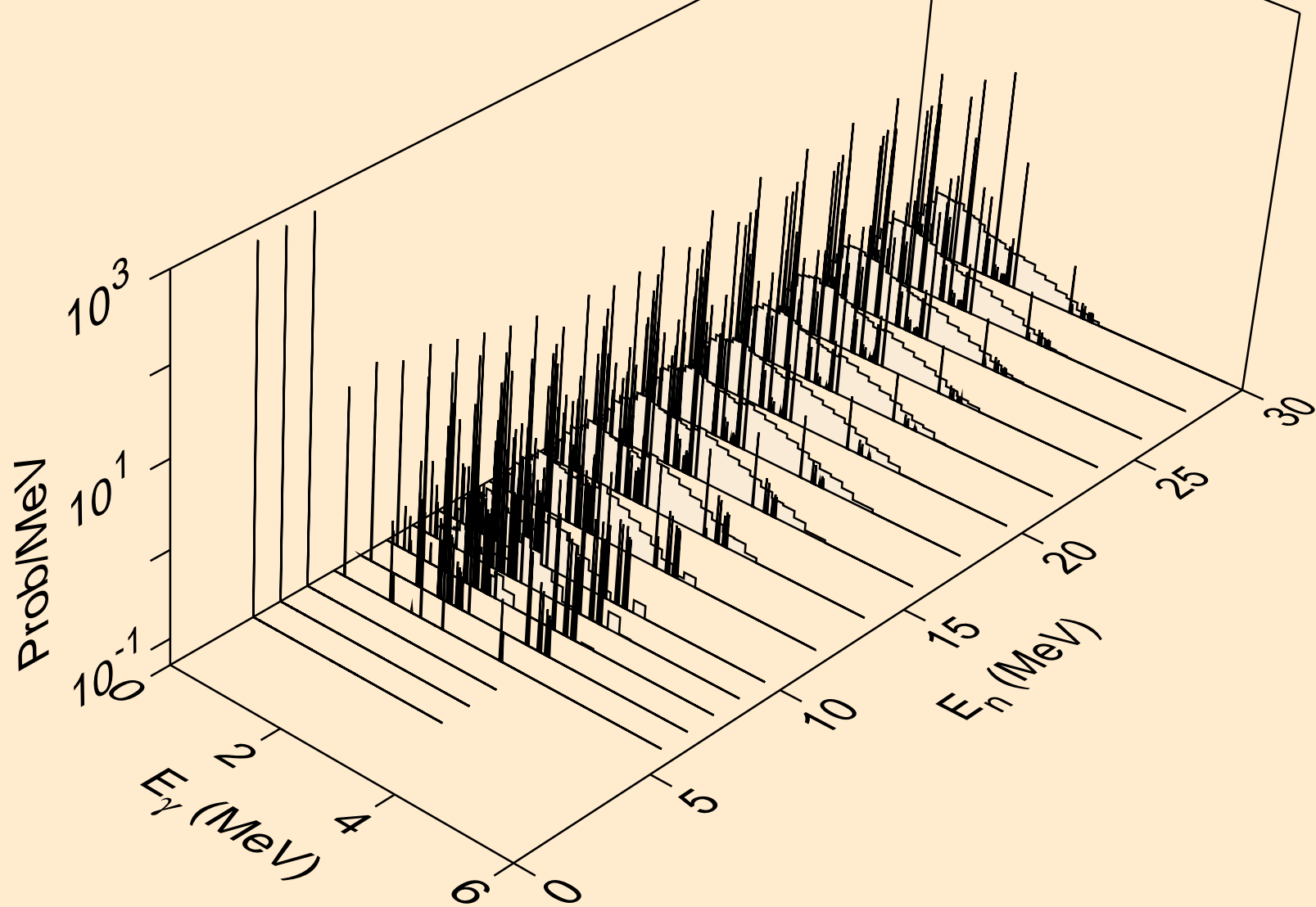

GD146 PROTON ACER TENDL-2021 LIBRARY; T=0.K  
Photon emission for (n,d)

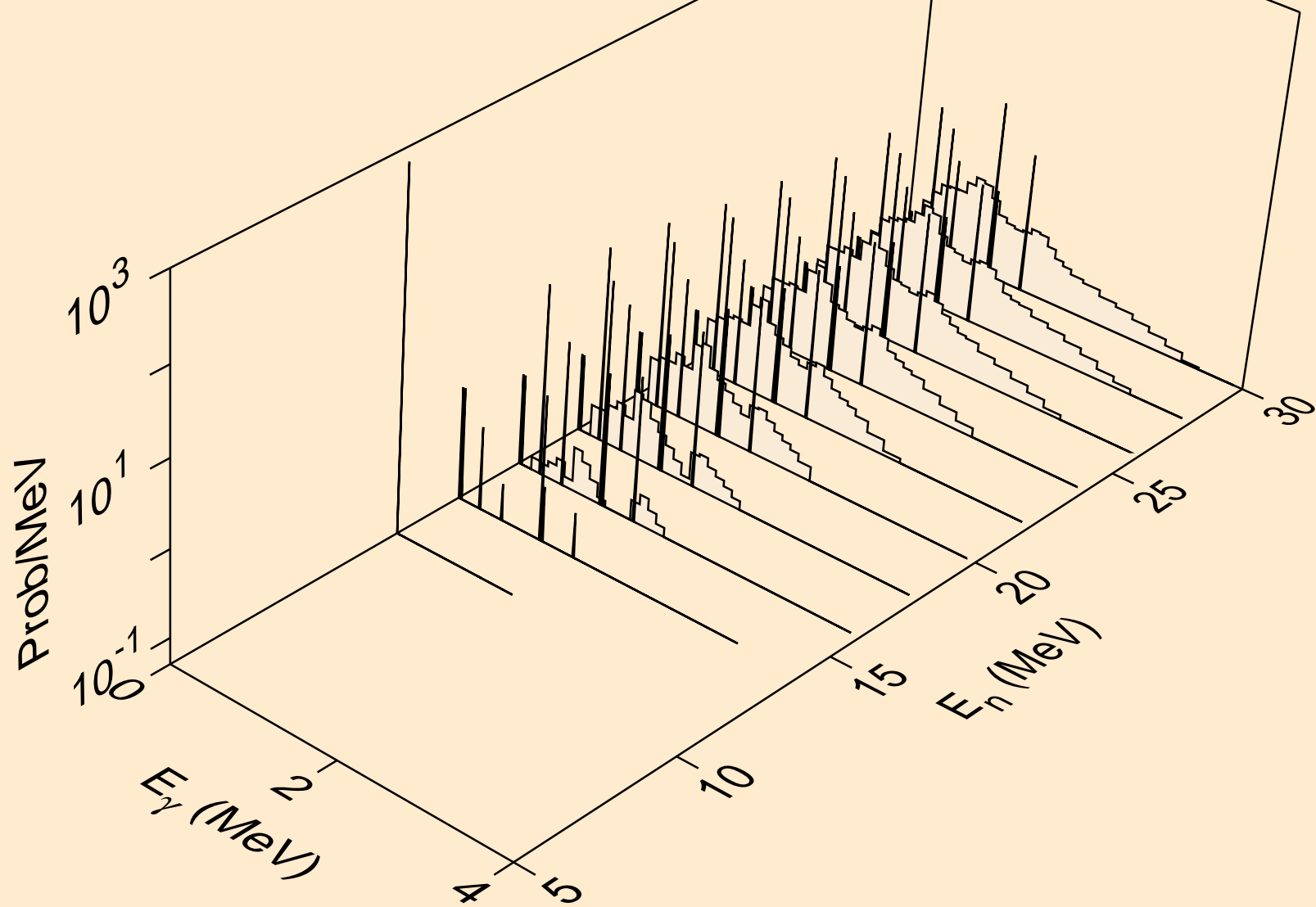

GD146 PROTON ACER TENDL-2021 LIBRARY; T=0.K  
Photon emission for (n,t)

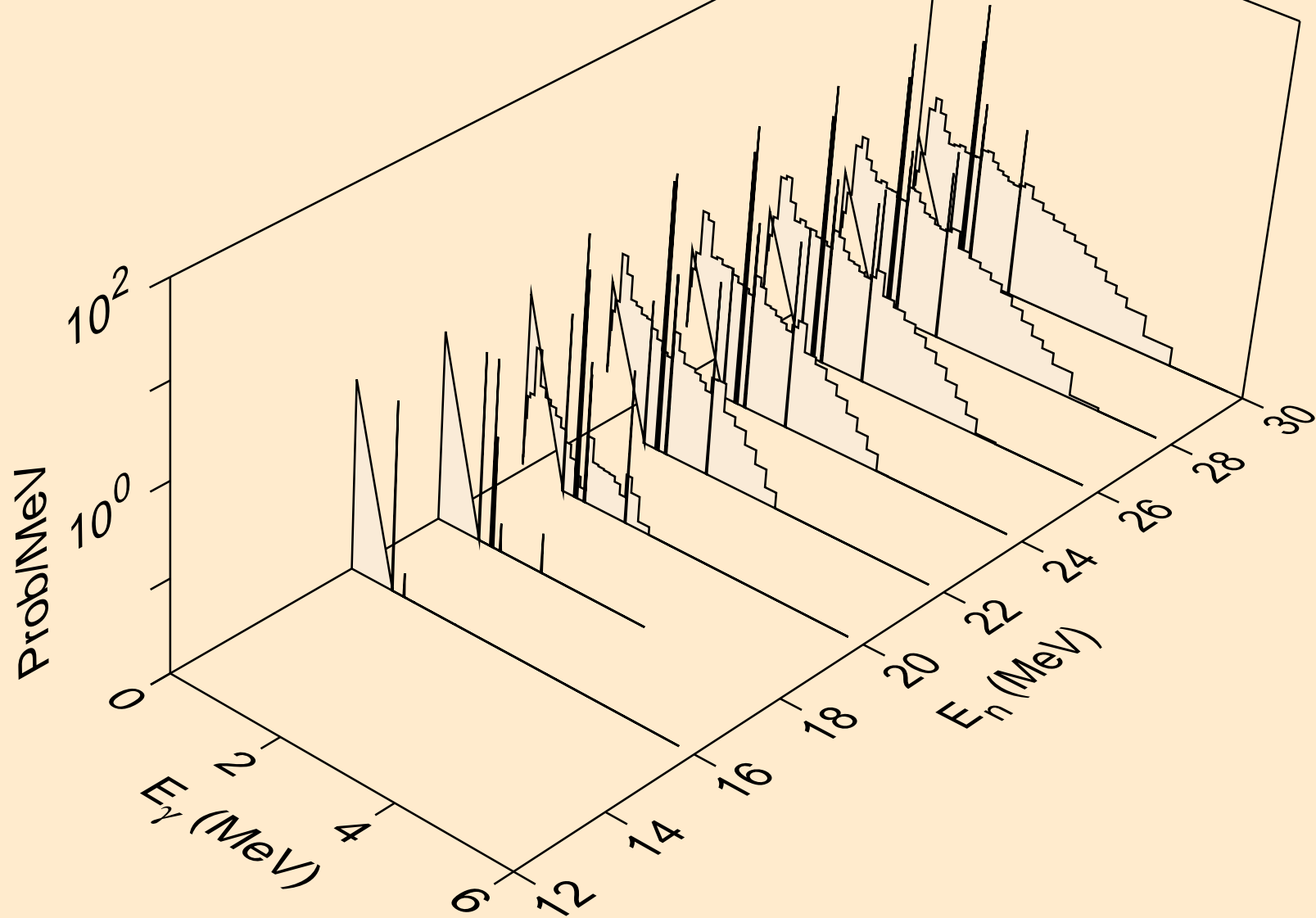

GD146 PROTON ACER TENDL-2021 LIBRARY; T=0.K  
Photon emission for (n,he3)

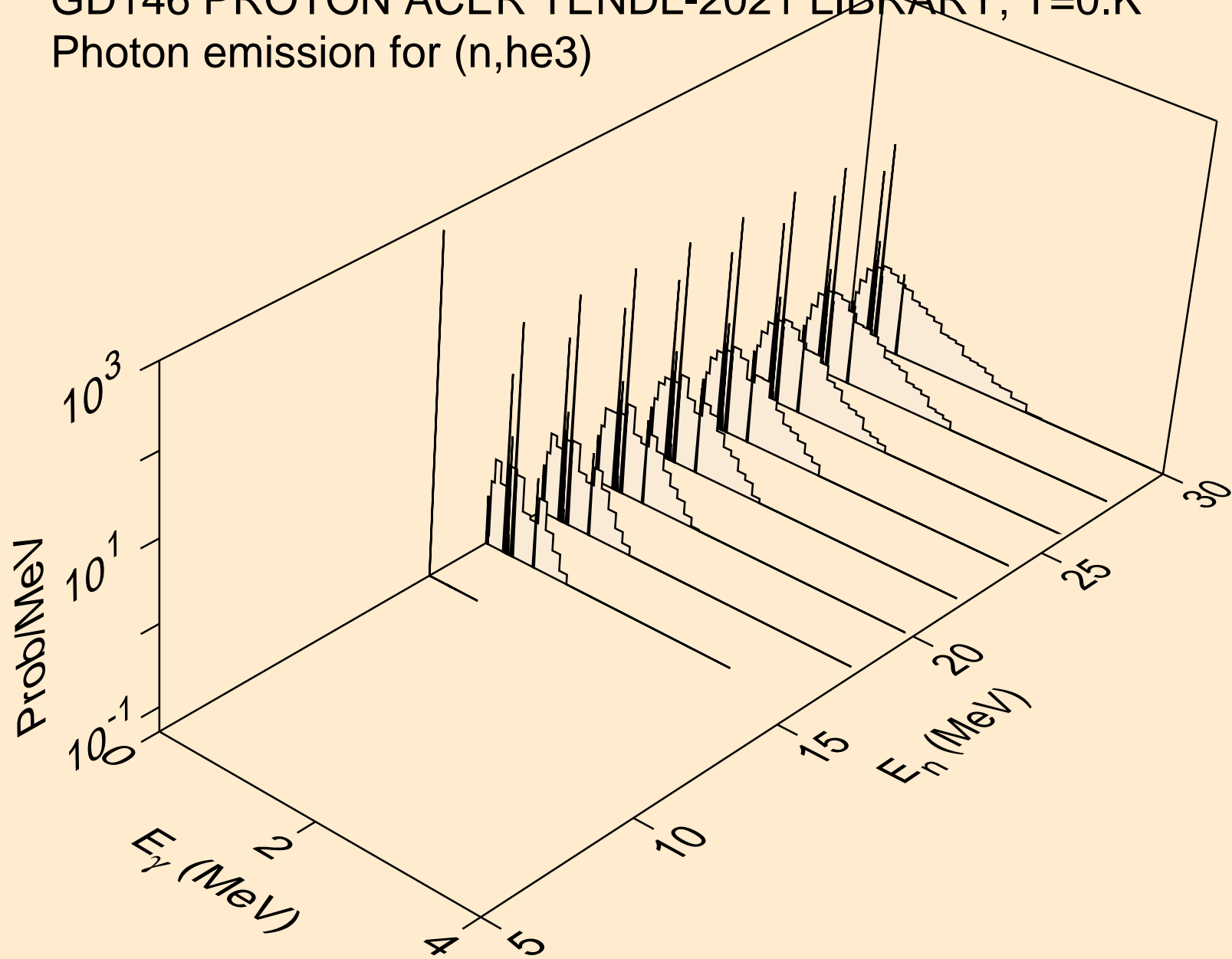

GD146 PROTON ACER TENDL-2021 LIBRARY; T=0.K  
Photon emission for (n,a)

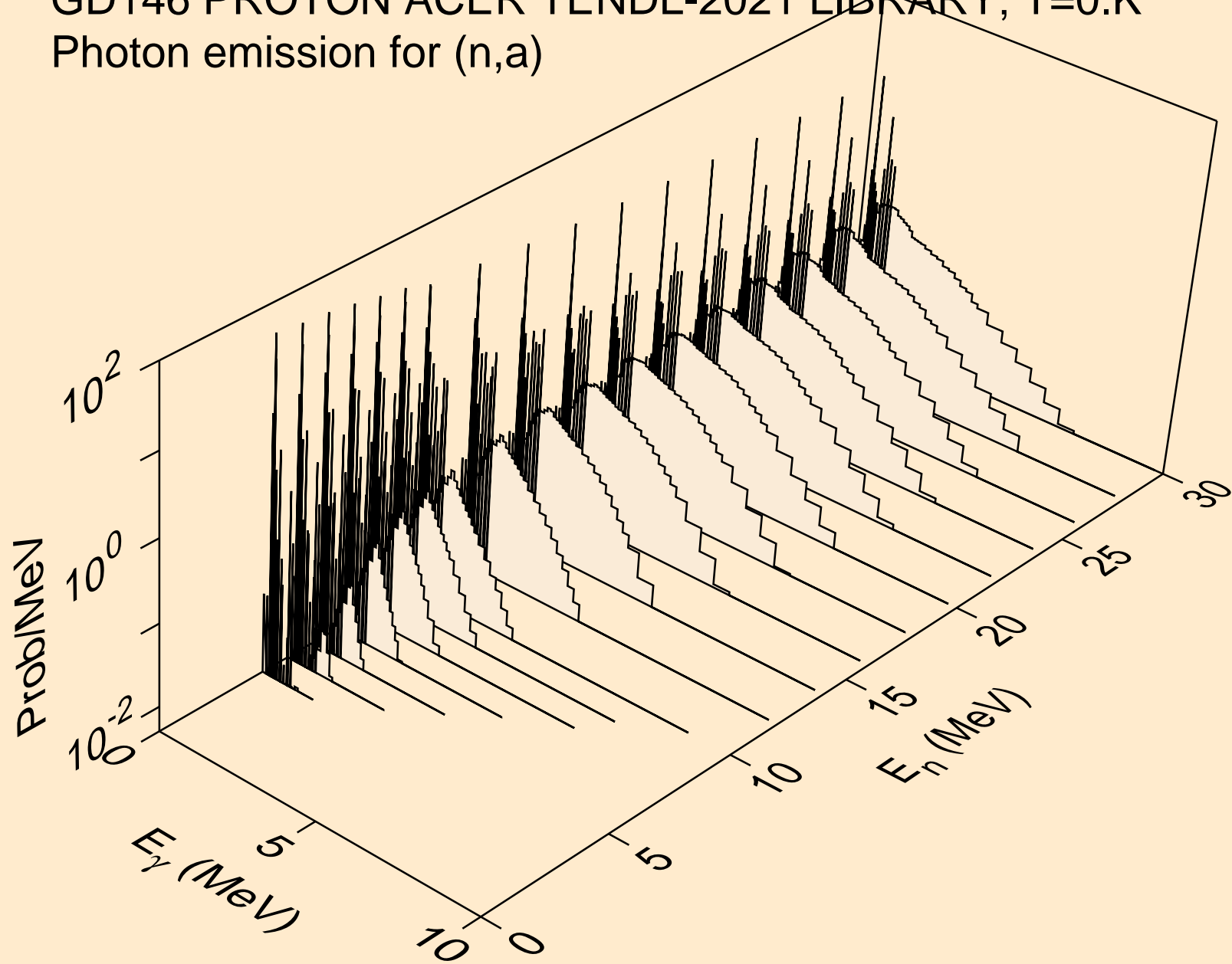

GD146 PROTON ACER TENDL-2021 LIBRARY; T=0.K  
Photon emission for (n,2a)

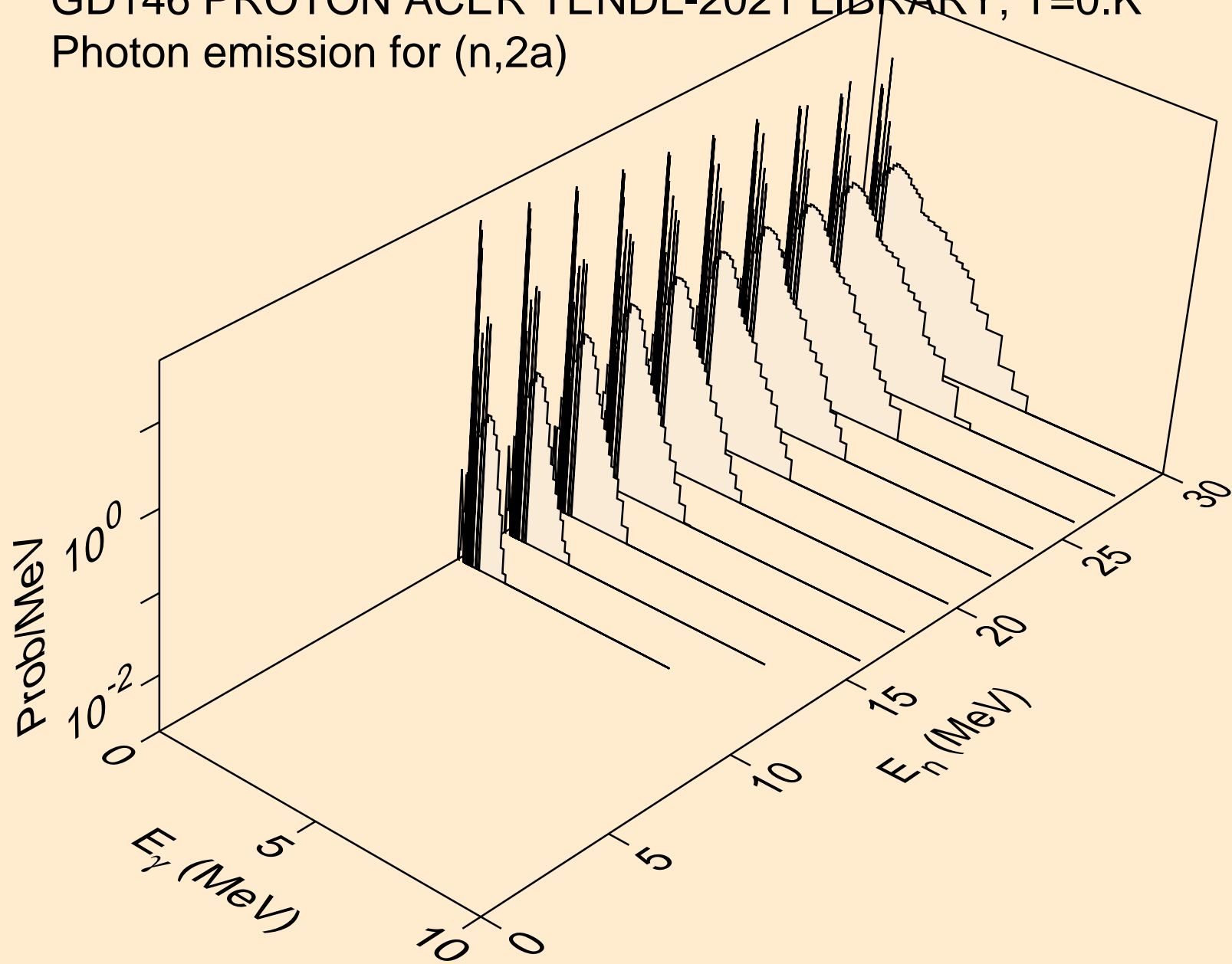

GD146 PROTON ACER TENDL-2021 LIBRARY; T=0.K  
Photon emission for (n,2p)

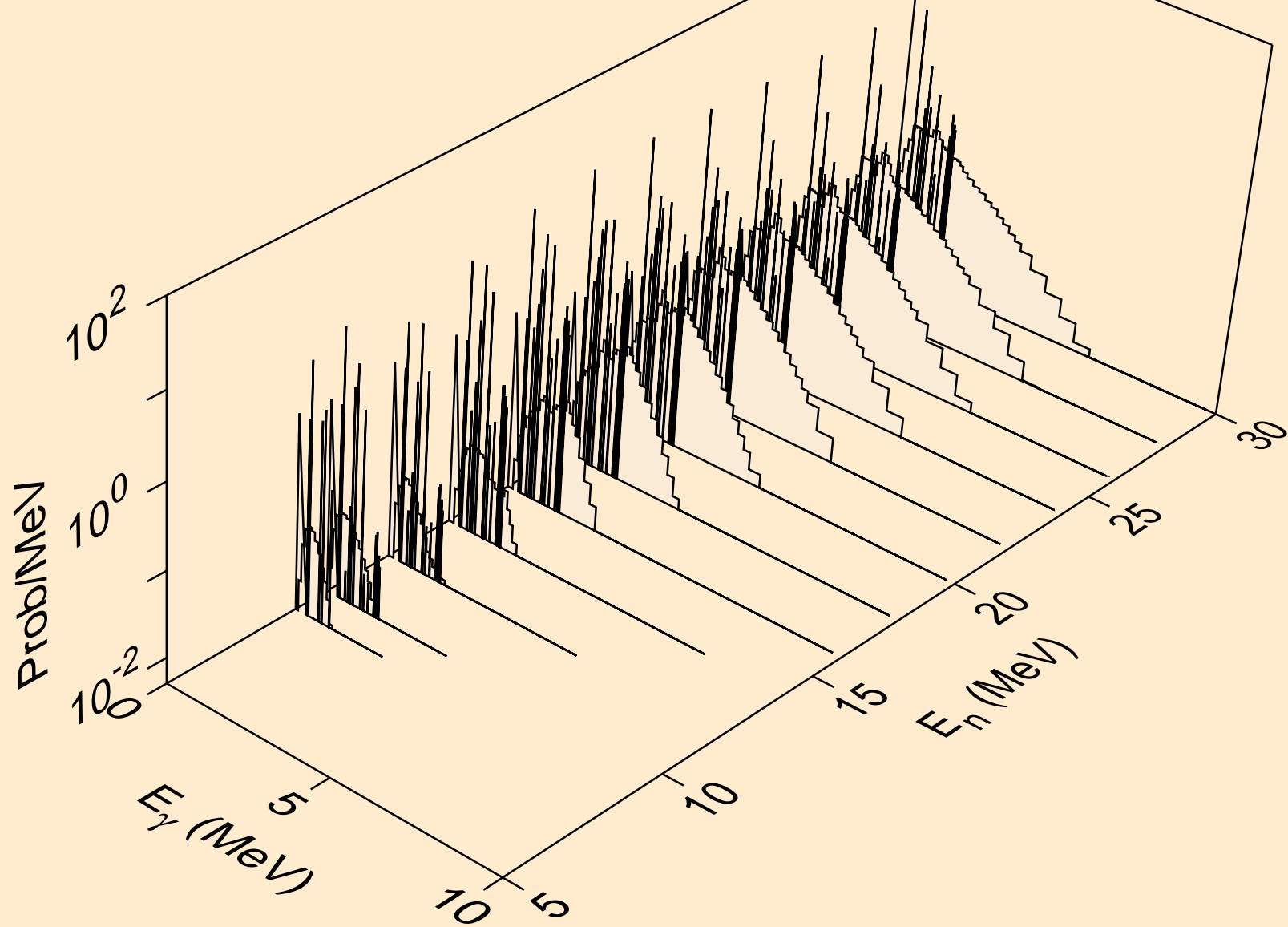



GD146 PROTON ACER TENDL-2021 LIBRARY; T=0.K  
Photon emission for (n,pa)

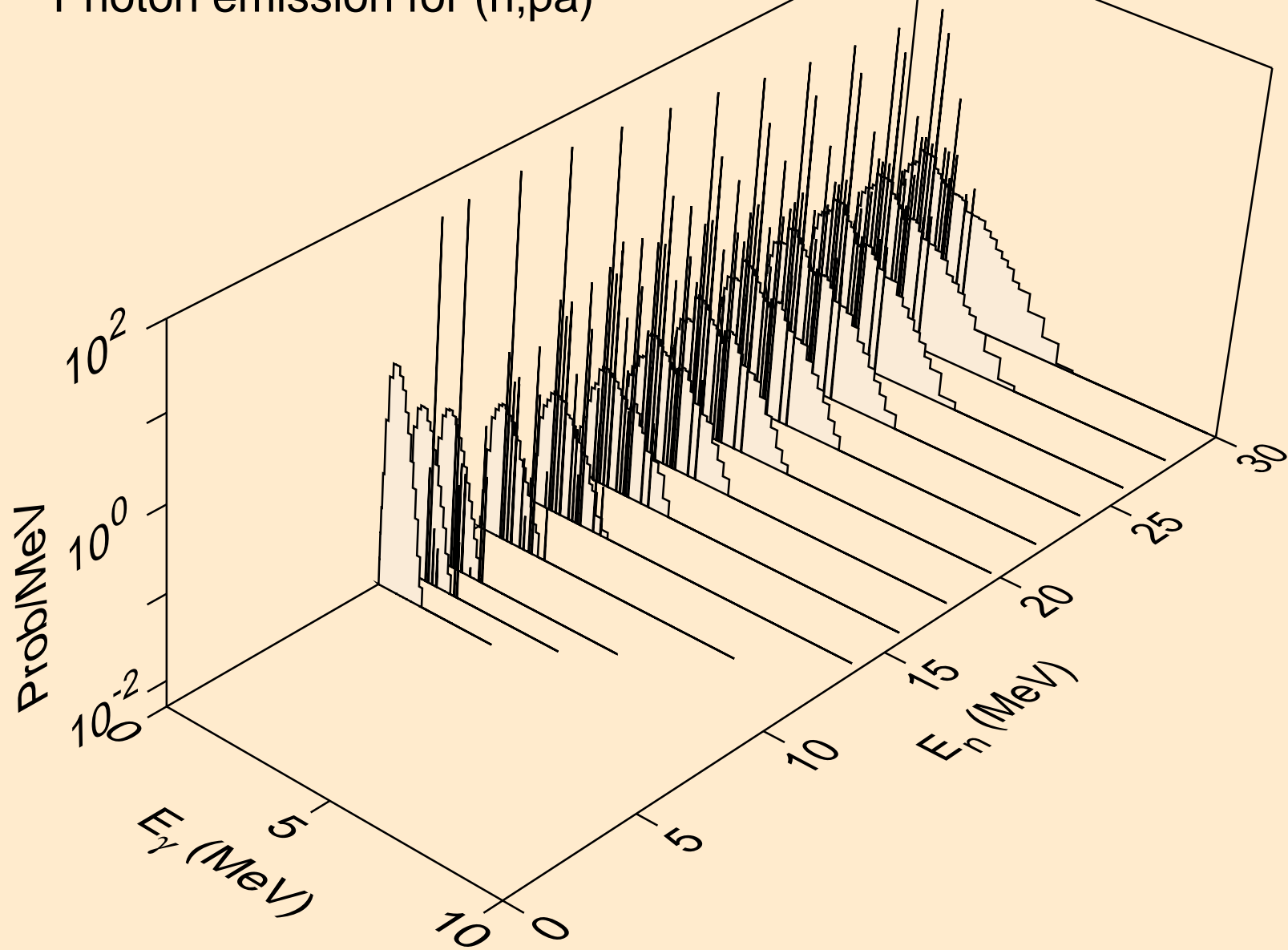

GD146 PROTON ACER TENDL-2021 LIBRARY; T=0.K  
Photon emission for (n,pd)

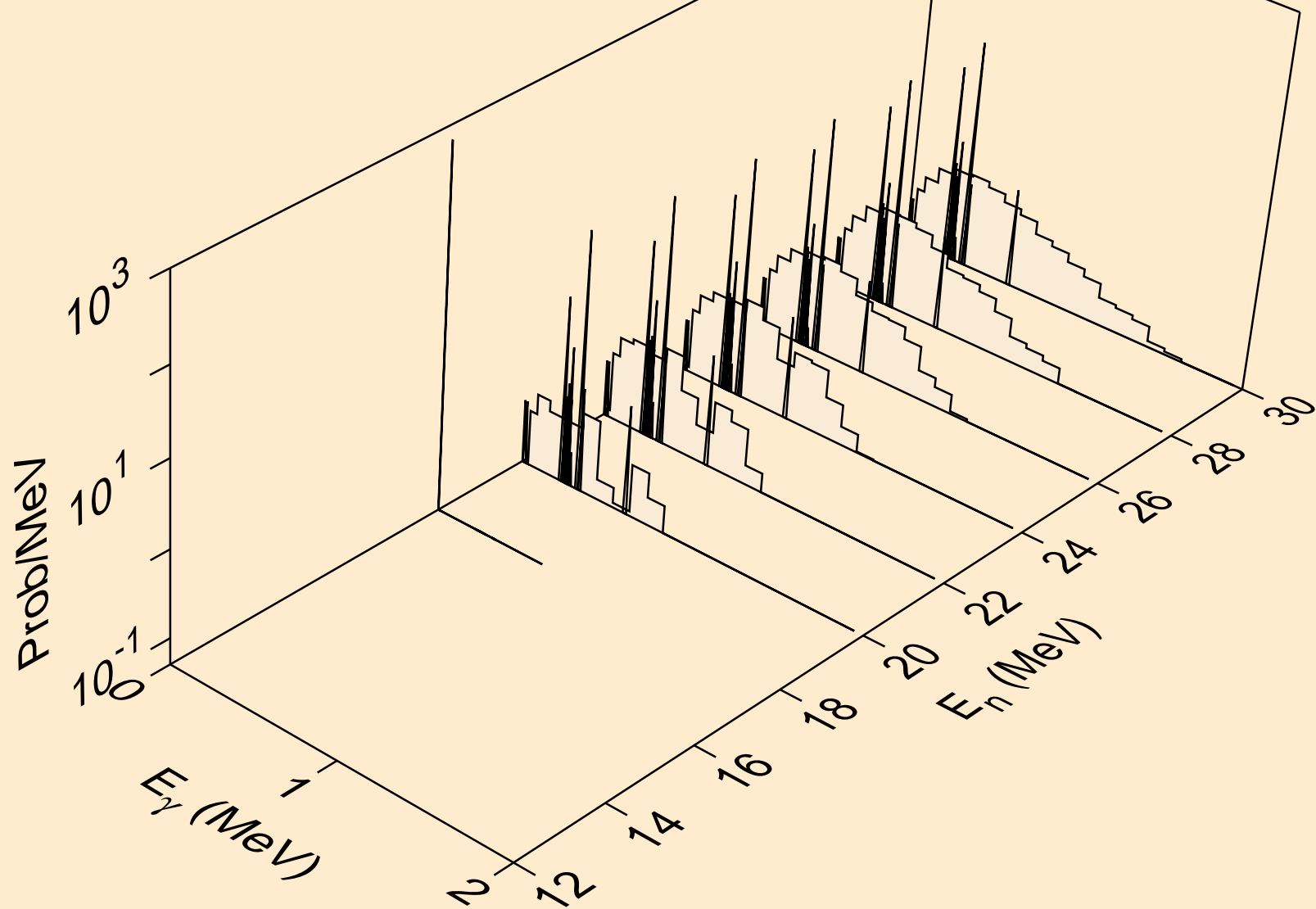

GD146 PROTON ACER TENDL-2021 LIBRARY; T=0.K  
Photon emission for (n,pt)

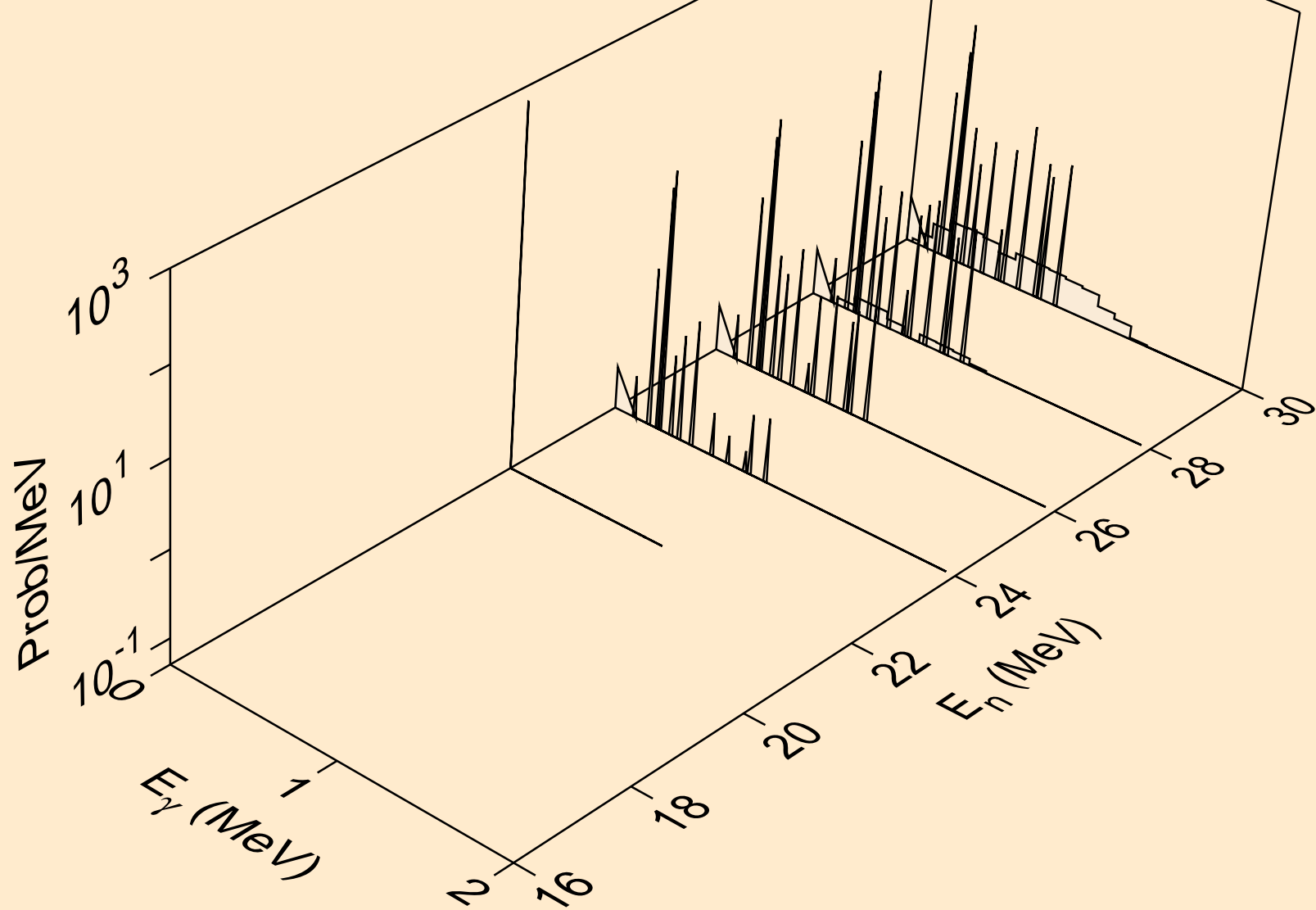

GD146 PROTON ACER TENDL-2021 LIBRARY; T=0.K  
Photon emission for (n,da)

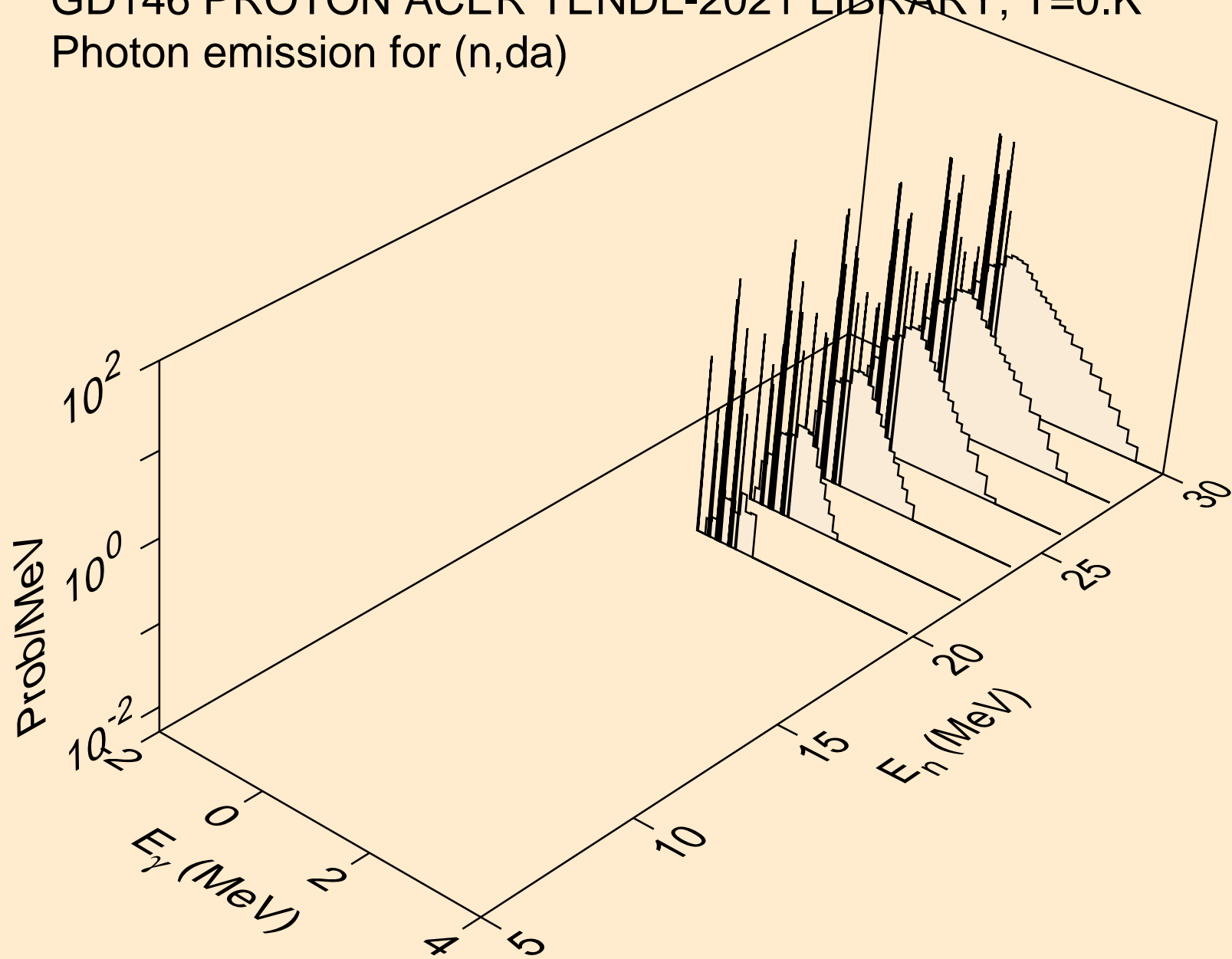

# GD146 PROTON ACER TENDL-2021 LIBRARY; T=0.K

## Particle heating contributions

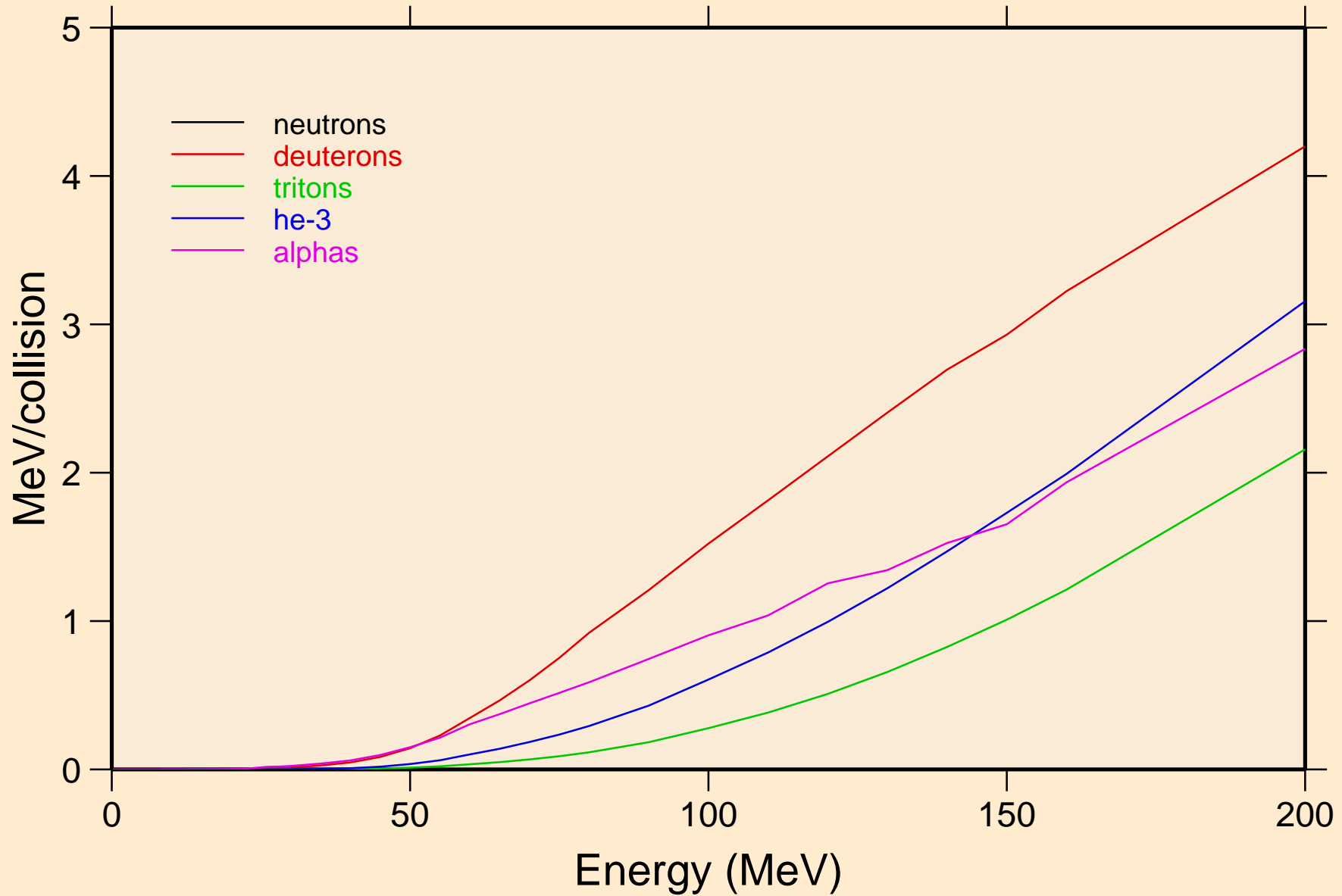

GD146 PROTON ACER TENDL-2021 LIBRARY; T=0.K  
Recoil Heating

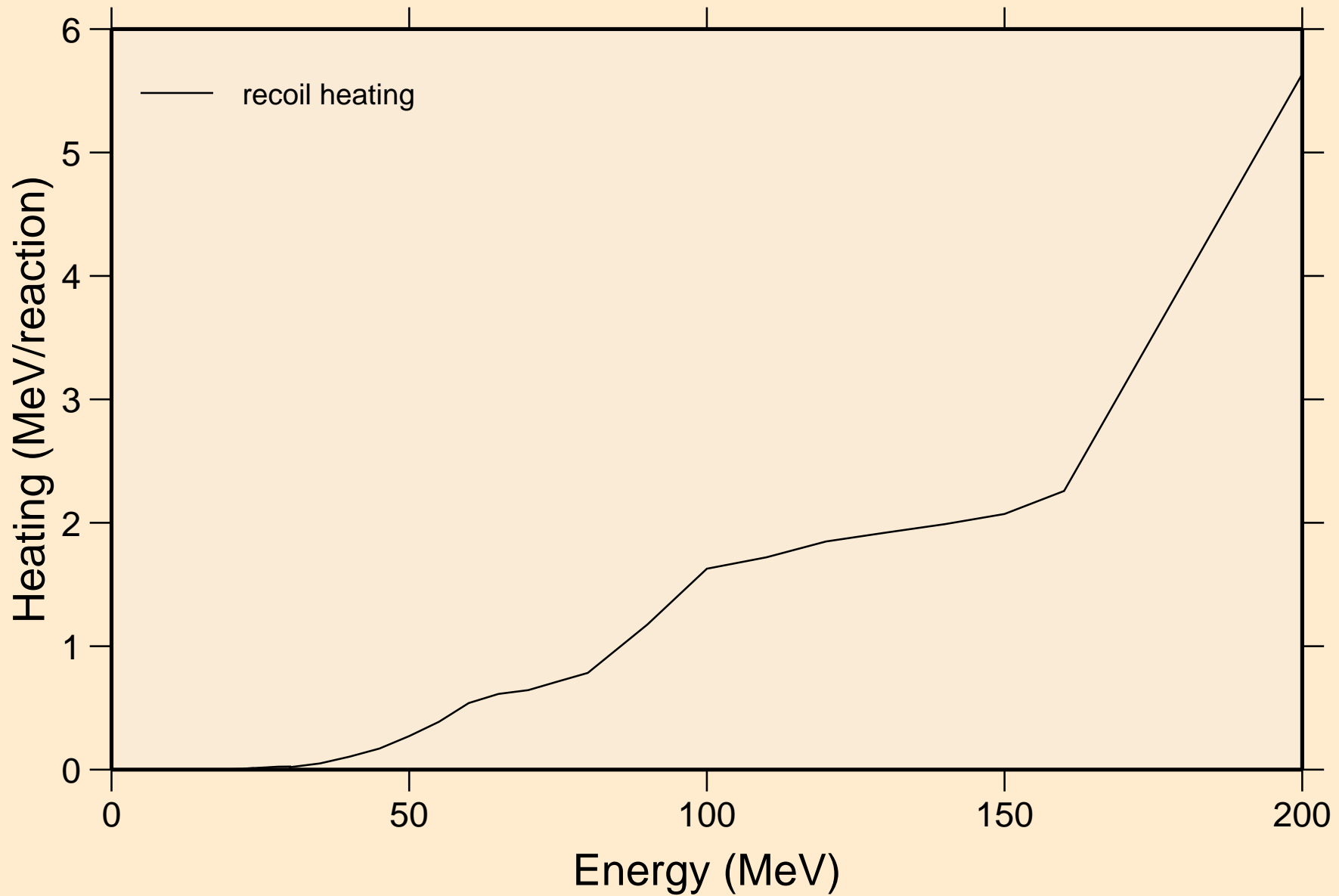

GD146 PROTON ACER TENDL-2021 LIBRARY; T=0.K  
Particle production cross sections

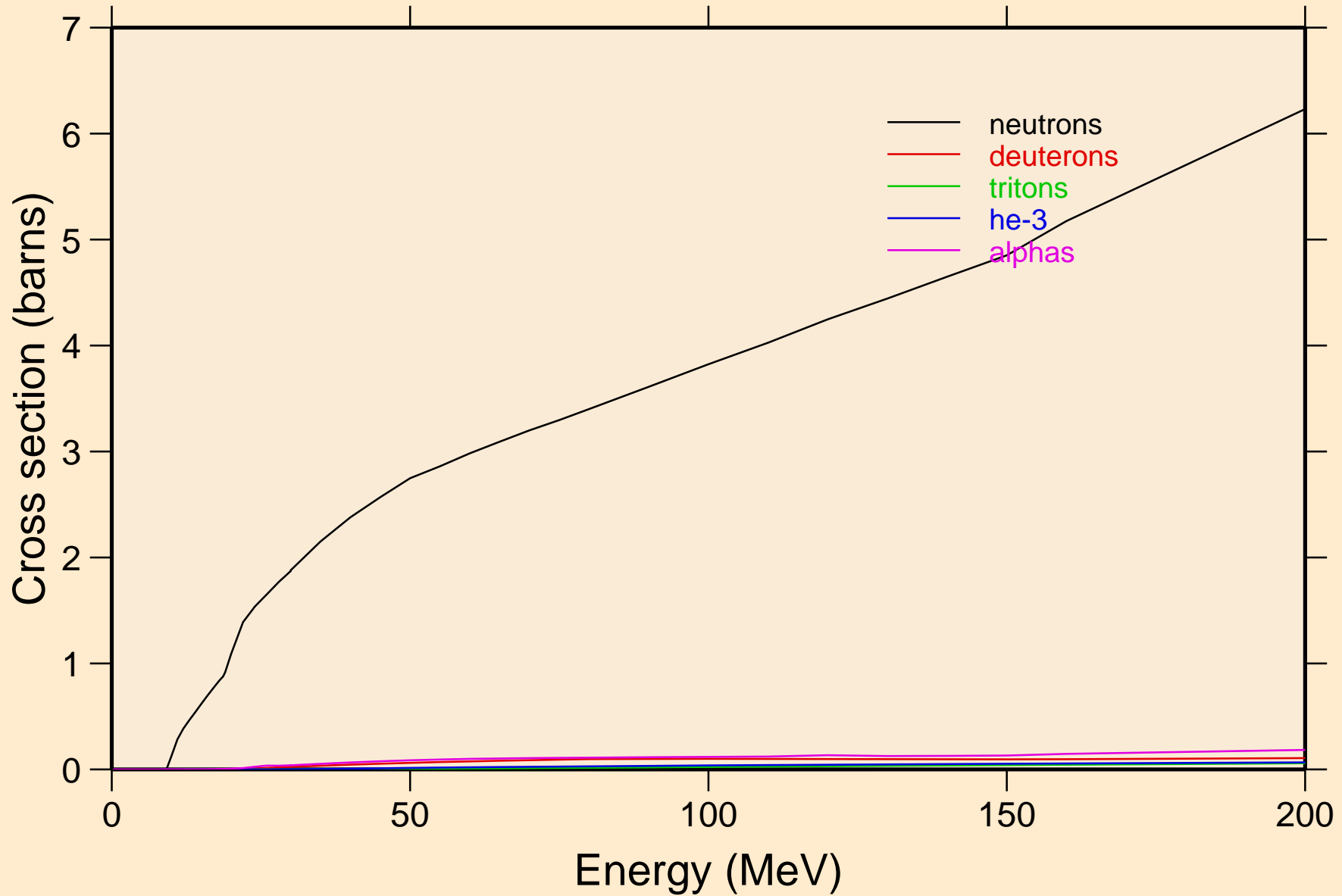

GD146 PROTON ACER TENDL-2021 LIBRARY; T=0.K  
neutrons from (p,n)

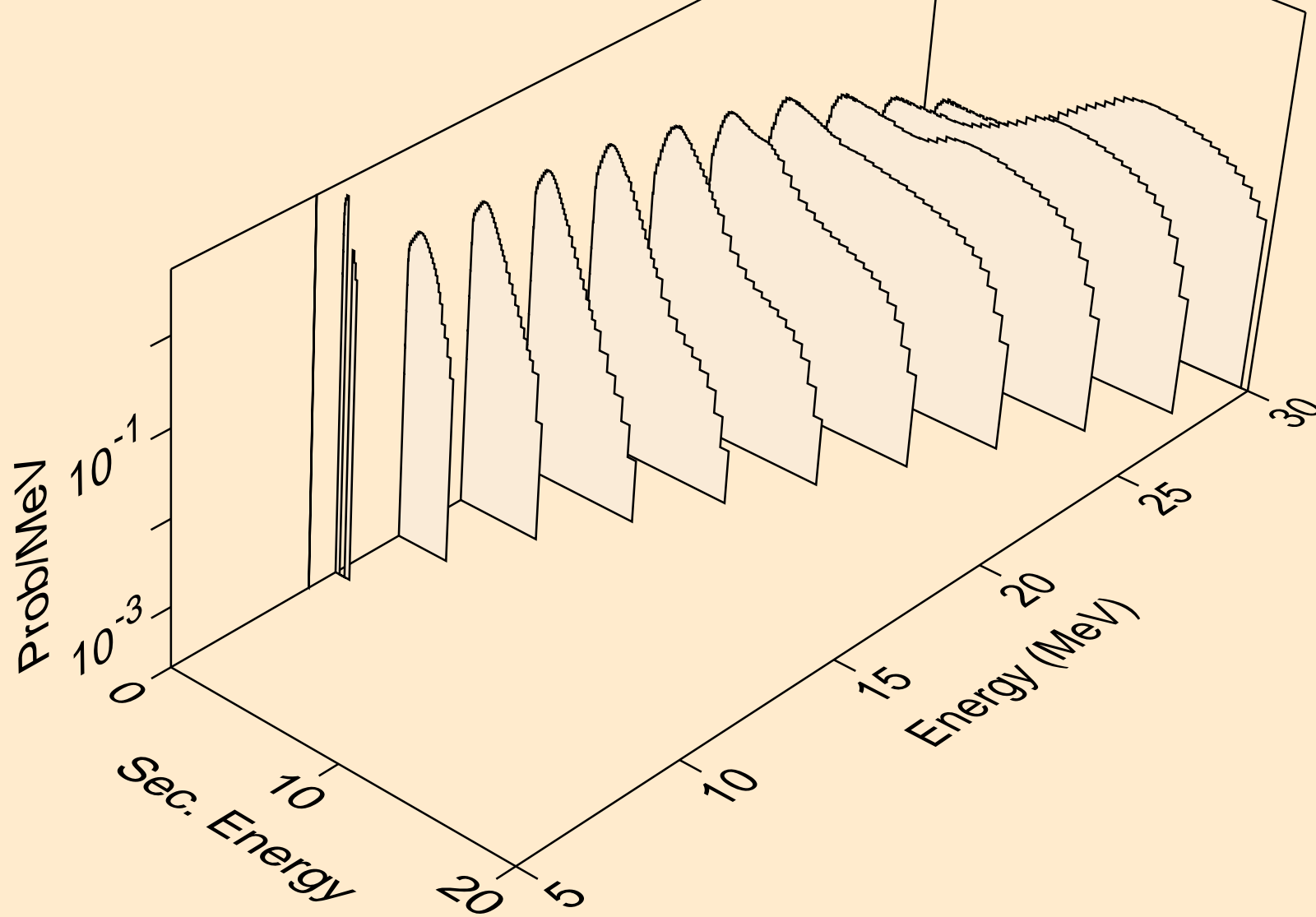



GD146 PROTON ACER TENDL-2021 LIBRARY; T=0.K  
neutrons from (p,x)

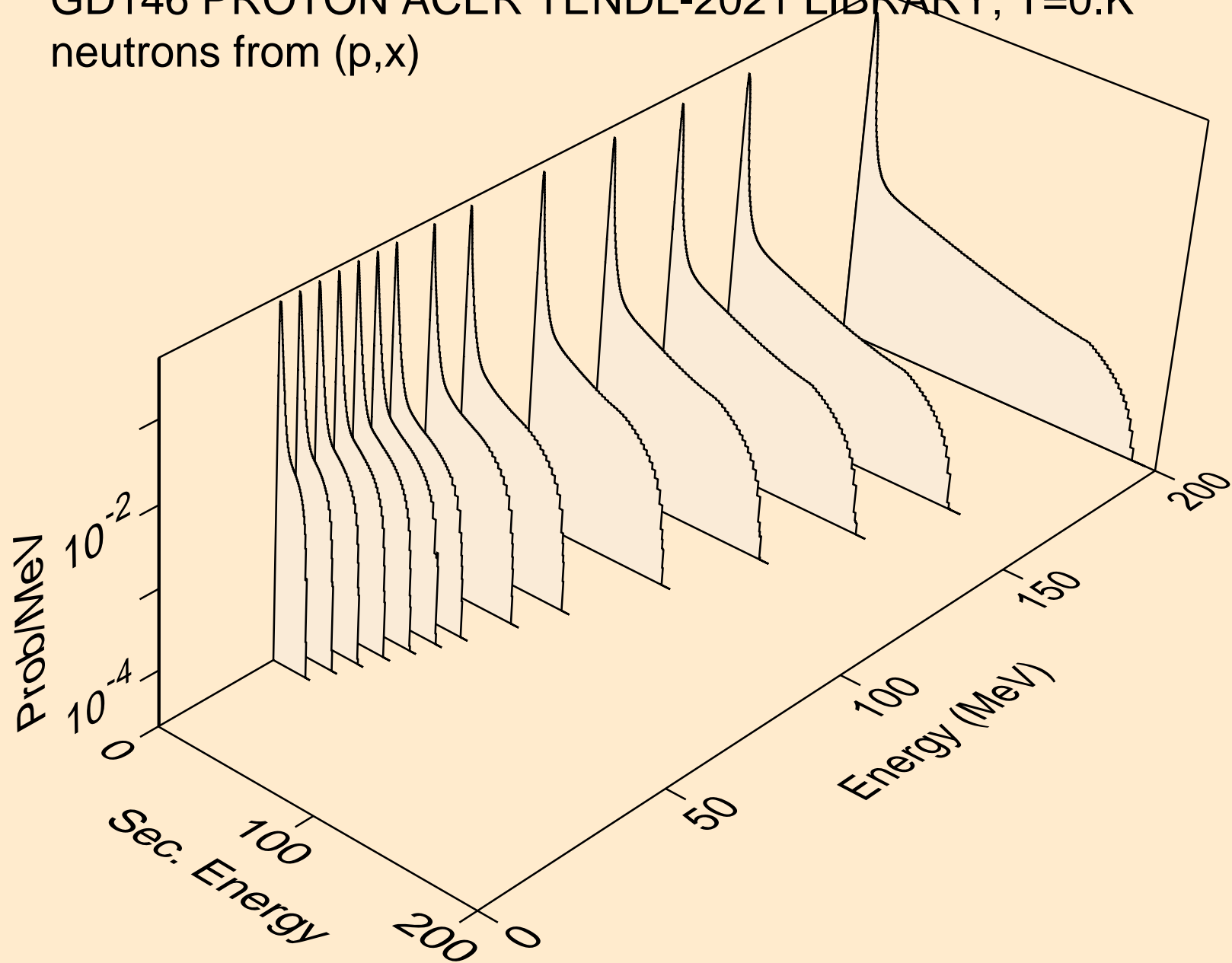

GD146 PROTON ACER TENDL-2021 LIBRARY; T=0.K  
neutrons from (p,2n)

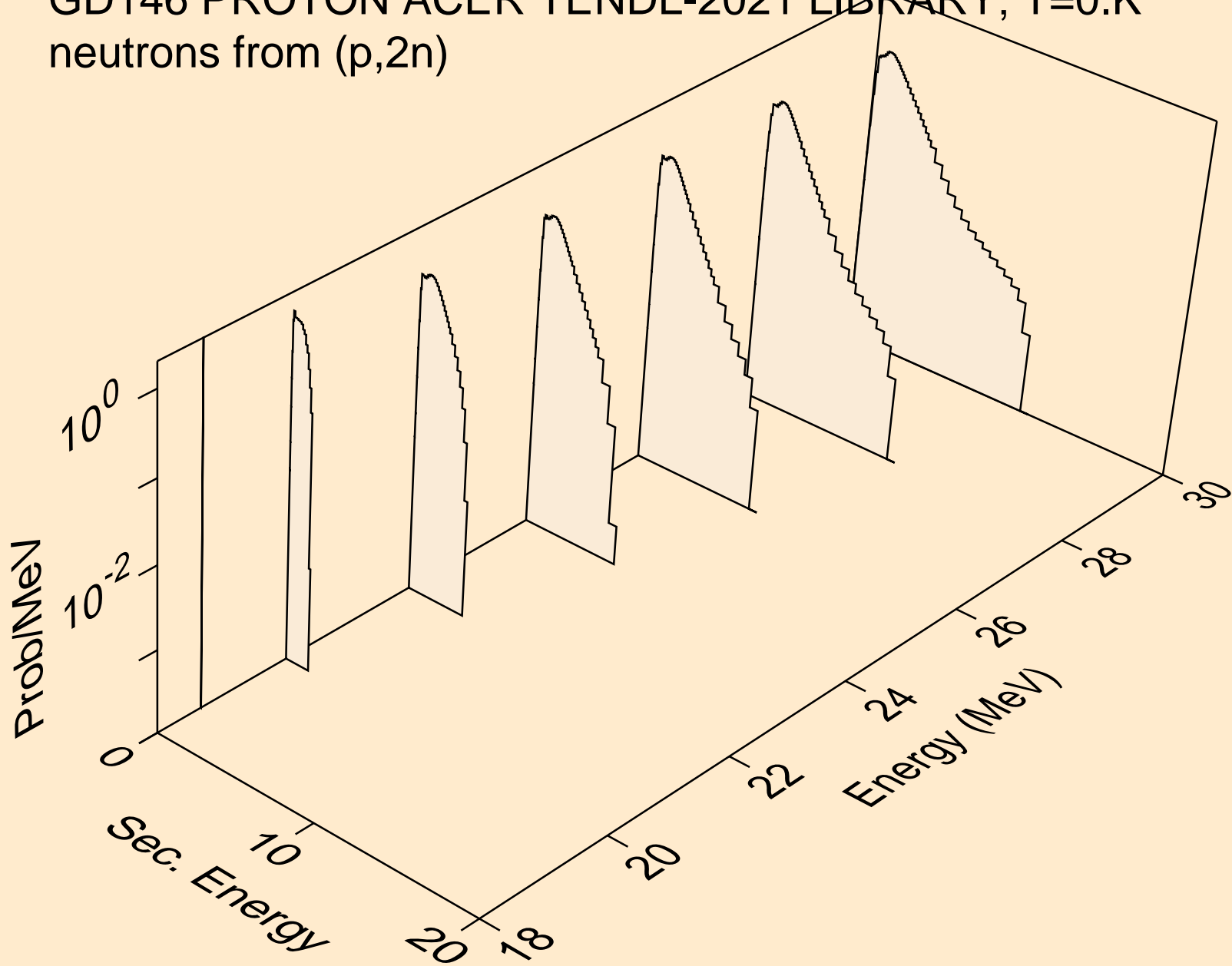

GD146 PROTON ACER TENDL-2021 LIBRARY; T=0.K  
neutrons from (p,n\*)a

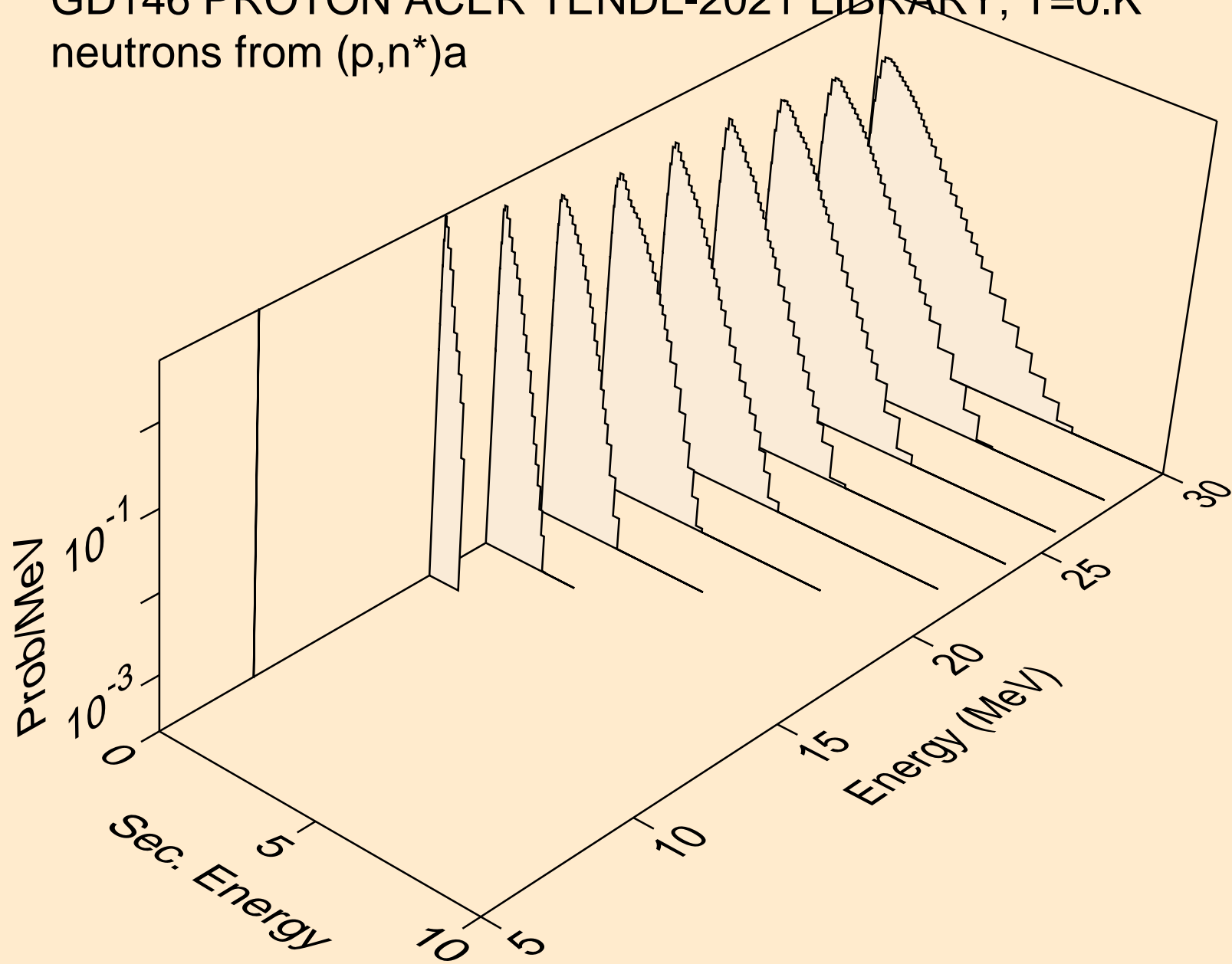

GD146 PROTON ACER TENDL-2021 LIBRARY; T=0.K  
neutrons from (p,2n)a

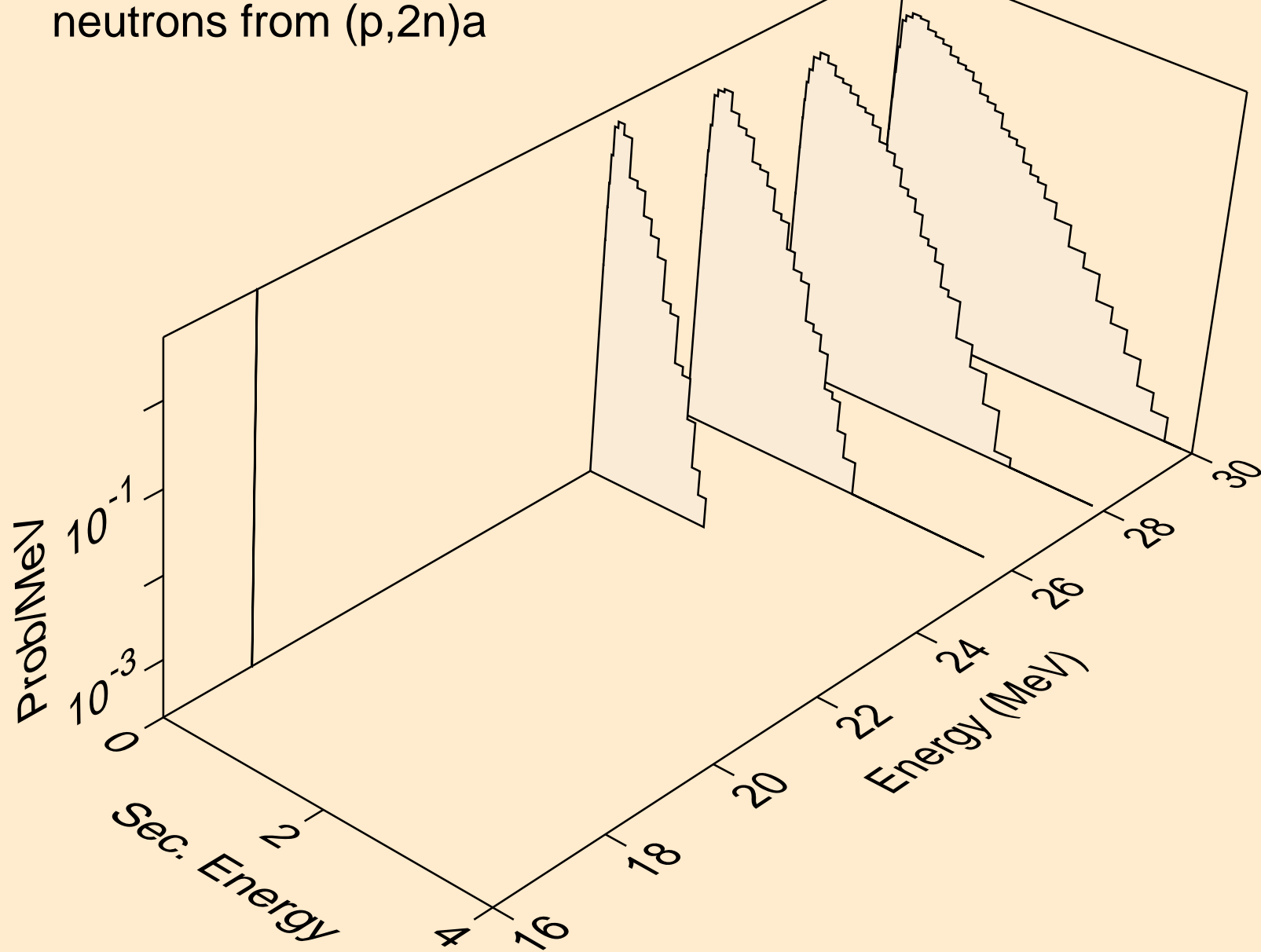

GD146 PROTON ACER TENDL-2021 LIBRARY; T=0.K  
neutrons from (p,n\*)p

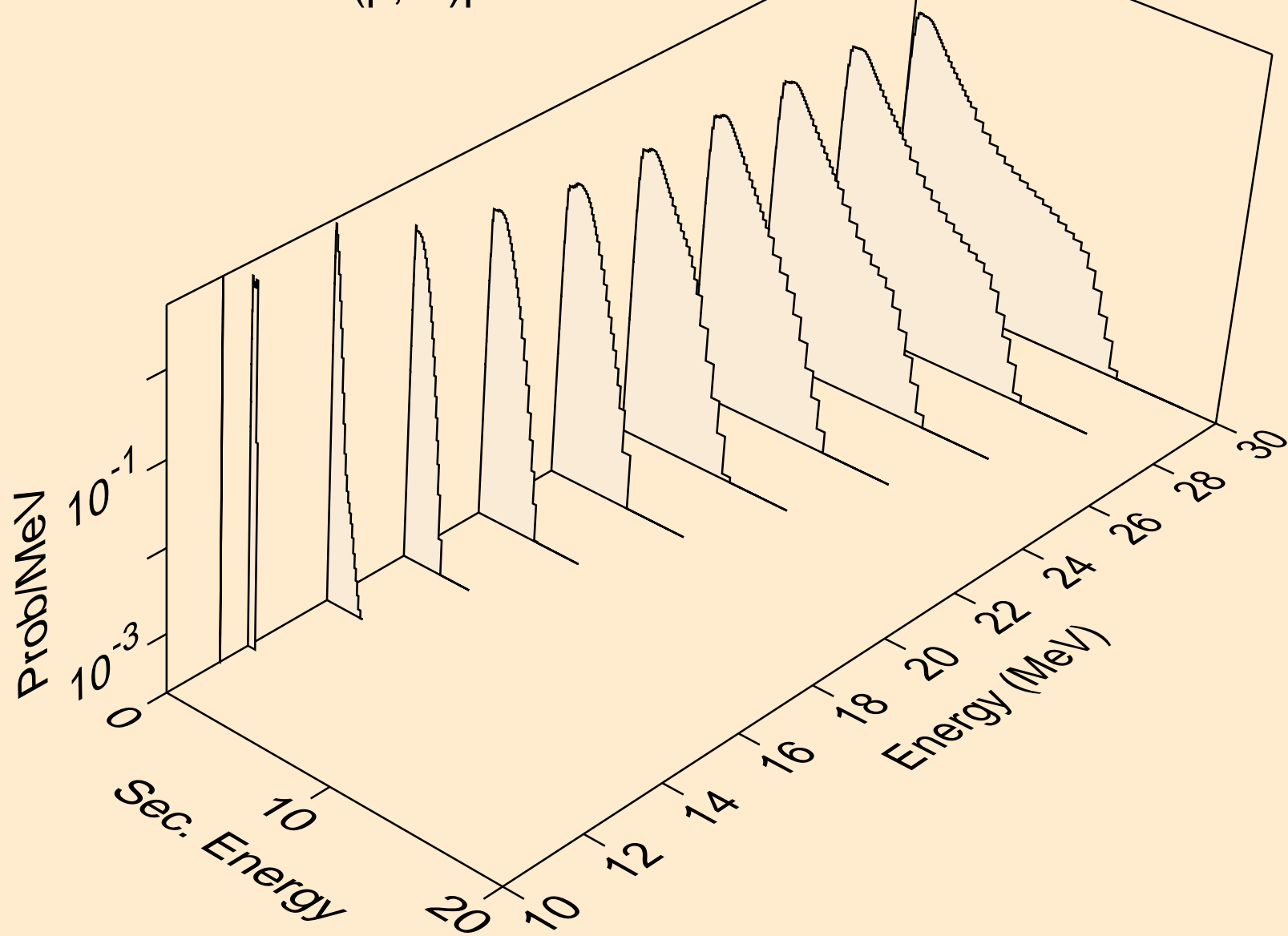

GD146 PROTON ACER TENDL-2021 LIBRARY; T=0.K  
neutrons from (p,n\*)2a

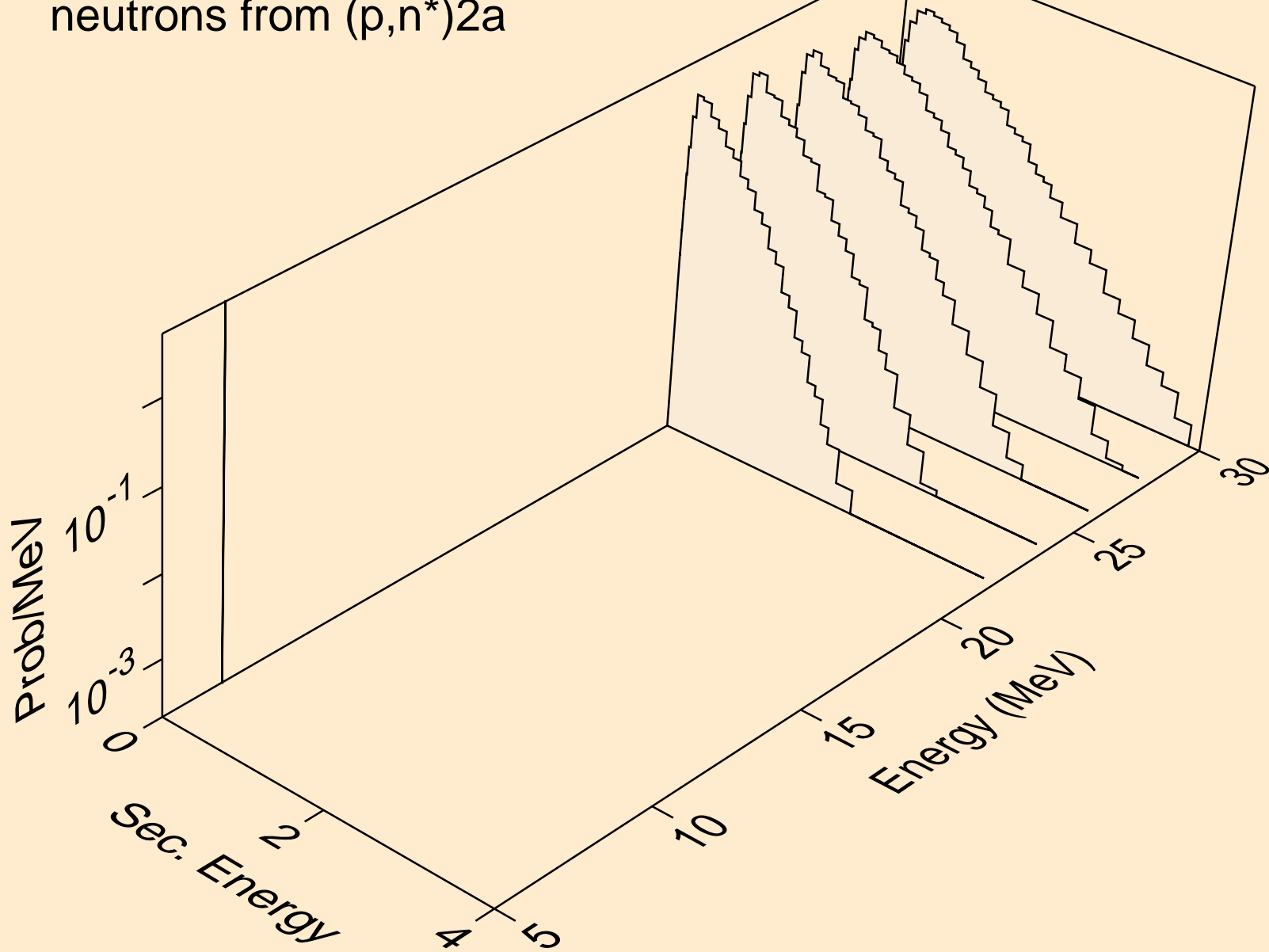

GD146 PROTON ACER TENDL-2021 LIBRARY; T=0.K  
neutrons from (p,n\*)d

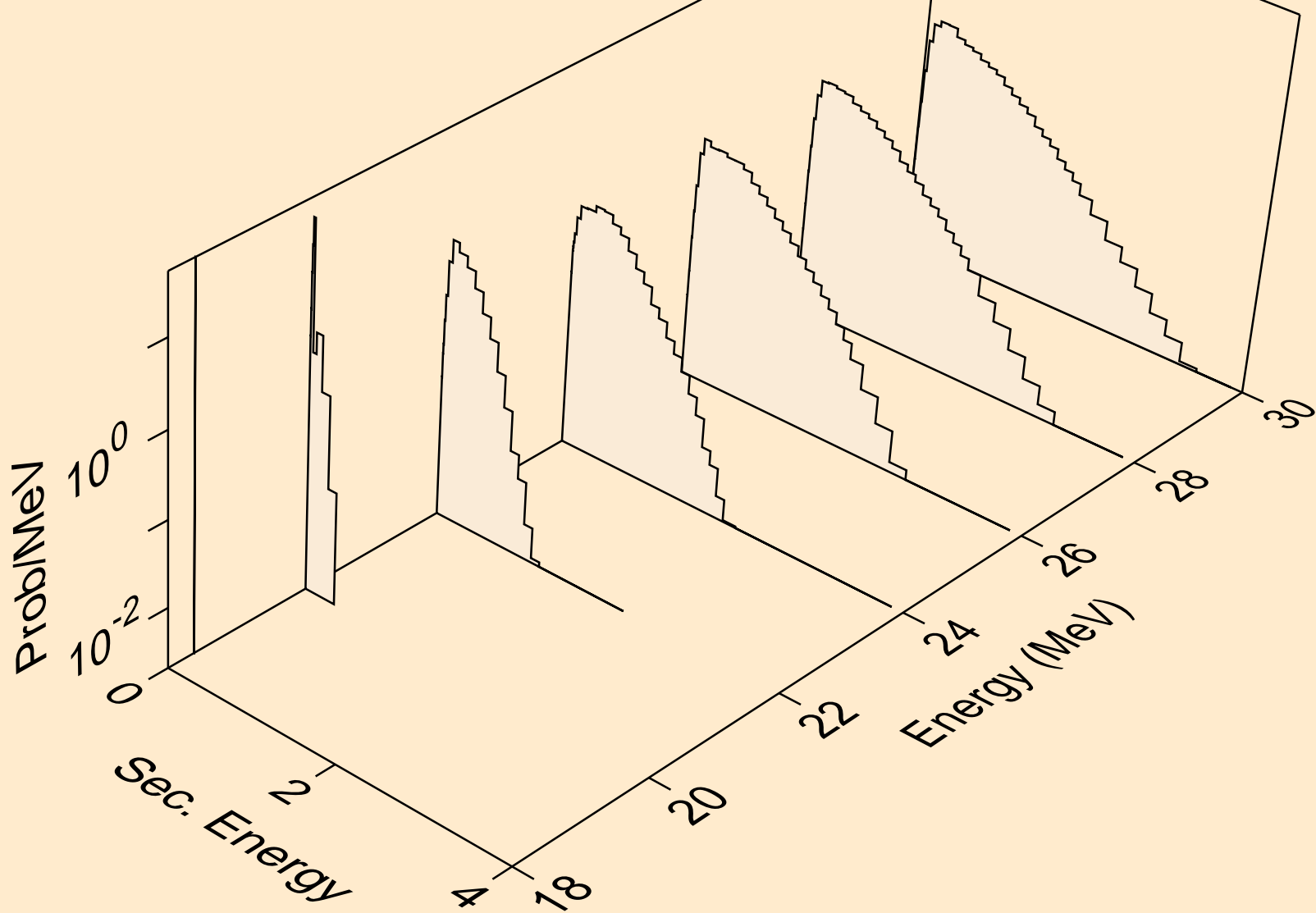

GD146 PROTON ACER TENDL-2021 LIBRARY; T=0.K  
neutrons from (p,n\*)t

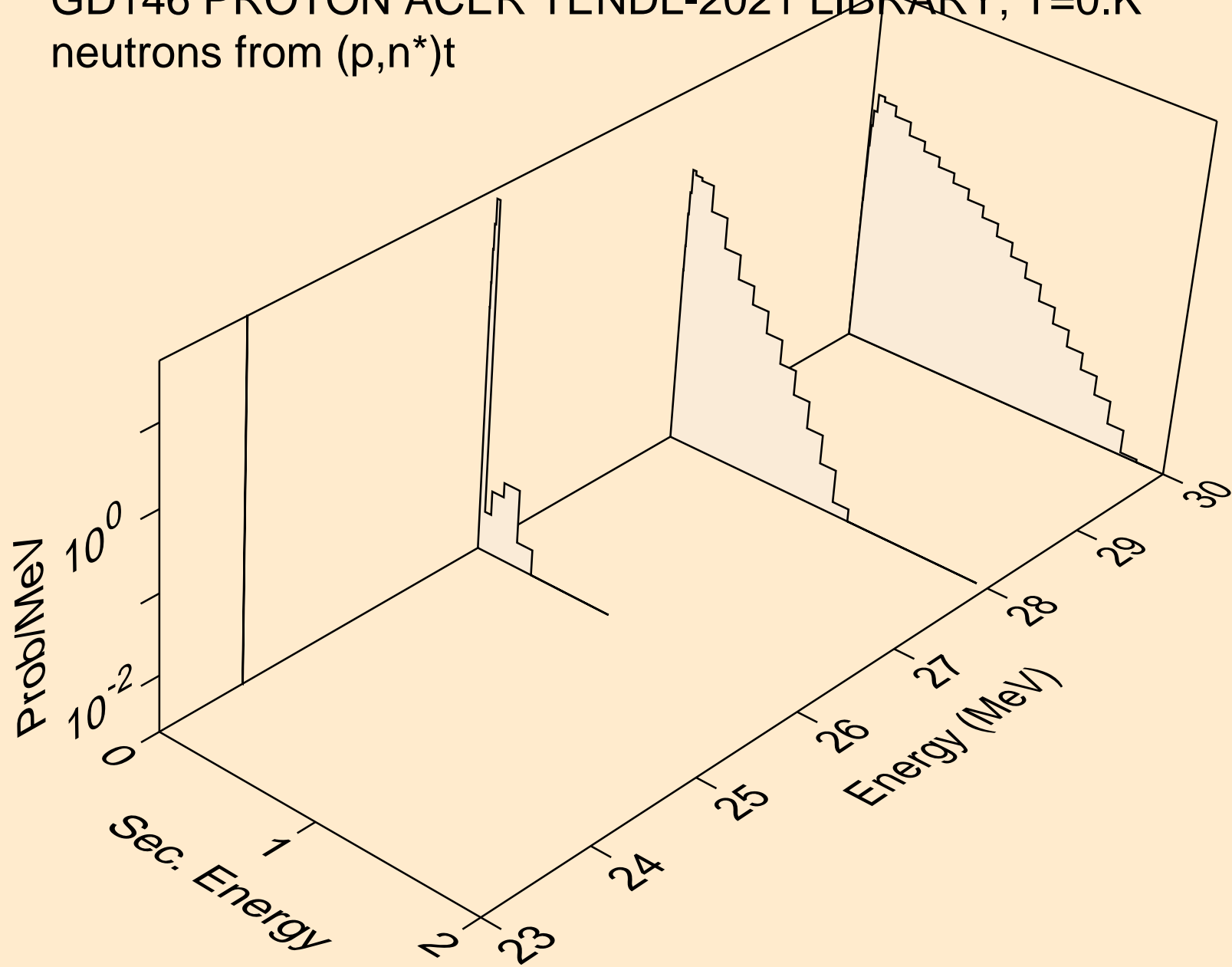



GD146 PROTON ACER TENDL-2021 LIBRARY; T=0.K  
neutrons from (p,n\*)he3

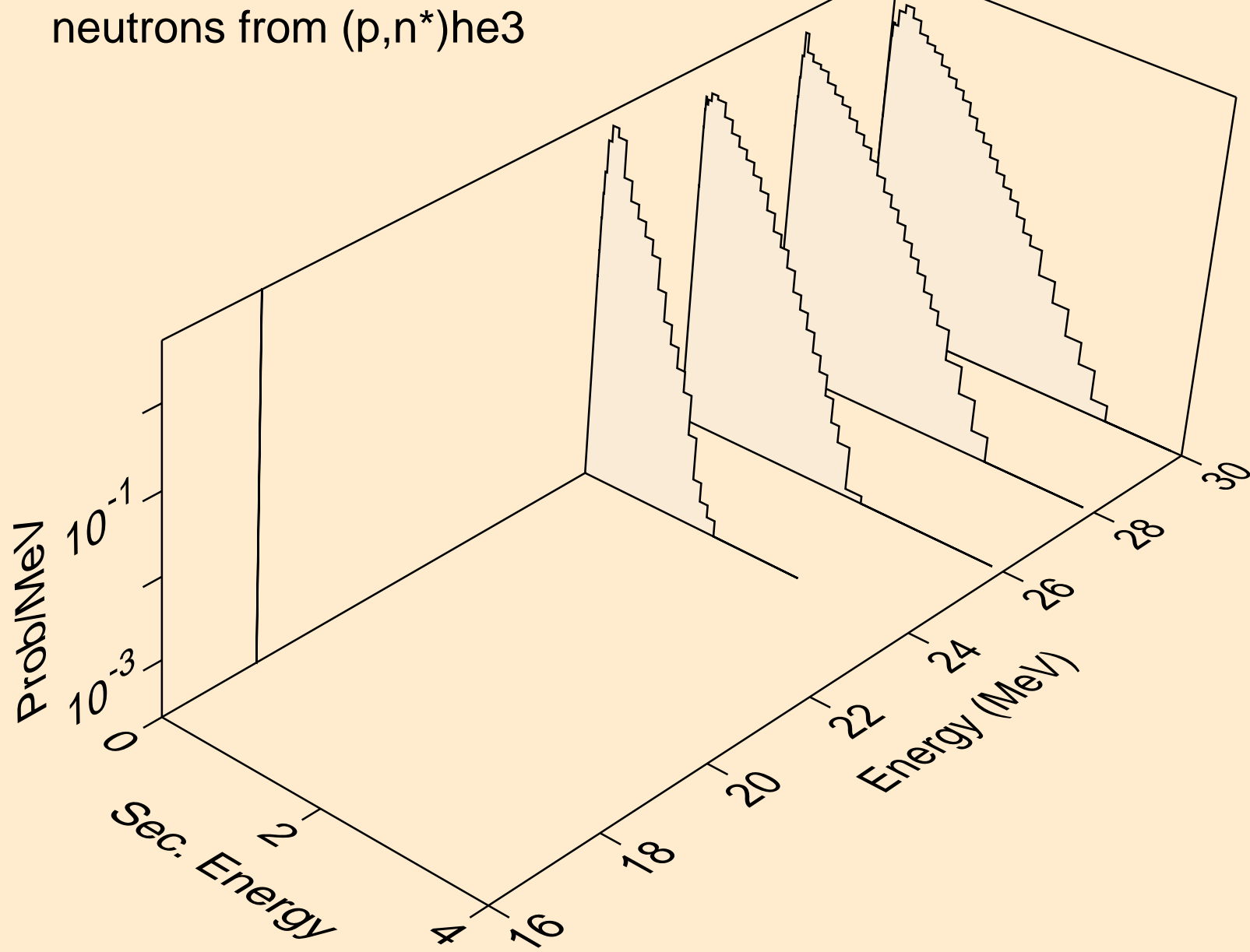

GD146 PROTON ACER TENDL-2021 LIBRARY; T=0.K  
neutrons from (p,2np)

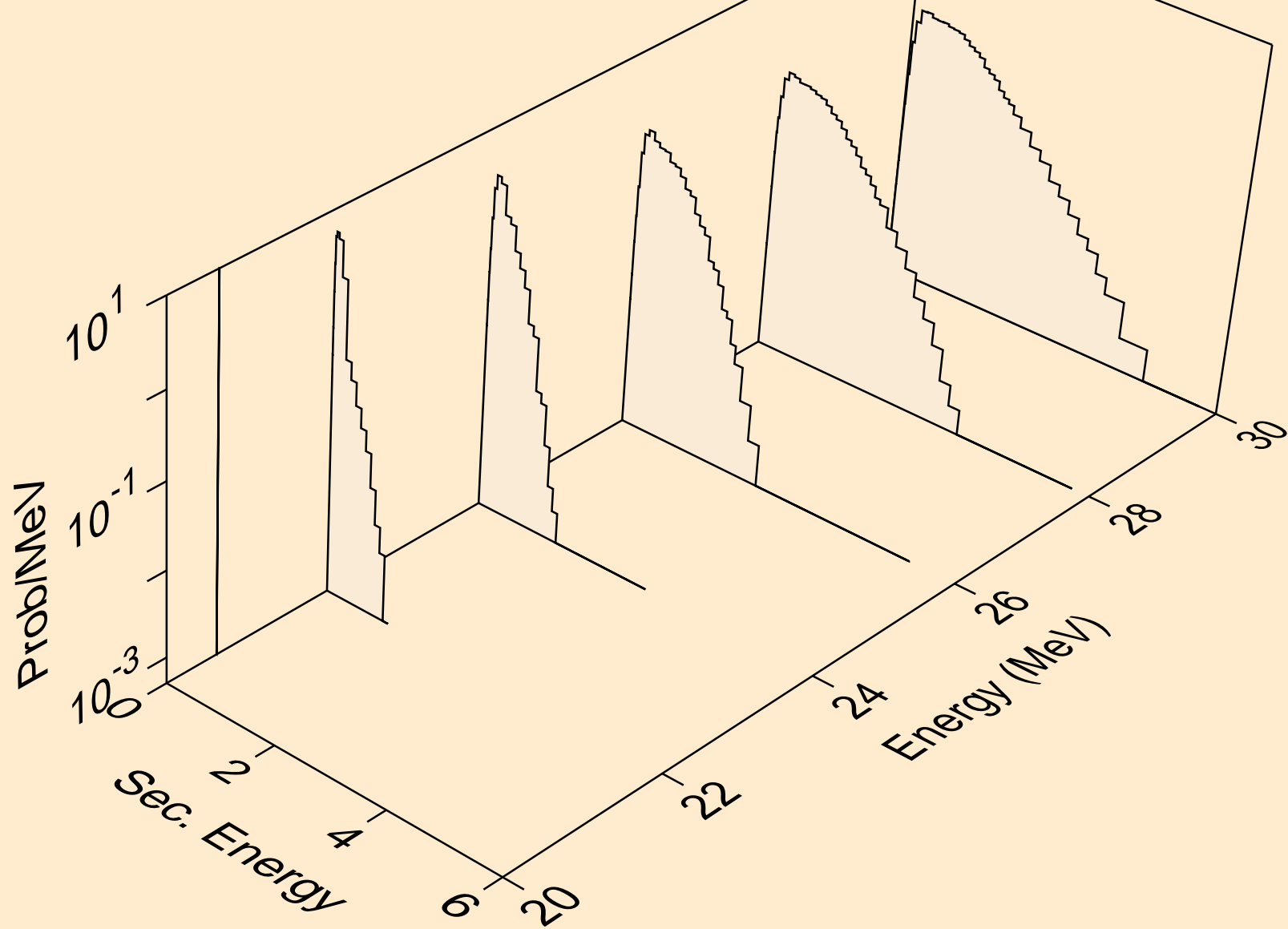

GD146 PROTON ACER TENDL-2021 LIBRARY; T=0.K  
neutrons from (p,2np)

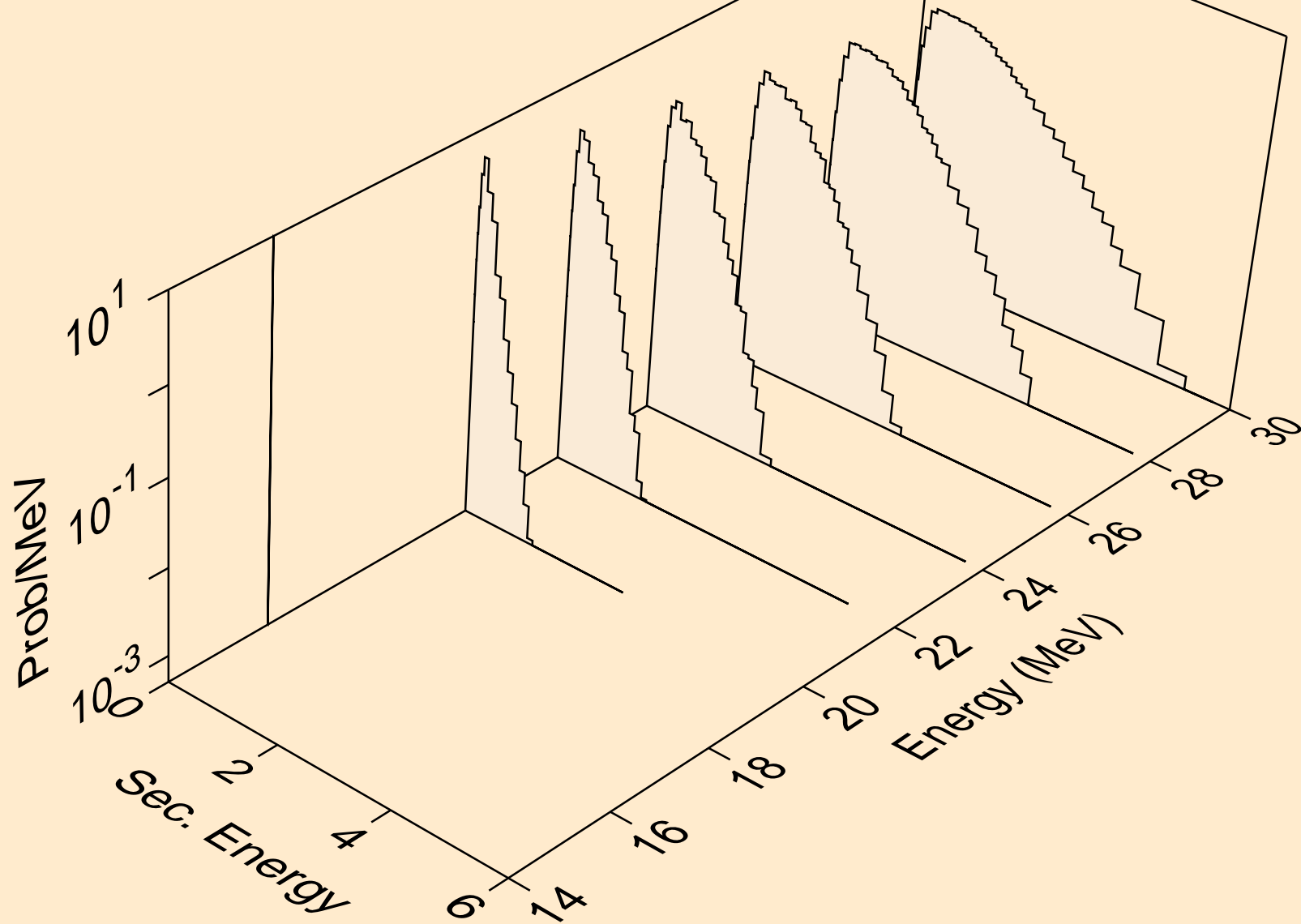

GD146 PROTON ACER TENDL-2021 LIBRARY; T=0.K  
neutrons from (p,npa)

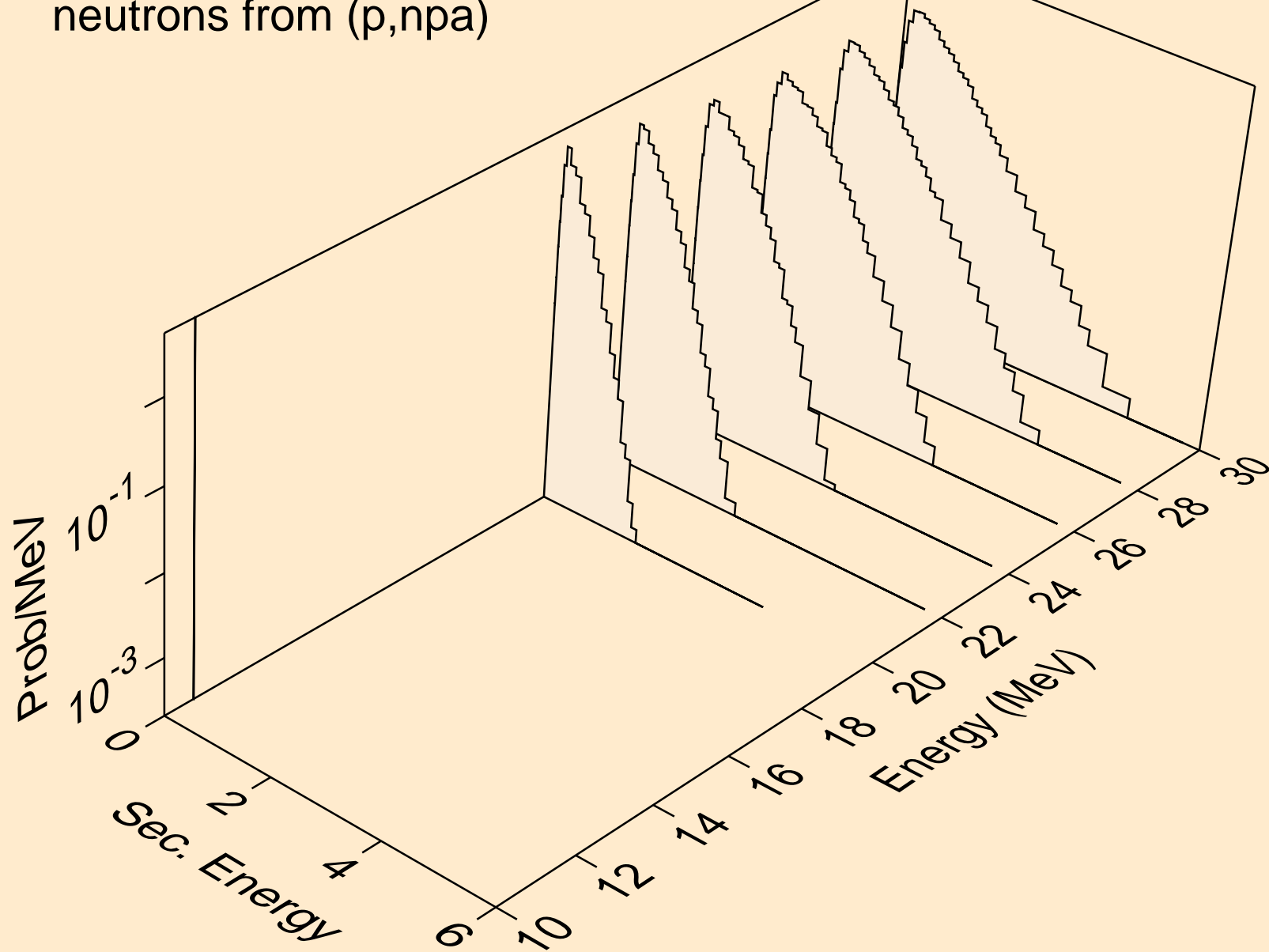

GD146 PROTON ACER TENDL-2021 LIBRARY; T=0.K  
deuterons from (p,x)

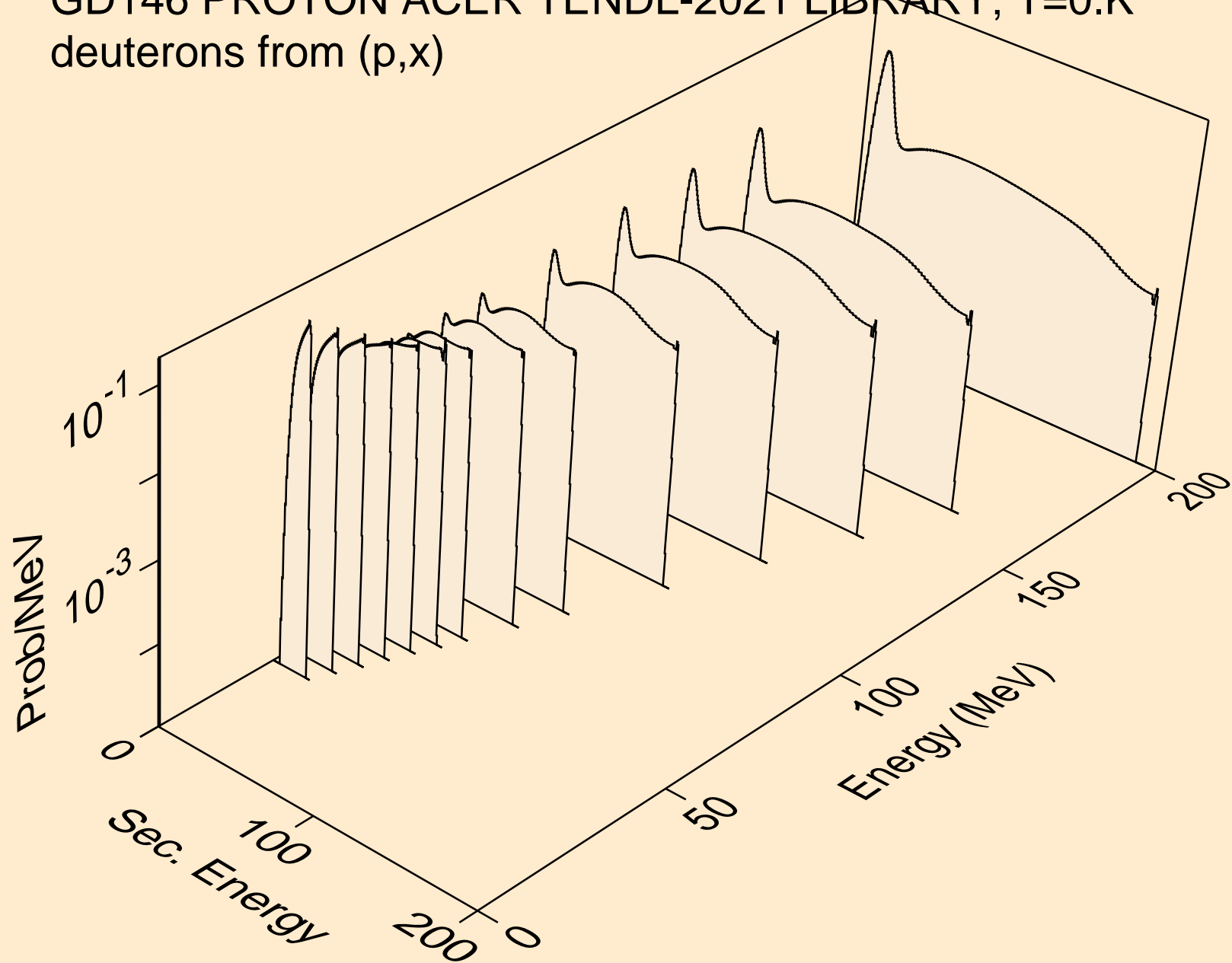

GD146 PROTON ACER TENDL-2021 LIBRARY; T=0.K  
deuterons from (p,n\*)d

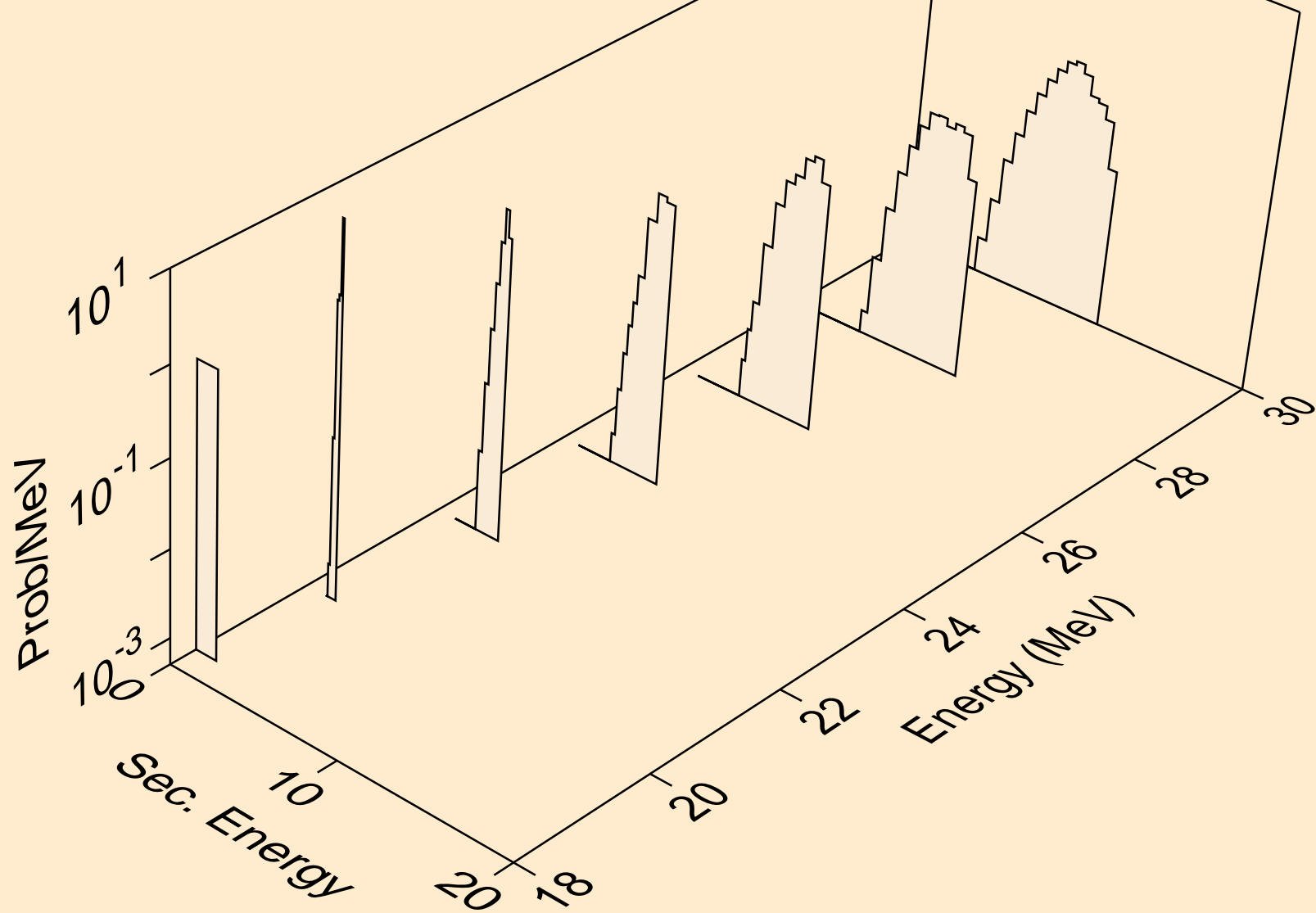

GD146 PROTON ACER TENDL-2021 LIBRARY; T=0.K  
deuterons from (p,d)

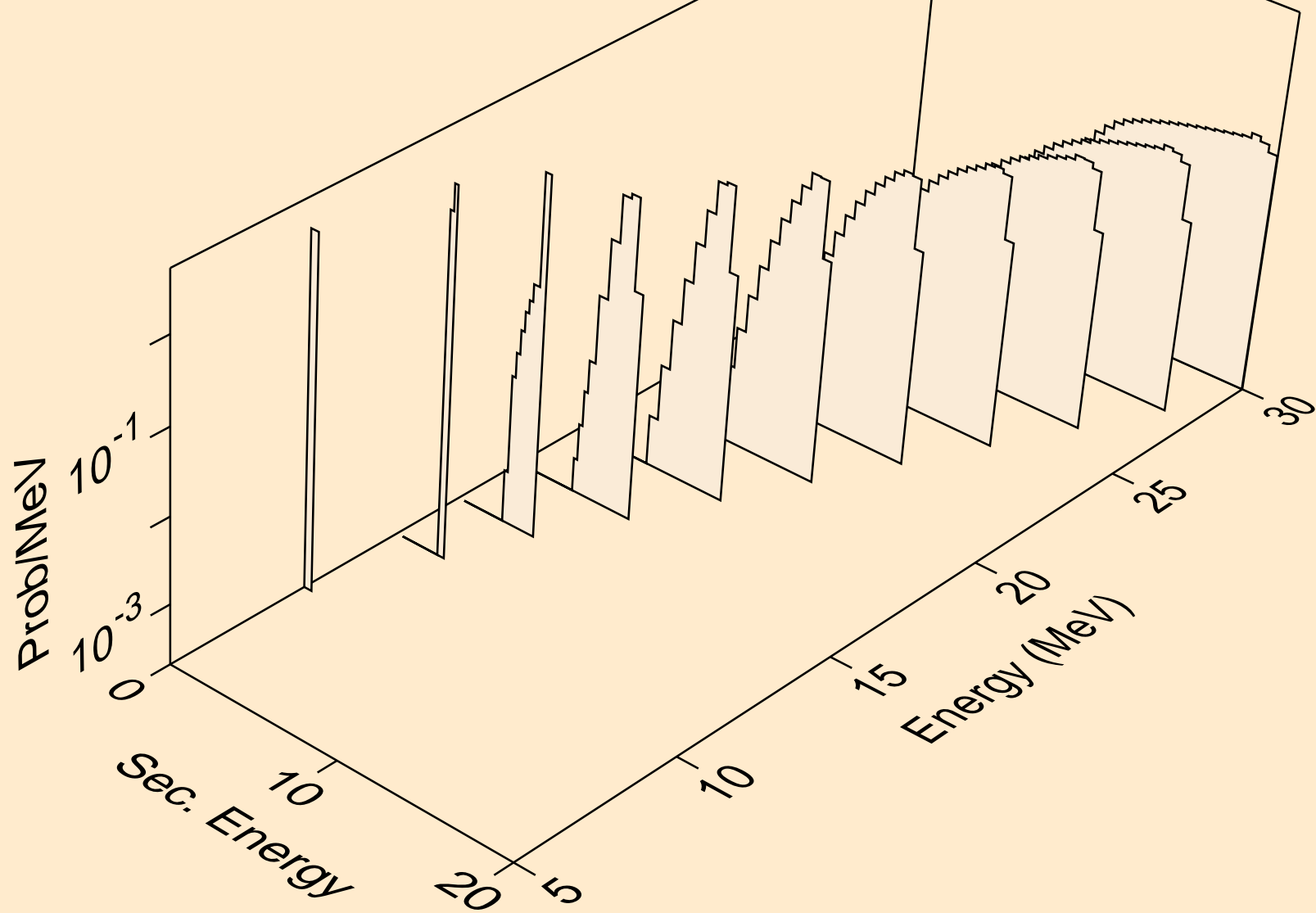

GD146 PROTON ACER TENDL-2021 LIBRARY; T=0.K  
deuterons from (p,pd)

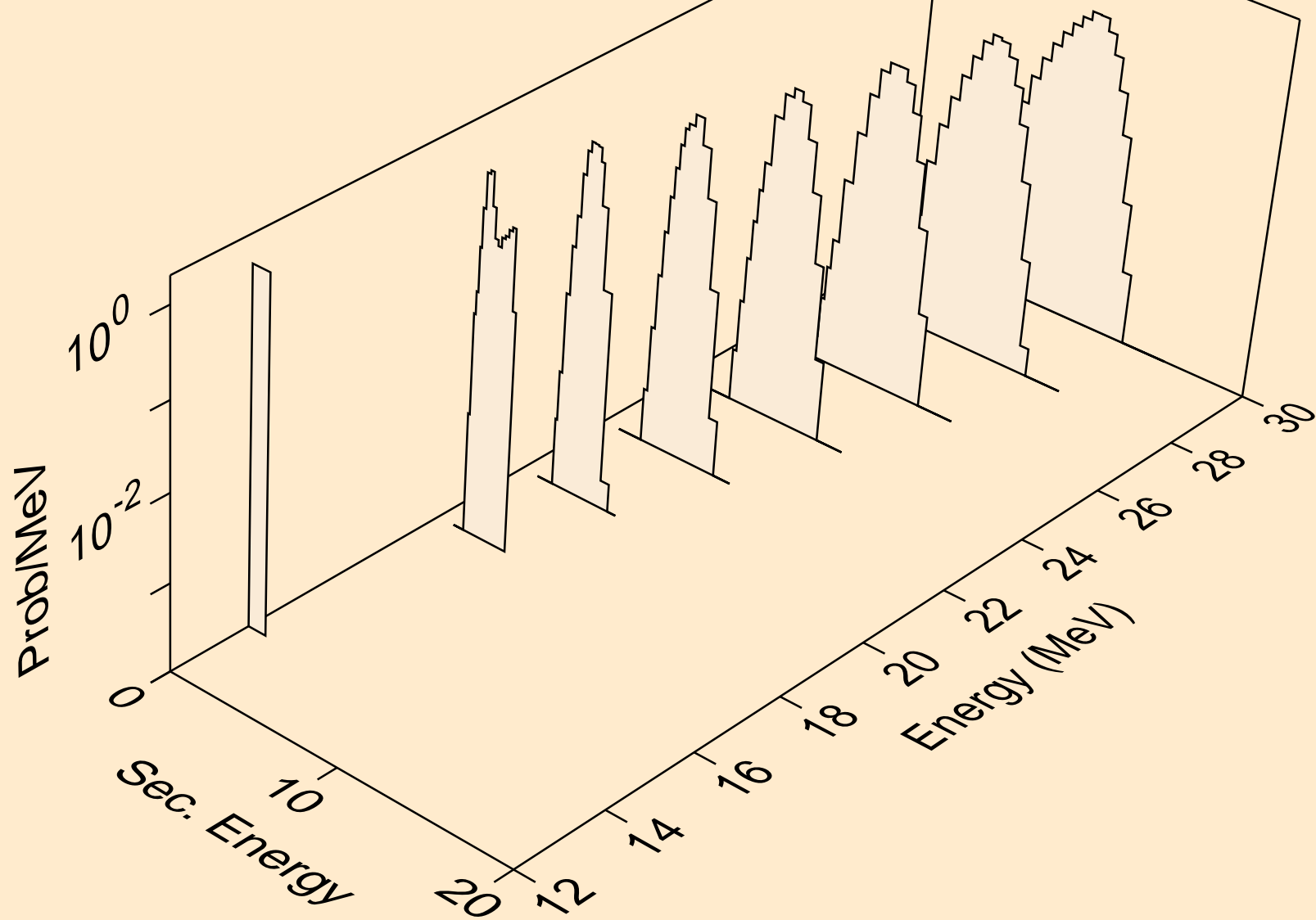



GD146 PROTON ACER TENDL-2021 LIBRARY; T=0.K  
deuterons from (p,da)

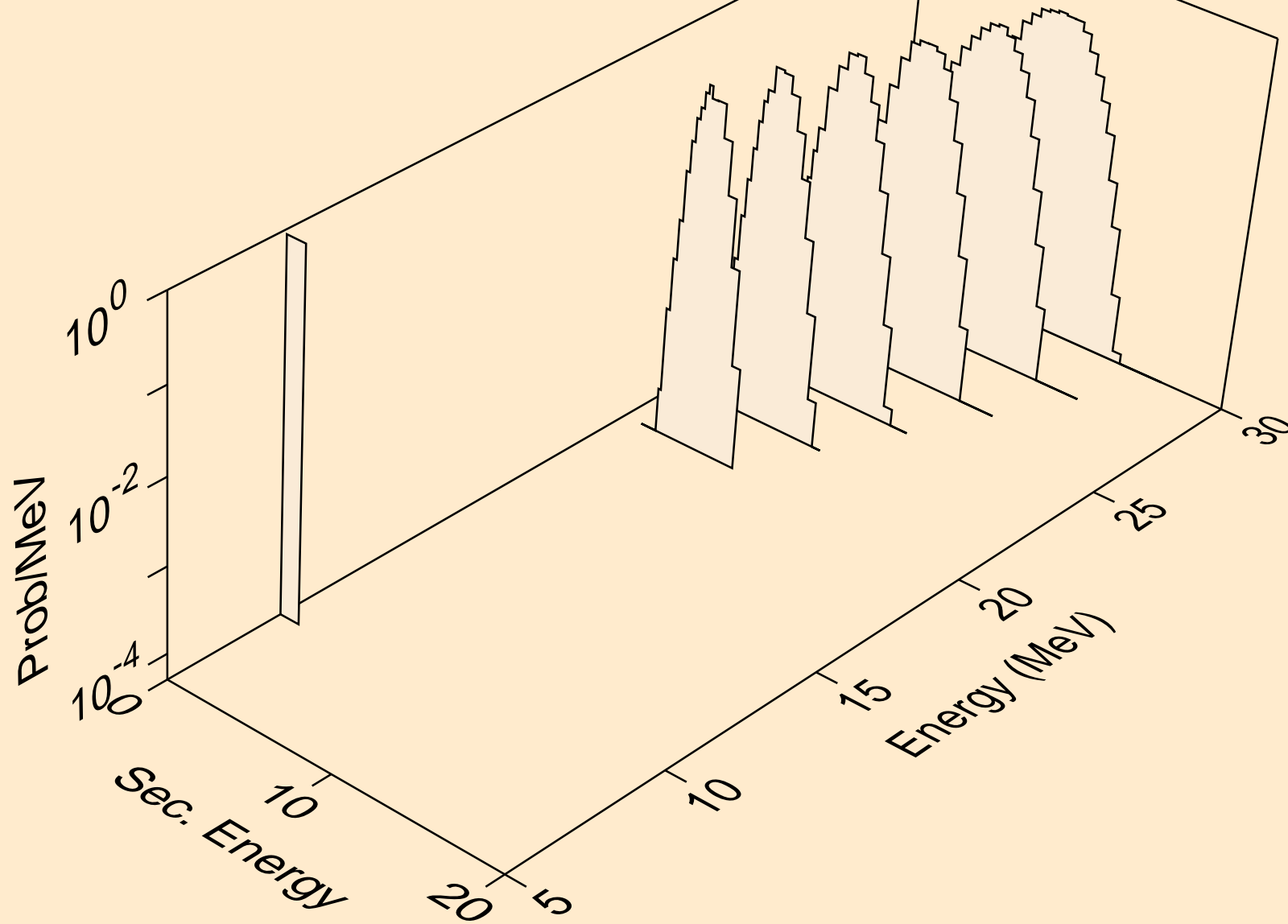

GD146 PROTON ACER TENDL-2021 LIBRARY; T=0.K  
tritons from (p,x)

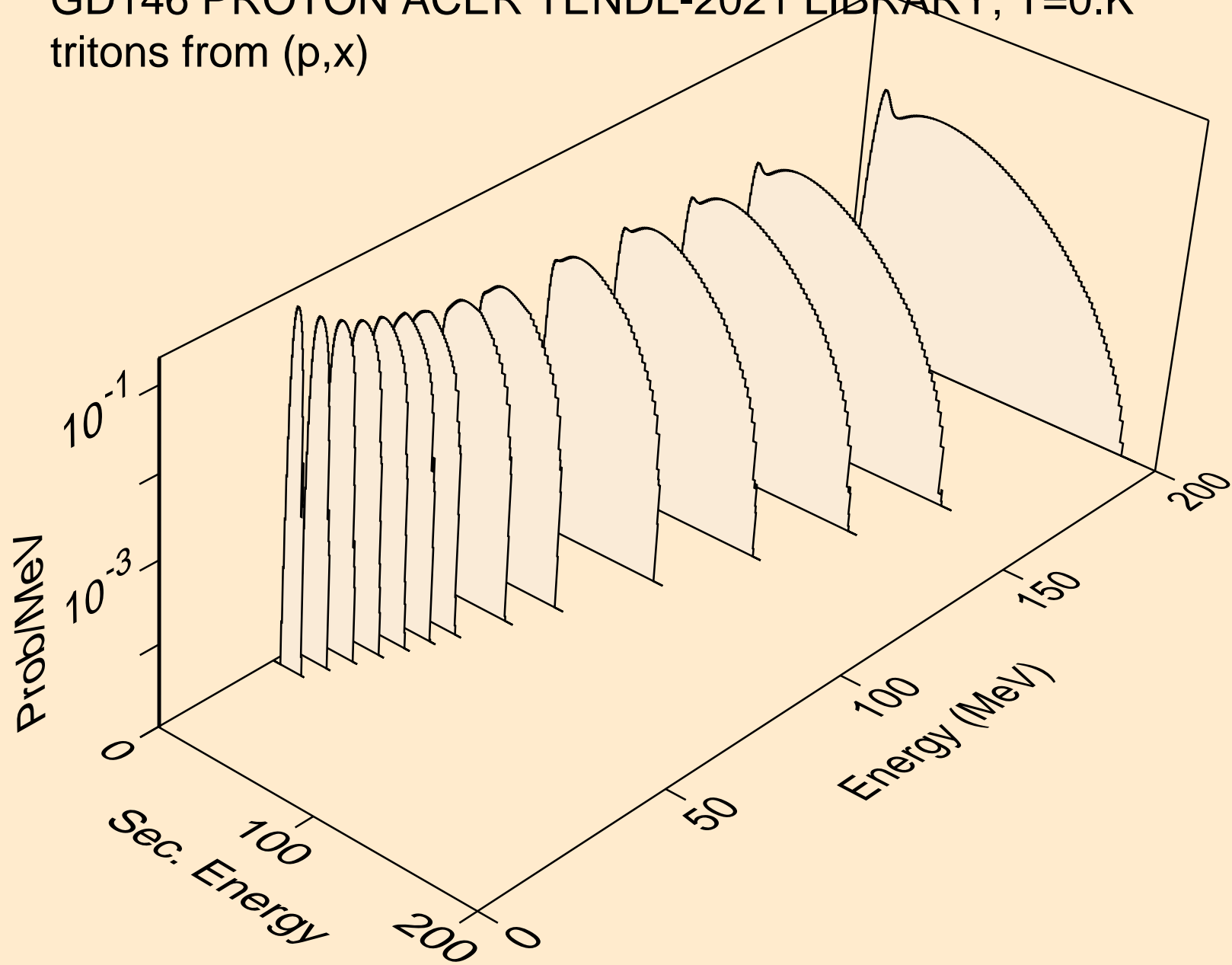

GD146 PROTON ACER TENDL-2021 LIBRARY; T=0.K  
tritons from (p,n\*)t

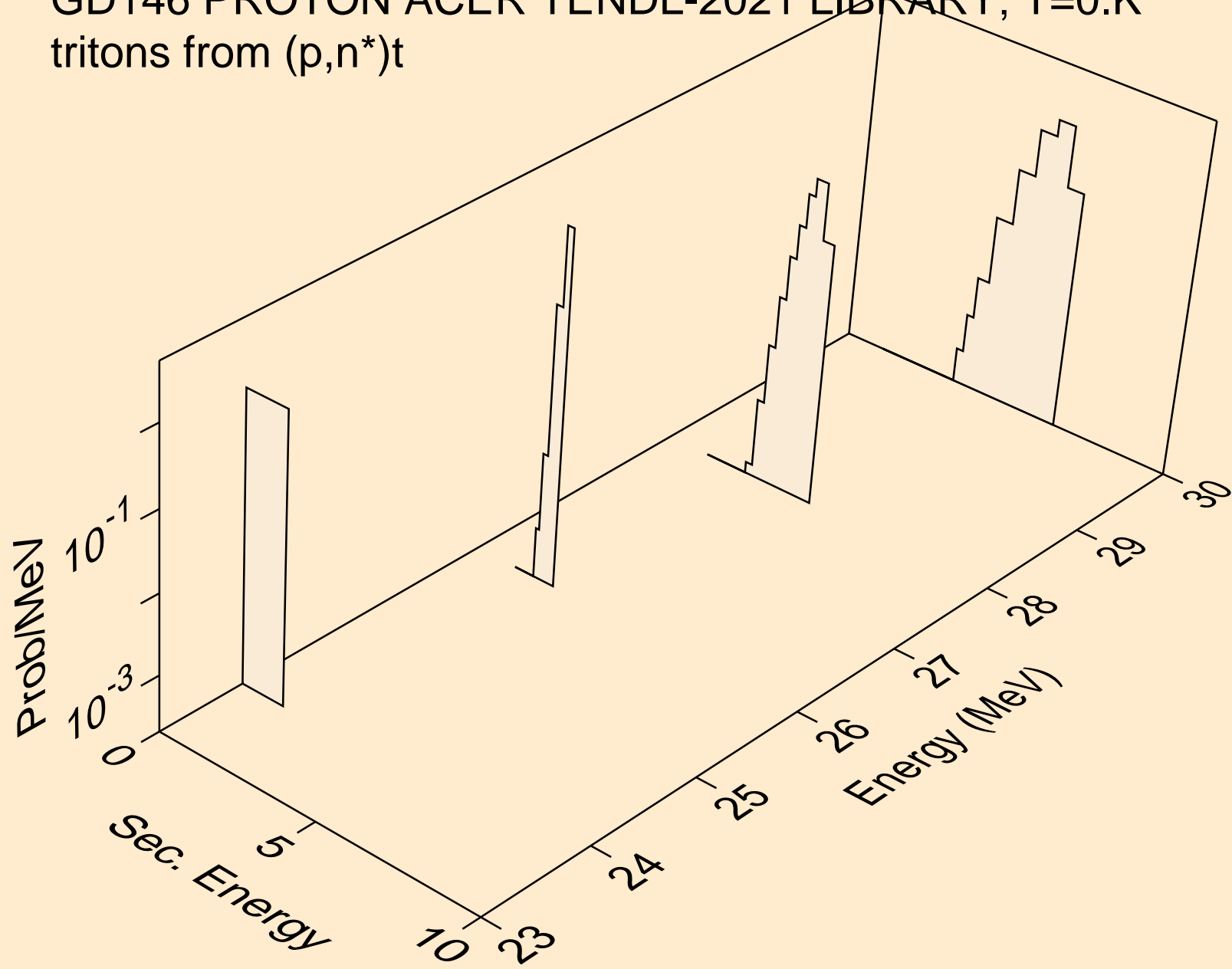

GD146 PROTON ACER TENDL-2021 LIBRARY; T=0.K  
tritons from (p,t)

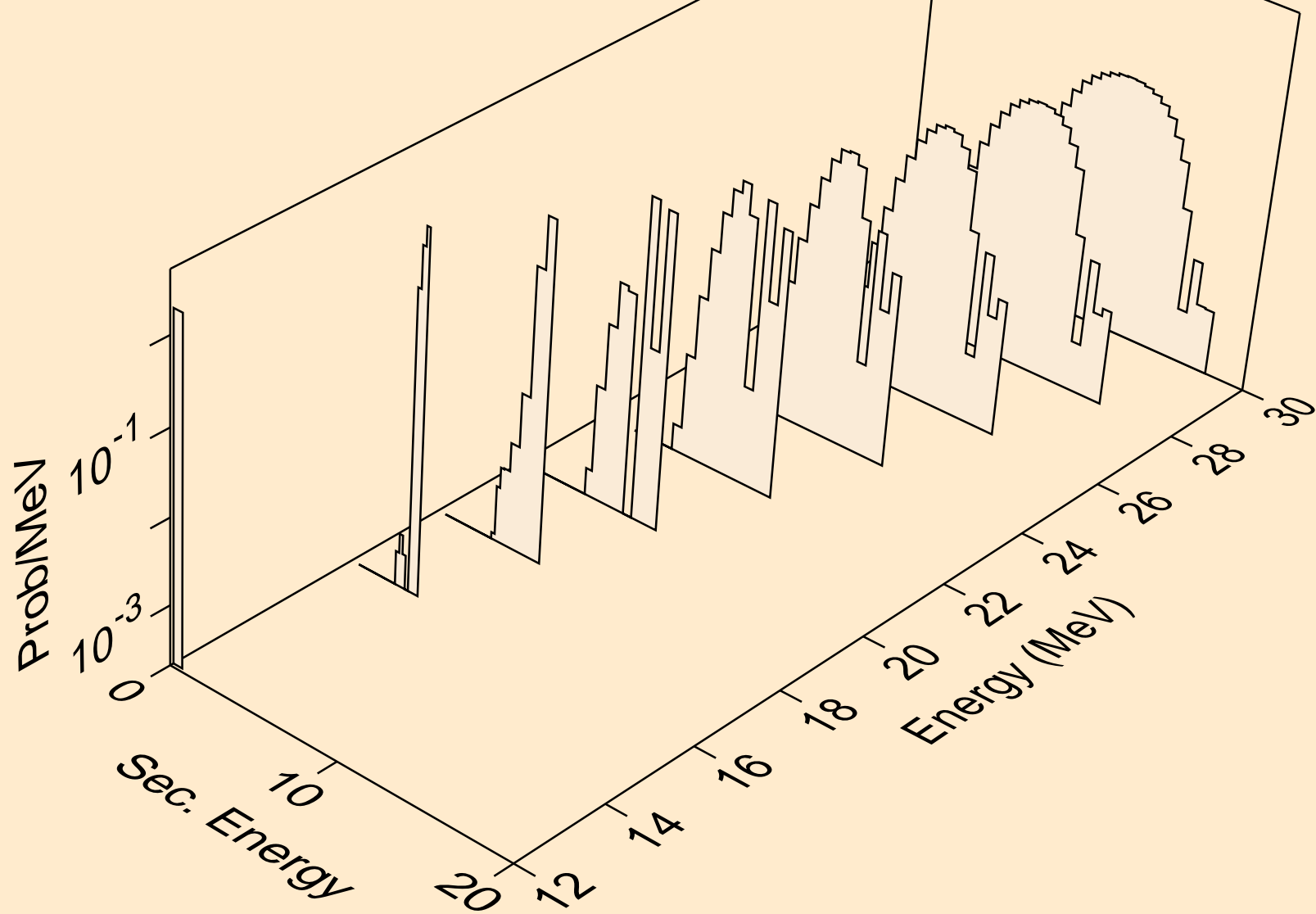

GD146 PROTON ACER TENDL-2021 LIBRARY; T=0.K  
tritons from (p,pt)

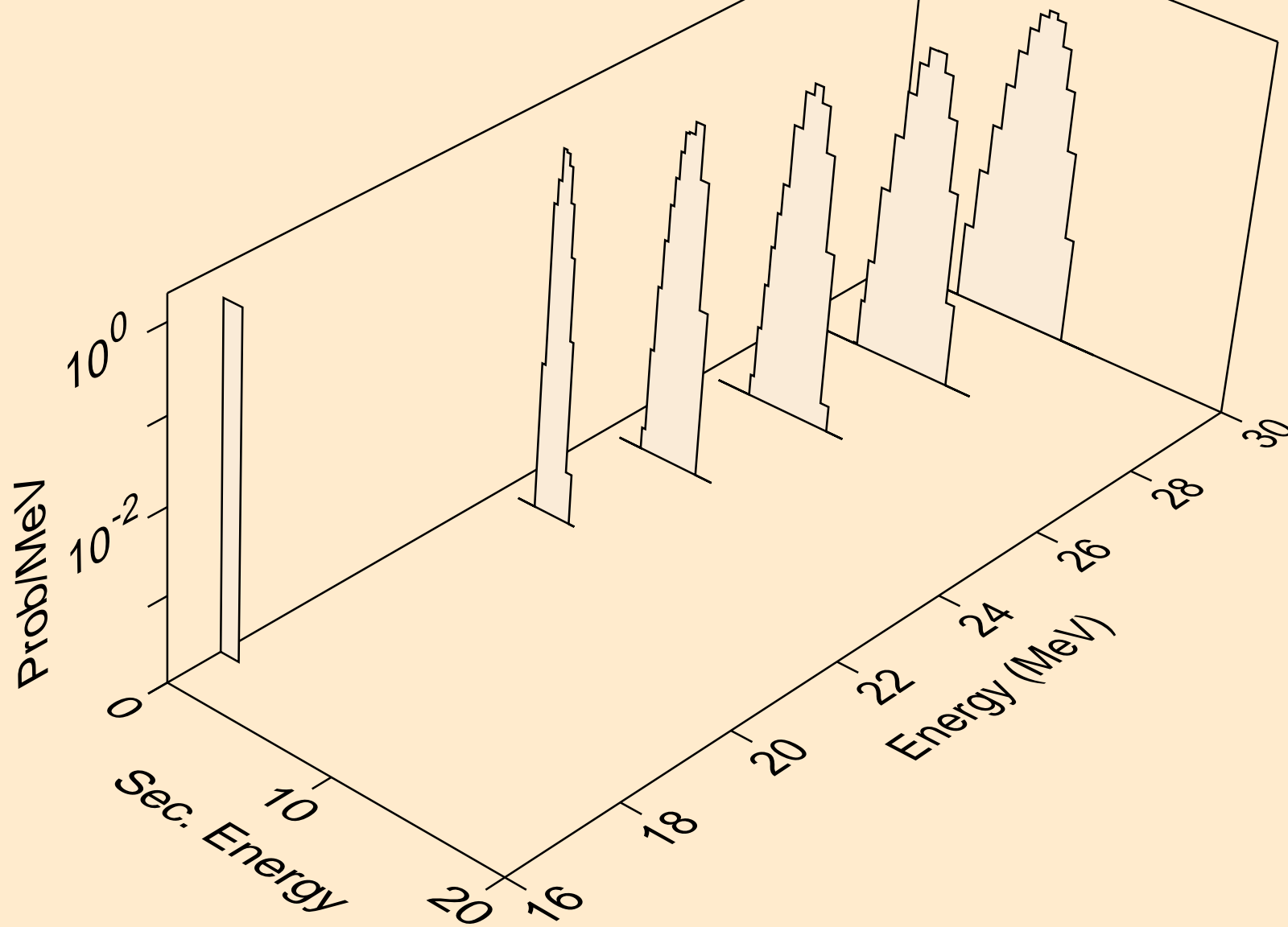

GD146 PROTON ACER TENDL-2021 LIBRARY; T=0.K  
he3s from (p,x)

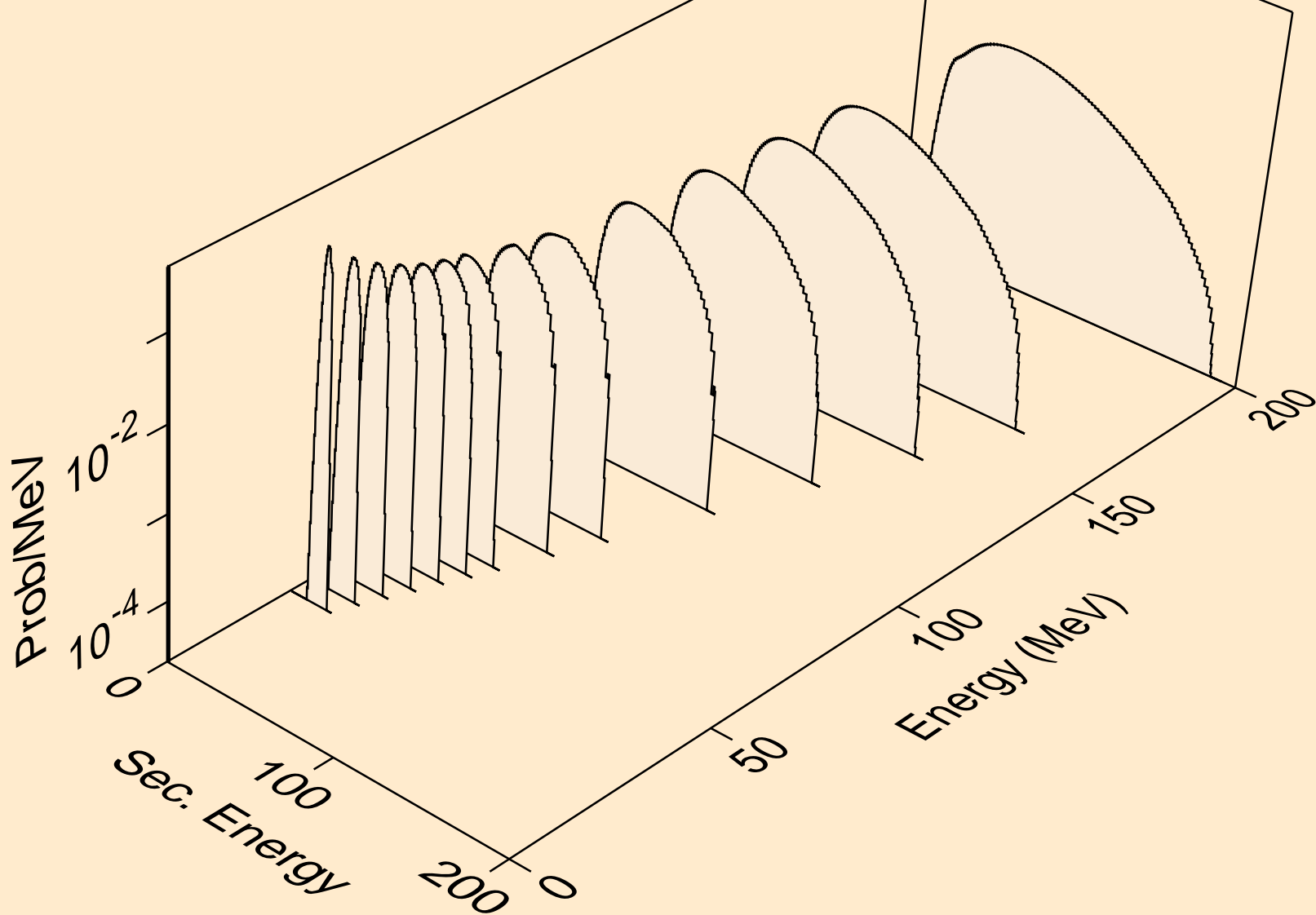

GD146 PROTON ACER TENDL-2021 LIBRARY; T=0.K  
he3s from (p,n\*)he3

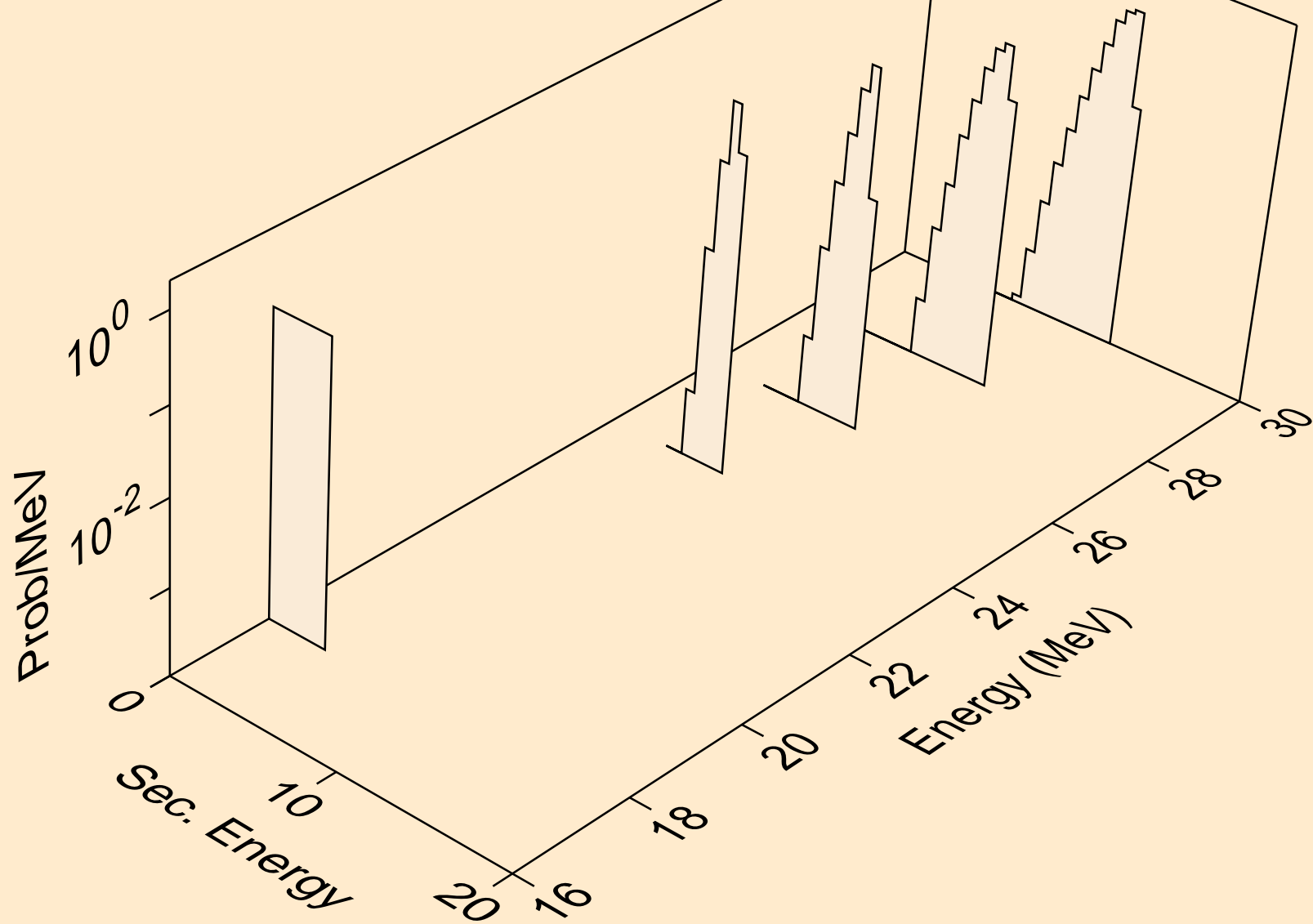

GD146 PROTON ACER TENDL-2021 LIBRARY; T=0.K  
he3s from (p,he3)

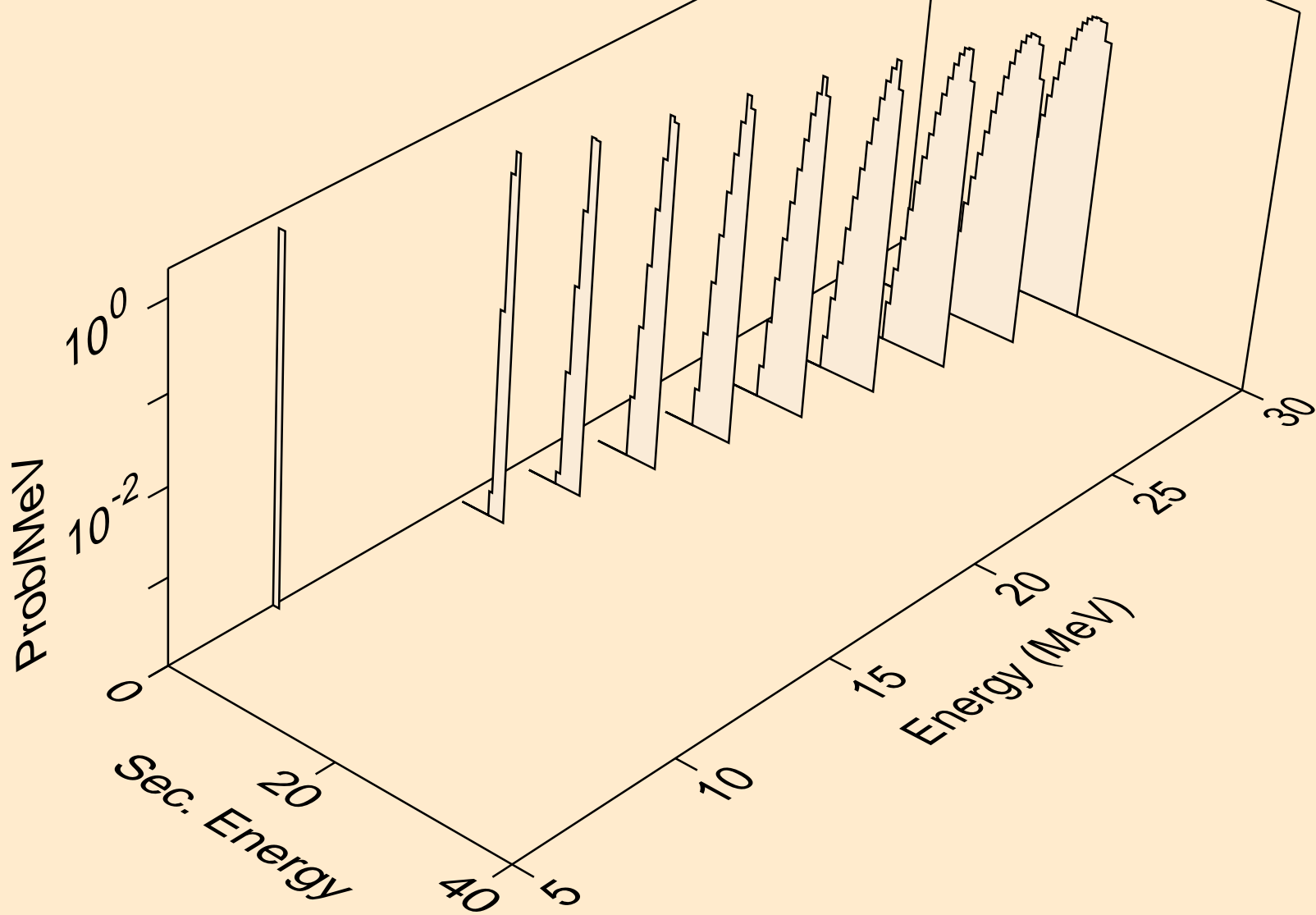



GD146 PROTON ACER TENDL-2021 LIBRARY; T=0.K  
alphas from (p,x)

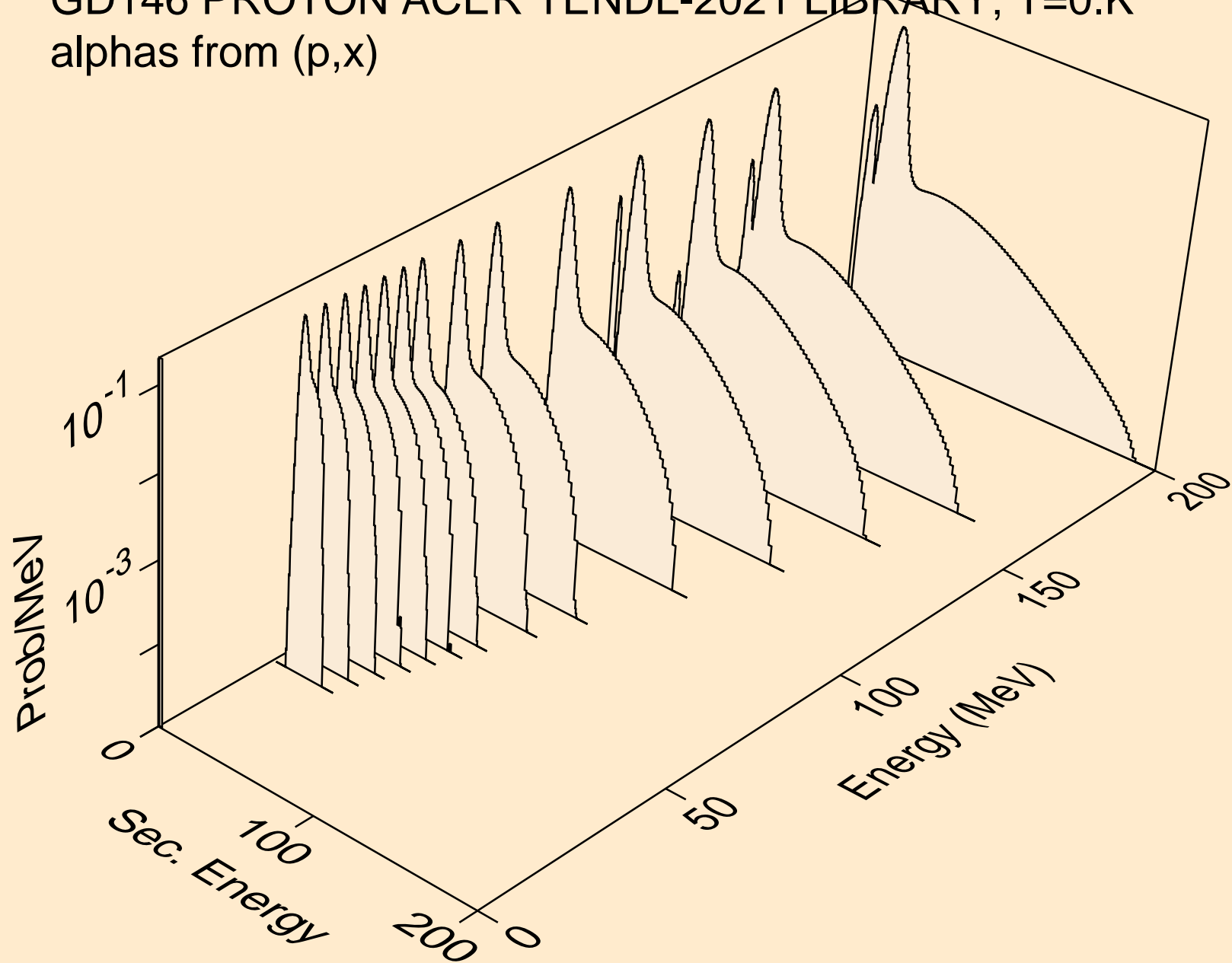

GD146 PROTON ACER TENDL-2021 LIBRARY; T=0.K  
alphas from (p,n\*)a

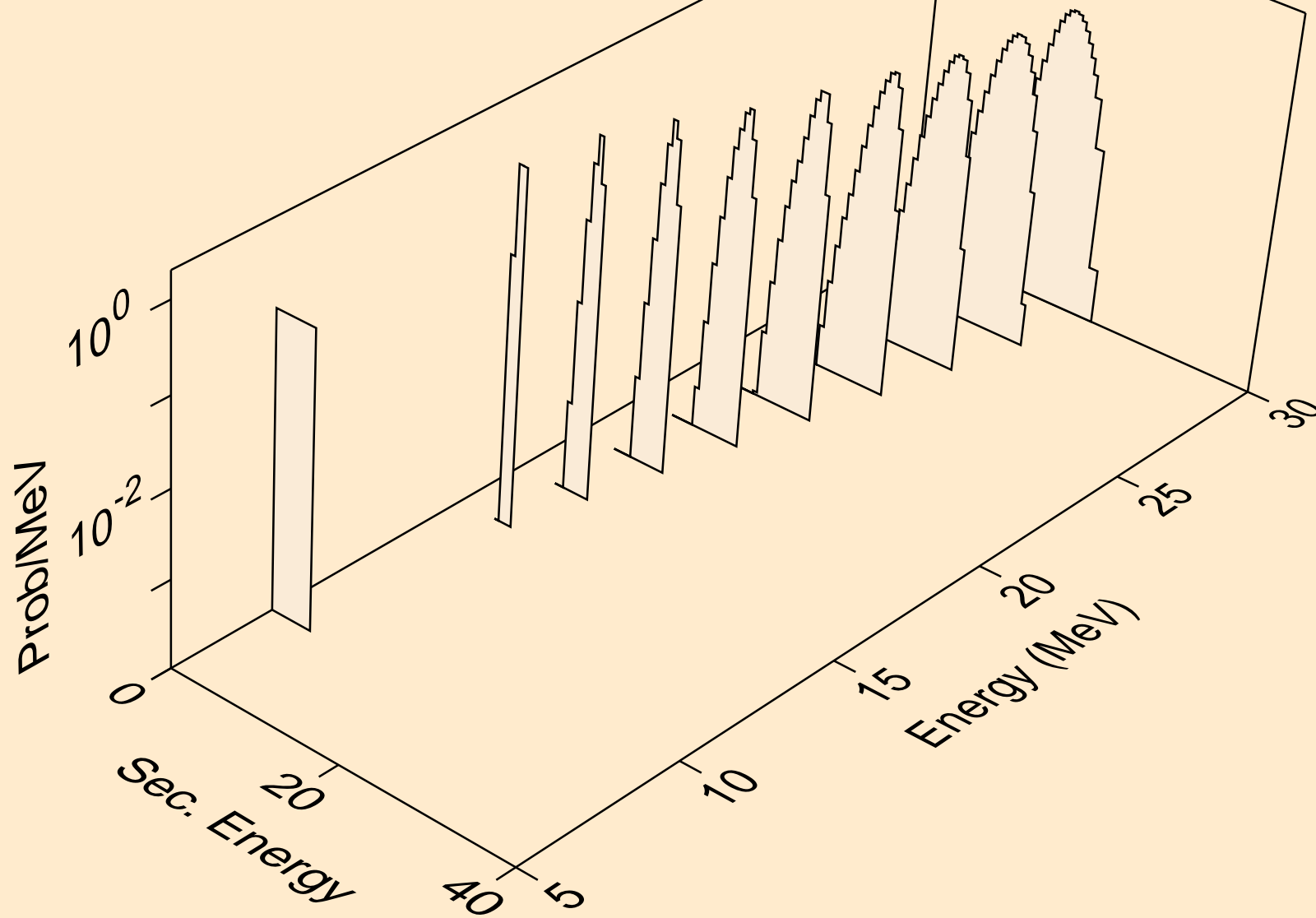

GD146 PROTON ACER TENDL-2021 LIBRARY; T=0.K  
alphas from (p,2n)a

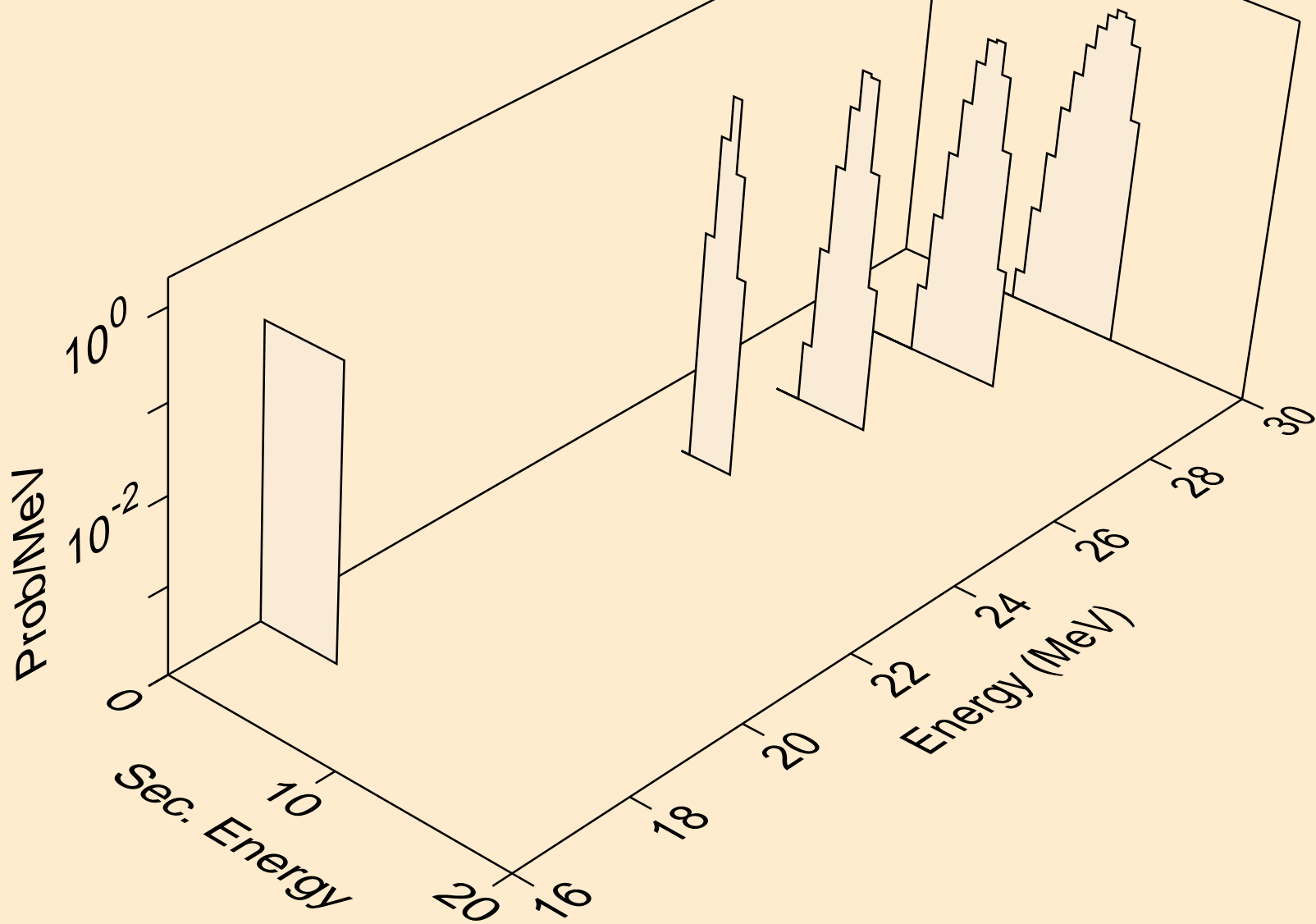

GD146 PROTON ACER TENDL-2021 LIBRARY; T=0.K  
alphas from (p,n\*)2a

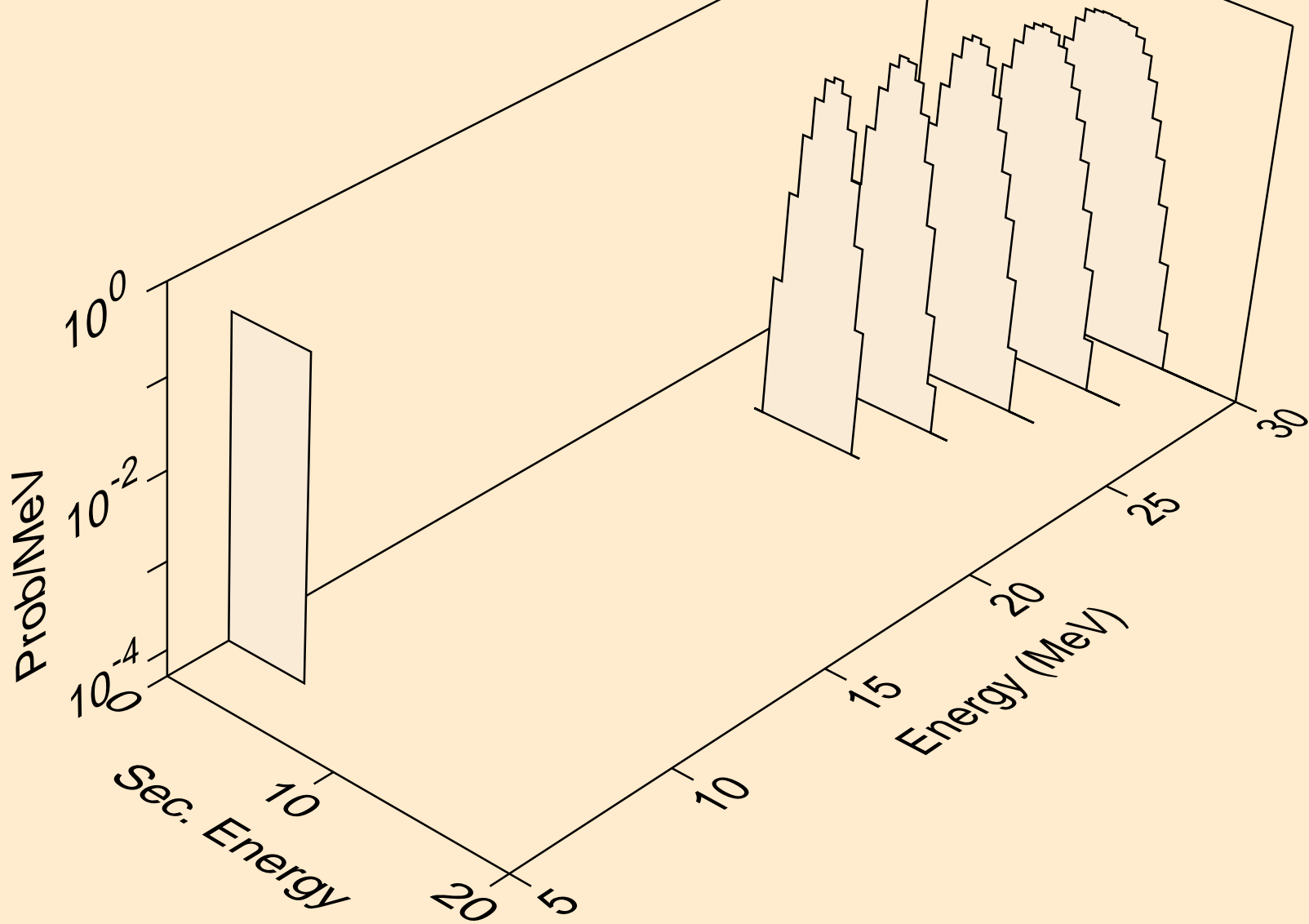

GD146 PROTON ACER TENDL-2021 LIBRARY; T=0.K  
alphas from (p,npa)

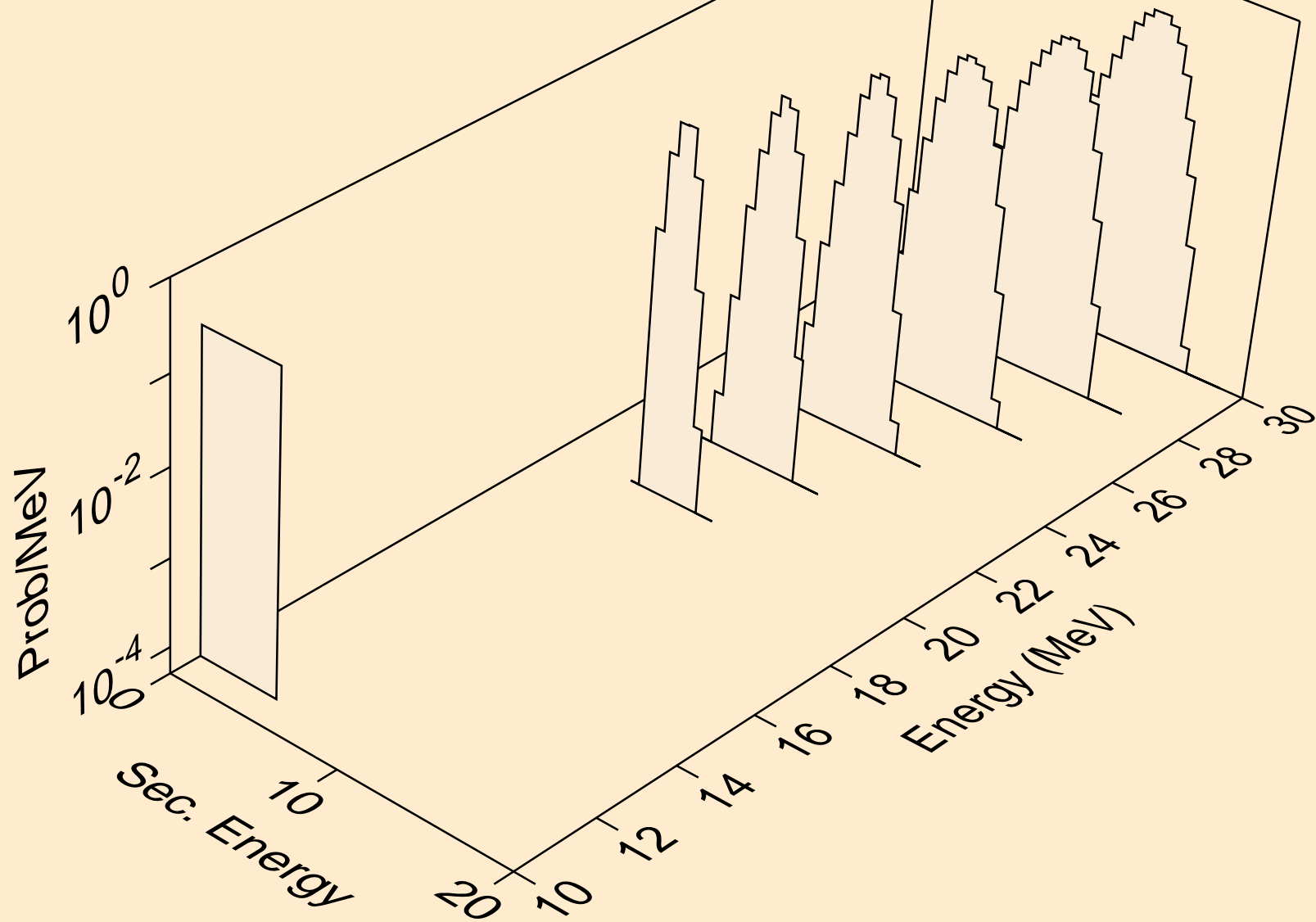

GD146 PROTON ACER TENDL-2021 LIBRARY; T=0.K  
alphas from (p,a)

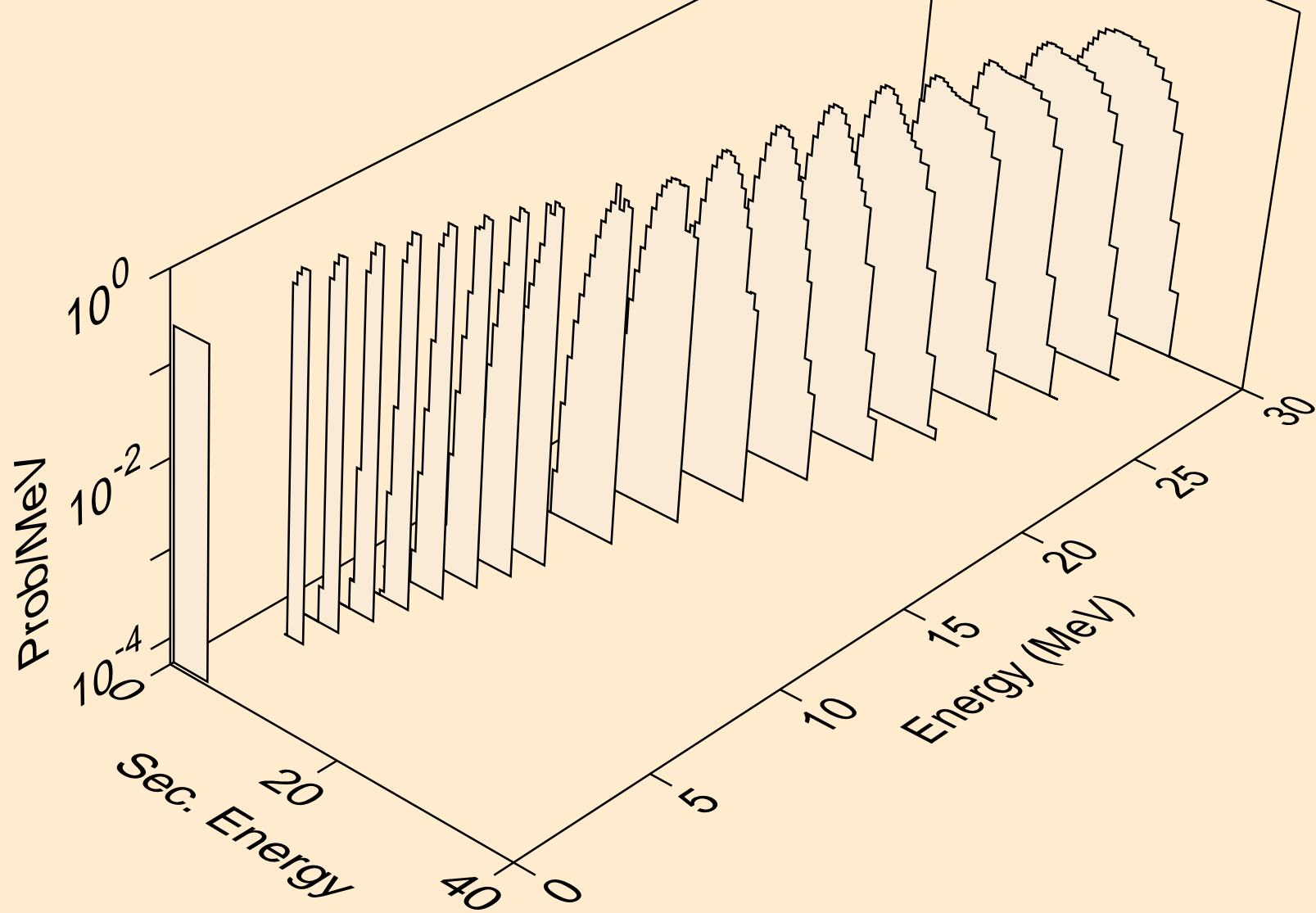

GD146 PROTON ACER TENDL-2021 LIBRARY; T=0.K  
alphas from (p,2a)

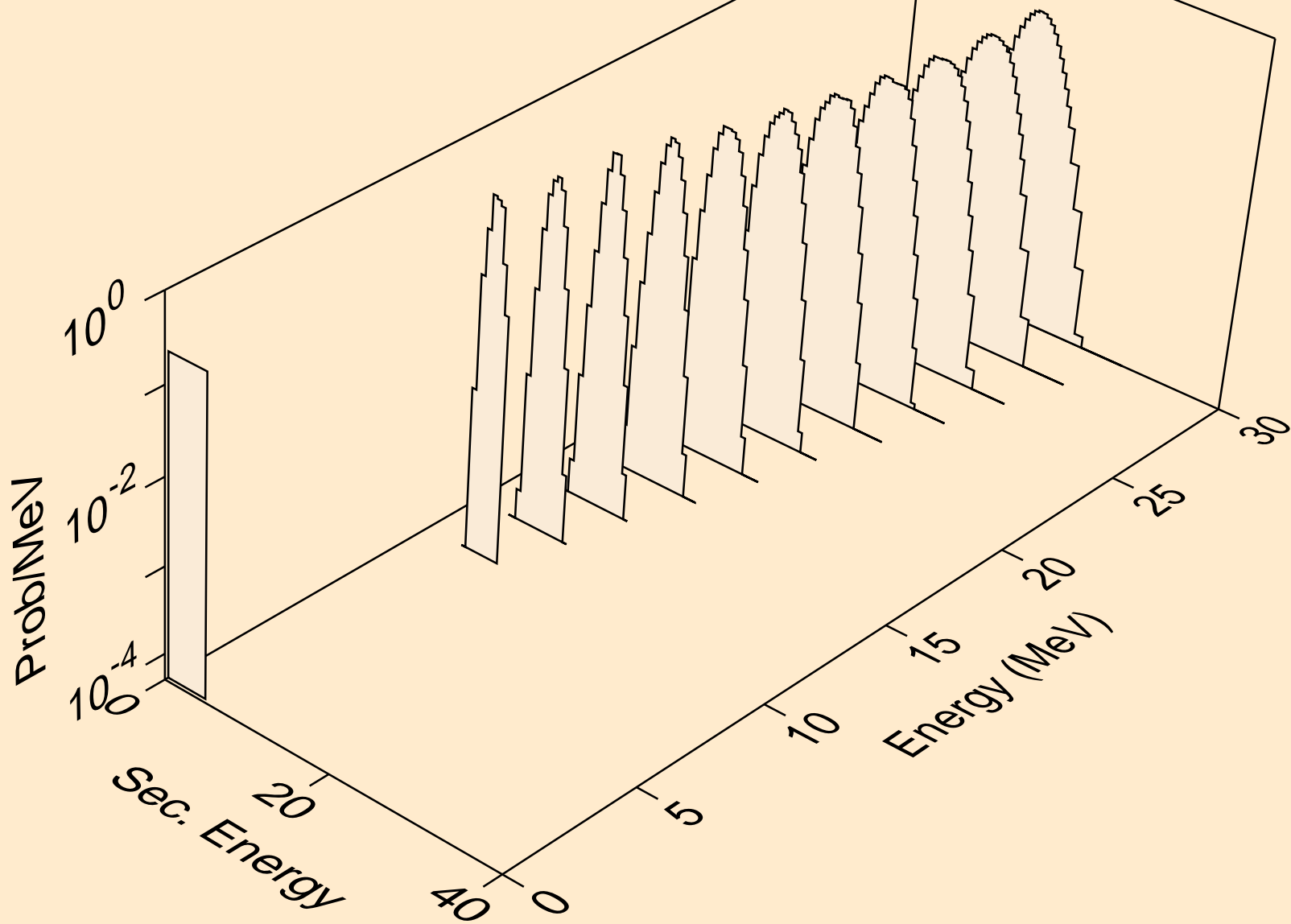

GD146 PROTON ACER TENDL-2021 LIBRARY; T=0.K  
alphas from (p,pa)

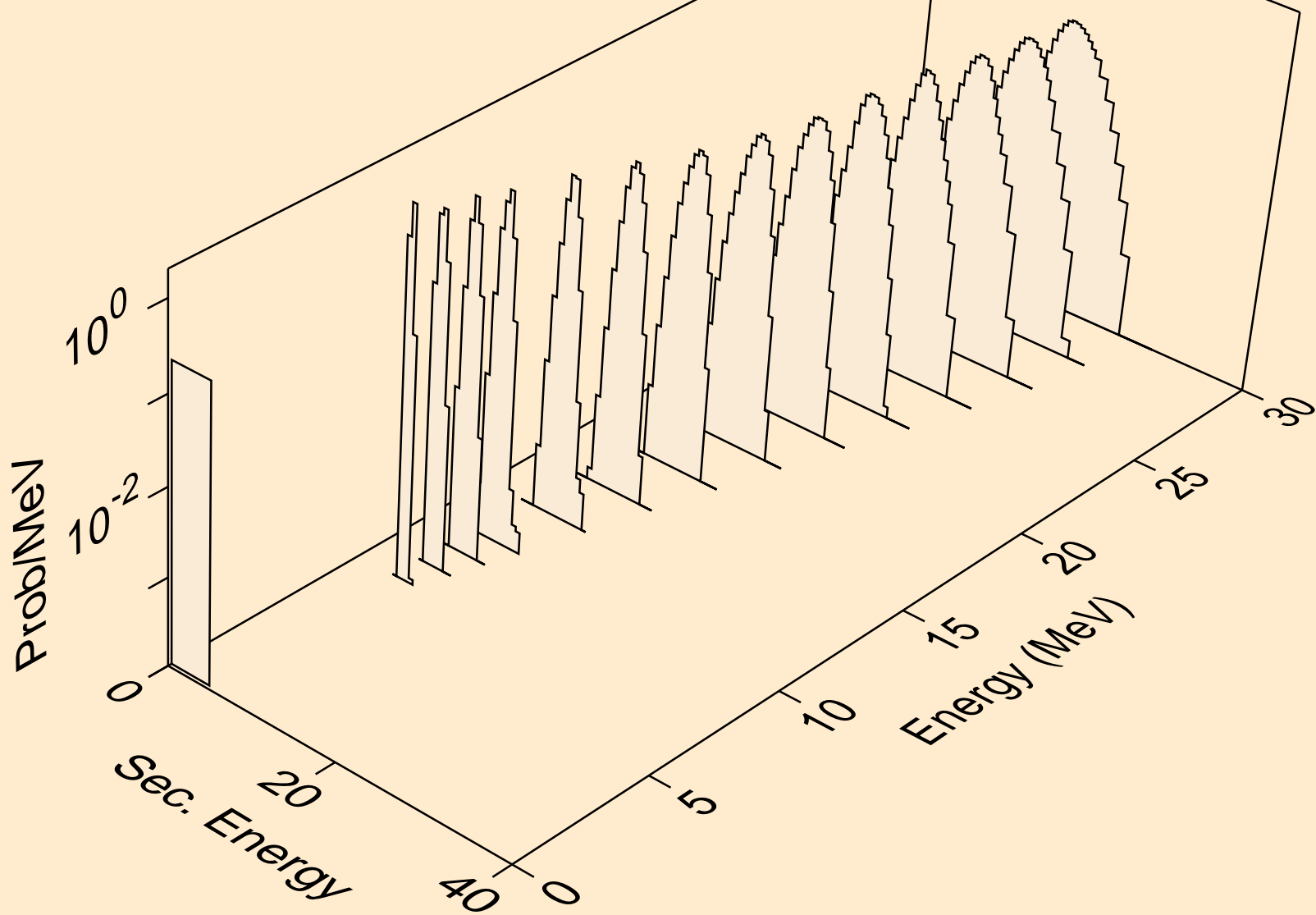



GD146 PROTON ACER TENDL-2021 LIBRARY; T=0.K  
alphas from (p,da)

