

# HG182 PROTON ACER TENDL-2021 LIBRARY; T=0.K

## Principal cross sections

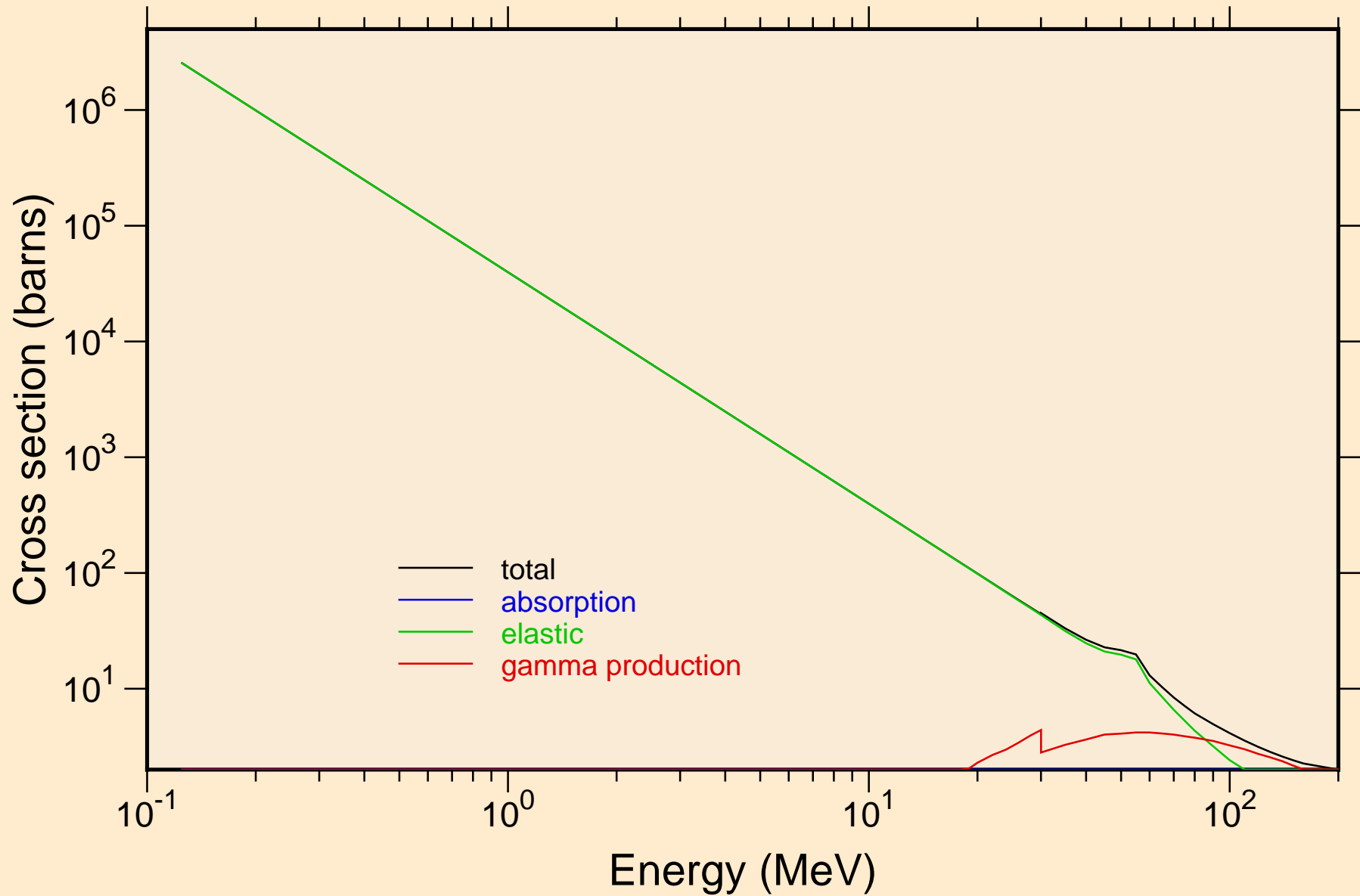

HG182 PROTON ACER TENDL-2021 LIBRARY; T=0.K  
Heating

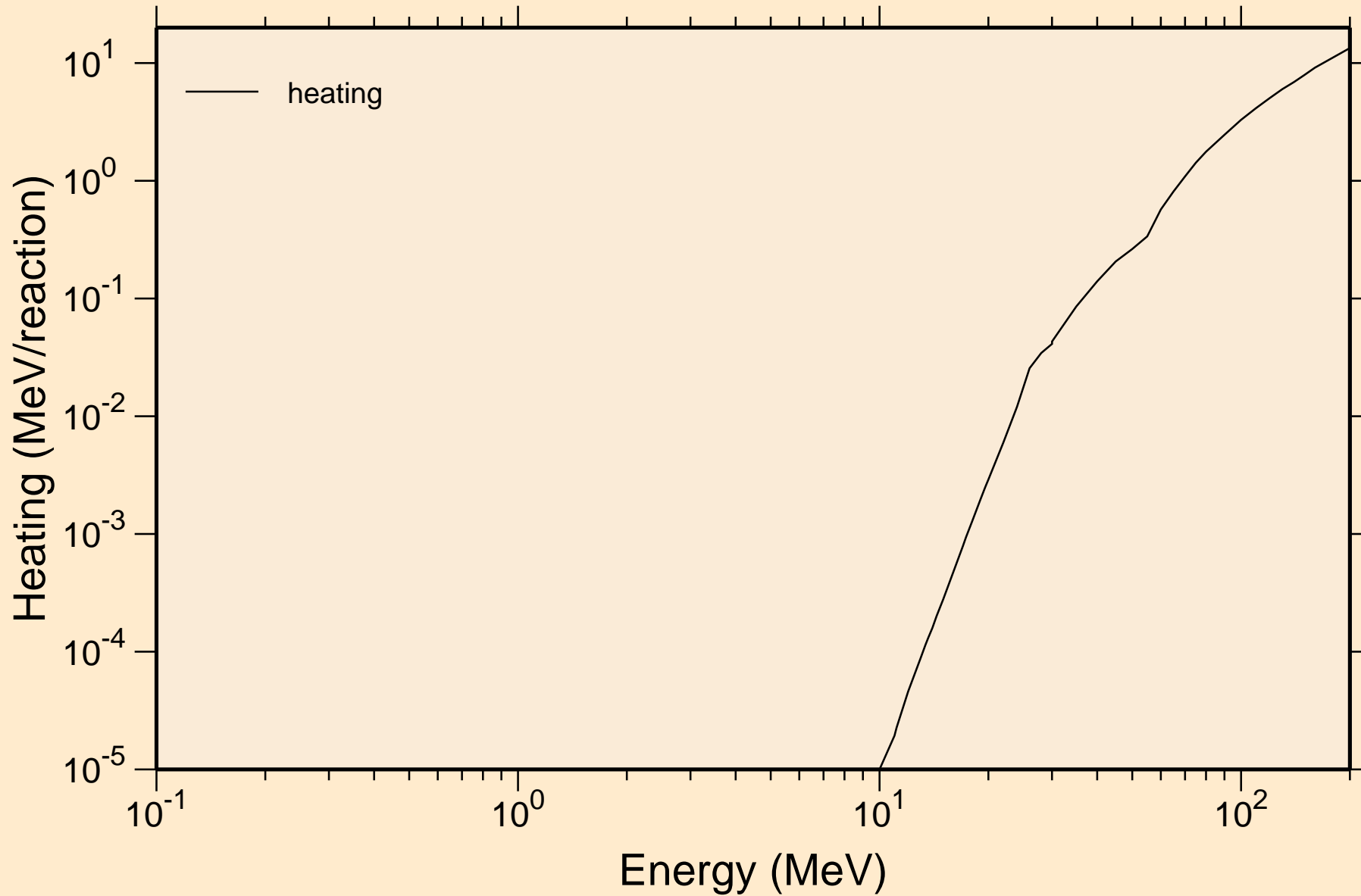

# HG182 PROTON ACER TENDL-2021 LIBRARY; T=0.K

## Principal cross sections

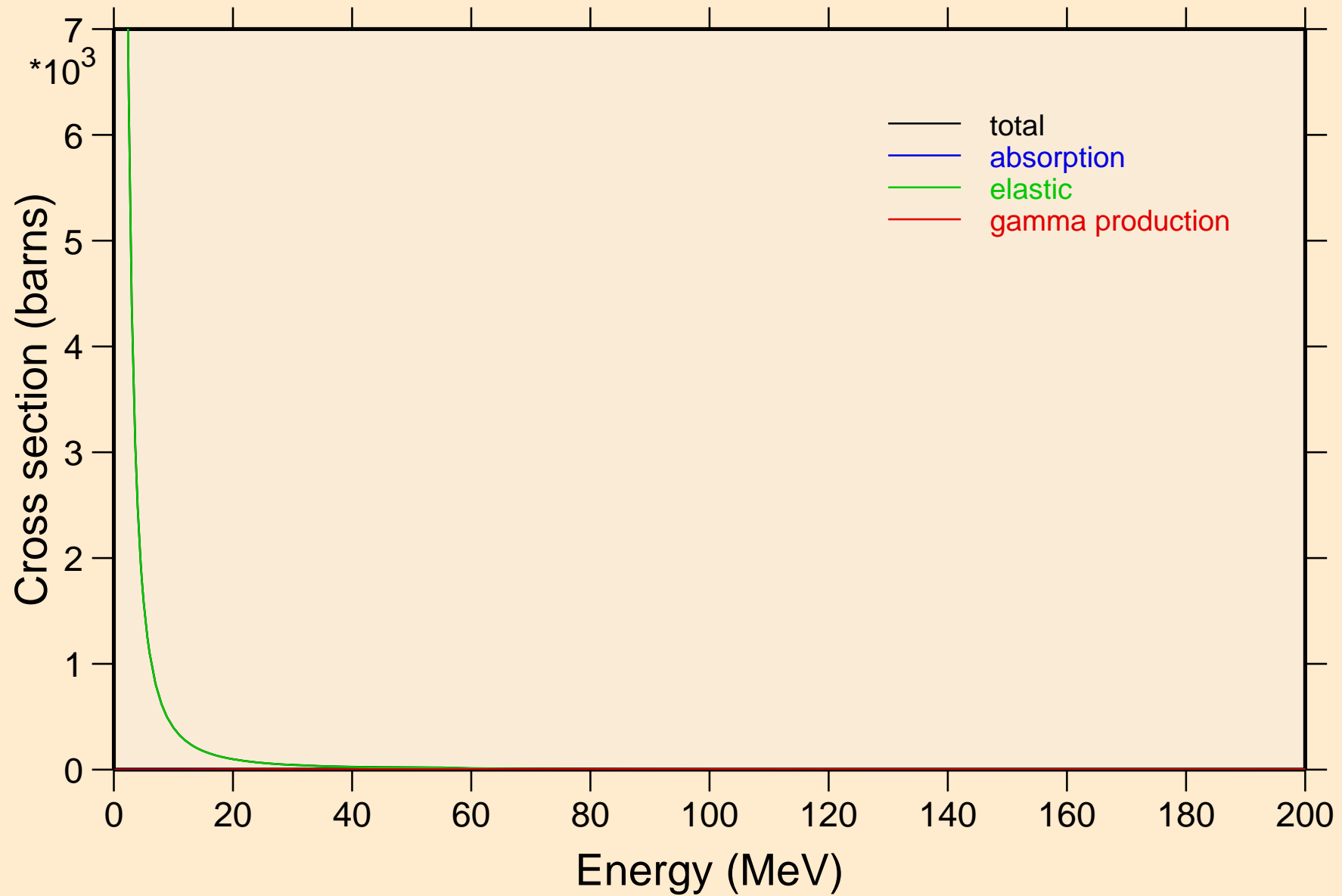

# HG182 PROTON ACER TENDL-2021 LIBRARY; T=0.K

## Heating

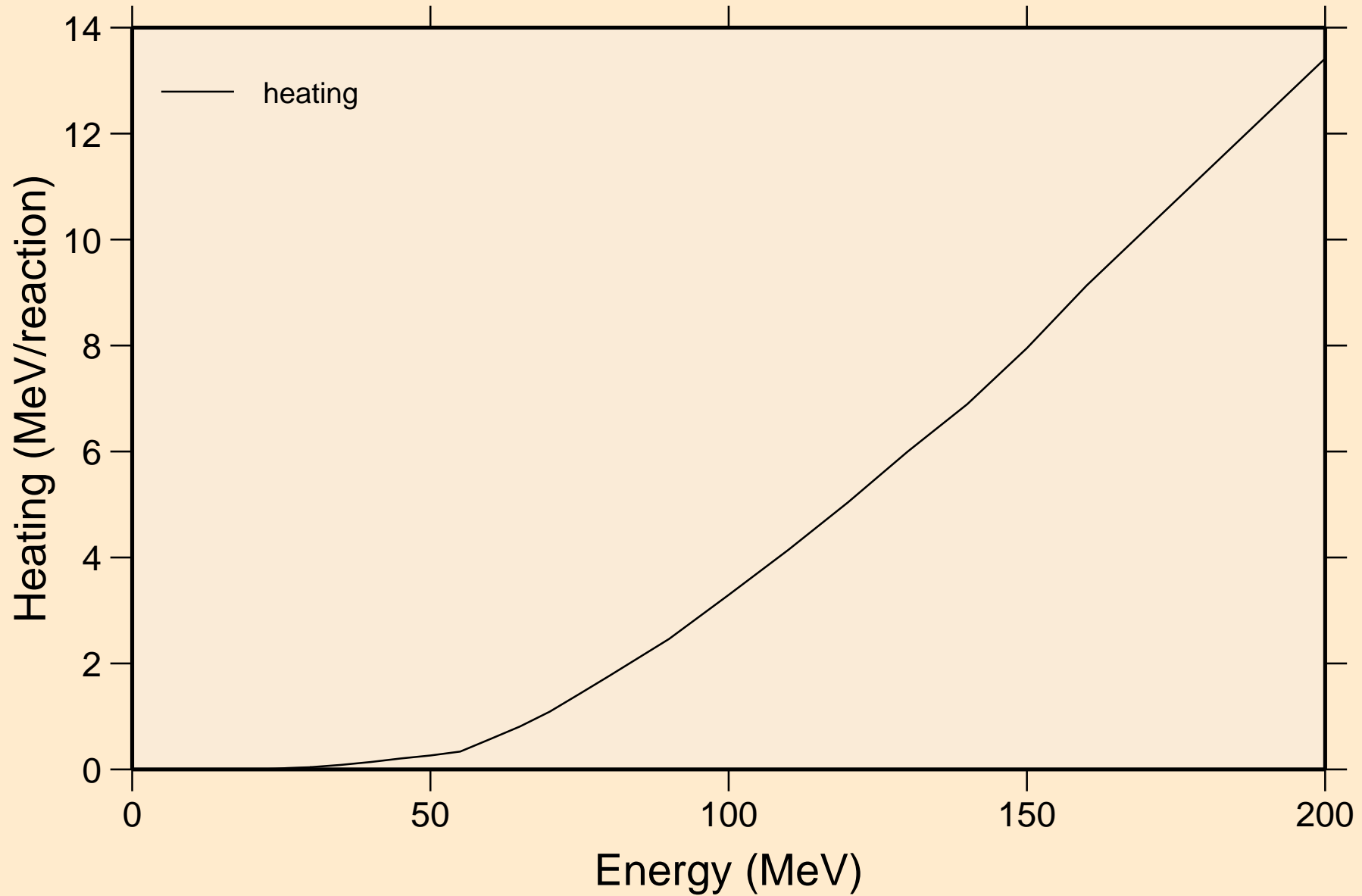

# HG182 PROTON ACER TENDL-2021 LIBRARY; T=0.K

## Threshold reactions

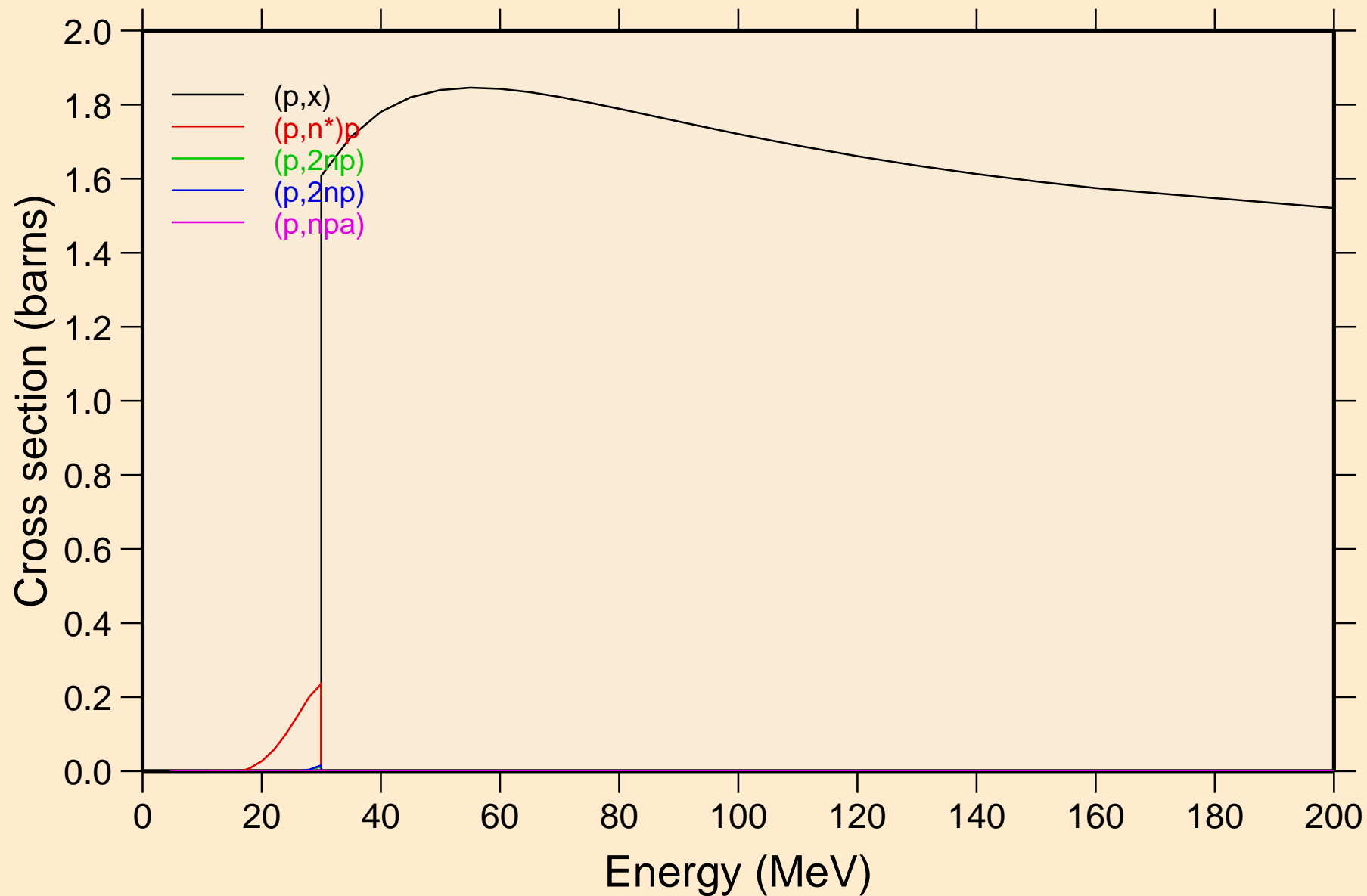

# HG182 PROTON ACER TENDL-2021 LIBRARY; T=0.K

## Threshold reactions

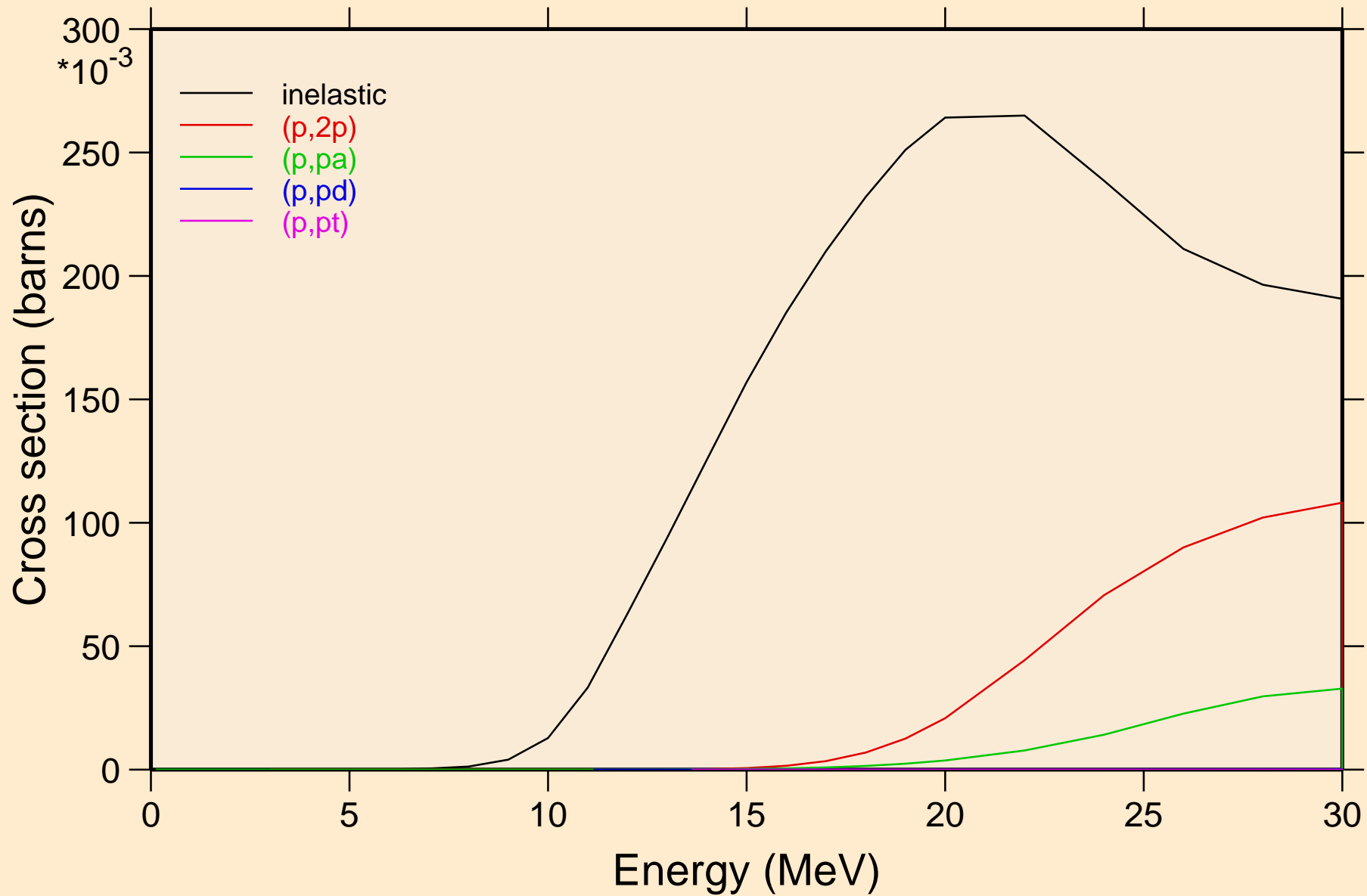

HG182 PROTON ACER TENDL-2021 LIBRARY; T=0.K  
Threshold reactions

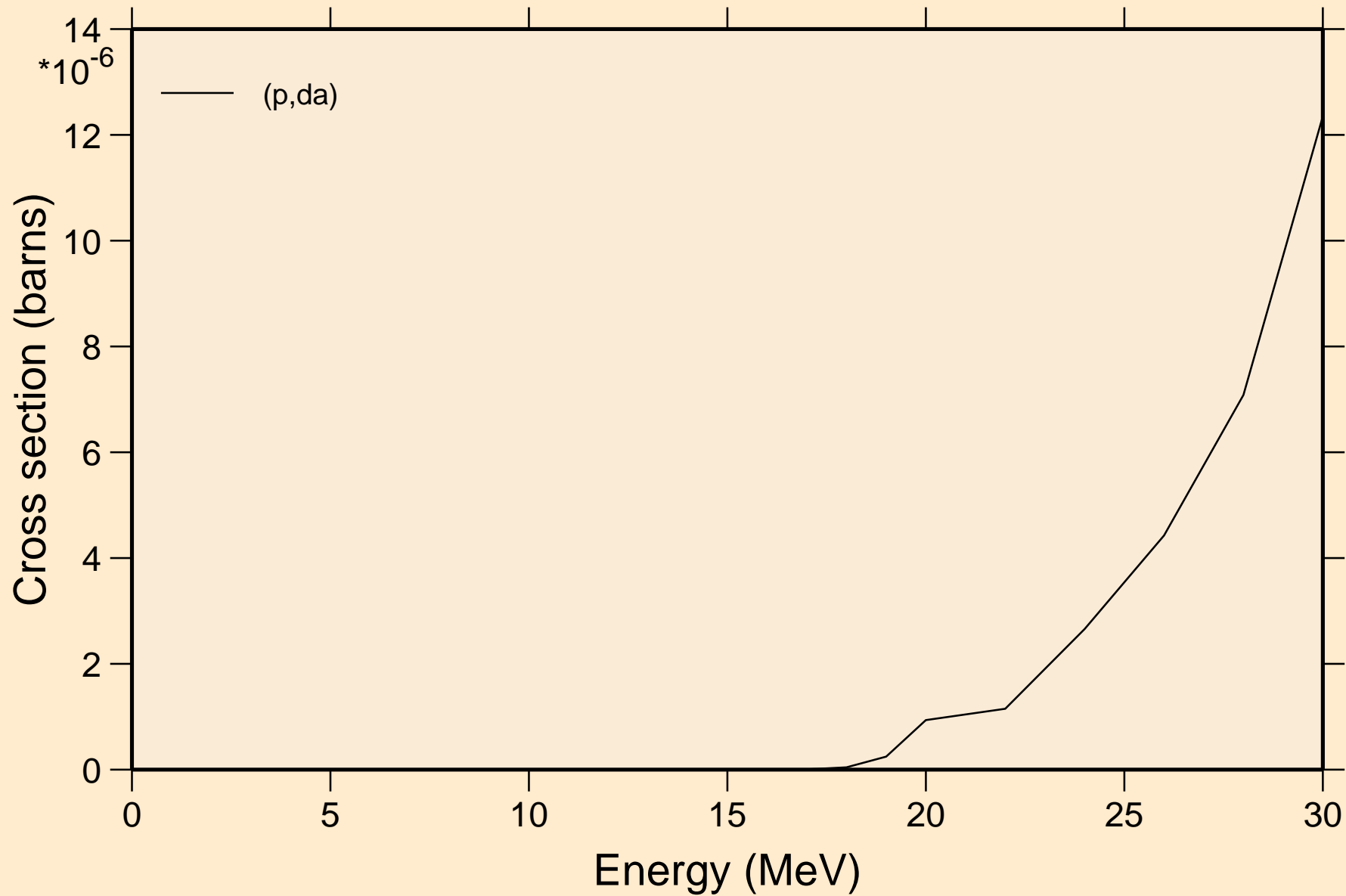

HG182 PROTON ACER TENDL-2021 LIBRARY; T=0.K  
angular distribution for elastic

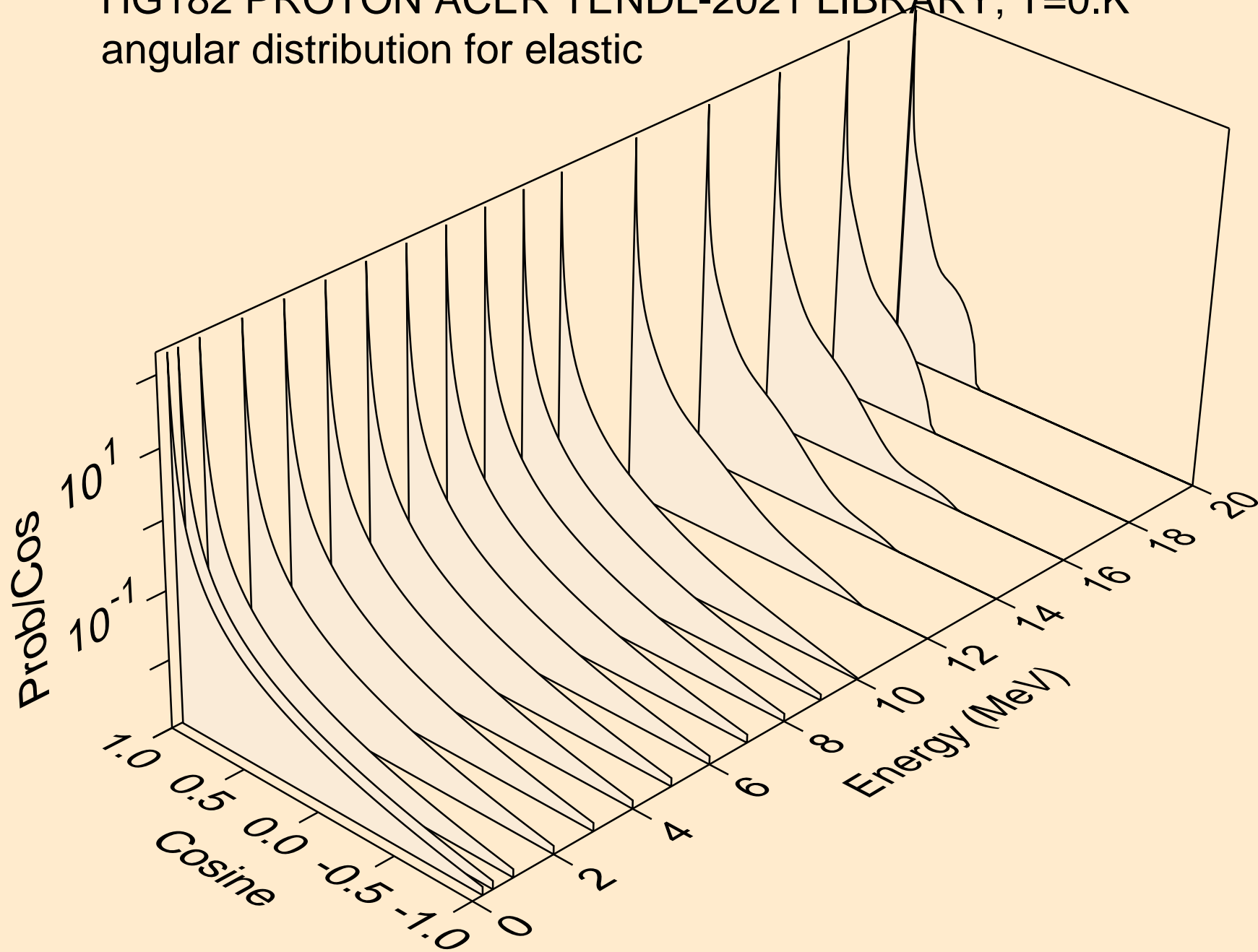



HG182 PROTON ACER TENDL-2021 LIBRARY; T=0.K  
angular distribution for elastic

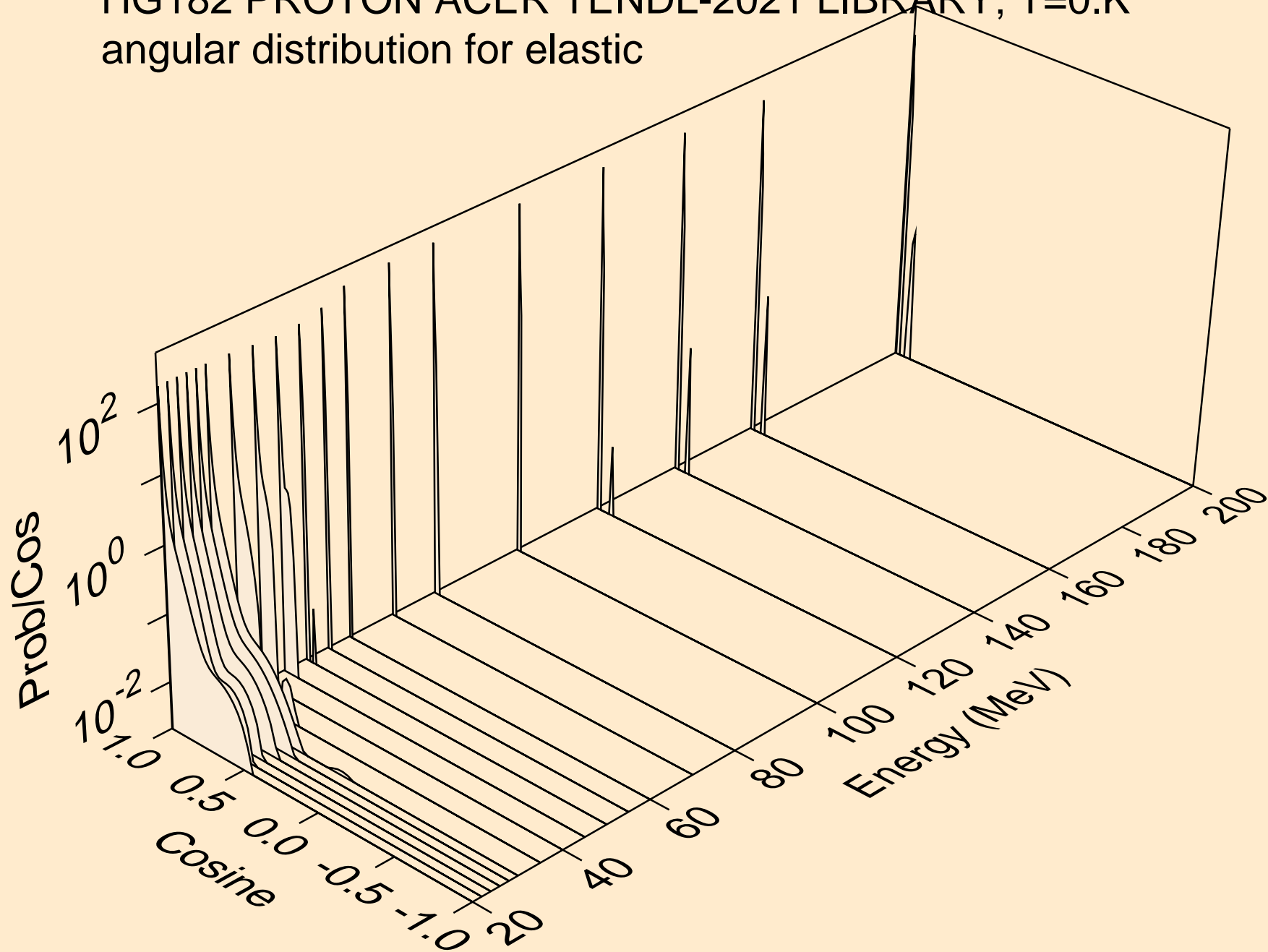

HG182 PROTON ACER TENDL-2021 LIBRARY; T=0.K  
Proton emission for (p,x)

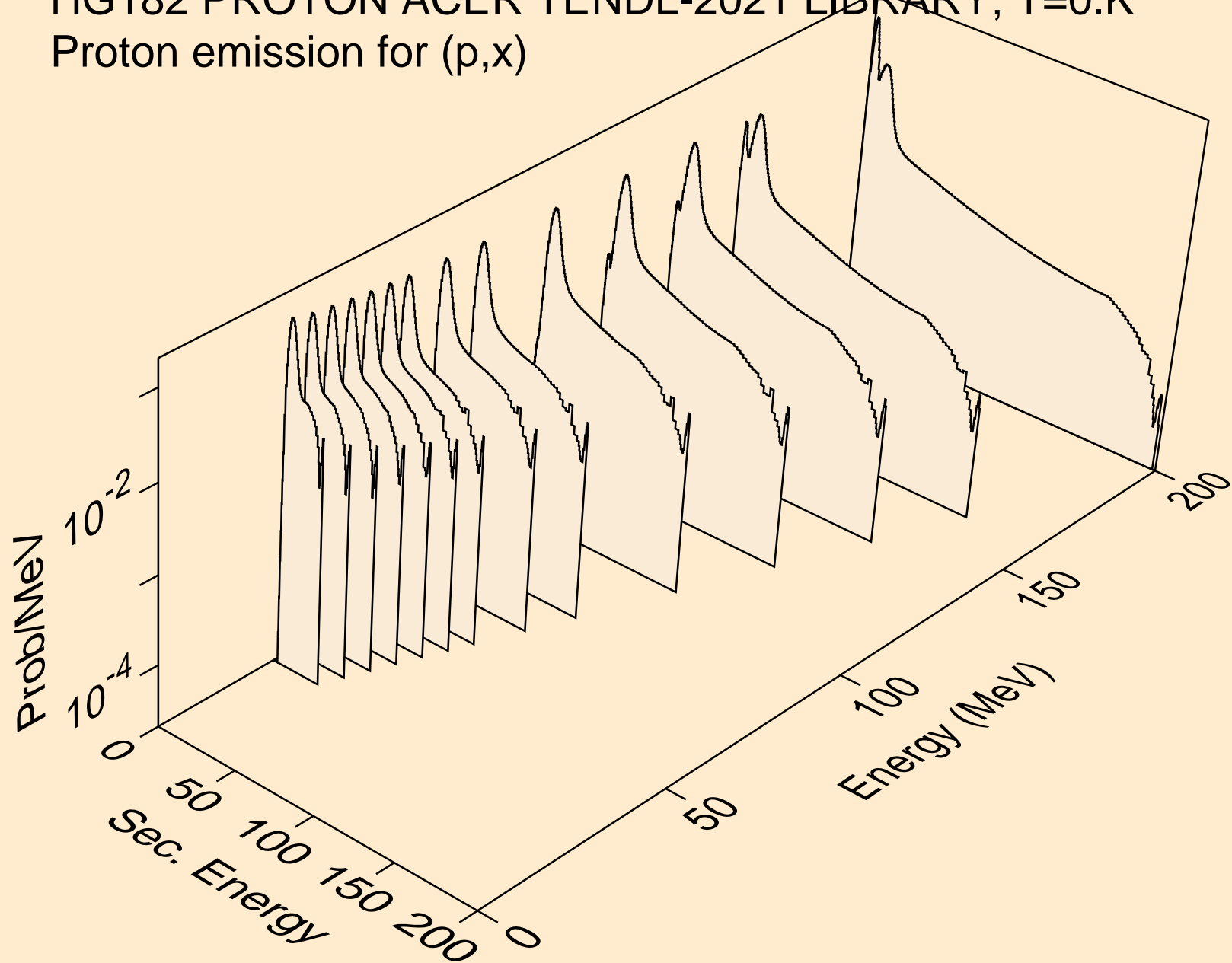

HG182 PROTON ACER TENDL-2021 LIBRARY; T=0.K  
Proton emission for (p,n\*)p

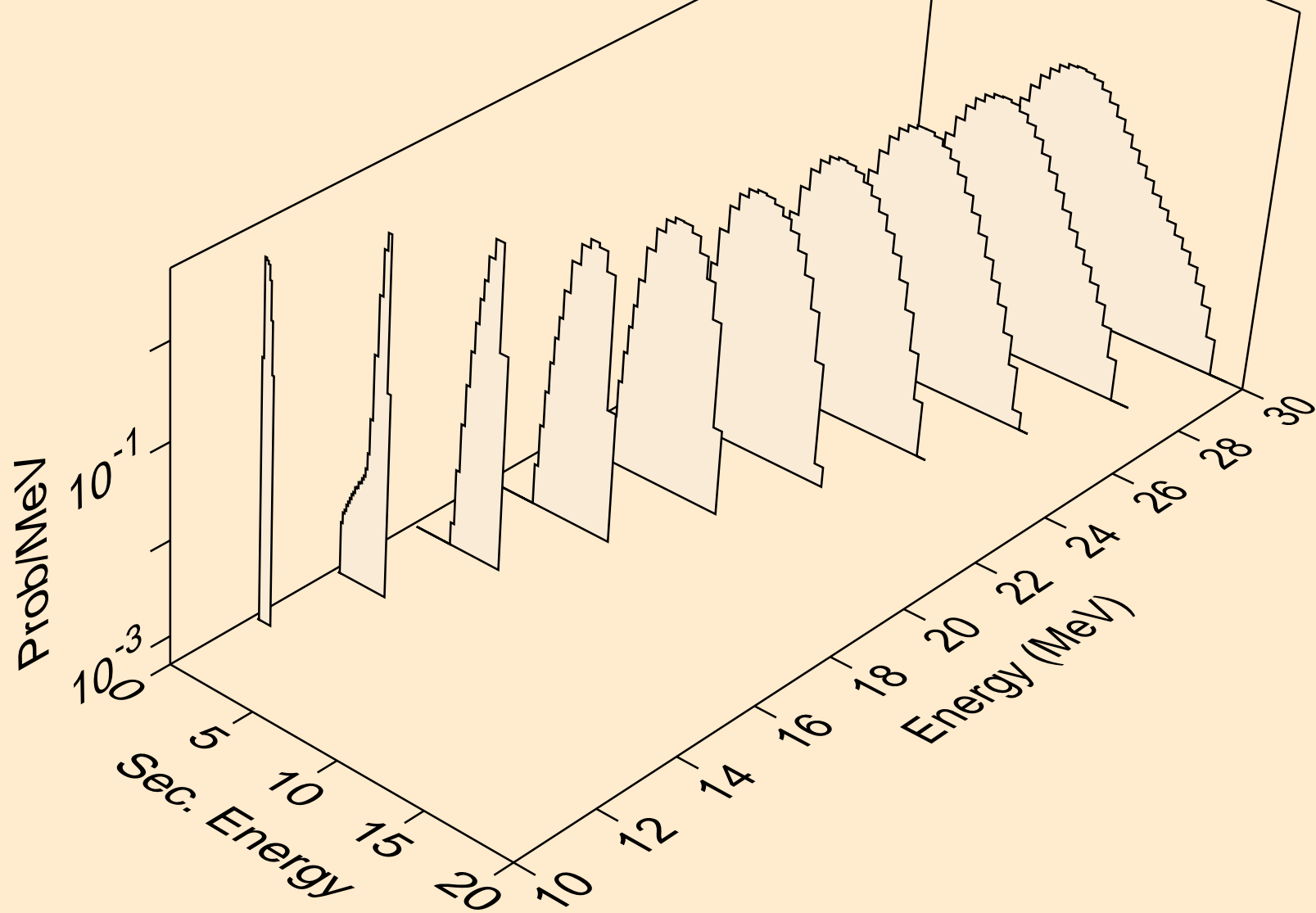

HG182 PROTON ACER TENDL-2021 LIBRARY; T=0.K  
Proton emission for (p,2np)

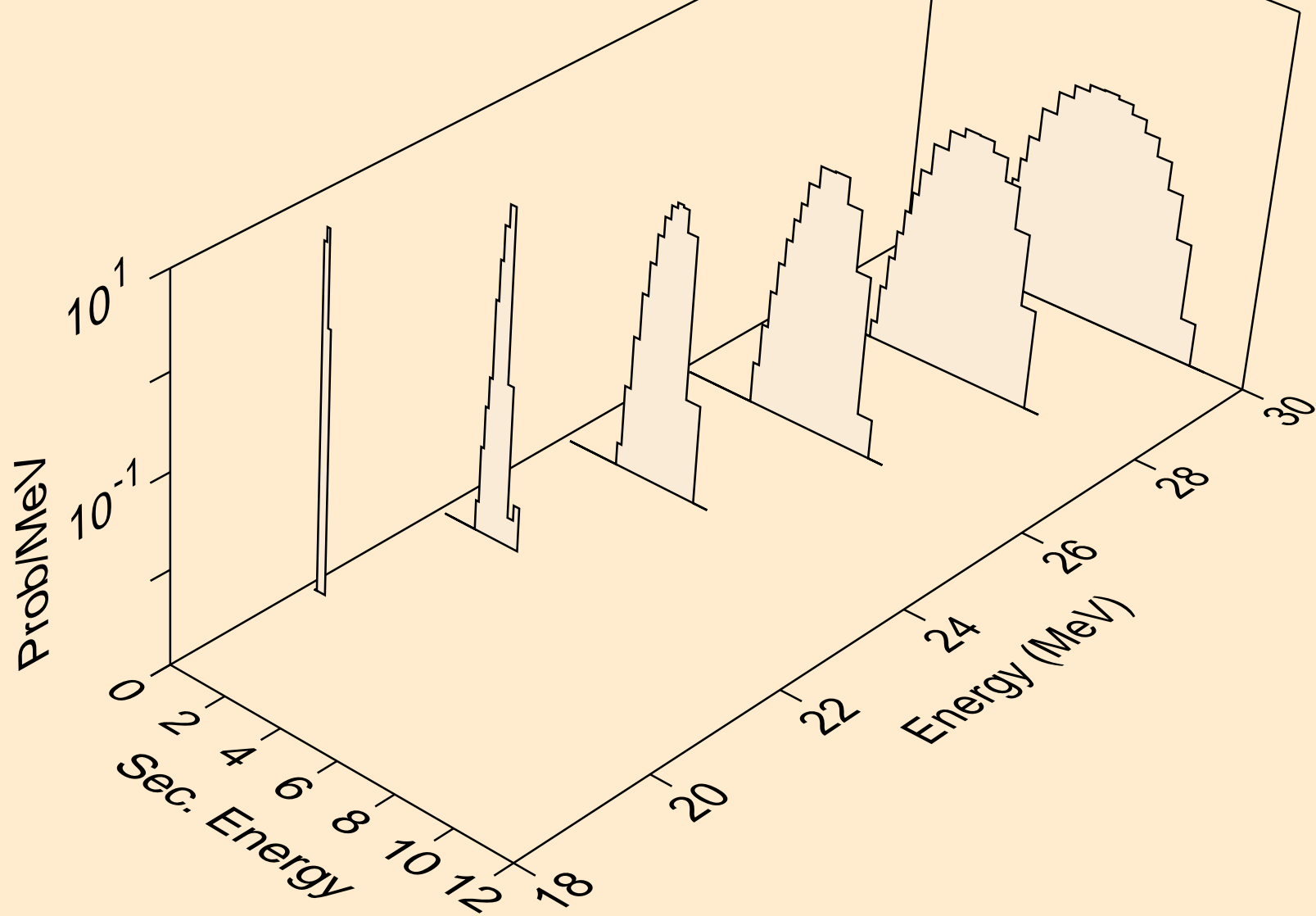

HG182 PROTON ACER TENDL-2021 LIBRARY; T=0.K  
Proton emission for (p,2np)

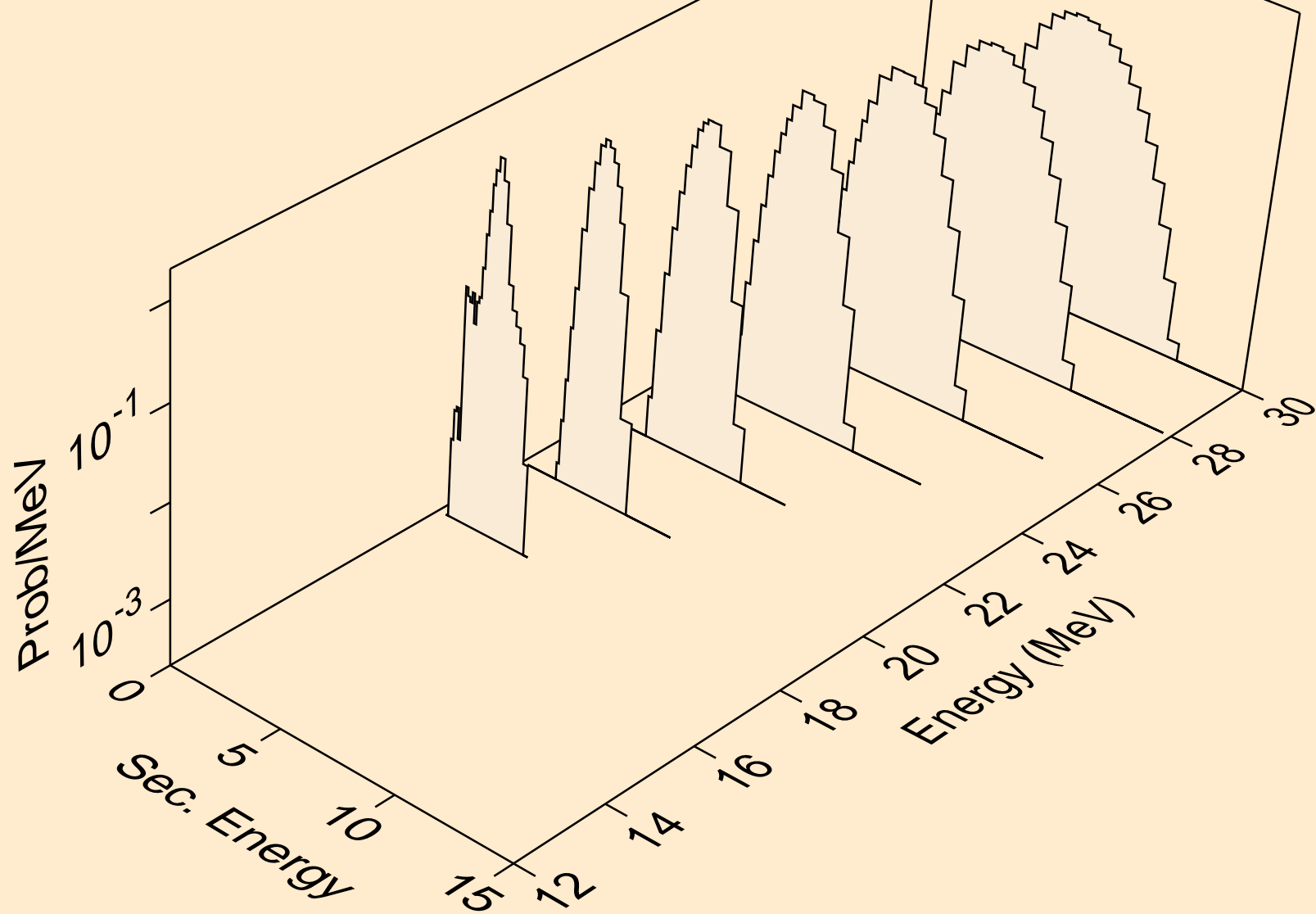

HG182 PROTON ACER TENDL-2021 LIBRARY; T=0.K  
Proton emission for (p,npa)

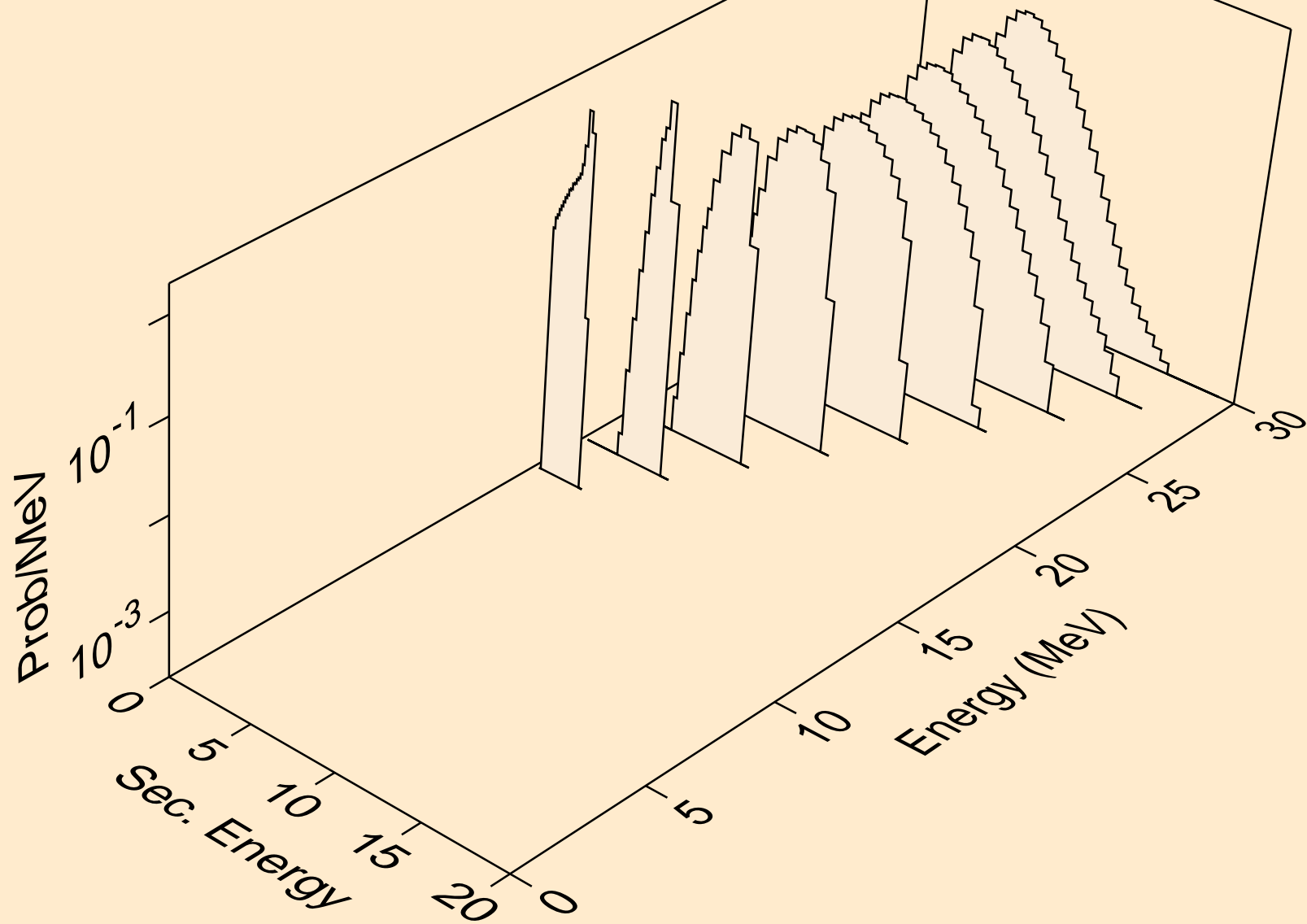

HG182 PROTON ACER TENDL-2021 LIBRARY; T=0.K  
Proton emission for inelastic

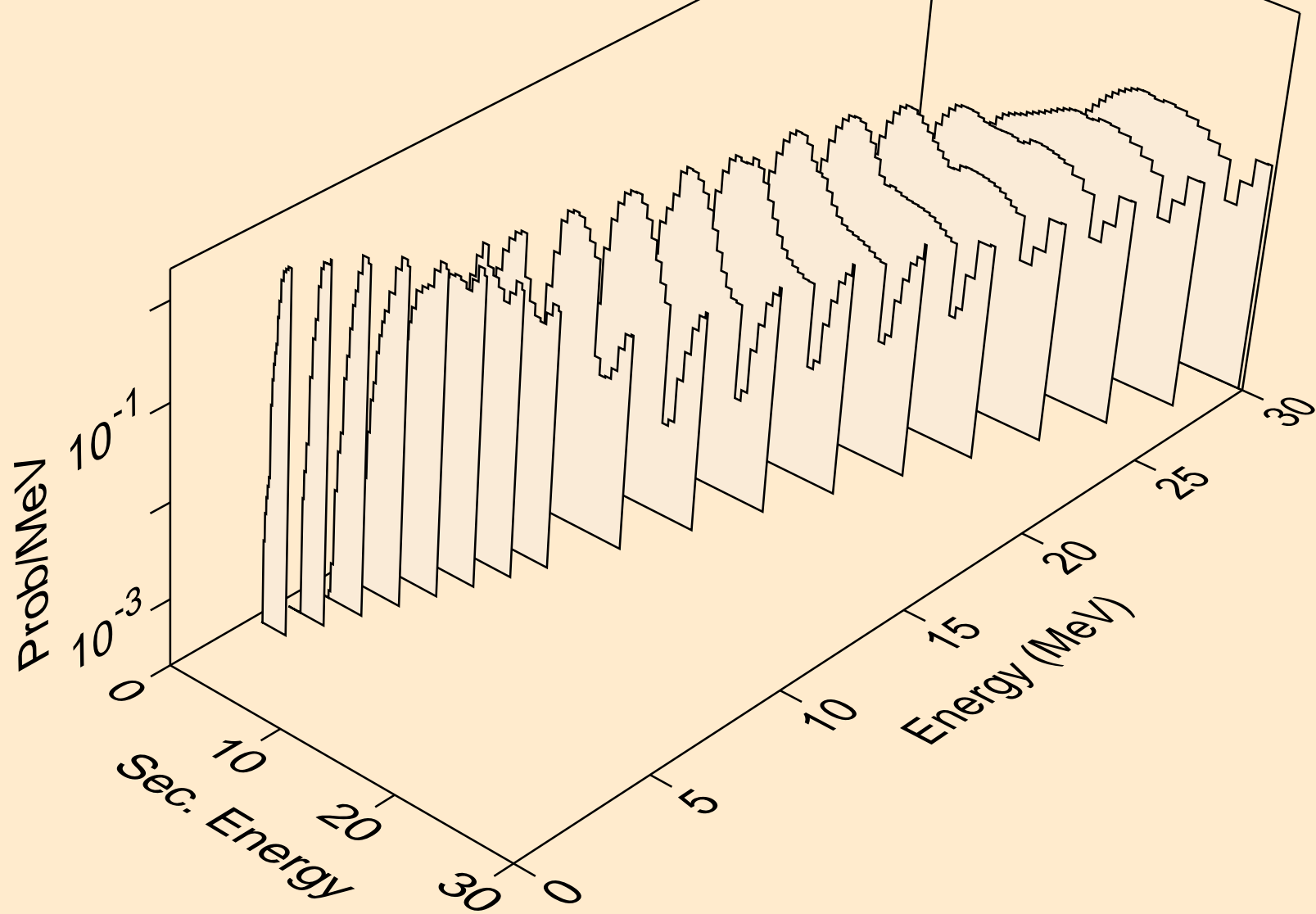

HG182 PROTON ACER TENDL-2021 LIBRARY; T=0.K  
Proton emission for (p,2p)

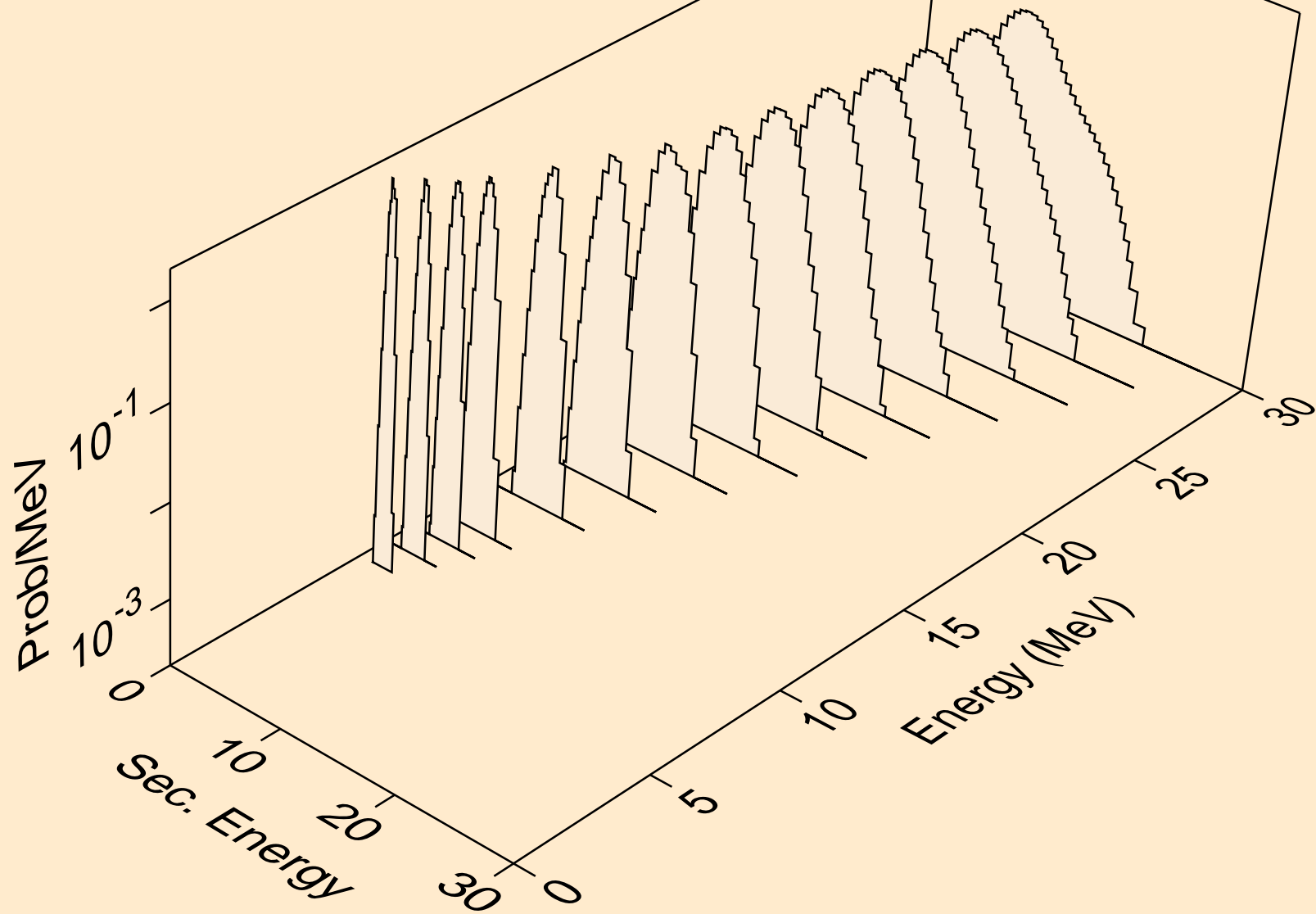



HG182 PROTON ACER TENDL-2021 LIBRARY; T=0.K  
Proton emission for (p,pa)

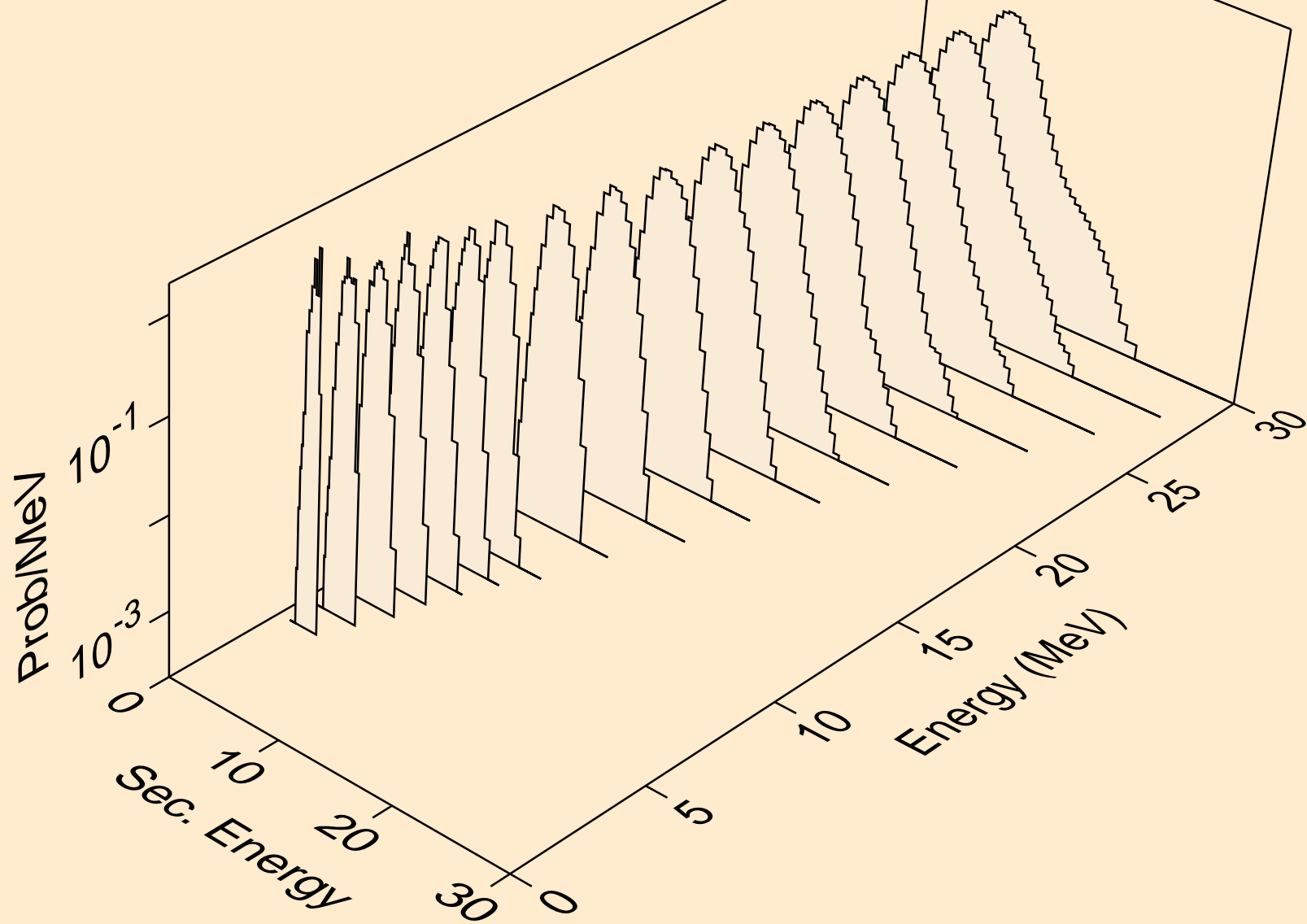

HG182 PROTON ACER TENDL-2021 LIBRARY; T=0.K  
Proton emission for (p,pd)

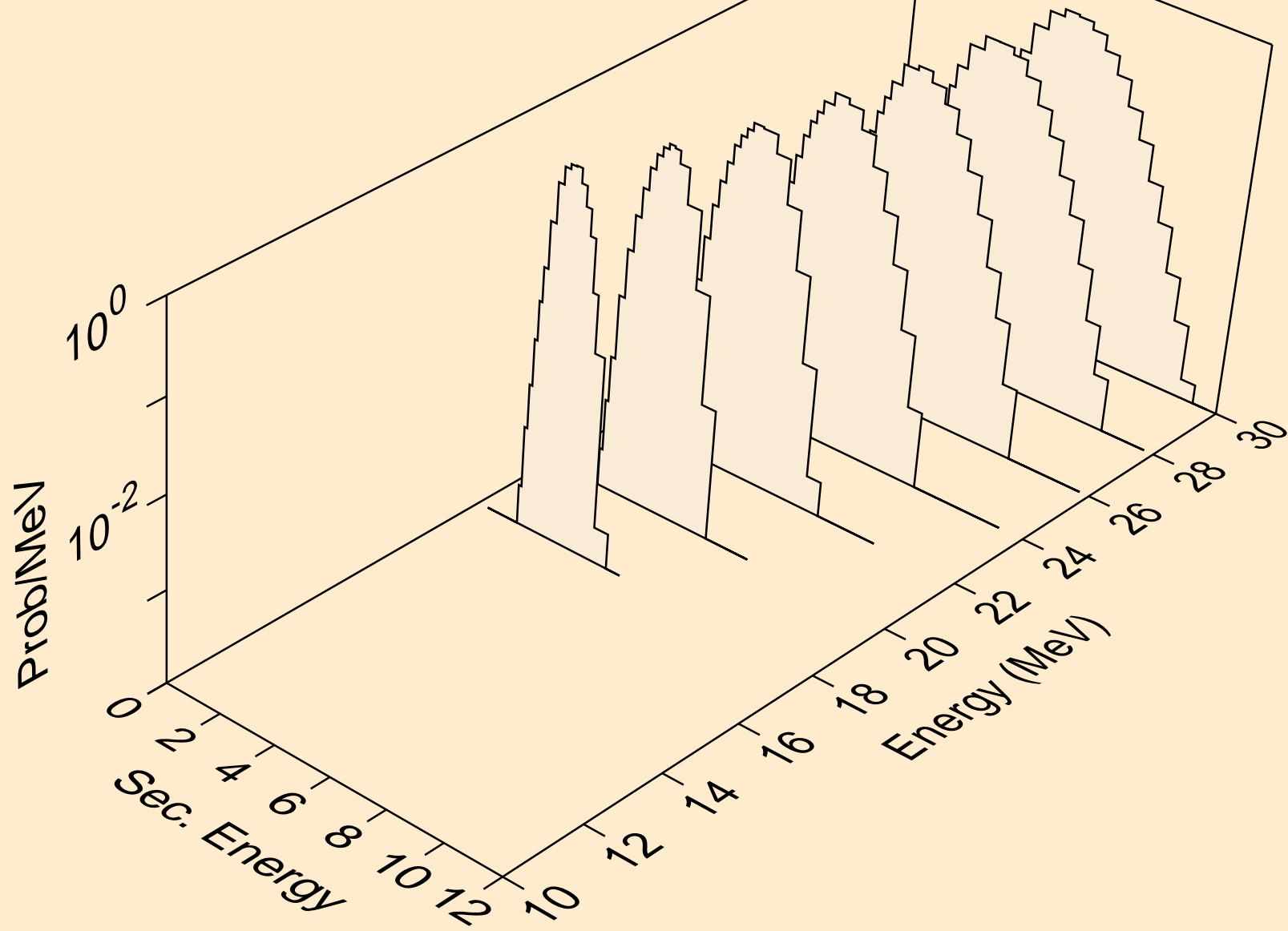

HG182 PROTON ACER TENDL-2021 LIBRARY; T=0.K  
Proton emission for (p,pt)

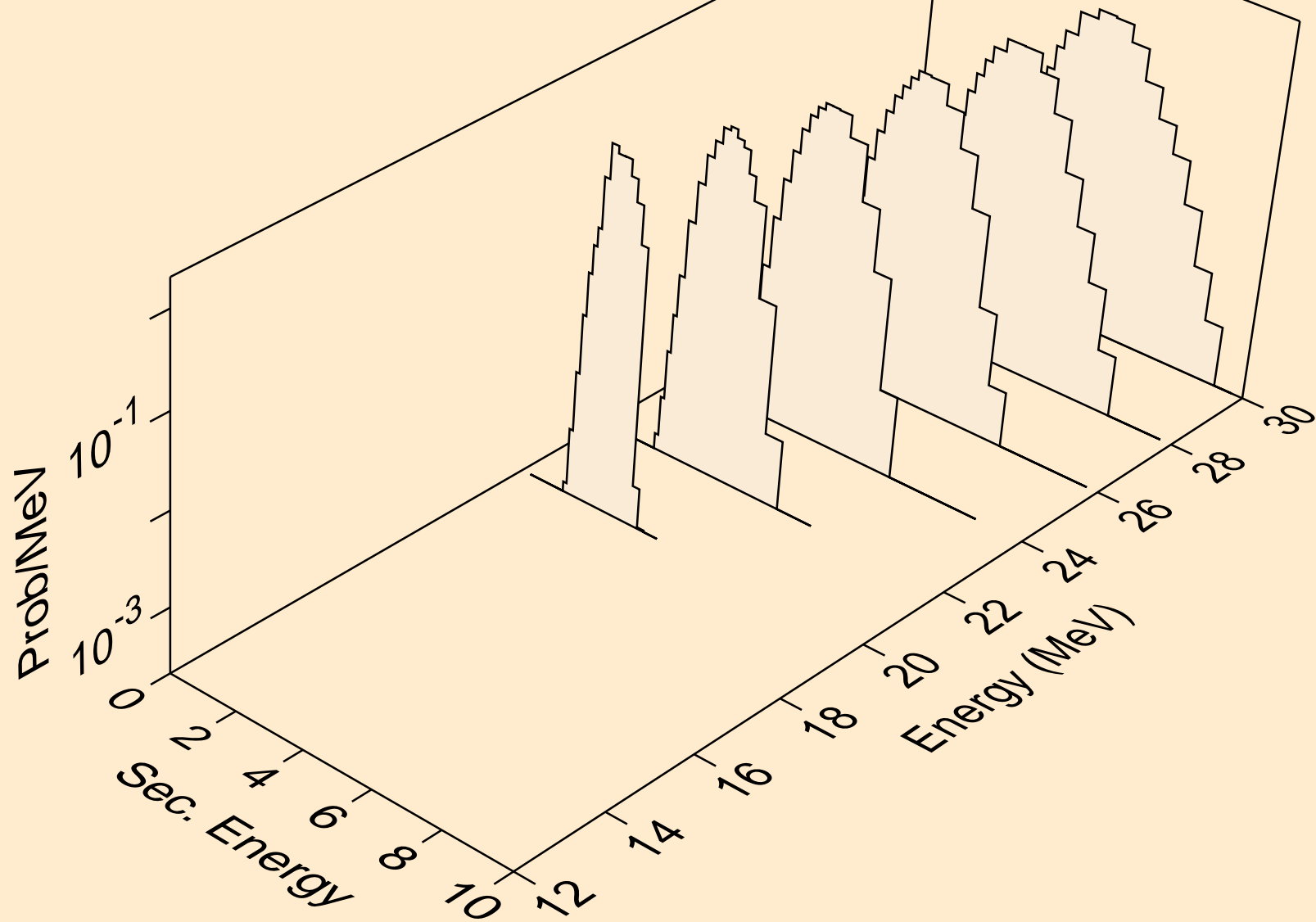

HG182 PROTON ACER TENDL-2021 LIBRARY; T=0.K  
Photon emission for (z,n)

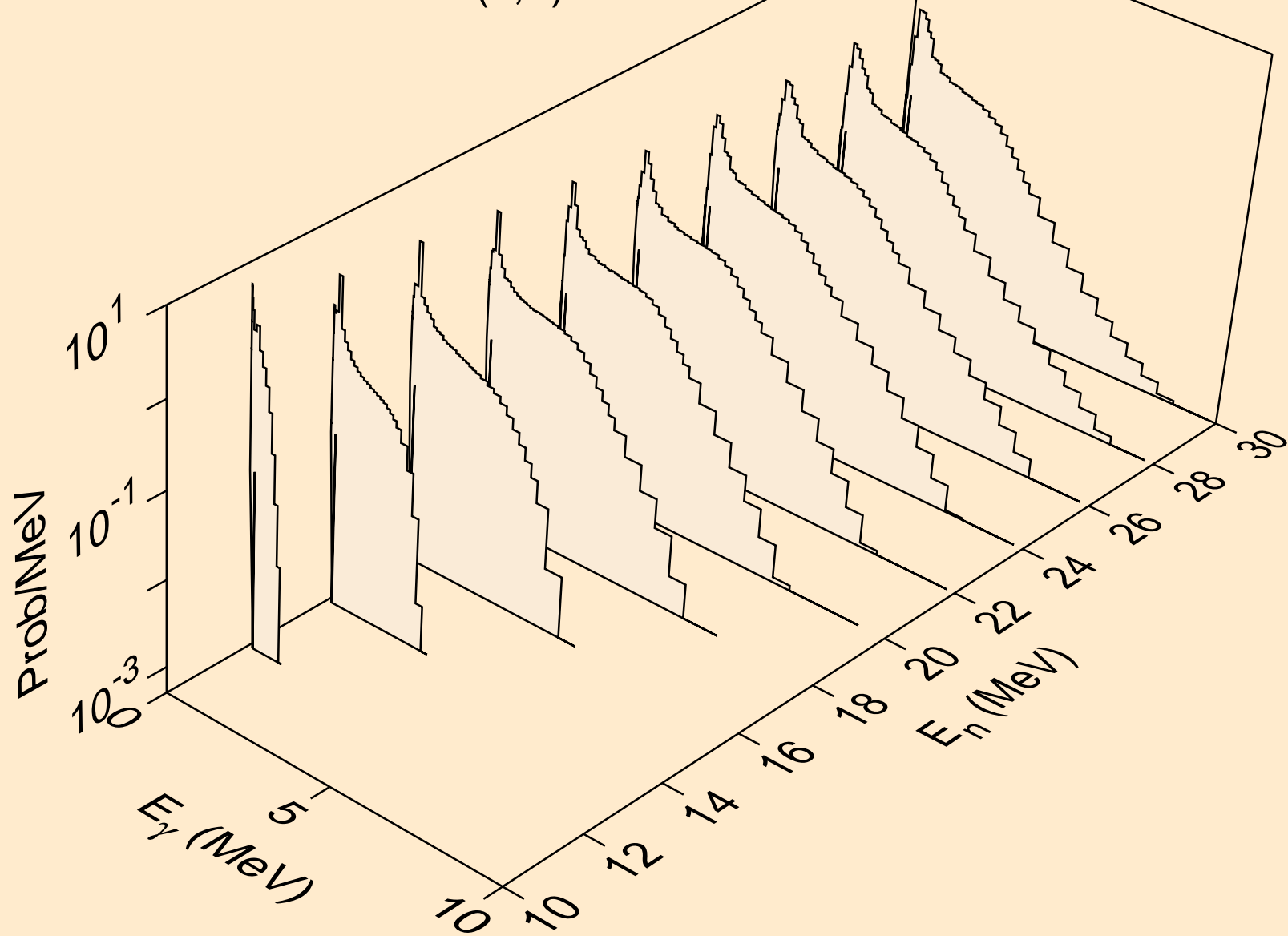

HG182 PROTON ACER TENDL-2021 LIBRARY; T=0.K  
Photon emission for (n,x)

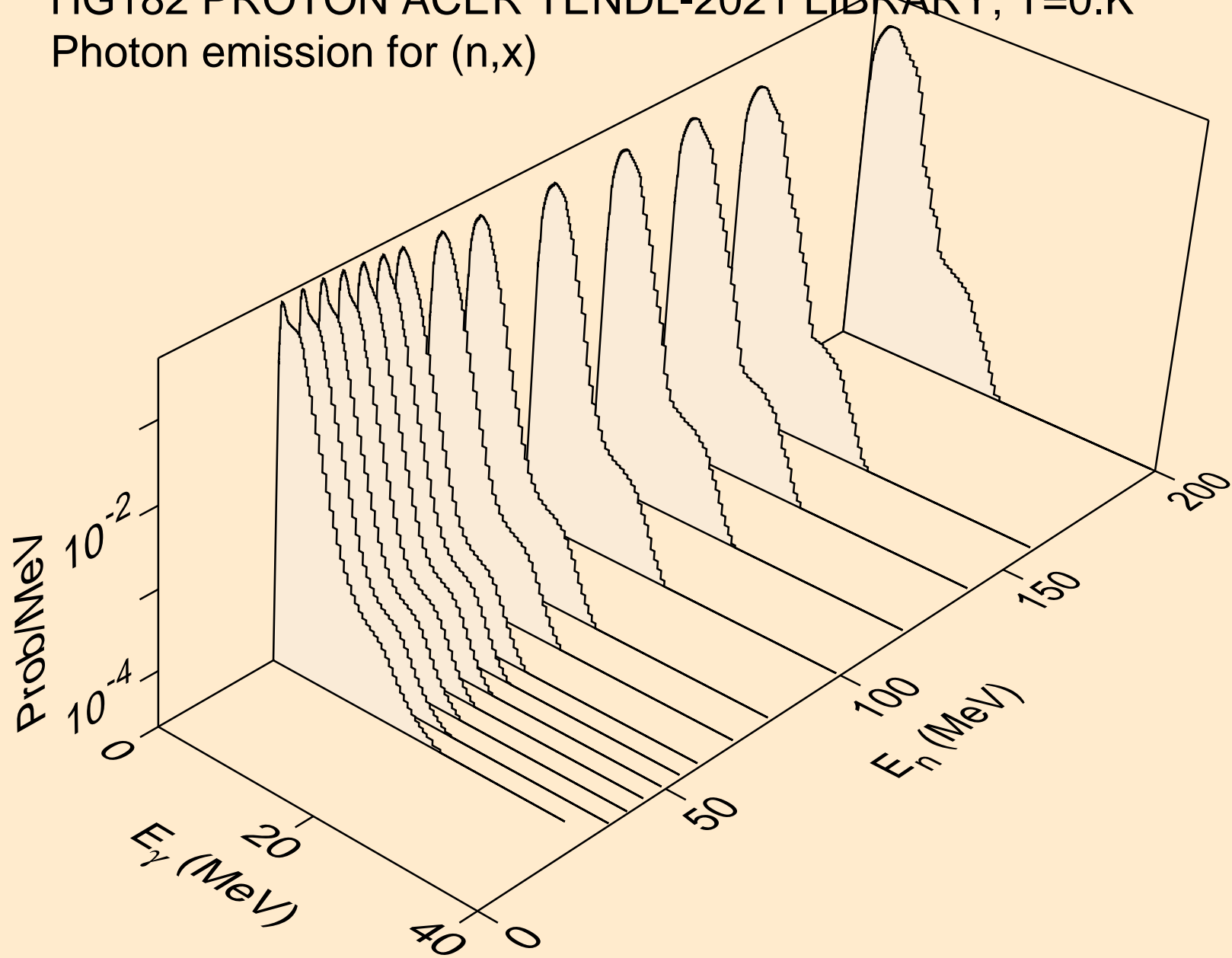

HG182 PROTON ACER TENDL-2021 LIBRARY; T=0.K  
Photon emission for (n,2n)

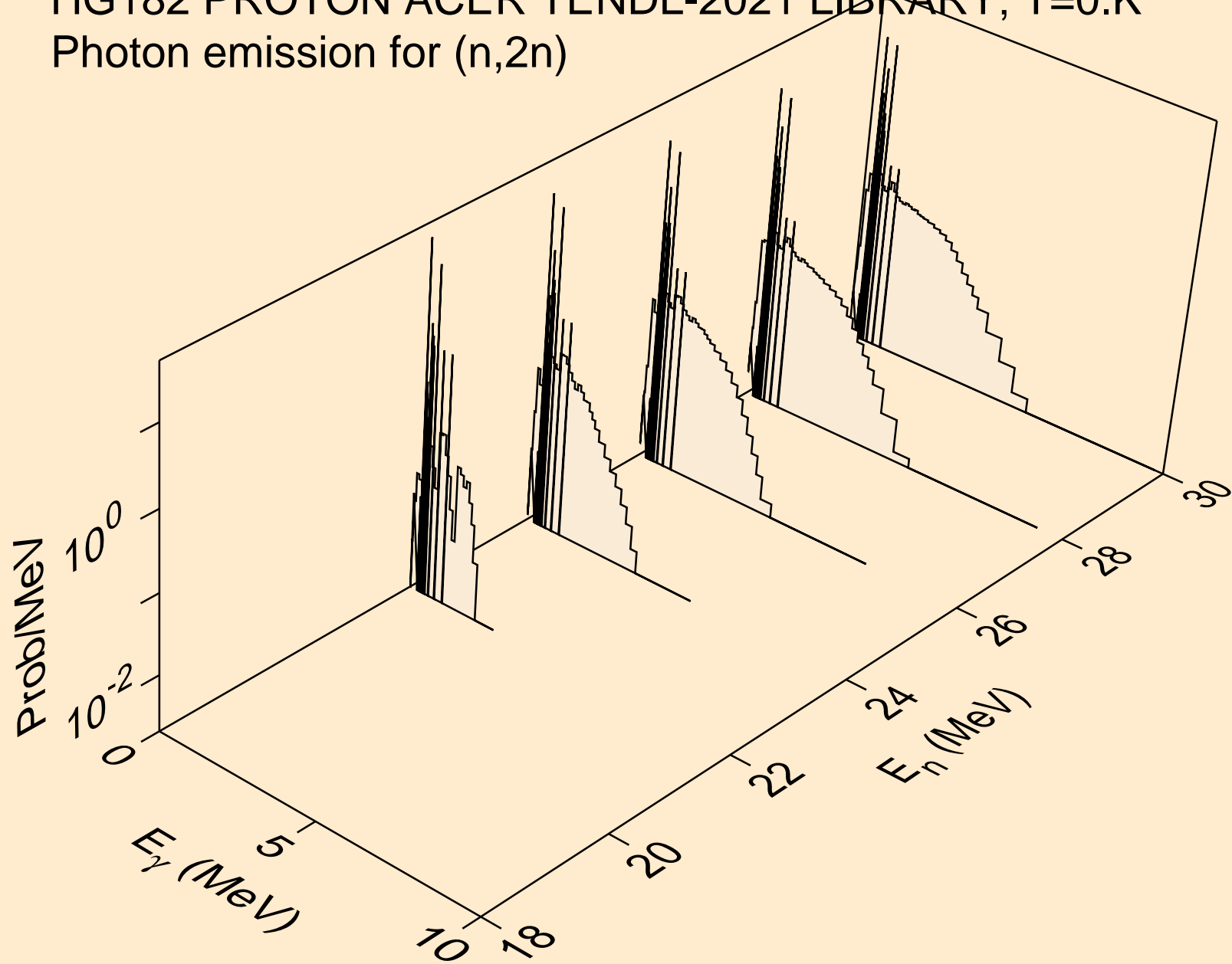

HG182 PROTON ACER TENDL-2021 LIBRARY; T=0.K  
Photon emission for (n,n\*)a

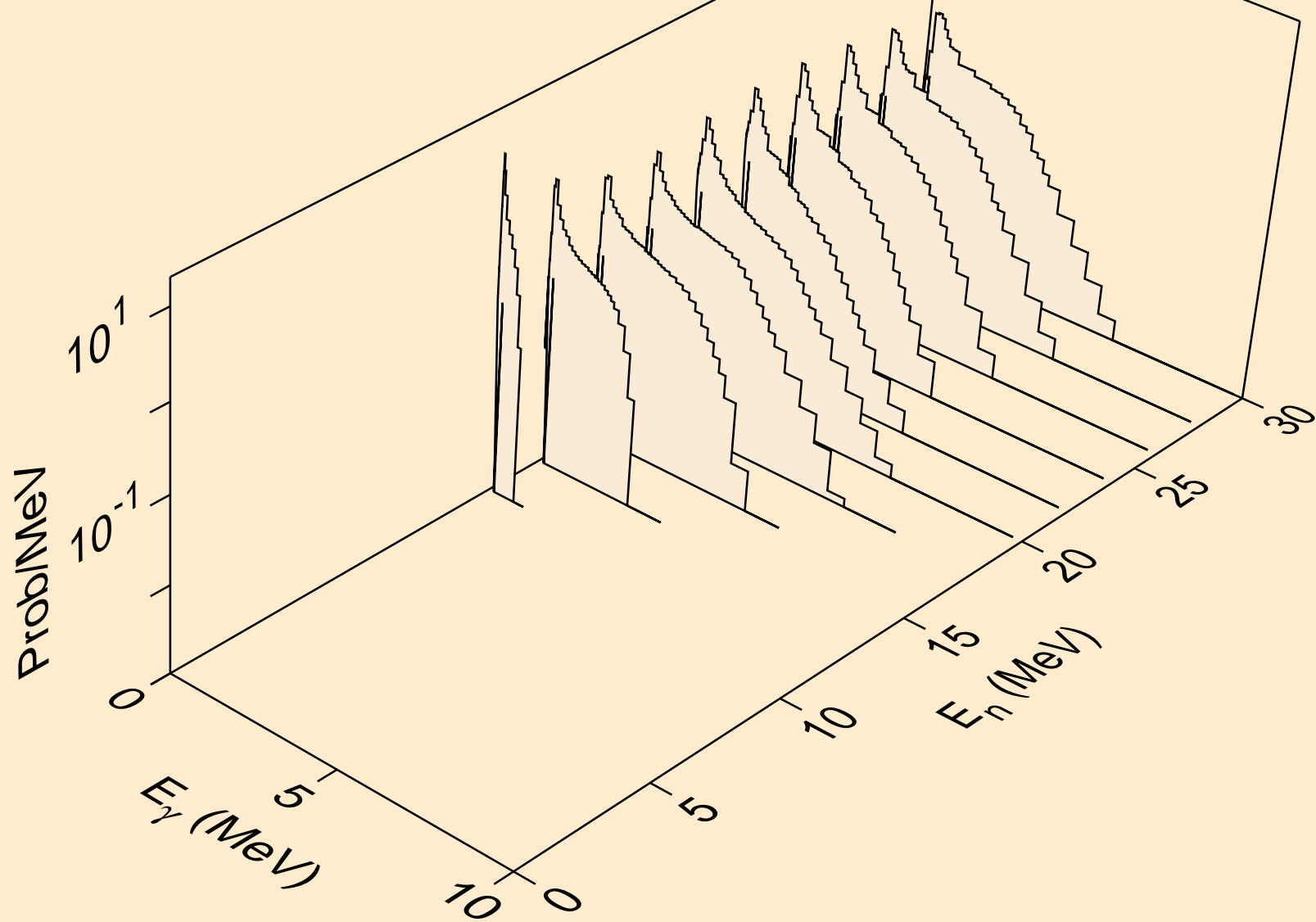

HG182 PROTON ACER TENDL-2021 LIBRARY; T=0.K  
Photon emission for (n,2n)a

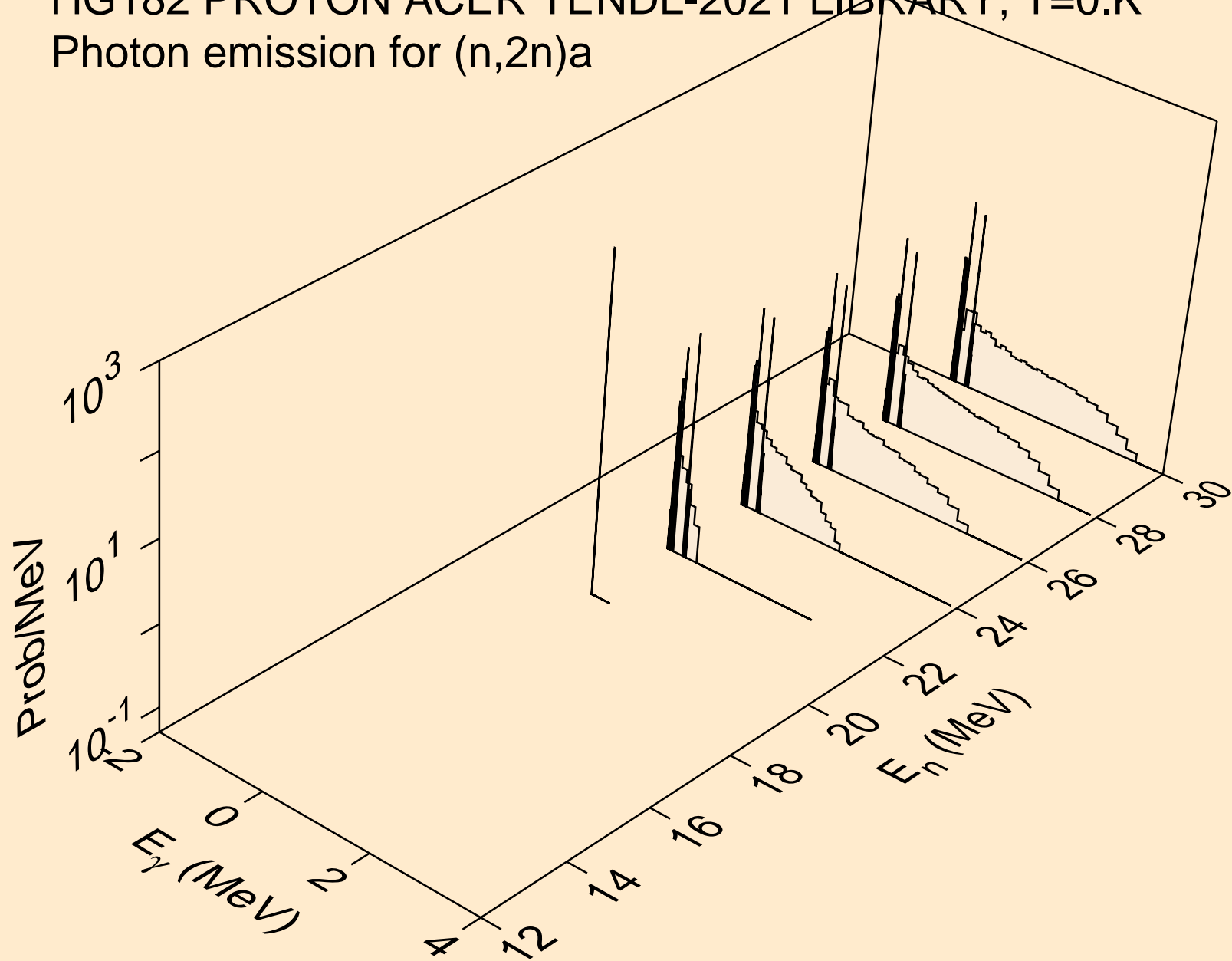



HG182 PROTON ACER TENDL-2021 LIBRARY; T=0.K  
Photon emission for (n,n\*)p

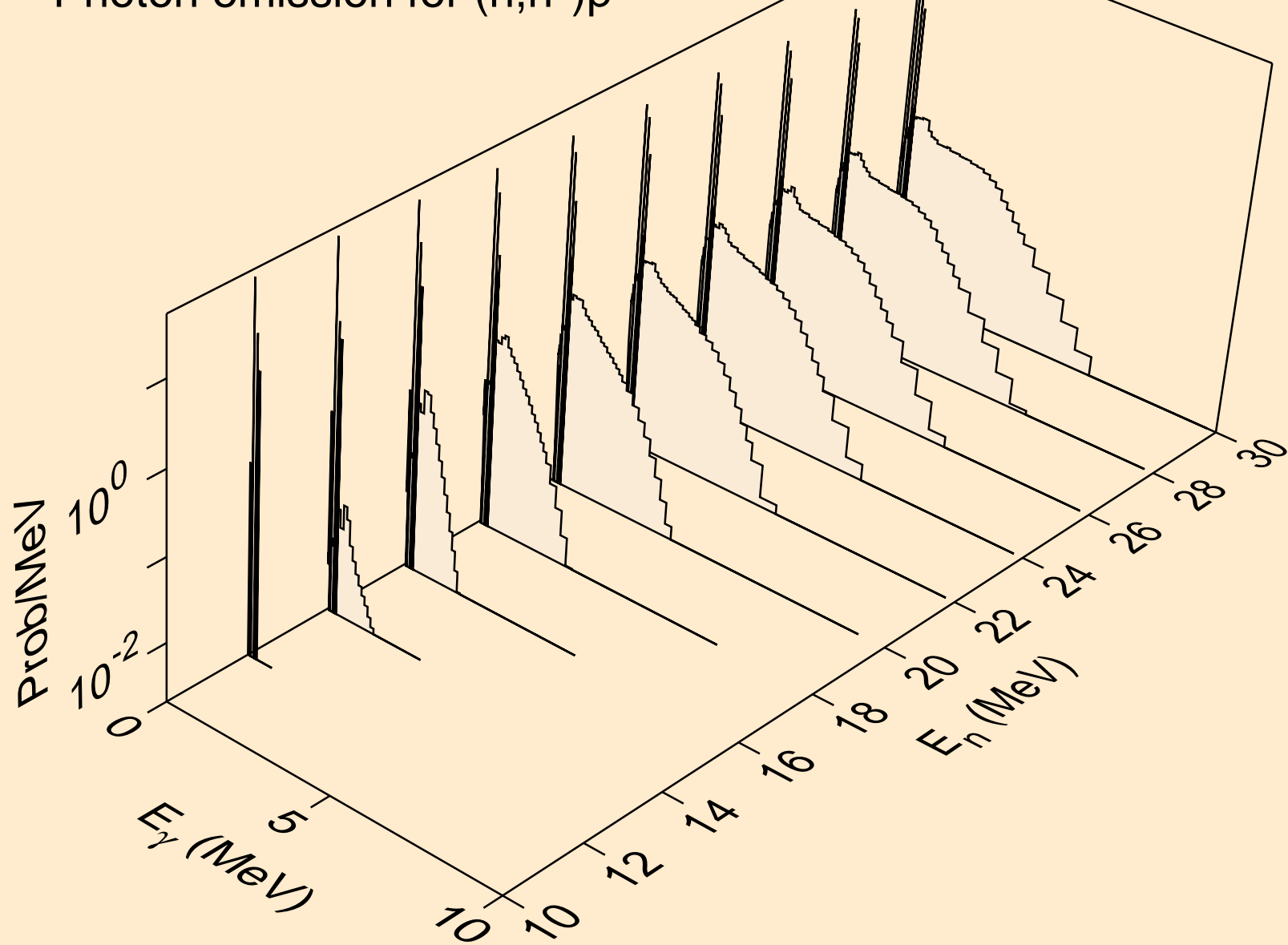

HG182 PROTON ACER TENDL-2021 LIBRARY; T=0.K  
Photon emission for (n,n\*)2a

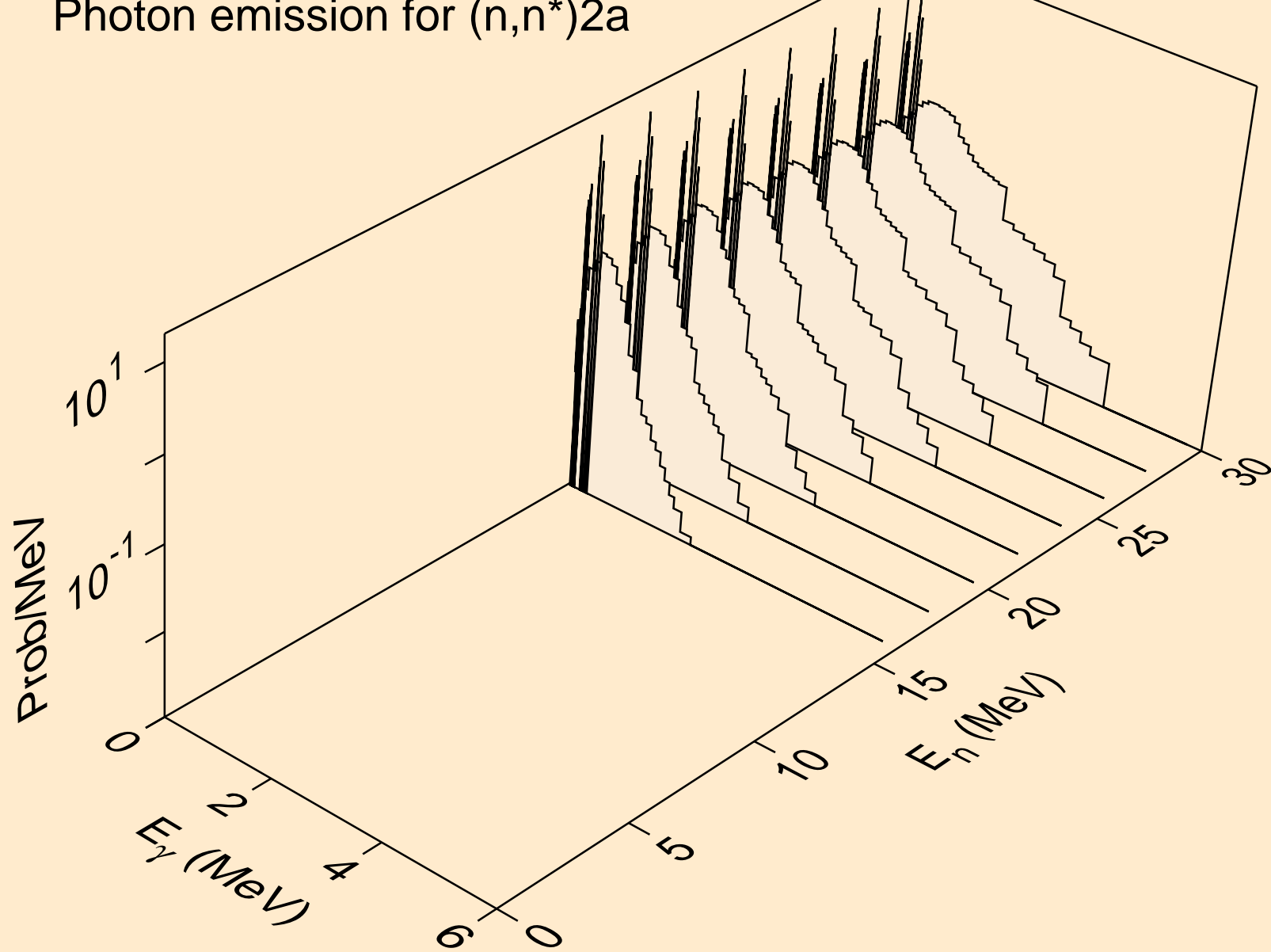

HG182 PROTON ACER TENDL-2021 LIBRARY; T=0.K  
Photon emission for (n,n\*)d

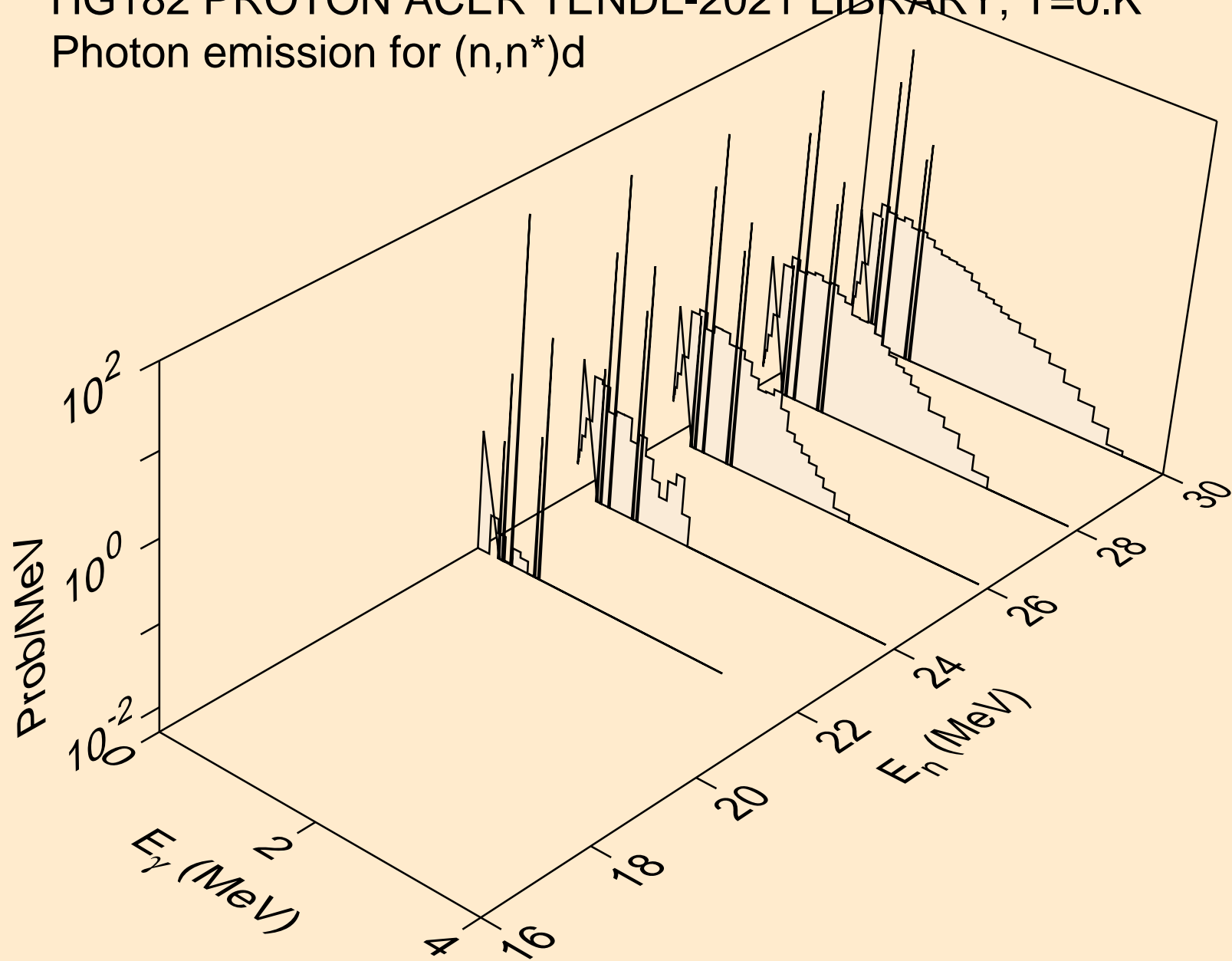

HG182 PROTON ACER TENDL-2021 LIBRARY; T=0.K  
Photon emission for (n,n\*)he3

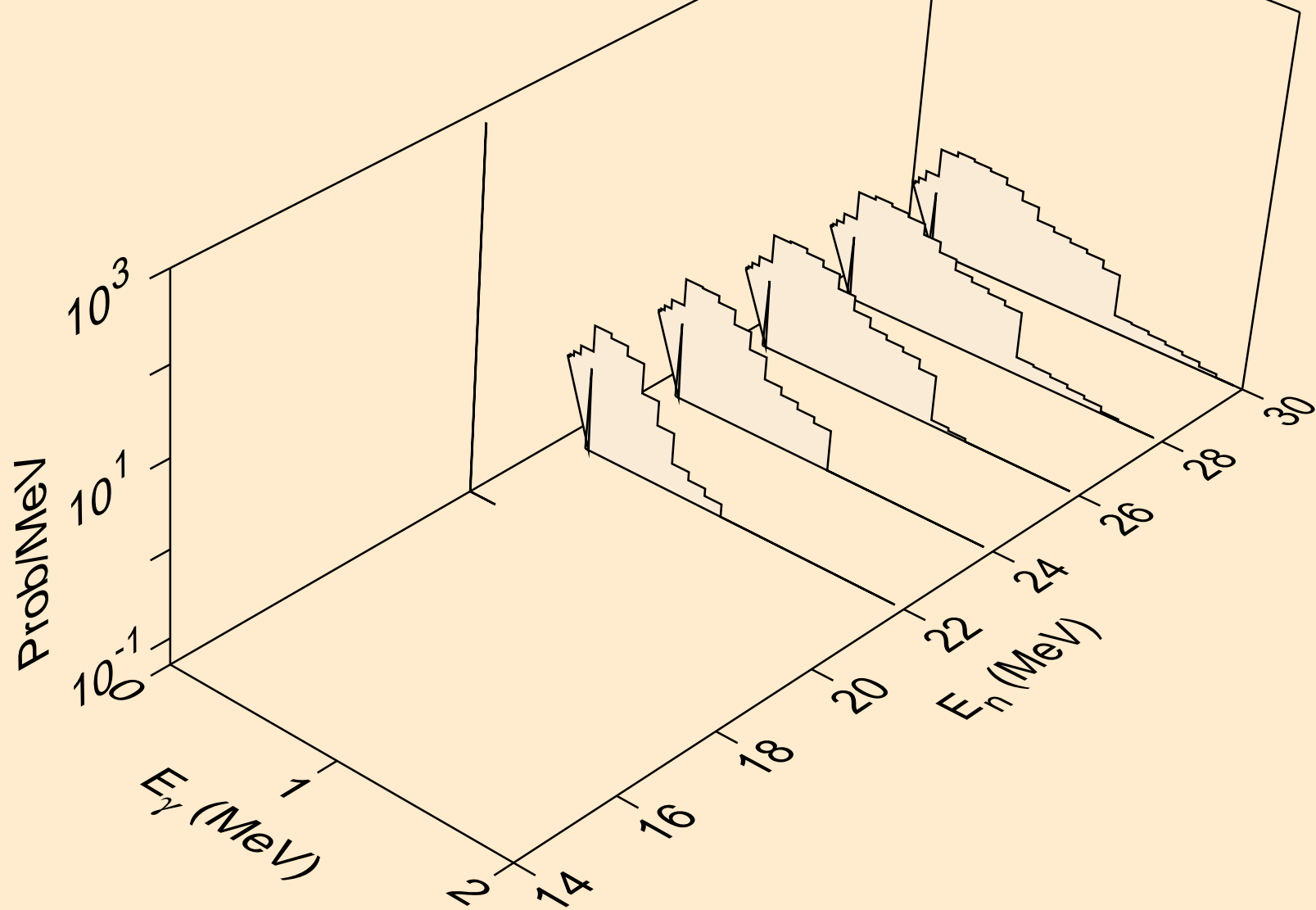

HG182 PROTON ACER TENDL-2021 LIBRARY; T=0.K  
Photon emission for (n,2np)

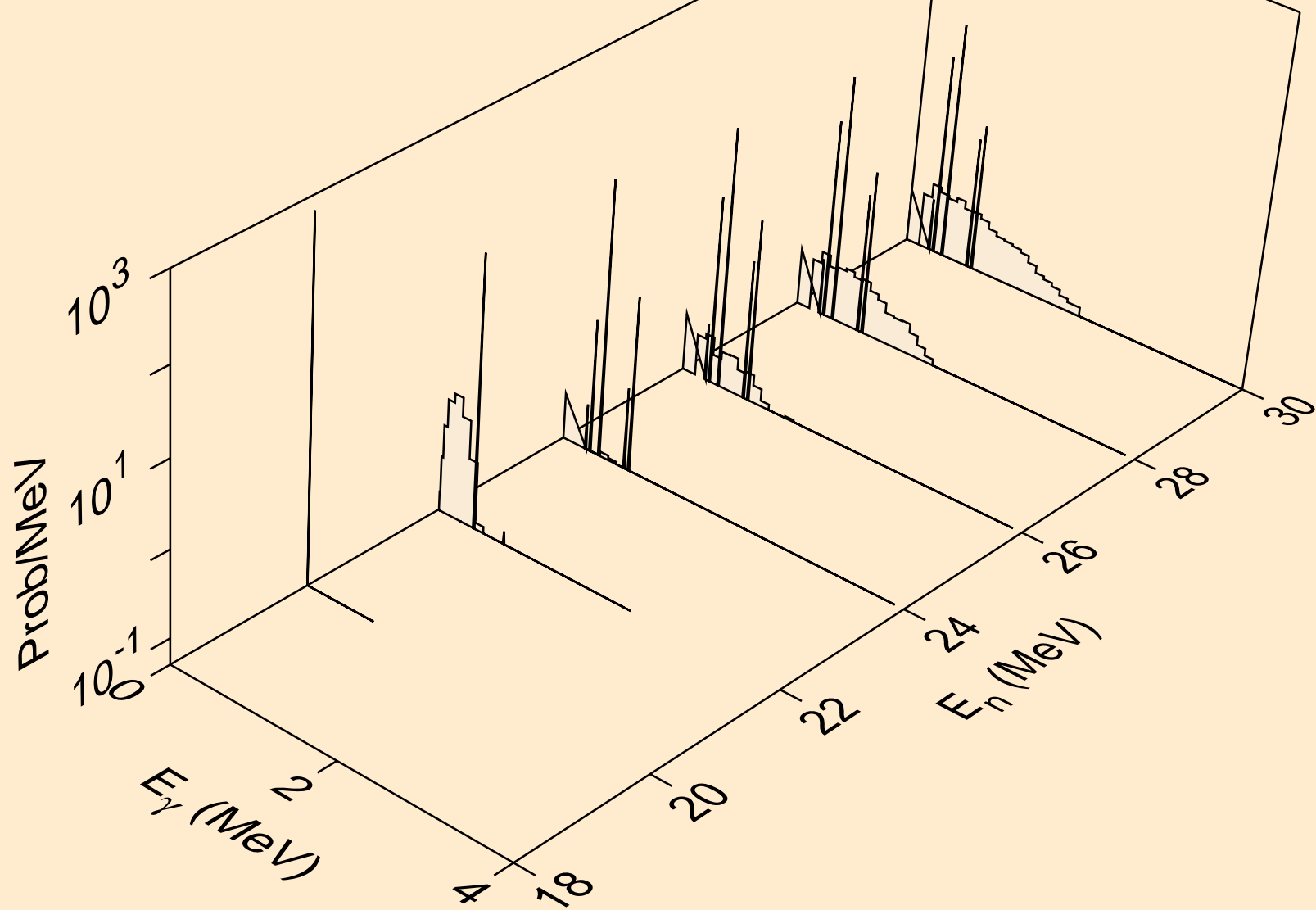

HG182 PROTON ACER TENDL-2021 LIBRARY; T=0.K  
Photon emission for (n,2np)

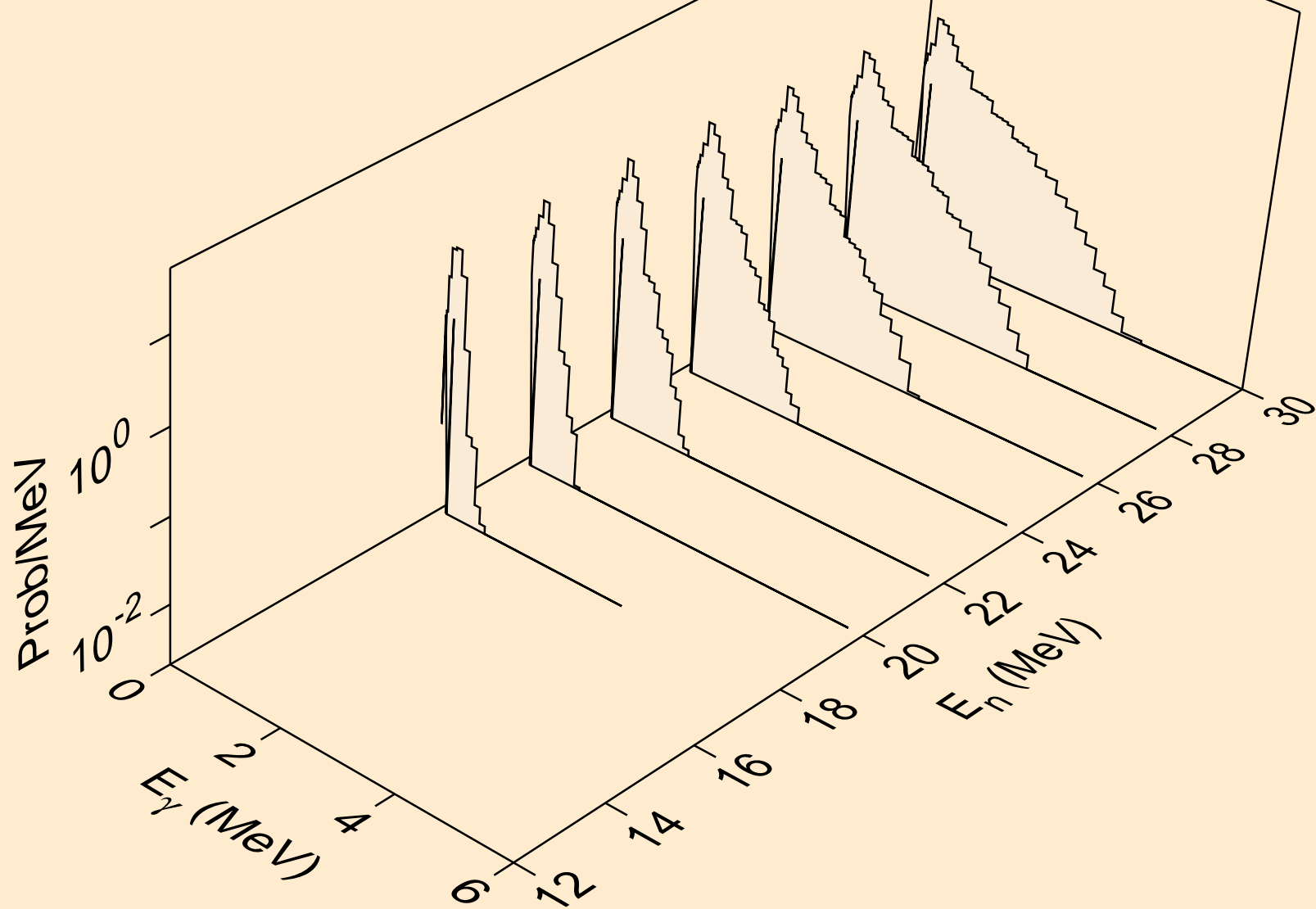

HG182 PROTON ACER TENDL-2021 LIBRARY; T=0.K  
Photon emission for (n,npa)

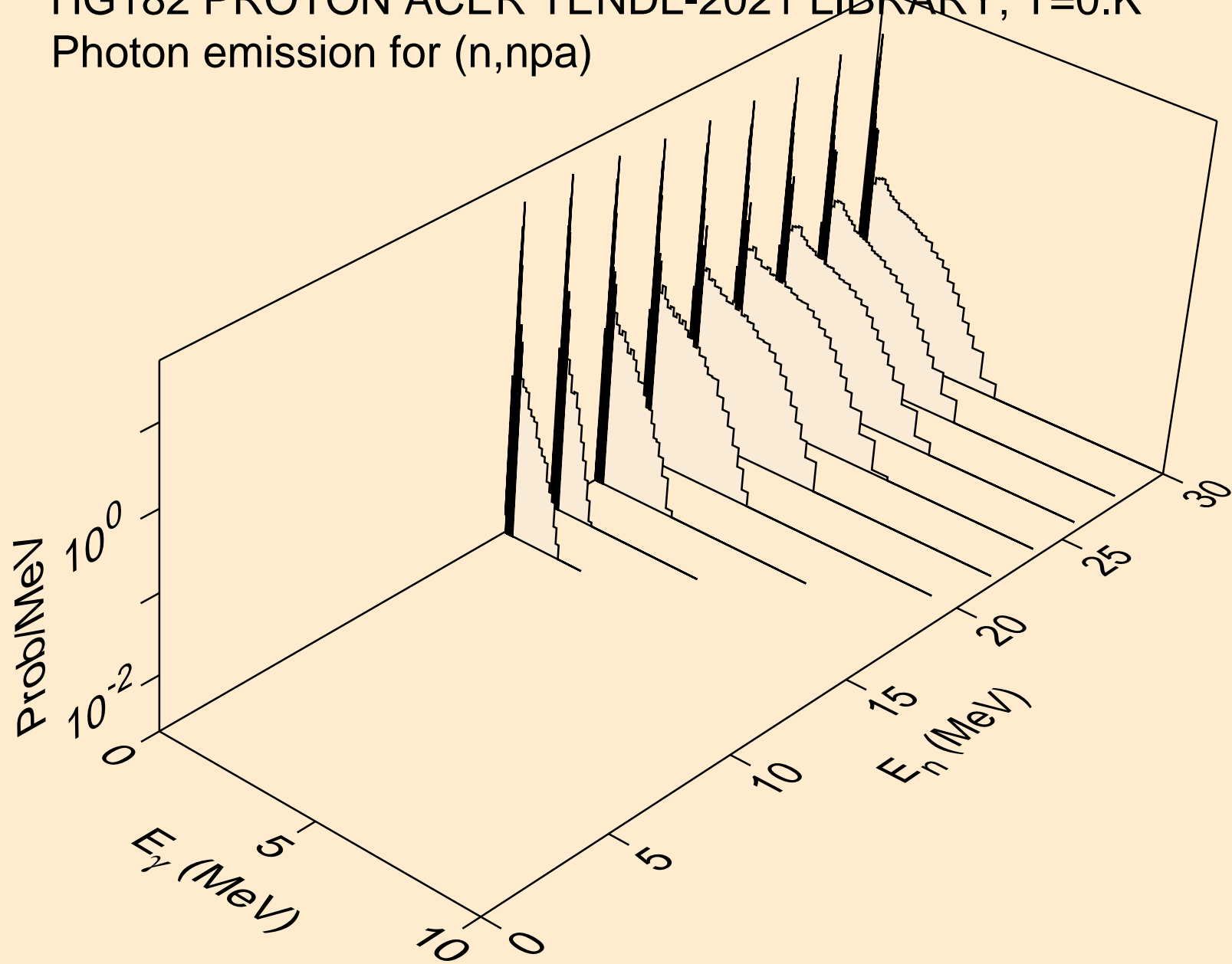

HG182 PROTON ACER TENDL-2021 LIBRARY; T=0.K  
Photon emission for (n,gma)

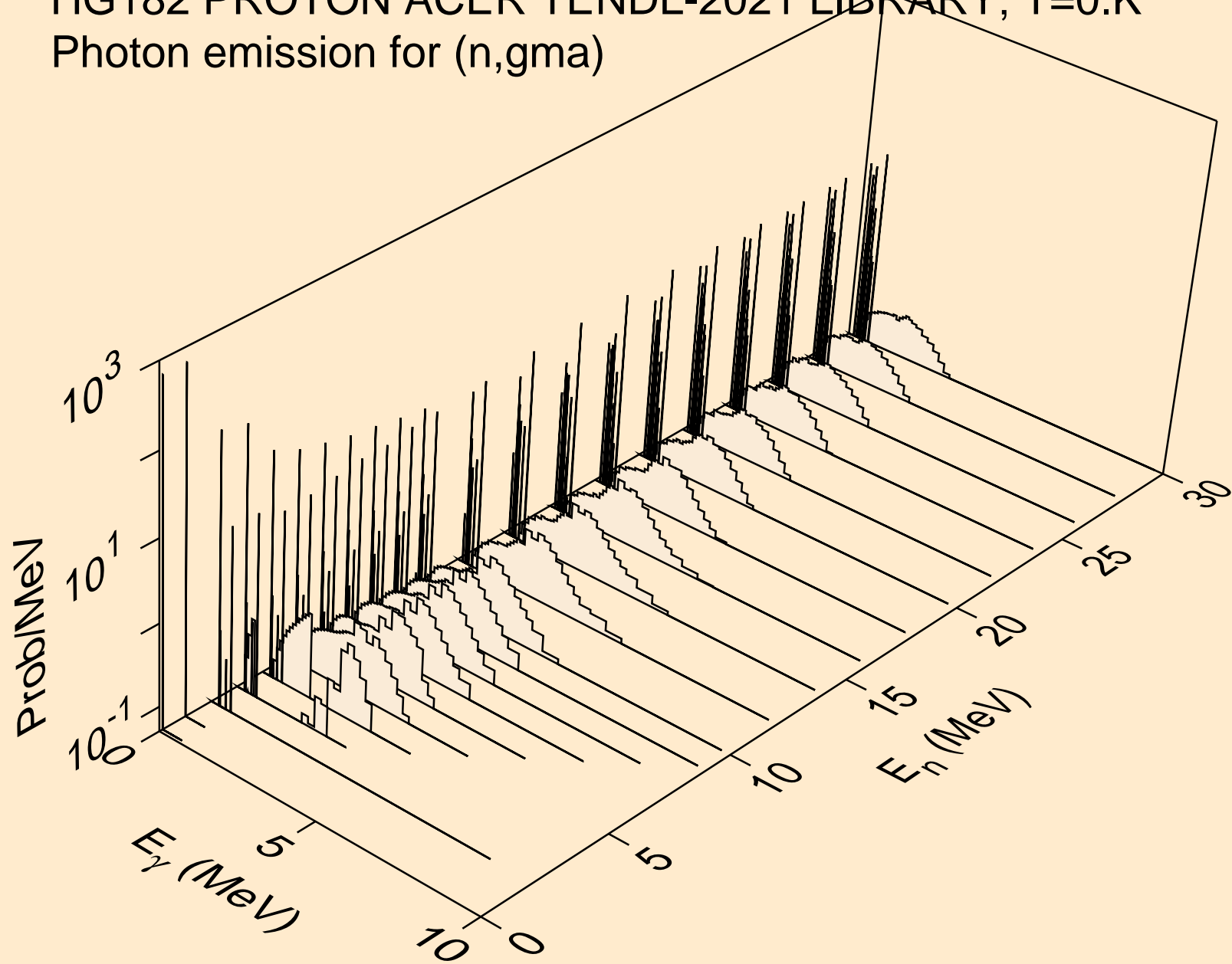



HG182 PROTON ACER TENDL-2021 LIBRARY; T=0.K  
Photon emission for inelastic

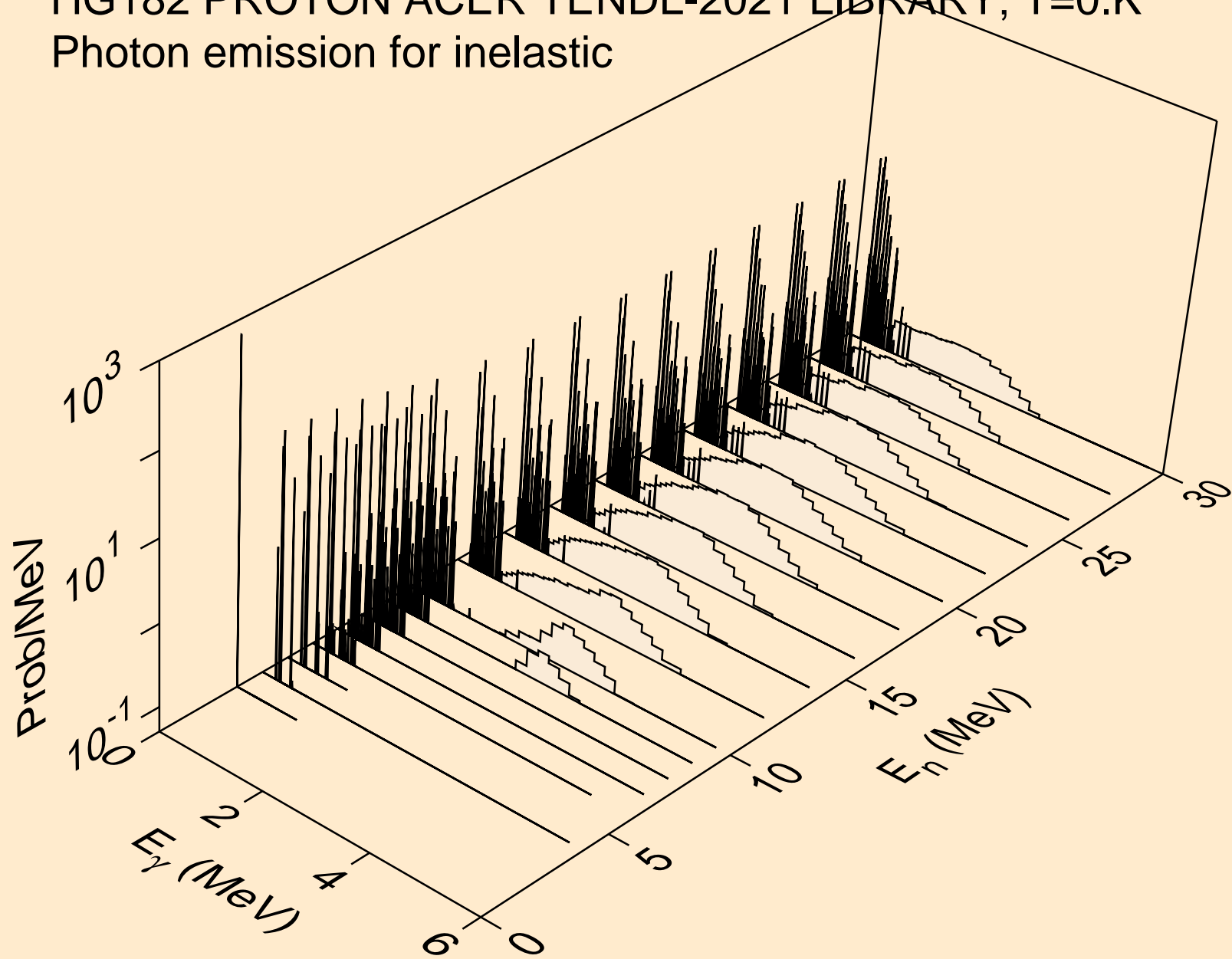

HG182 PROTON ACER TENDL-2021 LIBRARY; T=0.K  
Photon emission for (n,d)

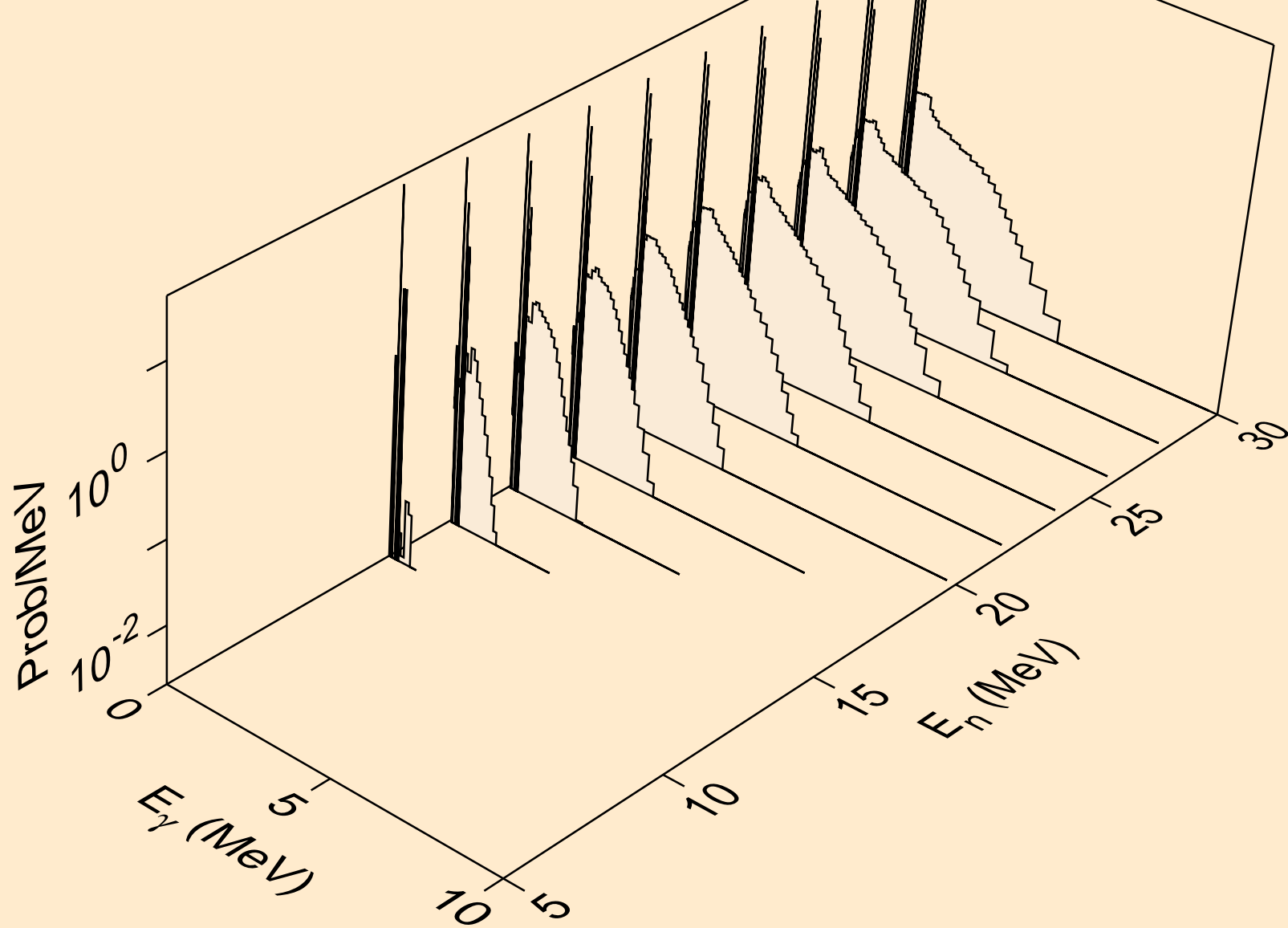

HG182 PROTON ACER TENDL-2021 LIBRARY; T=0.K  
Photon emission for (n,t)

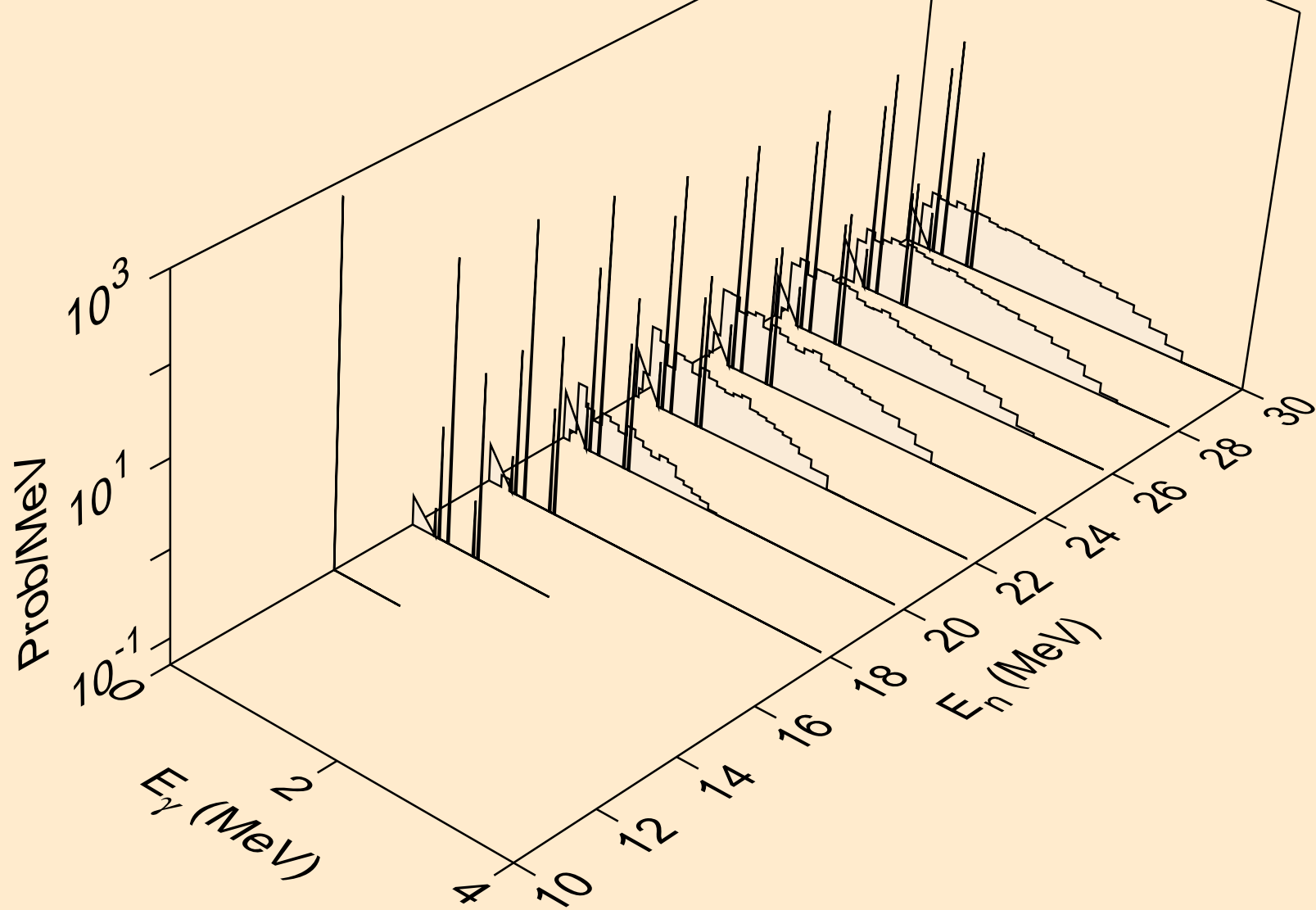

HG182 PROTON ACER TENDL-2021 LIBRARY; T=0.K  
Photon emission for (n,he3)

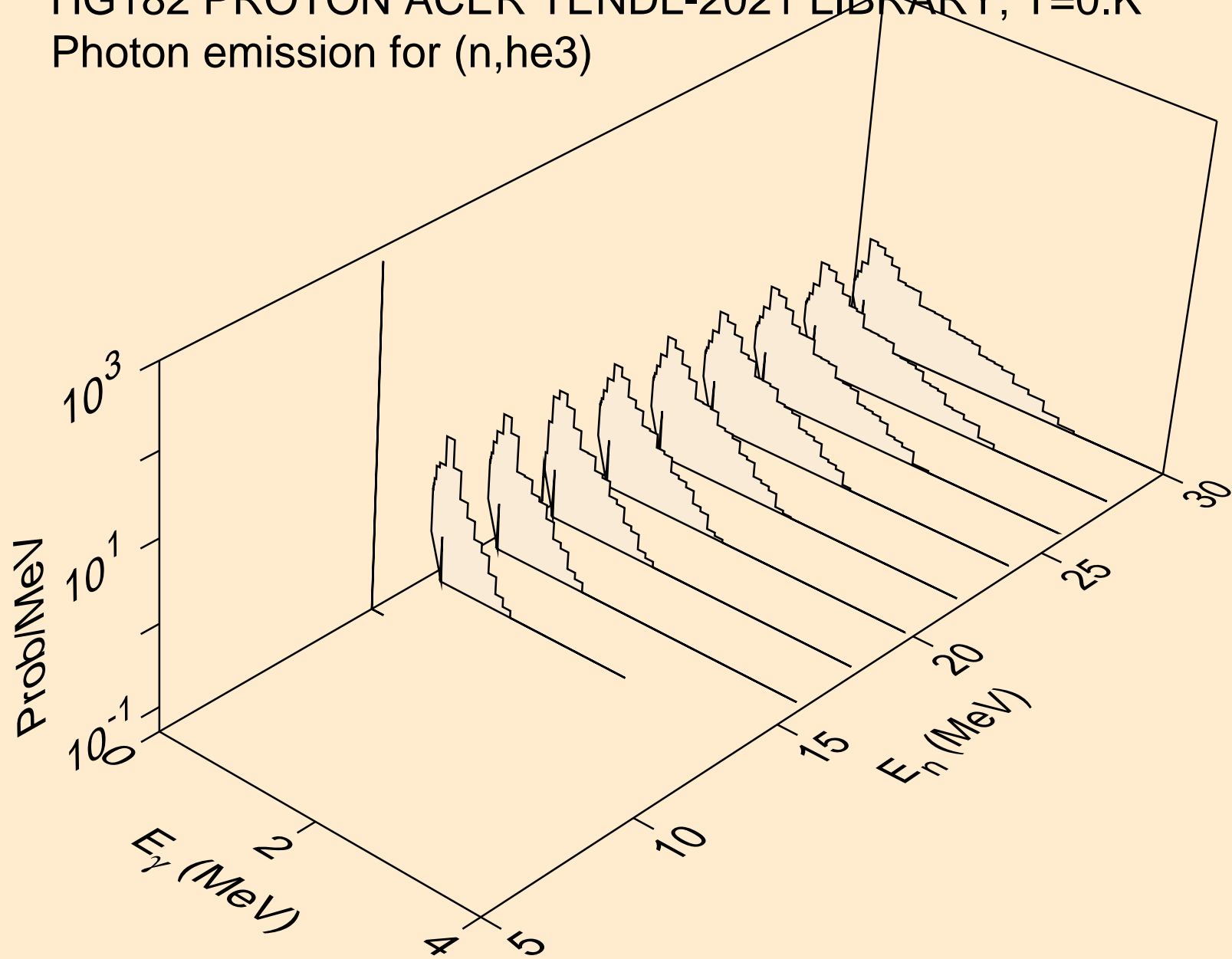

HG182 PROTON ACER TENDL-2021 LIBRARY; T=0.K  
Photon emission for (n,a)

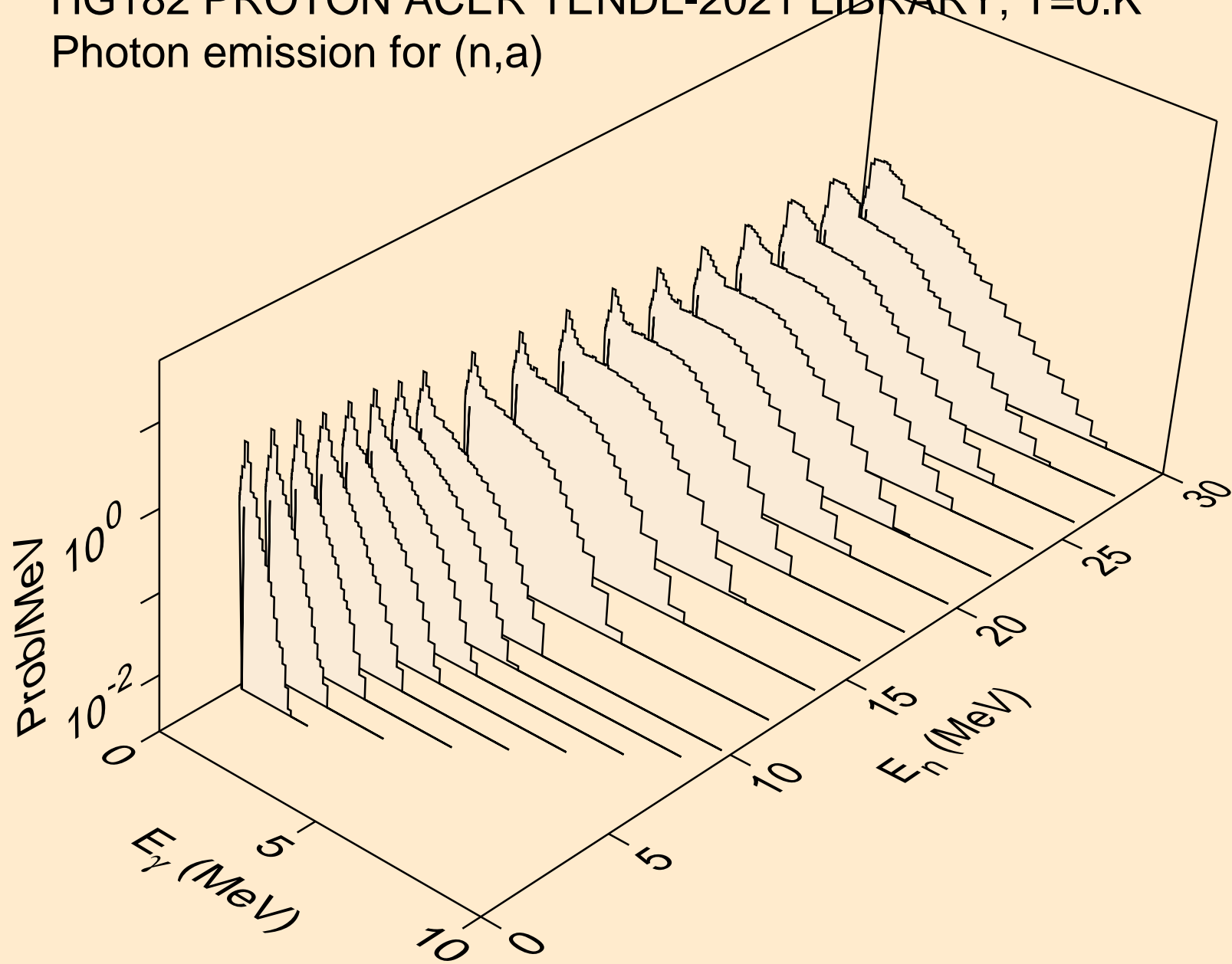

HG182 PROTON ACER TENDL-2021 LIBRARY; T=0.K  
Photon emission for (n,2a)

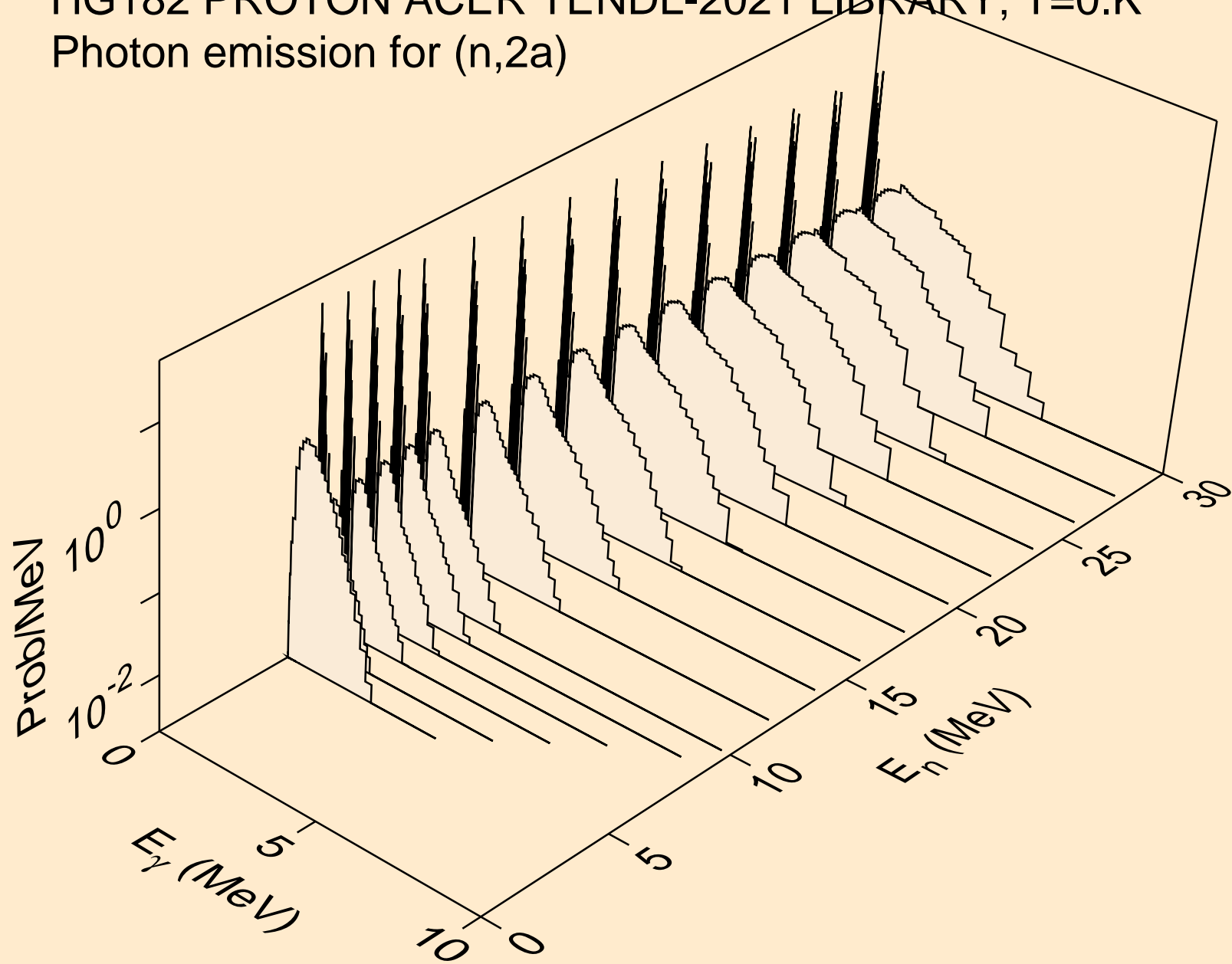

HG182 PROTON ACER TENDL-2021 LIBRARY; T=0.K  
Photon emission for (n,3a)

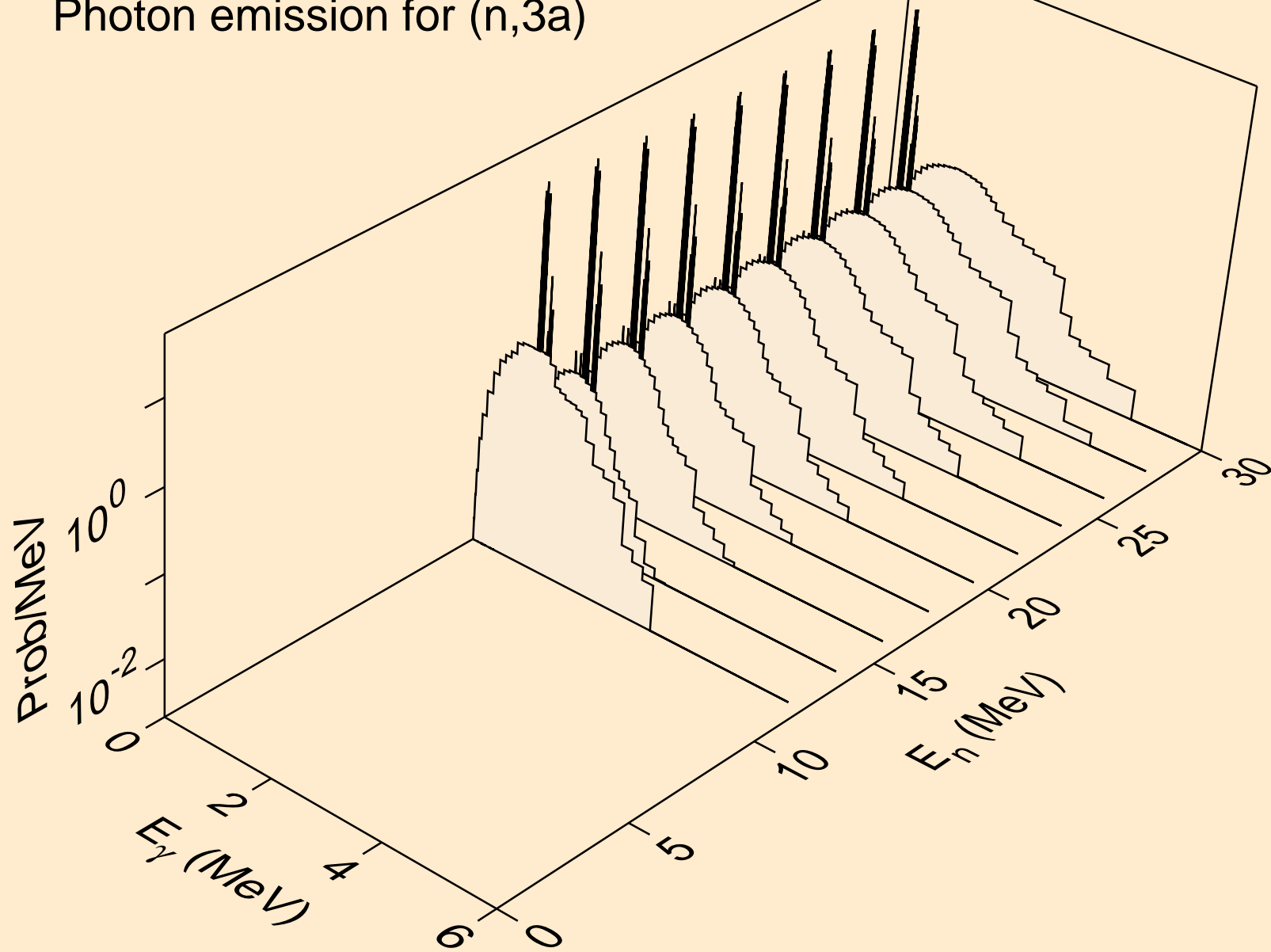

HG182 PROTON ACER TENDL-2021 LIBRARY; T=0.K  
Photon emission for (n,2p)

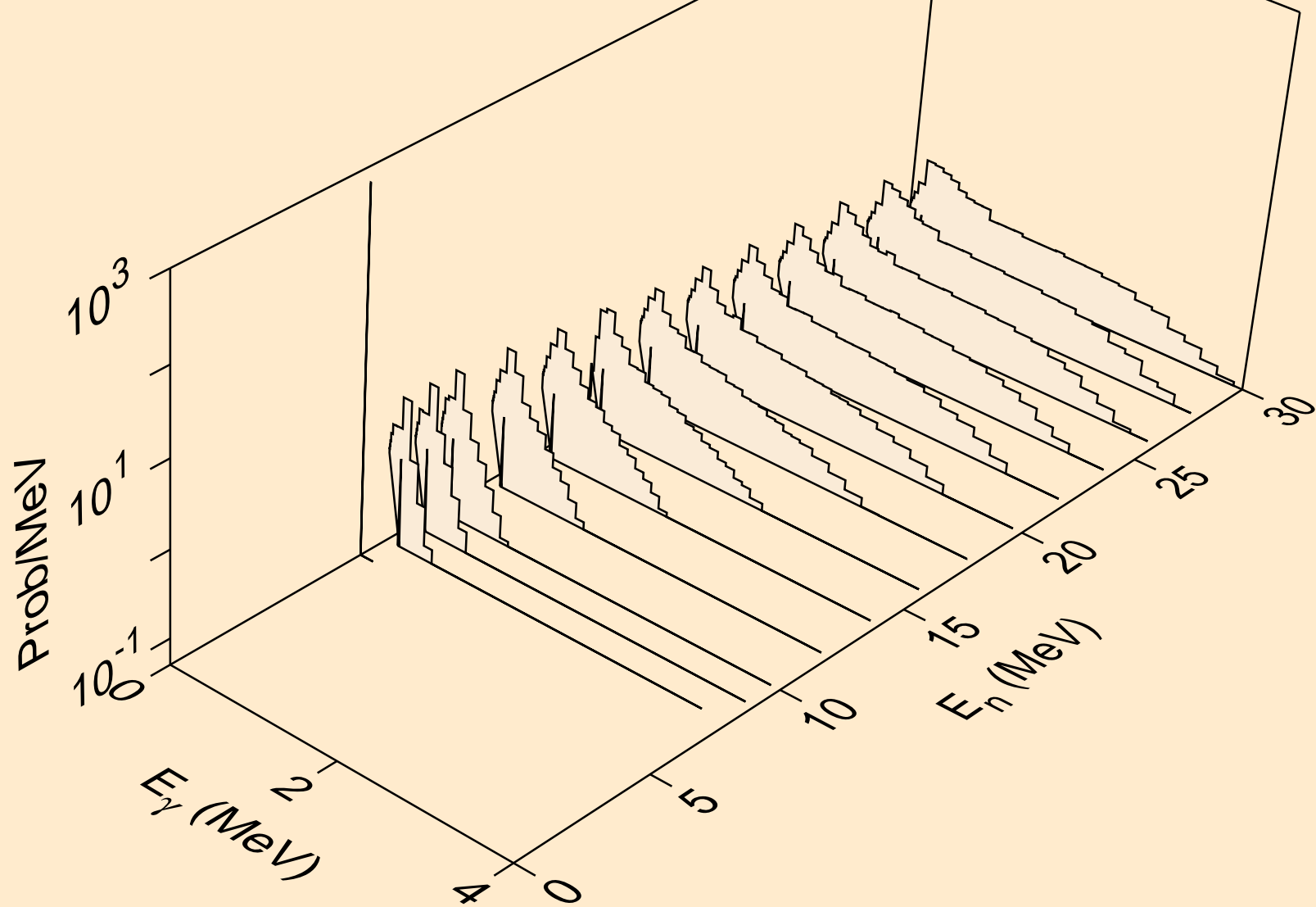



HG182 PROTON ACER TENDL-2021 LIBRARY; T=0.K  
Photon emission for (n,pa)

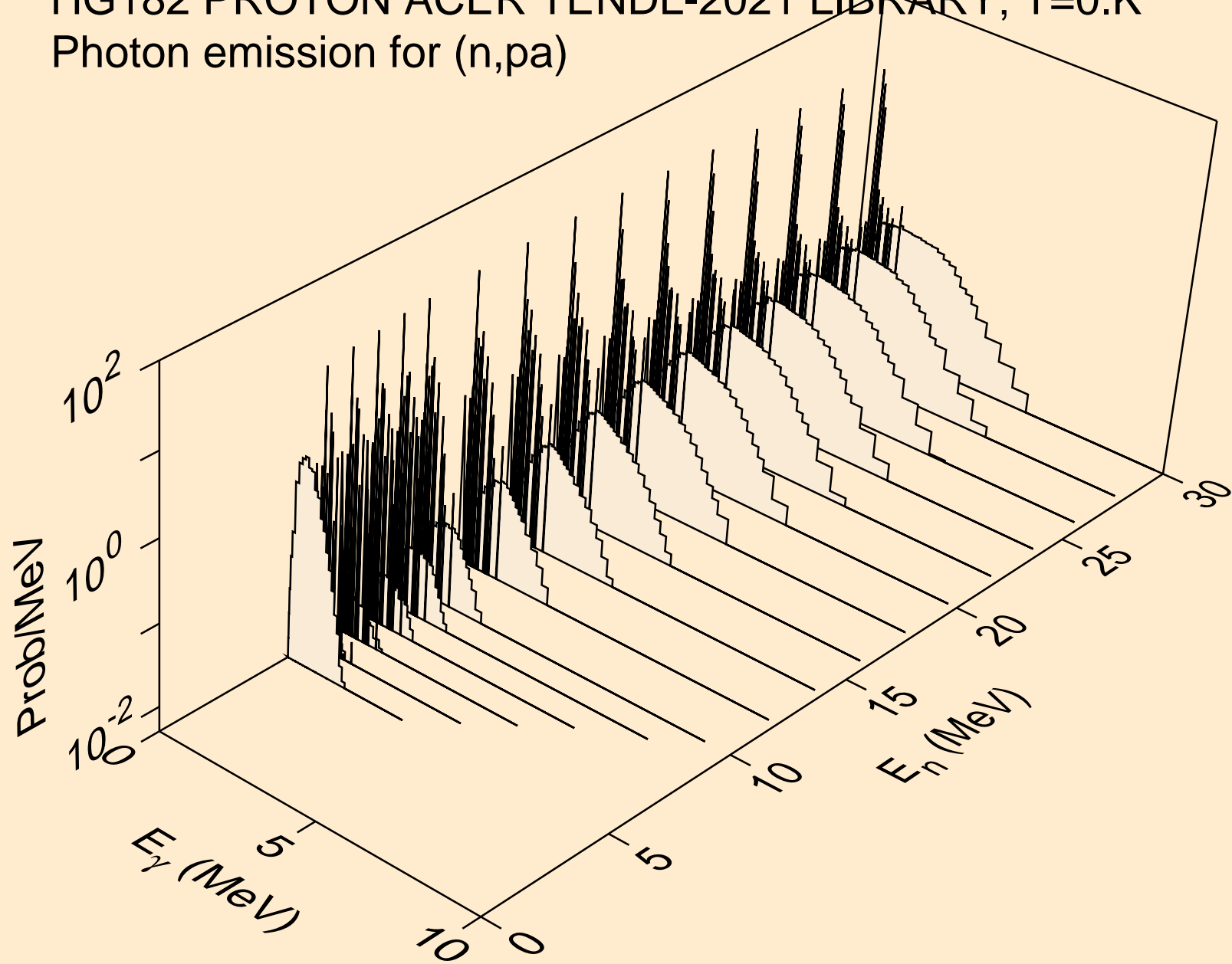

HG182 PROTON ACER TENDL-2021 LIBRARY; T=0.K  
Photon emission for (n,pd)

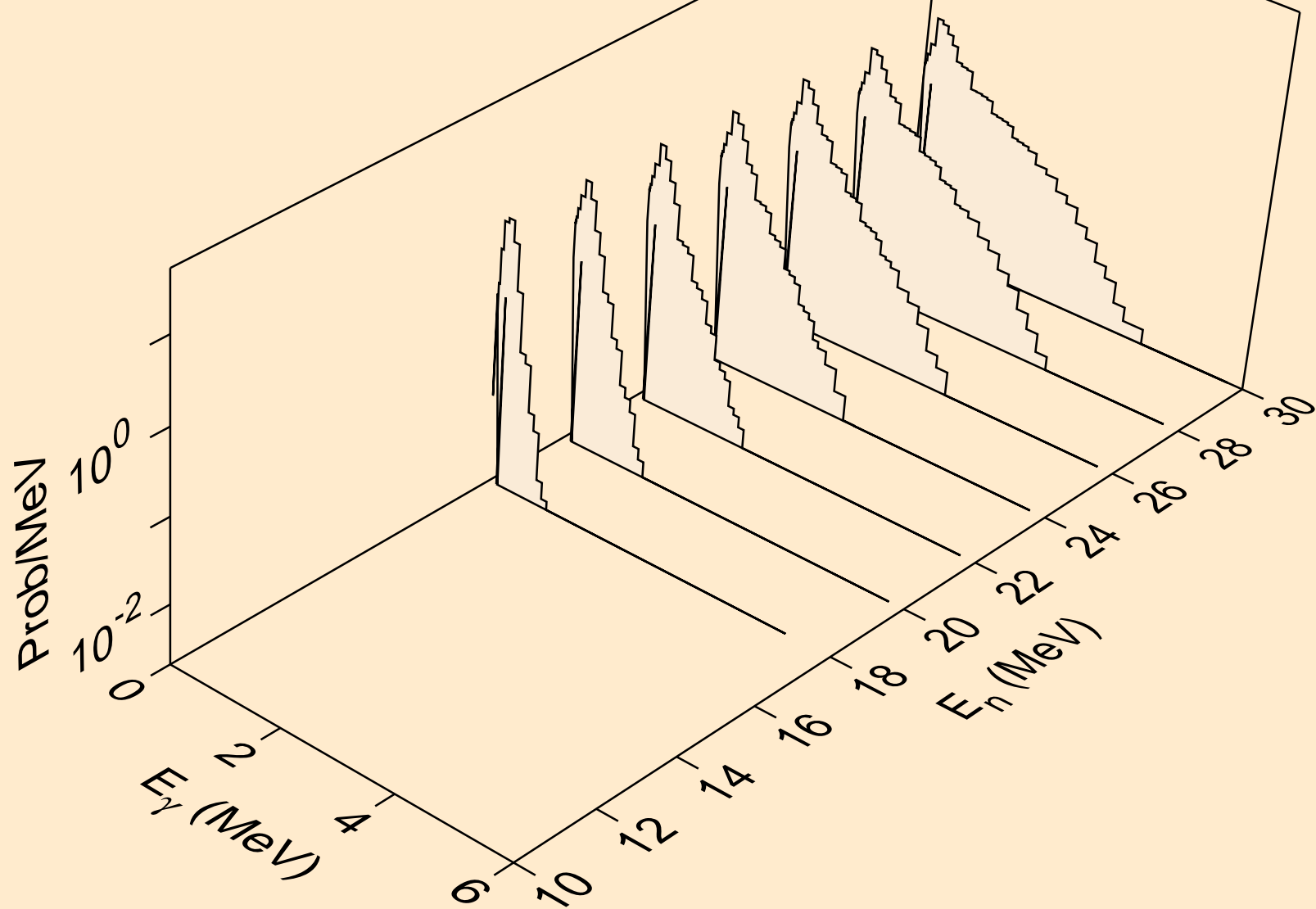

HG182 PROTON ACER TENDL-2021 LIBRARY; T=0.K  
Photon emission for (n,pt)

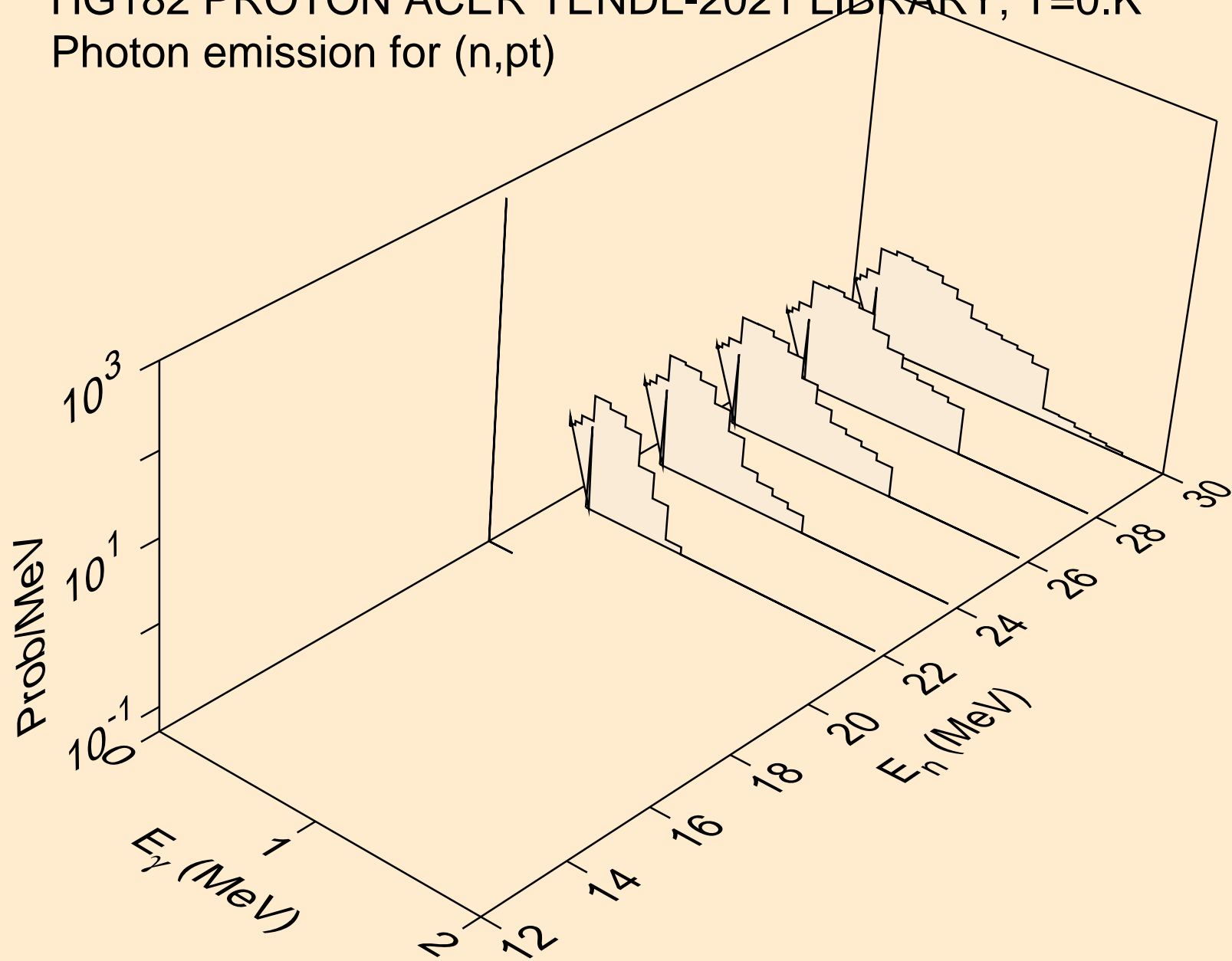

HG182 PROTON ACER TENDL-2021 LIBRARY; T=0.K  
Photon emission for (n,da)

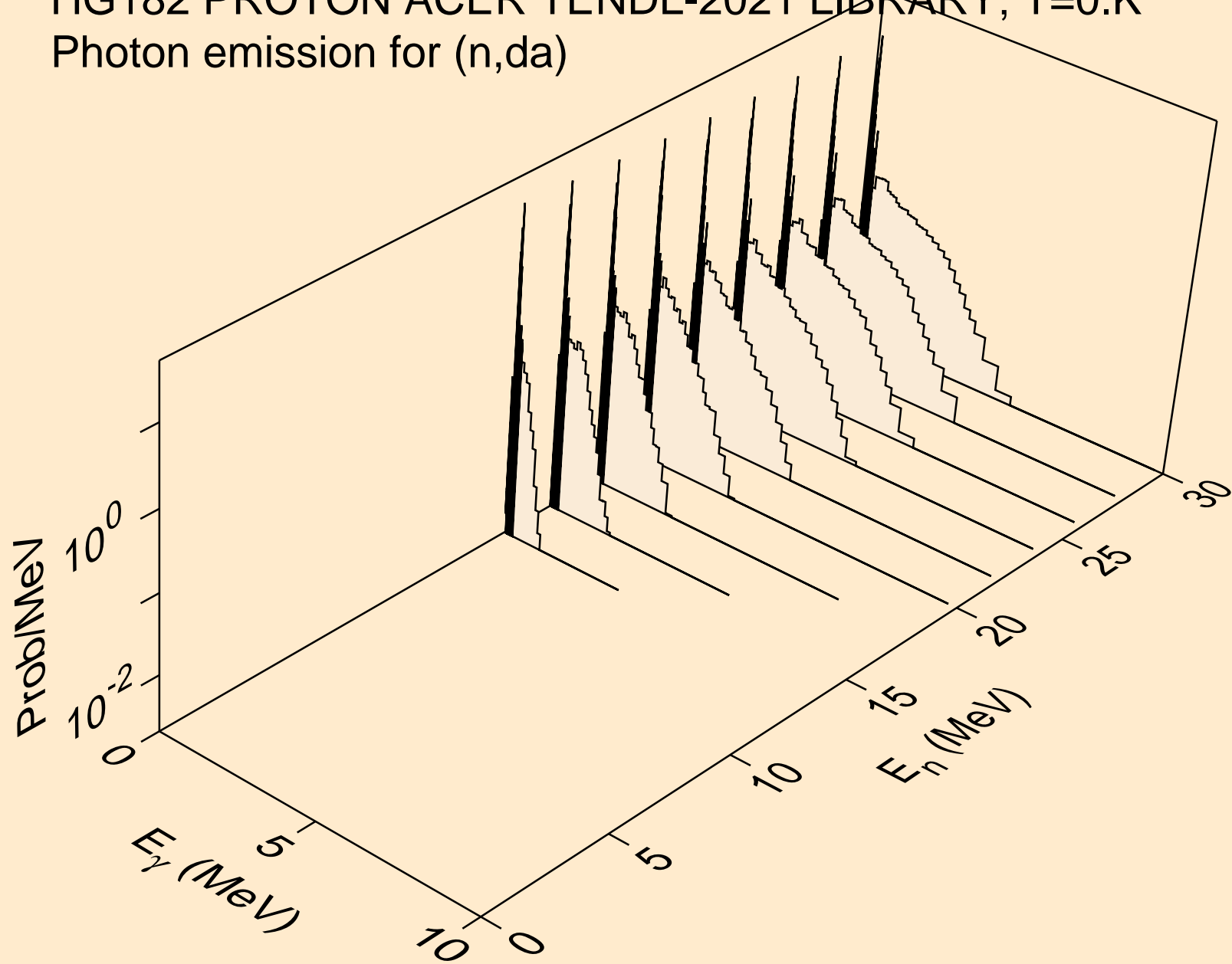

# HG182 PROTON ACER TENDL-2021 LIBRARY; T=0.K

## Particle heating contributions

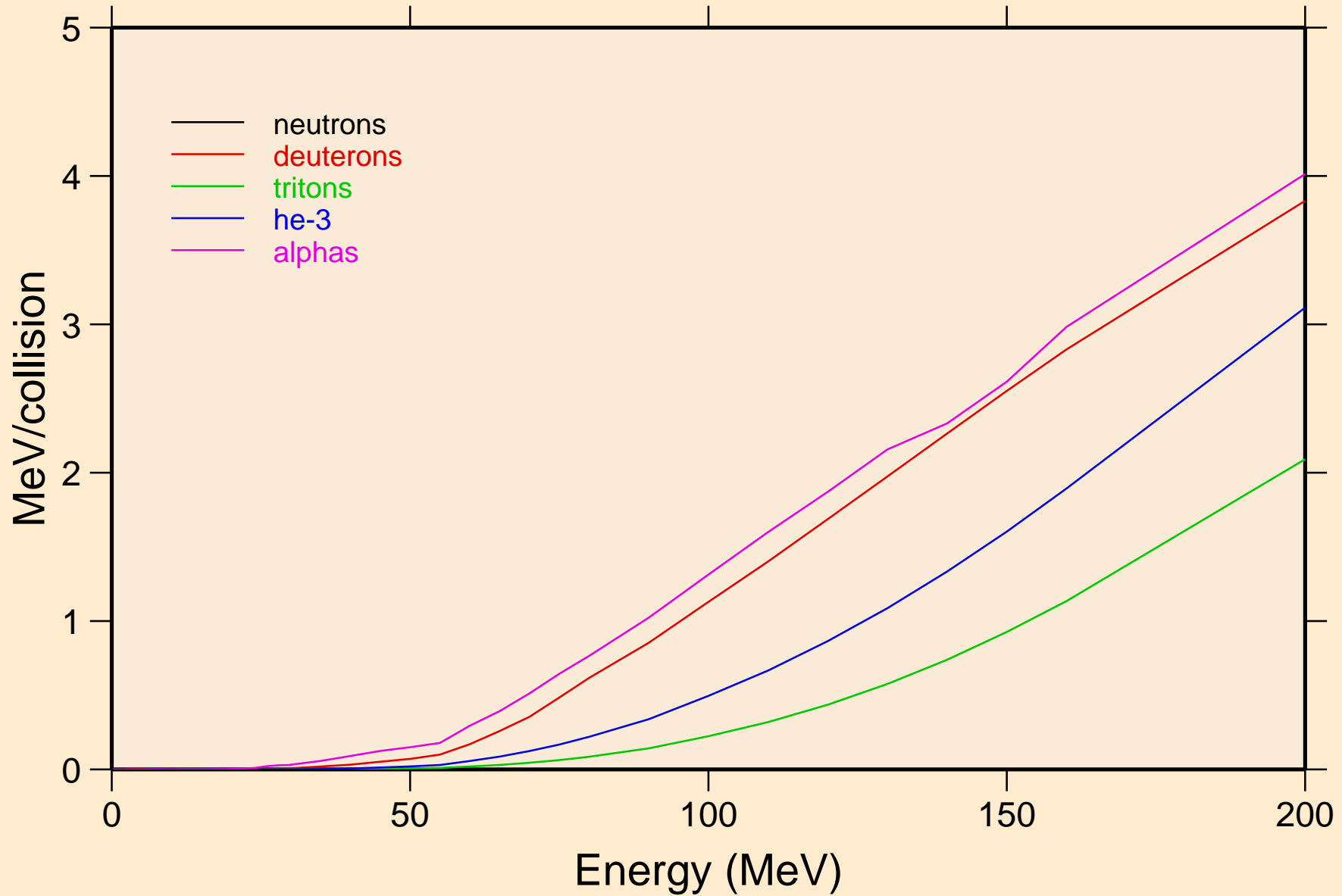

HG182 PROTON ACER TENDL-2021 LIBRARY; T=0.K  
Recoil Heating

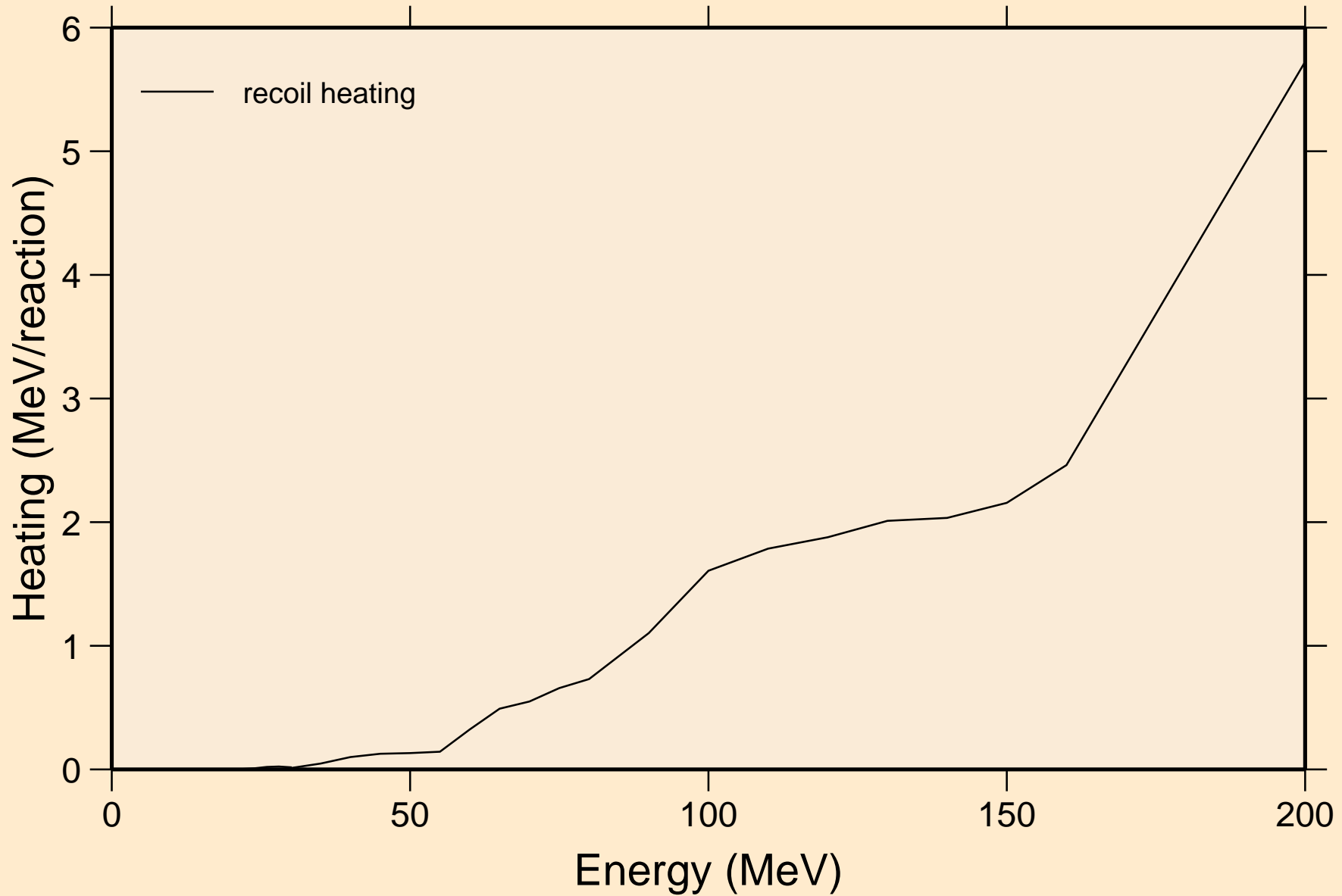

HG182 PROTON ACER TENDL-2021 LIBRARY; T=0.K  
Particle production cross sections

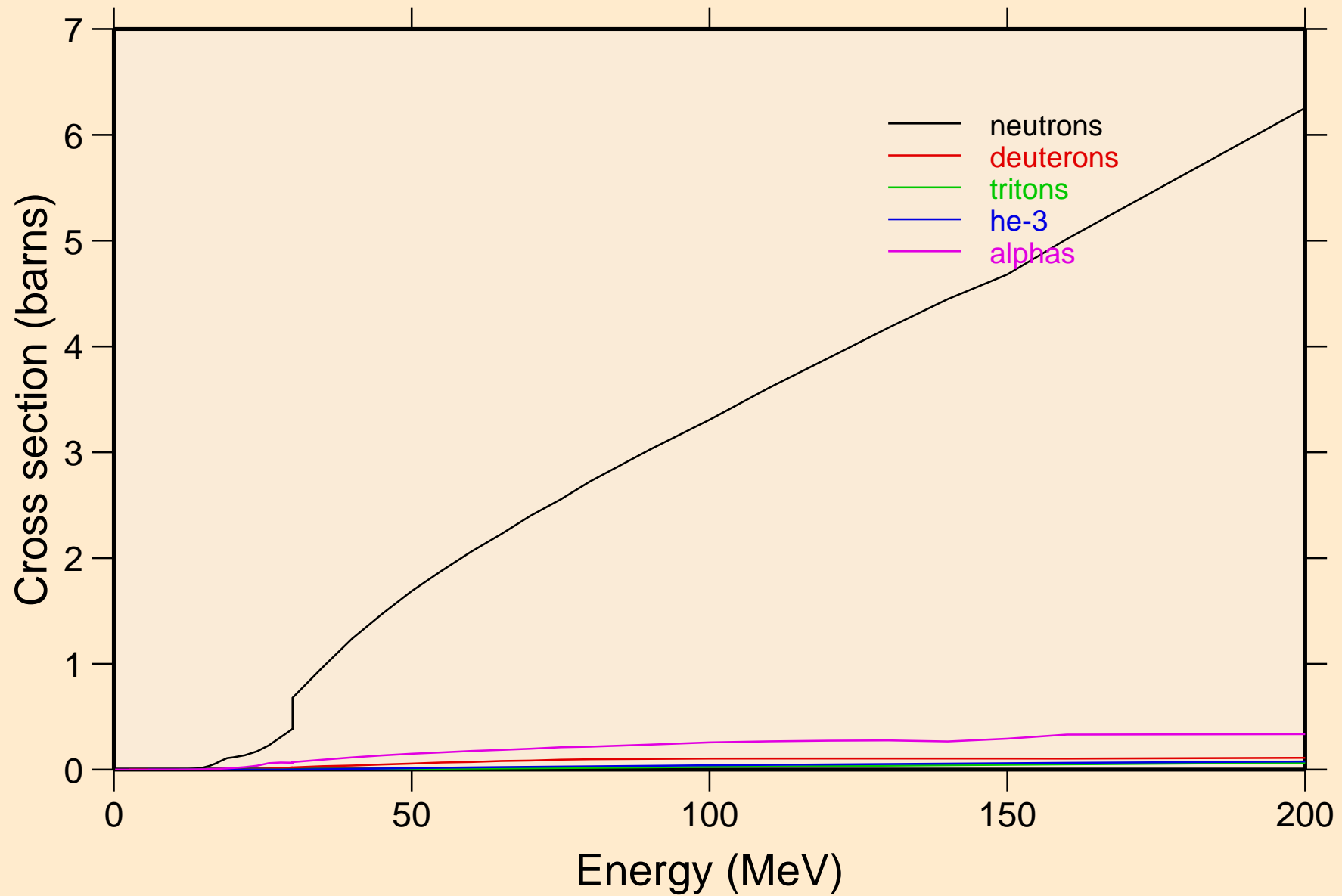

HG182 PROTON ACER TENDL-2021 LIBRARY; T=0.K  
neutrons from (p,n)

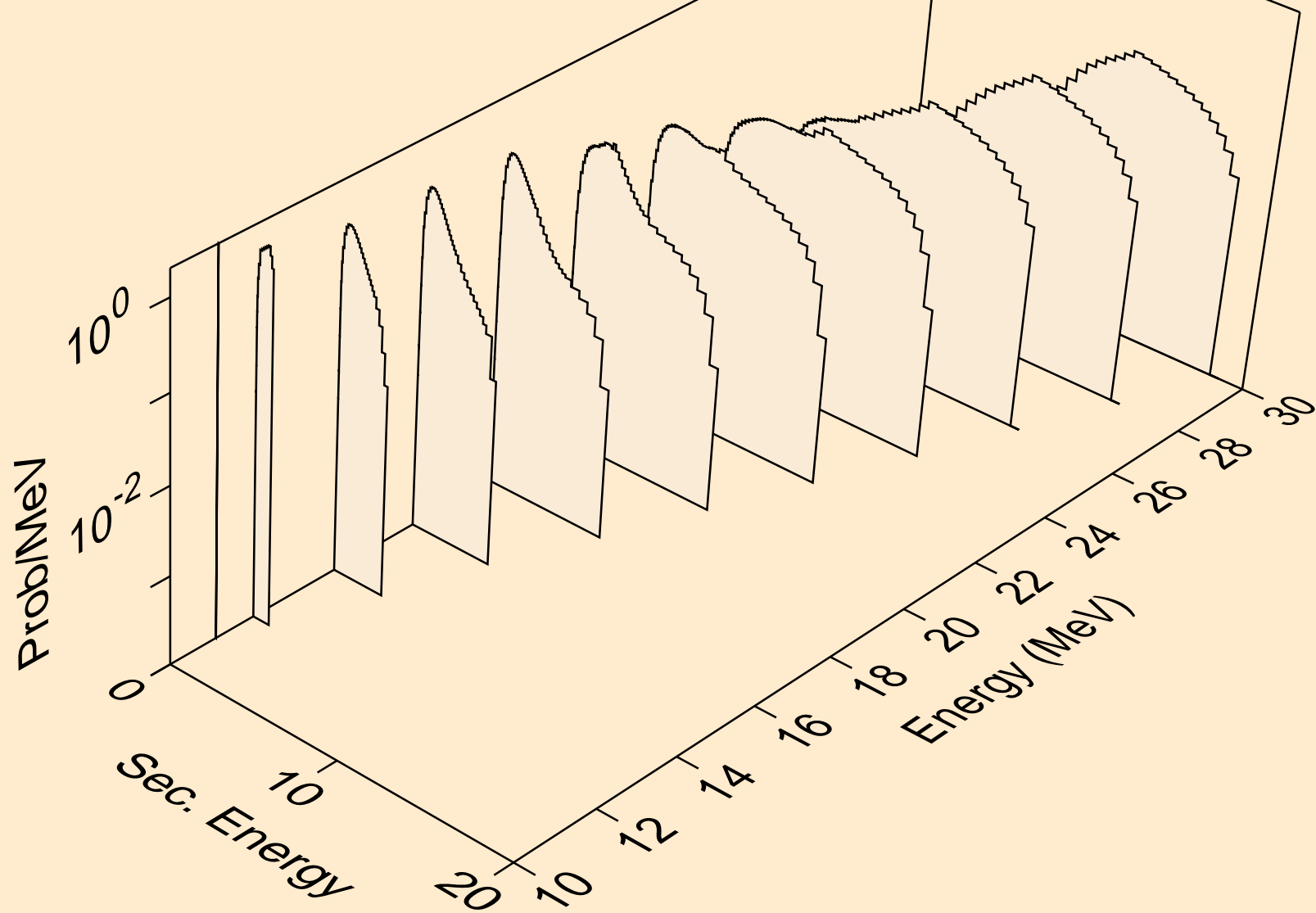



HG182 PROTON ACER TENDL-2021 LIBRARY; T=0.K  
neutrons from (p,x)

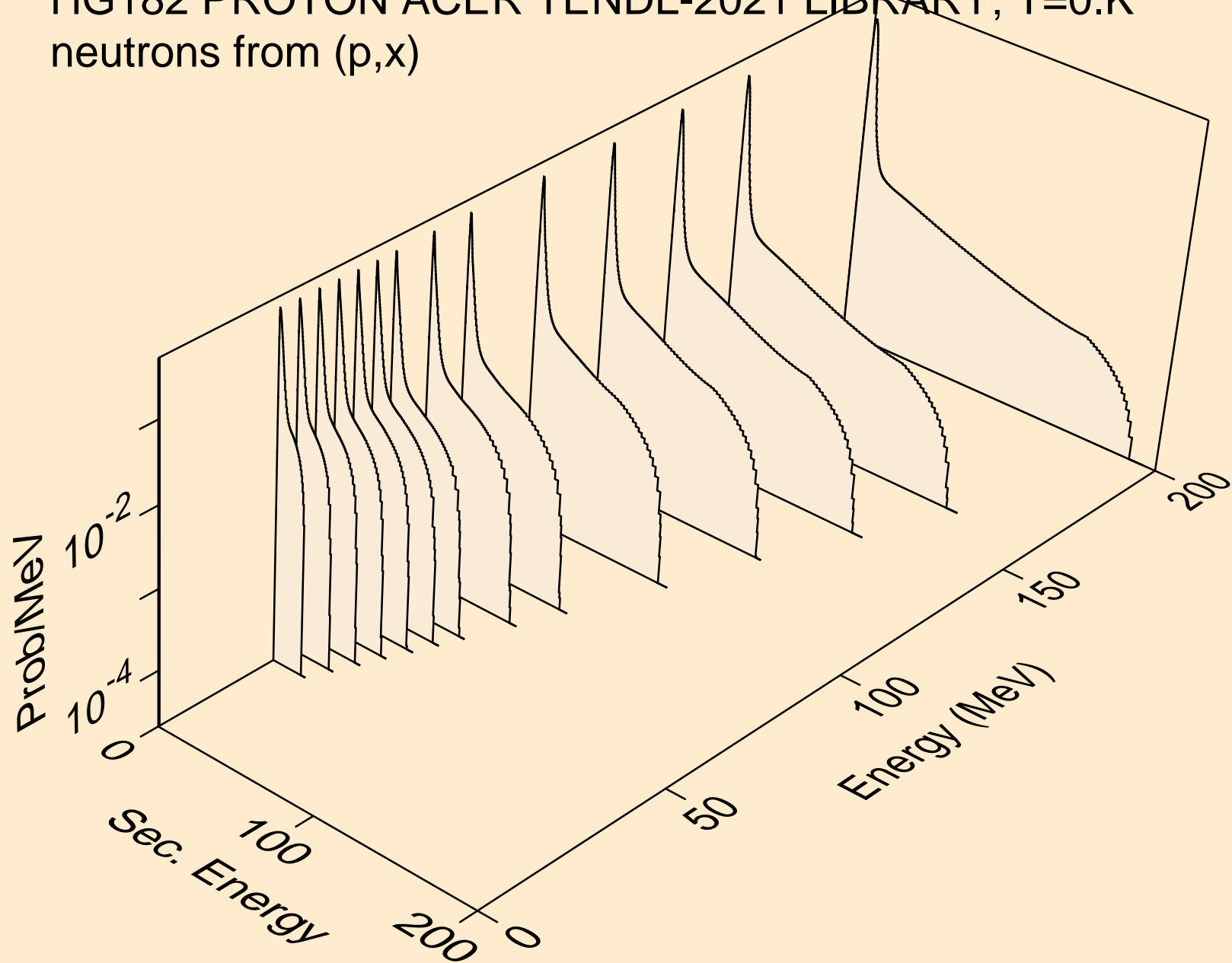

HG182 PROTON ACER TENDL-2021 LIBRARY; T=0.K  
neutrons from (p,2n)

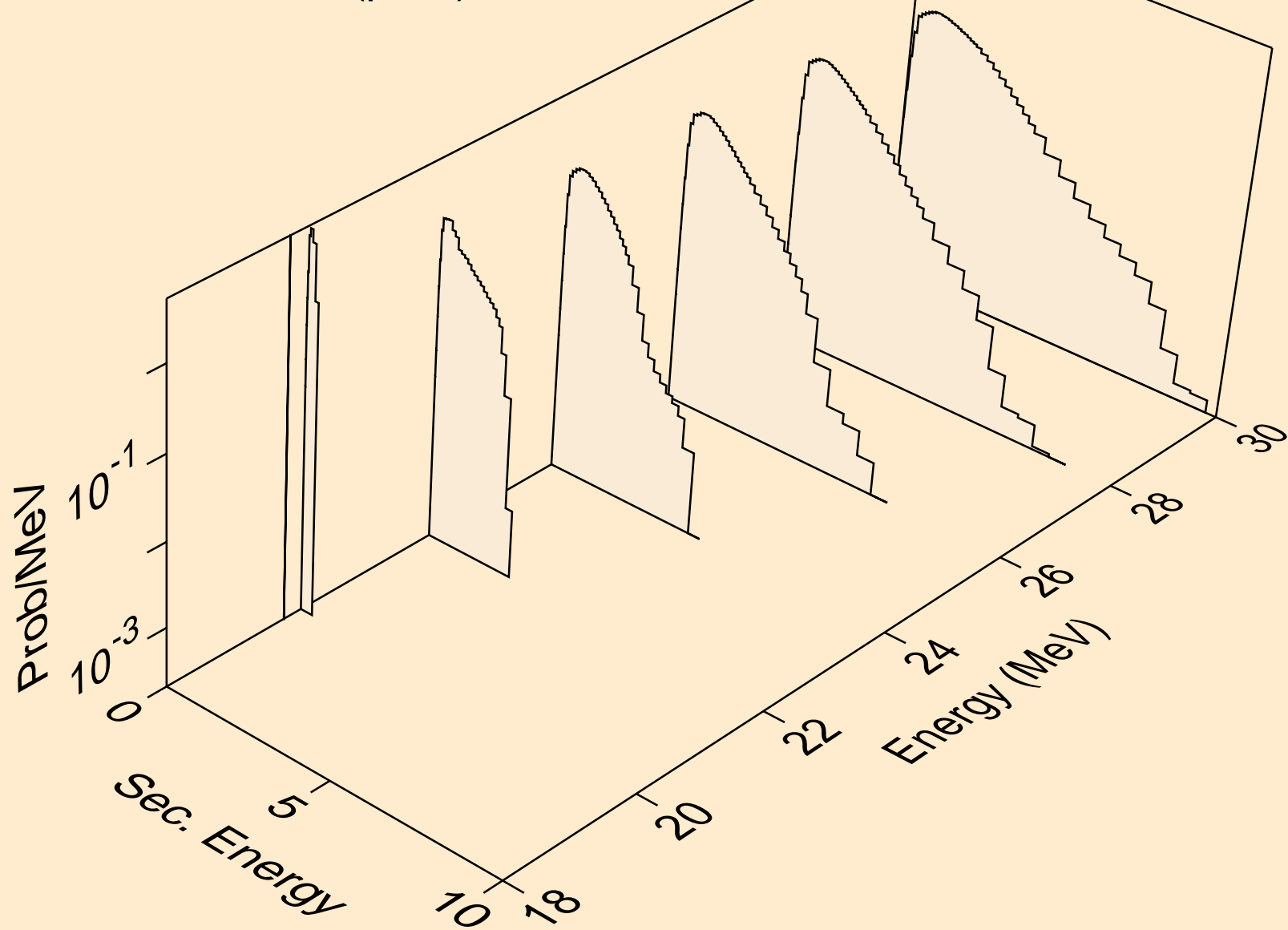

HG182 PROTON ACER TENDL-2021 LIBRARY; T=0.K  
neutrons from (p,n\*)a

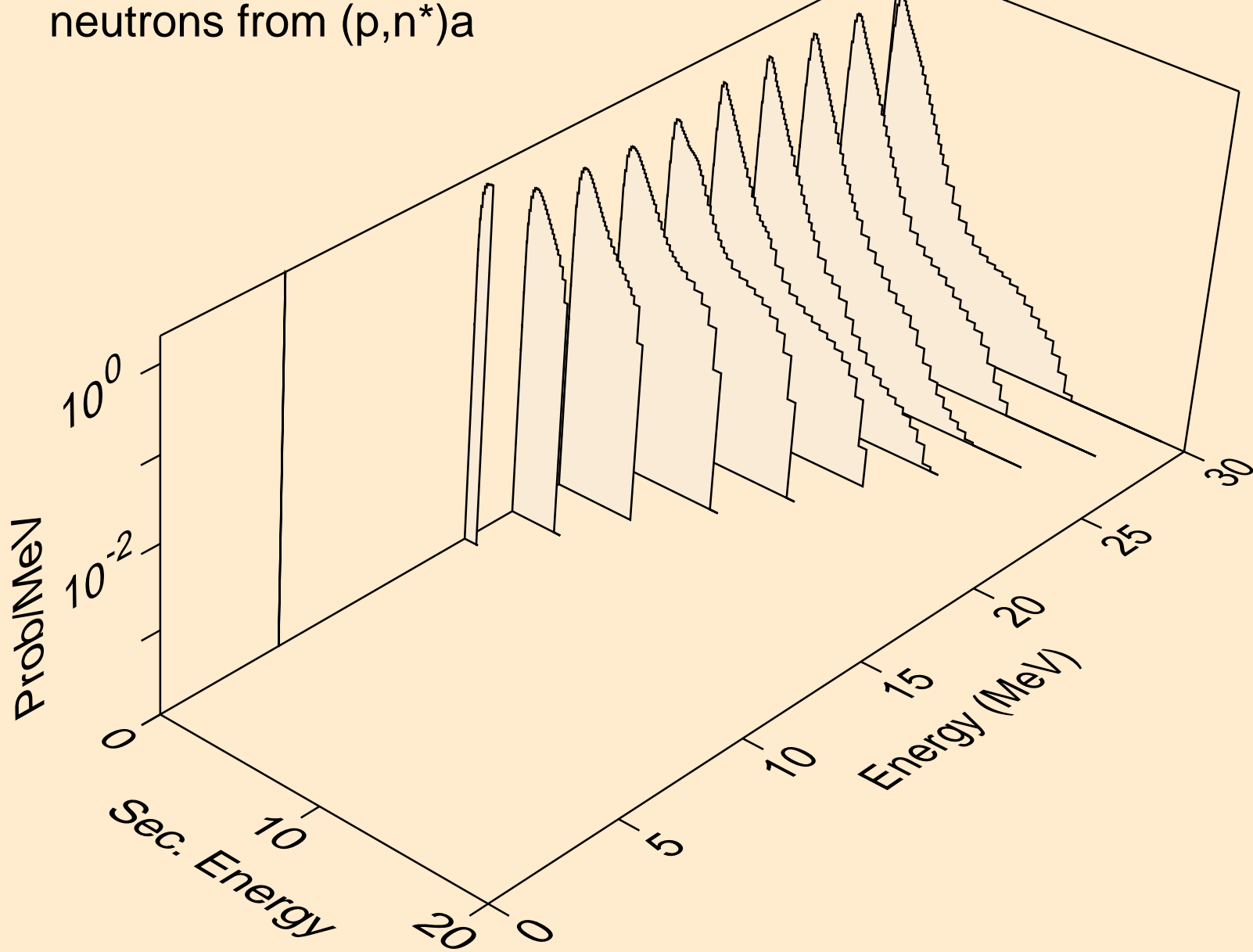

HG182 PROTON ACER TENDL-2021 LIBRARY; T=0.K  
neutrons from (p,2n)a

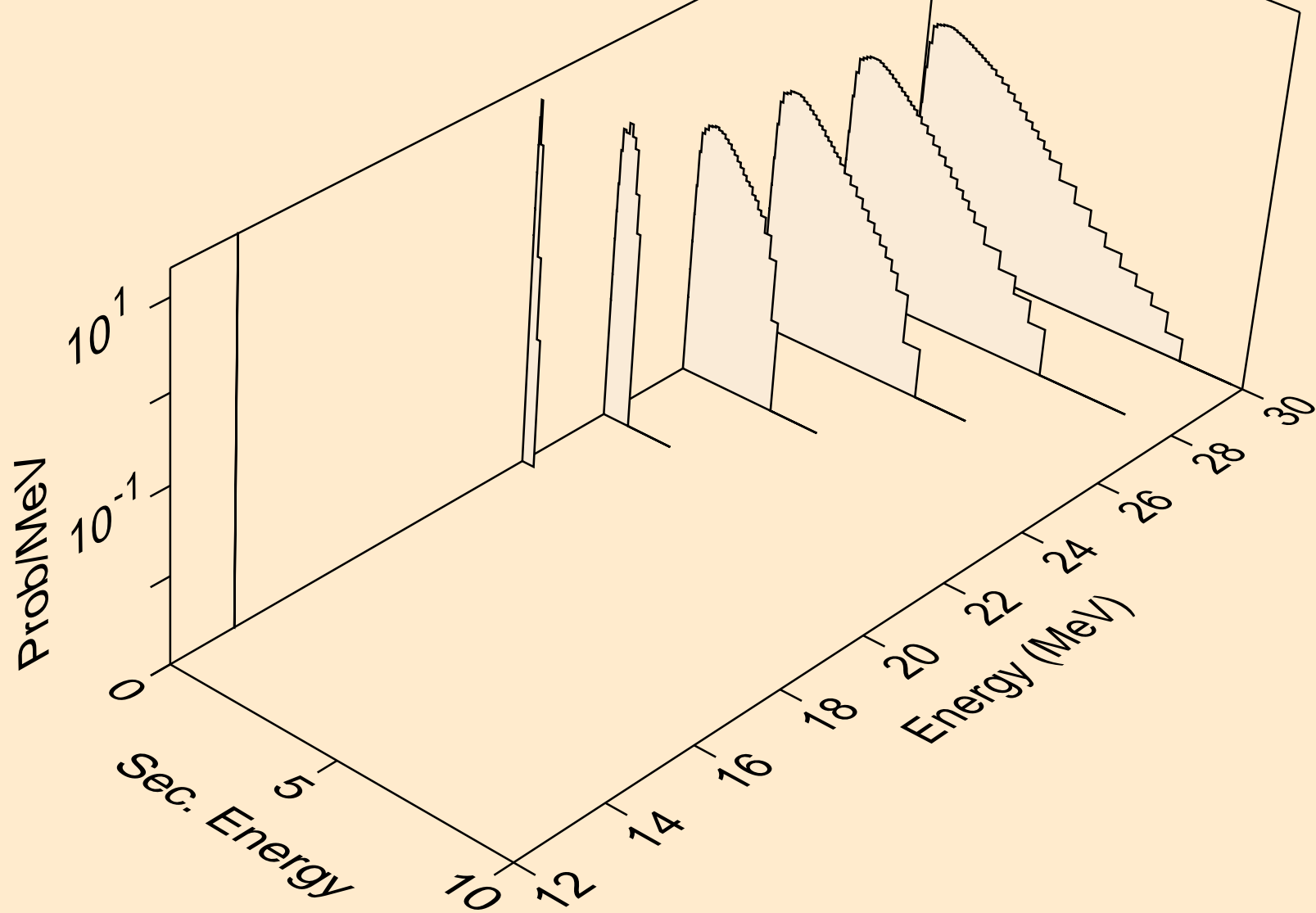

HG182 PROTON ACER TENDL-2021 LIBRARY; T=0.K  
neutrons from (p,n\*)p

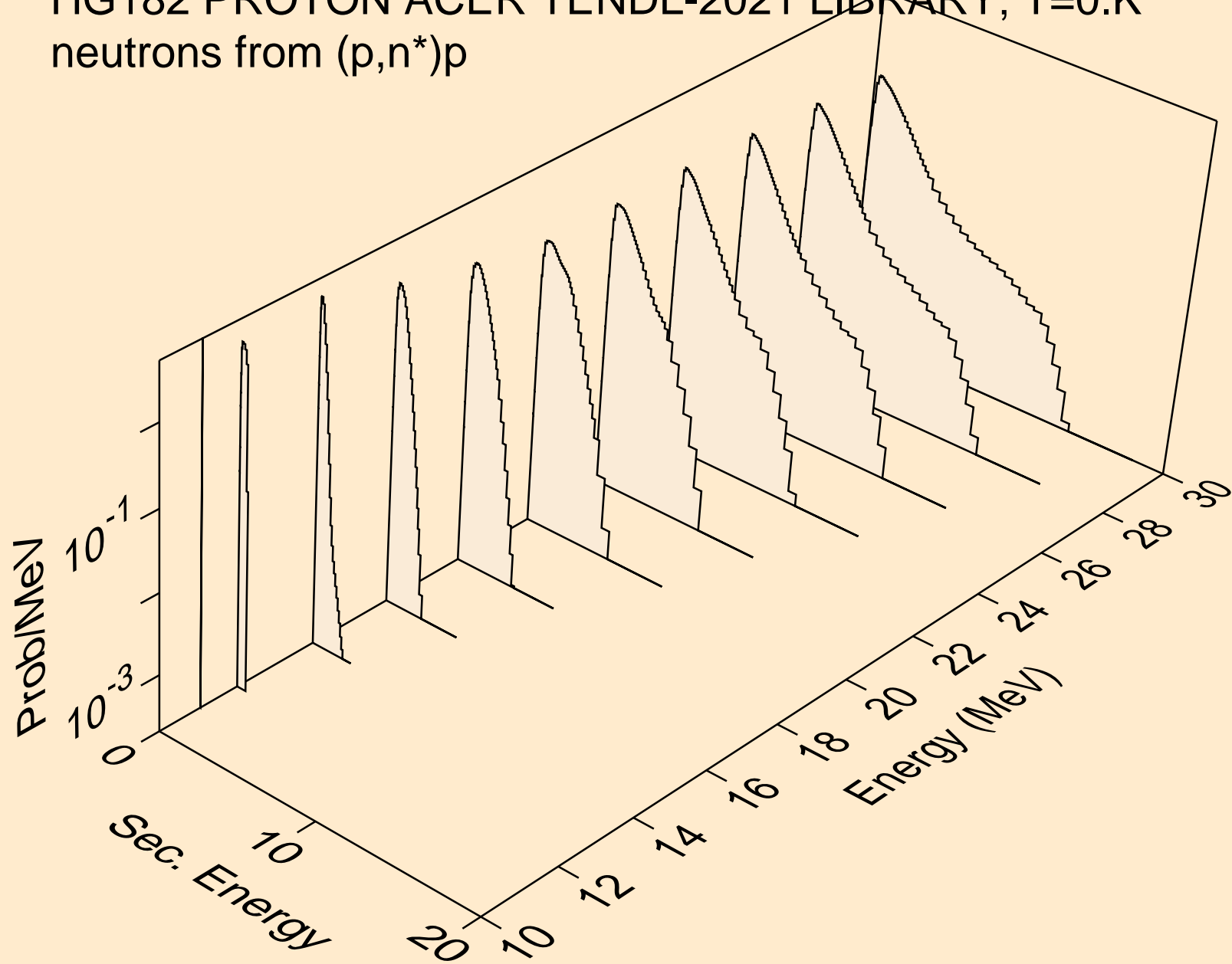

HG182 PROTON ACER TENDL-2021 LIBRARY; T=0.K  
neutrons from (p,n\*)2a

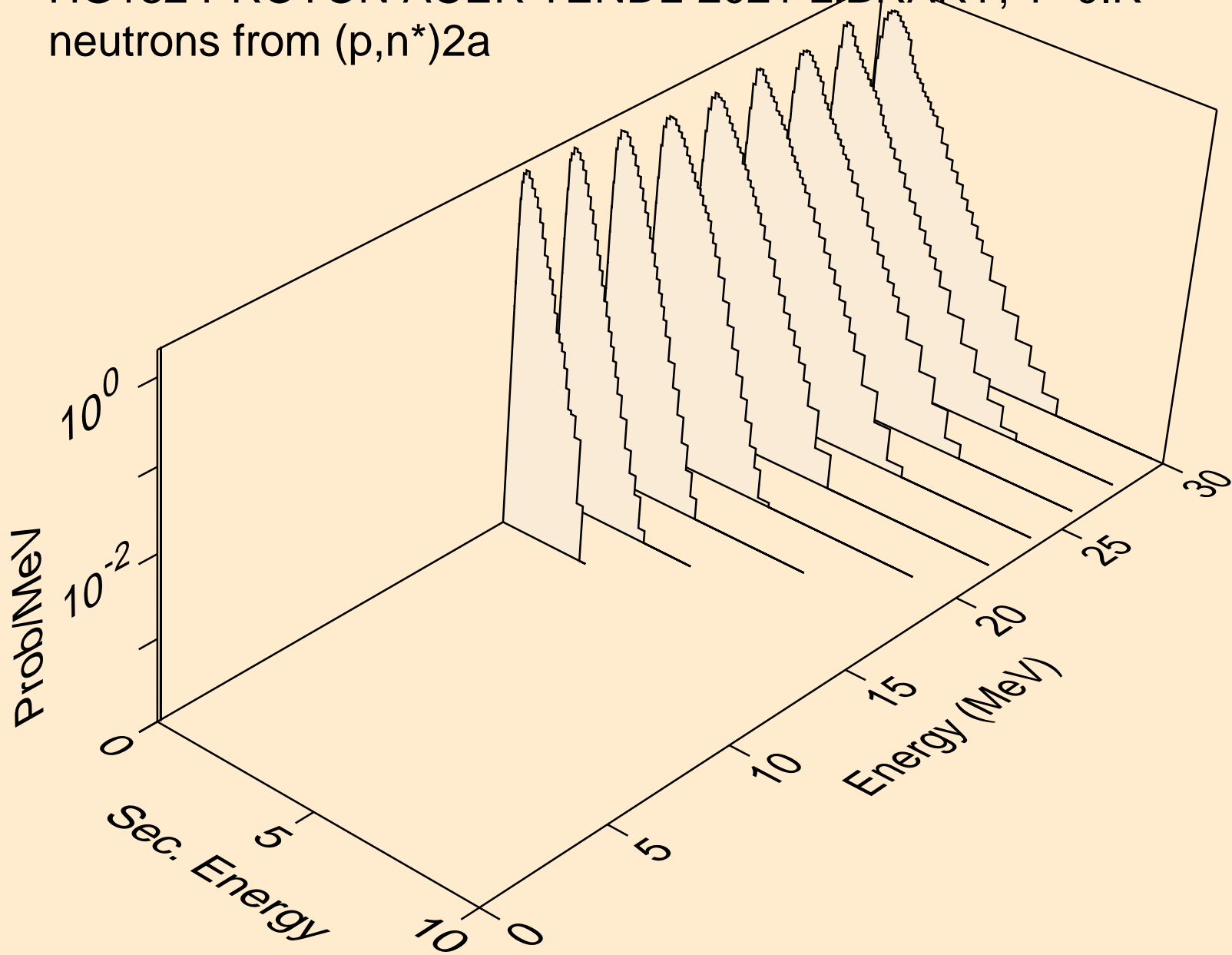

HG182 PROTON ACER TENDL-2021 LIBRARY; T=0.K  
neutrons from (p,n\*)d

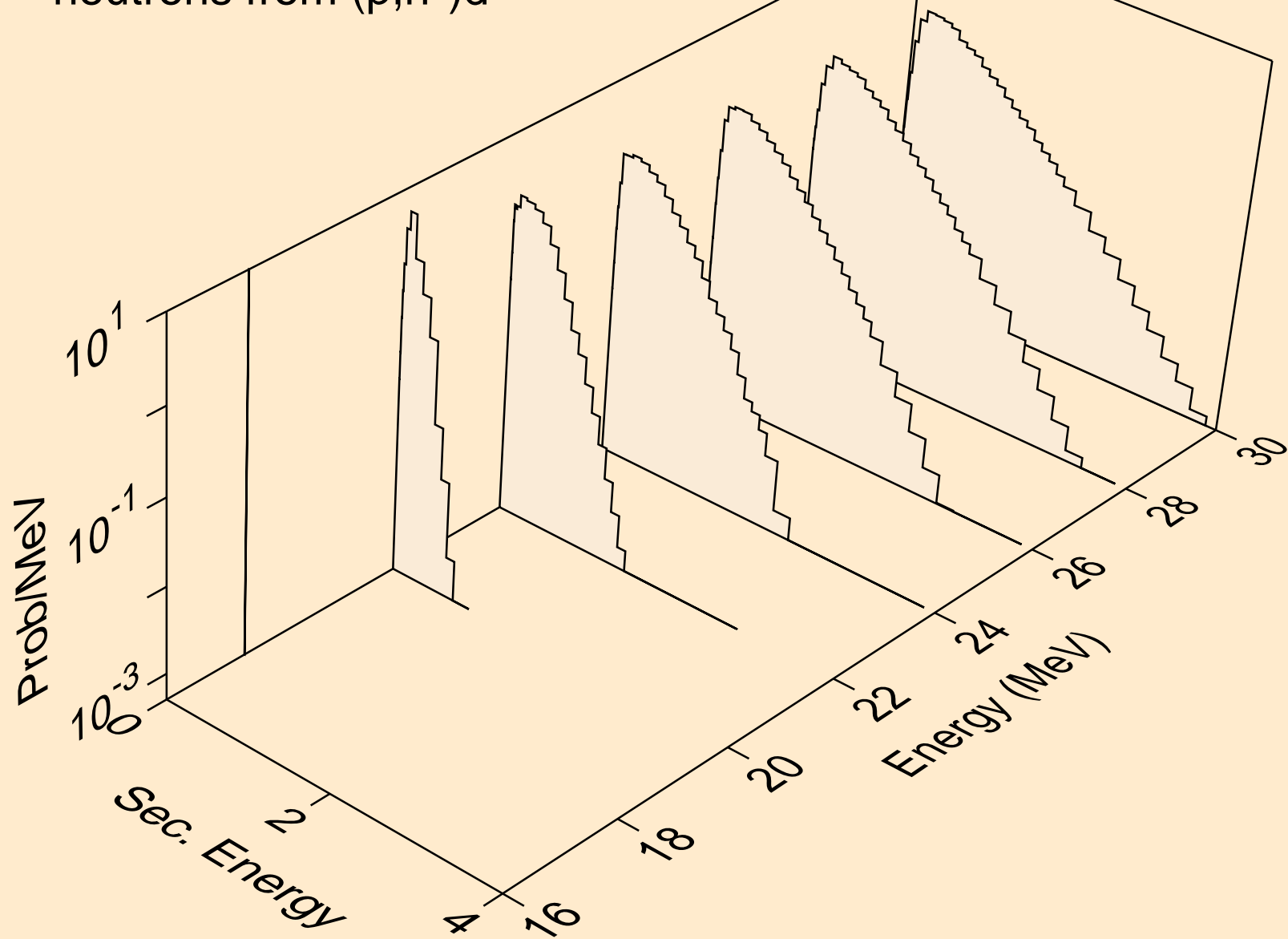

HG182 PROTON ACER TENDL-2021 LIBRARY; T=0.K  
neutrons from (p,n\*)he3

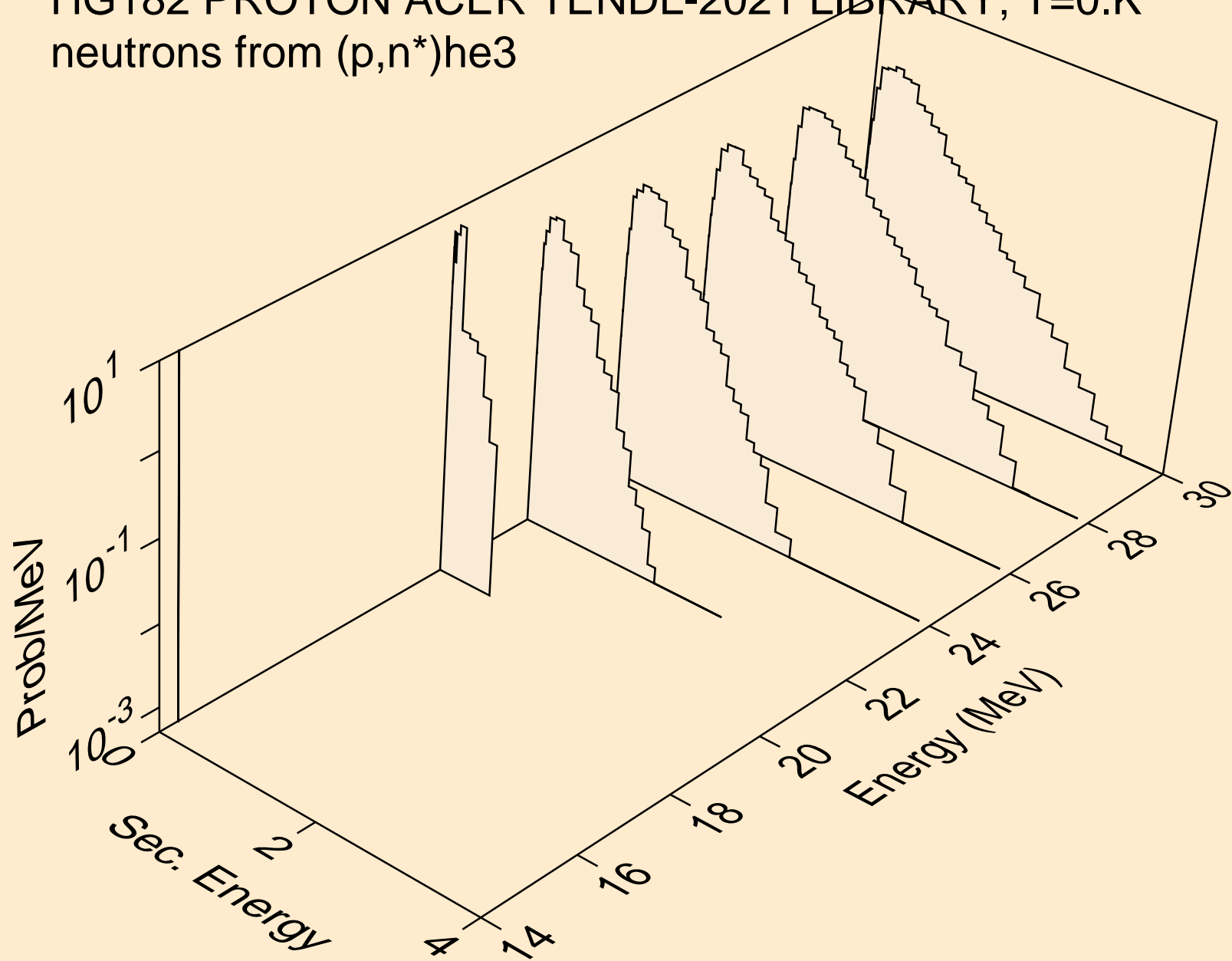



HG182 PROTON ACER TENDL-2021 LIBRARY; T=0.K  
neutrons from (p,2np)

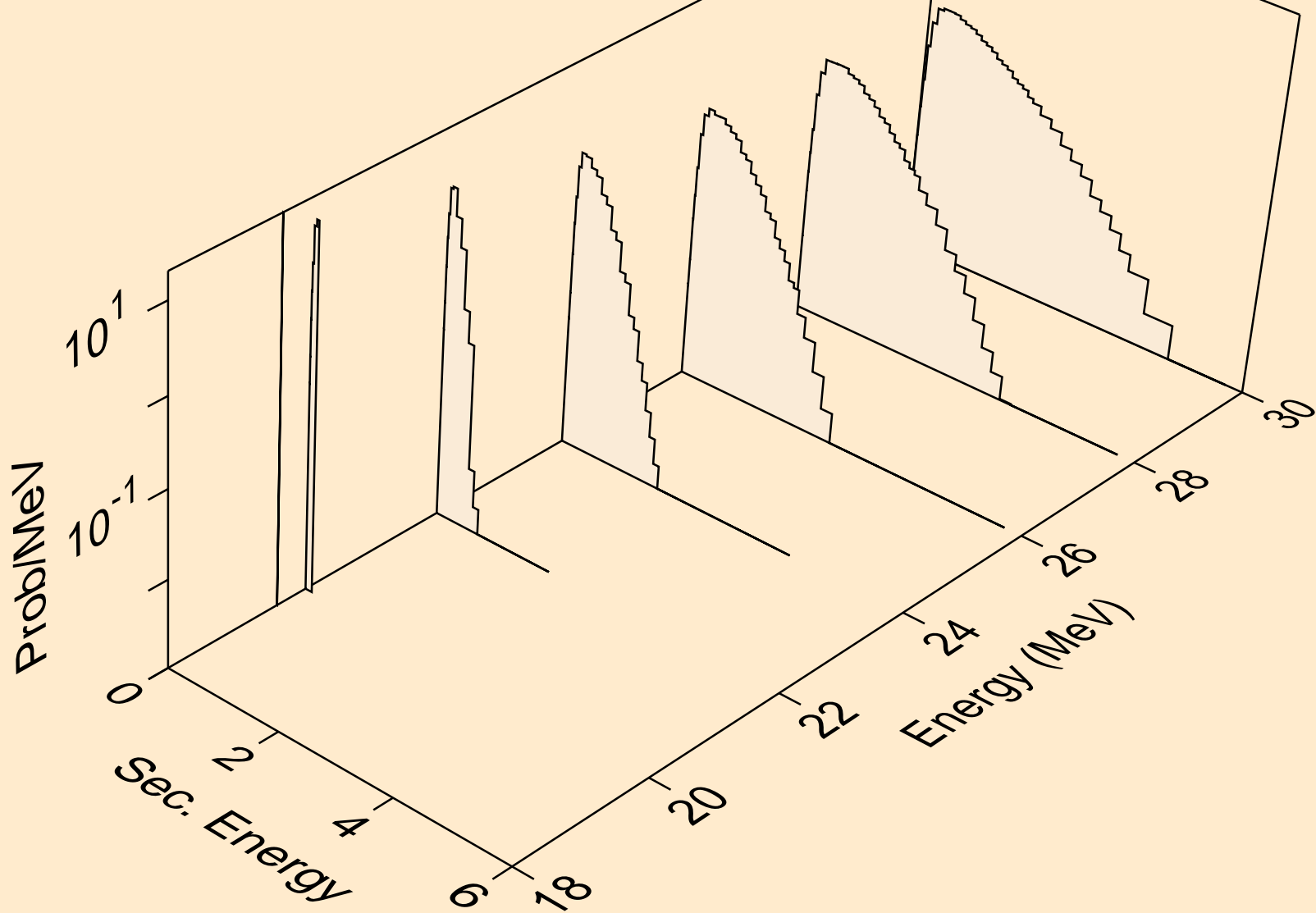

HG182 PROTON ACER TENDL-2021 LIBRARY; T=0.K  
neutrons from (p,2np)

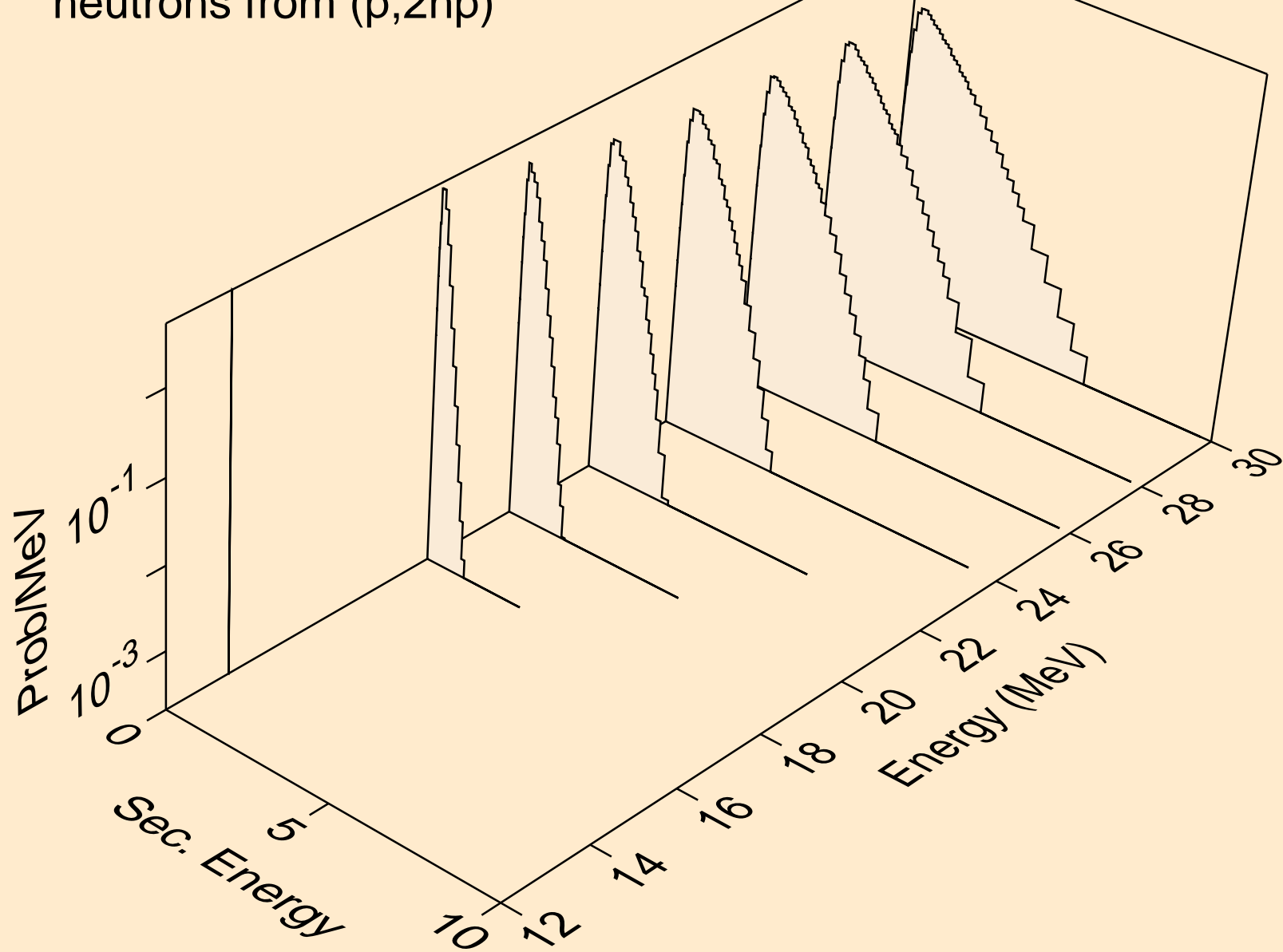

HG182 PROTON ACER TENDL-2021 LIBRARY; T=0.K  
neutrons from (p,npa)

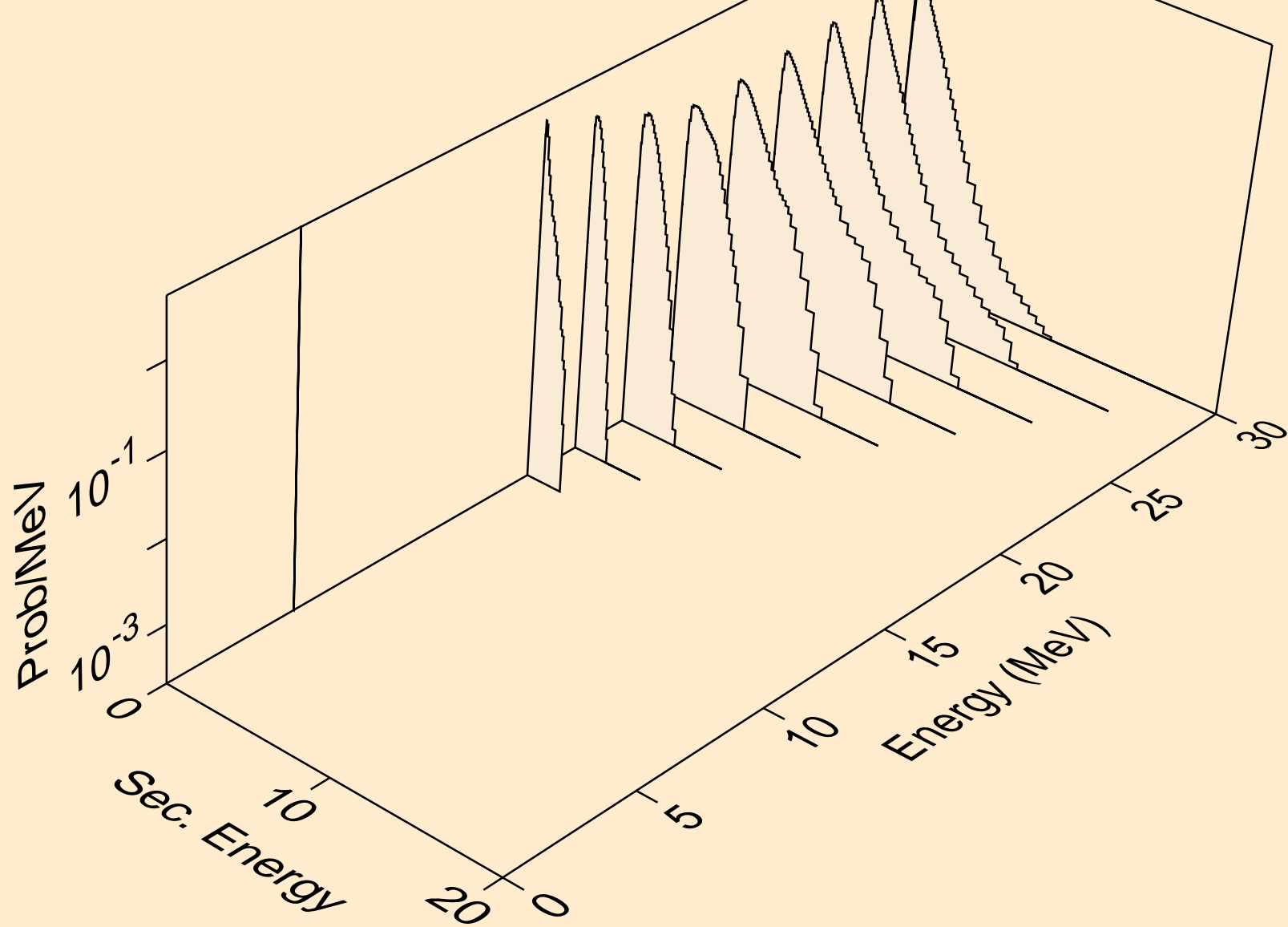

HG182 PROTON ACER TENDL-2021 LIBRARY; T=0.K  
deuterons from (p,x)

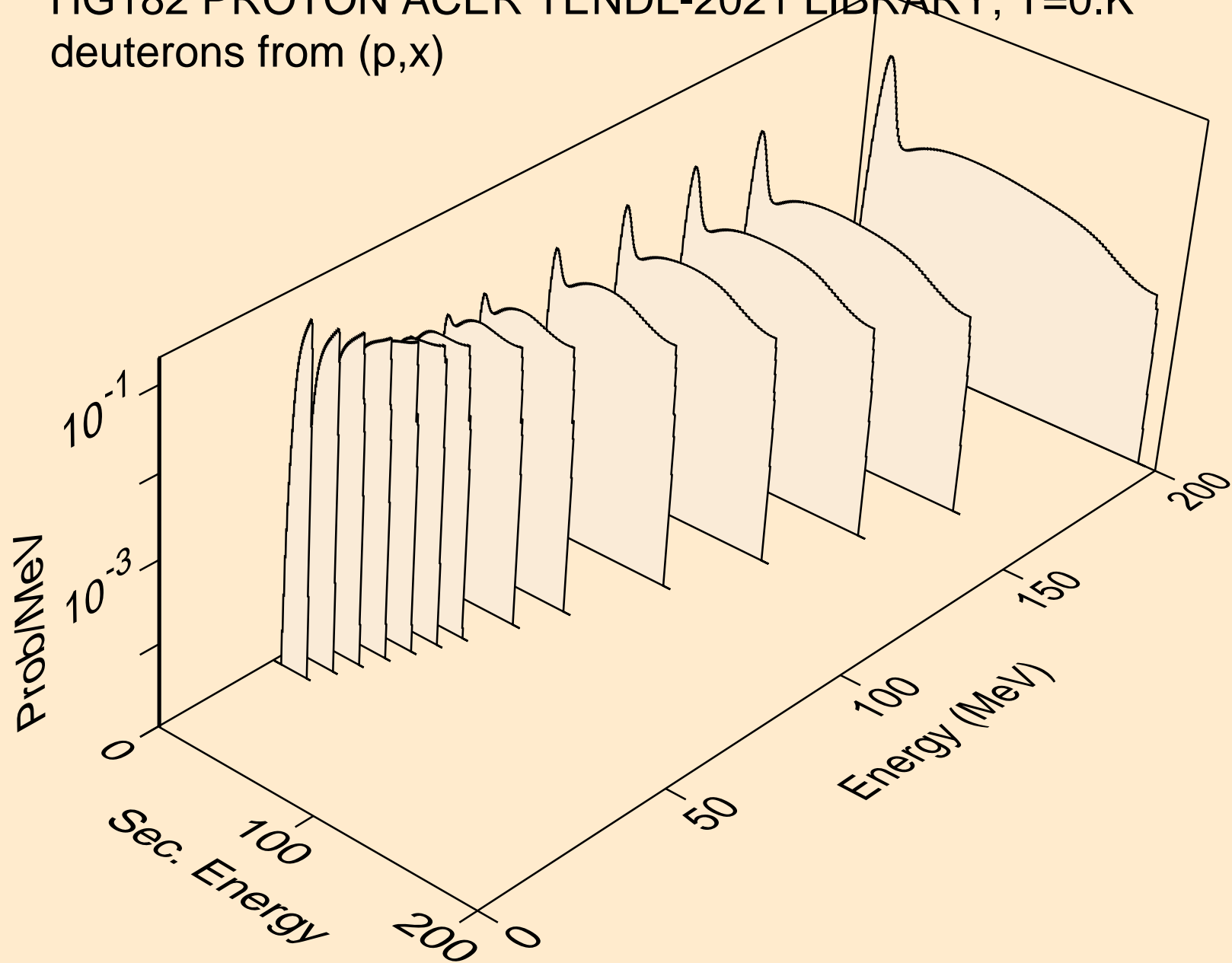

HG182 PROTON ACER TENDL-2021 LIBRARY; T=0.K  
deuterons from (p,n\*)d

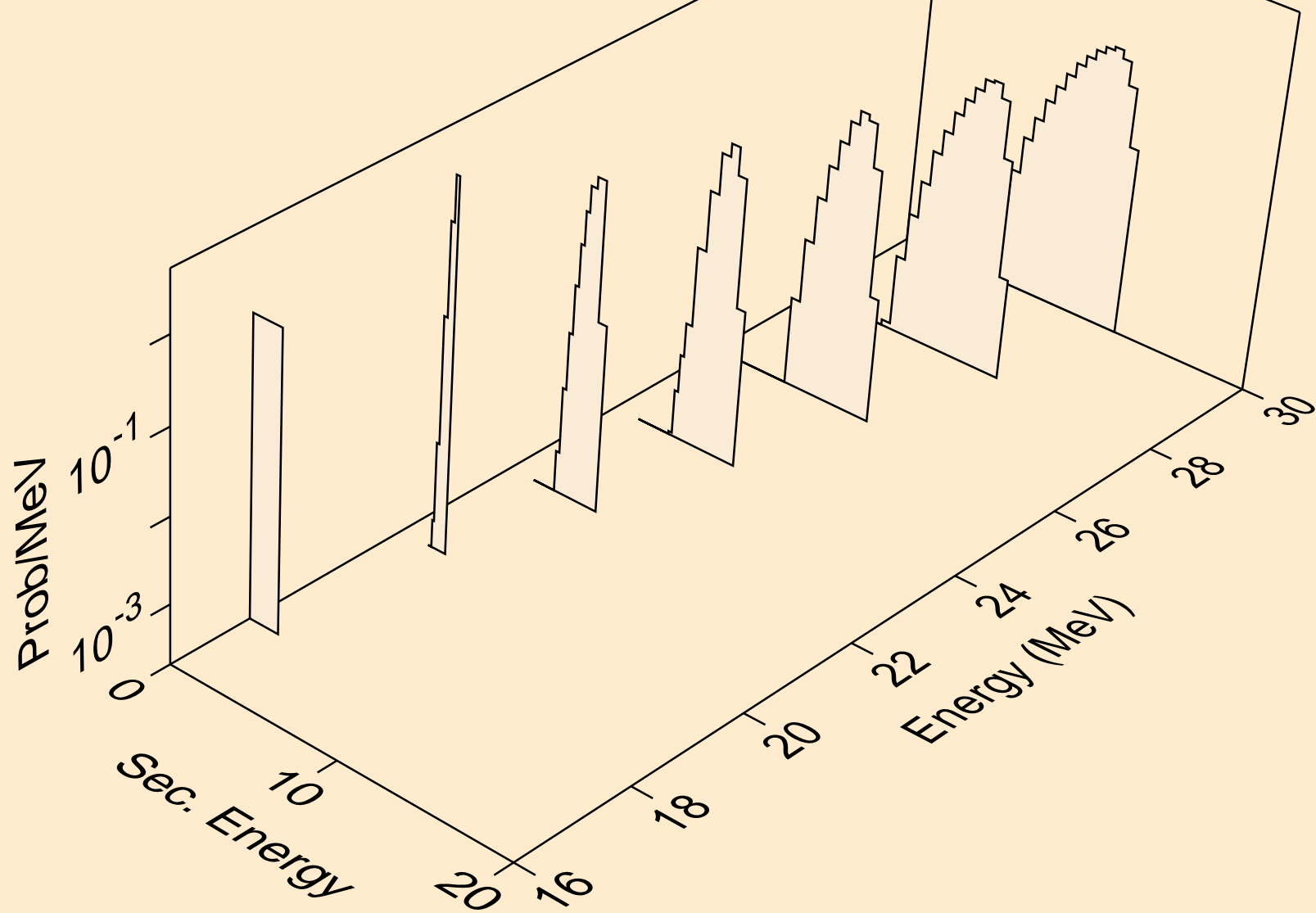

HG182 PROTON ACER TENDL-2021 LIBRARY; T=0.K  
deuterons from (p,d)

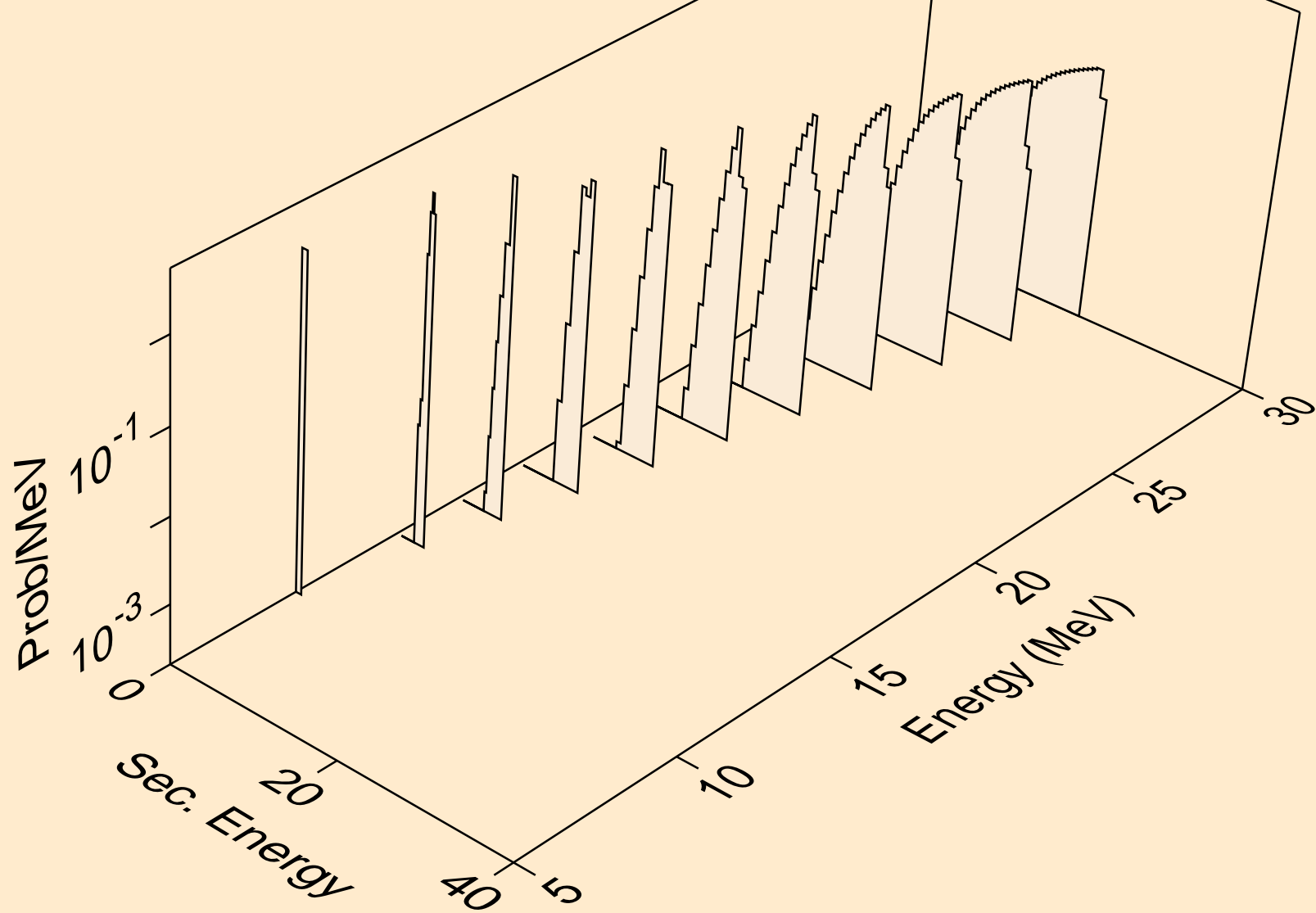

HG182 PROTON ACER TENDL-2021 LIBRARY; T=0.K  
deuterons from (p,pd)

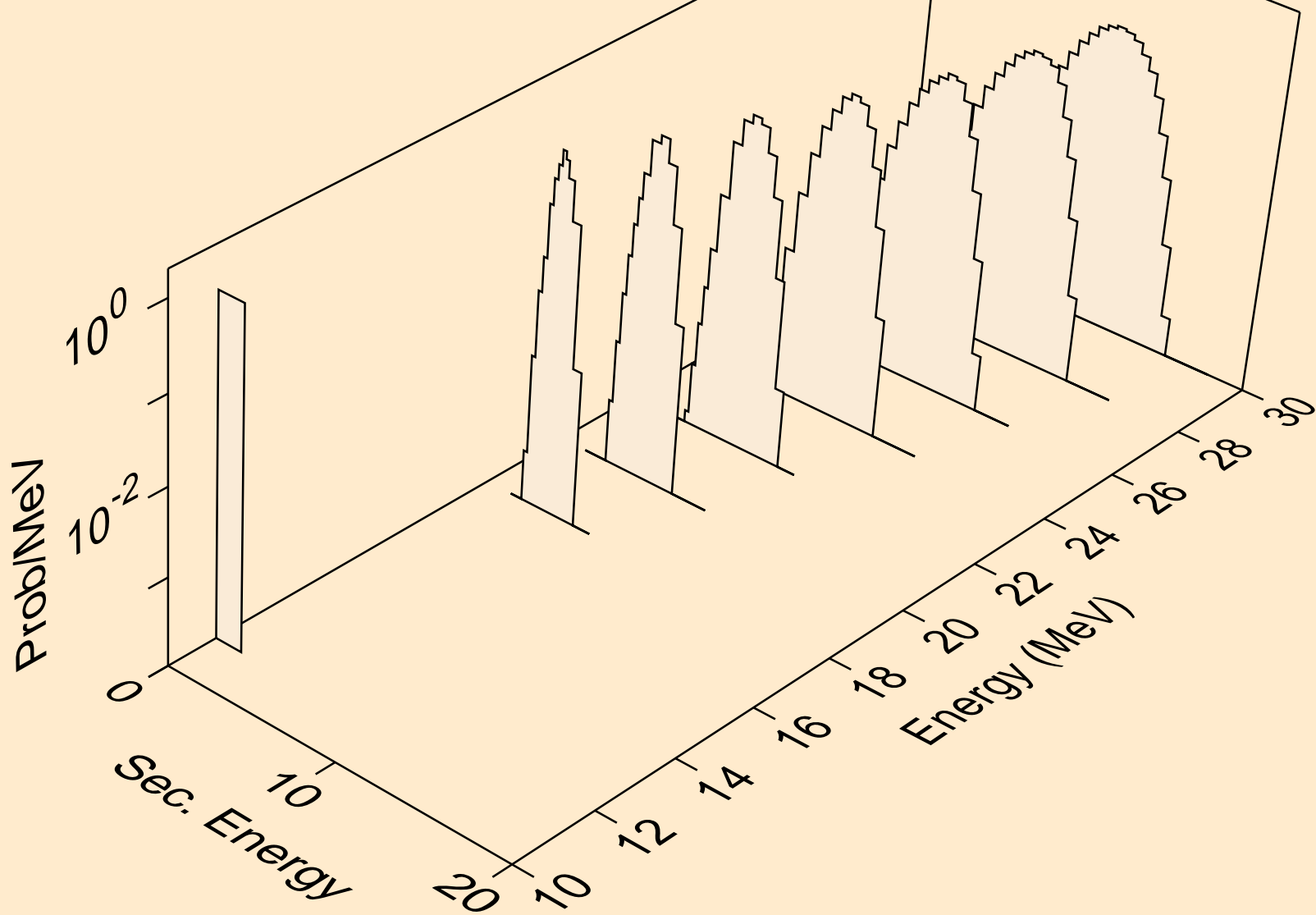

HG182 PROTON ACER TENDL-2021 LIBRARY; T=0.K  
deuterons from (p,da)

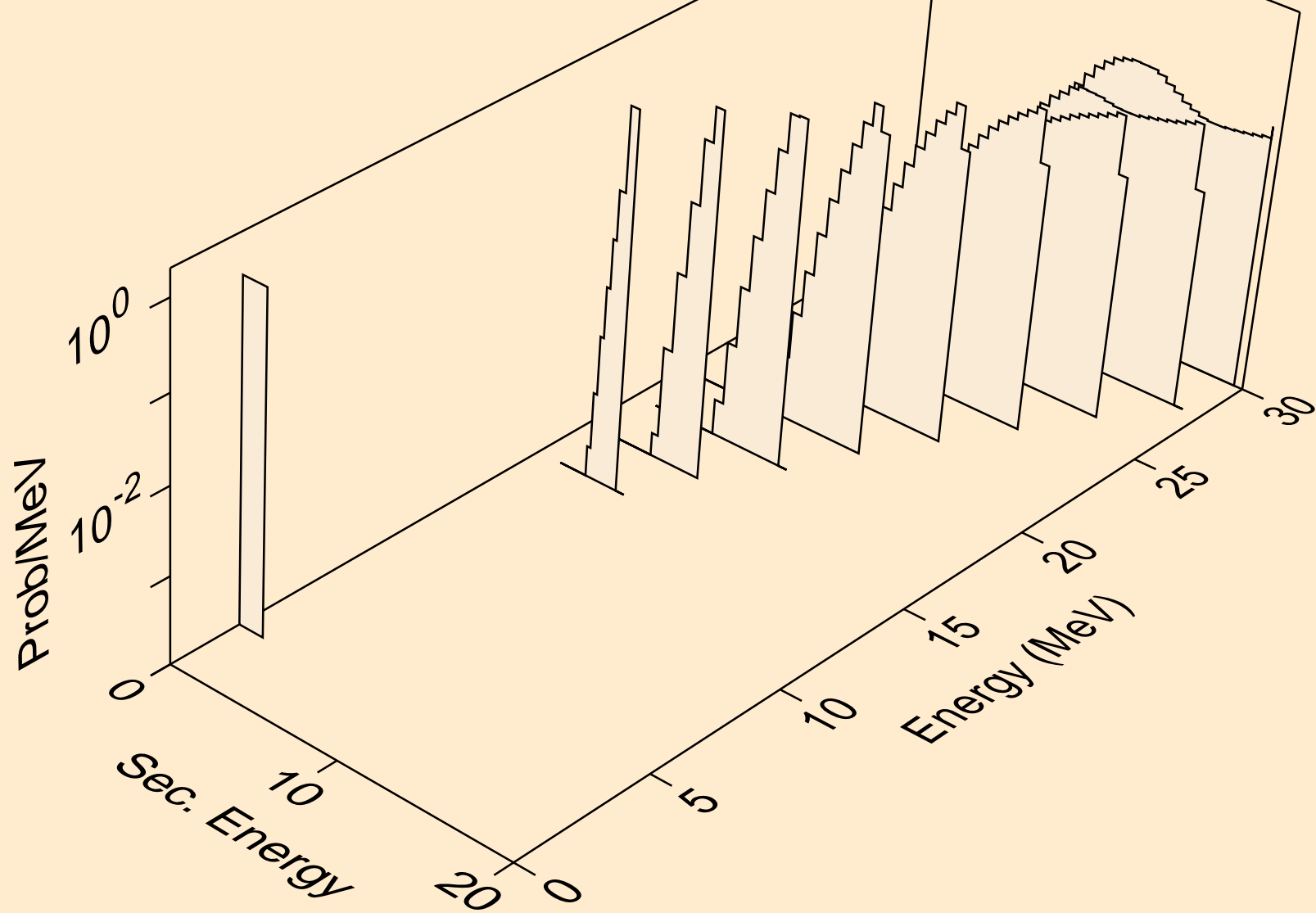



HG182 PROTON ACER TENDL-2021 LIBRARY; T=0.K  
tritons from (p,x)

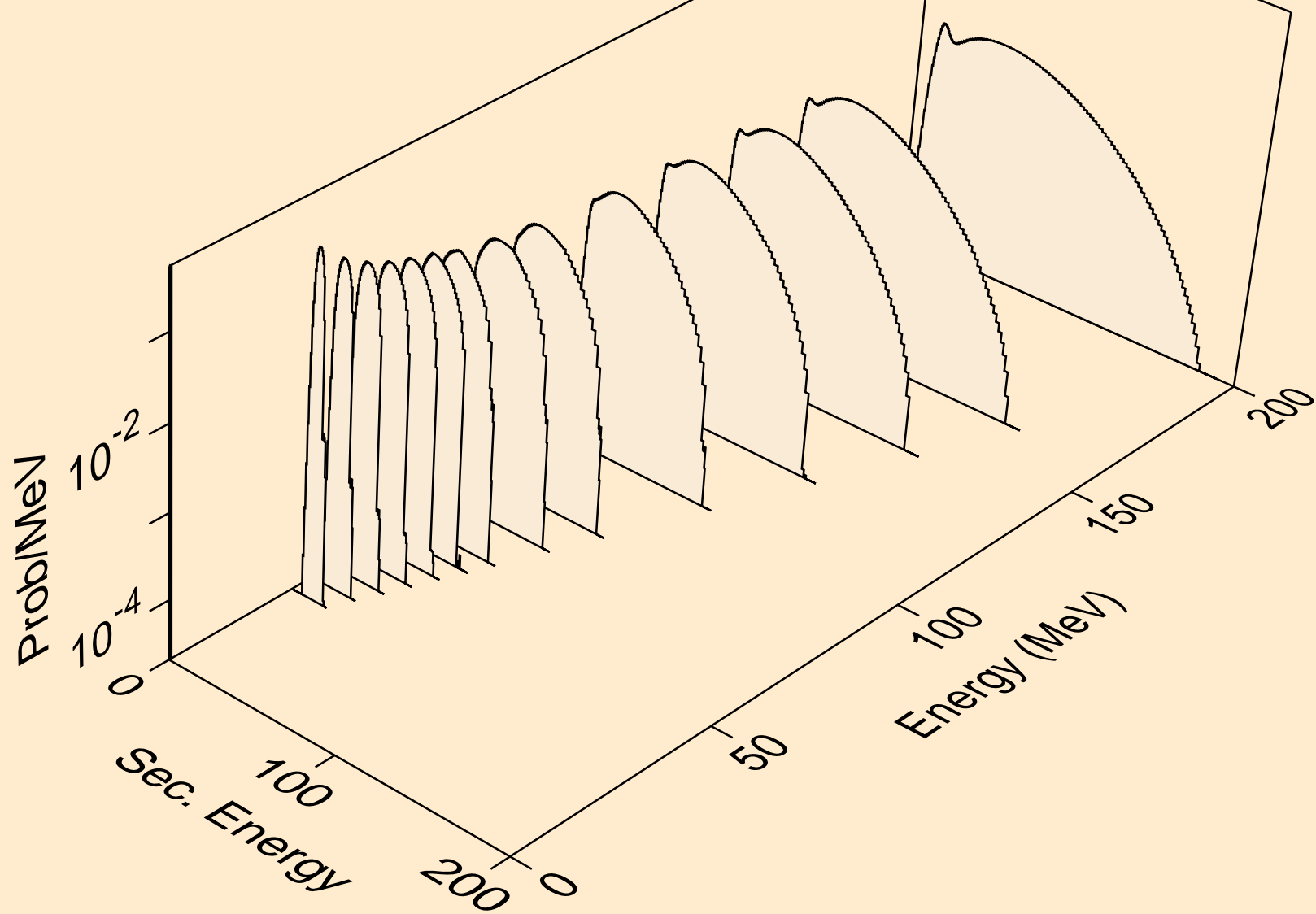

HG182 PROTON ACER TENDL-2021 LIBRARY; T=0.K  
tritons from (p,t)

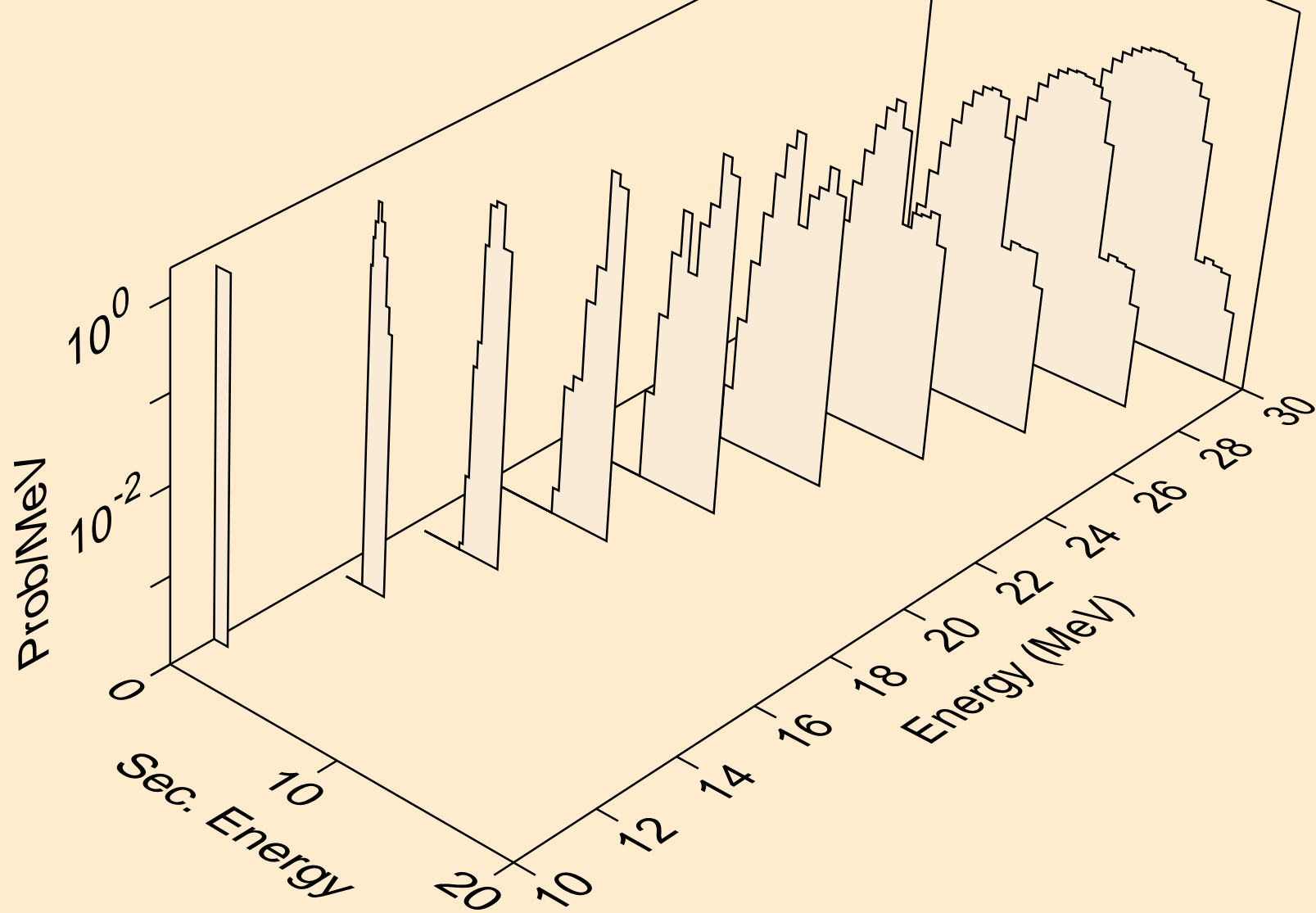

HG182 PROTON ACER TENDL-2021 LIBRARY; T=0.K  
tritons from (p,pt)

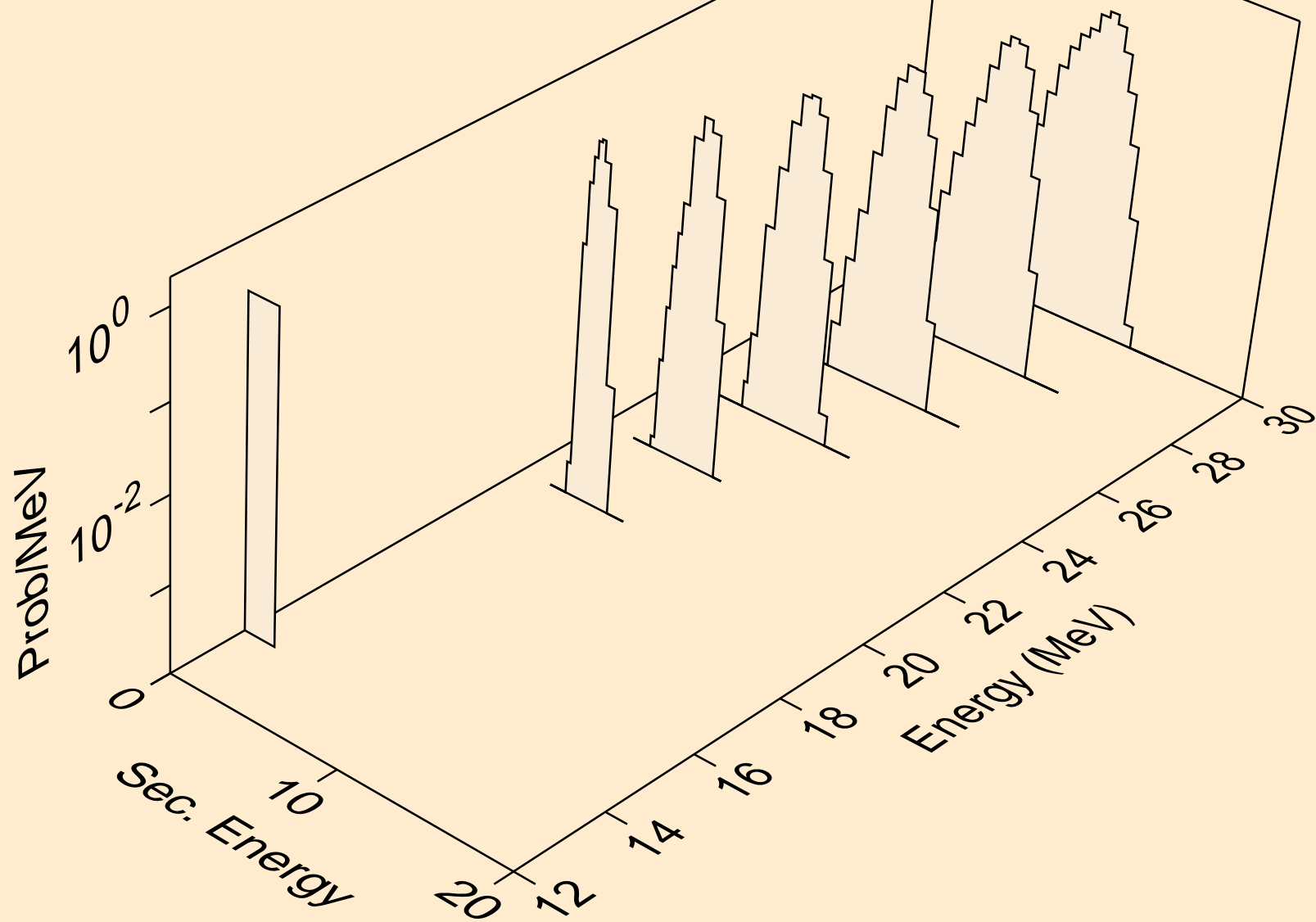

HG182 PROTON ACER TENDL-2021 LIBRARY; T=0.K  
he3s from (p,x)

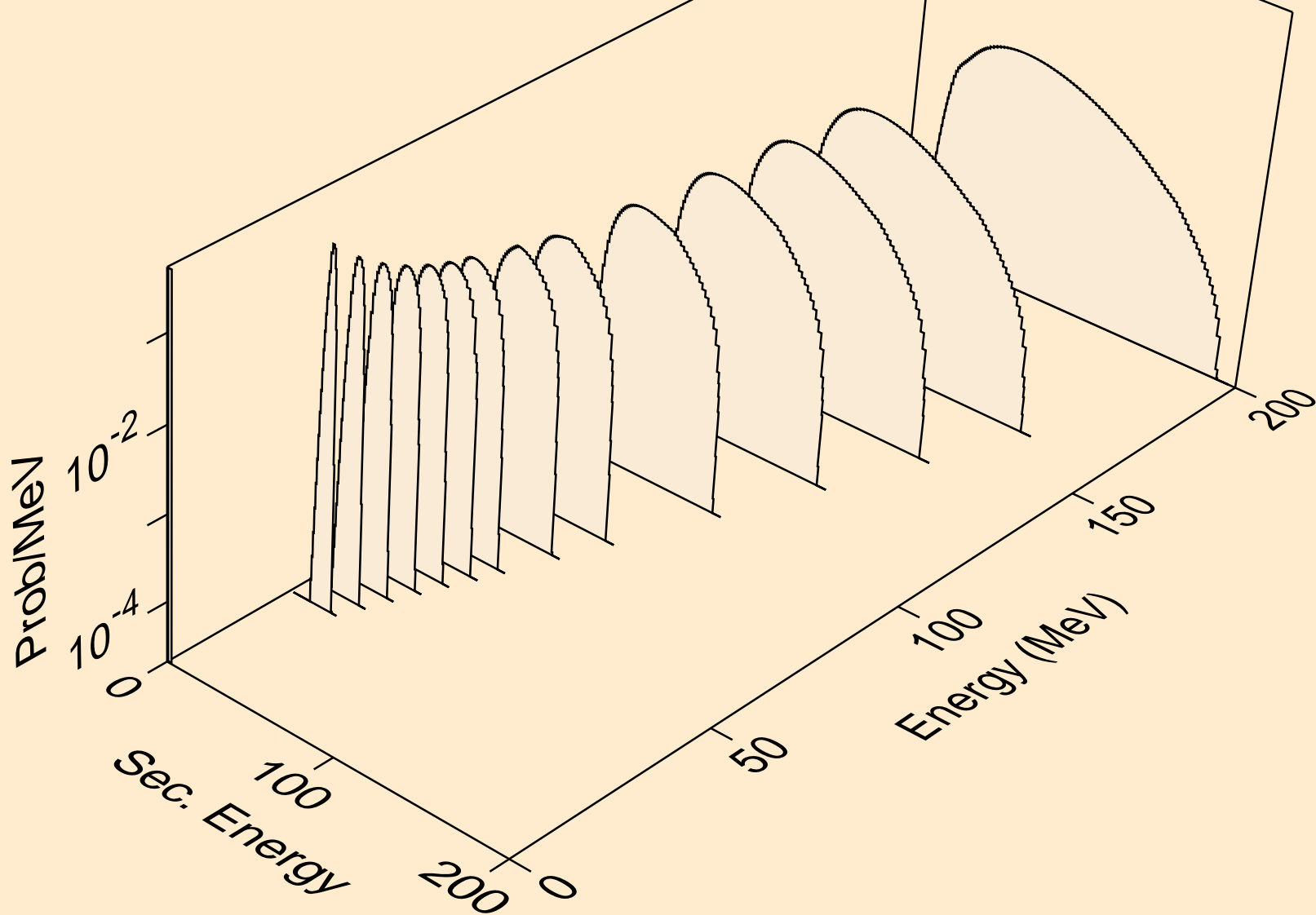

HG182 PROTON ACER TENDL-2021 LIBRARY; T=0.K  
he3s from (p,n\*)he3

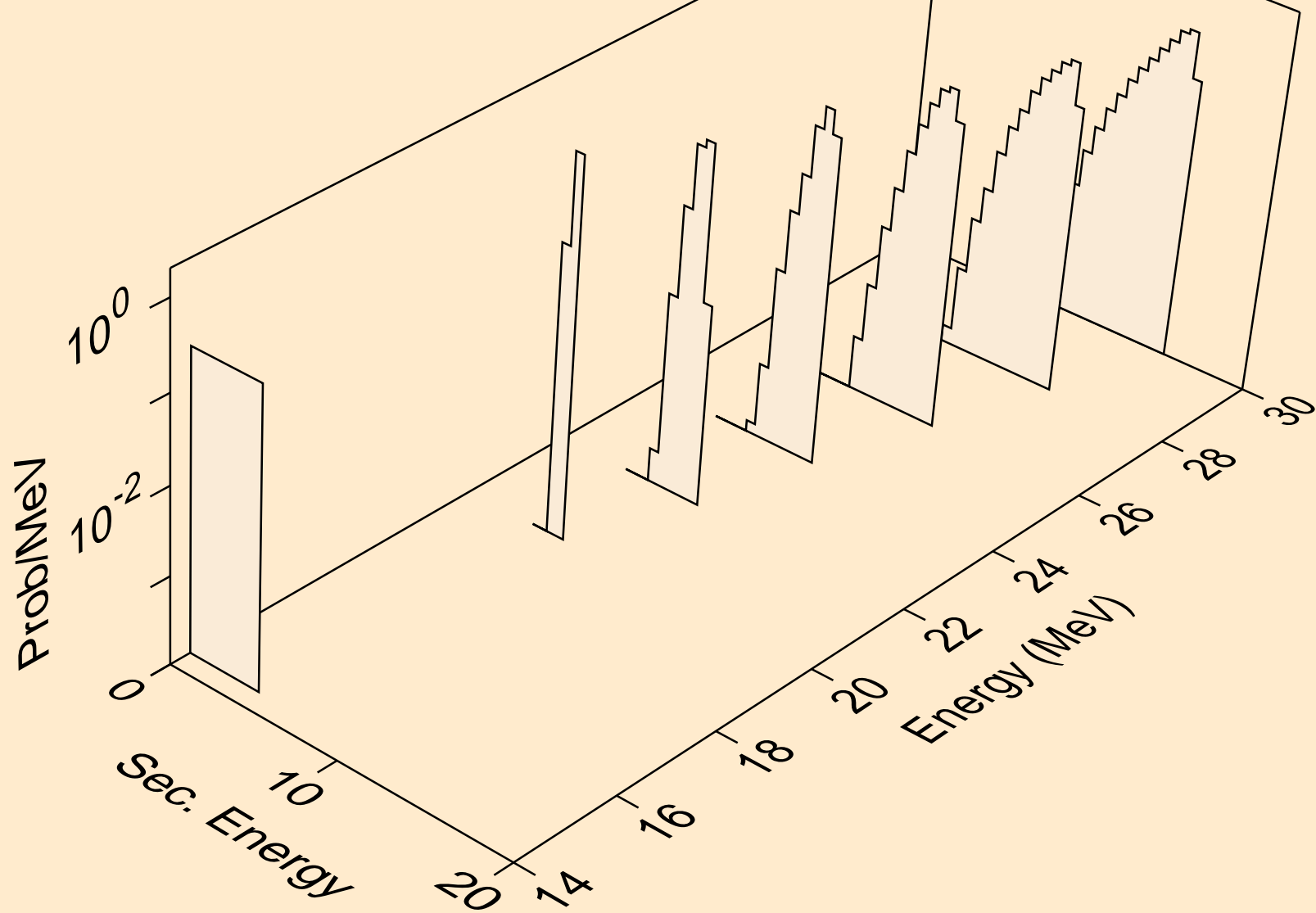

HG182 PROTON ACER TENDL-2021 LIBRARY; T=0.K  
he3s from (p,he3)

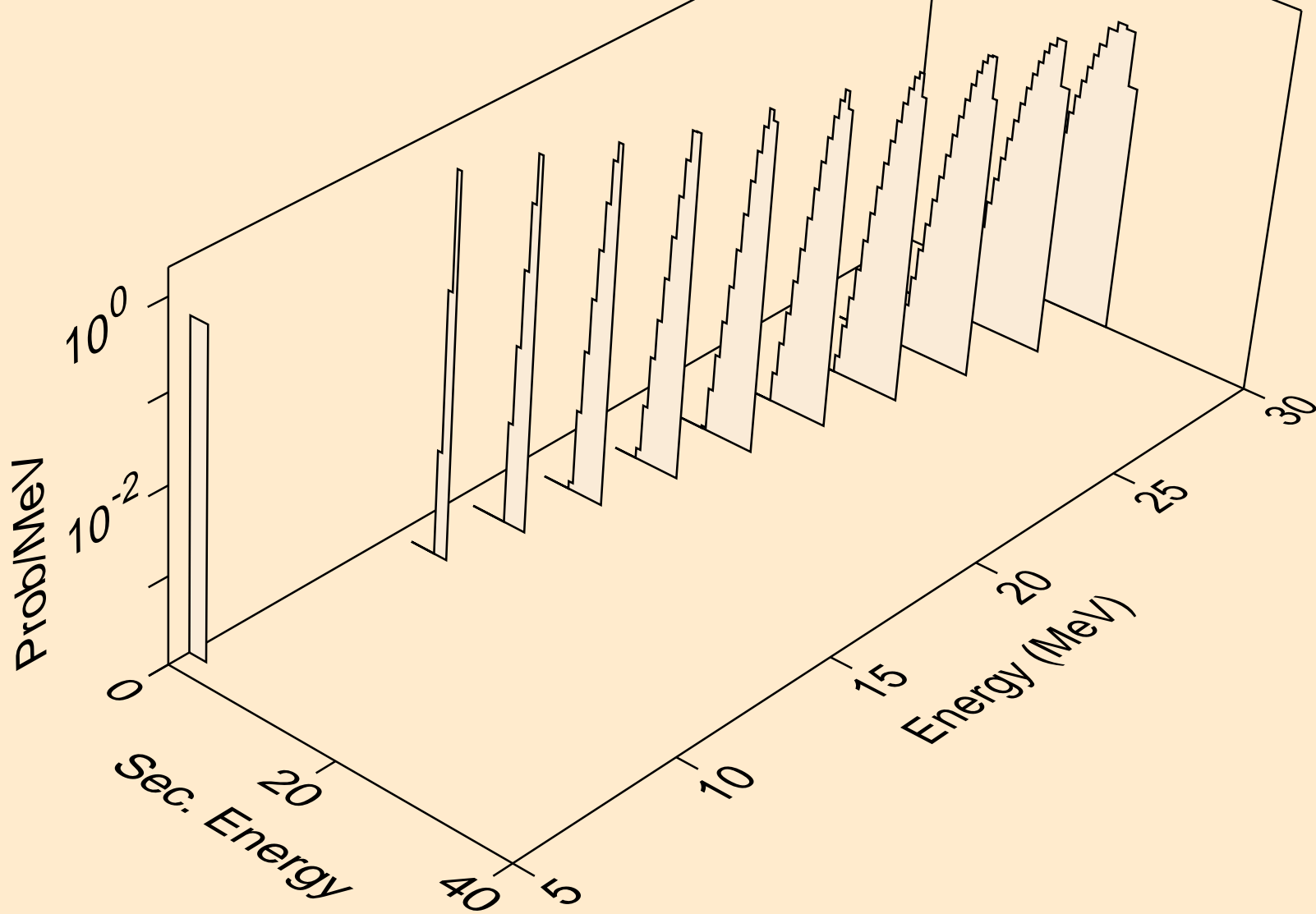

HG182 PROTON ACER TENDL-2021 LIBRARY; T=0.K  
alphas from (p,x)

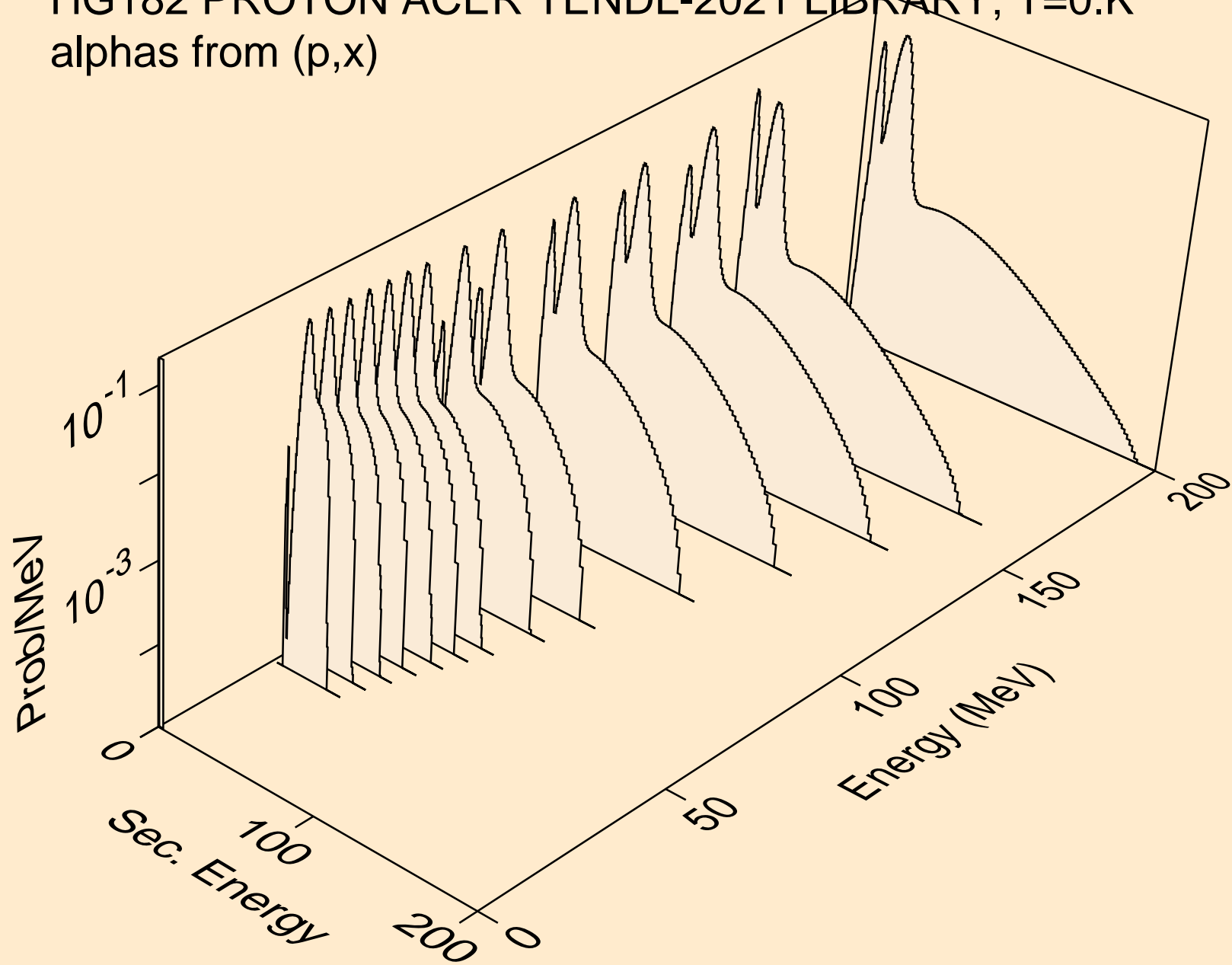

HG182 PROTON ACER TENDL-2021 LIBRARY; T=0.K  
alphas from (p,n\*)a

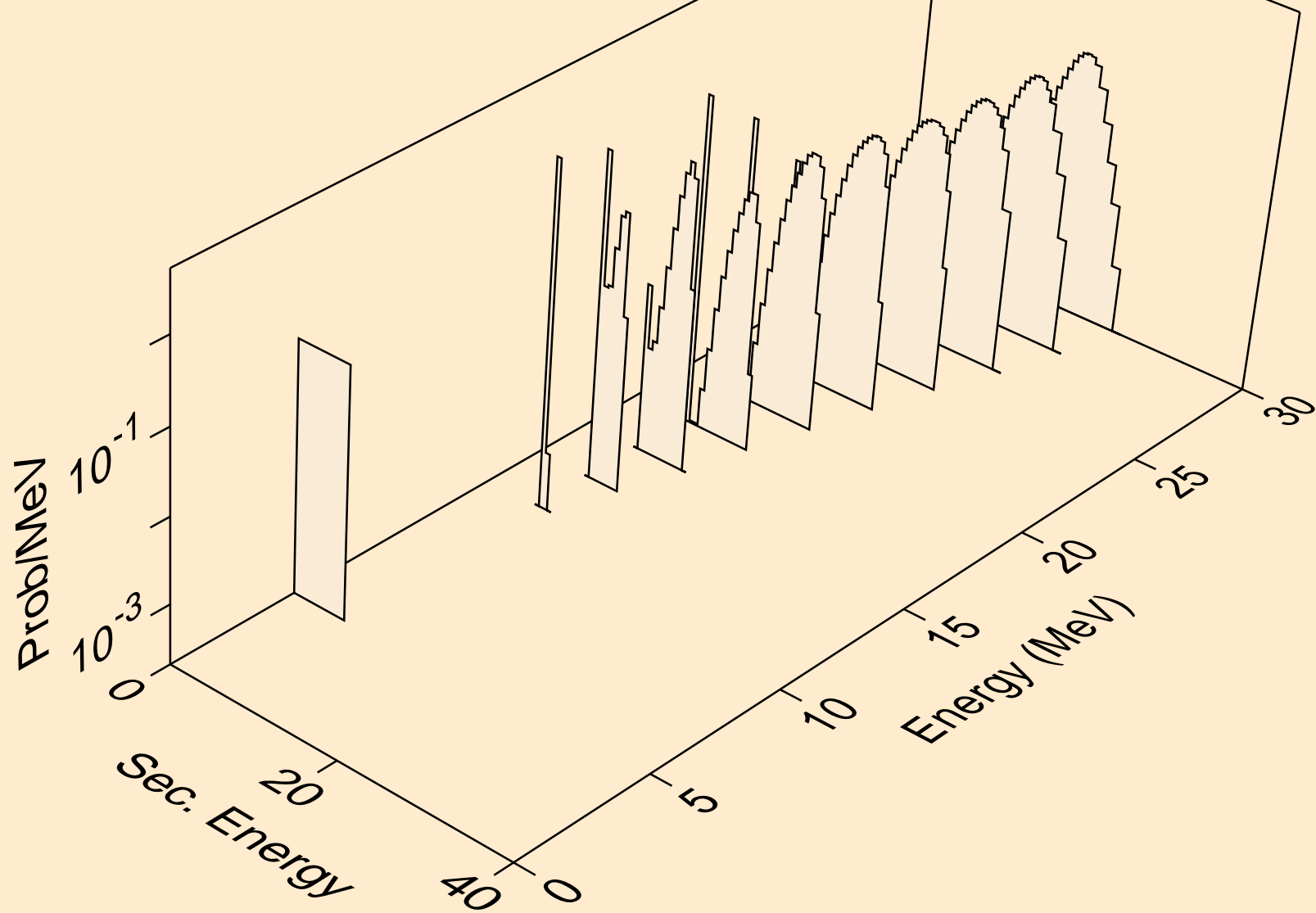



HG182 PROTON ACER TENDL-2021 LIBRARY; T=0.K  
alphas from (p,2n)a

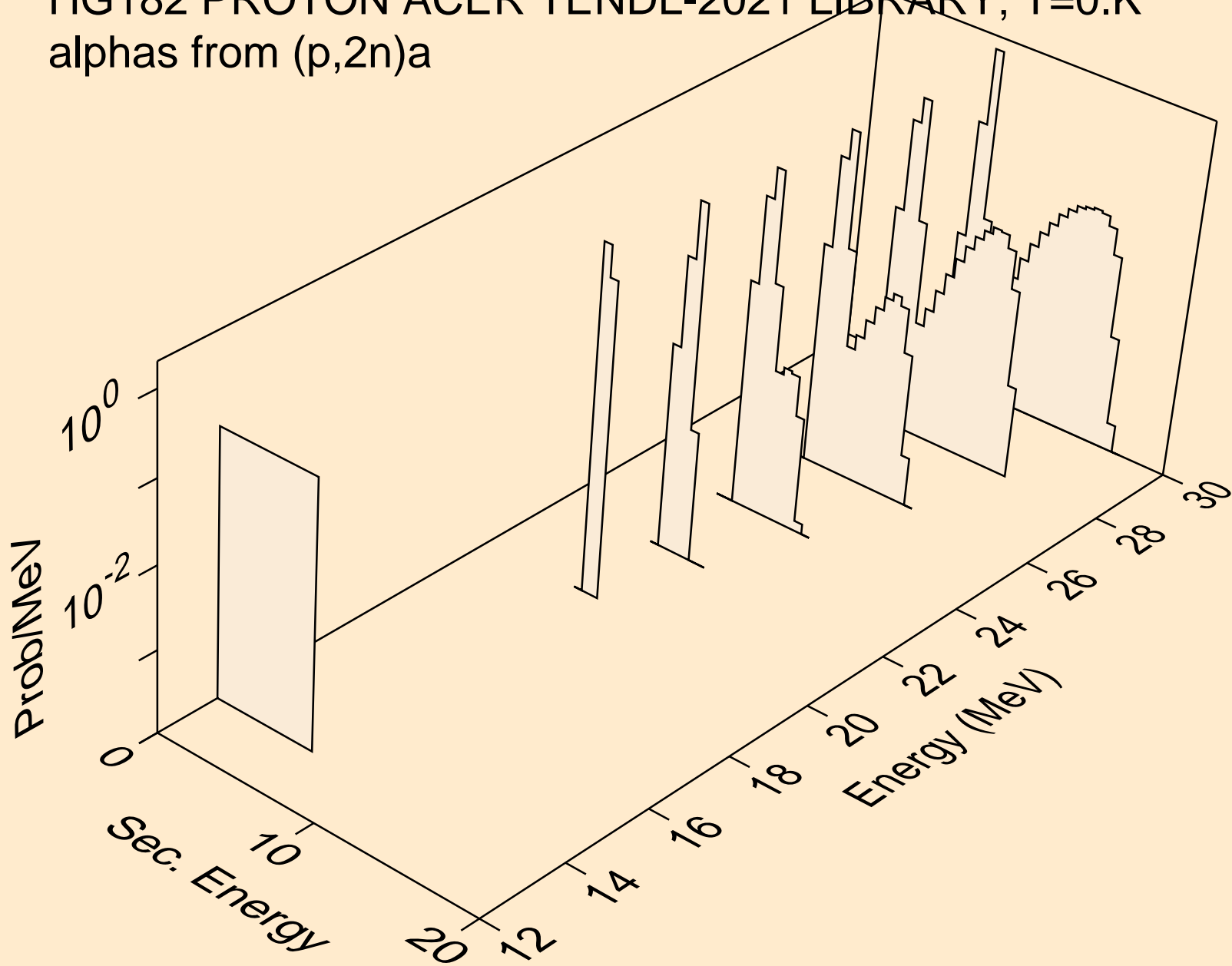

HG182 PROTON ACER TENDL-2021 LIBRARY; T=0.K  
alphas from (p,n\*)2a

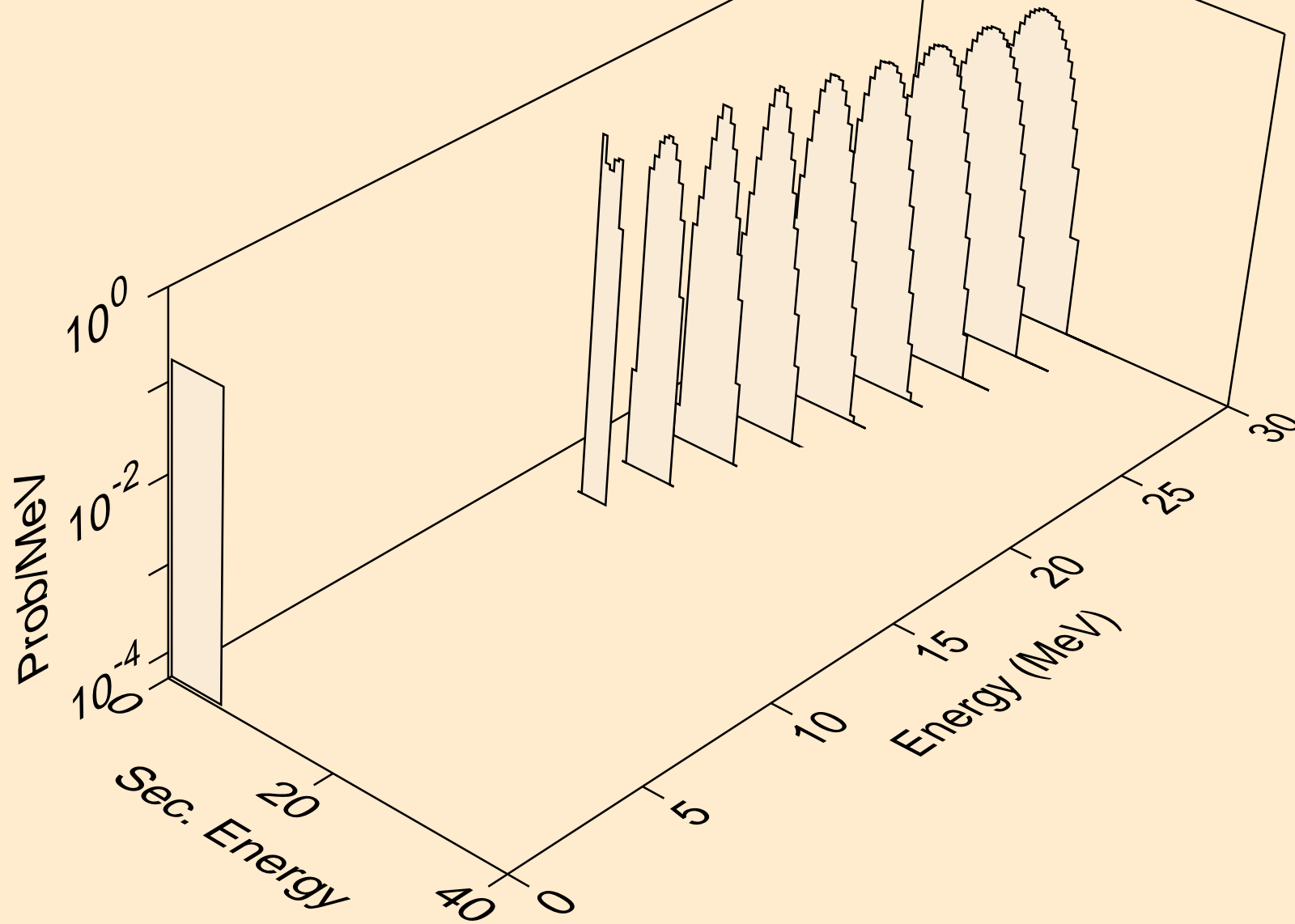

HG182 PROTON ACER TENDL-2021 LIBRARY; T=0.K  
alphas from (p,npa)

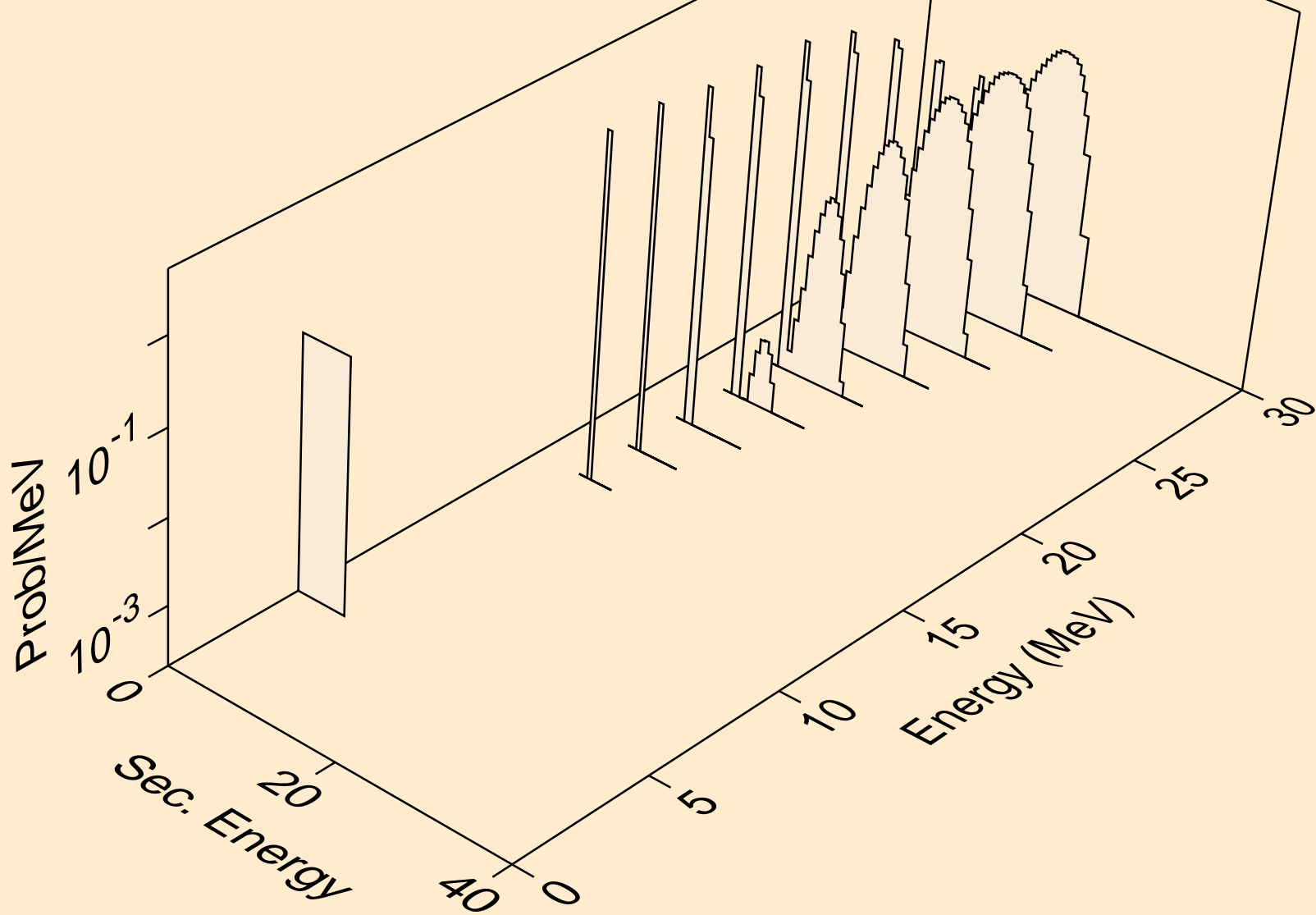

HG182 PROTON ACER TENDL-2021 LIBRARY; T=0.K  
alphas from (p,a)

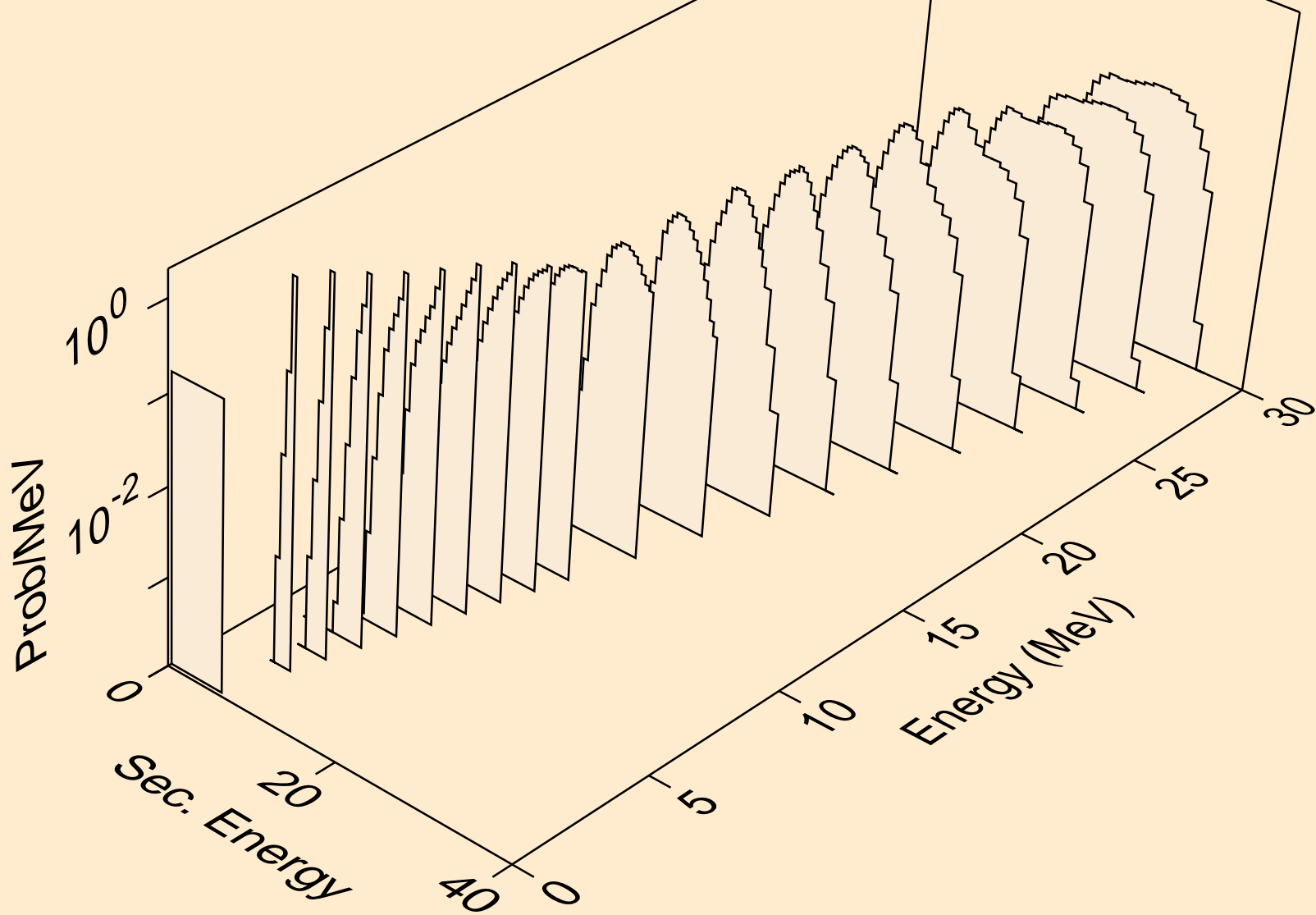

HG182 PROTON ACER TENDL-2021 LIBRARY; T=0.K  
alphas from (p,2a)

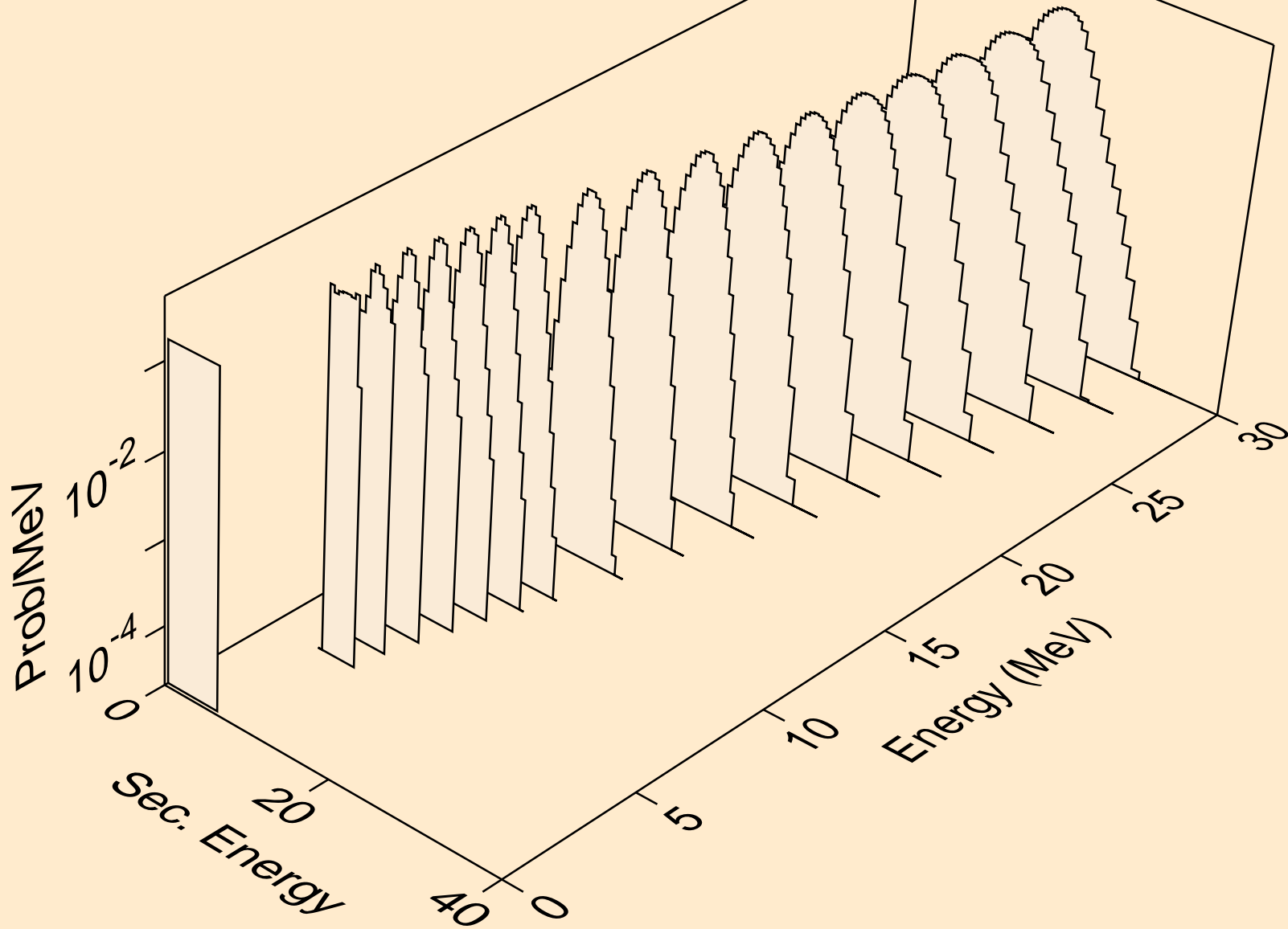

HG182 PROTON ACER TENDL-2021 LIBRARY; T=0.K  
alphas from (p,3a)

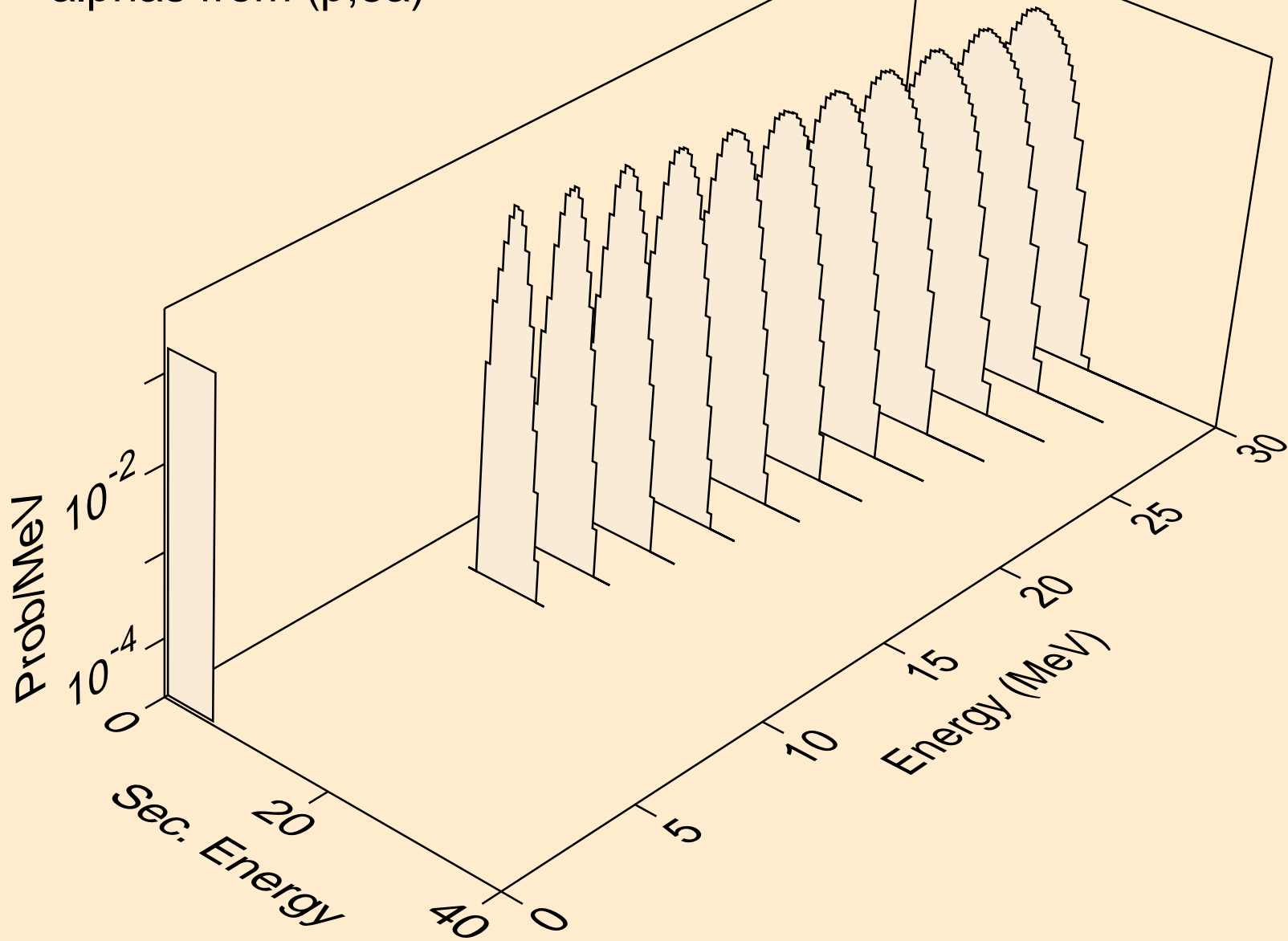

HG182 PROTON ACER TENDL-2021 LIBRARY; T=0.K  
alphas from (p,pa)

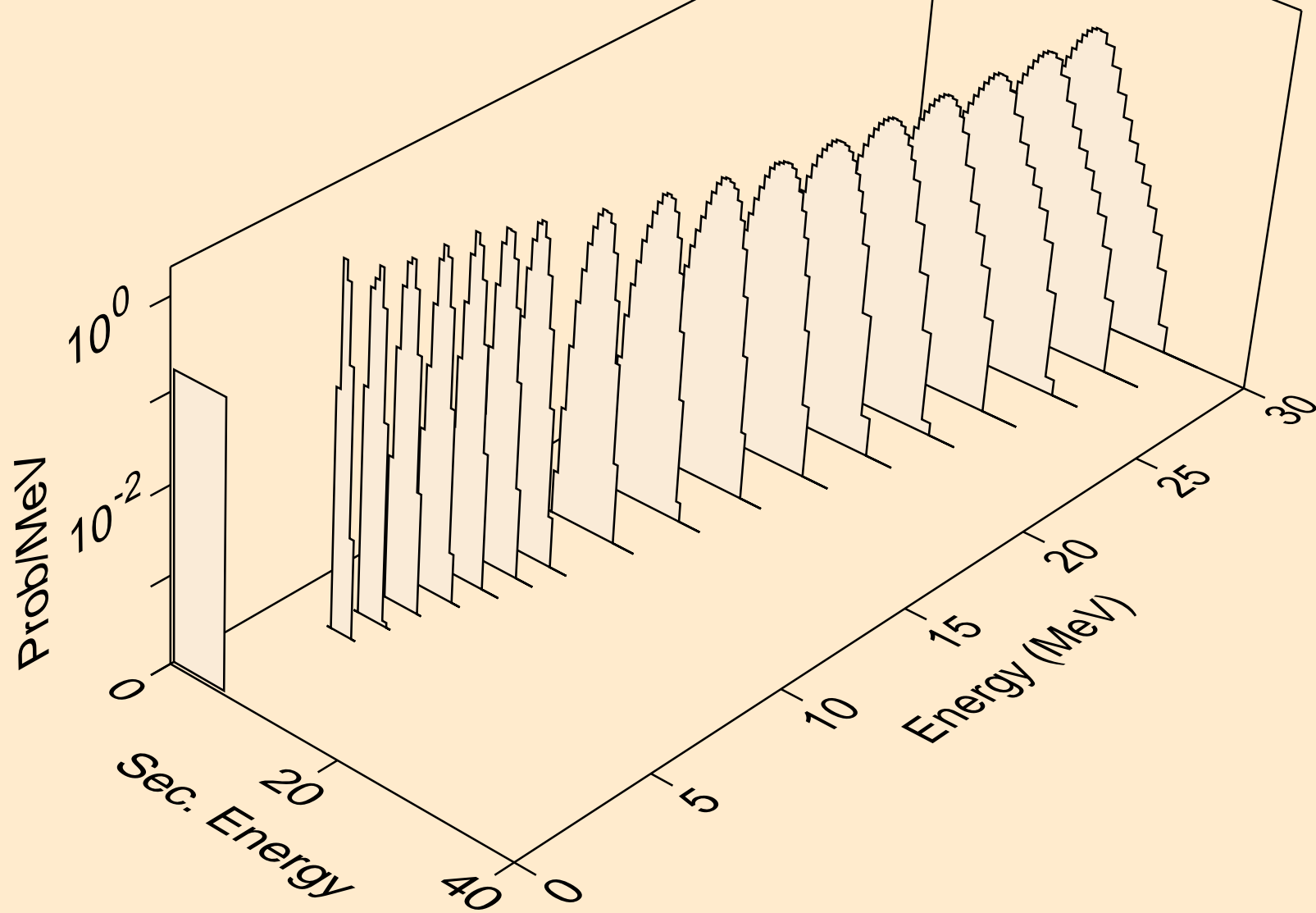

HG182 PROTON ACER TENDL-2021 LIBRARY; T=0.K  
alphas from (p,da)

