

# HG197 PROTON ACER TENDL-2021 LIBRARY; T=0.K

## Principal cross sections

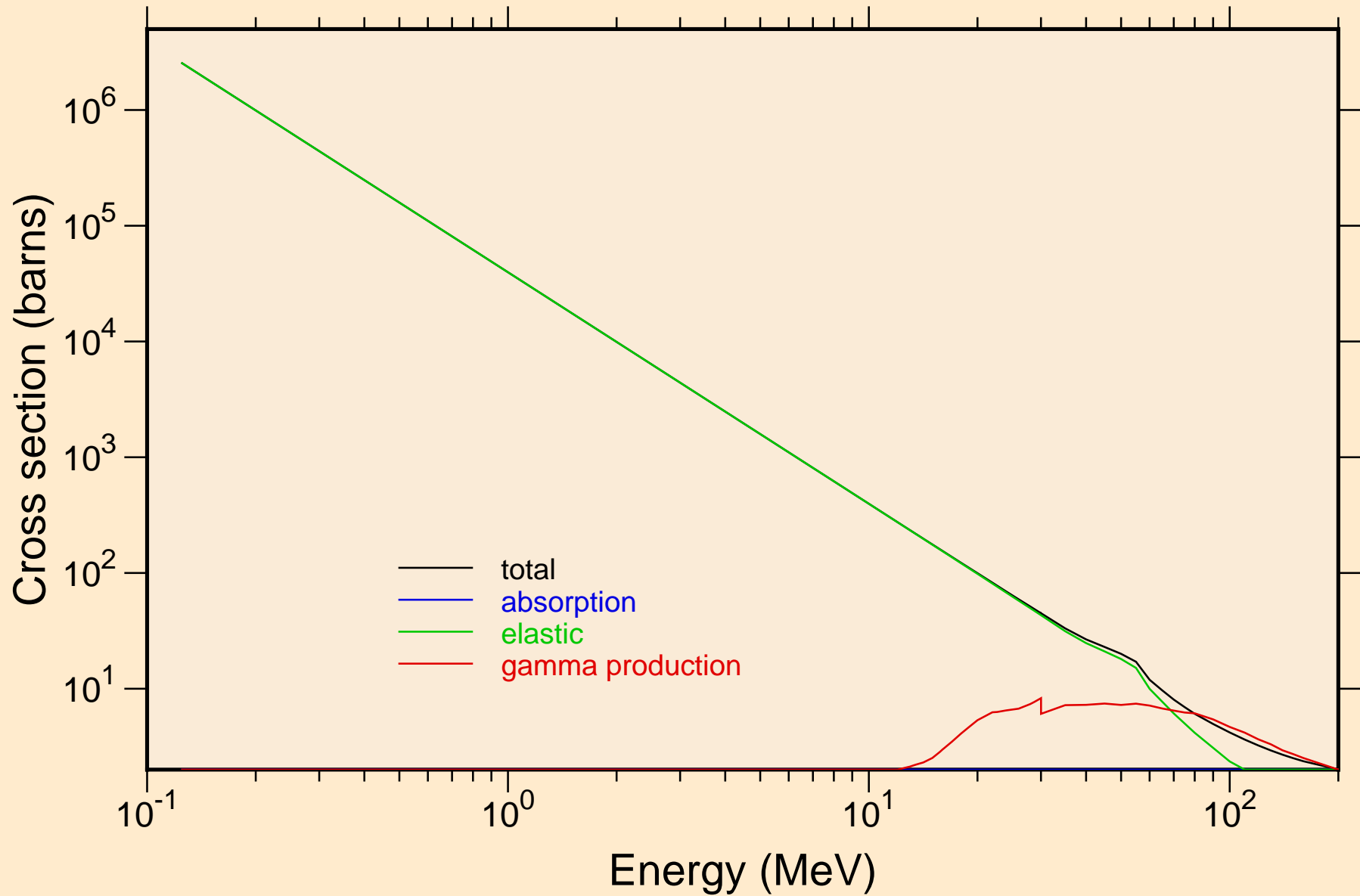

HG197 PROTON ACER TENDL-2021 LIBRARY; T=0.K  
Heating

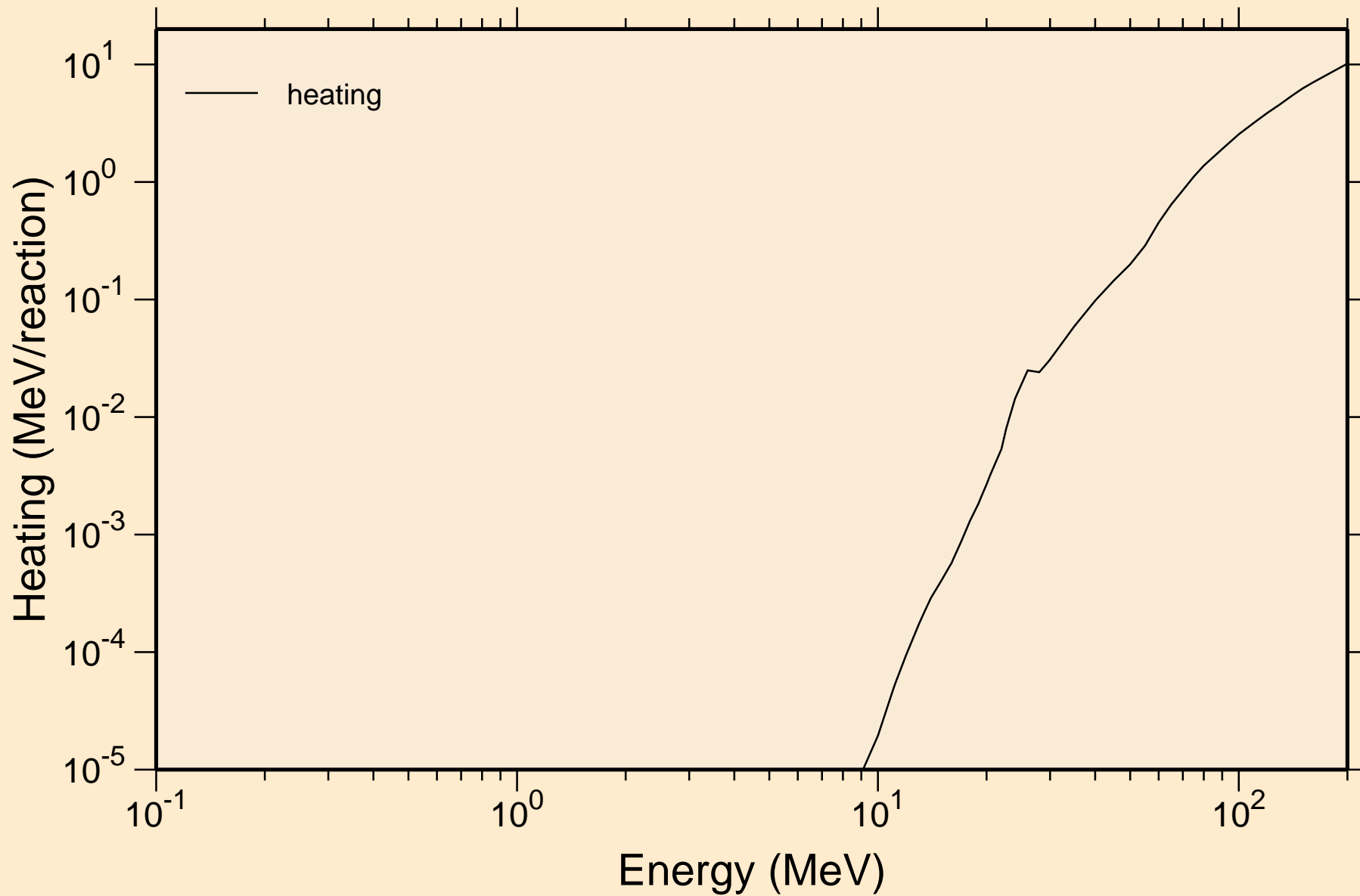

# HG197 PROTON ACER TENDL-2021 LIBRARY; T=0.K

## Principal cross sections

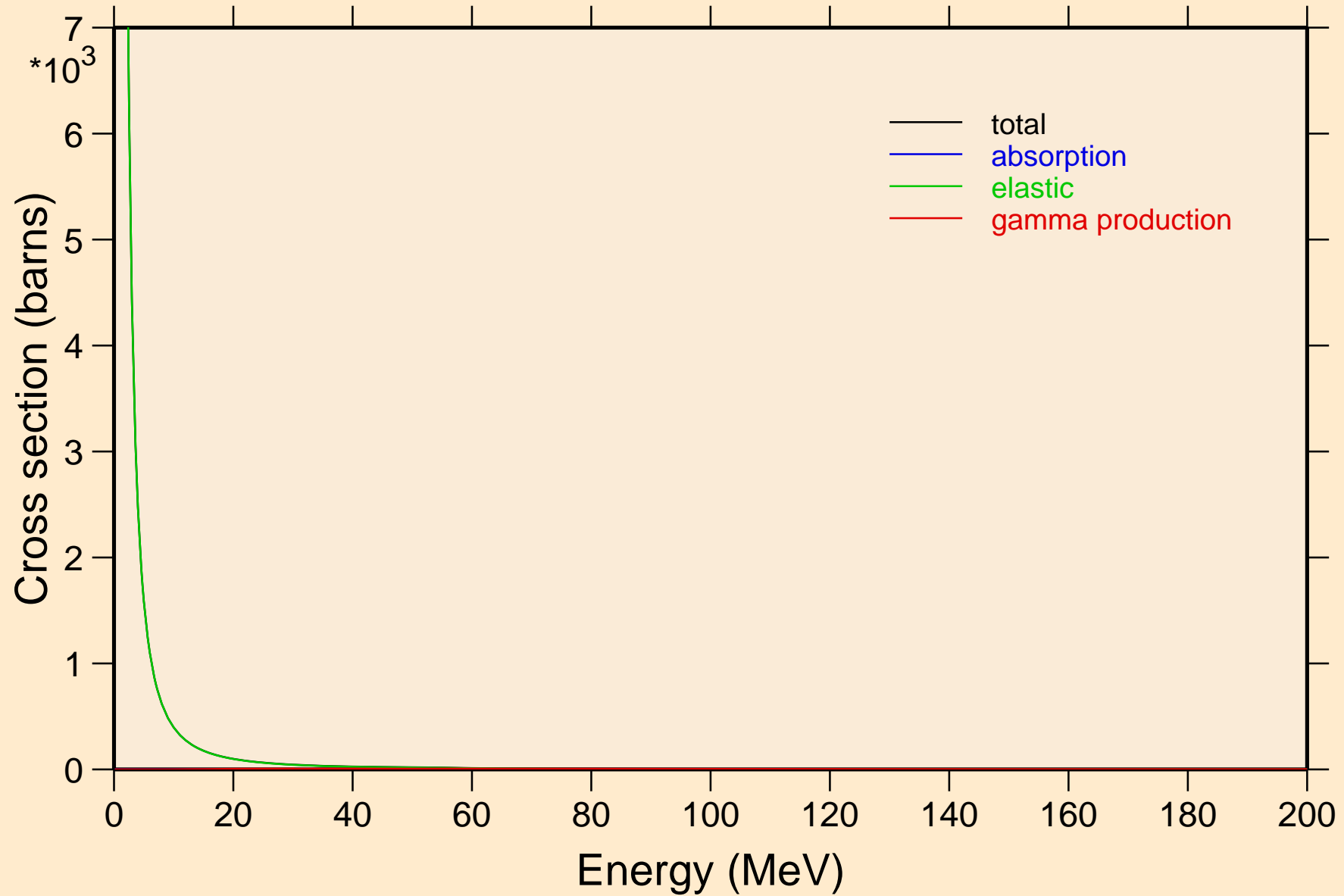

# HG197 PROTON ACER TENDL-2021 LIBRARY; T=0.K

## Heating

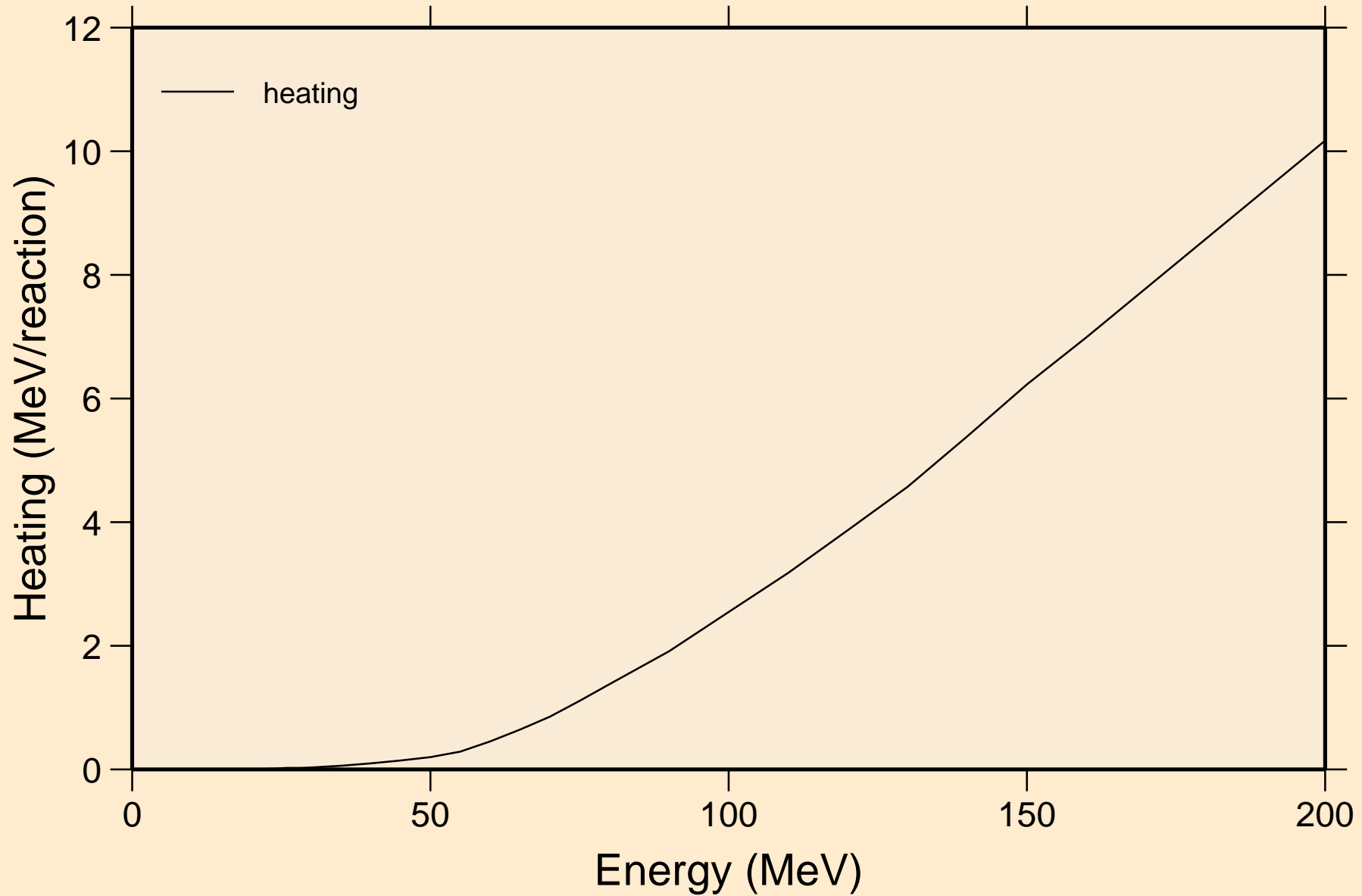

# HG197 PROTON ACER TENDL-2021 LIBRARY; T=0.K

## Threshold reactions

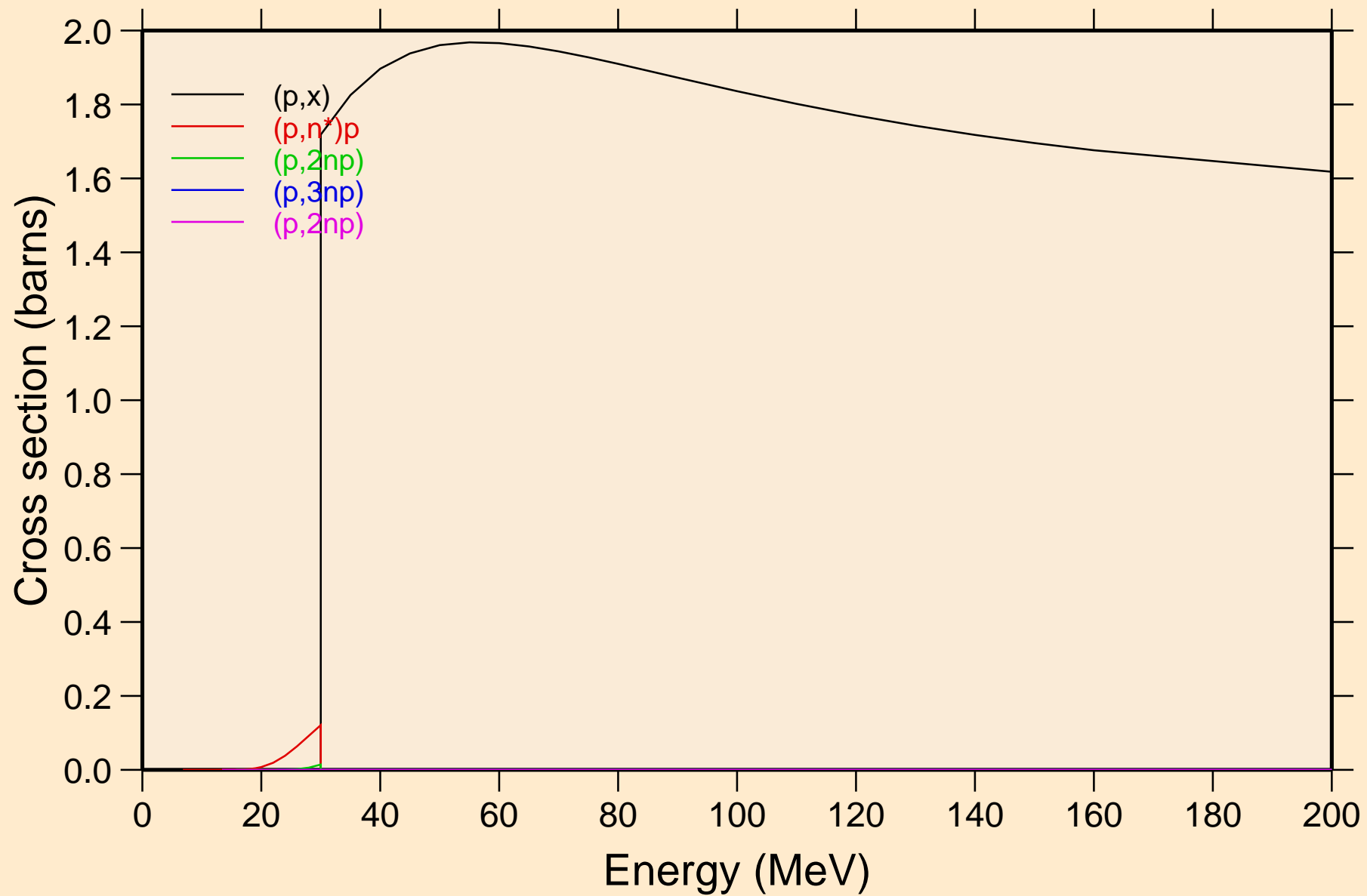

# HG197 PROTON ACER TENDL-2021 LIBRARY; T=0.K

## Threshold reactions

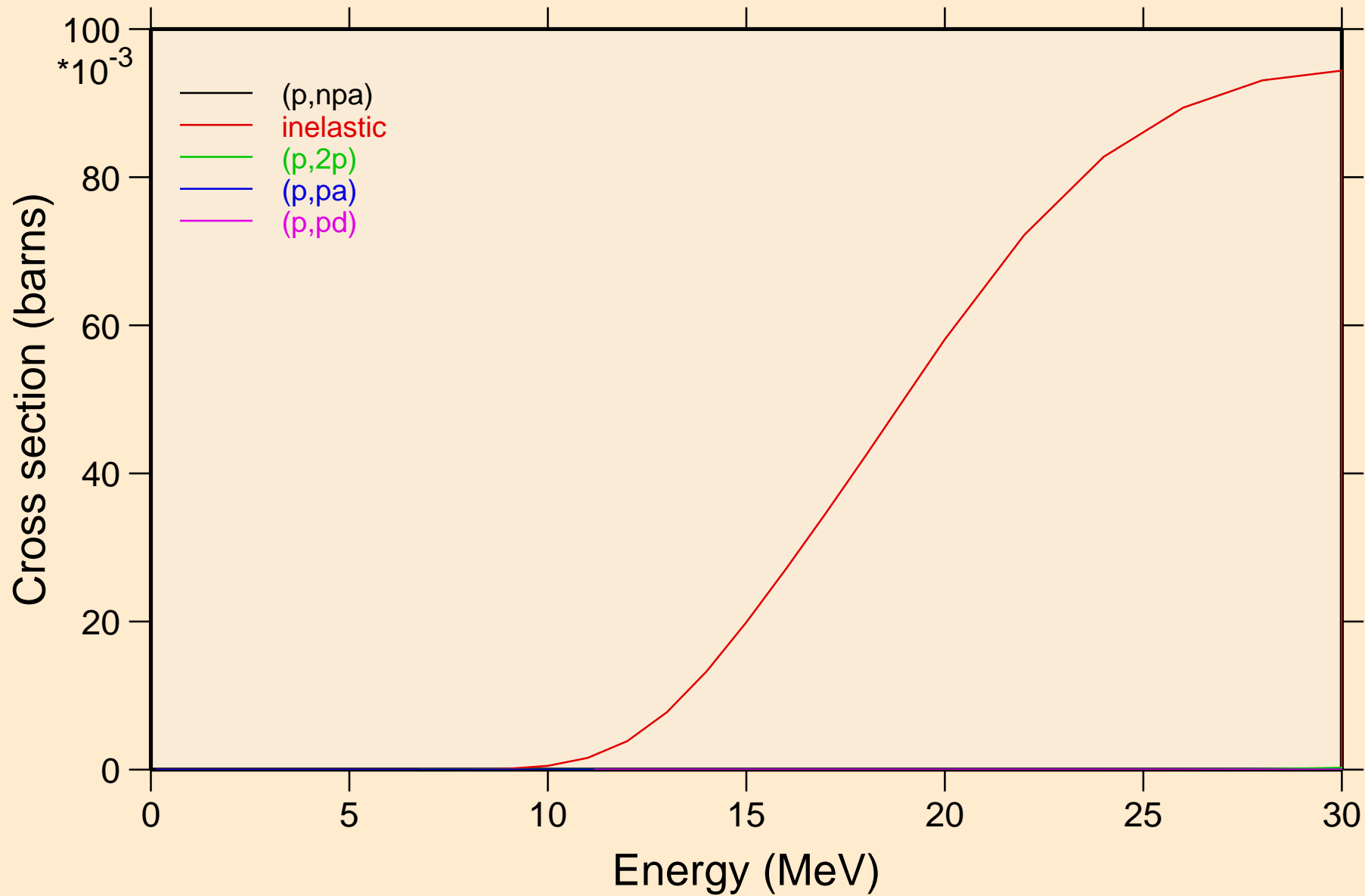

HG197 PROTON ACER TENDL-2021 LIBRARY; T=0.K  
Threshold reactions

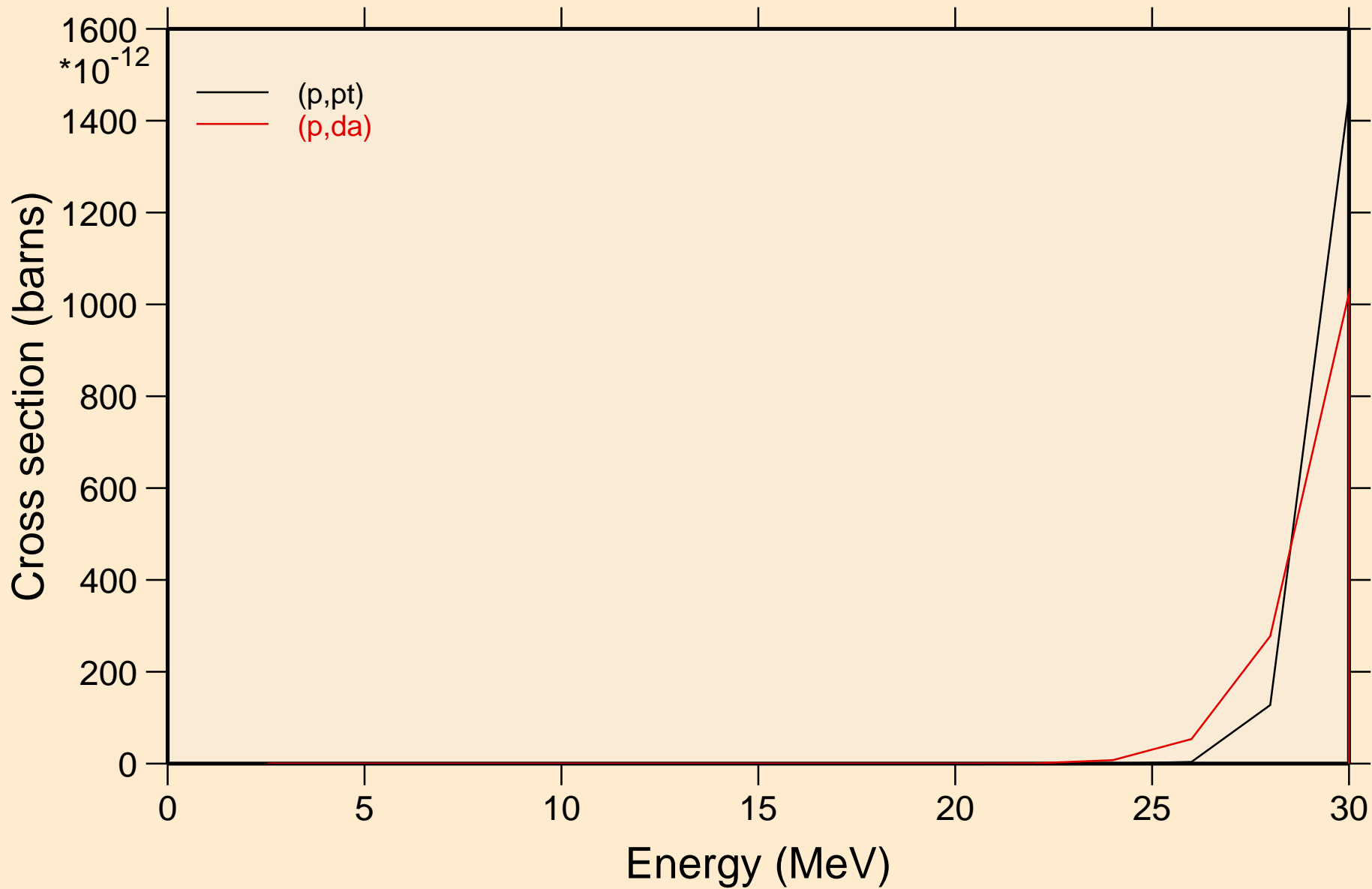

HG197 PROTON ACER TENDL-2021 LIBRARY; T=0.K  
angular distribution for elastic

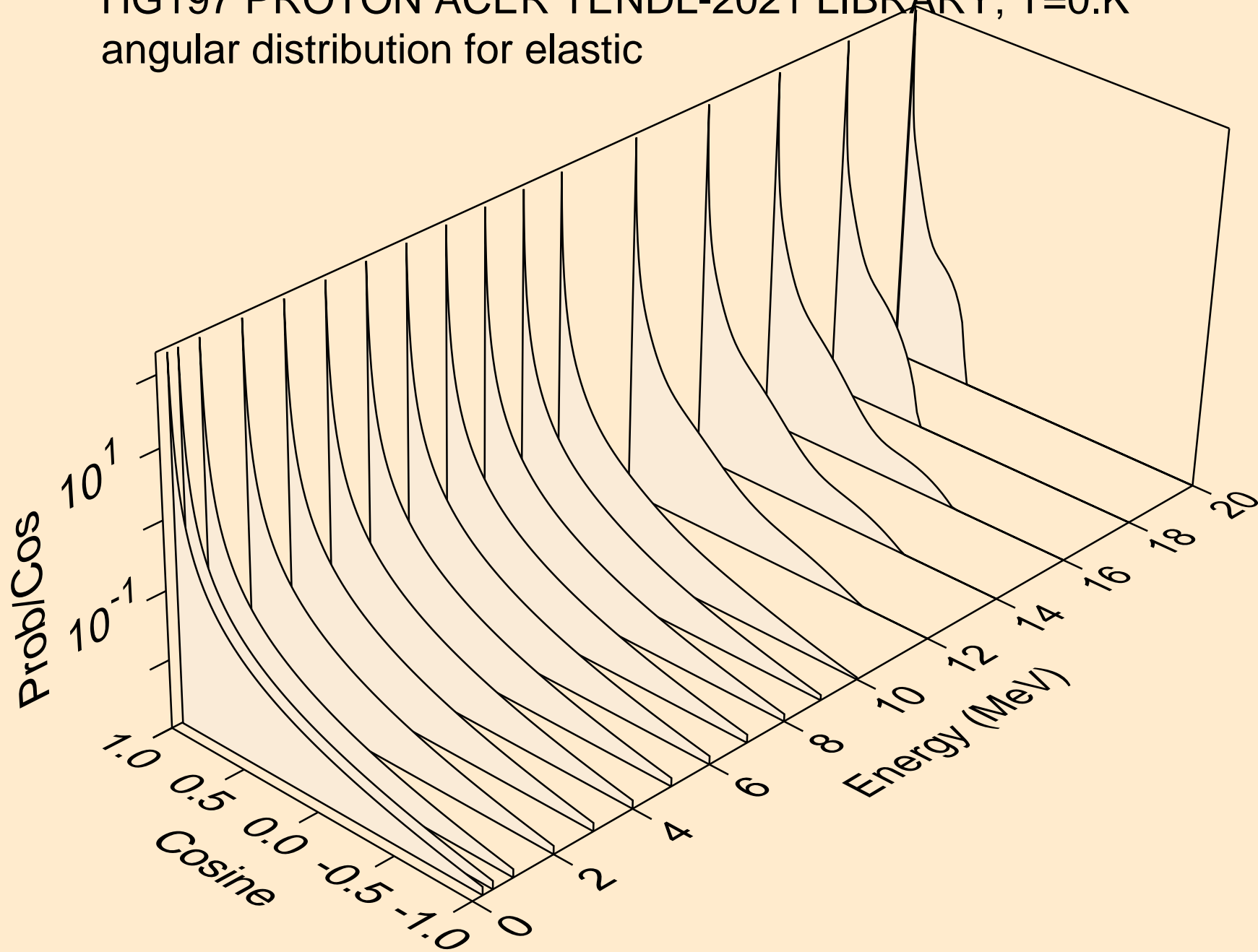



HG197 PROTON ACER TENDL-2021 LIBRARY; T=0.K  
angular distribution for elastic

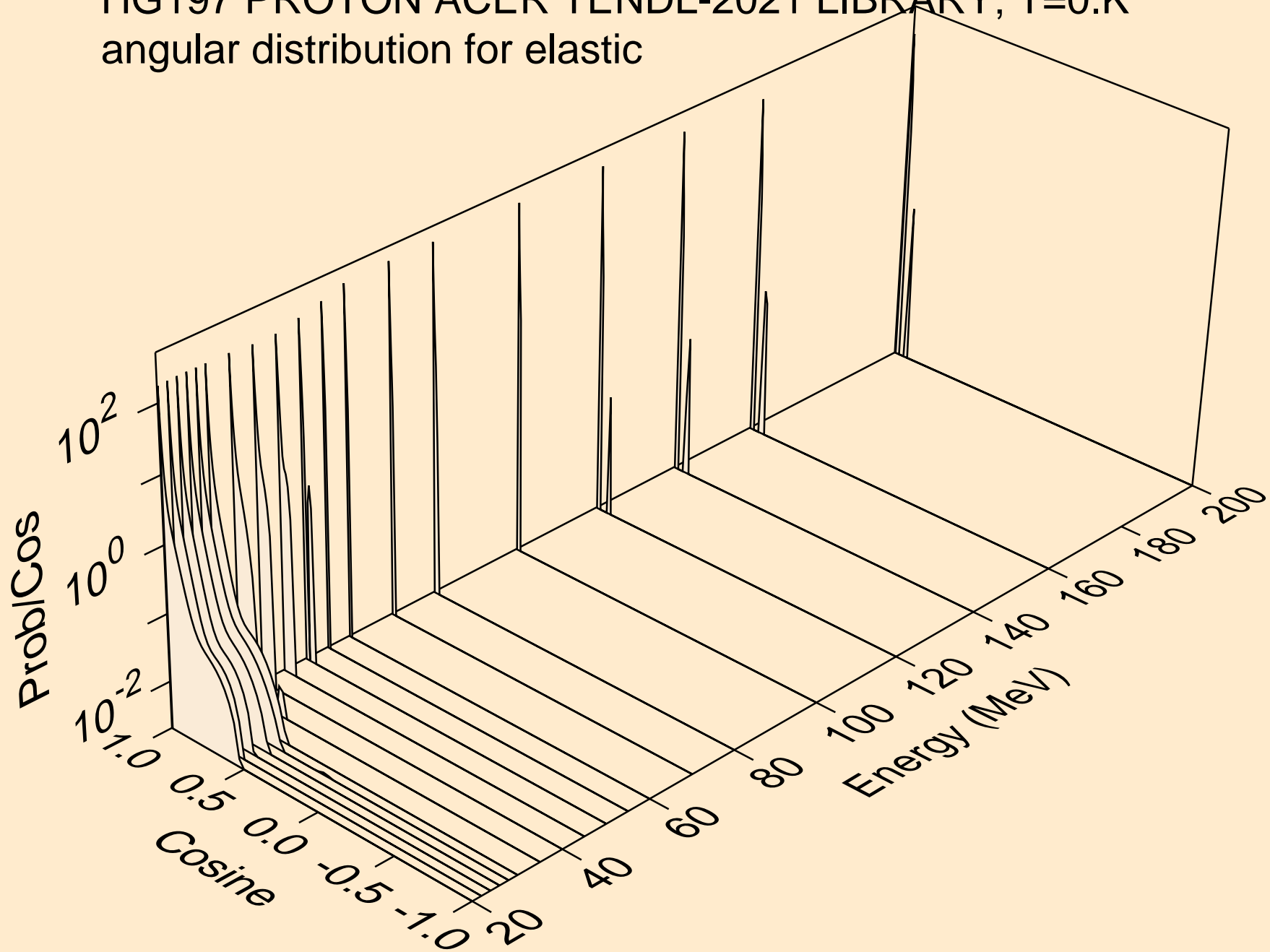

HG197 PROTON ACER TENDL-2021 LIBRARY; T=0.K  
Proton emission for (p,x)

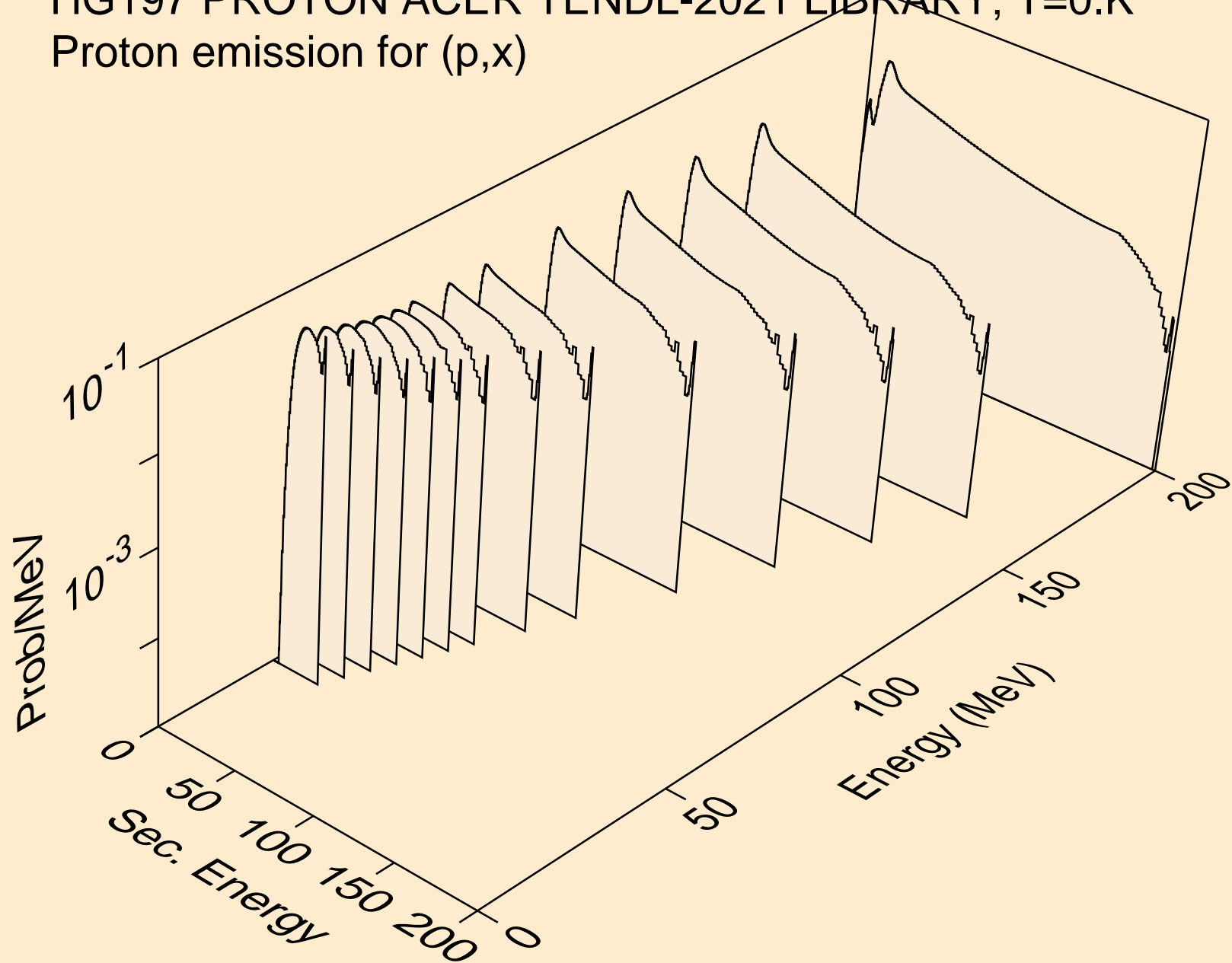

HG197 PROTON ACER TENDL-2021 LIBRARY; T=0.K  
Proton emission for (p,n\*)p

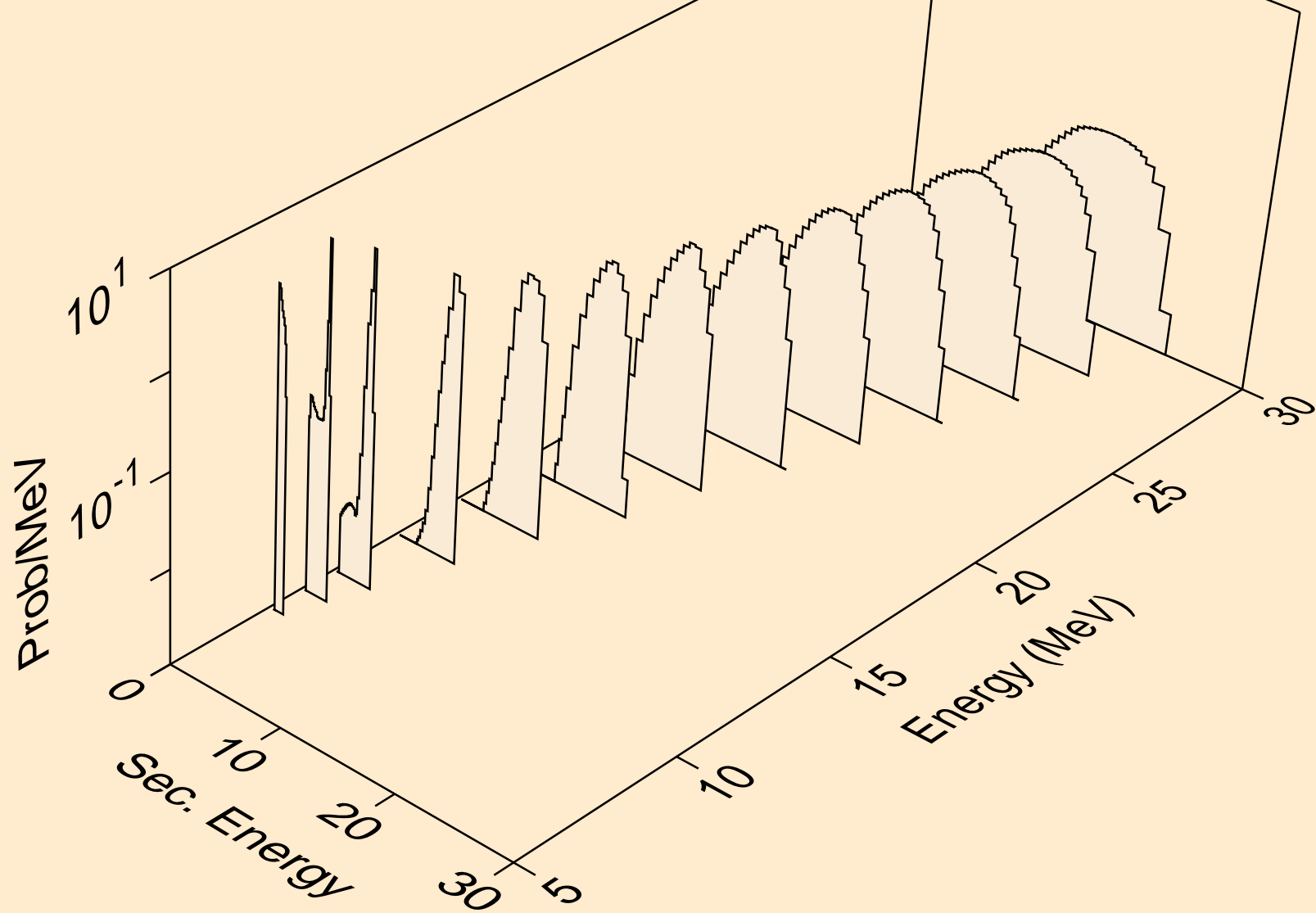

HG197 PROTON ACER TENDL-2021 LIBRARY; T=0.K  
Proton emission for (p,2np)

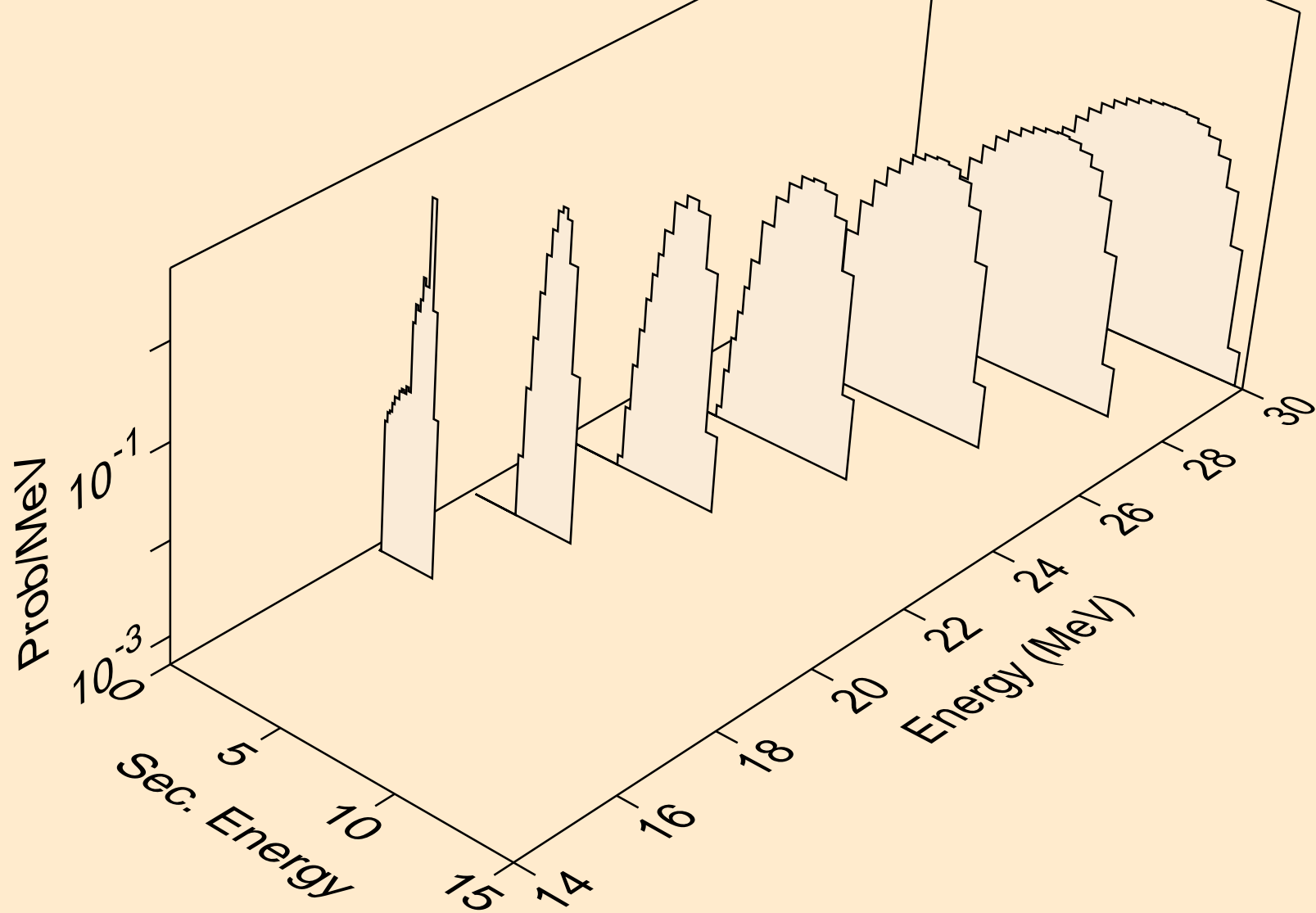

HG197 PROTON ACER TENDL-2021 LIBRARY; T=0.K  
Proton emission for (p,3np)

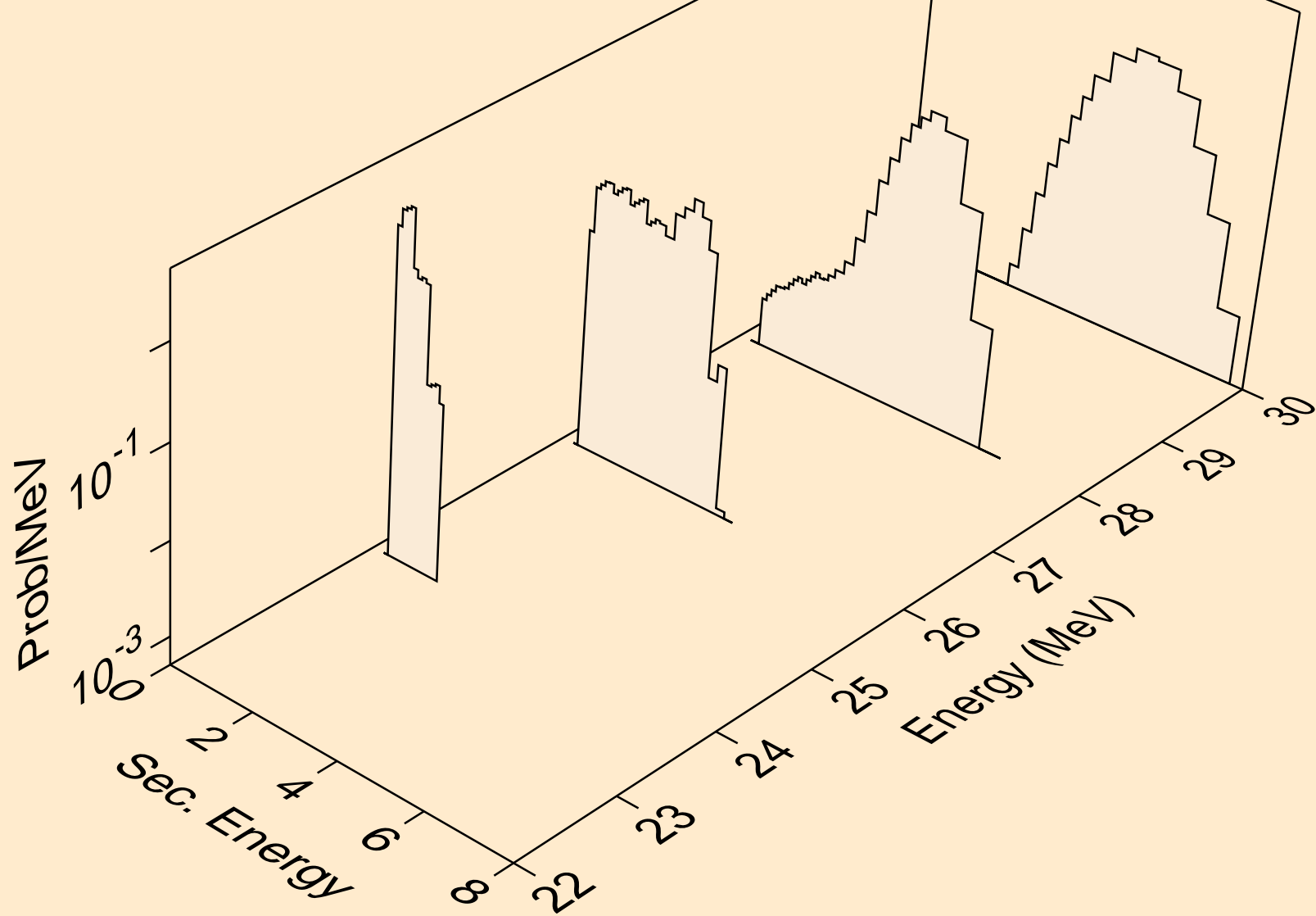

HG197 PROTON ACER TENDL-2021 LIBRARY; T=0.K  
Proton emission for (p,2np)

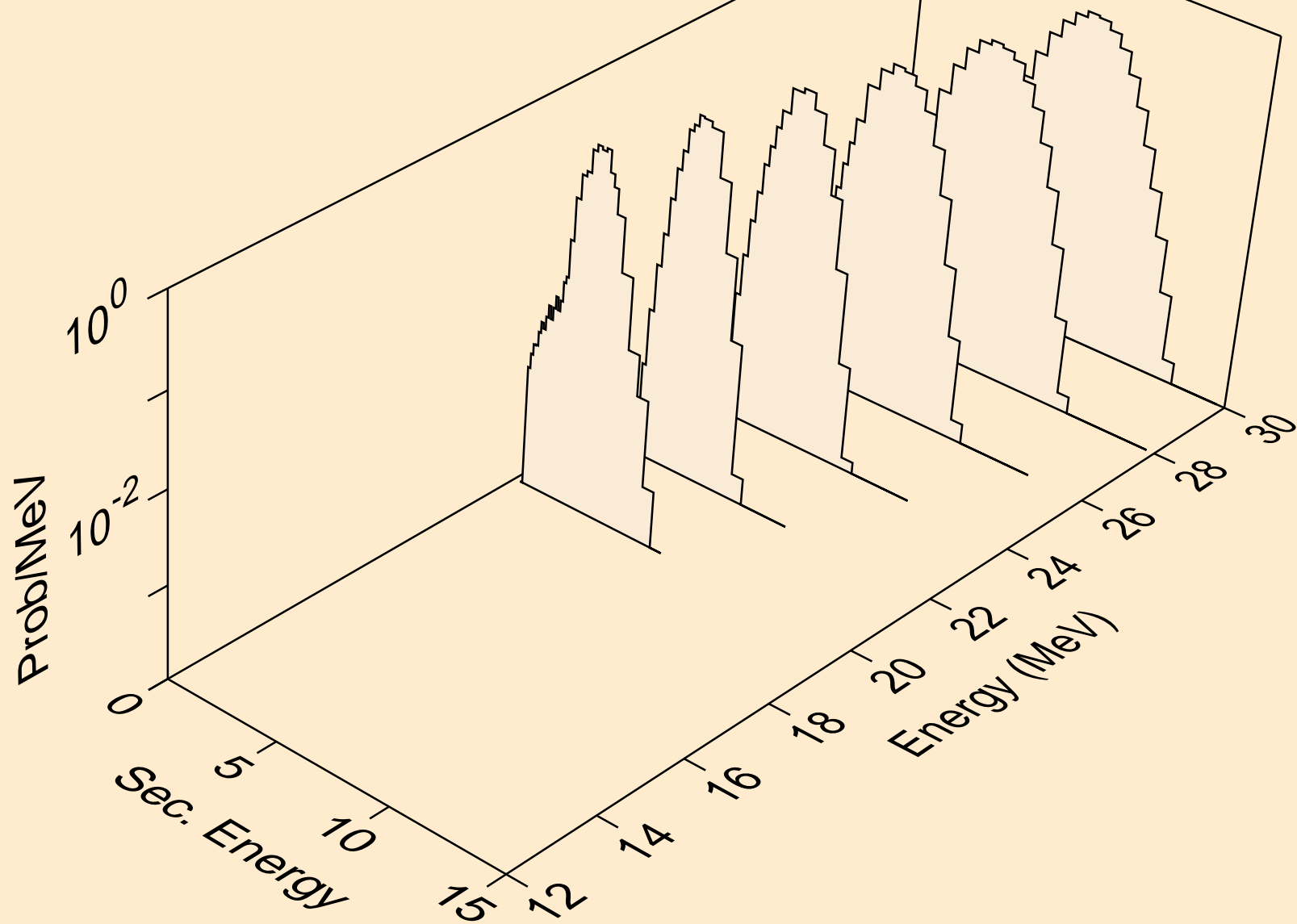

HG197 PROTON ACER TENDL-2021 LIBRARY; T=0.K  
Proton emission for (p,npa)

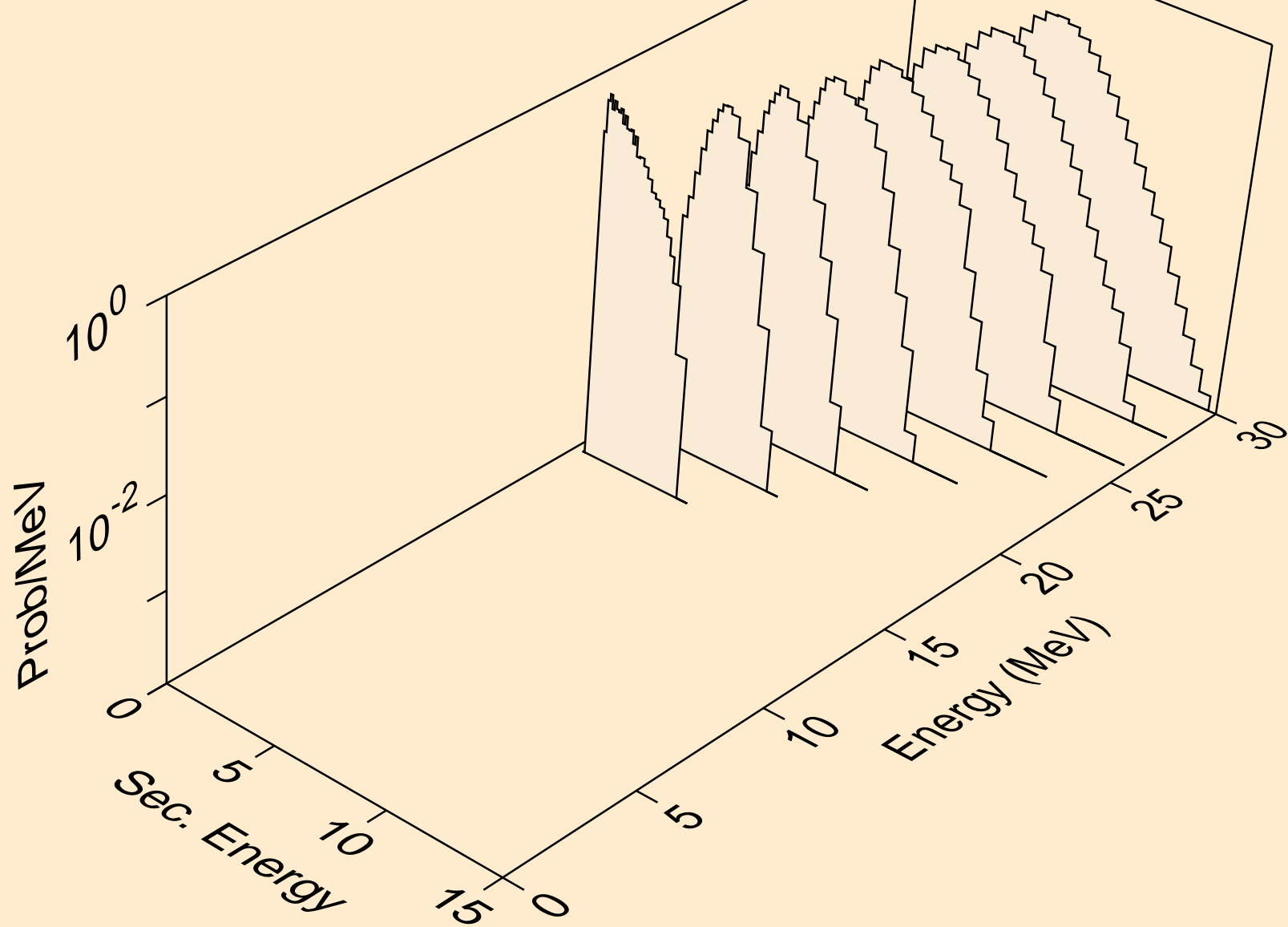

HG197 PROTON ACER TENDL-2021 LIBRARY; T=0.K  
Proton emission for inelastic

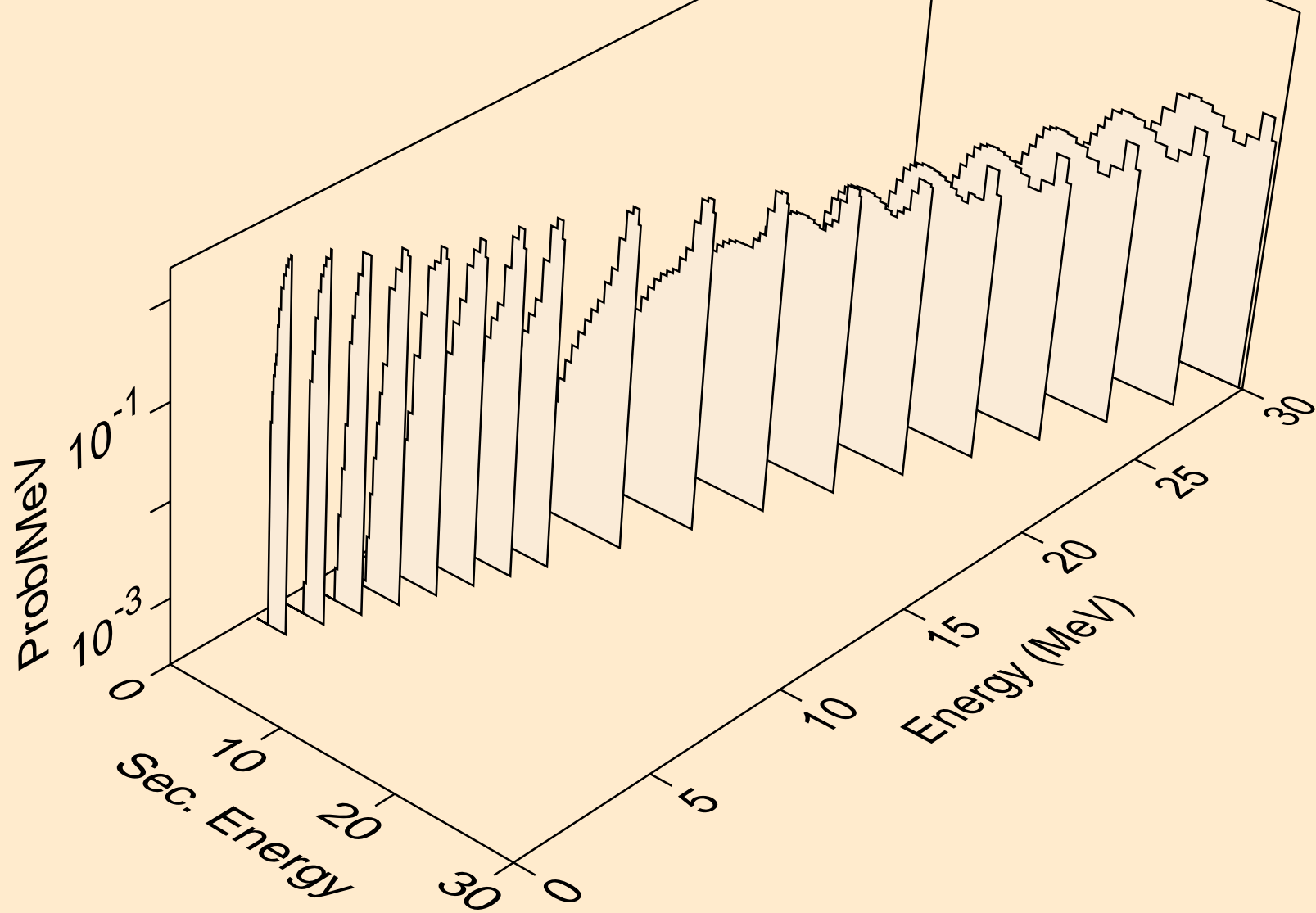



HG197 PROTON ACER TENDL-2021 LIBRARY; T=0.K  
Proton emission for (p,2p)

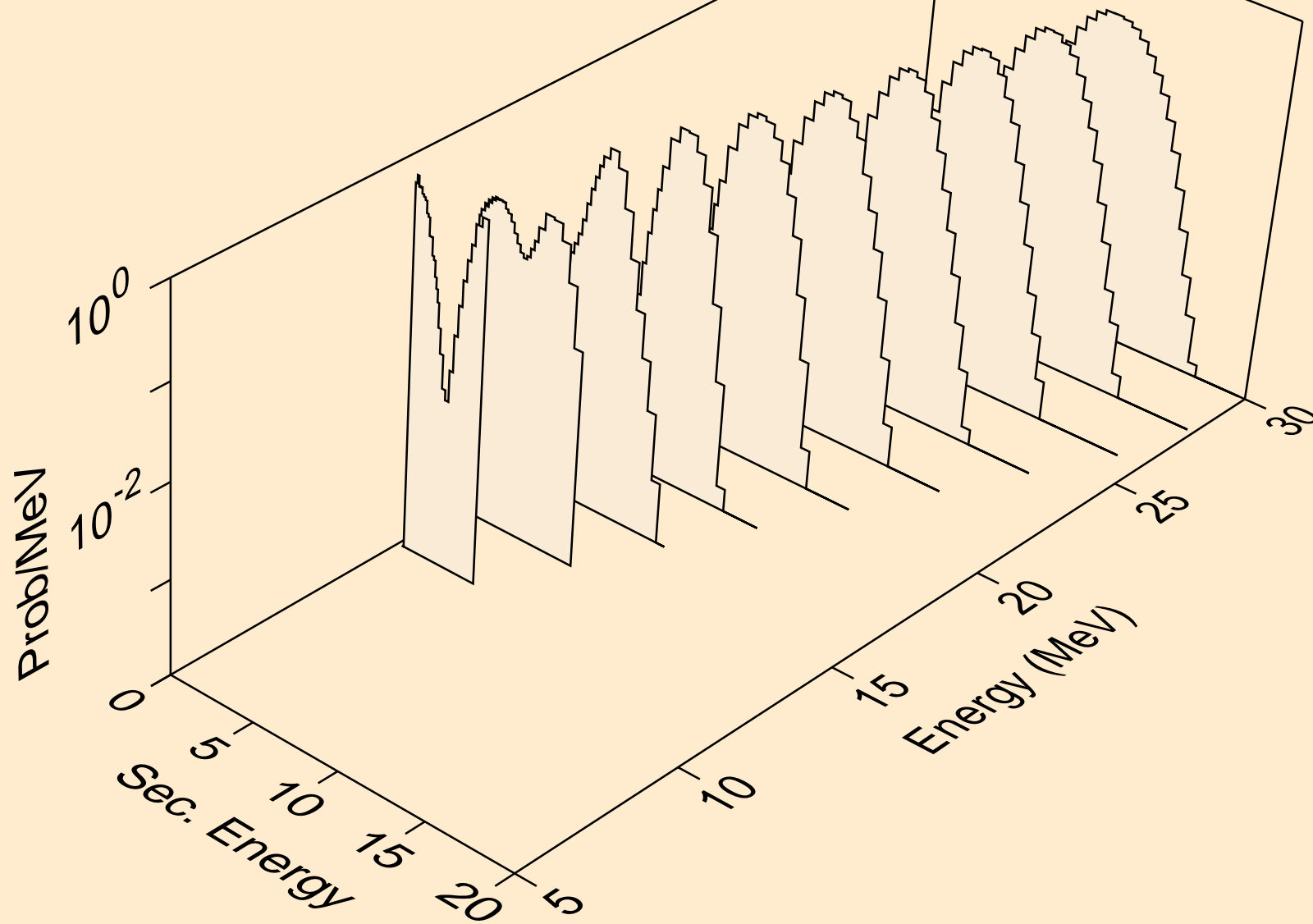

HG197 PROTON ACER TENDL-2021 LIBRARY; T=0.K  
Proton emission for (p,pa)

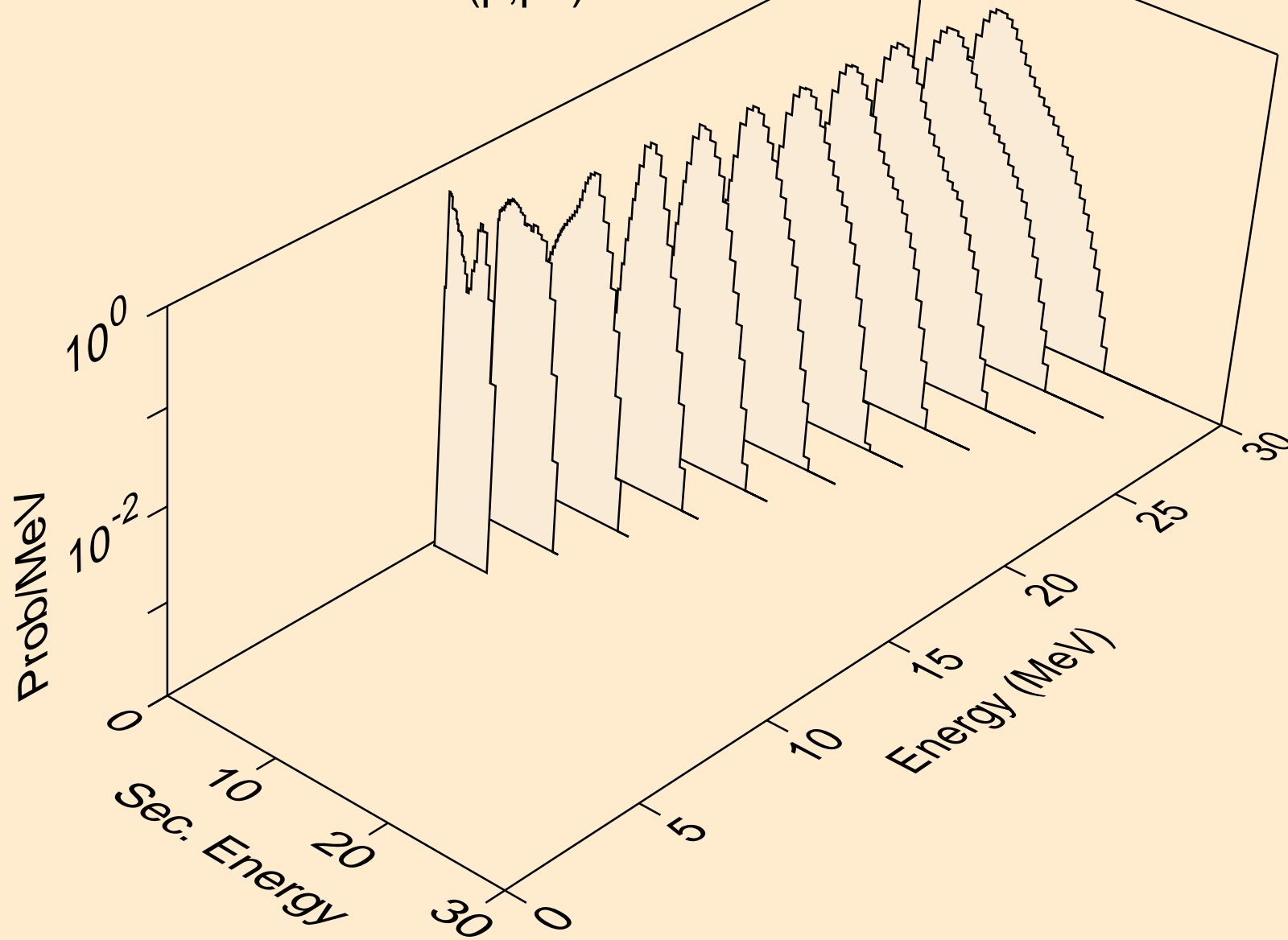

HG197 PROTON ACER TENDL-2021 LIBRARY; T=0.K  
Proton emission for (p,pd)

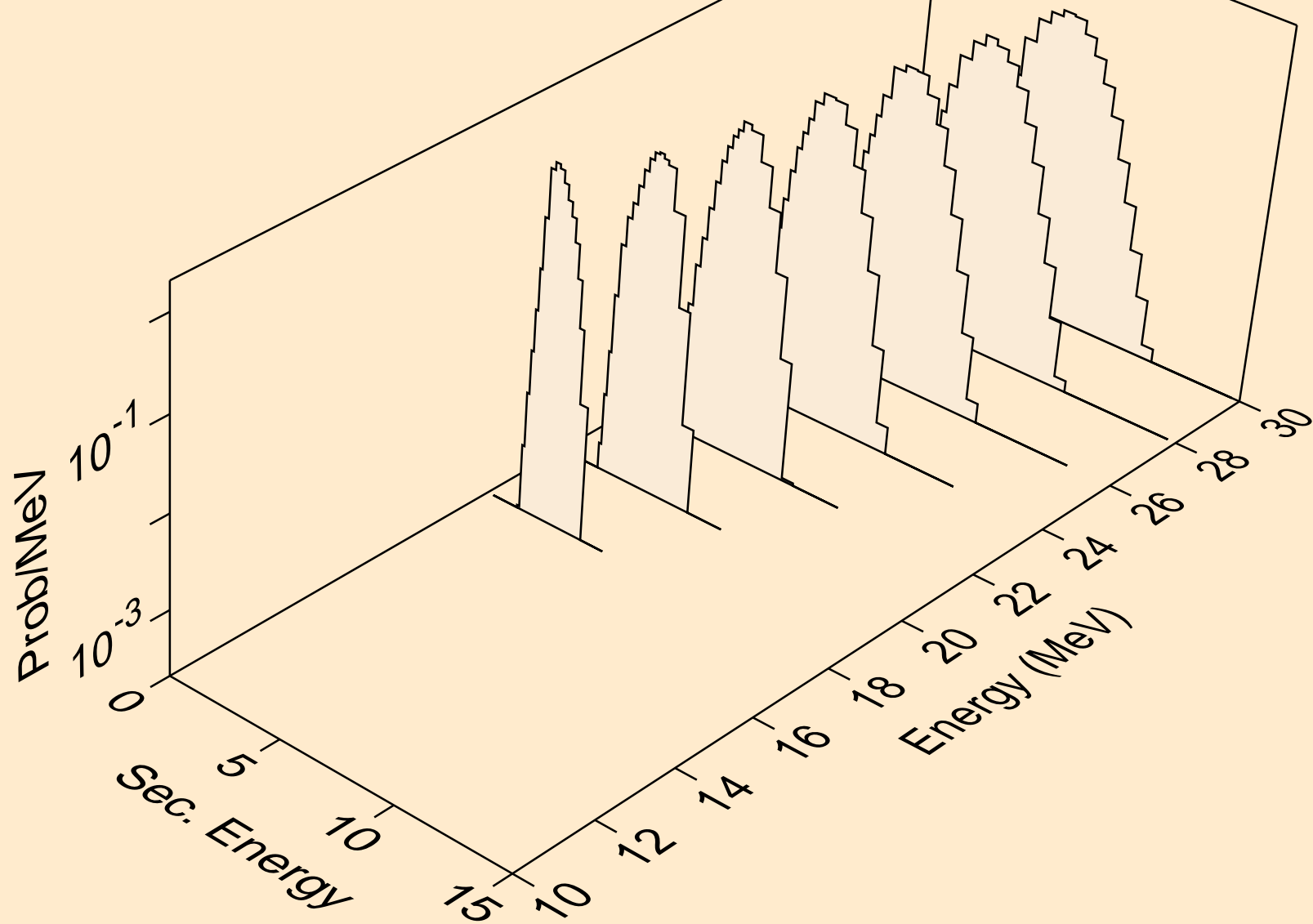

HG197 PROTON ACER TENDL-2021 LIBRARY; T=0.K  
Proton emission for (p,pt)

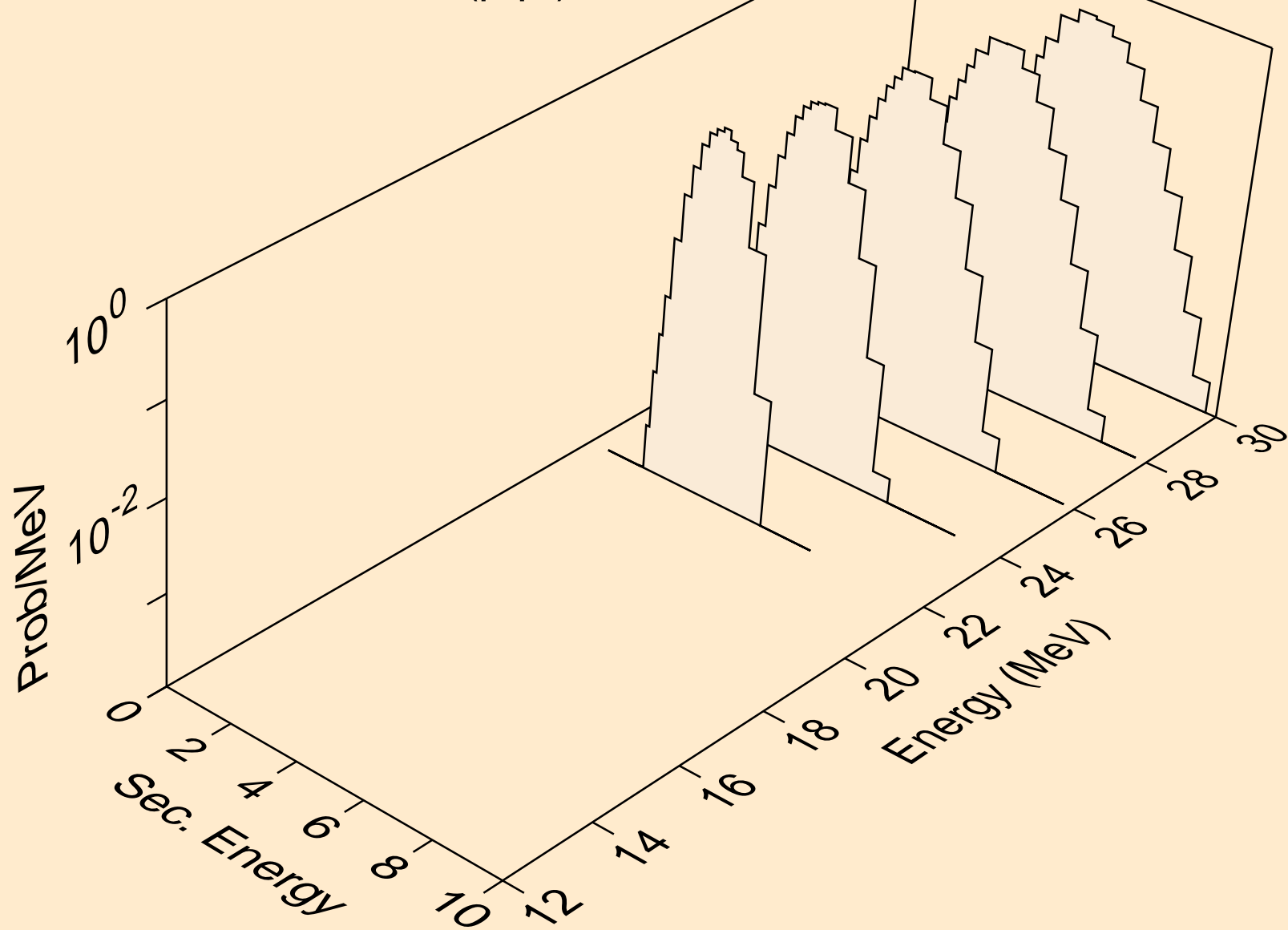

HG197 PROTON ACER TENDL-2021 LIBRARY; T=0.K  
Photon emission for (z,n)

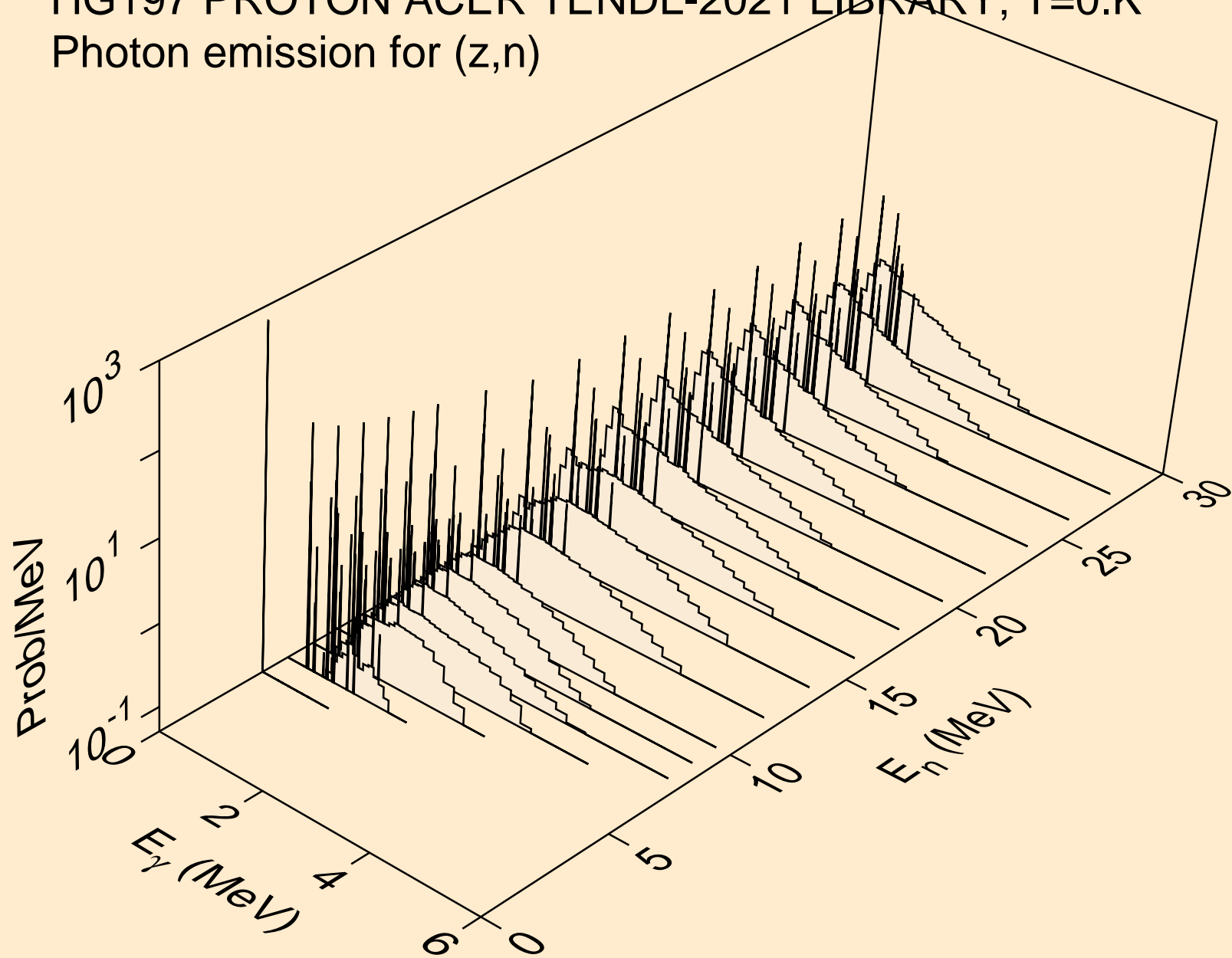

HG197 PROTON ACER TENDL-2021 LIBRARY; T=0.K  
Photon emission for (n,x)

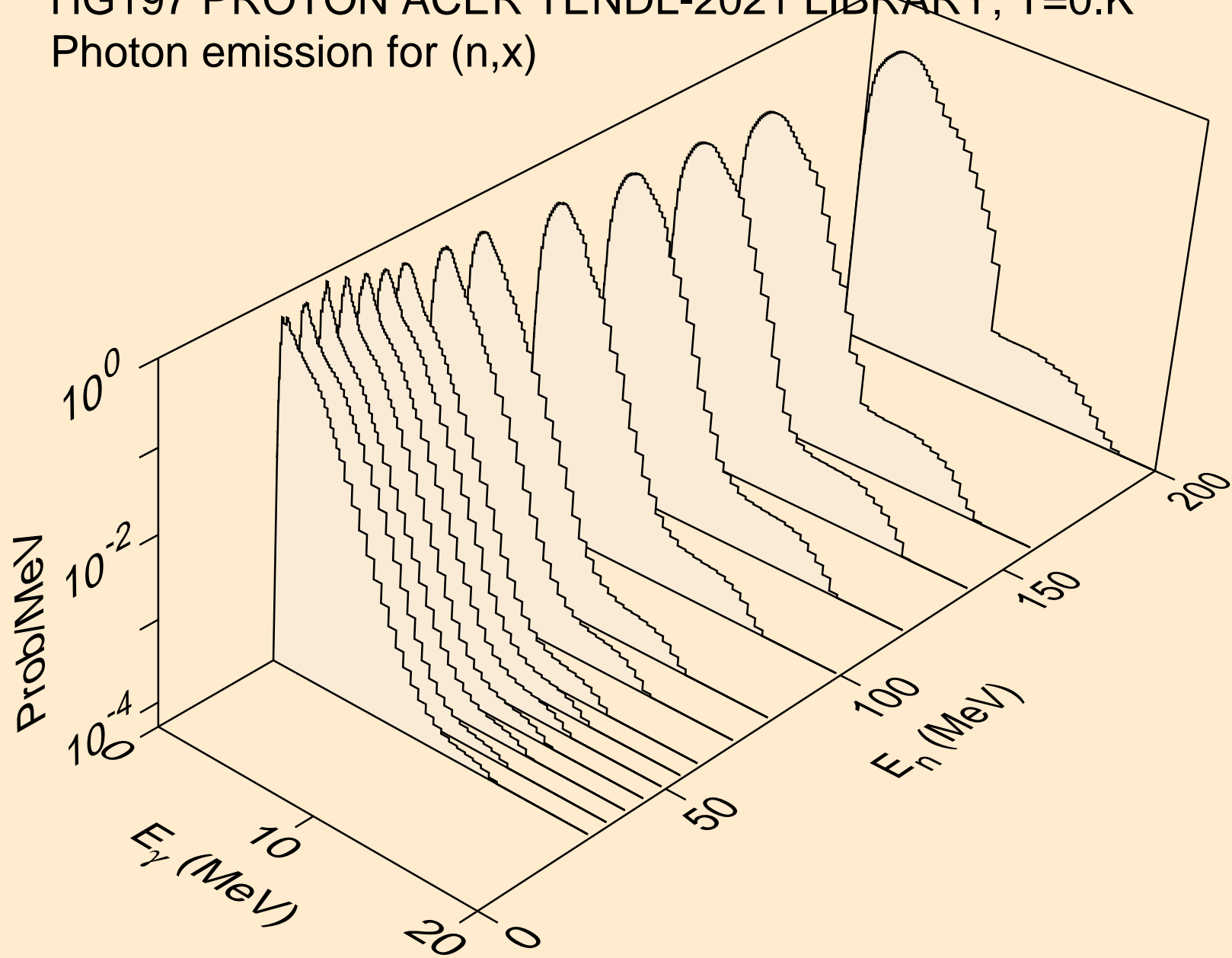

HG197 PROTON ACER TENDL-2021 LIBRARY; T=0.K  
Photon emission for (n,2nd)

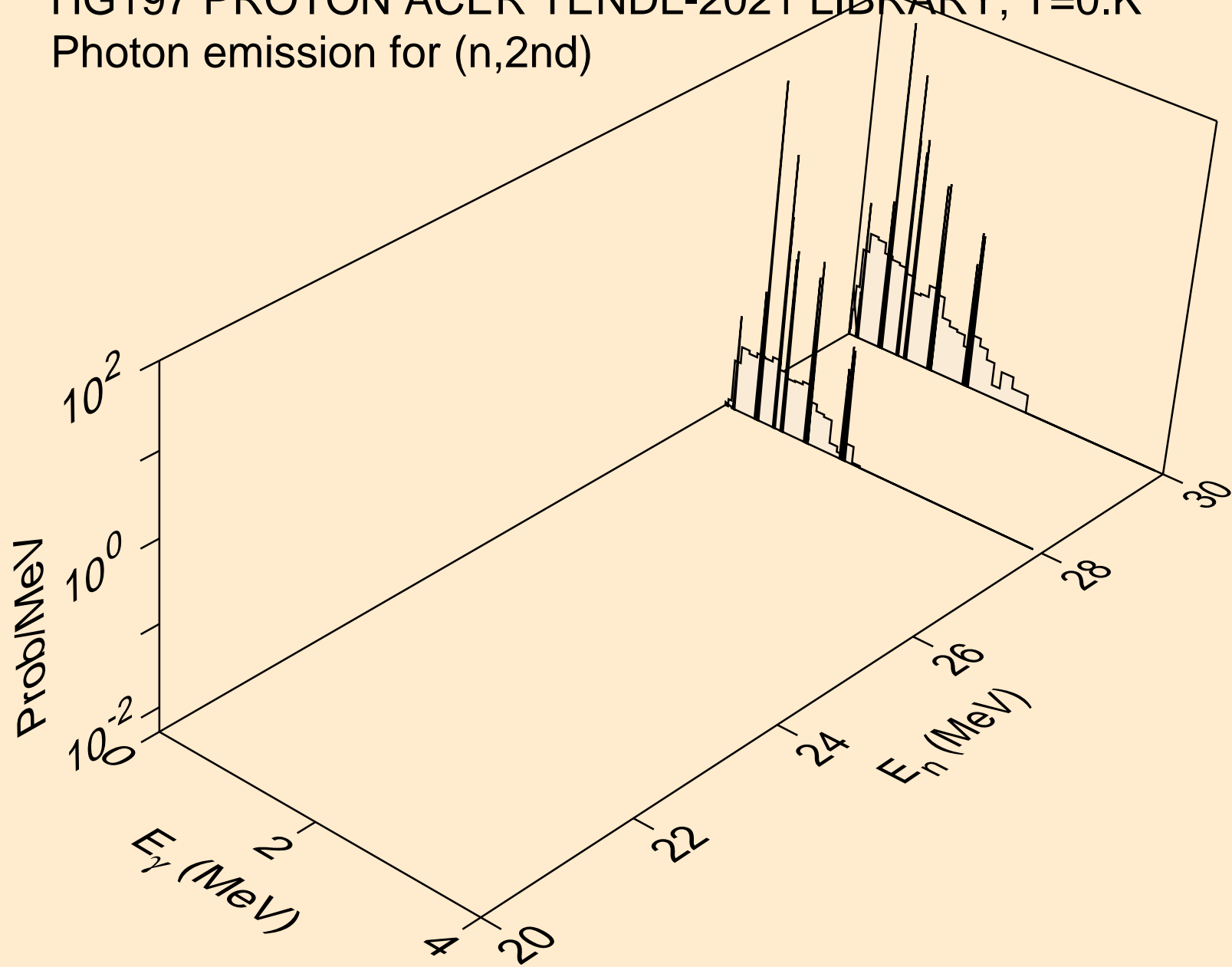

HG197 PROTON ACER TENDL-2021 LIBRARY; T=0.K  
Photon emission for (n,2n)

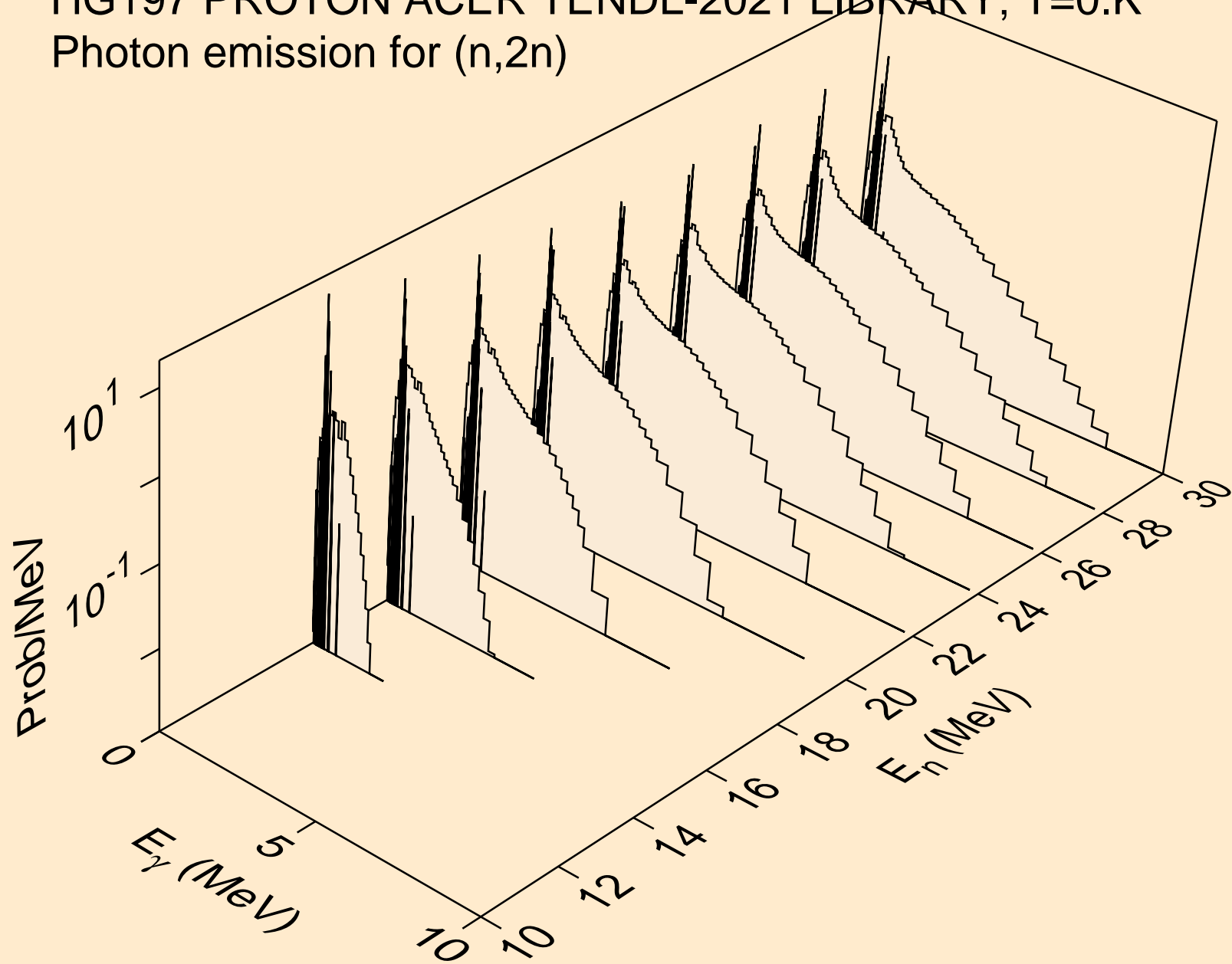



HG197 PROTON ACER TENDL-2021 LIBRARY; T=0.K  
Photon emission for (n,3n)

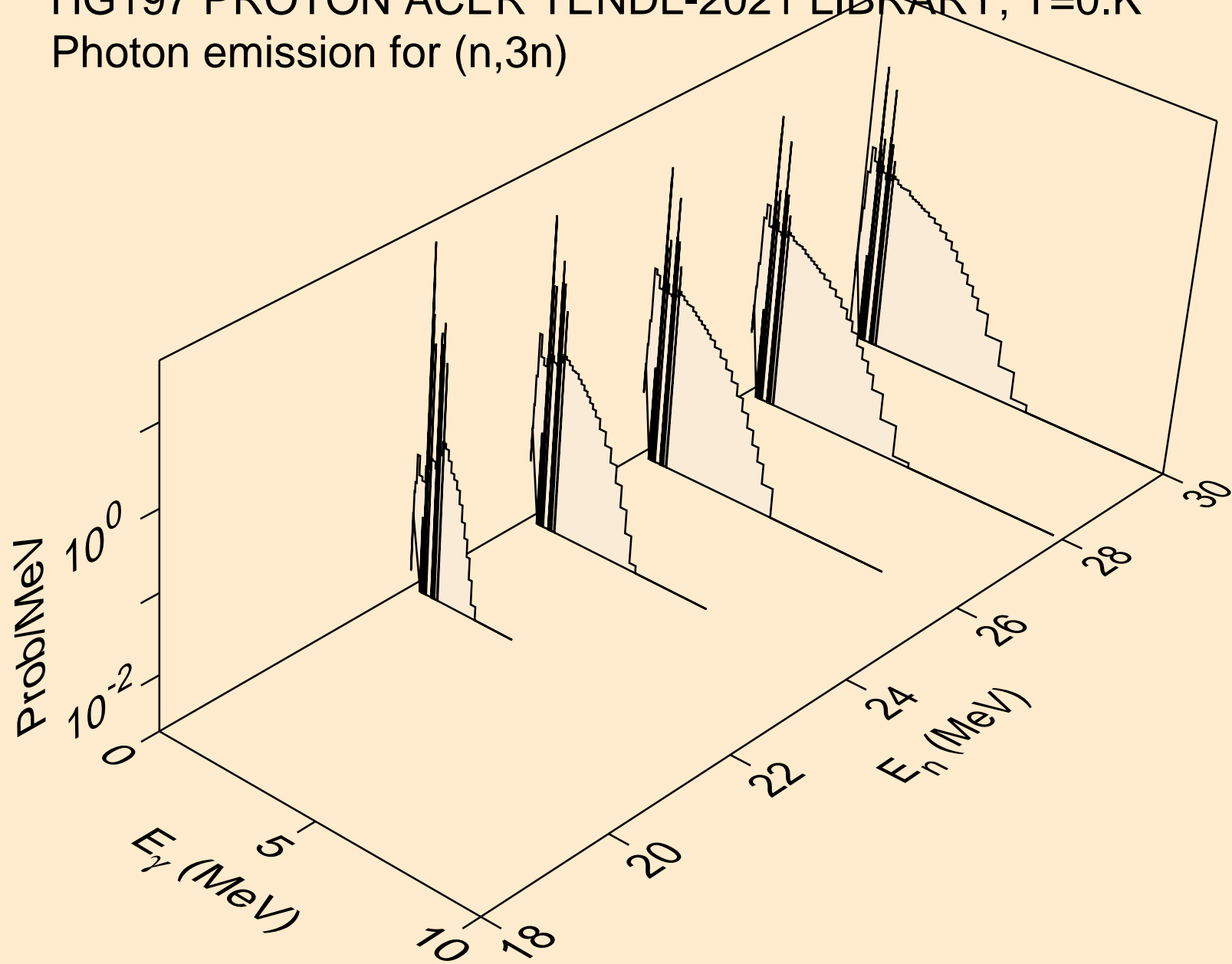

HG197 PROTON ACER TENDL-2021 LIBRARY; T=0.K  
Photon emission for (n,n\*)a

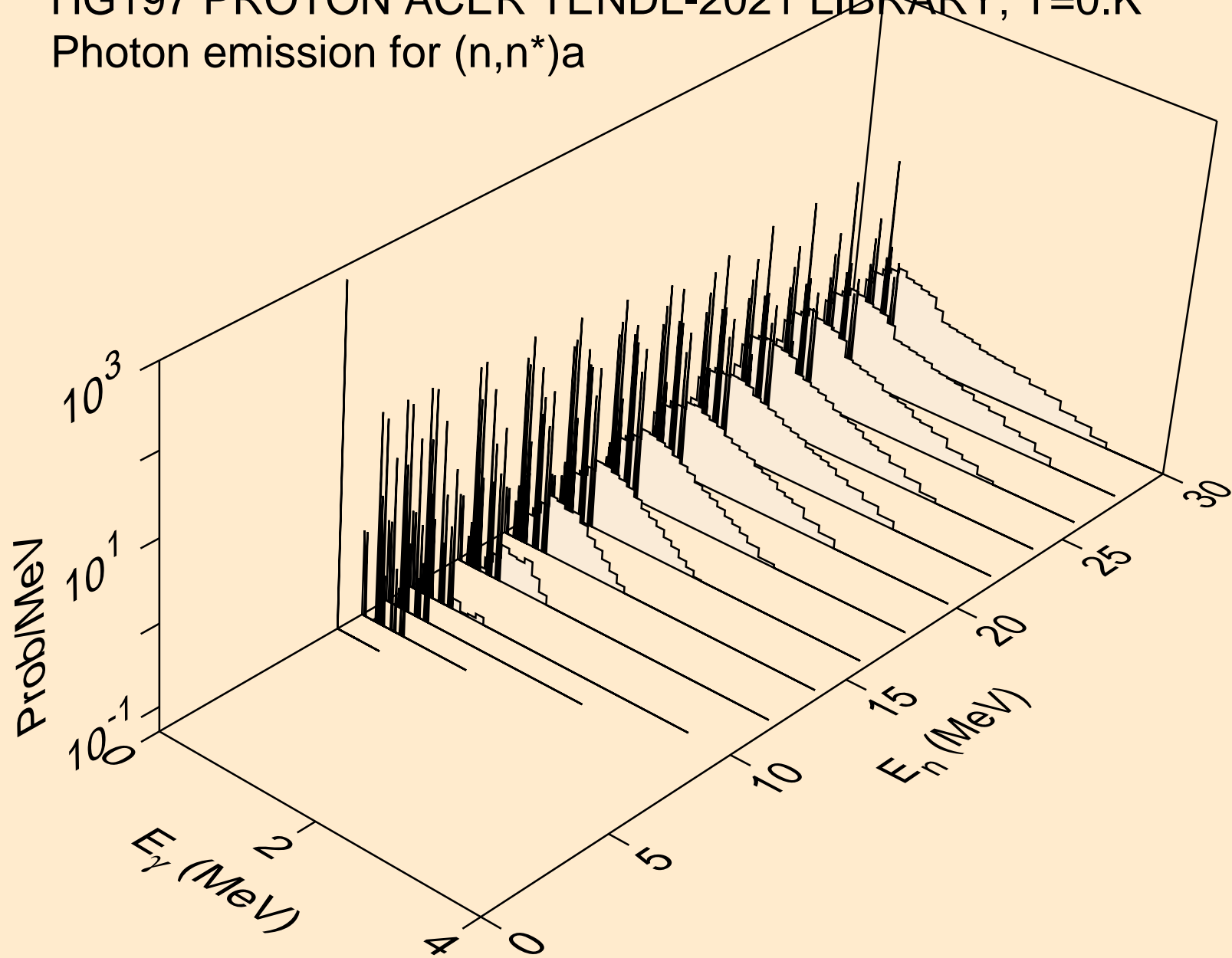

HG197 PROTON ACER TENDL-2021 LIBRARY; T=0.K  
Photon emission for (n,2n)a

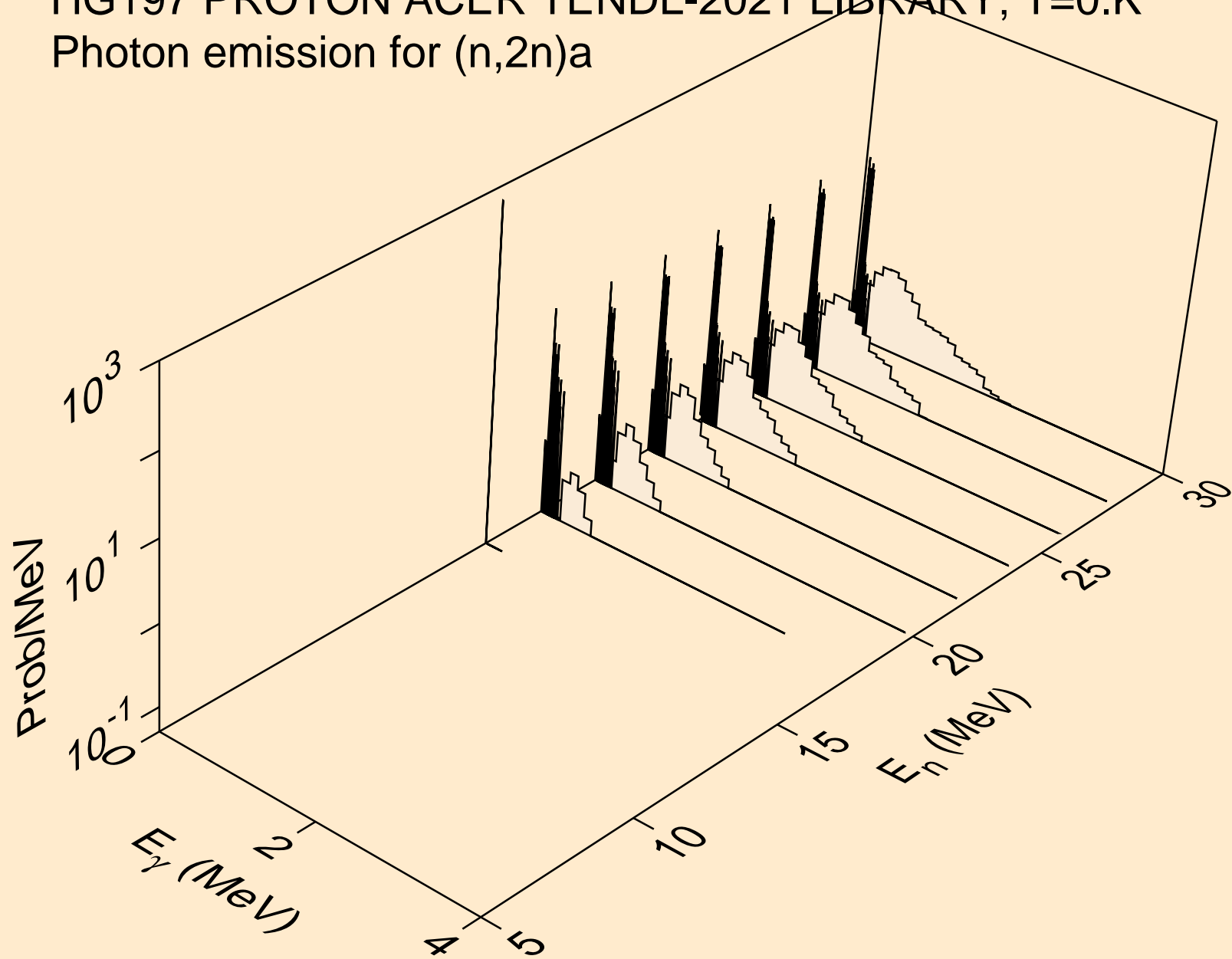

HG197 PROTON ACER TENDL-2021 LIBRARY; T=0.K  
Photon emission for (n,3n)a

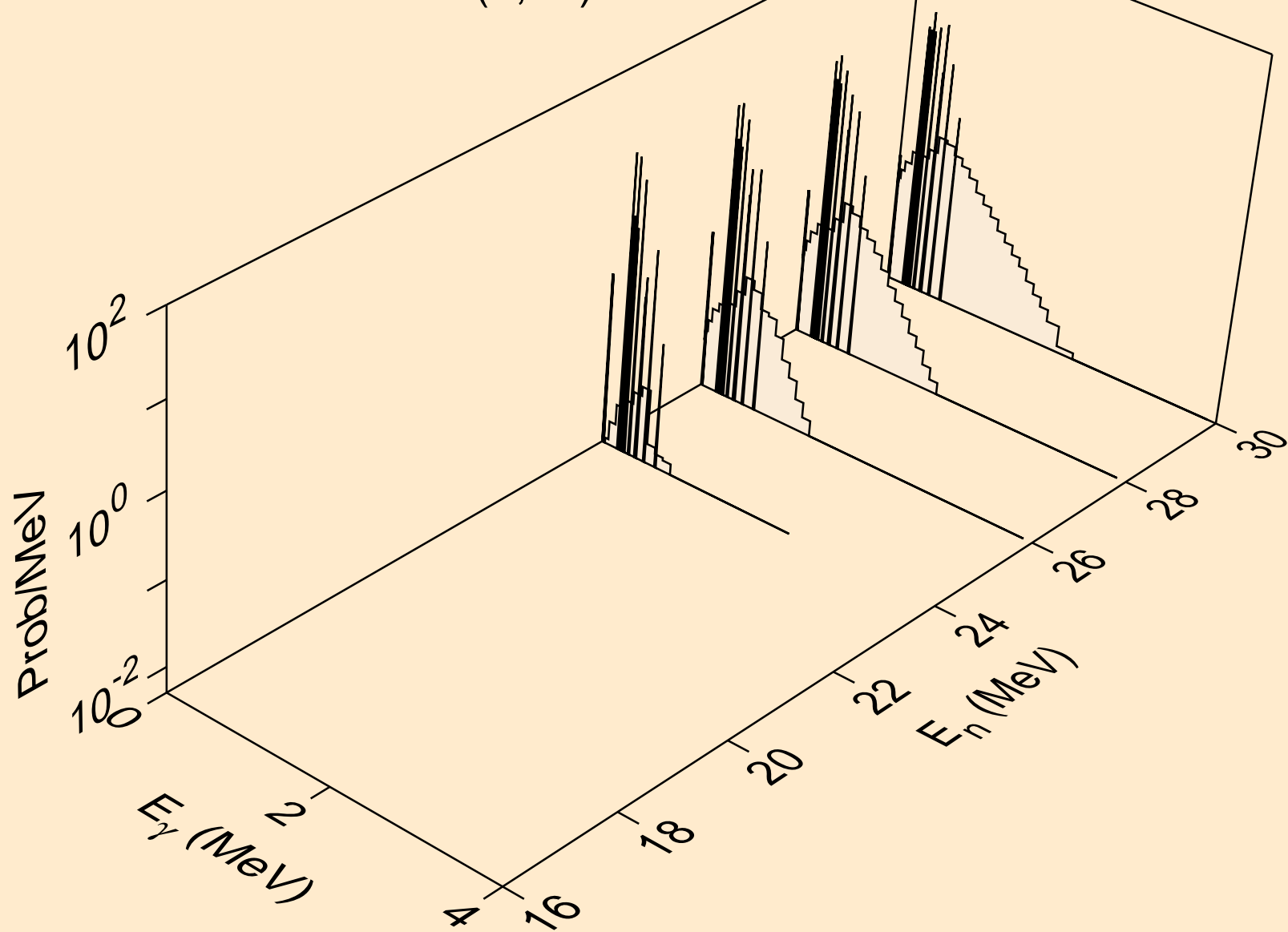

HG197 PROTON ACER TENDL-2021 LIBRARY; T=0.K  
Photon emission for (n,n\*)p

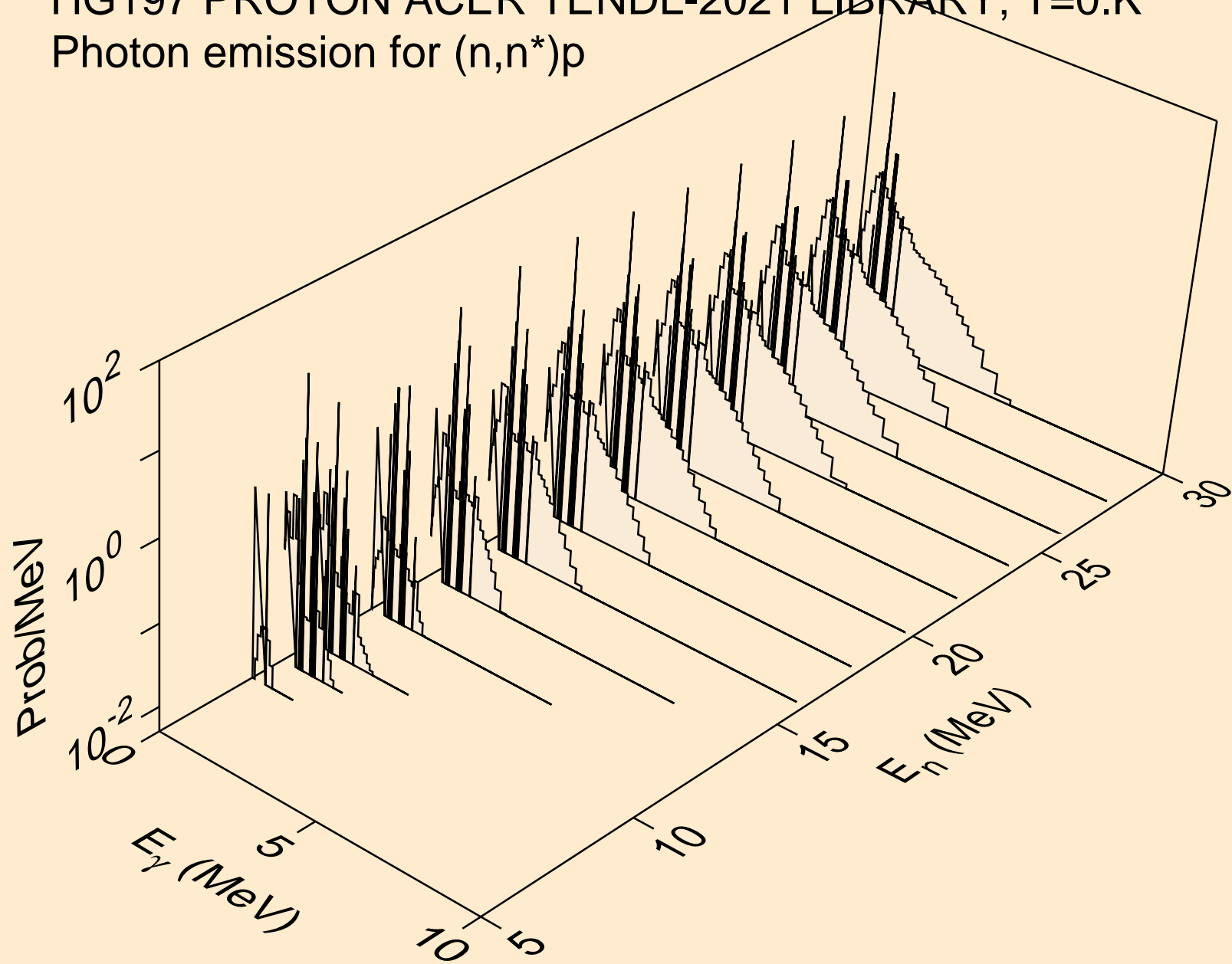

HG197 PROTON ACER TENDL-2021 LIBRARY; T=0.K  
Photon emission for (n,n\*)2a

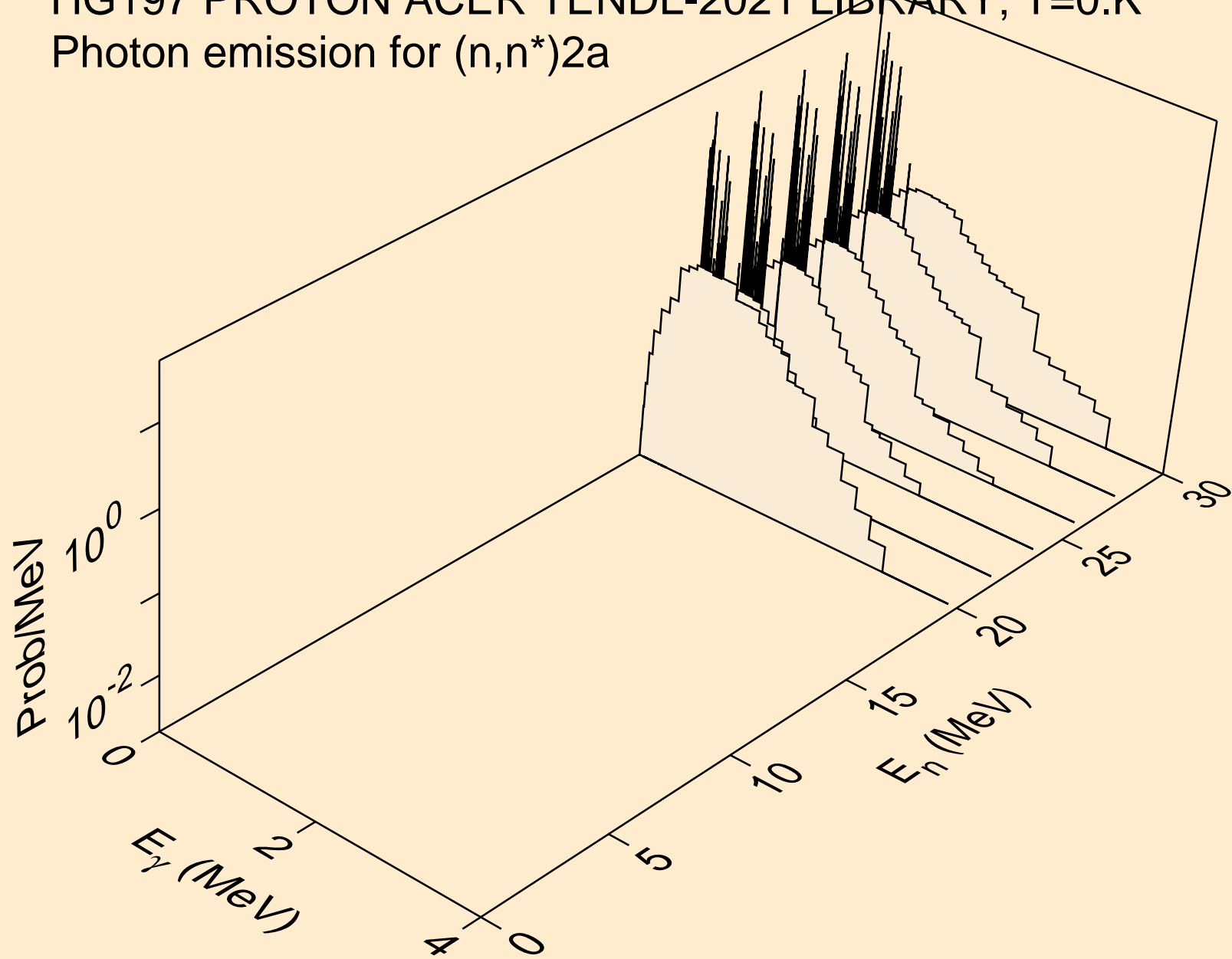

HG197 PROTON ACER TENDL-2021 LIBRARY; T=0.K  
Photon emission for (n,n\*)d

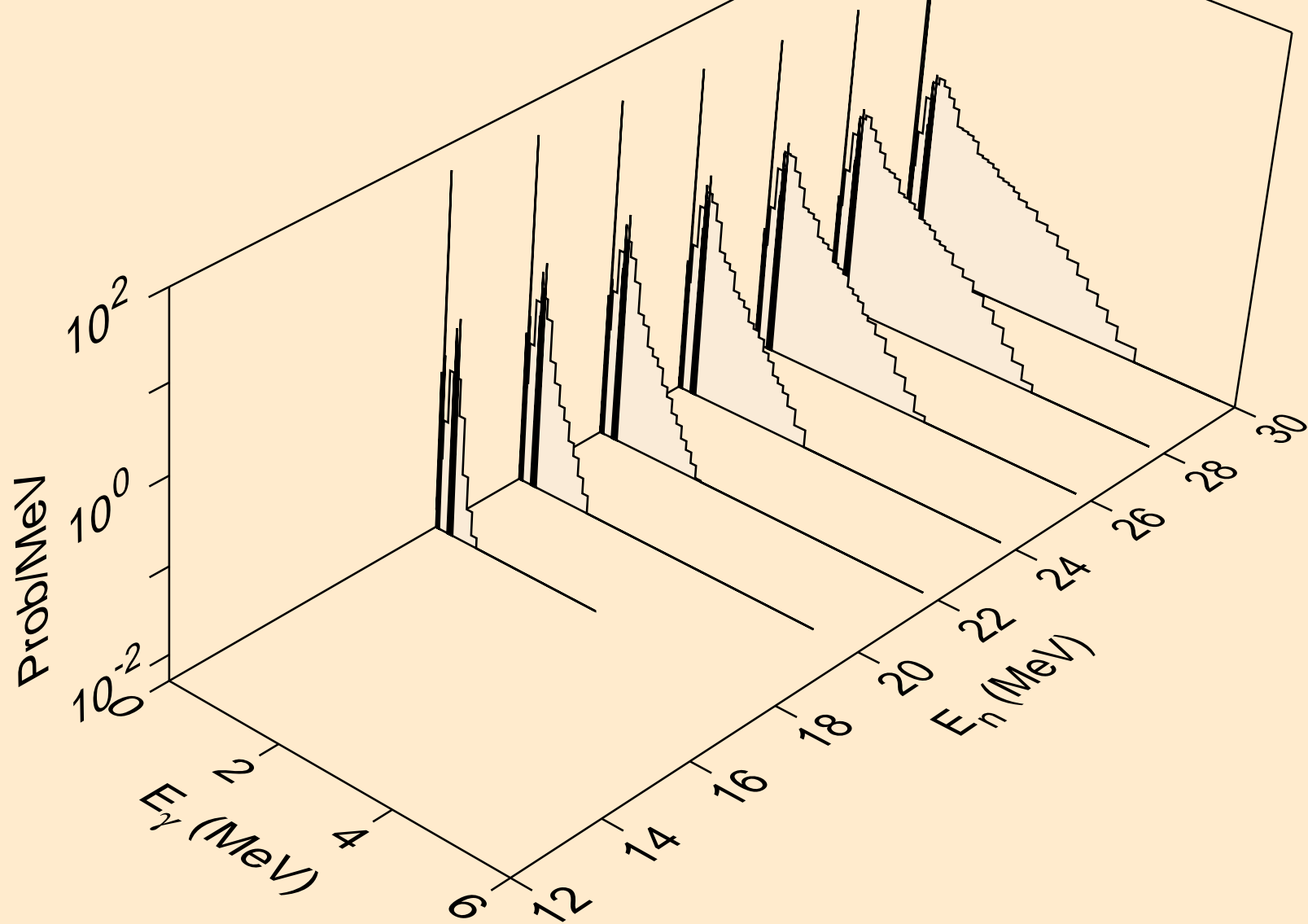

HG197 PROTON ACER TENDL-2021 LIBRARY; T=0.K  
Photon emission for (n,n\*)t

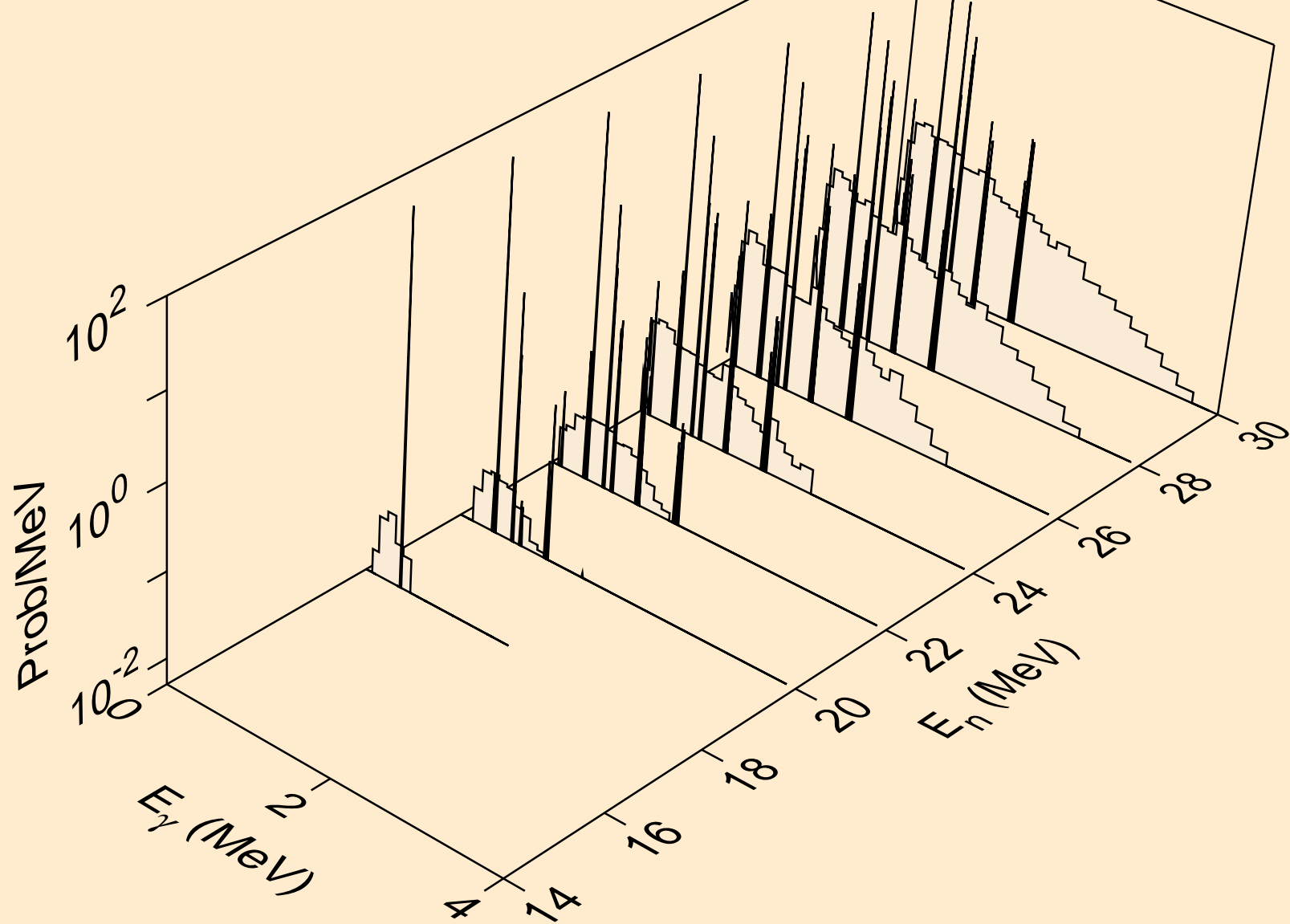



HG197 PROTON ACER TENDL-2021 LIBRARY; T=0.K  
Photon emission for (n,n\*)he3

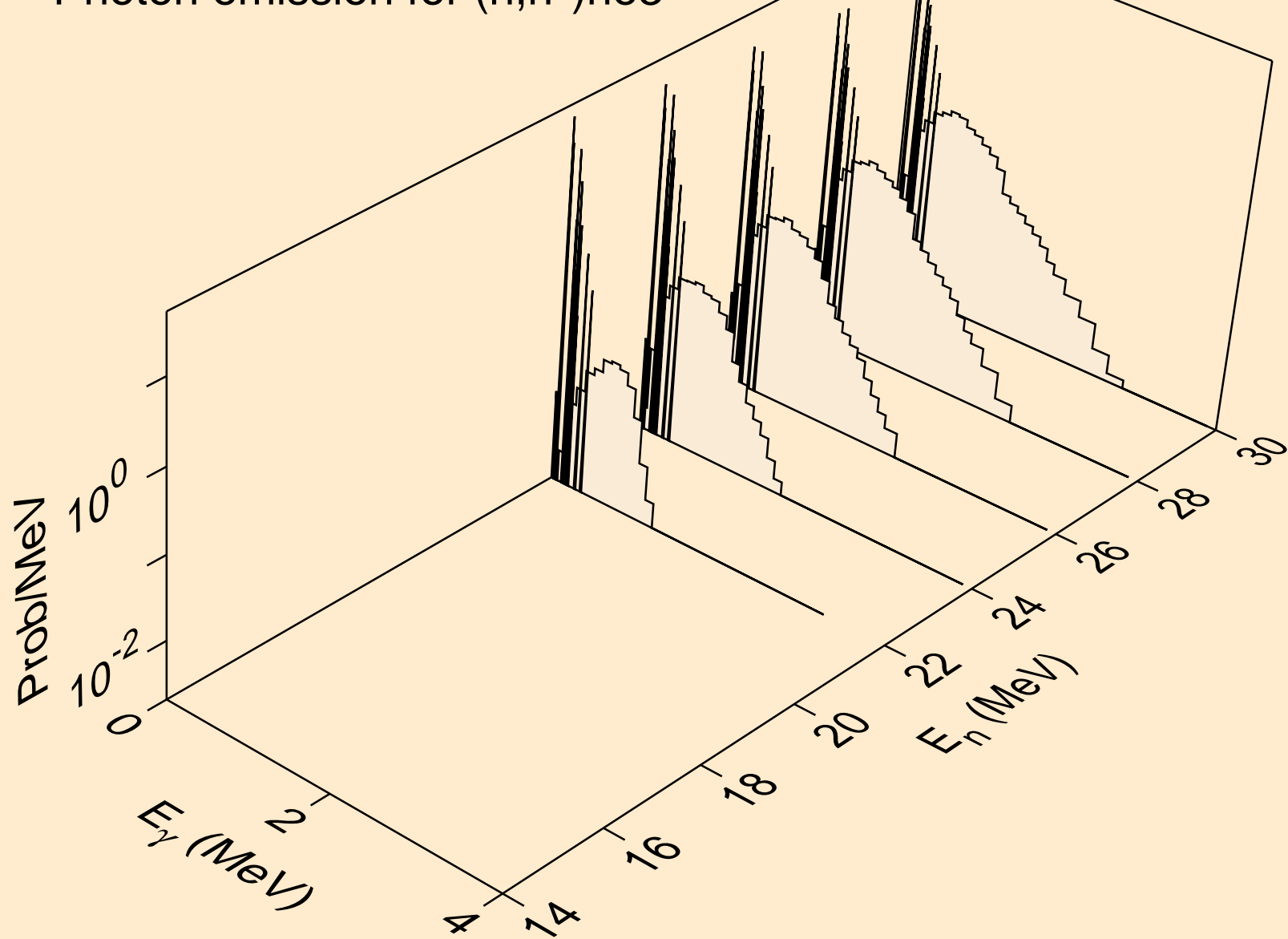

HG197 PROTON ACER TENDL-2021 LIBRARY; T=0.K  
Photon emission for (n,4n)

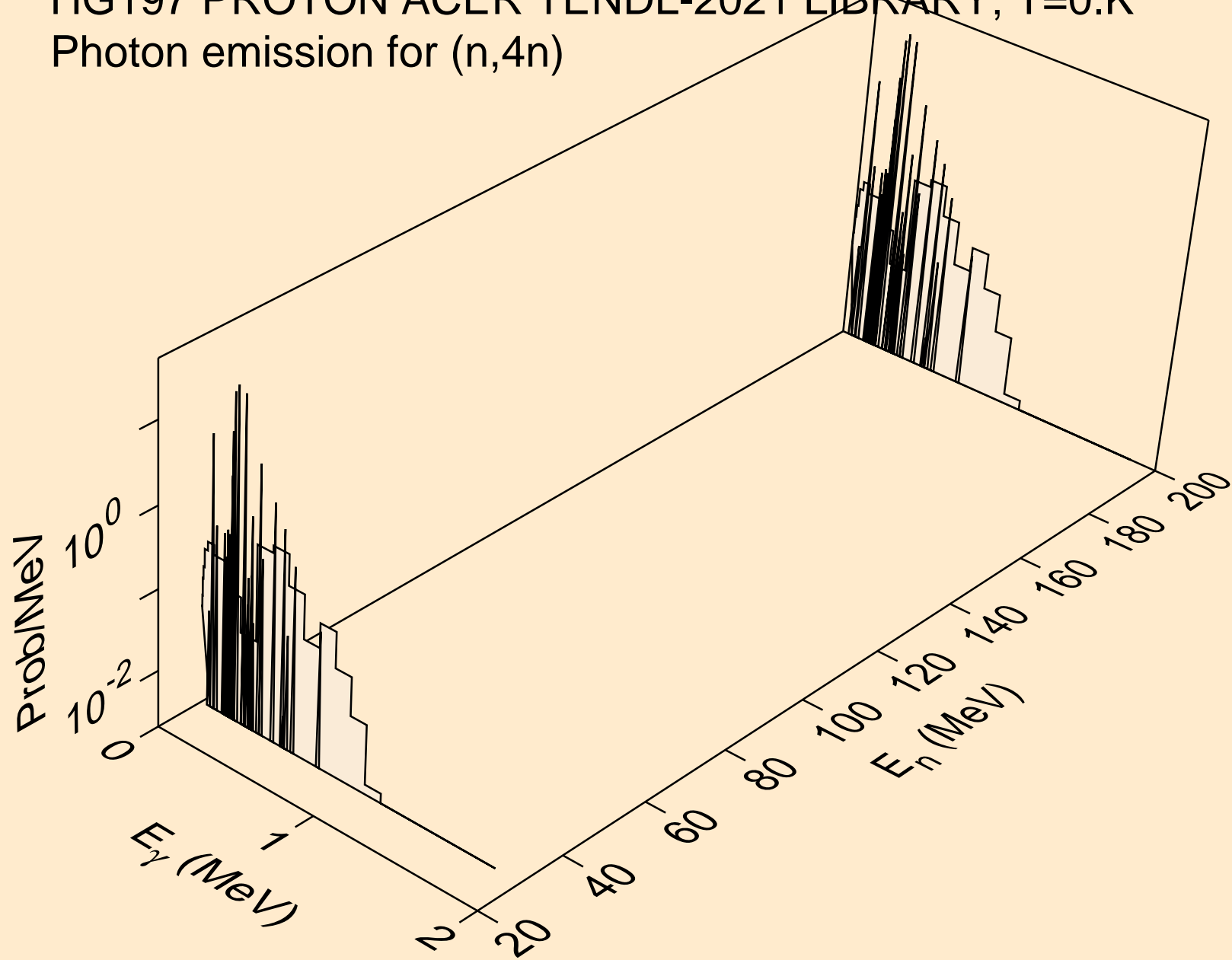

HG197 PROTON ACER TENDL-2021 LIBRARY; T=0.K  
Photon emission for (n,2np)

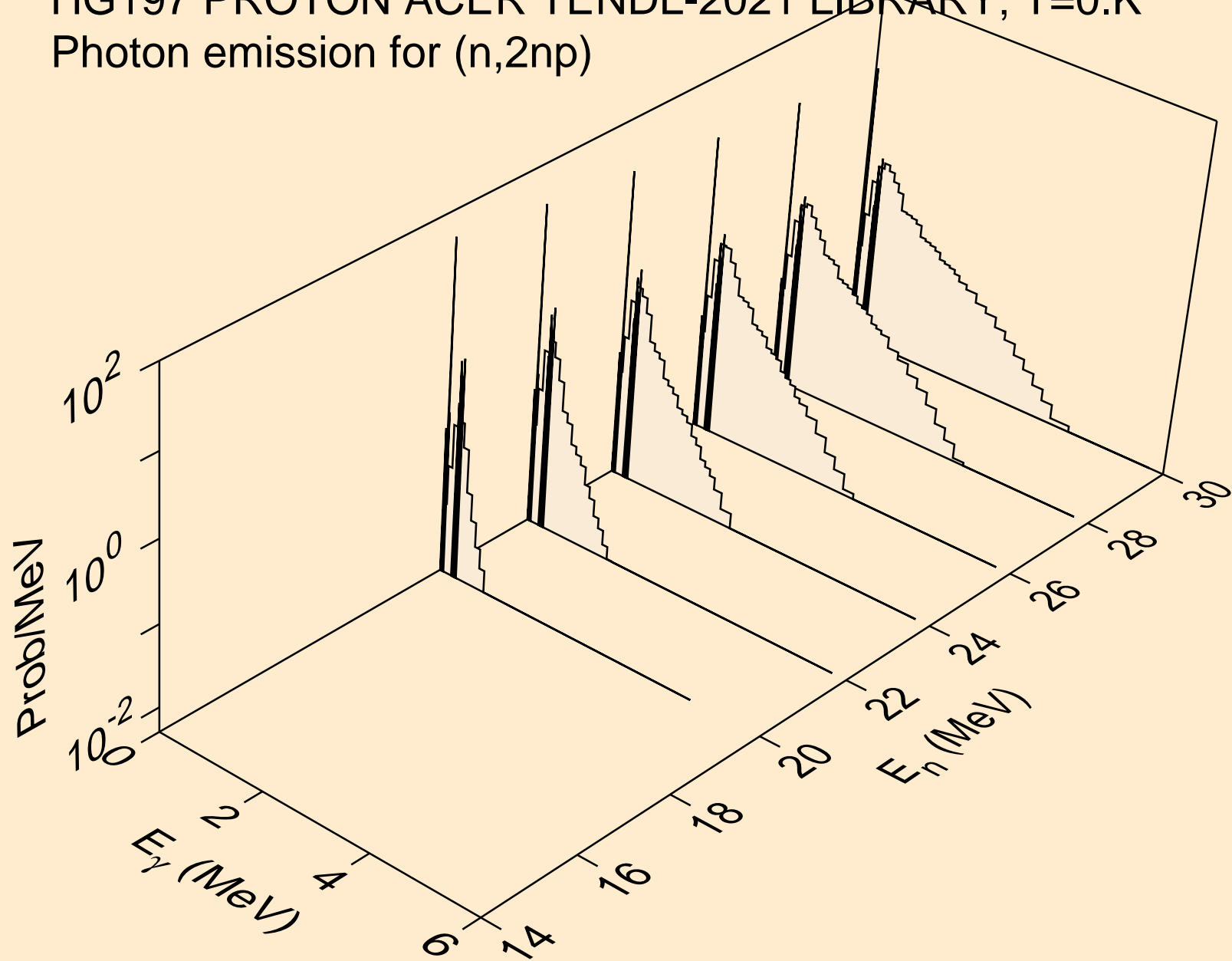

HG197 PROTON ACER TENDL-2021 LIBRARY; T=0.K  
Photon emission for (n,3np)

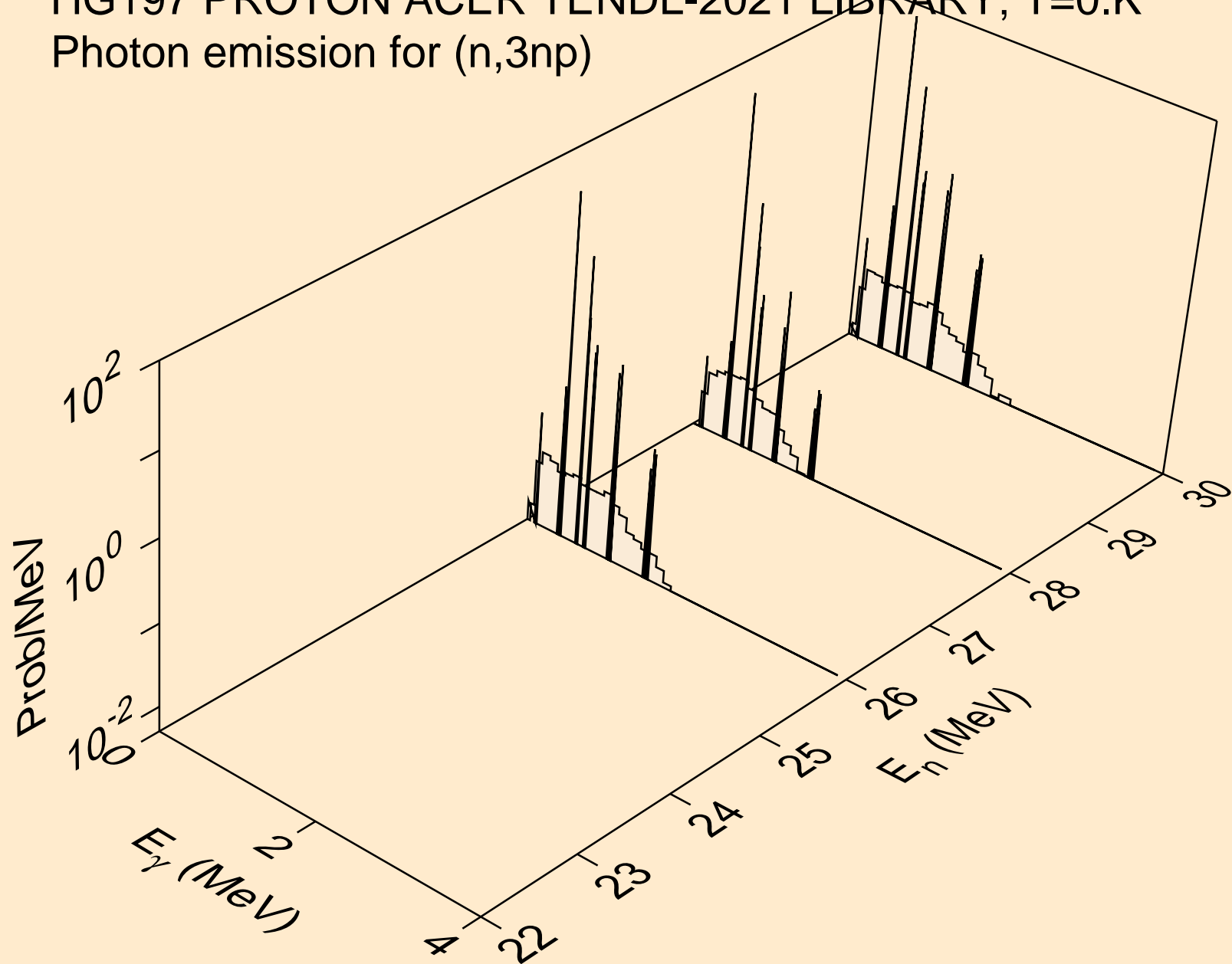

HG197 PROTON ACER TENDL-2021 LIBRARY; T=0.K  
Photon emission for (n,2np)

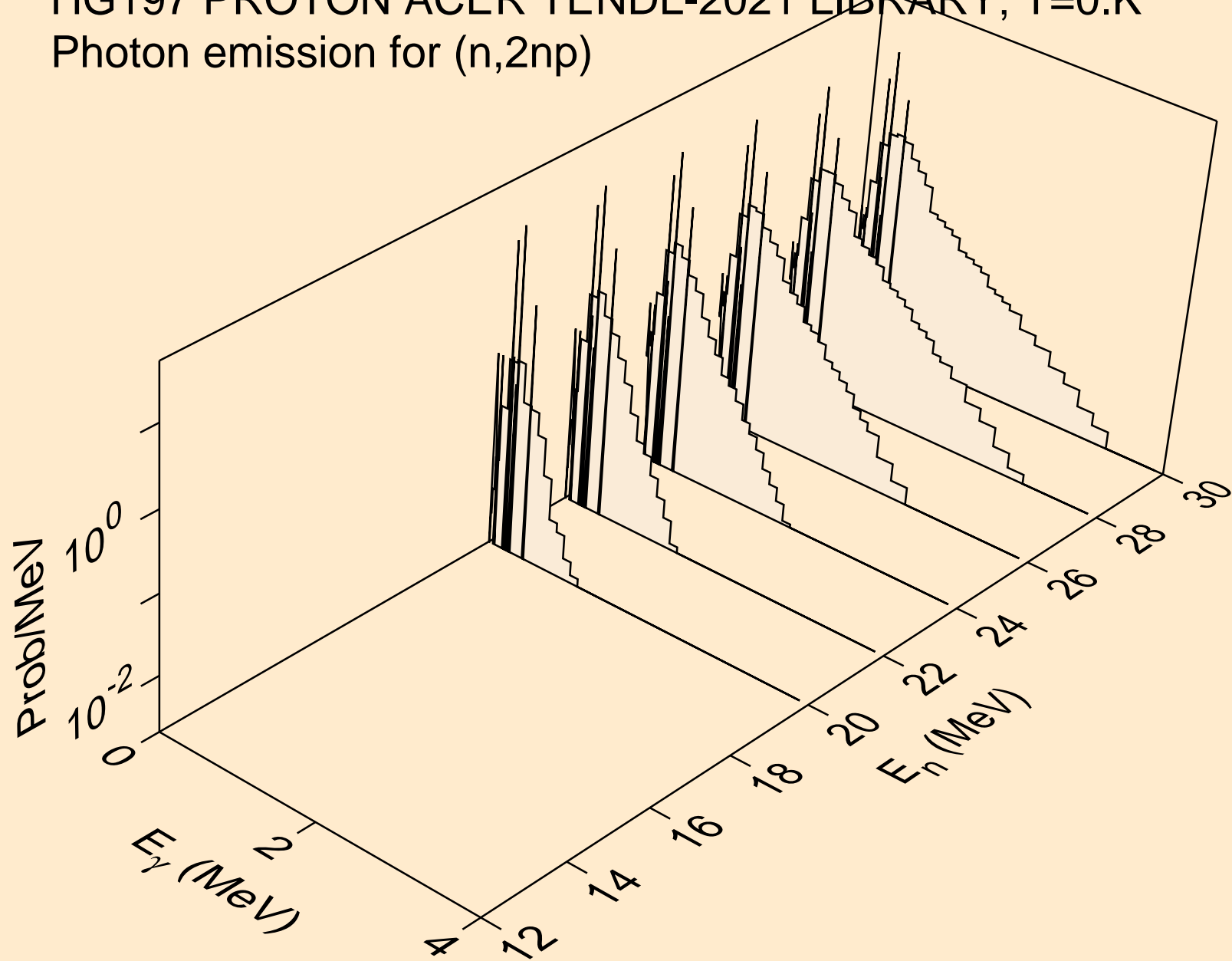

HG197 PROTON ACER TENDL-2021 LIBRARY; T=0.K  
Photon emission for (n,npa)

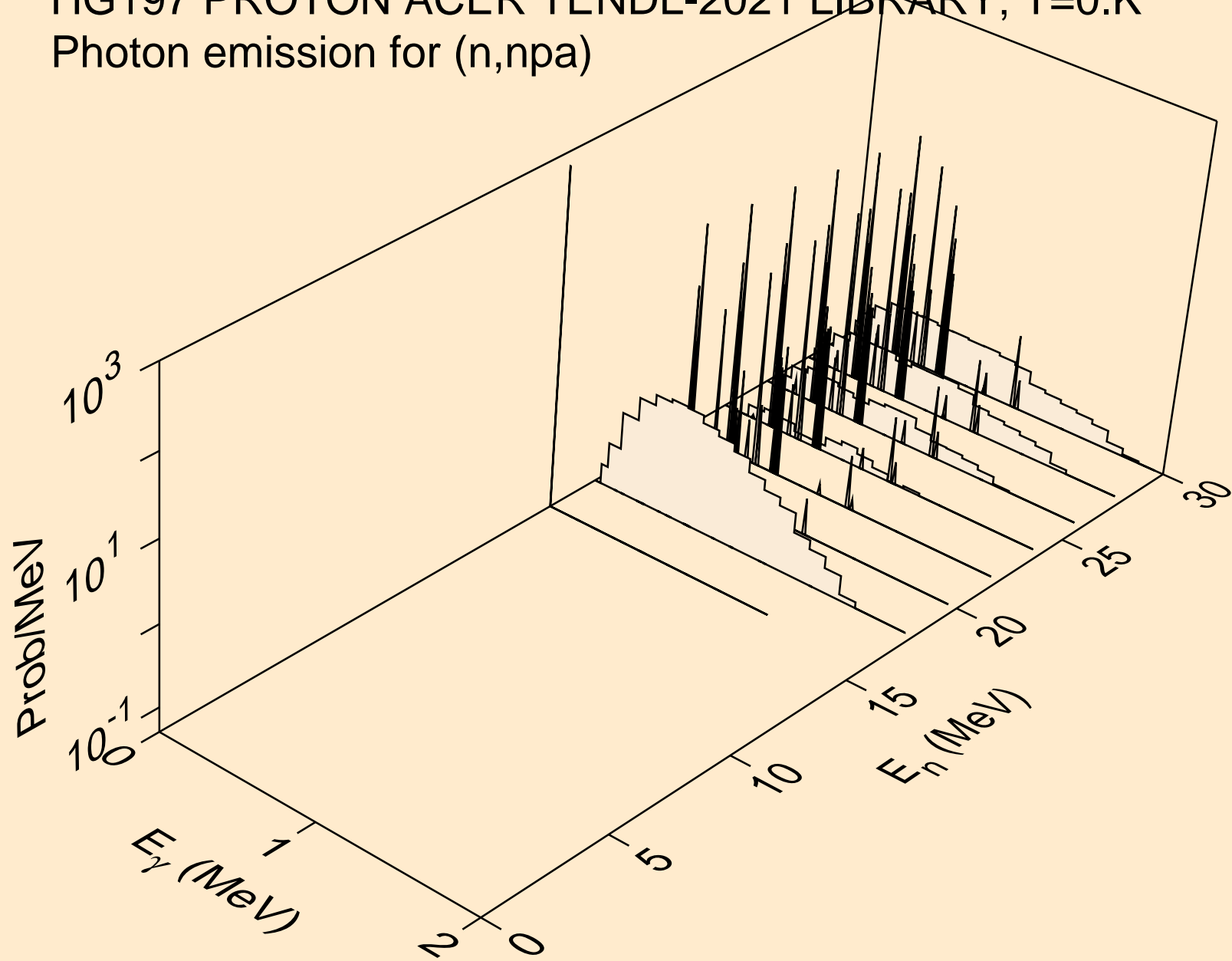

HG197 PROTON ACER TENDL-2021 LIBRARY; T=0.K  
Photon emission for (n,gma)

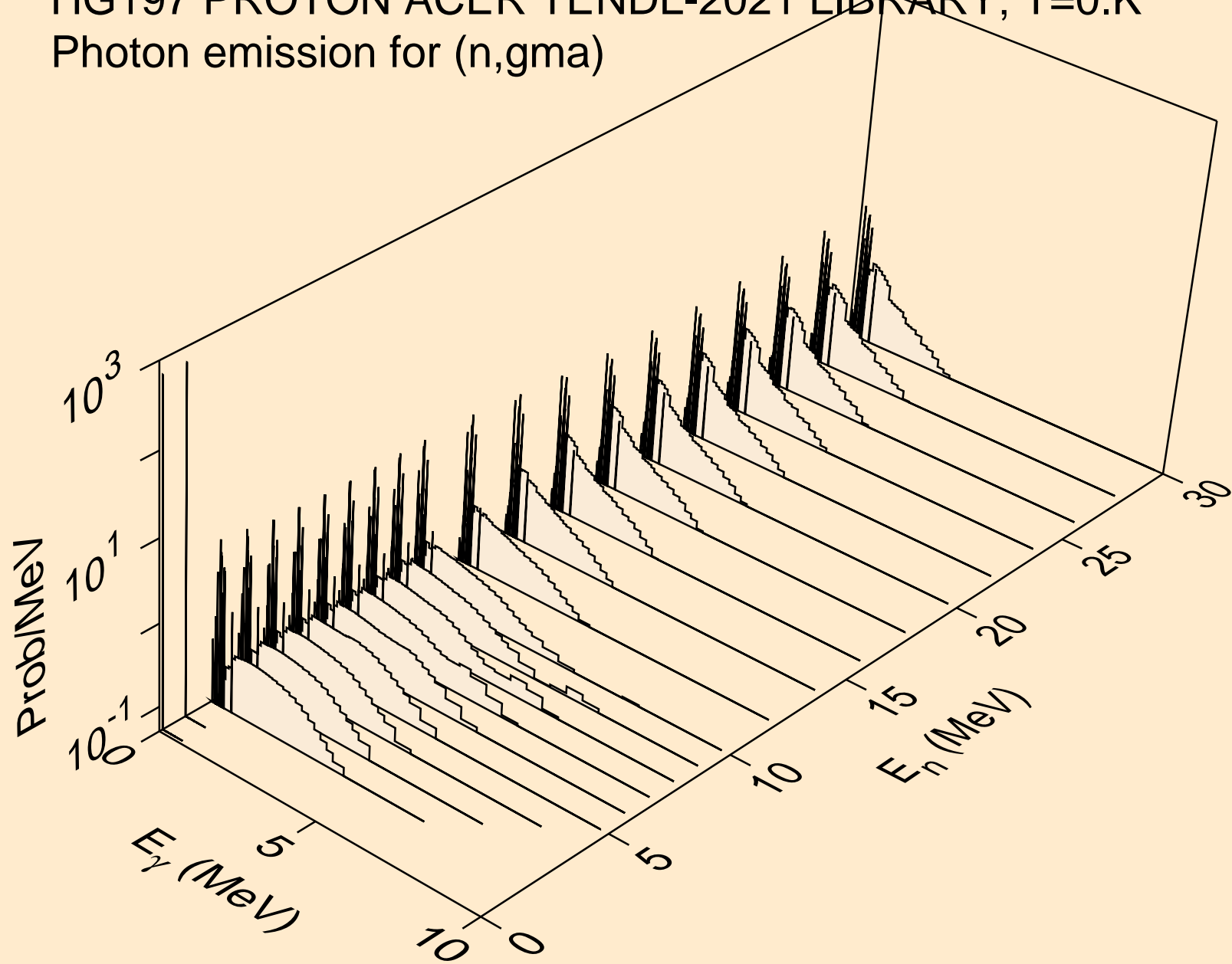

HG197 PROTON ACER TENDL-2021 LIBRARY; T=0.K  
Photon emission for inelastic

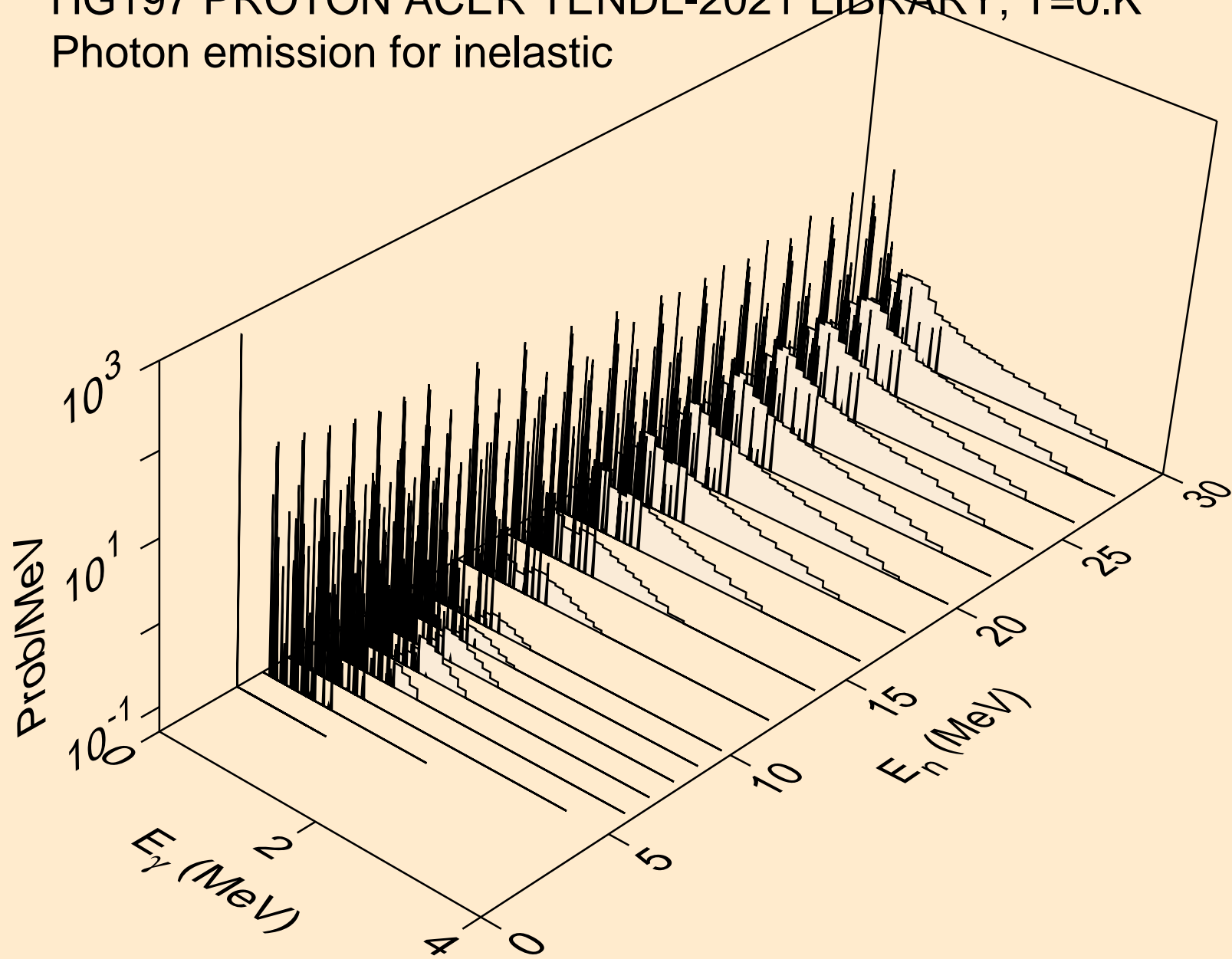



HG197 PROTON ACER TENDL-2021 LIBRARY; T=0.K  
Photon emission for (n,d)

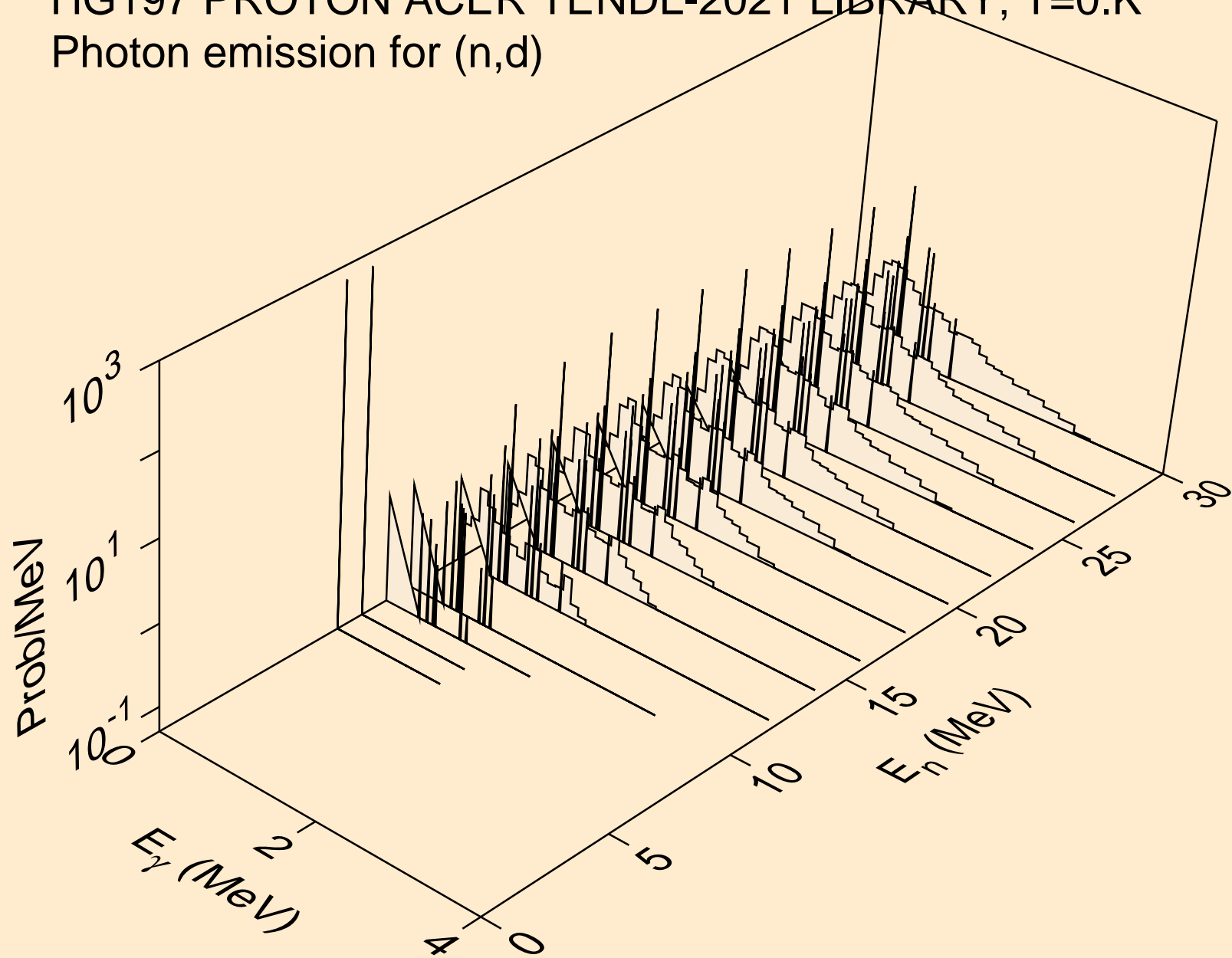

HG197 PROTON ACER TENDL-2021 LIBRARY; T=0.K  
Photon emission for (n,t)

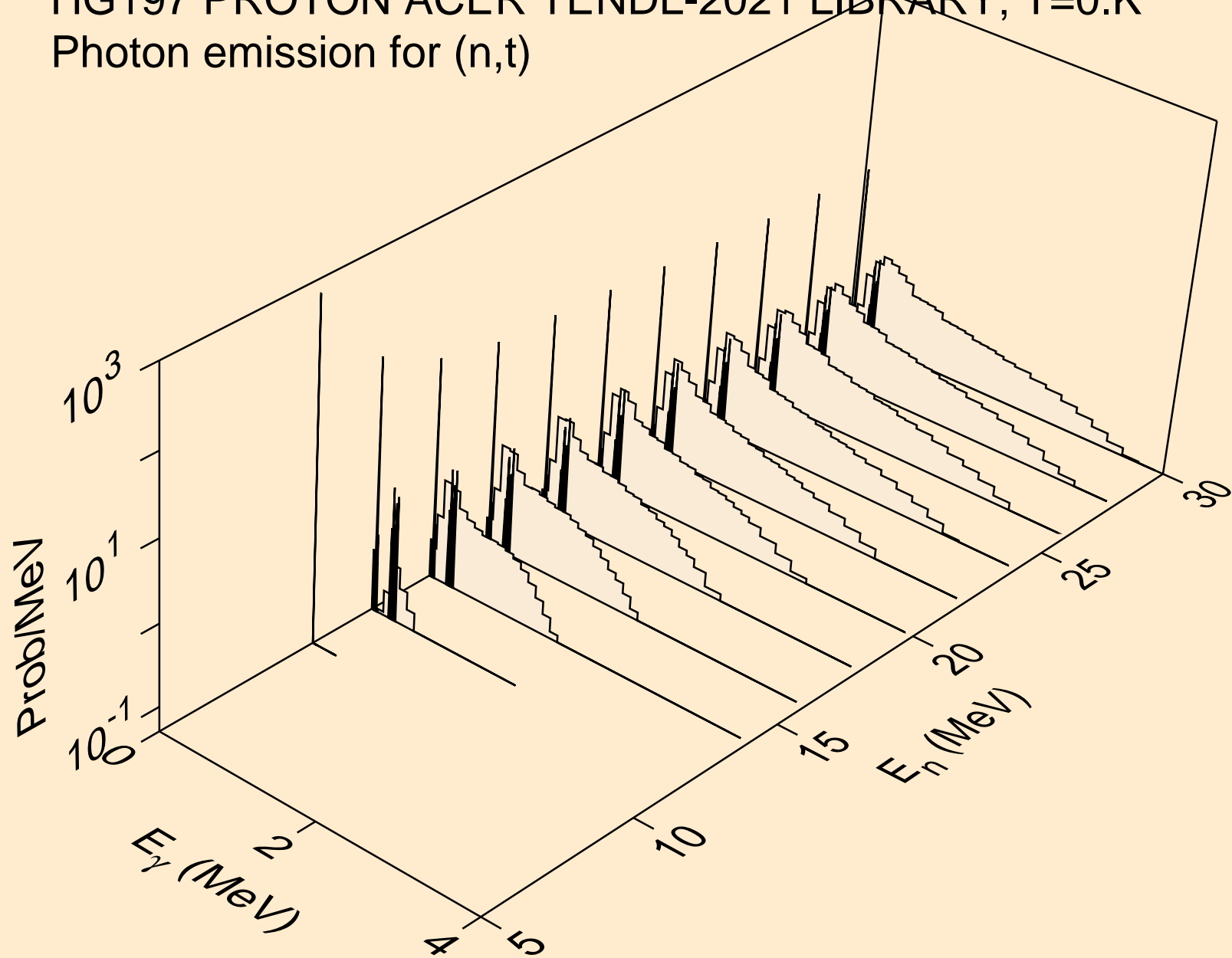

HG197 PROTON ACER TENDL-2021 LIBRARY; T=0.K  
Photon emission for (n,he3)

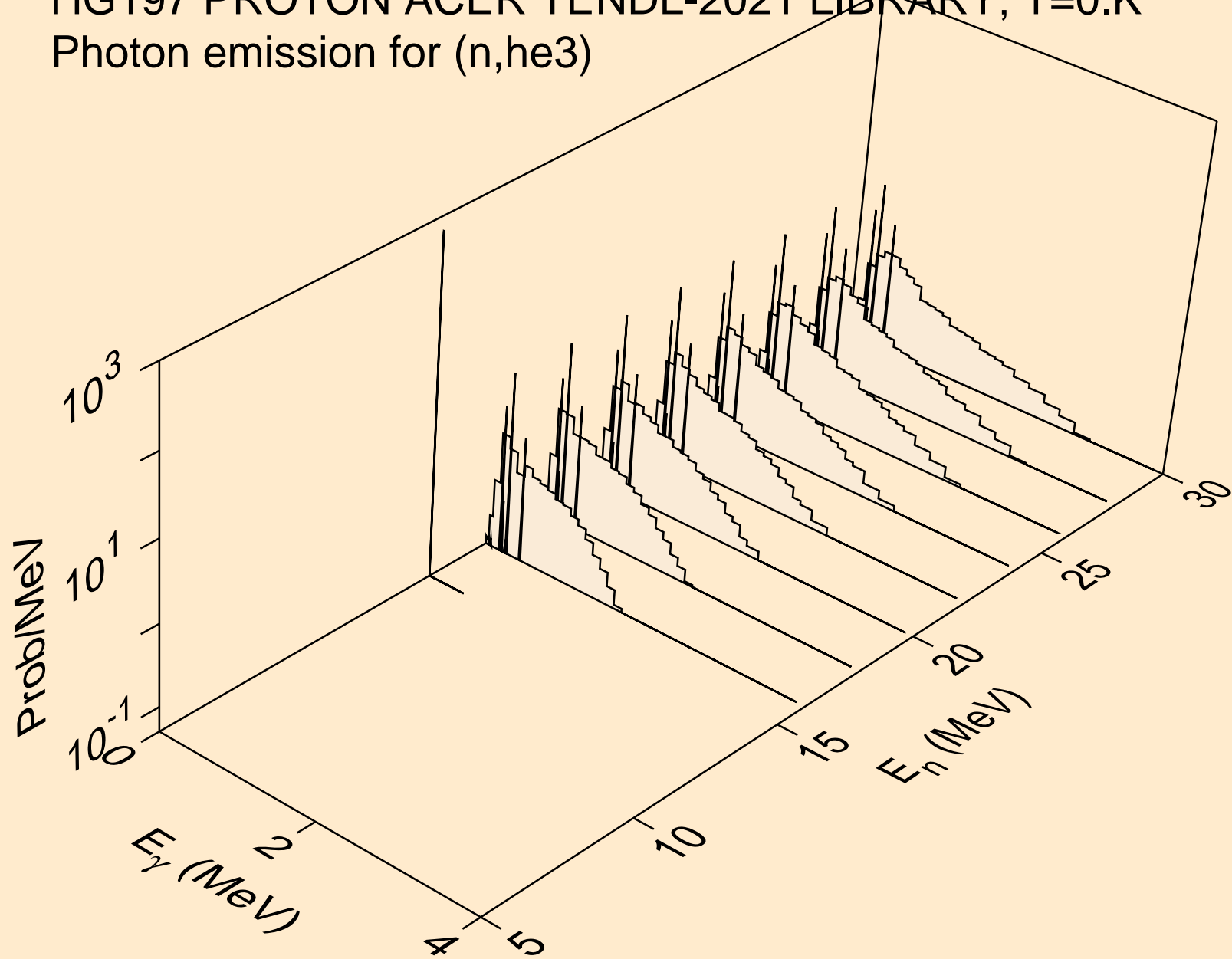

HG197 PROTON ACER TENDL-2021 LIBRARY; T=0.K  
Photon emission for (n,a)

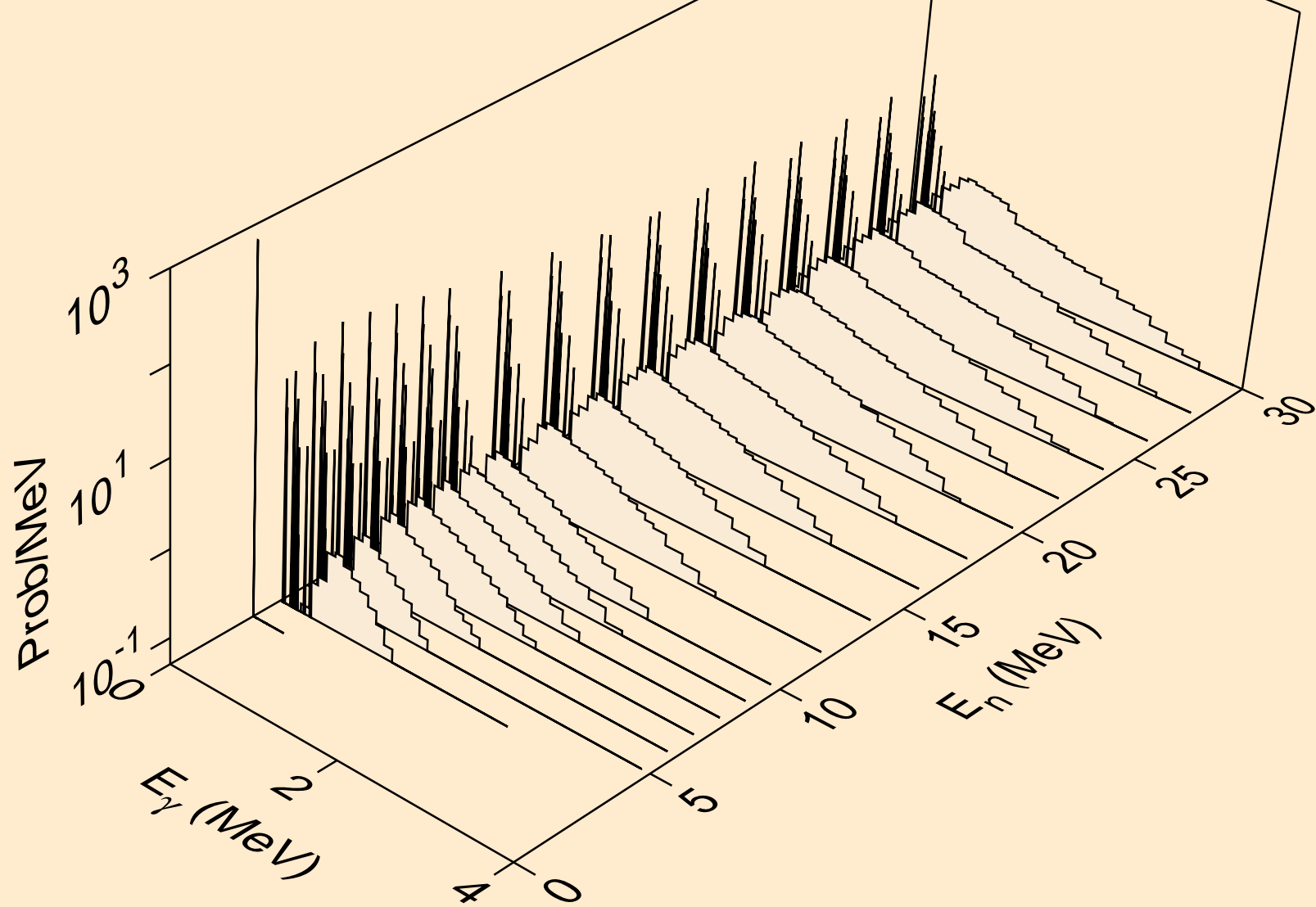

HG197 PROTON ACER TENDL-2021 LIBRARY; T=0.K  
Photon emission for (n,2a)

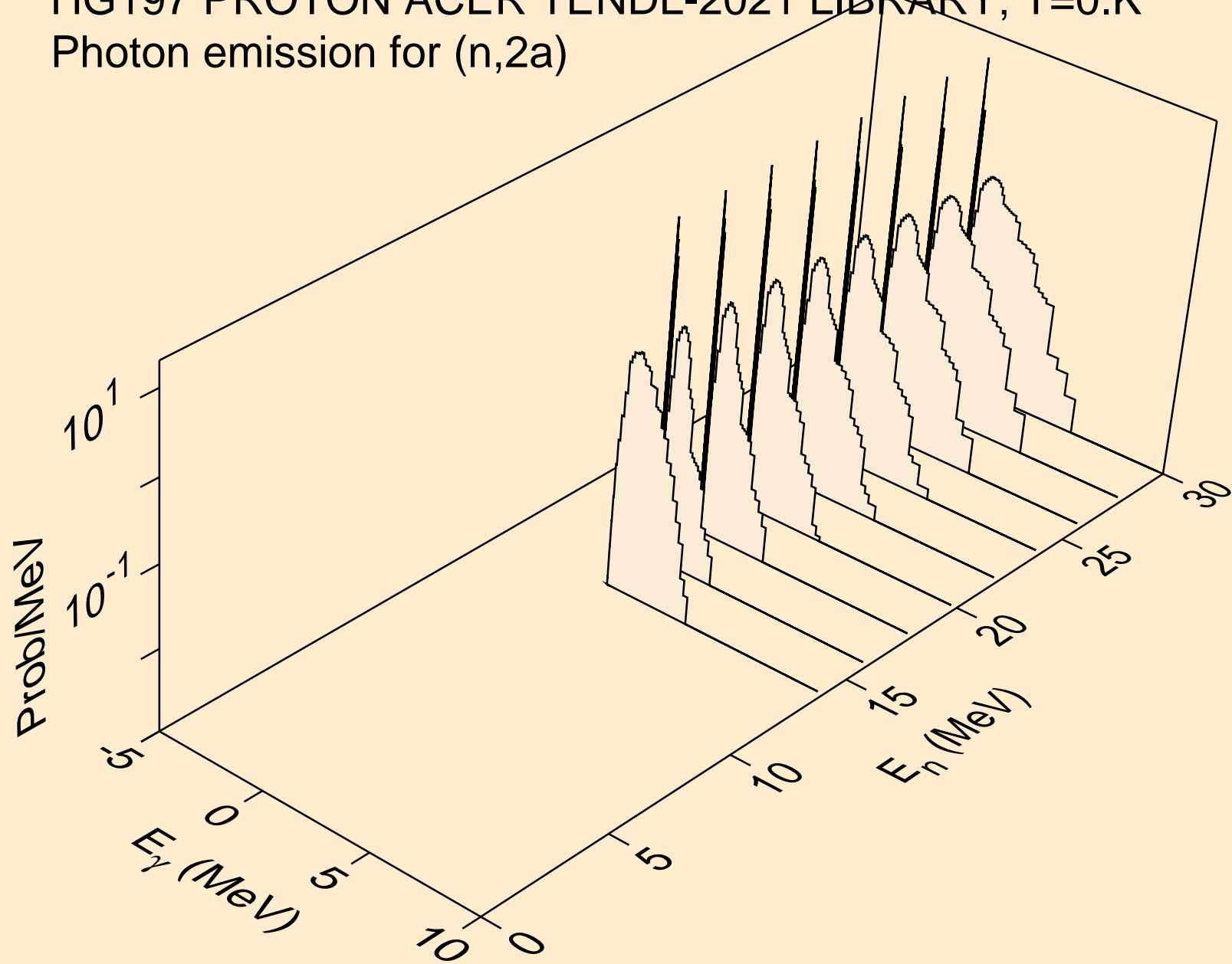

HG197 PROTON ACER TENDL-2021 LIBRARY; T=0.K  
Photon emission for (n,2p)

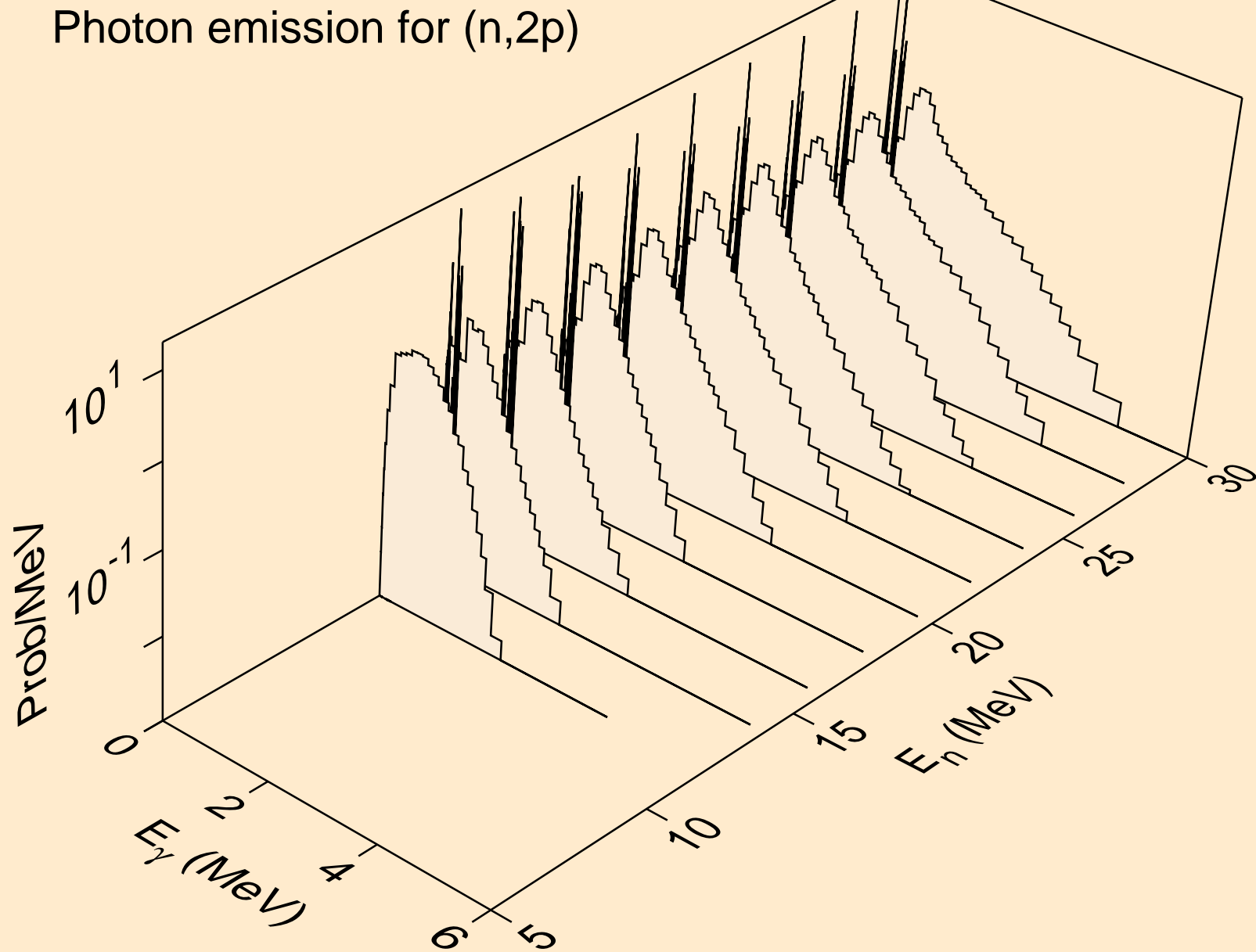

HG197 PROTON ACER TENDL-2021 LIBRARY; T=0.K  
Photon emission for (n,p)

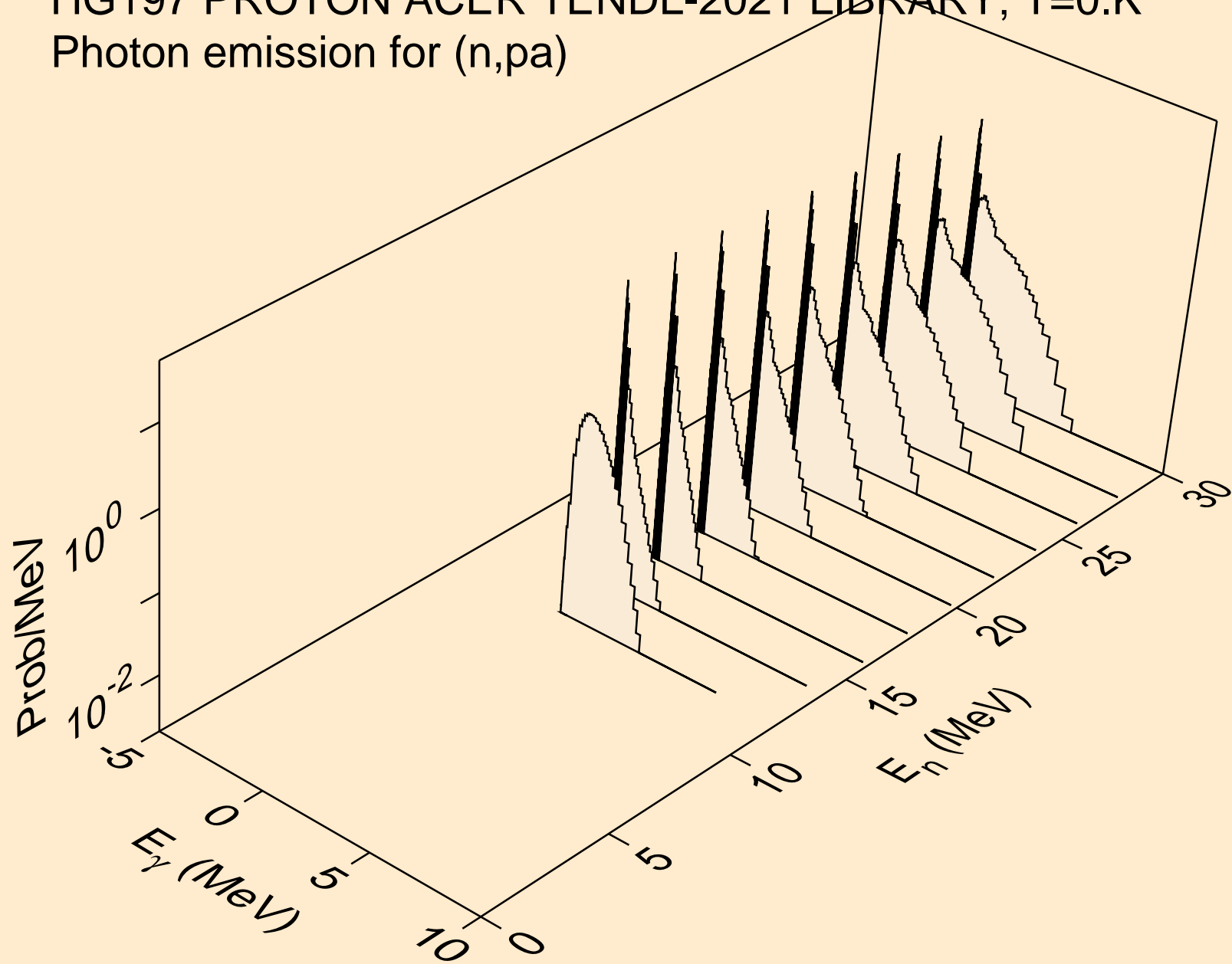

HG197 PROTON ACER TENDL-2021 LIBRARY; T=0.K  
Photon emission for (n,pd)

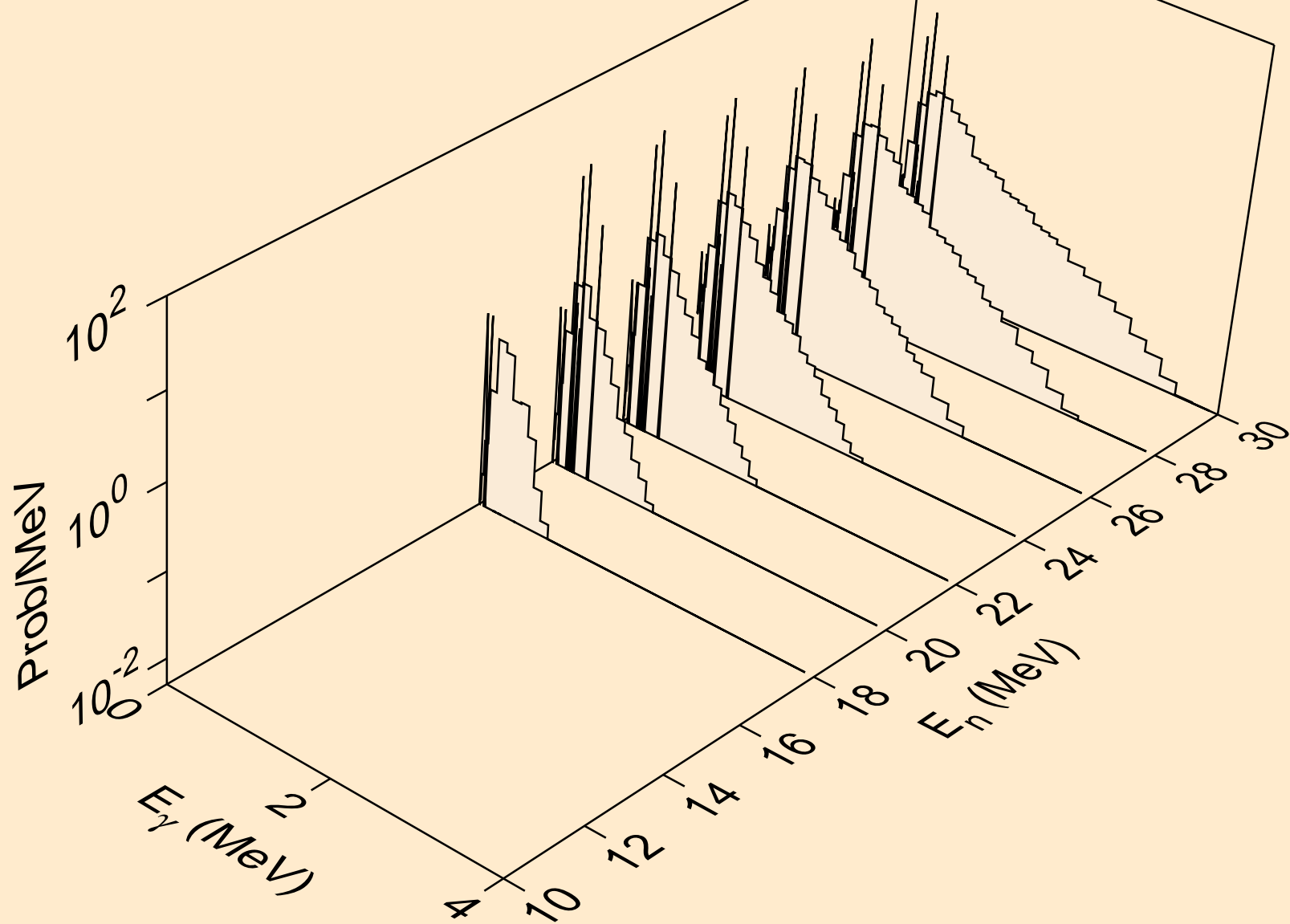



HG197 PROTON ACER TENDL-2021 LIBRARY; T=0.K  
Photon emission for (n,pt)

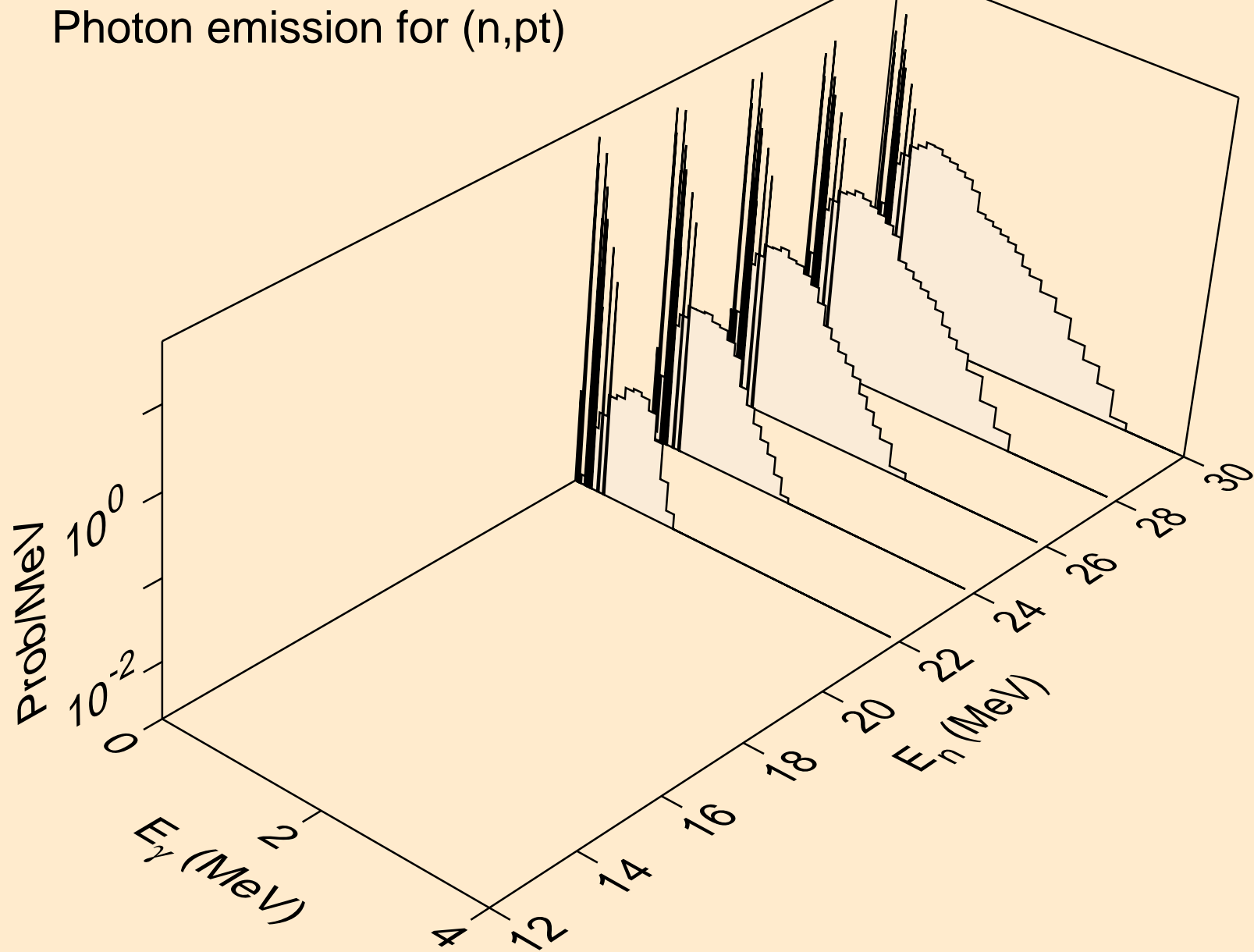

HG197 PROTON ACER TENDL-2021 LIBRARY; T=0.K  
Photon emission for (n,da)

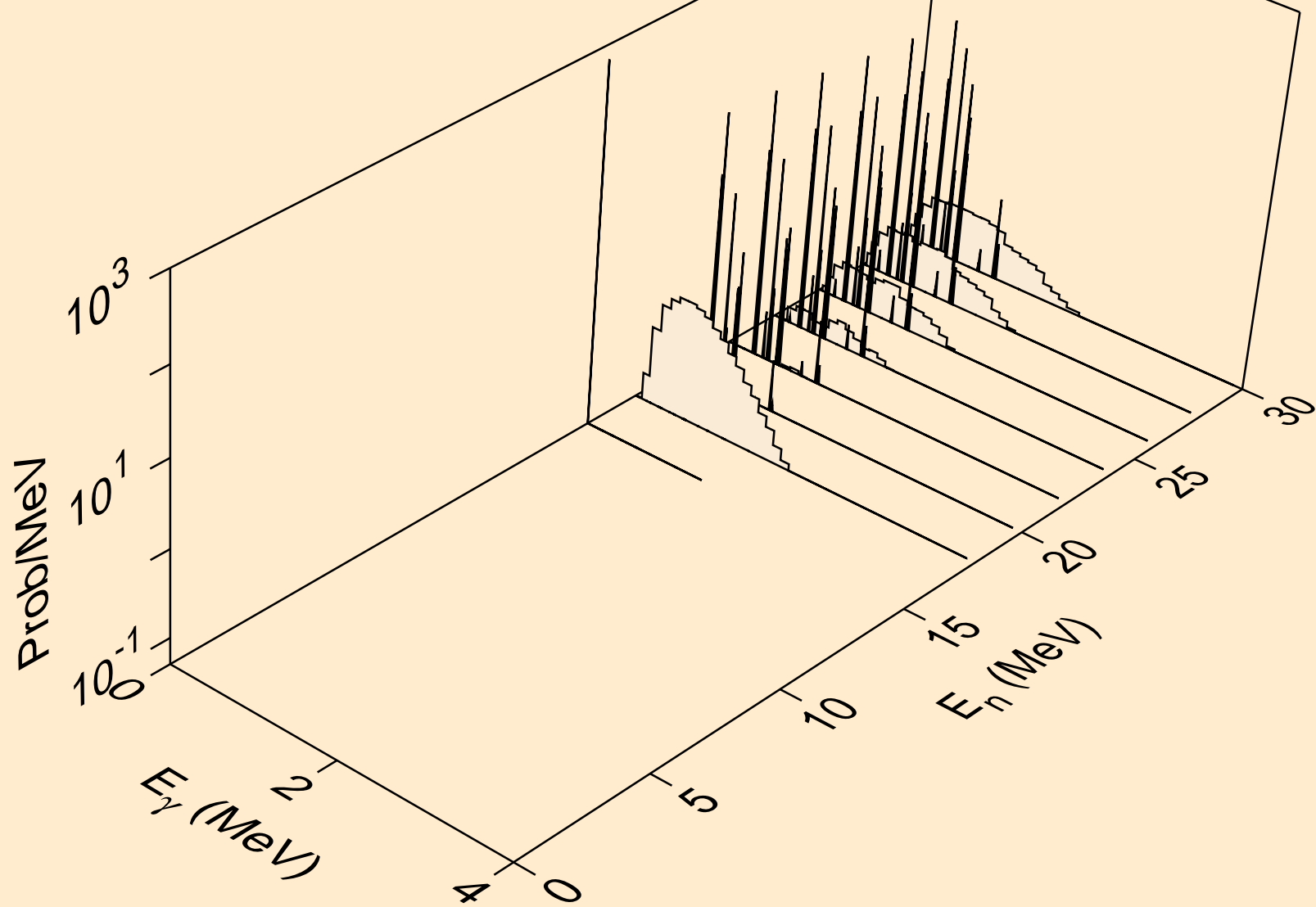

# HG197 PROTON ACER TENDL-2021 LIBRARY; T=0.K

## Particle heating contributions

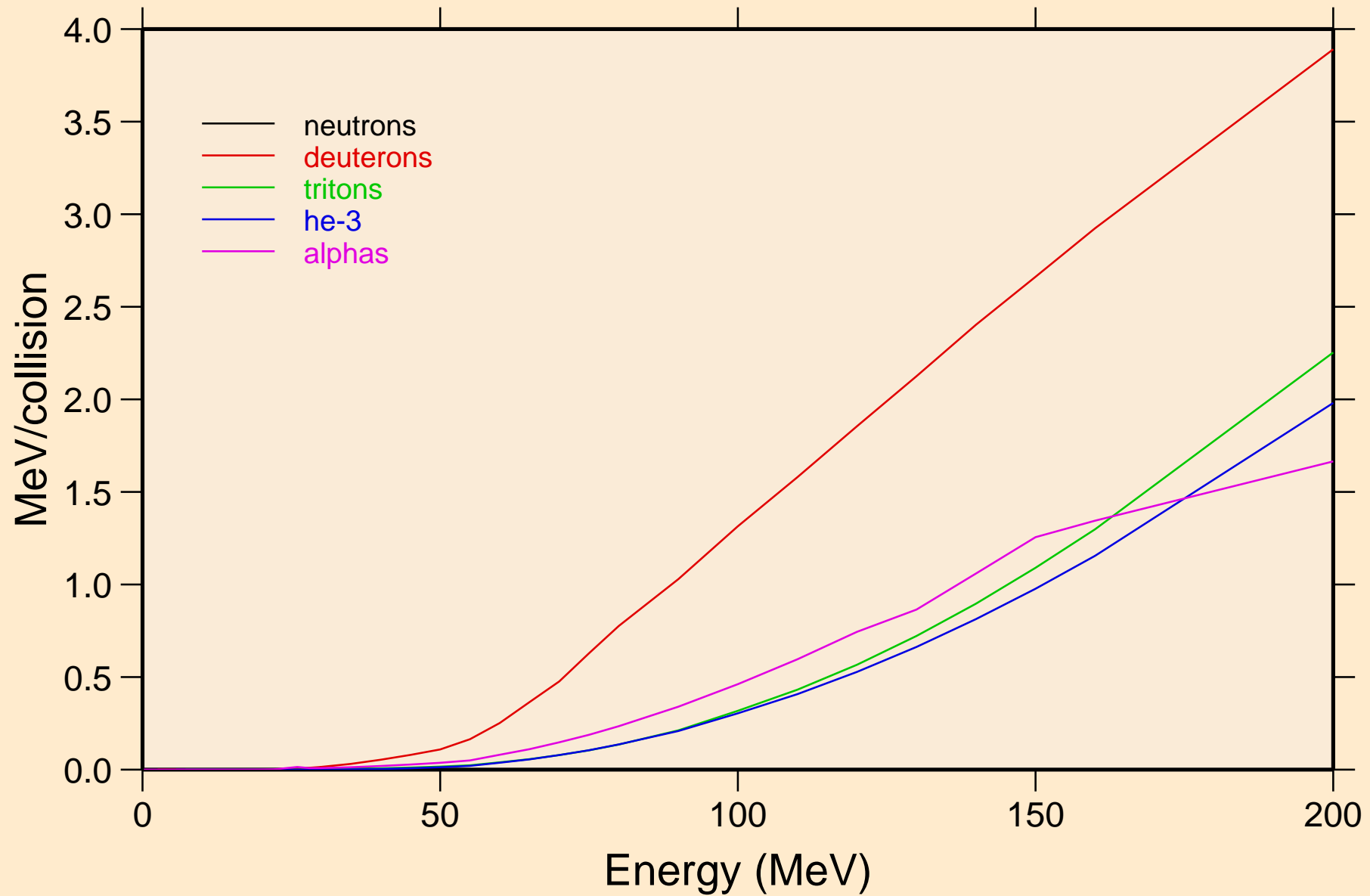

HG197 PROTON ACER TENDL-2021 LIBRARY; T=0.K  
Recoil Heating

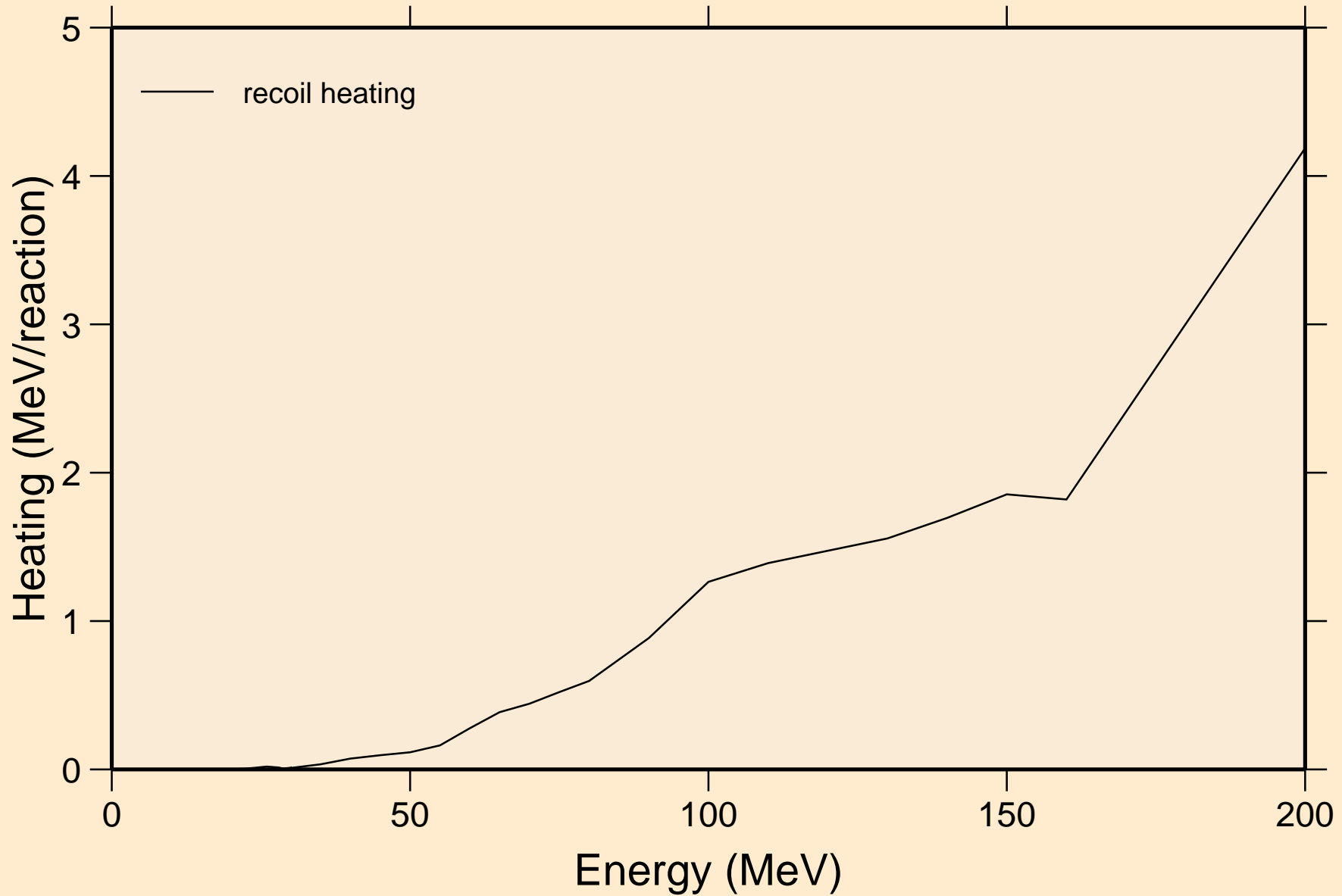

HG197 PROTON ACER TENDL-2021 LIBRARY; T=0.K  
Particle production cross sections

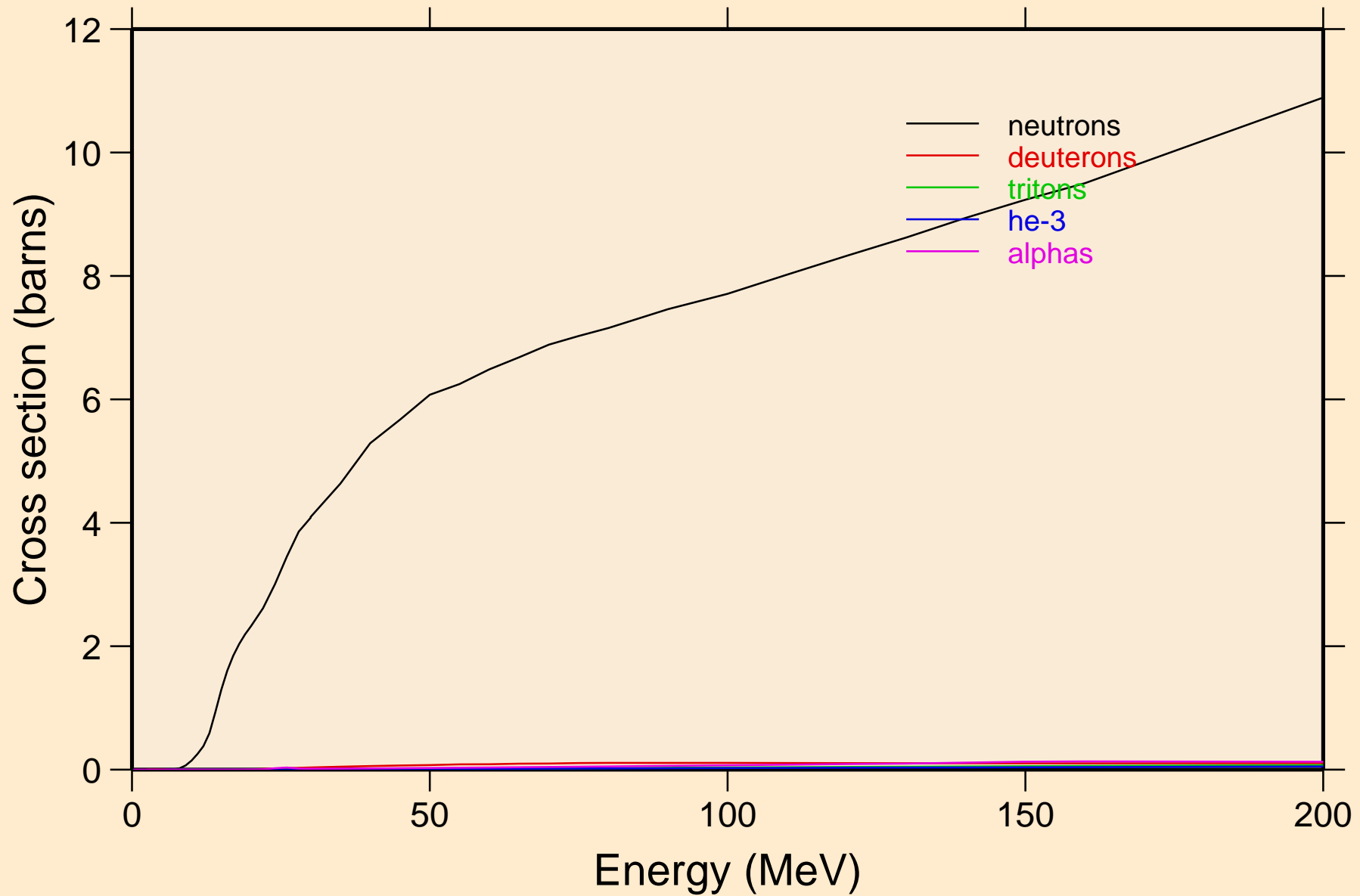

HG197 PROTON ACER TENDL-2021 LIBRARY; T=0.K  
neutrons from (p,n)

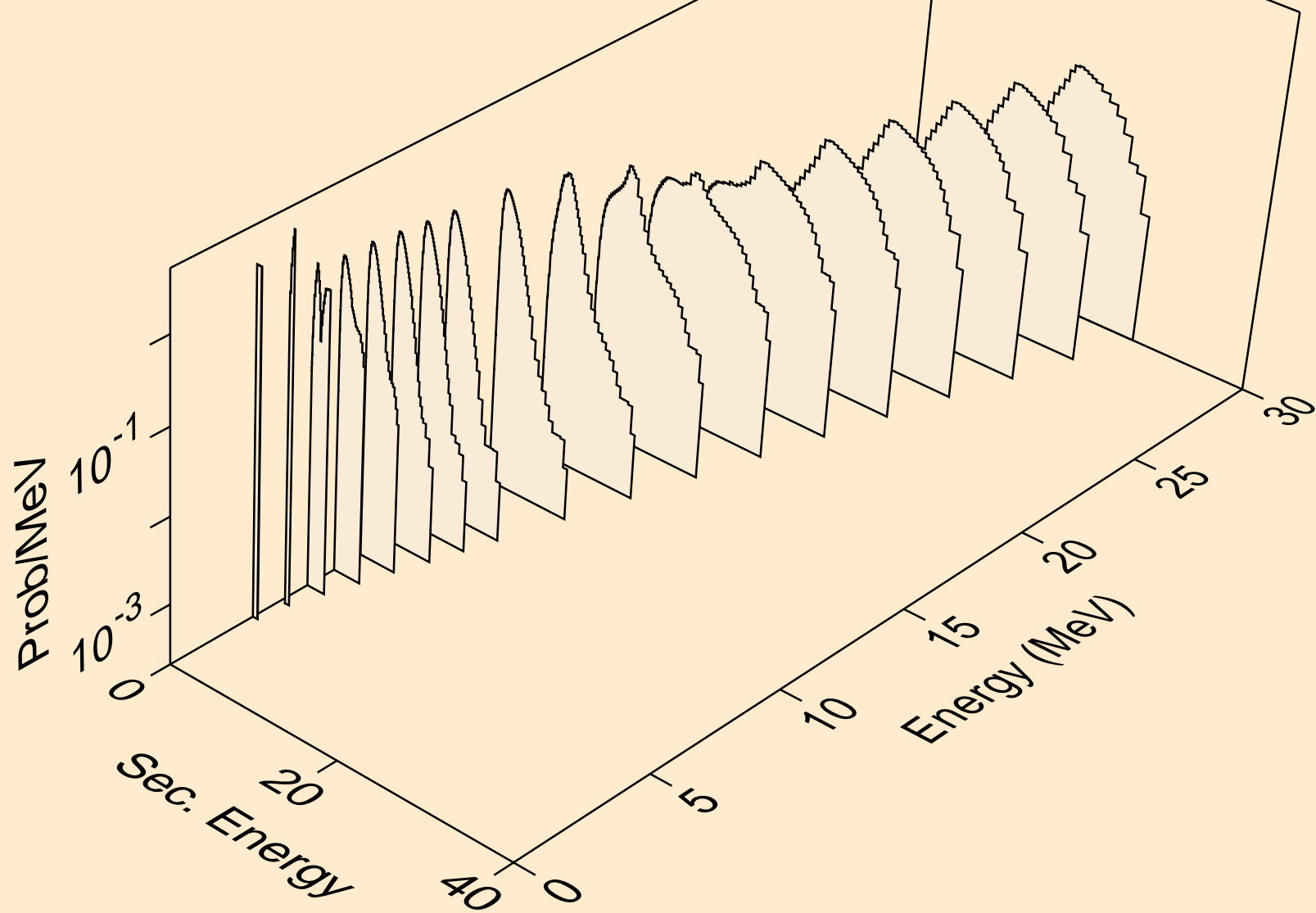

HG197 PROTON ACER TENDL-2021 LIBRARY; T=0.K  
neutrons from (p,x)

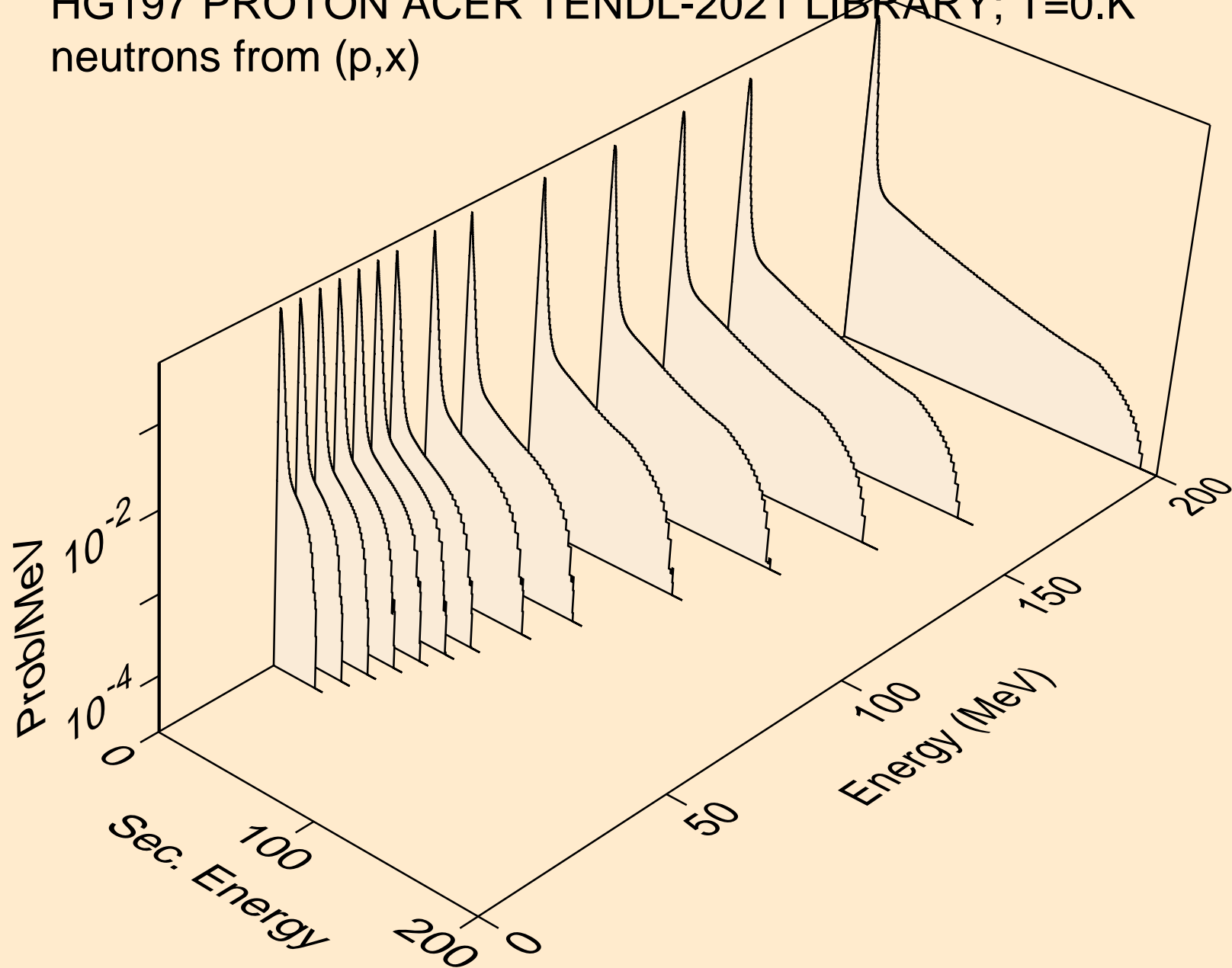

HG197 PROTON ACER TENDL-2021 LIBRARY; T=0.K  
neutrons from (p,2nd)

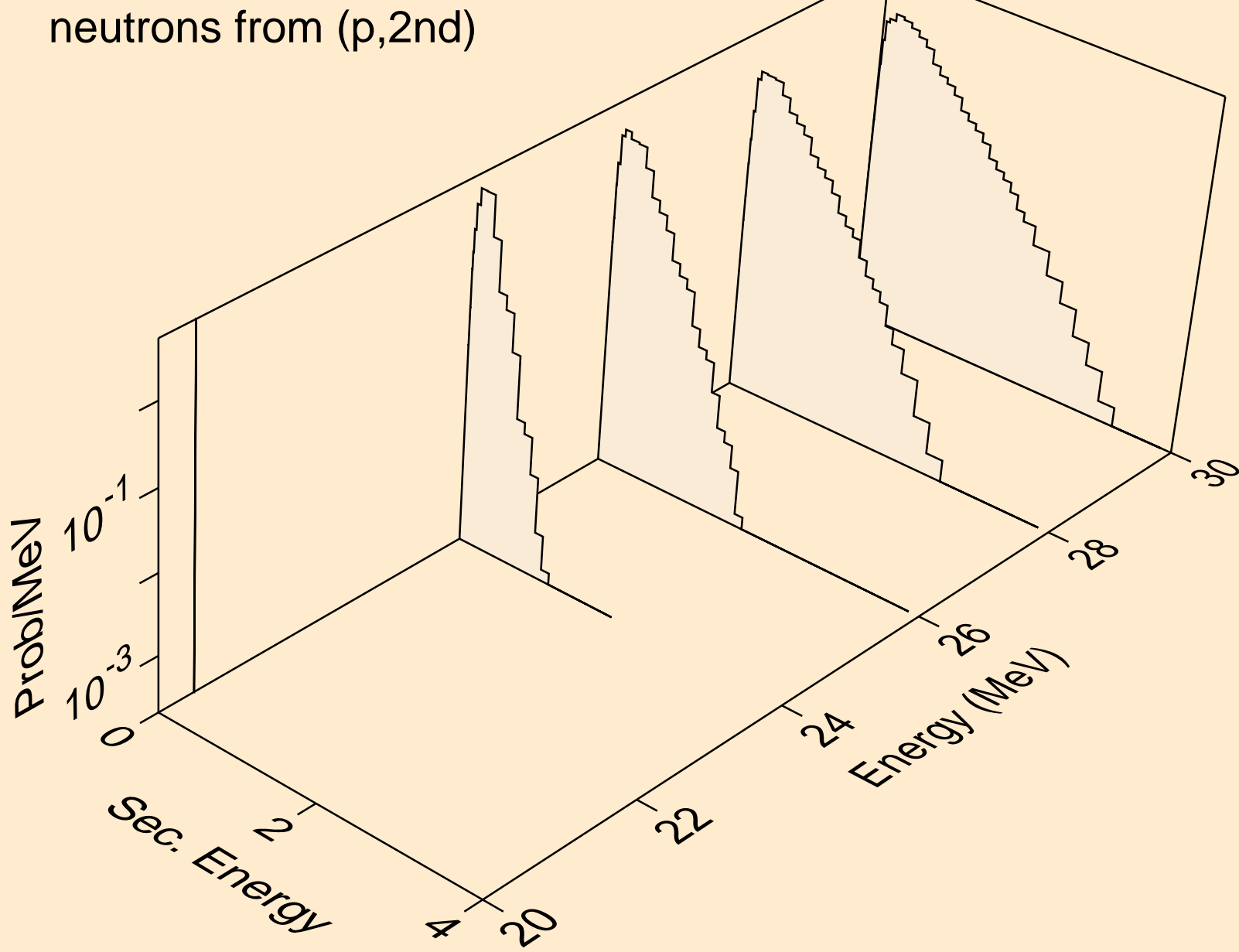



HG197 PROTON ACER TENDL-2021 LIBRARY; T=0.K  
neutrons from (p,2n)

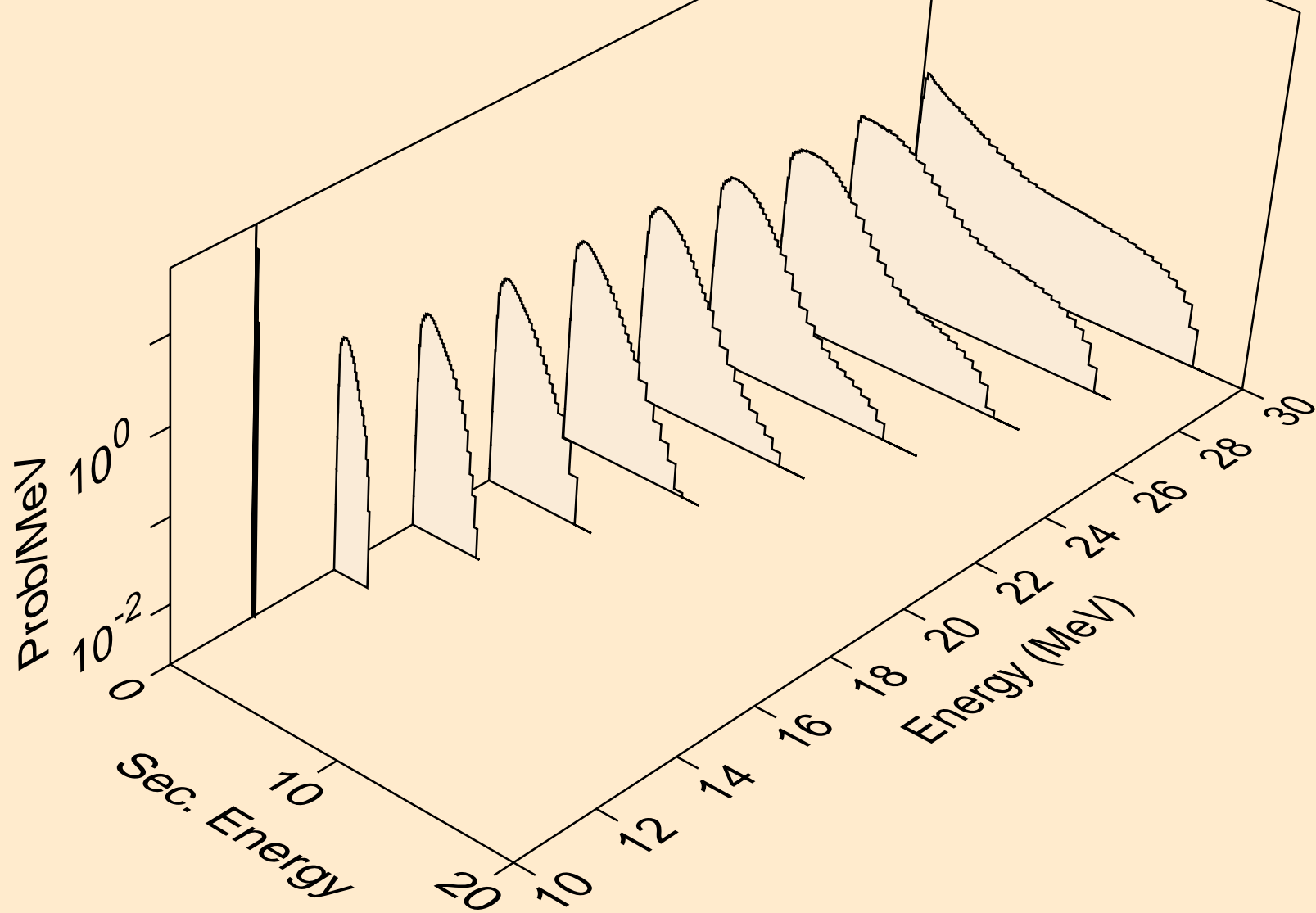

HG197 PROTON ACER TENDL-2021 LIBRARY; T=0.K  
neutrons from (p,3n)

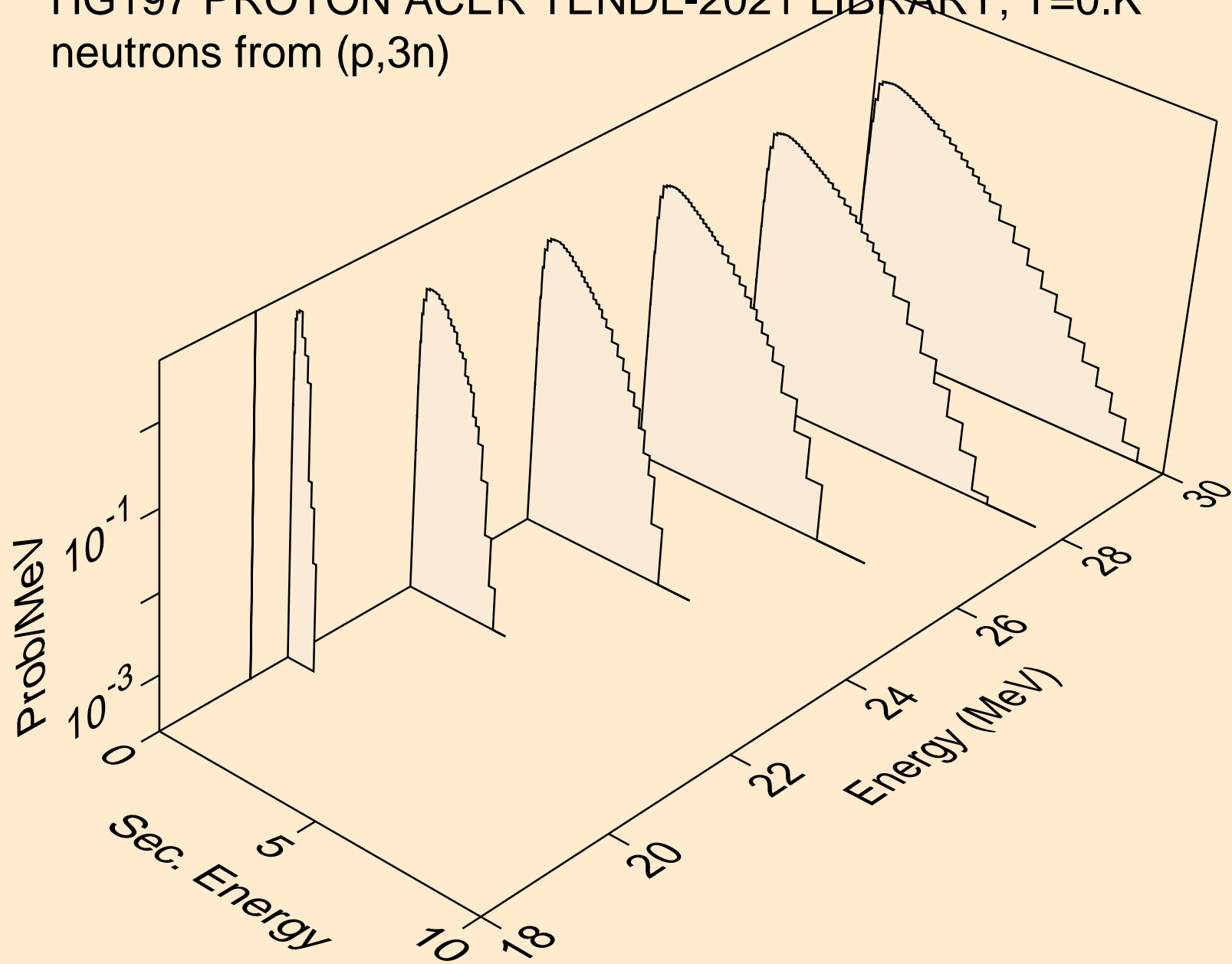

HG197 PROTON ACER TENDL-2021 LIBRARY; T=0.K  
neutrons from (p,n\*)a

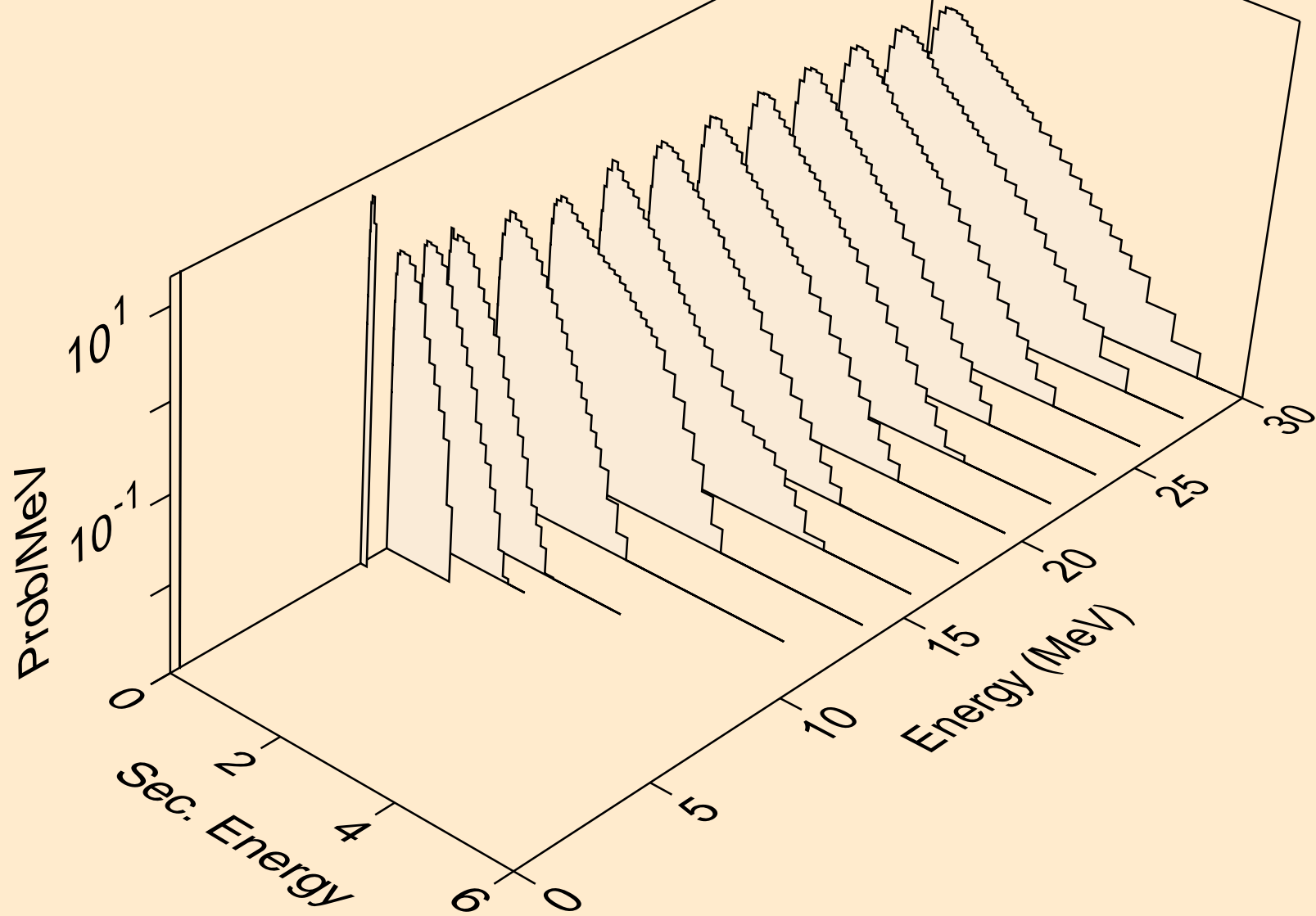

HG197 PROTON ACER TENDL-2021 LIBRARY; T=0.K  
neutrons from (p,2n)a

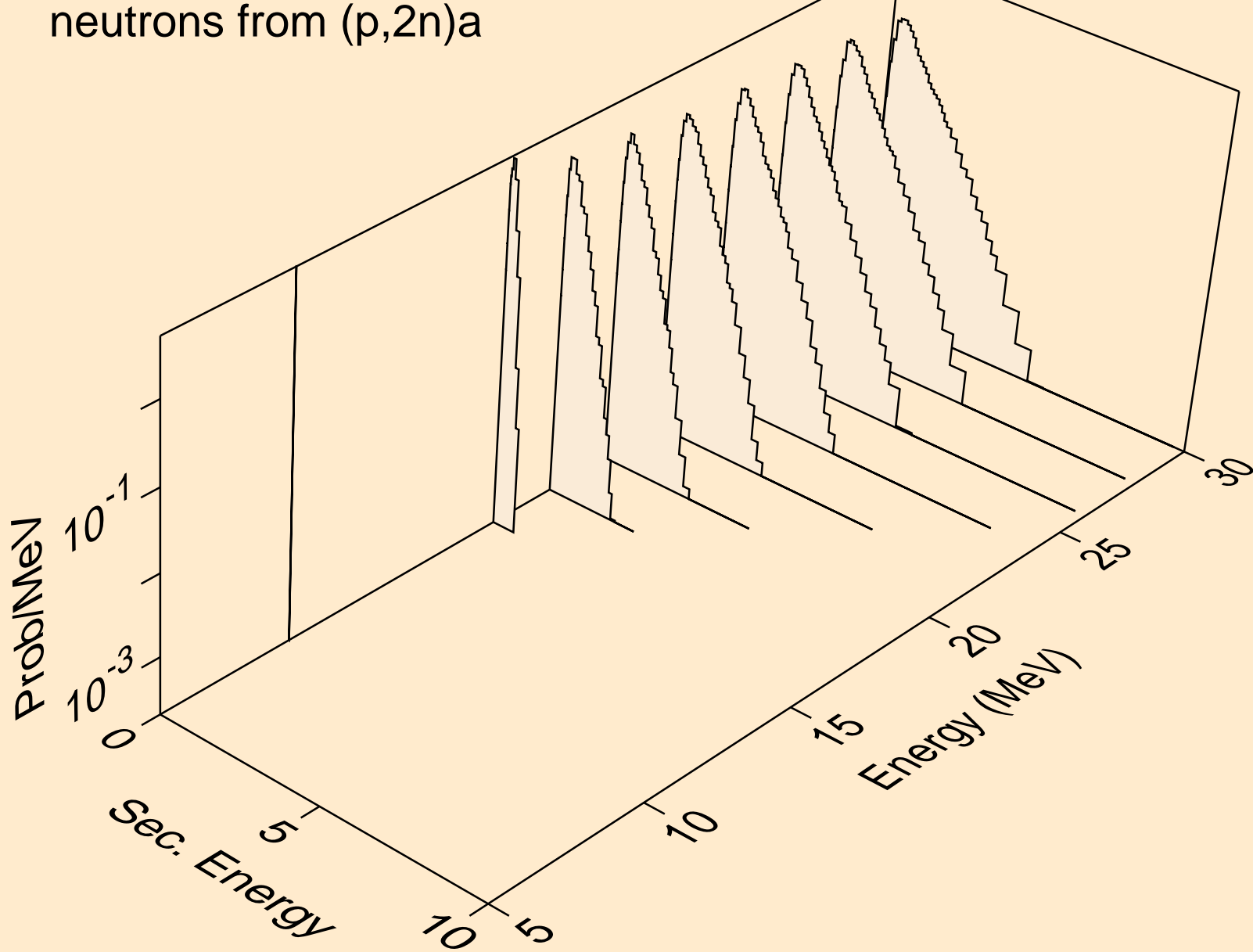

HG197 PROTON ACER TENDL-2021 LIBRARY; T=0.K  
neutrons from (p,3n)a

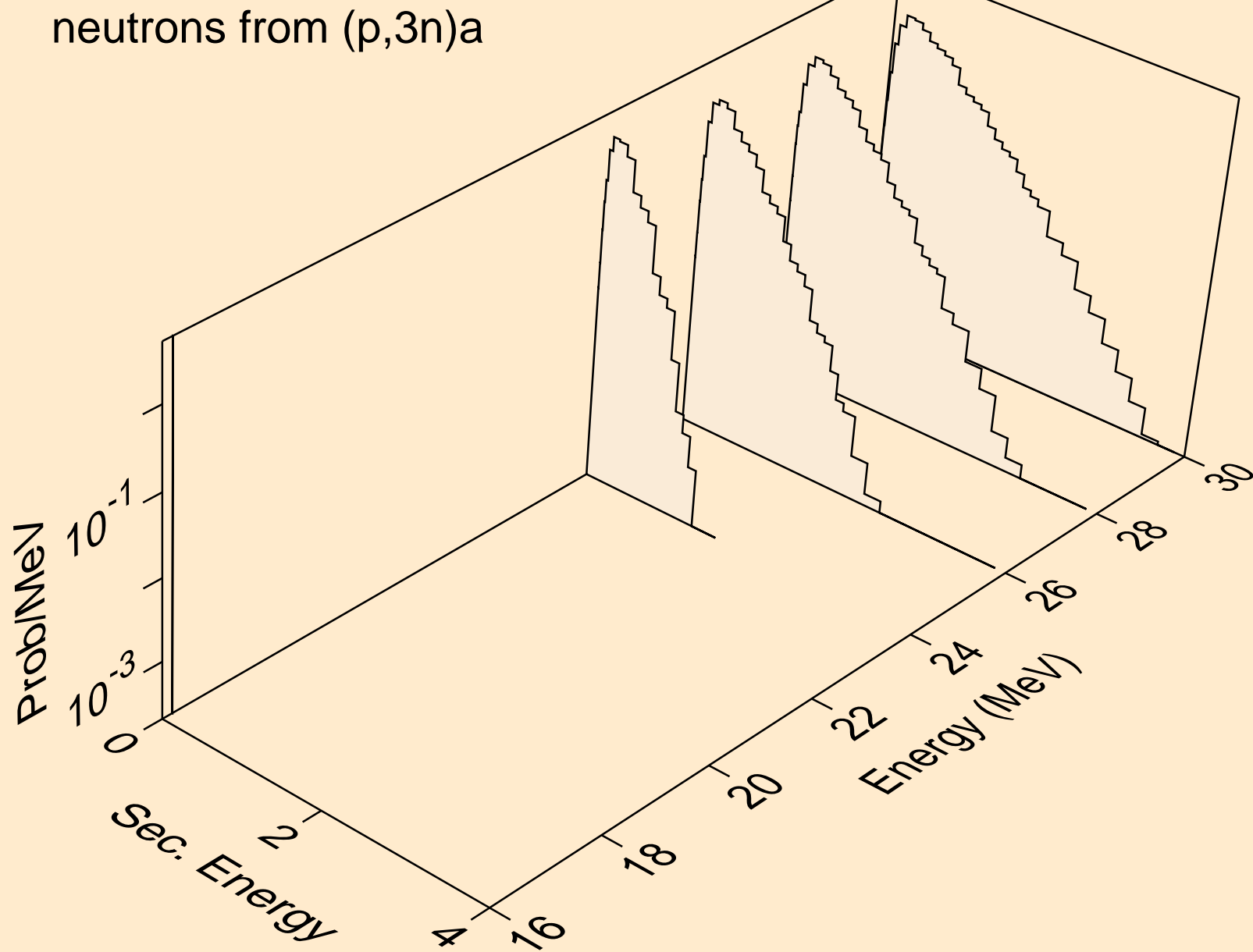

HG197 PROTON ACER TENDL-2021 LIBRARY; T=0.K  
neutrons from (p,n\*)p

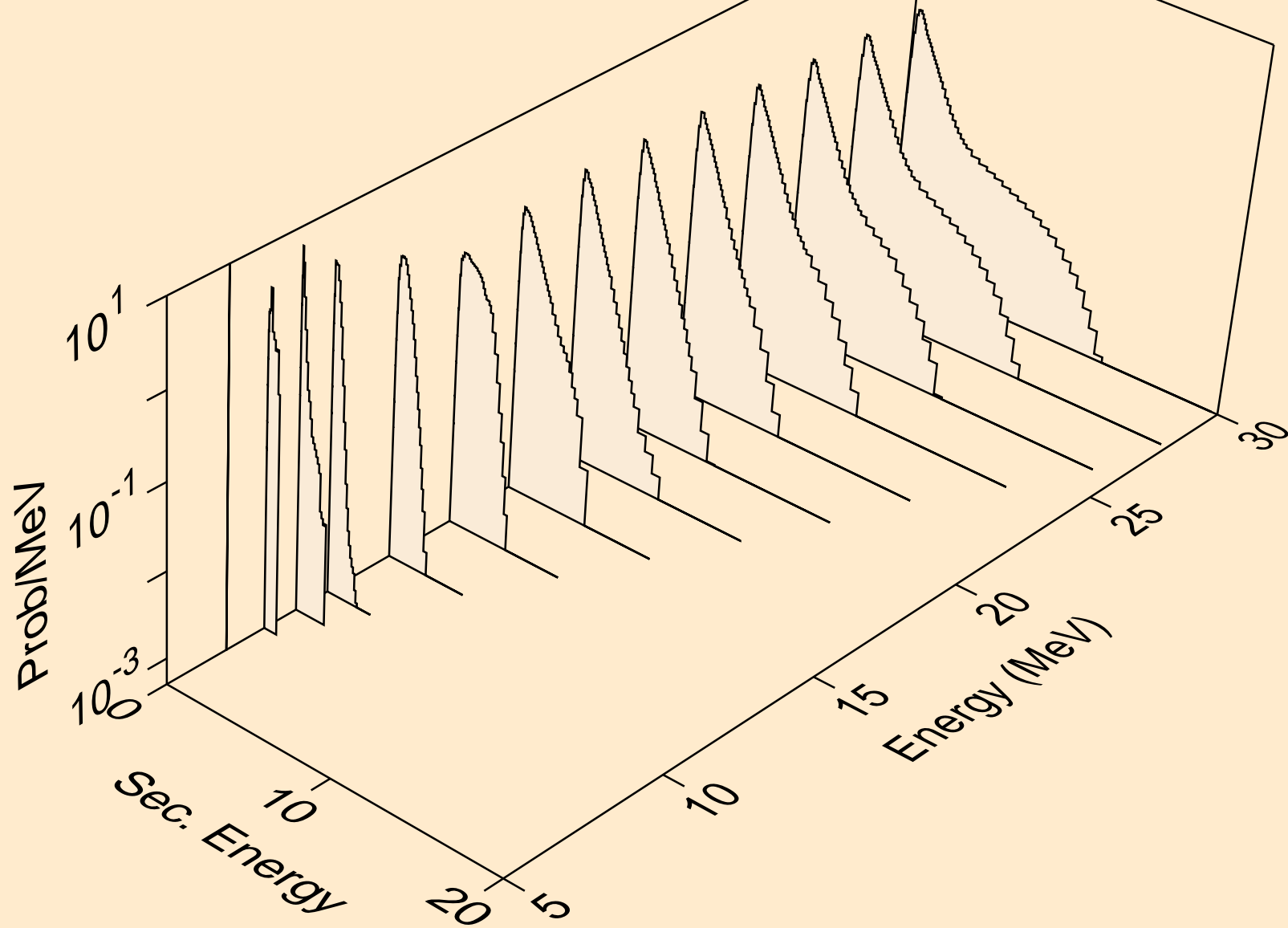

HG197 PROTON ACER TENDL-2021 LIBRARY; T=0.K  
neutrons from (p,n\*)2a

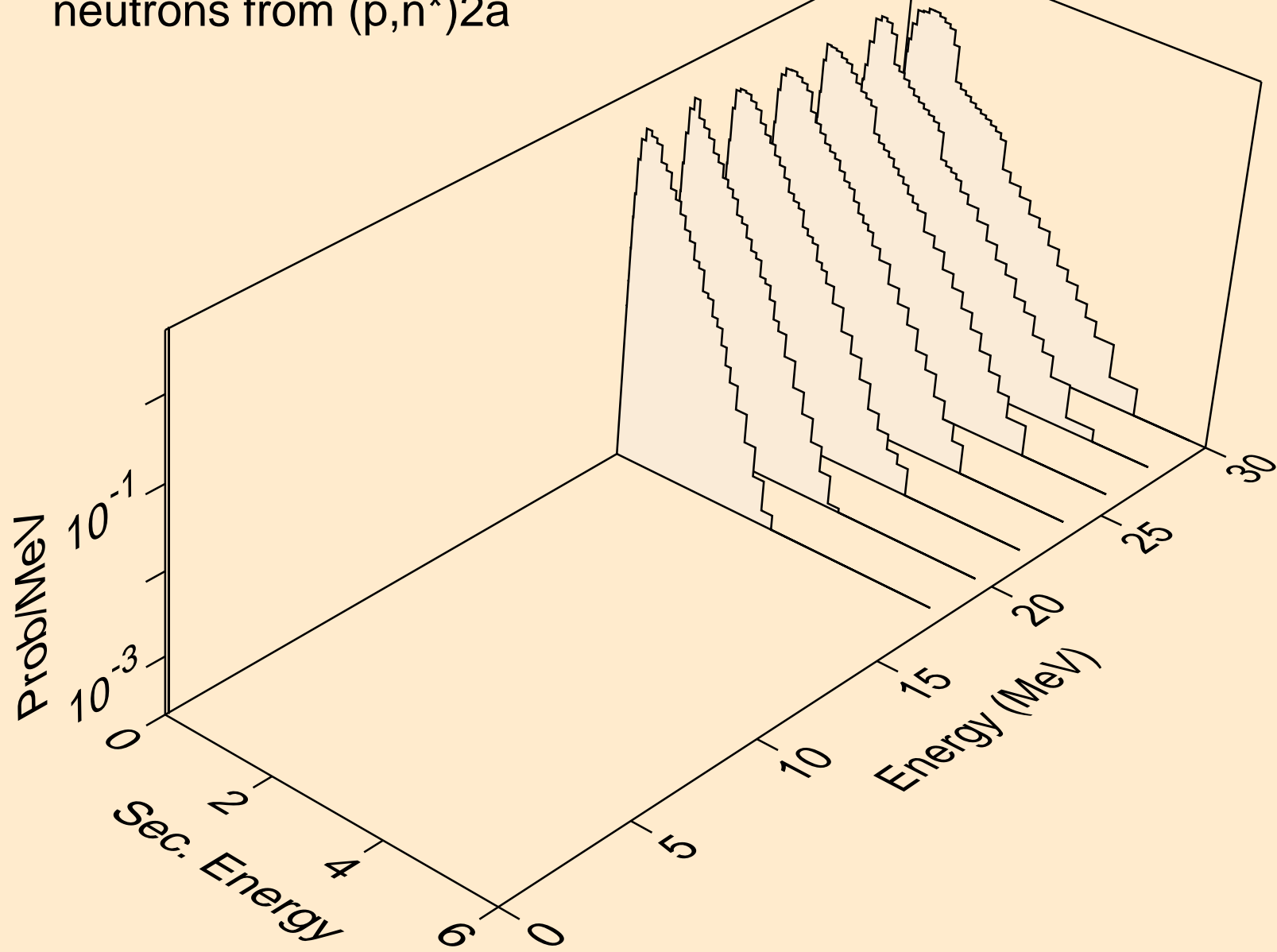

HG197 PROTON ACER TENDL-2021 LIBRARY; T=0.K  
neutrons from (p,n\*)d

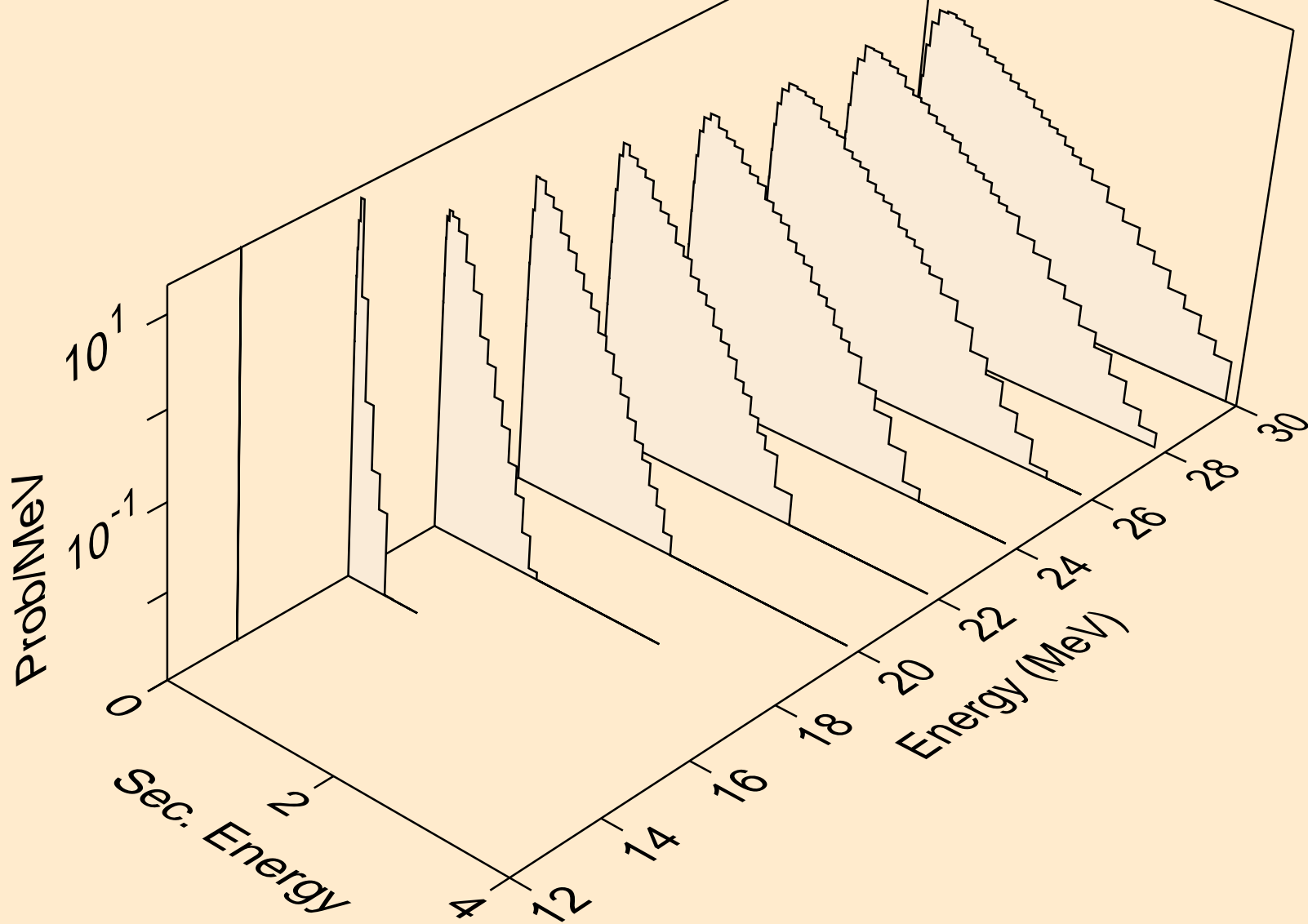



HG197 PROTON ACER TENDL-2021 LIBRARY; T=0.K  
neutrons from (p,n\*)t

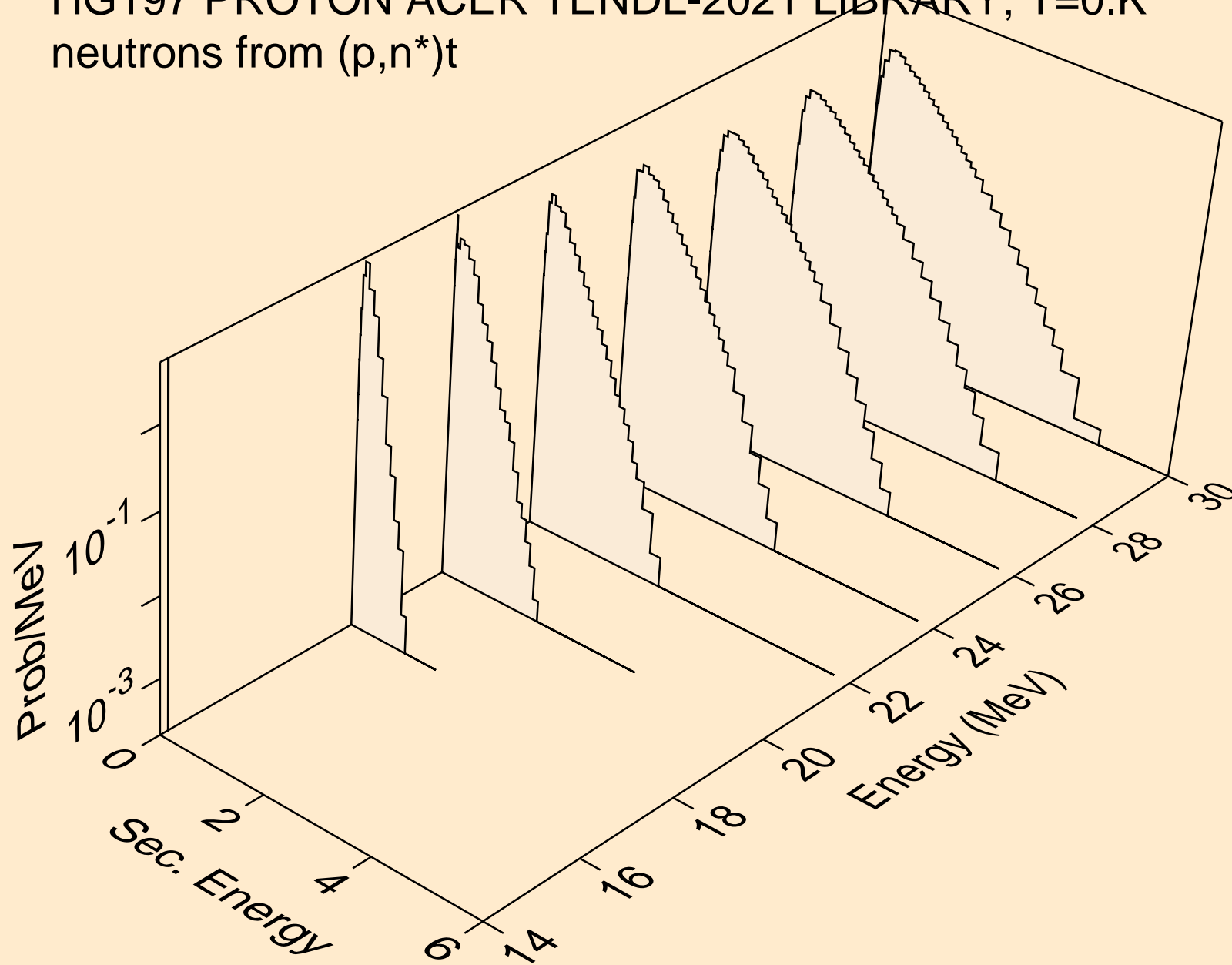

HG197 PROTON ACER TENDL-2021 LIBRARY; T=0.K  
neutrons from (p,n\*)he3

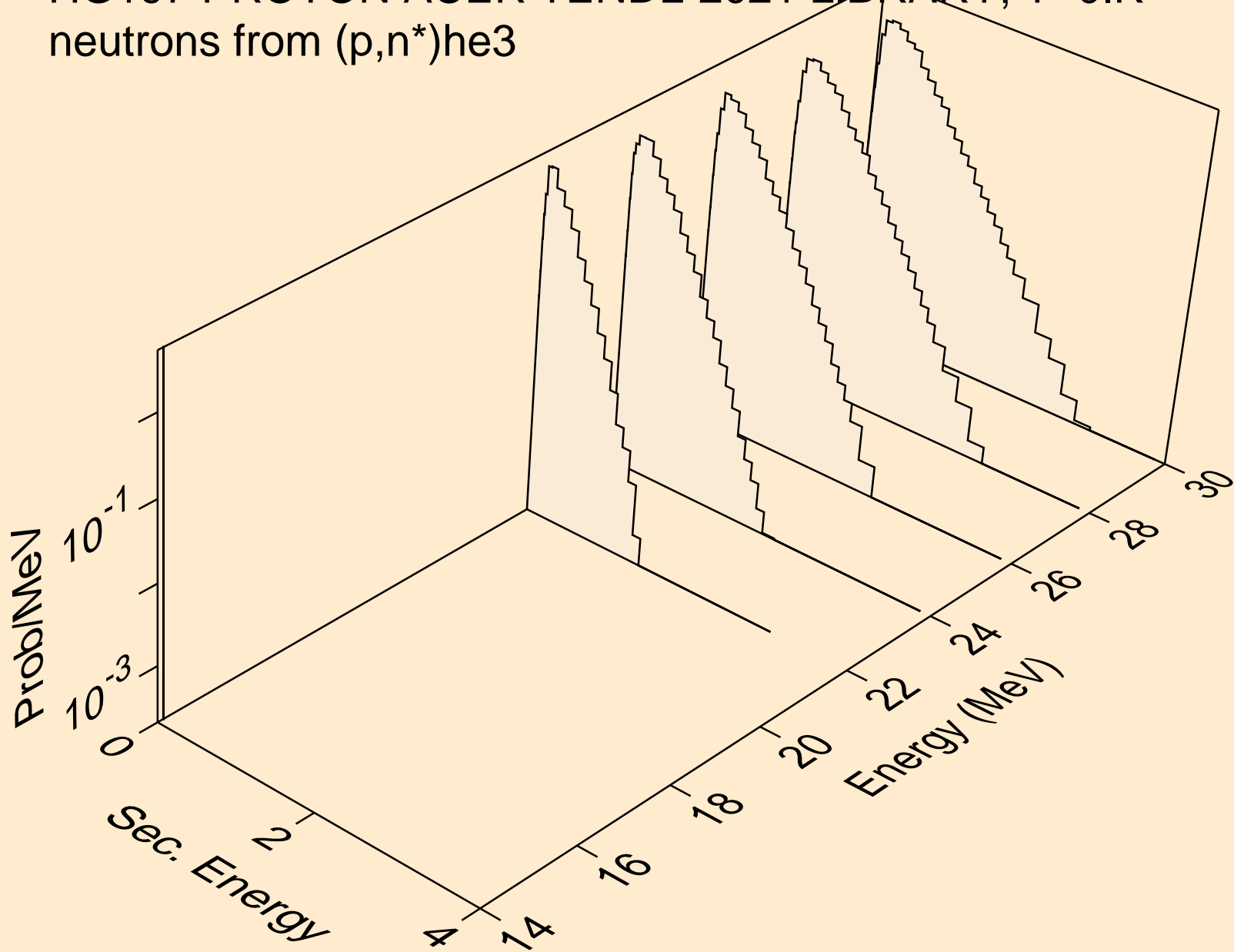

HG197 PROTON ACER TENDL-2021 LIBRARY; T=0.K  
neutrons from (p,4n)

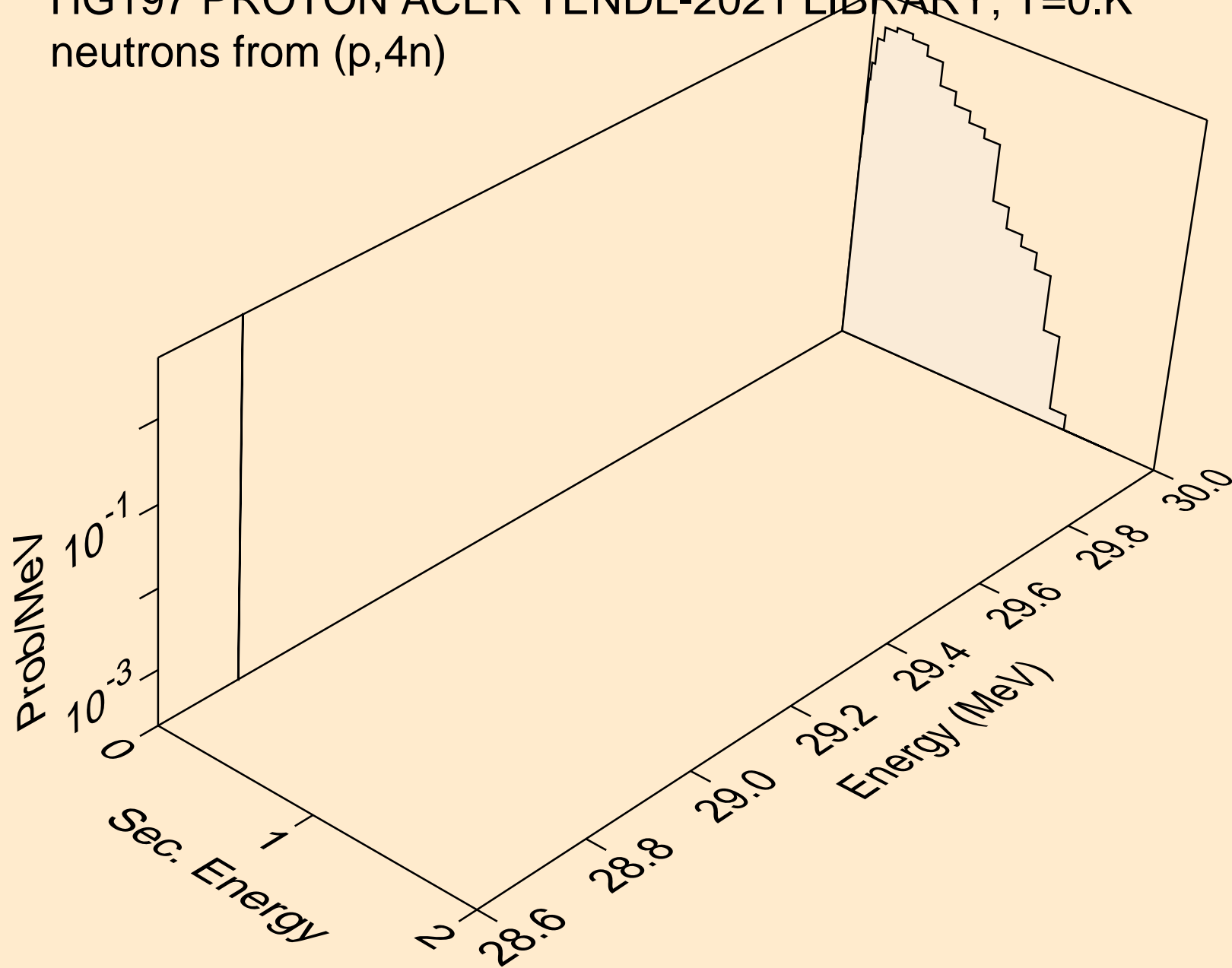

HG197 PROTON ACER TENDL-2021 LIBRARY; T=0.K  
neutrons from (p,2np)

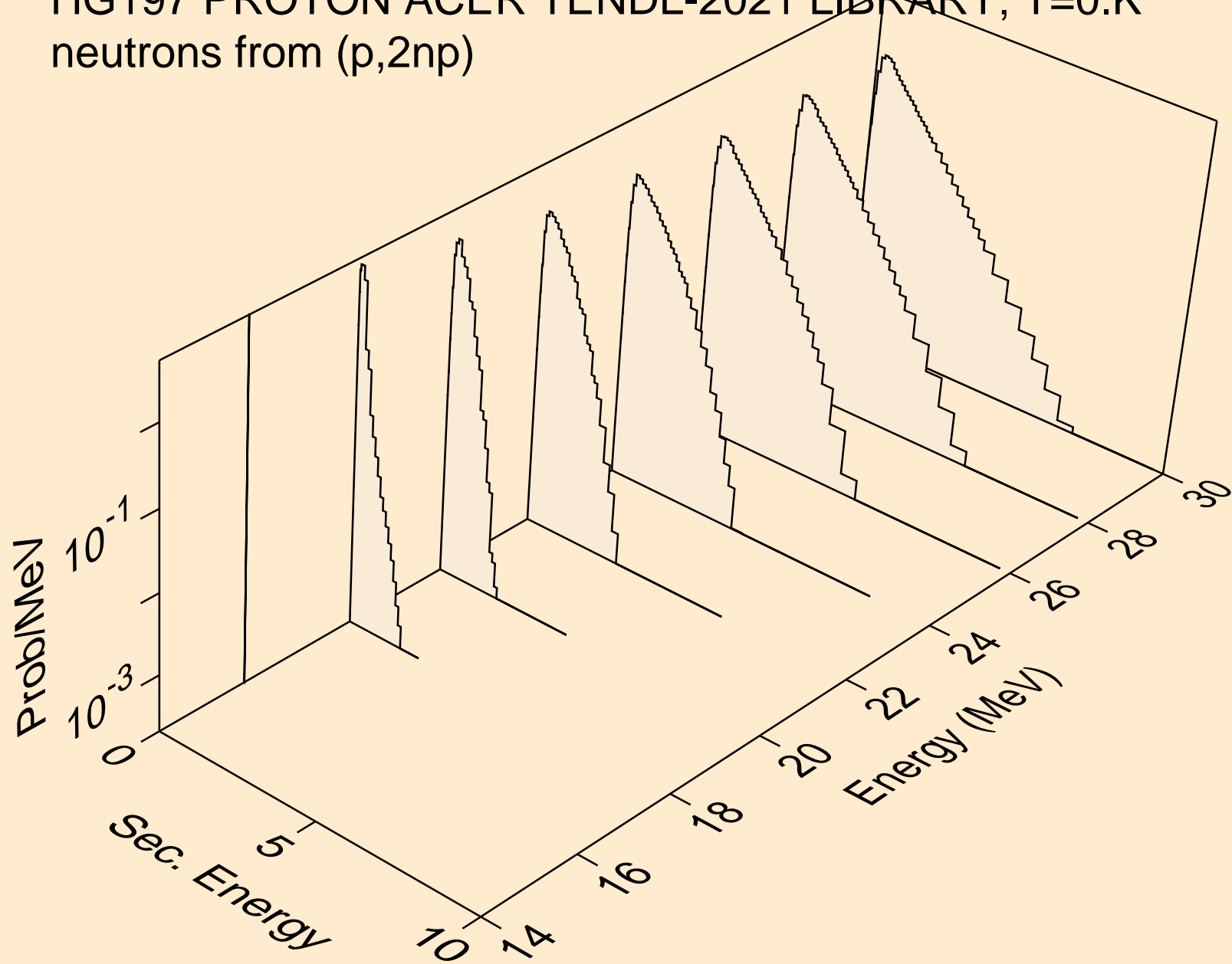

HG197 PROTON ACER TENDL-2021 LIBRARY; T=0.K  
neutrons from (p,3np)

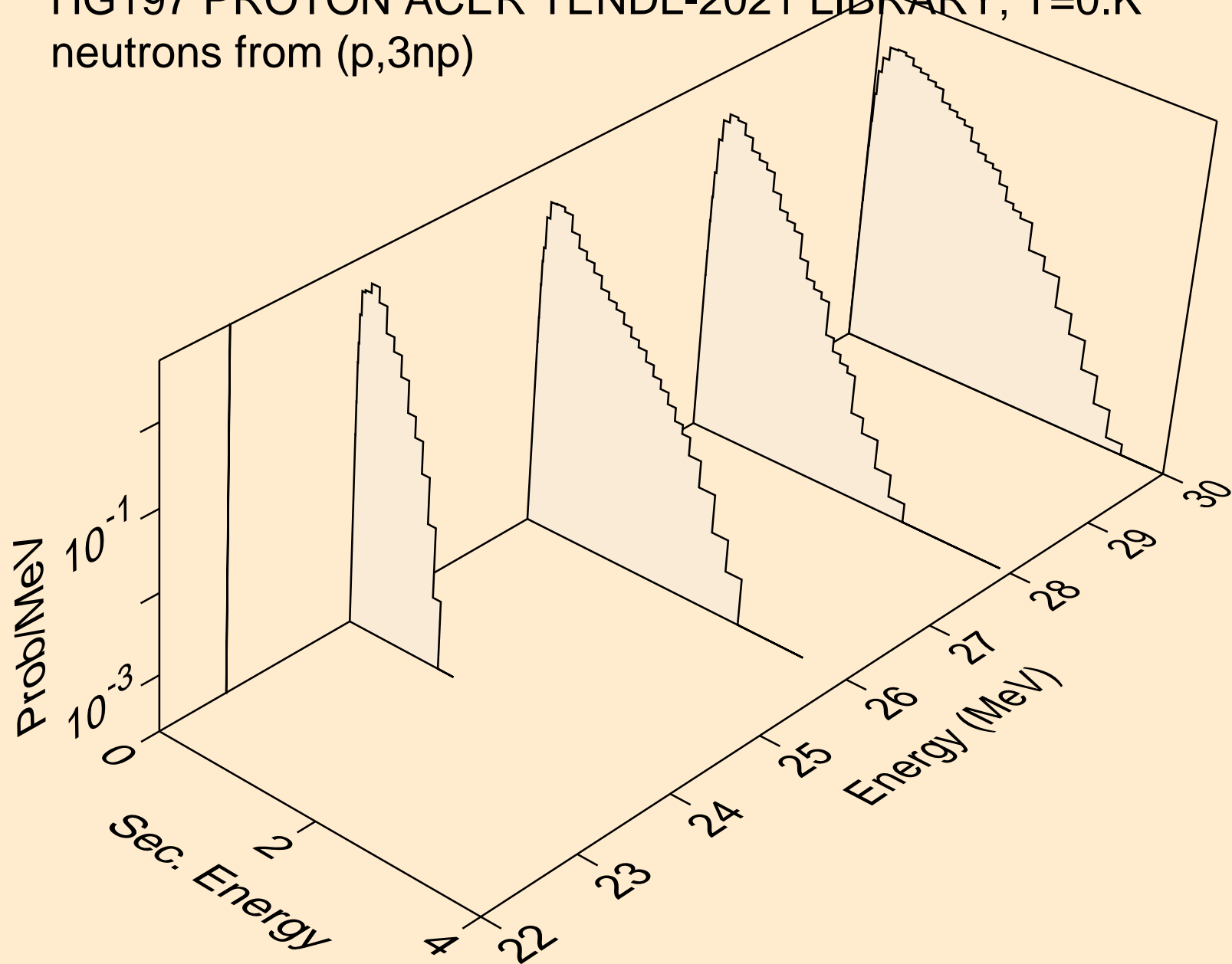

HG197 PROTON ACER TENDL-2021 LIBRARY; T=0.K  
neutrons from (p,2np)

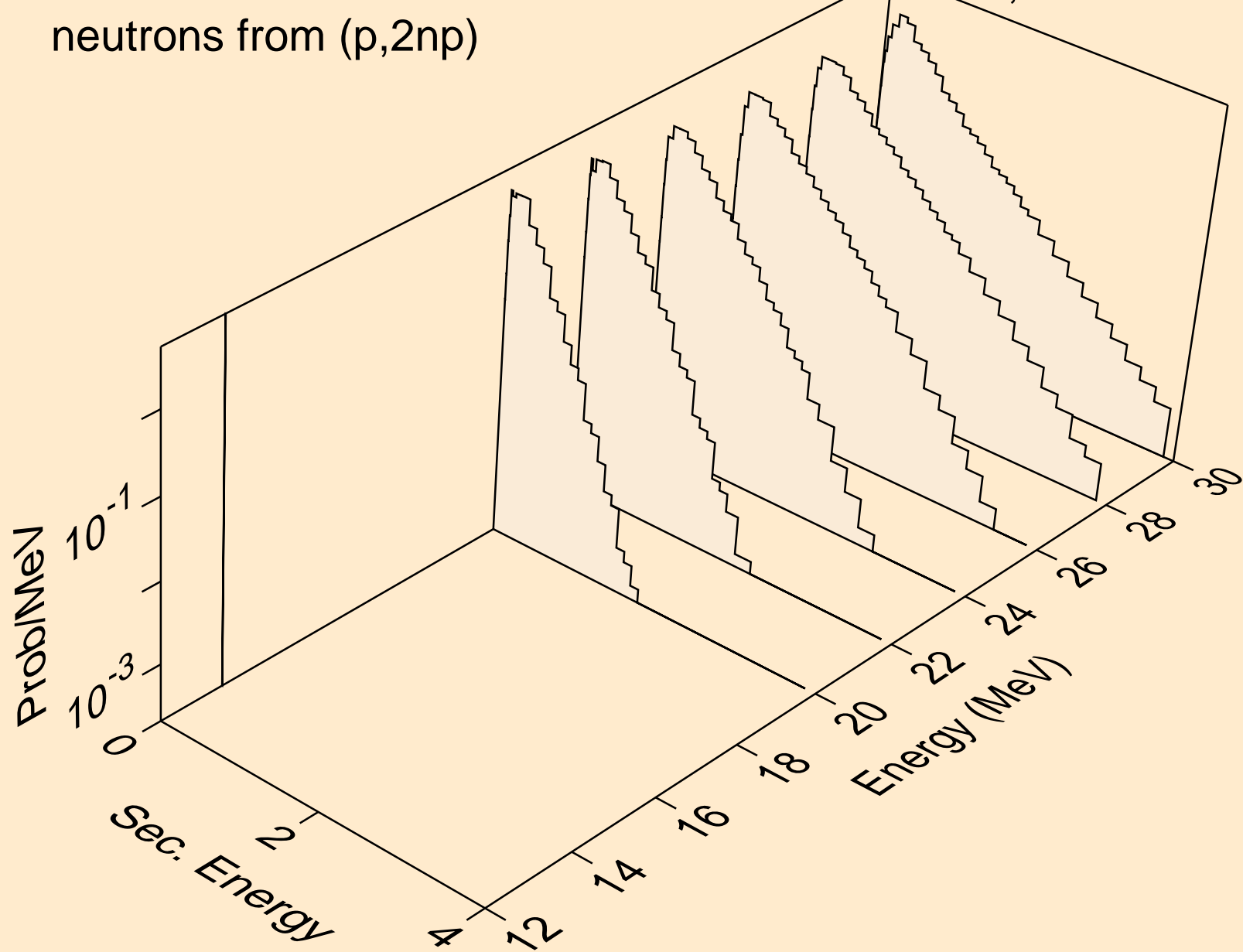

HG197 PROTON ACER TENDL-2021 LIBRARY; T=0.K  
neutrons from (p,npa)

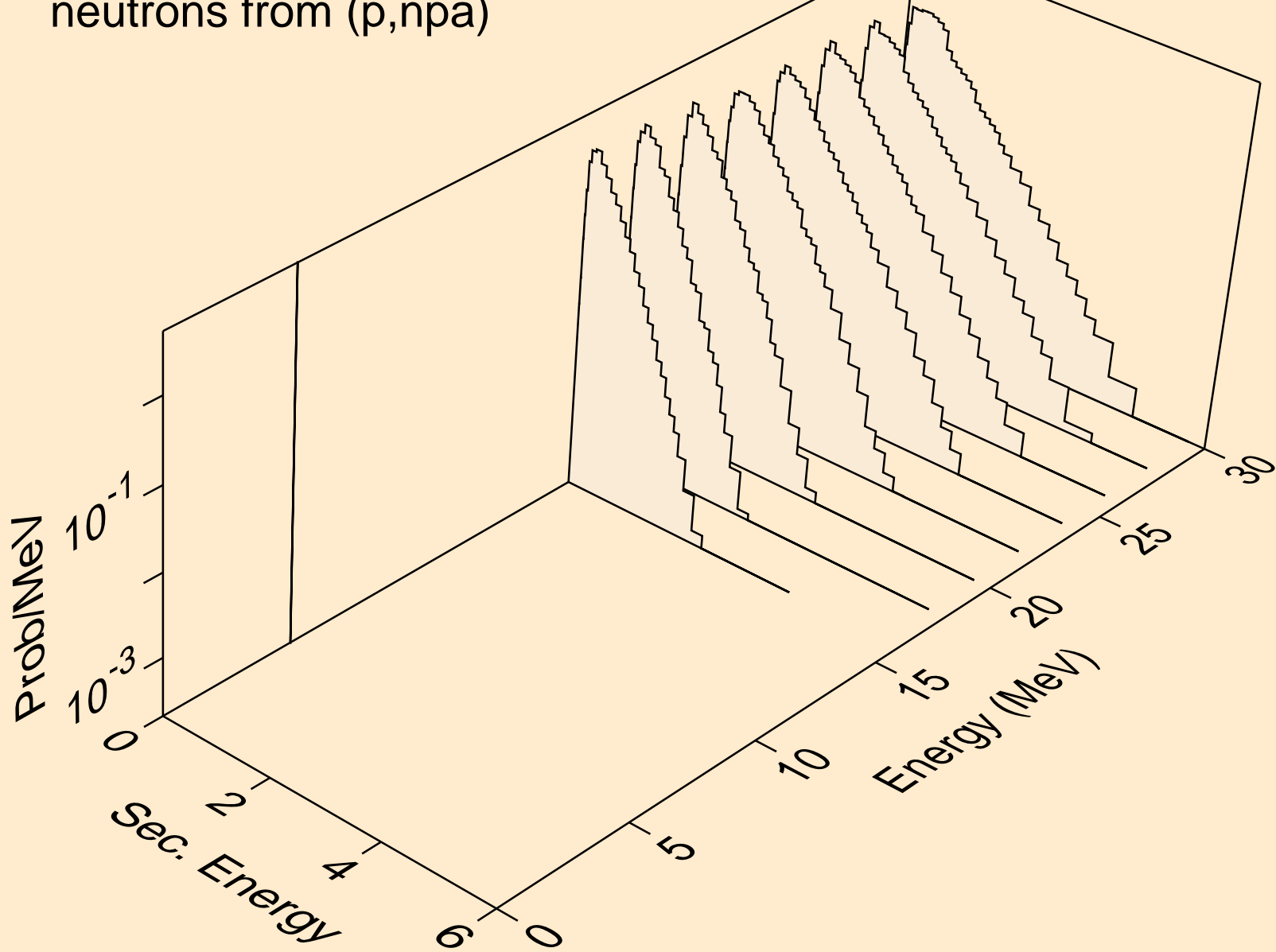

HG197 PROTON ACER TENDL-2021 LIBRARY; T=0.K  
deuterons from (p,x)

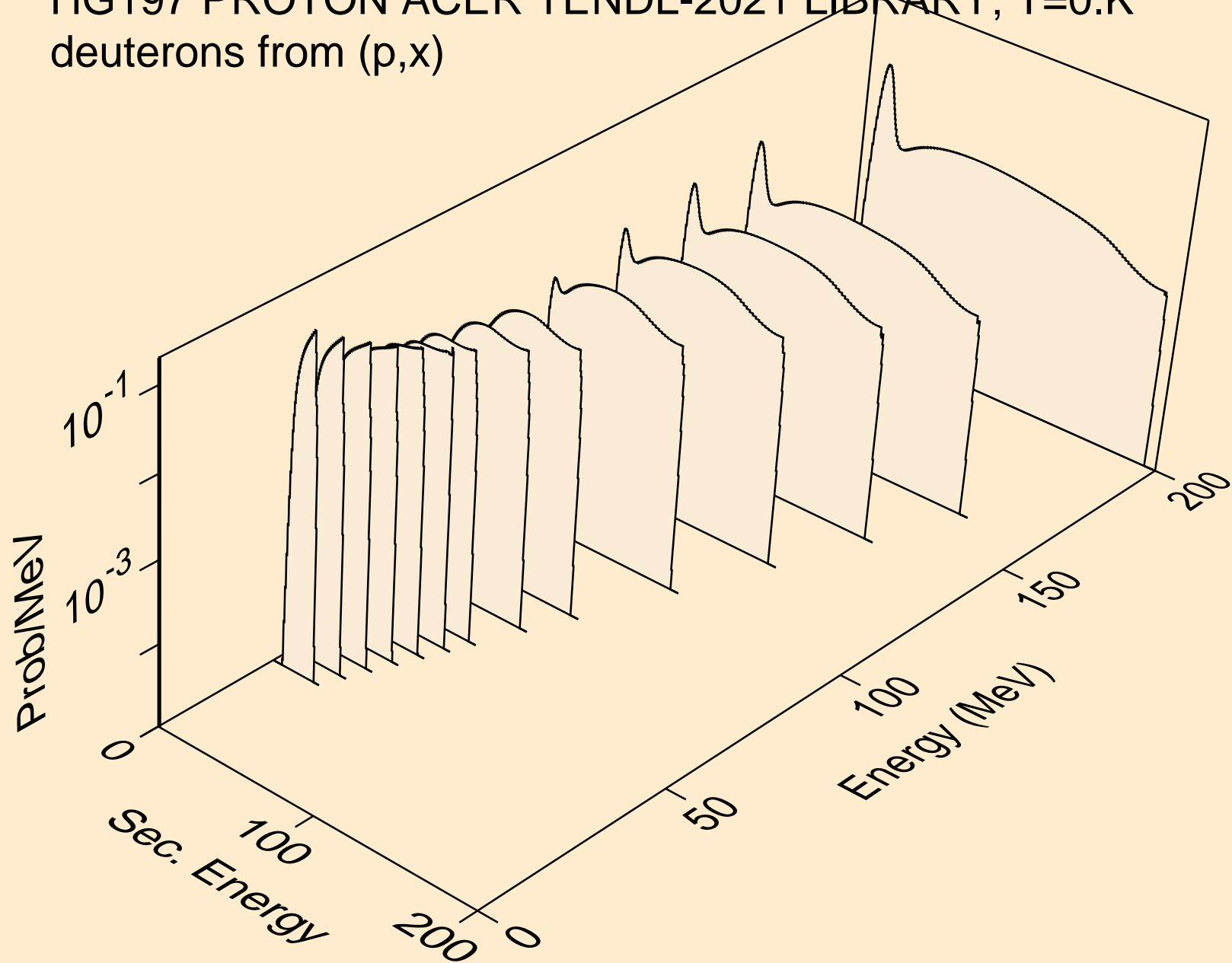



HG197 PROTON ACER TENDL-2021 LIBRARY; T=0.K  
deuterons from (p,2nd)

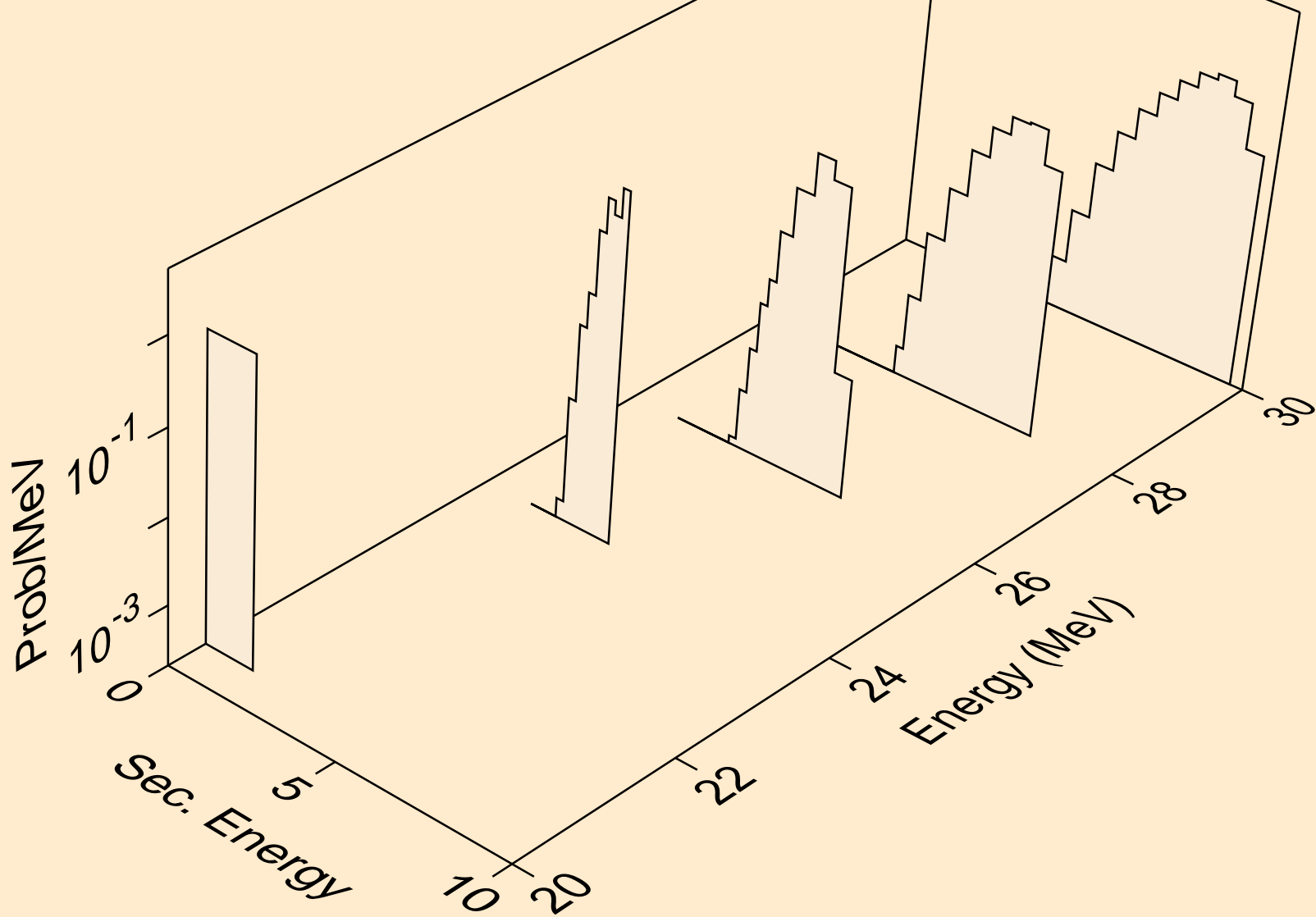

HG197 PROTON ACER TENDL-2021 LIBRARY; T=0.K  
deuterons from (p,n\*)d

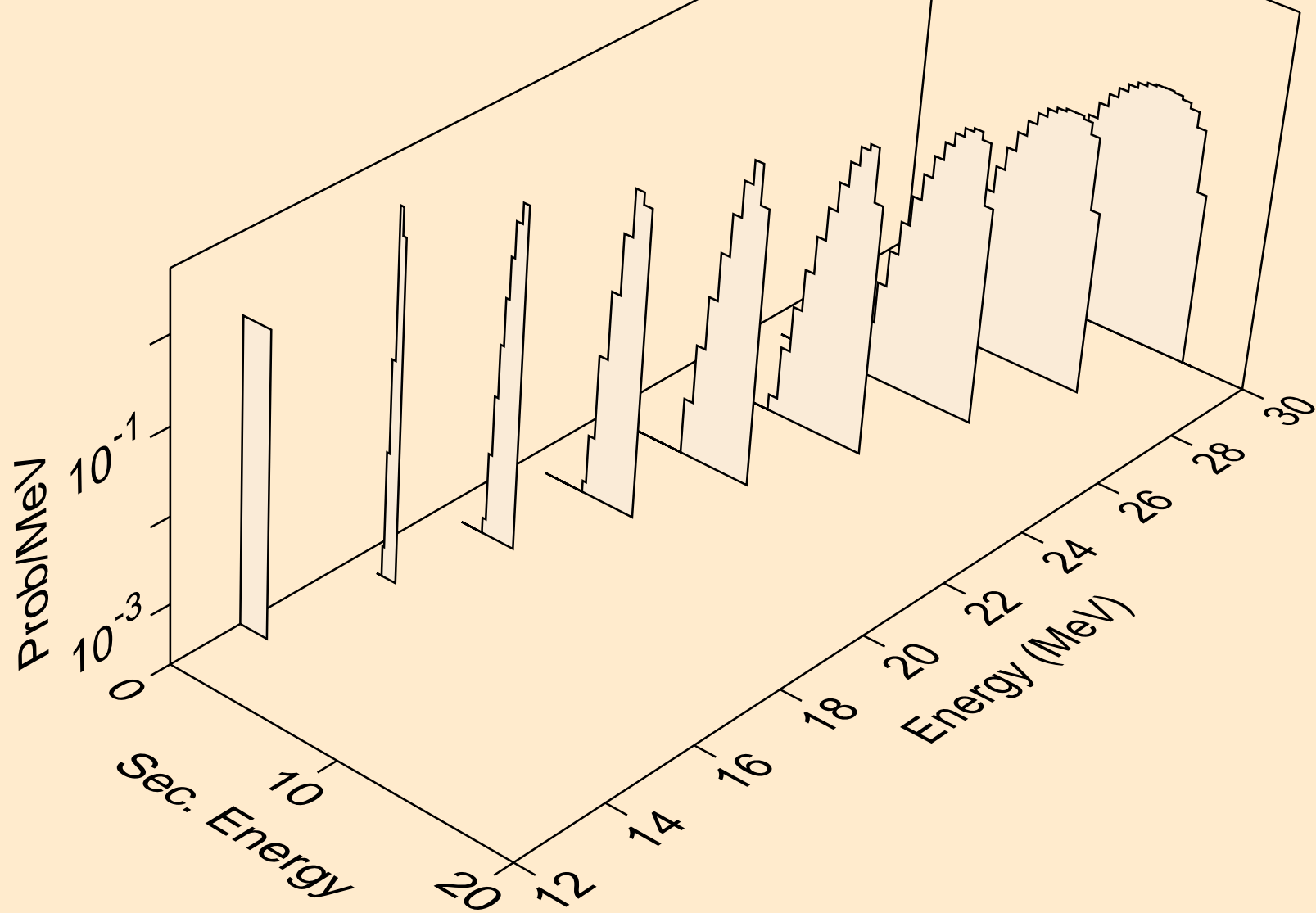

HG197 PROTON ACER TENDL-2021 LIBRARY; T=0.K  
deuterons from (p,d)

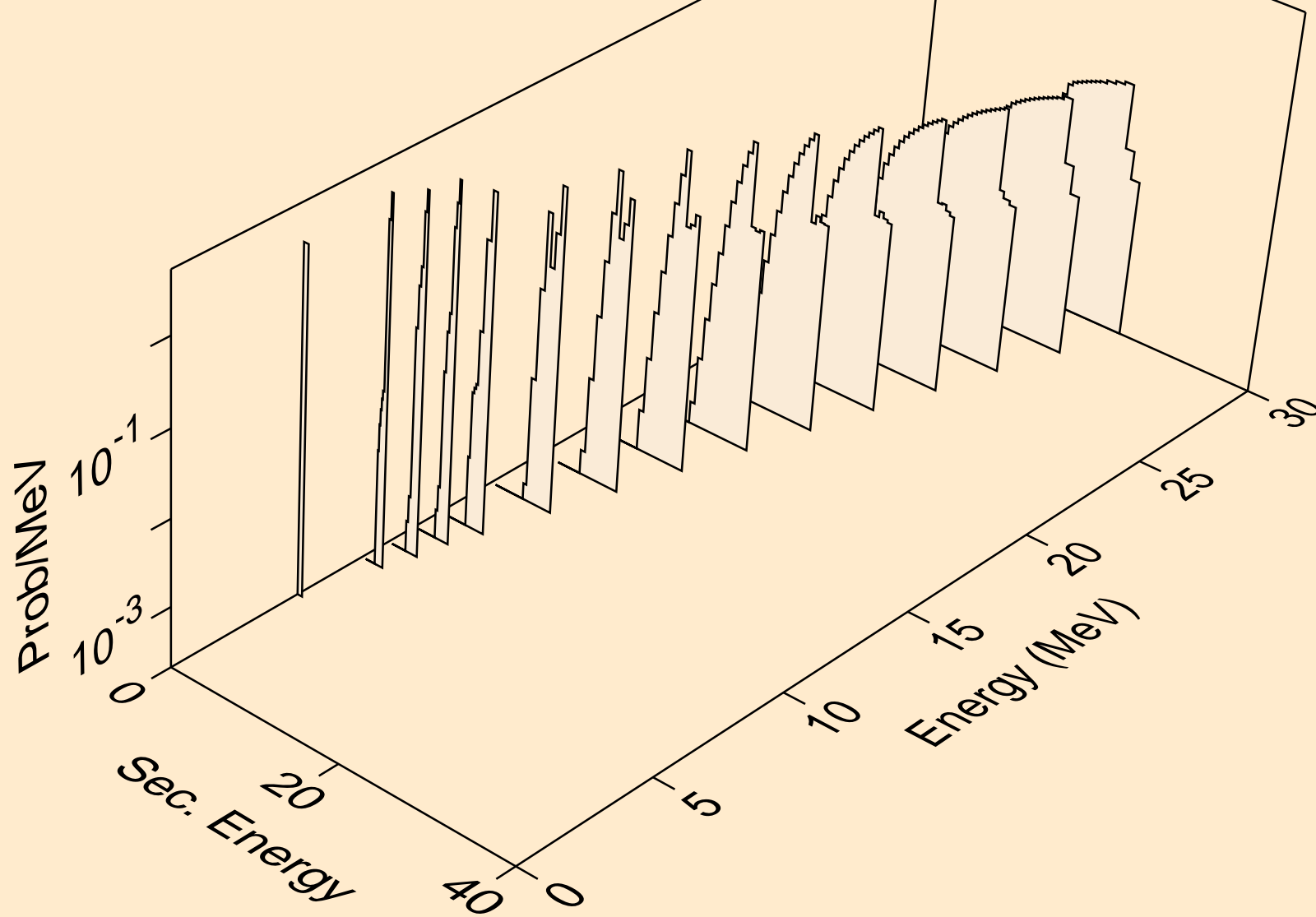

HG197 PROTON ACER TENDL-2021 LIBRARY; T=0.K  
deuterons from (p,pd)

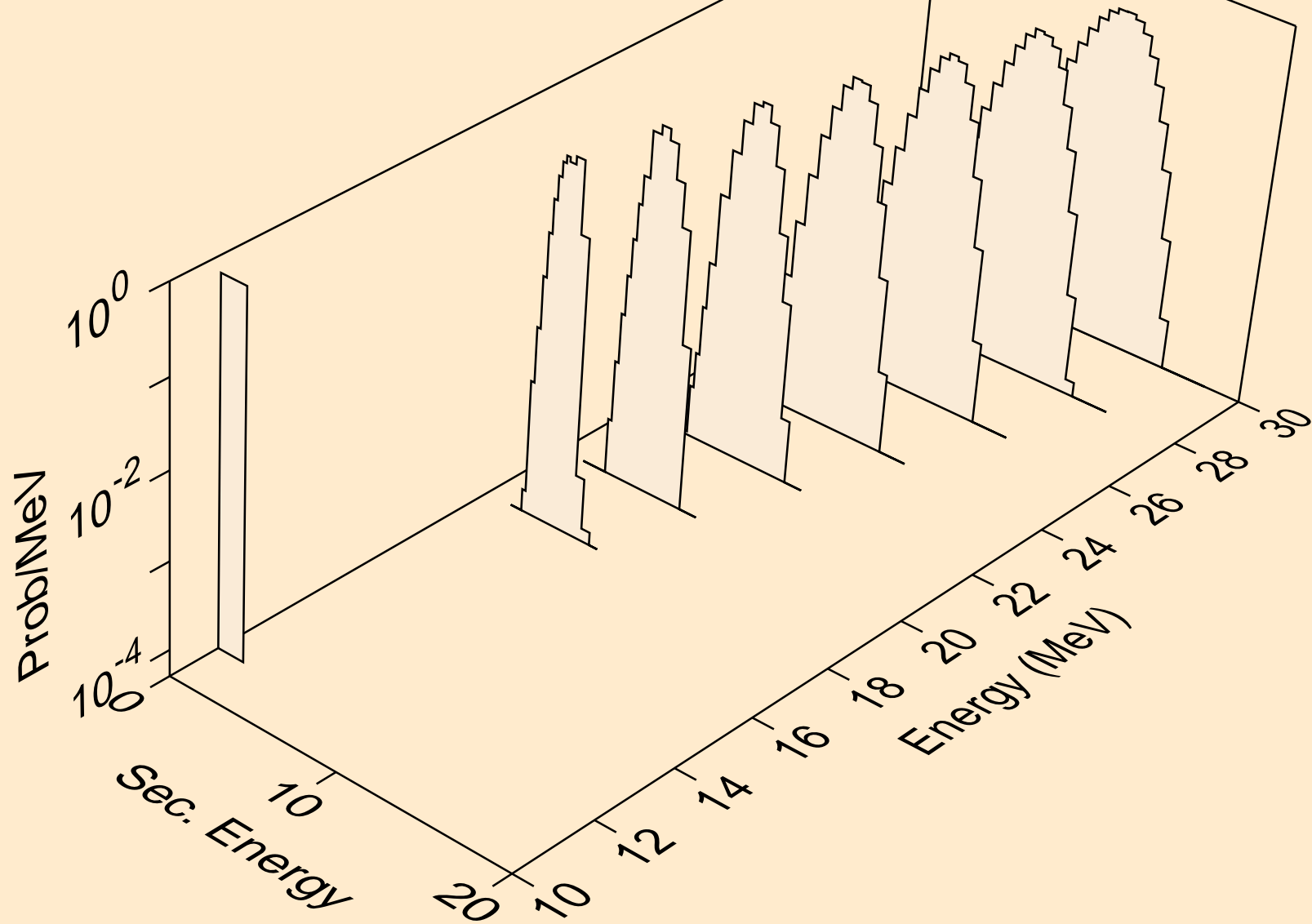

HG197 PROTON ACER TENDL-2021 LIBRARY; T=0.K  
deuterons from (p,da)

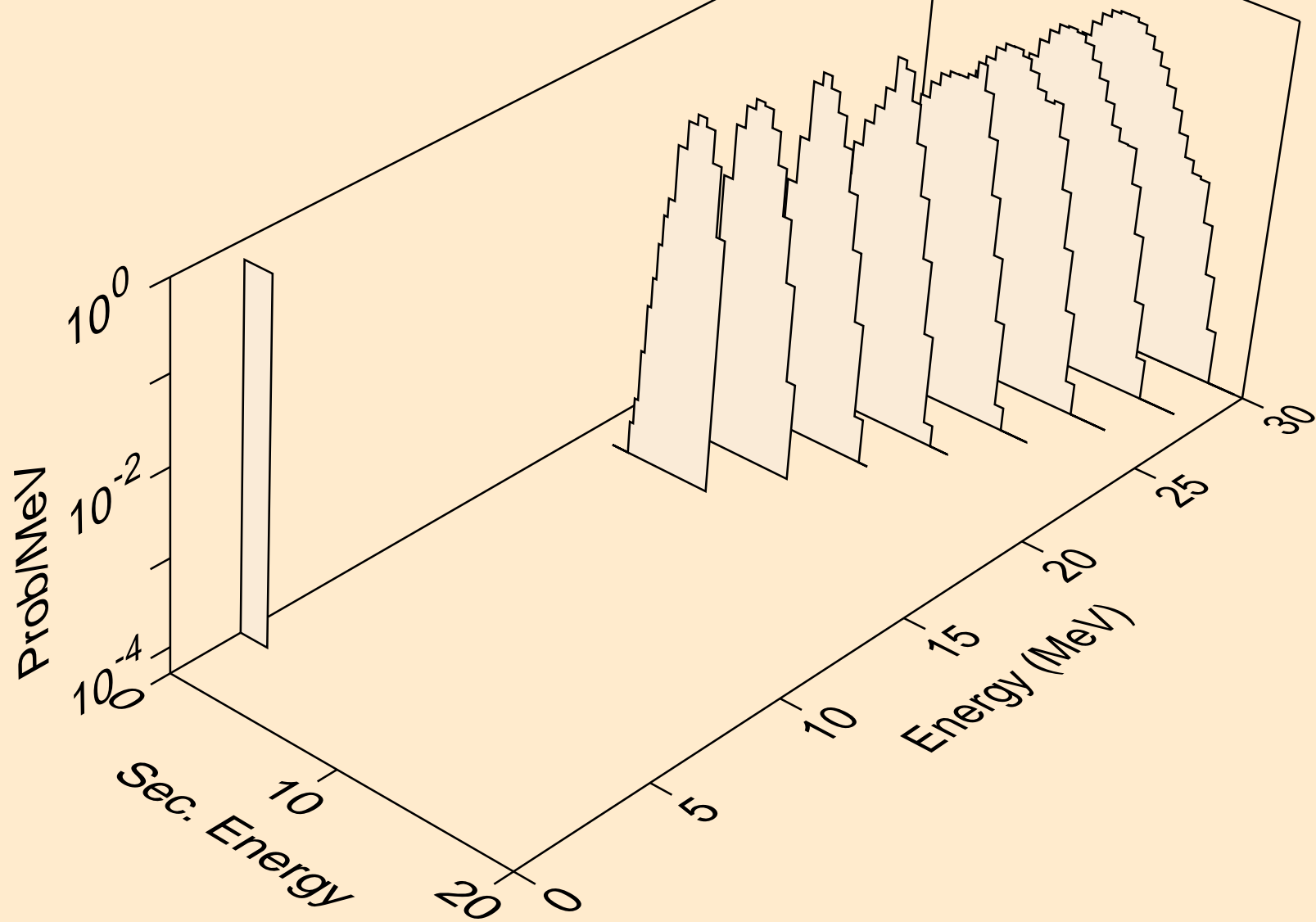

HG197 PROTON ACER TENDL-2021 LIBRARY; T=0.K  
tritons from (p,x)

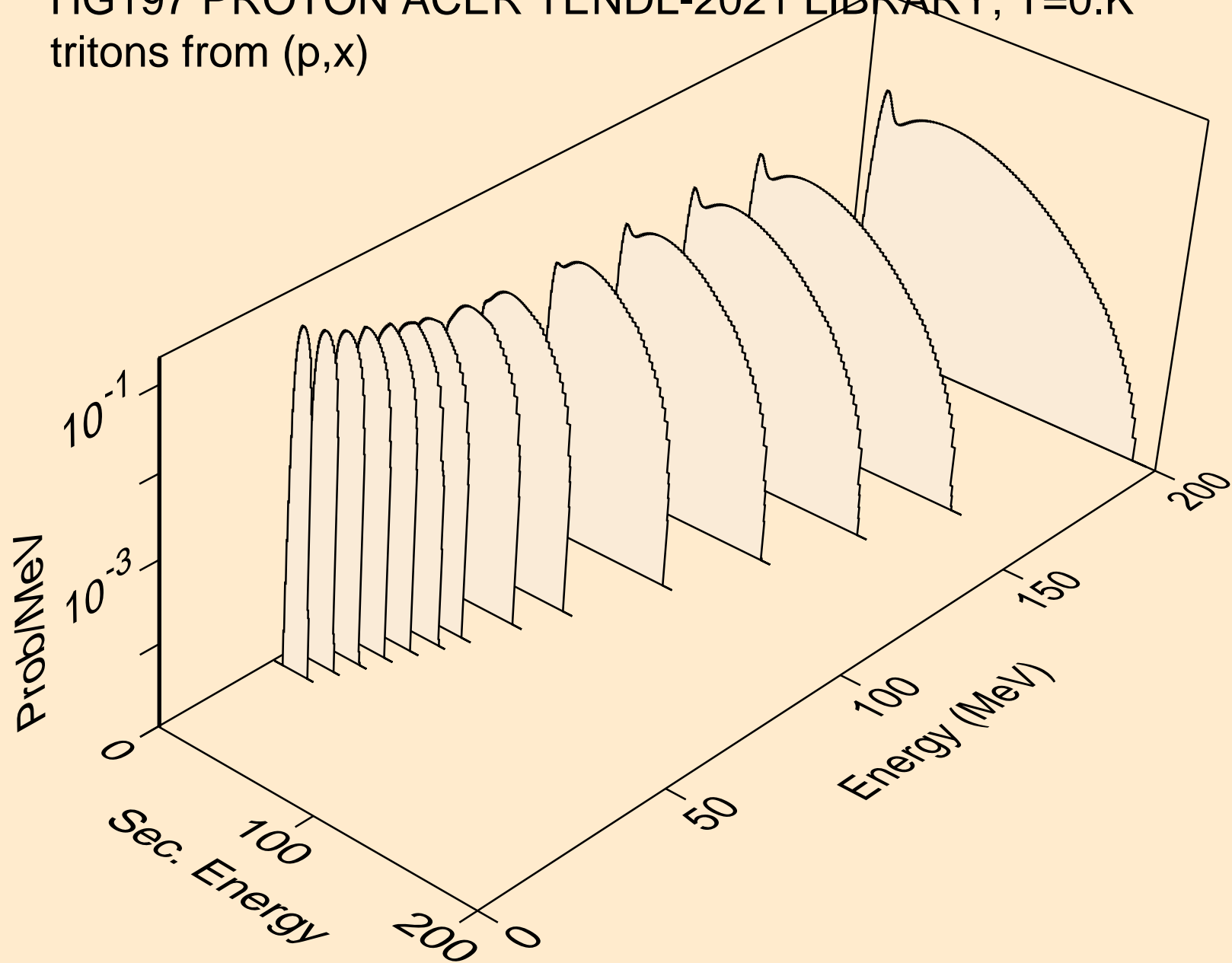

HG197 PROTON ACER TENDL-2021 LIBRARY; T=0.K  
tritons from (p,n\*)t

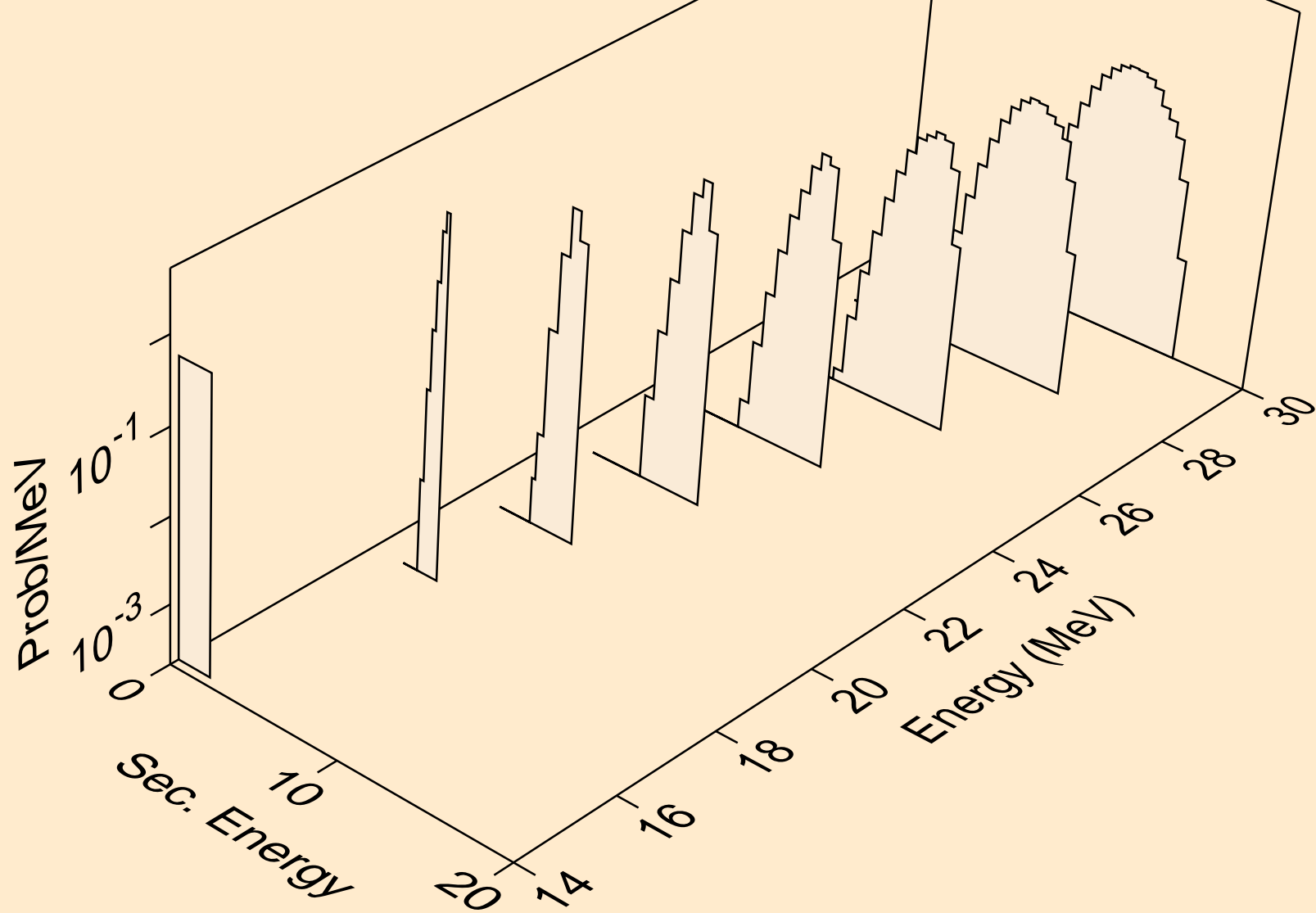

HG197 PROTON ACER TENDL-2021 LIBRARY; T=0.K  
tritons from (p,t)

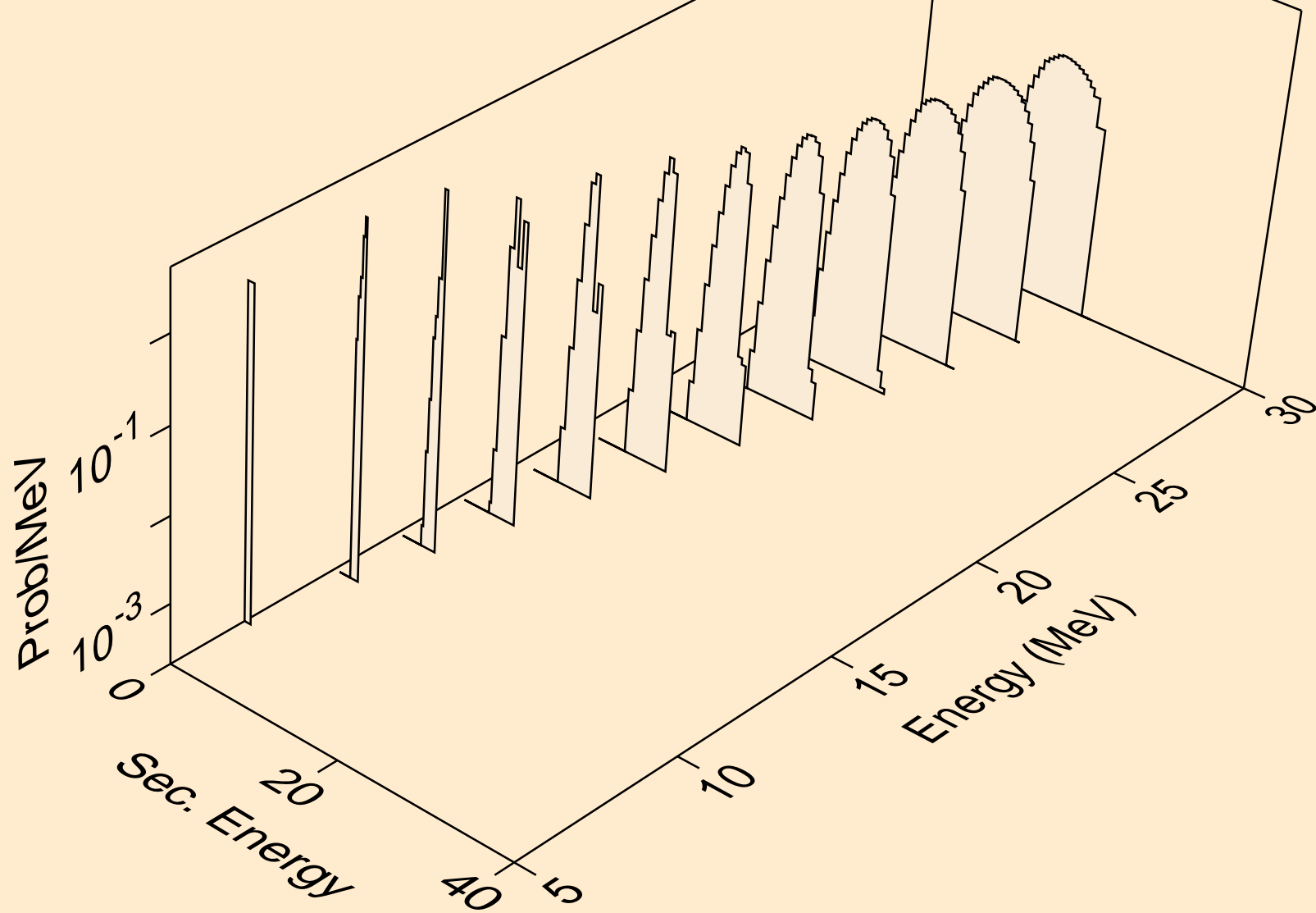



HG197 PROTON ACER TENDL-2021 LIBRARY; T=0.K  
tritons from (p,pt)

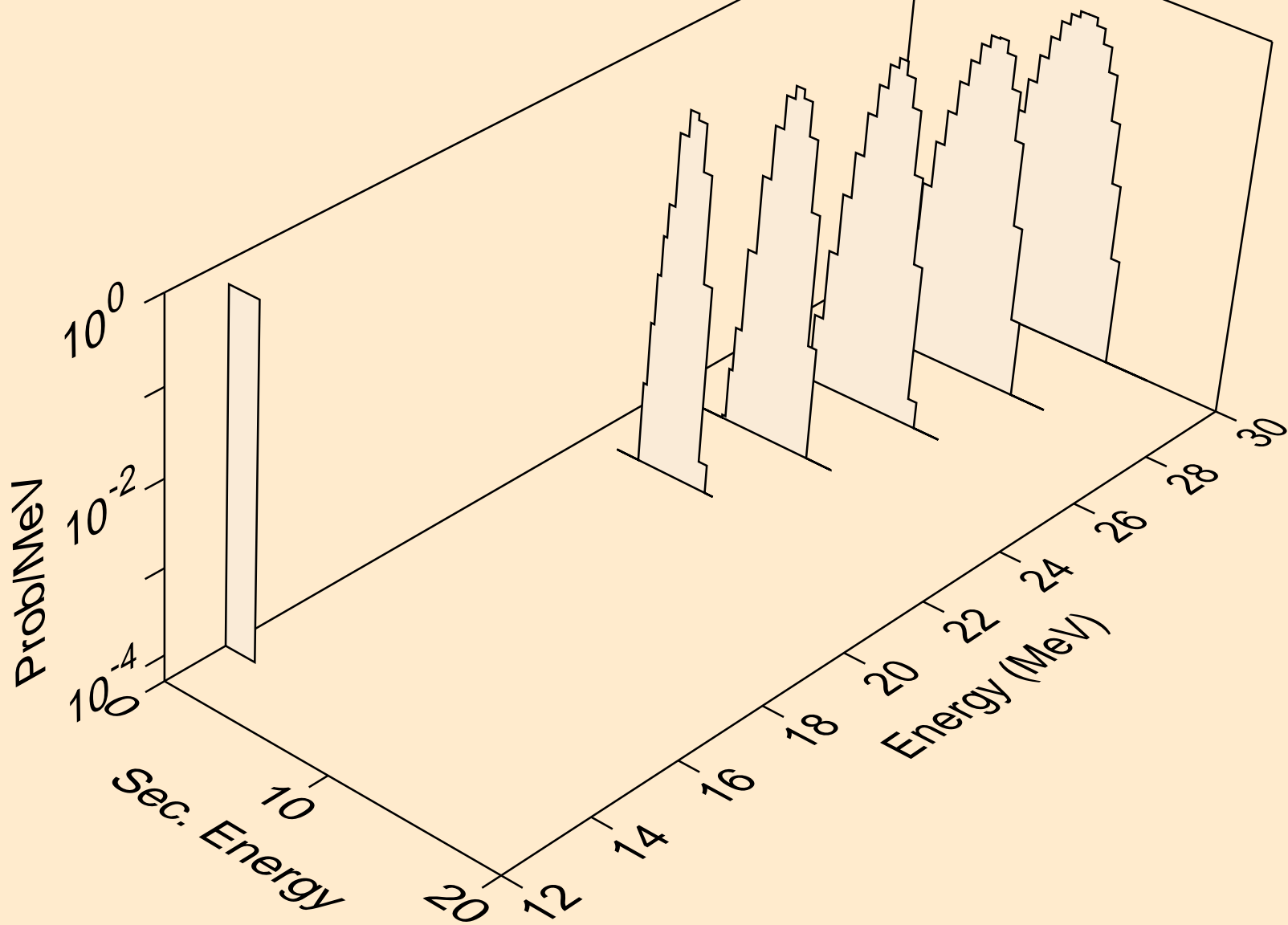

HG197 PROTON ACER TENDL-2021 LIBRARY; T=0.K  
he3s from (p,x)

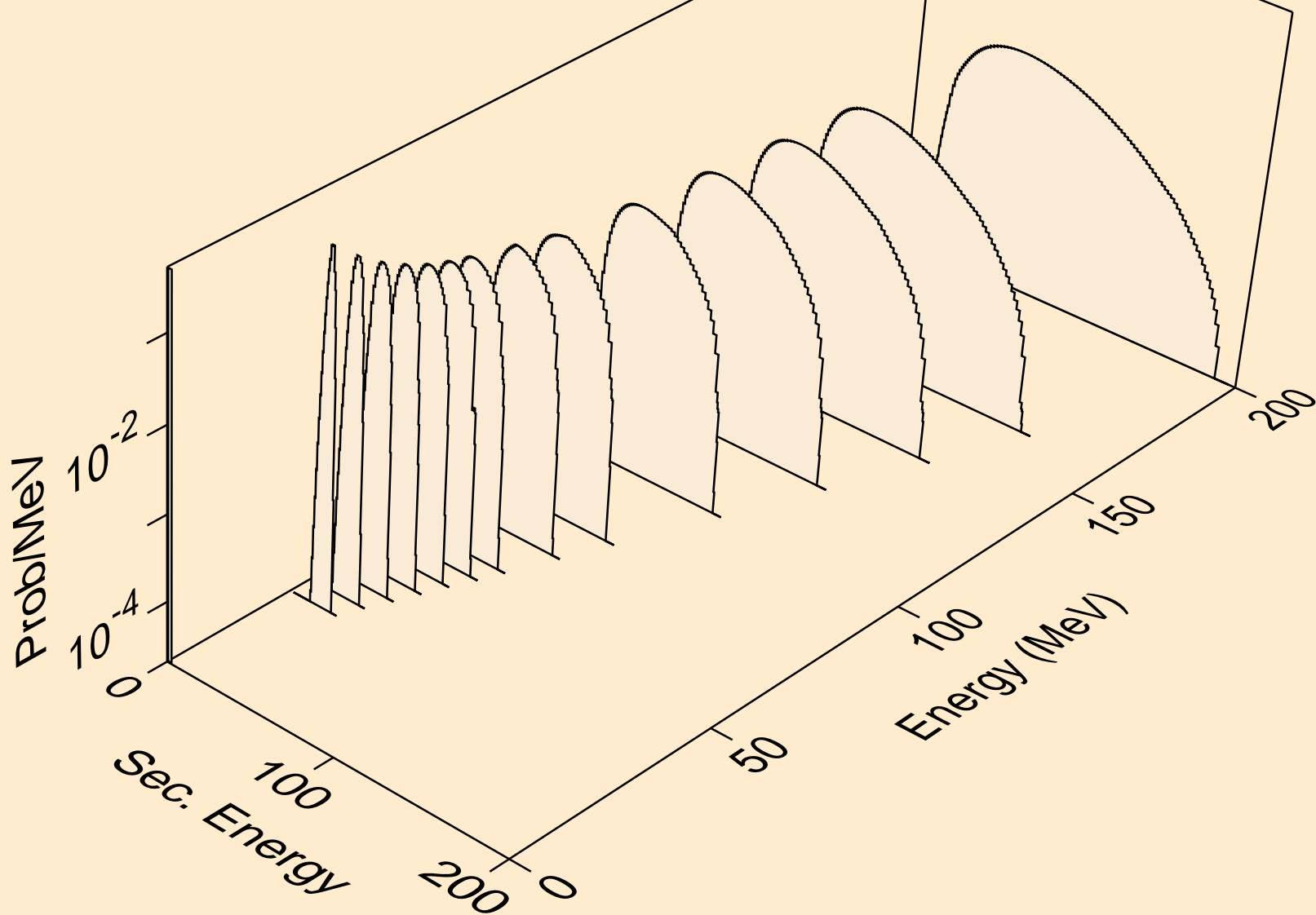

HG197 PROTON ACER TENDL-2021 LIBRARY; T=0.K  
he3s from (p,n\*)he3

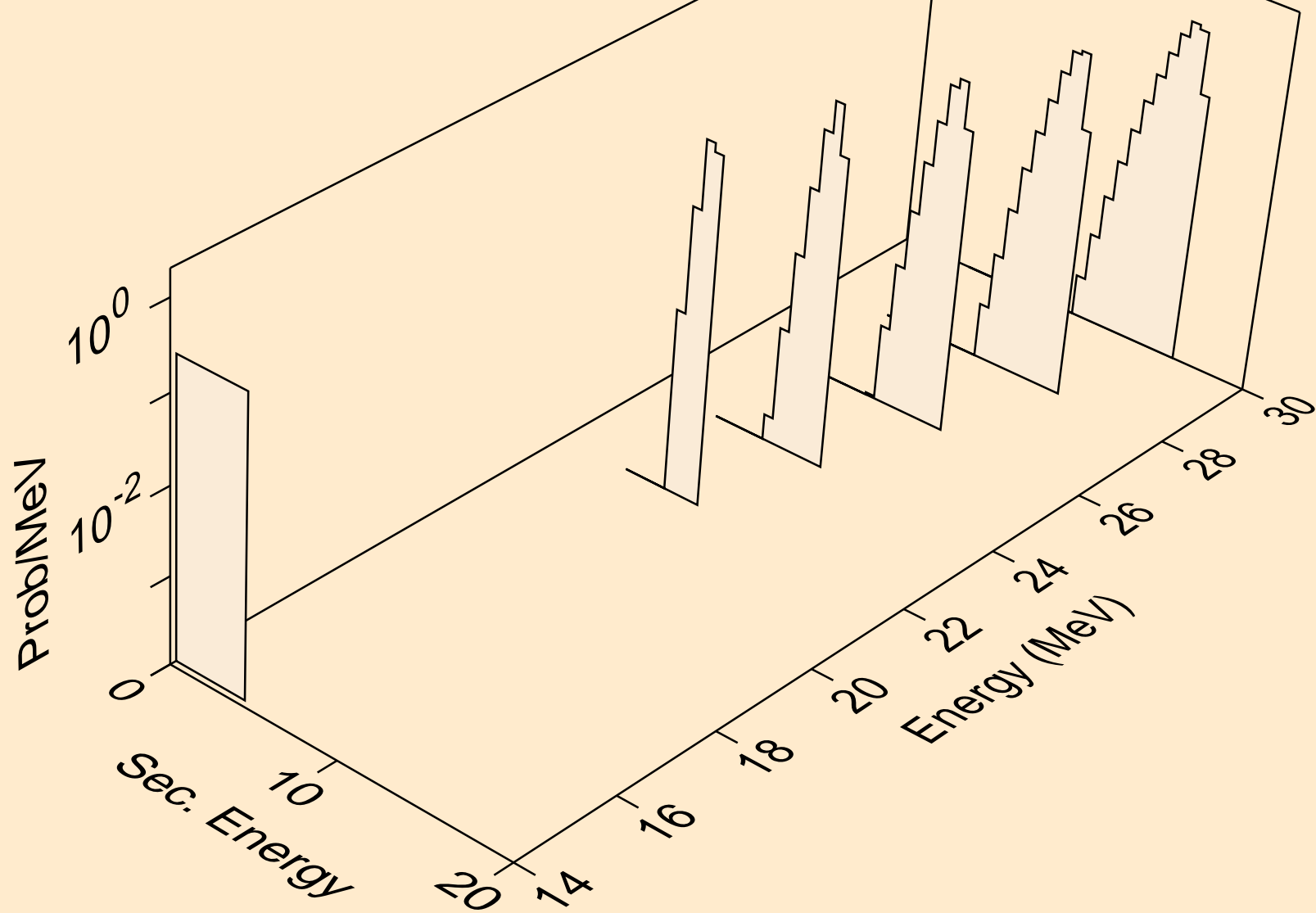

HG197 PROTON ACER TENDL-2021 LIBRARY; T=0.K  
he3s from (p,he3)

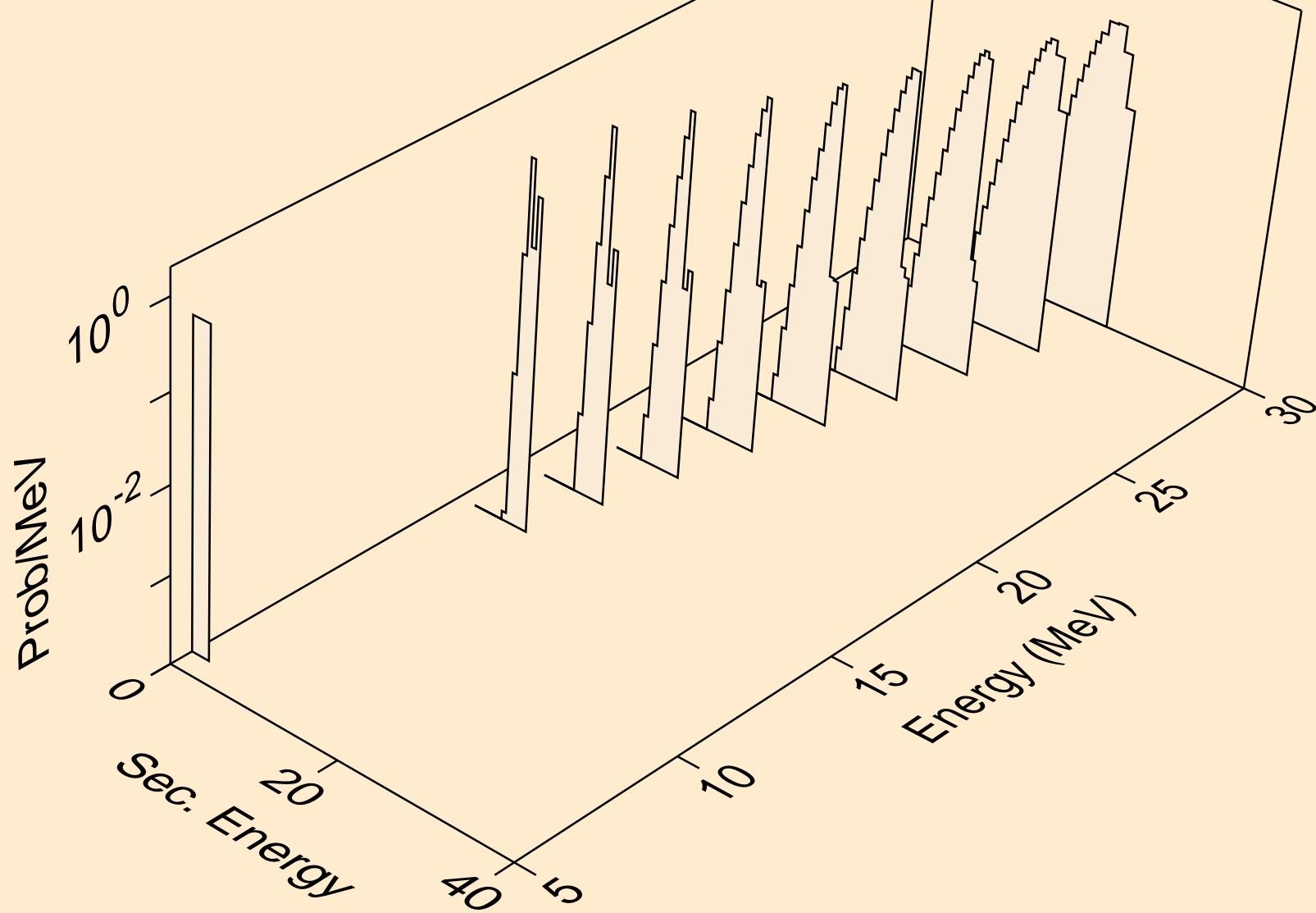

HG197 PROTON ACER TENDL-2021 LIBRARY; T=0.K  
alphas from (p,x)

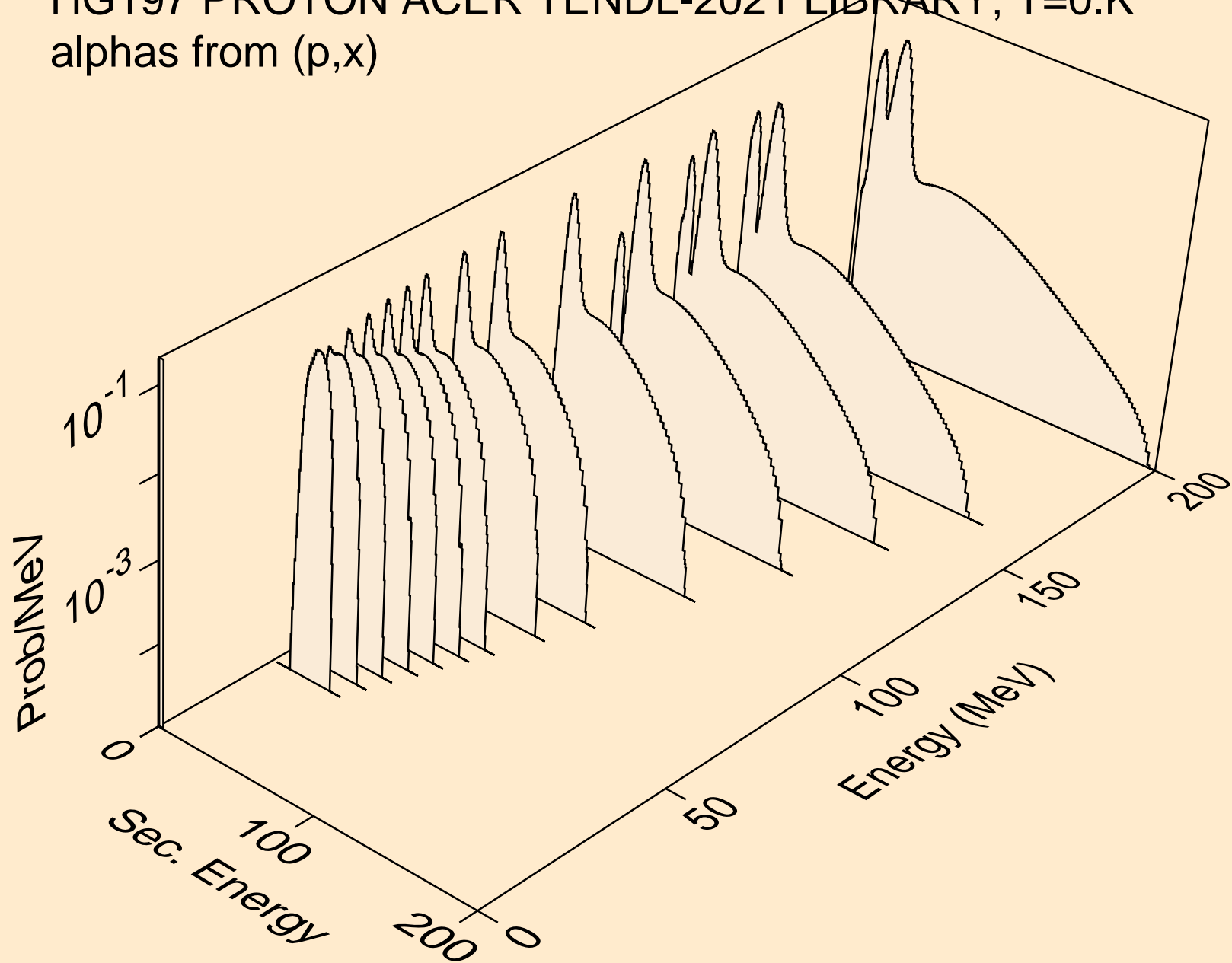

HG197 PROTON ACER TENDL-2021 LIBRARY; T=0.K  
alphas from (p,n\*)a

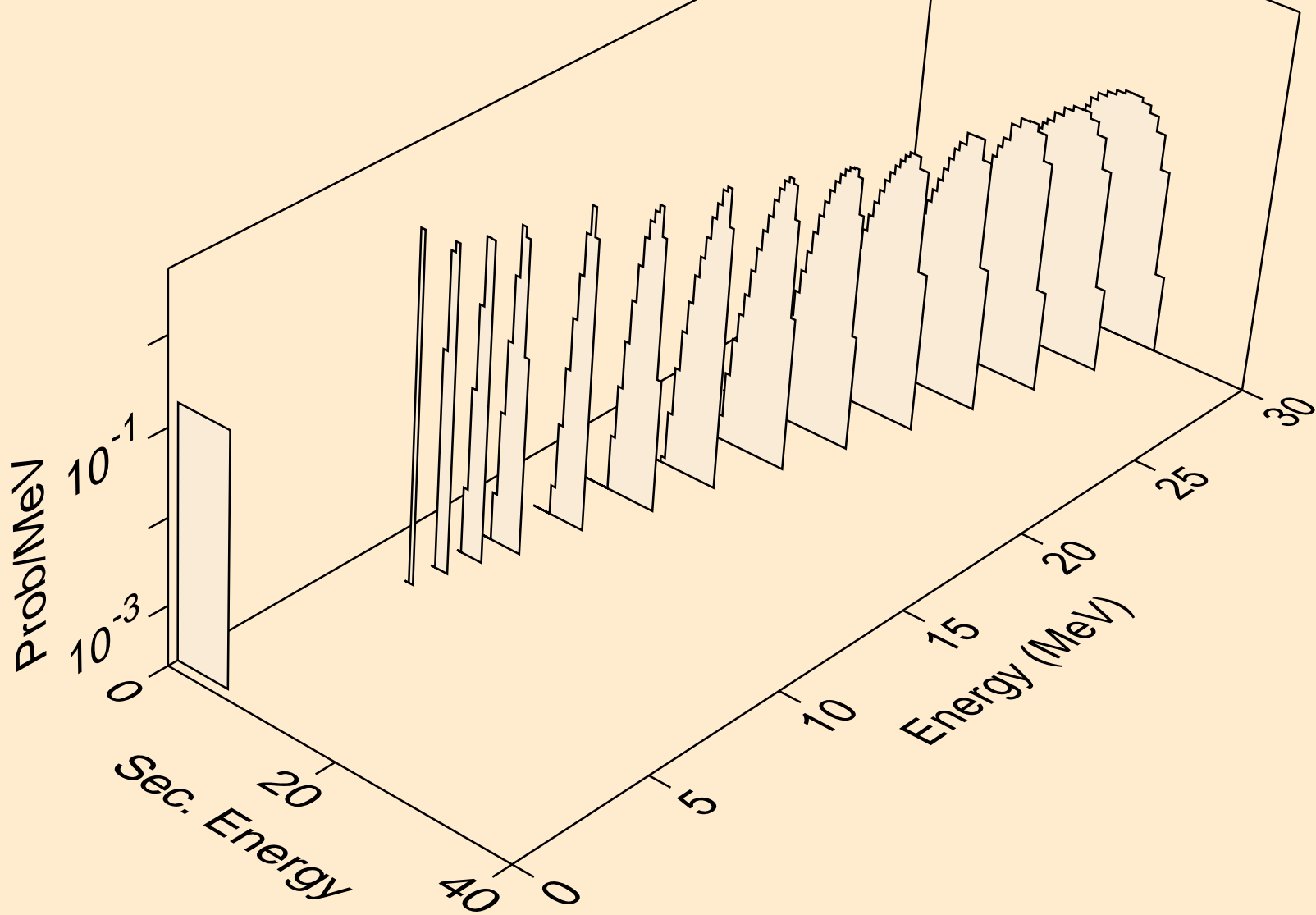

HG197 PROTON ACER TENDL-2021 LIBRARY; T=0.K  
alphas from (p,2n)a

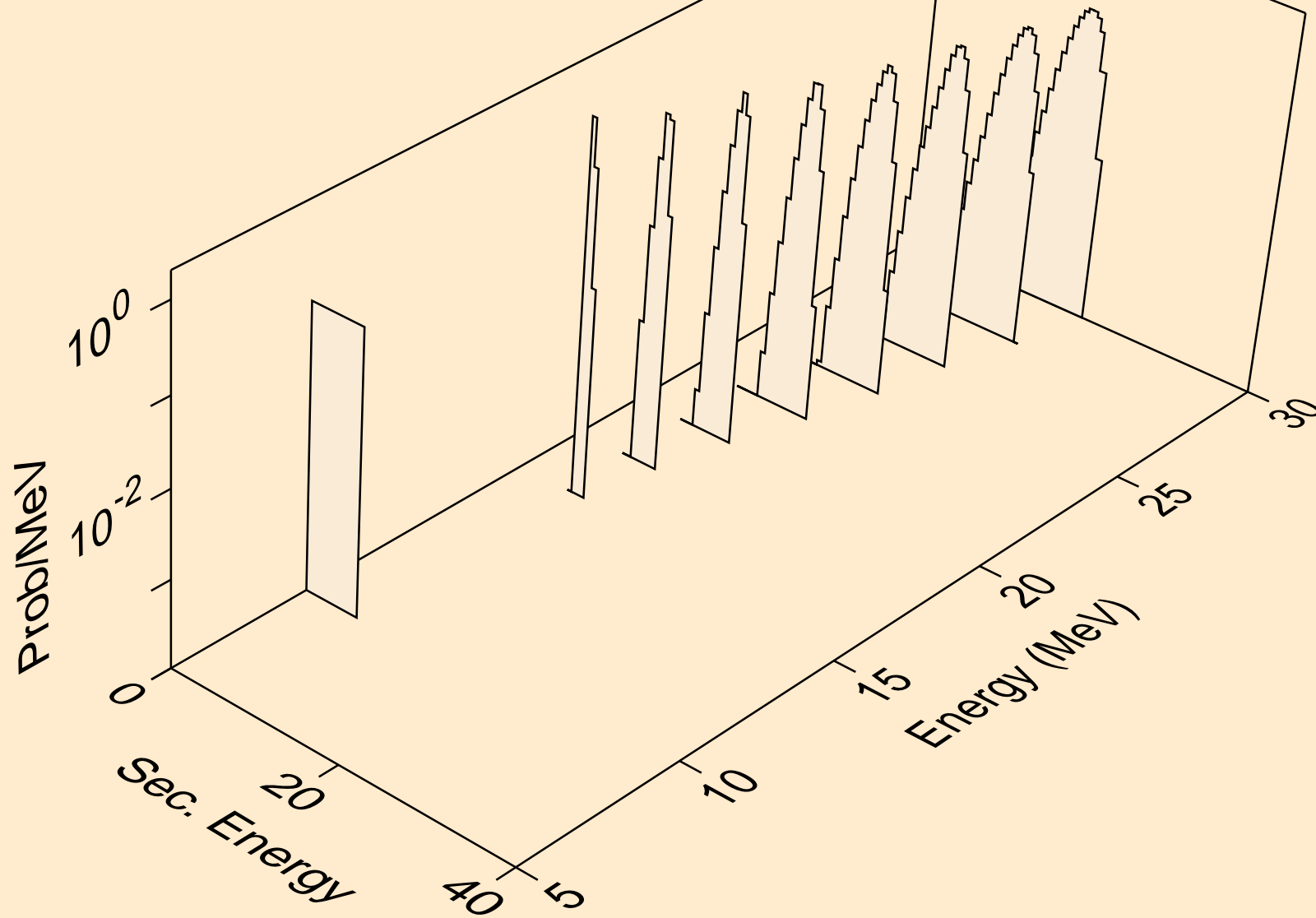

HG197 PROTON ACER TENDL-2021 LIBRARY; T=0.K  
alphas from (p,3n)a

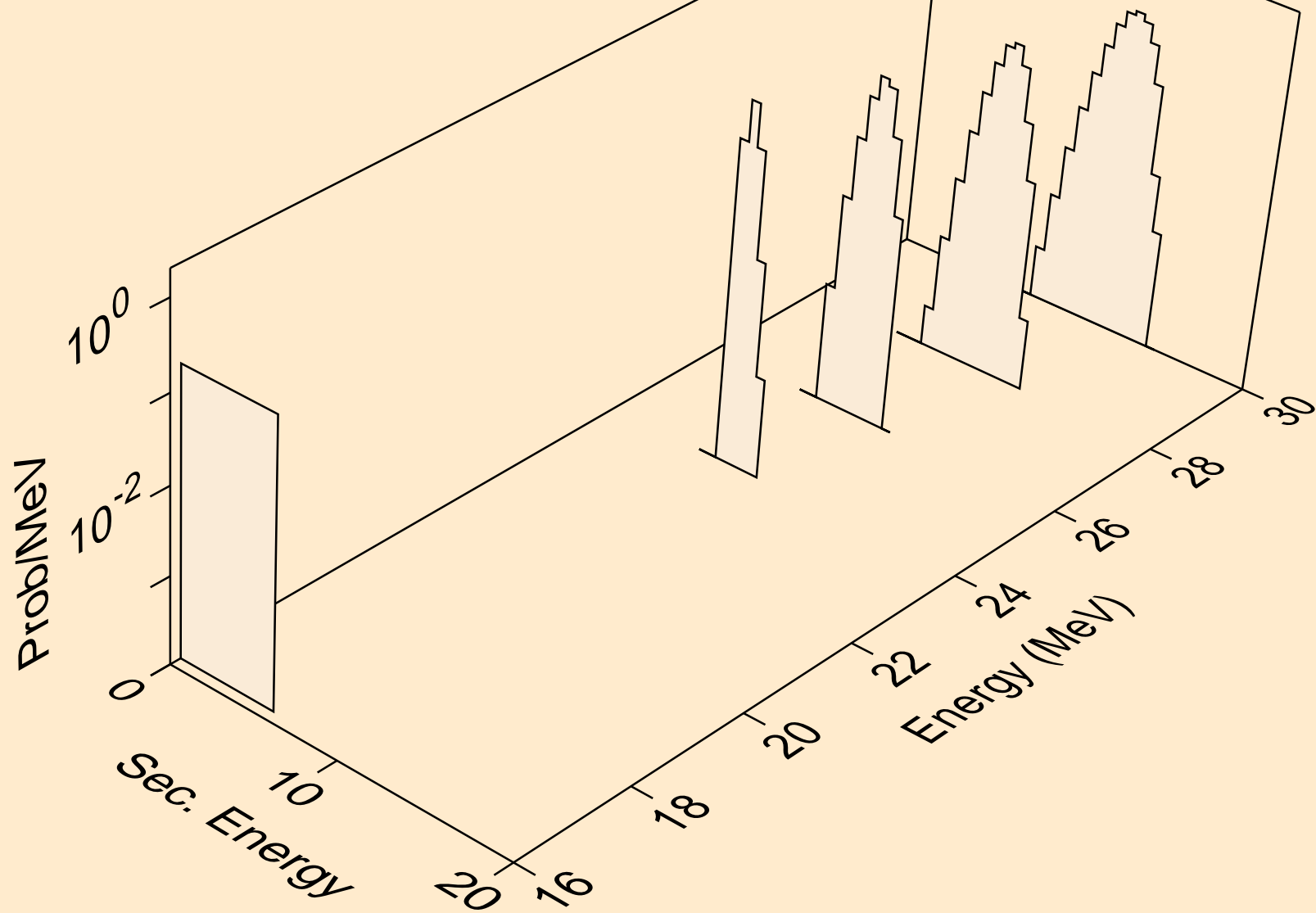



HG197 PROTON ACER TENDL-2021 LIBRARY; T=0.K  
alphas from (p,n\*)2a

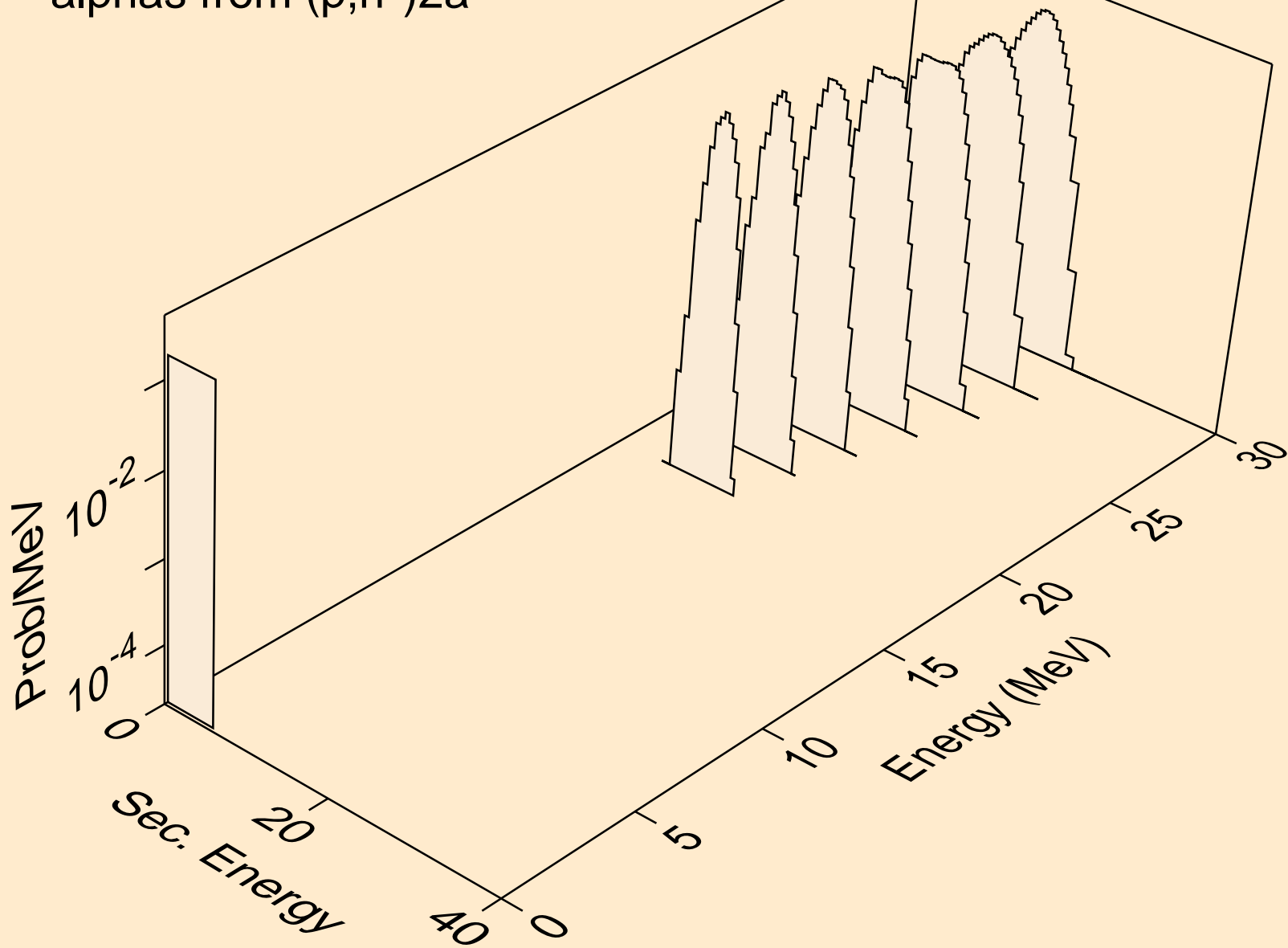

HG197 PROTON ACER TENDL-2021 LIBRARY; T=0.K  
alphas from (p,npa)

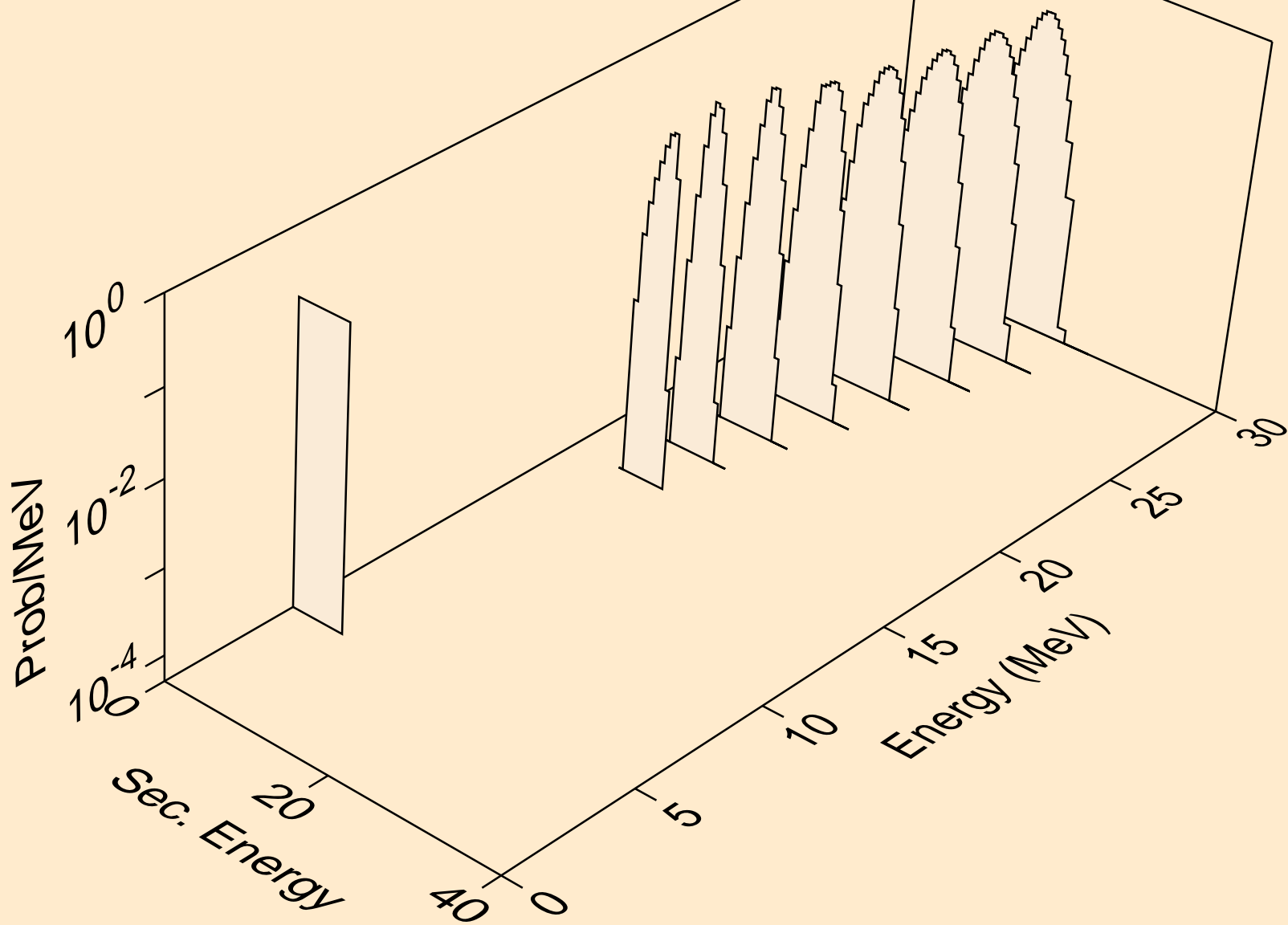

HG197 PROTON ACER TENDL-2021 LIBRARY; T=0.K  
alphas from (p,a)

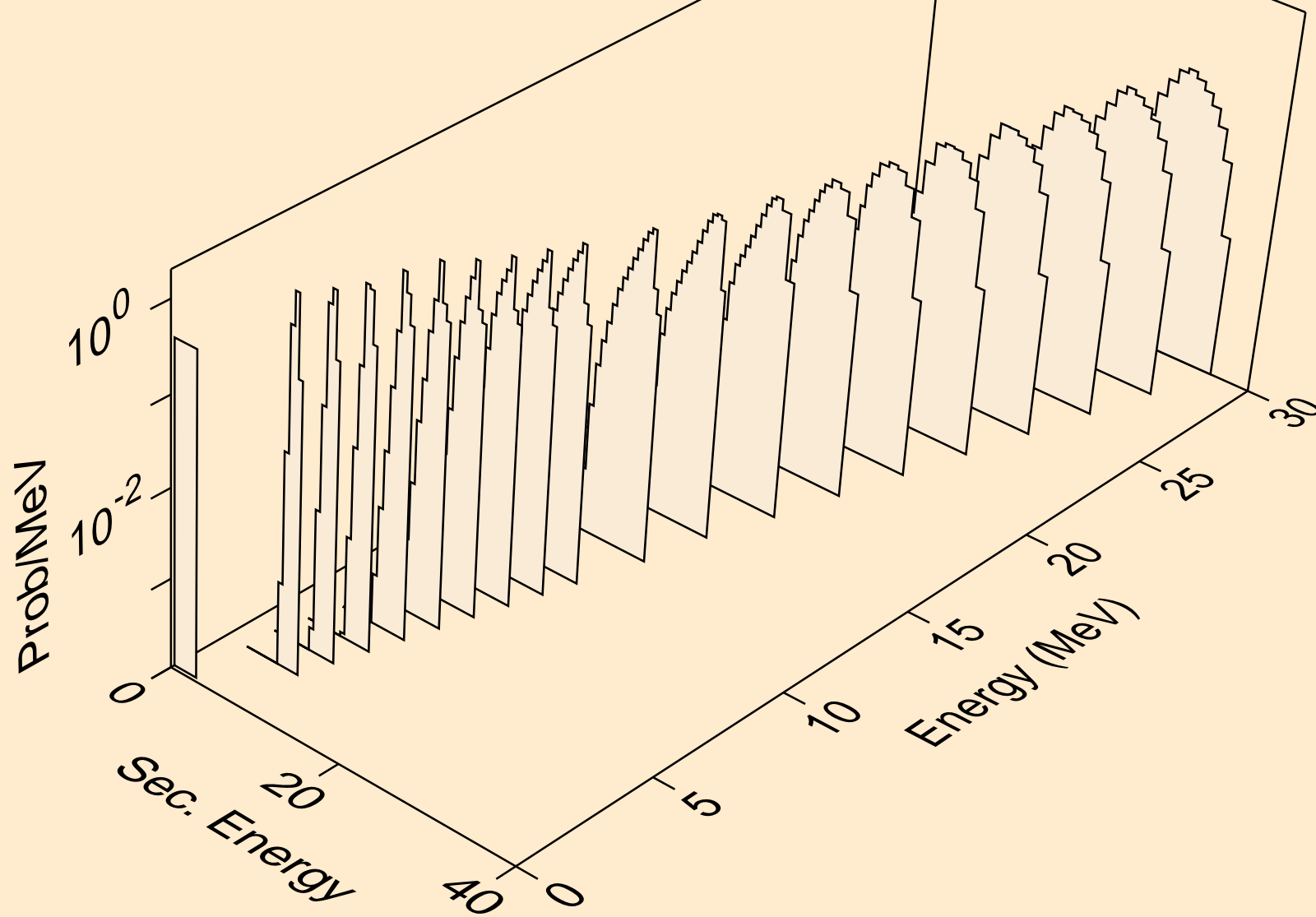

HG197 PROTON ACER TENDL-2021 LIBRARY; T=0.K  
alphas from (p,2a)

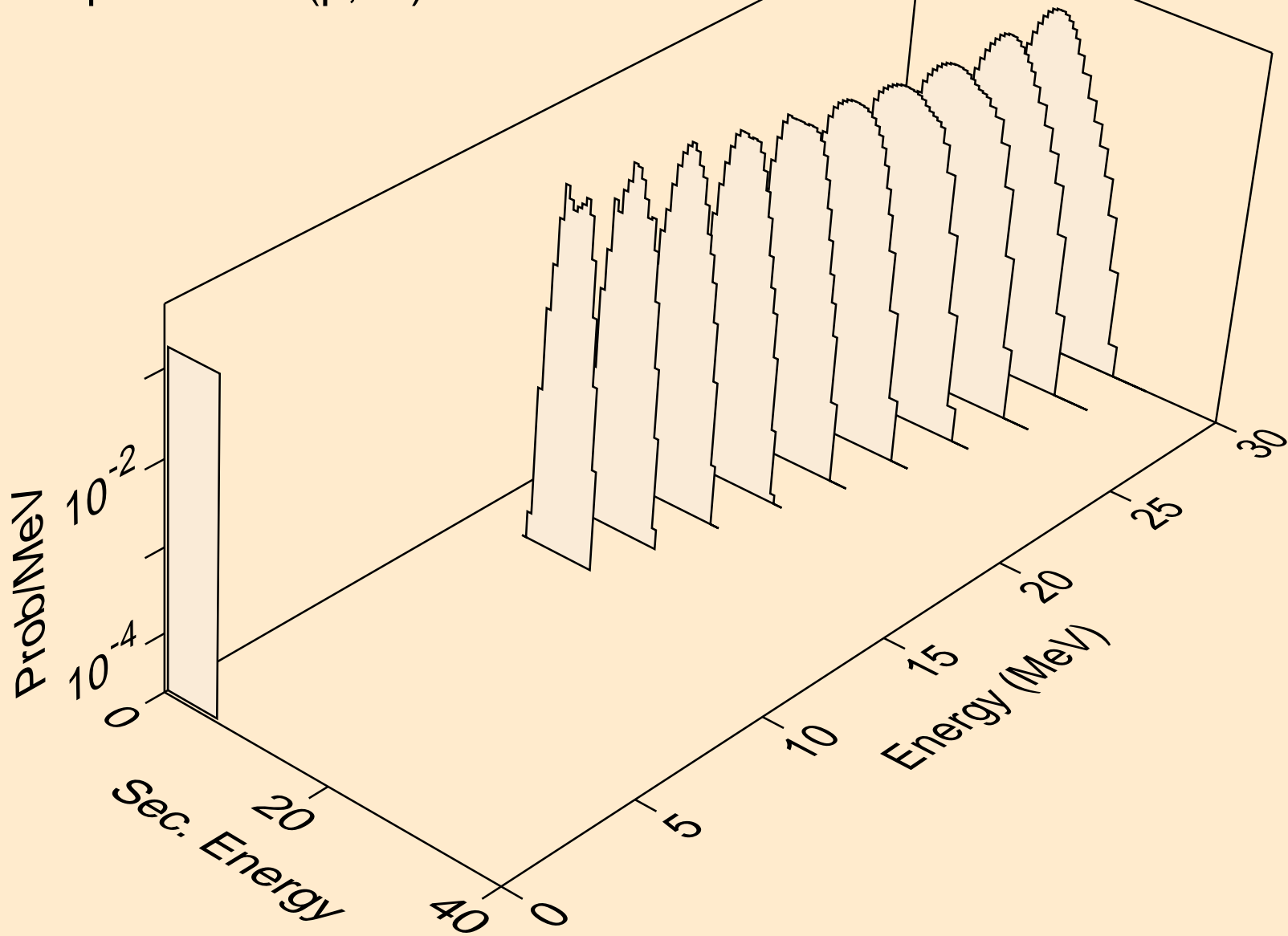

HG197 PROTON ACER TENDL-2021 LIBRARY; T=0.K  
alphas from (p,pa)

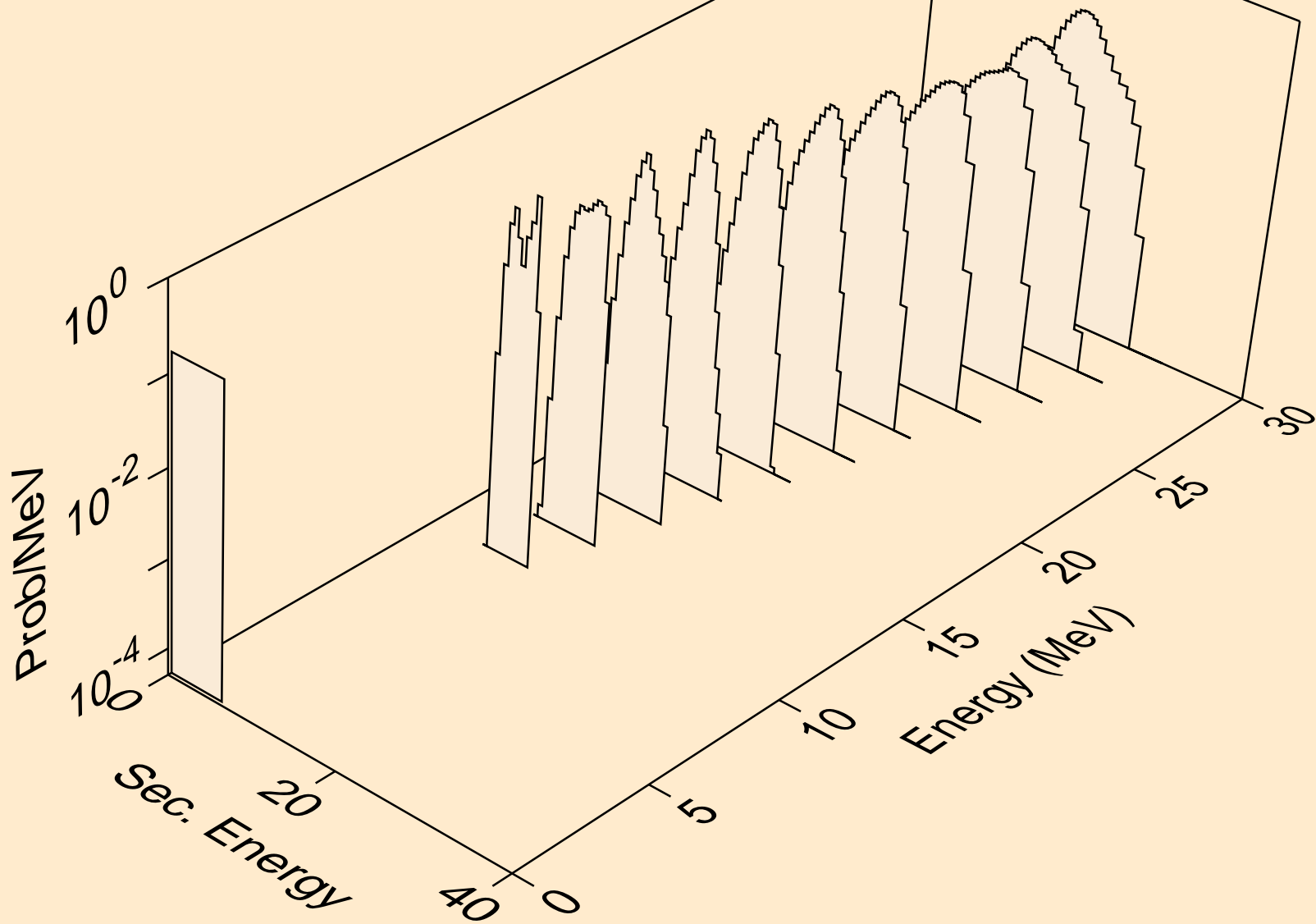

HG197 PROTON ACER TENDL-2021 LIBRARY; T=0.K  
alphas from (p,da)

