

# HO153 PROTON ACER TENDL-2021 LIBRARY; T=0.K

## Principal cross sections

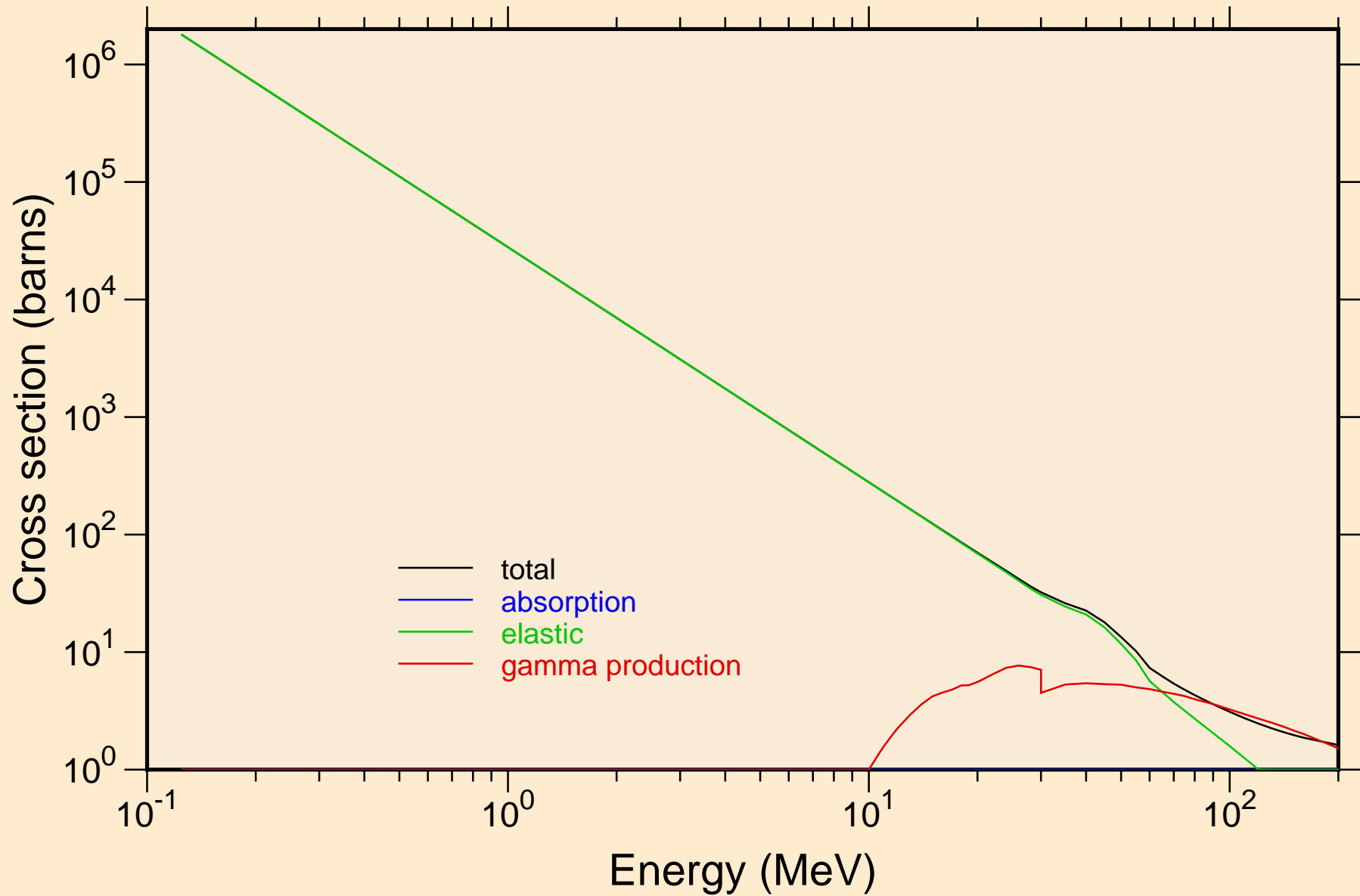

HO153 PROTON ACER TENDL-2021 LIBRARY; T=0.K  
Heating

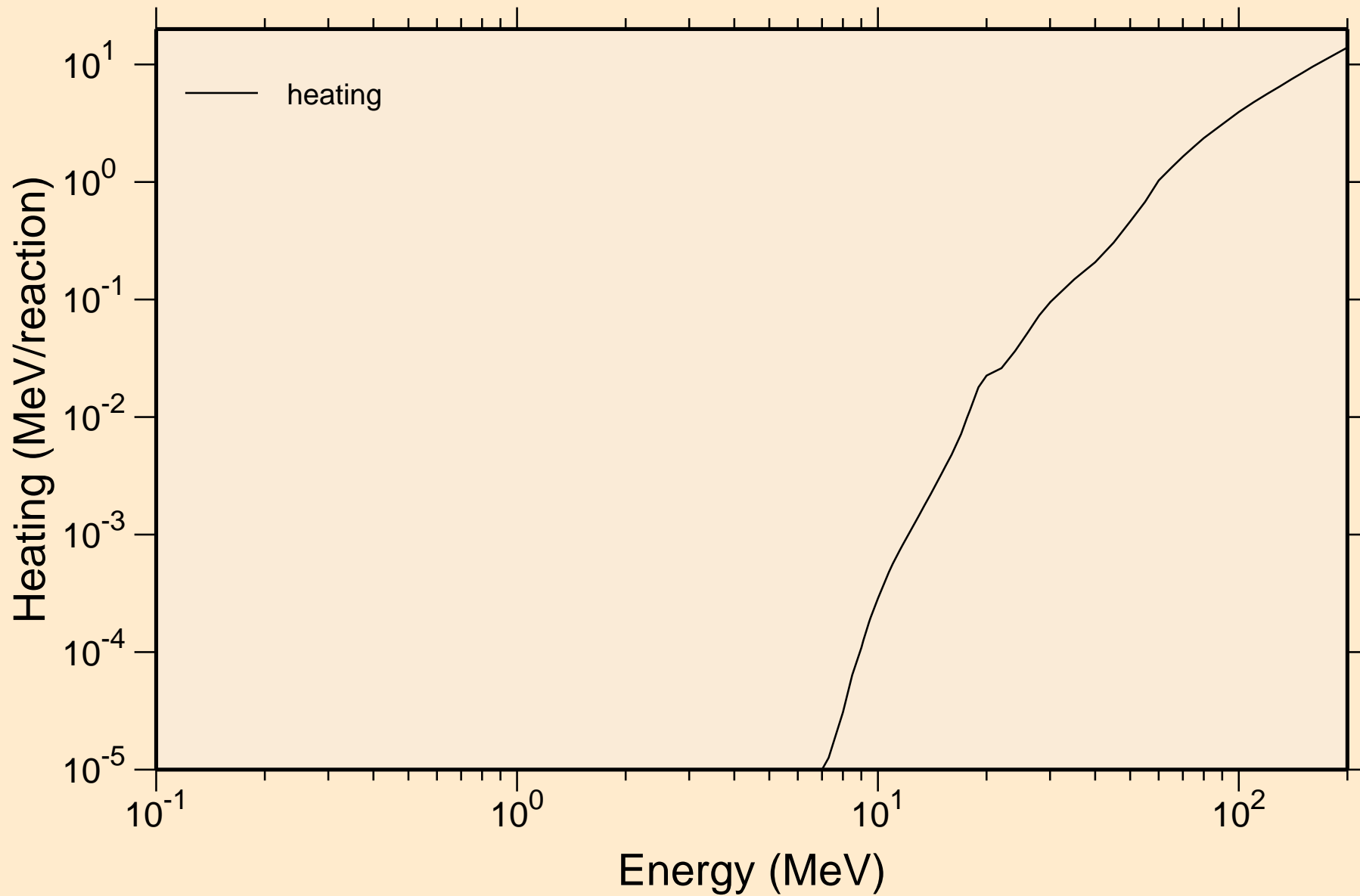

# HO153 PROTON ACER TENDL-2021 LIBRARY; T=0.K

## Principal cross sections

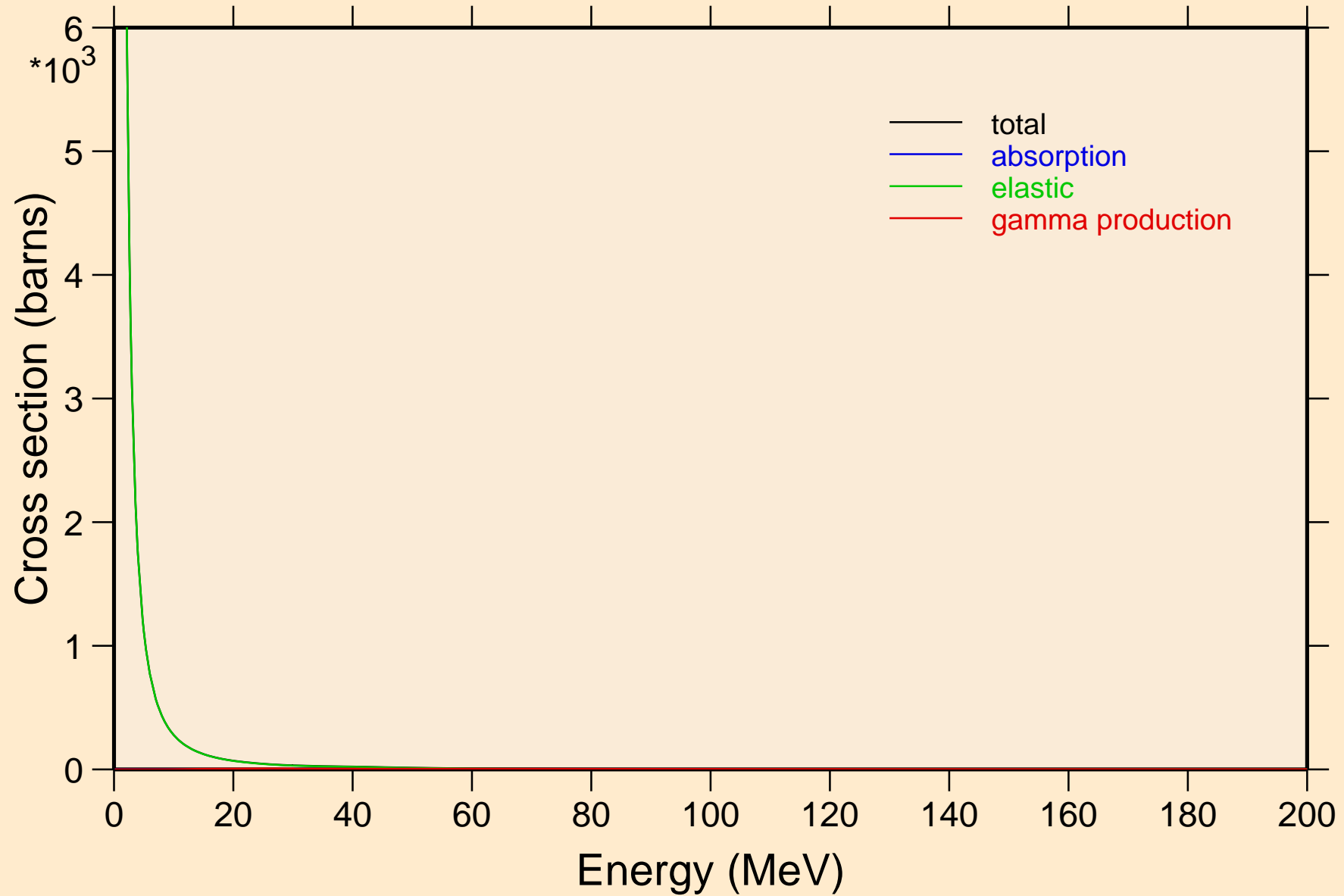

# HO153 PROTON ACER TENDL-2021 LIBRARY; T=0.K

## Heating

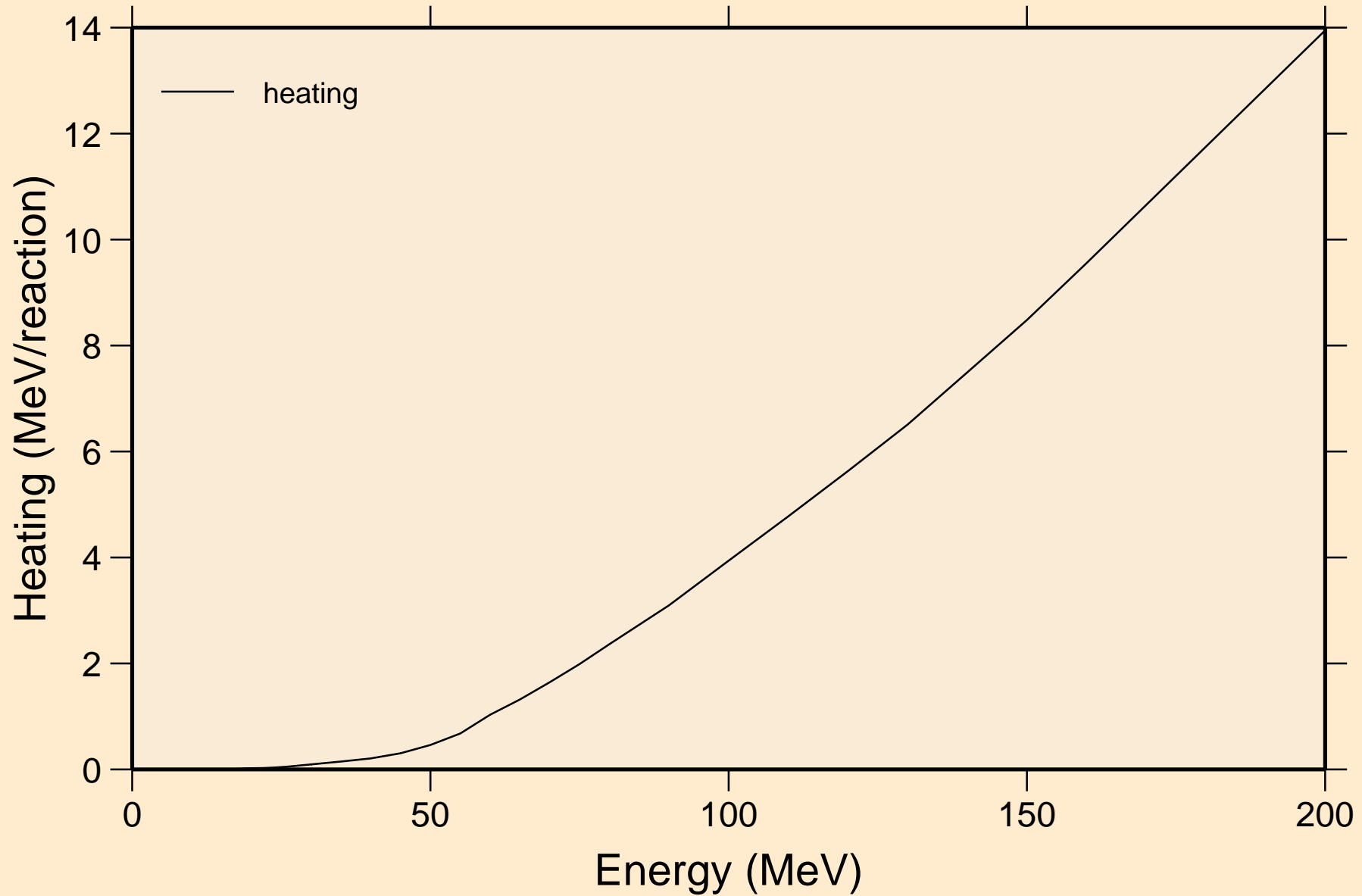

# HO153 PROTON ACER TENDL-2021 LIBRARY; T=0.K

## Threshold reactions

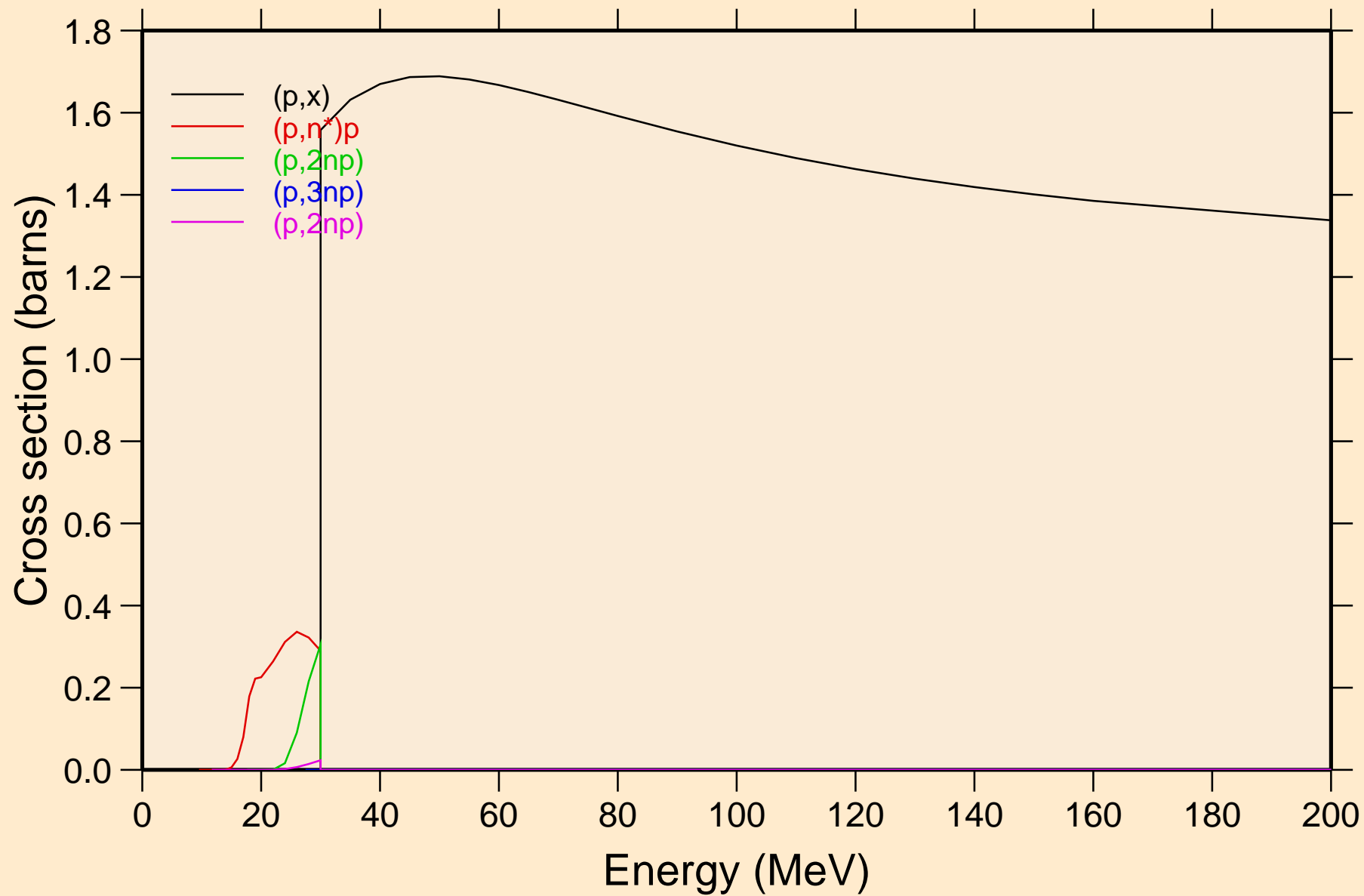

# HO153 PROTON ACER TENDL-2021 LIBRARY; T=0.K

## Threshold reactions

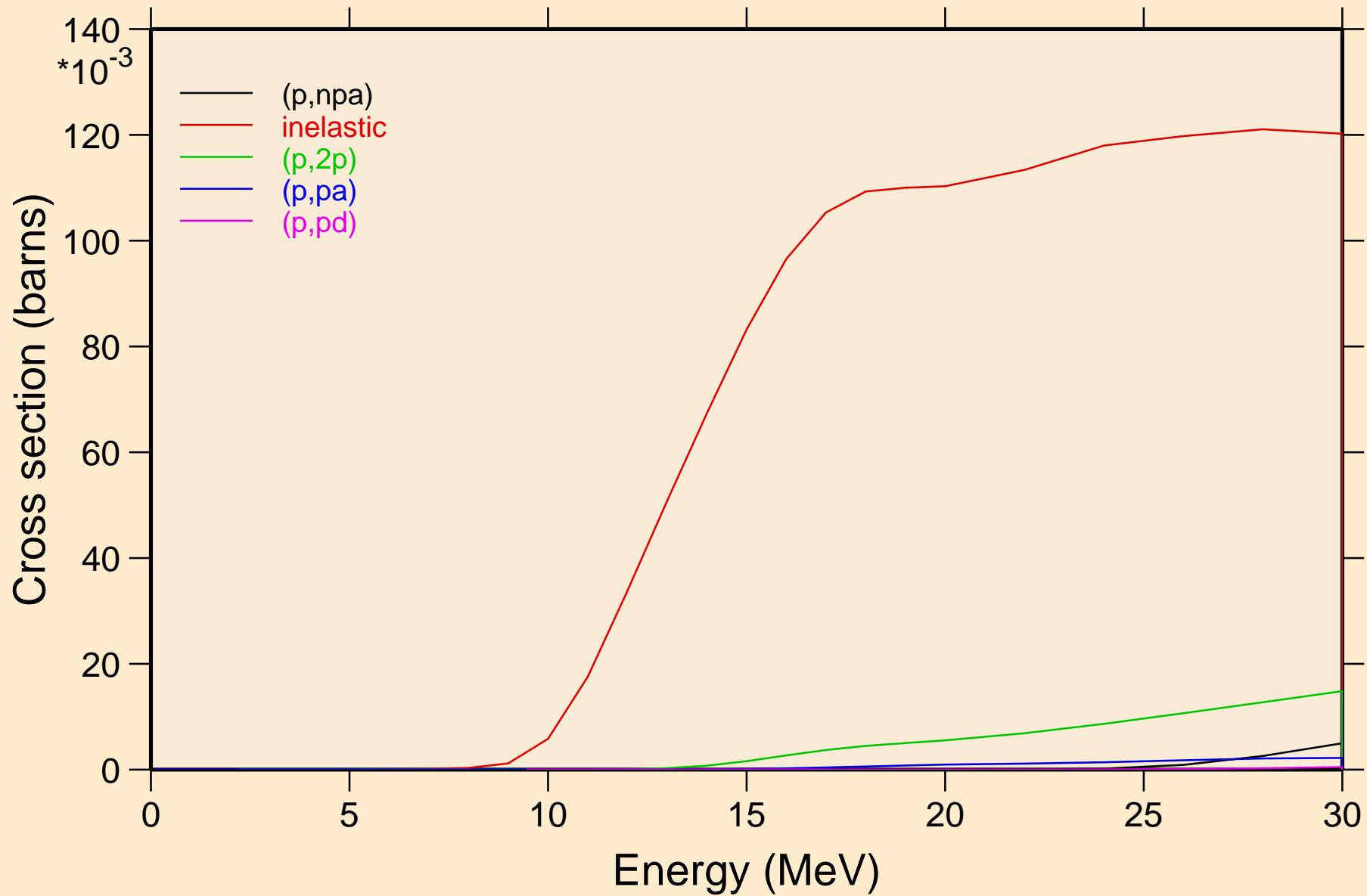

# HO153 PROTON ACER TENDL-2021 LIBRARY; T=0.K

## Threshold reactions

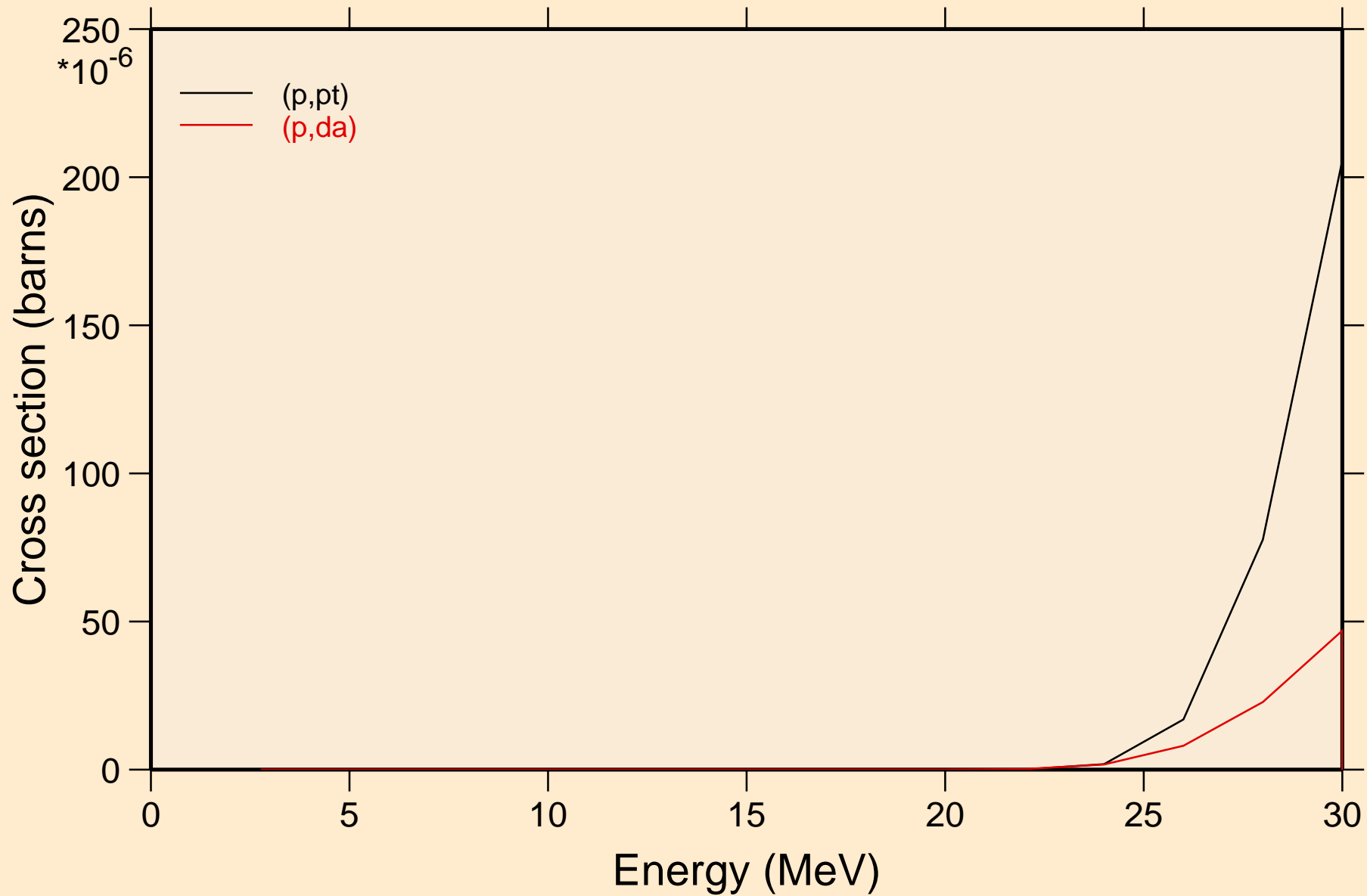

HO153 PROTON ACER TENDL-2021 LIBRARY; T=0.K  
angular distribution for elastic

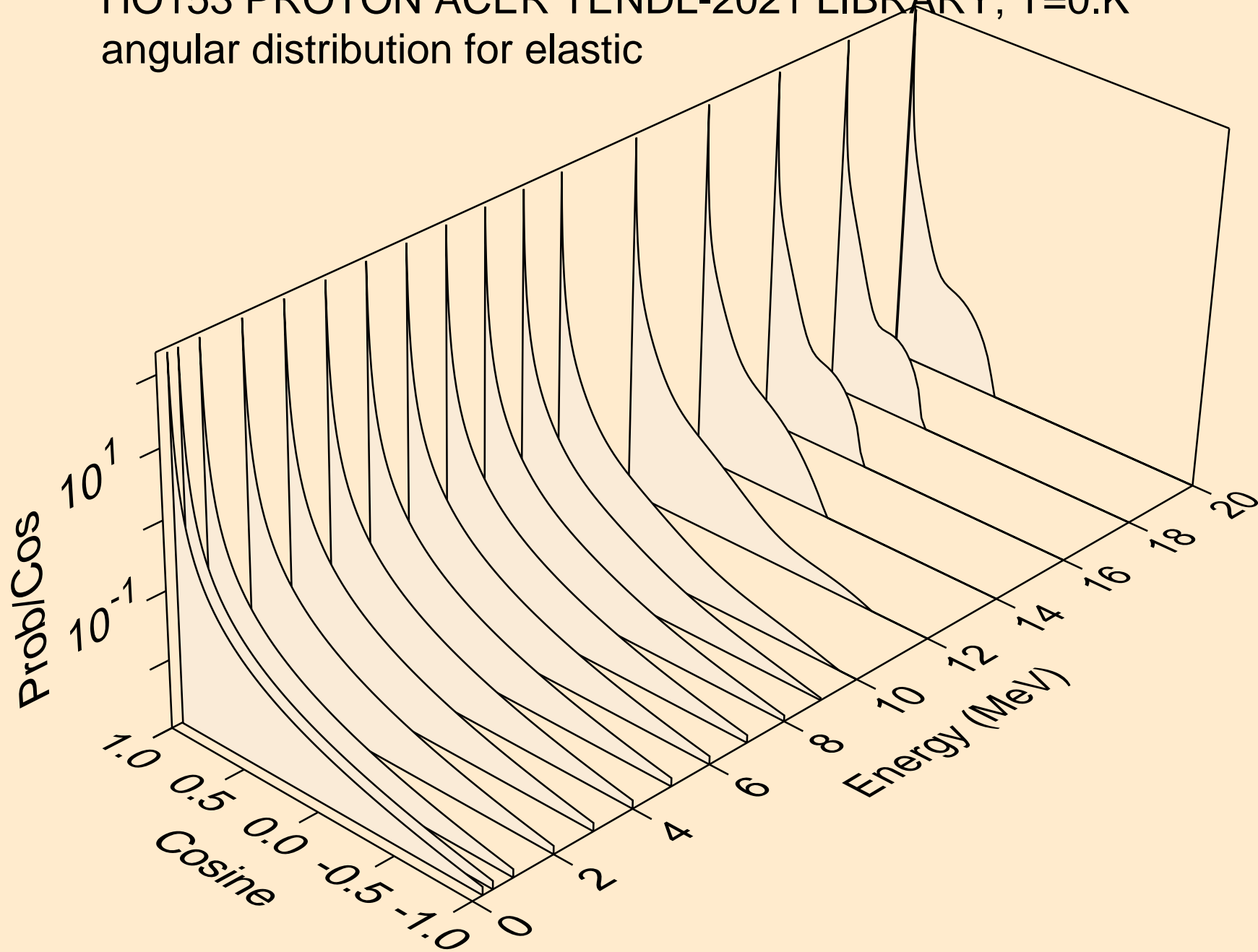



HO153 PROTON ACER TENDL-2021 LIBRARY; T=0.K  
angular distribution for elastic

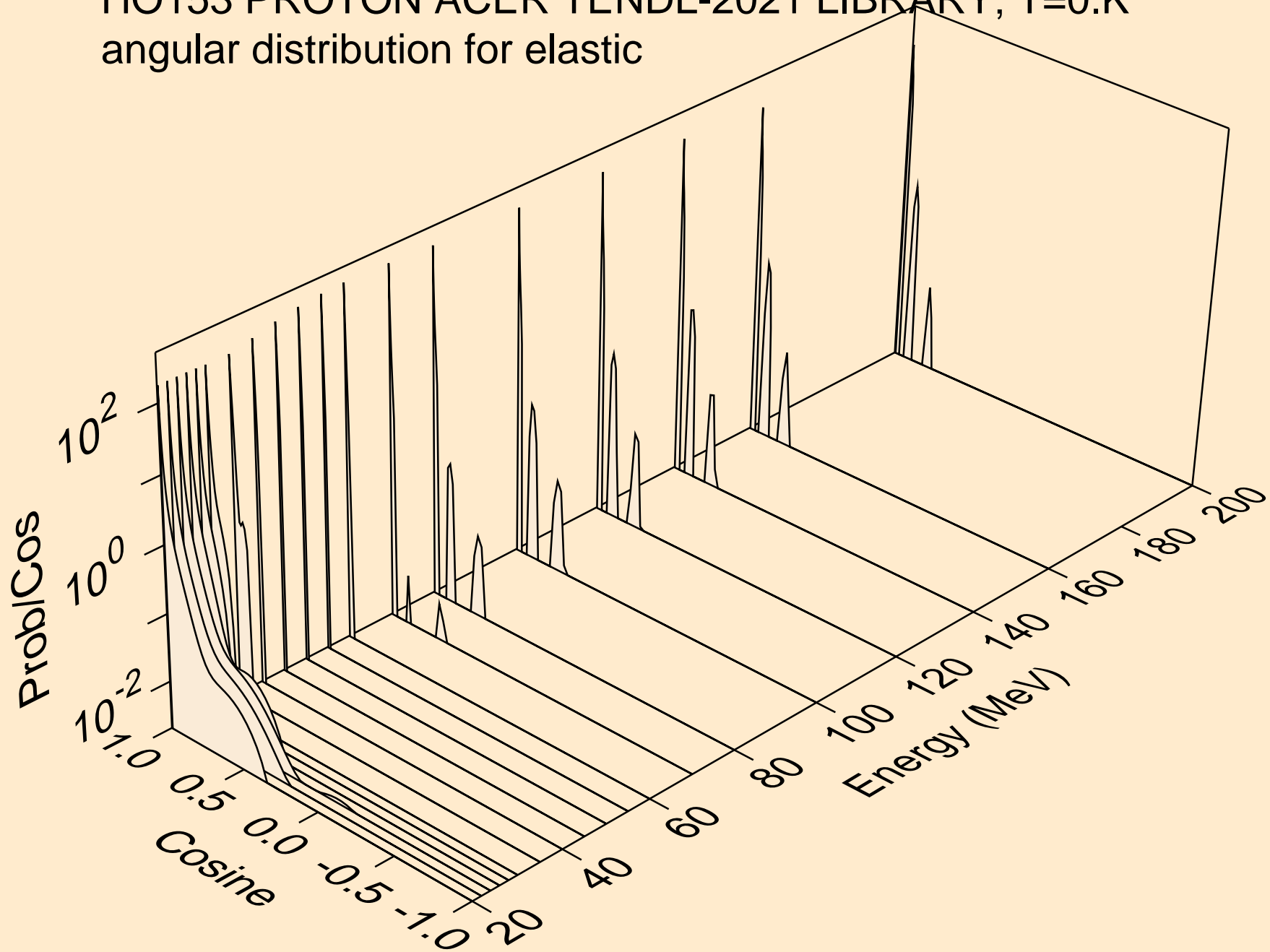

HO153 PROTON ACER TENDL-2021 LIBRARY; T=0.K  
Proton emission for (p,x)

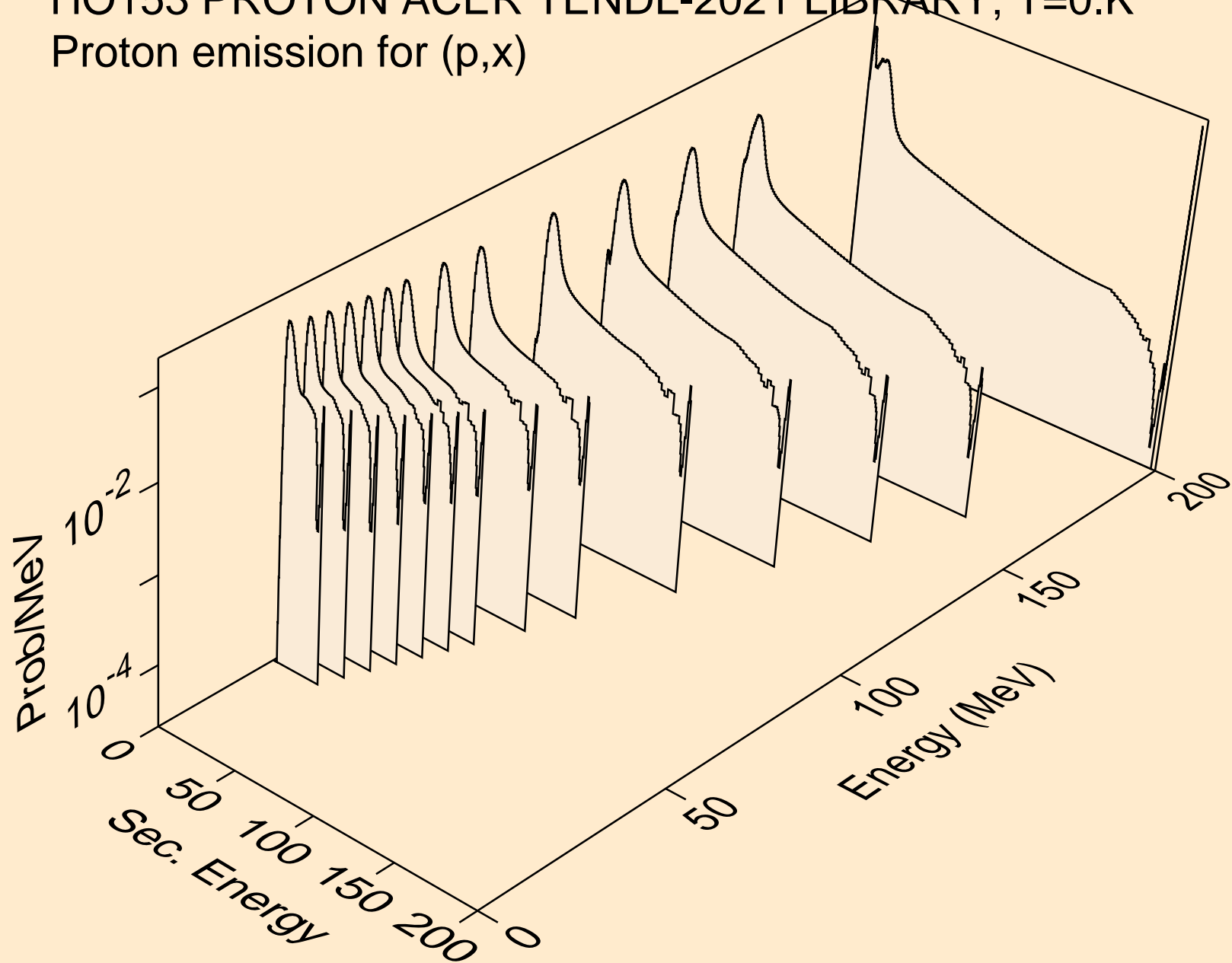

HO153 PROTON ACER TENDL-2021 LIBRARY; T=0.K  
Proton emission for (p,n\*)p

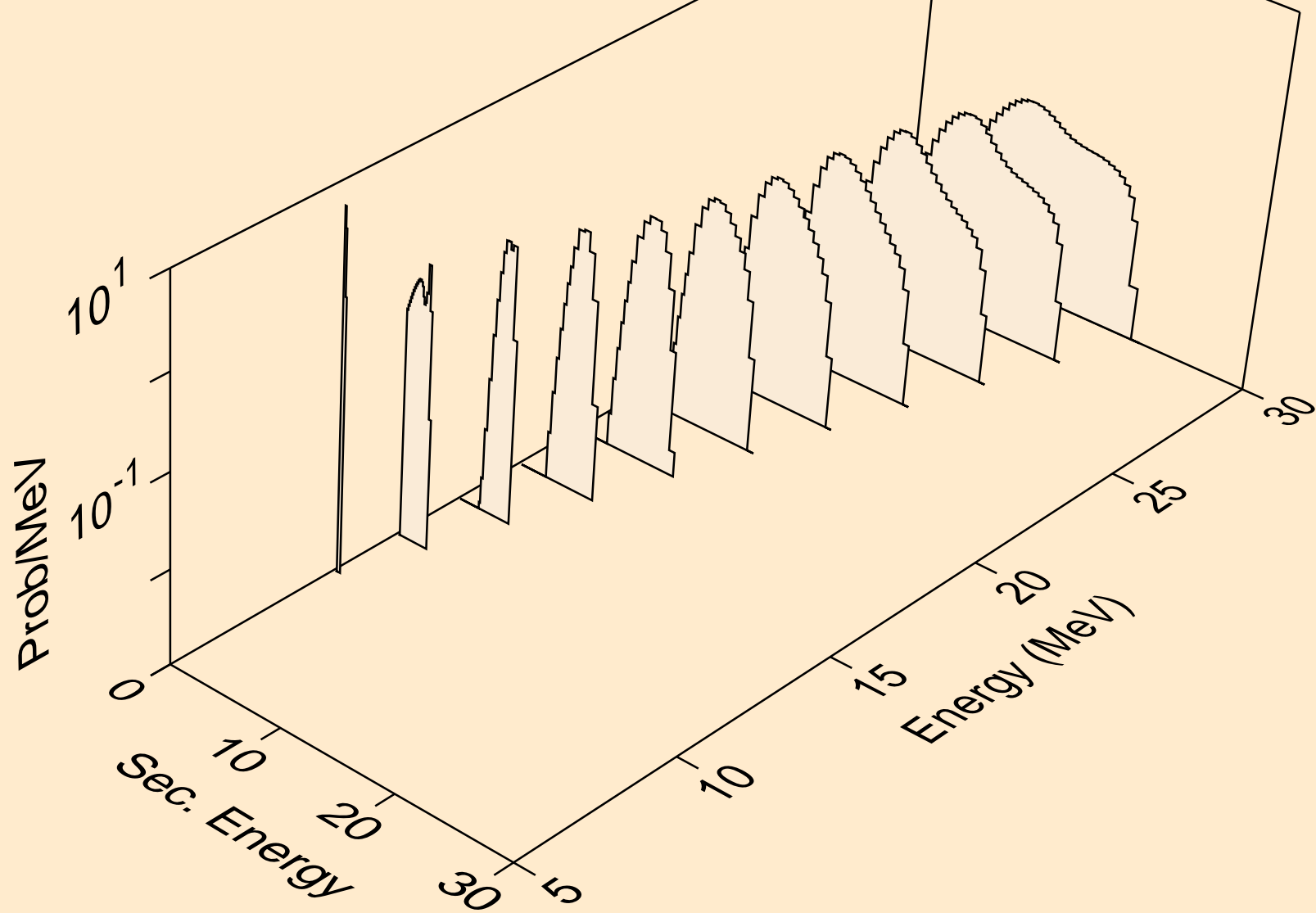

HO153 PROTON ACER TENDL-2021 LIBRARY; T=0.K  
Proton emission for (p,2np)

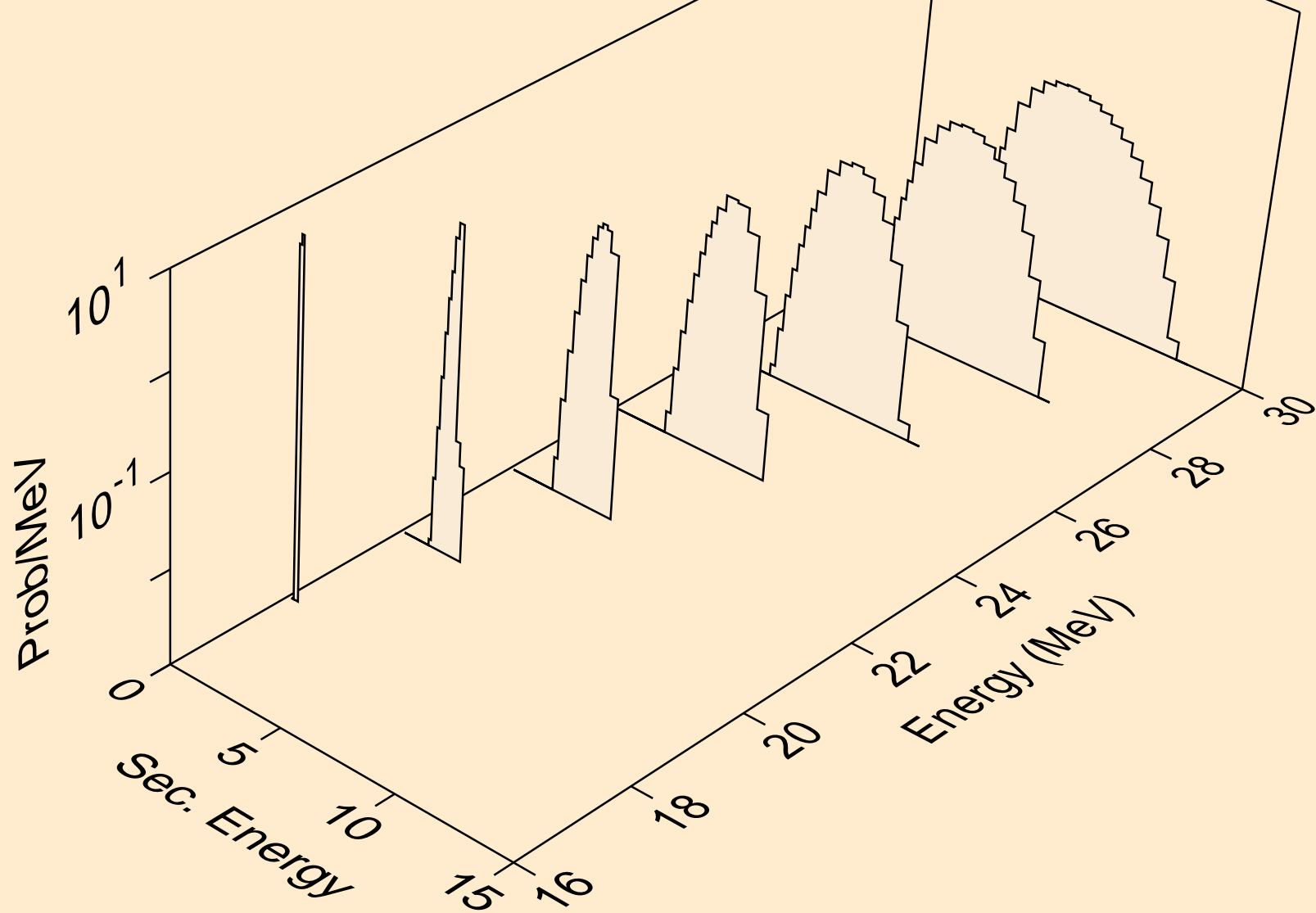

HO153 PROTON ACER TENDL-2021 LIBRARY; T=0.K  
Proton emission for (p,3np)

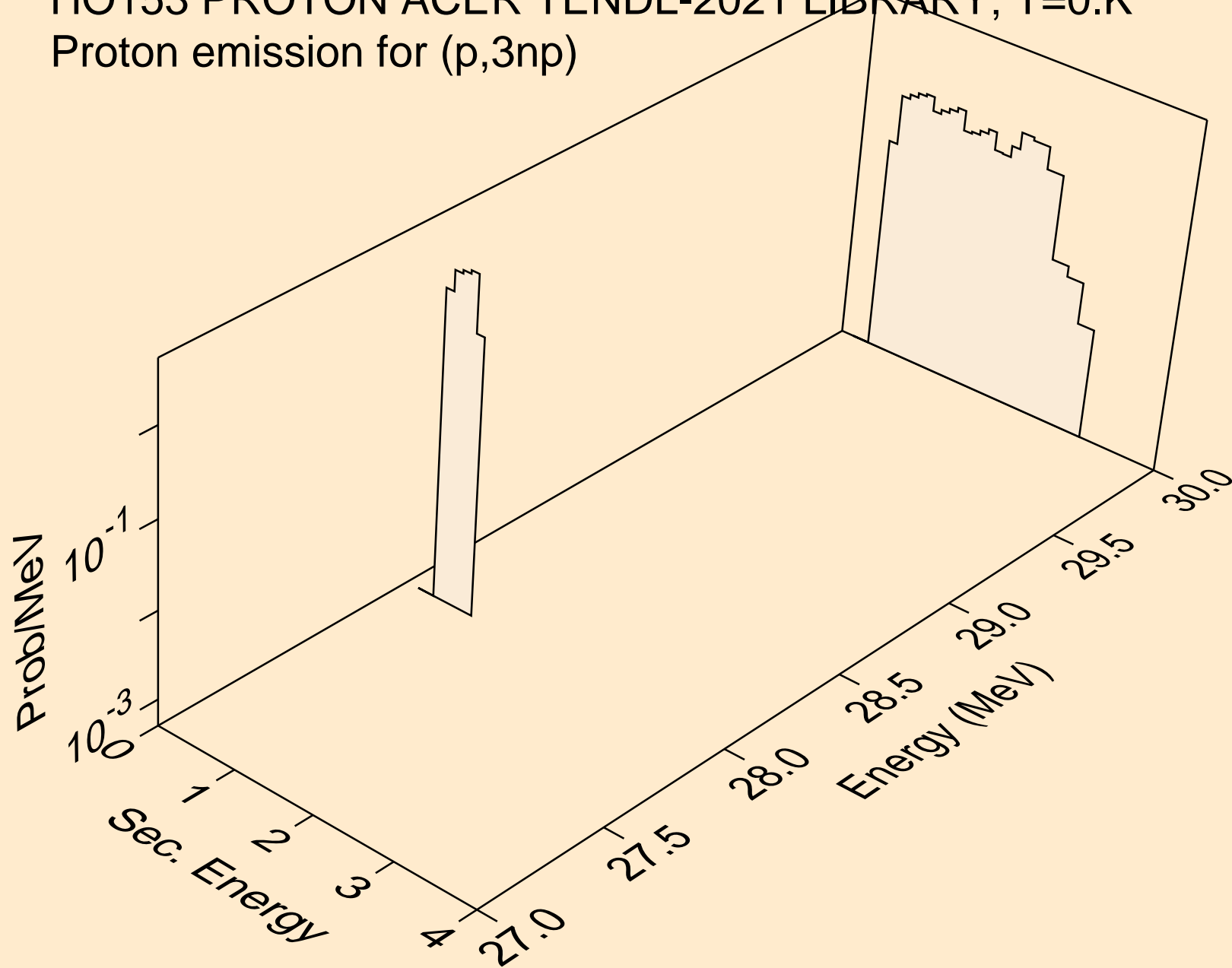

HO153 PROTON ACER TENDL-2021 LIBRARY; T=0.K  
Proton emission for (p,2np)

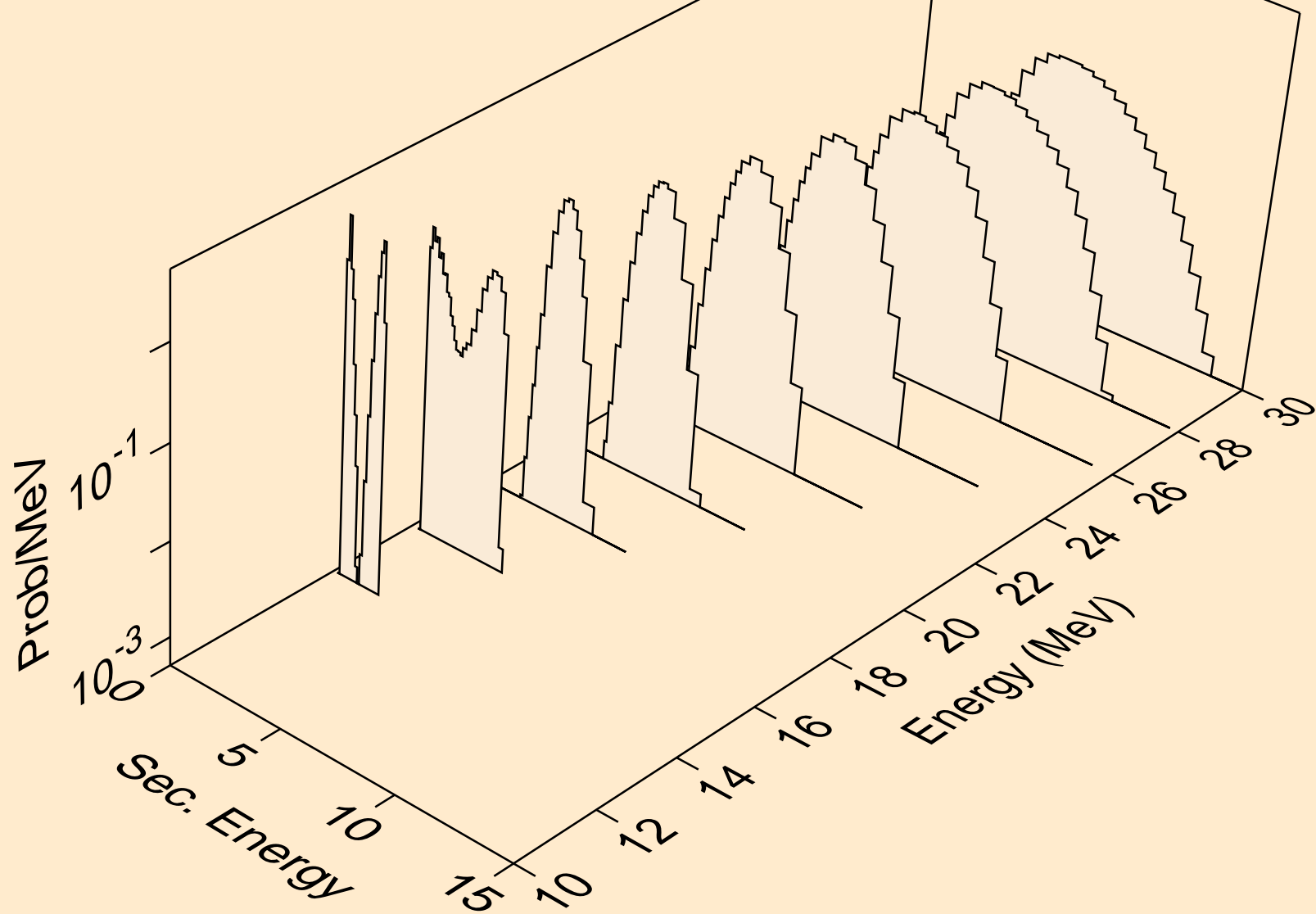

HO153 PROTON ACER TENDL-2021 LIBRARY; T=0.K  
Proton emission for (p,npa)

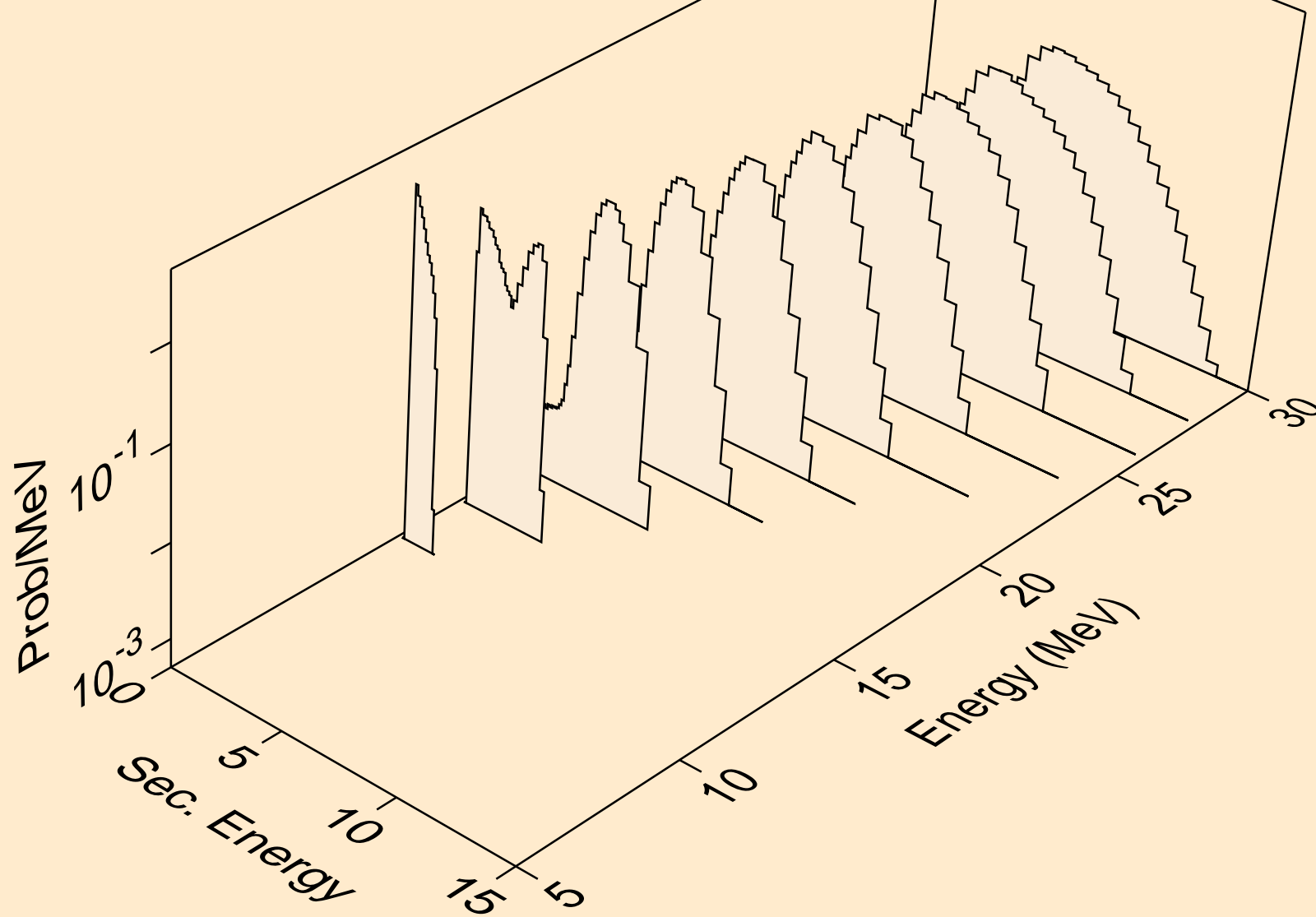

HO153 PROTON ACER TENDL-2021 LIBRARY; T=0.K  
Proton emission for inelastic

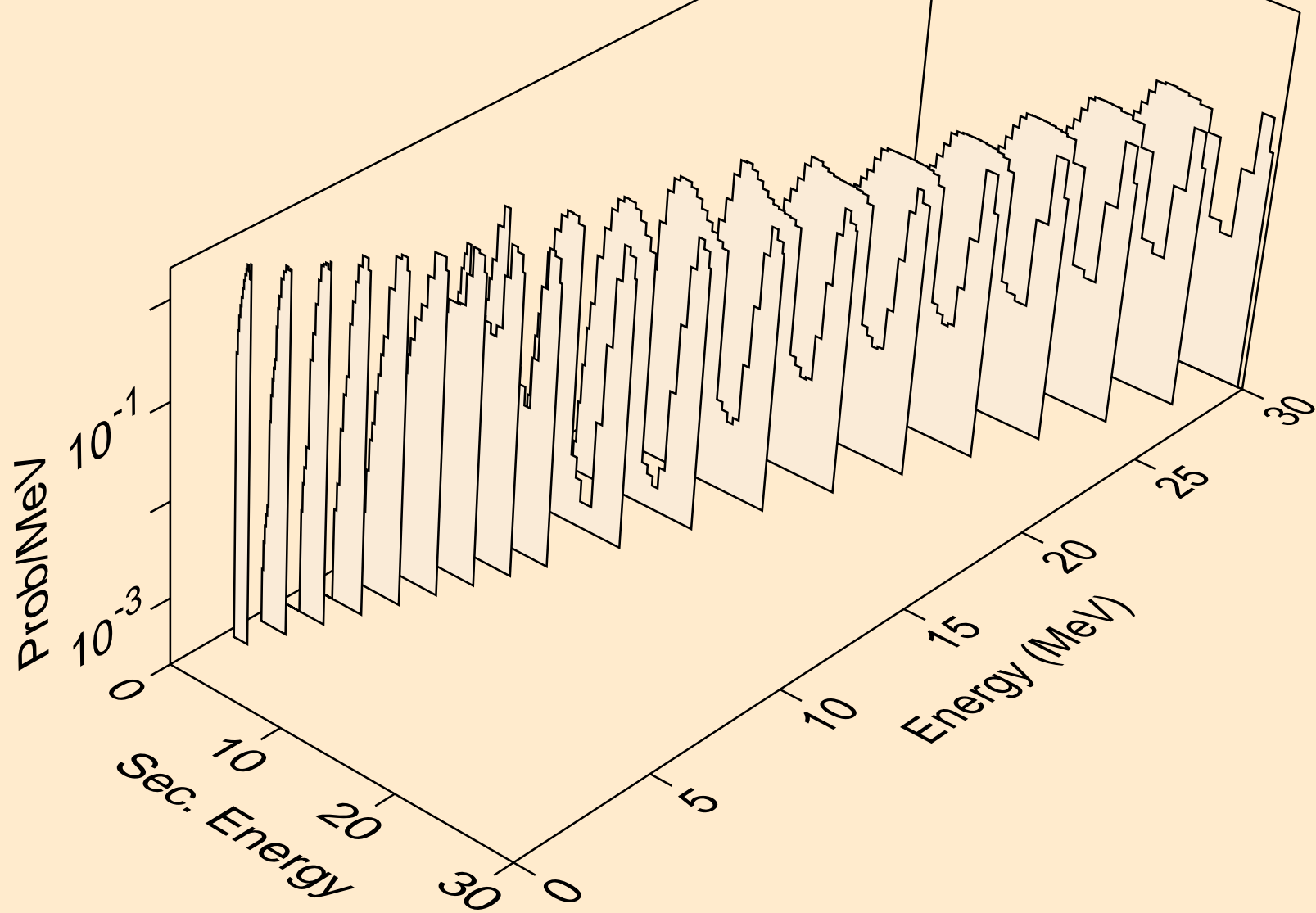



HO153 PROTON ACER TENDL-2021 LIBRARY; T=0.K  
Proton emission for (p,2p)

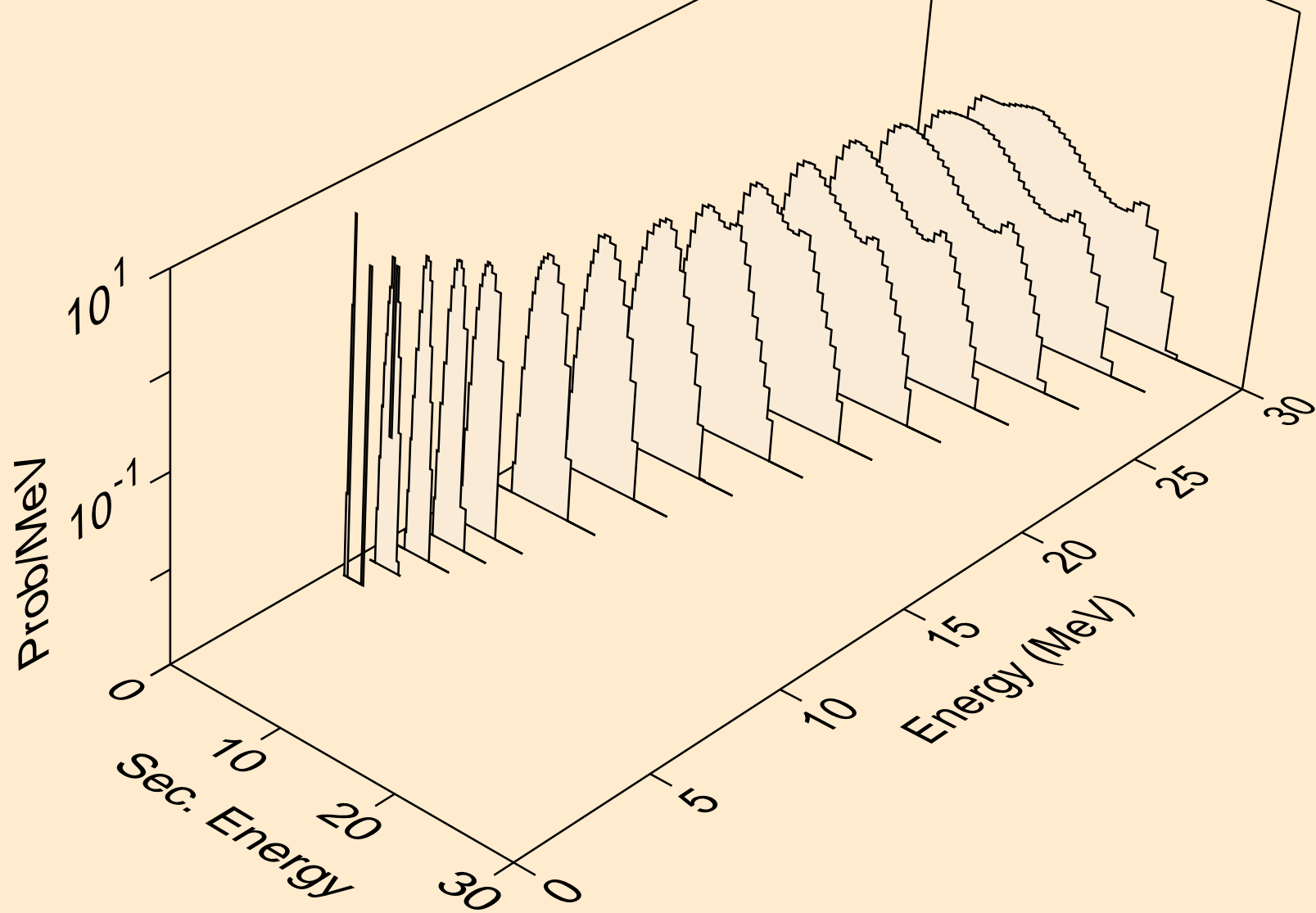

HO153 PROTON ACER TENDL-2021 LIBRARY; T=0.K  
Proton emission for (p,pa)

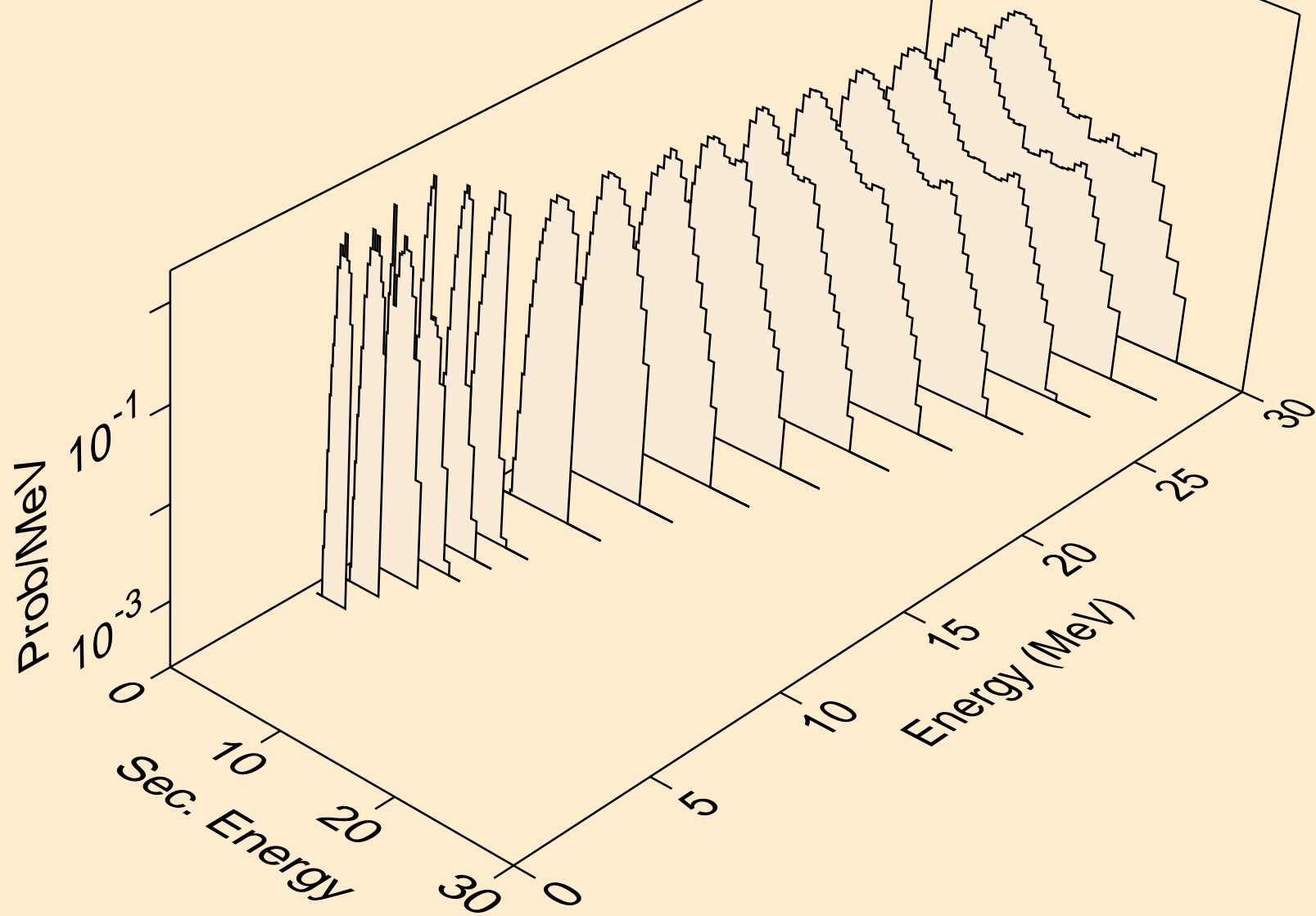

HO153 PROTON ACER TENDL-2021 LIBRARY; T=0.K  
Proton emission for (p,pd)

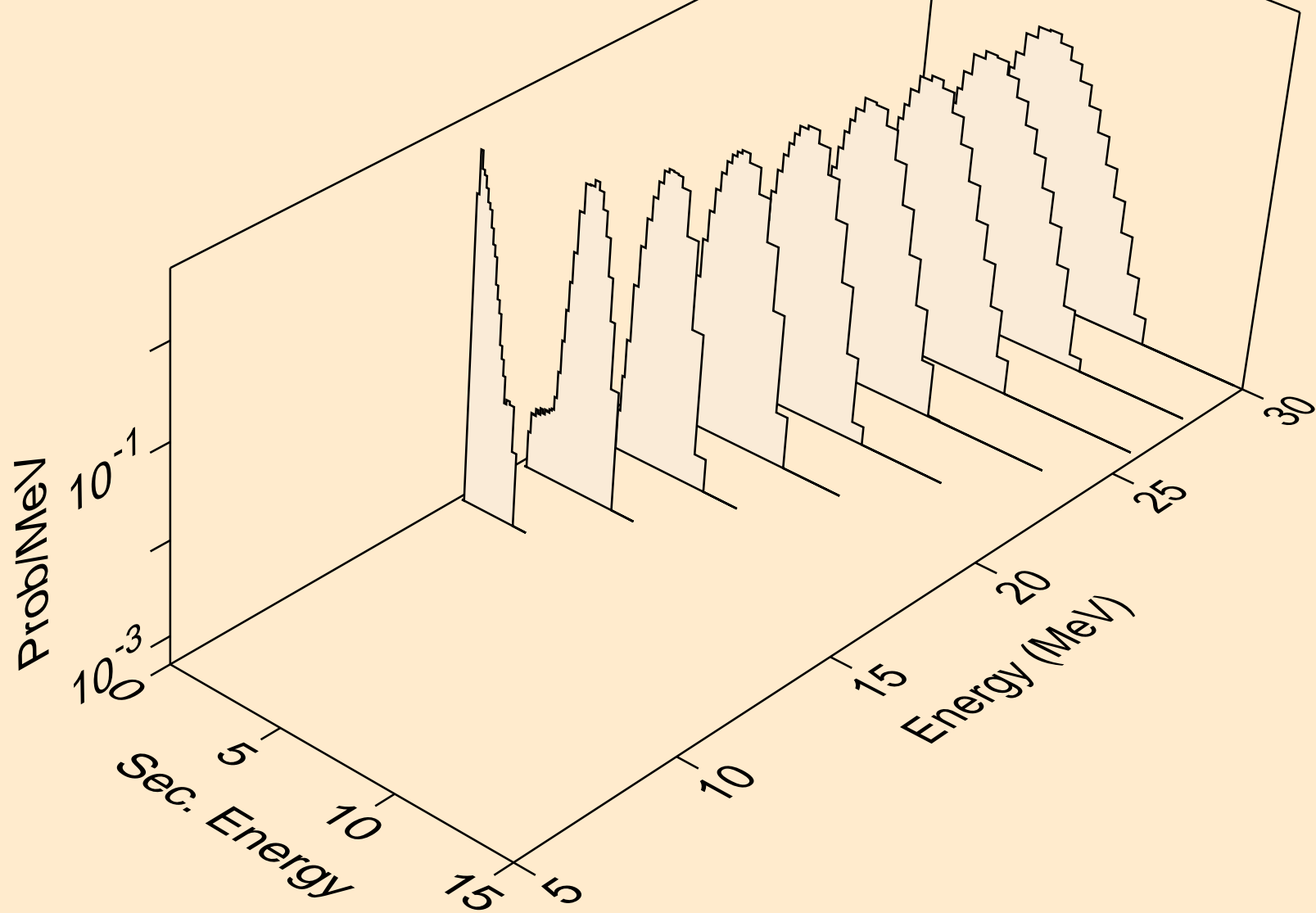

HO153 PROTON ACER TENDL-2021 LIBRARY; T=0.K  
Proton emission for (p,pt)

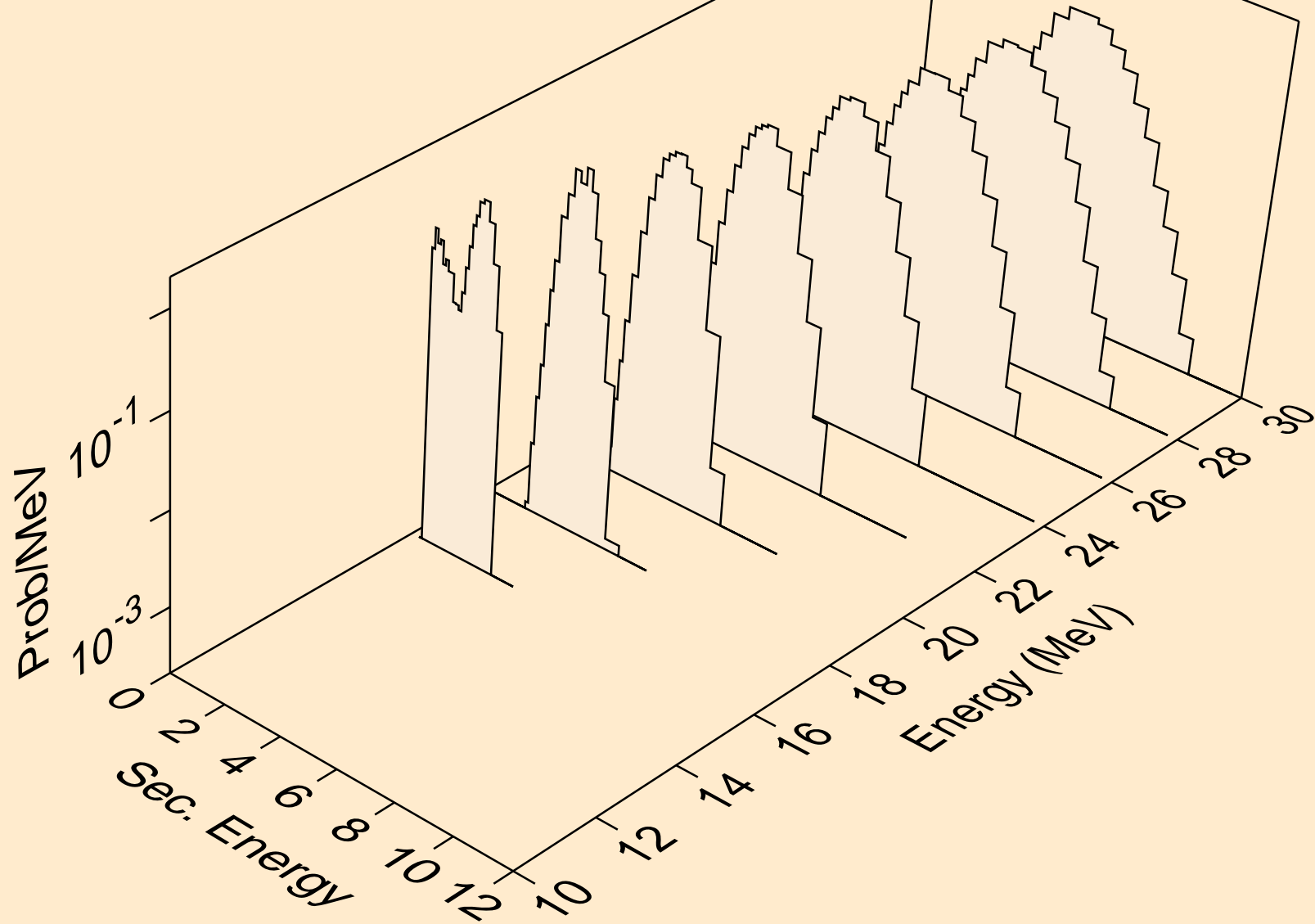

HO153 PROTON ACER TENDL-2021 LIBRARY; T=0.K  
Photon emission for (z,n)

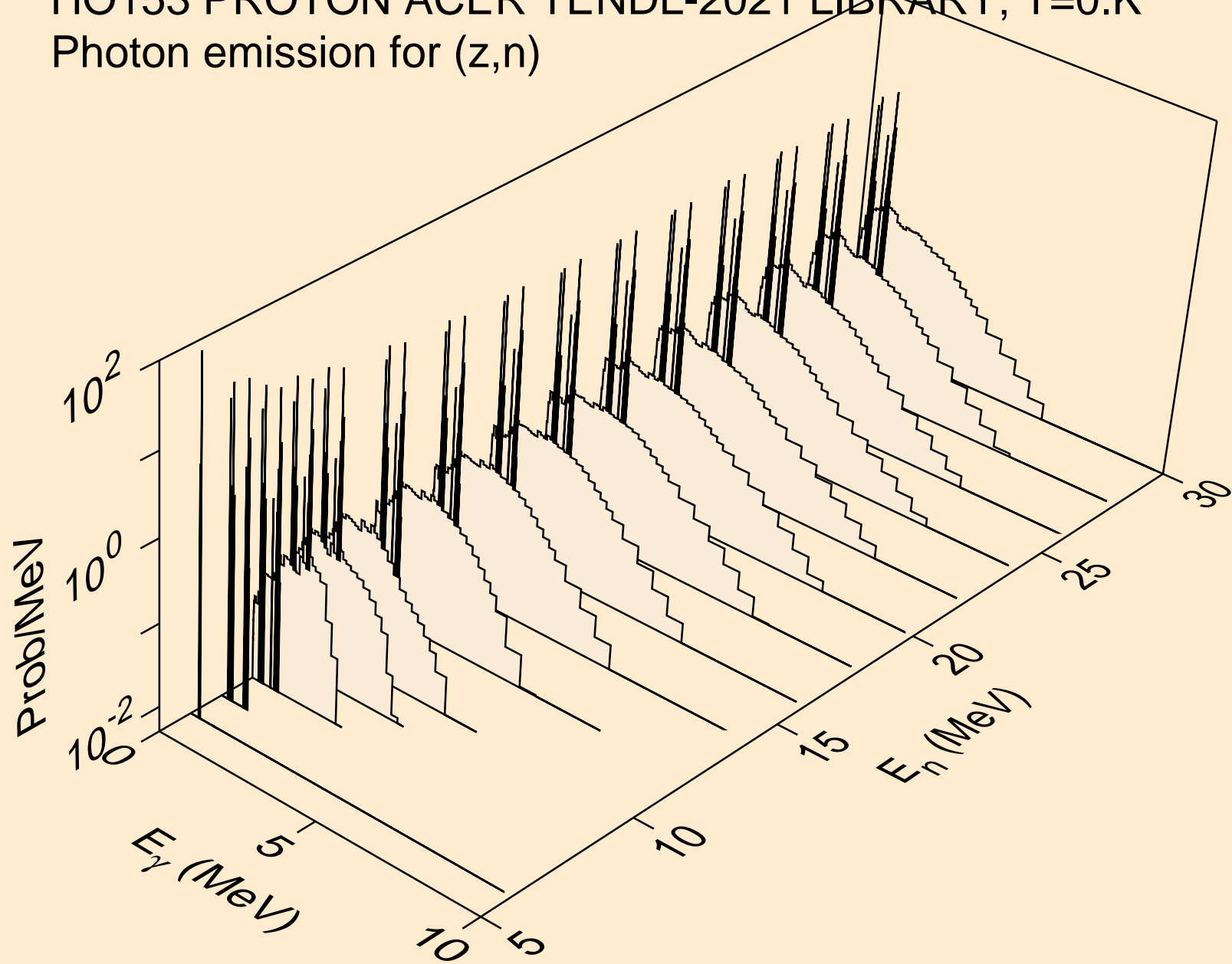

HO153 PROTON ACER TENDL-2021 LIBRARY; T=0.K  
Photon emission for (n,x)

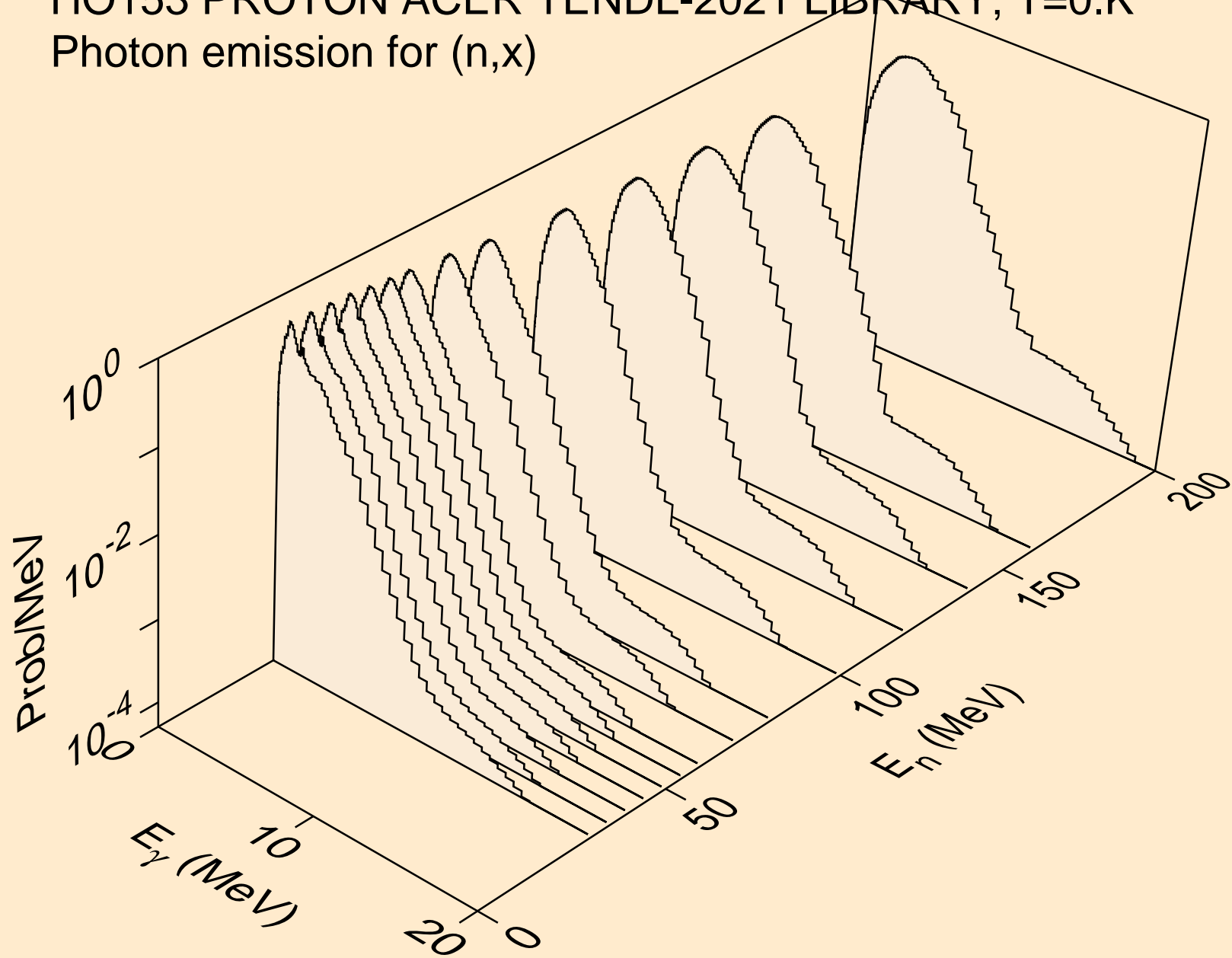

HO153 PROTON ACER TENDL-2021 LIBRARY; T=0.K  
Photon emission for (n,2nd)

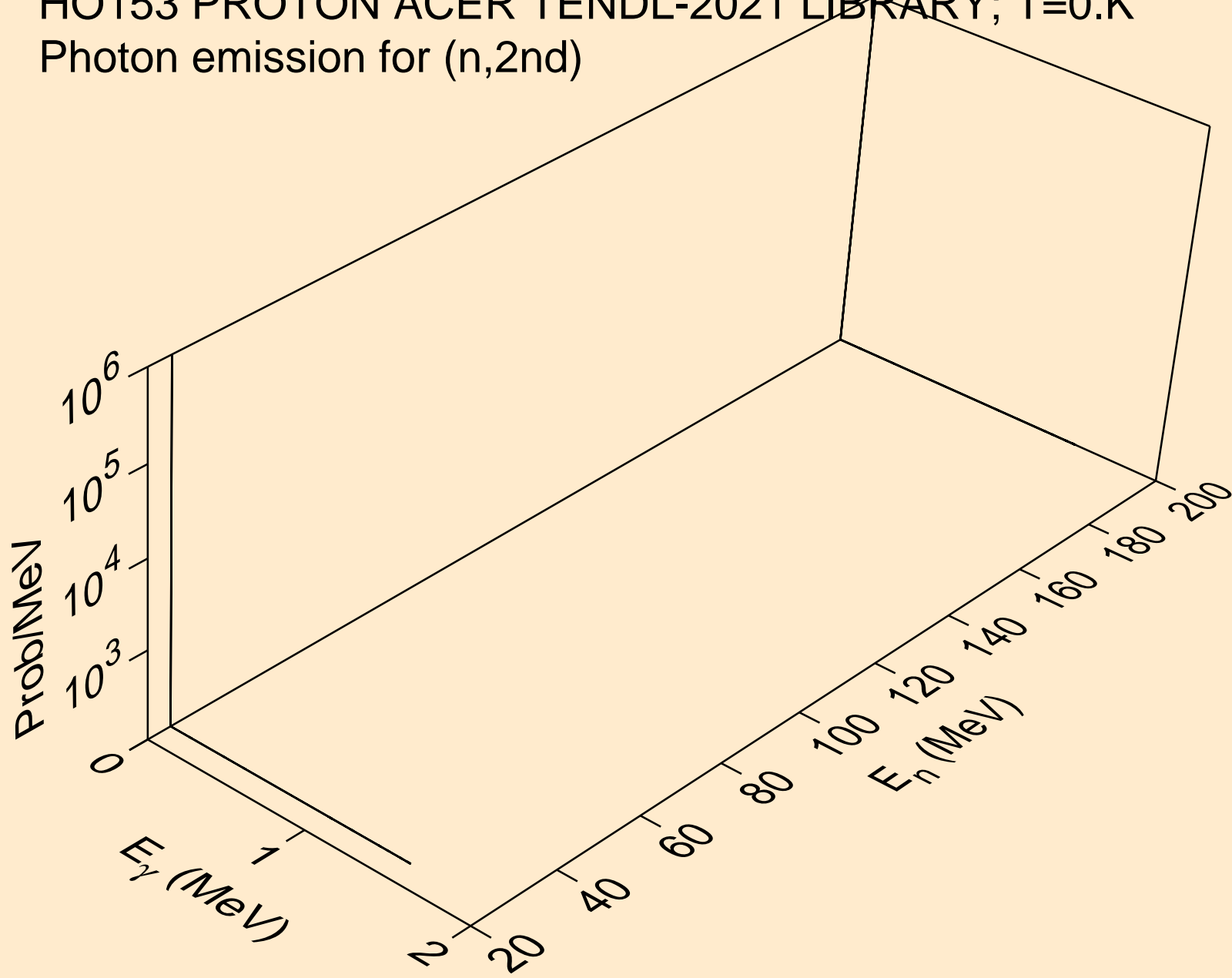

HO153 PROTON ACER TENDL-2021 LIBRARY; T=0.K  
Photon emission for (n,2n)

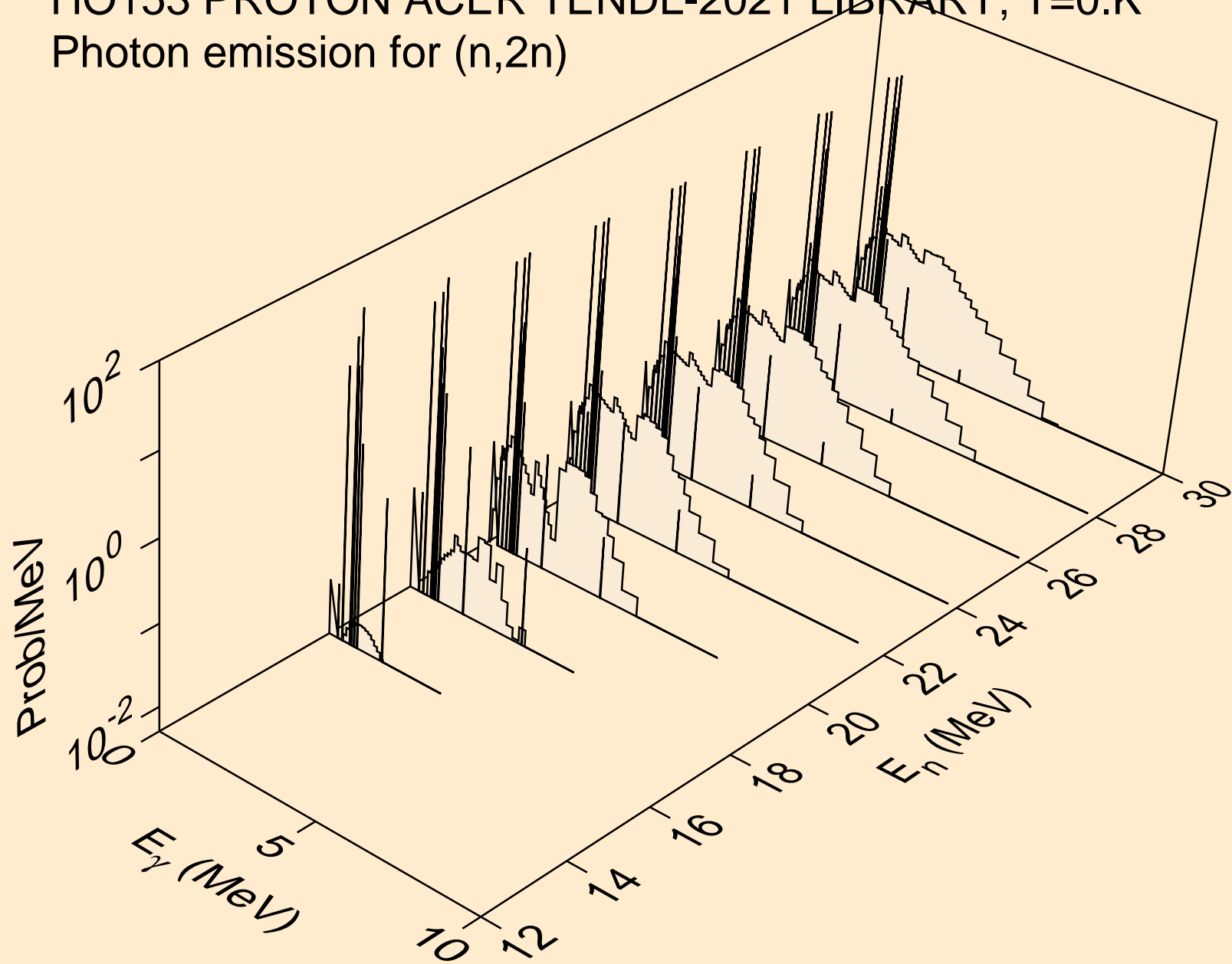



HO153 PROTON ACER TENDL-2021 LIBRARY; T=0.K  
Photon emission for (n,3n)

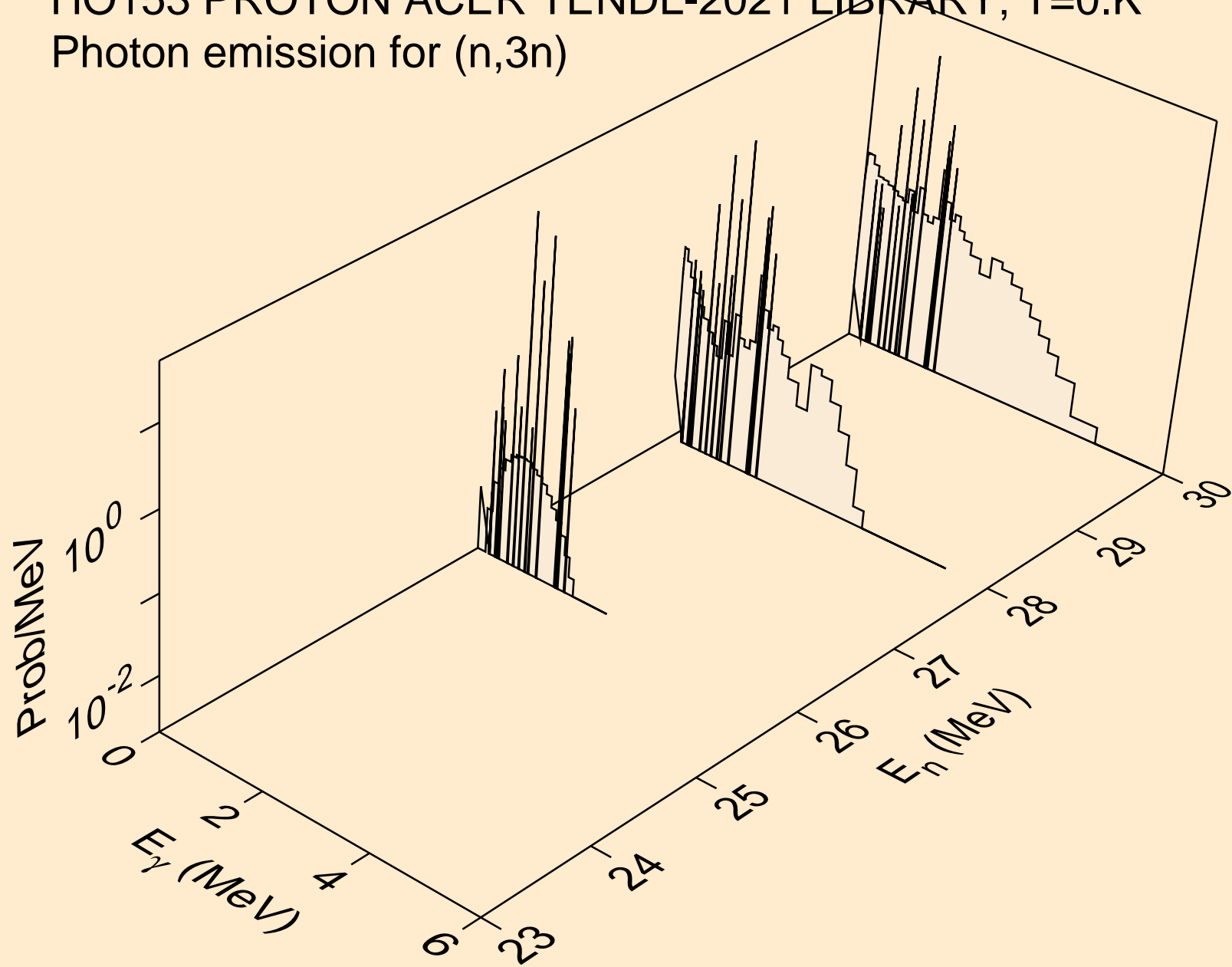

HO153 PROTON ACER TENDL-2021 LIBRARY; T=0.K  
Photon emission for (n,n\*)a

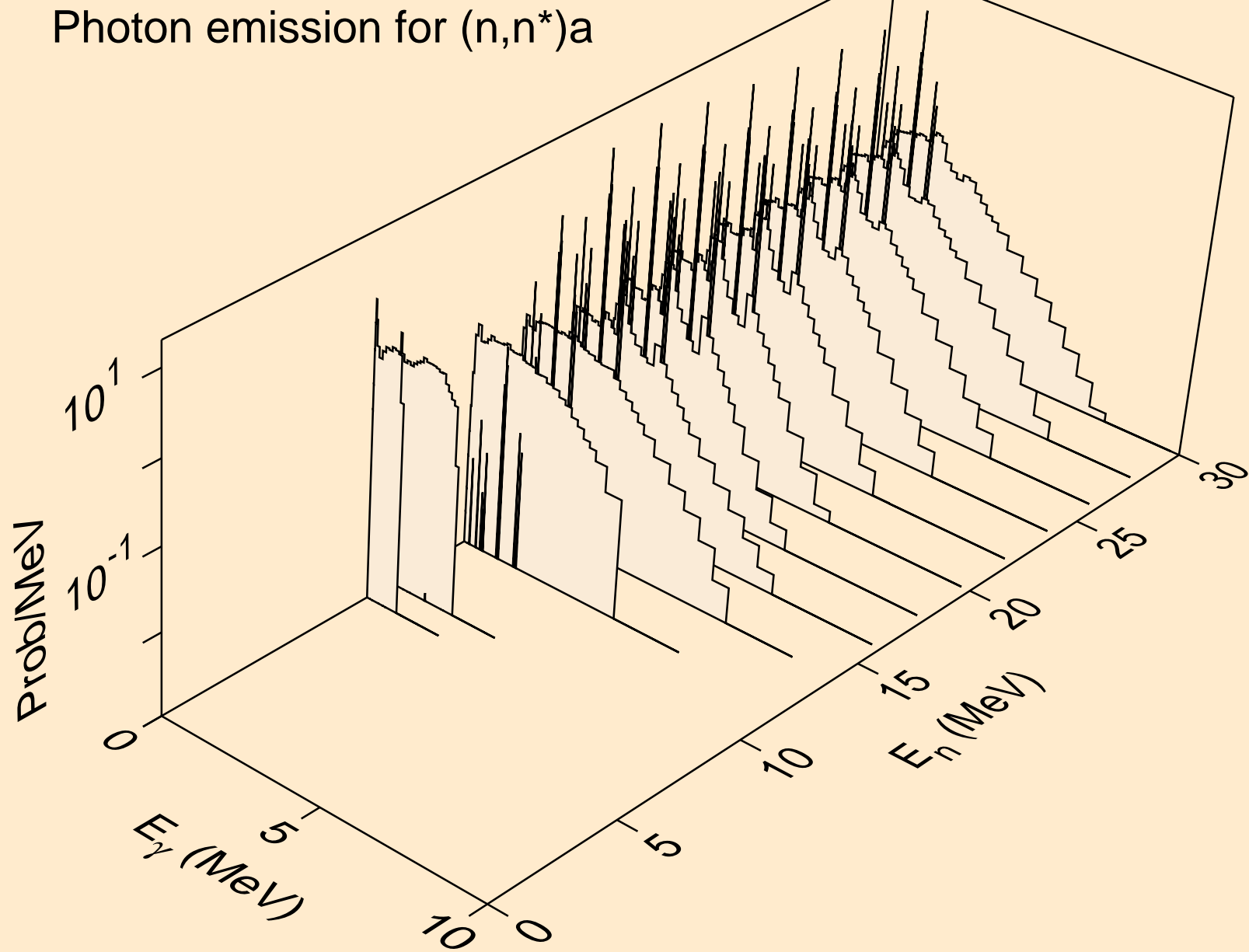

HO153 PROTON ACER TENDL-2021 LIBRARY; T=0.K  
Photon emission for (n,2n)a

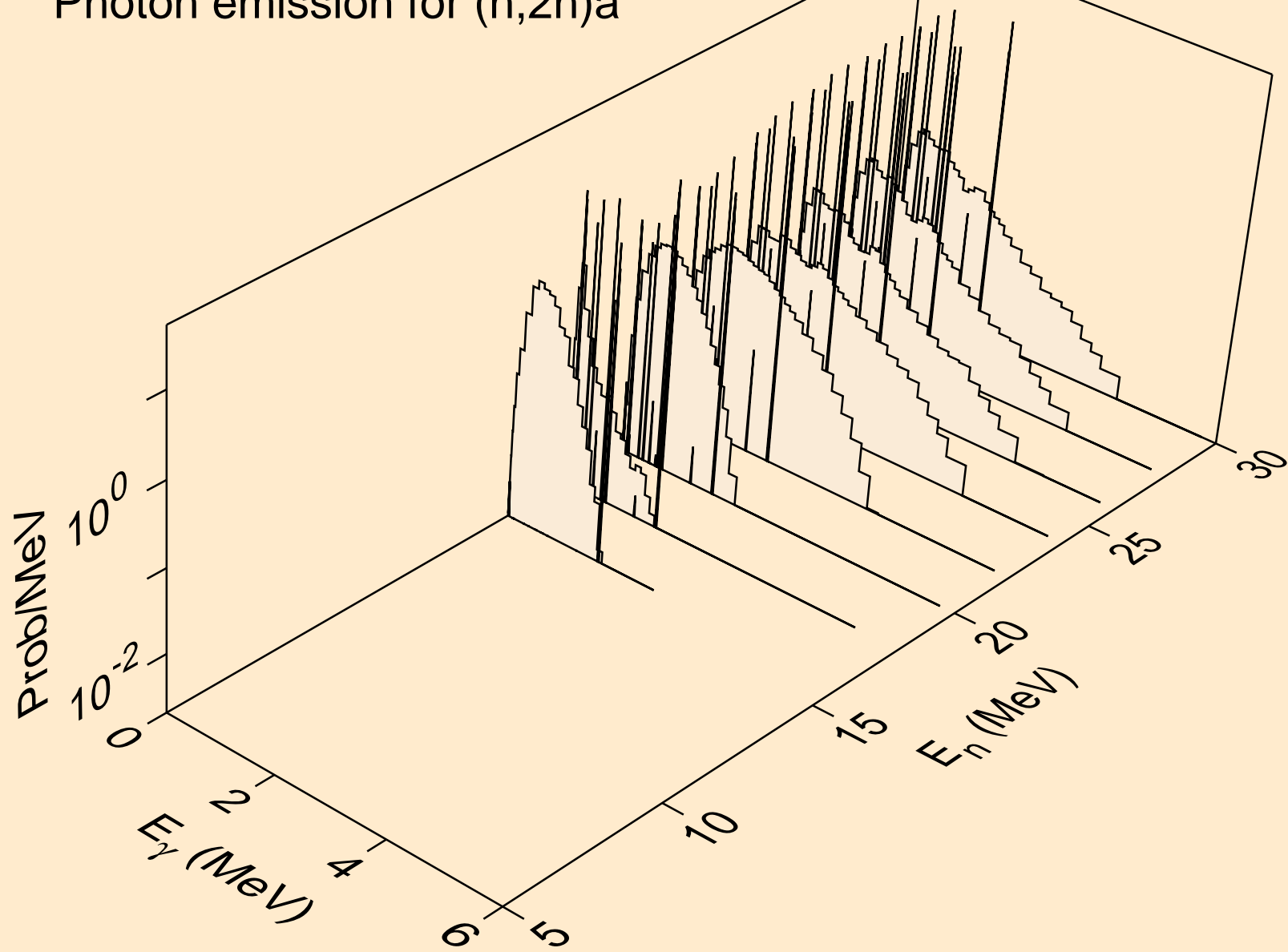

HO153 PROTON ACER TENDL-2021 LIBRARY; T=0.K  
Photon emission for (n,3n)a

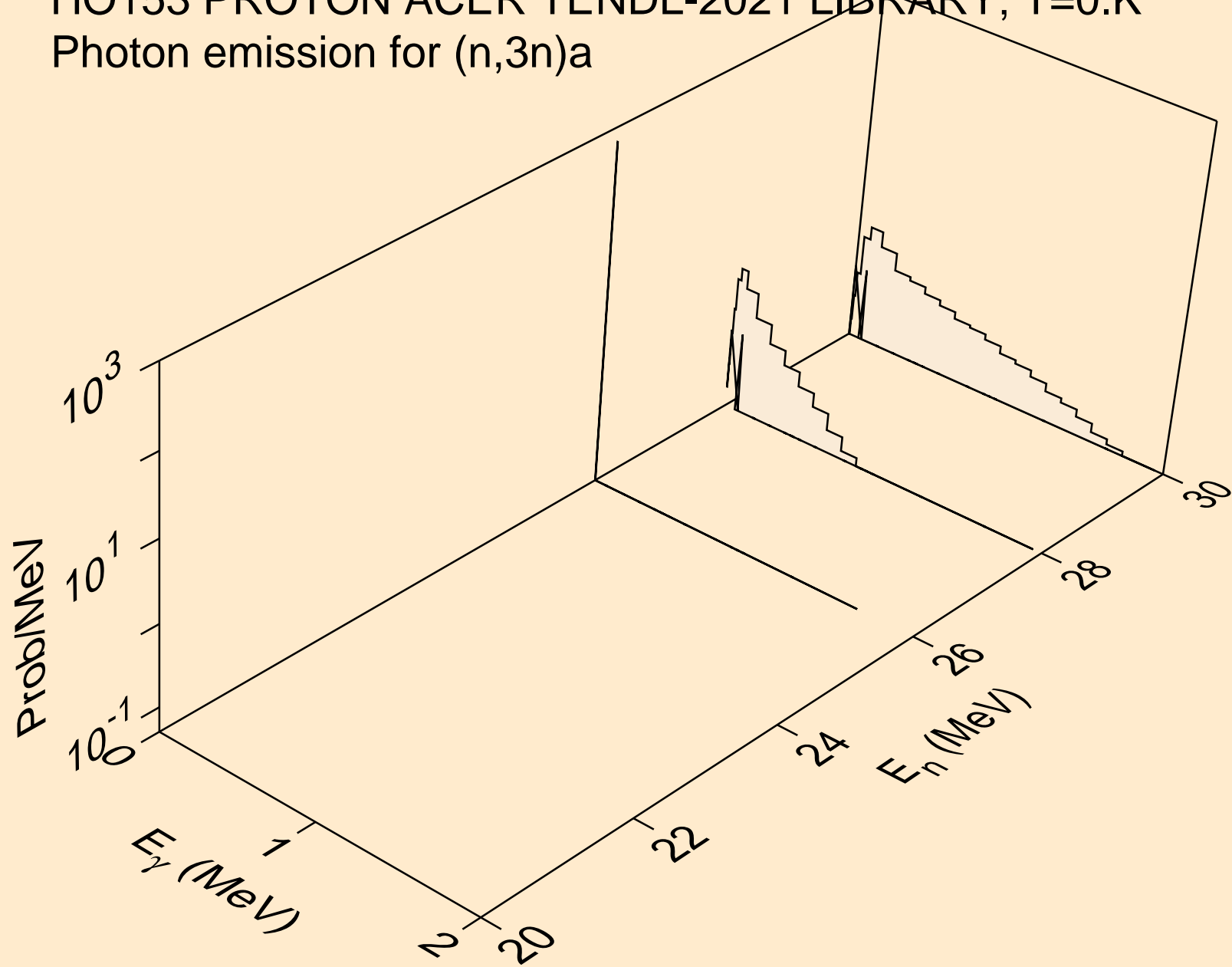

HO153 PROTON ACER TENDL-2021 LIBRARY; T=0.K  
Photon emission for (n,n\*)p

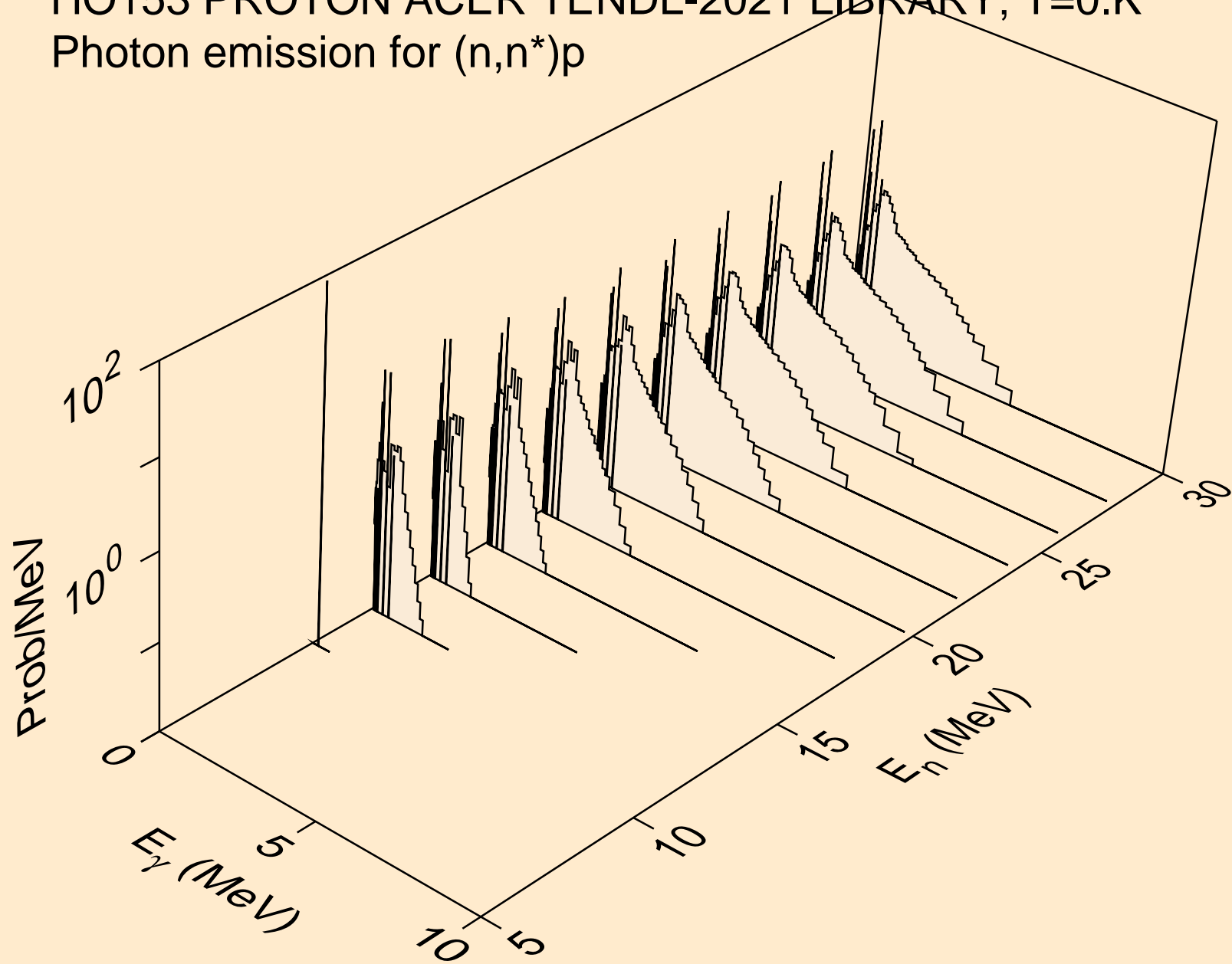

HO153 PROTON ACER TENDL-2021 LIBRARY; T=0.K  
Photon emission for (n,n\*)2a

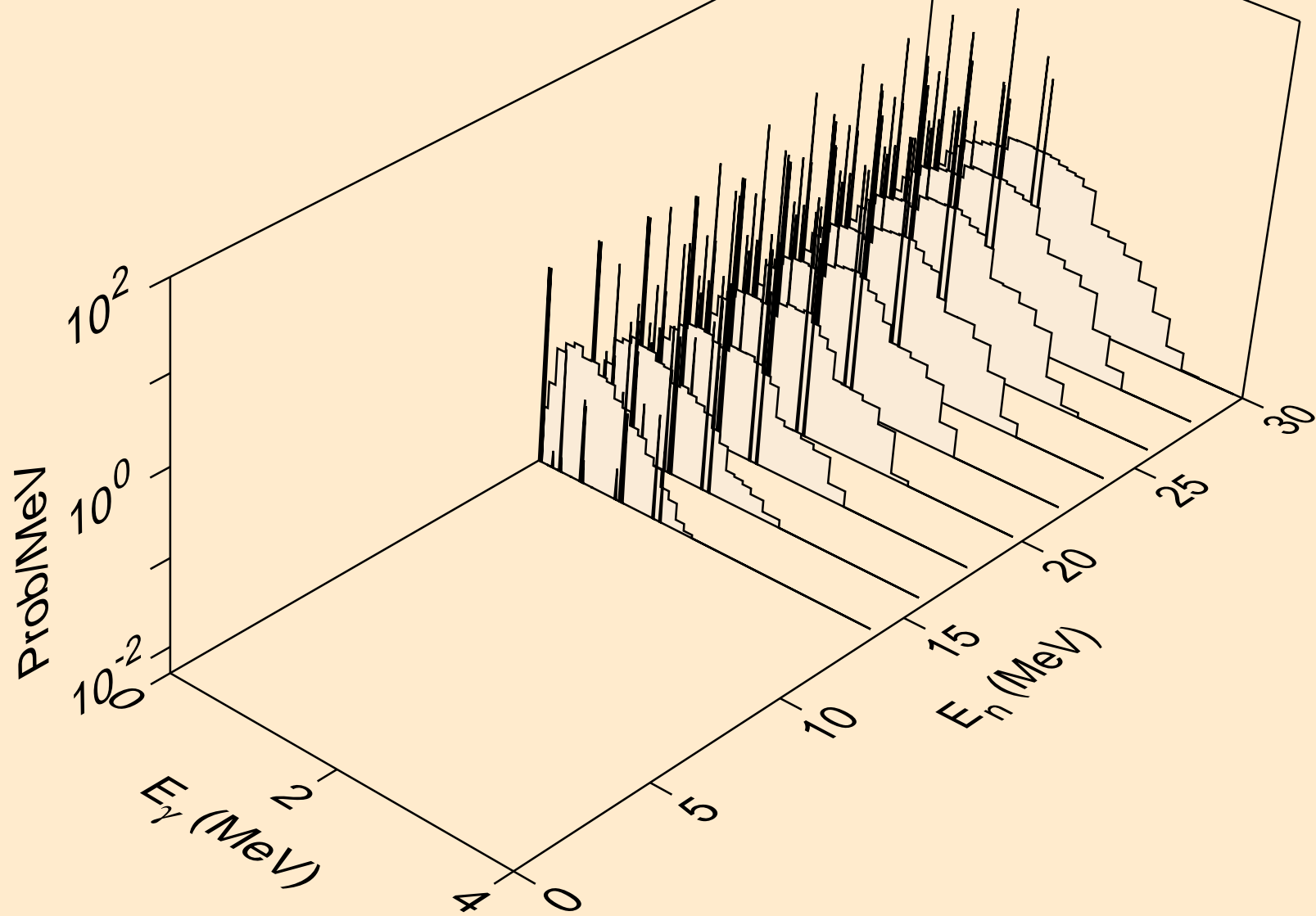

HO153 PROTON ACER TENDL-2021 LIBRARY; T=0.K  
Photon emission for (n,n\*)d

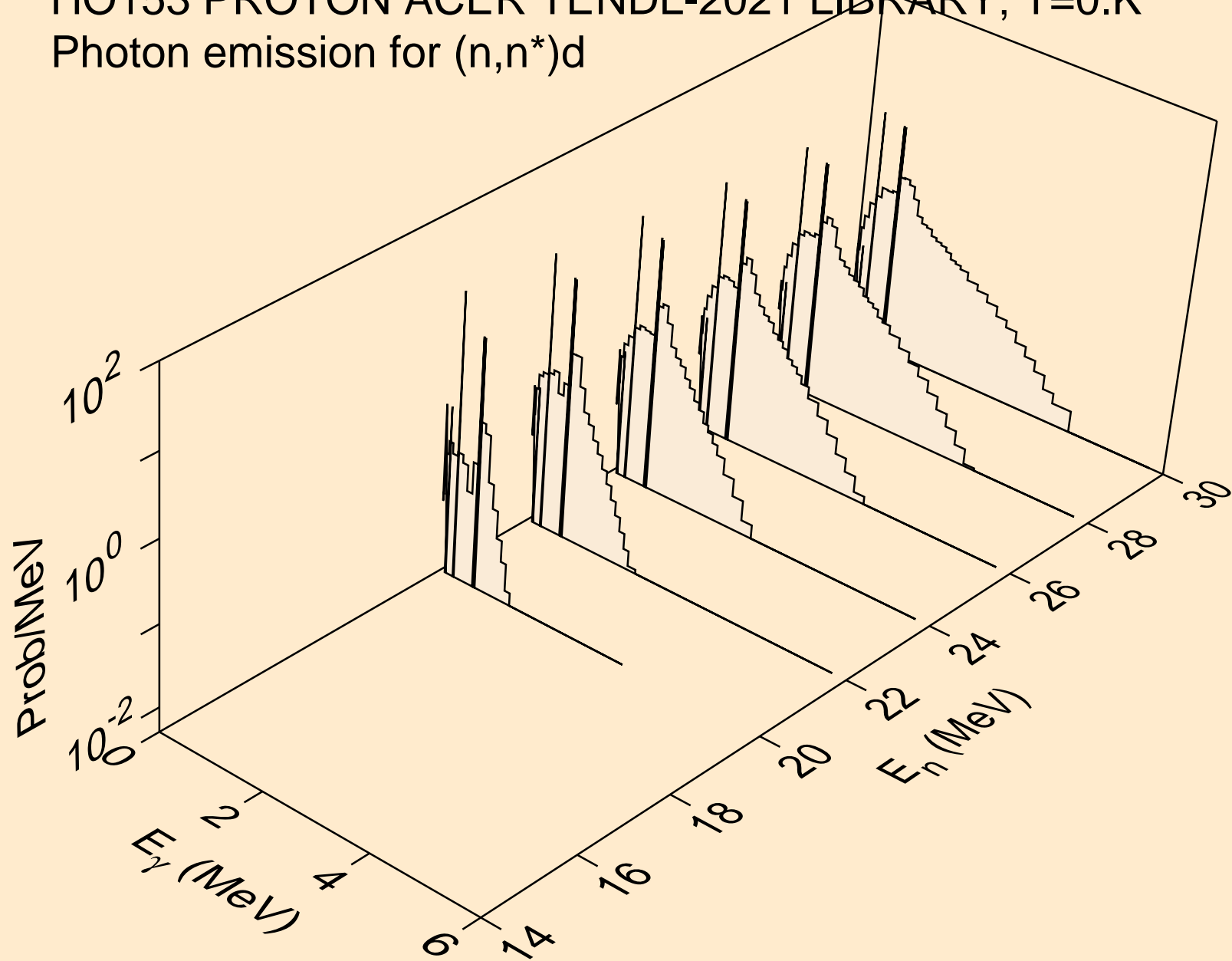

HO153 PROTON ACER TENDL-2021 LIBRARY; T=0.K  
Photon emission for (n,n\*)t

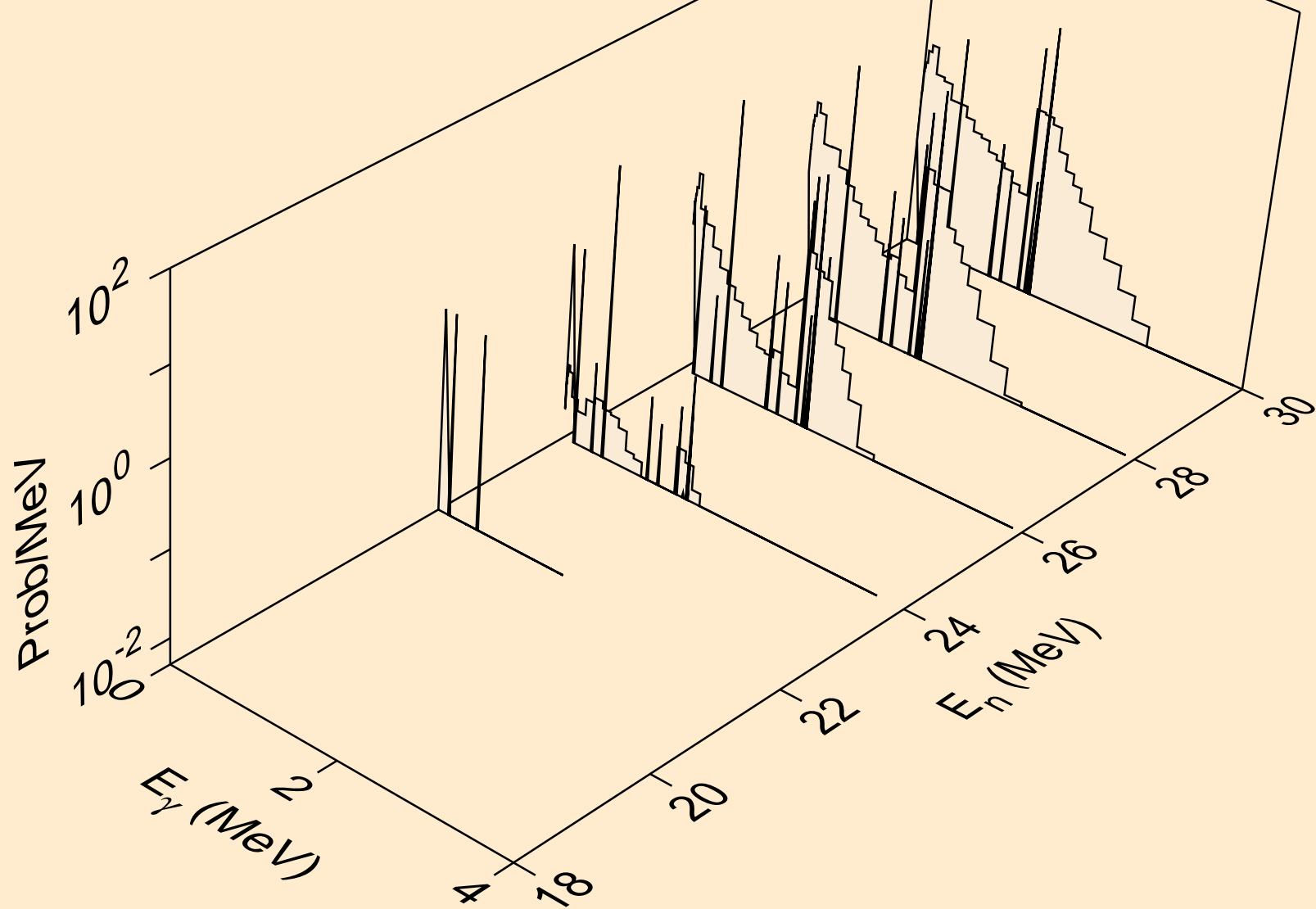



HO153 PROTON ACER TENDL-2021 LIBRARY; T=0.K  
Photon emission for (n,n\*)he3

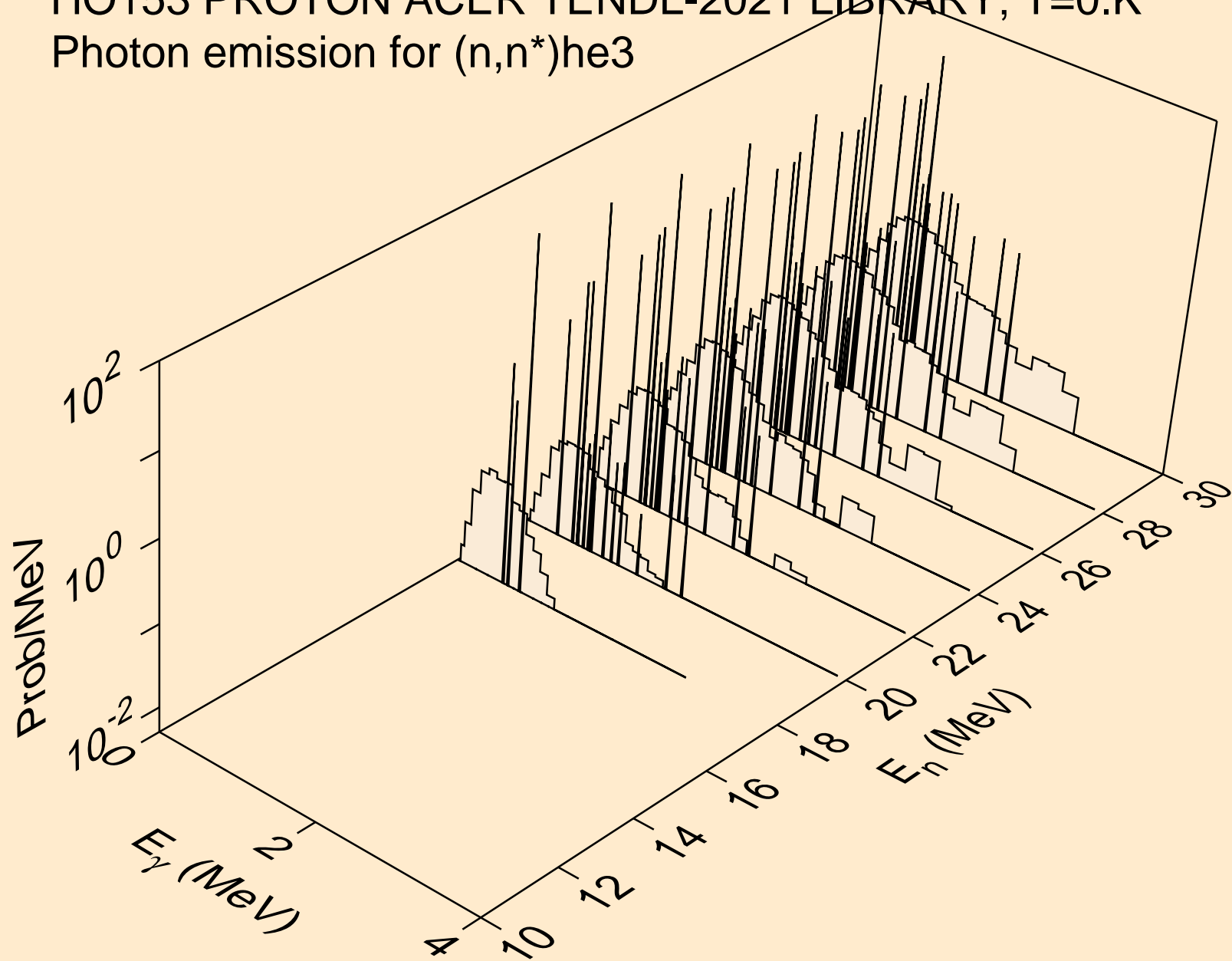

HO153 PROTON ACER TENDL-2021 LIBRARY; T=0.K  
Photon emission for (n,2np)

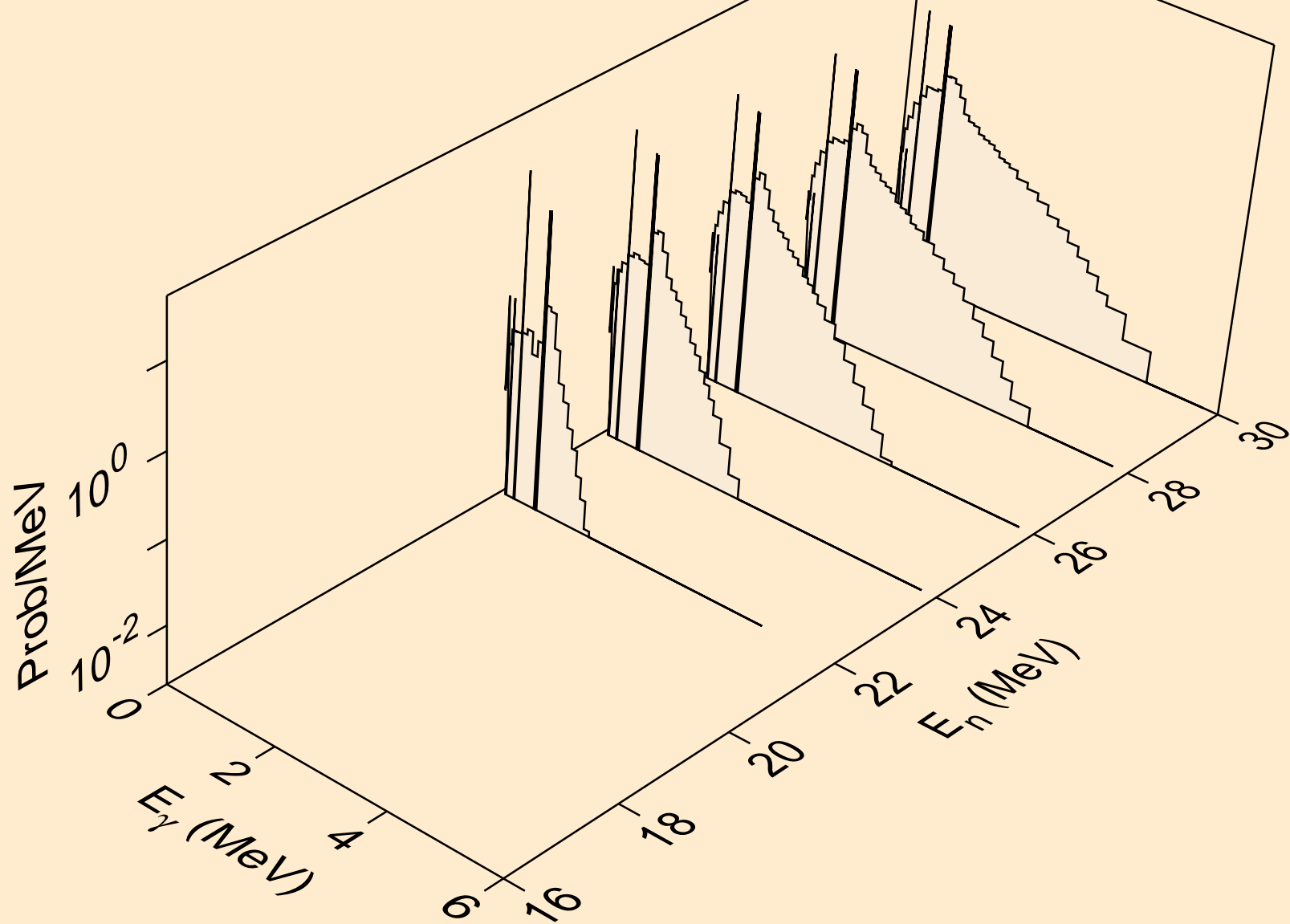

HO153 PROTON ACER TENDL-2021 LIBRARY; T=0.K  
Photon emission for (n,3np)

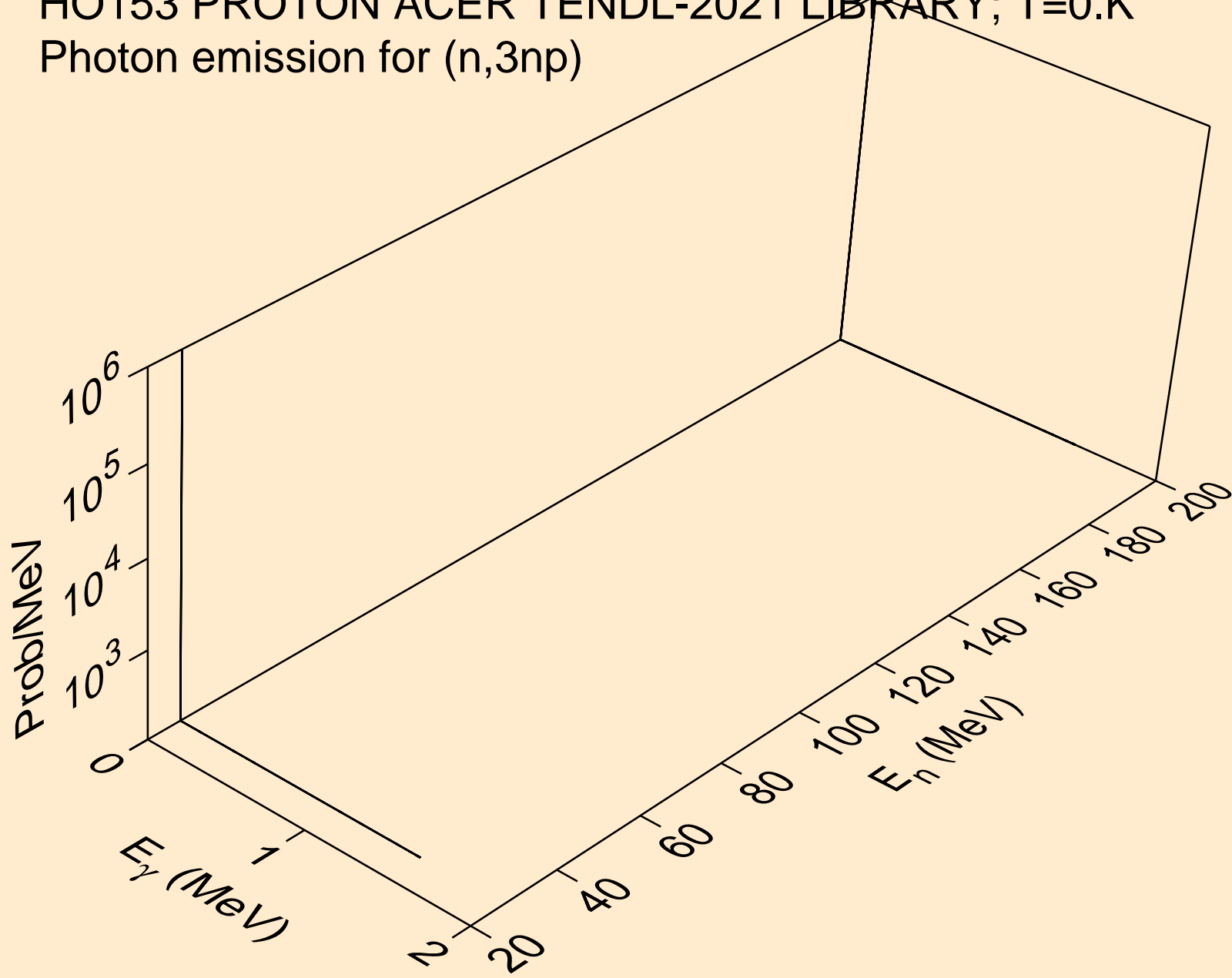

HO153 PROTON ACER TENDL-2021 LIBRARY; T=0.K  
Photon emission for (n,2np)

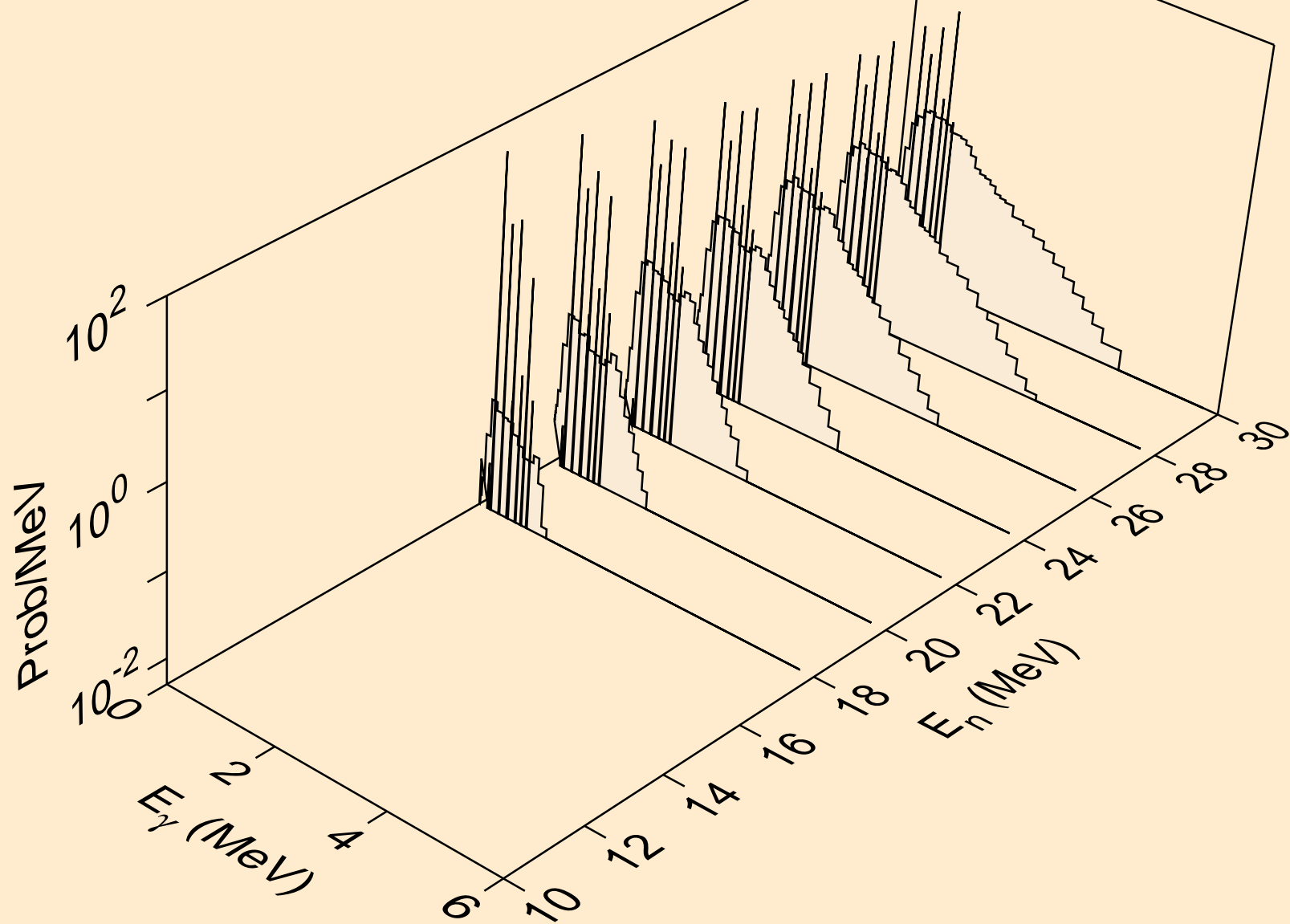

HO153 PROTON ACER TENDL-2021 LIBRARY; T=0.K  
Photon emission for (n,npa)

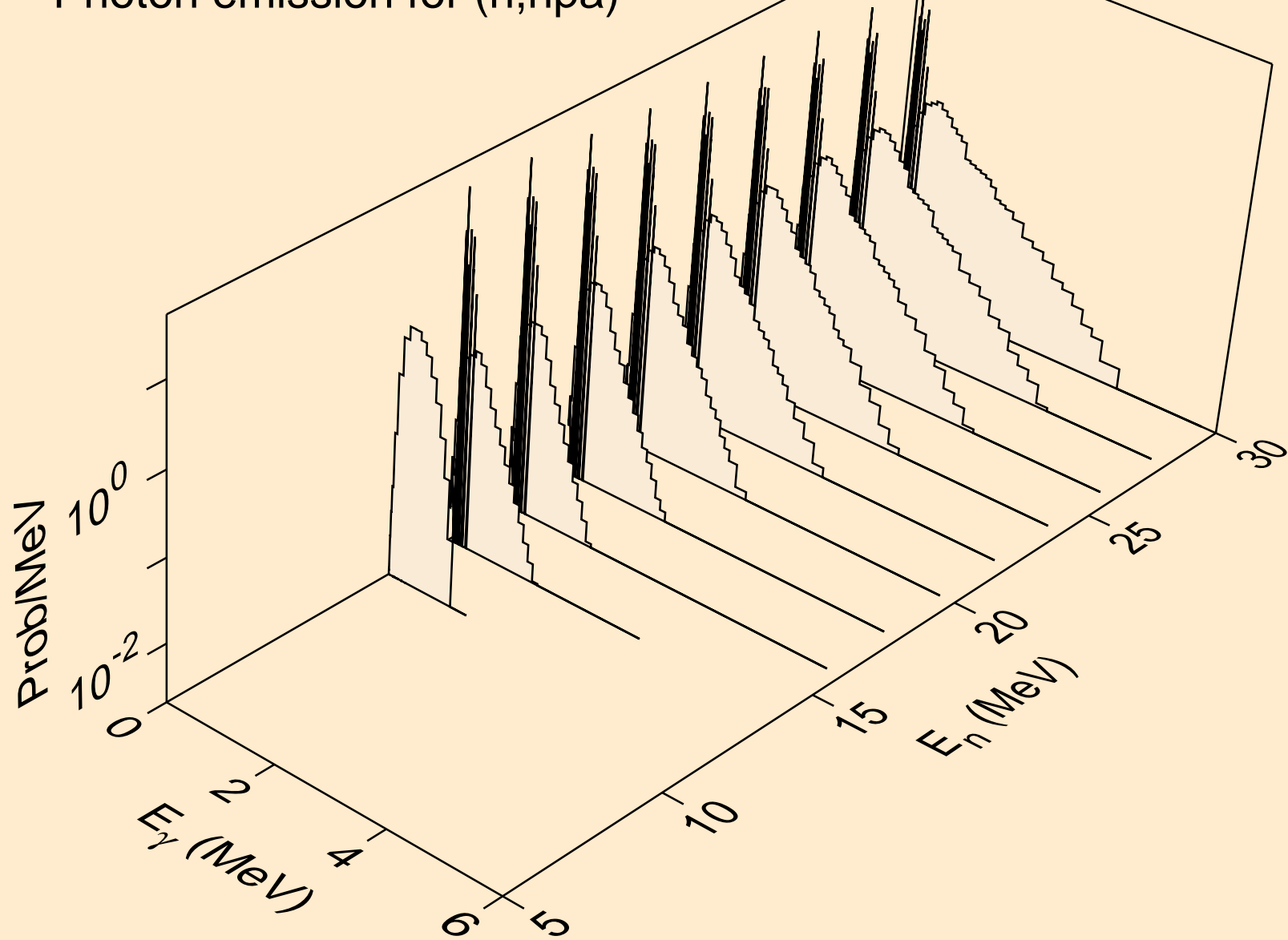

HO153 PROTON ACER TENDL-2021 LIBRARY; T=0.K  
Photon emission for (n,gma)

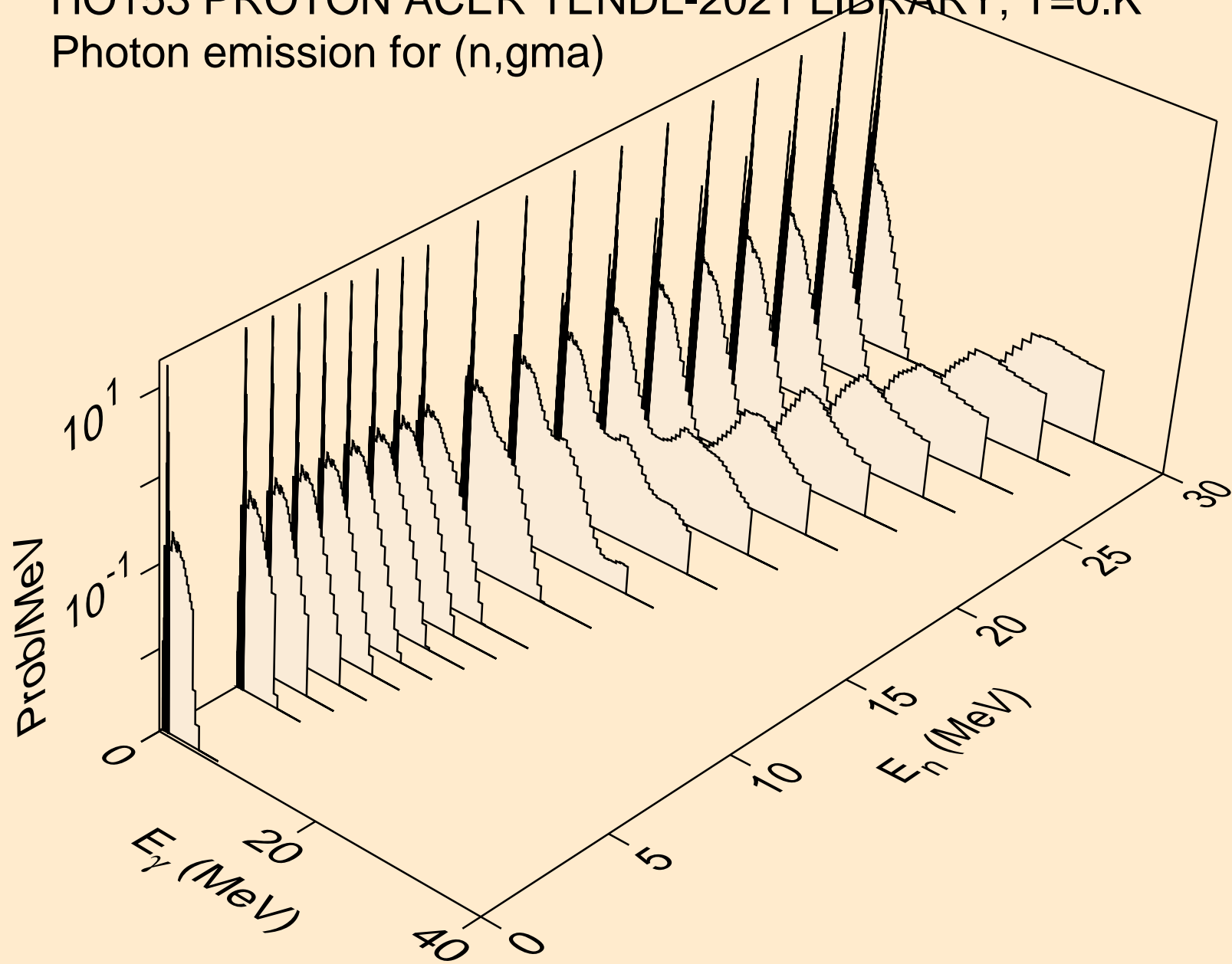

HO153 PROTON ACER TENDL-2021 LIBRARY; T=0.K  
Photon emission for inelastic

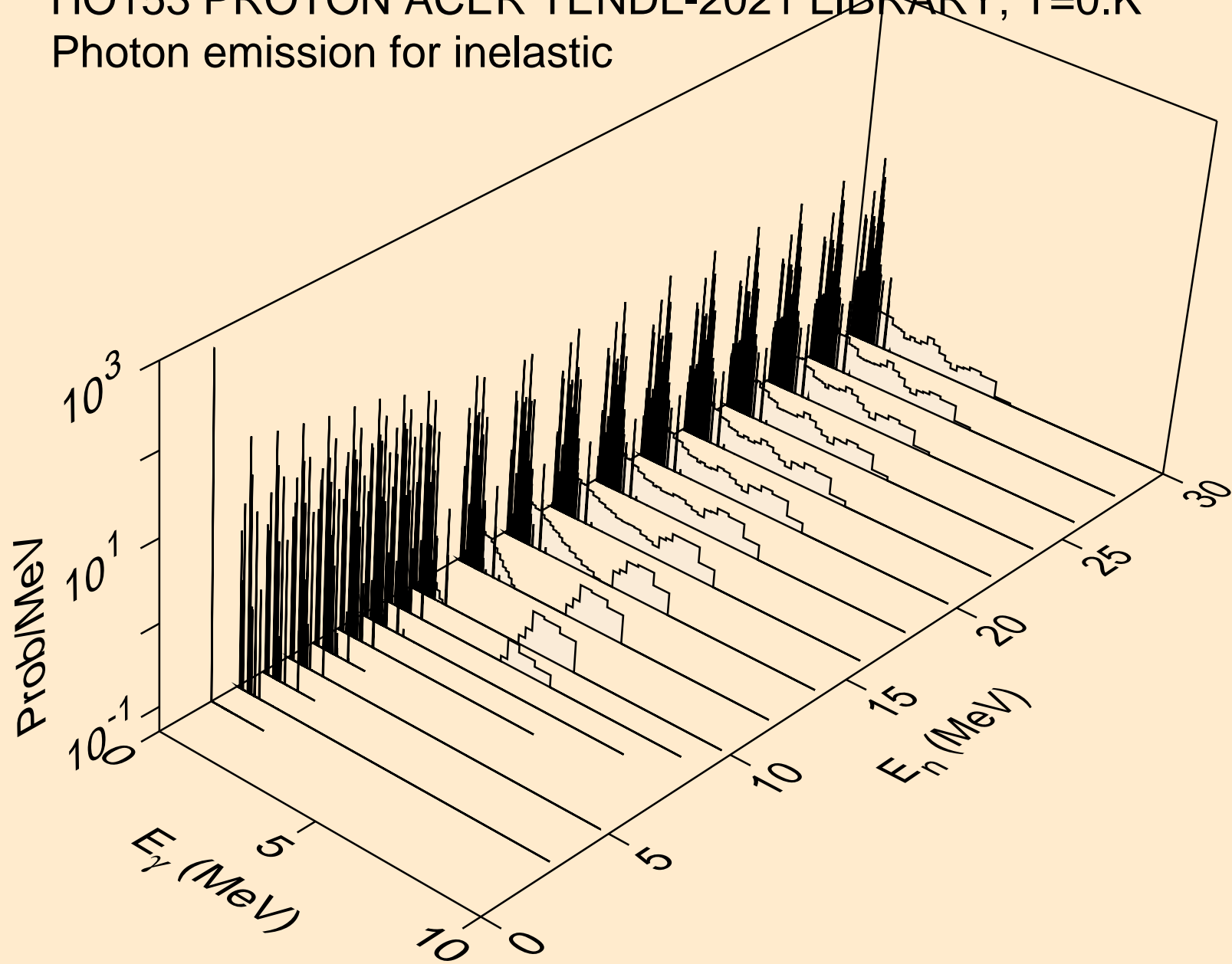

HO153 PROTON ACER TENDL-2021 LIBRARY; T=0.K  
Photon emission for (n,d)

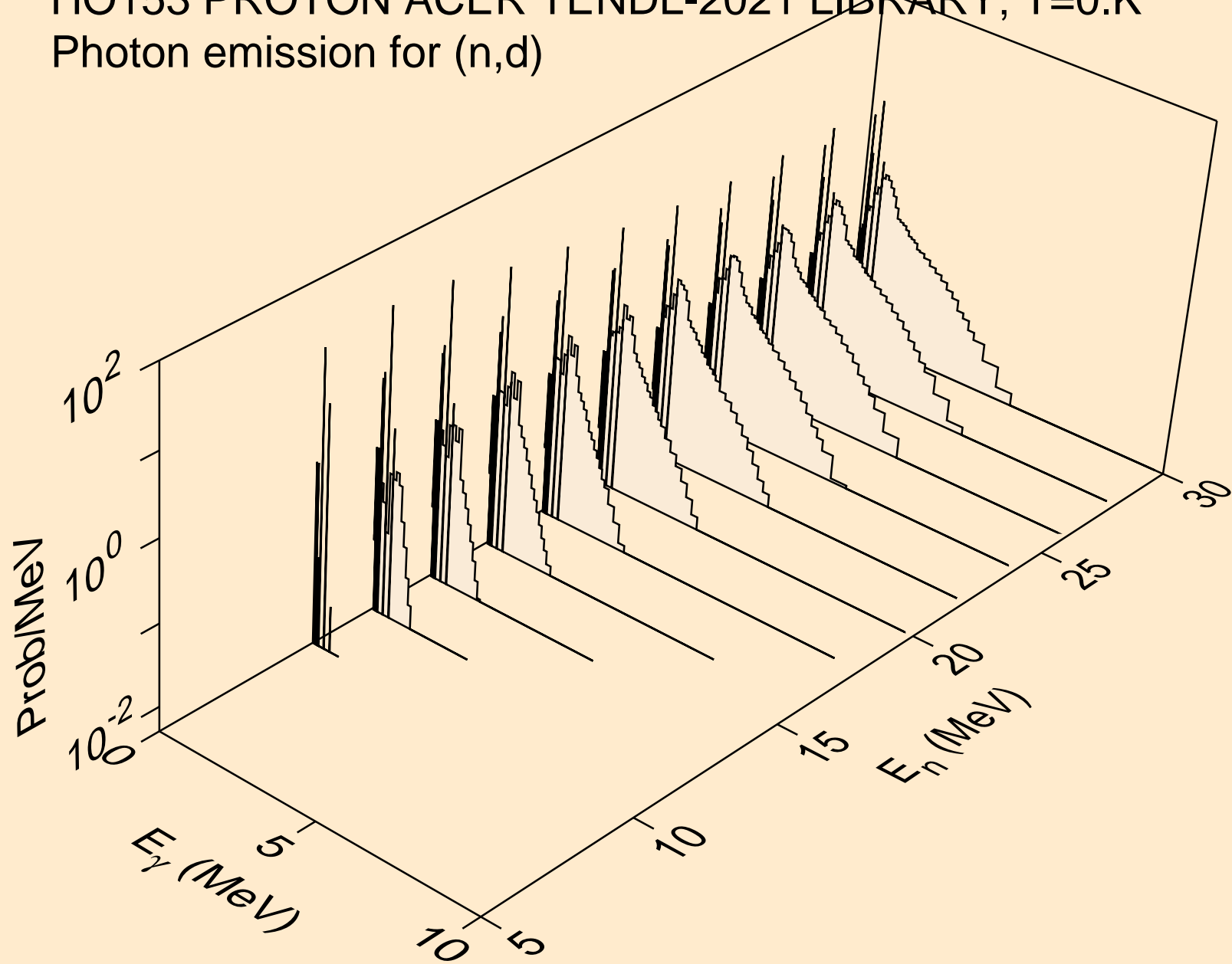



HO153 PROTON ACER TENDL-2021 LIBRARY; T=0.K  
Photon emission for (n,t)

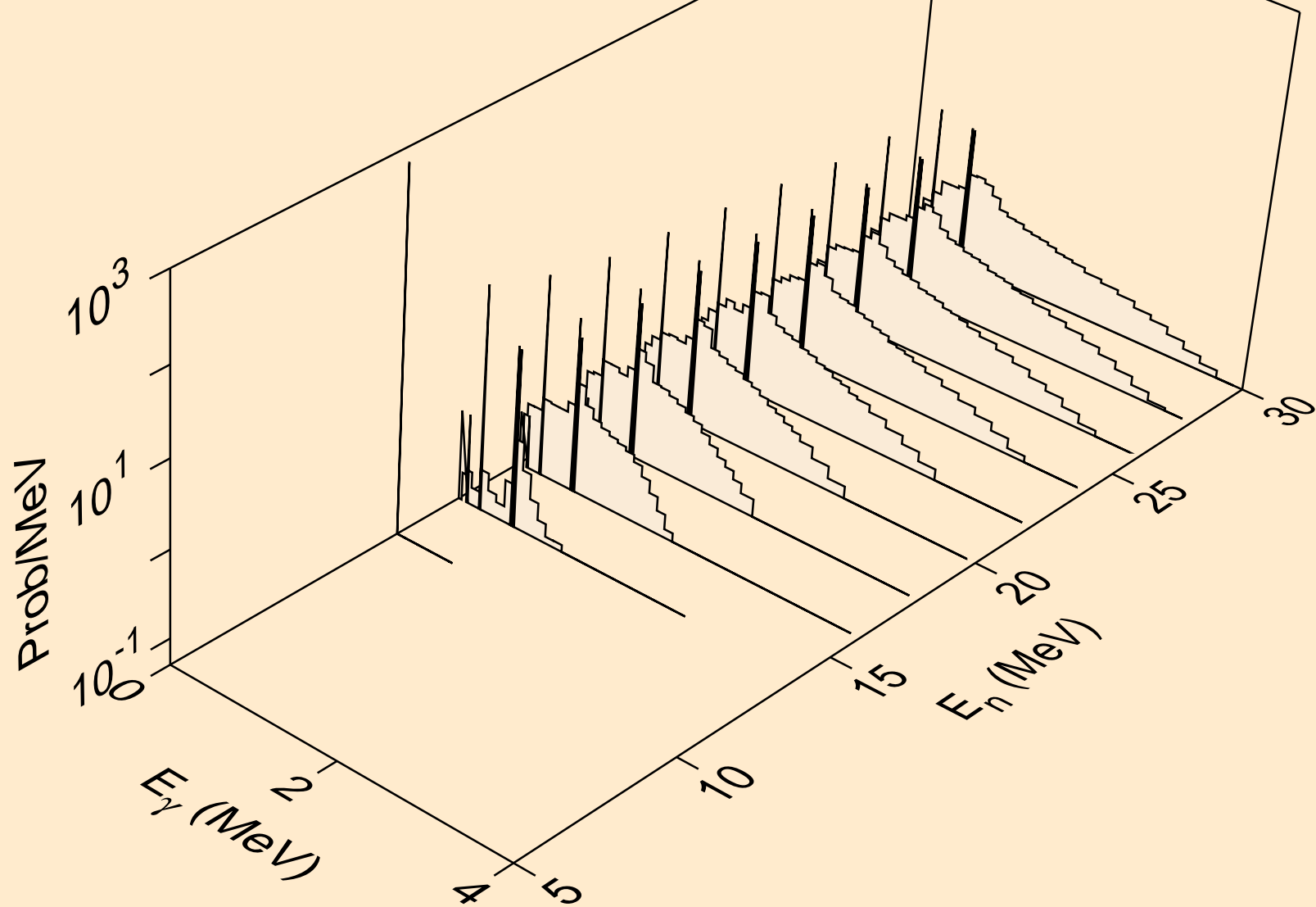

HO153 PROTON ACER TENDL-2021 LIBRARY; T=0.K  
Photon emission for (n,he3)

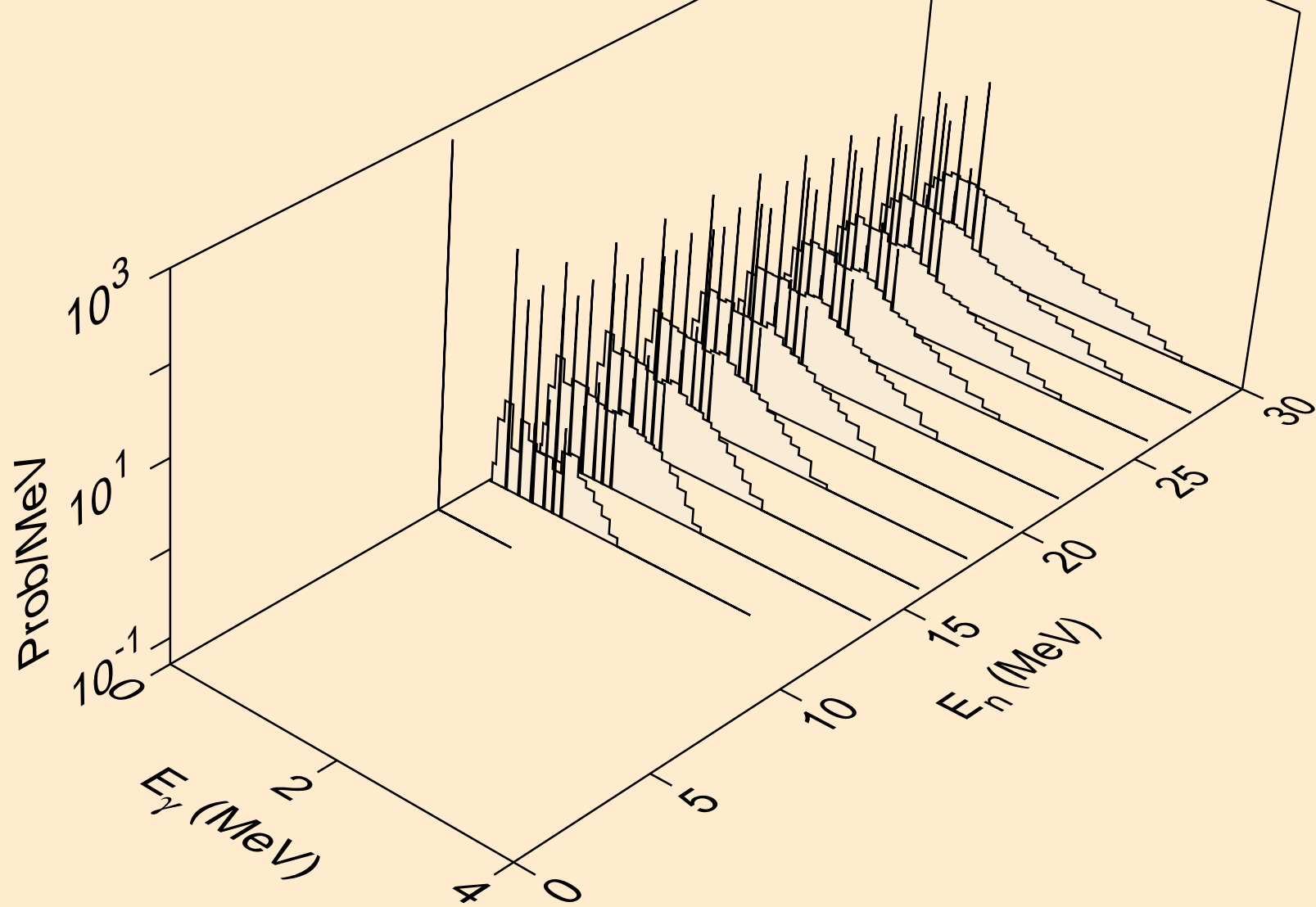

HO153 PROTON ACER TENDL-2021 LIBRARY; T=0.K  
Photon emission for (n,a)

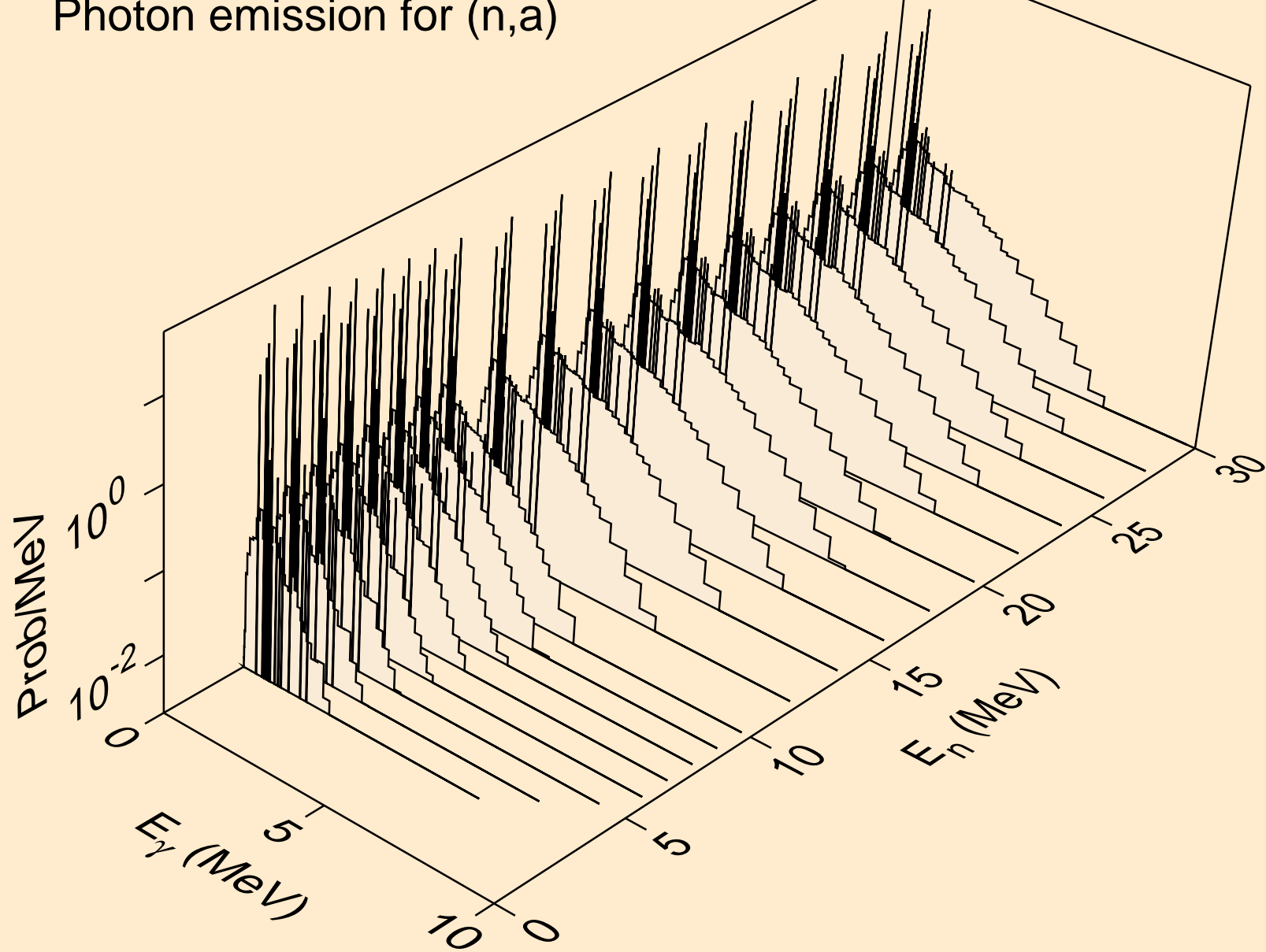

HO153 PROTON ACER TENDL-2021 LIBRARY; T=0.K  
Photon emission for (n,2a)

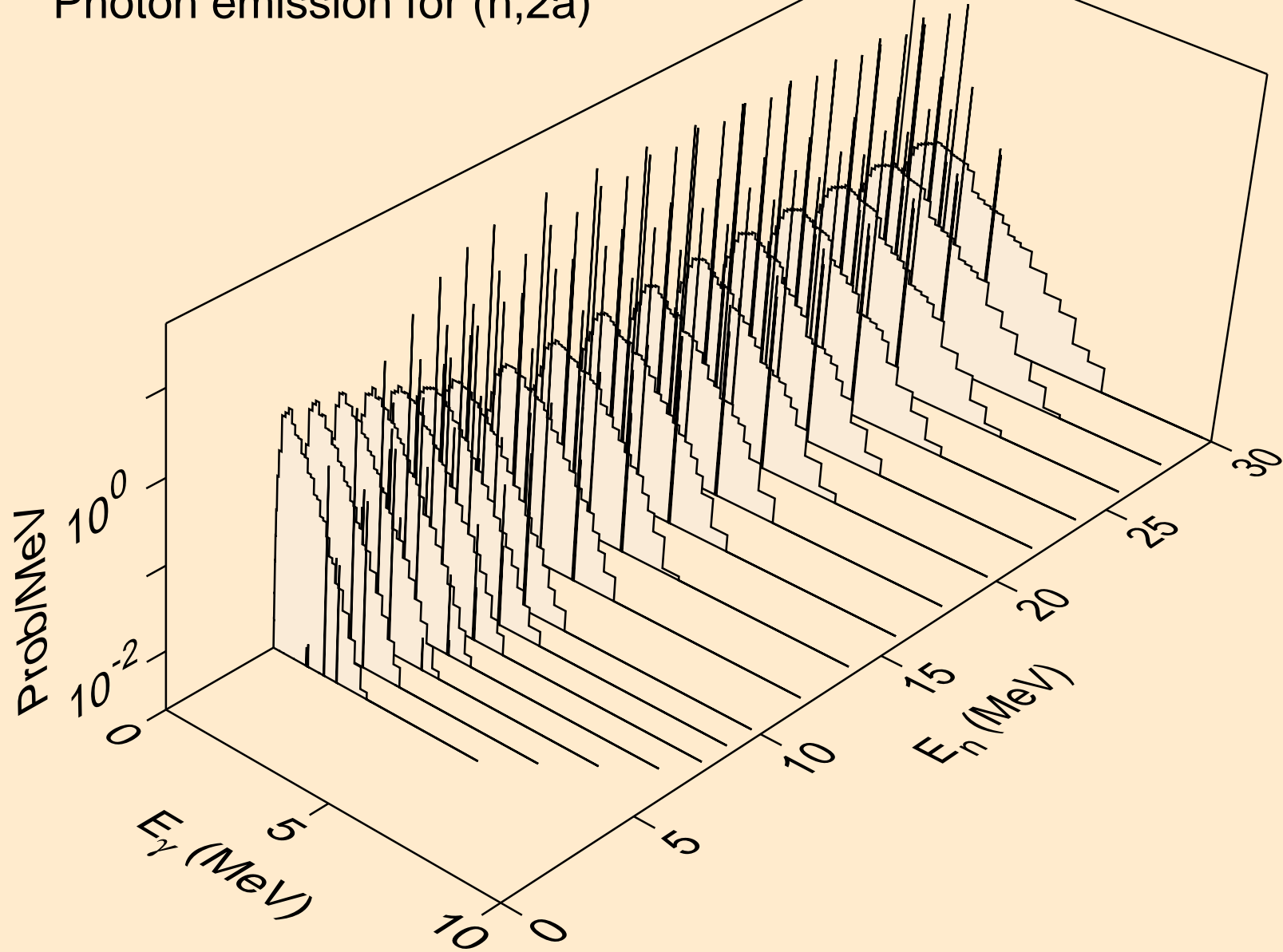

HO153 PROTON ACER TENDL-2021 LIBRARY; T=0.K  
Photon emission for (n,2p)

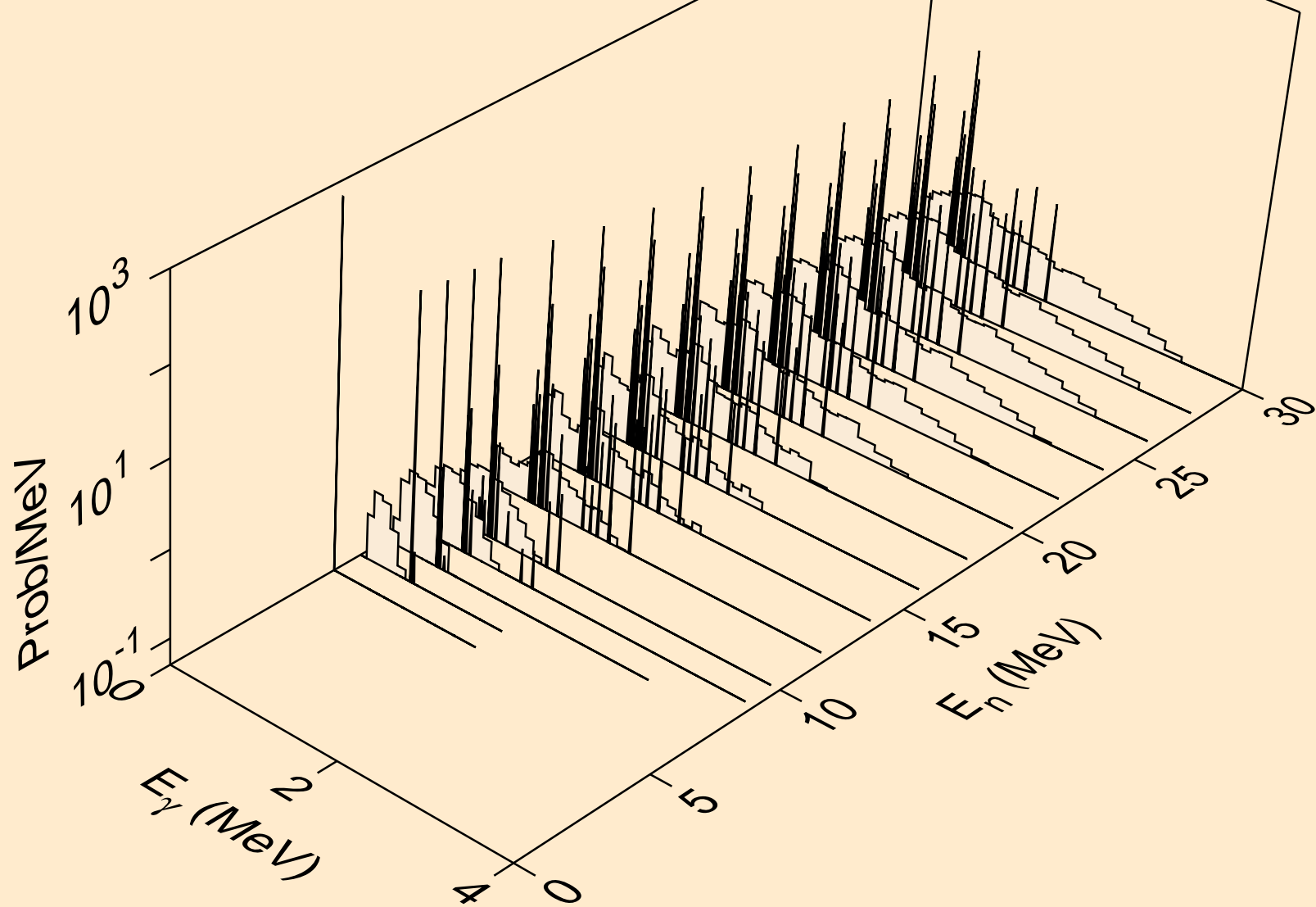

HO153 PROTON ACER TENDL-2021 LIBRARY; T=0.K  
Photon emission for (n,pa)

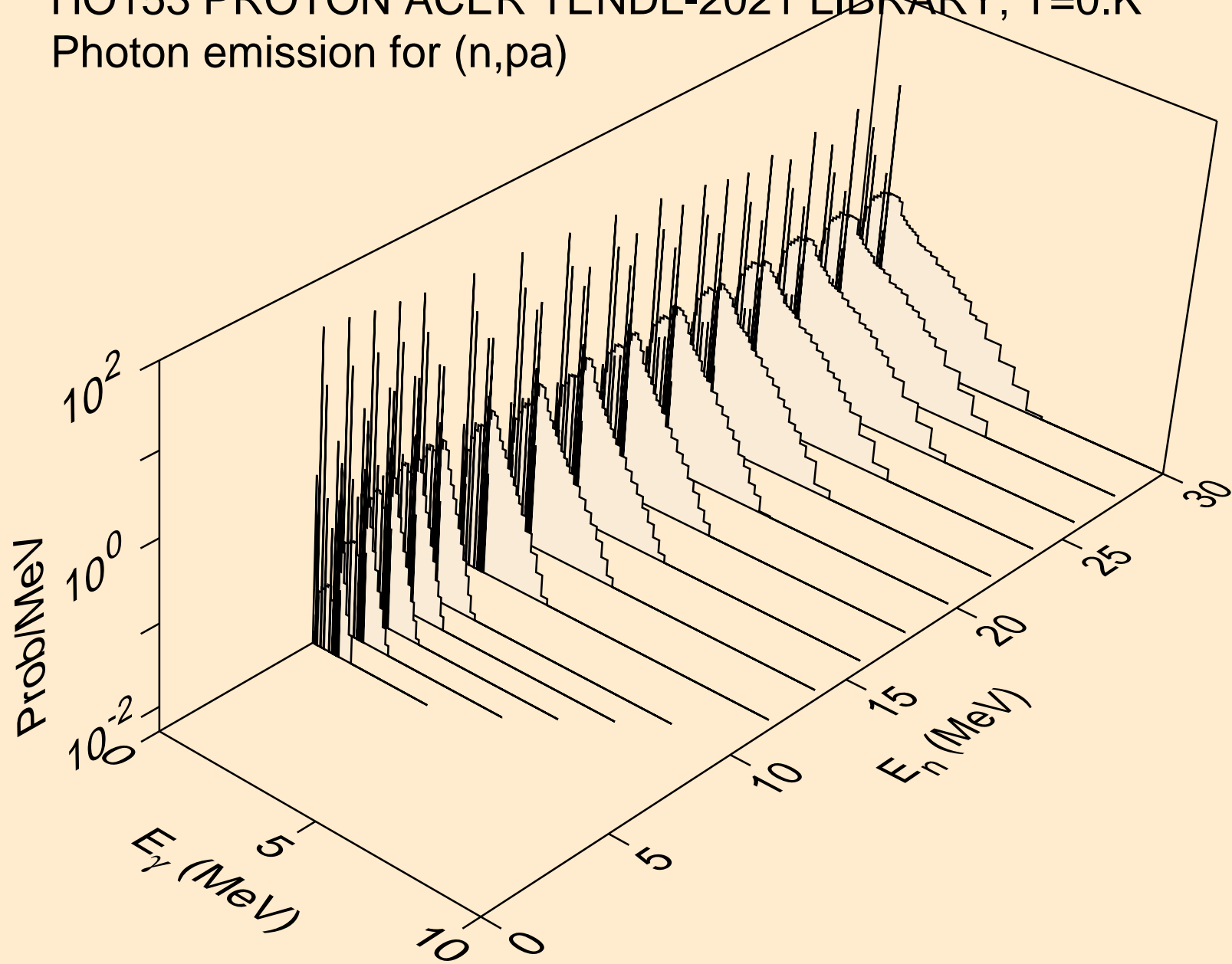

HO153 PROTON ACER TENDL-2021 LIBRARY; T=0.K  
Photon emission for (n,pd)

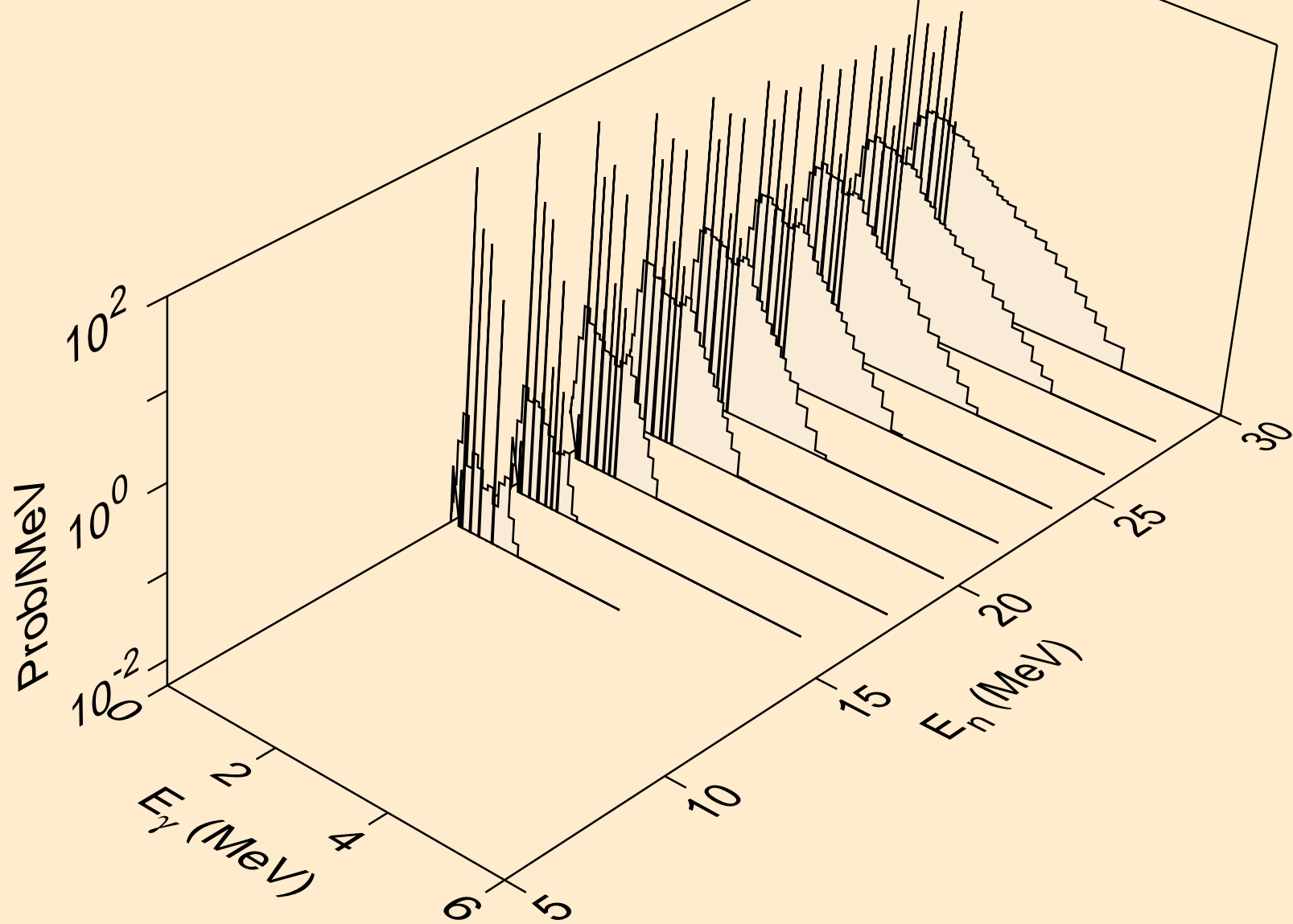

HO153 PROTON ACER TENDL-2021 LIBRARY; T=0.K  
Photon emission for (n,pt)

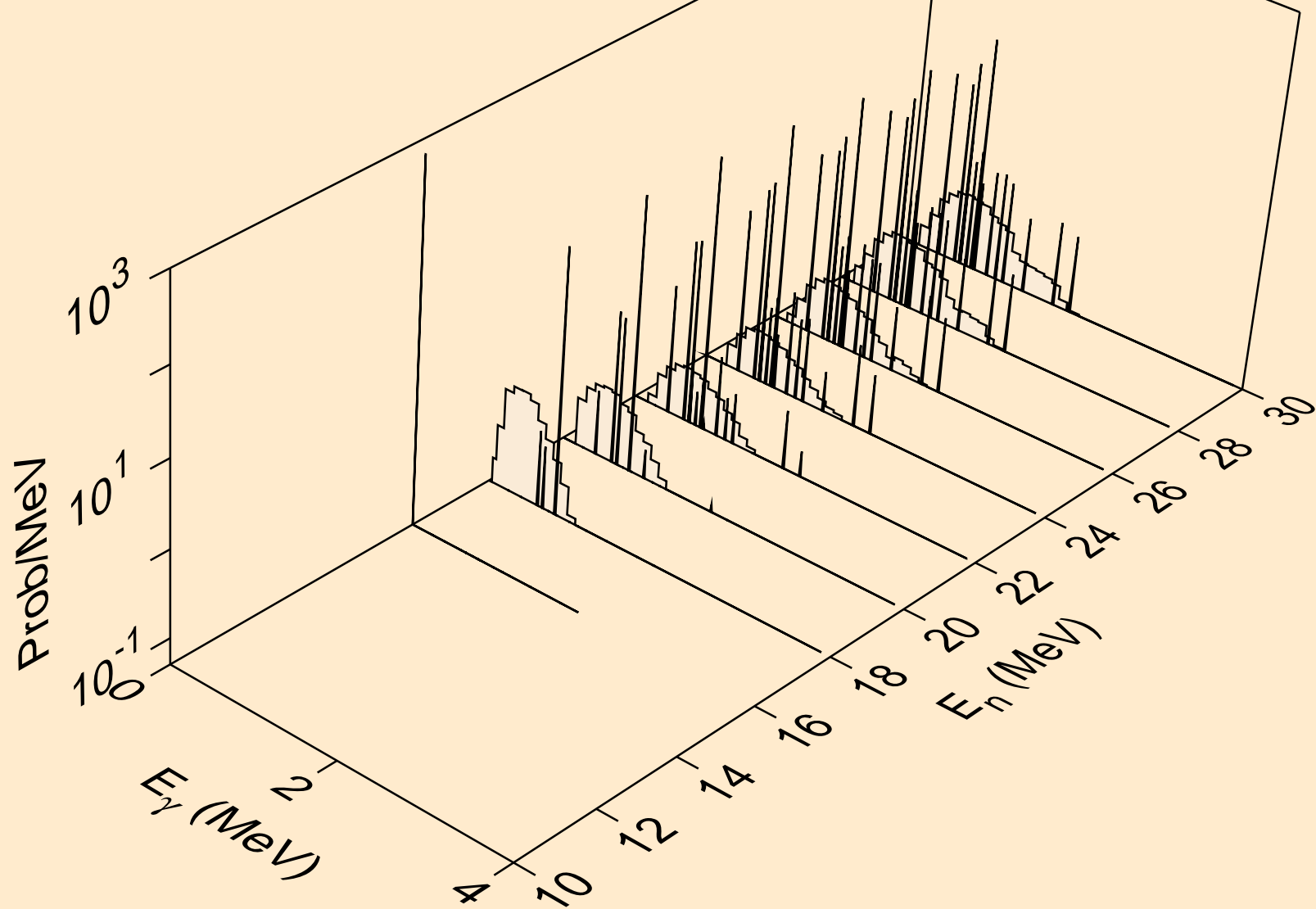



HO153 PROTON ACER TENDL-2021 LIBRARY; T=0.K  
Photon emission for (n,da)

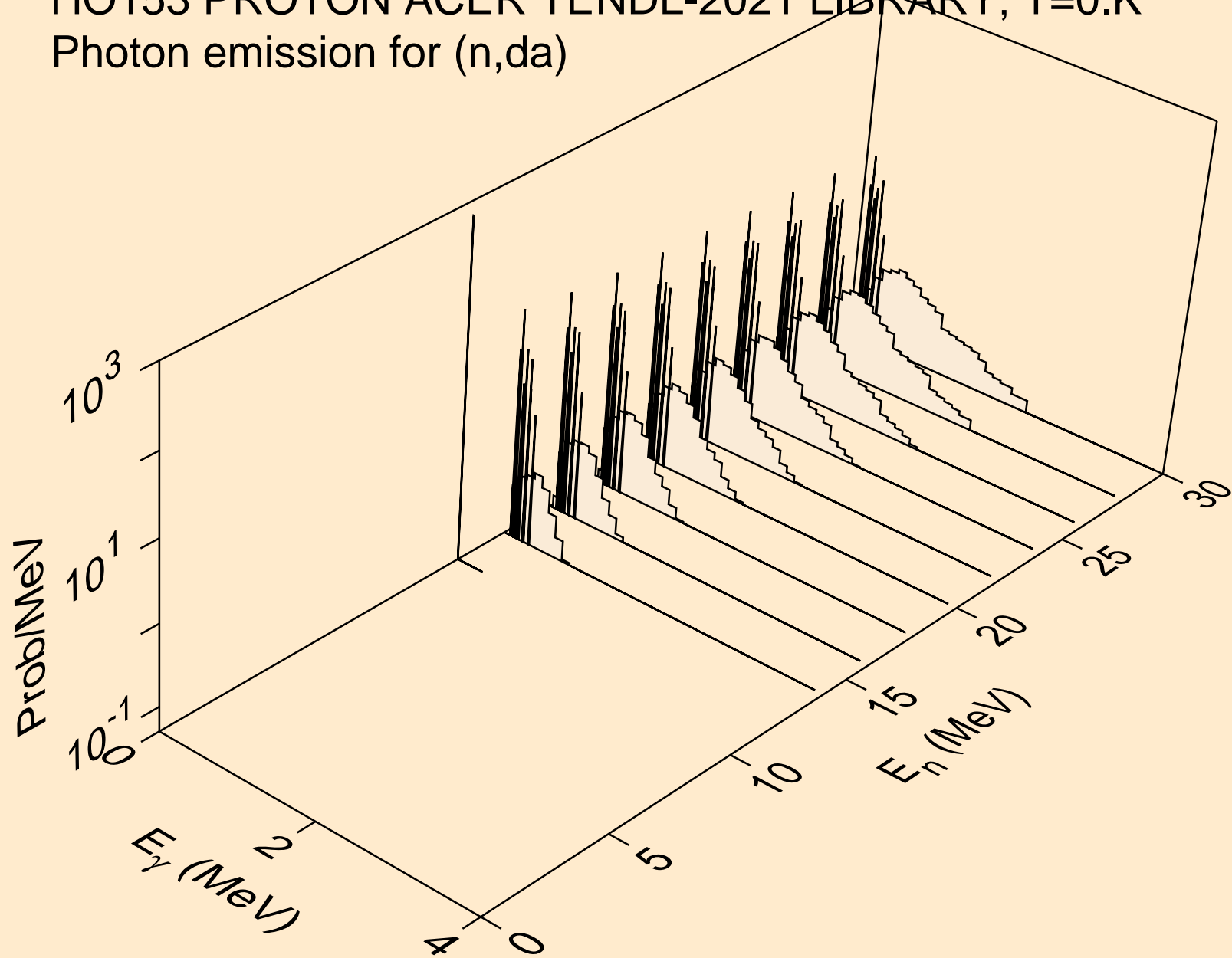

# HO153 PROTON ACER TENDL-2021 LIBRARY; T=0.K

## Particle heating contributions

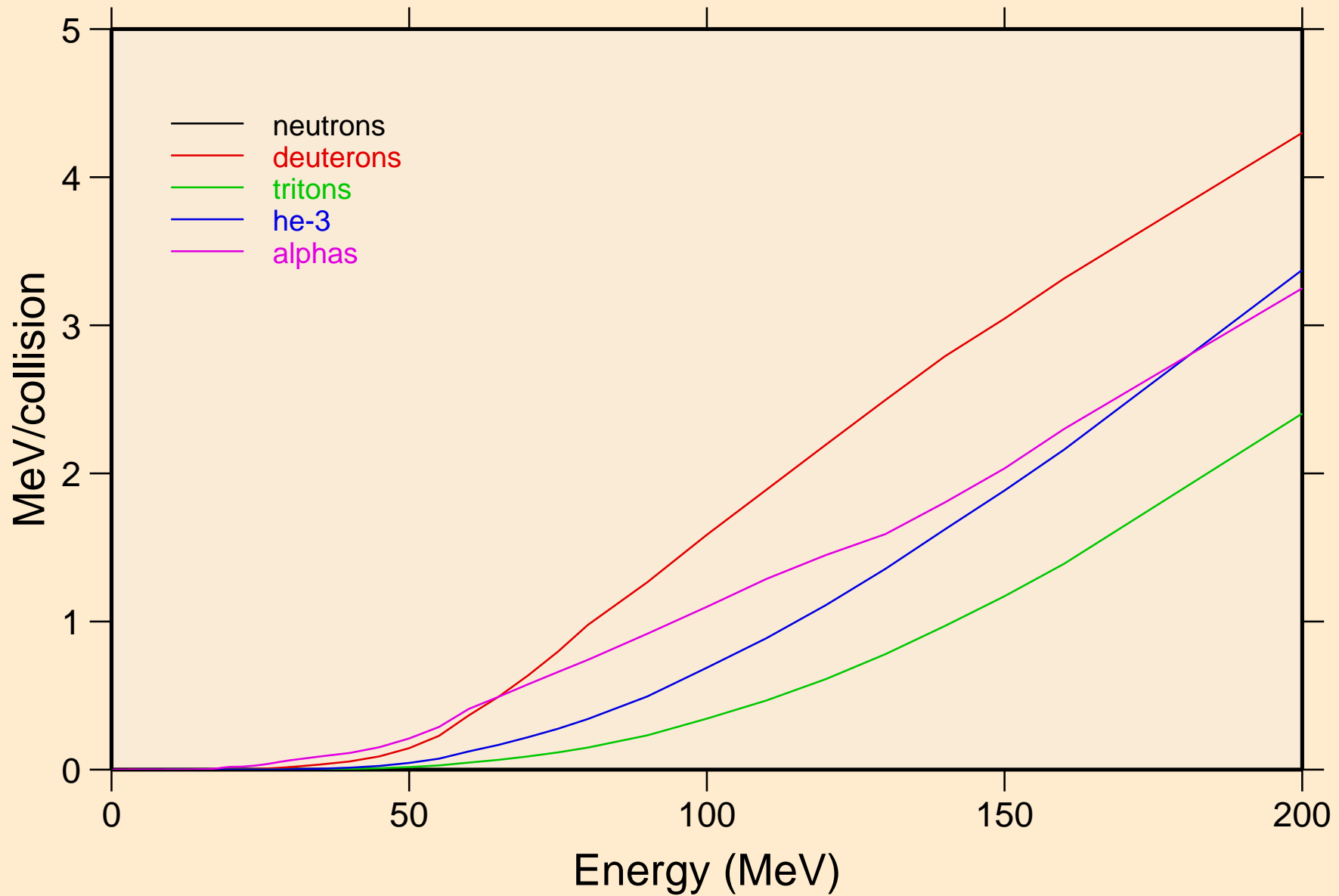

HO153 PROTON ACER TENDL-2021 LIBRARY; T=0.K  
Recoil Heating

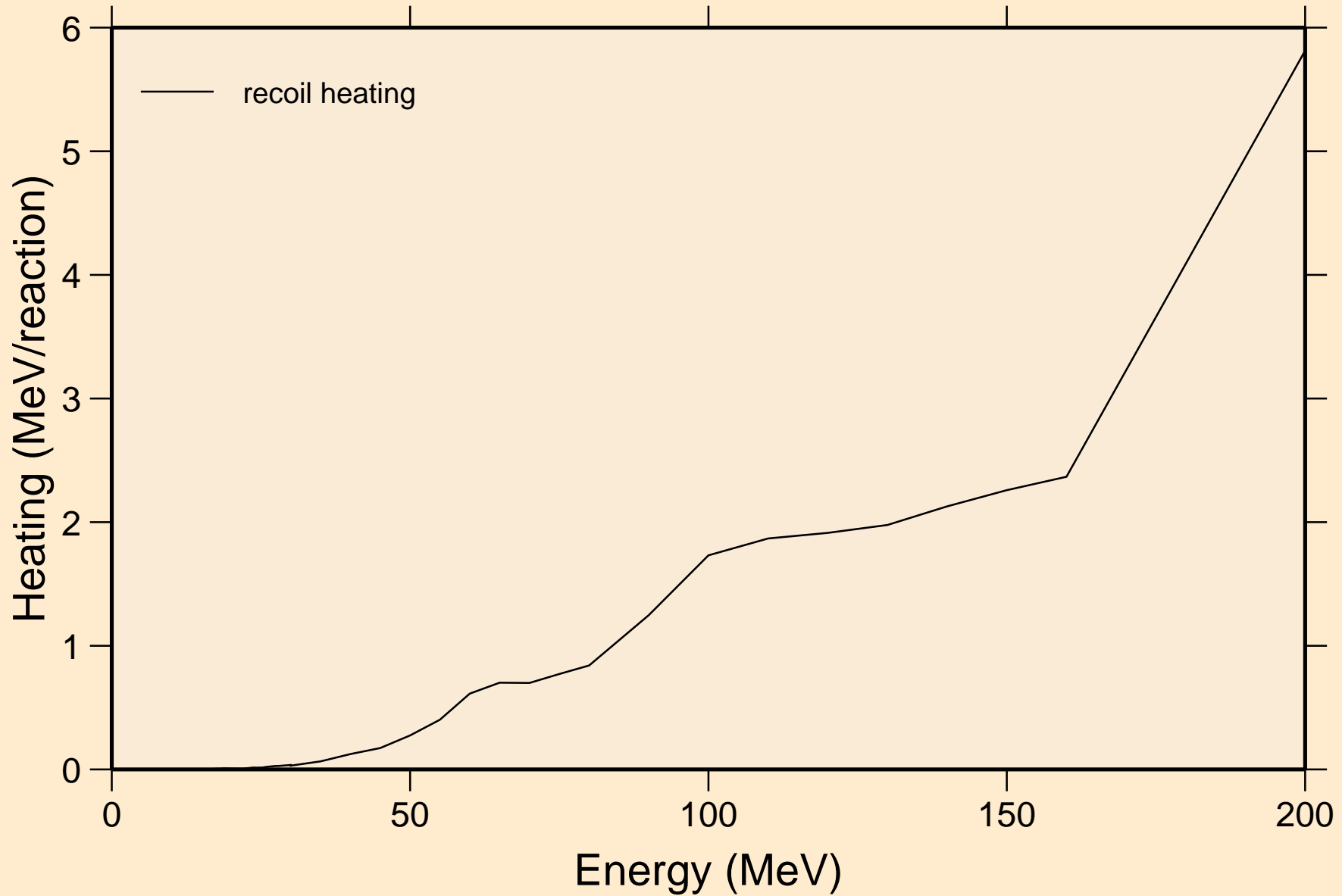

# HO153 PROTON ACER TENDL-2021 LIBRARY; T=0.K

## Particle production cross sections

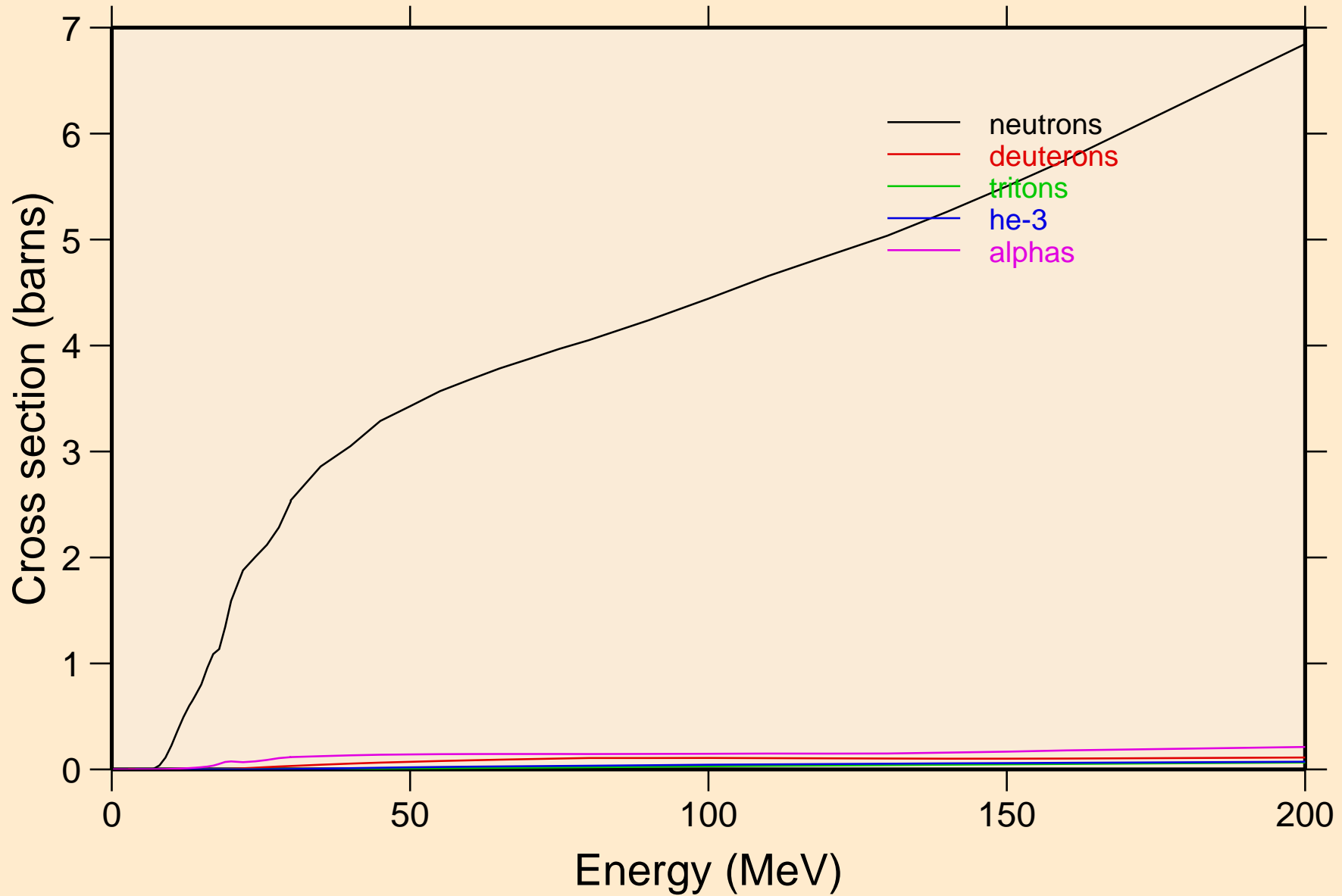

HO153 PROTON ACER TENDL-2021 LIBRARY; T=0.K  
neutrons from (p,n)

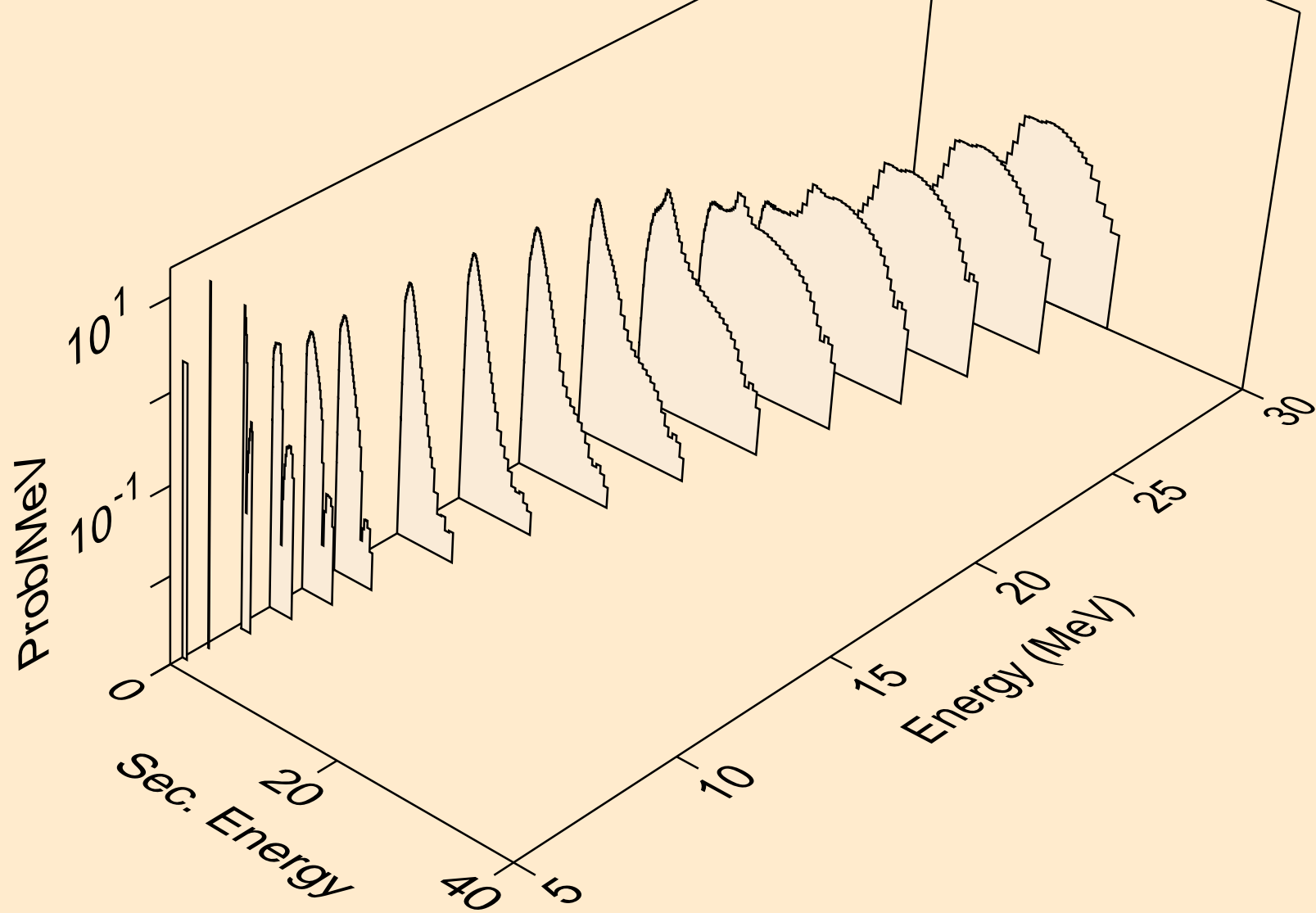

HO153 PROTON ACER TENDL-2021 LIBRARY; T=0.K  
neutrons from (p,x)

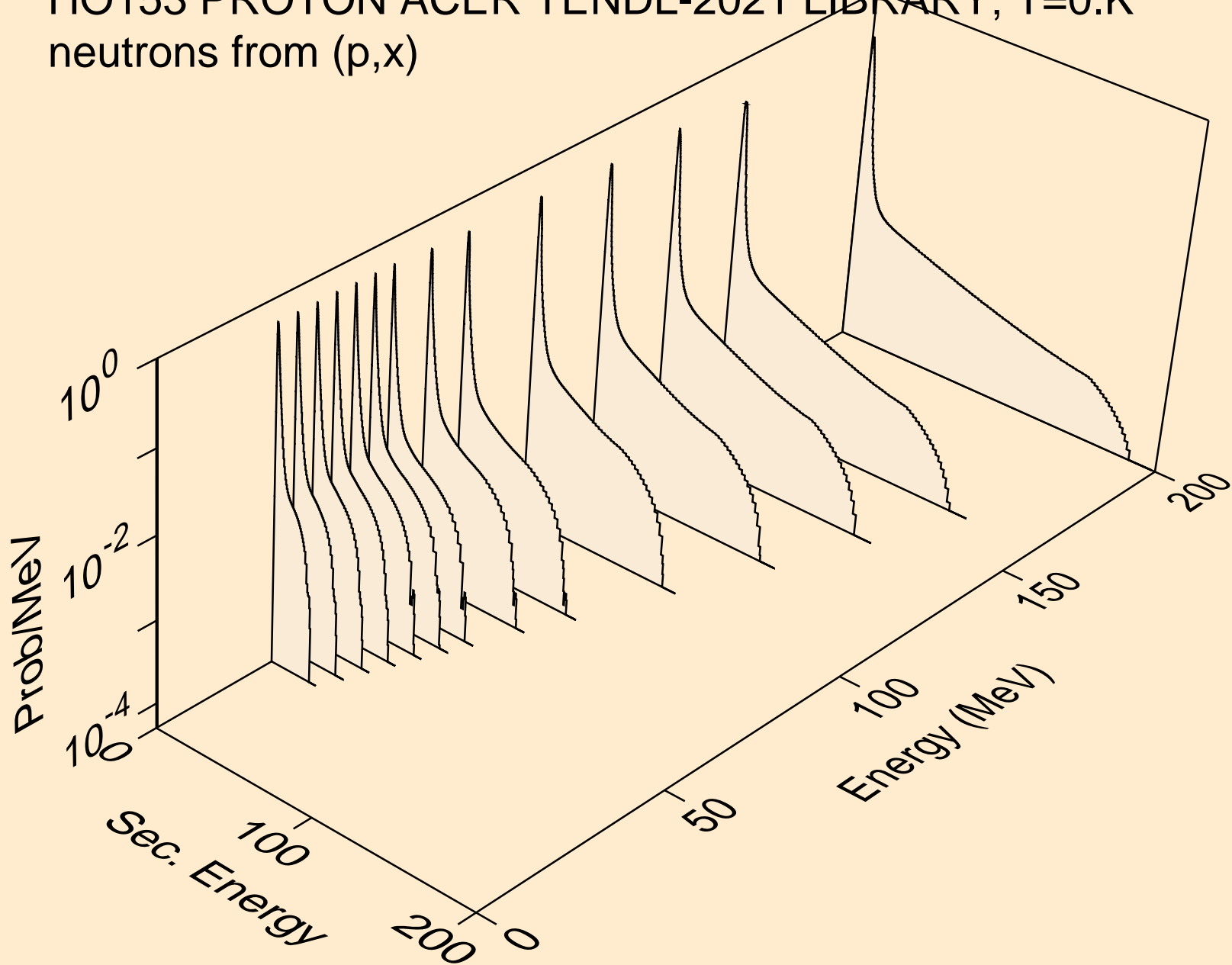

HO153 PROTON ACER TENDL-2021 LIBRARY; T=0.K  
neutrons from (p,2nd)

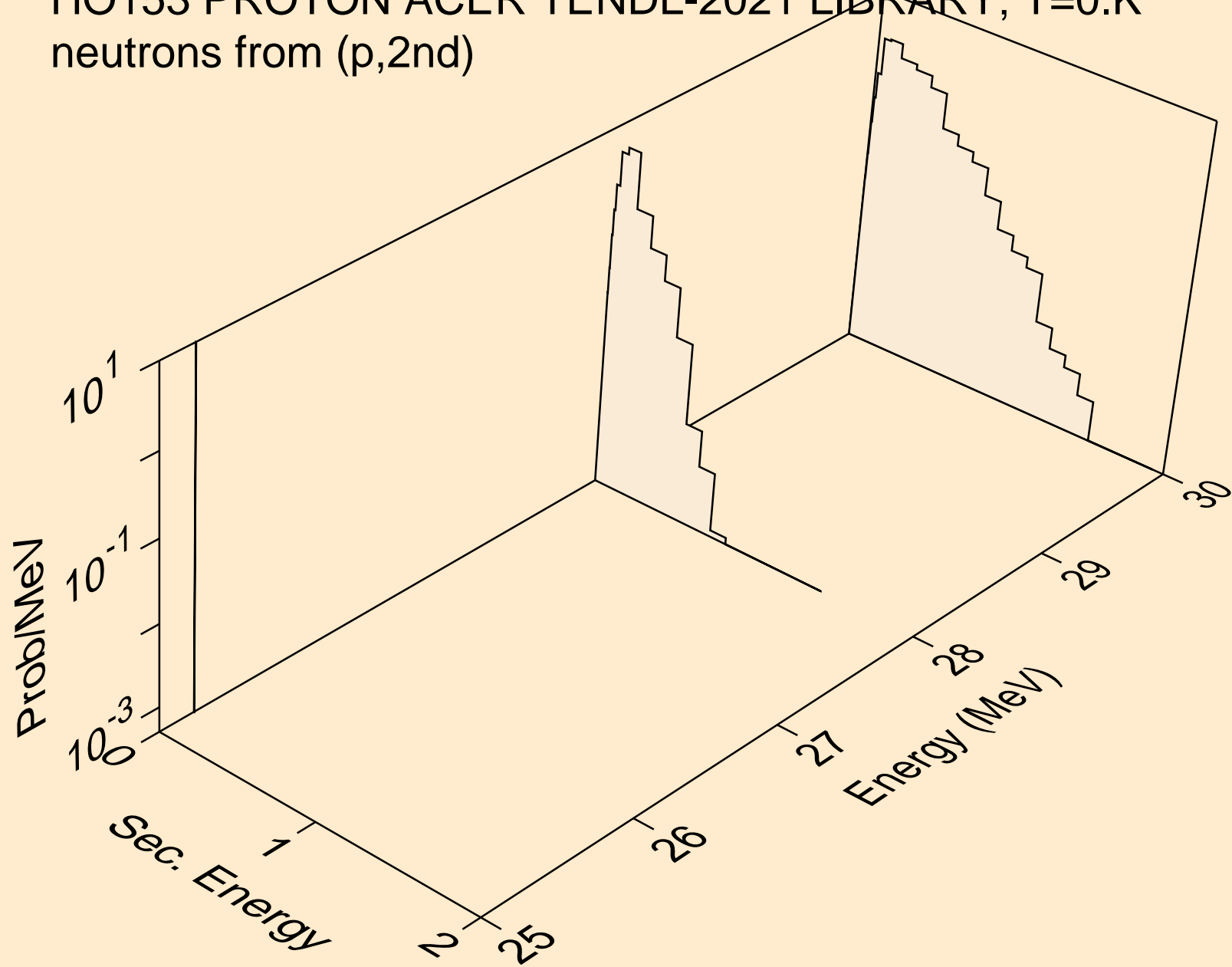

HO153 PROTON ACER TENDL-2021 LIBRARY; T=0.K  
neutrons from (p,2n)

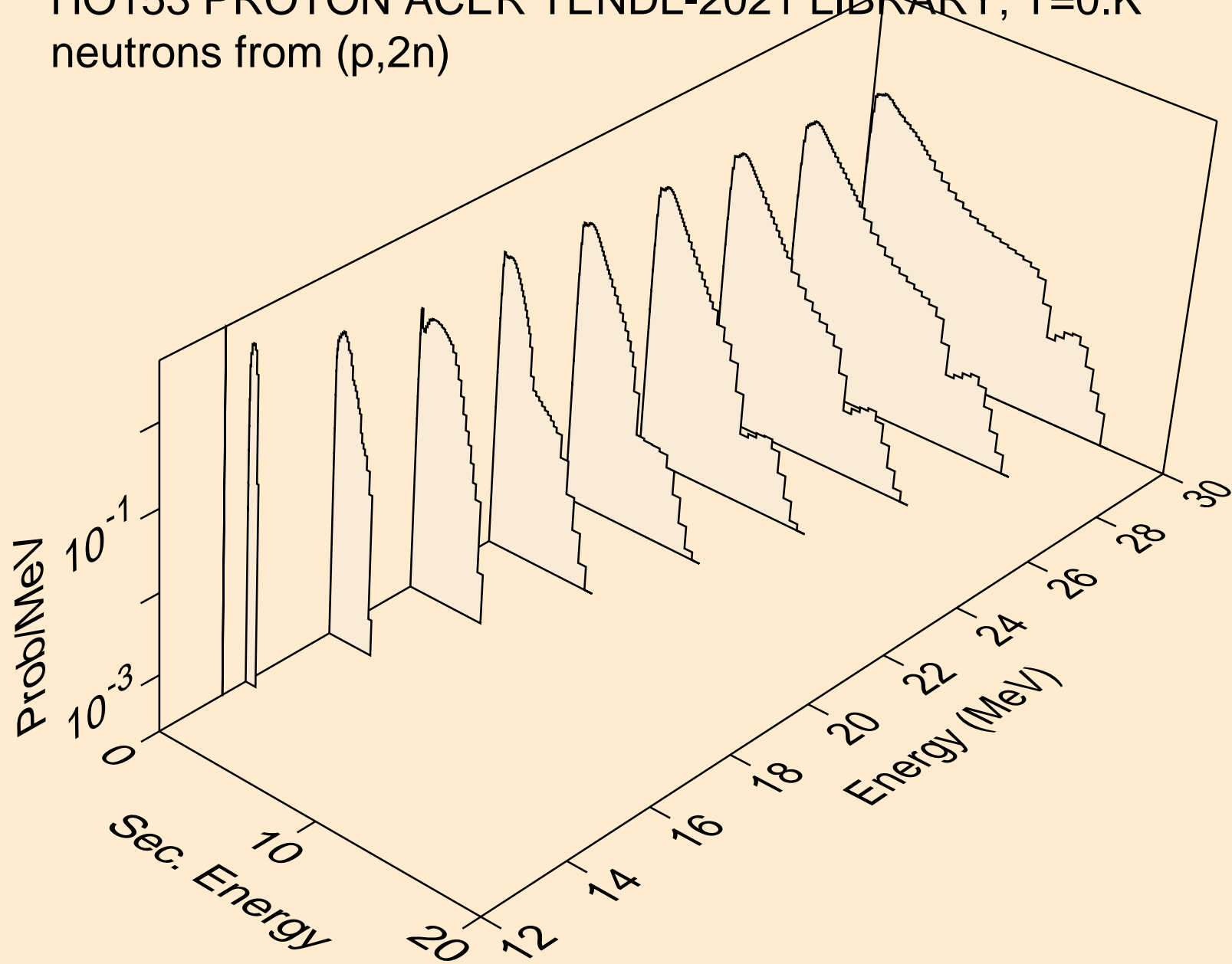



HO153 PROTON ACER TENDL-2021 LIBRARY; T=0.K  
neutrons from (p,3n)

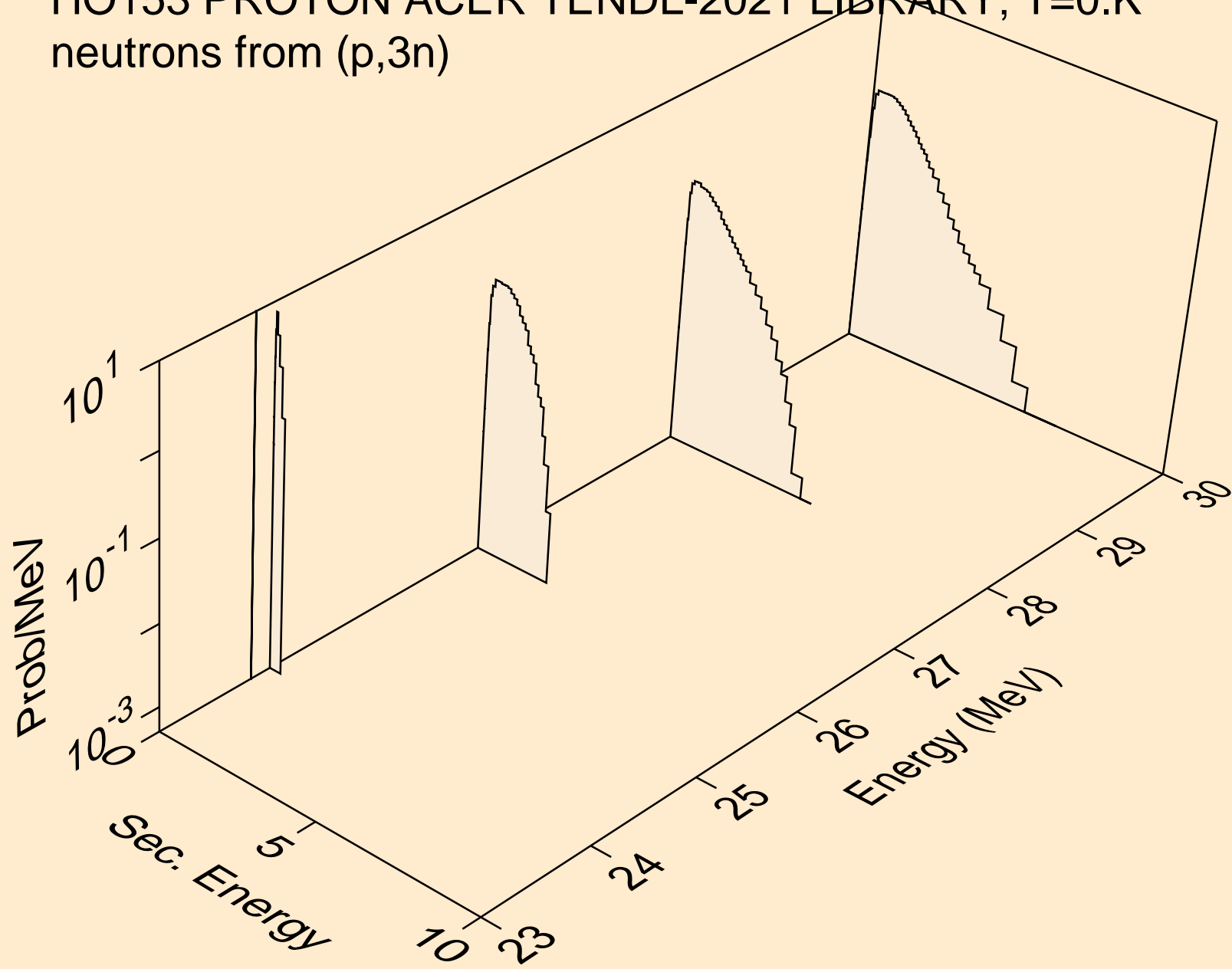

HO153 PROTON ACER TENDL-2021 LIBRARY; T=0.K  
neutrons from (p,n\*)a

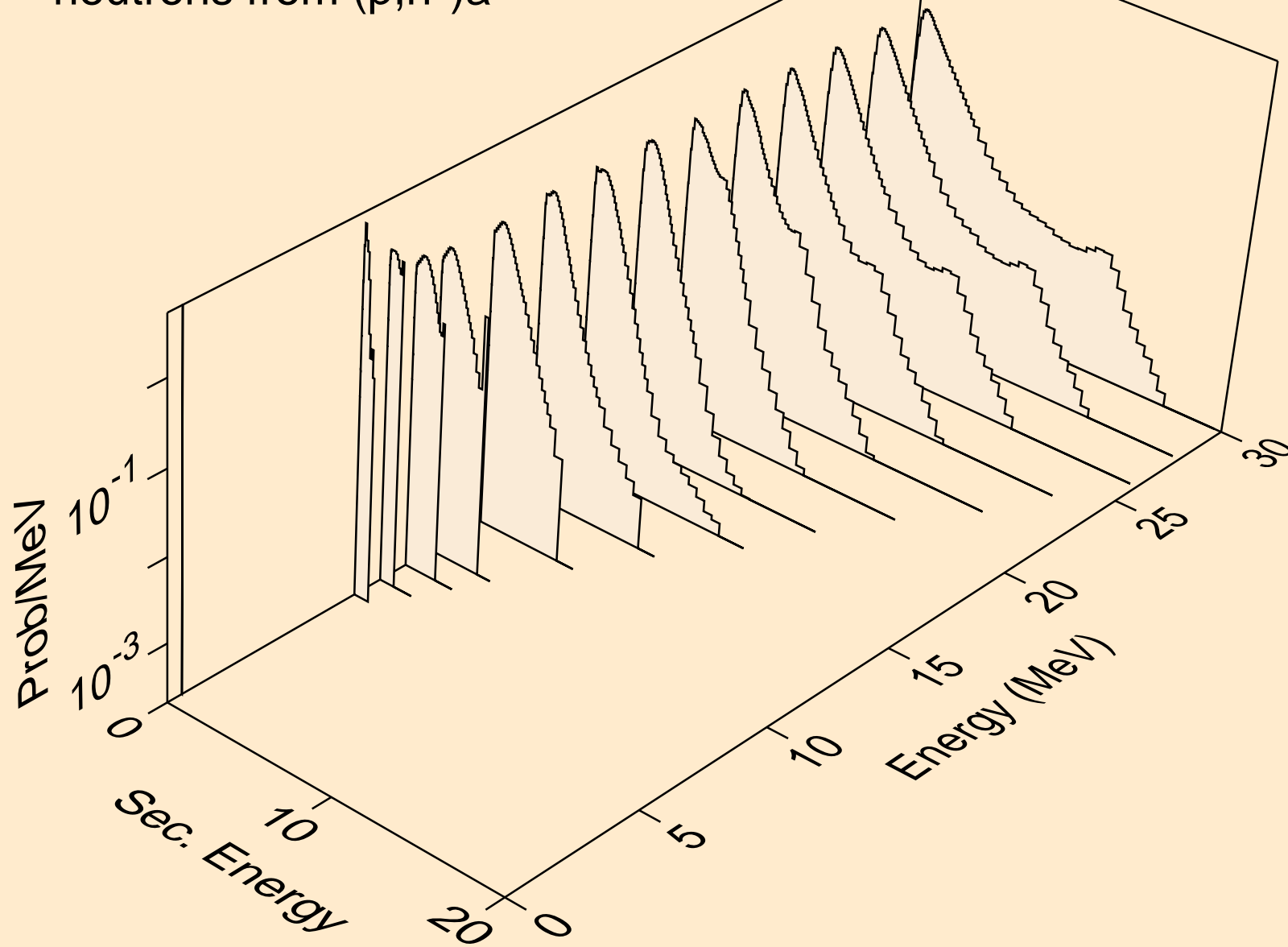

HO153 PROTON ACER TENDL-2021 LIBRARY; T=0.K  
neutrons from (p,2n)a

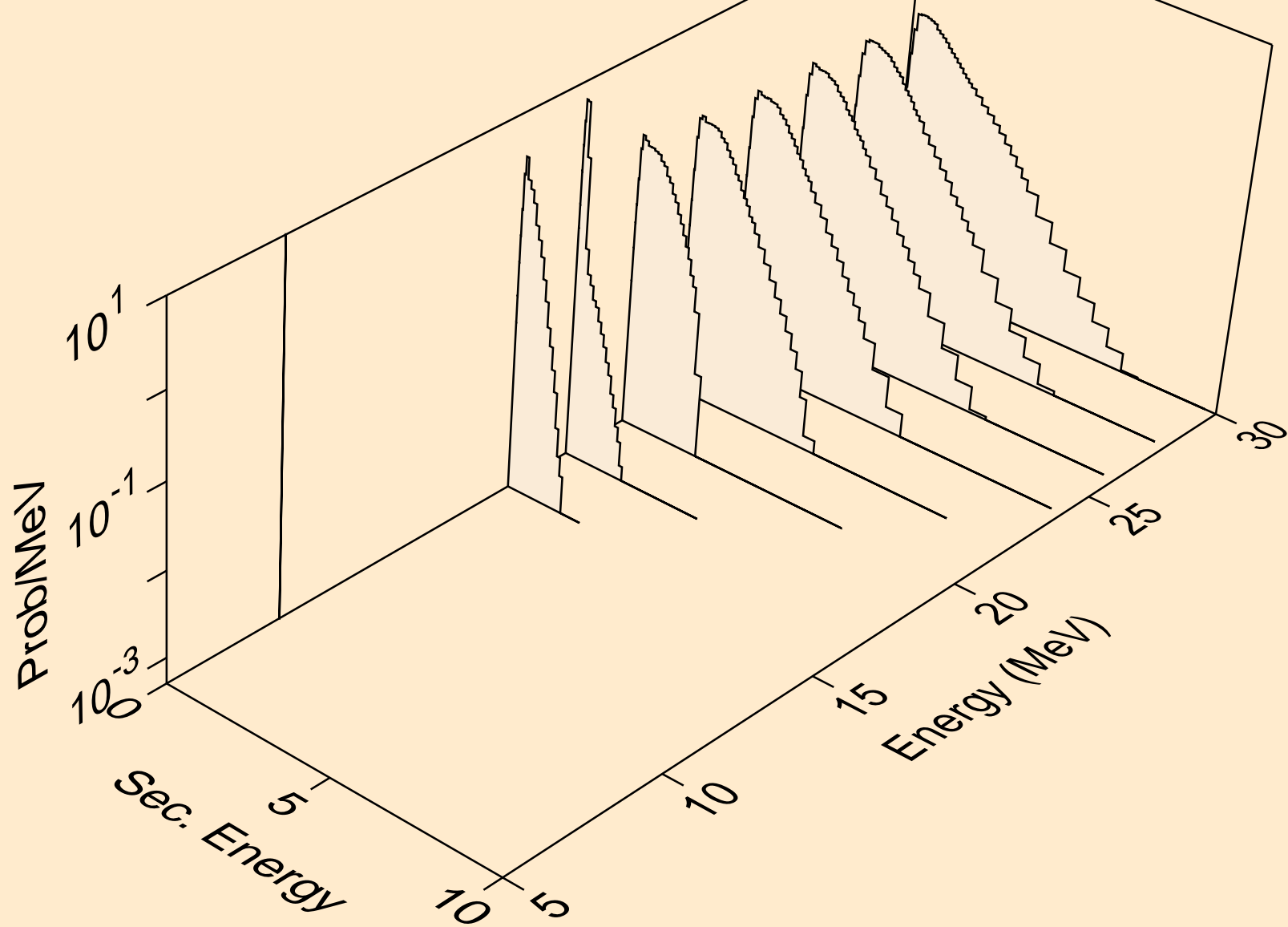

HO153 PROTON ACER TENDL-2021 LIBRARY; T=0.K  
neutrons from (p,3n)a

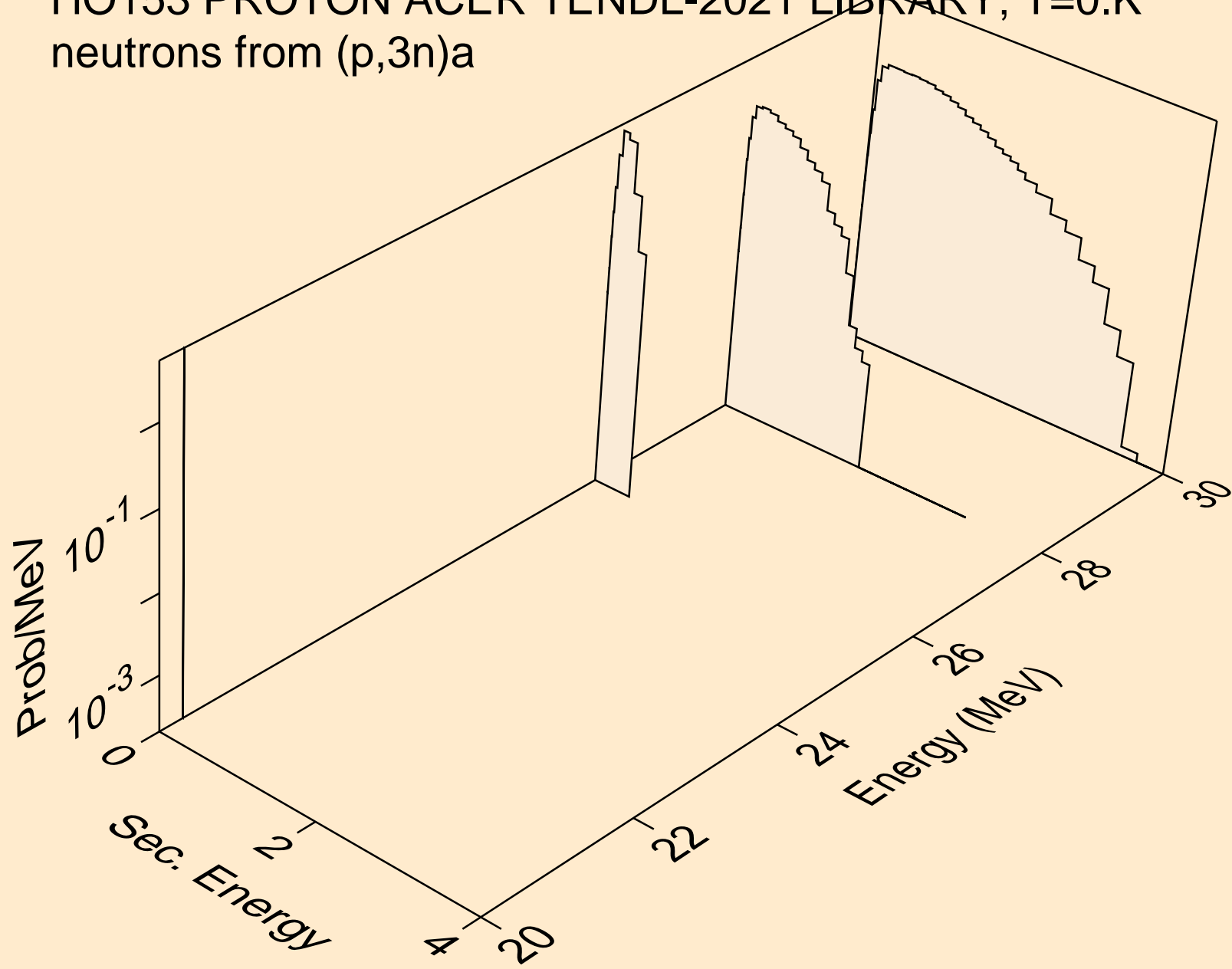

HO153 PROTON ACER TENDL-2021 LIBRARY; T=0.K  
neutrons from (p,n\*)p

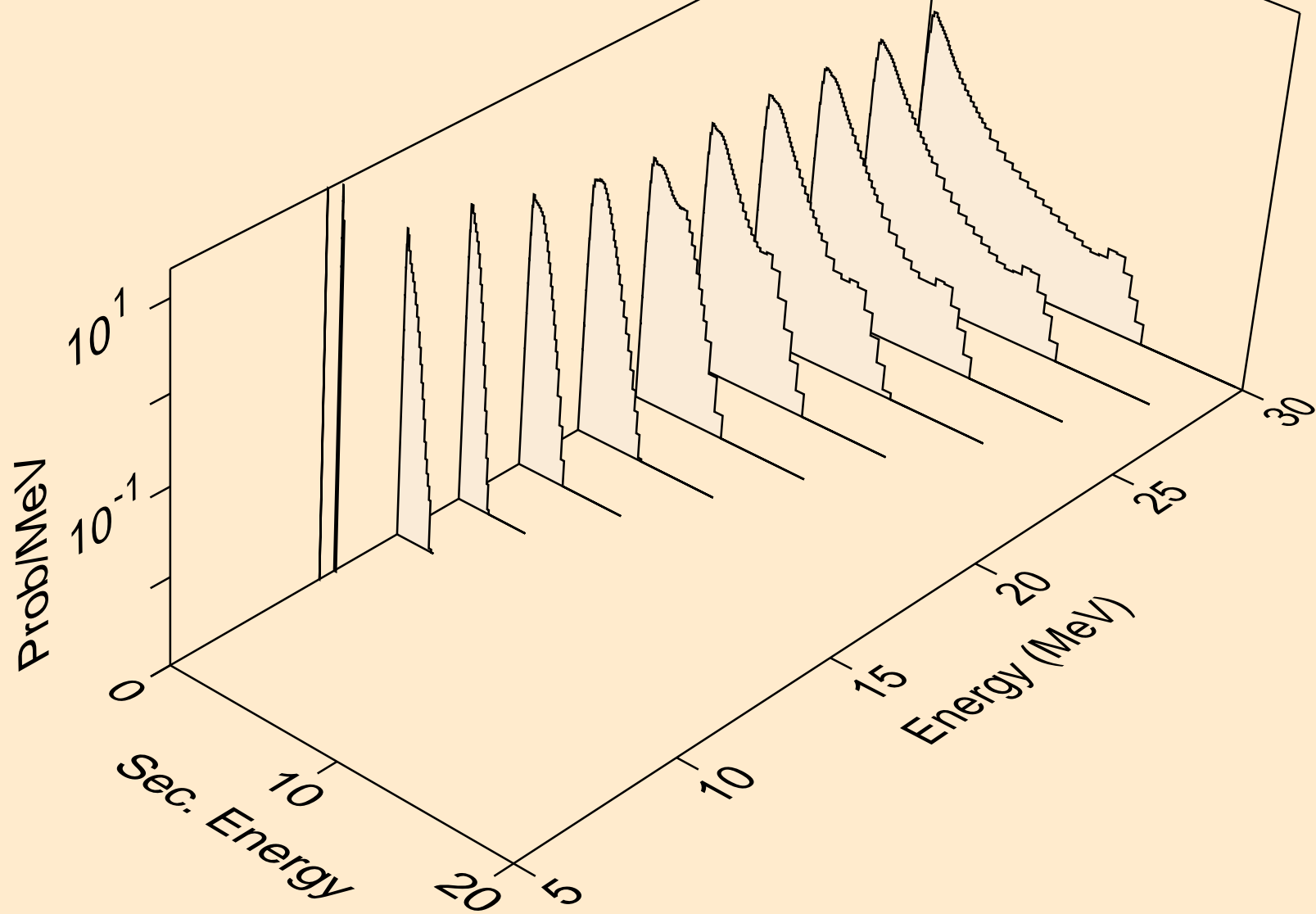

HO153 PROTON ACER TENDL-2021 LIBRARY; T=0.K  
neutrons from (p,n\*)2a

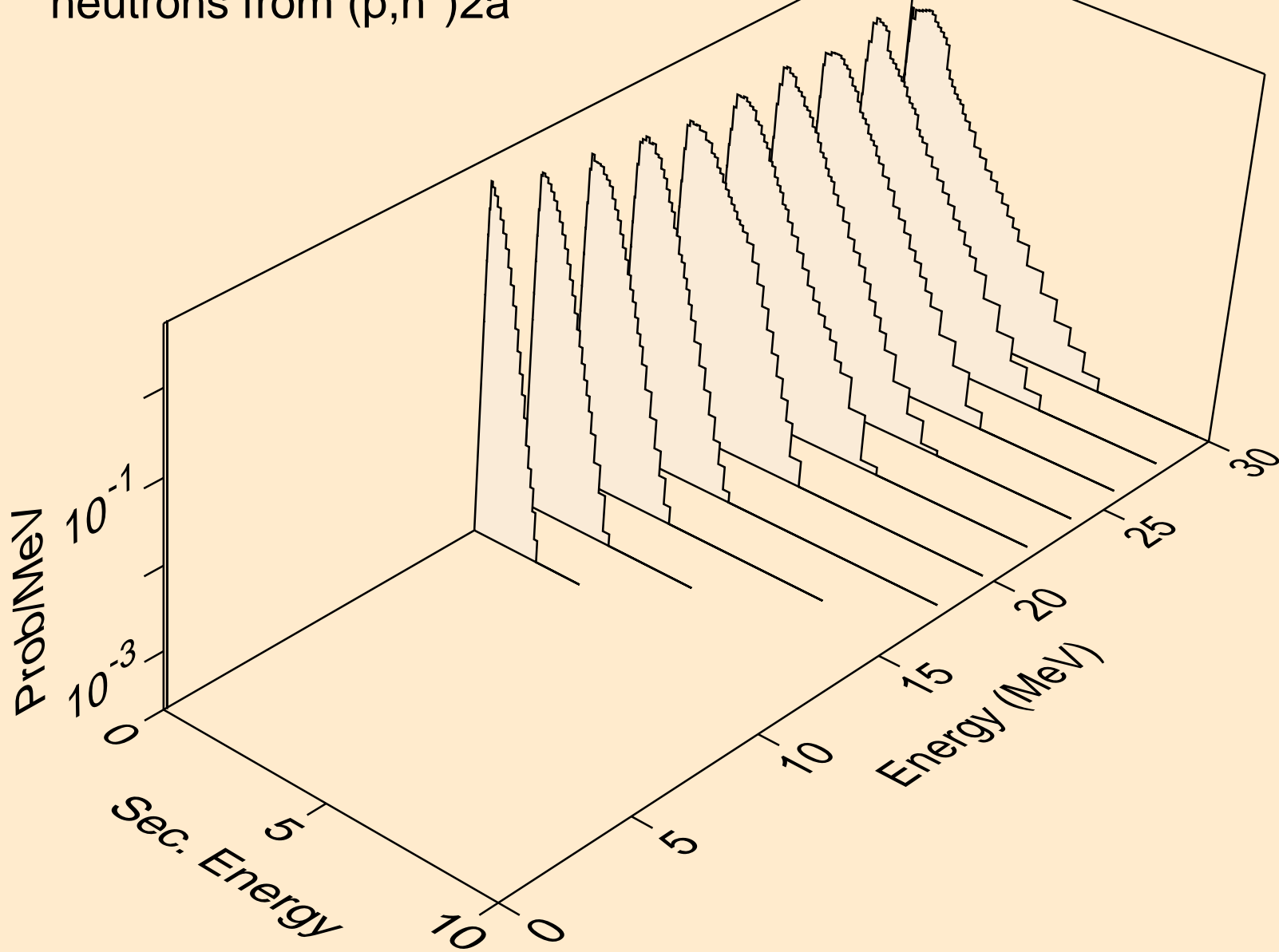

HO153 PROTON ACER TENDL-2021 LIBRARY; T=0.K  
neutrons from (p,n\*)d

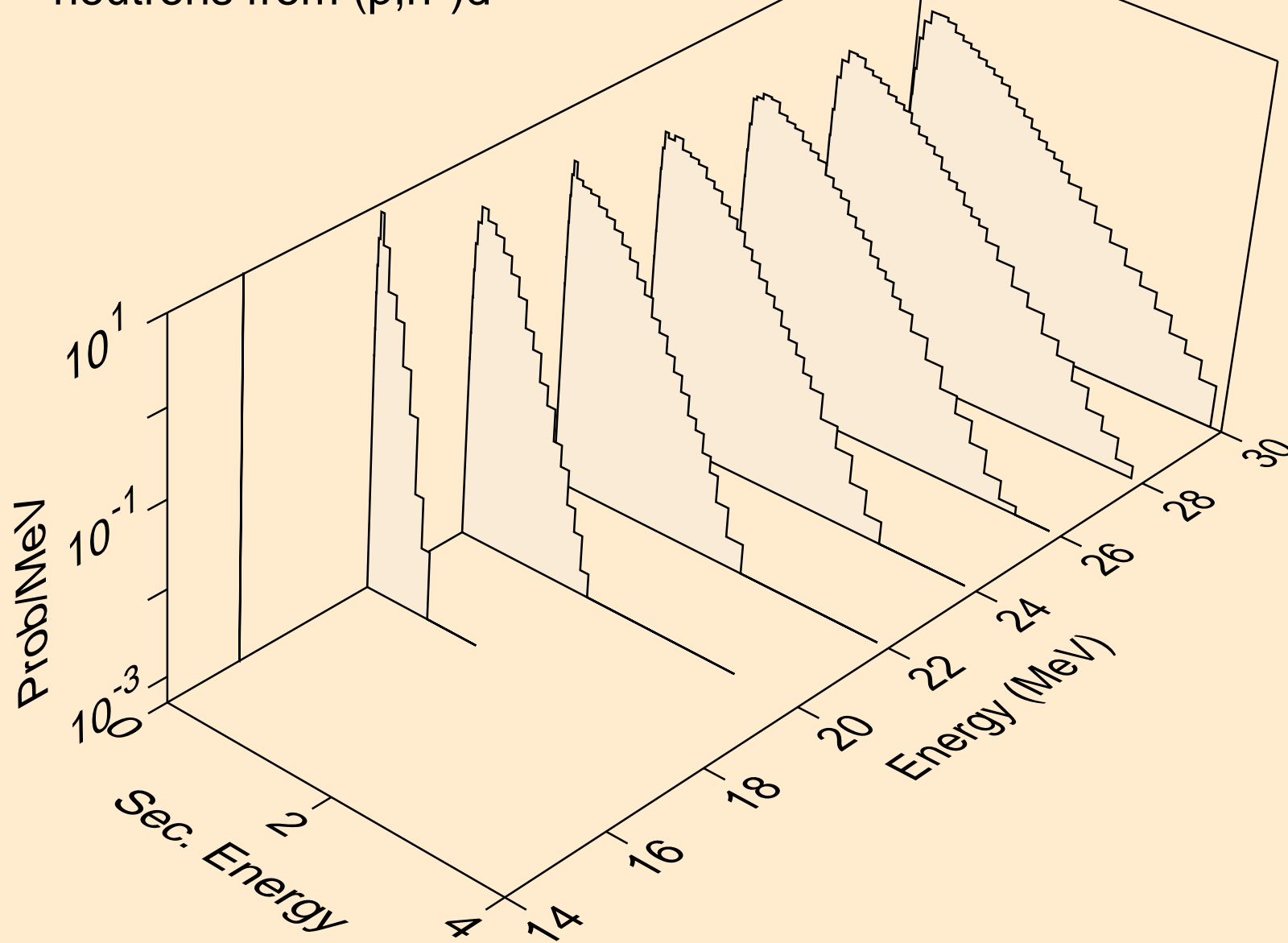

HO153 PROTON ACER TENDL-2021 LIBRARY; T=0.K  
neutrons from (p,n\*)t

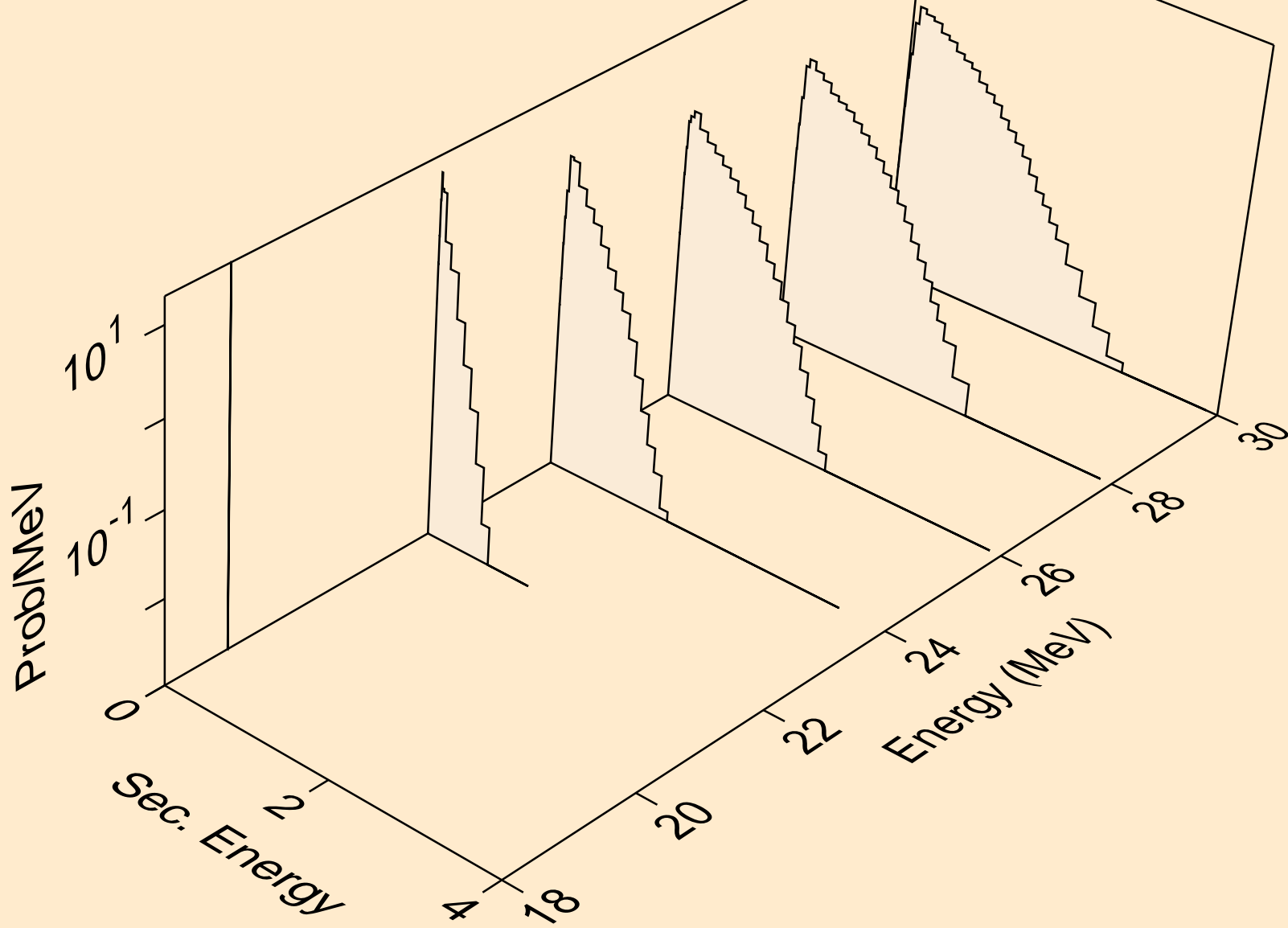



HO153 PROTON ACER TENDL-2021 LIBRARY; T=0.K  
neutrons from (p,n\*)he3

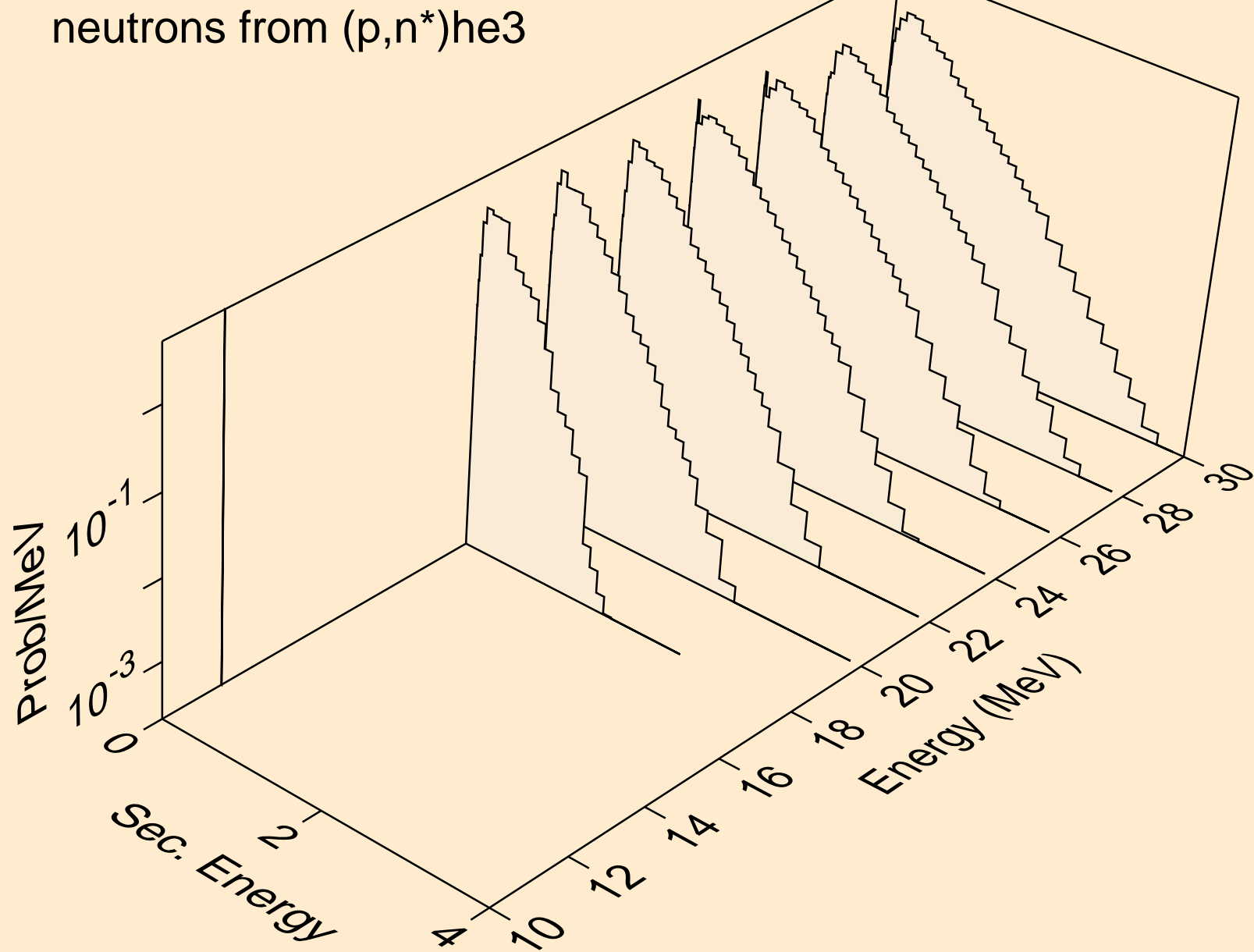

HO153 PROTON ACER TENDL-2021 LIBRARY; T=0.K  
neutrons from (p,2np)

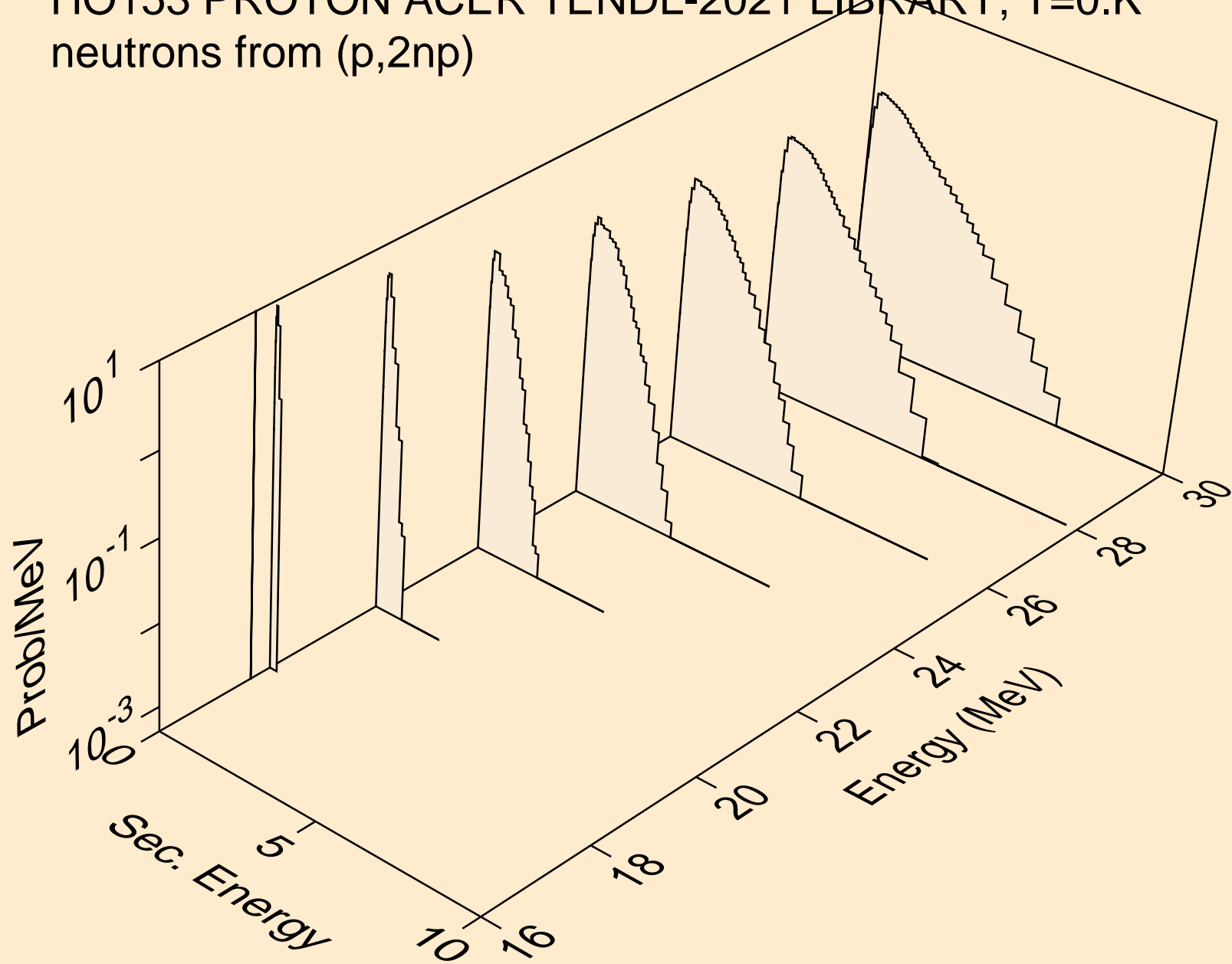

HO153 PROTON ACER TENDL-2021 LIBRARY; T=0.K  
neutrons from (p,3np)

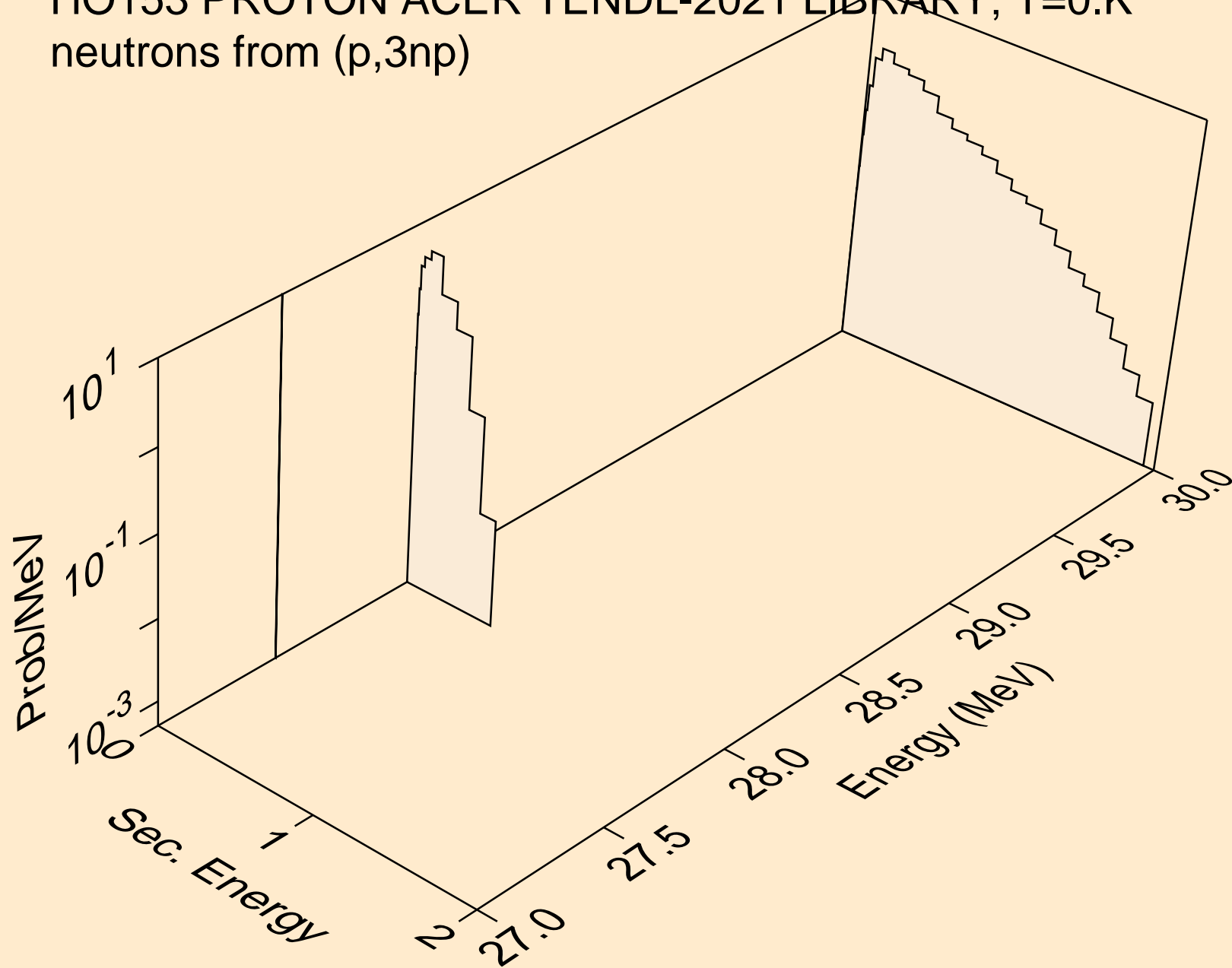

HO153 PROTON ACER TENDL-2021 LIBRARY; T=0.K  
neutrons from (p,2np)

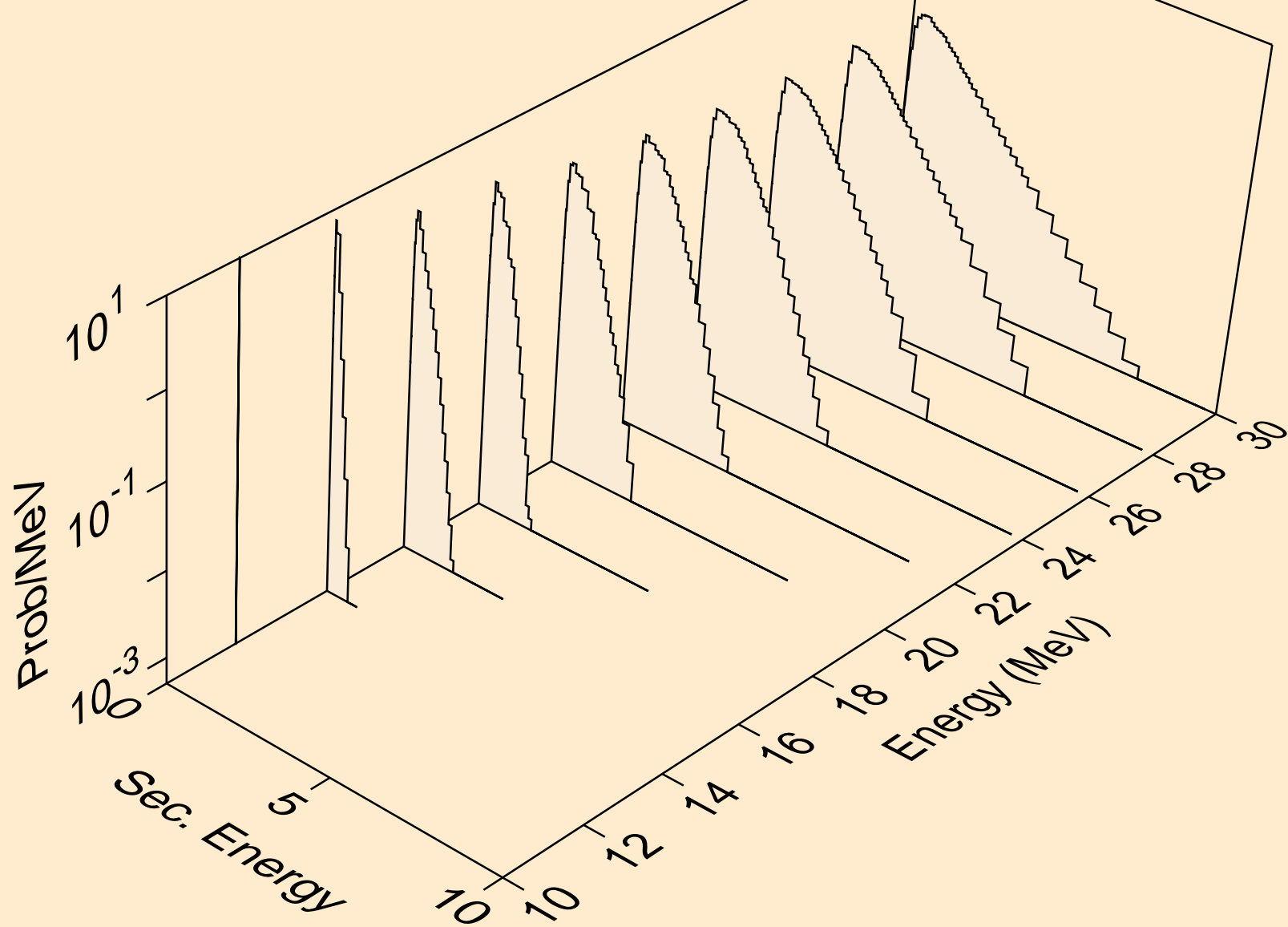

HO153 PROTON ACER TENDL-2021 LIBRARY; T=0.K  
neutrons from (p,npa)

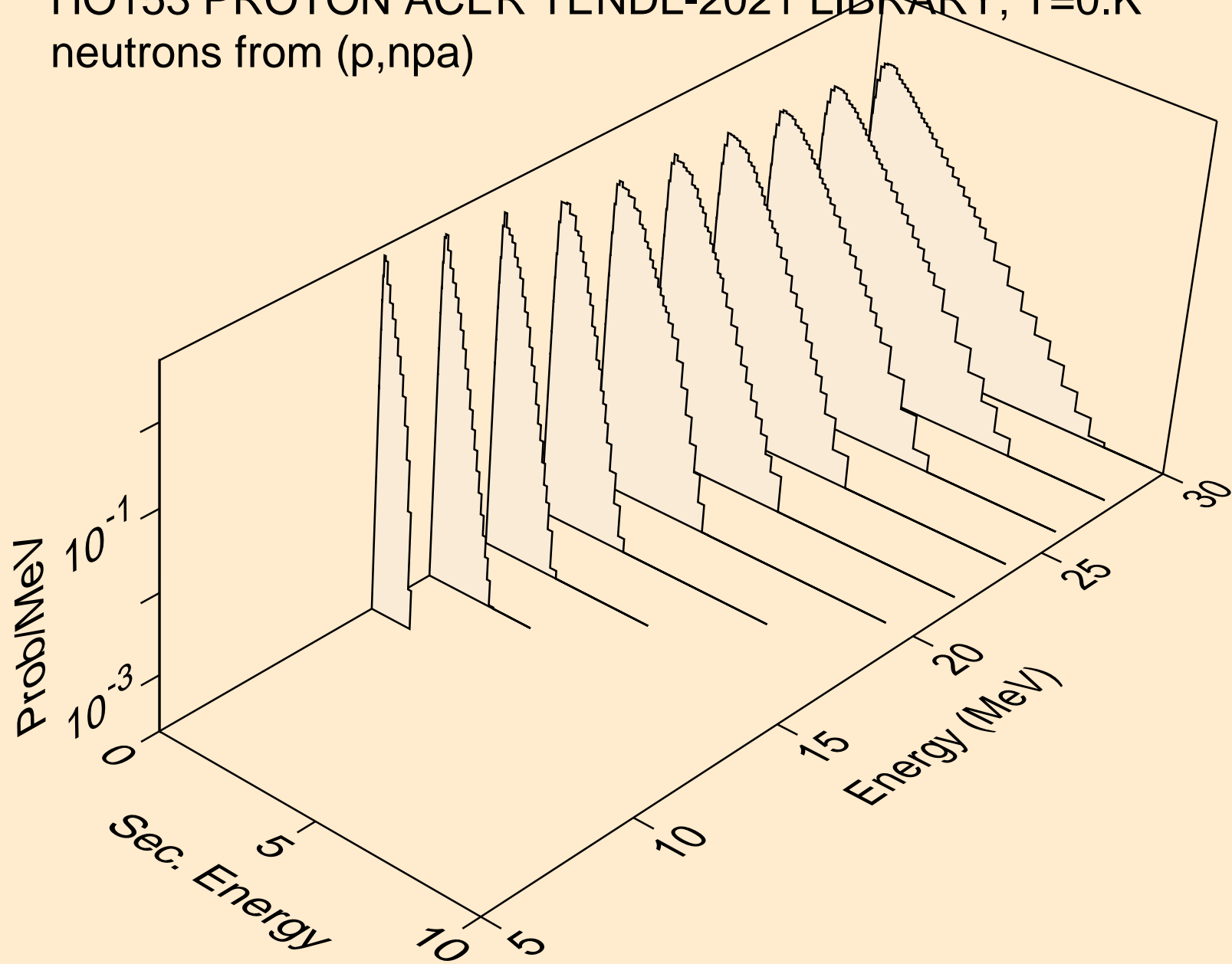

HO153 PROTON ACER TENDL-2021 LIBRARY; T=0.K  
deuterons from (p,x)

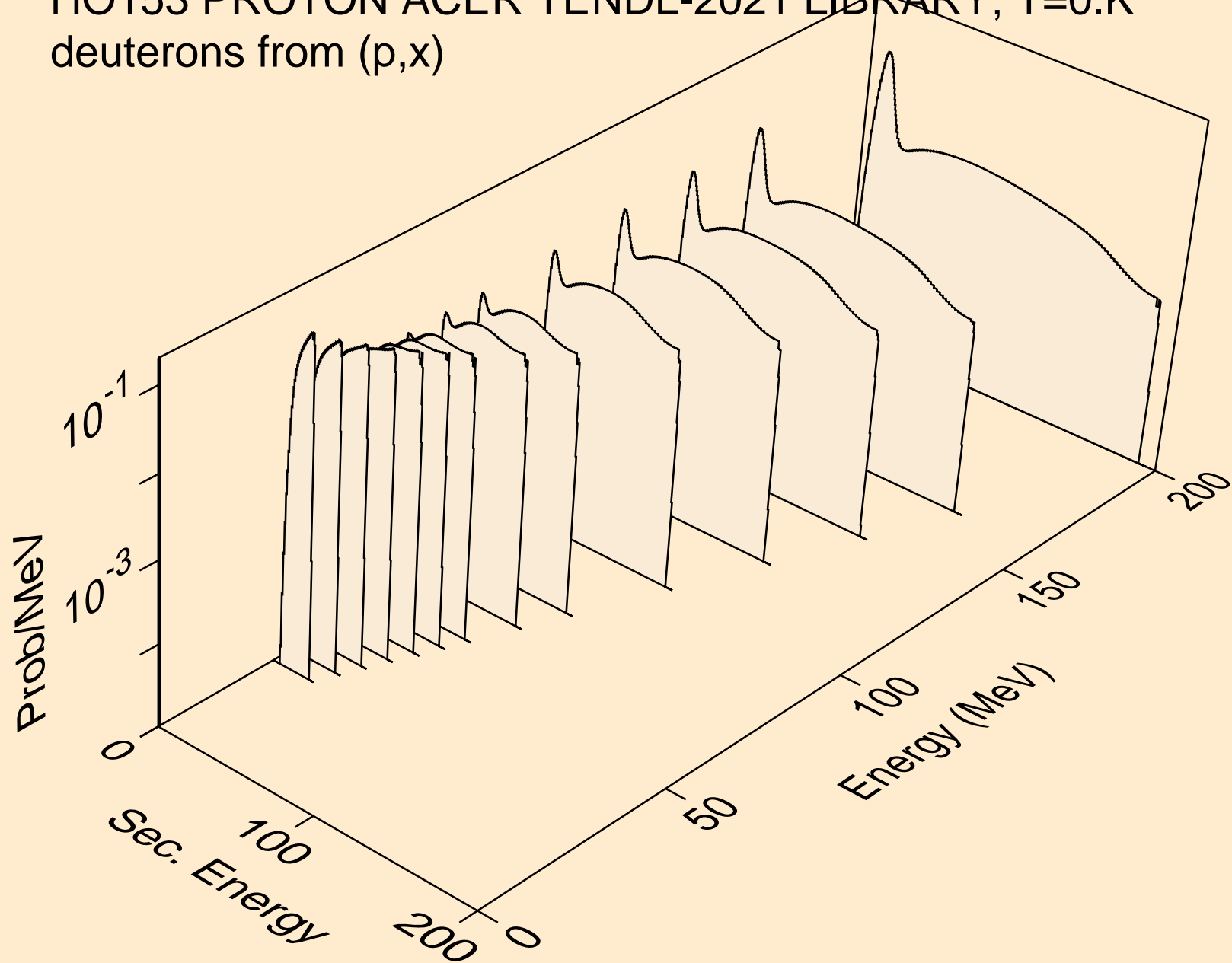

HO153 PROTON ACER TENDL-2021 LIBRARY; T=0.K  
deuterons from (p,2nd)

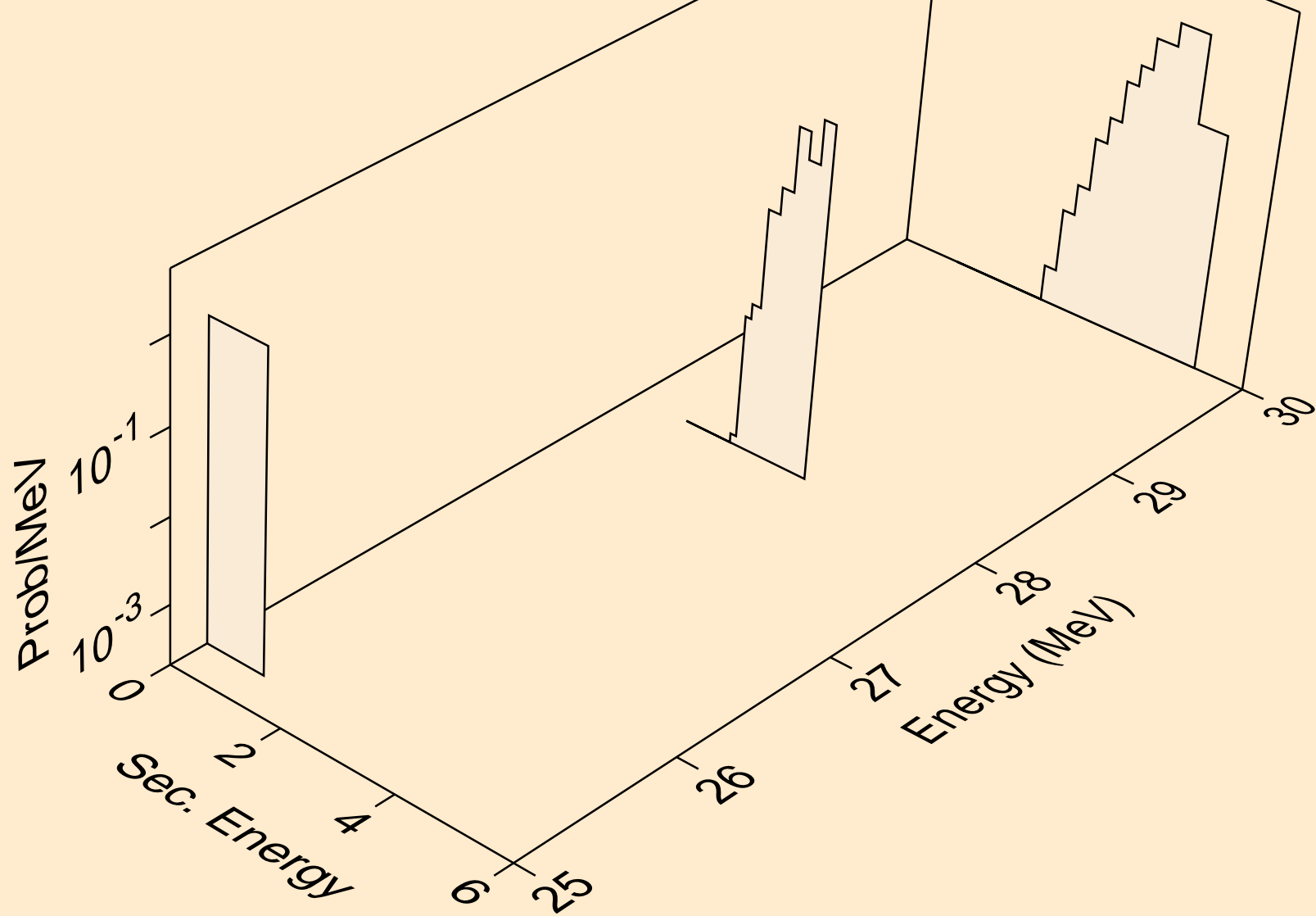

HO153 PROTON ACER TENDL-2021 LIBRARY; T=0.K  
deuterons from (p,n\*)d

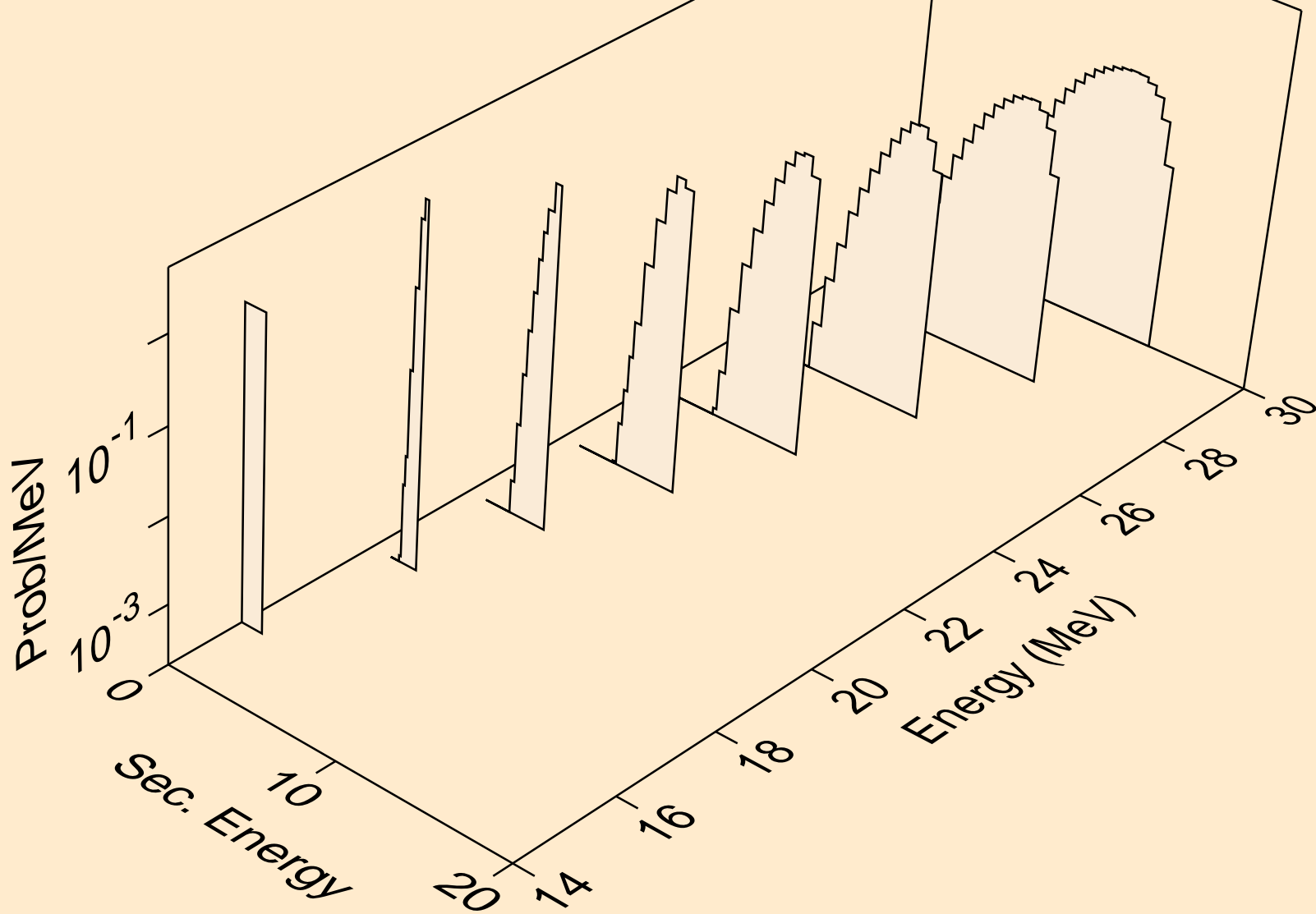



HO153 PROTON ACER TENDL-2021 LIBRARY; T=0.K  
deuterons from (p,d)

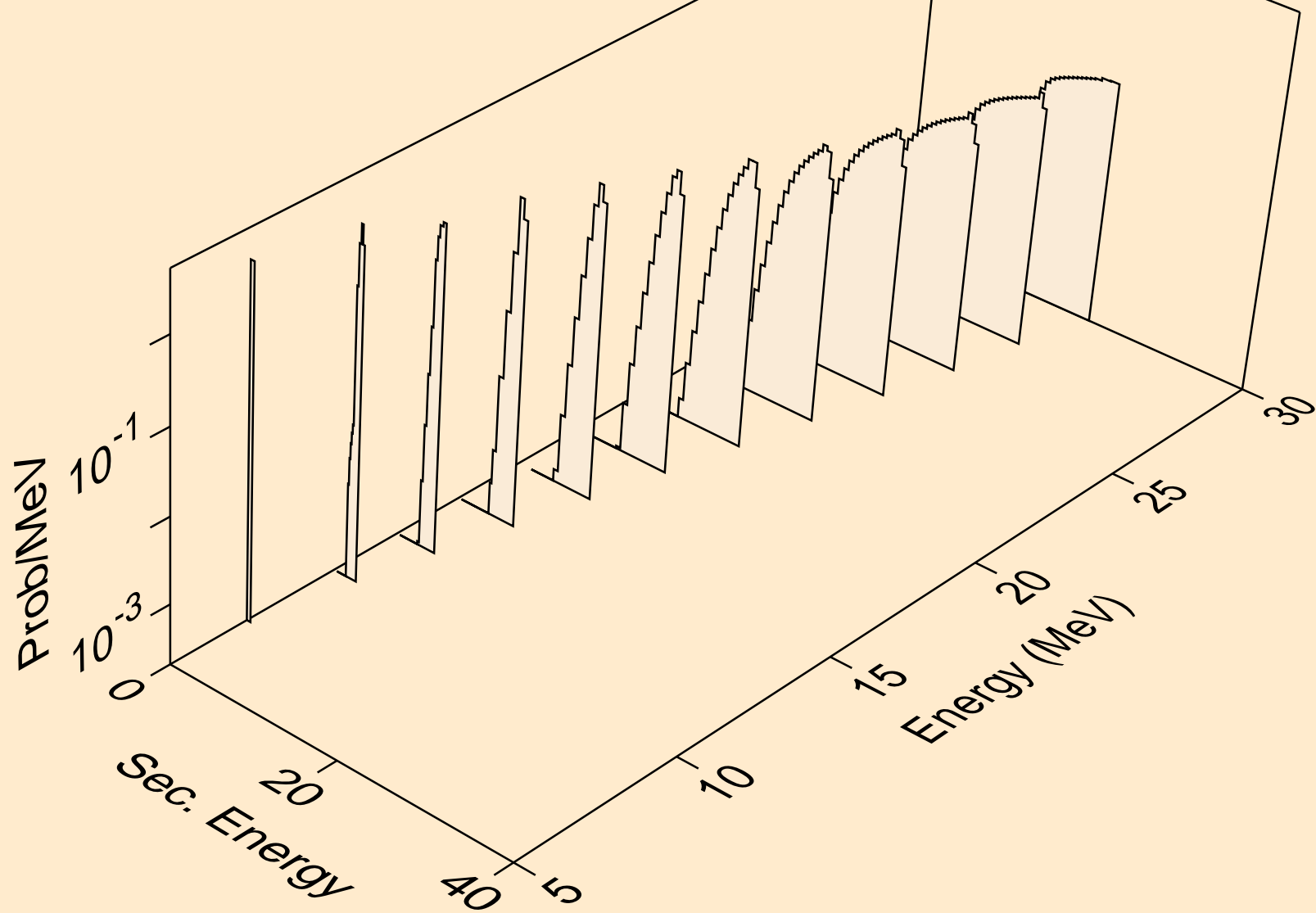

HO153 PROTON ACER TENDL-2021 LIBRARY; T=0.K  
deuterons from (p,pd)

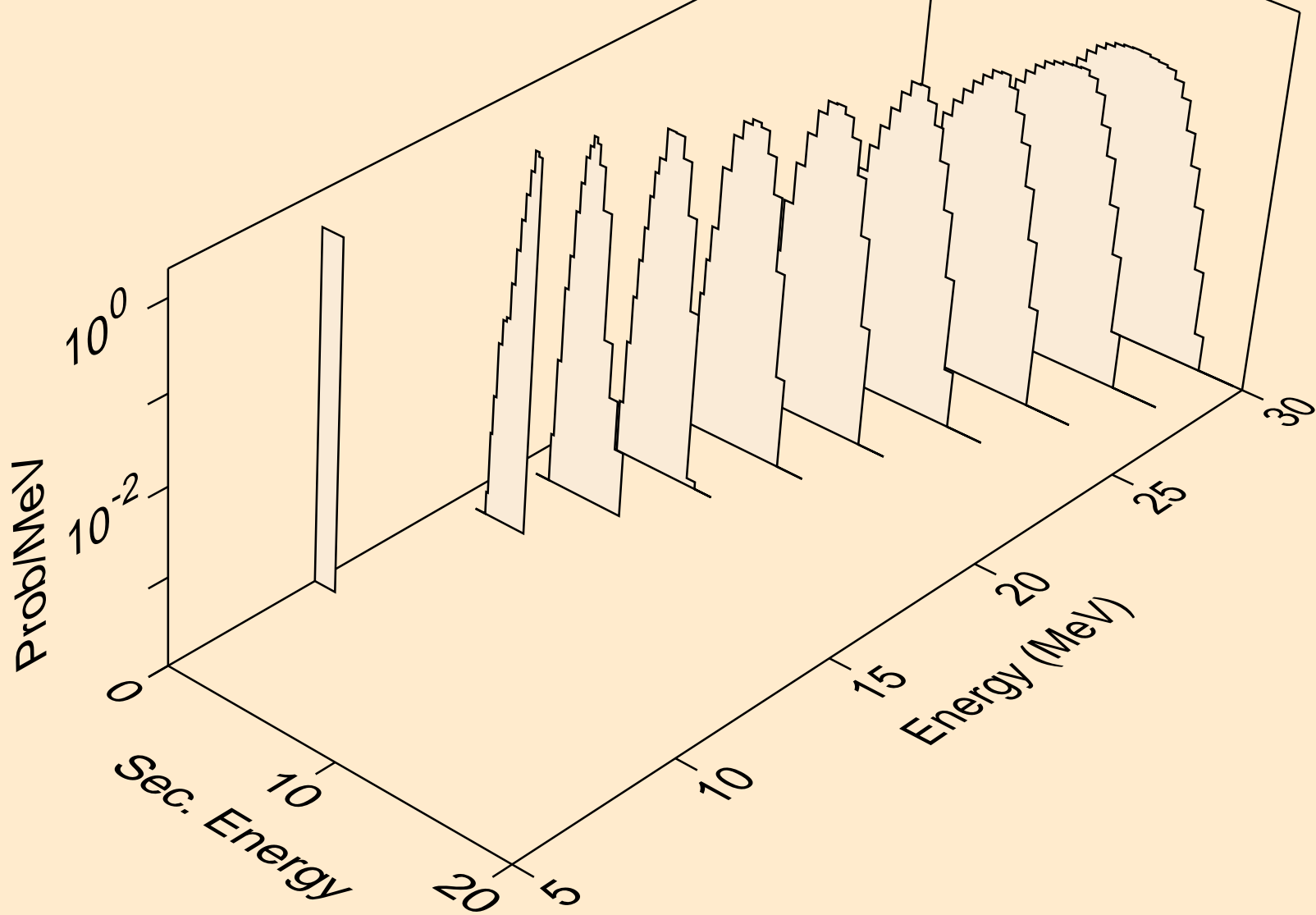

HO153 PROTON ACER TENDL-2021 LIBRARY; T=0.K  
deuterons from (p,da)

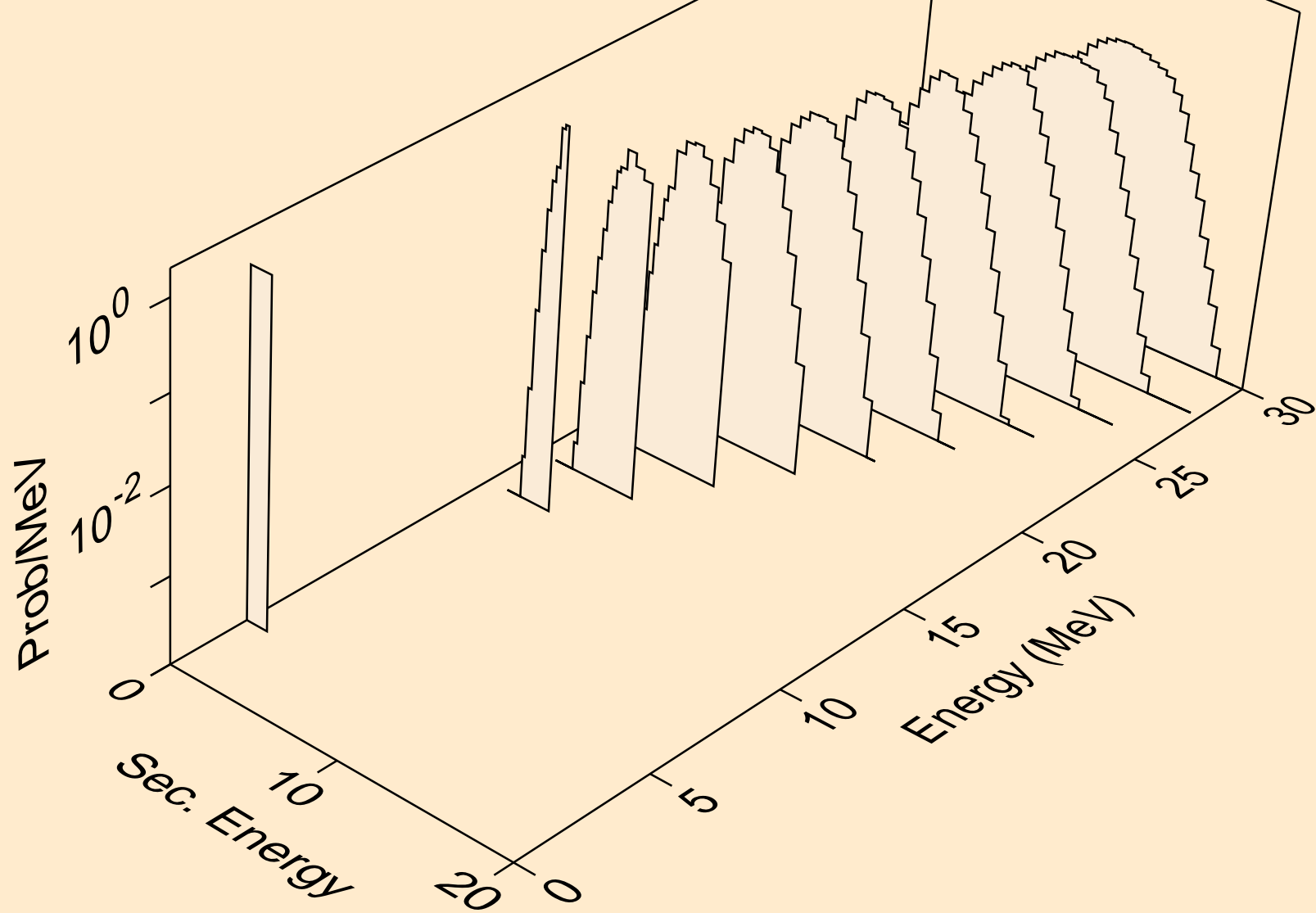

HO153 PROTON ACER TENDL-2021 LIBRARY; T=0.K  
tritons from (p,x)

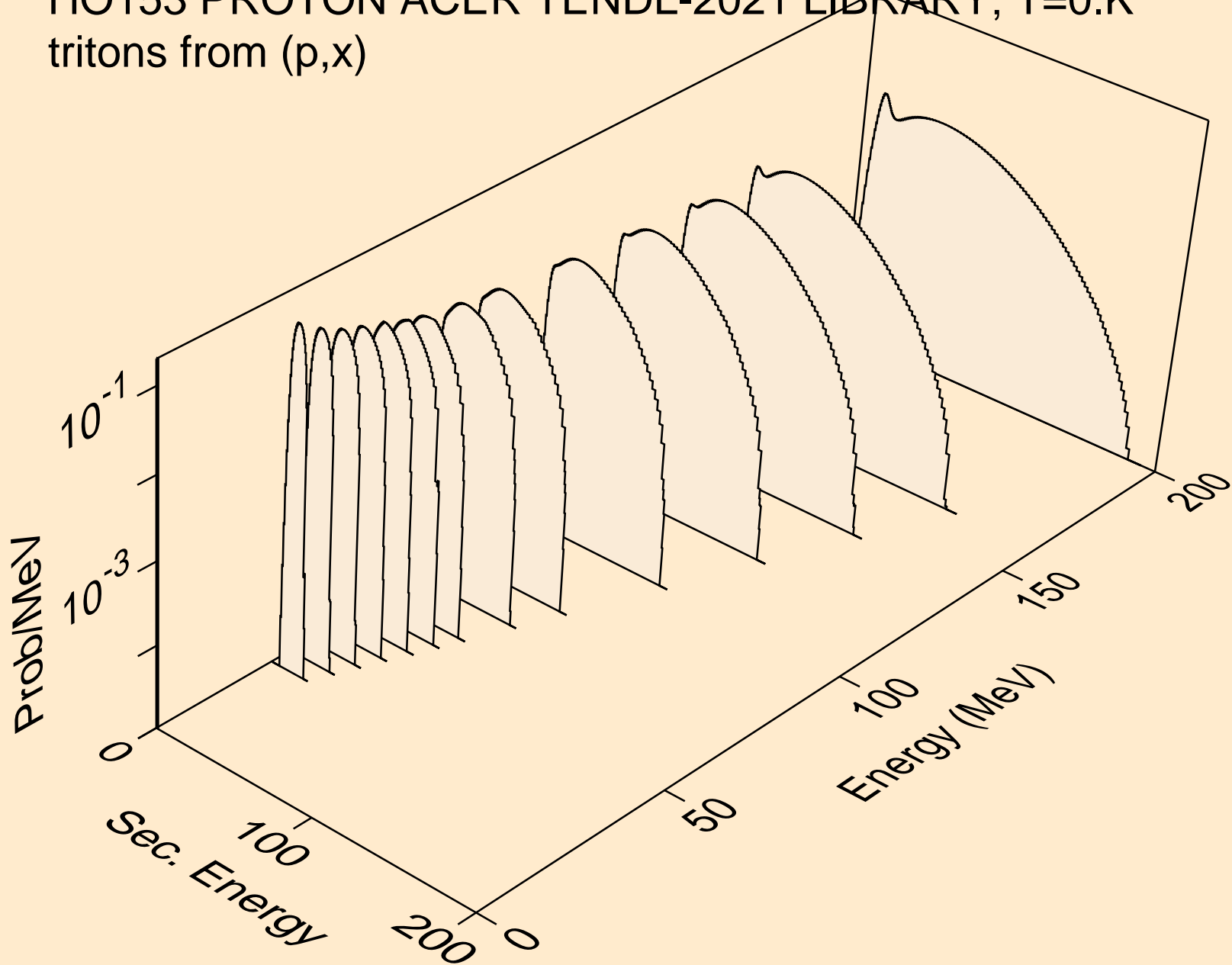

HO153 PROTON ACER TENDL-2021 LIBRARY; T=0.K  
tritons from (p,n\*)t

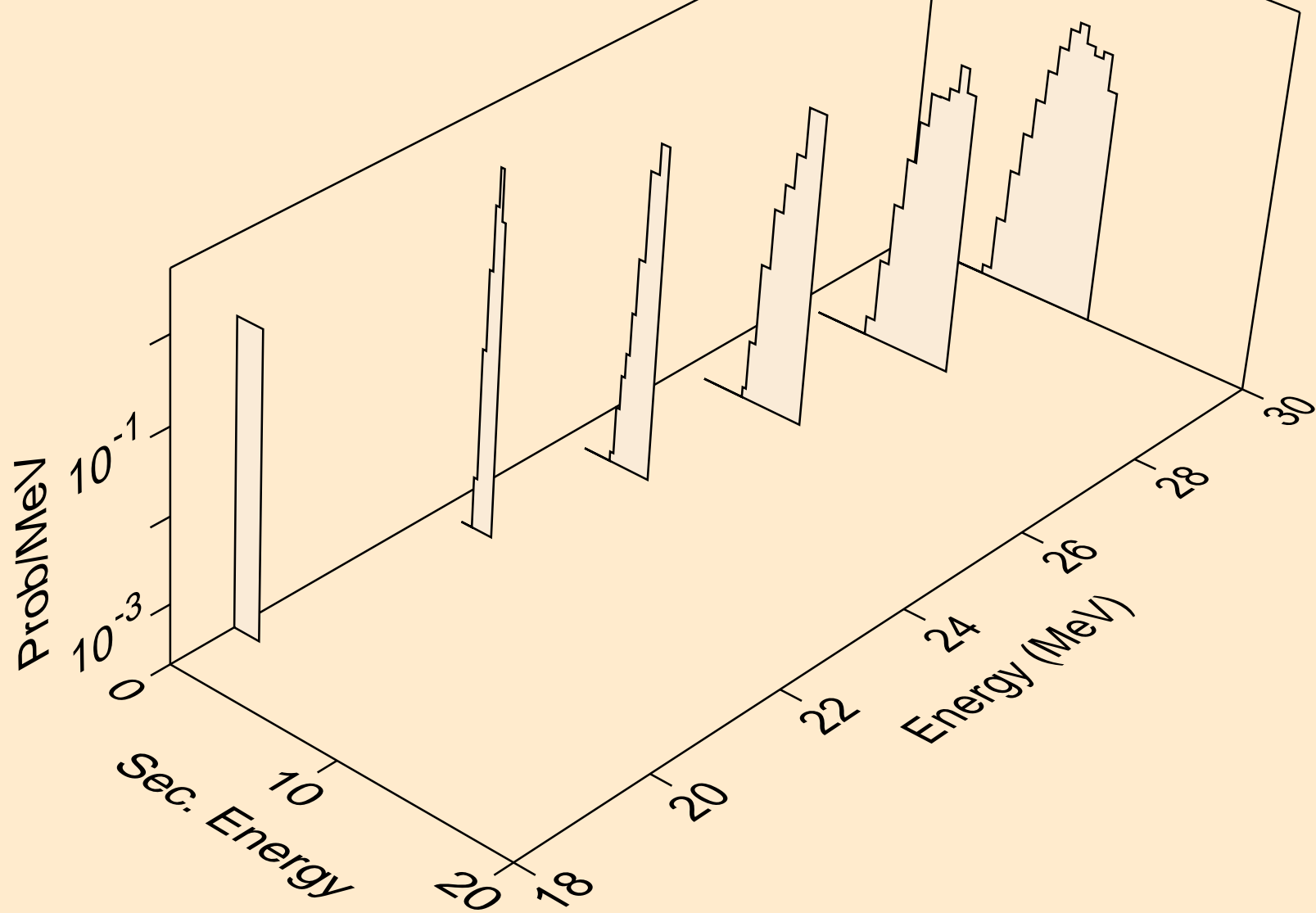

HO153 PROTON ACER TENDL-2021 LIBRARY; T=0.K  
tritons from (p,t)

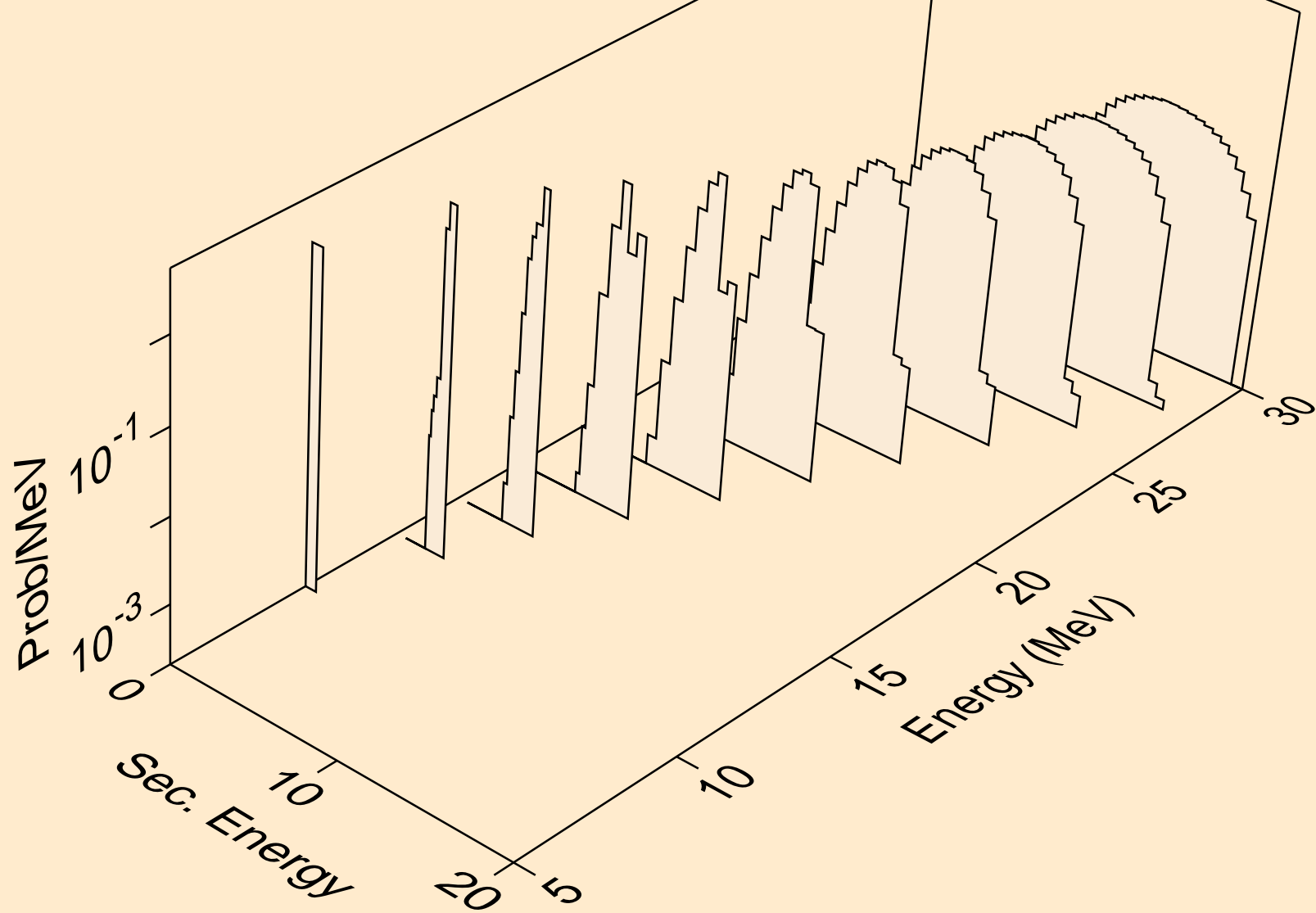

HO153 PROTON ACER TENDL-2021 LIBRARY; T=0.K  
tritons from (p,pt)

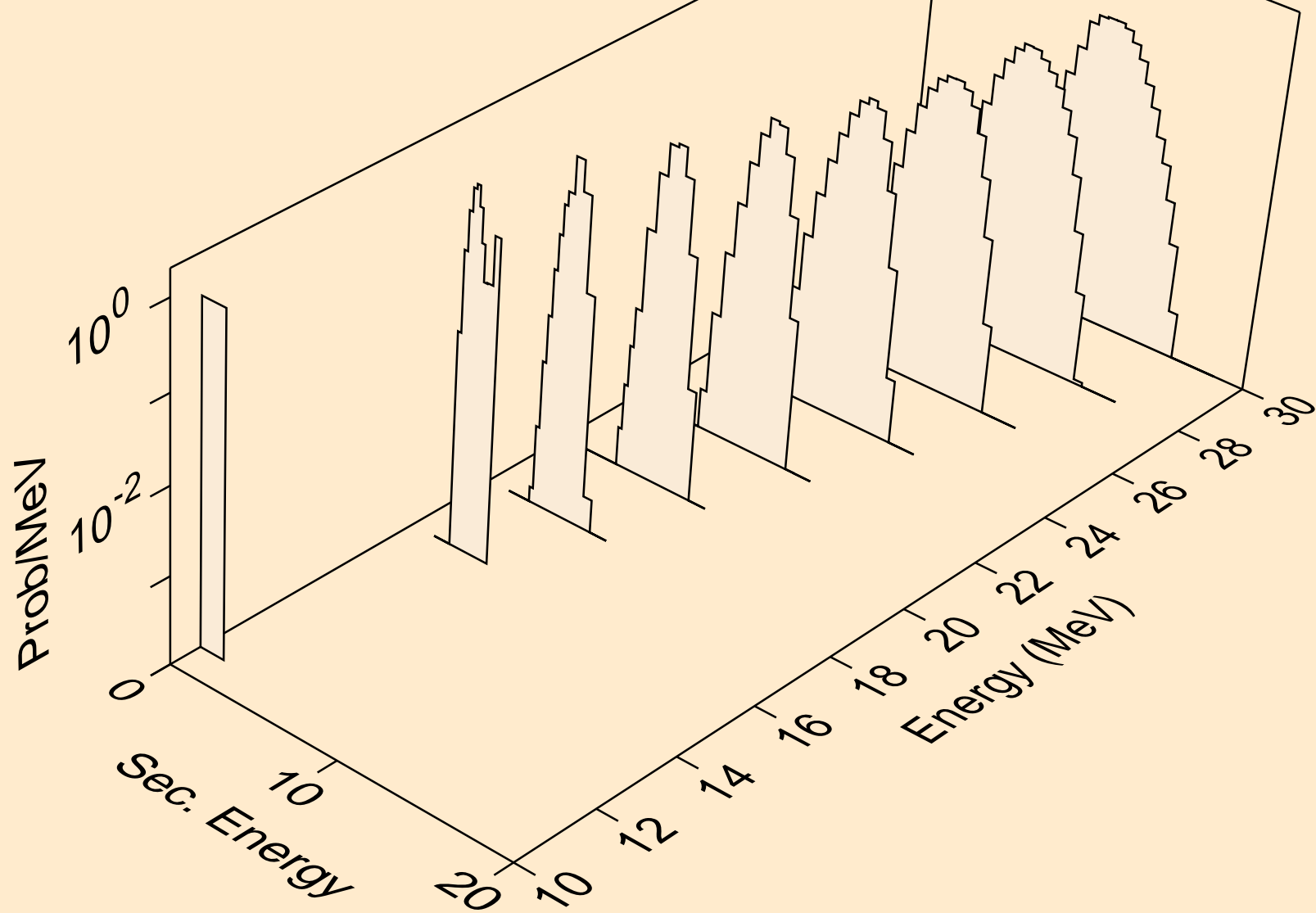

HO153 PROTON ACER TENDL-2021 LIBRARY; T=0.K  
he3s from (p,x)

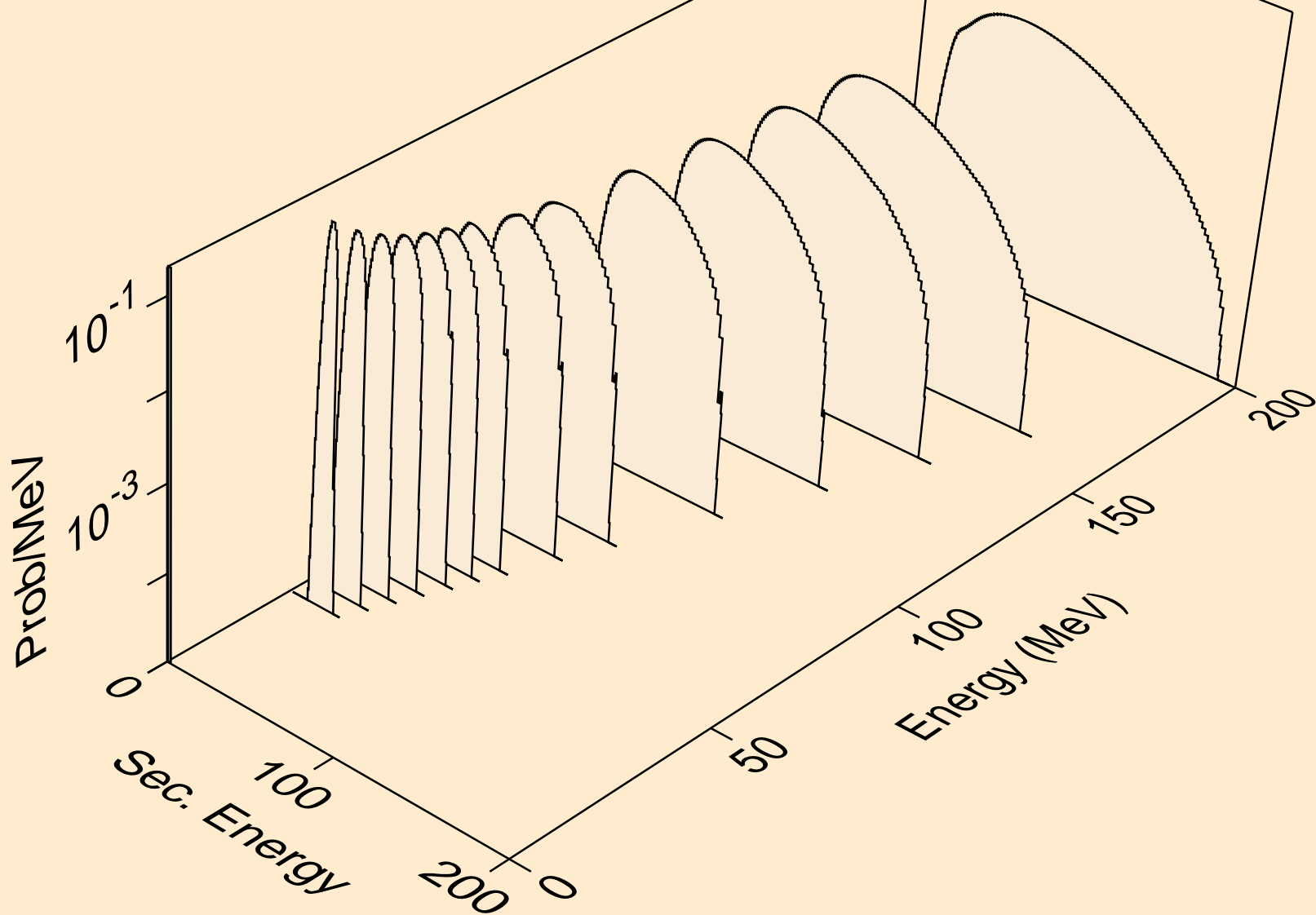



HO153 PROTON ACER TENDL-2021 LIBRARY; T=0.K  
he3s from (p,n\*)he3

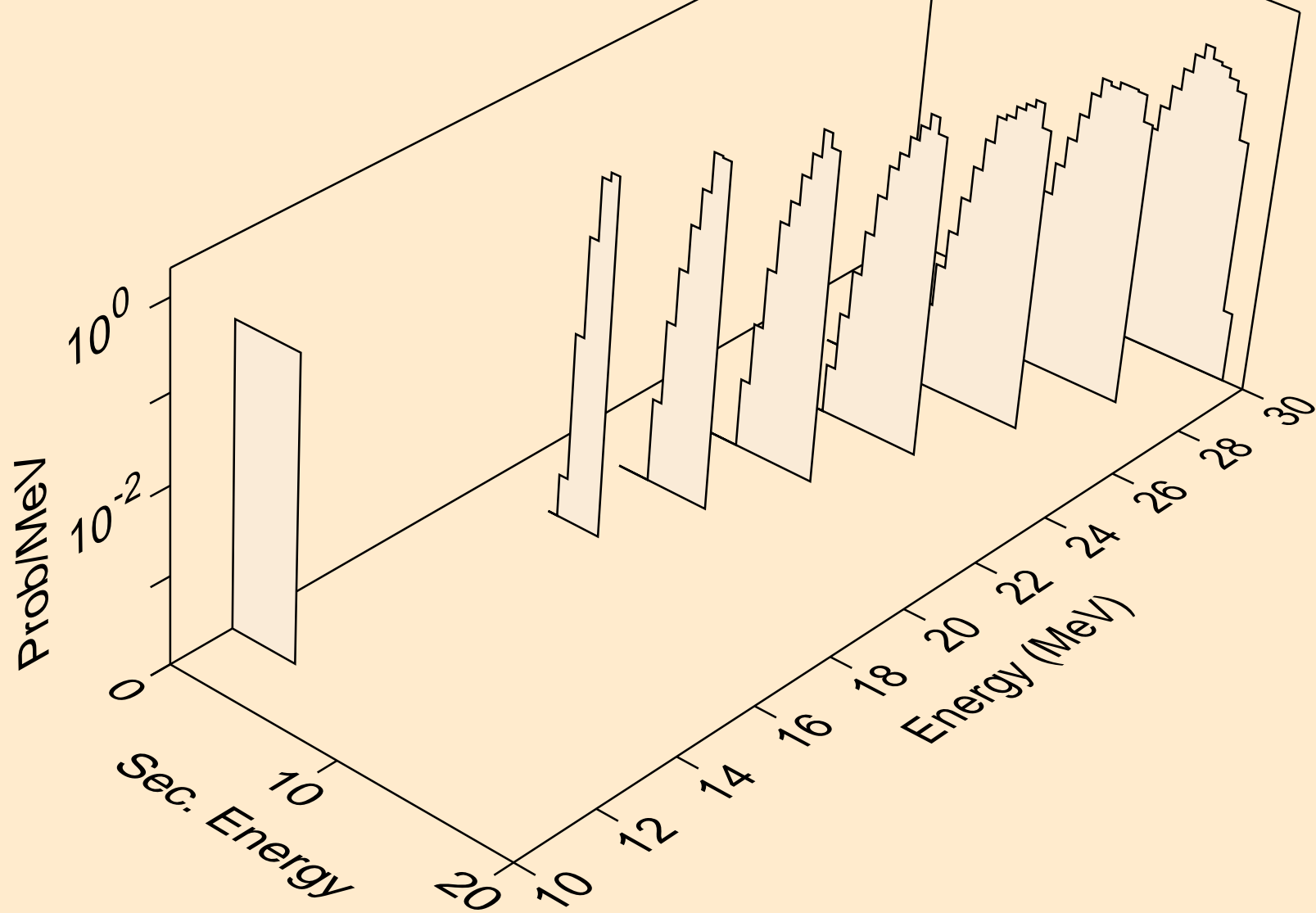

HO153 PROTON ACER TENDL-2021 LIBRARY; T=0.K  
he3s from (p,he3)

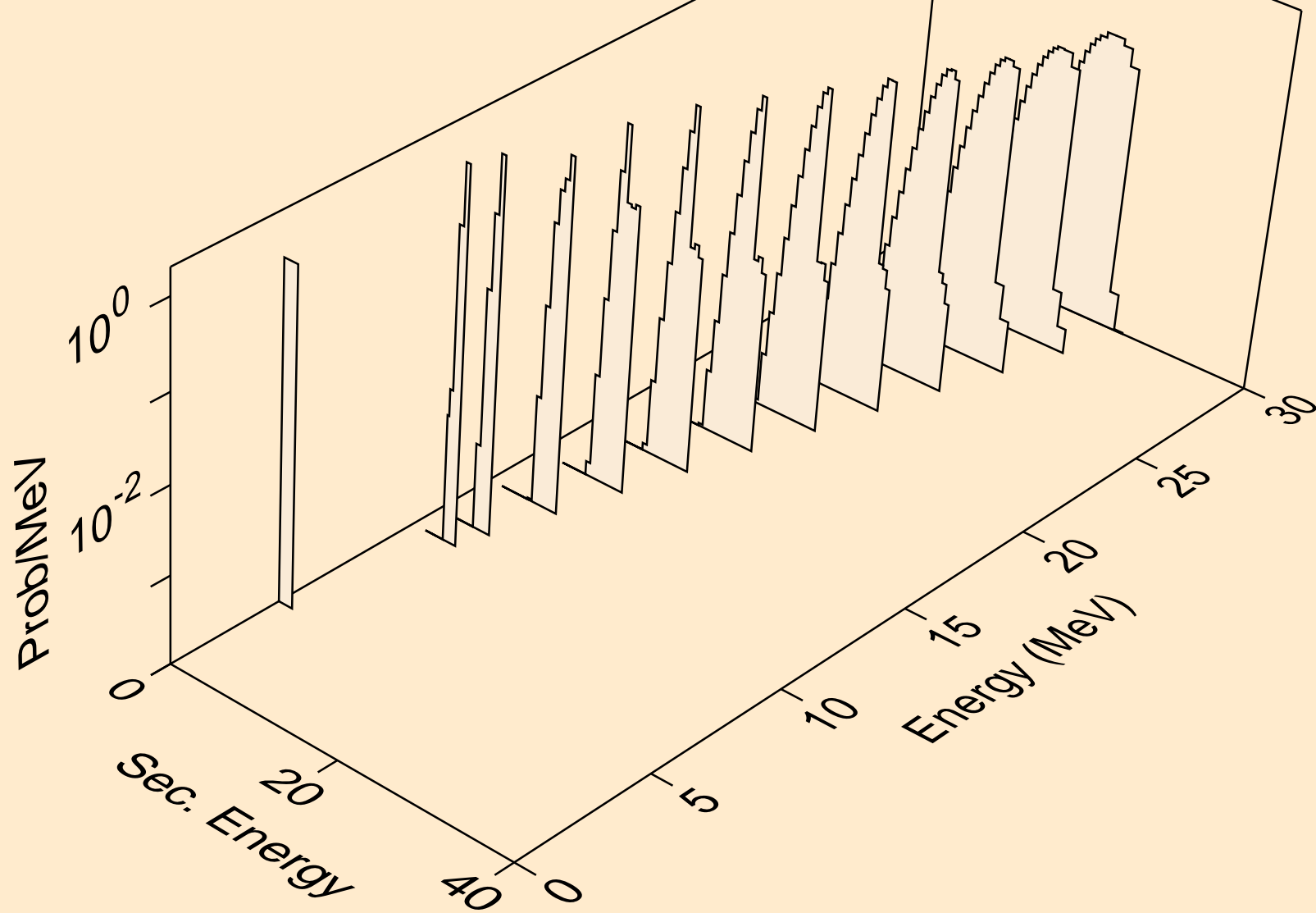

HO153 PROTON ACER TENDL-2021 LIBRARY; T=0.K  
alphas from (p,x)

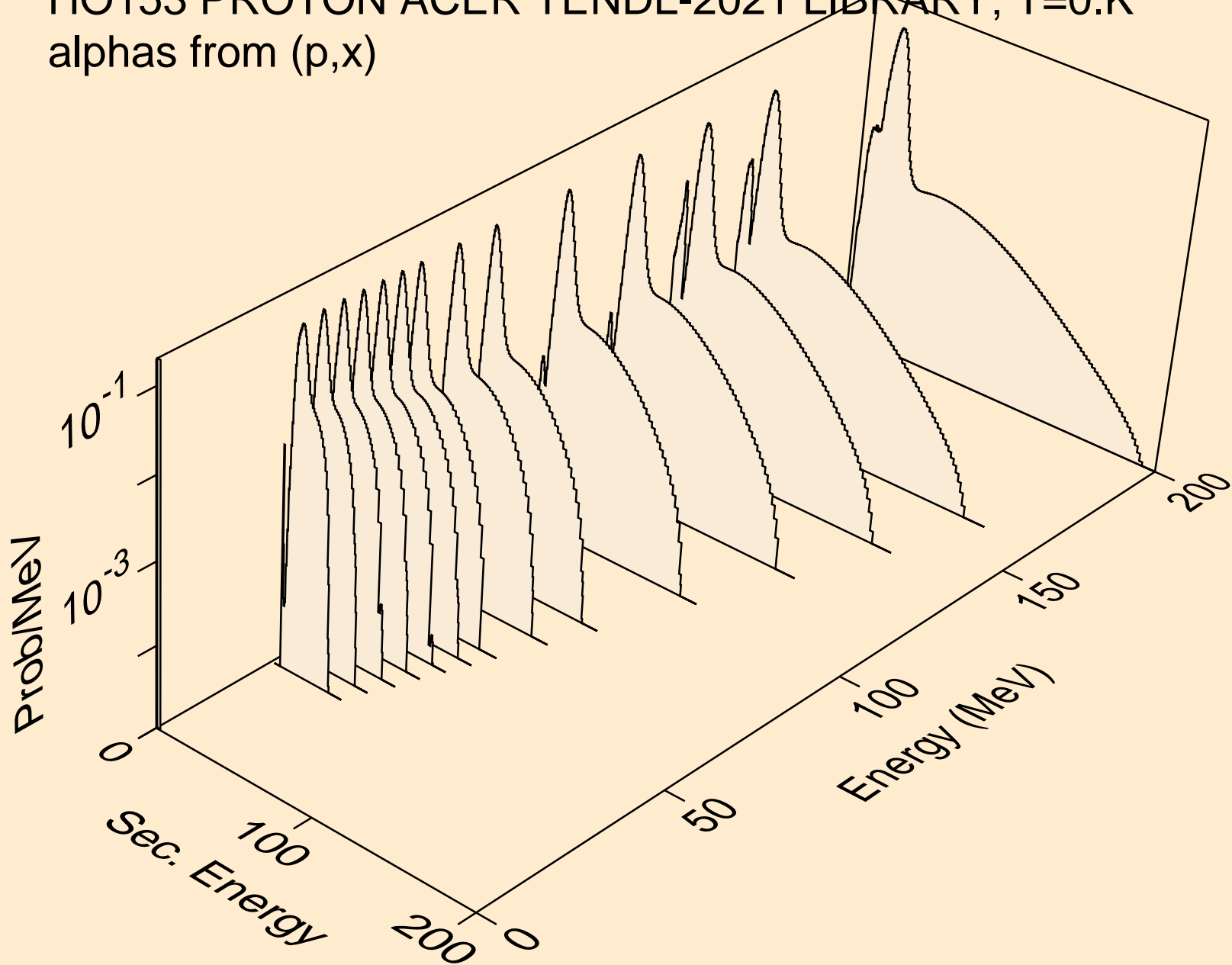

HO153 PROTON ACER TENDL-2021 LIBRARY; T=0.K  
alphas from (p,n\*)a

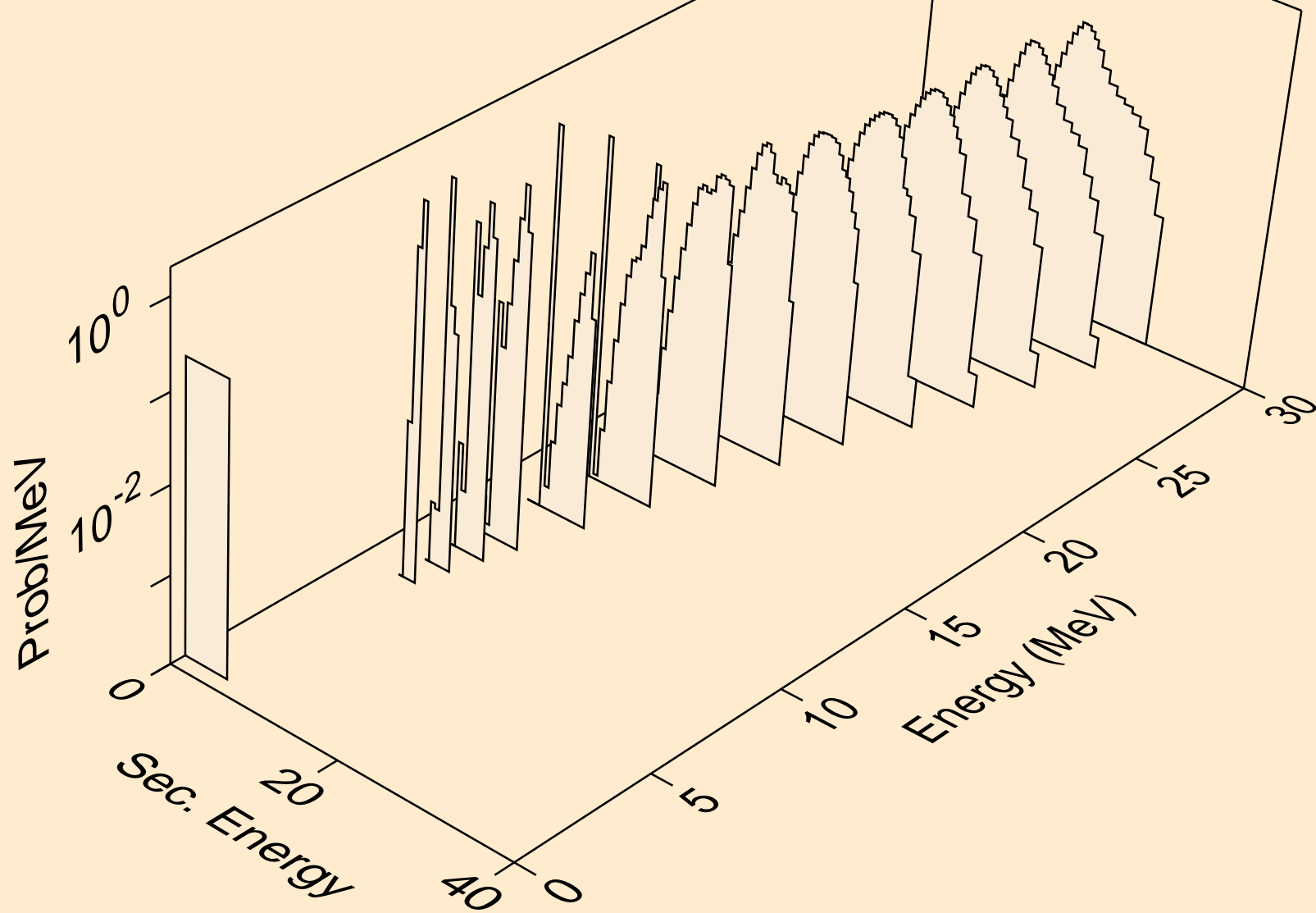

HO153 PROTON ACER TENDL-2021 LIBRARY; T=0.K  
alphas from (p,2n)a

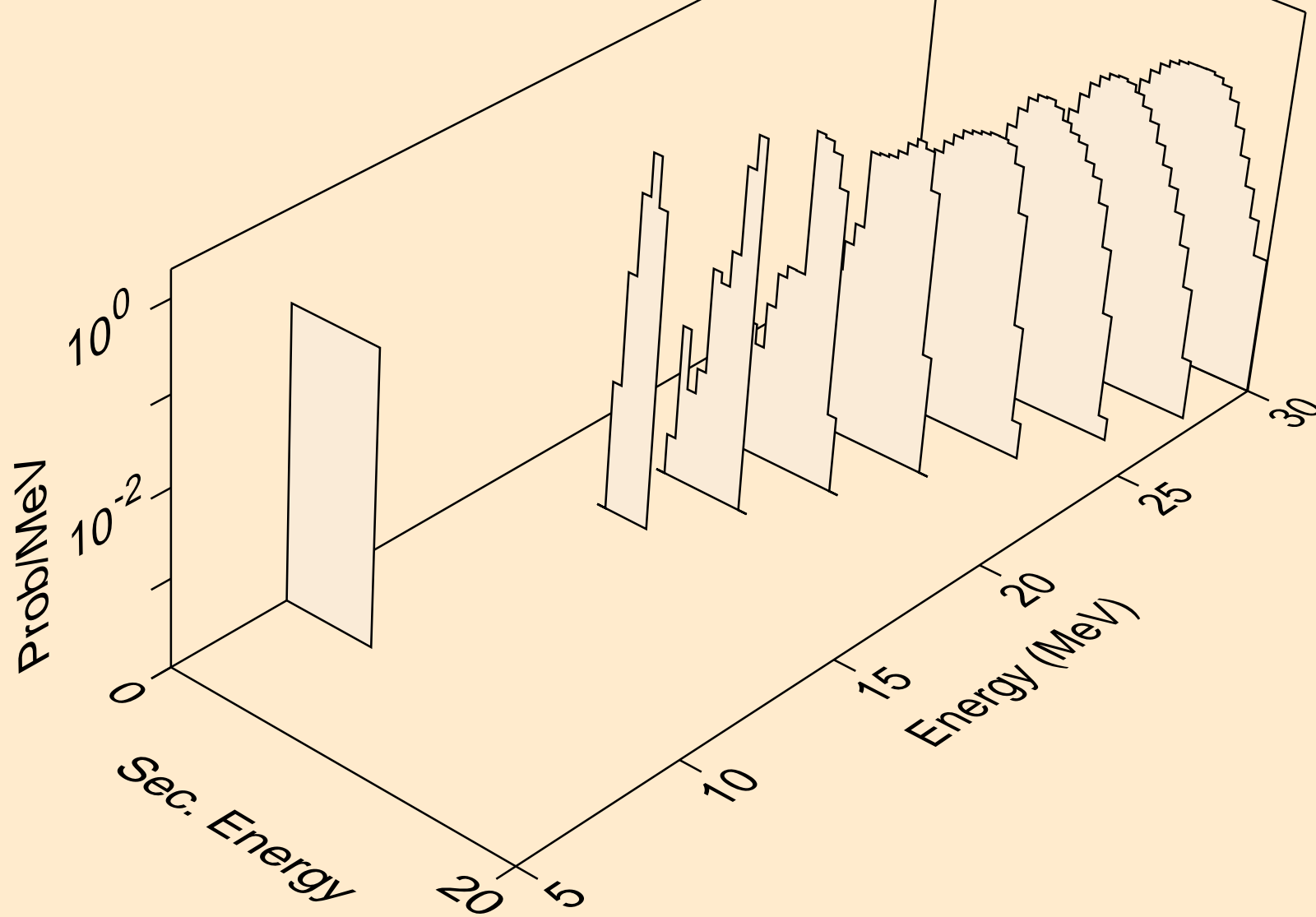

HO153 PROTON ACER TENDL-2021 LIBRARY; T=0.K  
alphas from (p,3n)a

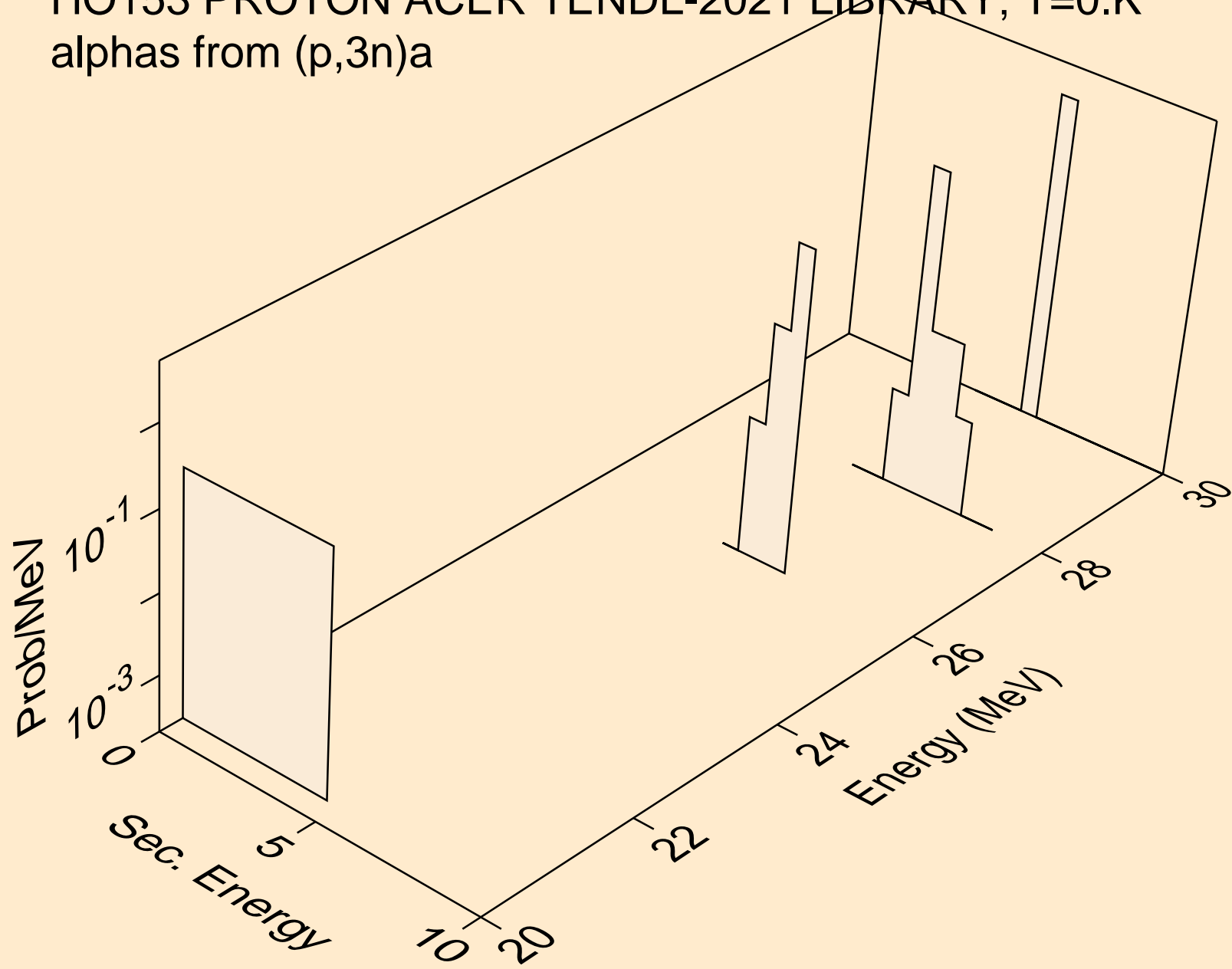

HO153 PROTON ACER TENDL-2021 LIBRARY; T=0.K  
alphas from (p,n\*)2a

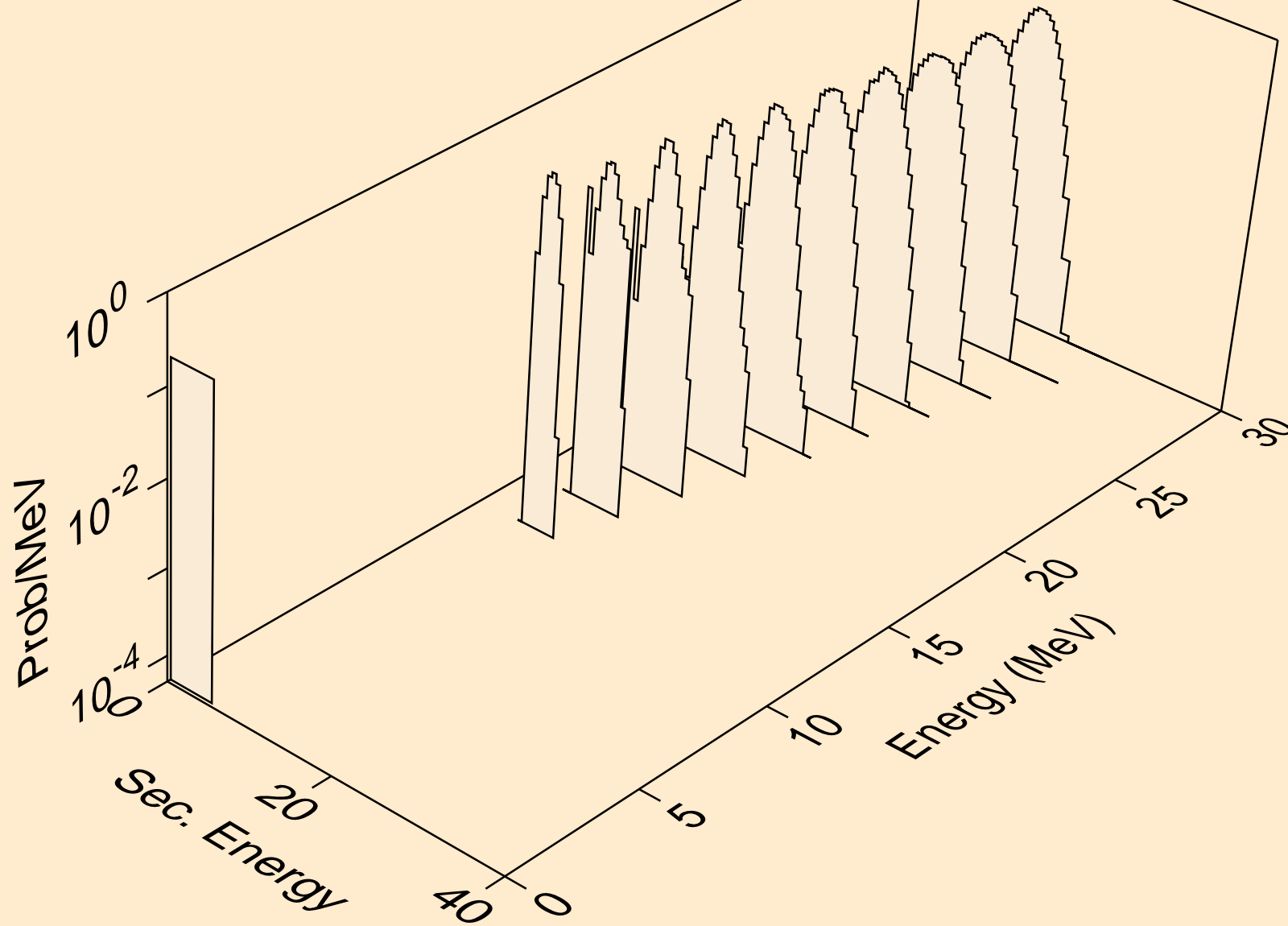

HO153 PROTON ACER TENDL-2021 LIBRARY; T=0.K  
alphas from (p,npa)

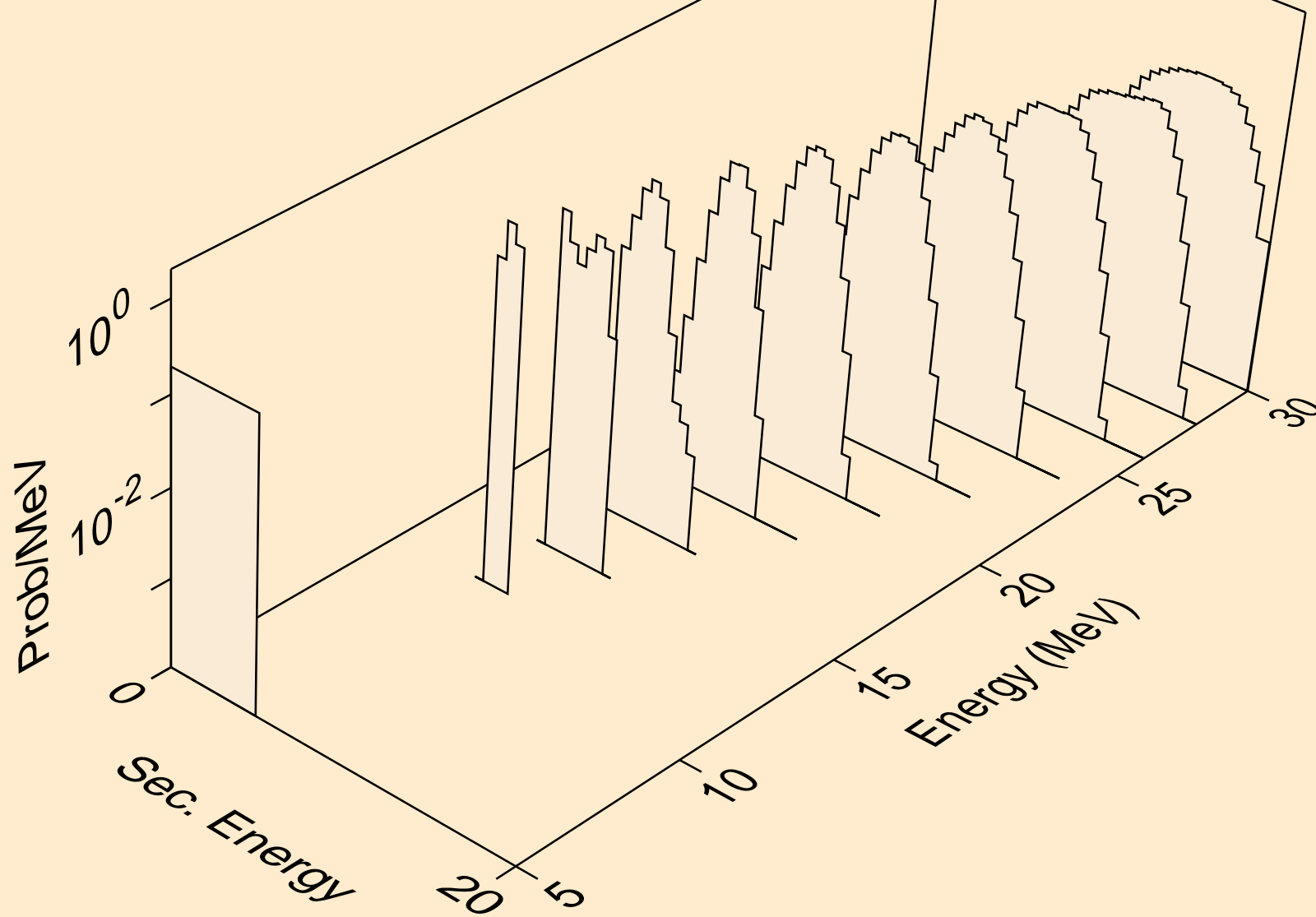



HO153 PROTON ACER TENDL-2021 LIBRARY; T=0.K  
alphas from (p,a)

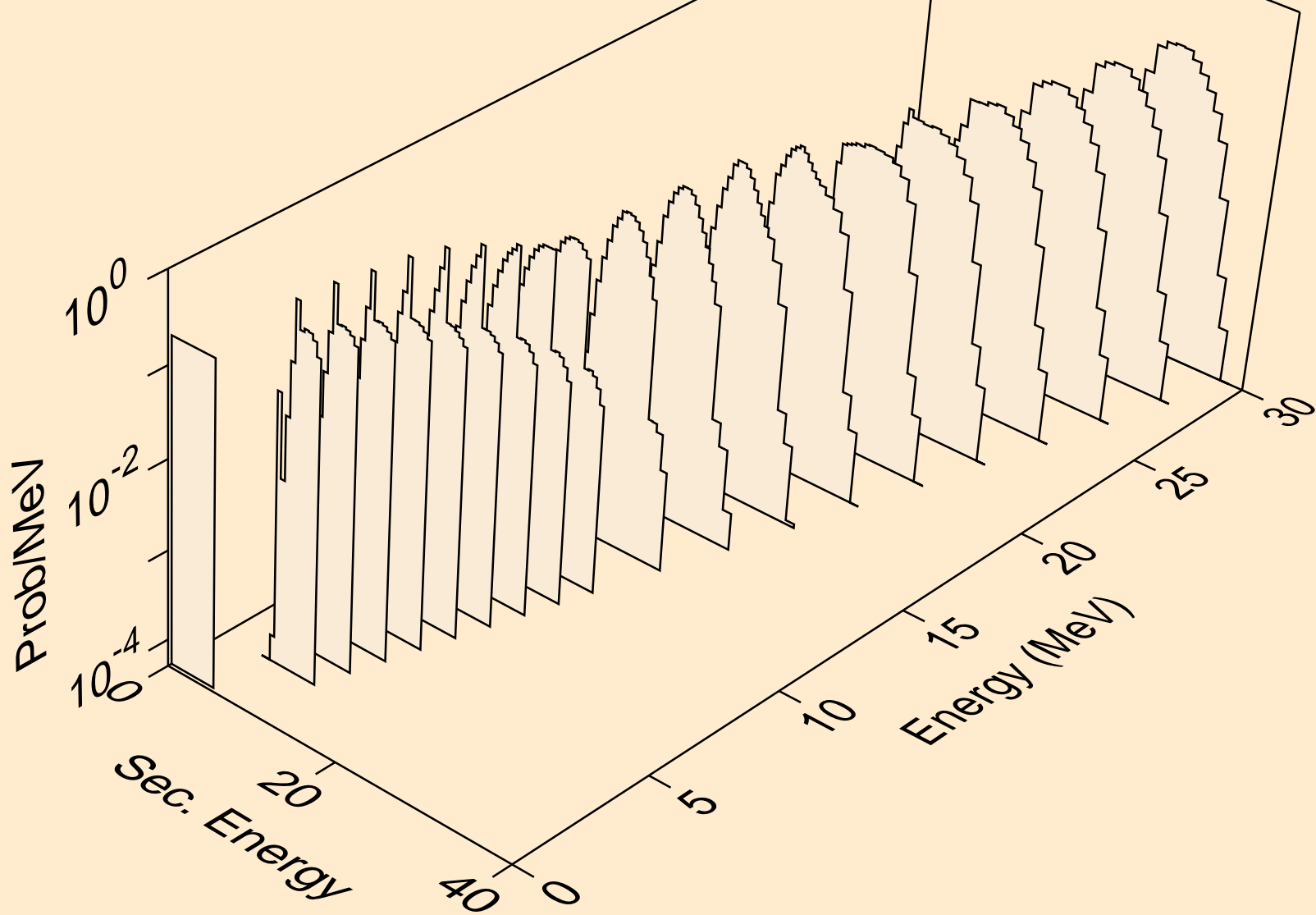

HO153 PROTON ACER TENDL-2021 LIBRARY; T=0.K  
alphas from (p,2a)

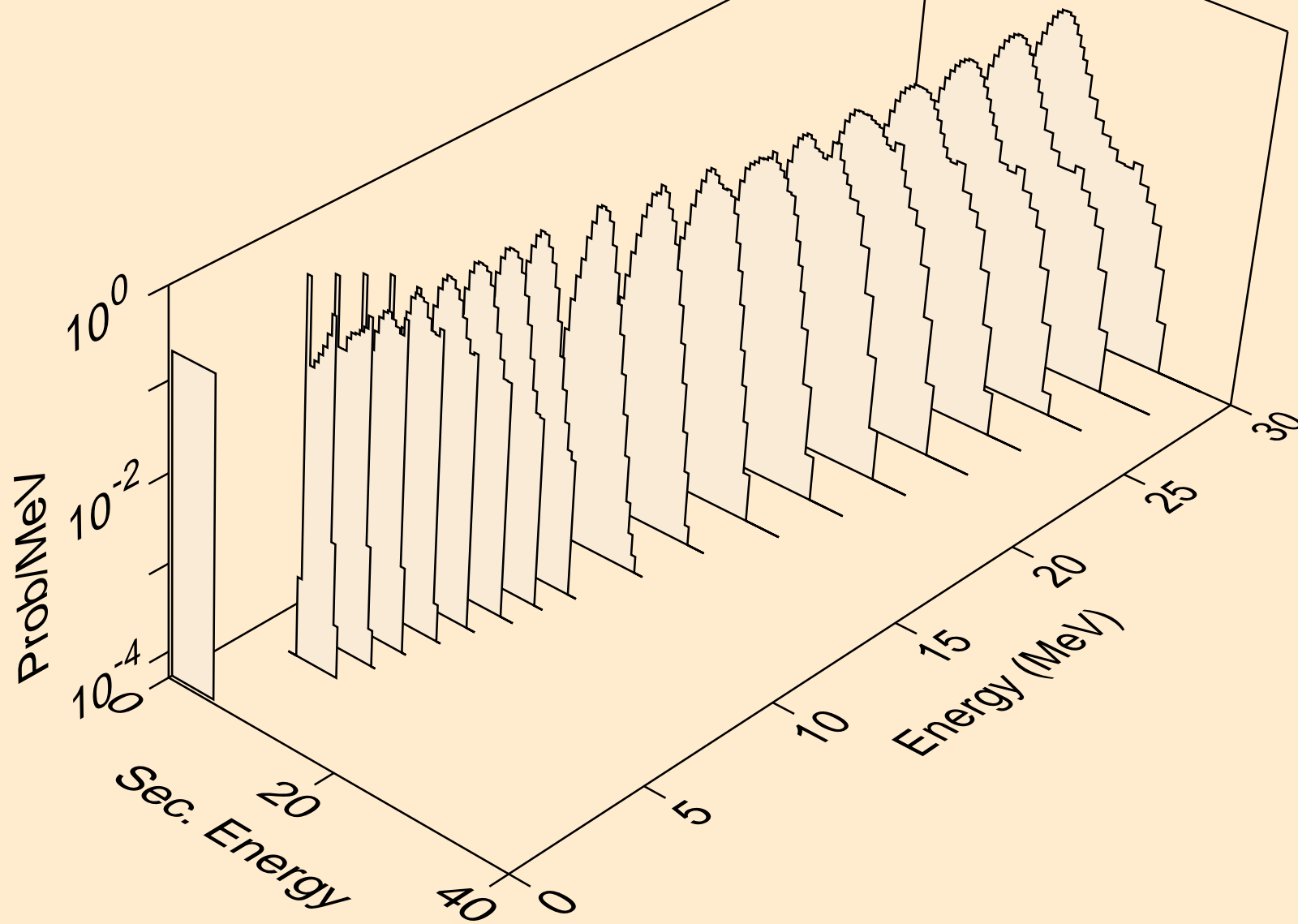

HO153 PROTON ACER TENDL-2021 LIBRARY; T=0.K  
alphas from (p,pa)

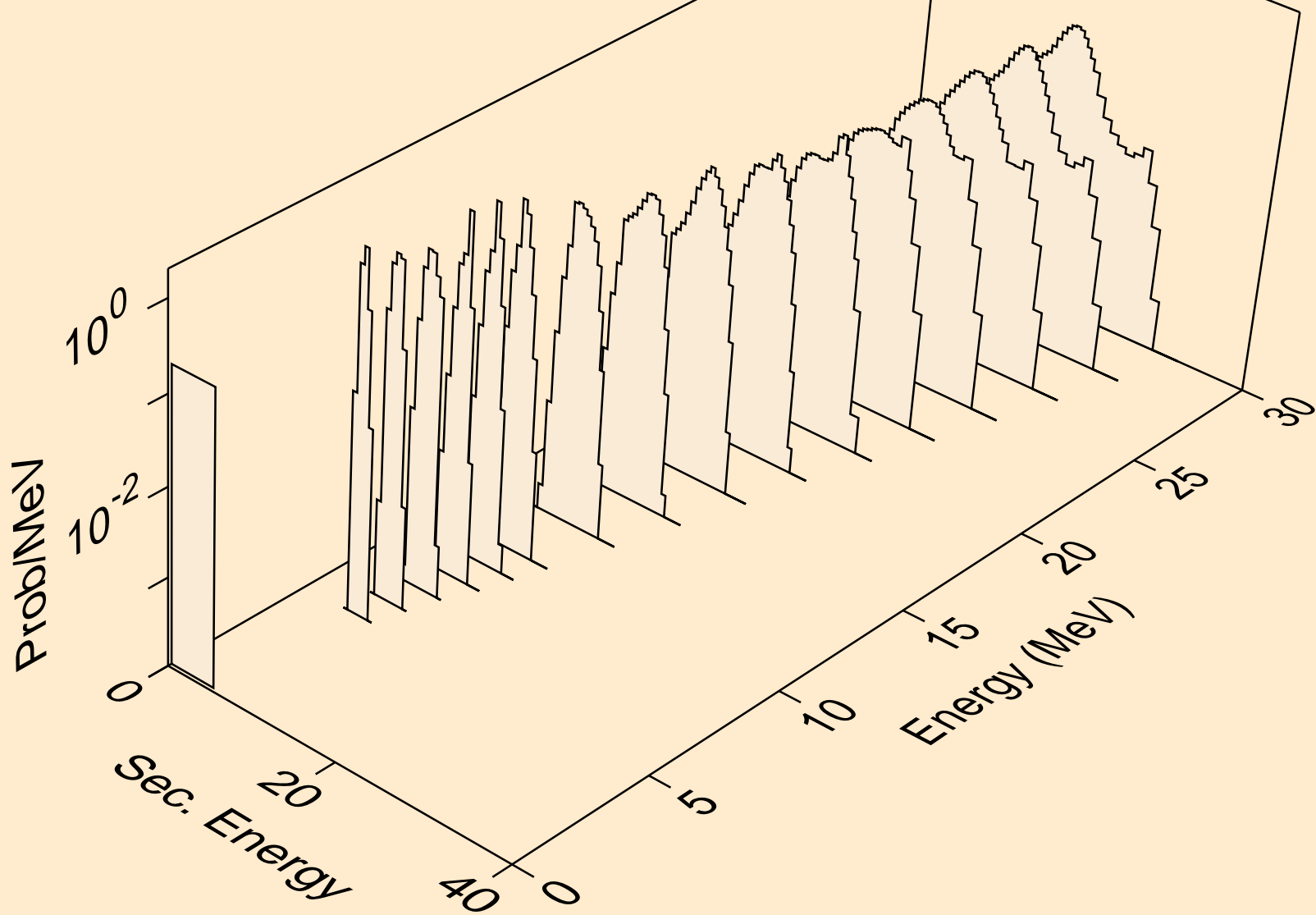

HO153 PROTON ACER TENDL-2021 LIBRARY; T=0.K  
alphas from (p,da)

