

# HO156N PROTON ACER TENDL-2021 LIBRARY; T=0.K

## Principal cross sections

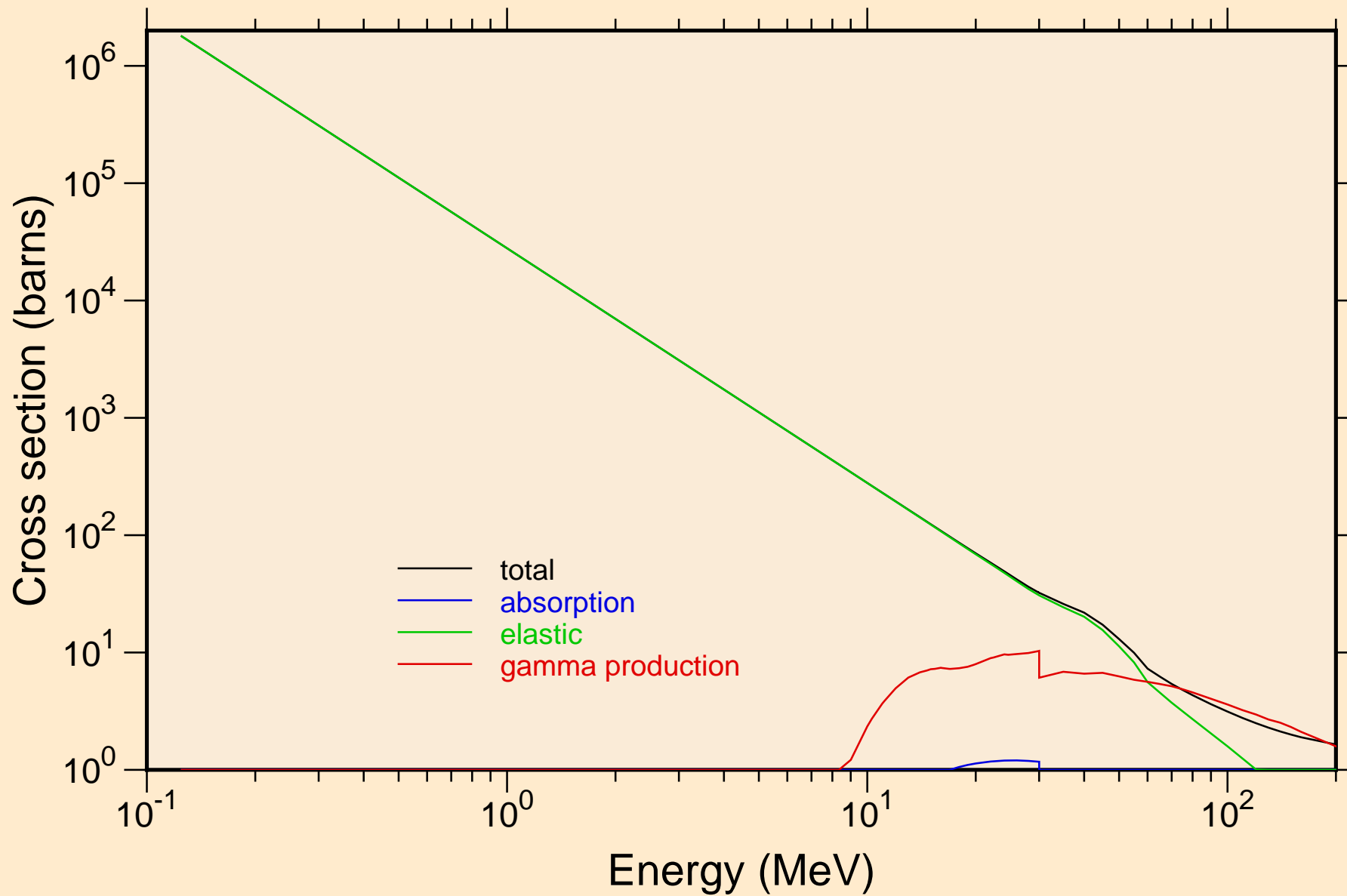

HO156N PROTON ACER TENDL-2021 LIBRARY; T=0.K  
Heating

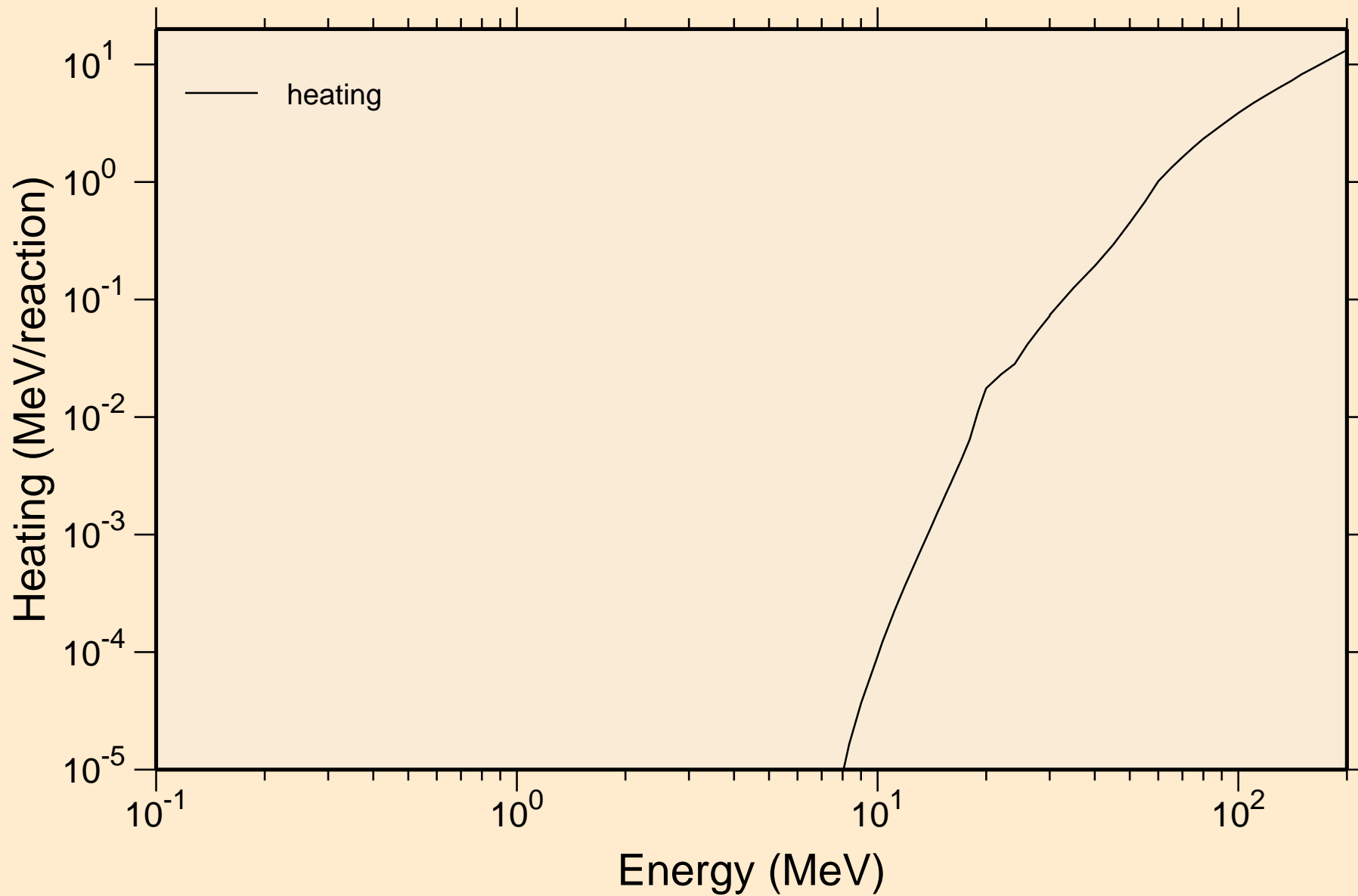

HO156N PROTON ACER TENDL-2021 LIBRARY; T=0.K  
Principal cross sections

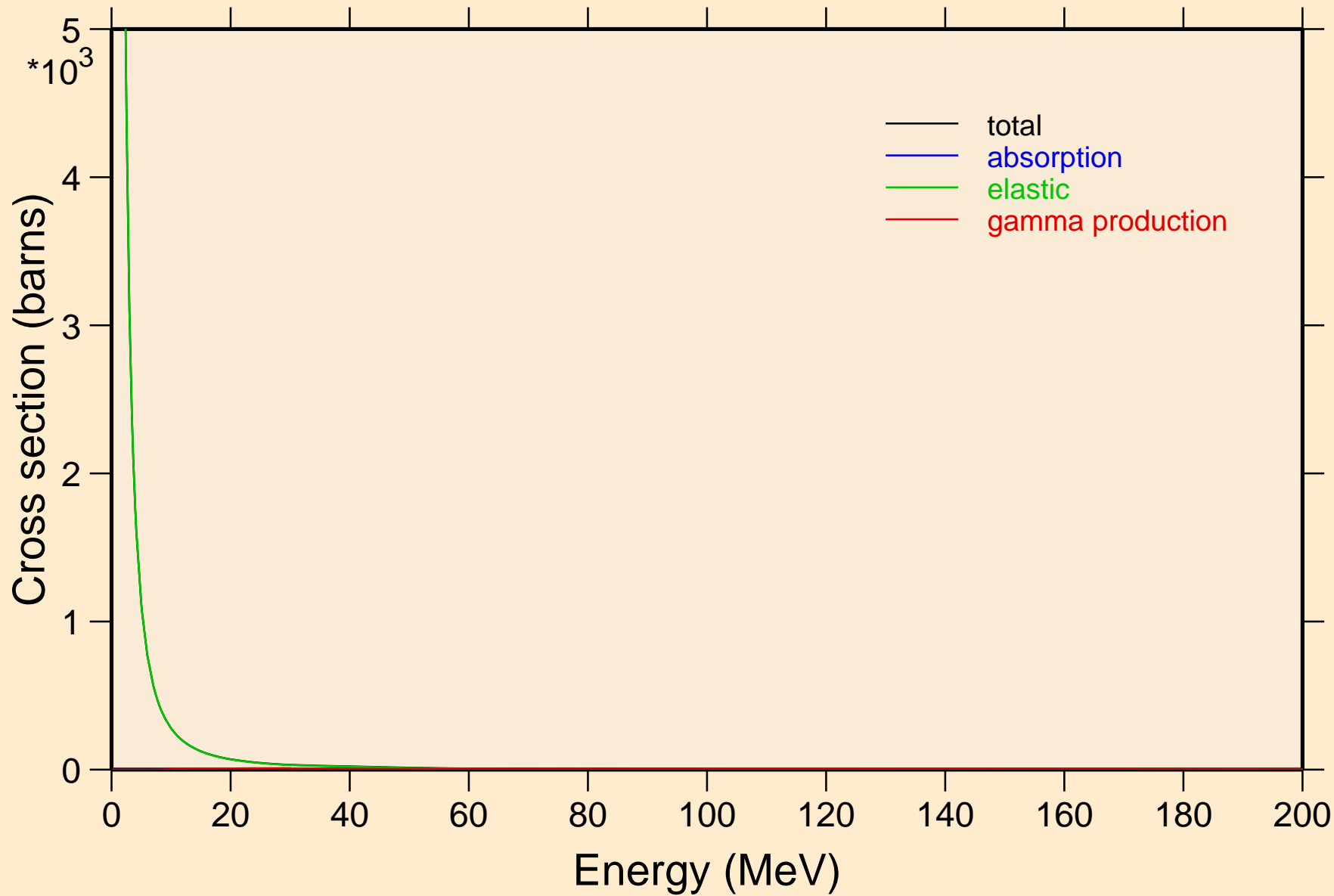

# HO156N PROTON ACER TENDL-2021 LIBRARY; T=0.K

## Heating

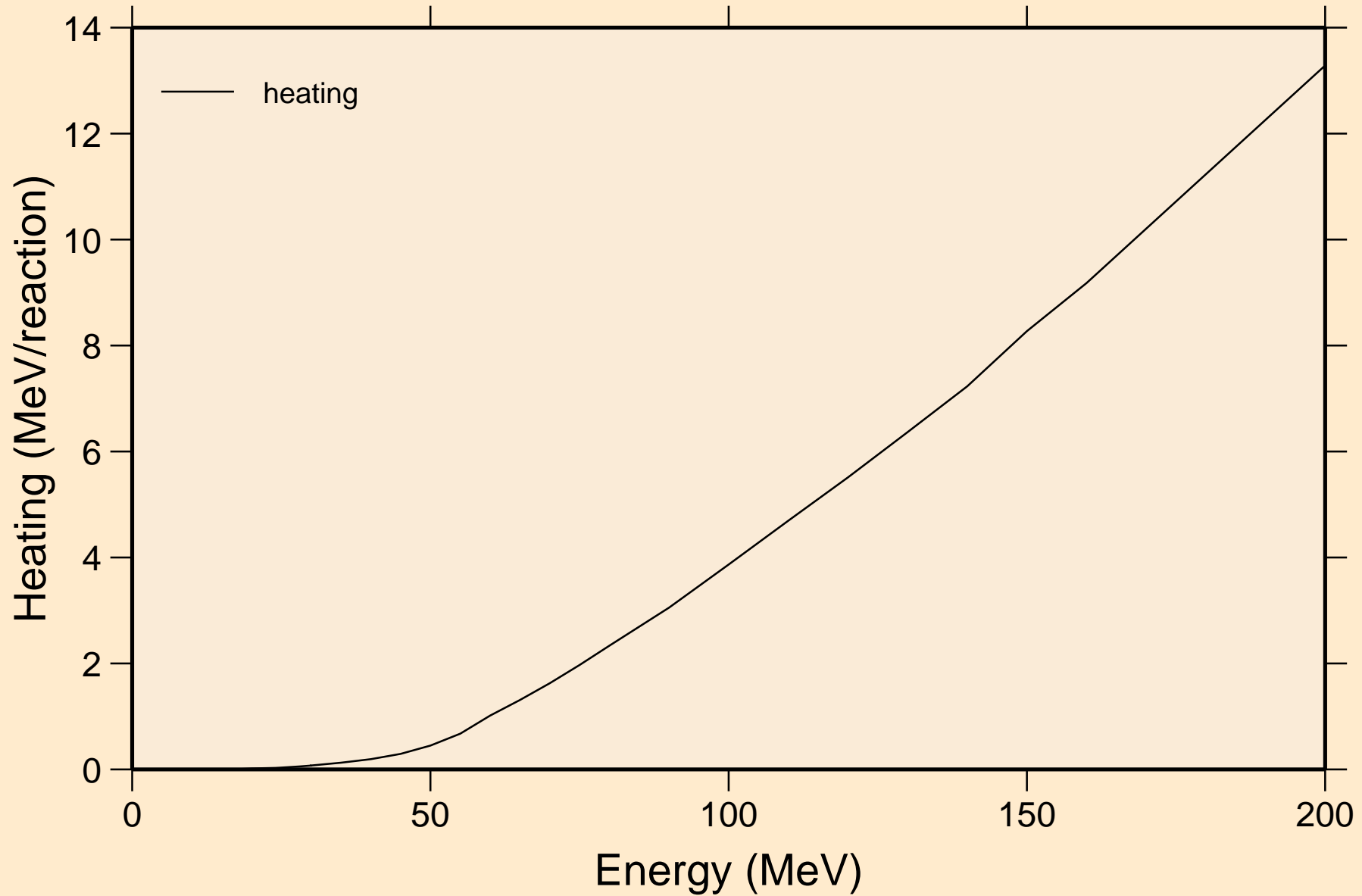

# HO156N PROTON ACER TENDL-2021 LIBRARY; T=0.K

## Threshold reactions

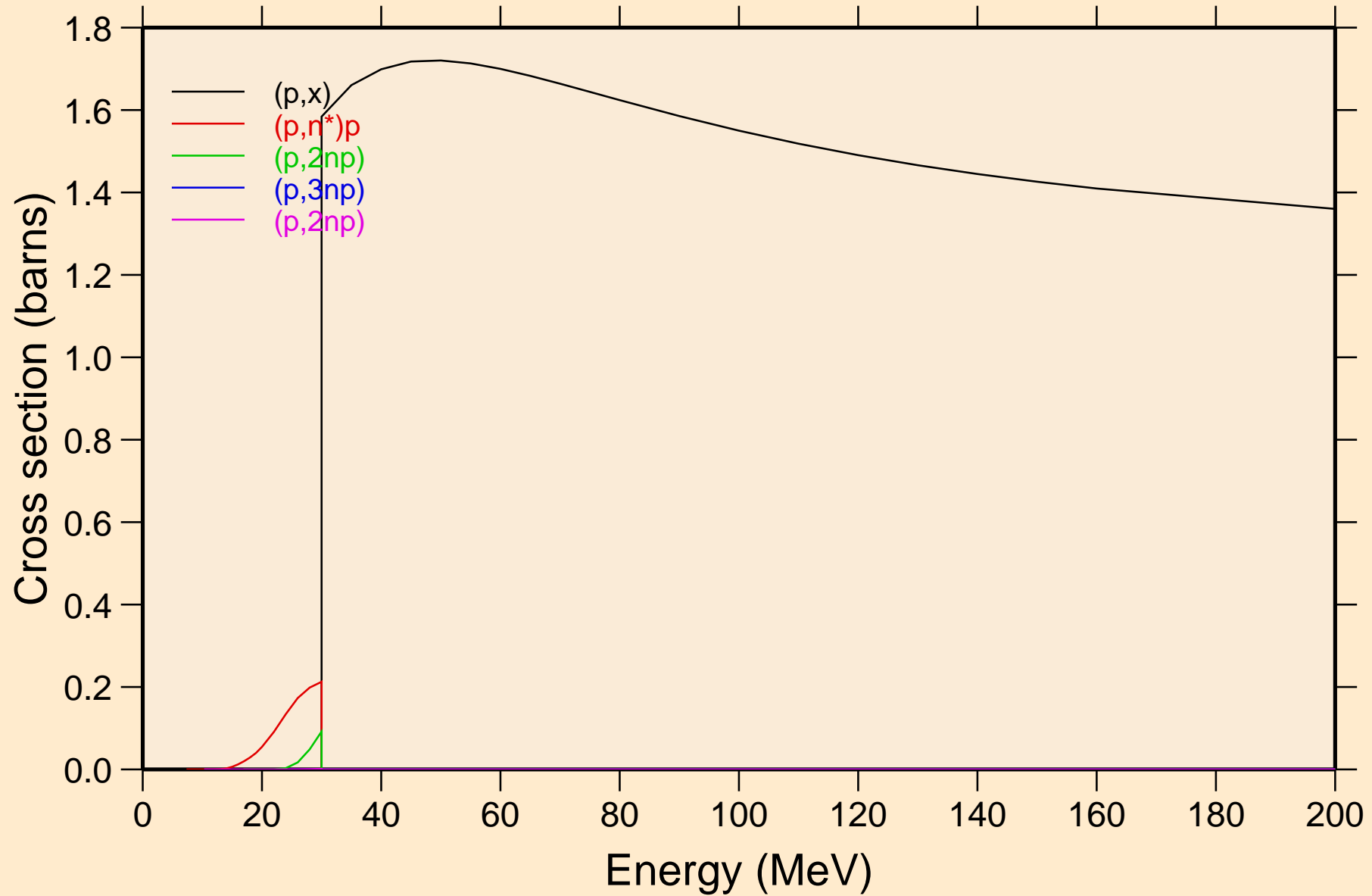

# HO156N PROTON ACER TENDL-2021 LIBRARY; T=0.K

## Threshold reactions

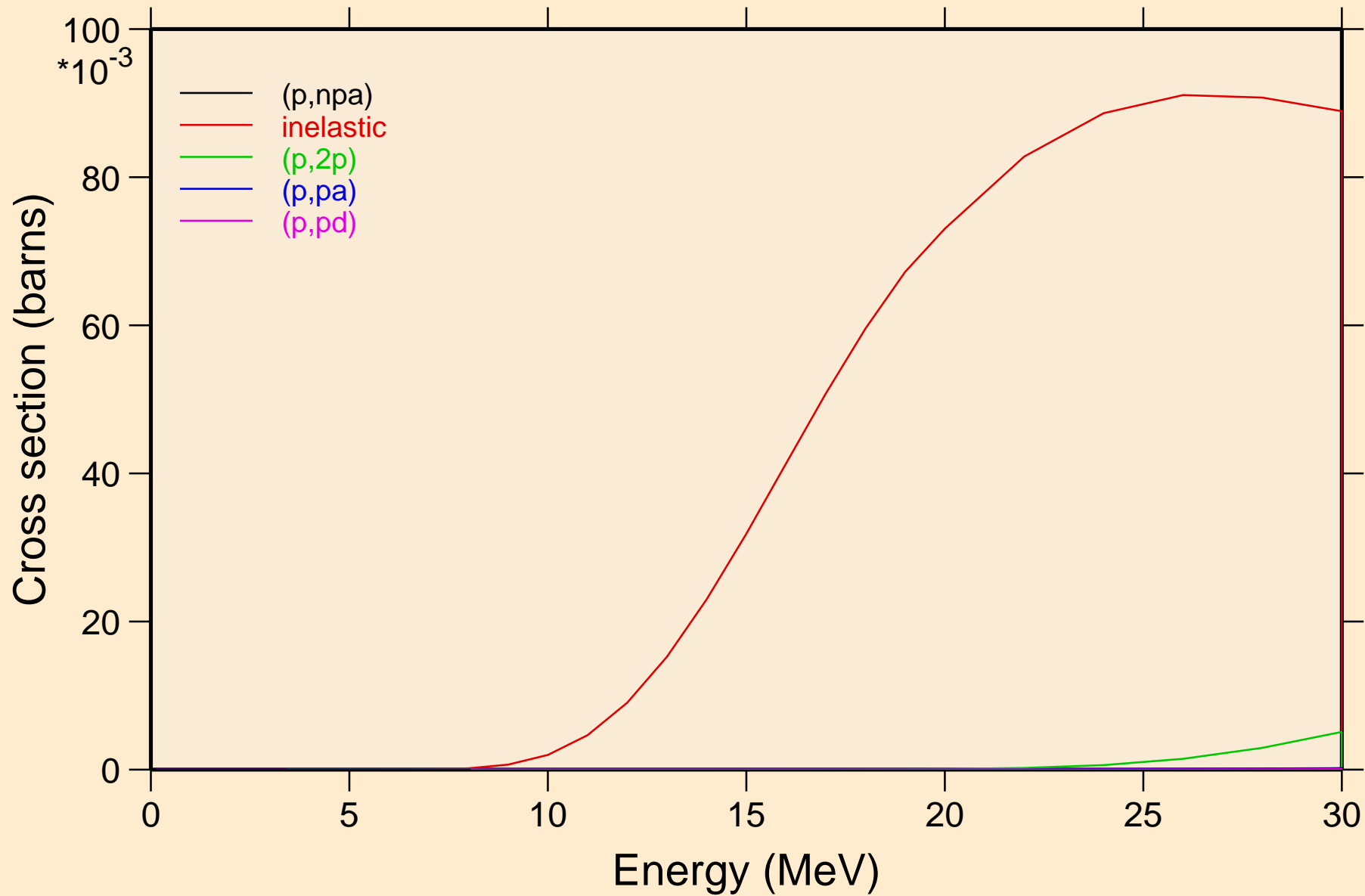

HO156N PROTON ACER TENDL-2021 LIBRARY; T=0.K  
Threshold reactions

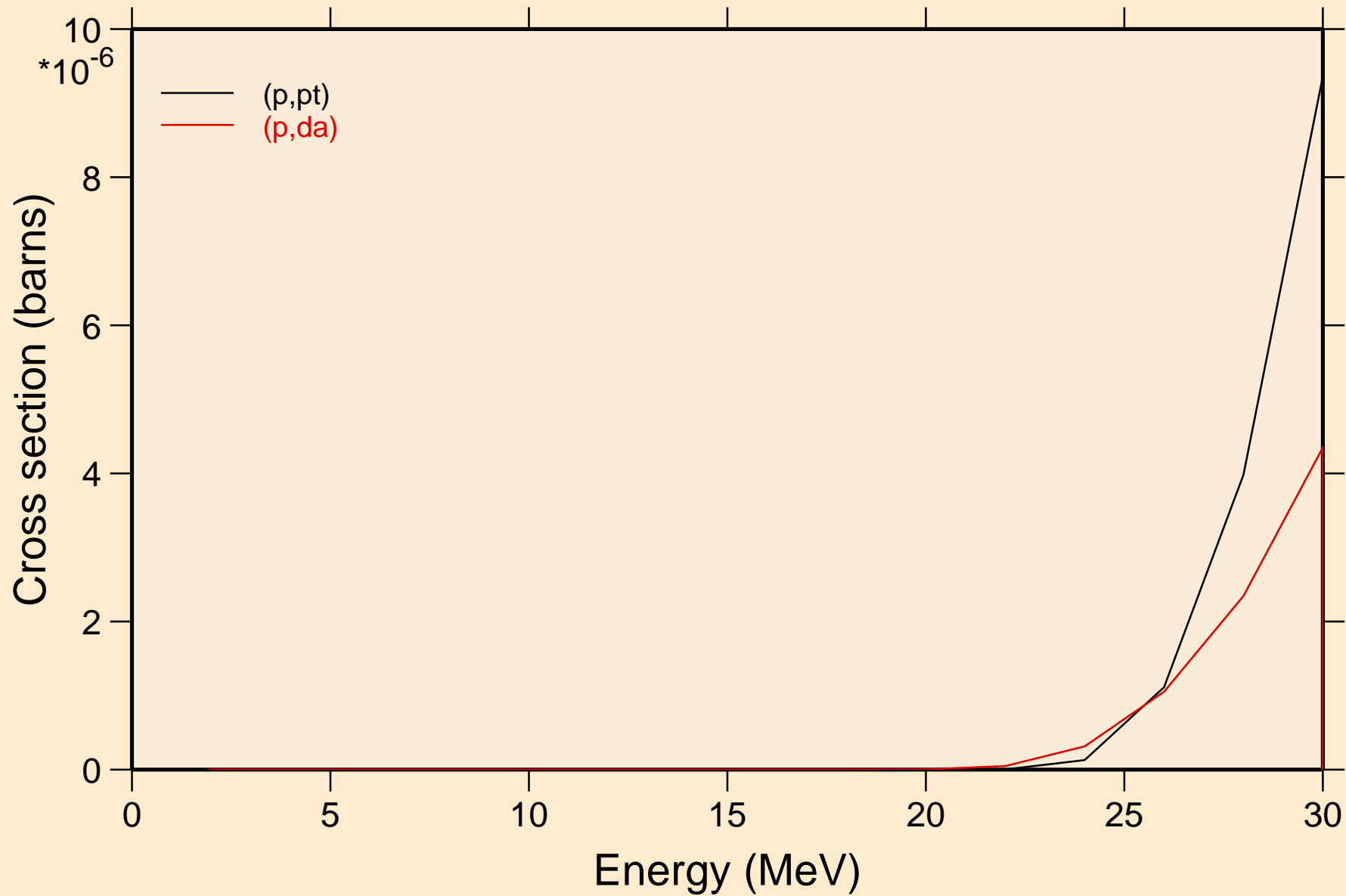

HO156N PROTON ACER TENDL-2021 LIBRARY; T=0.K  
angular distribution for elastic

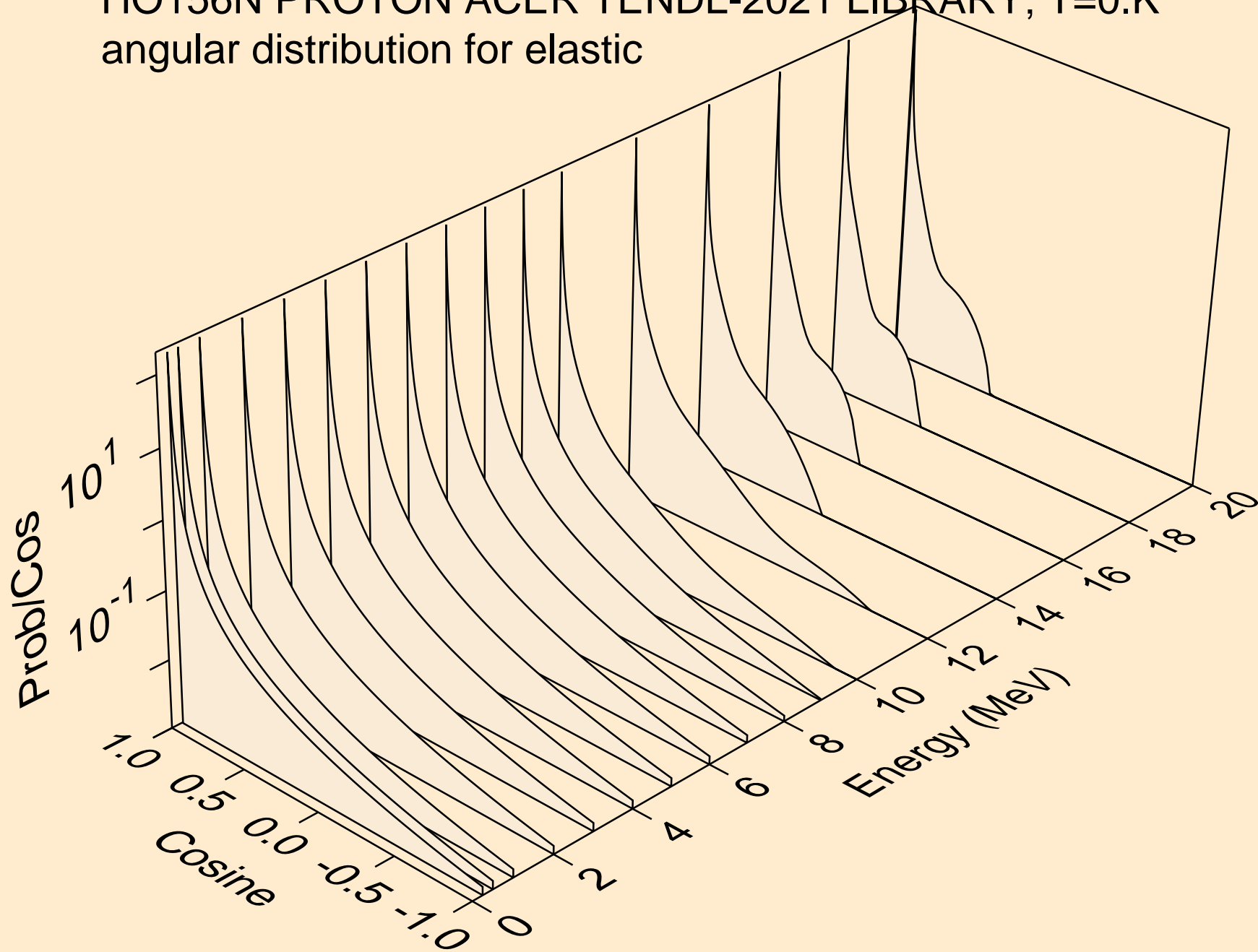



HO156N PROTON ACER TENDL-2021 LIBRARY; T=0.K  
angular distribution for elastic

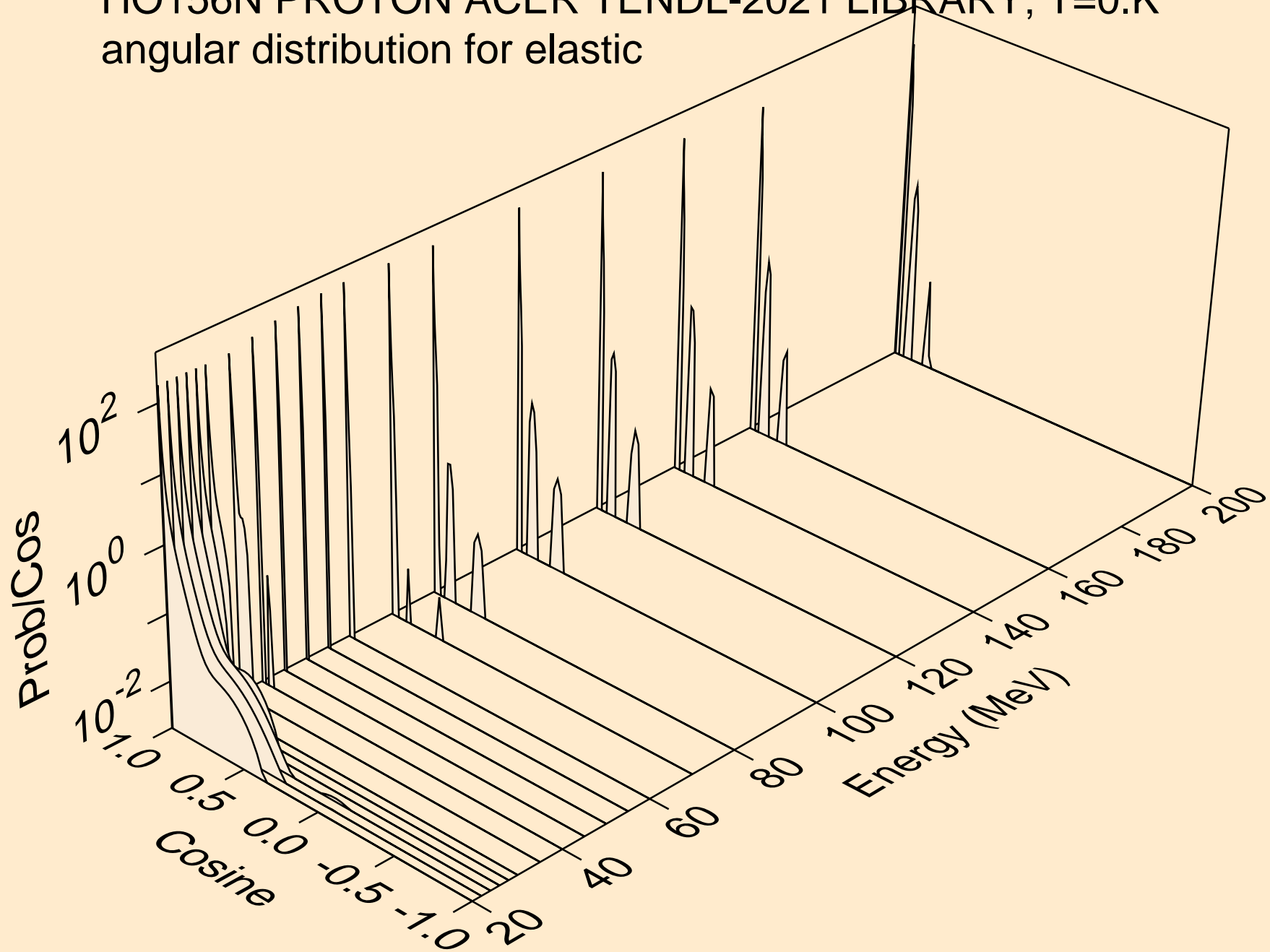

HO156N PROTON ACER TENDL-2021 LIBRARY; T=0.K  
Proton emission for (p,x)

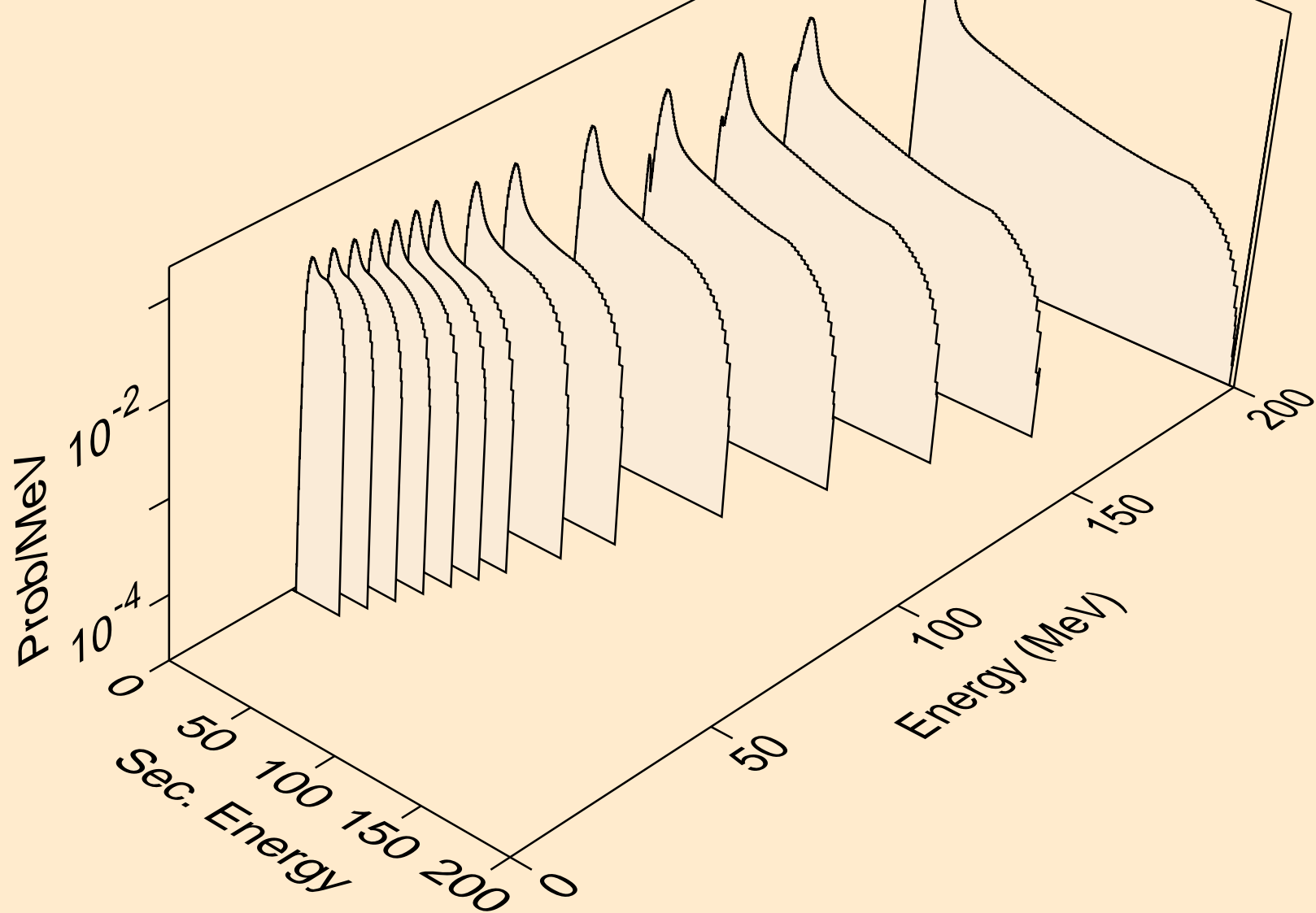

HO156N PROTON ACER TENDL-2021 LIBRARY; T=0.K  
Proton emission for (p,n\*)p

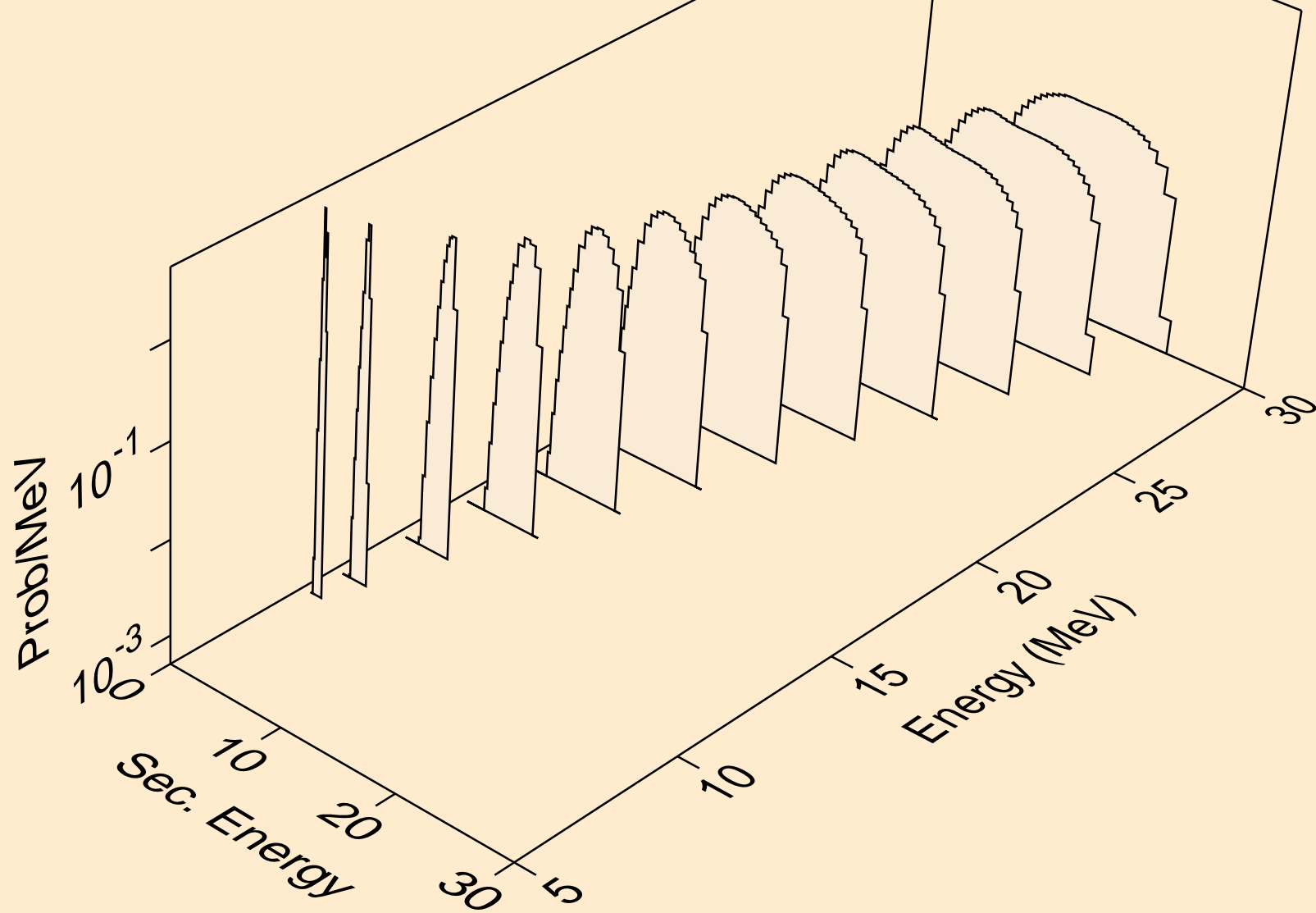

HO156N PROTON ACER TENDL-2021 LIBRARY; T=0.K  
Proton emission for (p,2np)

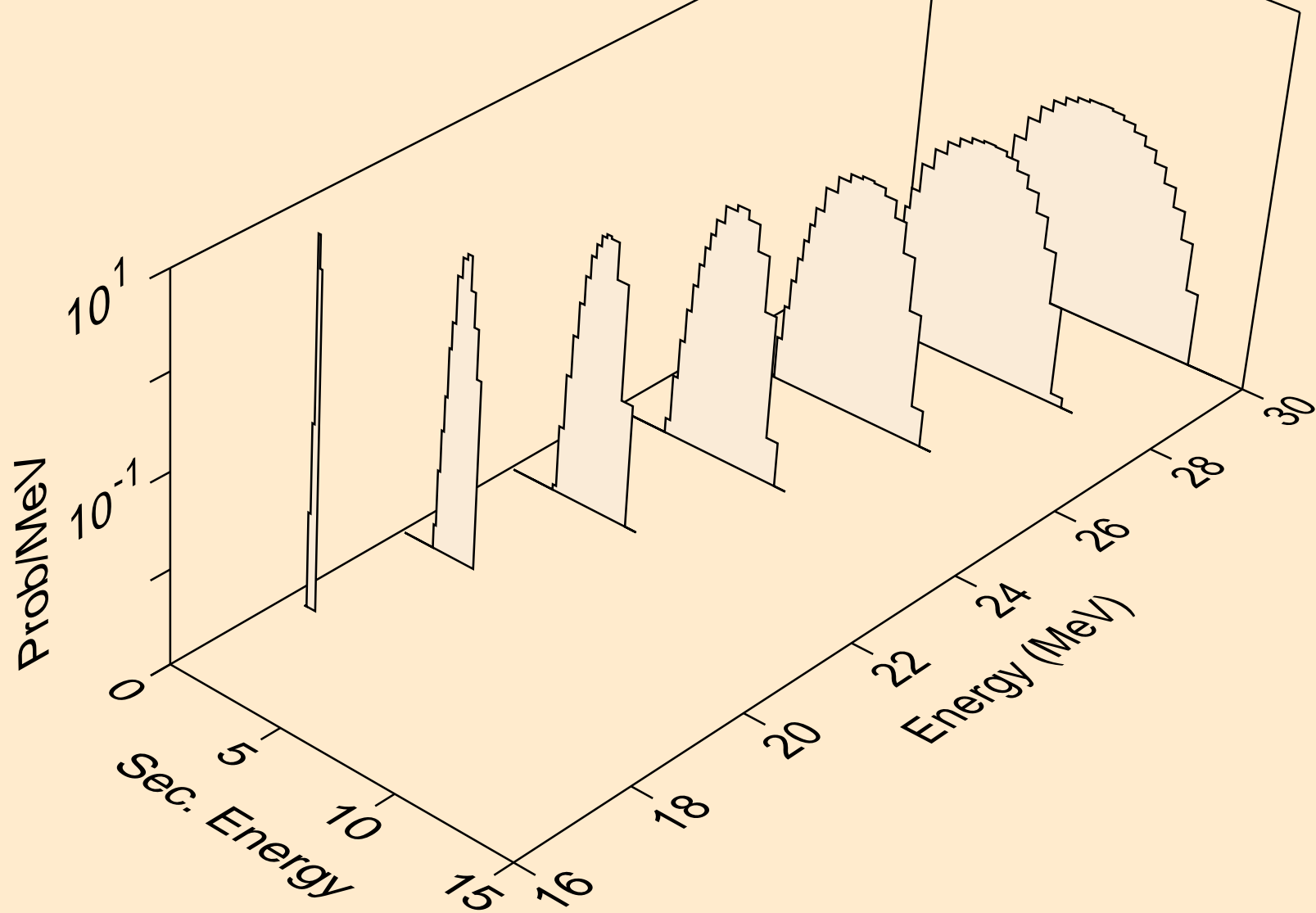

HO156N PROTON ACER TENDL-2021 LIBRARY; T=0.K  
Proton emission for (p,3np)

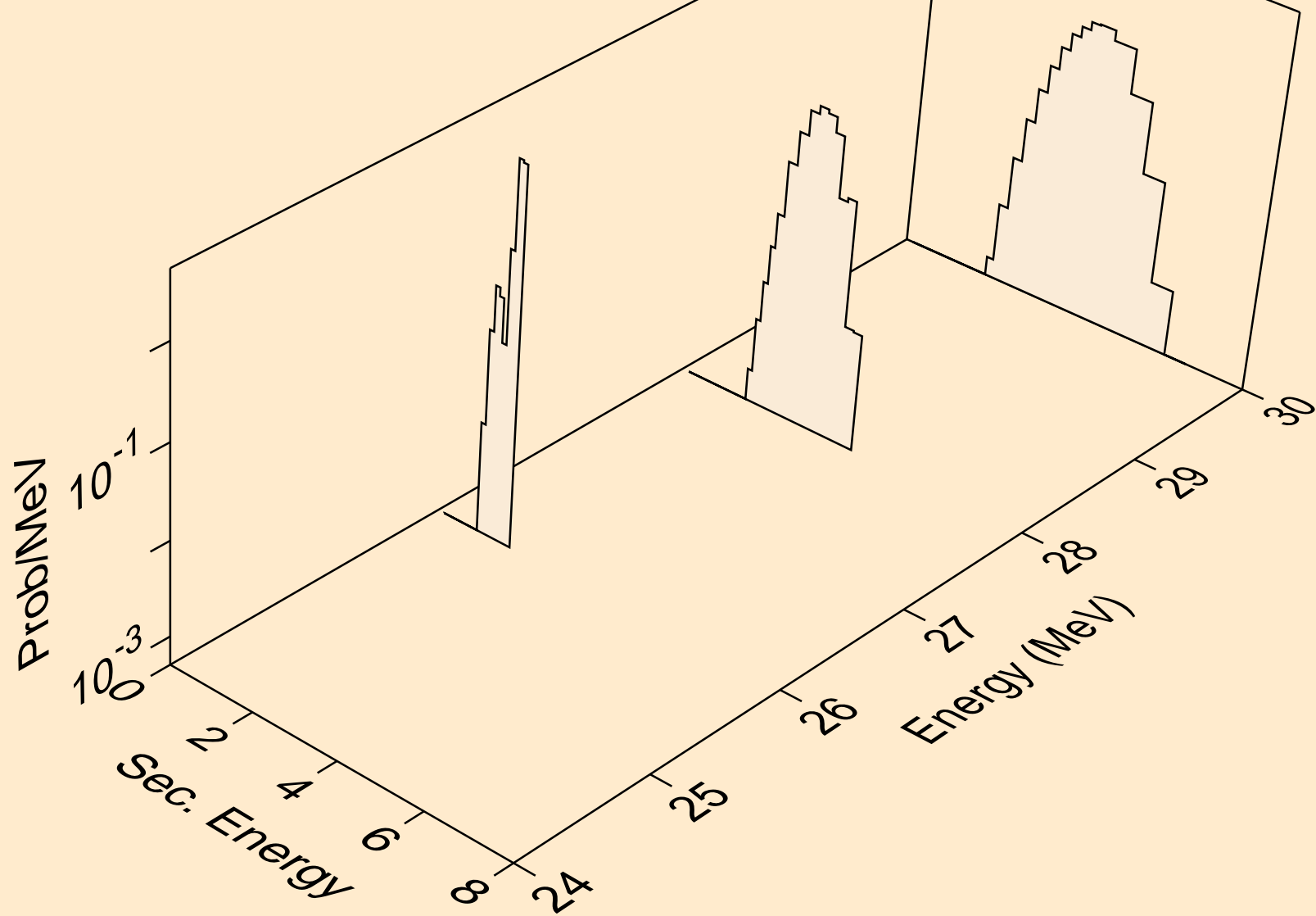

HO156N PROTON ACER TENDL-2021 LIBRARY; T=0.K  
Proton emission for (p,2np)

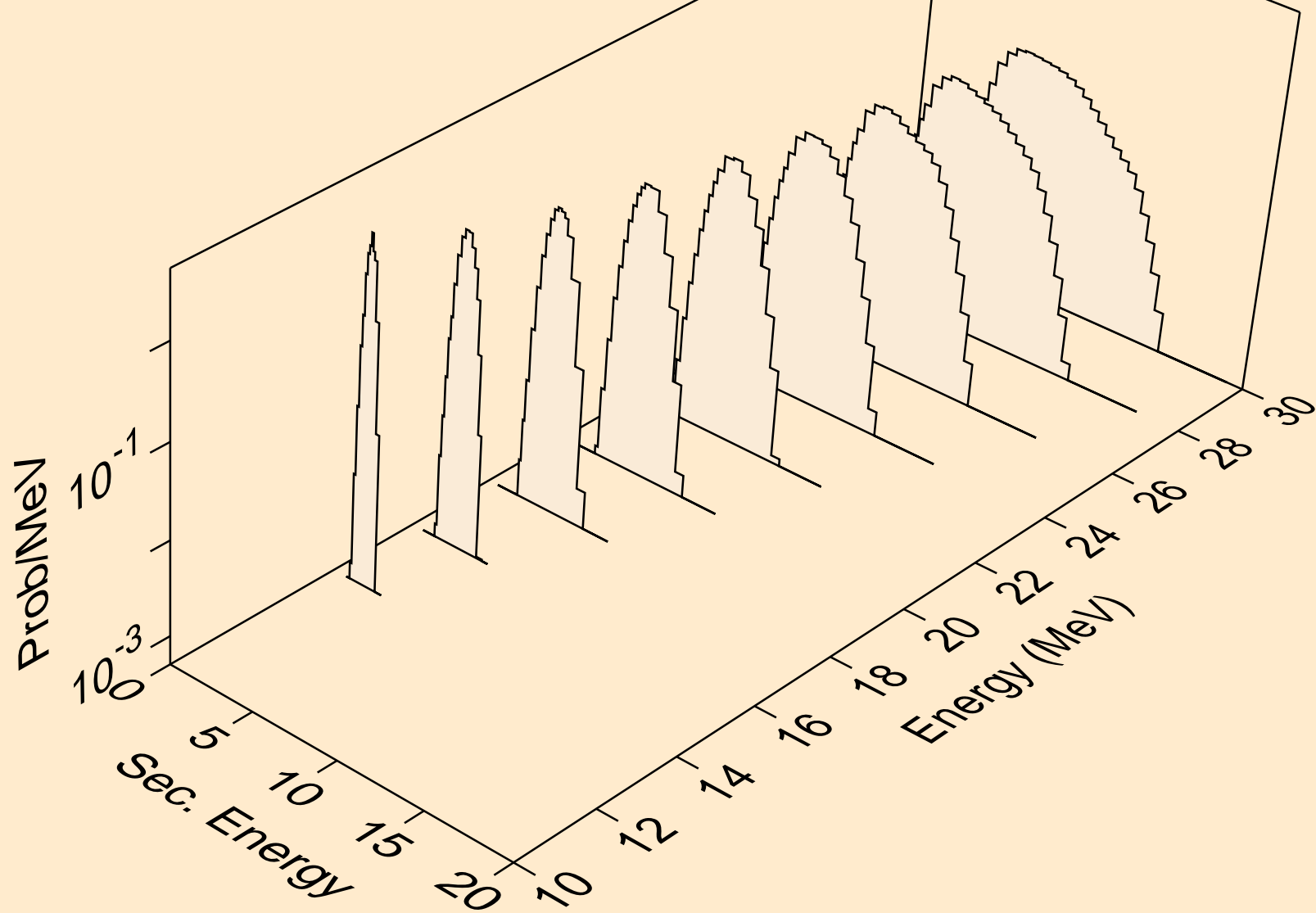

HO156N PROTON ACER TENDL-2021 LIBRARY; T=0.K  
Proton emission for (p,npa)

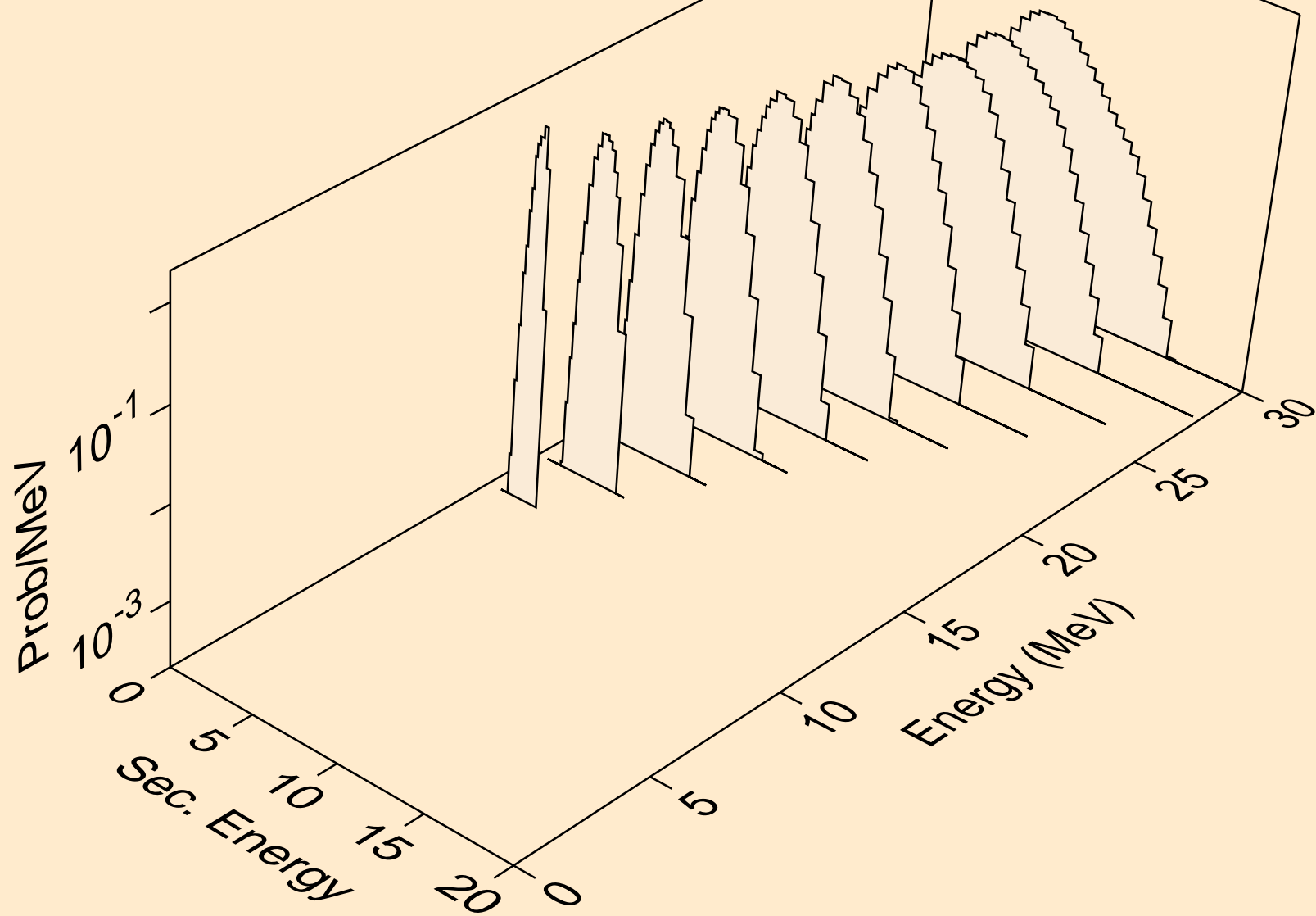

HO156N PROTON ACER TENDL-2021 LIBRARY; T=0.K  
Proton emission for inelastic

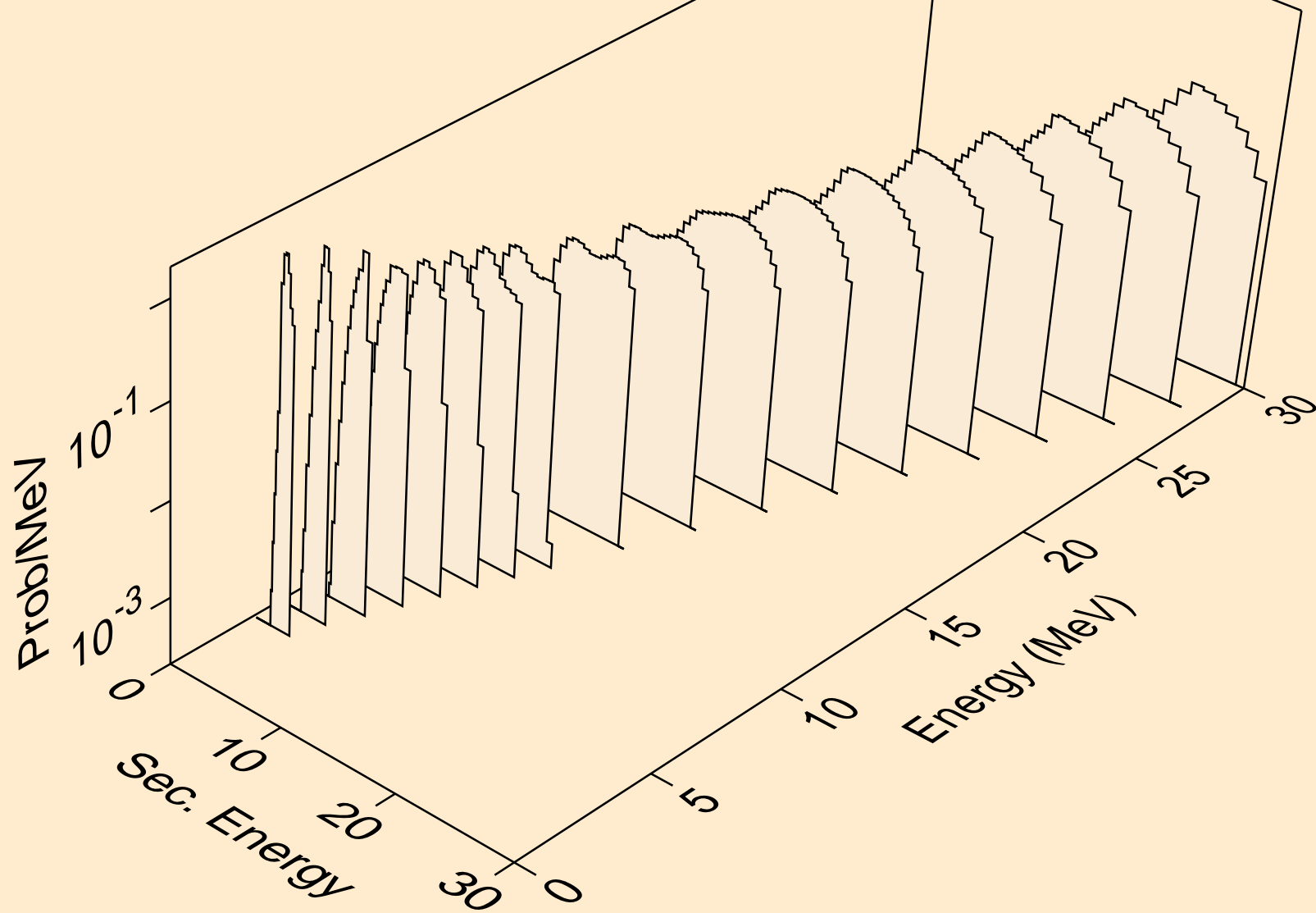



HO156N PROTON ACER TENDL-2021 LIBRARY; T=0.K  
Proton emission for (p,2p)

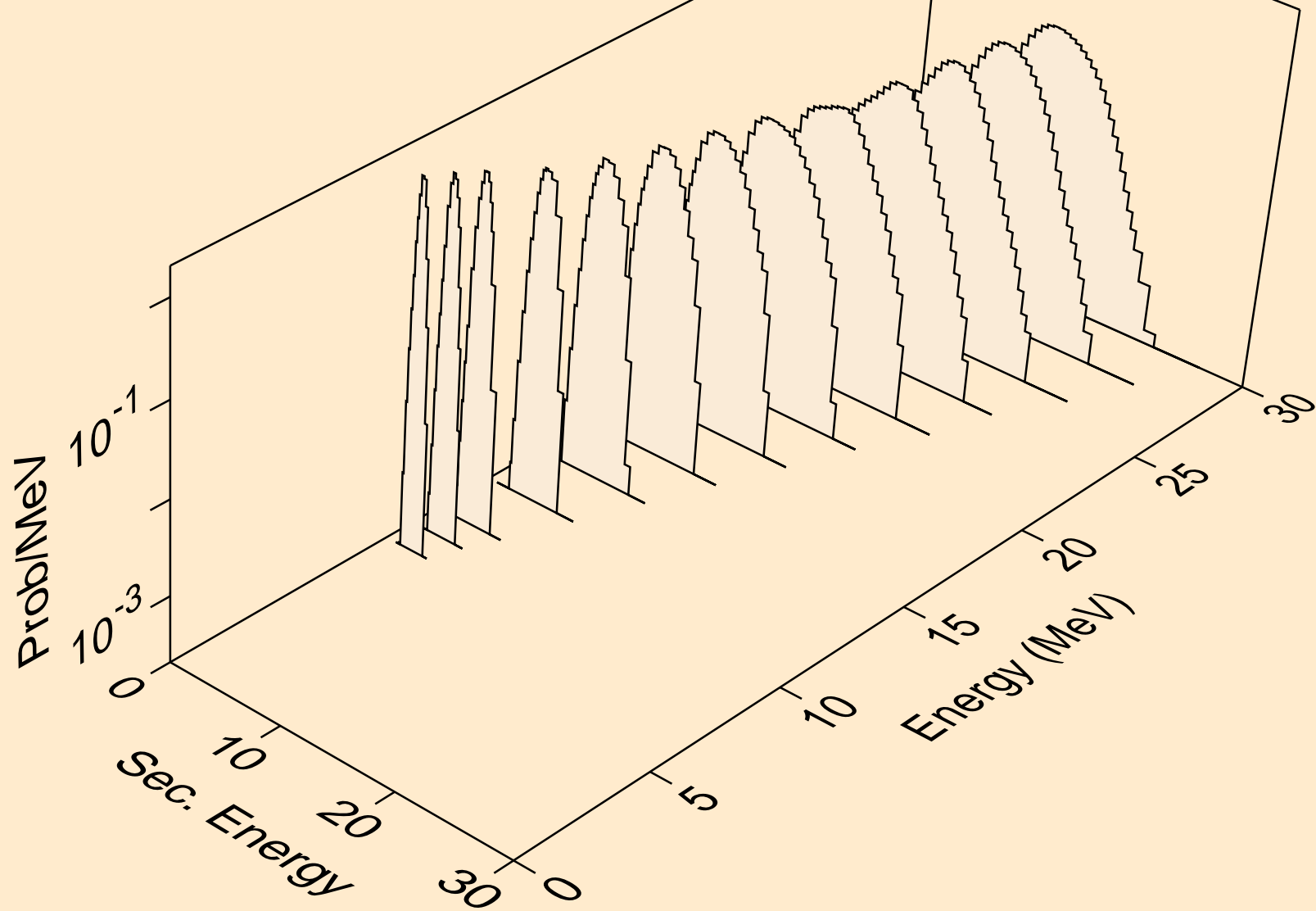

HO156N PROTON ACER TENDL-2021 LIBRARY; T=0.K  
Proton emission for (p,pa)

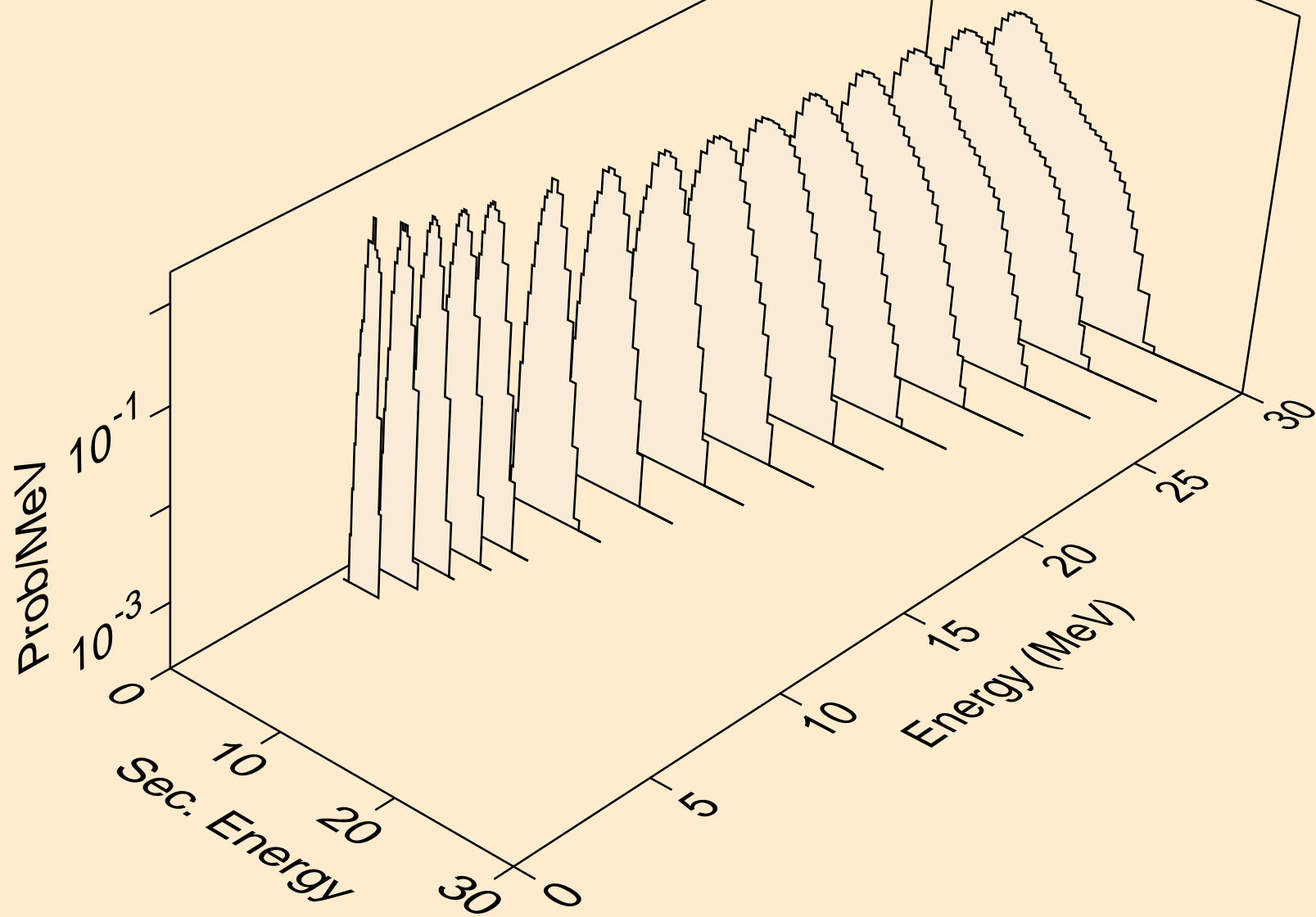

HO156N PROTON ACER TENDL-2021 LIBRARY; T=0.K  
Proton emission for (p,pd)

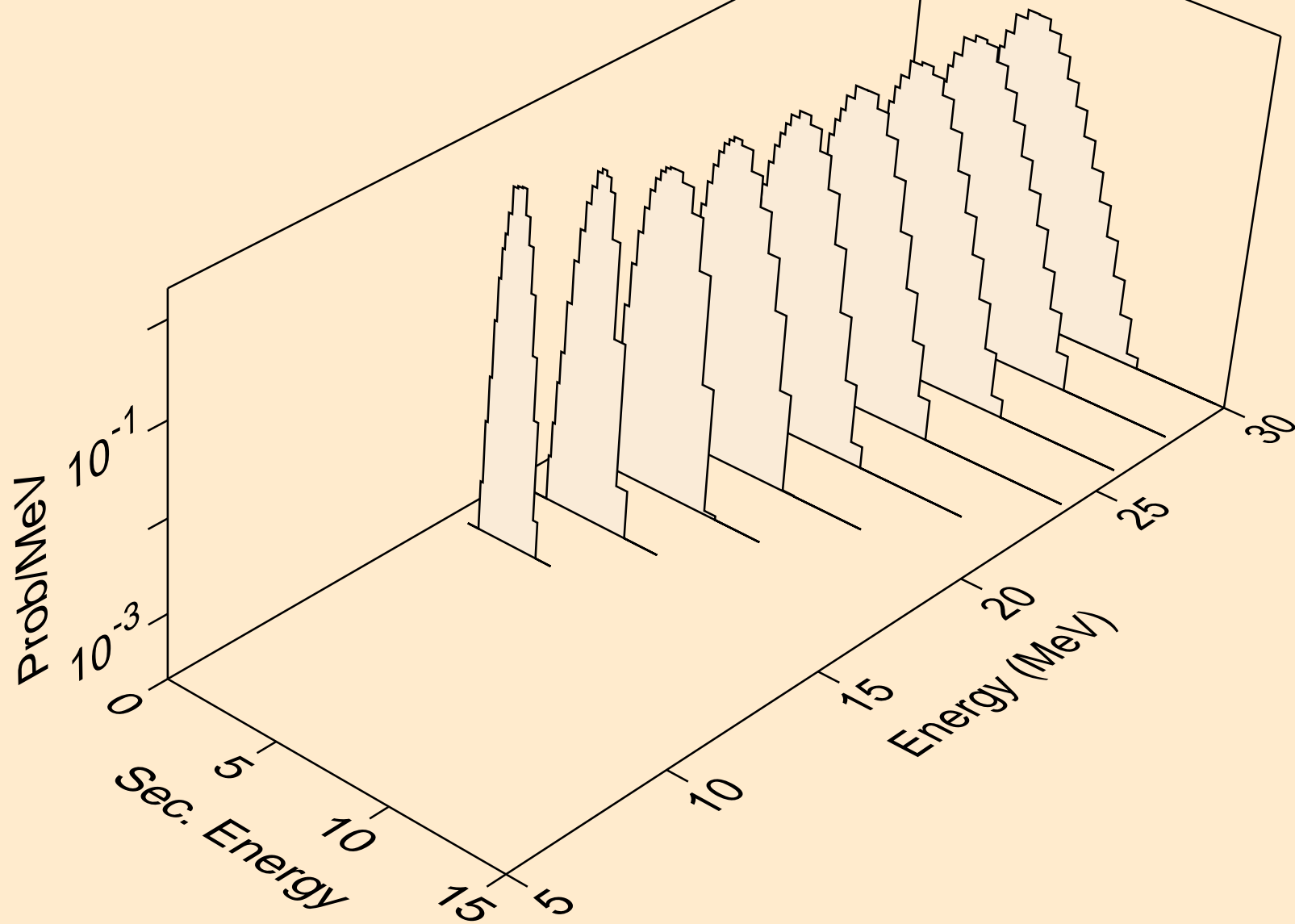

HO156N PROTON ACER TENDL-2021 LIBRARY; T=0.K  
Proton emission for (p,pt)

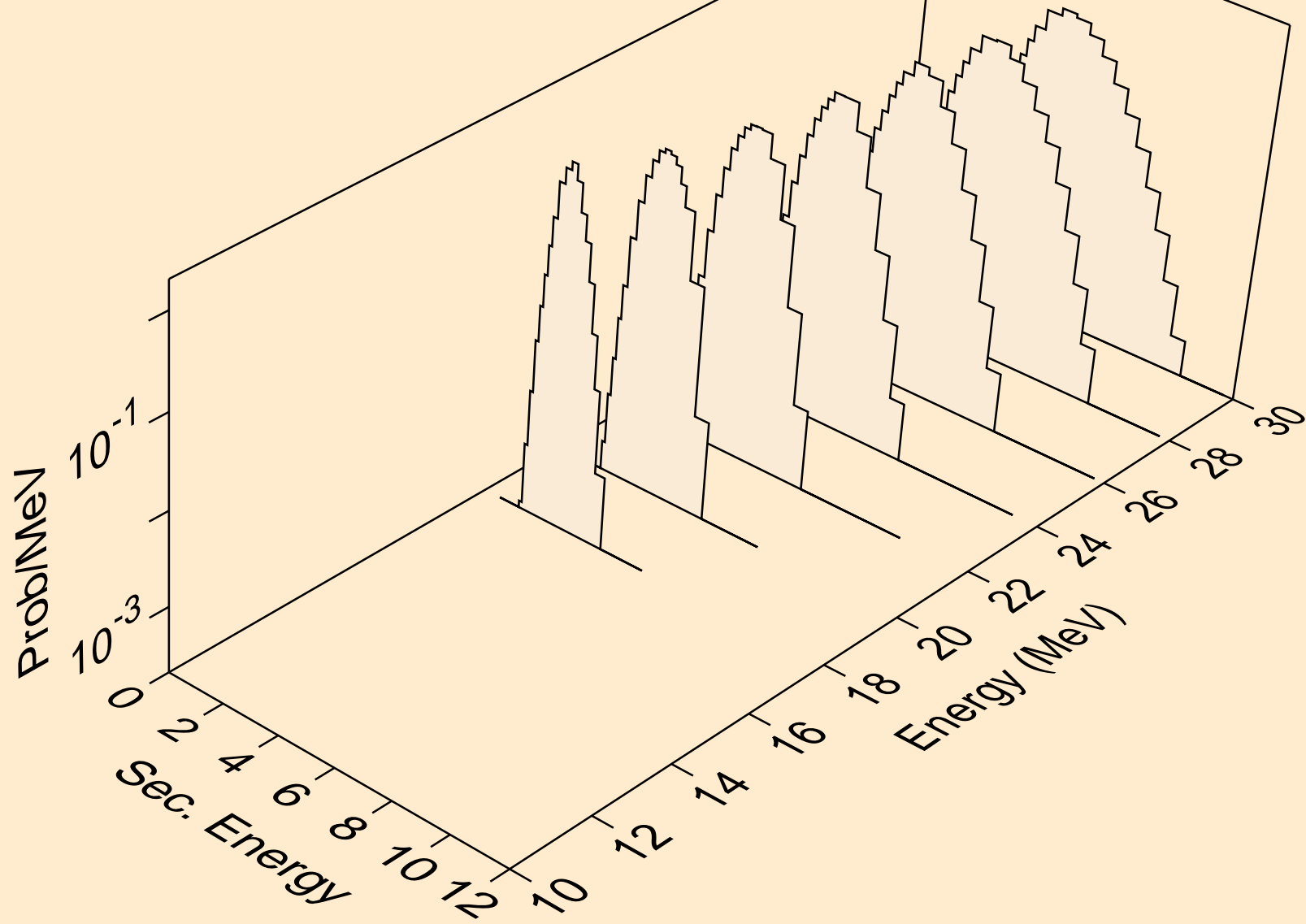

HO156N PROTON ACER TENDL-2021 LIBRARY; T=0.K  
Photon emission for (z,n)

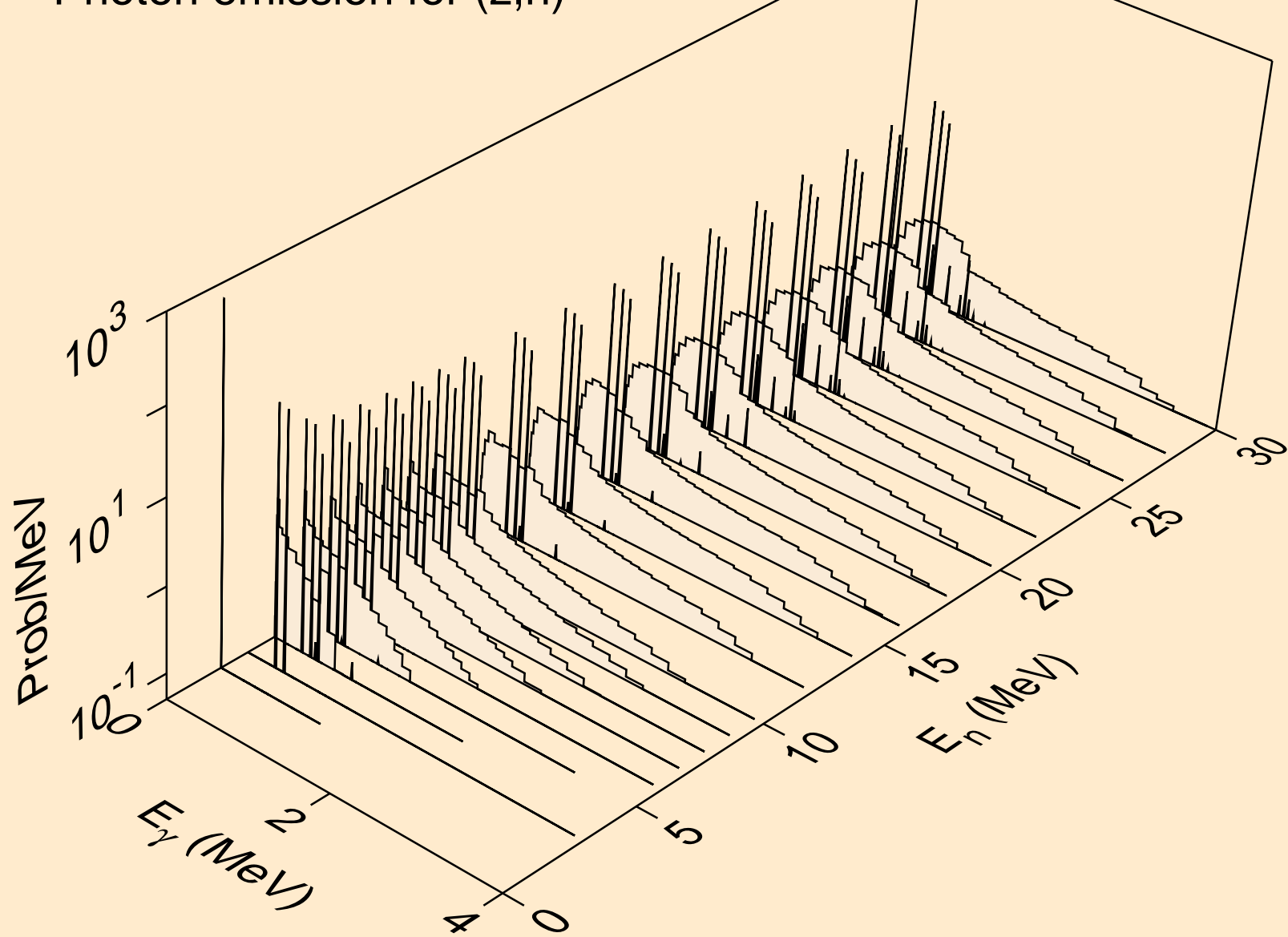

HO156N PROTON ACER TENDL-2021 LIBRARY; T=0.K  
Photon emission for (n,x)

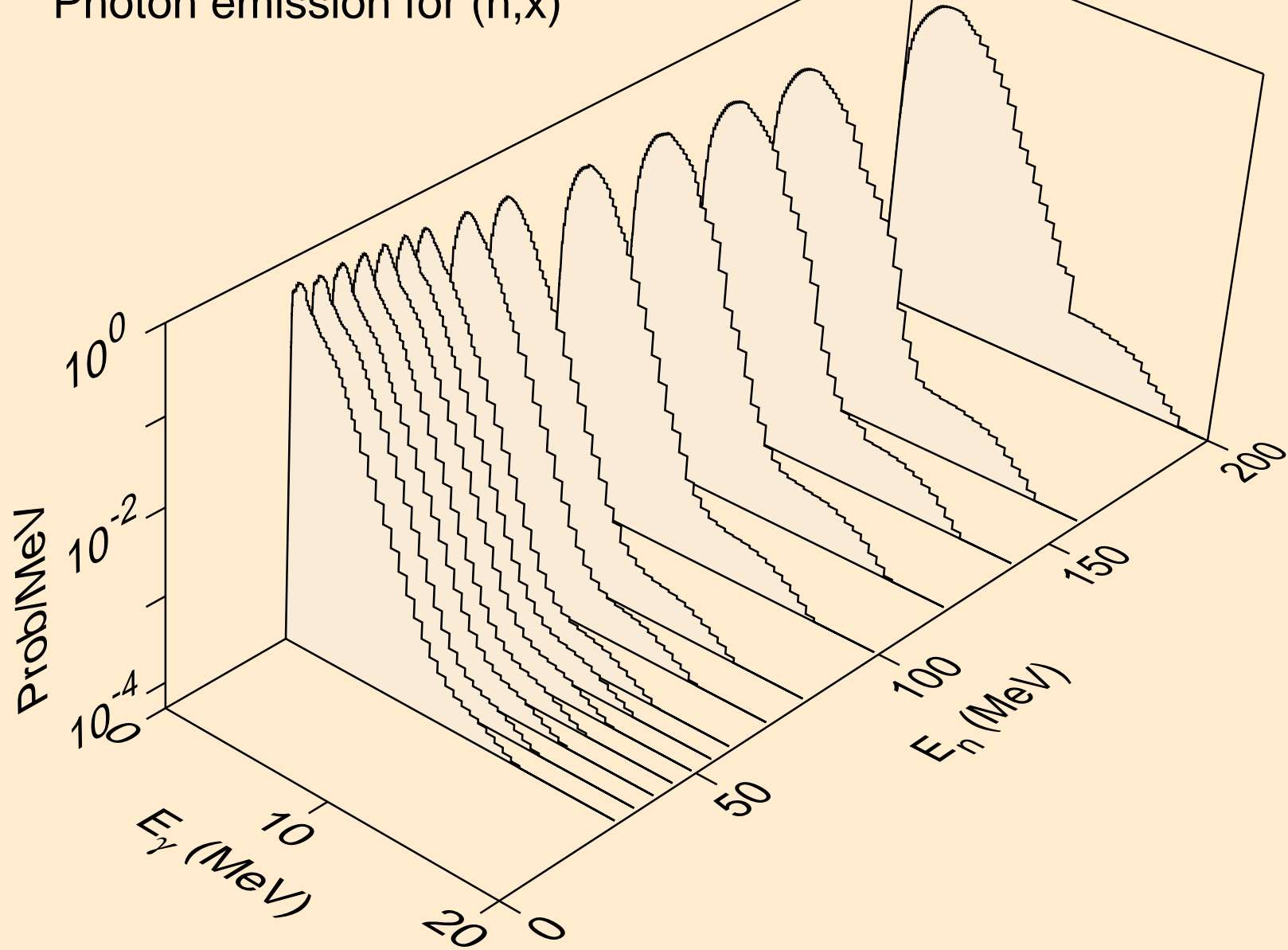

HO156N PROTON ACER TENDL-2021 LIBRARY; T=0.K  
Photon emission for (n,2nd)

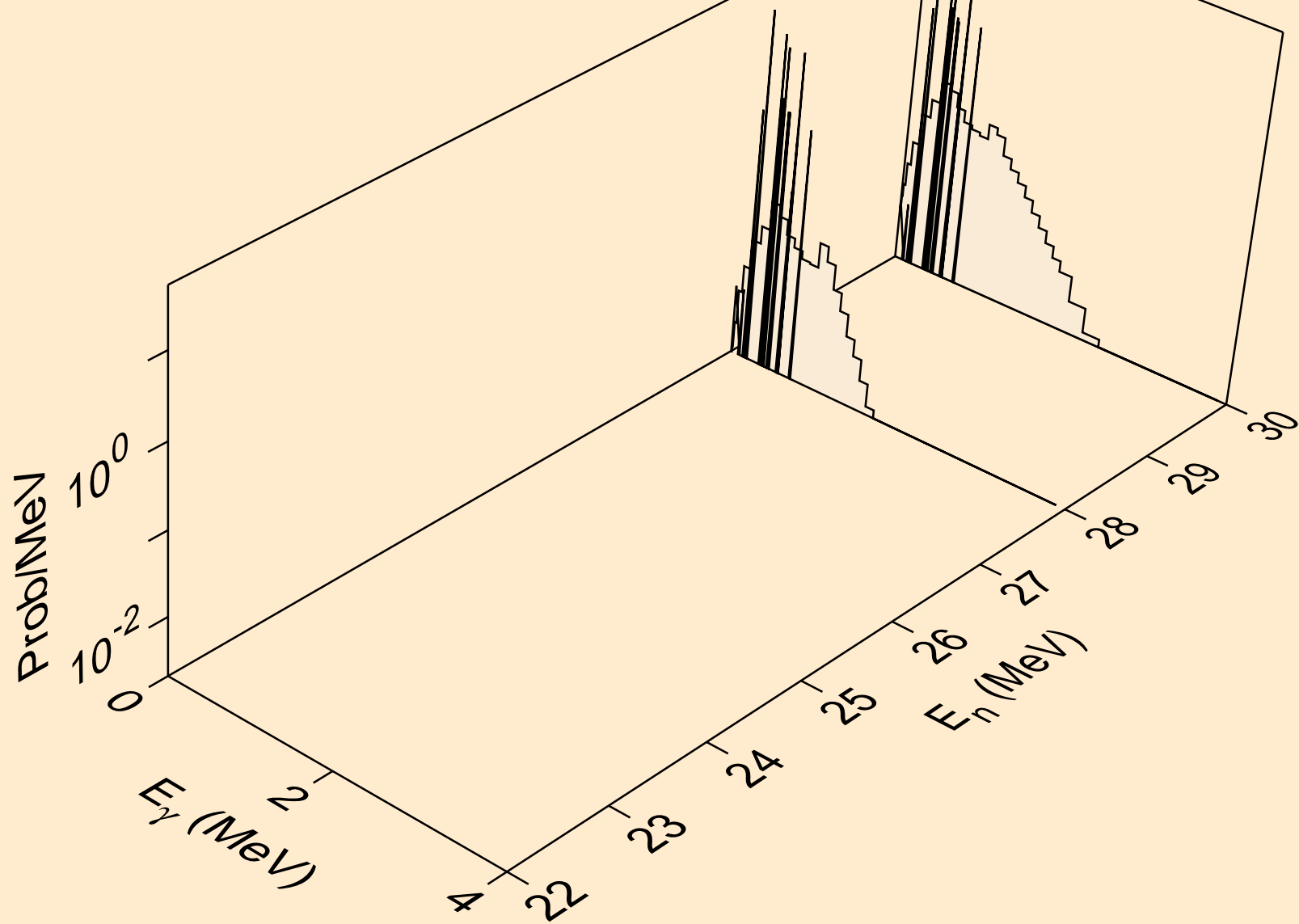

HO156N PROTON ACER TENDL-2021 LIBRARY; T=0.K  
Photon emission for (n,2n)

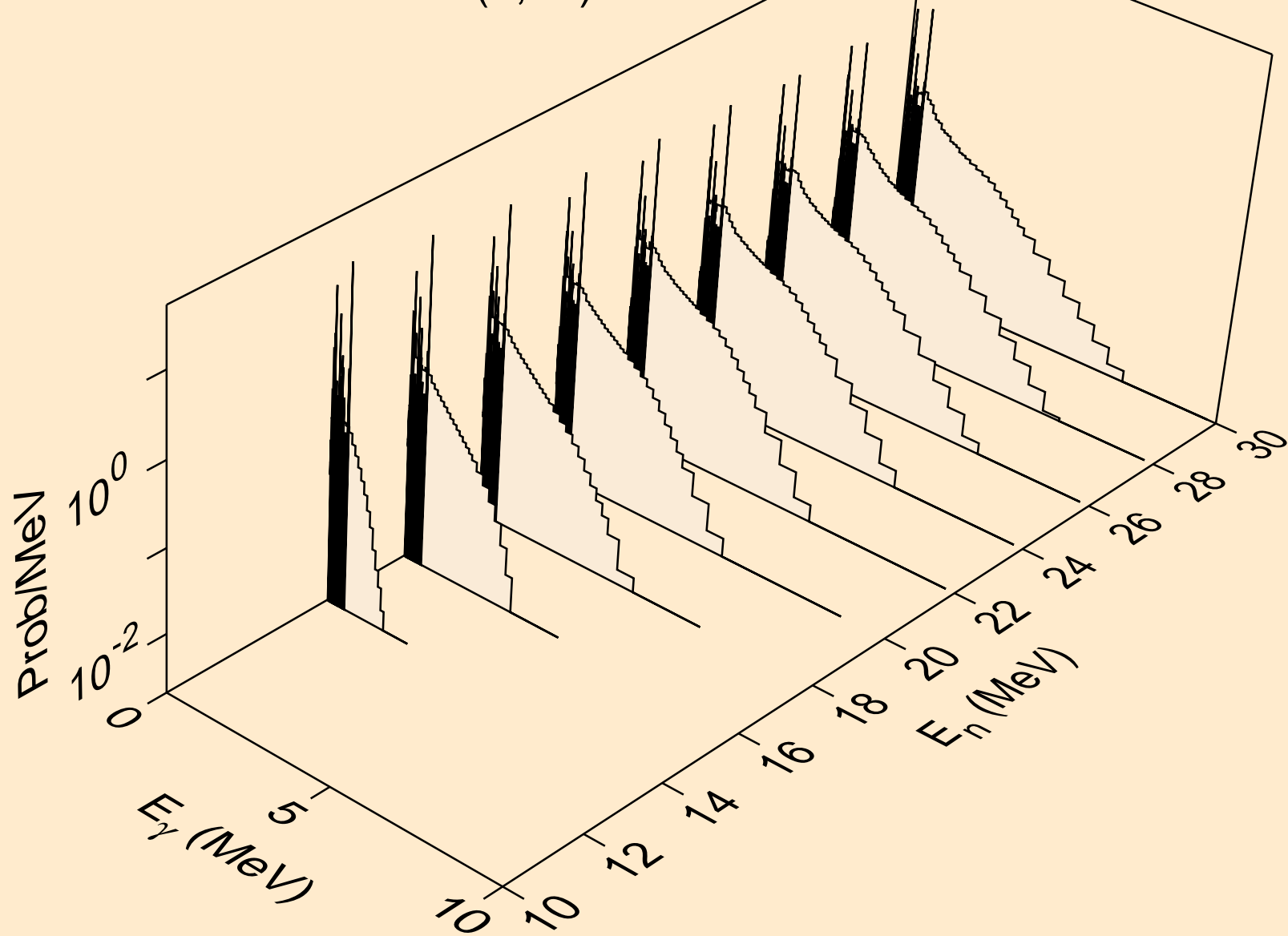



HO156N PROTON ACER TENDL-2021 LIBRARY; T=0.K  
Photon emission for (n,3n)

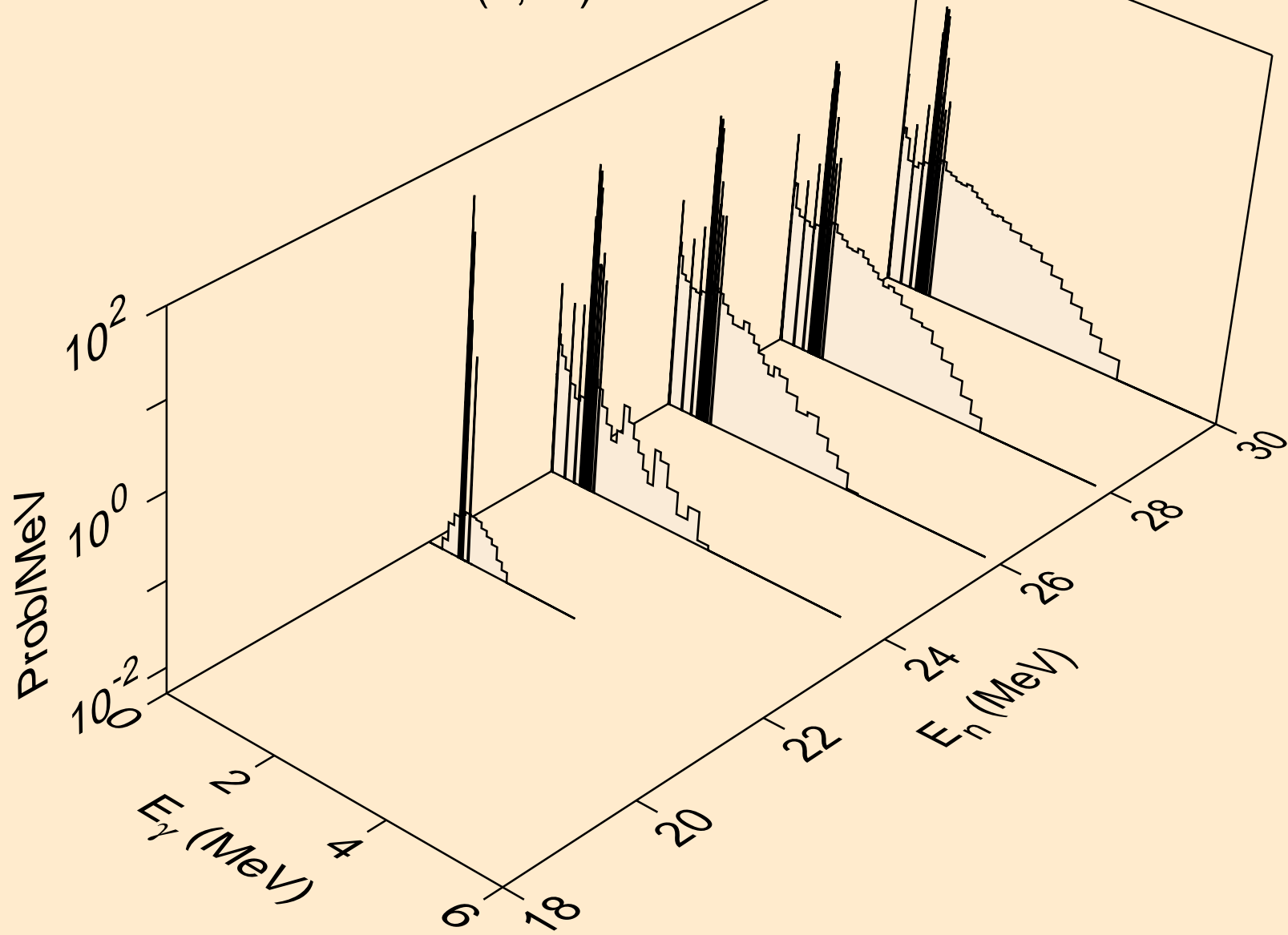

HO156N PROTON ACER TENDL-2021 LIBRARY; T=0.K  
Photon emission for (n,n\*)a

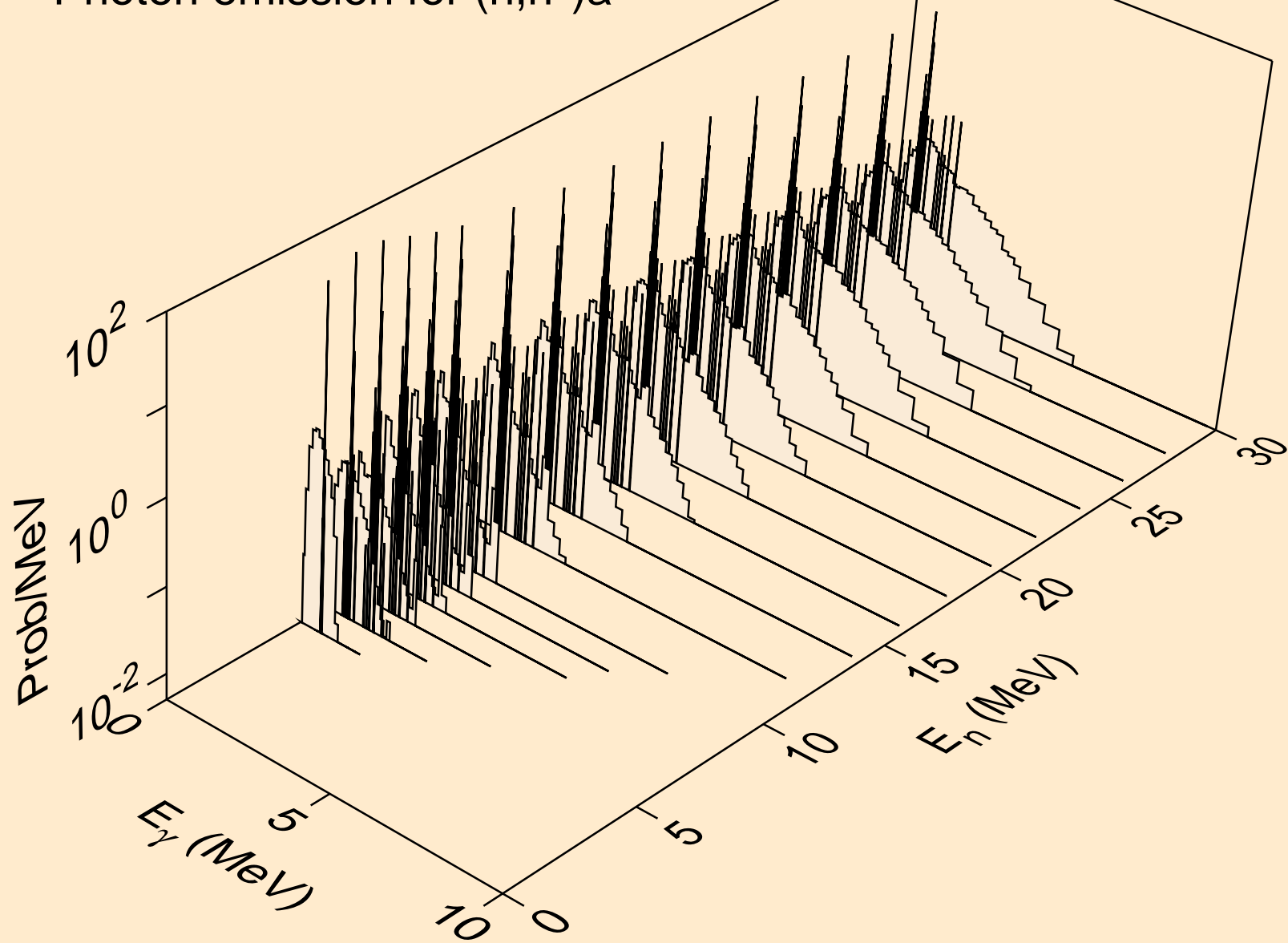

HO156N PROTON ACER TENDL-2021 LIBRARY; T=0.K  
Photon emission for (n,2n)a

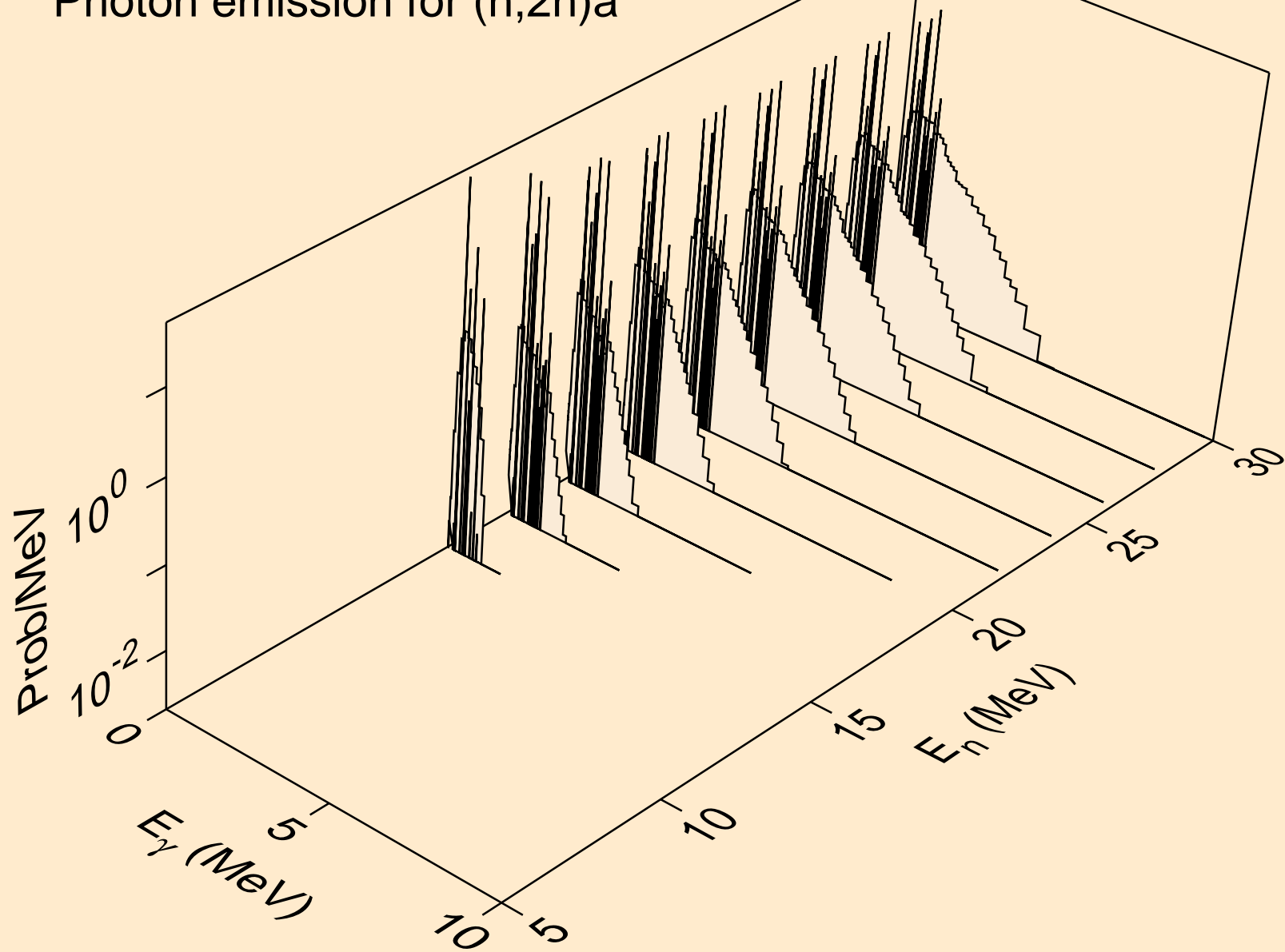

HO156N PROTON ACER TENDL-2021 LIBRARY; T=0.K  
Photon emission for (n,3n)a

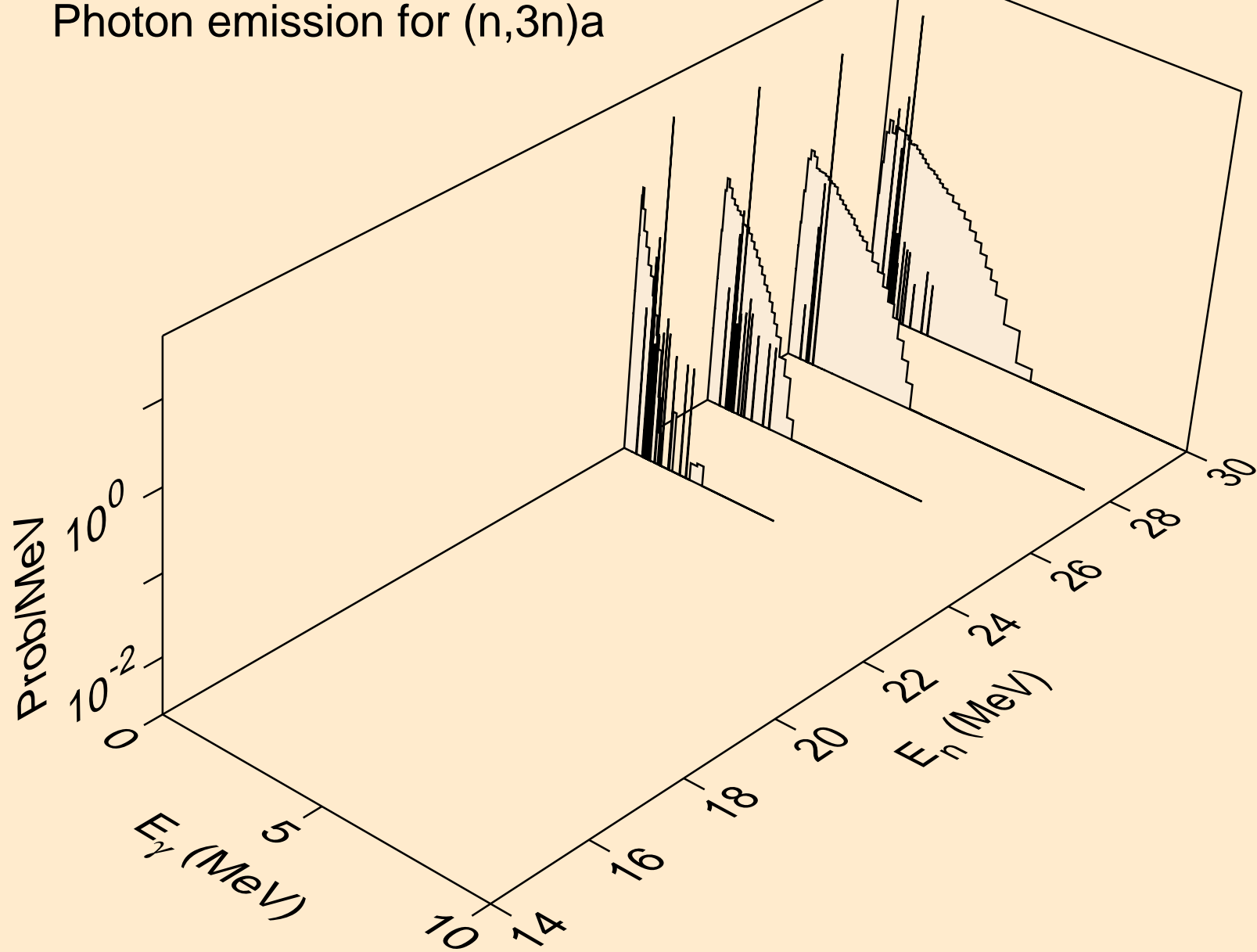

HO156N PROTON ACER TENDL-2021 LIBRARY; T=0.K  
Photon emission for (n,n\*)p

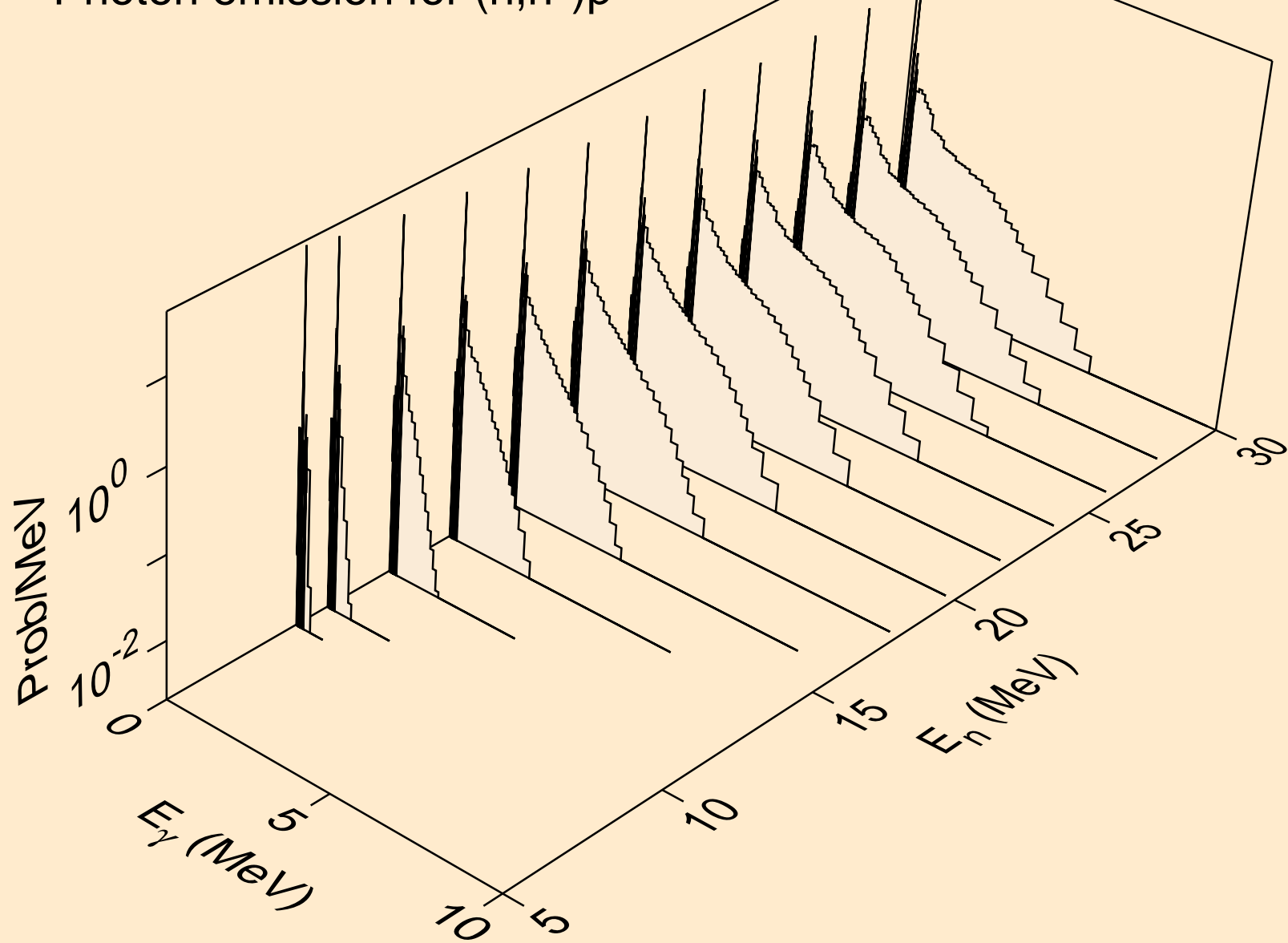

HO156N PROTON ACER TENDL-2021 LIBRARY; T=0.K  
Photon emission for (n,n\*)2a

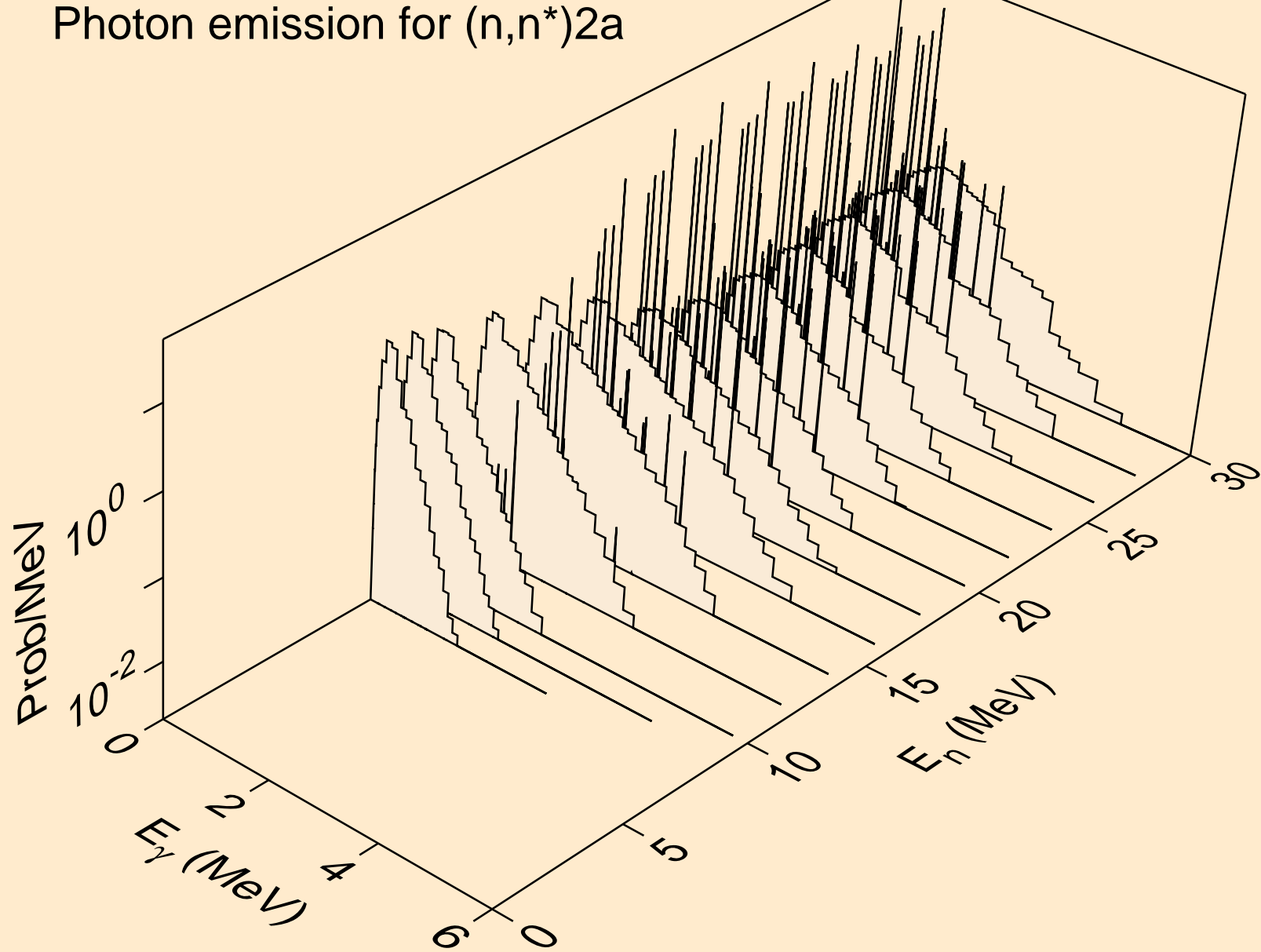

HO156N PROTON ACER TENDL-2021 LIBRARY; T=0.K  
Photon emission for (n,2n)2a

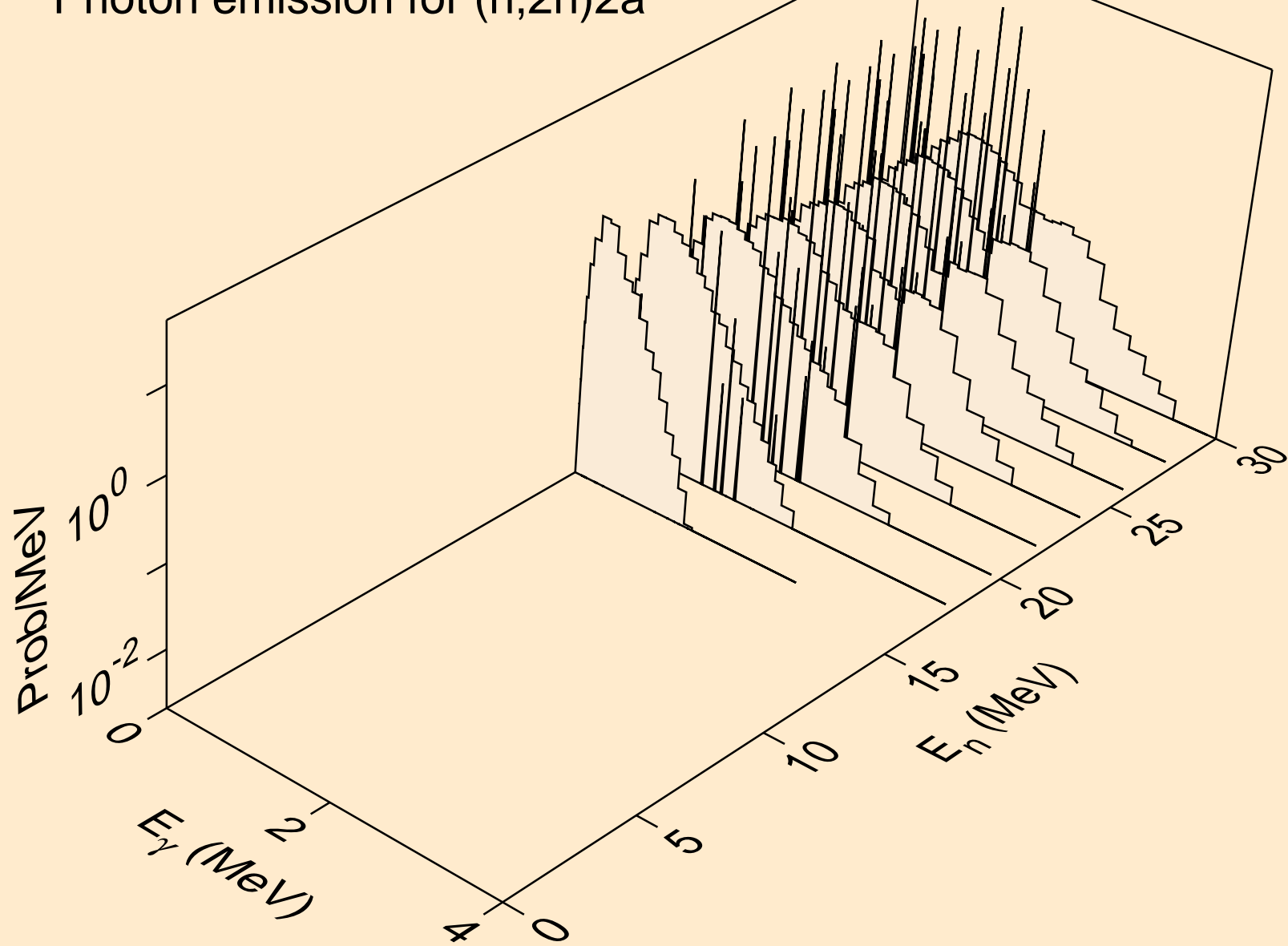

HO156N PROTON ACER TENDL-2021 LIBRARY; T=0.K  
Photon emission for (n,n\*)d

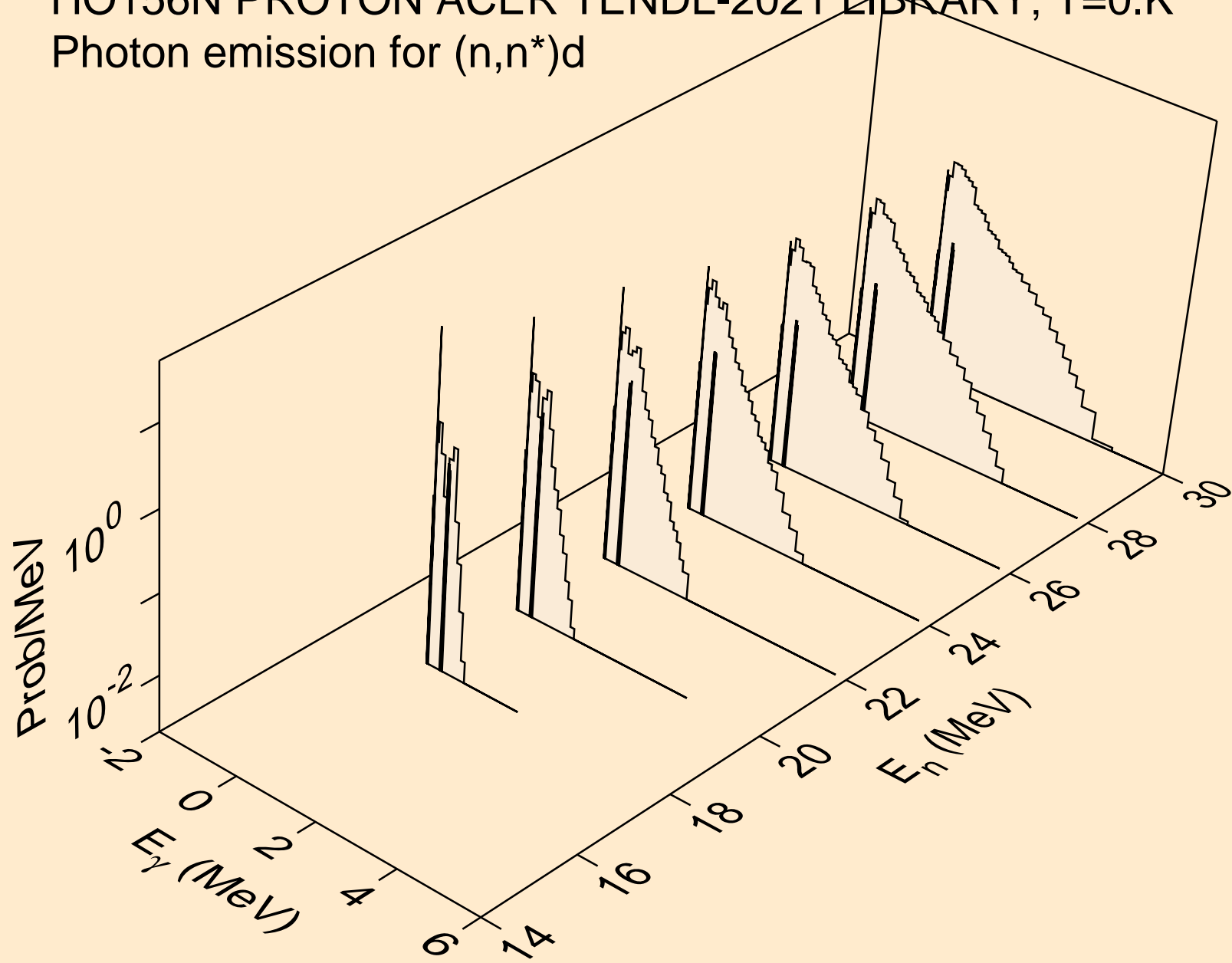



HO156N PROTON ACER TENDL-2021 LIBRARY; T=0.K  
Photon emission for (n,n\*)t

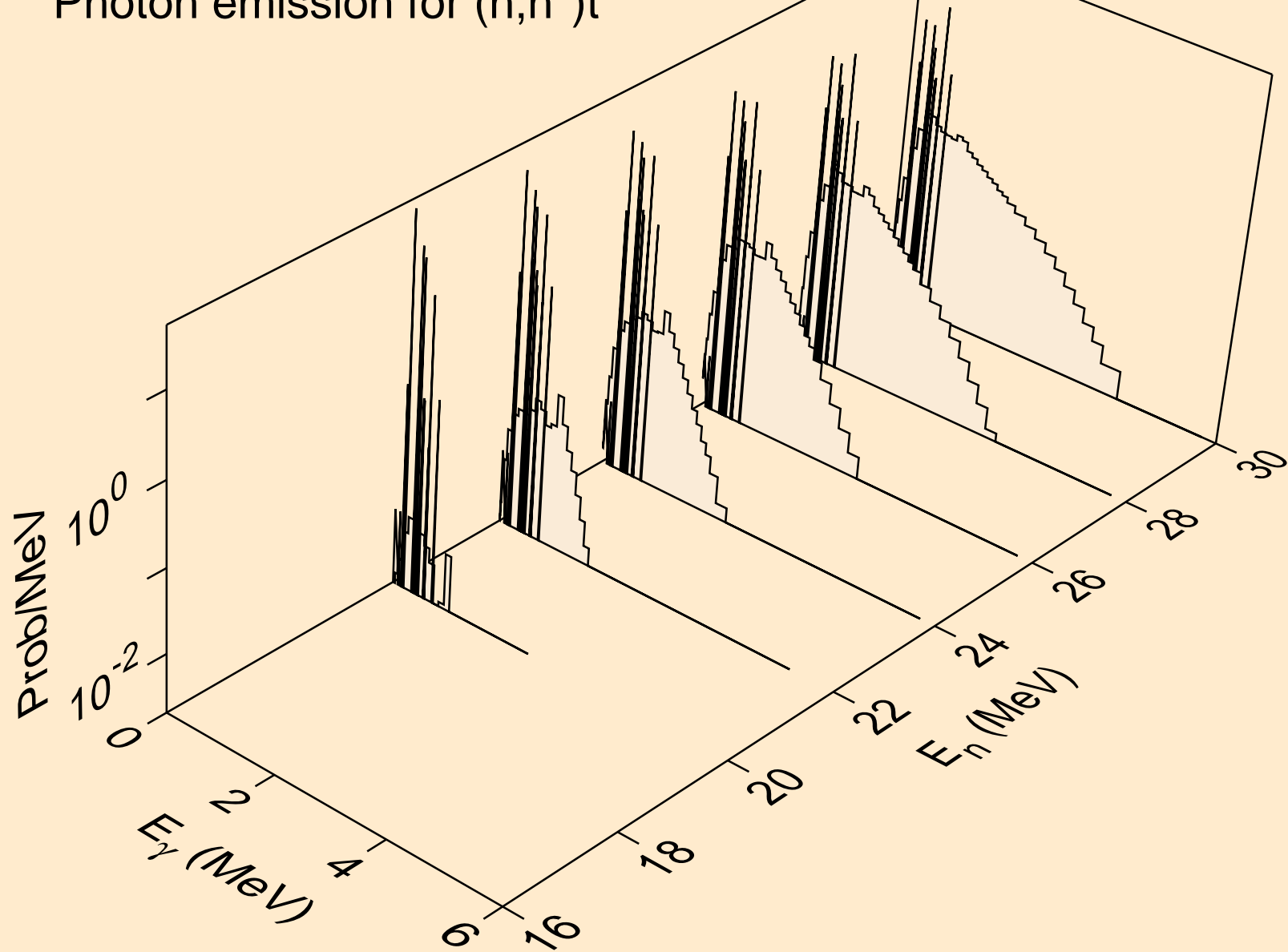

HO156N PROTON ACER TENDL-2021 LIBRARY; T=0.K  
Photon emission for (n,n\*)he3

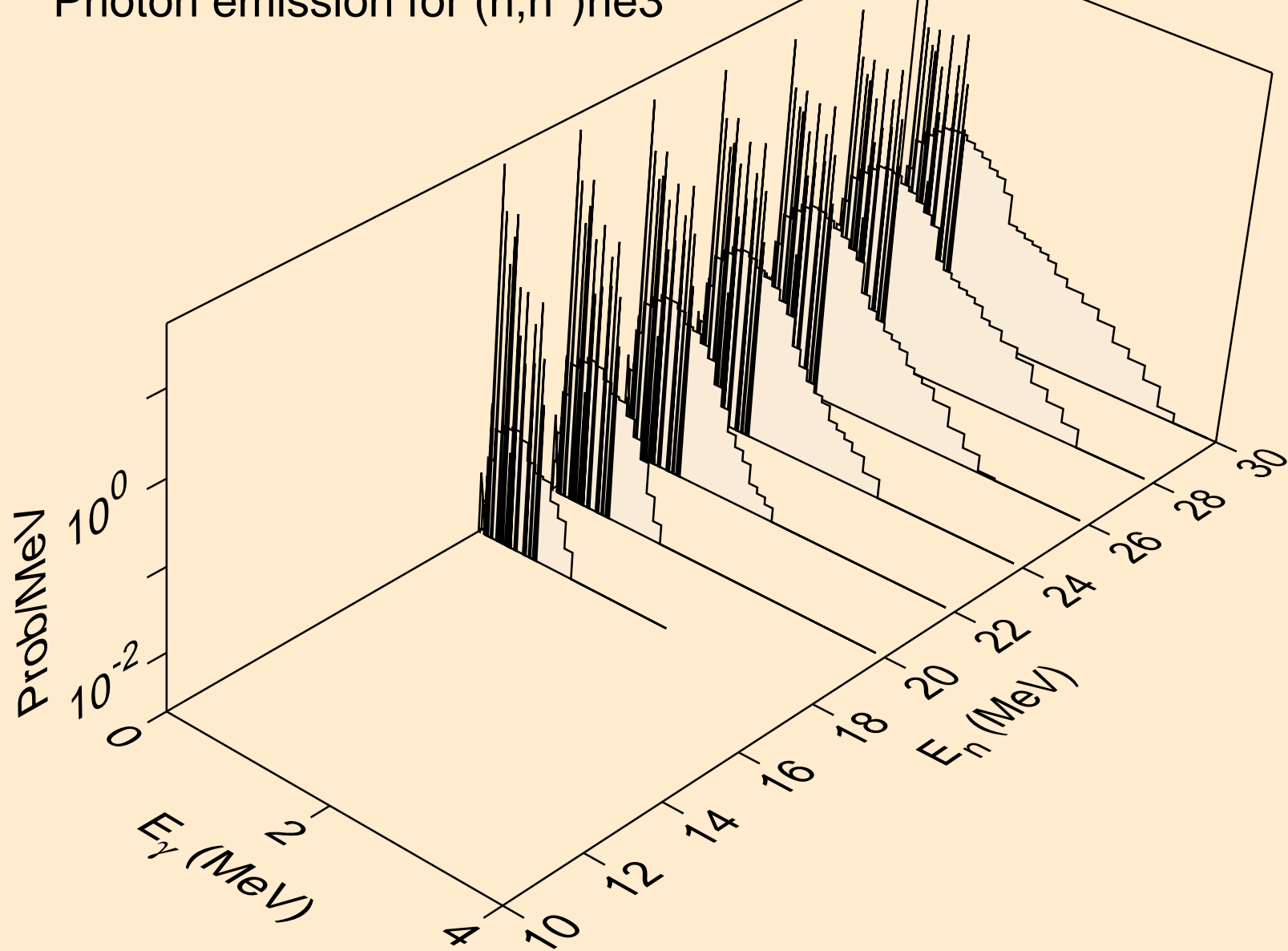

HO156N PROTON ACER TENDL-2021 LIBRARY; T=0.K  
Photon emission for (n,4n)

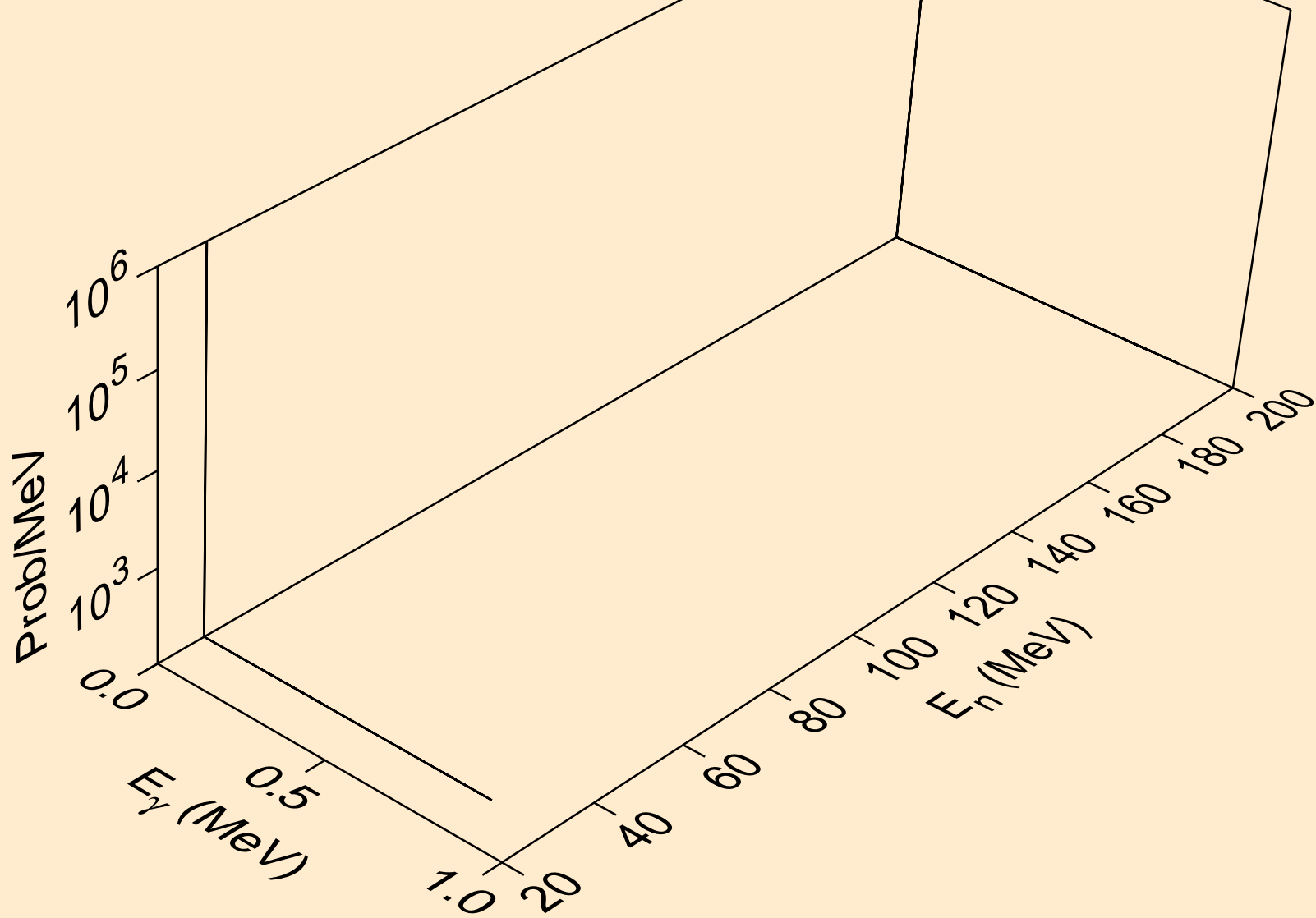

HO156N PROTON ACER TENDL-2021 LIBRARY; T=0.K  
Photon emission for (n,2np)

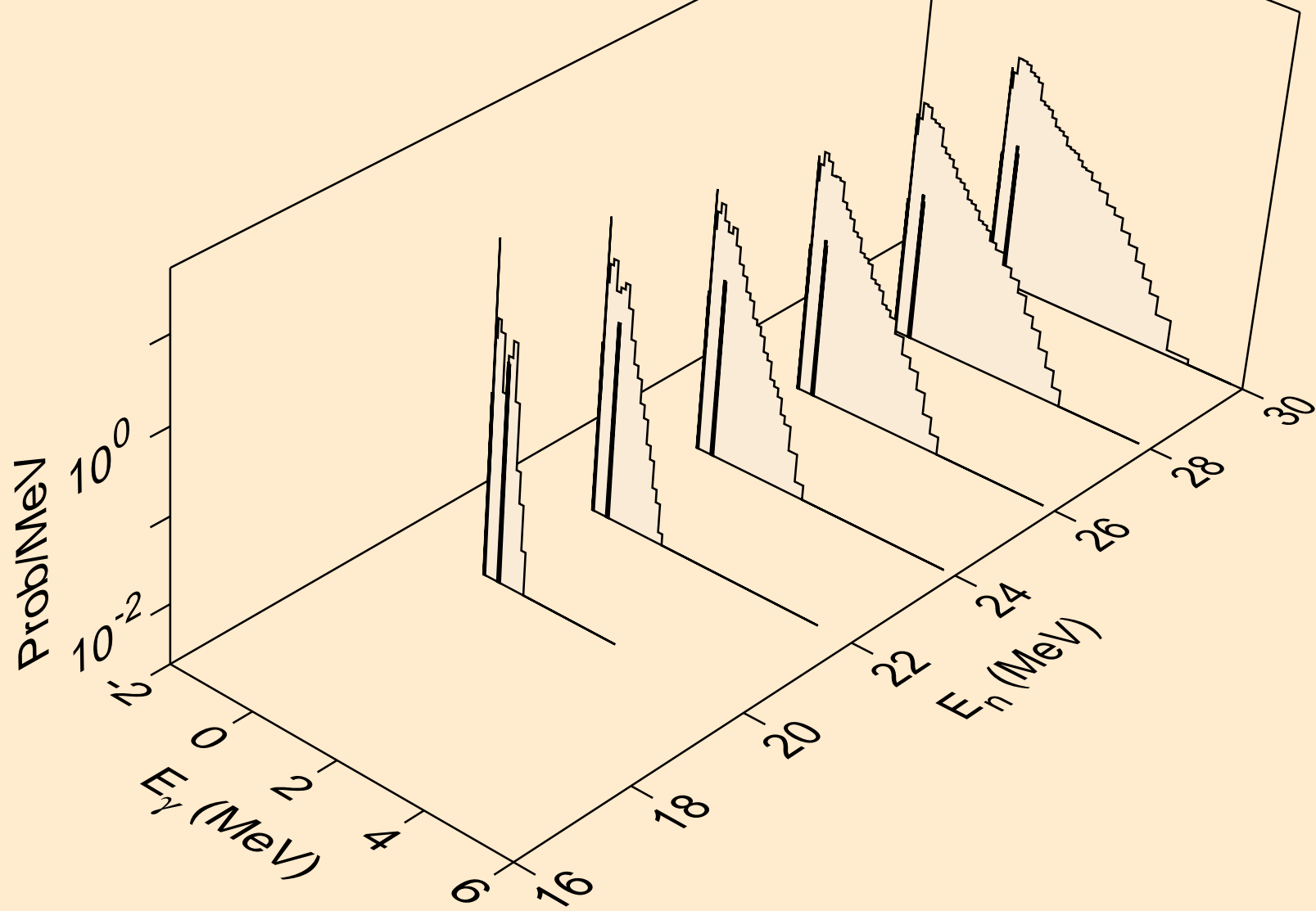

HO156N PROTON ACER TENDL-2021 LIBRARY; T=0.K  
Photon emission for (n,3np)

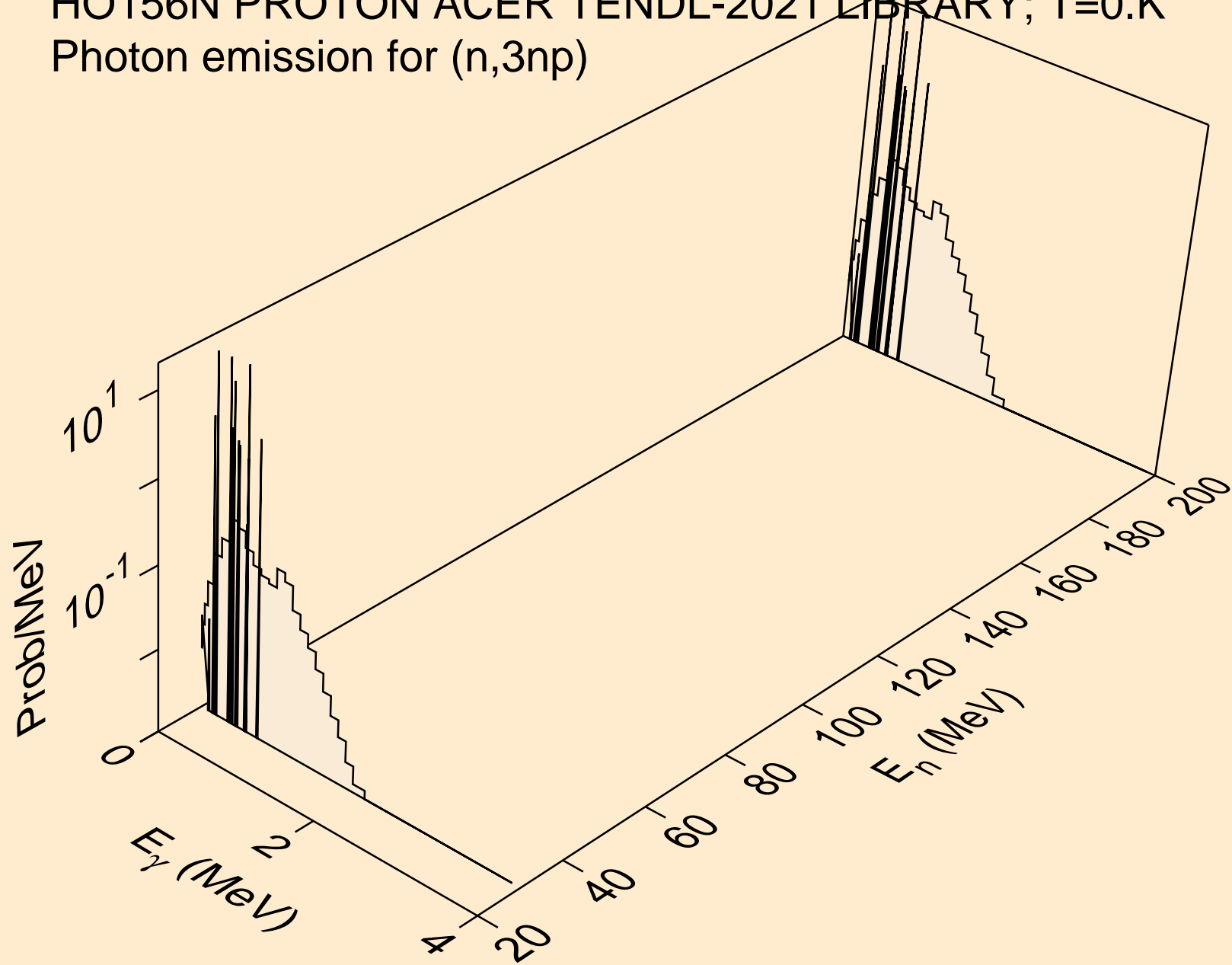

HO156N PROTON ACER TENDL-2021 LIBRARY; T=0.K  
Photon emission for (n,2np)

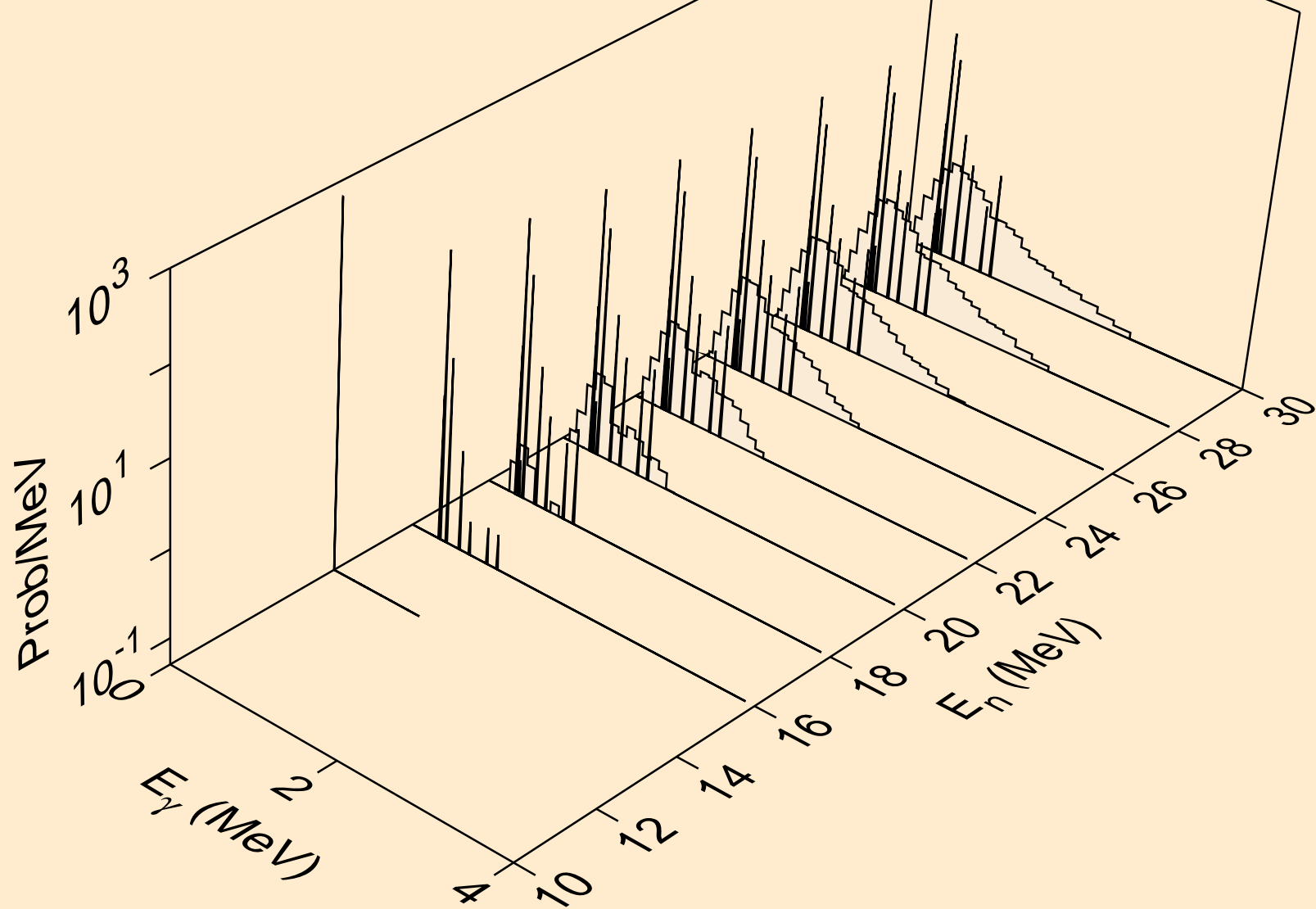

HO156N PROTON ACER TENDL-2021 LIBRARY; T=0.K  
Photon emission for (n,npa)

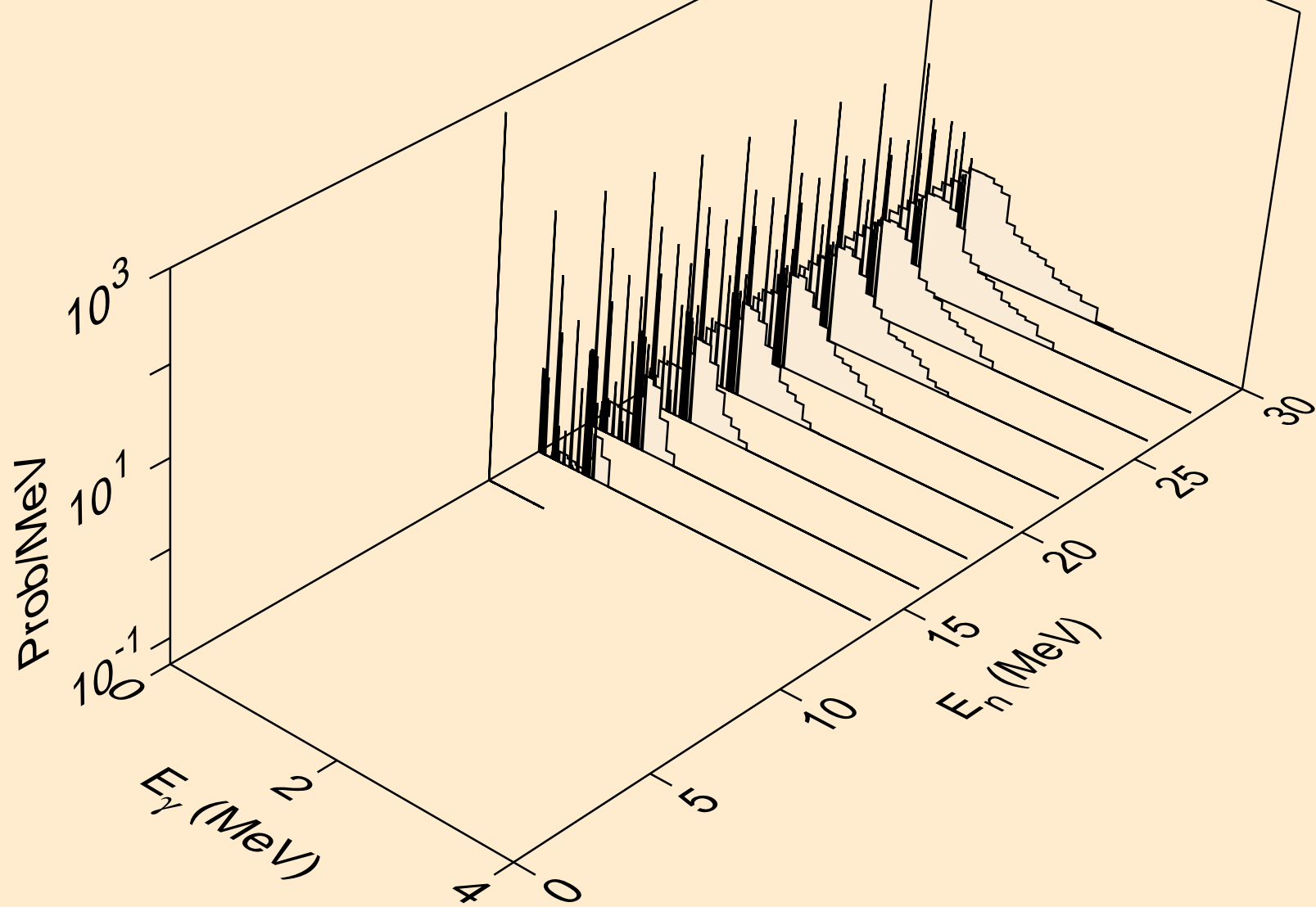

HO156N PROTON ACER TENDL-2021 LIBRARY; T=0.K  
Photon emission for (n,gma)

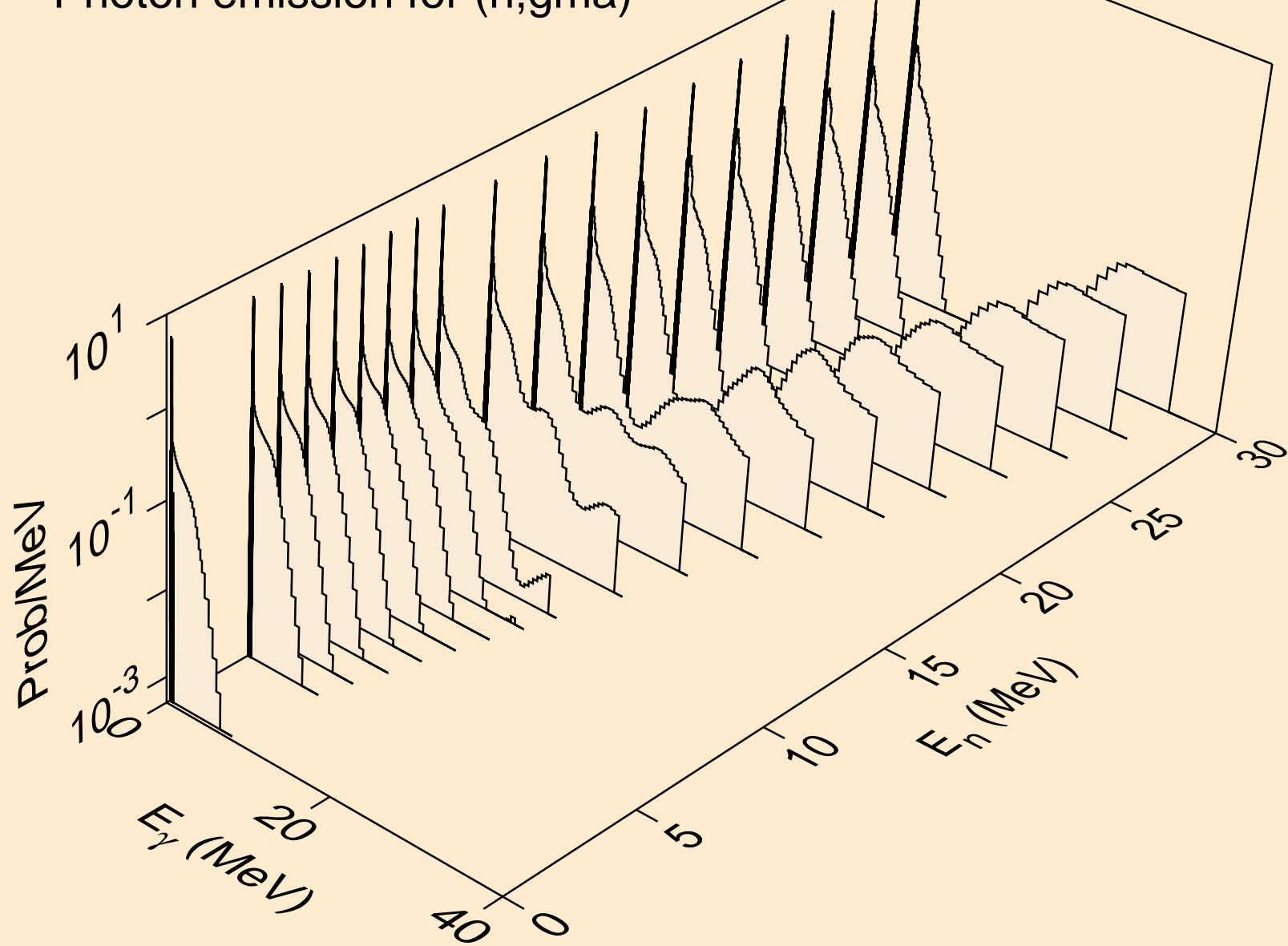



HO156N PROTON ACER TENDL-2021 LIBRARY; T=0.K  
Photon emission for inelastic

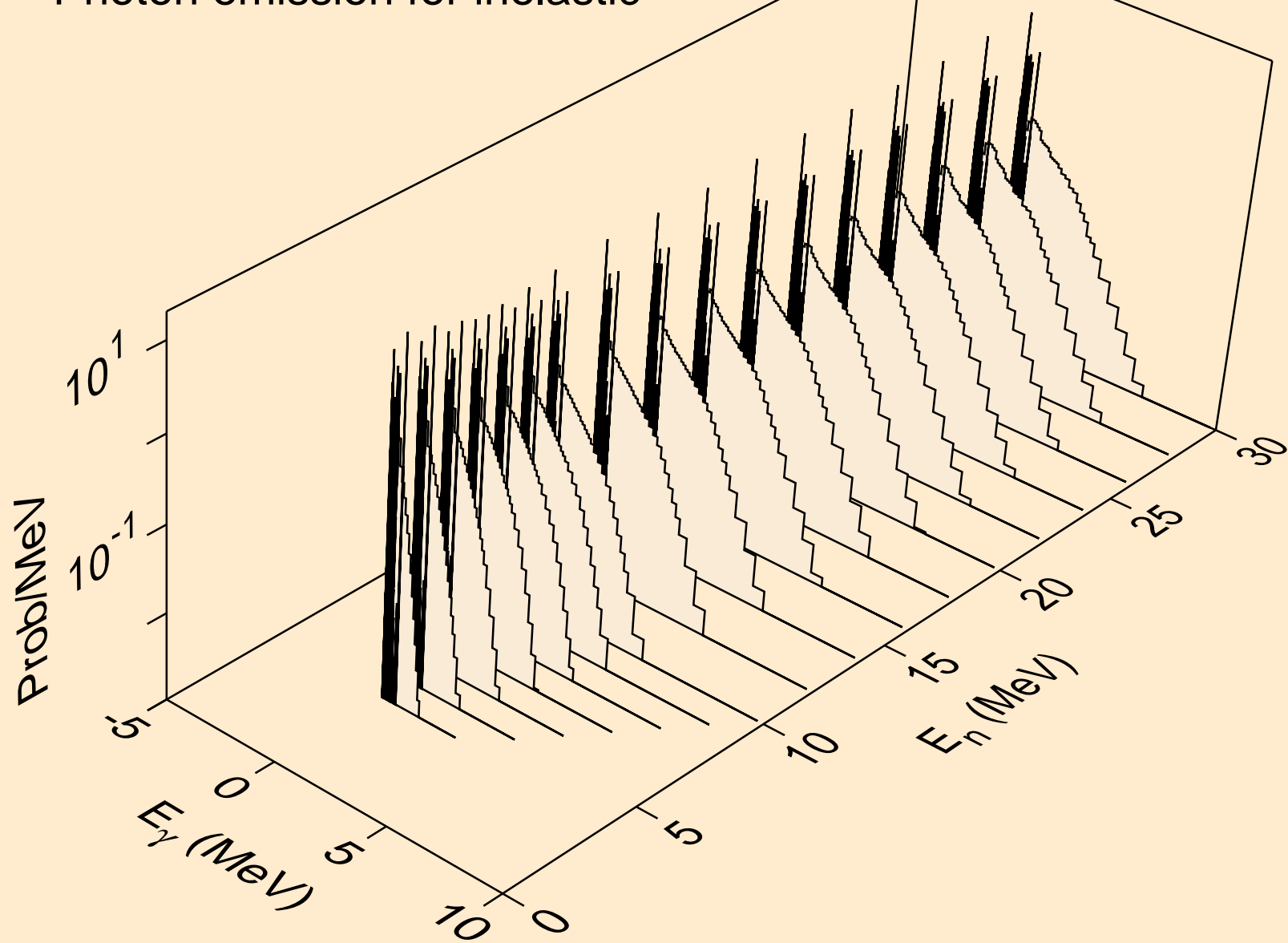

HO156N PROTON ACER TENDL-2021 LIBRARY; T=0.K  
Photon emission for (n,d)

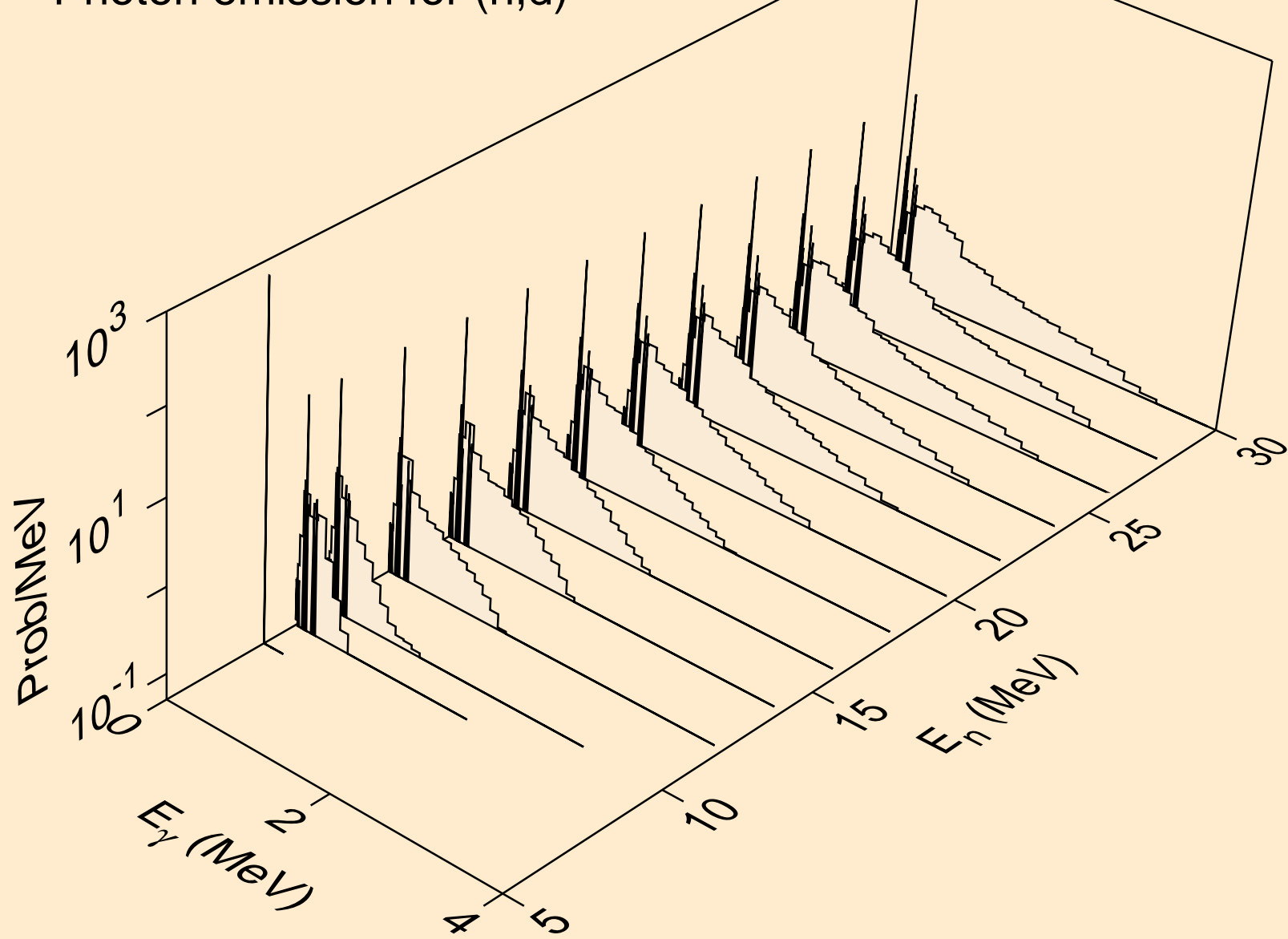

HO156N PROTON ACER TENDL-2021 LIBRARY; T=0.K  
Photon emission for (n,t)

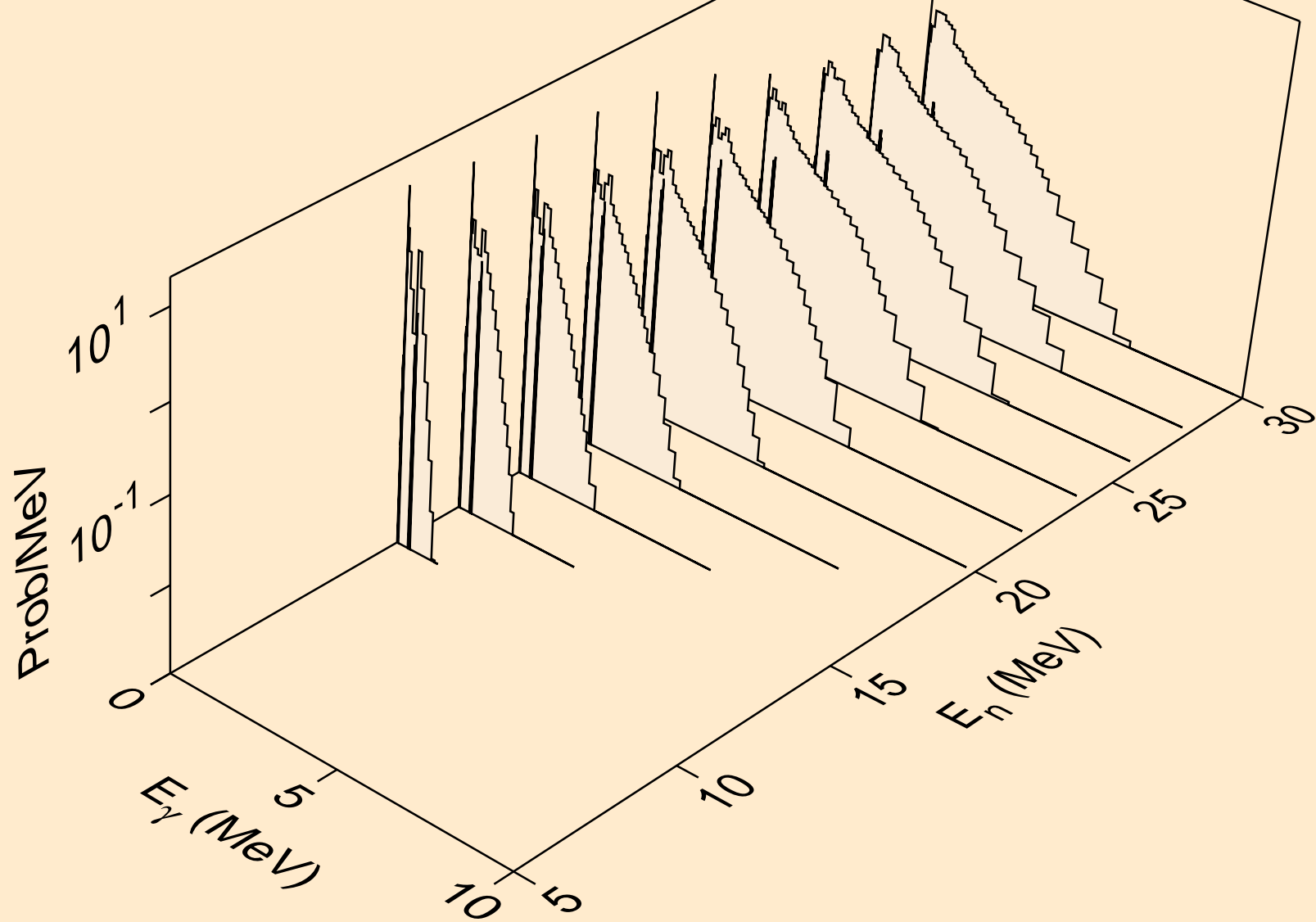

HO156N PROTON ACER TENDL-2021 LIBRARY; T=0.K  
Photon emission for (n,he3)

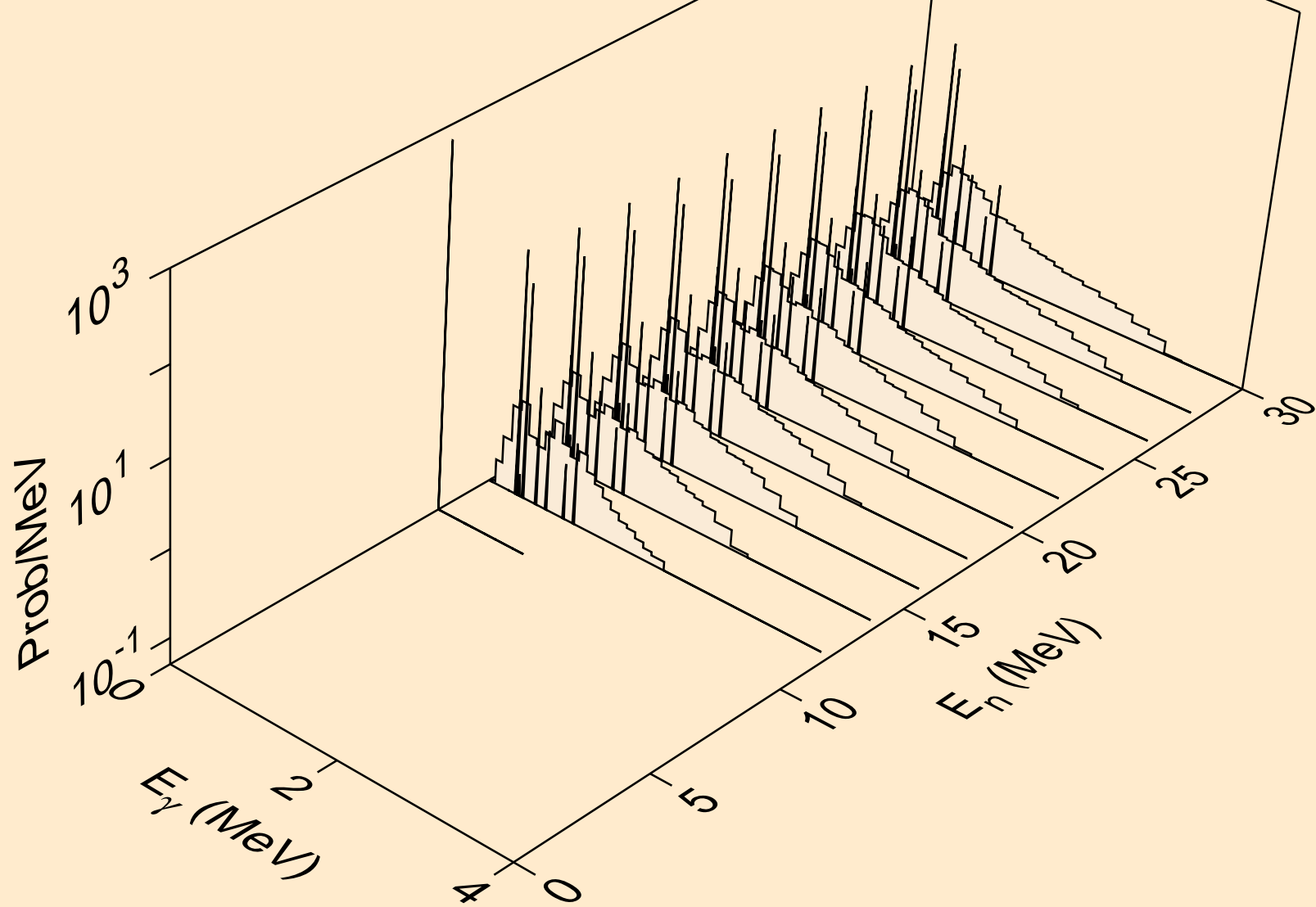

HO156N PROTON ACER TENDL-2021 LIBRARY; T=0.K  
Photon emission for (n,a)

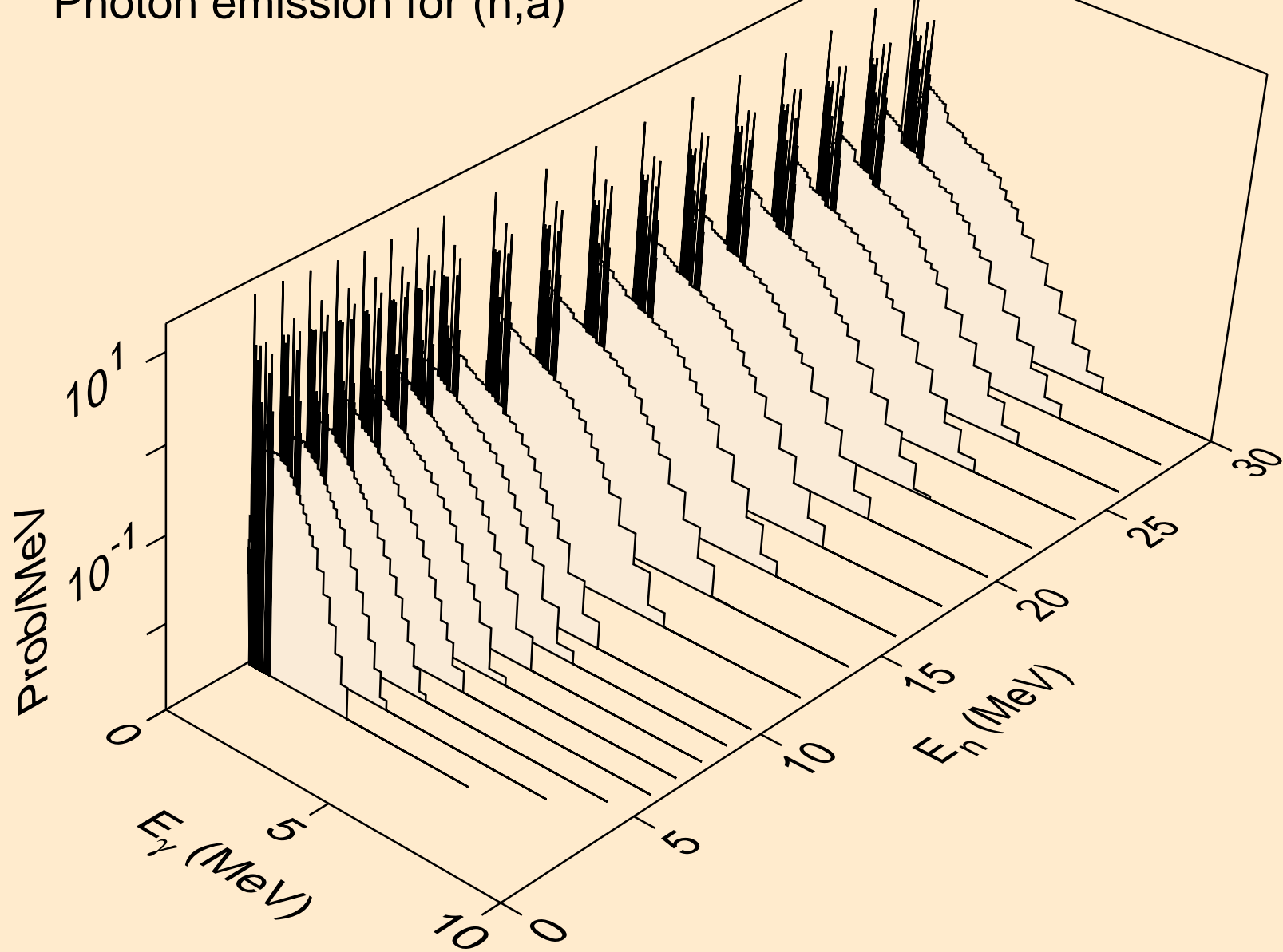

HO156N PROTON ACER TENDL-2021 LIBRARY; T=0.K  
Photon emission for (n,2a)

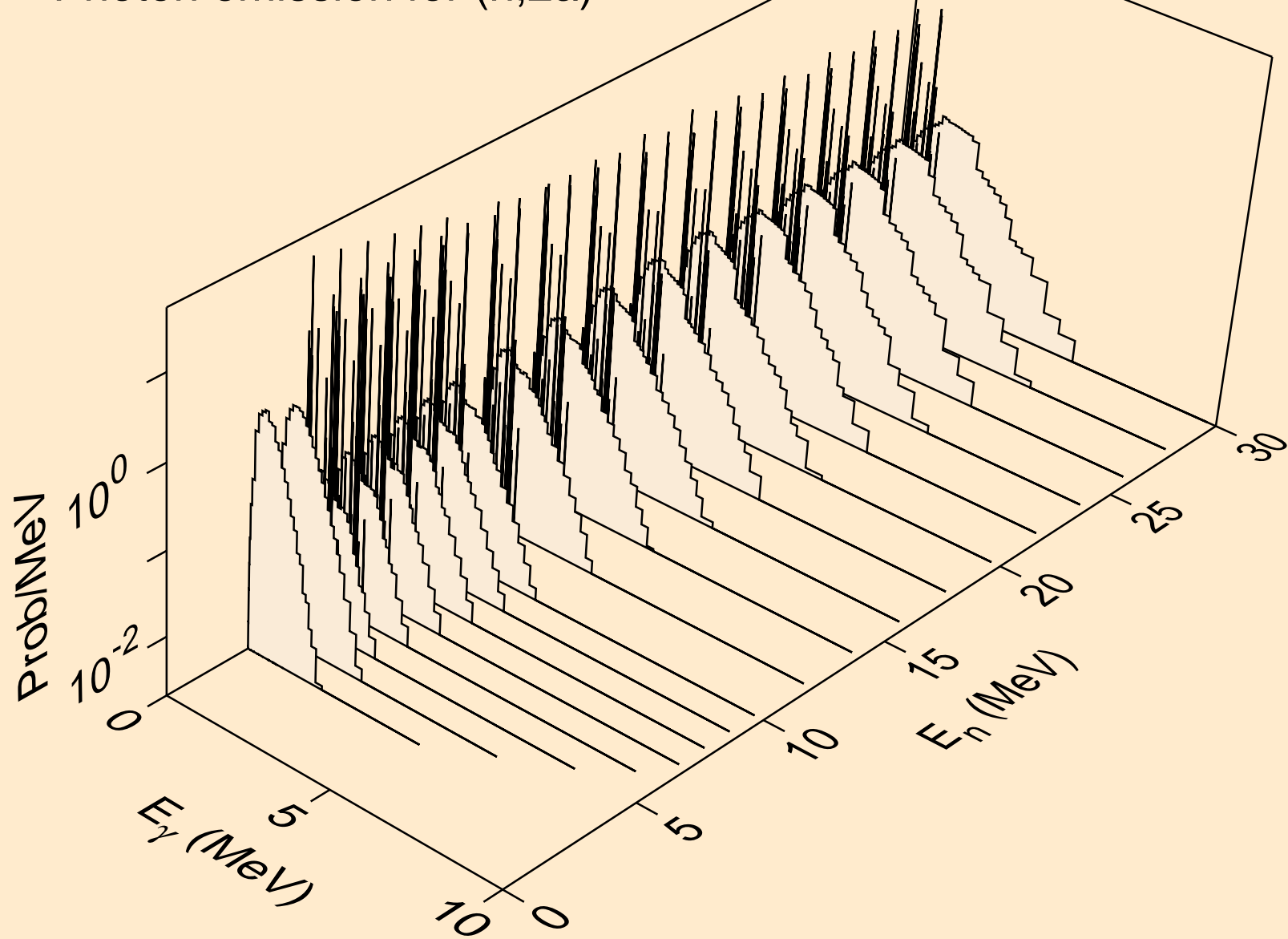

HO156N PROTON ACER TENDL-2021 LIBRARY; T=0.K  
Photon emission for (n,2p)

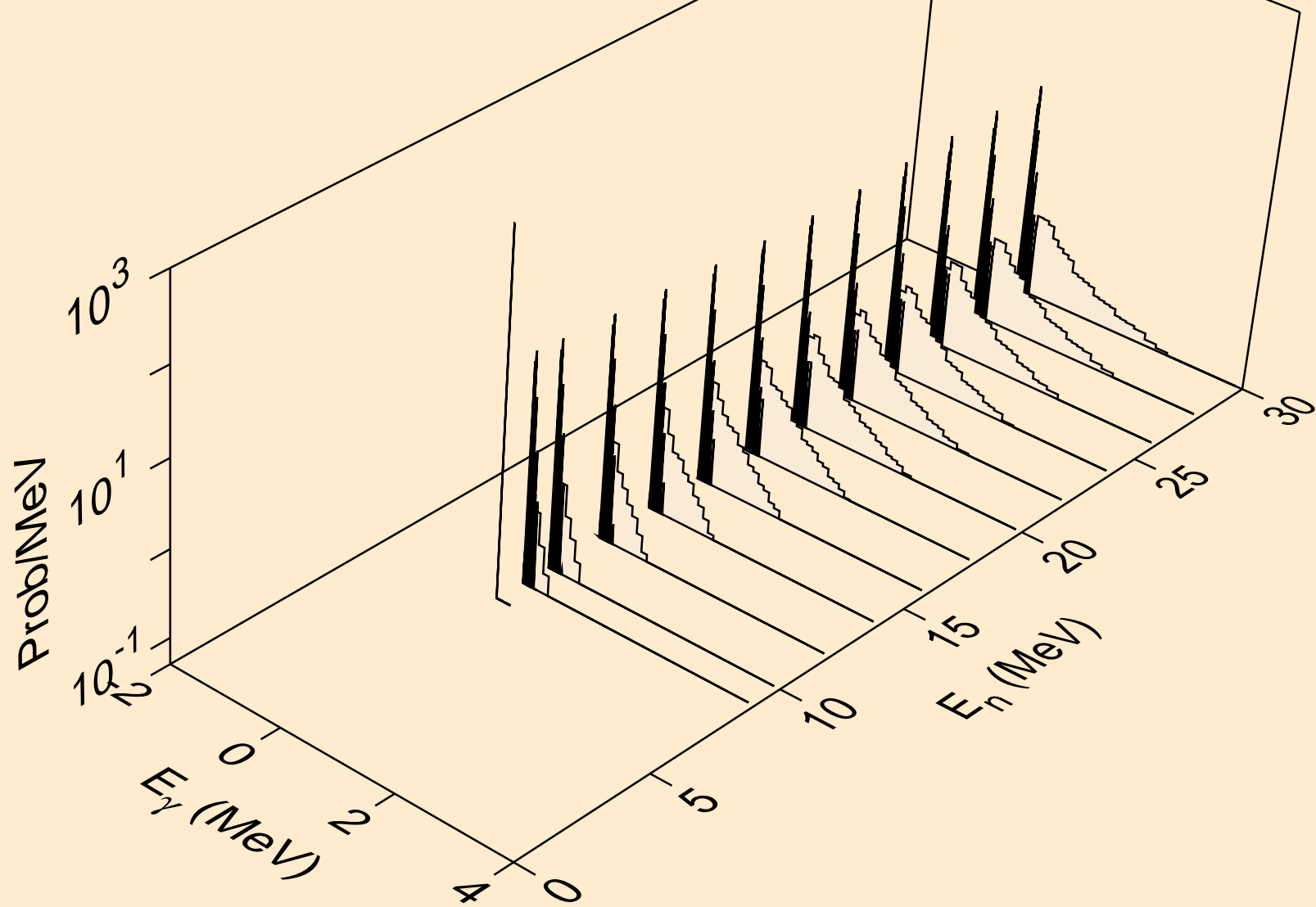

HO156N PROTON ACER TENDL-2021 LIBRARY; T=0.K  
Photon emission for (n,pa)

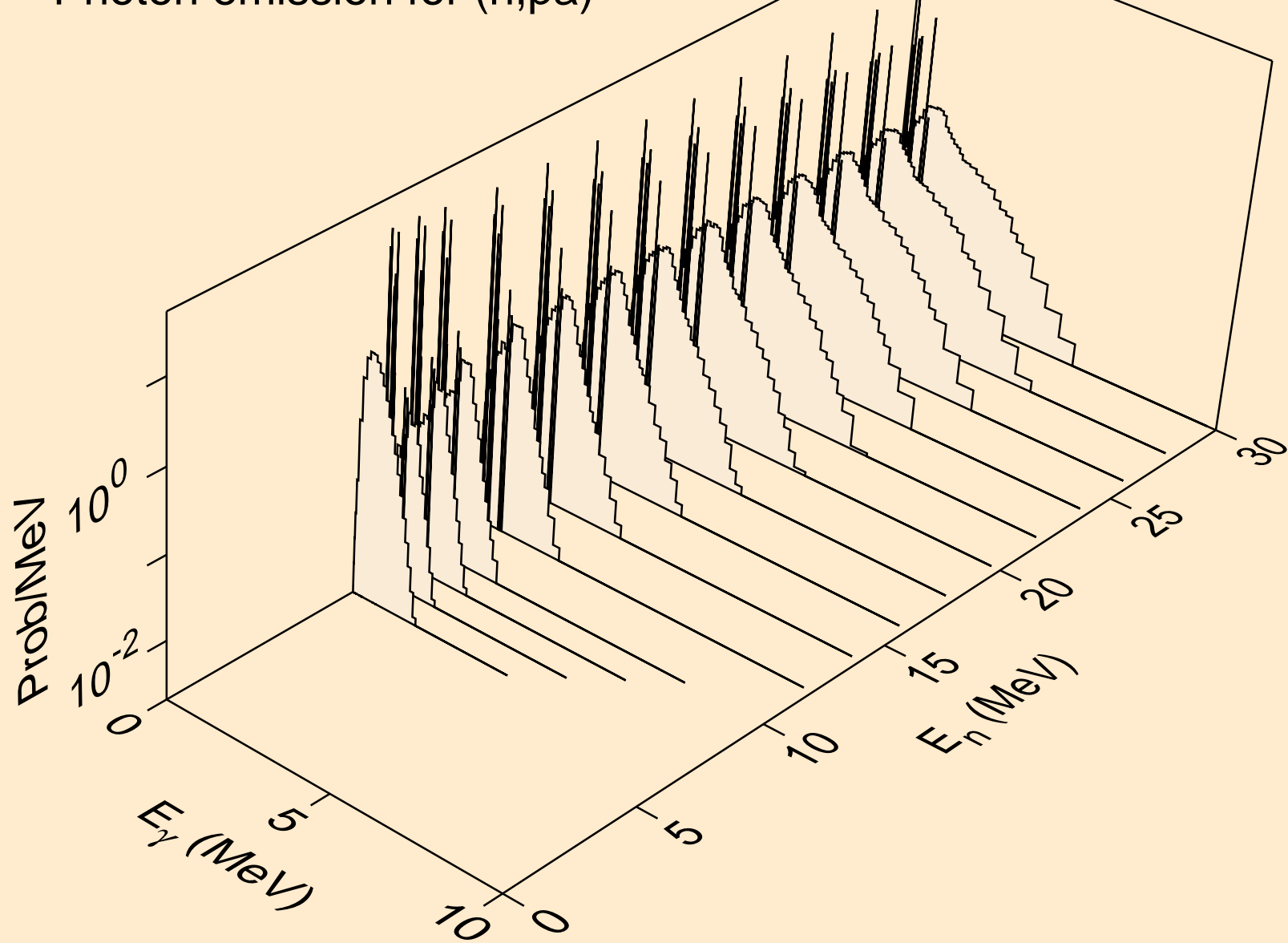



HO156N PROTON ACER TENDL-2021 LIBRARY; T=0.K  
Photon emission for (n,pd)

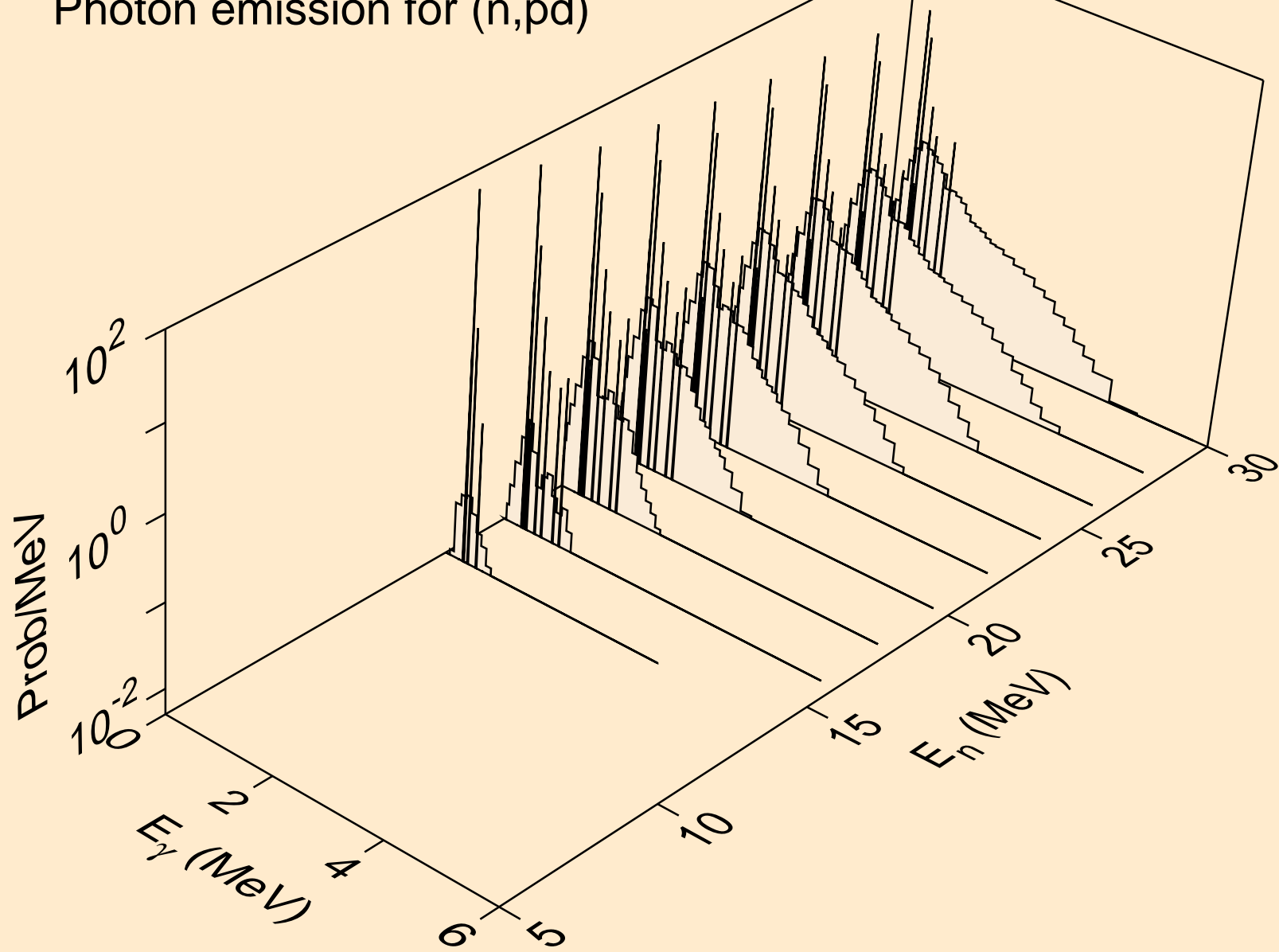

HO156N PROTON ACER TENDL-2021 LIBRARY; T=0.K  
Photon emission for (n,pt)

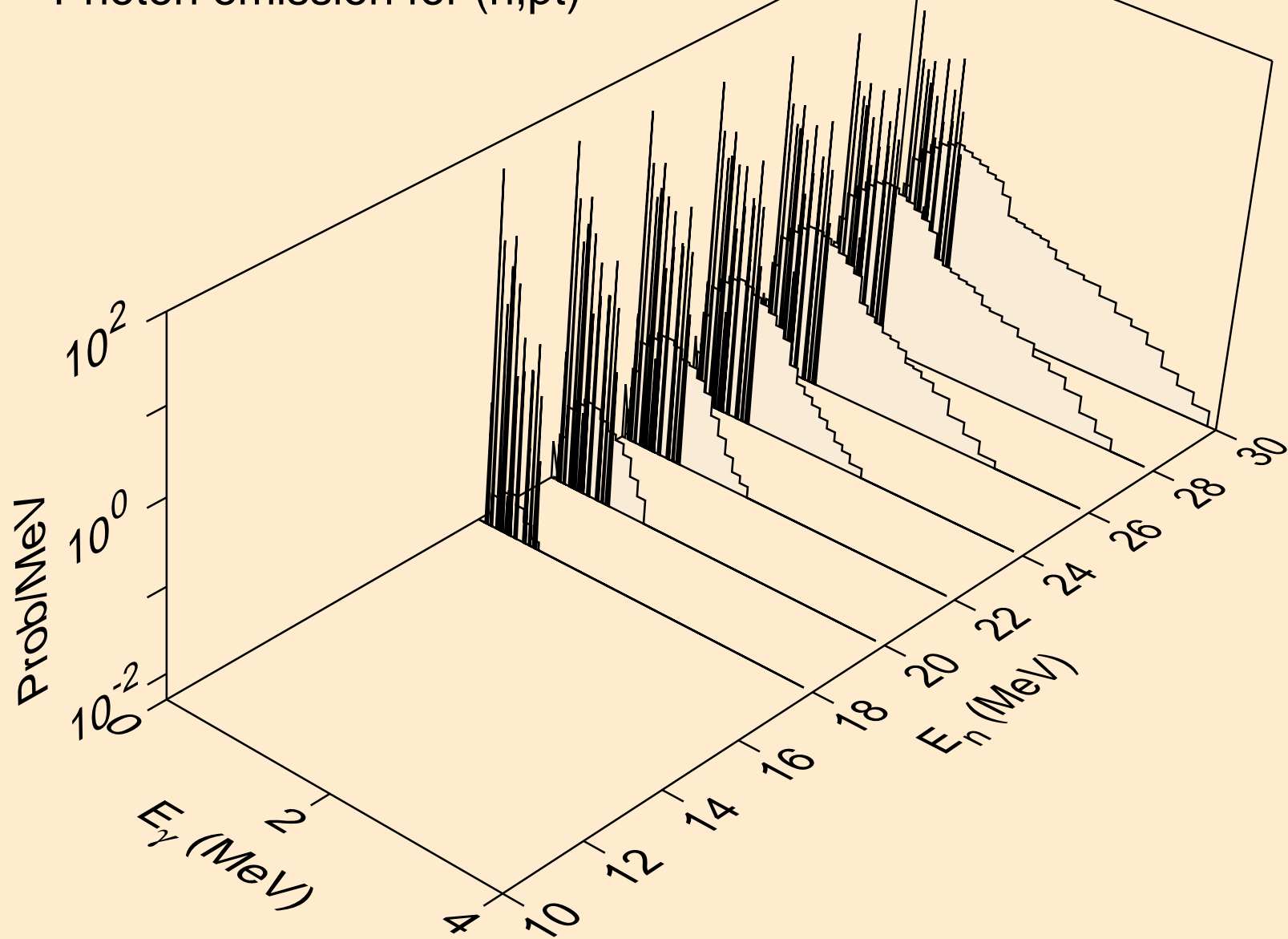

HO156N PROTON ACER TENDL-2021 LIBRARY; T=0.K  
Photon emission for (n,da)

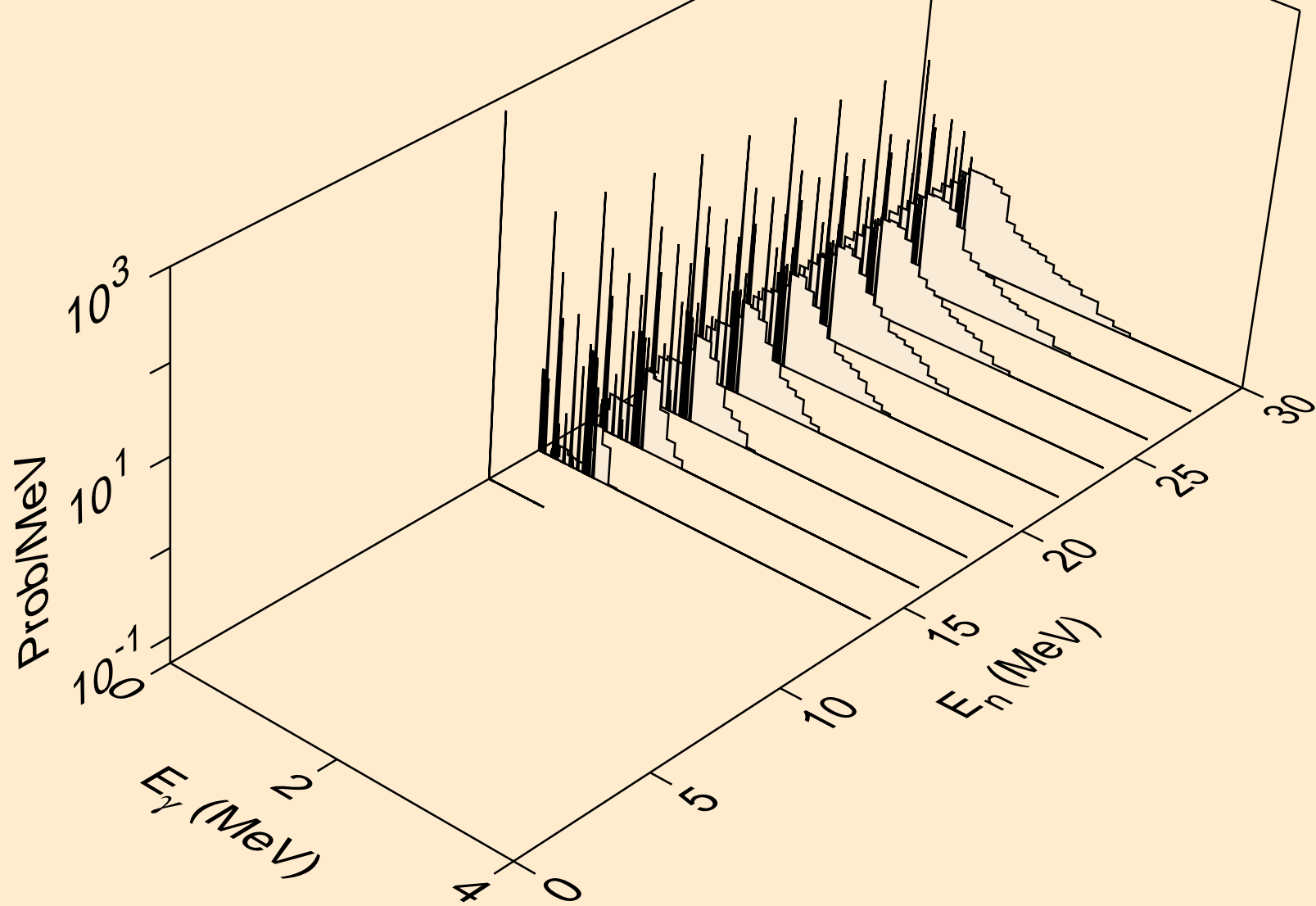

# HO156N PROTON ACER TENDL-2021 LIBRARY; T=0.K

## Particle heating contributions

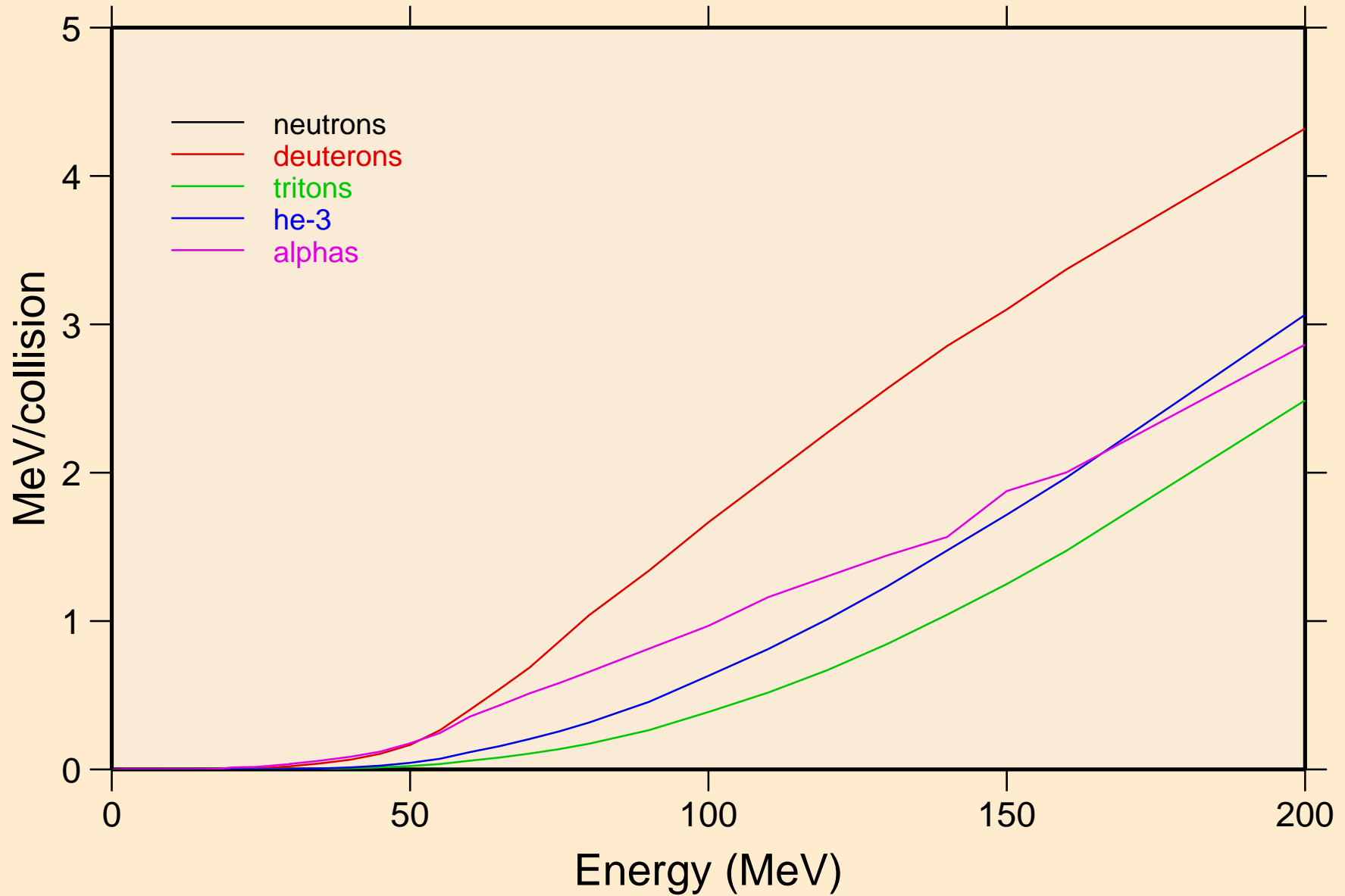

HO156N PROTON ACER TENDL-2021 LIBRARY; T=0.K  
Recoil Heating

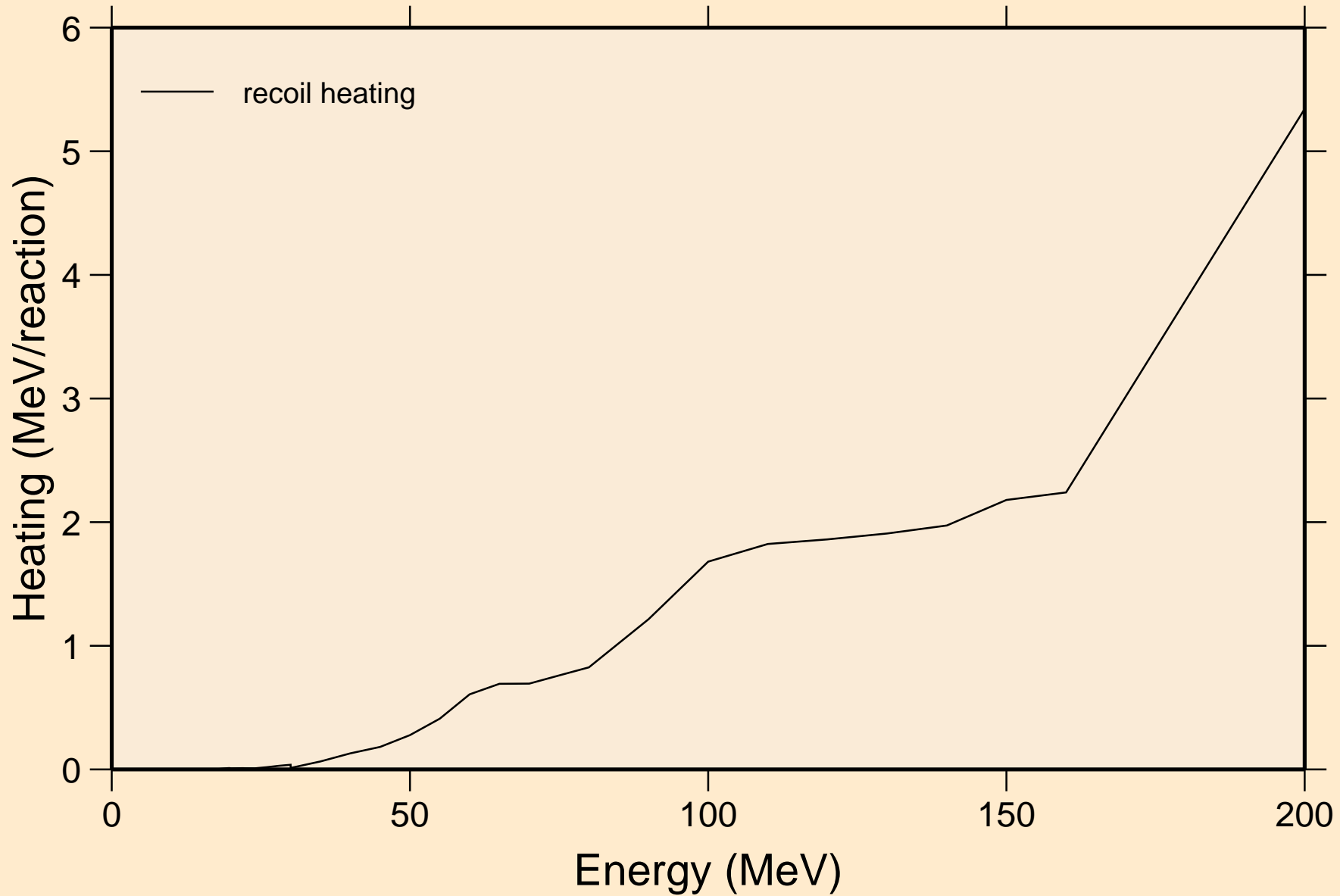

HO156N PROTON ACER TENDL-2021 LIBRARY; T=0.K  
Particle production cross sections

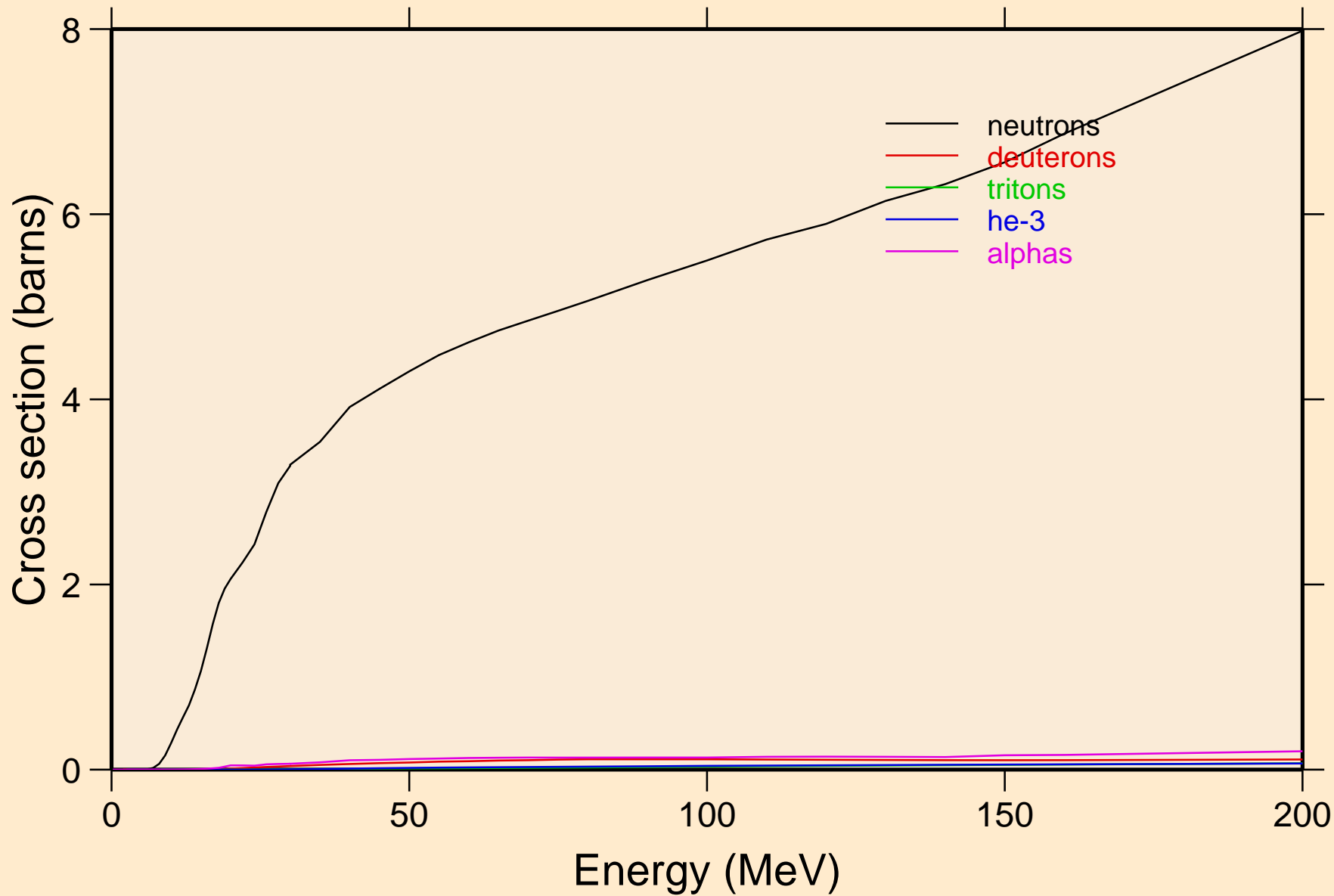

HO156N PROTON ACER TENDL-2021 LIBRARY; T=0.K  
neutrons from (p,n)

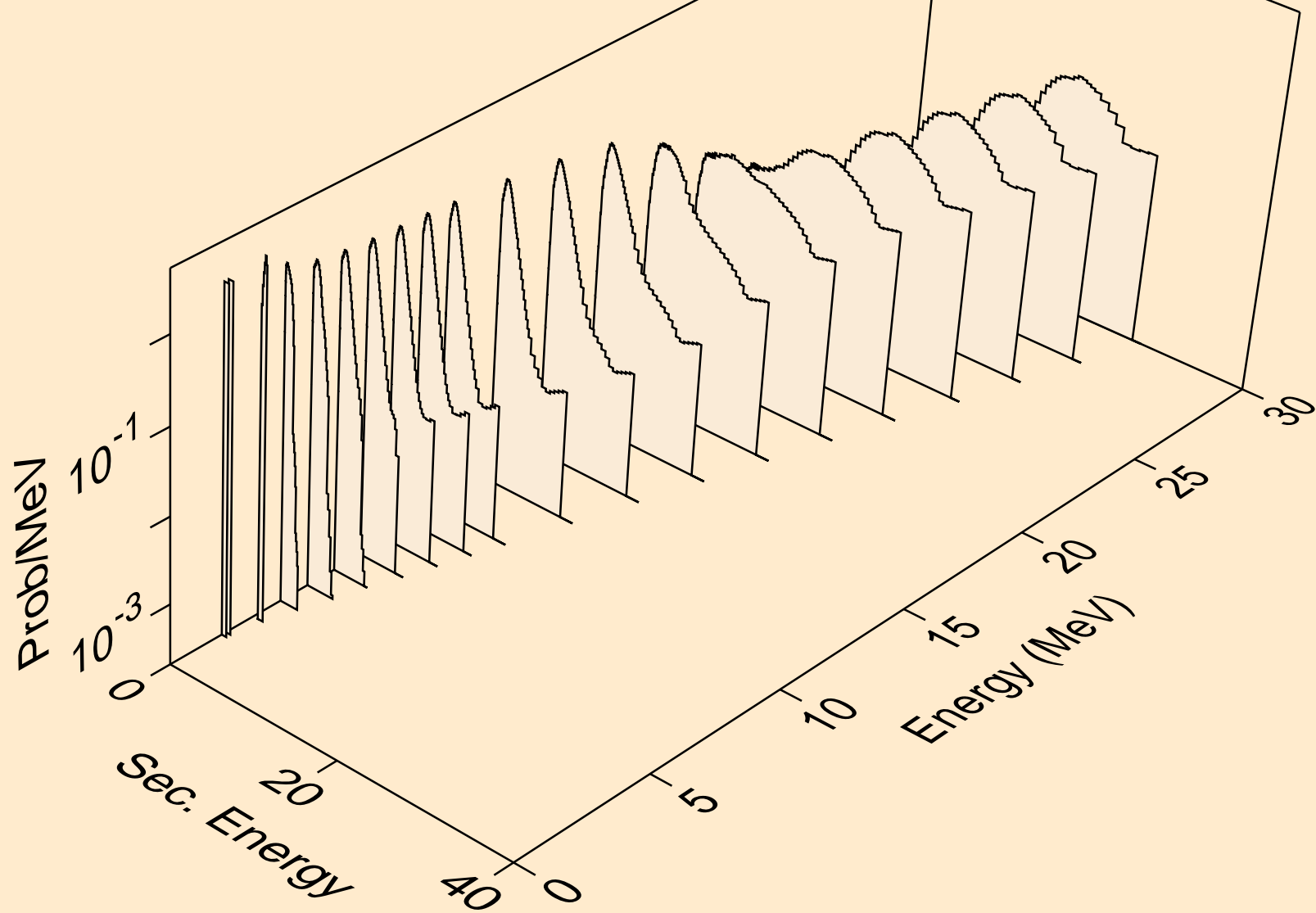

HO156N PROTON ACER TENDL-2021 LIBRARY; T=0.K  
neutrons from (p,x)

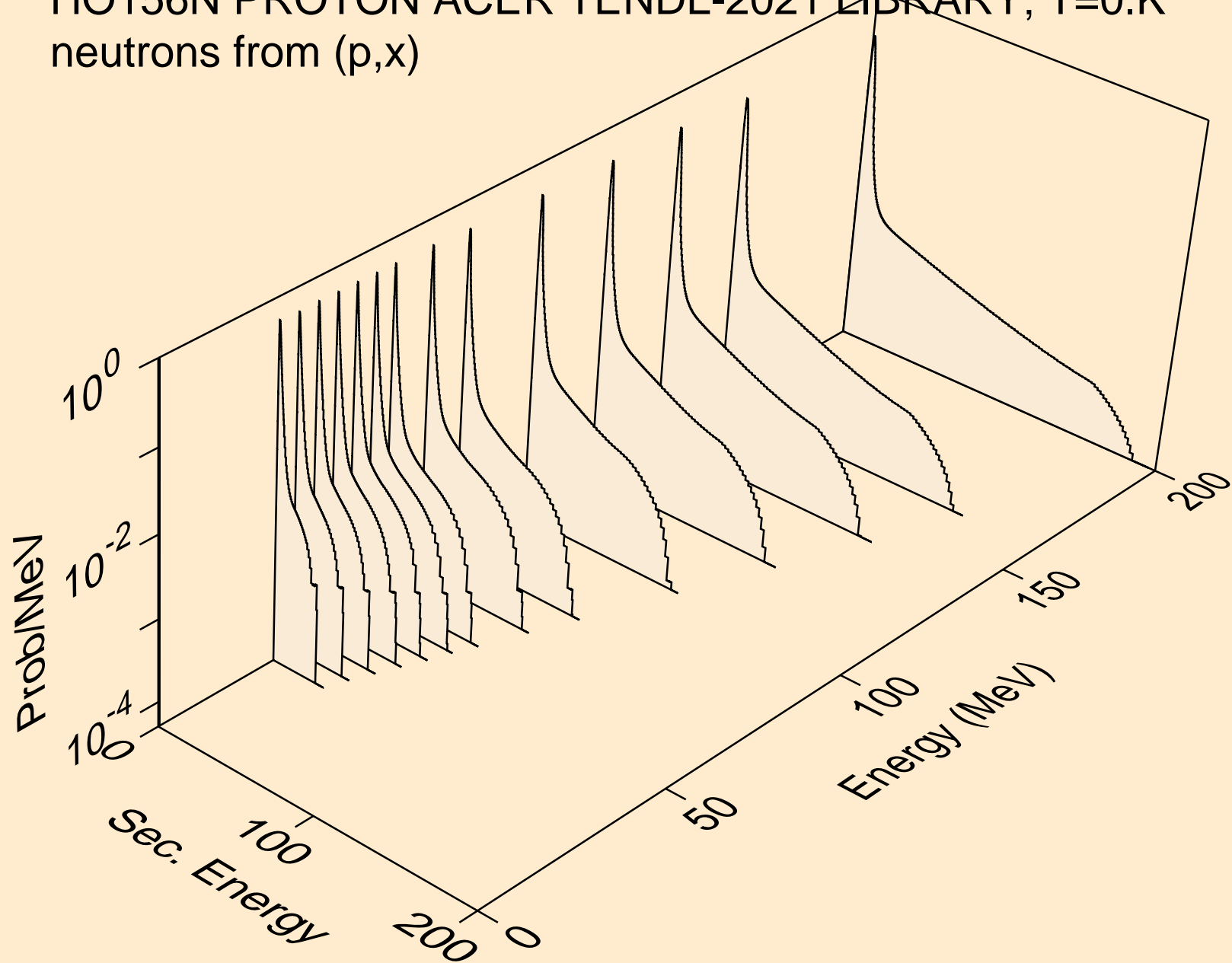



HO156N PROTON ACER TENDL-2021 LIBRARY; T=0.K  
neutrons from (p,2nd)

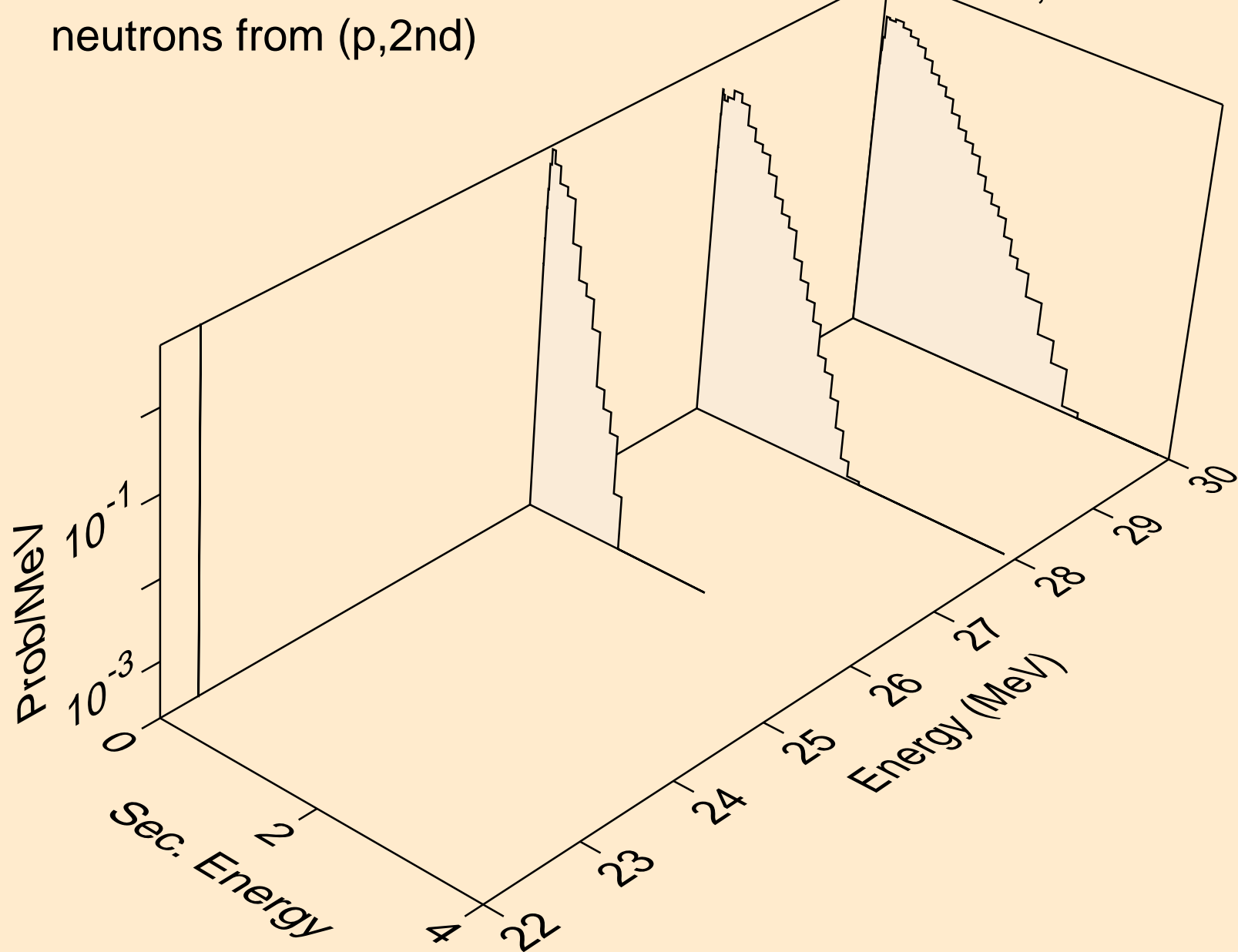

HO156N PROTON ACER TENDL-2021 LIBRARY; T=0.K  
neutrons from (p,2n)

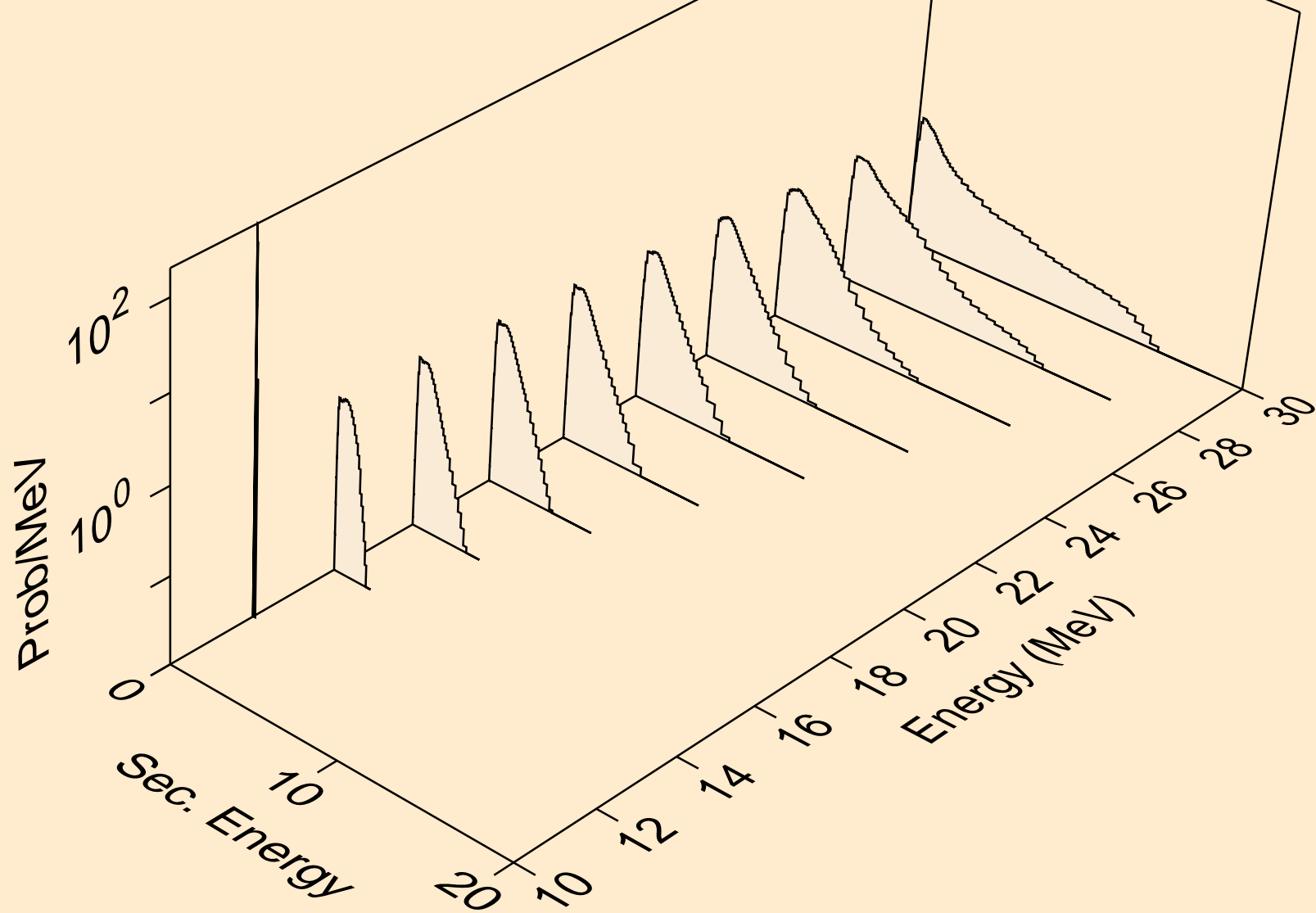

HO156N PROTON ACER TENDL-2021 LIBRARY; T=0.K  
neutrons from (p,3n)

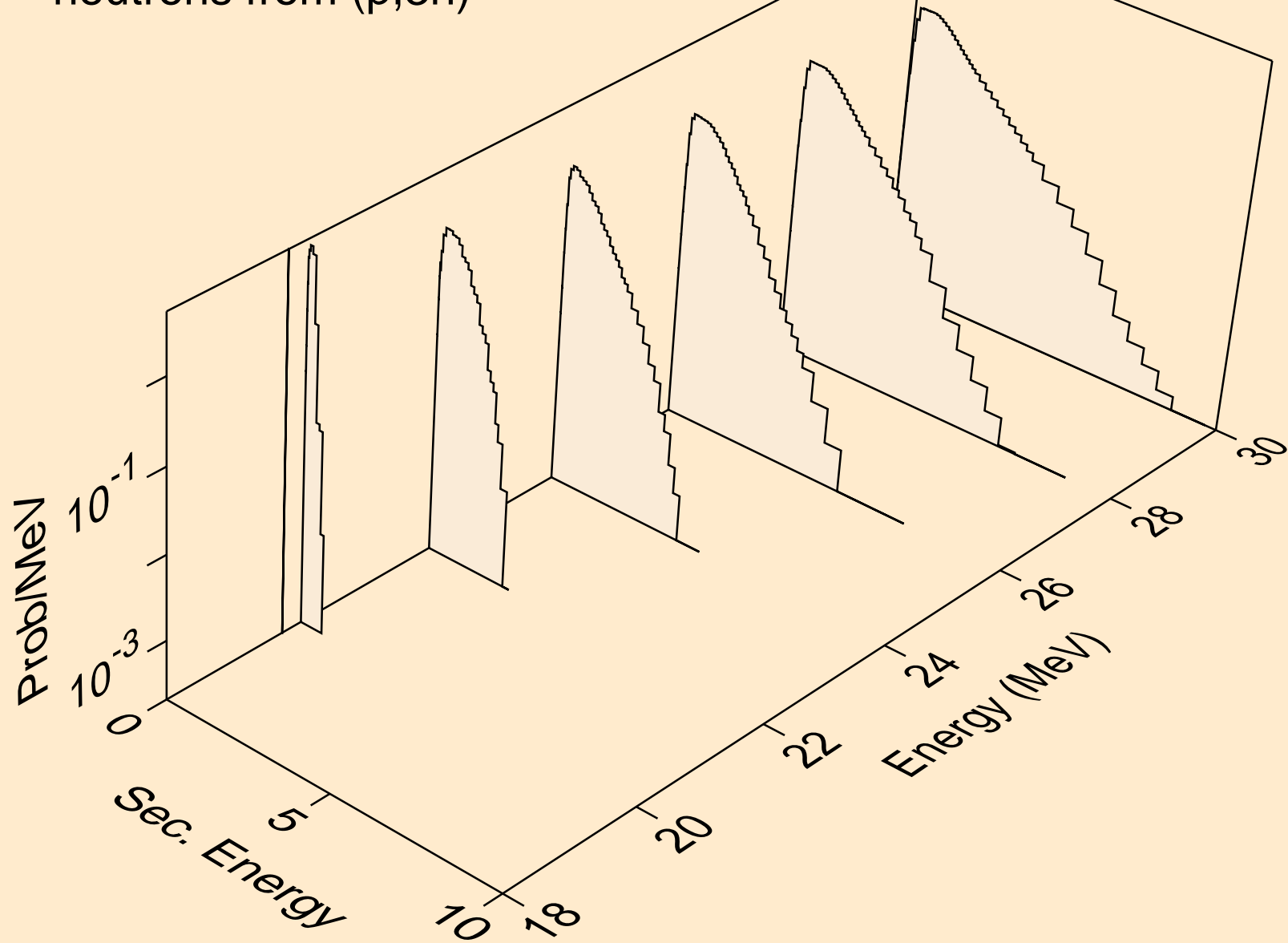

HO156N PROTON ACER TENDL-2021 LIBRARY; T=0.K  
neutrons from (p,n\*)a

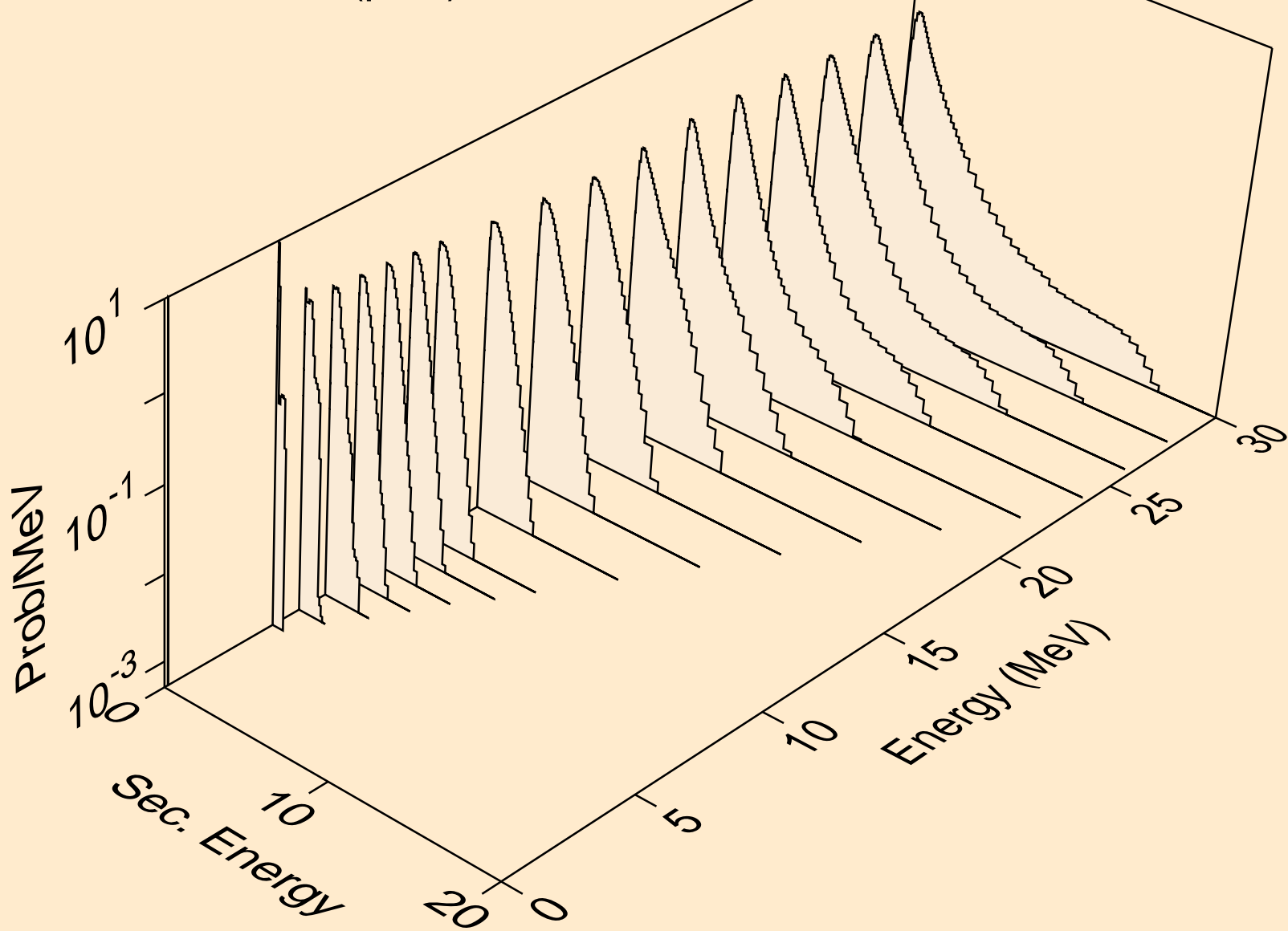

HO156N PROTON ACER TENDL-2021 LIBRARY; T=0.K  
neutrons from (p,2n)a

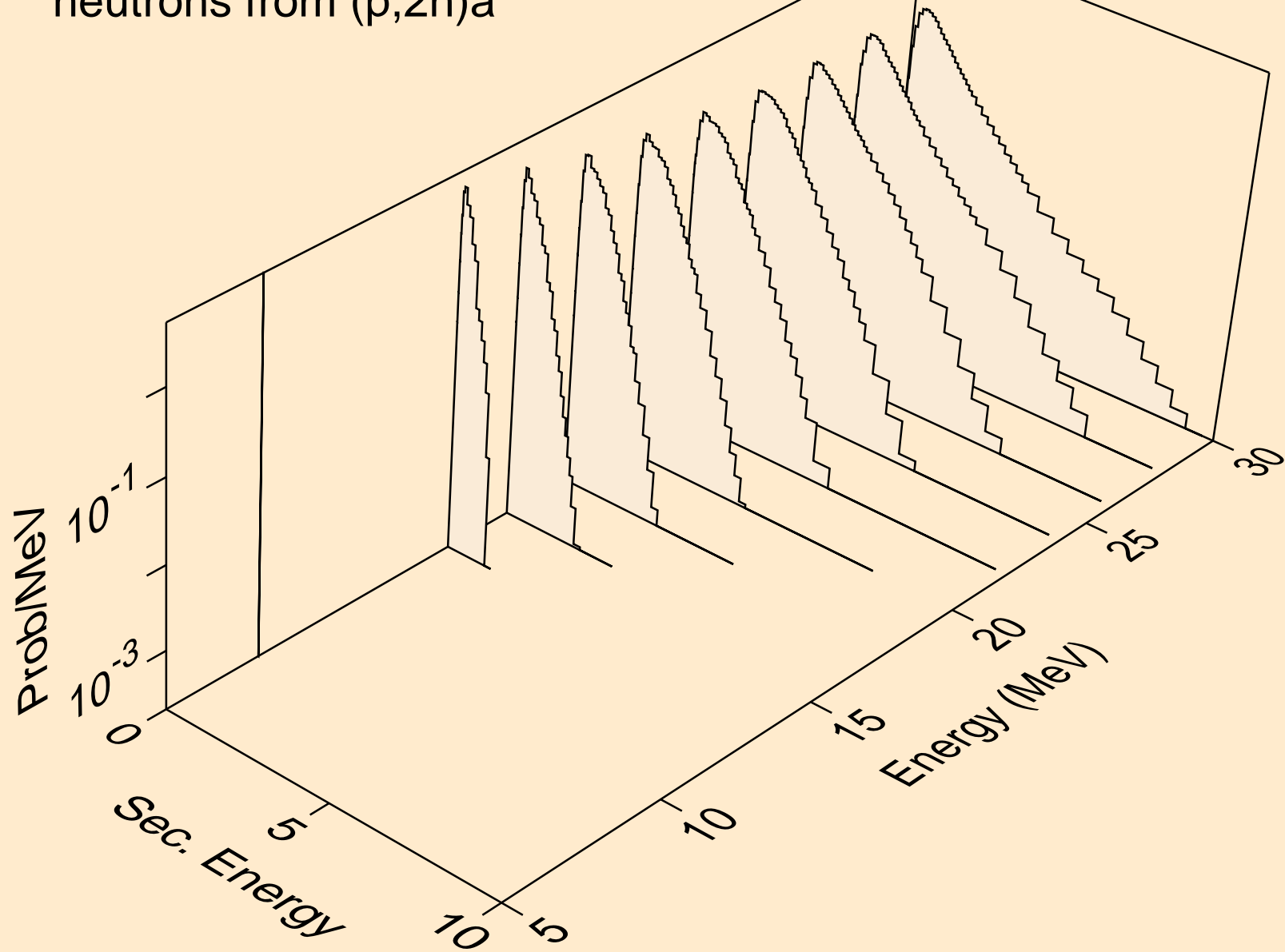

HO156N PROTON ACER TENDL-2021 LIBRARY; T=0.K  
neutrons from (p,3n)a

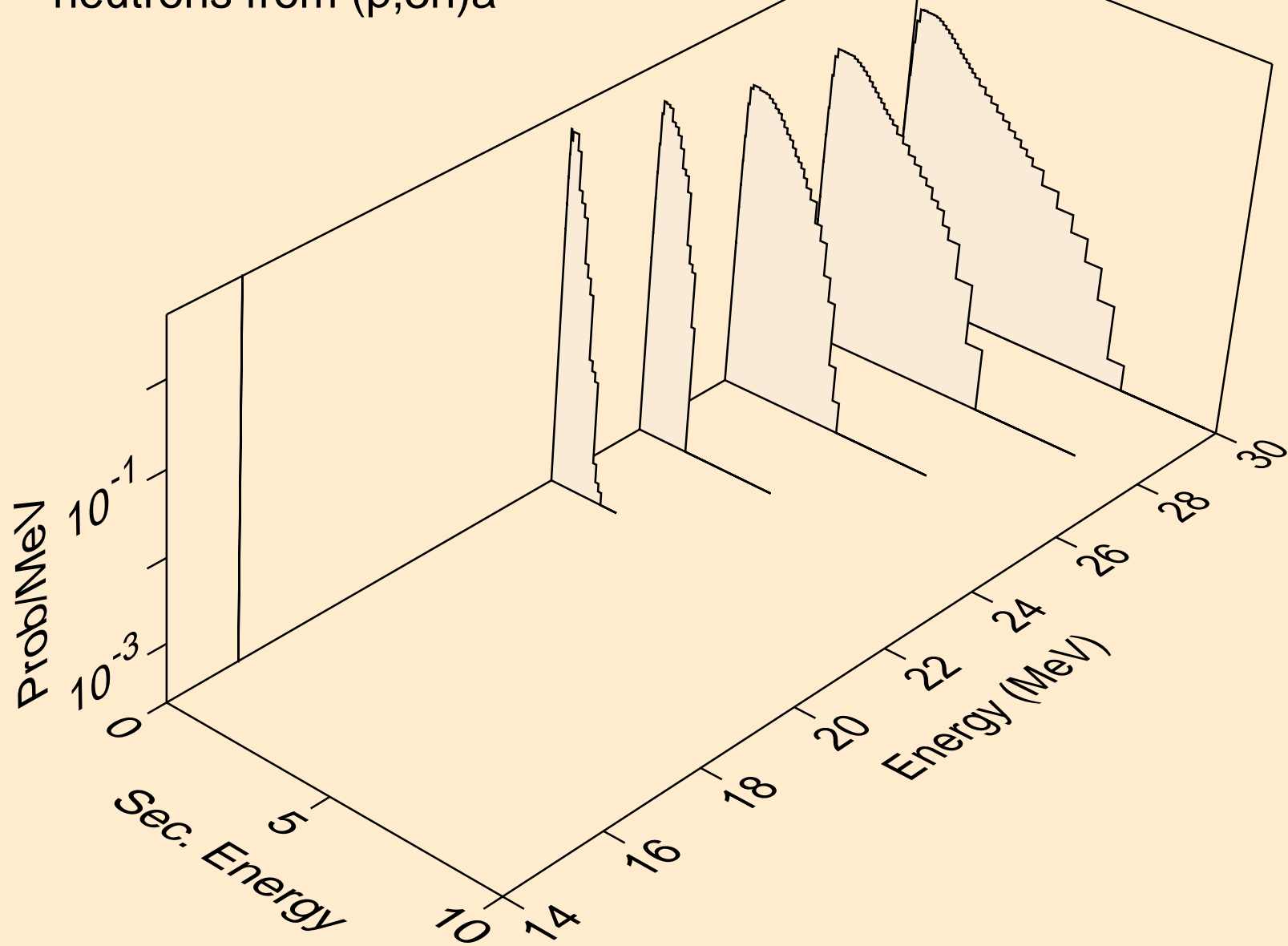

HO156N PROTON ACER TENDL-2021 LIBRARY; T=0.K  
neutrons from (p,n\*)p

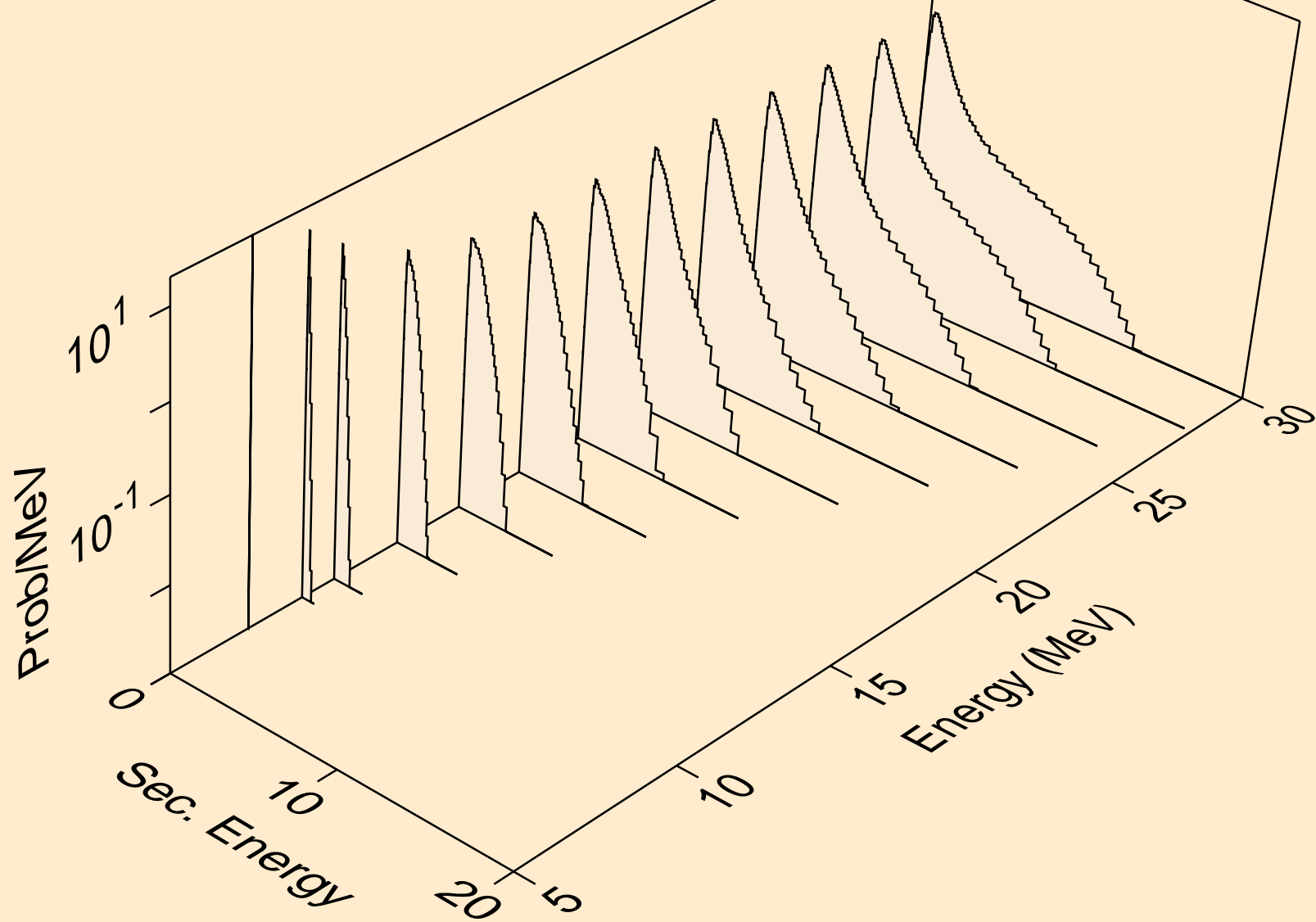

HO156N PROTON ACER TENDL-2021 LIBRARY; T=0.K  
neutrons from (p,n\*)2a

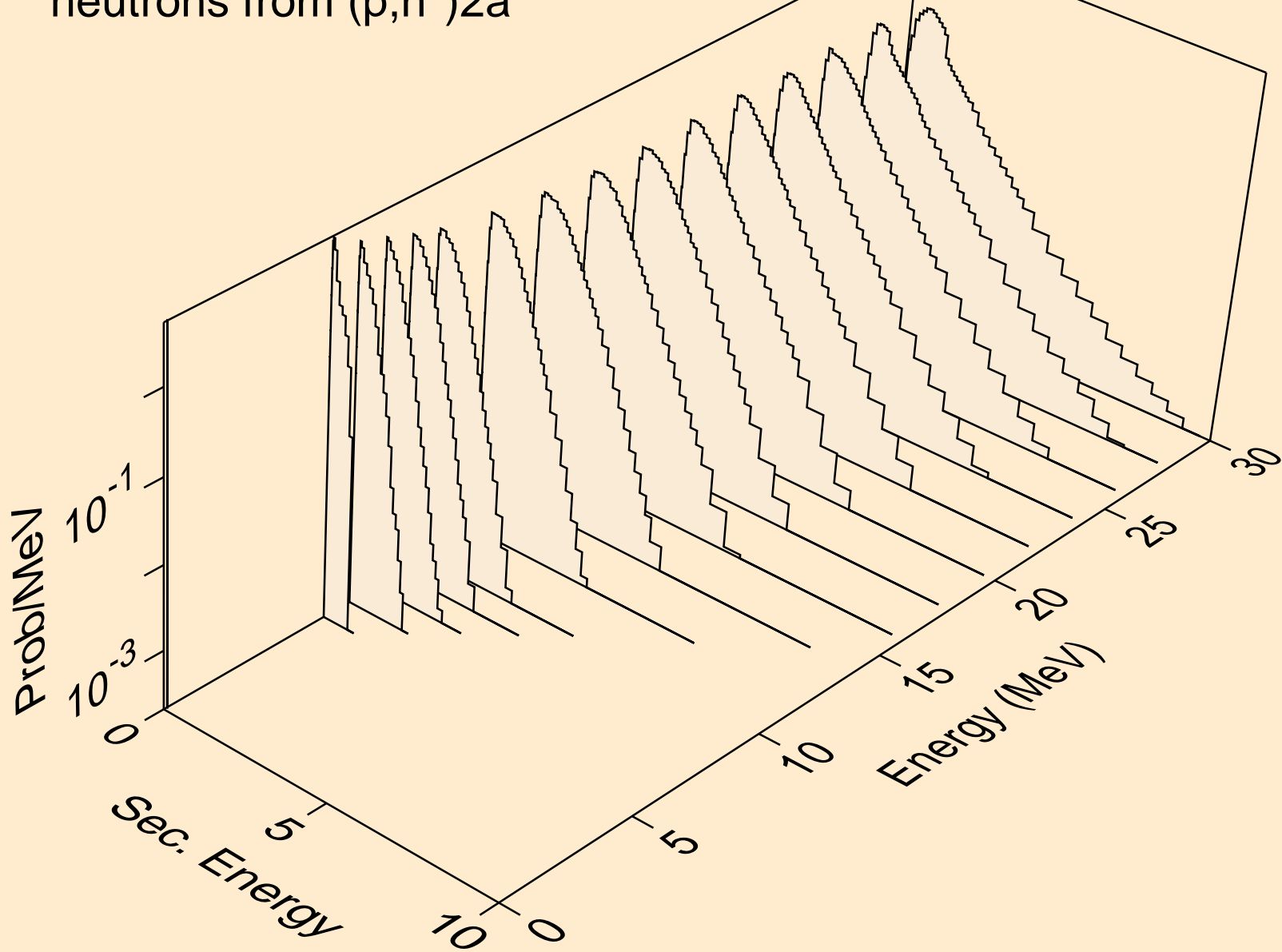



HO156N PROTON ACER TENDL-2021 LIBRARY; T=0.K  
neutrons from (p,2n)2a

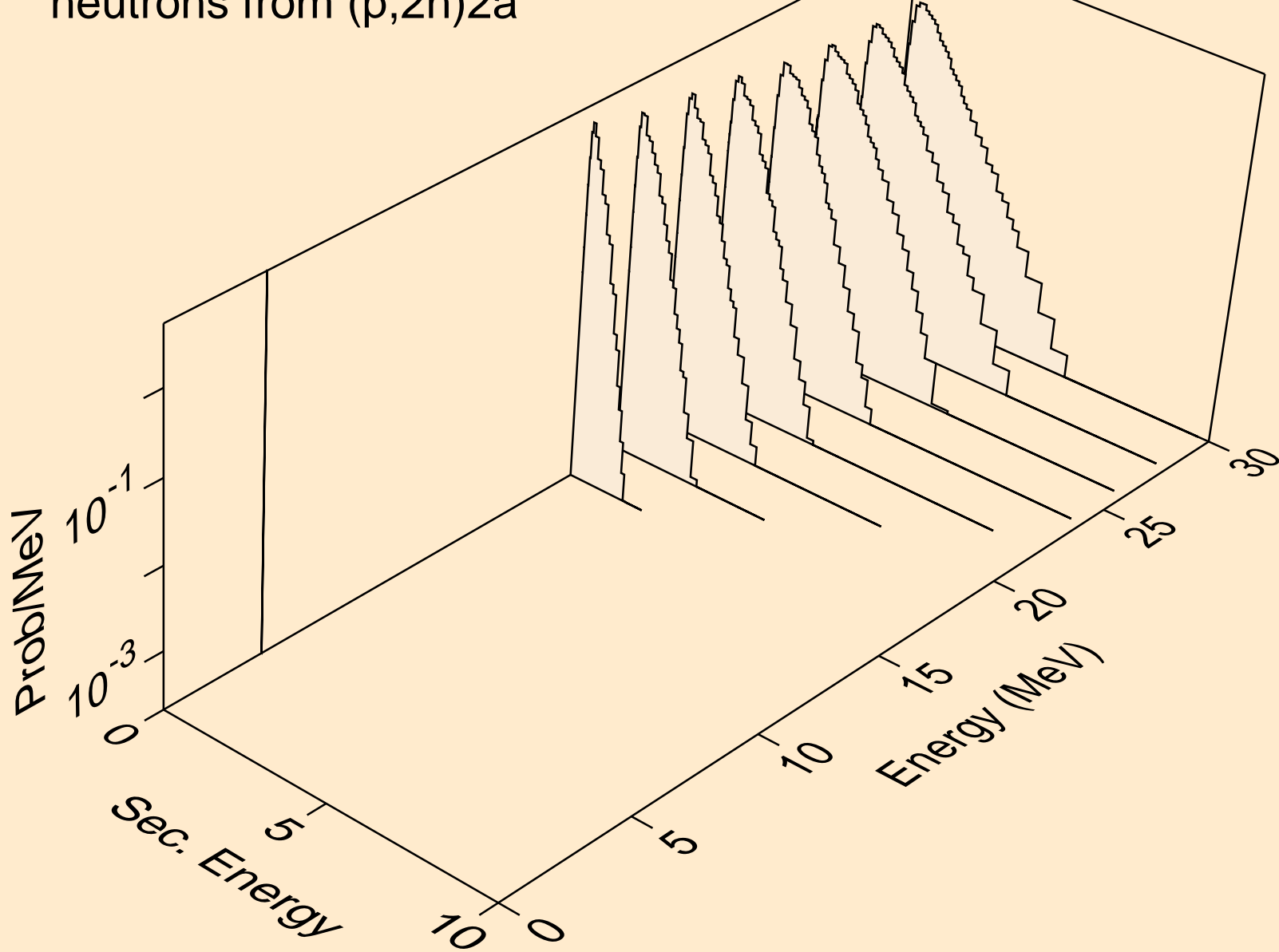

HO156N PROTON ACER TENDL-2021 LIBRARY; T=0.K  
neutrons from (p,n\*)d

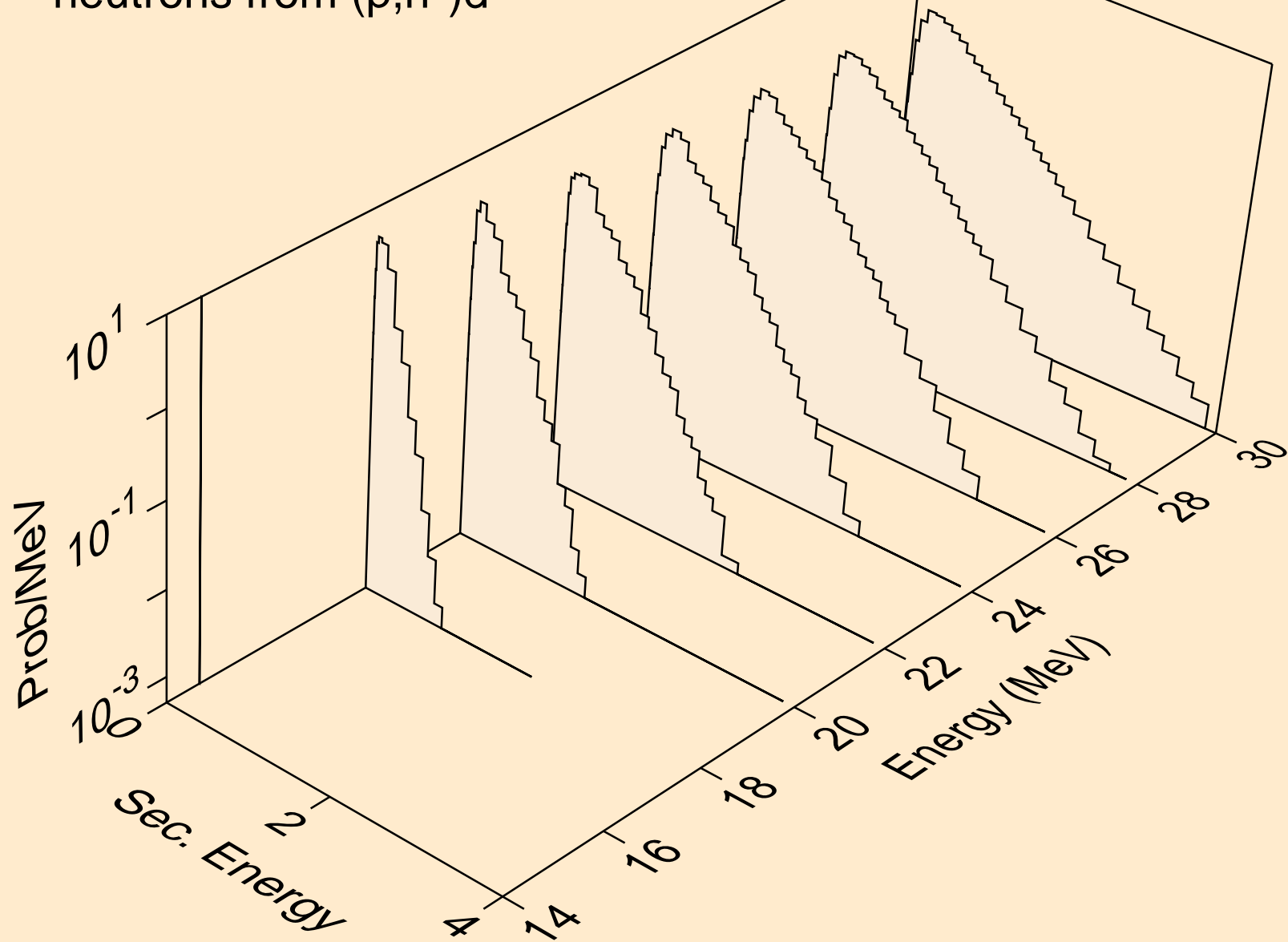

HO156N PROTON ACER TENDL-2021 LIBRARY; T=0.K  
neutrons from (p,n\*)t

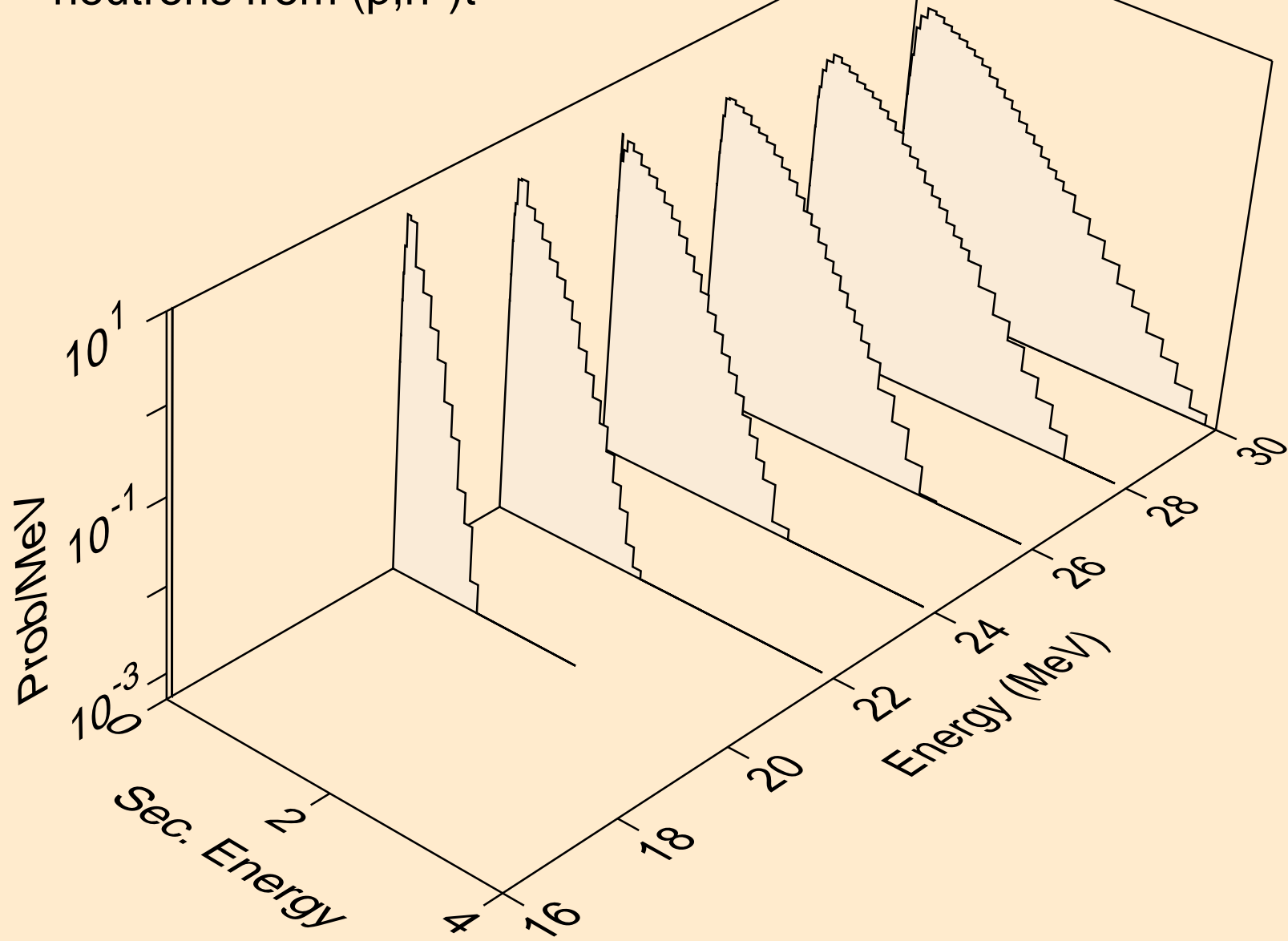

HO156N PROTON ACER TENDL-2021 LIBRARY; T=0.K  
neutrons from (p,n\*)he3

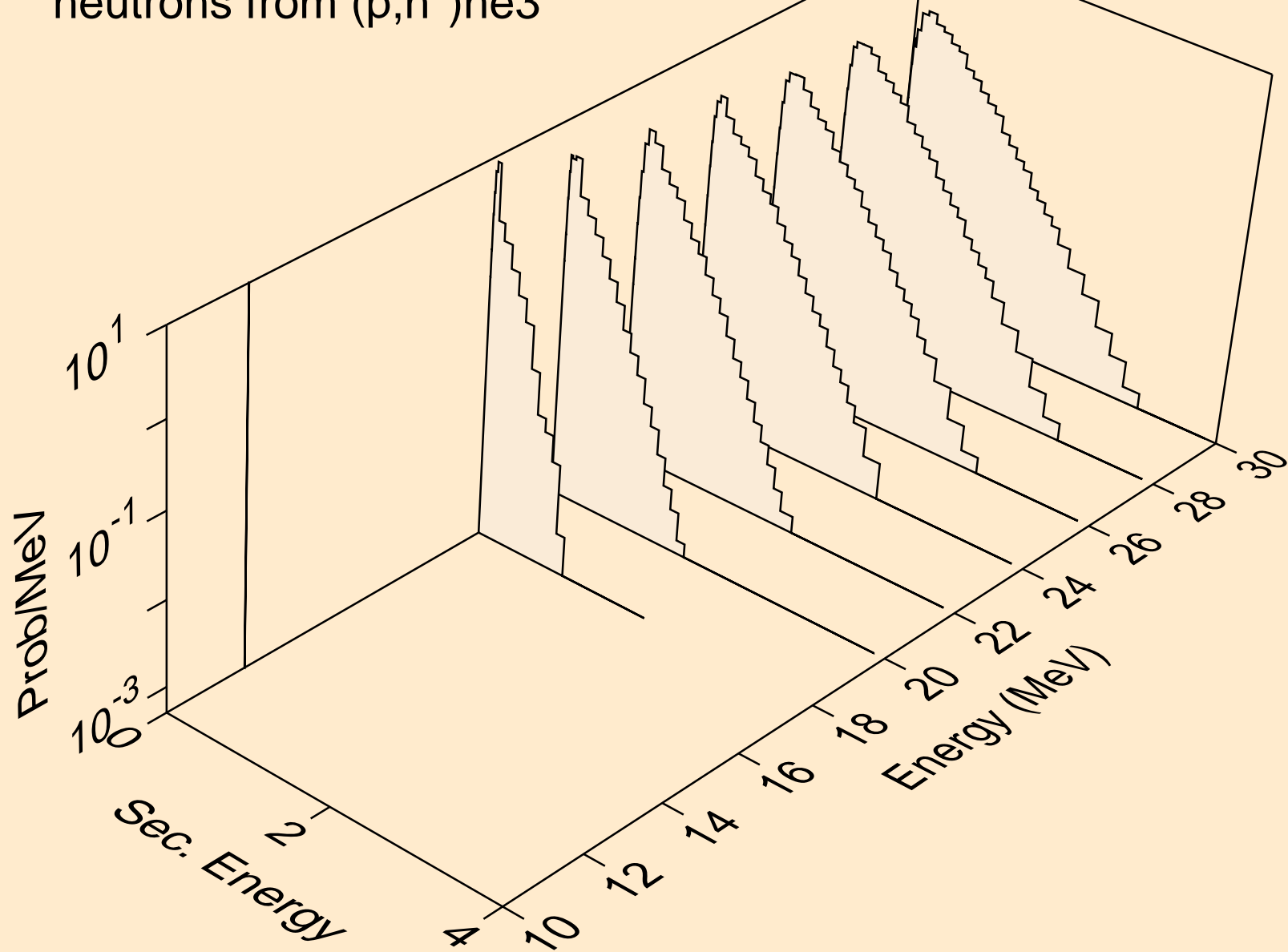

HO156N PROTON ACER TENDL-2021 LIBRARY; T=0.K  
neutrons from (p,4n)

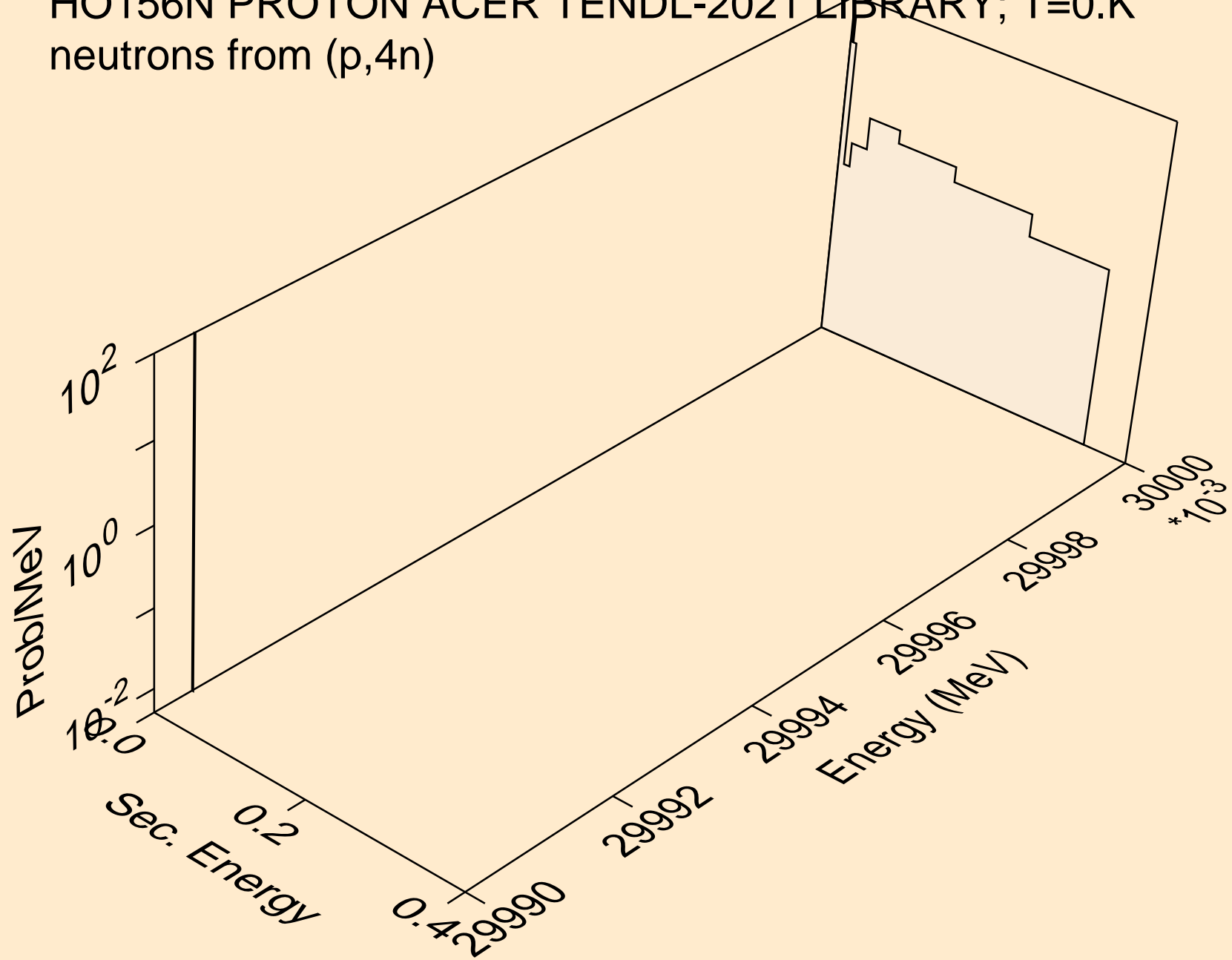

HO156N PROTON ACER TENDL-2021 LIBRARY; T=0.K  
neutrons from (p,2np)

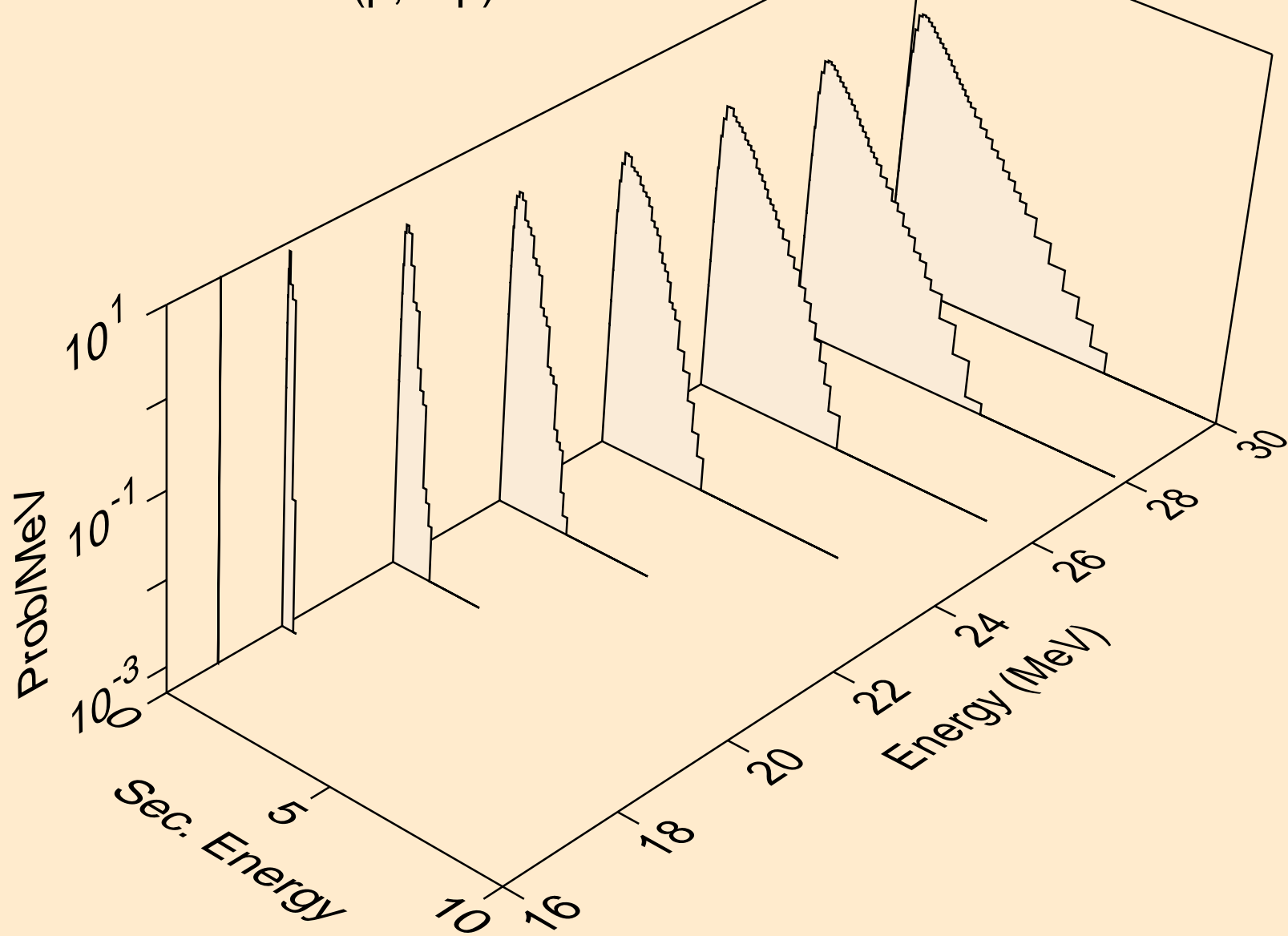

HO156N PROTON ACER TENDL-2021 LIBRARY; T=0.K  
neutrons from (p,3np)

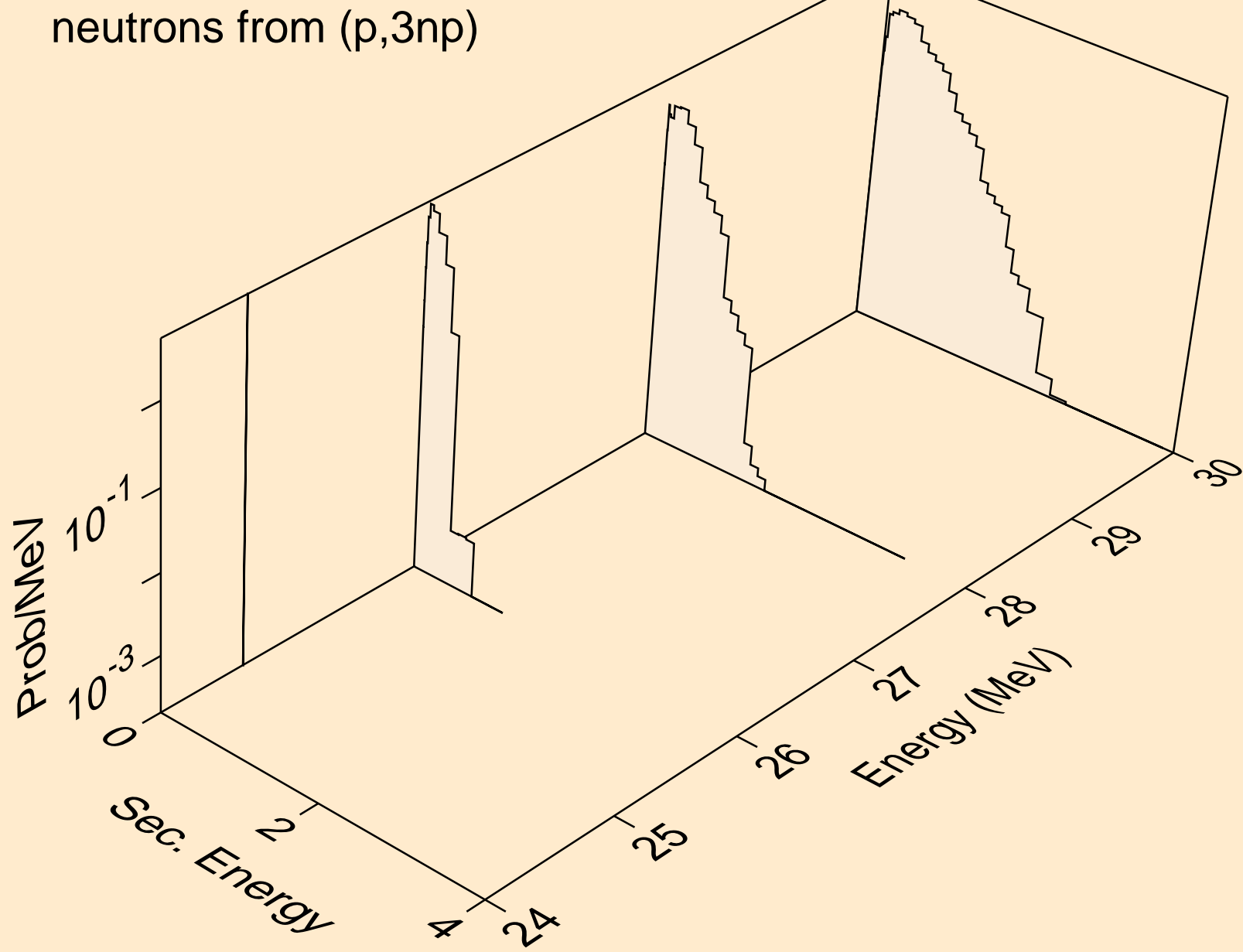

HO156N PROTON ACER TENDL-2021 LIBRARY; T=0.K  
neutrons from (p,2np)

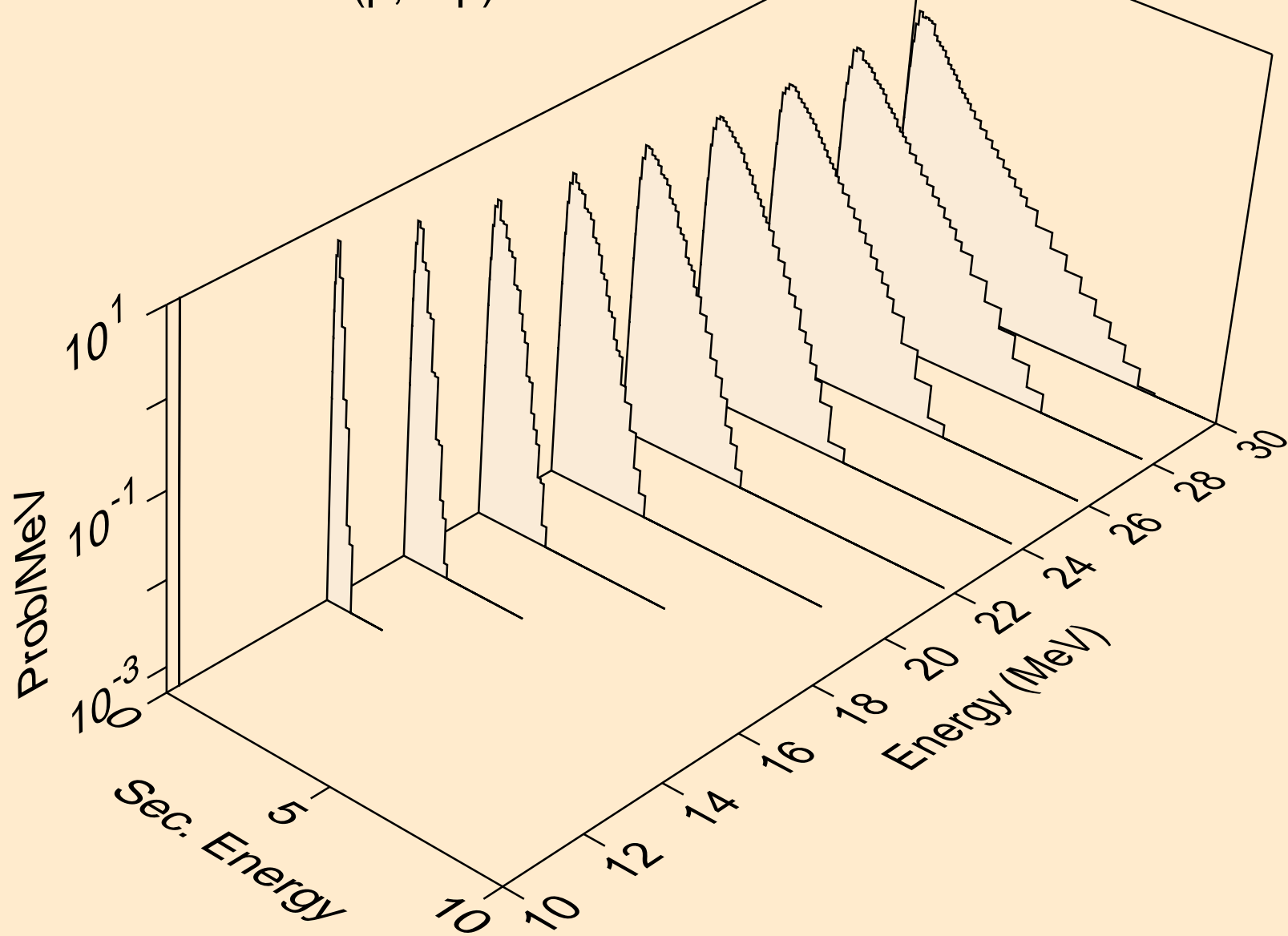



HO156N PROTON ACER TENDL-2021 LIBRARY; T=0.K  
neutrons from (p,npa)

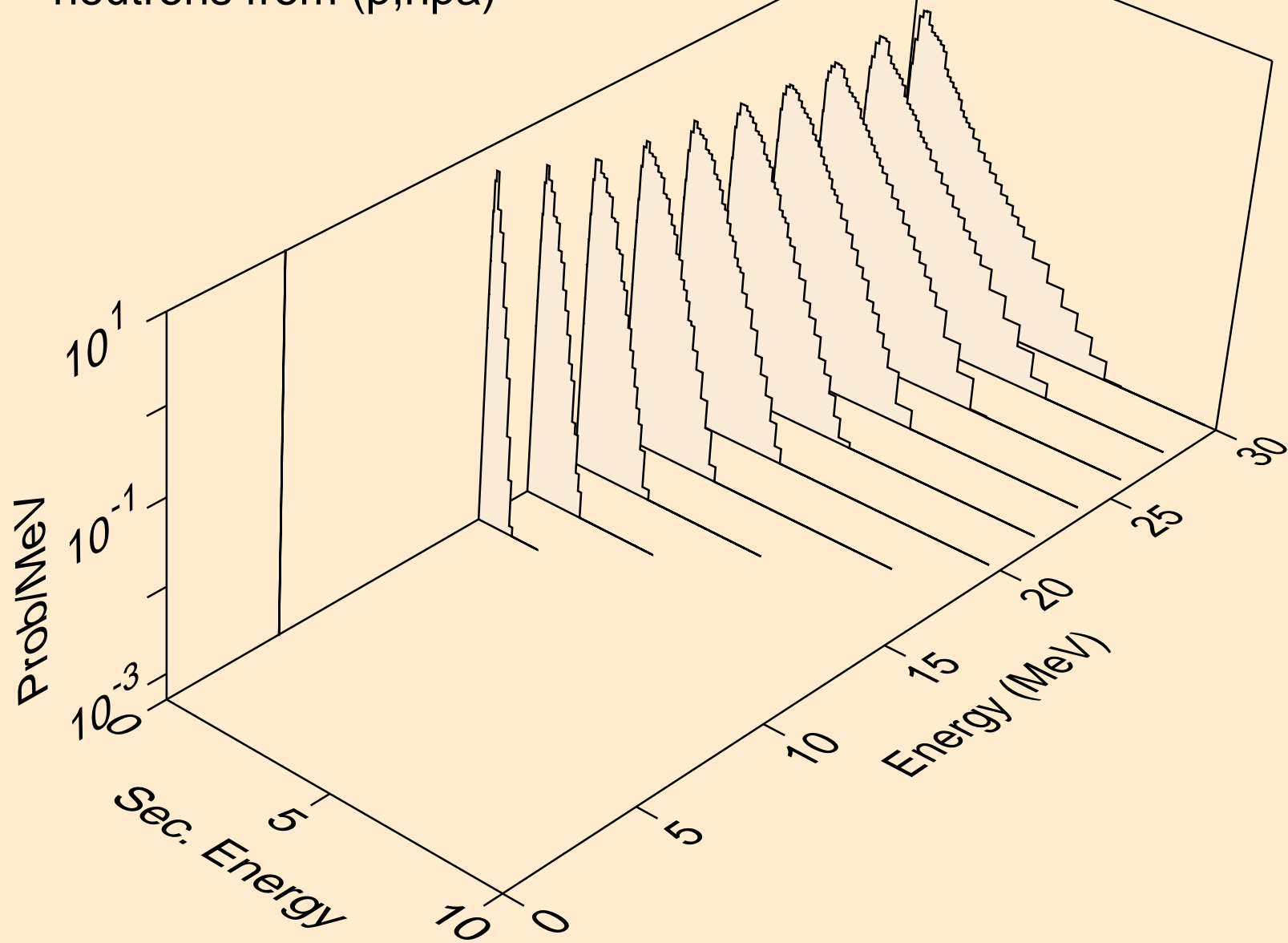

HO156N PROTON ACER TENDL-2021 LIBRARY; T=0.K  
deuterons from (p,x)

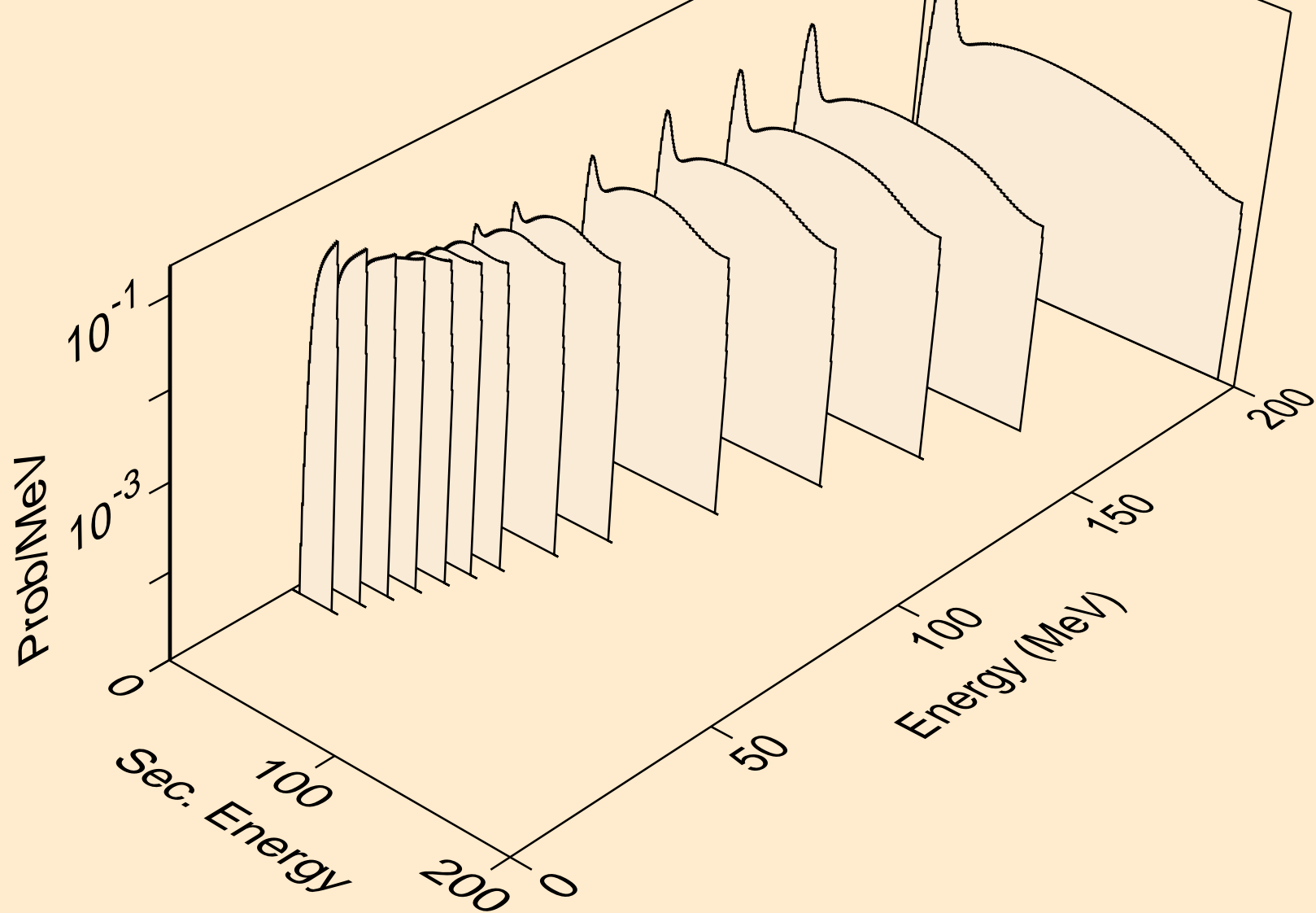

HO156N PROTON ACER TENDL-2021 LIBRARY; T=0.K  
deuterons from (p,2nd)

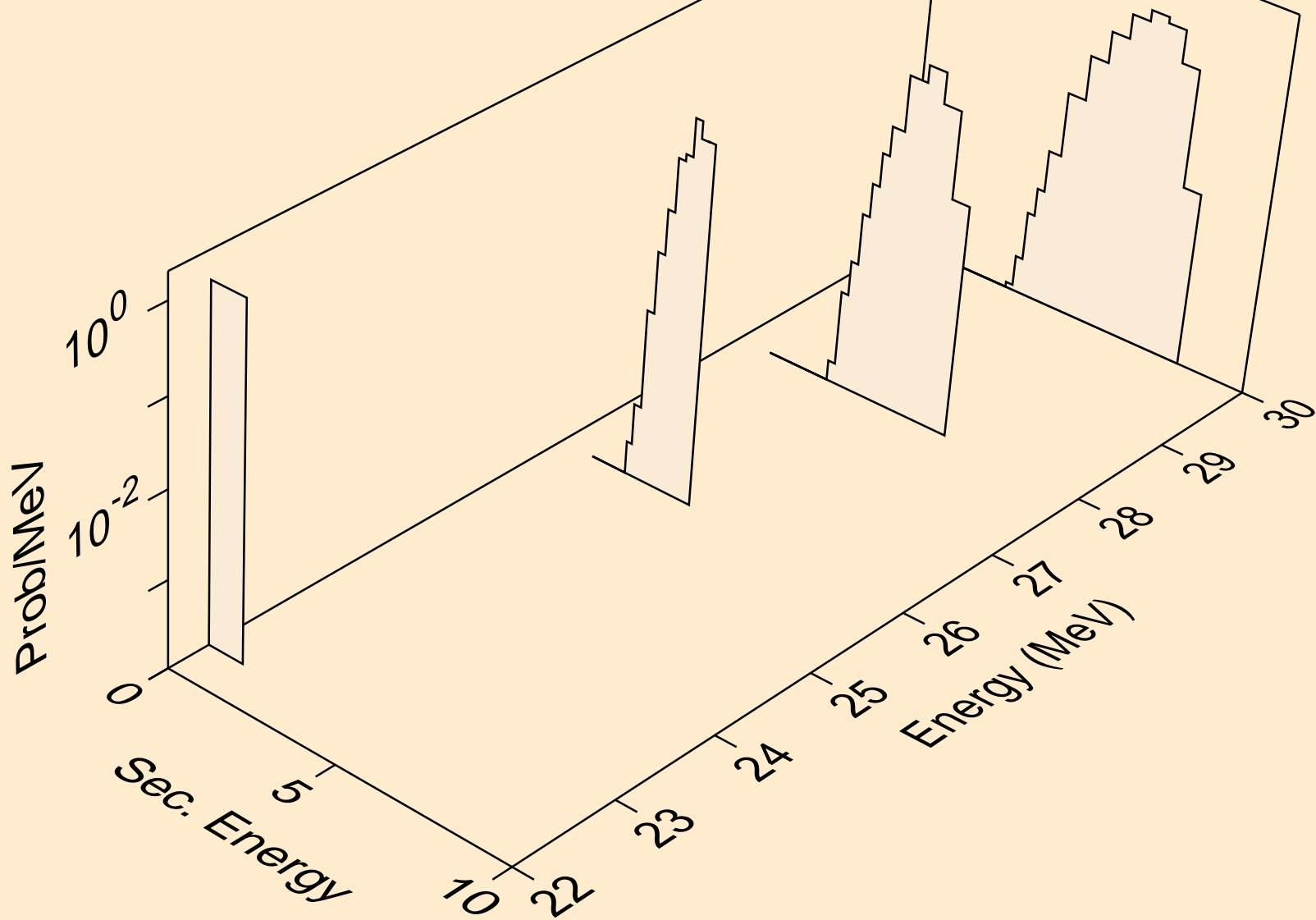

HO156N PROTON ACER TENDL-2021 LIBRARY; T=0.K  
deuterons from (p,n\*)d

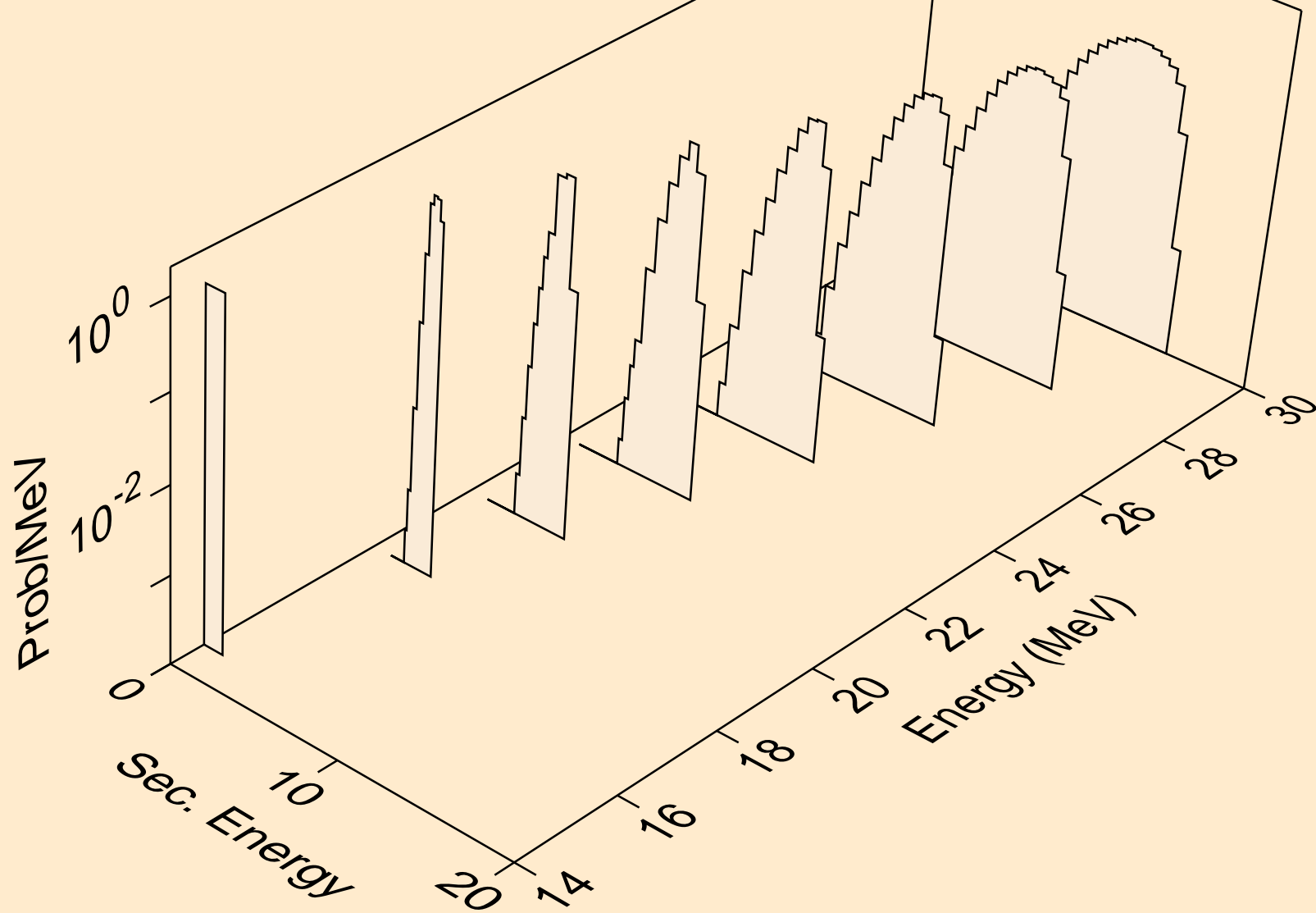

HO156N PROTON ACER TENDL-2021 LIBRARY; T=0.K  
deuterons from (p,d)

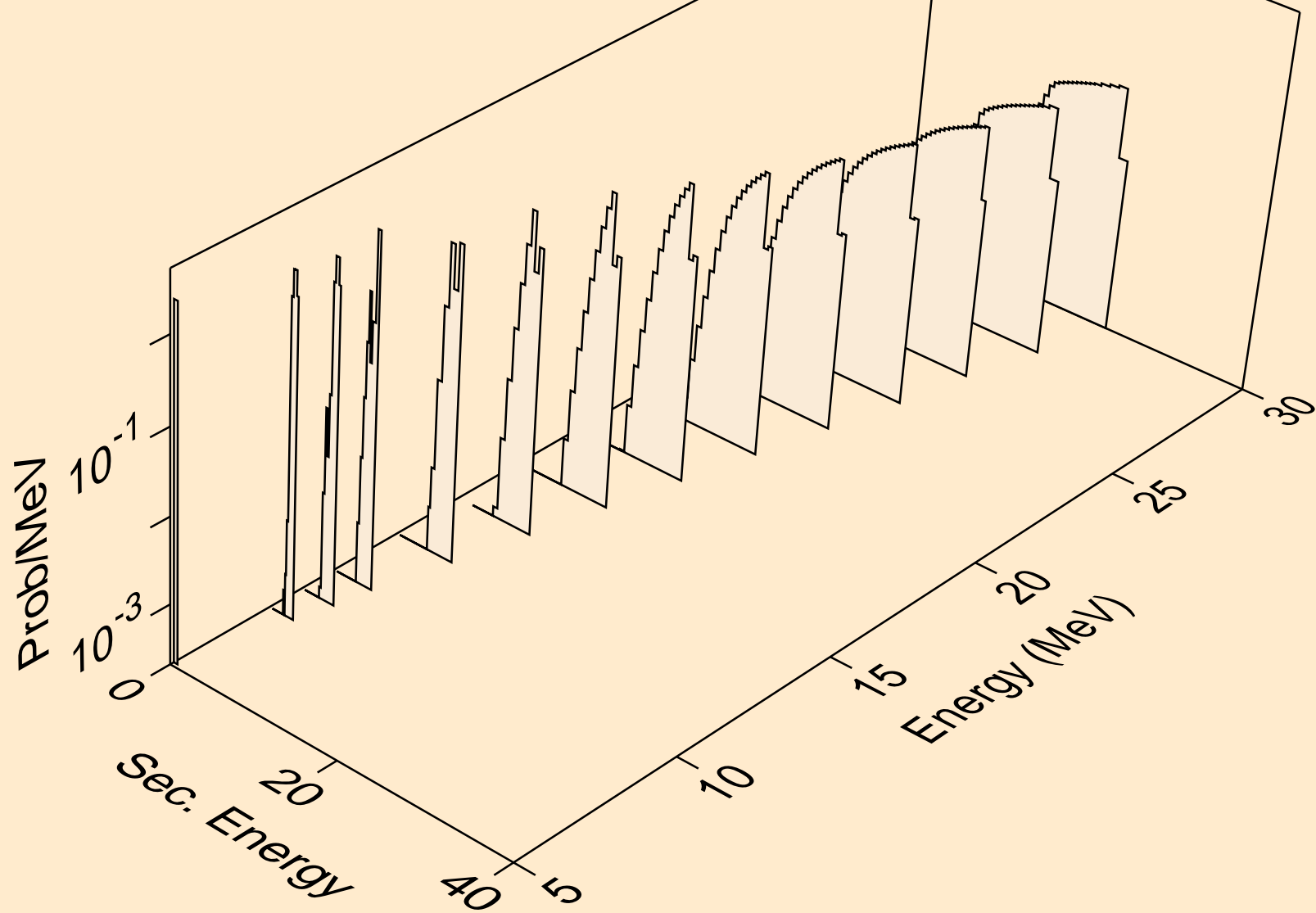

HO156N PROTON ACER TENDL-2021 LIBRARY; T=0.K  
deuterons from (p,pd)

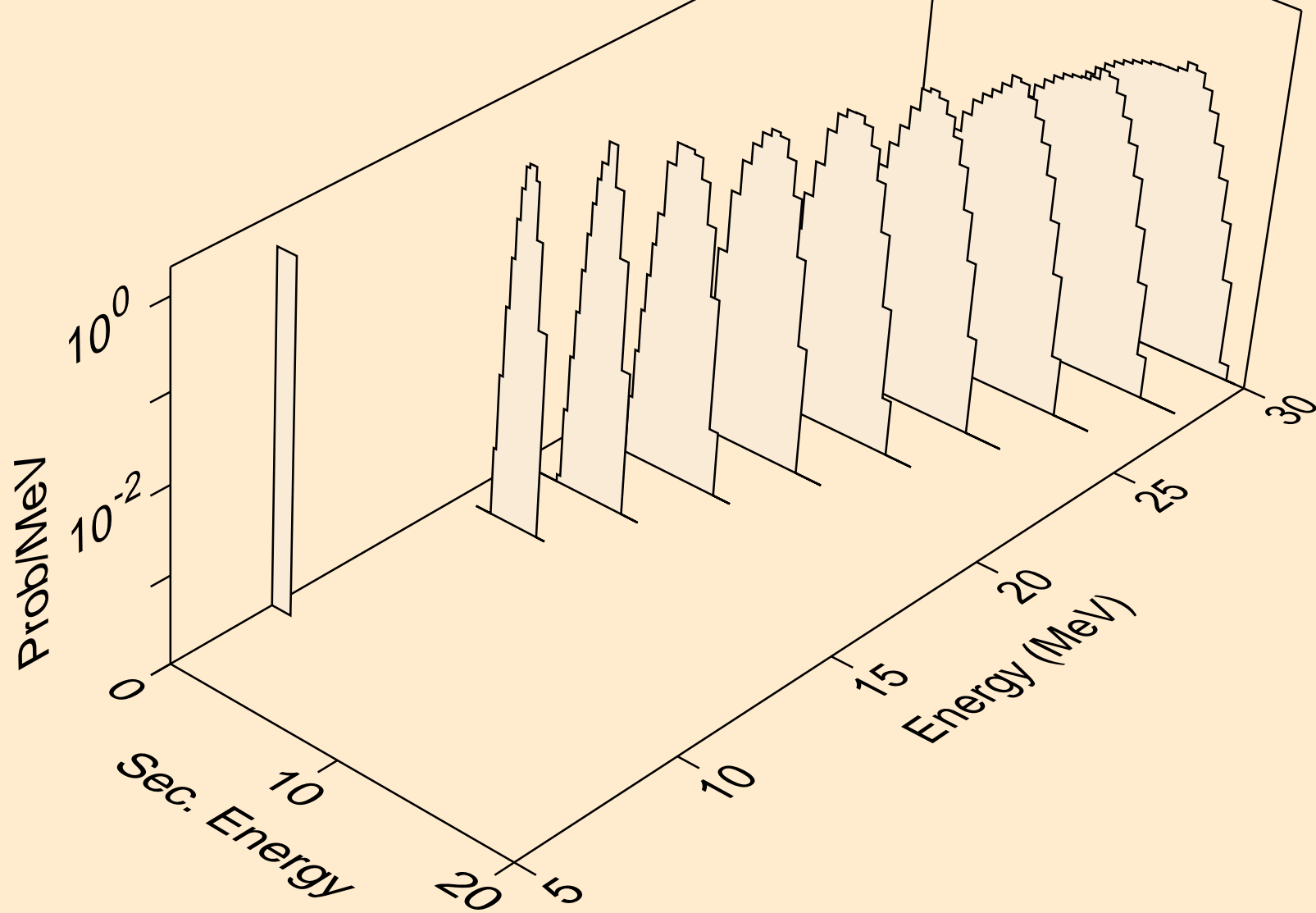

HO156N PROTON ACER TENDL-2021 LIBRARY; T=0.K  
deuterons from (p,da)

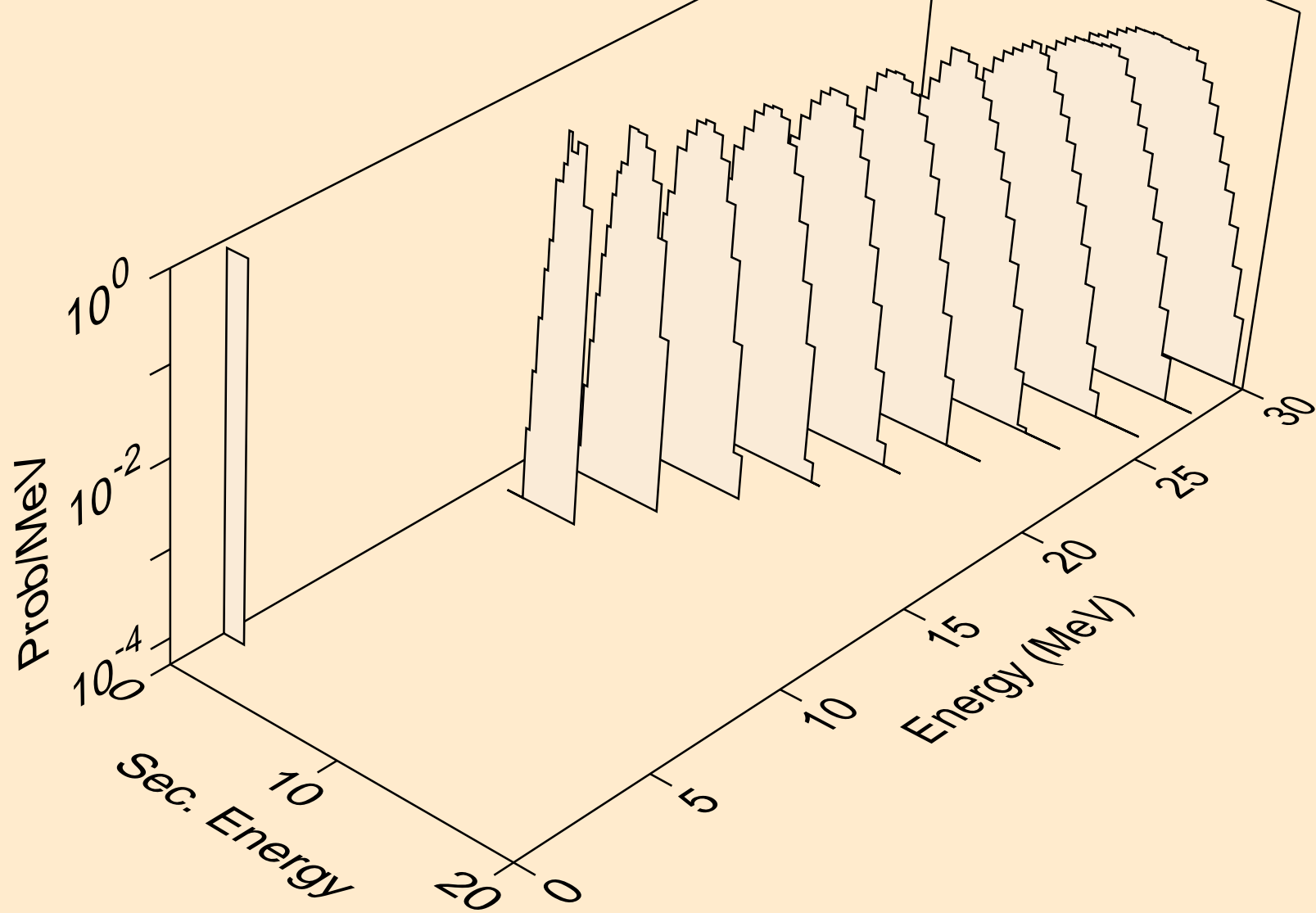

HO156N PROTON ACER TENDL-2021 LIBRARY; T=0.K  
tritons from (p,x)

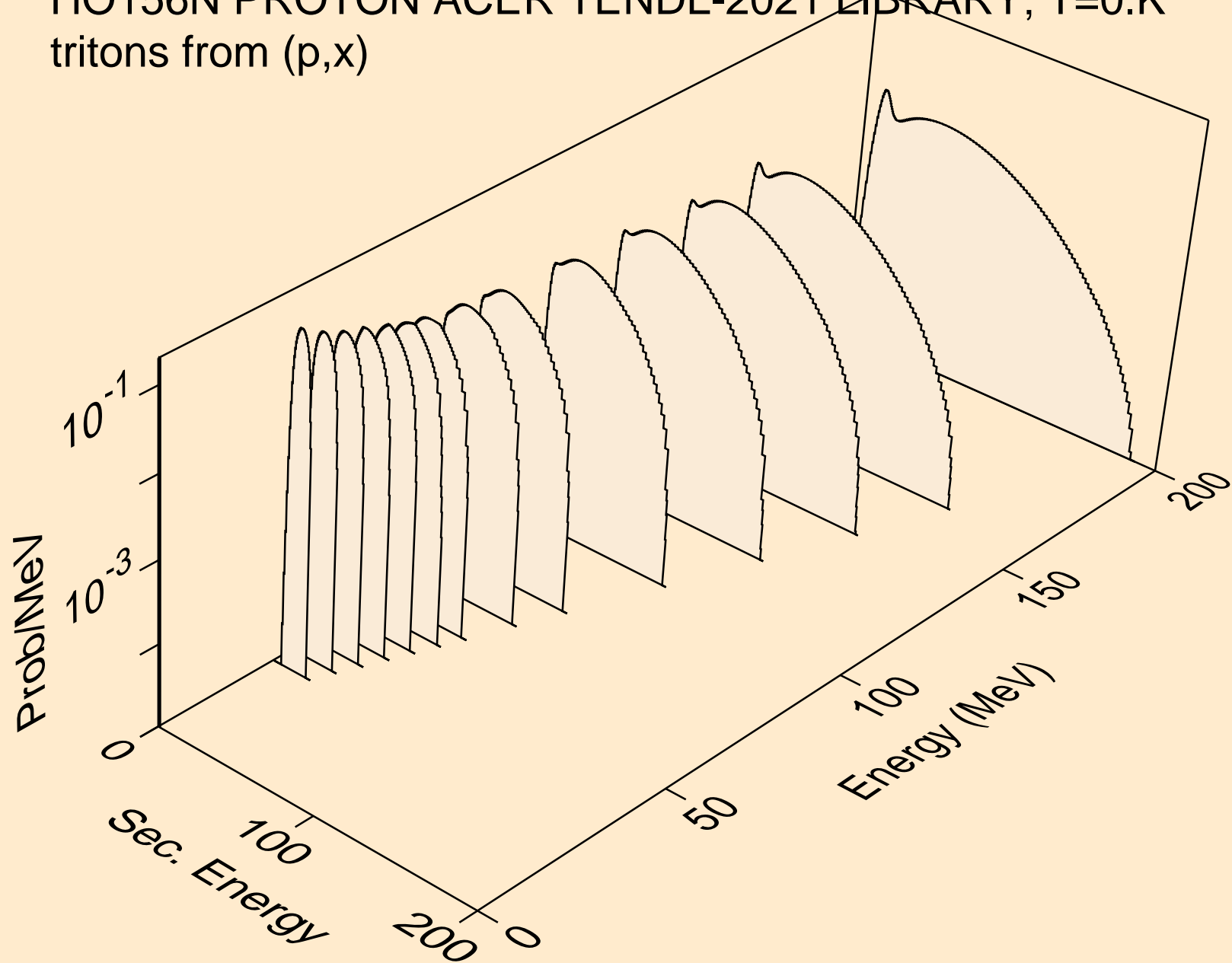



HO156N PROTON ACER TENDL-2021 LIBRARY; T=0.K  
tritons from (p,n\*)t

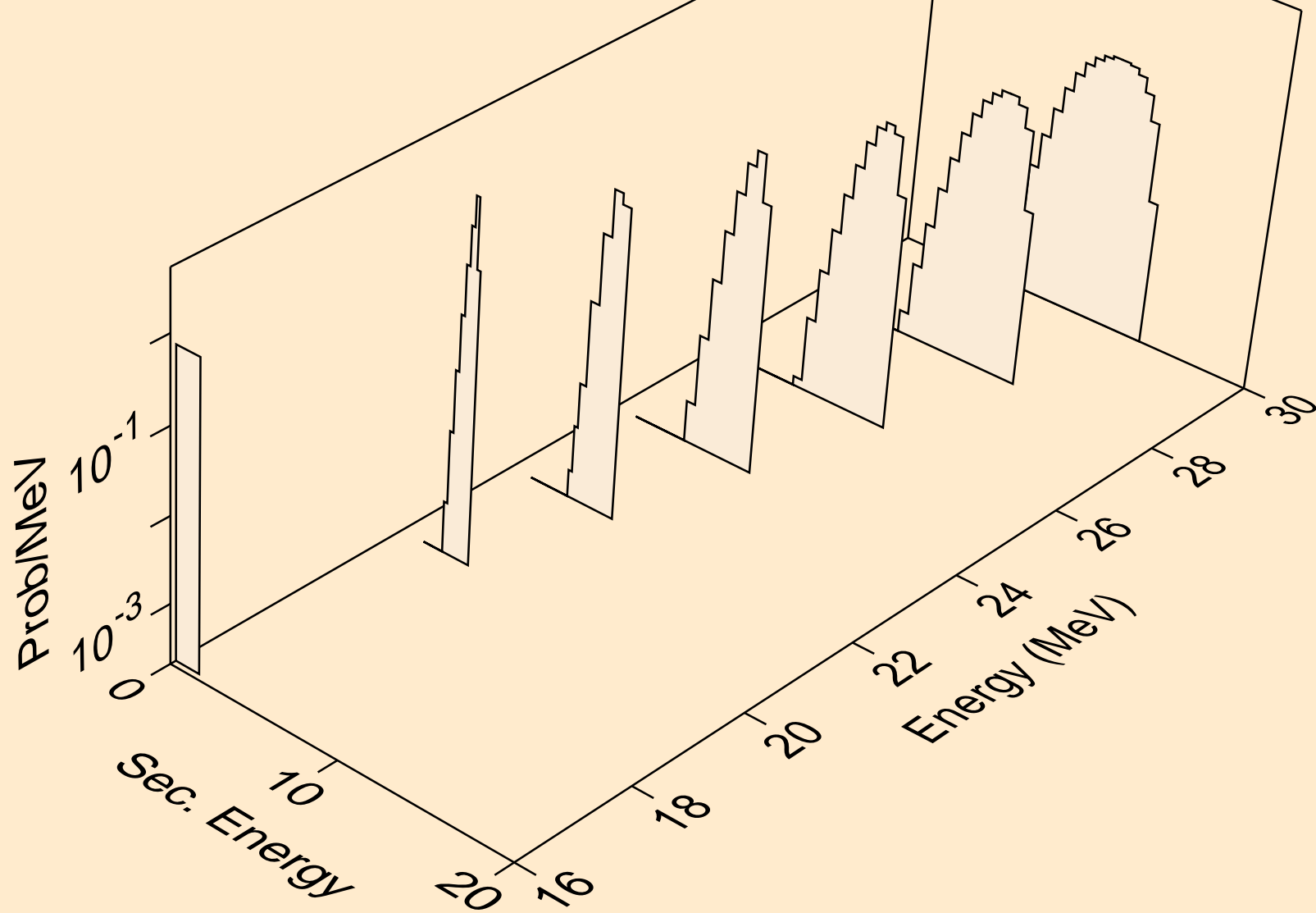

HO156N PROTON ACER TENDL-2021 LIBRARY; T=0.K  
tritons from (p,t)

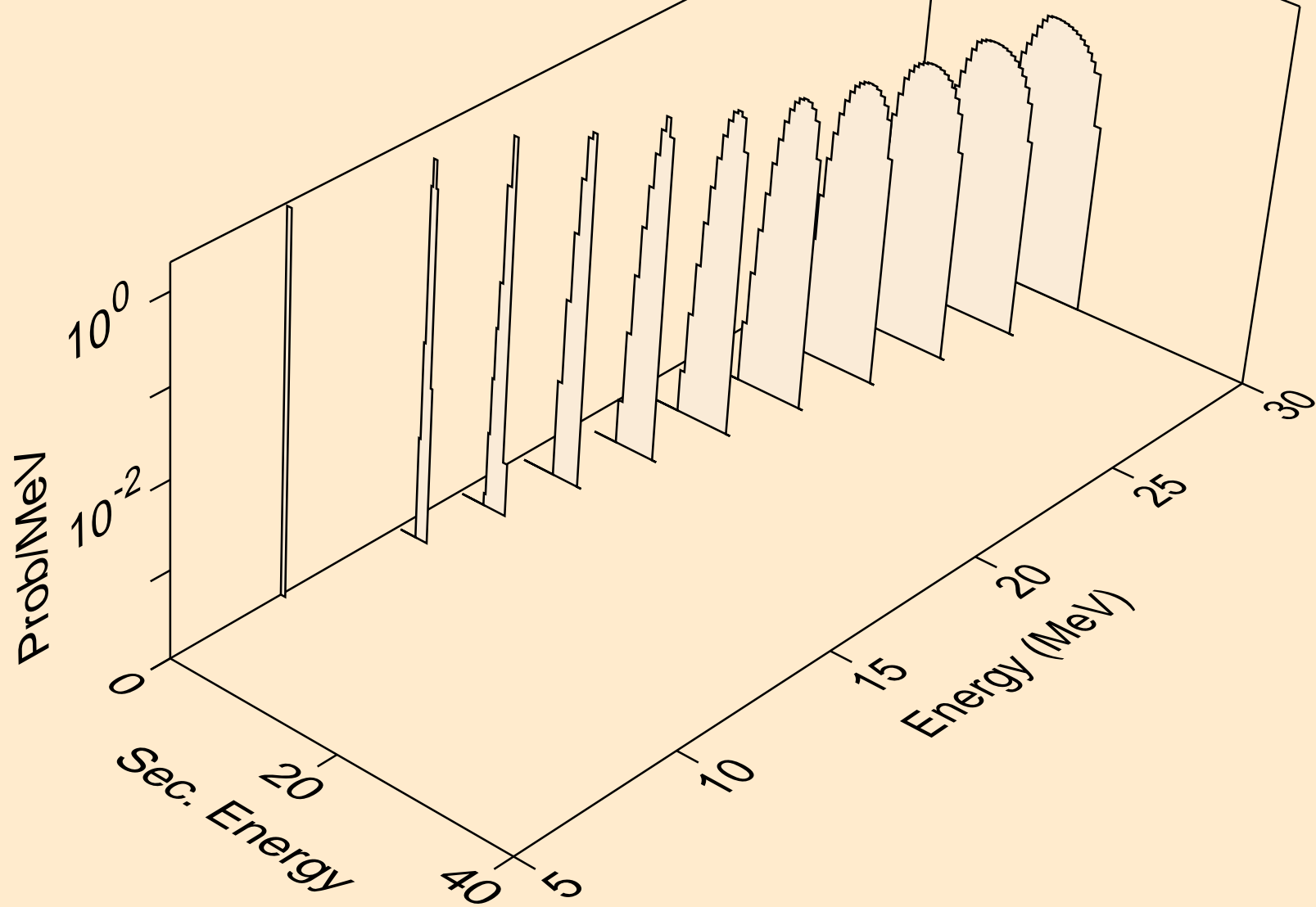

HO156N PROTON ACER TENDL-2021 LIBRARY; T=0.K  
tritons from (p,pt)

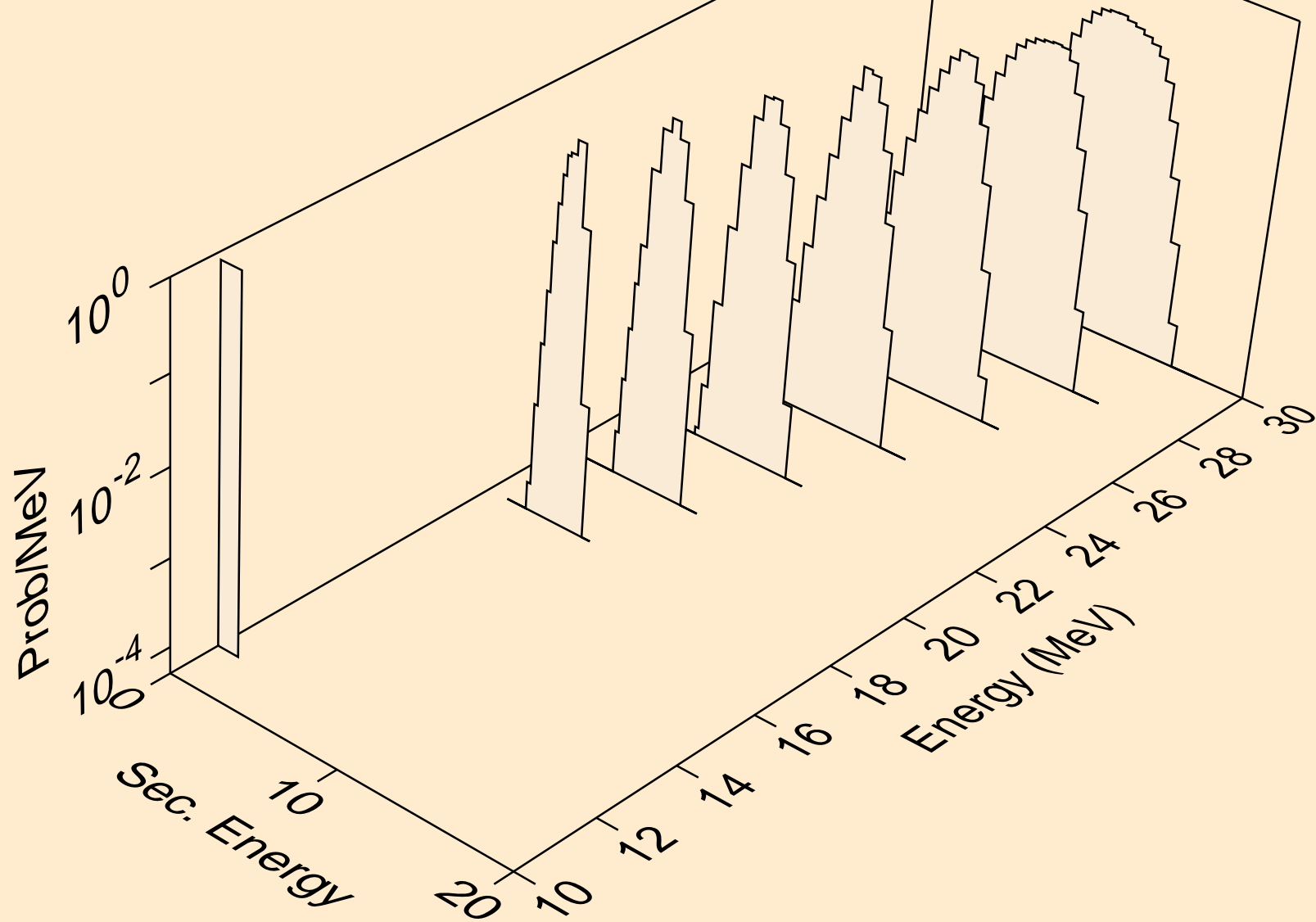

HO156N PROTON ACER TENDL-2021 LIBRARY; T=0.K  
he3s from (p,x)

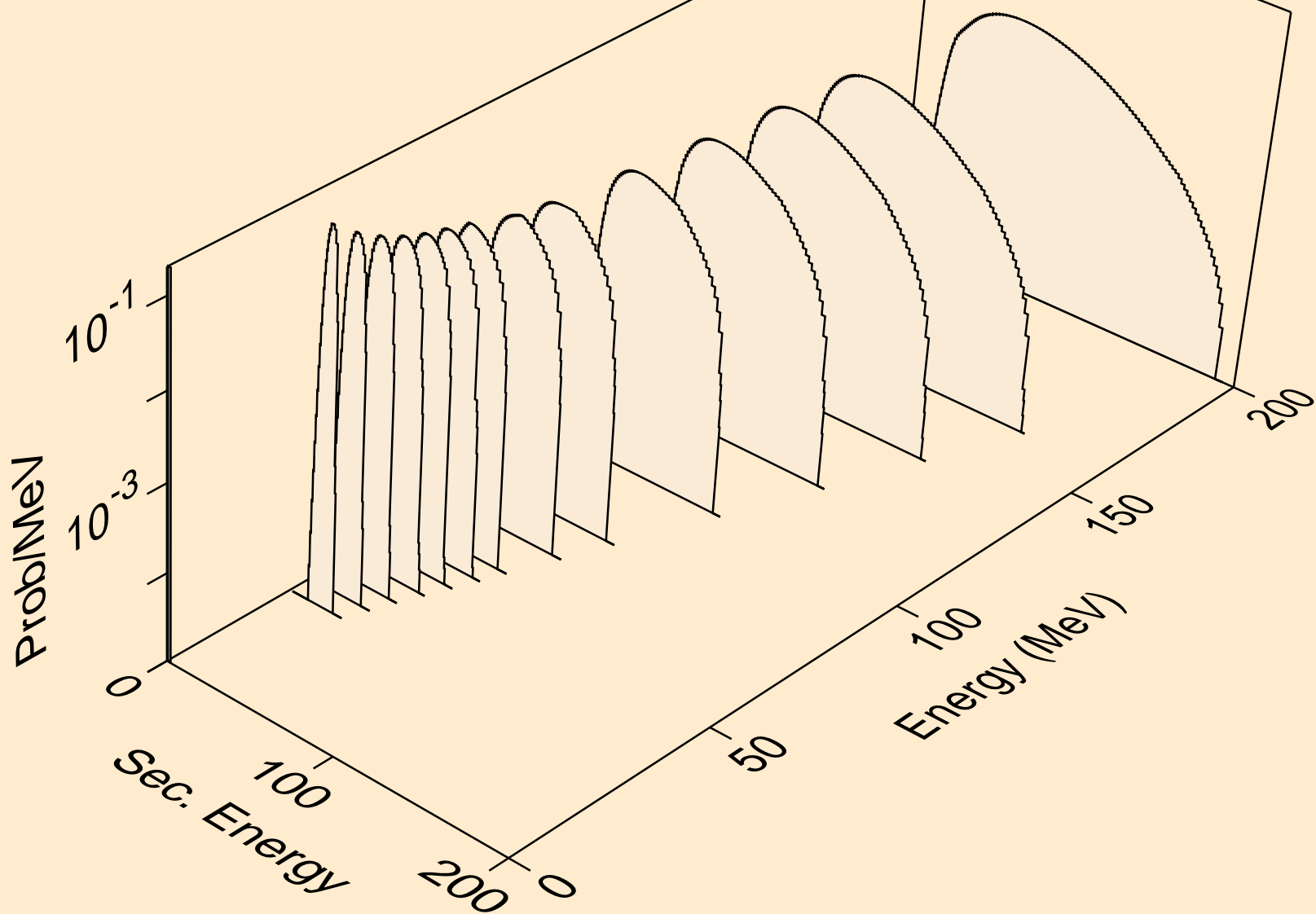

HO156N PROTON ACER TENDL-2021 LIBRARY; T=0.K  
he3s from (p,n\*)he3

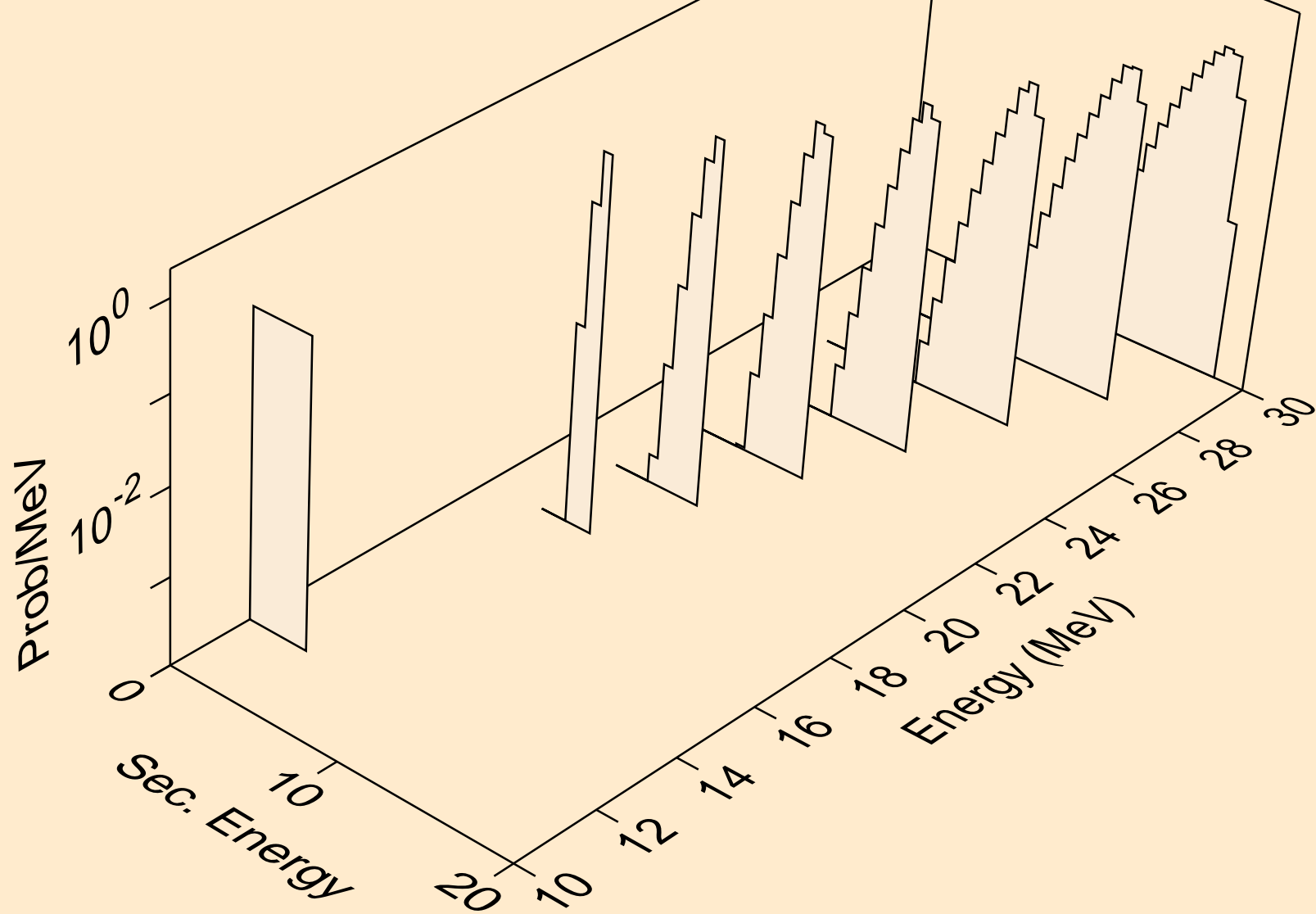

HO156N PROTON ACER TENDL-2021 LIBRARY; T=0.K  
he3s from (p,he3)

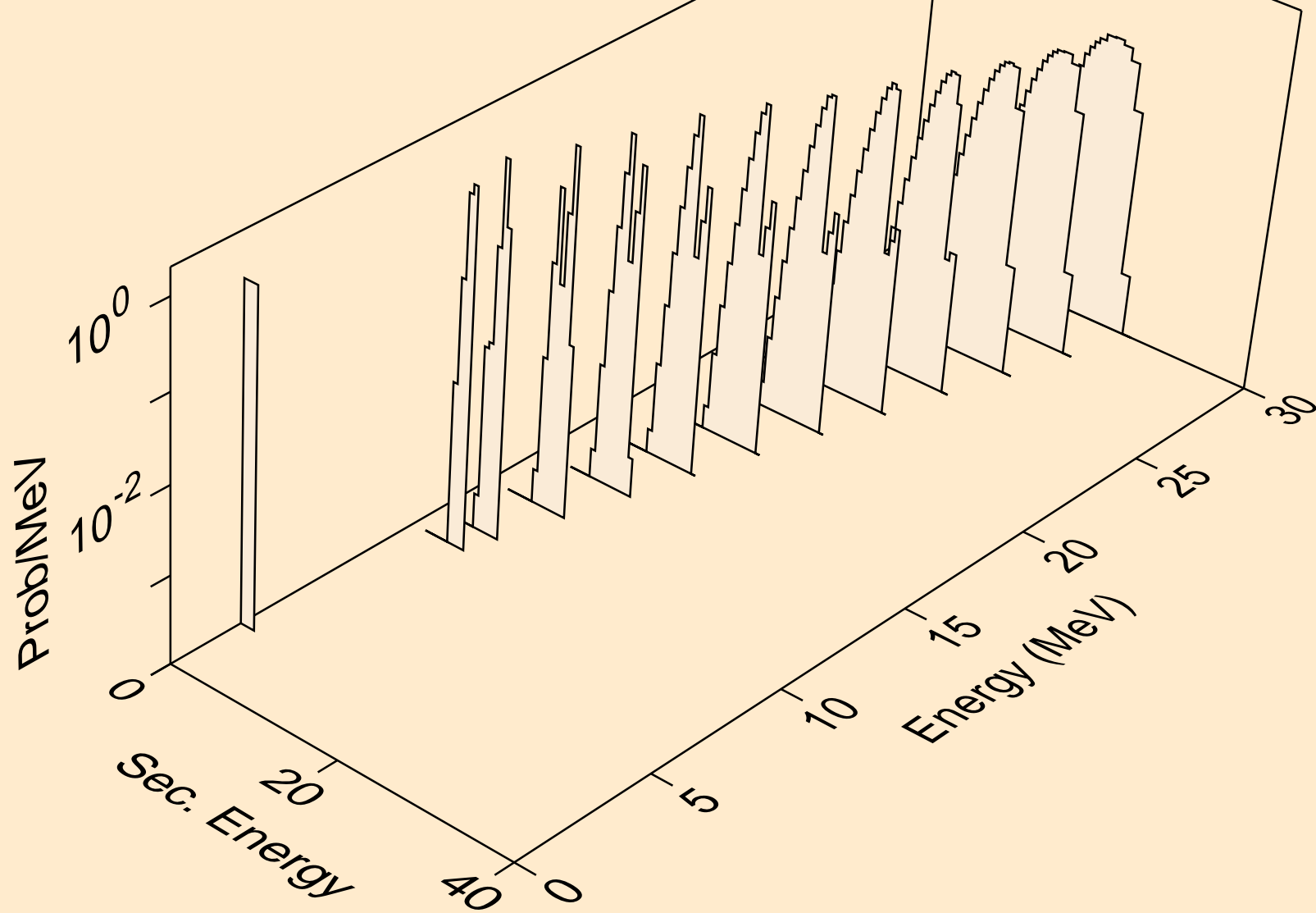

HO156N PROTON ACER TENDL-2021 LIBRARY; T=0.K  
alphas from (p,x)

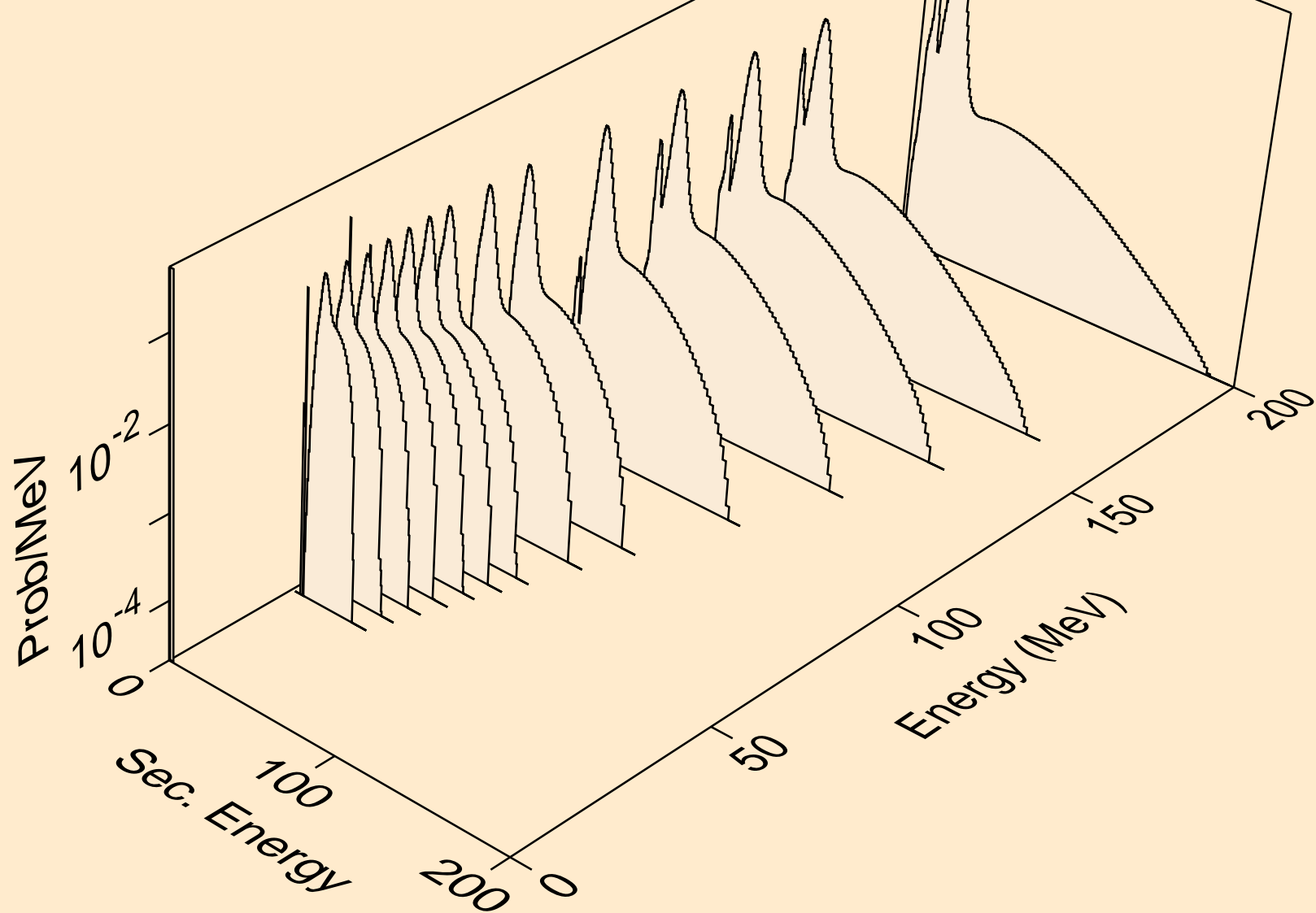

HO156N PROTON ACER TENDL-2021 LIBRARY; T=0.K  
alphas from (p,n\*)a

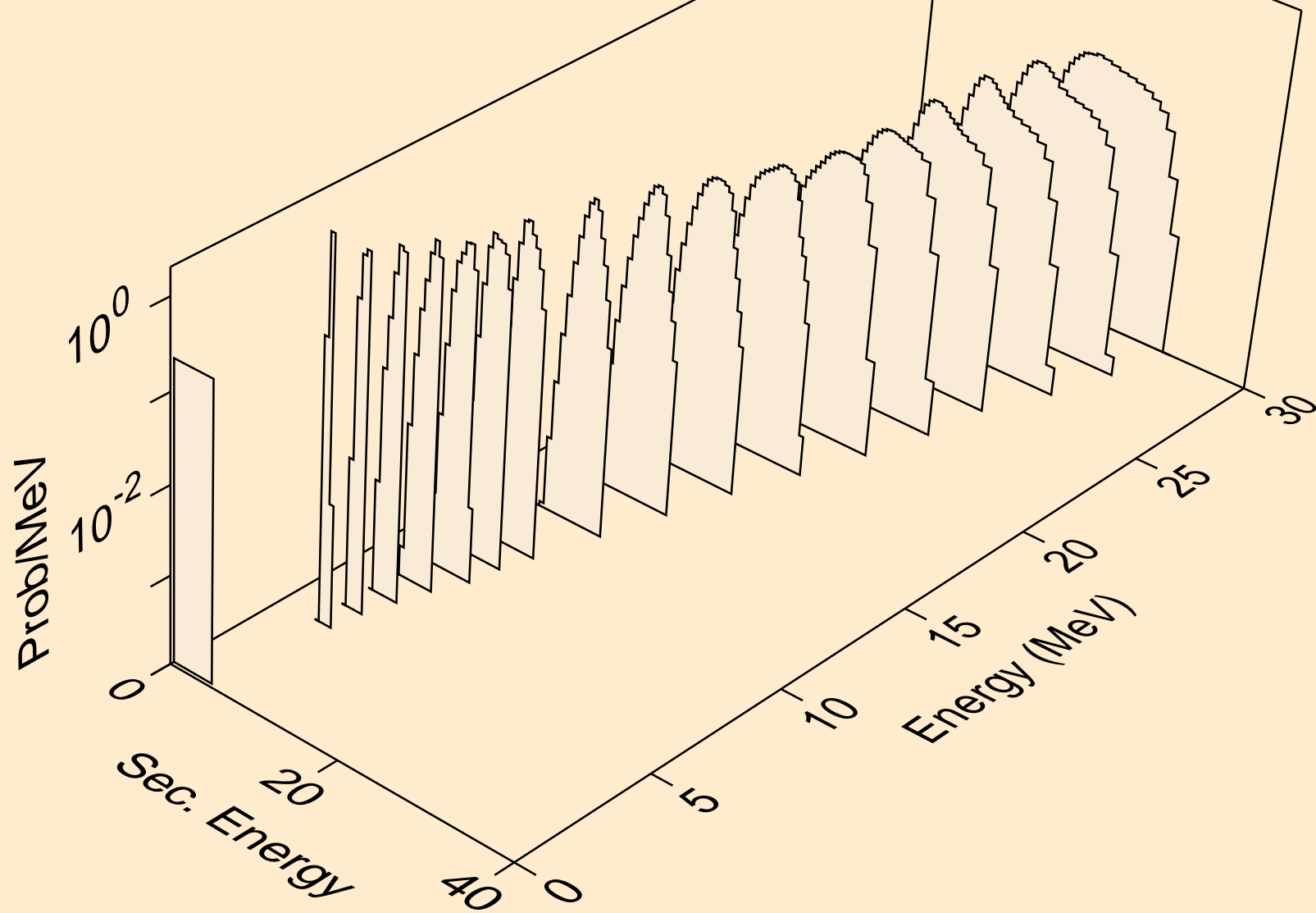



HO156N PROTON ACER TENDL-2021 LIBRARY; T=0.K  
alphas from (p,2n)a

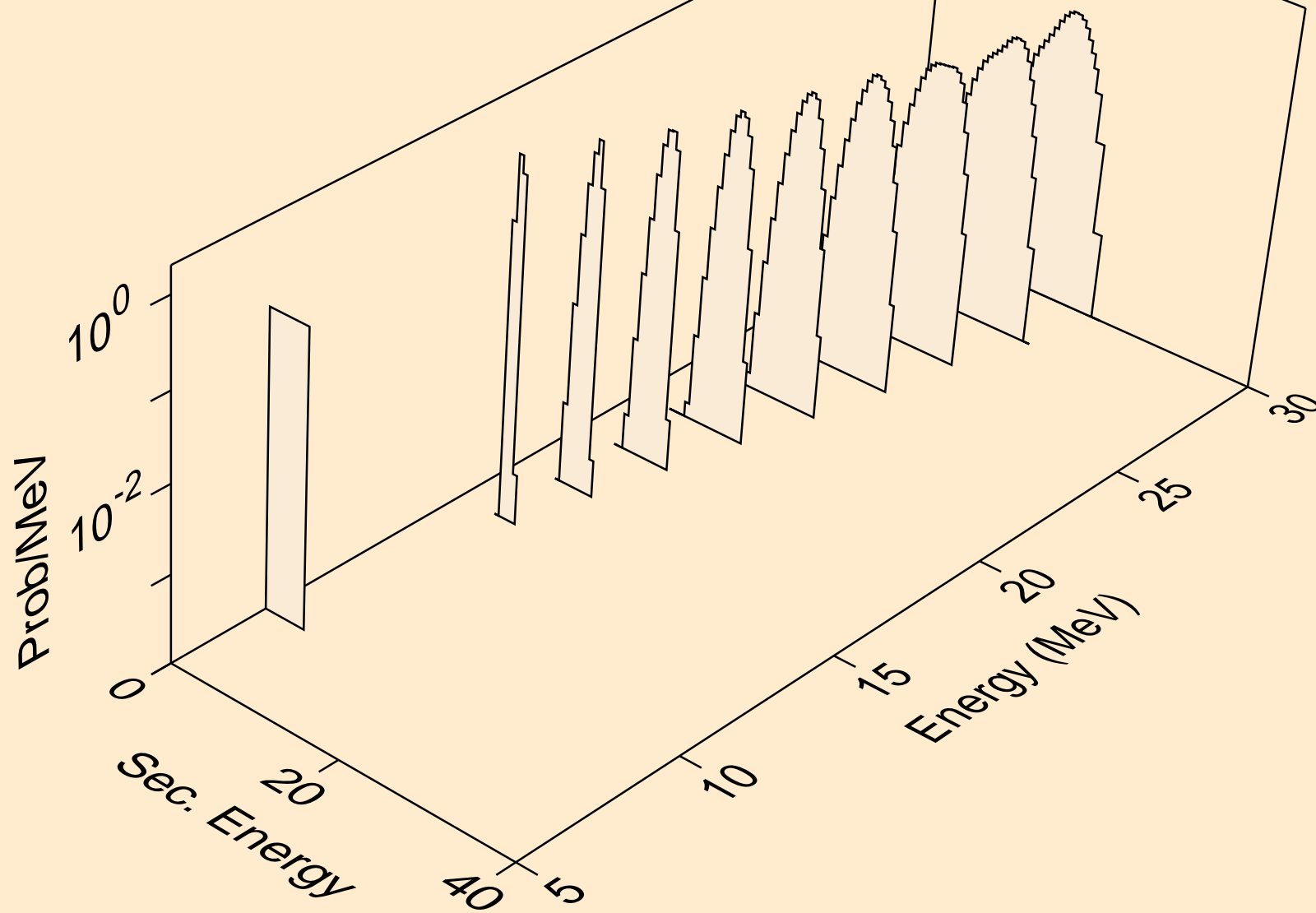

HO156N PROTON ACER TENDL-2021 LIBRARY; T=0.K  
alphas from (p,3n)a

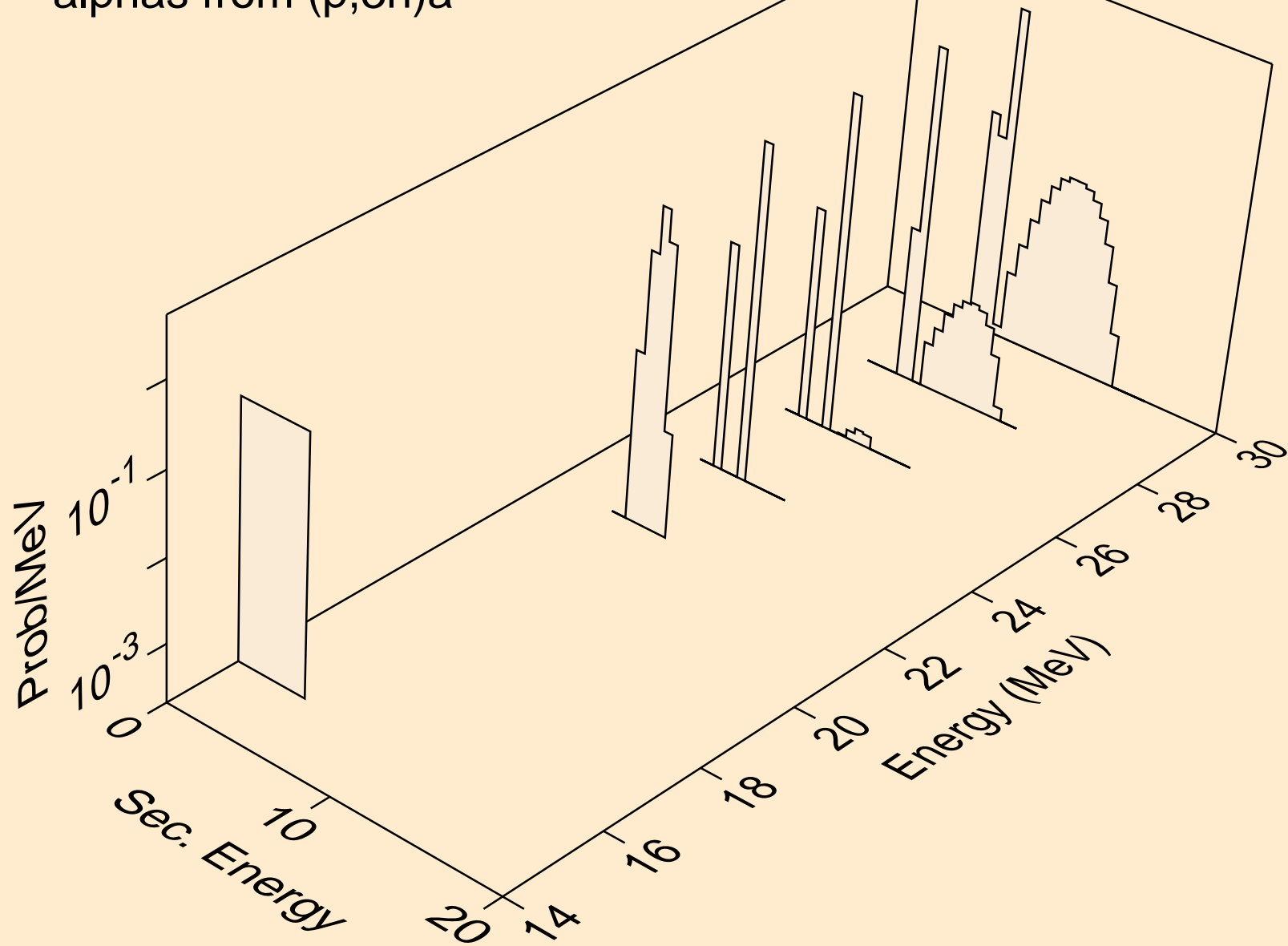

HO156N PROTON ACER TENDL-2021 LIBRARY; T=0.K  
alphas from (p,n\*)2a

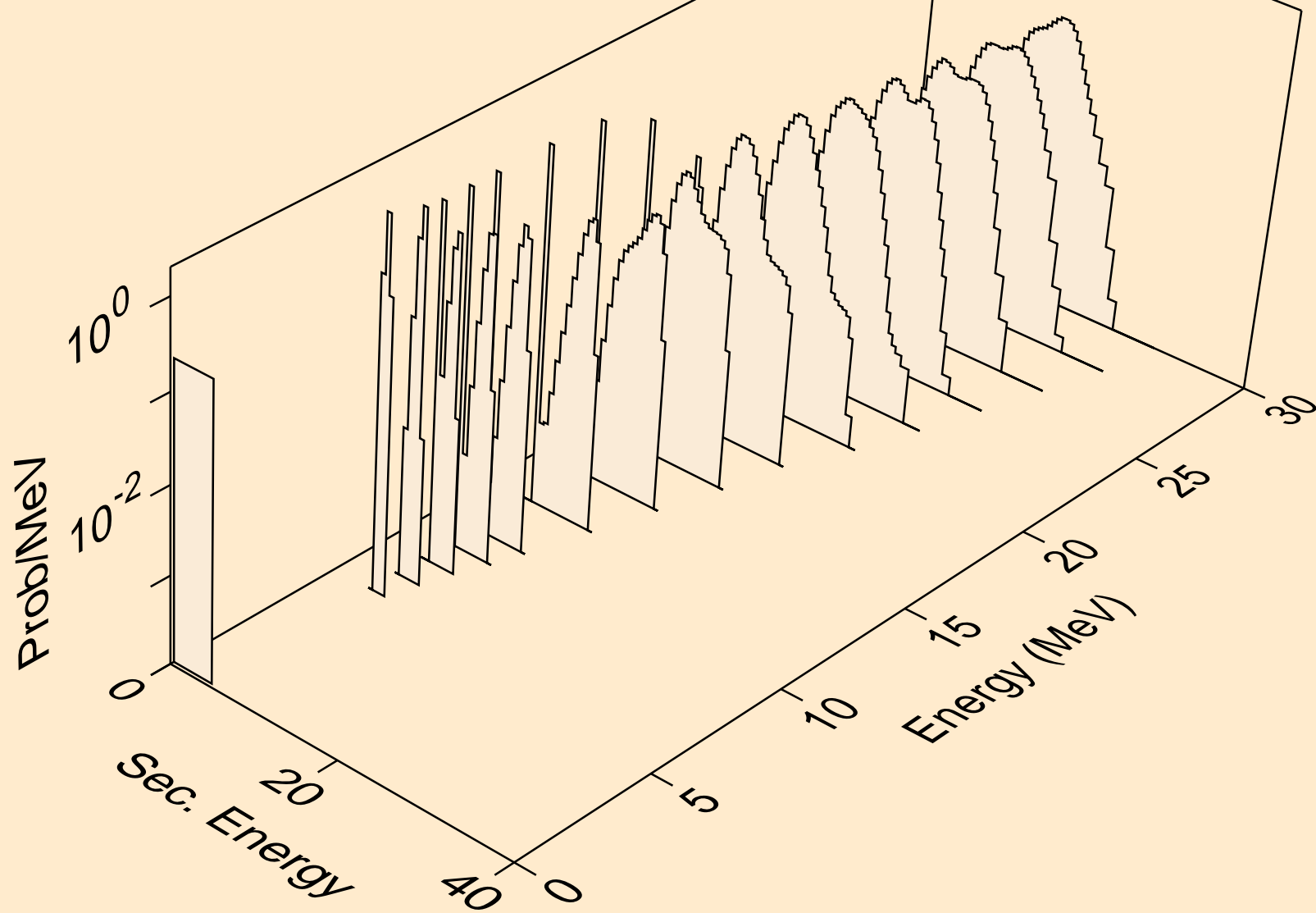

HO156N PROTON ACER TENDL-2021 LIBRARY; T=0.K  
alphas from (p,2n)2a

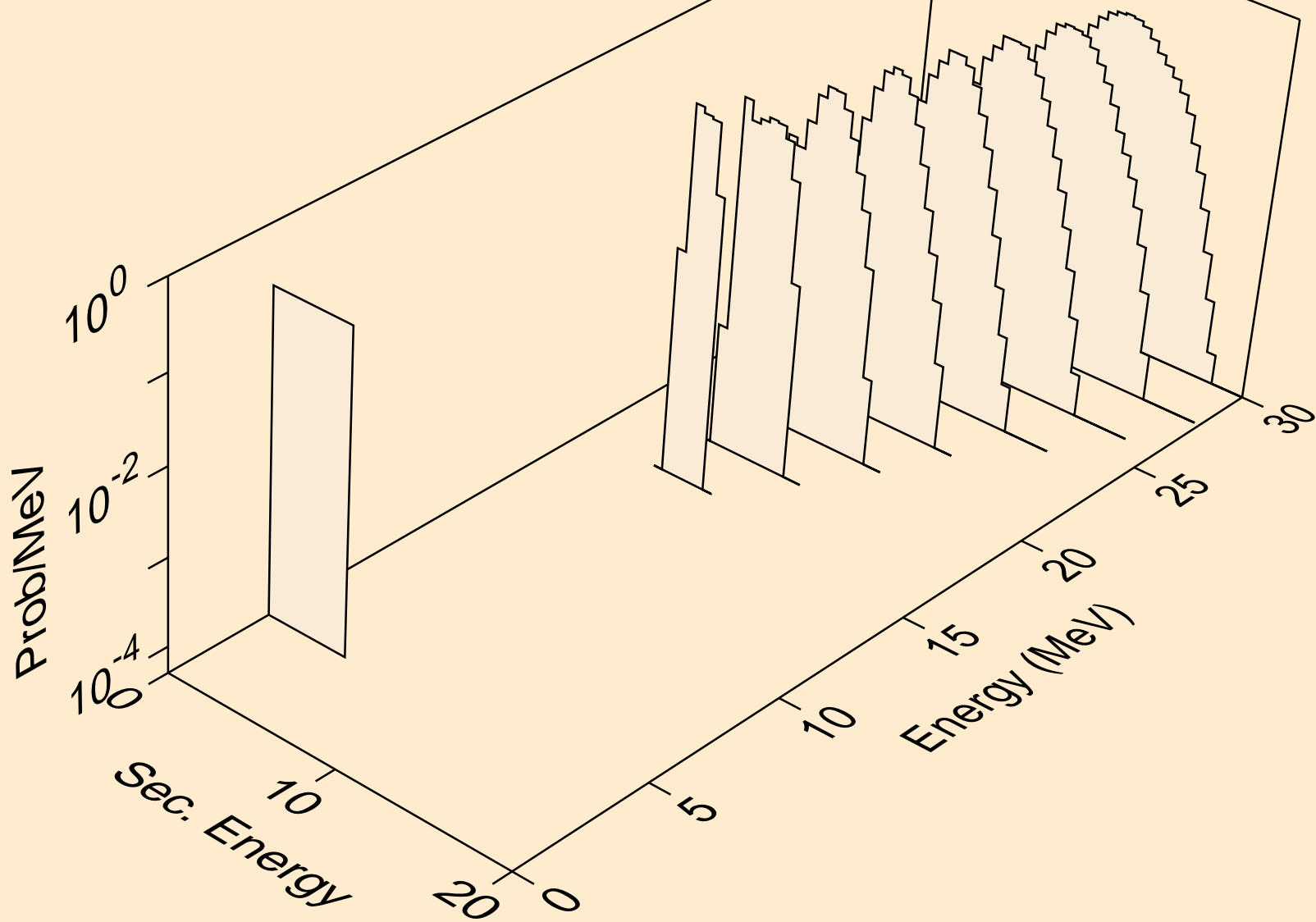

HO156N PROTON ACER TENDL-2021 LIBRARY; T=0.K  
alphas from (p,npa)

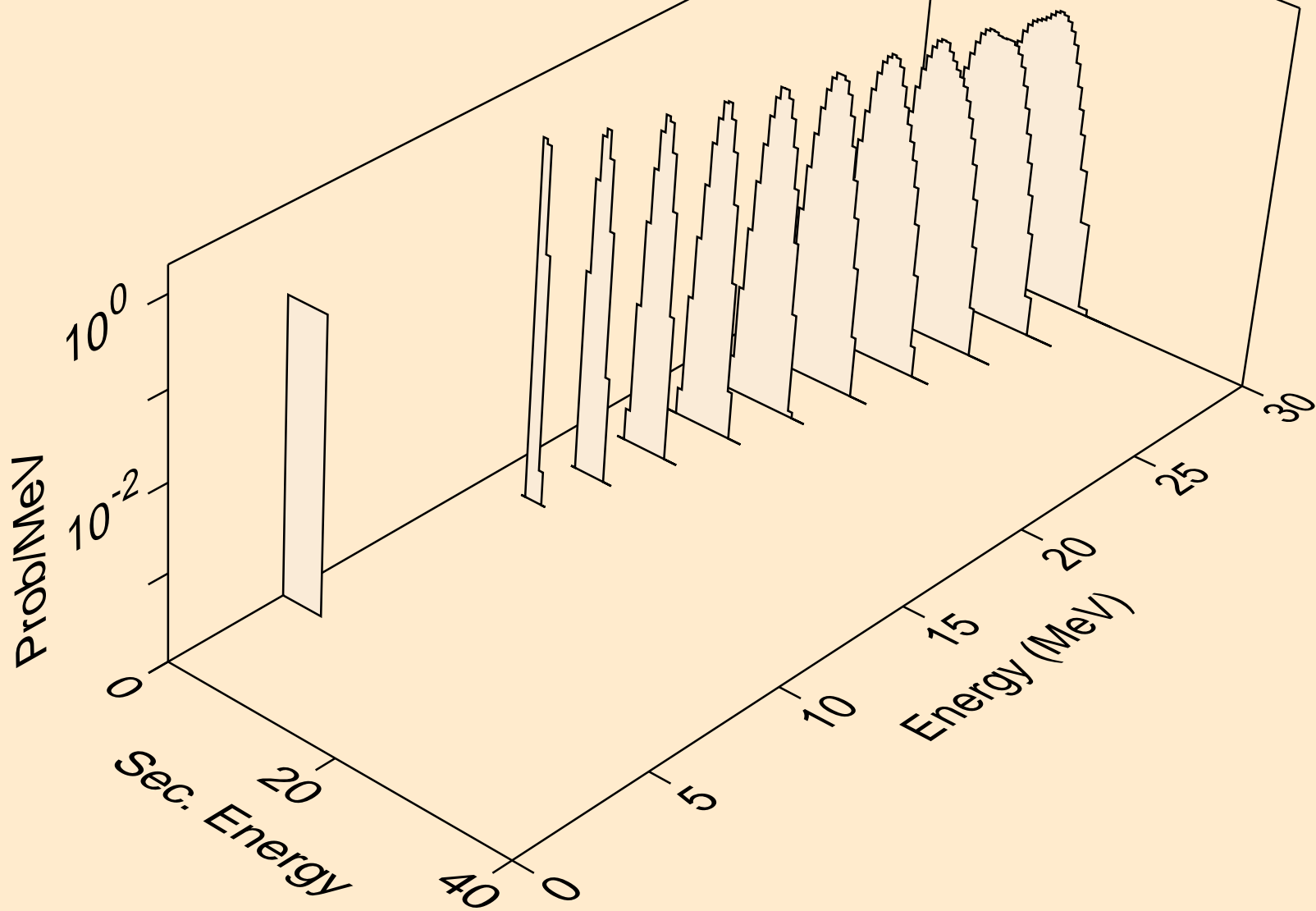

HO156N PROTON ACER TENDL-2021 LIBRARY; T=0.K  
alphas from (p,a)

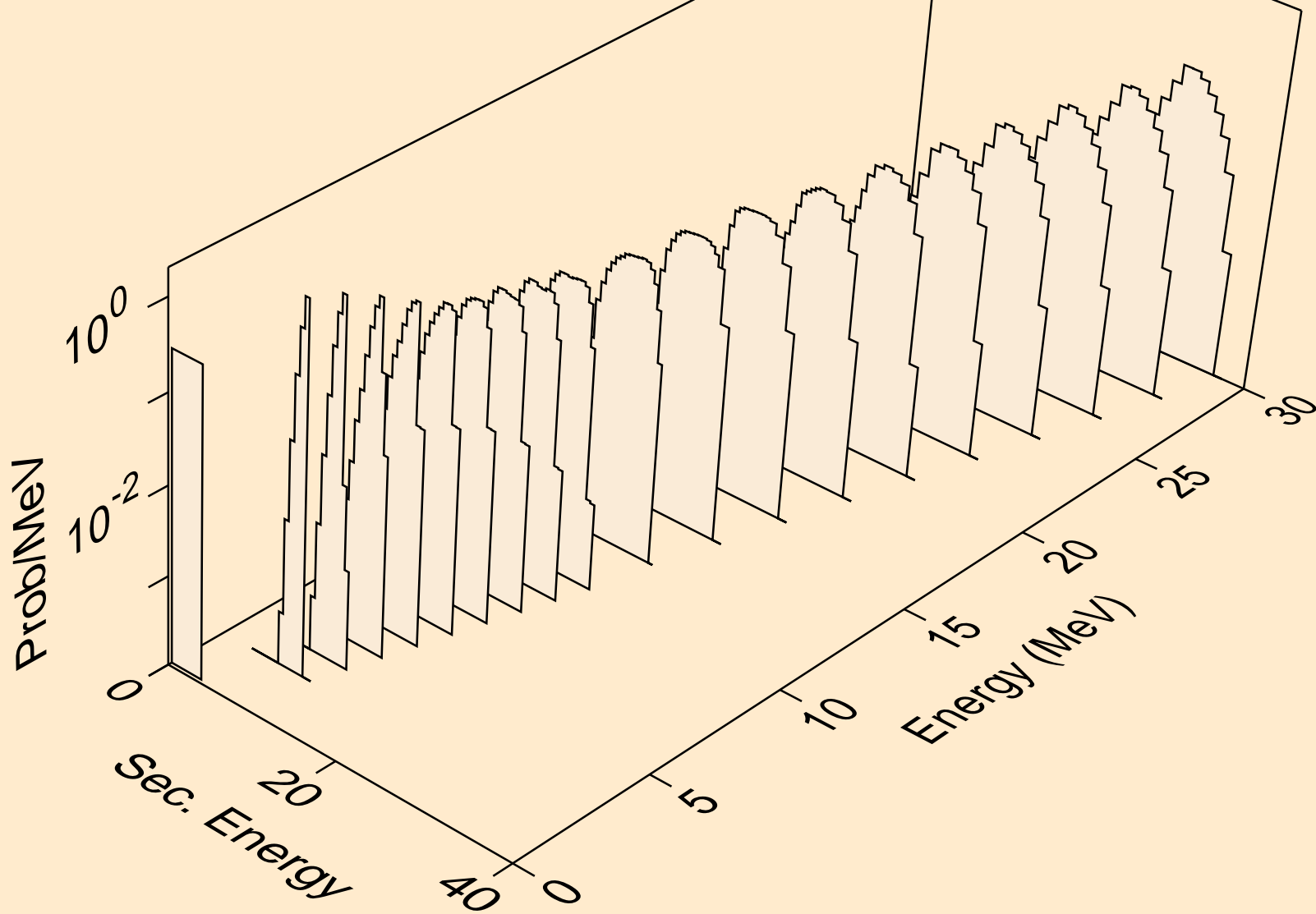

HO156N PROTON ACER TENDL-2021 LIBRARY; T=0.K  
alphas from (p,2a)

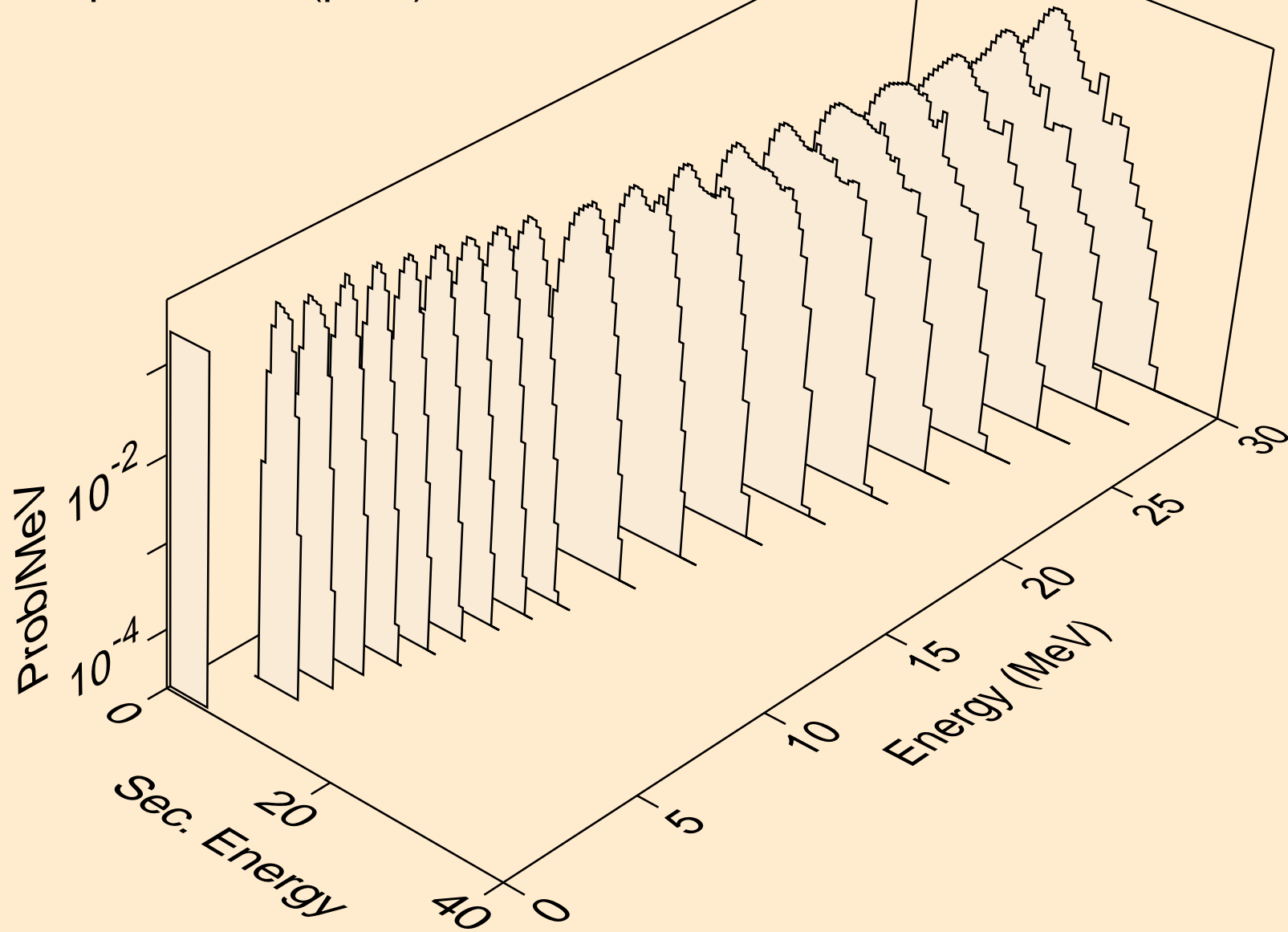

HO156N PROTON ACER TENDL-2021 LIBRARY; T=0.K  
alphas from (p,pa)

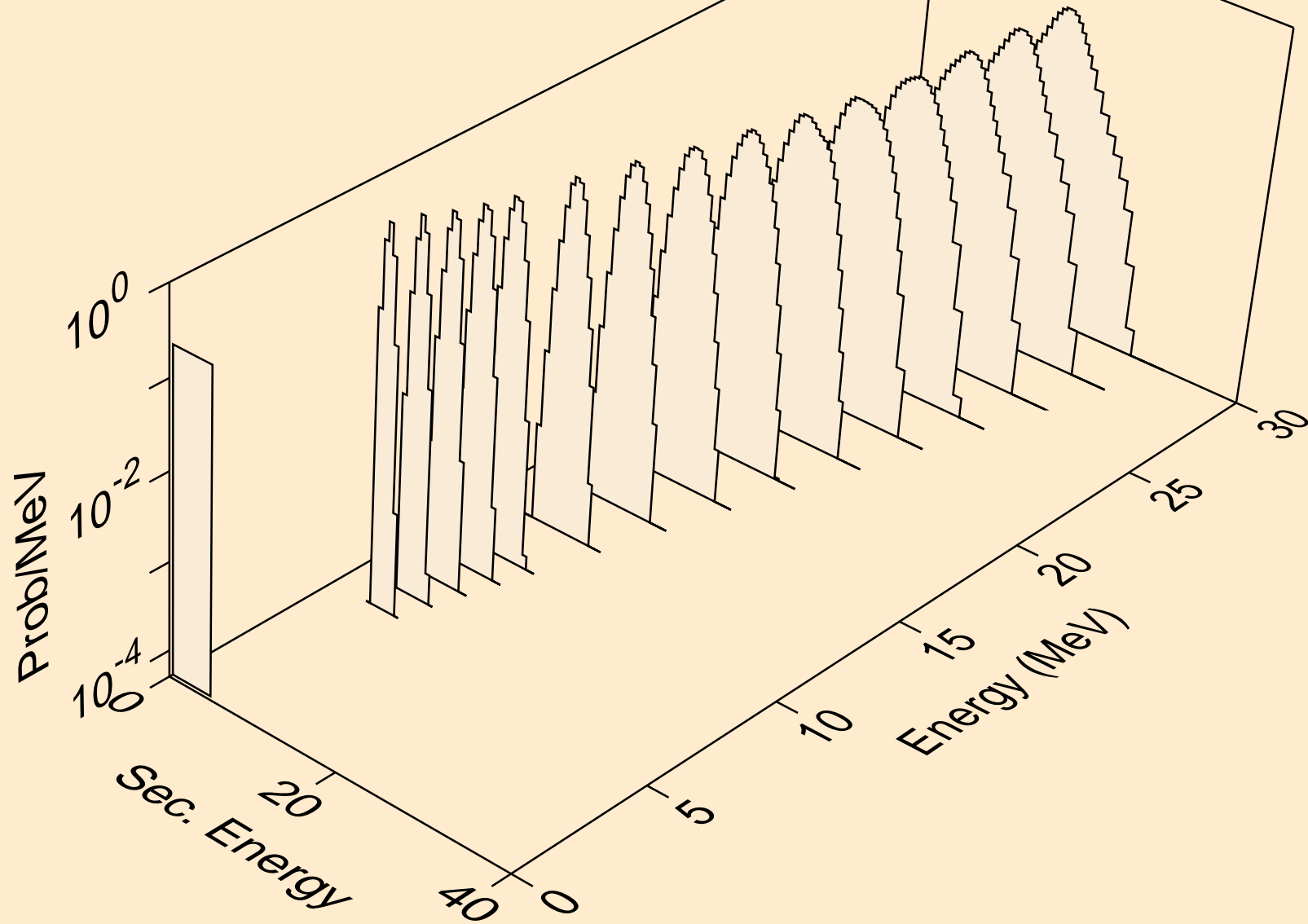



HO156N PROTON ACER TENDL-2021 LIBRARY; T=0.K  
alphas from (p,da)

