

HS268 PROTON ACER TENDL-2021 LIBRARY; T=0.K

Principal cross sections

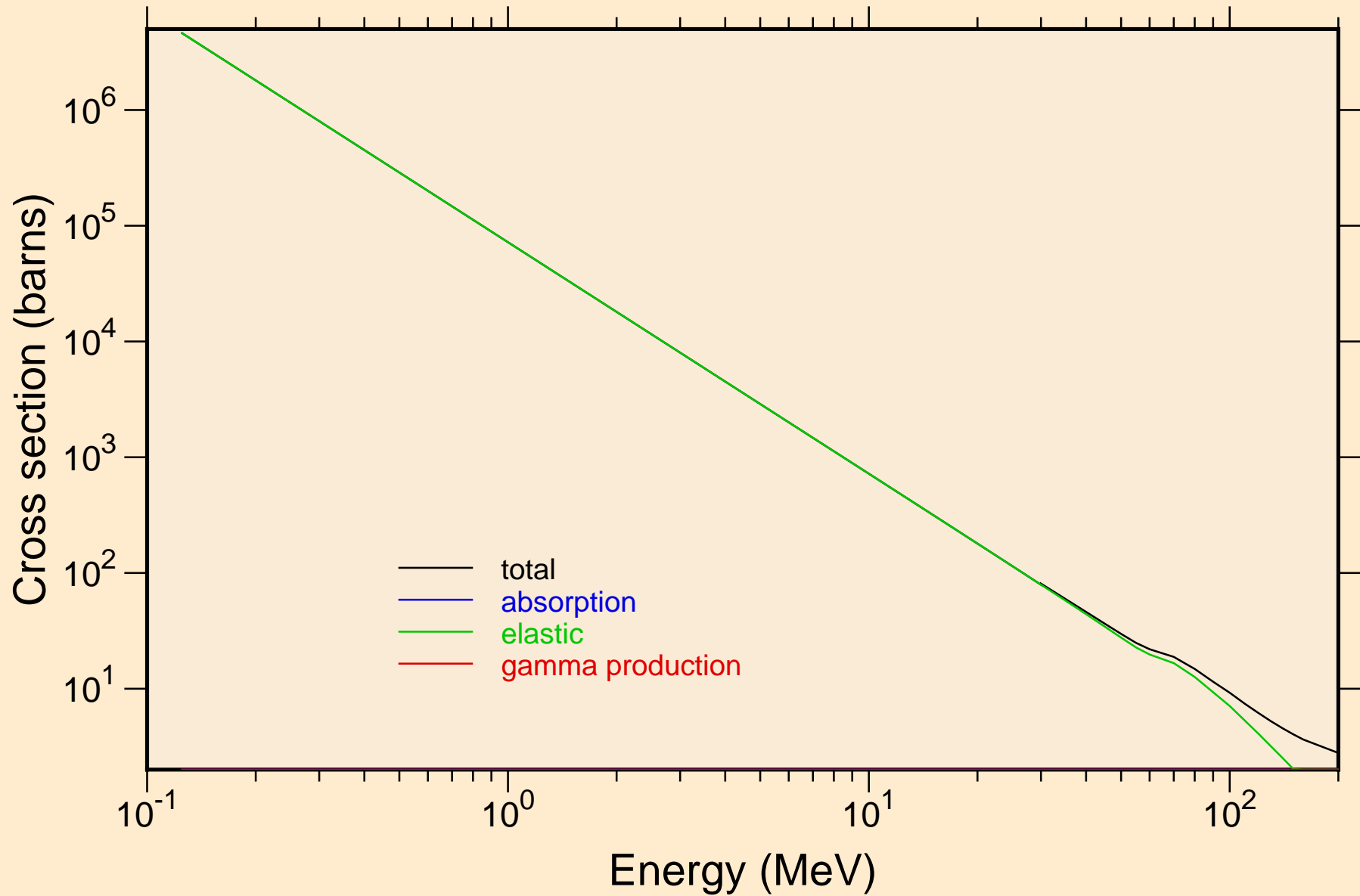

HS268 PROTON ACER TENDL-2021 LIBRARY; T=0.K

Heating

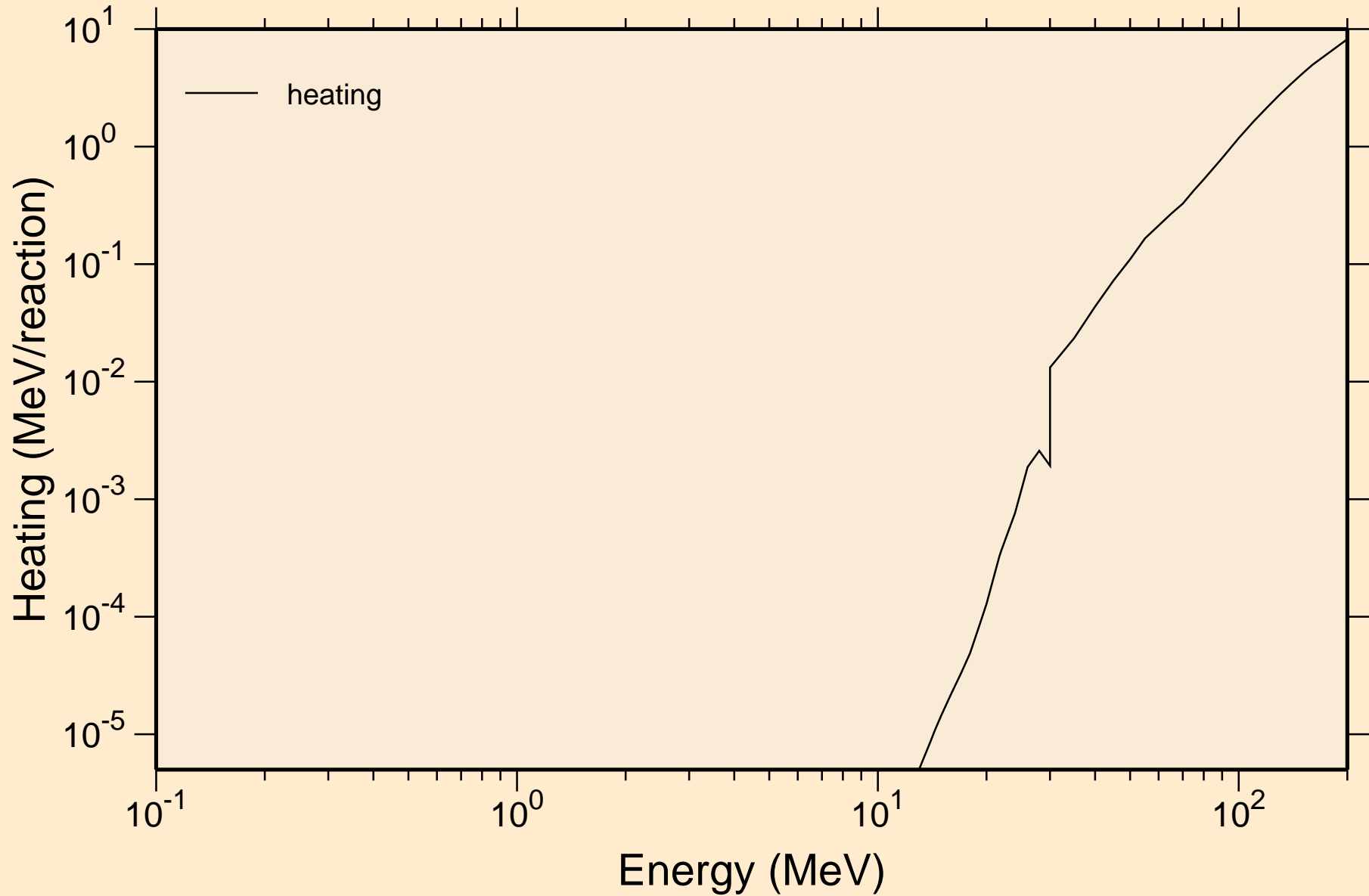

HS268 PROTON ACER TENDL-2021 LIBRARY; T=0.K

Principal cross sections

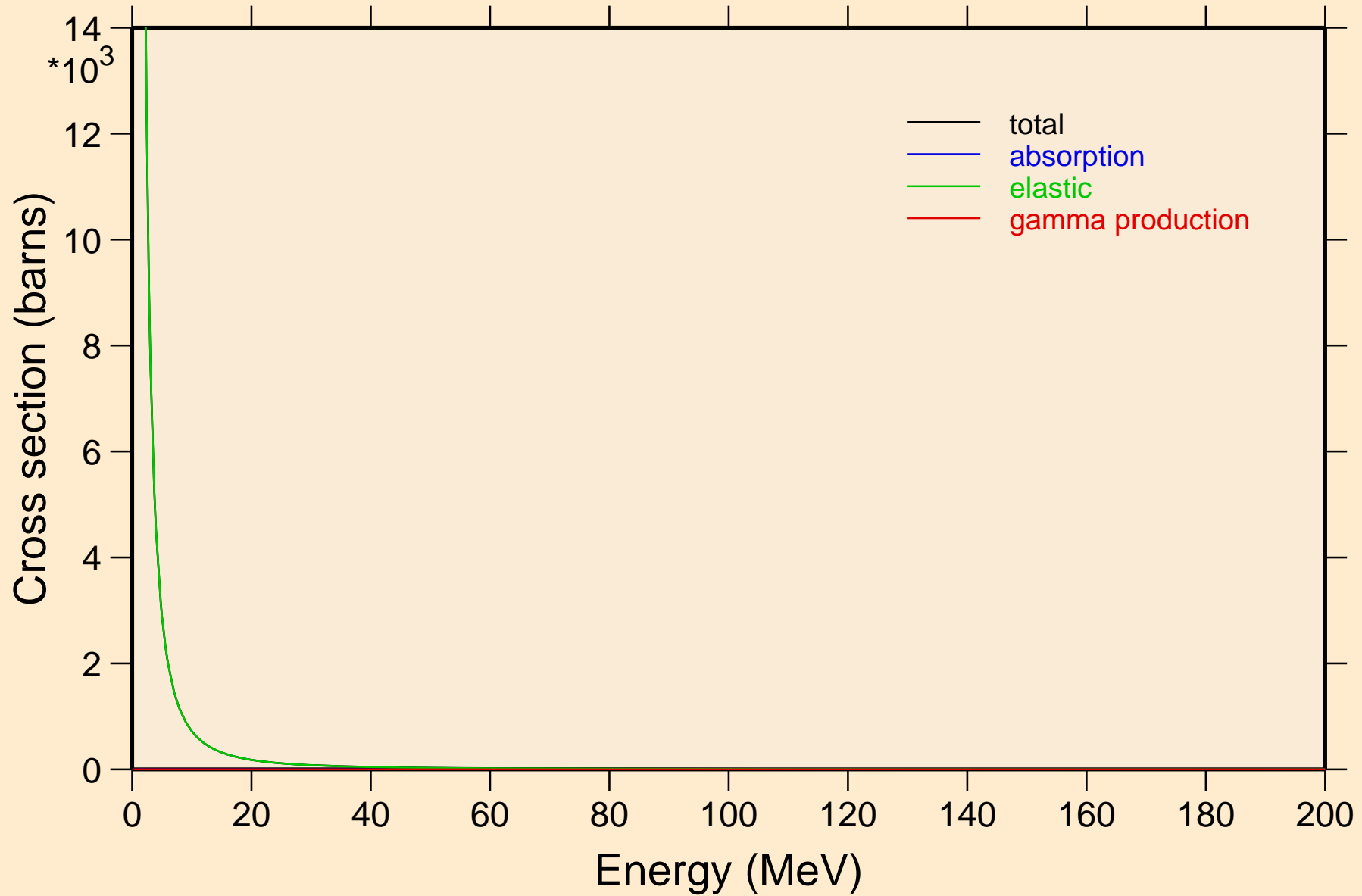

HS268 PROTON ACER TENDL-2021 LIBRARY; T=0.K

Heating

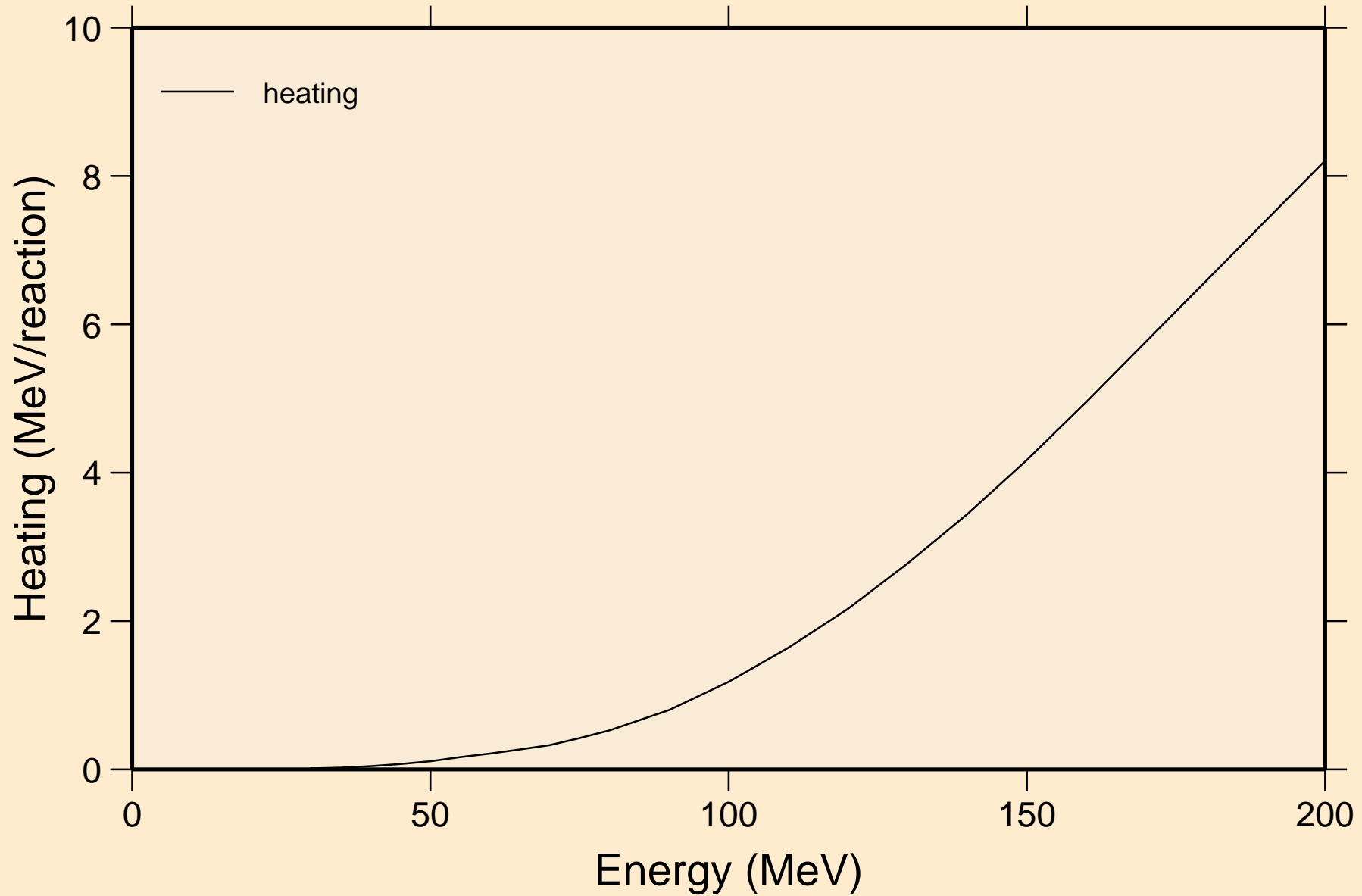

HS268 PROTON ACER TENDL-2021 LIBRARY; T=0.K

Threshold reactions

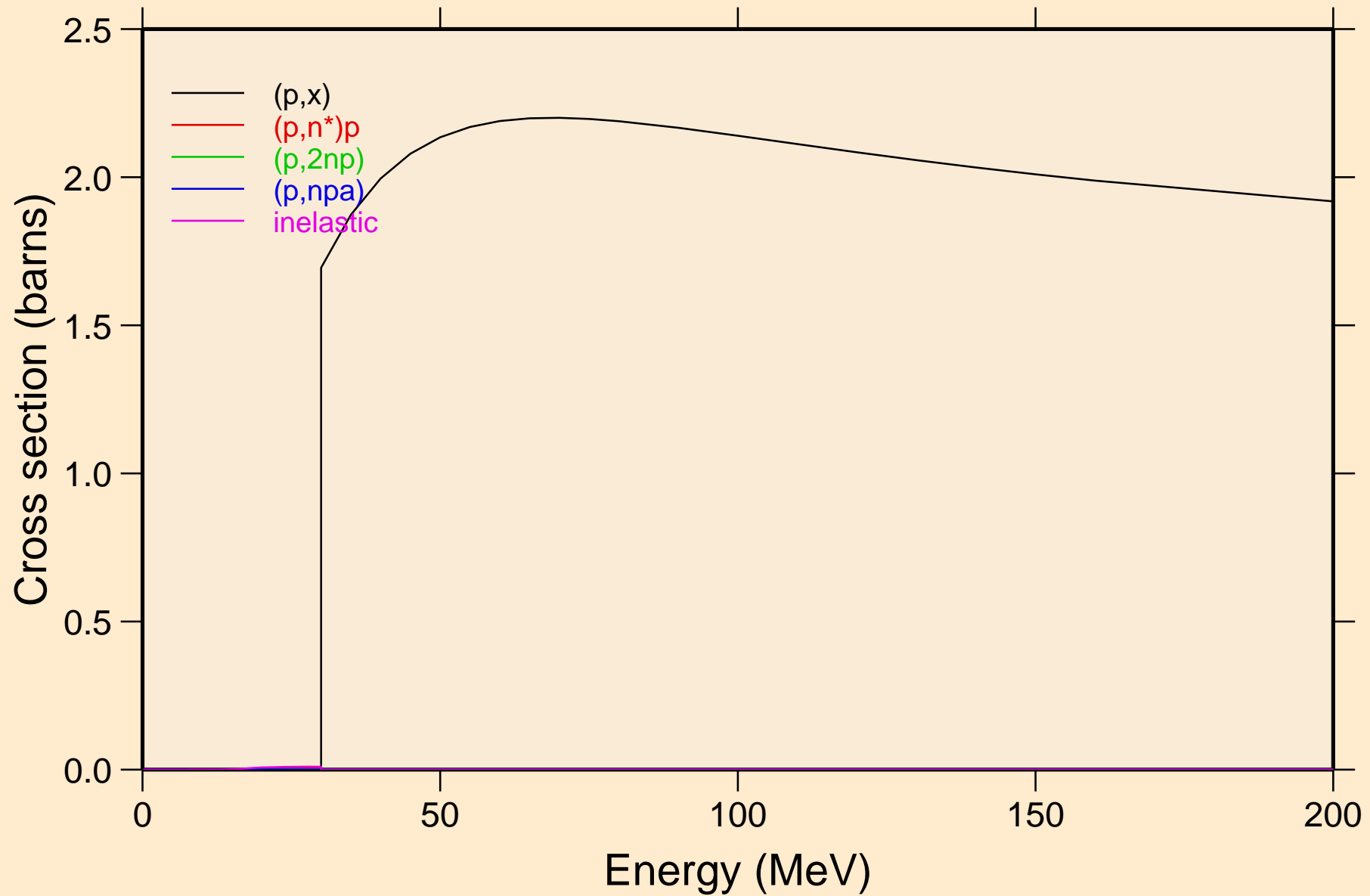

HS268 PROTON ACER TENDL-2021 LIBRARY; T=0.K

Threshold reactions

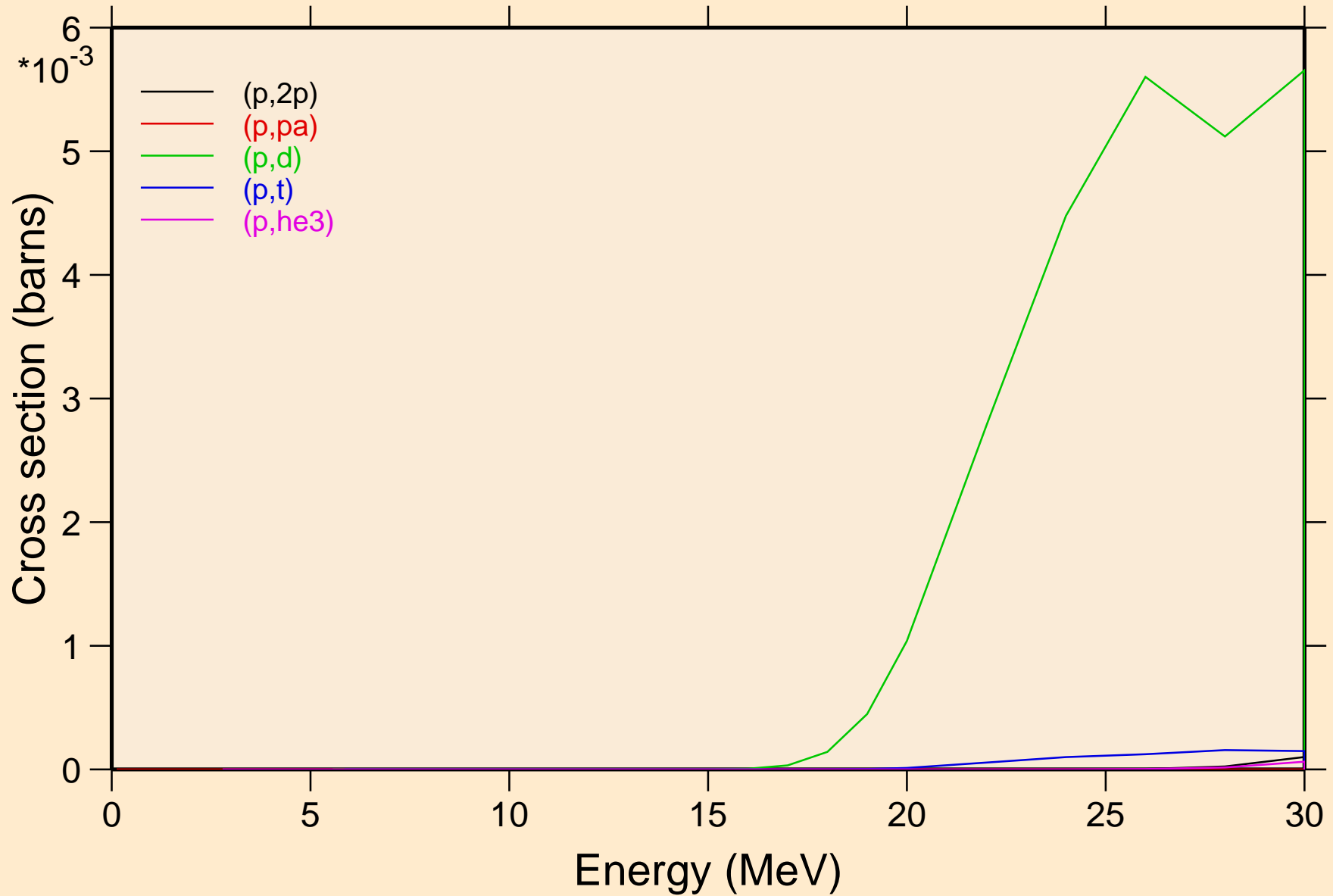

HS268 PROTON ACER TENDL-2021 LIBRARY; T=0.K

Threshold reactions

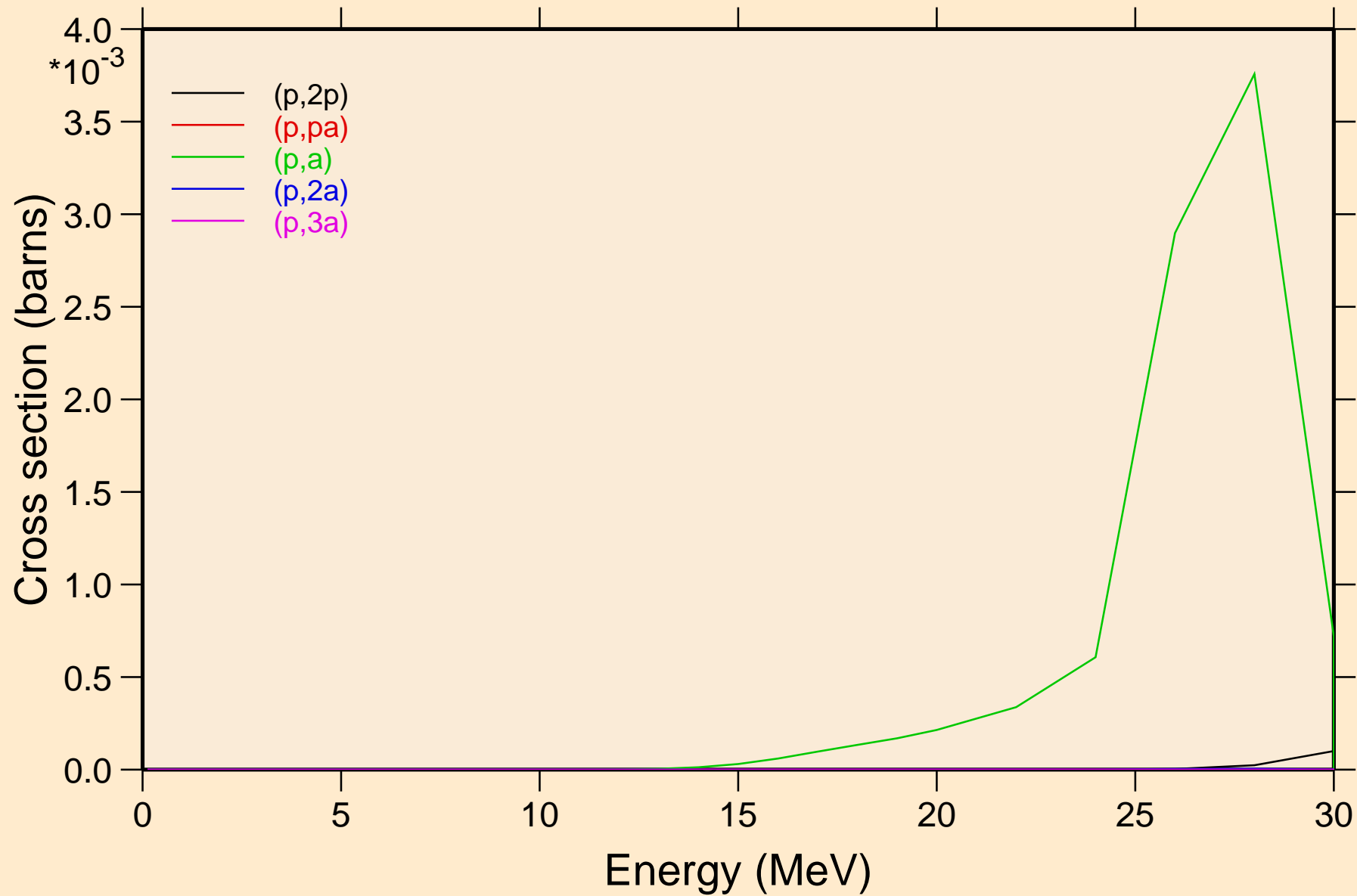

HS268 PROTON ACER TENDL-2021 LIBRARY; T=0.K

Threshold reactions

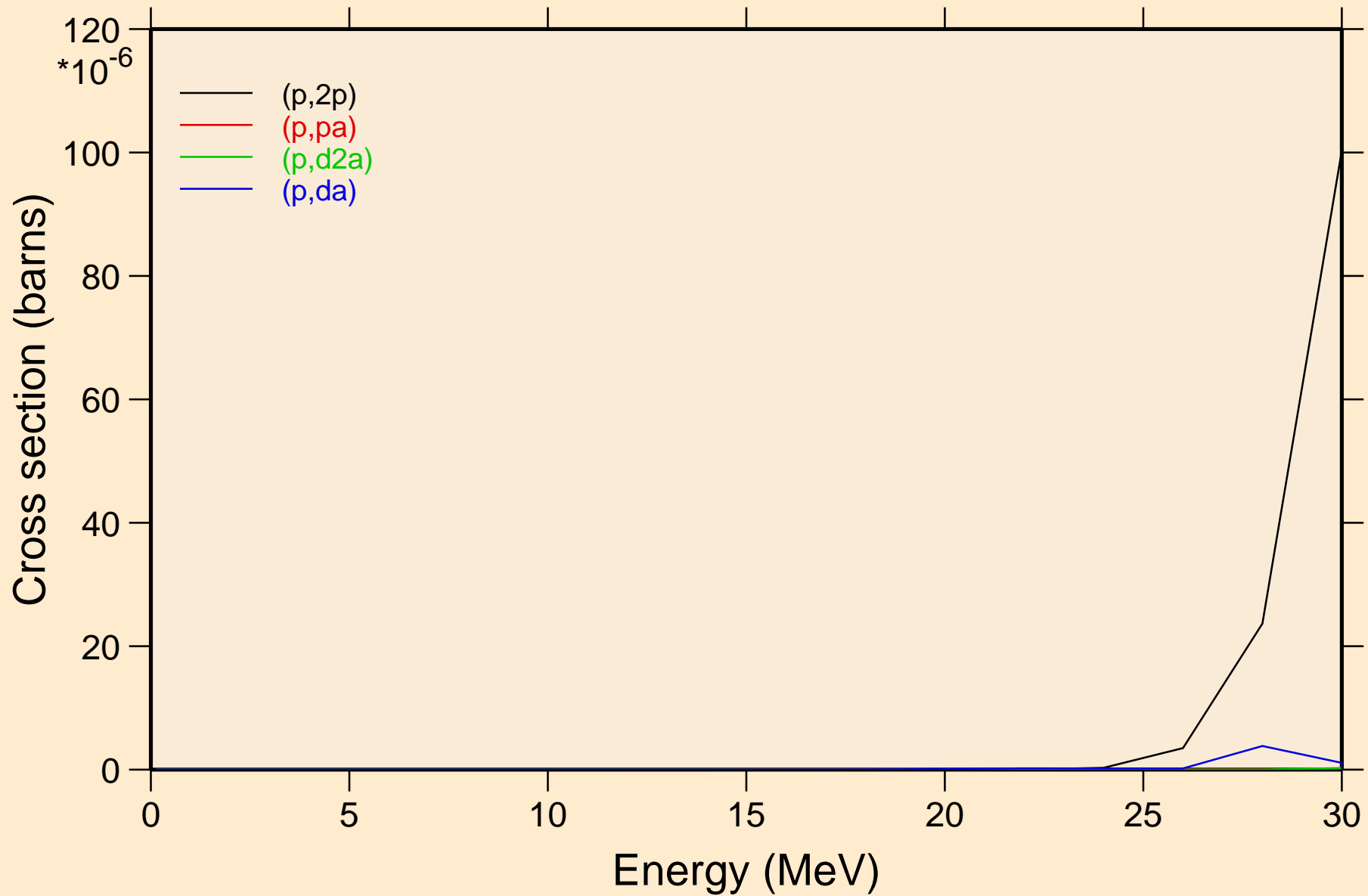

HS268 PROTON ACER TENDL-2021 LIBRARY; T=0.K
angular distribution for elastic

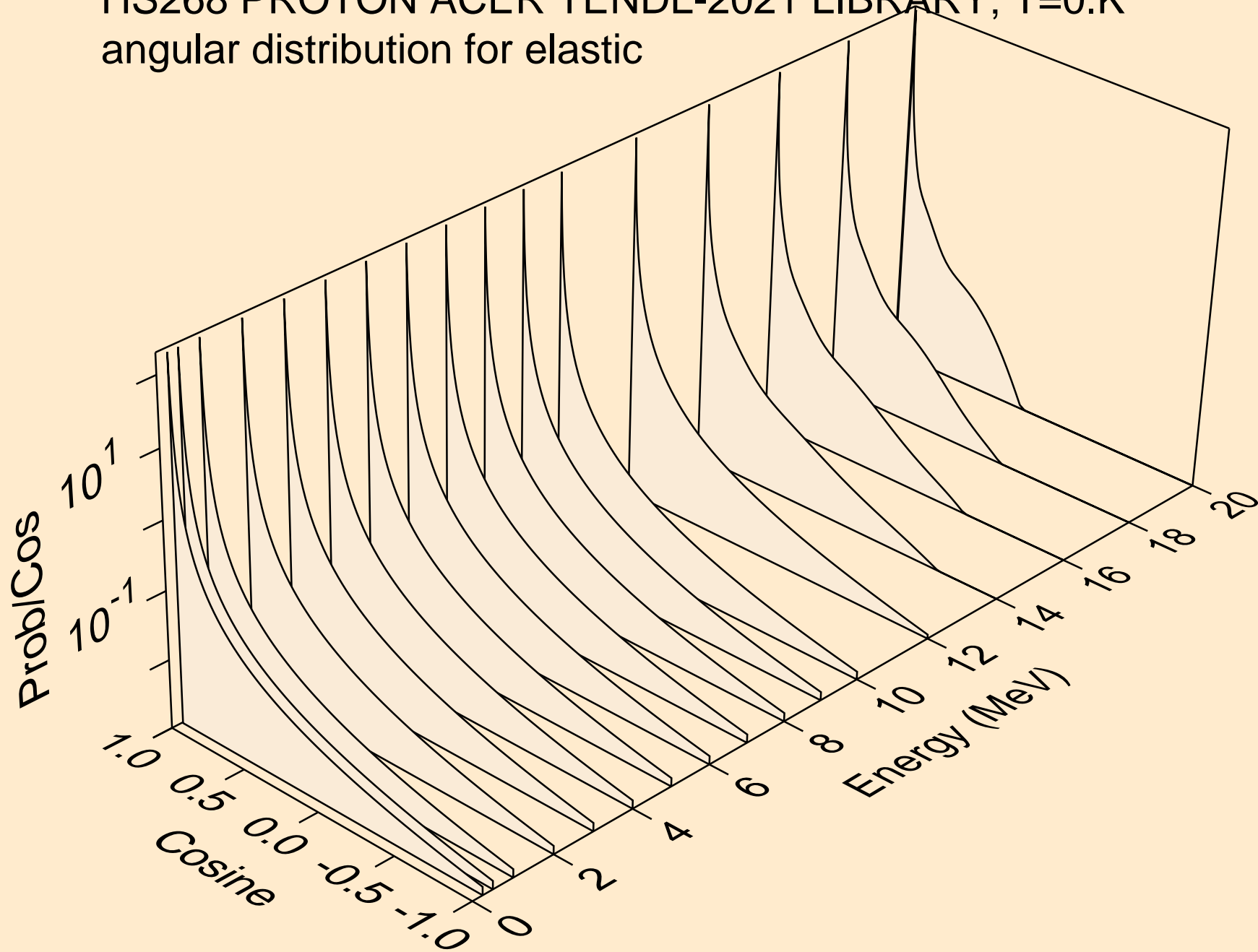

HS268 PROTON ACER TENDL-2021 LIBRARY; T=0.K
angular distribution for elastic

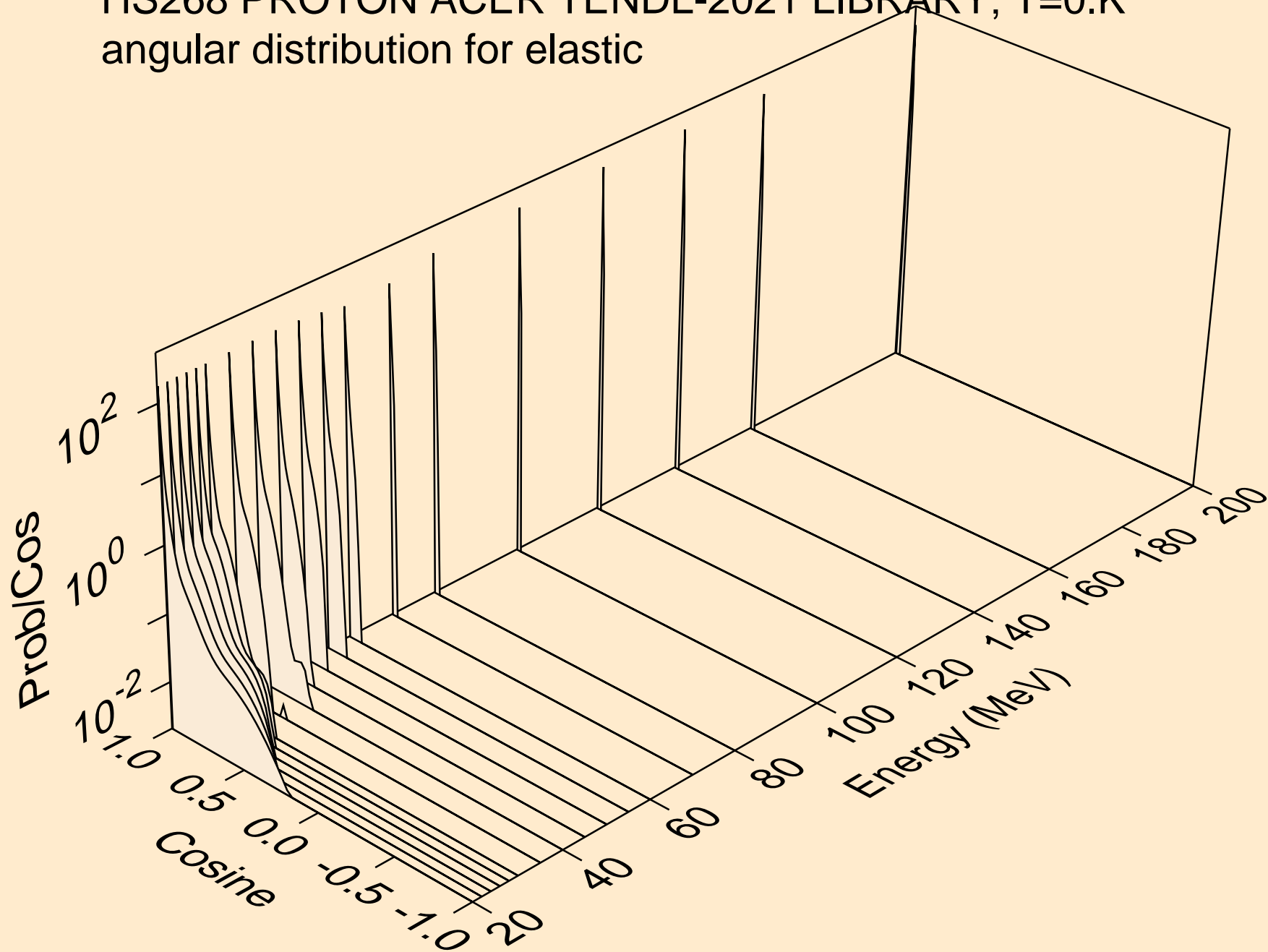

HS268 PROTON ACER TENDL-2021 LIBRARY; T=0.K
Proton emission for (p,x)

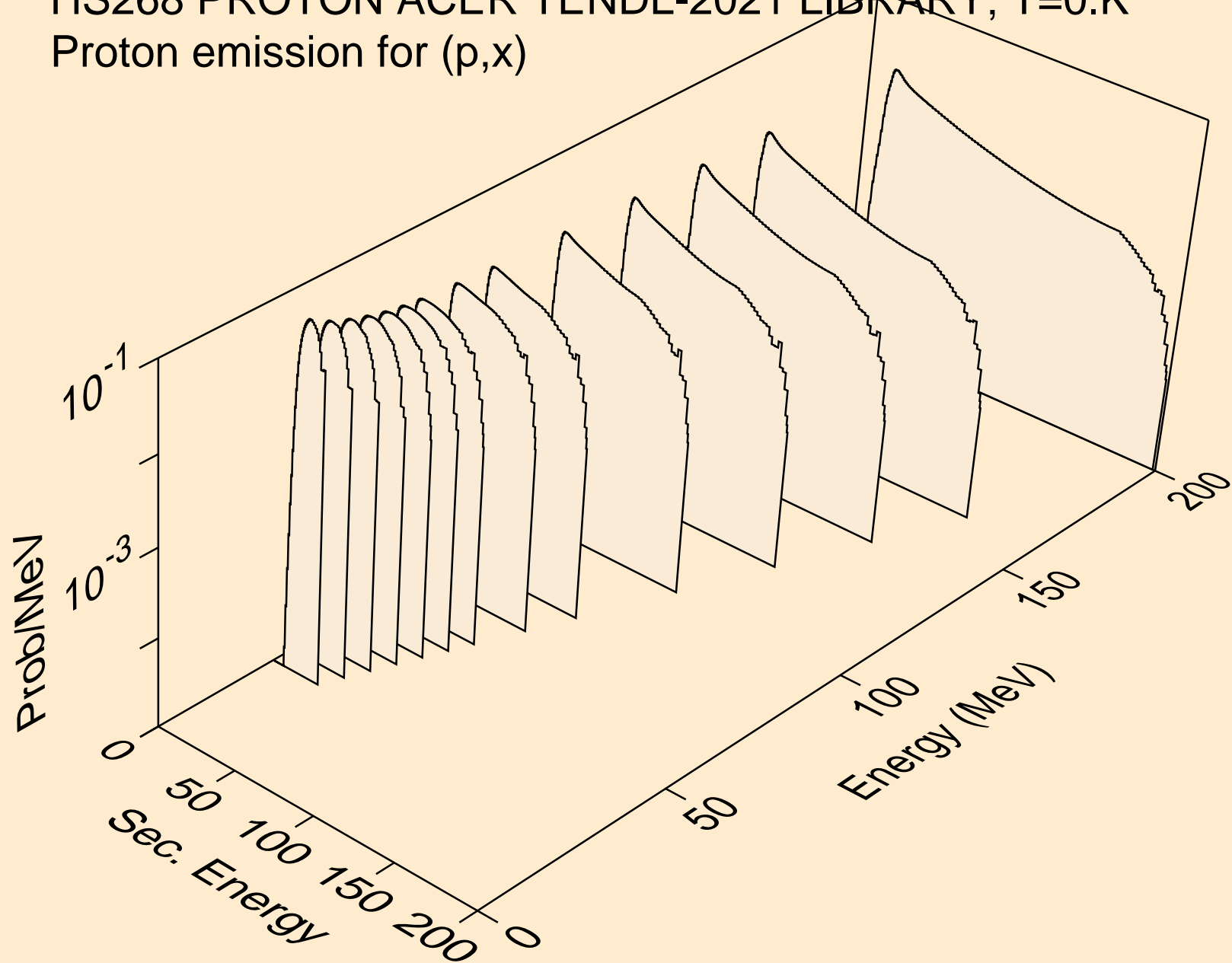

HS268 PROTON ACER TENDL-2021 LIBRARY; T=0.K
Proton emission for (p,n*)p

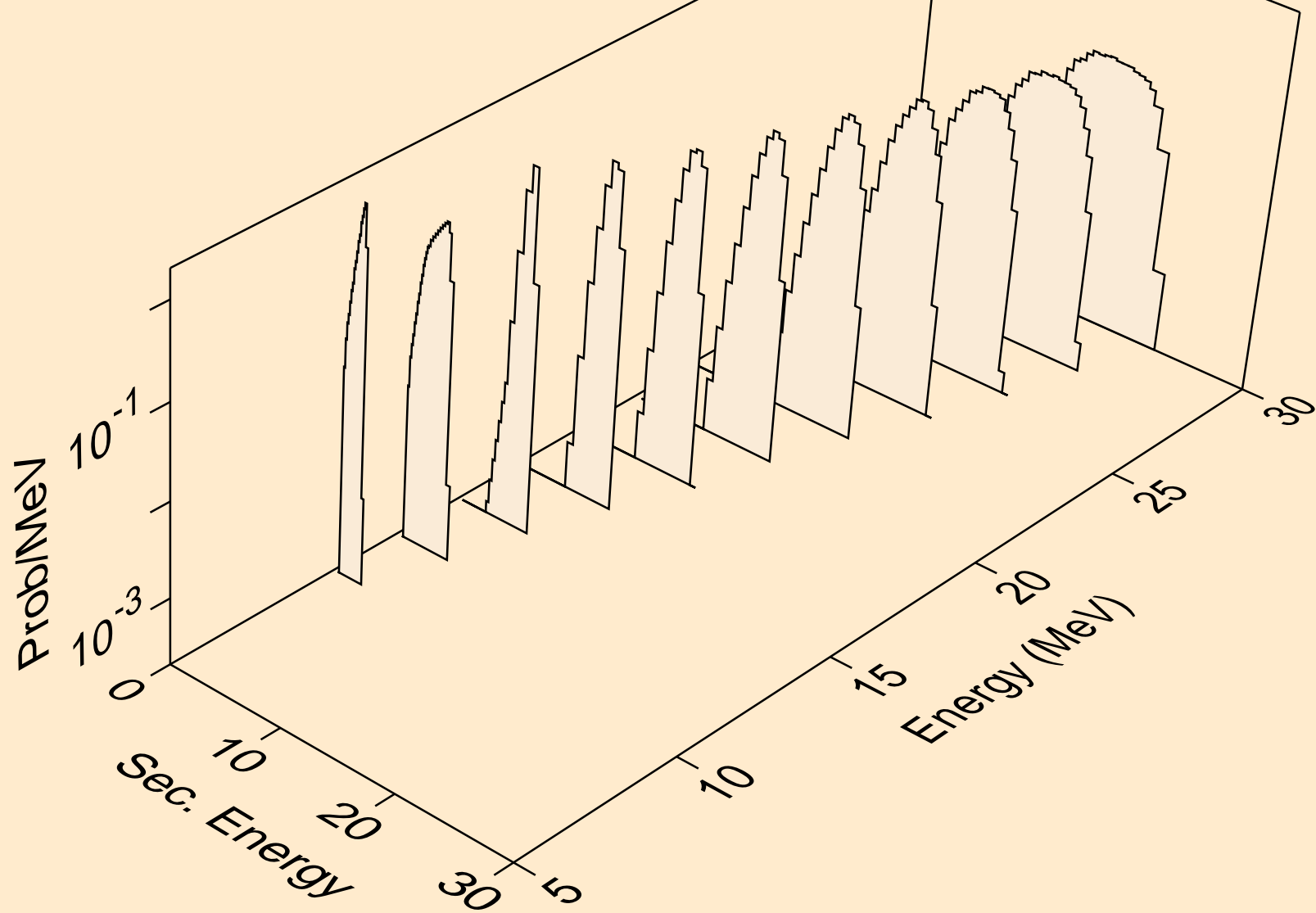

HS268 PROTON ACER TENDL-2021 LIBRARY; T=0.K
Proton emission for (p,2np)

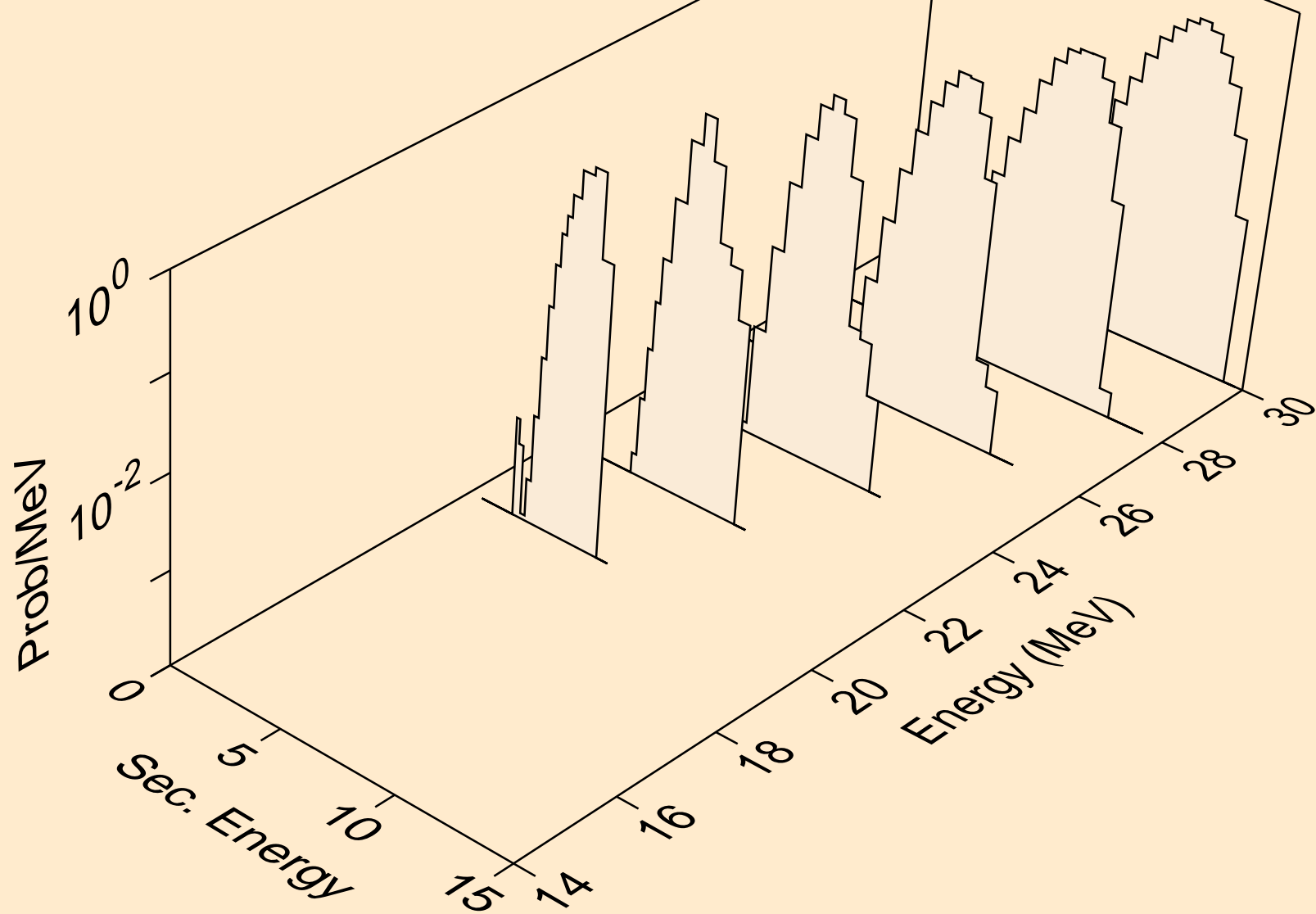

HS268 PROTON ACER TENDL-2021 LIBRARY; T=0.K
Proton emission for (p,npa)

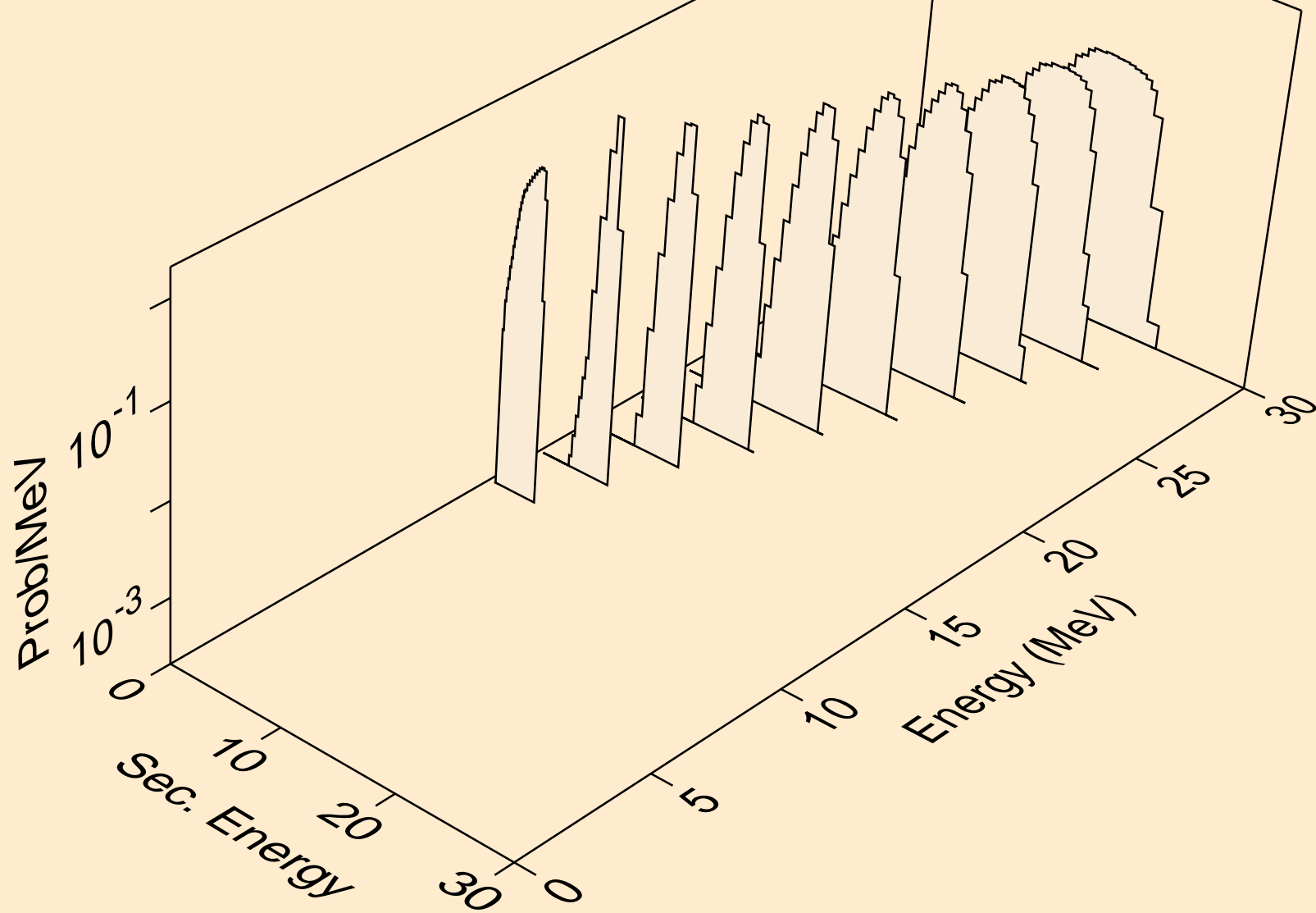

HS268 PROTON ACER TENDL-2021 LIBRARY; T=0.K
Proton emission for inelastic

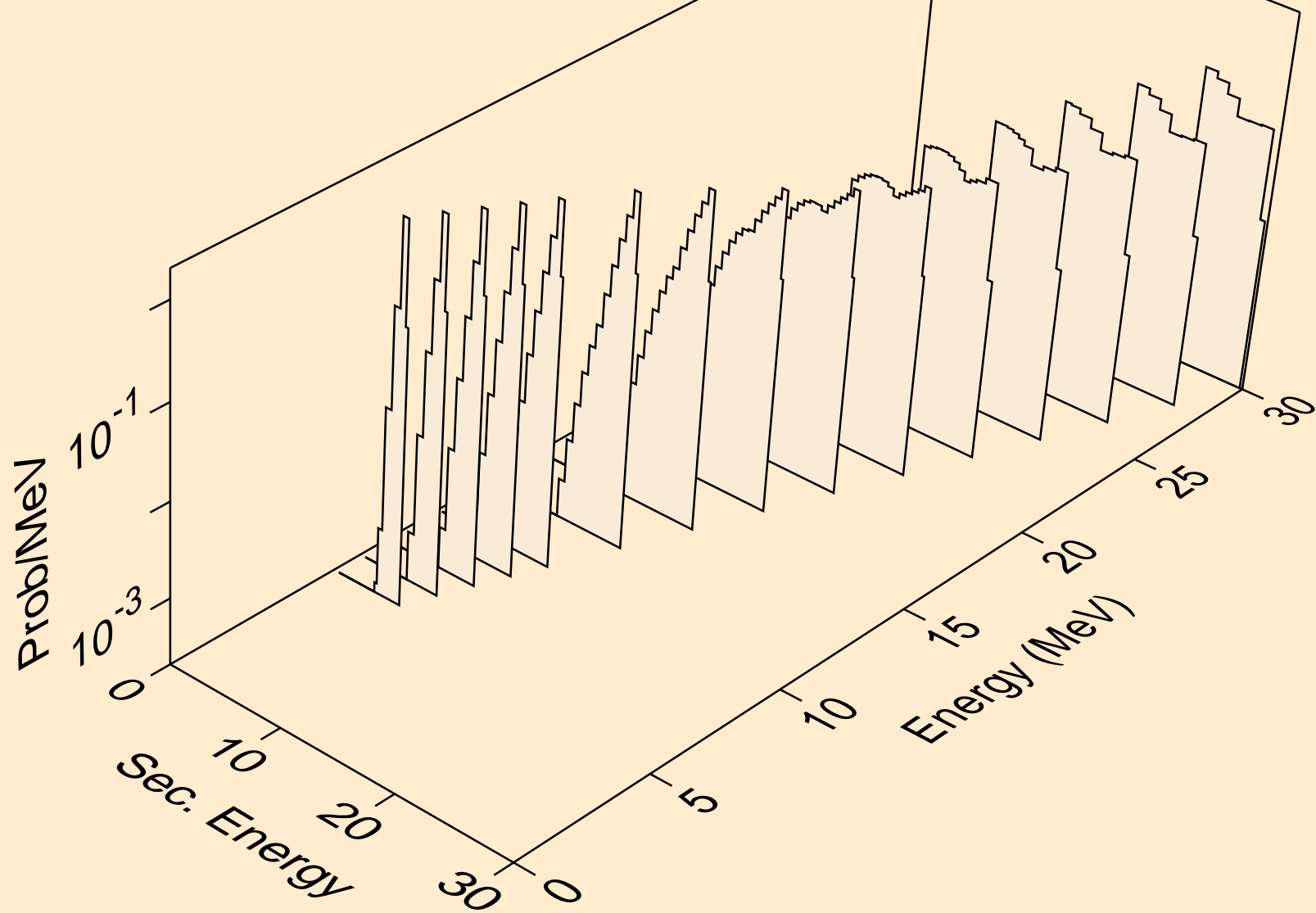

HS268 PROTON ACER TENDL-2021 LIBRARY; T=0.K
Proton emission for (p,2p)

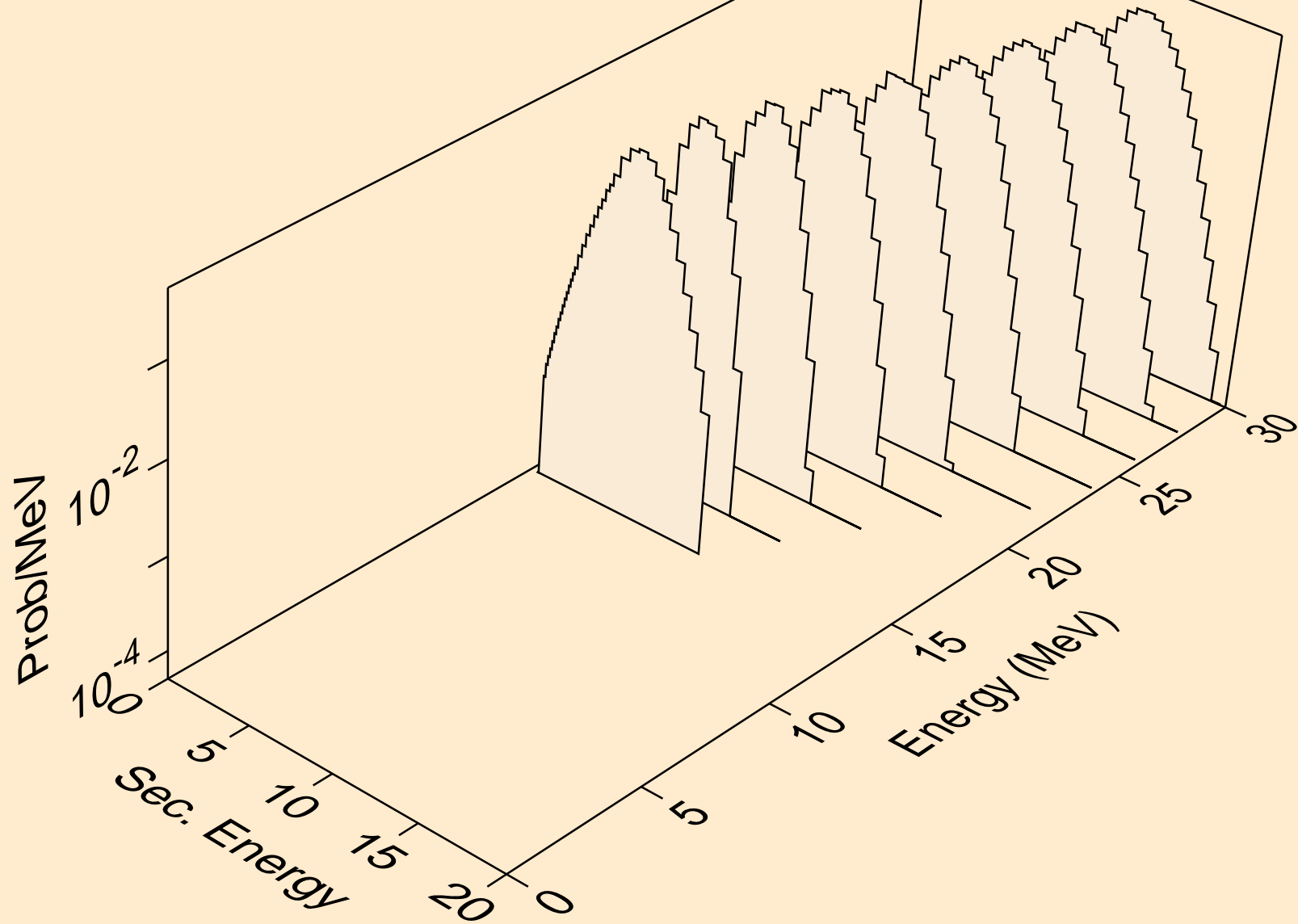

HS268 PROTON ACER TENDL-2021 LIBRARY; T=0.K
Proton emission for (p,pa)

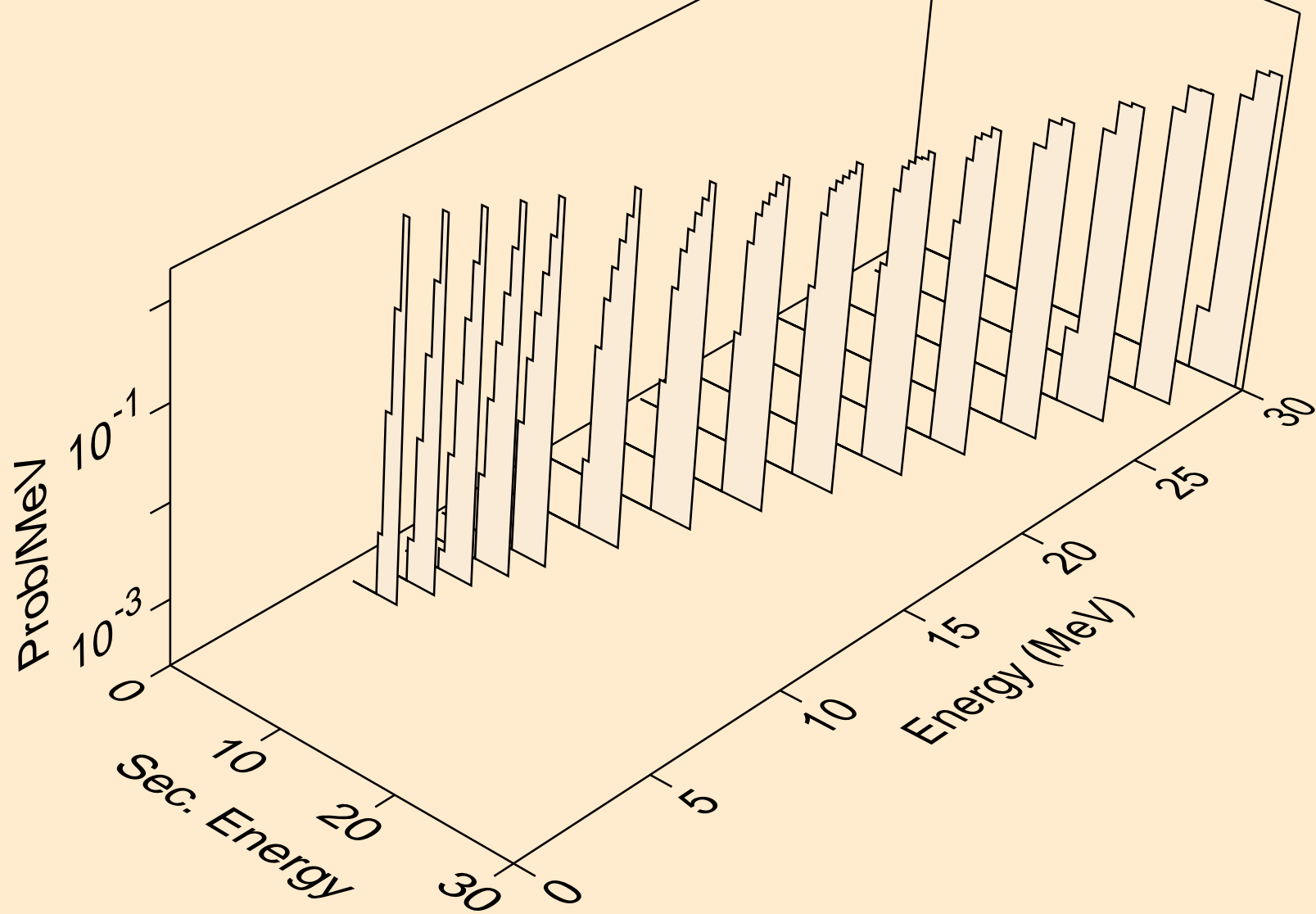

HS268 PROTON ACER TENDL-2021 LIBRARY; T=0.K
Photon emission for (z,n)

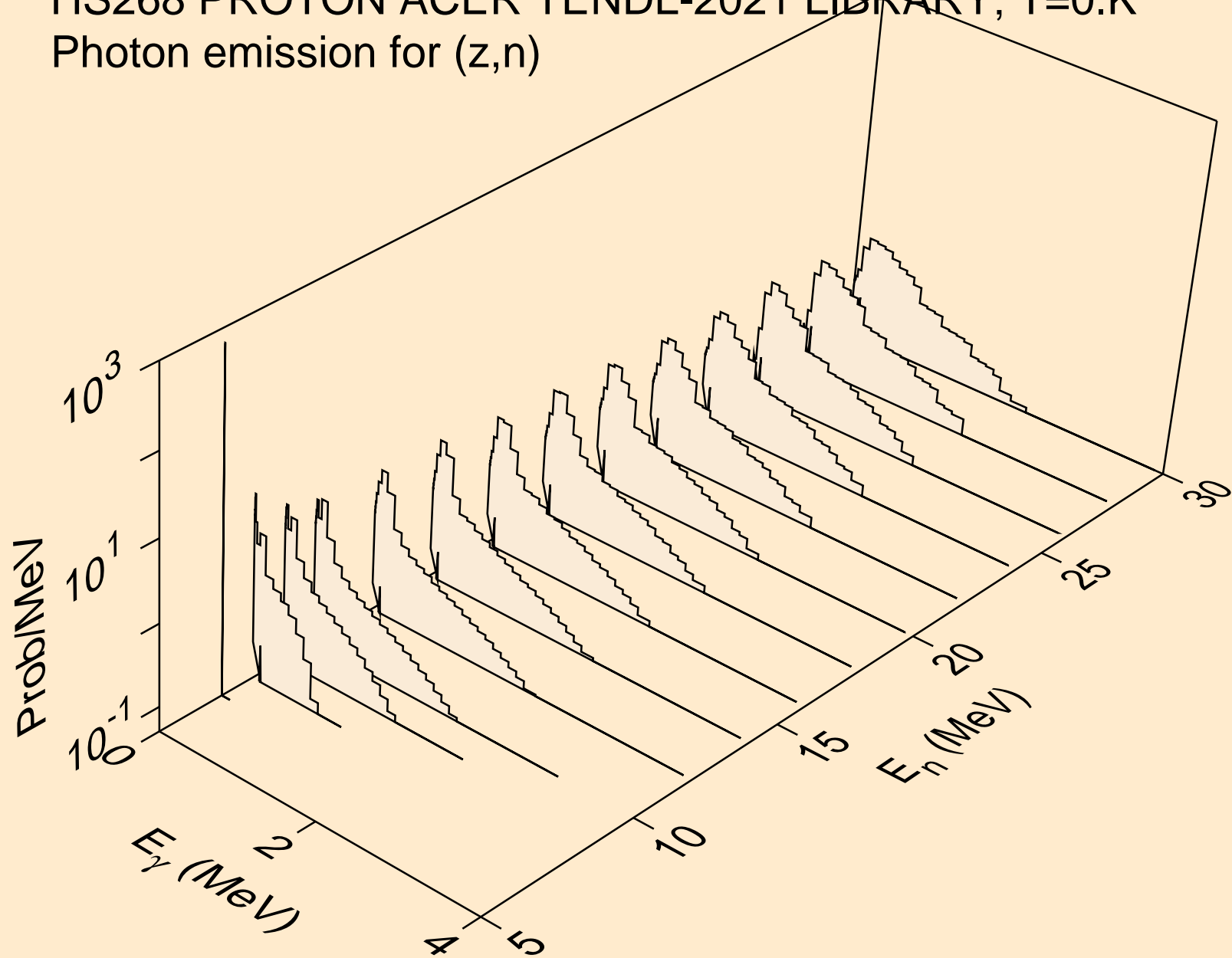

HS268 PROTON ACER TENDL-2021 LIBRARY; T=0.K
Photon emission for (n,x)

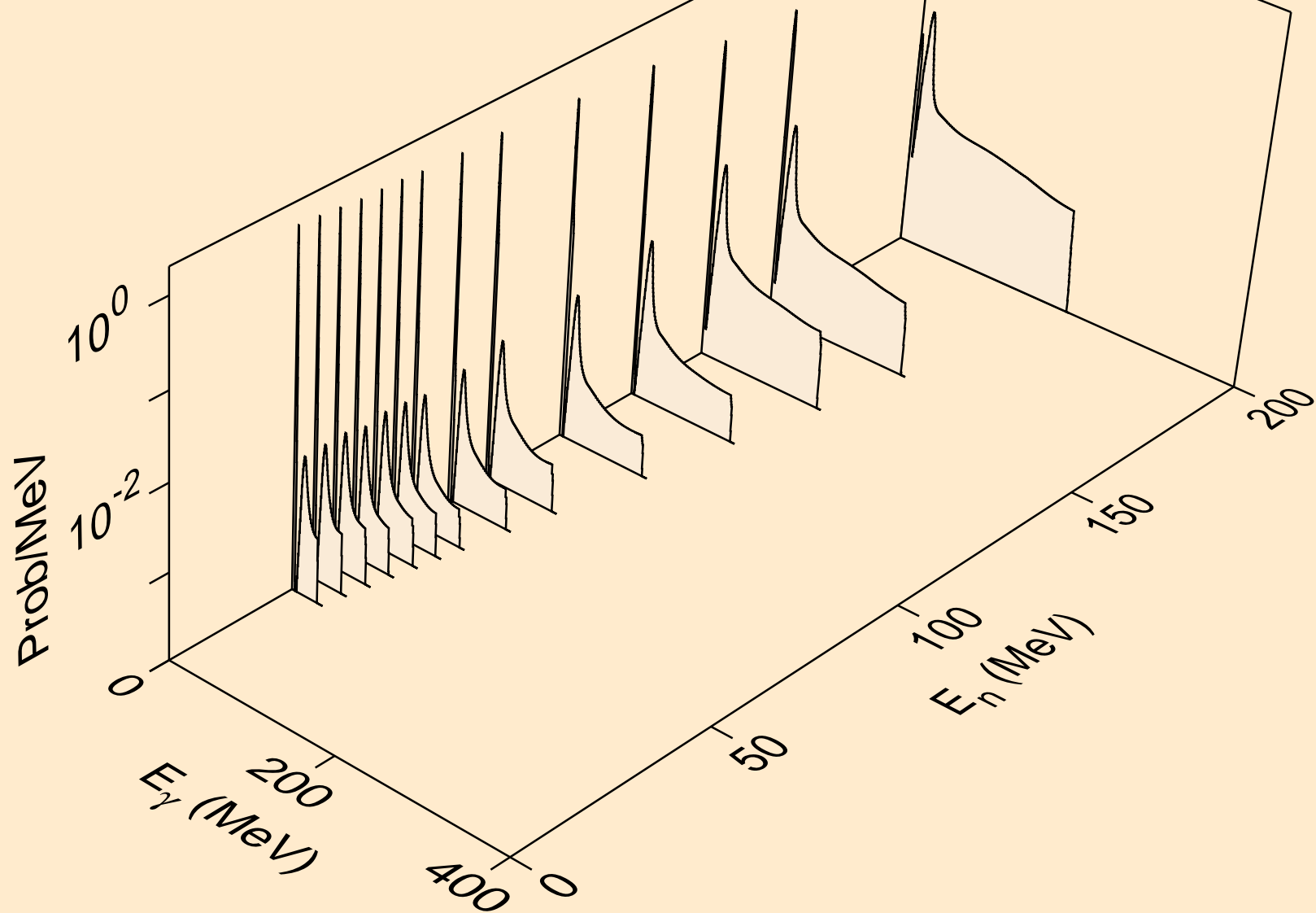

HS268 PROTON ACER TENDL-2021 LIBRARY; T=0.K
Photon emission for (n,2n)

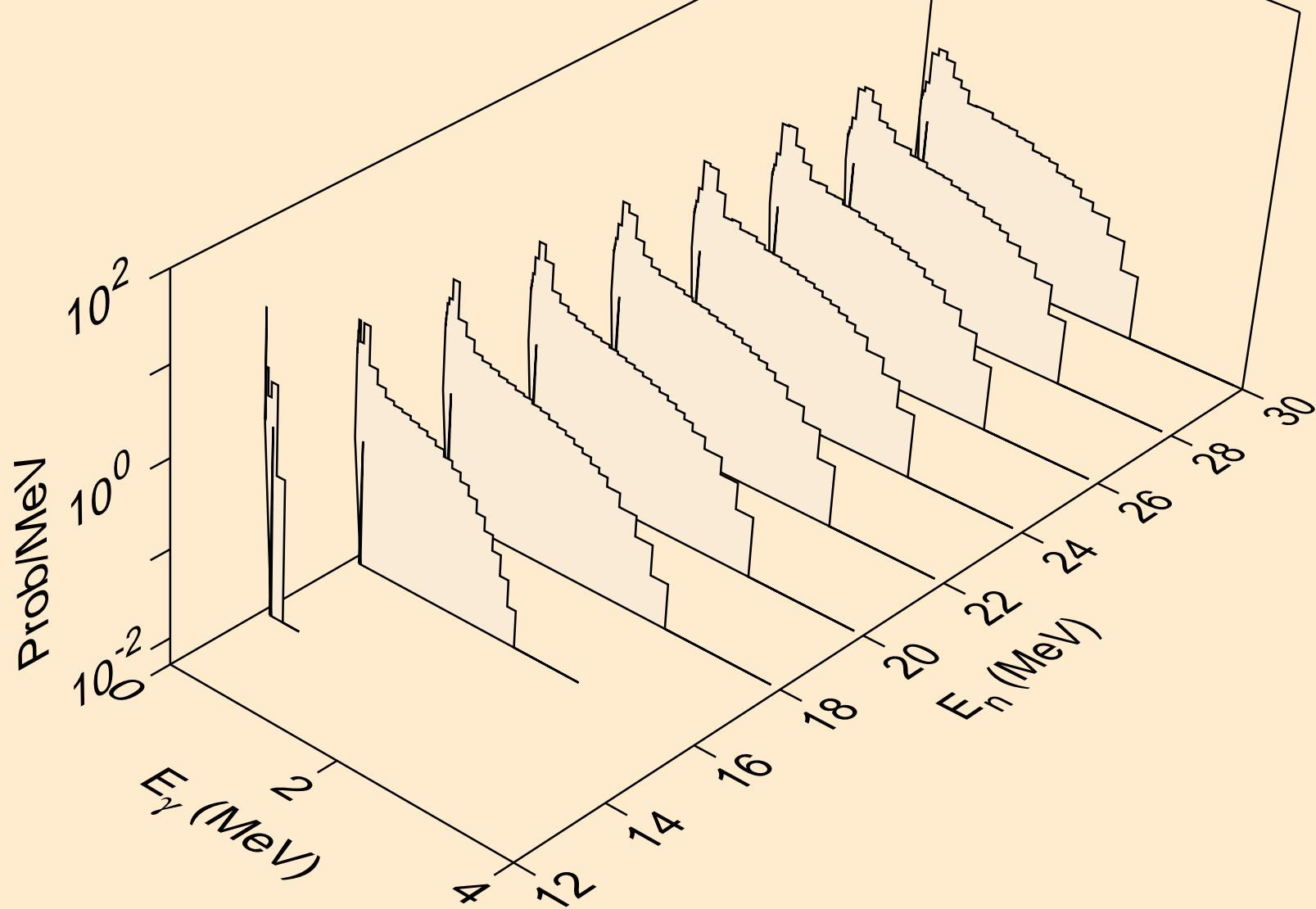

HS268 PROTON ACER TENDL-2021 LIBRARY; T=0.K
Photon emission for (n,3n)

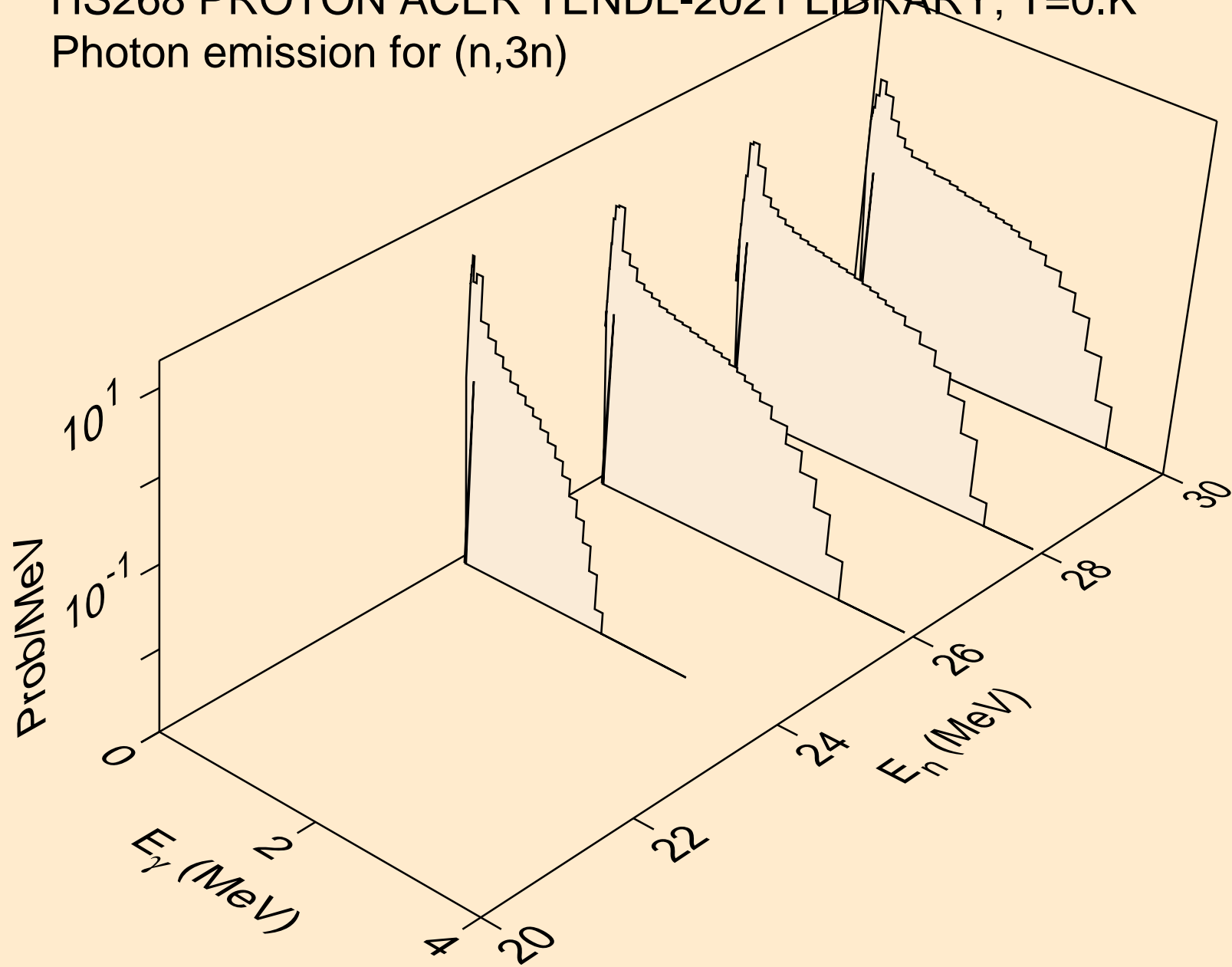

HS268 PROTON ACER TENDL-2021 LIBRARY; T=0.K
Photon emission for (n,n*)a

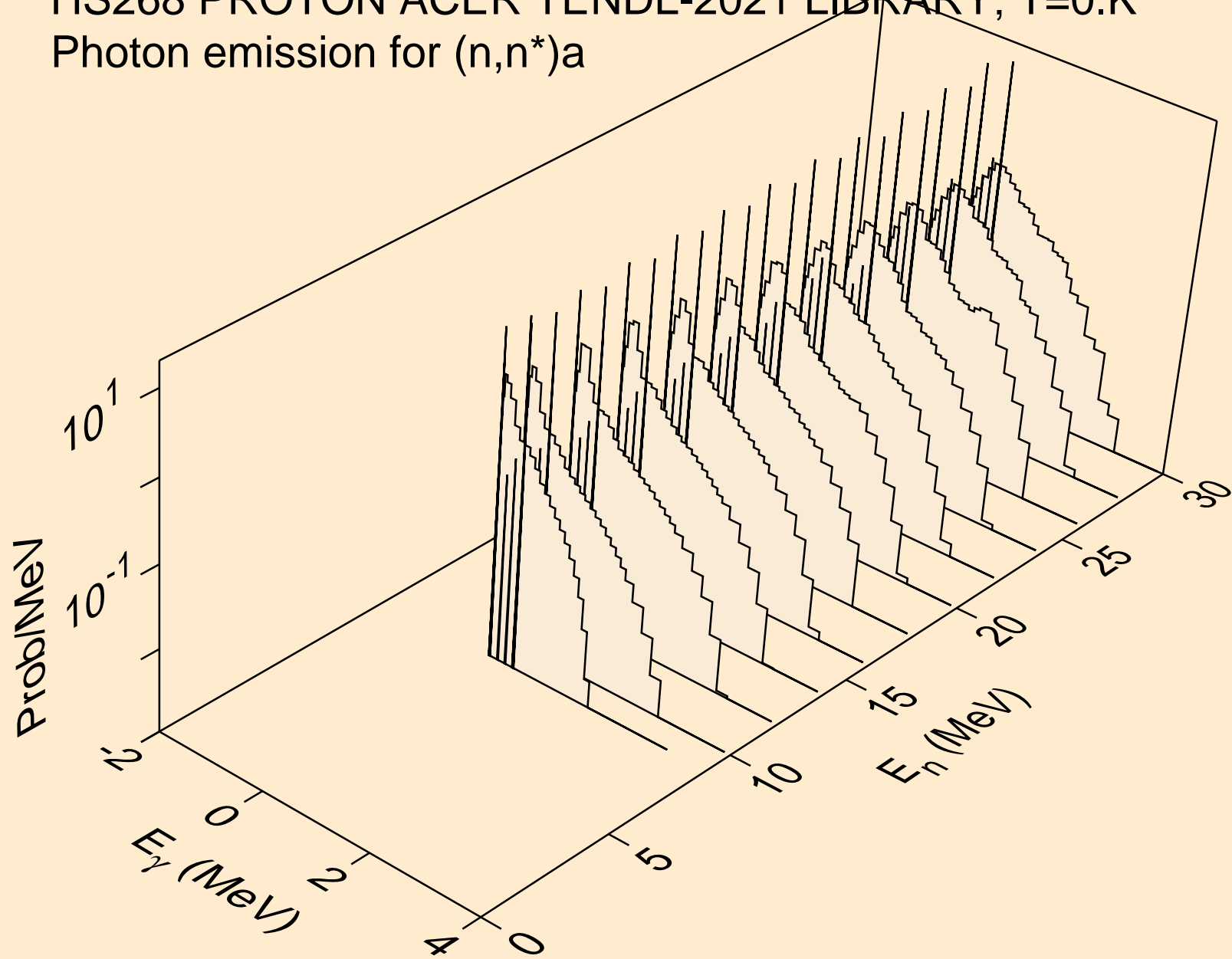

HS268 PROTON ACER TENDL-2021 LIBRARY; T=0.K
Photon emission for (n,n*)3a

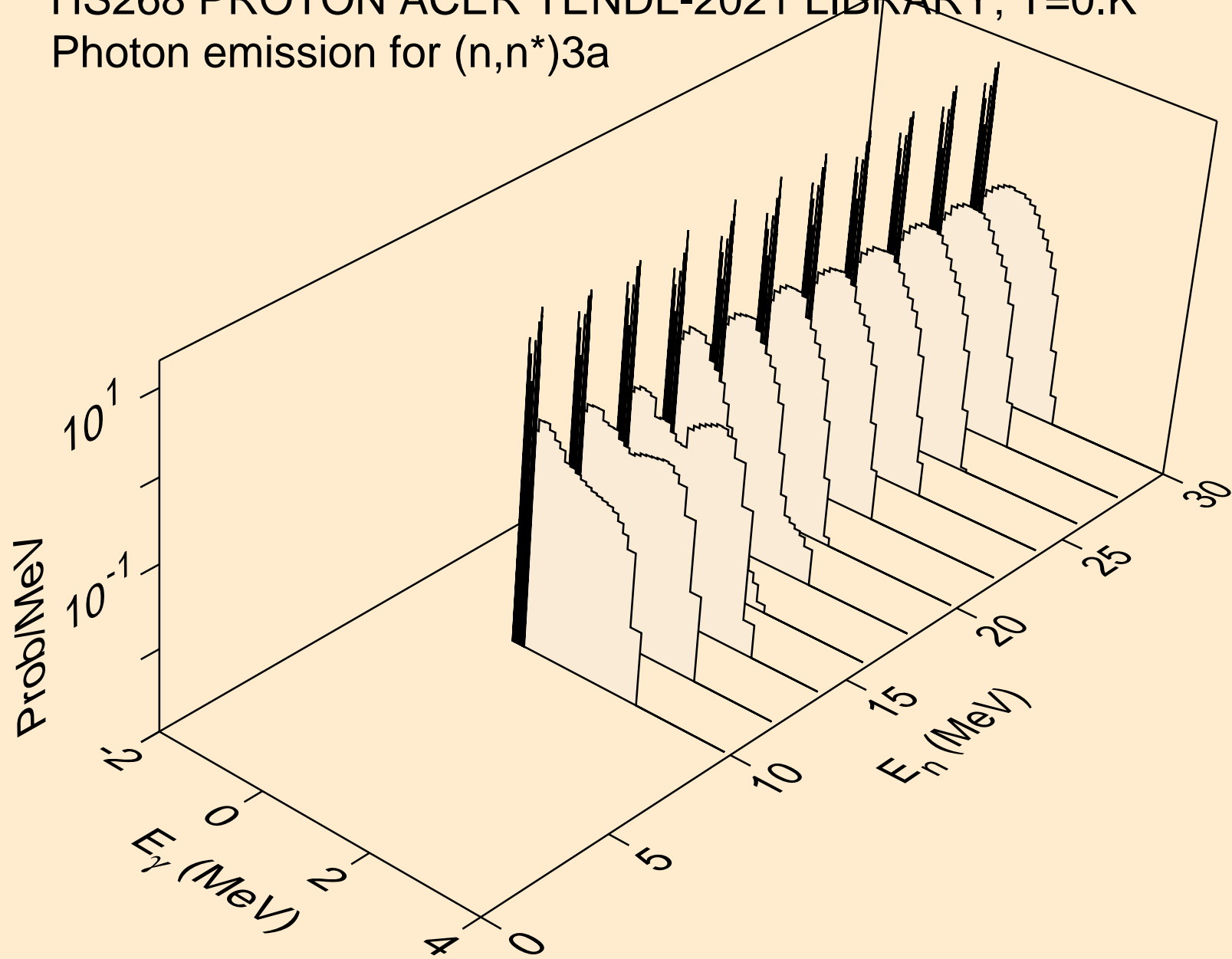

HS268 PROTON ACER TENDL-2021 LIBRARY; T=0.K
Photon emission for (n,2n)a

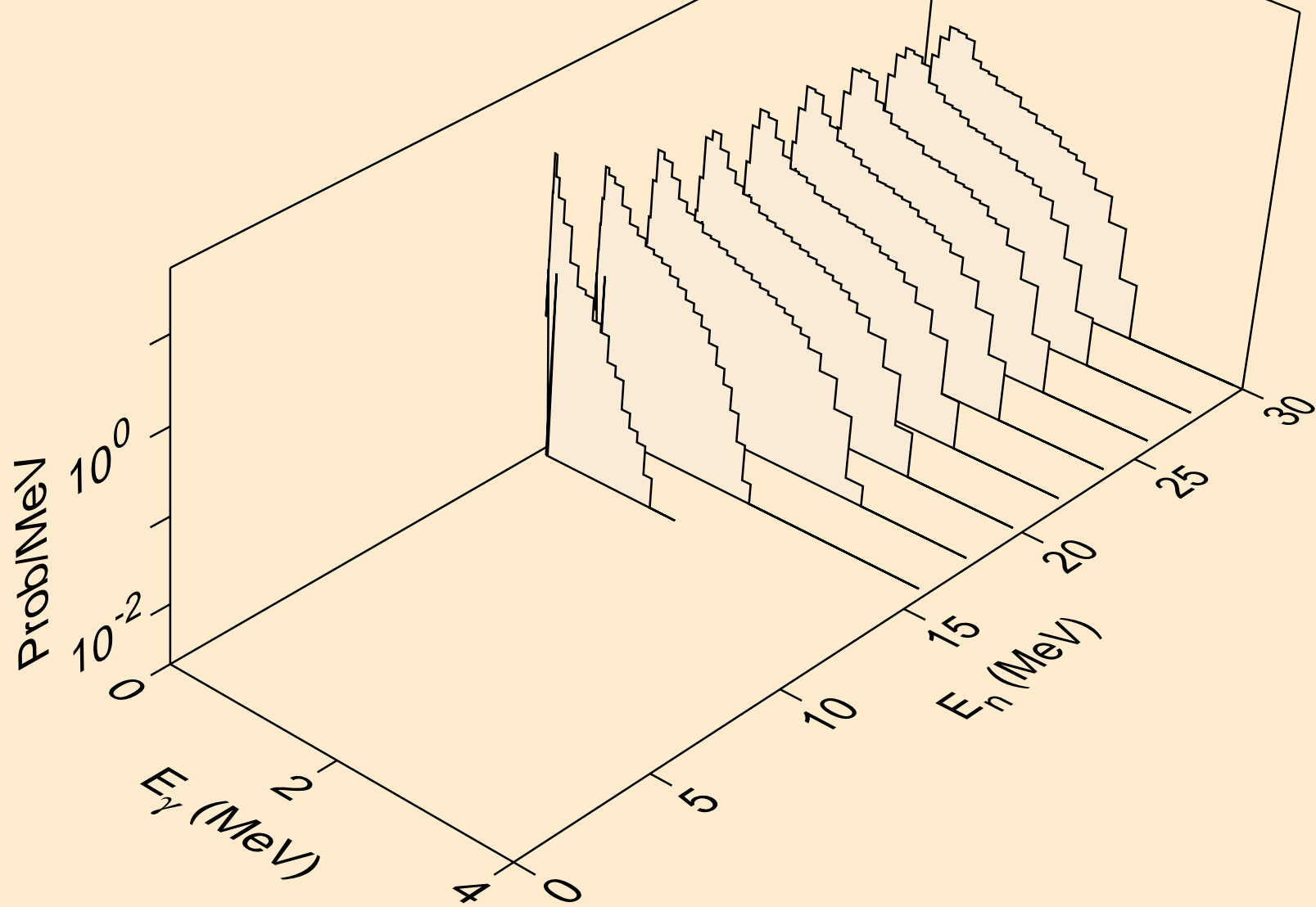

HS268 PROTON ACER TENDL-2021 LIBRARY; T=0.K
Photon emission for (n,3n)a

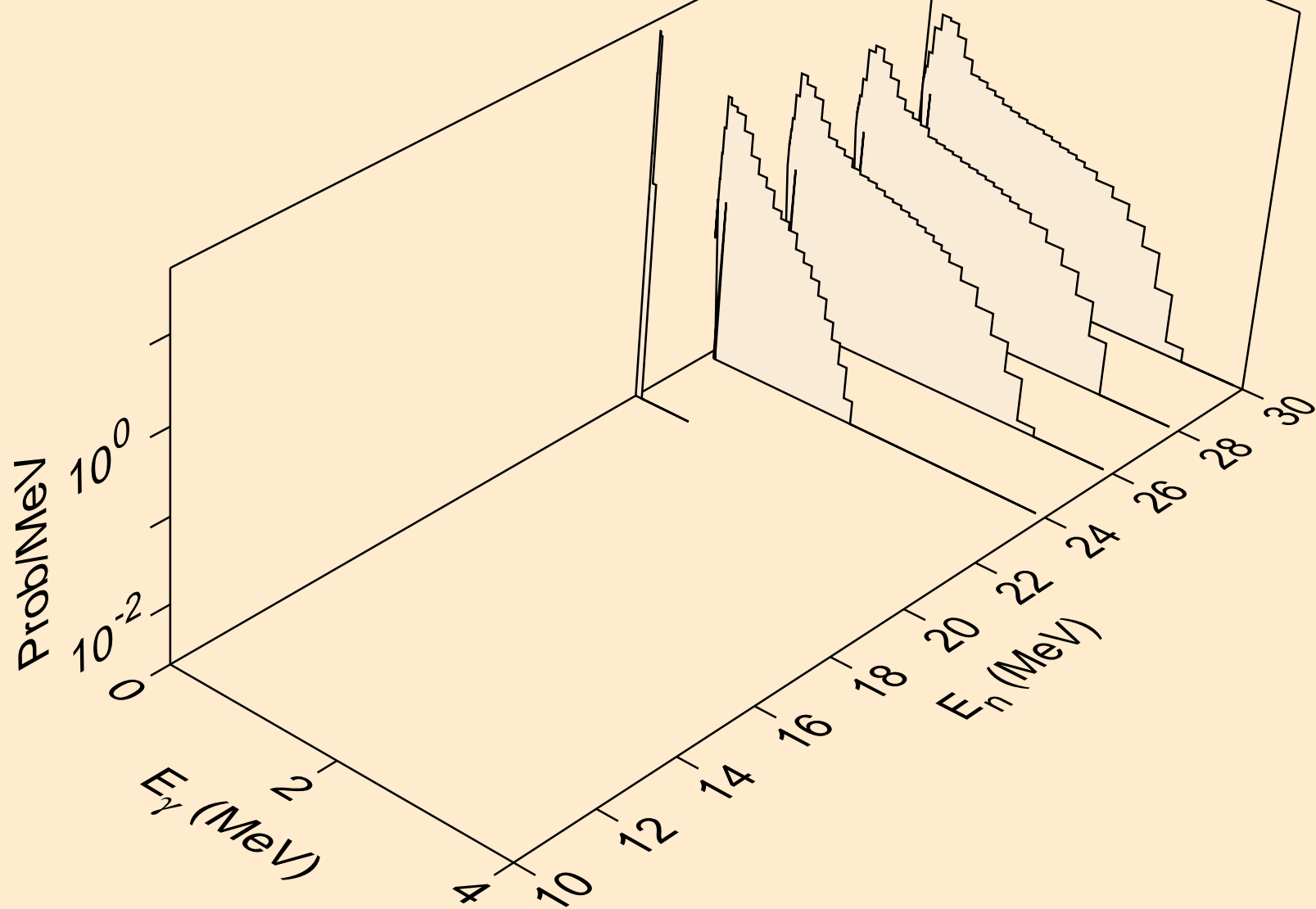

HS268 PROTON ACER TENDL-2021 LIBRARY; T=0.K
Photon emission for (n,n*)p

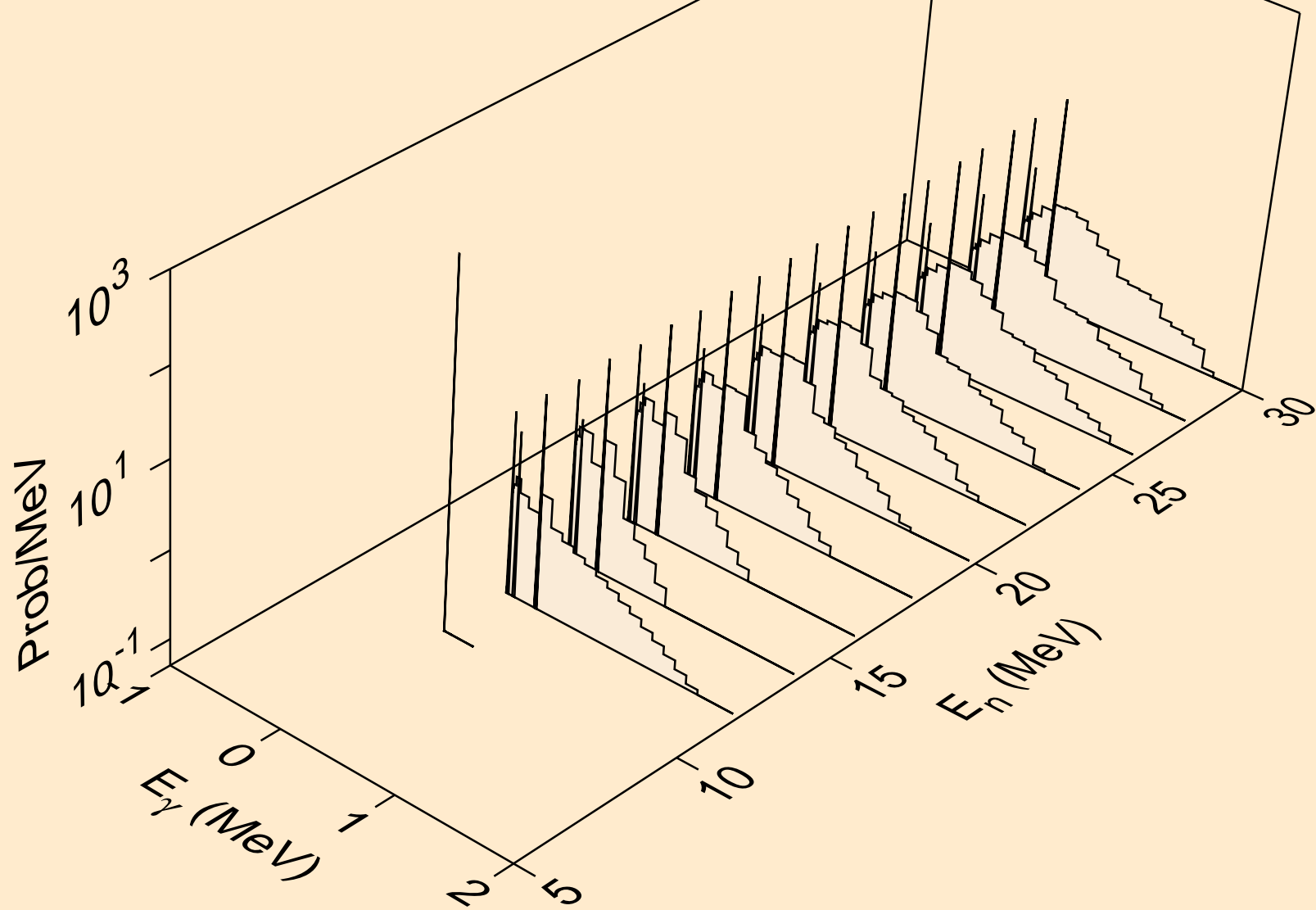

HS268 PROTON ACER TENDL-2021 LIBRARY; T=0.K
Photon emission for (n,n*)2a

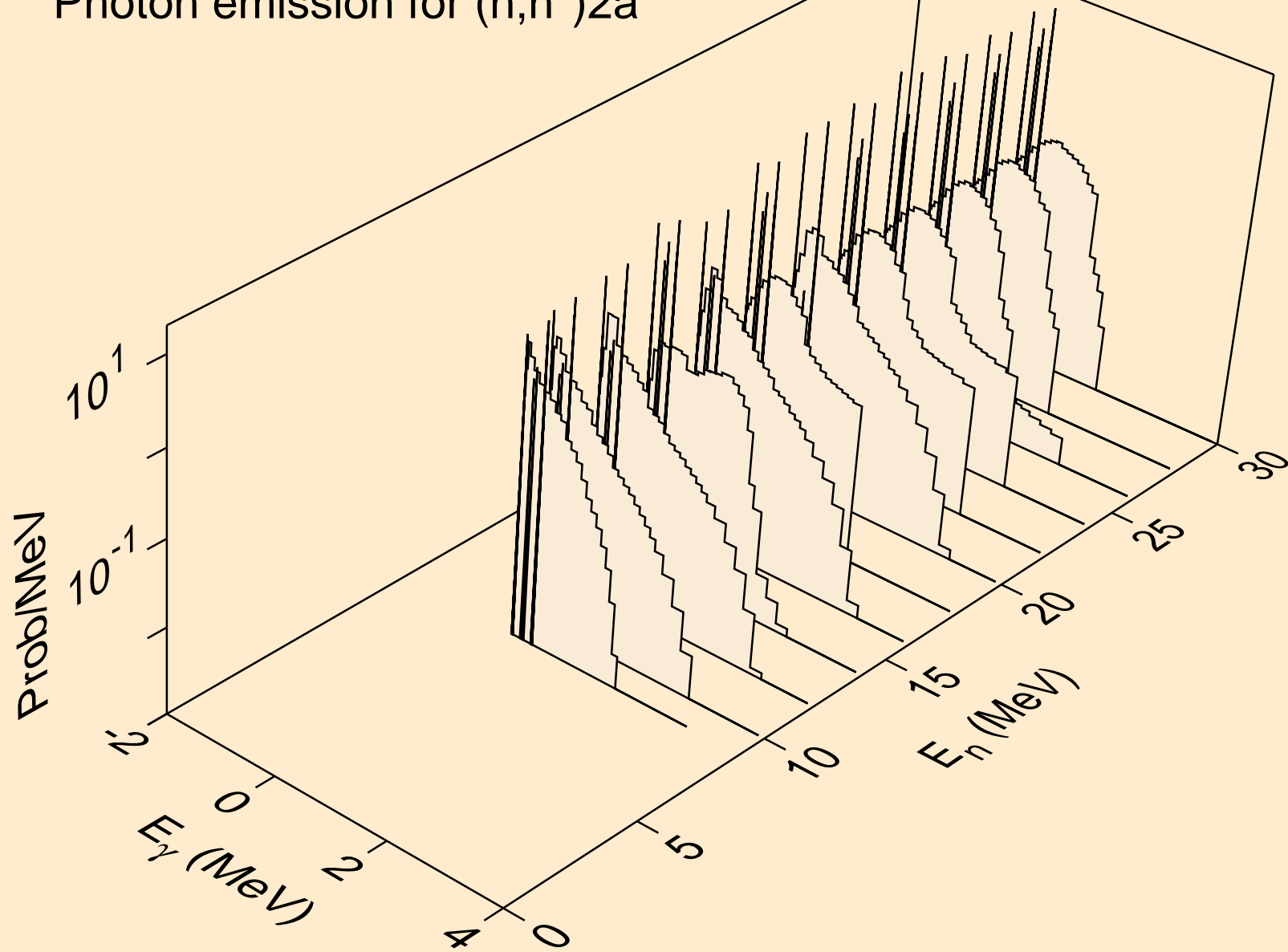

HS268 PROTON ACER TENDL-2021 LIBRARY; T=0.K
Photon emission for (n,n*)d

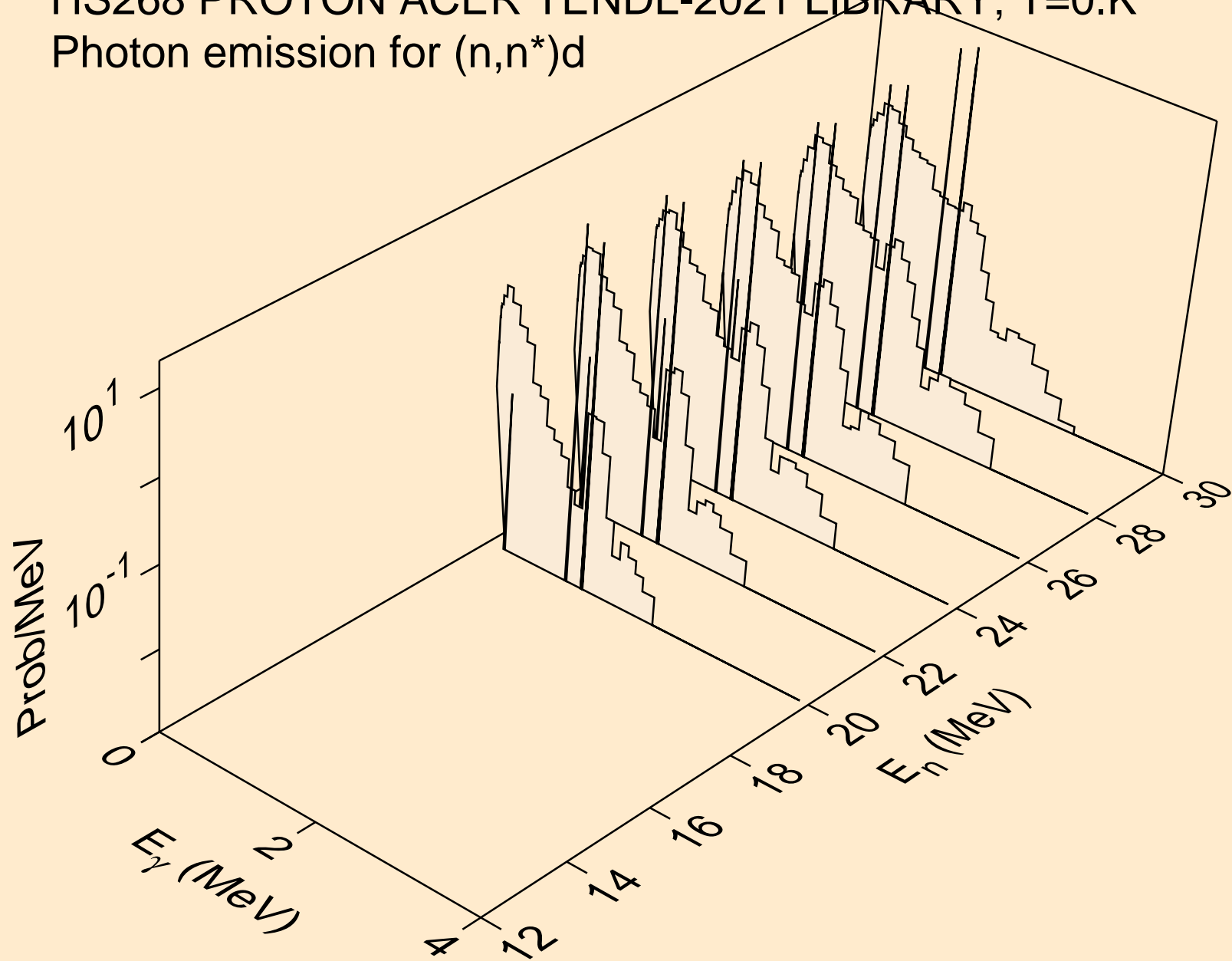

HS268 PROTON ACER TENDL-2021 LIBRARY; T=0.K
Photon emission for (n,n*)t

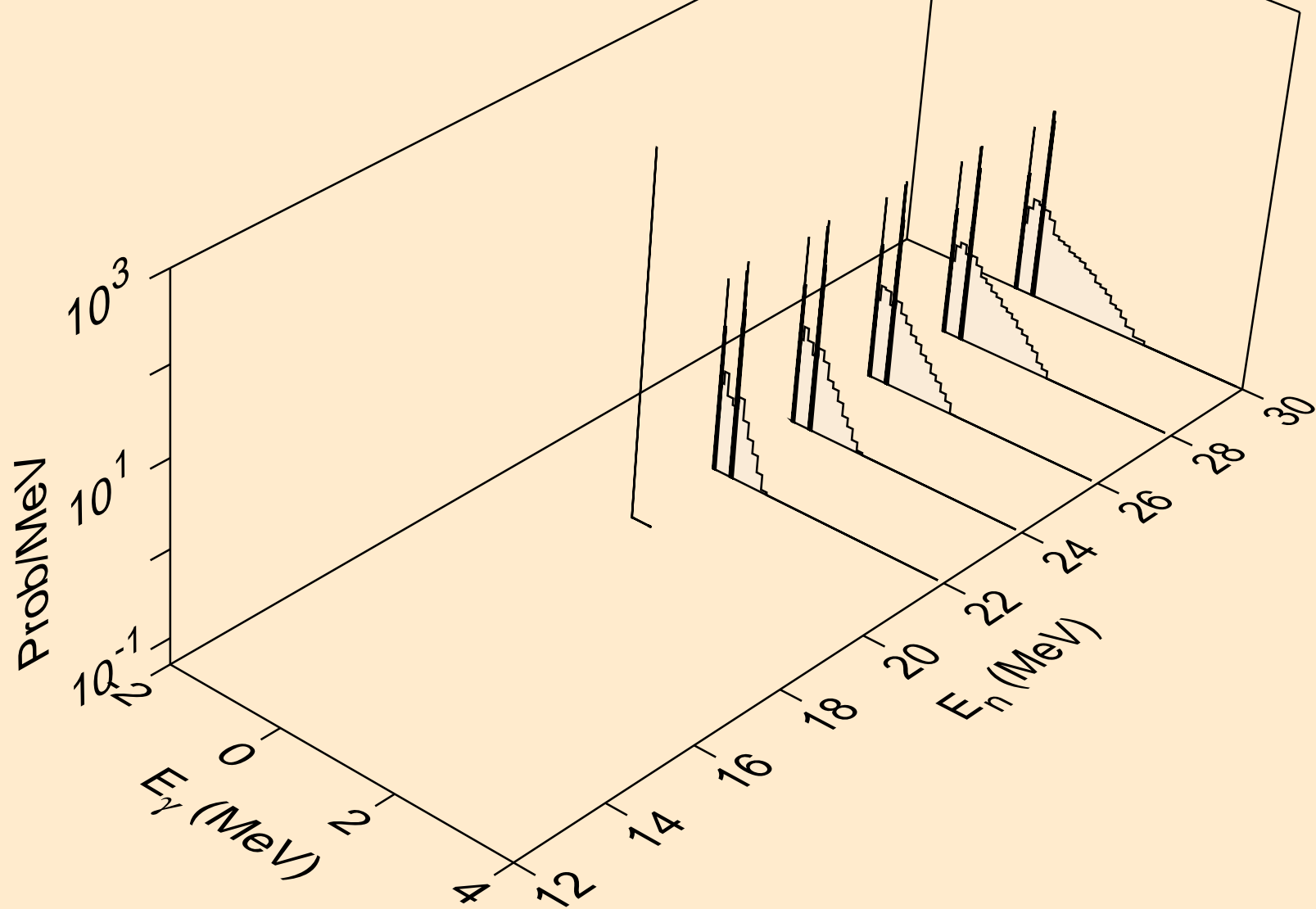

HS268 PROTON ACER TENDL-2021 LIBRARY; T=0.K
Photon emission for (n,2np)

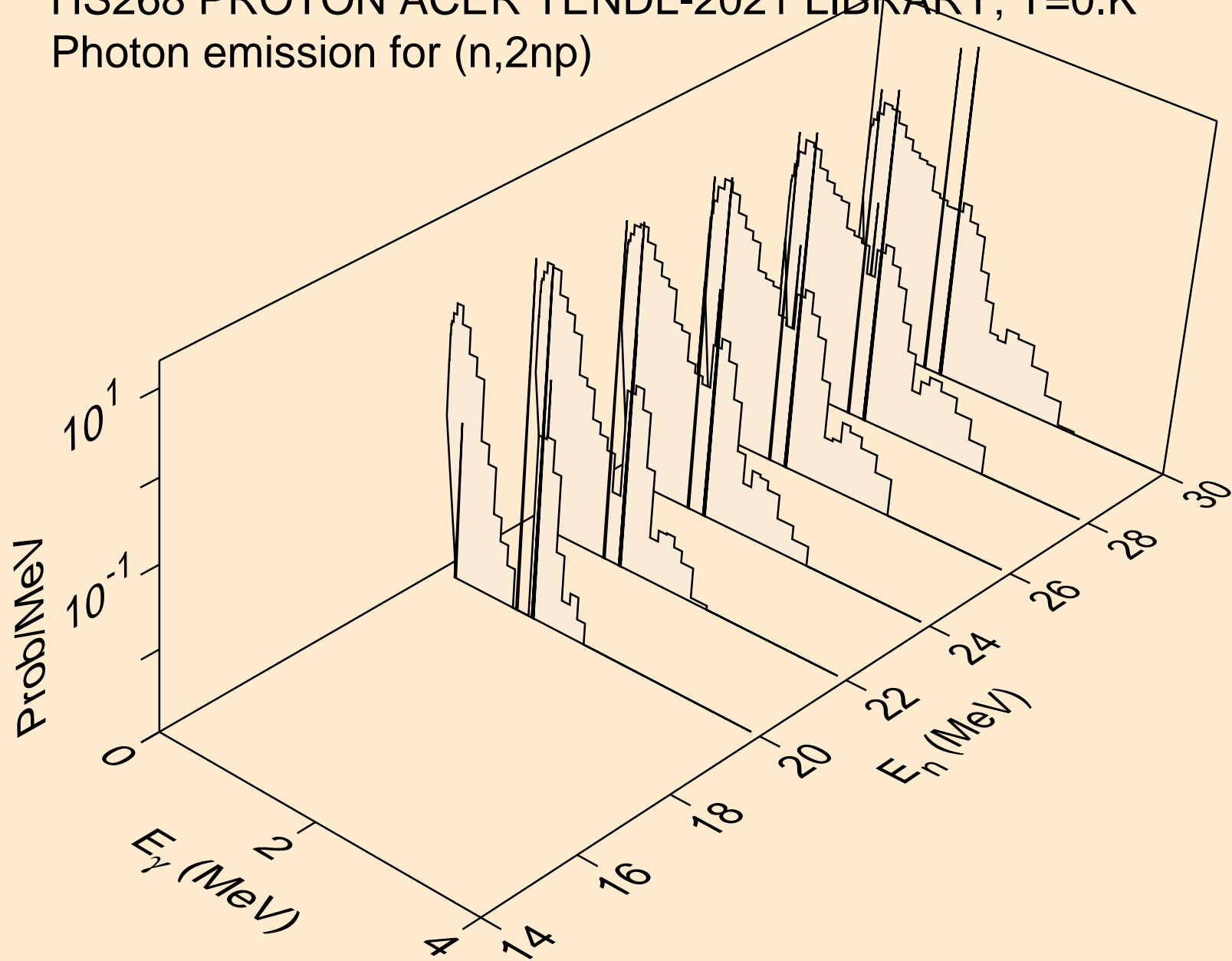

HS268 PROTON ACER TENDL-2021 LIBRARY; T=0.K
Photon emission for (n,npa)

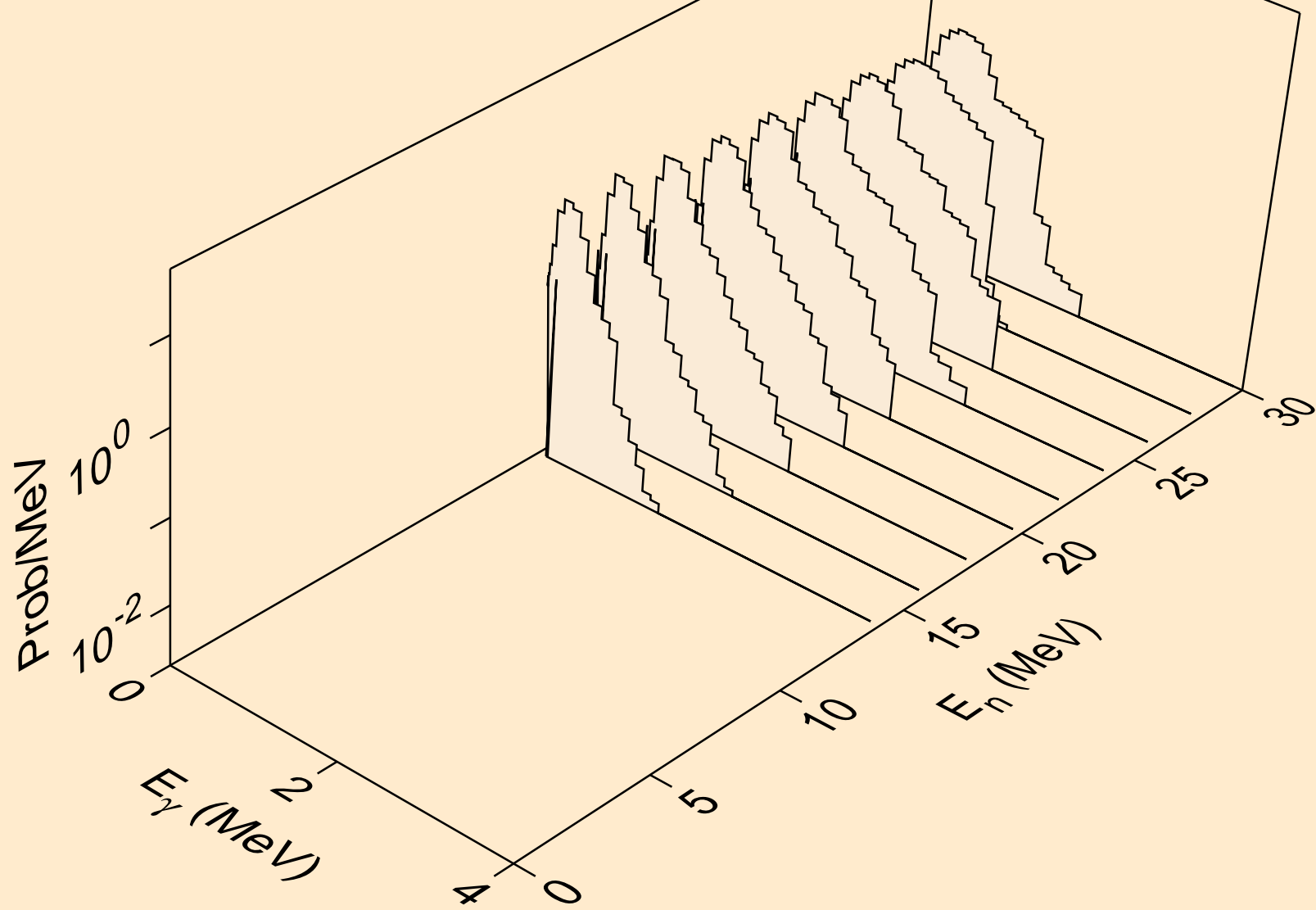

HS268 PROTON ACER TENDL-2021 LIBRARY; T=0.K
Photon emission for (n,gma)

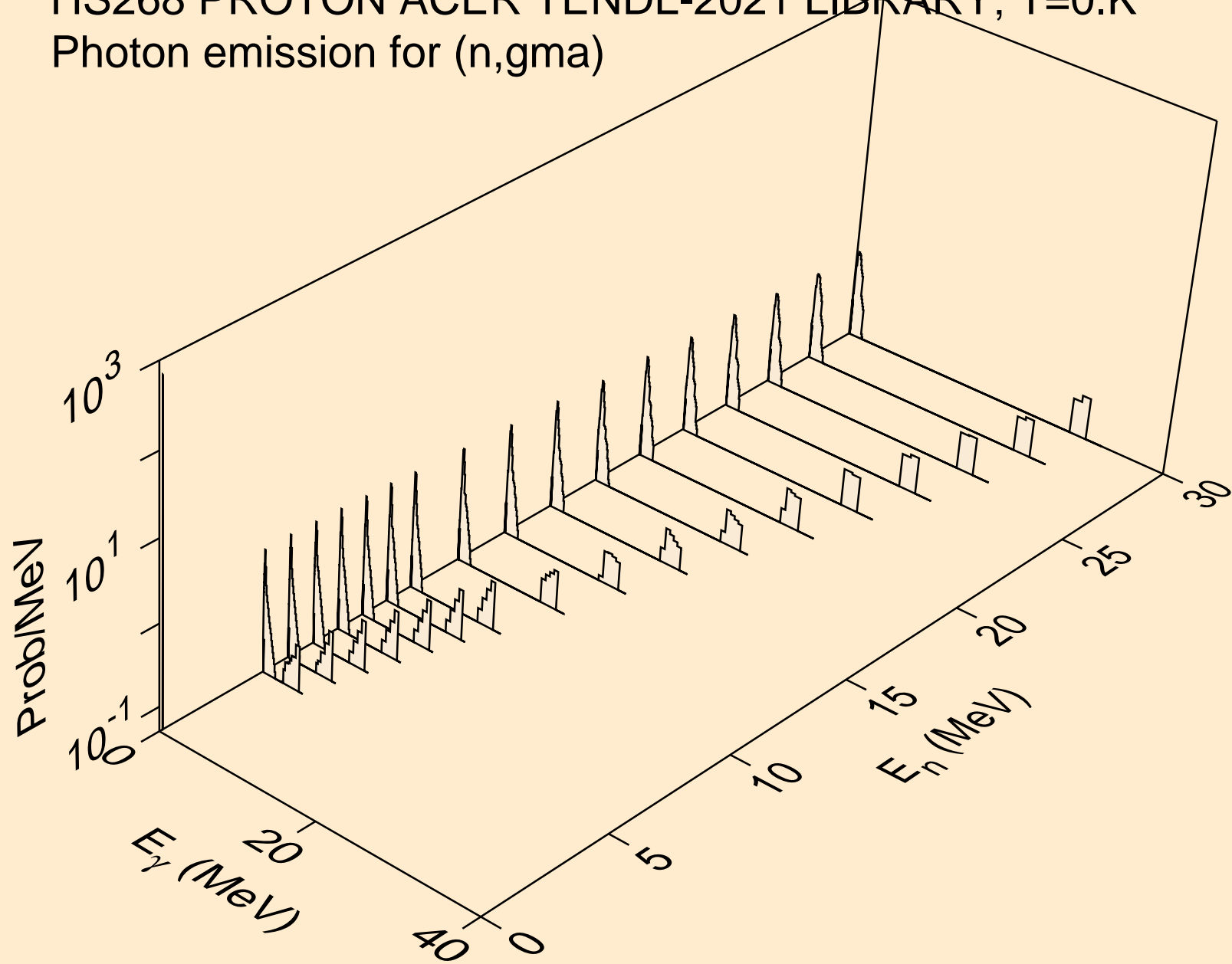

HS268 PROTON ACER TENDL-2021 LIBRARY; T=0.K
Photon emission for inelastic

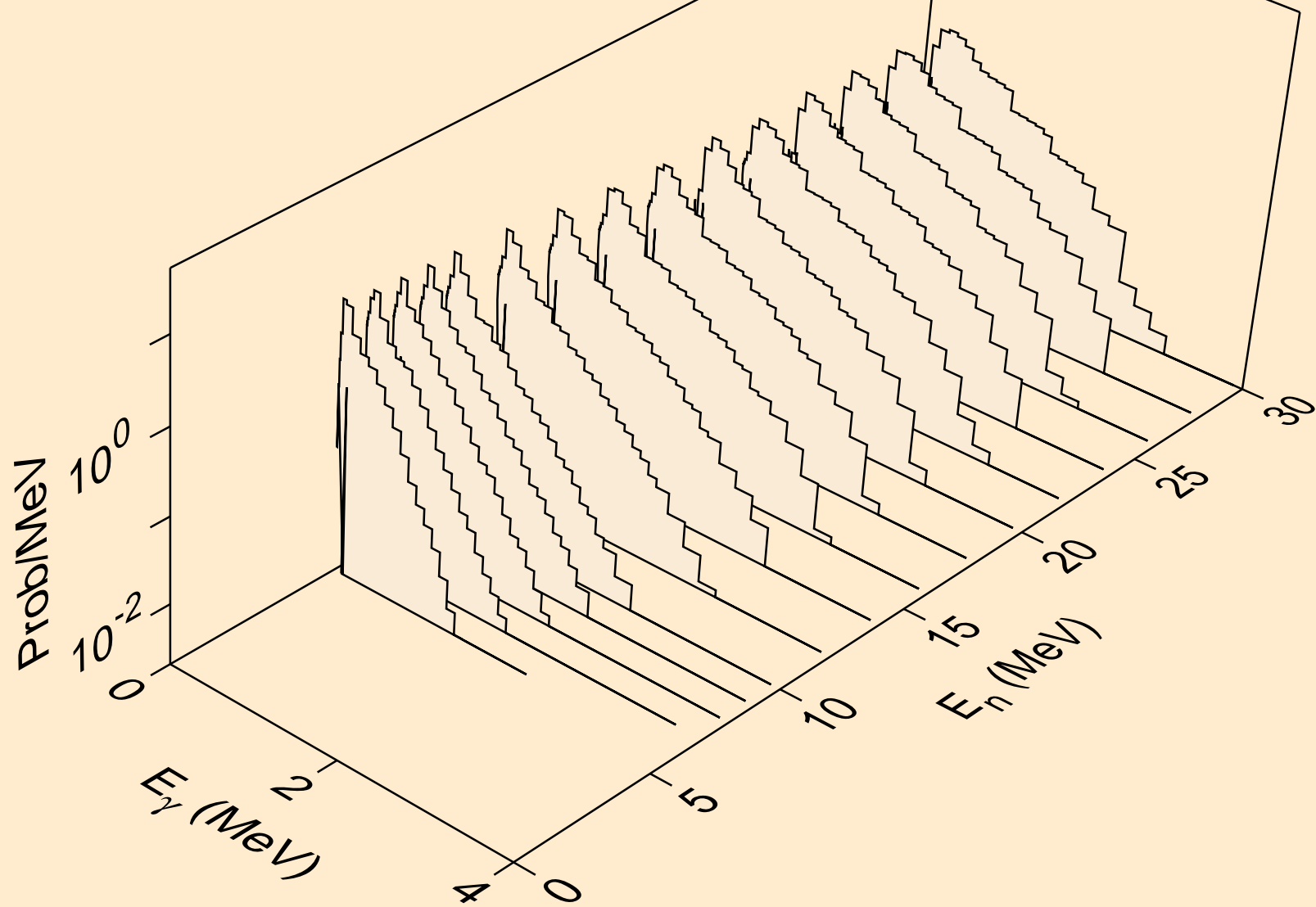

HS268 PROTON ACER TENDL-2021 LIBRARY; T=0.K
Photon emission for (n,d)

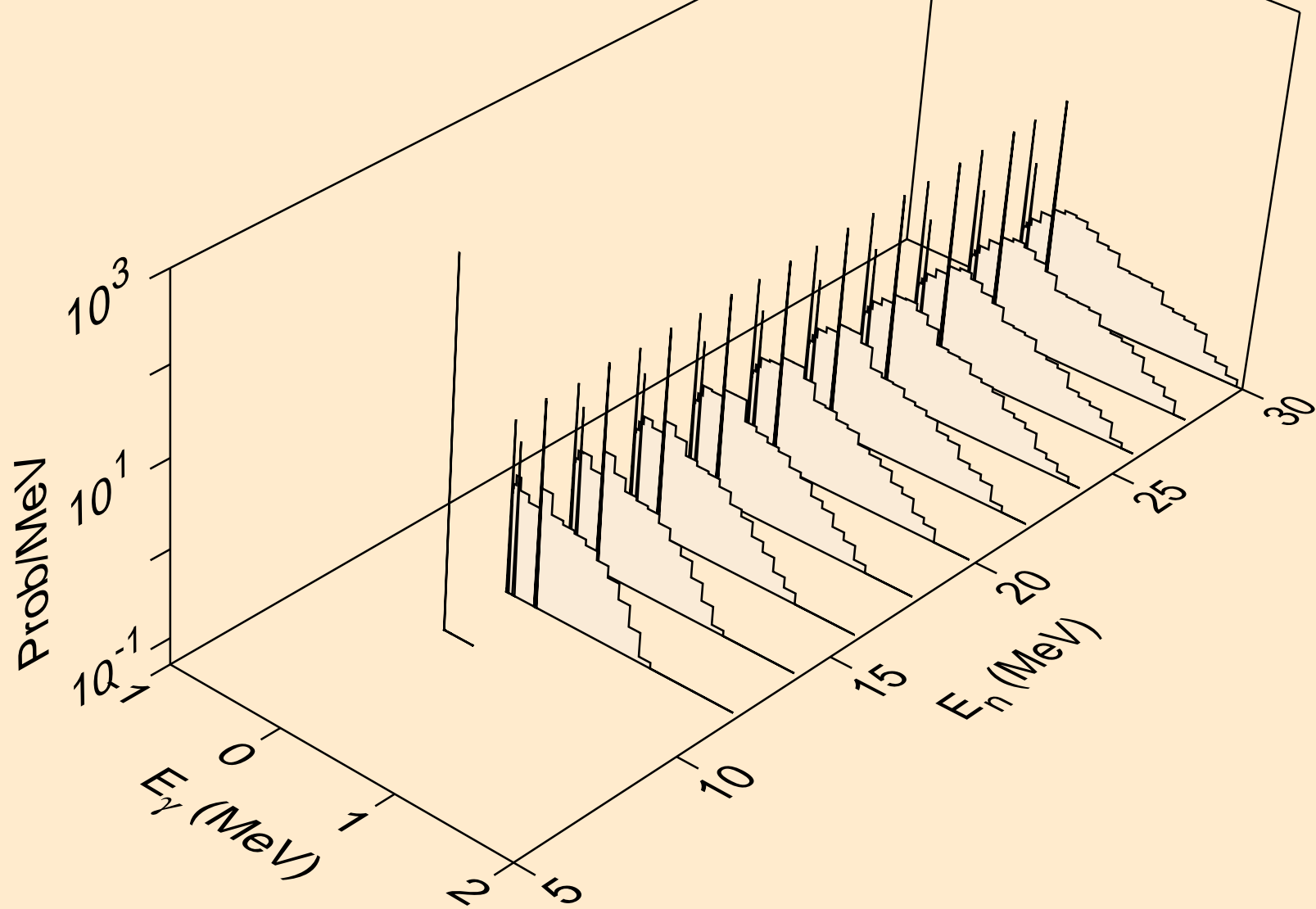

HS268 PROTON ACER TENDL-2021 LIBRARY; T=0.K
Photon emission for (n,t)

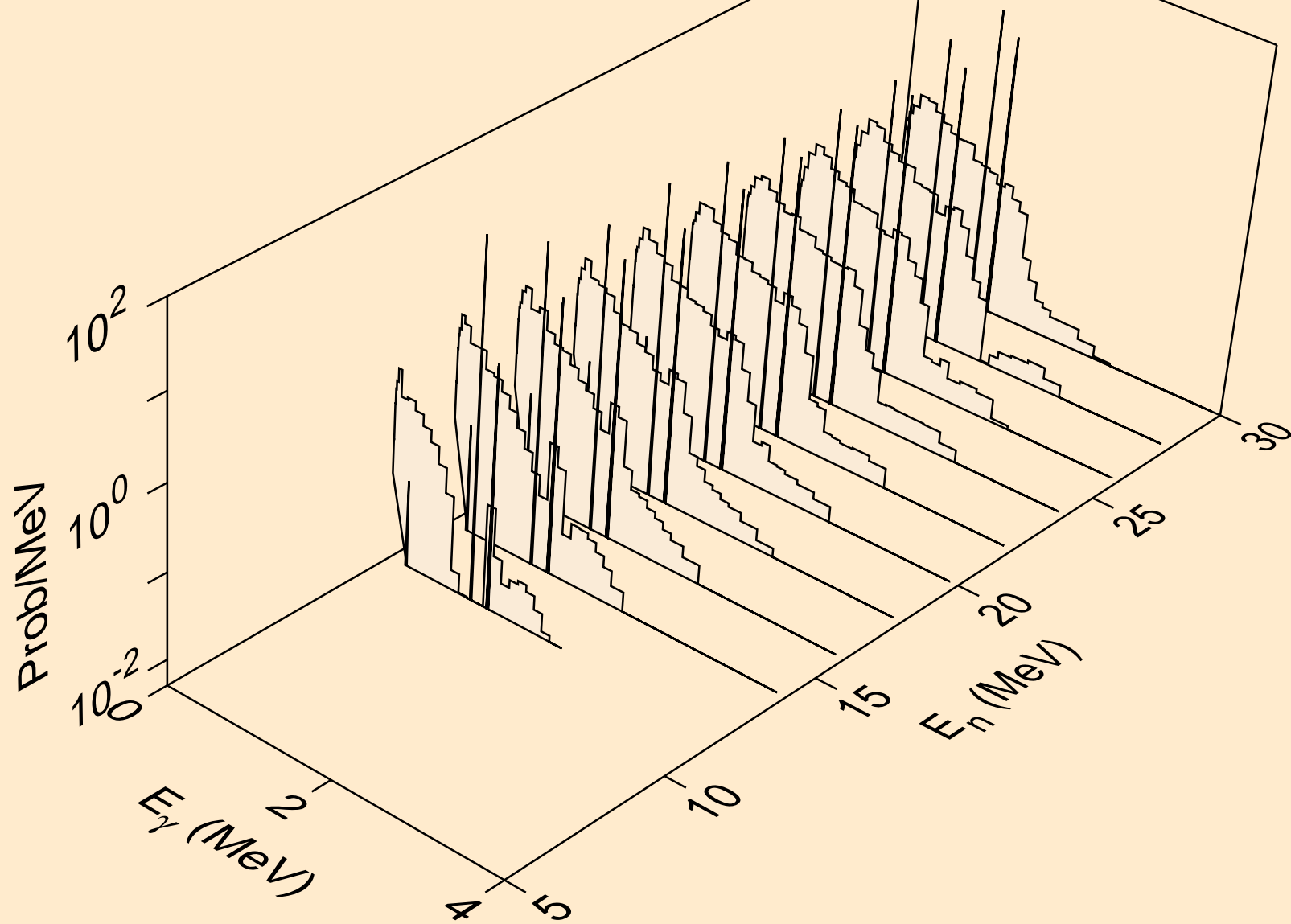

HS268 PROTON ACER TENDL-2021 LIBRARY; T=0.K
Photon emission for (n,he3)

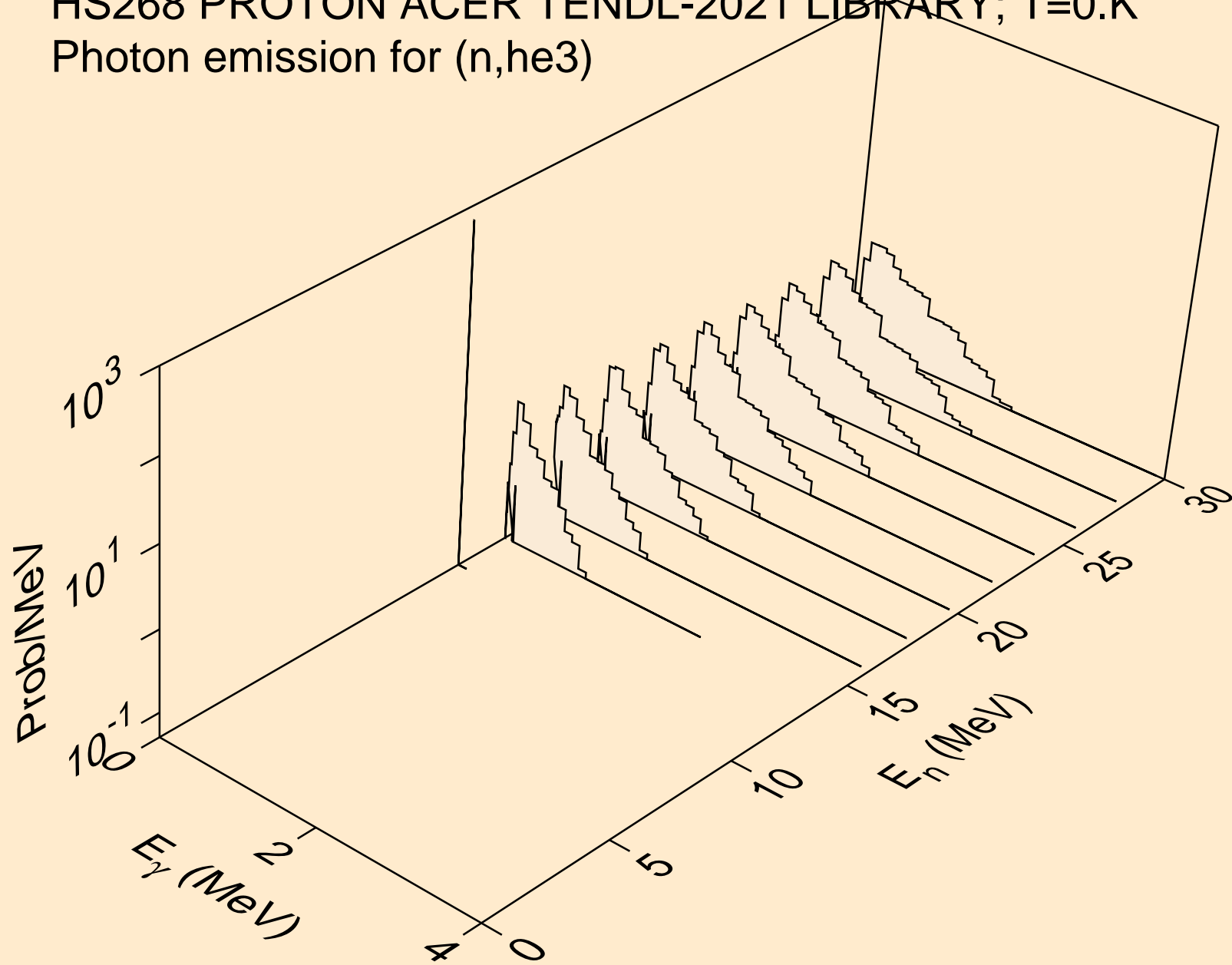

HS268 PROTON ACER TENDL-2021 LIBRARY; T=0.K
Photon emission for (n,a)

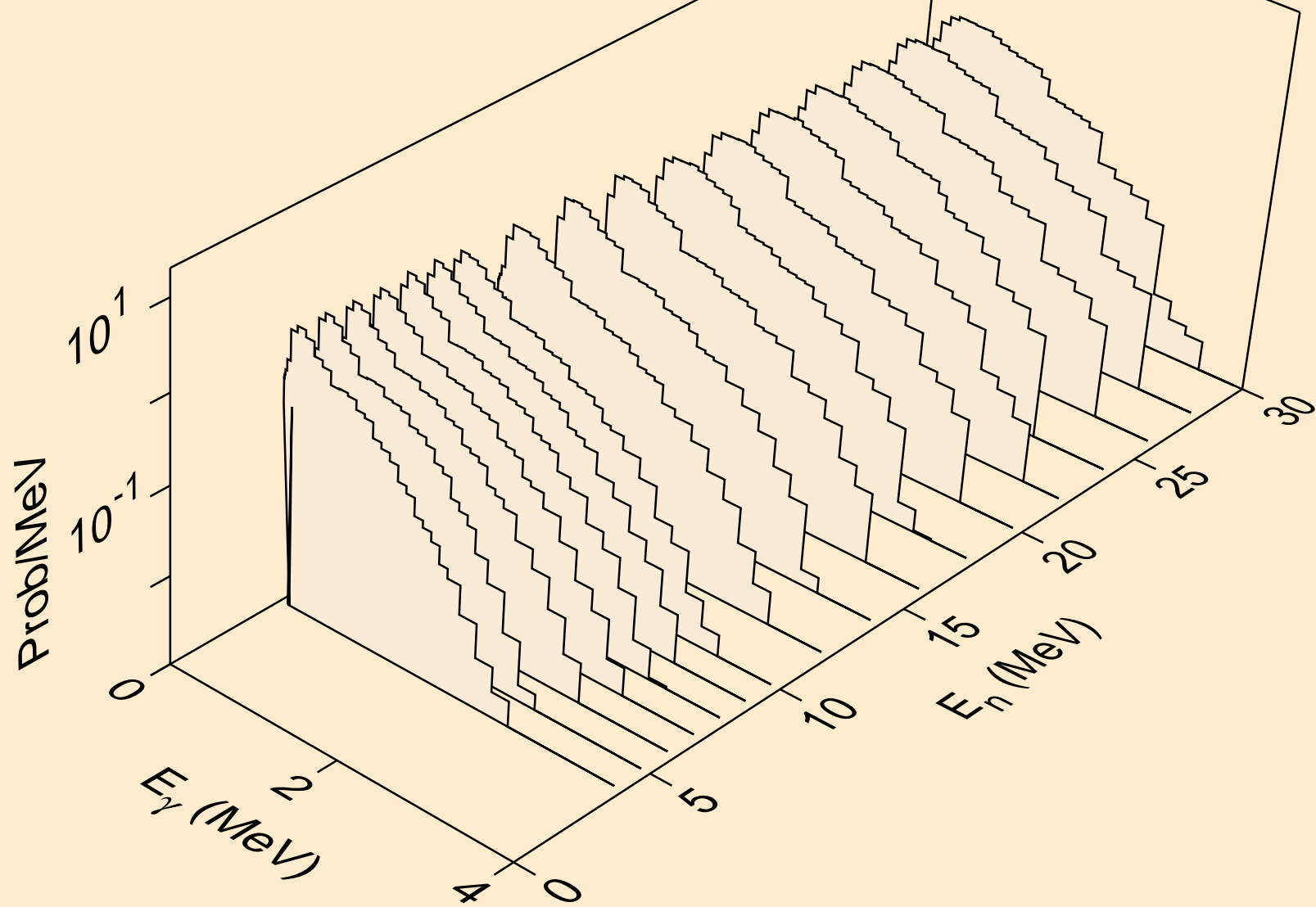

HS268 PROTON ACER TENDL-2021 LIBRARY; T=0.K
Photon emission for (n,2a)

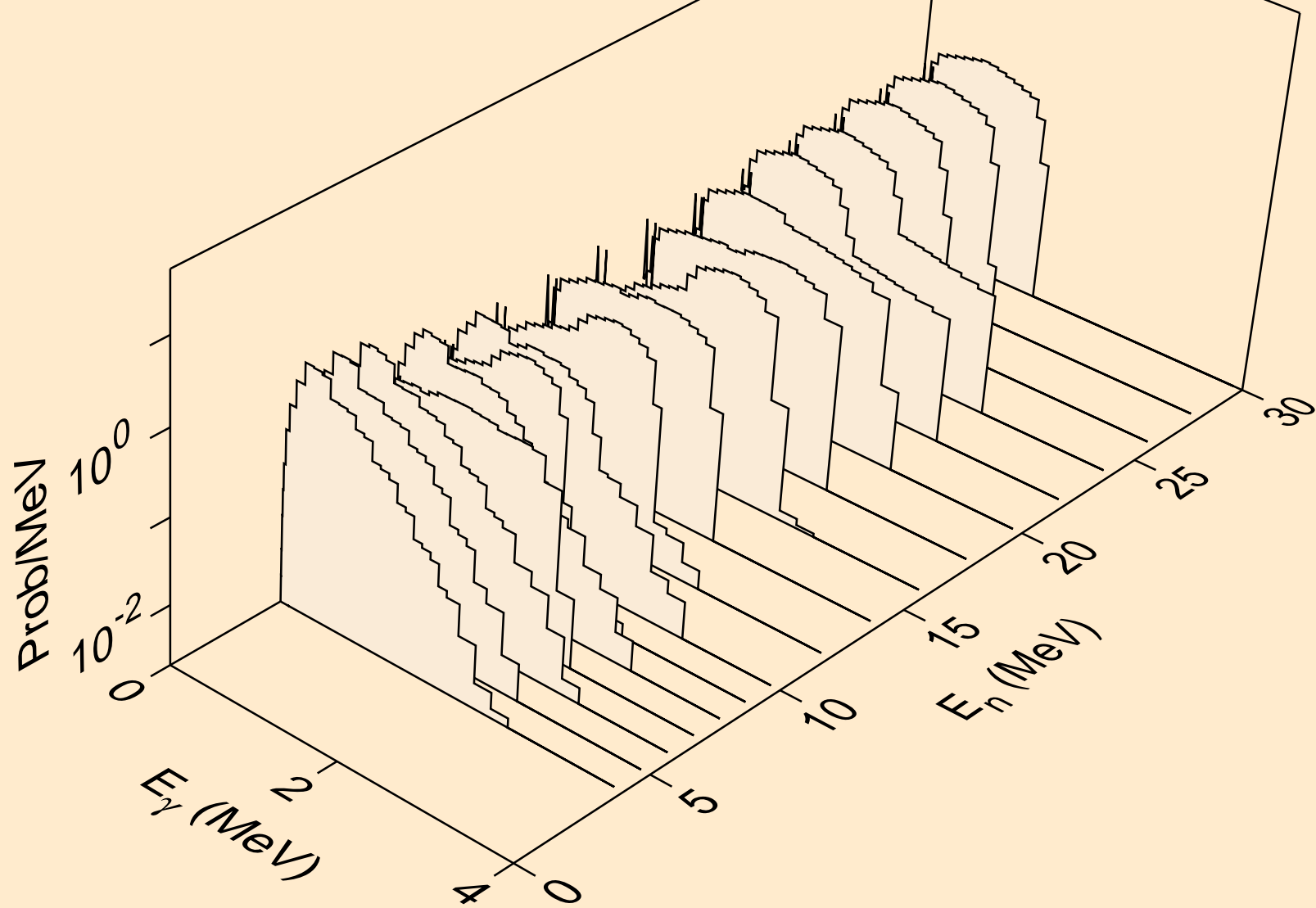

HS268 PROTON ACER TENDL-2021 LIBRARY; T=0.K
Photon emission for (n,3a)

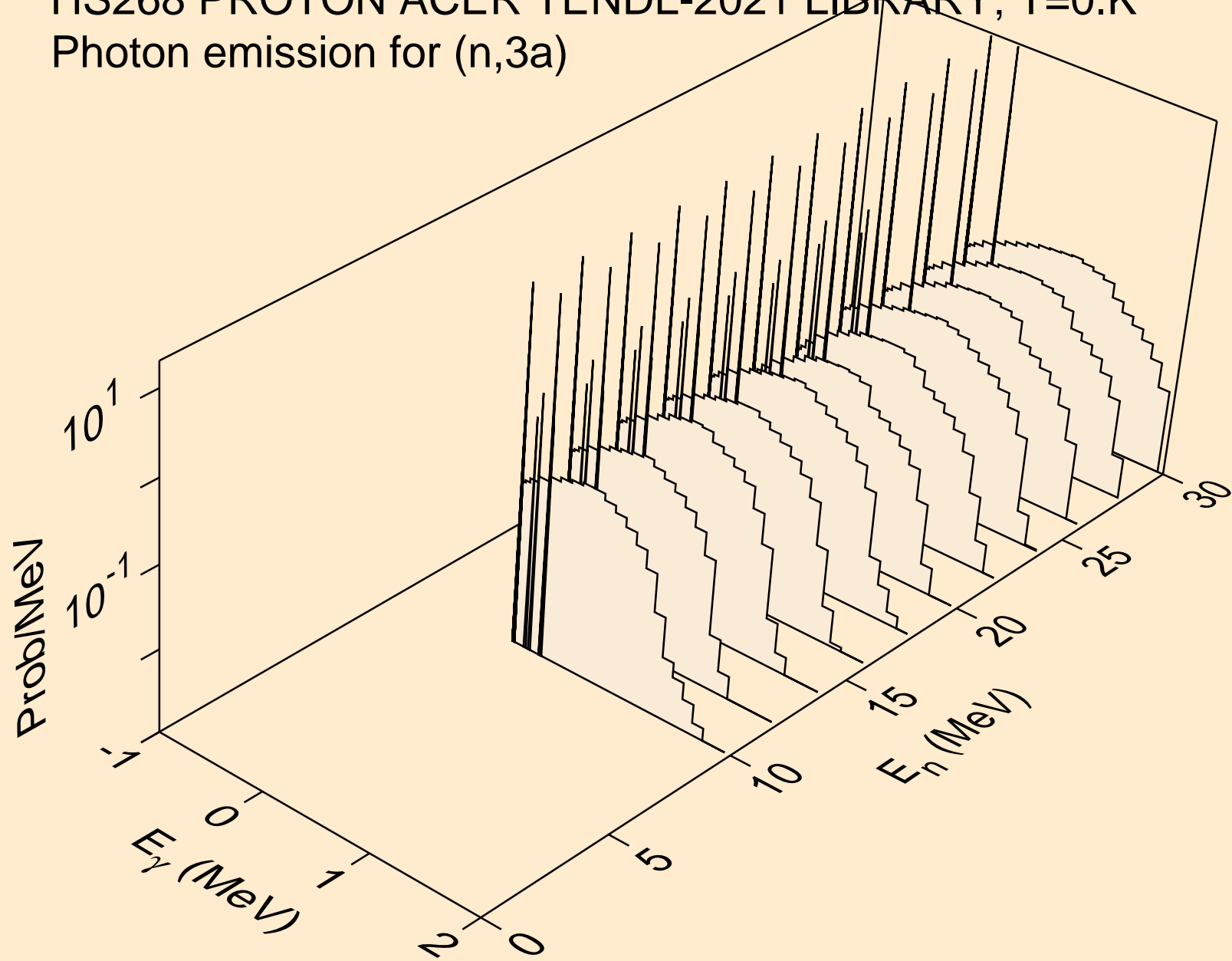

HS268 PROTON ACER TENDL-2021 LIBRARY; T=0.K
Photon emission for (n,2p)

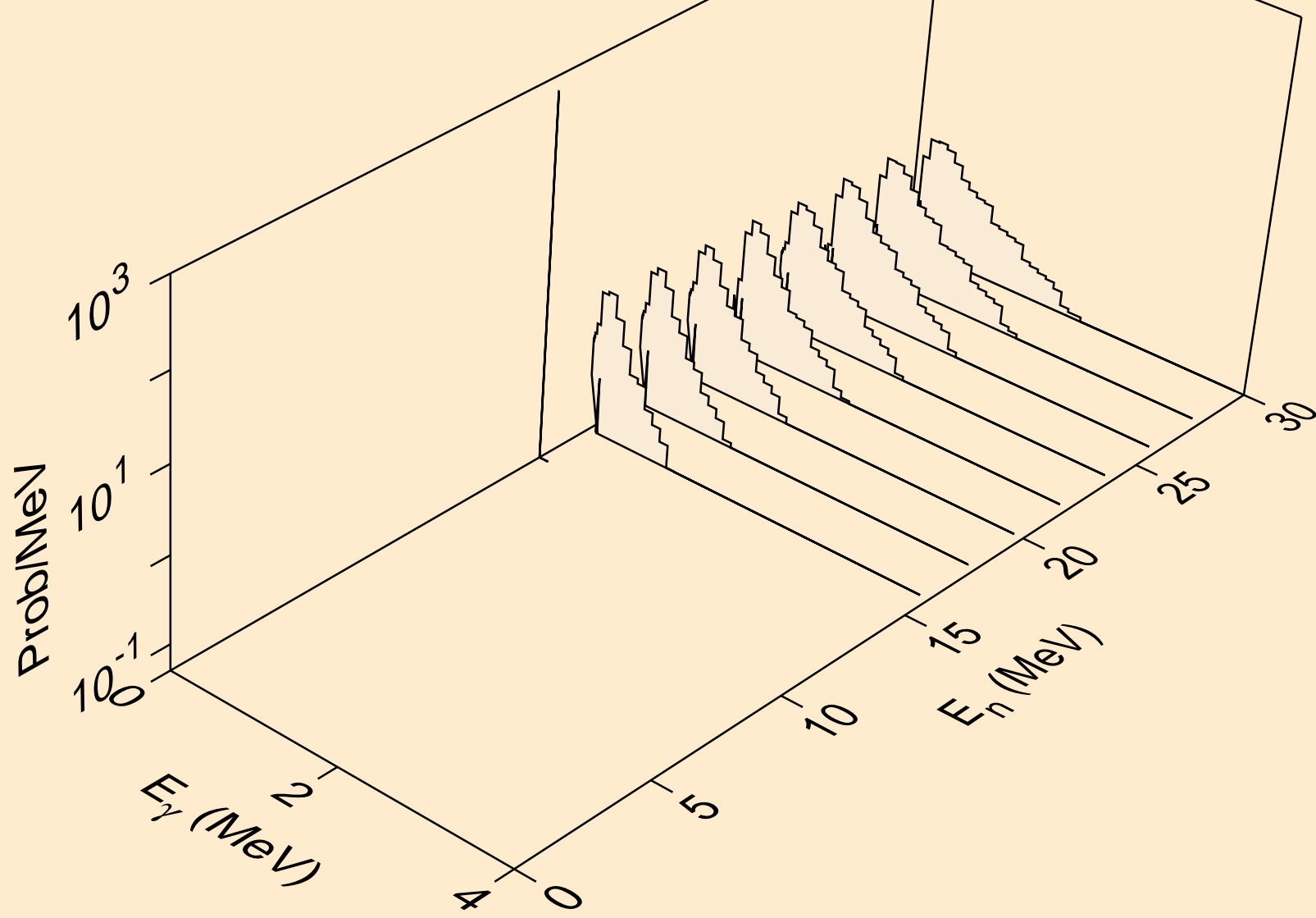

HS268 PROTON ACER TENDL-2021 LIBRARY; T=0.K
Photon emission for (n,pa)

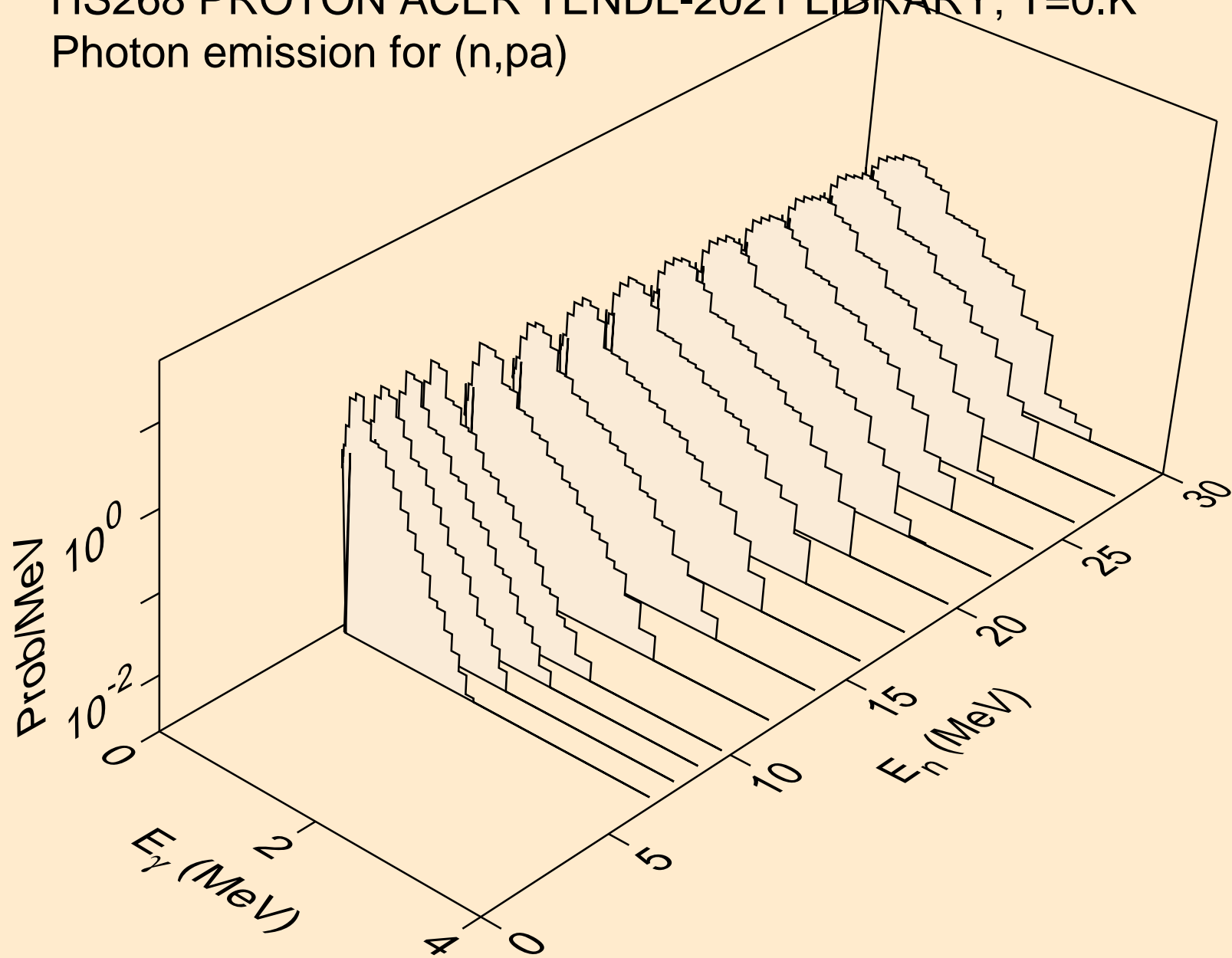

HS268 PROTON ACER TENDL-2021 LIBRARY; T=0.K
Photon emission for (n,d2a)

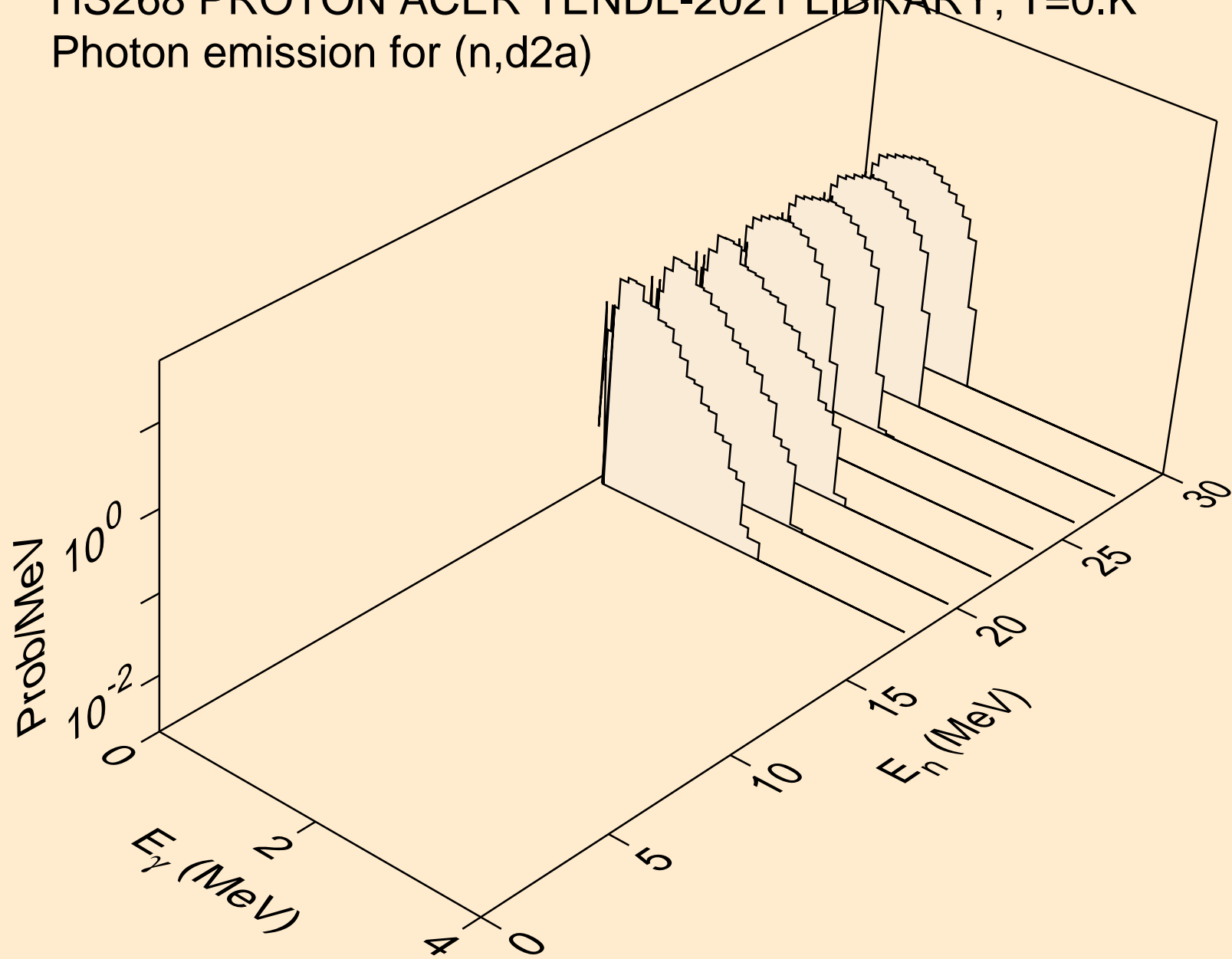

HS268 PROTON ACER TENDL-2021 LIBRARY; T=0.K
Photon emission for (n,da)

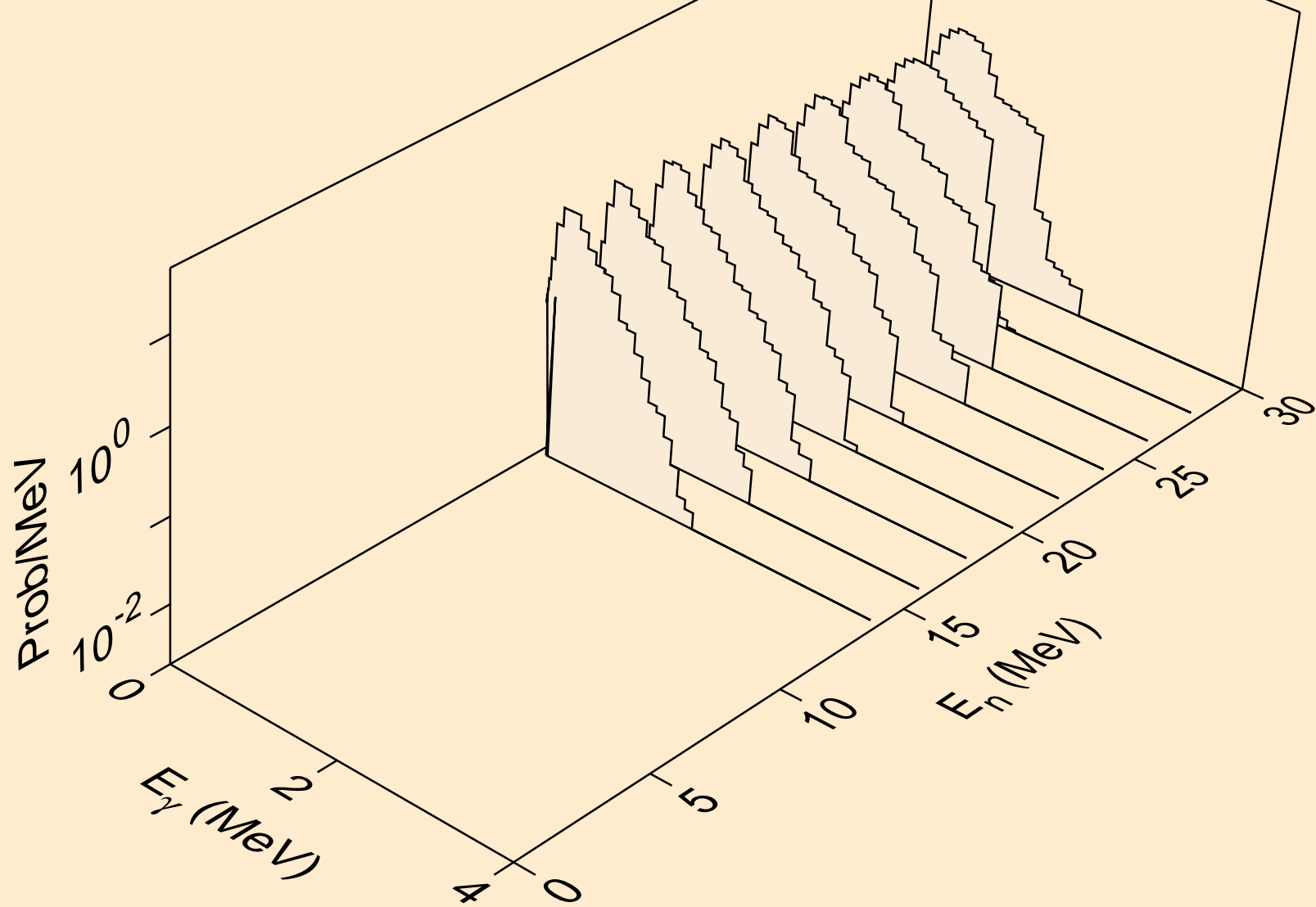

HS268 PROTON ACER TENDL-2021 LIBRARY; T=0.K

Particle heating contributions

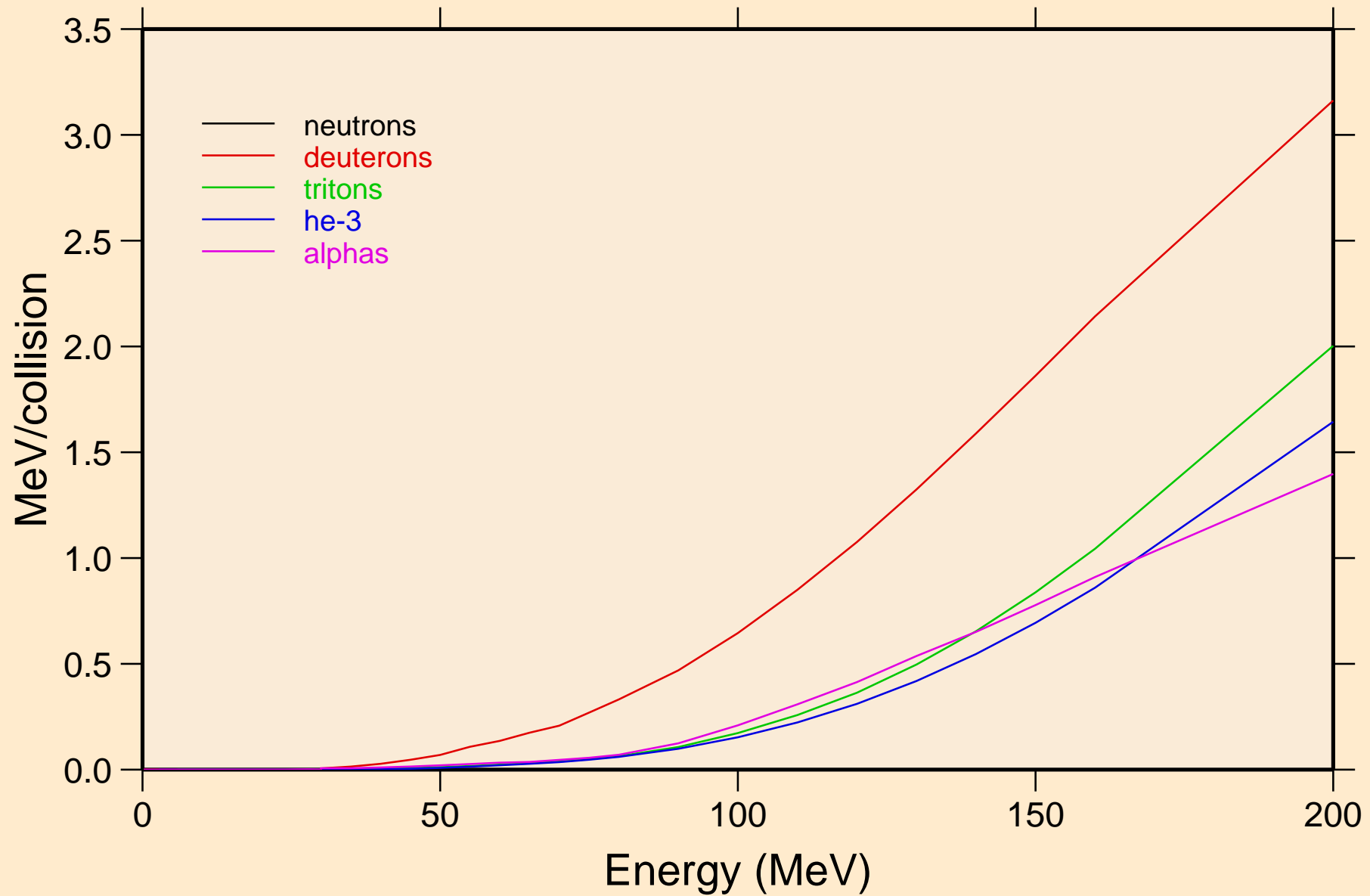

HS268 PROTON ACER TENDL-2021 LIBRARY; T=0.K
Recoil Heating

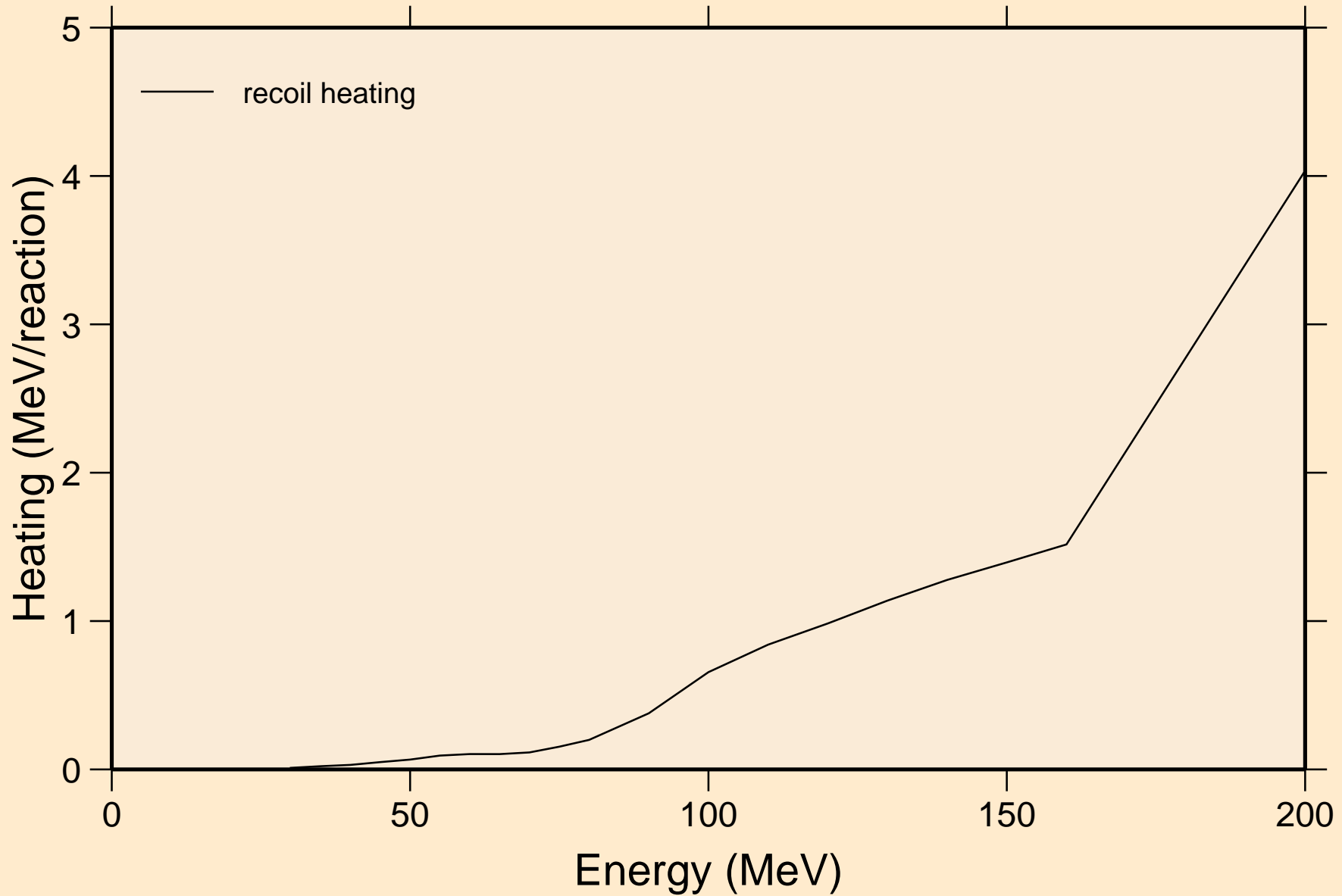

HS268 PROTON ACER TENDL-2021 LIBRARY; T=0.K

Particle production cross sections

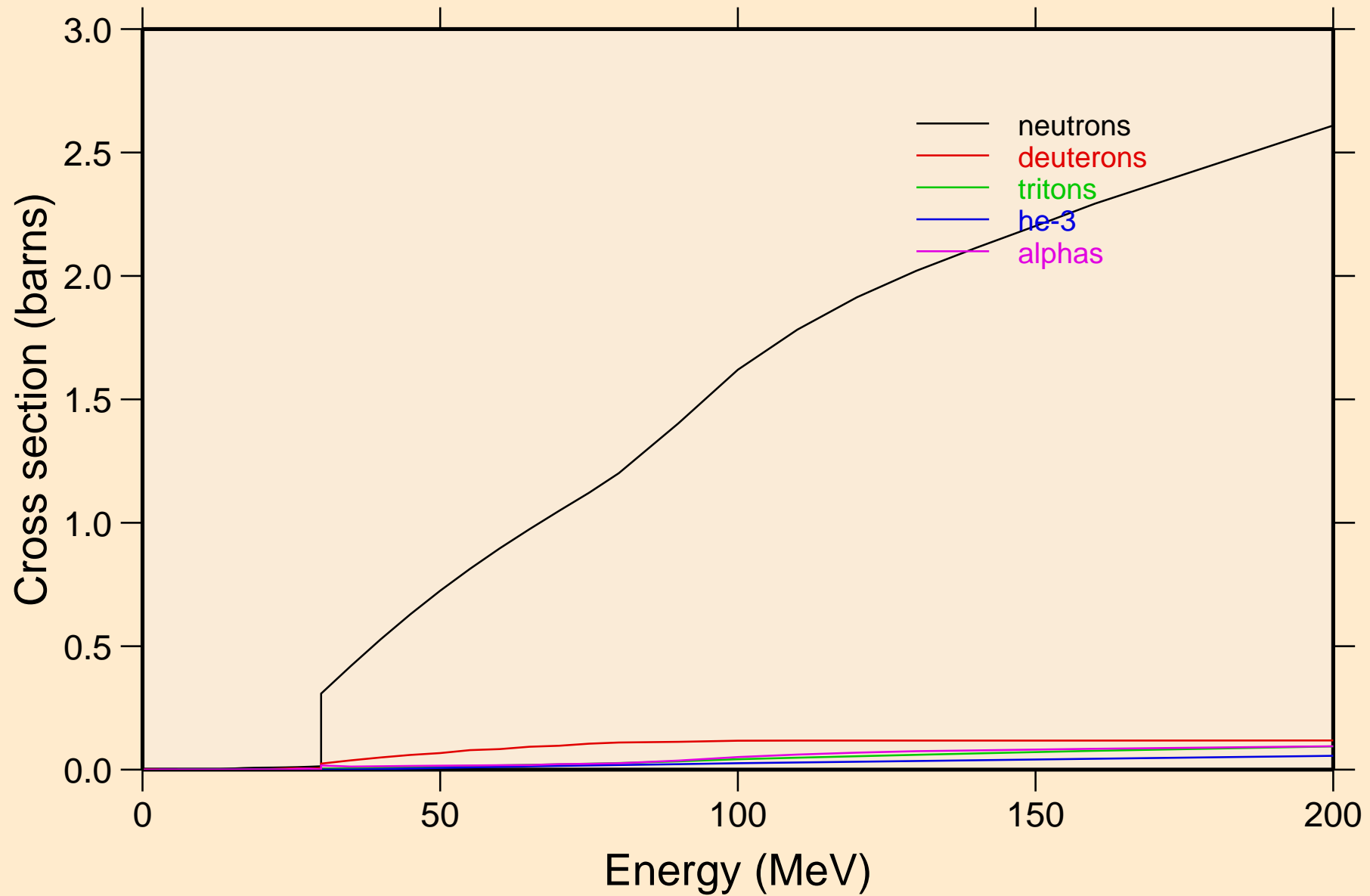

HS268 PROTON ACER TENDL-2021 LIBRARY; T=0.K
neutrons from (p,n)

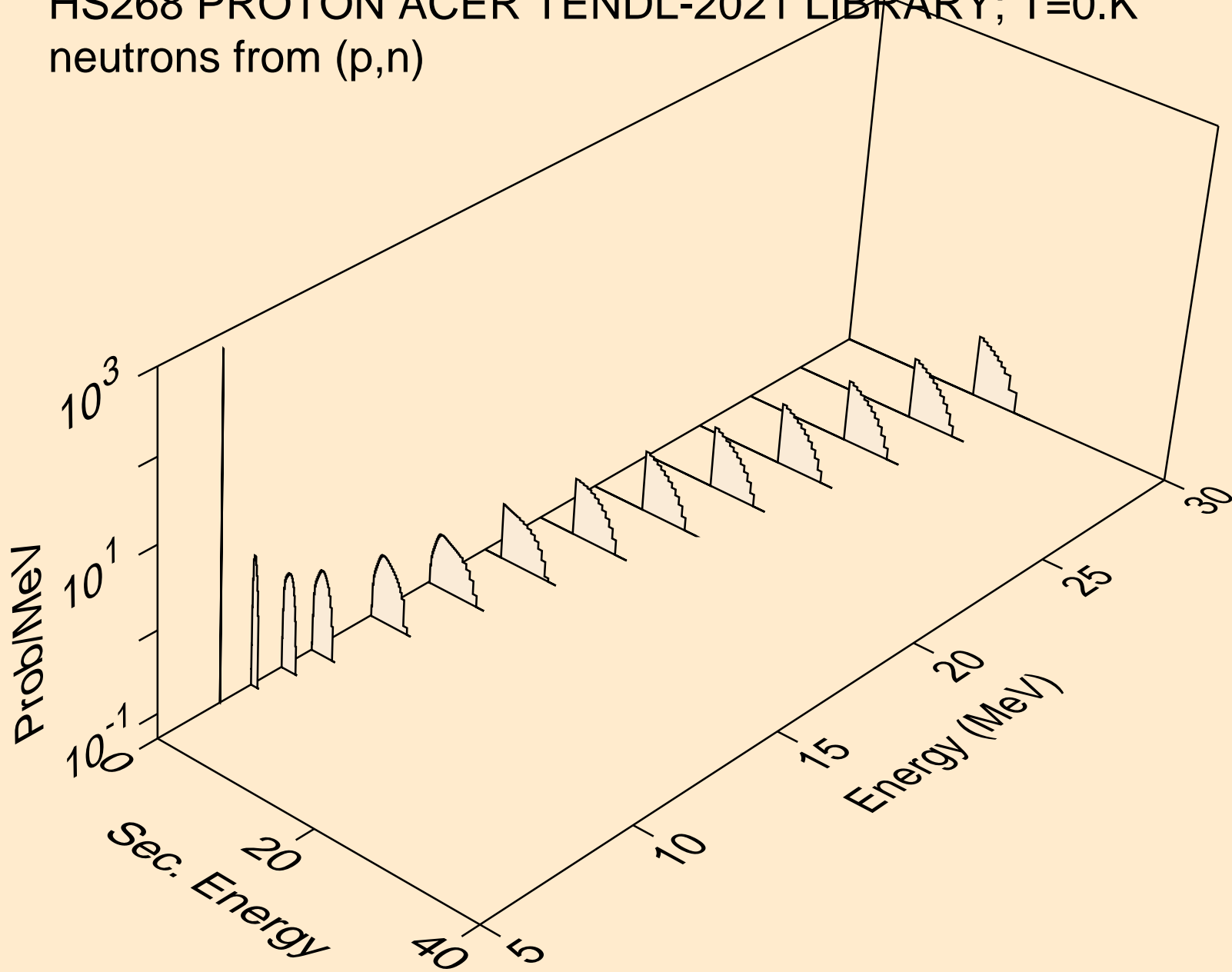

HS268 PROTON ACER TENDL-2021 LIBRARY; T=0.K
neutrons from (p,x)

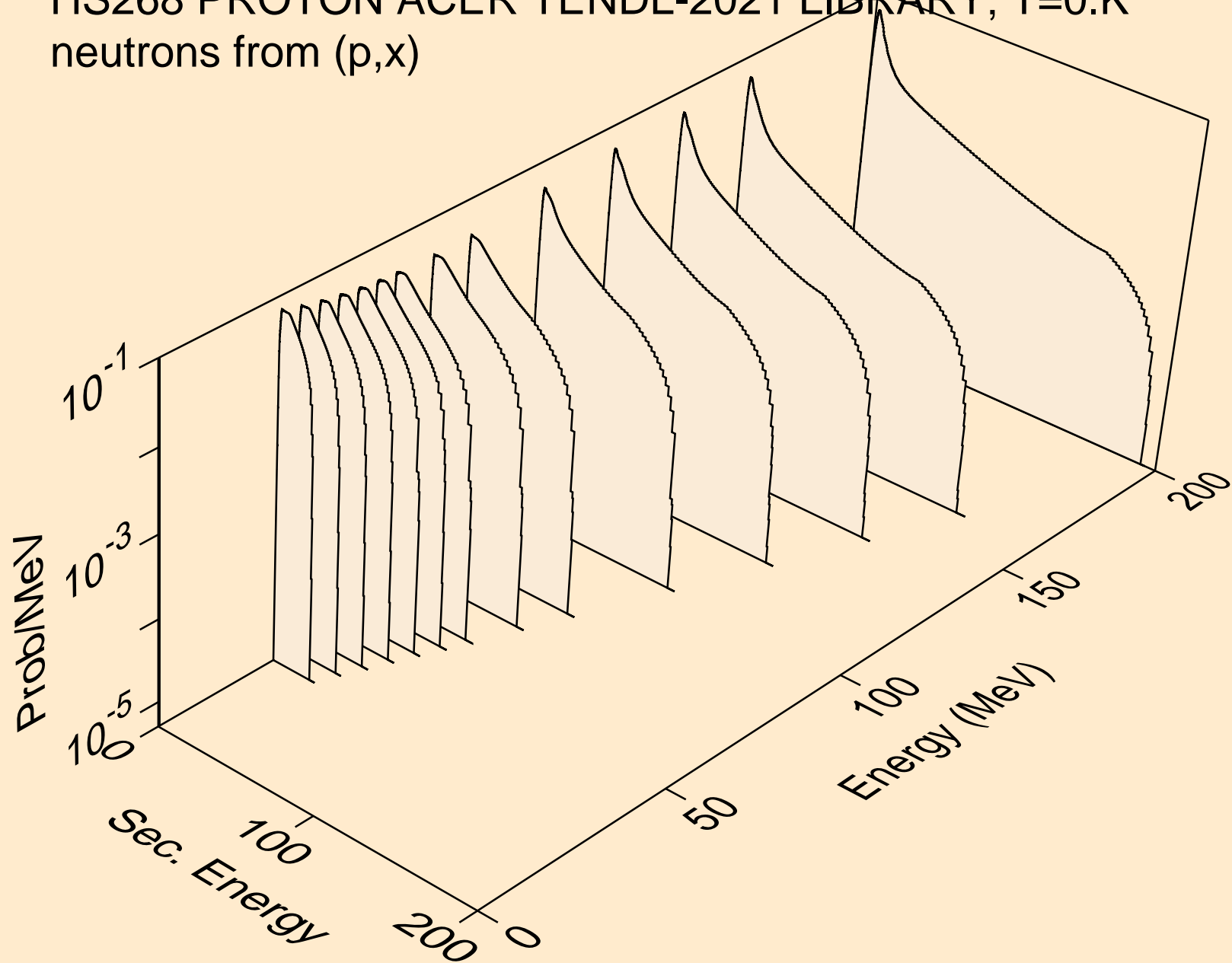

HS268 PROTON ACER TENDL-2021 LIBRARY; T=0.K
neutrons from (p,2n)

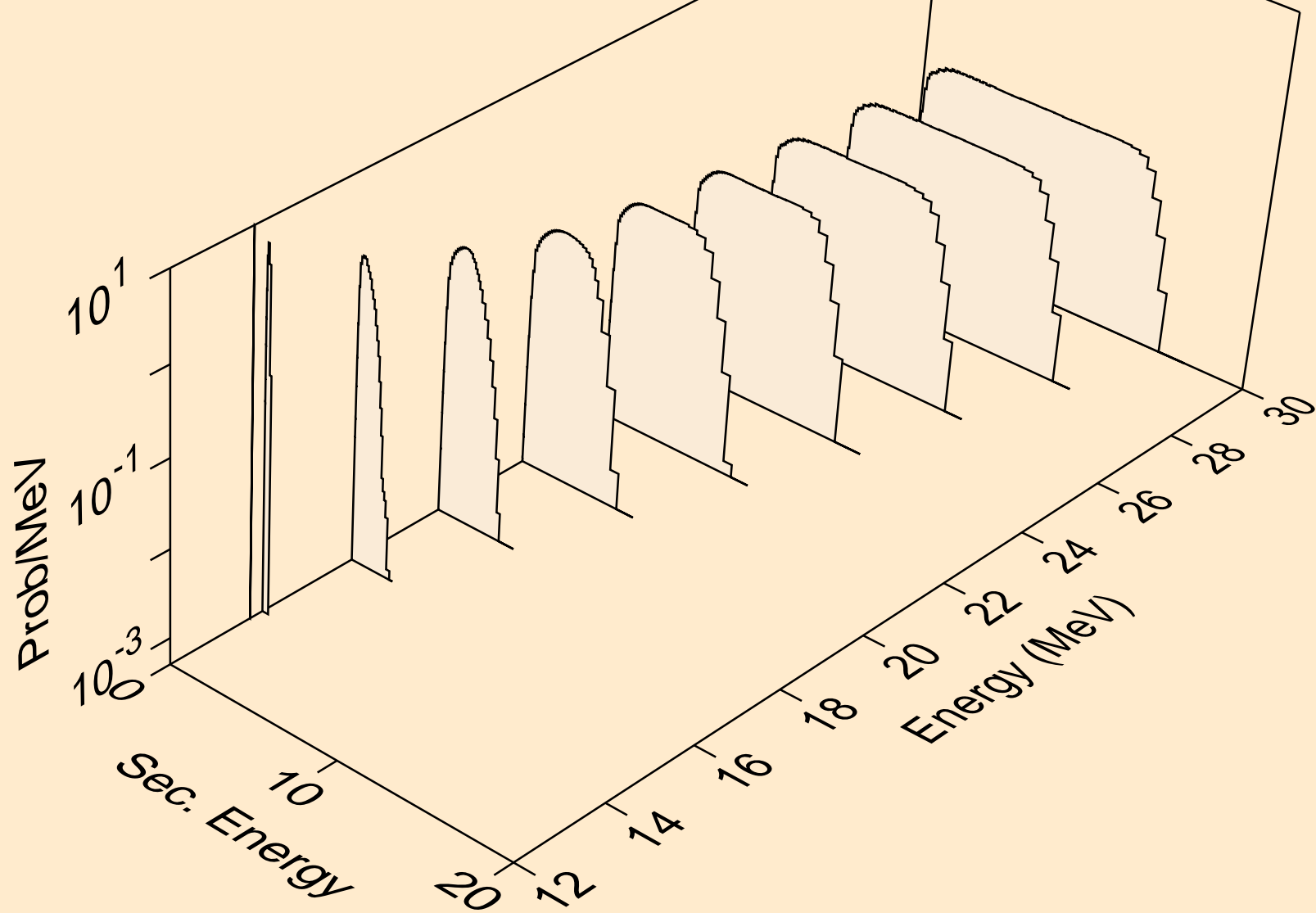

HS268 PROTON ACER TENDL-2021 LIBRARY; T=0.K
neutrons from (p,3n)

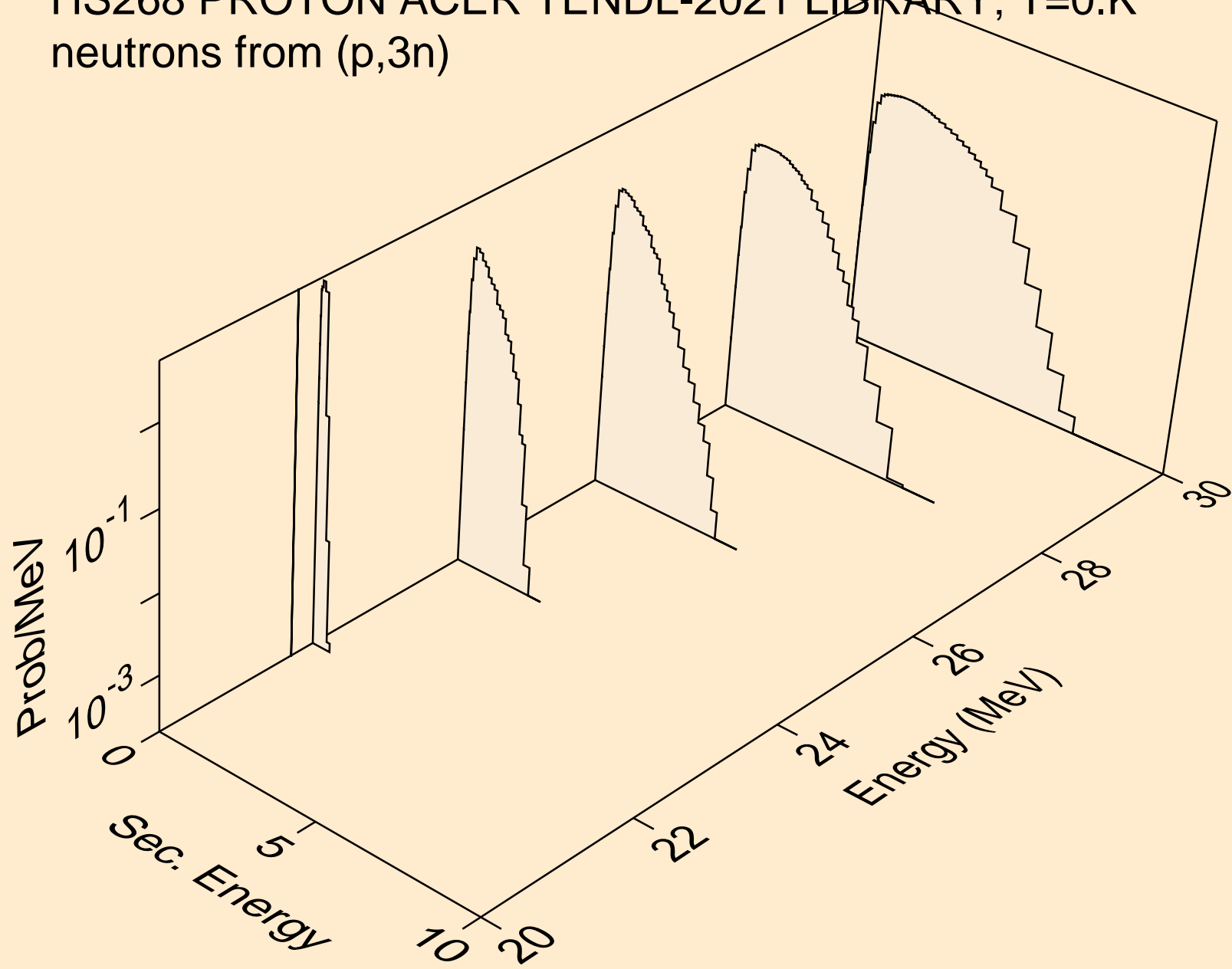

HS268 PROTON ACER TENDL-2021 LIBRARY; T=0.K
neutrons from (p,n*)a

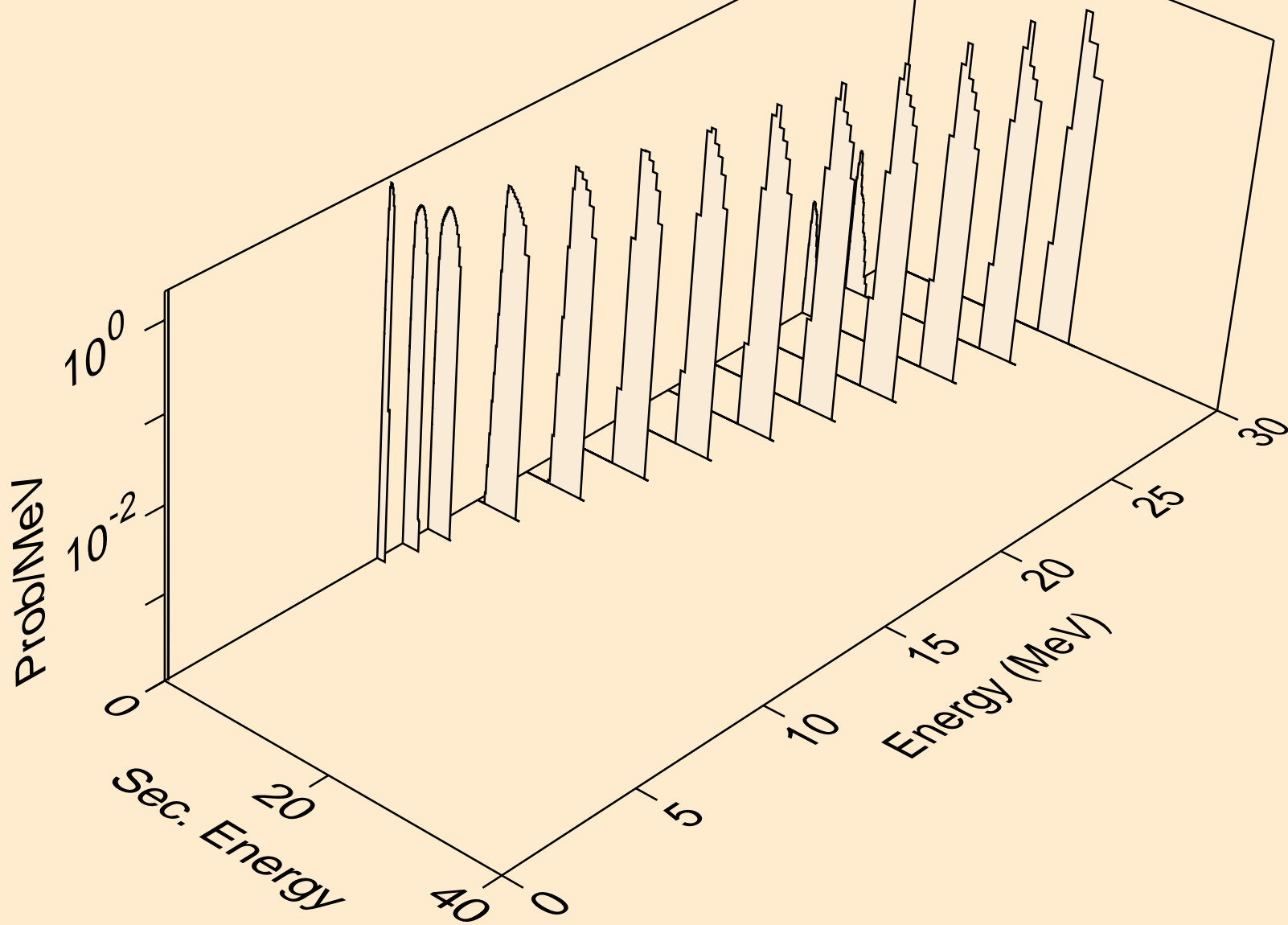

HS268 PROTON ACER TENDL-2021 LIBRARY; T=0.K
neutrons from (p,n*)3a

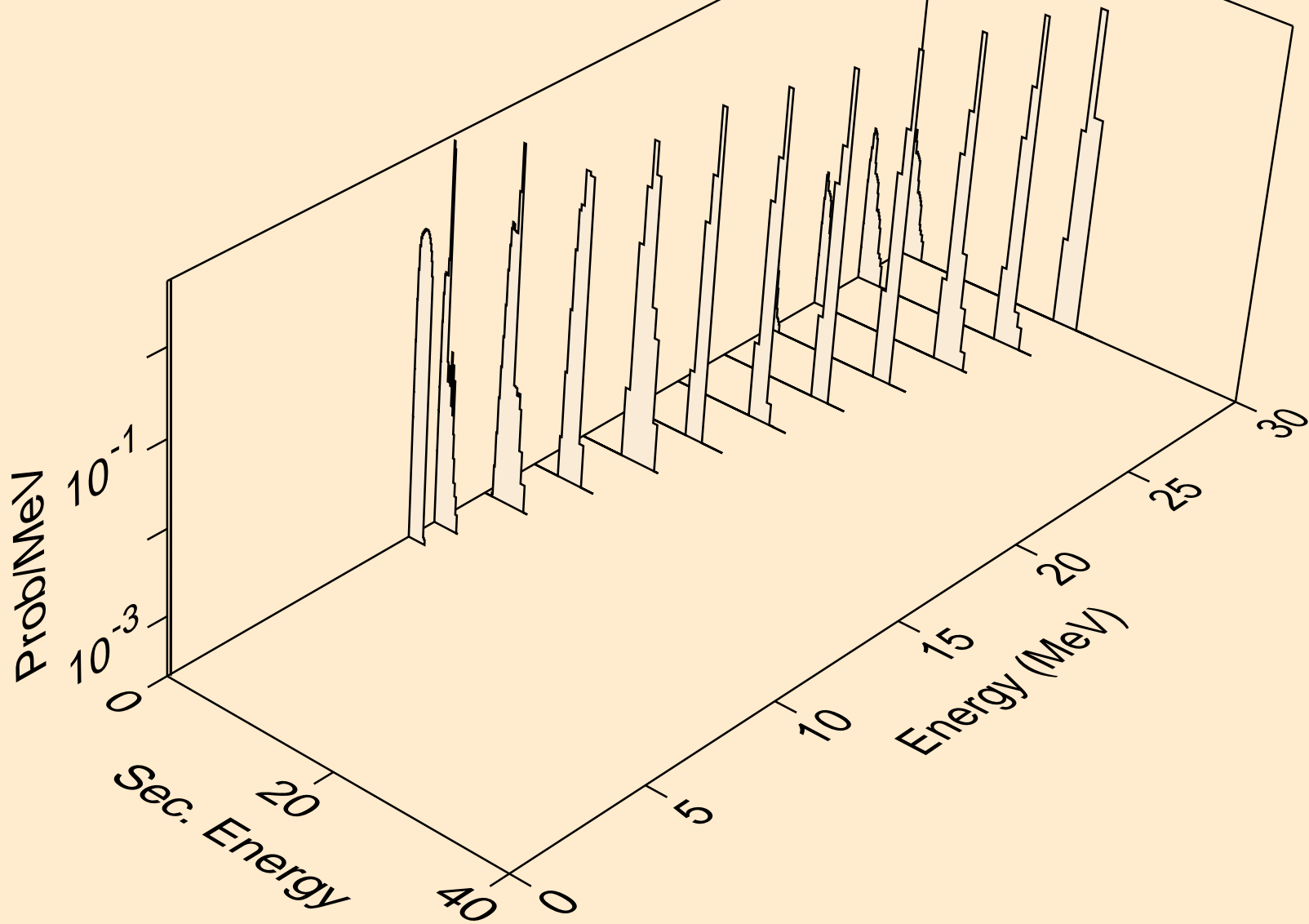

HS268 PROTON ACER TENDL-2021 LIBRARY; T=0.K
neutrons from (p,2n)a

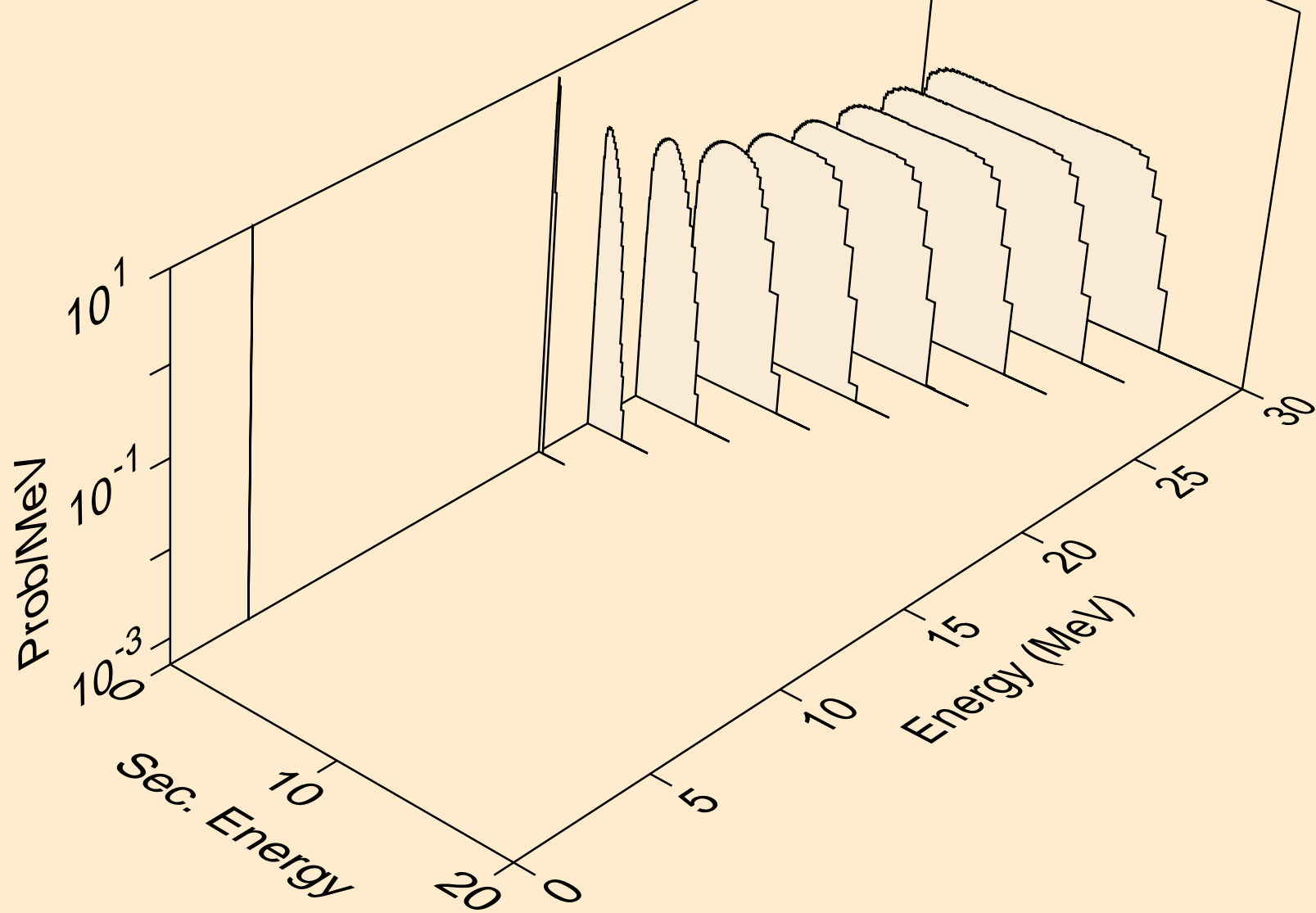

HS268 PROTON ACER TENDL-2021 LIBRARY; T=0.K
neutrons from (p,3n)a

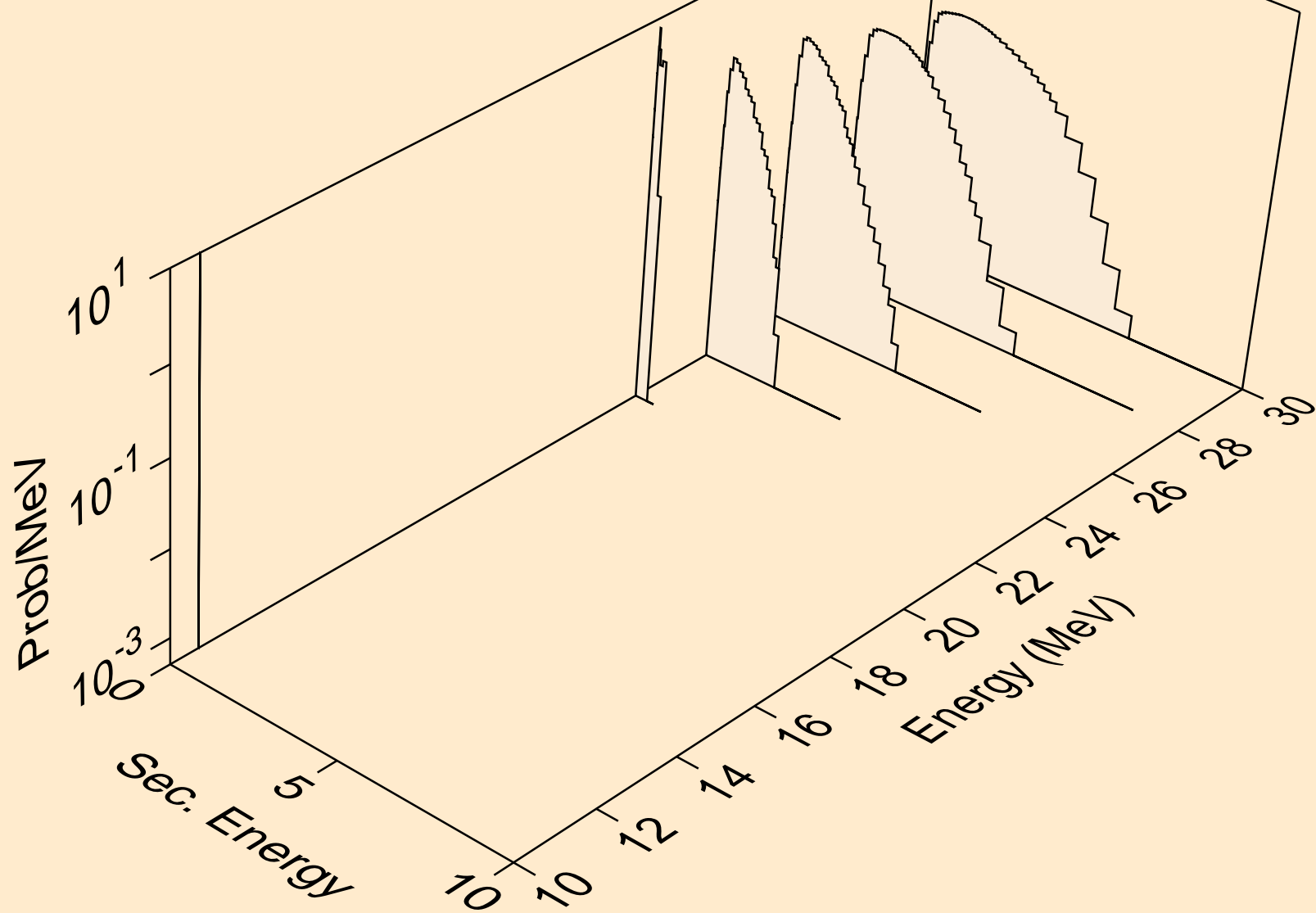

HS268 PROTON ACER TENDL-2021 LIBRARY; T=0.K
neutrons from (p,n*)p

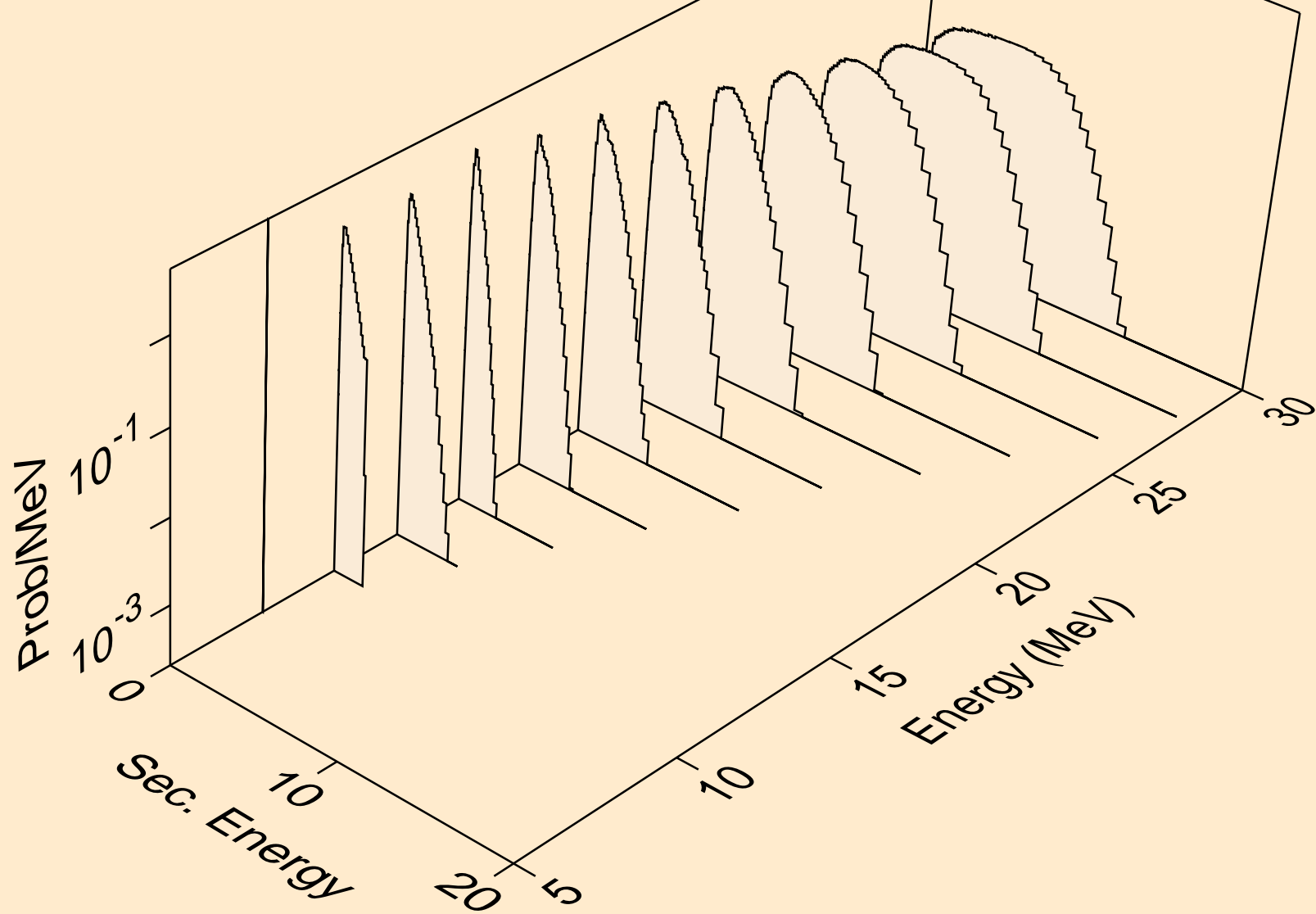

HS268 PROTON ACER TENDL-2021 LIBRARY; T=0.K
neutrons from (p,n*)2a

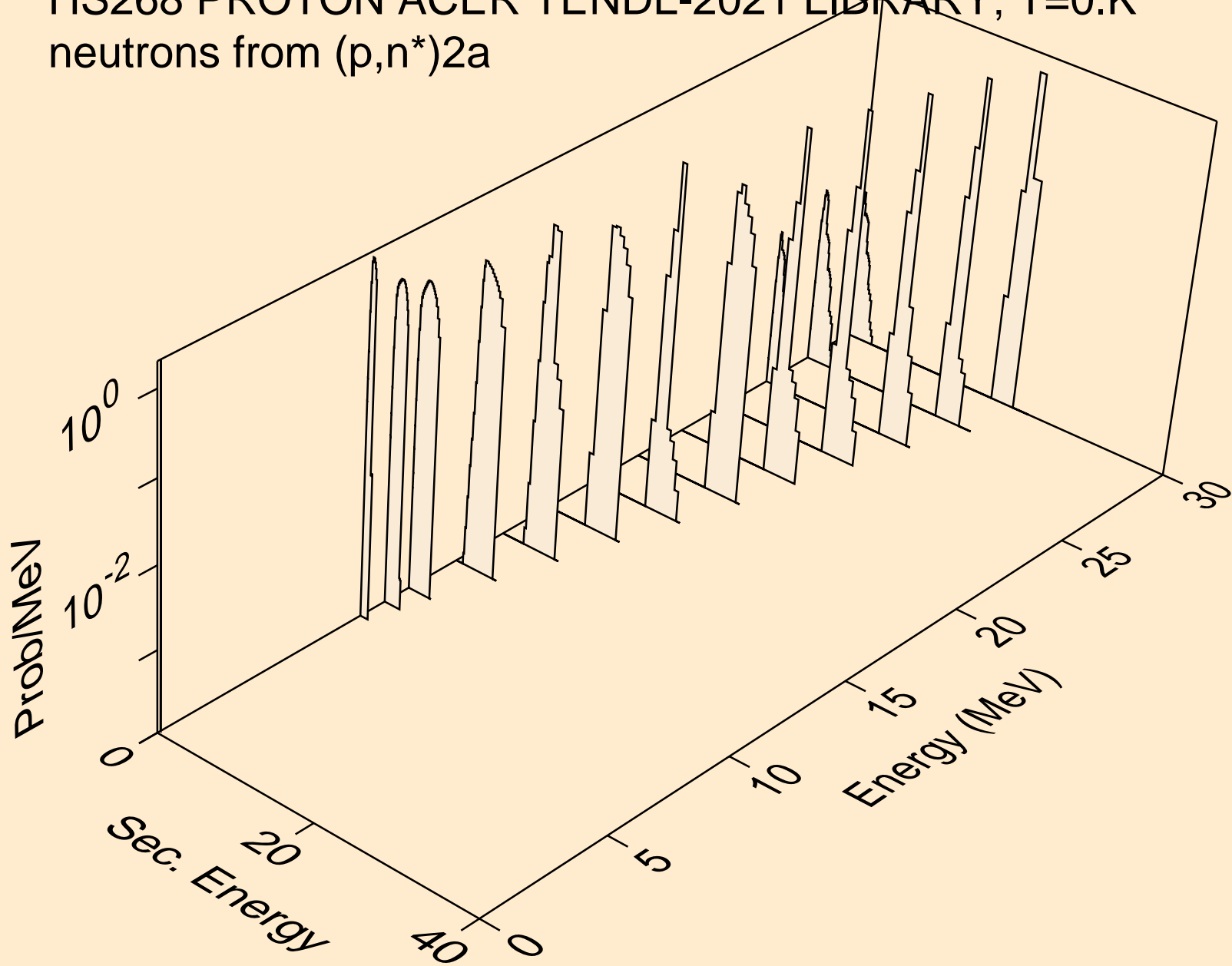

HS268 PROTON ACER TENDL-2021 LIBRARY; T=0.K
neutrons from (p,n*)d

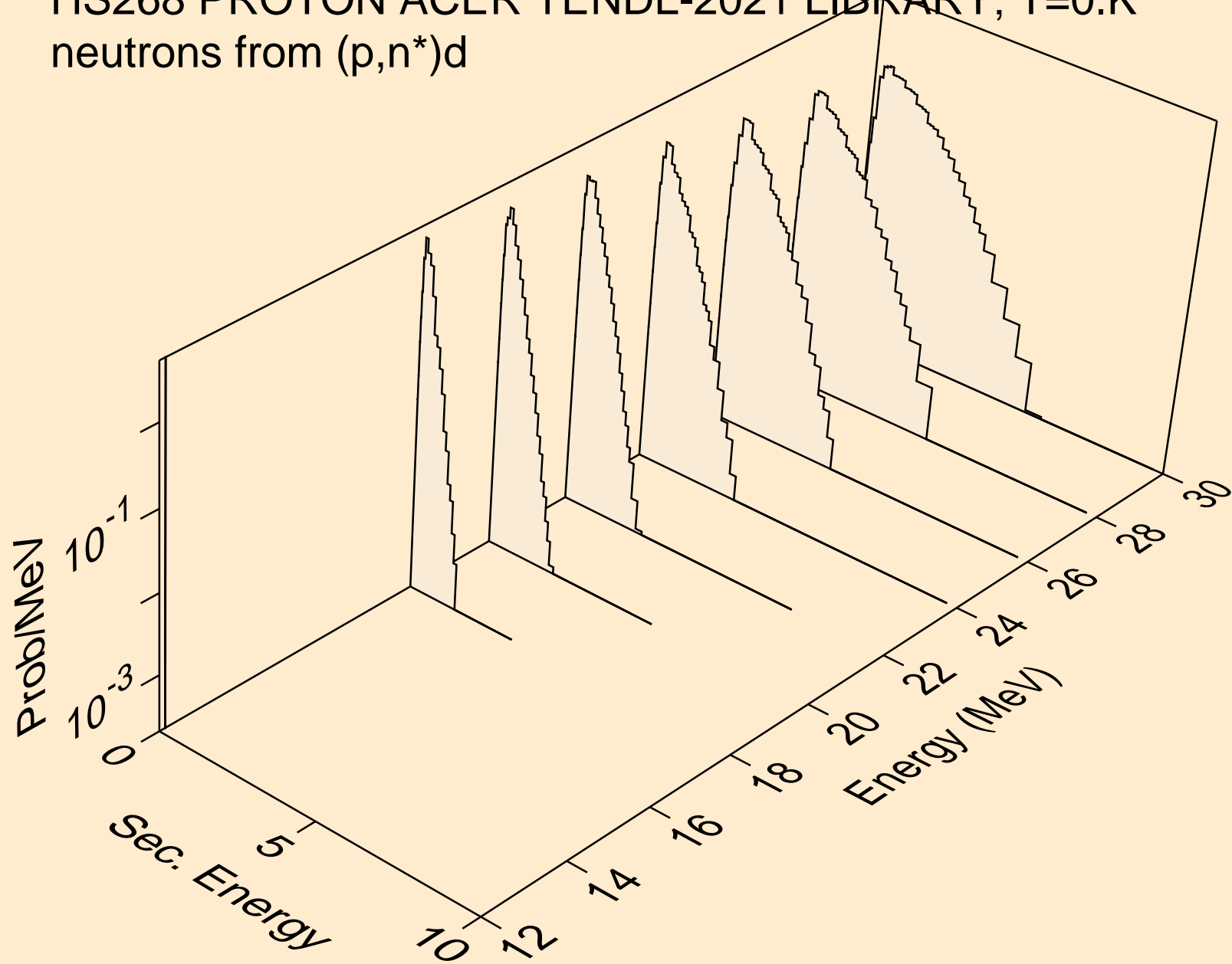

HS268 PROTON ACER TENDL-2021 LIBRARY; T=0.K
neutrons from (p,n*)t

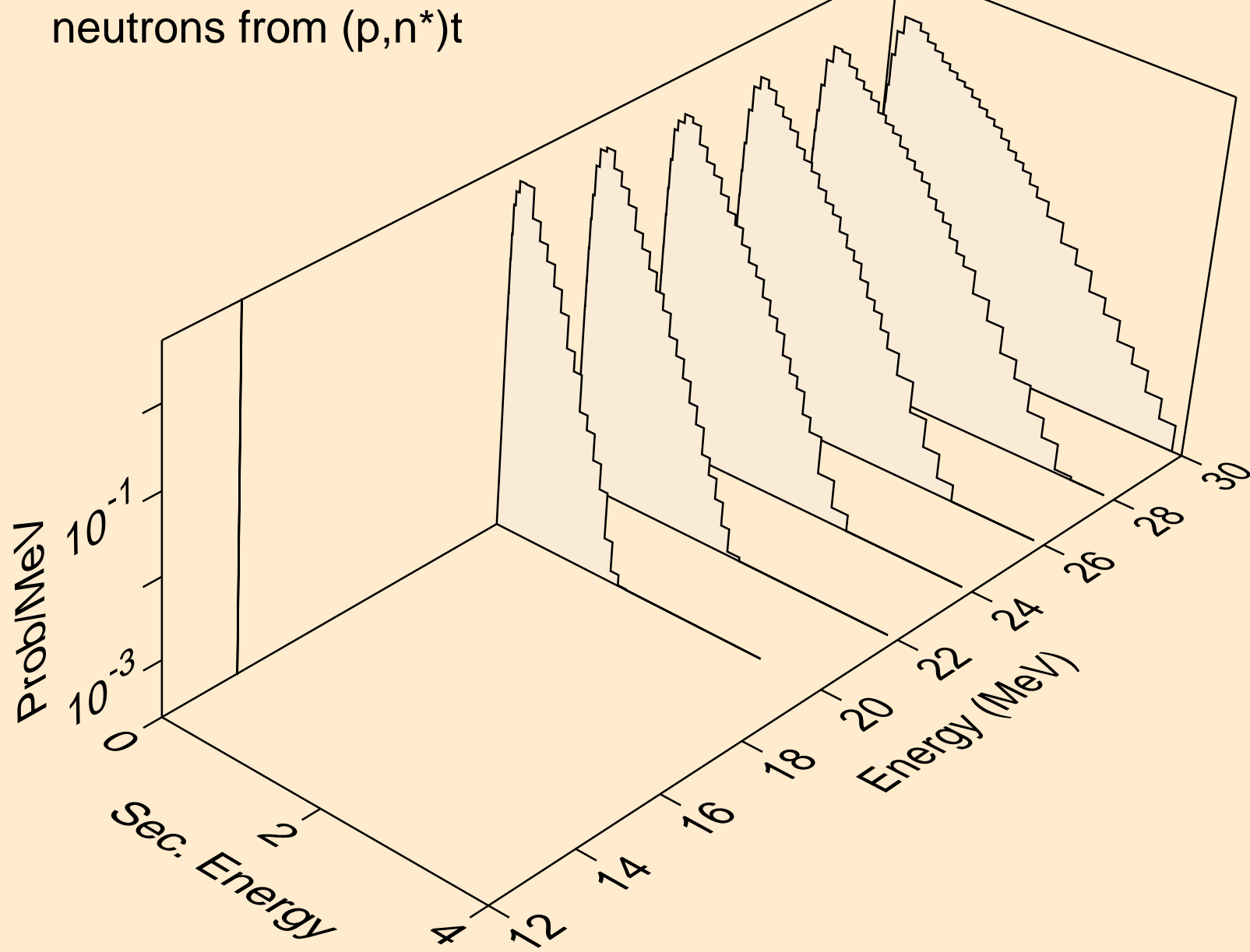

HS268 PROTON ACER TENDL-2021 LIBRARY; T=0.K
neutrons from (p,2np)

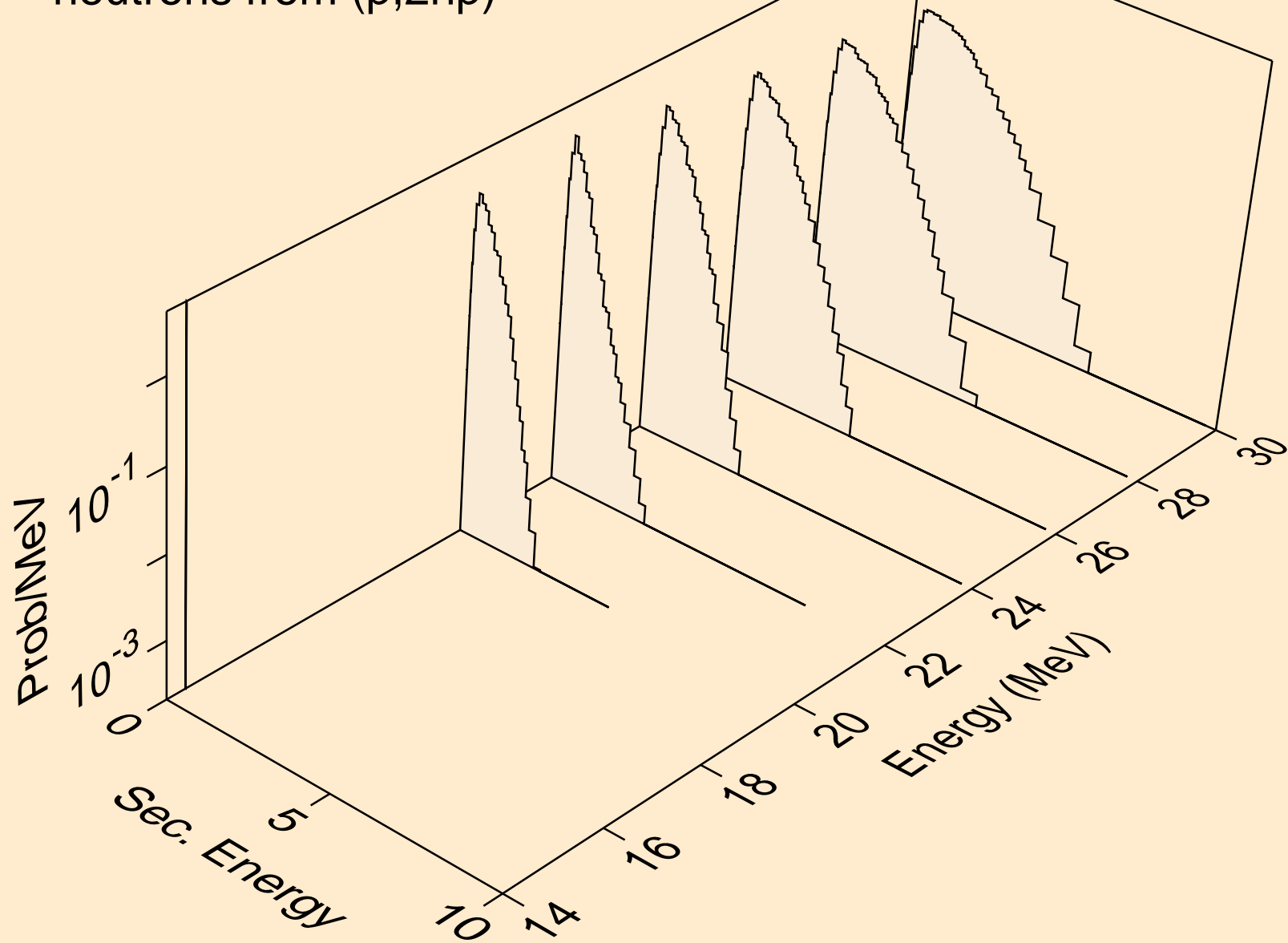

HS268 PROTON ACER TENDL-2021 LIBRARY; T=0.K
neutrons from (p,npa)

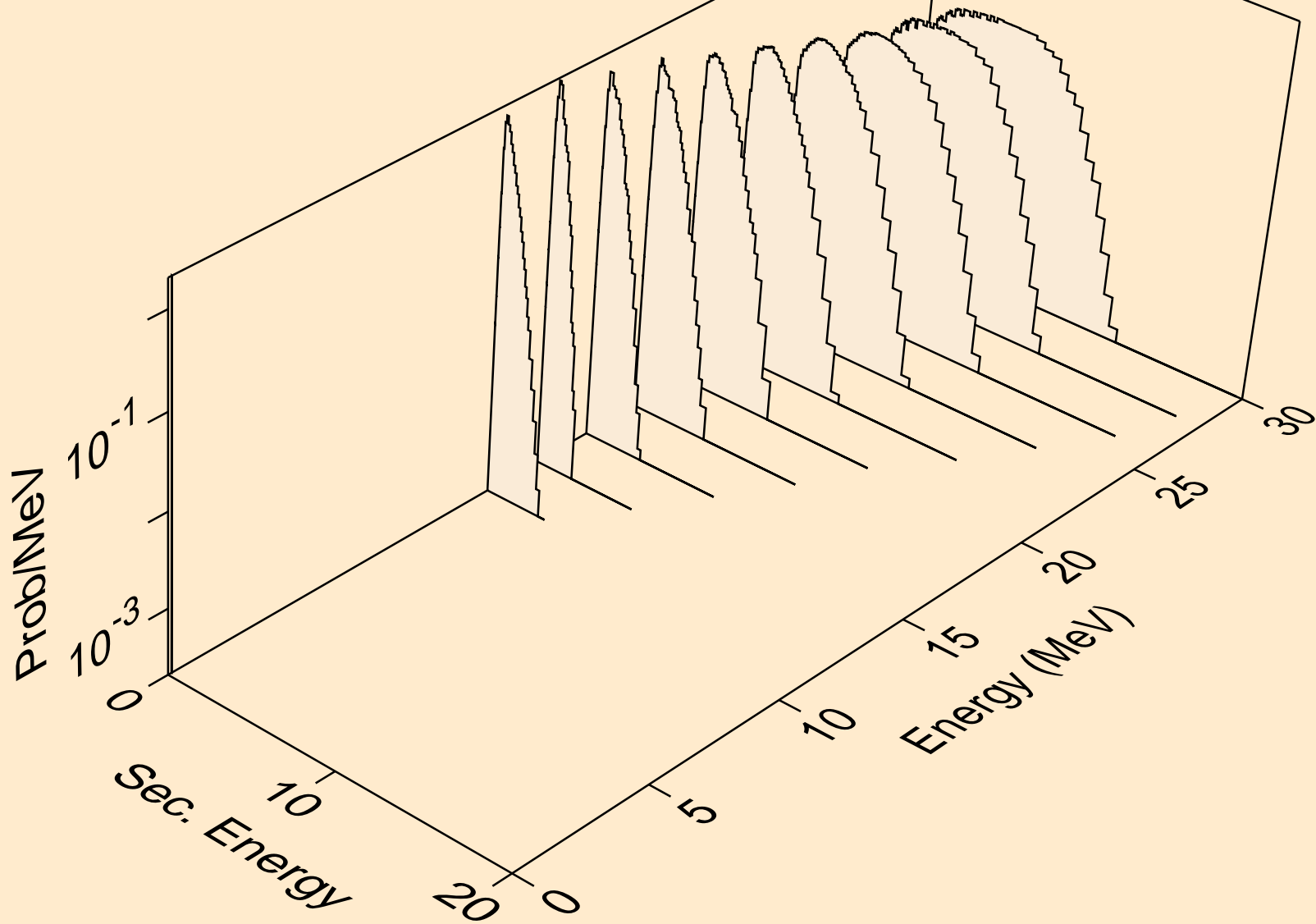

HS268 PROTON ACER TENDL-2021 LIBRARY; T=0.K
deuterons from (p,x)

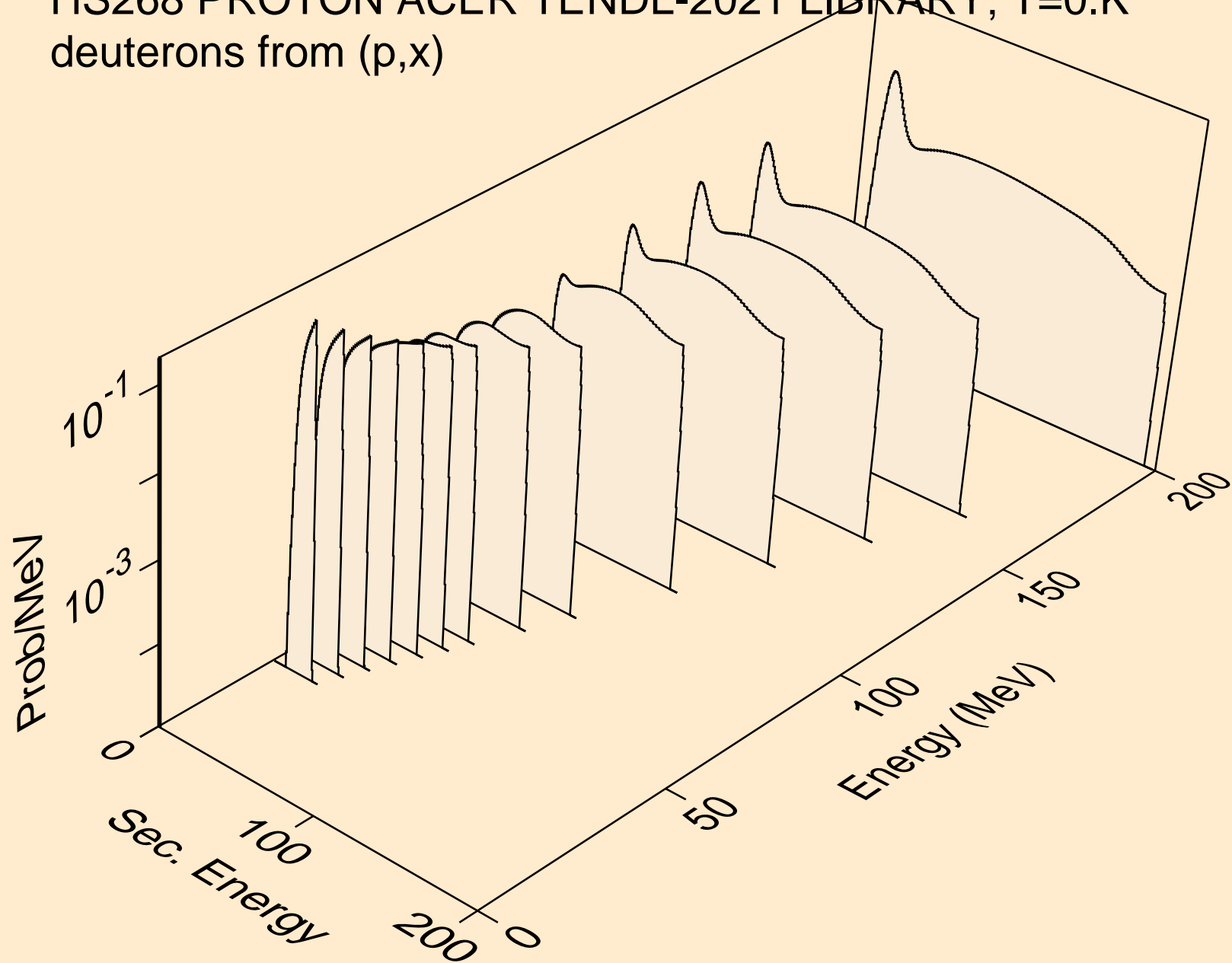

HS268 PROTON ACER TENDL-2021 LIBRARY; T=0.K
deuterons from (p,n*)d

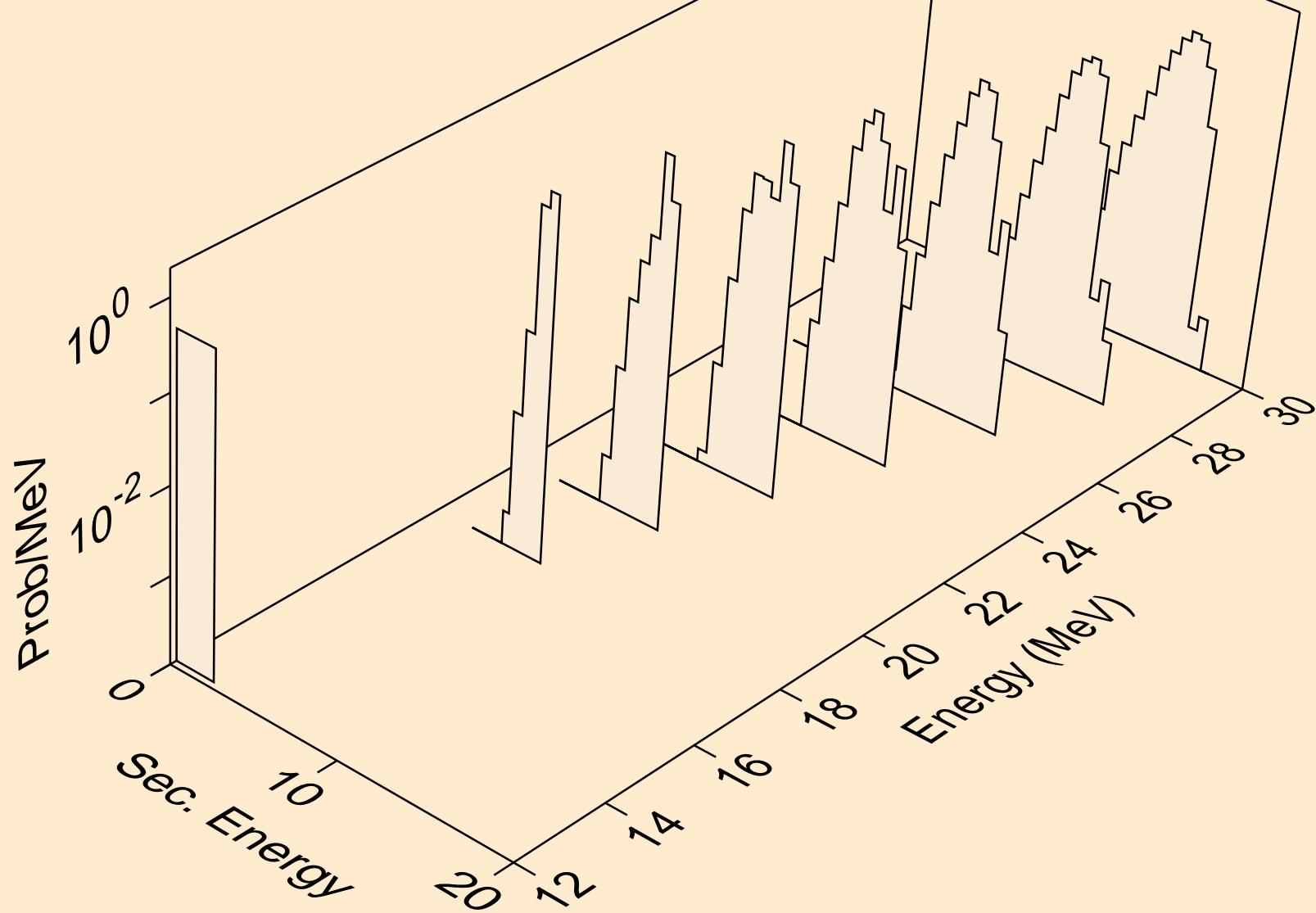

HS268 PROTON ACER TENDL-2021 LIBRARY; T=0.K
deuterons from (p,d)

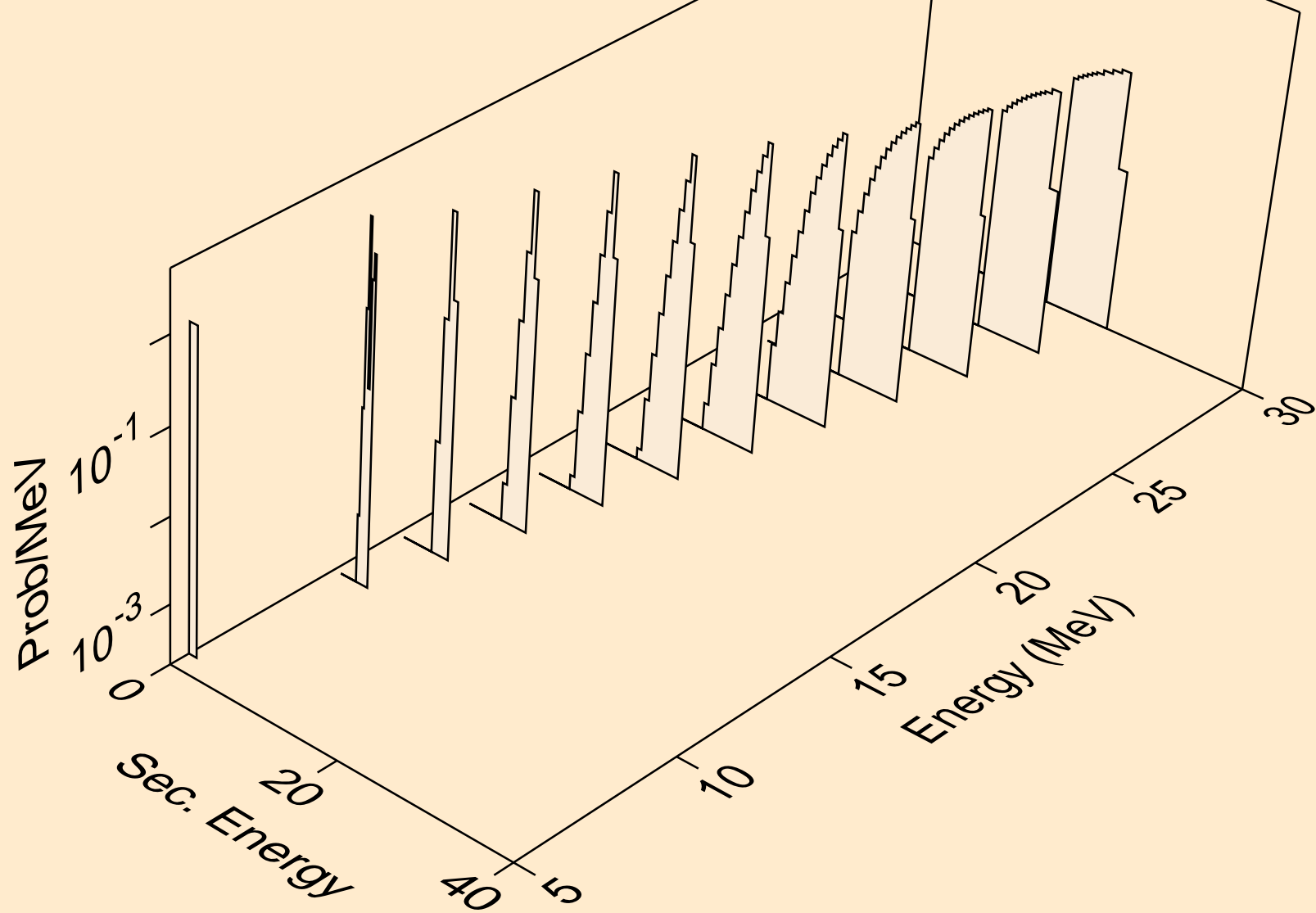

HS268 PROTON ACER TENDL-2021 LIBRARY; T=0.K
deuterons from (p,d2a)

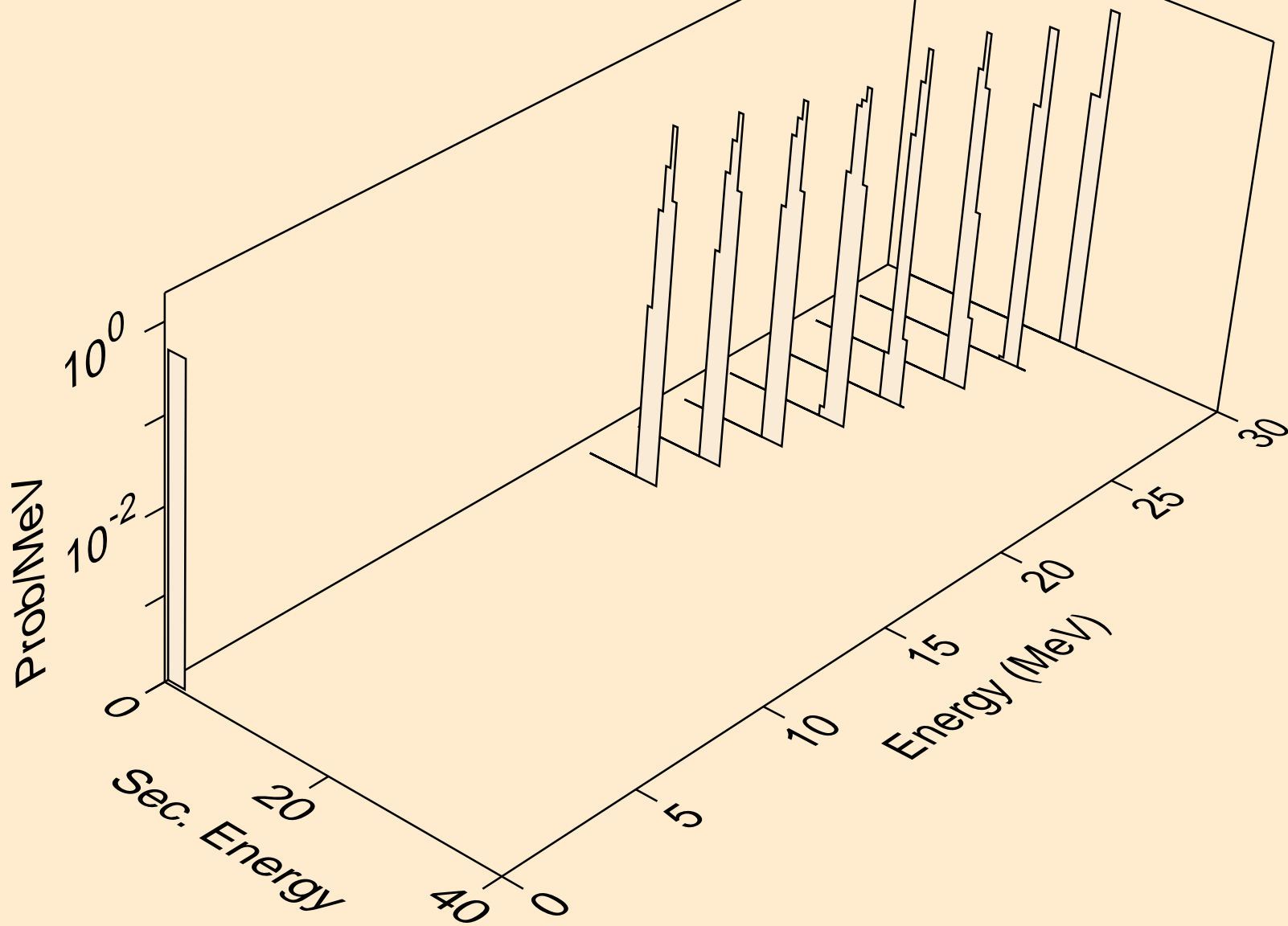

HS268 PROTON ACER TENDL-2021 LIBRARY; T=0.K
deuterons from (p,da)

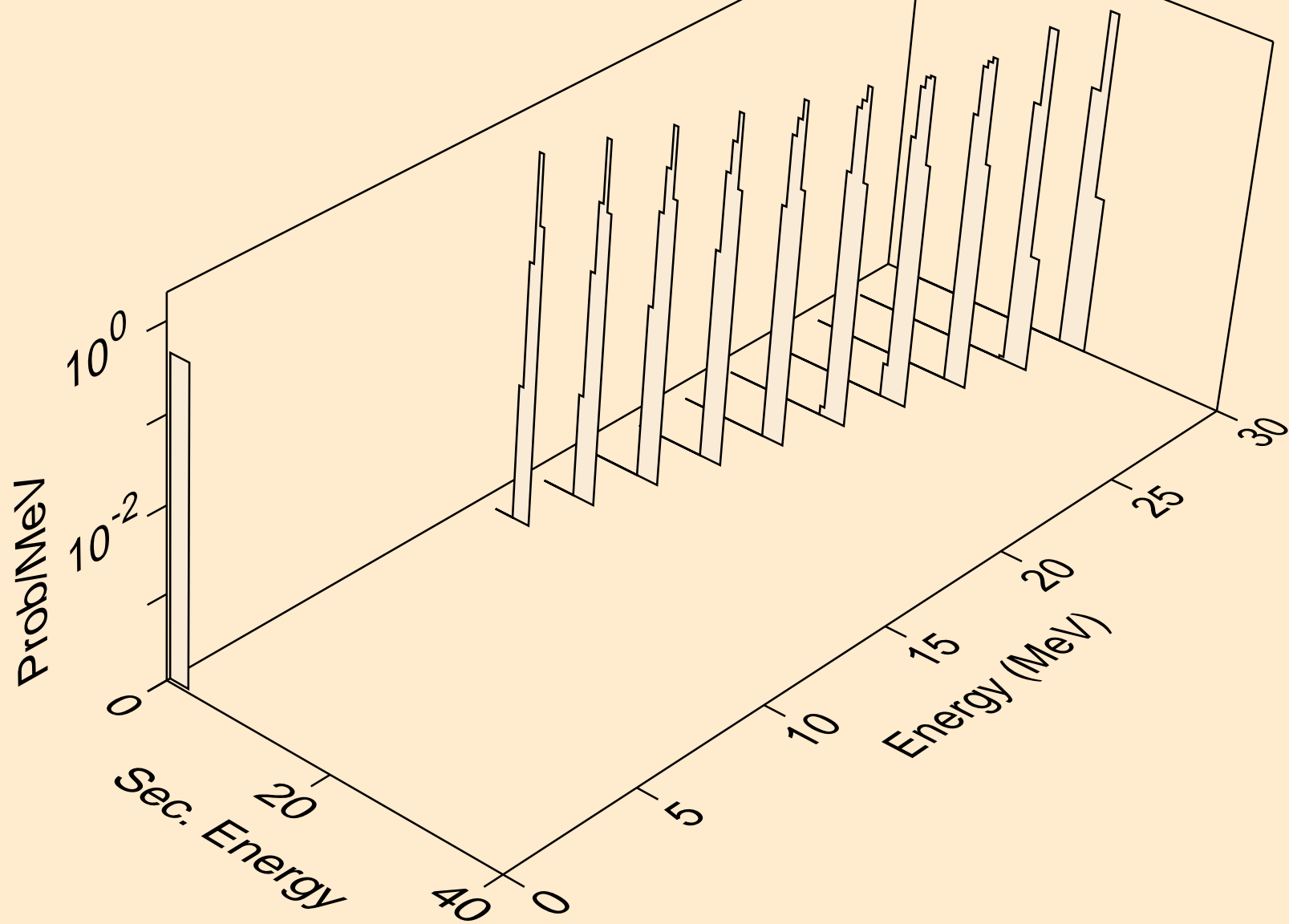

HS268 PROTON ACER TENDL-2021 LIBRARY; T=0.K
tritons from (p,x)

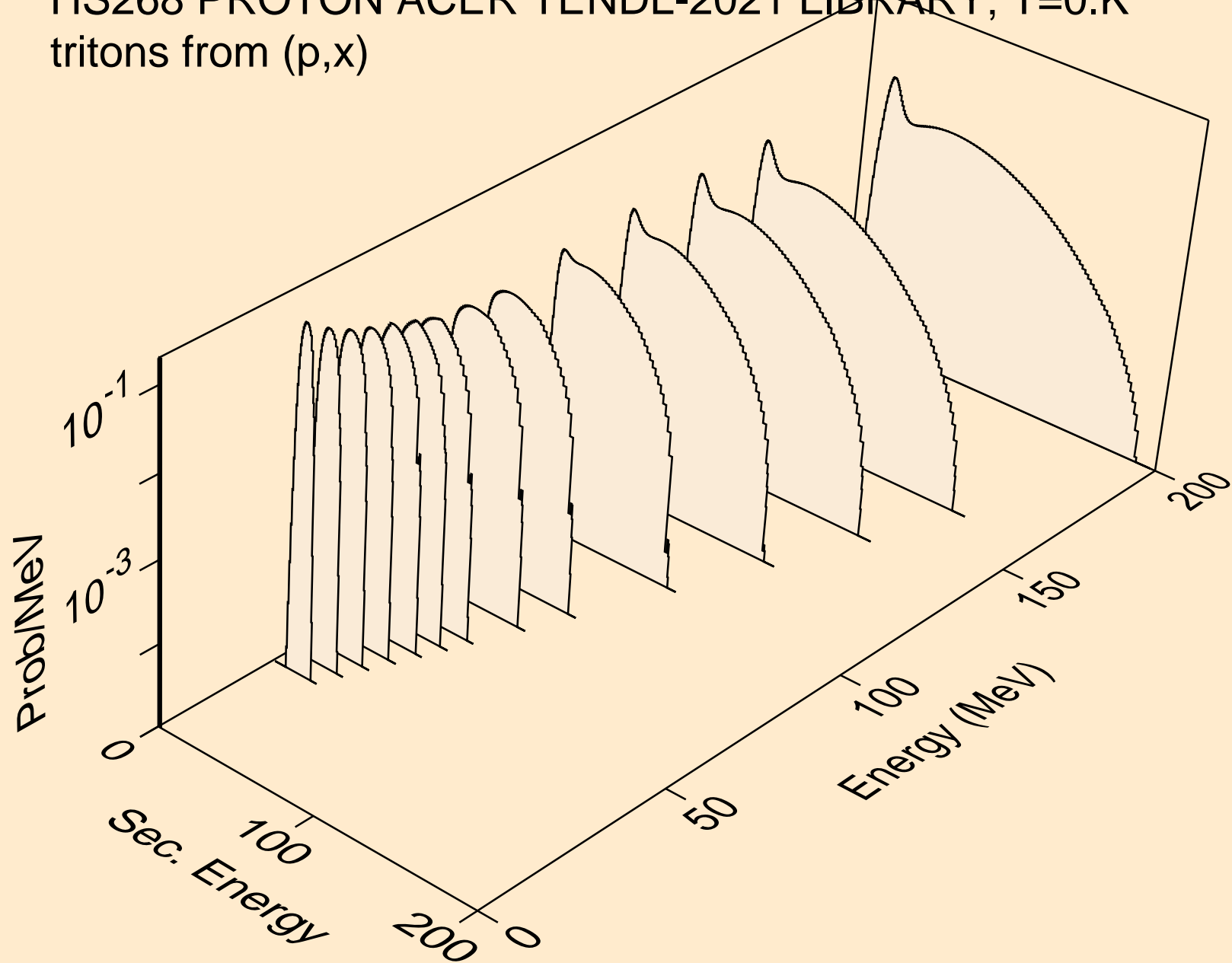

HS268 PROTON ACER TENDL-2021 LIBRARY; T=0.K
tritons from (p,n*)t

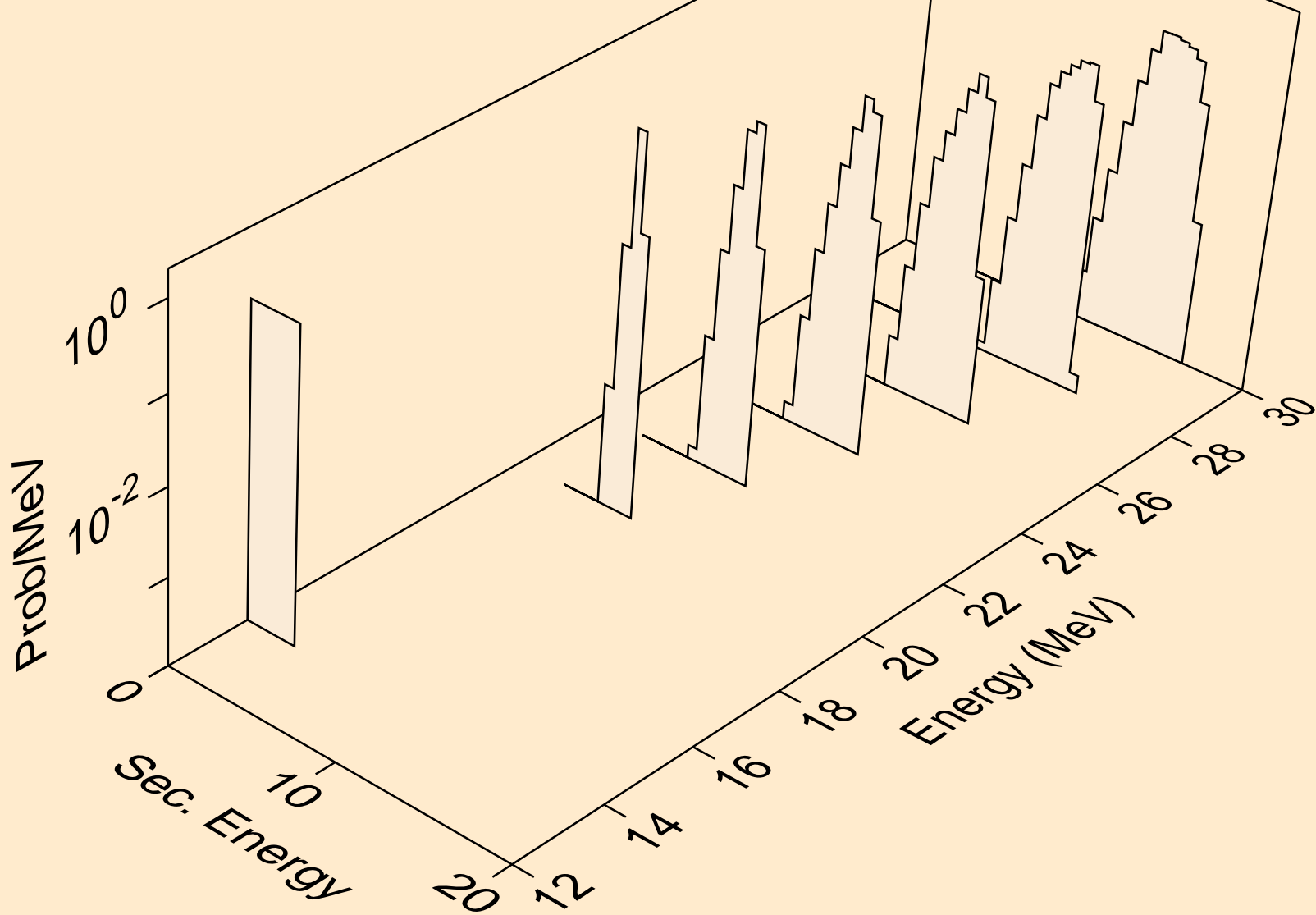

HS268 PROTON ACER TENDL-2021 LIBRARY; T=0.K
tritons from (p,t)

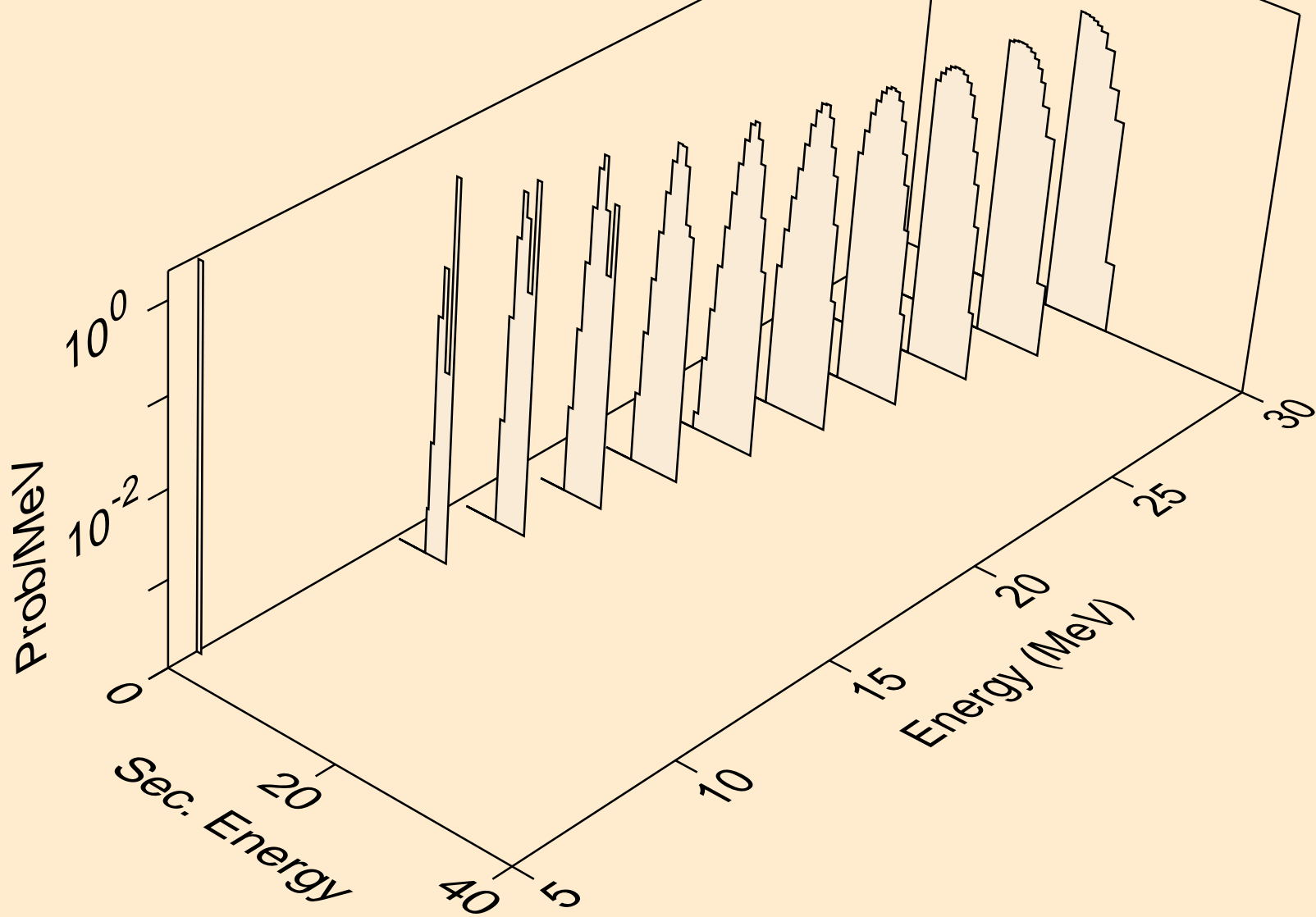

HS268 PROTON ACER TENDL-2021 LIBRARY; T=0.K
he3s from (p,x)

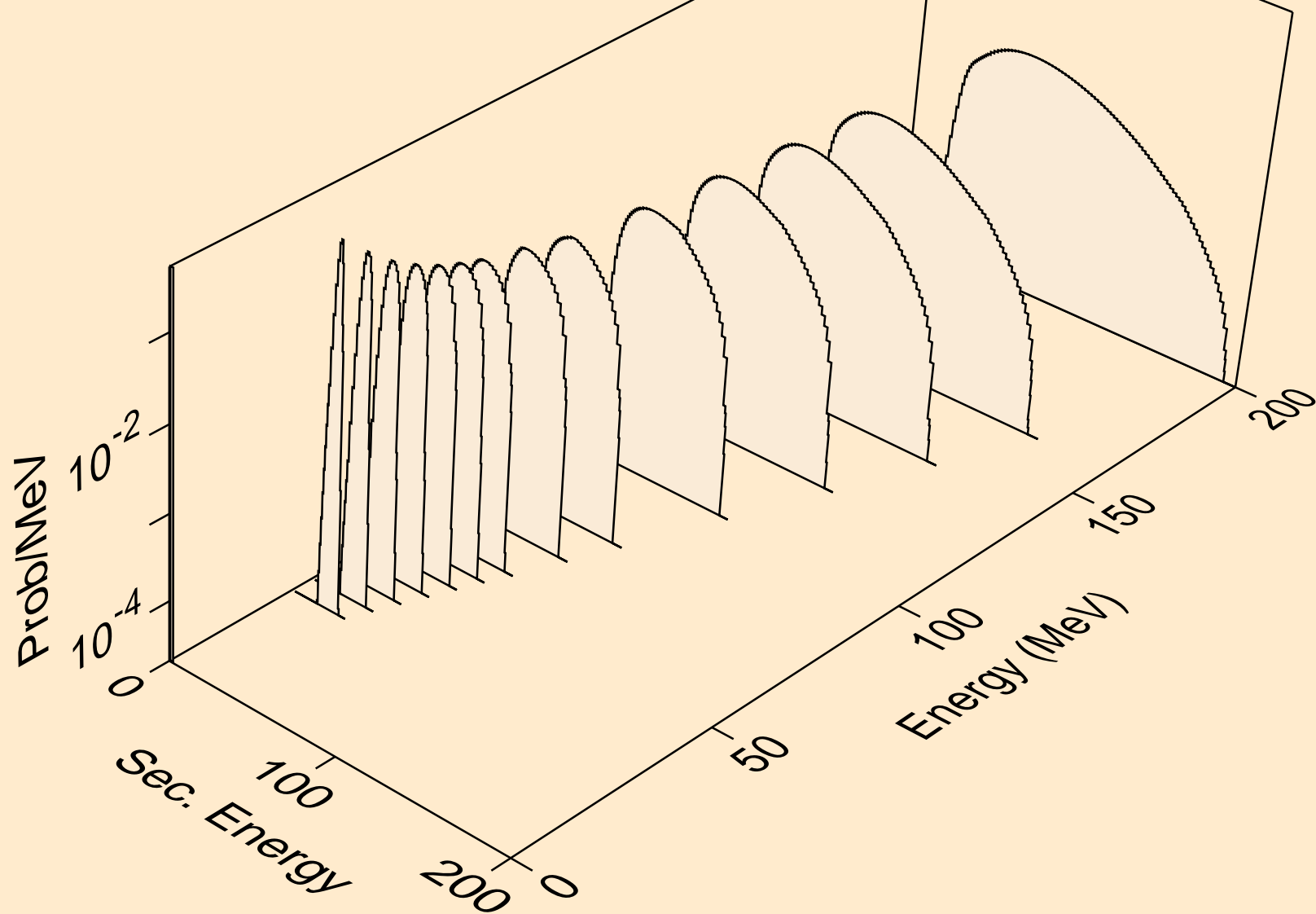

HS268 PROTON ACER TENDL-2021 LIBRARY; T=0.K
he3s from (p,he3)

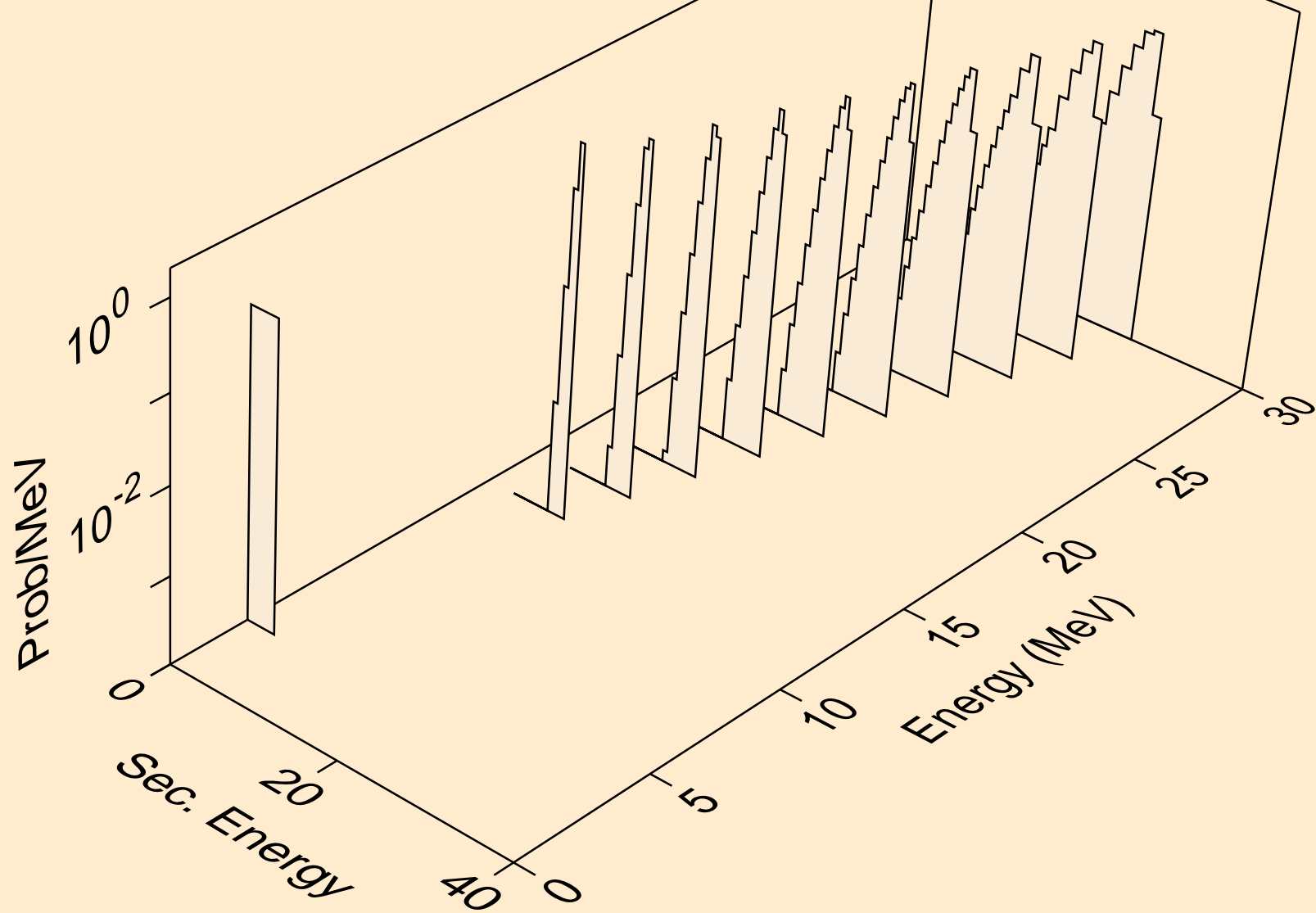

HS268 PROTON ACER TENDL-2021 LIBRARY; T=0.K
alphas from (p,x)

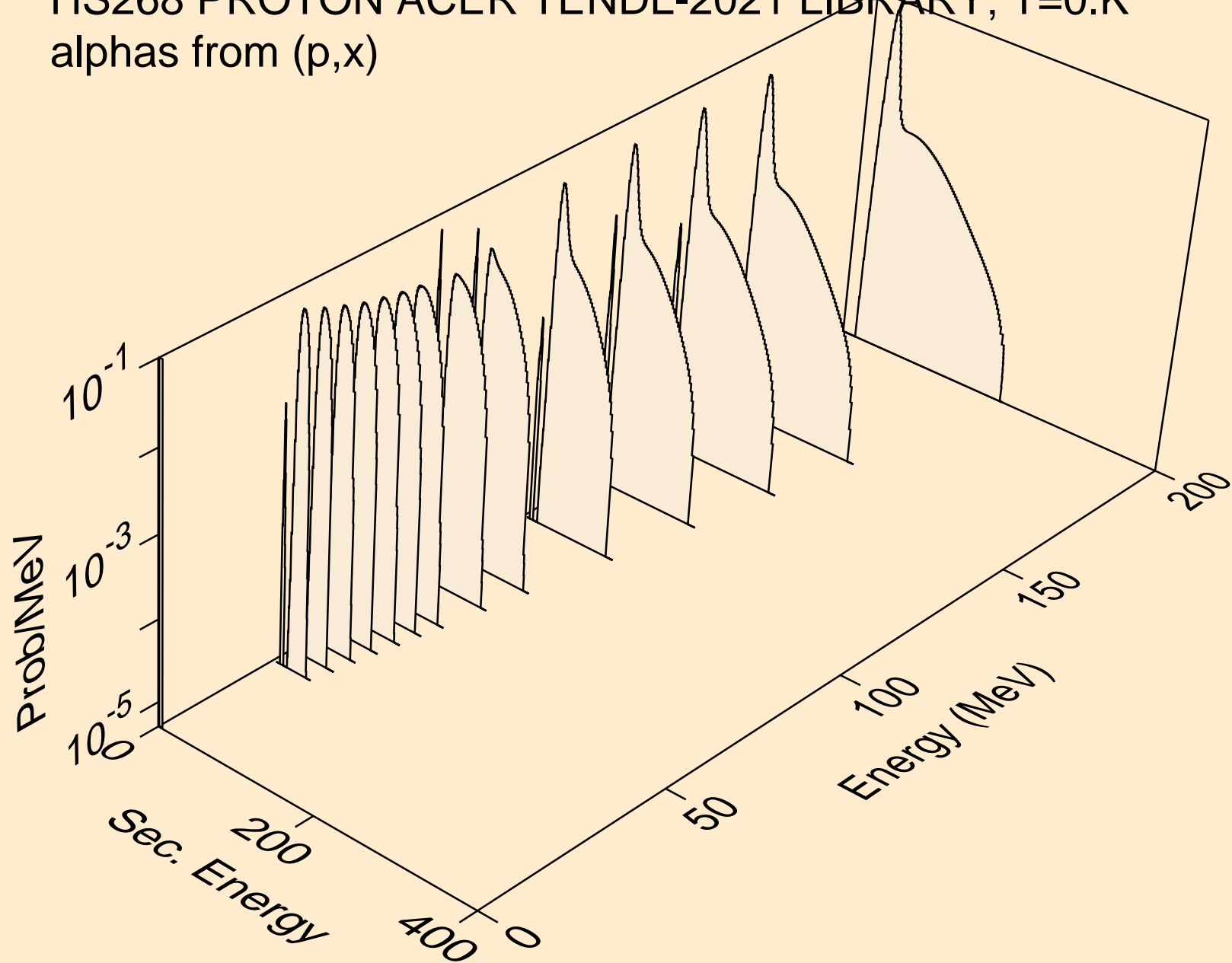

HS268 PROTON ACER TENDL-2021 LIBRARY; T=0.K
alphas from (p,n*)a

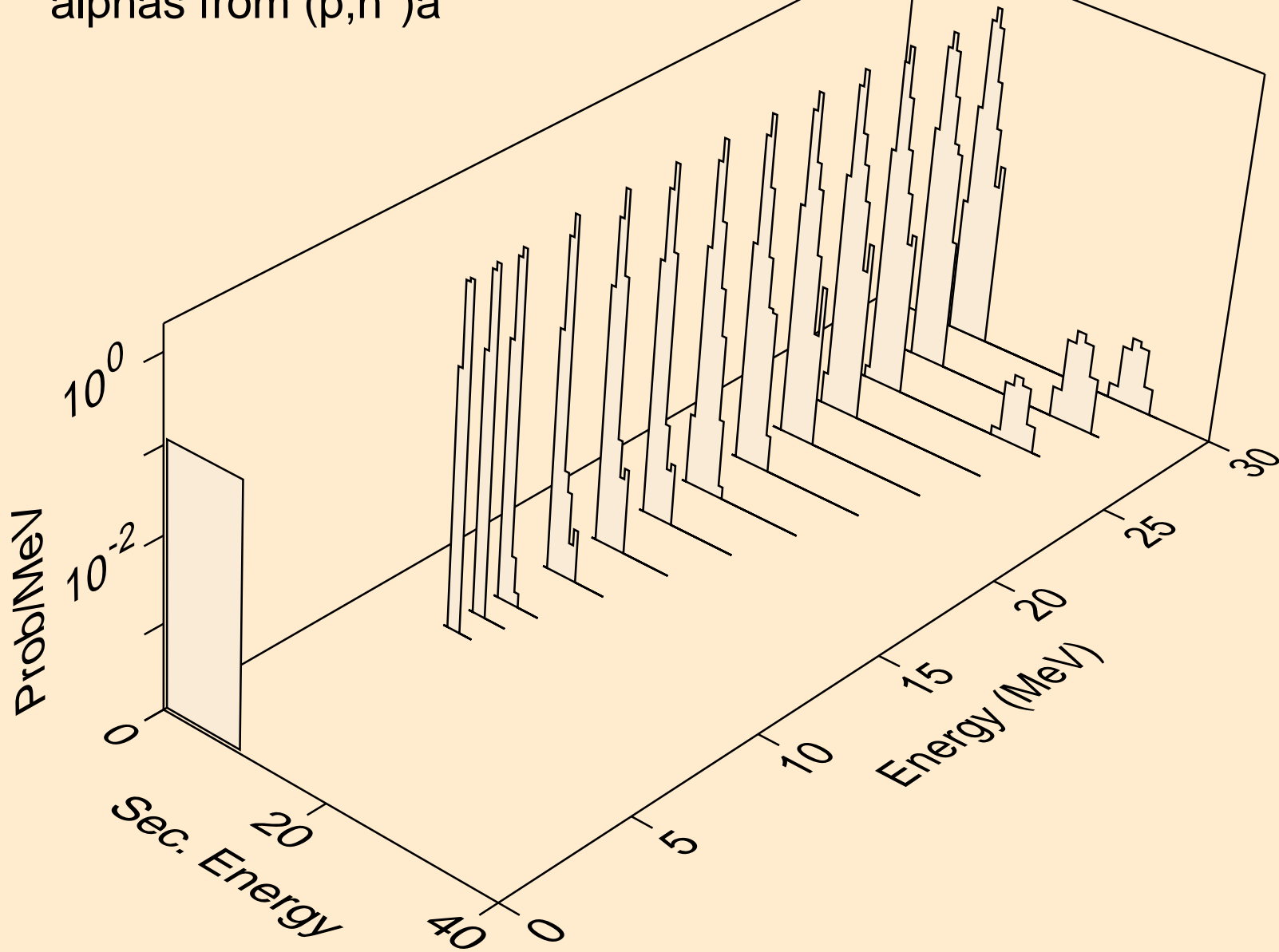

HS268 PROTON ACER TENDL-2021 LIBRARY; T=0.K
alphas from (p,n*)3a

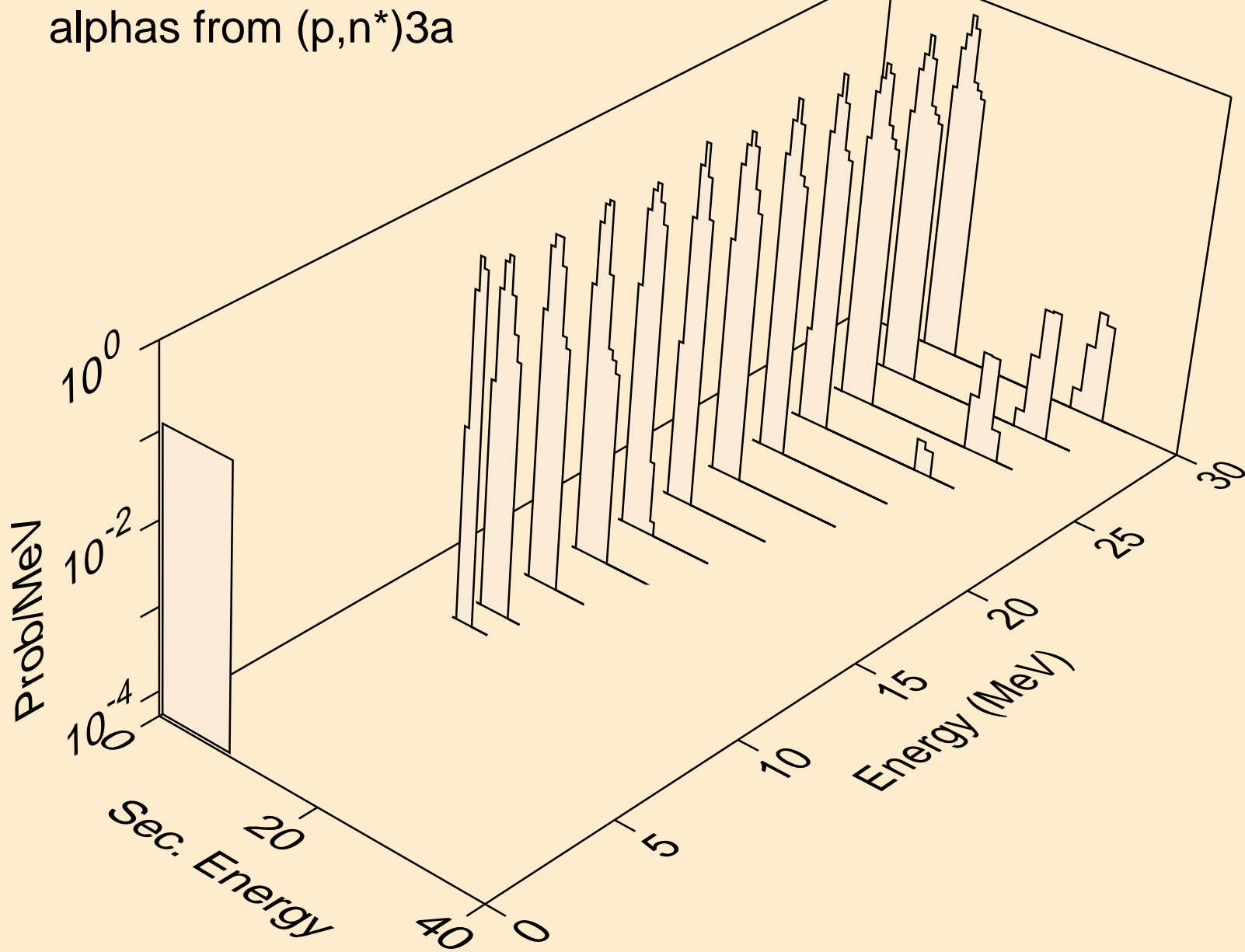

HS268 PROTON ACER TENDL-2021 LIBRARY; T=0.K
alphas from (p,2n)a

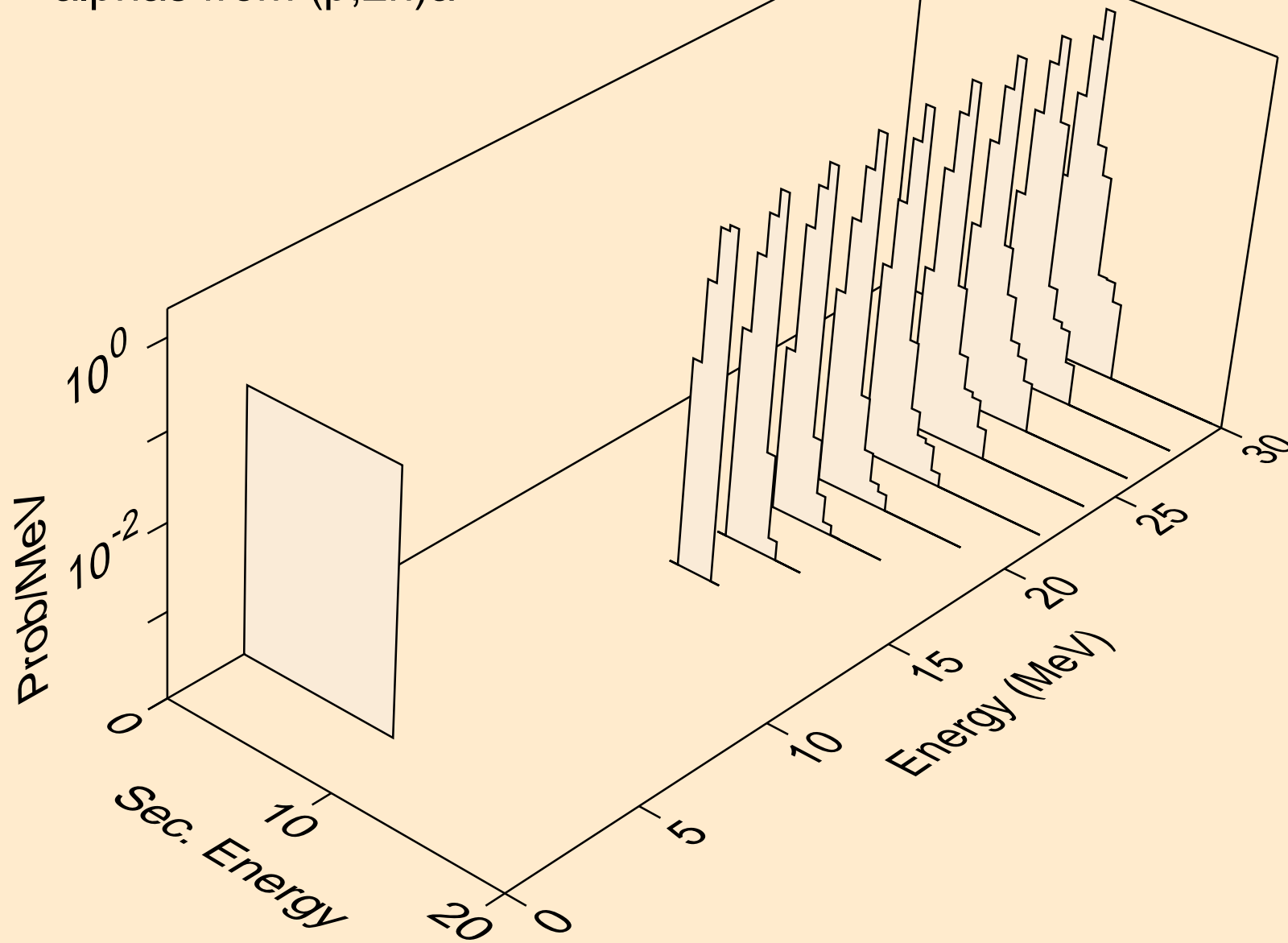

HS268 PROTON ACER TENDL-2021 LIBRARY; T=0.K
alphas from (p,3n)a

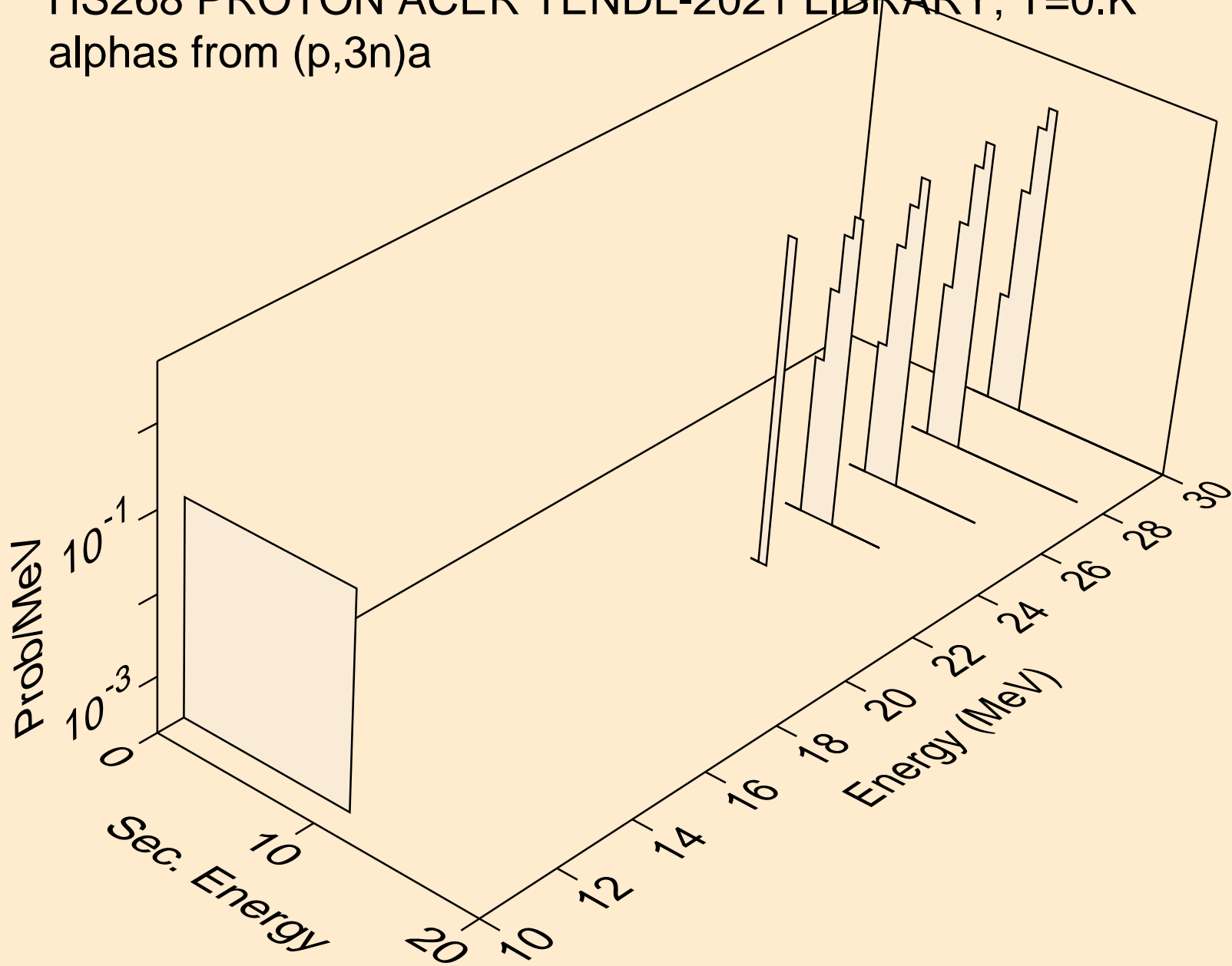

HS268 PROTON ACER TENDL-2021 LIBRARY; T=0.K
alphas from (p,n*)2a

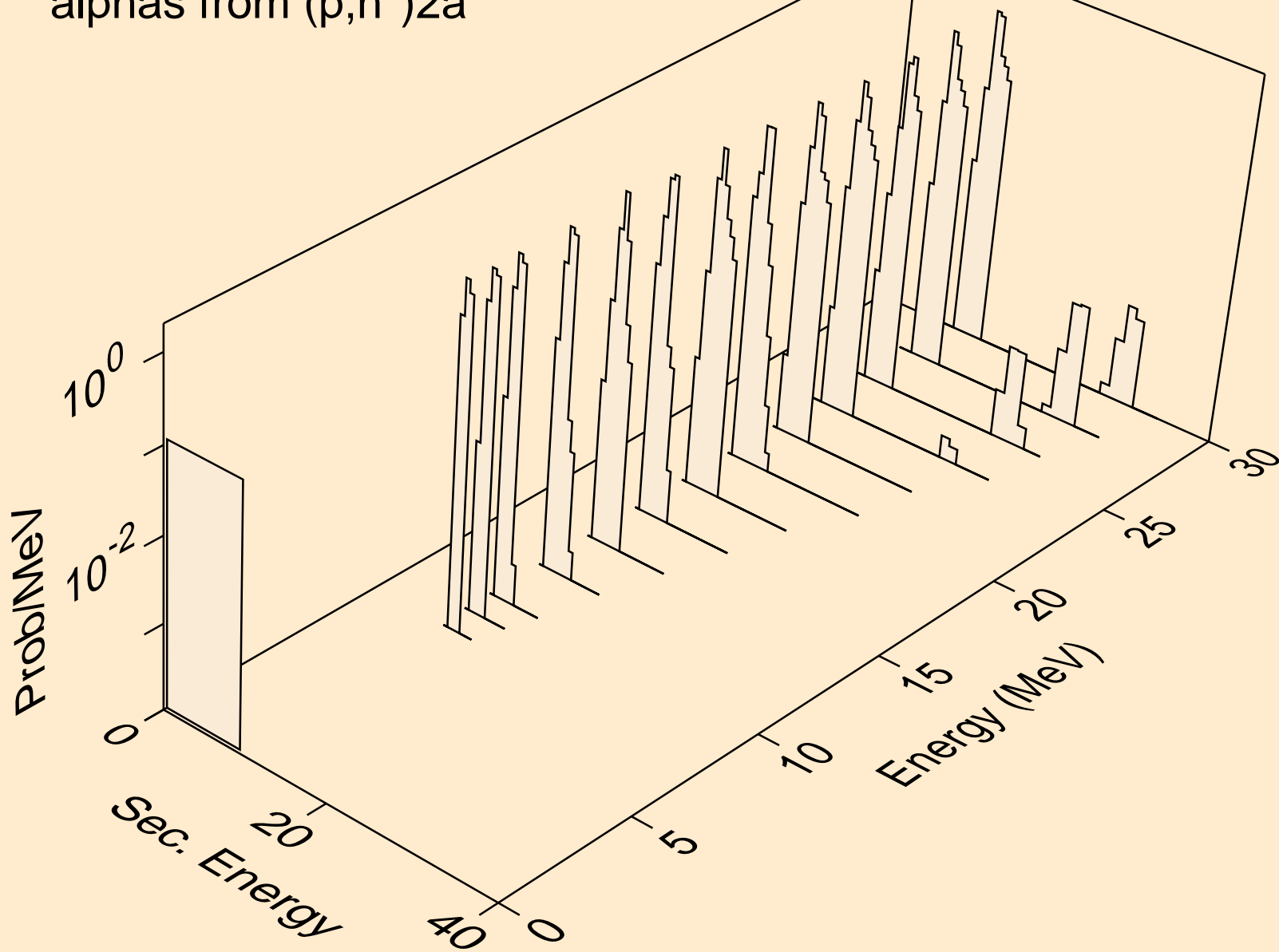

HS268 PROTON ACER TENDL-2021 LIBRARY; T=0.K
alphas from (p,npa)

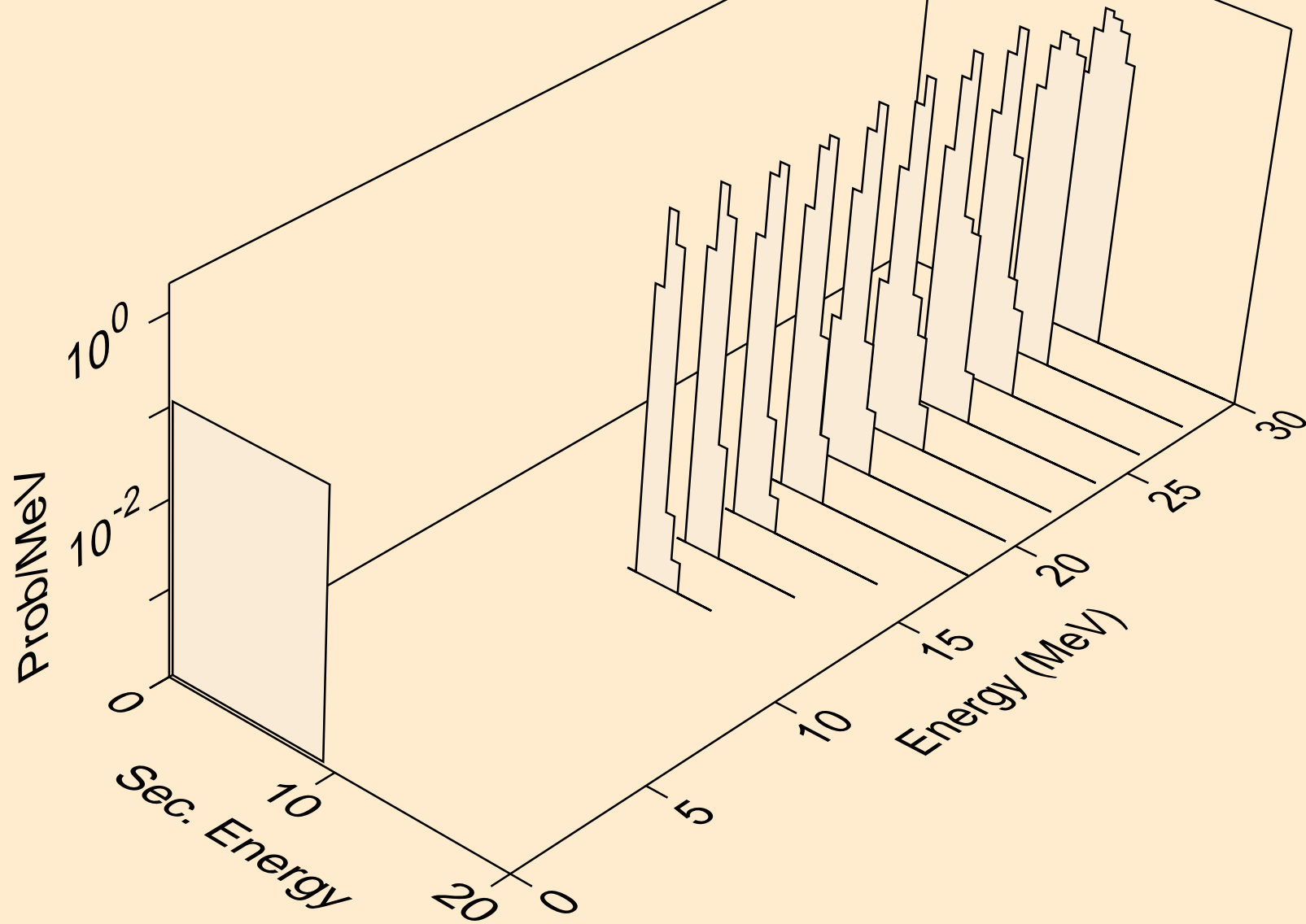

HS268 PROTON ACER TENDL-2021 LIBRARY; T=0.K
alphas from (p,a)

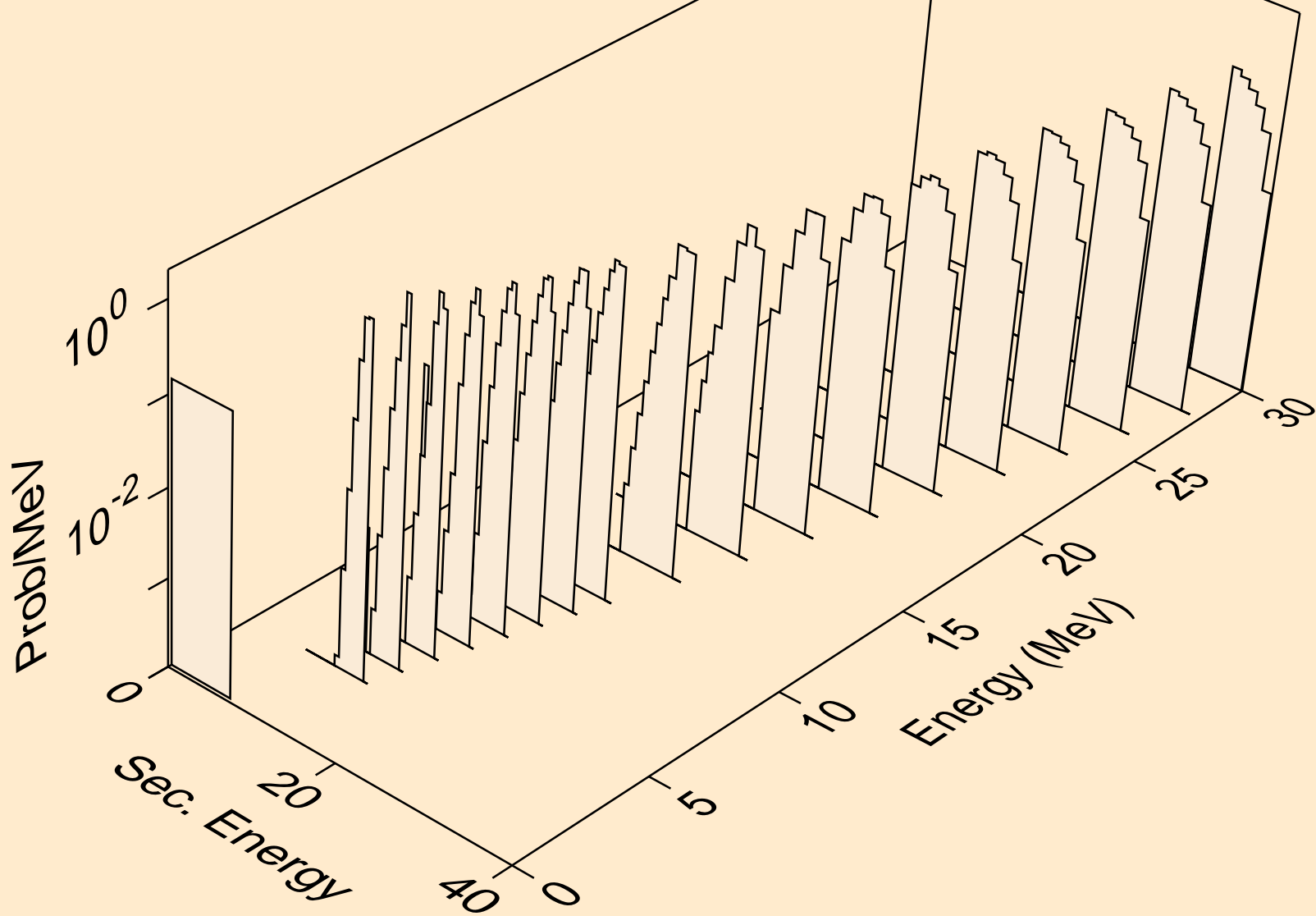

HS268 PROTON ACER TENDL-2021 LIBRARY; T=0.K
alphas from (p,2a)

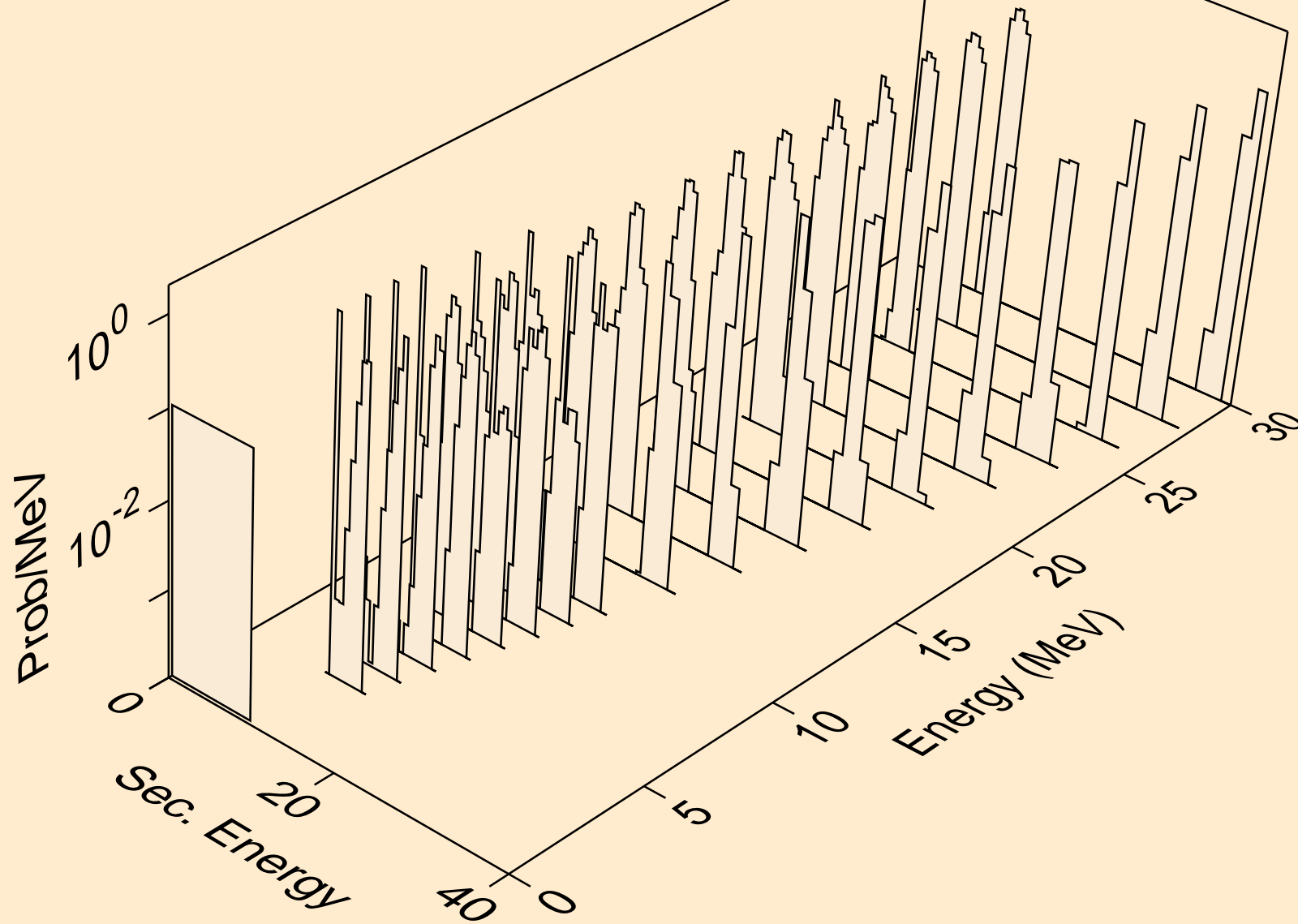

HS268 PROTON ACER TENDL-2021 LIBRARY; T=0.K
alphas from (p,3a)

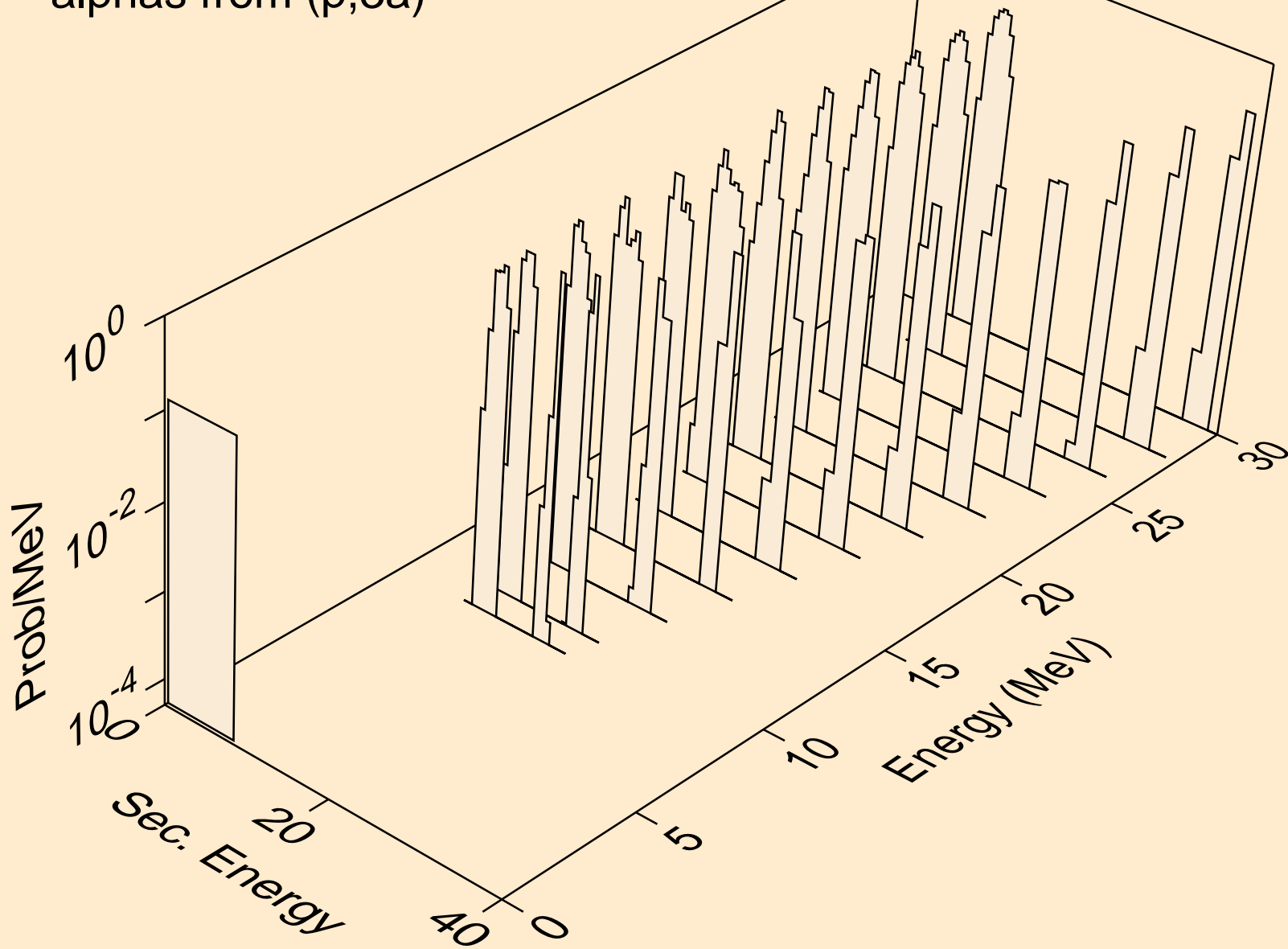

HS268 PROTON ACER TENDL-2021 LIBRARY; T=0.K
alphas from (p,pa)

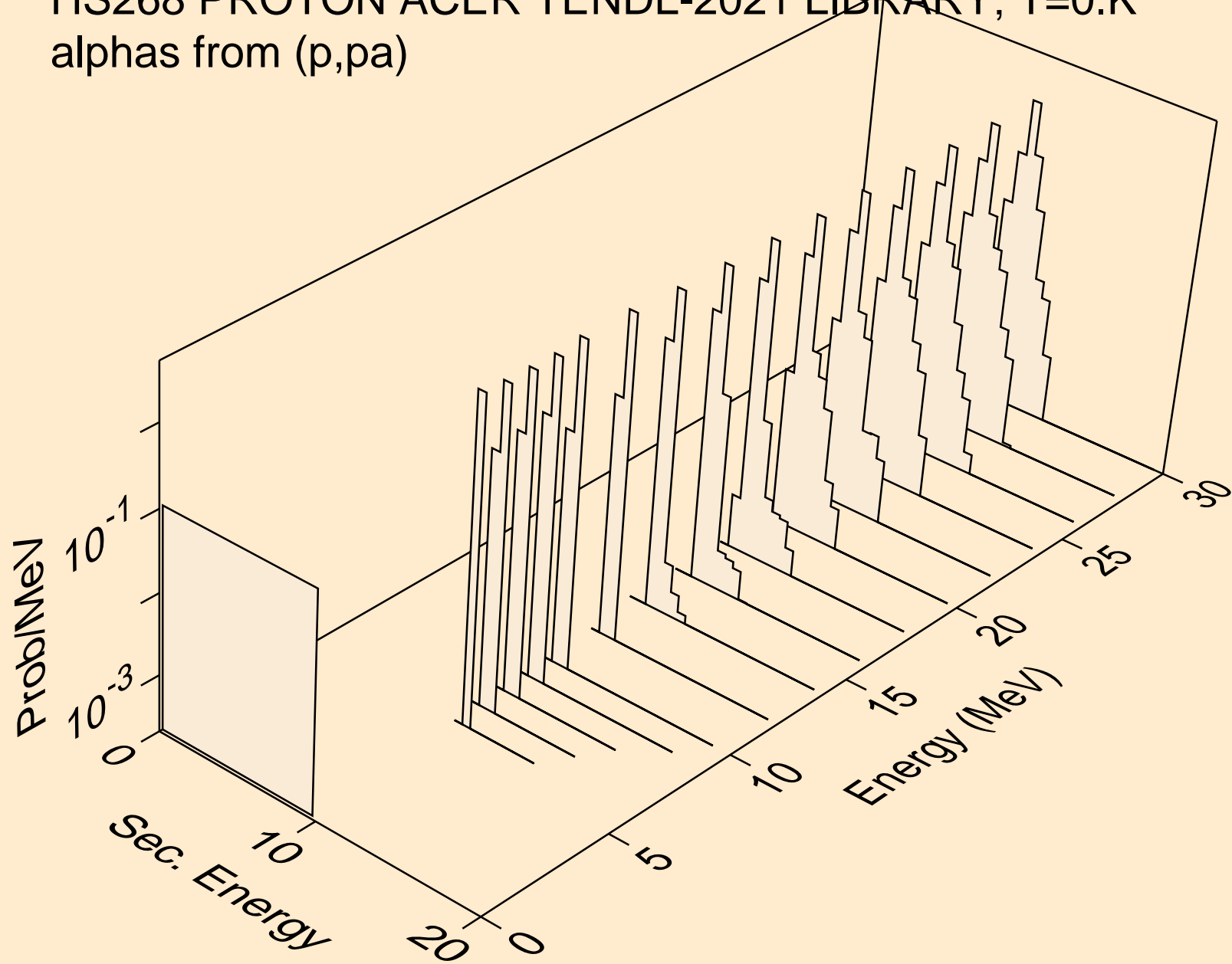

HS268 PROTON ACER TENDL-2021 LIBRARY; T=0.K
alphas from (p,d2a)

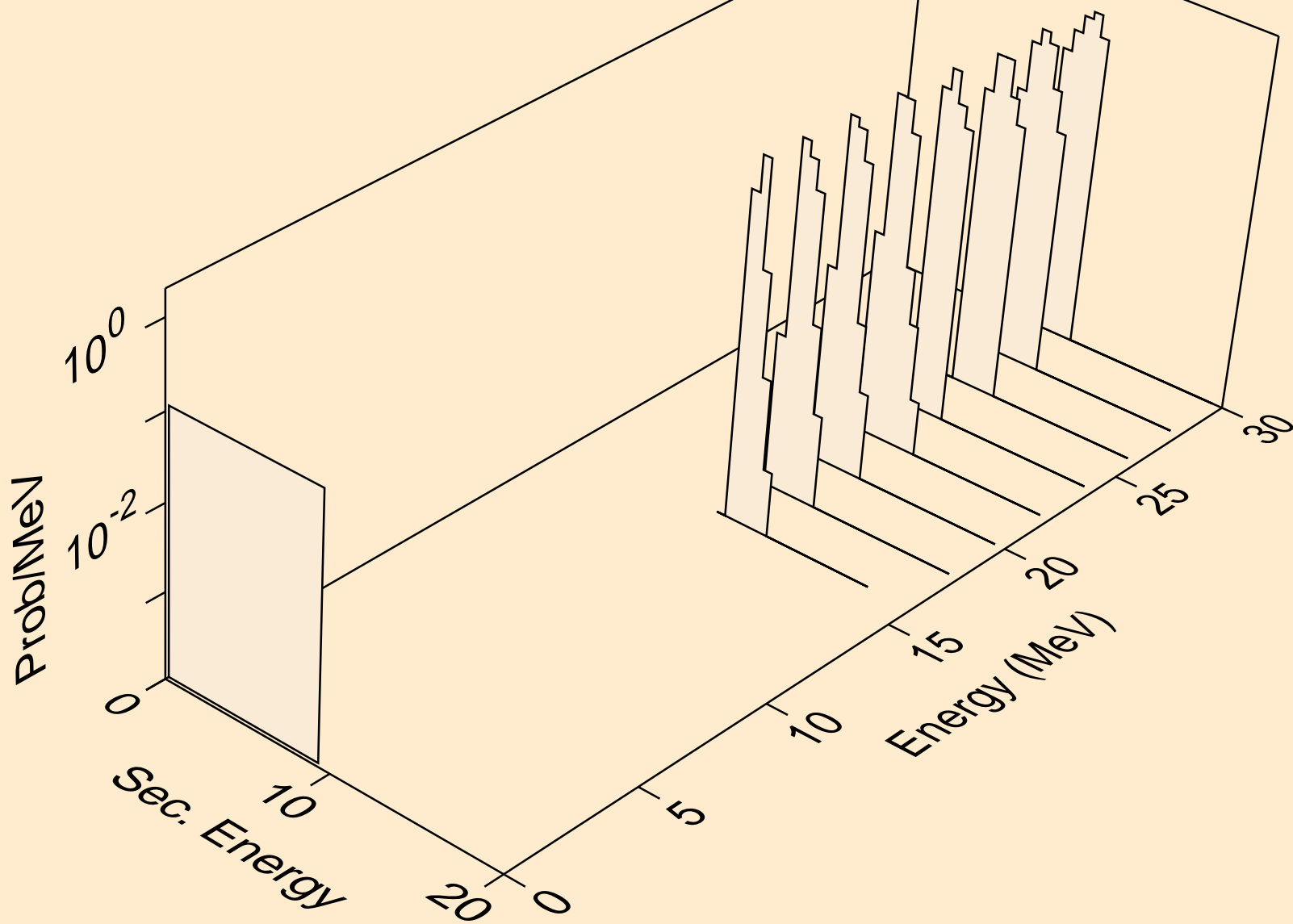

HS268 PROTON ACER TENDL-2021 LIBRARY; T=0.K
alphas from (p,da)

