

HS270 PROTON ACER TENDL-2021 LIBRARY; T=0.K

Principal cross sections

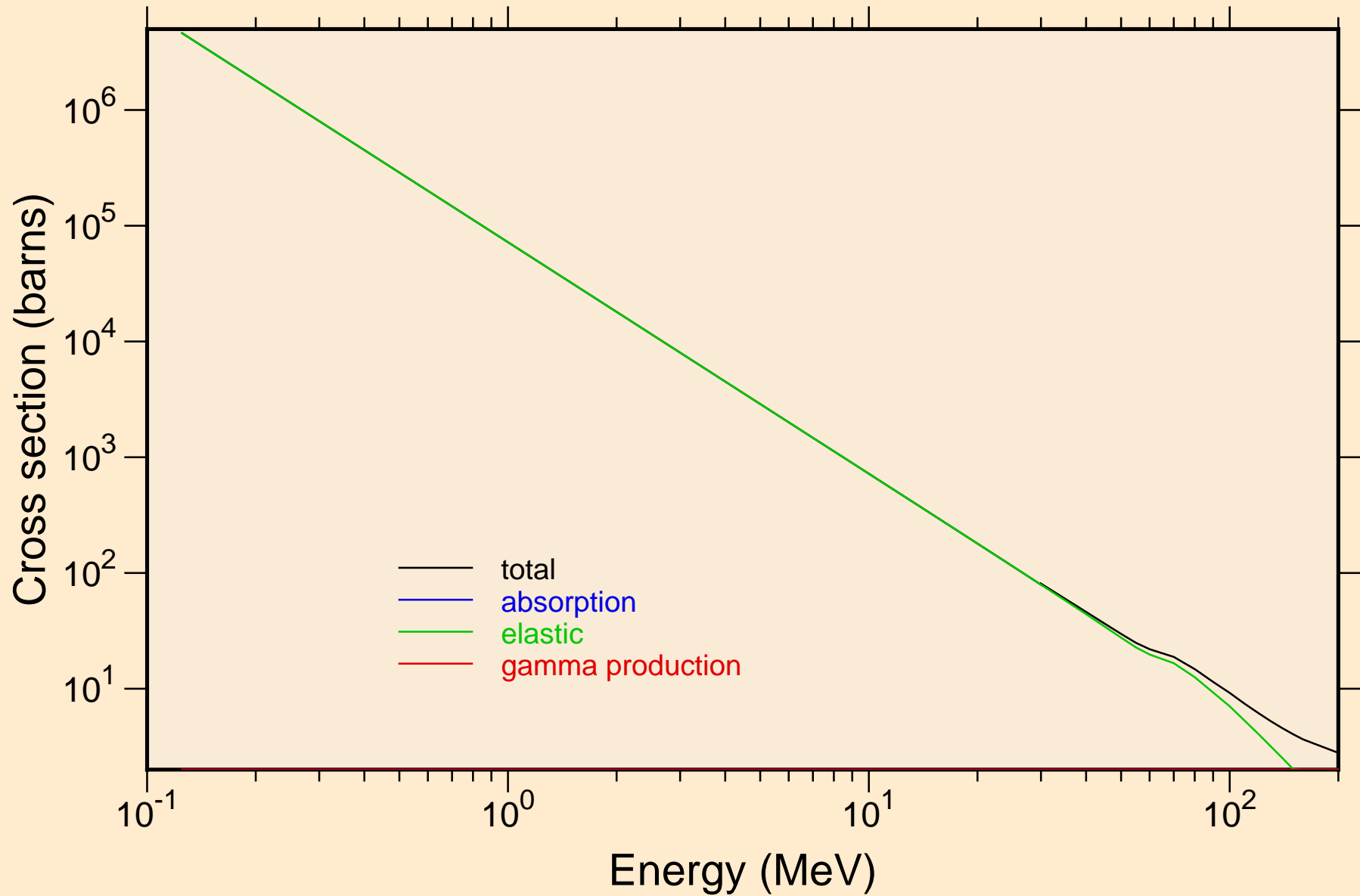

HS270 PROTON ACER TENDL-2021 LIBRARY; T=0.K

Heating

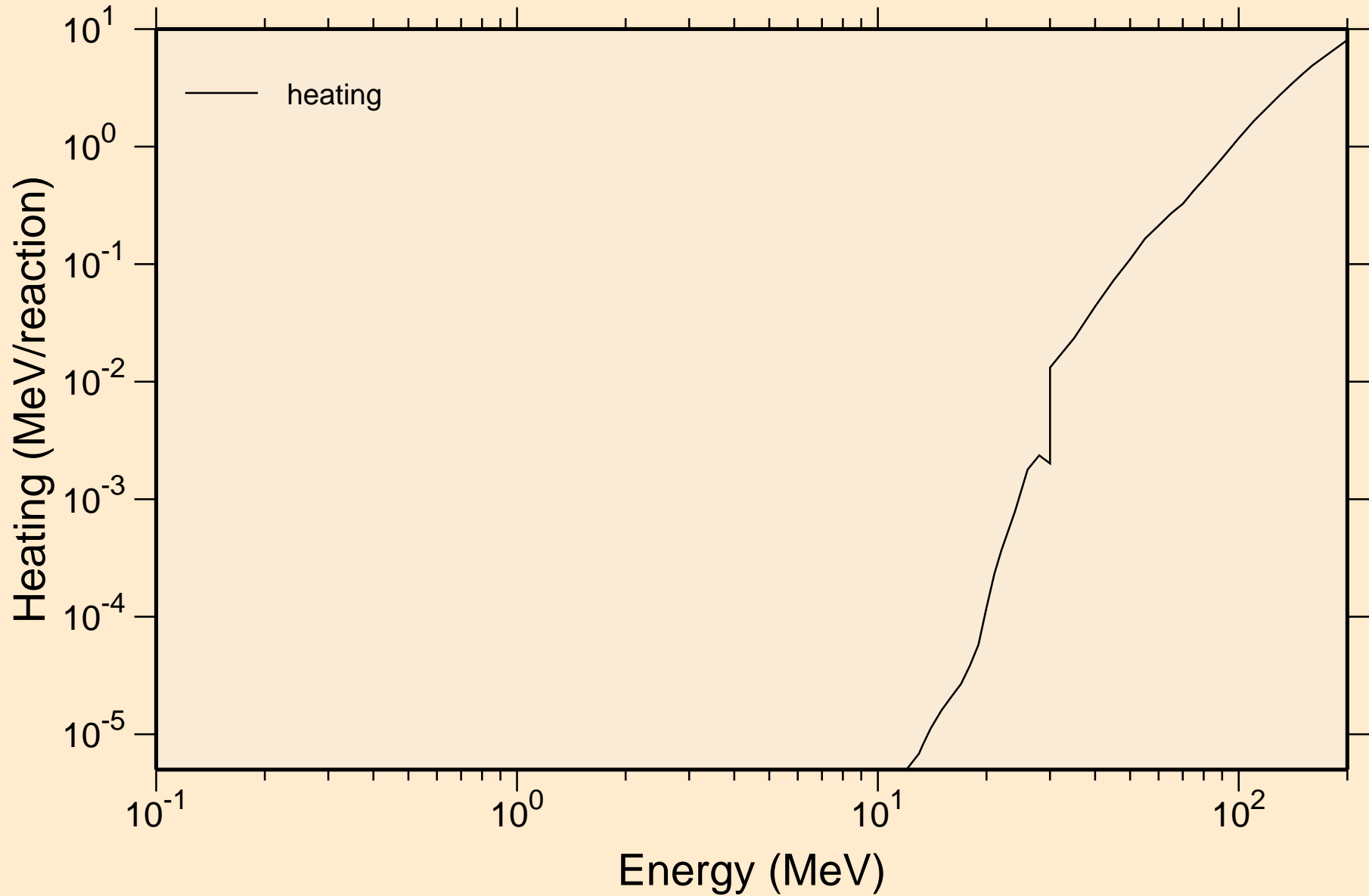

HS270 PROTON ACER TENDL-2021 LIBRARY; T=0.K

Principal cross sections

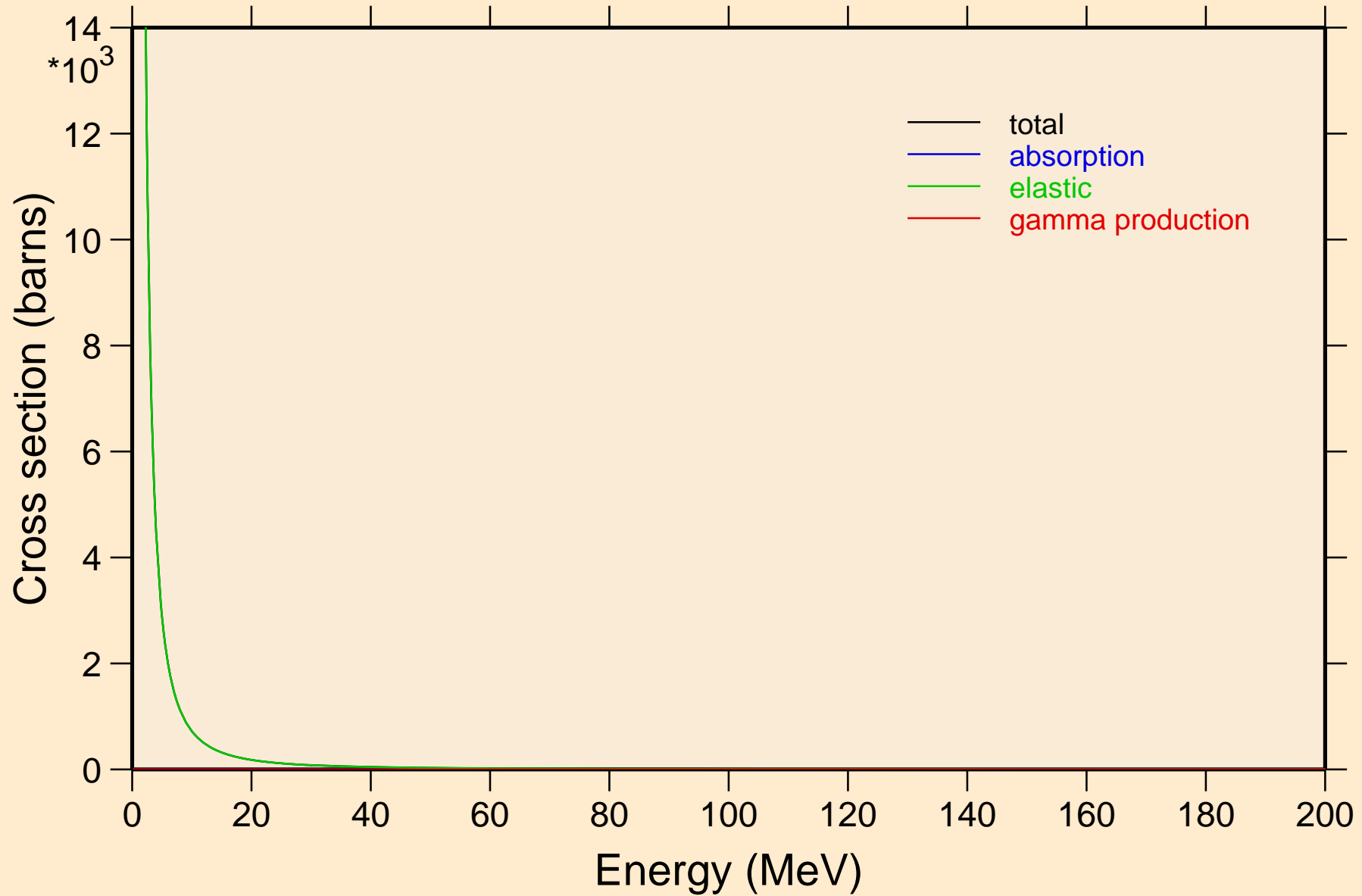

HS270 PROTON ACER TENDL-2021 LIBRARY; T=0.K

Heating

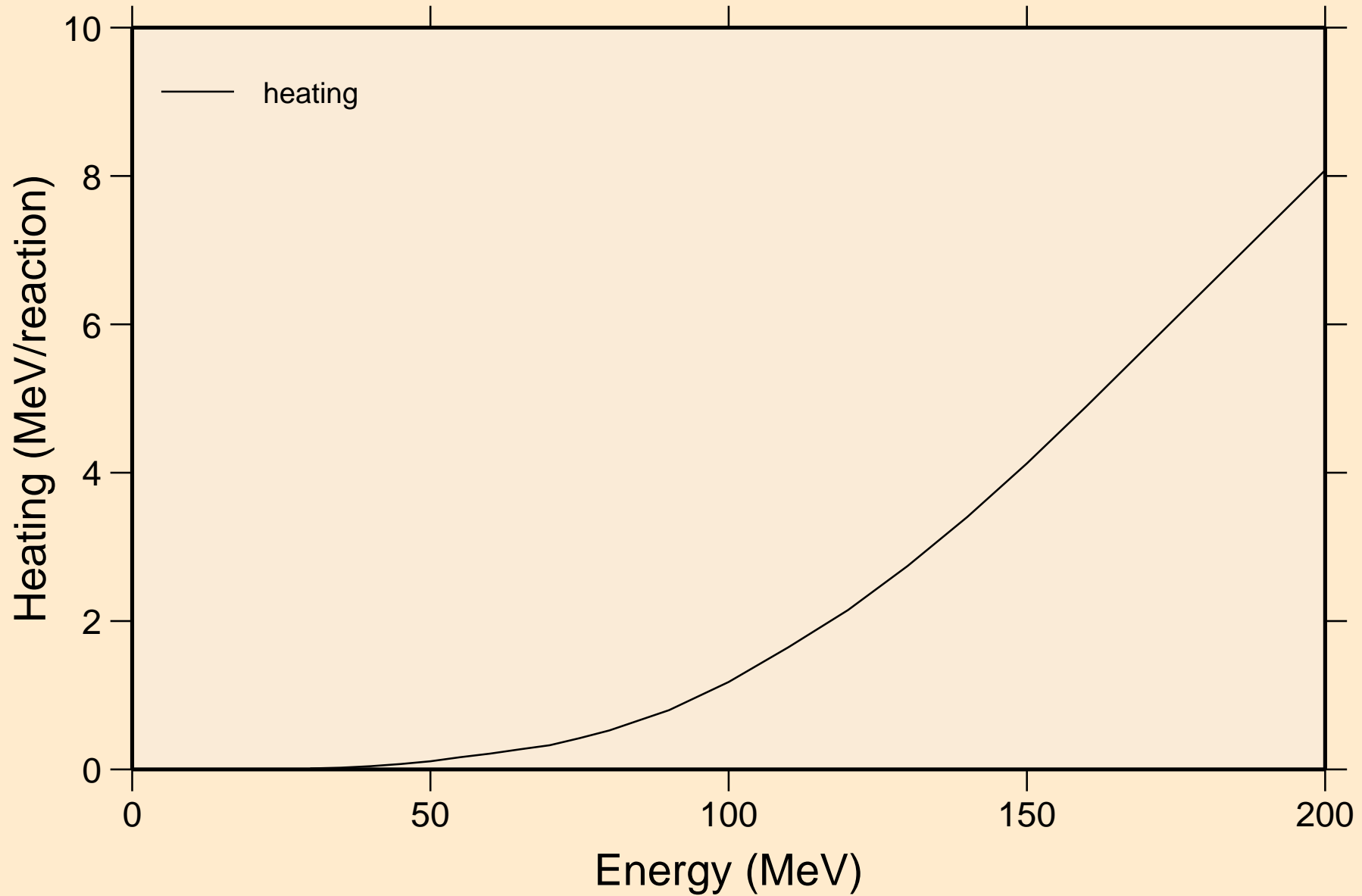

HS270 PROTON ACER TENDL-2021 LIBRARY; T=0.K

Threshold reactions

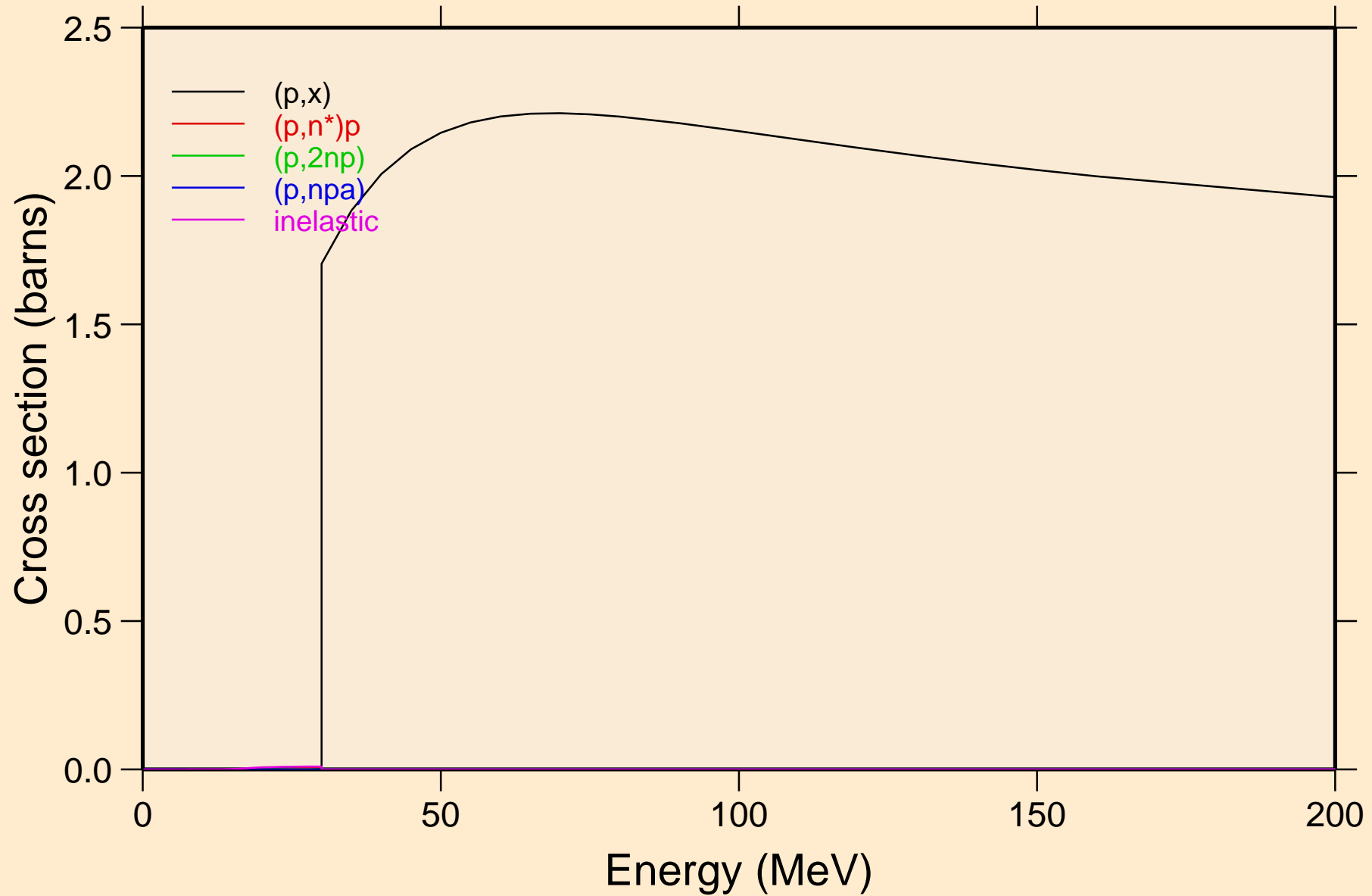

HS270 PROTON ACER TENDL-2021 LIBRARY; T=0.K
Threshold reactions

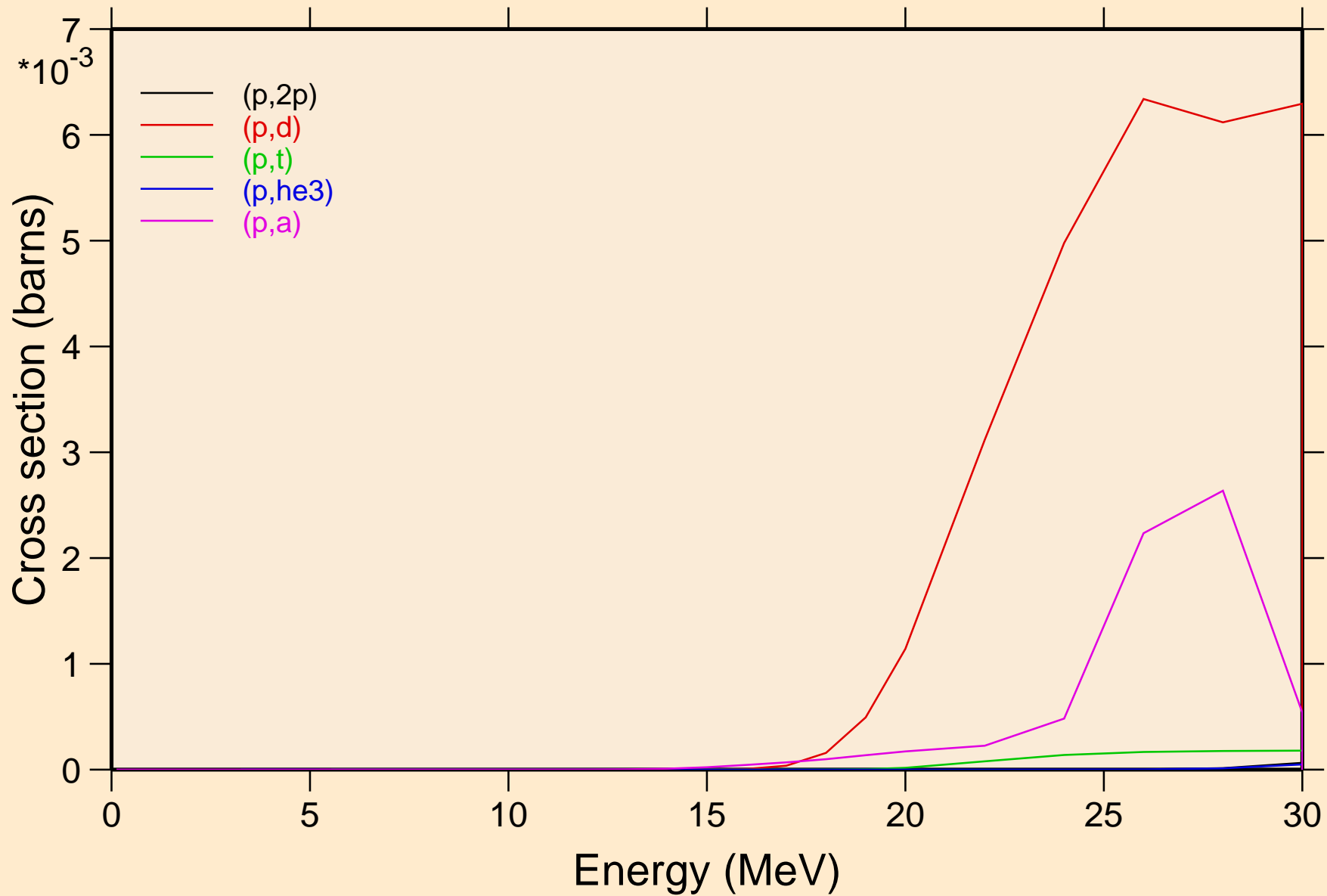

HS270 PROTON ACER TENDL-2021 LIBRARY; T=0.K

Threshold reactions

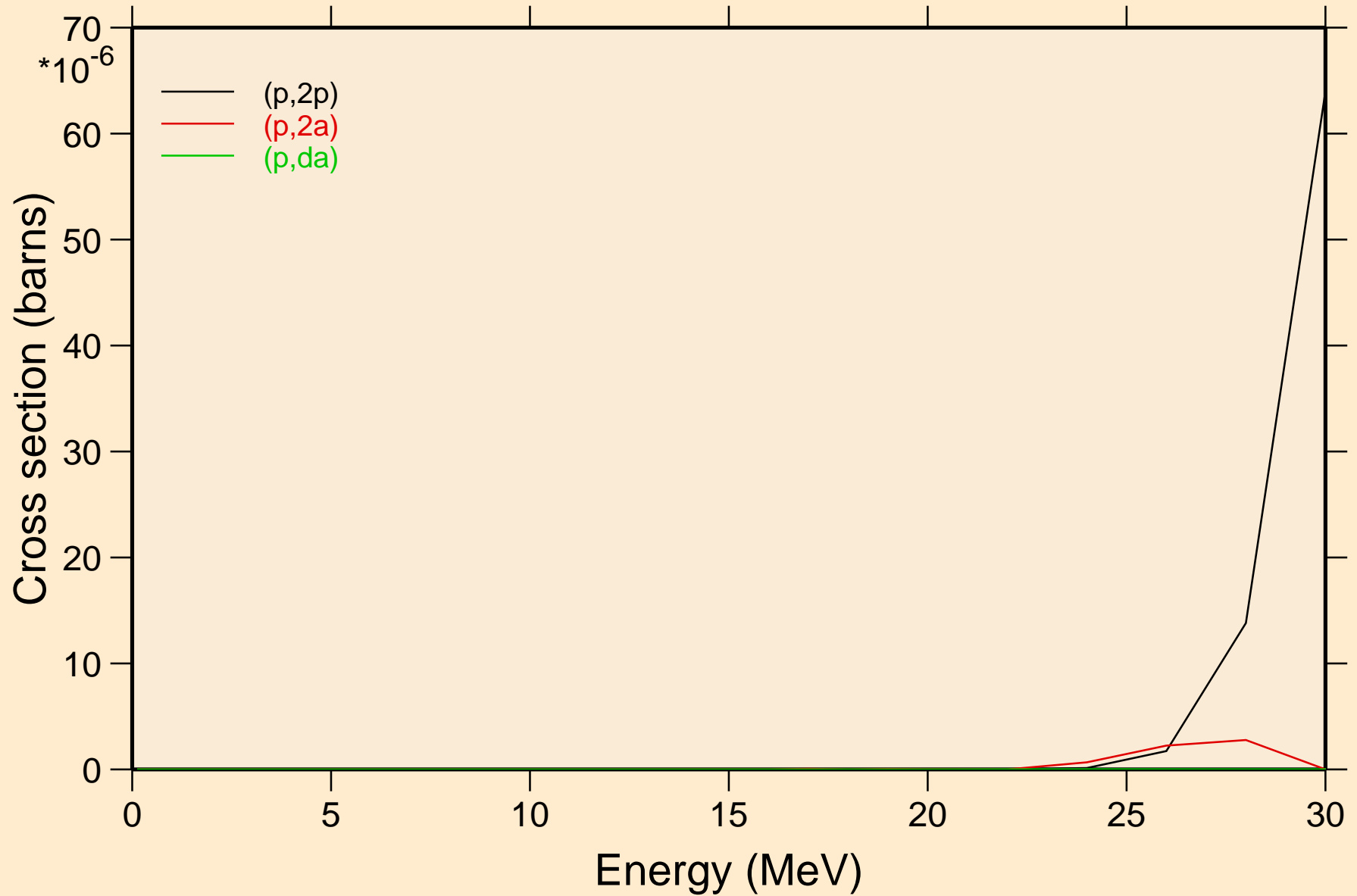

HS270 PROTON ACER TENDL-2021 LIBRARY; T=0.K
angular distribution for elastic

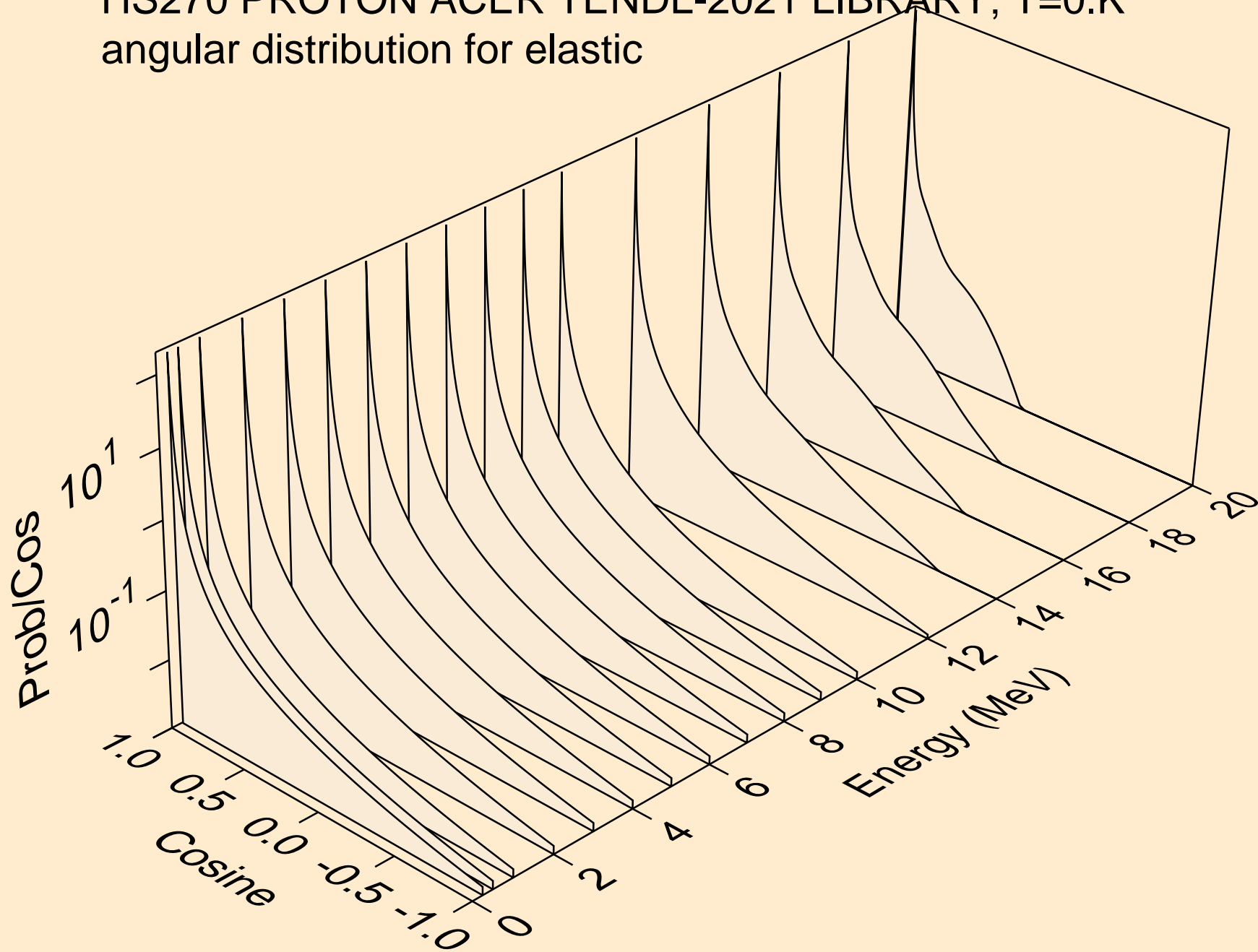

HS270 PROTON ACER TENDL-2021 LIBRARY; T=0.K
angular distribution for elastic

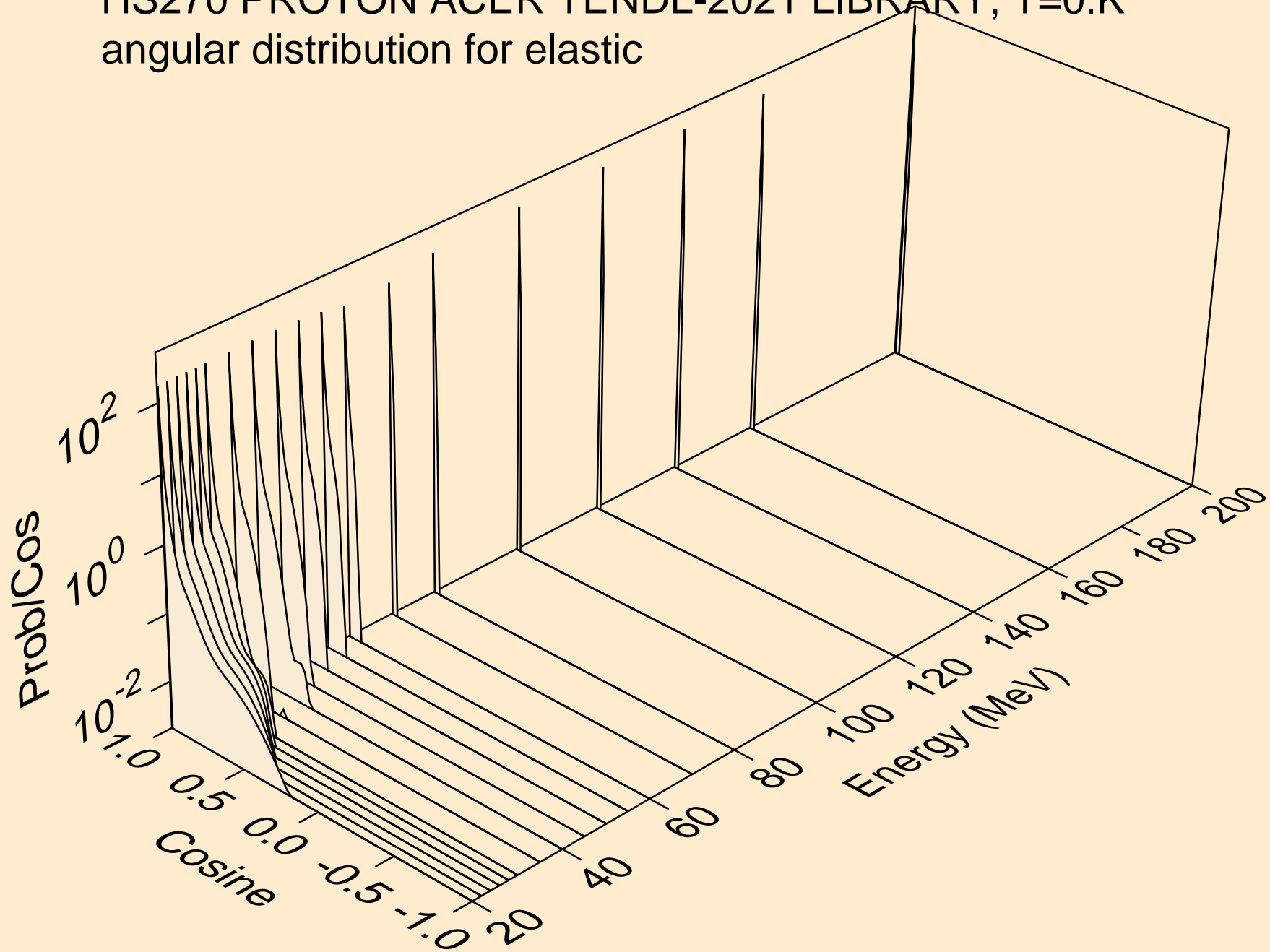

HS270 PROTON ACER TENDL-2021 LIBRARY; T=0.K
Proton emission for (p,x)

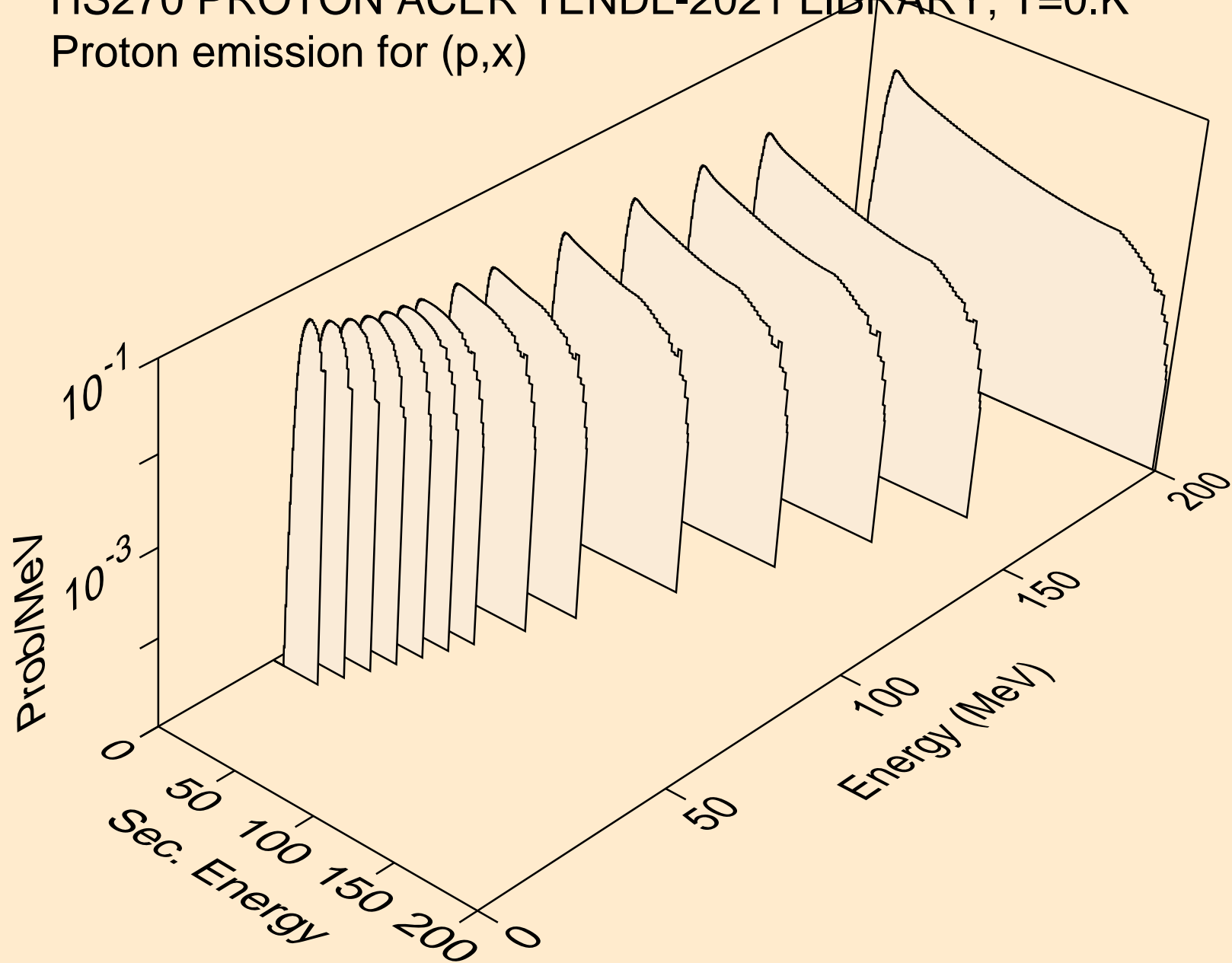

HS270 PROTON ACER TENDL-2021 LIBRARY; T=0.K
Proton emission for (p,n*)p

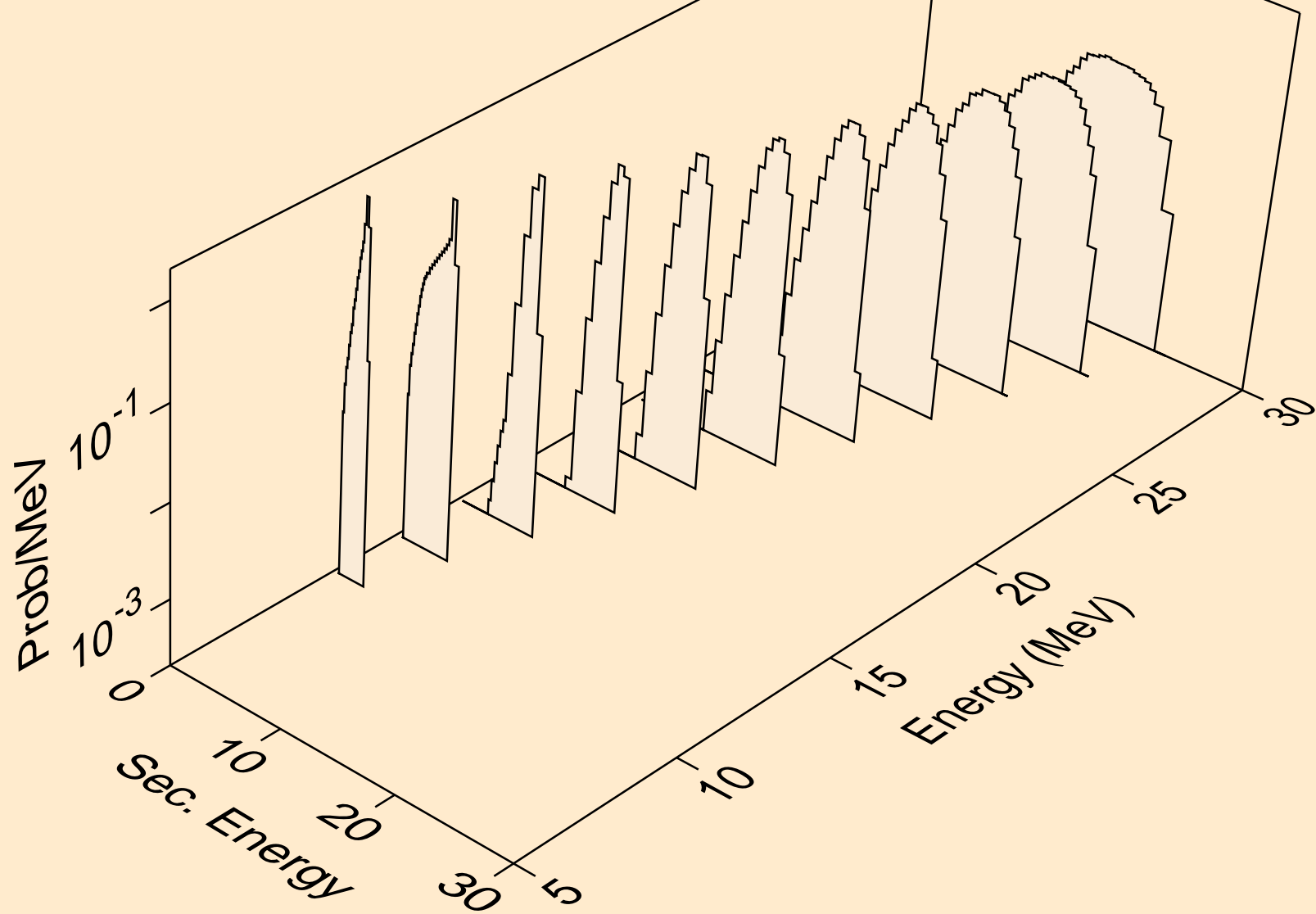

HS270 PROTON ACER TENDL-2021 LIBRARY; T=0.K
Proton emission for (p,2np)

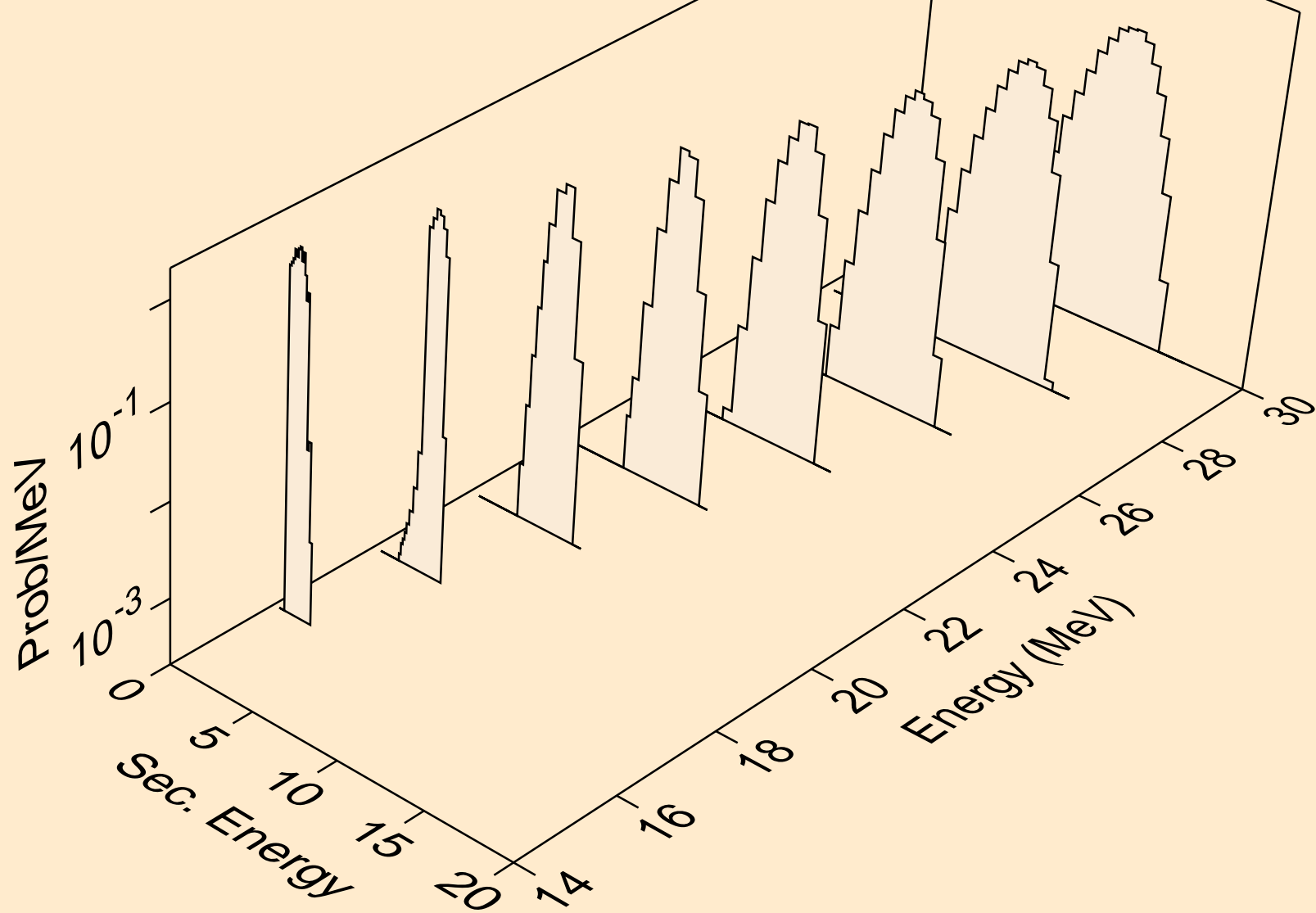

HS270 PROTON ACER TENDL-2021 LIBRARY; T=0.K
Proton emission for (p,npa)

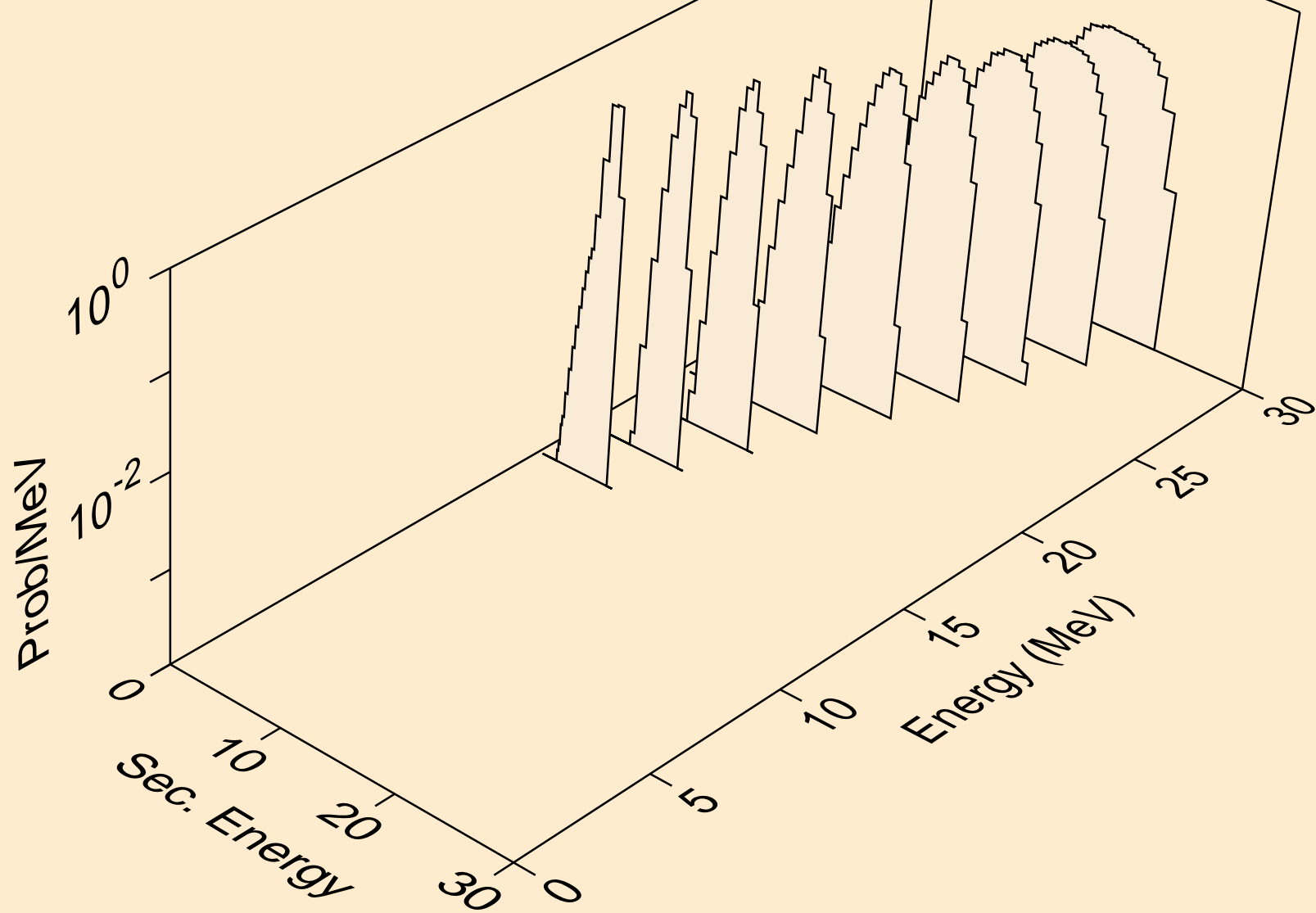

HS270 PROTON ACER TENDL-2021 LIBRARY; T=0.K
Proton emission for inelastic

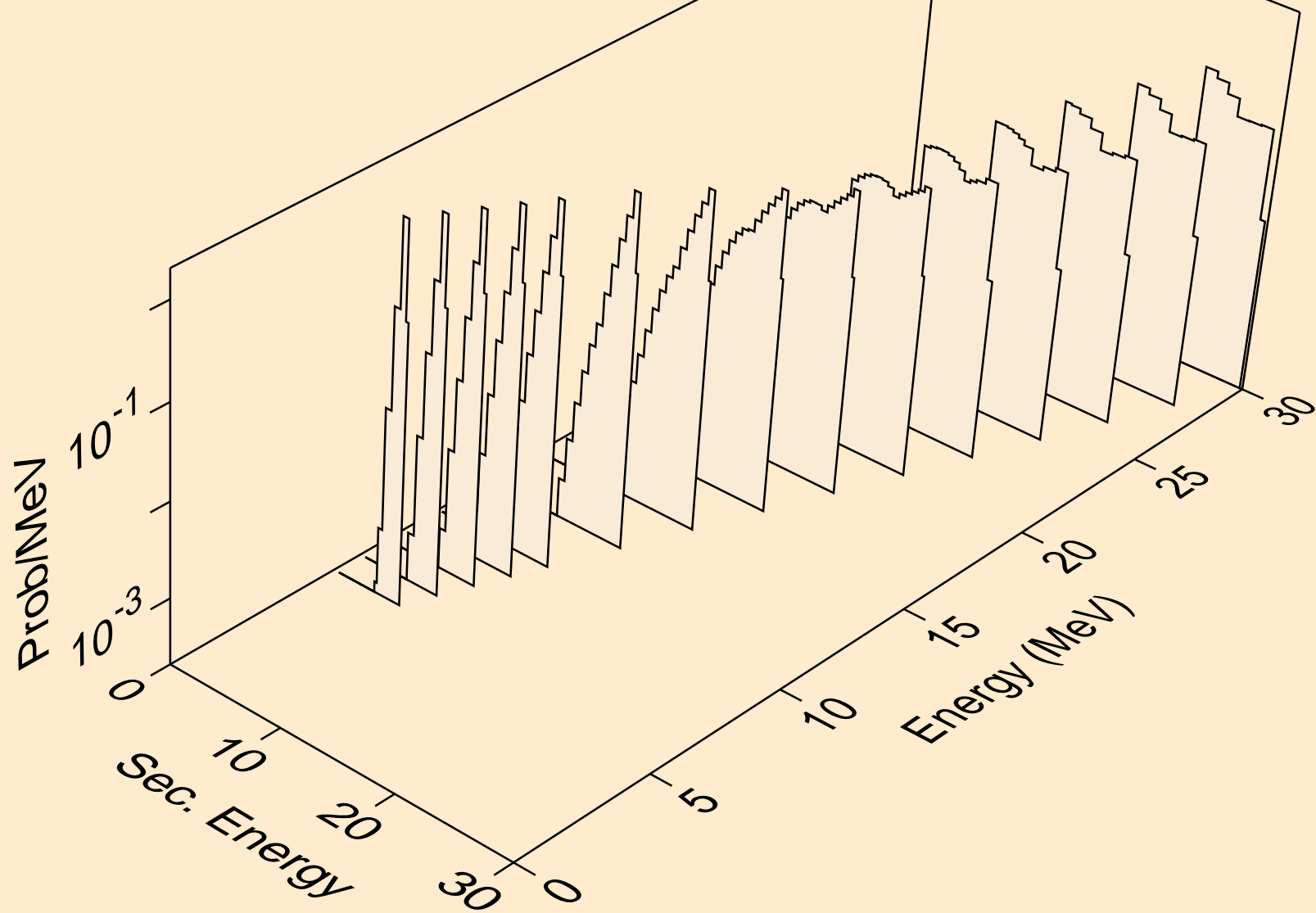

HS270 PROTON ACER TENDL-2021 LIBRARY; T=0.K
Proton emission for (p,2p)

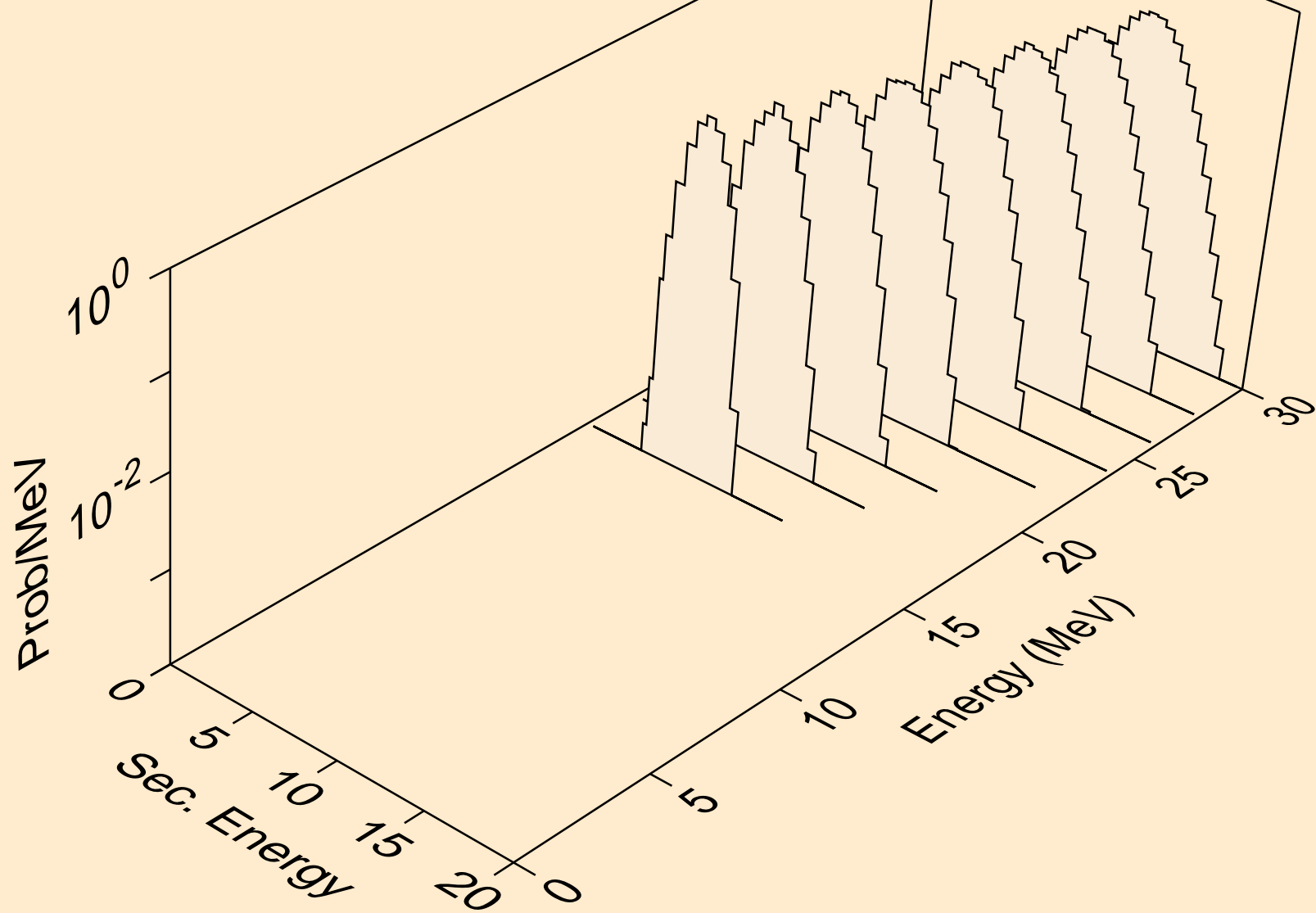

HS270 PROTON ACER TENDL-2021 LIBRARY; T=0.K
Photon emission for (z,n)

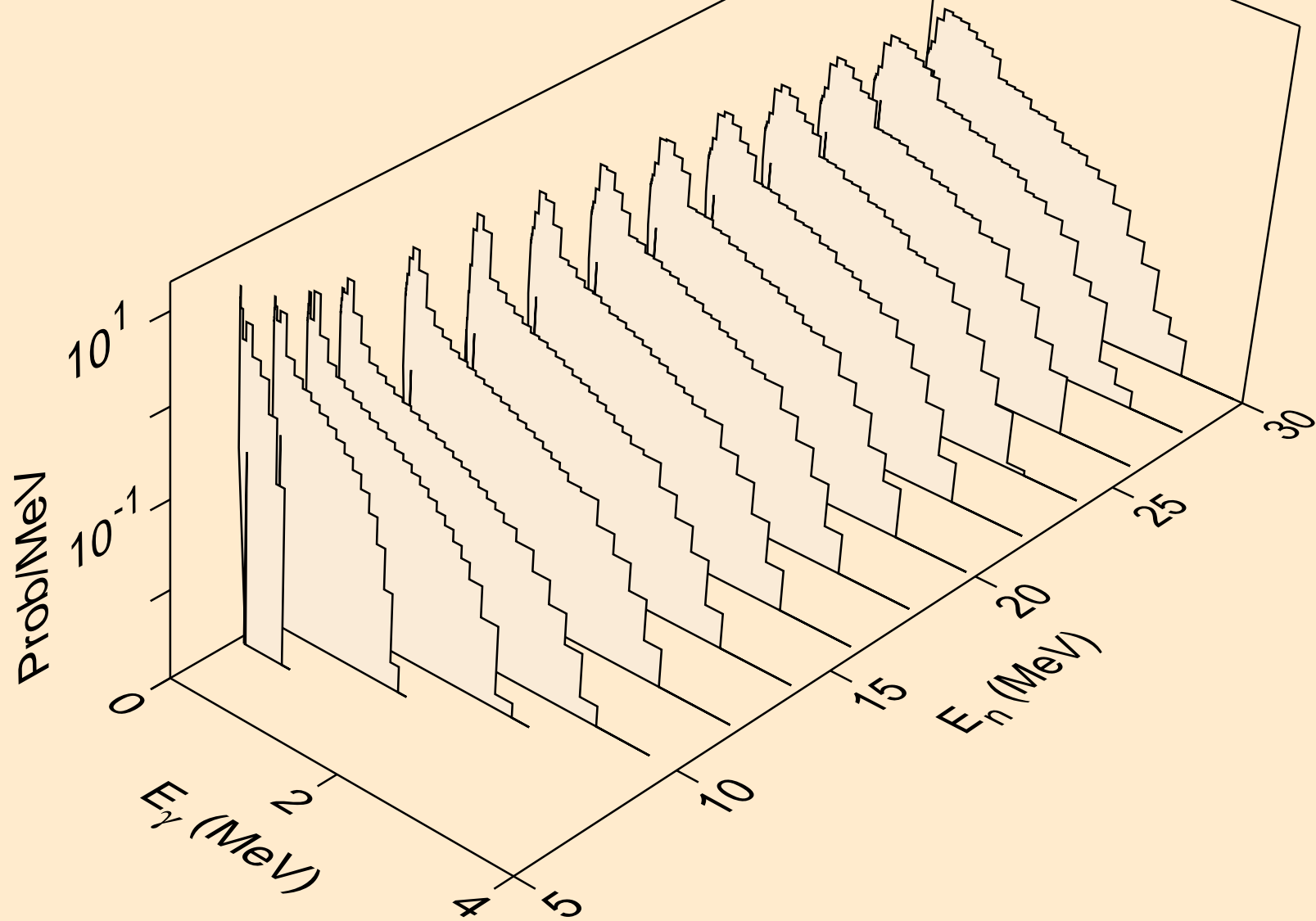

HS270 PROTON ACER TENDL-2021 LIBRARY; T=0.K
Photon emission for (n,x)

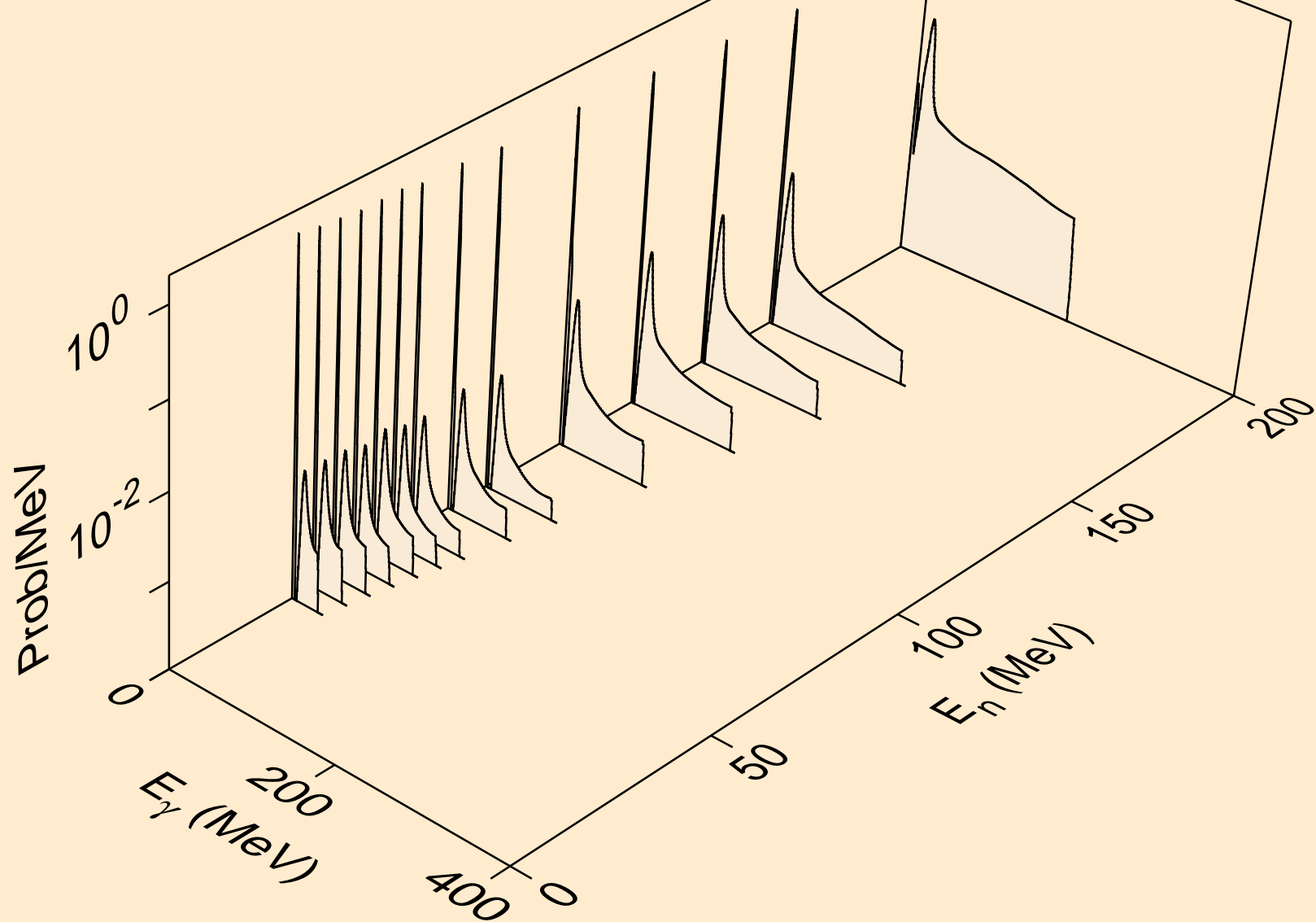

HS270 PROTON ACER TENDL-2021 LIBRARY; T=0.K
Photon emission for (n,2n)

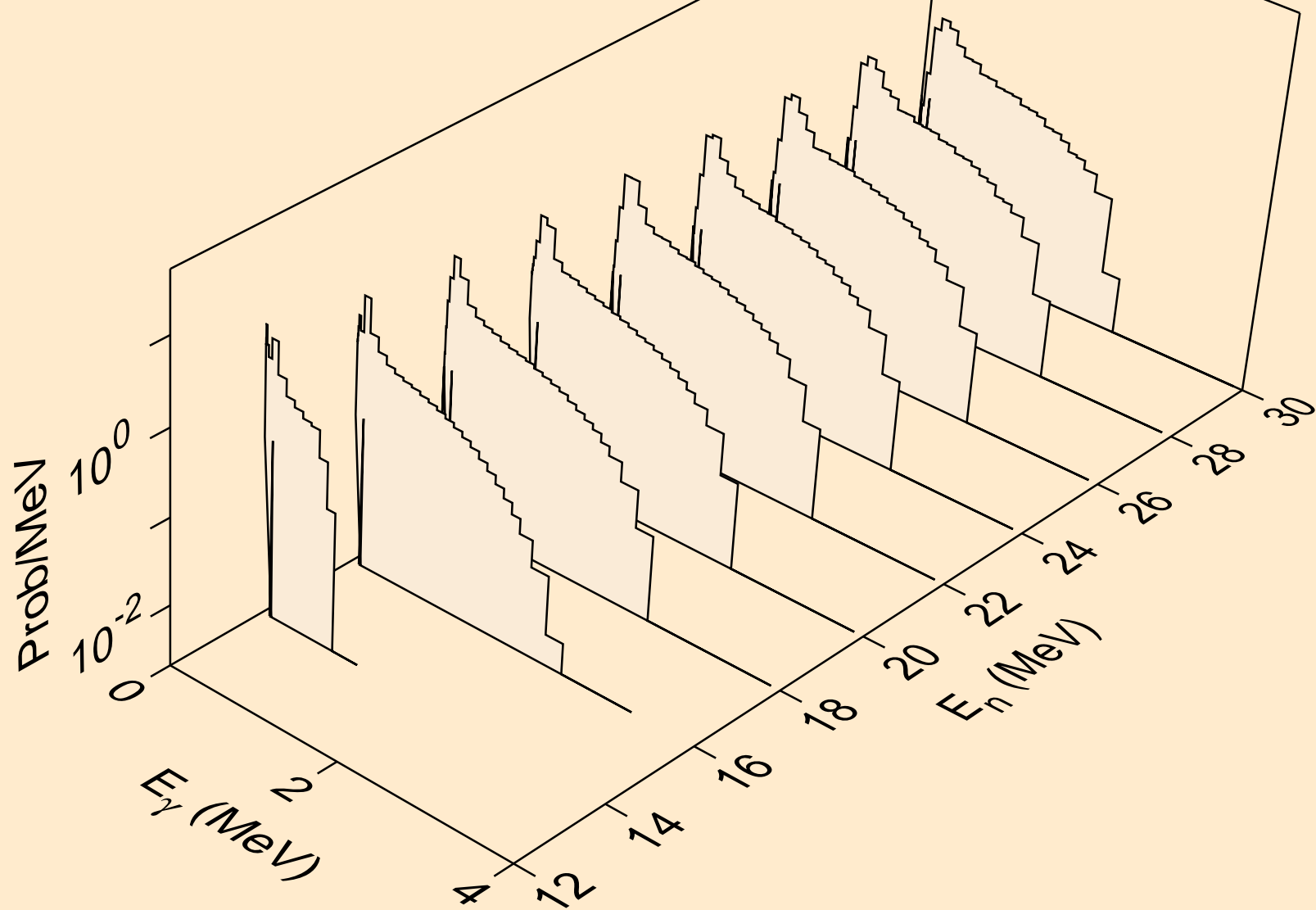

HS270 PROTON ACER TENDL-2021 LIBRARY; T=0.K
Photon emission for (n,3n)

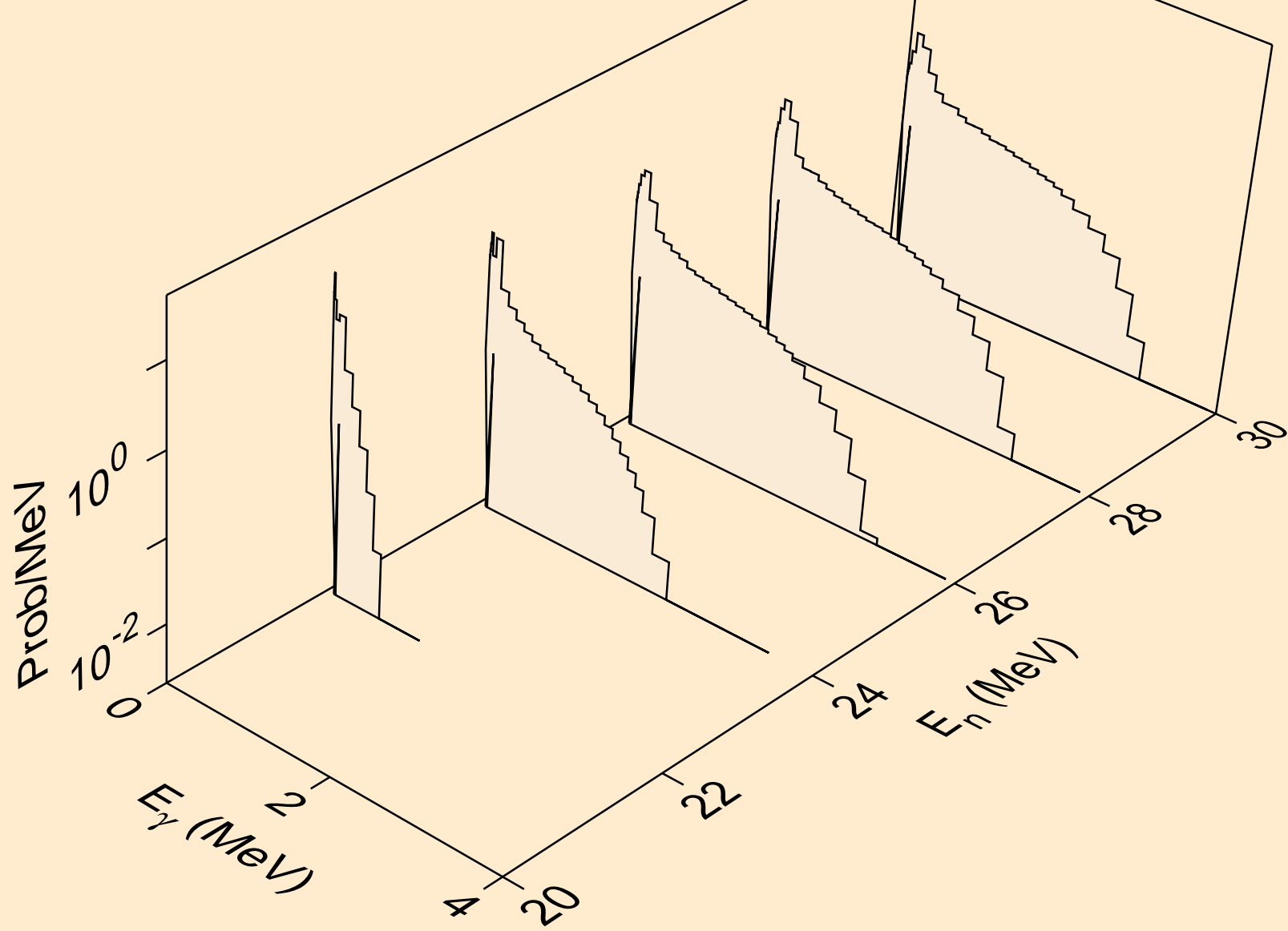

HS270 PROTON ACER TENDL-2021 LIBRARY; T=0.K
Photon emission for (n,n*)a

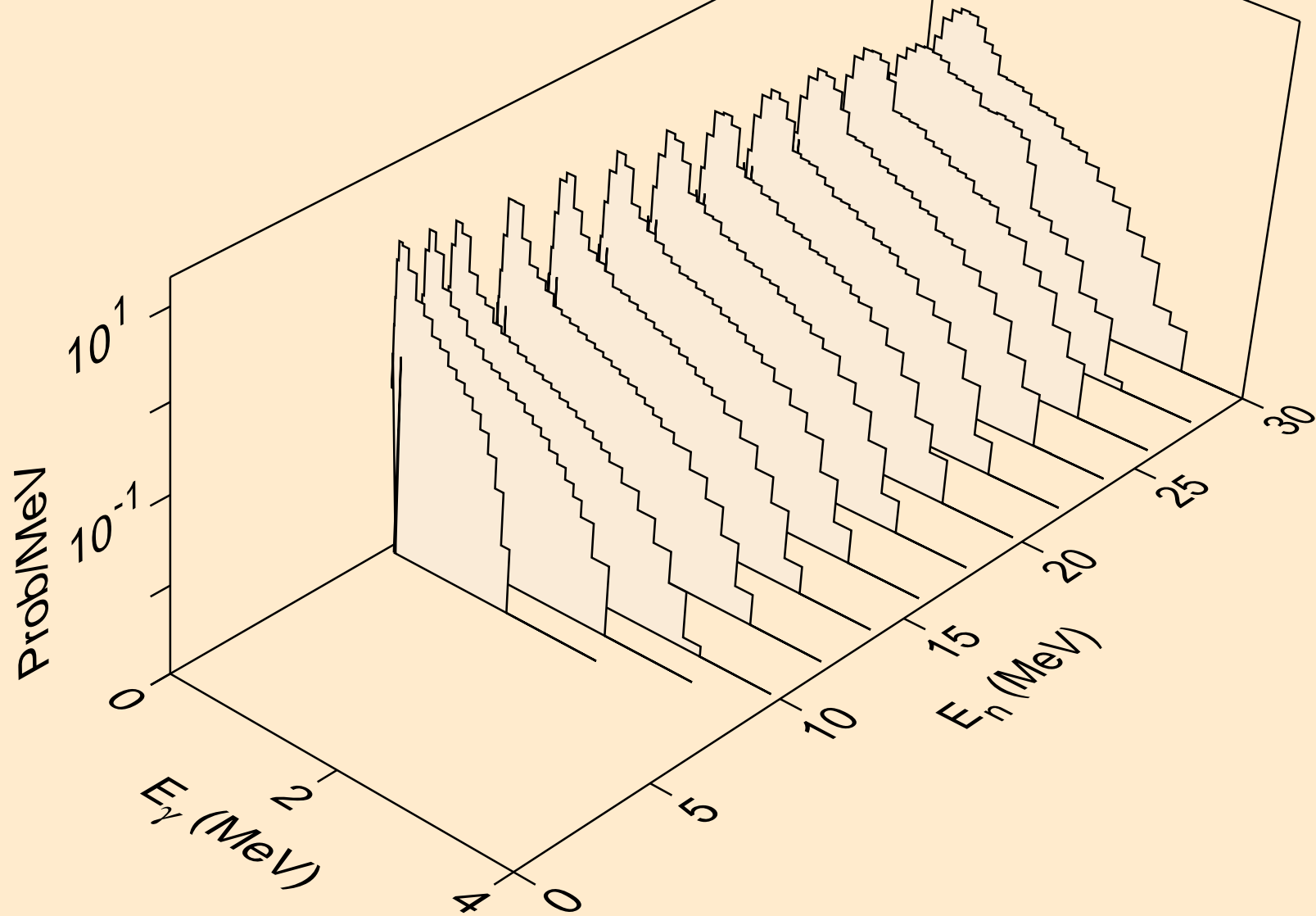

HS270 PROTON ACER TENDL-2021 LIBRARY; T=0.K
Photon emission for (n,n*)3a

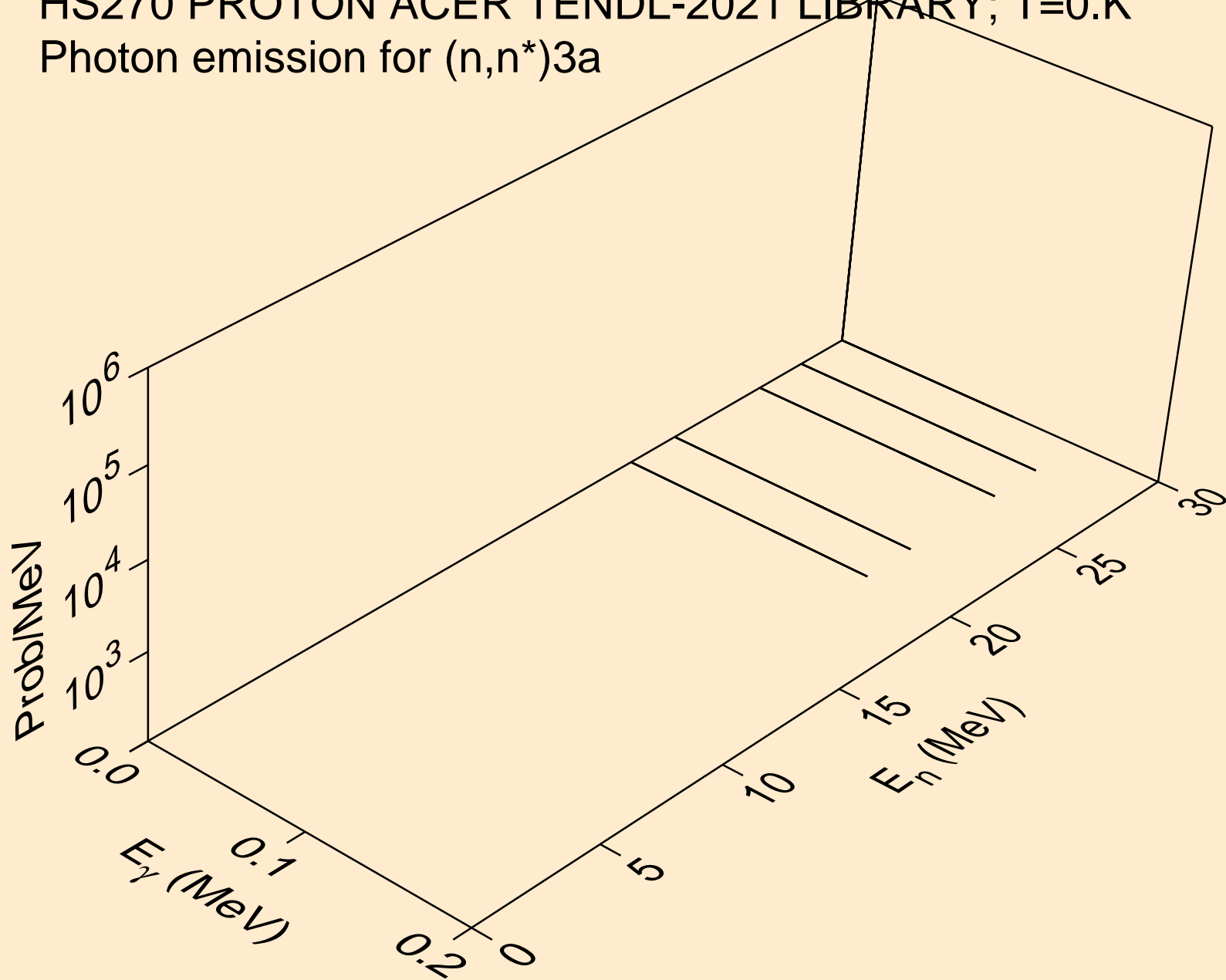

HS270 PROTON ACER TENDL-2021 LIBRARY; T=0.K
Photon emission for (n,2n)a

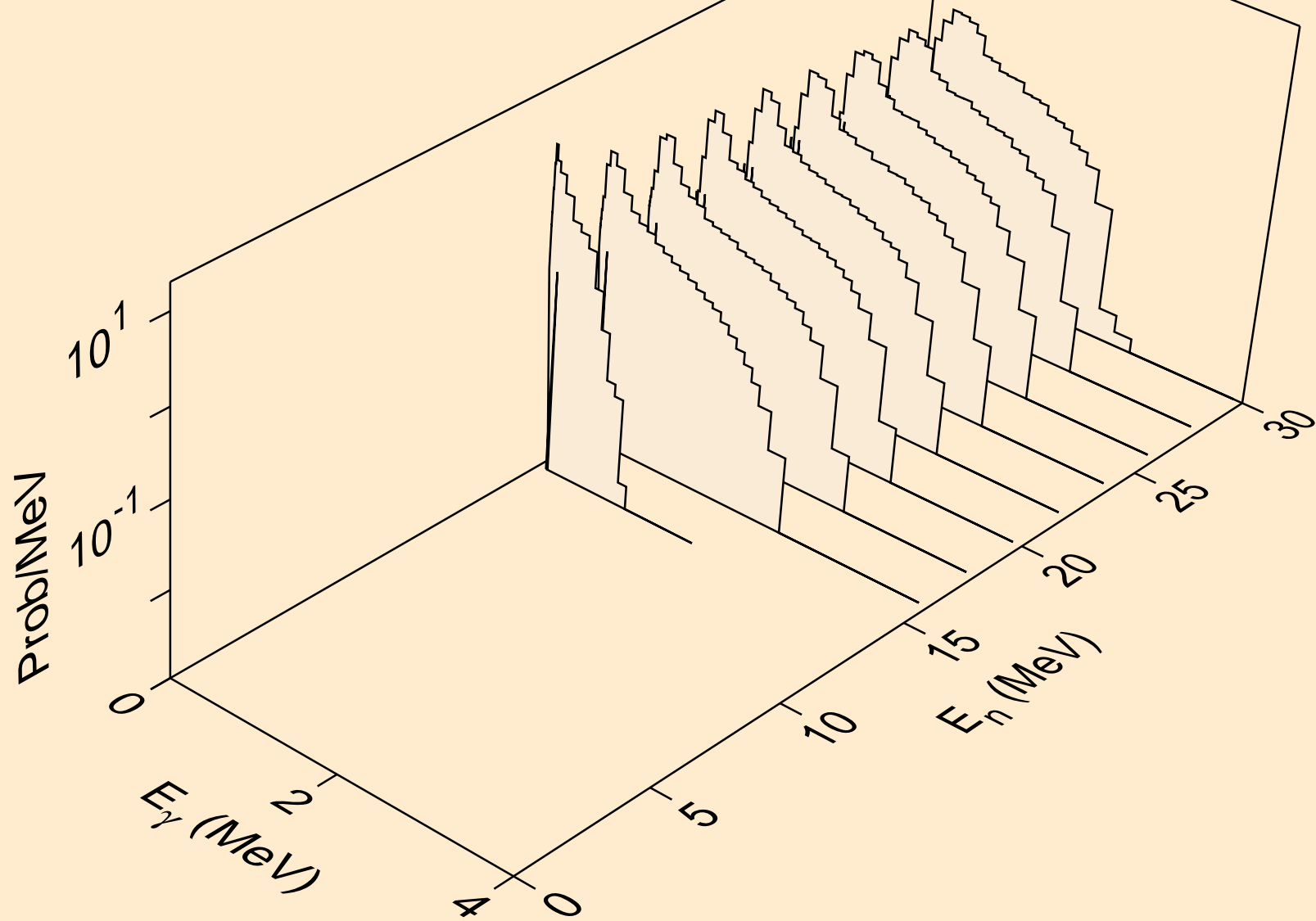

HS270 PROTON ACER TENDL-2021 LIBRARY; T=0.K
Photon emission for (n,3n)a

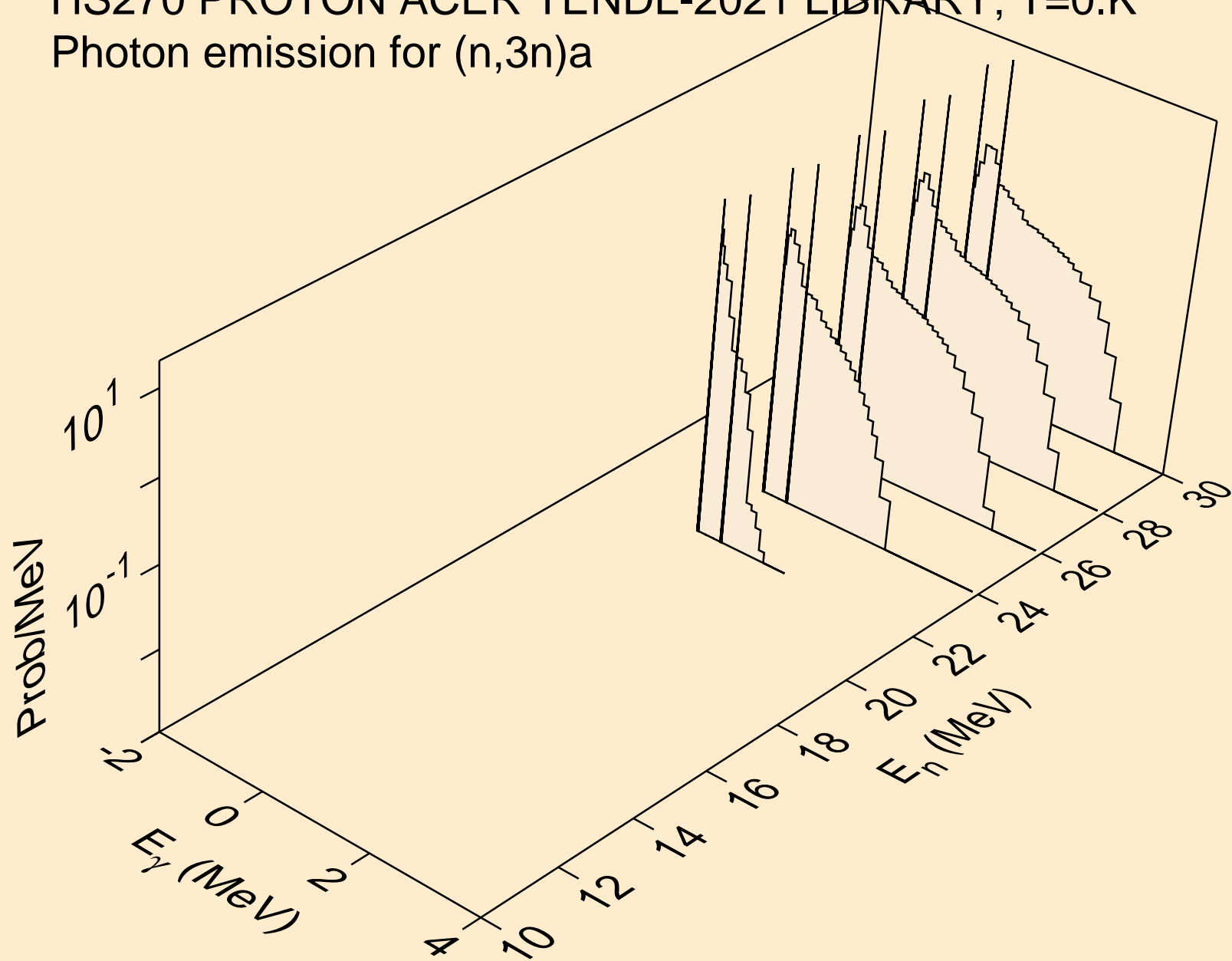

HS270 PROTON ACER TENDL-2021 LIBRARY; T=0.K
Photon emission for (n,n*)p

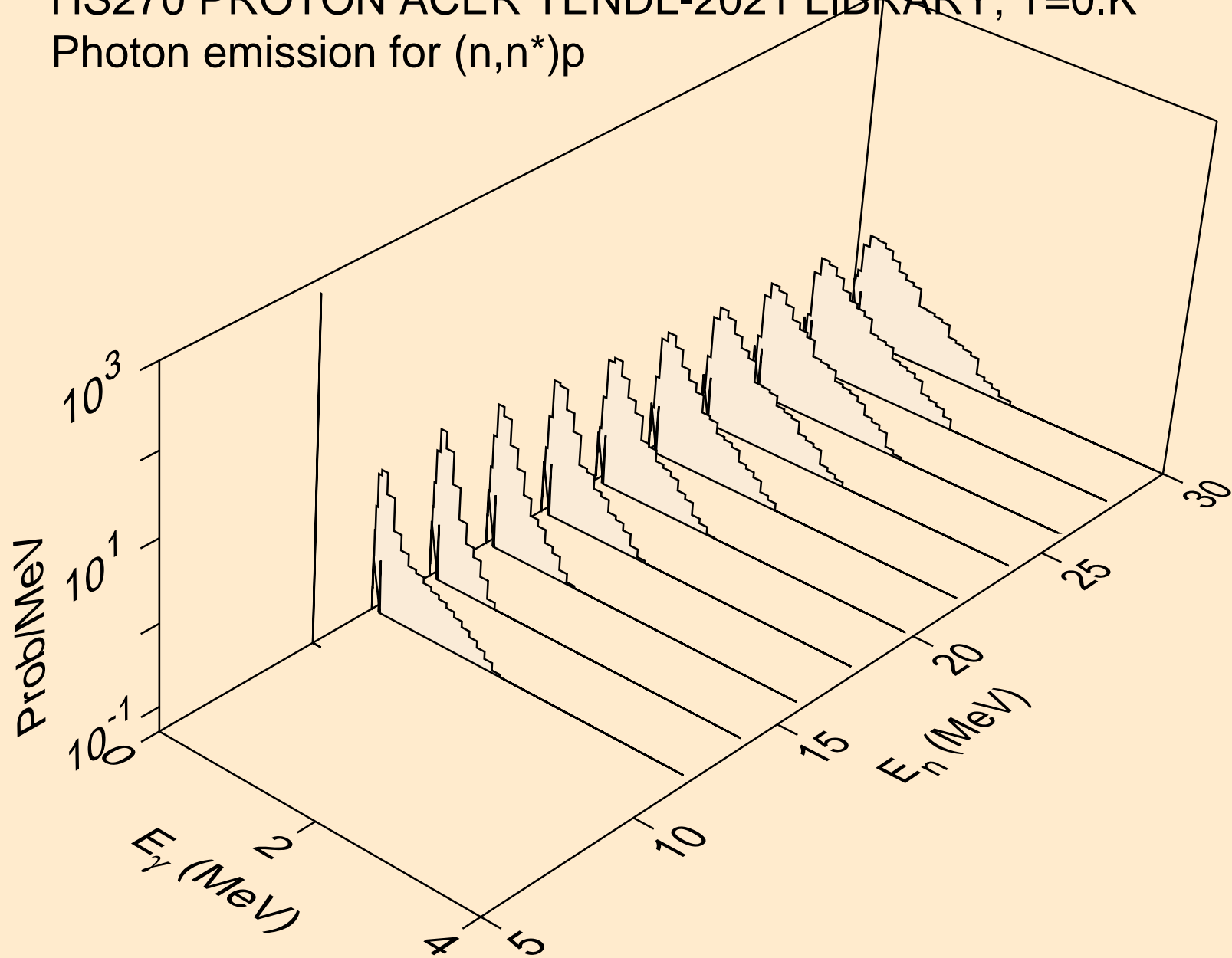

HS270 PROTON ACER TENDL-2021 LIBRARY; T=0.K
Photon emission for (n,n*)2a

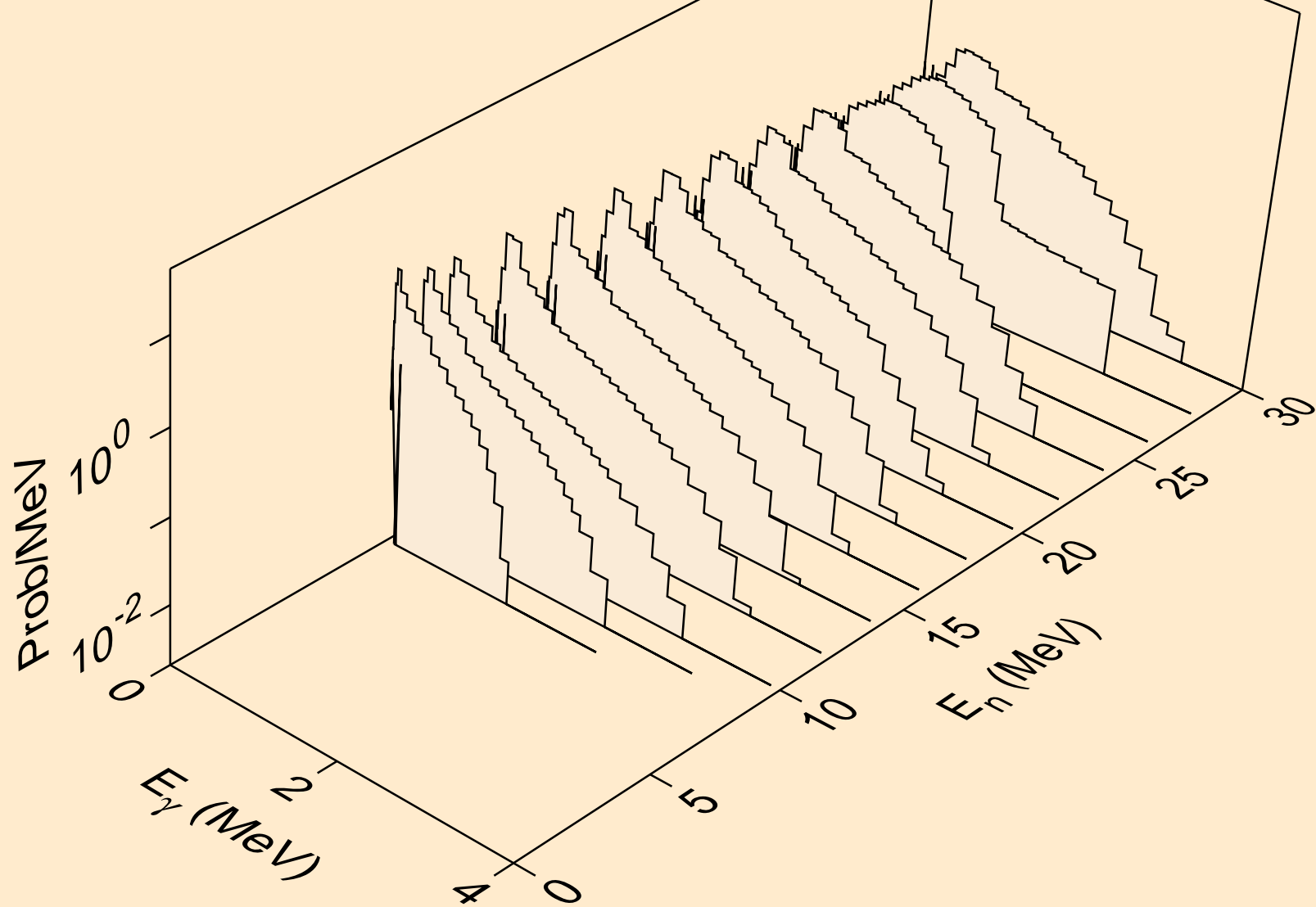

HS270 PROTON ACER TENDL-2021 LIBRARY; T=0.K
Photon emission for (n,n*)d

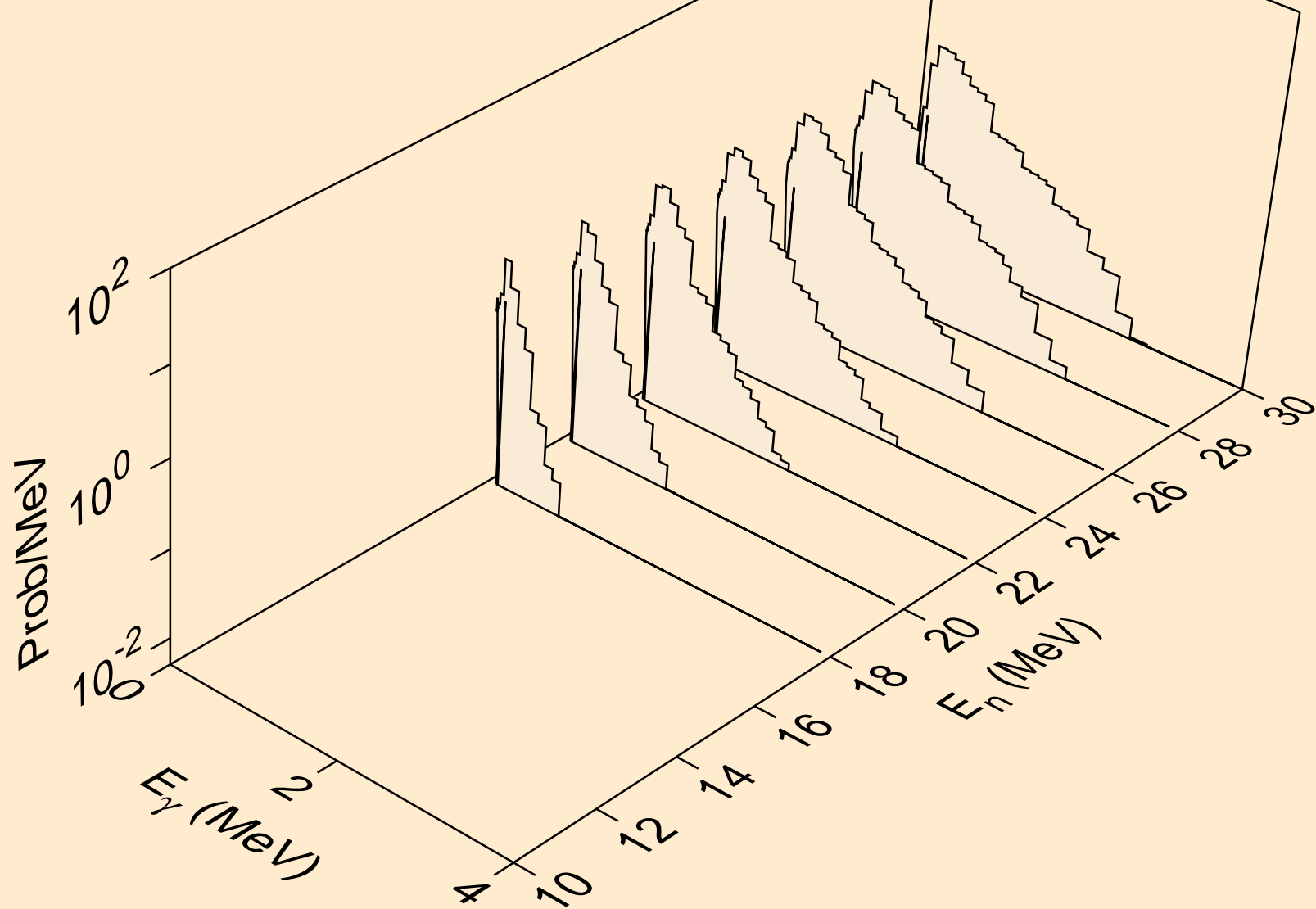

HS270 PROTON ACER TENDL-2021 LIBRARY; T=0.K
Photon emission for (n,n*)t

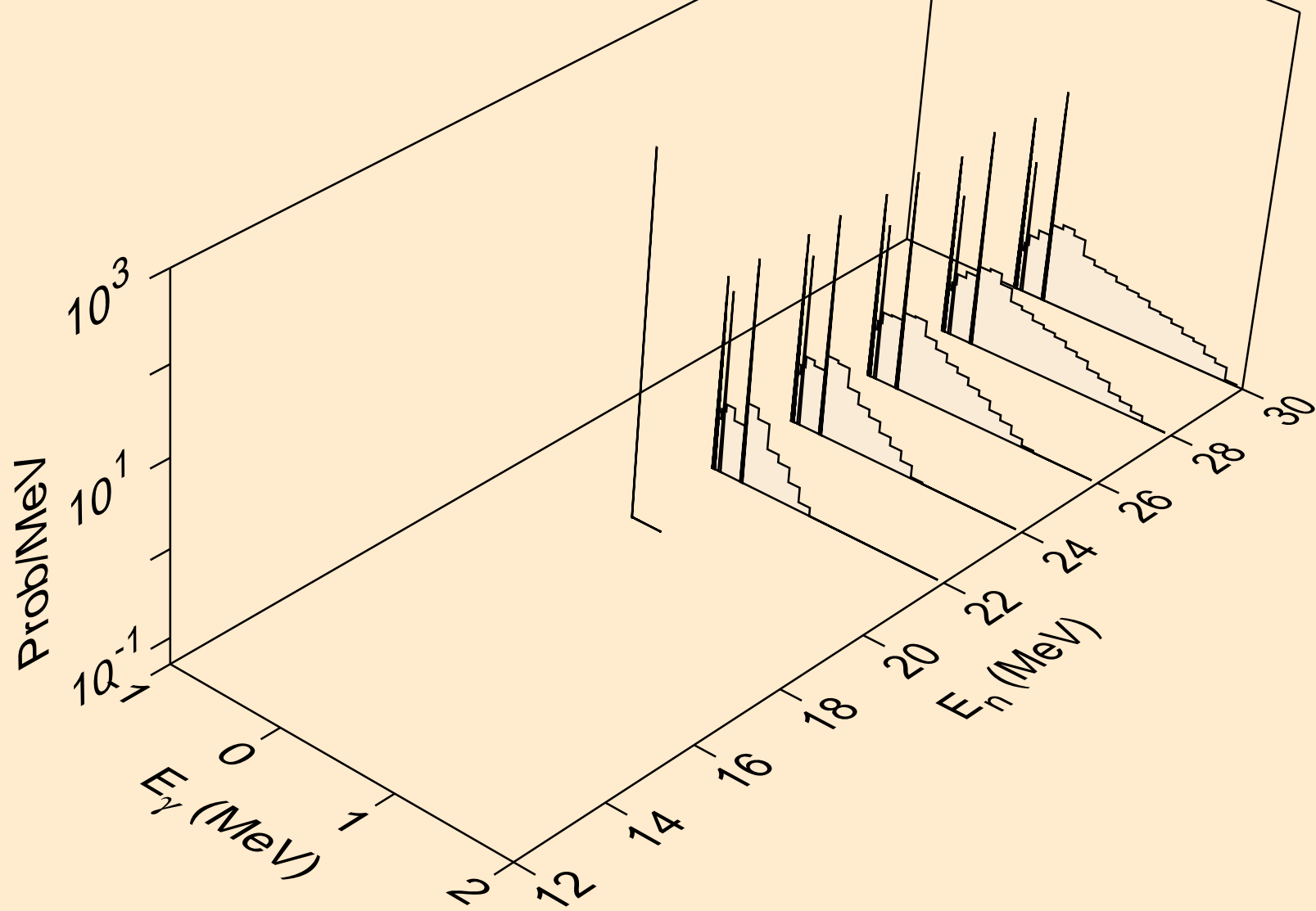

HS270 PROTON ACER TENDL-2021 LIBRARY; T=0.K
Photon emission for (n,2np)

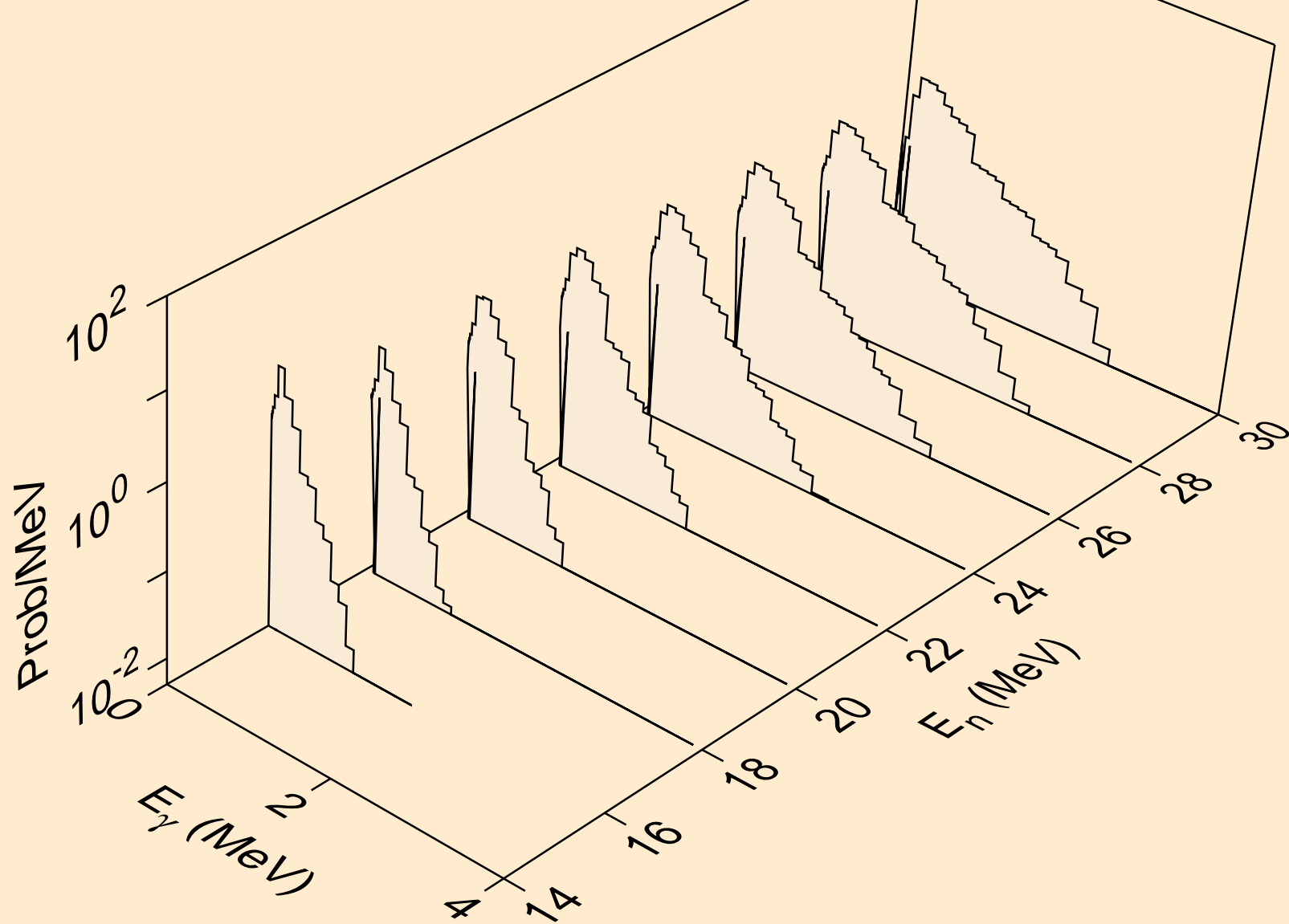

HS270 PROTON ACER TENDL-2021 LIBRARY; T=0.K
Photon emission for (n,npa)

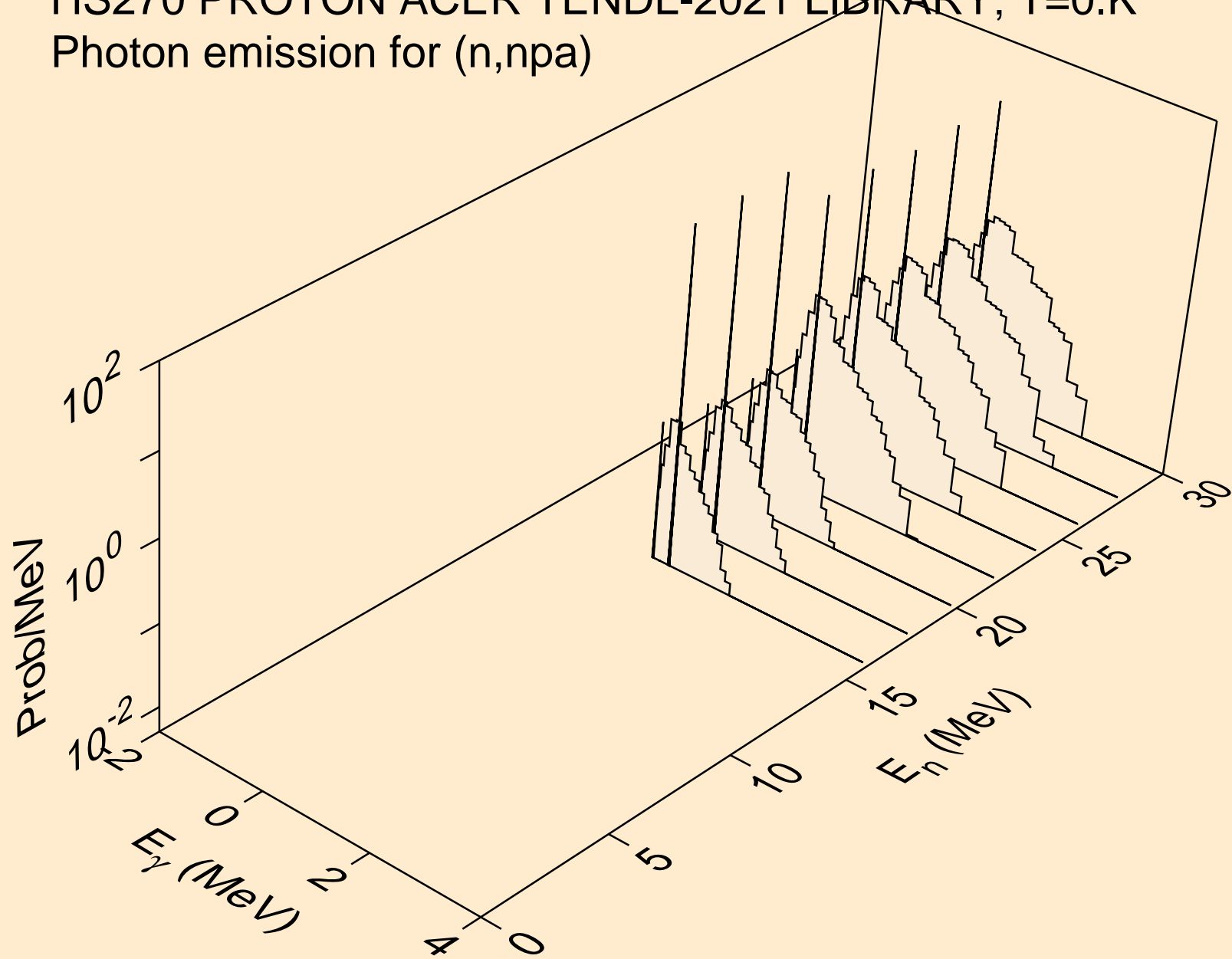

HS270 PROTON ACER TENDL-2021 LIBRARY; T=0.K
Photon emission for (n,gma)

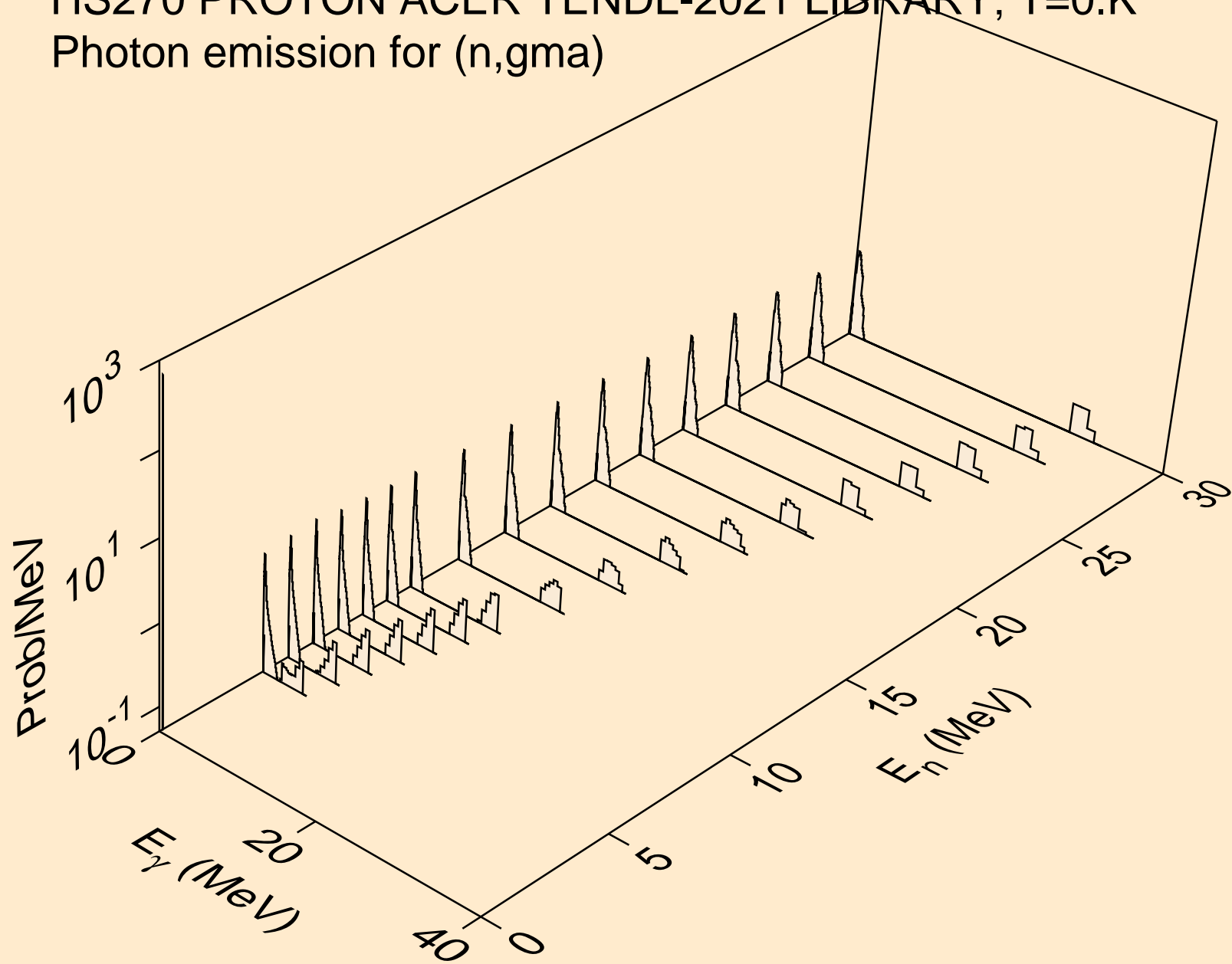

HS270 PROTON ACER TENDL-2021 LIBRARY; T=0.K
Photon emission for inelastic

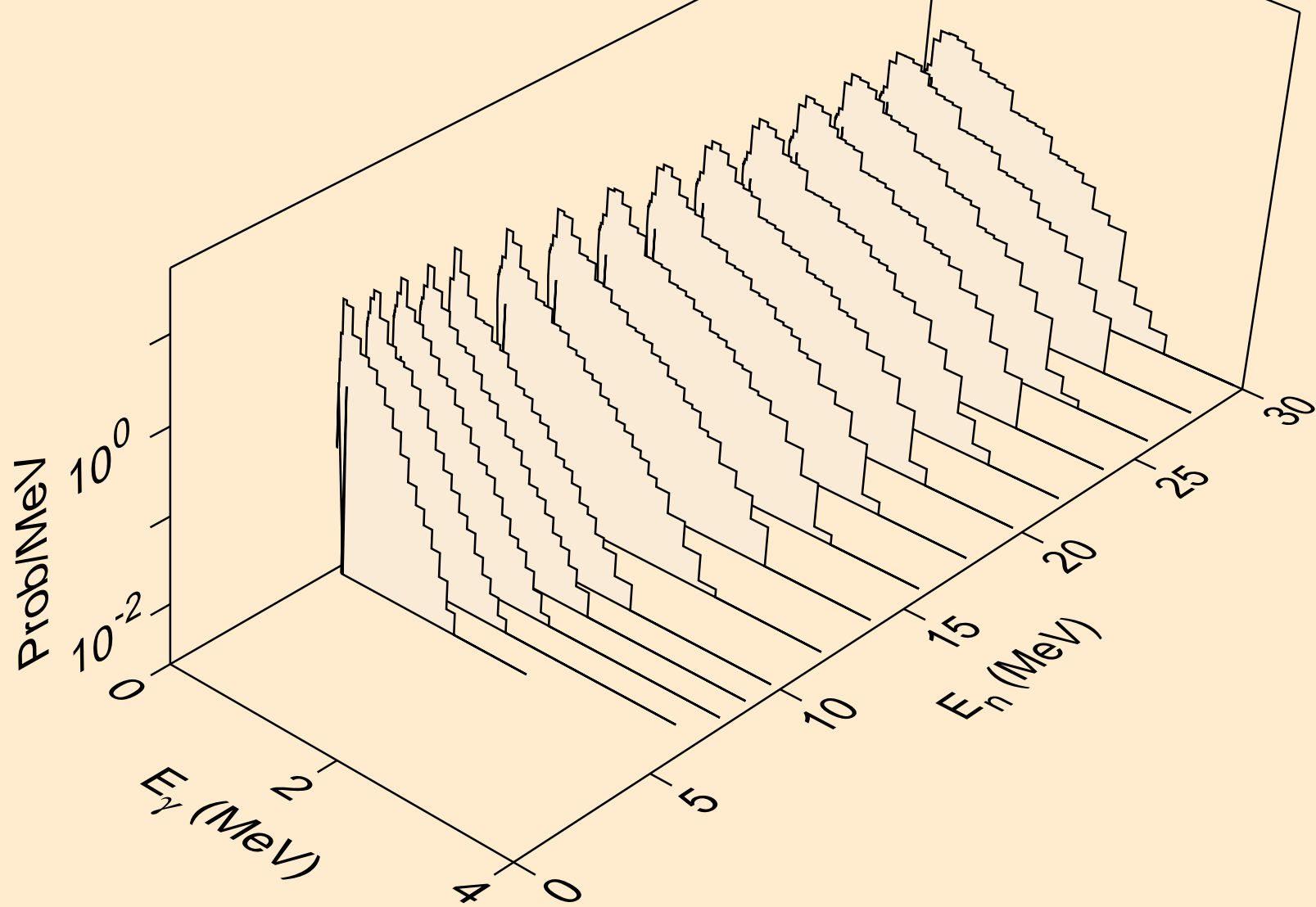

HS270 PROTON ACER TENDL-2021 LIBRARY; T=0.K
Photon emission for (n,d)

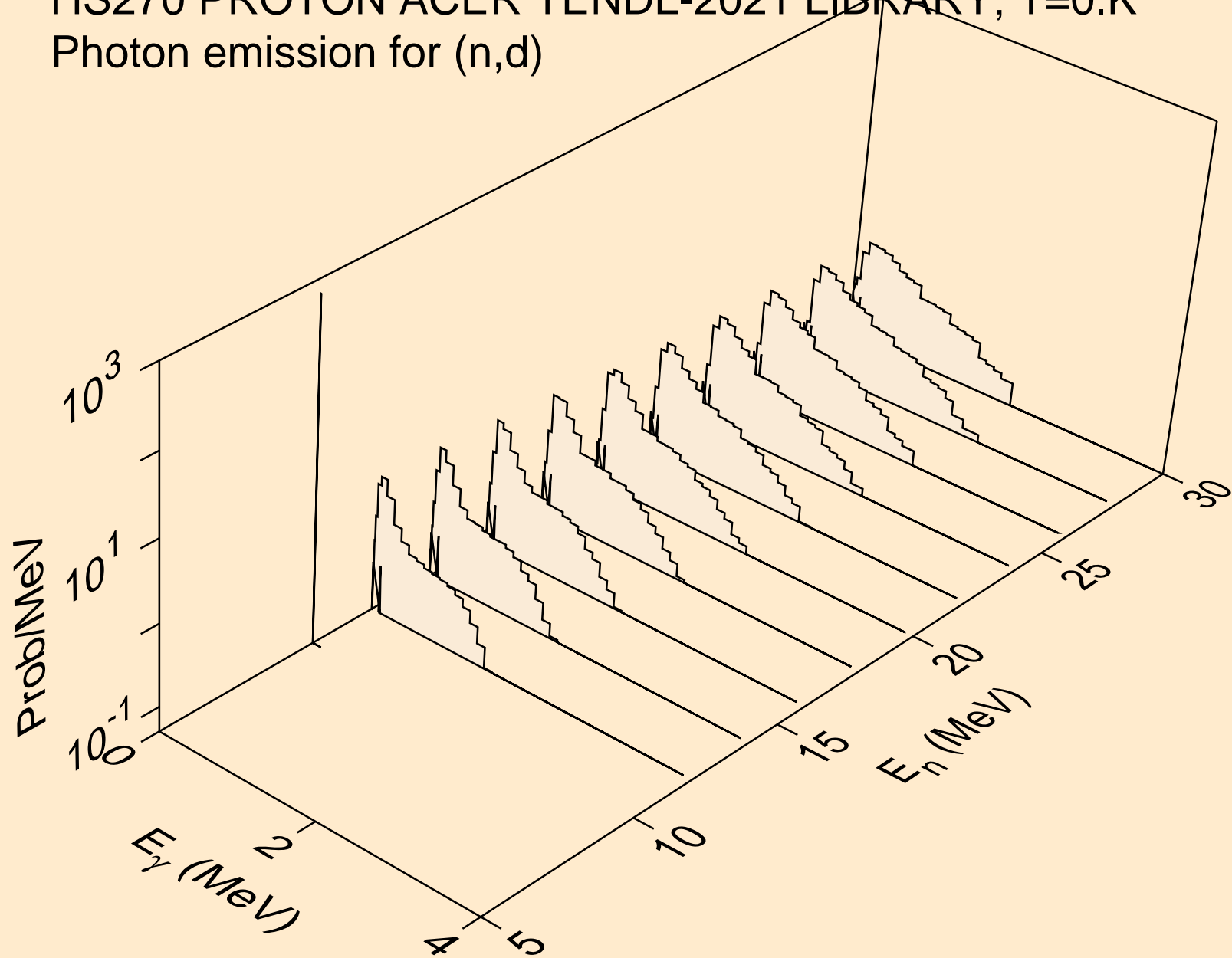

HS270 PROTON ACER TENDL-2021 LIBRARY; T=0.K
Photon emission for (n,t)

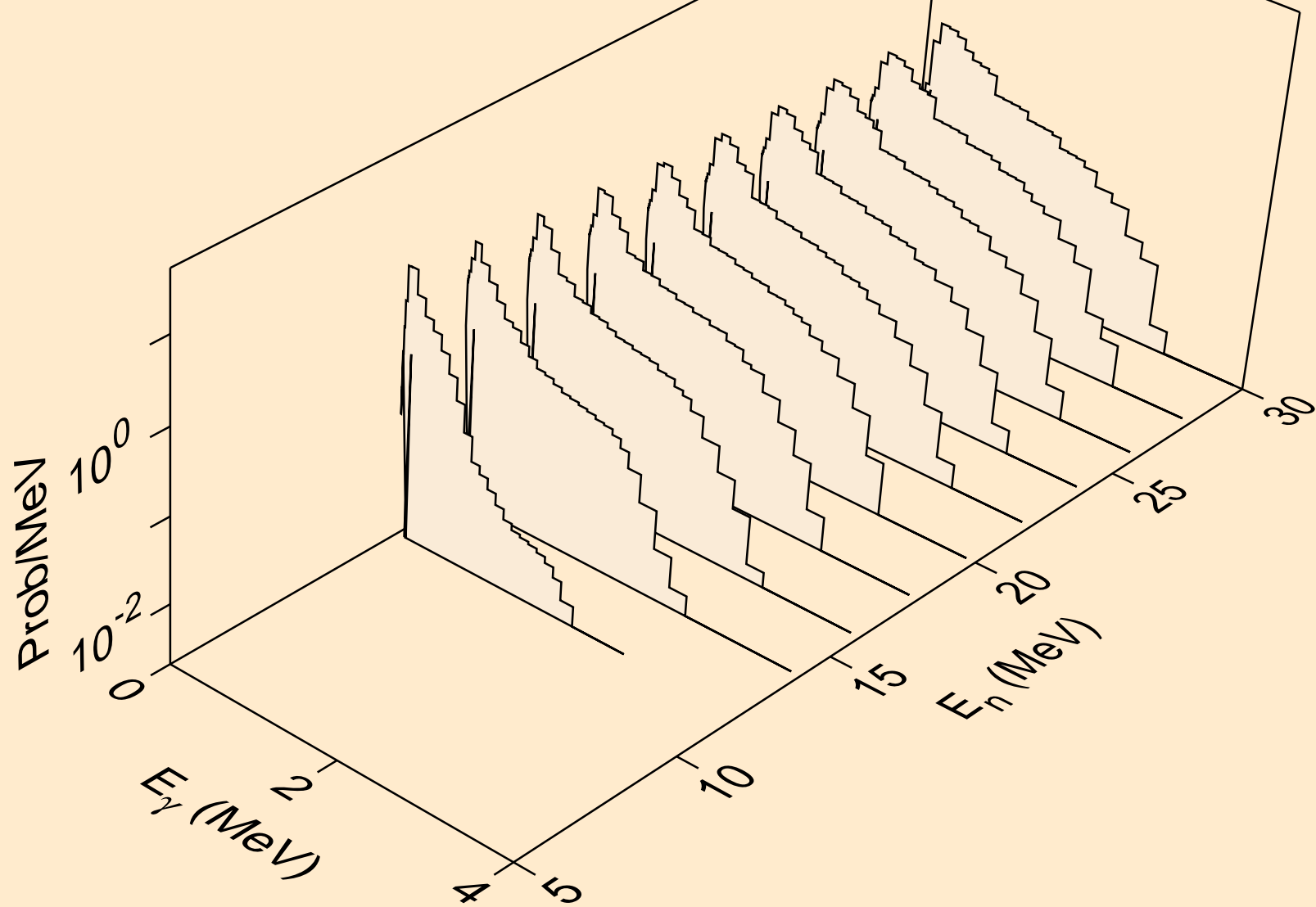

HS270 PROTON ACER TENDL-2021 LIBRARY; T=0.K
Photon emission for (n,he3)

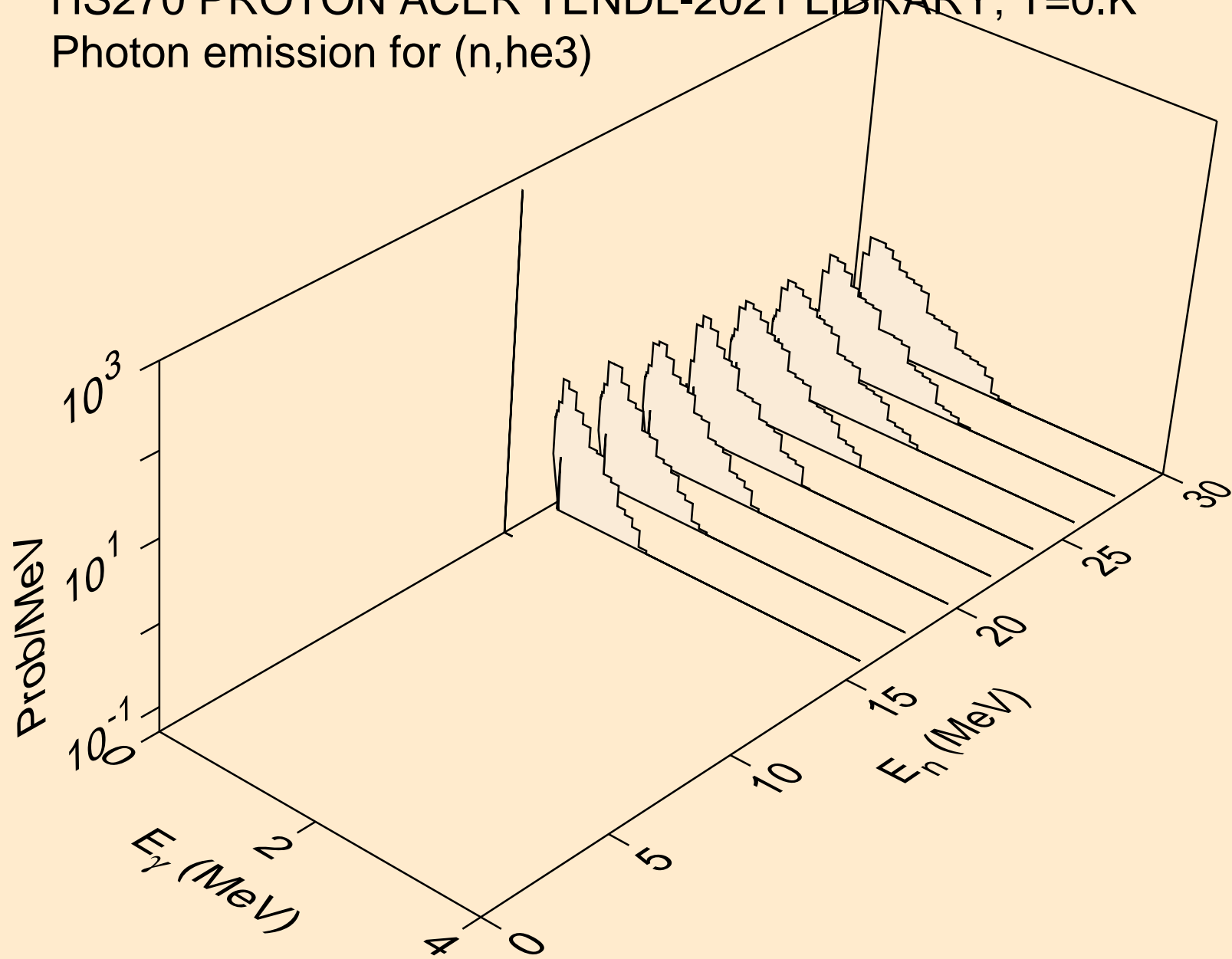

HS270 PROTON ACER TENDL-2021 LIBRARY; T=0.K
Photon emission for (n,a)

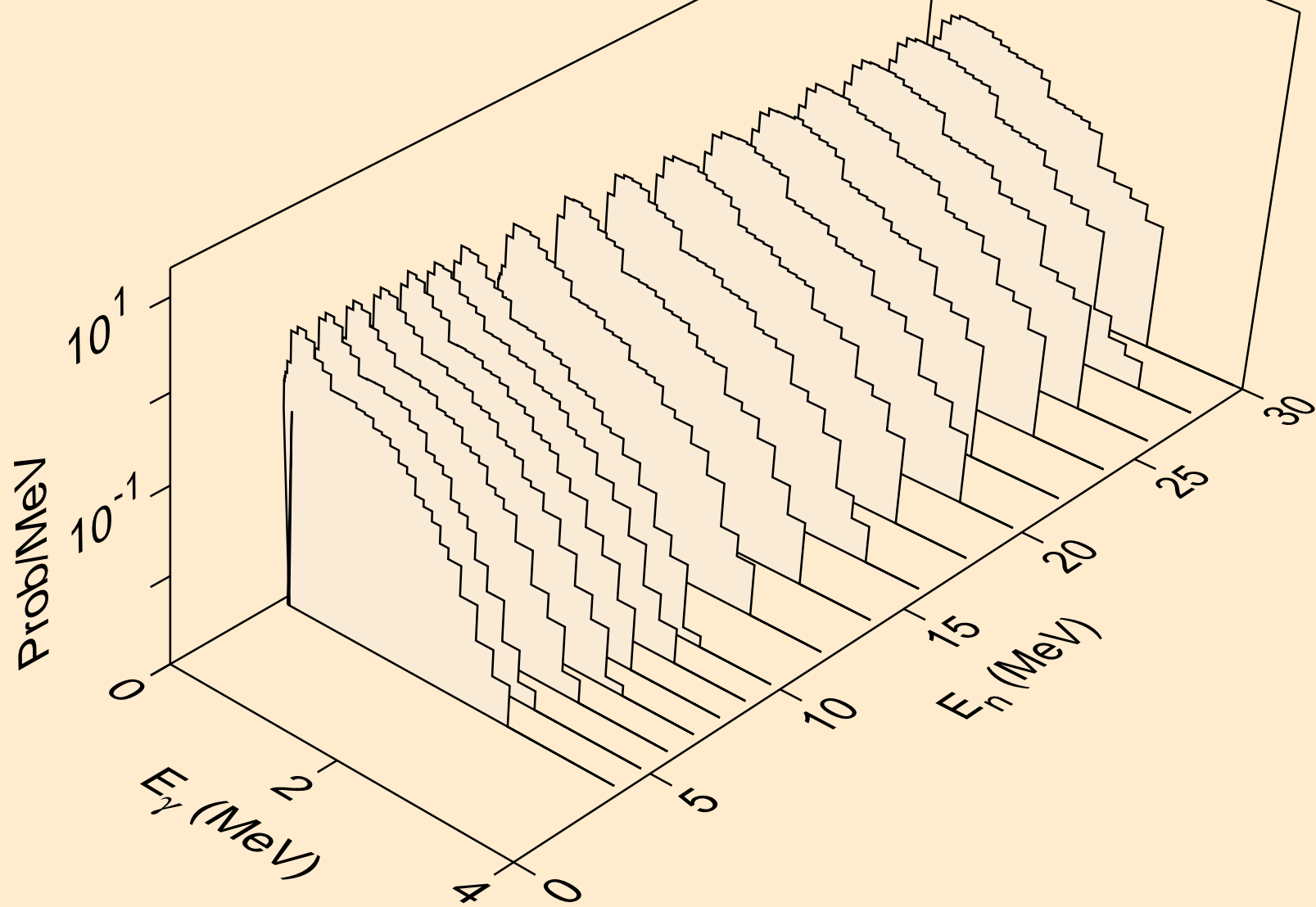

HS270 PROTON ACER TENDL-2021 LIBRARY; T=0.K
Photon emission for (n,2a)

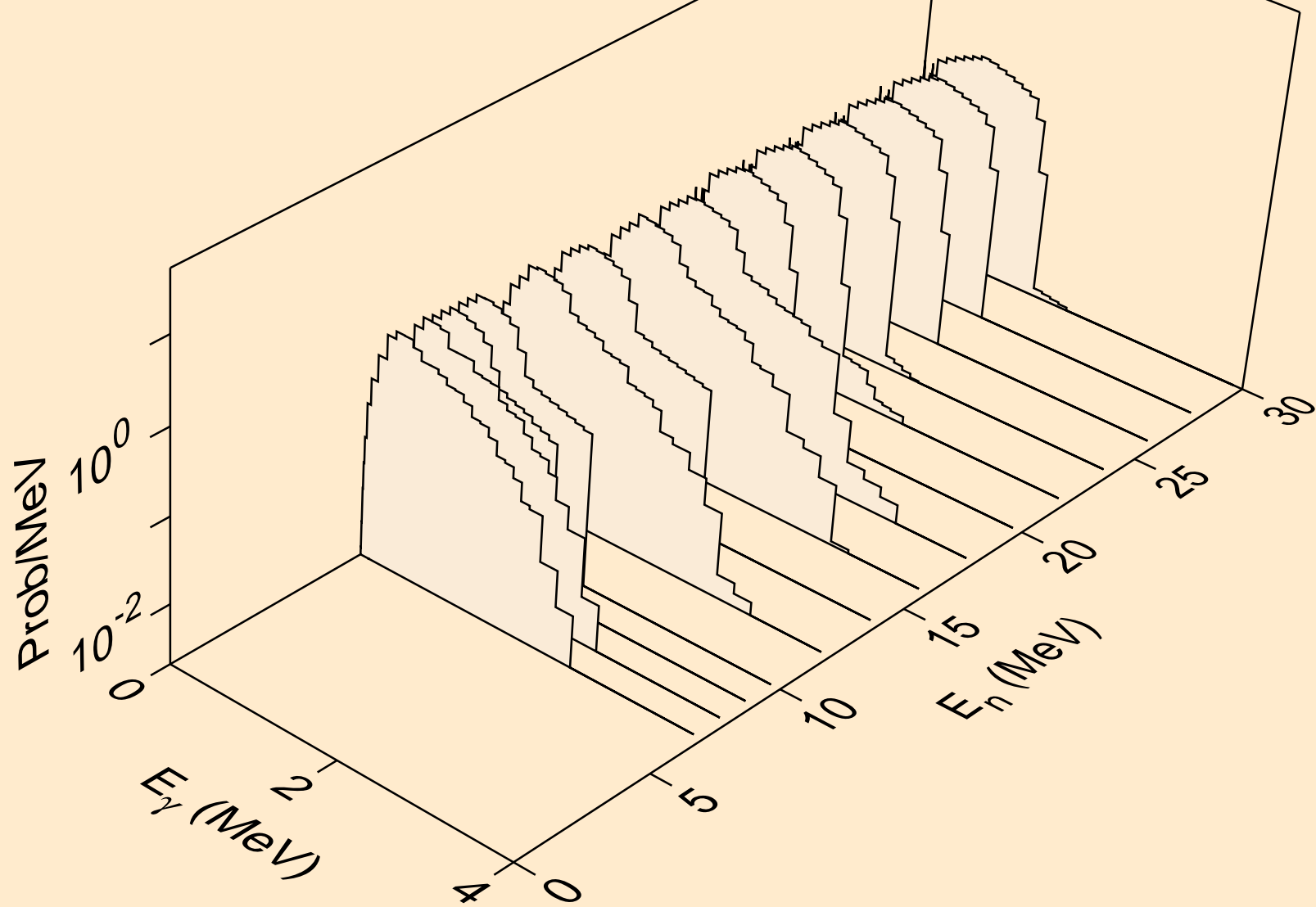

HS270 PROTON ACER TENDL-2021 LIBRARY; T=0.K
Photon emission for (n,2p)

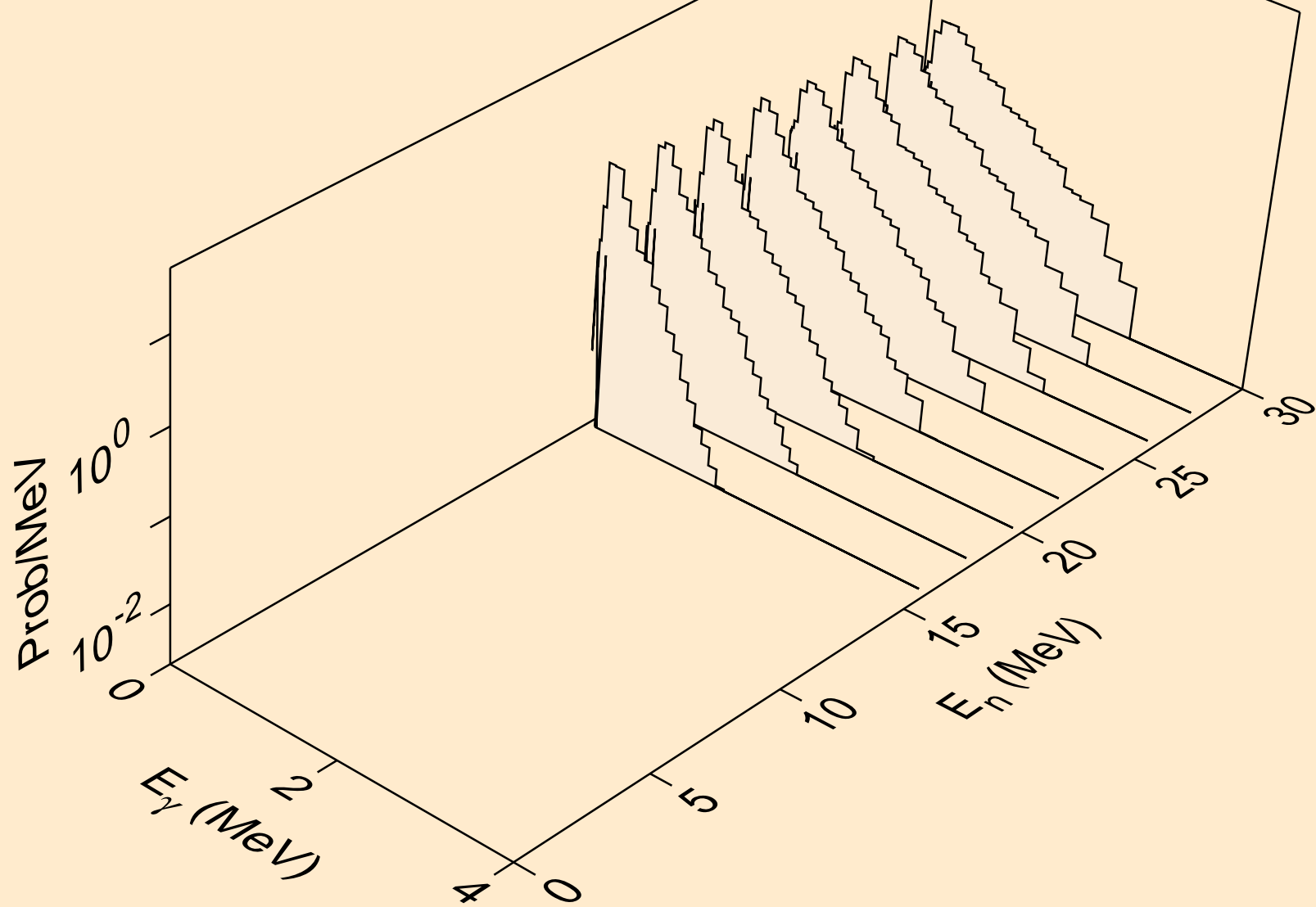

HS270 PROTON ACER TENDL-2021 LIBRARY; T=0.K
Photon emission for (n,da)

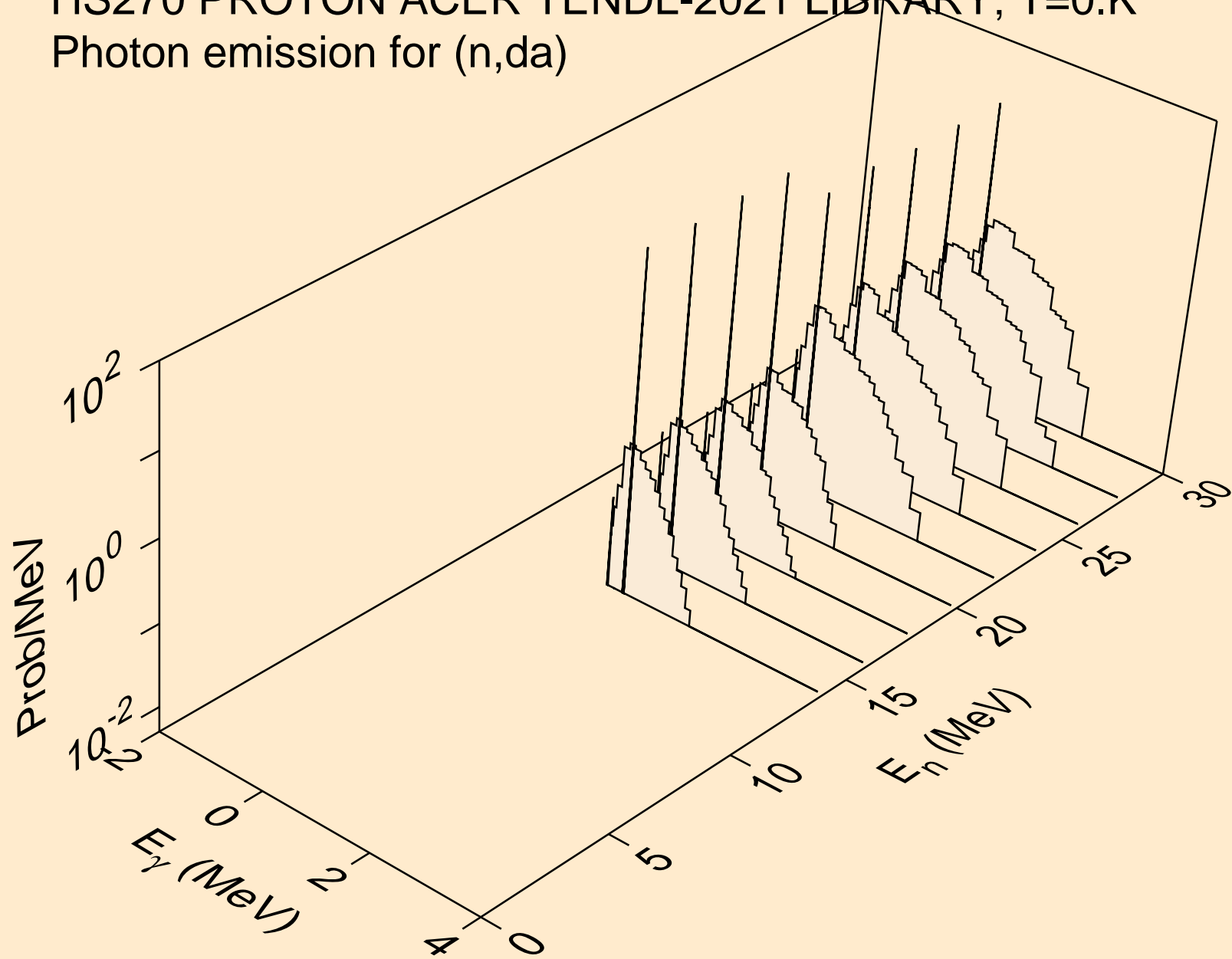

HS270 PROTON ACER TENDL-2021 LIBRARY; T=0.K

Particle heating contributions

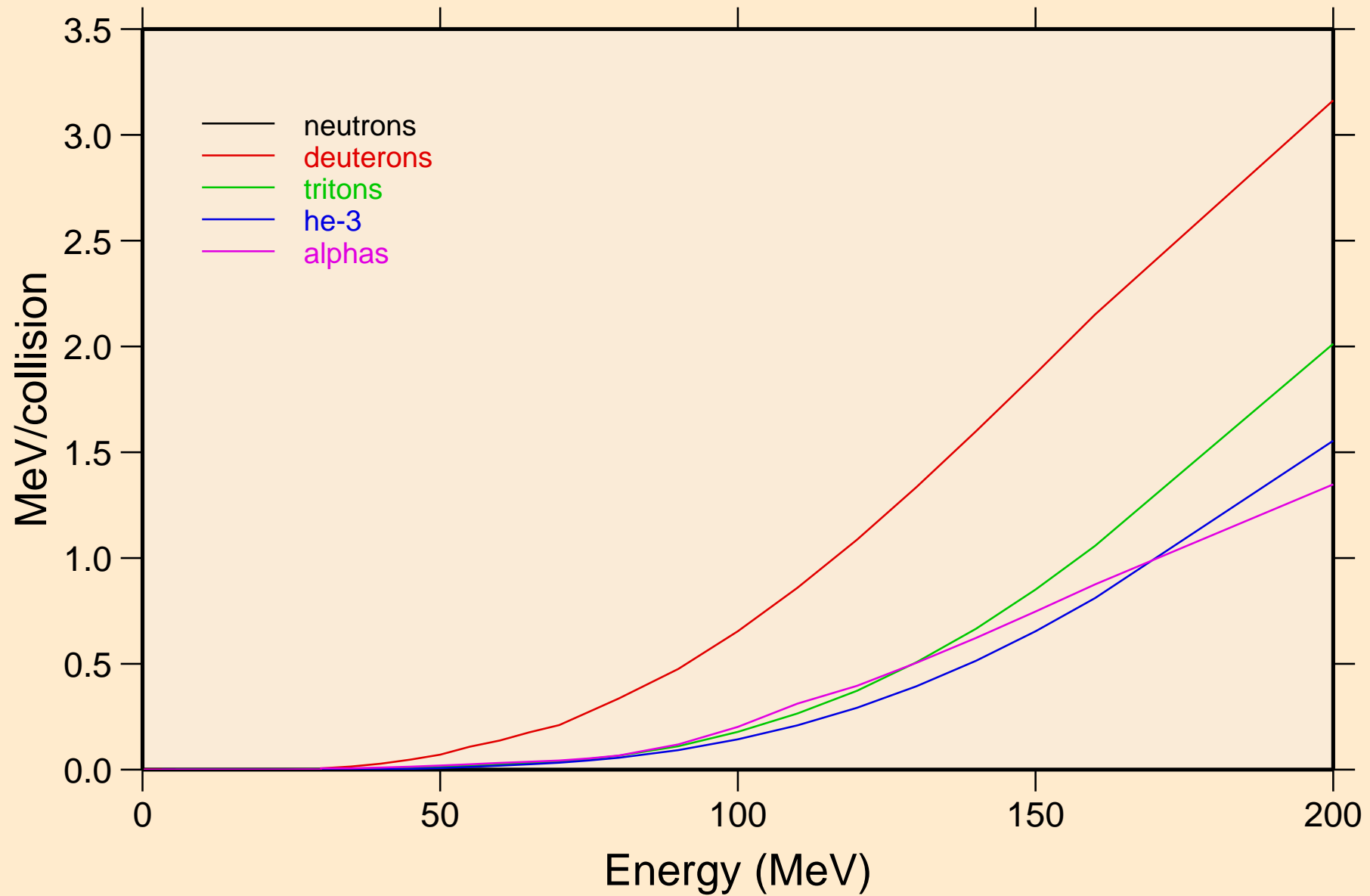

HS270 PROTON ACER TENDL-2021 LIBRARY; T=0.K
Recoil Heating

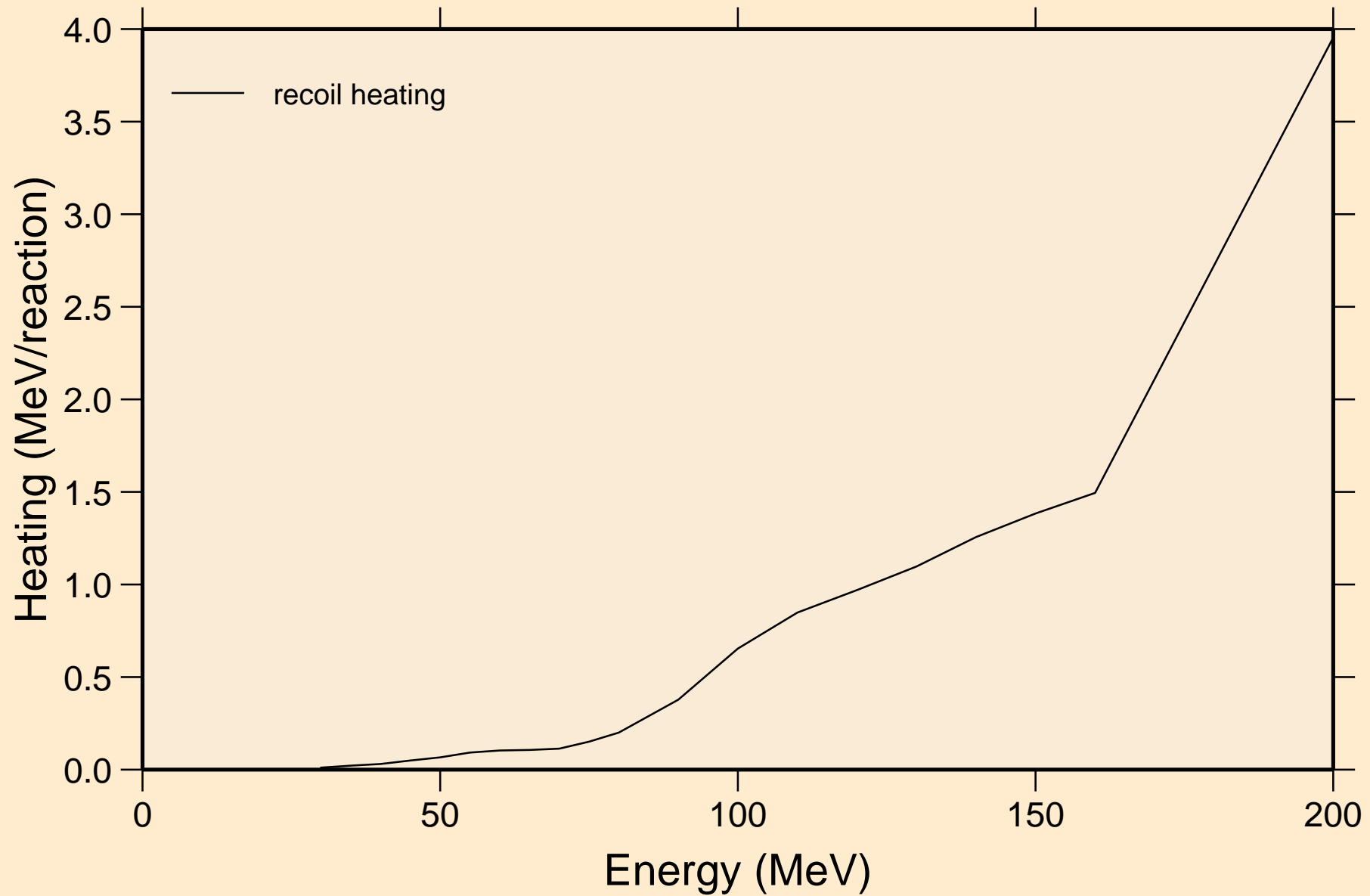

HS270 PROTON ACER TENDL-2021 LIBRARY; T=0.K

Particle production cross sections

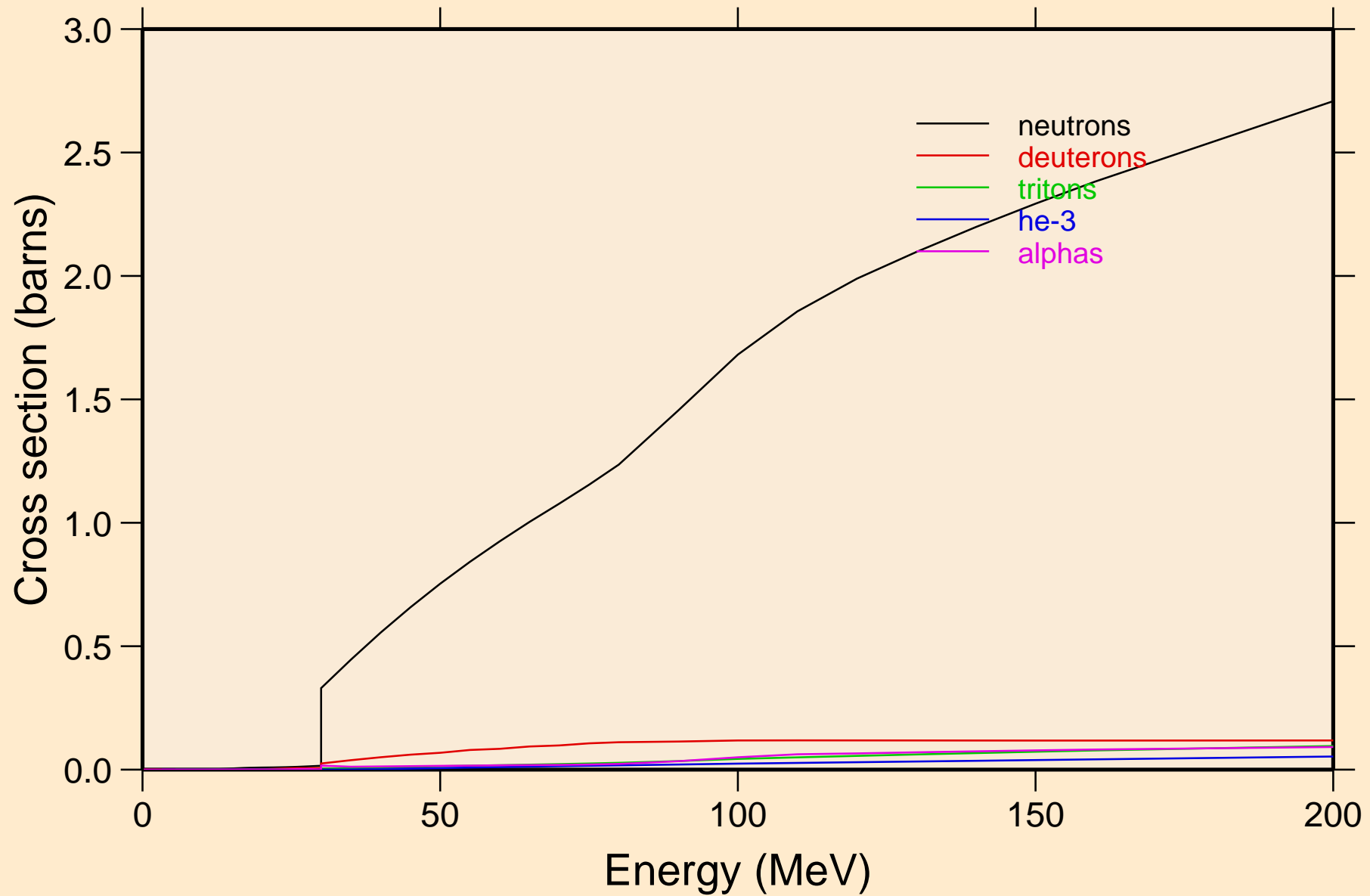

HS270 PROTON ACER TENDL-2021 LIBRARY; T=0.K
neutrons from (p,n)

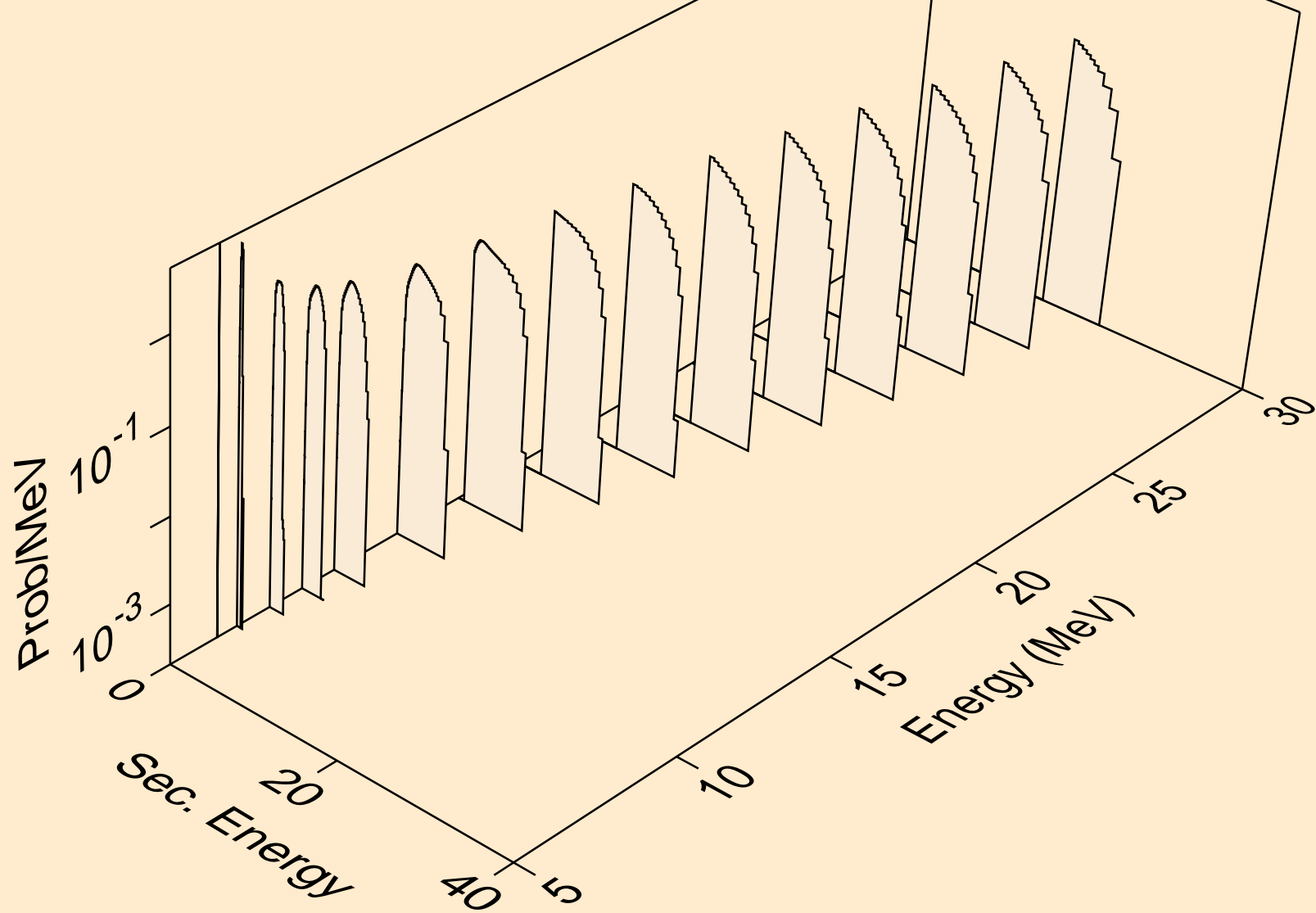

HS270 PROTON ACER TENDL-2021 LIBRARY; T=0.K
neutrons from (p,x)

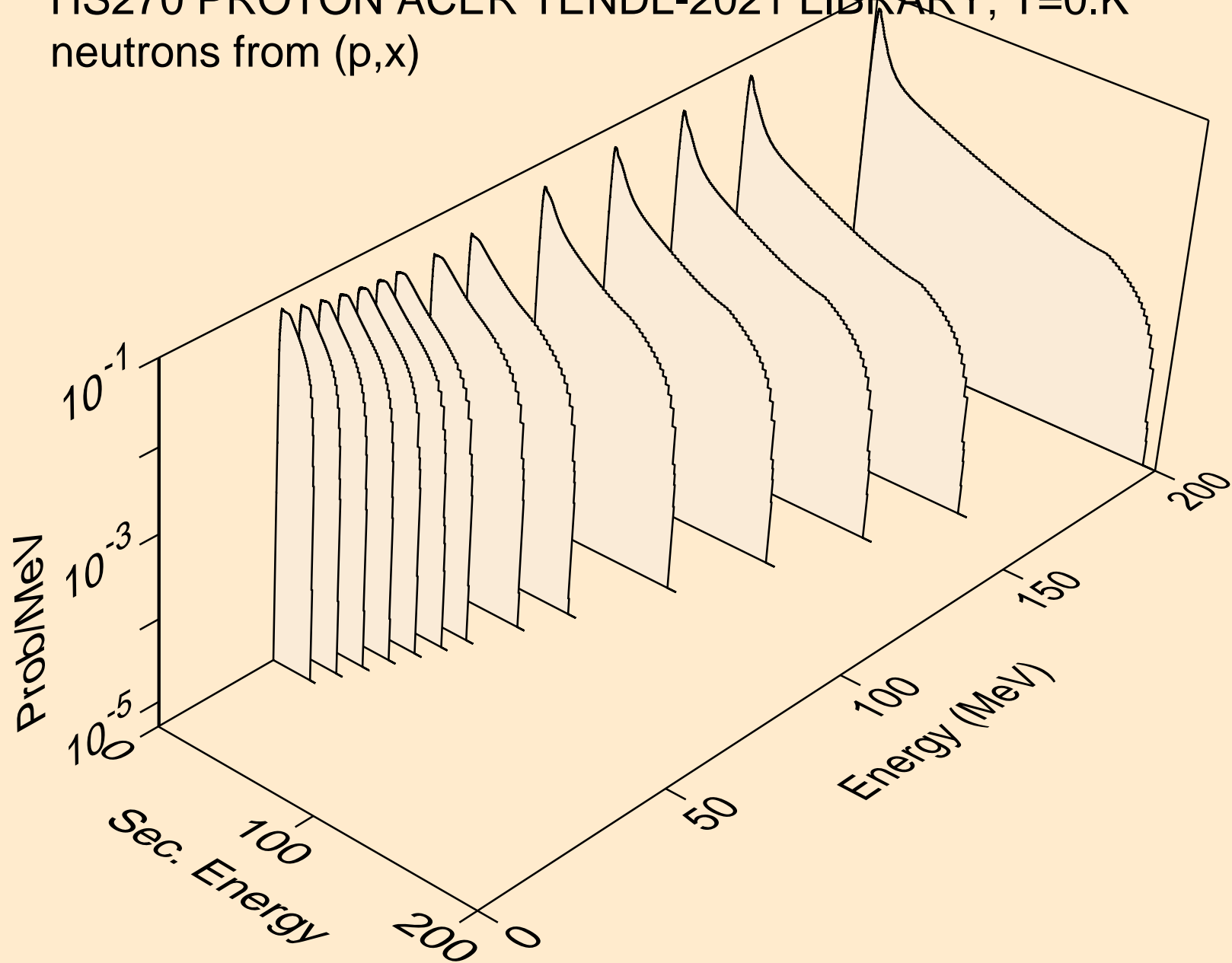

HS270 PROTON ACER TENDL-2021 LIBRARY; T=0.K
neutrons from (p,2n)

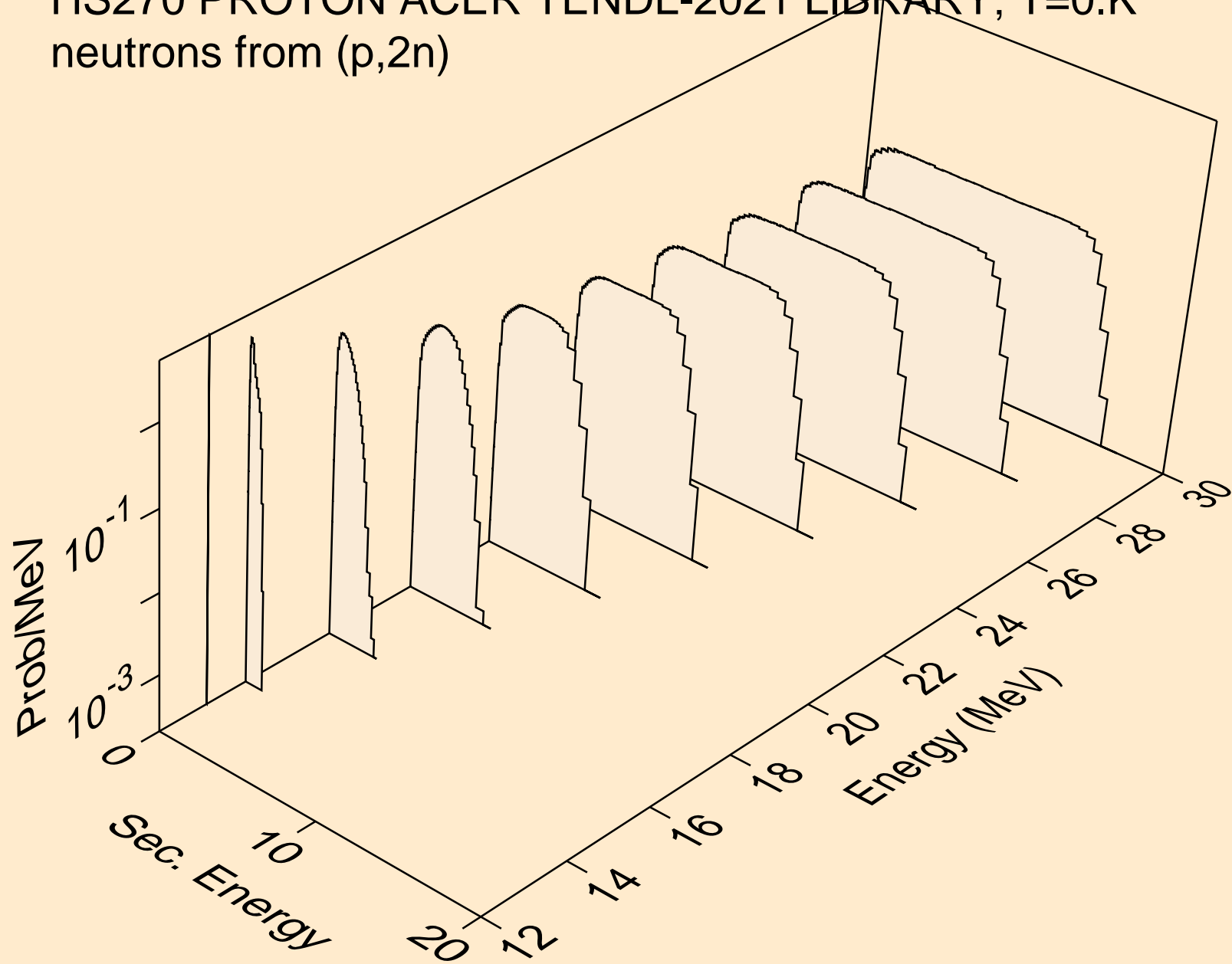

HS270 PROTON ACER TENDL-2021 LIBRARY; T=0.K
neutrons from (p,3n)

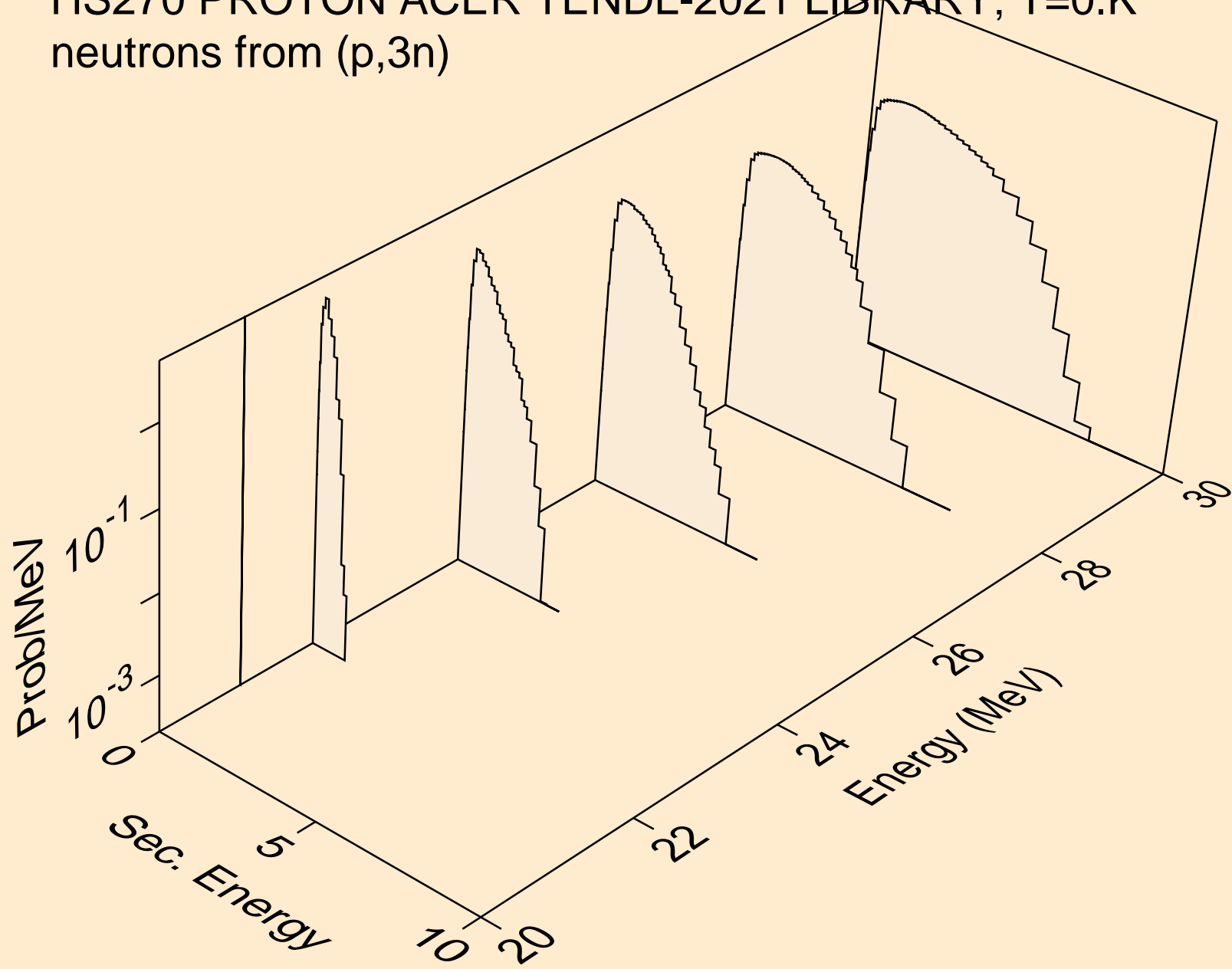

HS270 PROTON ACER TENDL-2021 LIBRARY; T=0.K
neutrons from (p,n*)a

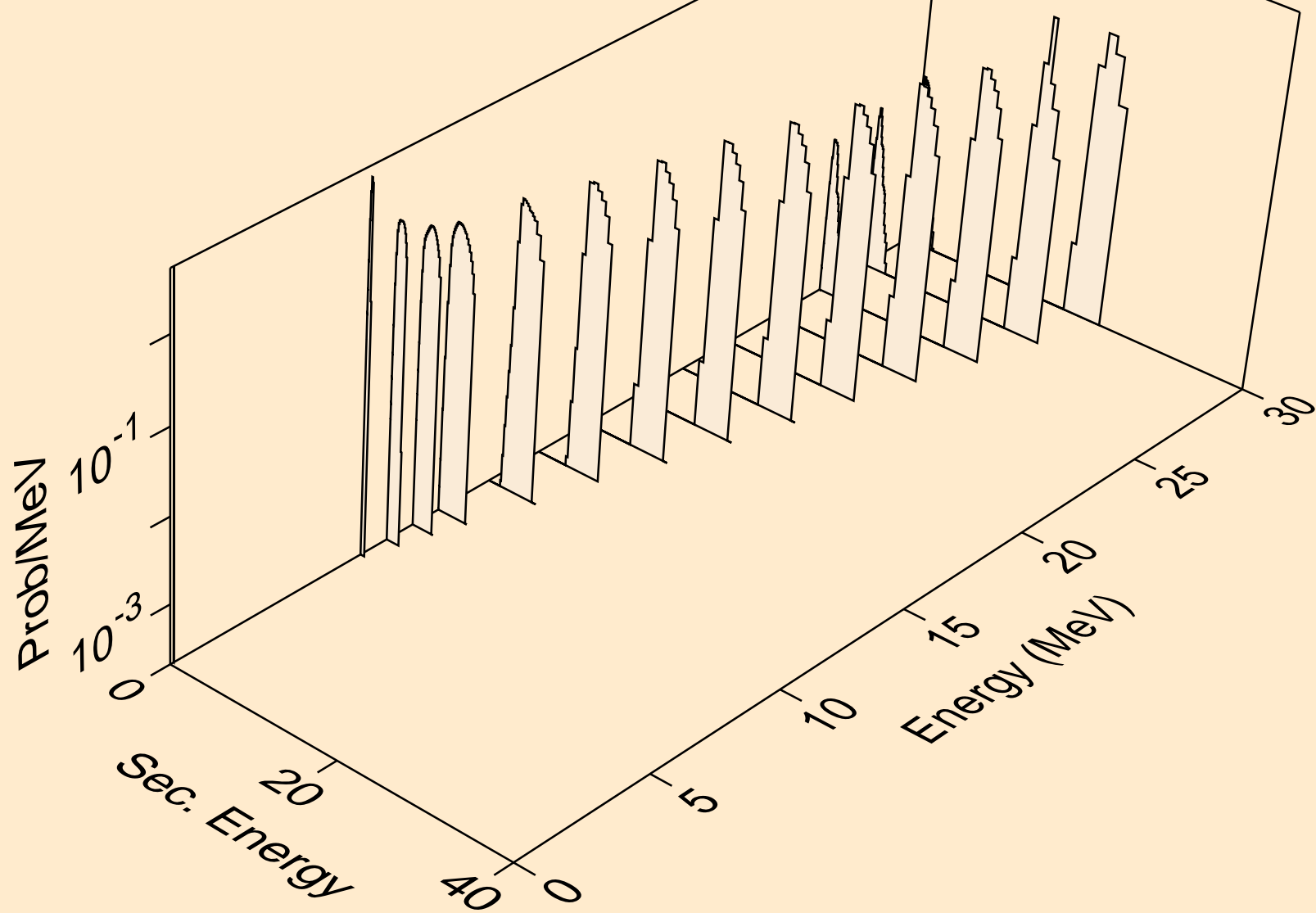

HS270 PROTON ACER TENDL-2021 LIBRARY; T=0.K
neutrons from (p,n*)3a

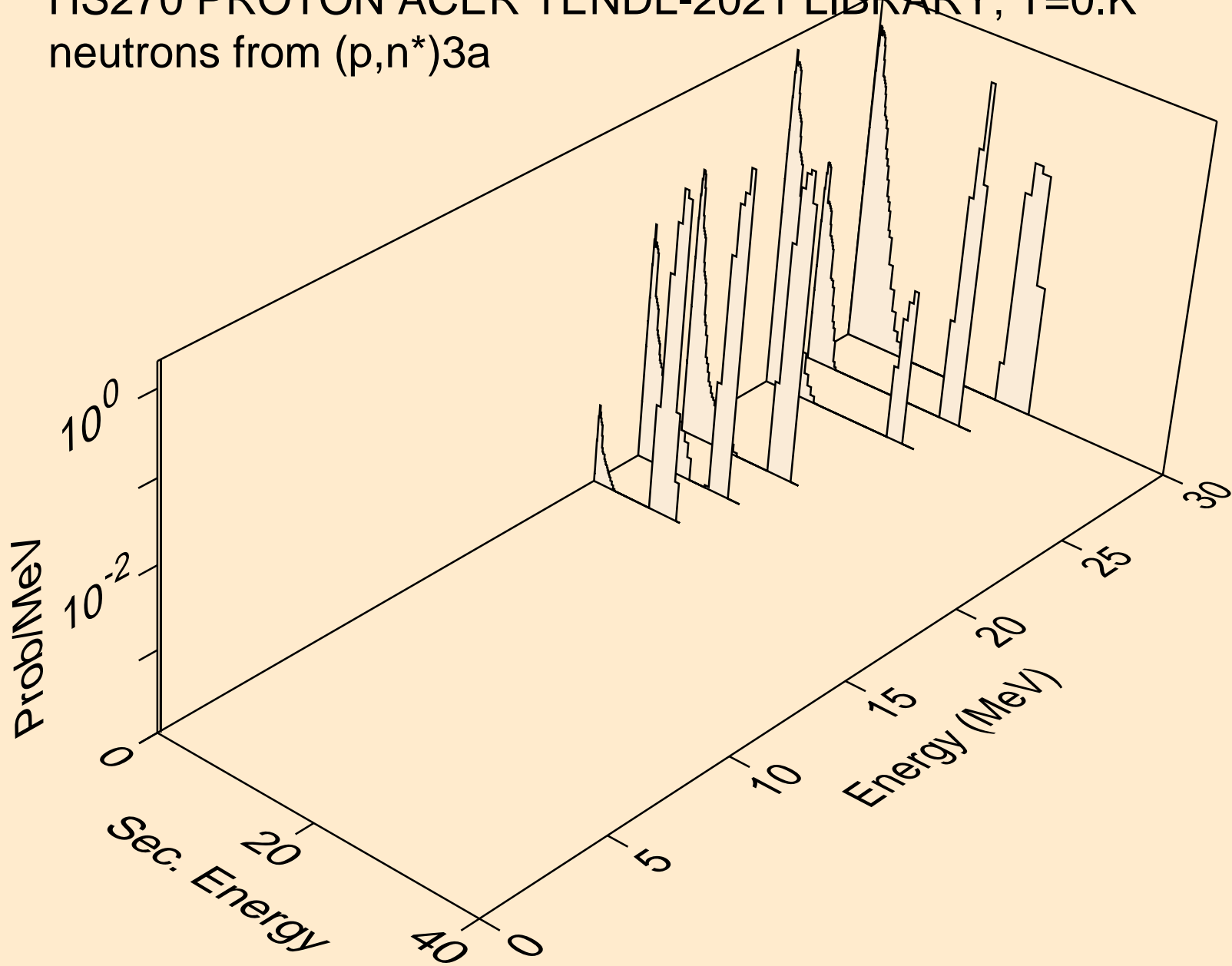

HS270 PROTON ACER TENDL-2021 LIBRARY; T=0.K
neutrons from (p,2n)a

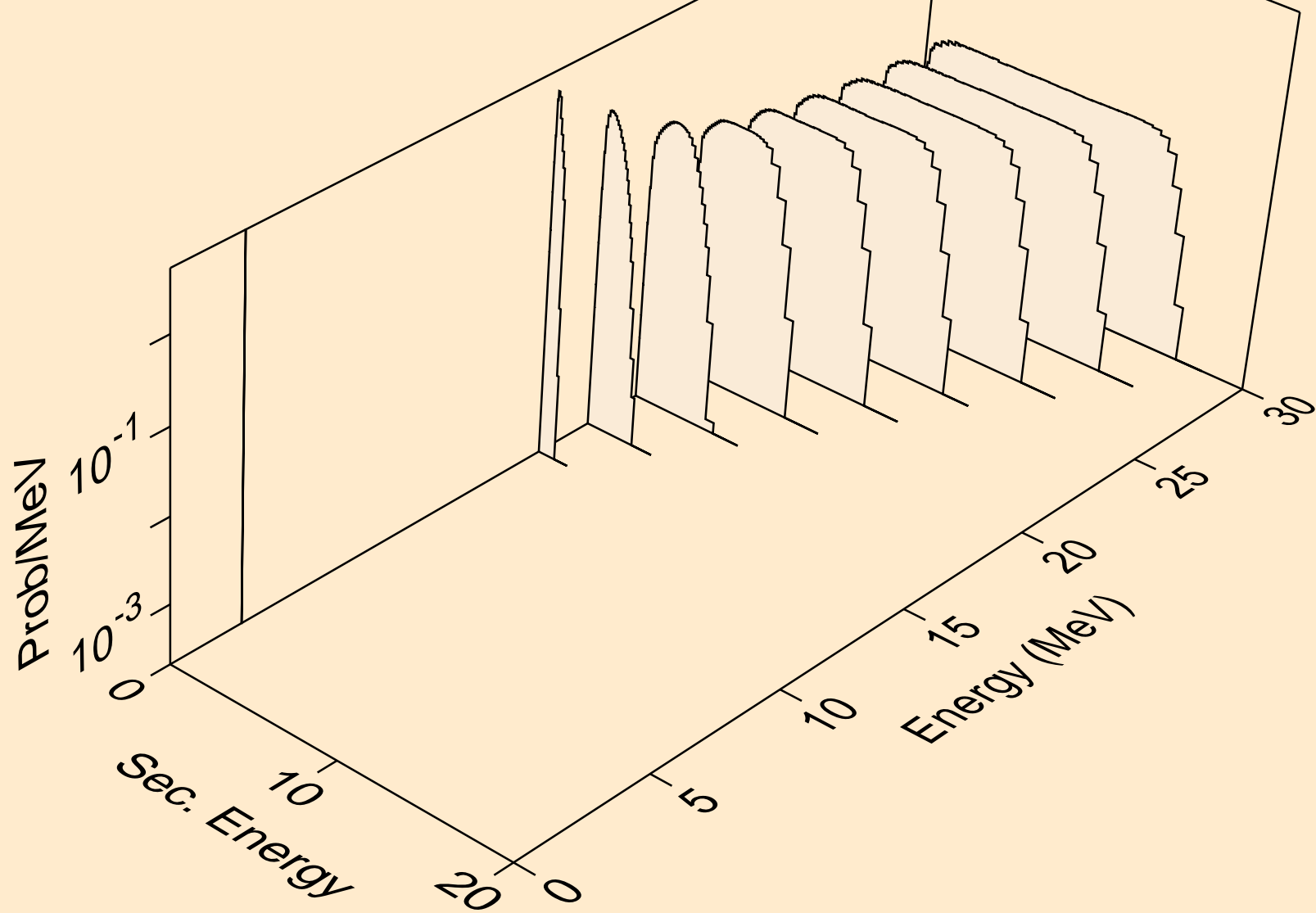

HS270 PROTON ACER TENDL-2021 LIBRARY; T=0.K
neutrons from (p,3n)a

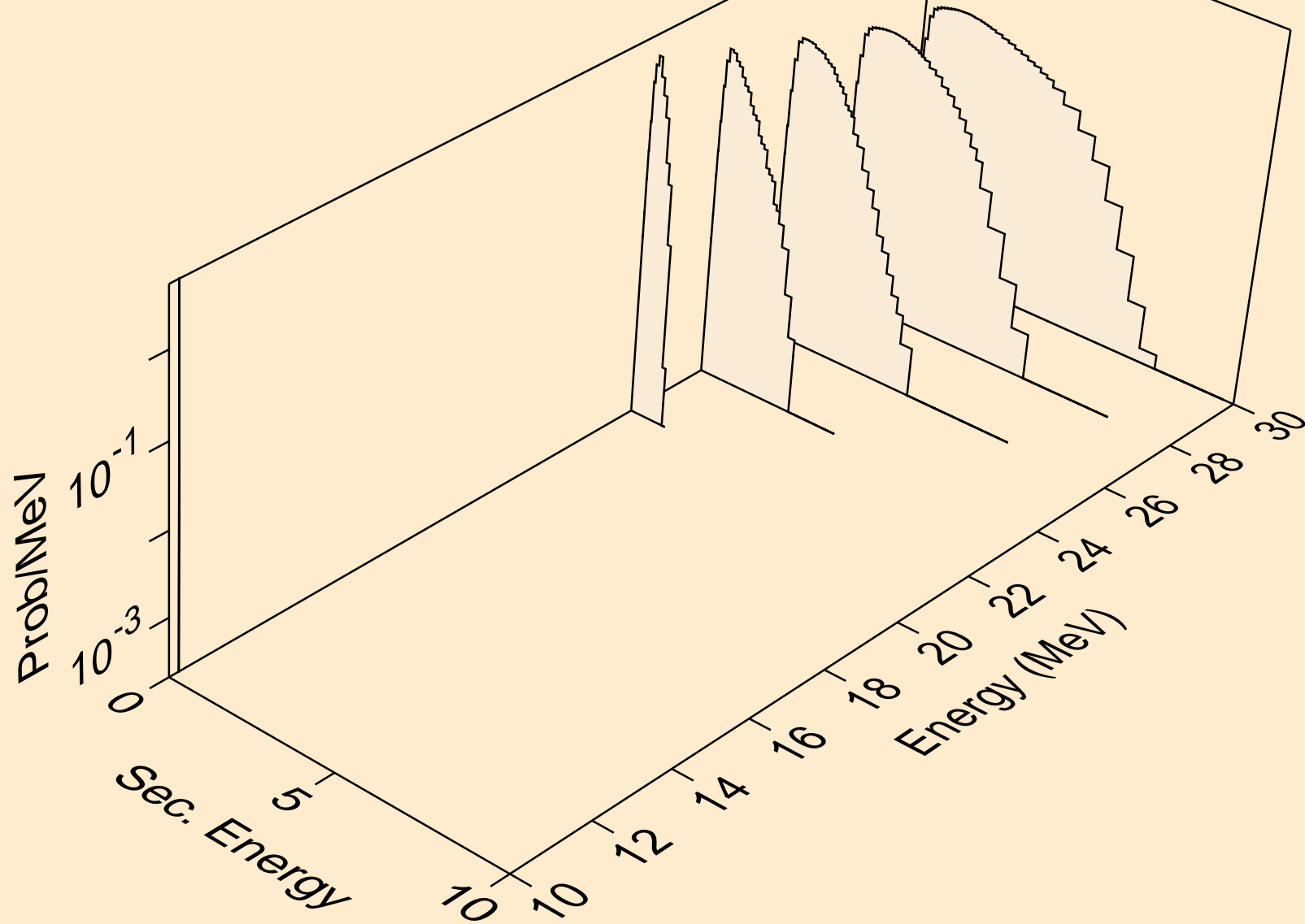

HS270 PROTON ACER TENDL-2021 LIBRARY; T=0.K
neutrons from (p,n*)p

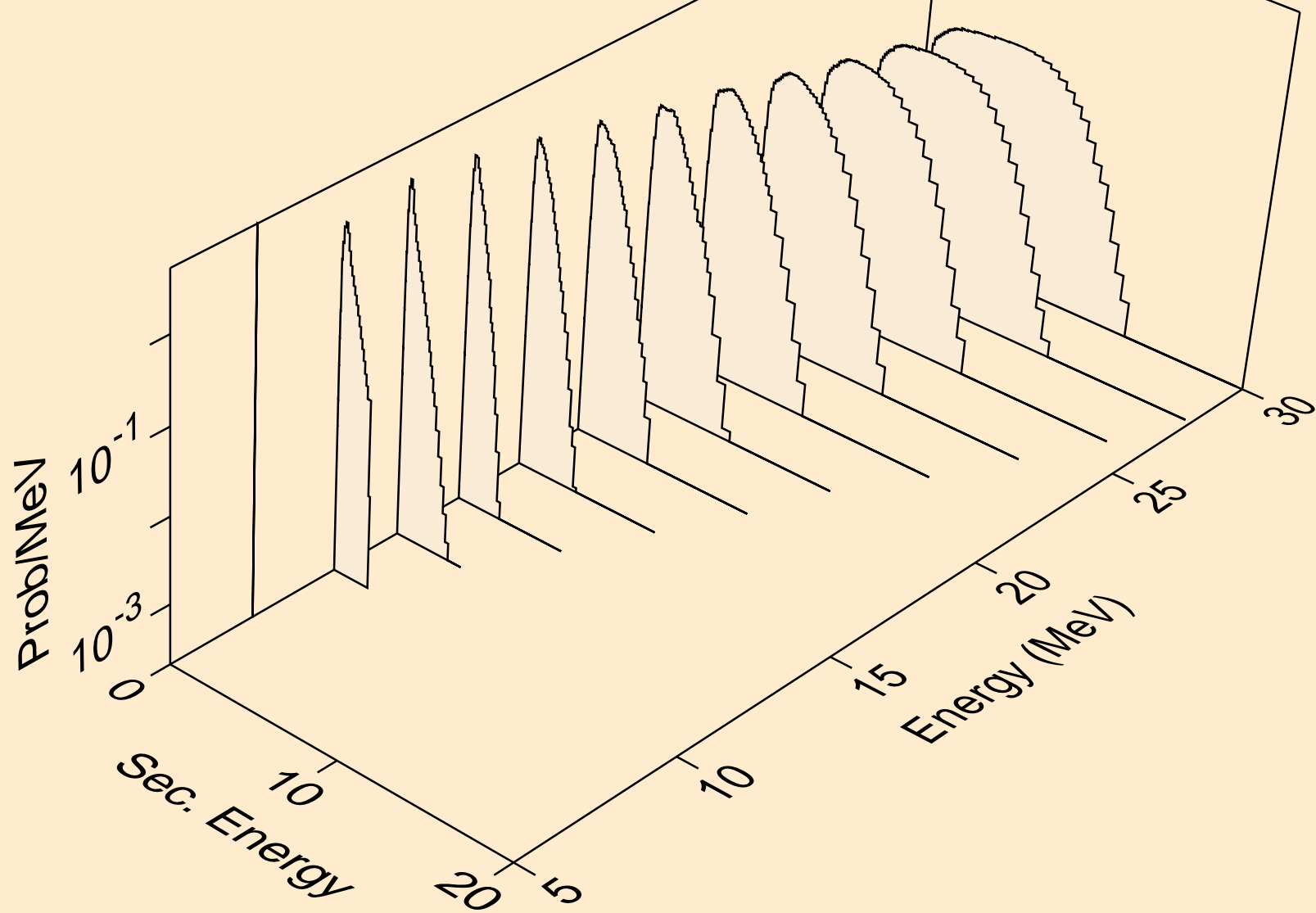

HS270 PROTON ACER TENDL-2021 LIBRARY; T=0.K
neutrons from (p,n*)2a

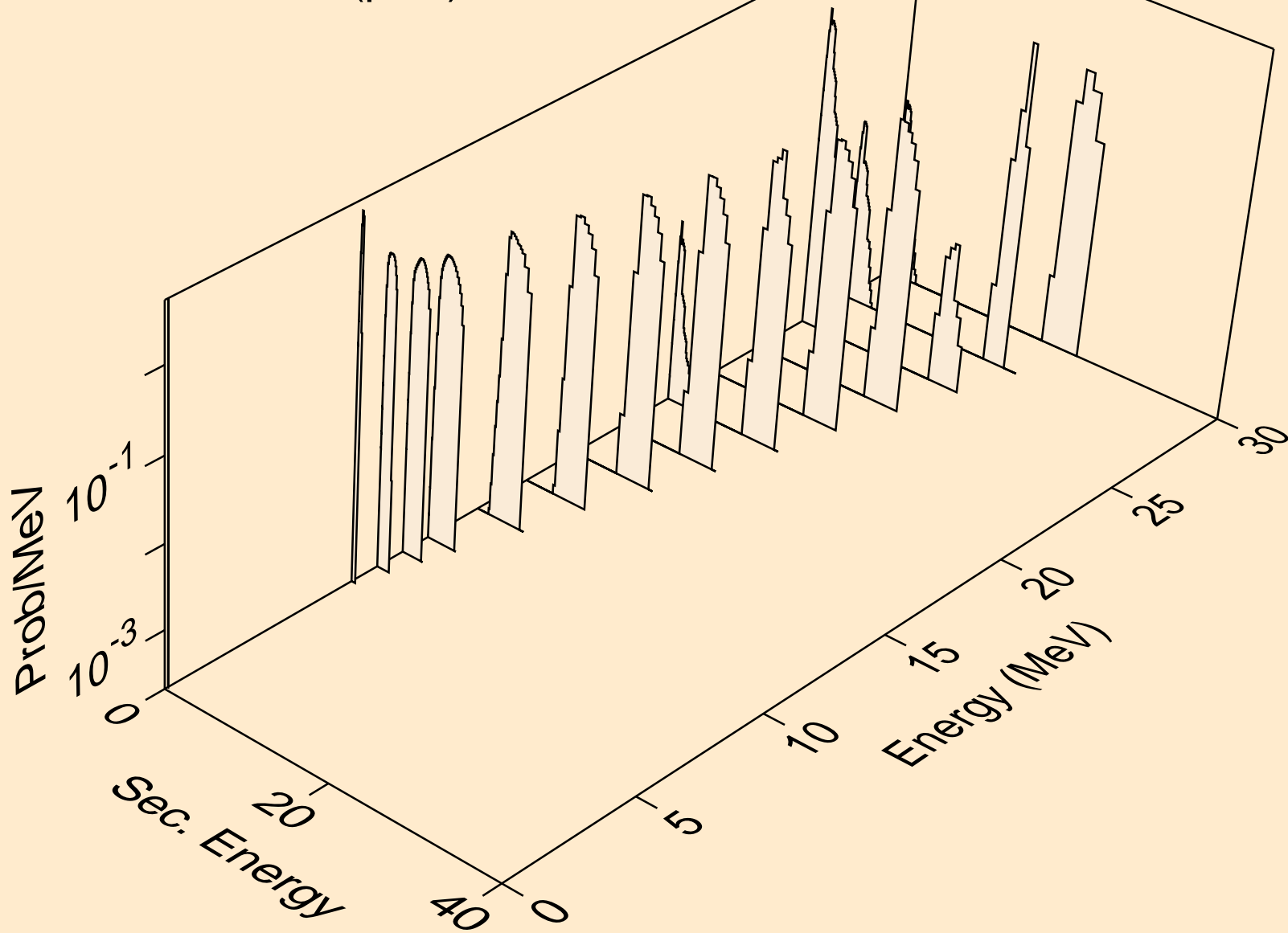

HS270 PROTON ACER TENDL-2021 LIBRARY; T=0.K
neutrons from (p,n*)d

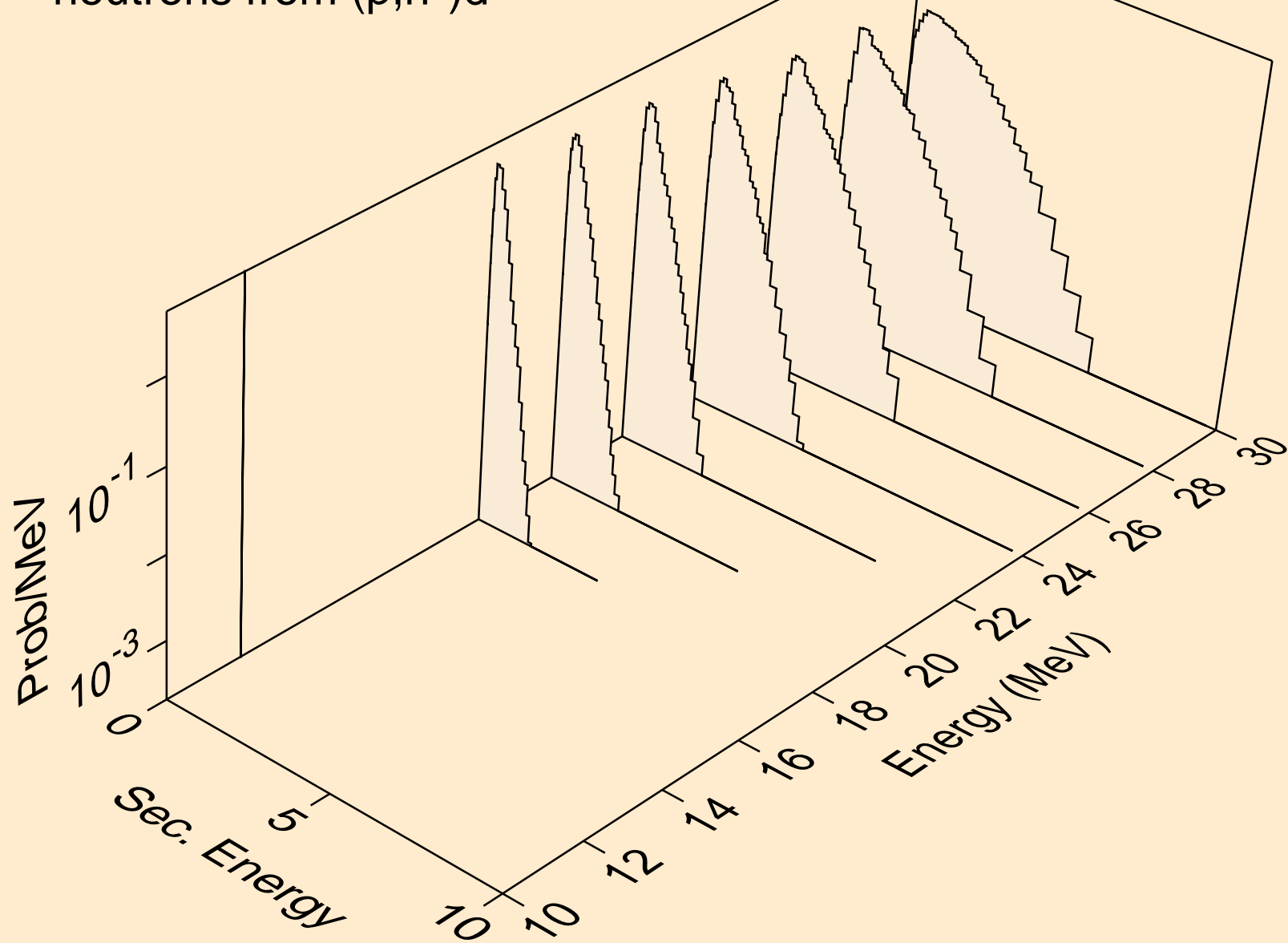

HS270 PROTON ACER TENDL-2021 LIBRARY; T=0.K
neutrons from (p,n*)t

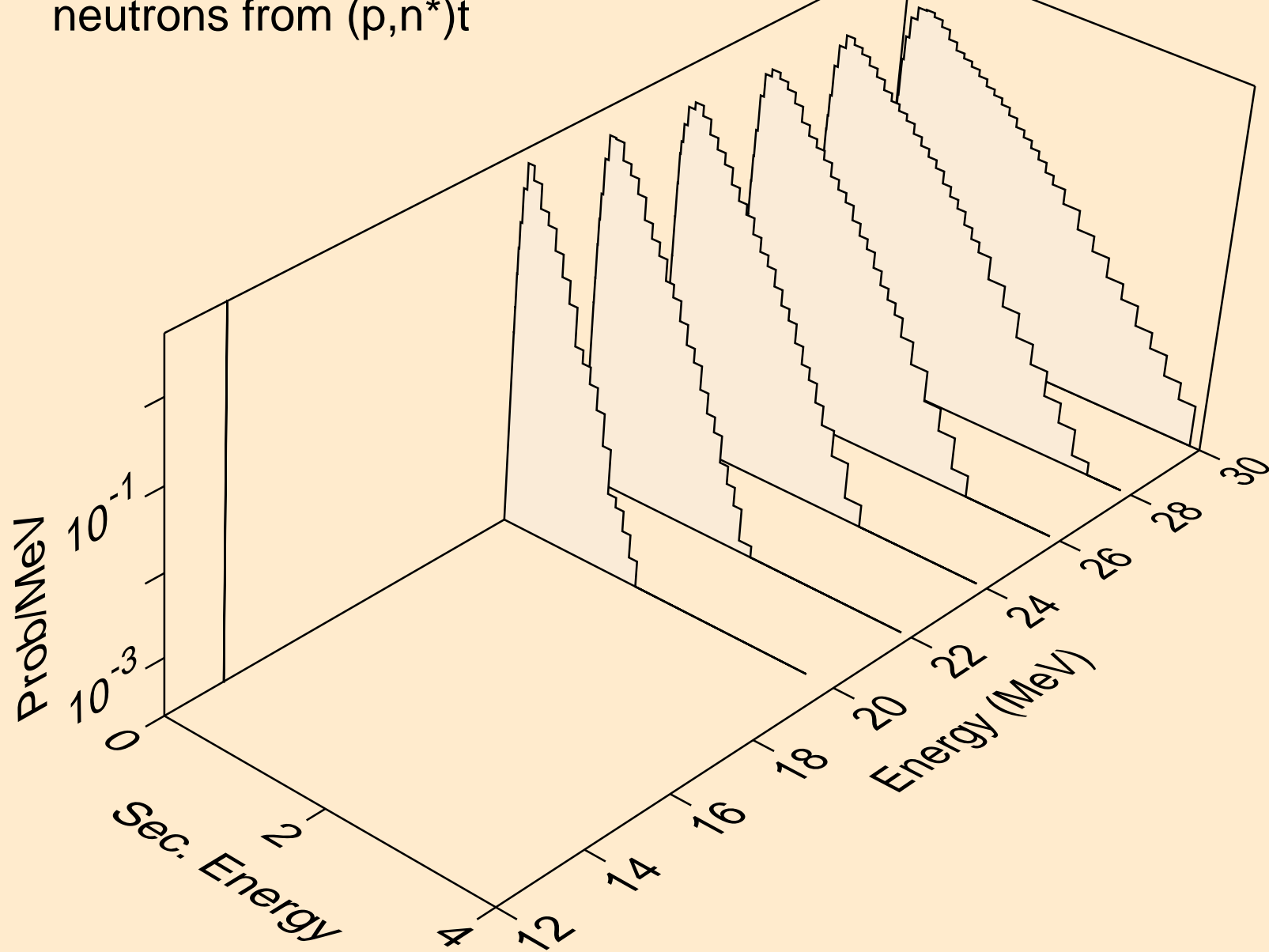

HS270 PROTON ACER TENDL-2021 LIBRARY; T=0.K
neutrons from (p,2np)

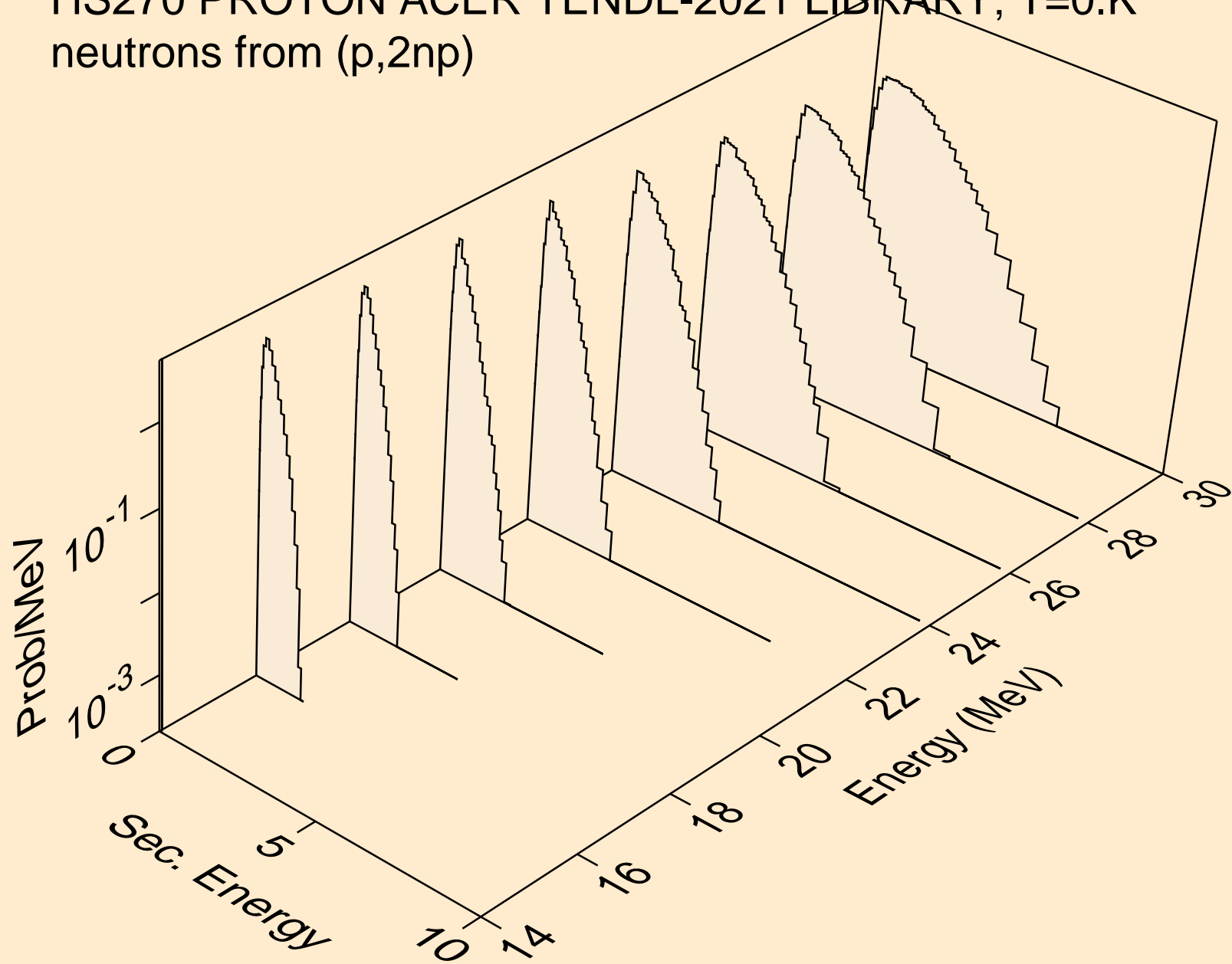

HS270 PROTON ACER TENDL-2021 LIBRARY; T=0.K
neutrons from (p,npa)

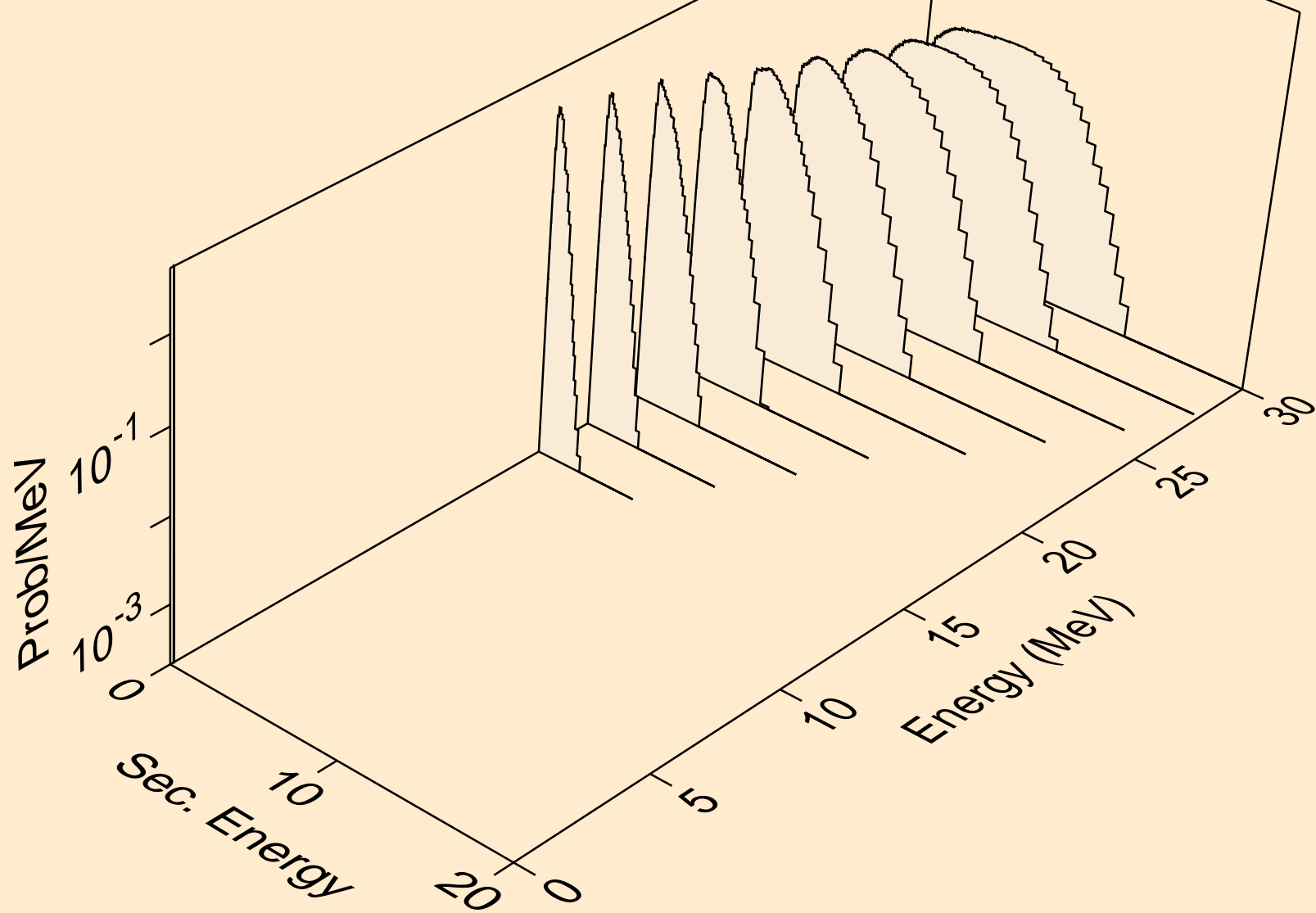

HS270 PROTON ACER TENDL-2021 LIBRARY; T=0.K
deuterons from (p,x)

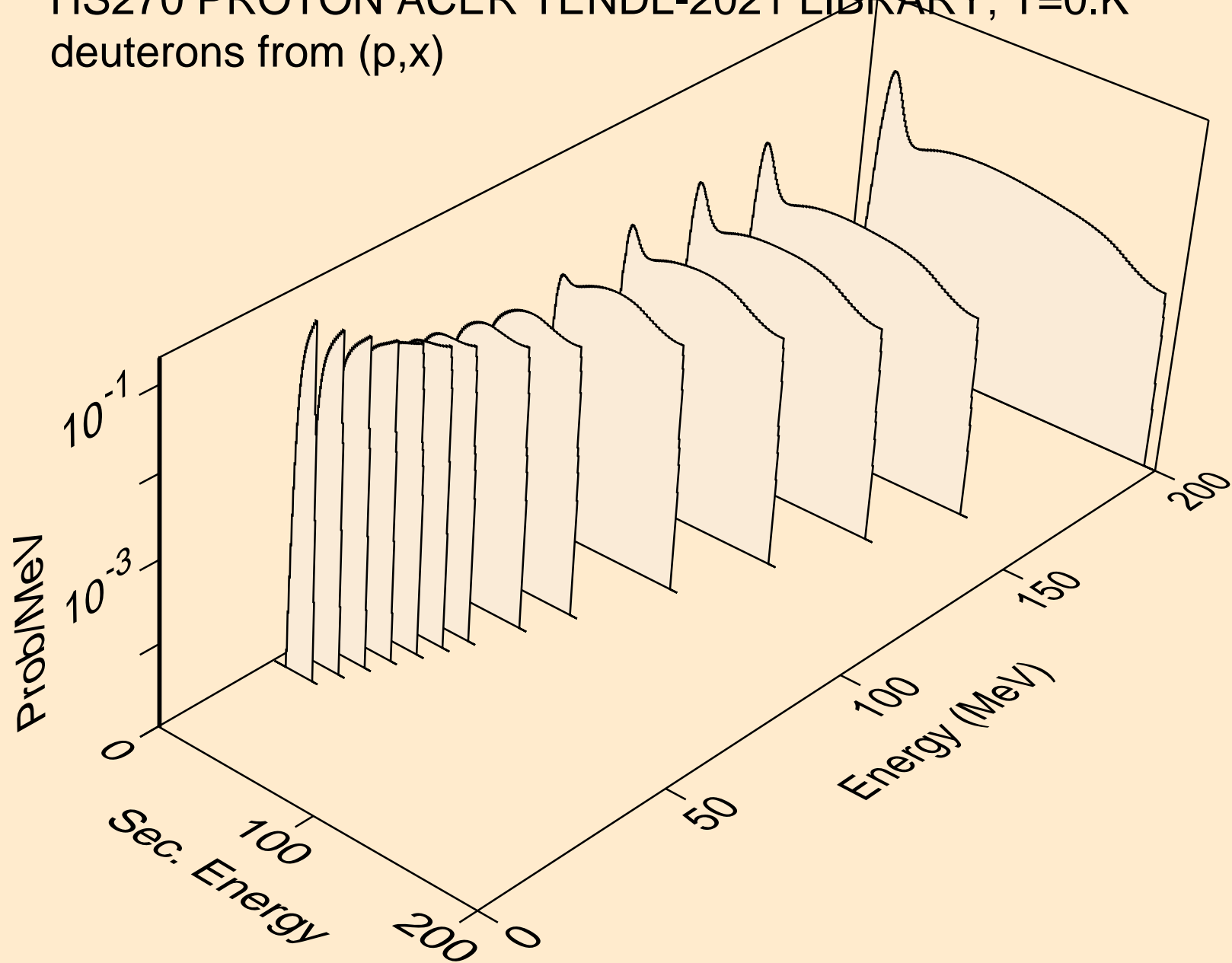

HS270 PROTON ACER TENDL-2021 LIBRARY; T=0.K
deuterons from (p,n*)d

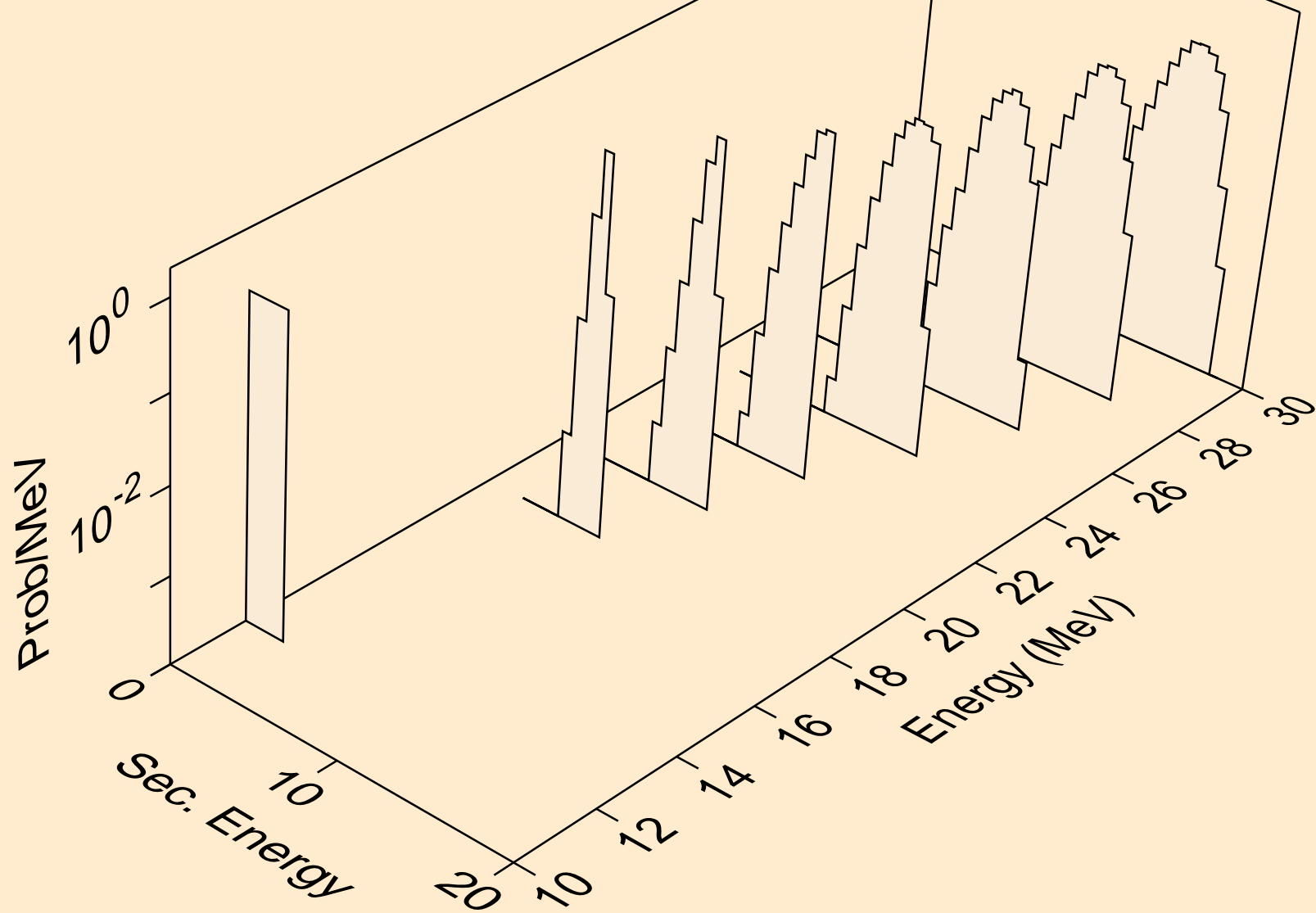

HS270 PROTON ACER TENDL-2021 LIBRARY; T=0.K
deuterons from (p,d)

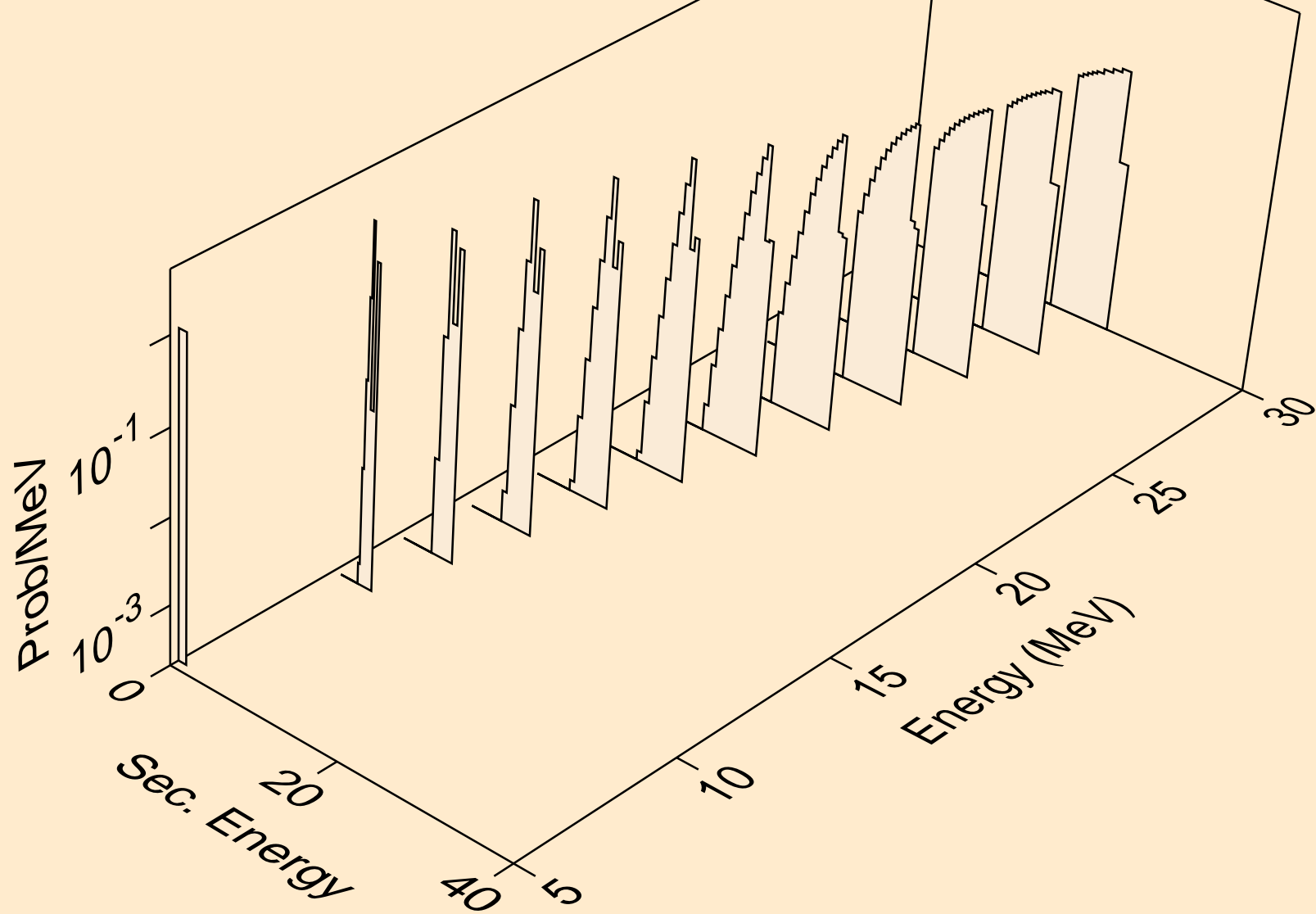

HS270 PROTON ACER TENDL-2021 LIBRARY; T=0.K
deuterons from (p,da)

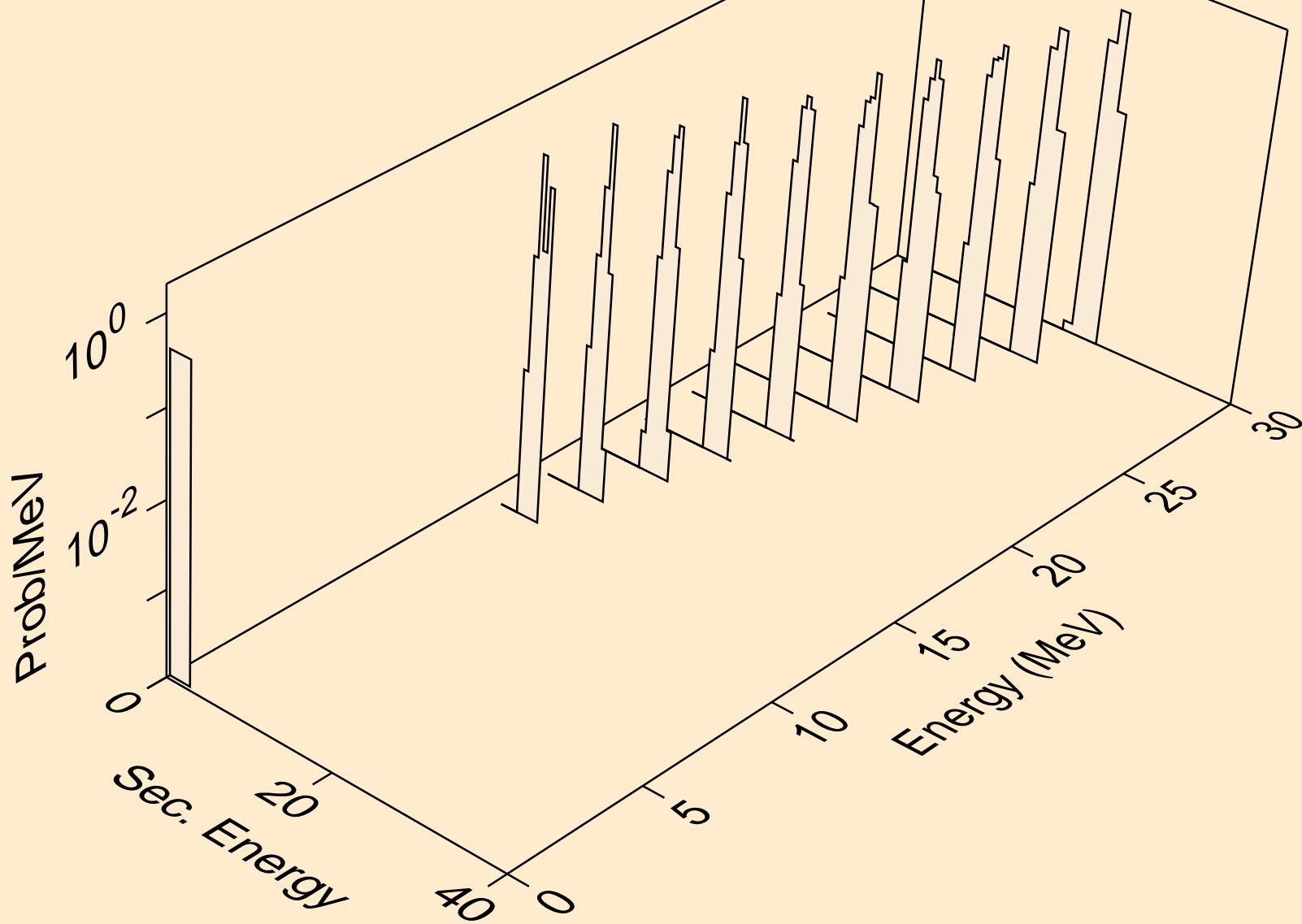

HS270 PROTON ACER TENDL-2021 LIBRARY; T=0.K
tritons from (p,x)

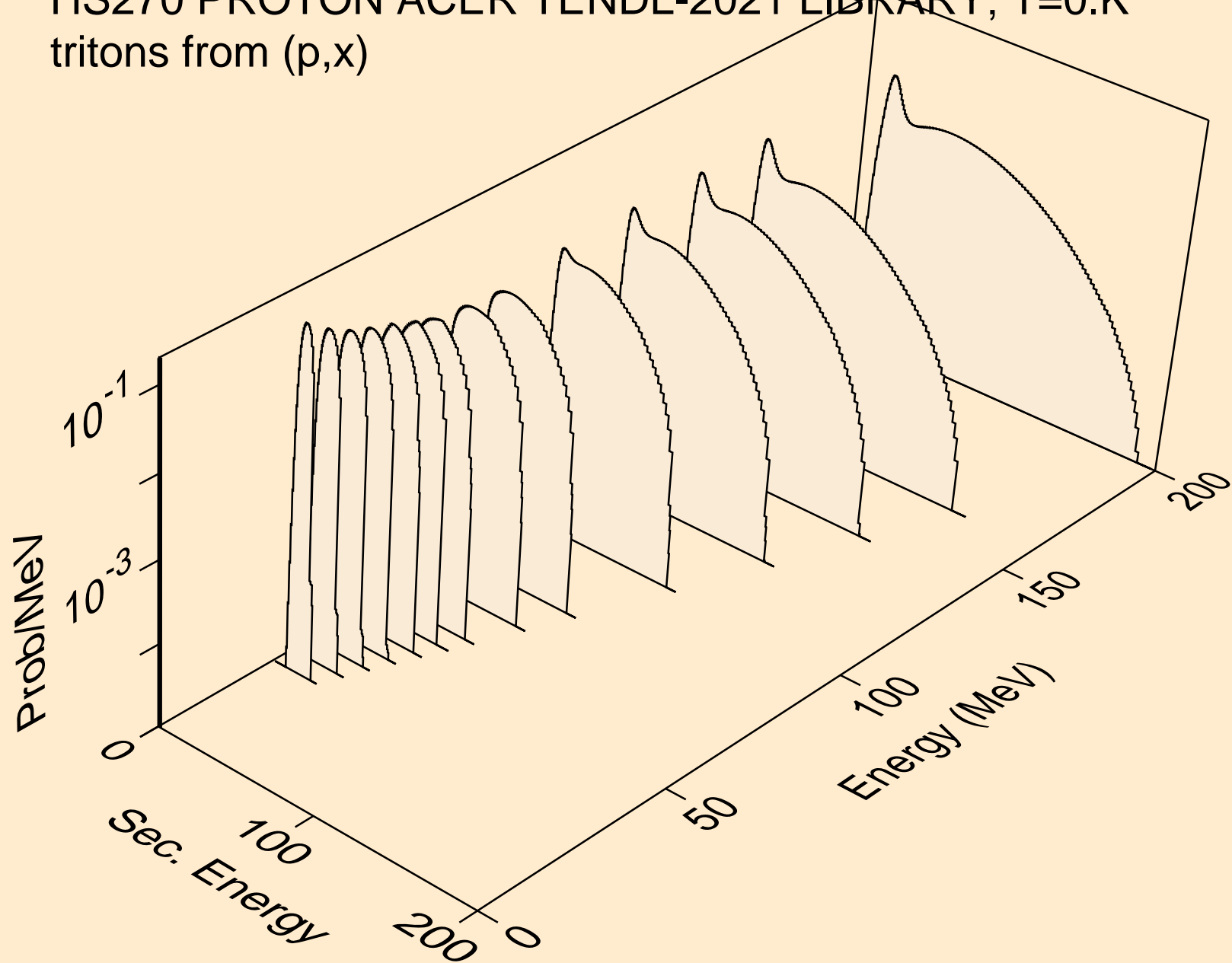

HS270 PROTON ACER TENDL-2021 LIBRARY; T=0.K
tritons from (p,n*)t

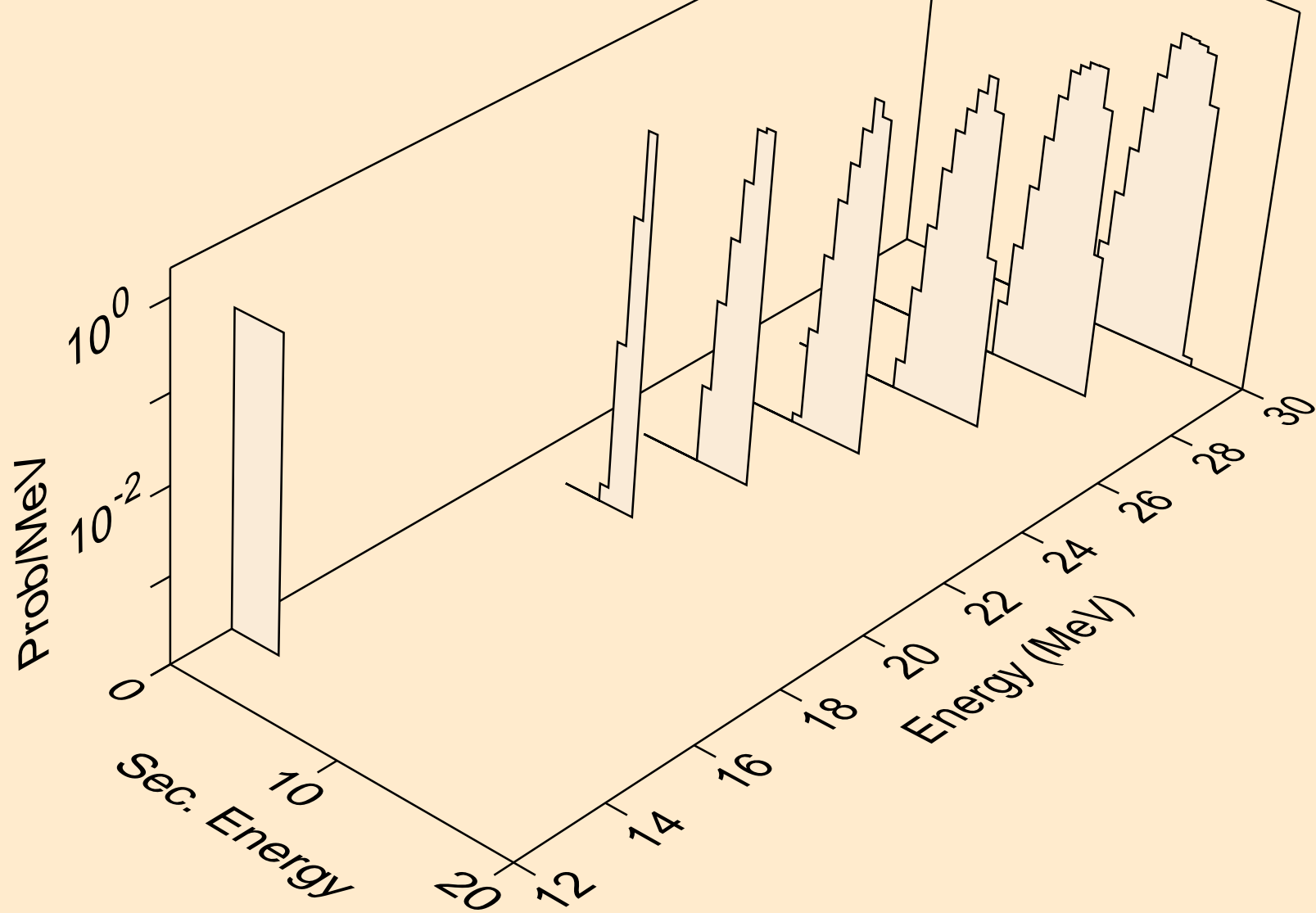

HS270 PROTON ACER TENDL-2021 LIBRARY; T=0.K
tritons from (p,t)

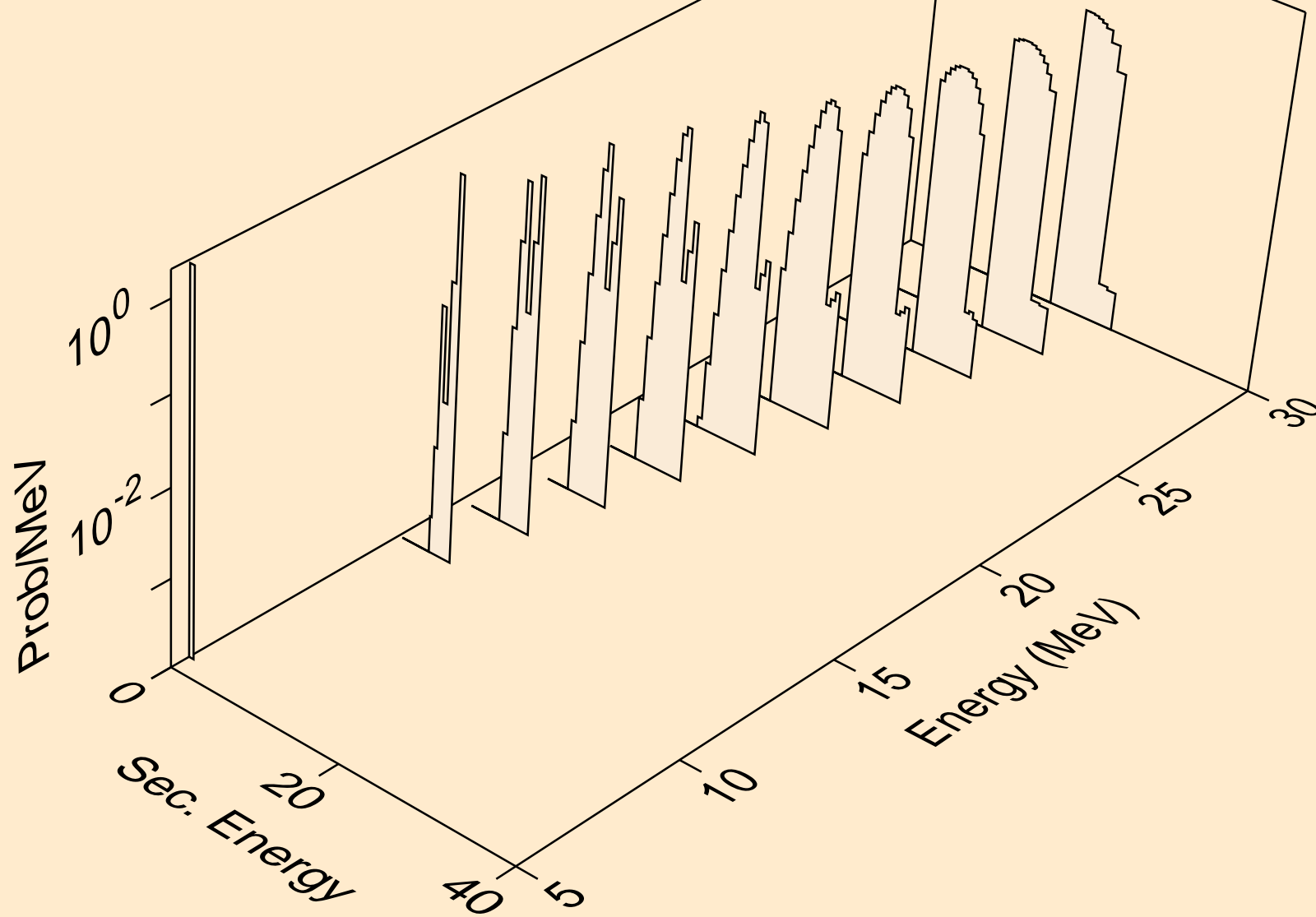

HS270 PROTON ACER TENDL-2021 LIBRARY; T=0.K
he3s from (p,x)

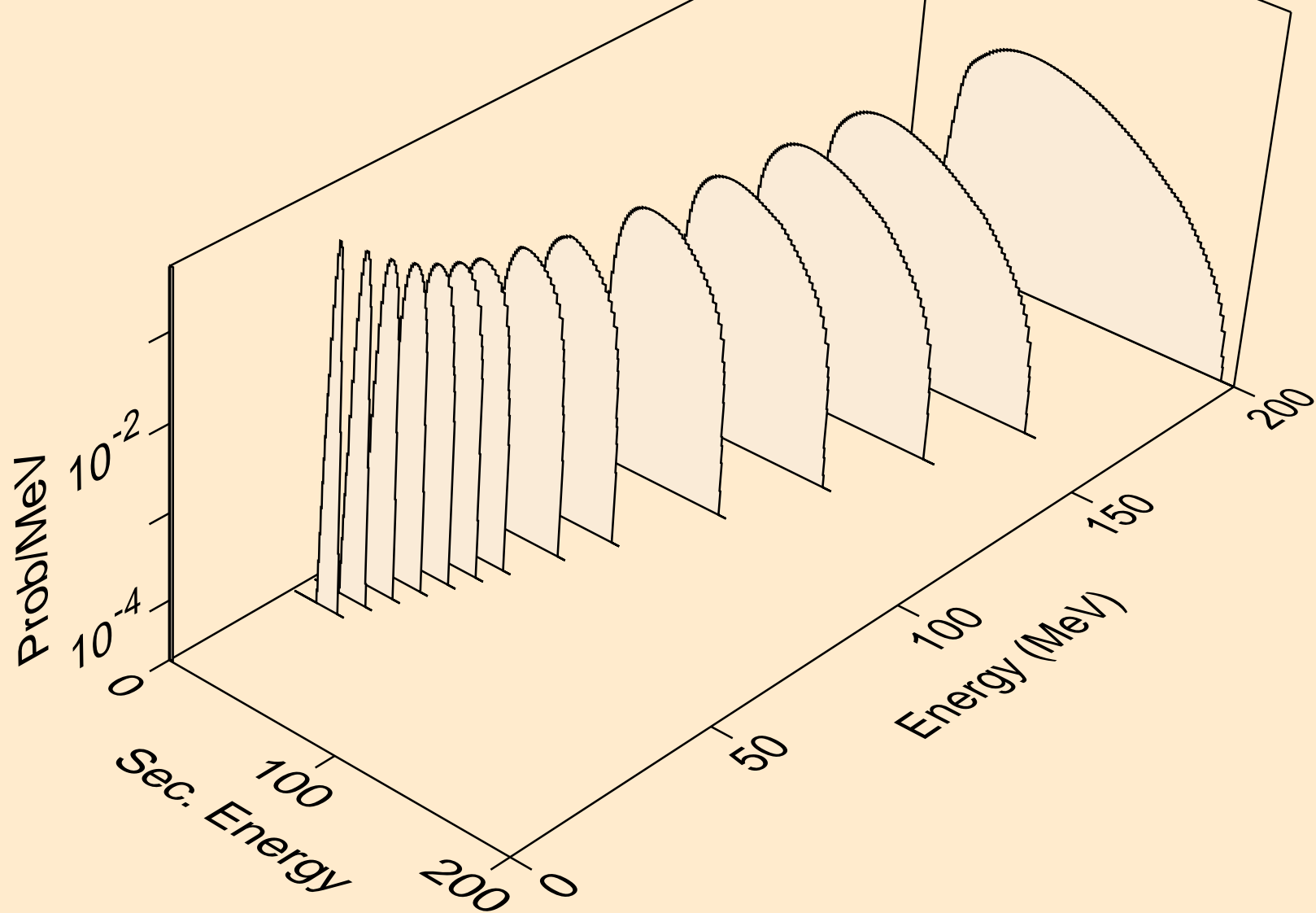

HS270 PROTON ACER TENDL-2021 LIBRARY; T=0.K
he3s from (p,he3)

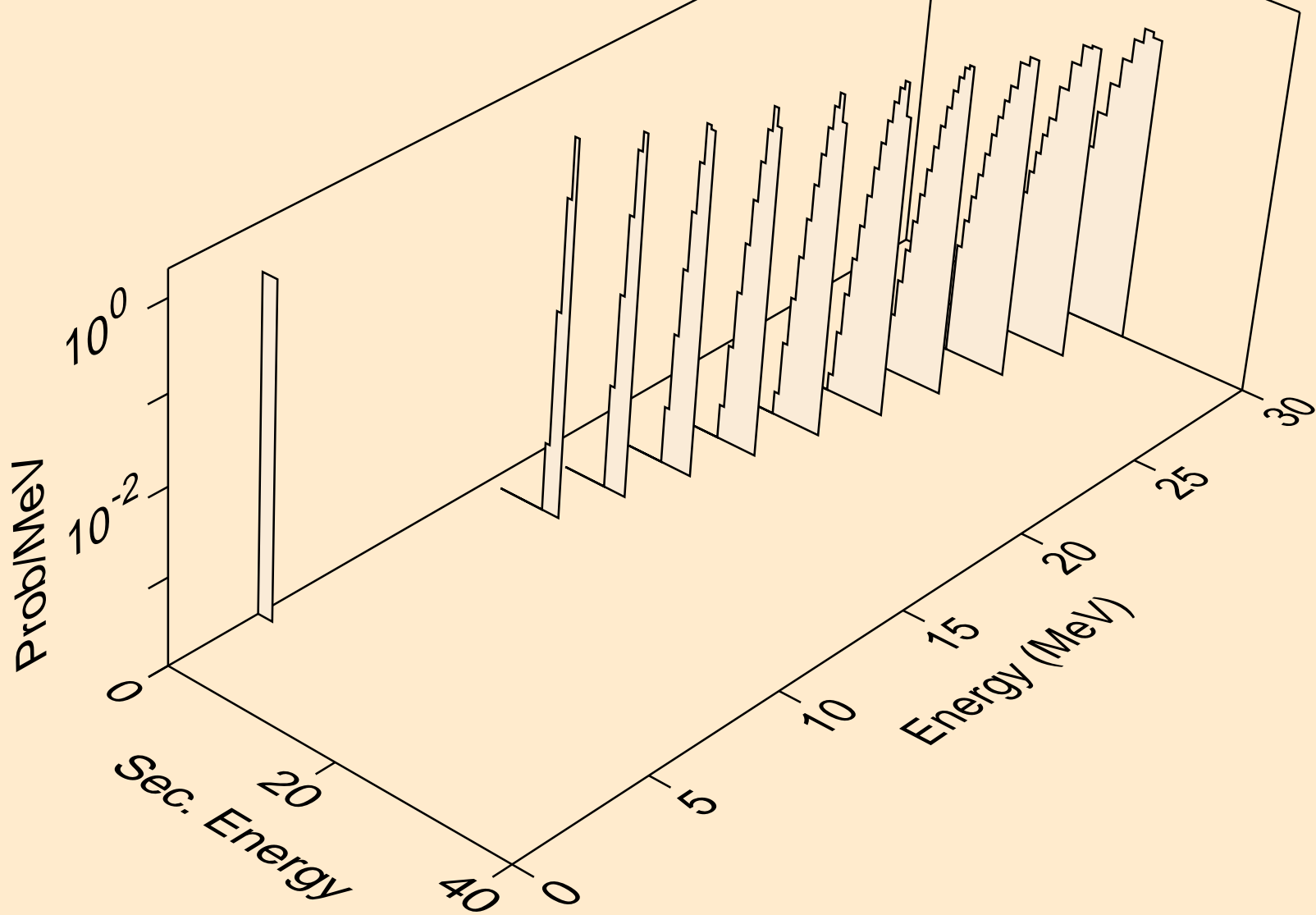

HS270 PROTON ACER TENDL-2021 LIBRARY; T=0.K
alphas from (p,x)

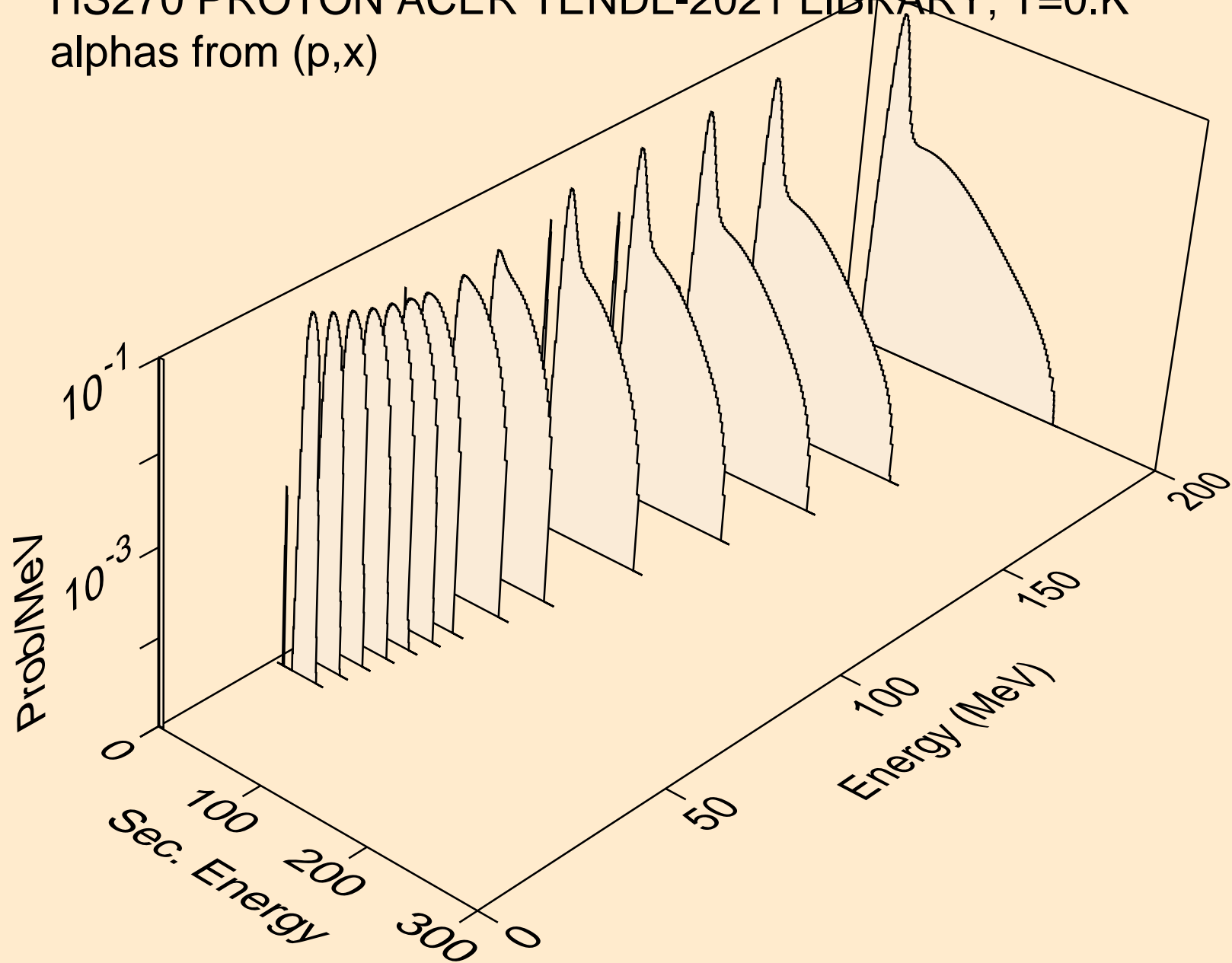

HS270 PROTON ACER TENDL-2021 LIBRARY; T=0.K
alphas from (p,n*)a

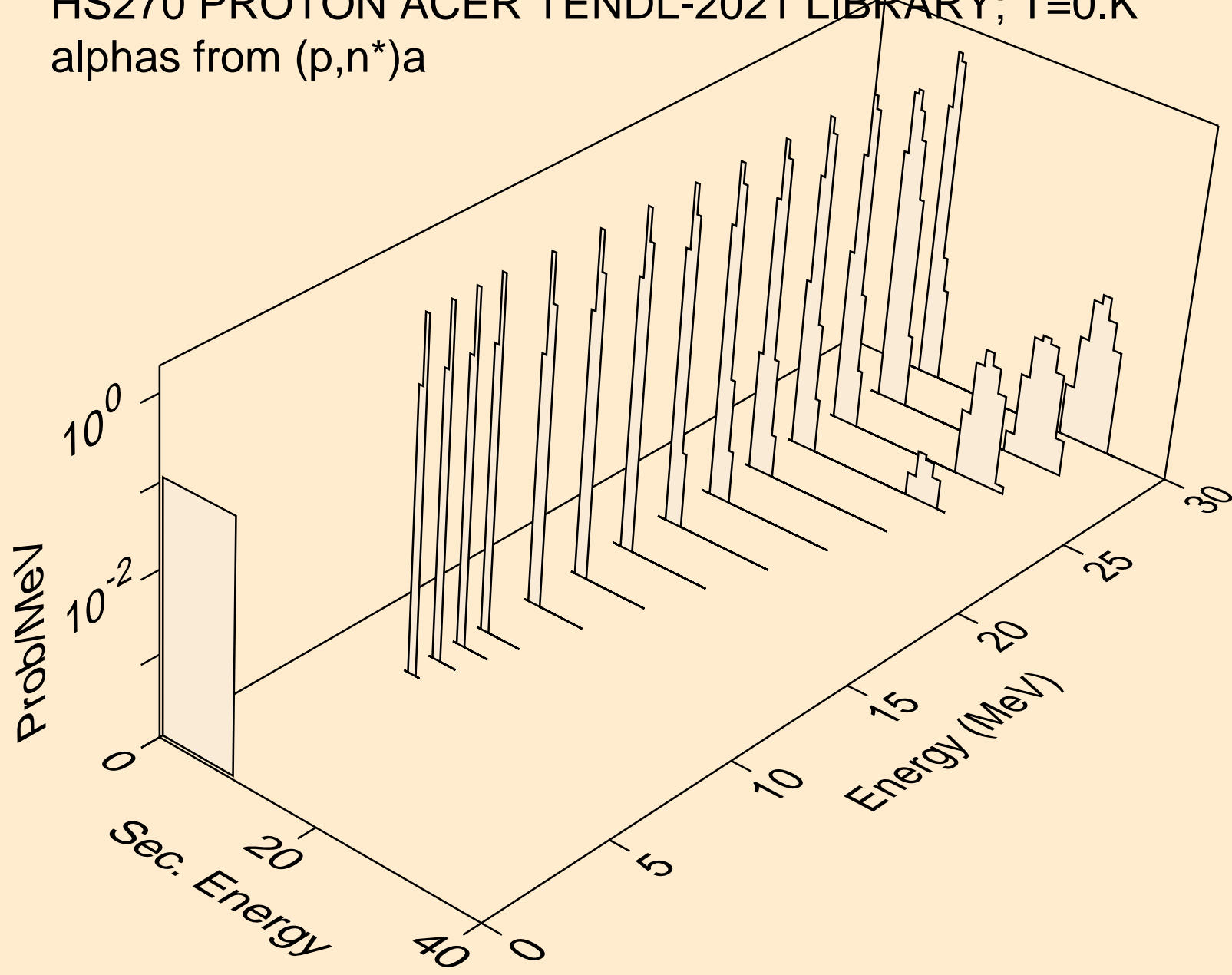

HS270 PROTON ACER TENDL-2021 LIBRARY; T=0.K
alphas from (p,n*)3a

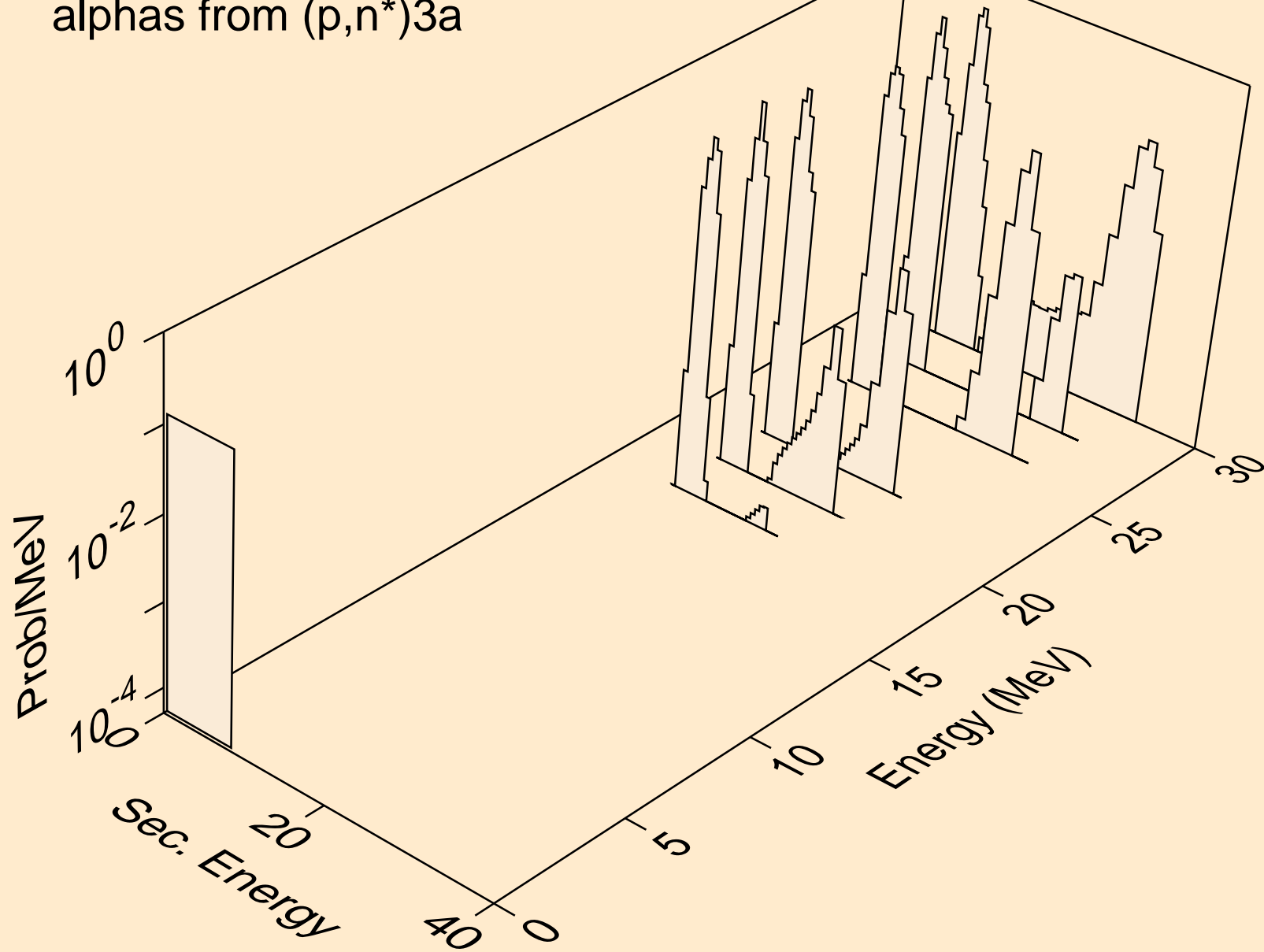

HS270 PROTON ACER TENDL-2021 LIBRARY; T=0.K
alphas from (p,2n)a

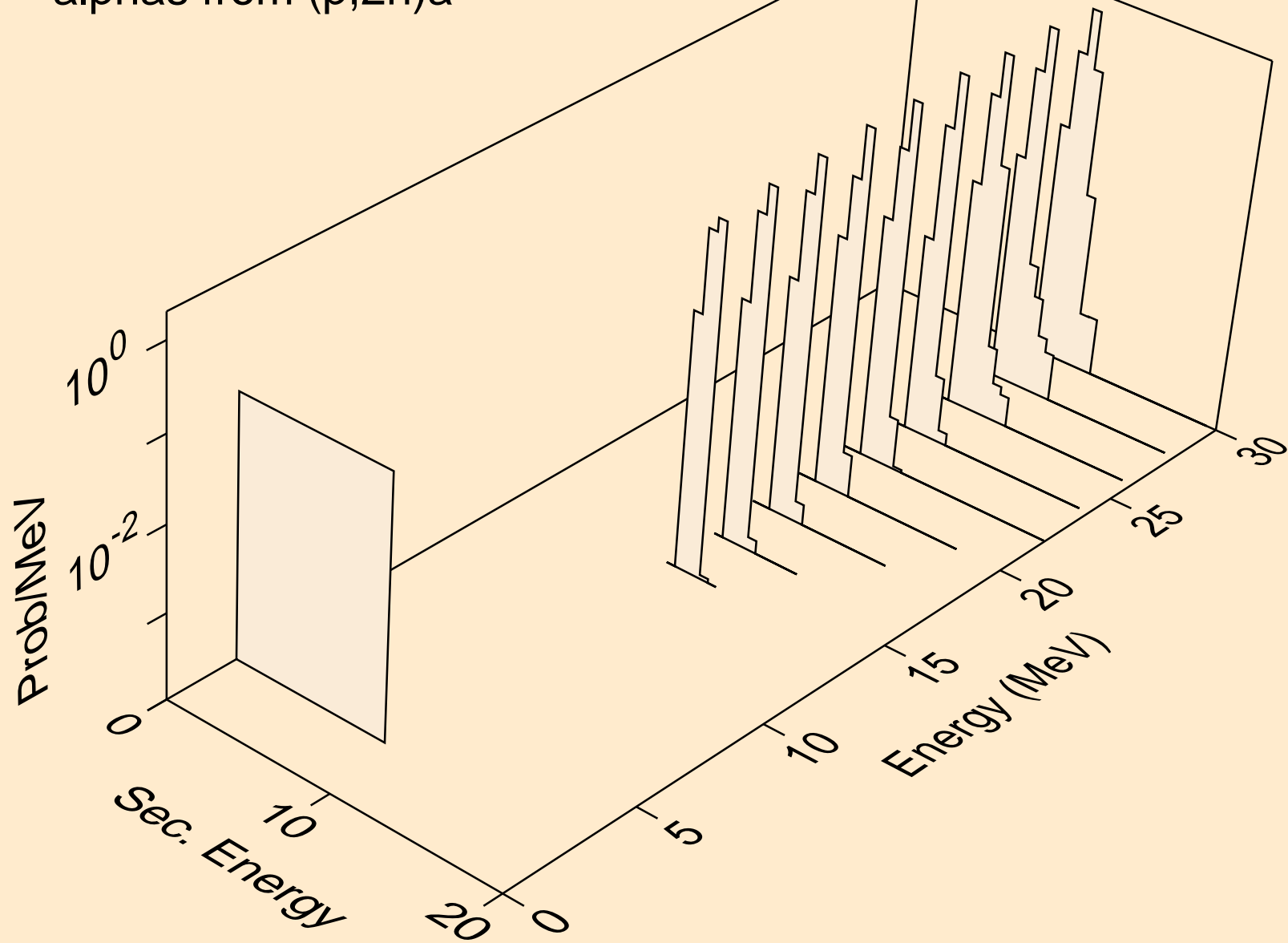

HS270 PROTON ACER TENDL-2021 LIBRARY; T=0.K
alphas from (p,3n)a

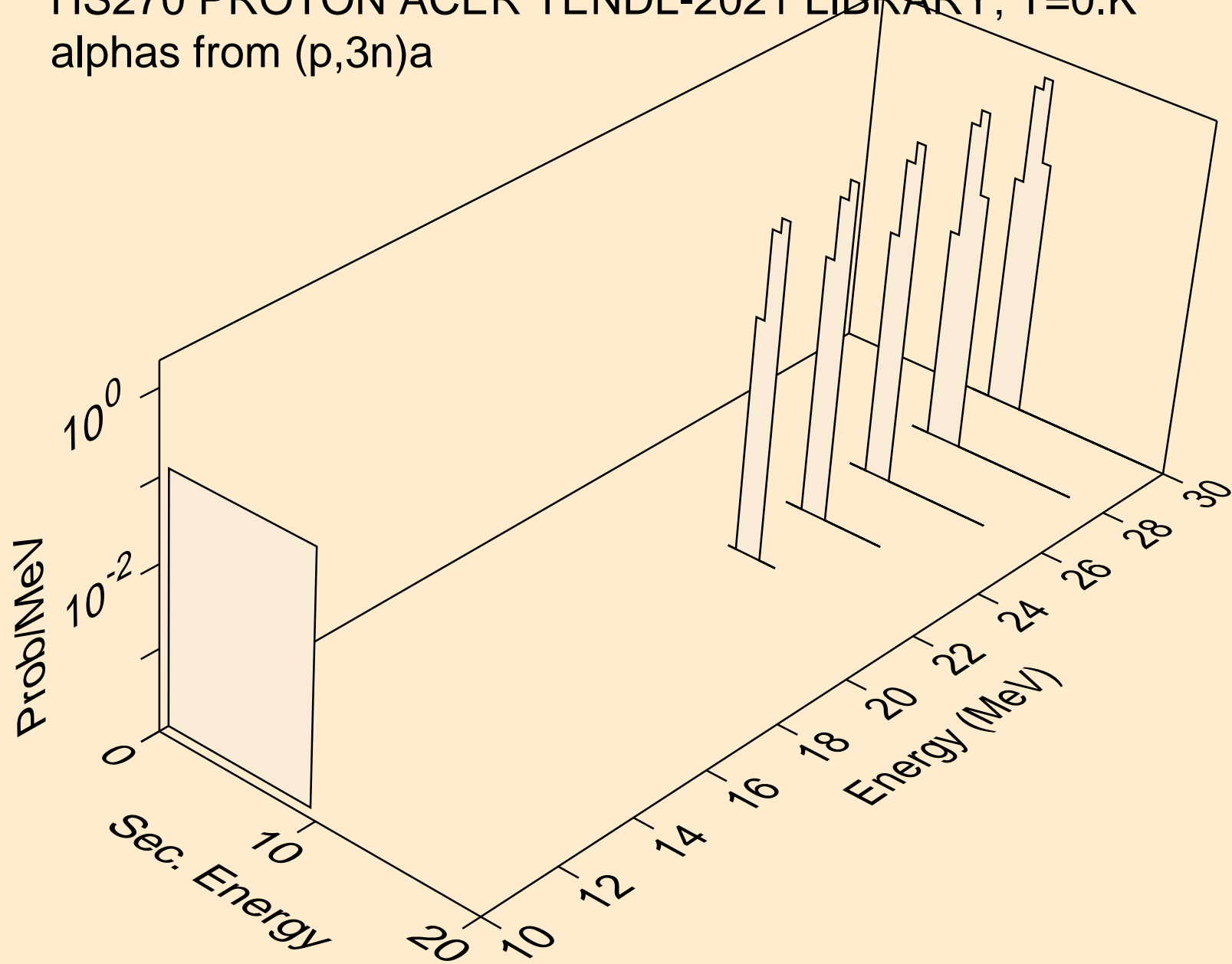

HS270 PROTON ACER TENDL-2021 LIBRARY; T=0.K
alphas from (p,n*)2a

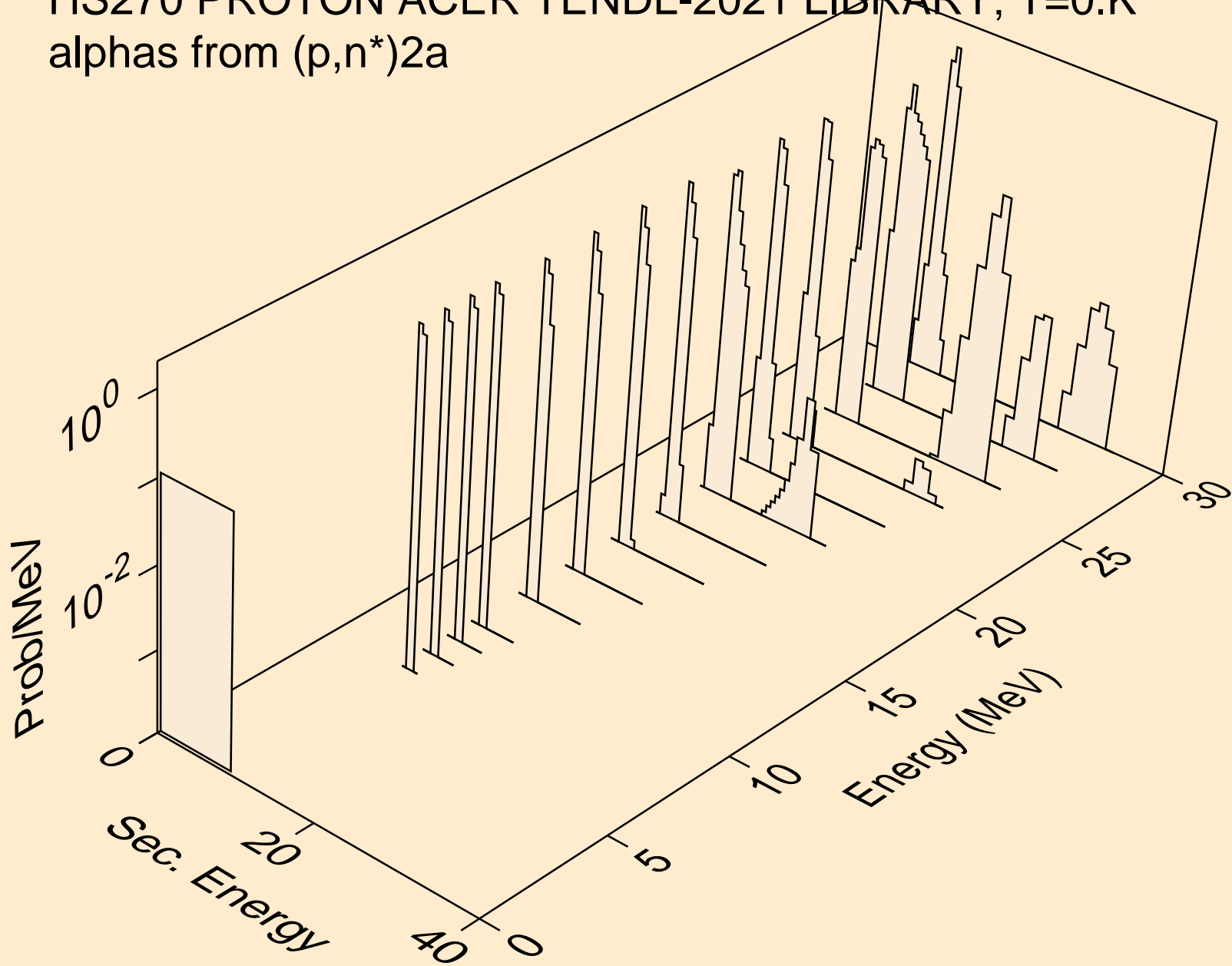

HS270 PROTON ACER TENDL-2021 LIBRARY; T=0.K
alphas from (p,npa)

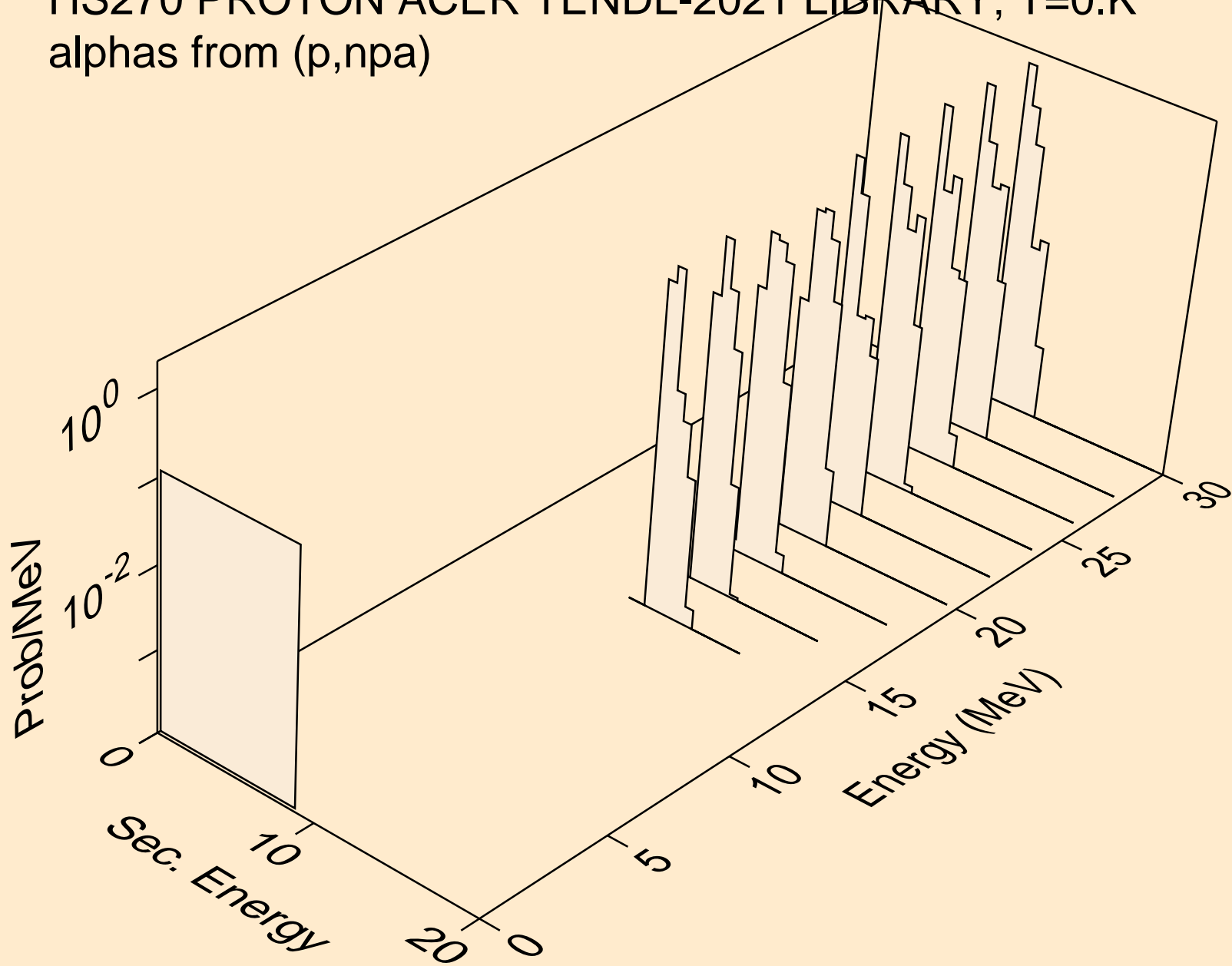

HS270 PROTON ACER TENDL-2021 LIBRARY; T=0.K
alphas from (p,a)

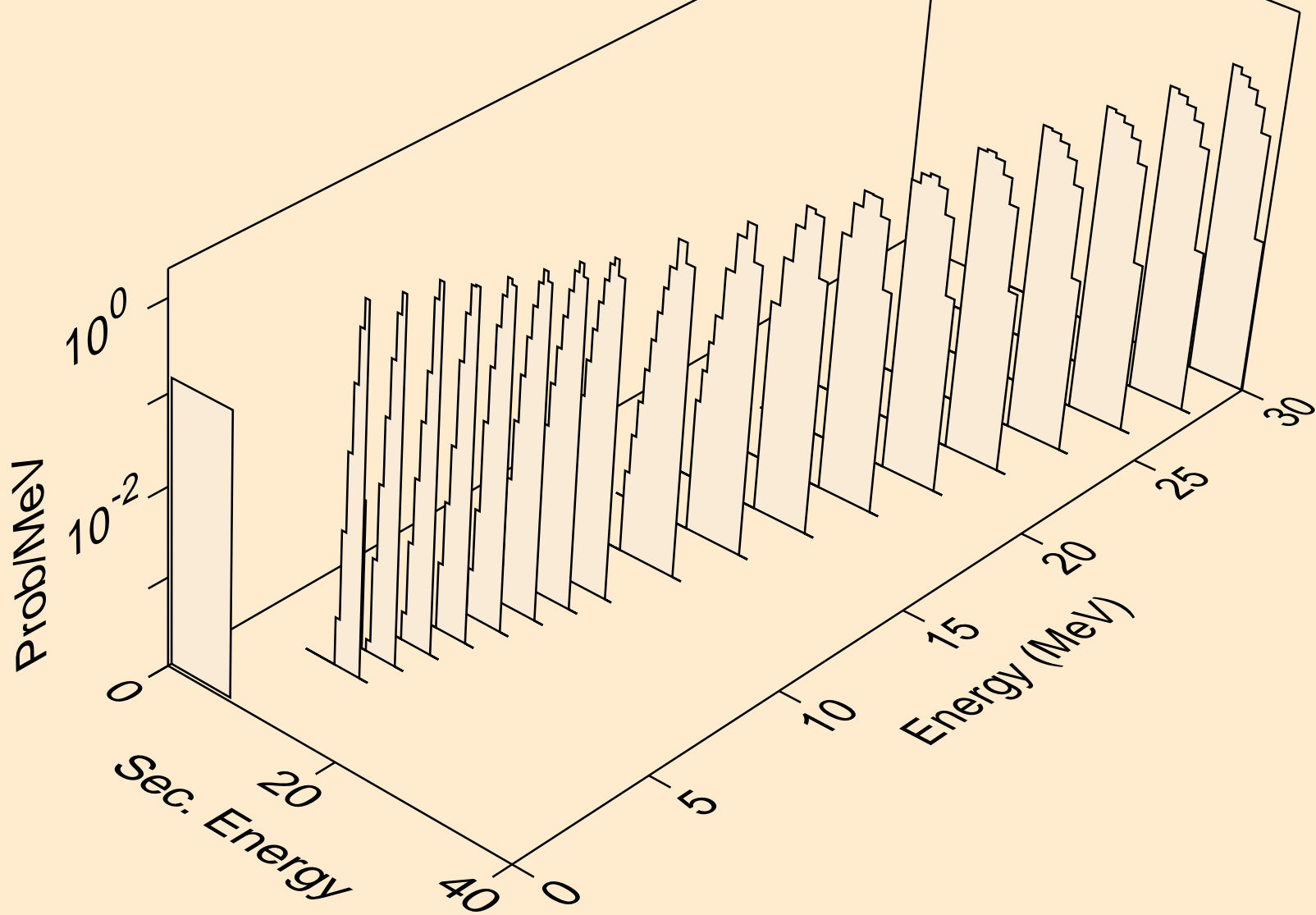

HS270 PROTON ACER TENDL-2021 LIBRARY; T=0.K
alphas from (p,2a)

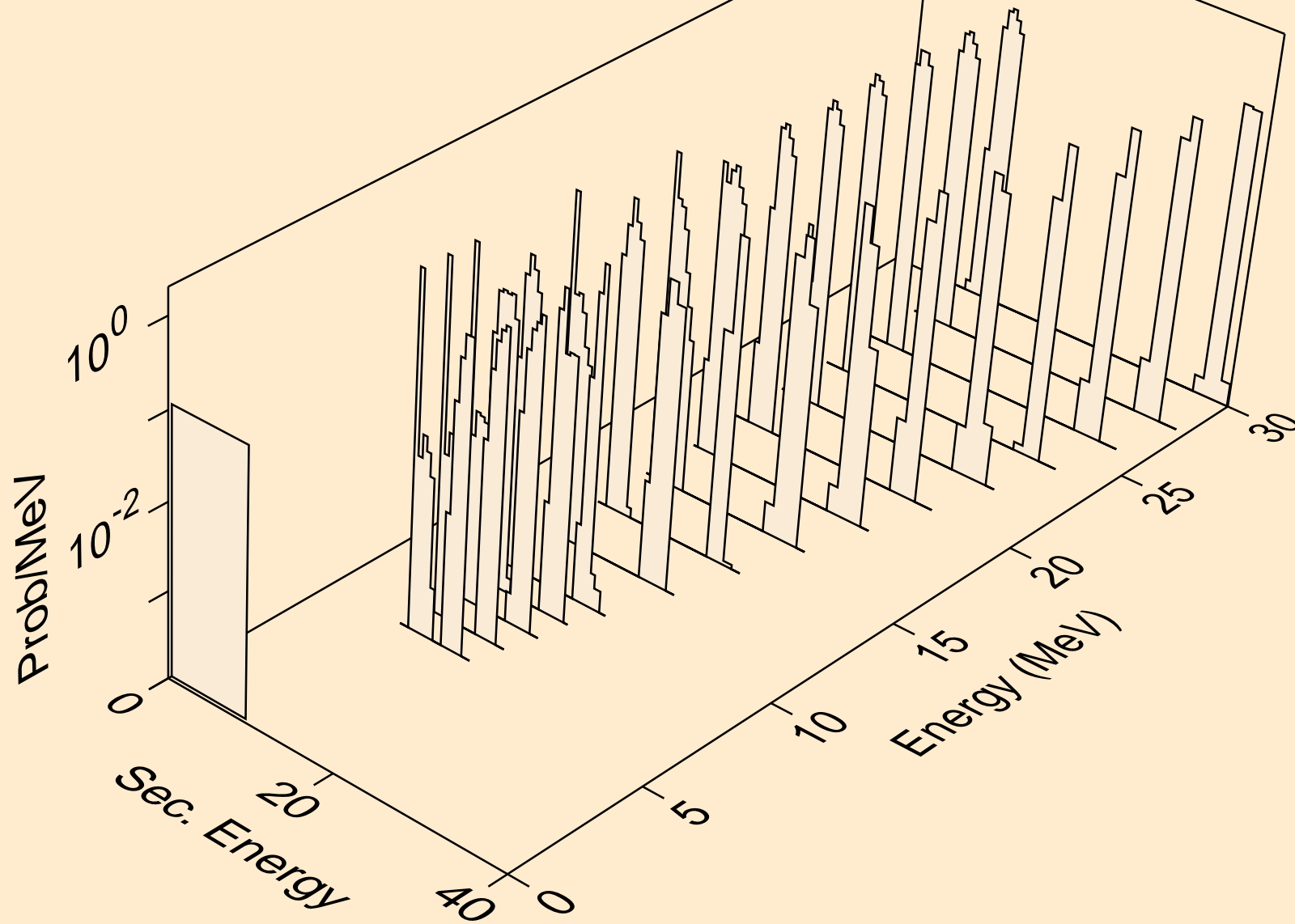

HS270 PROTON ACER TENDL-2021 LIBRARY; T=0.K
alphas from (p,da)

