

# HS272 PROTON ACER TENDL-2021 LIBRARY; T=0.K

## Principal cross sections

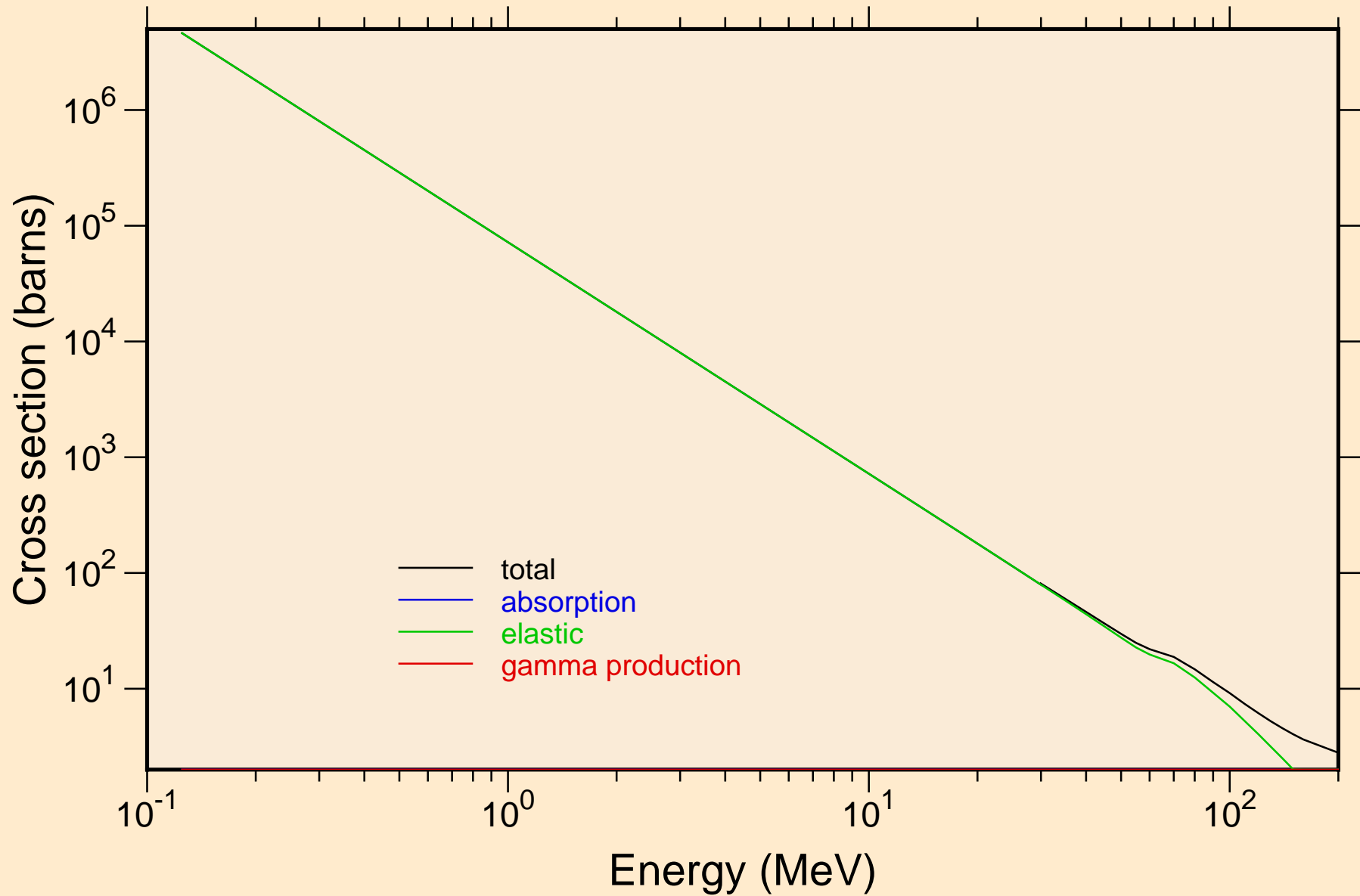

# HS272 PROTON ACER TENDL-2021 LIBRARY; T=0.K

## Heating

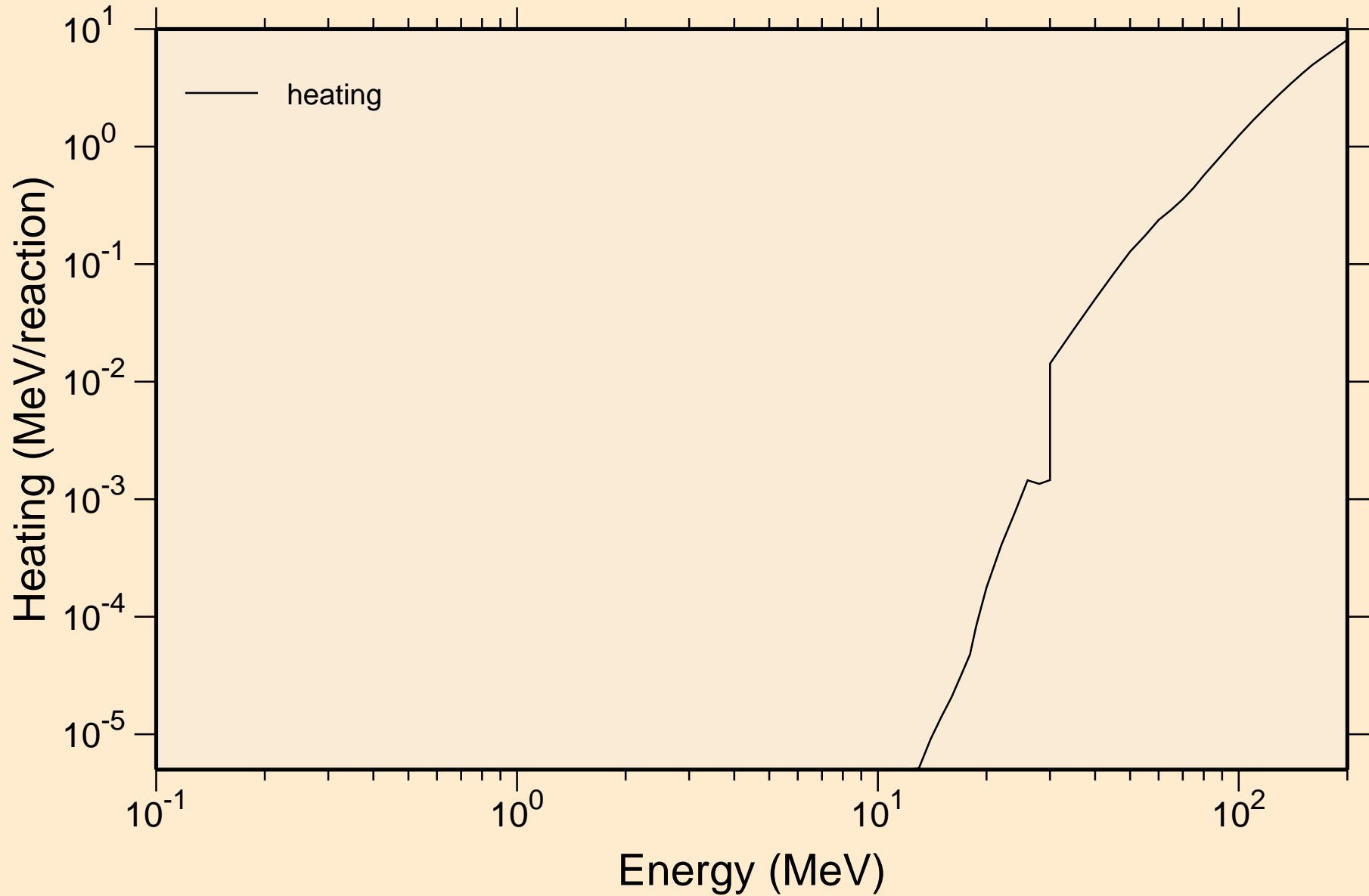

# HS272 PROTON ACER TENDL-2021 LIBRARY; T=0.K

## Principal cross sections

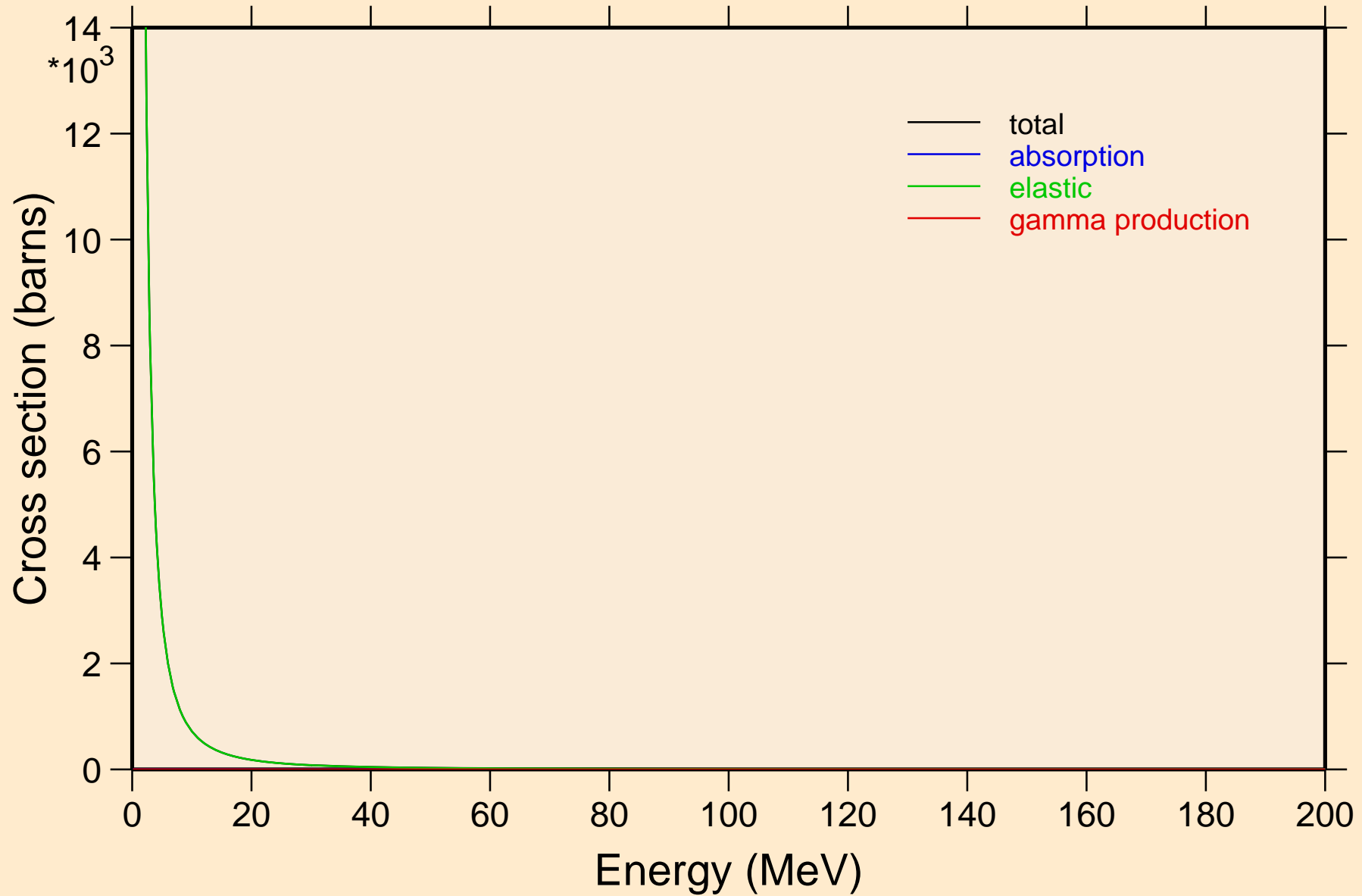

# HS272 PROTON ACER TENDL-2021 LIBRARY; T=0.K

## Heating

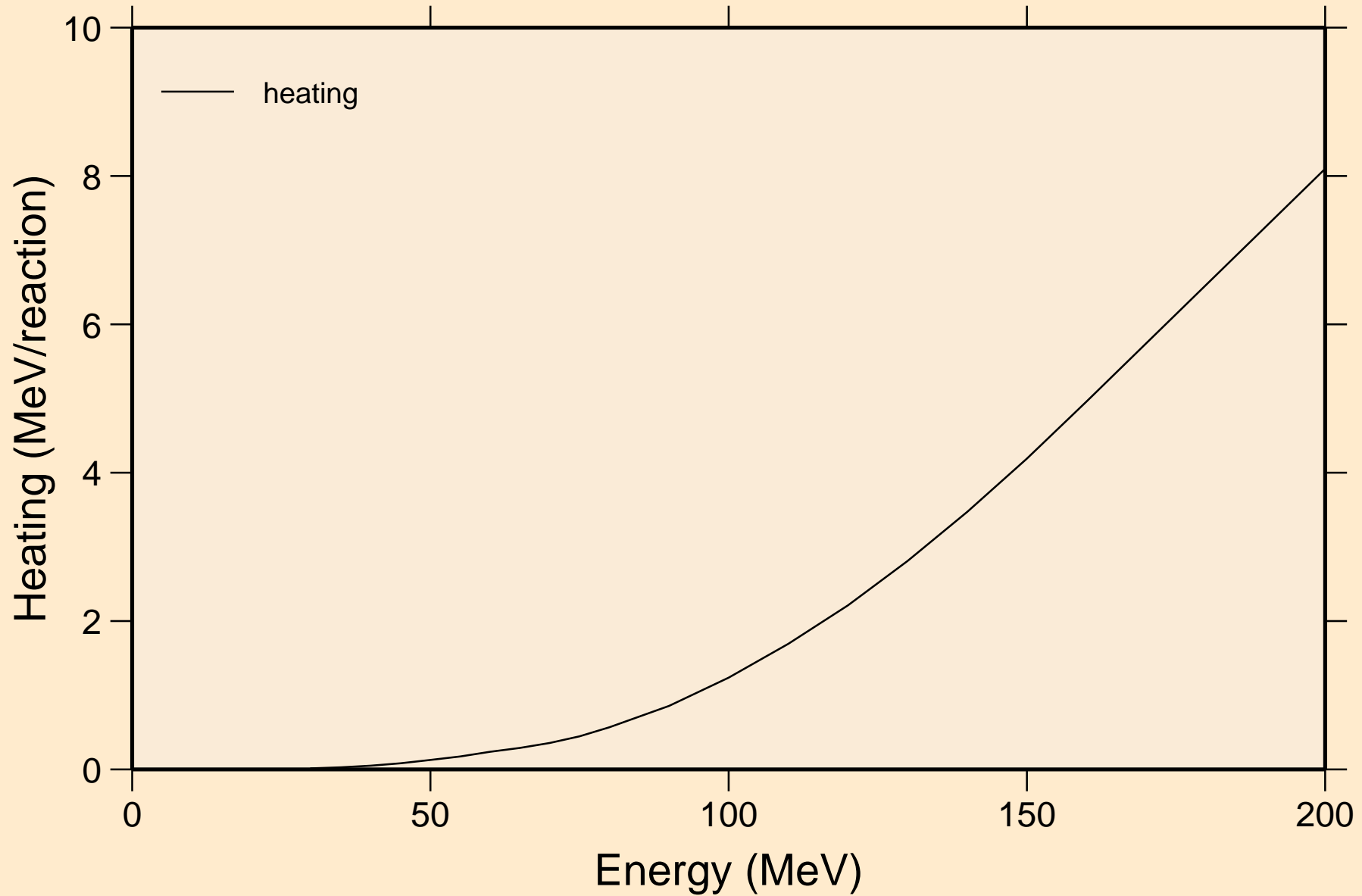

# HS272 PROTON ACER TENDL-2021 LIBRARY; T=0.K

## Threshold reactions

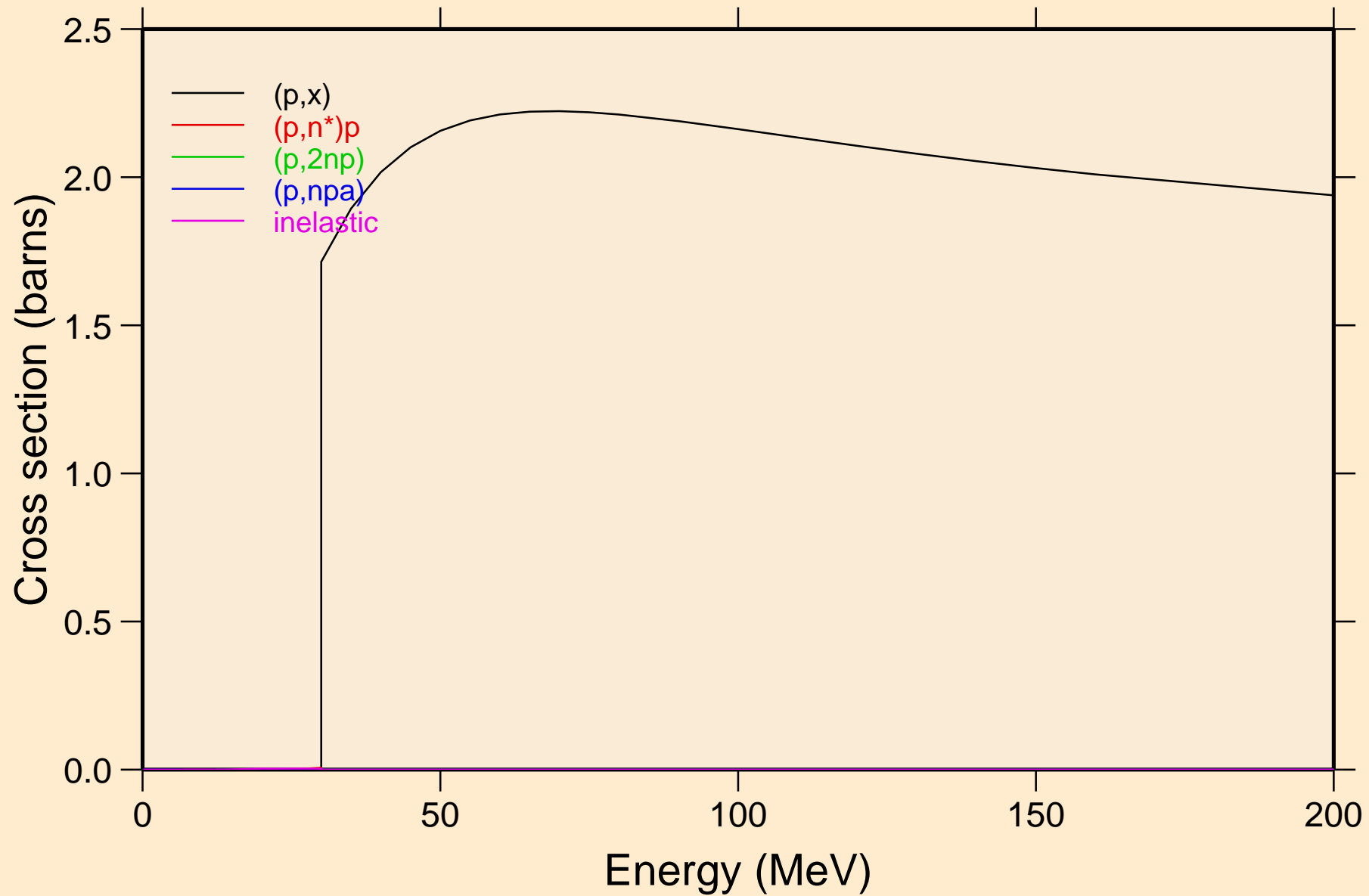

# HS272 PROTON ACER TENDL-2021 LIBRARY; T=0.K

## Threshold reactions

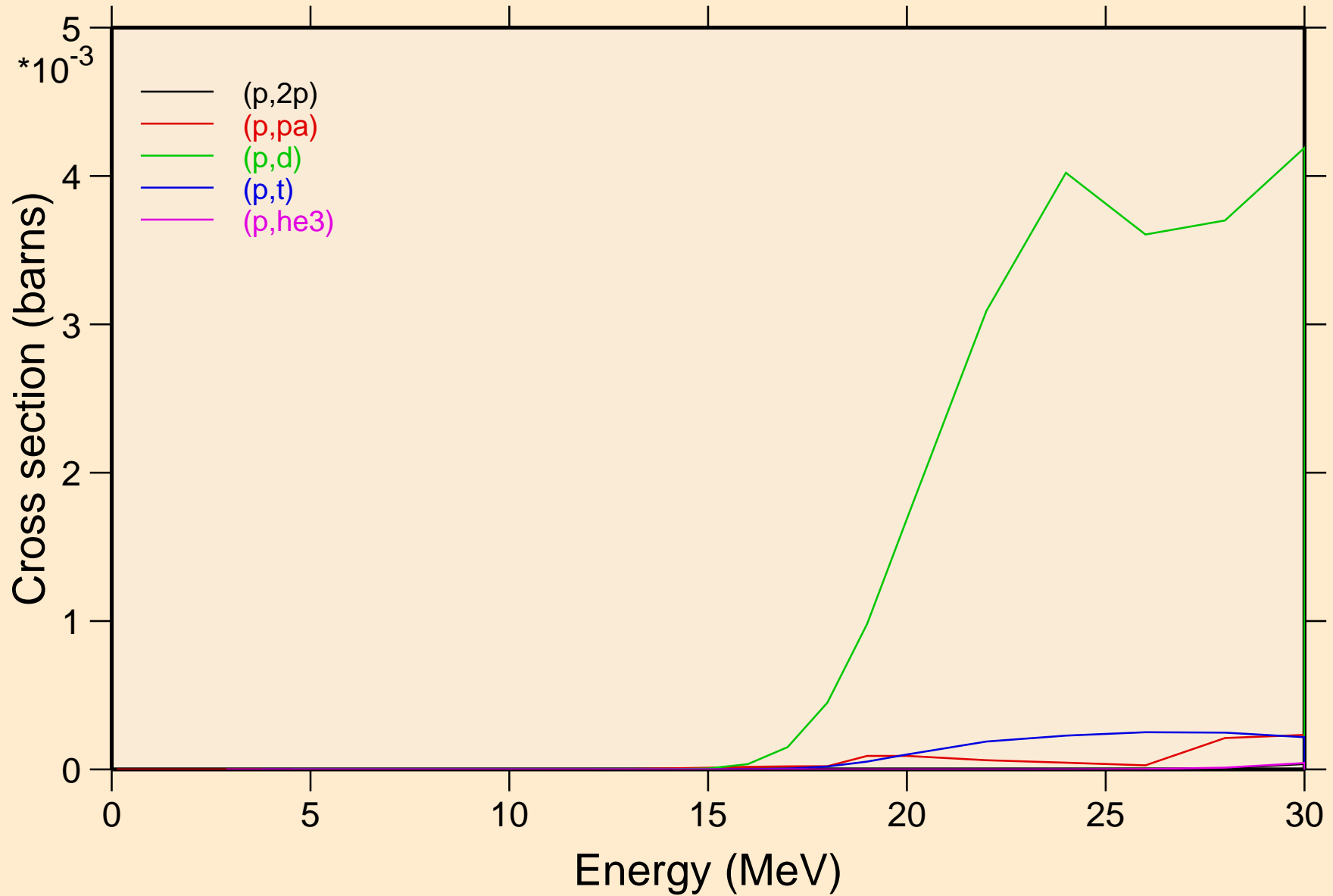

# HS272 PROTON ACER TENDL-2021 LIBRARY; T=0.K

## Threshold reactions

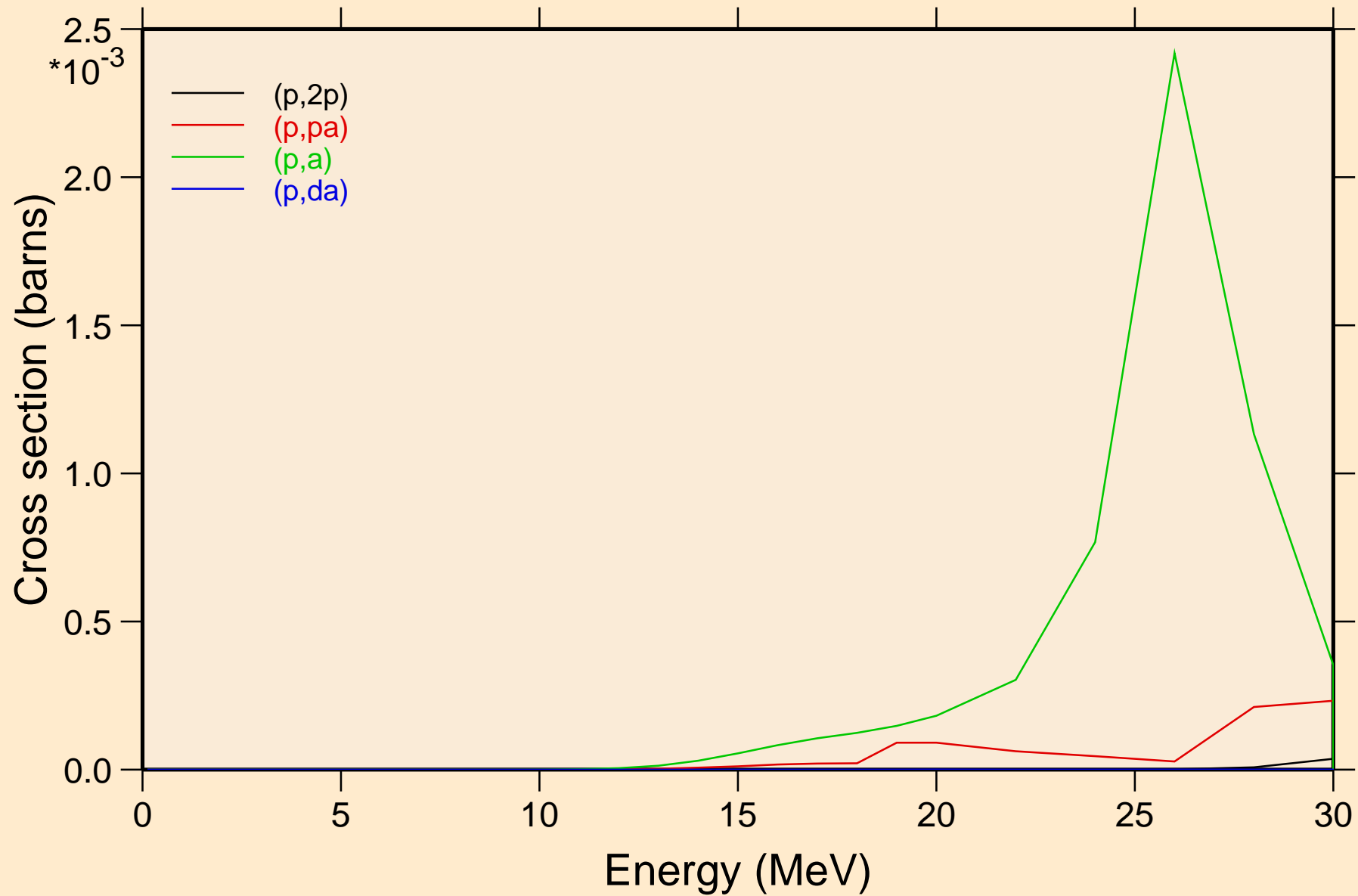

HS272 PROTON ACER TENDL-2021 LIBRARY; T=0.K  
angular distribution for elastic

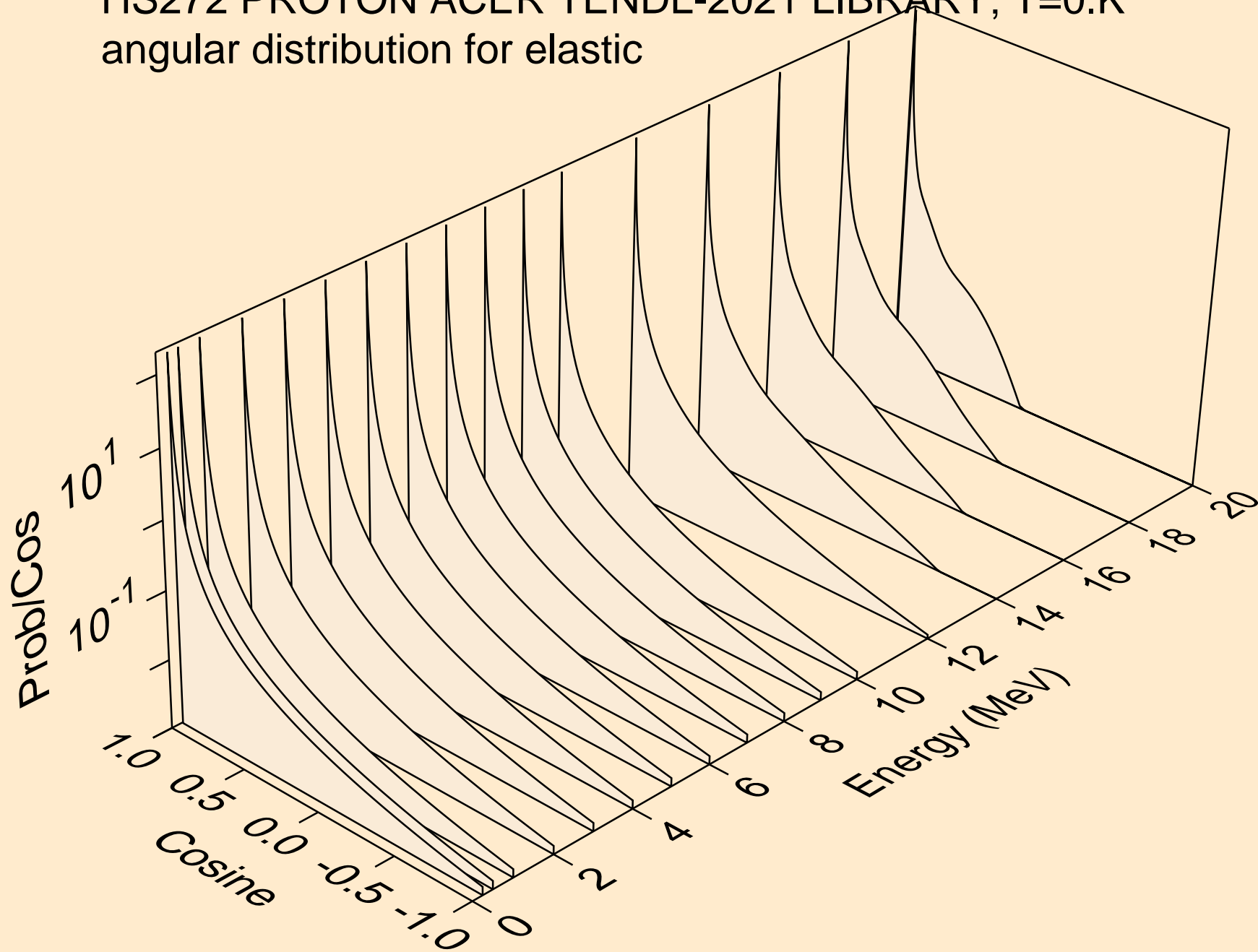



HS272 PROTON ACER TENDL-2021 LIBRARY; T=0.K  
angular distribution for elastic

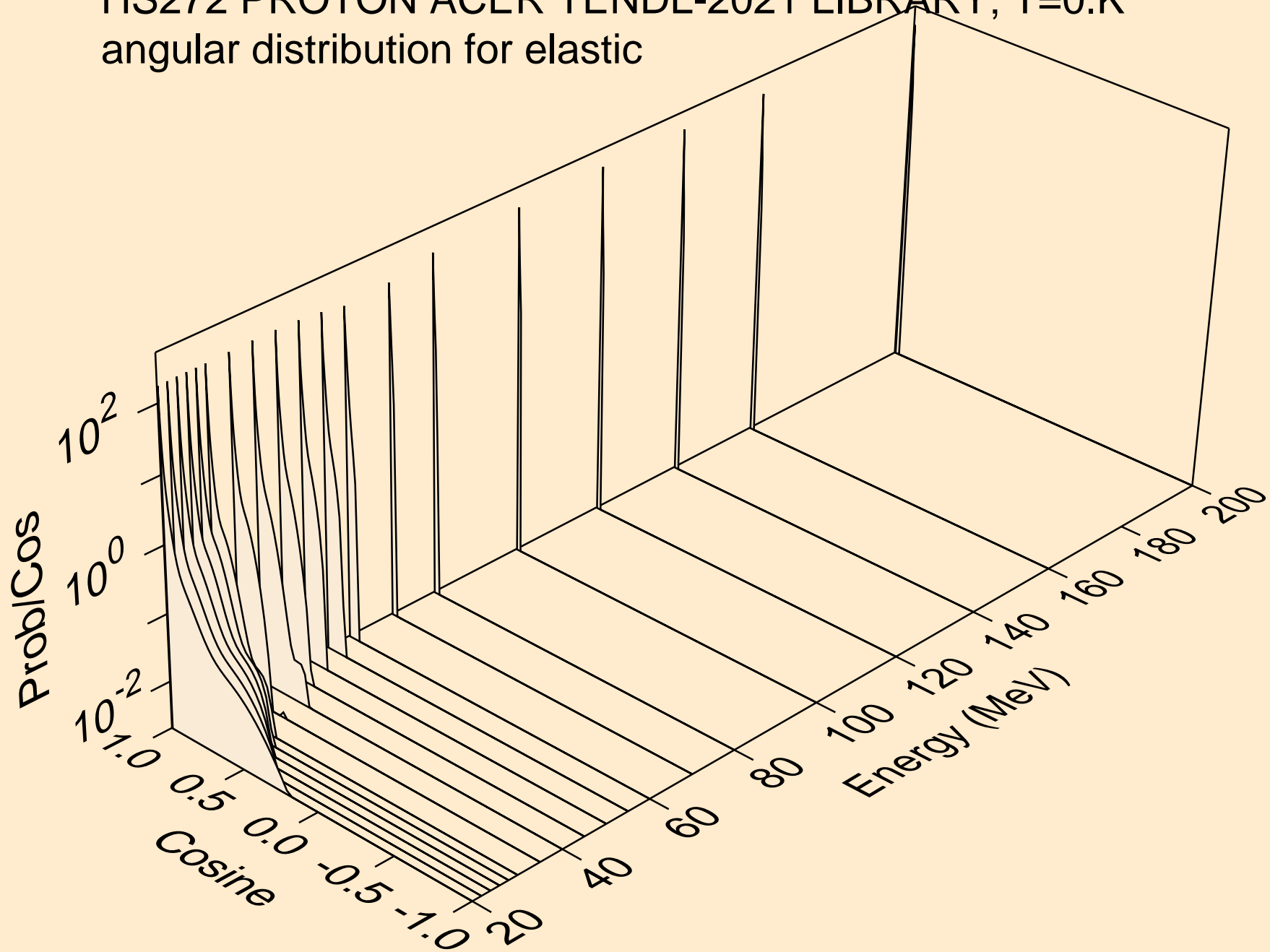

HS272 PROTON ACER TENDL-2021 LIBRARY; T=0.K  
Proton emission for (p,x)

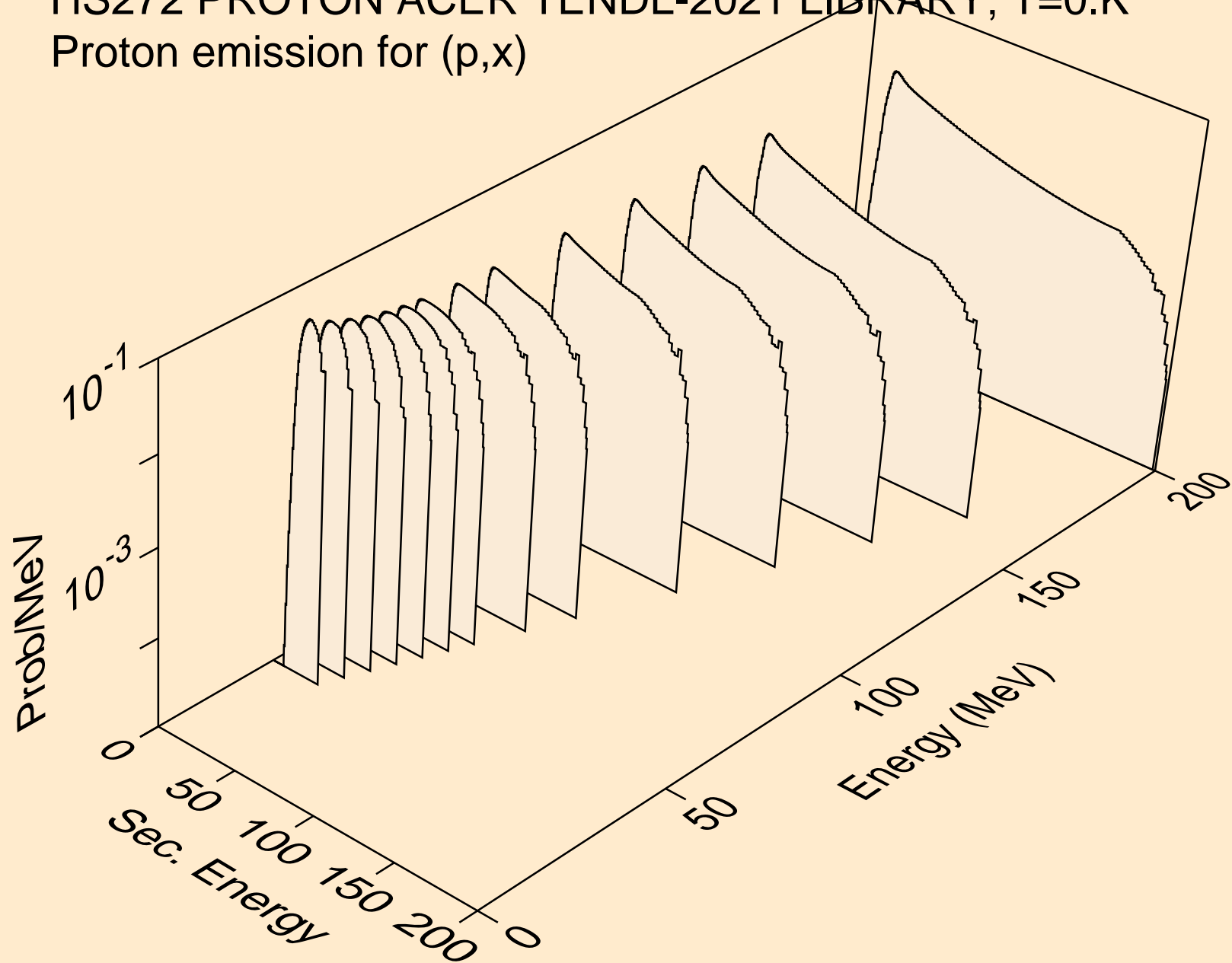

HS272 PROTON ACER TENDL-2021 LIBRARY; T=0.K  
Proton emission for (p,n\*)p

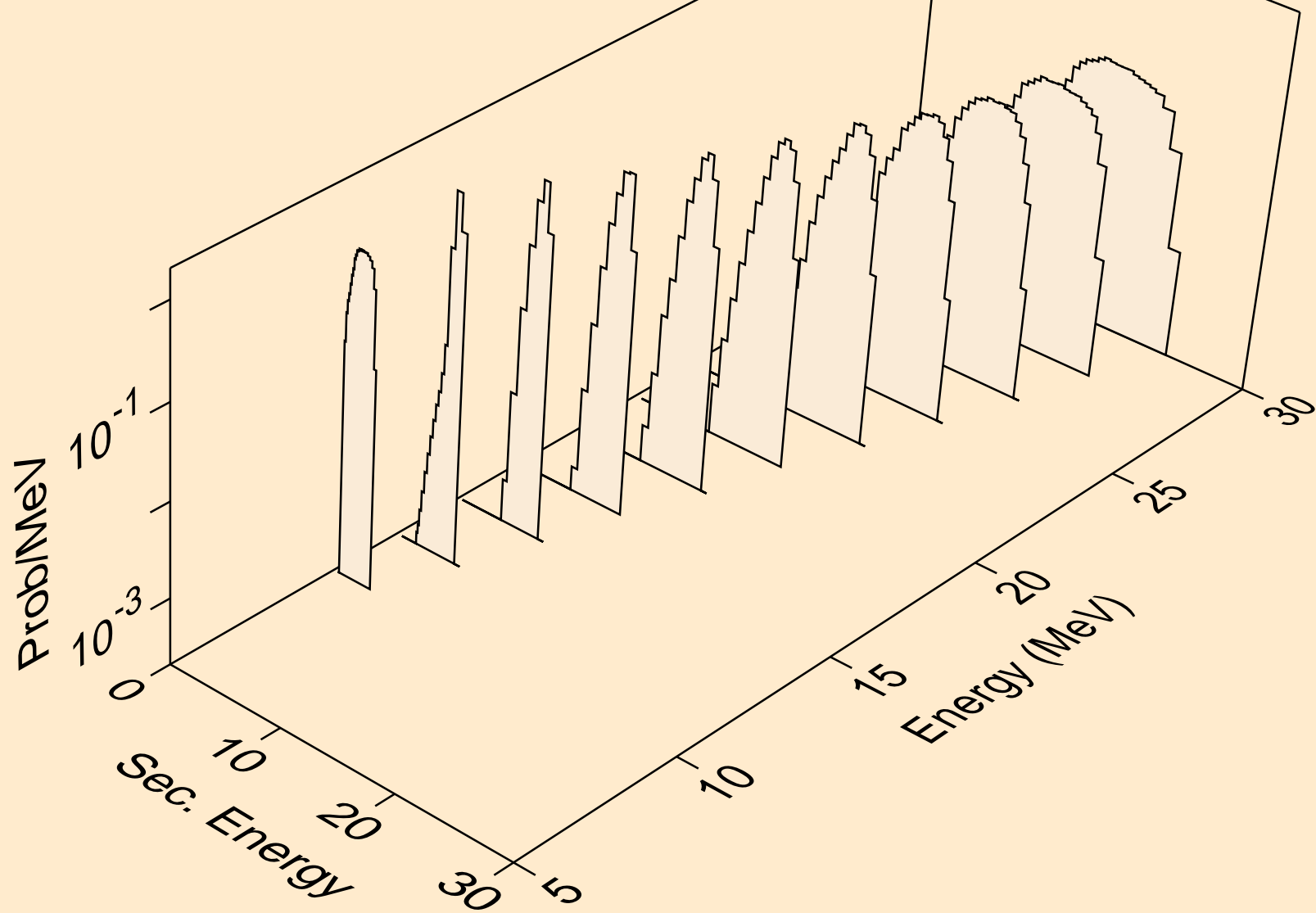

HS272 PROTON ACER TENDL-2021 LIBRARY; T=0.K  
Proton emission for (p,2np)

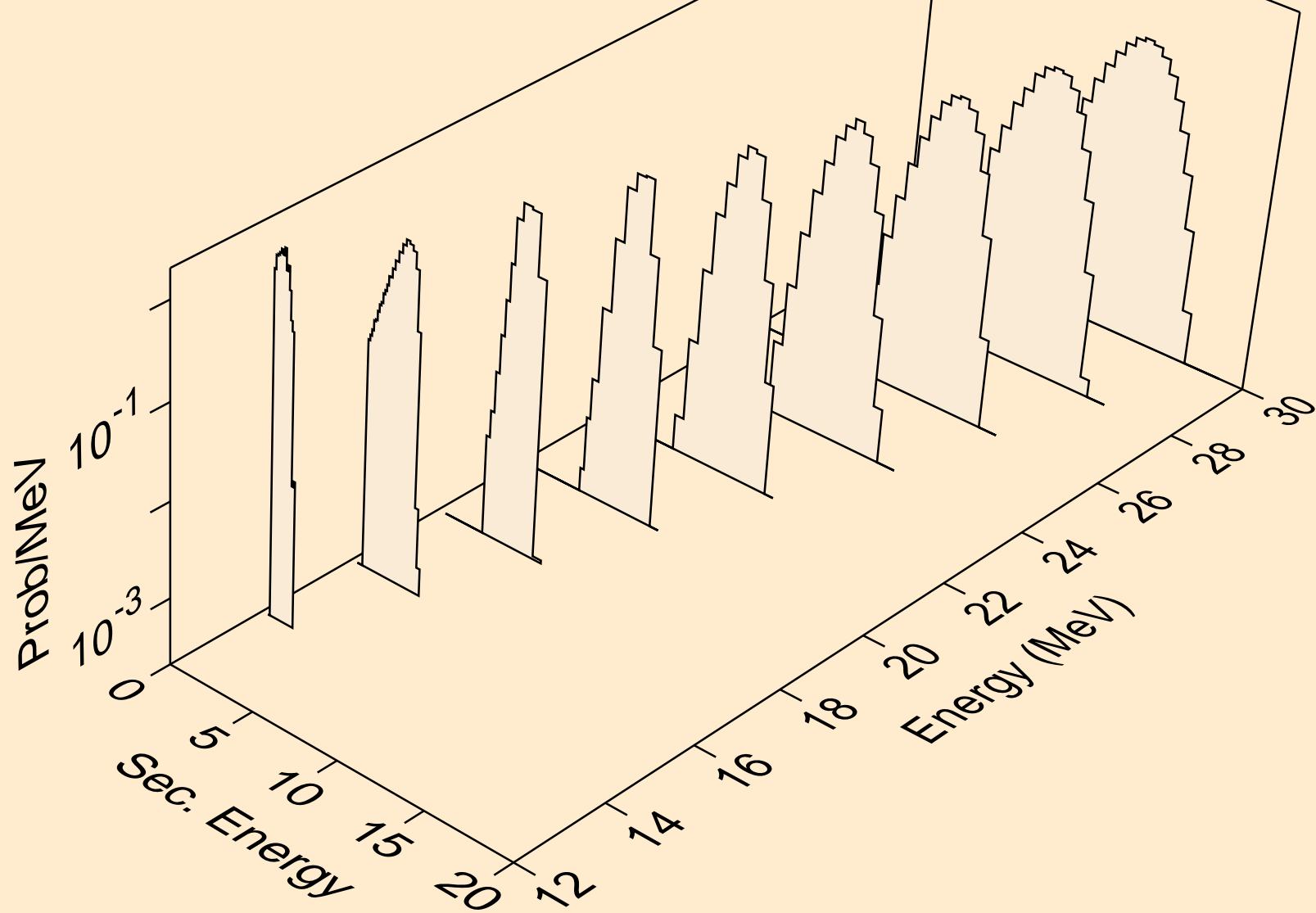

HS272 PROTON ACER TENDL-2021 LIBRARY; T=0.K  
Proton emission for (p,npa)

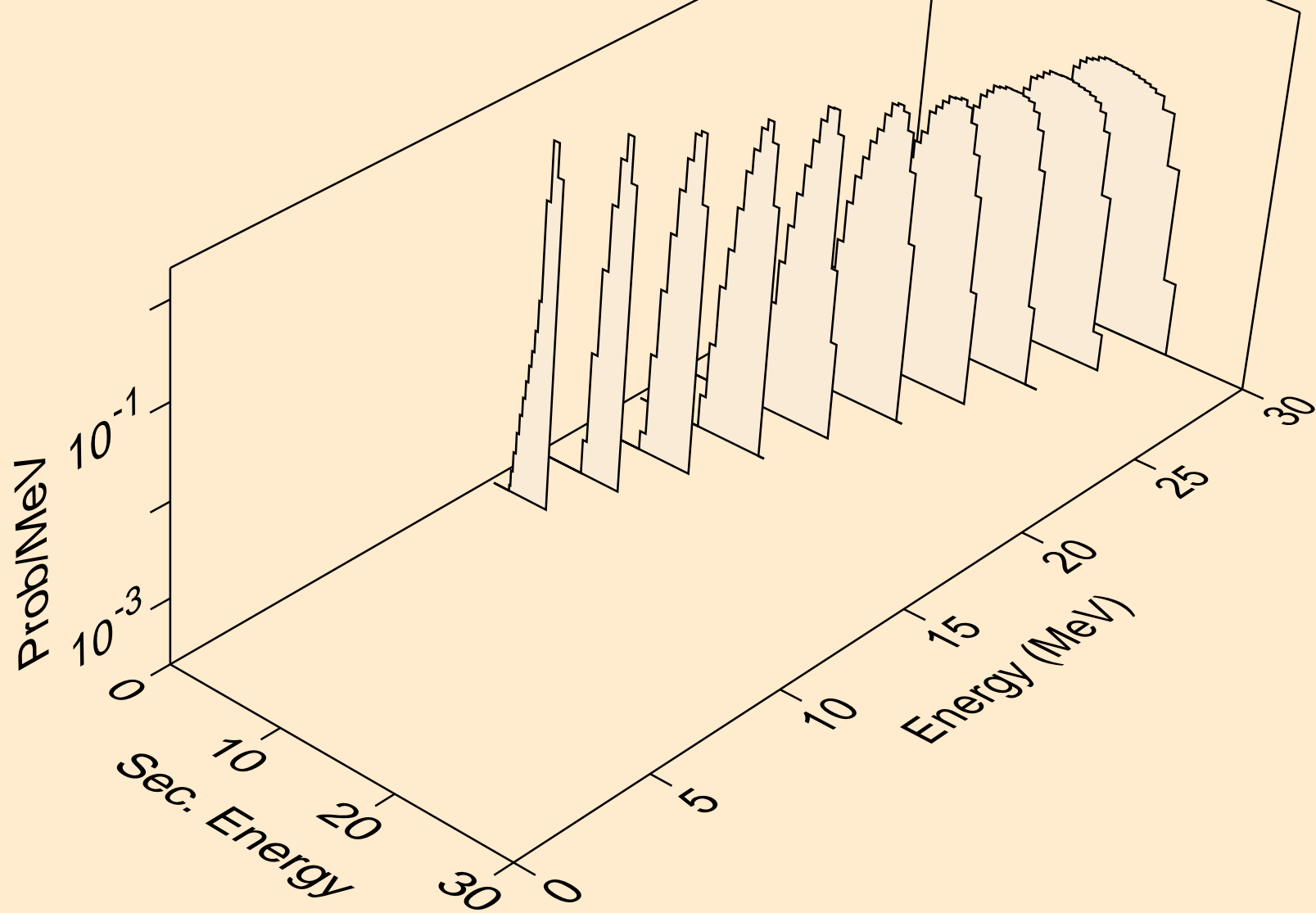

HS272 PROTON ACER TENDL-2021 LIBRARY; T=0.K  
Proton emission for inelastic

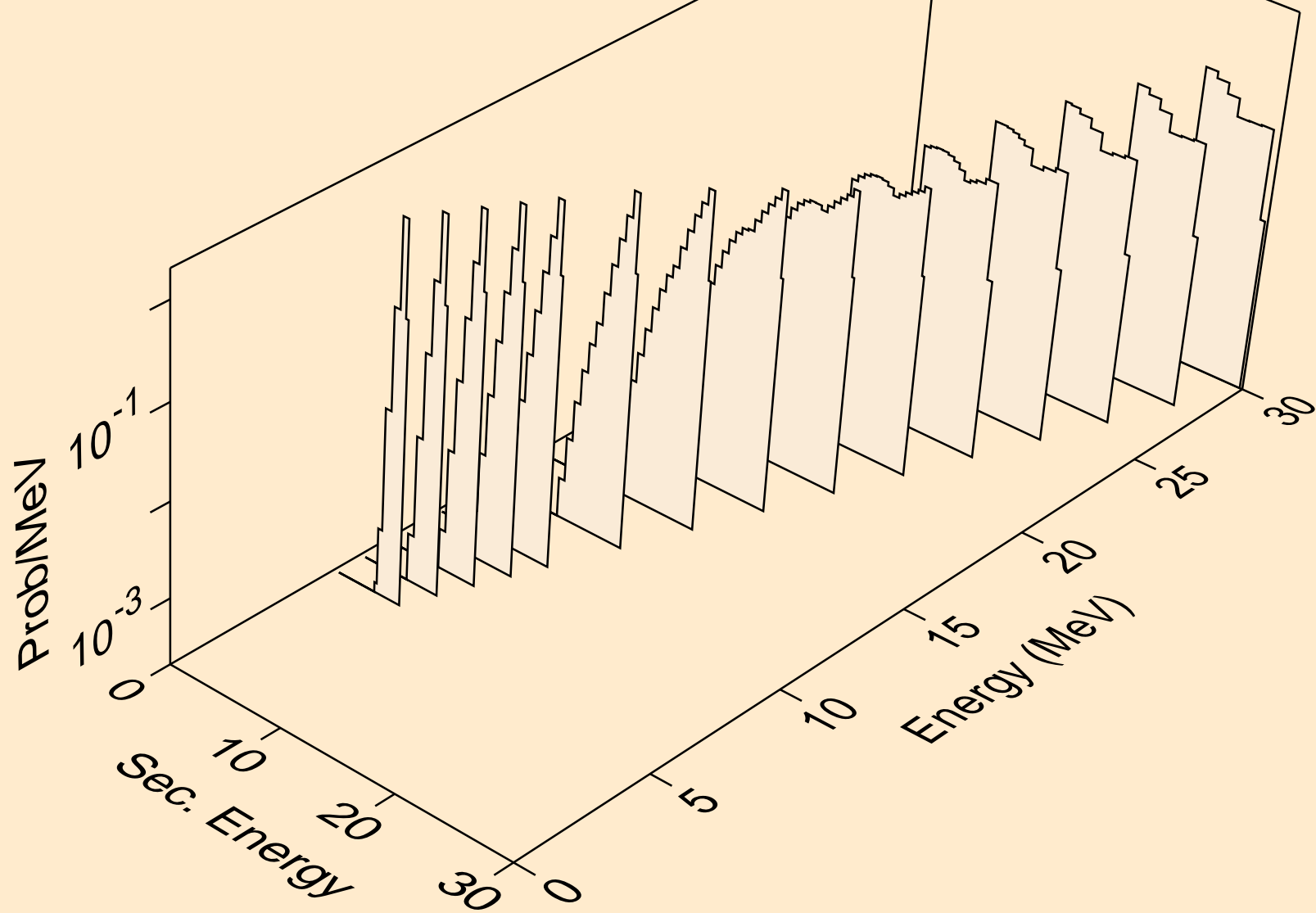

HS272 PROTON ACER TENDL-2021 LIBRARY; T=0.K  
Proton emission for (p,2p)

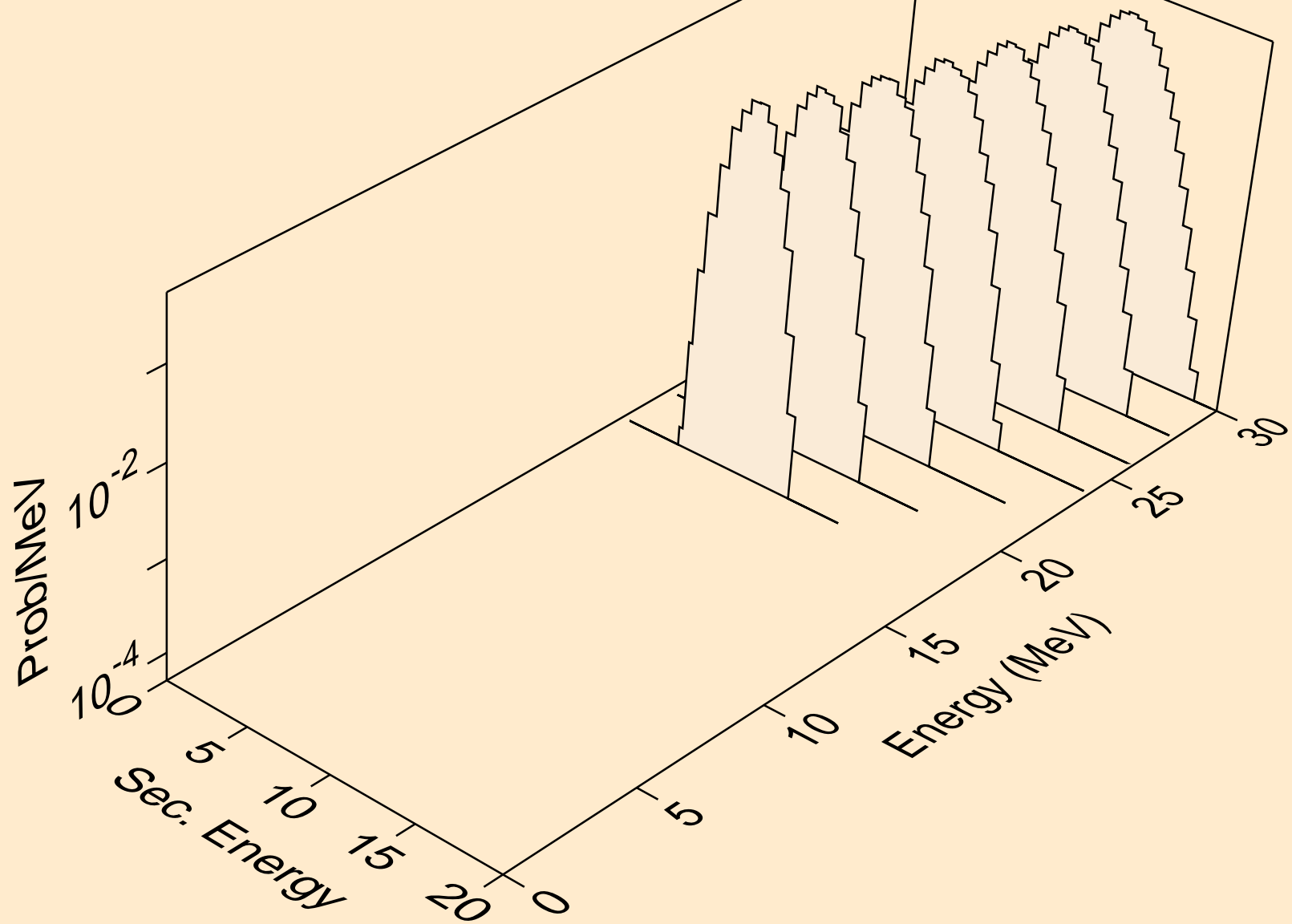

HS272 PROTON ACER TENDL-2021 LIBRARY; T=0.K  
Proton emission for (p,pa)

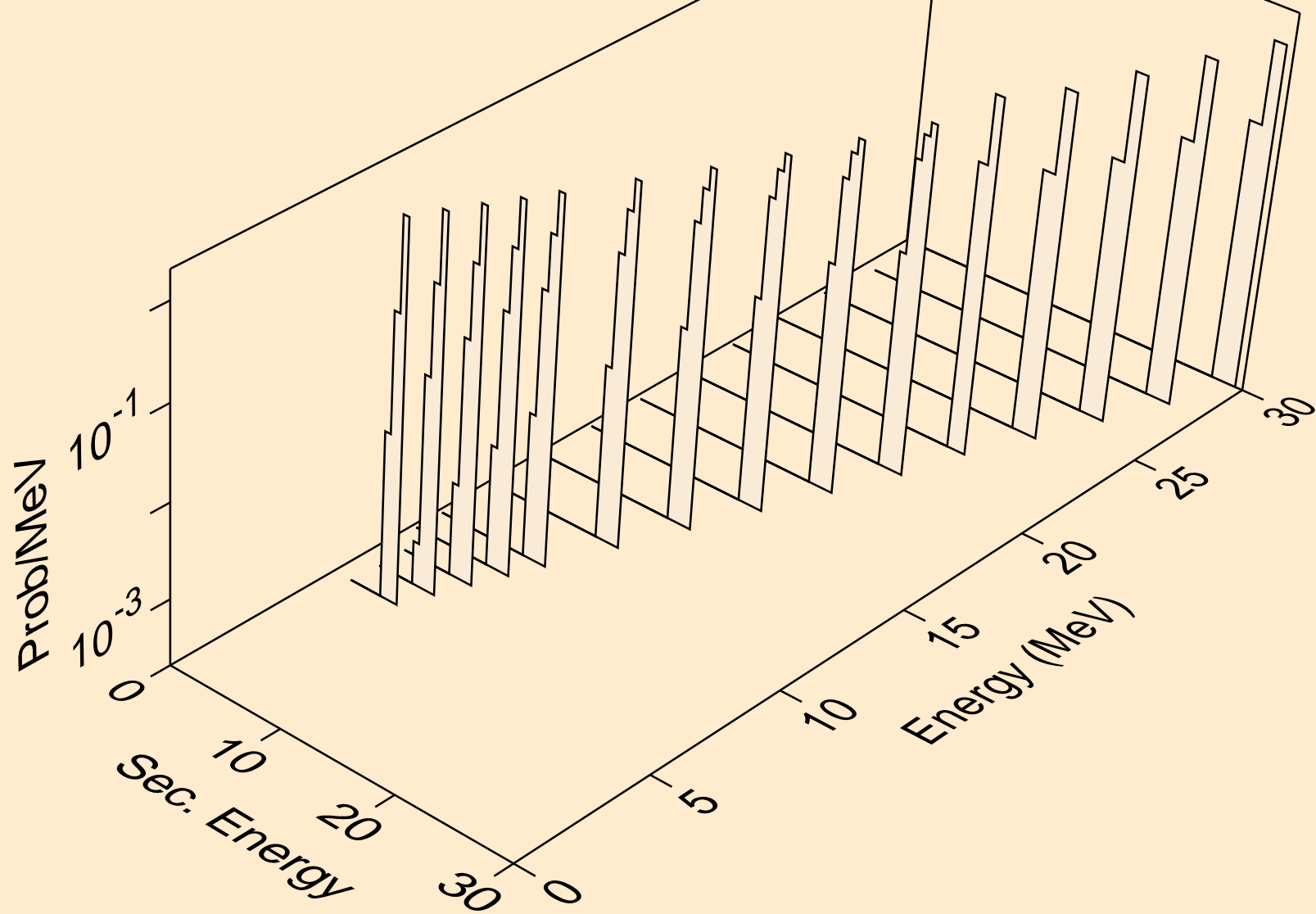



HS272 PROTON ACER TENDL-2021 LIBRARY; T=0.K  
Photon emission for (z,n)

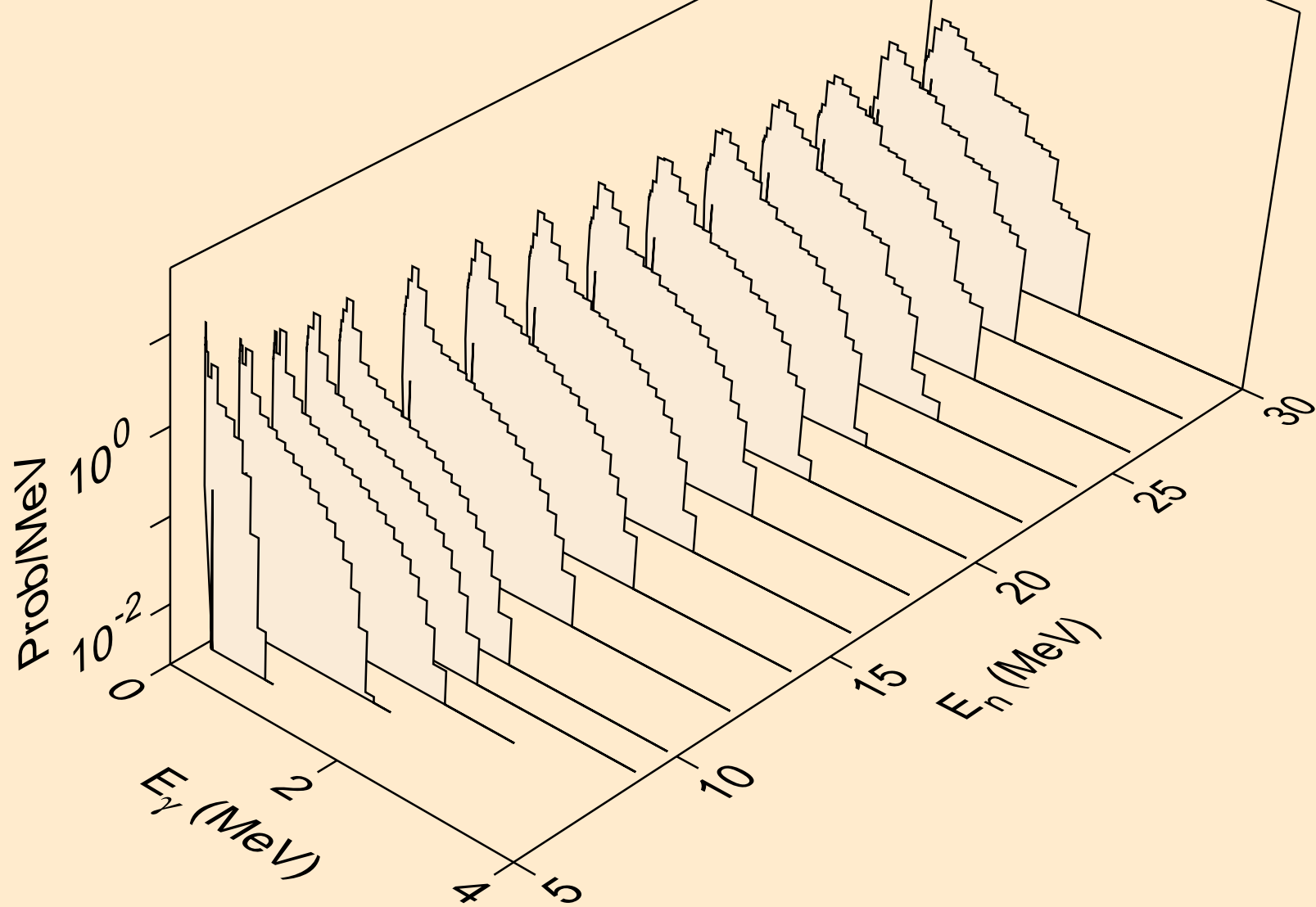

HS272 PROTON ACER TENDL-2021 LIBRARY; T=0.K  
Photon emission for (n,x)

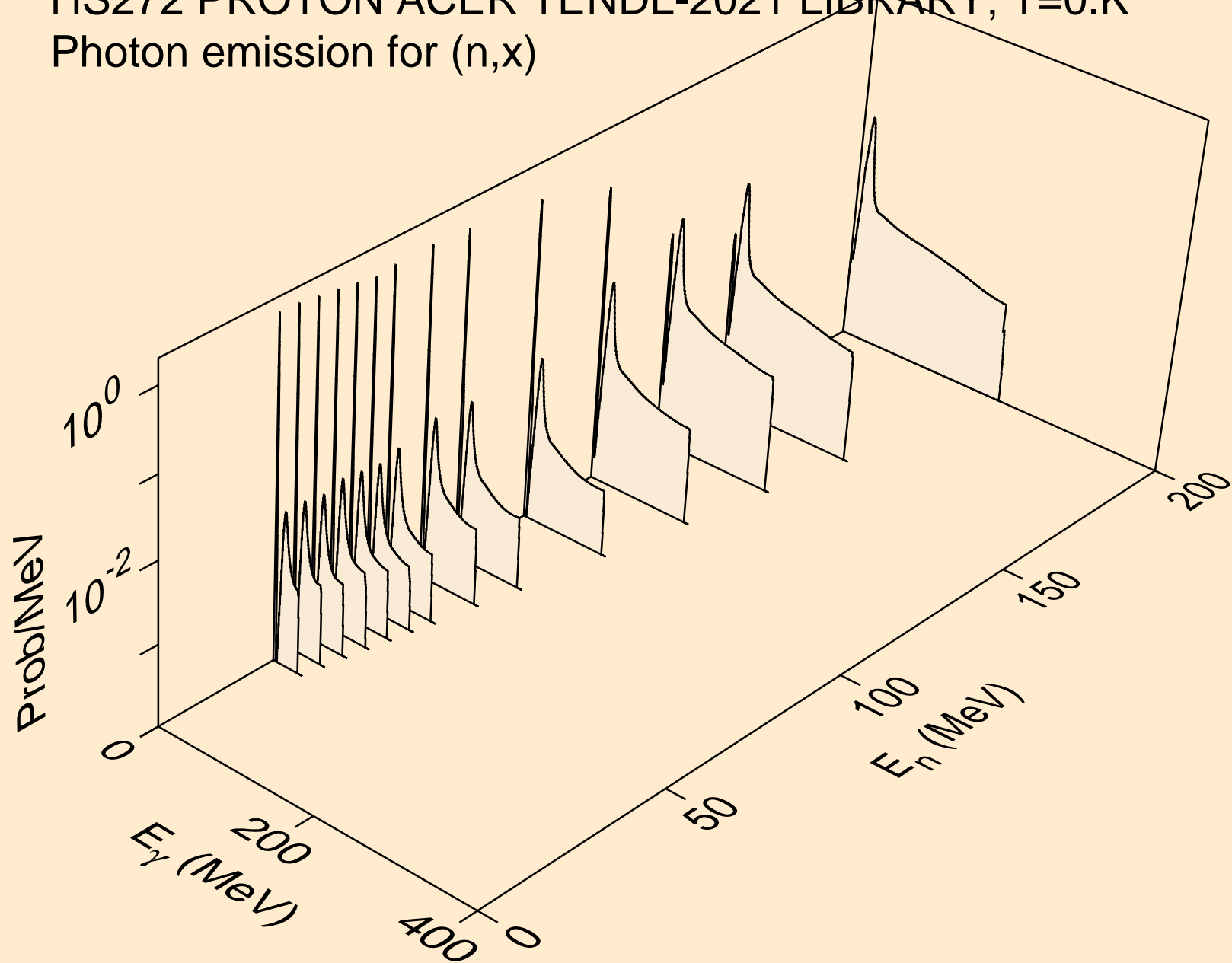

HS272 PROTON ACER TENDL-2021 LIBRARY; T=0.K  
Photon emission for (n,2n)

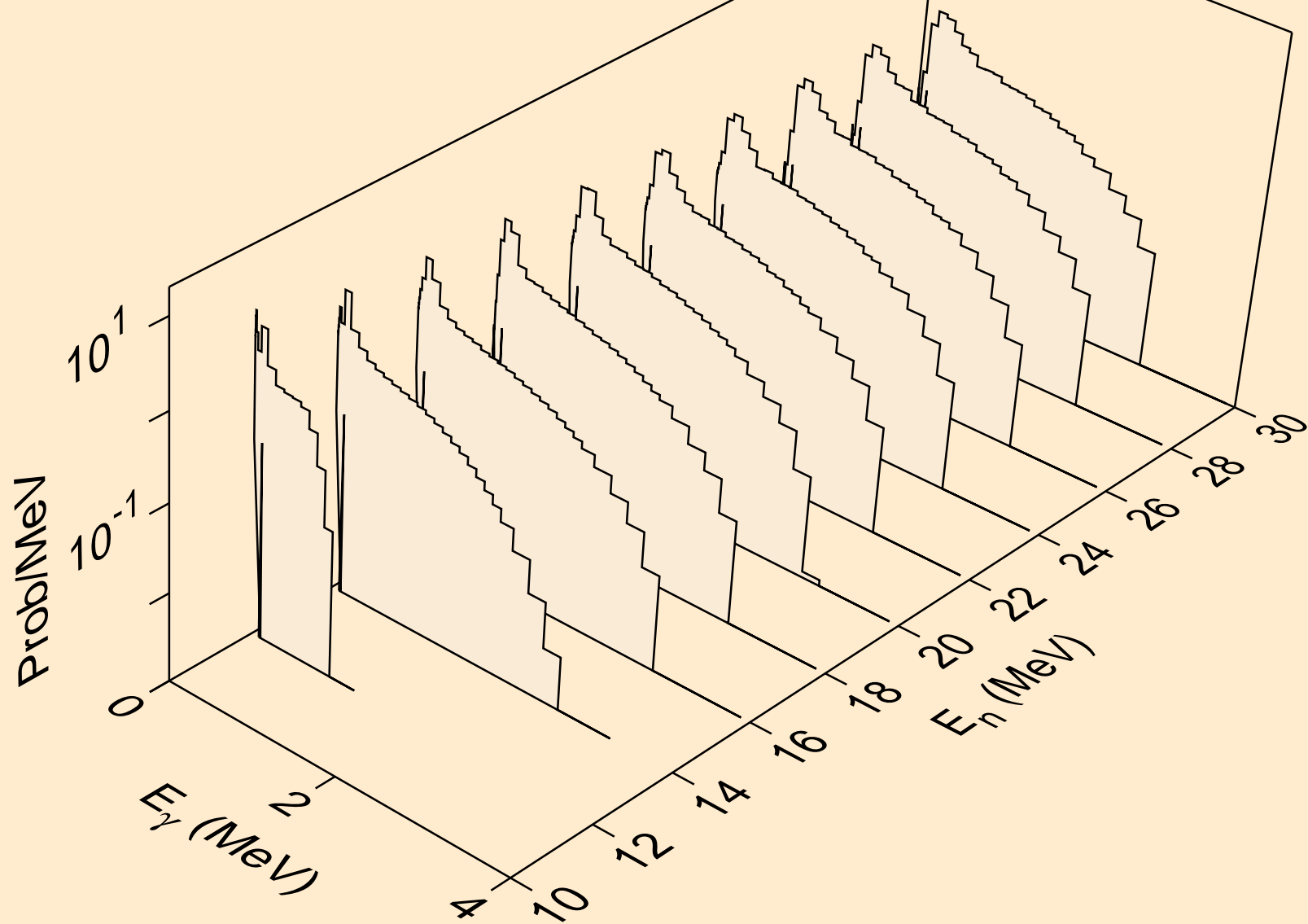

HS272 PROTON ACER TENDL-2021 LIBRARY; T=0.K  
Photon emission for (n,3n)

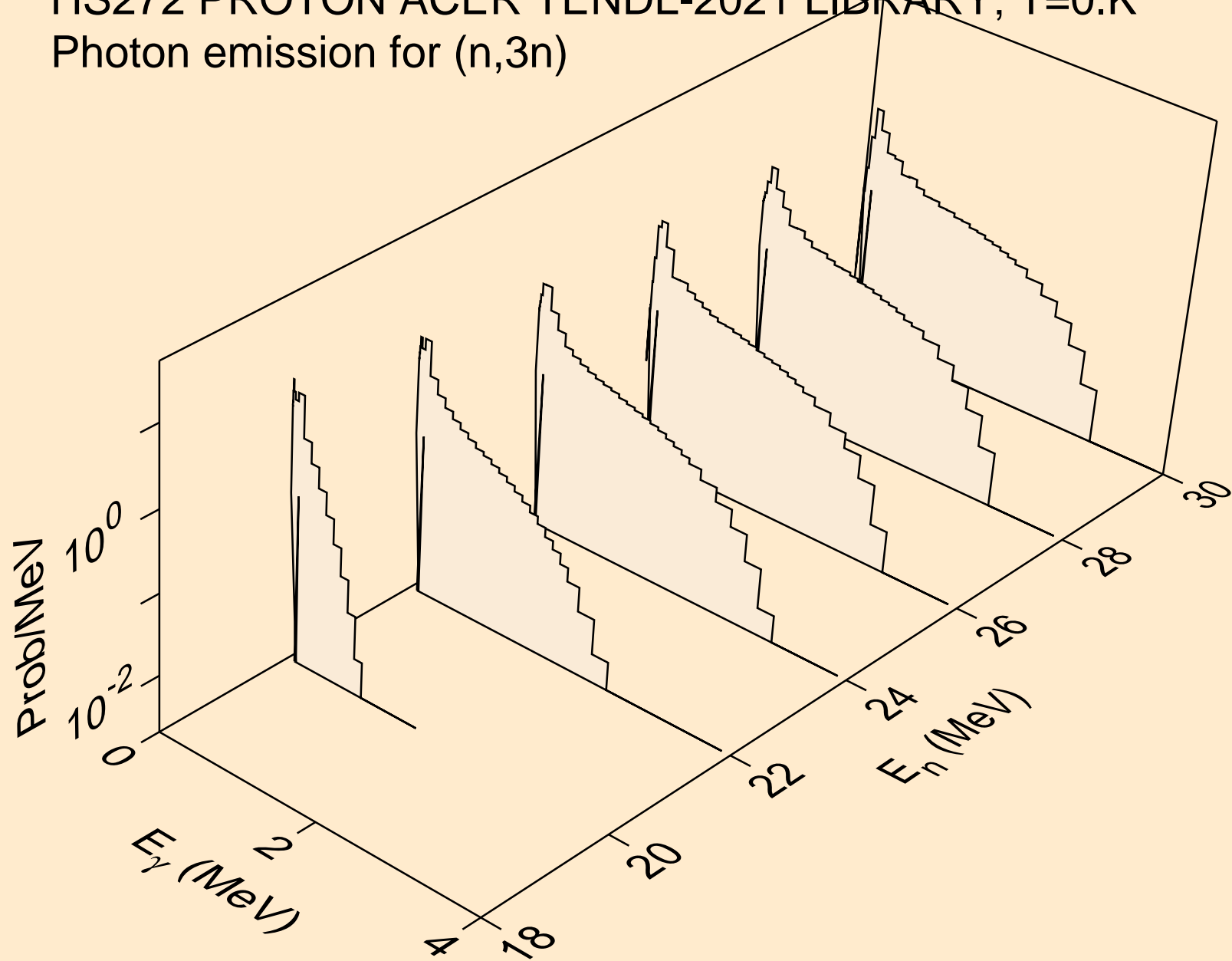

HS272 PROTON ACER TENDL-2021 LIBRARY; T=0.K  
Photon emission for (n,n\*)a

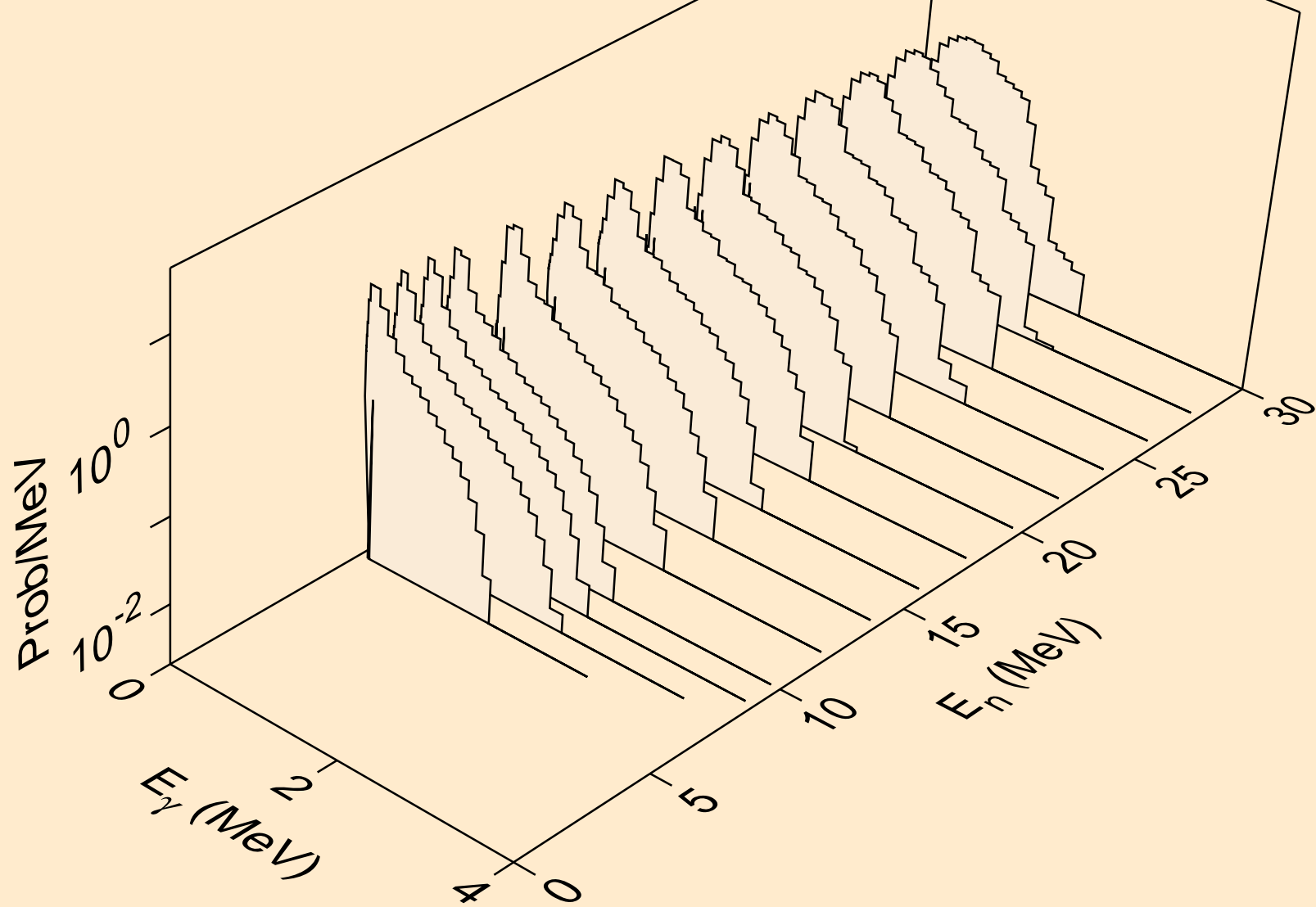

HS272 PROTON ACER TENDL-2021 LIBRARY; T=0.K  
Photon emission for (n,2n) $\alpha$

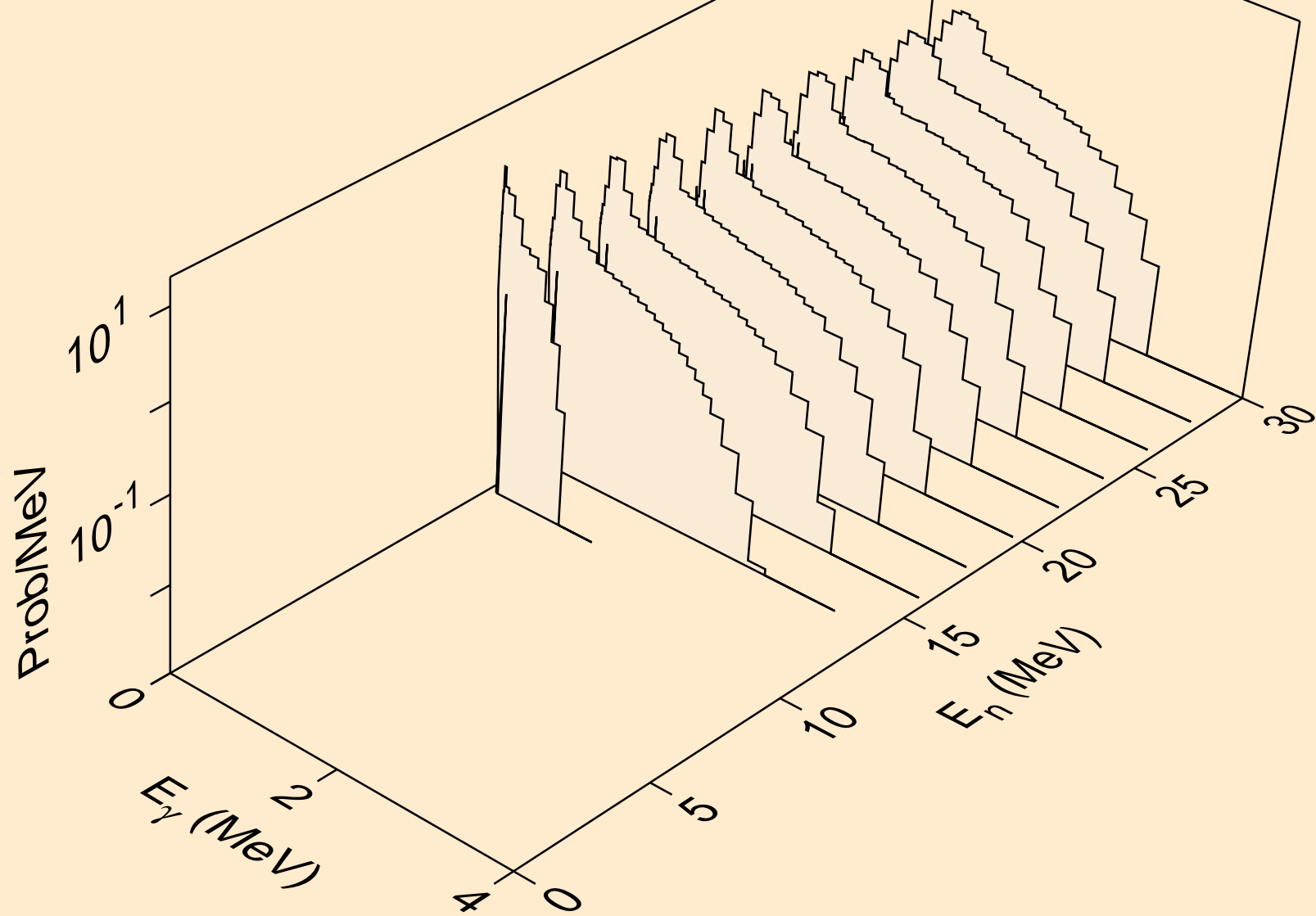

HS272 PROTON ACER TENDL-2021 LIBRARY; T=0.K  
Photon emission for (n,3n)a

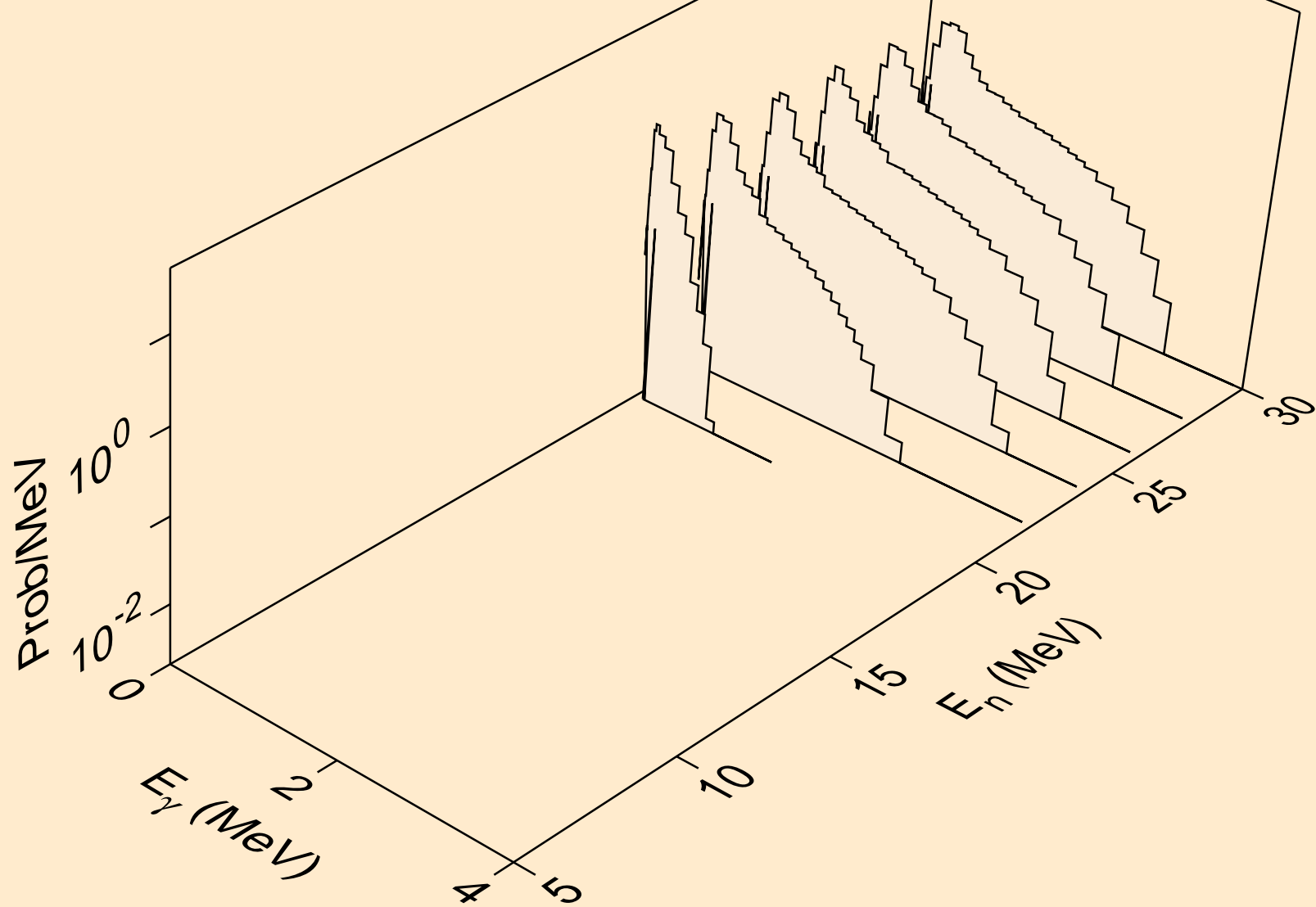

HS272 PROTON ACER TENDL-2021 LIBRARY; T=0.K  
Photon emission for (n,n\*)p

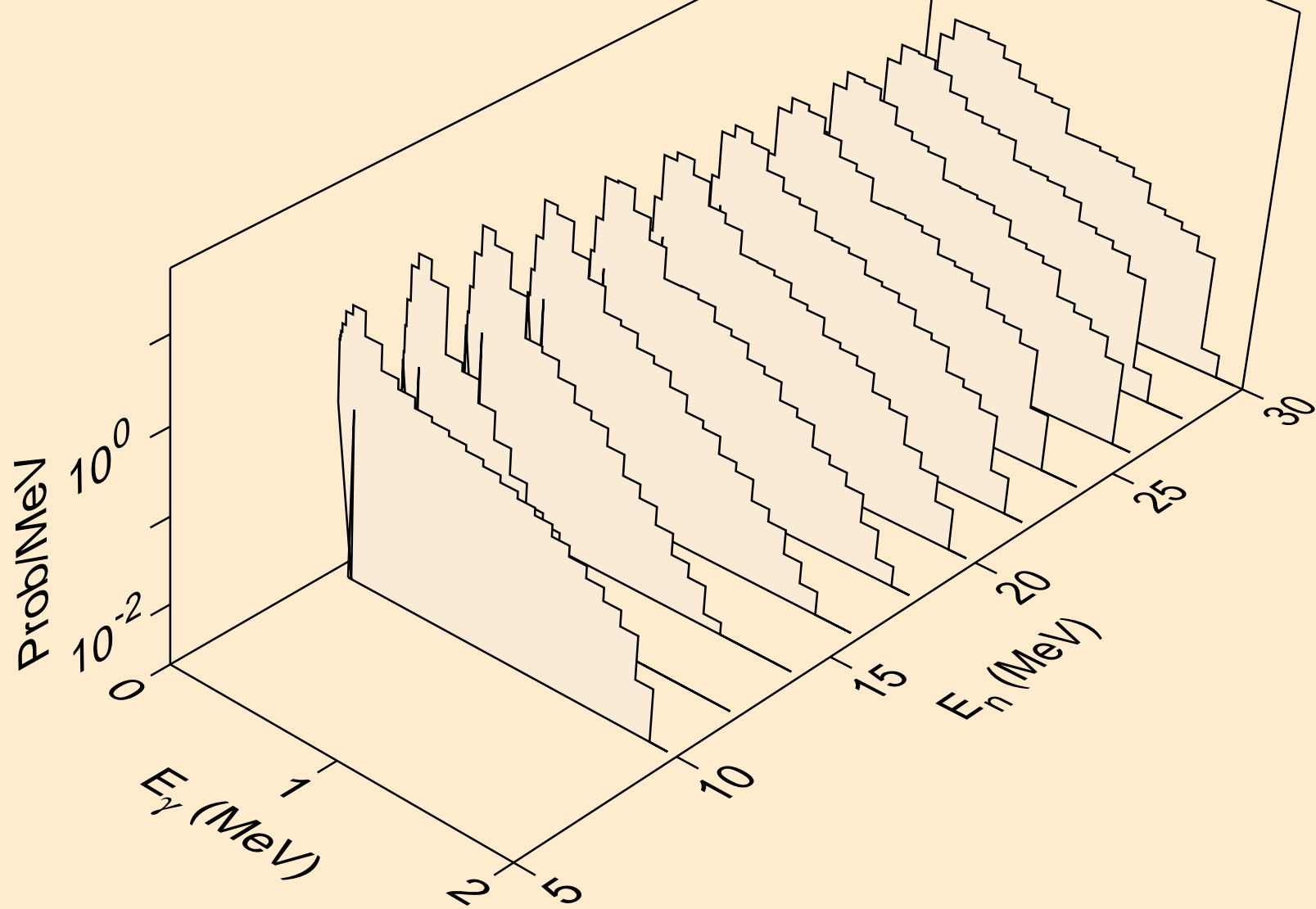



HS272 PROTON ACER TENDL-2021 LIBRARY; T=0.K  
Photon emission for (n,n\*)2a

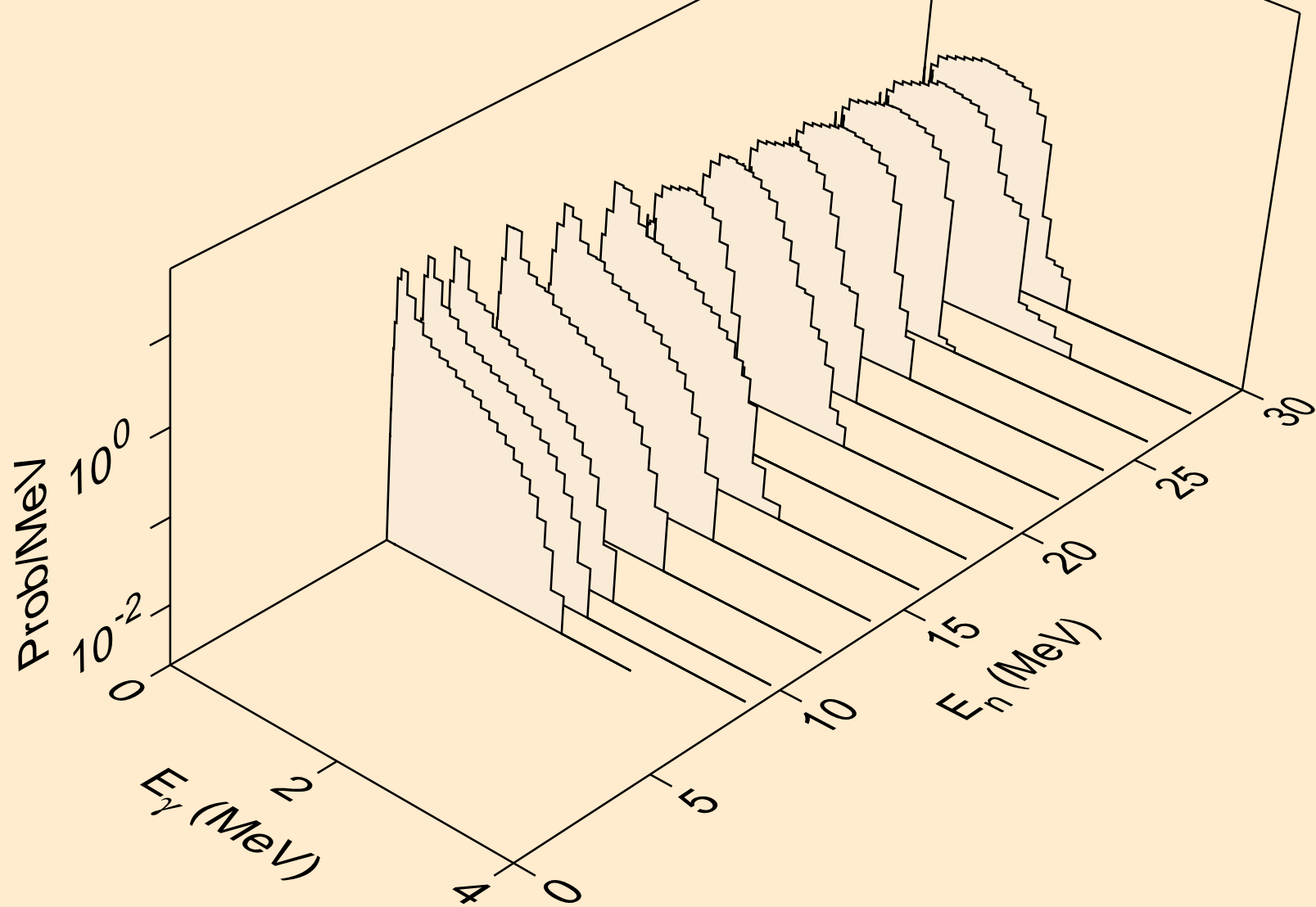

HS272 PROTON ACER TENDL-2021 LIBRARY; T=0.K  
Photon emission for (n,n\*)d

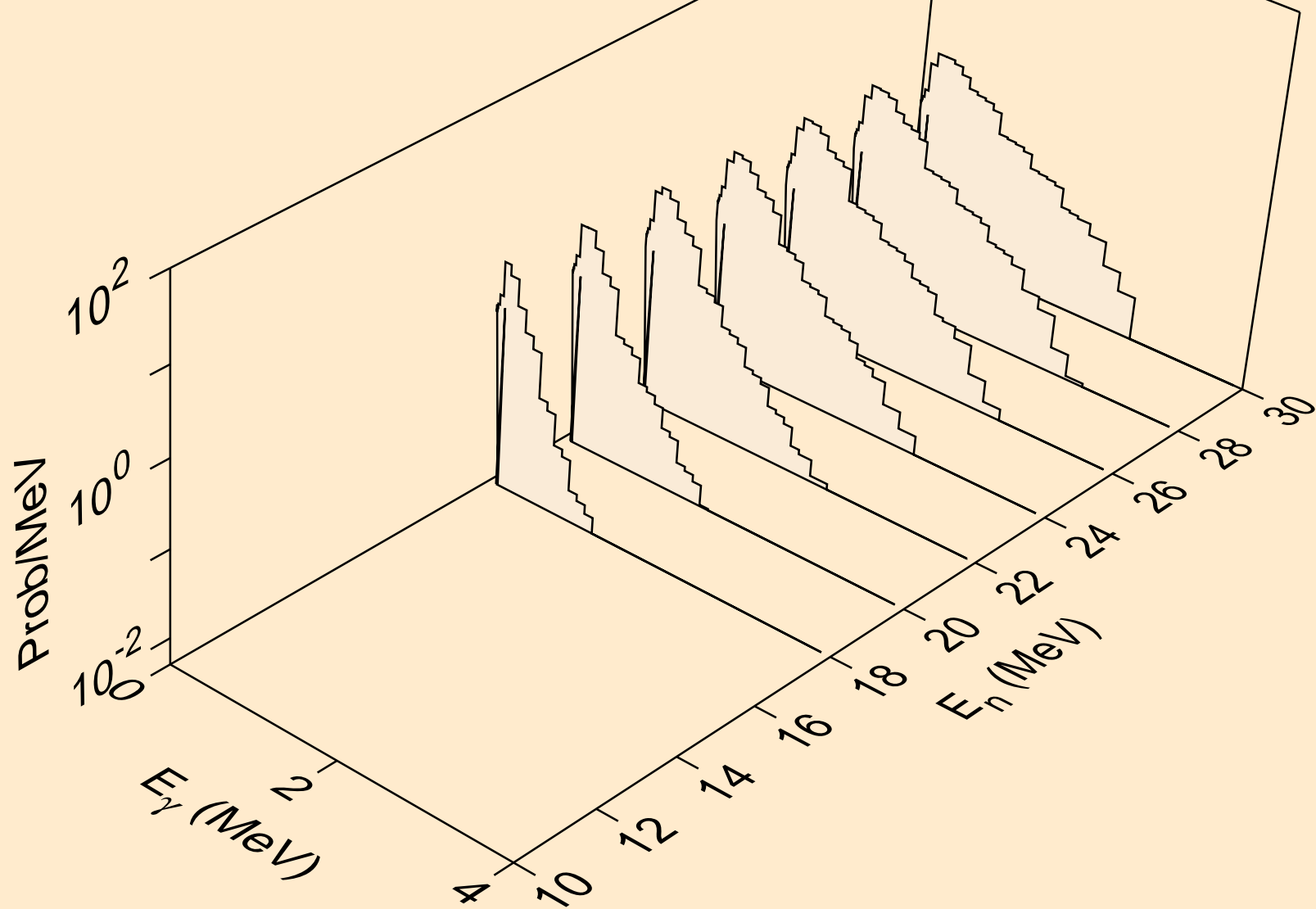

HS272 PROTON ACER TENDL-2021 LIBRARY; T=0.K  
Photon emission for (n,n\*)t

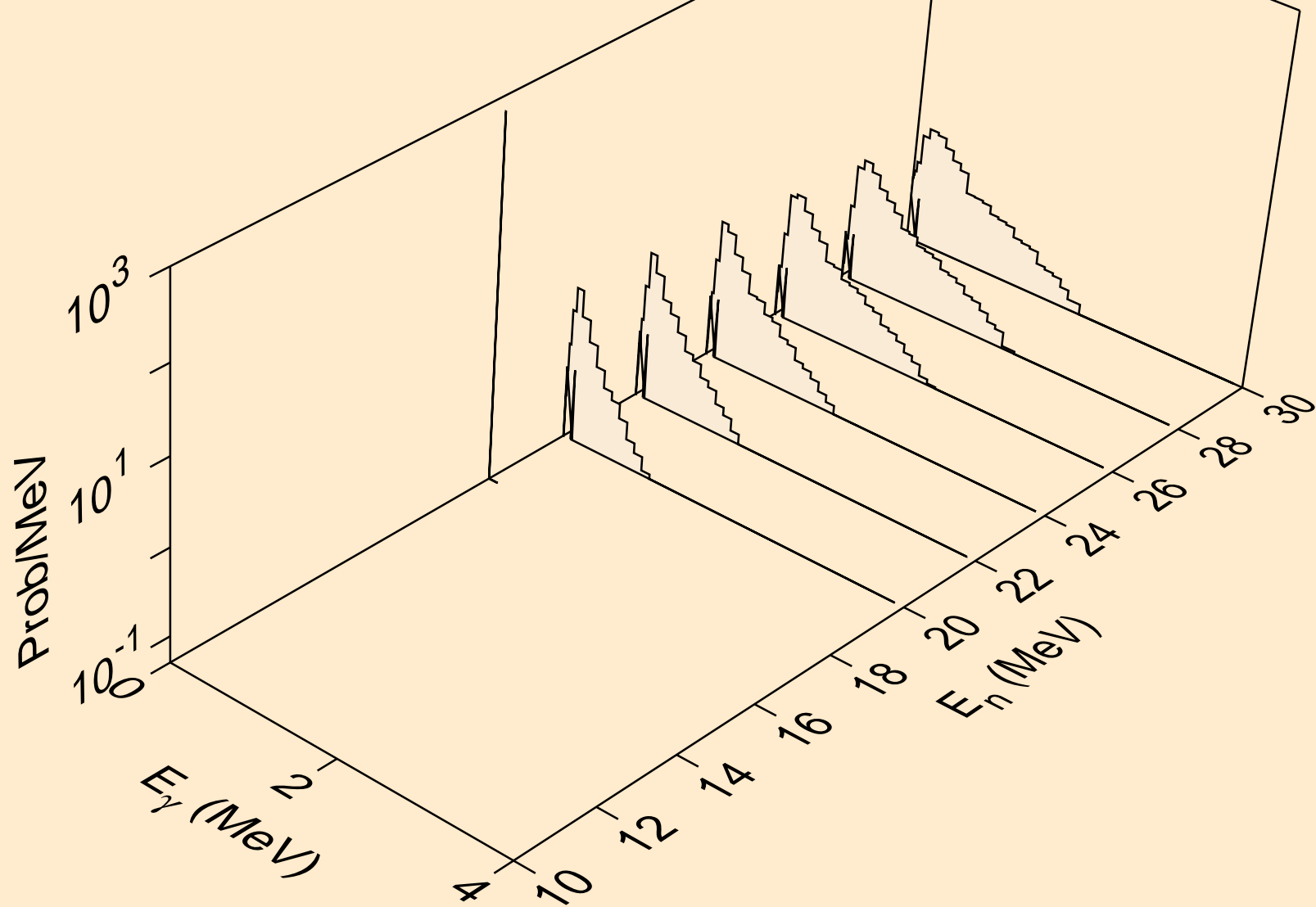

HS272 PROTON ACER TENDL-2021 LIBRARY; T=0.K  
Photon emission for (n,2np)

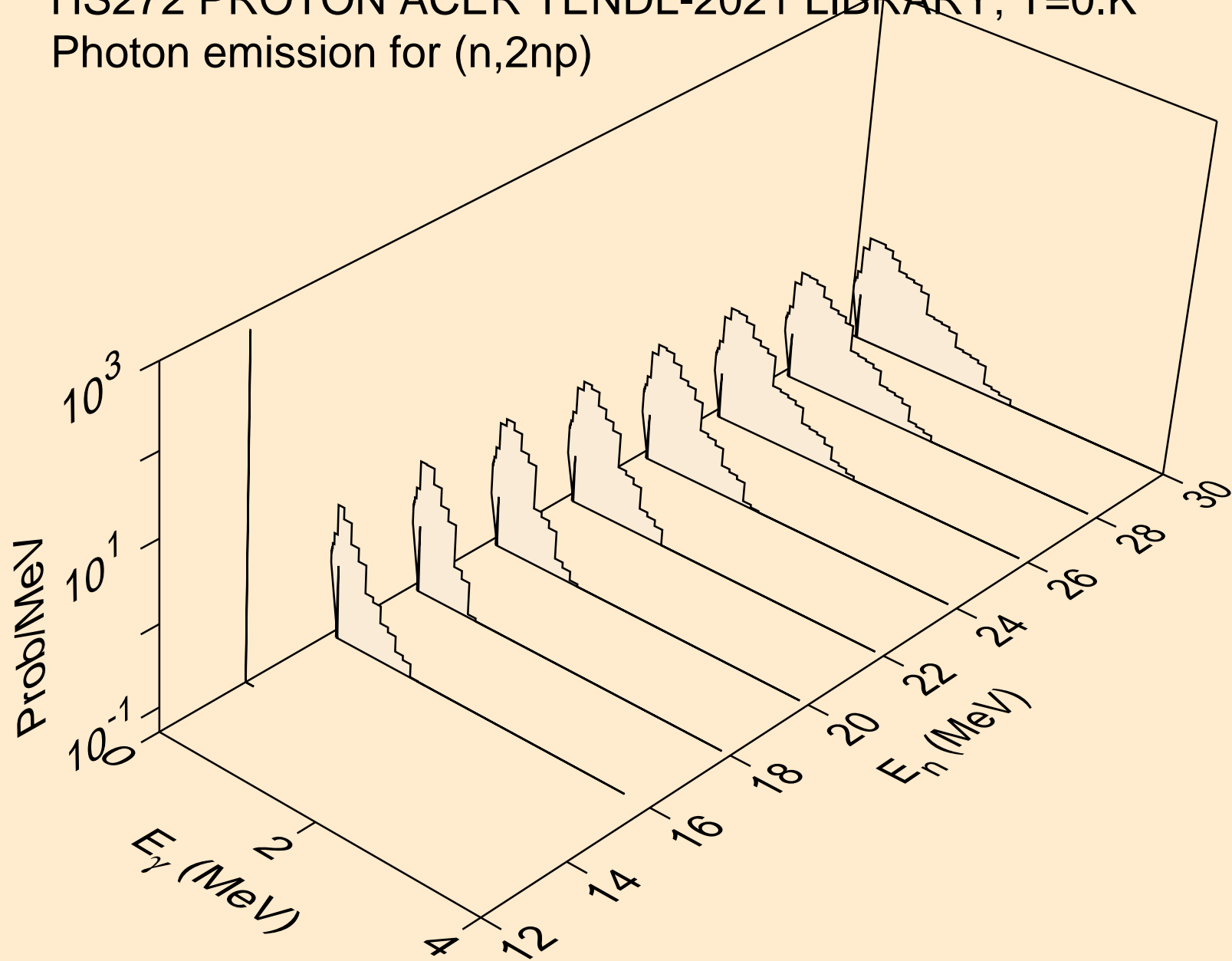

HS272 PROTON ACER TENDL-2021 LIBRARY; T=0.K  
Photon emission for (n,npa)

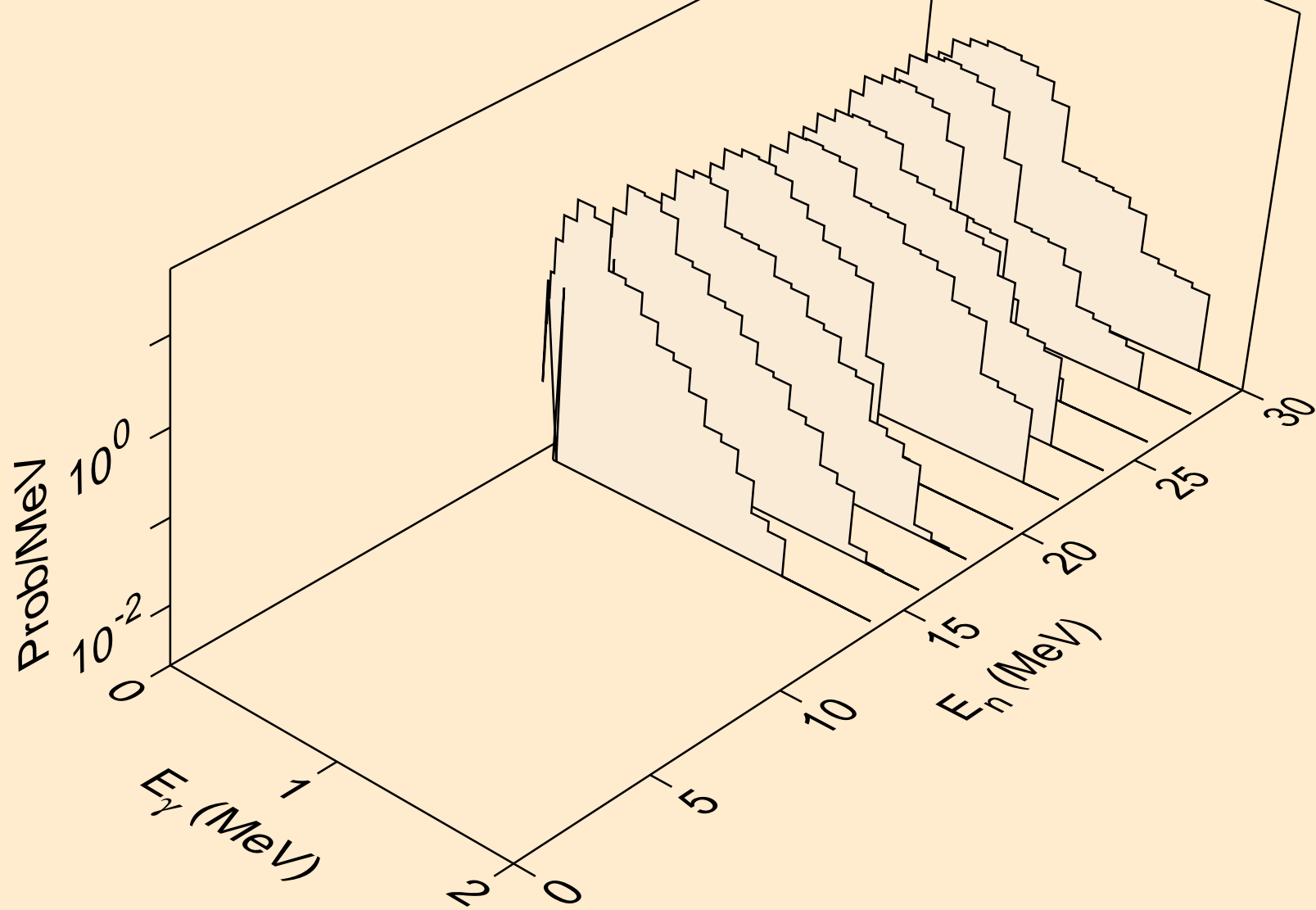

HS272 PROTON ACER TENDL-2021 LIBRARY; T=0.K  
Photon emission for (n,gma)

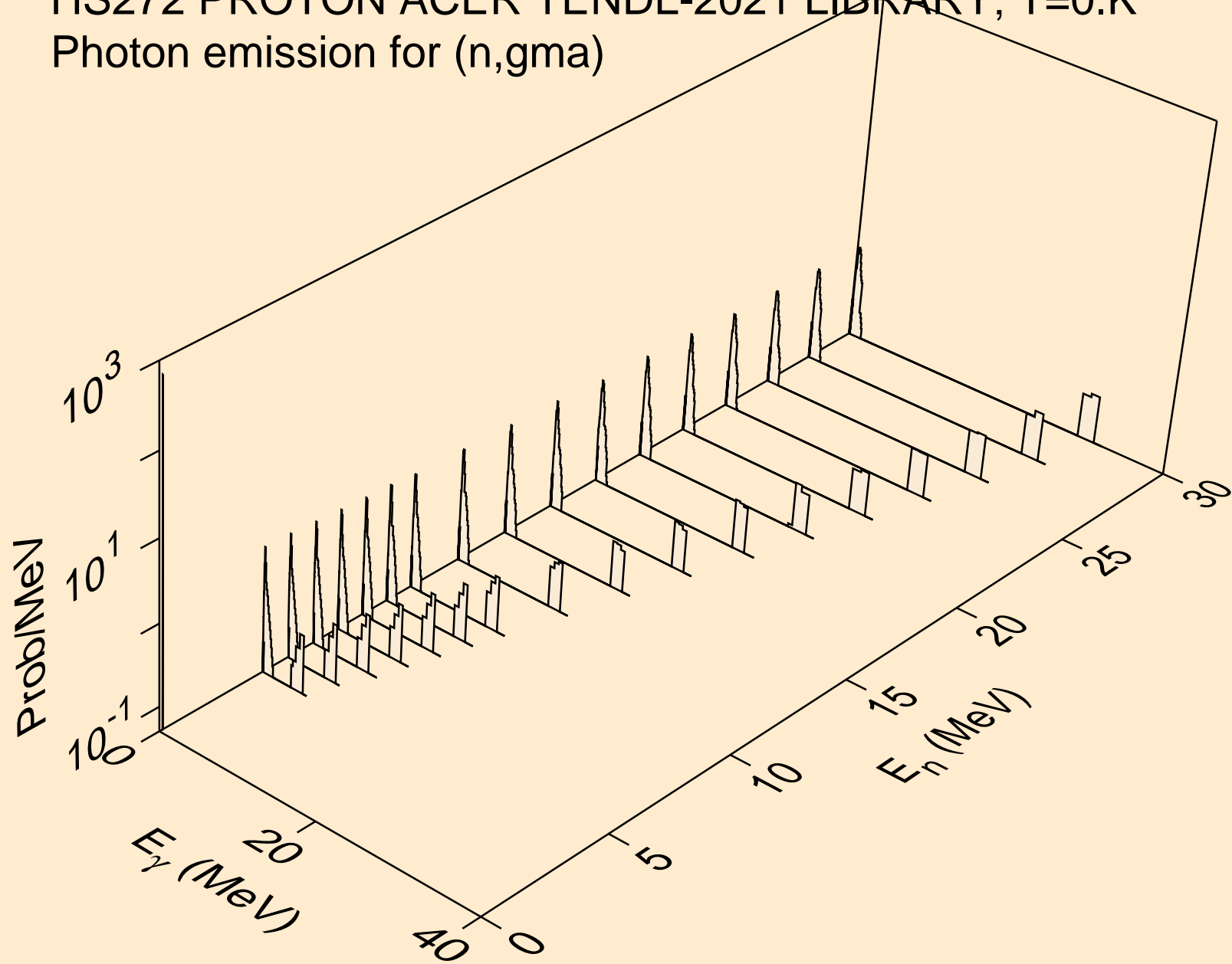

HS272 PROTON ACER TENDL-2021 LIBRARY; T=0.K  
Photon emission for inelastic

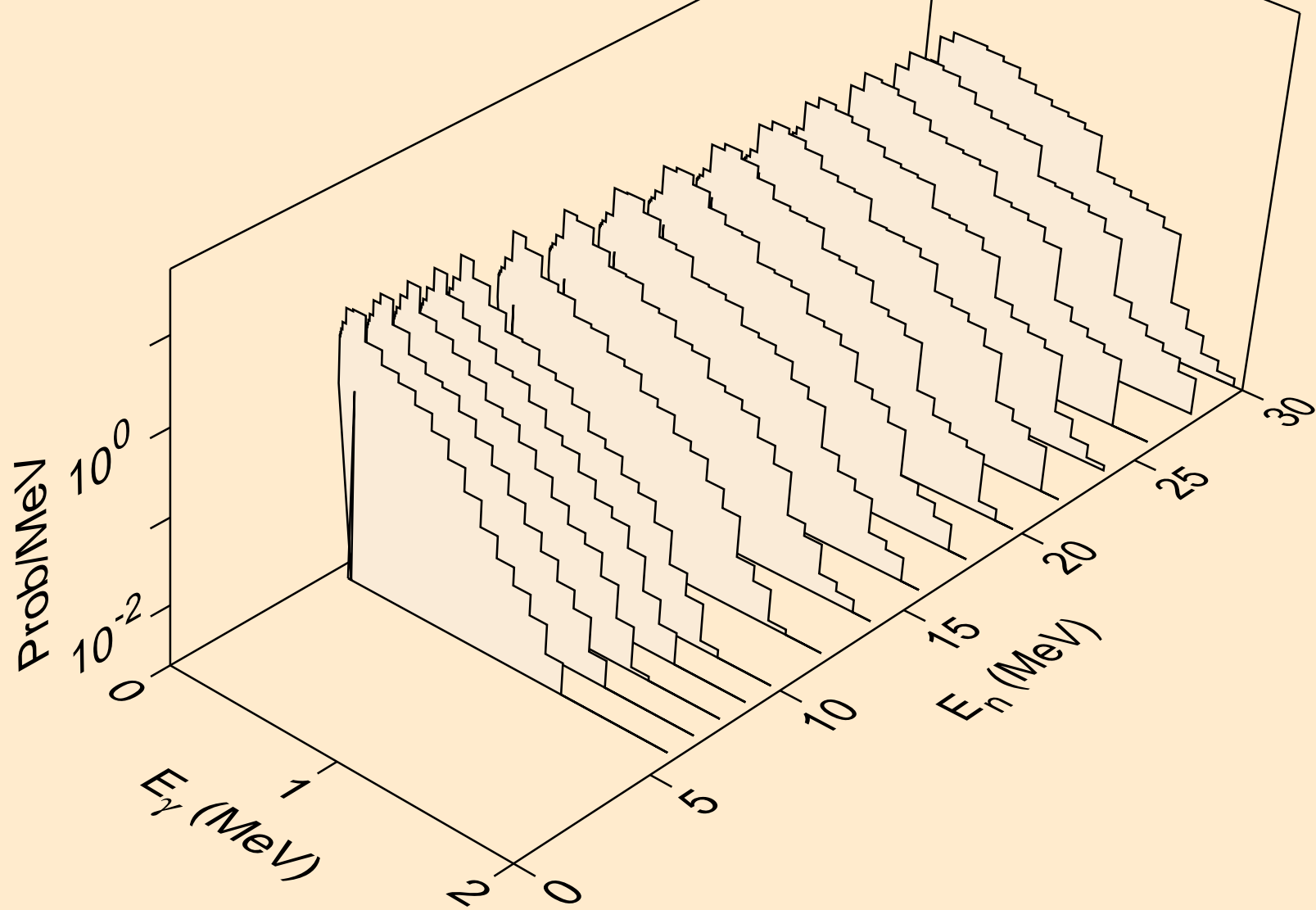

HS272 PROTON ACER TENDL-2021 LIBRARY; T=0.K  
Photon emission for (n,d)

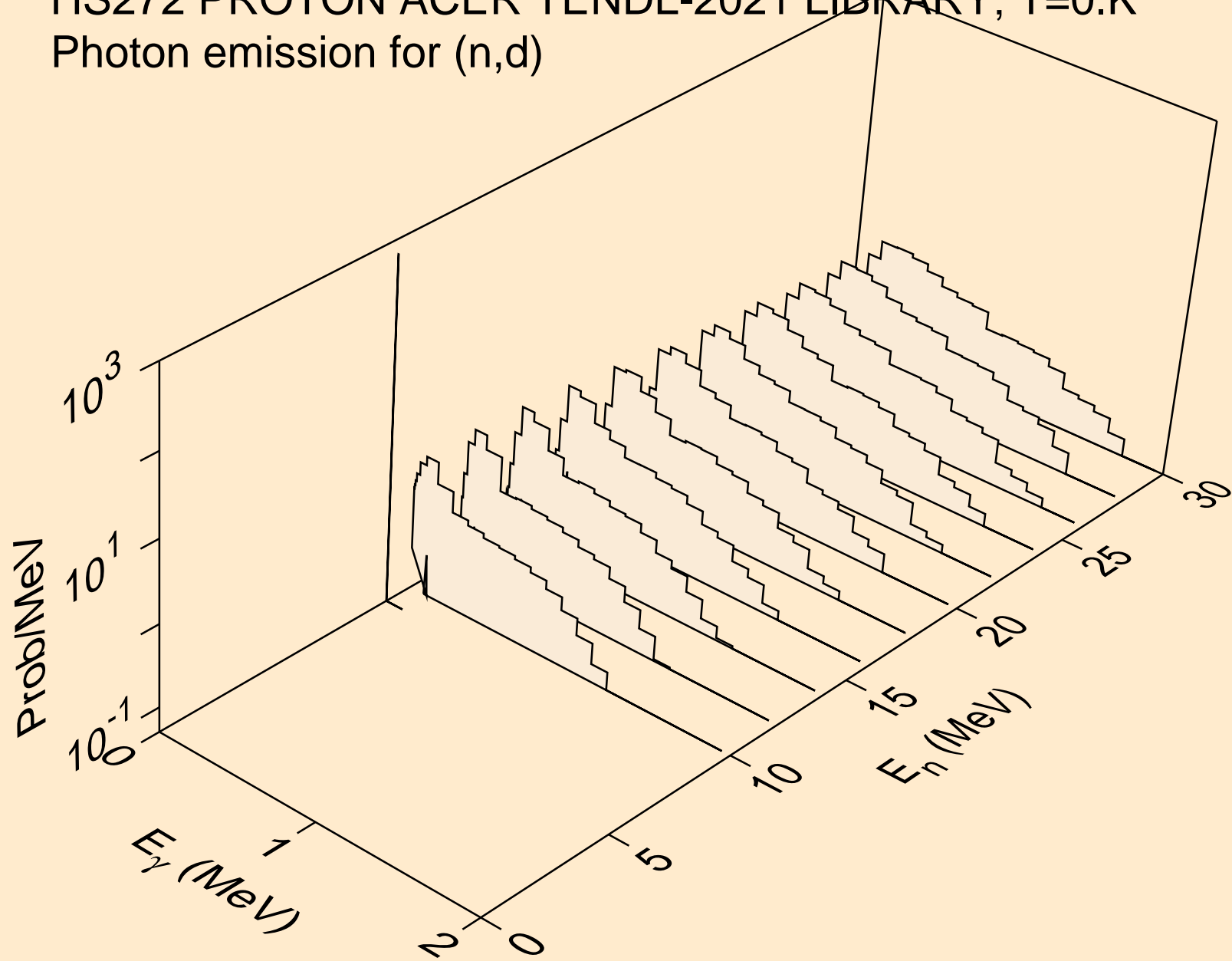



HS272 PROTON ACER TENDL-2021 LIBRARY; T=0.K  
Photon emission for (n,t)

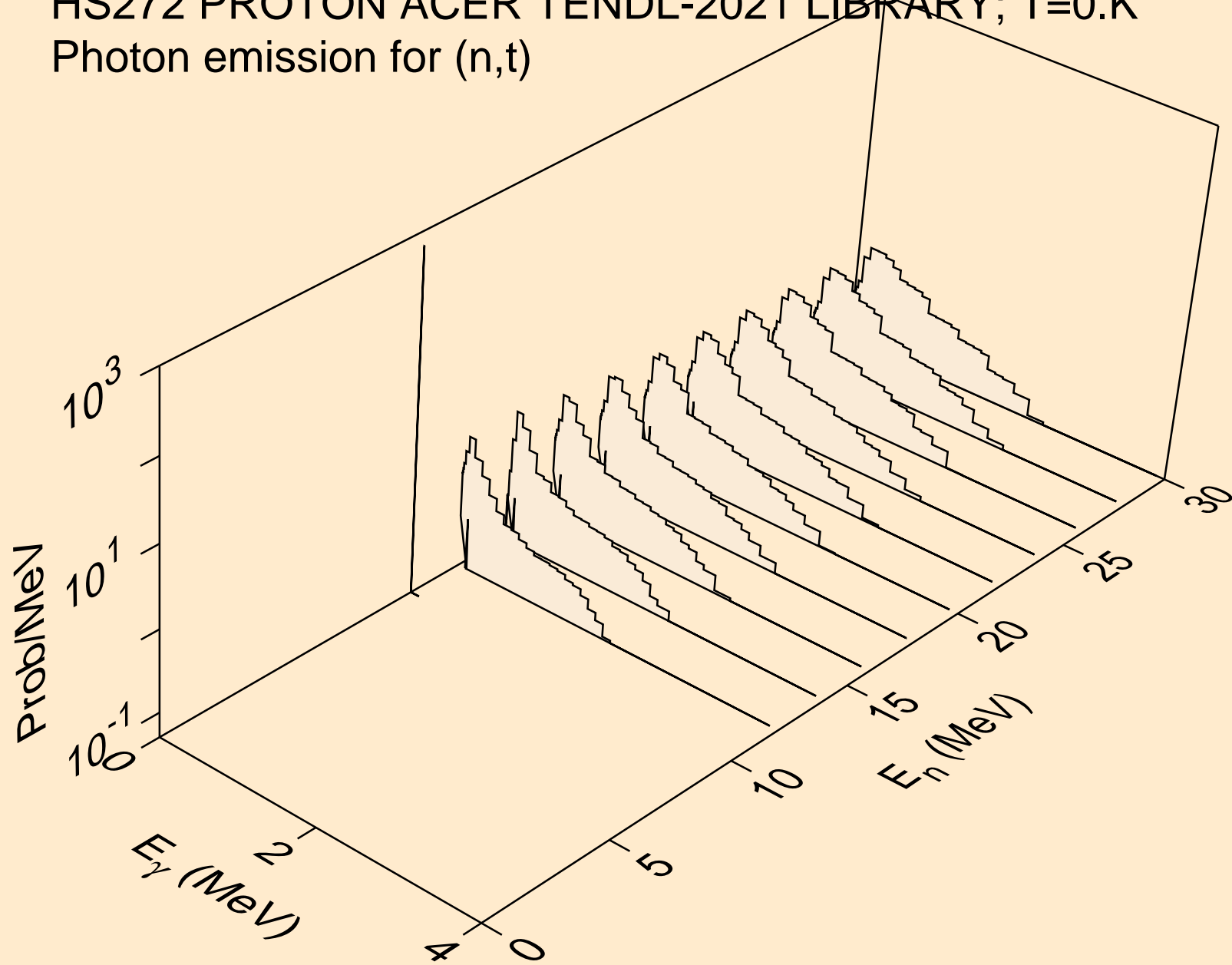

HS272 PROTON ACER TENDL-2021 LIBRARY; T=0.K  
Photon emission for (n,he3)

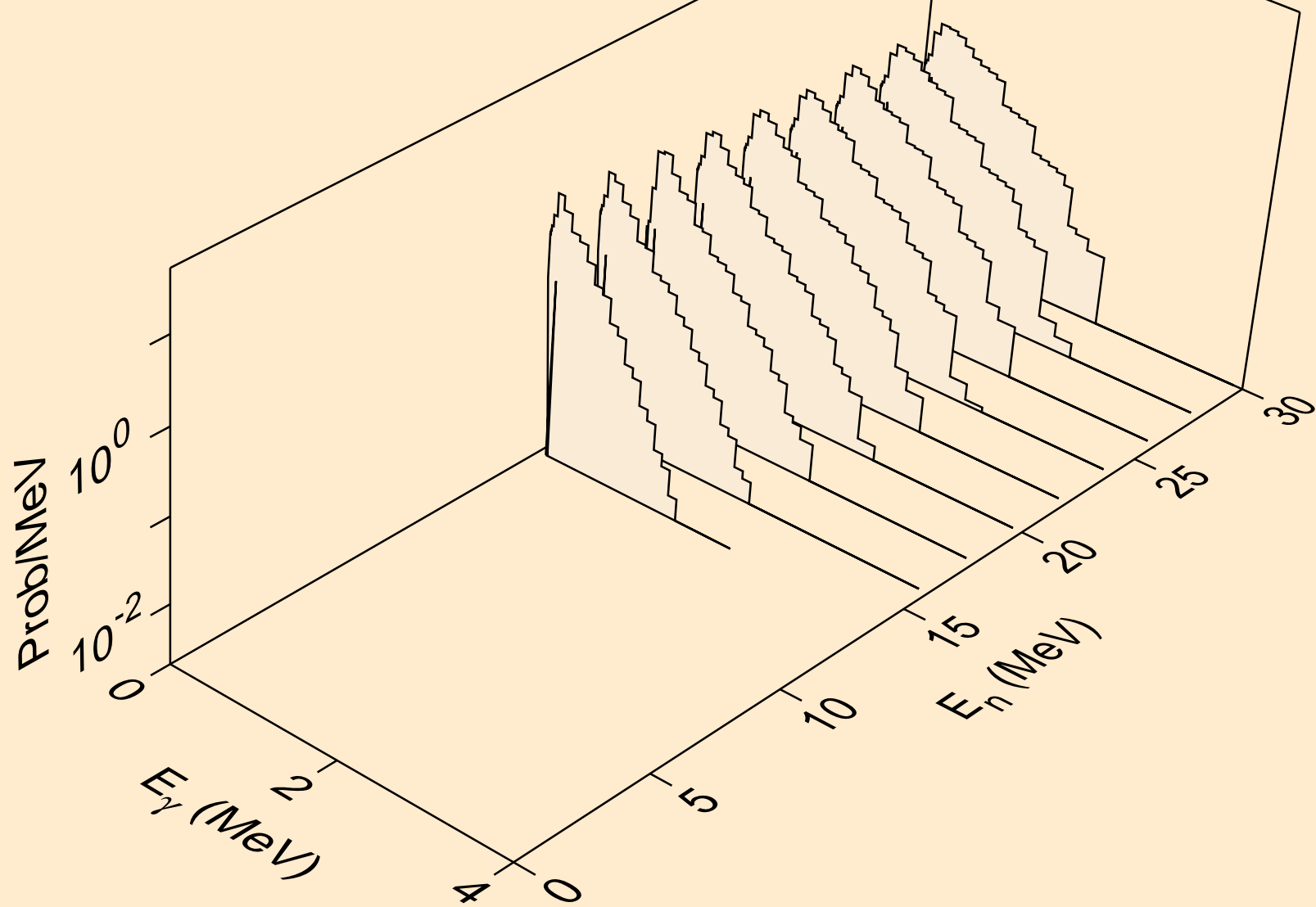

HS272 PROTON ACER TENDL-2021 LIBRARY; T=0.K  
Photon emission for (n,a)

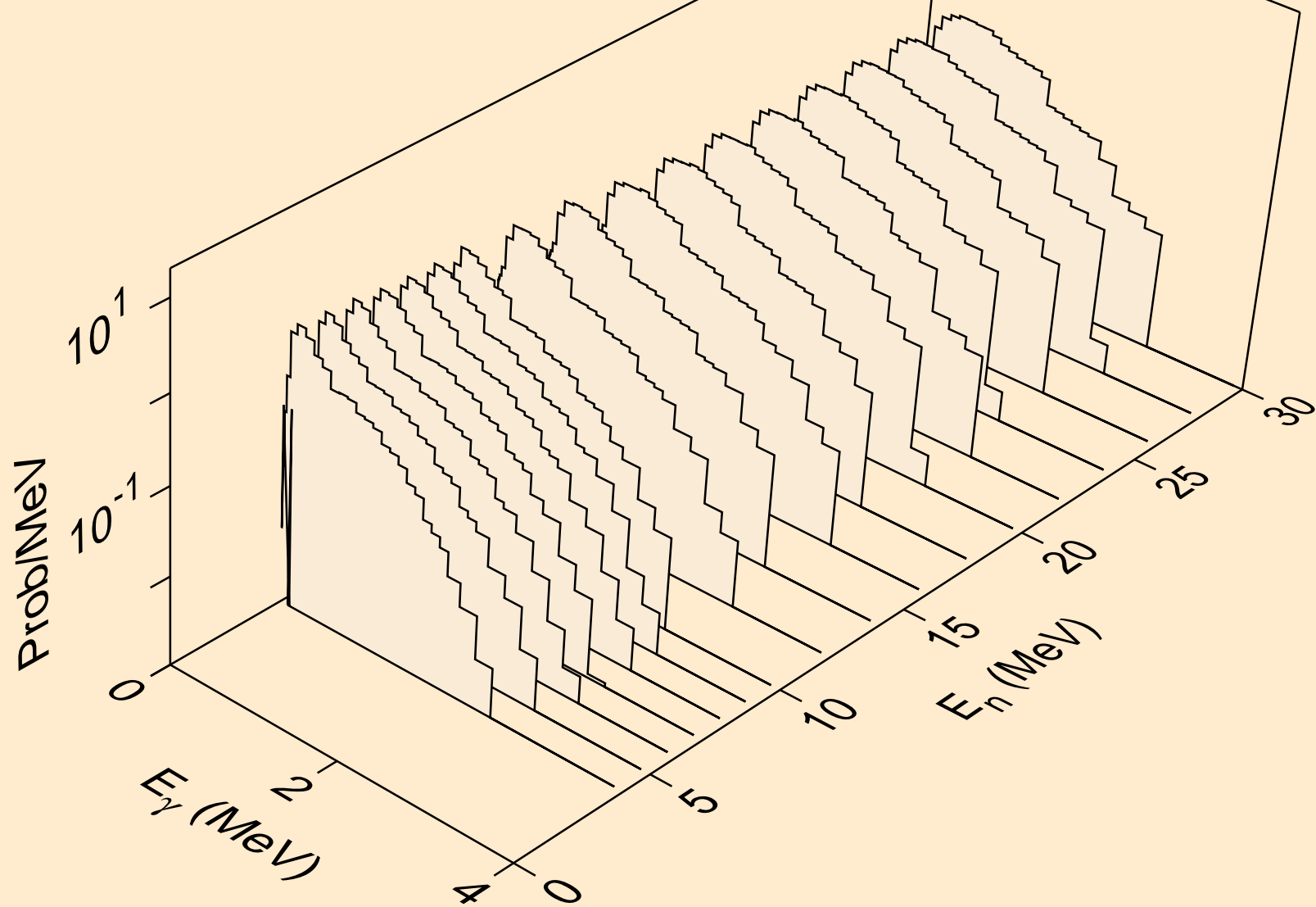

HS272 PROTON ACER TENDL-2021 LIBRARY; T=0.K  
Photon emission for (n,2p)

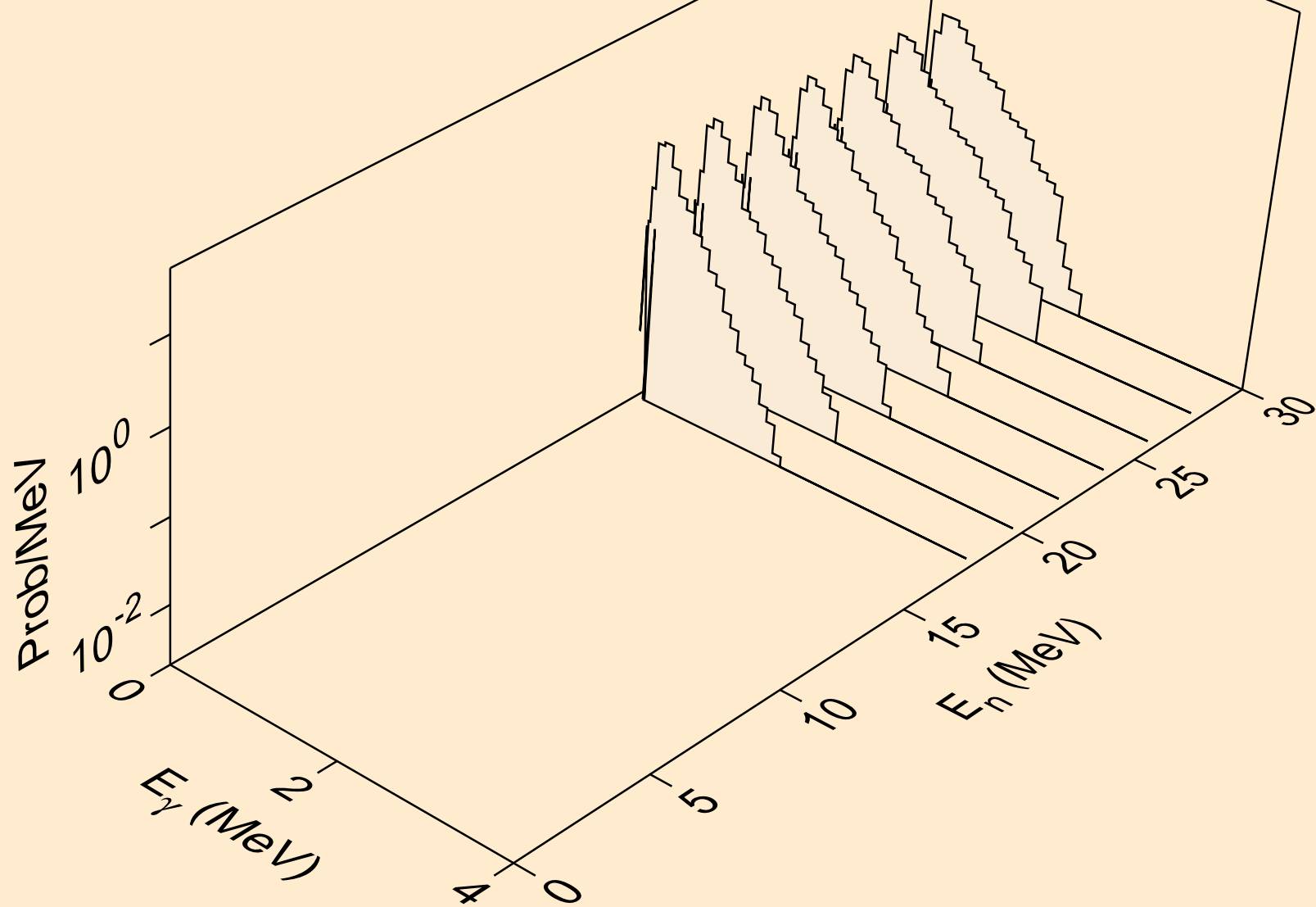

HS272 PROTON ACER TENDL-2021 LIBRARY; T=0.K  
Photon emission for (n,pa)

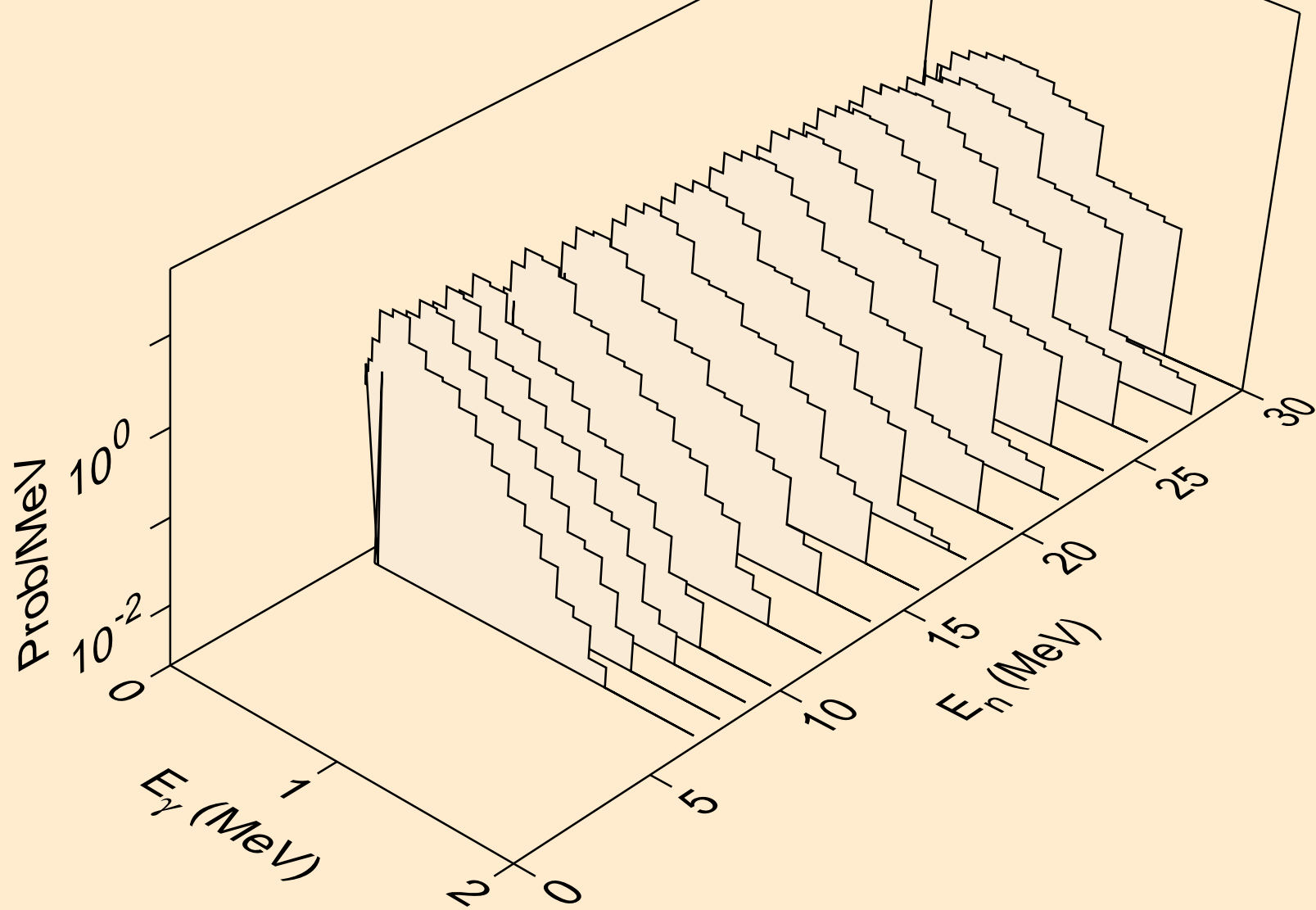

HS272 PROTON ACER TENDL-2021 LIBRARY; T=0.K  
Photon emission for (n,da)

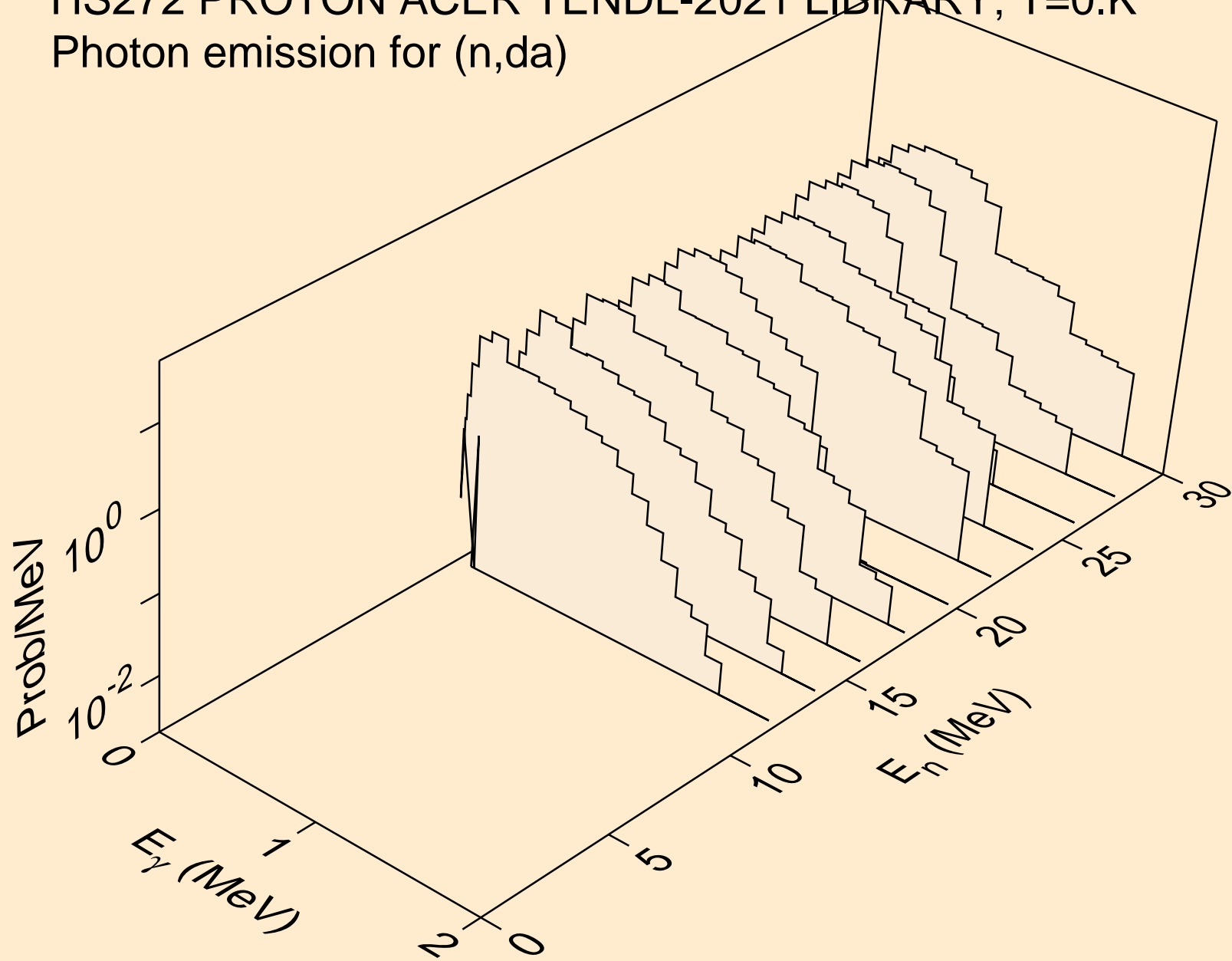

# HS272 PROTON ACER TENDL-2021 LIBRARY; T=0.K

## Particle heating contributions

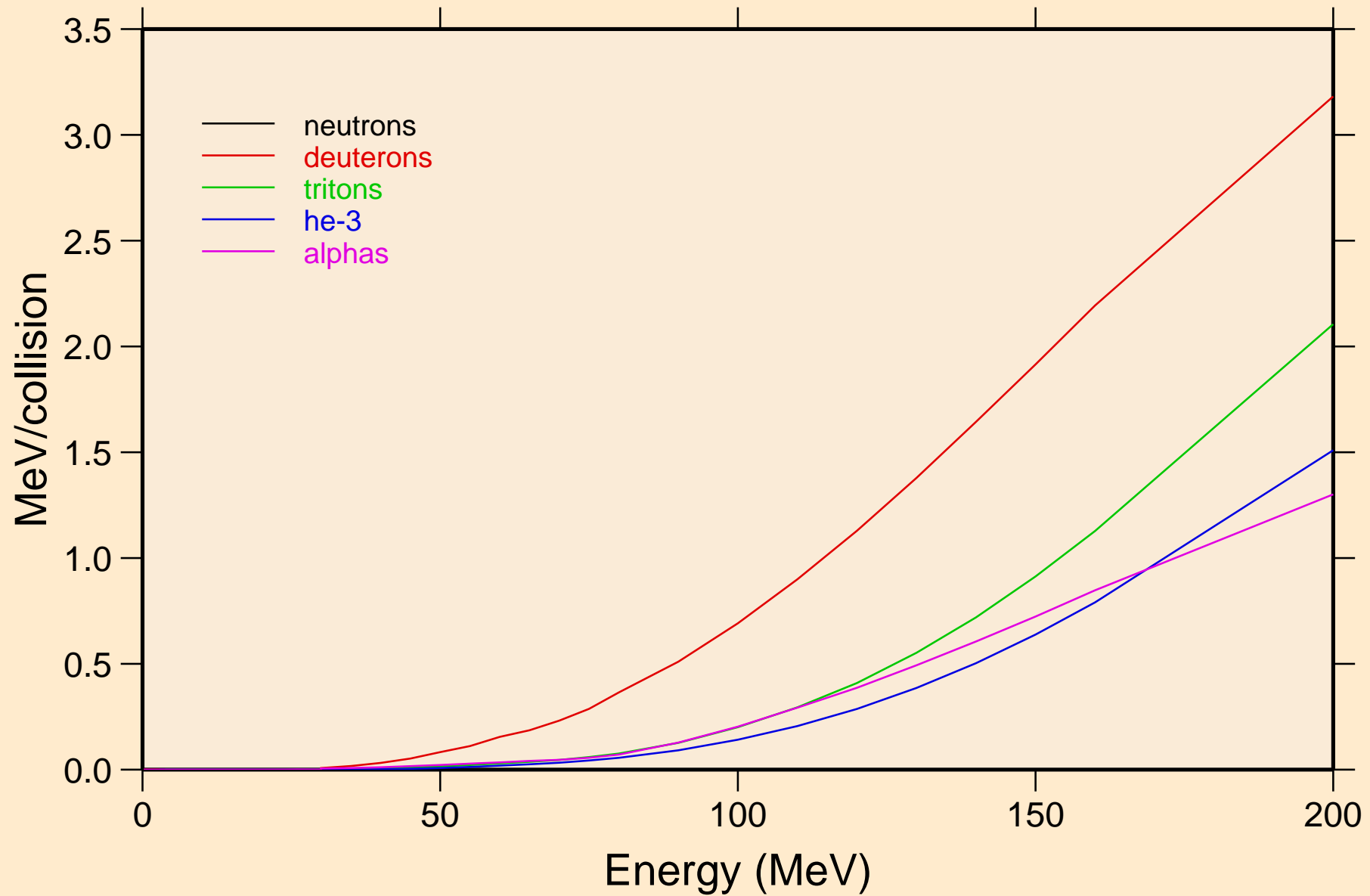

# HS272 PROTON ACER TENDL-2021 LIBRARY; T=0.K

## Recoil Heating

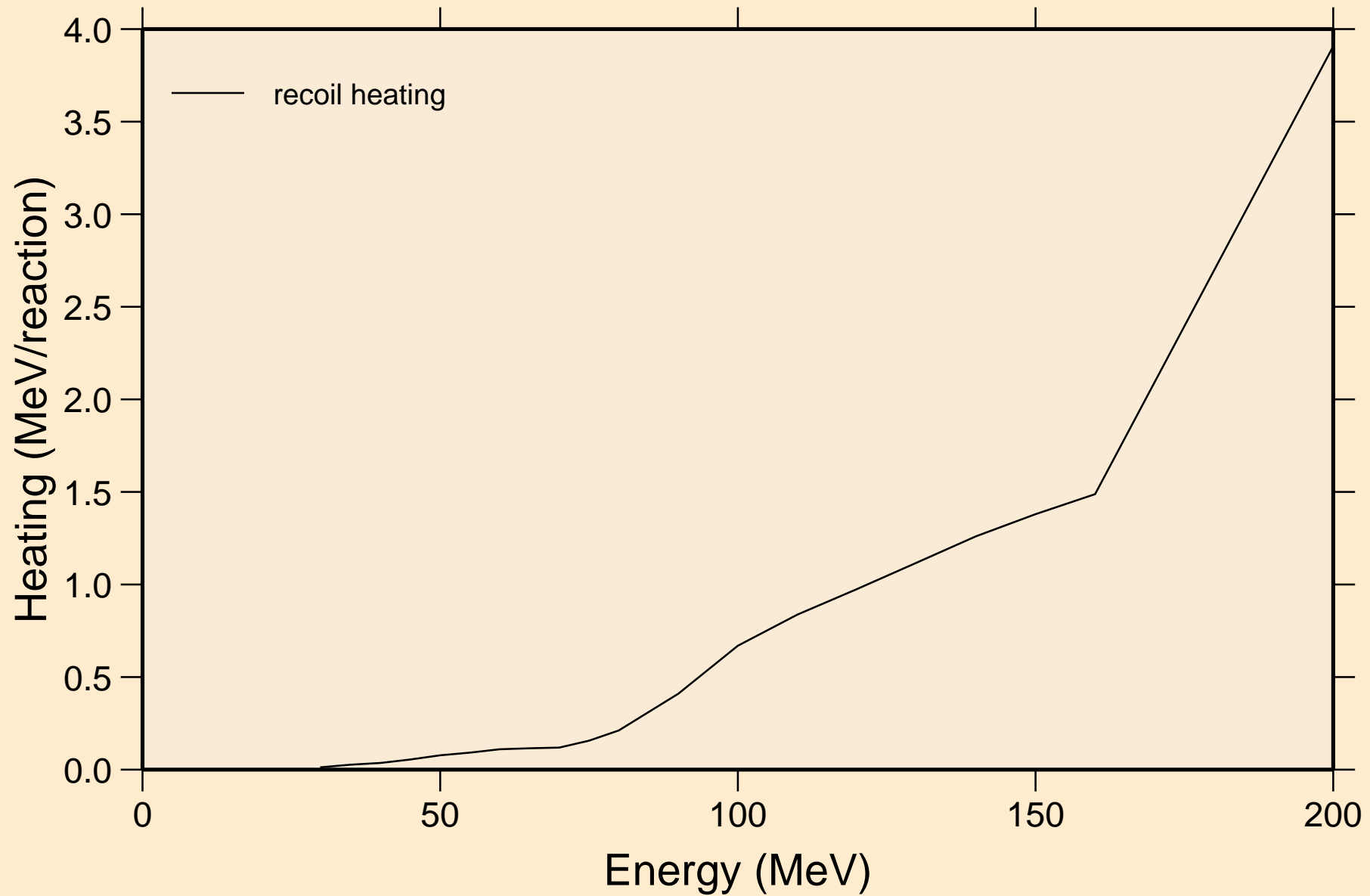



# HS272 PROTON ACER TENDL-2021 LIBRARY; T=0.K

## Particle production cross sections

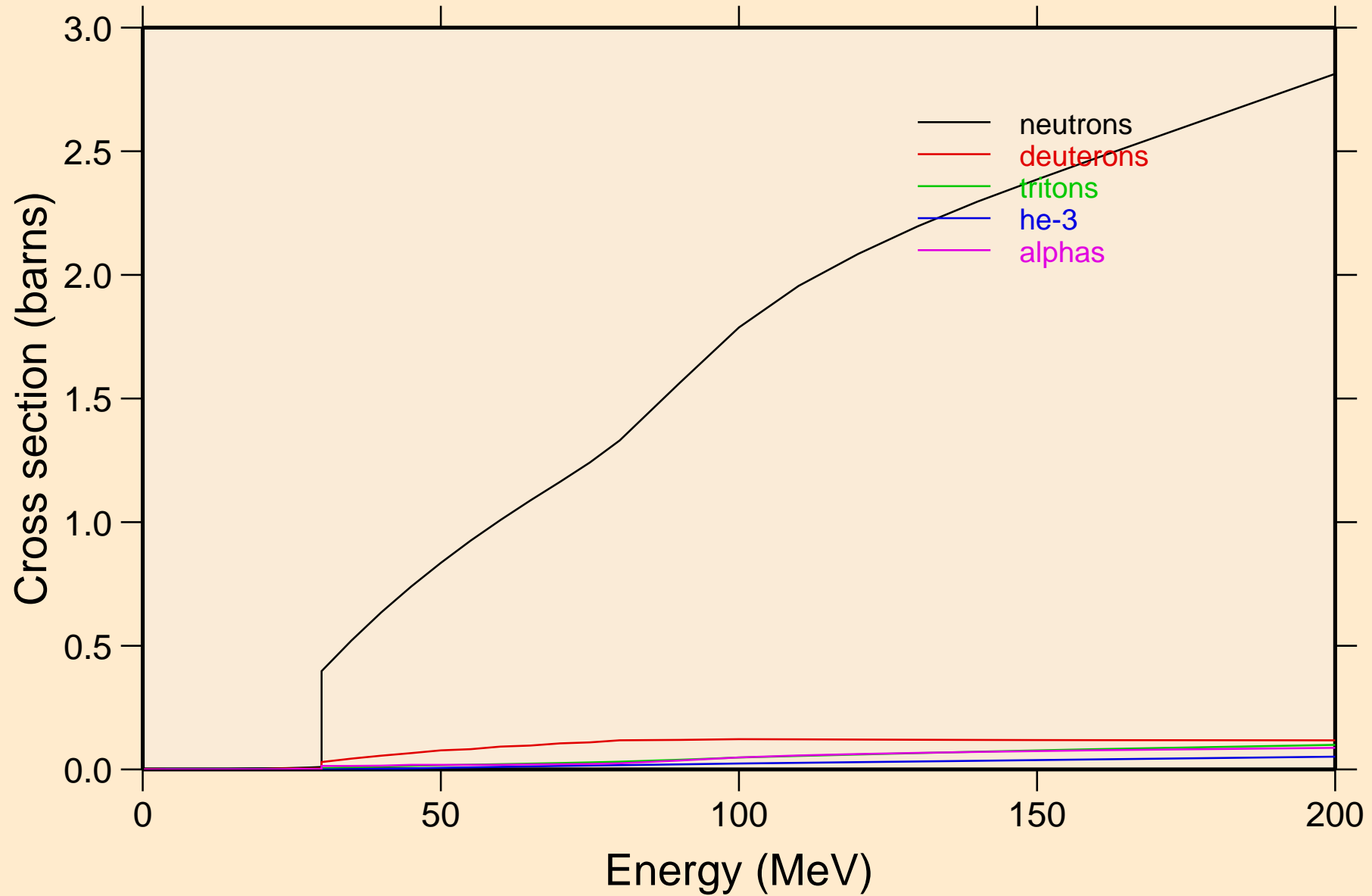

HS272 PROTON ACER TENDL-2021 LIBRARY; T=0.K  
neutrons from (p,n)

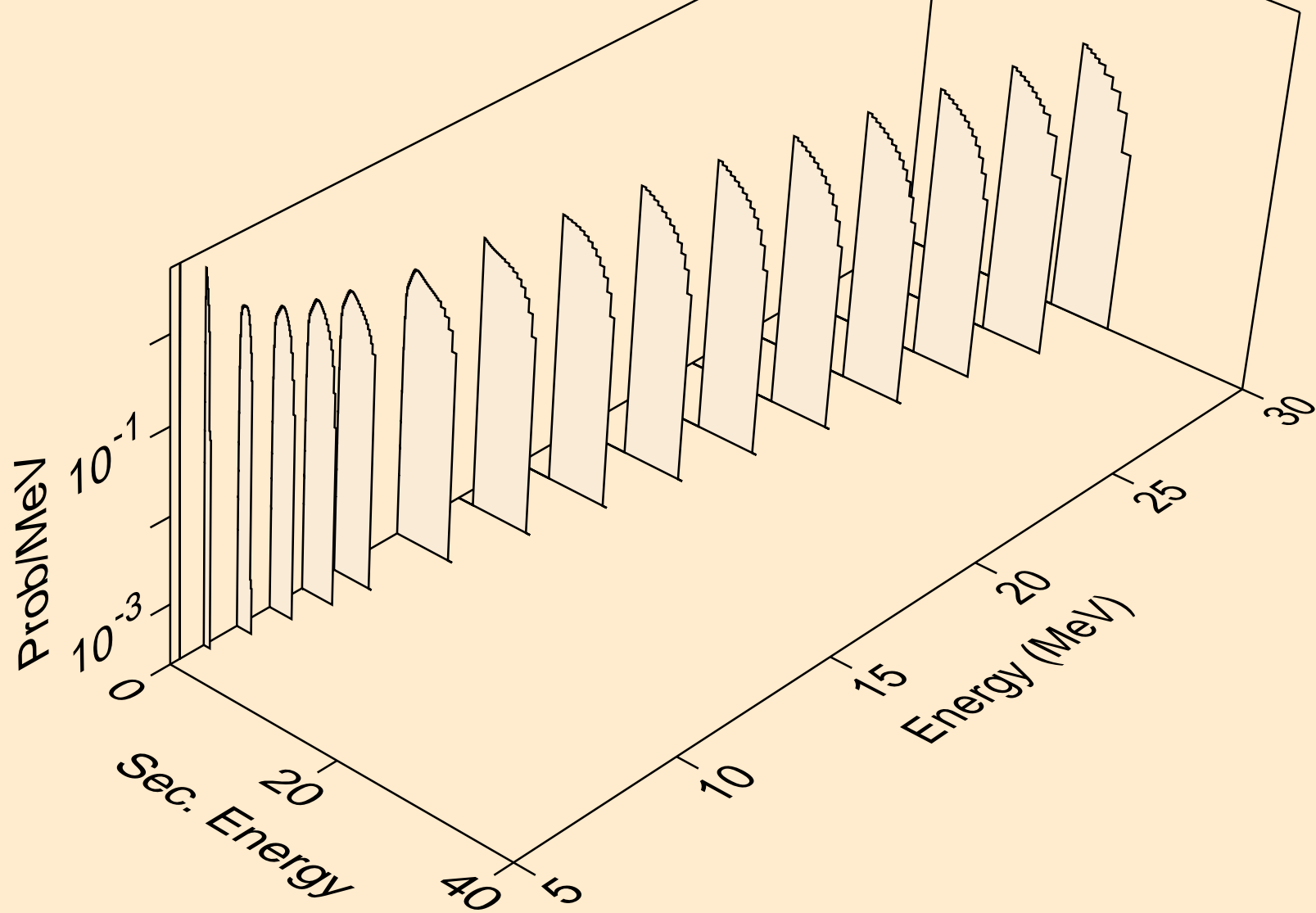

HS272 PROTON ACER TENDL-2021 LIBRARY; T=0.K  
neutrons from (p,x)

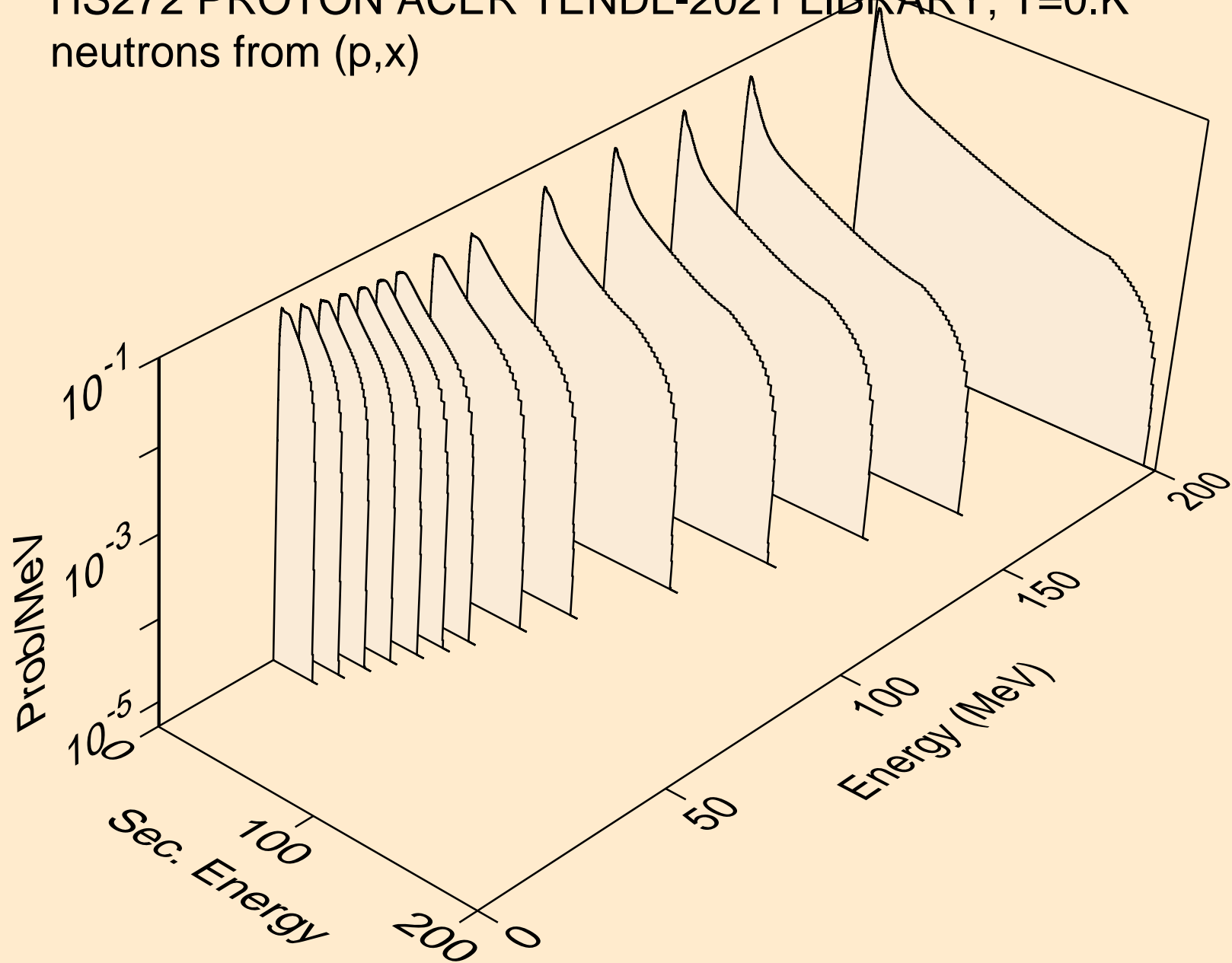

HS272 PROTON ACER TENDL-2021 LIBRARY; T=0.K  
neutrons from (p,2n)

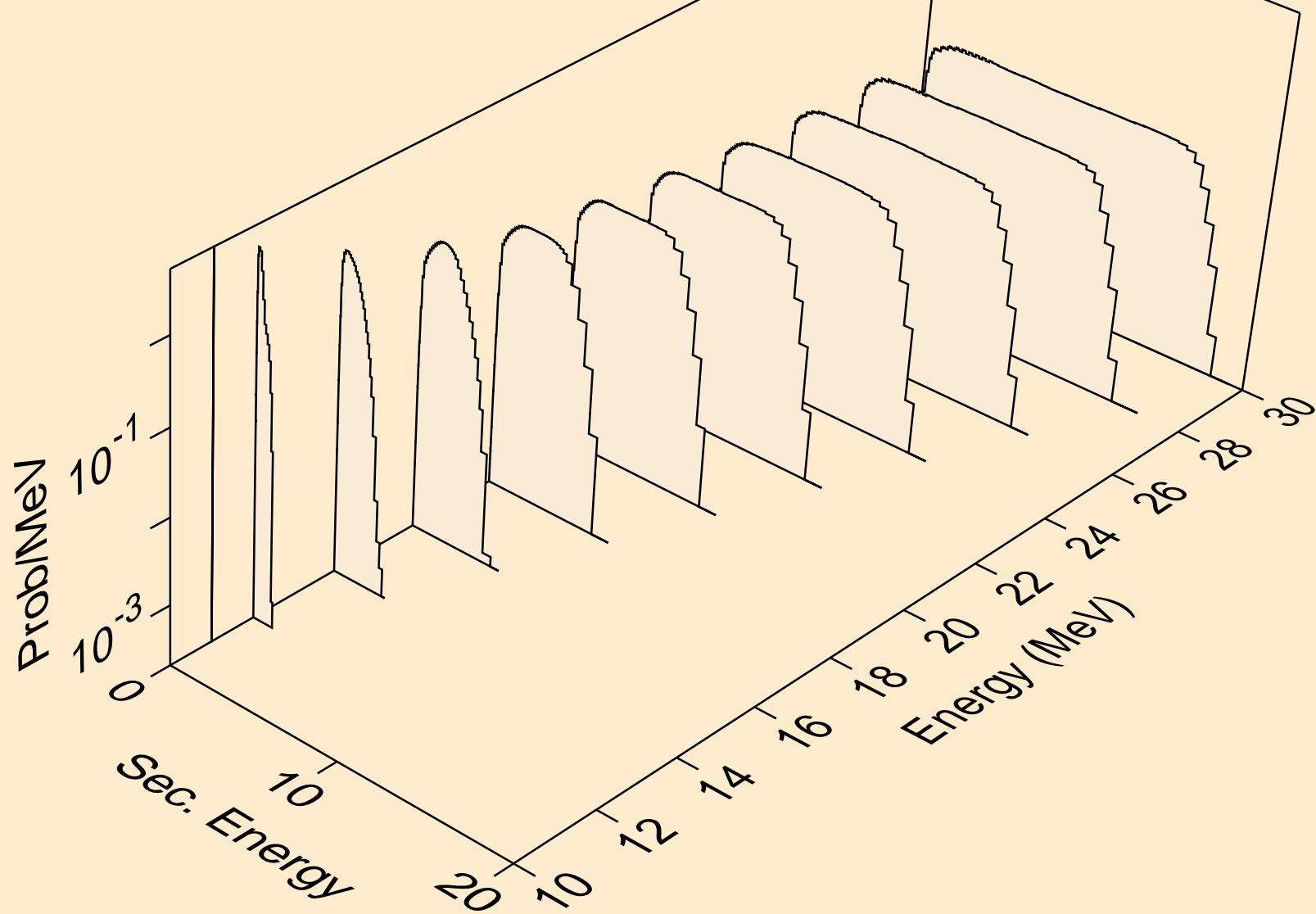

HS272 PROTON ACER TENDL-2021 LIBRARY; T=0.K  
neutrons from (p,3n)

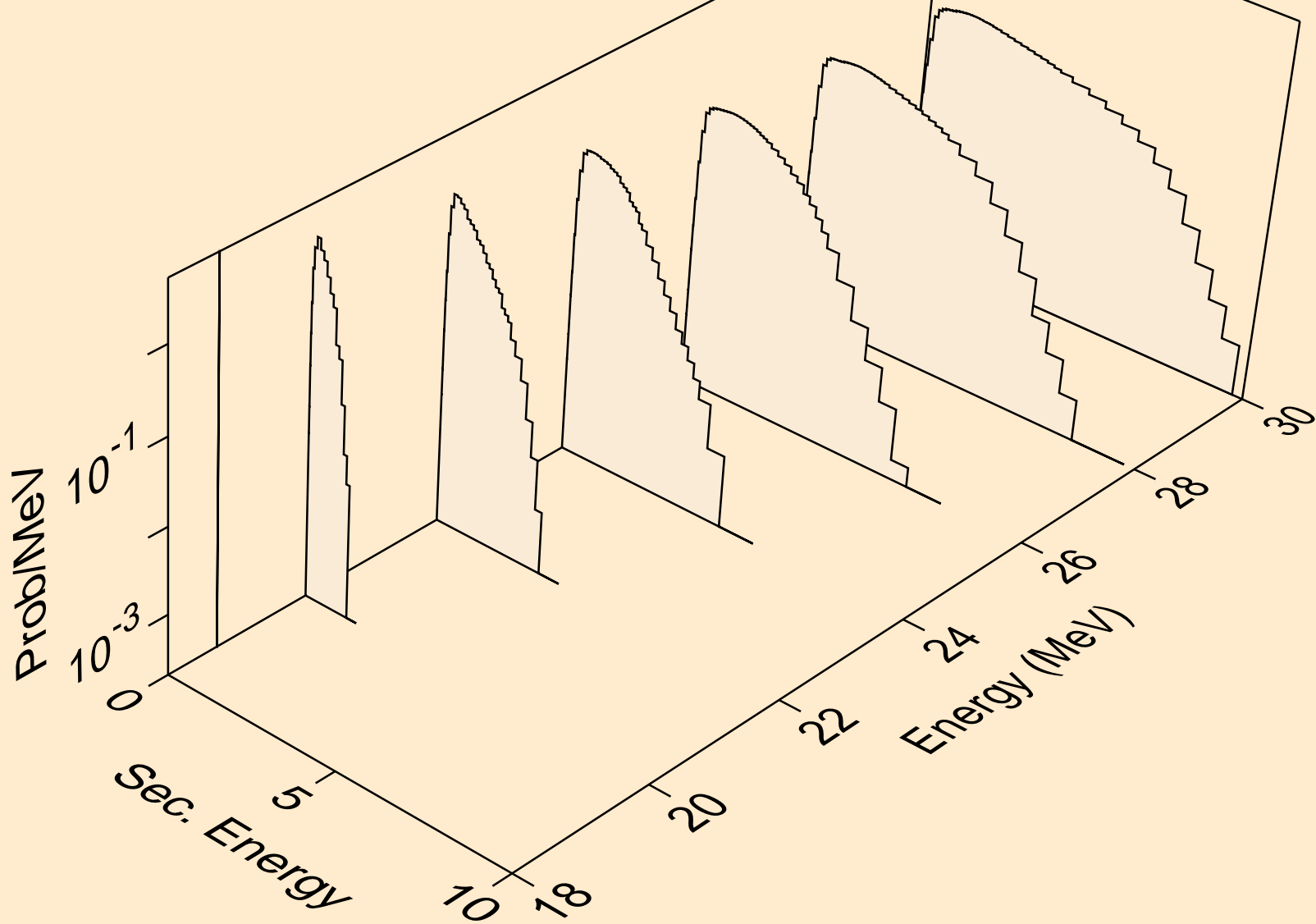

HS272 PROTON ACER TENDL-2021 LIBRARY; T=0.K  
neutrons from (p,n\*)a

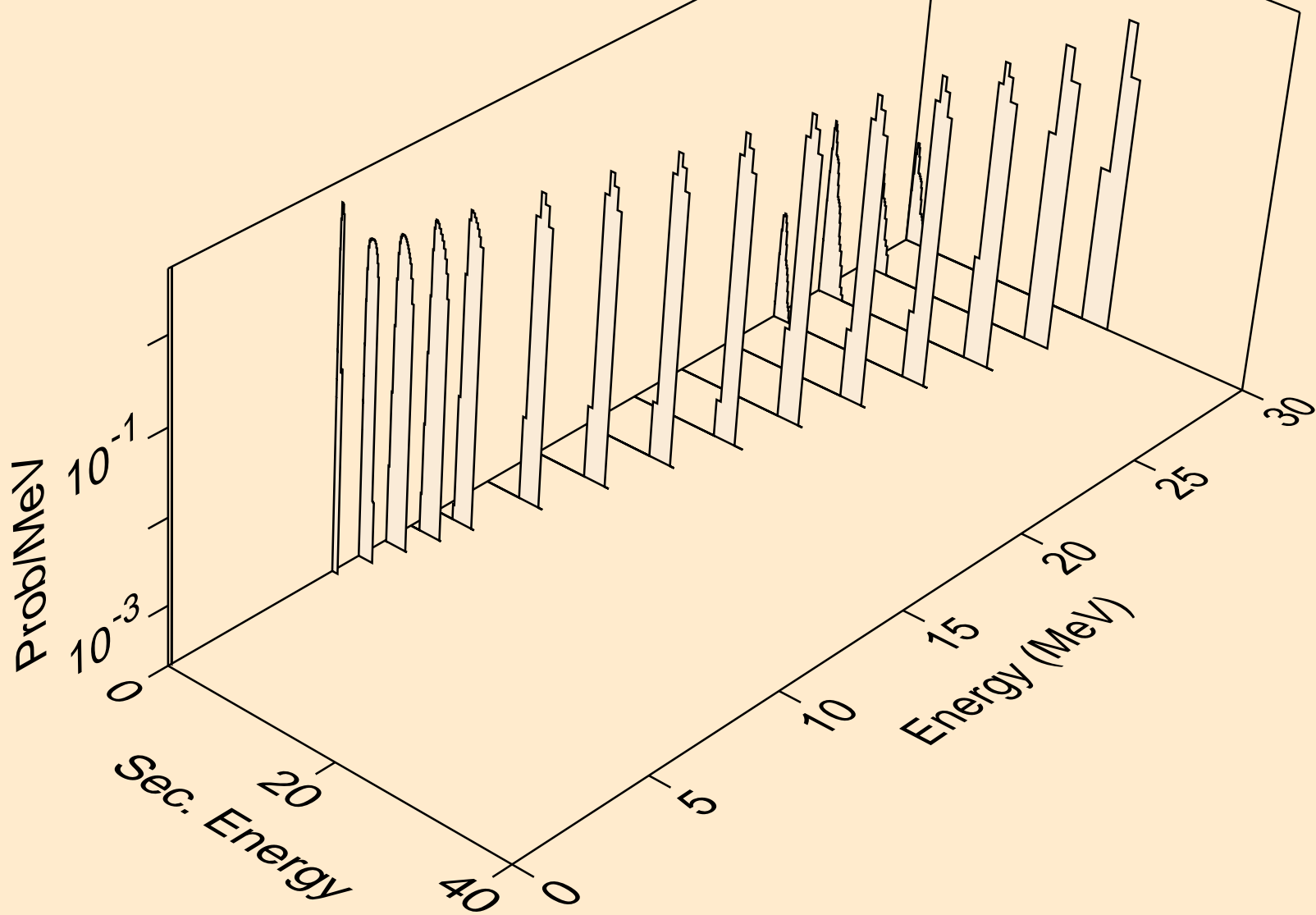

HS272 PROTON ACER TENDL-2021 LIBRARY; T=0.K  
neutrons from (p,2n)a

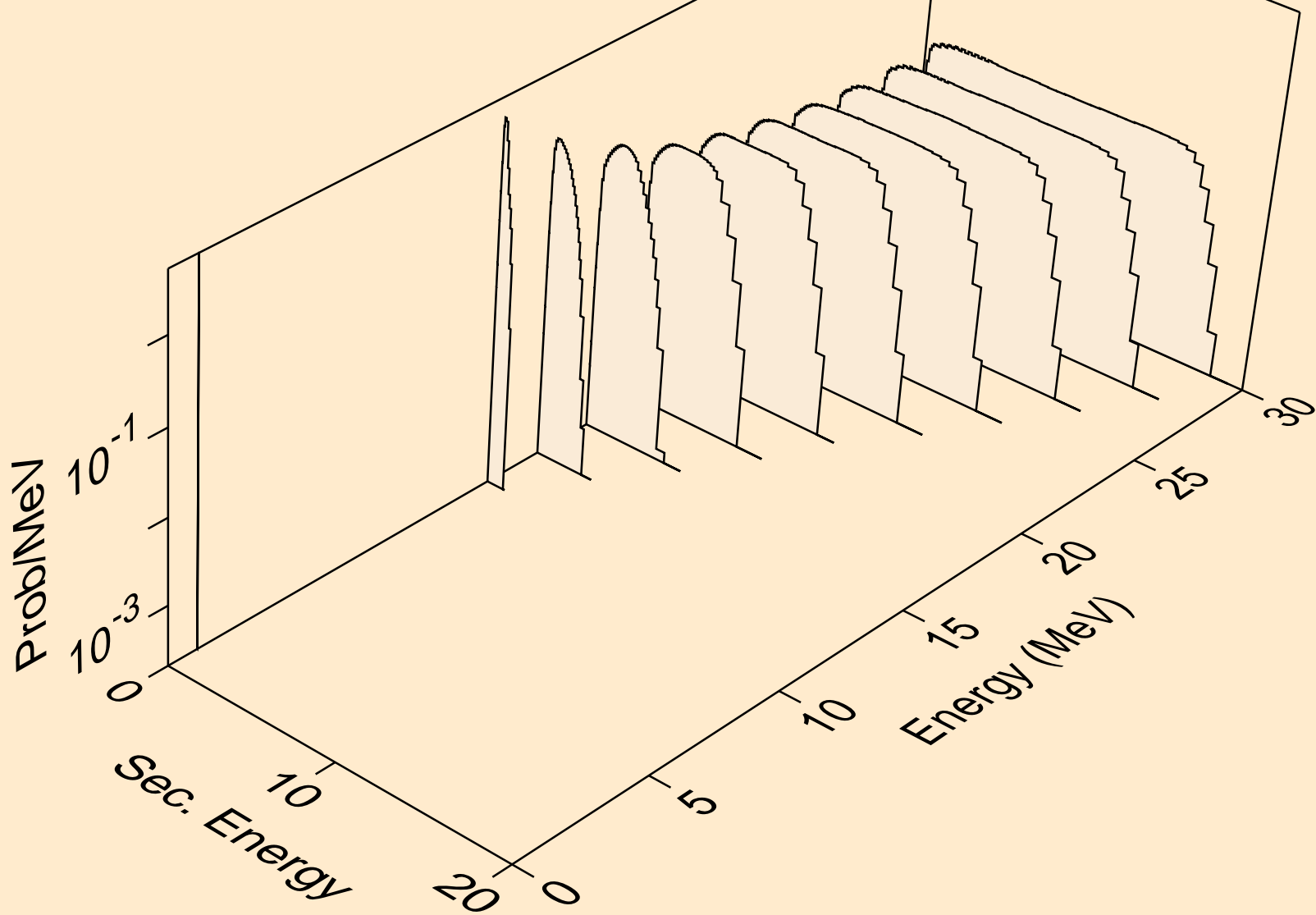

HS272 PROTON ACER TENDL-2021 LIBRARY; T=0.K  
neutrons from (p,3n)a

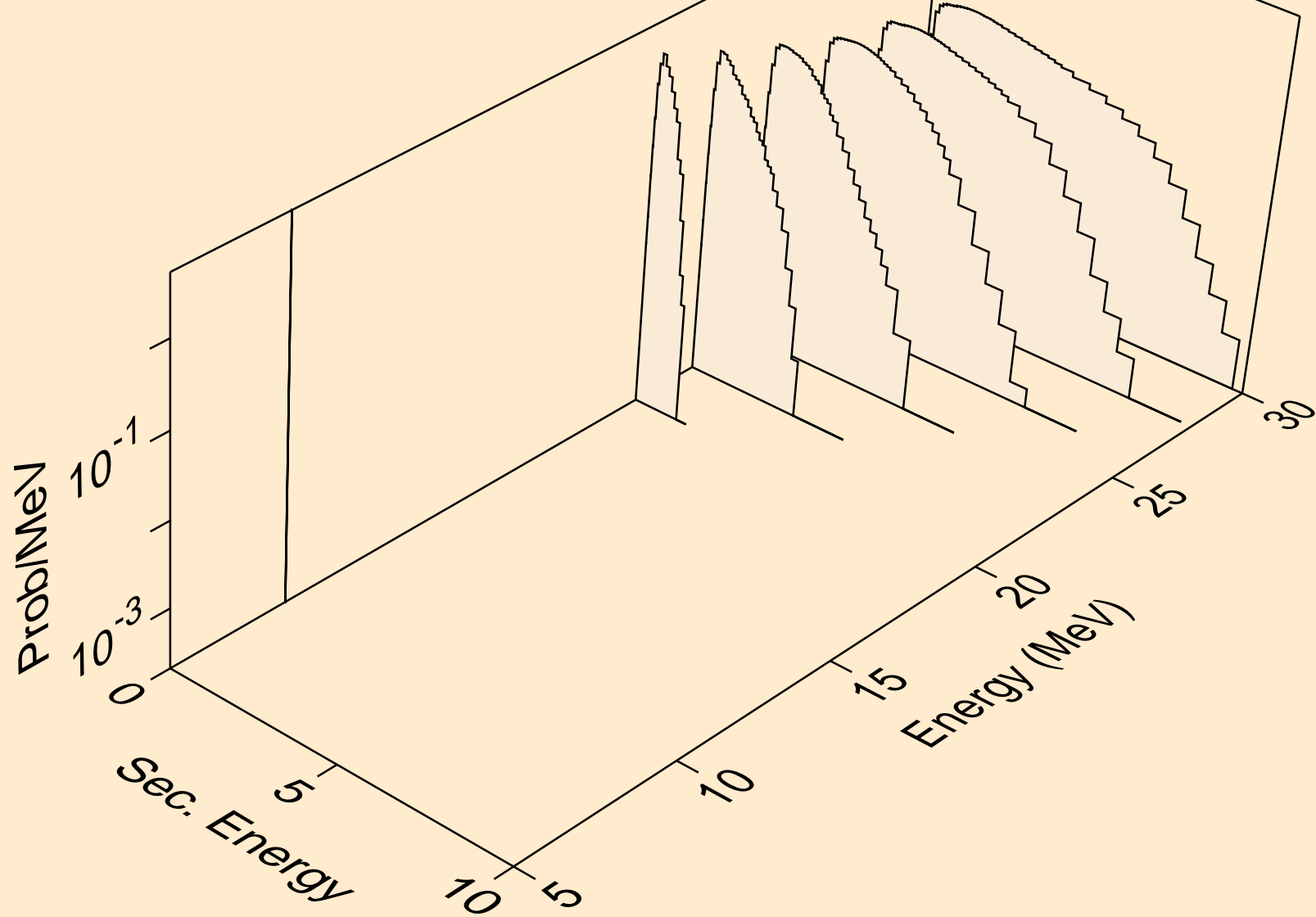



HS272 PROTON ACER TENDL-2021 LIBRARY; T=0.K  
neutrons from (p,n\*)p

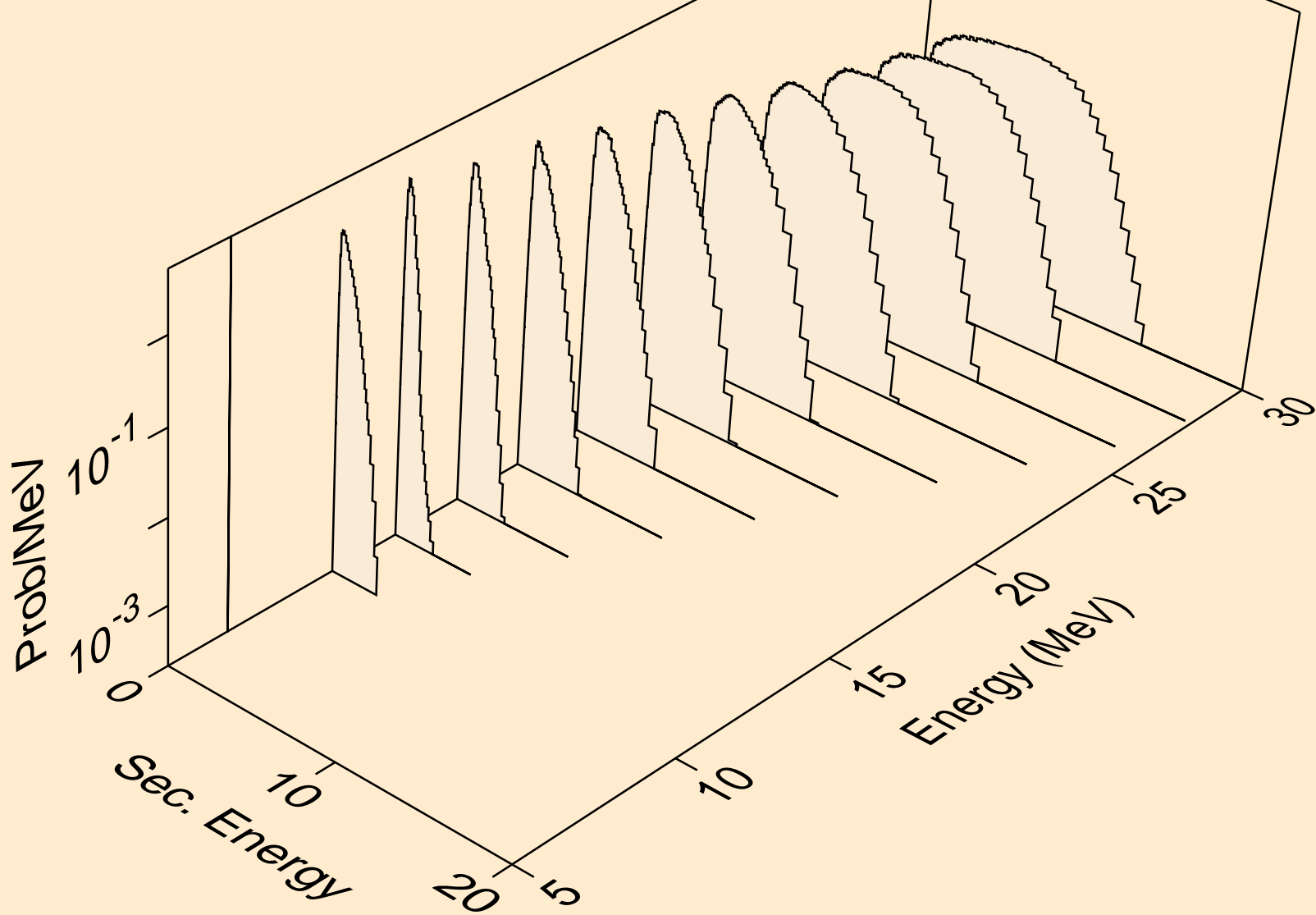

HS272 PROTON ACER TENDL-2021 LIBRARY; T=0.K  
neutrons from (p,n\*)2a

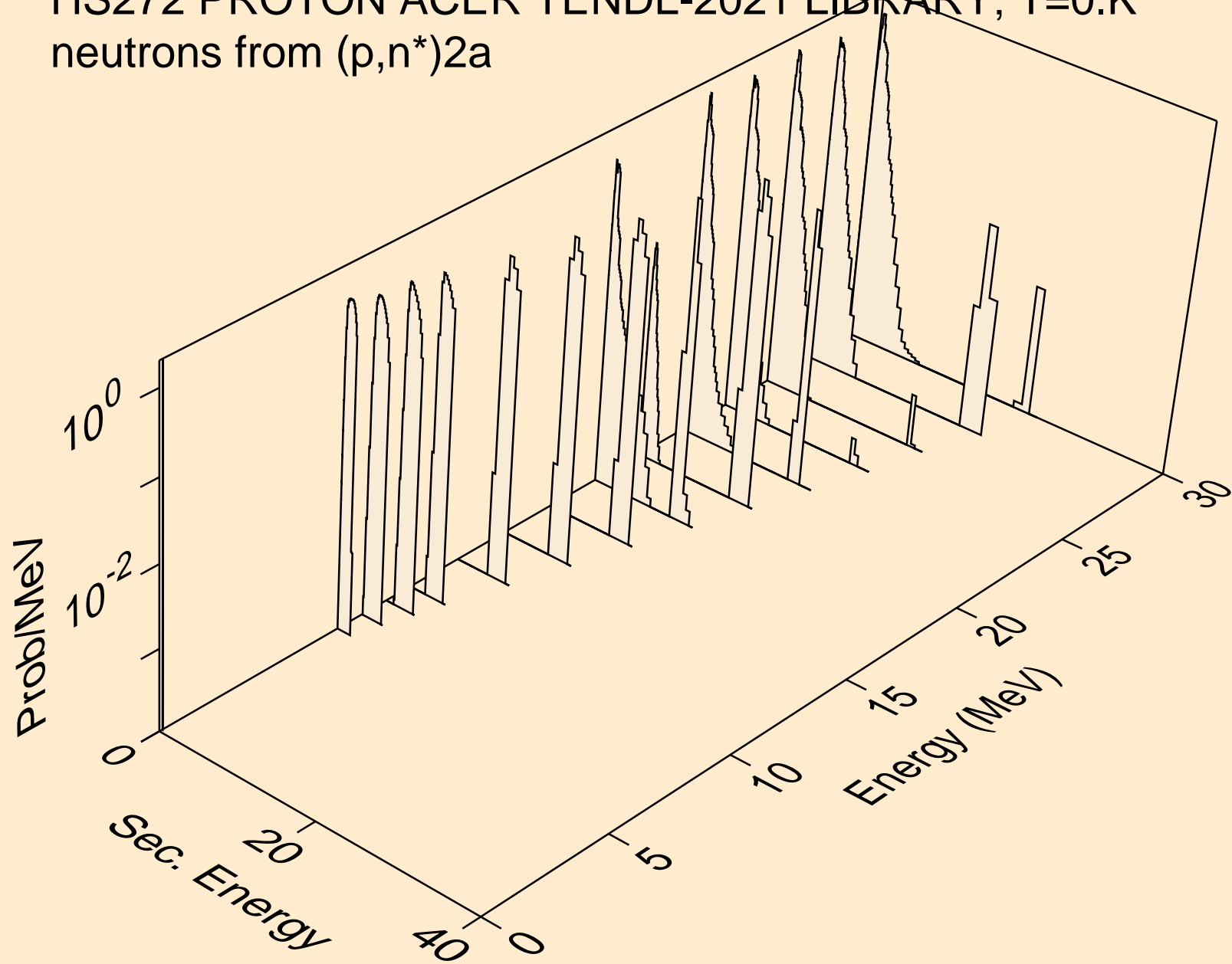

HS272 PROTON ACER TENDL-2021 LIBRARY; T=0.K  
neutrons from (p,n\*)d

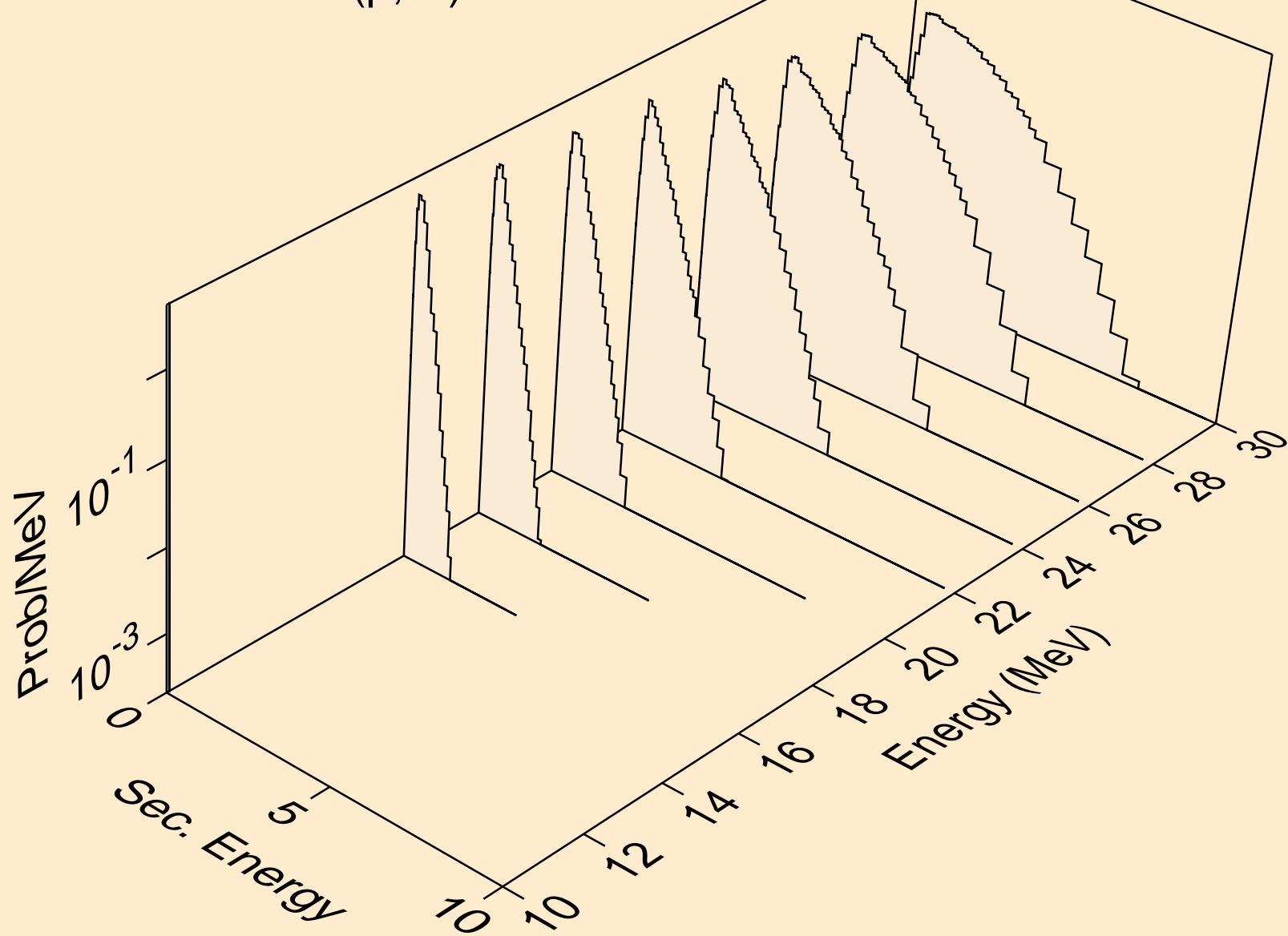

HS272 PROTON ACER TENDL-2021 LIBRARY; T=0.K  
neutrons from (p,n\*)t

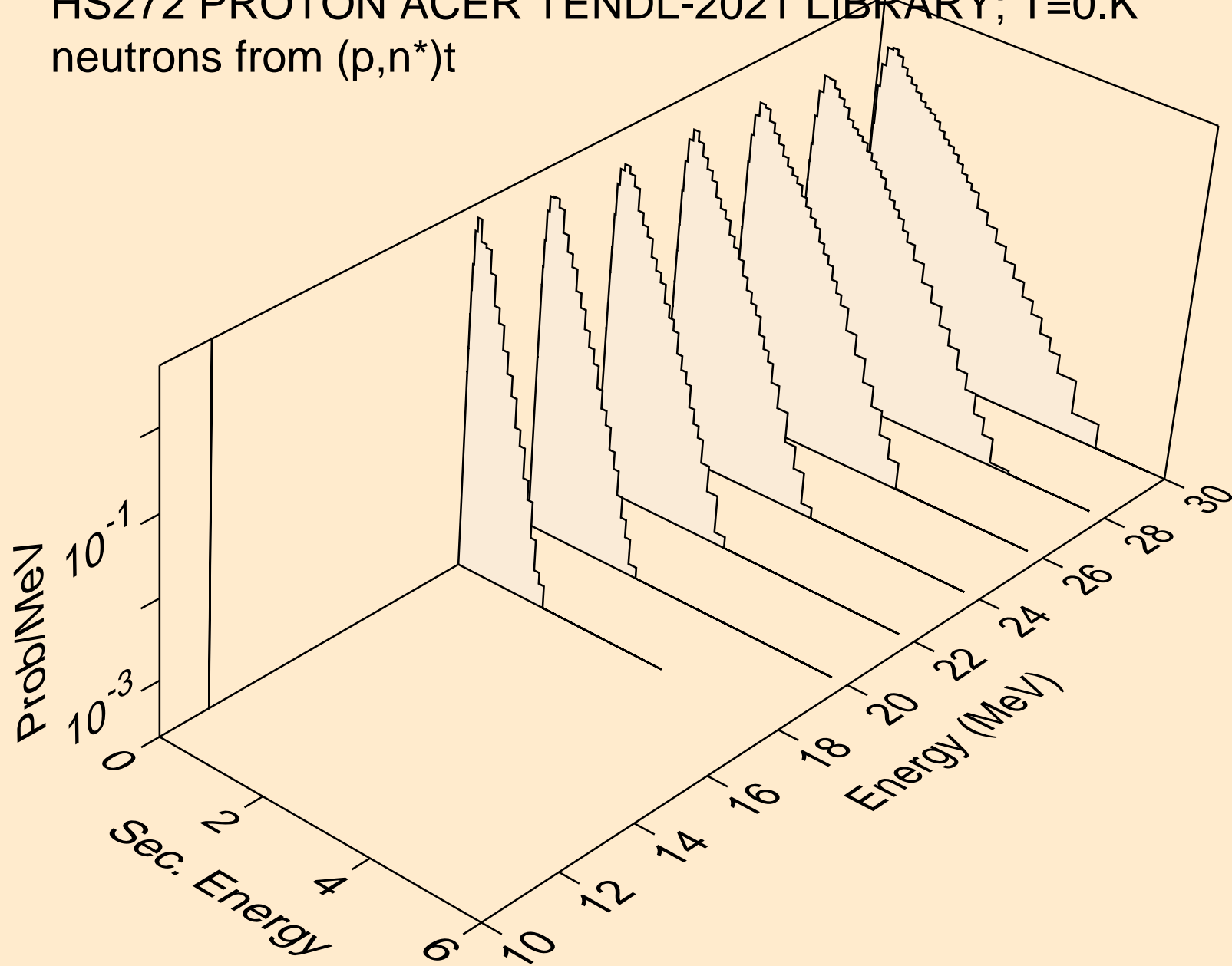

HS272 PROTON ACER TENDL-2021 LIBRARY; T=0.K  
neutrons from (p,2np)

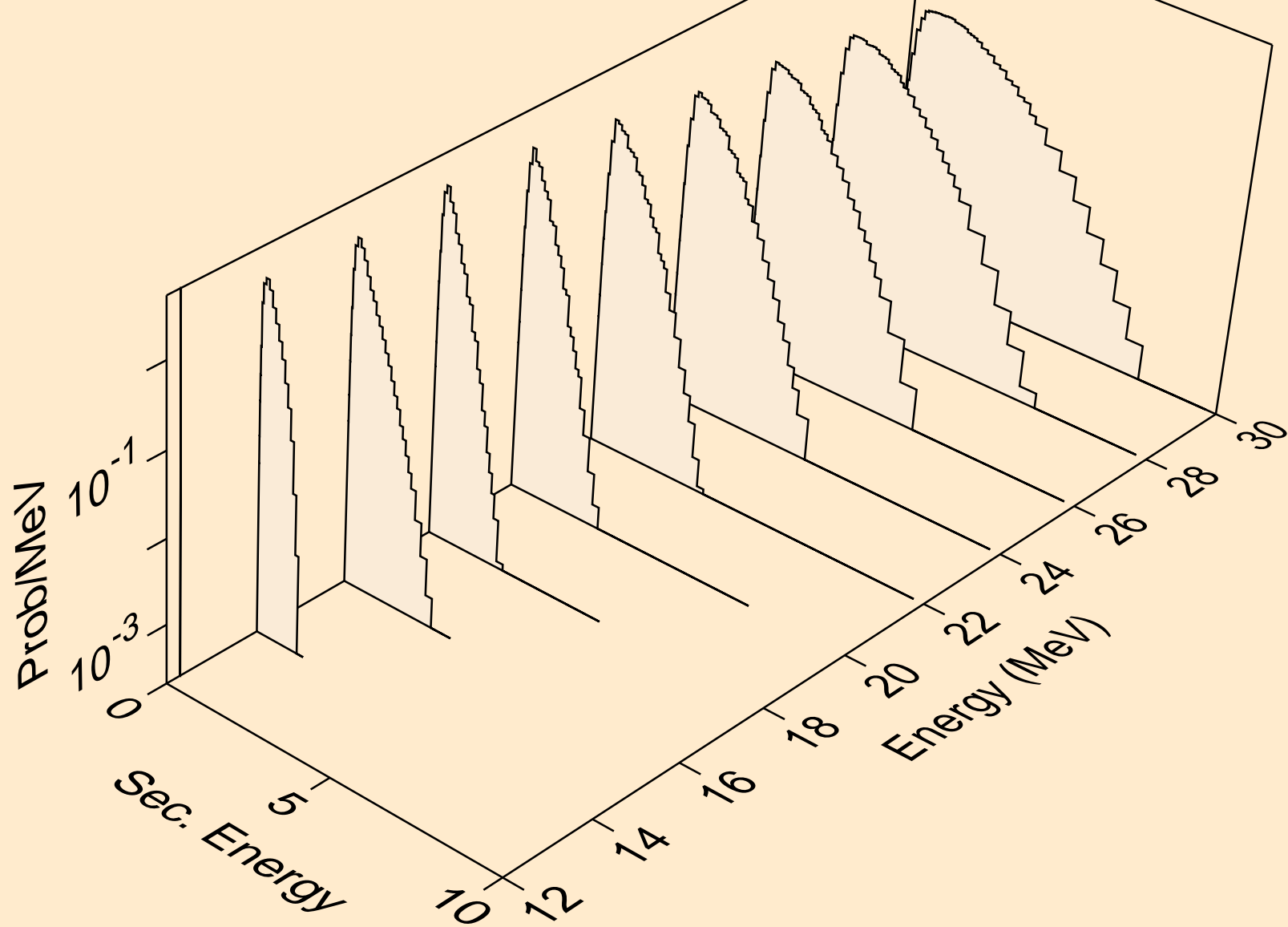

HS272 PROTON ACER TENDL-2021 LIBRARY; T=0.K  
neutrons from (p,npa)

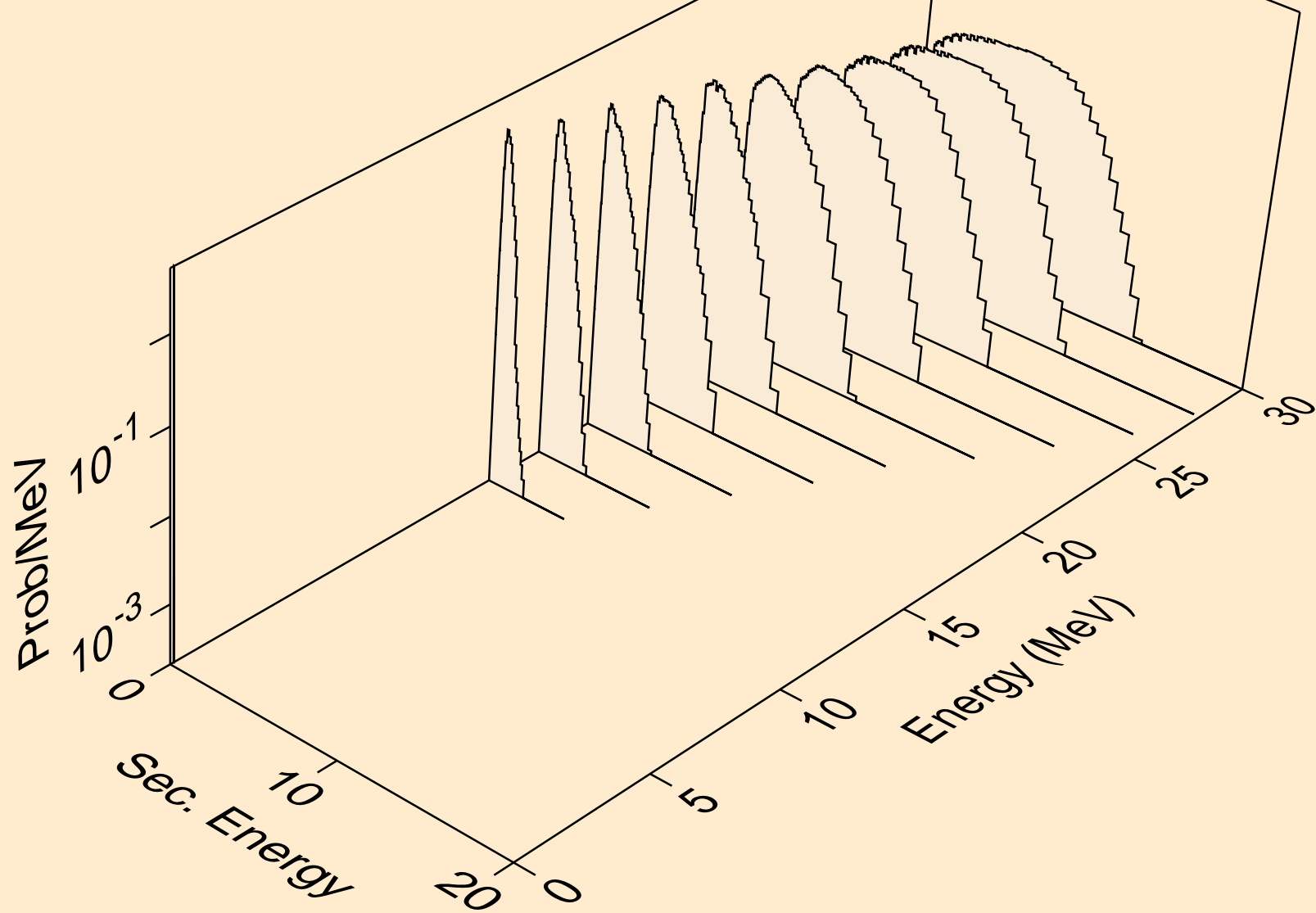

HS272 PROTON ACER TENDL-2021 LIBRARY; T=0.K  
deuterons from (p,x)

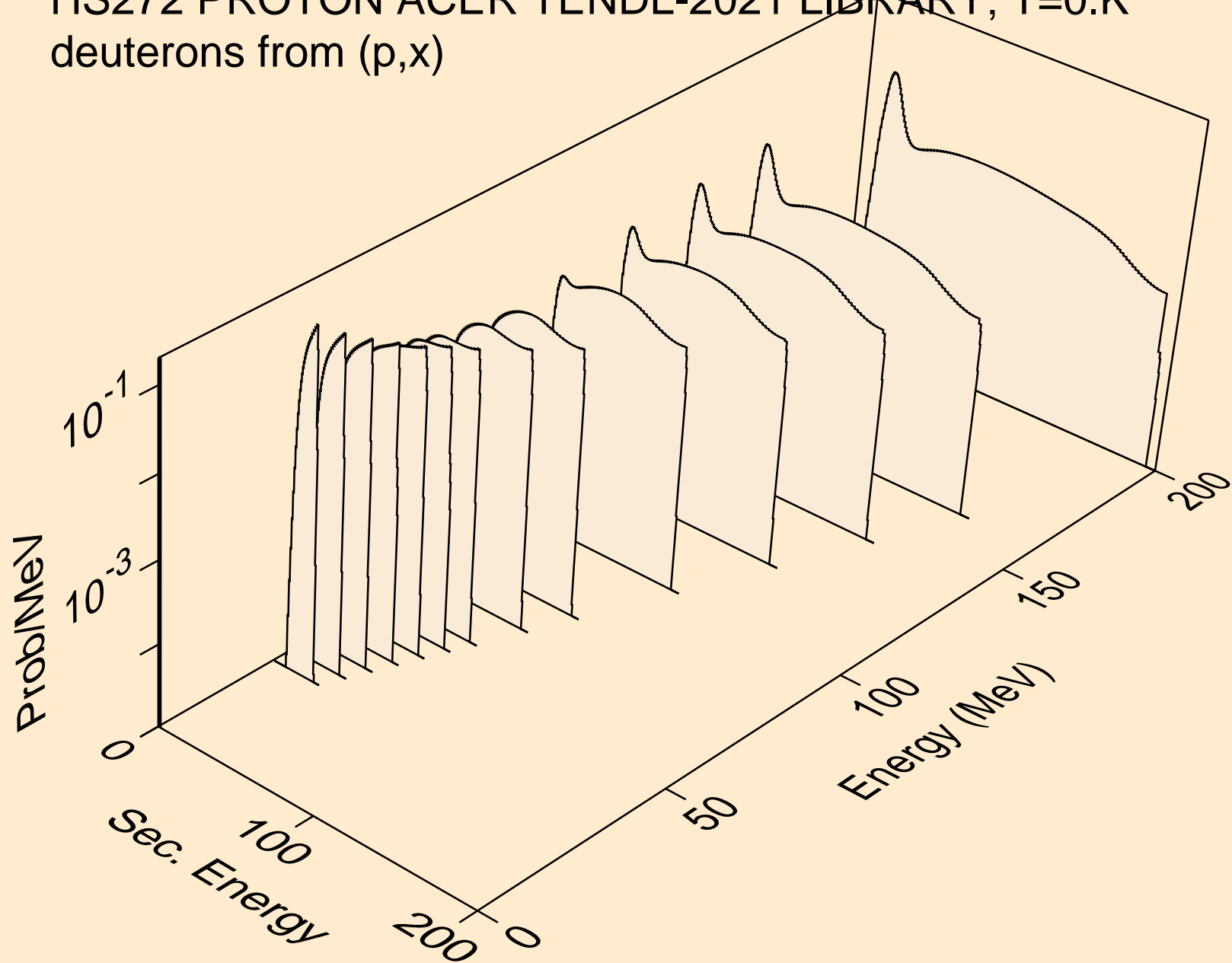

HS272 PROTON ACER TENDL-2021 LIBRARY; T=0.K  
deuterons from (p,n\*)d

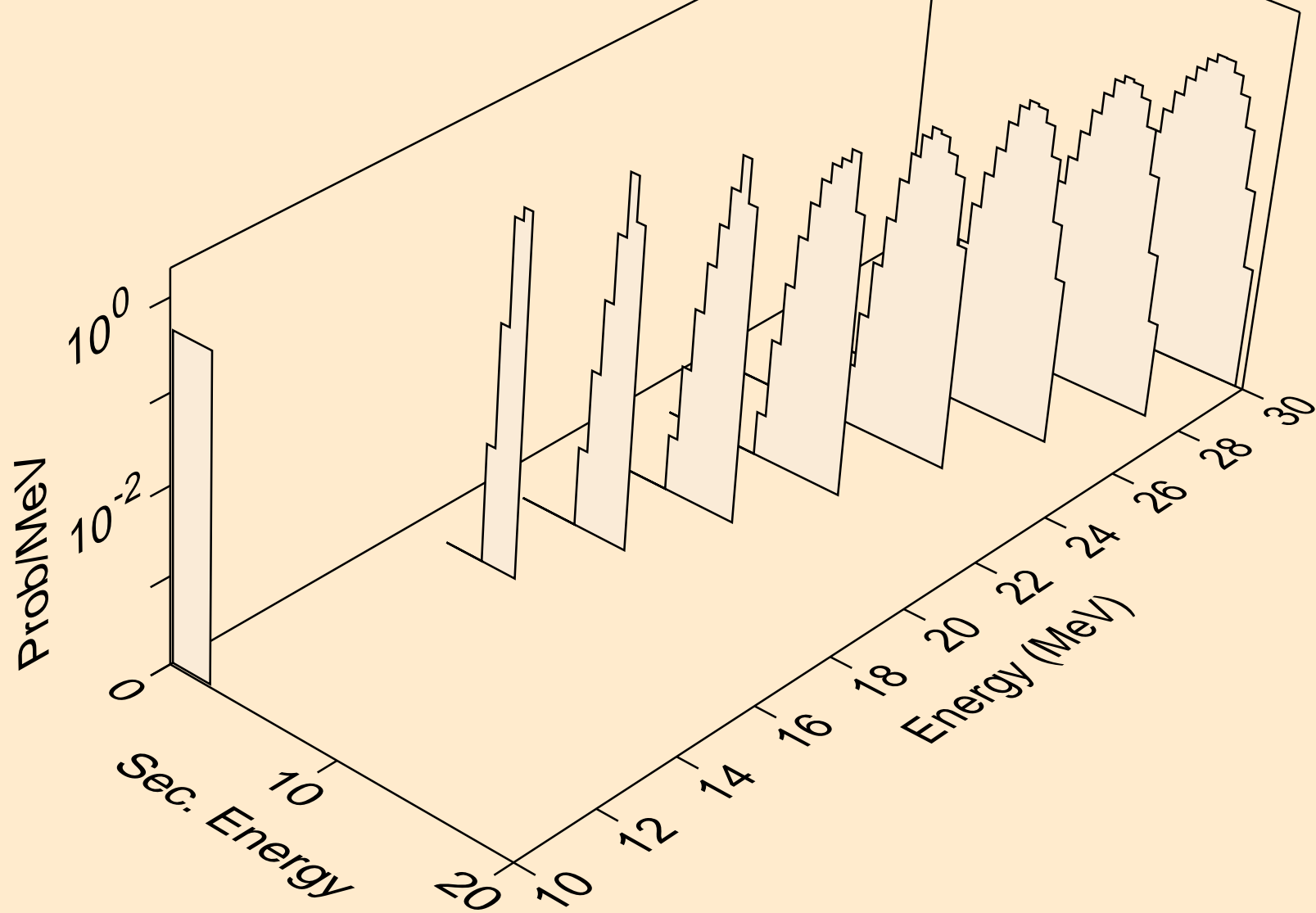



HS272 PROTON ACER TENDL-2021 LIBRARY; T=0.K  
deuterons from (p,d)

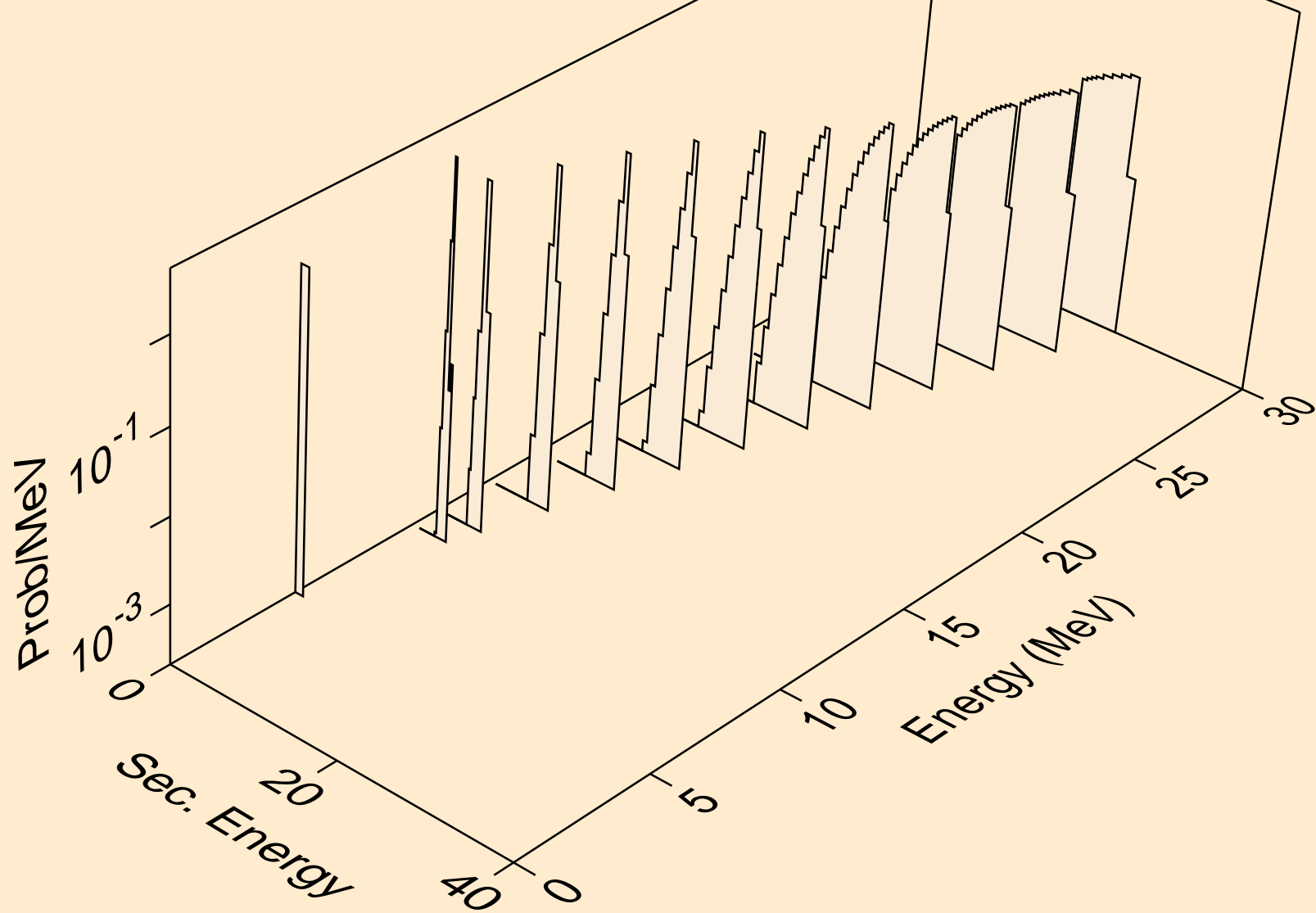

HS272 PROTON ACER TENDL-2021 LIBRARY; T=0.K  
deuterons from (p,da)

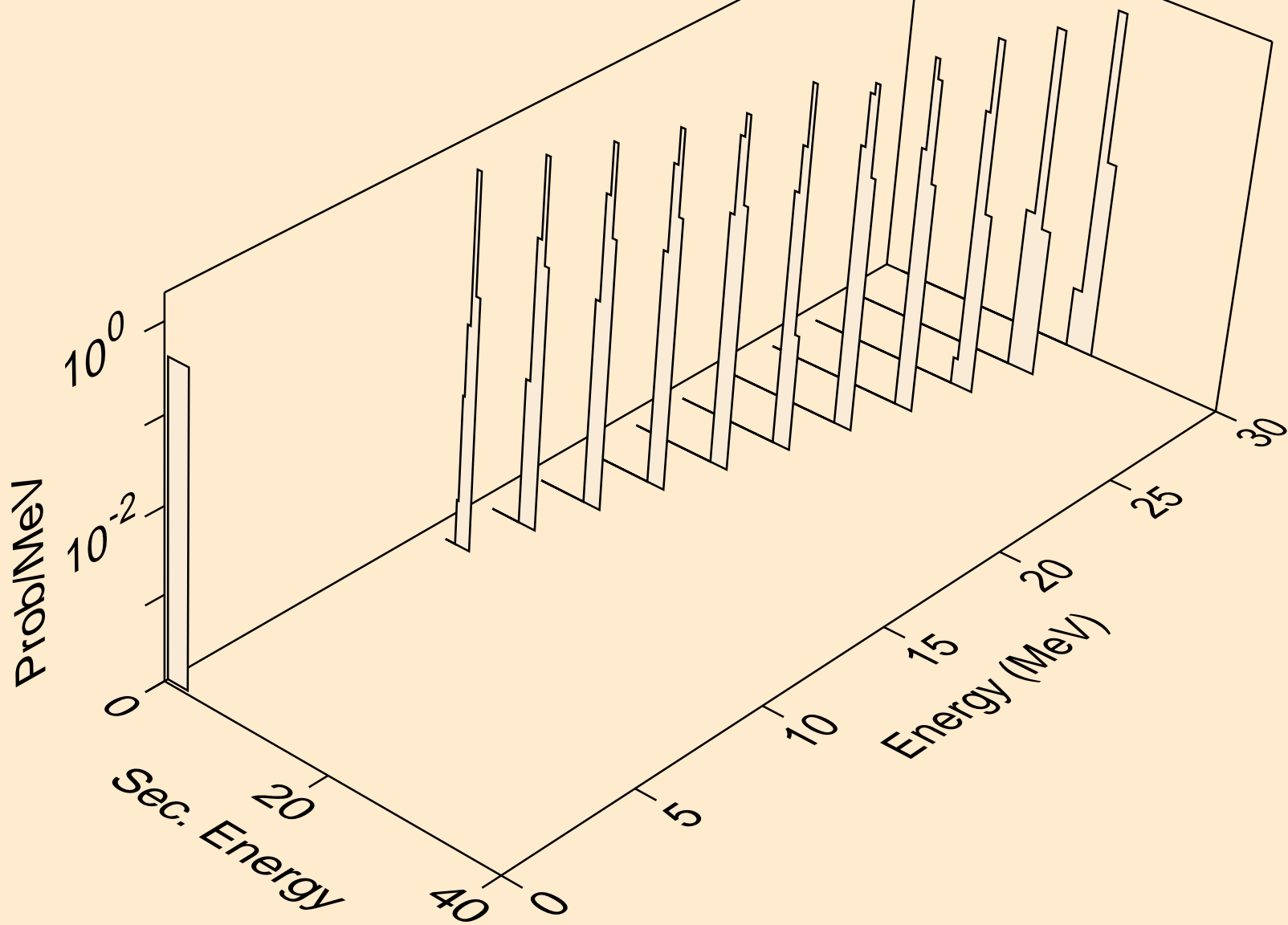

HS272 PROTON ACER TENDL-2021 LIBRARY; T=0.K  
tritons from (p,x)

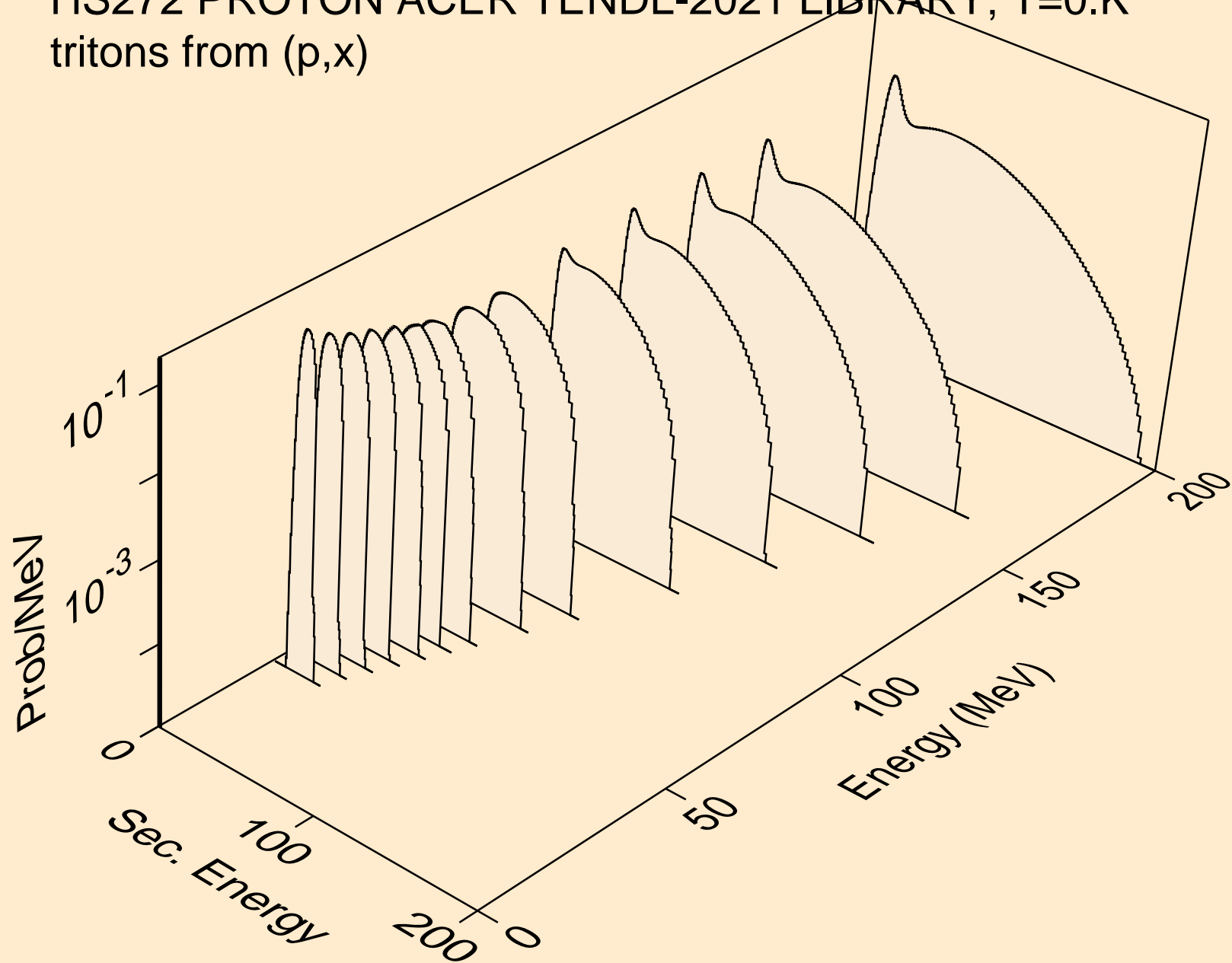

# HS272 PROTON ACER TENDL-2021 LIBRARY; T=0.K

tritons from (p,n\*)t

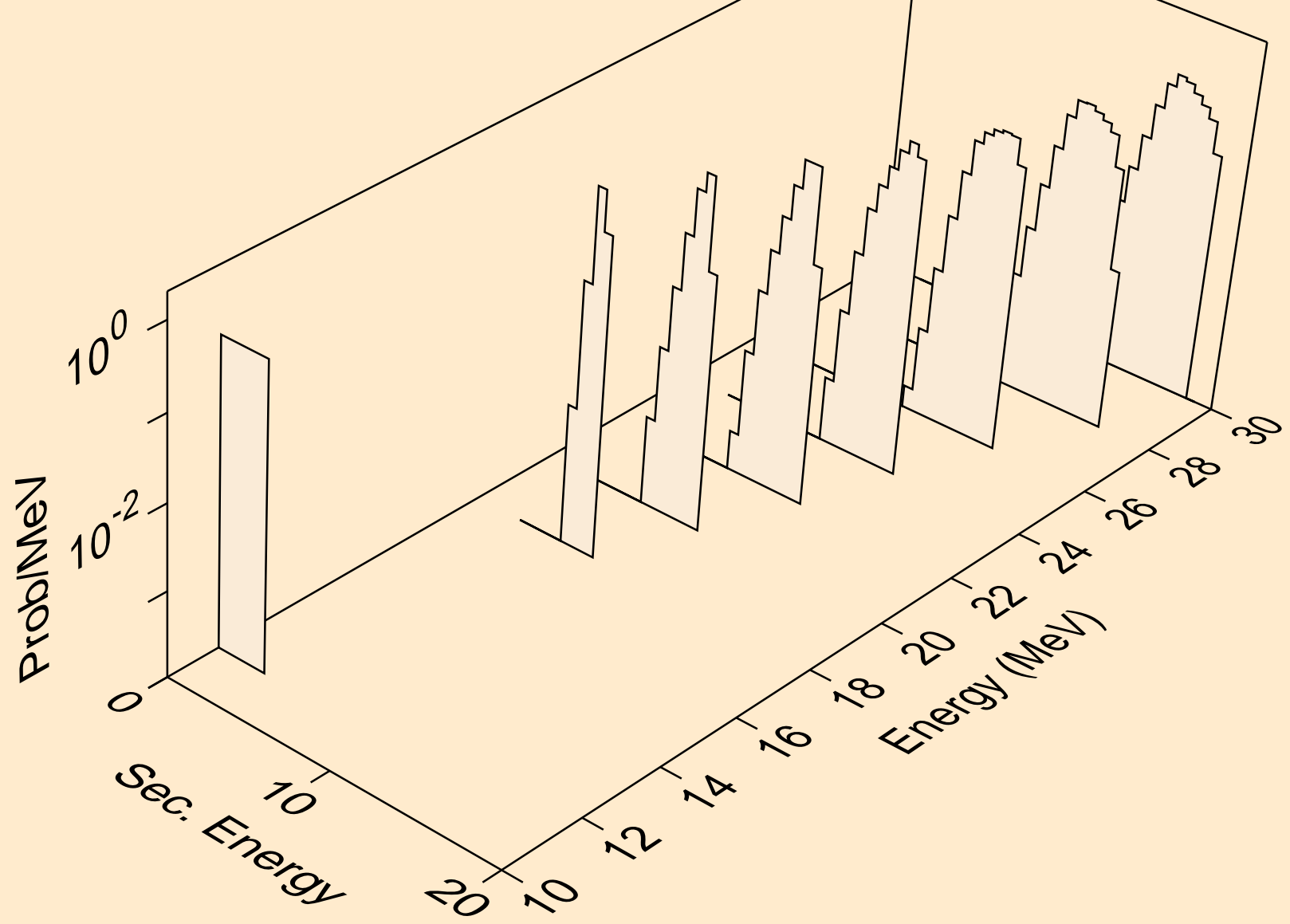

HS272 PROTON ACER TENDL-2021 LIBRARY; T=0.K  
tritons from (p,t)

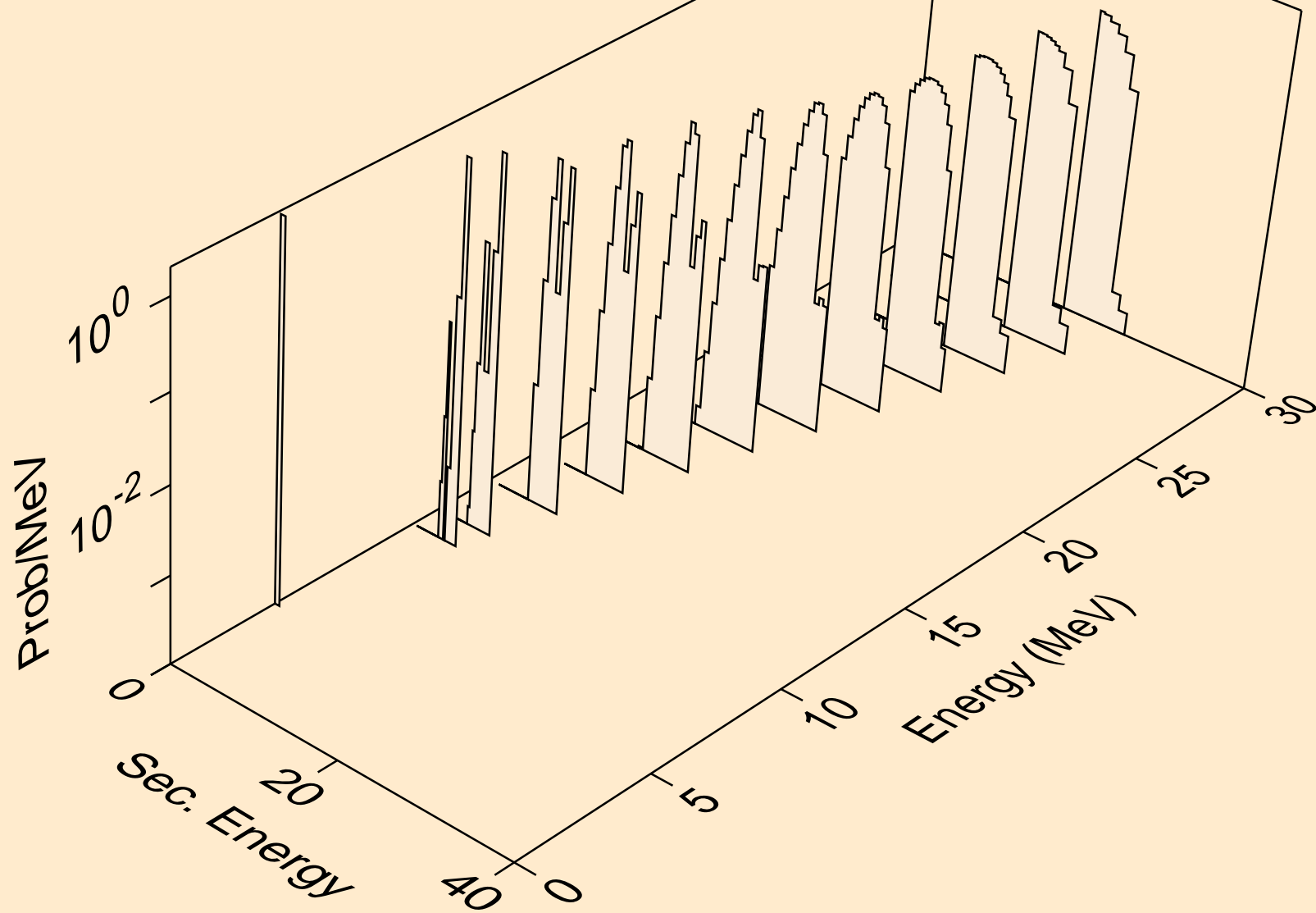

HS272 PROTON ACER TENDL-2021 LIBRARY; T=0.K  
he3s from (p,x)

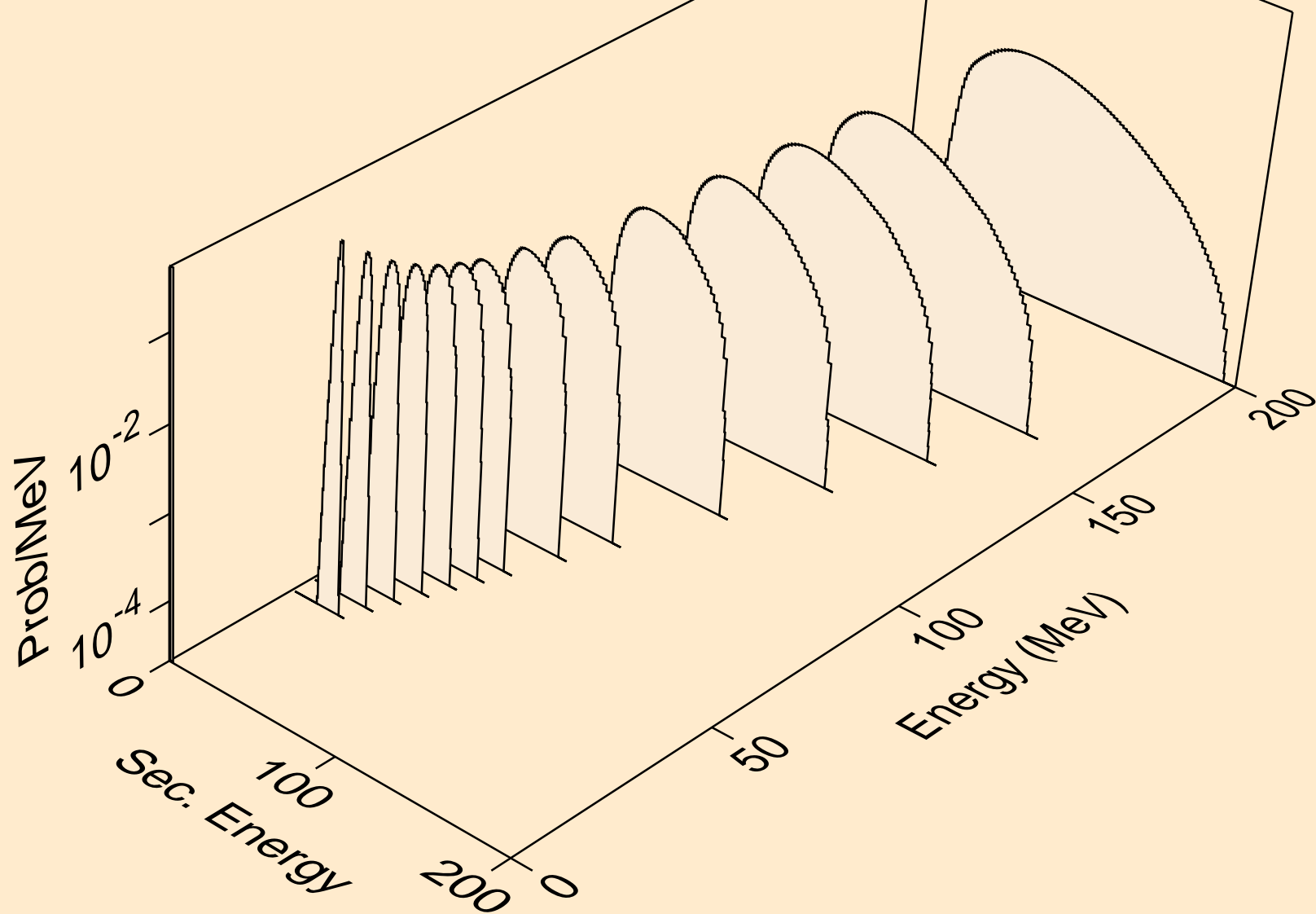

HS272 PROTON ACER TENDL-2021 LIBRARY; T=0.K  
he3s from (p,he3)

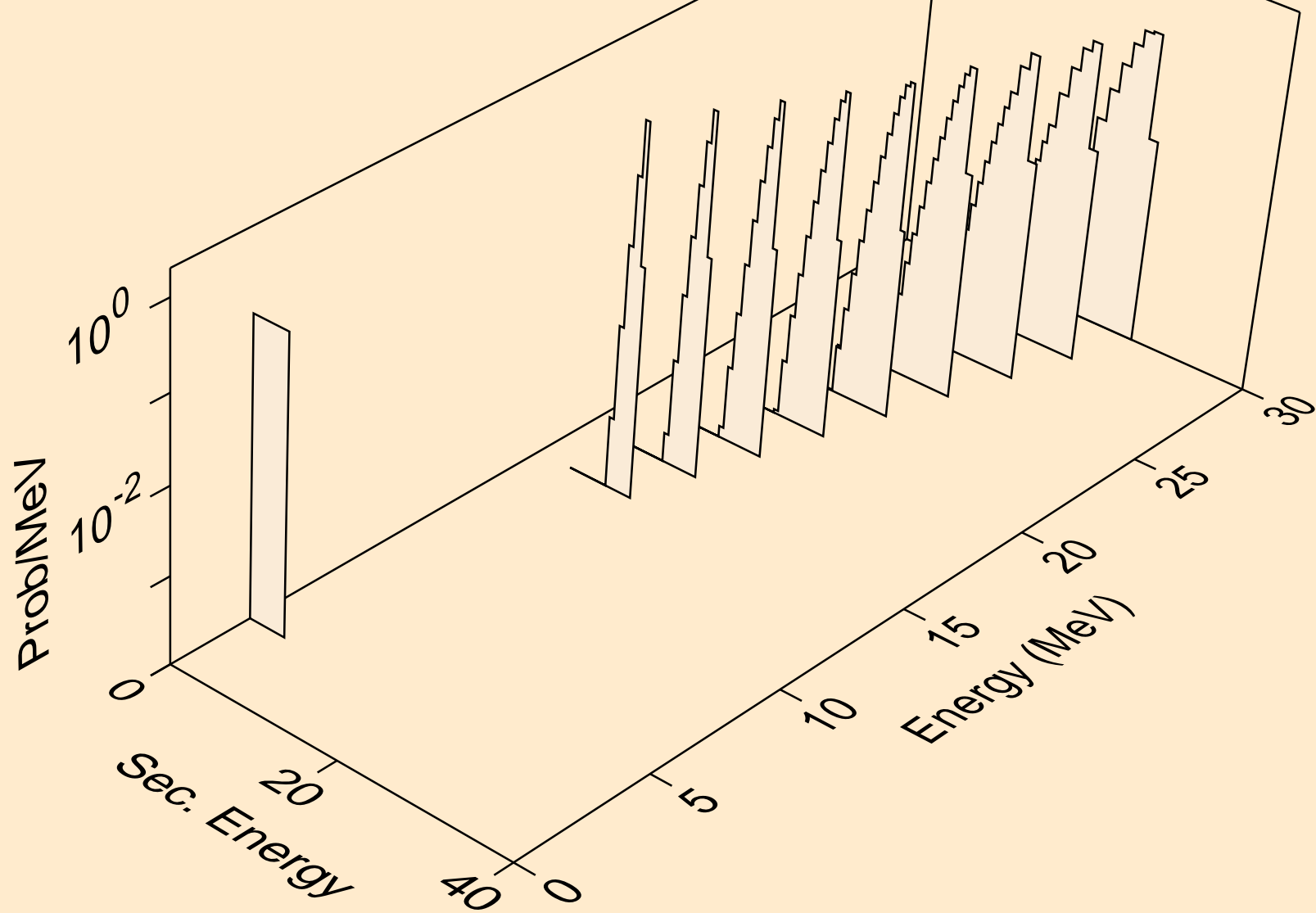

HS272 PROTON ACER TENDL-2021 LIBRARY; T=0.K  
alphas from (p,x)

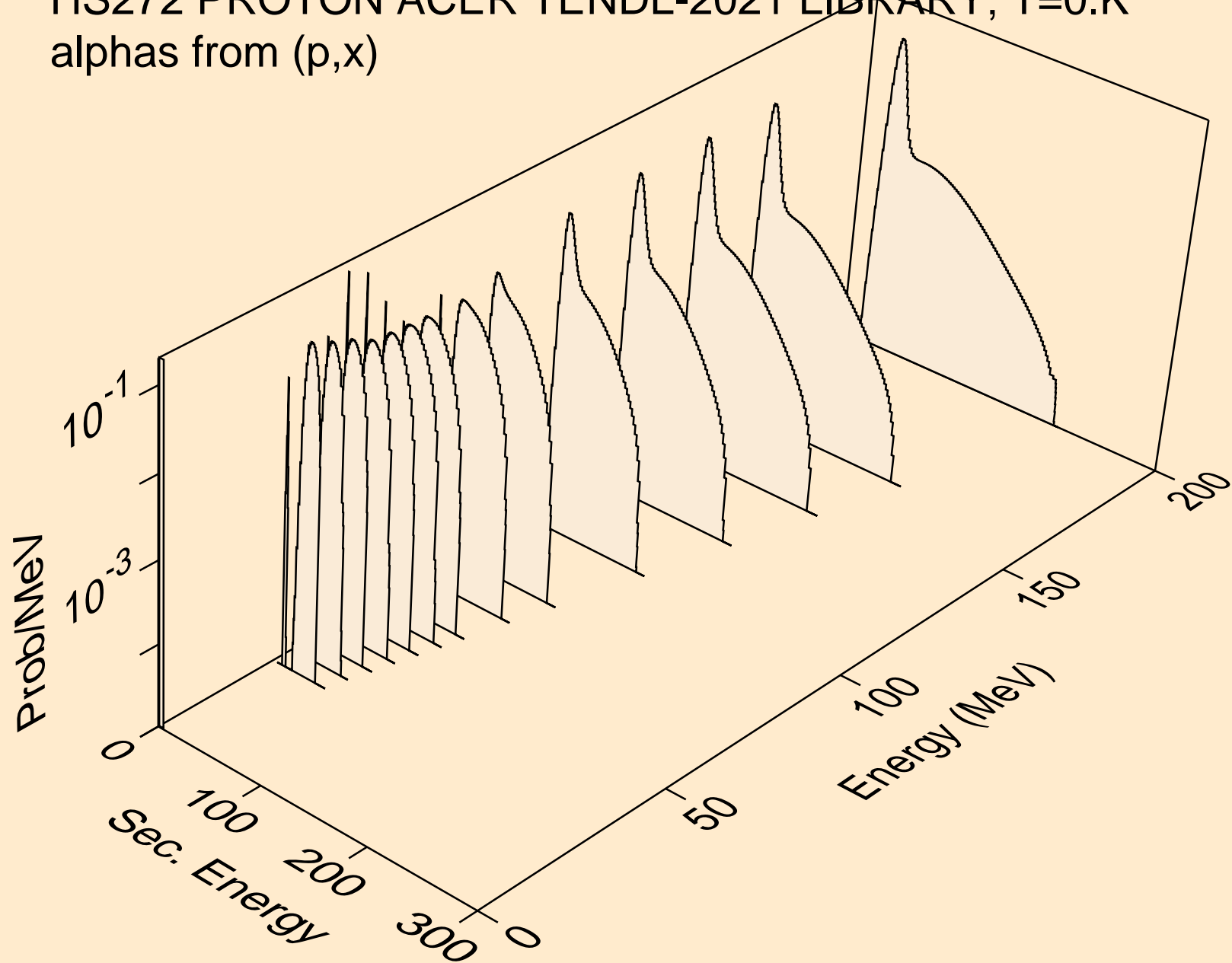



HS272 PROTON ACER TENDL-2021 LIBRARY; T=0.K  
alphas from (p,n\*)a

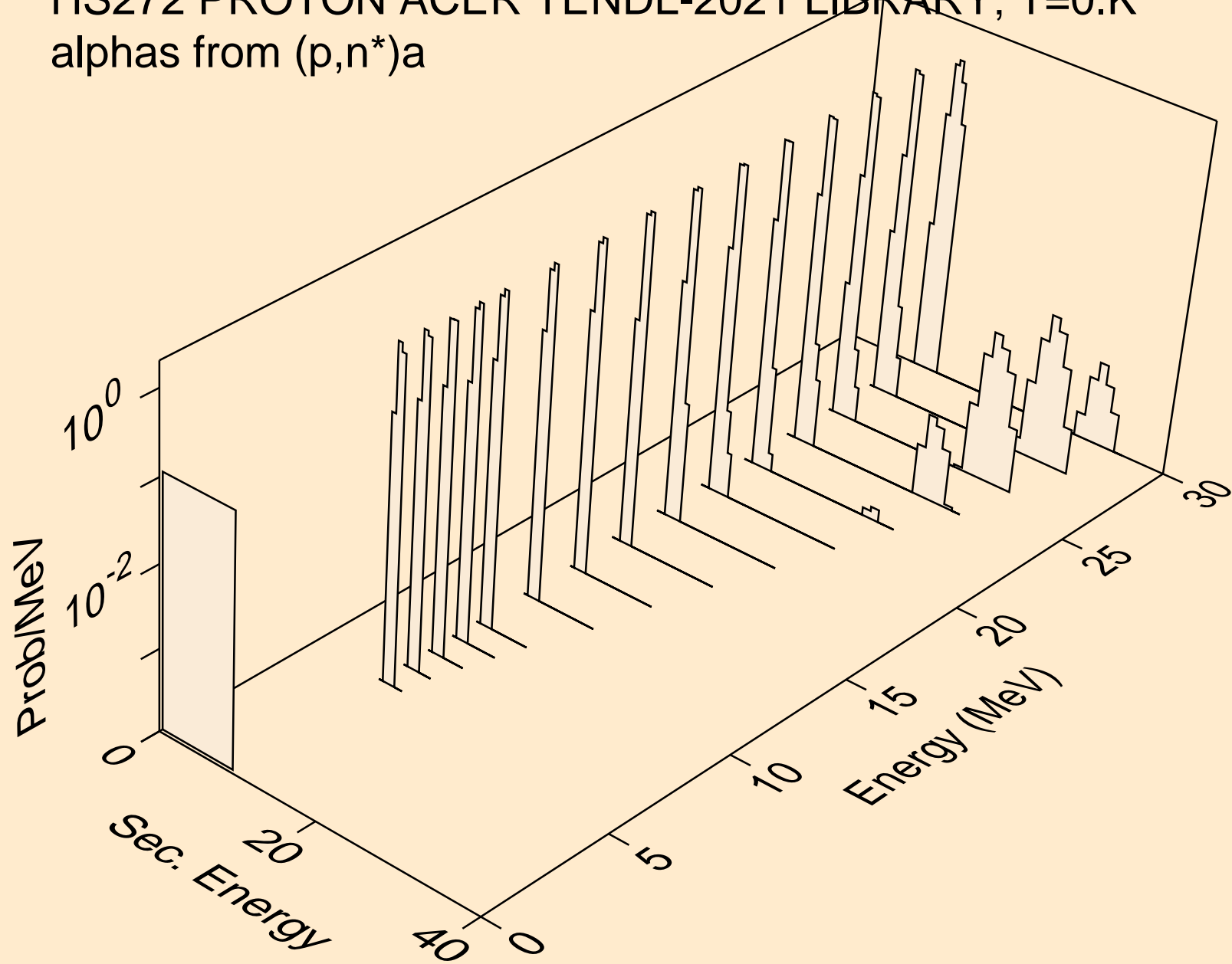

HS272 PROTON ACER TENDL-2021 LIBRARY; T=0.K  
alphas from (p,2n)a

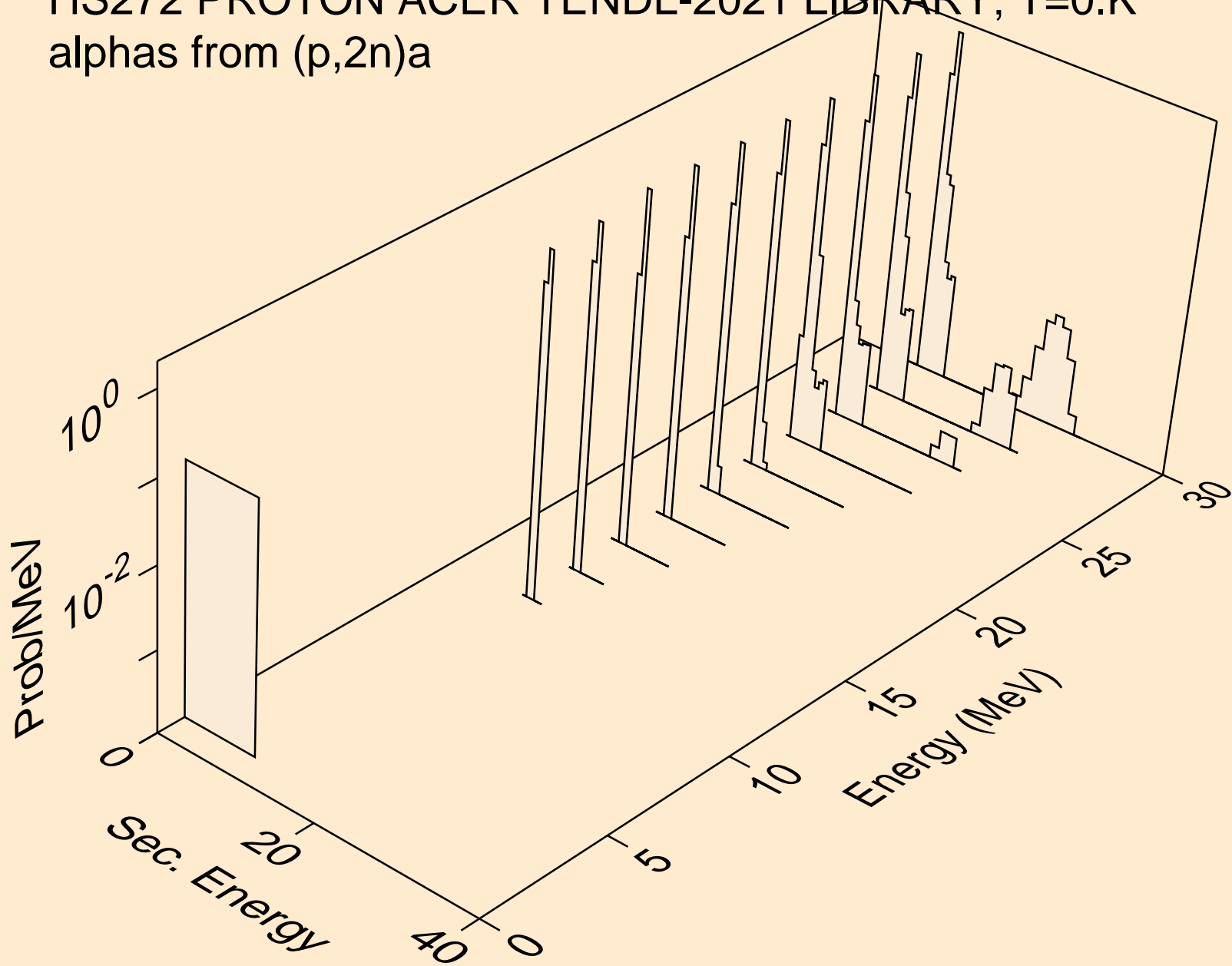

HS272 PROTON ACER TENDL-2021 LIBRARY; T=0.K  
alphas from (p,3n)a

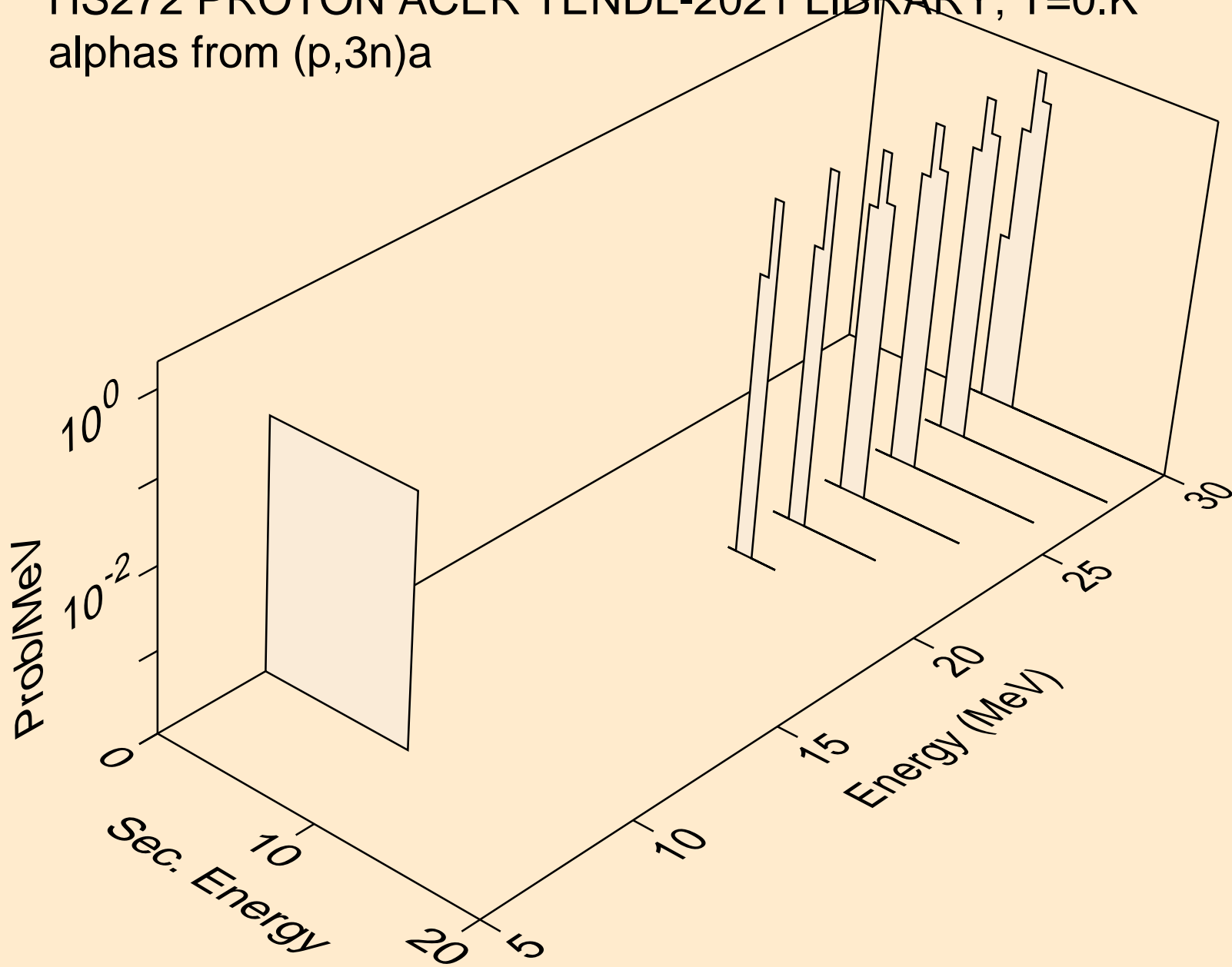

HS272 PROTON ACER TENDL-2021 LIBRARY; T=0.K  
alphas from (p,n\*)2a

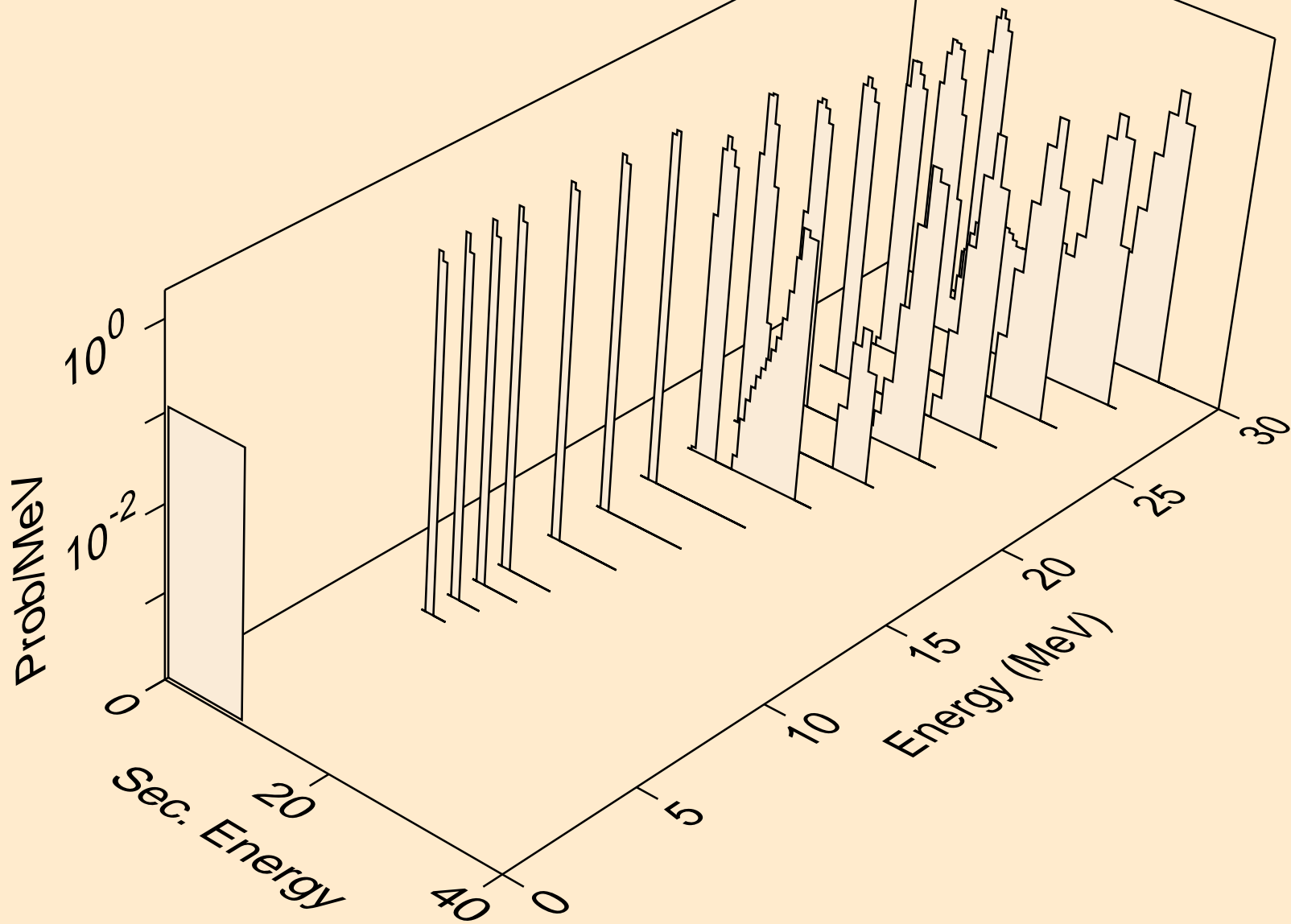

HS272 PROTON ACER TENDL-2021 LIBRARY; T=0.K  
alphas from (p,npa)

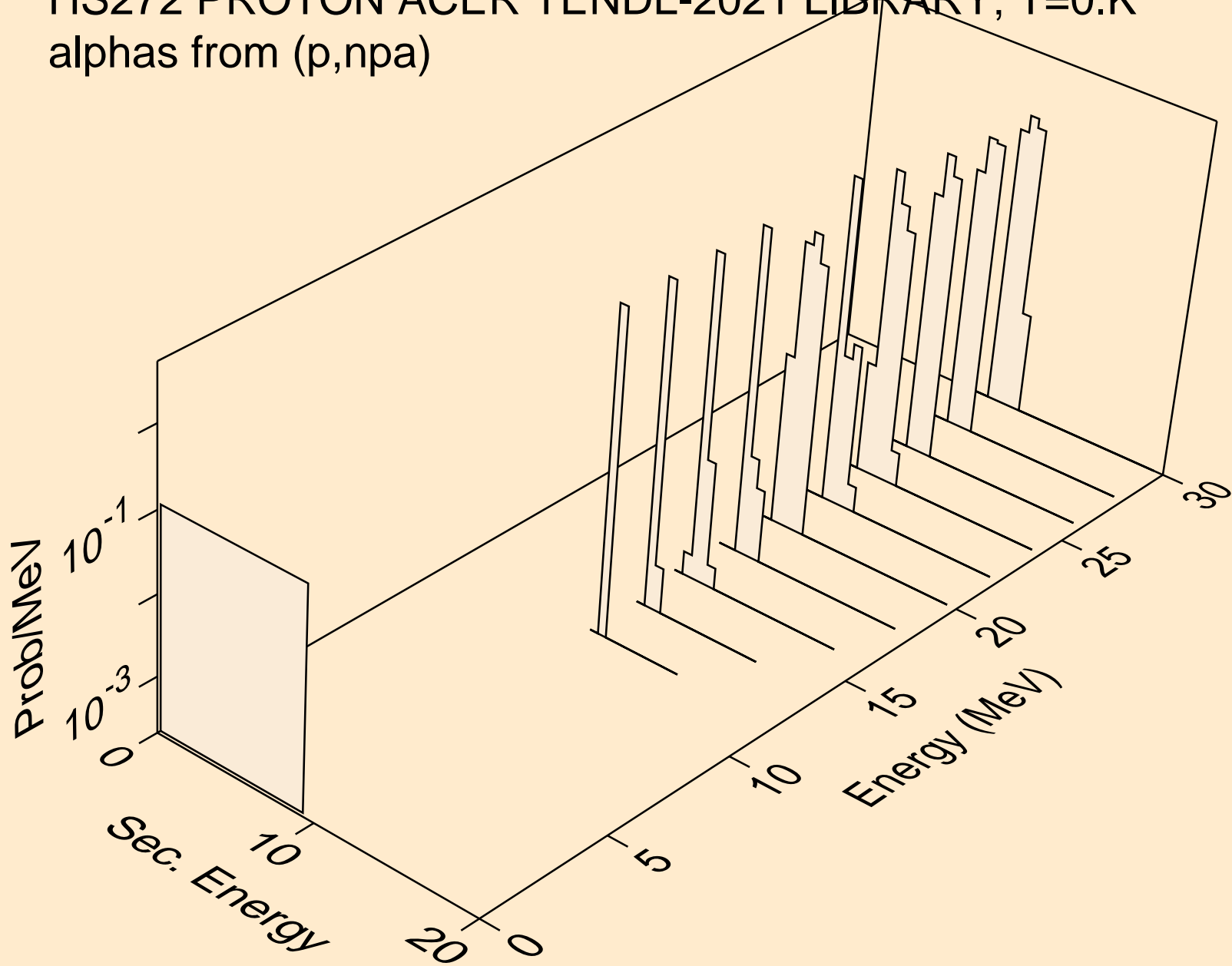

HS272 PROTON ACER TENDL-2021 LIBRARY; T=0.K  
alphas from (p,a)

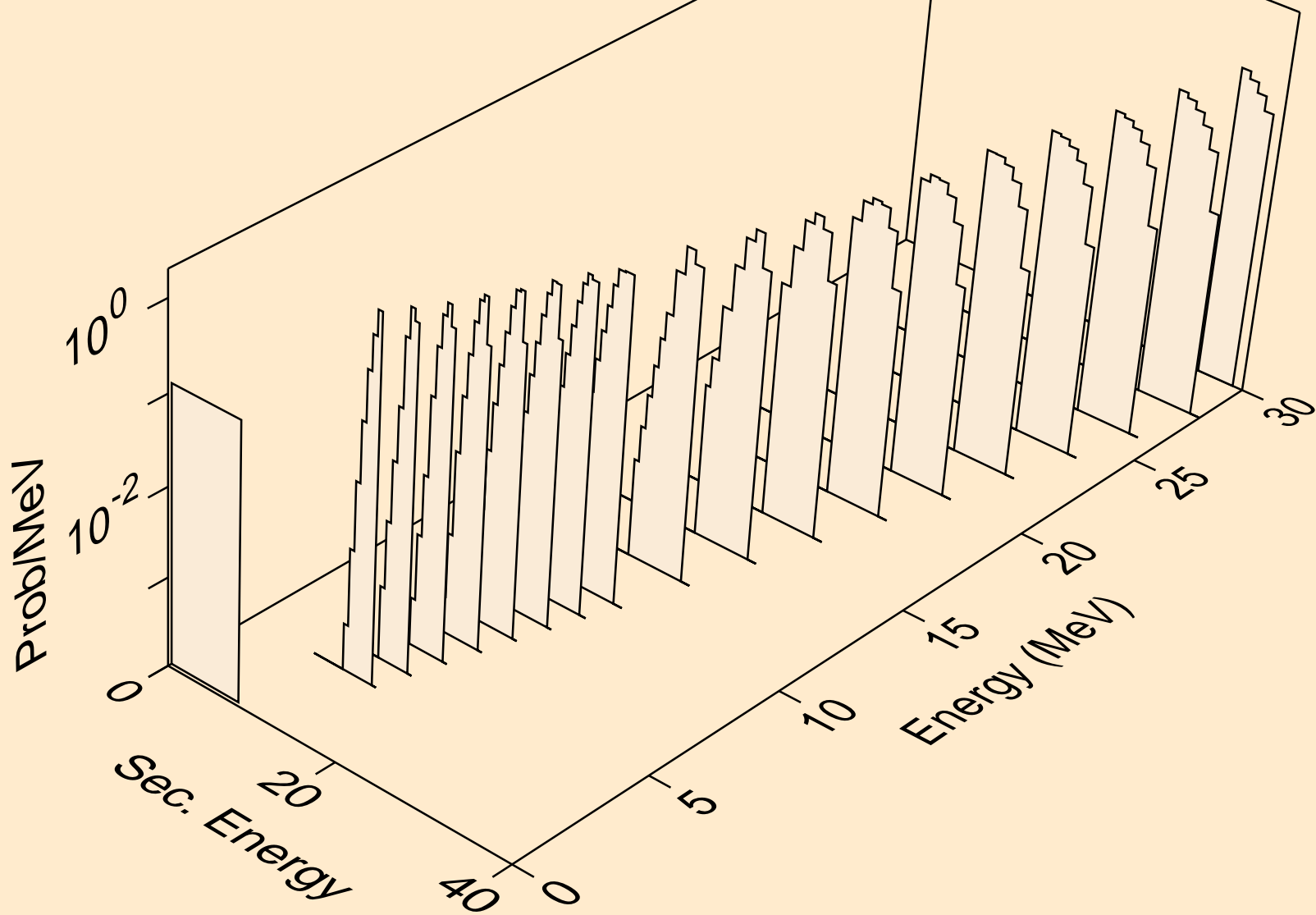

HS272 PROTON ACER TENDL-2021 LIBRARY; T=0.K  
alphas from (p,pa)

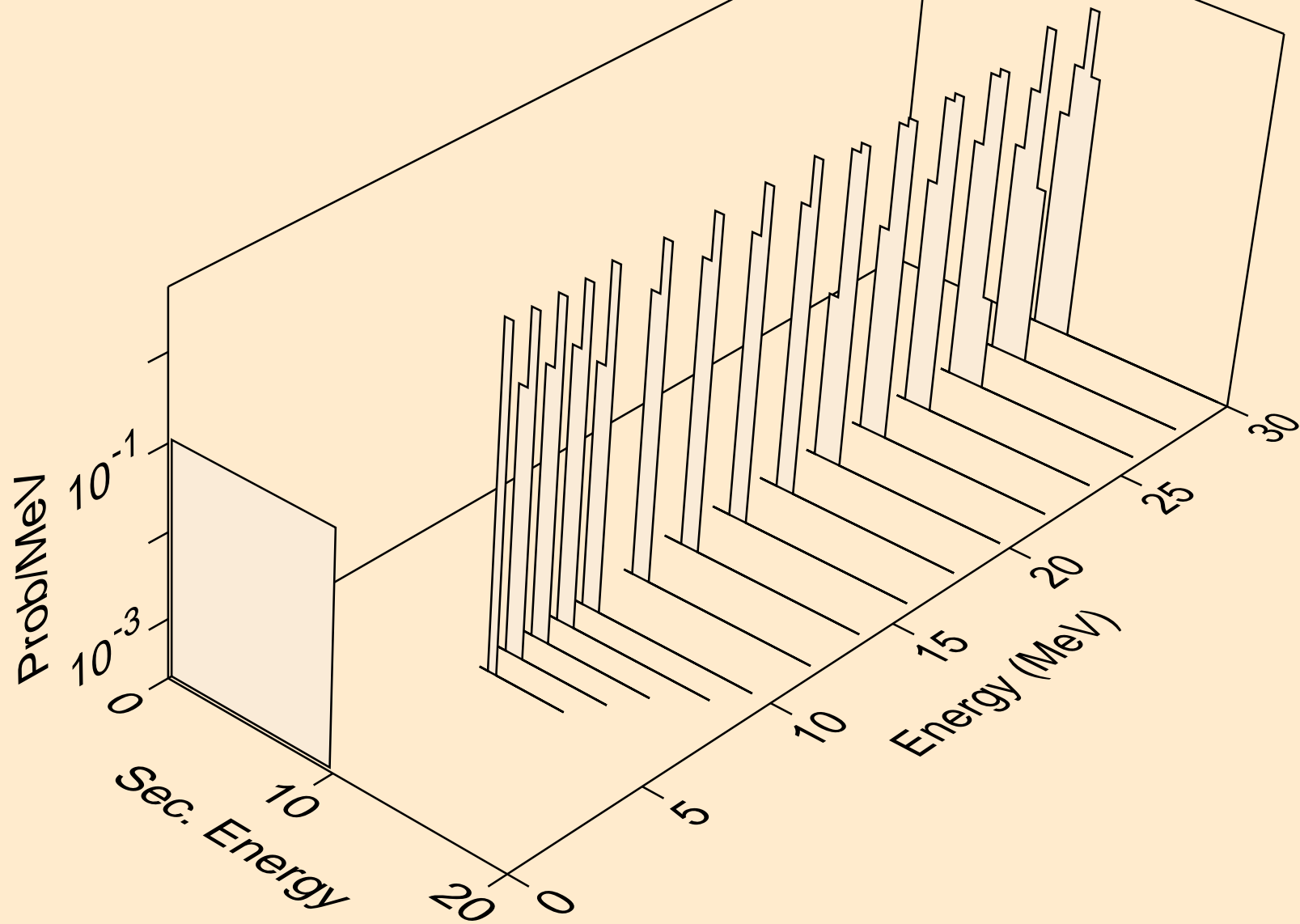

HS272 PROTON ACER TENDL-2021 LIBRARY; T=0.K  
alphas from (p,da)

