

# I127 PROTON ACER TENDL-2021 LIBRARY; T=0.K

## Principal cross sections

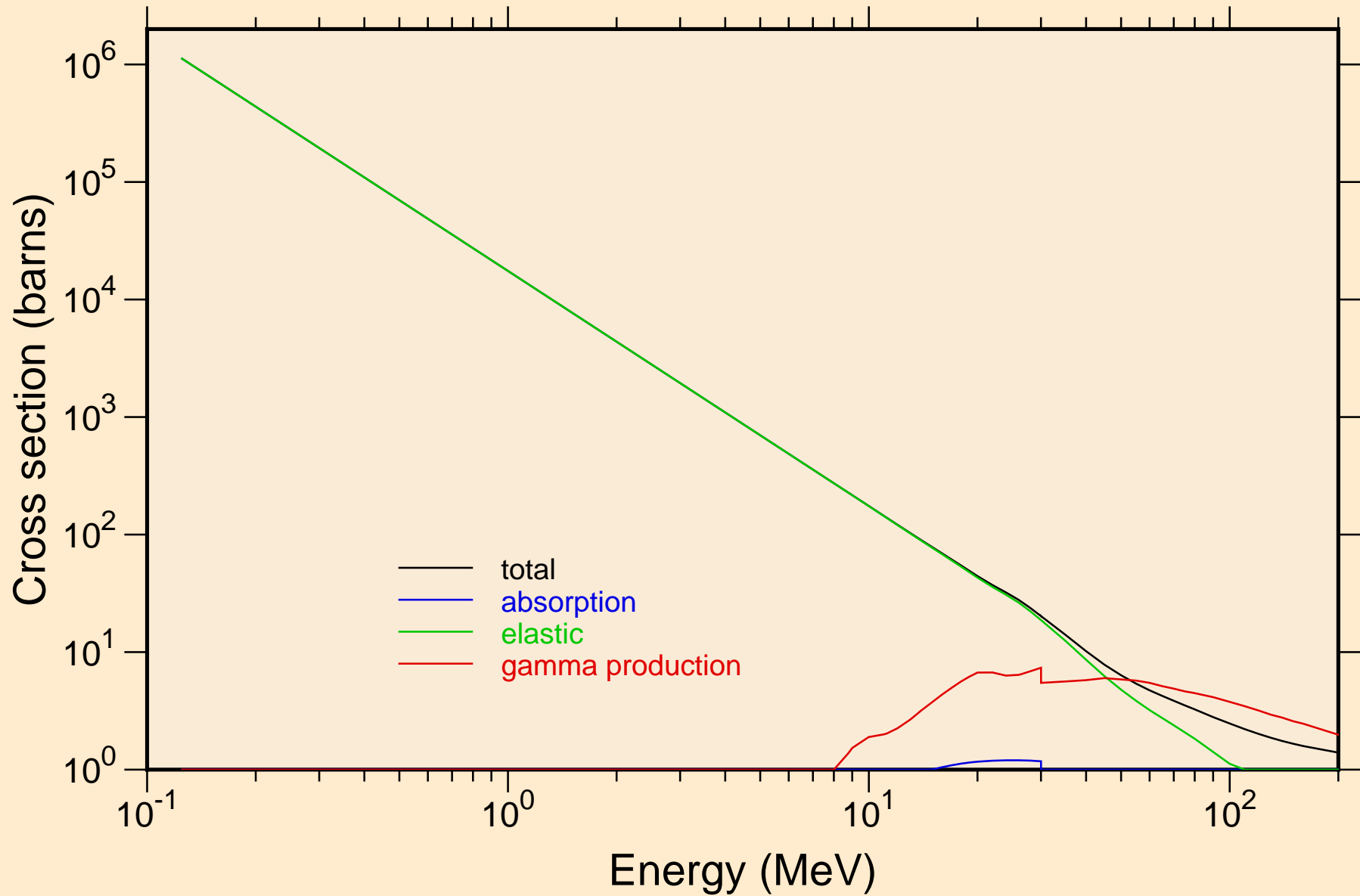

# I127 PROTON ACER TENDL-2021 LIBRARY; T=0.K

## Heating

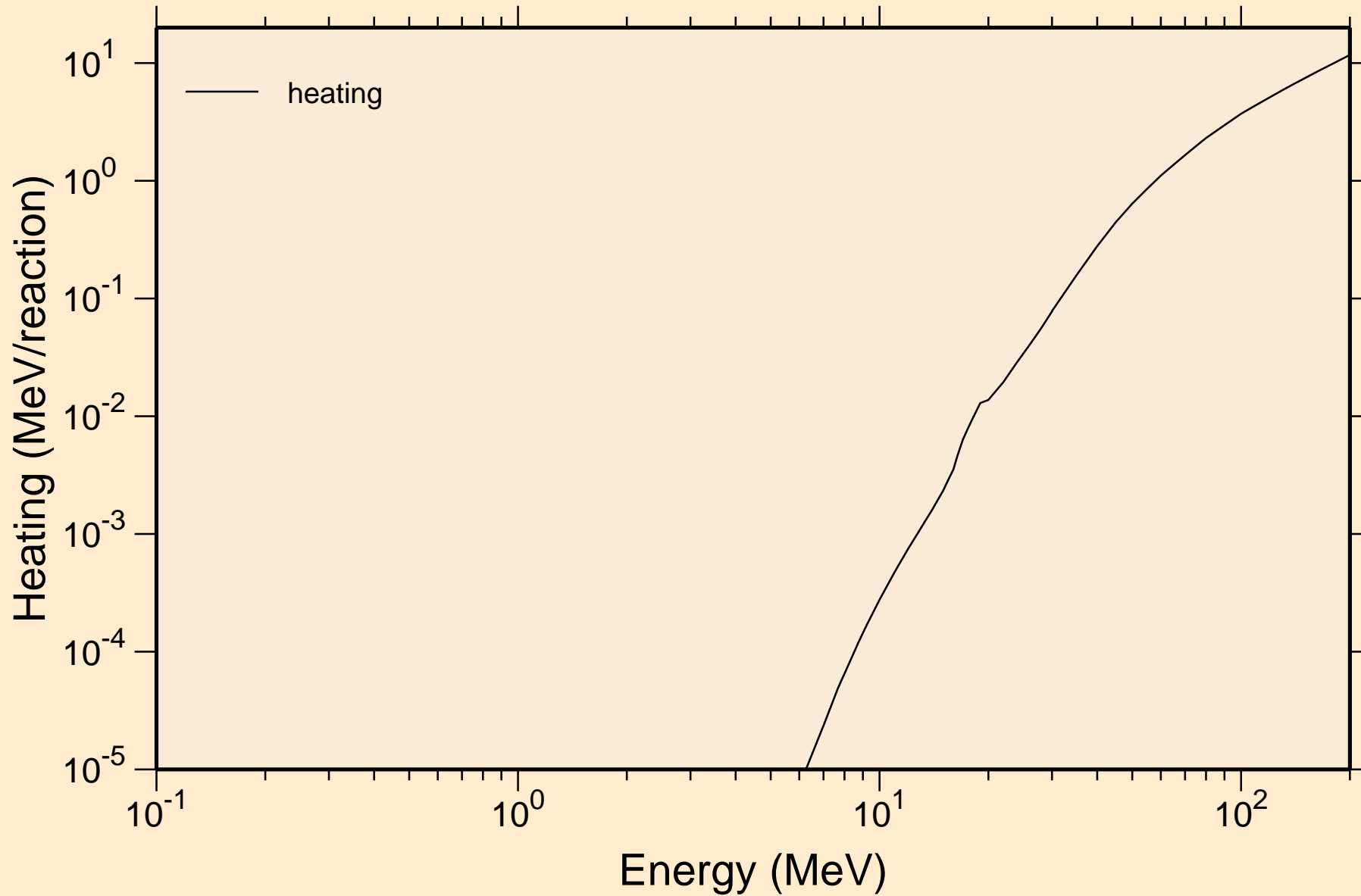

# I127 PROTON ACER TENDL-2021 LIBRARY; T=0.K

## Principal cross sections

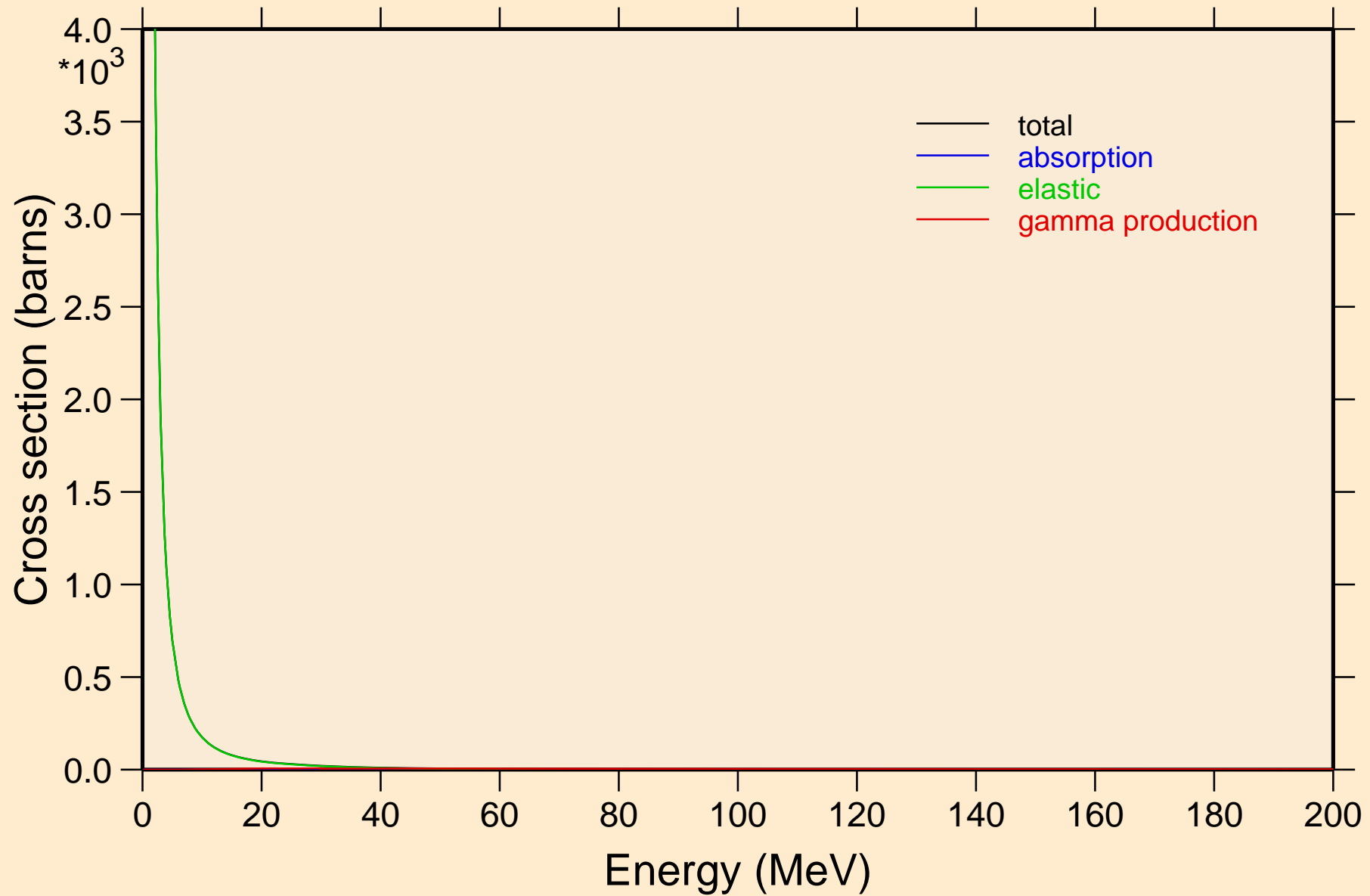

# I127 PROTON ACER TENDL-2021 LIBRARY; T=0.K

## Heating

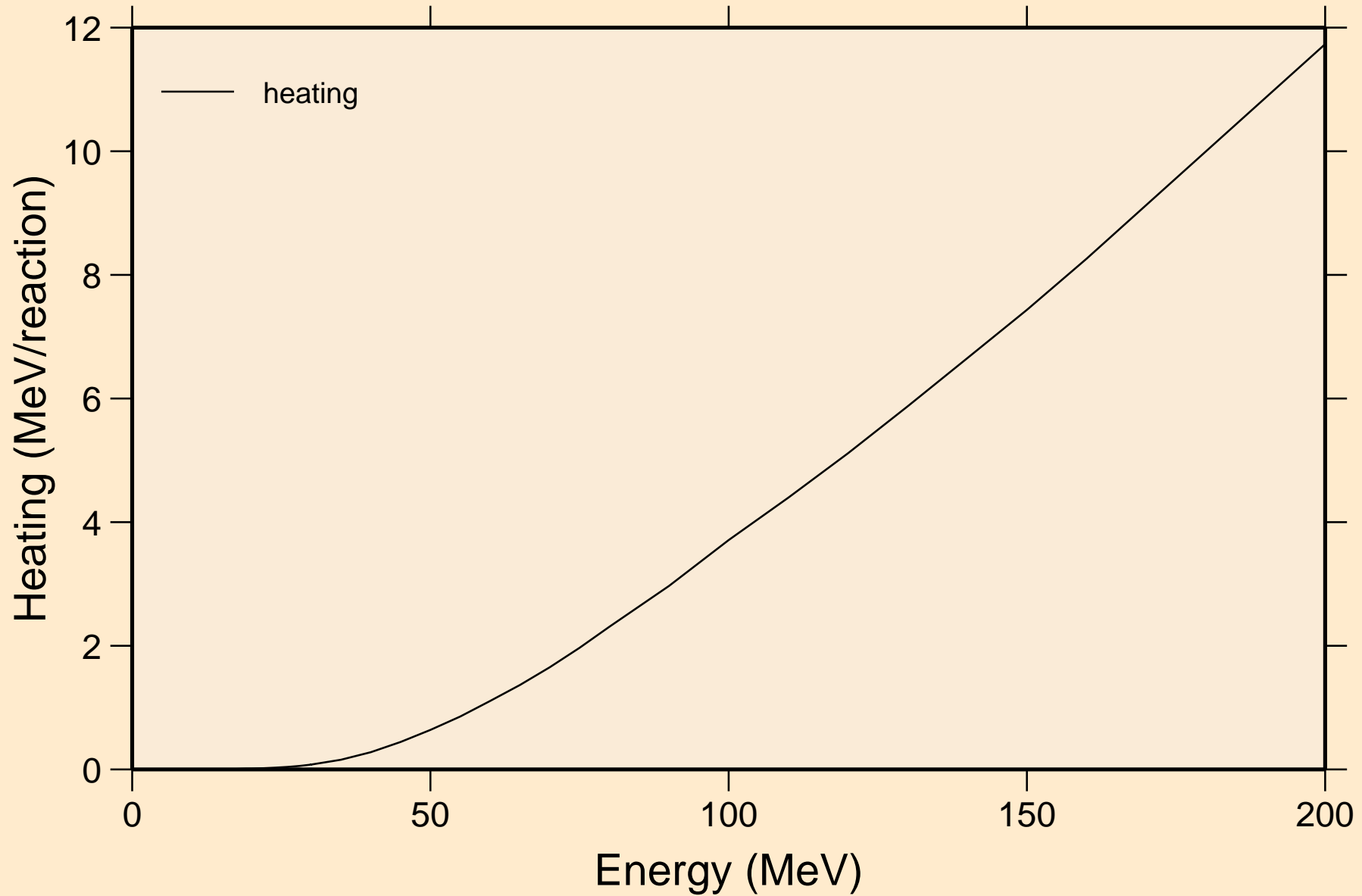

# I127 PROTON ACER TENDL-2021 LIBRARY; T=0.K

## Threshold reactions

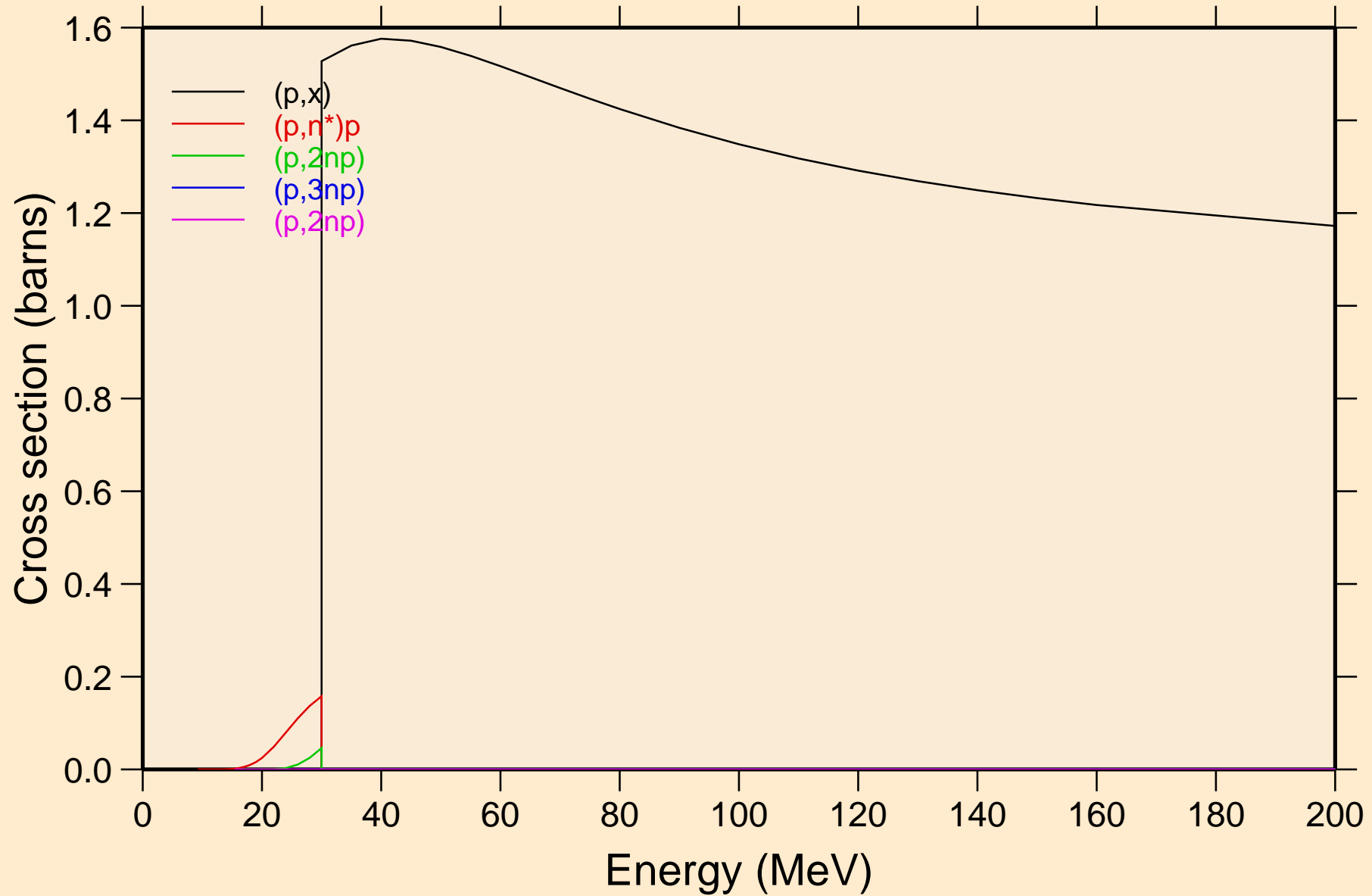

I127 PROTON ACER TENDL-2021 LIBRARY; T=0.K  
Threshold reactions

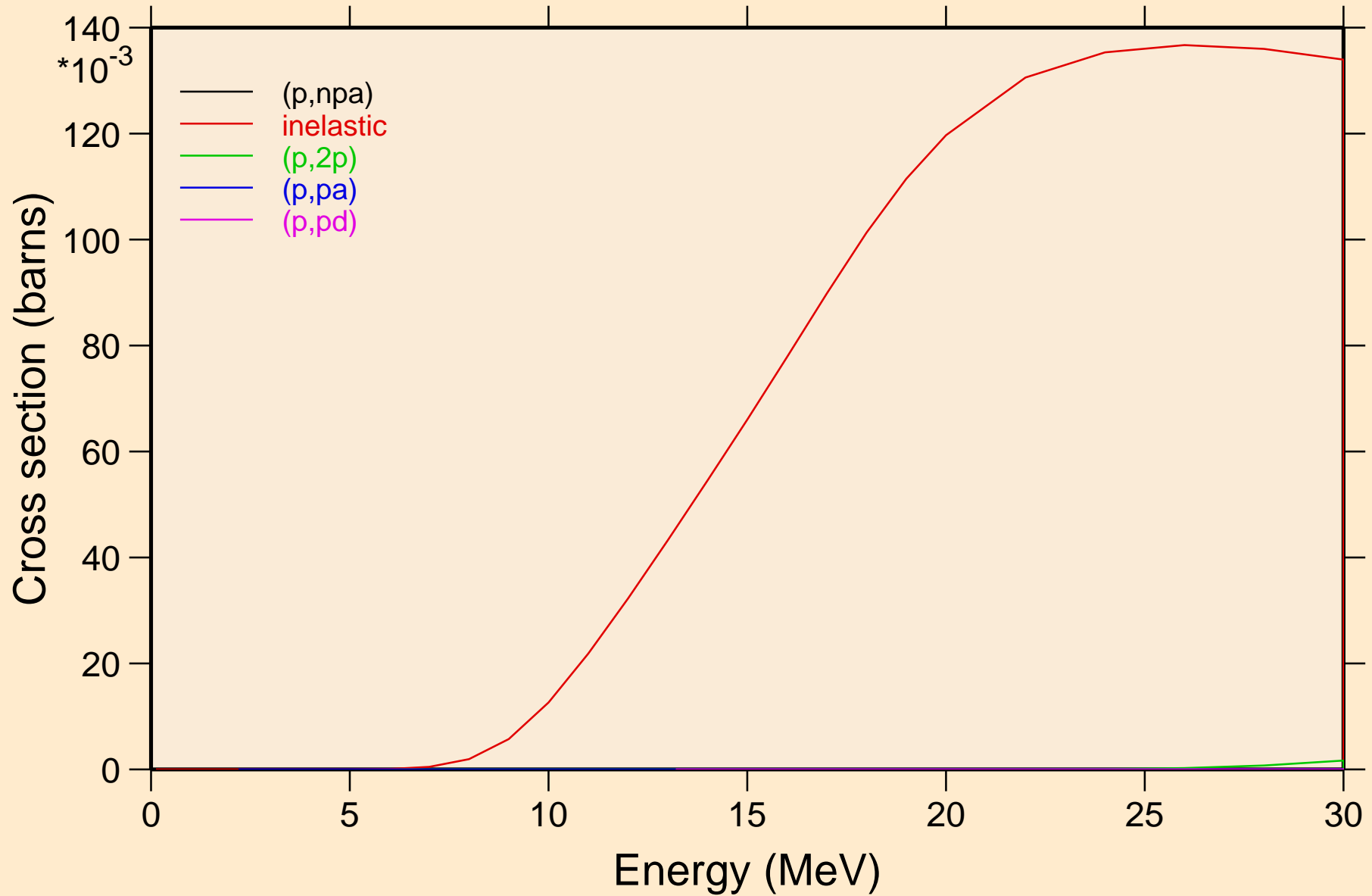

# I127 PROTON ACER TENDL-2021 LIBRARY; T=0.K

## Threshold reactions

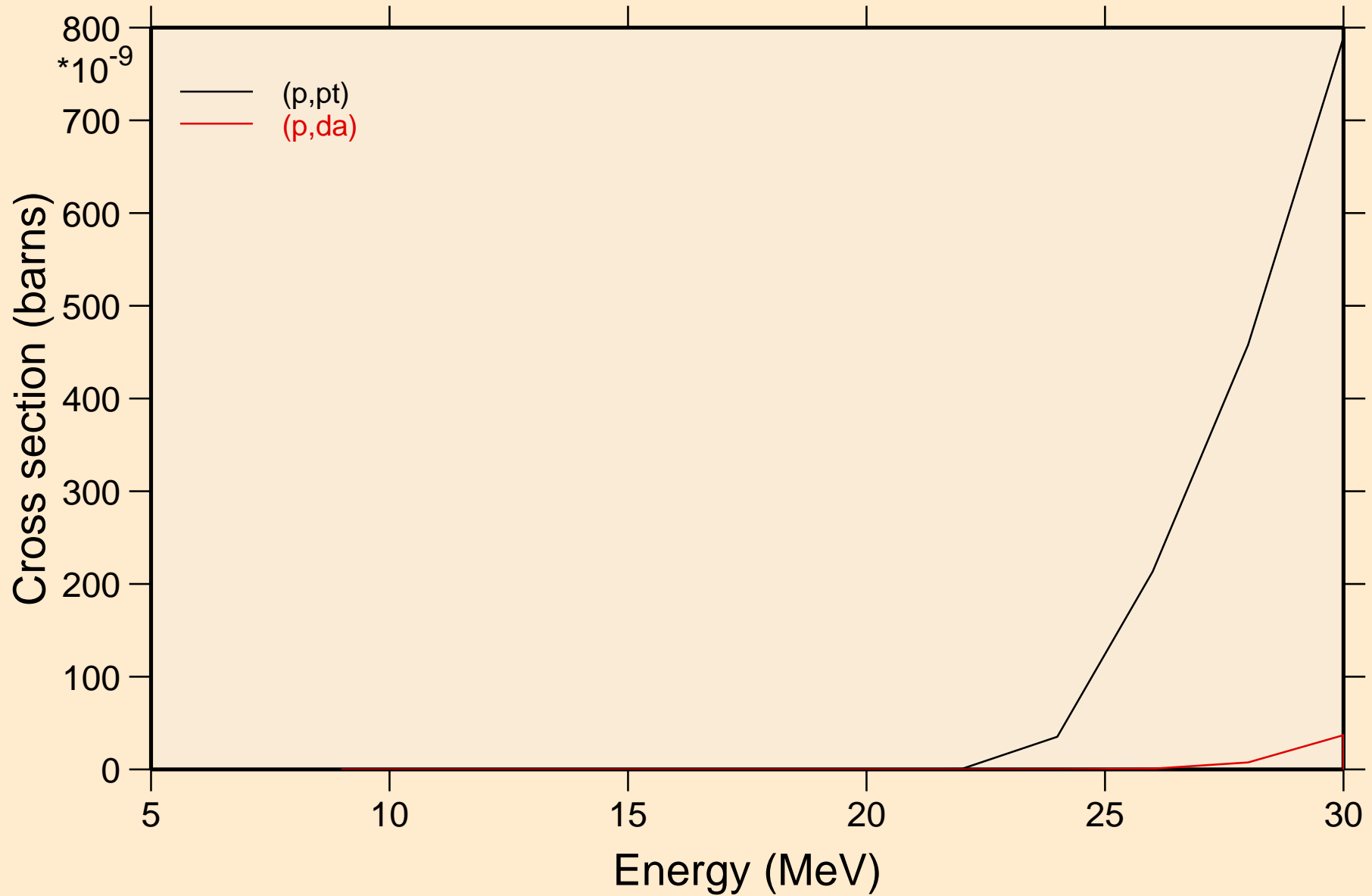

I127 PROTON ACER TENDL-2021 LIBRARY; T=0.K  
angular distribution for elastic

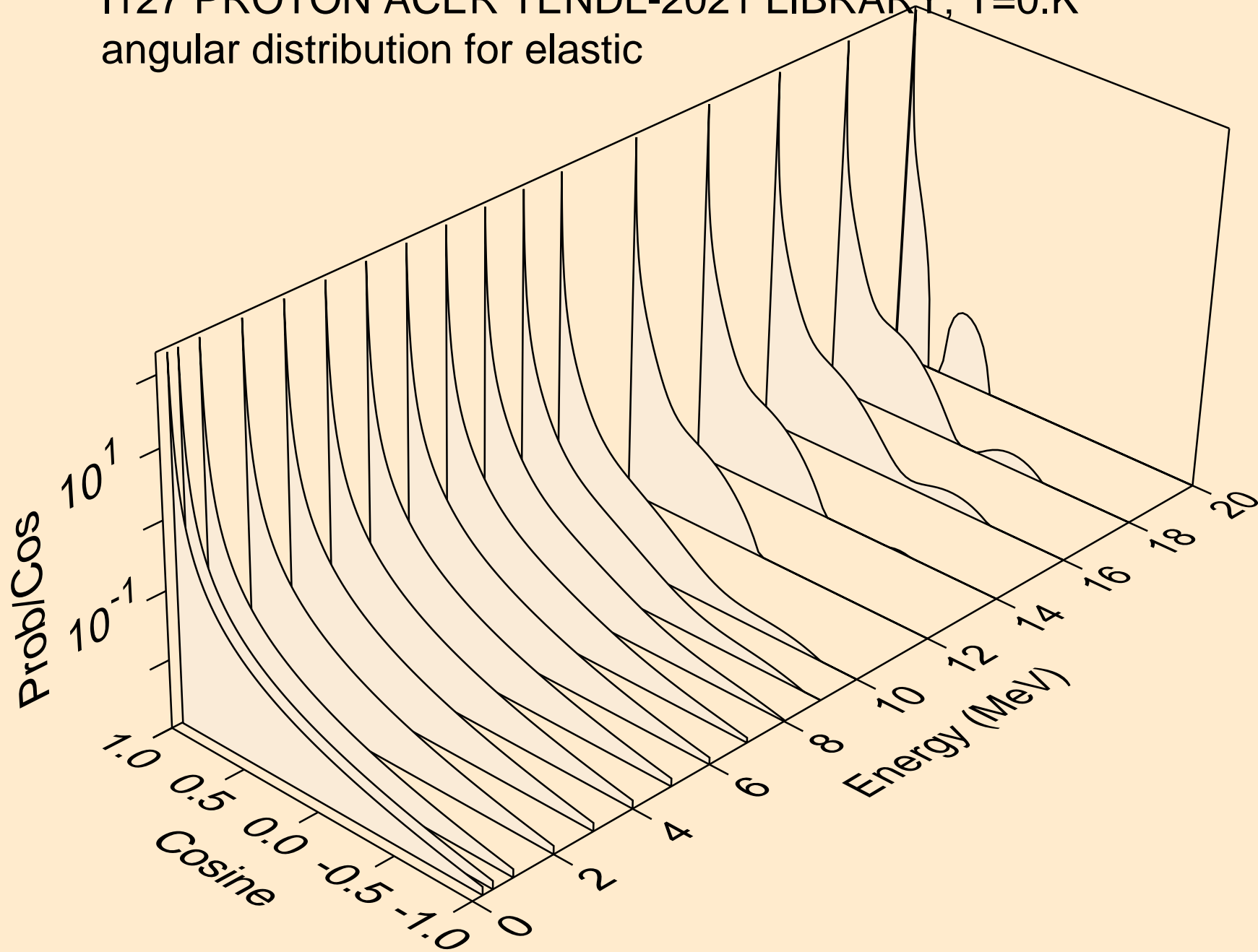



I127 PROTON ACER TENDL-2021 LIBRARY; T=0.K  
angular distribution for elastic

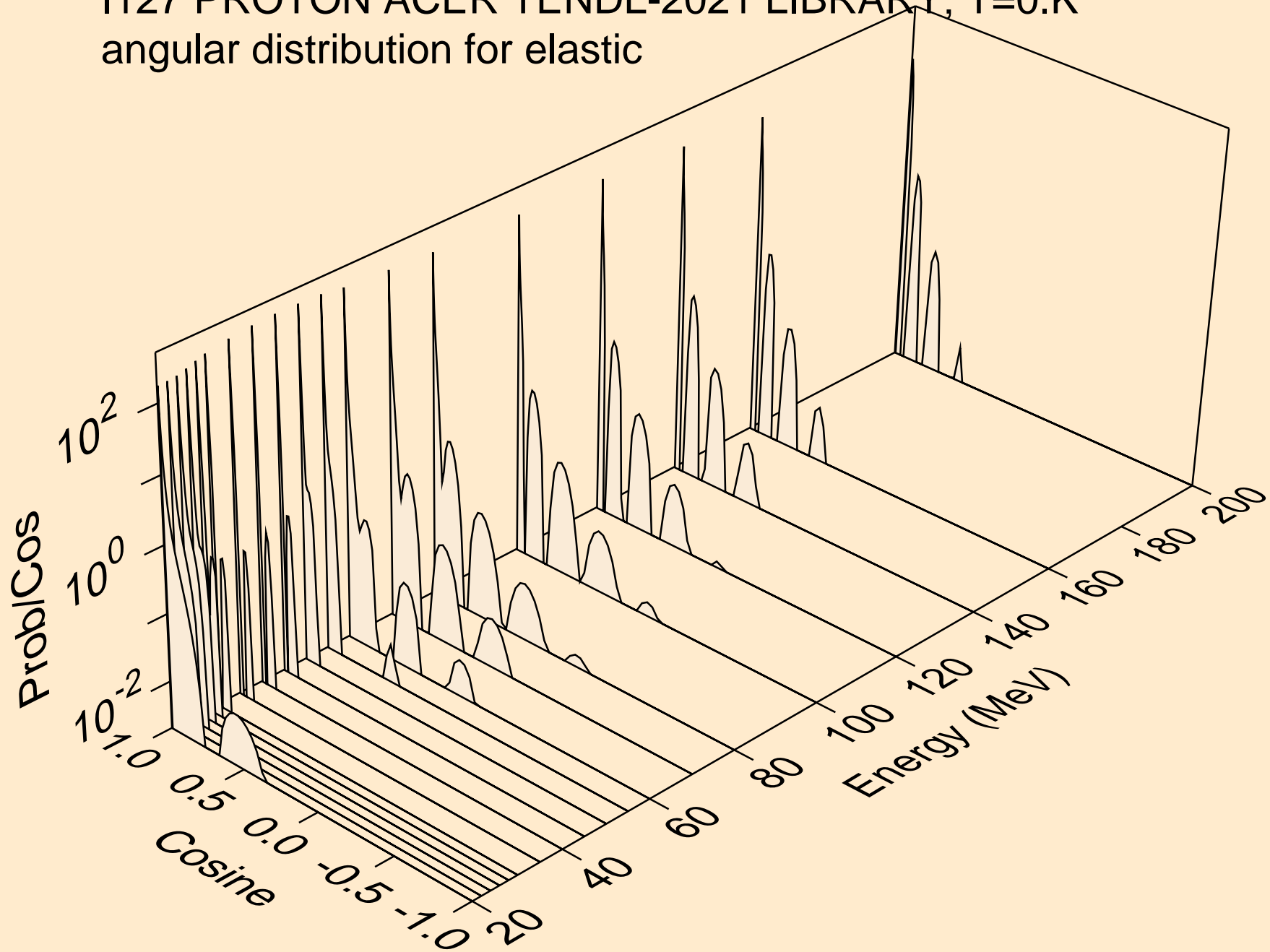

I127 PROTON ACER TENDL-2021 LIBRARY; T=0.K  
Proton emission for (p,x)

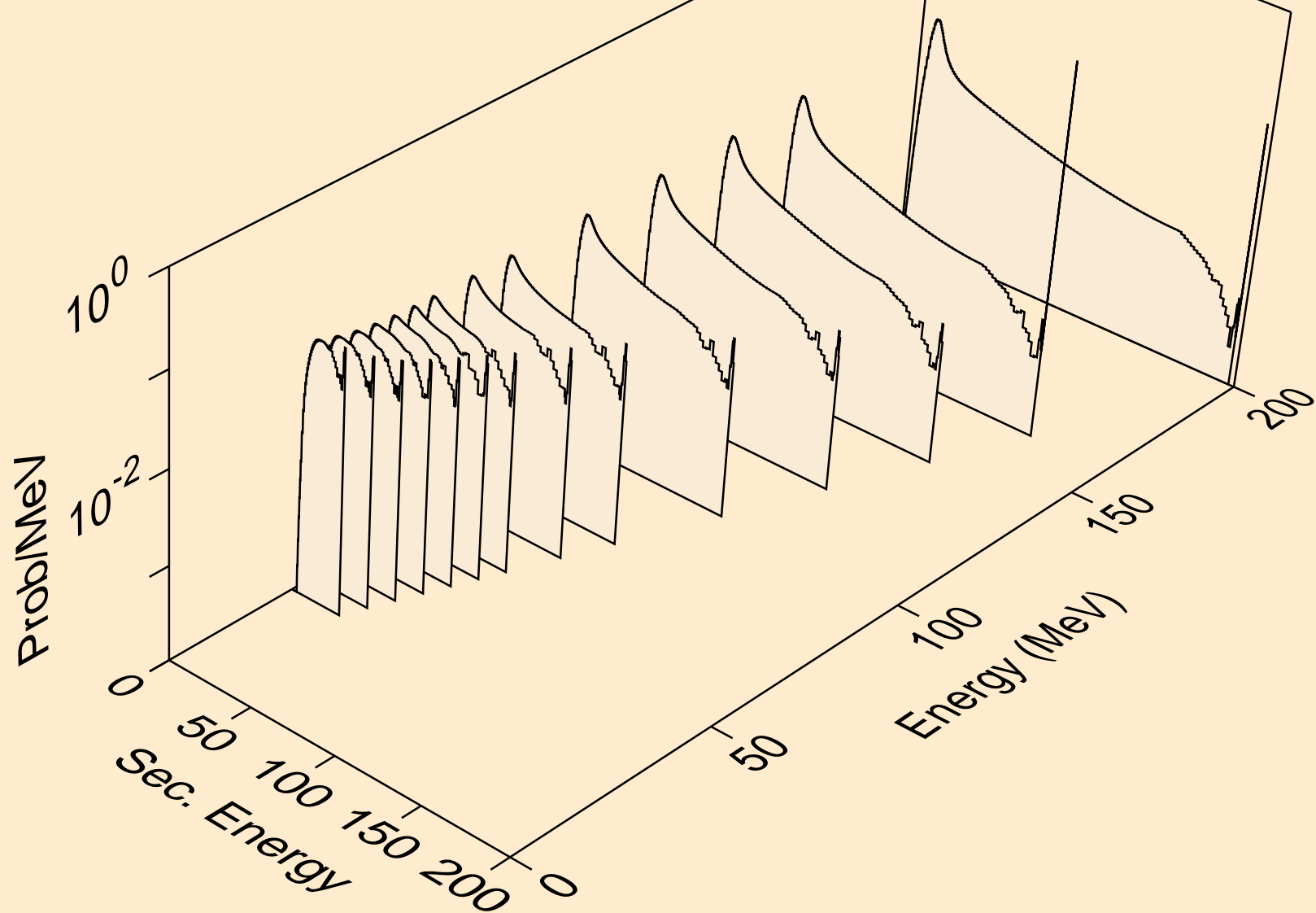

I127 PROTON ACER TENDL-2021 LIBRARY; T=0.K  
Proton emission for (p,n\*)p

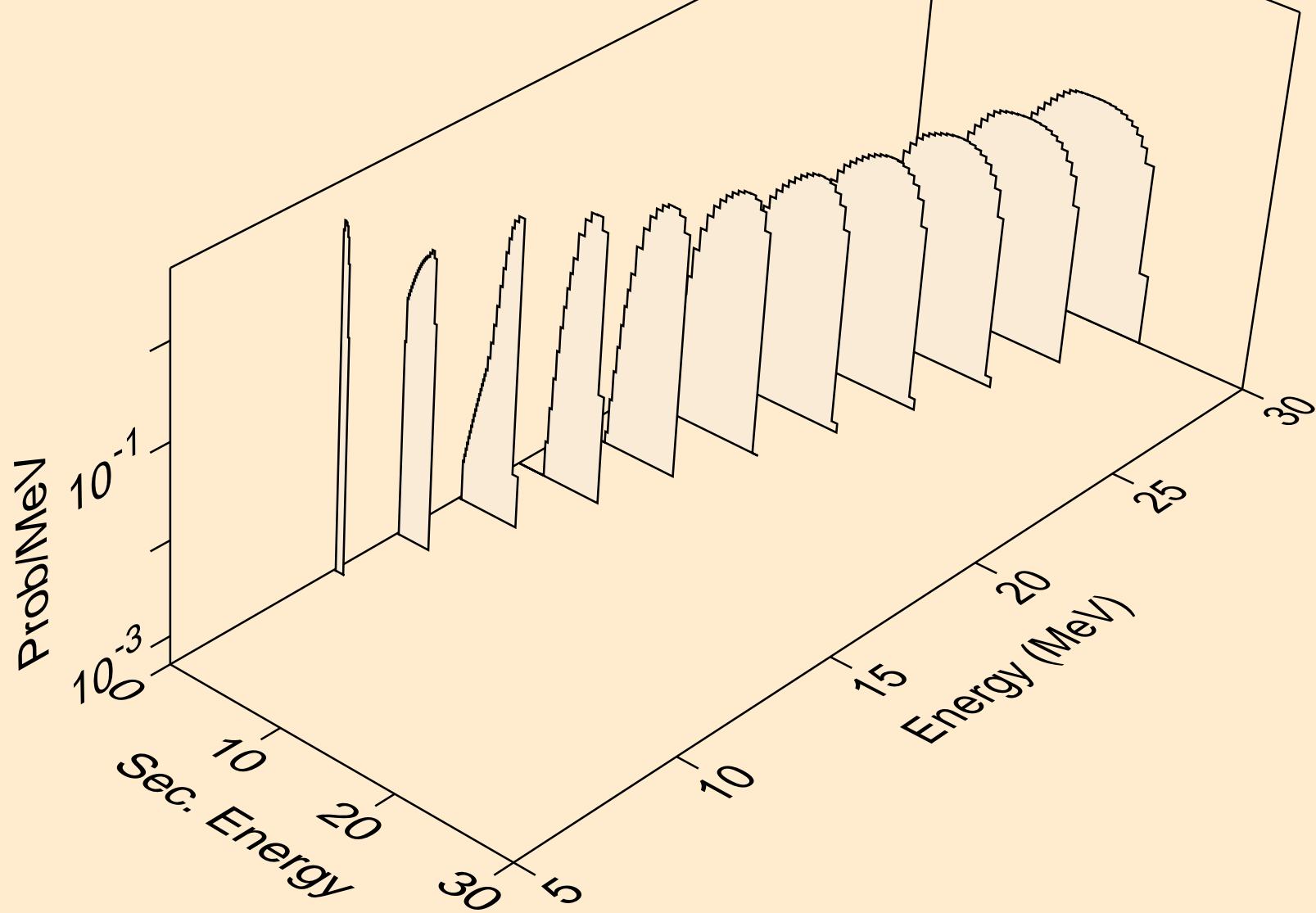

I127 PROTON ACER TENDL-2021 LIBRARY; T=0.K  
Proton emission for (p,2np)

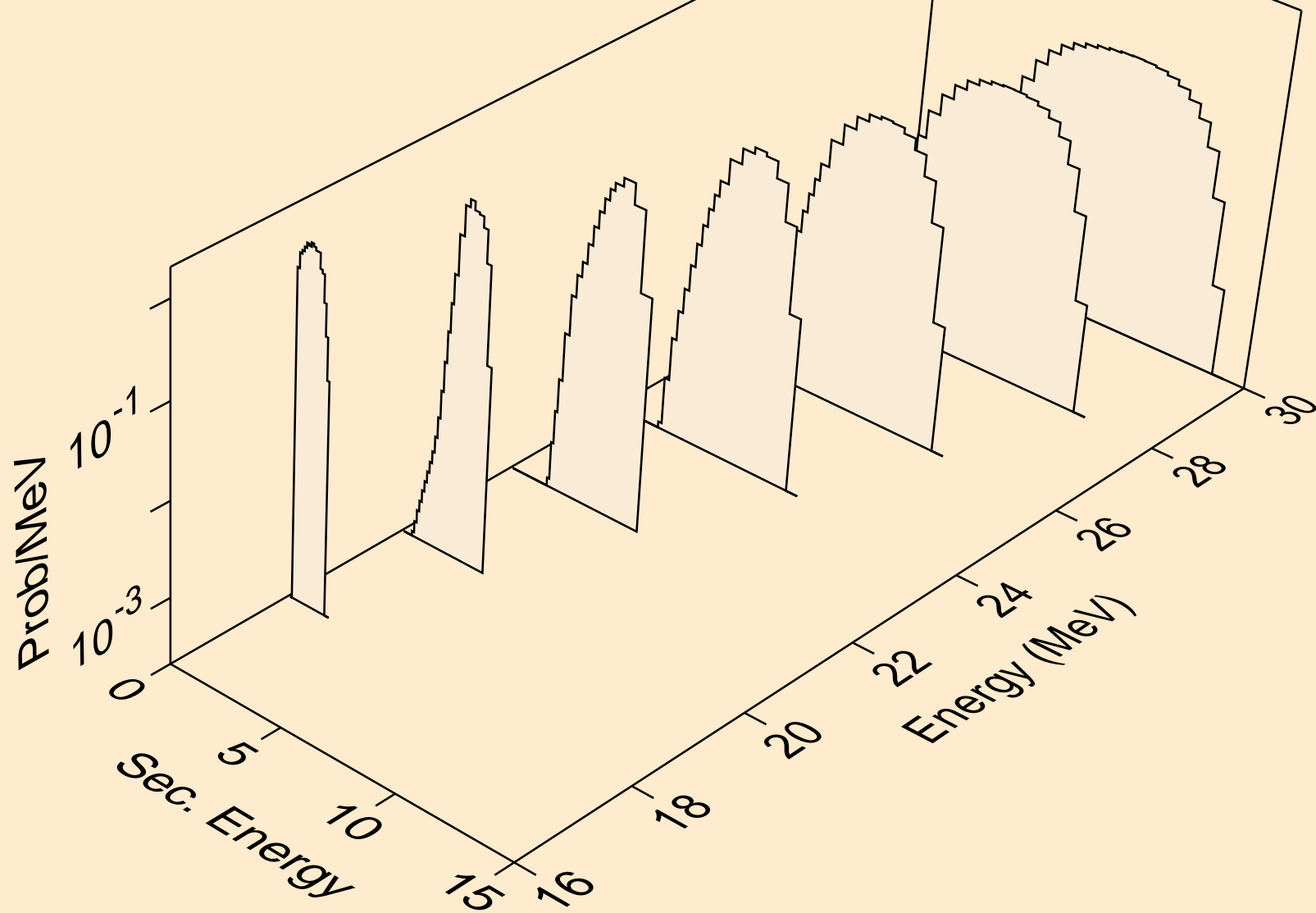

I127 PROTON ACER TENDL-2021 LIBRARY; T=0.K  
Proton emission for (p,3np)

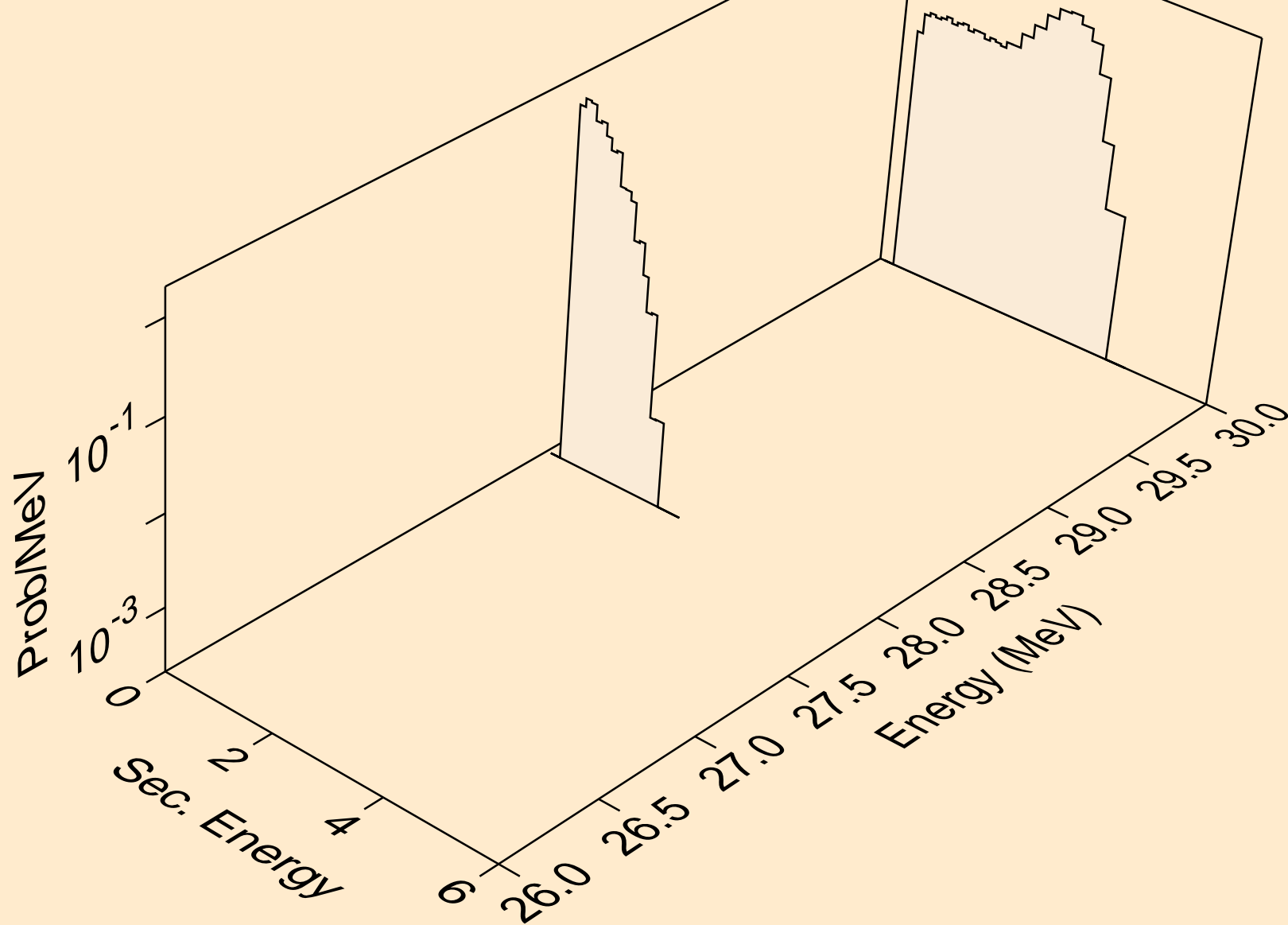

I127 PROTON ACER TENDL-2021 LIBRARY; T=0.K  
Proton emission for (p,2np)

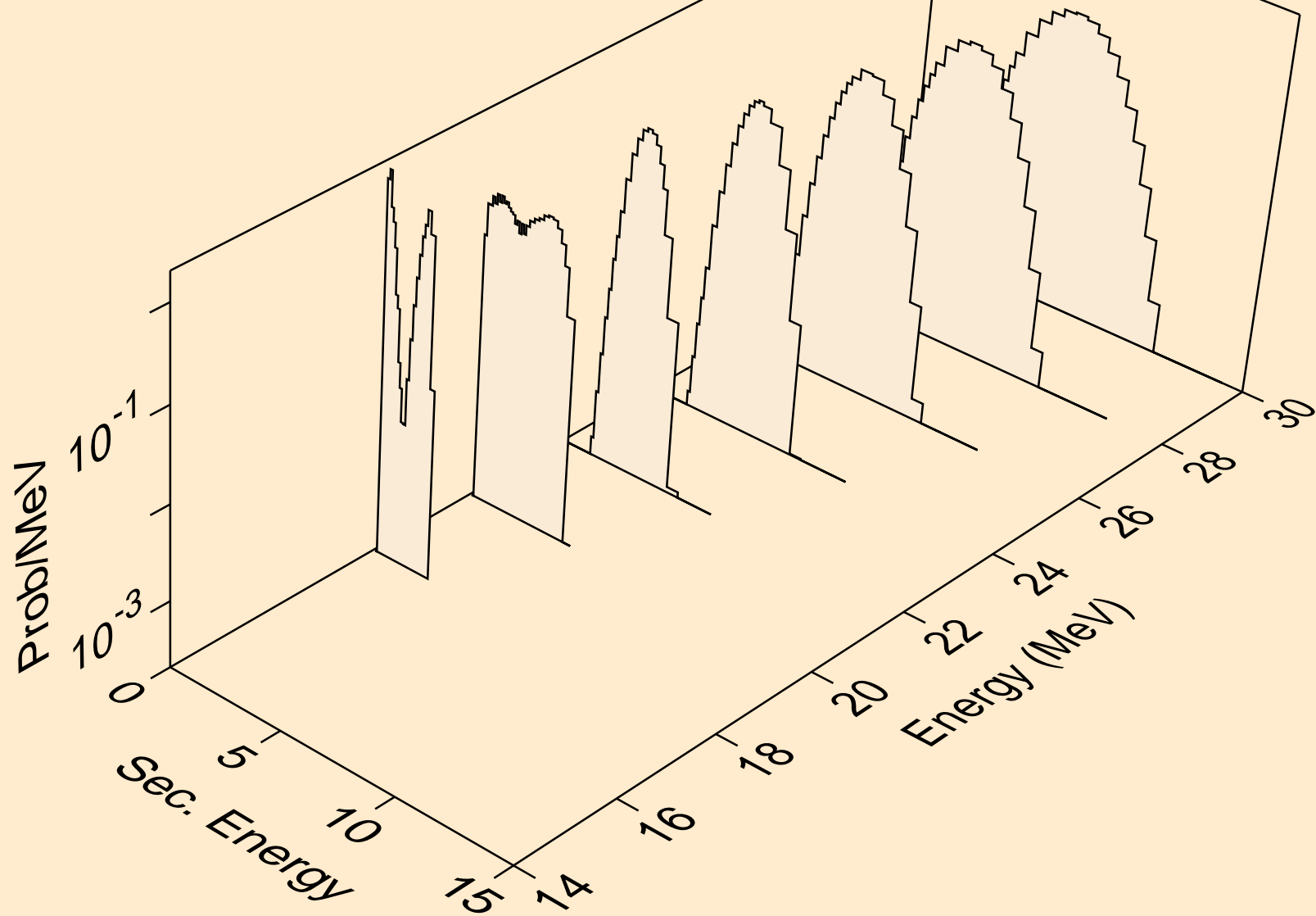

I127 PROTON ACER TENDL-2021 LIBRARY; T=0.K  
Proton emission for (p,npa)

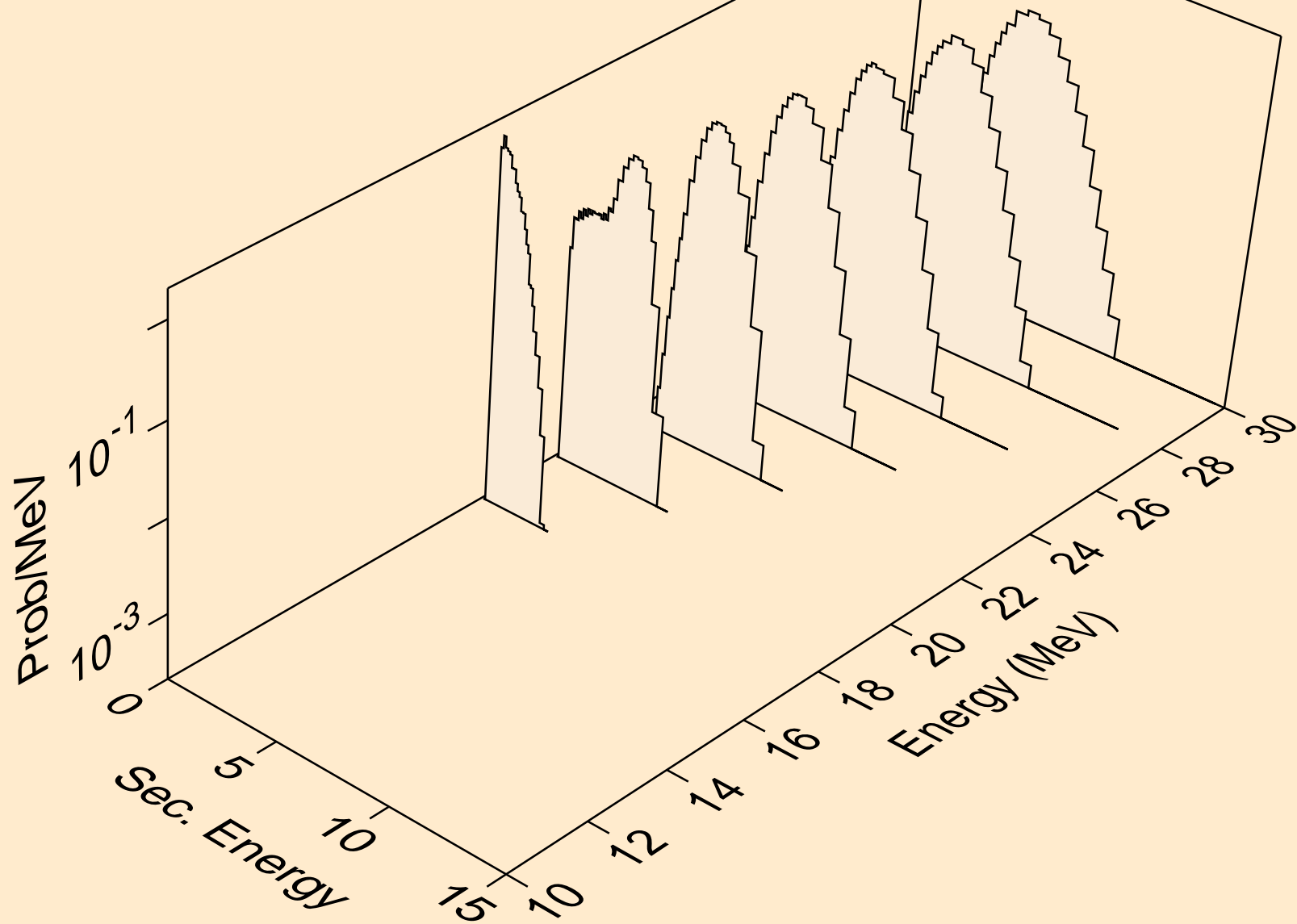

I127 PROTON ACER TENDL-2021 LIBRARY; T=0.K  
Proton emission for inelastic

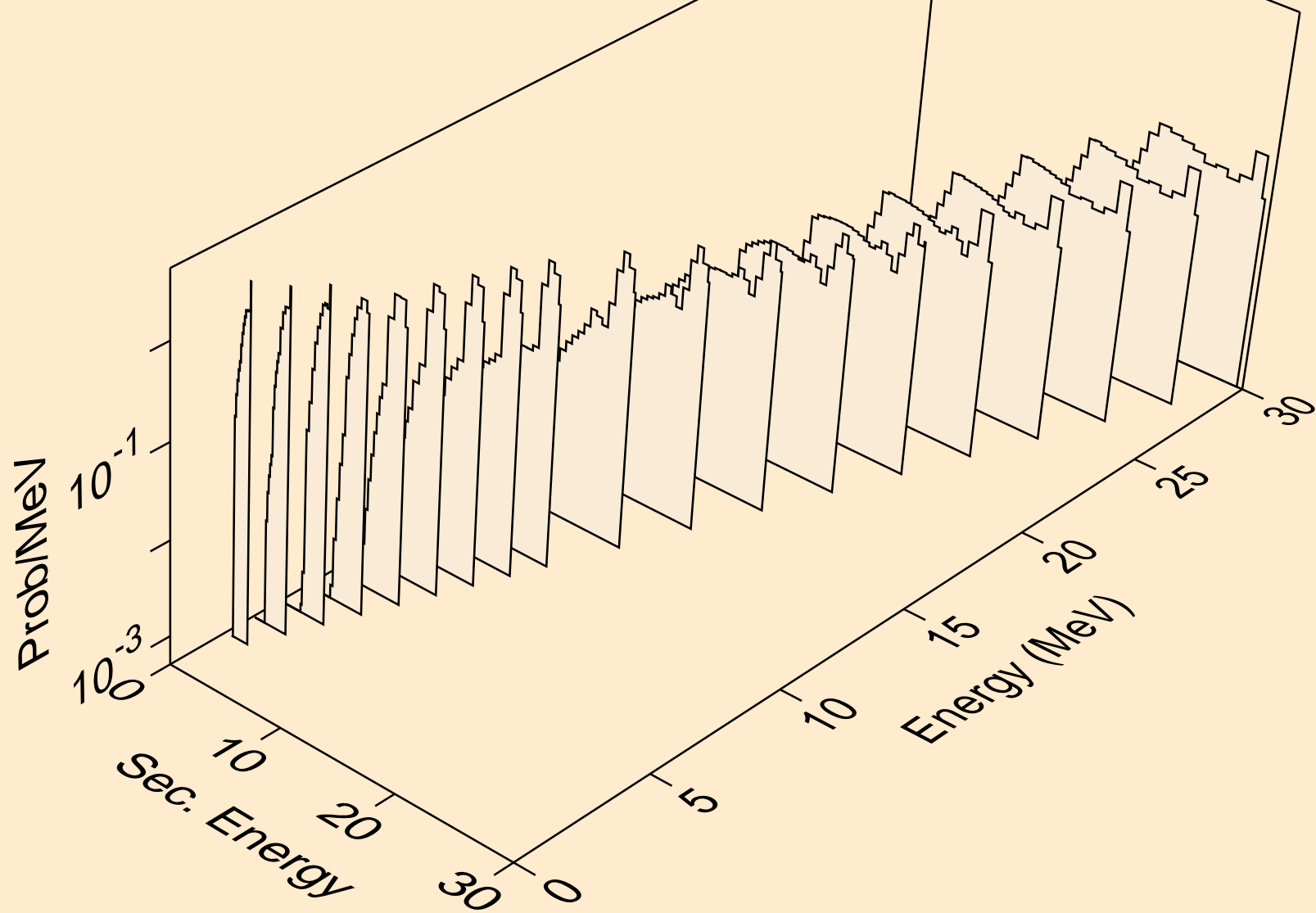



I127 PROTON ACER TENDL-2021 LIBRARY; T=0.K  
Proton emission for (p,2p)

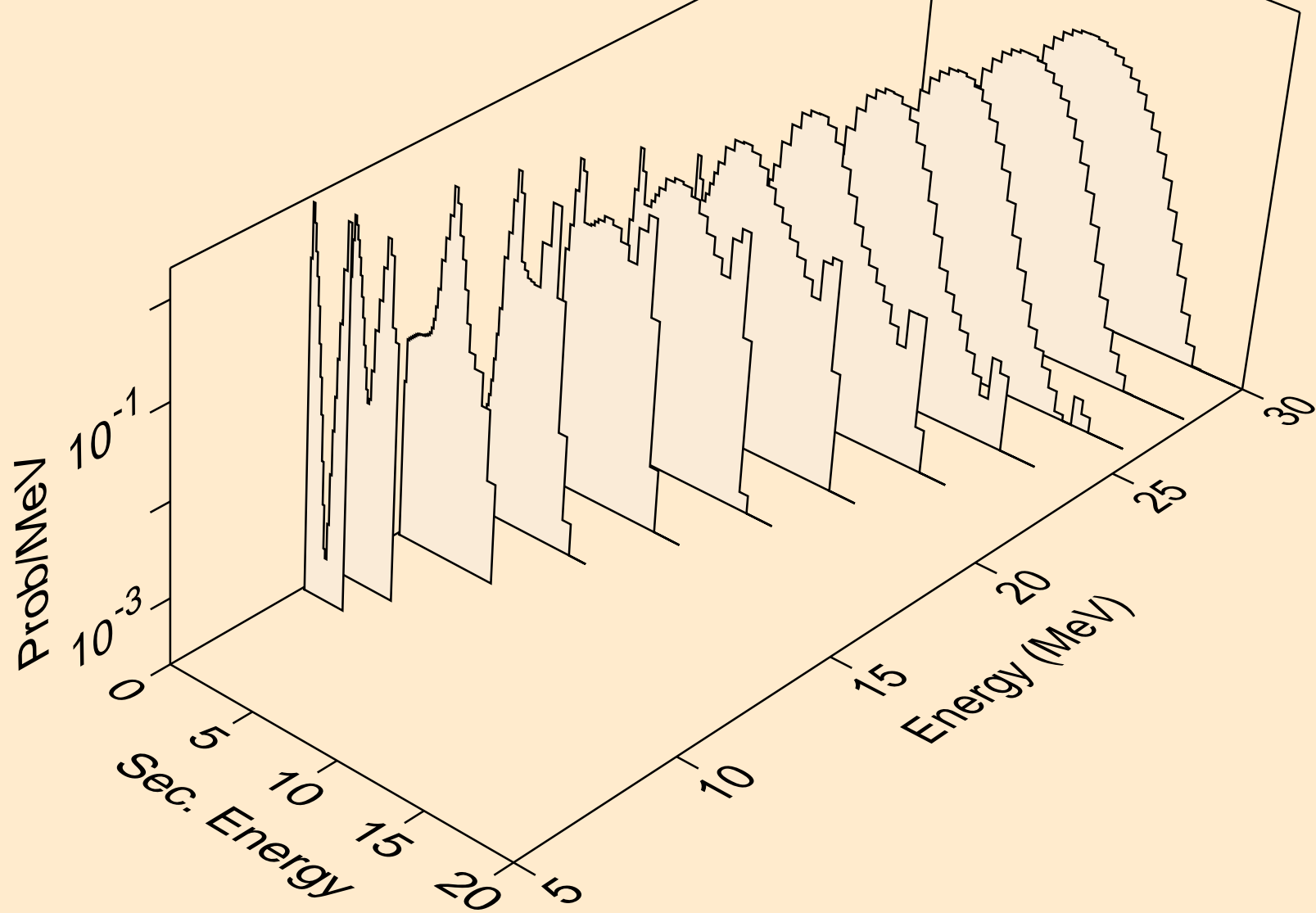

I127 PROTON ACER TENDL-2021 LIBRARY; T=0.K  
Proton emission for (p,pa)

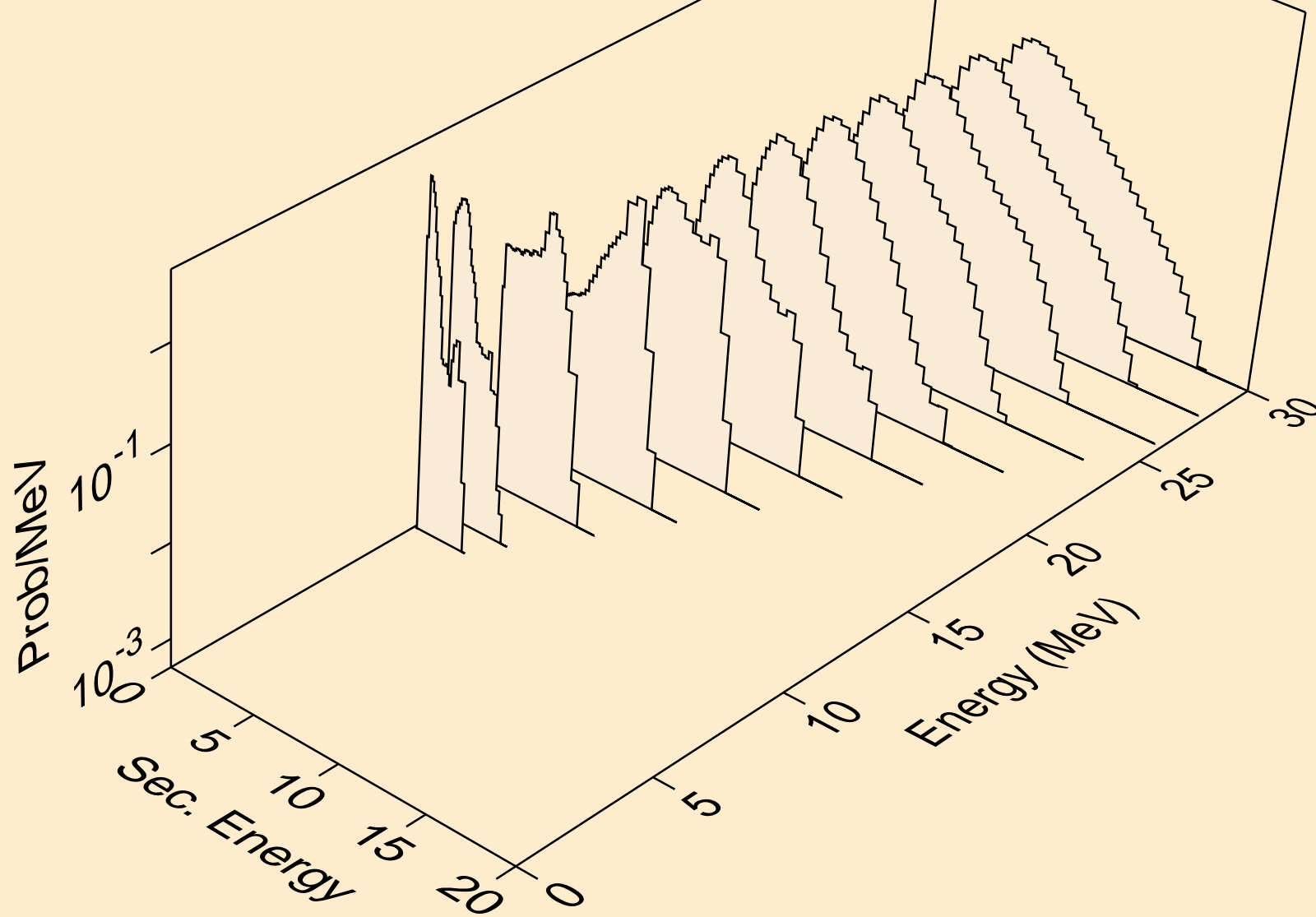

I127 PROTON ACER TENDL-2021 LIBRARY; T=0.K  
Proton emission for (p,pd)

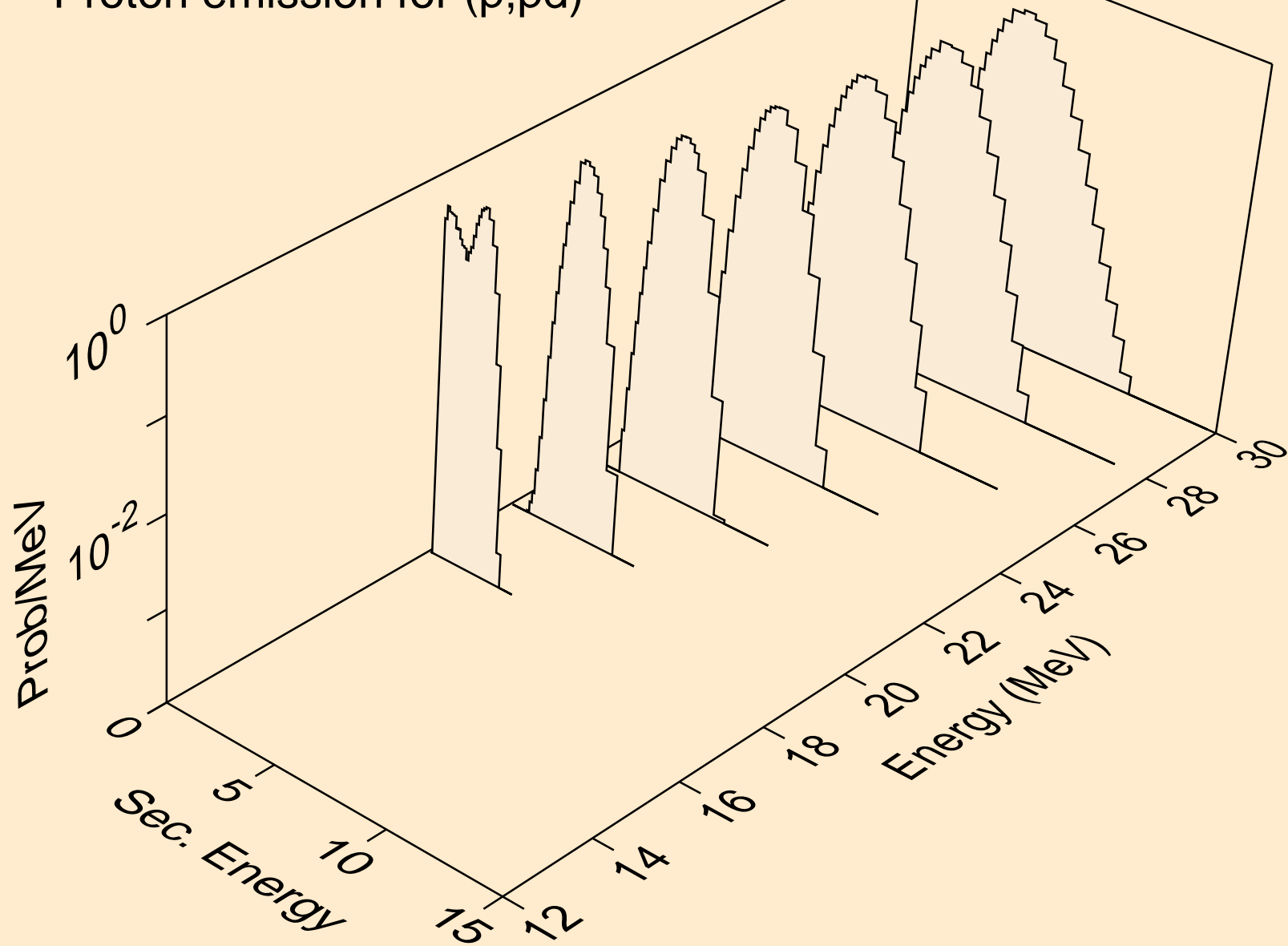

I127 PROTON ACER TENDL-2021 LIBRARY; T=0.K  
Proton emission for (p,pt)

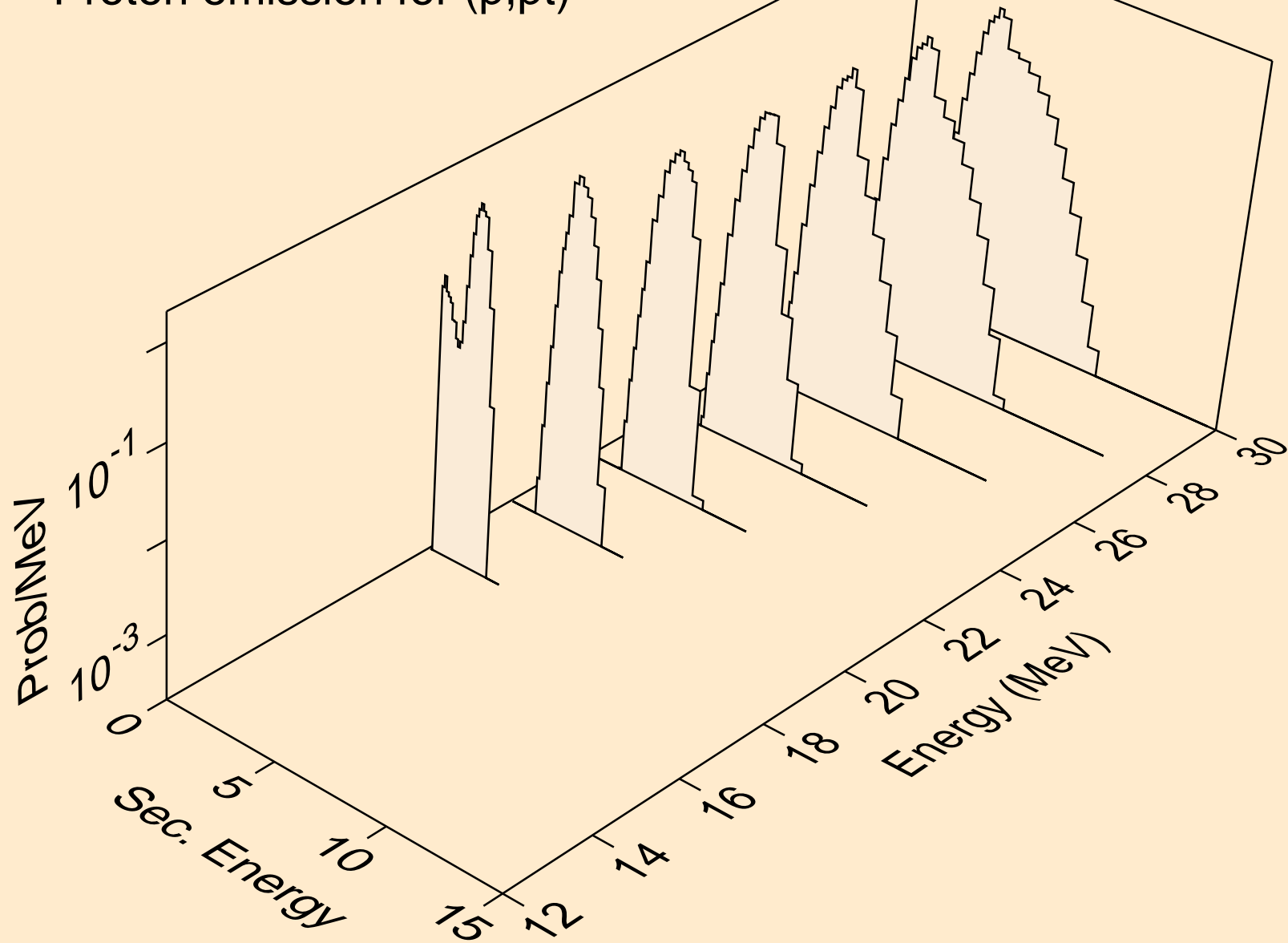

I127 PROTON ACER TENDL-2021 LIBRARY; T=0.K  
Photon emission for (z,n)

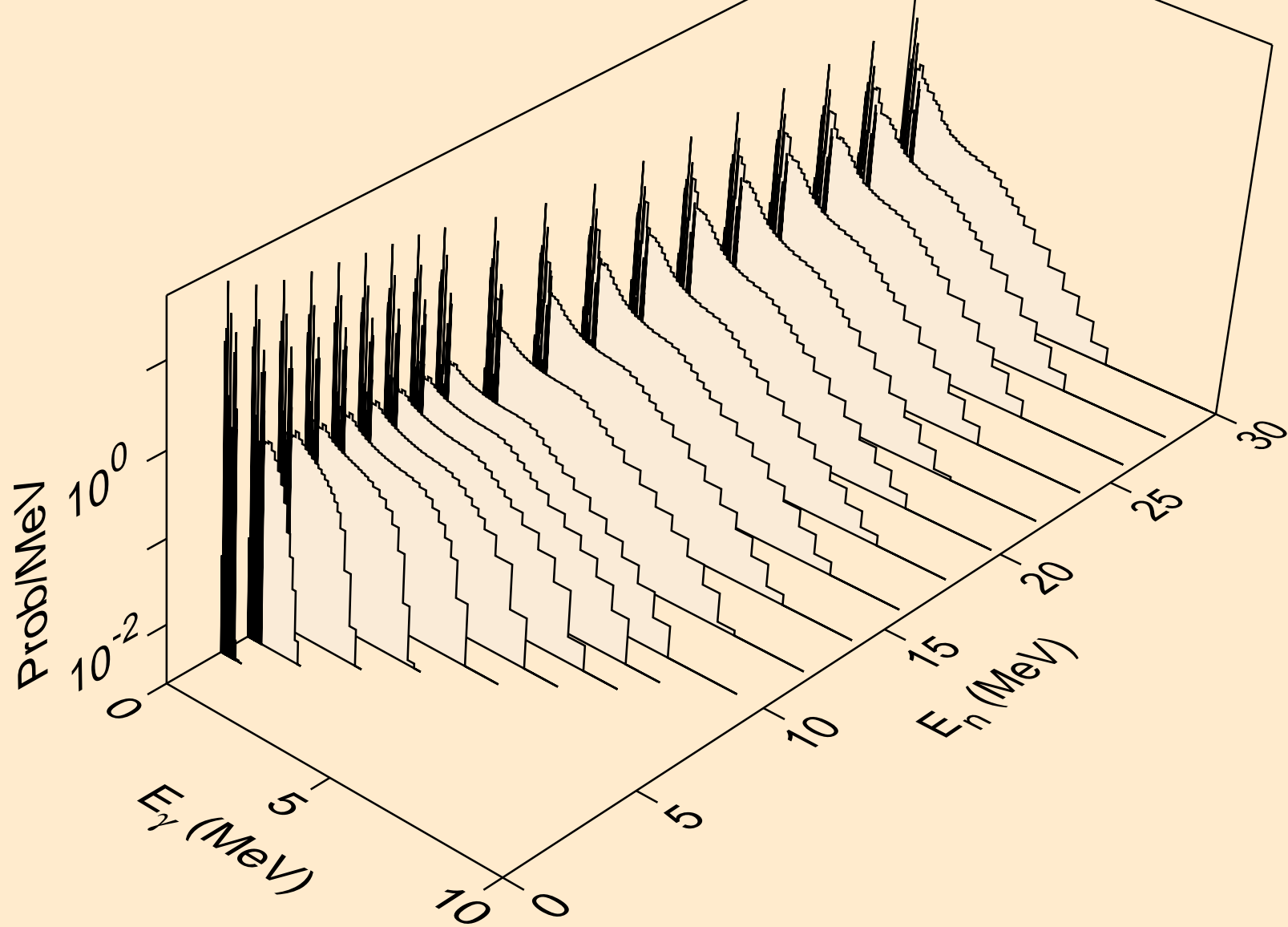

I127 PROTON ACER TENDL-2021 LIBRARY; T=0.K  
Photon emission for (n,x)

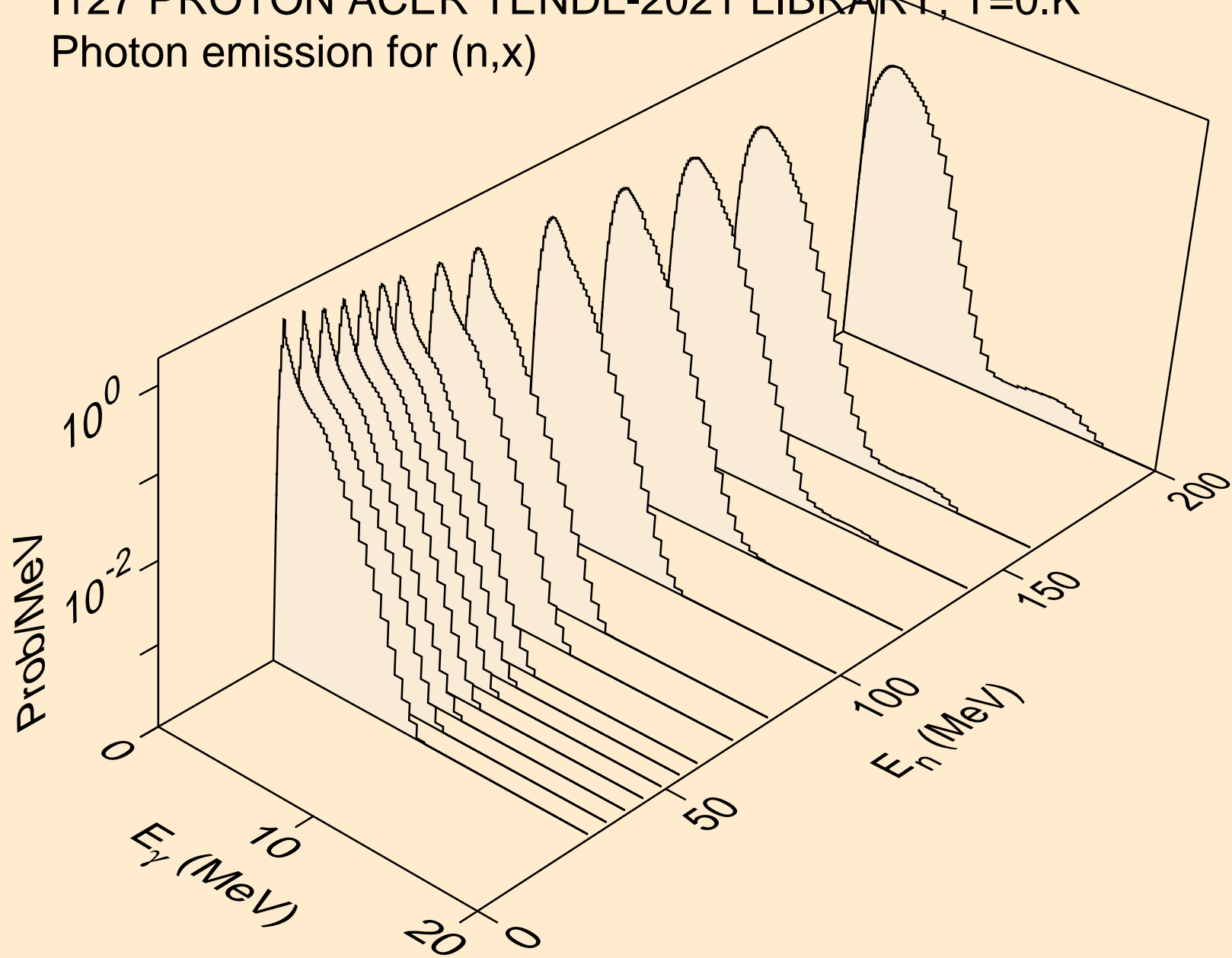

I127 PROTON ACER TENDL-2021 LIBRARY; T=0.K  
Photon emission for (n,2nd)

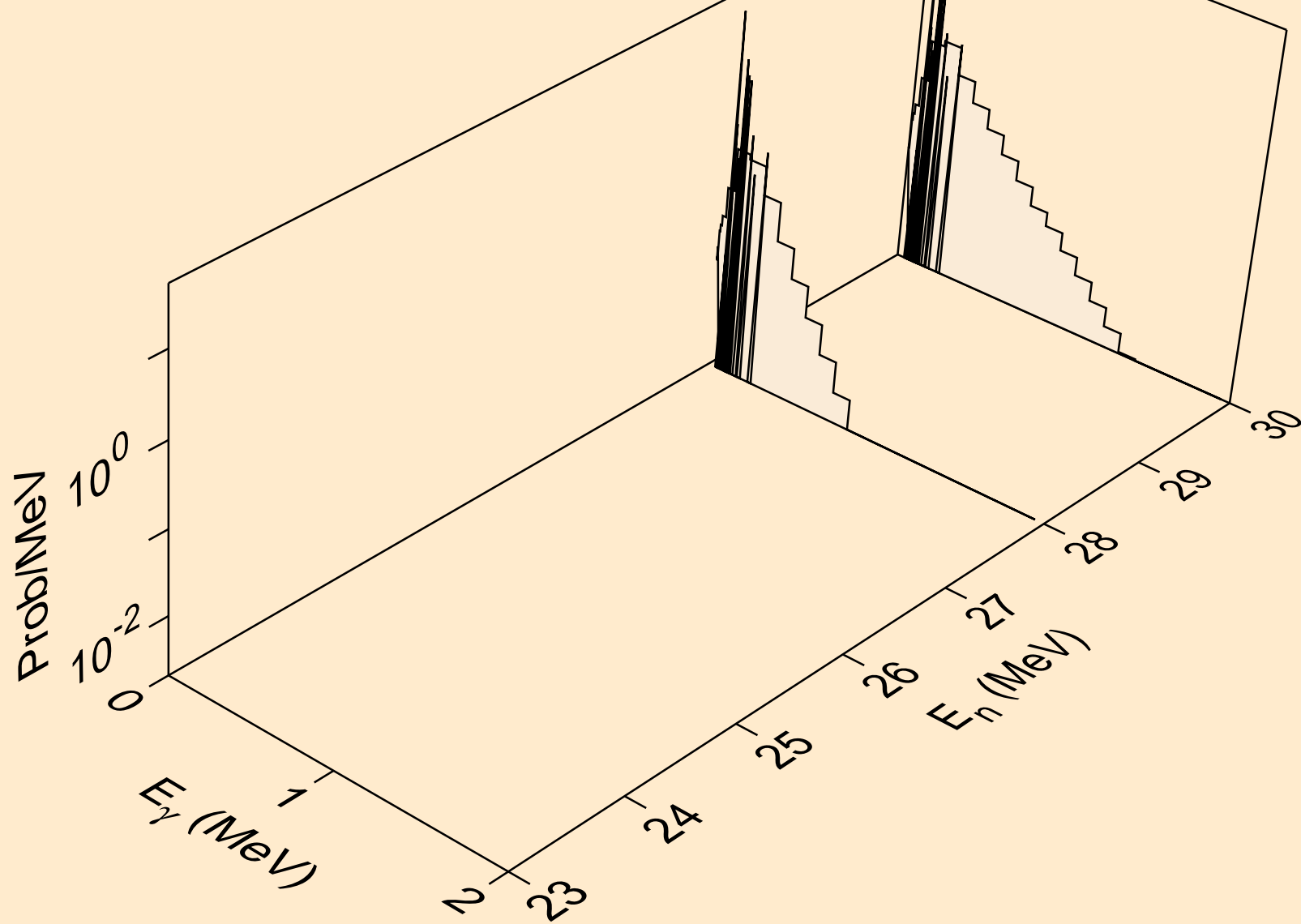

I127 PROTON ACER TENDL-2021 LIBRARY; T=0.K  
Photon emission for (n,2n)

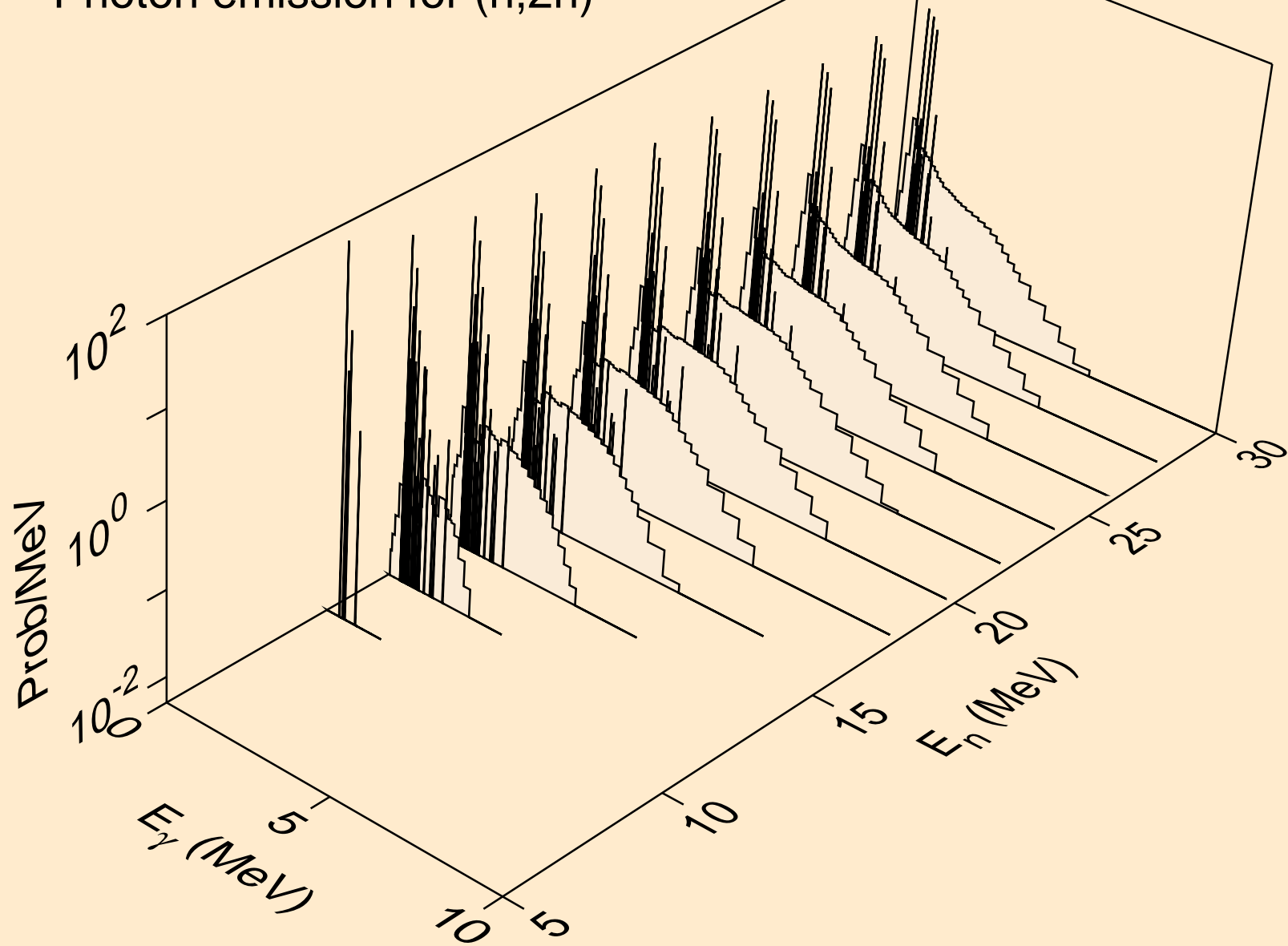



I127 PROTON ACER TENDL-2021 LIBRARY; T=0.K  
Photon emission for (n,3n)

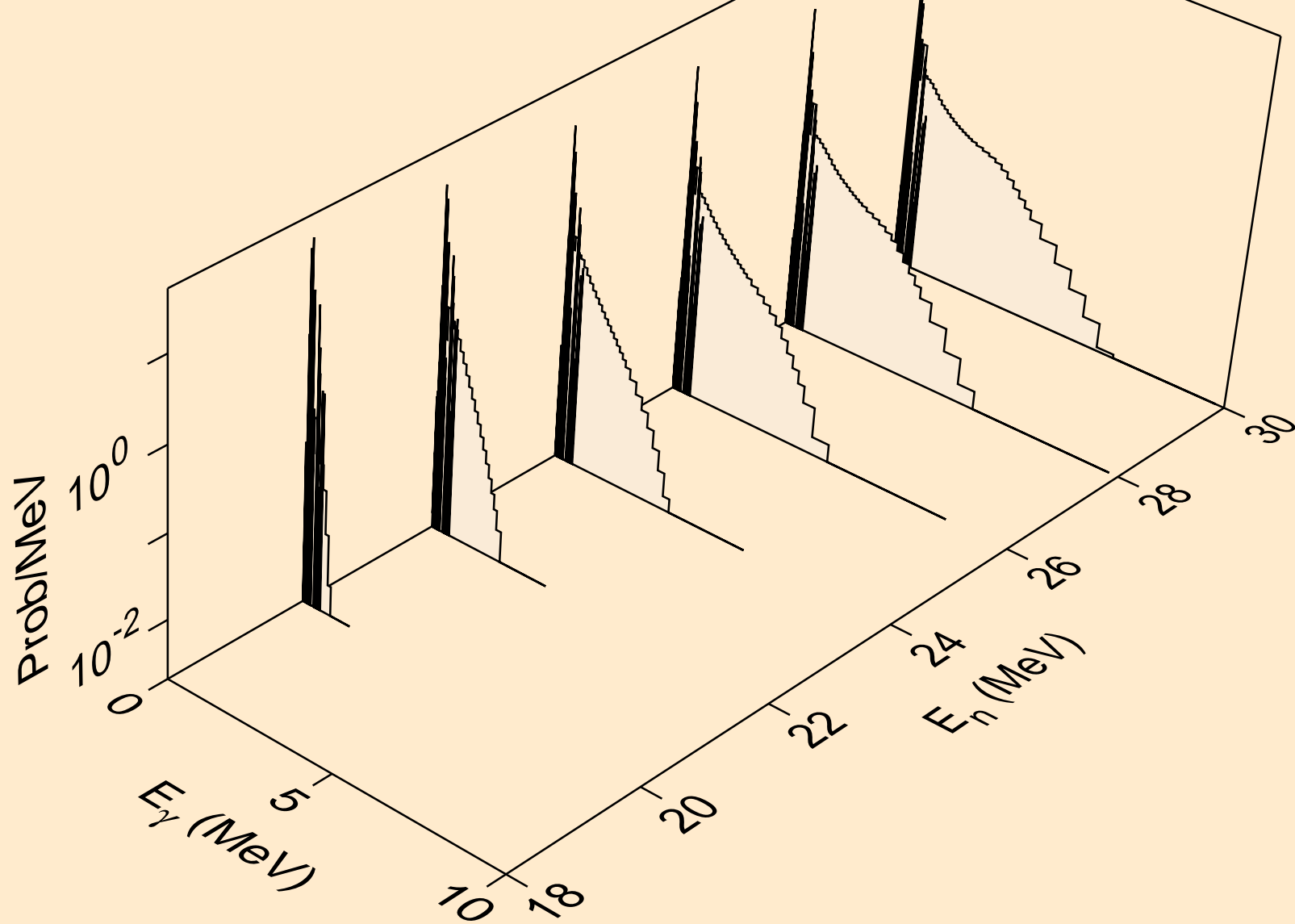

I127 PROTON ACER TENDL-2021 LIBRARY; T=0.K  
Photon emission for (n,n\*)a

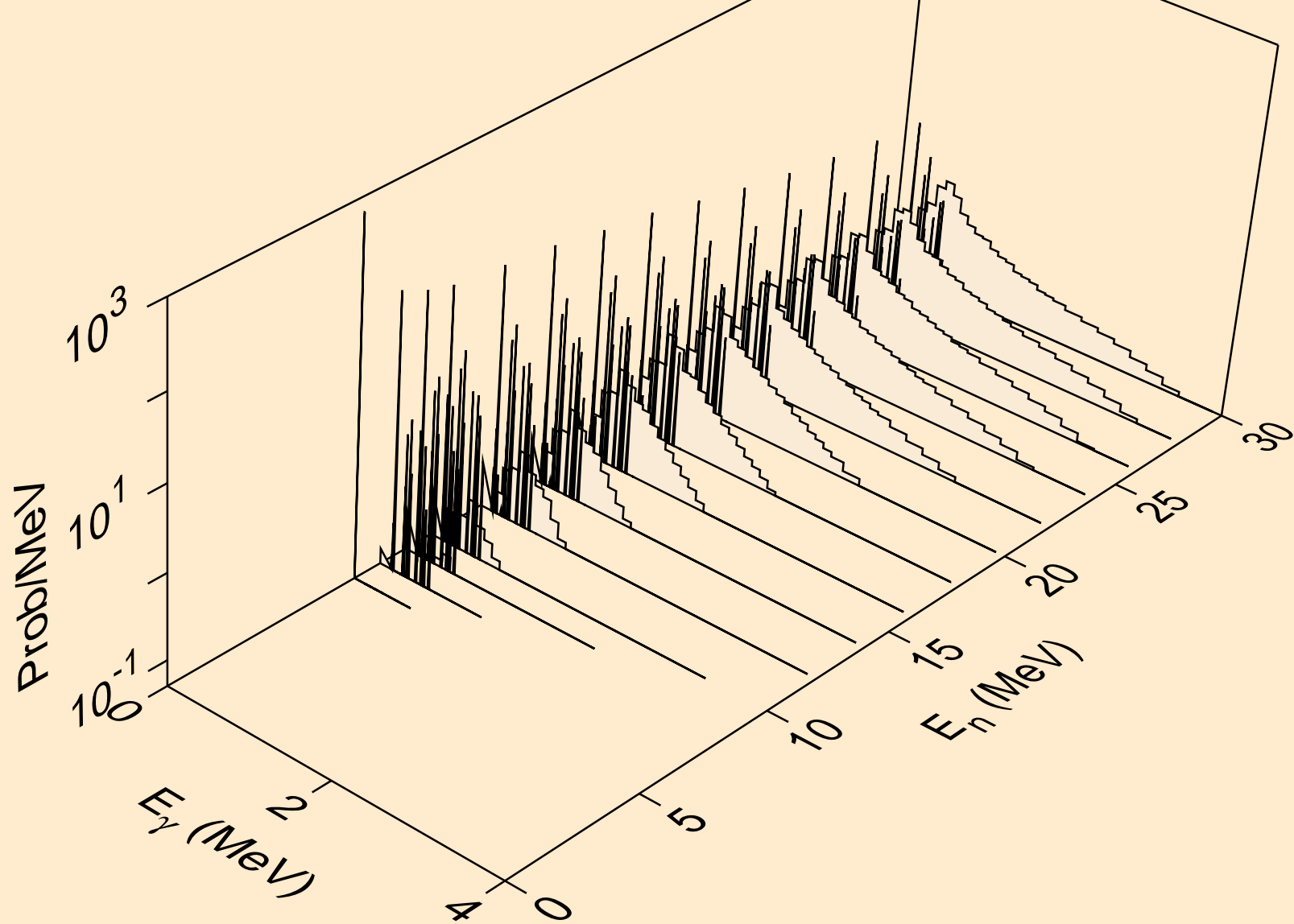

I127 PROTON ACER TENDL-2021 LIBRARY; T=0.K  
Photon emission for (n,2n)a

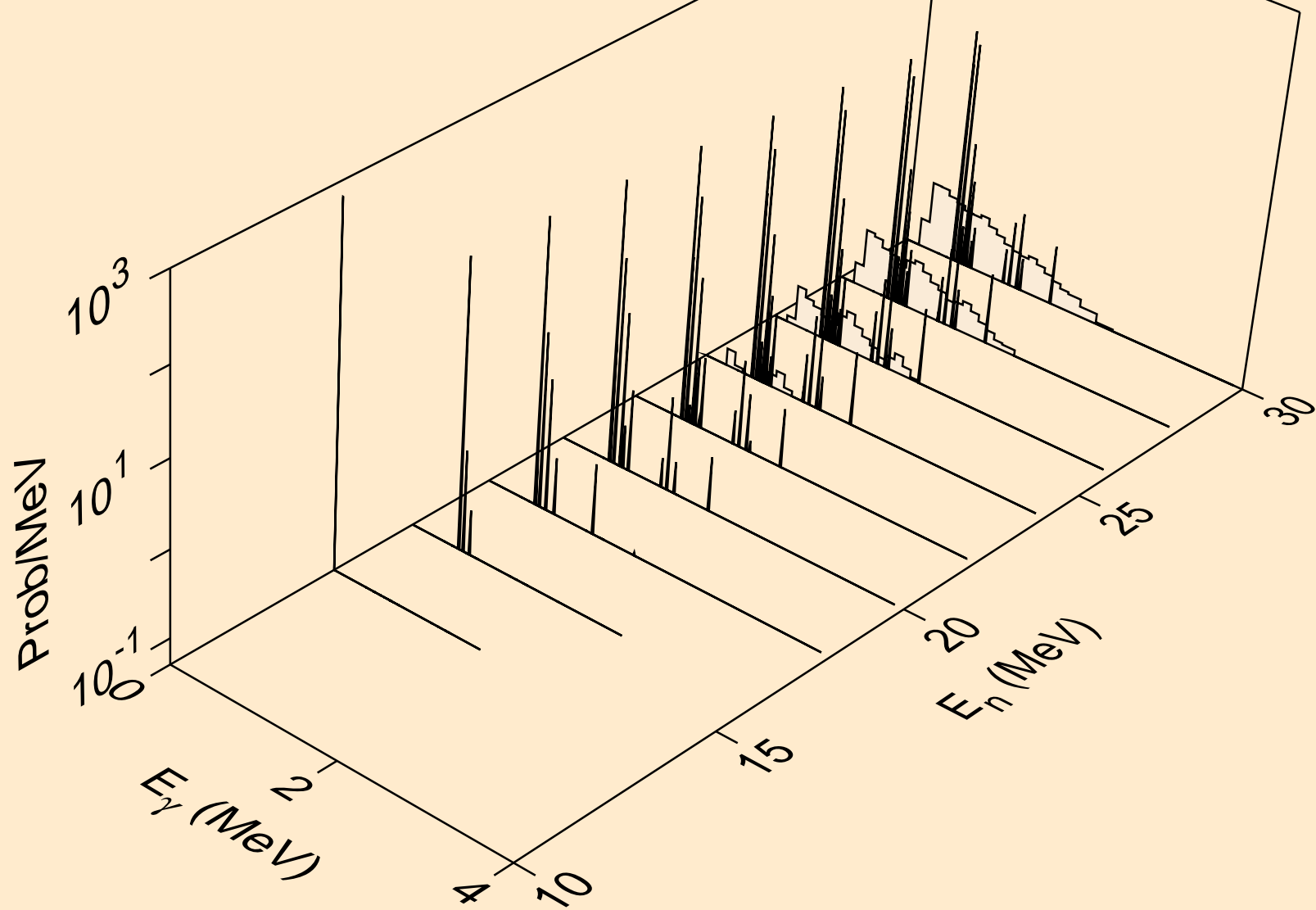

I127 PROTON ACER TENDL-2021 LIBRARY; T=0.K  
Photon emission for (n,3n)a

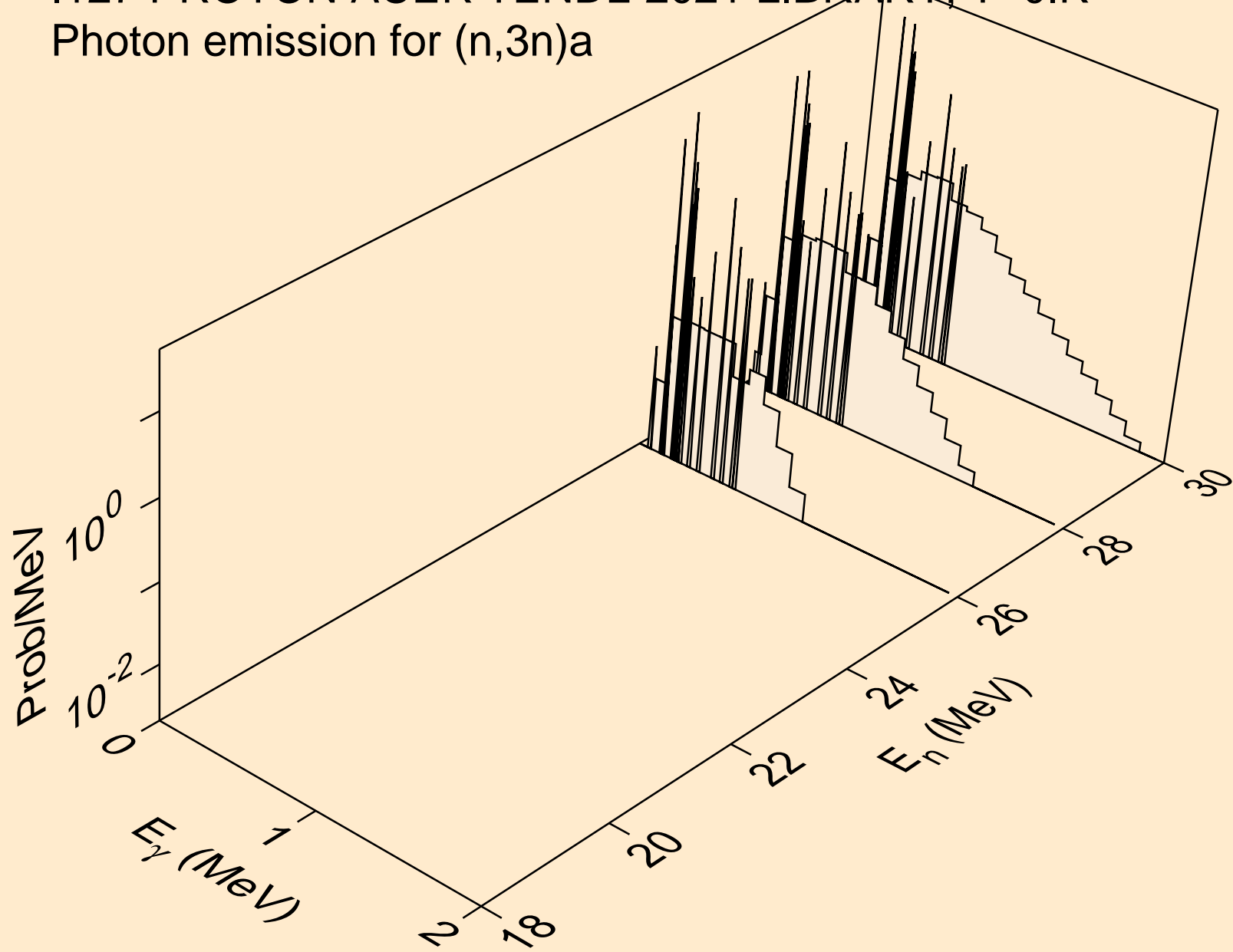

I127 PROTON ACER TENDL-2021 LIBRARY; T=0.K  
Photon emission for (n,n\*)p

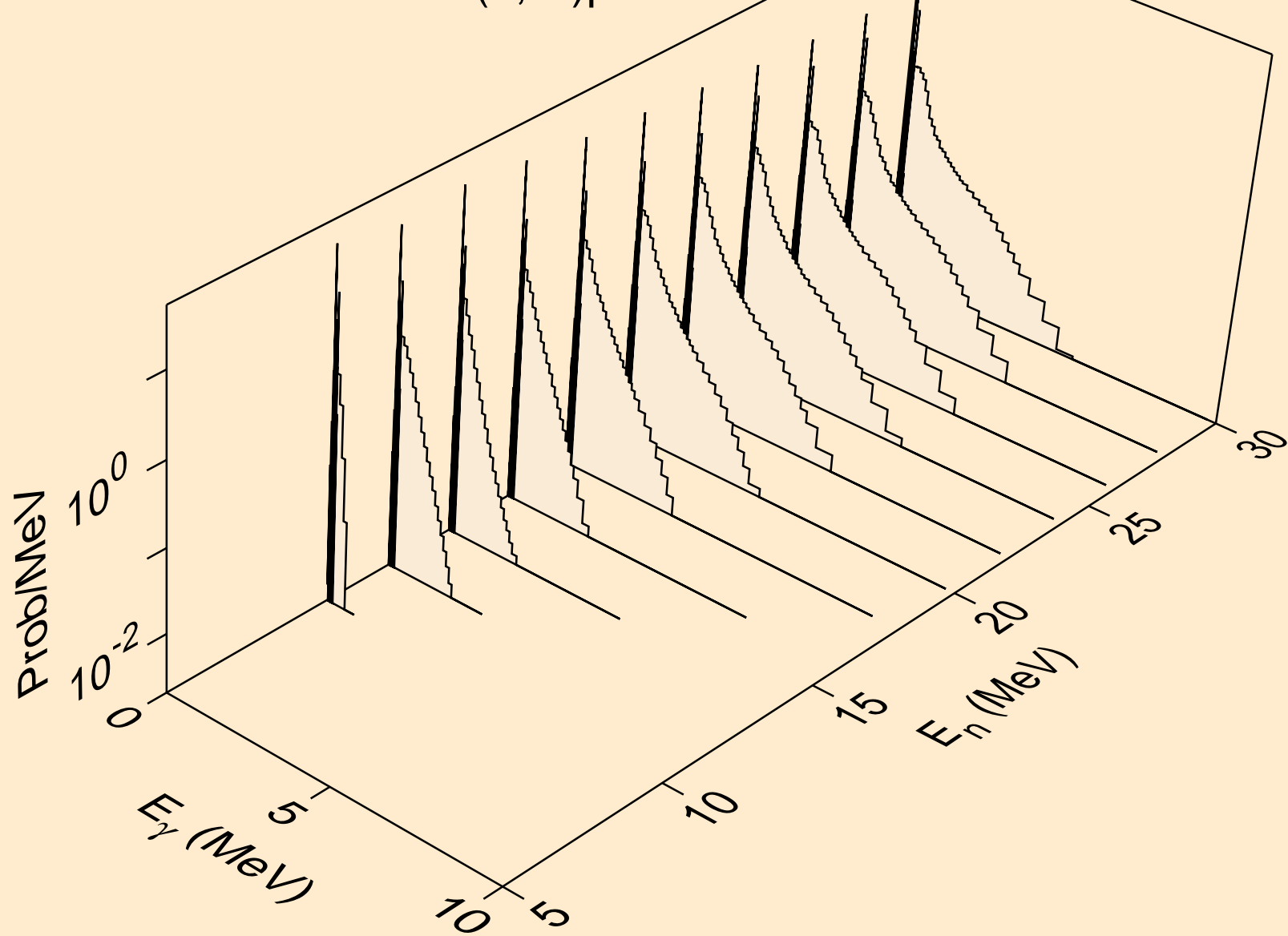

I127 PROTON ACER TENDL-2021 LIBRARY; T=0.K  
Photon emission for (n,n\*)2a

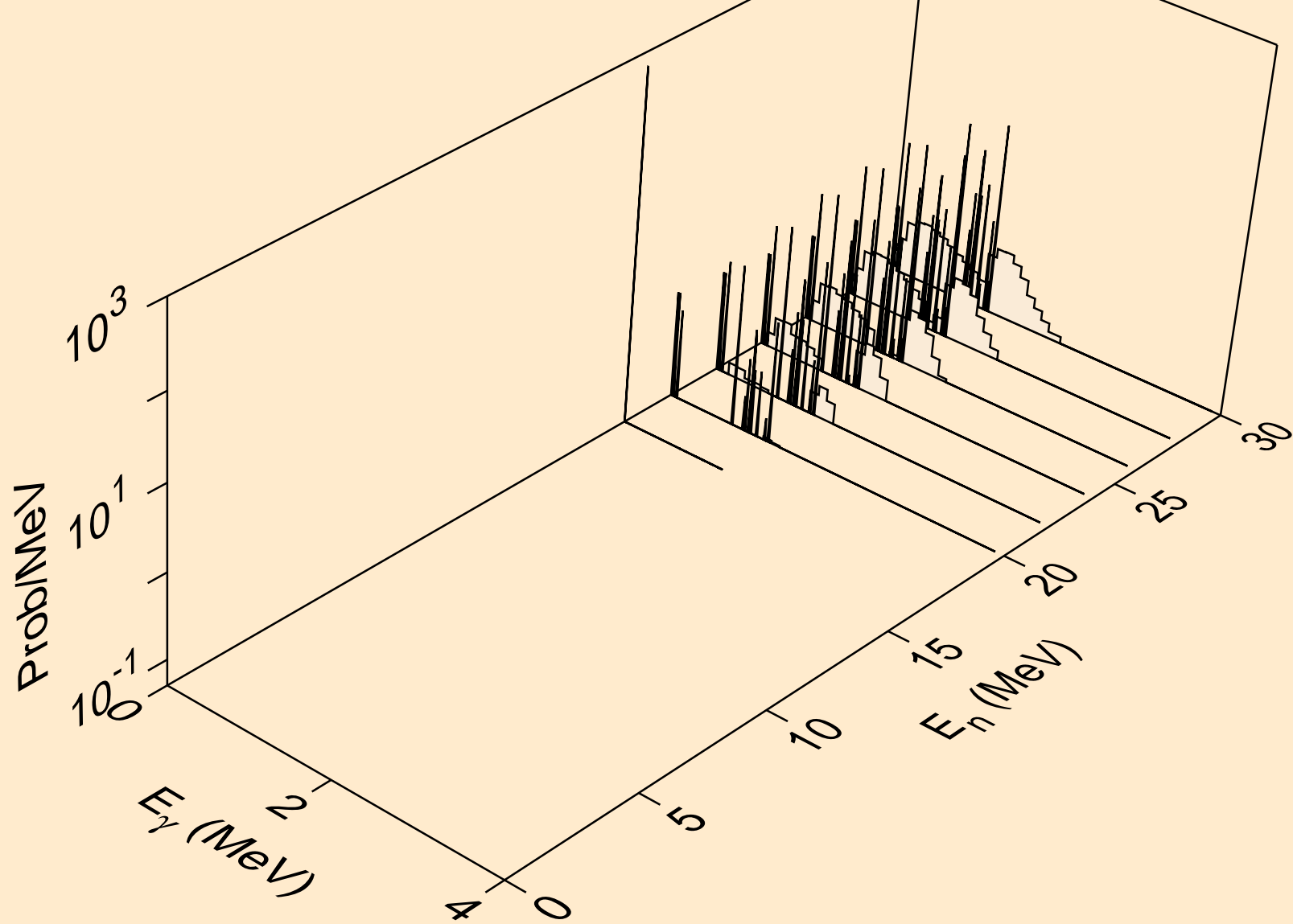

I127 PROTON ACER TENDL-2021 LIBRARY; T=0.K  
Photon emission for (n,n\*)d

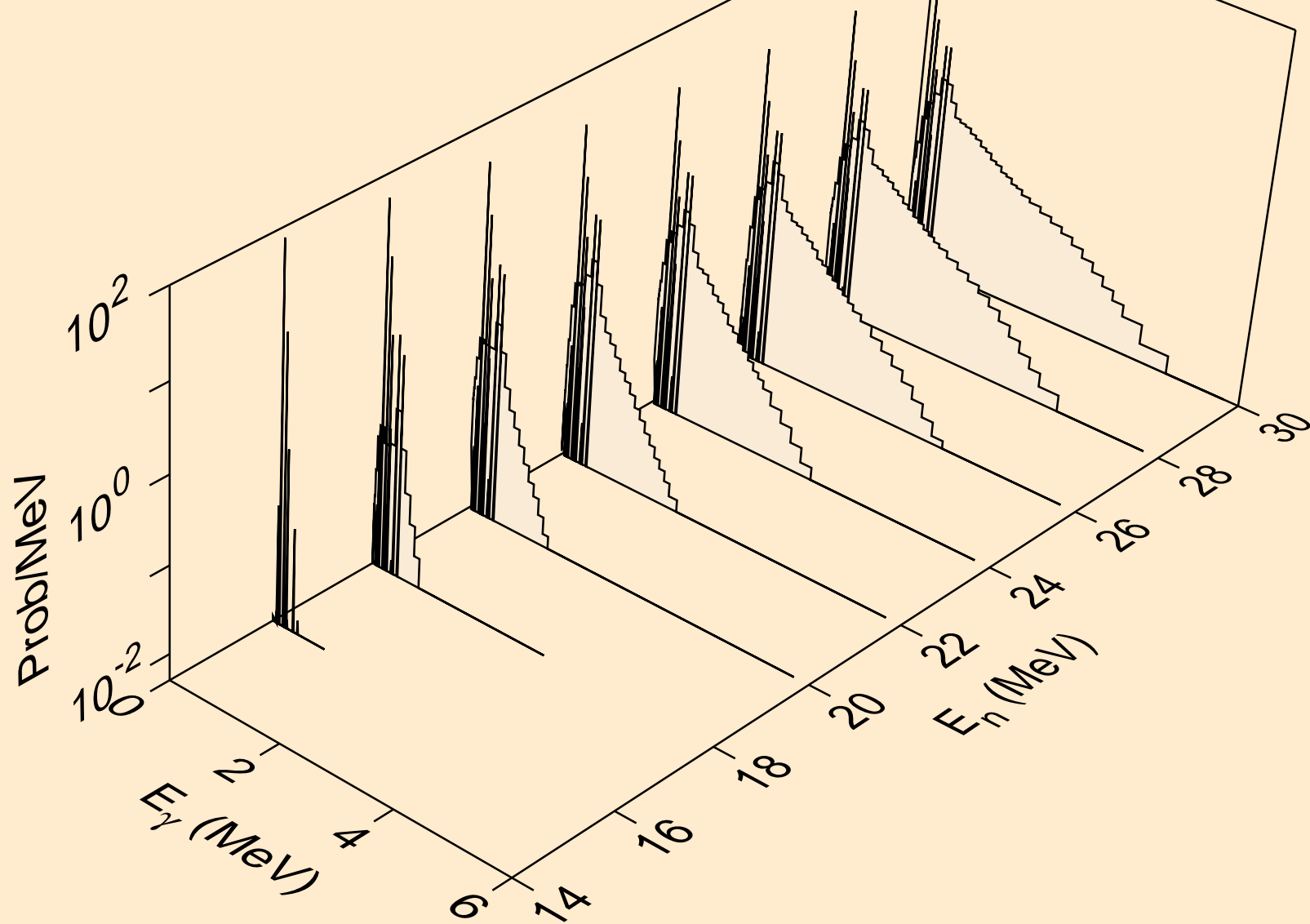

I127 PROTON ACER TENDL-2021 LIBRARY; T=0.K  
Photon emission for (n,n\*)t

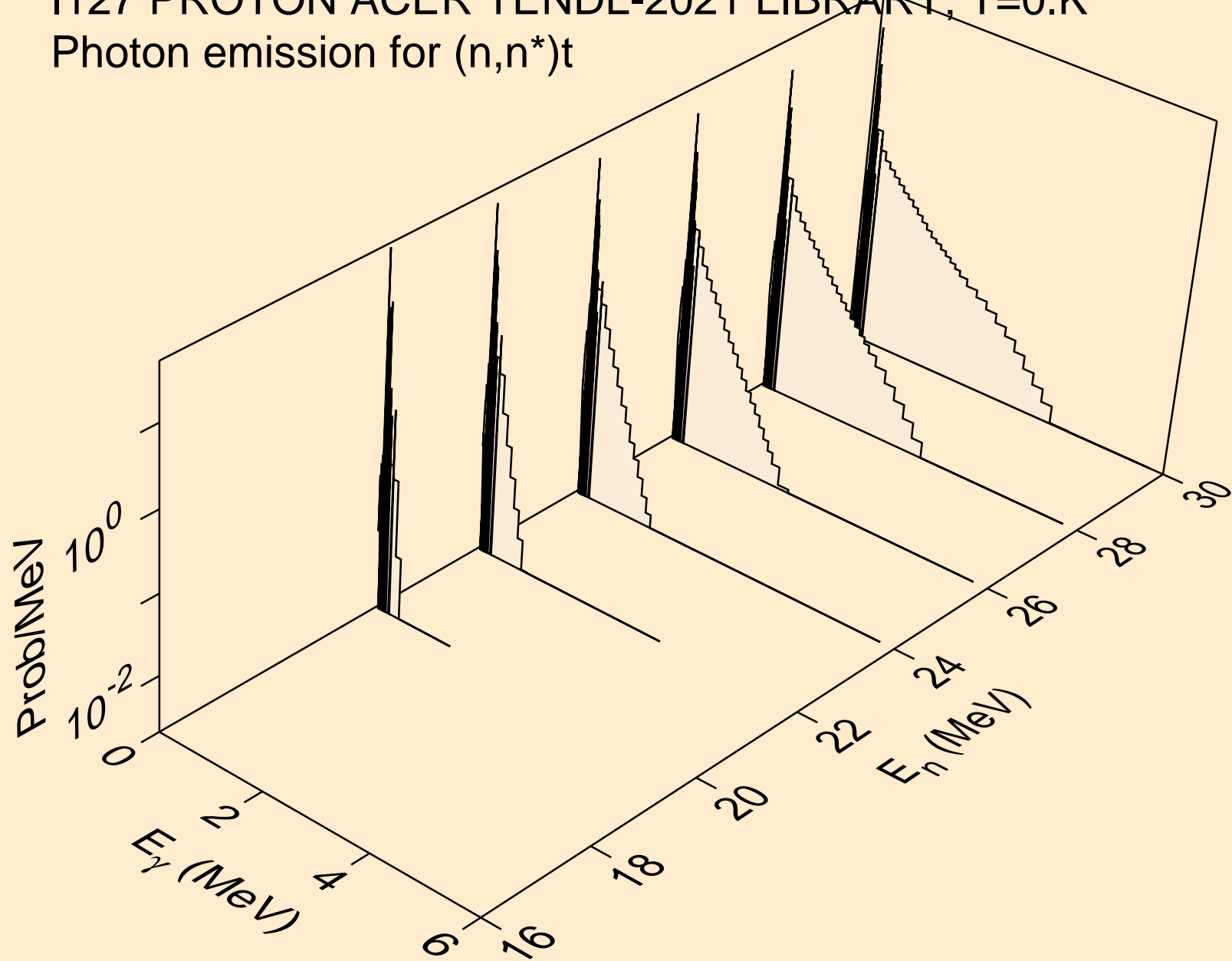



I127 PROTON ACER TENDL-2021 LIBRARY; T=0.K  
Photon emission for (n,n\*)he3

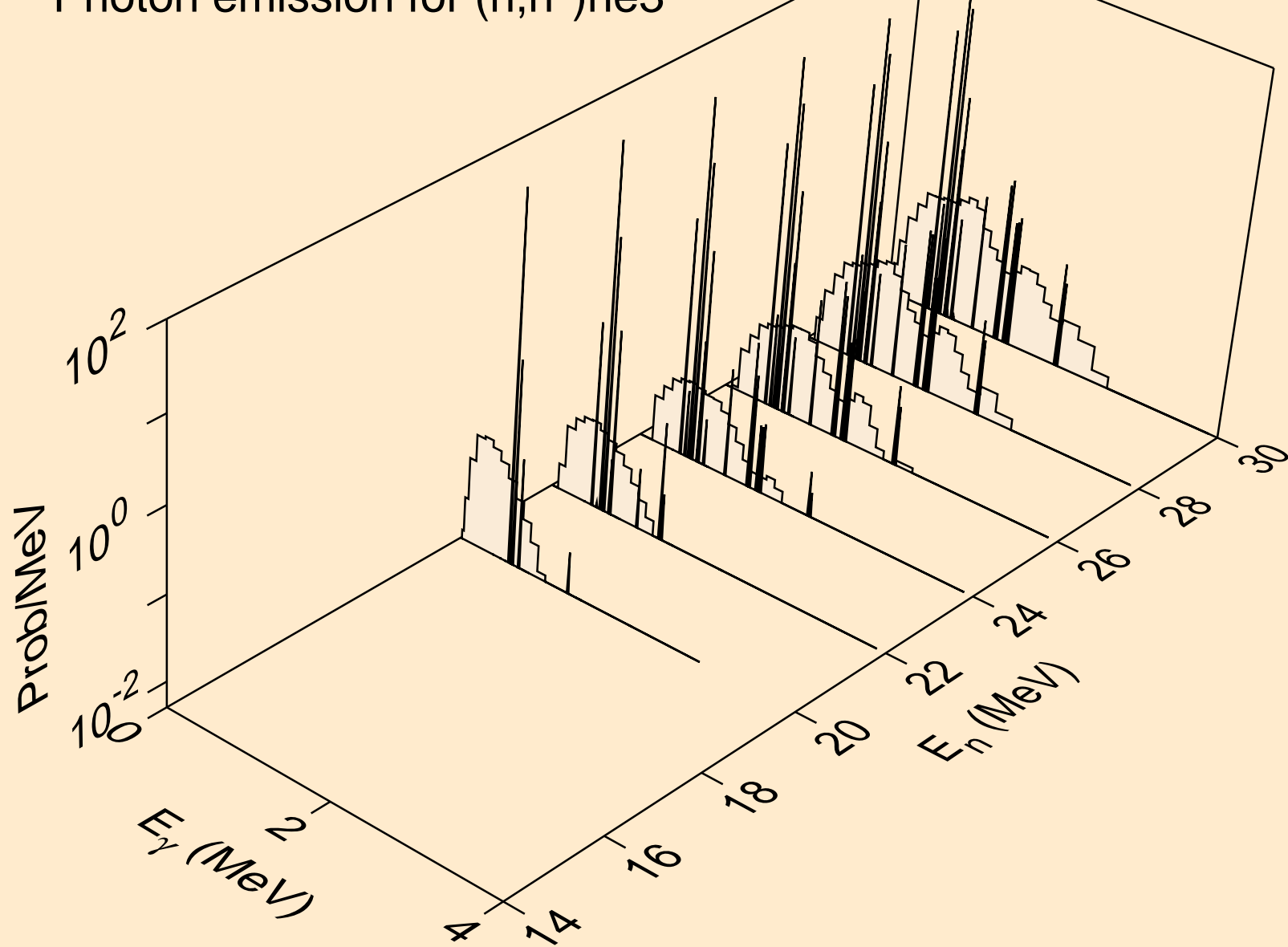

I127 PROTON ACER TENDL-2021 LIBRARY; T=0.K  
Photon emission for (n,4n)

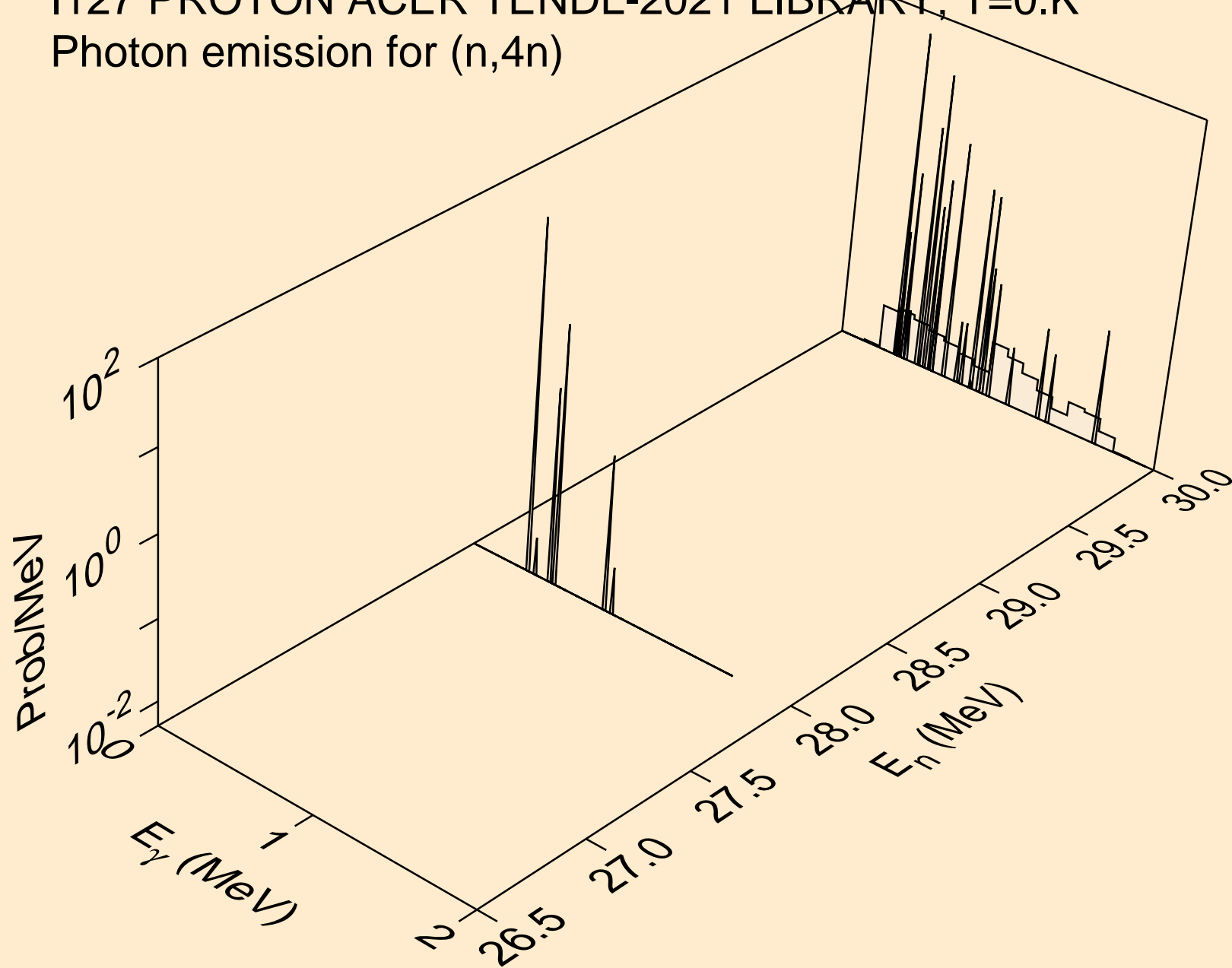

I127 PROTON ACER TENDL-2021 LIBRARY; T=0.K  
Photon emission for (n,2np)

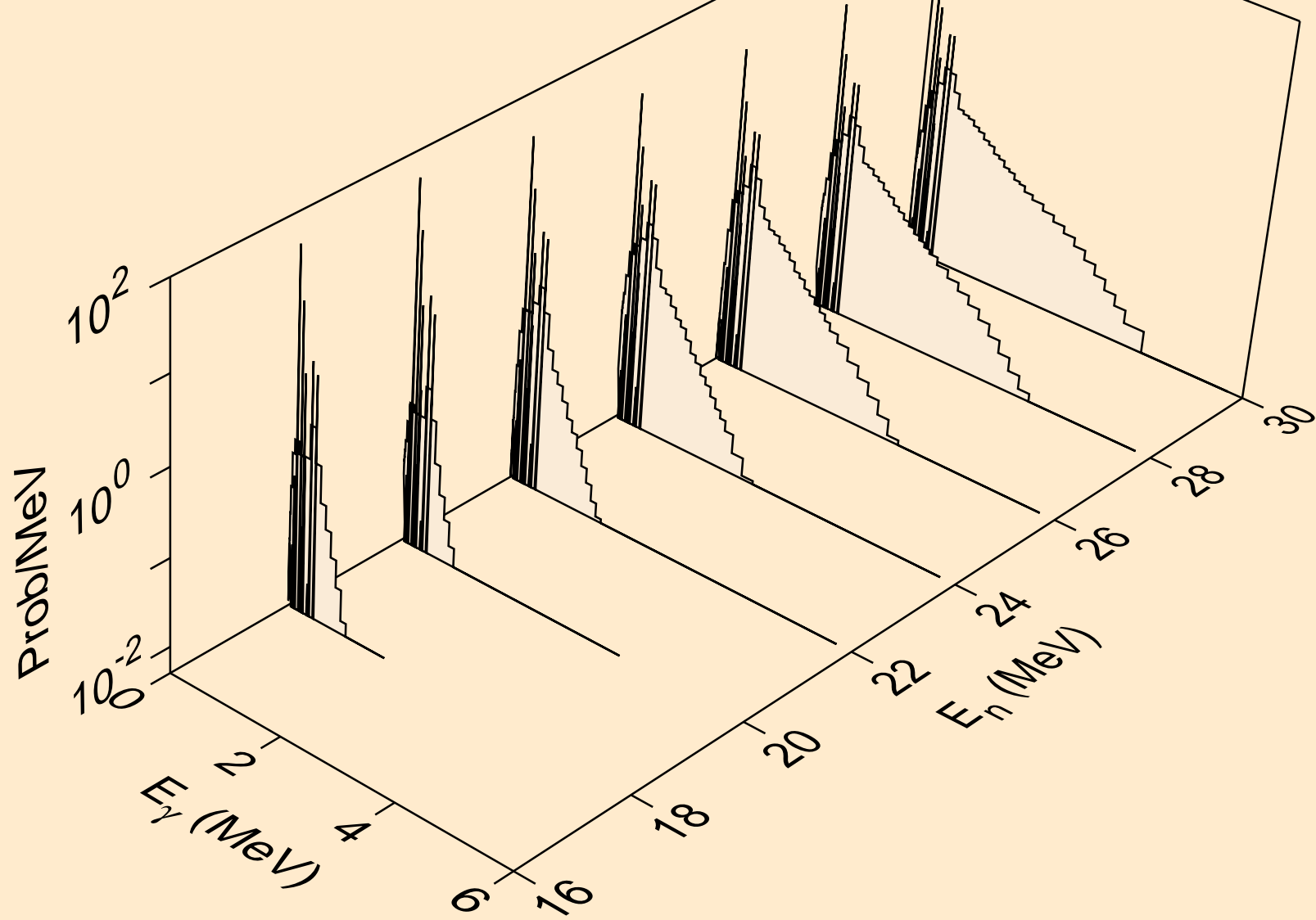

I127 PROTON ACER TENDL-2021 LIBRARY; T=0.K  
Photon emission for (n,3np)

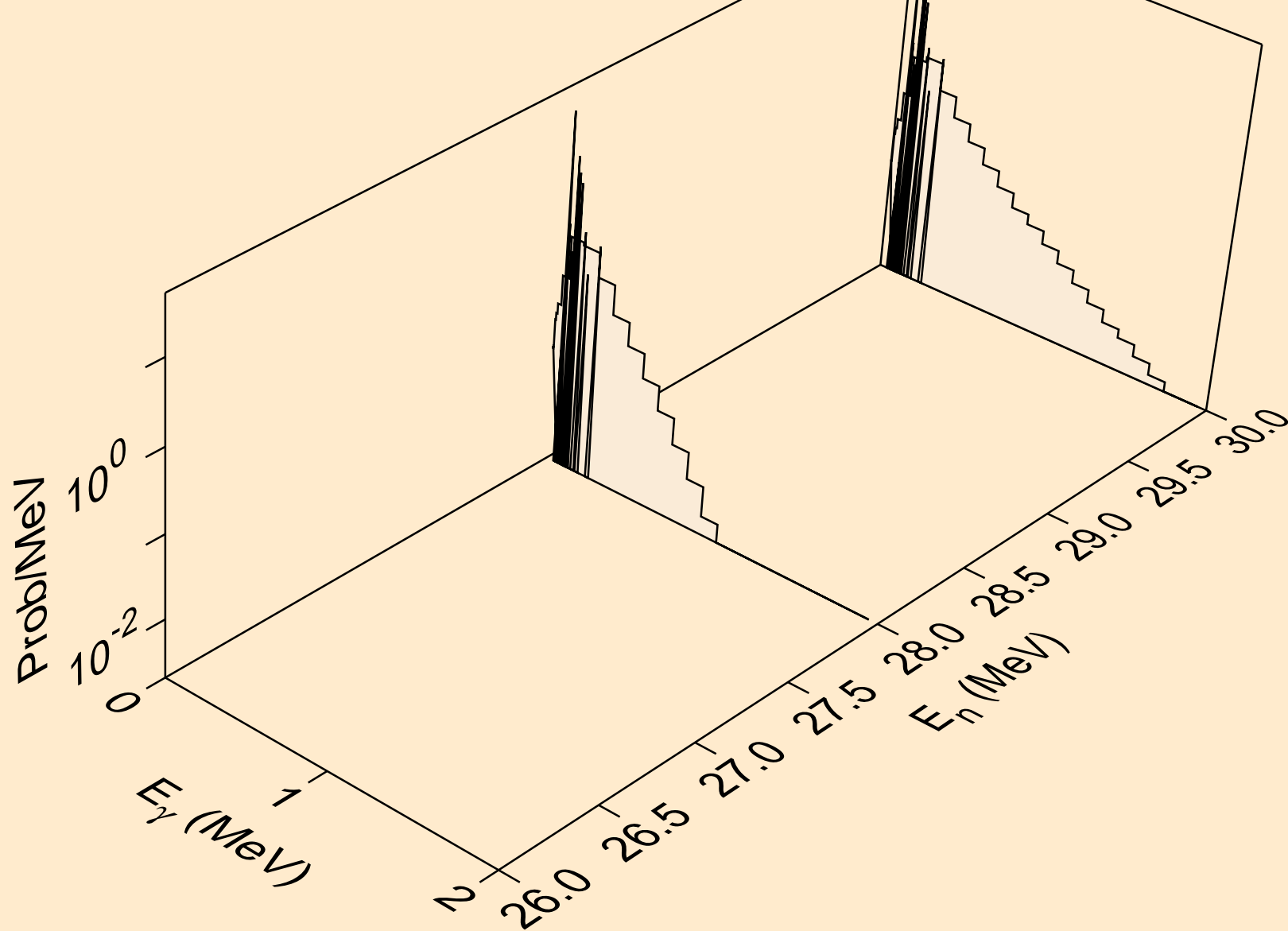

I127 PROTON ACER TENDL-2021 LIBRARY; T=0.K  
Photon emission for (n,2np)

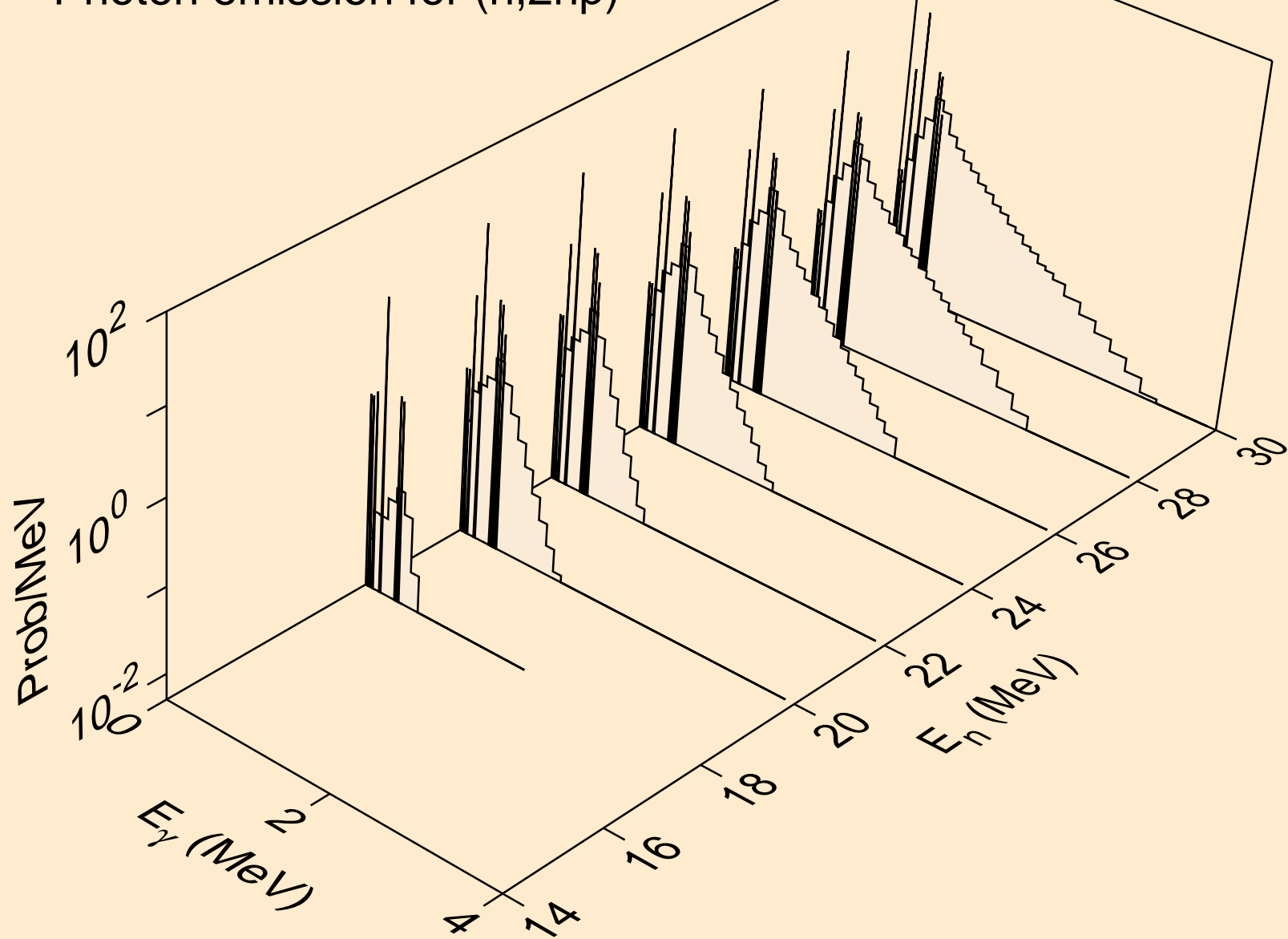

I127 PROTON ACER TENDL-2021 LIBRARY; T=0.K  
Photon emission for (n,npa)

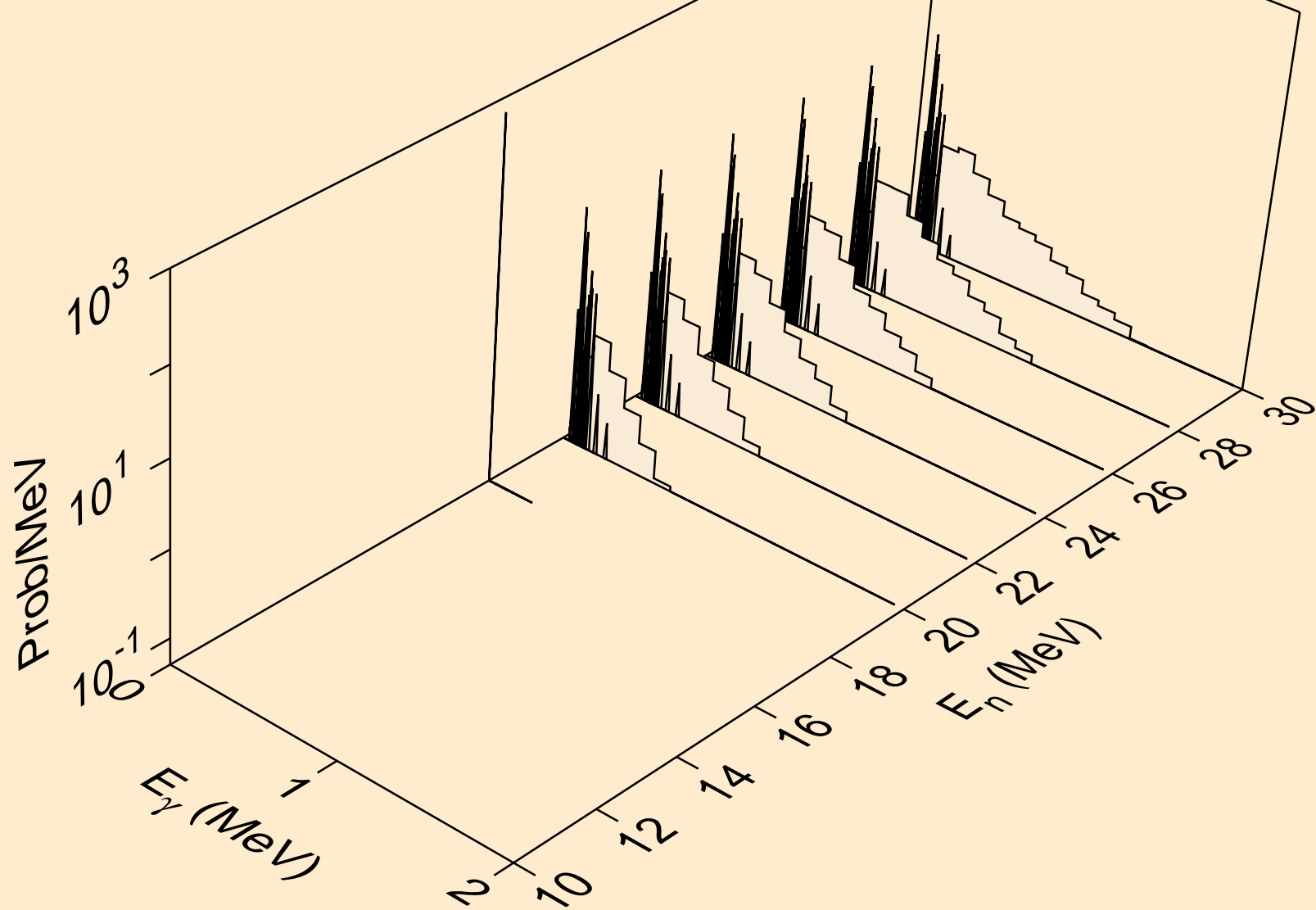

I127 PROTON ACER TENDL-2021 LIBRARY; T=0.K  
Photon emission for (n,gma)

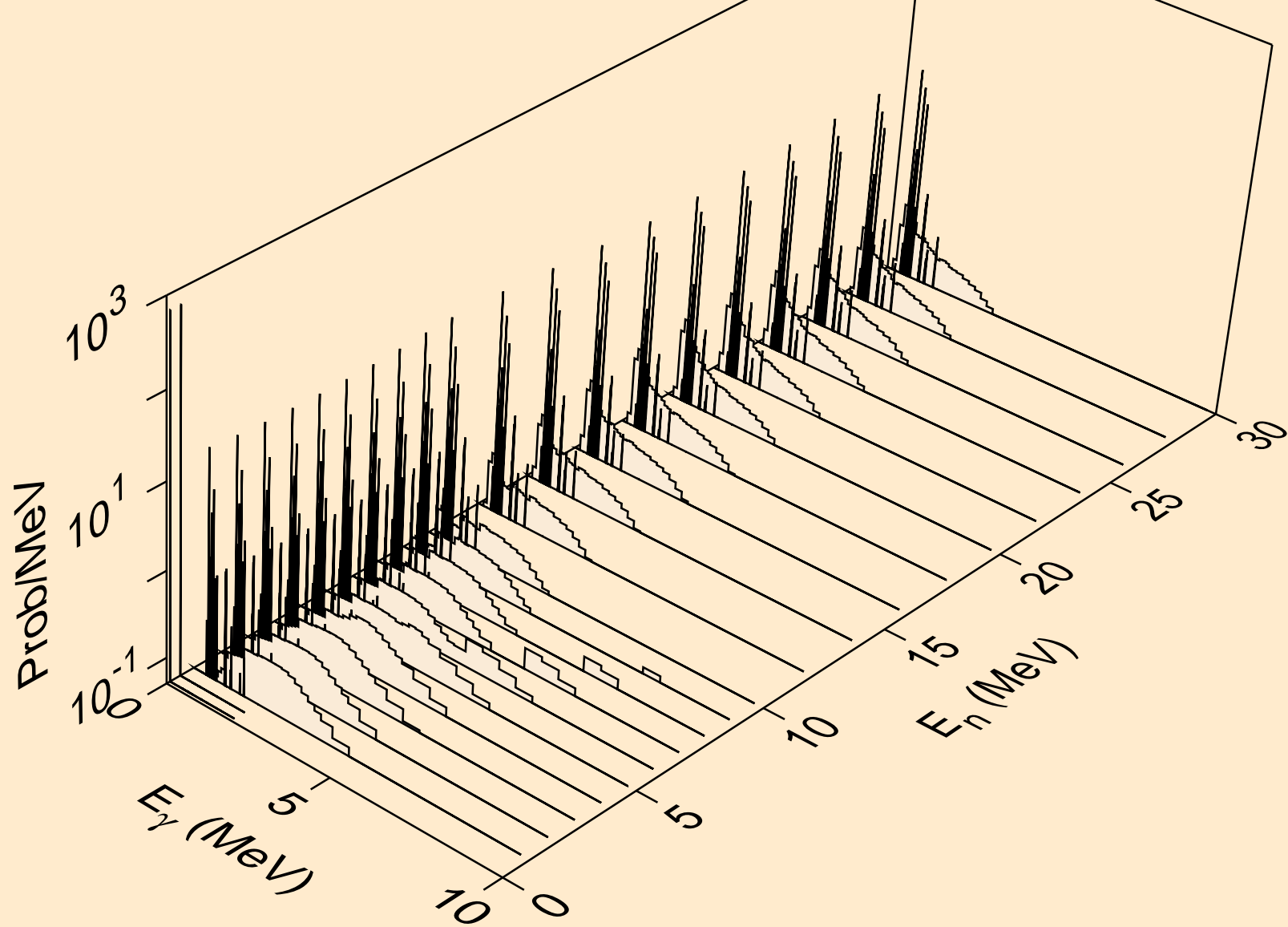

I127 PROTON ACER TENDL-2021 LIBRARY; T=0.K  
Photon emission for inelastic

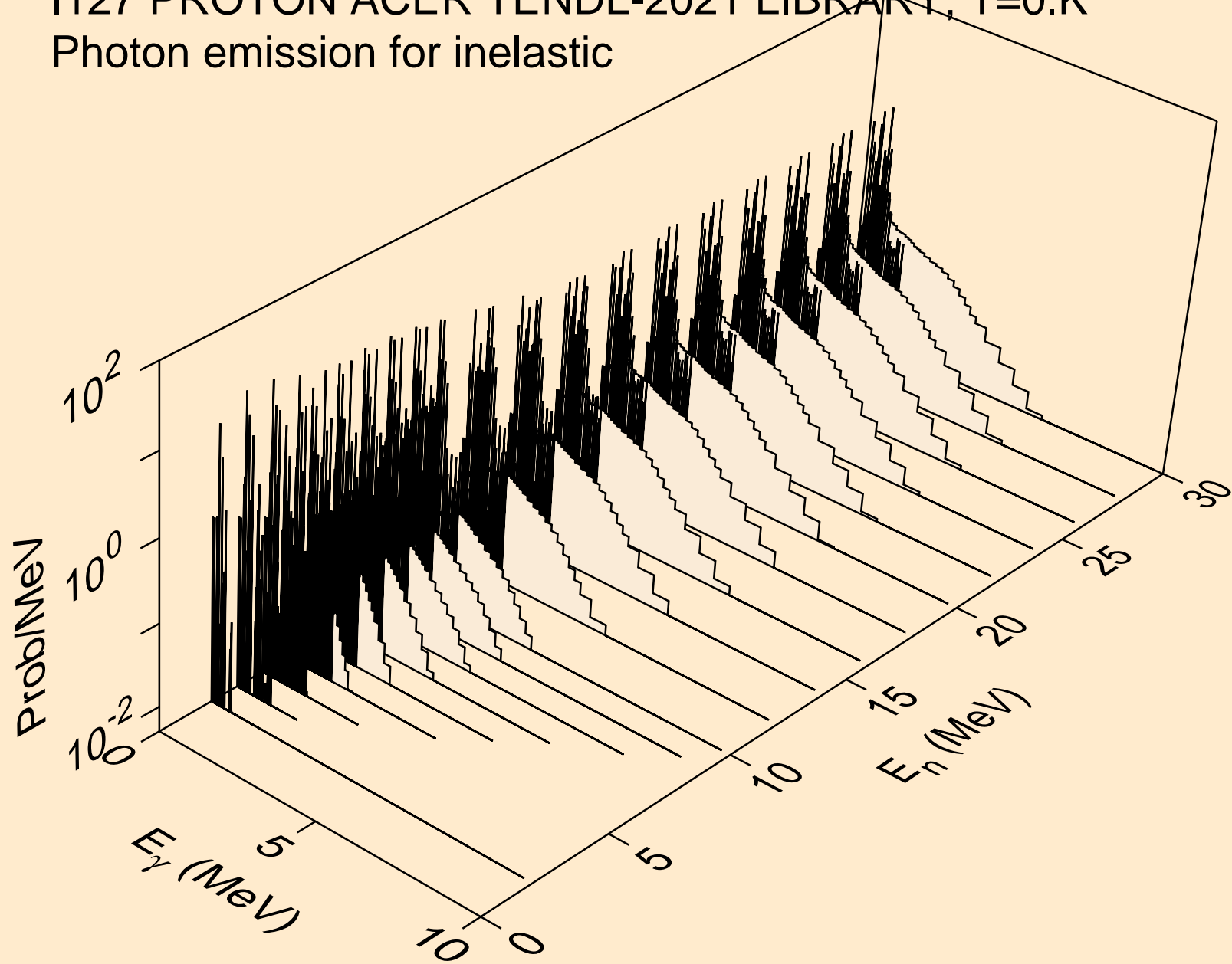



I127 PROTON ACER TENDL-2021 LIBRARY; T=0.K  
Photon emission for (n,d)

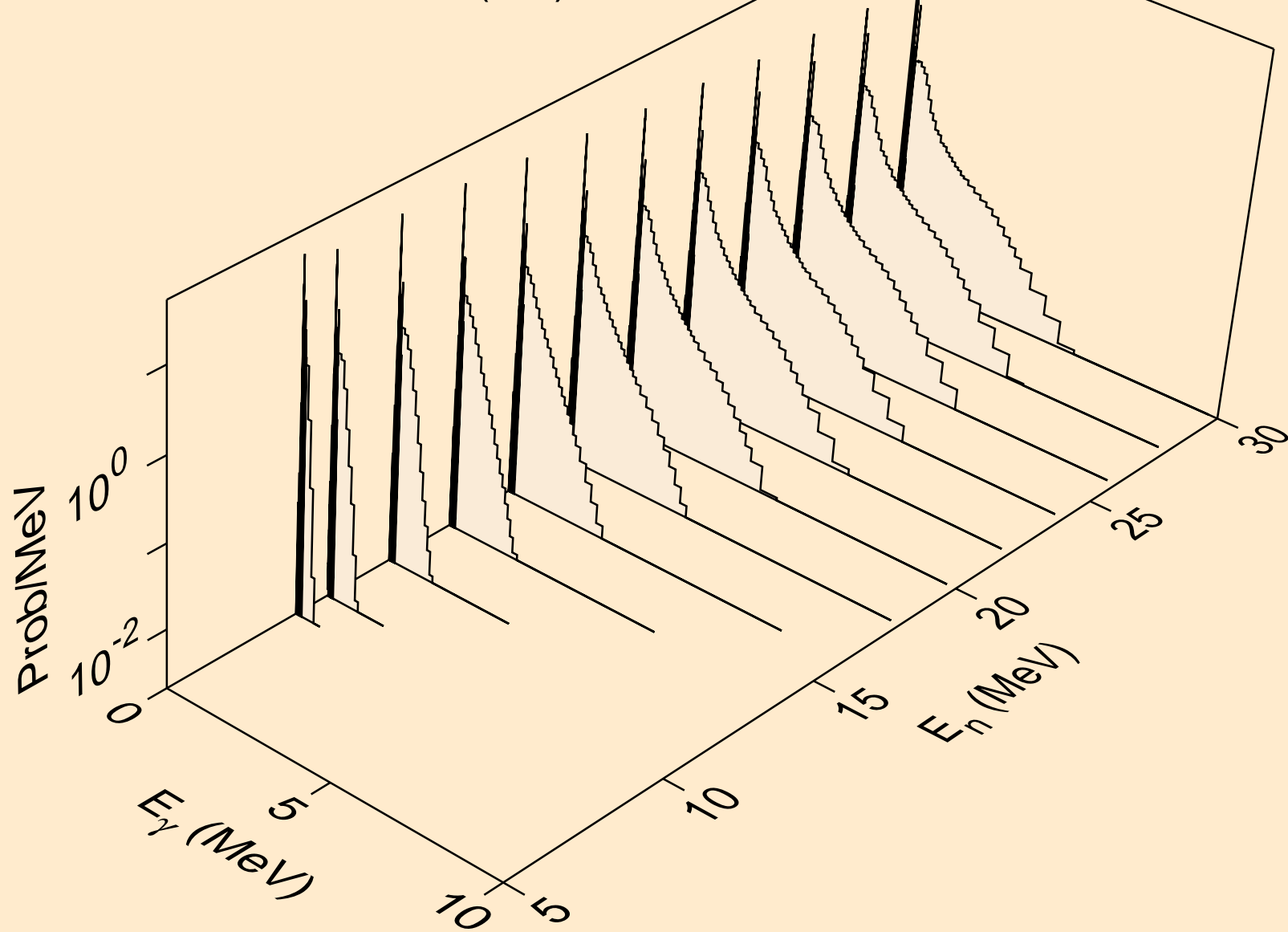

I127 PROTON ACER TENDL-2021 LIBRARY; T=0.K  
Photon emission for (n,t)

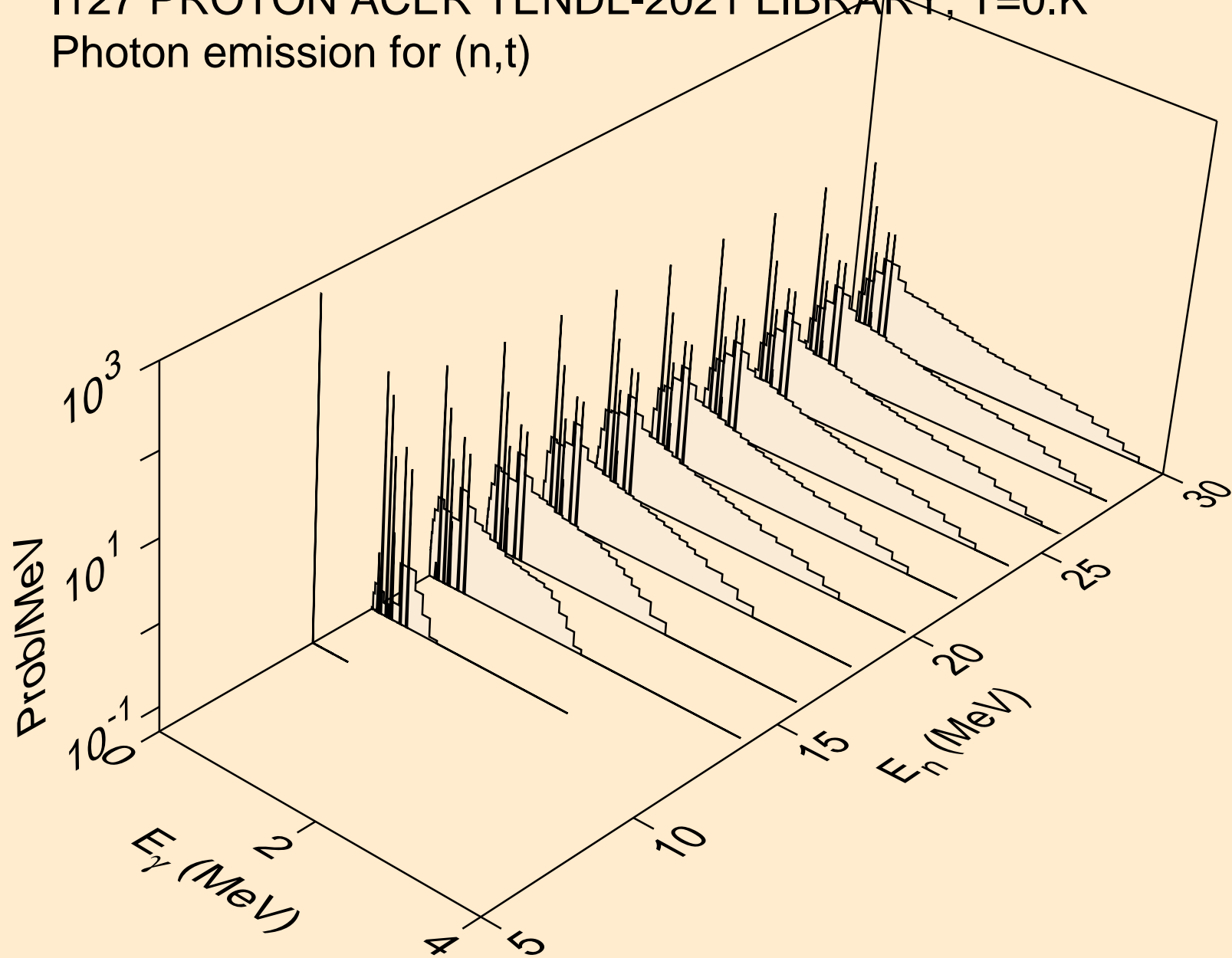

I127 PROTON ACER TENDL-2021 LIBRARY; T=0.K  
Photon emission for (n,he3)

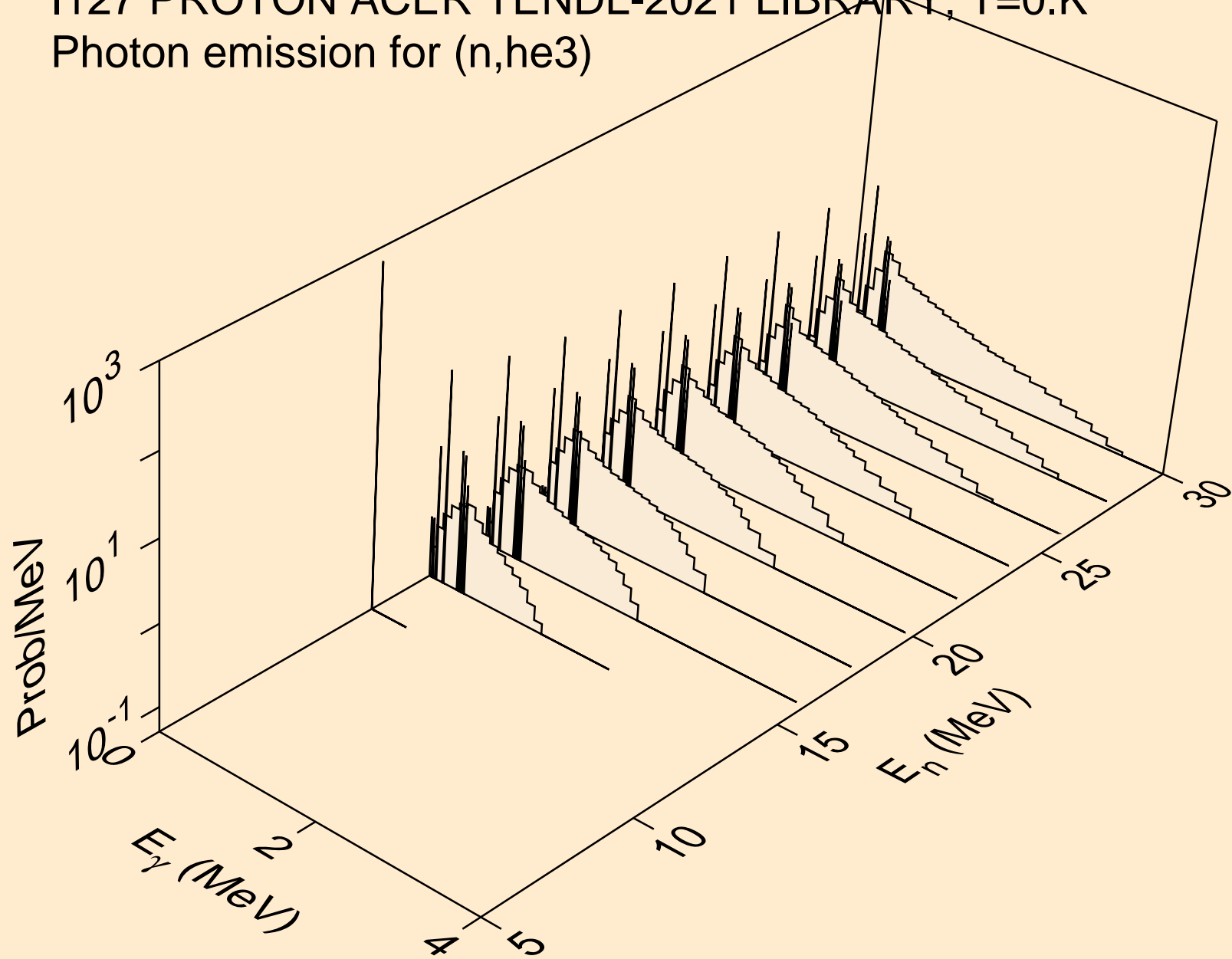

I127 PROTON ACER TENDL-2021 LIBRARY; T=0.K  
Photon emission for (n,a)

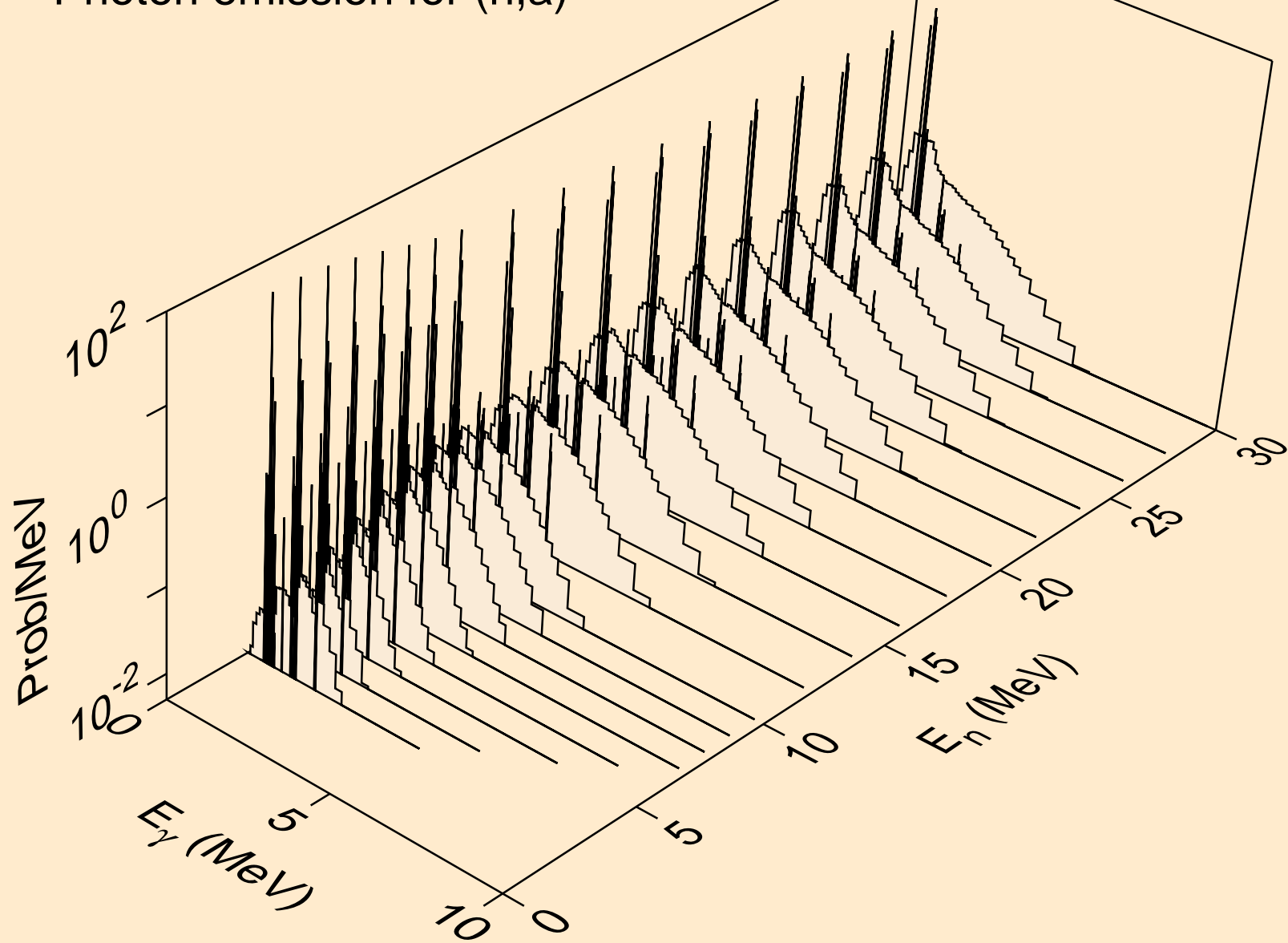

I127 PROTON ACER TENDL-2021 LIBRARY; T=0.K  
Photon emission for (n,2a)

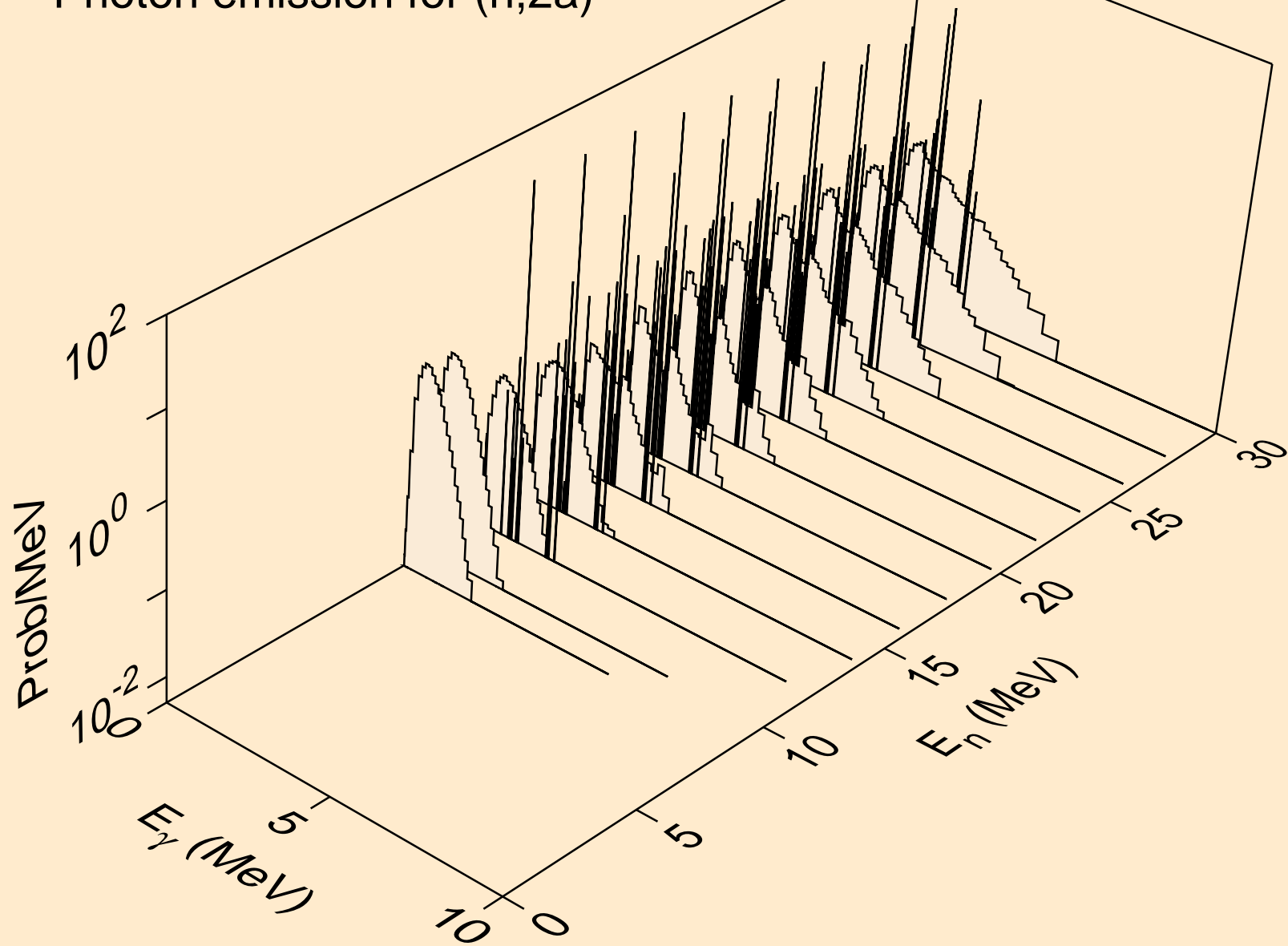

I127 PROTON ACER TENDL-2021 LIBRARY; T=0.K  
Photon emission for (n,2p)

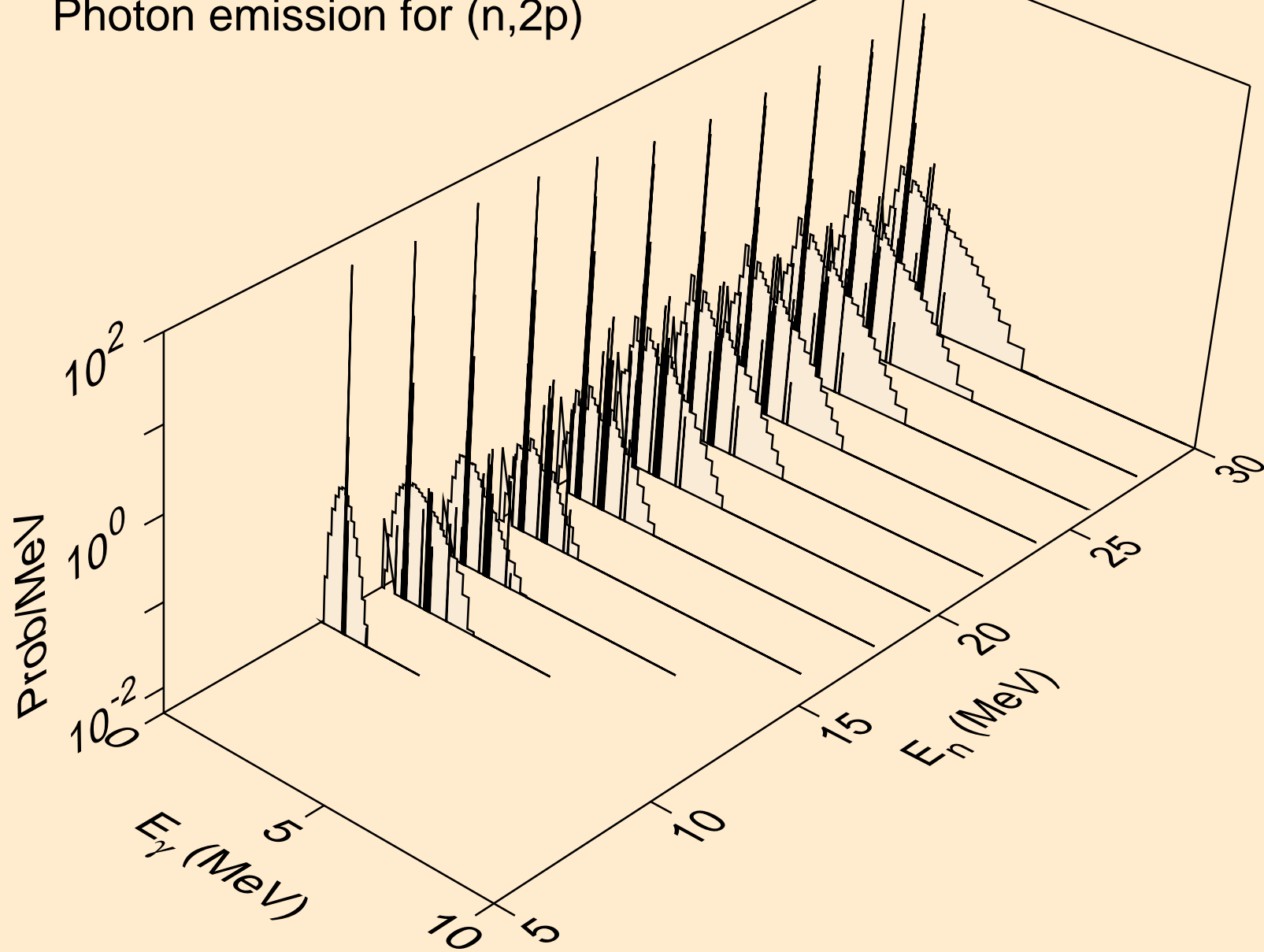

I127 PROTON ACER TENDL-2021 LIBRARY; T=0.K  
Photon emission for (n,pa)

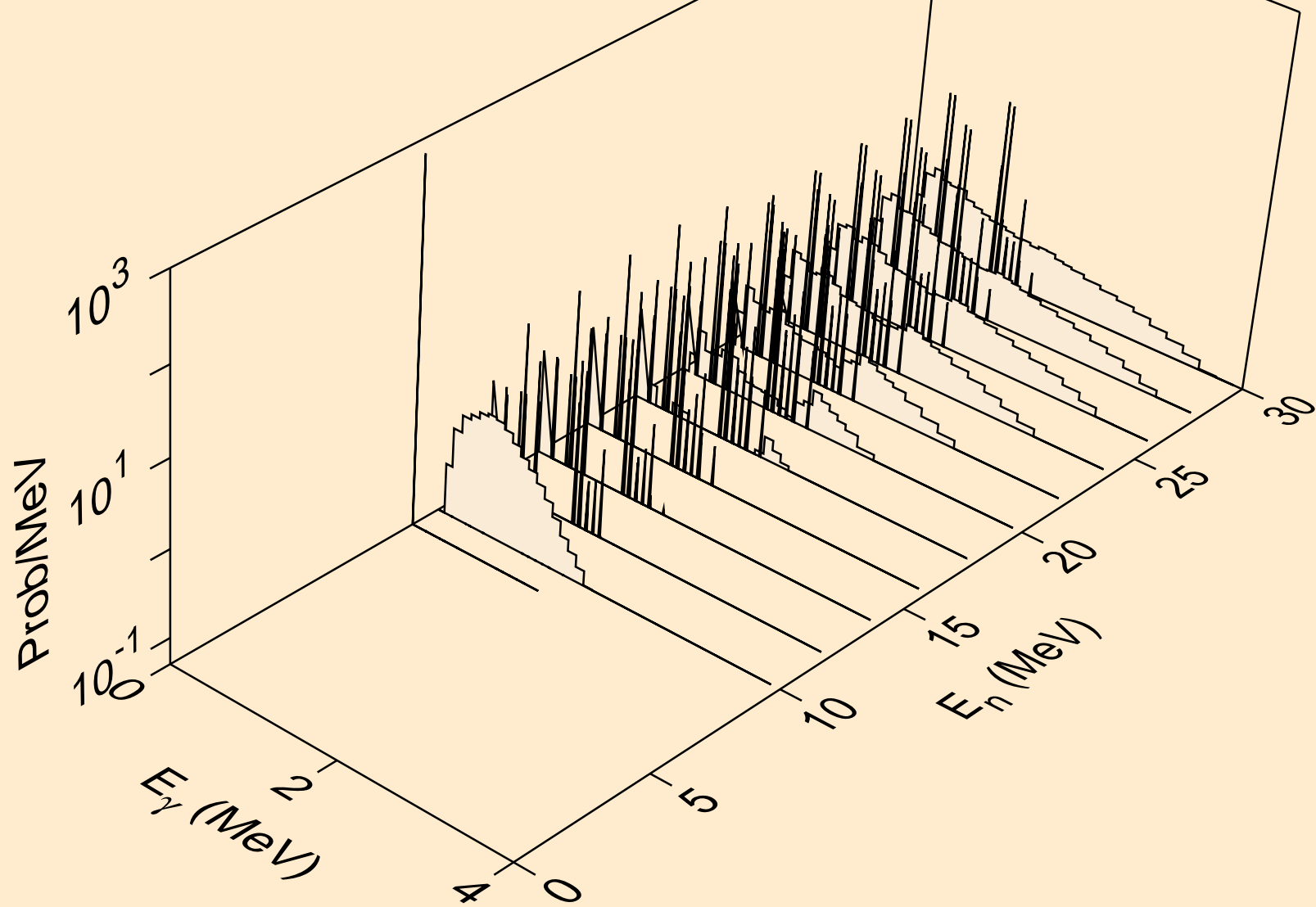

I127 PROTON ACER TENDL-2021 LIBRARY; T=0.K  
Photon emission for (n,pd)

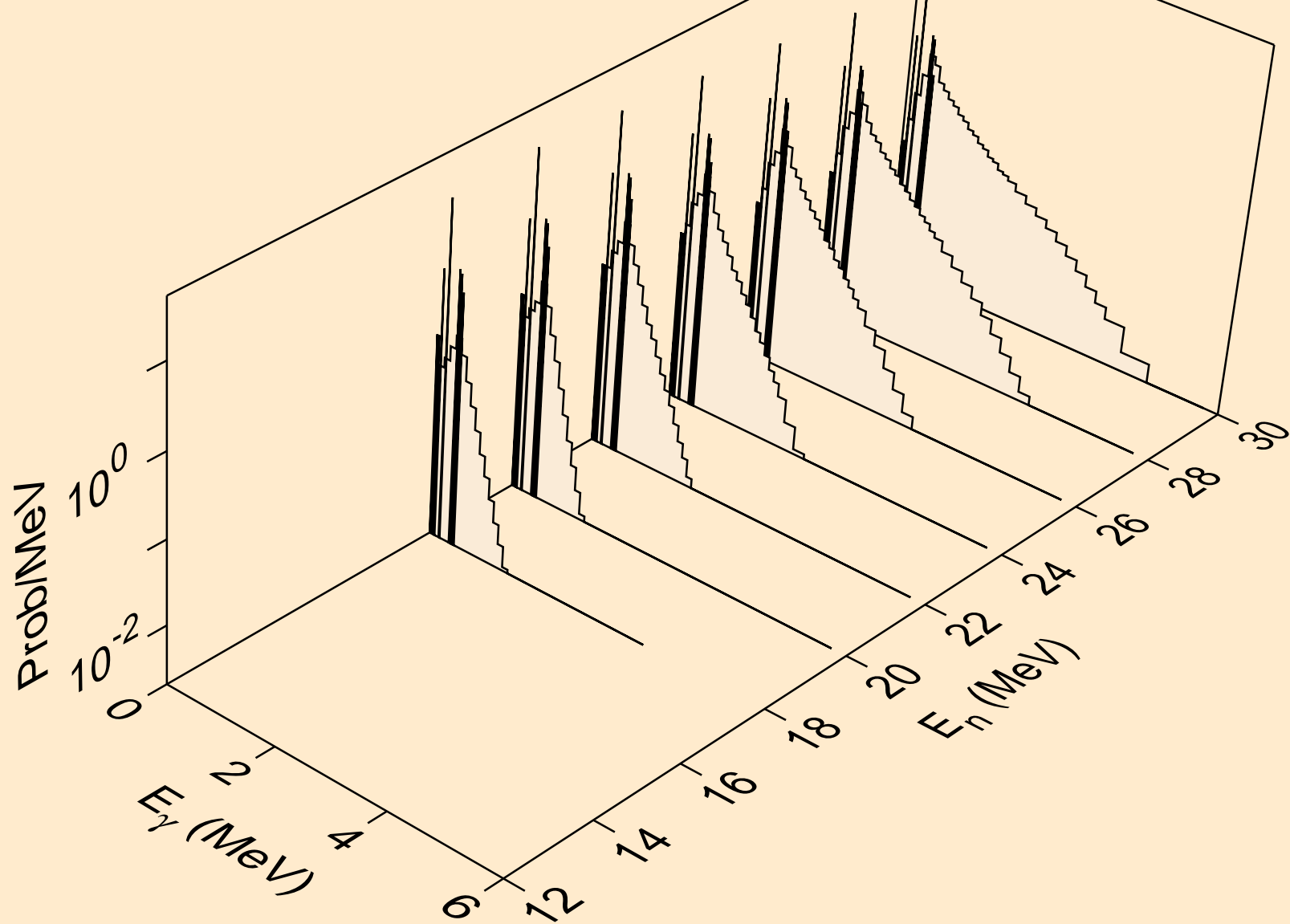



I127 PROTON ACER TENDL-2021 LIBRARY; T=0.K  
Photon emission for (n,pt)

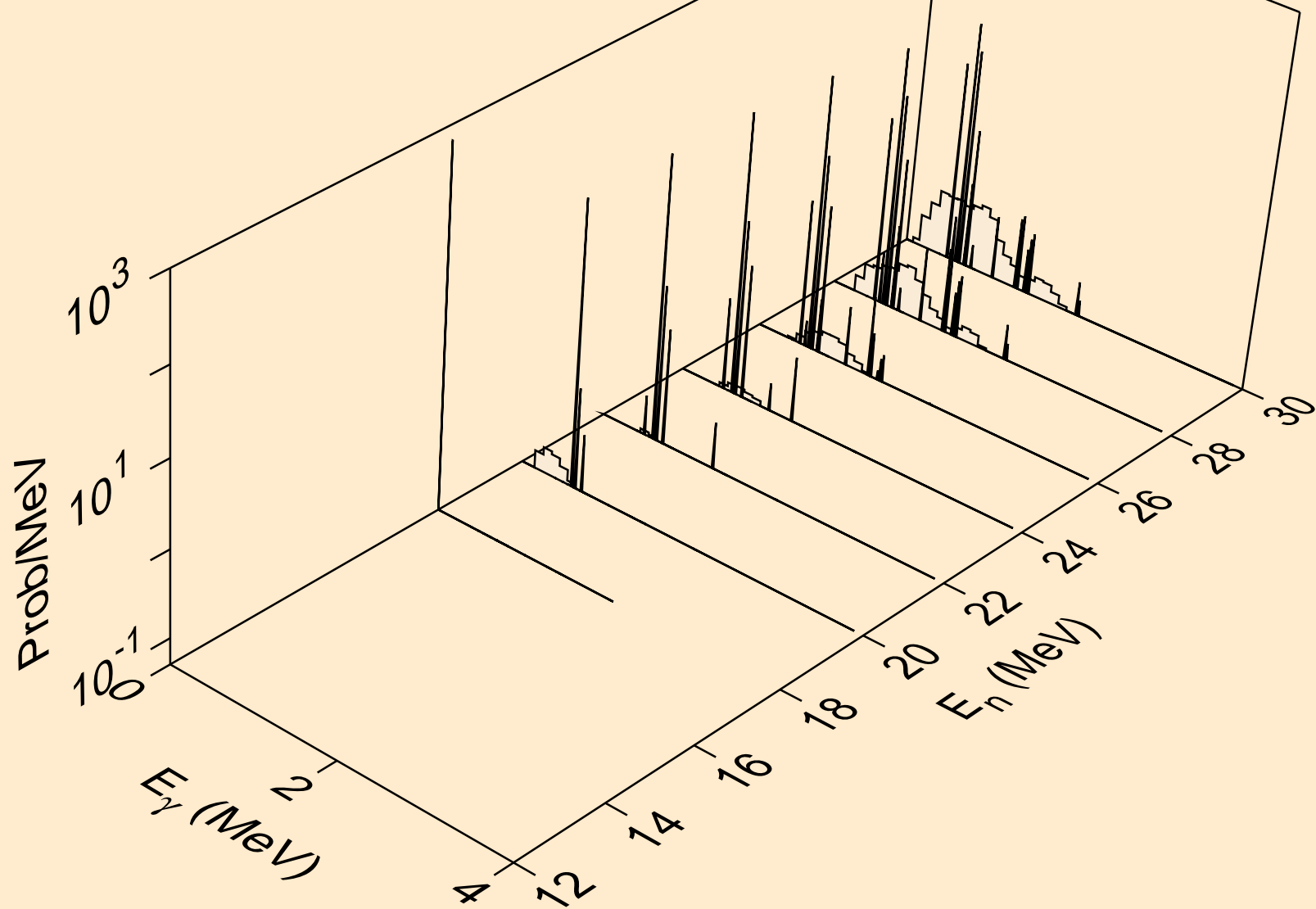

I127 PROTON ACER TENDL-2021 LIBRARY; T=0.K  
Photon emission for (n,da)

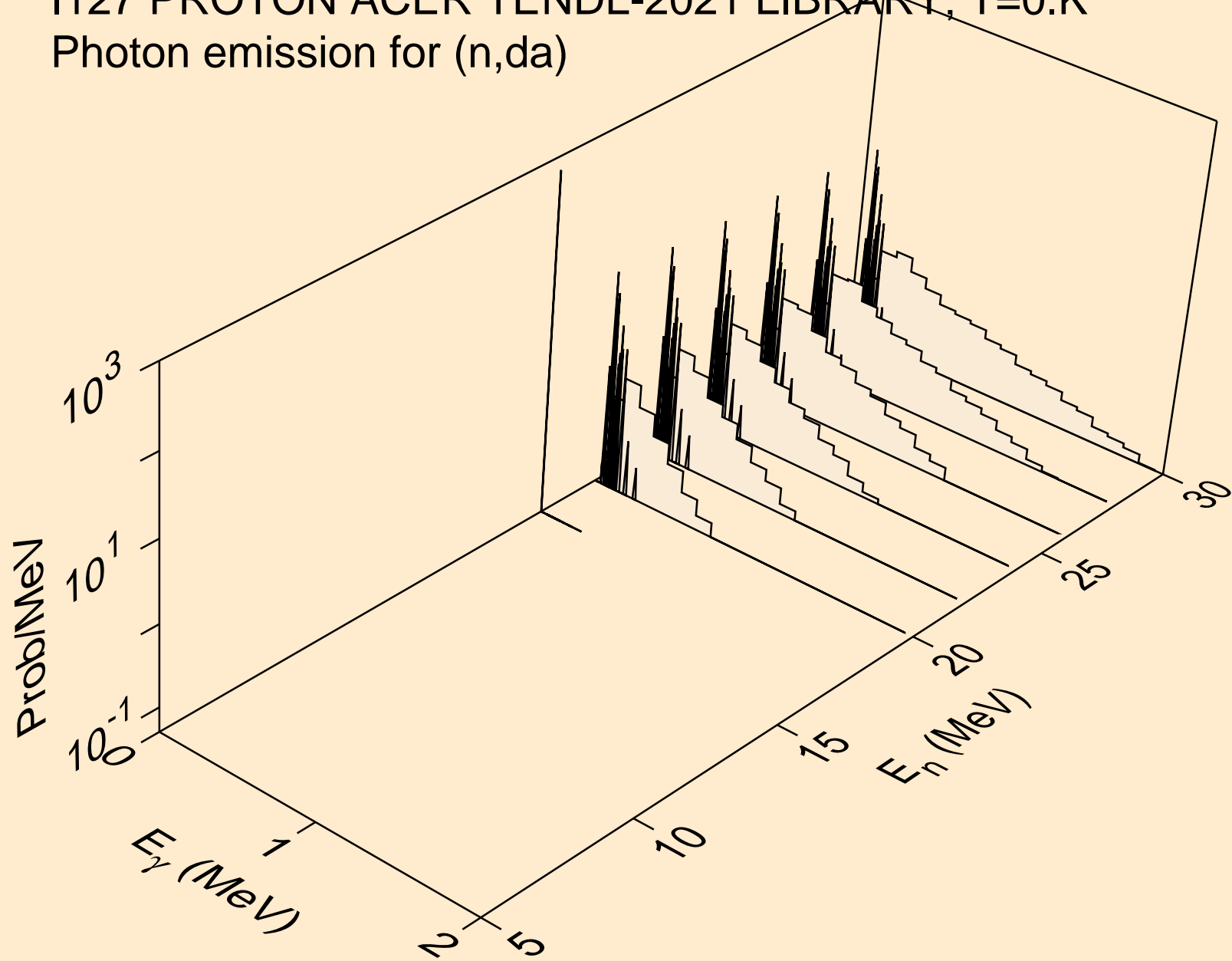

# I127 PROTON ACER TENDL-2021 LIBRARY; T=0.K

## Particle heating contributions

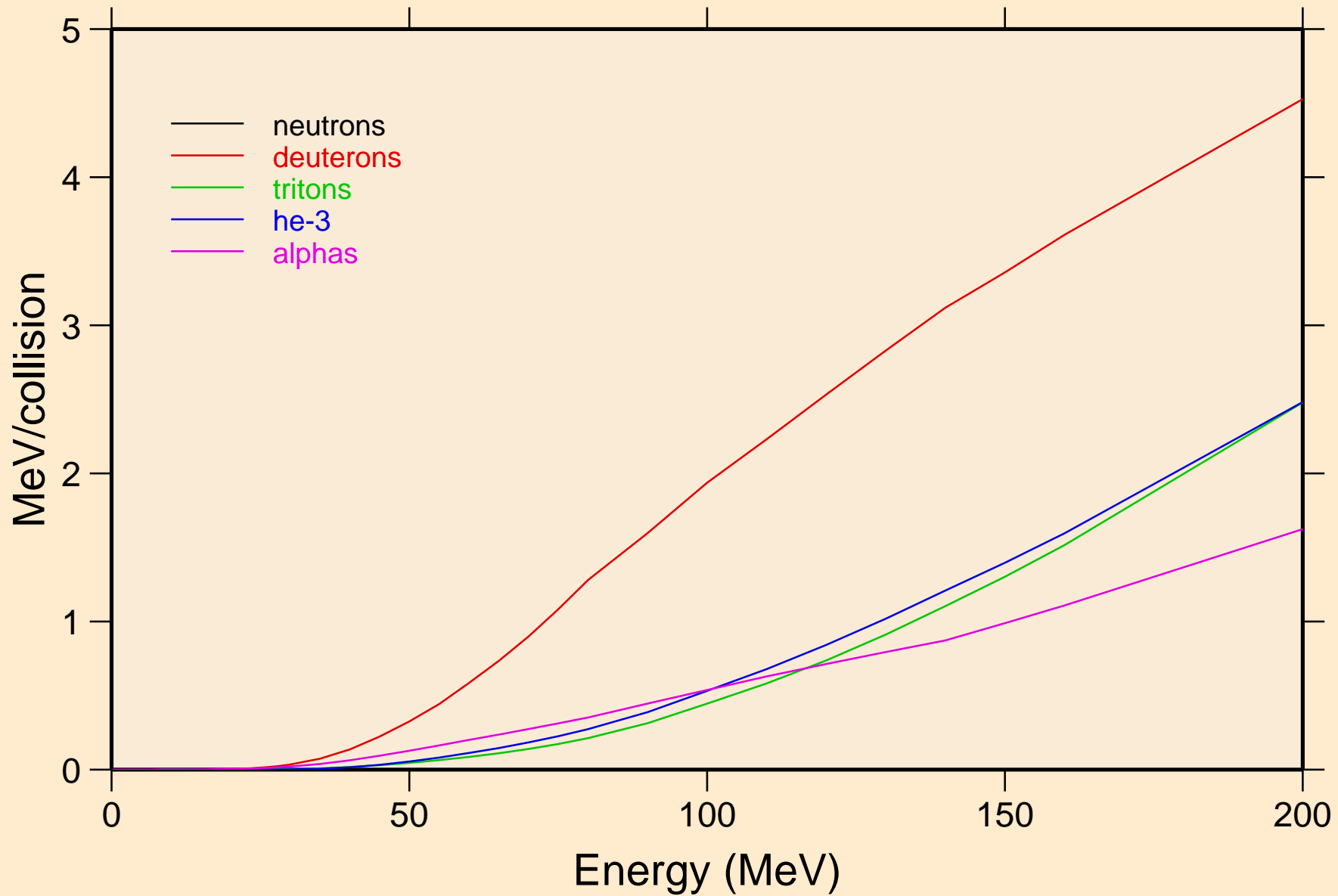

I127 PROTON ACER TENDL-2021 LIBRARY; T=0.K  
Recoil Heating

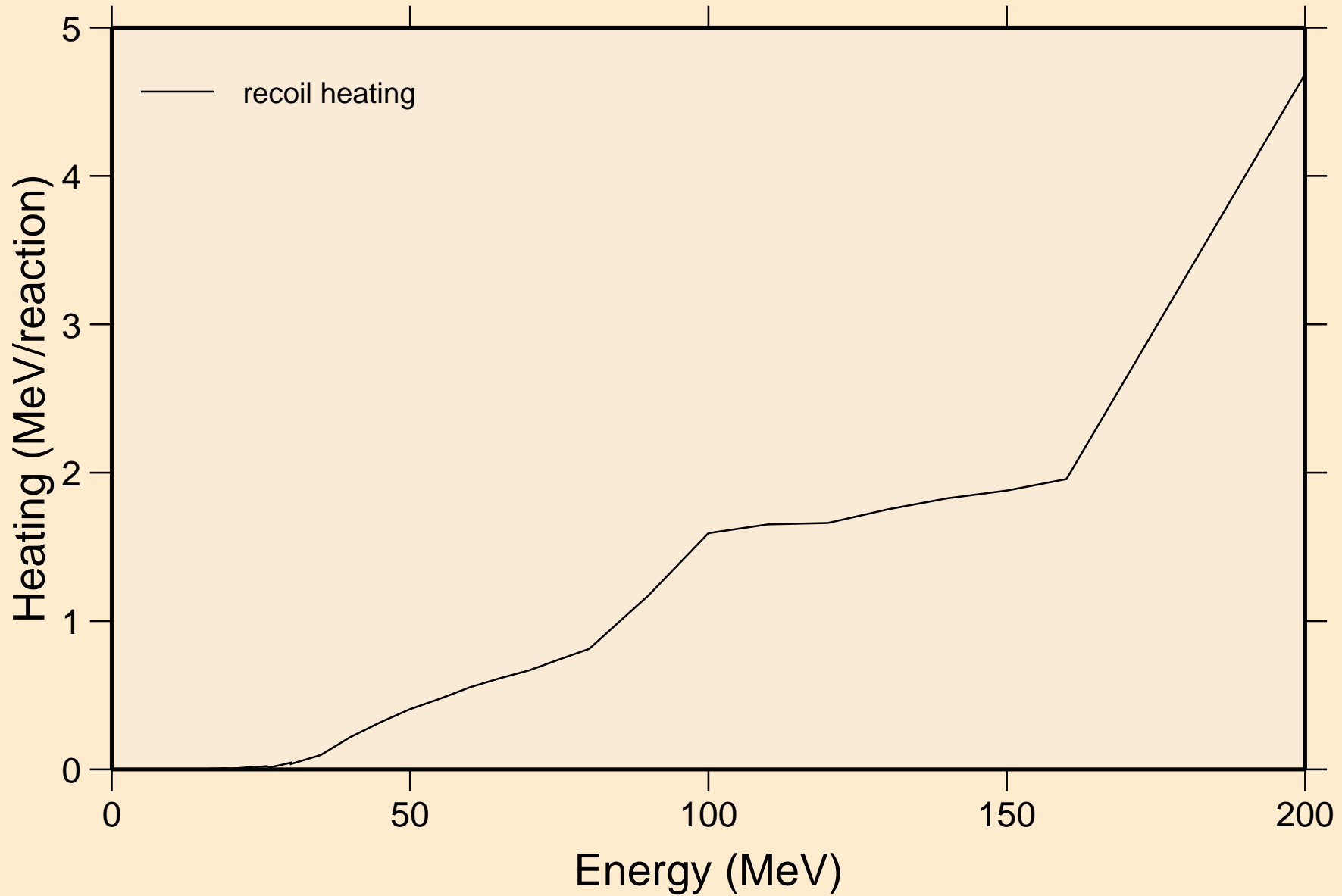

I127 PROTON ACER TENDL-2021 LIBRARY; T=0.K  
Particle production cross sections

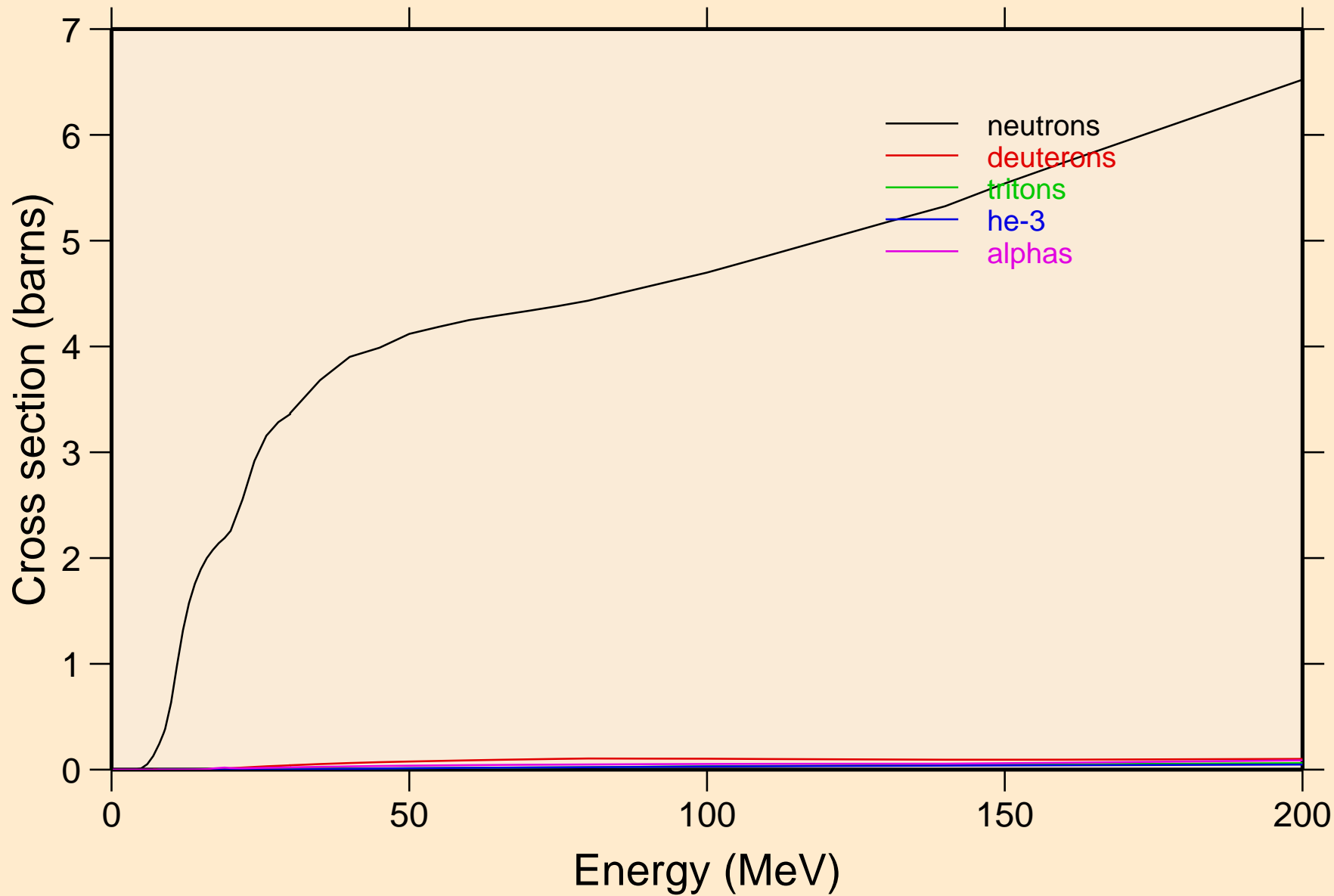

I127 PROTON ACER TENDL-2021 LIBRARY; T=0.K  
neutrons from (p,n)

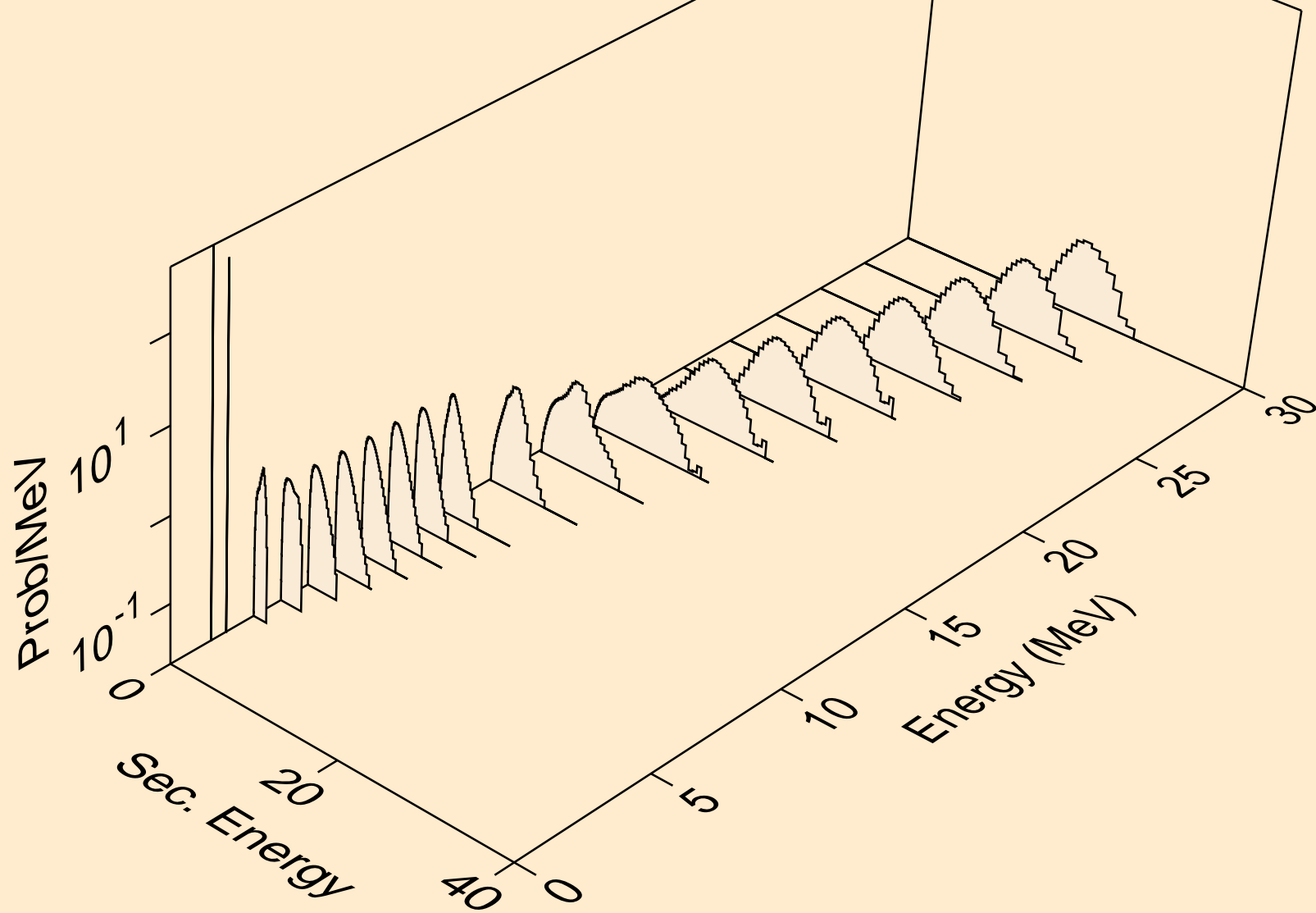

I127 PROTON ACER TENDL-2021 LIBRARY; T=0.K  
neutrons from (p,x)

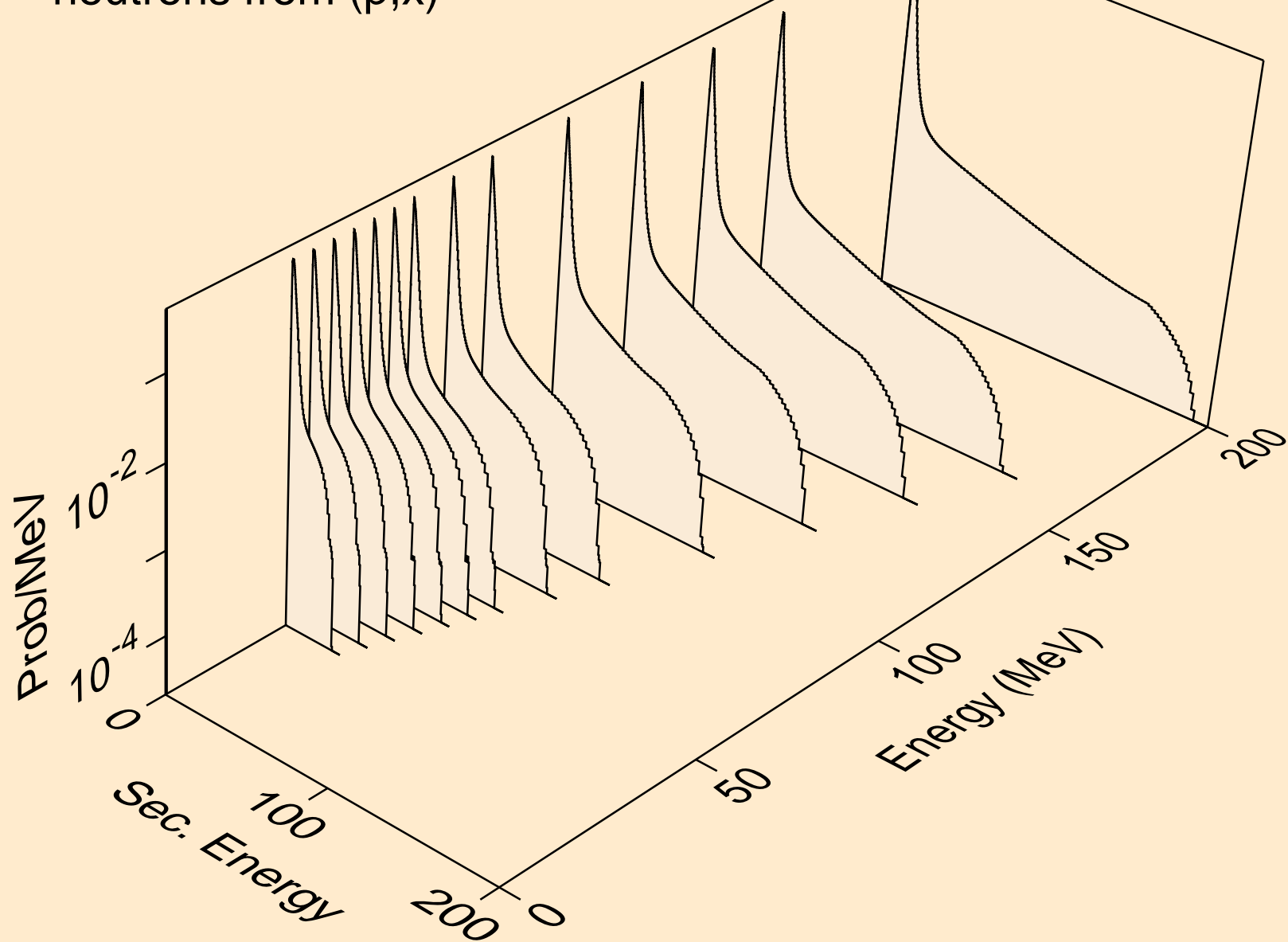

I127 PROTON ACER TENDL-2021 LIBRARY; T=0.K  
neutrons from (p,2nd)

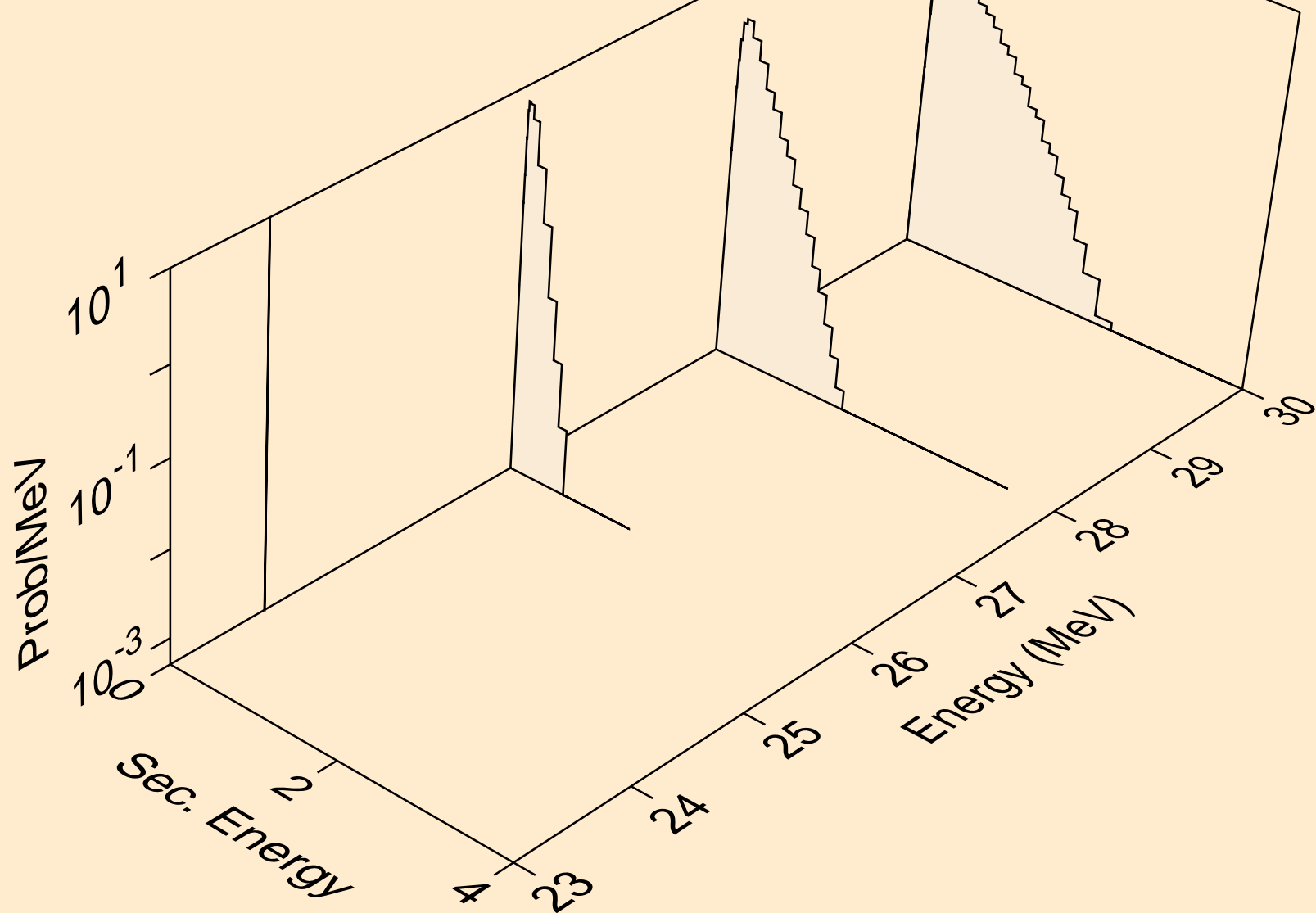



I127 PROTON ACER TENDL-2021 LIBRARY; T=0.K  
neutrons from (p,2n)

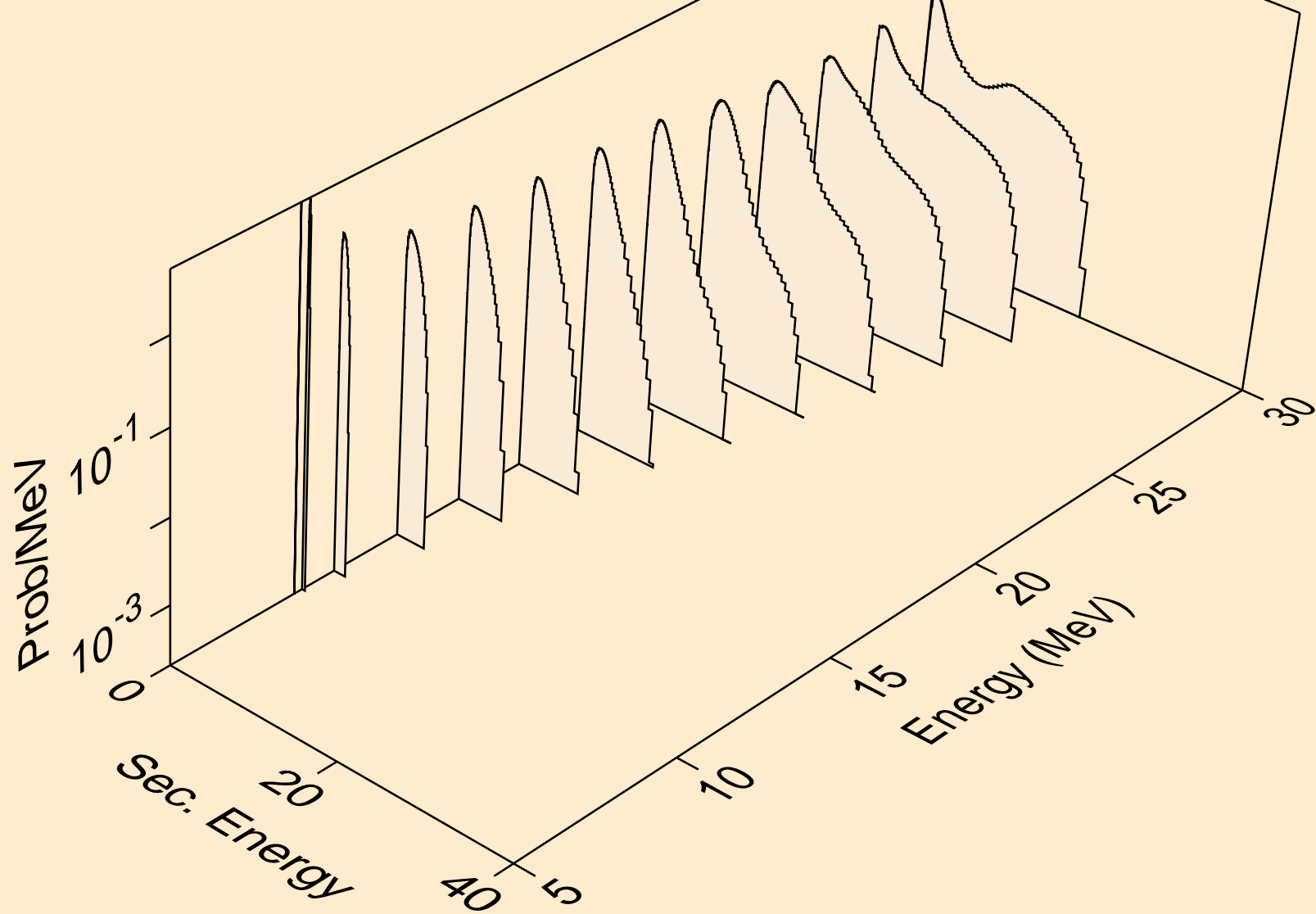

I127 PROTON ACER TENDL-2021 LIBRARY; T=0.K  
neutrons from (p,3n)

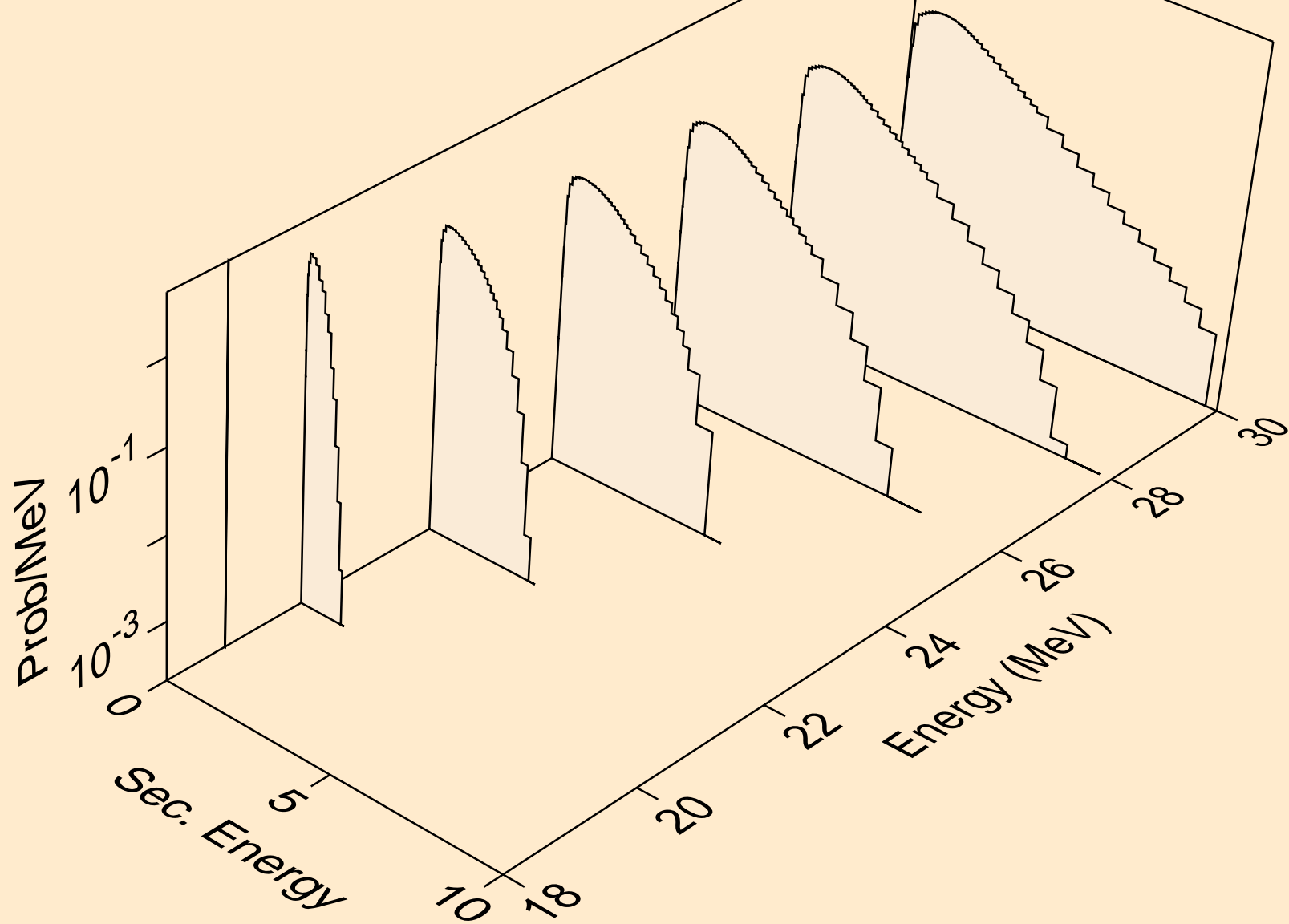

I127 PROTON ACER TENDL-2021 LIBRARY; T=0.K  
neutrons from (p,n\*)a

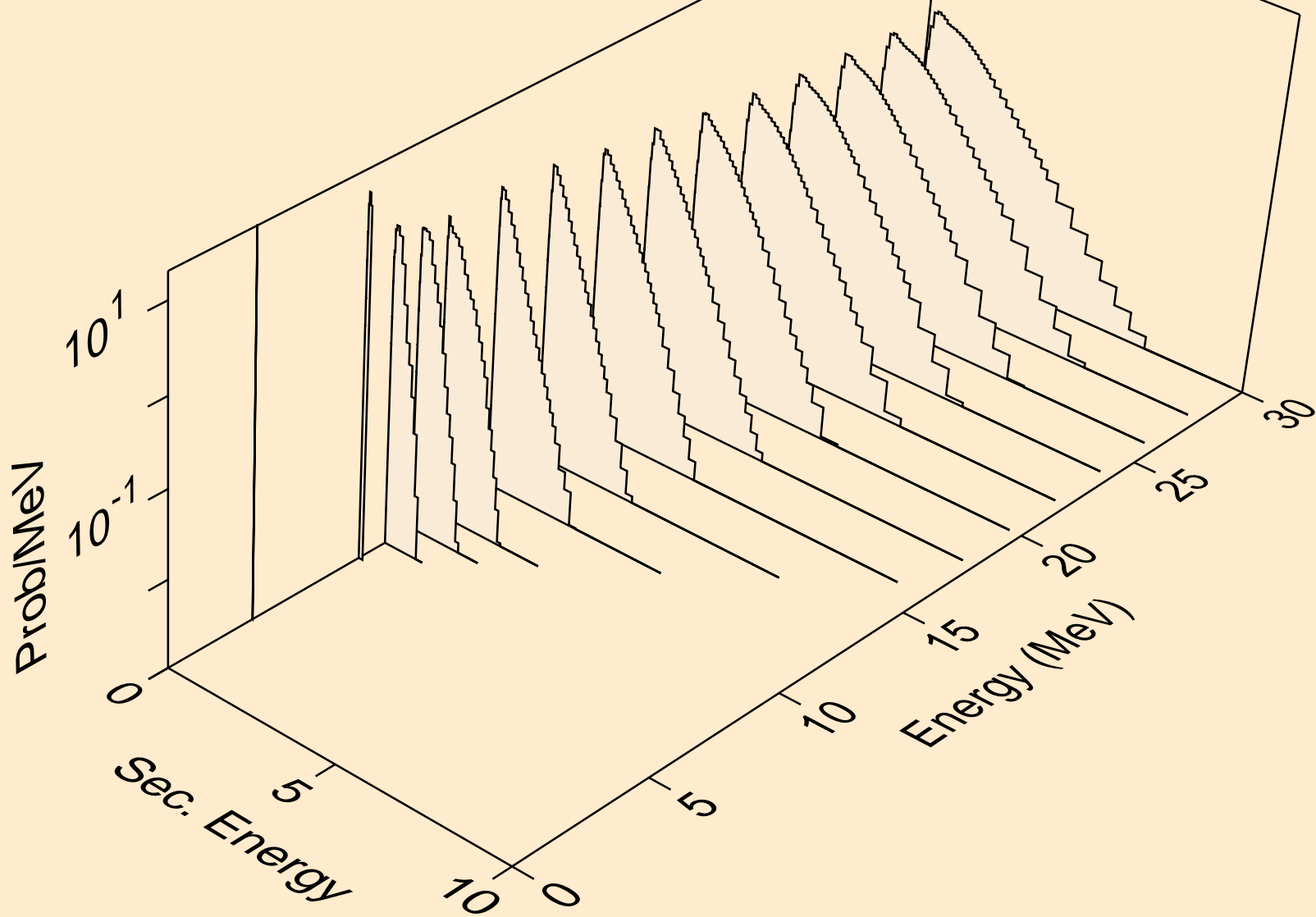

I127 PROTON ACER TENDL-2021 LIBRARY; T=0.K  
neutrons from (p,2n)a

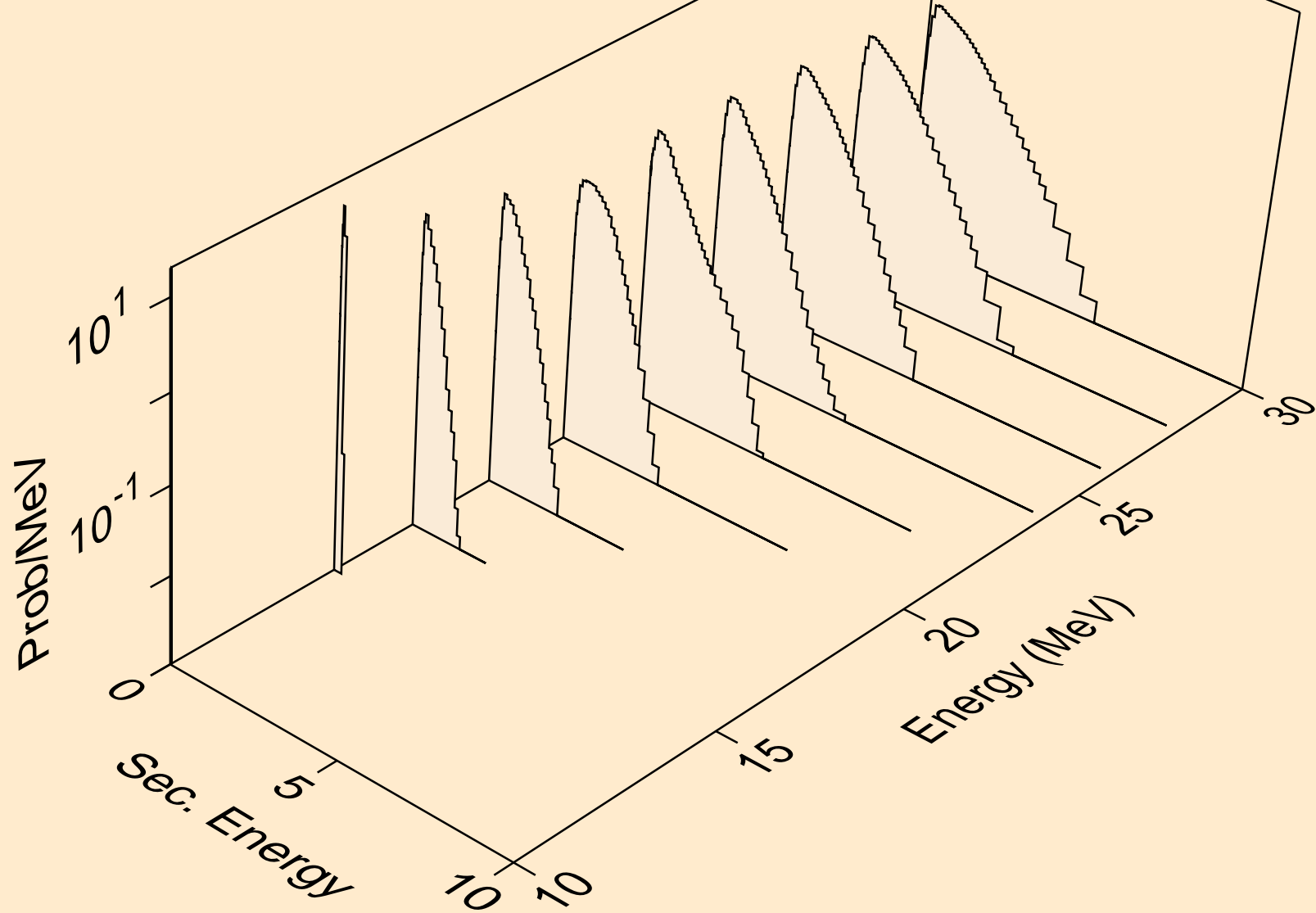

I127 PROTON ACER TENDL-2021 LIBRARY; T=0.K  
neutrons from (p,3n)a

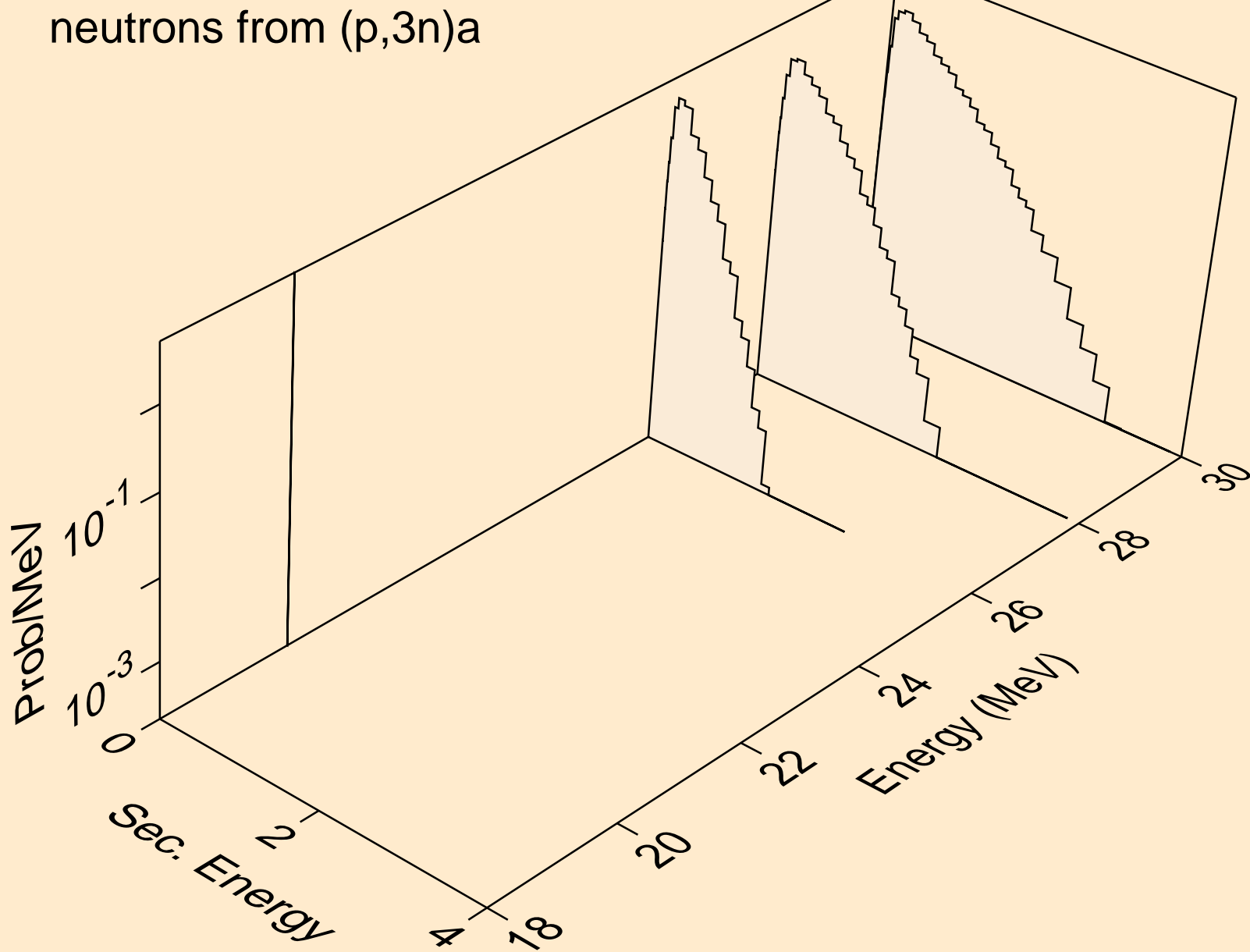

I127 PROTON ACER TENDL-2021 LIBRARY; T=0.K  
neutrons from (p,n\*)p

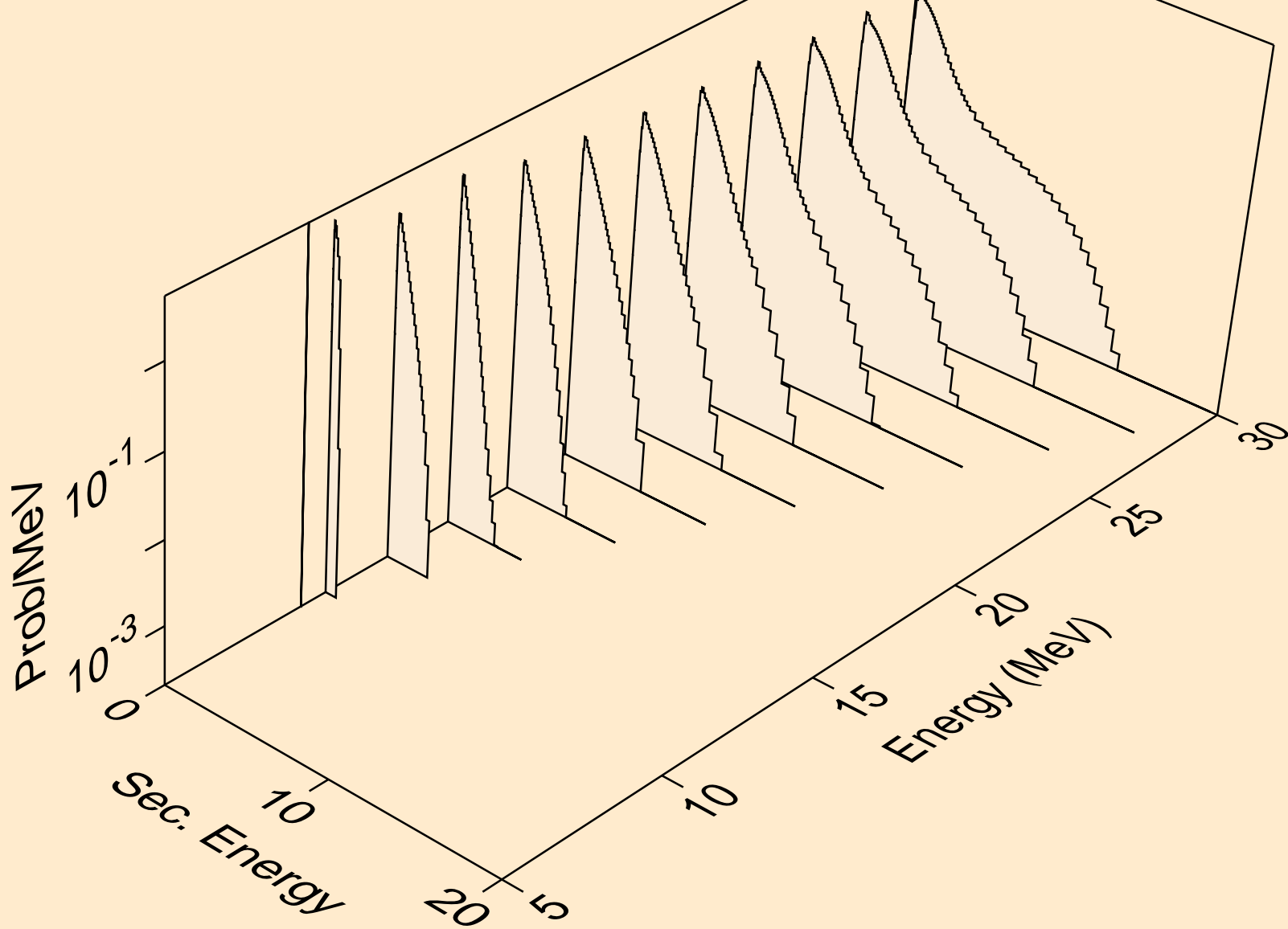

I127 PROTON ACER TENDL-2021 LIBRARY; T=0.K  
neutrons from (p,n\*)2a

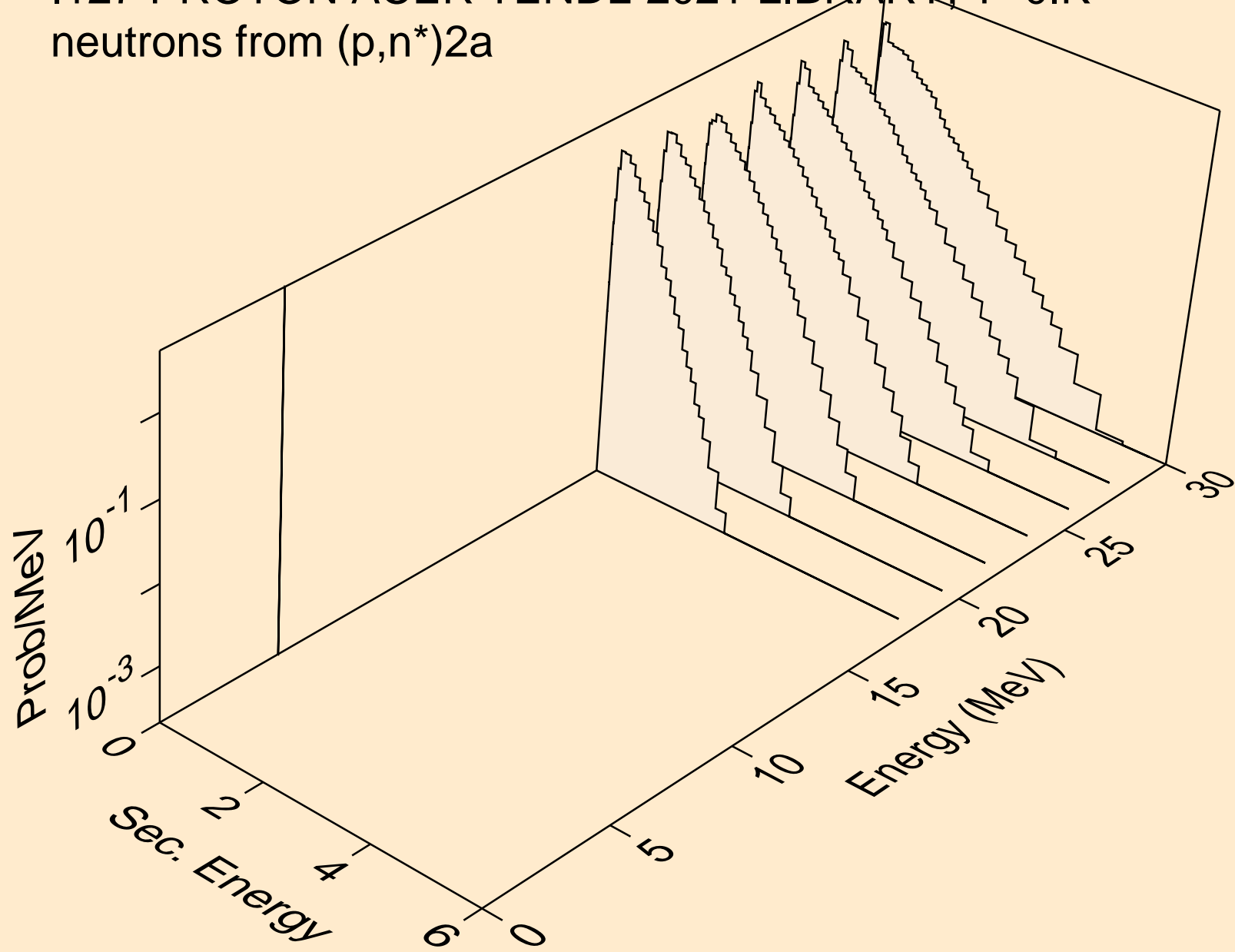

I127 PROTON ACER TENDL-2021 LIBRARY; T=0.K  
neutrons from (p,n\*)d

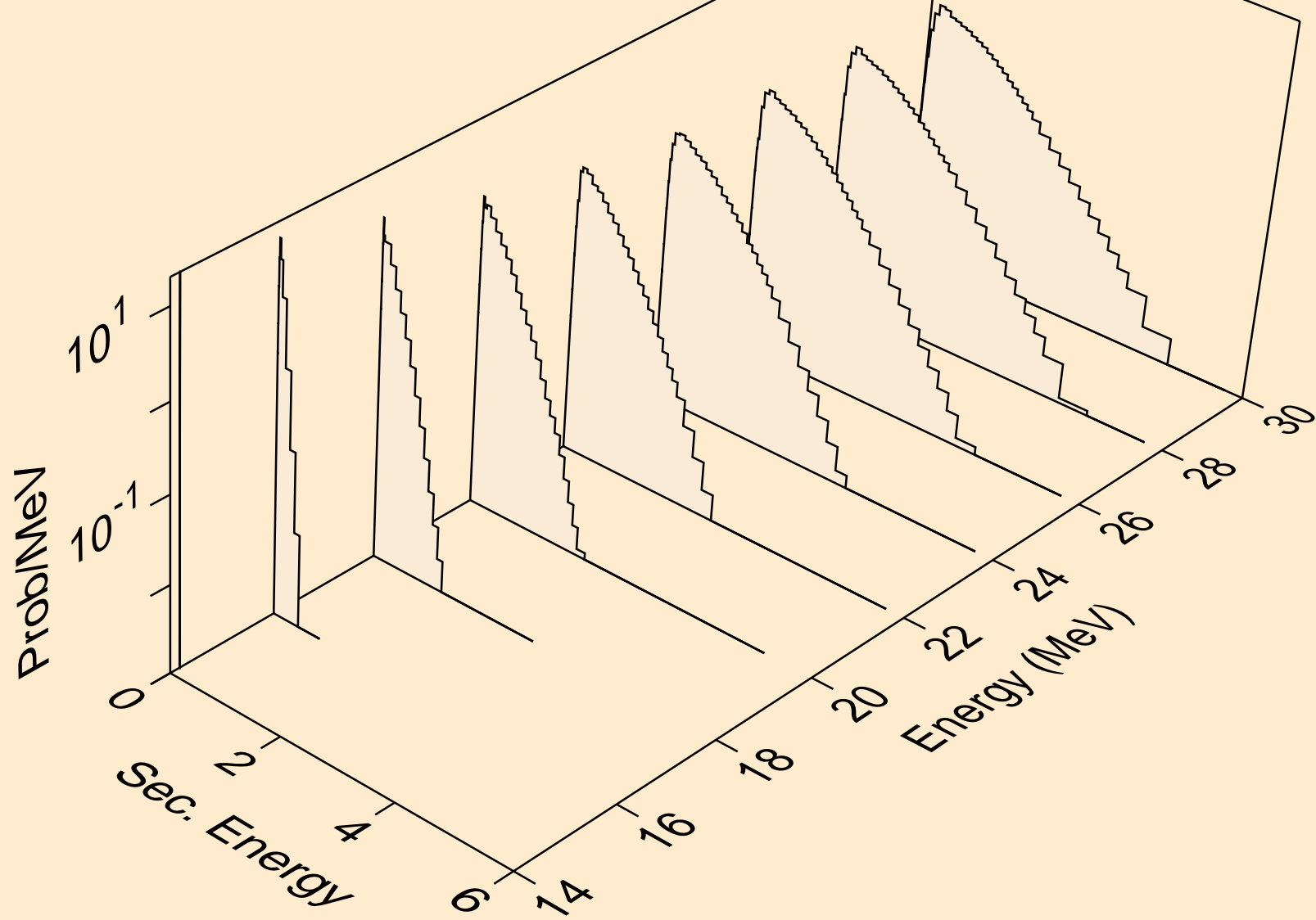



I127 PROTON ACER TENDL-2021 LIBRARY; T=0.K  
neutrons from (p,n\*)t

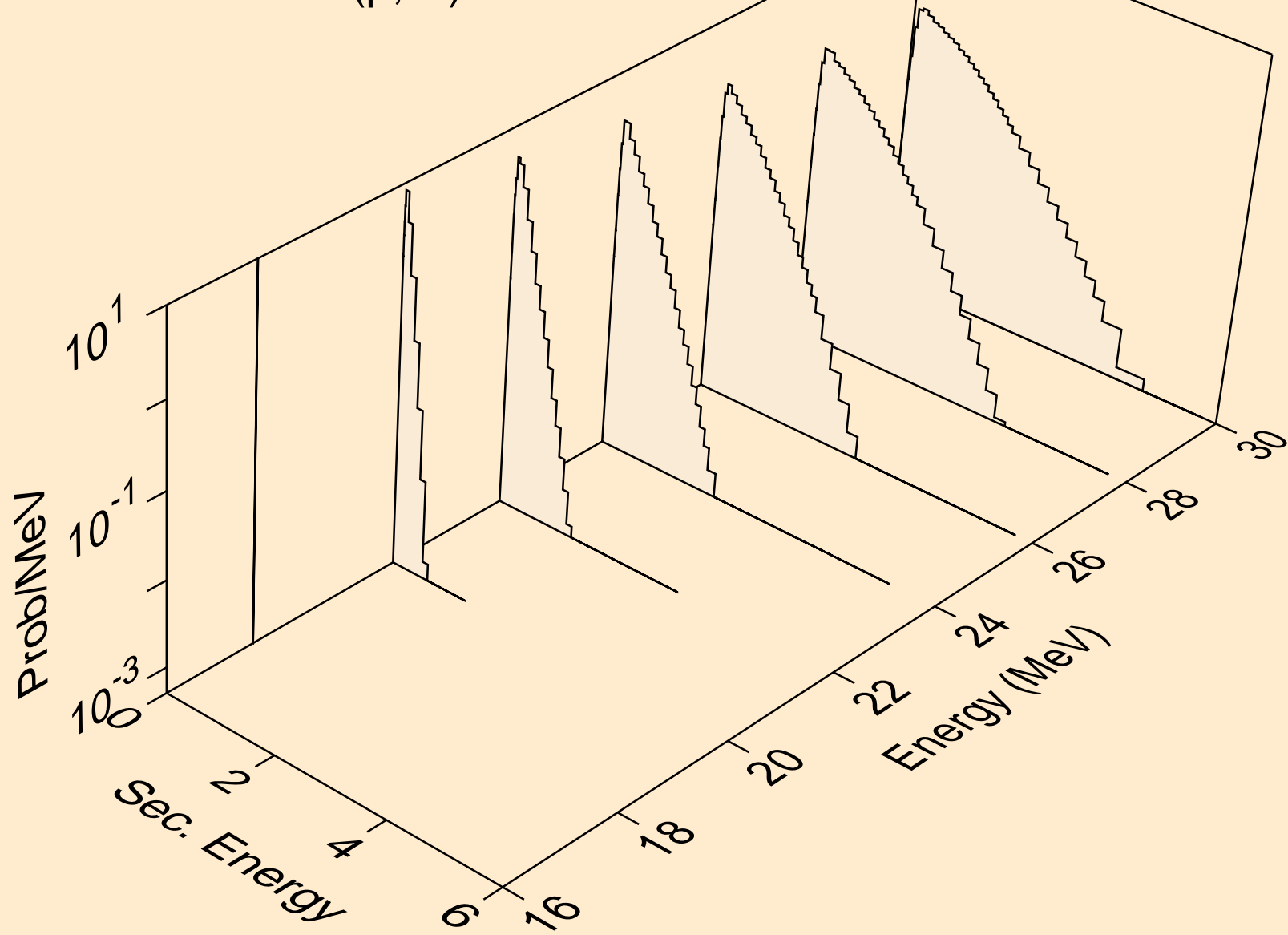

I127 PROTON ACER TENDL-2021 LIBRARY; T=0.K  
neutrons from (p,n\*)he3

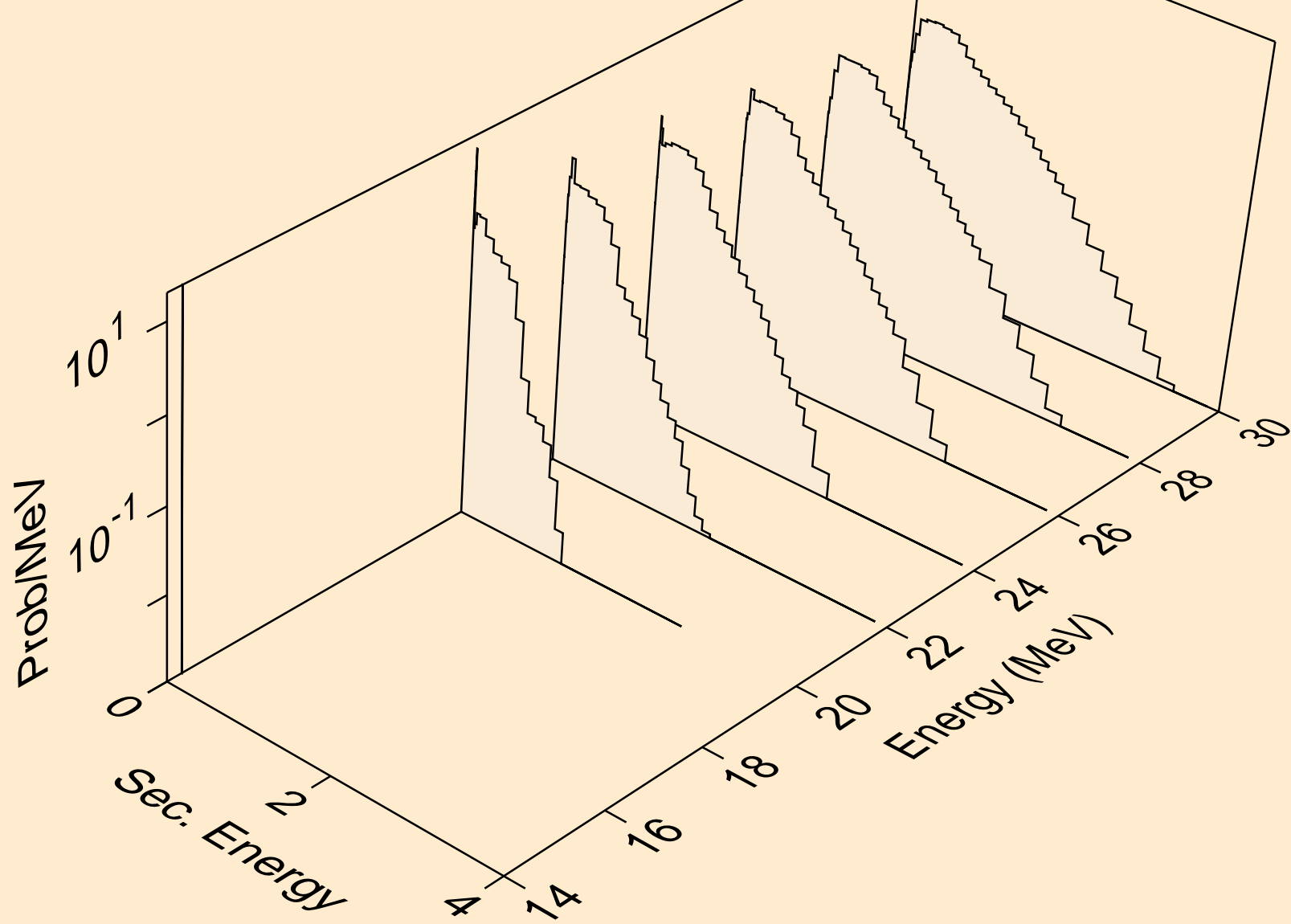

I127 PROTON ACER TENDL-2021 LIBRARY; T=0.K  
neutrons from (p,4n)

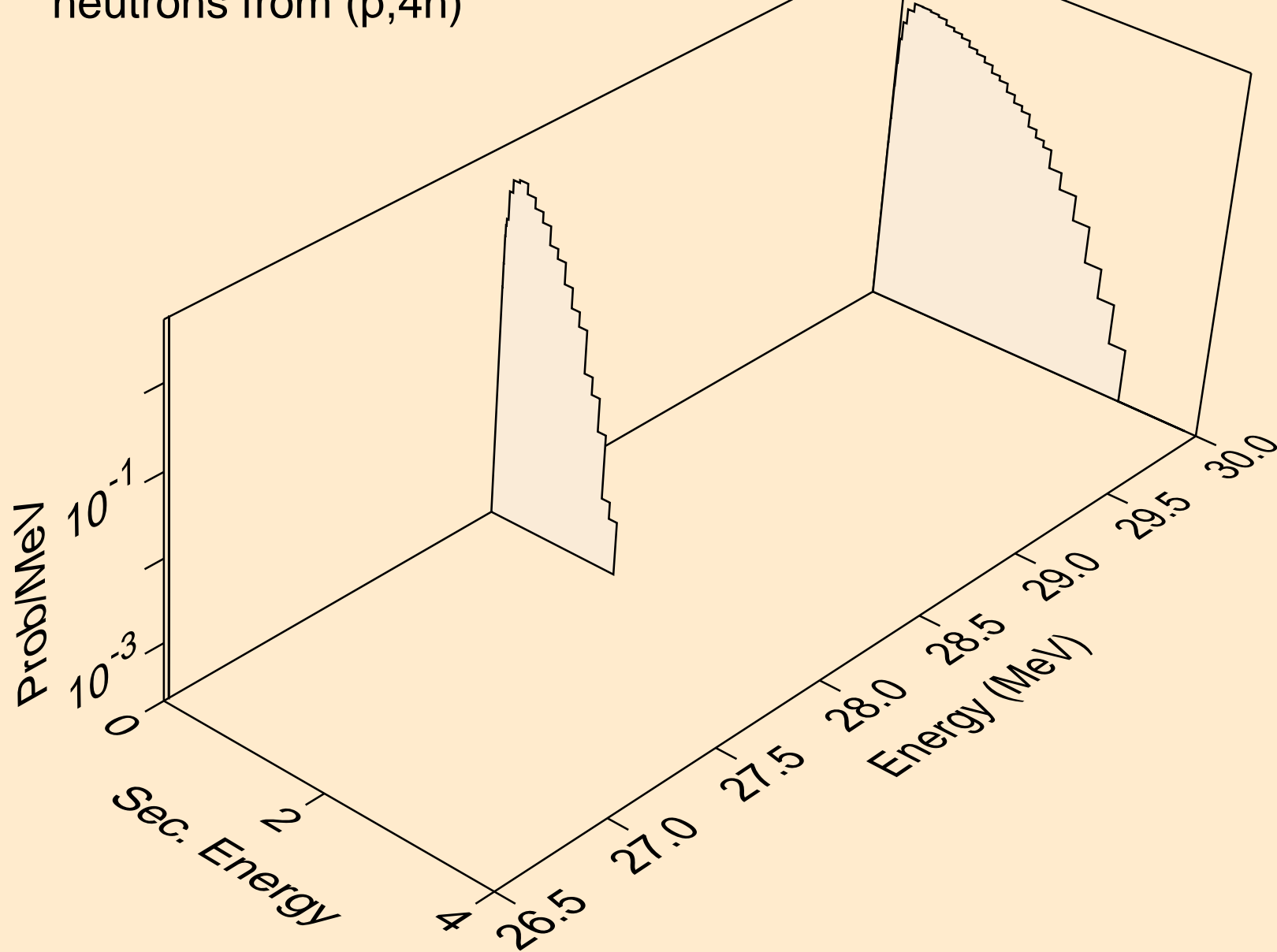

I127 PROTON ACER TENDL-2021 LIBRARY; T=0.K  
neutrons from (p,2np)

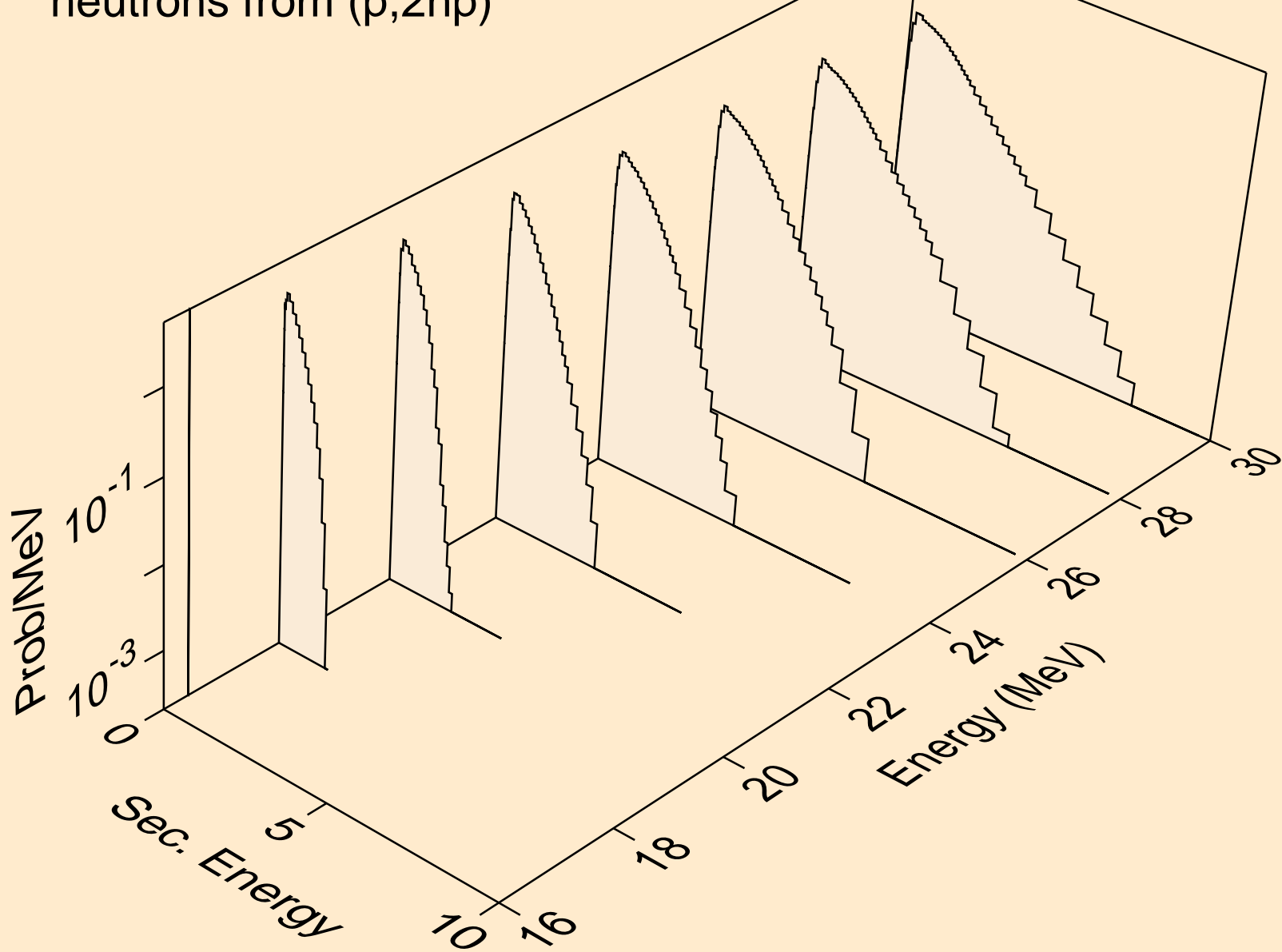

I127 PROTON ACER TENDL-2021 LIBRARY; T=0.K  
neutrons from (p,3np)

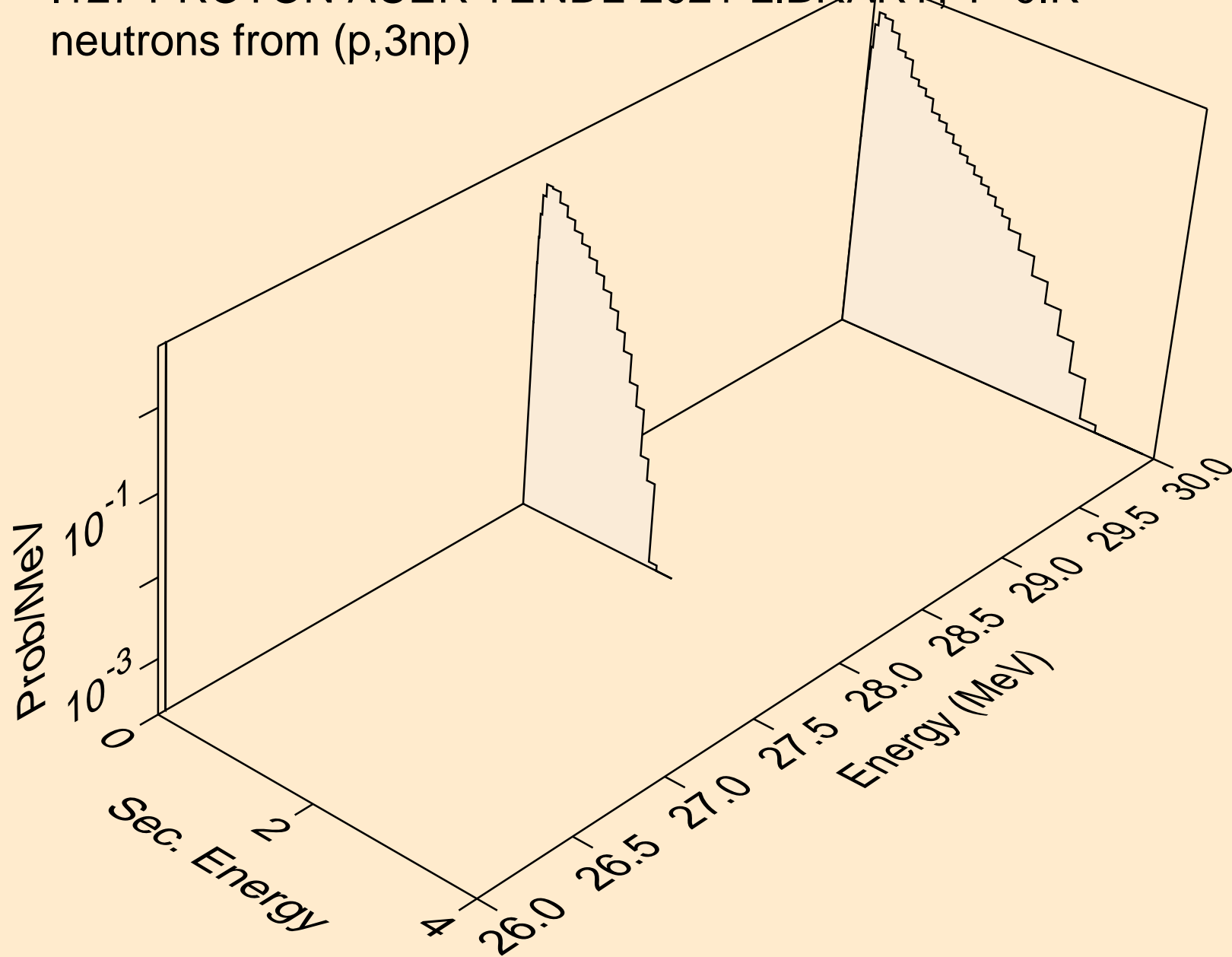

I127 PROTON ACER TENDL-2021 LIBRARY; T=0.K  
neutrons from (p,2np)

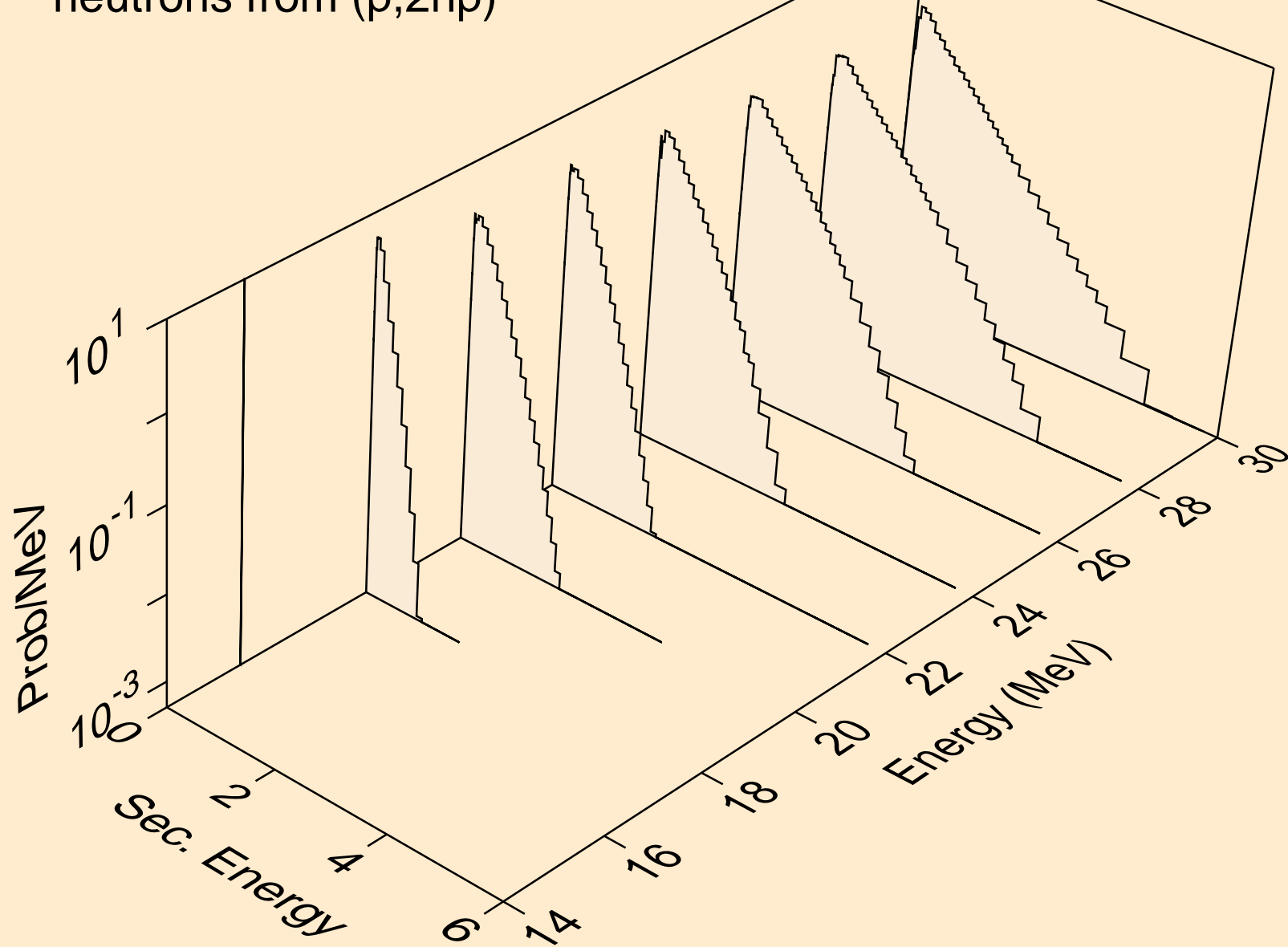

I127 PROTON ACER TENDL-2021 LIBRARY; T=0.K  
neutrons from (p,npa)

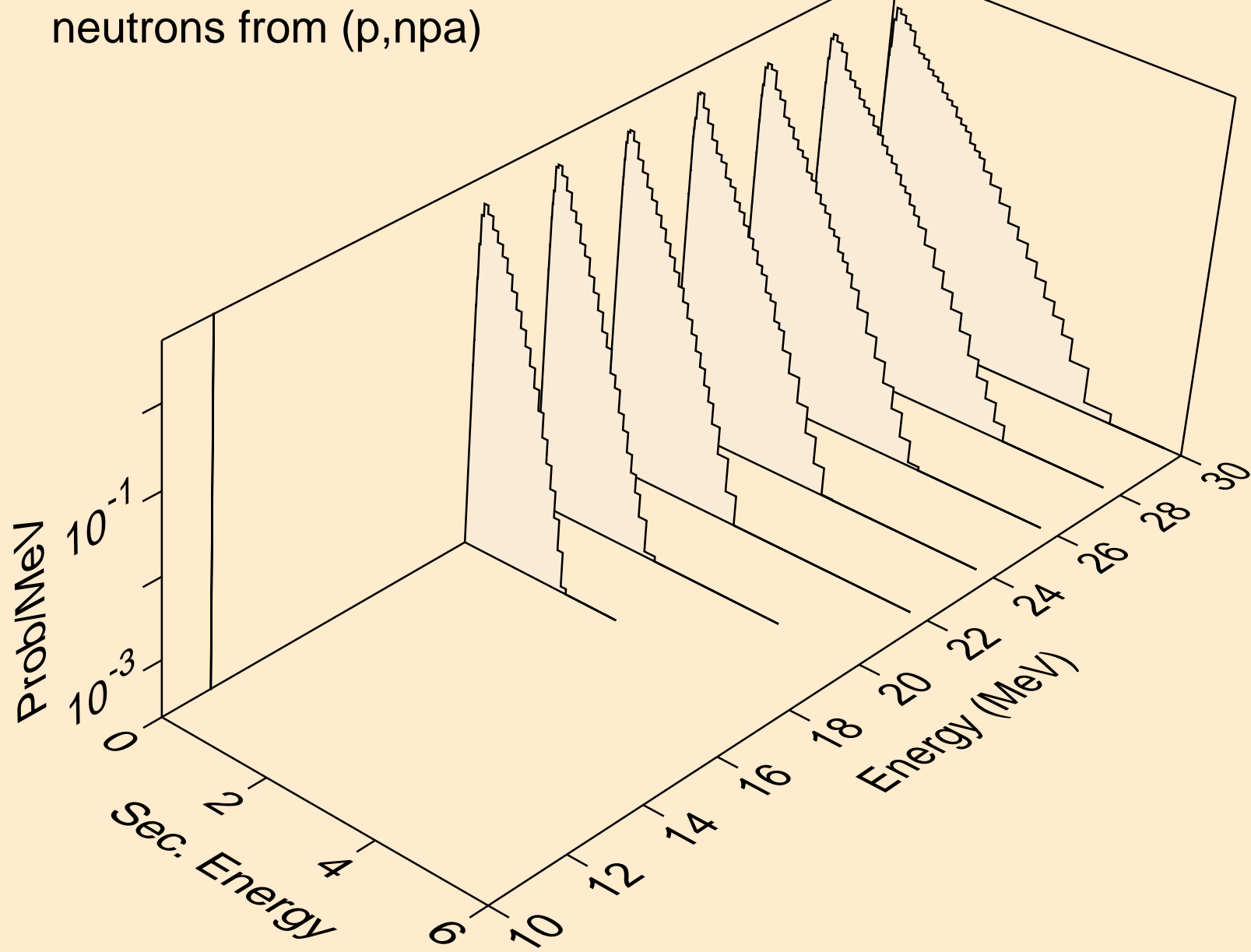

I127 PROTON ACER TENDL-2021 LIBRARY; T=0.K  
deuterons from (p,x)

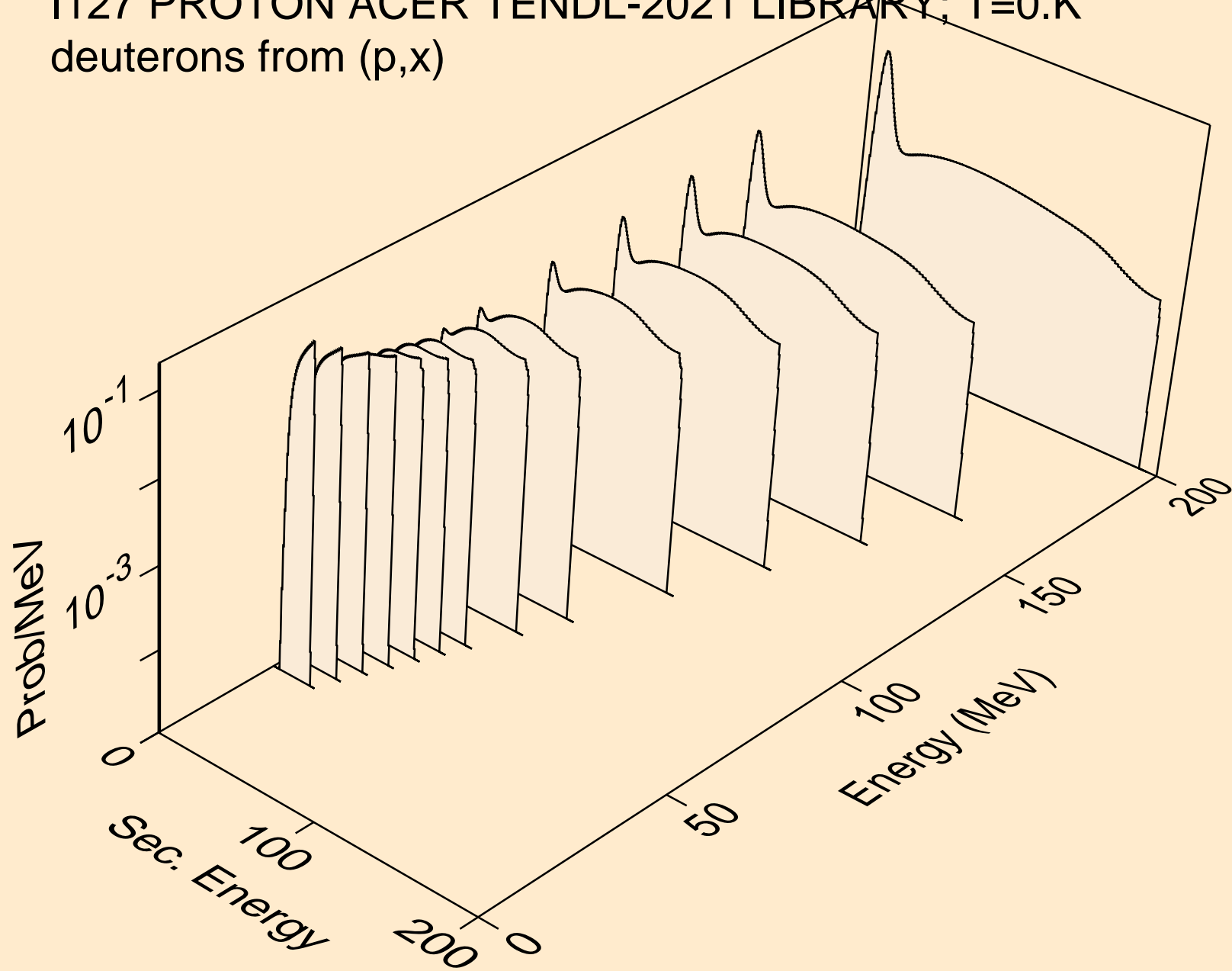



I127 PROTON ACER TENDL-2021 LIBRARY; T=0.K  
deuterons from (p,2nd)

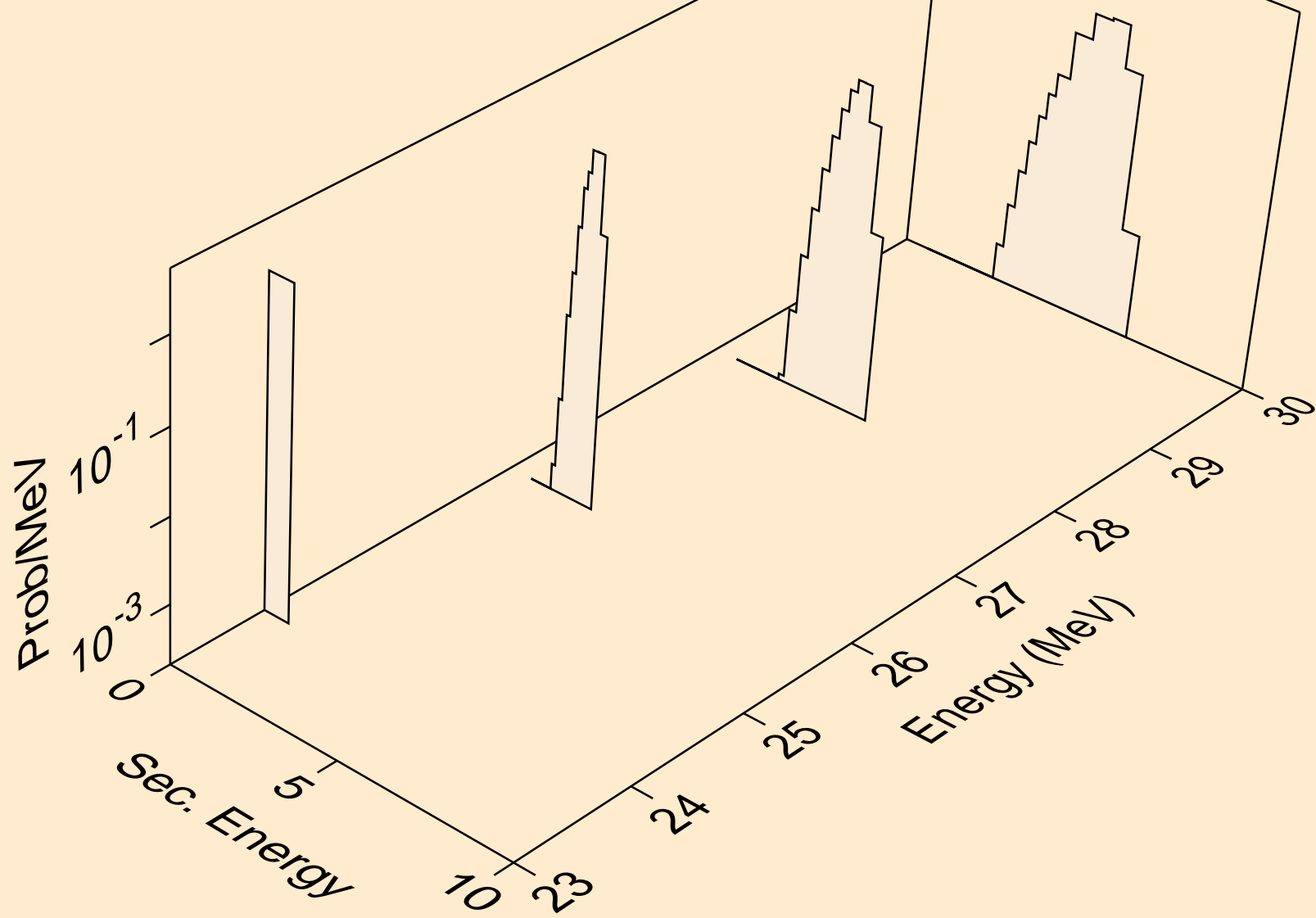

I127 PROTON ACER TENDL-2021 LIBRARY; T=0.K  
deuterons from (p,n\*)d

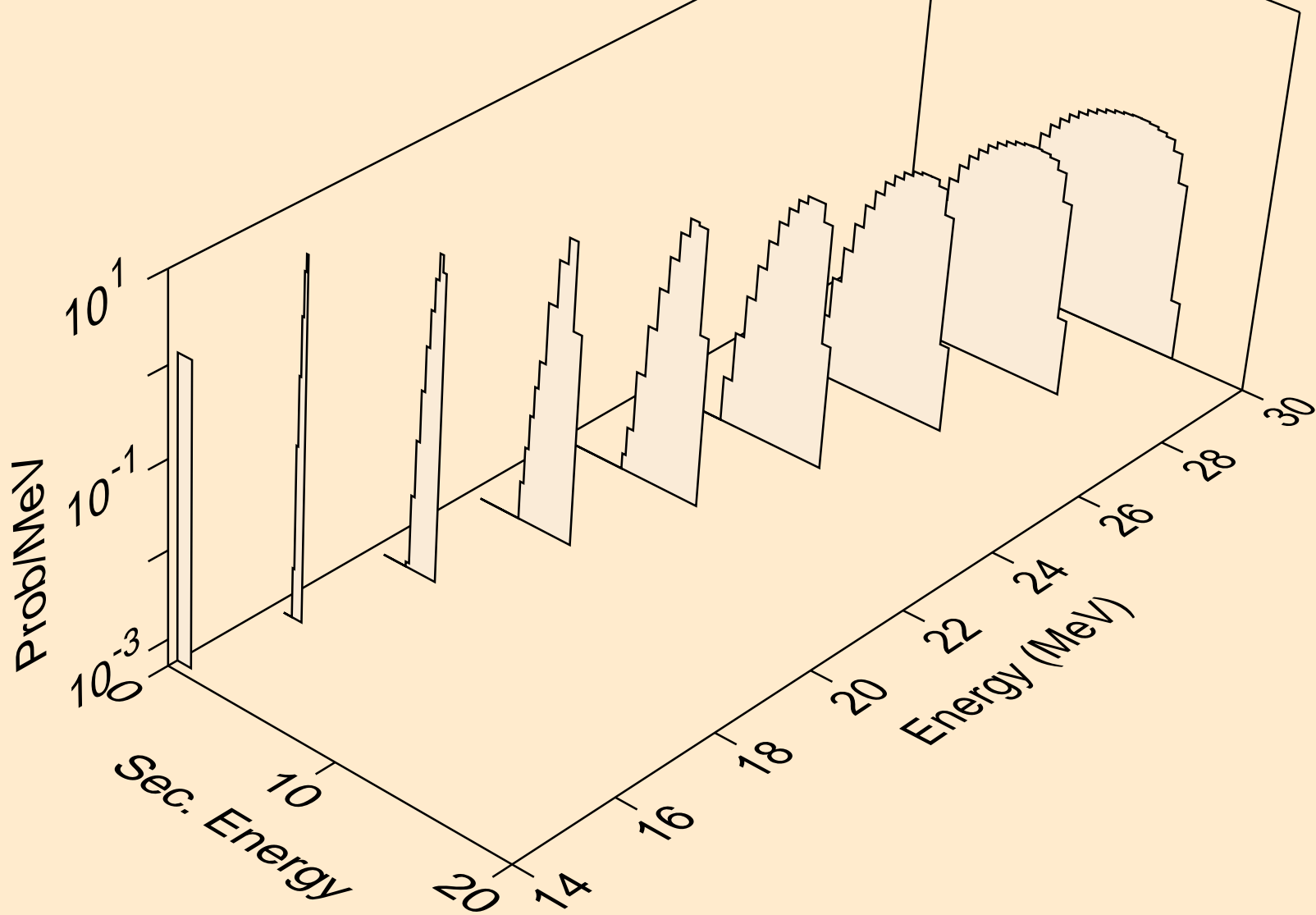

I127 PROTON ACER TENDL-2021 LIBRARY; T=0.K  
deuterons from (p,d)

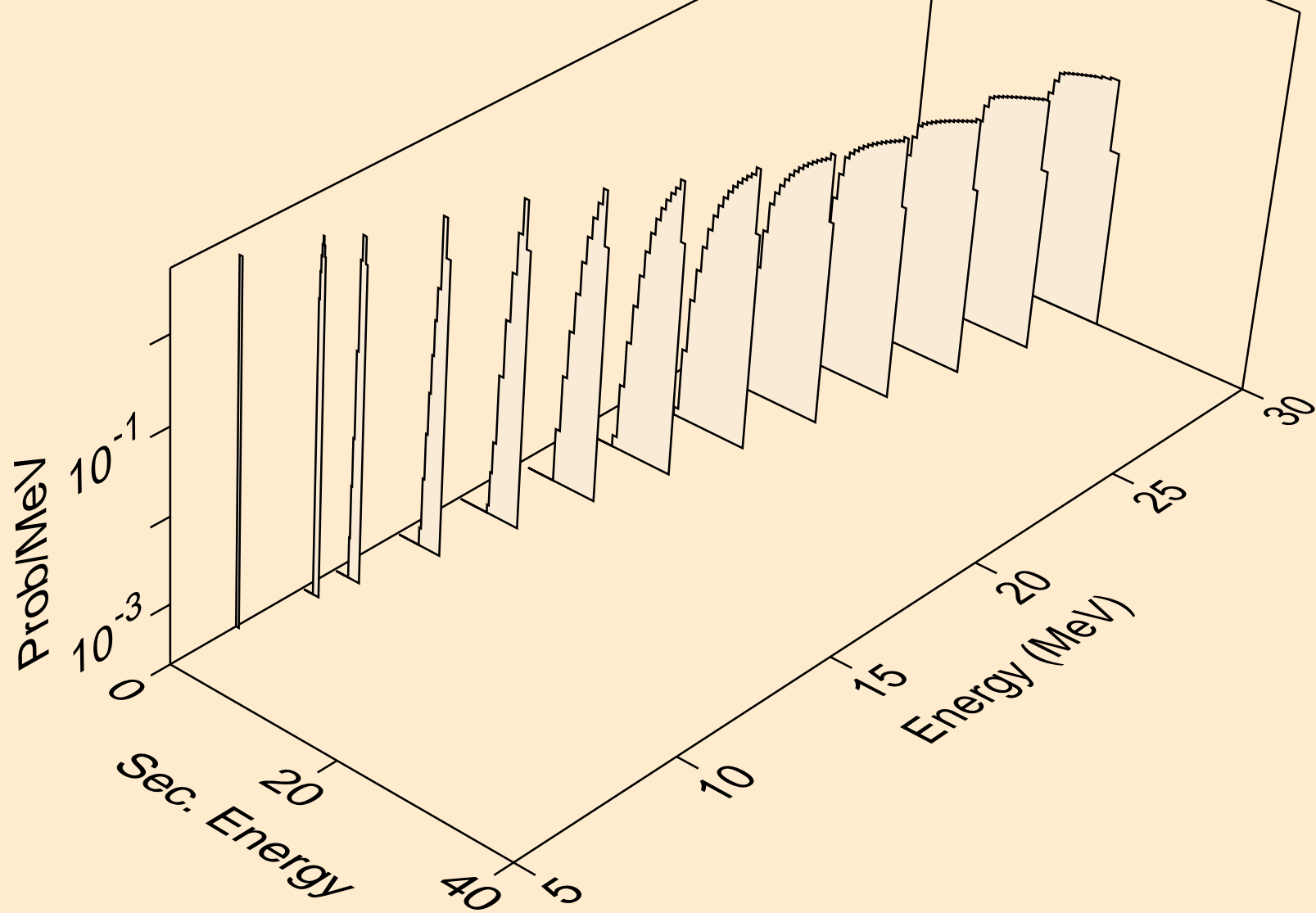

I127 PROTON ACER TENDL-2021 LIBRARY; T=0.K  
deuterons from (p,pd)

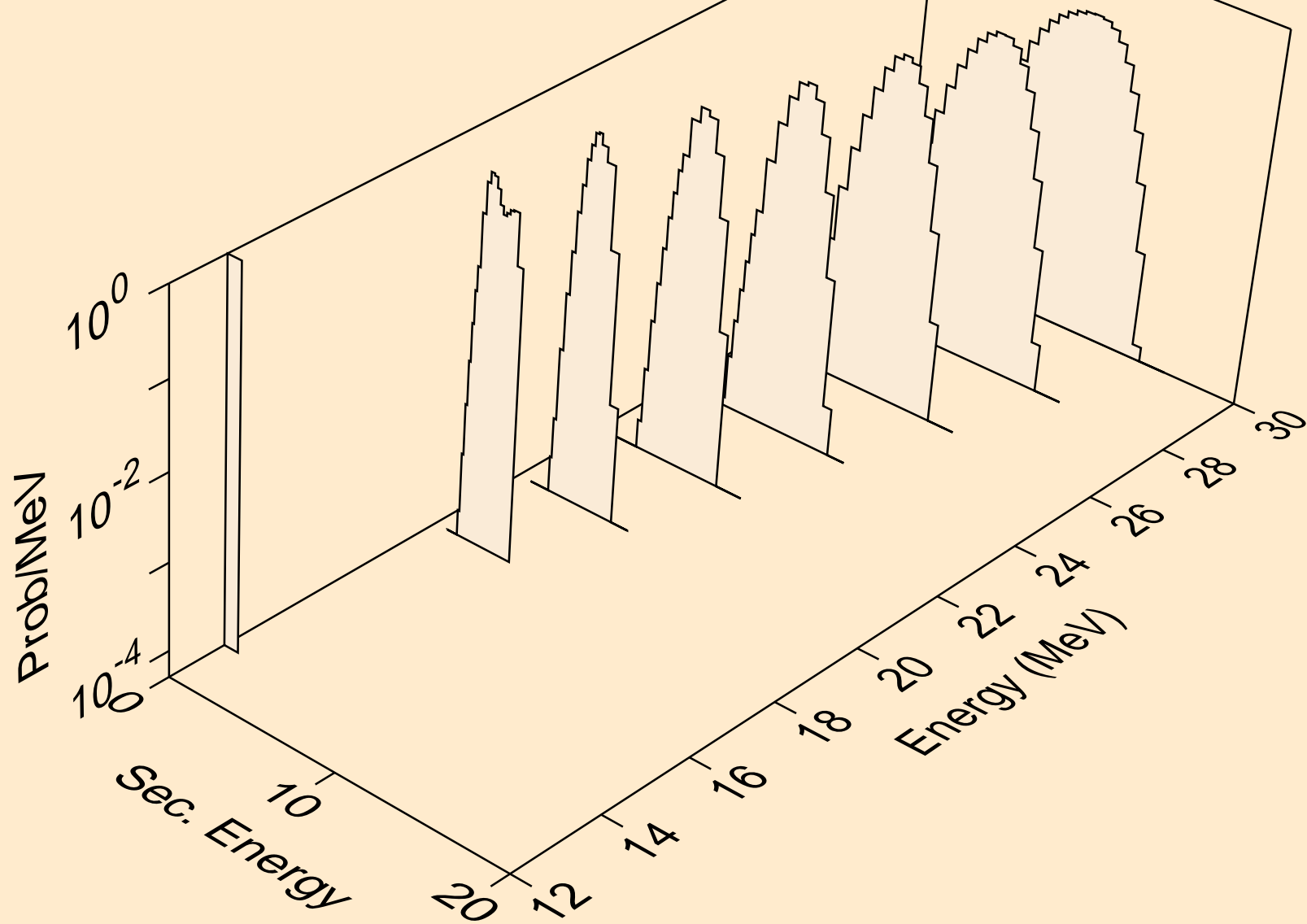

I127 PROTON ACER TENDL-2021 LIBRARY; T=0.K  
deuterons from (p,da)

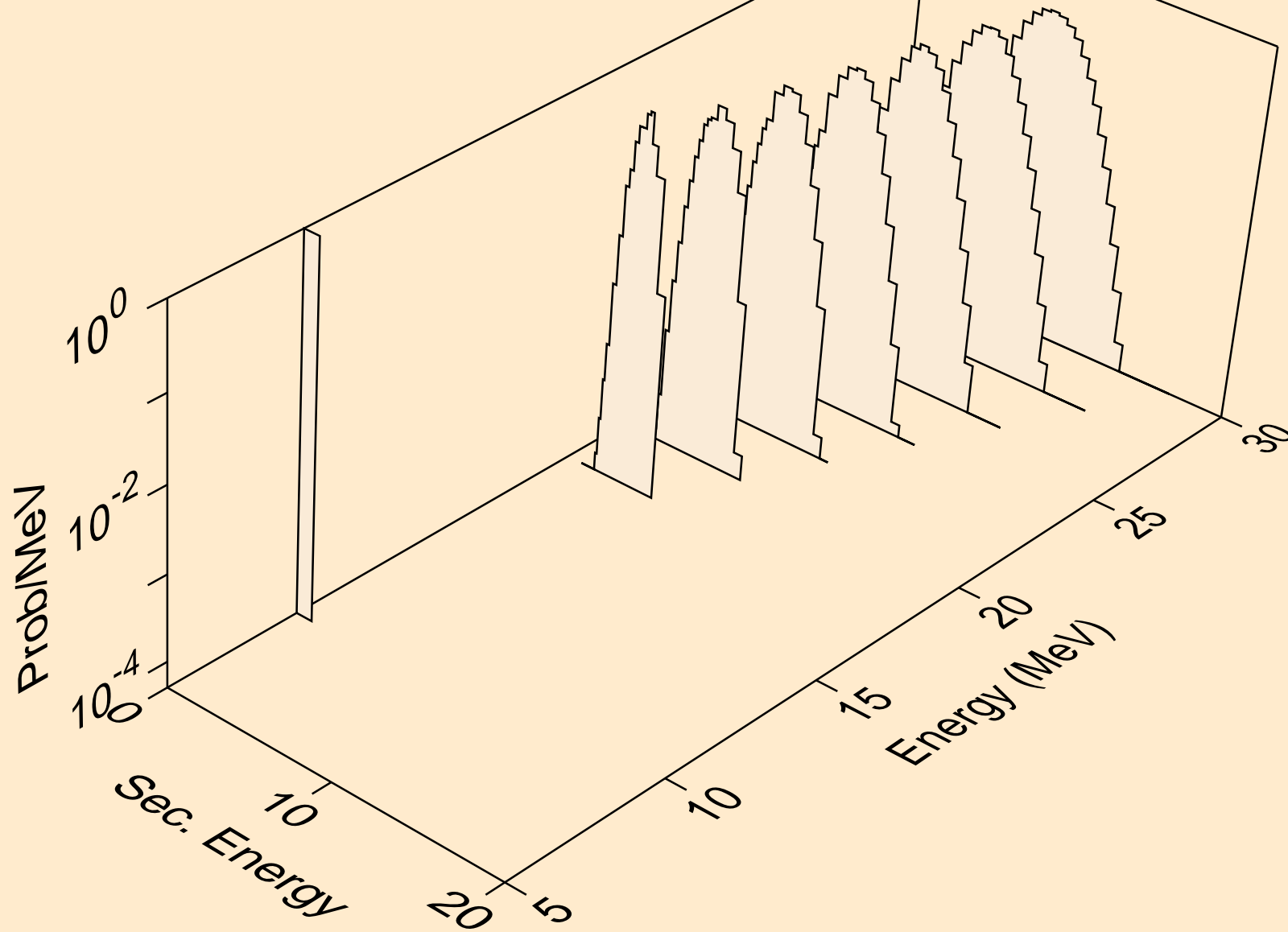

I127 PROTON ACER TENDL-2021 LIBRARY; T=0.K  
tritons from (p,x)

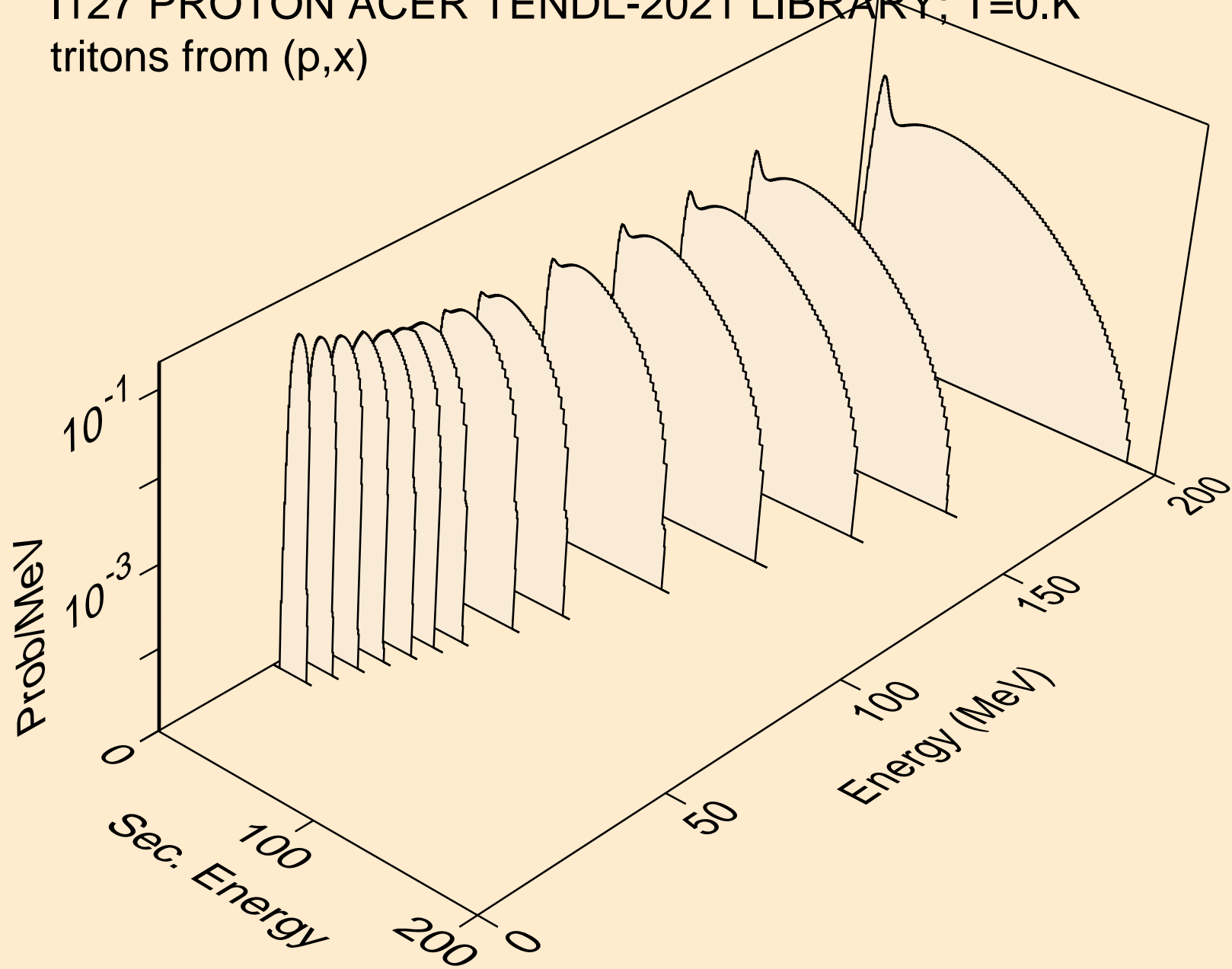

I127 PROTON ACER TENDL-2021 LIBRARY; T=0.K  
tritons from (p,n\*)t

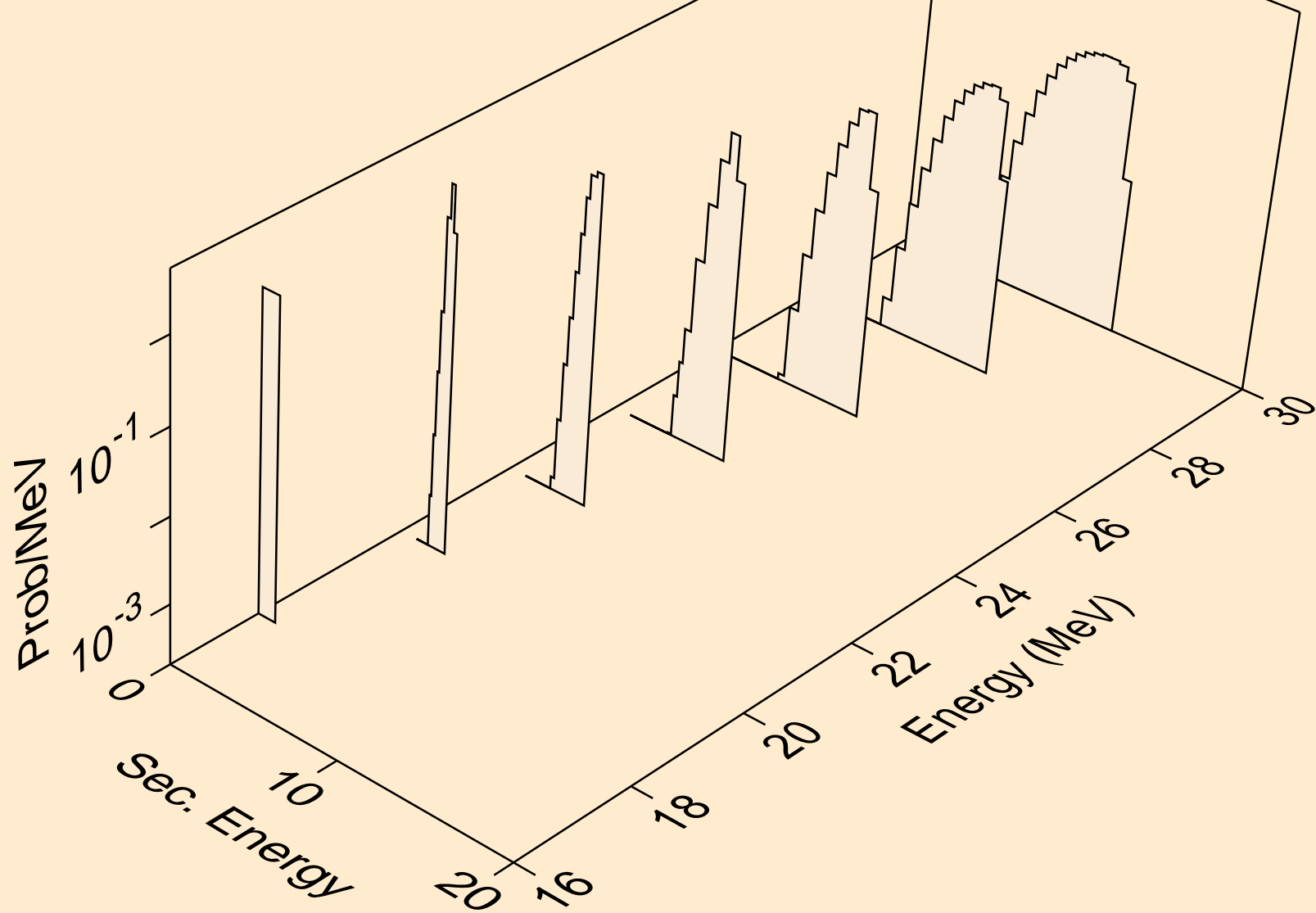

I127 PROTON ACER TENDL-2021 LIBRARY; T=0.K  
tritons from (p,t)

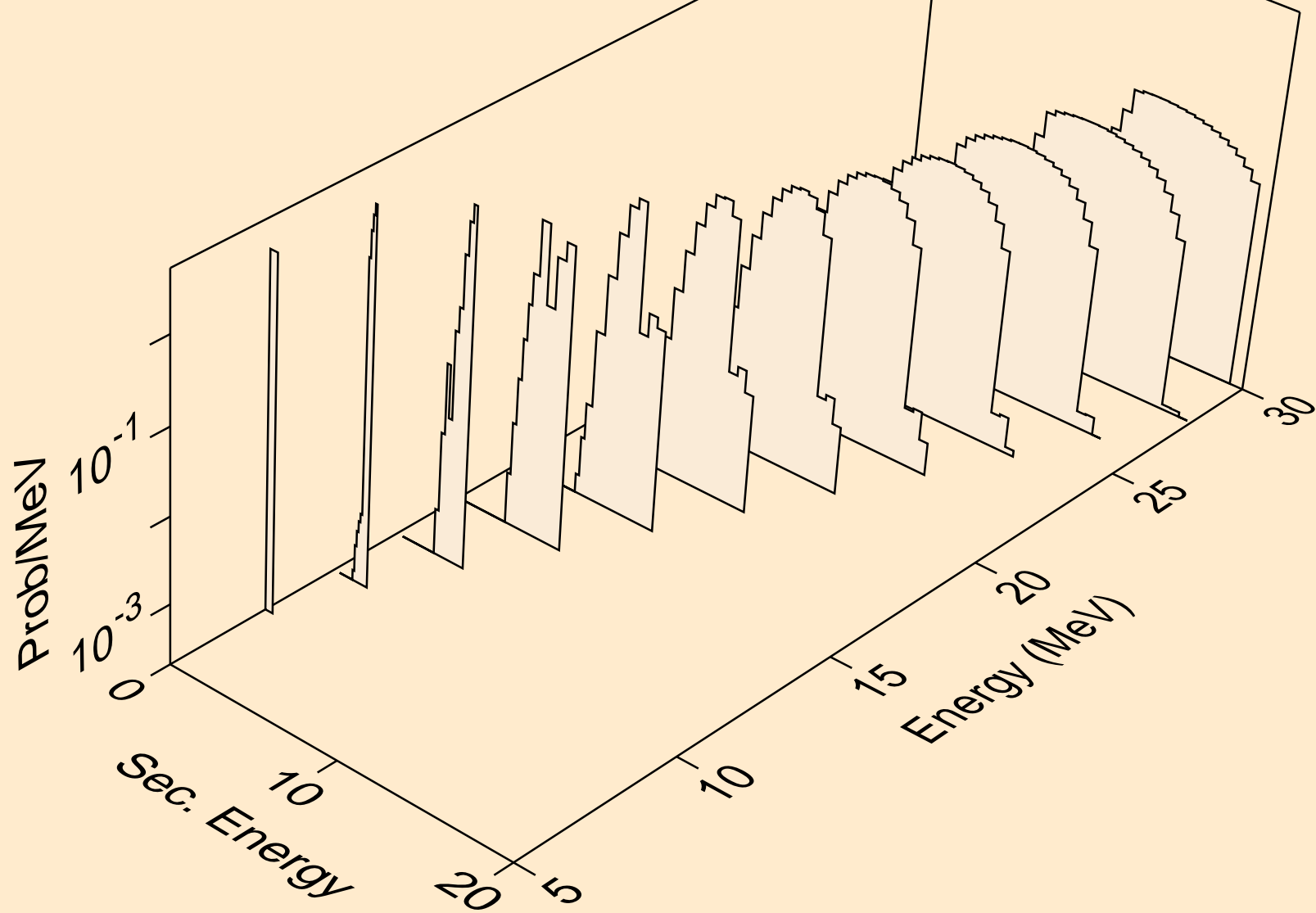



I127 PROTON ACER TENDL-2021 LIBRARY; T=0.K  
tritons from (p,pt)

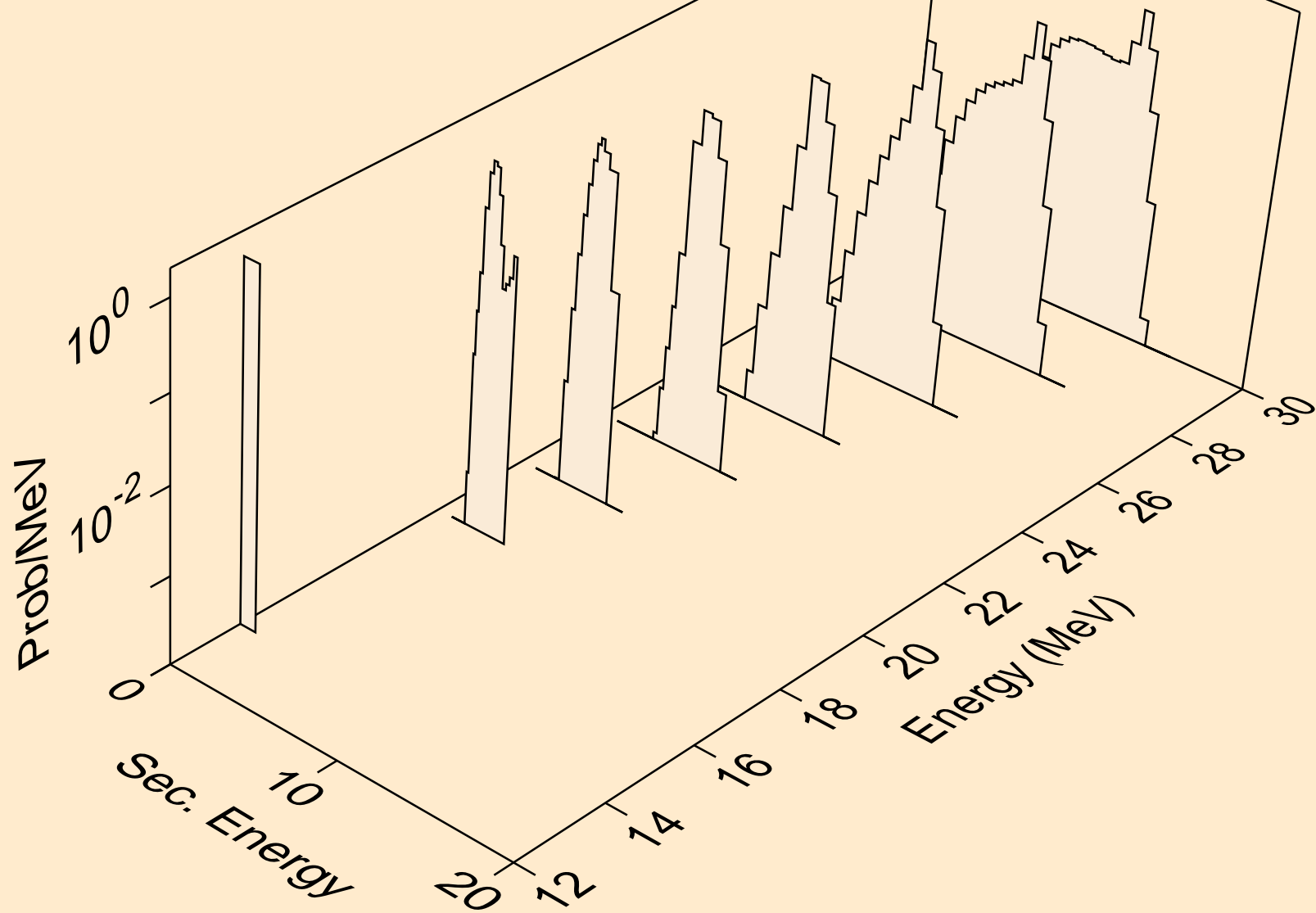

I127 PROTON ACER TENDL-2021 LIBRARY; T=0.K  
he3s from (p,x)

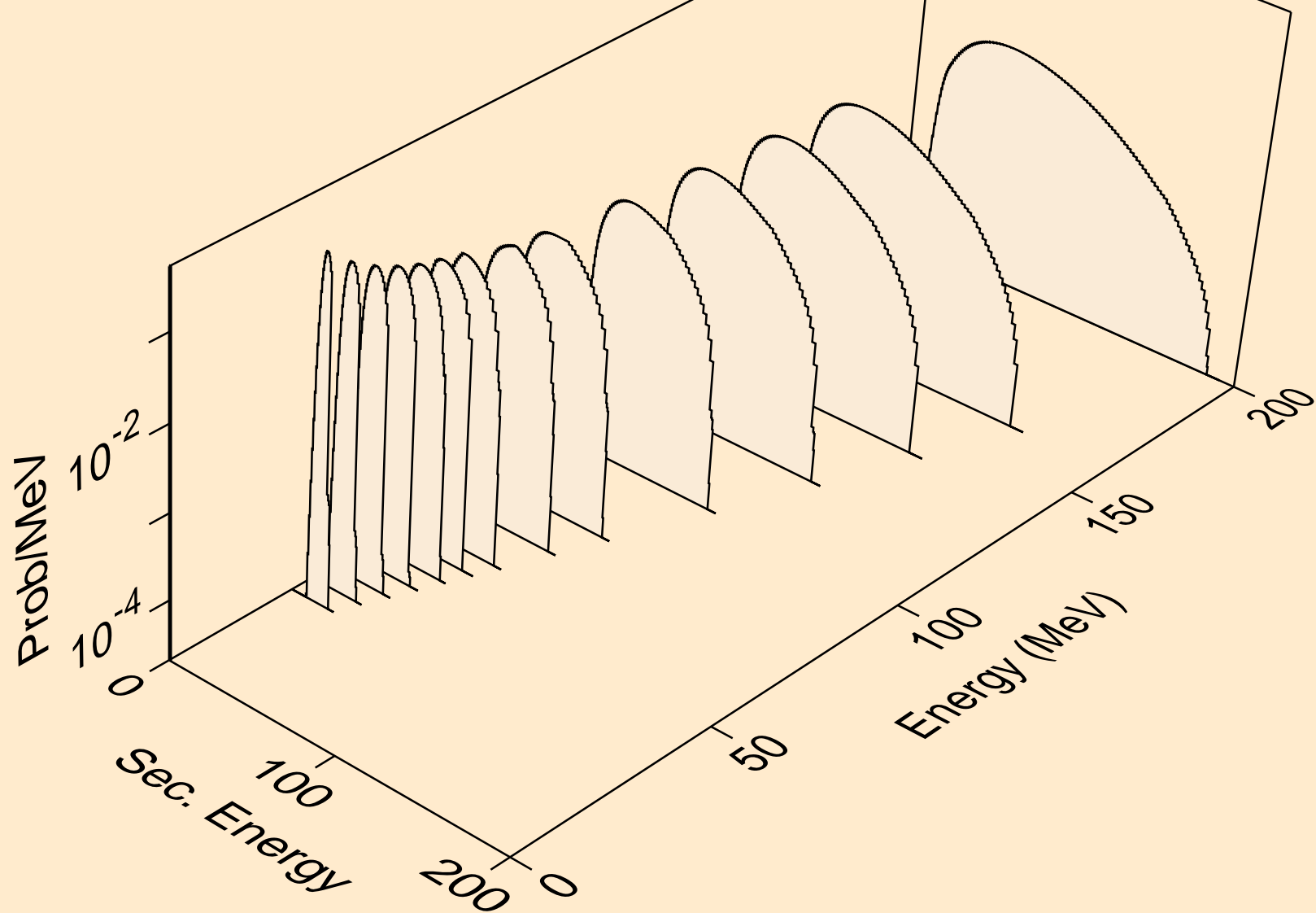

I127 PROTON ACER TENDL-2021 LIBRARY; T=0.K  
he3s from (p,n\*)he3

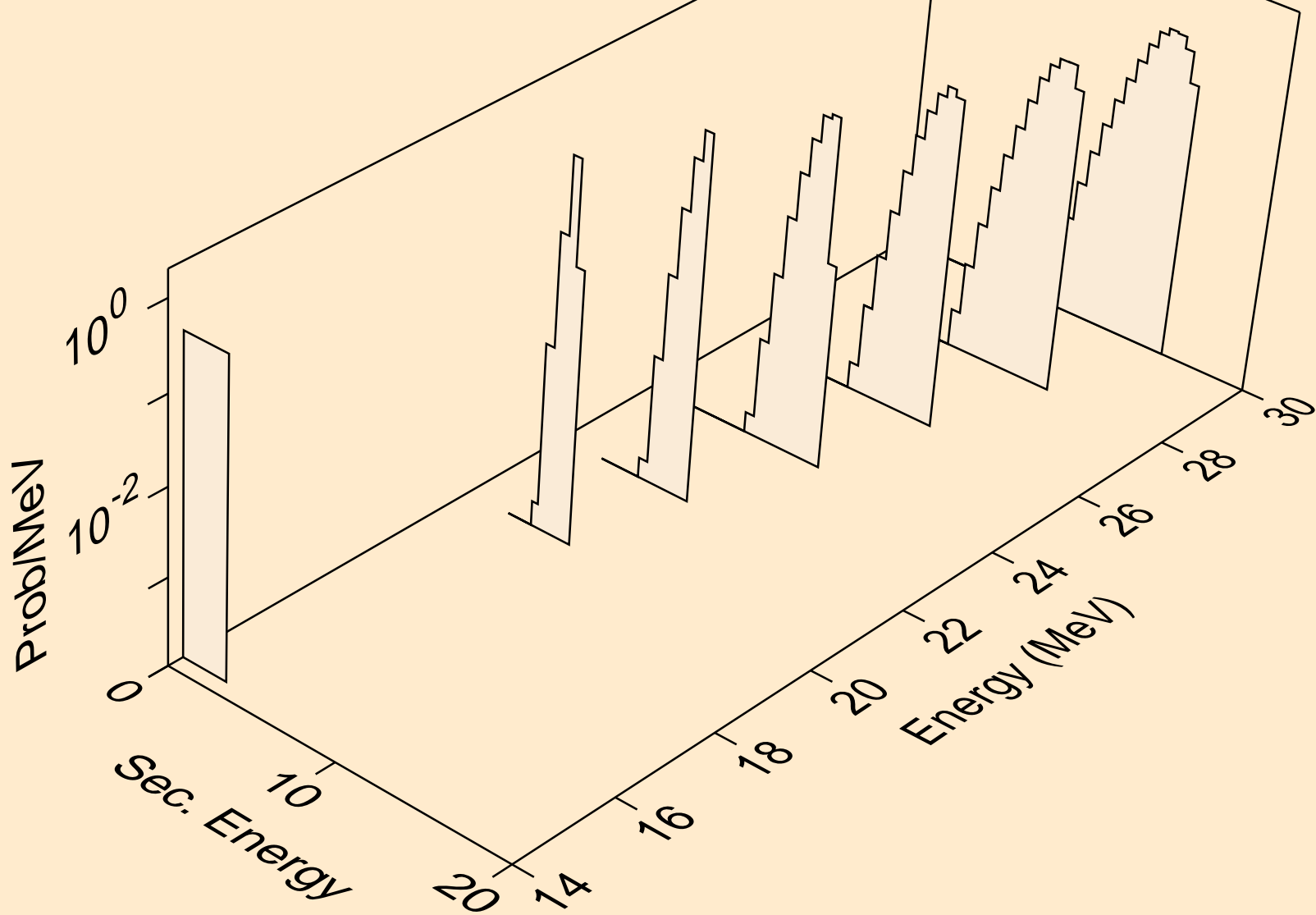

I127 PROTON ACER TENDL-2021 LIBRARY; T=0.K  
he3s from (p,he3)

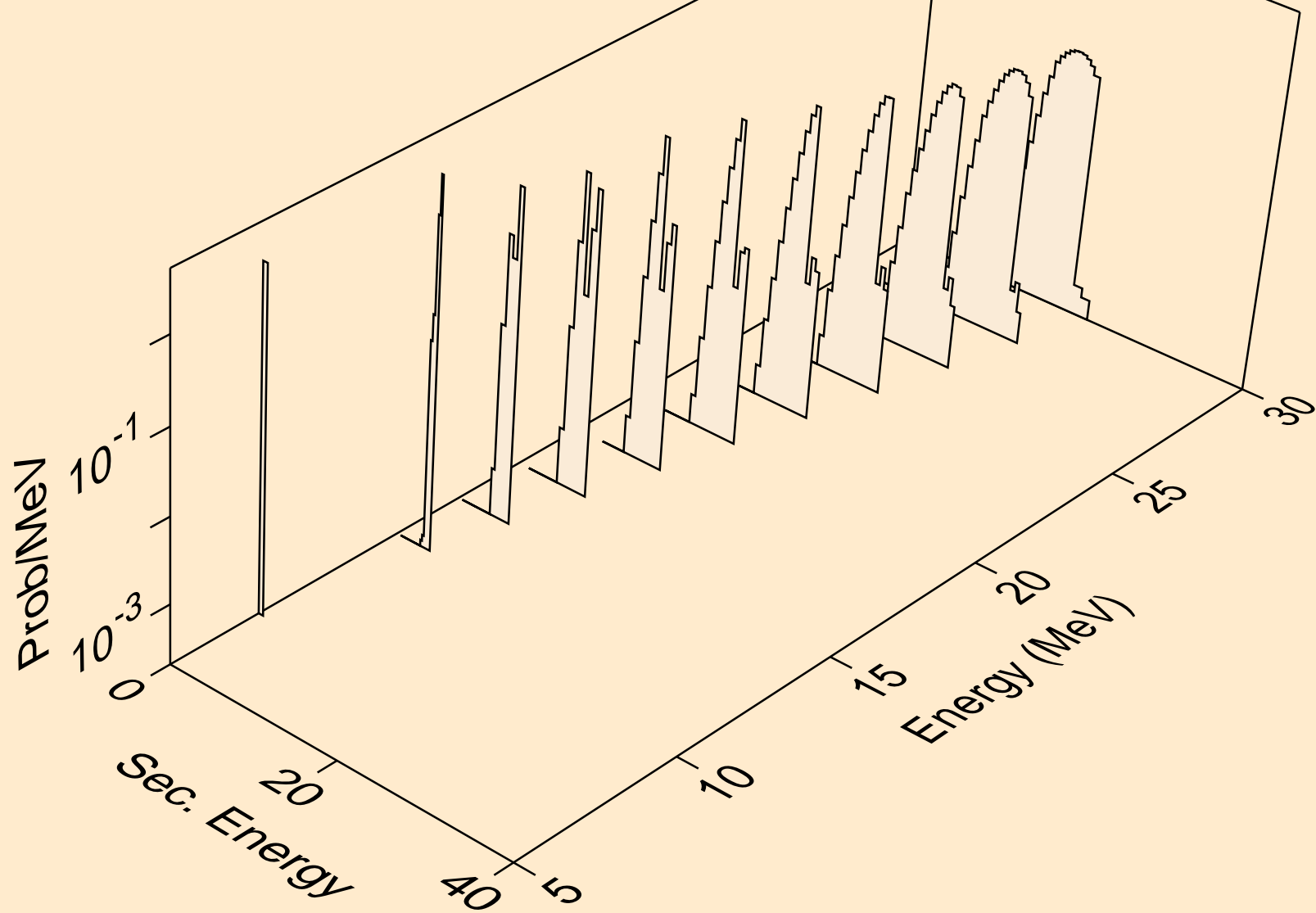

I127 PROTON ACER TENDL-2021 LIBRARY; T=0.K  
alphas from (p,x)

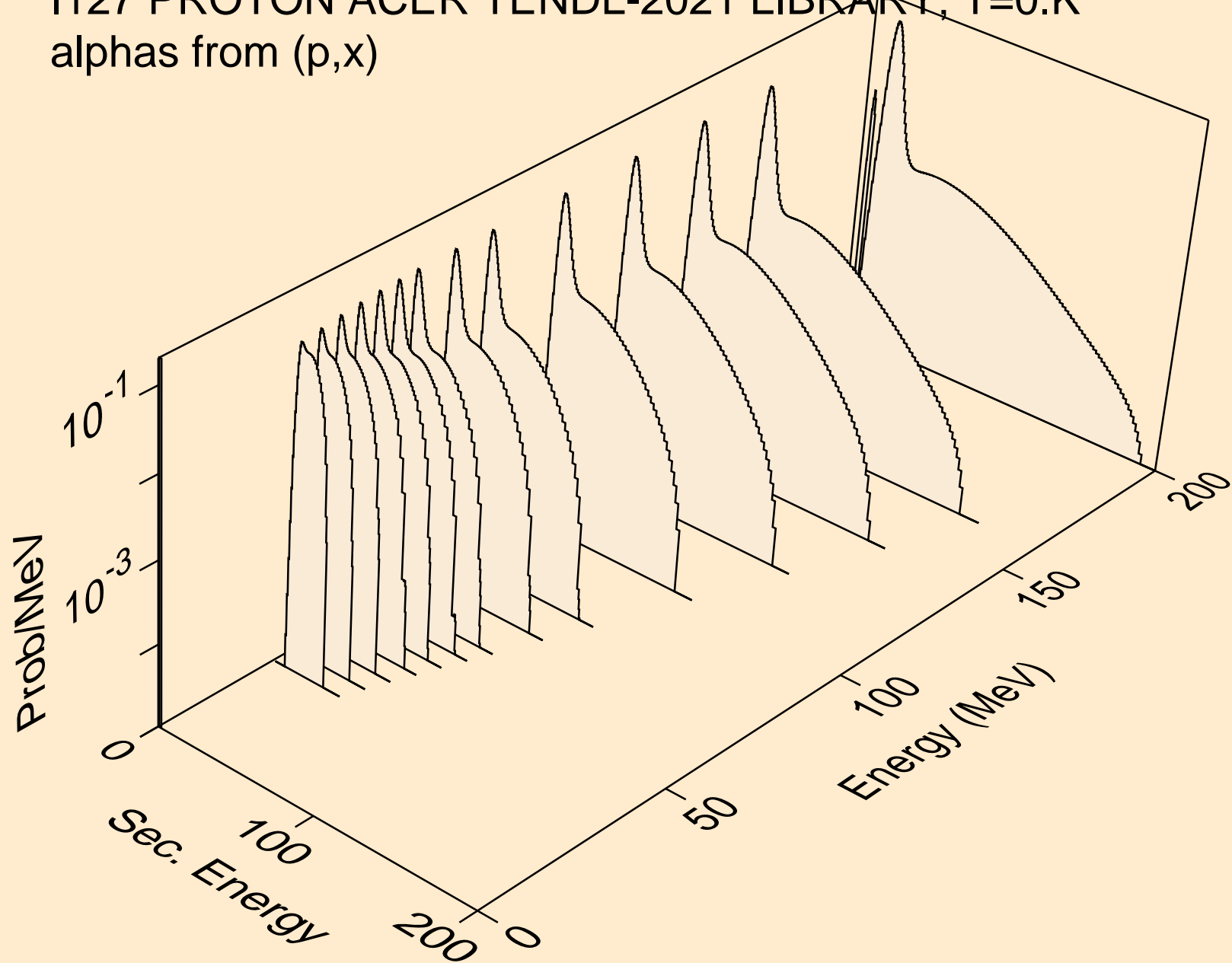

I127 PROTON ACER TENDL-2021 LIBRARY; T=0.K  
alphas from (p,n\*)a

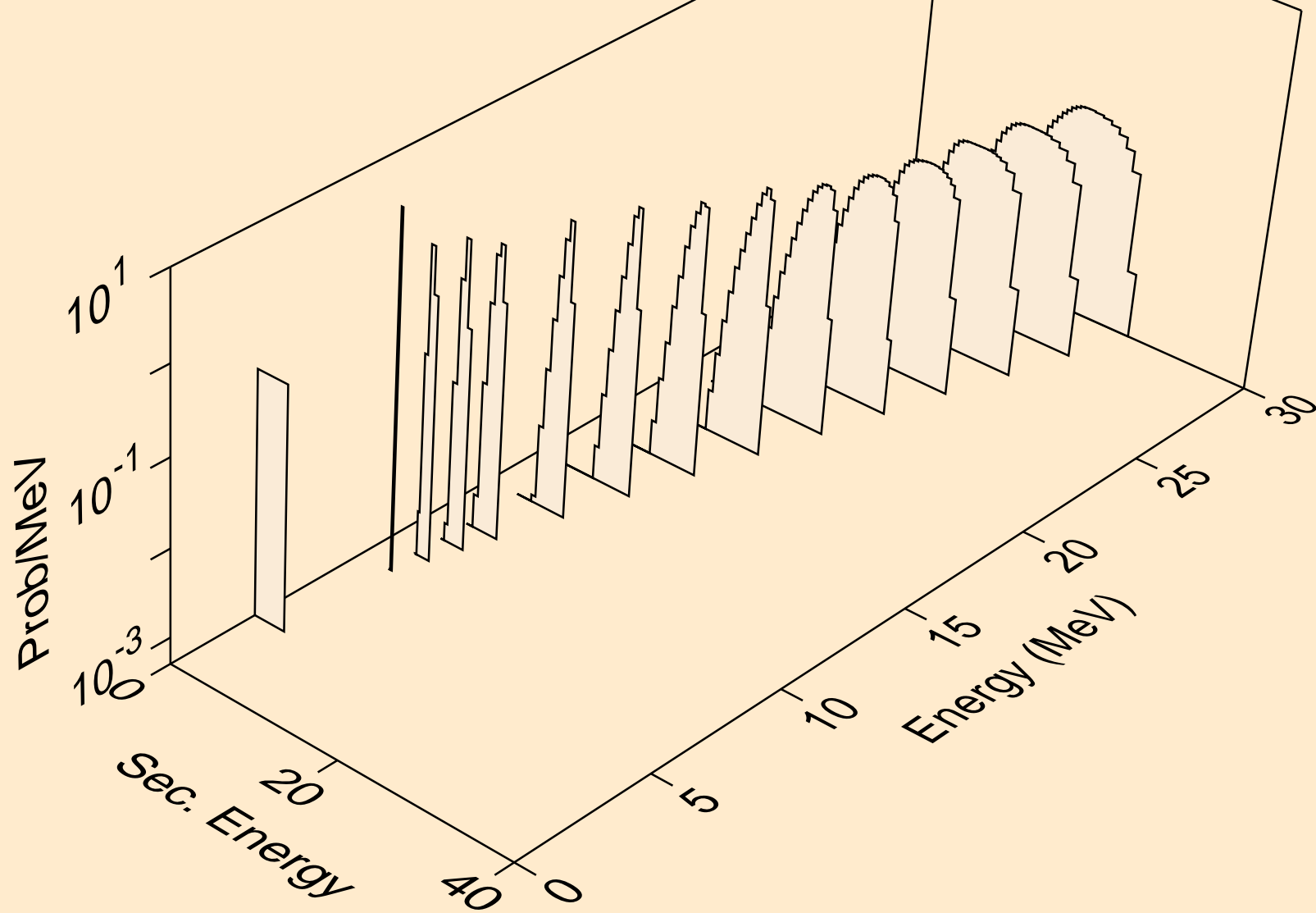

I127 PROTON ACER TENDL-2021 LIBRARY; T=0.K  
alphas from (p,2n)a

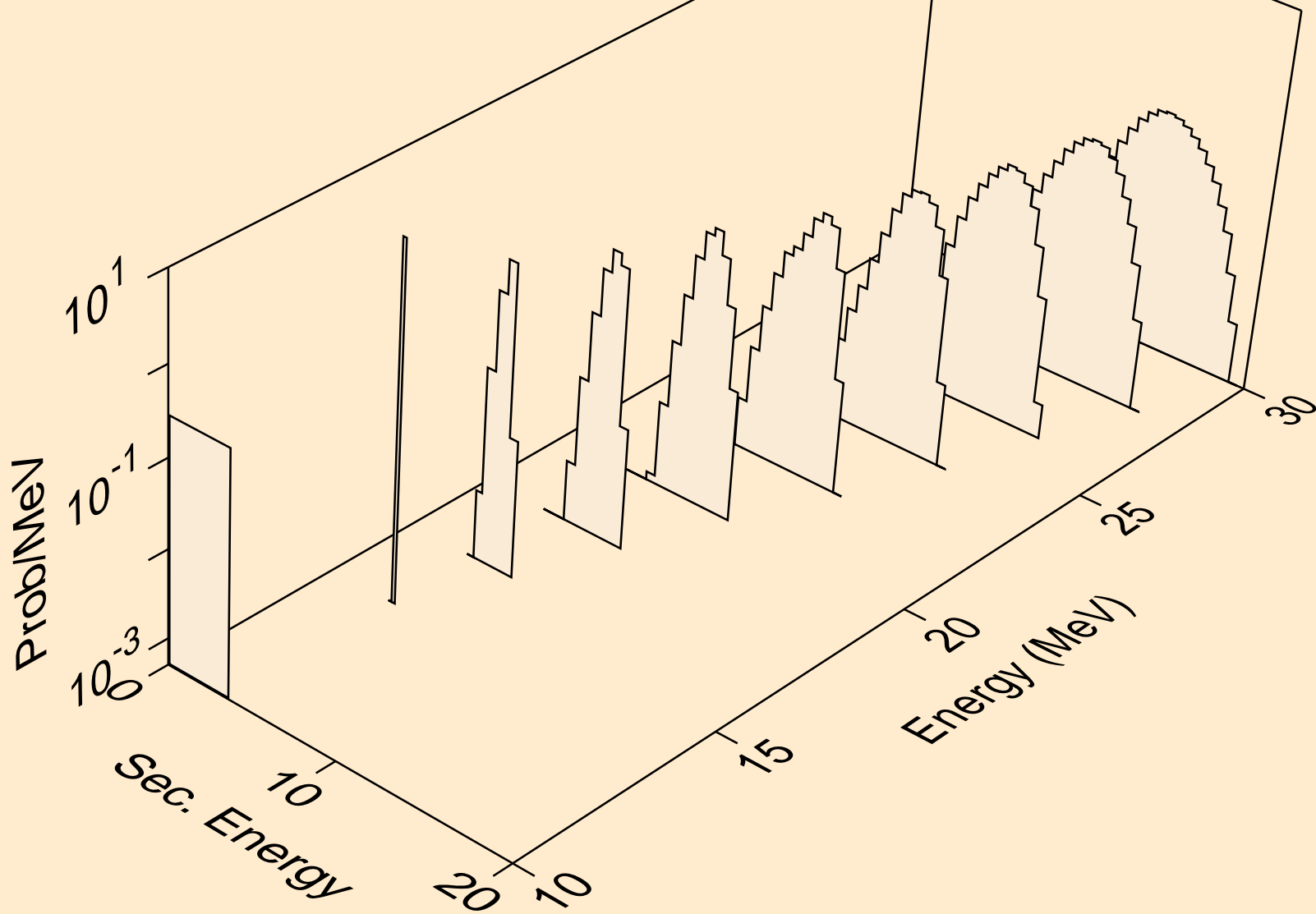

I127 PROTON ACER TENDL-2021 LIBRARY; T=0.K  
alphas from (p,3n)a

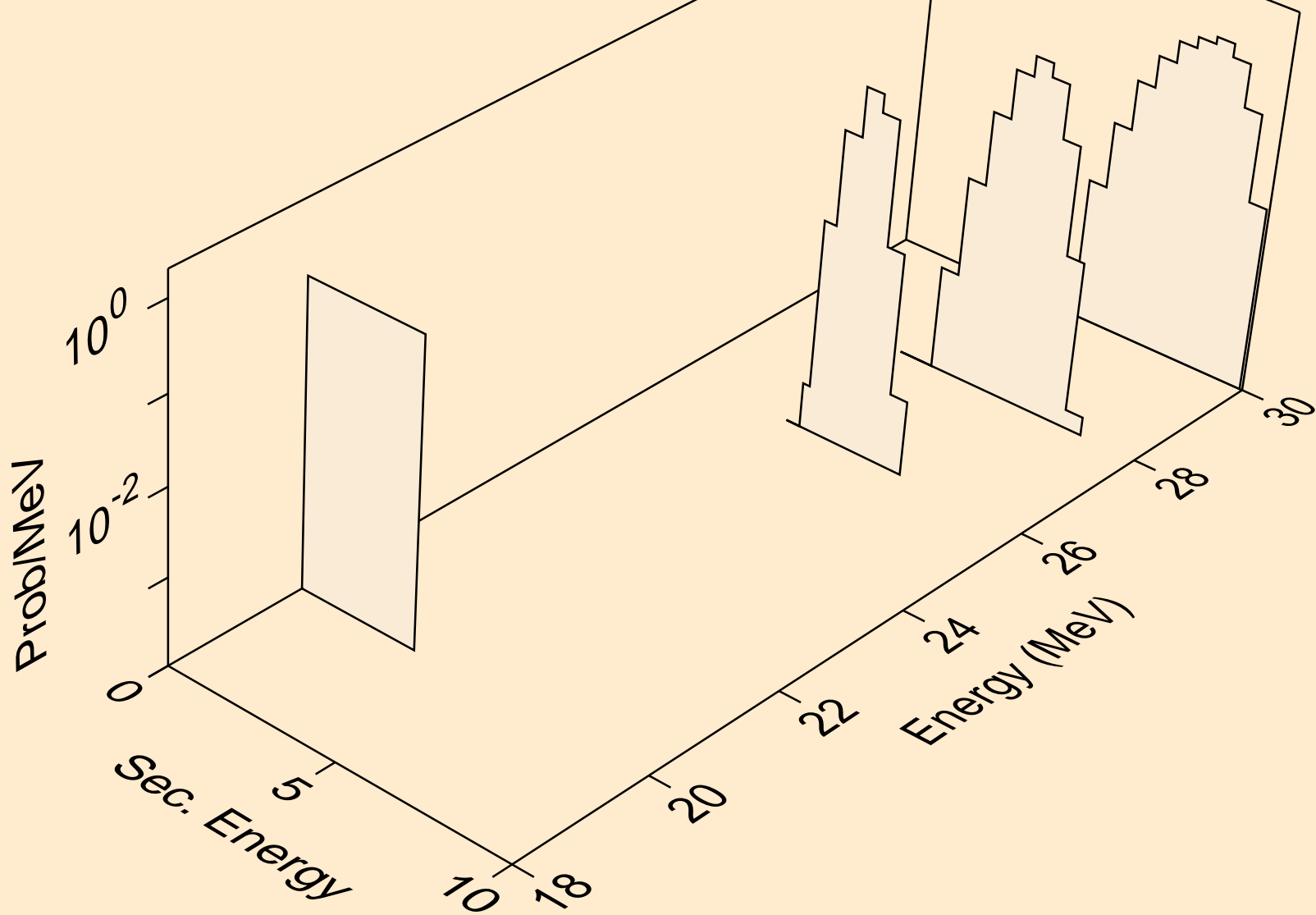



I127 PROTON ACER TENDL-2021 LIBRARY; T=0.K  
alphas from (p,n\*)2a

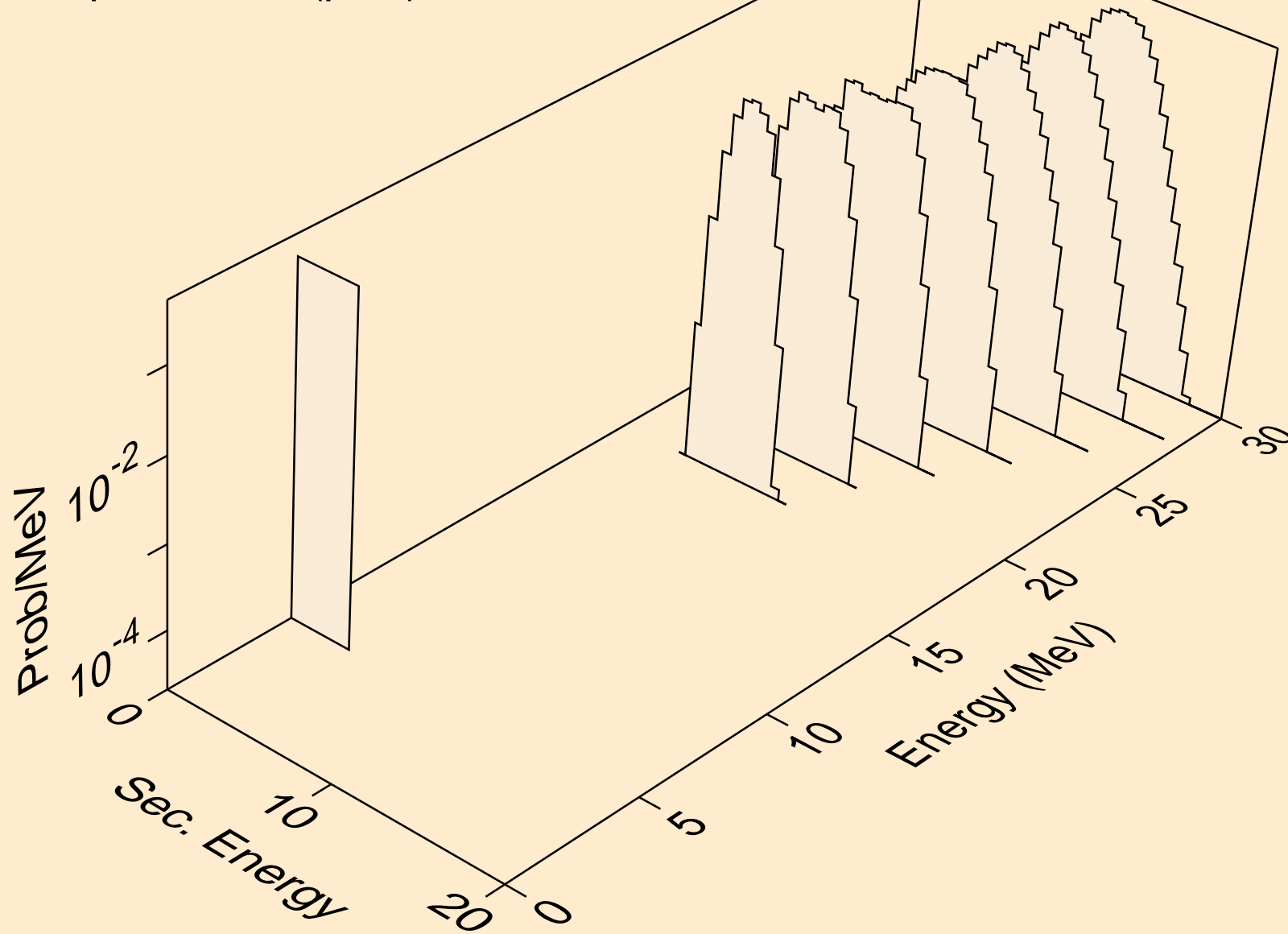

I127 PROTON ACER TENDL-2021 LIBRARY; T=0.K  
alphas from (p,npa)

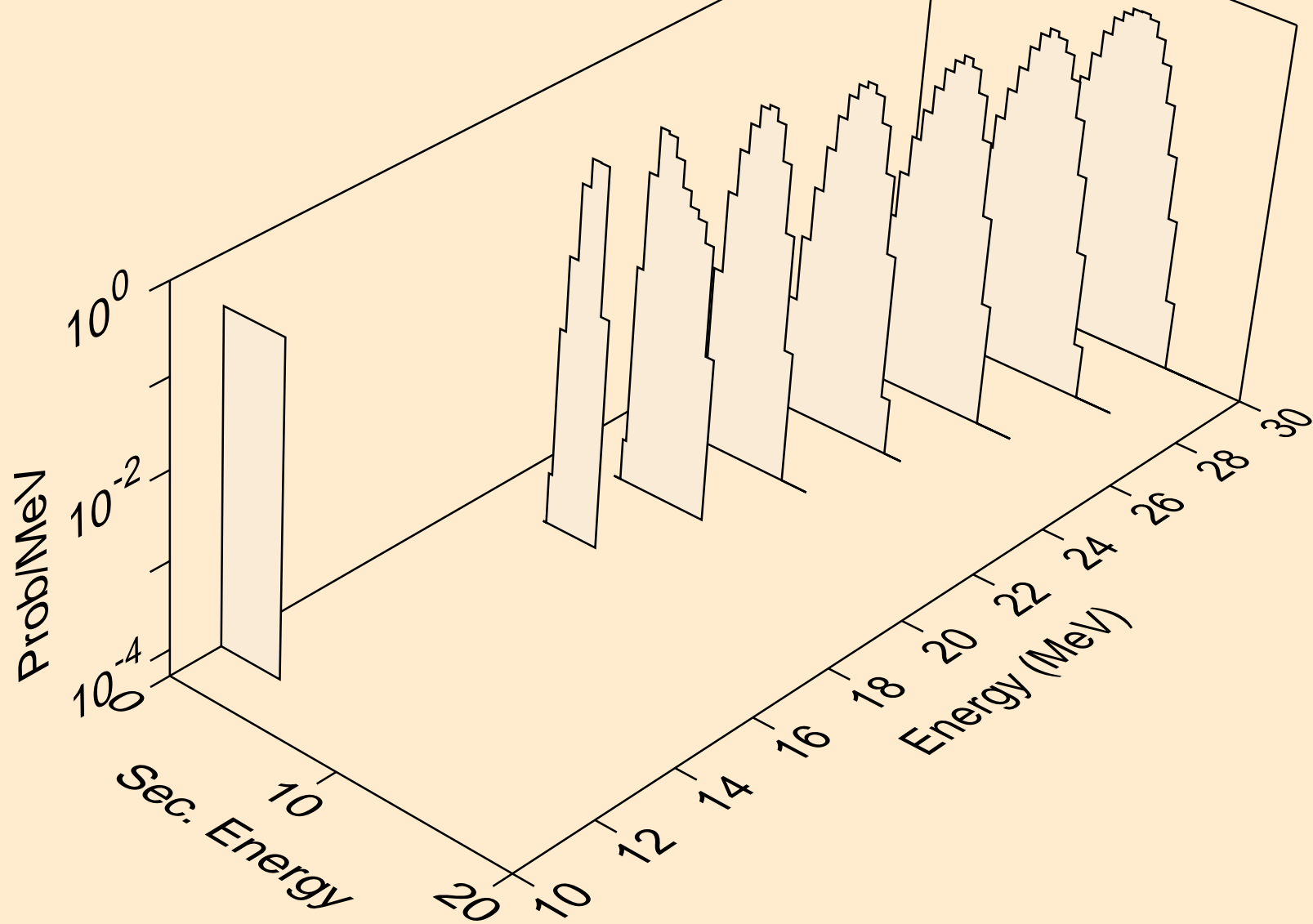

I127 PROTON ACER TENDL-2021 LIBRARY; T=0.K  
alphas from (p,a)

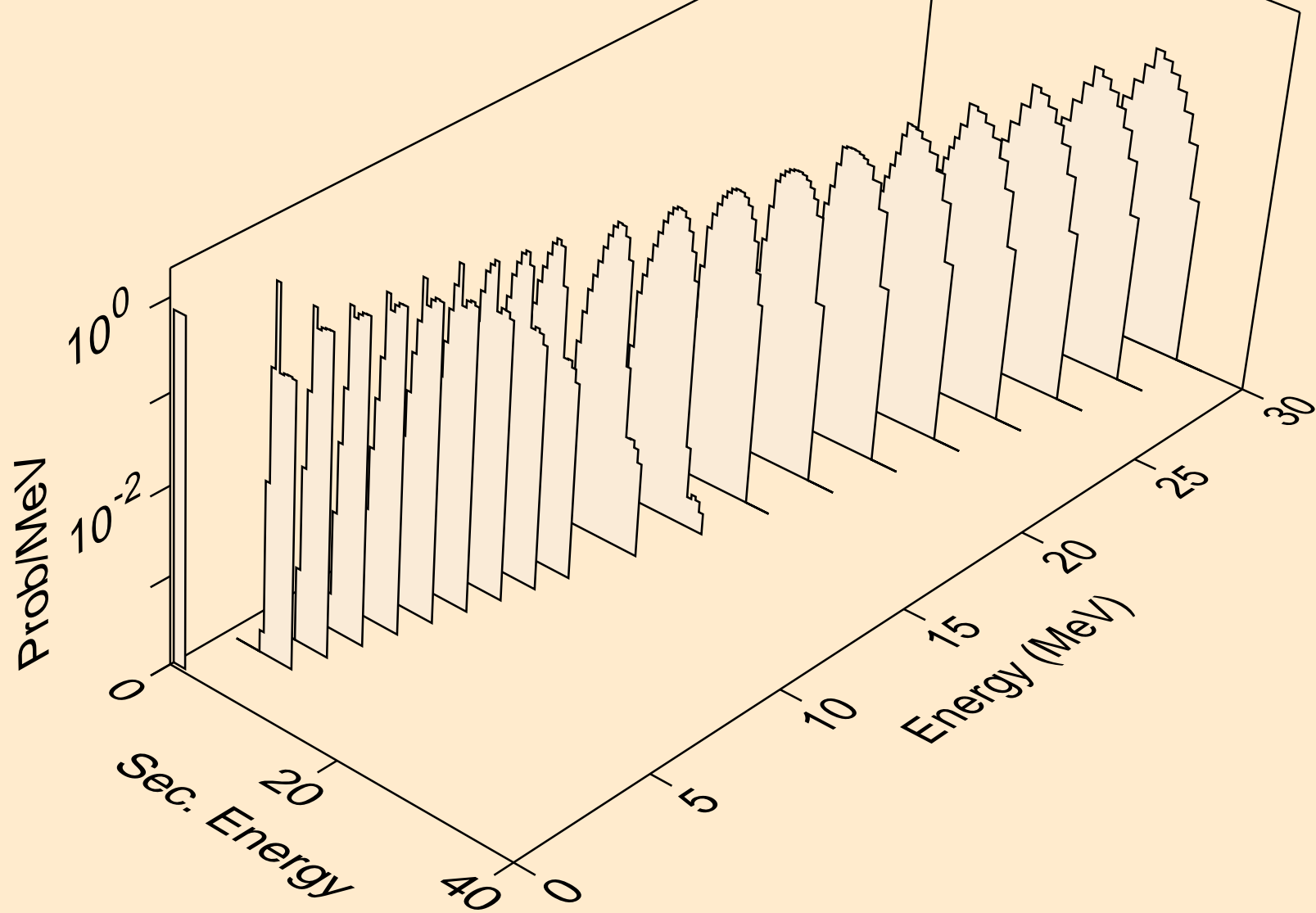

I127 PROTON ACER TENDL-2021 LIBRARY; T=0.K  
alphas from (p,2a)

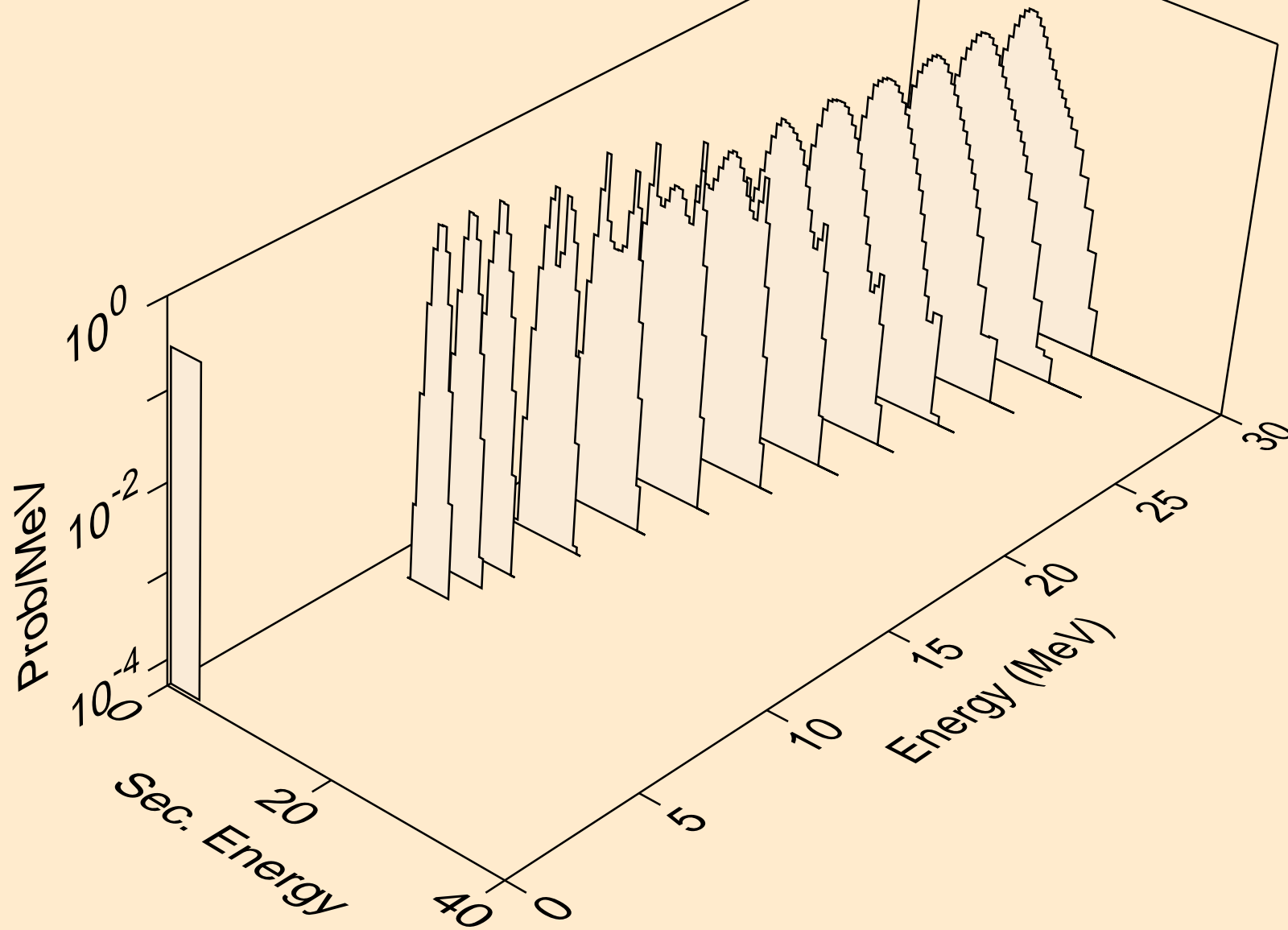

I127 PROTON ACER TENDL-2021 LIBRARY; T=0.K  
alphas from (p,pa)

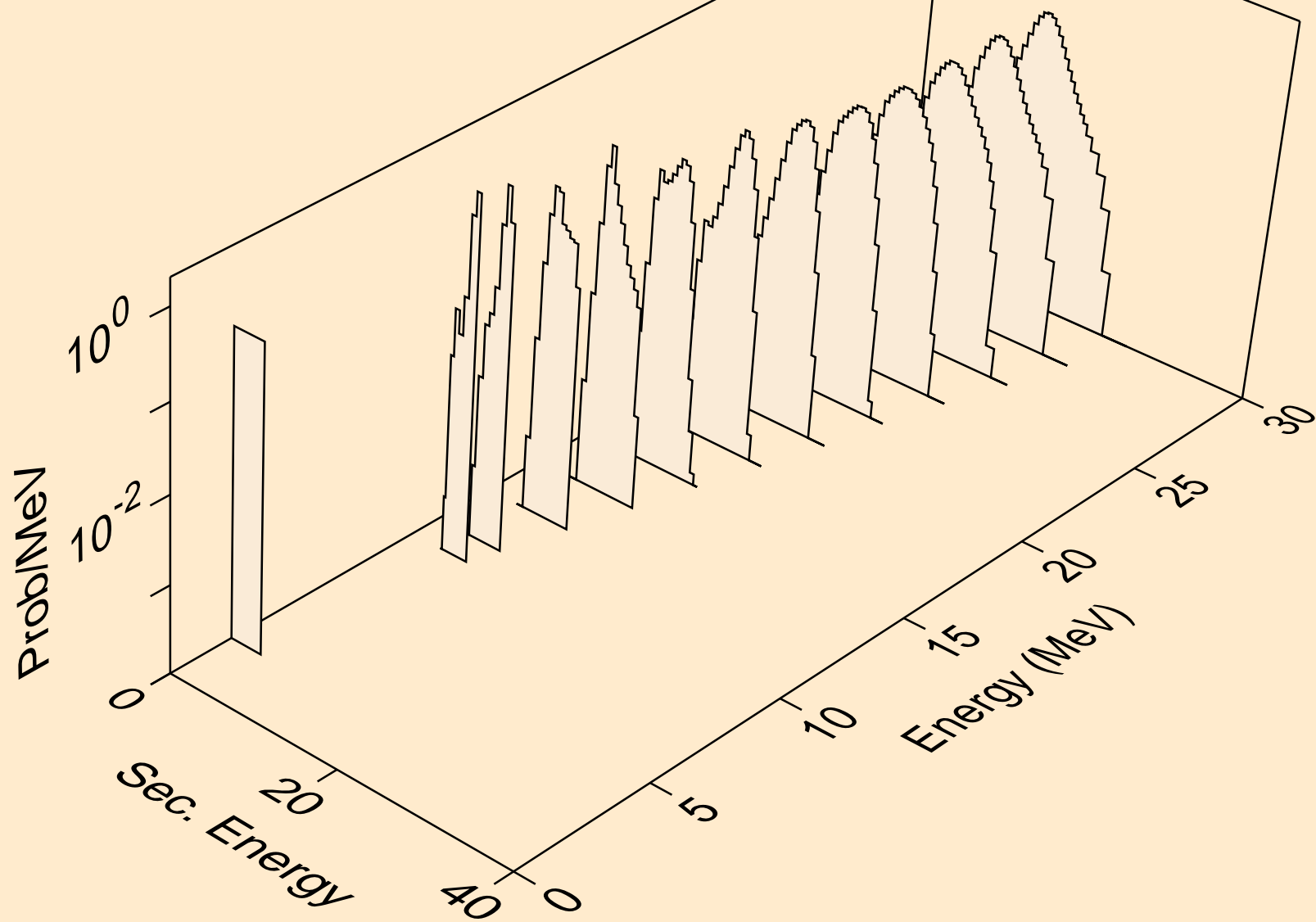

I127 PROTON ACER TENDL-2021 LIBRARY; T=0.K  
alphas from (p,da)

