

# IN127N PROTON ACER TENDL-2021 LIBRARY; T=0.K

## Principal cross sections

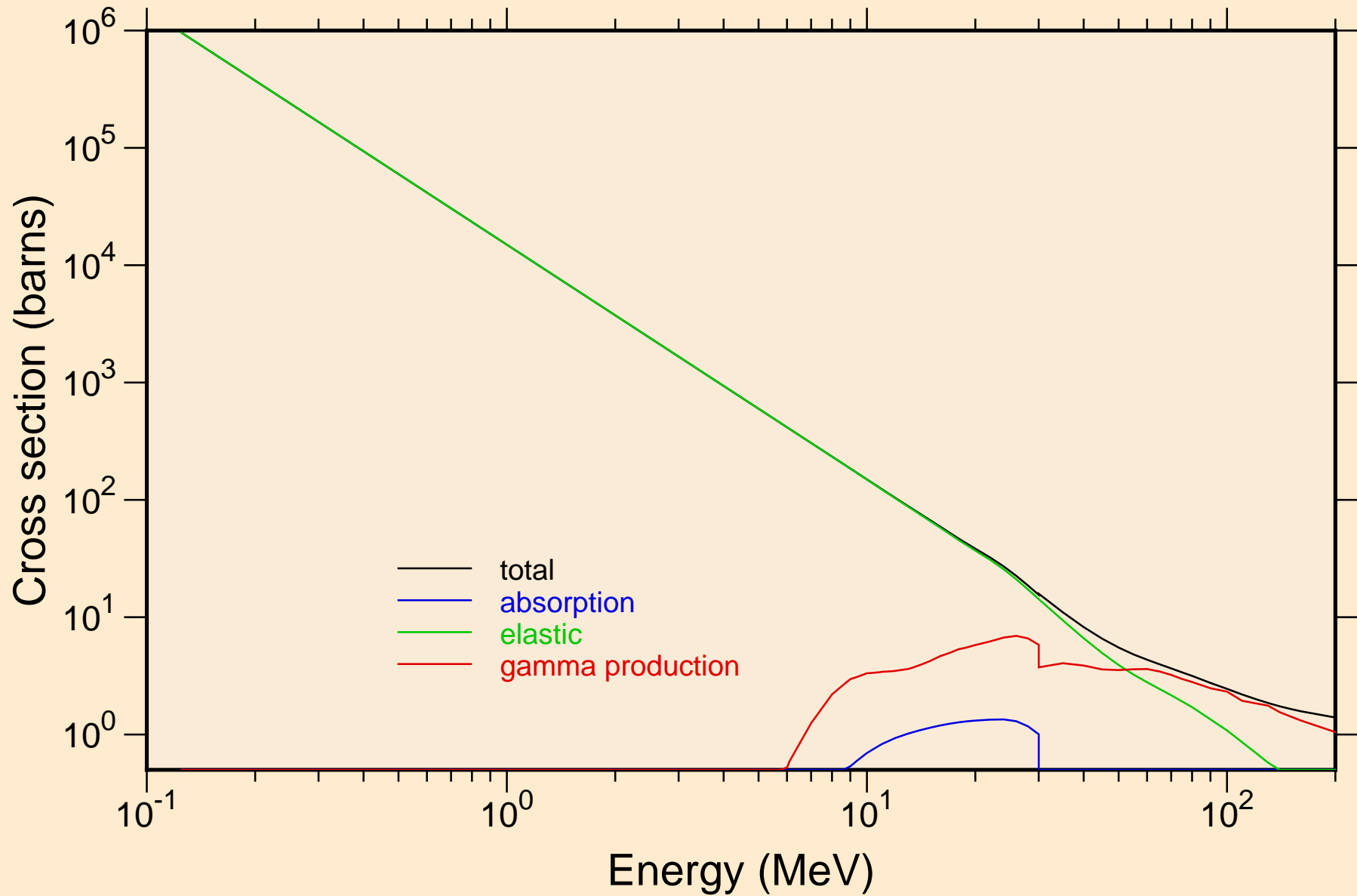

IN127N PROTON ACER TENDL-2021 LIBRARY; T=0.K  
Heating

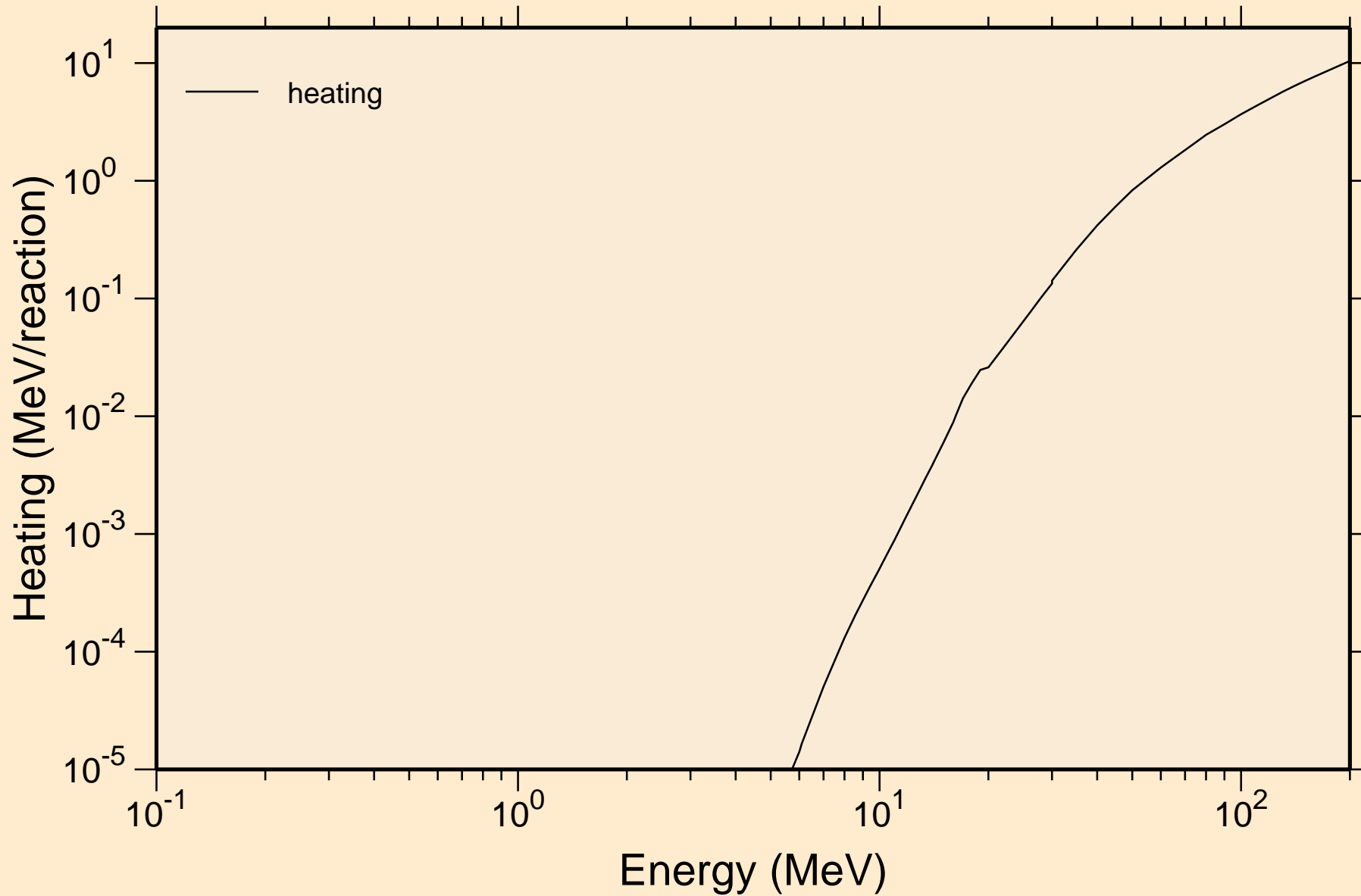

# IN127N PROTON ACER TENDL-2021 LIBRARY; T=0.K

## Principal cross sections

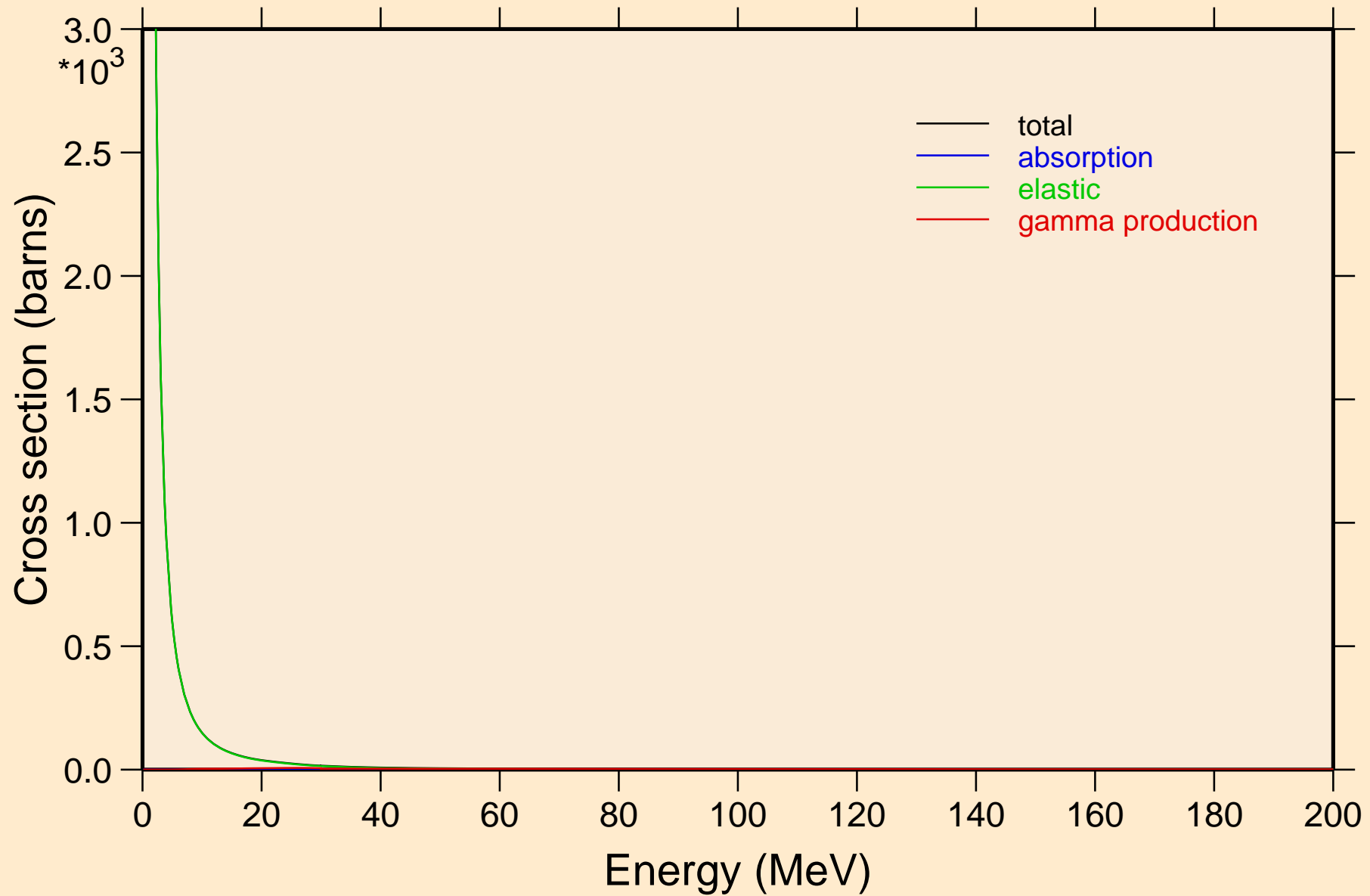

IN127N PROTON ACER TENDL-2021 LIBRARY; T=0.K

Heating

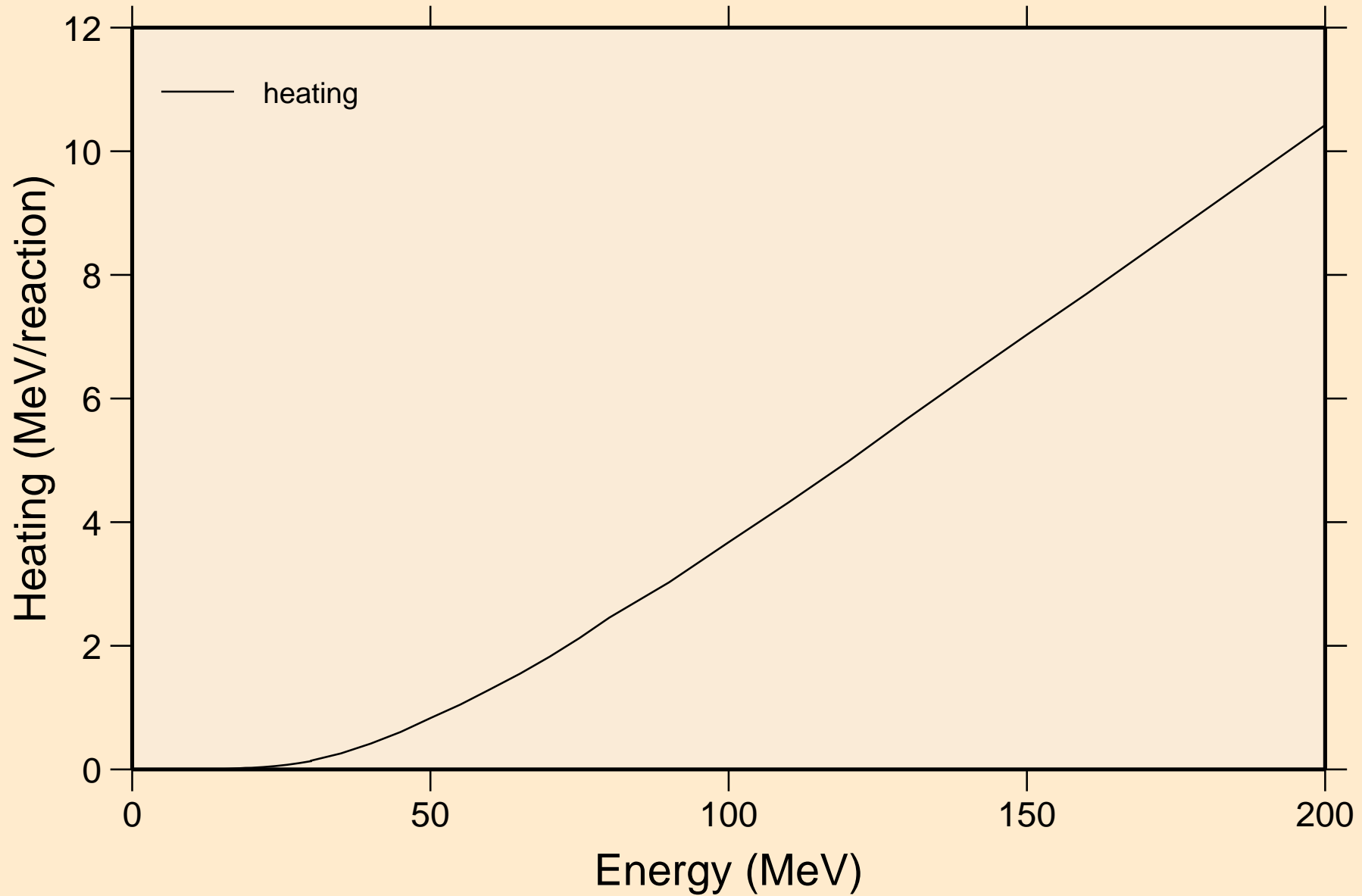

# IN127N PROTON ACER TENDL-2021 LIBRARY; T=0.K

## Threshold reactions

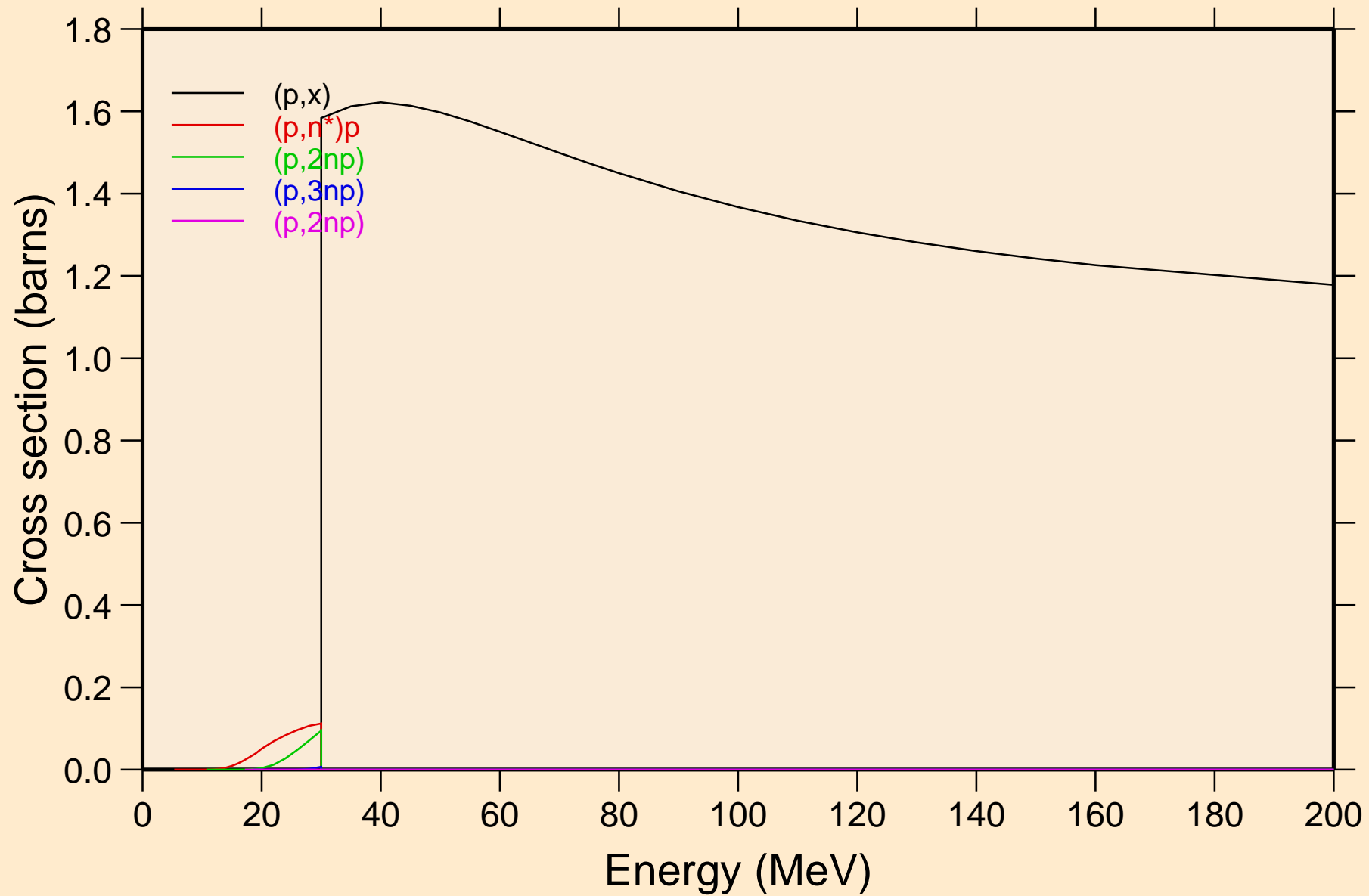

# IN127N PROTON ACER TENDL-2021 LIBRARY; T=0.K

## Threshold reactions

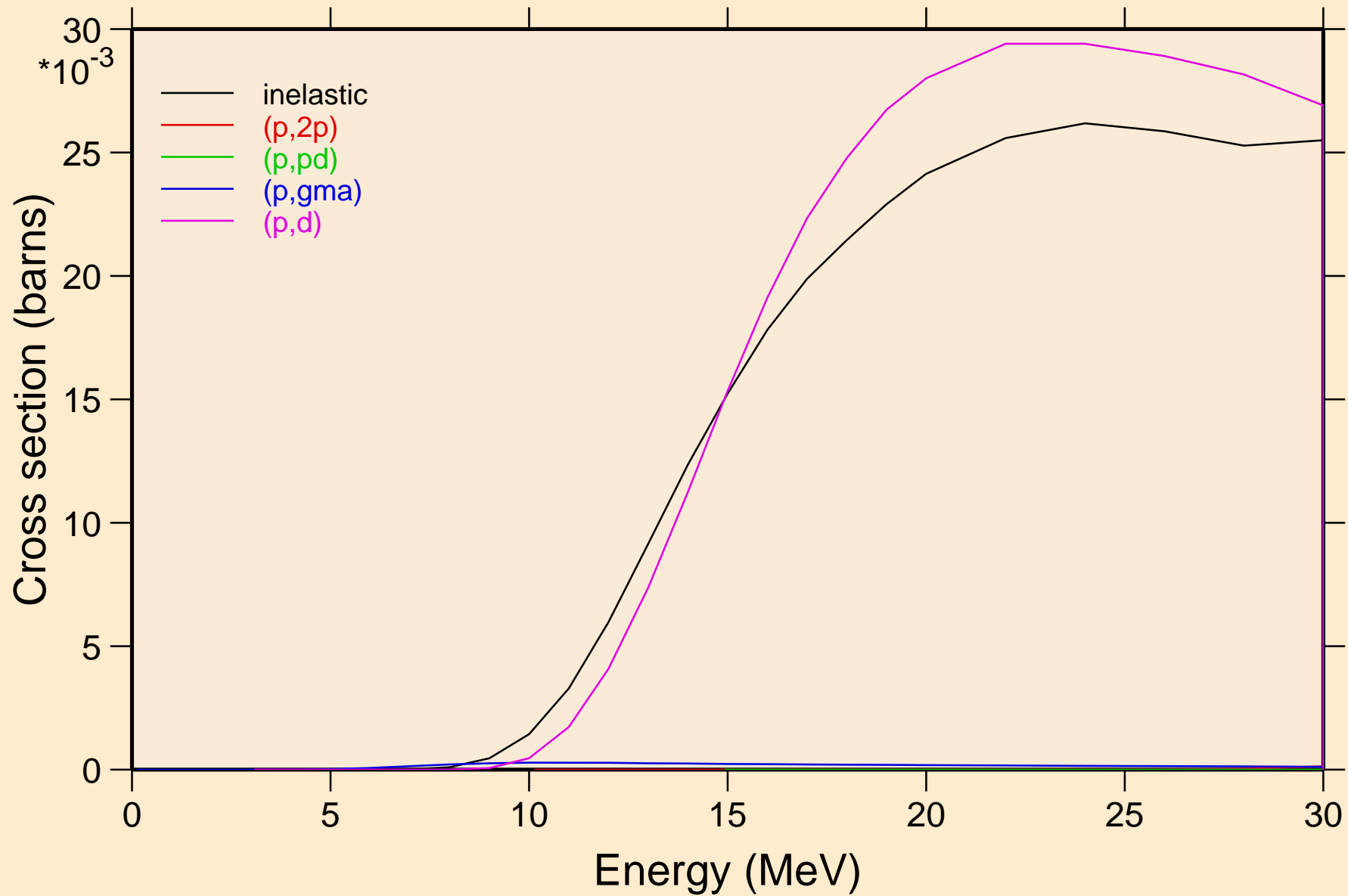

IN127N PROTON ACER TENDL-2021 LIBRARY; T=0.K  
Threshold reactions

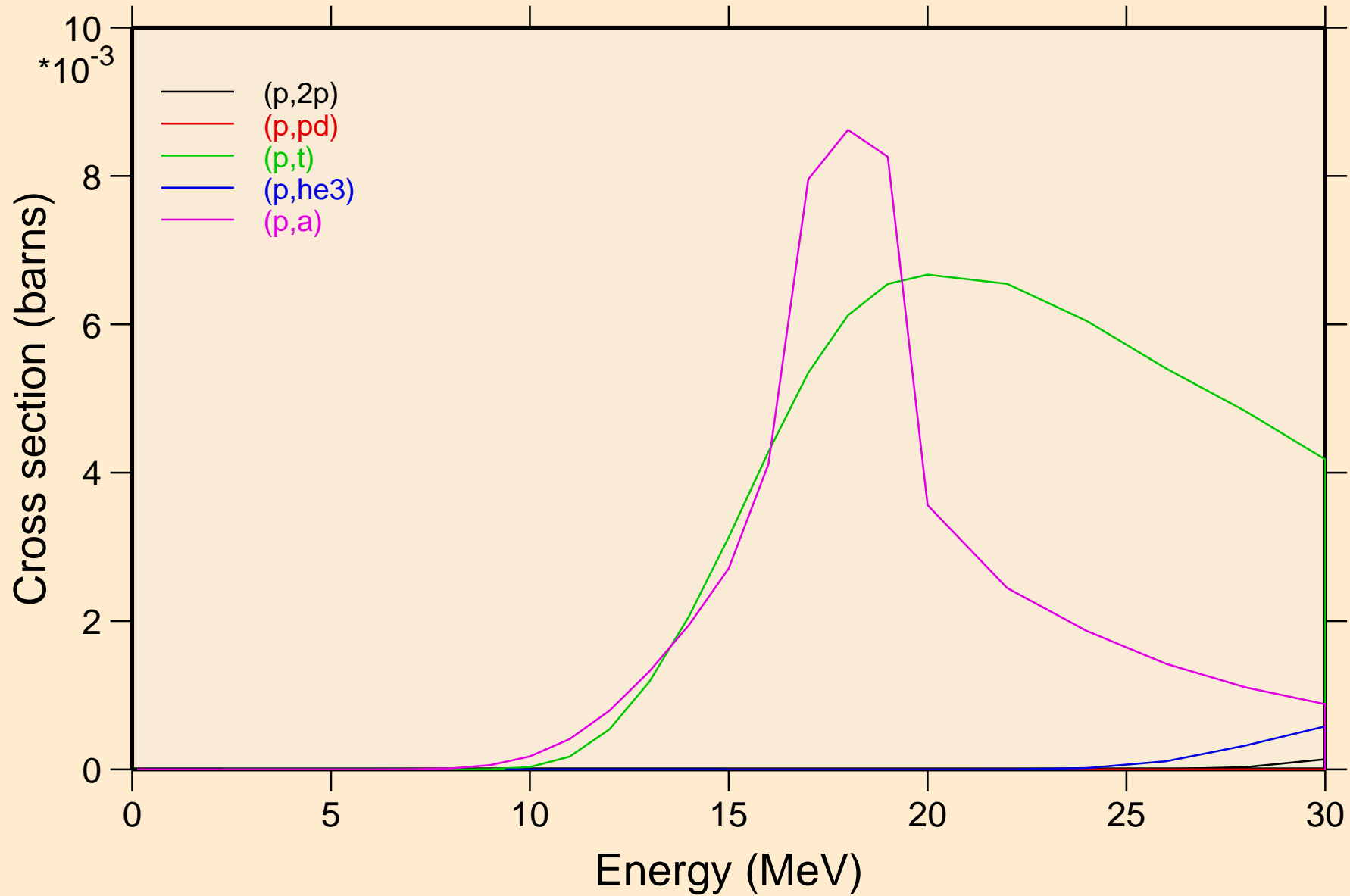

IN127N PROTON ACER TENDL-2021 LIBRARY; T=0.K  
Threshold reactions

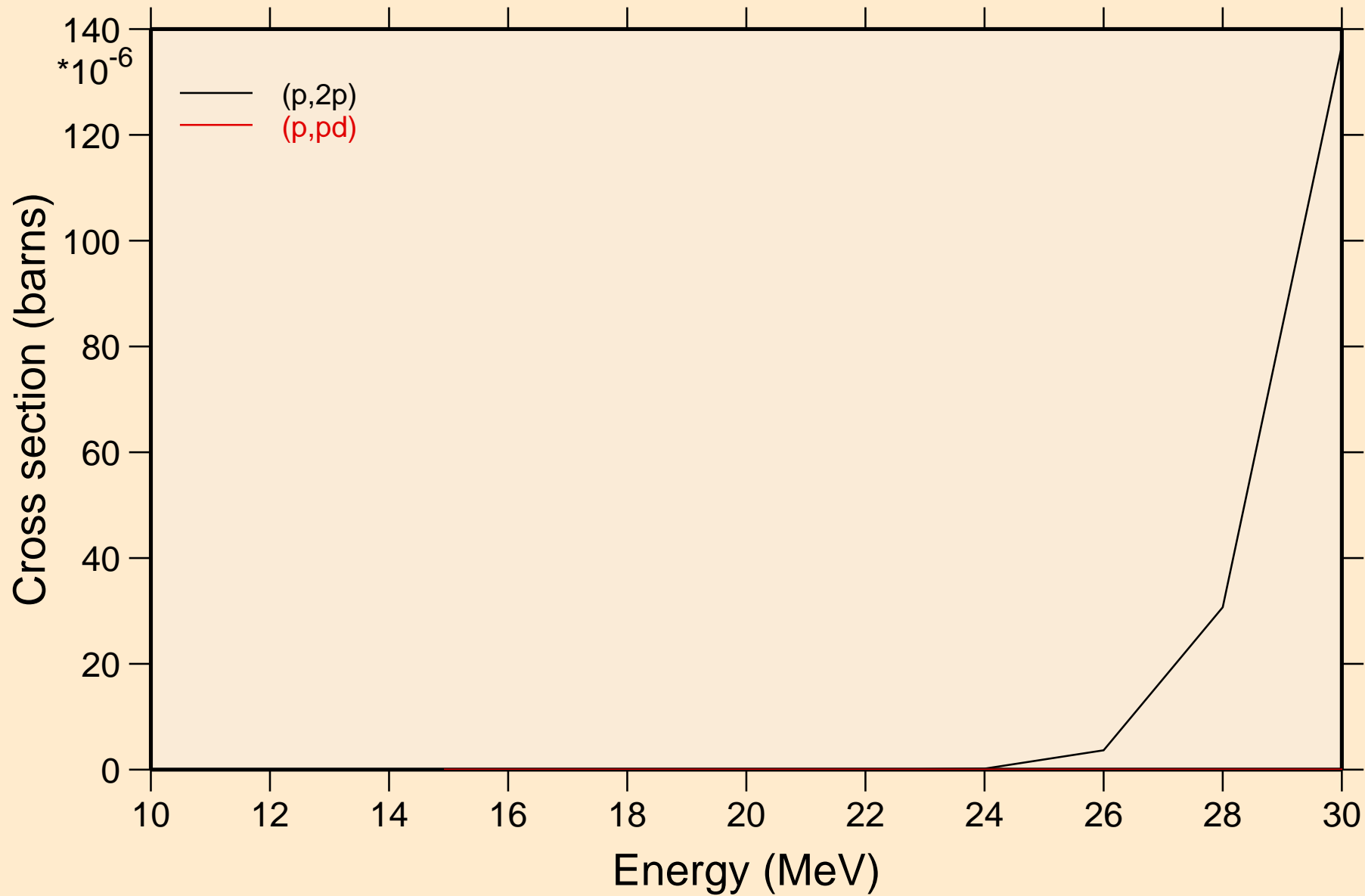



IN127N PROTON ACER TENDL-2021 LIBRARY; T=0.K  
angular distribution for elastic

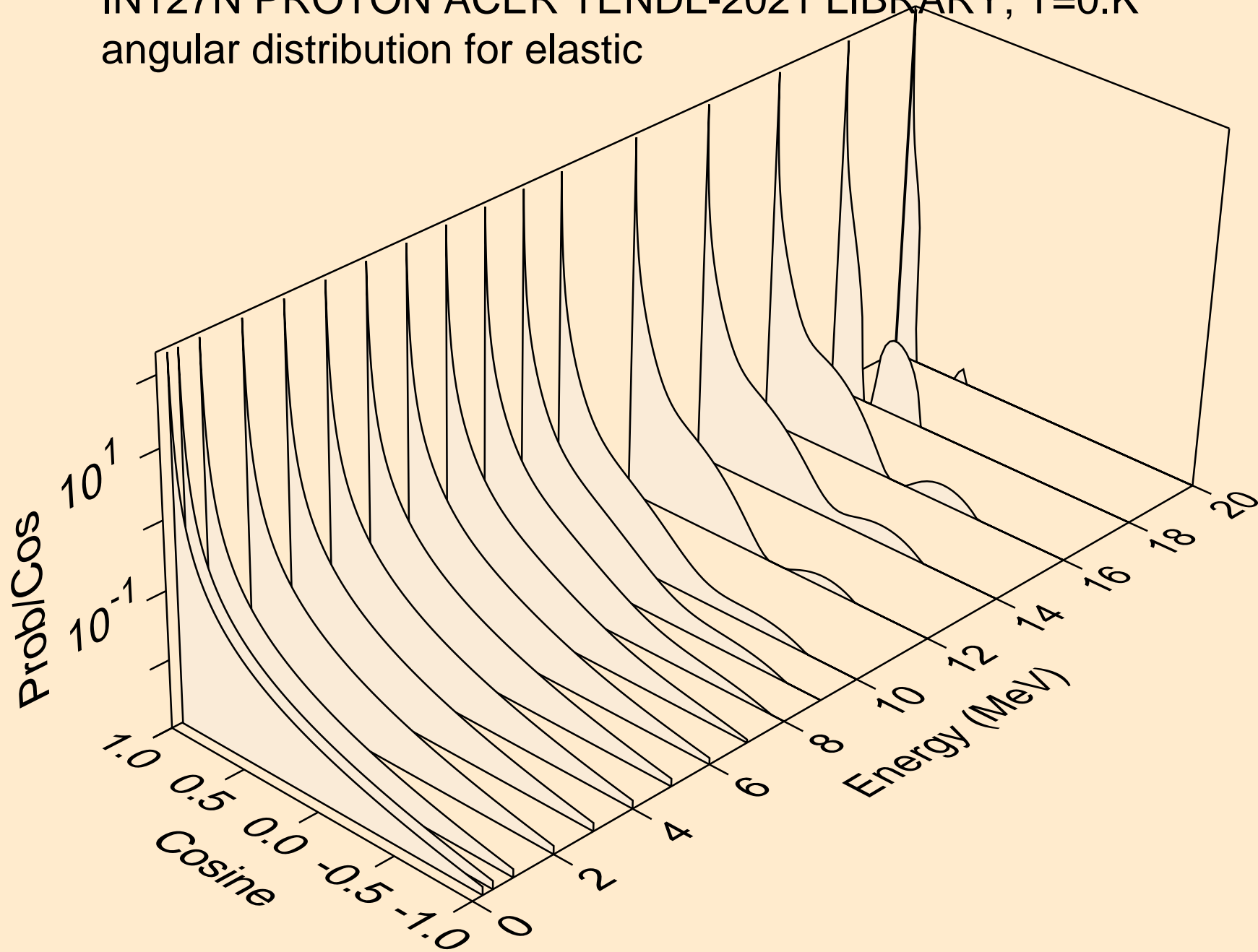

IN127N PROTON ACER TENDL-2021 LIBRARY; T=0.K  
angular distribution for elastic

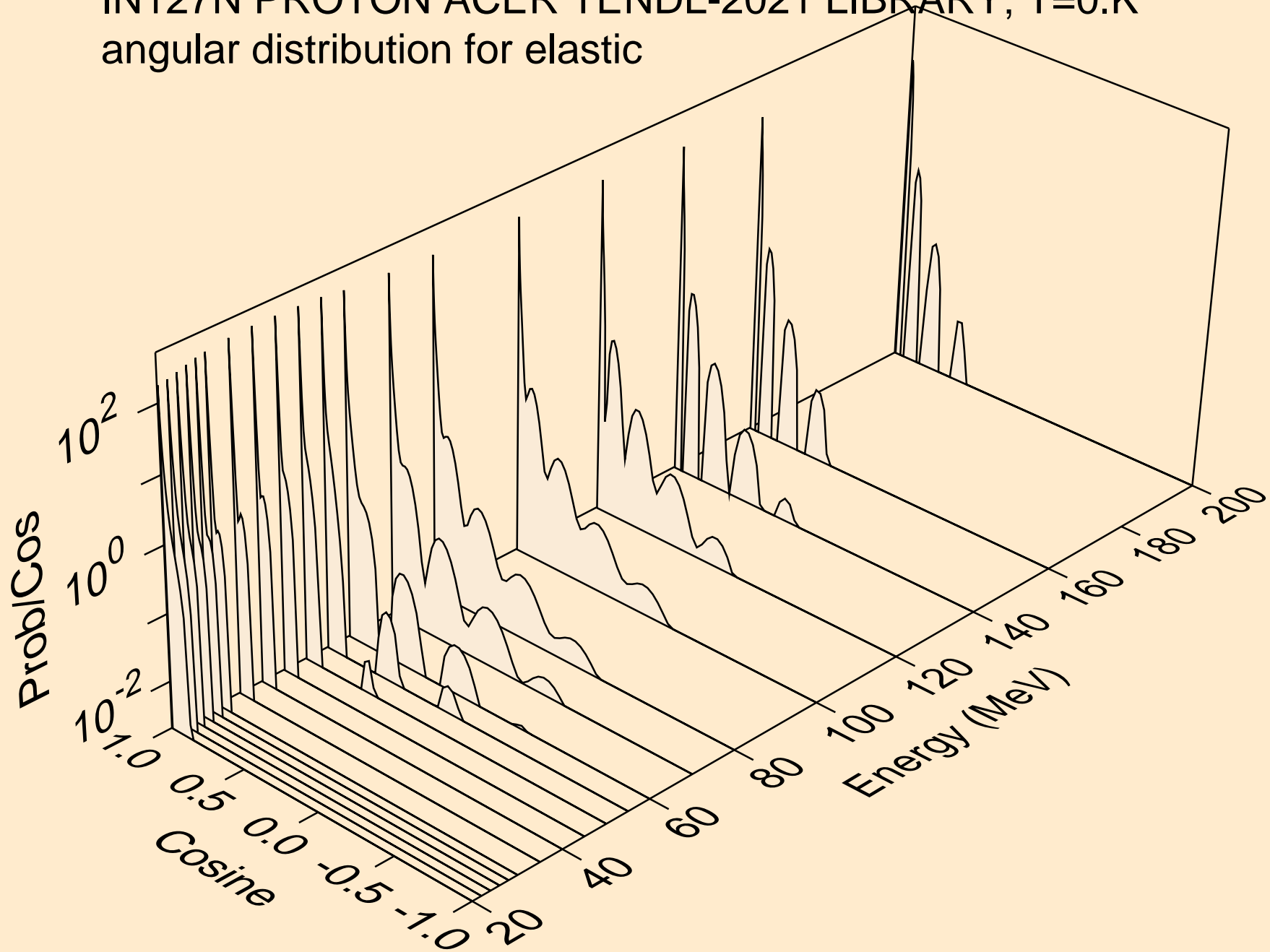

IN127N PROTON ACER TENDL-2021 LIBRARY; T=0.K  
Proton emission for (p,x)

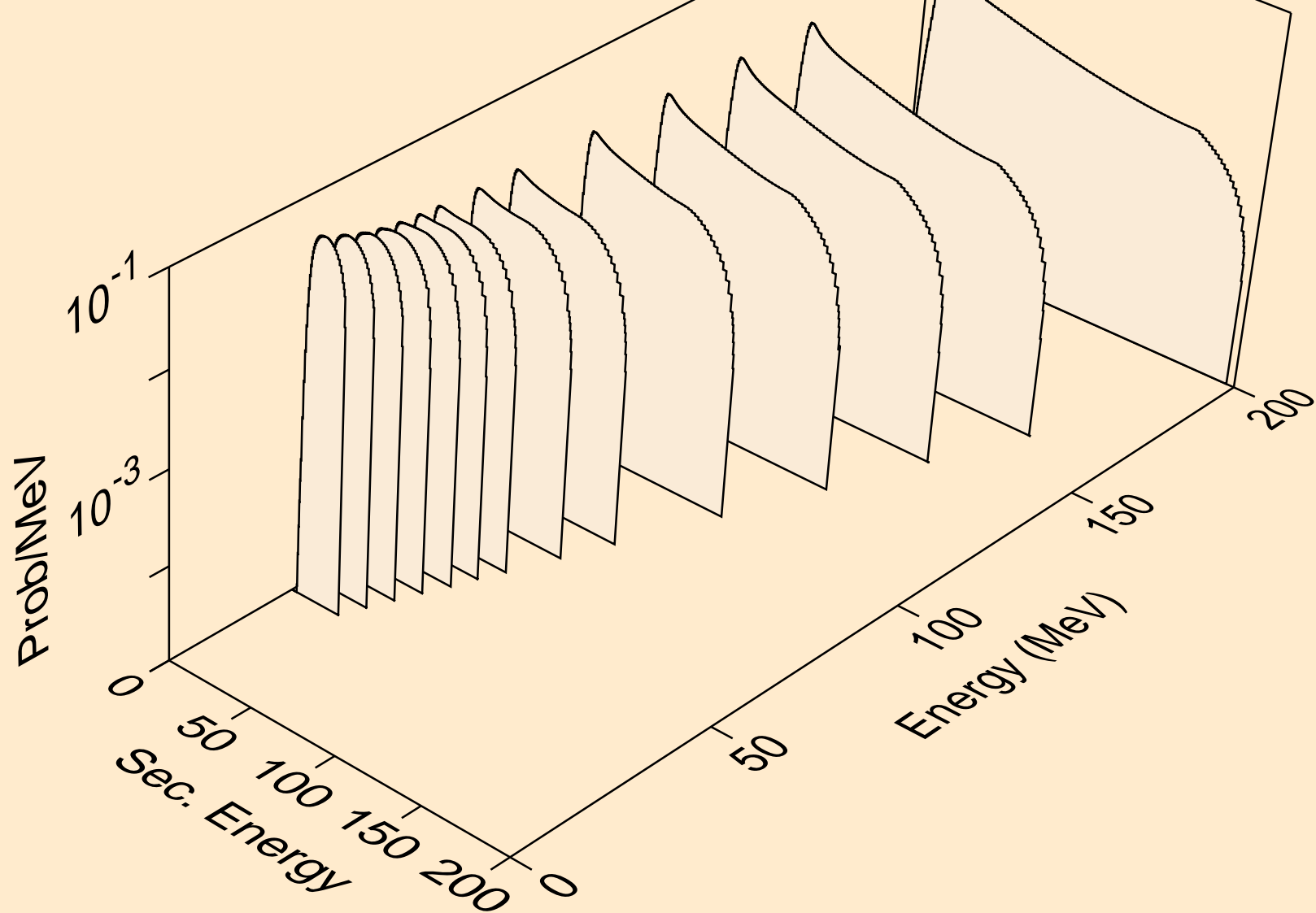

IN127N PROTON ACER TENDL-2021 LIBRARY; T=0.K  
Proton emission for (p,n\*)p

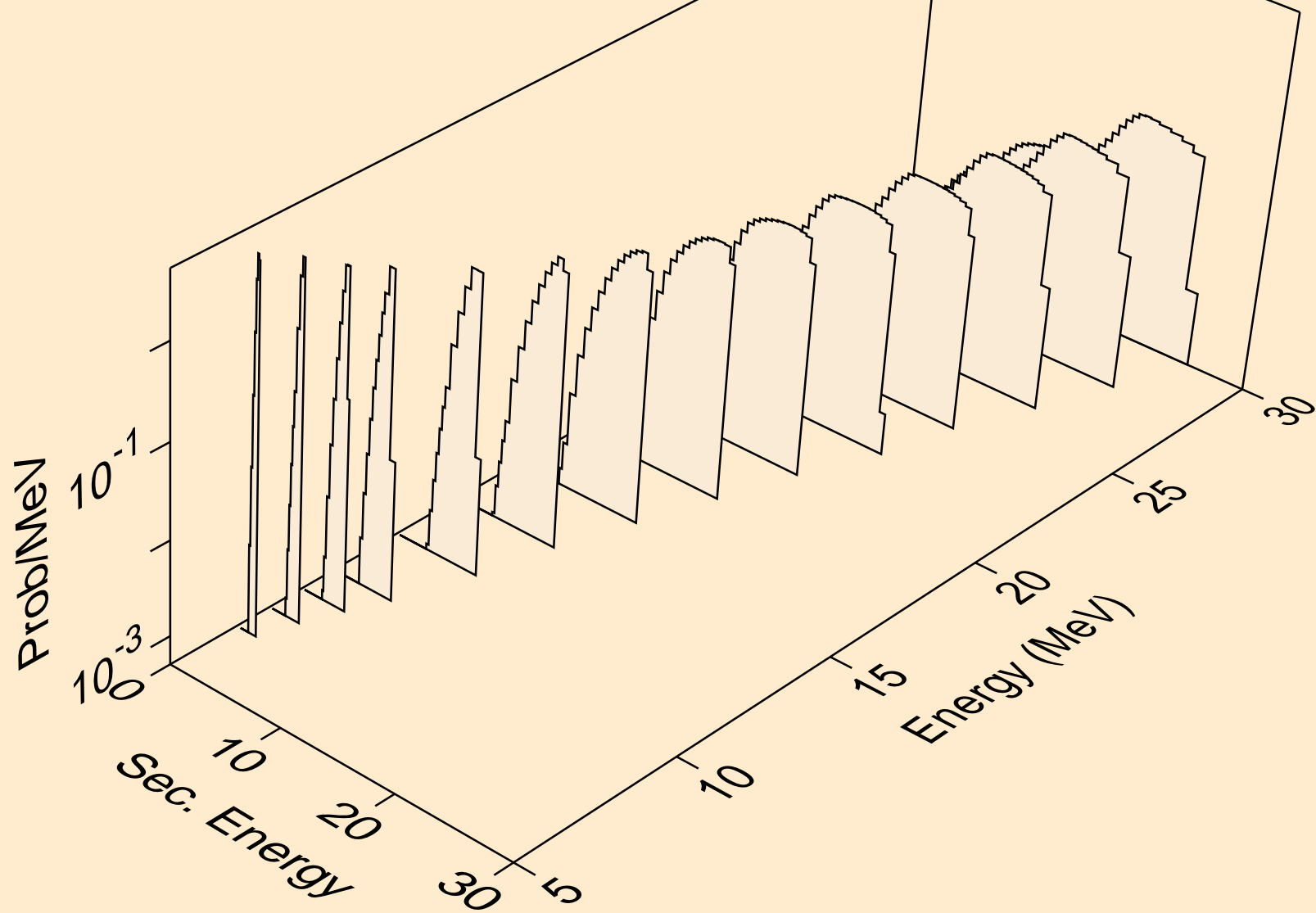

IN127N PROTON ACER TENDL-2021 LIBRARY; T=0.K  
Proton emission for (p,2np)

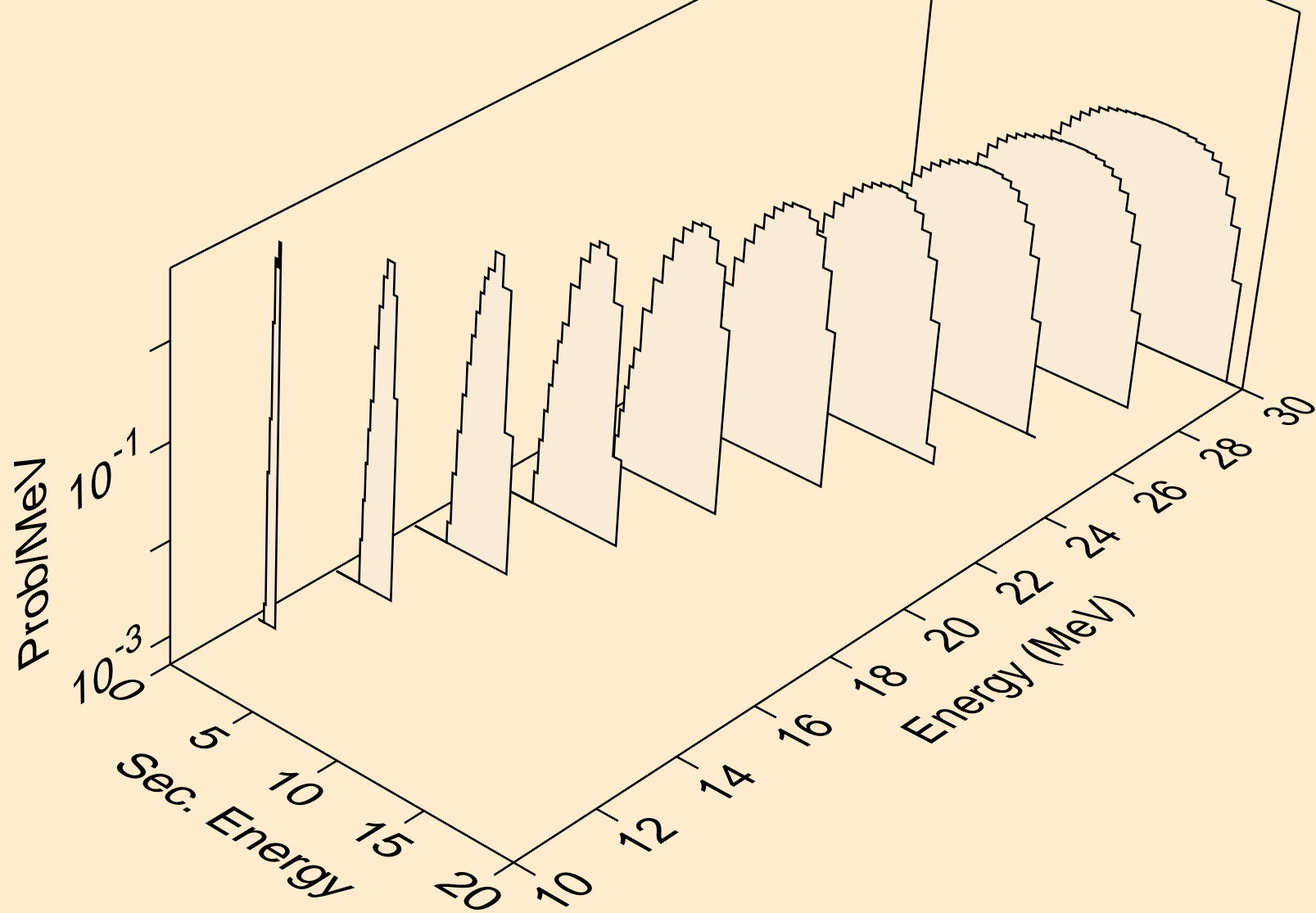

IN127N PROTON ACER TENDL-2021 LIBRARY; T=0.K  
Proton emission for (p,3np)

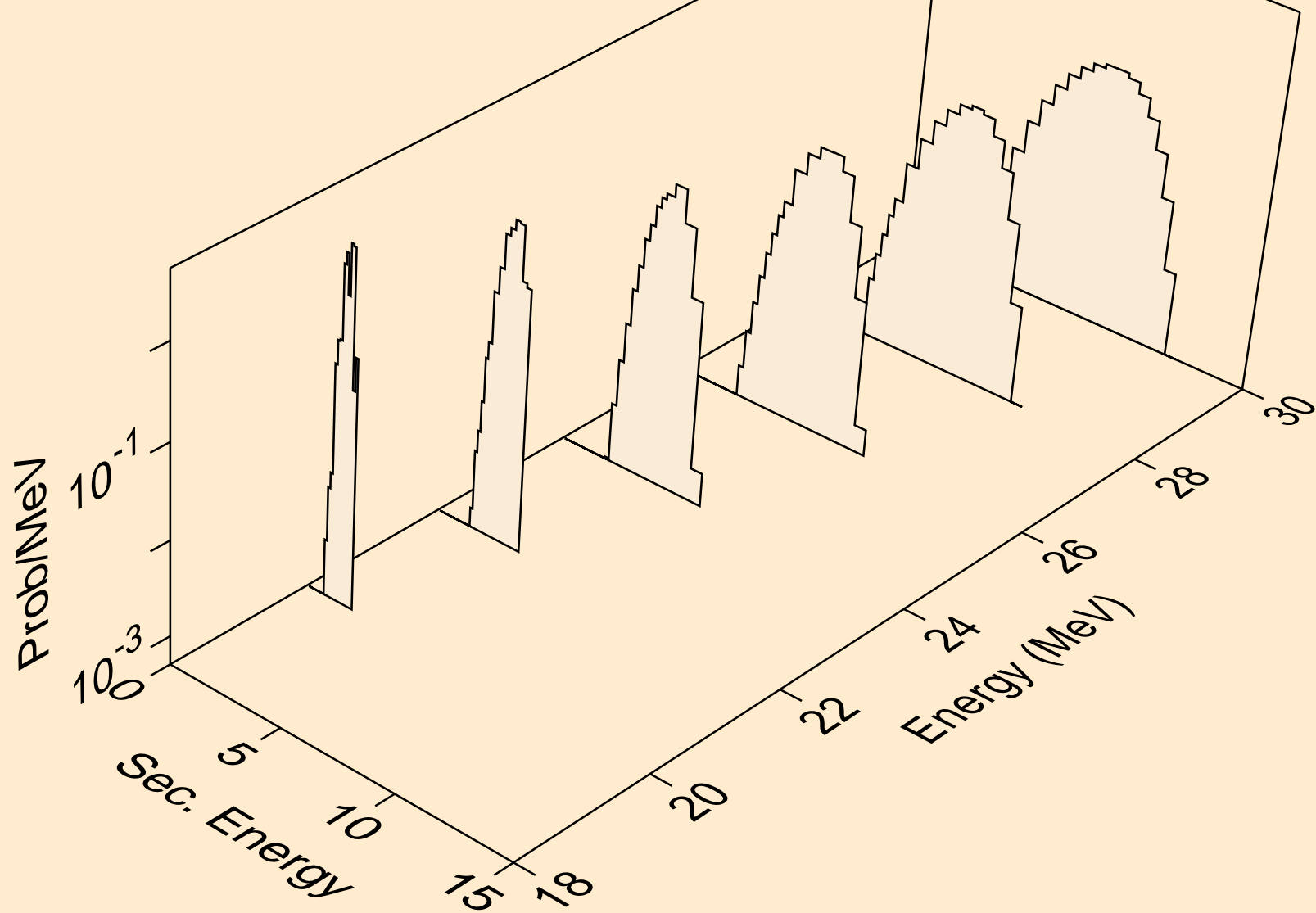

IN127N PROTON ACER TENDL-2021 LIBRARY; T=0.K  
Proton emission for (p,2np)

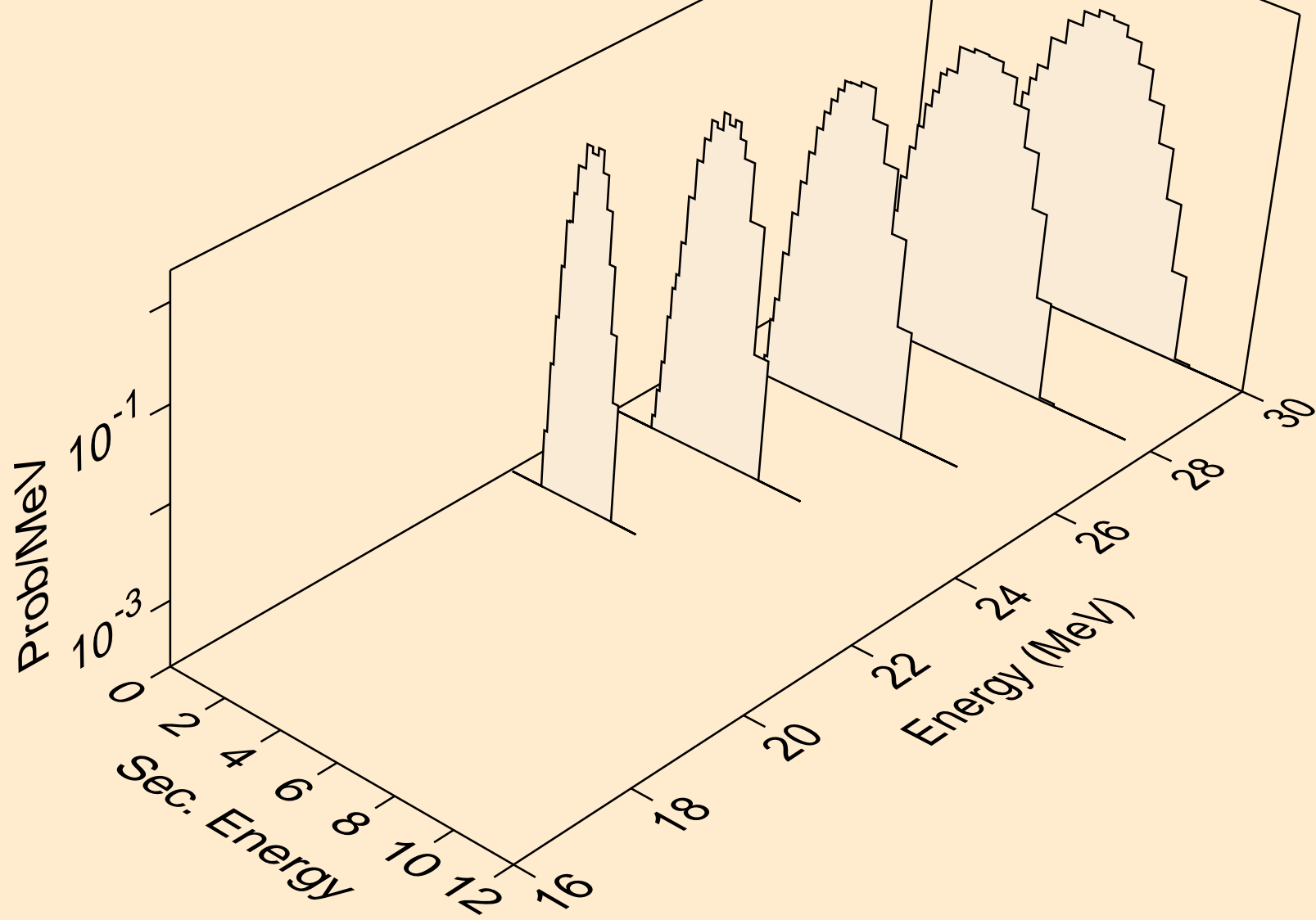

IN127N PROTON ACER TENDL-2021 LIBRARY; T=0.K  
Proton emission for inelastic

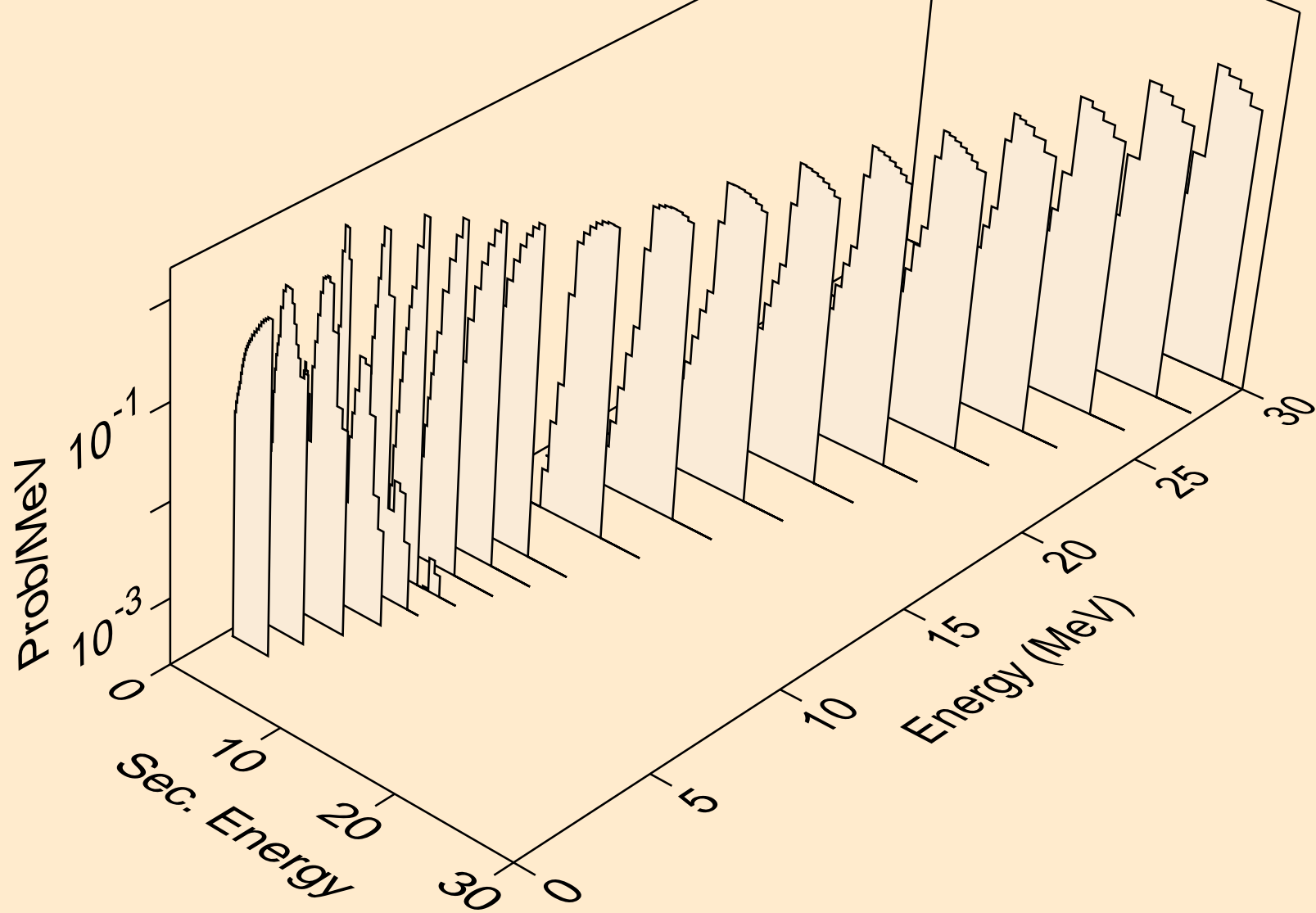



IN127N PROTON ACER TENDL-2021 LIBRARY; T=0.K  
Proton emission for (p,2p)

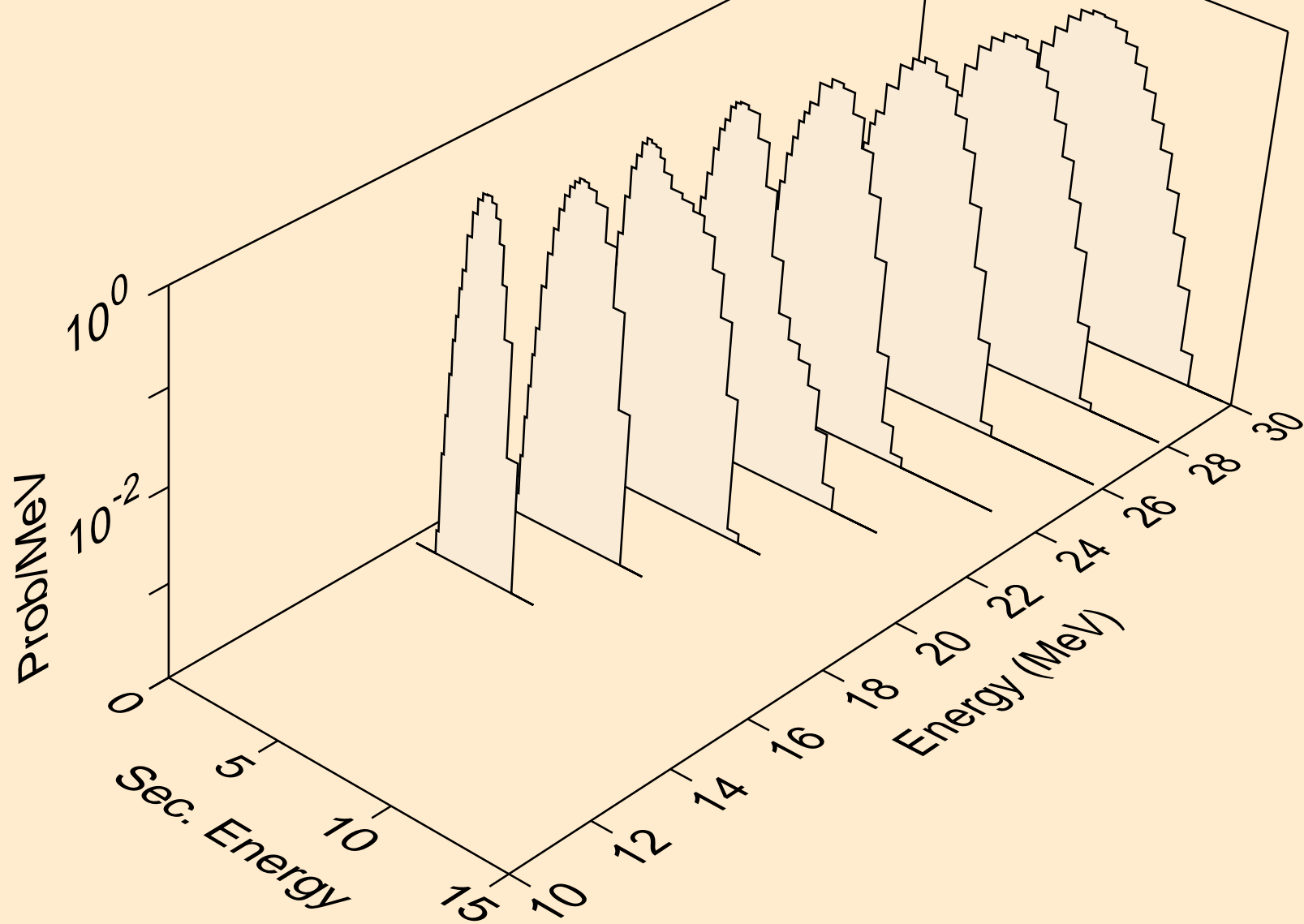

IN127N PROTON ACER TENDL-2021 LIBRARY; T=0.K  
Proton emission for (p,pd)

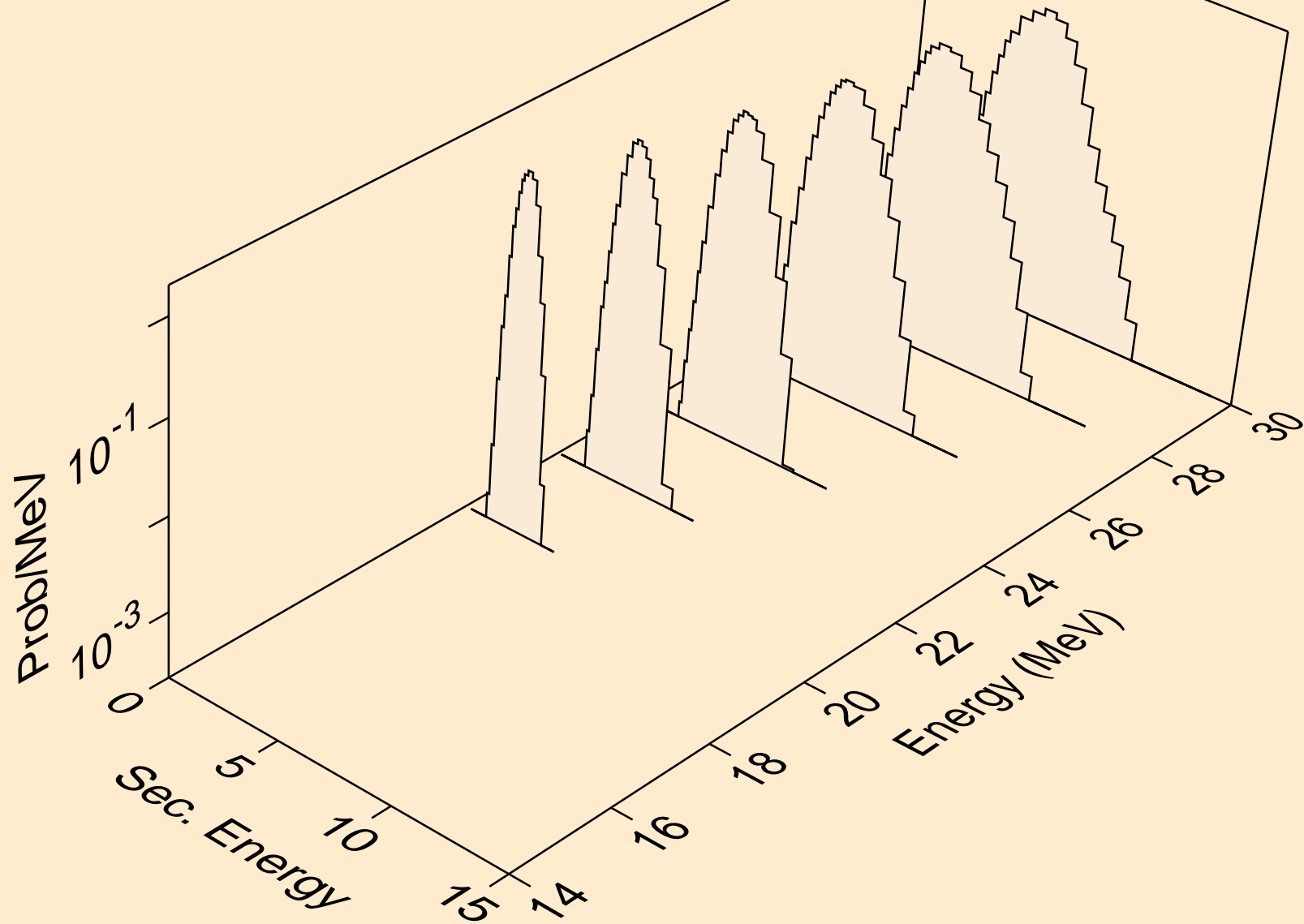

IN127N PROTON ACER TENDL-2021 LIBRARY; T=0.K  
Photon emission for (z,n)

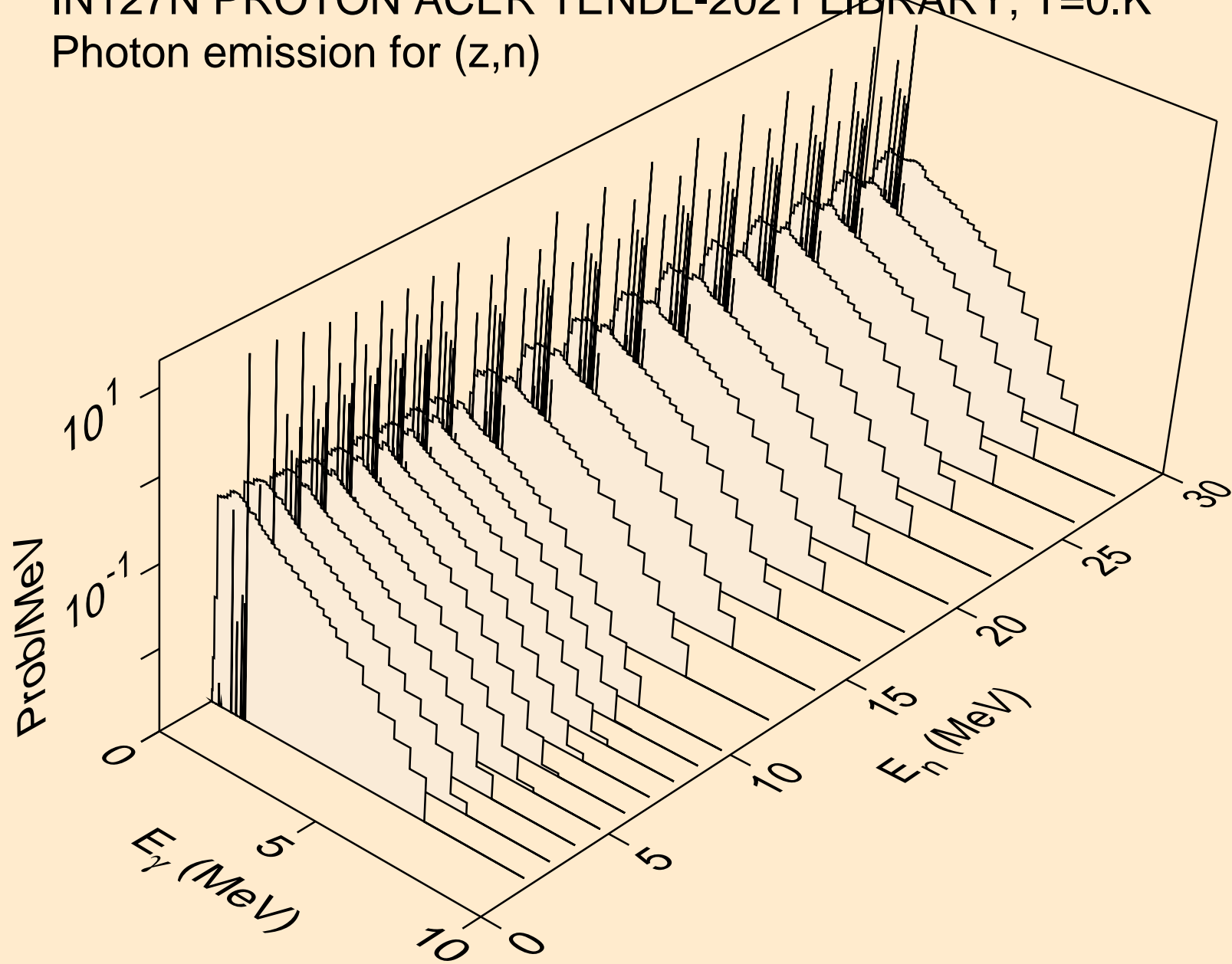

IN127N PROTON ACER TENDL-2021 LIBRARY; T=0.K  
Photon emission for (n,x)

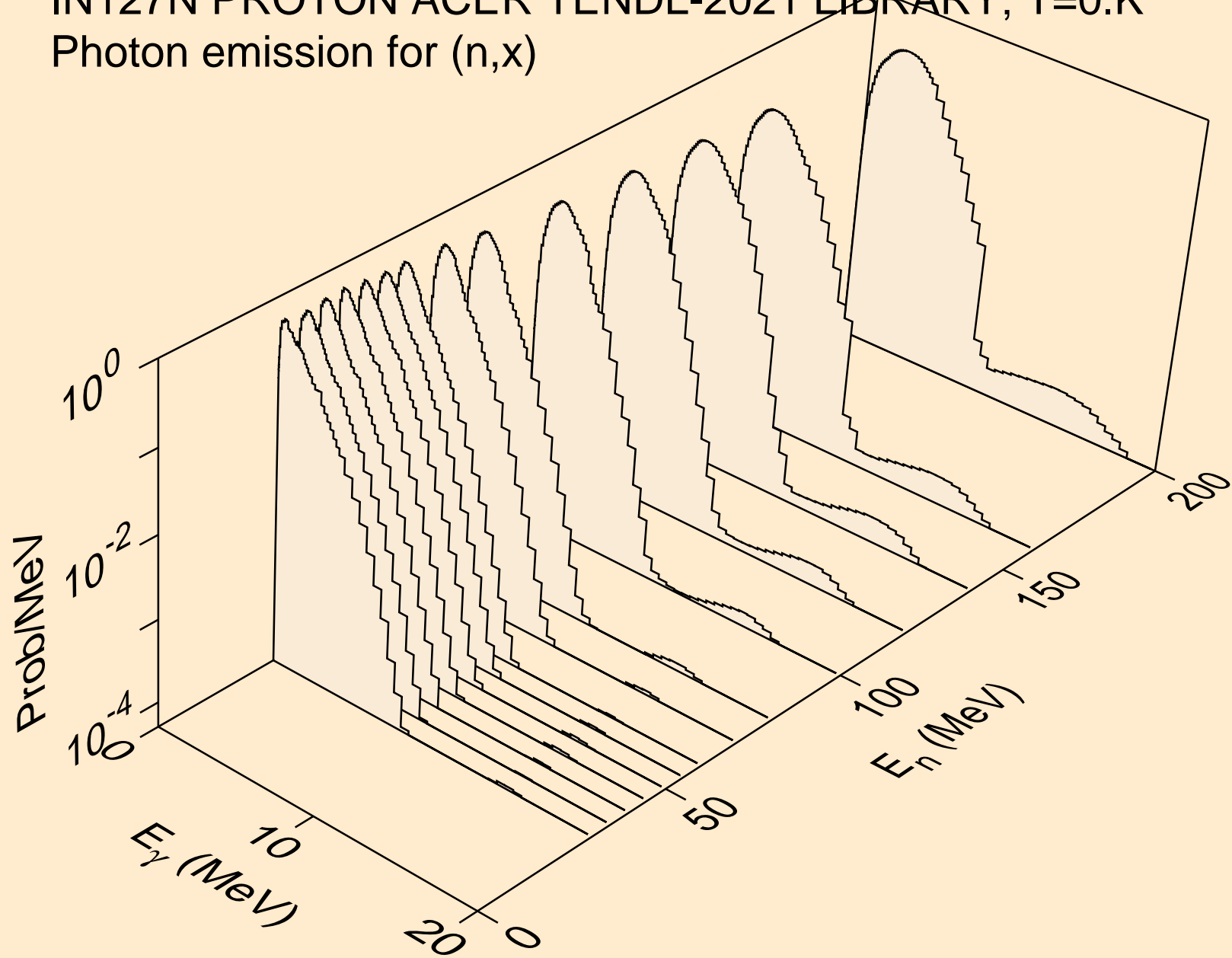

IN127N PROTON ACER TENDL-2021 LIBRARY; T=0.K  
Photon emission for (n,2nd)

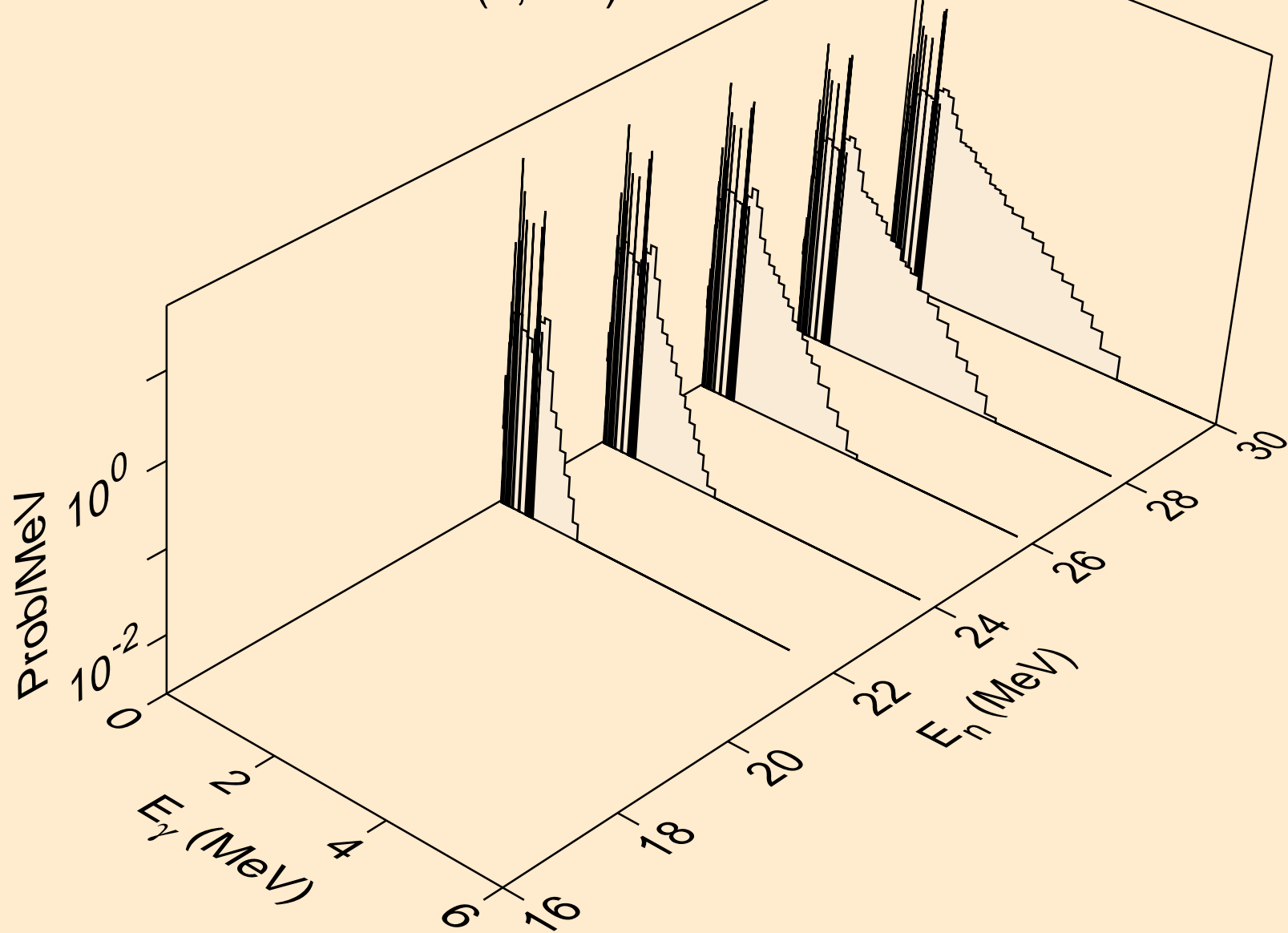

IN127N PROTON ACER TENDL-2021 LIBRARY; T=0.K  
Photon emission for (n,2n)

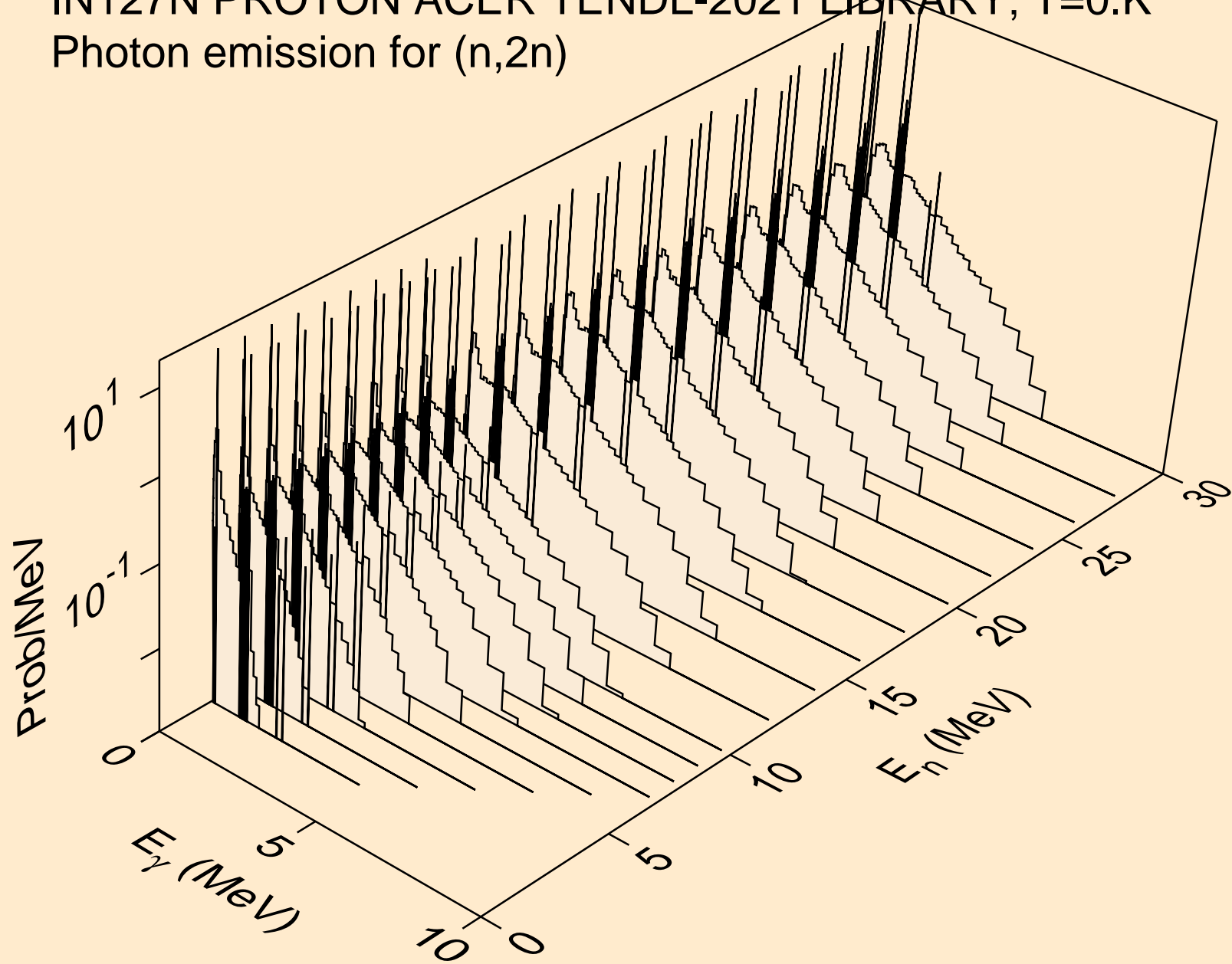

IN127N PROTON ACER TENDL-2021 LIBRARY; T=0.K  
Photon emission for (n,3n)

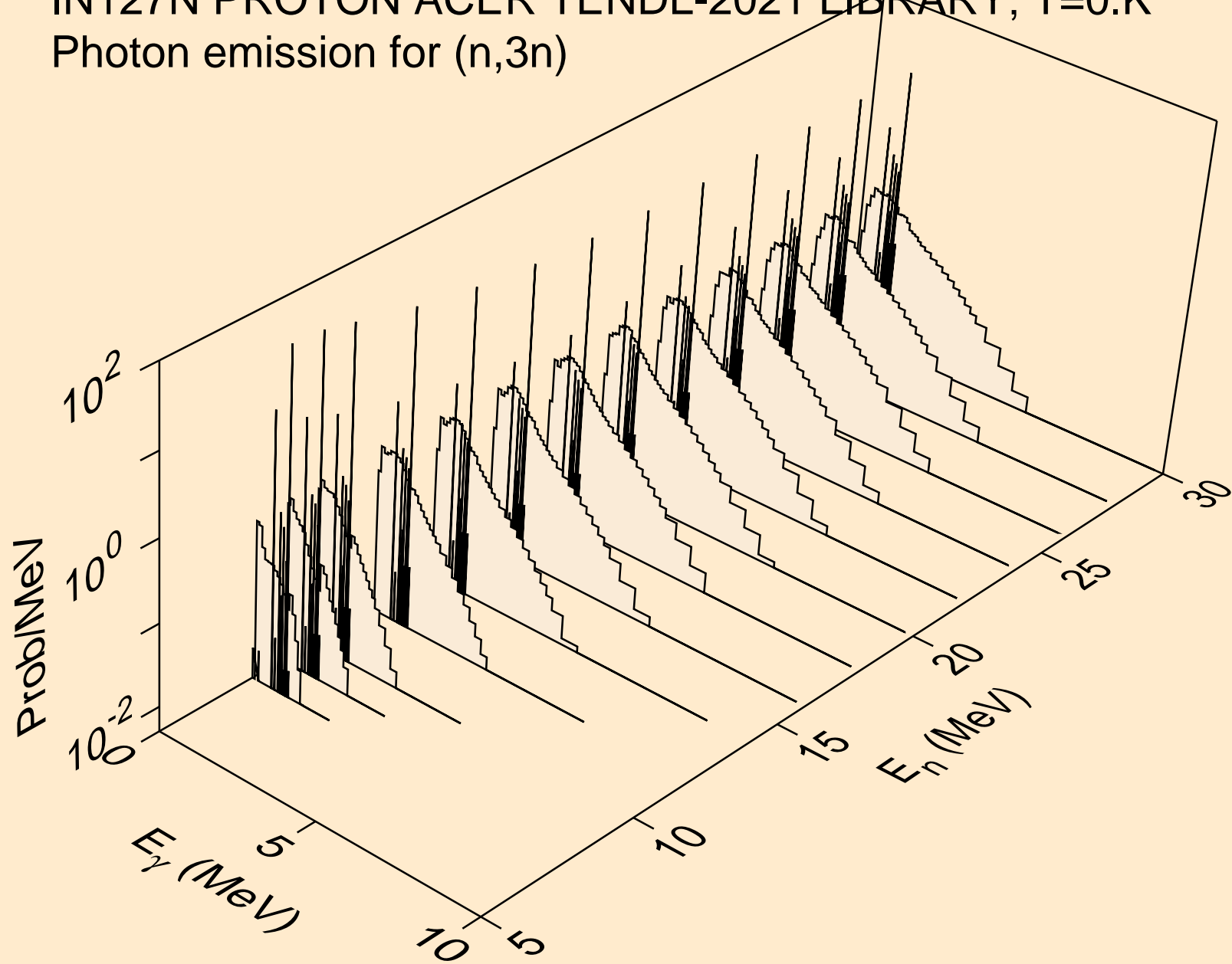

IN127N PROTON ACER TENDL-2021 LIBRARY; T=0.K  
Photon emission for (n,n\*)a

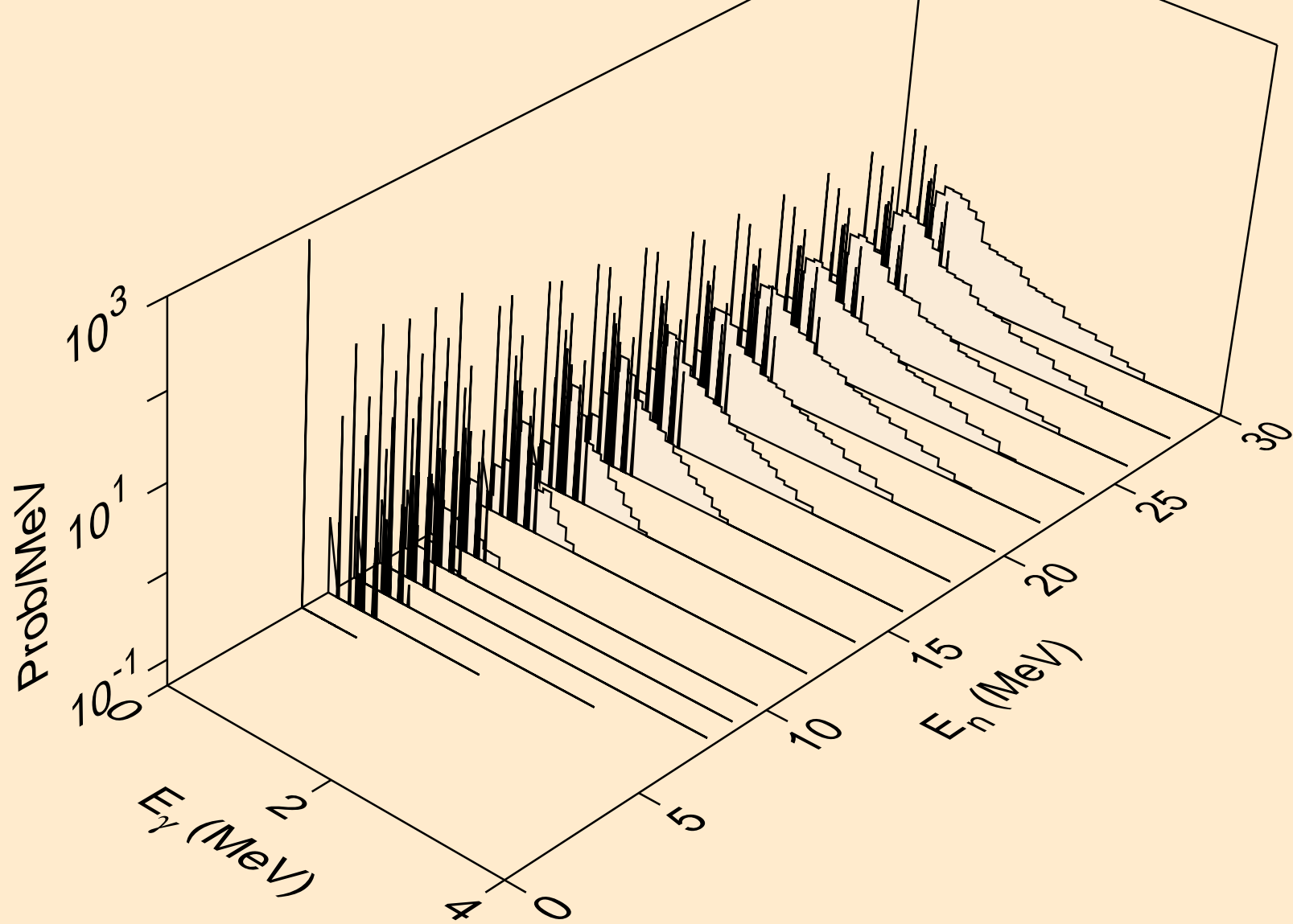



IN127N PROTON ACER TENDL-2021 LIBRARY; T=0.K  
Photon emission for (n,2n)a

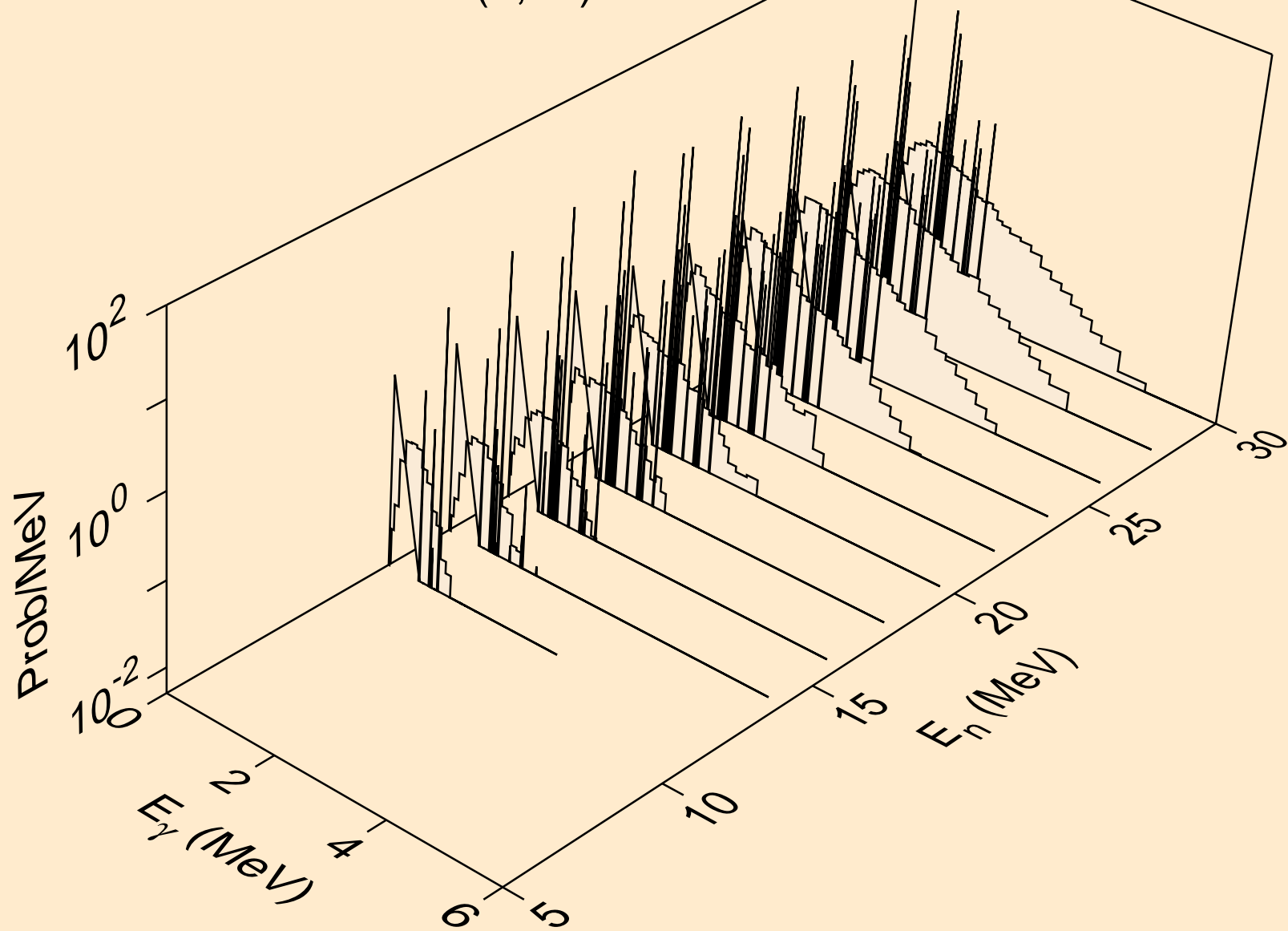

IN127N PROTON ACER TENDL-2021 LIBRARY; T=0.K  
Photon emission for (n,3n)a

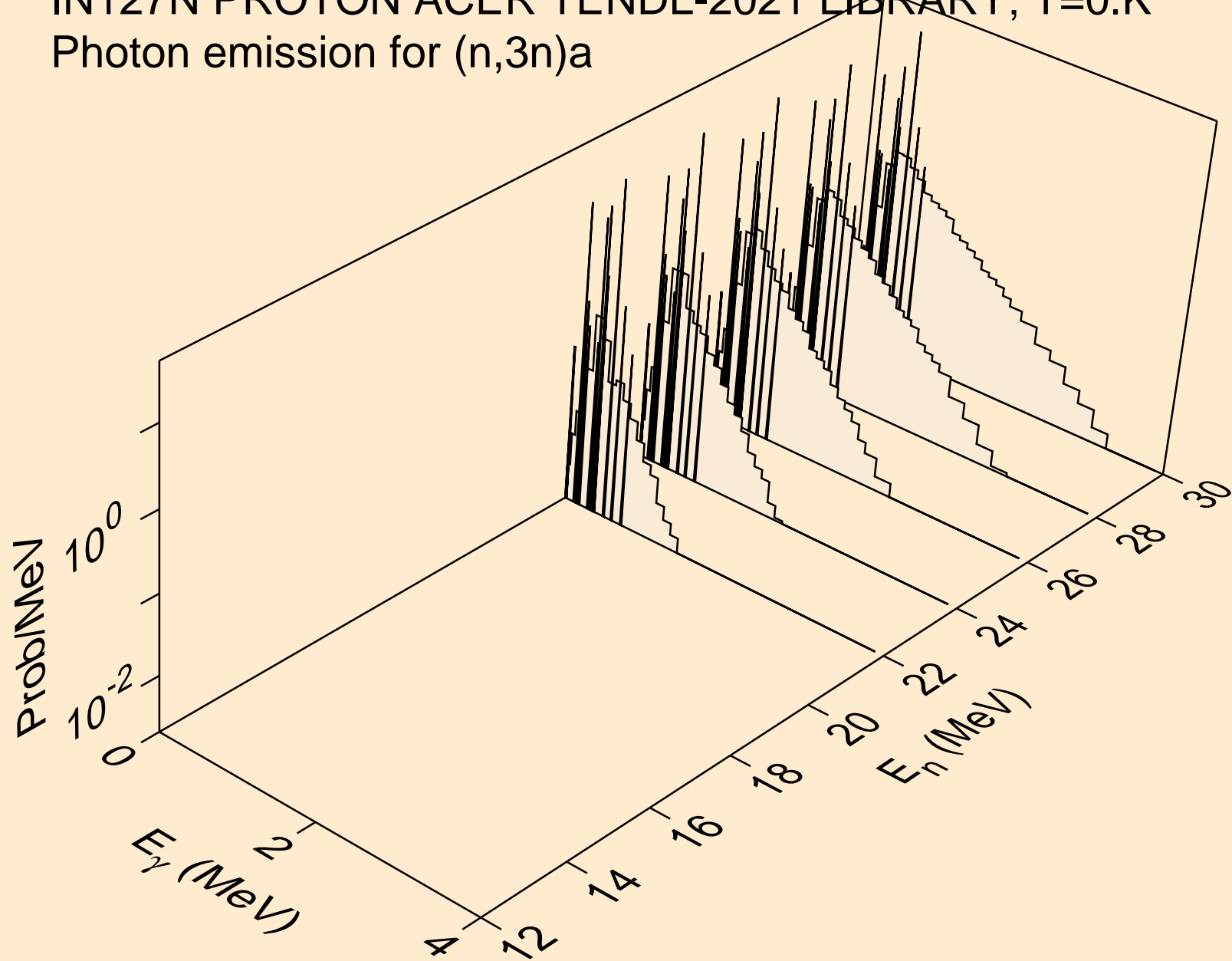

IN127N PROTON ACER TENDL-2021 LIBRARY; T=0.K  
Photon emission for (n,n\*)p

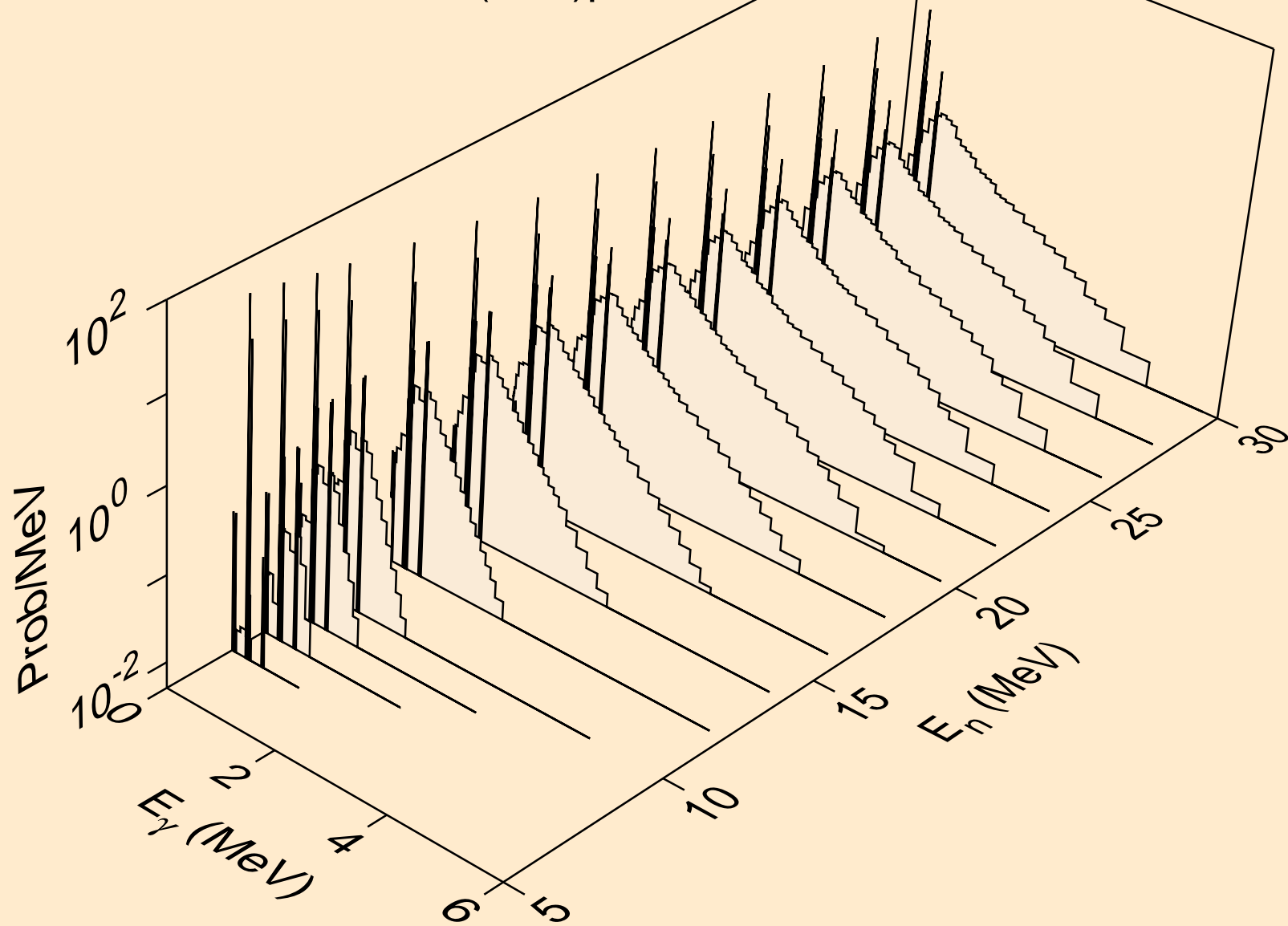

IN127N PROTON ACER TENDL-2021 LIBRARY; T=0.K  
Photon emission for (n,n\*)d

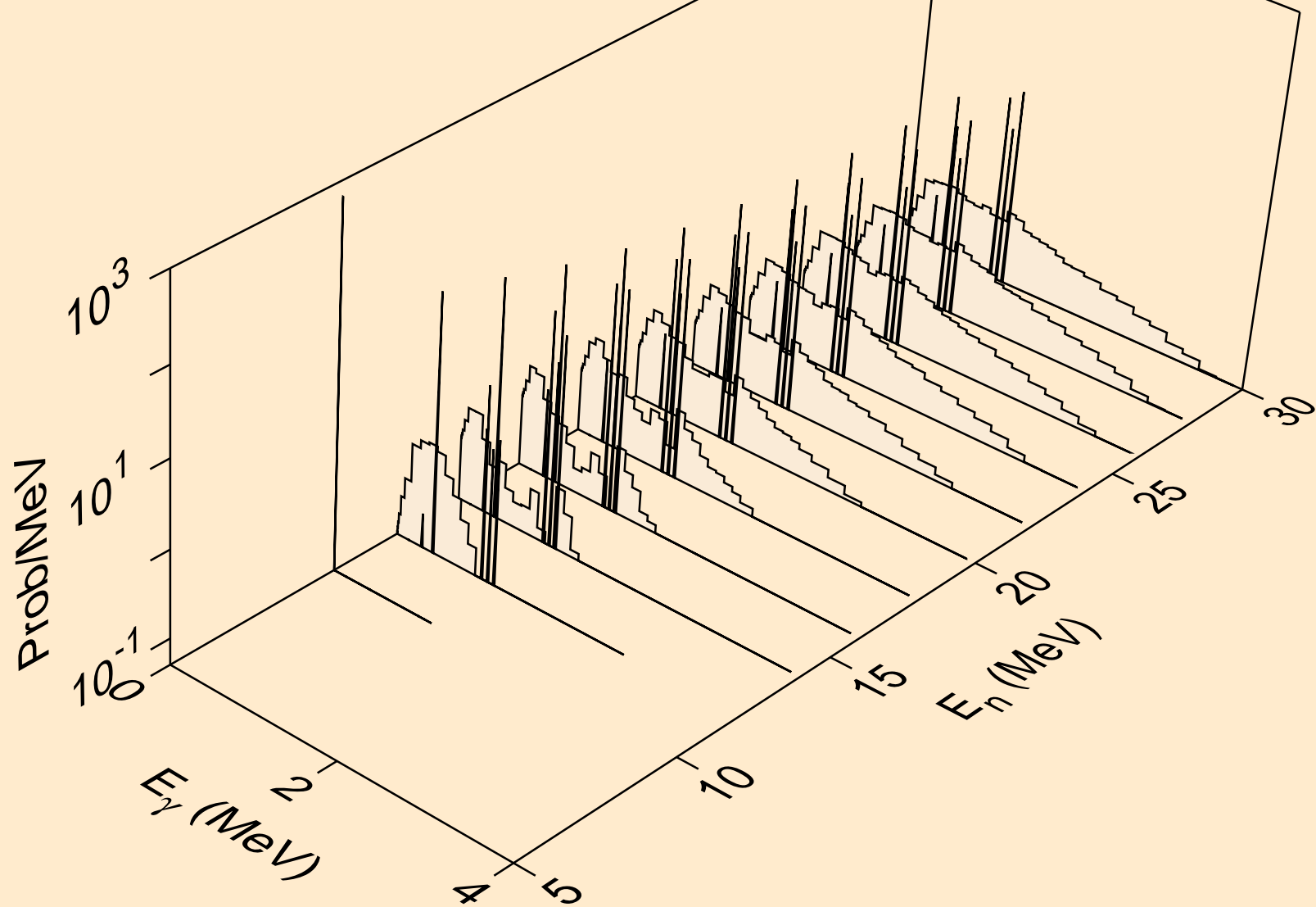

IN127N PROTON ACER TENDL-2021 LIBRARY; T=0.K  
Photon emission for (n,n\*)t

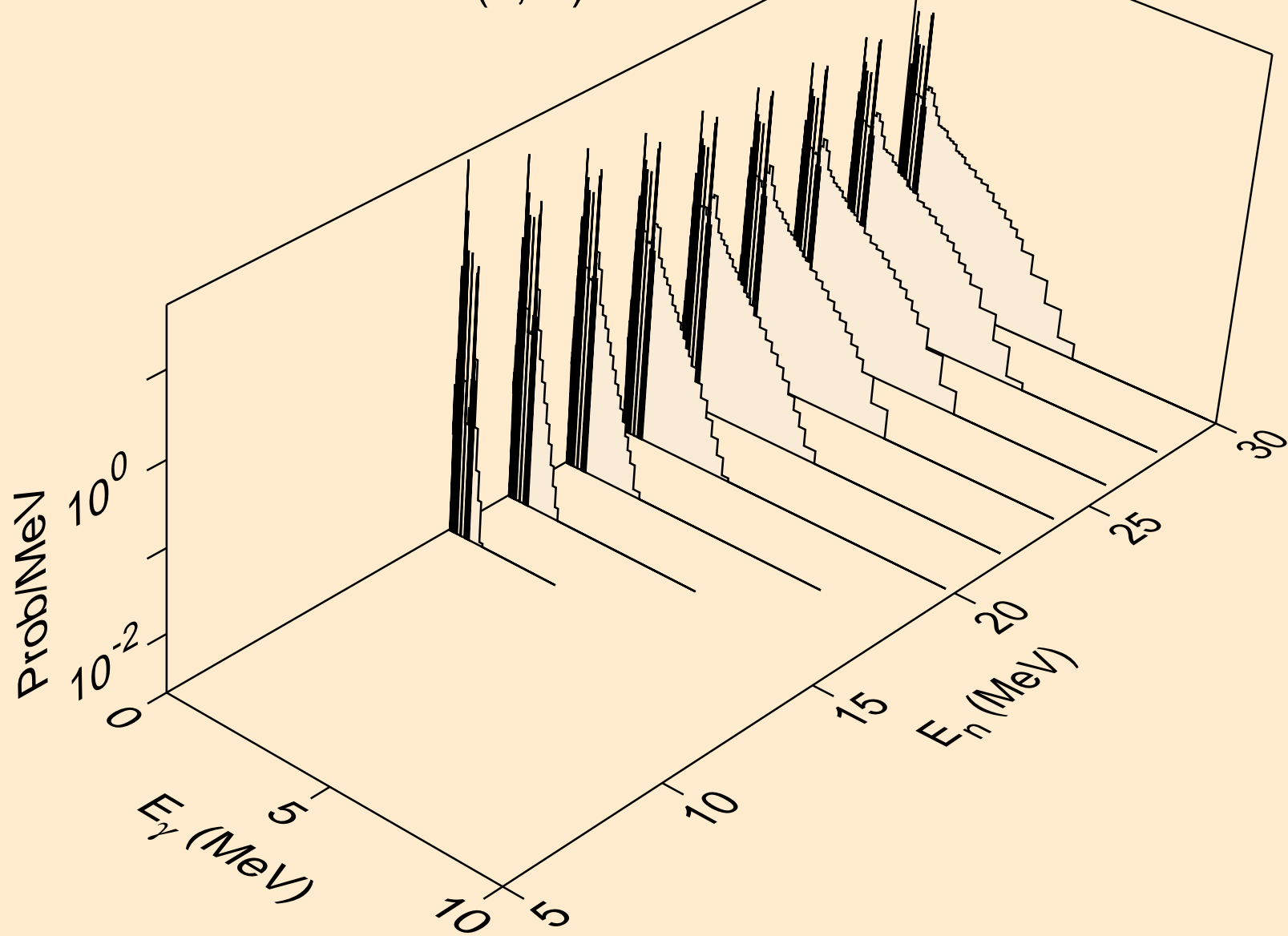

IN127N PROTON ACER TENDL-2021 LIBRARY; T=0.K  
Photon emission for (n,n\*)he3

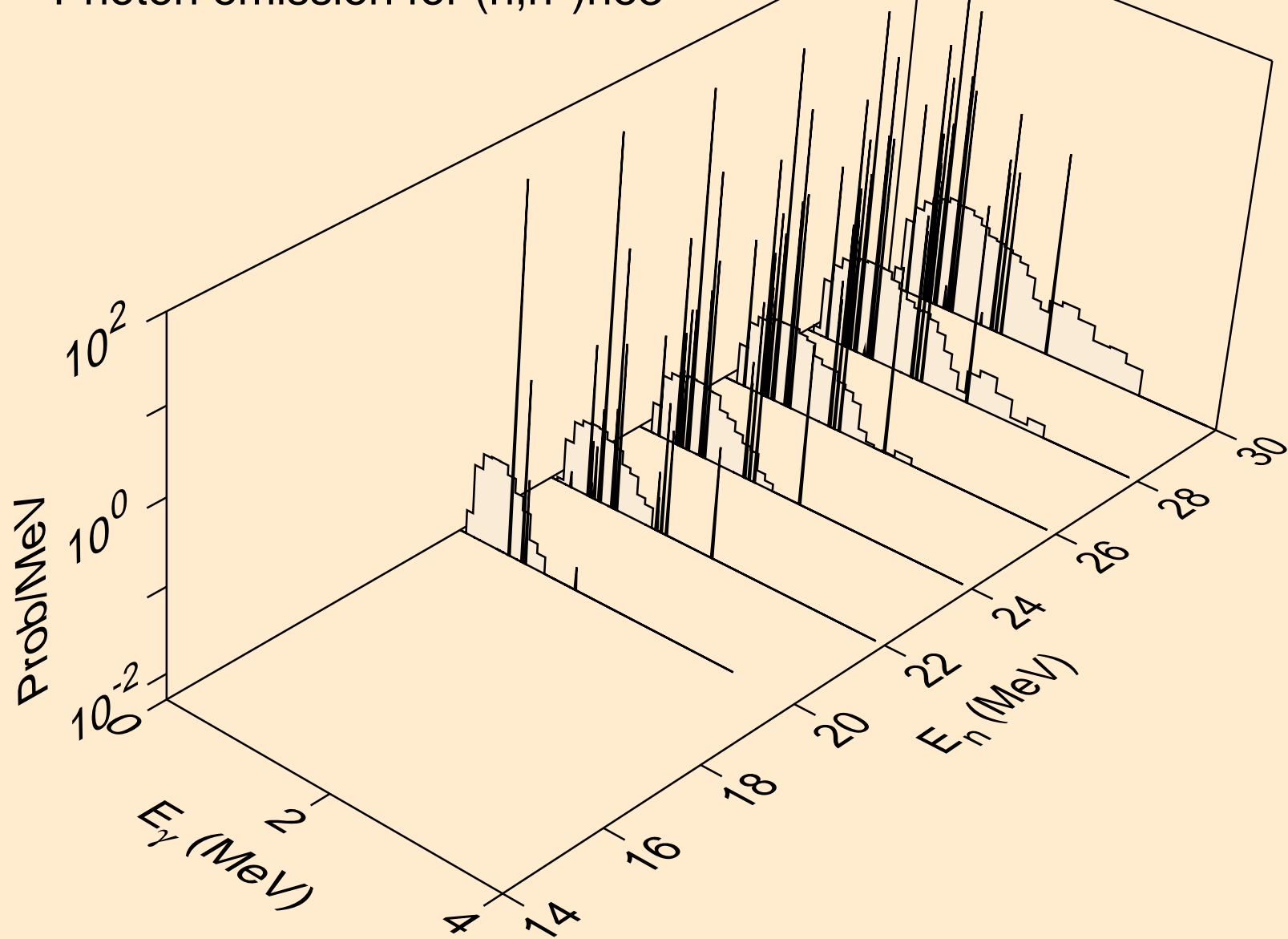

IN127N PROTON ACER TENDL-2021 LIBRARY; T=0.K  
Photon emission for (n,4n)

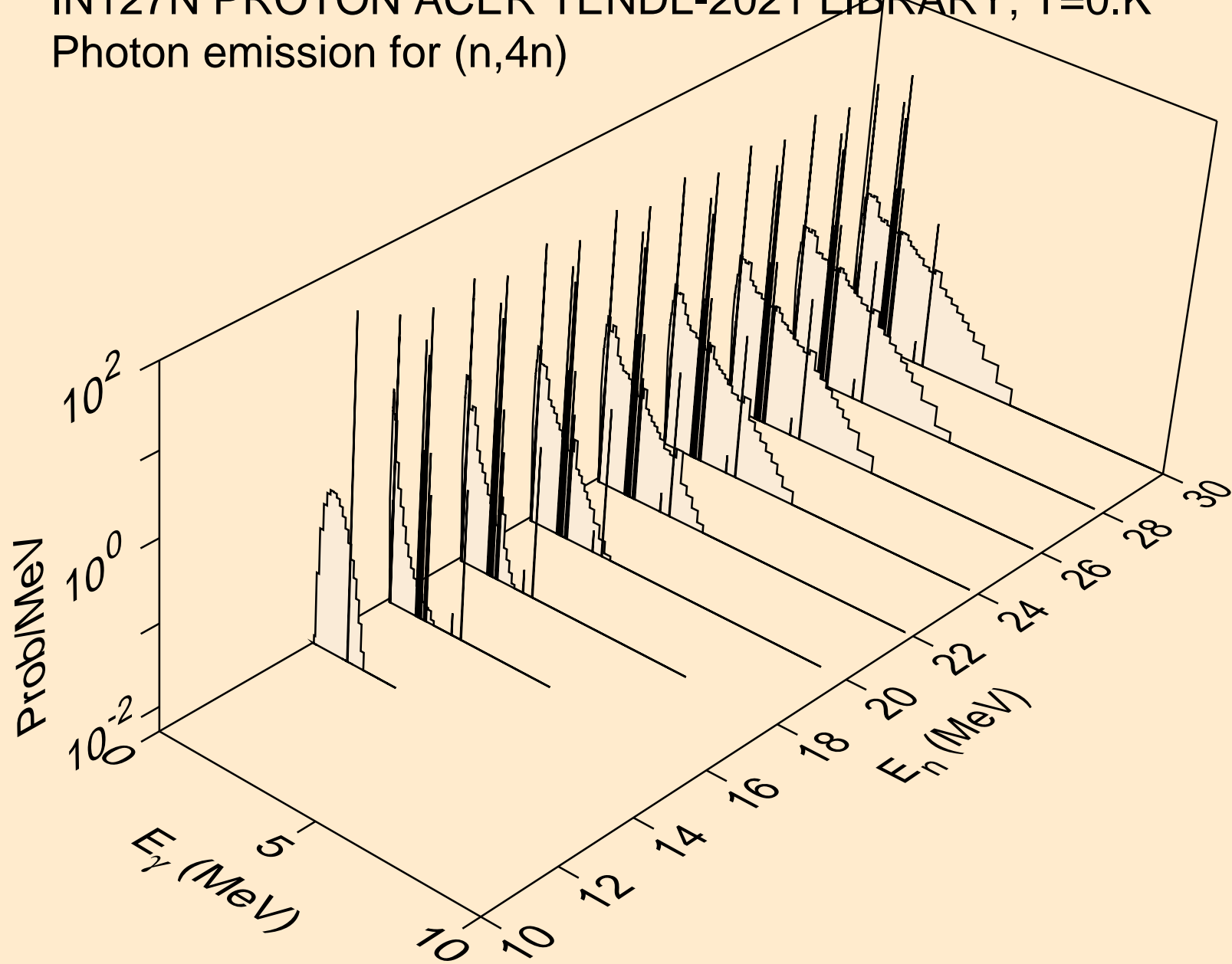

IN127N PROTON ACER TENDL-2021 LIBRARY; T=0.K  
Photon emission for (n,2np)

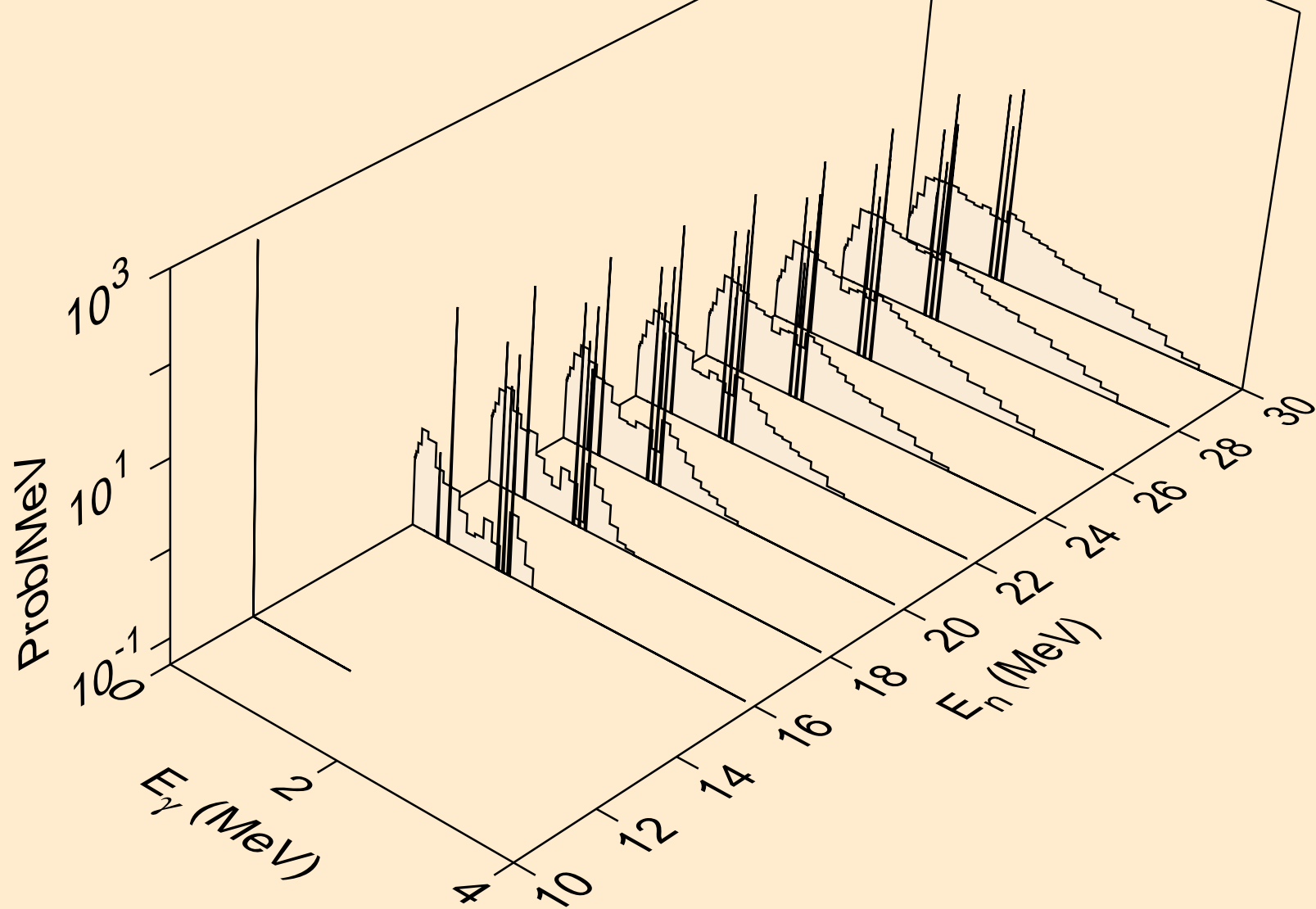



IN127N PROTON ACER TENDL-2021 LIBRARY; T=0.K  
Photon emission for (n,3np)

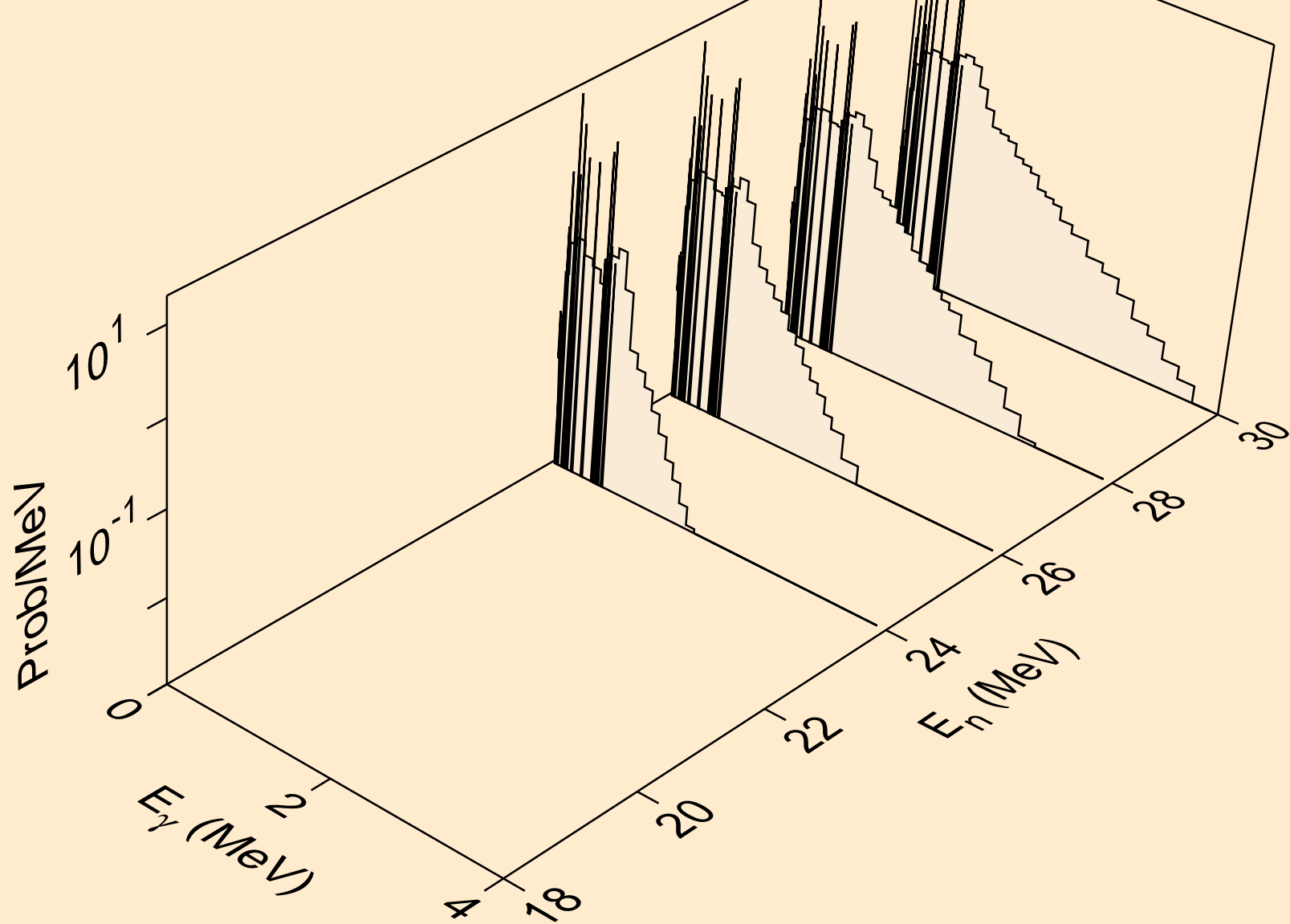

IN127N PROTON ACER TENDL-2021 LIBRARY; T=0.K  
Photon emission for (n,2np)

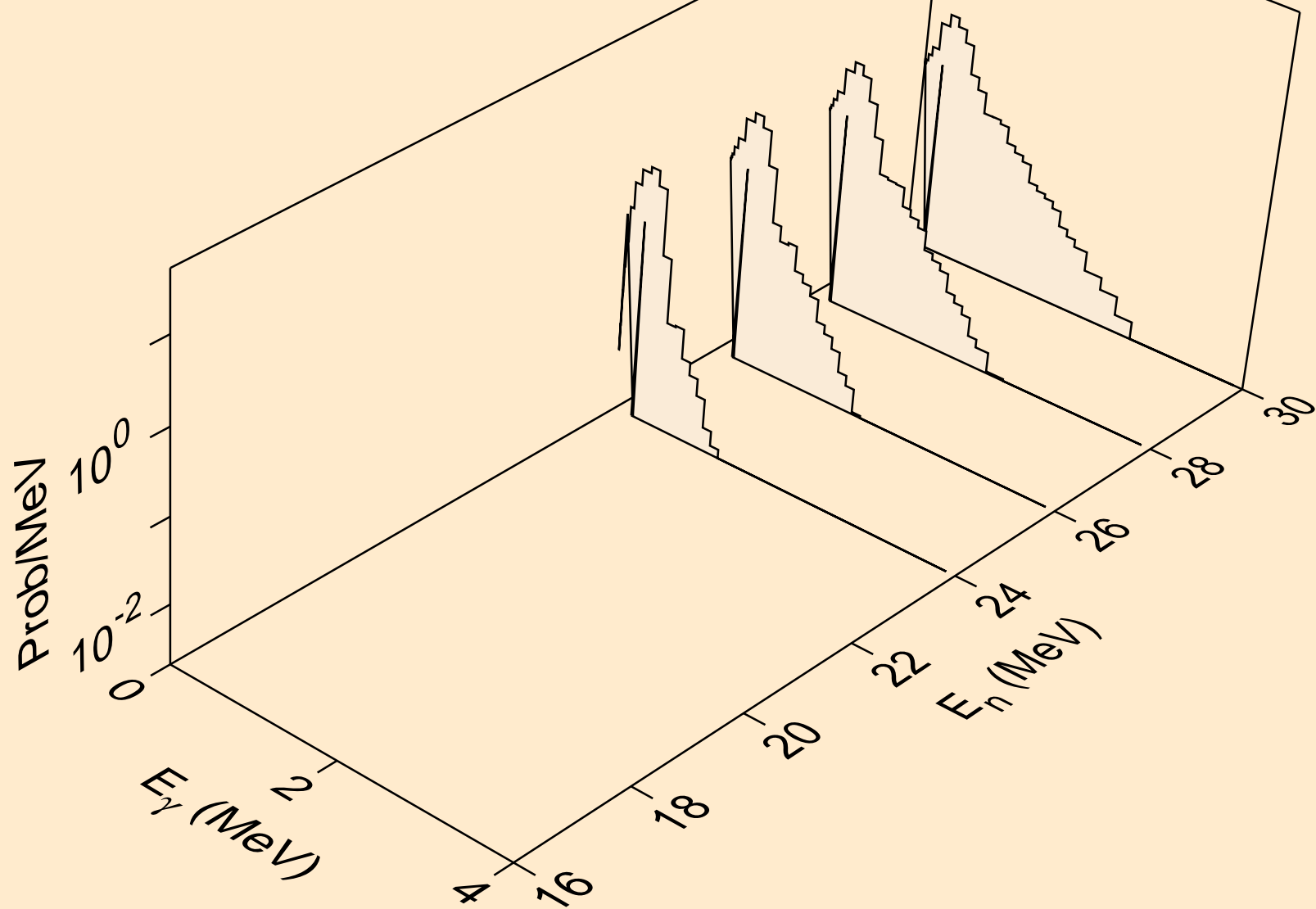

IN127N PROTON ACER TENDL-2021 LIBRARY; T=0.K  
Photon emission for (n,gma)

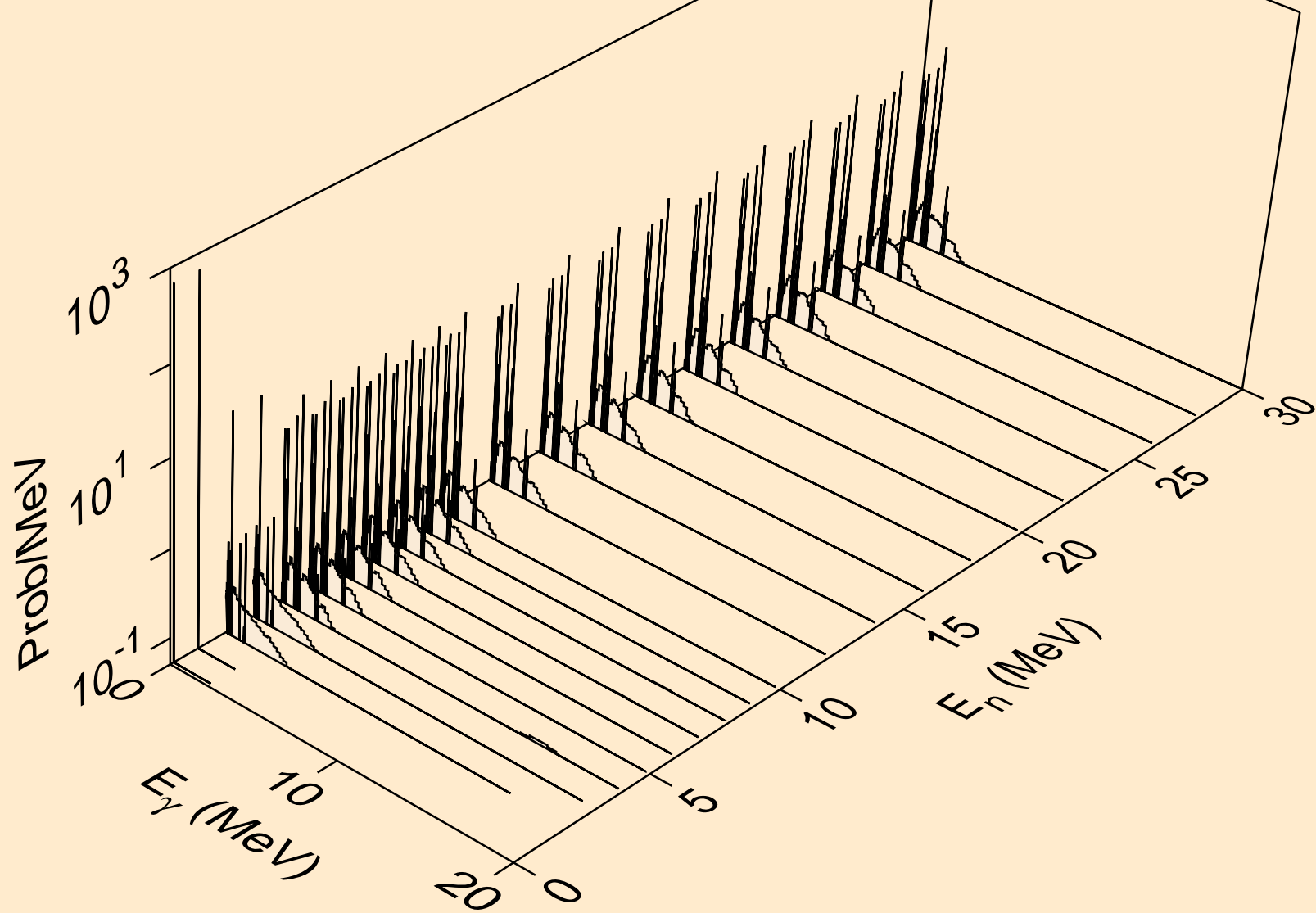

IN127N PROTON ACER TENDL-2021 LIBRARY; T=0.K  
Photon emission for inelastic

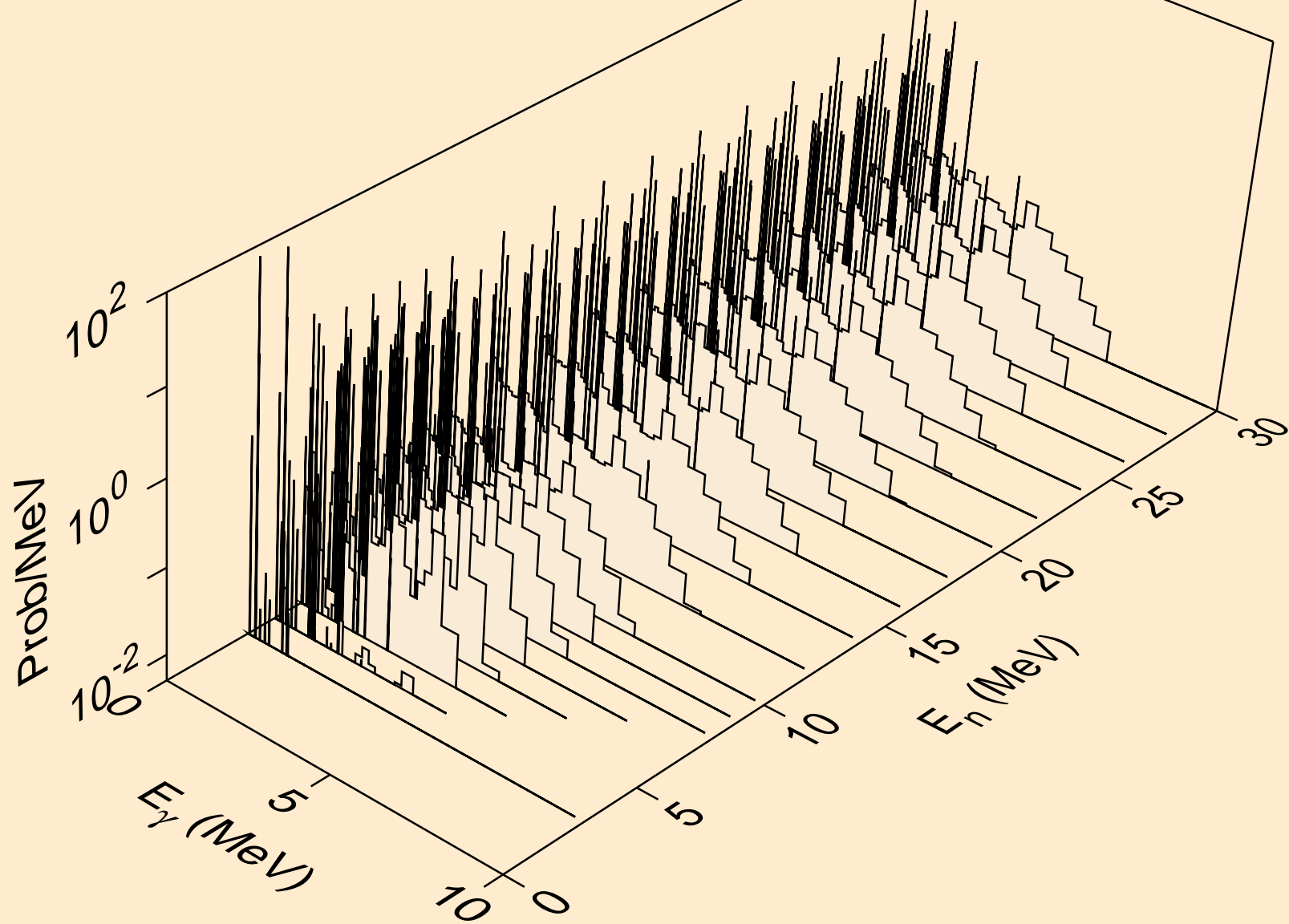

IN127N PROTON ACER TENDL-2021 LIBRARY; T=0.K  
Photon emission for (n,d)

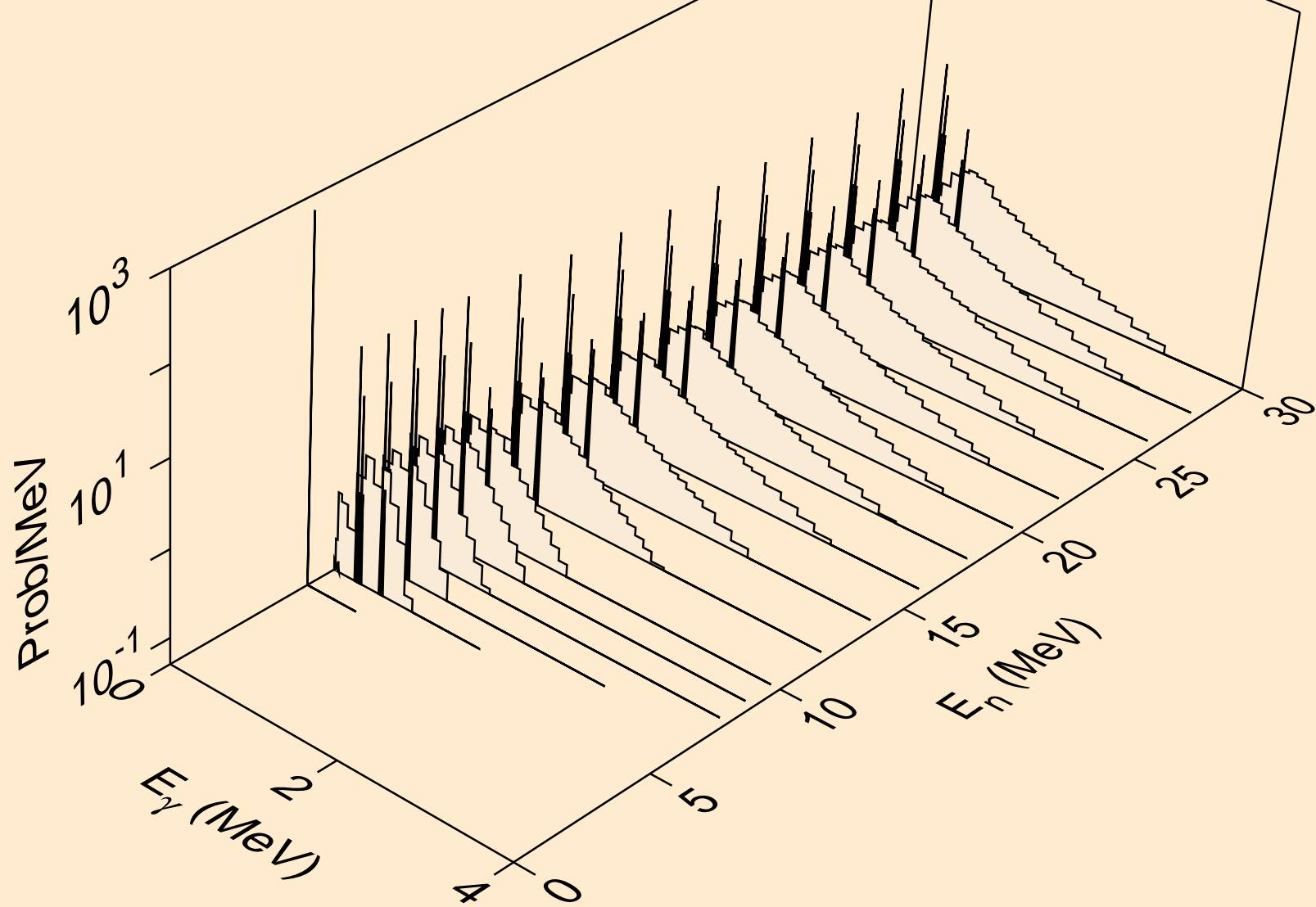

IN127N PROTON ACER TENDL-2021 LIBRARY; T=0.K  
Photon emission for (n,t)

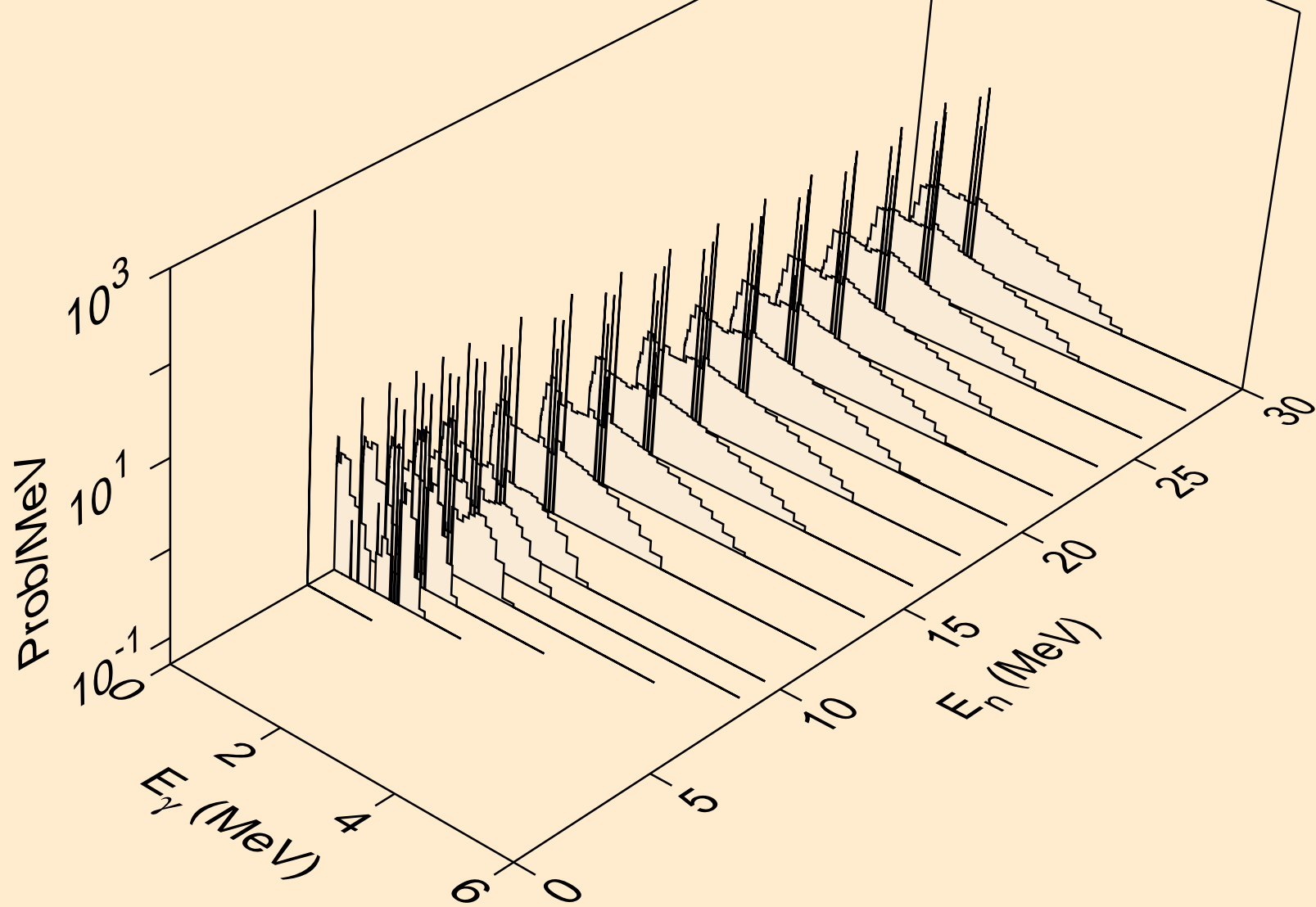

IN127N PROTON ACER TENDL-2021 LIBRARY; T=0.K  
Photon emission for (n,he3)

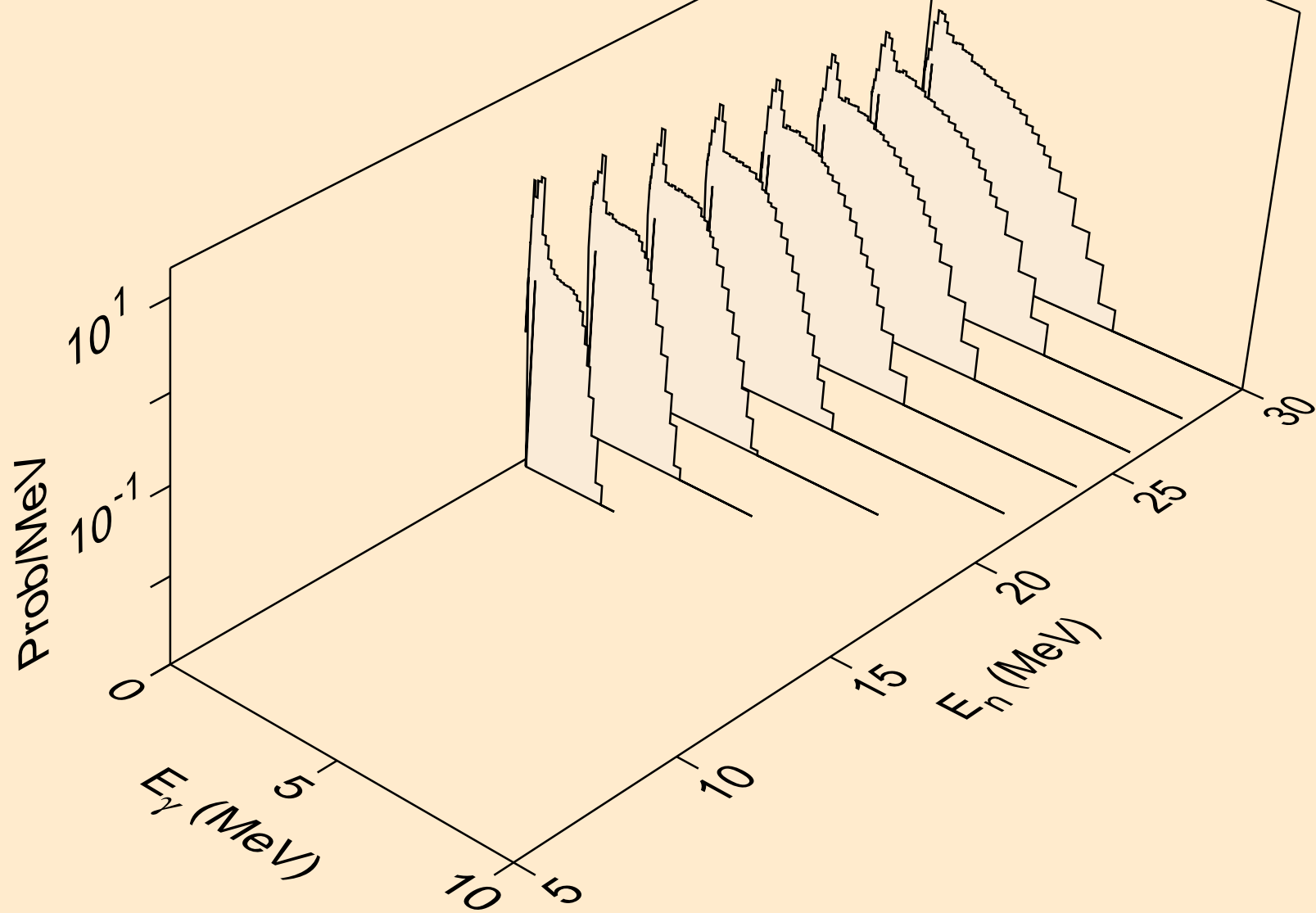

IN127N PROTON ACER TENDL-2021 LIBRARY; T=0.K  
Photon emission for (n,a)

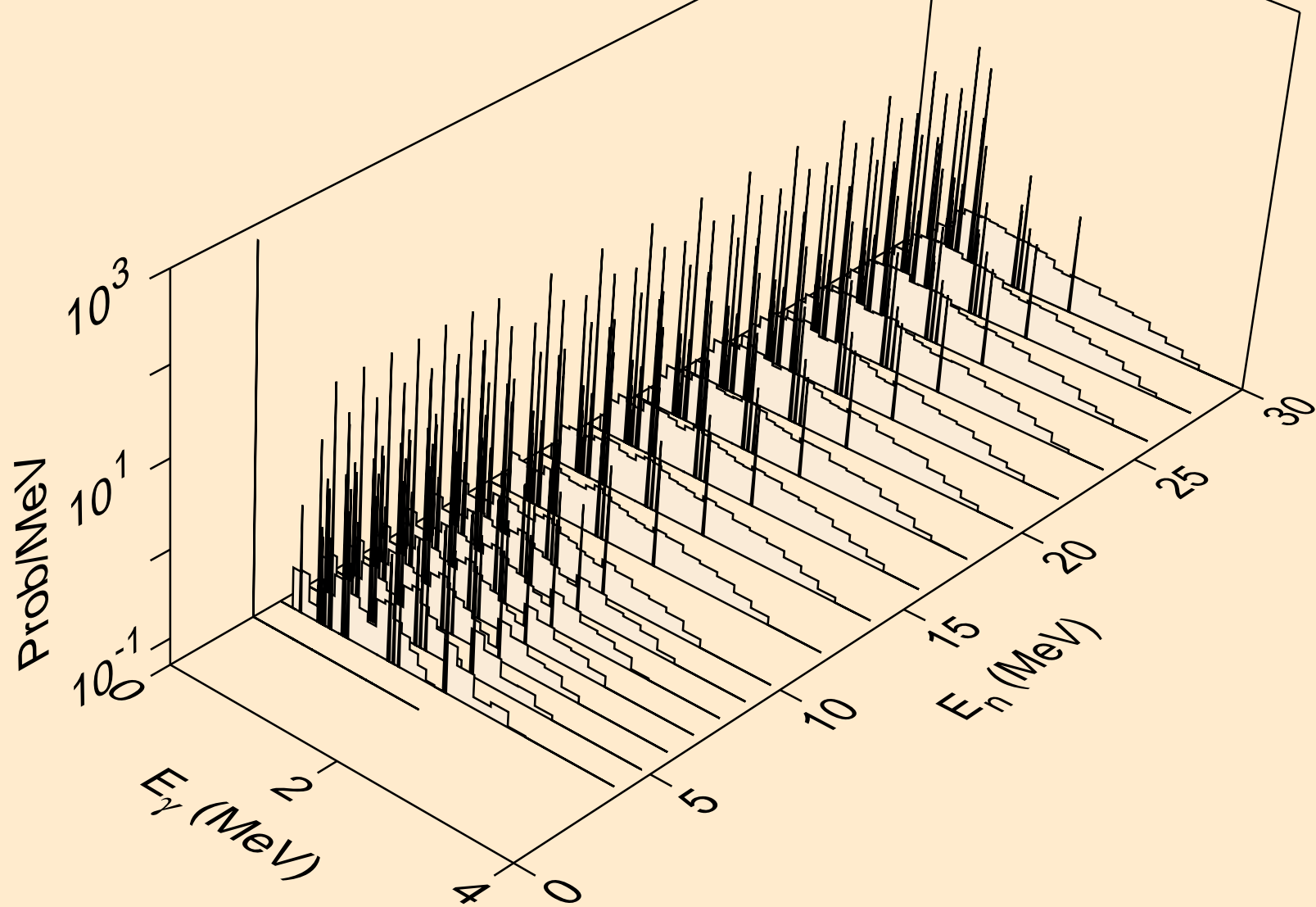



IN127N PROTON ACER TENDL-2021 LIBRARY; T=0.K  
Photon emission for (n,2p)

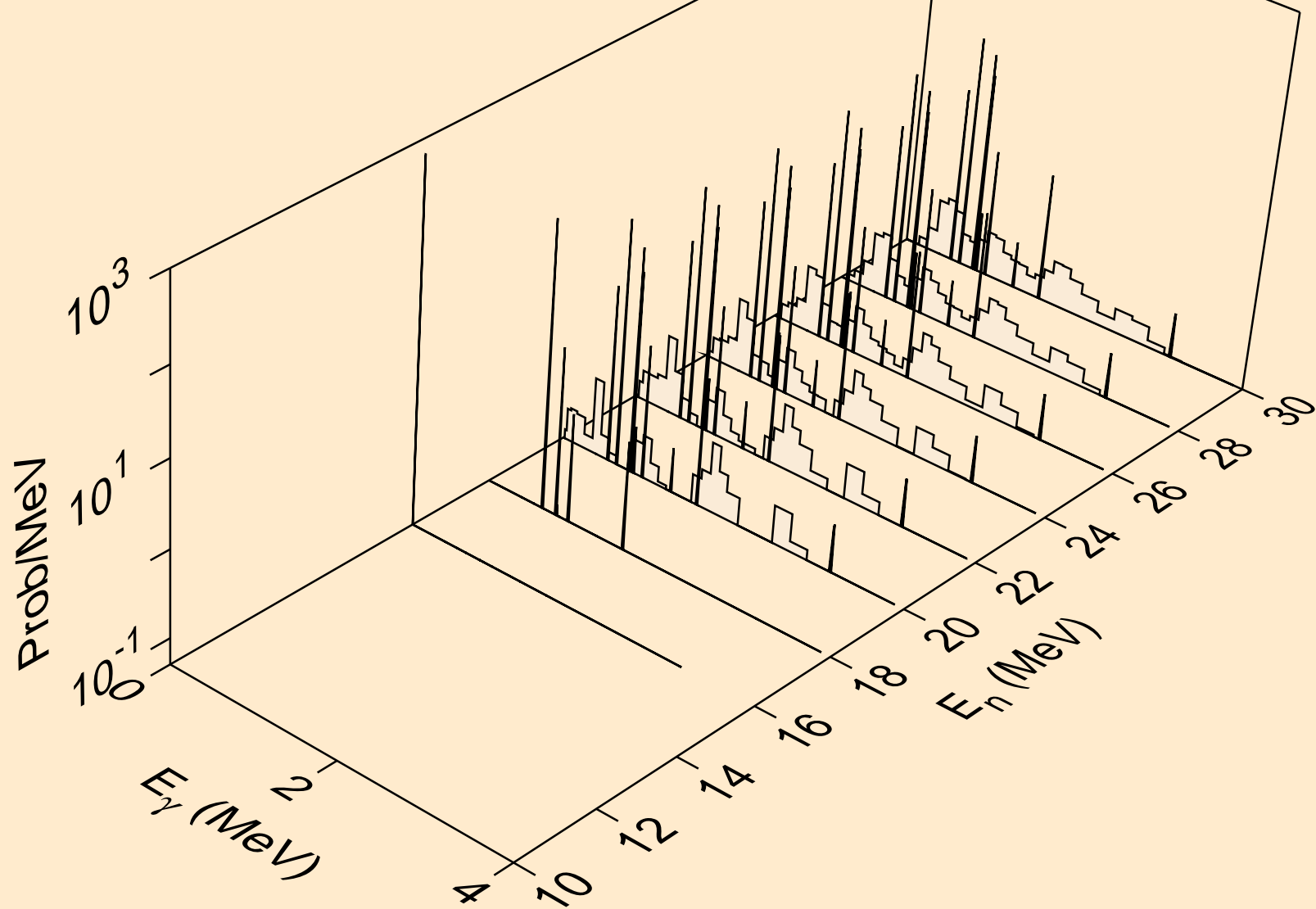

IN127N PROTON ACER TENDL-2021 LIBRARY; T=0.K  
Photon emission for (n,pd)

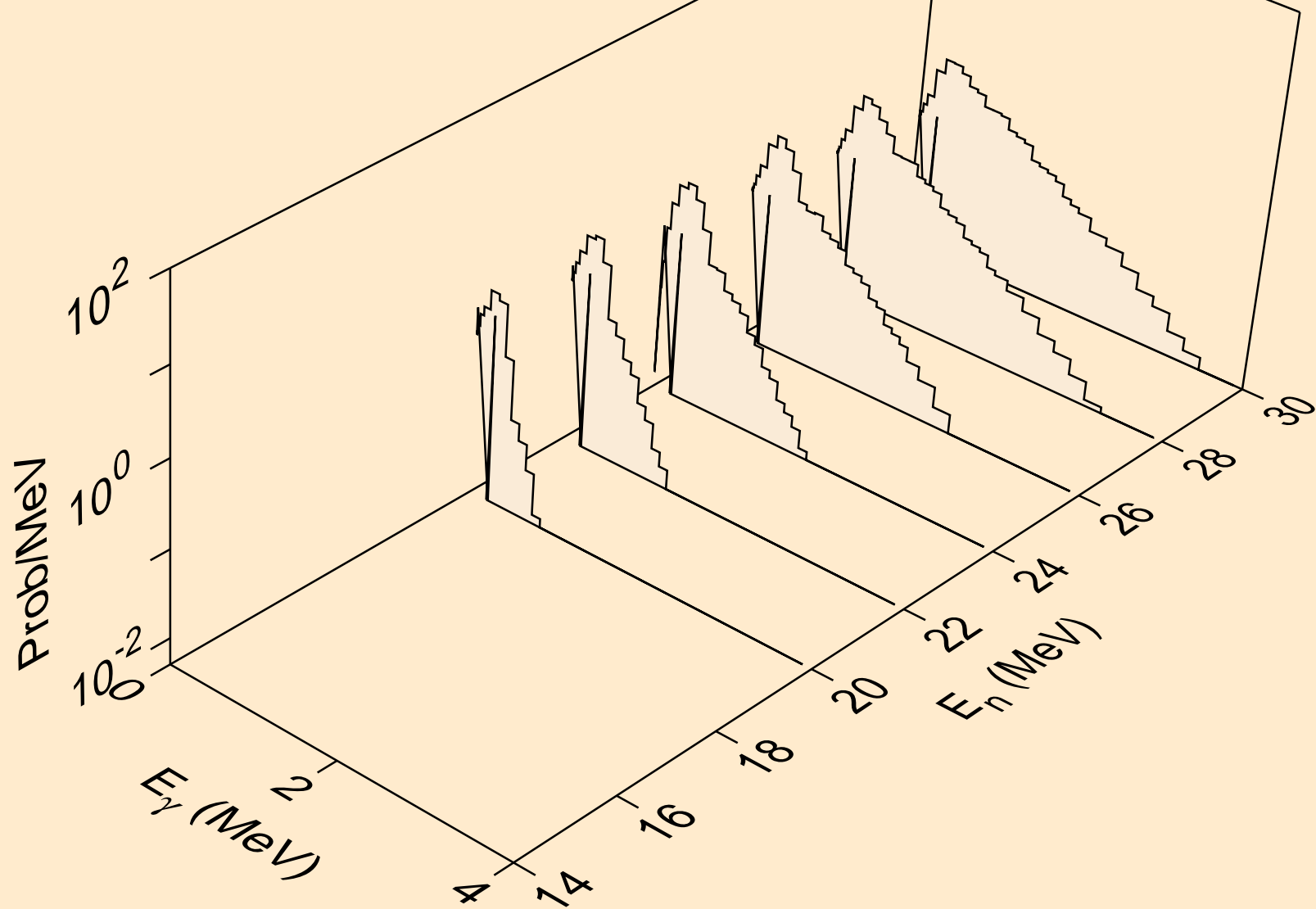

# IN127N PROTON ACER TENDL-2021 LIBRARY; T=0.K

## Particle heating contributions

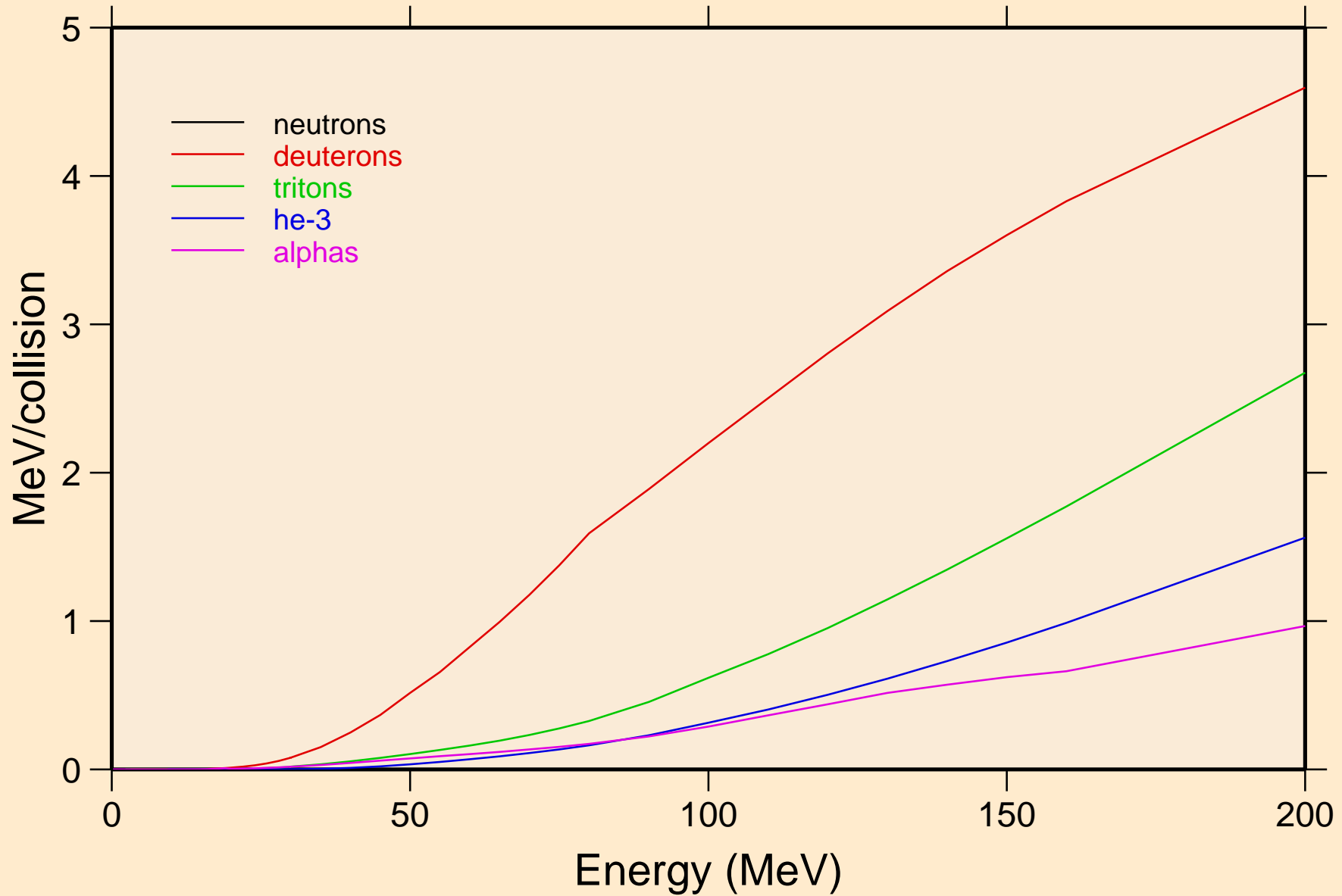

IN127N PROTON ACER TENDL-2021 LIBRARY; T=0.K  
Recoil Heating

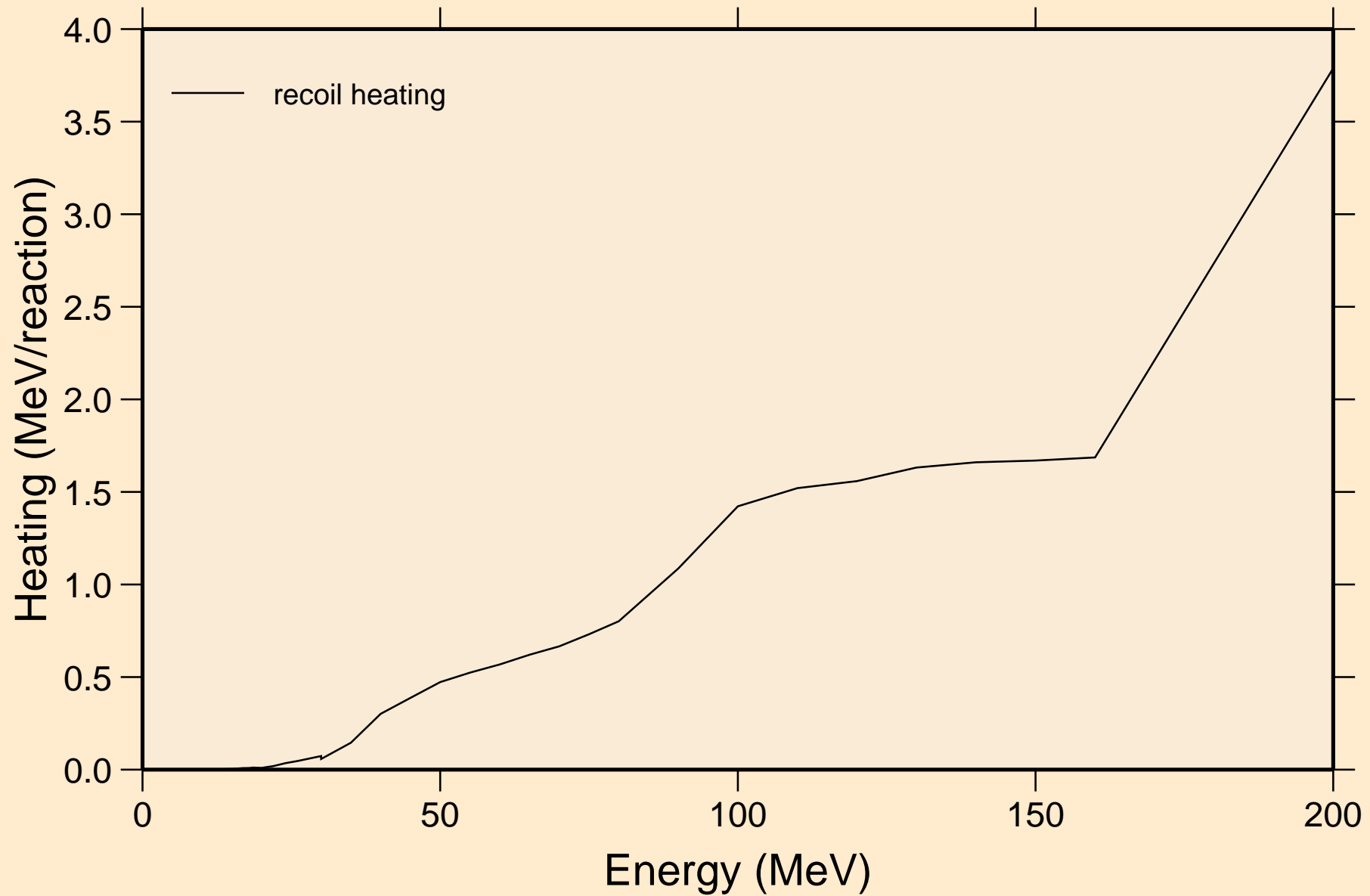

IN127N PROTON ACER TENDL-2021 LIBRARY; T=0.K  
Particle production cross sections

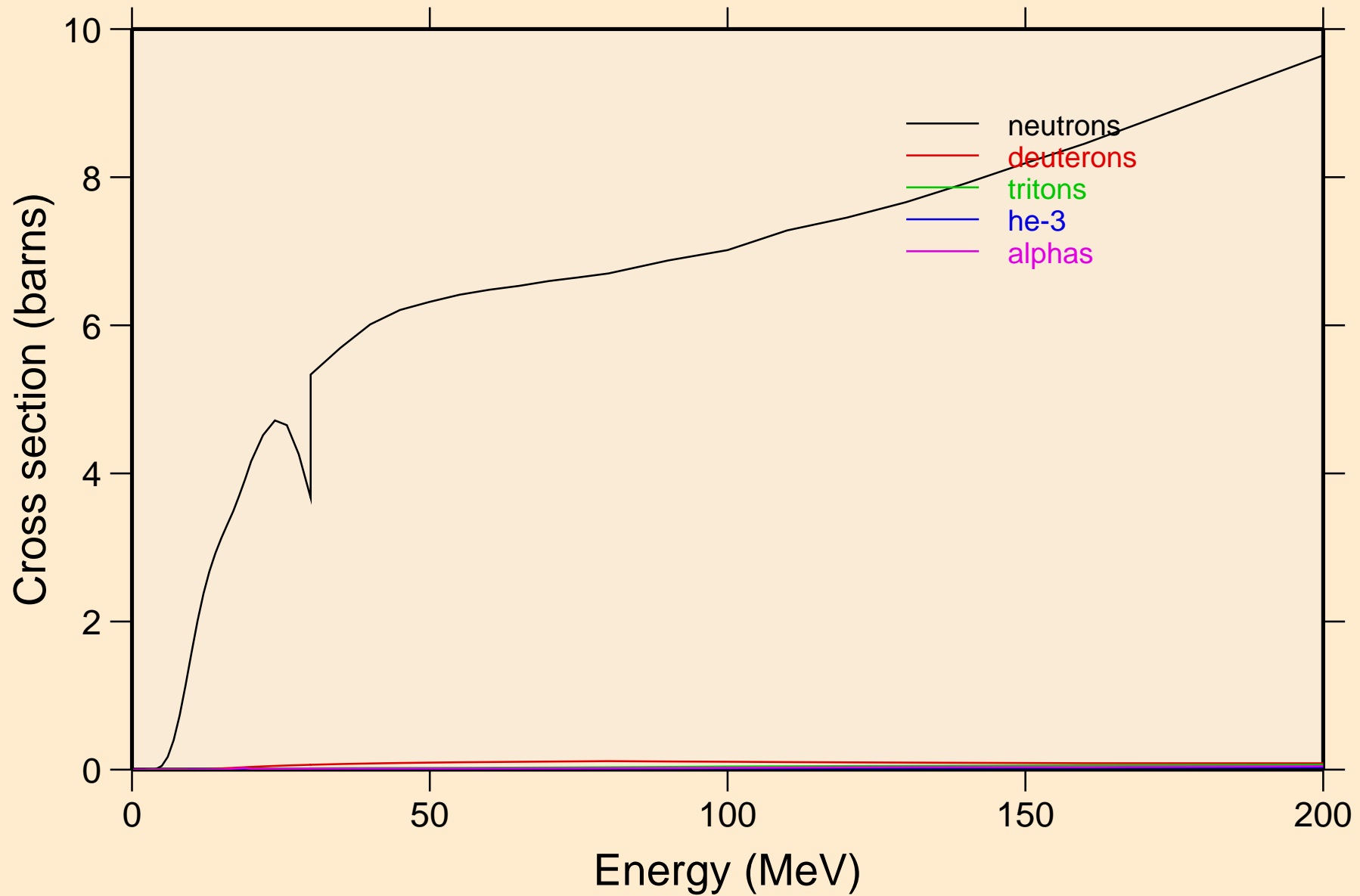

IN127N PROTON ACER TENDL-2021 LIBRARY; T=0.K  
neutrons from (p,n)

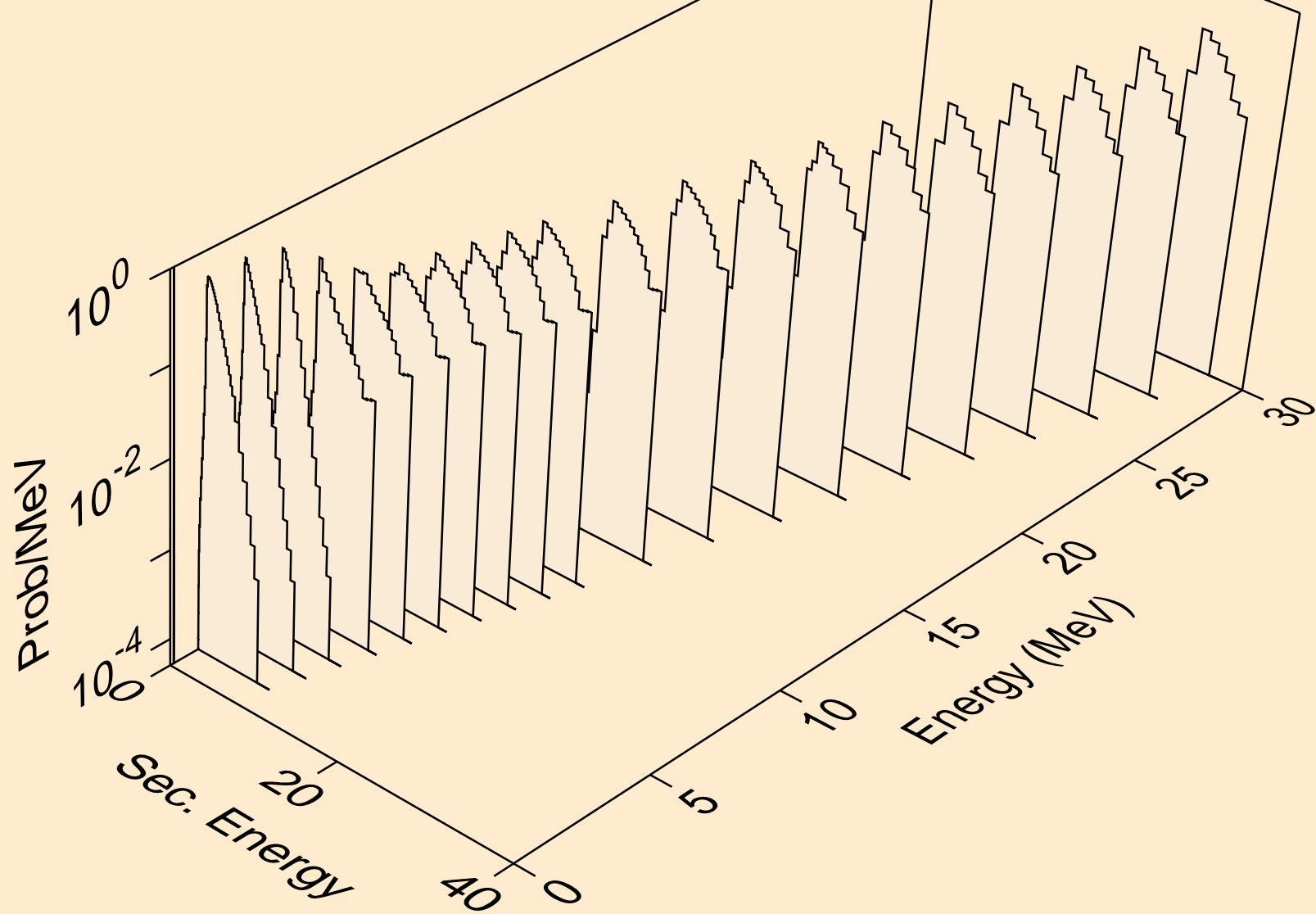

IN127N PROTON ACER TENDL-2021 LIBRARY; T=0.K  
neutrons from (p,x)

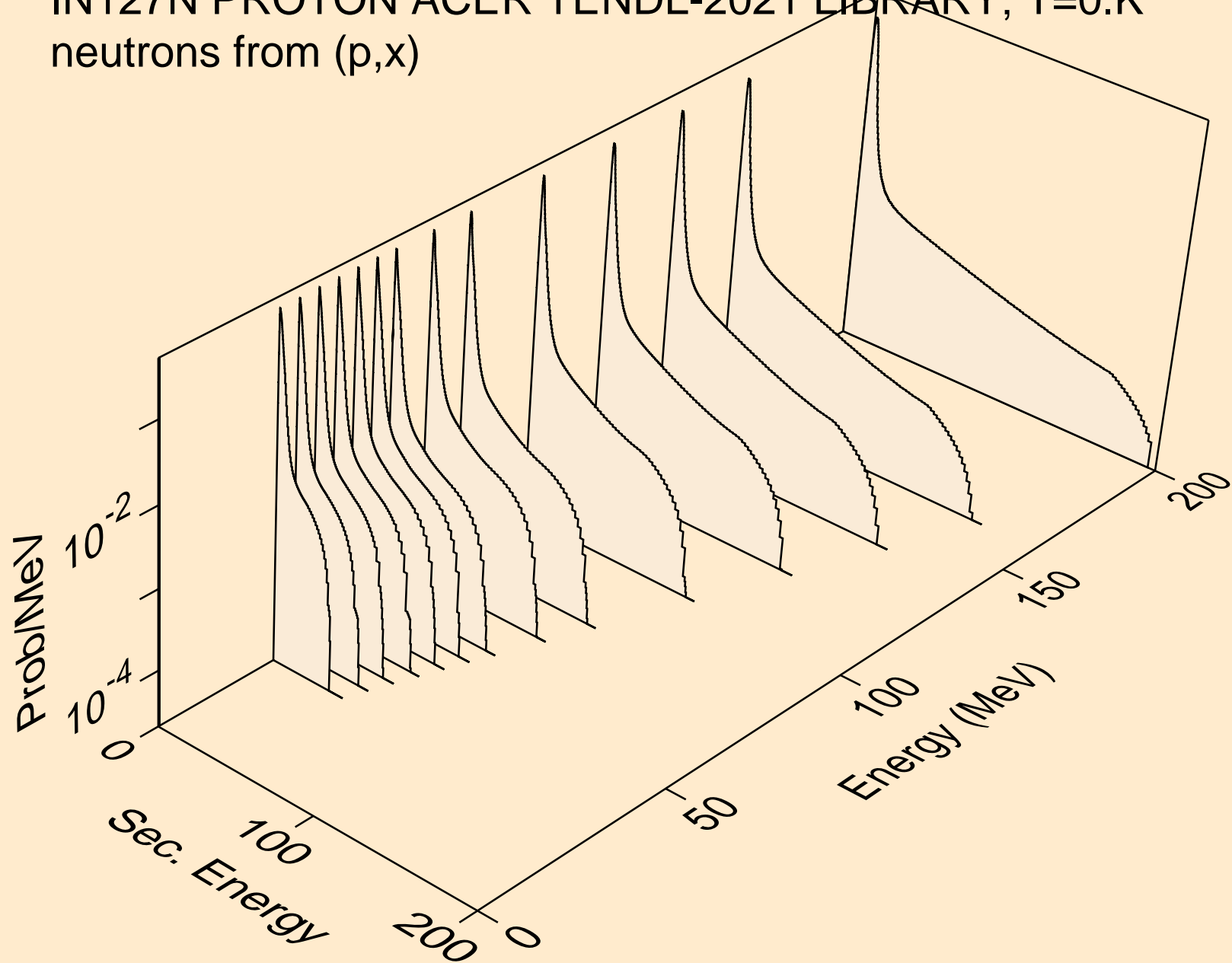

IN127N PROTON ACER TENDL-2021 LIBRARY; T=0.K  
neutrons from (p,2nd)

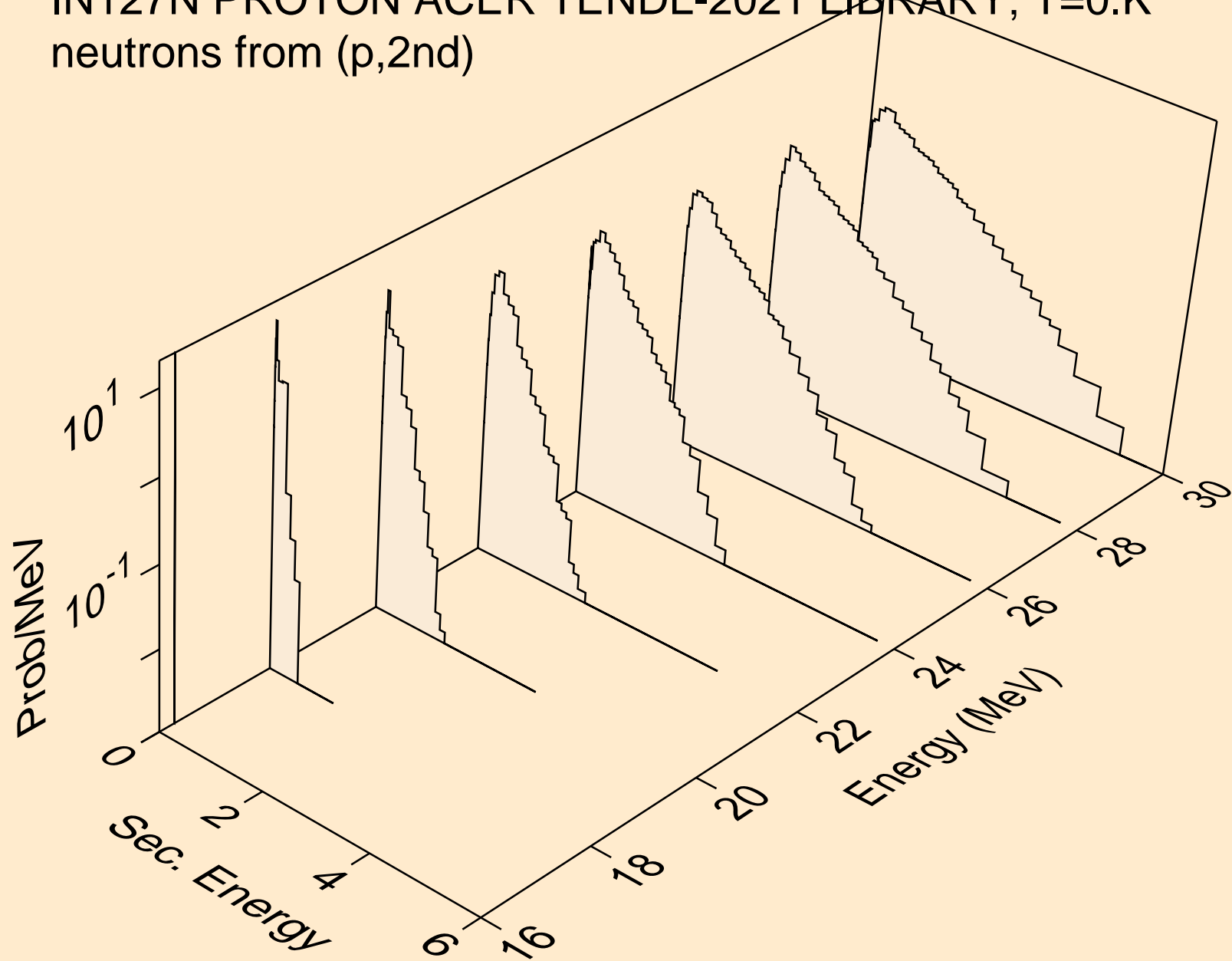



IN127N PROTON ACER TENDL-2021 LIBRARY; T=0.K  
neutrons from (p,2n)

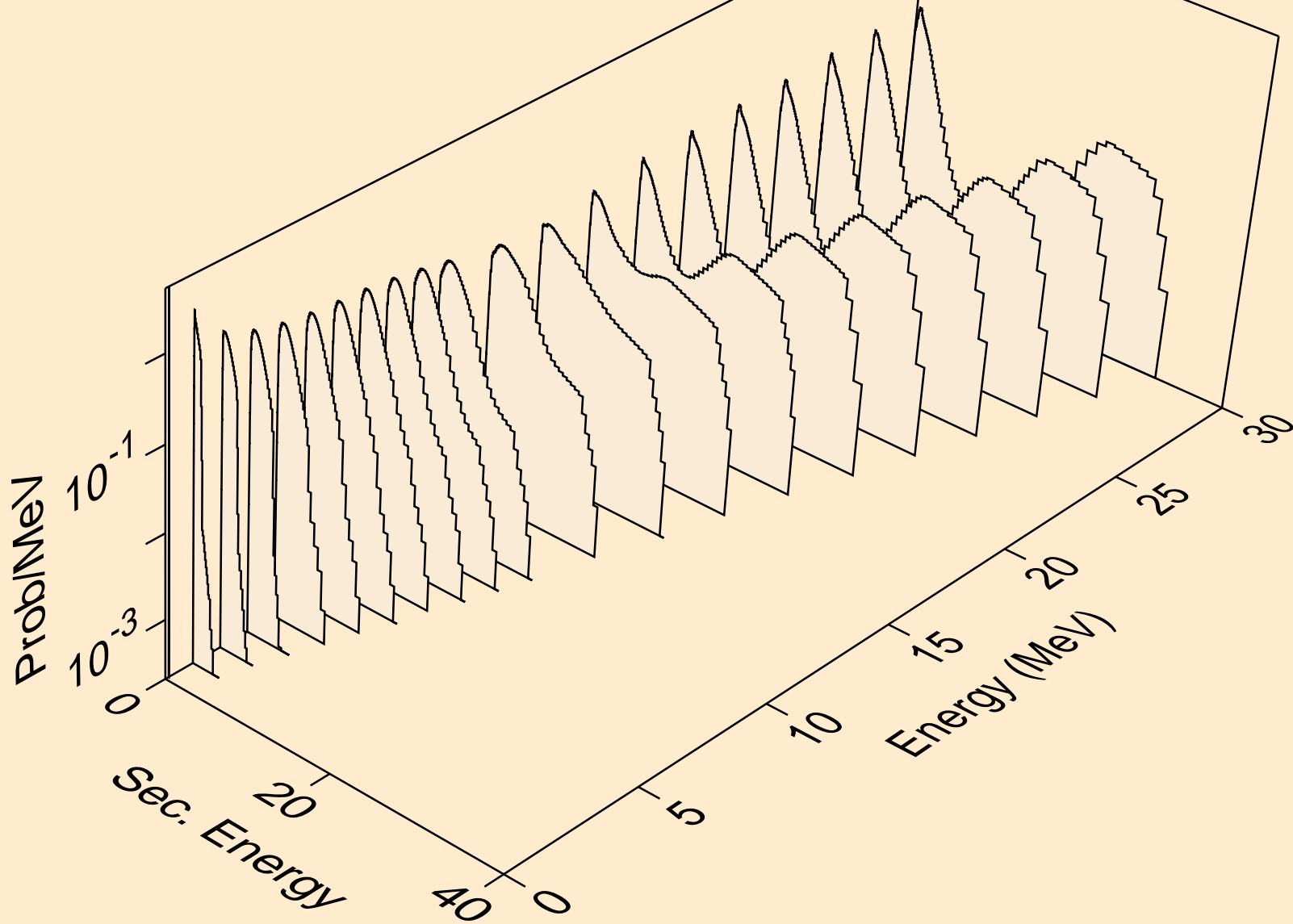

IN127N PROTON ACER TENDL-2021 LIBRARY; T=0.K  
neutrons from (p,3n)

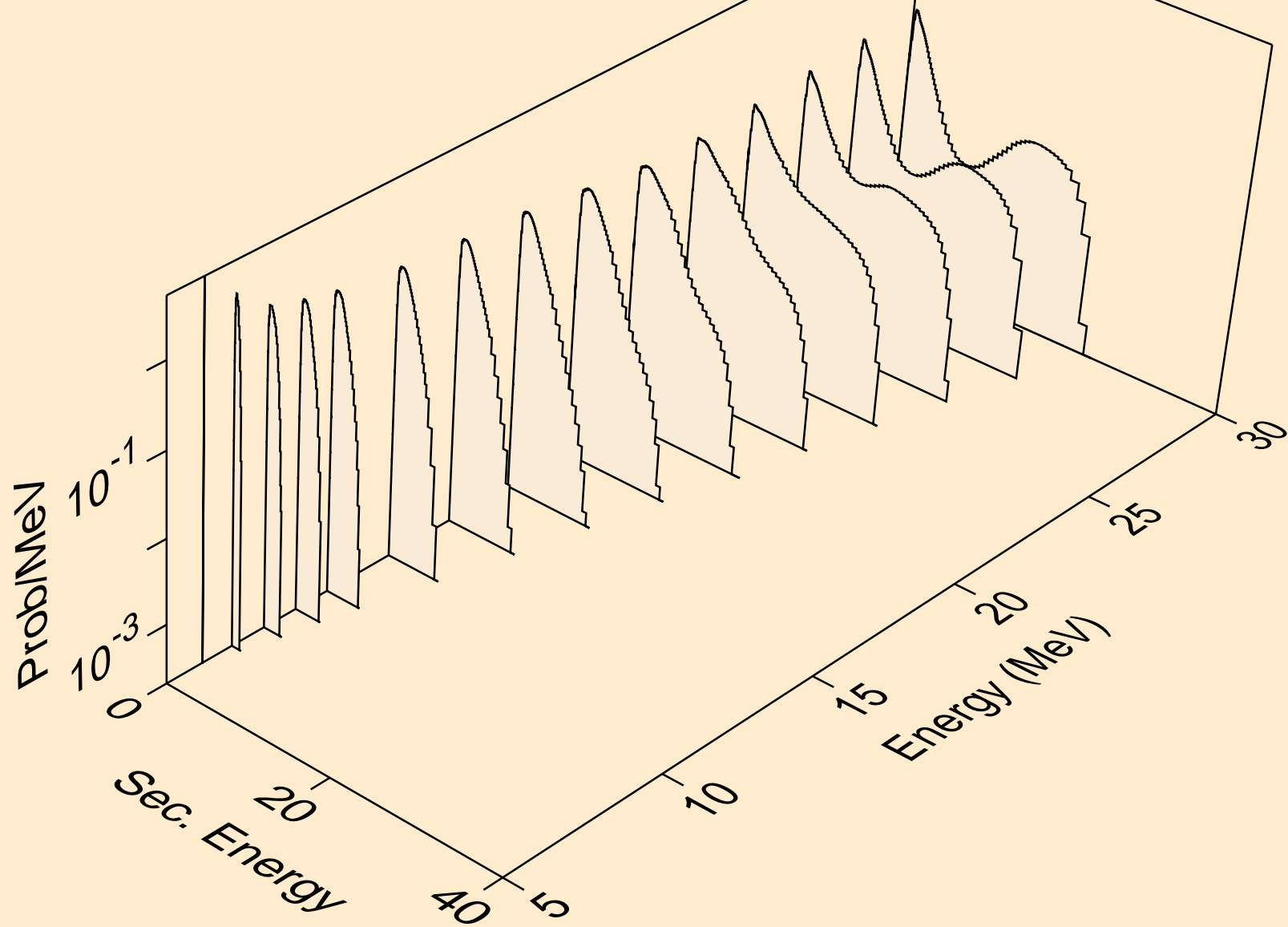

IN127N PROTON ACER TENDL-2021 LIBRARY; T=0.K  
neutrons from (p,n\*)a

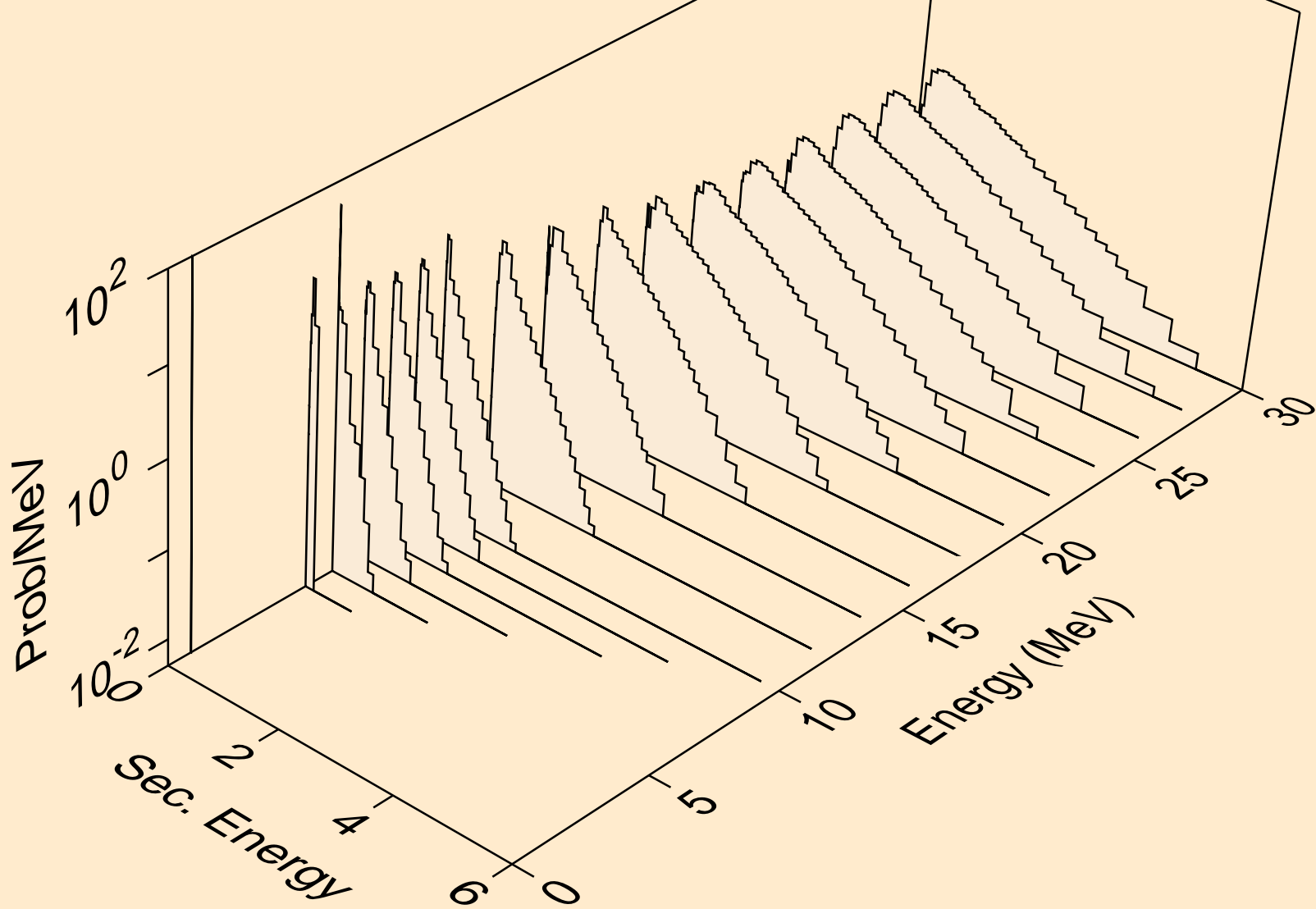

IN127N PROTON ACER TENDL-2021 LIBRARY; T=0.K  
neutrons from (p,2n)a

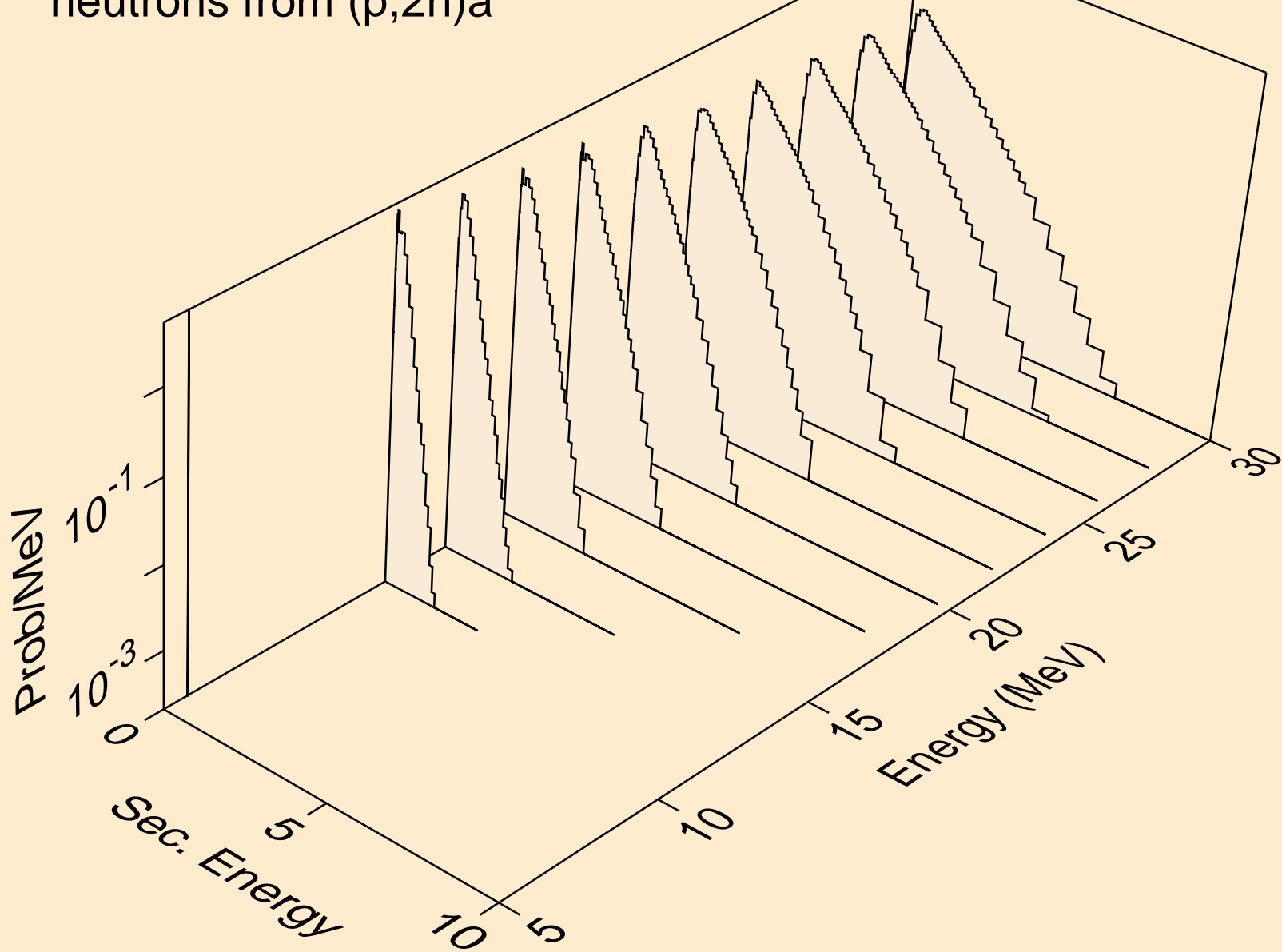

IN127N PROTON ACER TENDL-2021 LIBRARY; T=0.K  
neutrons from (p,3n)a

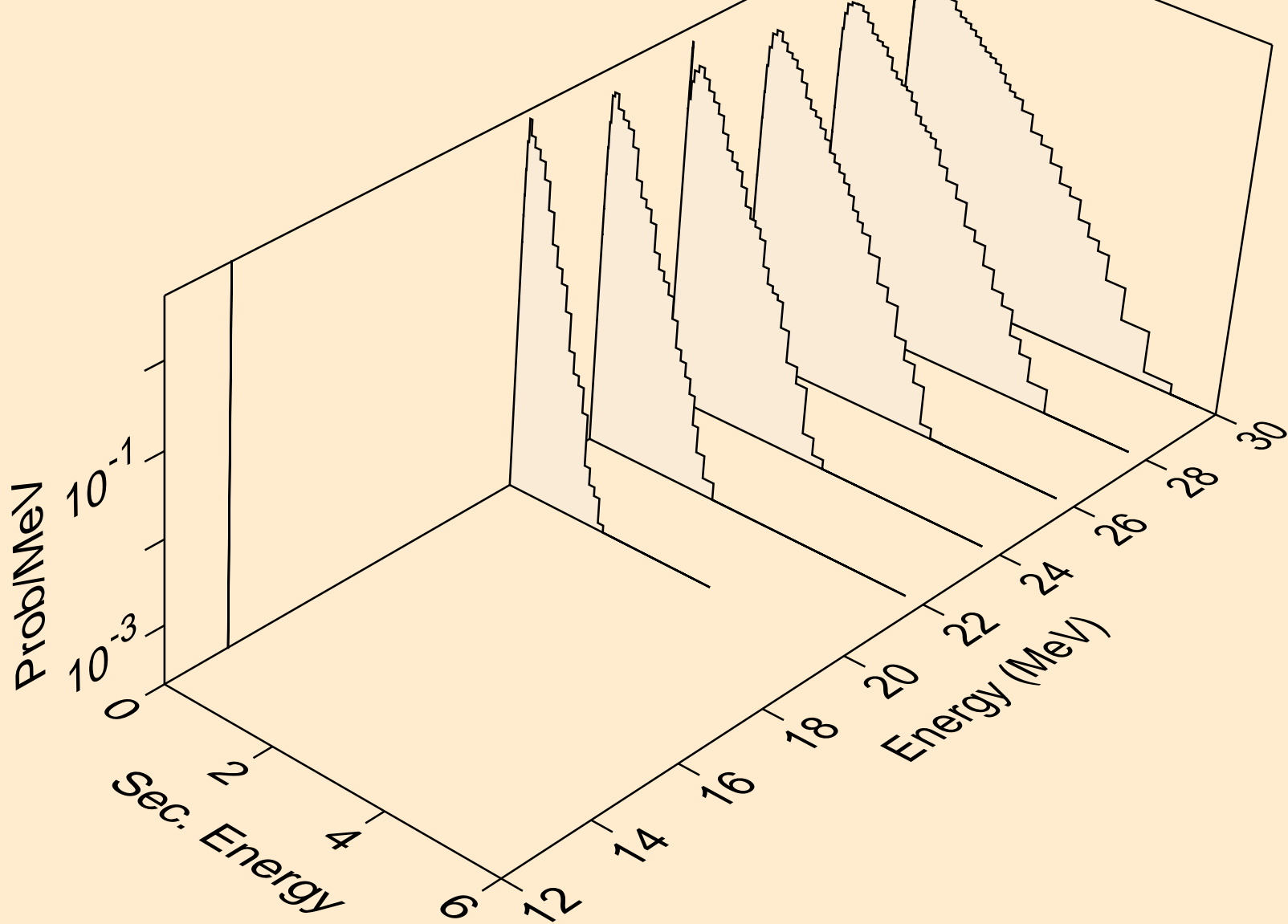

IN127N PROTON ACER TENDL-2021 LIBRARY; T=0.K  
neutrons from (p,n\*)p

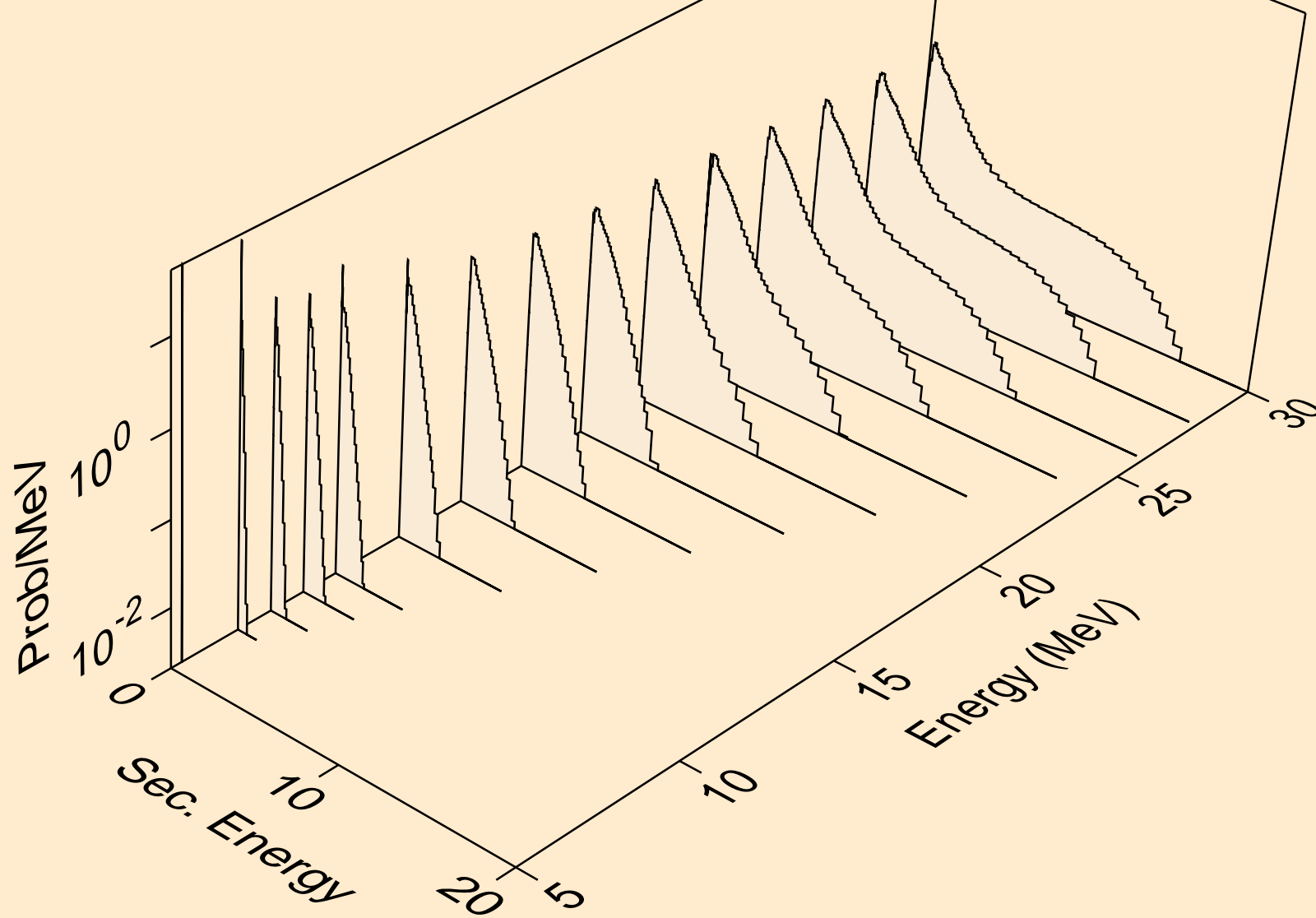

IN127N PROTON ACER TENDL-2021 LIBRARY; T=0.K  
neutrons from (p,n\*)d

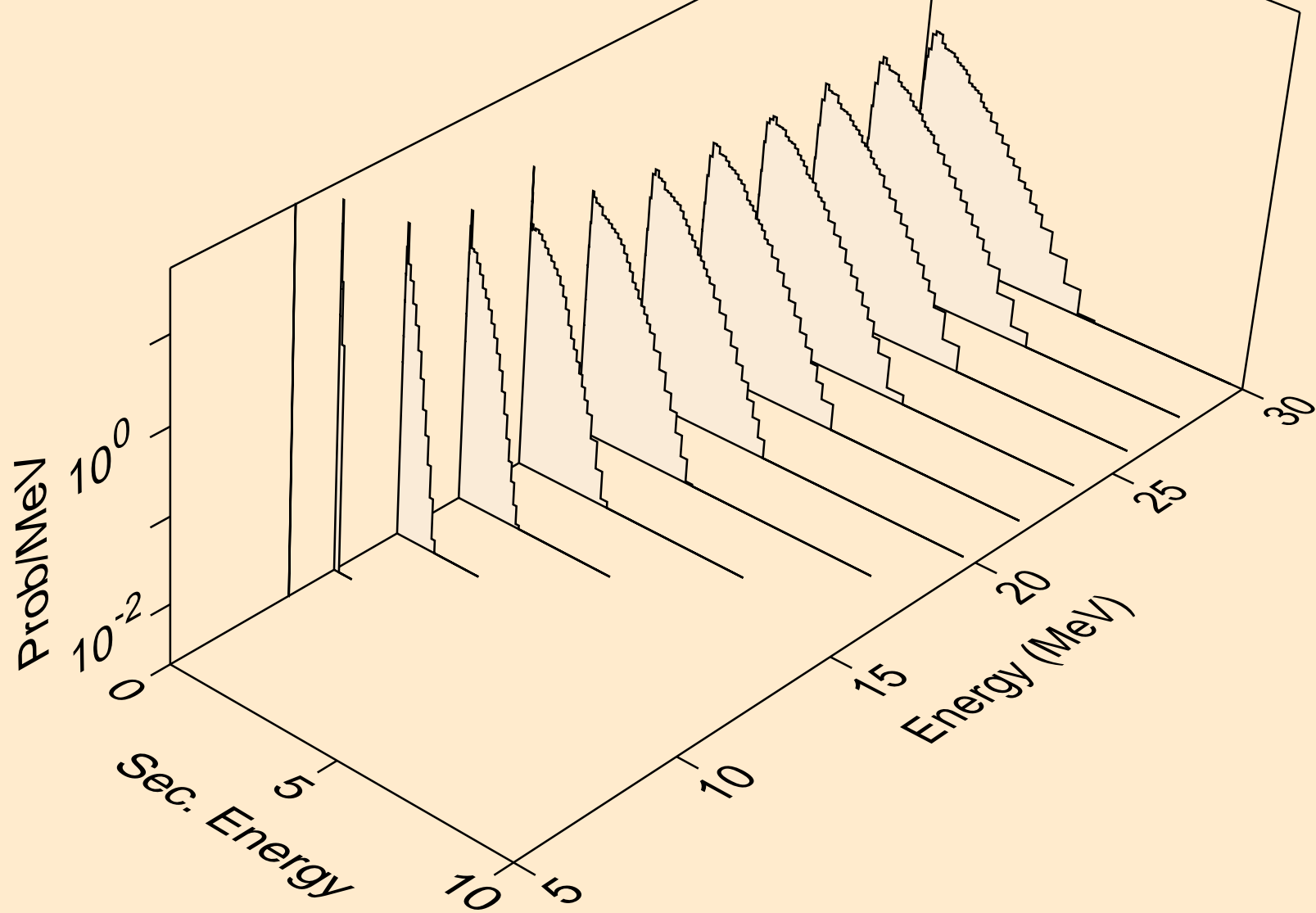

IN127N PROTON ACER TENDL-2021 LIBRARY; T=0.K  
neutrons from (p,n\*)t

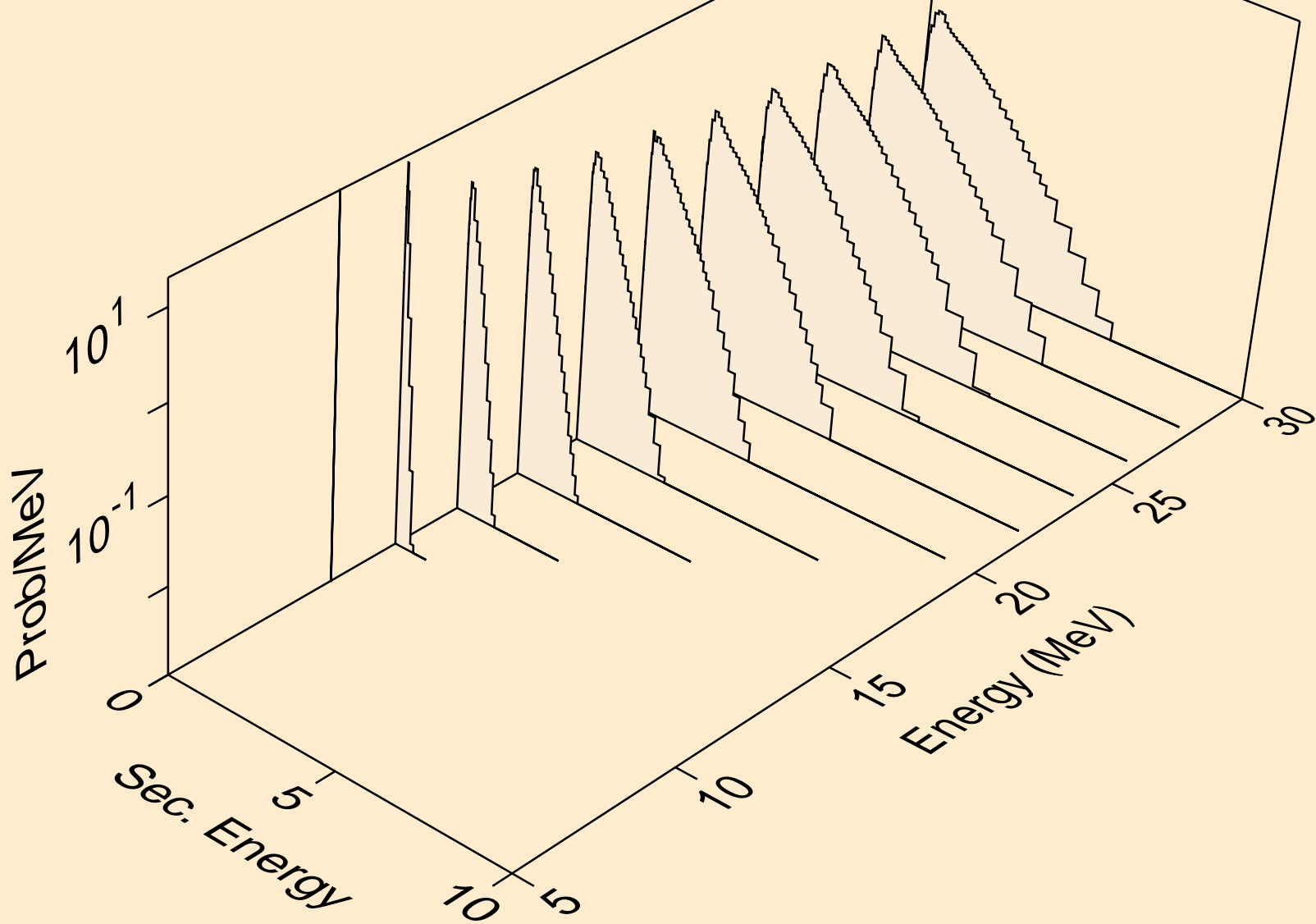



IN127N PROTON ACER TENDL-2021 LIBRARY; T=0.K  
neutrons from (p,n\*)he3

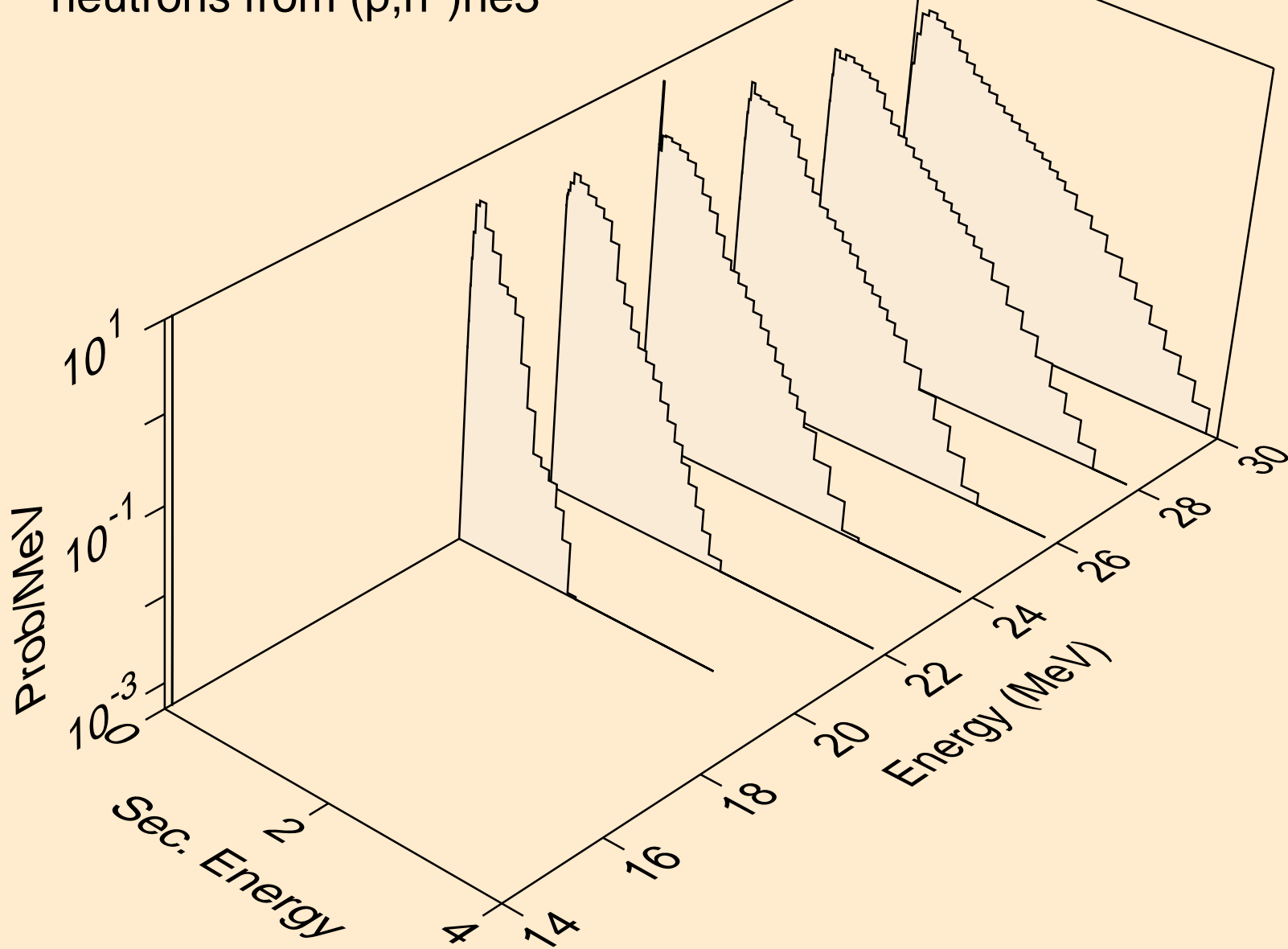

IN127N PROTON ACER TENDL-2021 LIBRARY; T=0.K  
neutrons from (p,4n)

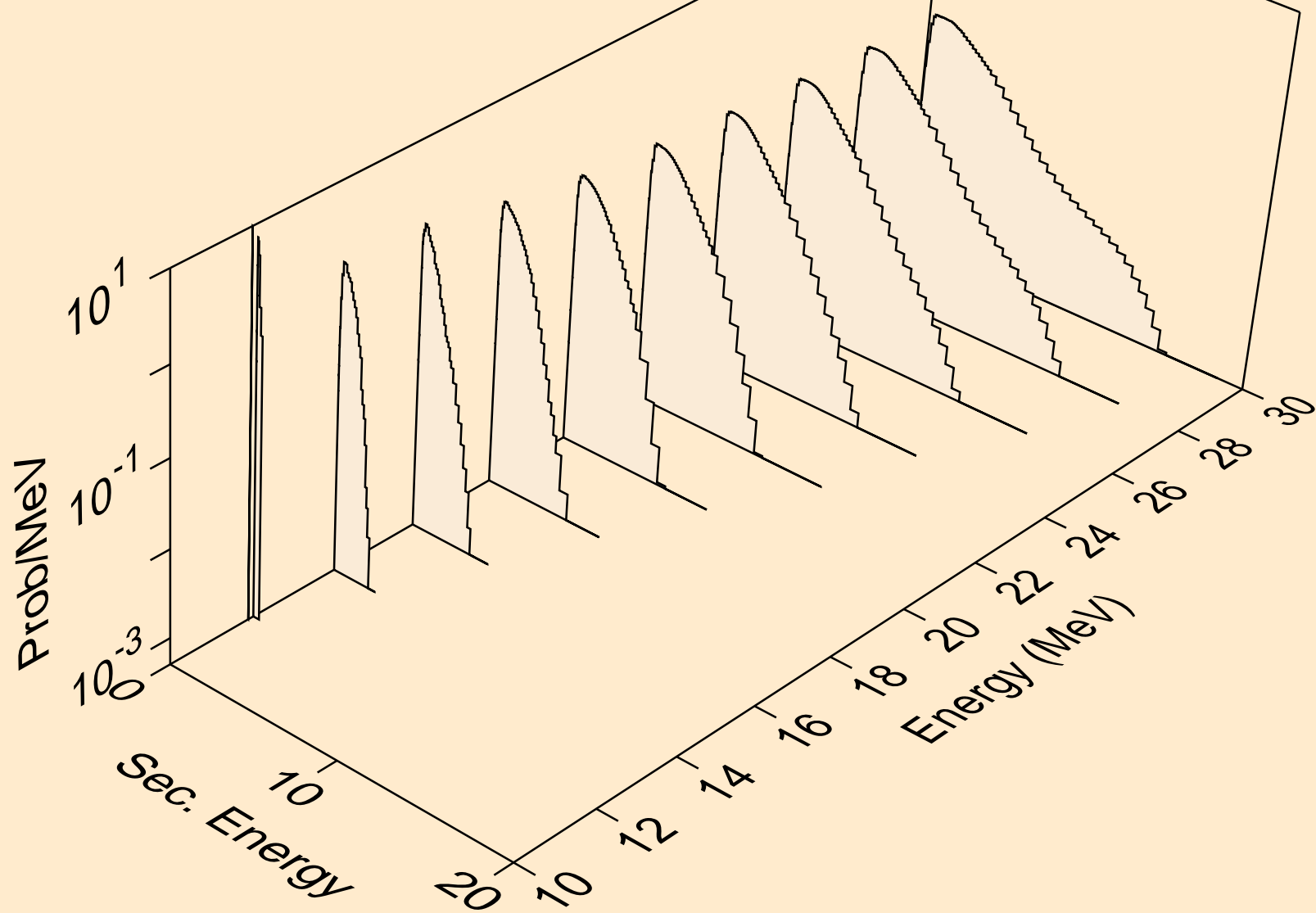

IN127N PROTON ACER TENDL-2021 LIBRARY; T=0.K  
neutrons from (p,2np)

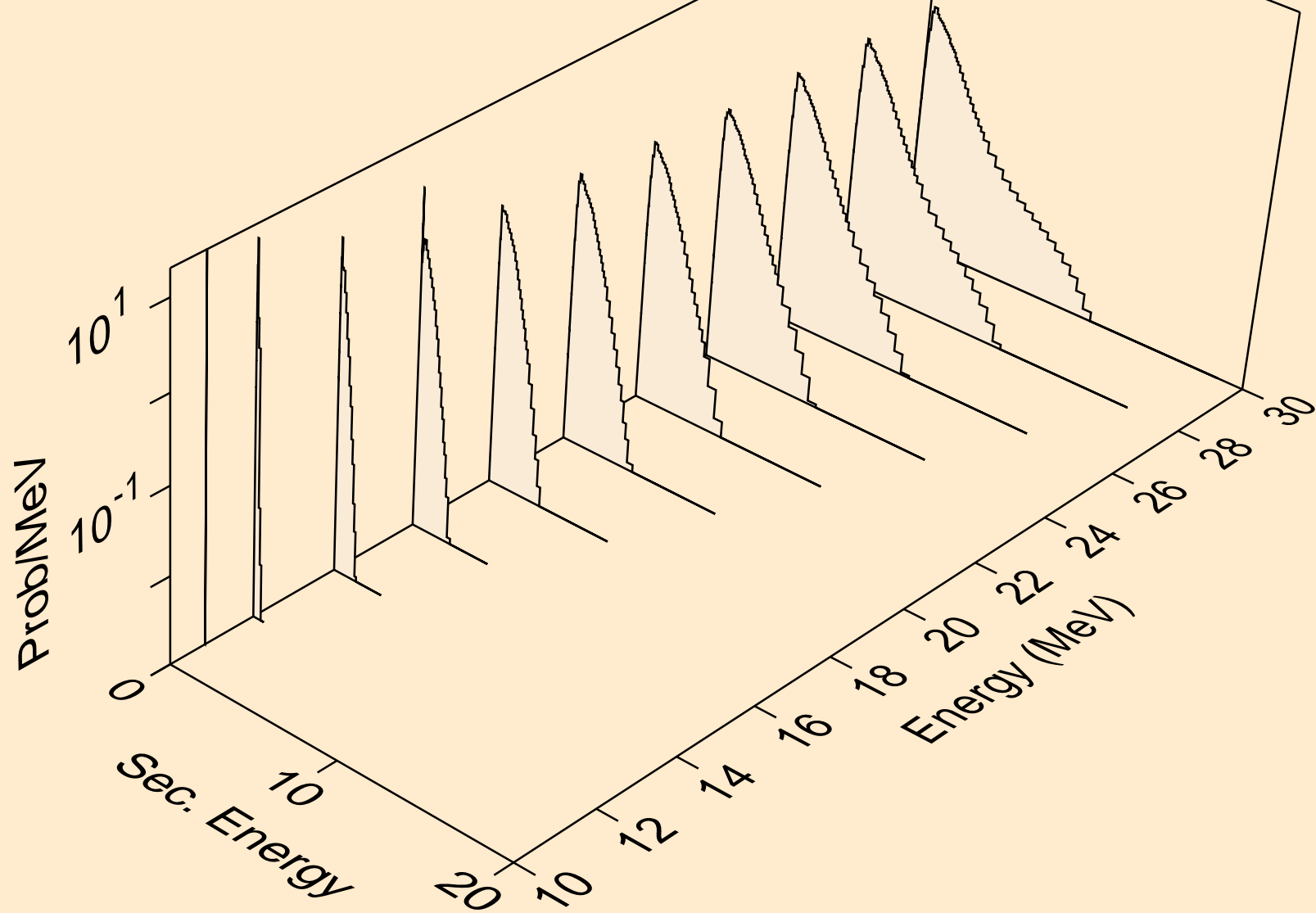

IN127N PROTON ACER TENDL-2021 LIBRARY; T=0.K  
neutrons from (p,3np)

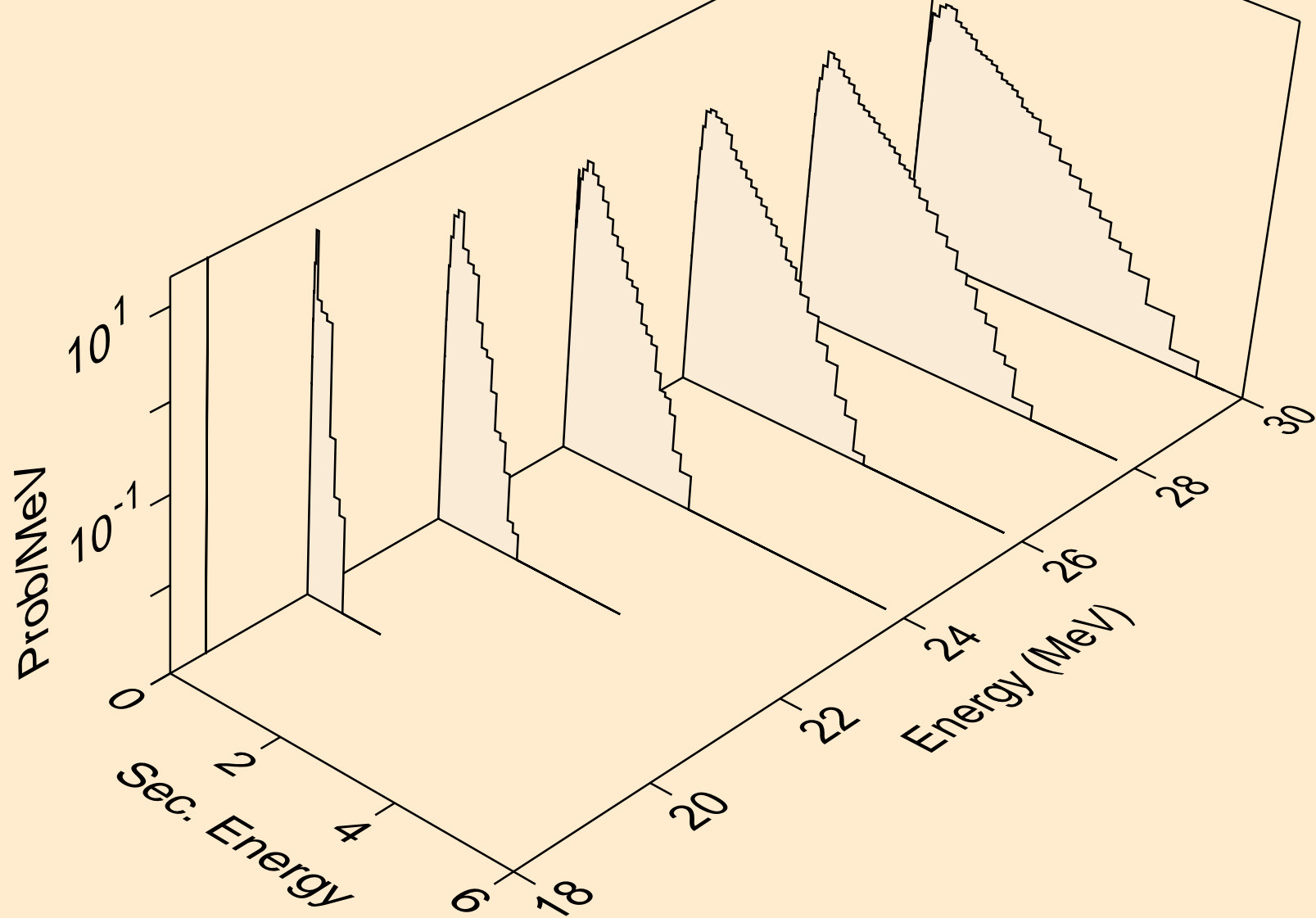

IN127N PROTON ACER TENDL-2021 LIBRARY; T=0.K  
neutrons from (p,2np)

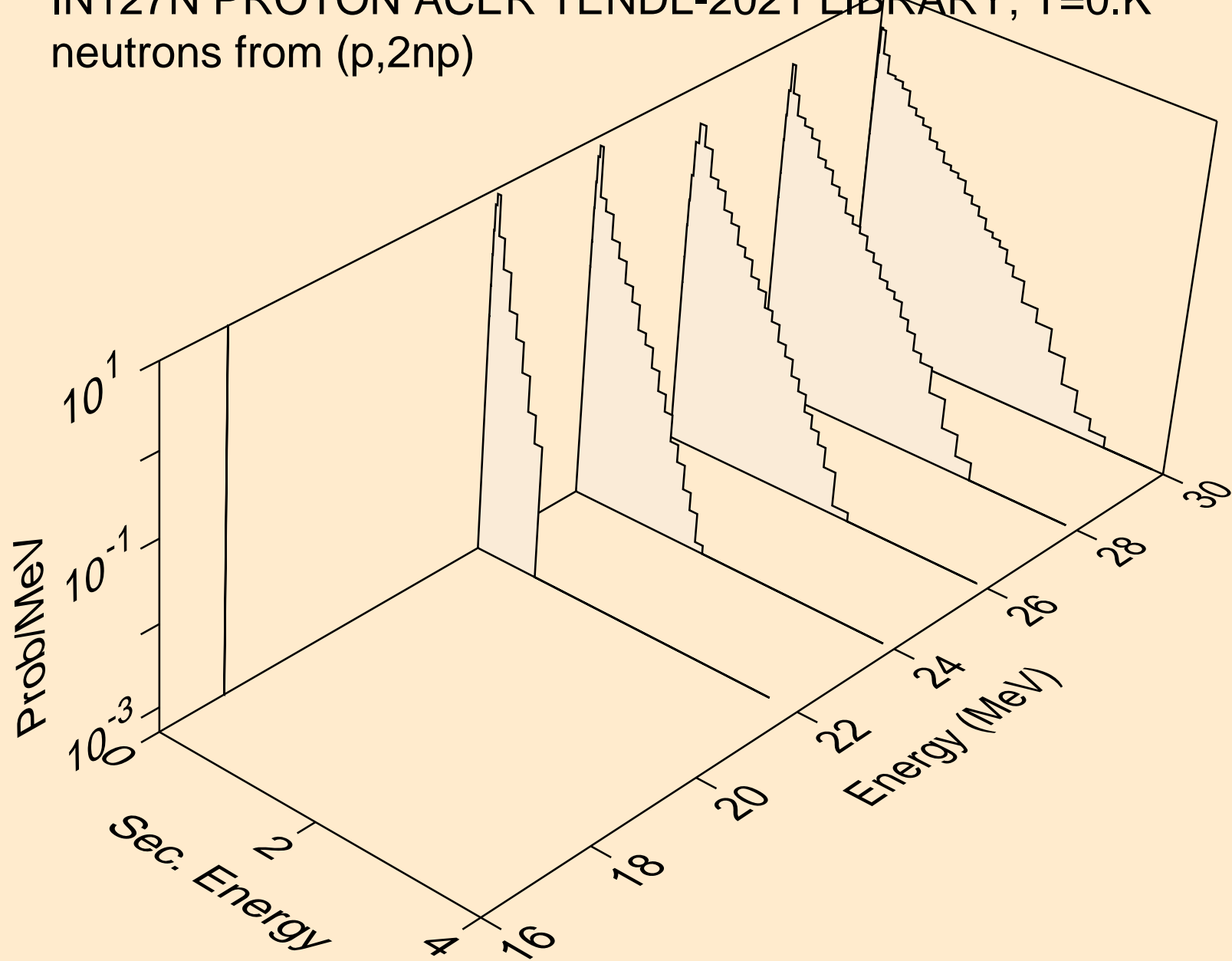

IN127N PROTON ACER TENDL-2021 LIBRARY; T=0.K  
deuterons from (p,x)

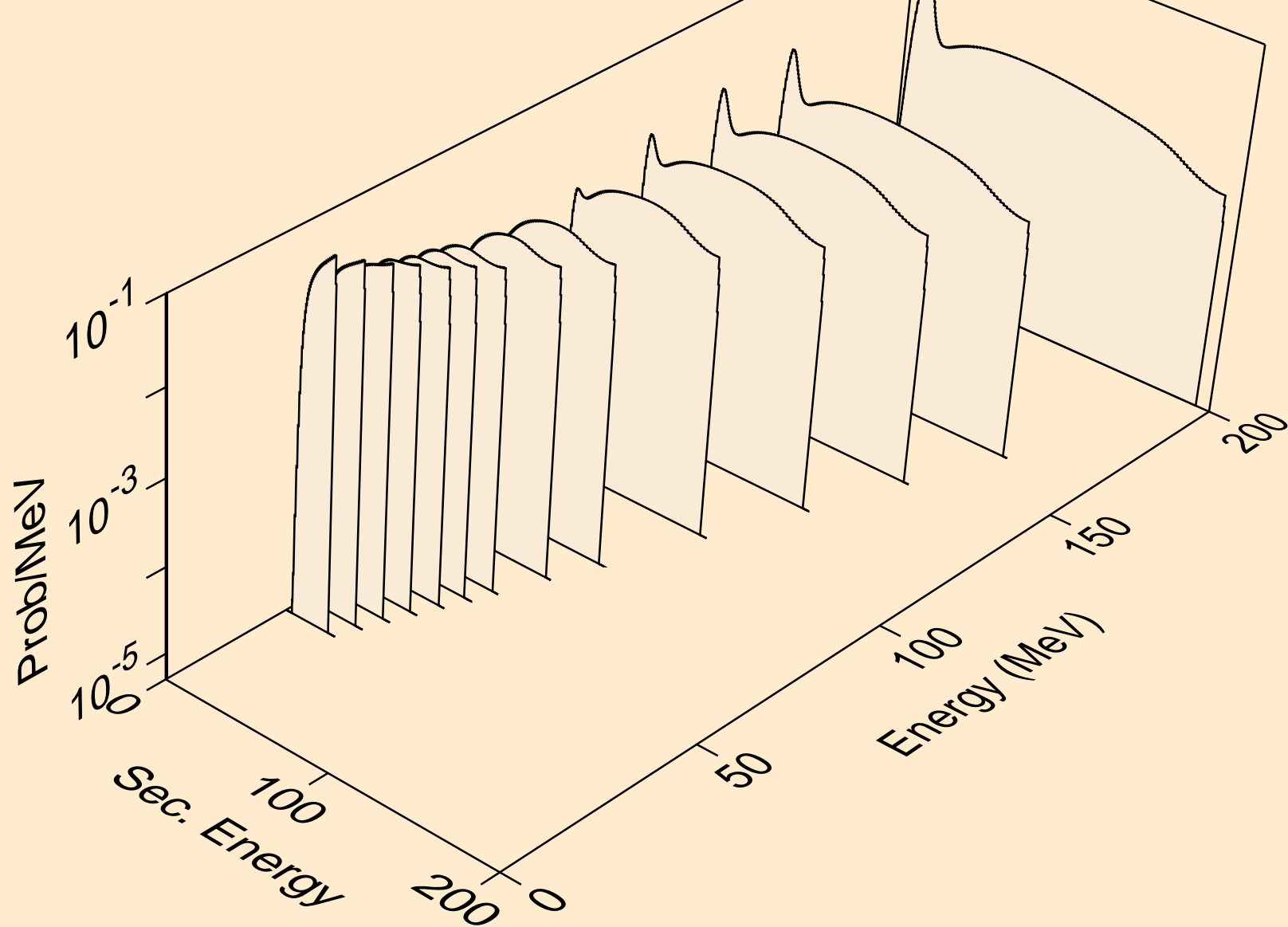

IN127N PROTON ACER TENDL-2021 LIBRARY; T=0.K  
deuterons from (p,2nd)

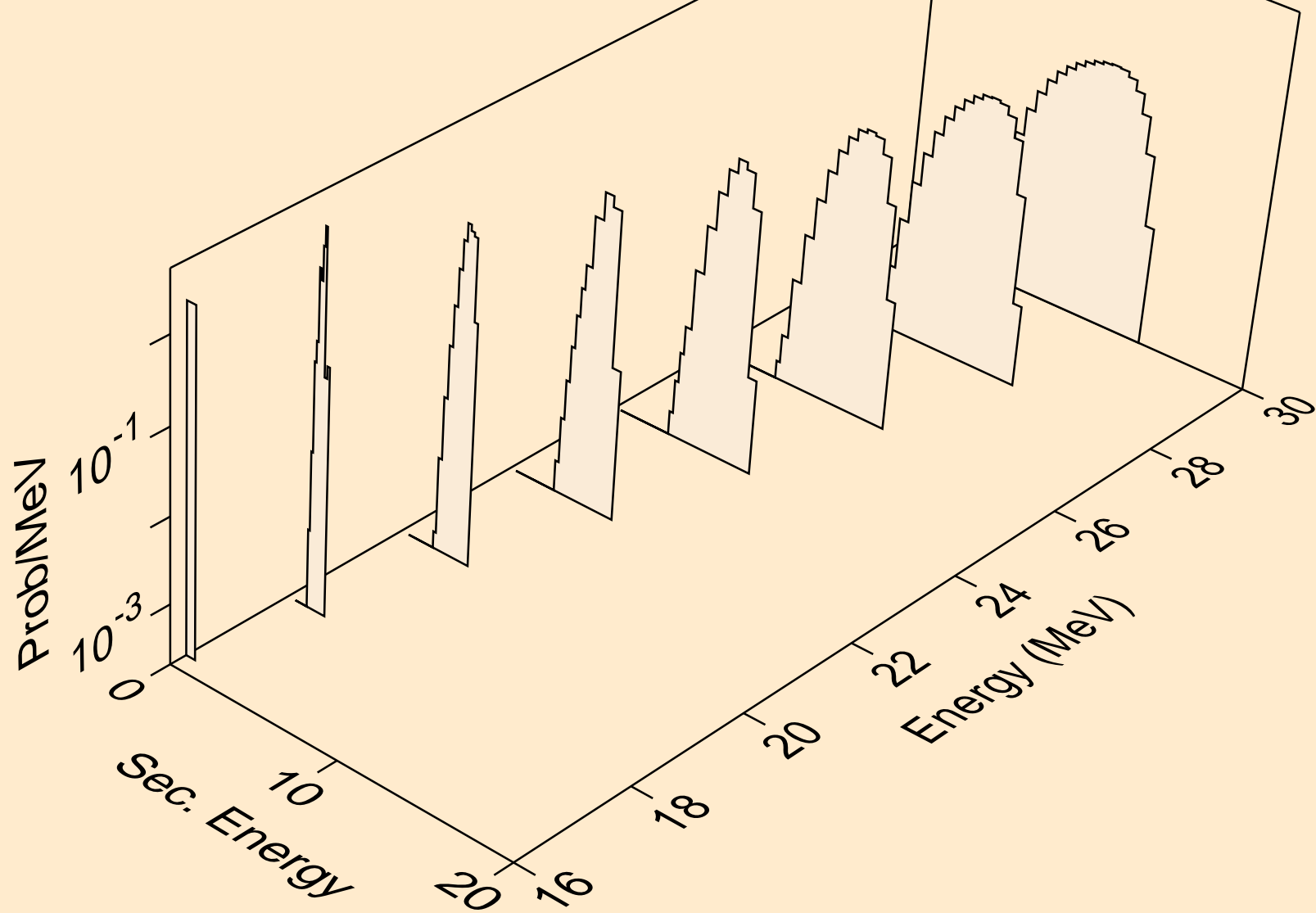

IN127N PROTON ACER TENDL-2021 LIBRARY; T=0.K  
deuterons from (p,n\*)d

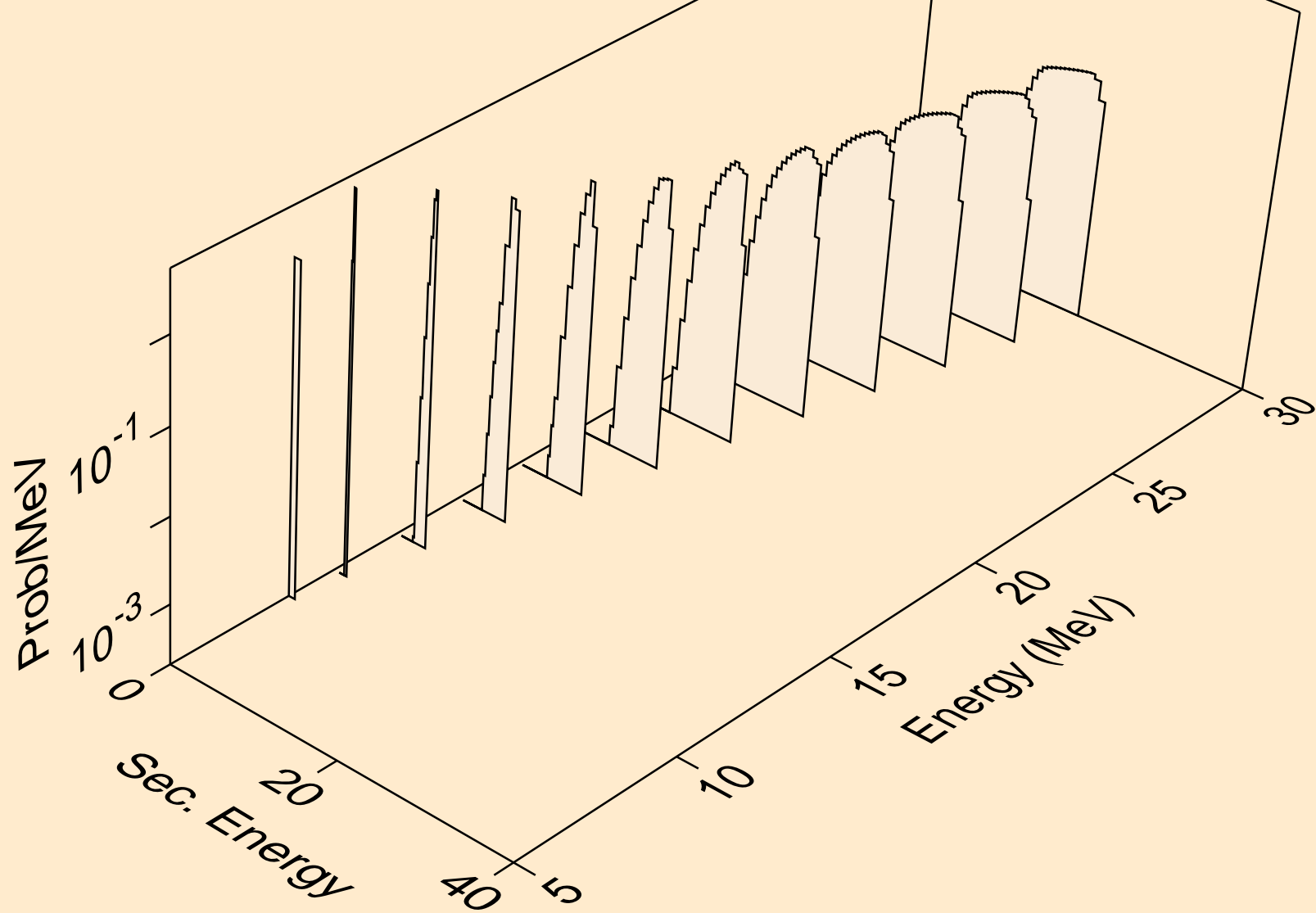



IN127N PROTON ACER TENDL-2021 LIBRARY; T=0.K  
deuterons from (p,d)

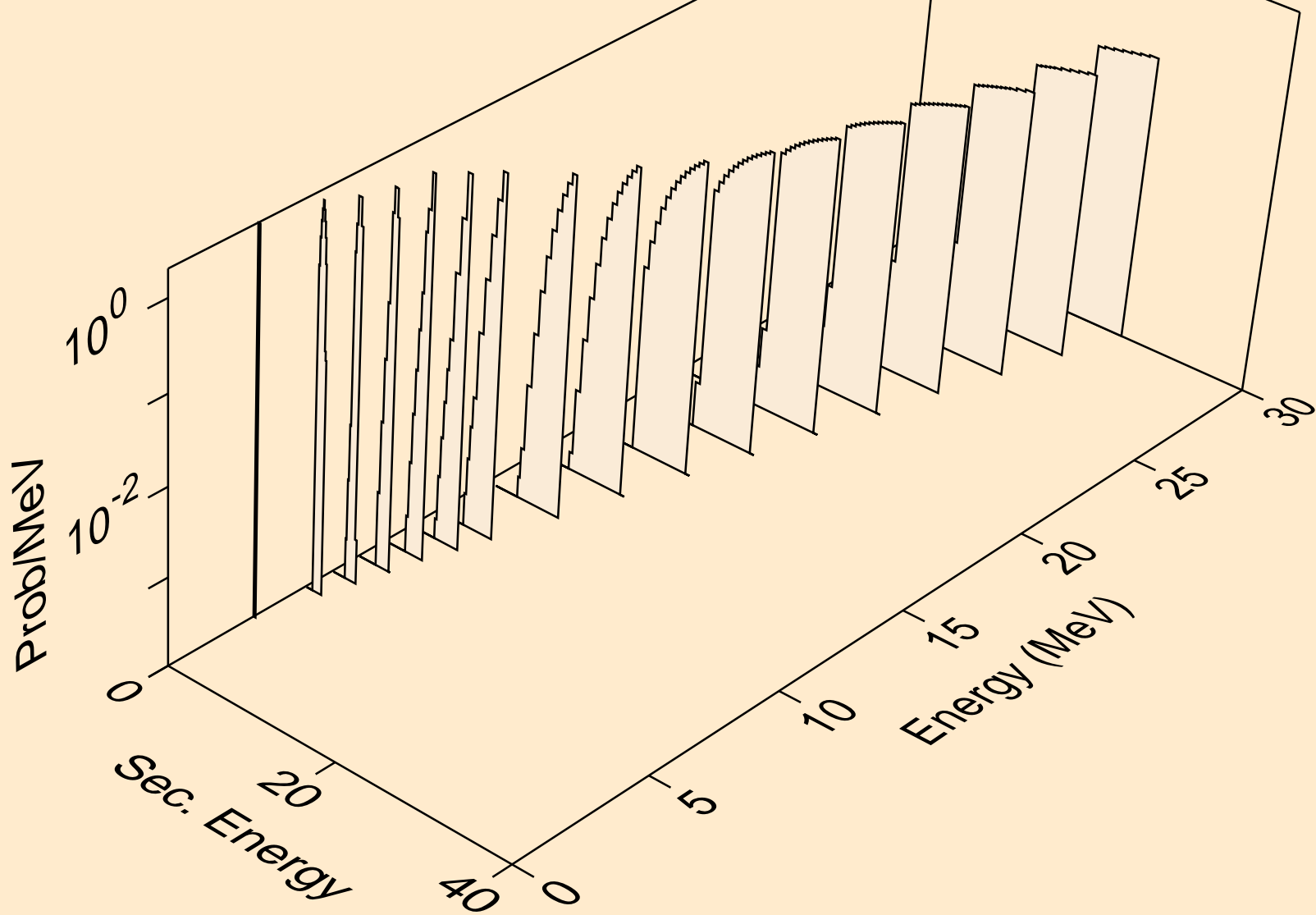

IN127N PROTON ACER TENDL-2021 LIBRARY; T=0.K  
deuterons from (p,pd)

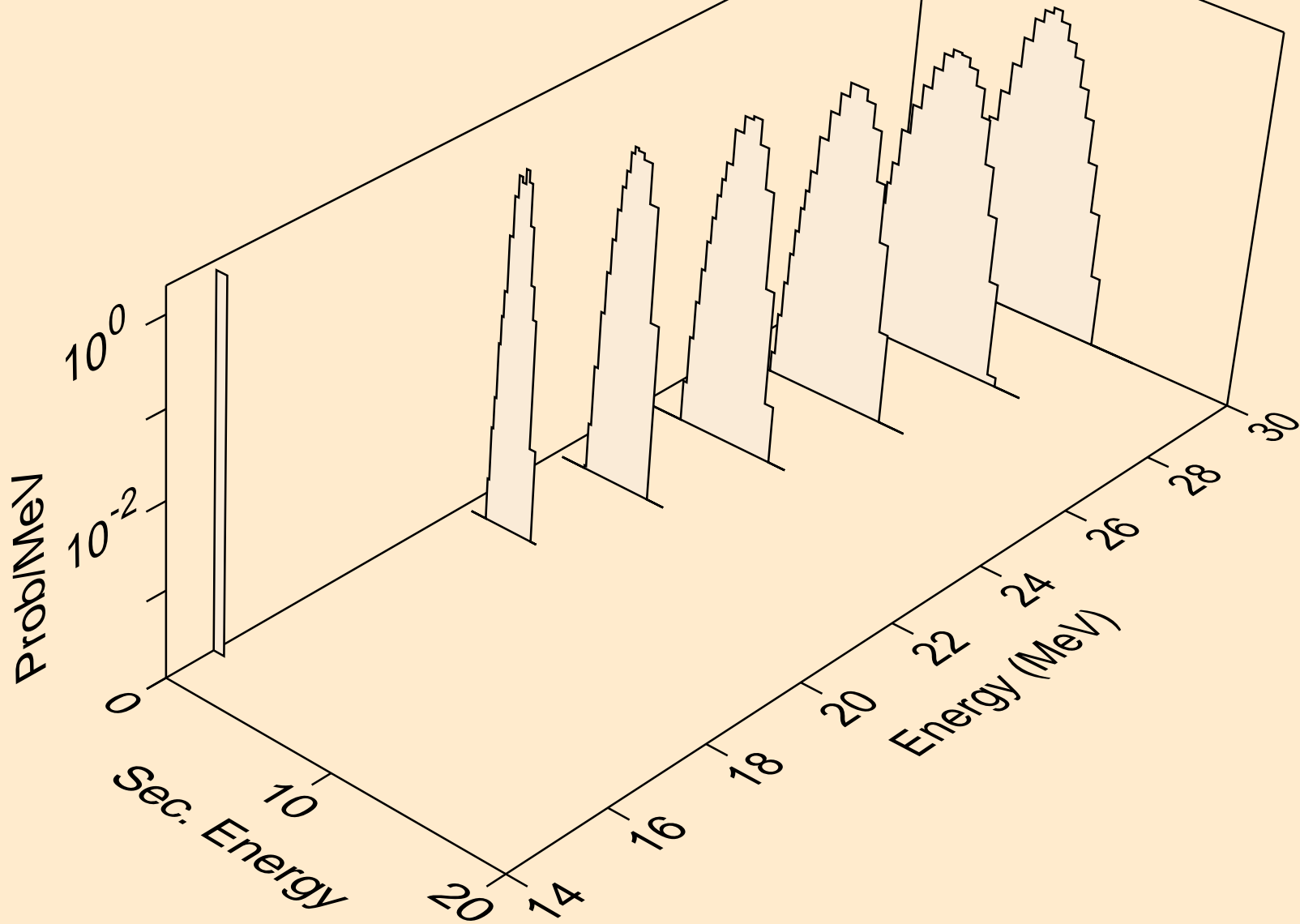

IN127N PROTON ACER TENDL-2021 LIBRARY; T=0.K  
tritons from (p,x)

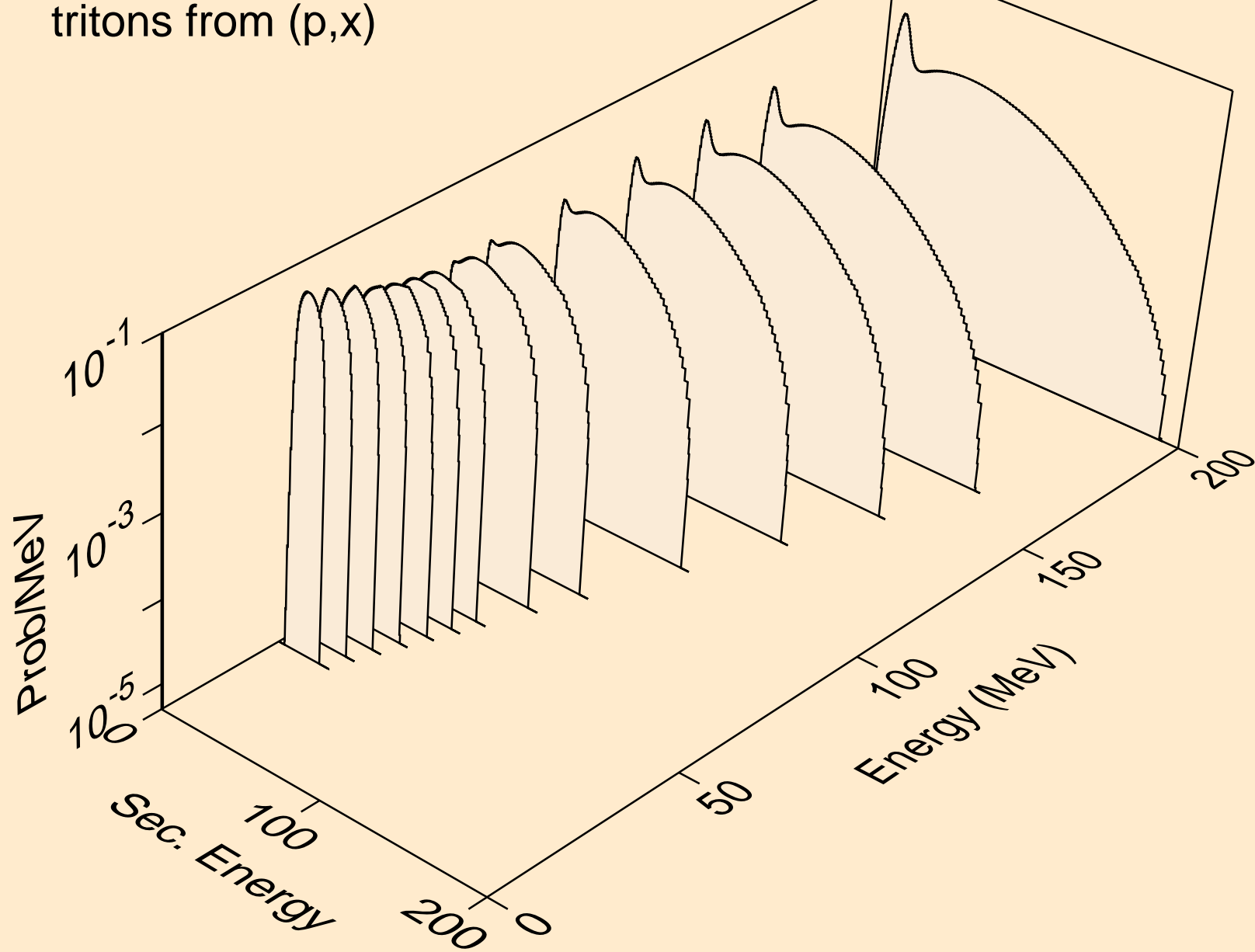

IN127N PROTON ACER TENDL-2021 LIBRARY; T=0.K  
tritons from (p,n\*)t

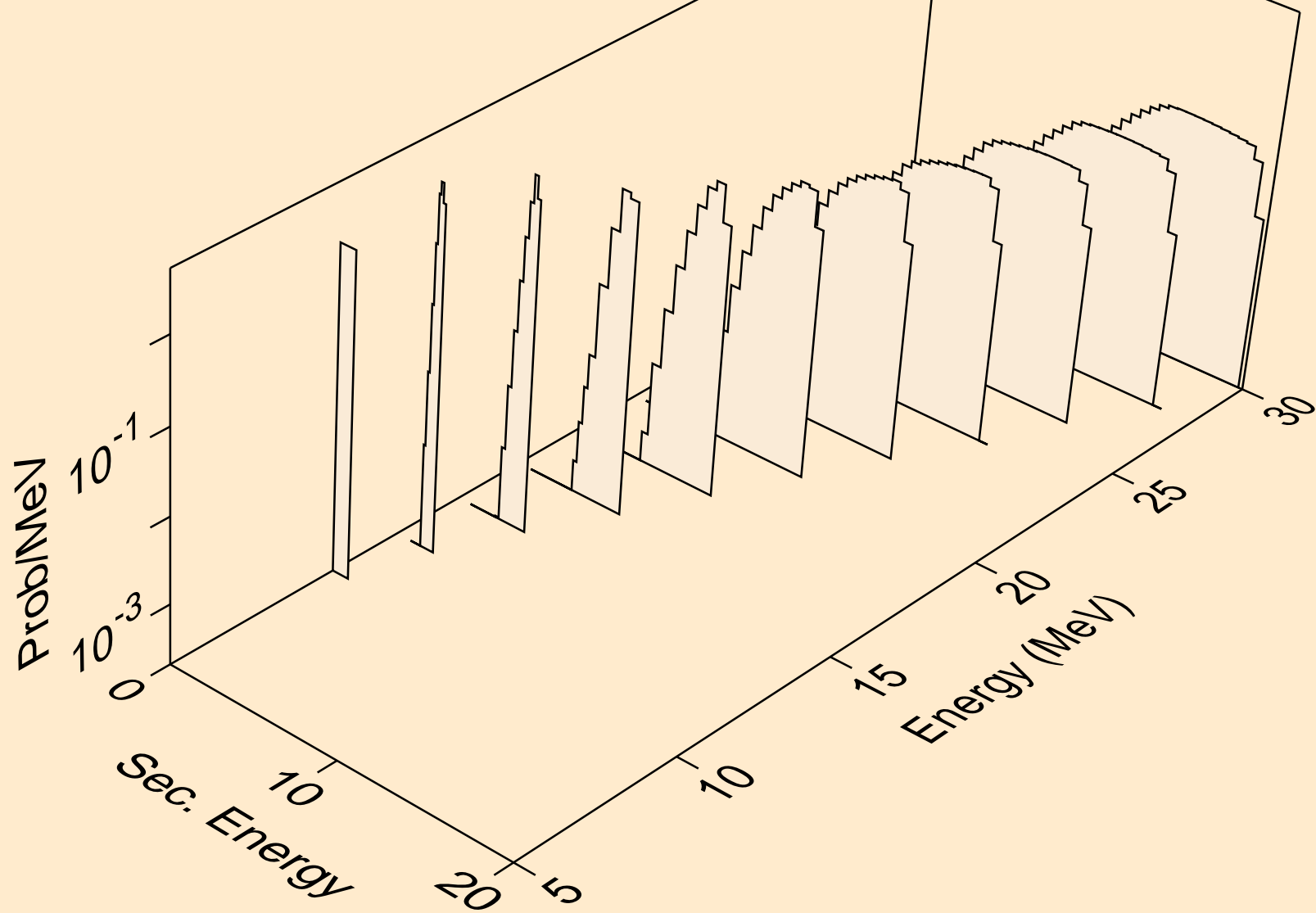

IN127N PROTON ACER TENDL-2021 LIBRARY; T=0.K  
tritons from (p,t)

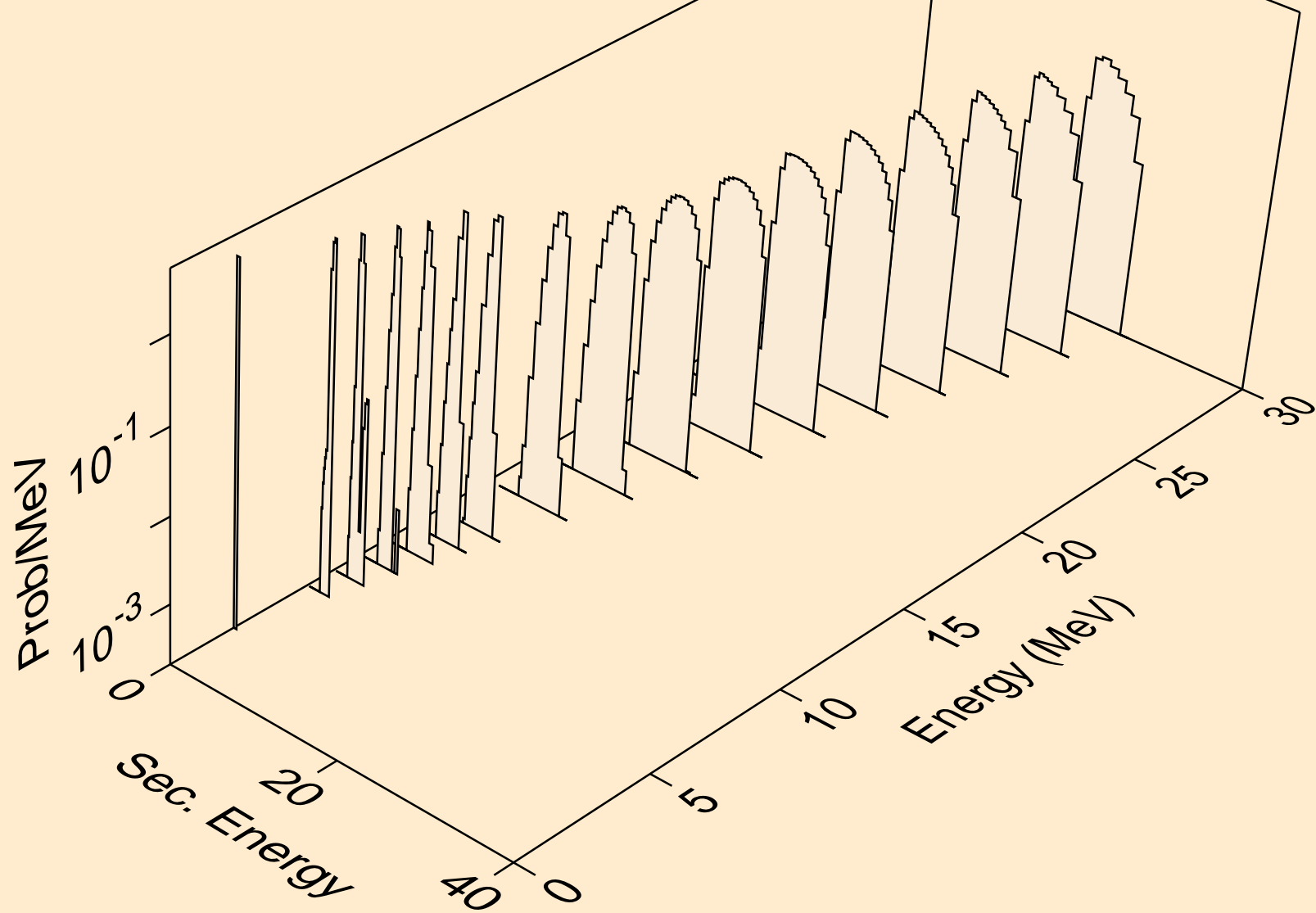

IN127N PROTON ACER TENDL-2021 LIBRARY; T=0.K  
he3s from (p,x)

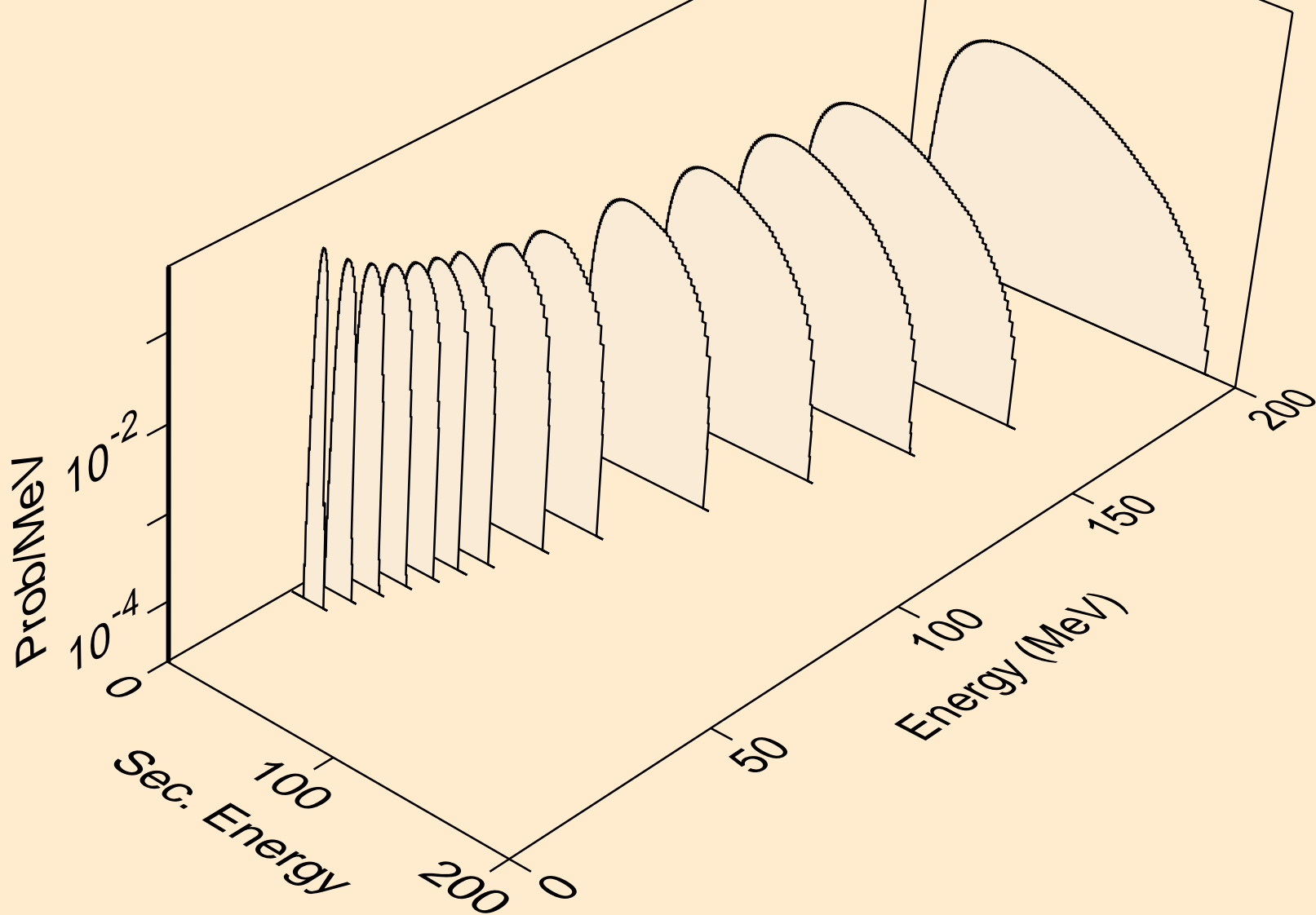

IN127N PROTON ACER TENDL-2021 LIBRARY; T=0.K  
he3s from (p,n\*)he3

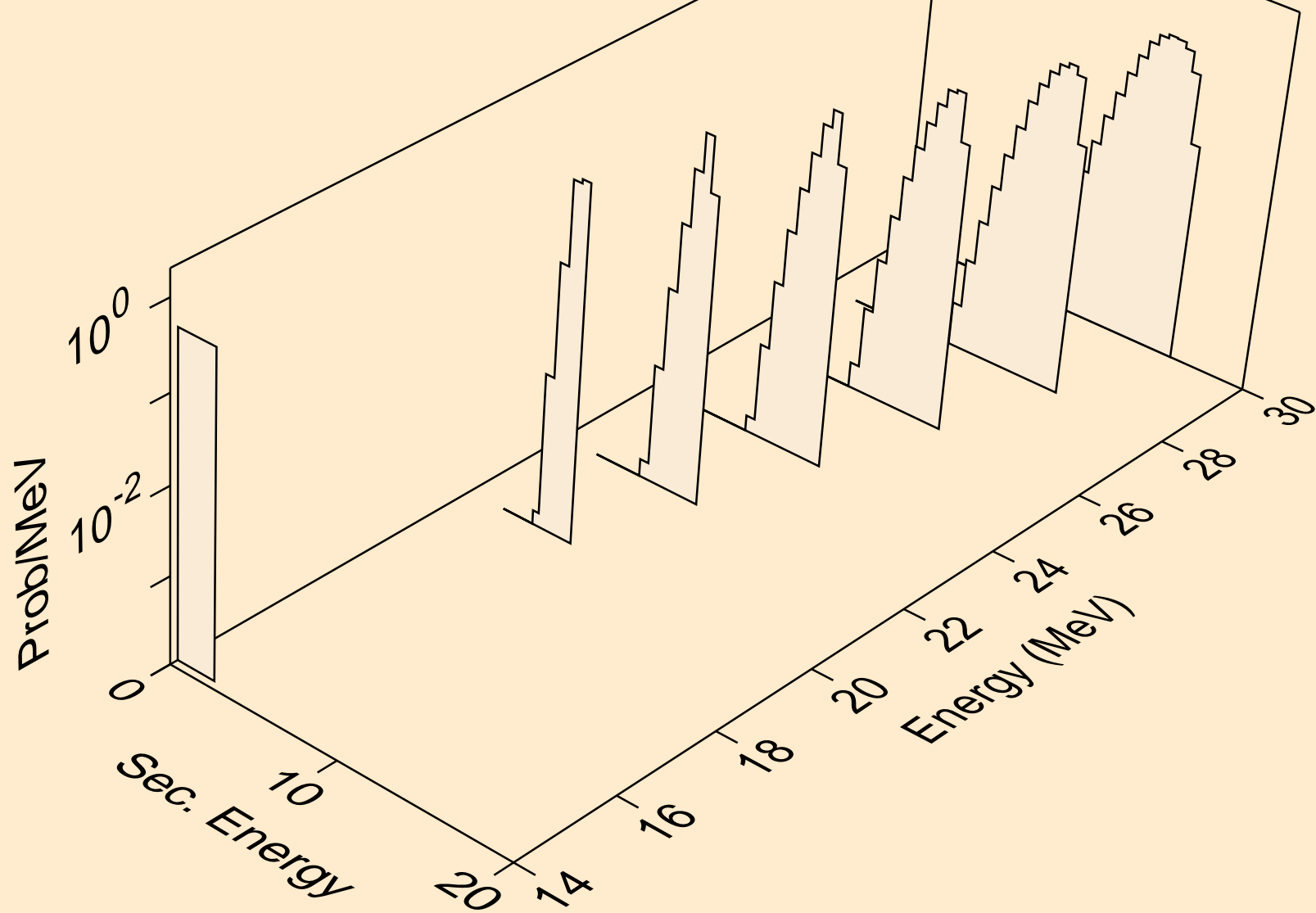

IN127N PROTON ACER TENDL-2021 LIBRARY; T=0.K  
he3s from (p,he3)

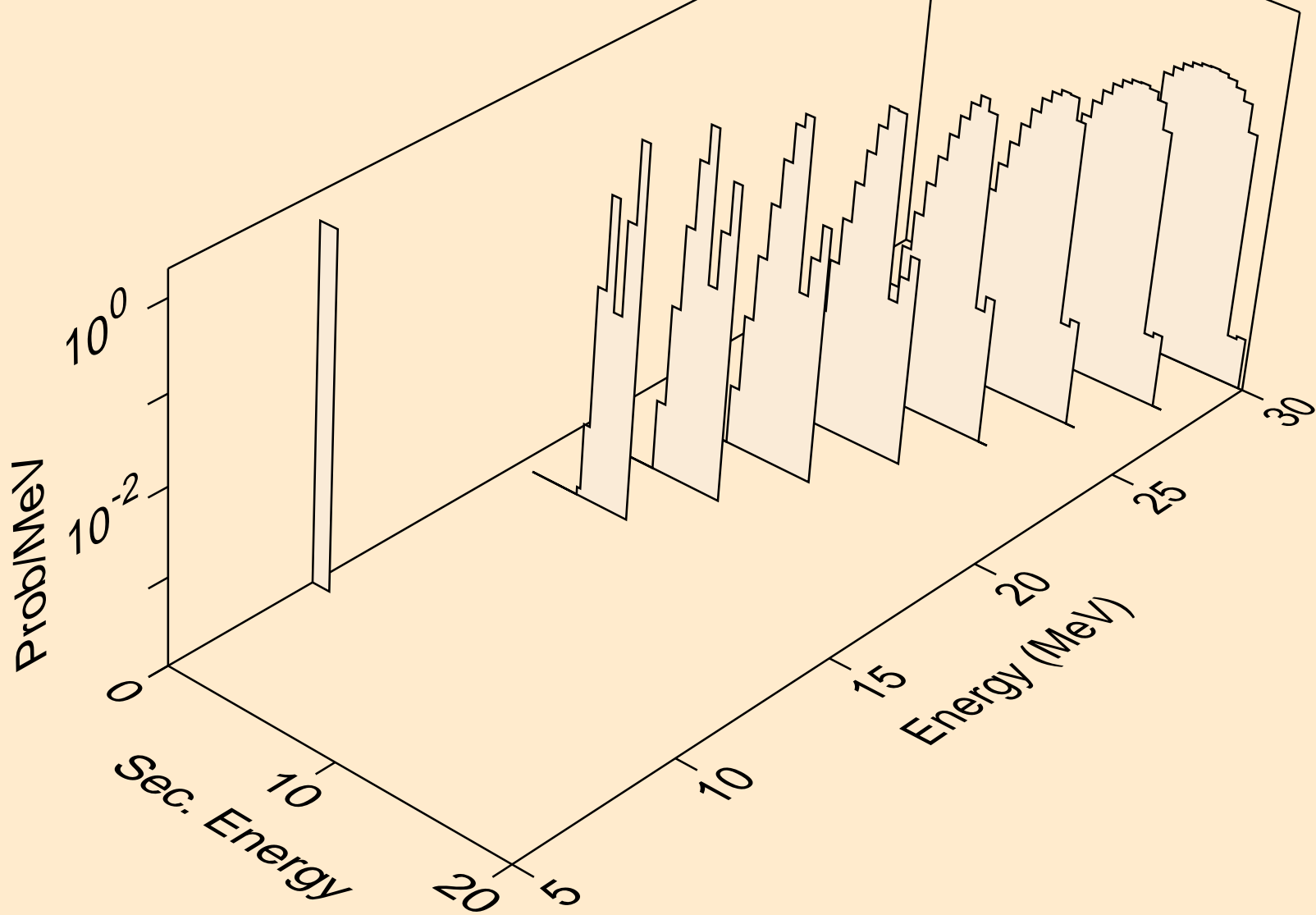



IN127N PROTON ACER TENDL-2021 LIBRARY; T=0.K  
alphas from (p,x)

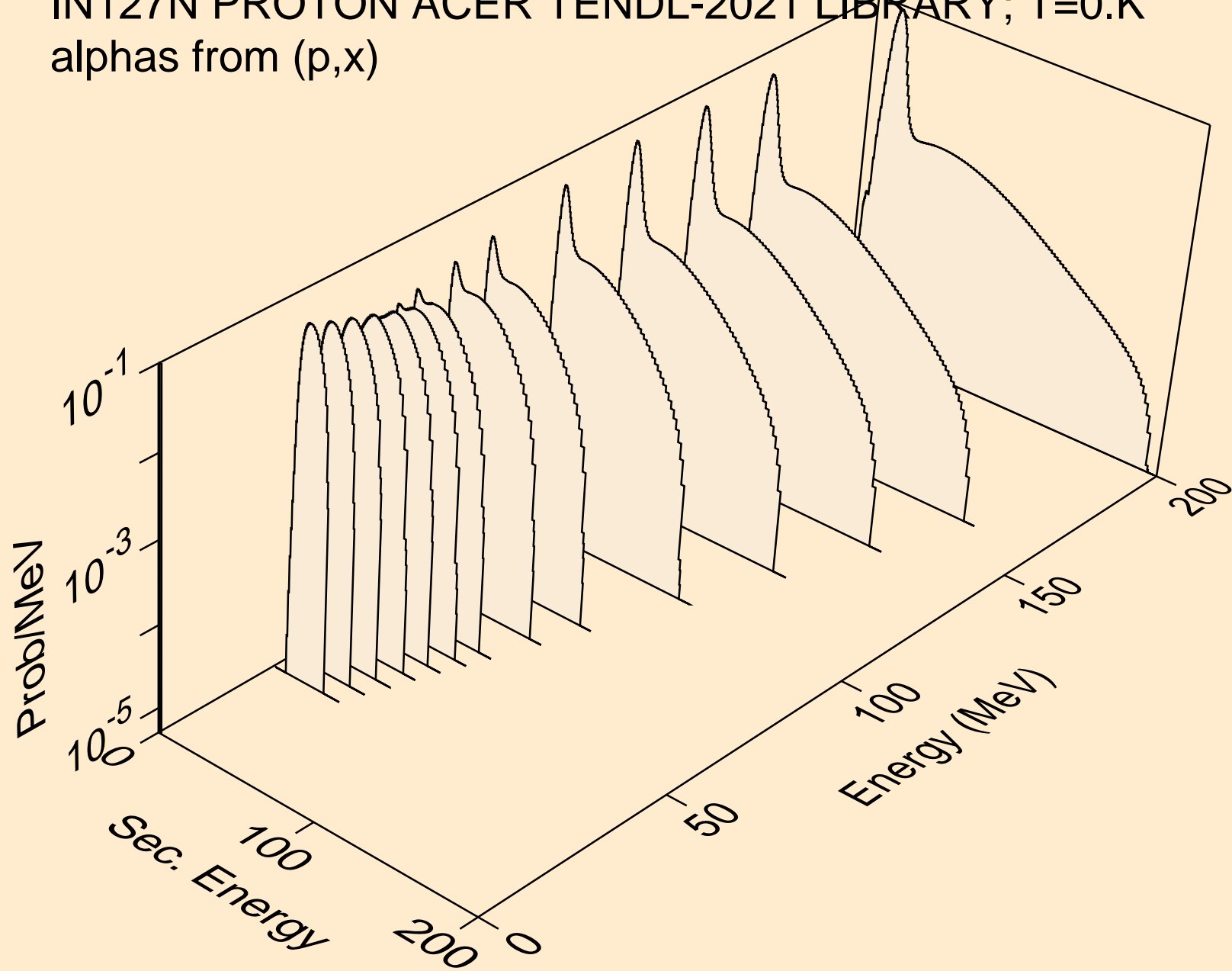

IN127N PROTON ACER TENDL-2021 LIBRARY; T=0.K  
alphas from (p,n\*)a

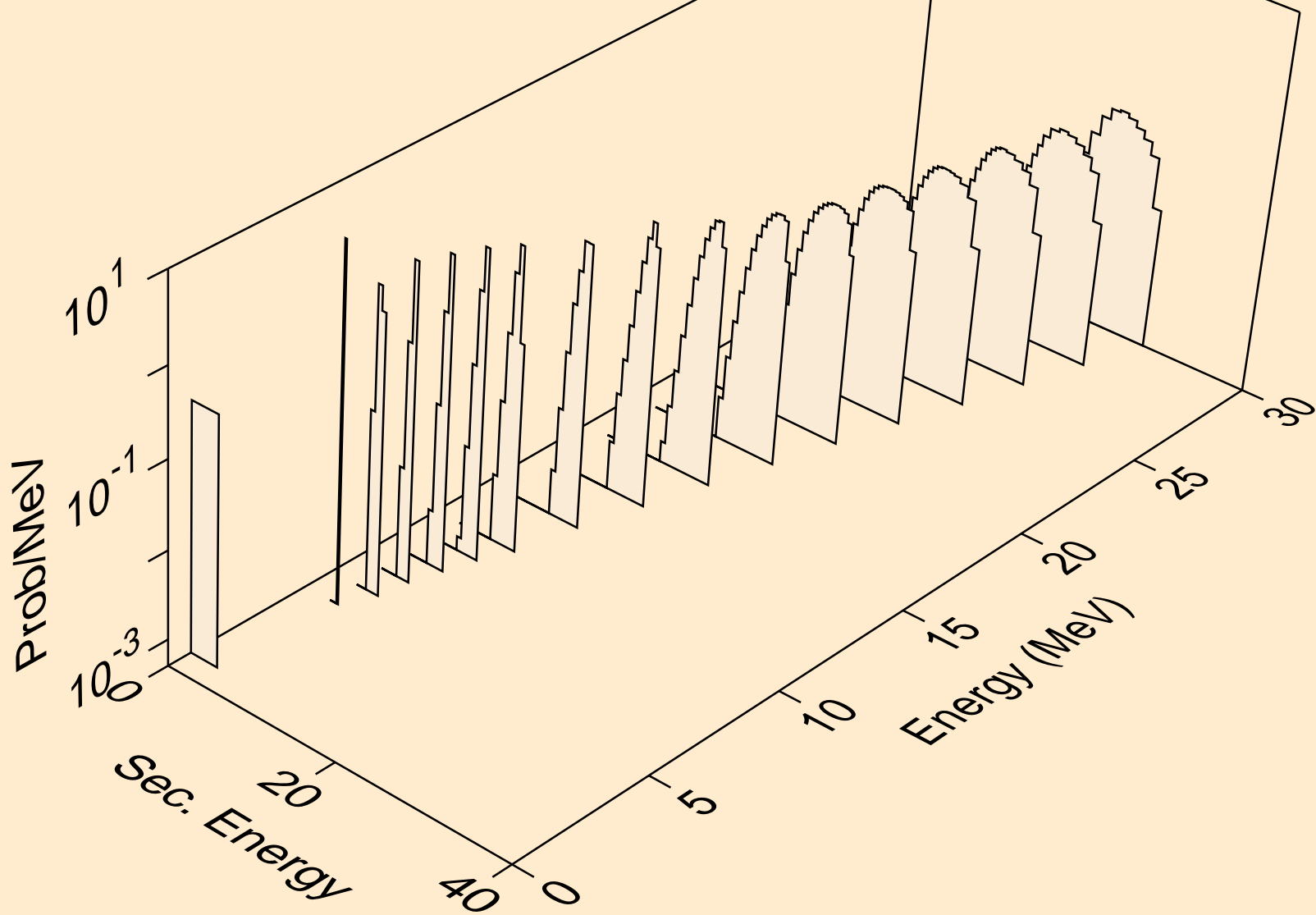

IN127N PROTON ACER TENDL-2021 LIBRARY; T=0.K  
alphas from (p,2n)a

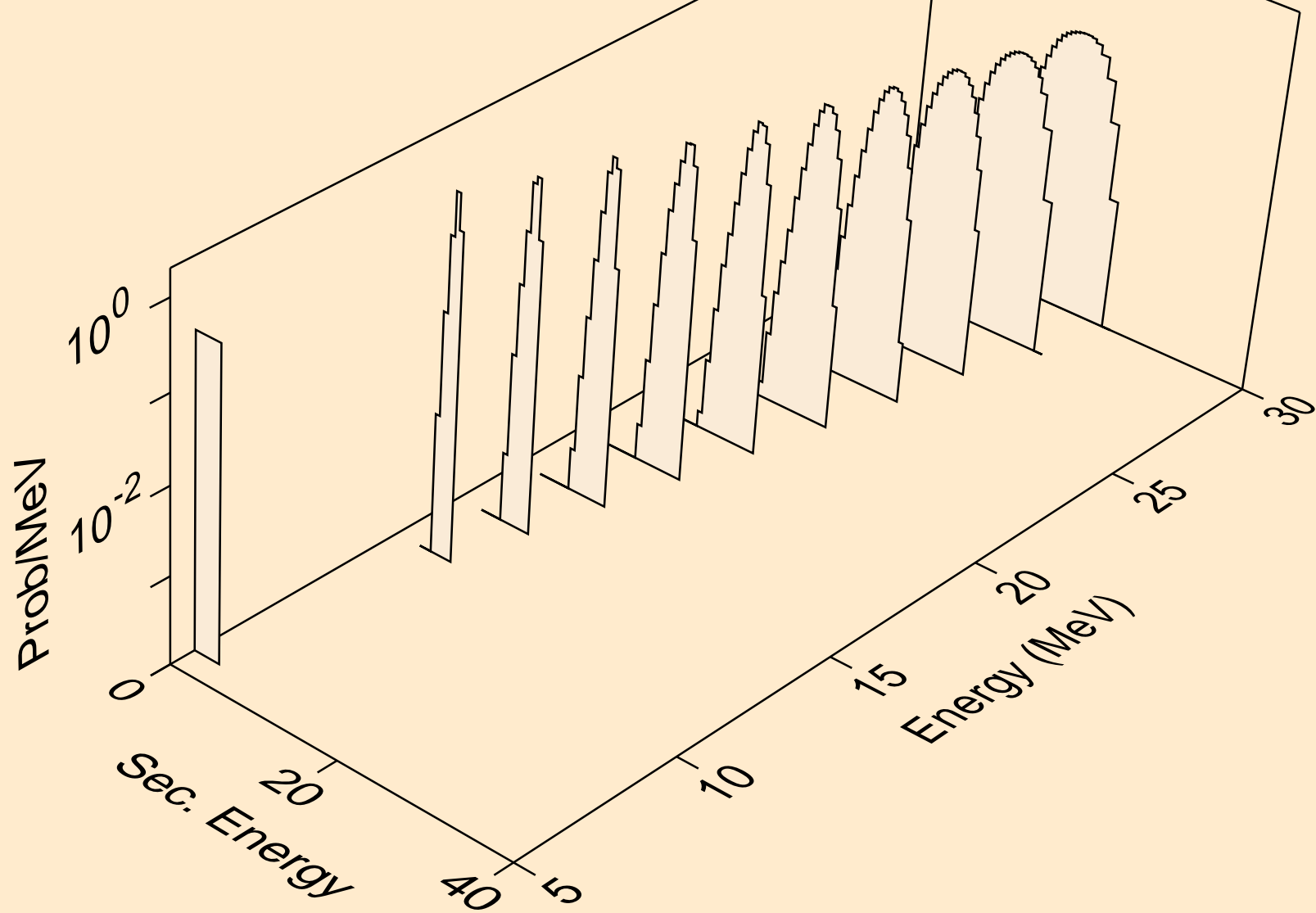

IN127N PROTON ACER TENDL-2021 LIBRARY; T=0.K  
alphas from (p,3n)a

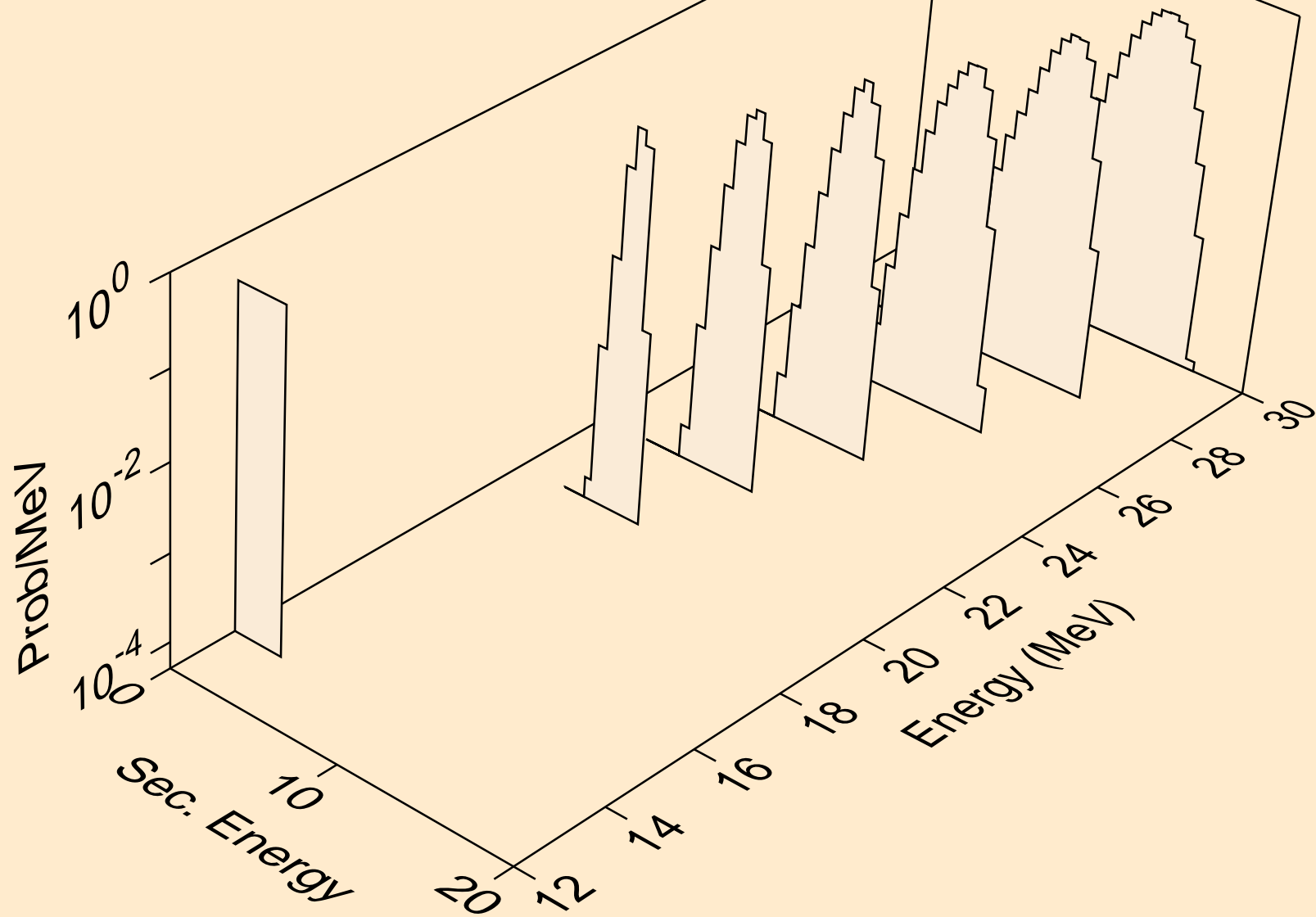

IN127N PROTON ACER TENDL-2021 LIBRARY; T=0.K  
alphas from (p,a)

