

KR087 PROTON ACER TENDL-2021 LIBRARY; T=0.K
Principal cross sections

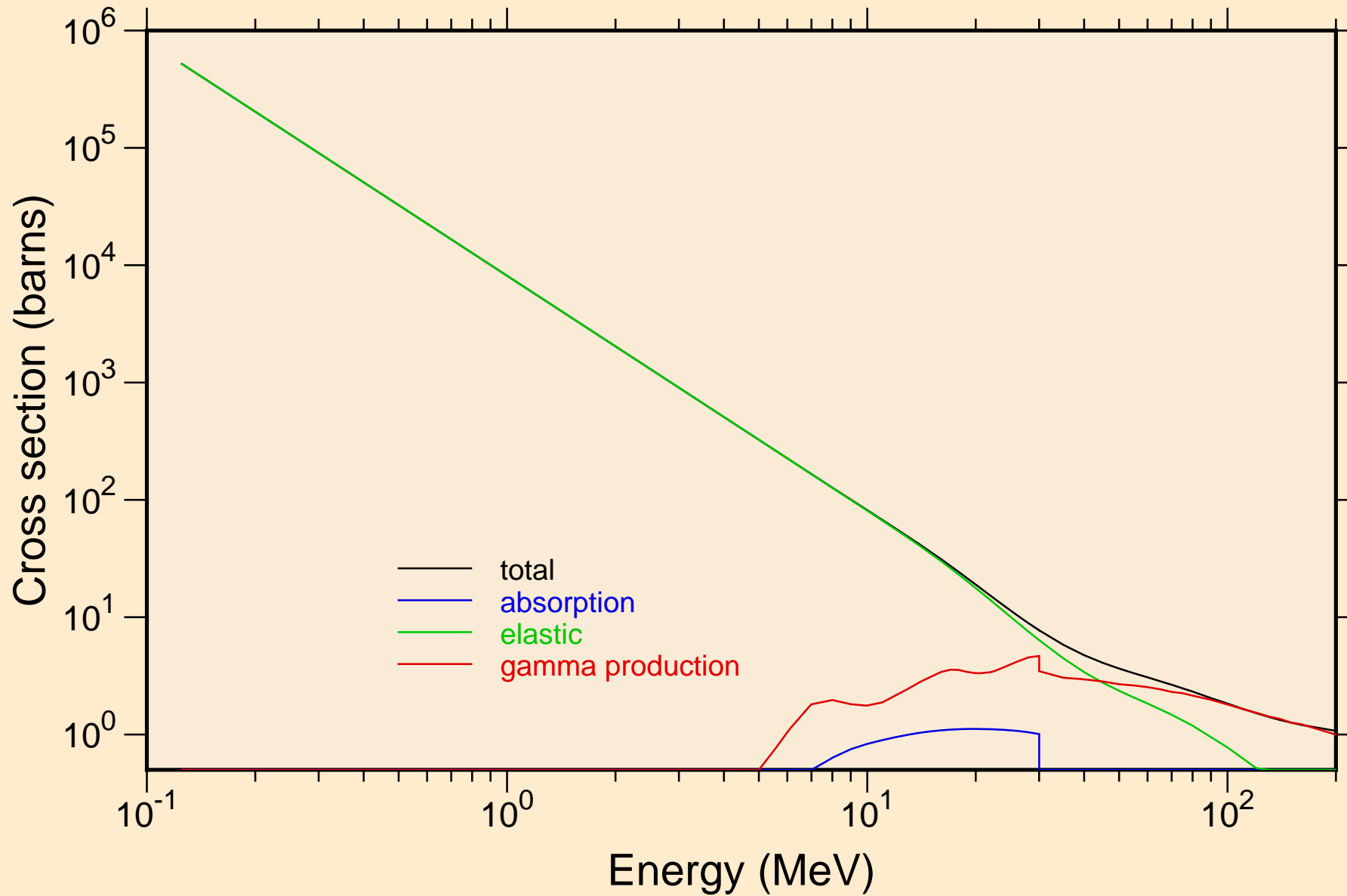

KR087 PROTON ACER TENDL-2021 LIBRARY; T=0.K

Heating

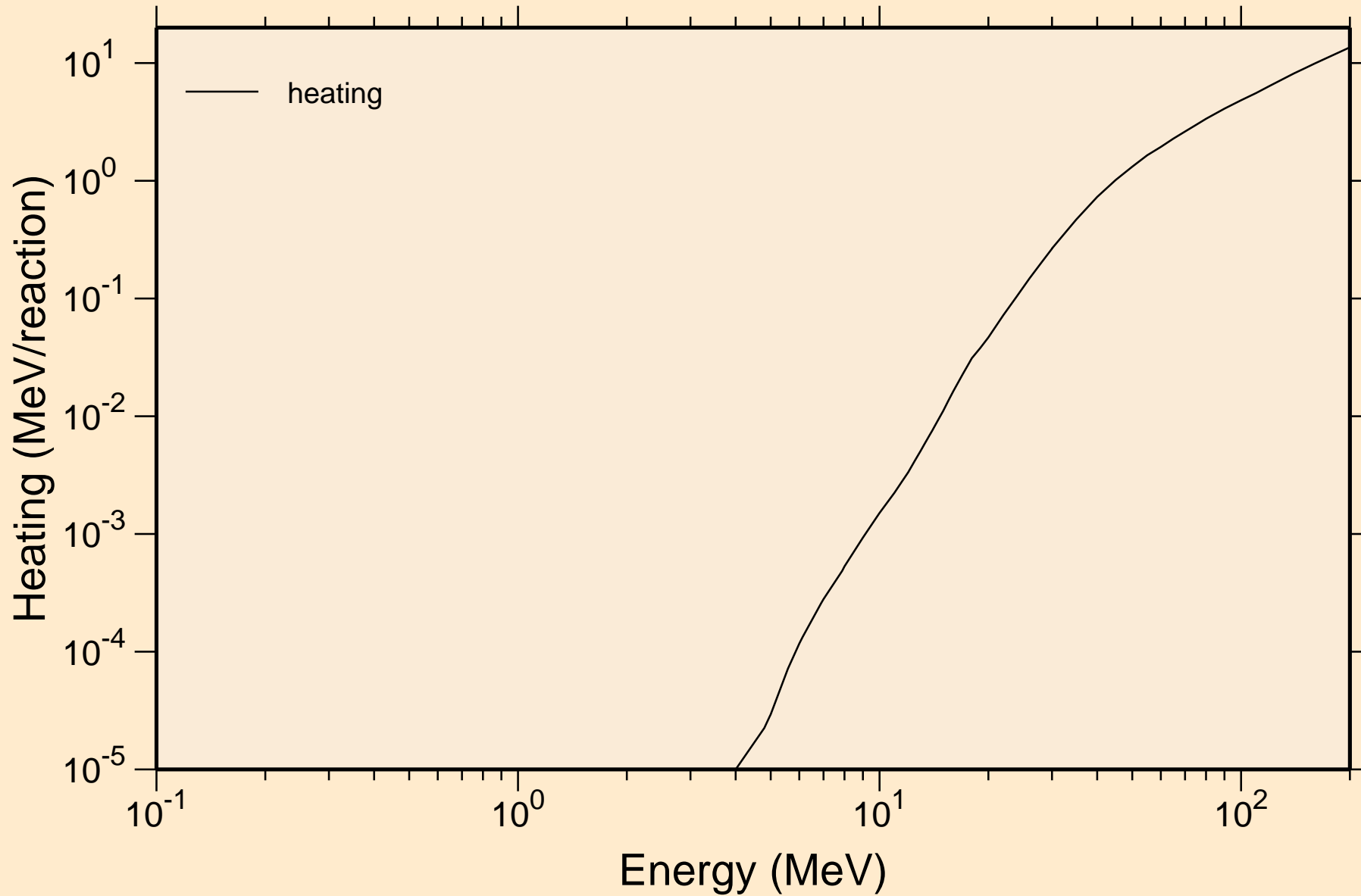

KR087 PROTON ACER TENDL-2021 LIBRARY; T=0.K

Principal cross sections

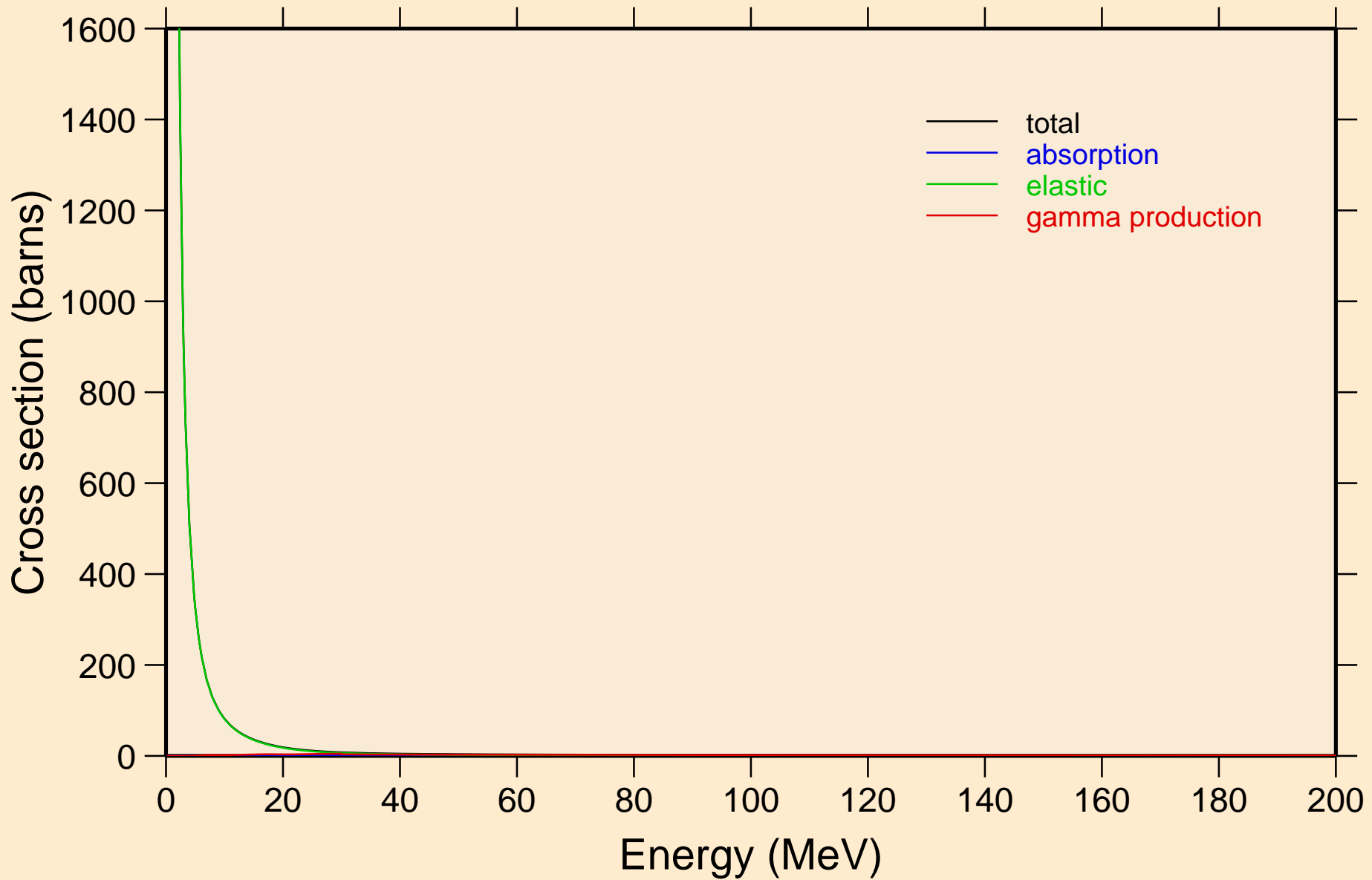

KR087 PROTON ACER TENDL-2021 LIBRARY; T=0.K

Heating

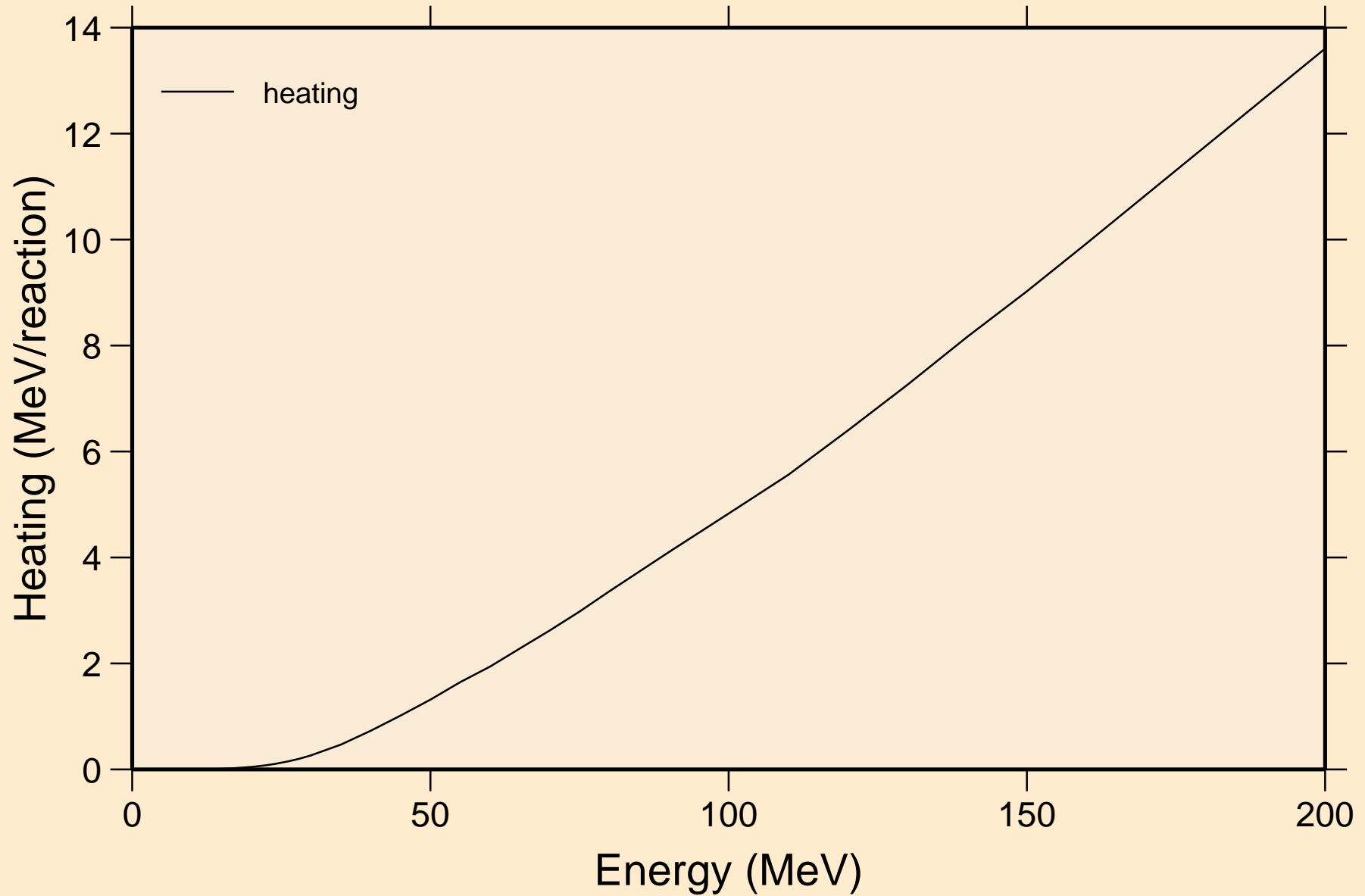

KR087 PROTON ACER TENDL-2021 LIBRARY; T=0.K

Threshold reactions

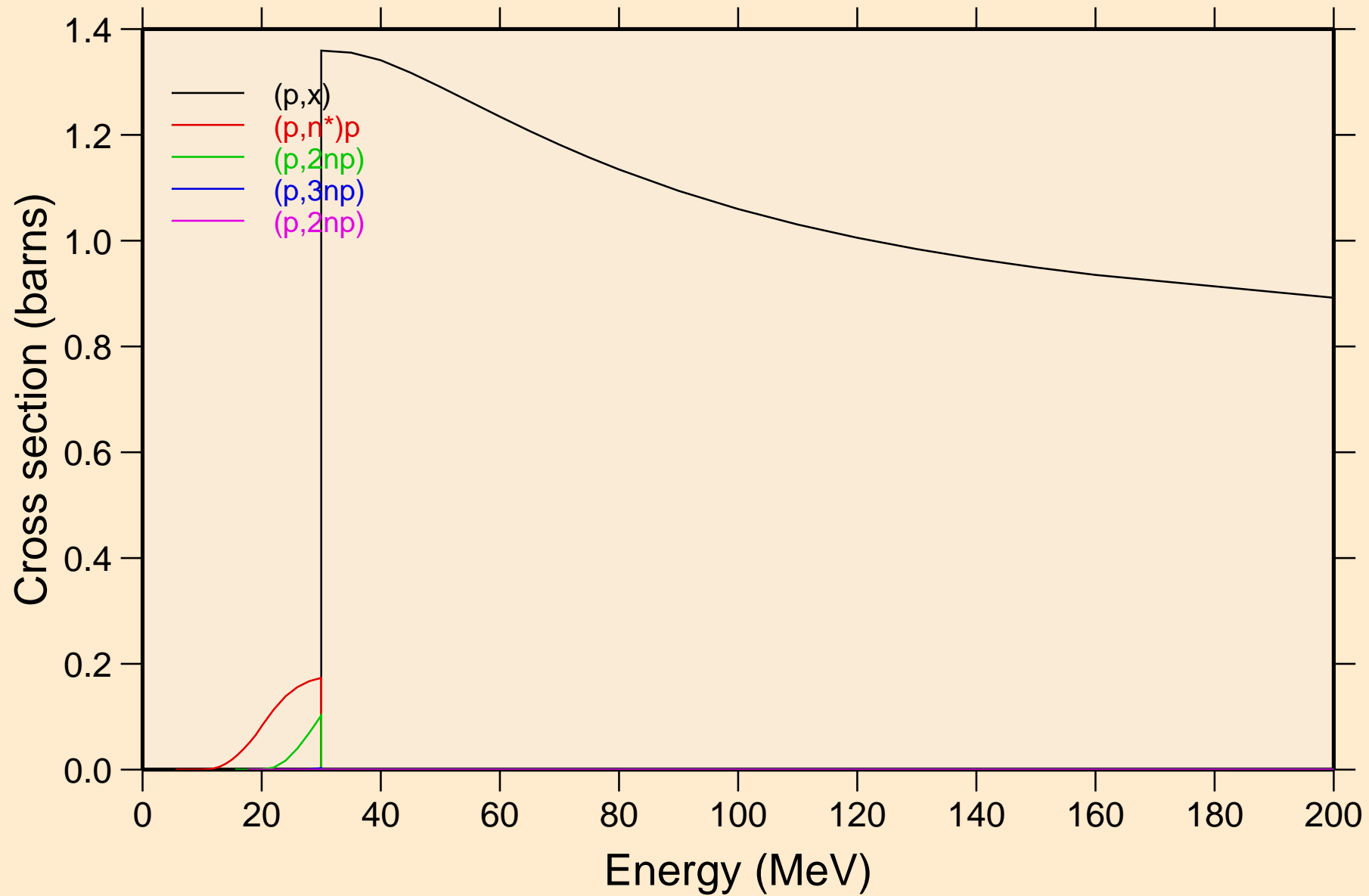

KR087 PROTON ACER TENDL-2021 LIBRARY; T=0.K
Threshold reactions

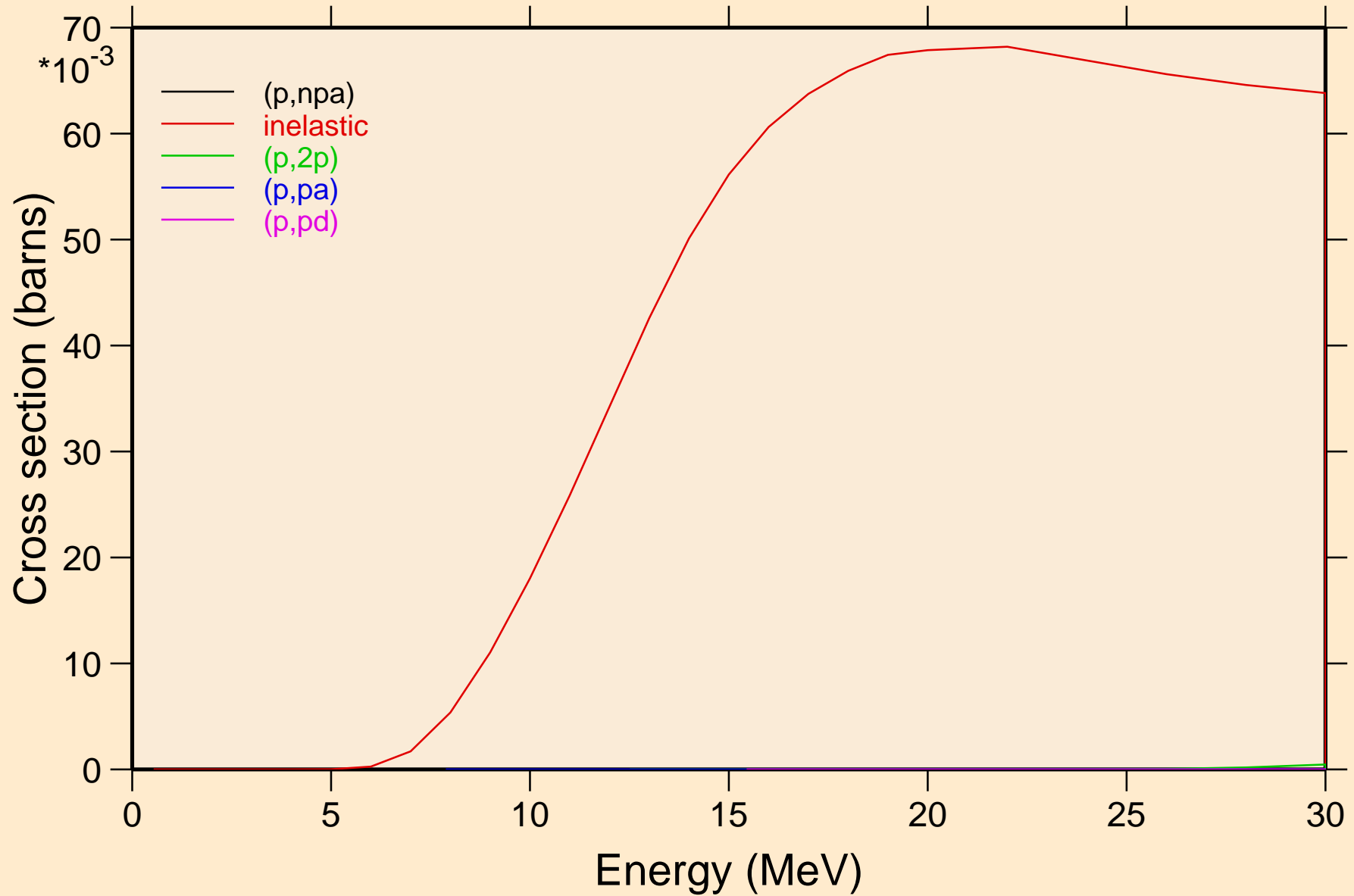

KR087 PROTON ACER TENDL-2021 LIBRARY; T=0.K
Threshold reactions

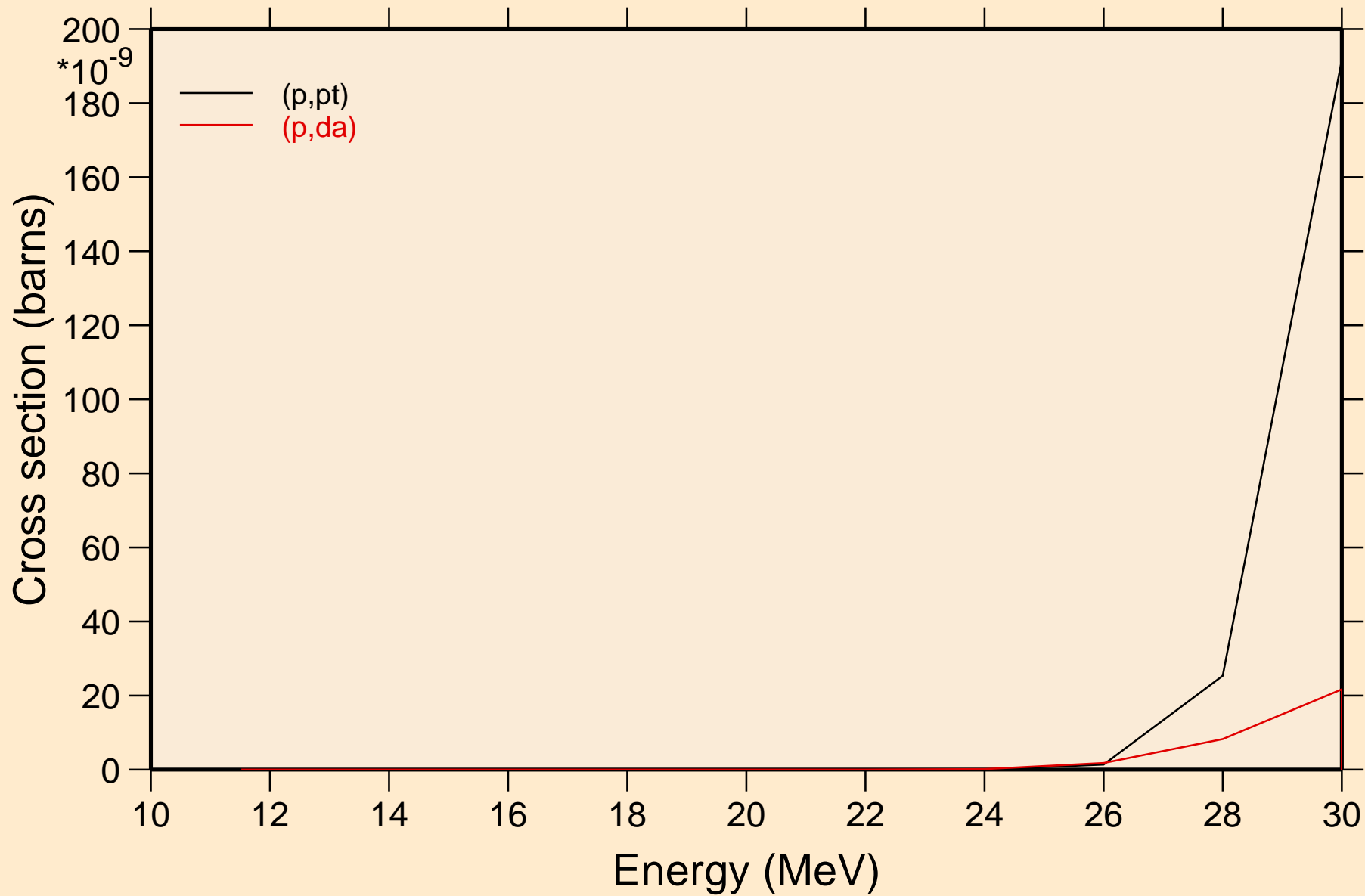

KR087 PROTON ACER TENDL-2021 LIBRARY; T=0.K
angular distribution for elastic

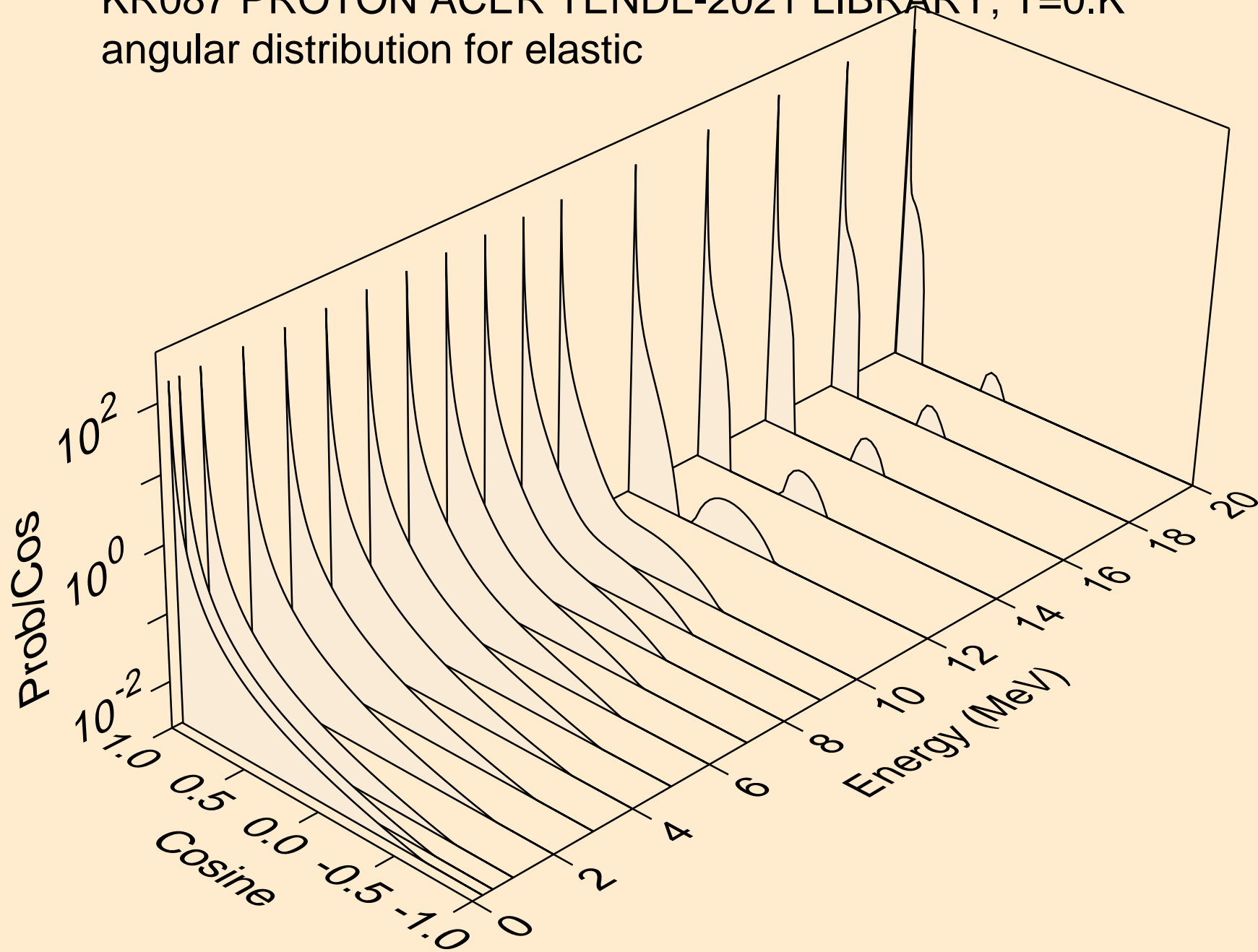

KR087 PROTON ACER TENDL-2021 LIBRARY; T=0.K
angular distribution for elastic

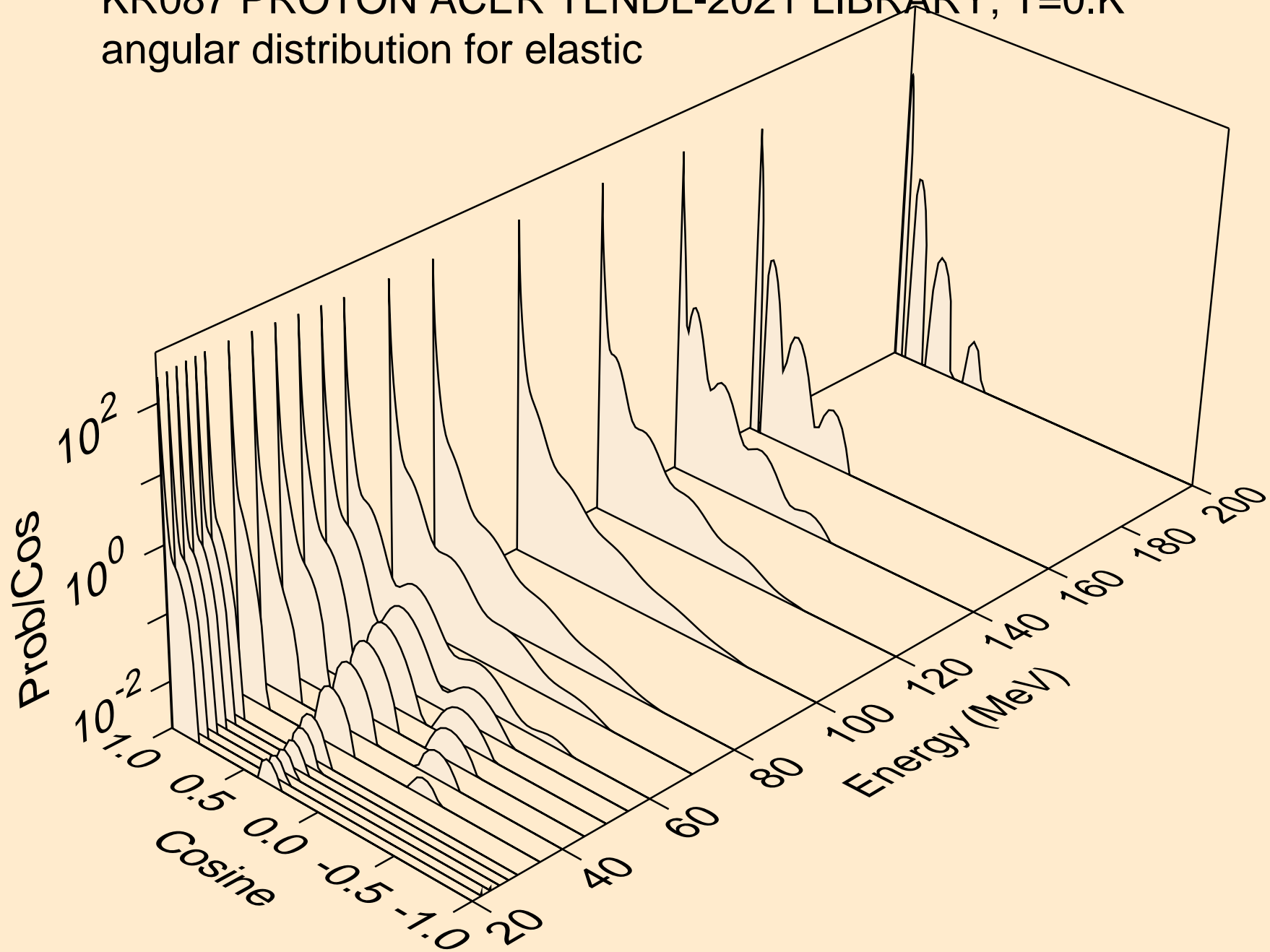

KR087 PROTON ACER TENDL-2021 LIBRARY; T=0.K
Proton emission for (p,x)

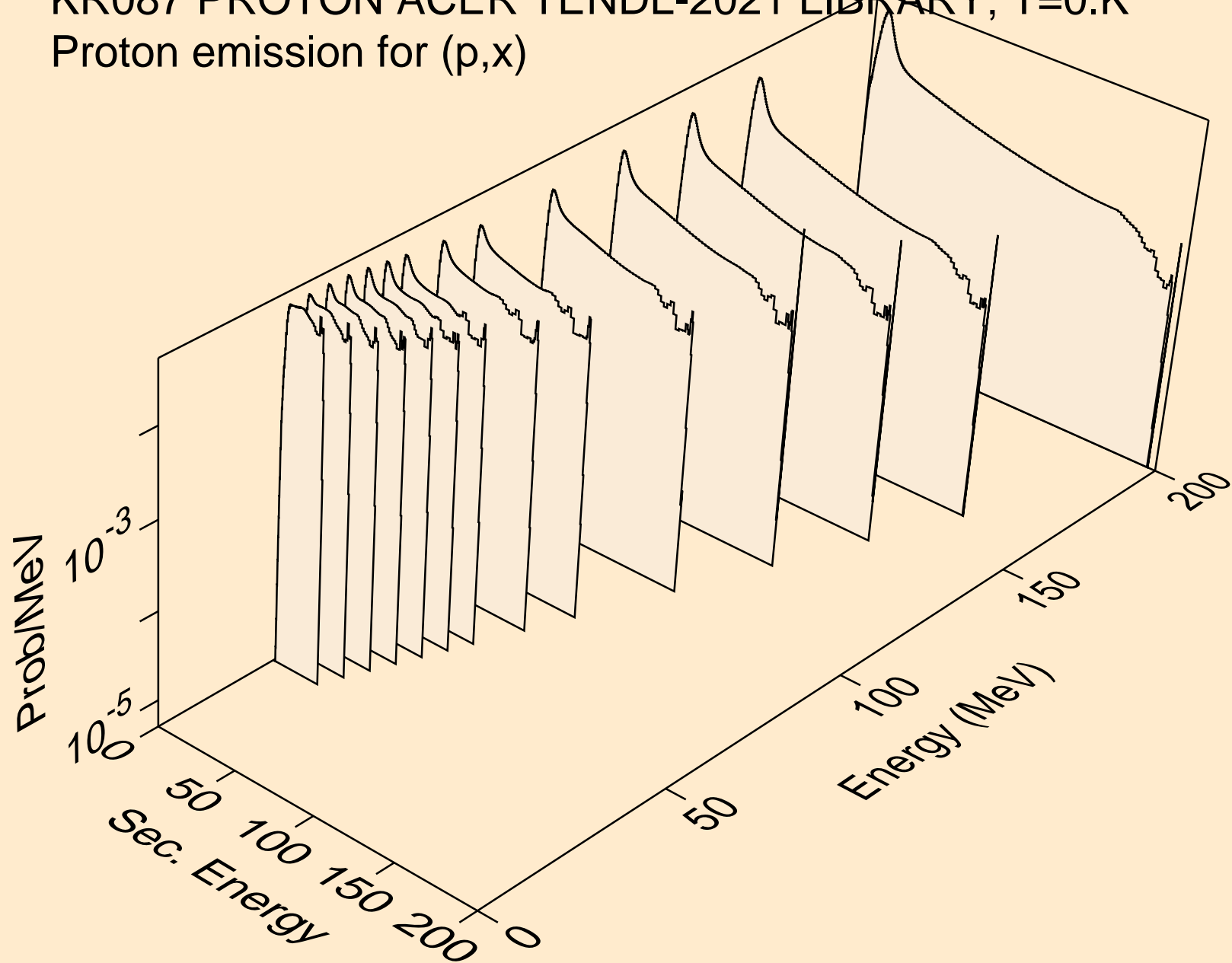

KR087 PROTON ACER TENDL-2021 LIBRARY; T=0.K
Proton emission for (p,n*)p

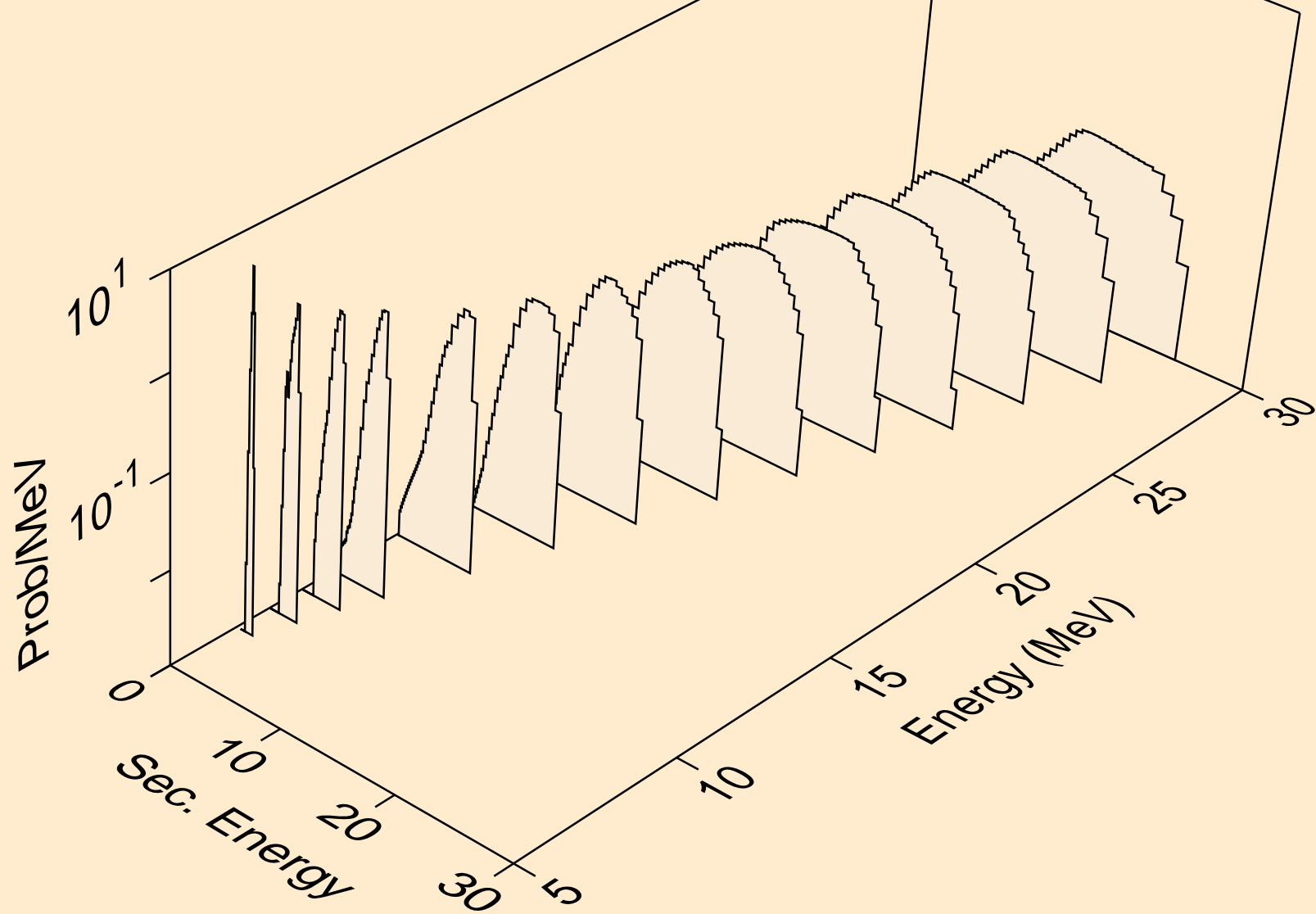

KR087 PROTON ACER TENDL-2021 LIBRARY; T=0.K
Proton emission for (p,2np)

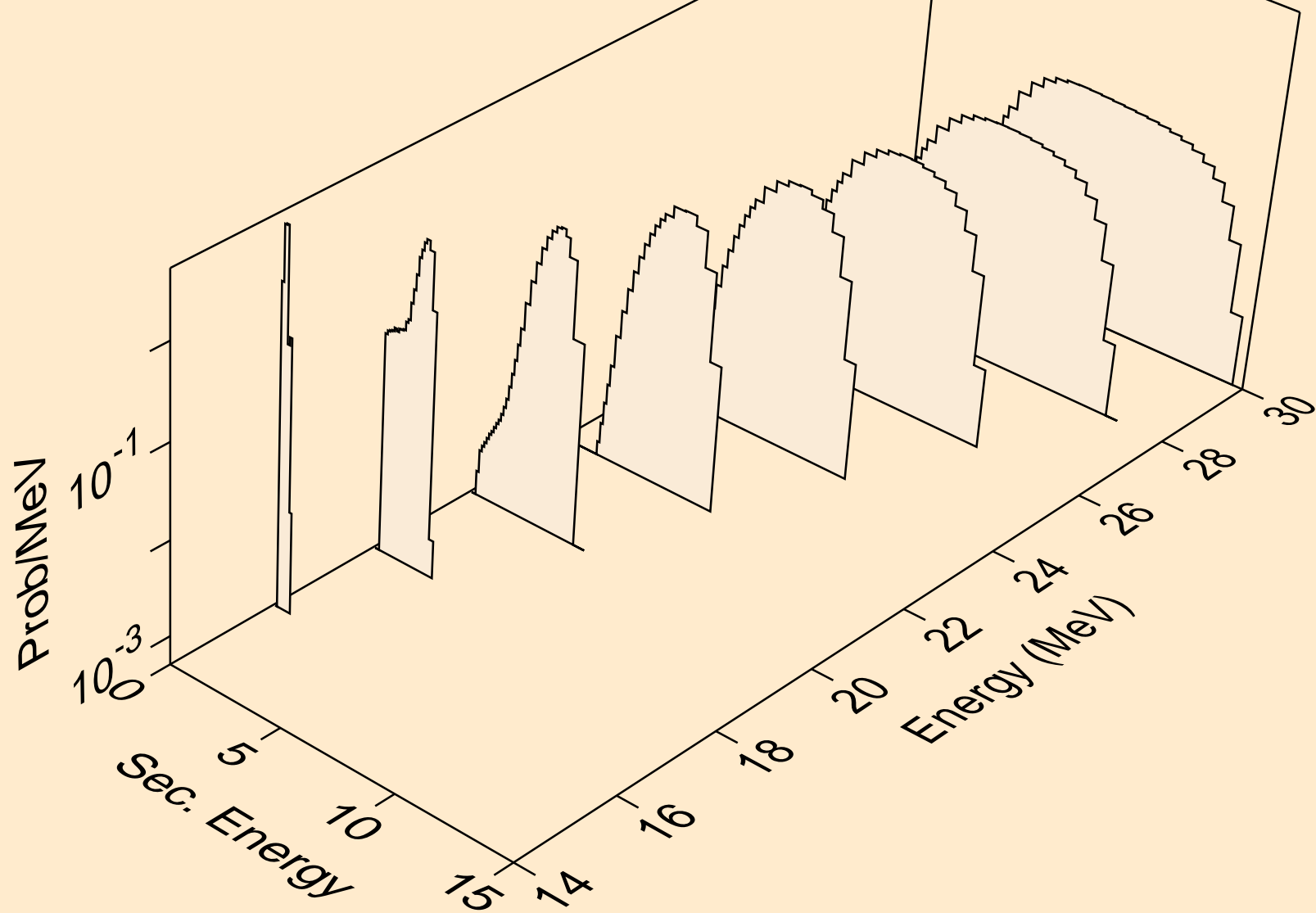

KR087 PROTON ACER TENDL-2021 LIBRARY; T=0.K
Proton emission for (p,3np)

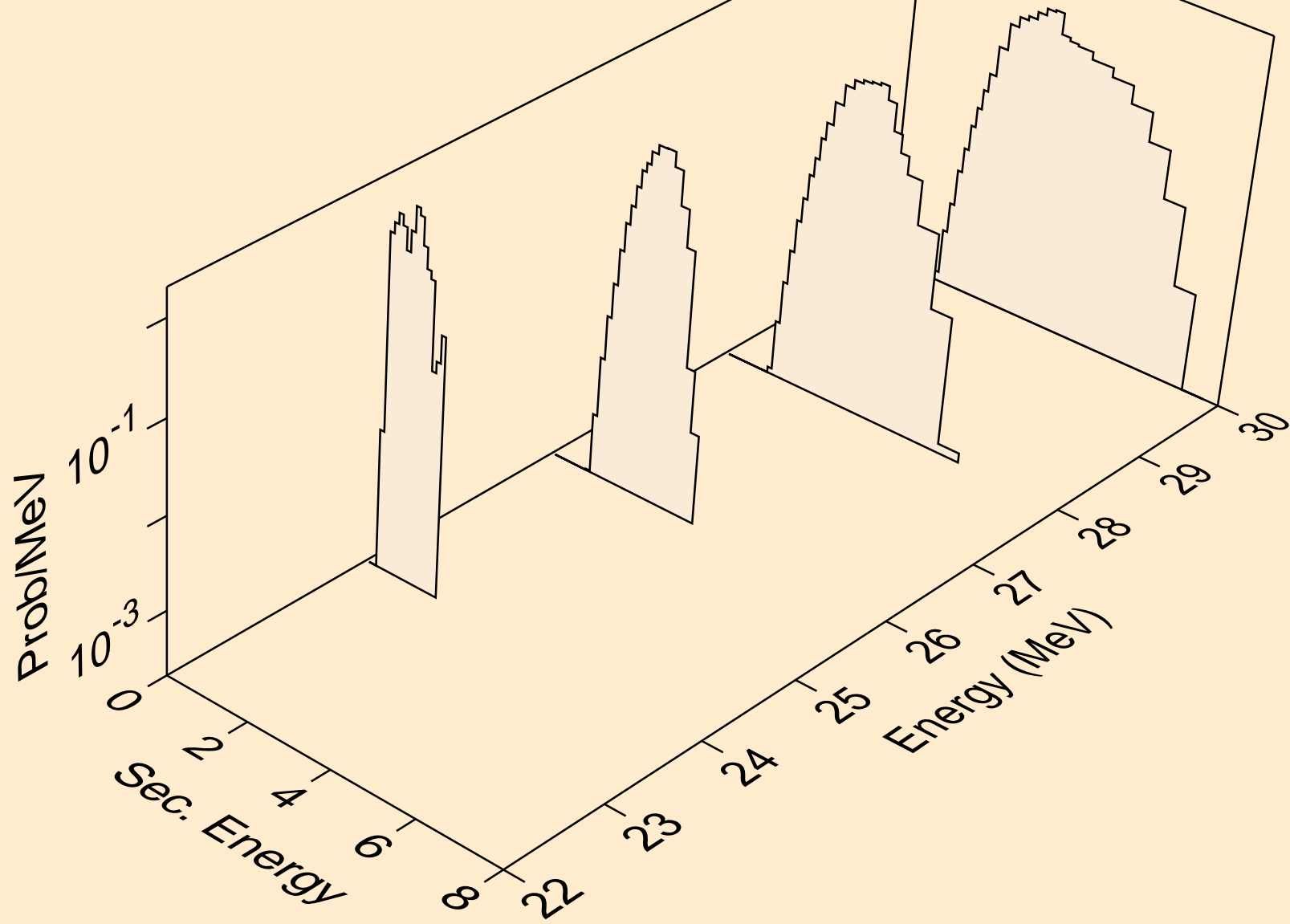

KR087 PROTON ACER TENDL-2021 LIBRARY; T=0.K
Proton emission for (p,2np)

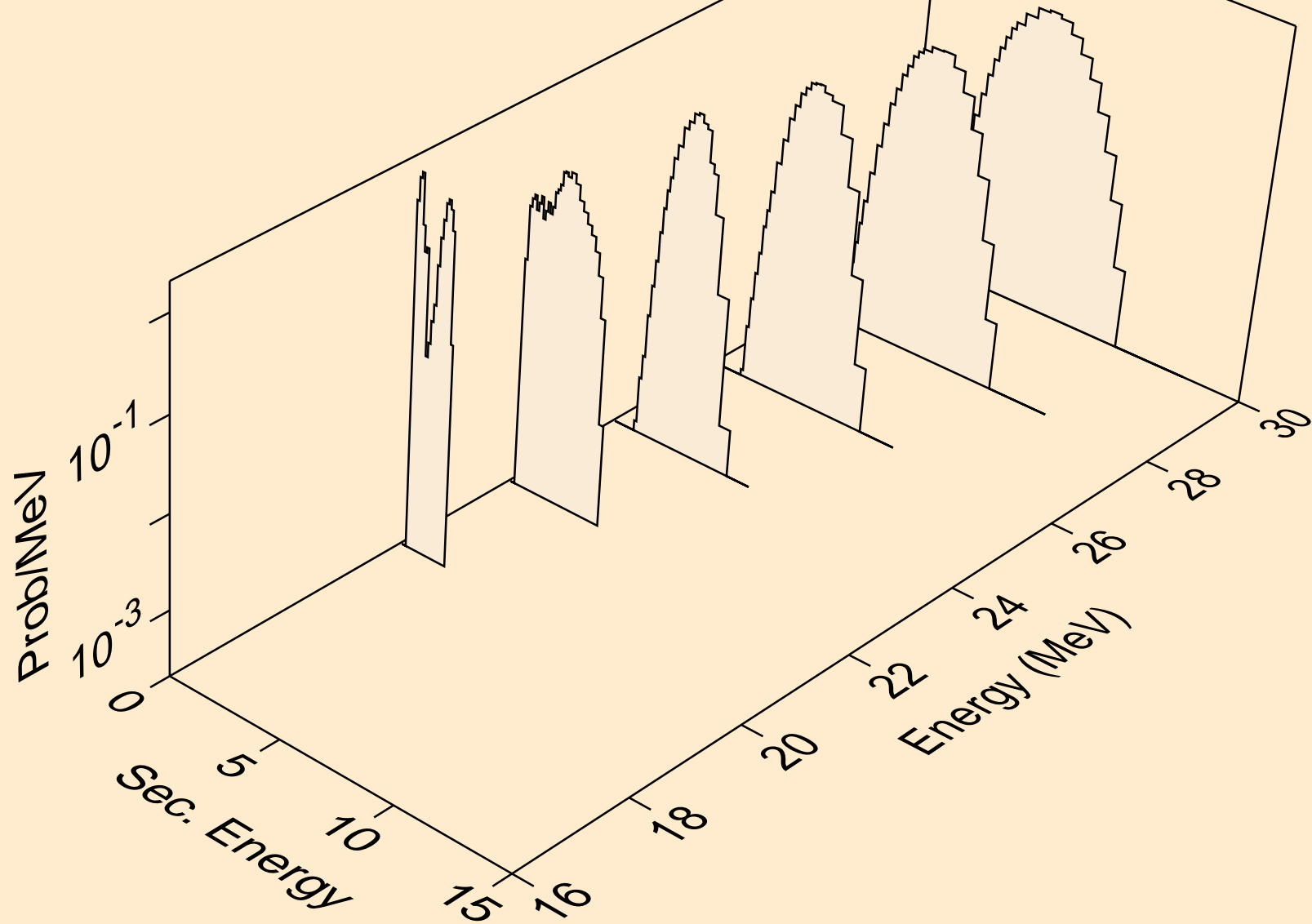

KR087 PROTON ACER TENDL-2021 LIBRARY; T=0.K
Proton emission for (p,npa)

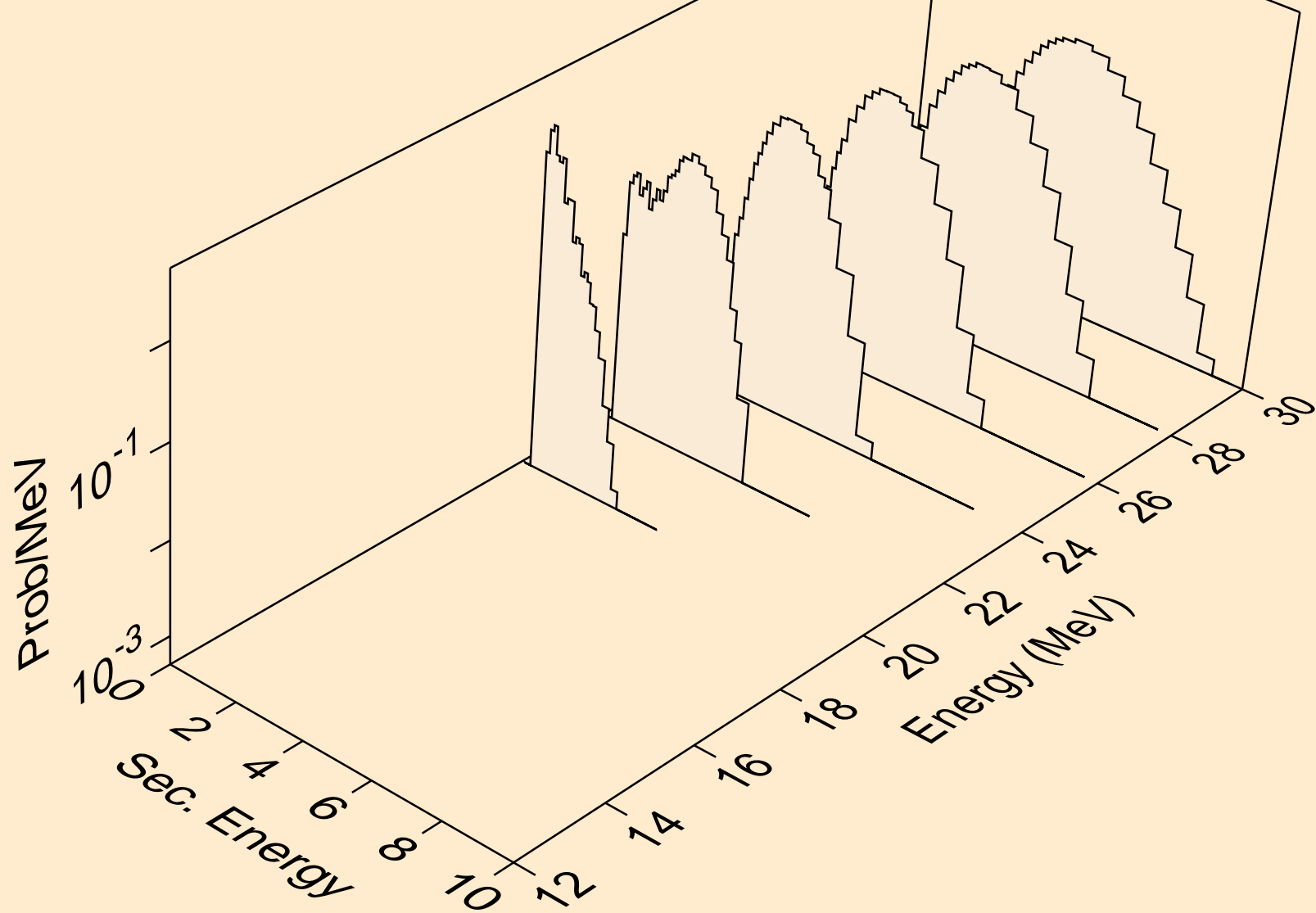

KR087 PROTON ACER TENDL-2021 LIBRARY; T=0.K
Proton emission for inelastic

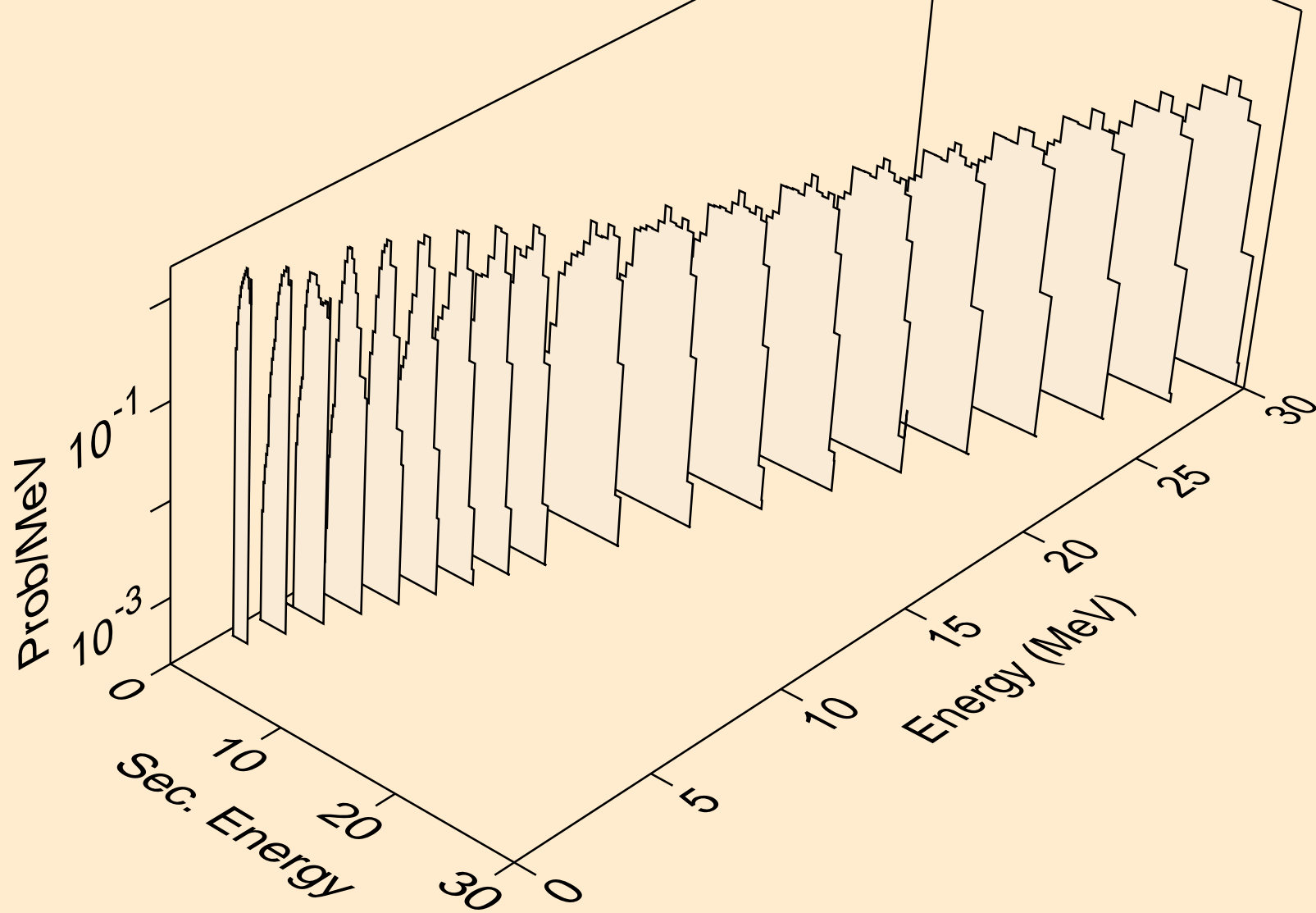

KR087 PROTON ACER TENDL-2021 LIBRARY; T=0.K
Proton emission for (p,2p)

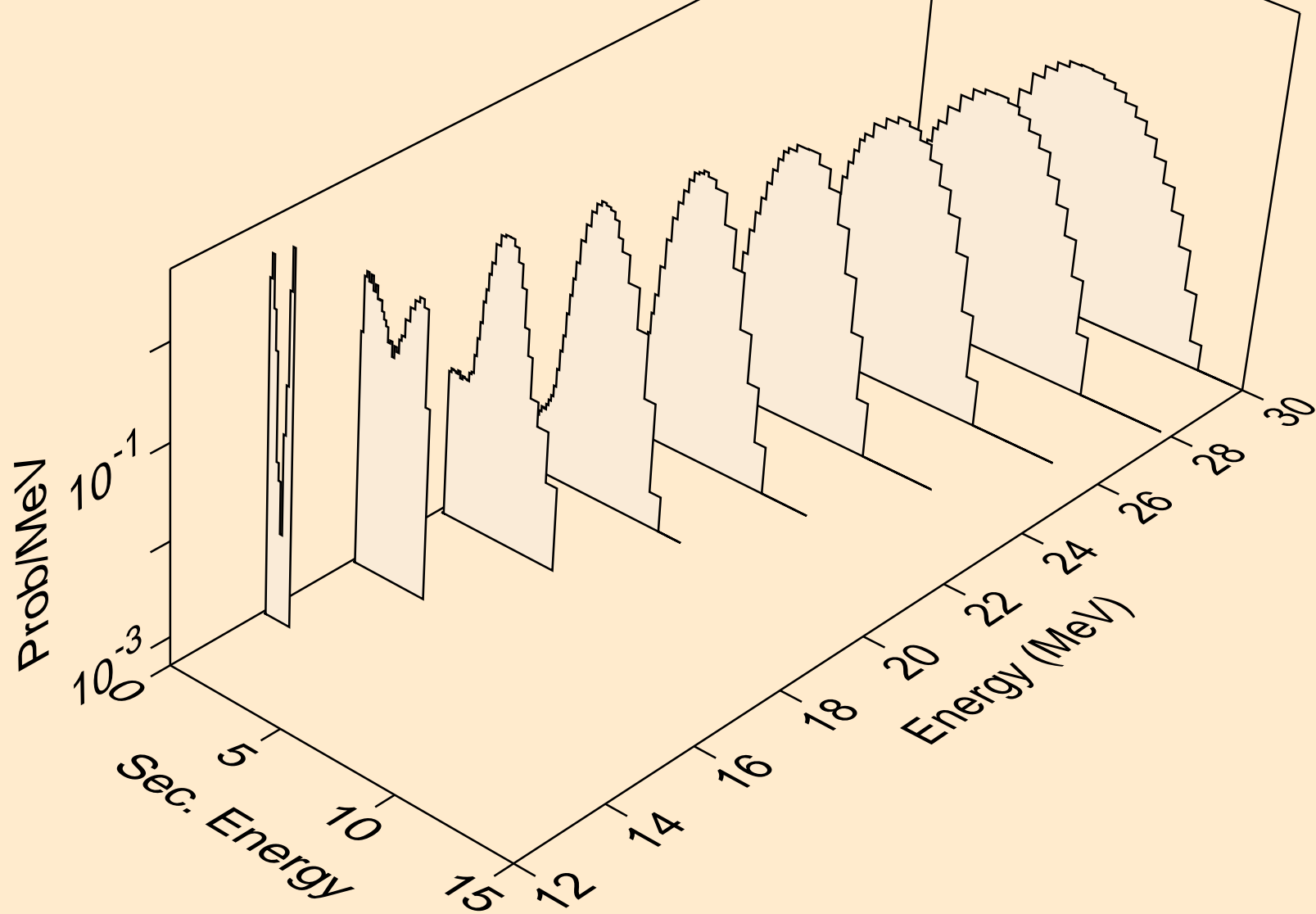

KR087 PROTON ACER TENDL-2021 LIBRARY; T=0.K
Proton emission for (p,pa)

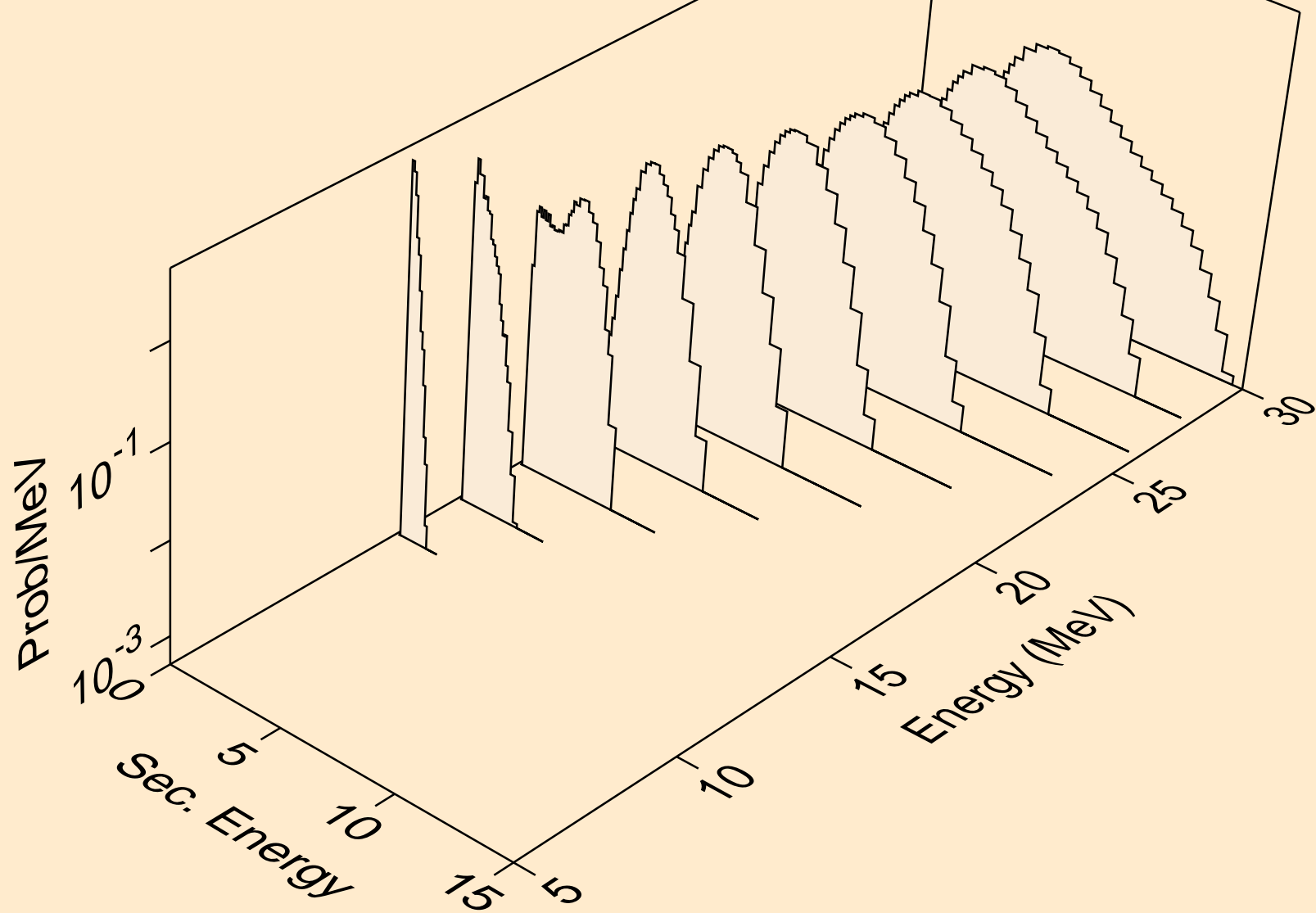

KR087 PROTON ACER TENDL-2021 LIBRARY; T=0.K
Proton emission for (p,pd)

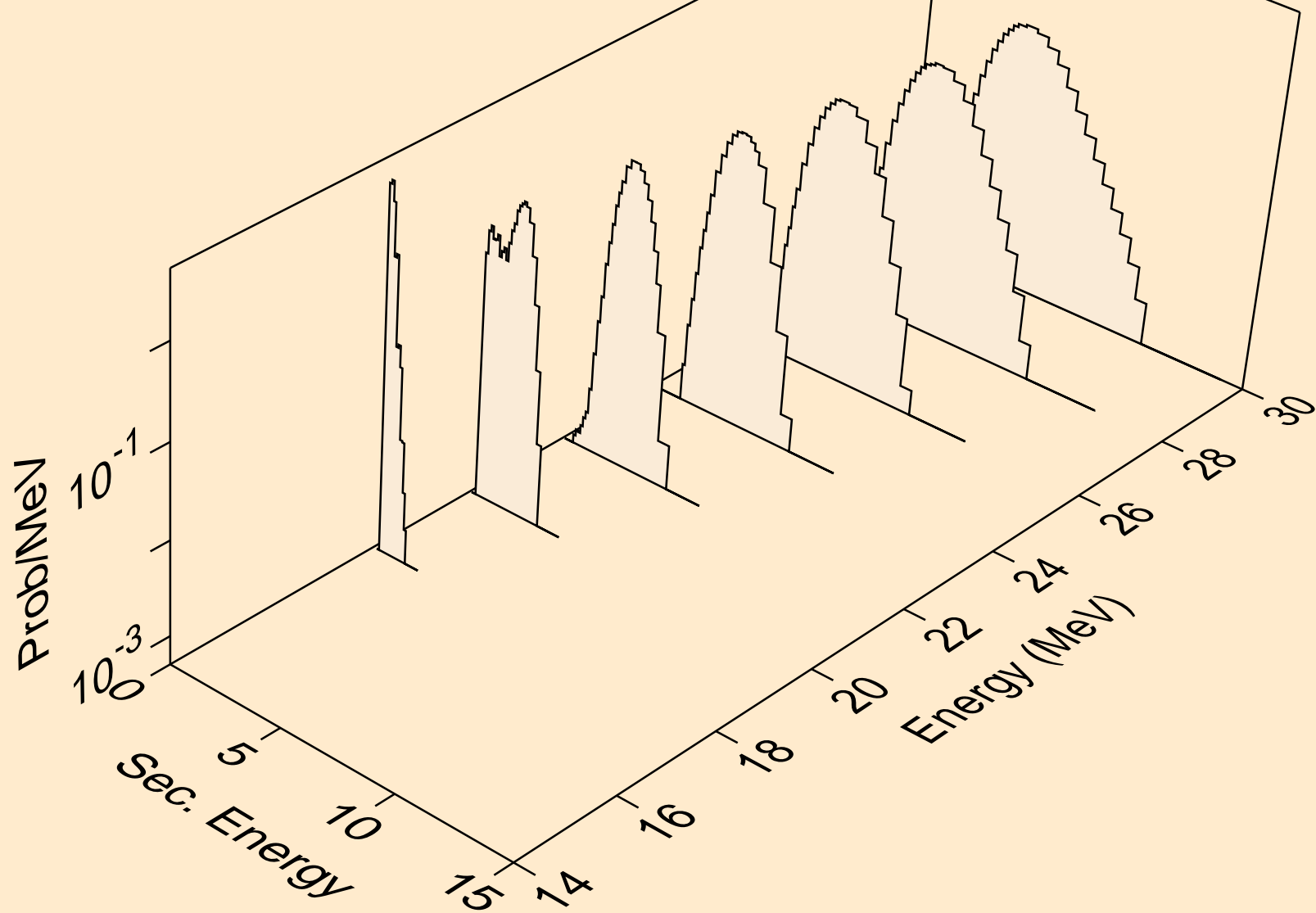

KR087 PROTON ACER TENDL-2021 LIBRARY; T=0.K
Proton emission for (p,pt)

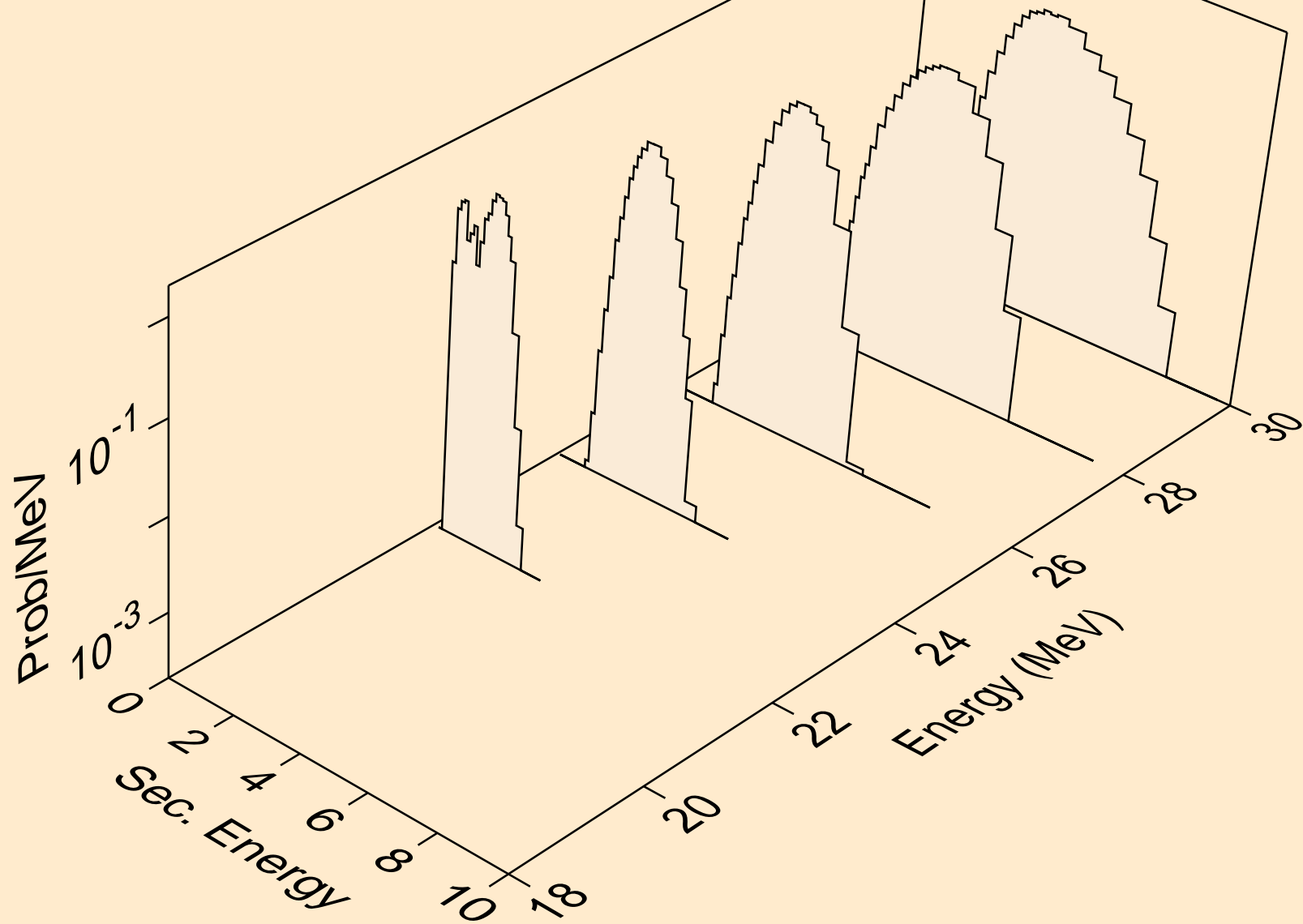

KR087 PROTON ACER TENDL-2021 LIBRARY; T=0.K
Photon emission for (z,n)

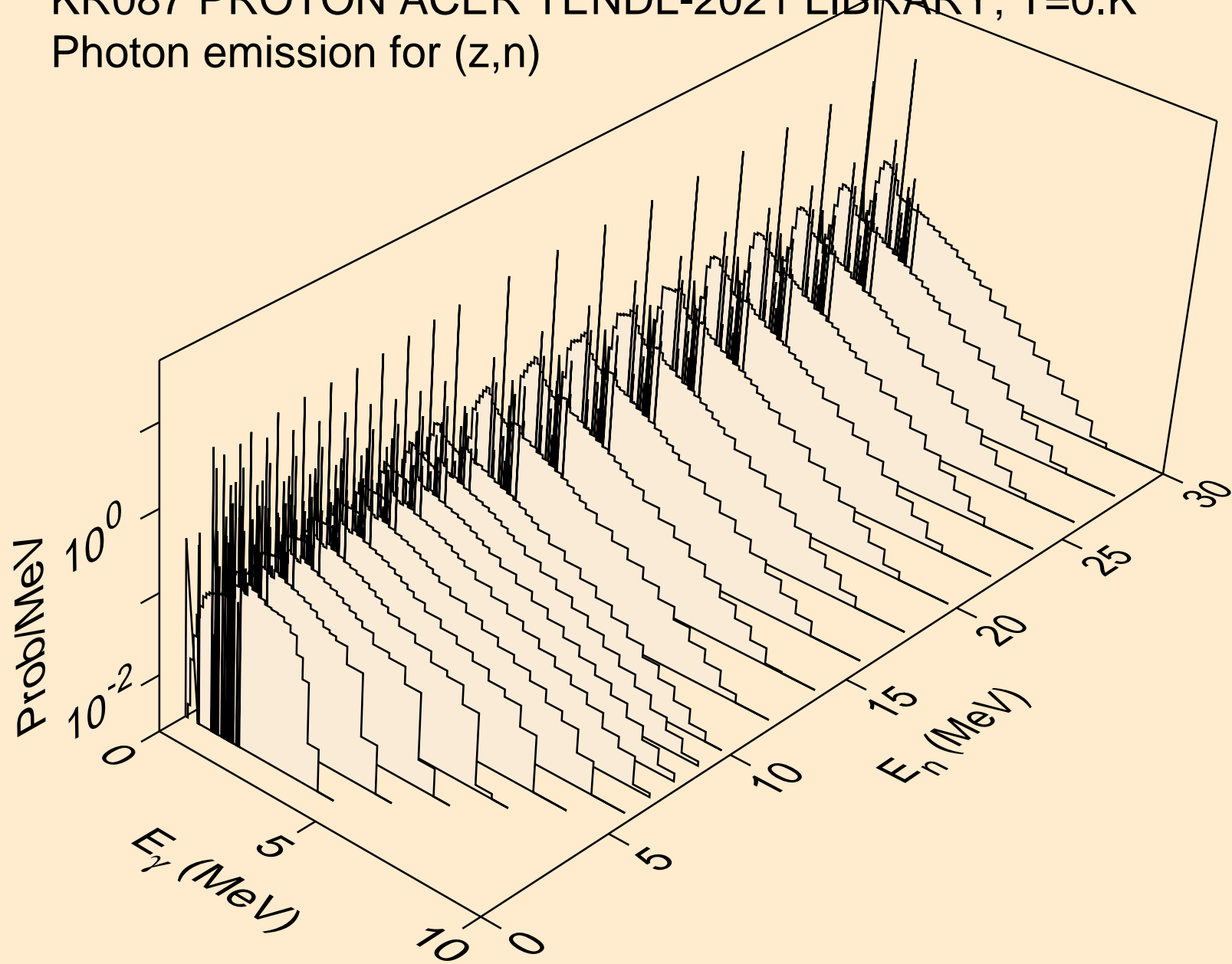

KR087 PROTON ACER TENDL-2021 LIBRARY; T=0.K
Photon emission for (n,x)

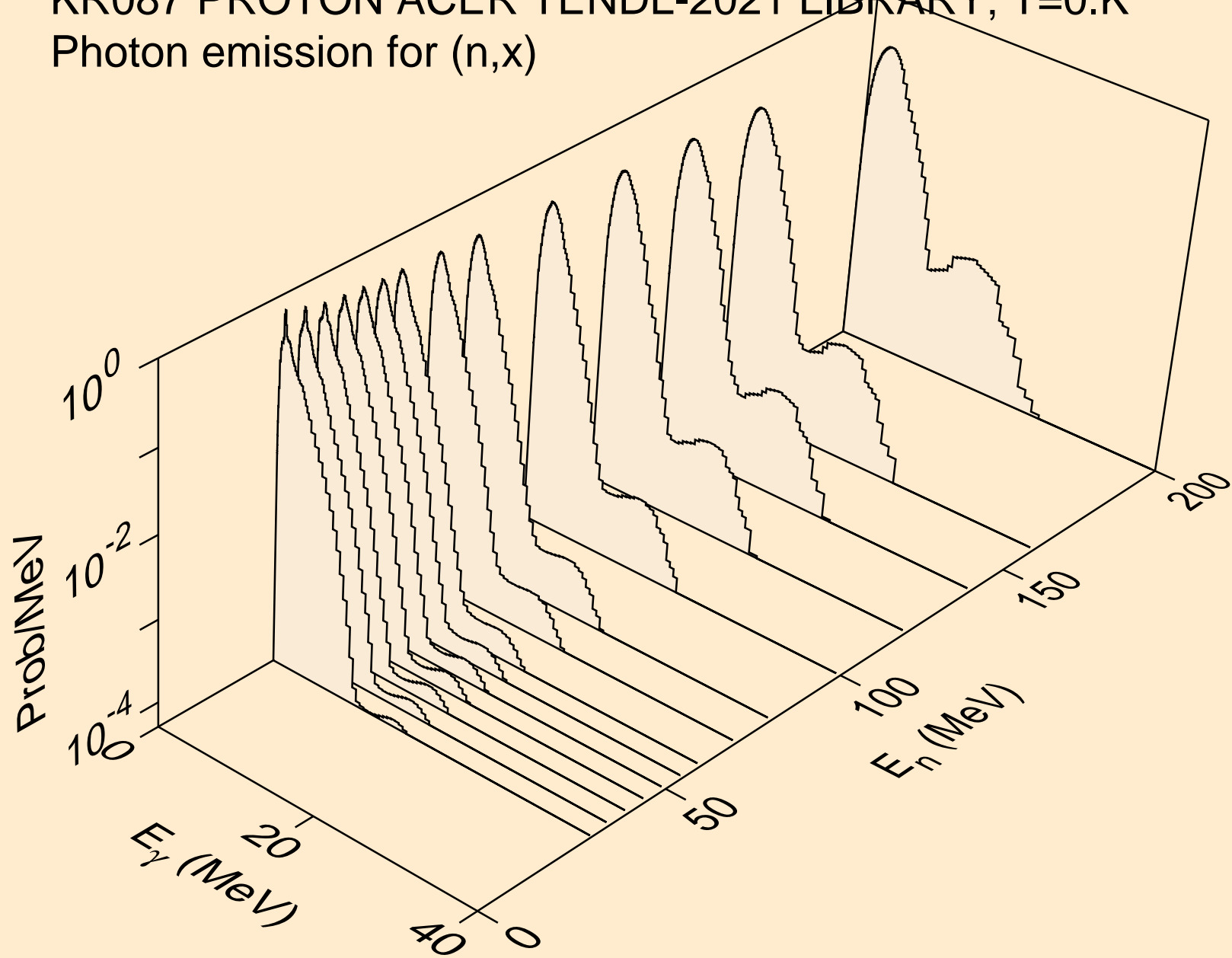

KR087 PROTON ACER TENDL-2021 LIBRARY; T=0.K
Photon emission for (n,2nd)

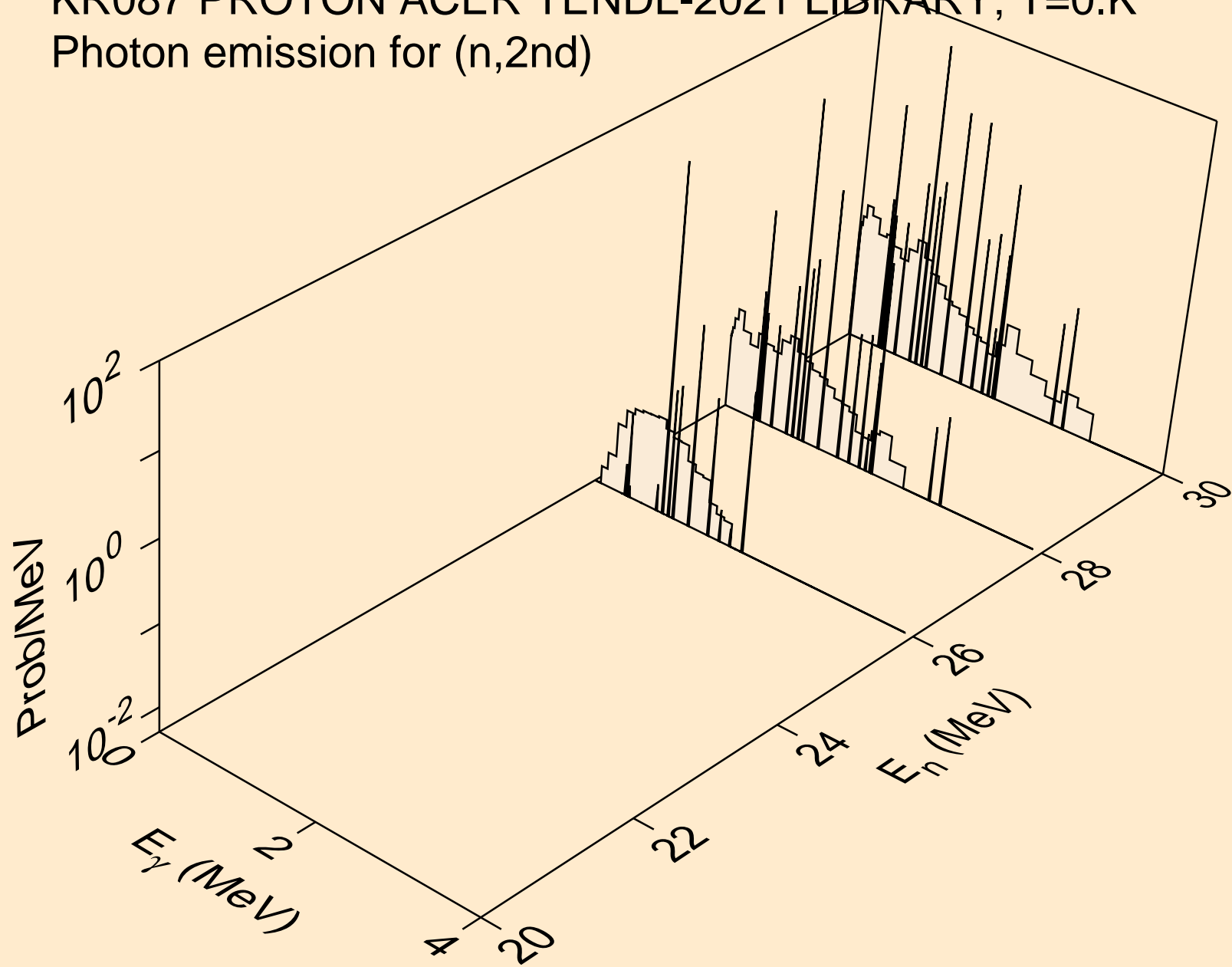

KR087 PROTON ACER TENDL-2021 LIBRARY; T=0.K
Photon emission for (n,2n)

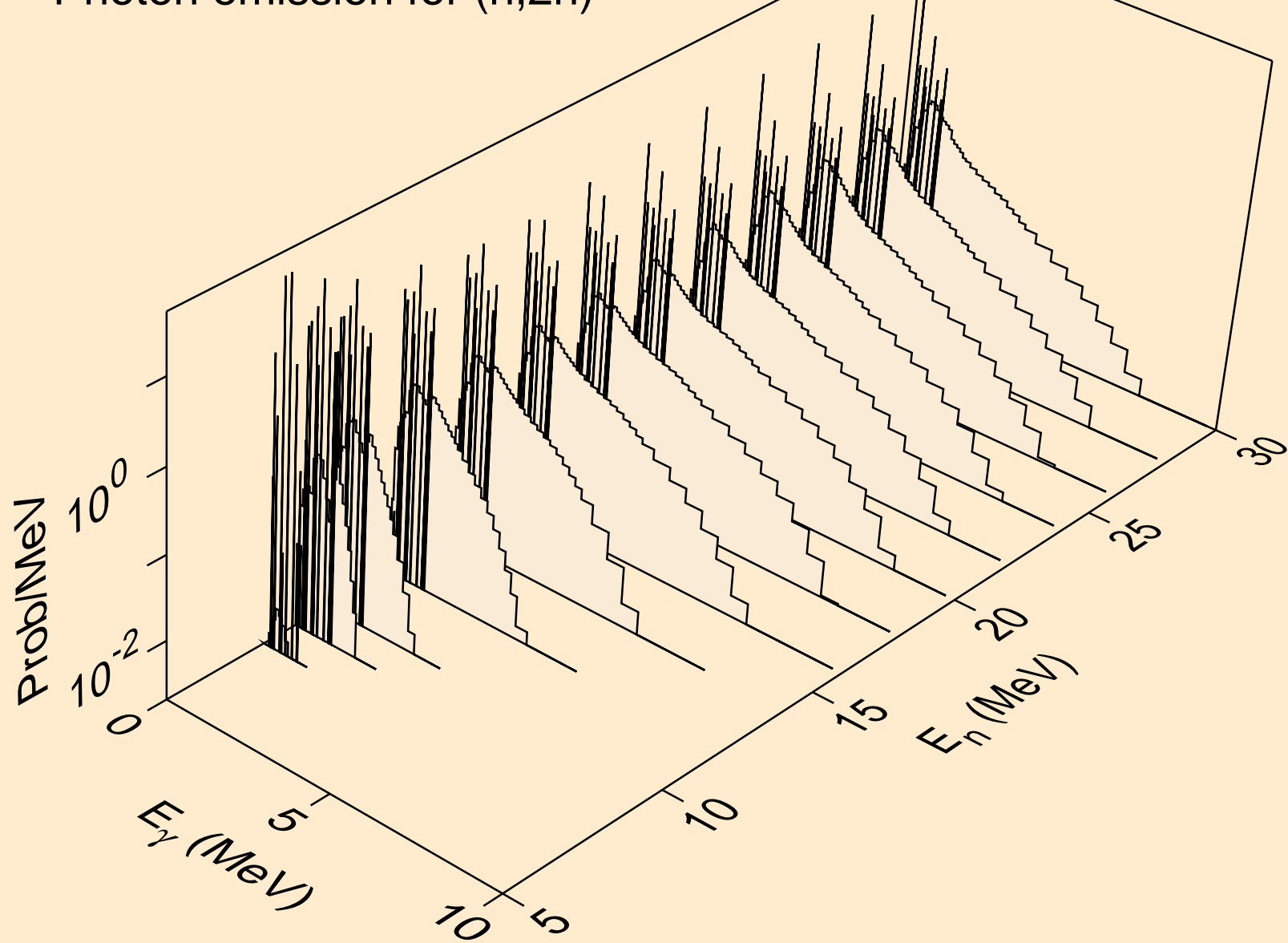

KR087 PROTON ACER TENDL-2021 LIBRARY; T=0.K
Photon emission for (n,3n)

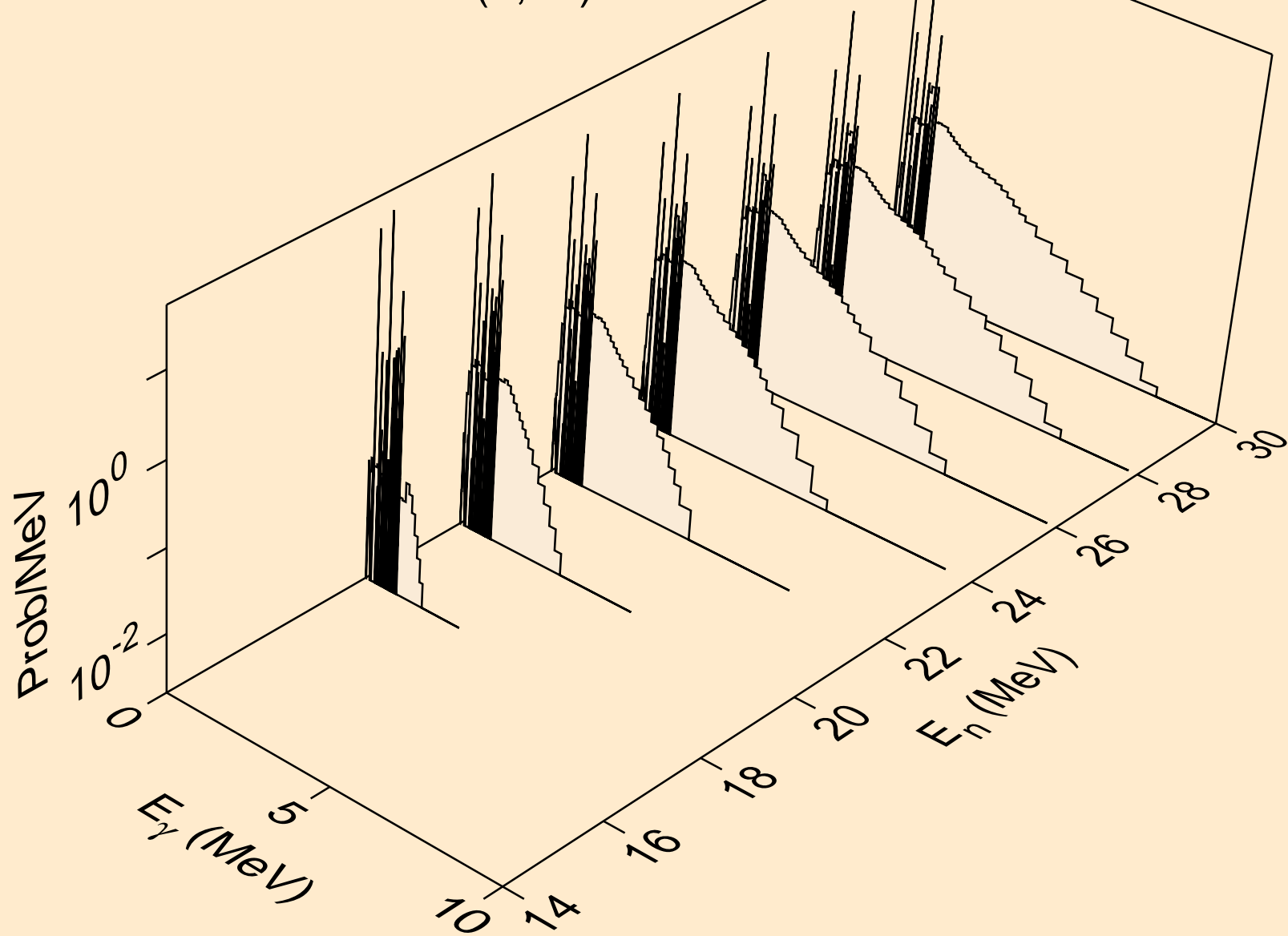

KR087 PROTON ACER TENDL-2021 LIBRARY; T=0.K
Photon emission for (n,n*)a

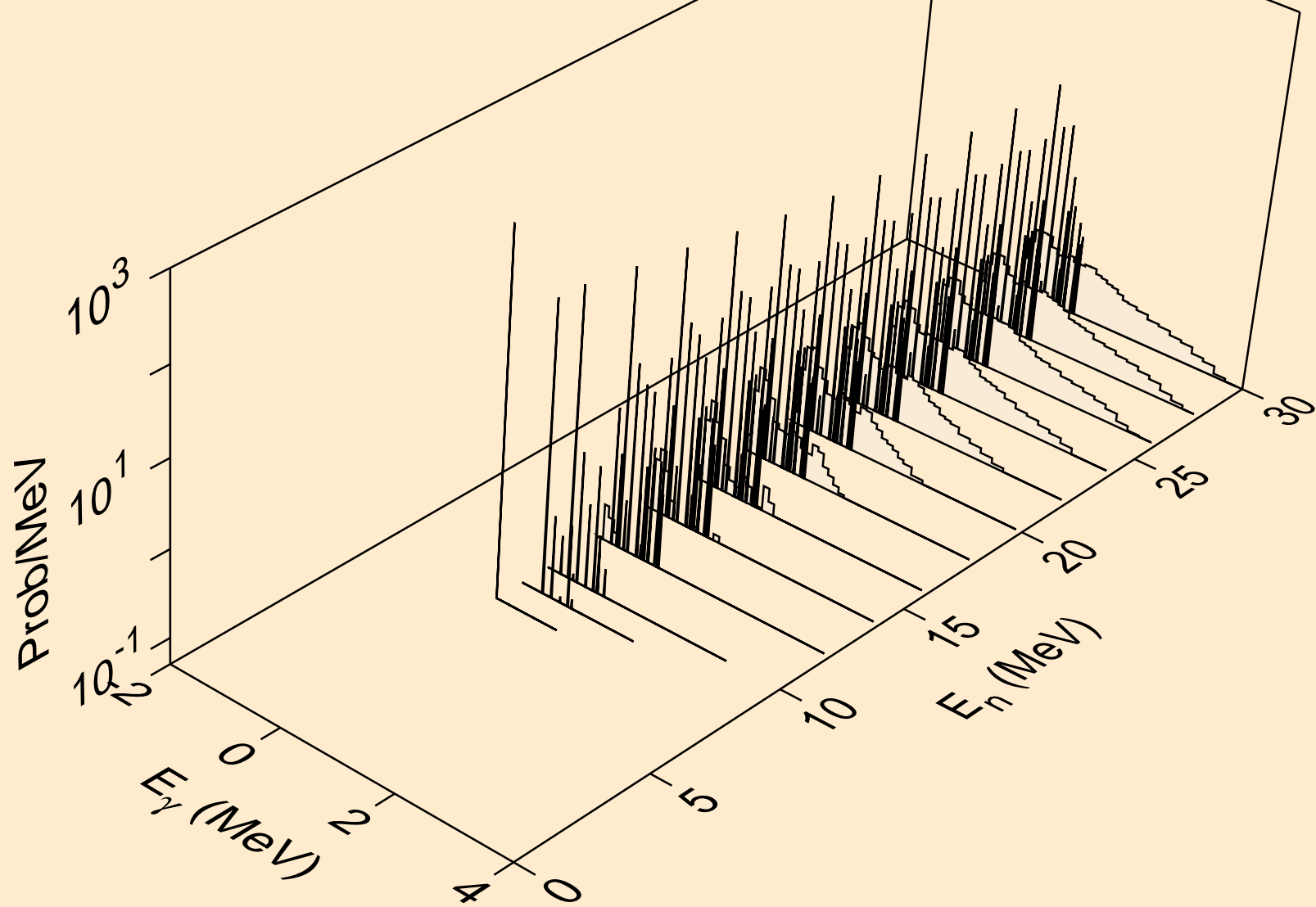

KR087 PROTON ACER TENDL-2021 LIBRARY; T=0.K
Photon emission for (n,2n)a

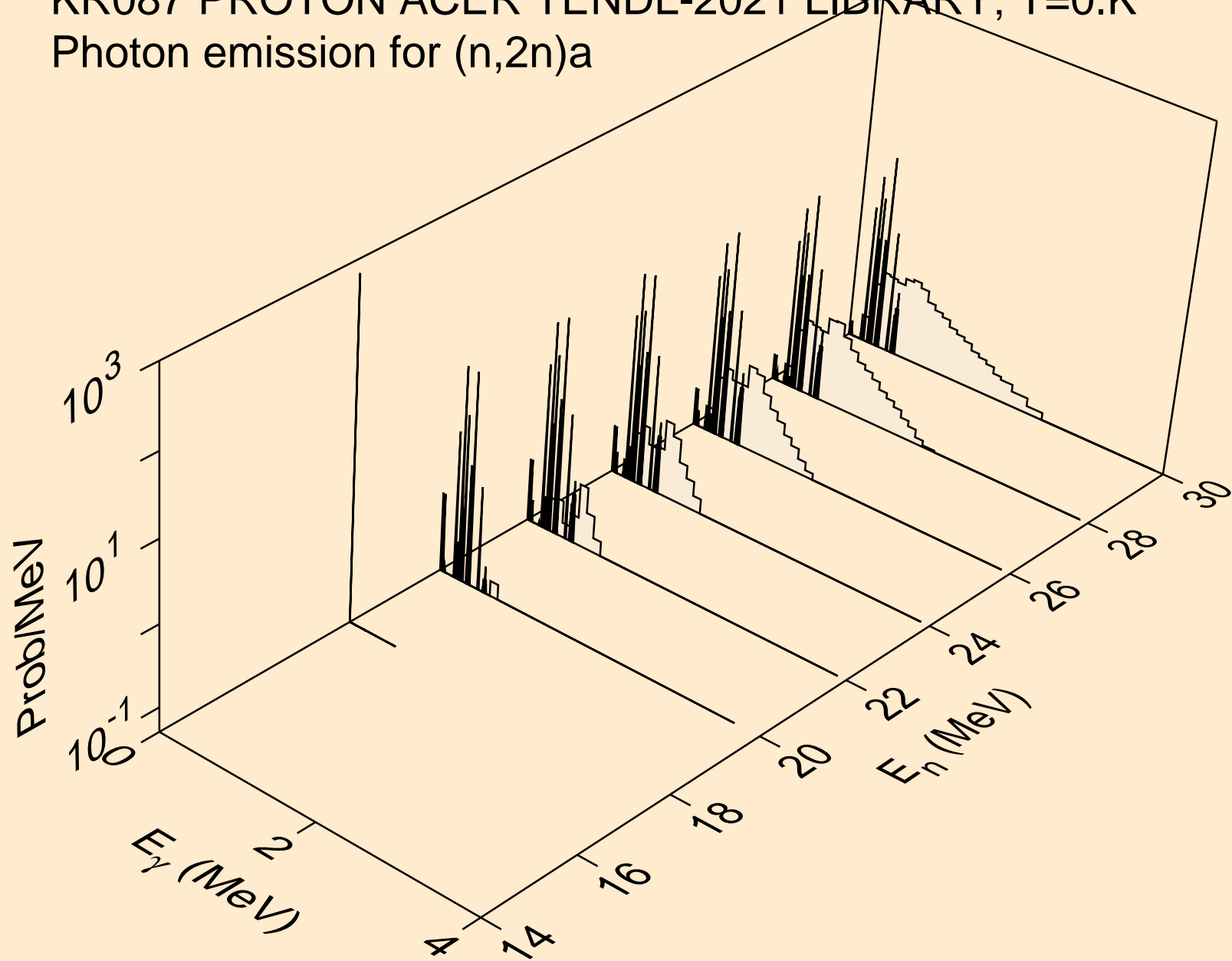

KR087 PROTON ACER TENDL-2021 LIBRARY; T=0.K
Photon emission for (n,3n)a

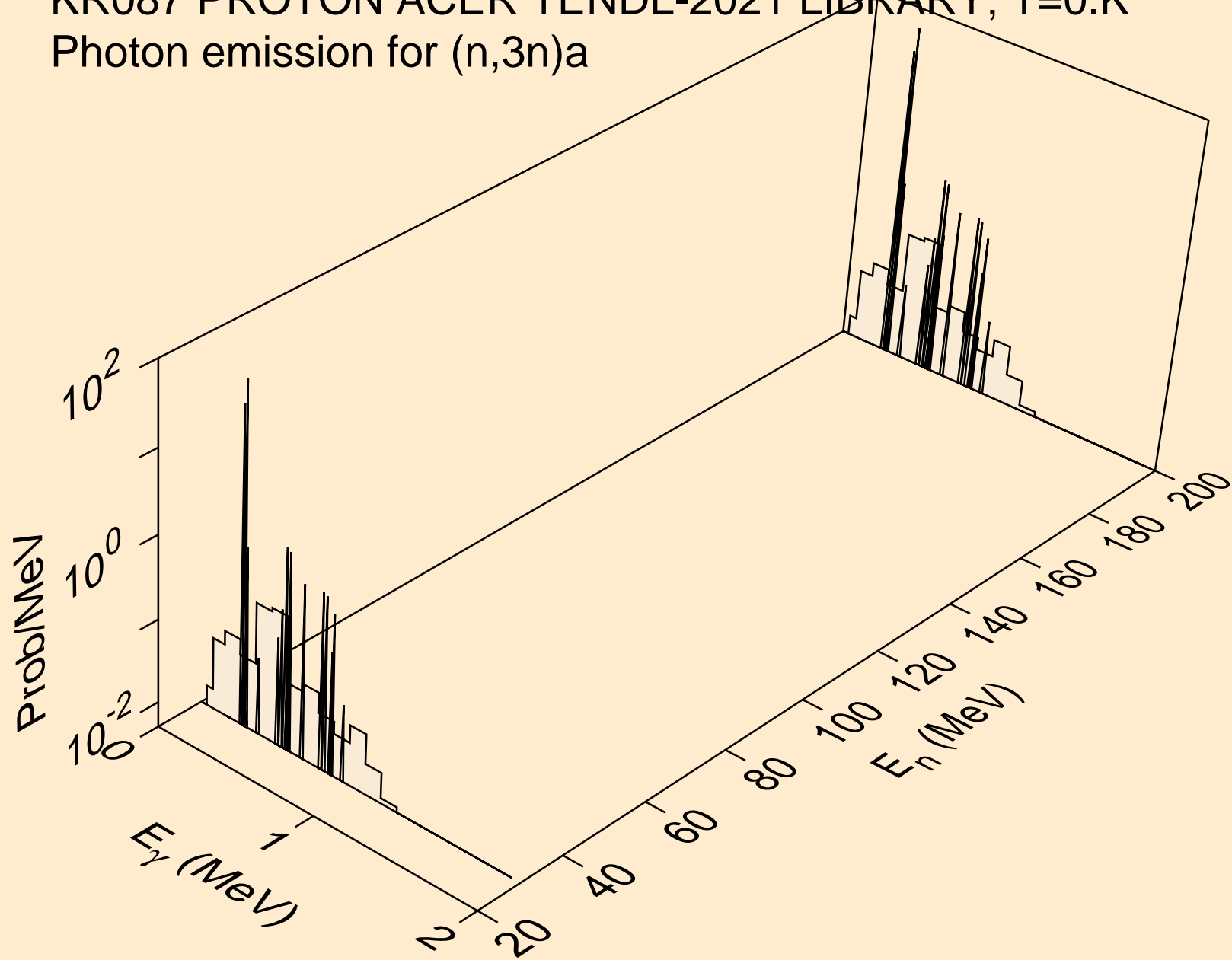

KR087 PROTON ACER TENDL-2021 LIBRARY; T=0.K
Photon emission for (n,n*)p

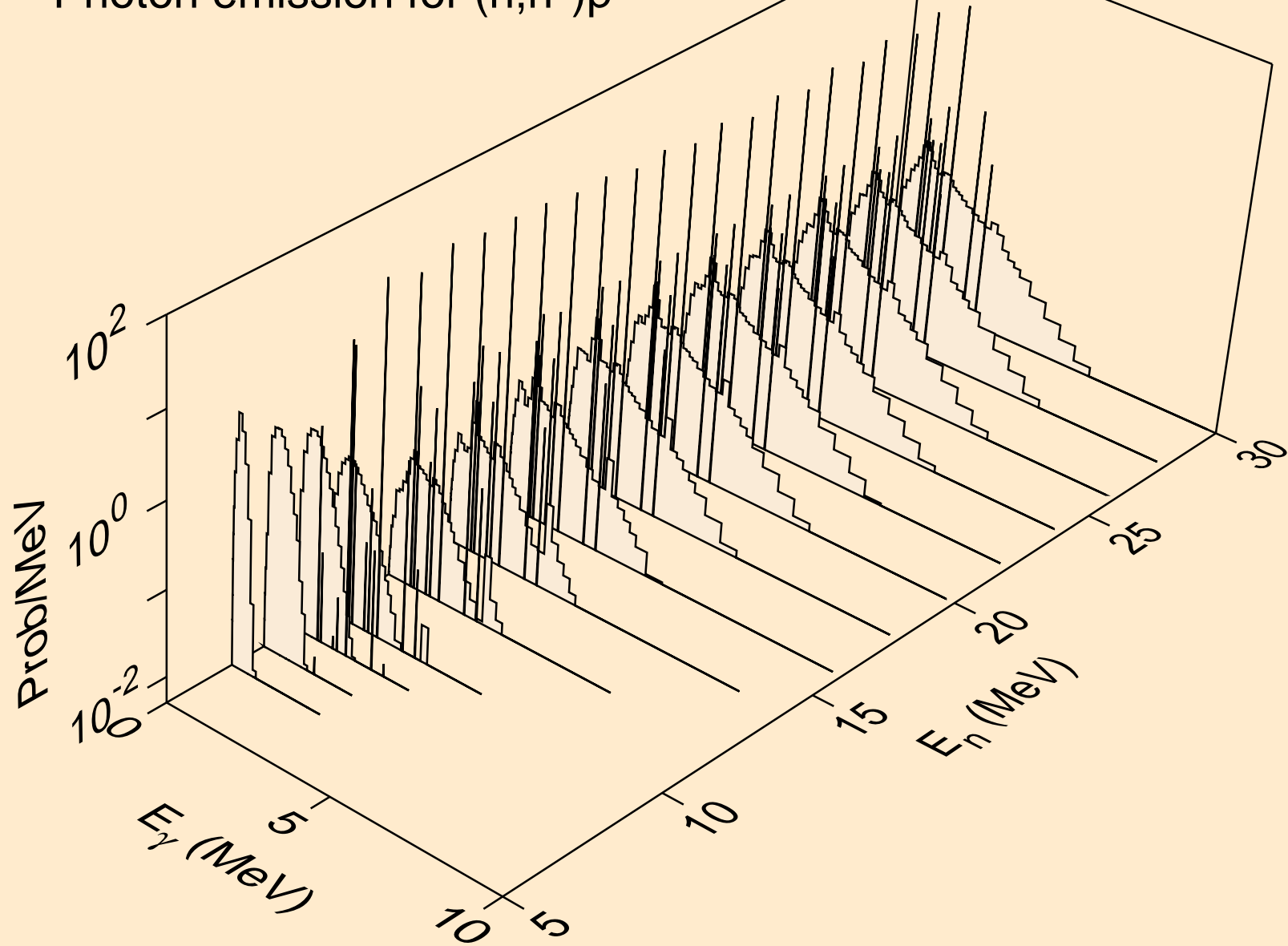

KR087 PROTON ACER TENDL-2021 LIBRARY; T=0.K
Photon emission for (n,n*)2a

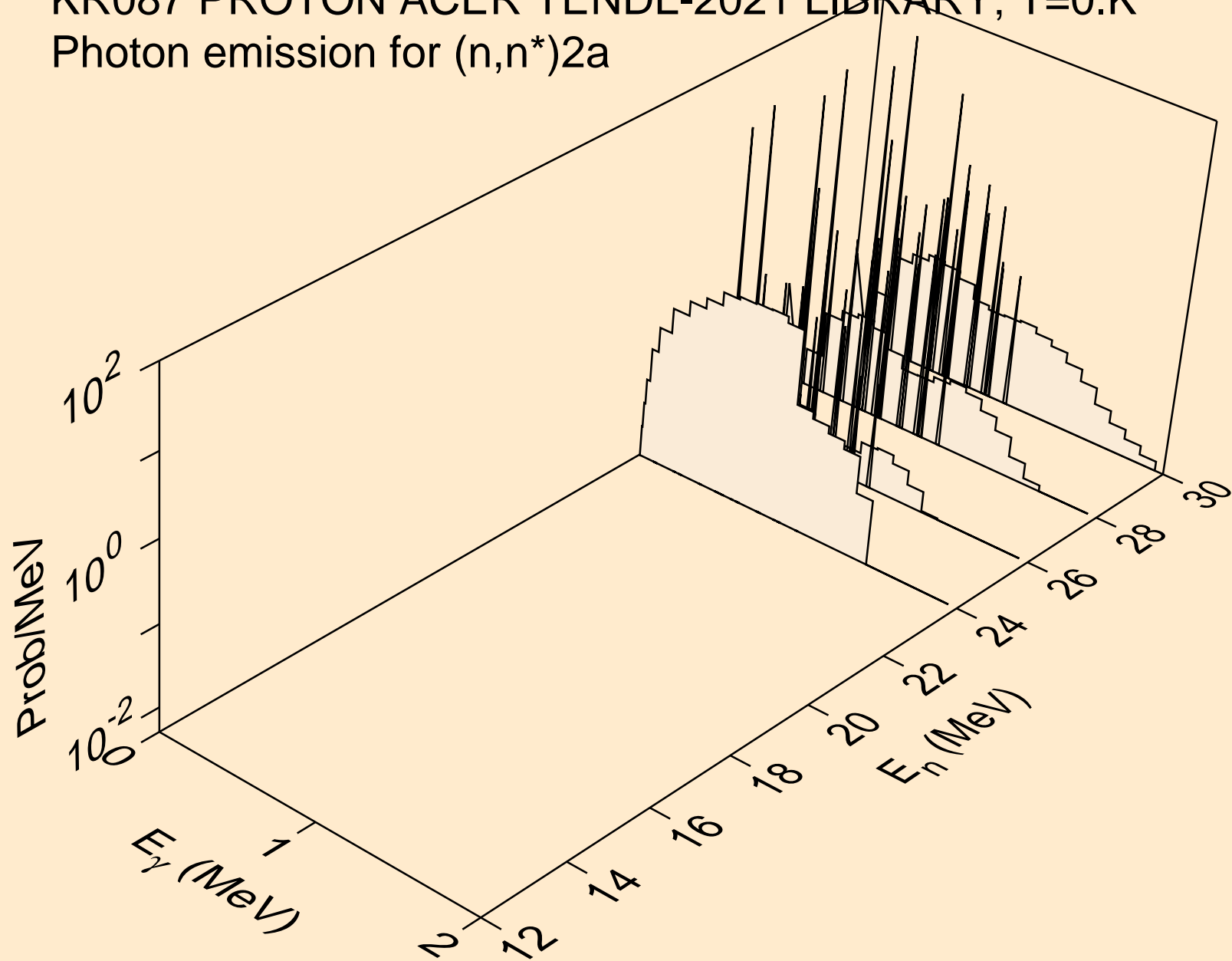

KR087 PROTON ACER TENDL-2021 LIBRARY; T=0.K
Photon emission for (n,n*)d

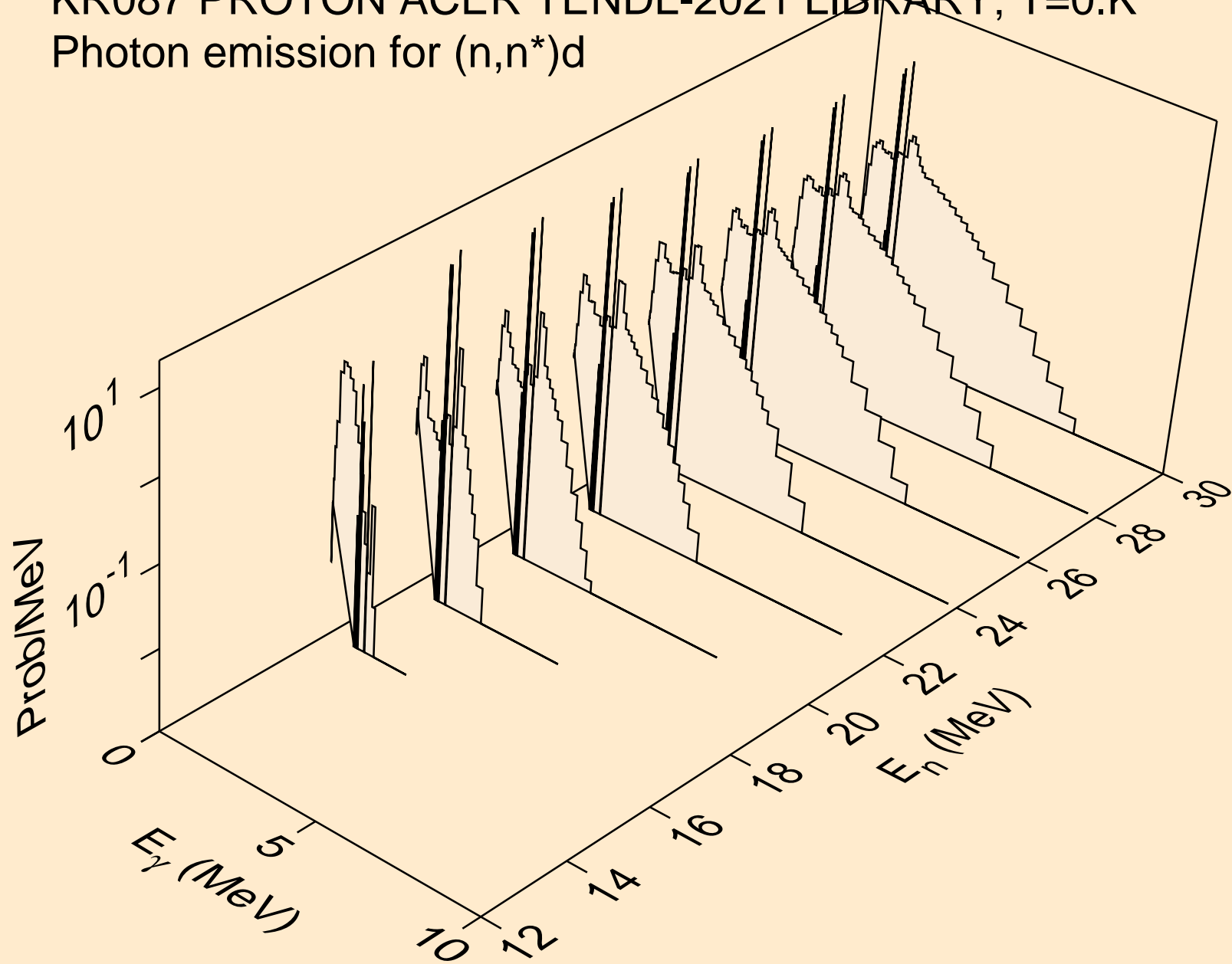

KR087 PROTON ACER TENDL-2021 LIBRARY; T=0.K
Photon emission for (n,n*)t

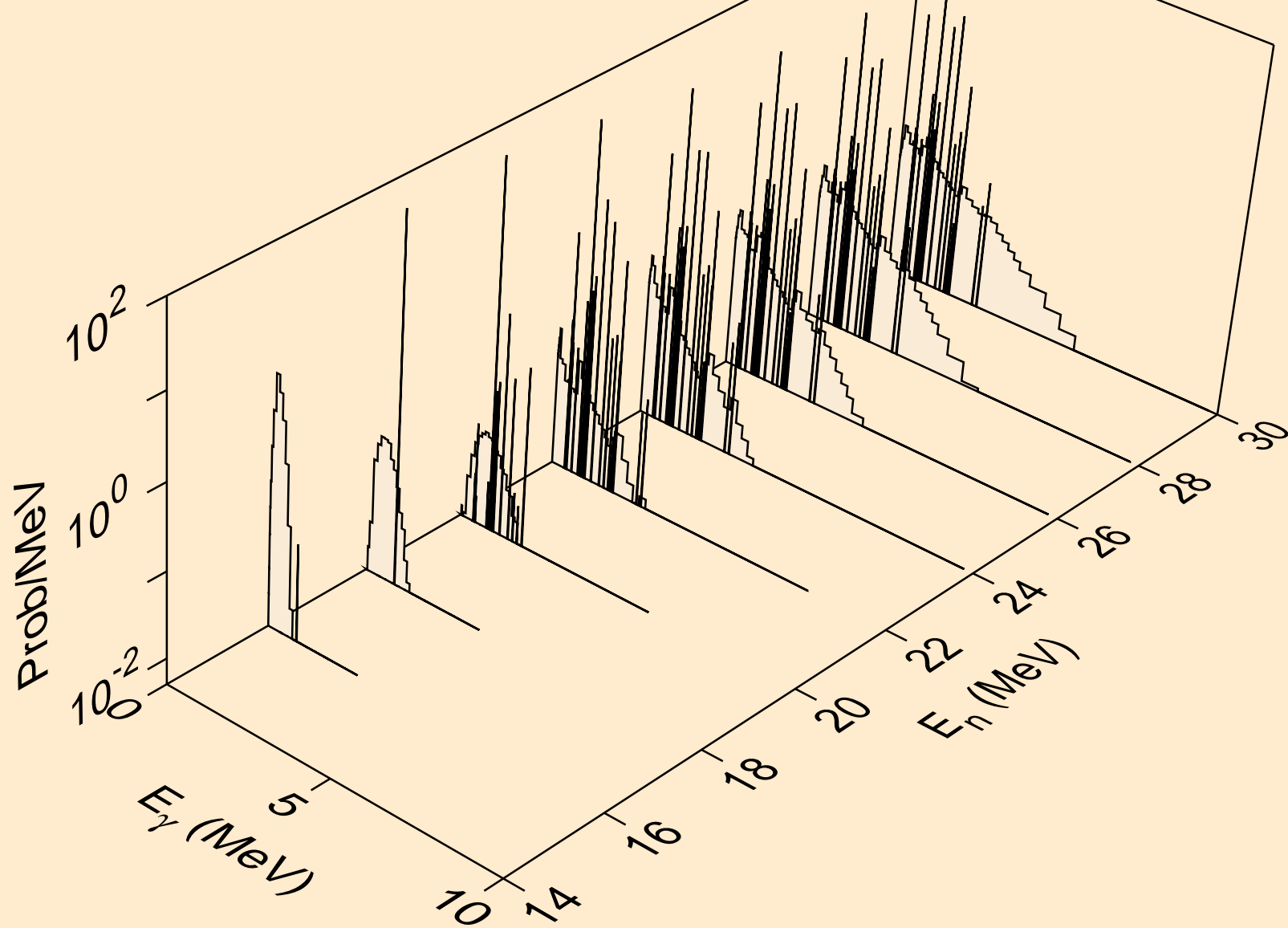

KR087 PROTON ACER TENDL-2021 LIBRARY; T=0.K
Photon emission for (n,n*)he3

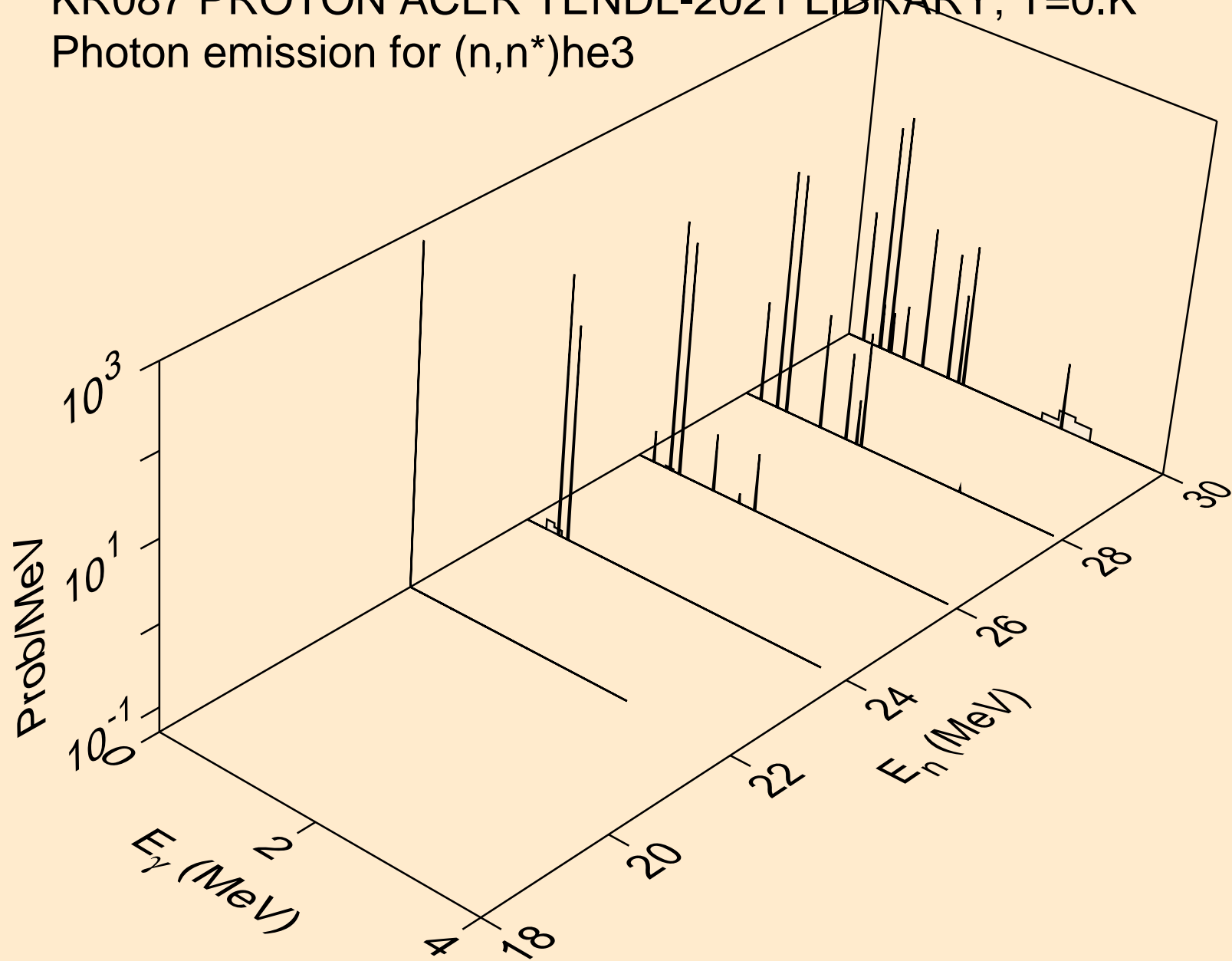

KR087 PROTON ACER TENDL-2021 LIBRARY; T=0.K
Photon emission for (n,4n)

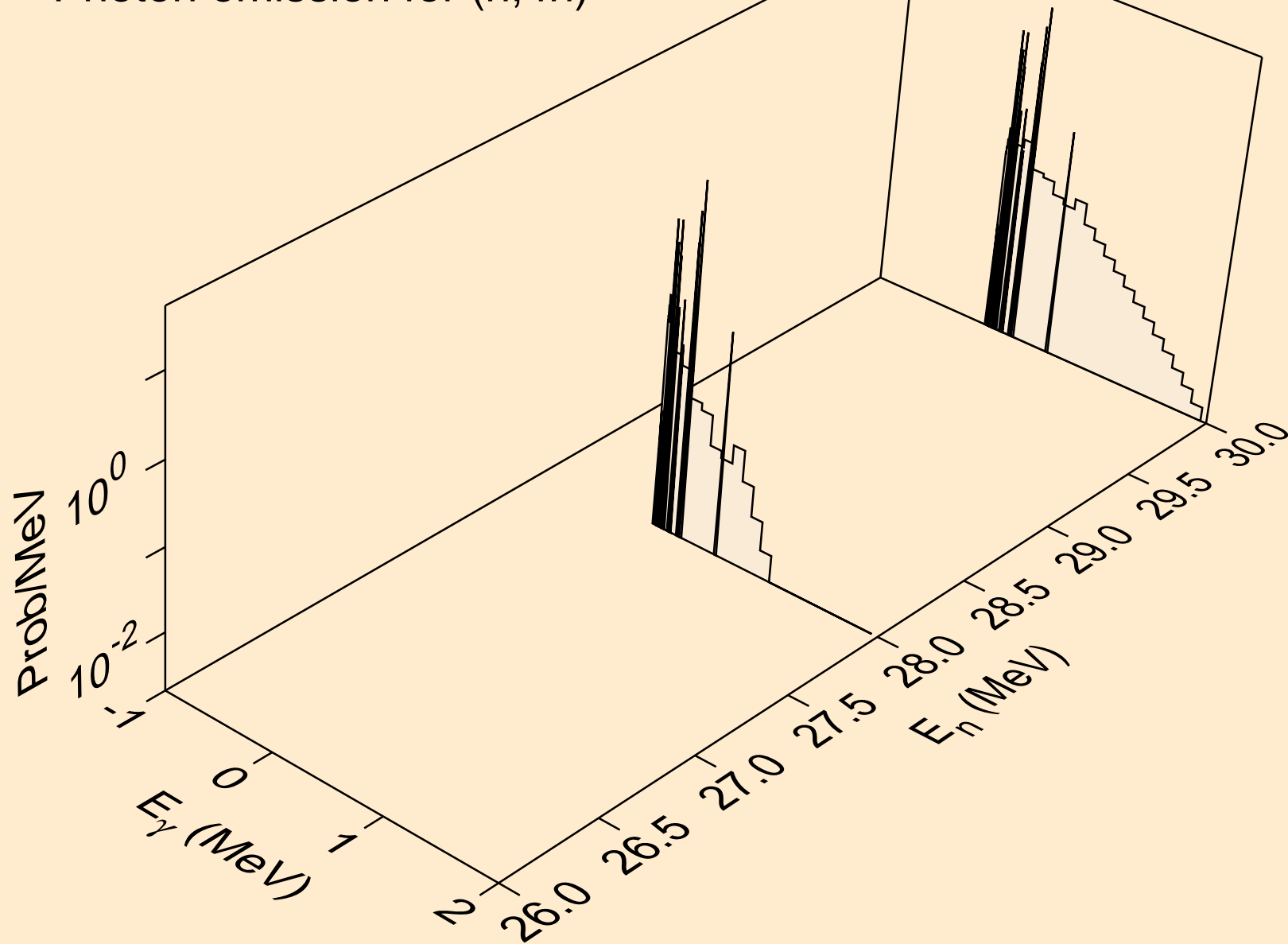

KR087 PROTON ACER TENDL-2021 LIBRARY; T=0.K
Photon emission for (n,2np)

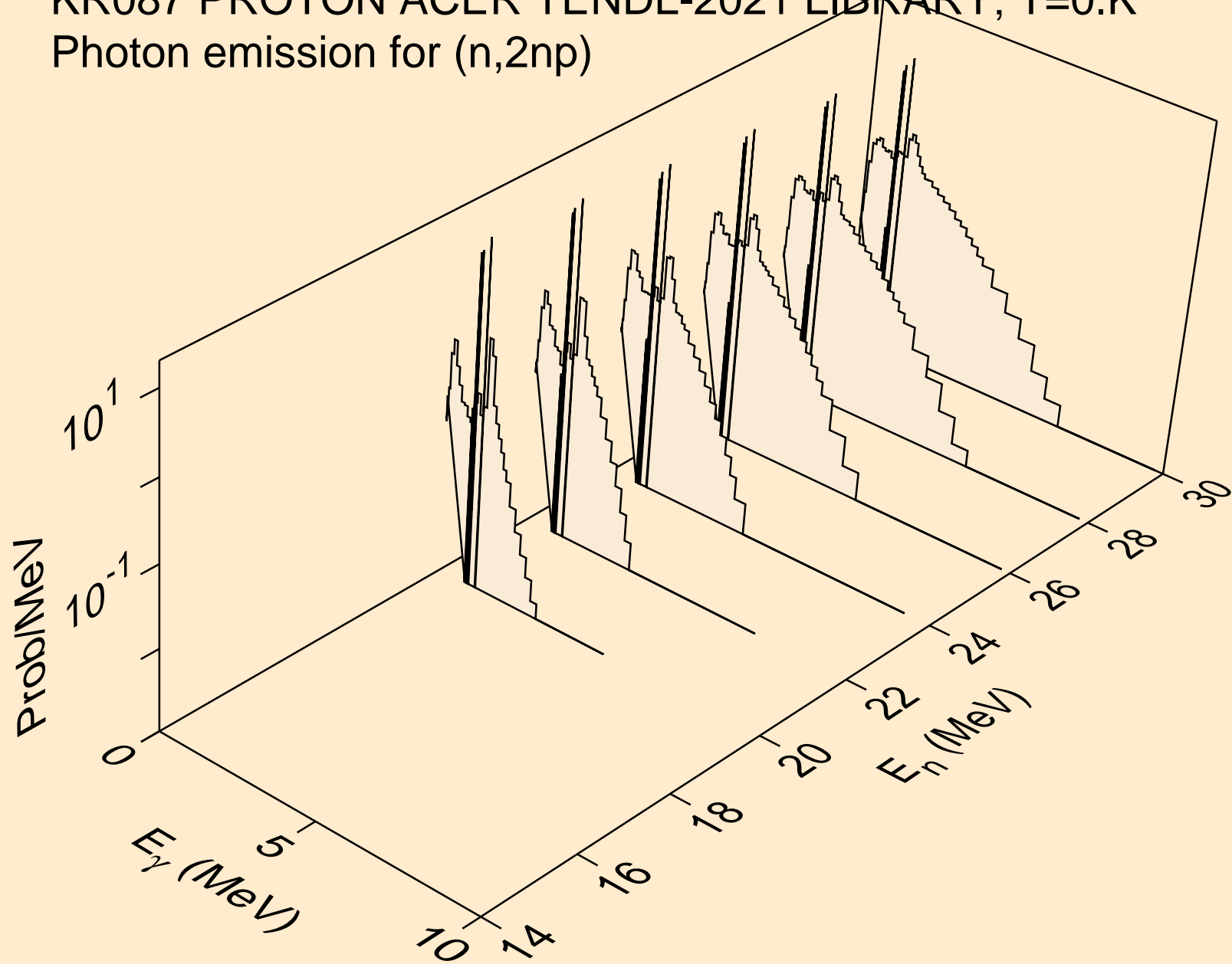

KR087 PROTON ACER TENDL-2021 LIBRARY; T=0.K
Photon emission for (n,3np)

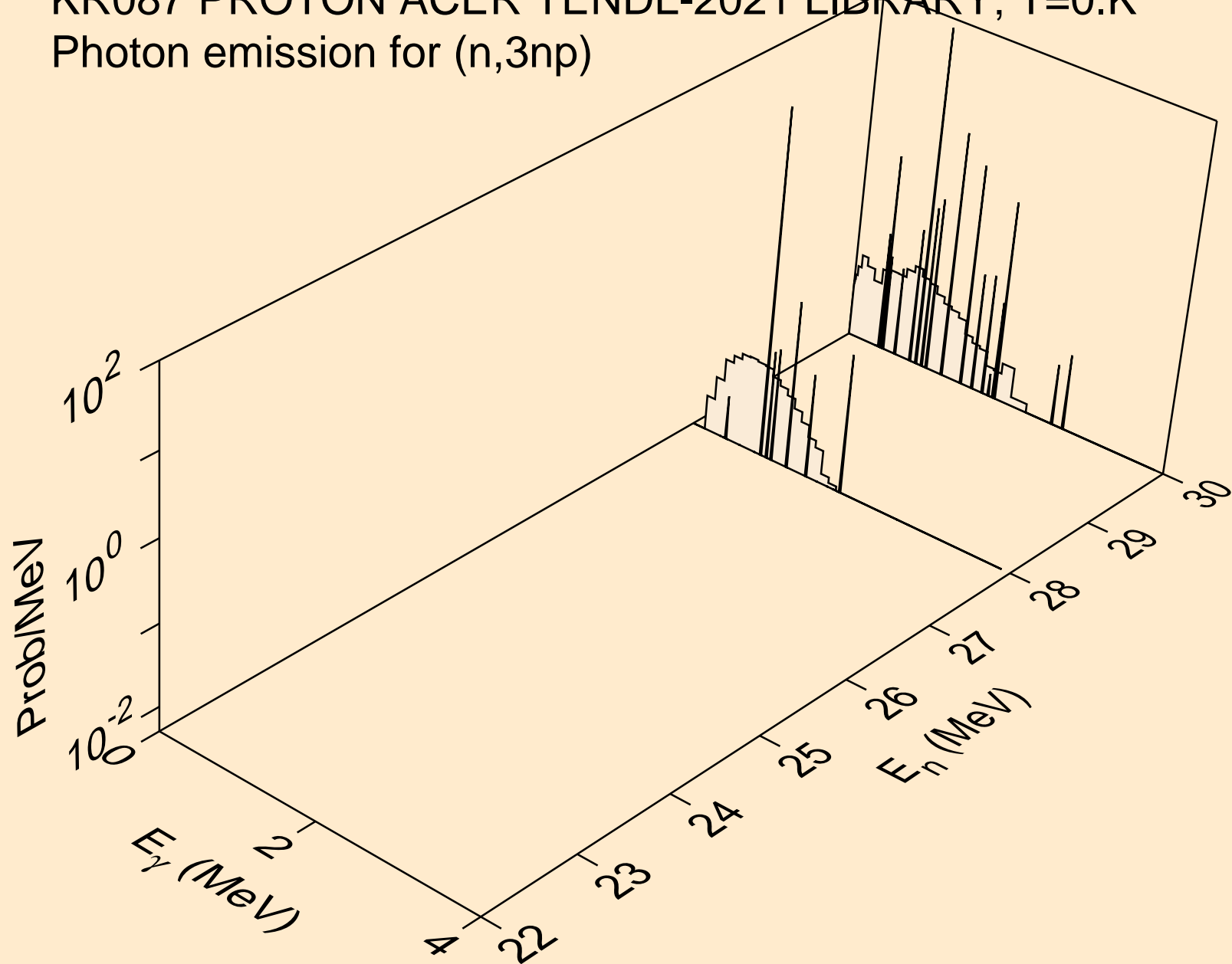

KR087 PROTON ACER TENDL-2021 LIBRARY; T=0.K
Photon emission for (n,2np)

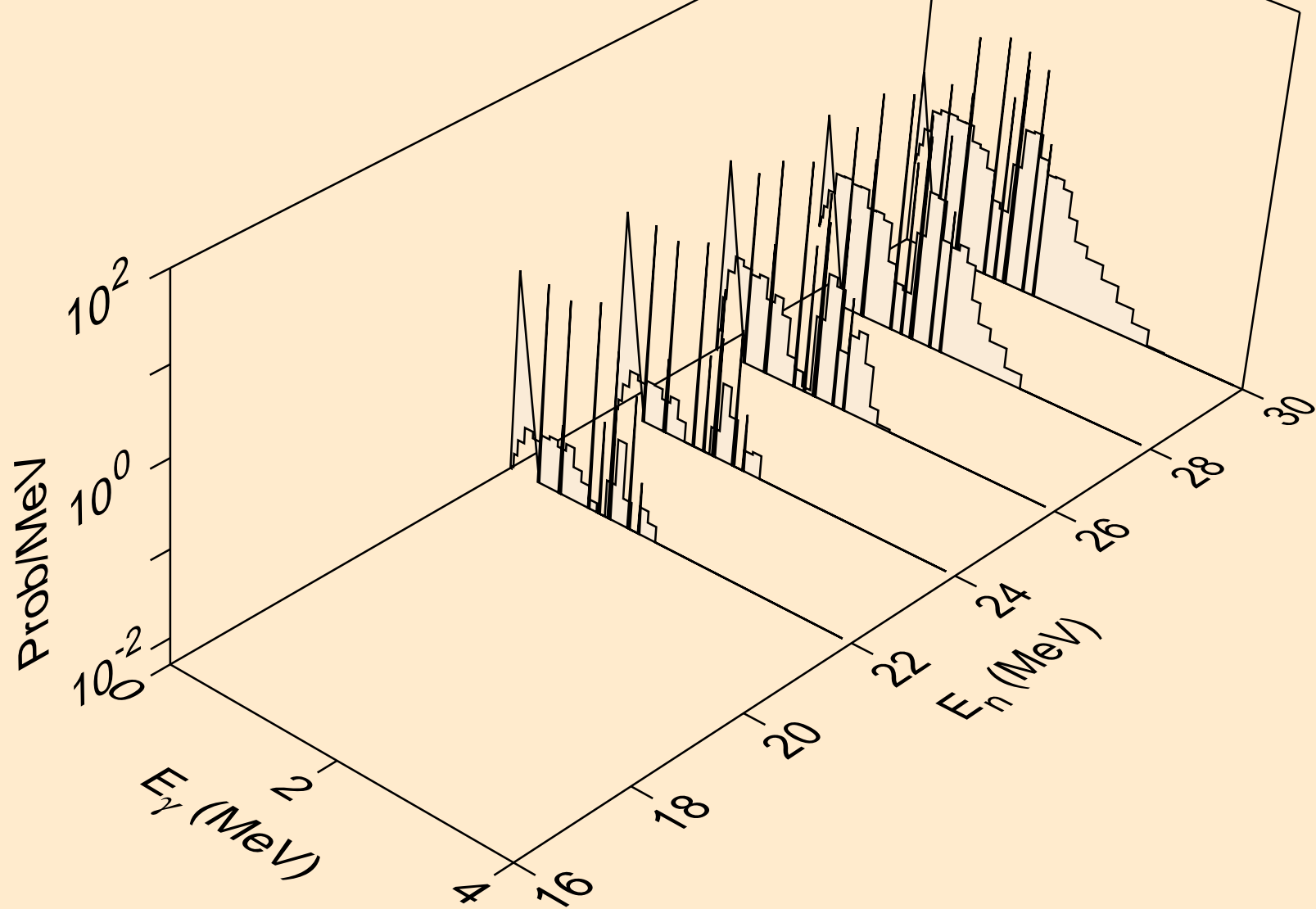

KR087 PROTON ACER TENDL-2021 LIBRARY; T=0.K
Photon emission for (n,npa)

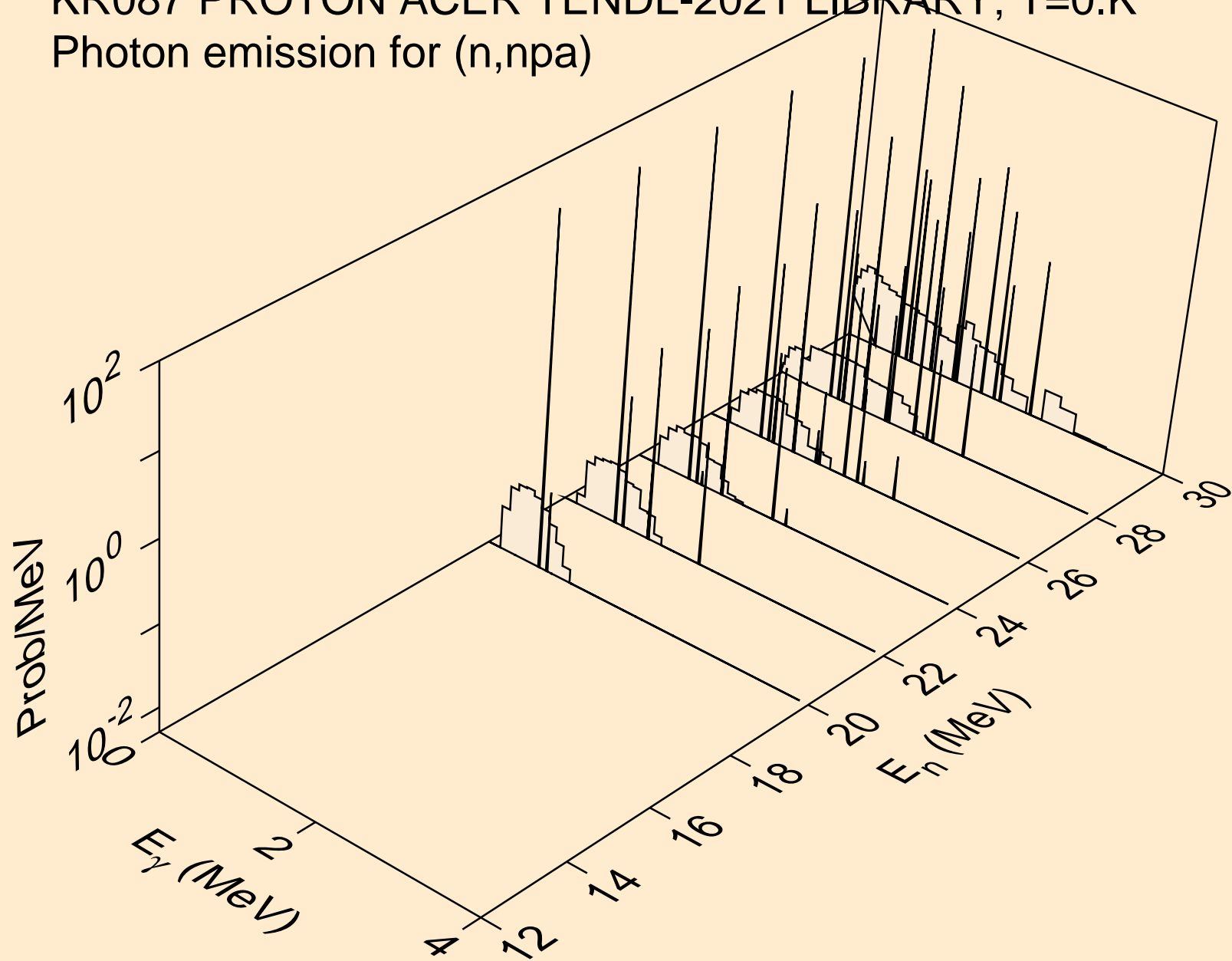

KR087 PROTON ACER TENDL-2021 LIBRARY; T=0.K
Photon emission for (n,gma)

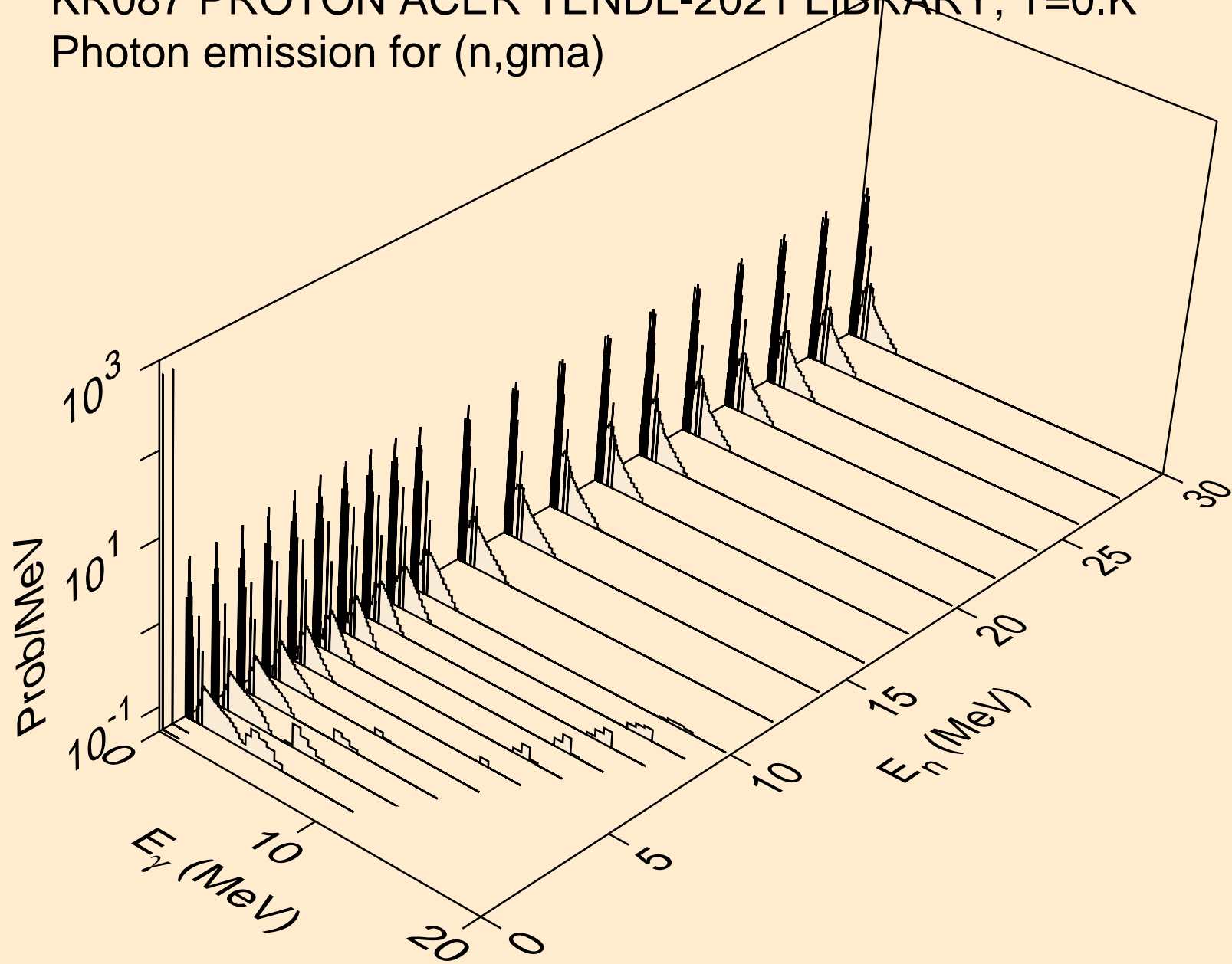

KR087 PROTON ACER TENDL-2021 LIBRARY; T=0.K
Photon emission for inelastic

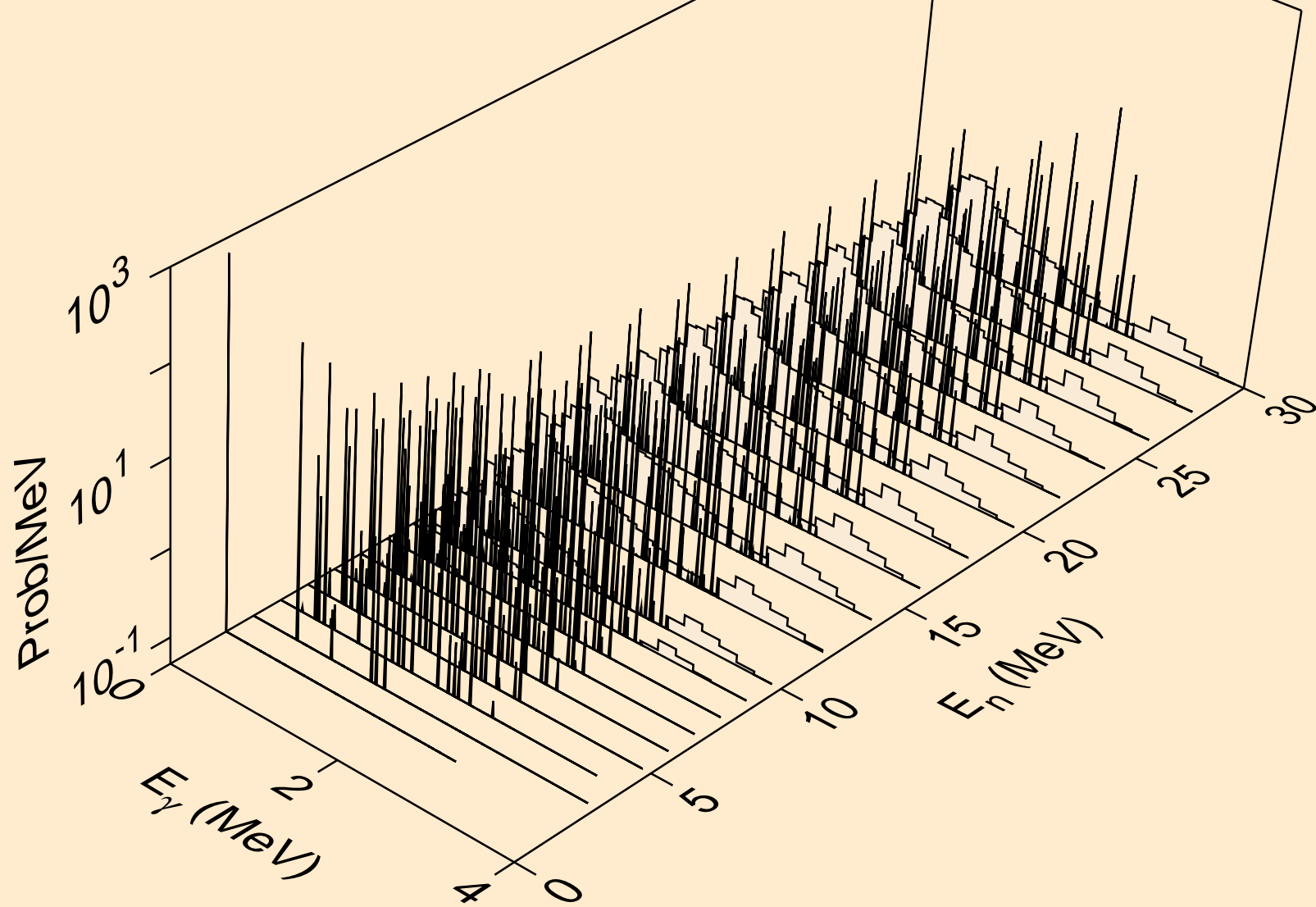

KR087 PROTON ACER TENDL-2021 LIBRARY; T=0.K
Photon emission for (n,d)

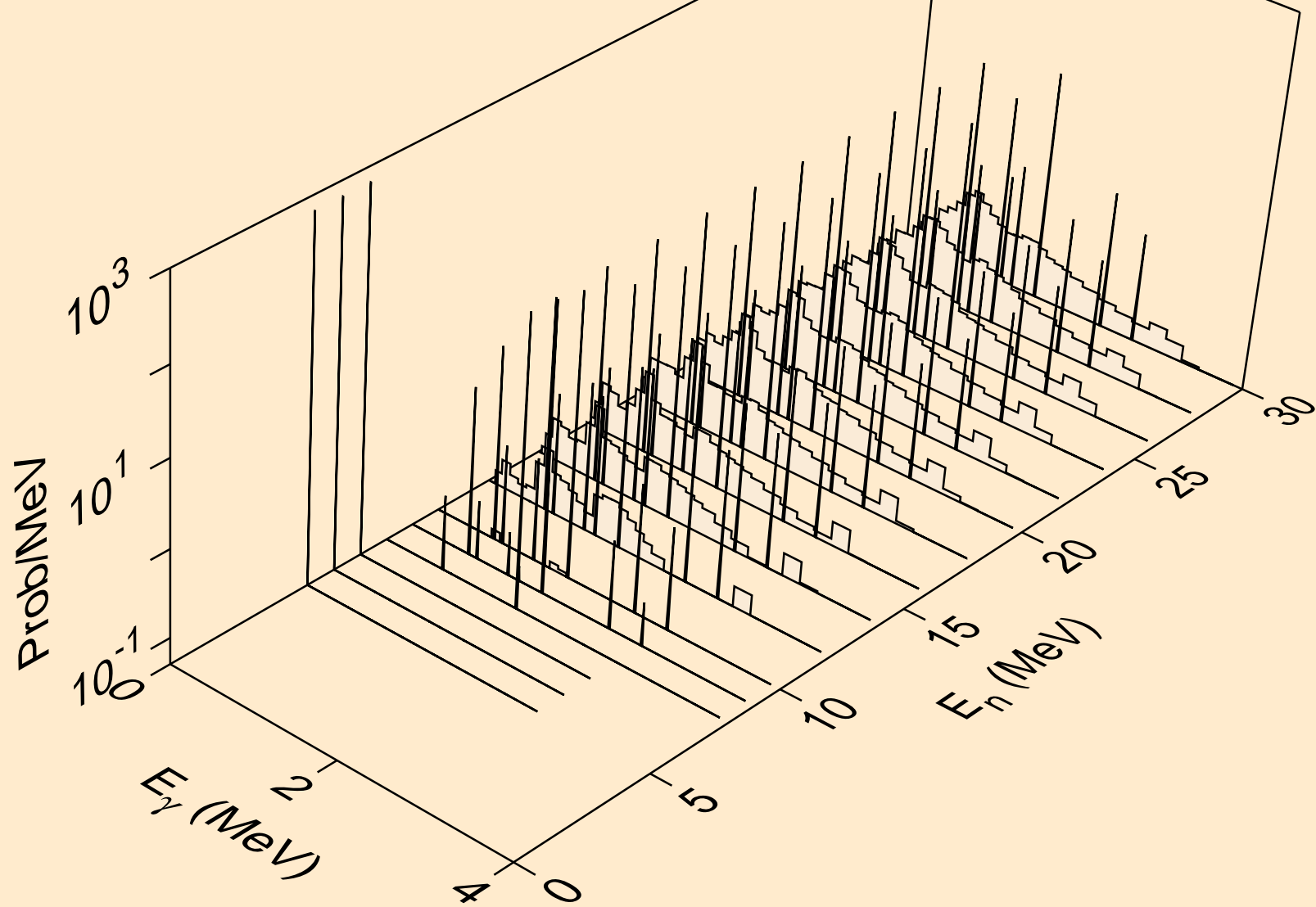

KR087 PROTON ACER TENDL-2021 LIBRARY; T=0.K
Photon emission for (n,t)

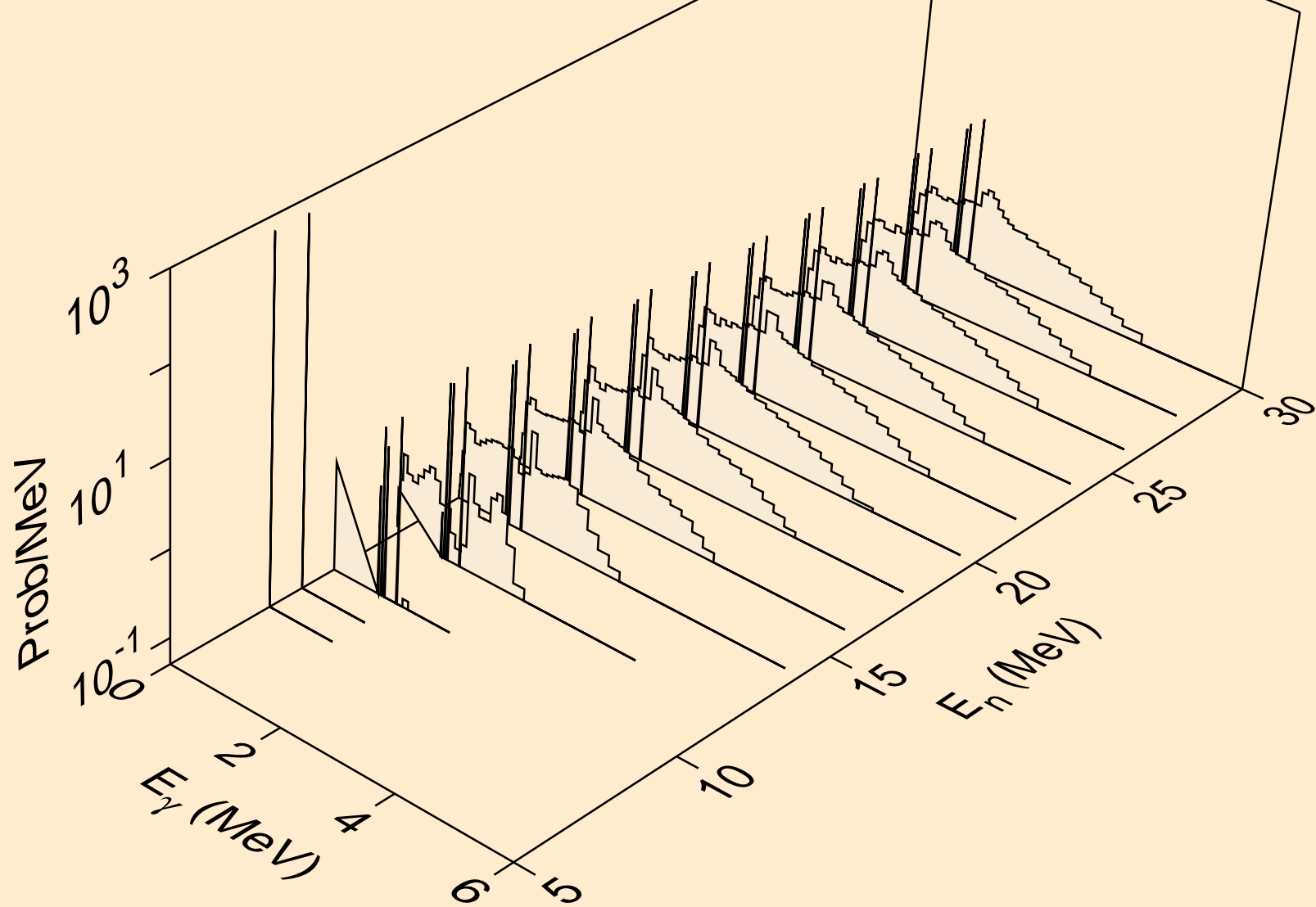

KR087 PROTON ACER TENDL-2021 LIBRARY; T=0.K
Photon emission for (n,he3)

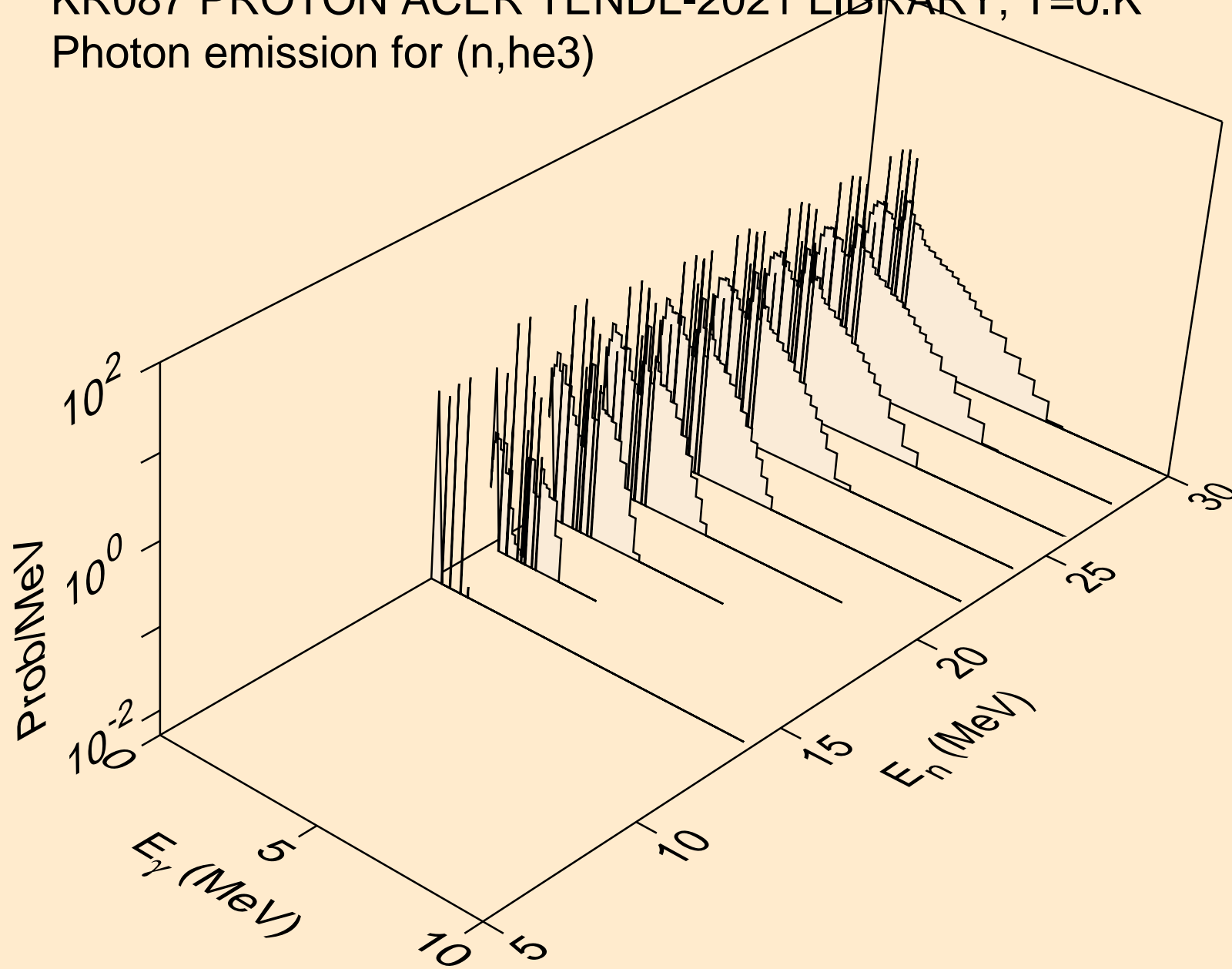

KR087 PROTON ACER TENDL-2021 LIBRARY; T=0.K
Photon emission for (n,a)

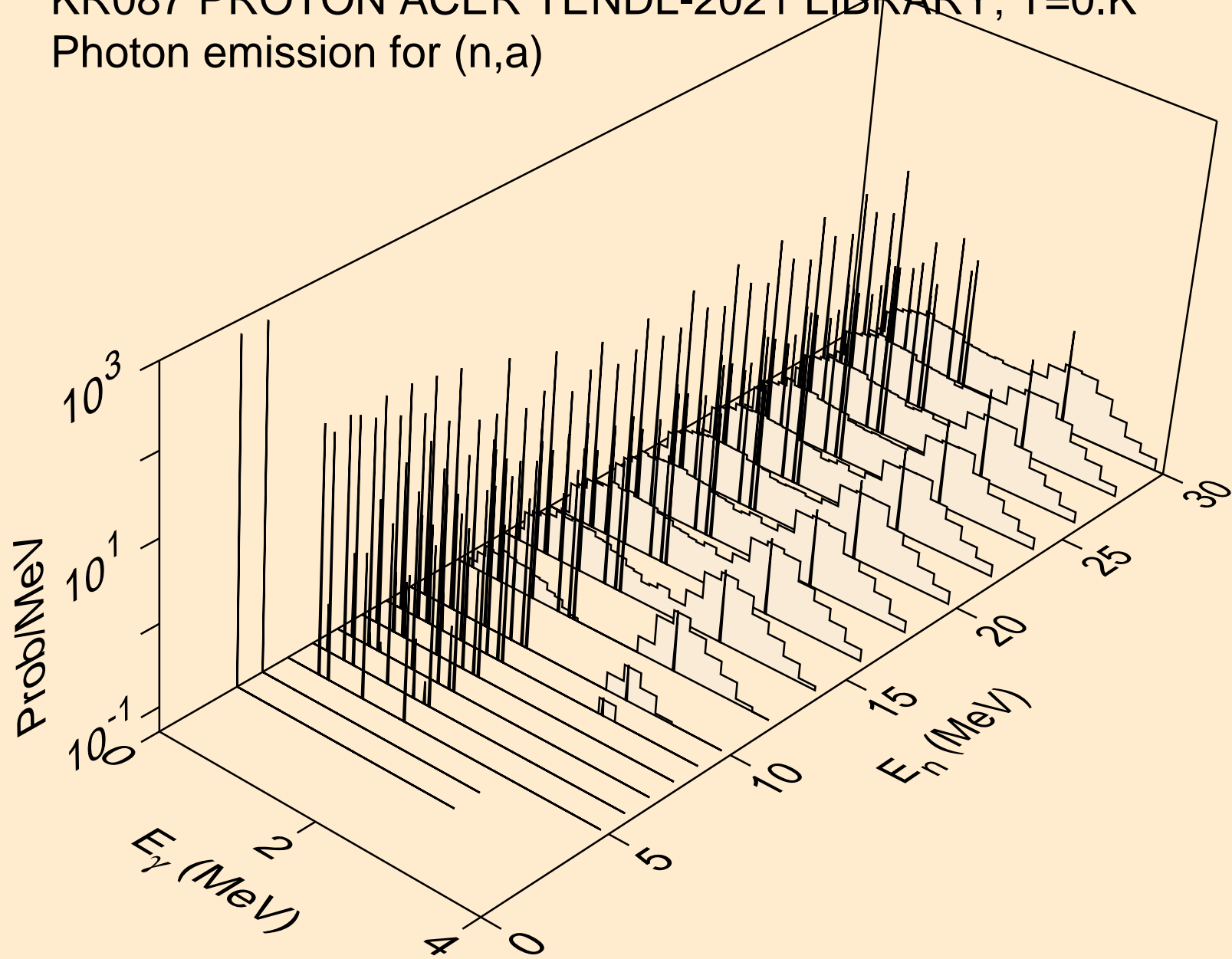

KR087 PROTON ACER TENDL-2021 LIBRARY; T=0.K
Photon emission for (n,2a)

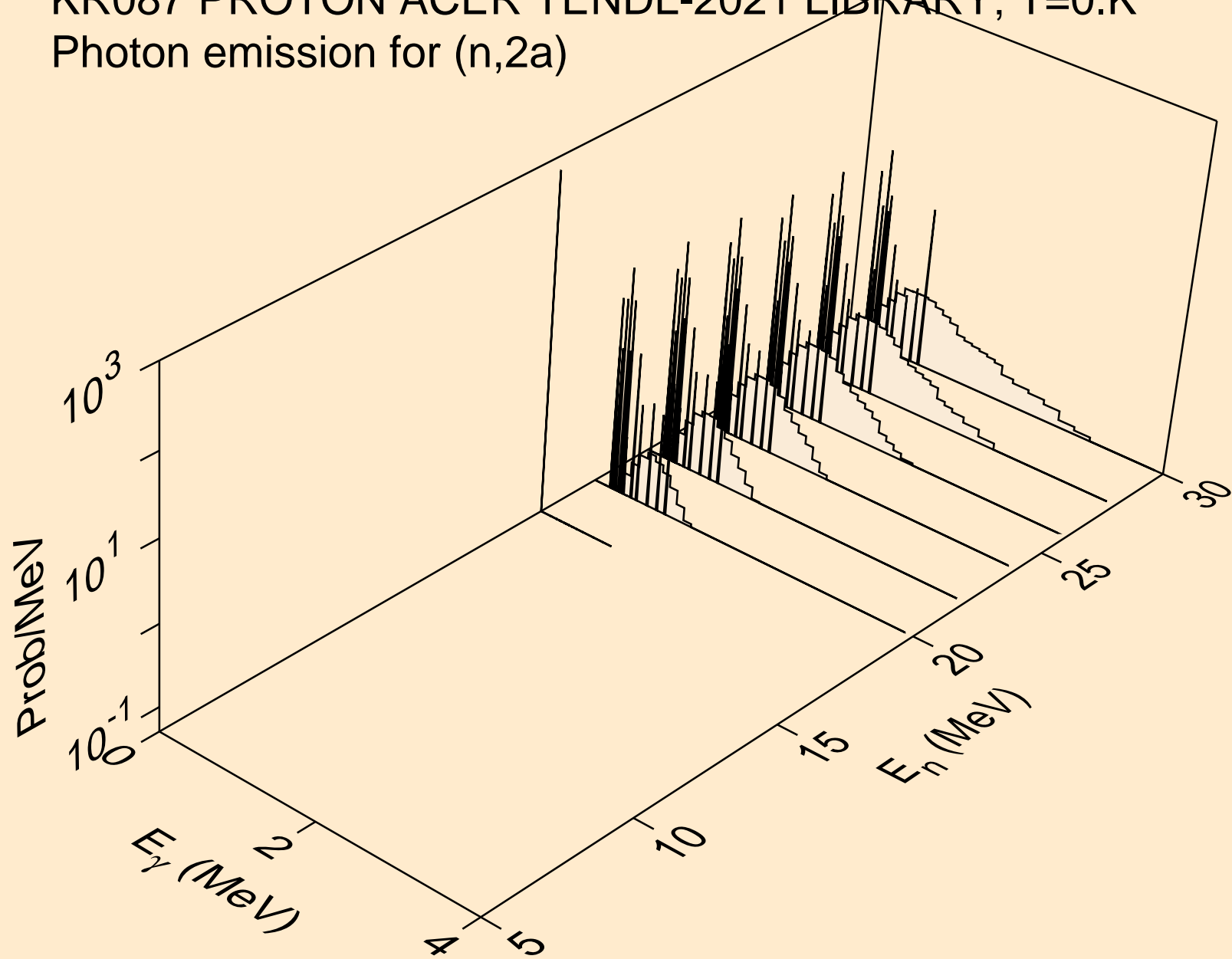

KR087 PROTON ACER TENDL-2021 LIBRARY; T=0.K
Photon emission for (n,2p)

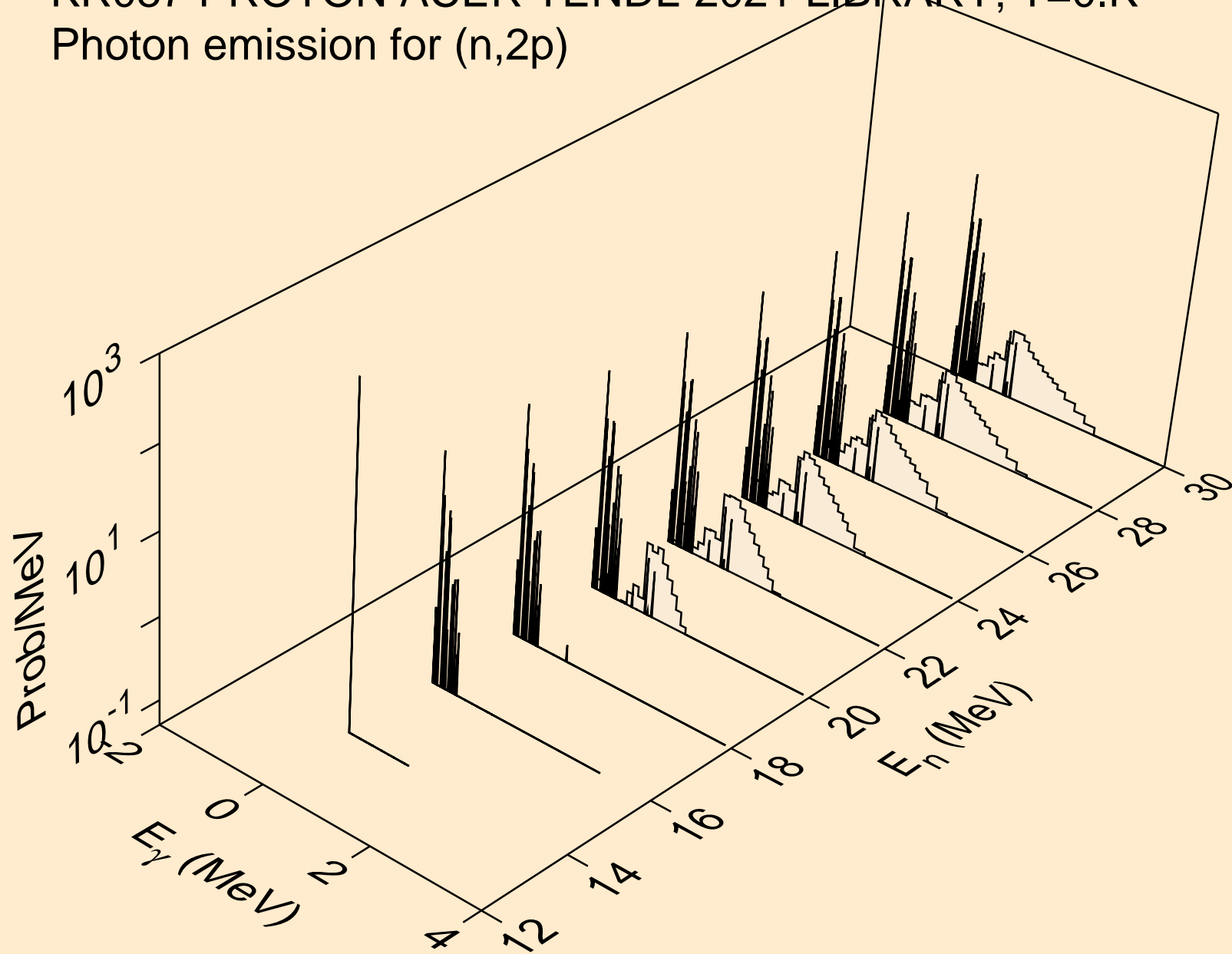

KR087 PROTON ACER TENDL-2021 LIBRARY; T=0.K
Photon emission for (n,pa)

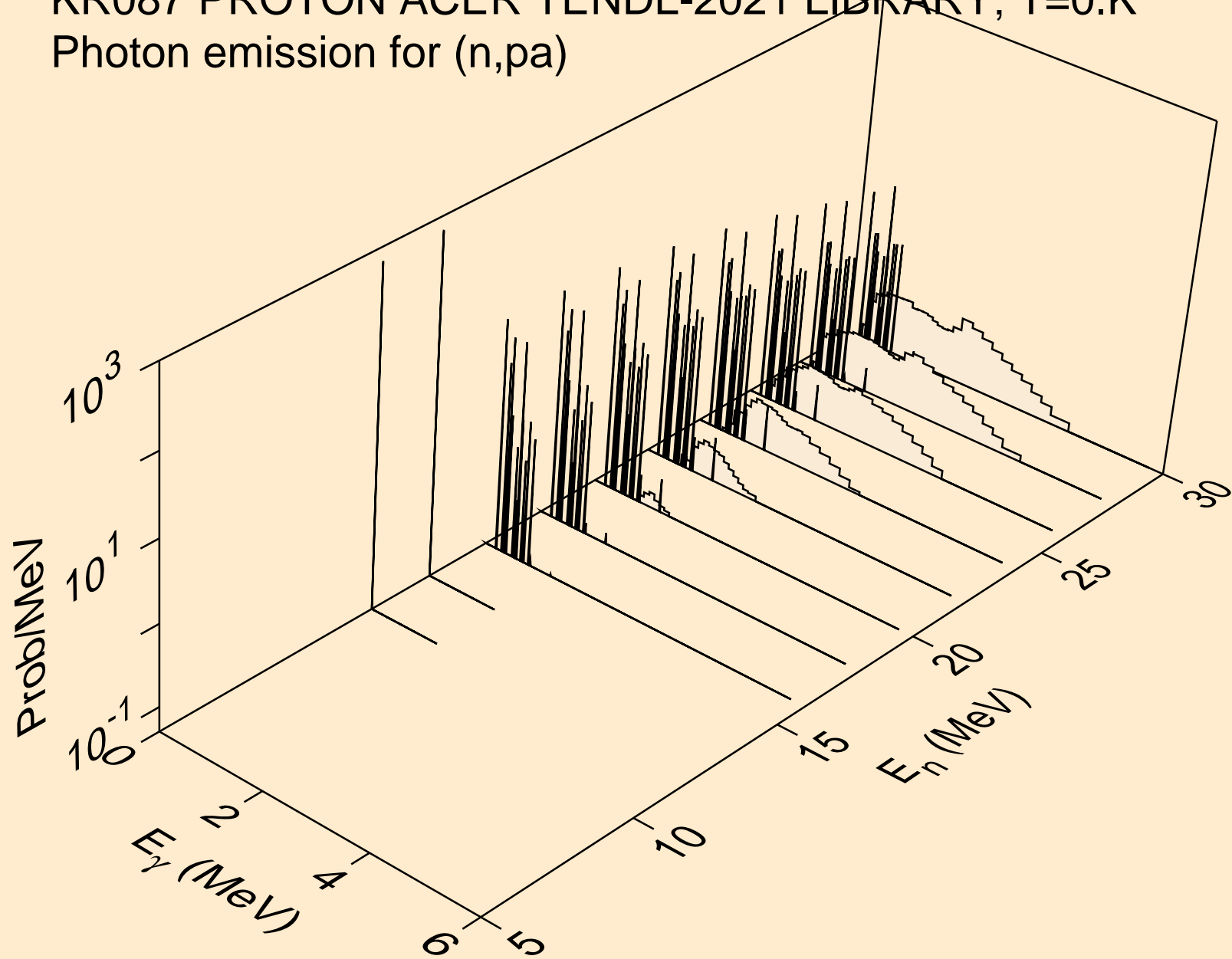

KR087 PROTON ACER TENDL-2021 LIBRARY; T=0.K
Photon emission for (n,pd)

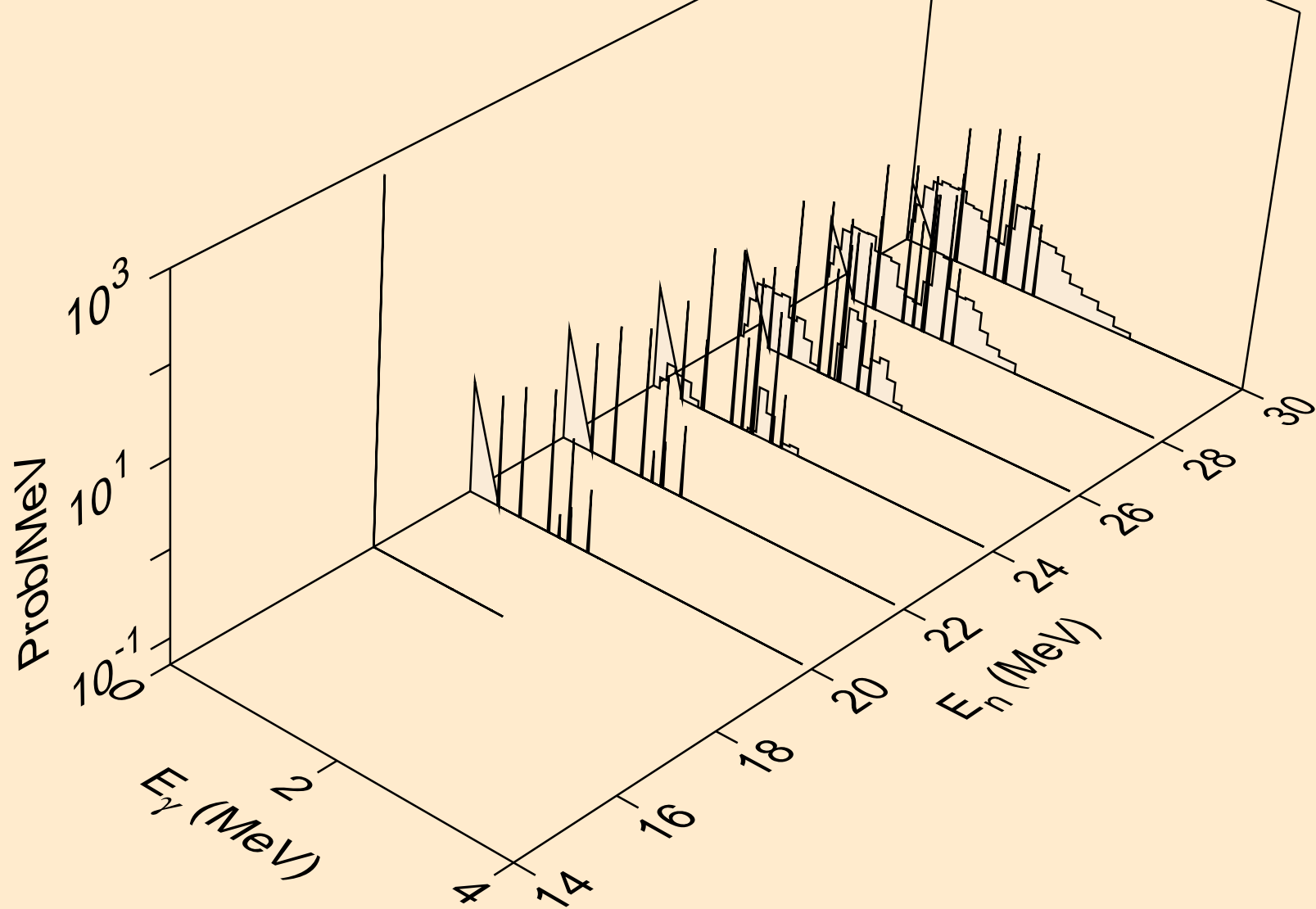

KR087 PROTON ACER TENDL-2021 LIBRARY; T=0.K
Photon emission for (n,pt)

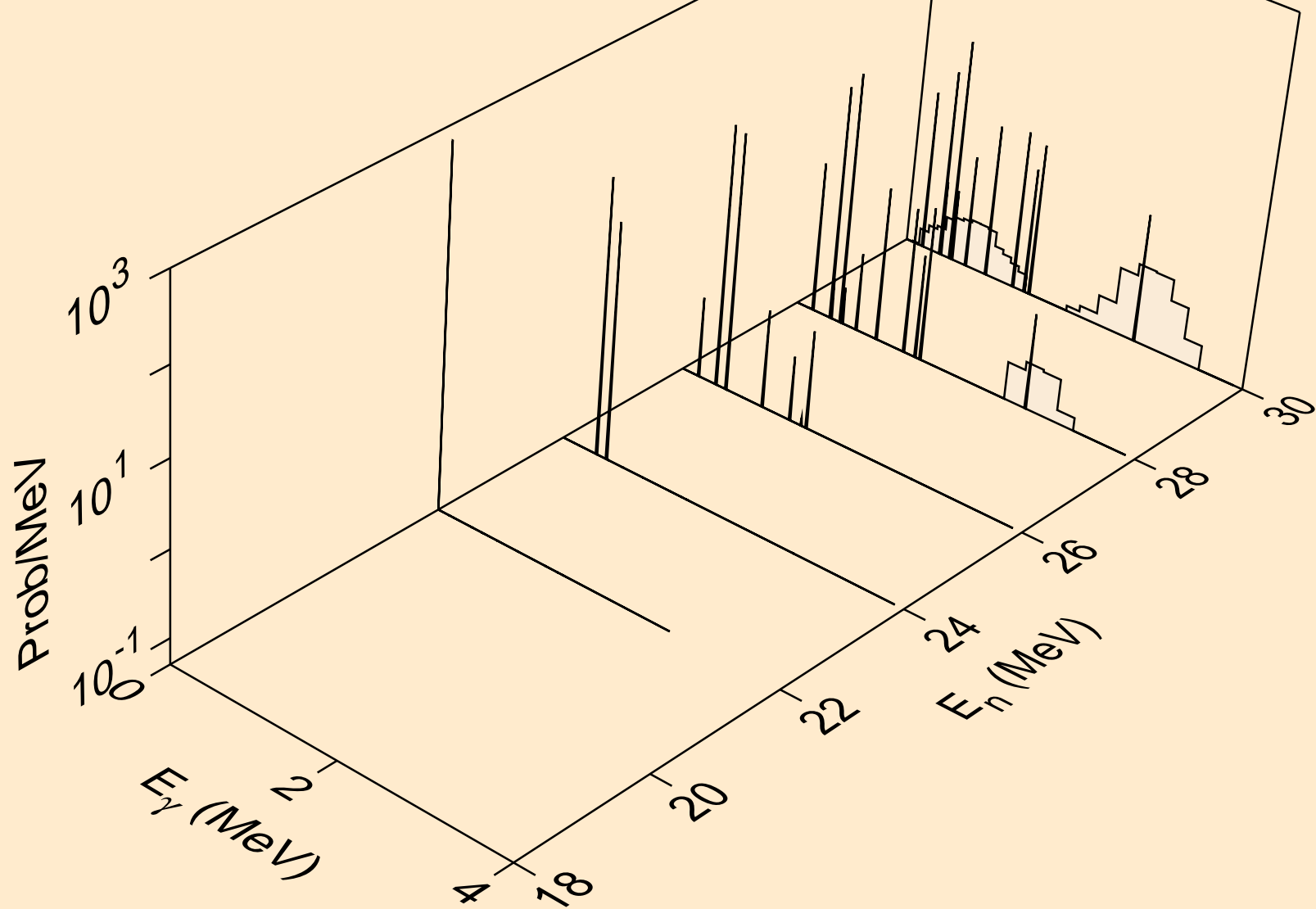

KR087 PROTON ACER TENDL-2021 LIBRARY; T=0.K
Photon emission for (n,da)

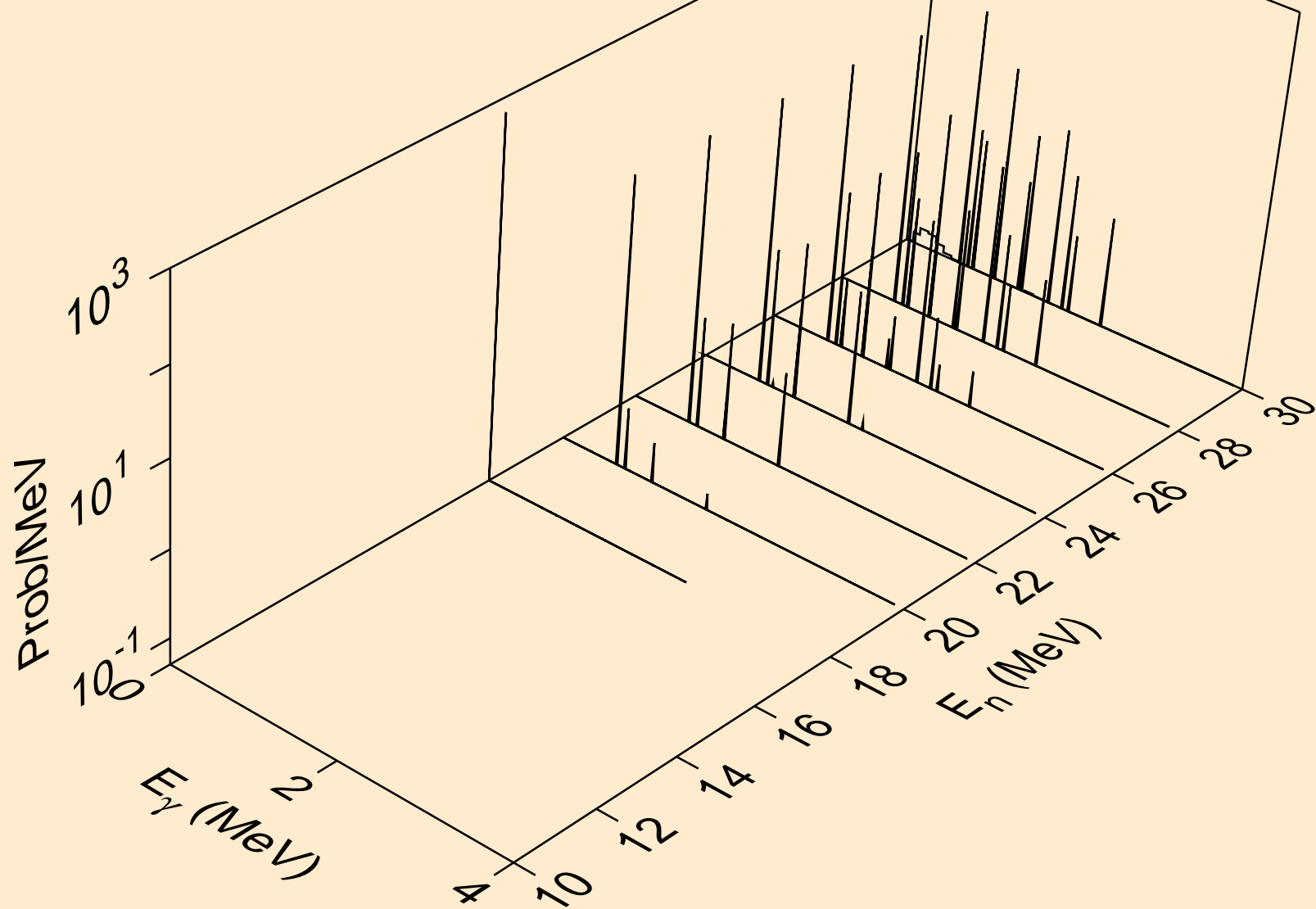

KR087 PROTON ACER TENDL-2021 LIBRARY; T=0.K
Particle heating contributions

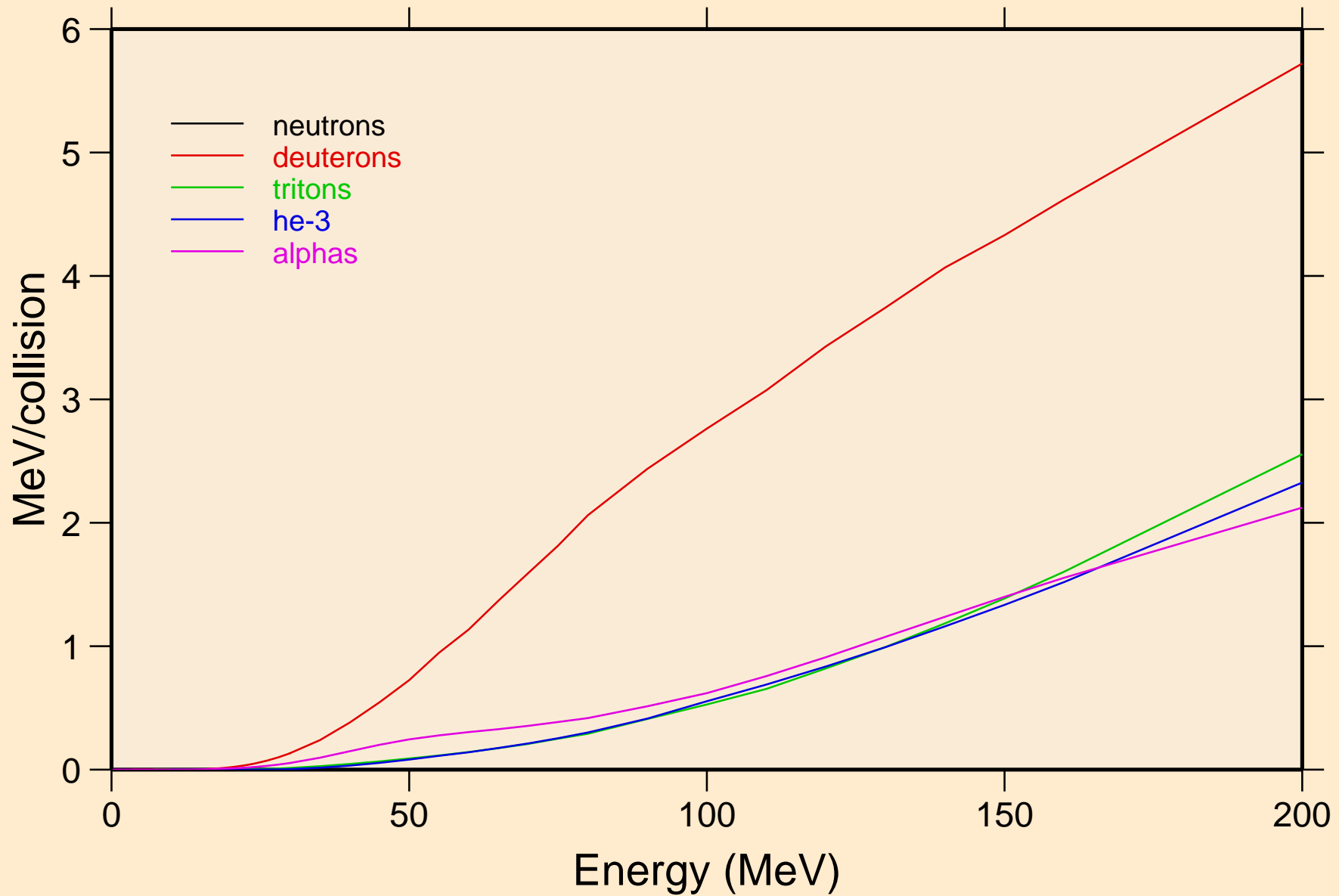

KR087 PROTON ACER TENDL-2021 LIBRARY; T=0.K
Recoil Heating

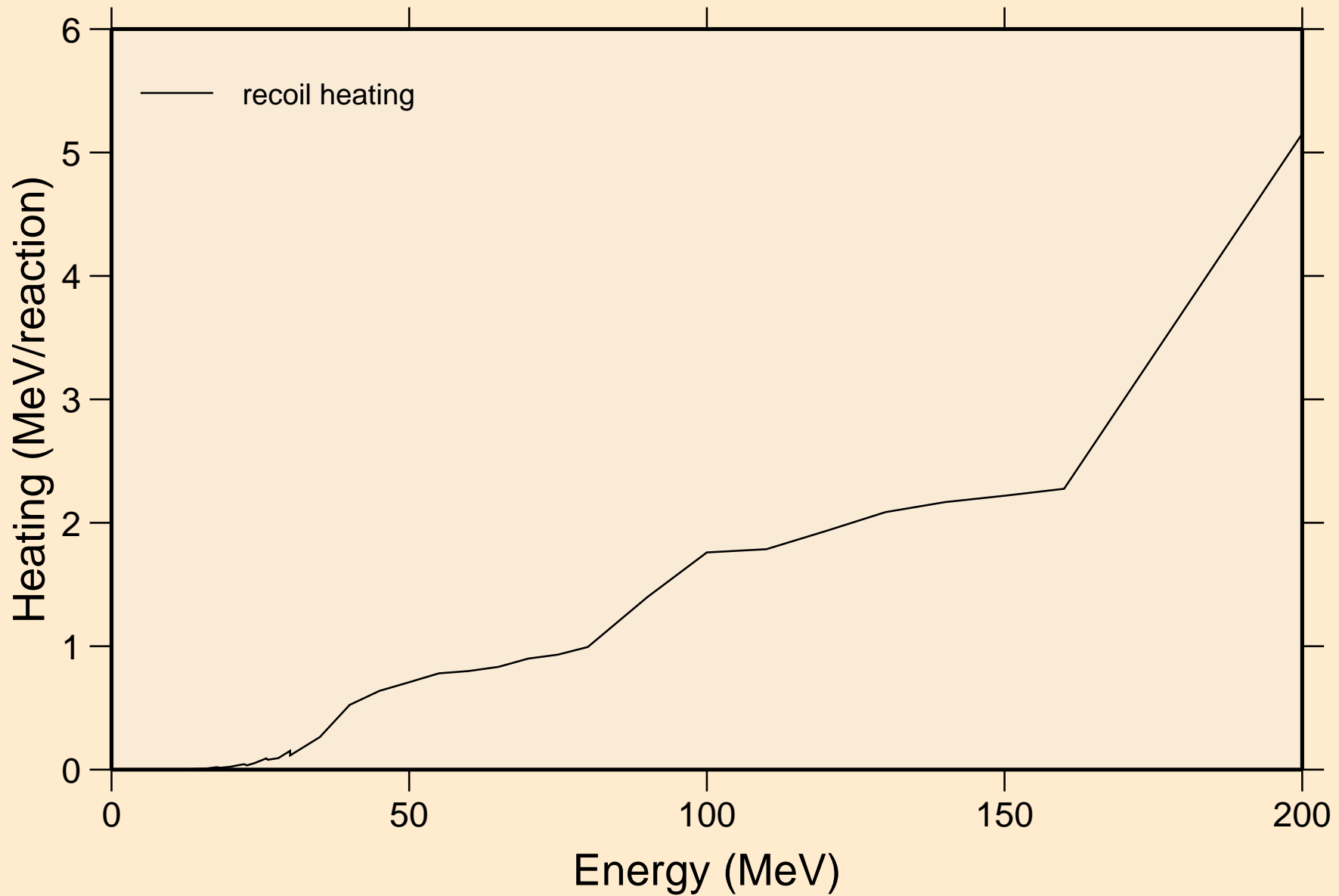

KR087 PROTON ACER TENDL-2021 LIBRARY; T=0.K
Particle production cross sections

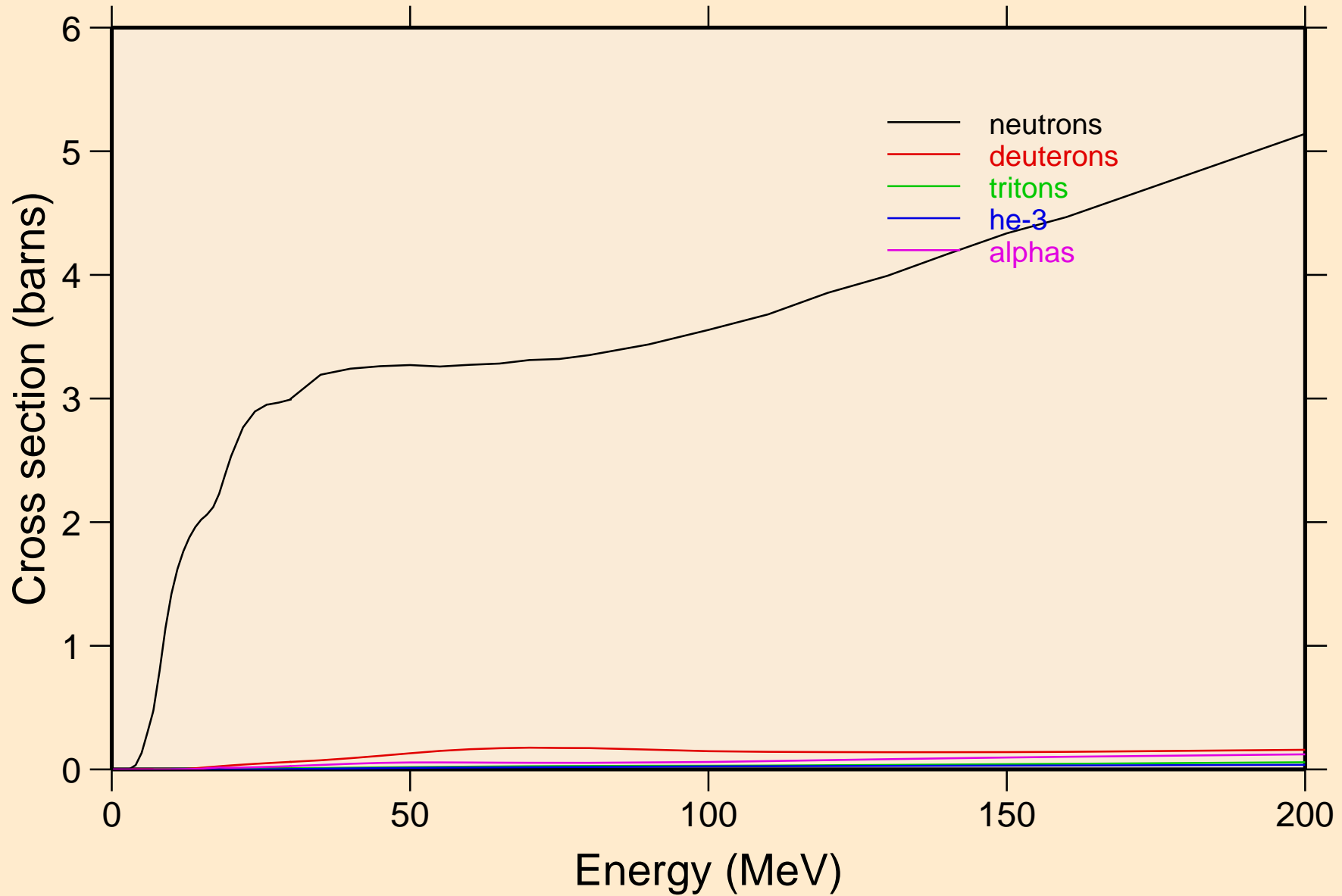

KR087 PROTON ACER TENDL-2021 LIBRARY; T=0.K
neutrons from (p,n)

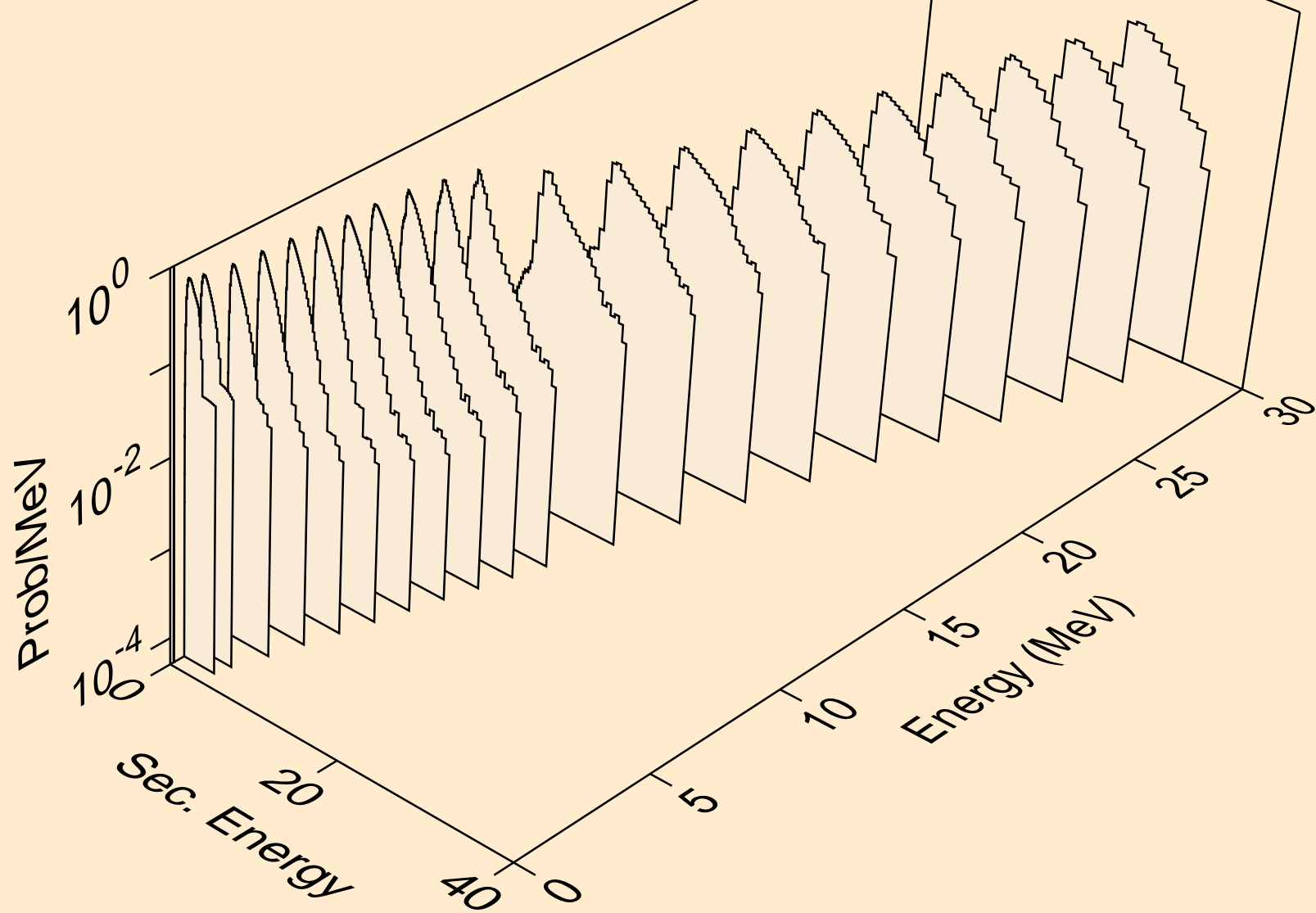

KR087 PROTON ACER TENDL-2021 LIBRARY; T=0.K
neutrons from (p,x)

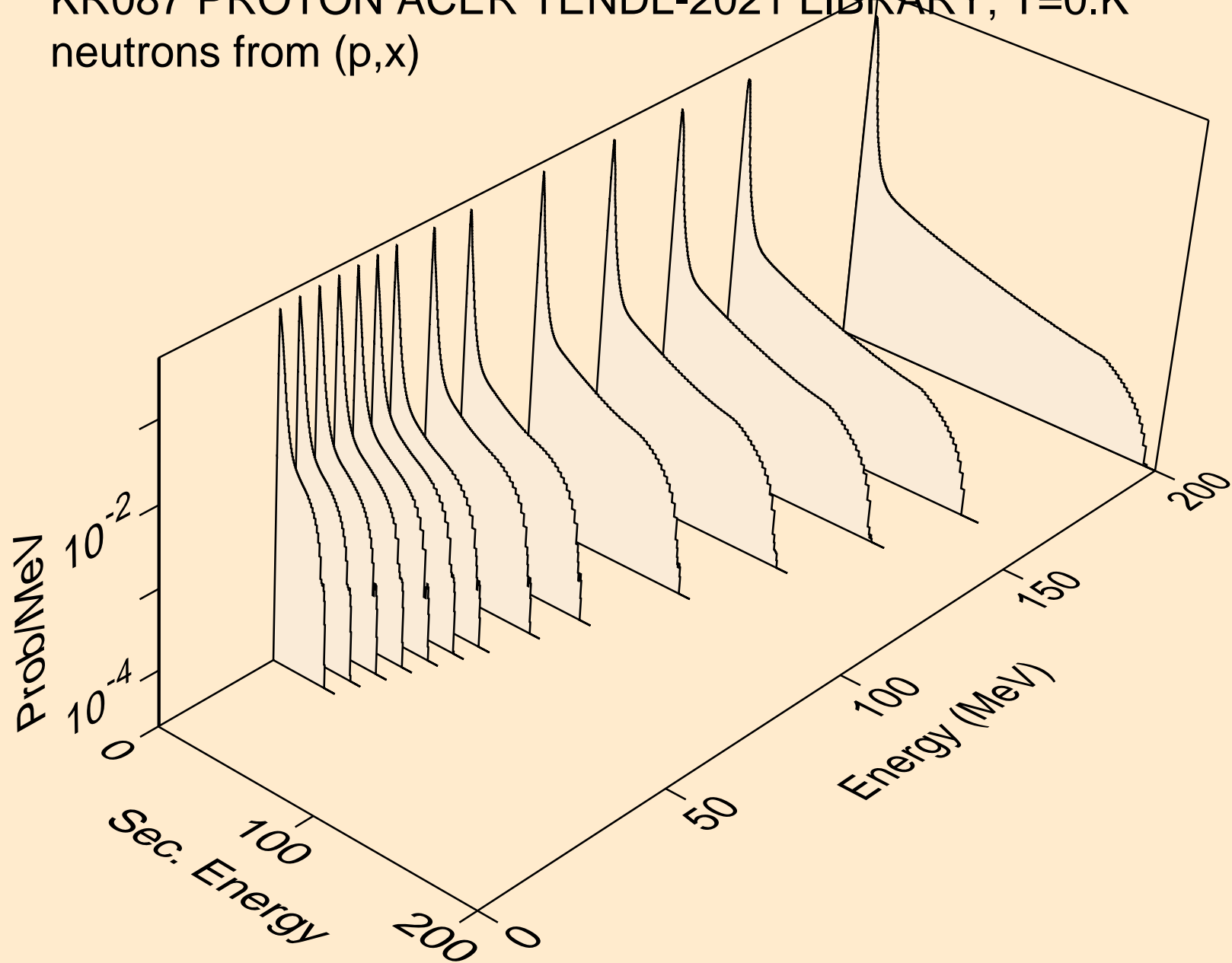

KR087 PROTON ACER TENDL-2021 LIBRARY; T=0.K
neutrons from (p,2nd)

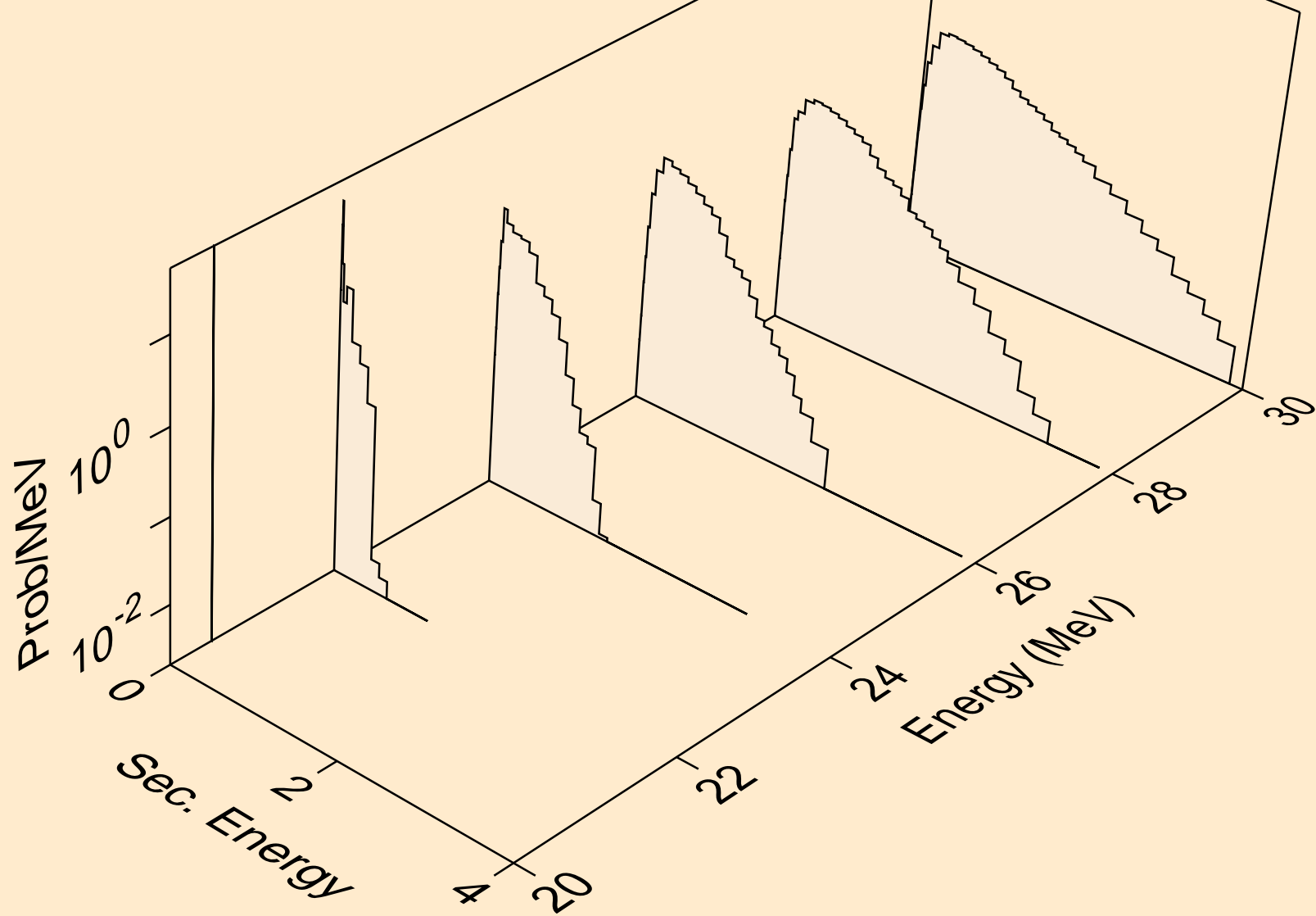

KR087 PROTON ACER TENDL-2021 LIBRARY; T=0.K
neutrons from (p,2n)

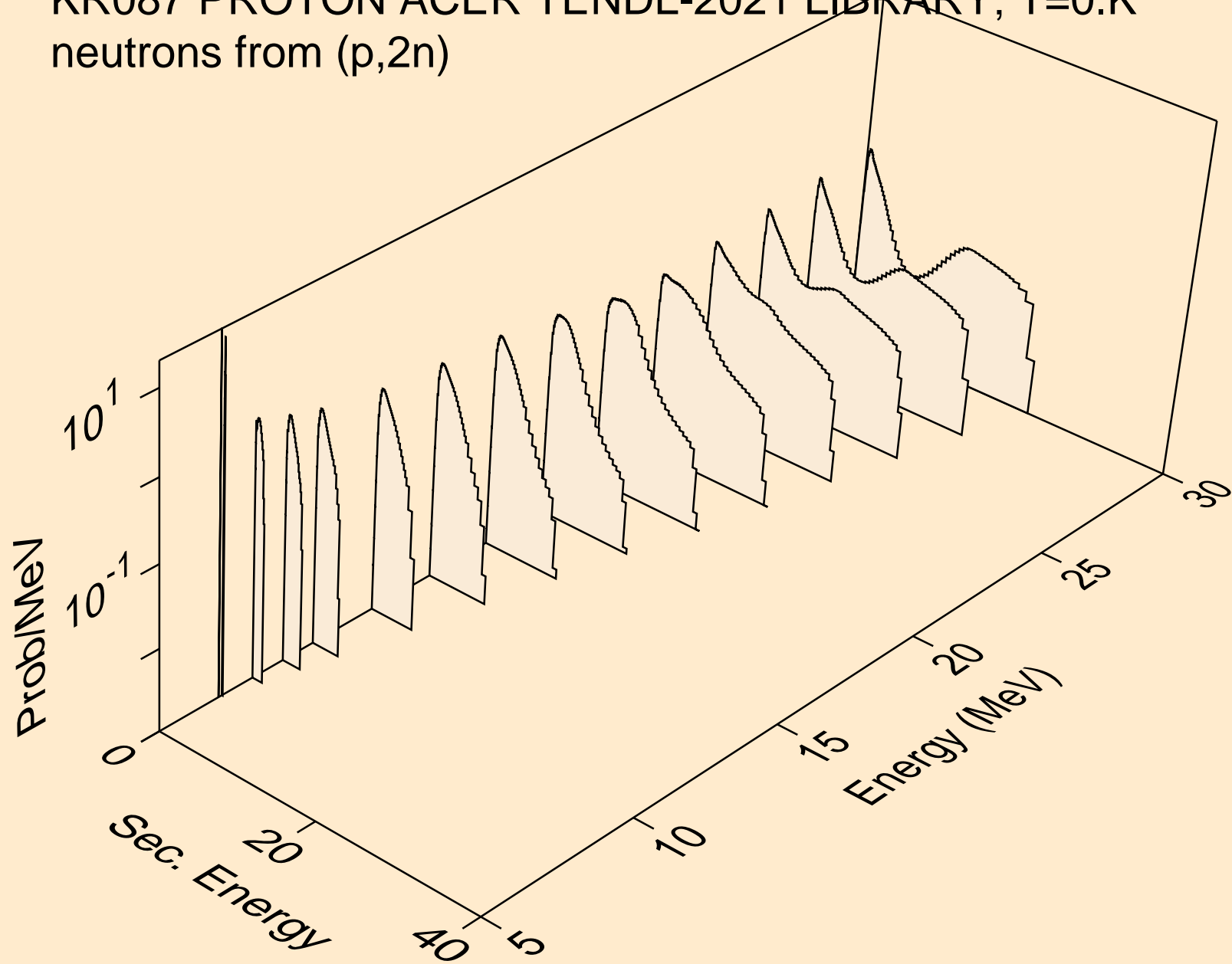

KR087 PROTON ACER TENDL-2021 LIBRARY; T=0.K
neutrons from (p,3n)

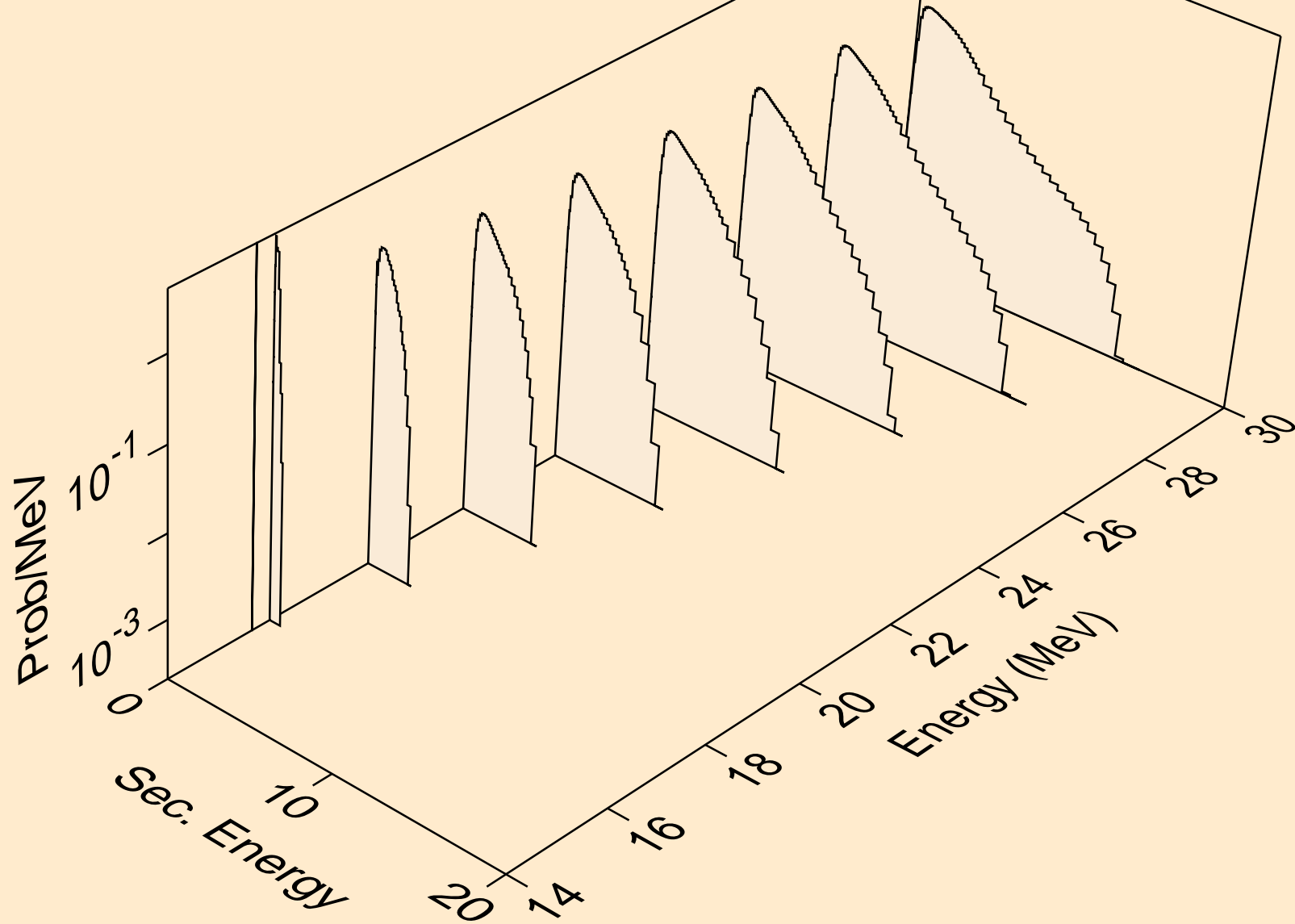

KR087 PROTON ACER TENDL-2021 LIBRARY; T=0.K
neutrons from (p,n*)a

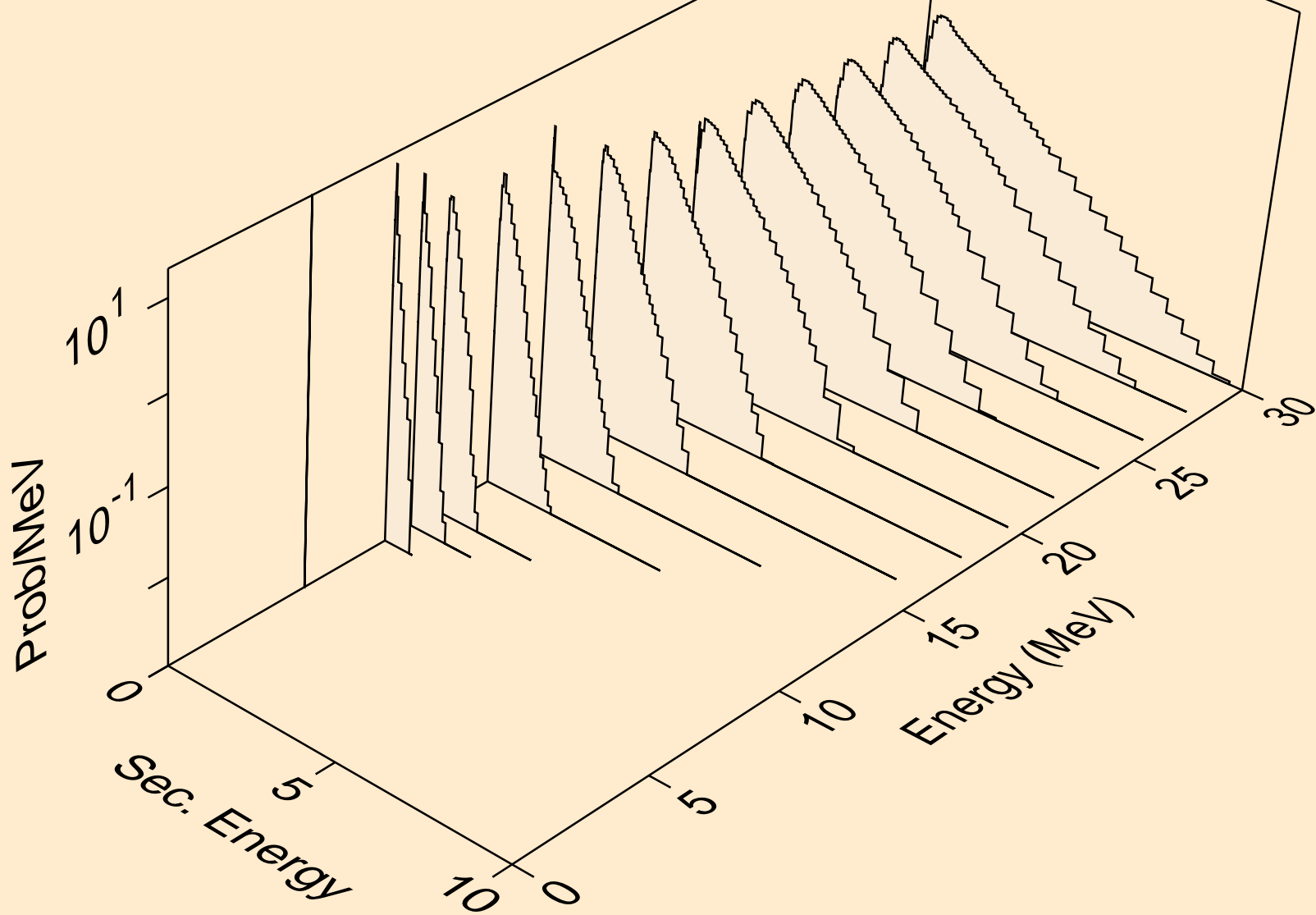

KR087 PROTON ACER TENDL-2021 LIBRARY; T=0.K
neutrons from (p,2n)a

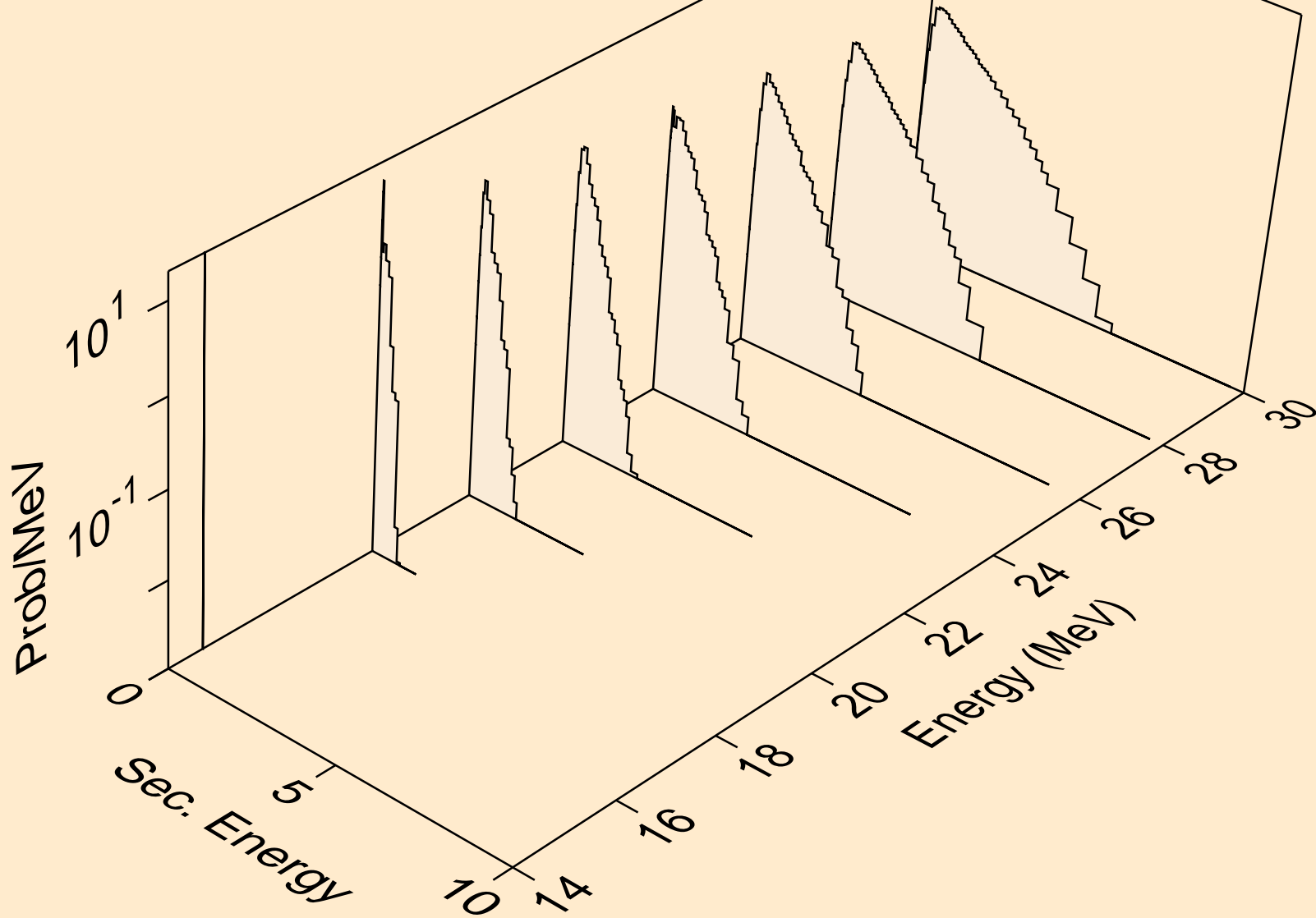

KR087 PROTON ACER TENDL-2021 LIBRARY; T=0.K
neutrons from (p,3n)a

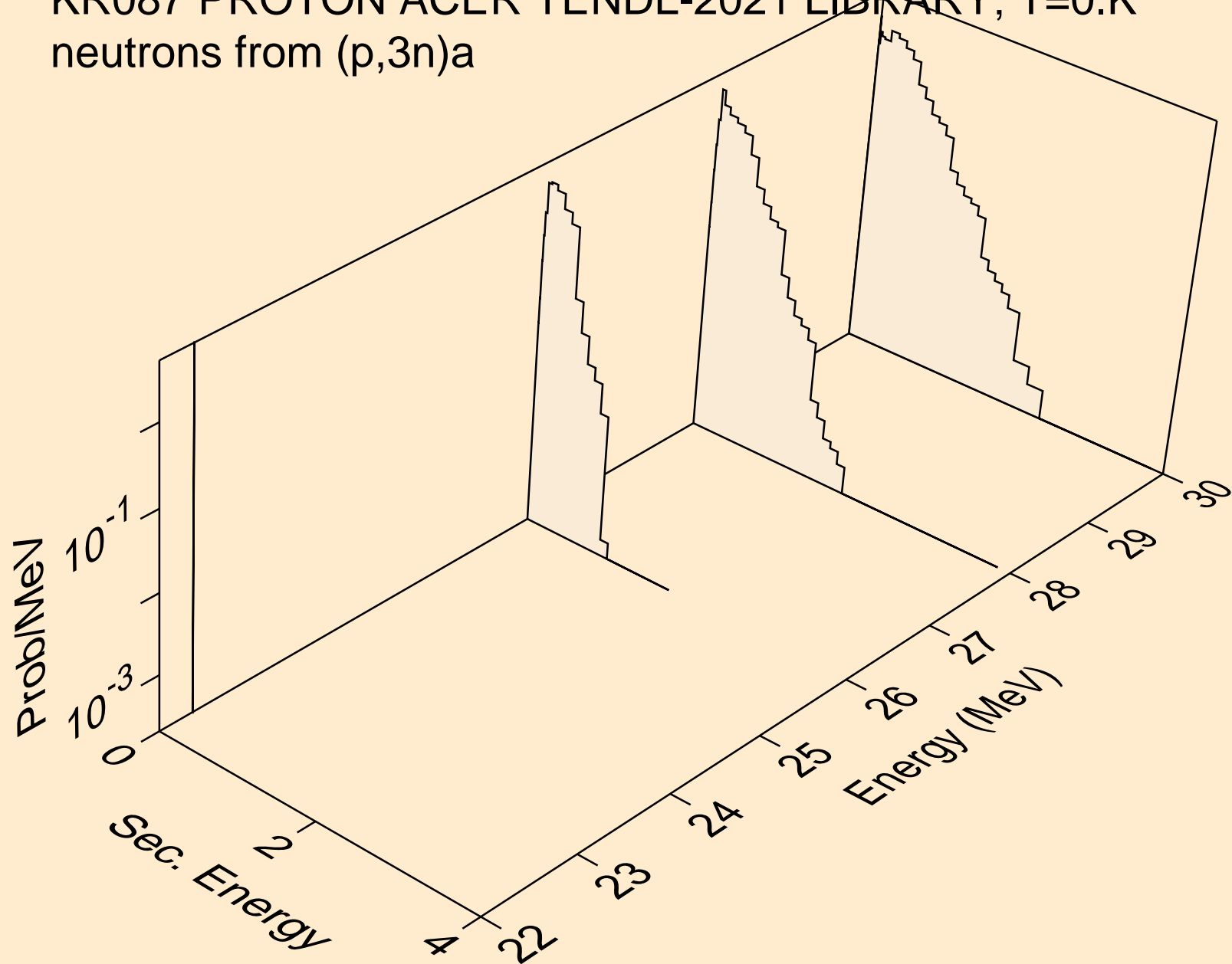

KR087 PROTON ACER TENDL-2021 LIBRARY; T=0.K
neutrons from (p,n*)p

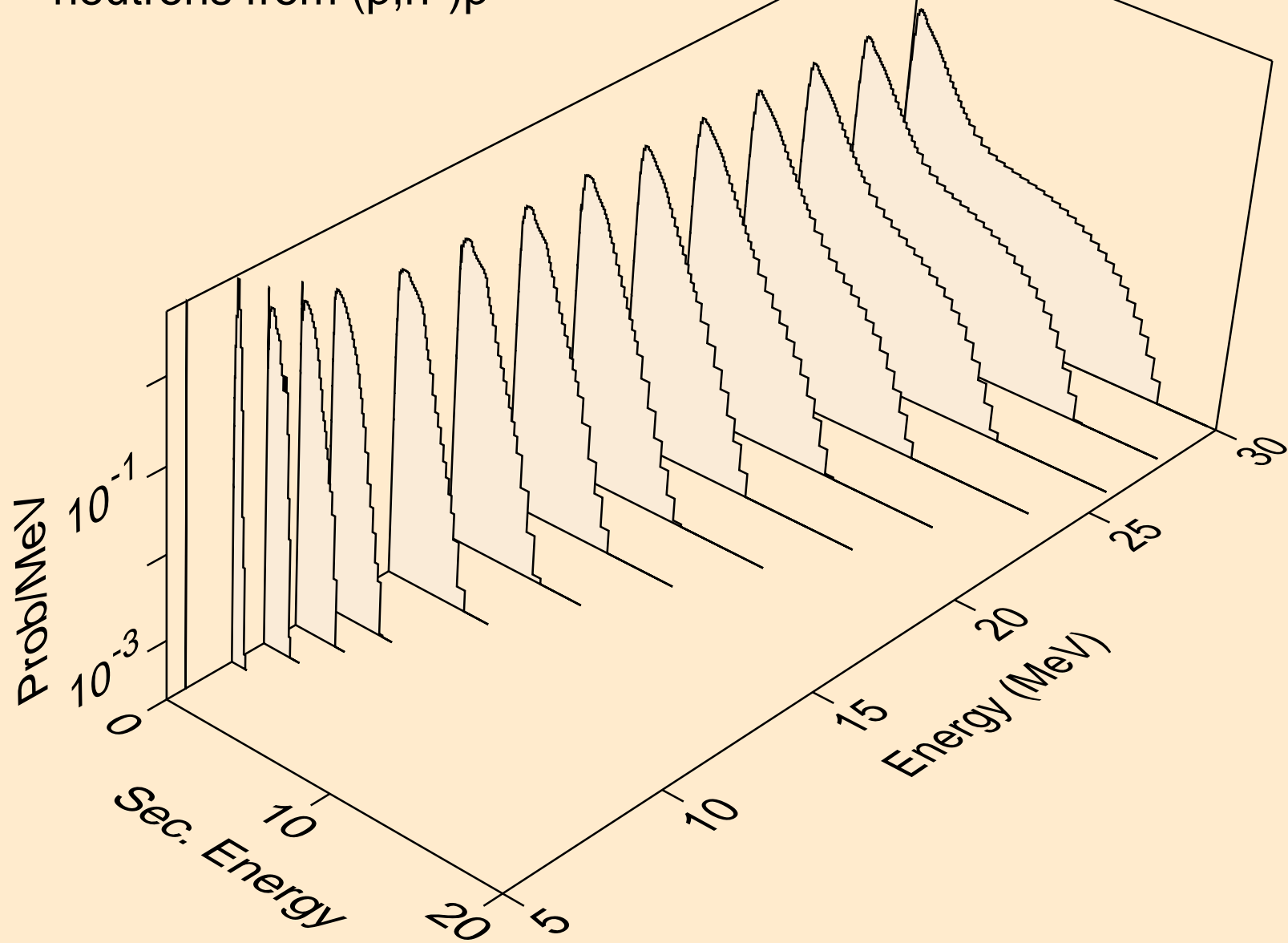

KR087 PROTON ACER TENDL-2021 LIBRARY; T=0.K
neutrons from (p,n*)2a

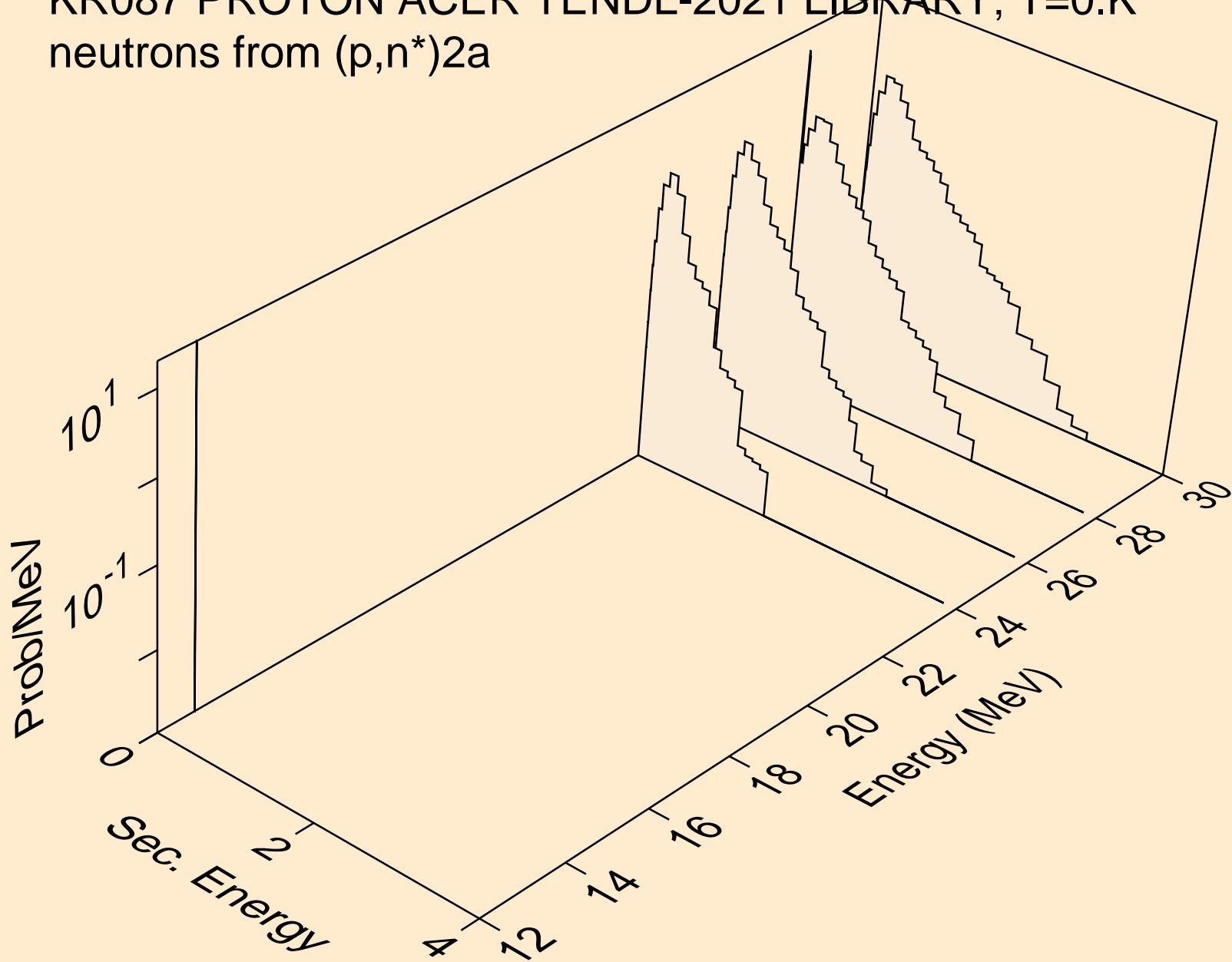

KR087 PROTON ACER TENDL-2021 LIBRARY; T=0.K
neutrons from (p,n*)d

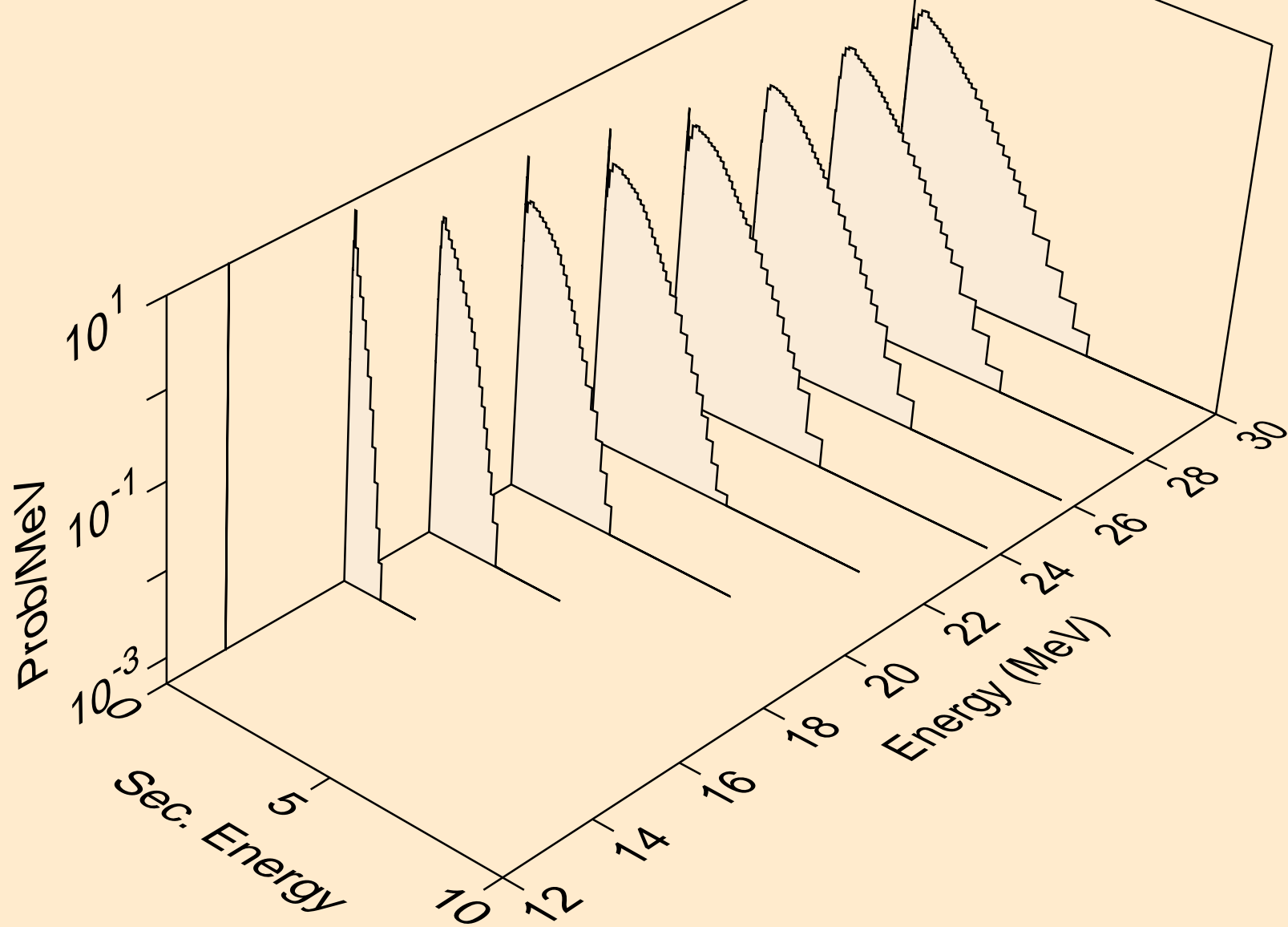

KR087 PROTON ACER TENDL-2021 LIBRARY; T=0.K
neutrons from (p,n*)t

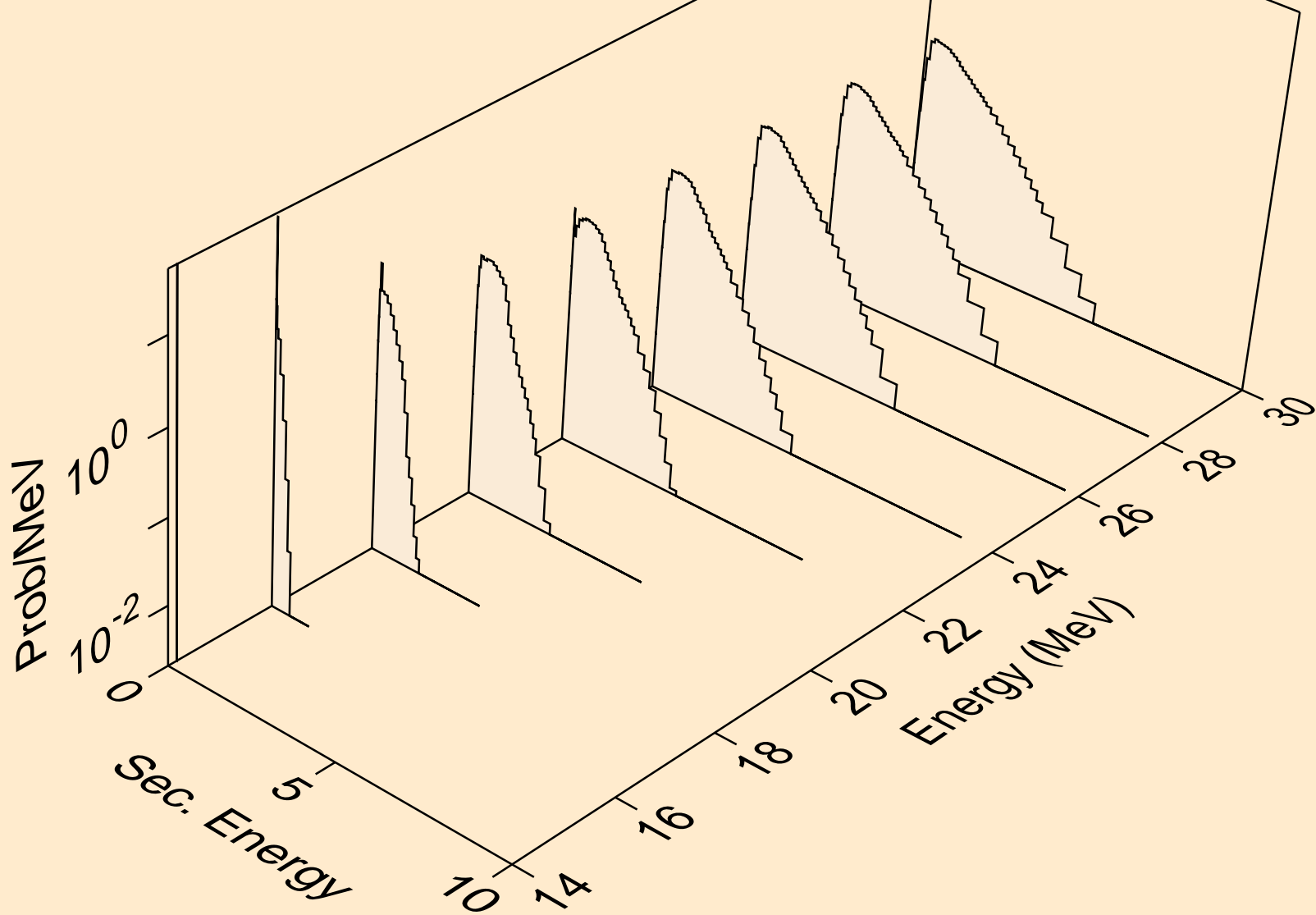

KR087 PROTON ACER TENDL-2021 LIBRARY; T=0.K
neutrons from (p,n*)he3

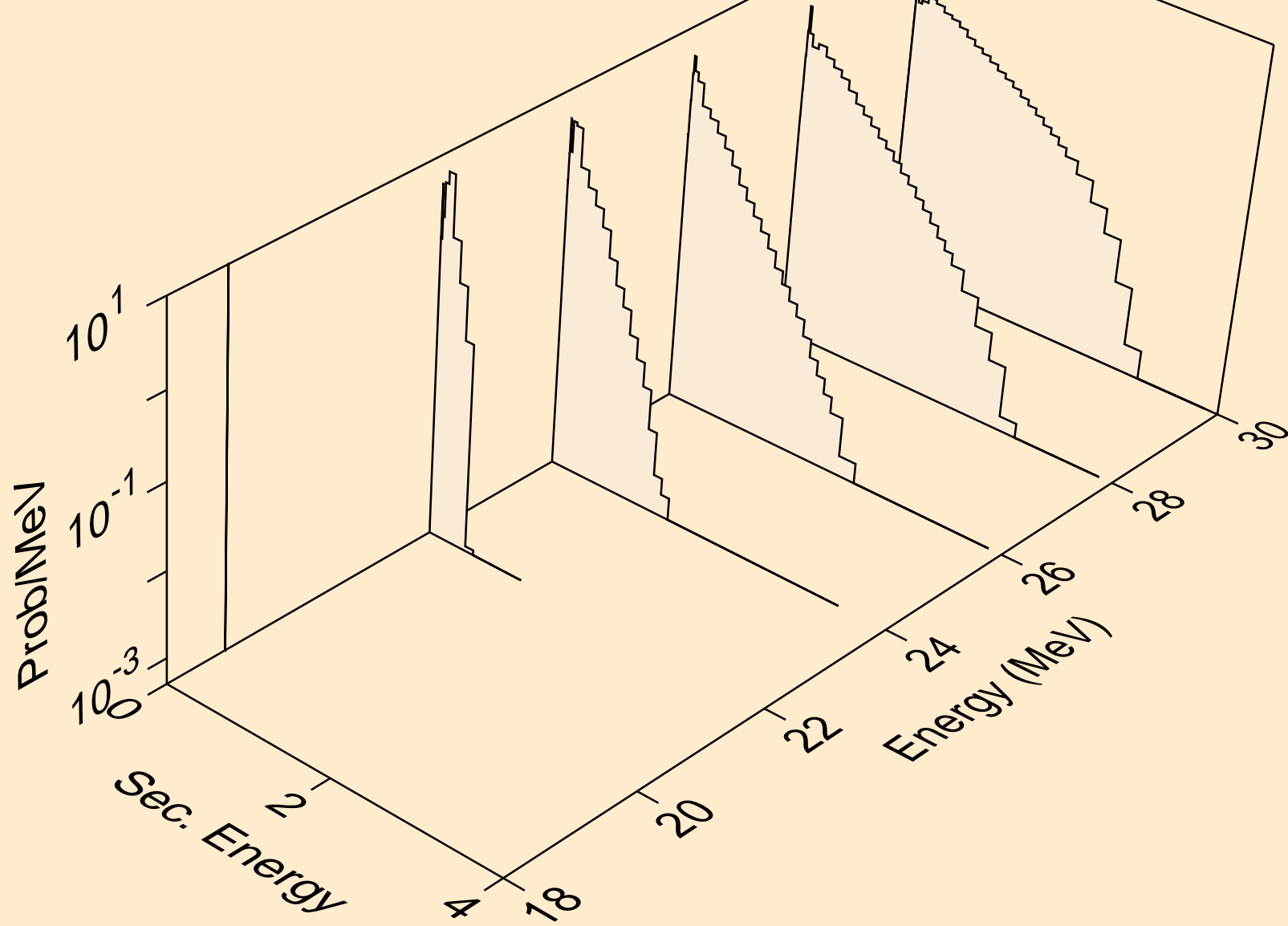

KR087 PROTON ACER TENDL-2021 LIBRARY; T=0.K
neutrons from (p,4n)

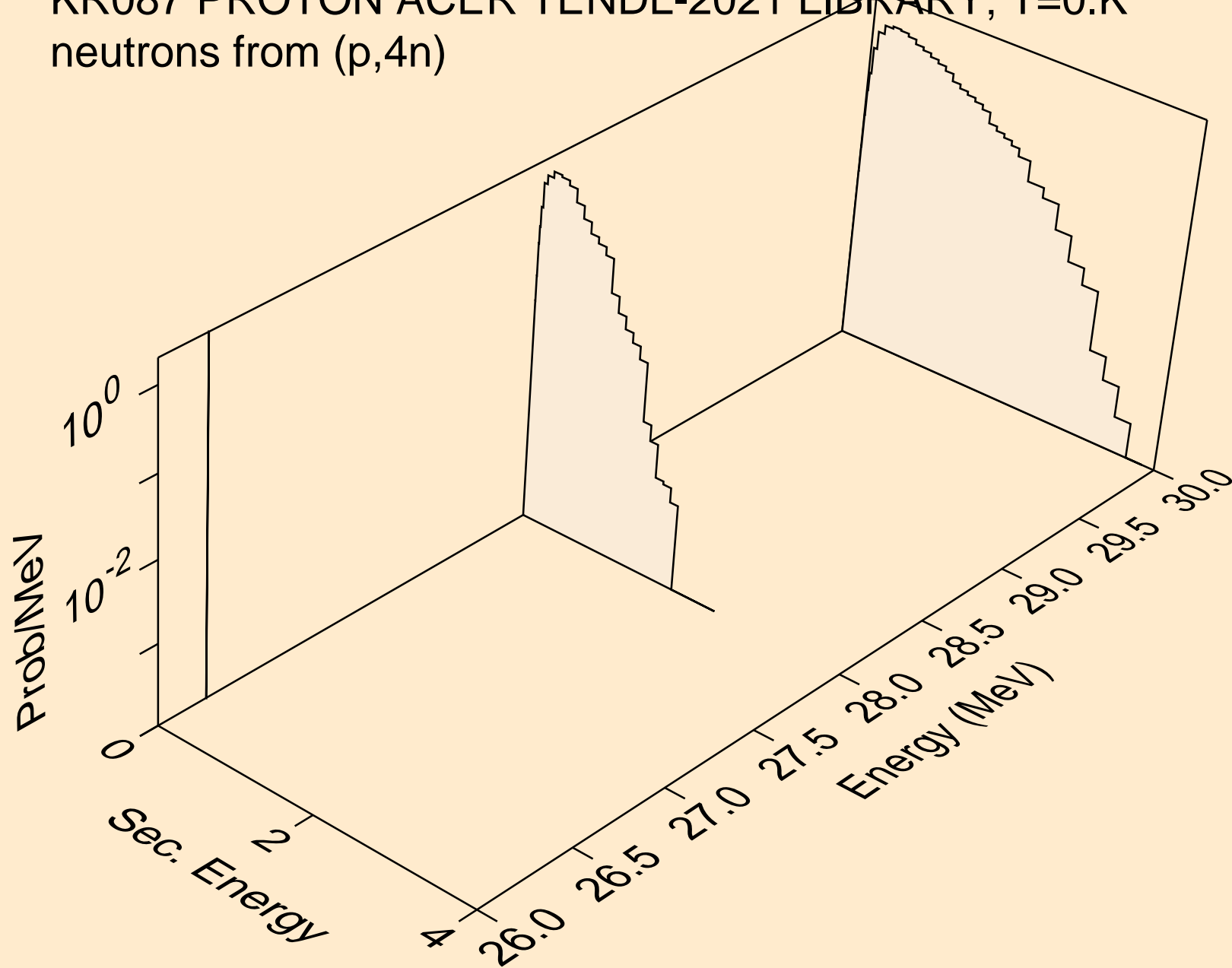

KR087 PROTON ACER TENDL-2021 LIBRARY; T=0.K
neutrons from (p,2np)

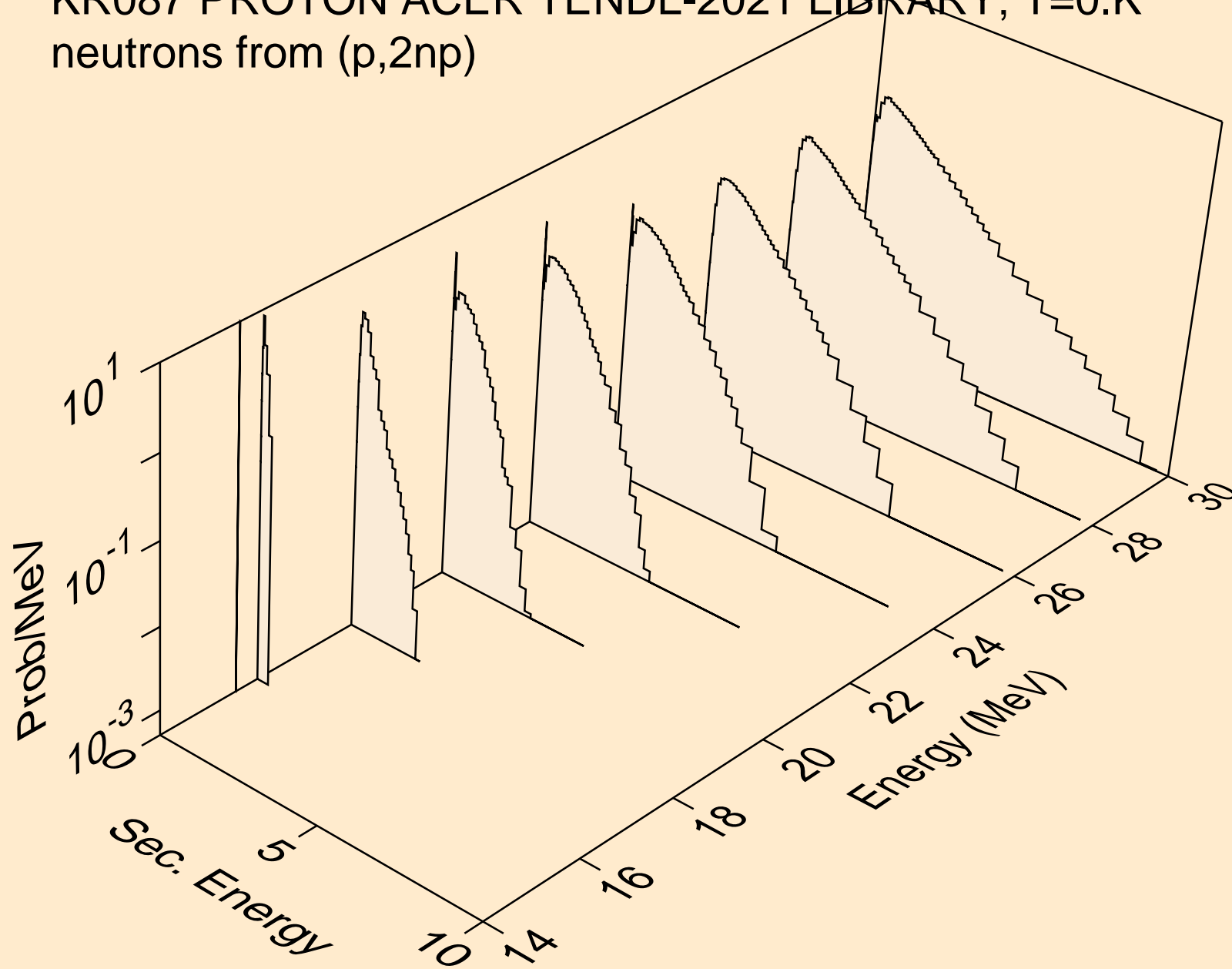

KR087 PROTON ACER TENDL-2021 LIBRARY; T=0.K
neutrons from (p,3np)

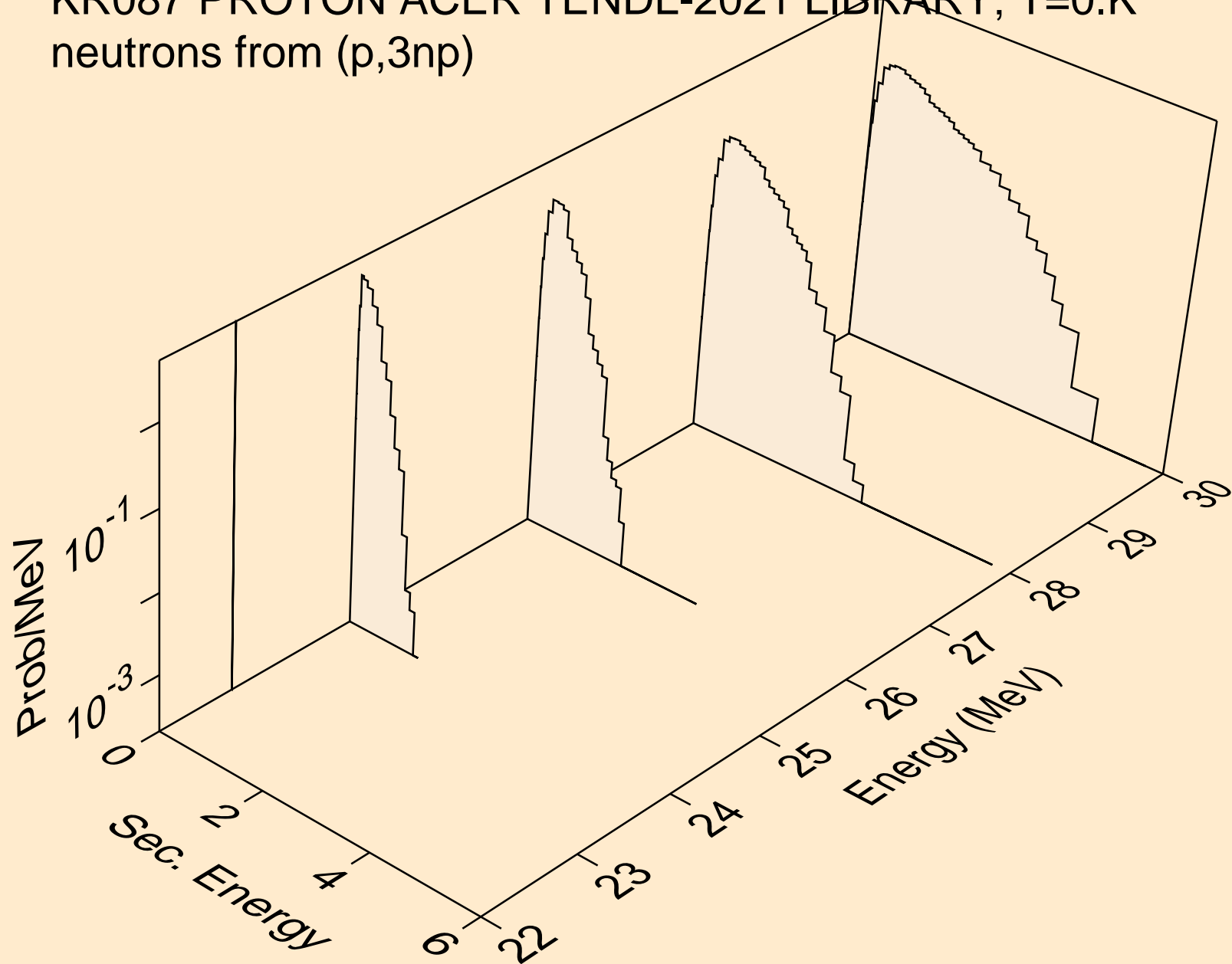

KR087 PROTON ACER TENDL-2021 LIBRARY; T=0.K
neutrons from (p,2np)

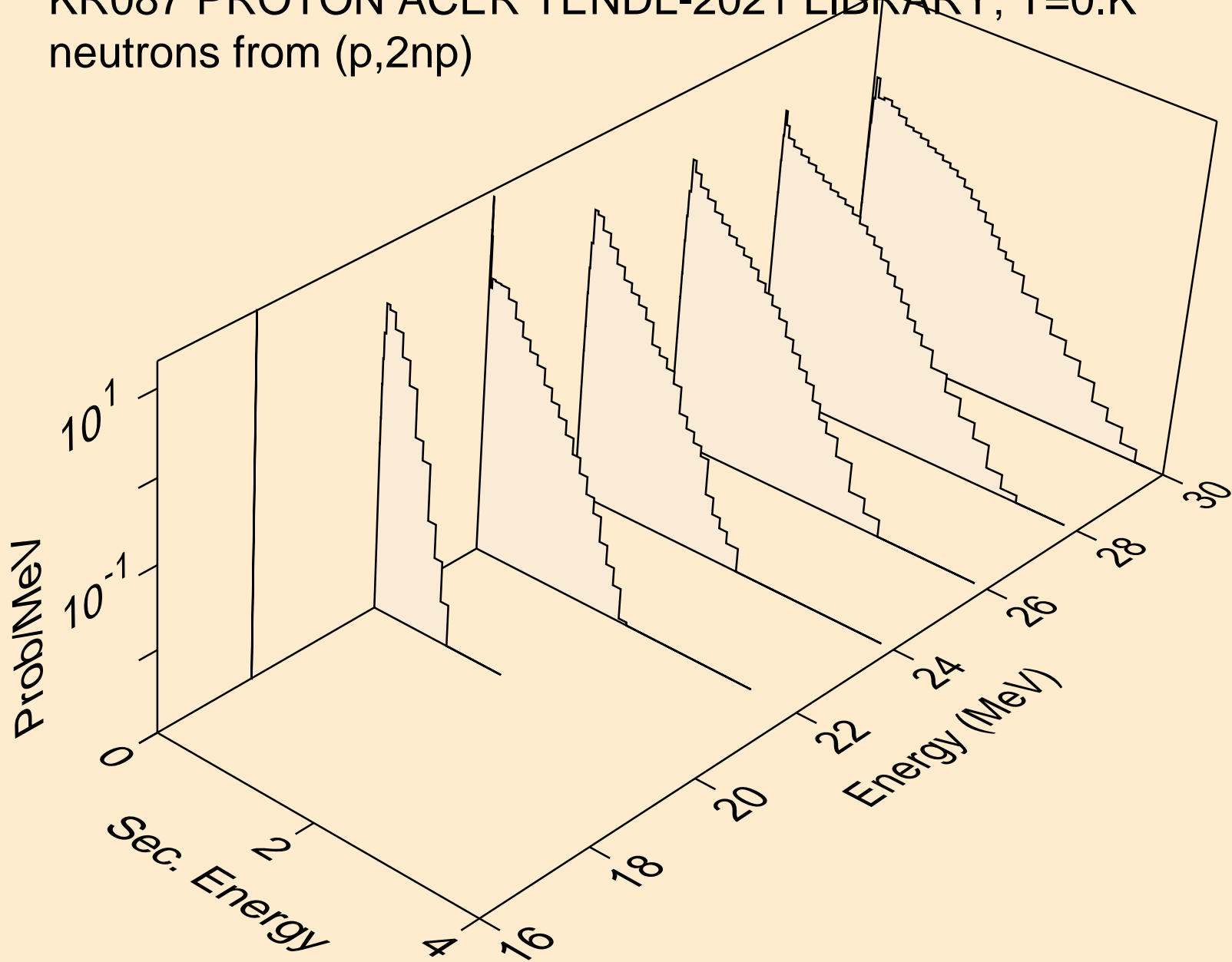

KR087 PROTON ACER TENDL-2021 LIBRARY; T=0.K
neutrons from (p,npa)

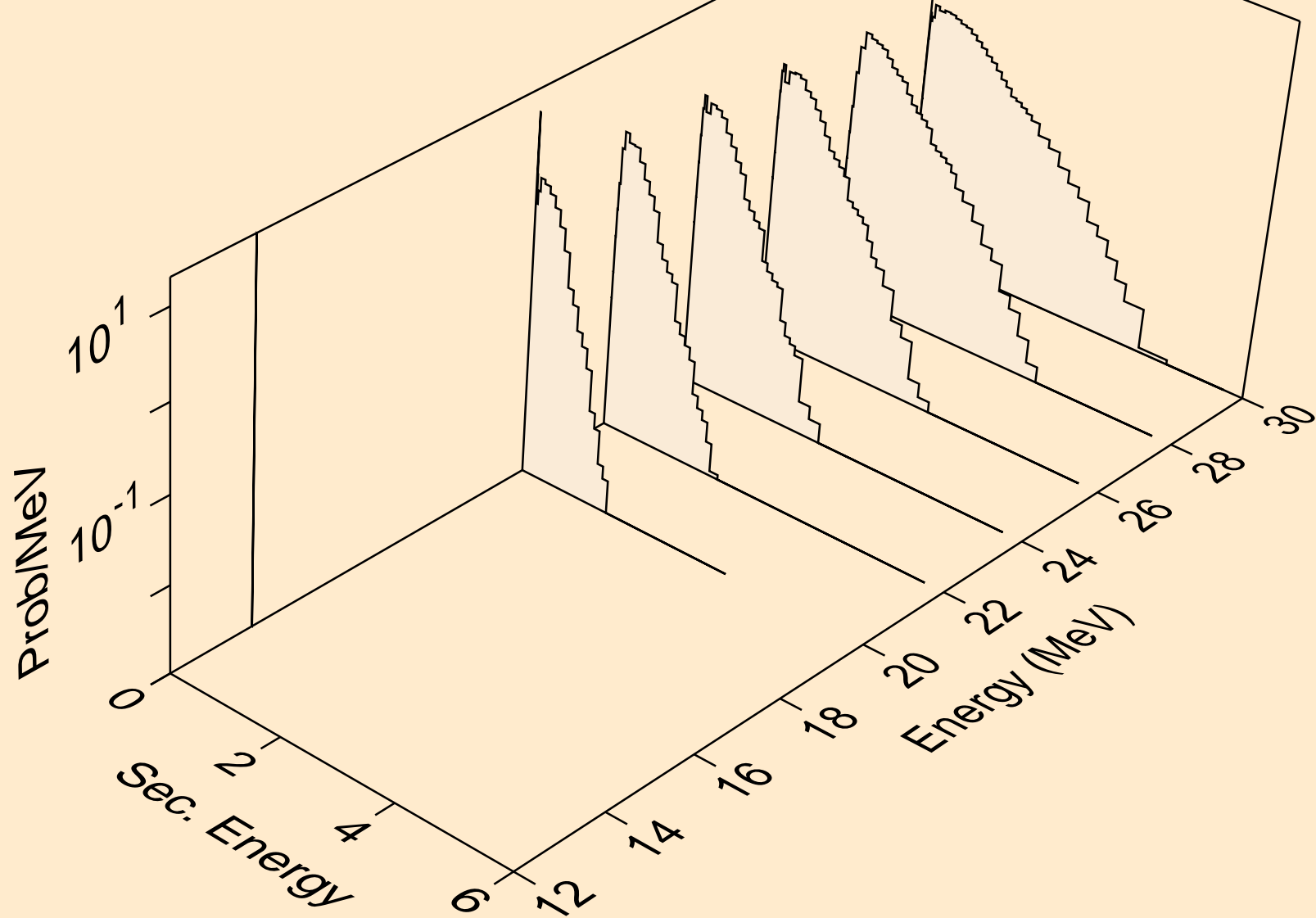

KR087 PROTON ACER TENDL-2021 LIBRARY; T=0.K
deuterons from (p,x)

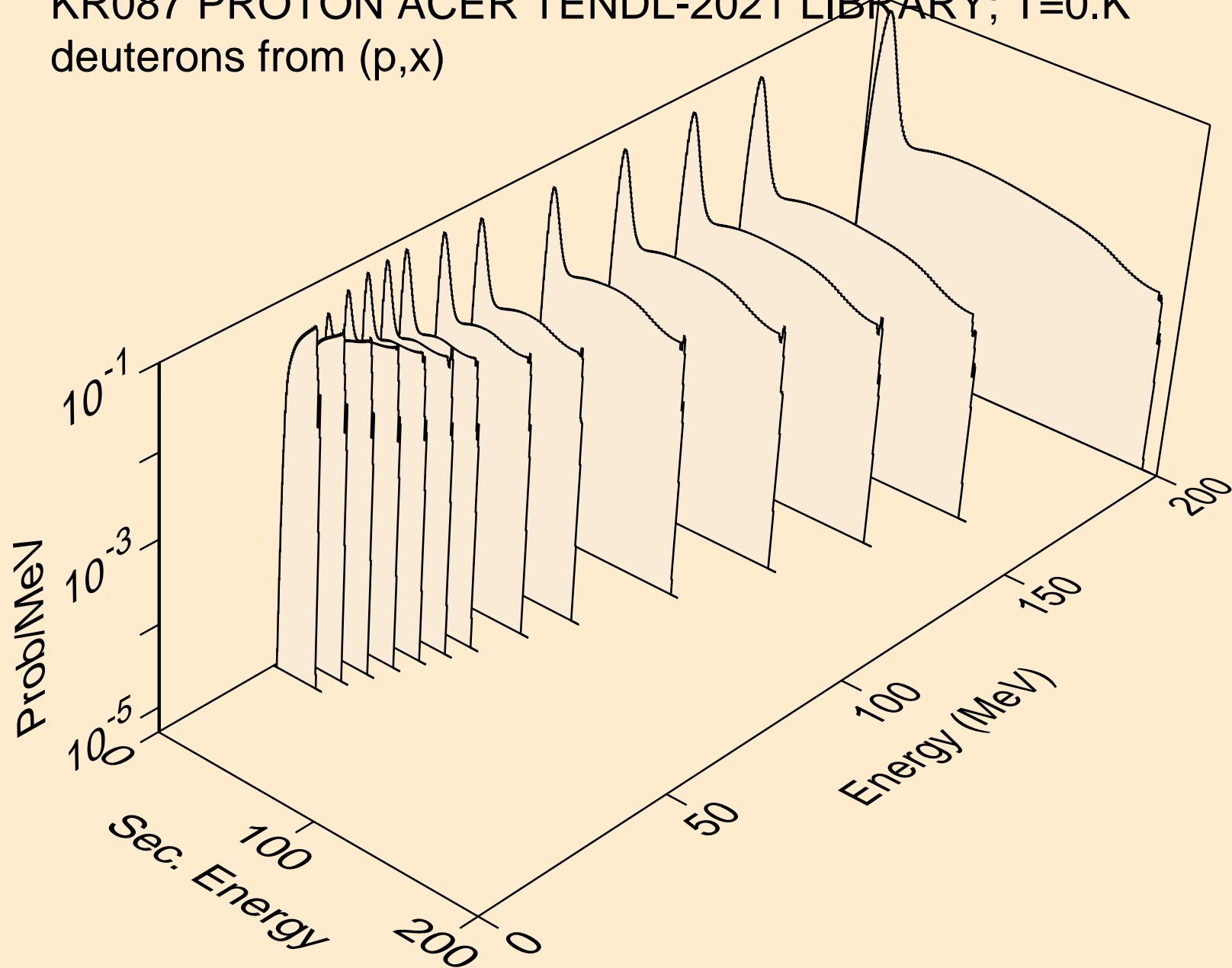

KR087 PROTON ACER TENDL-2021 LIBRARY; T=0.K
deuterons from (p,2nd)

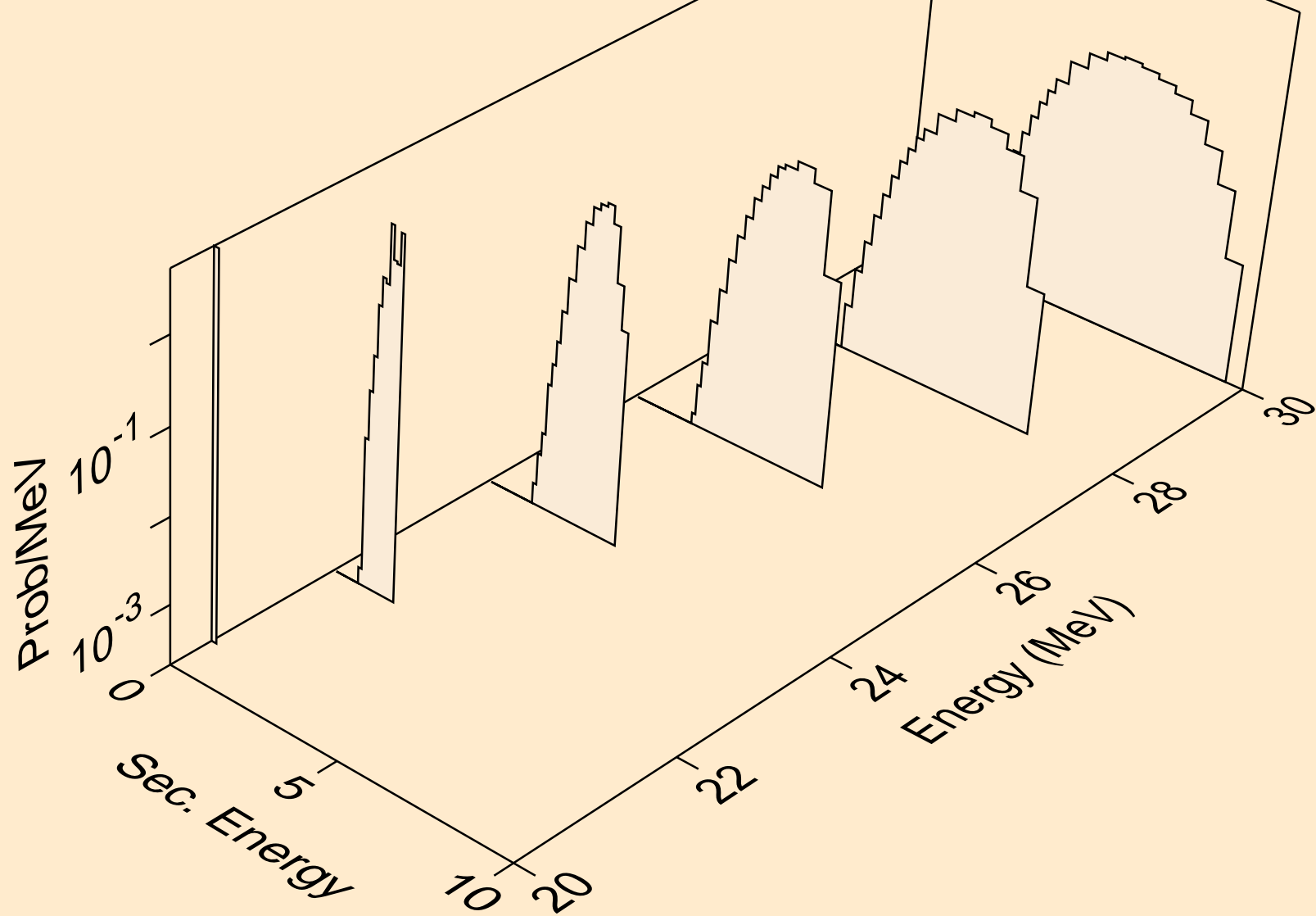

KR087 PROTON ACER TENDL-2021 LIBRARY; T=0.K
deuterons from (p,n*)d

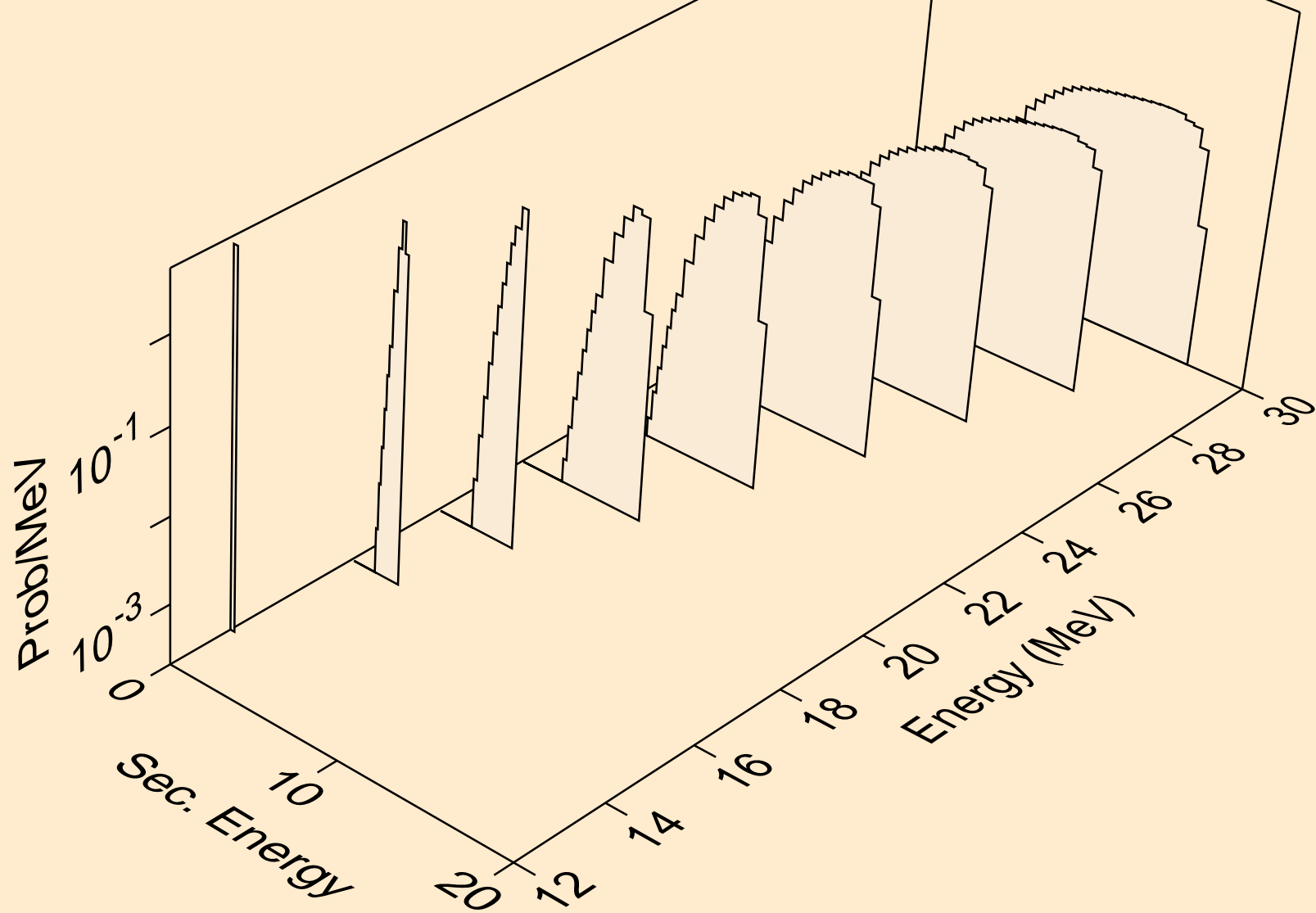

KR087 PROTON ACER TENDL-2021 LIBRARY; T=0.K
deuterons from (p,d)

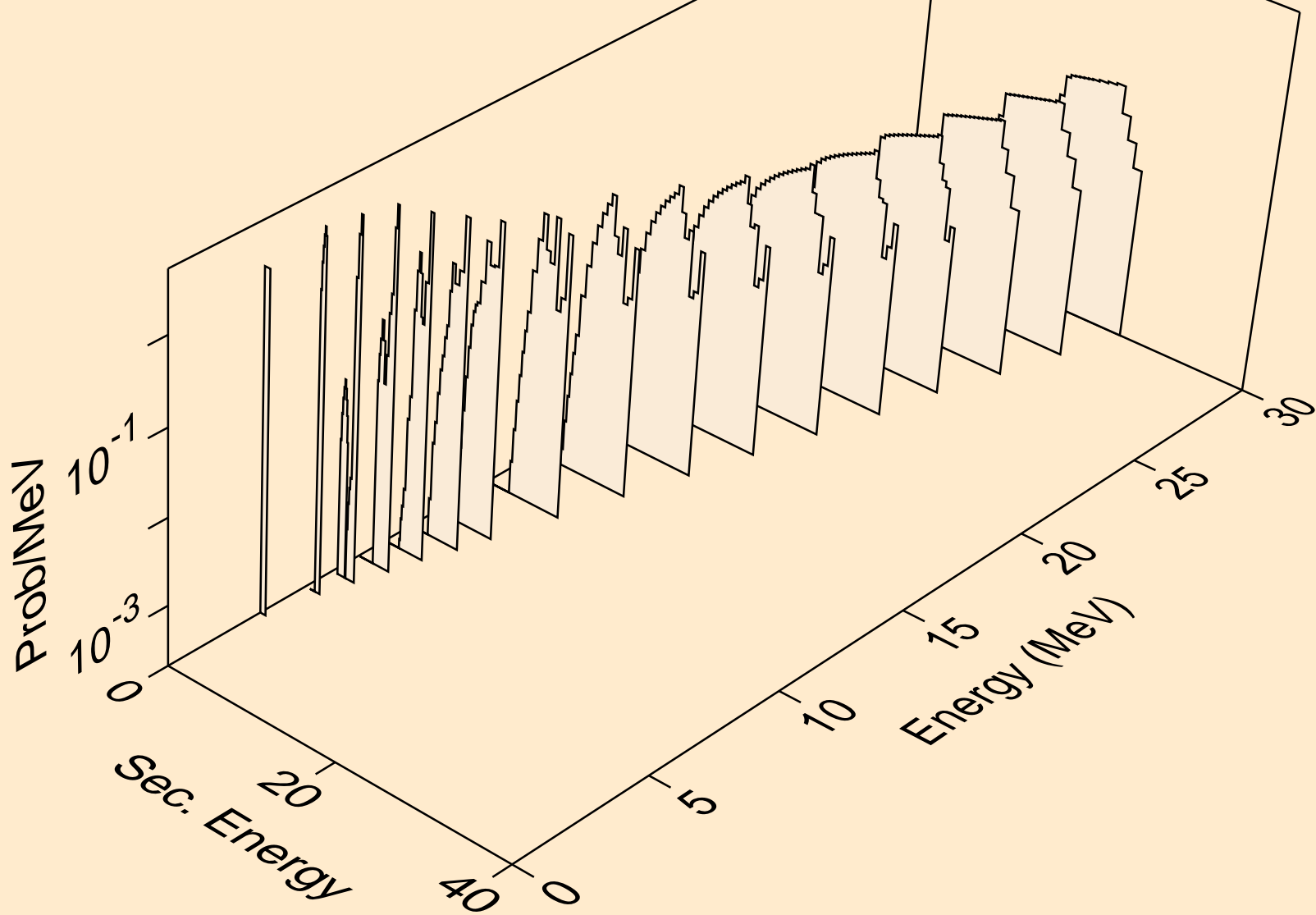

KR087 PROTON ACER TENDL-2021 LIBRARY; T=0.K
deuterons from (p,pd)

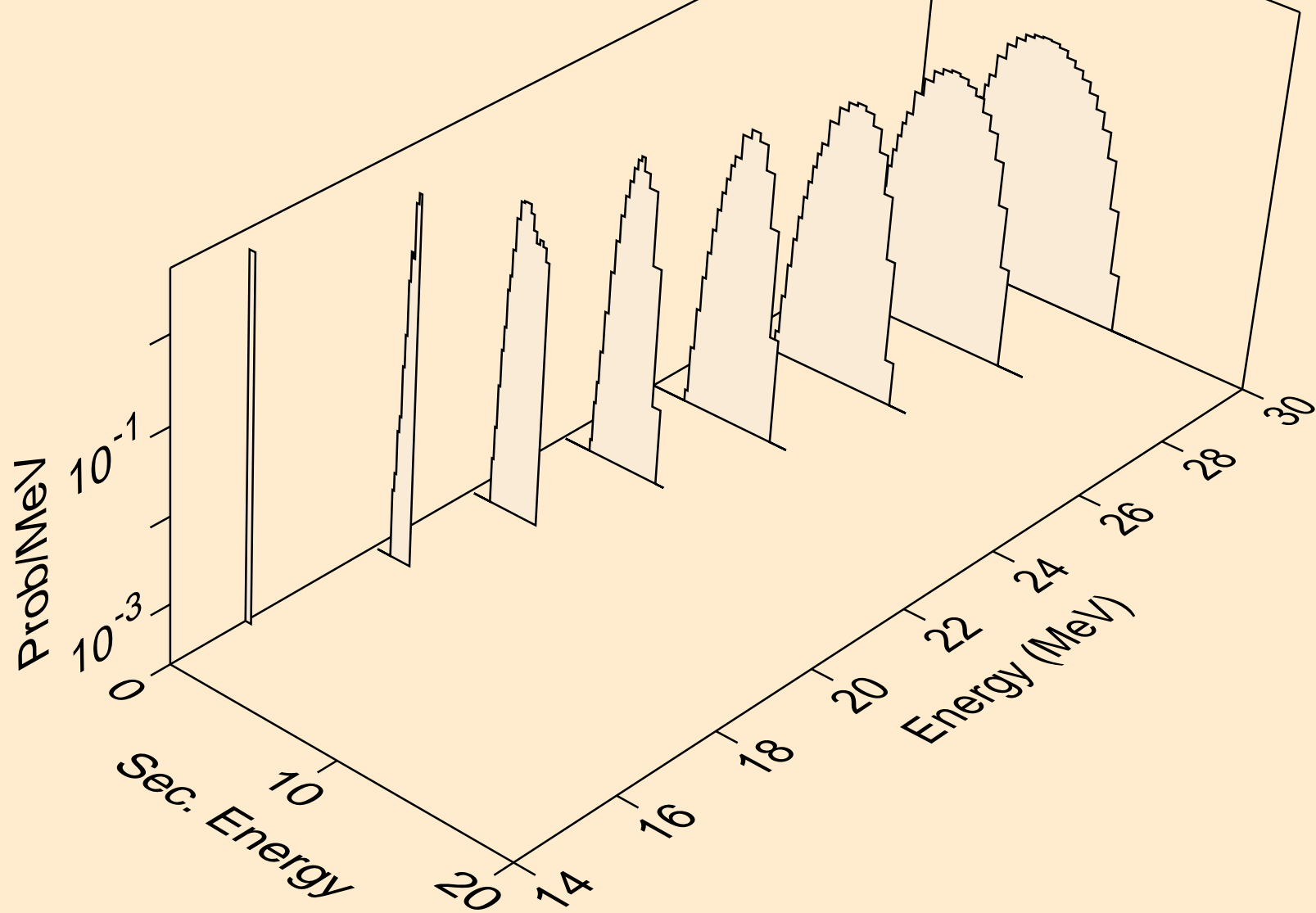

KR087 PROTON ACER TENDL-2021 LIBRARY; T=0.K
deuterons from (p,da)

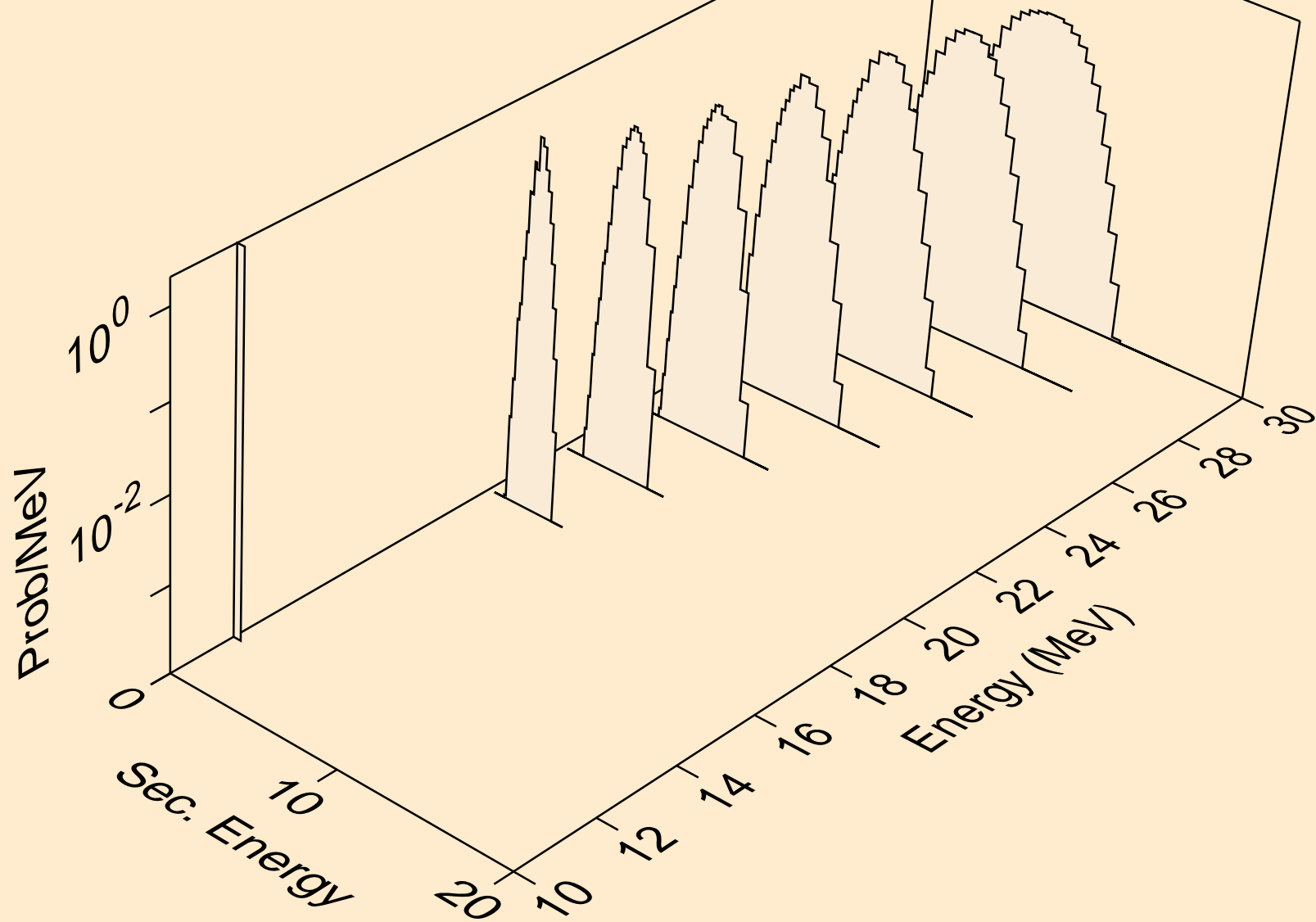

KR087 PROTON ACER TENDL-2021 LIBRARY; T=0.K
tritons from (p,x)

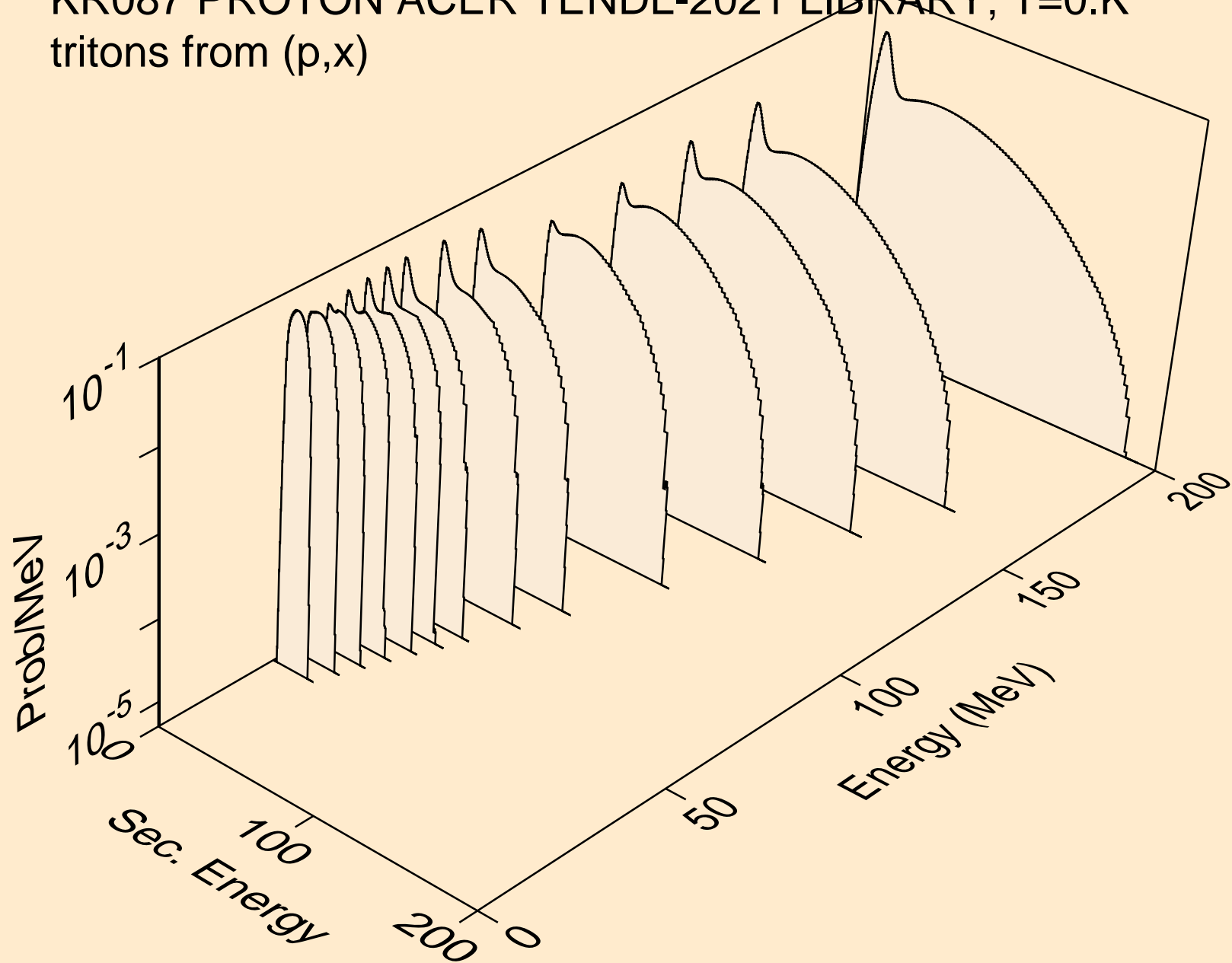

KR087 PROTON ACER TENDL-2021 LIBRARY; T=0.K
tritons from (p,n*)t

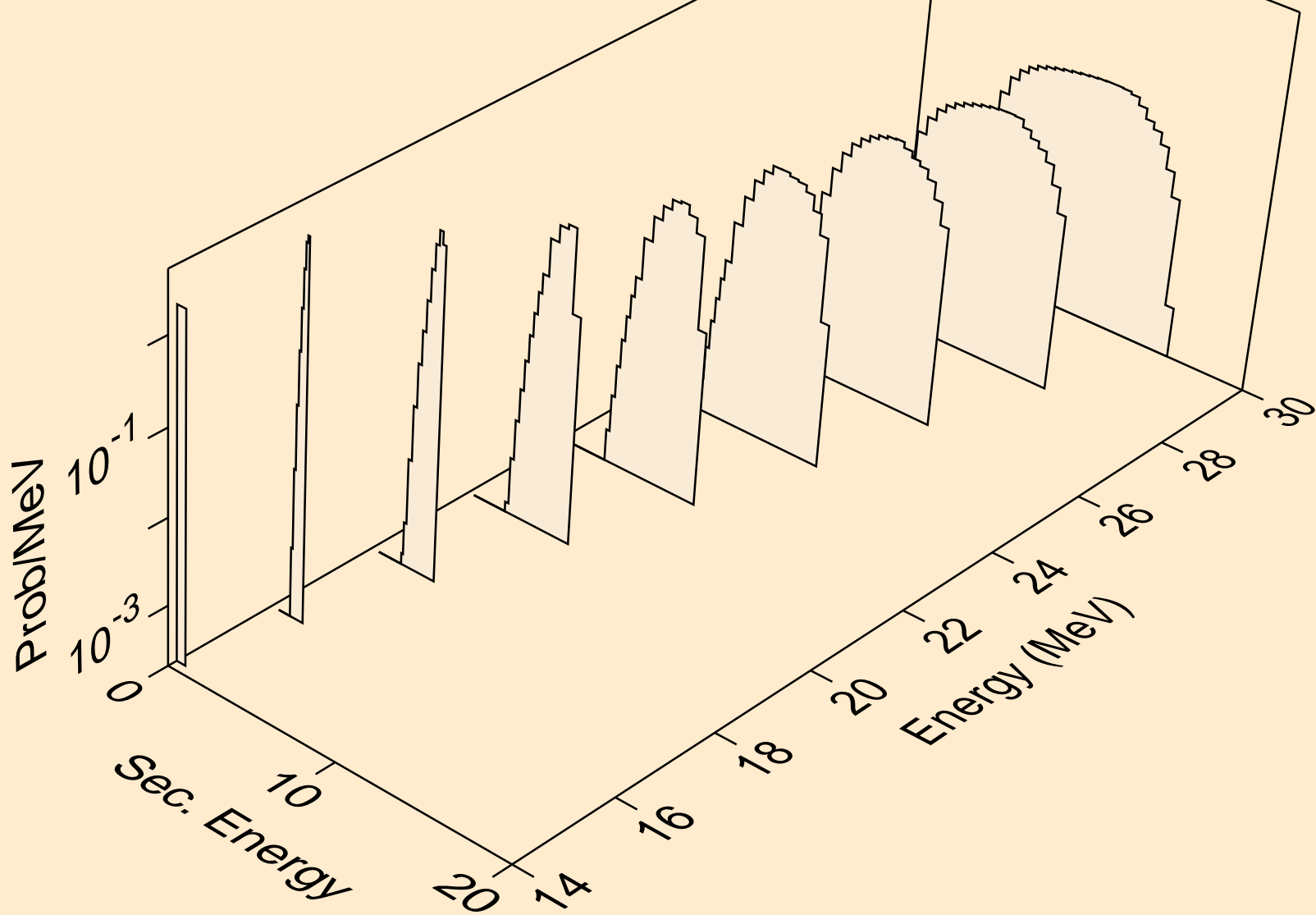

KR087 PROTON ACER TENDL-2021 LIBRARY; T=0.K
tritons from (p,t)

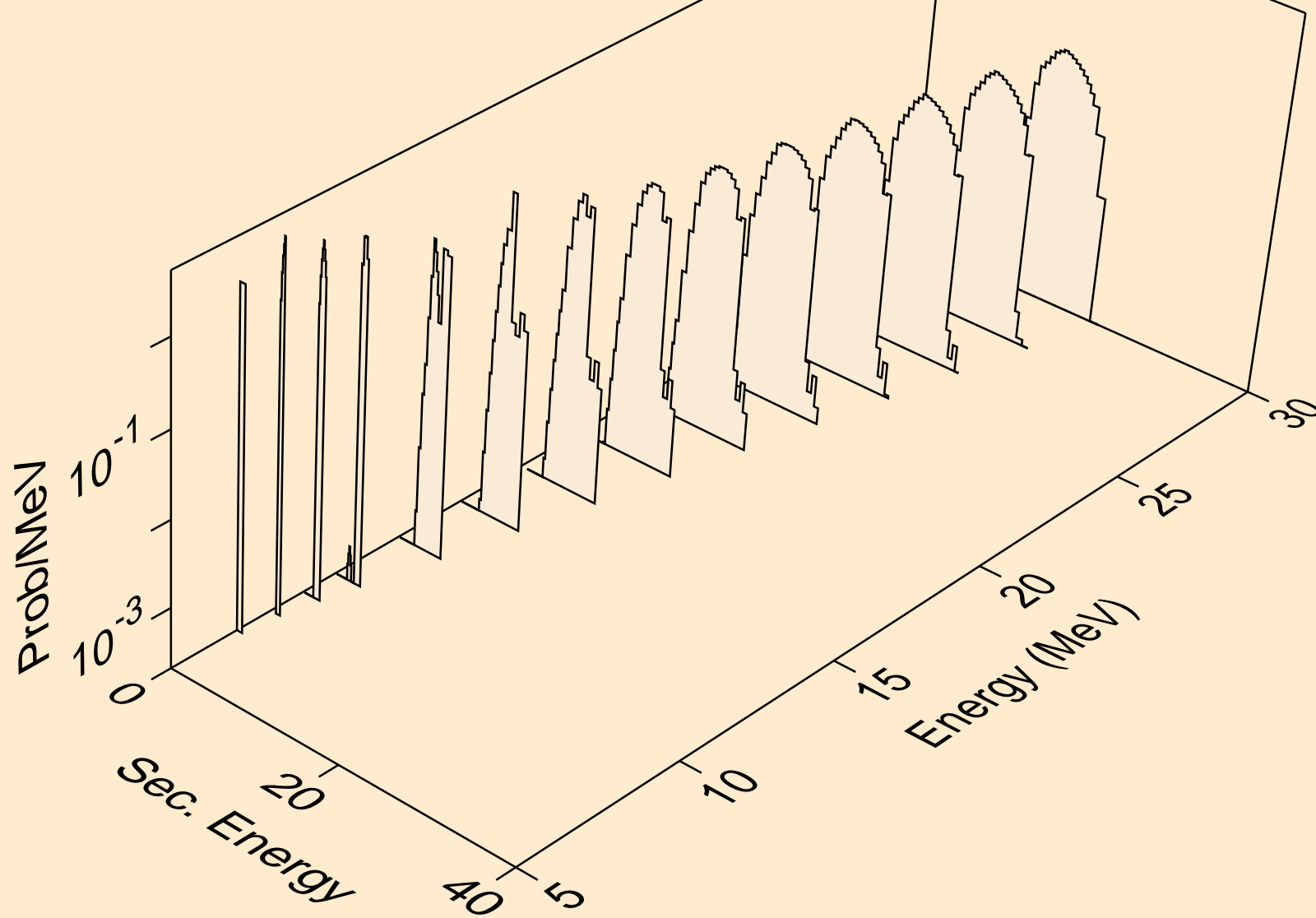

KR087 PROTON ACER TENDL-2021 LIBRARY; T=0.K
tritons from (p,pt)

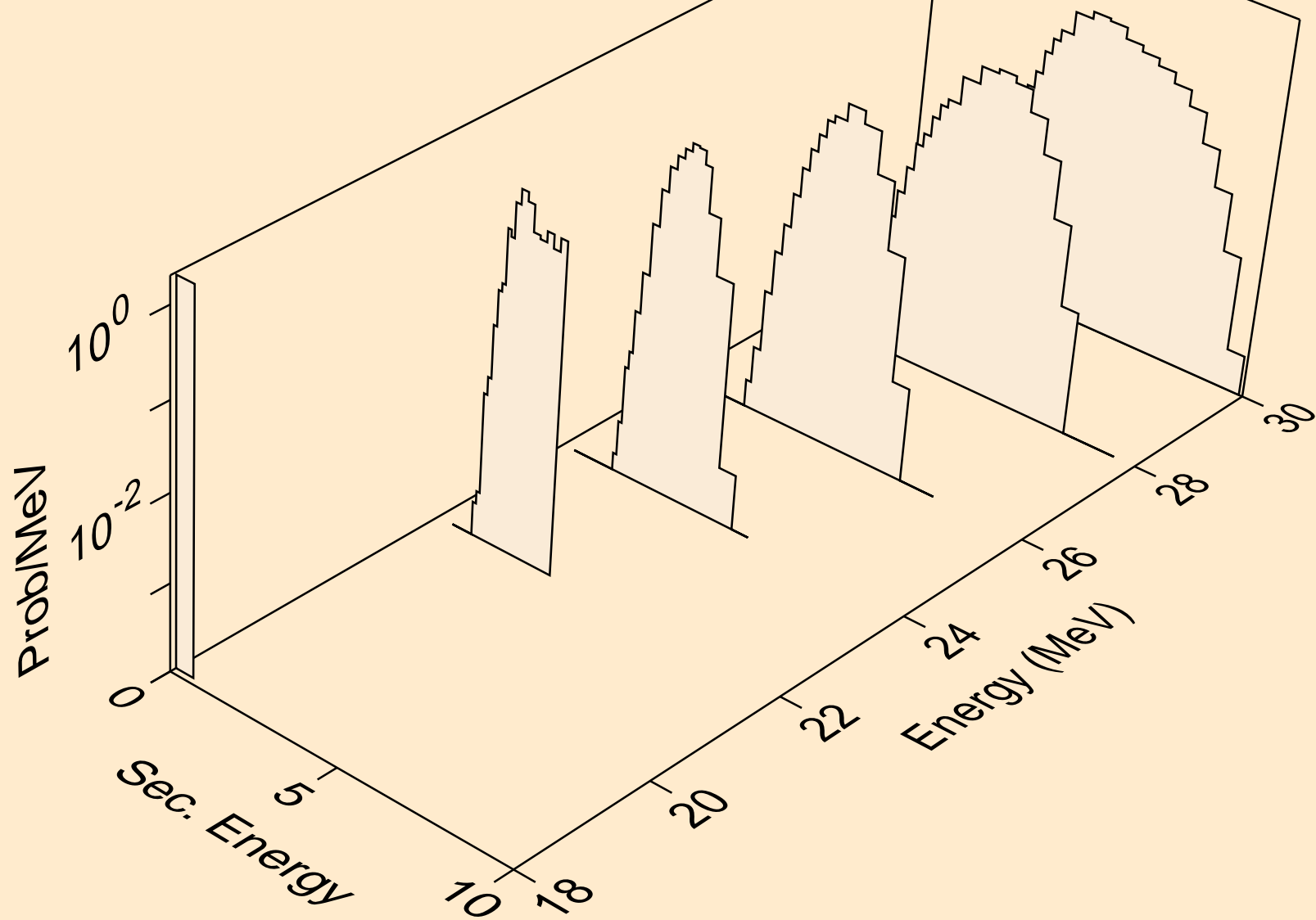

KR087 PROTON ACER TENDL-2021 LIBRARY; T=0.K
he3s from (p,x)

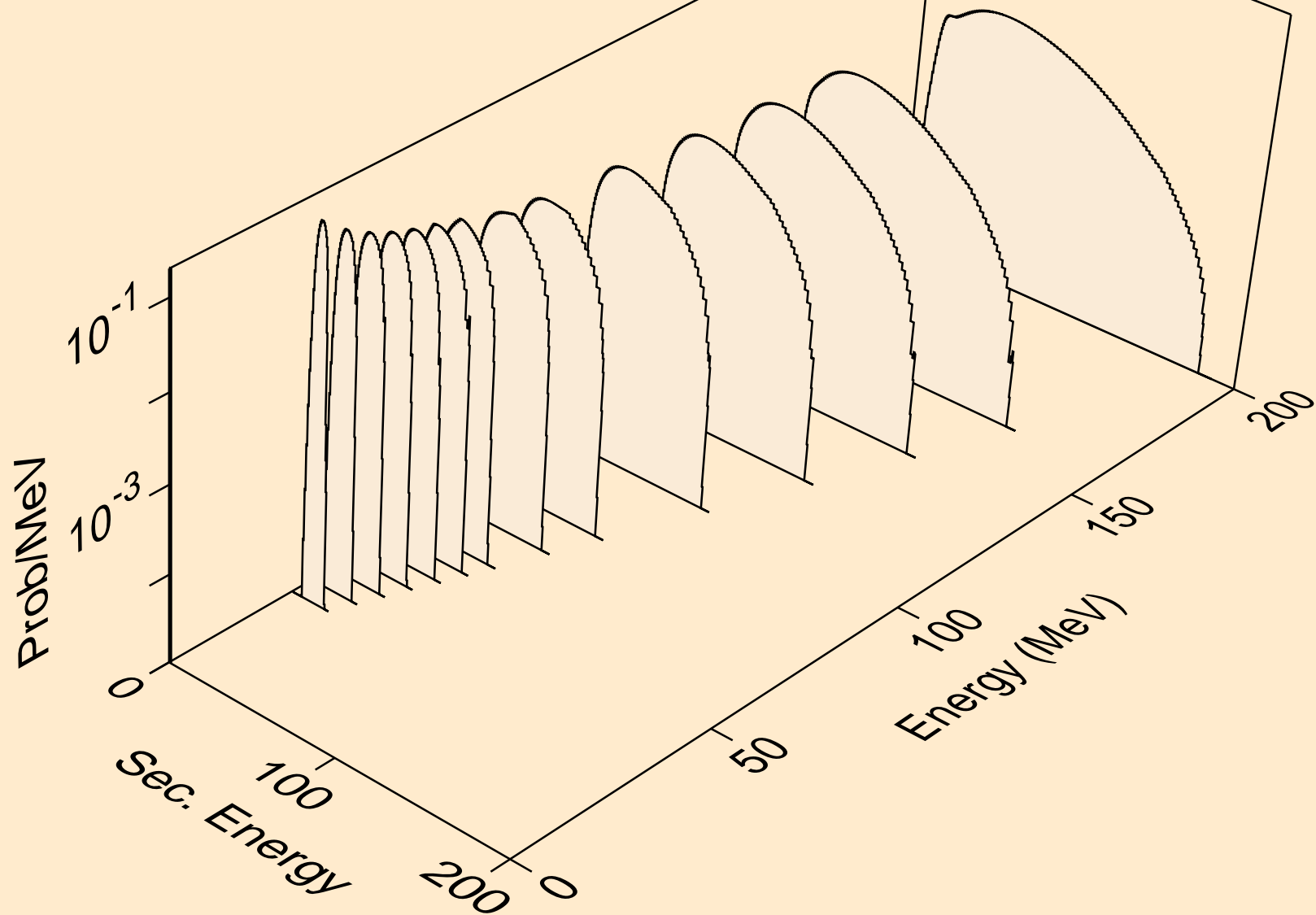

KR087 PROTON ACER TENDL-2021 LIBRARY; T=0.K
he3s from (p,n*)he3

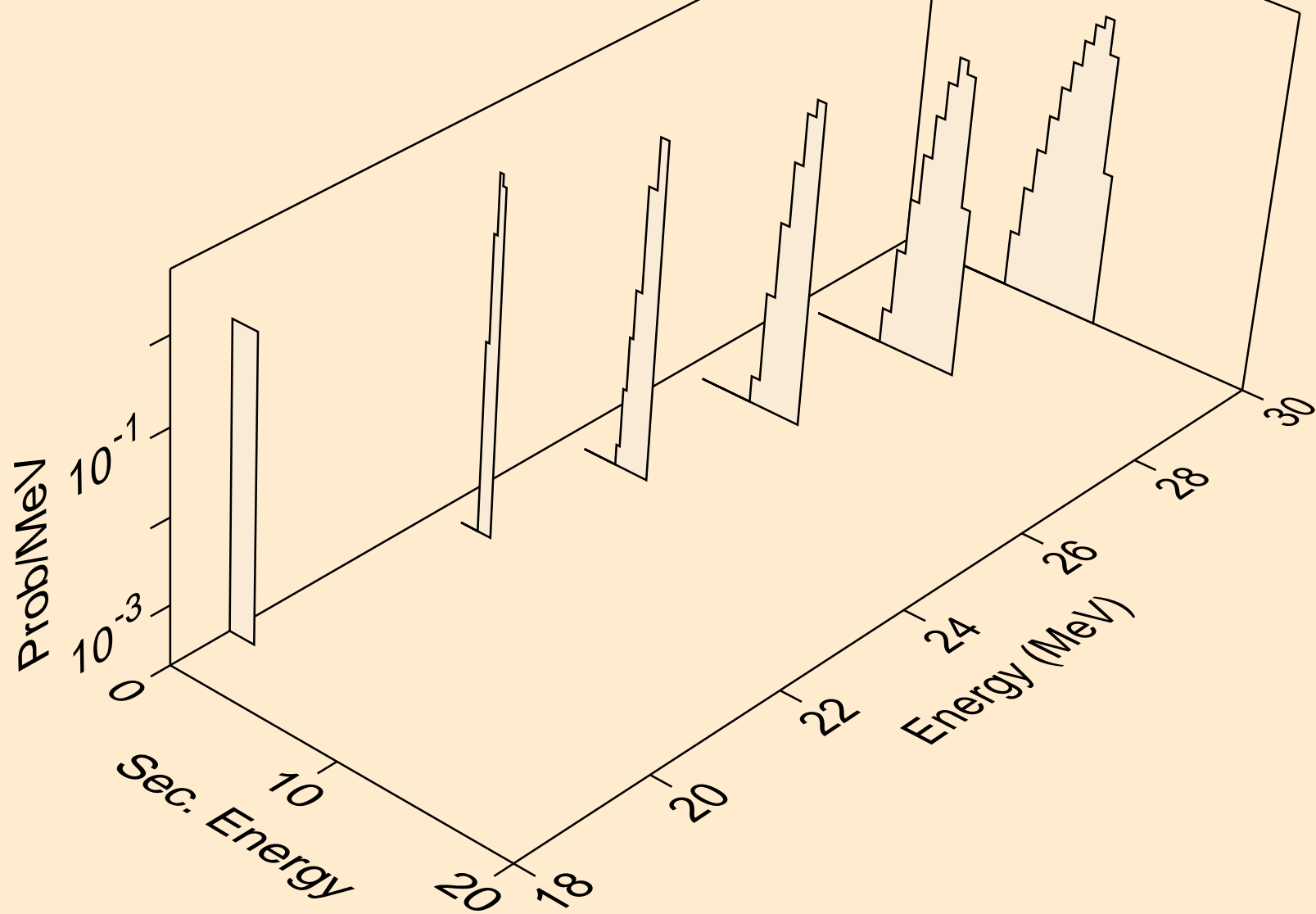

KR087 PROTON ACER TENDL-2021 LIBRARY; T=0.K
he3s from (p,he3)

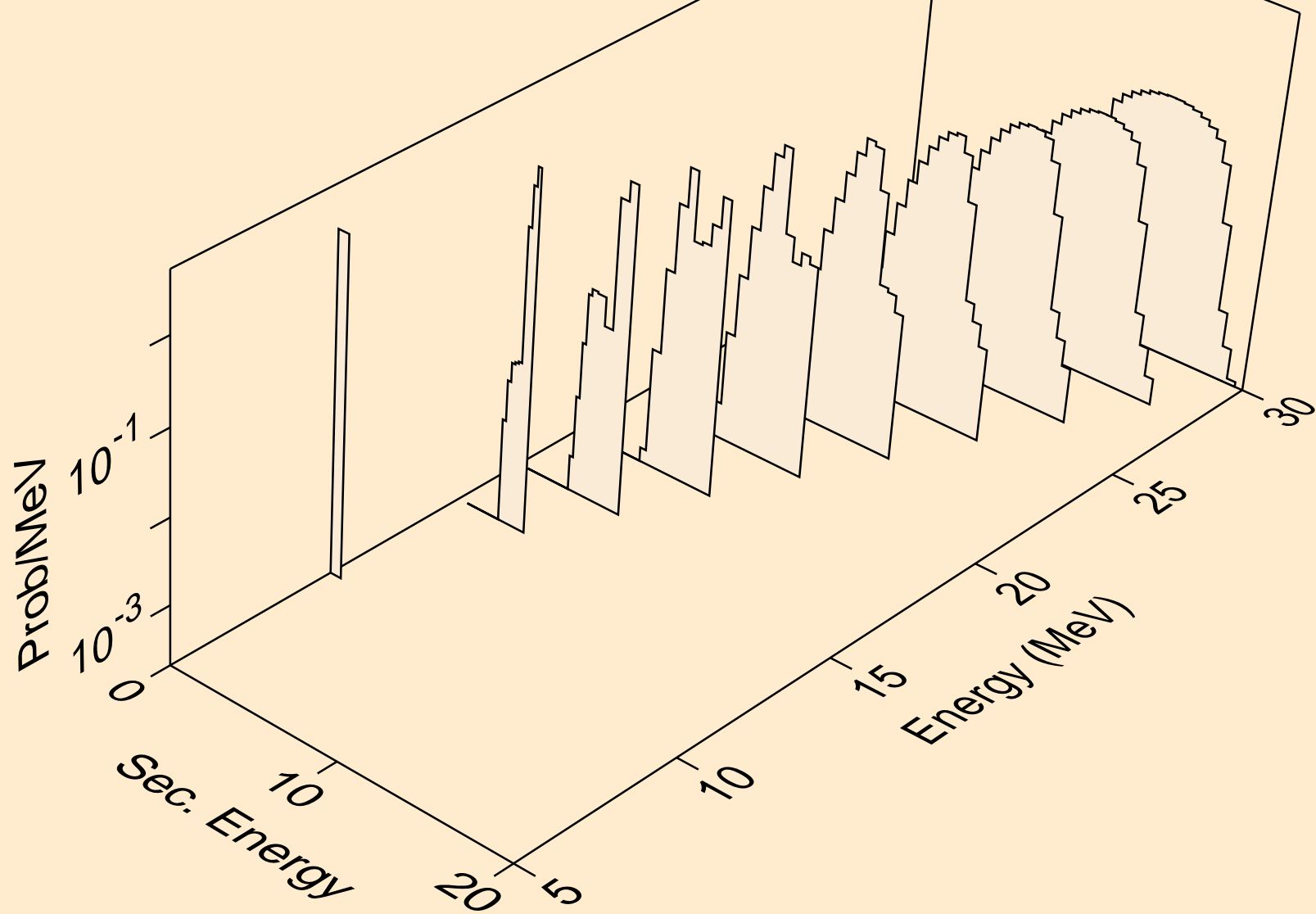

KR087 PROTON ACER TENDL-2021 LIBRARY; T=0.K
alphas from (p,x)

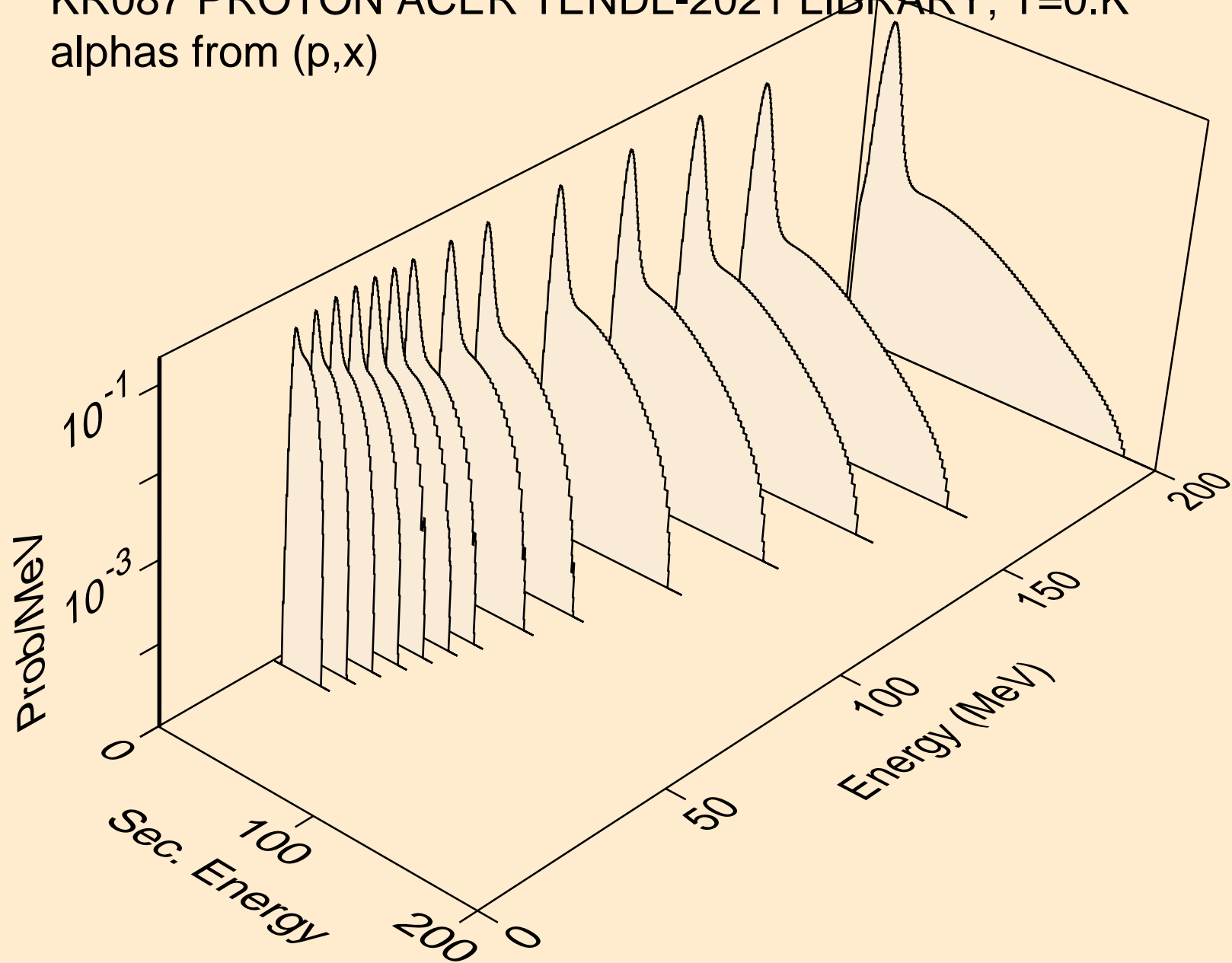

KR087 PROTON ACER TENDL-2021 LIBRARY; T=0.K
alphas from (p,n*)a

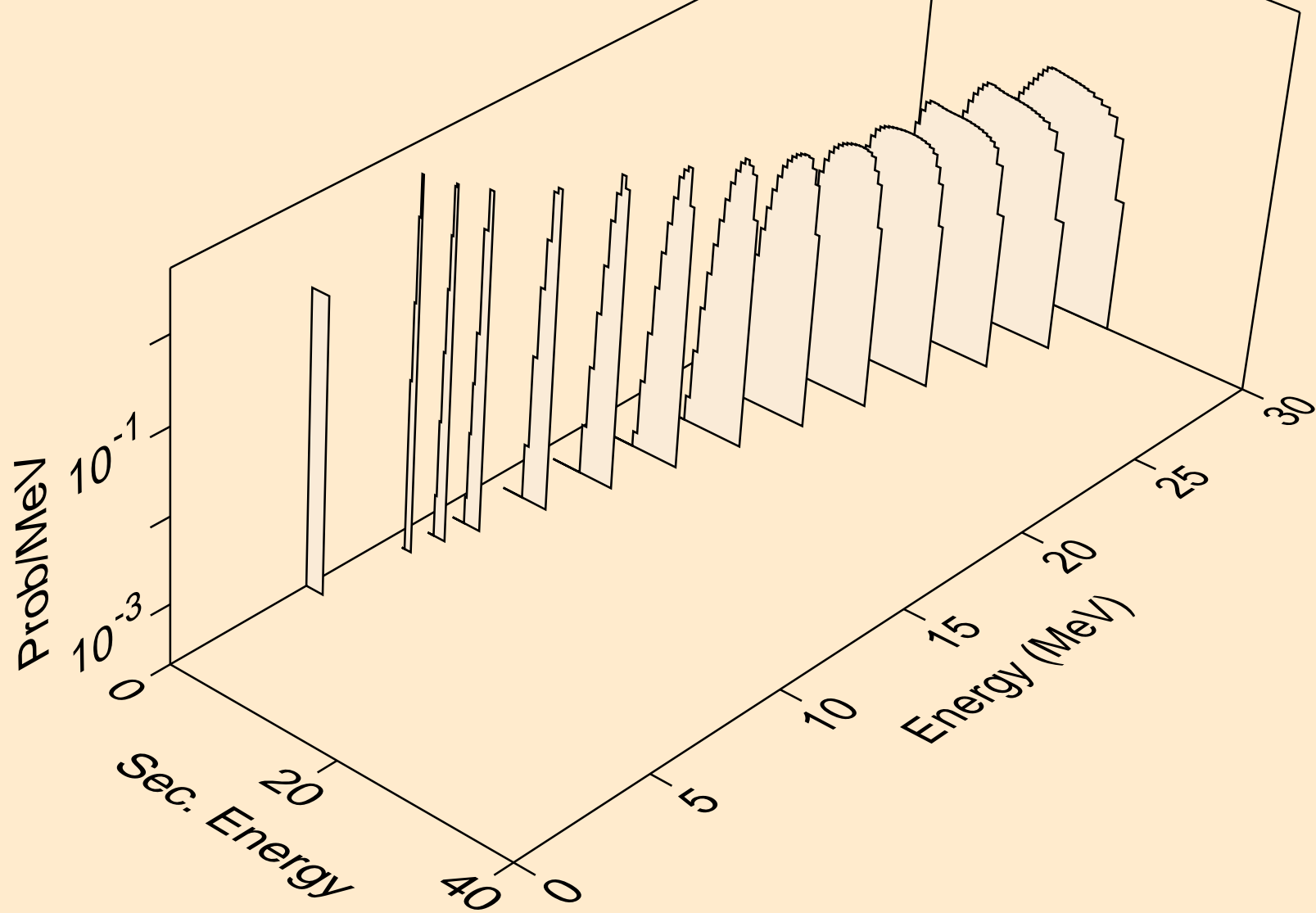

KR087 PROTON ACER TENDL-2021 LIBRARY; T=0.K
alphas from (p,2n)a

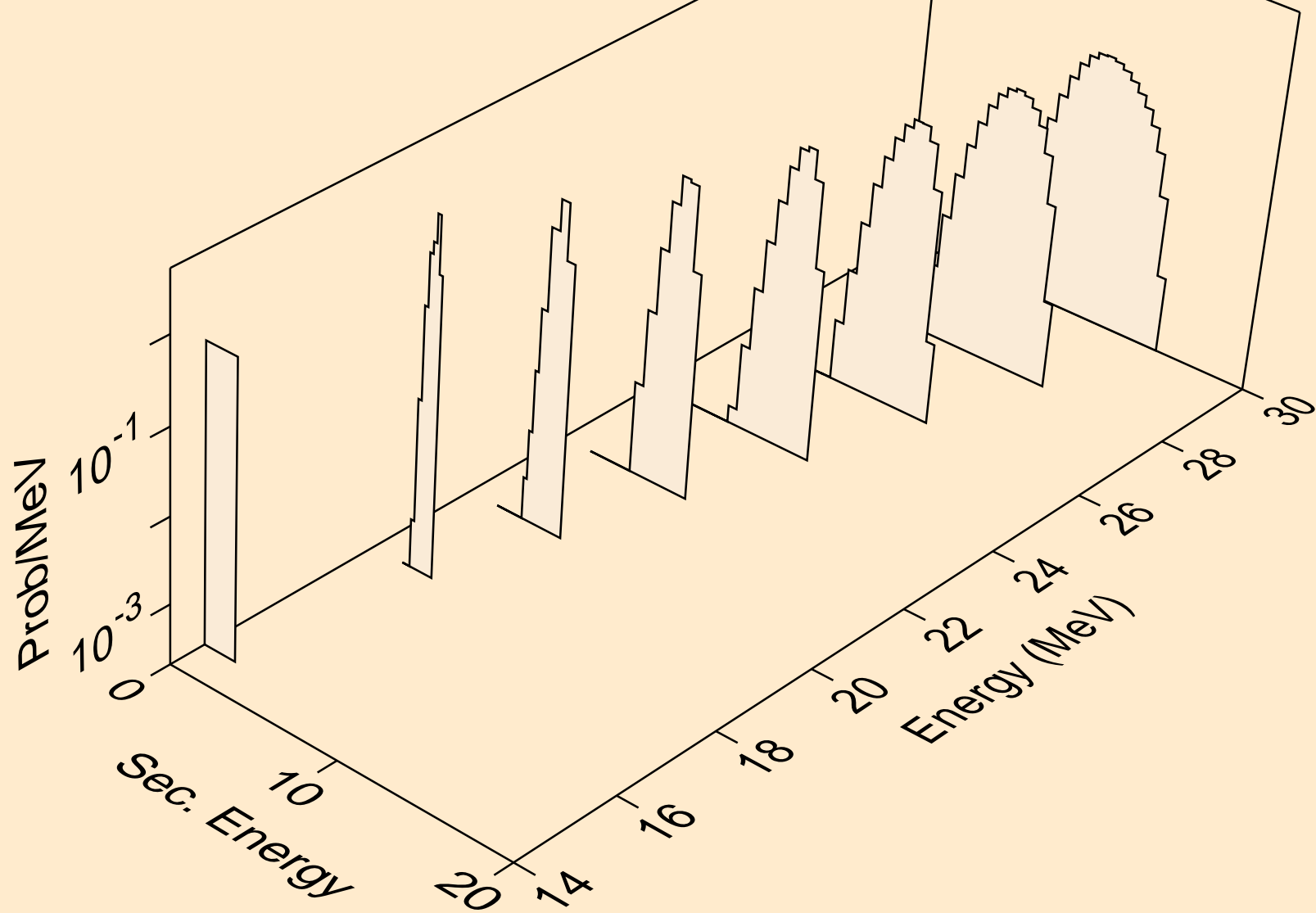

KR087 PROTON ACER TENDL-2021 LIBRARY; T=0.K
alphas from (p,3n)a

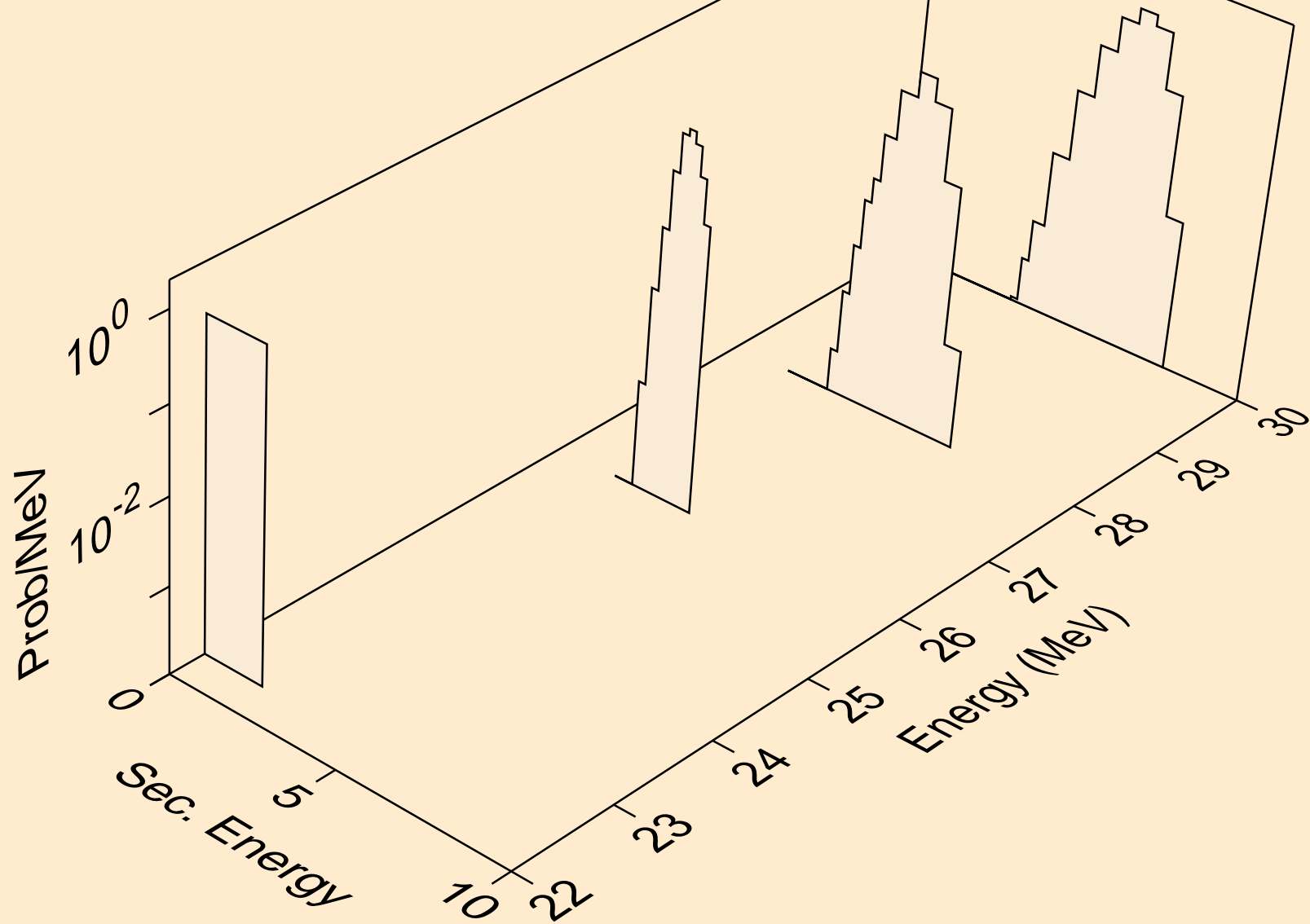

KR087 PROTON ACER TENDL-2021 LIBRARY; T=0.K
alphas from (p,n*)2a

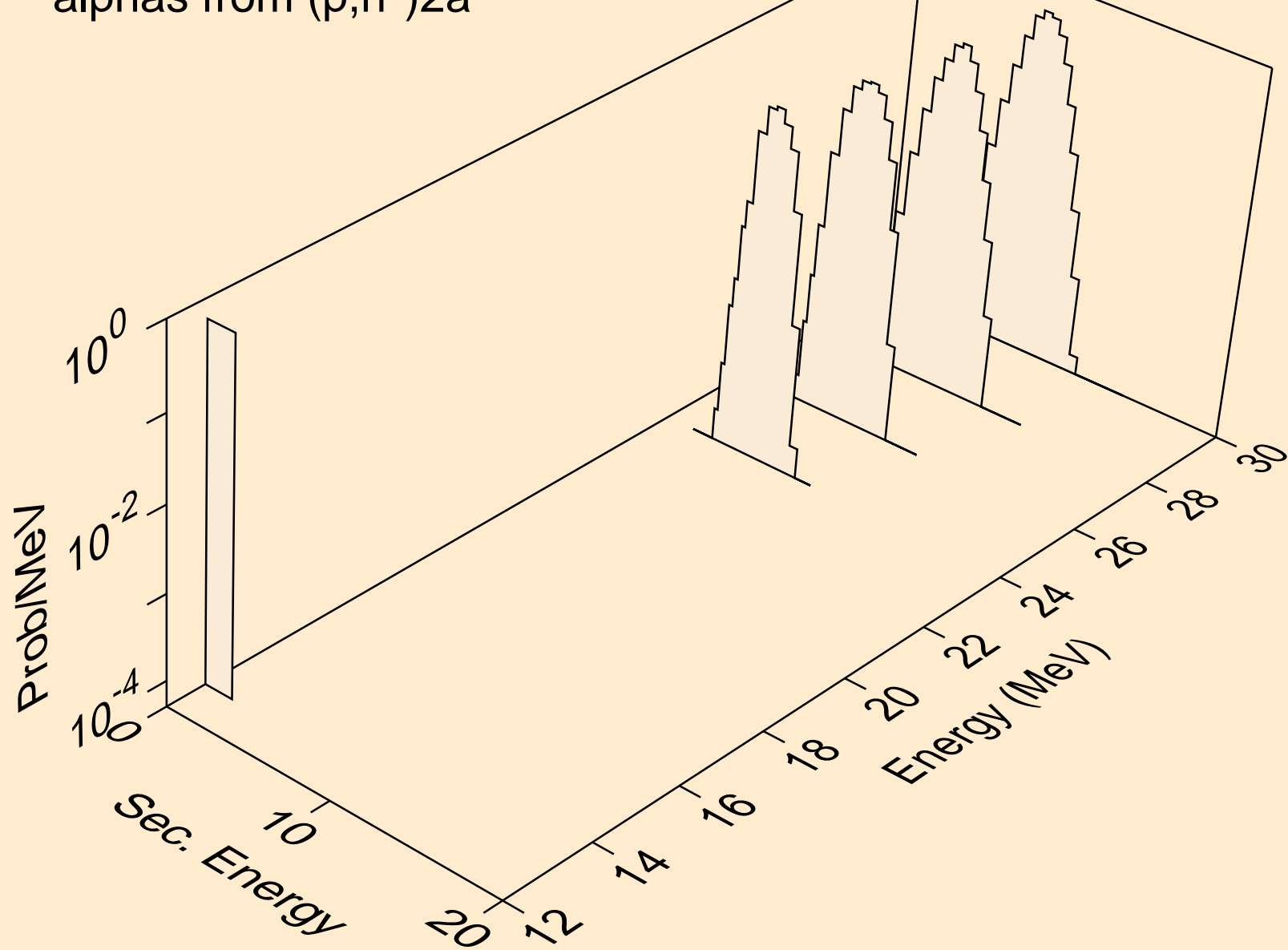

KR087 PROTON ACER TENDL-2021 LIBRARY; T=0.K
alphas from (p,npa)

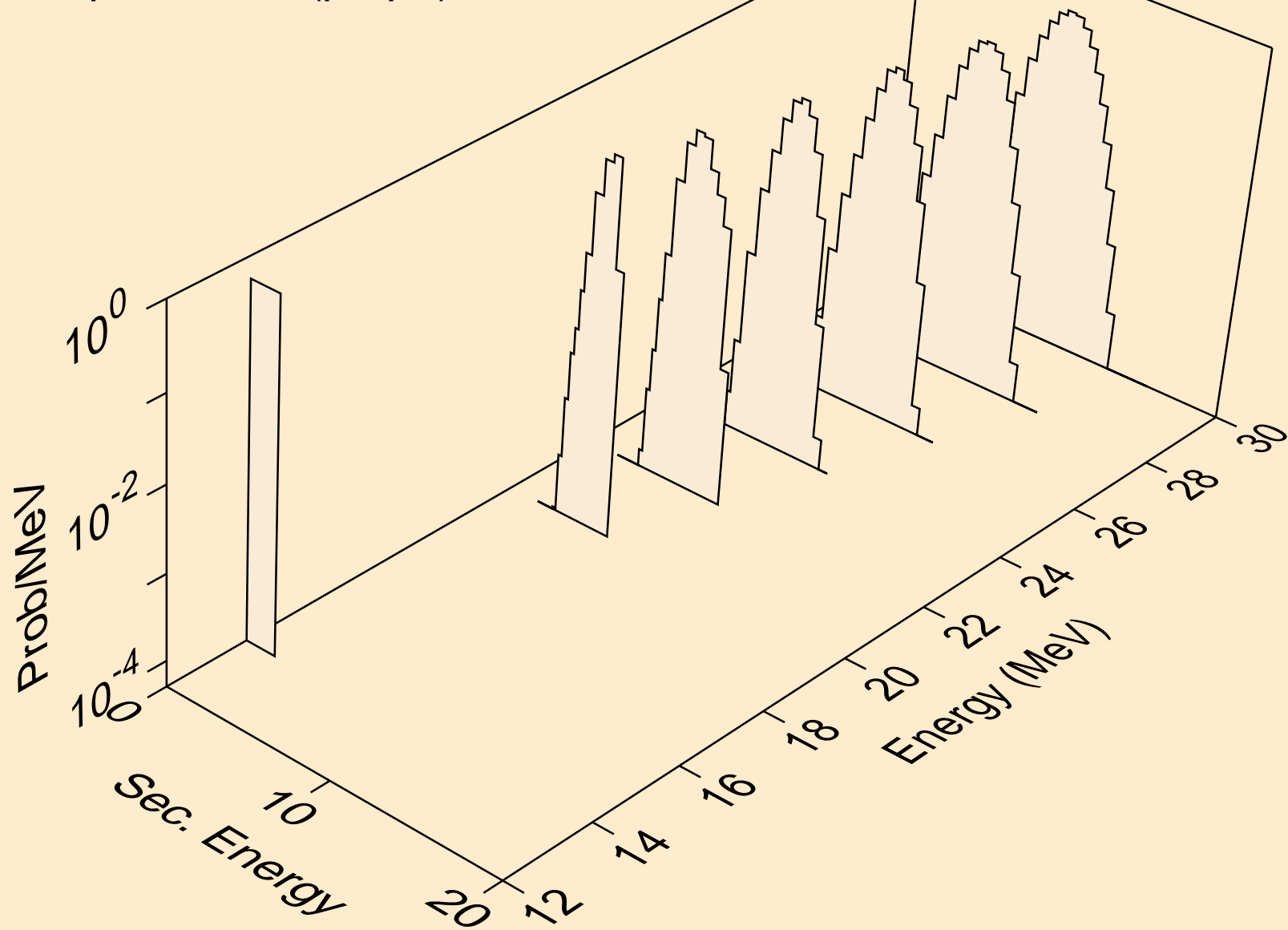

KR087 PROTON ACER TENDL-2021 LIBRARY; T=0.K
alphas from (p,a)

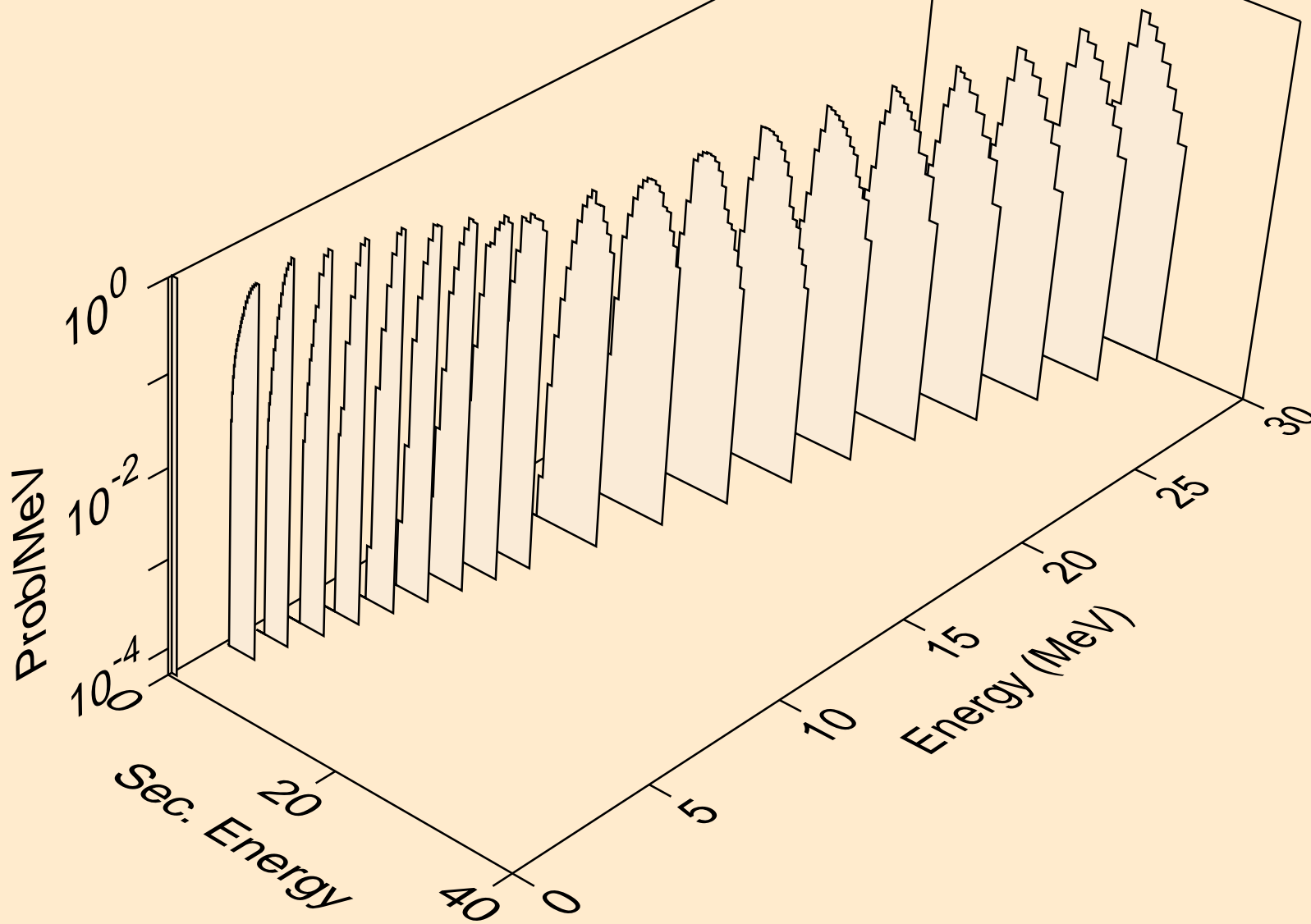

KR087 PROTON ACER TENDL-2021 LIBRARY; T=0.K
alphas from (p,2a)

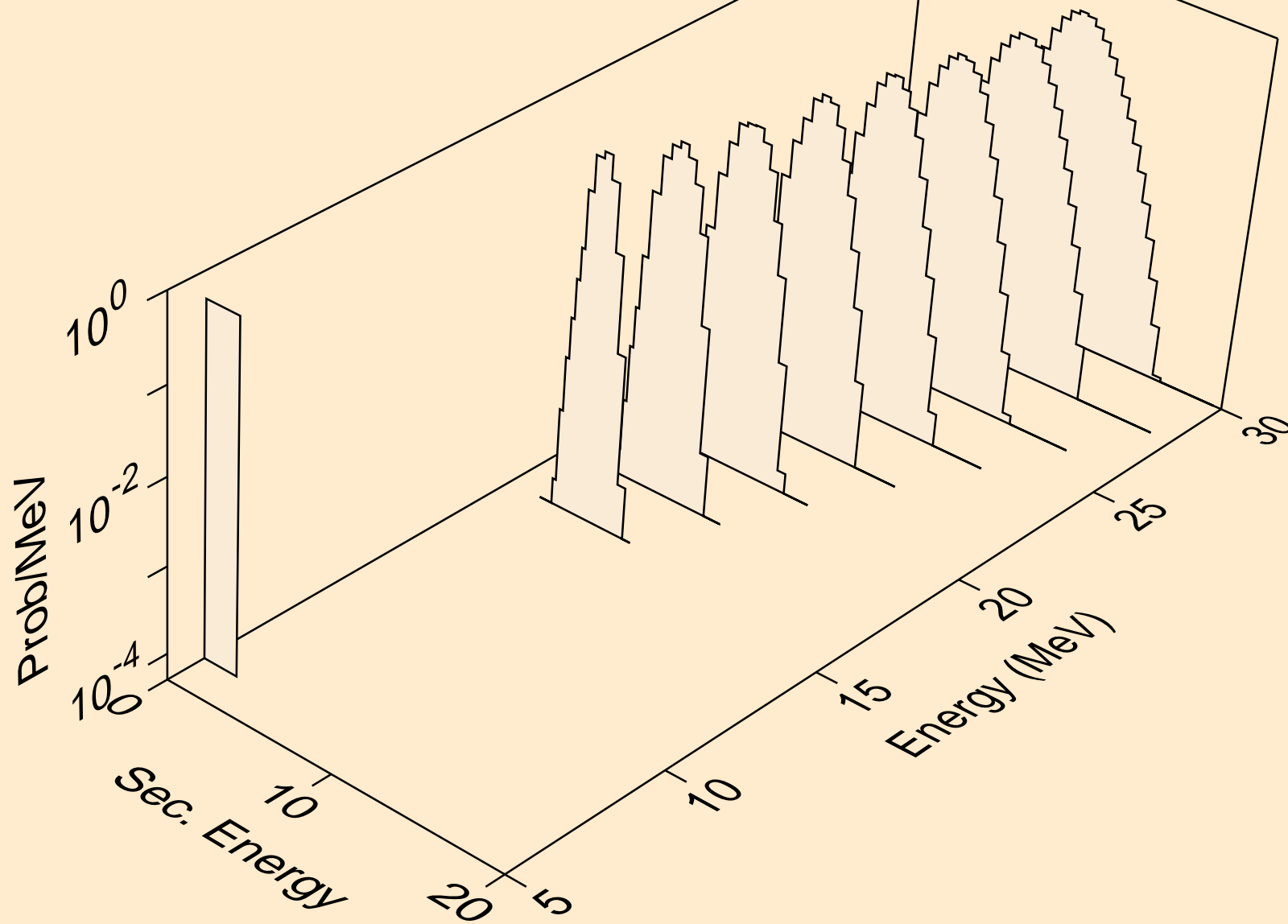

KR087 PROTON ACER TENDL-2021 LIBRARY; T=0.K
alphas from (p,pa)

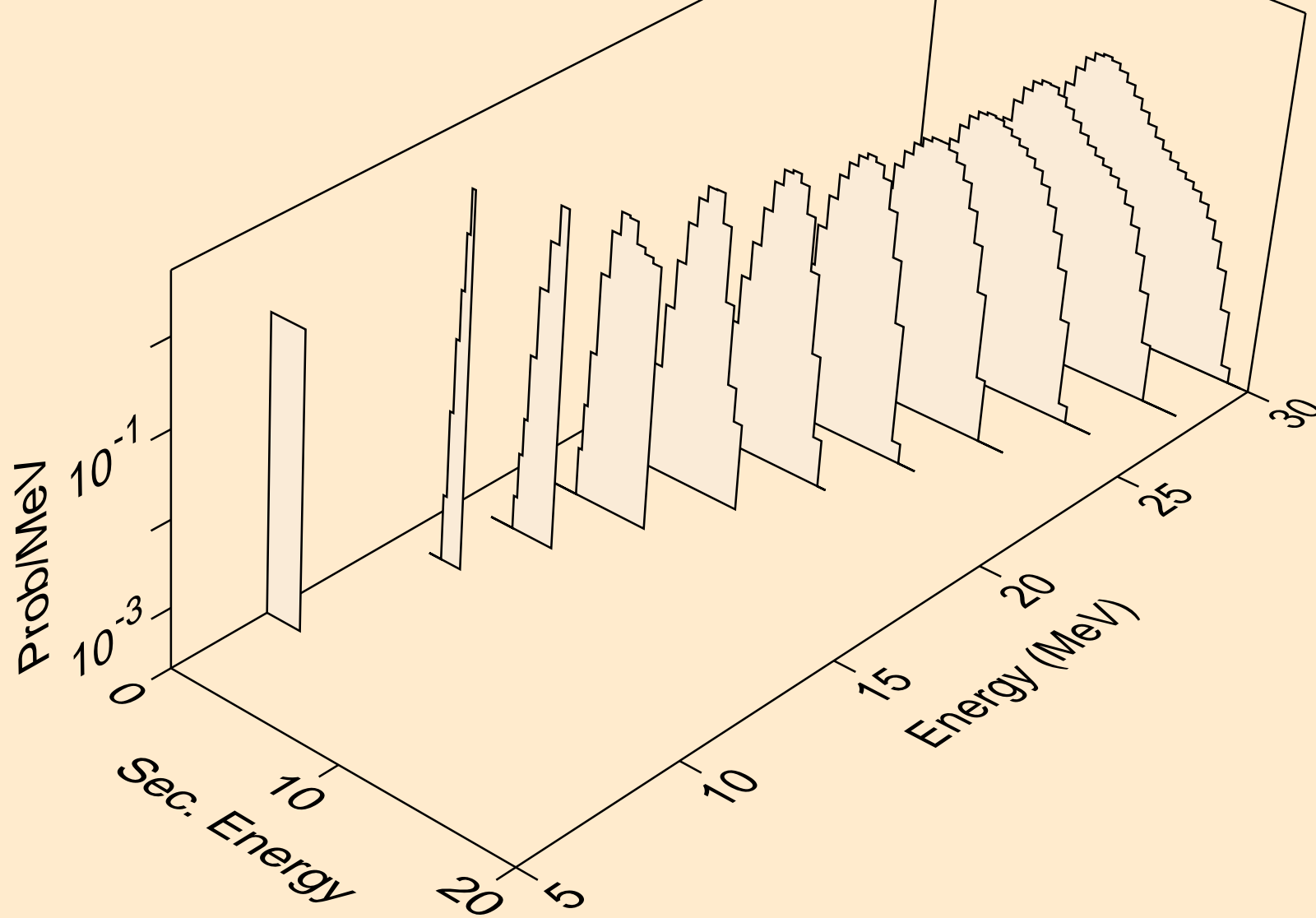

KR087 PROTON ACER TENDL-2021 LIBRARY; T=0.K
alphas from (p,da)

