

LA119 PROTON ACER TENDL-2021 LIBRARY; T=0.K  
Principal cross sections

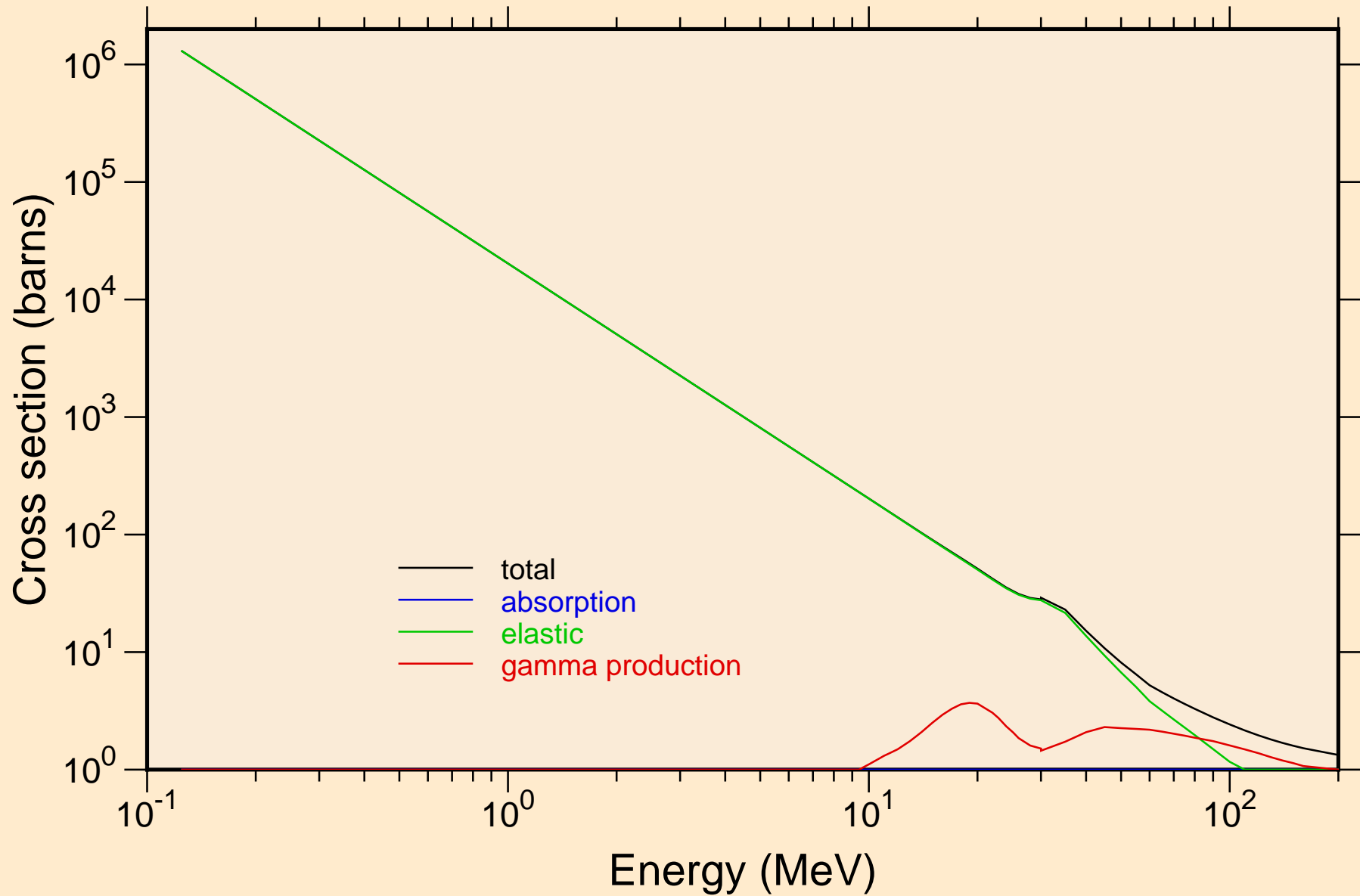

LA119 PROTON ACER TENDL-2021 LIBRARY; T=0.K  
Heating

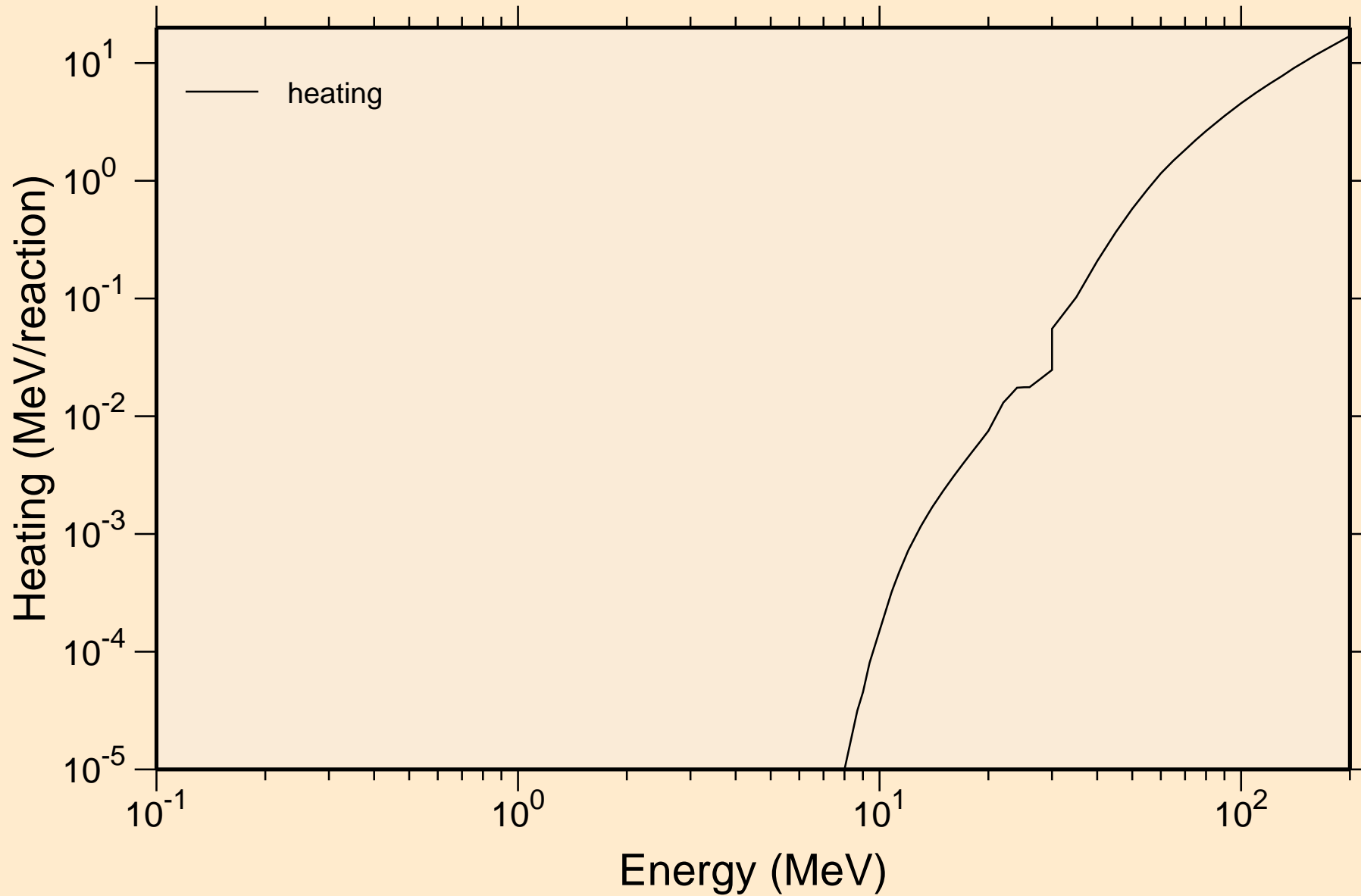

# LA119 PROTON ACER TENDL-2021 LIBRARY; T=0.K

## Principal cross sections

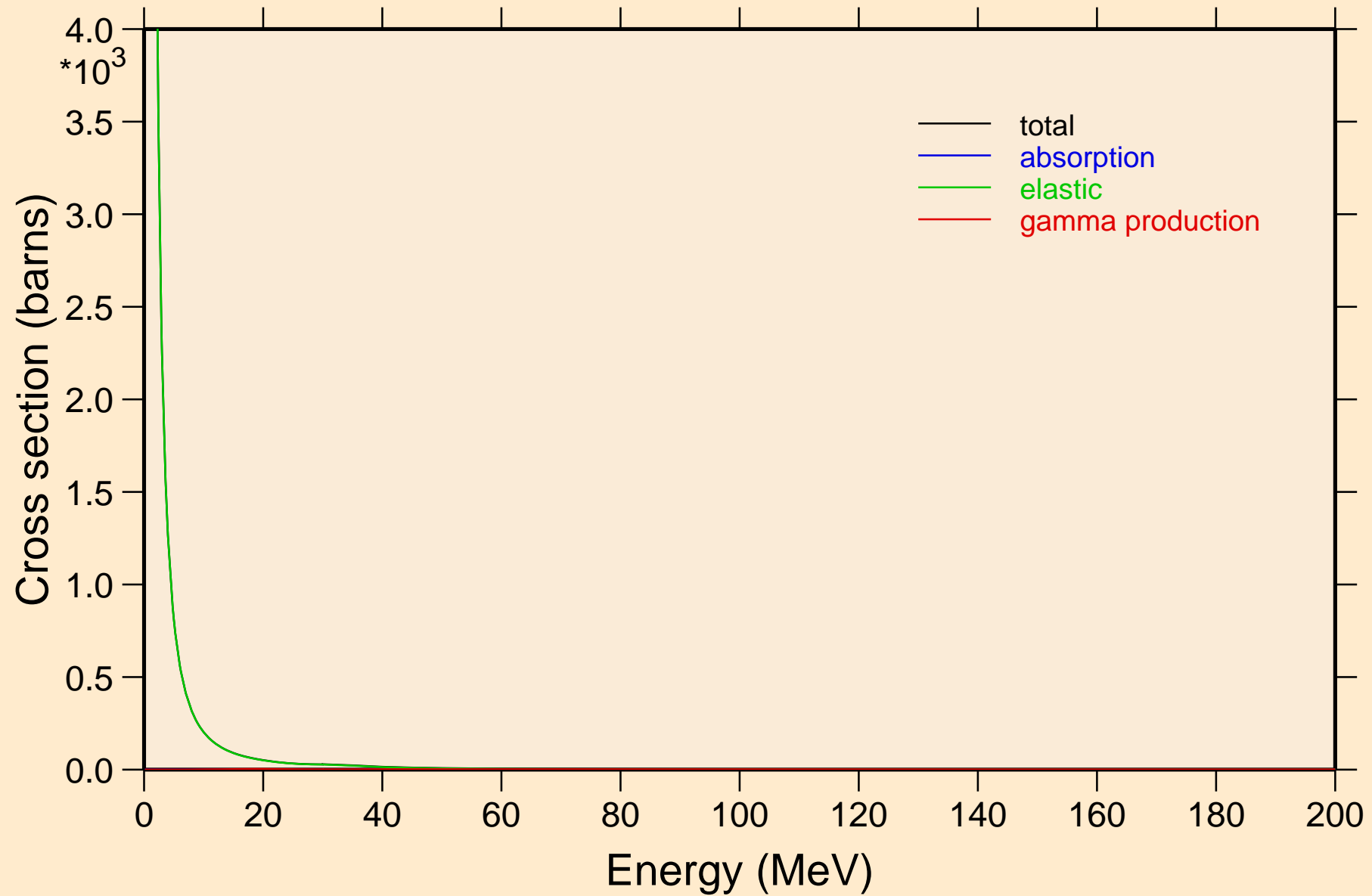

LA119 PROTON ACER TENDL-2021 LIBRARY; T=0.K

Heating

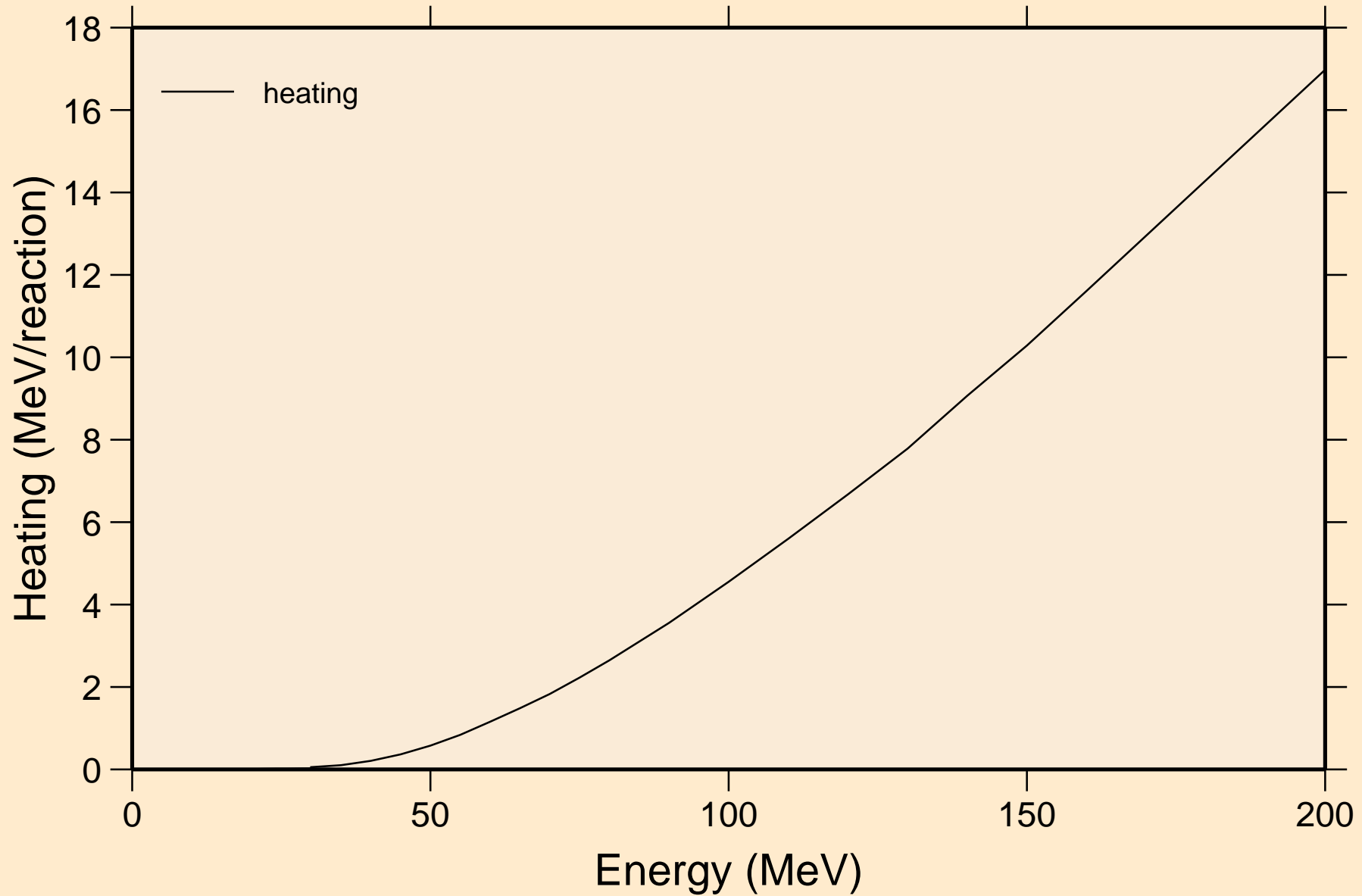

LA119 PROTON ACER TENDL-2021 LIBRARY; T=0.K  
Threshold reactions

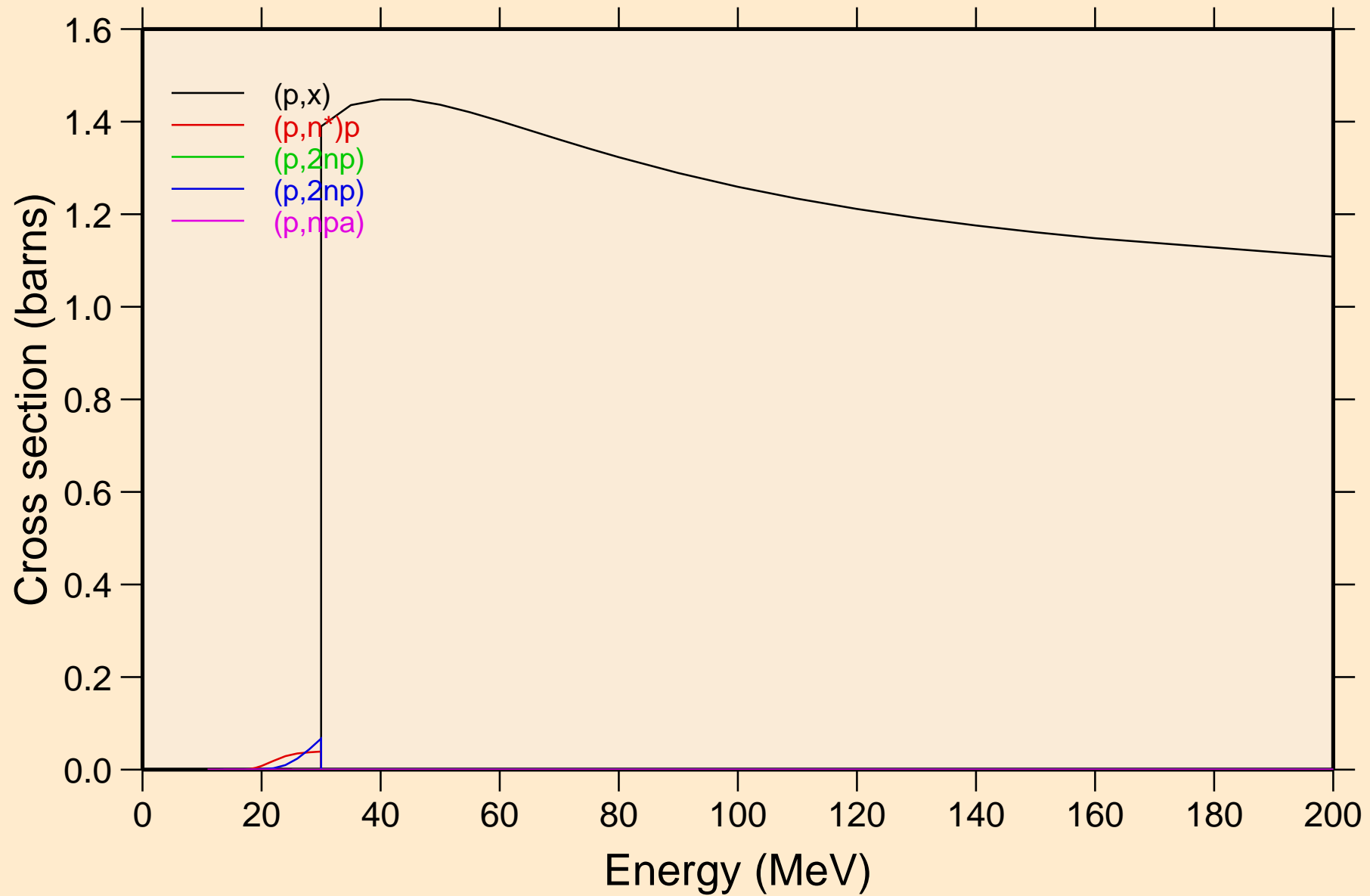

LA119 PROTON ACER TENDL-2021 LIBRARY; T=0.K  
Threshold reactions

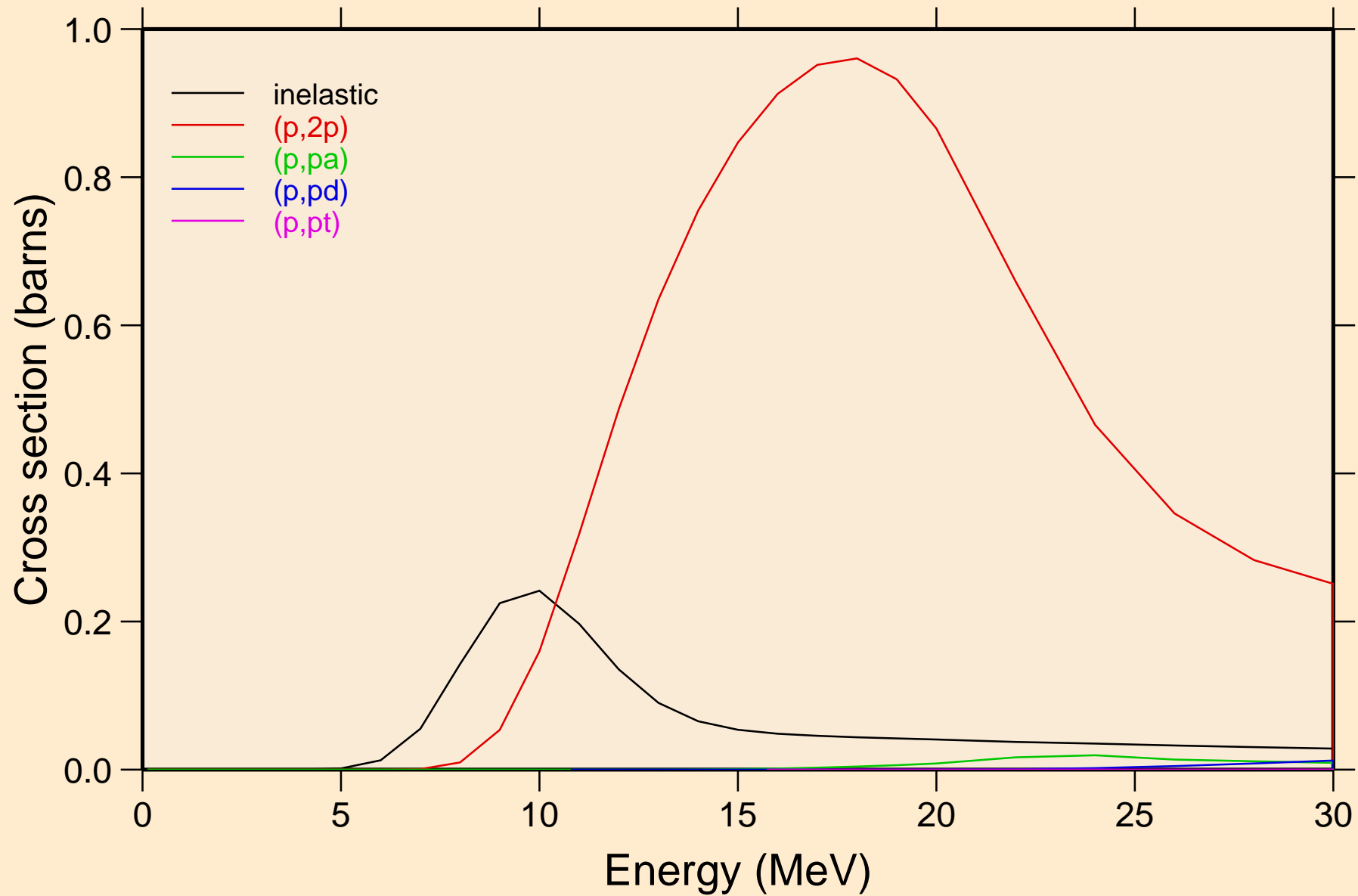

LA119 PROTON ACER TENDL-2021 LIBRARY; T=0.K  
Threshold reactions

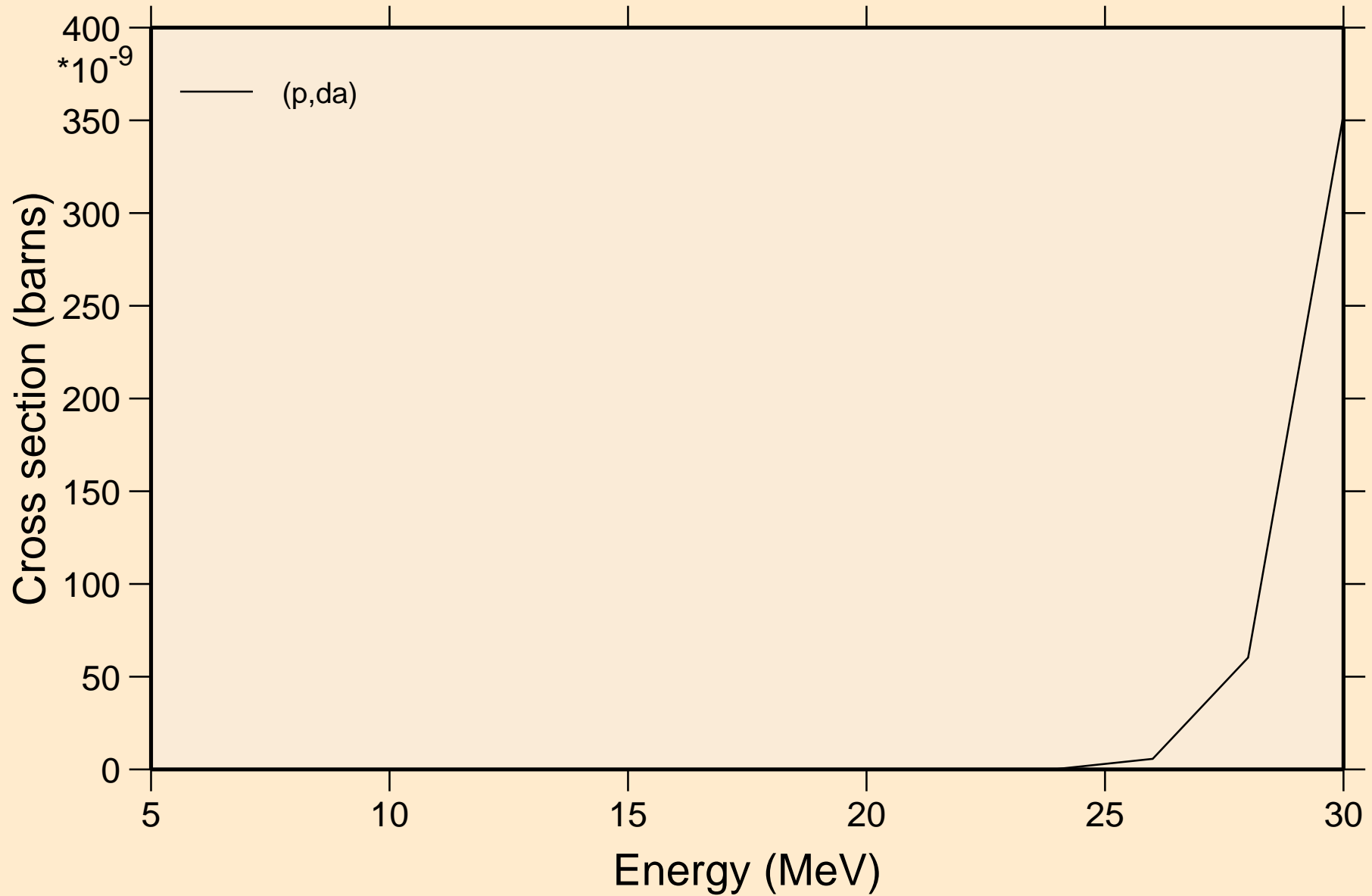

LA119 PROTON ACER TENDL-2021 LIBRARY; T=0.K  
angular distribution for elastic

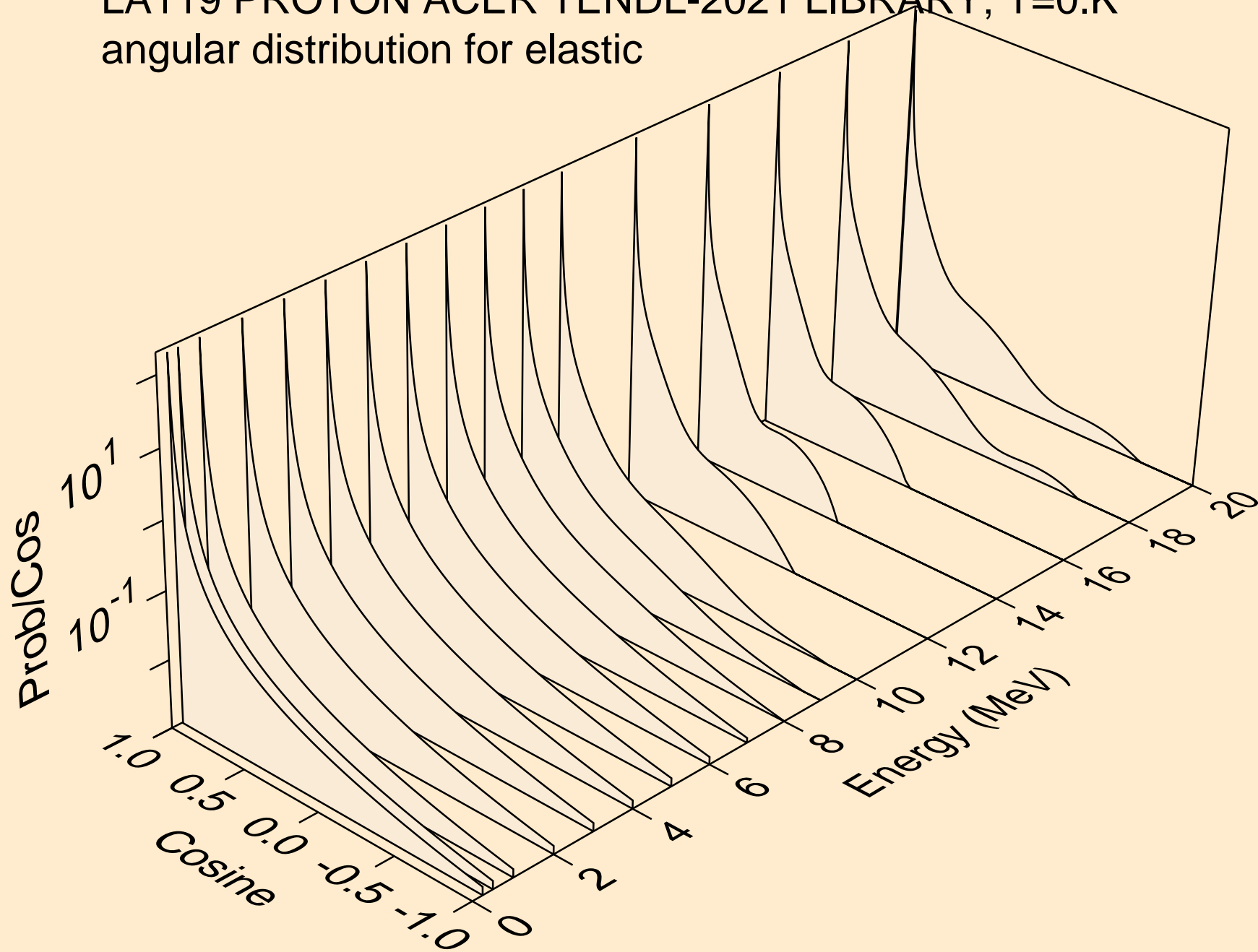



LA119 PROTON ACER TENDL-2021 LIBRARY; T=0.K  
angular distribution for elastic

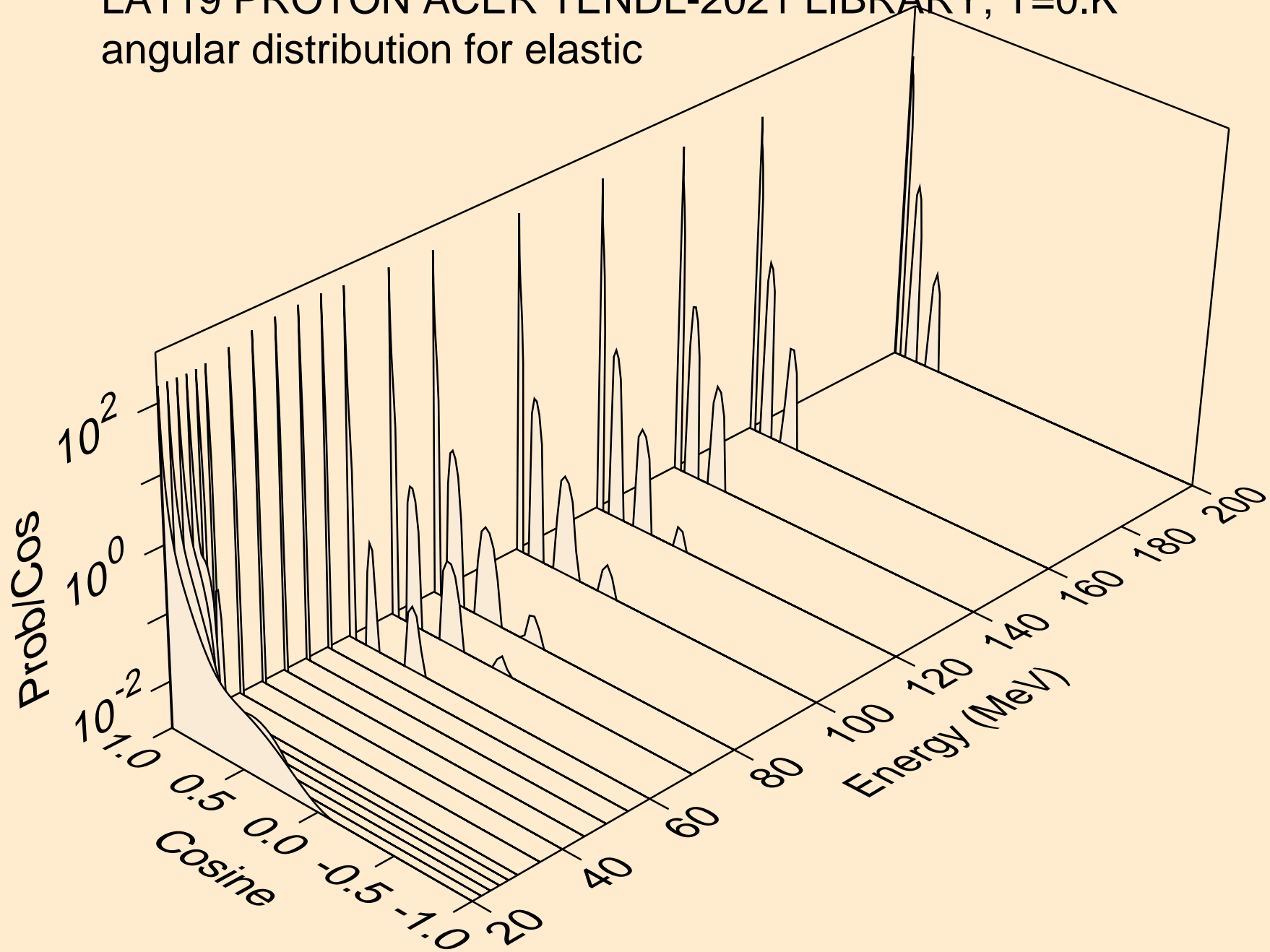

LA119 PROTON ACER TENDL-2021 LIBRARY; T=0.K  
Proton emission for (p,x)

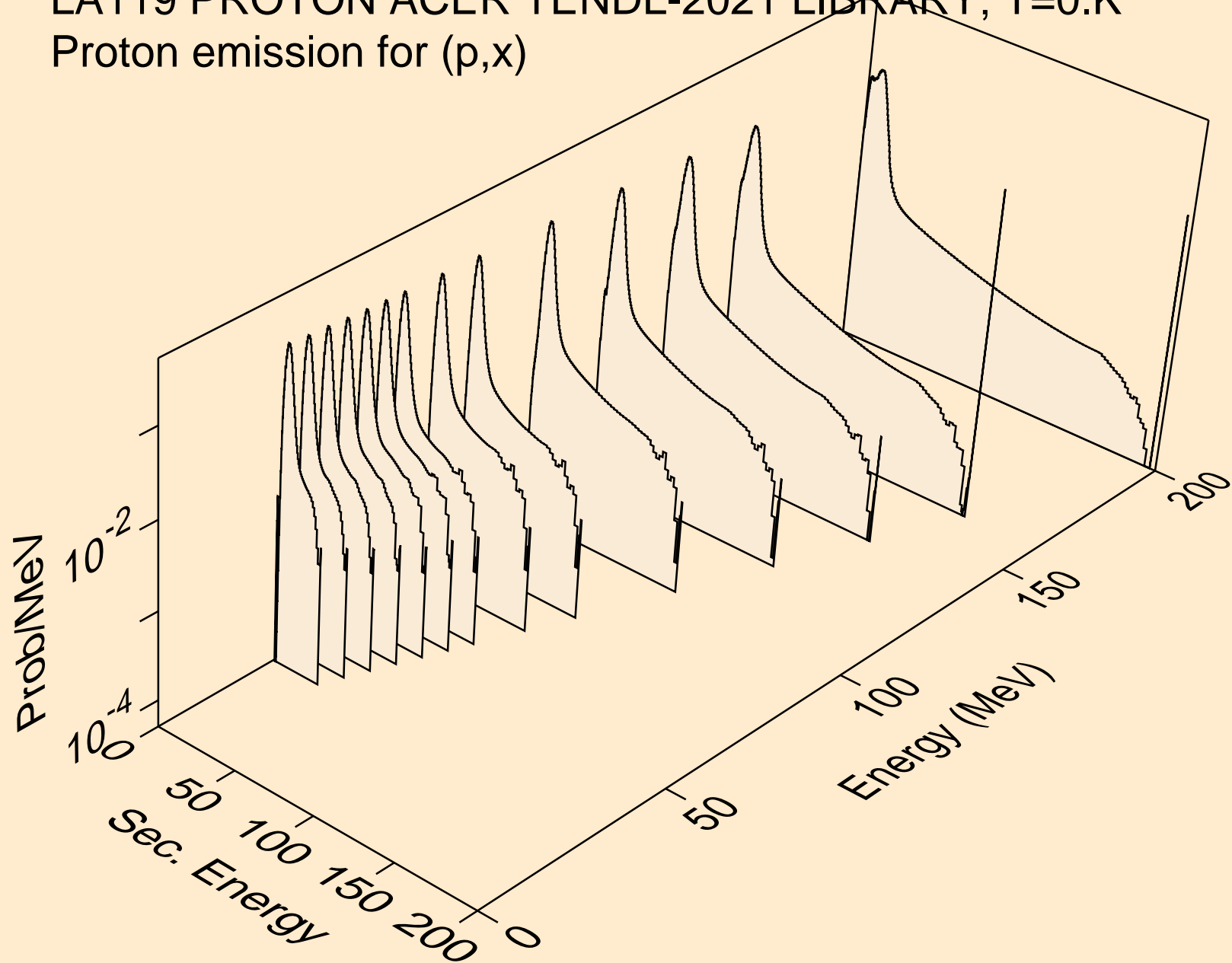

LA119 PROTON ACER TENDL-2021 LIBRARY; T=0.K  
Proton emission for (p,n\*)p

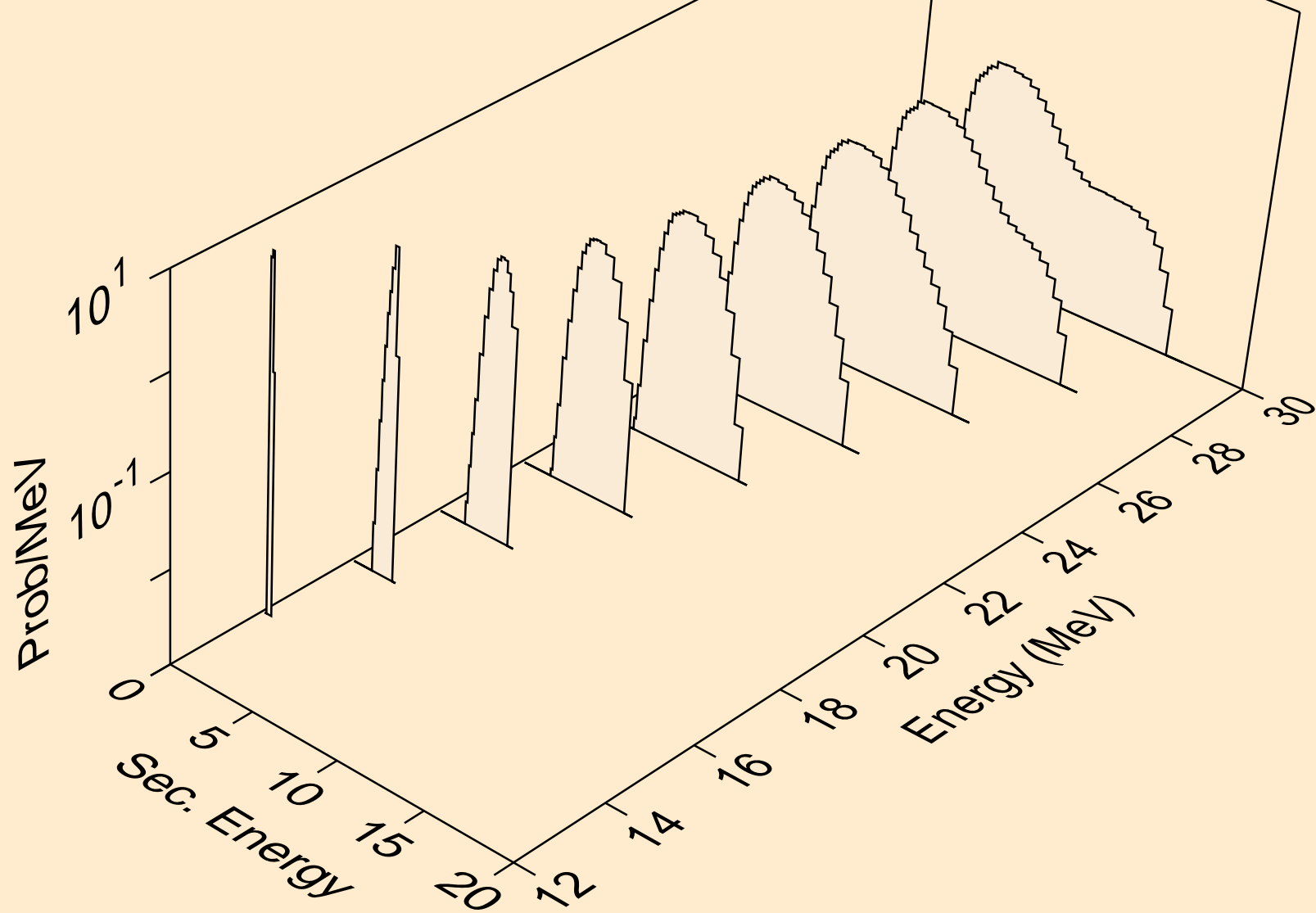

LA119 PROTON ACER TENDL-2021 LIBRARY; T=0.K  
Proton emission for (p,2np)

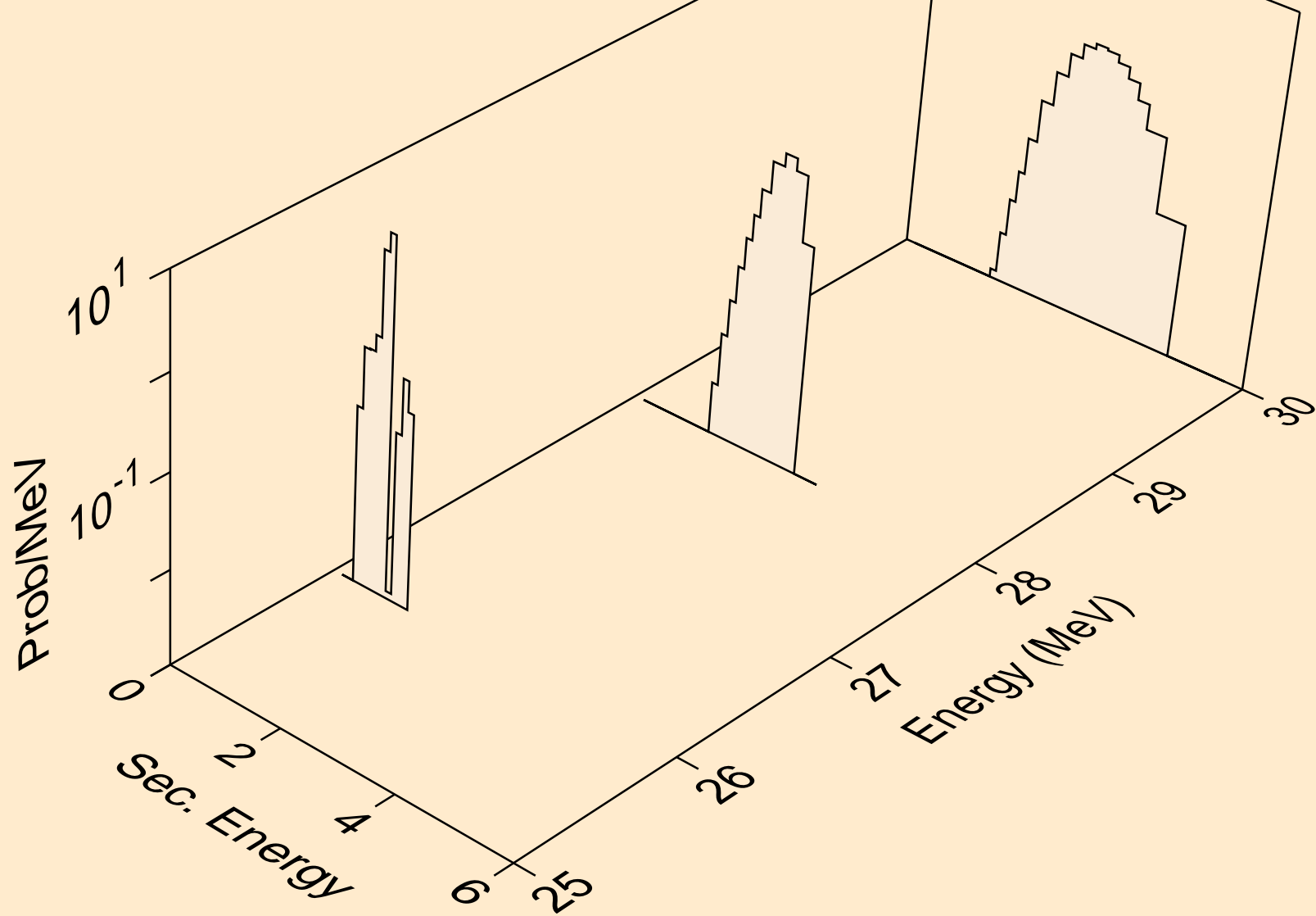

LA119 PROTON ACER TENDL-2021 LIBRARY; T=0.K  
Proton emission for (p,2np)

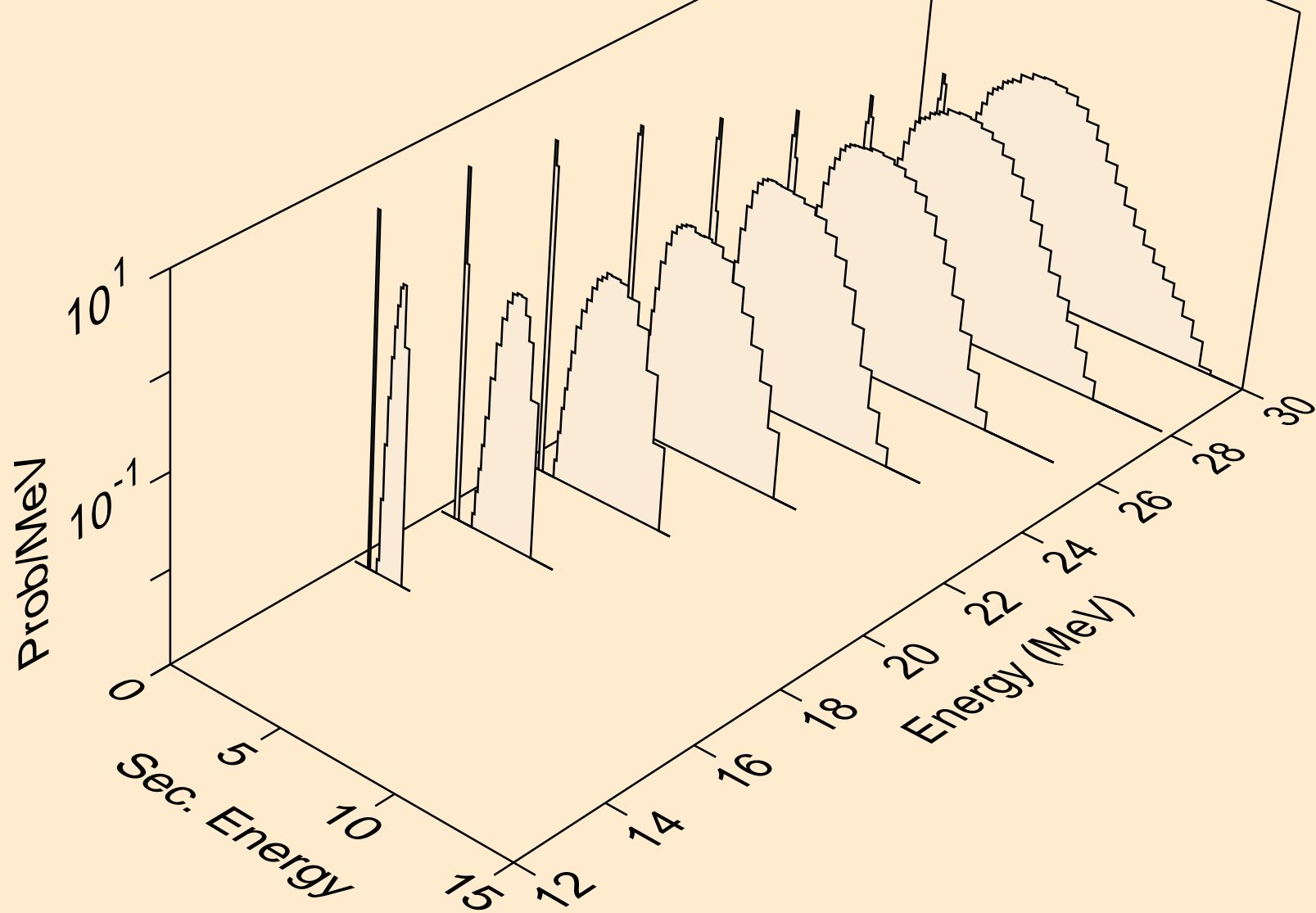

LA119 PROTON ACER TENDL-2021 LIBRARY; T=0.K  
Proton emission for (p,npa)

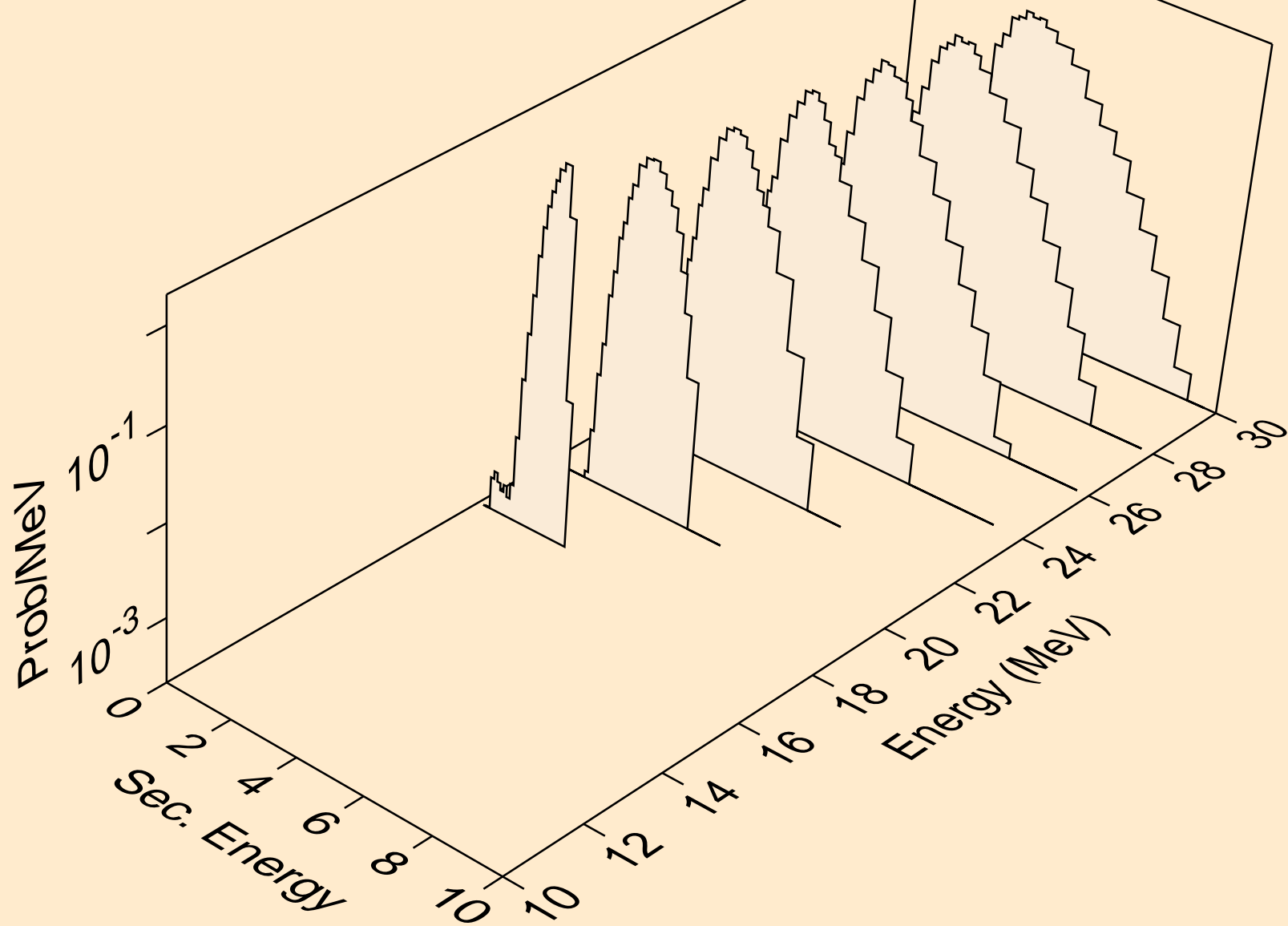

LA119 PROTON ACER TENDL-2021 LIBRARY; T=0.K  
Proton emission for inelastic

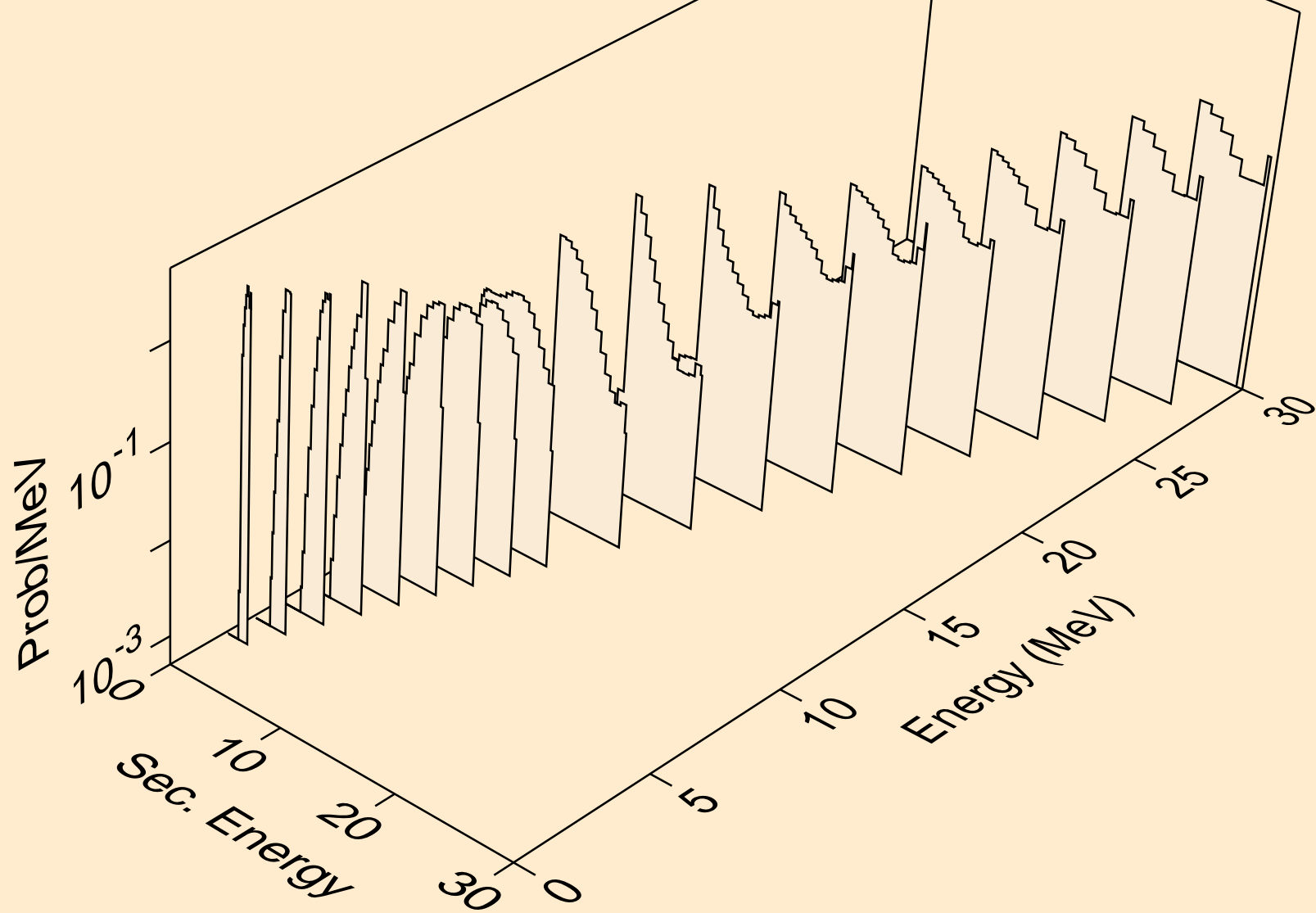

LA119 PROTON ACER TENDL-2021 LIBRARY; T=0.K  
Proton emission for (p,2p)

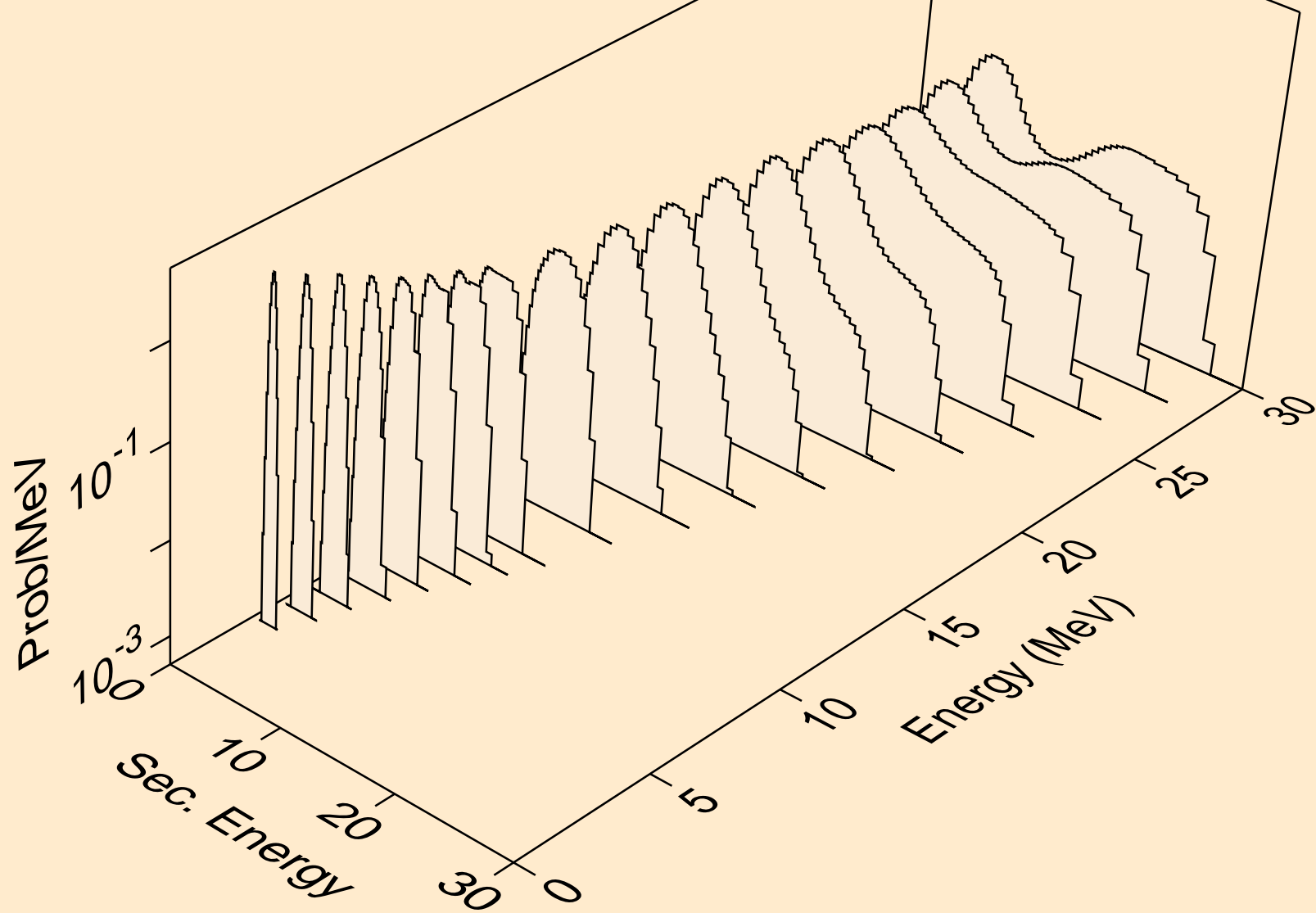



LA119 PROTON ACER TENDL-2021 LIBRARY; T=0.K  
Proton emission for (p,pa)

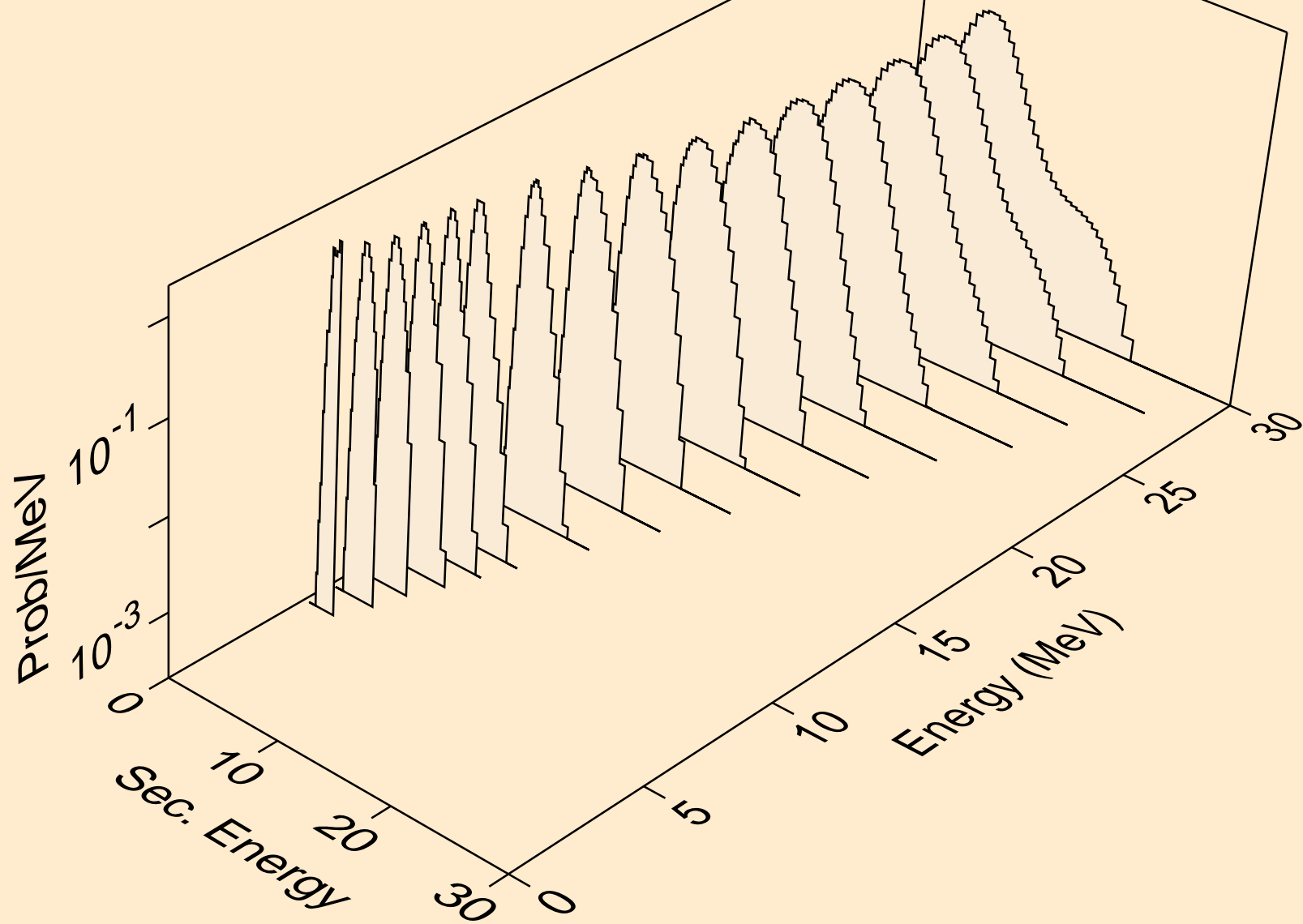

LA119 PROTON ACER TENDL-2021 LIBRARY; T=0.K  
Proton emission for (p,pd)

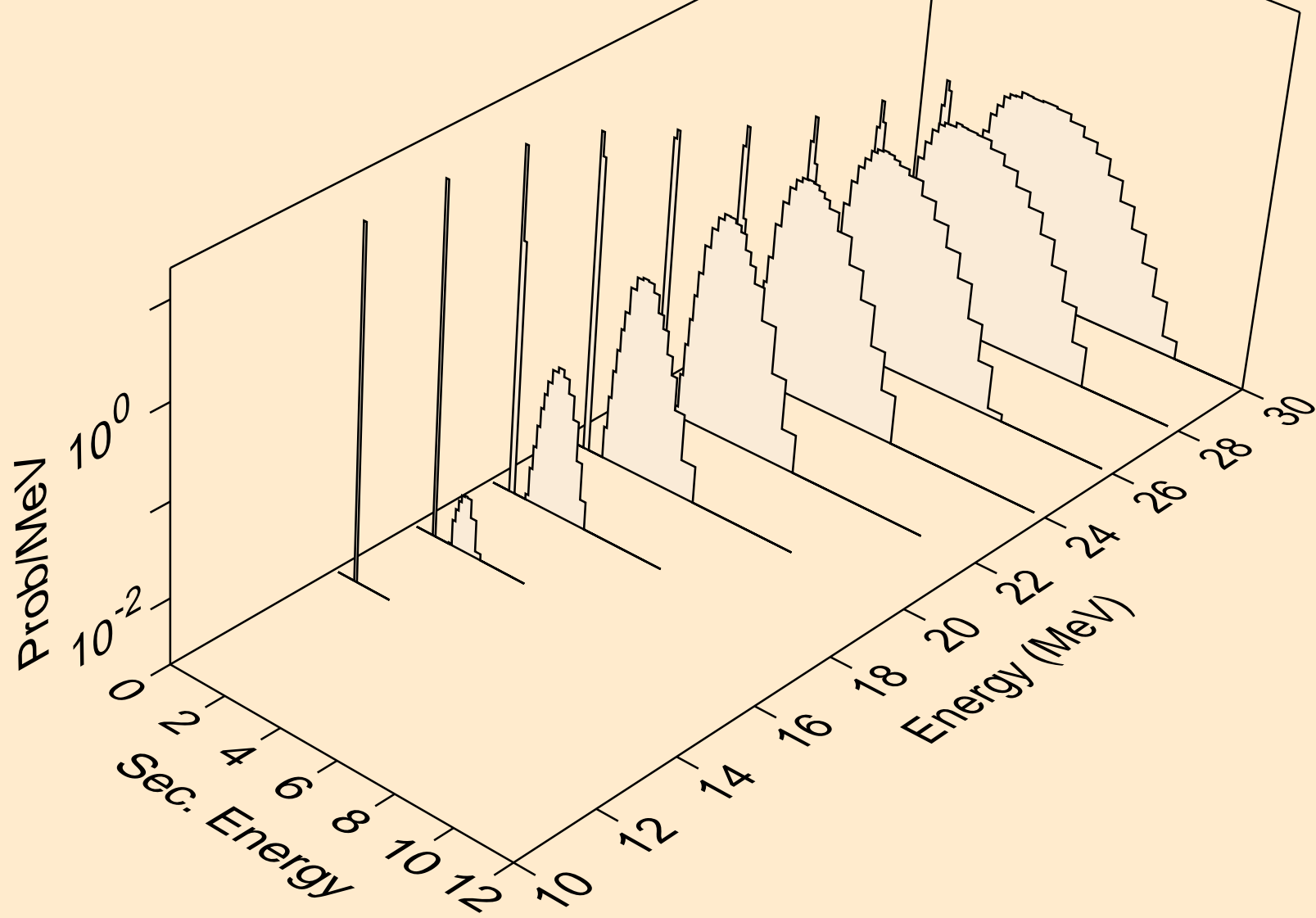

LA119 PROTON ACER TENDL-2021 LIBRARY; T=0.K  
Proton emission for (p,pt)

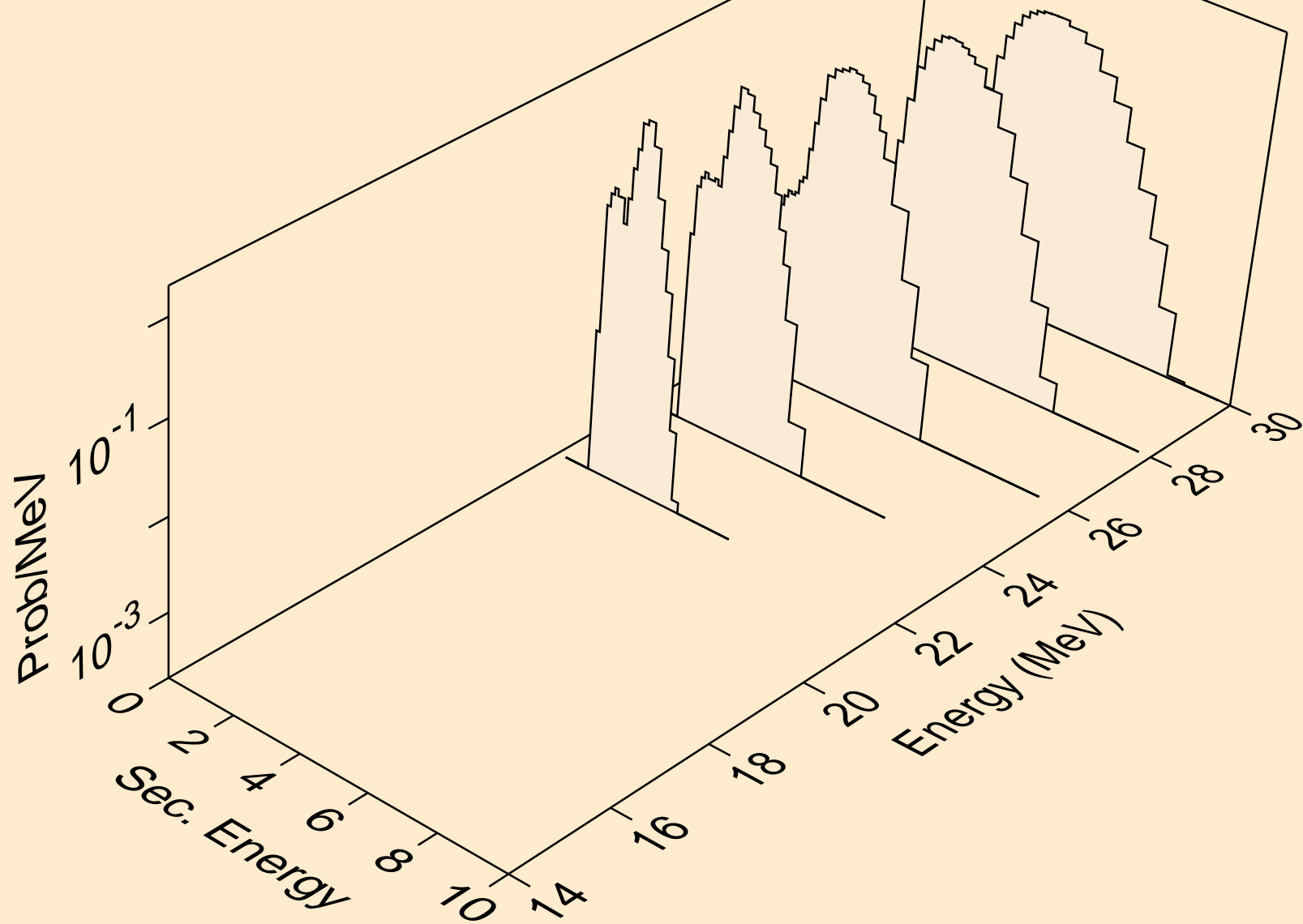

LA119 PROTON ACER TENDL-2021 LIBRARY; T=0.K  
Photon emission for (z,n)

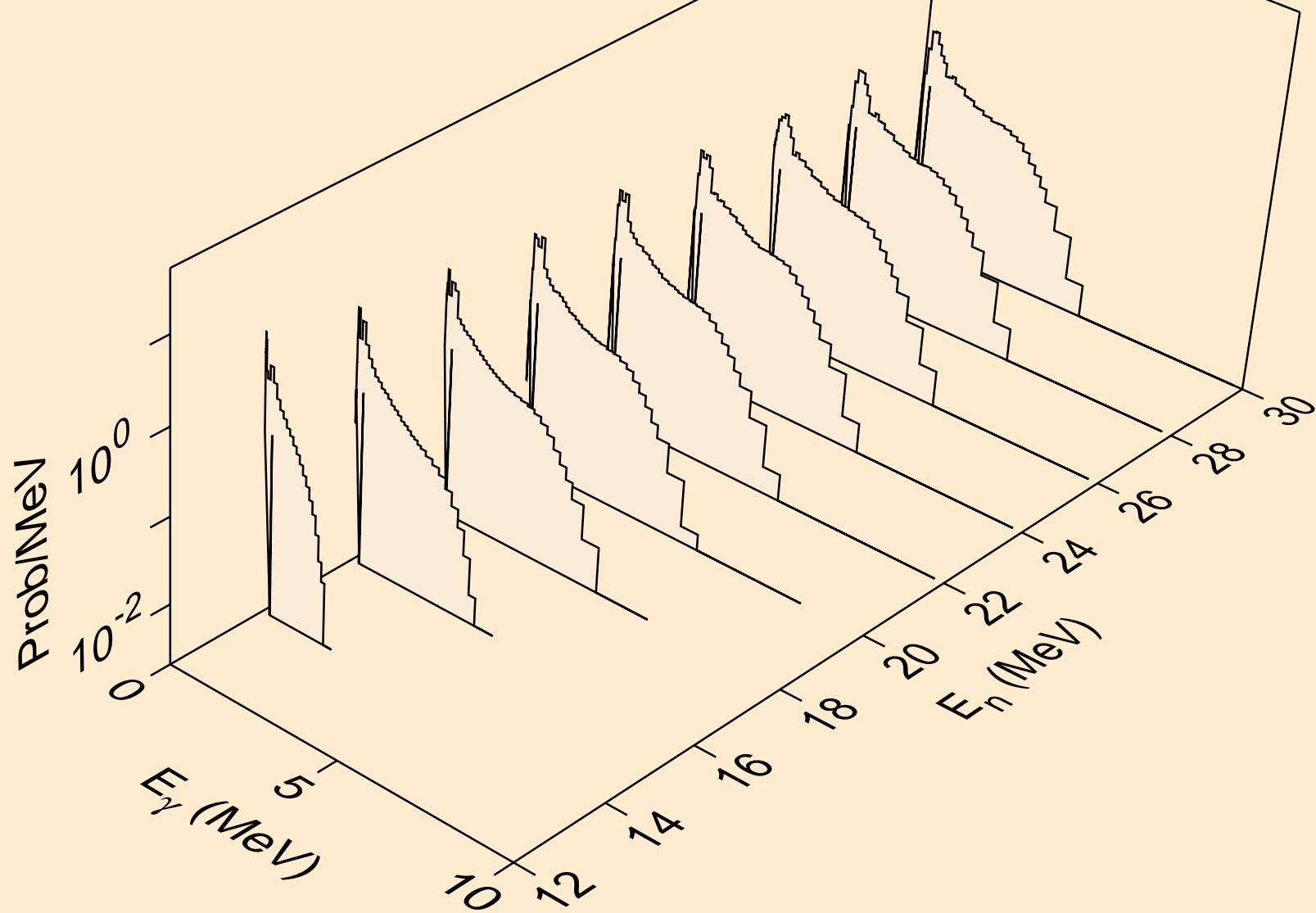

LA119 PROTON ACER TENDL-2021 LIBRARY; T=0.K  
Photon emission for (n,x)

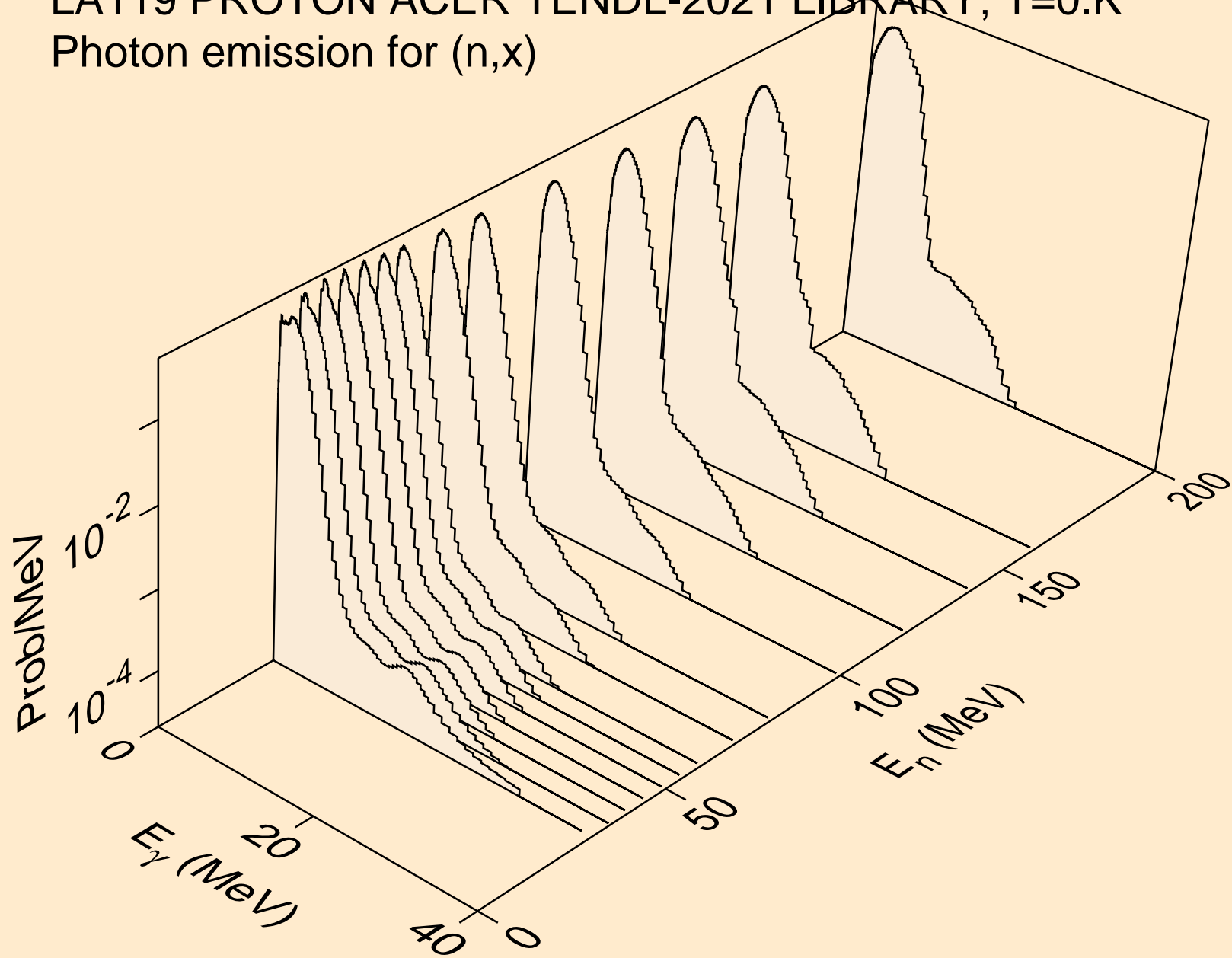

LA119 PROTON ACER TENDL-2021 LIBRARY; T=0.K  
Photon emission for (n,2n)

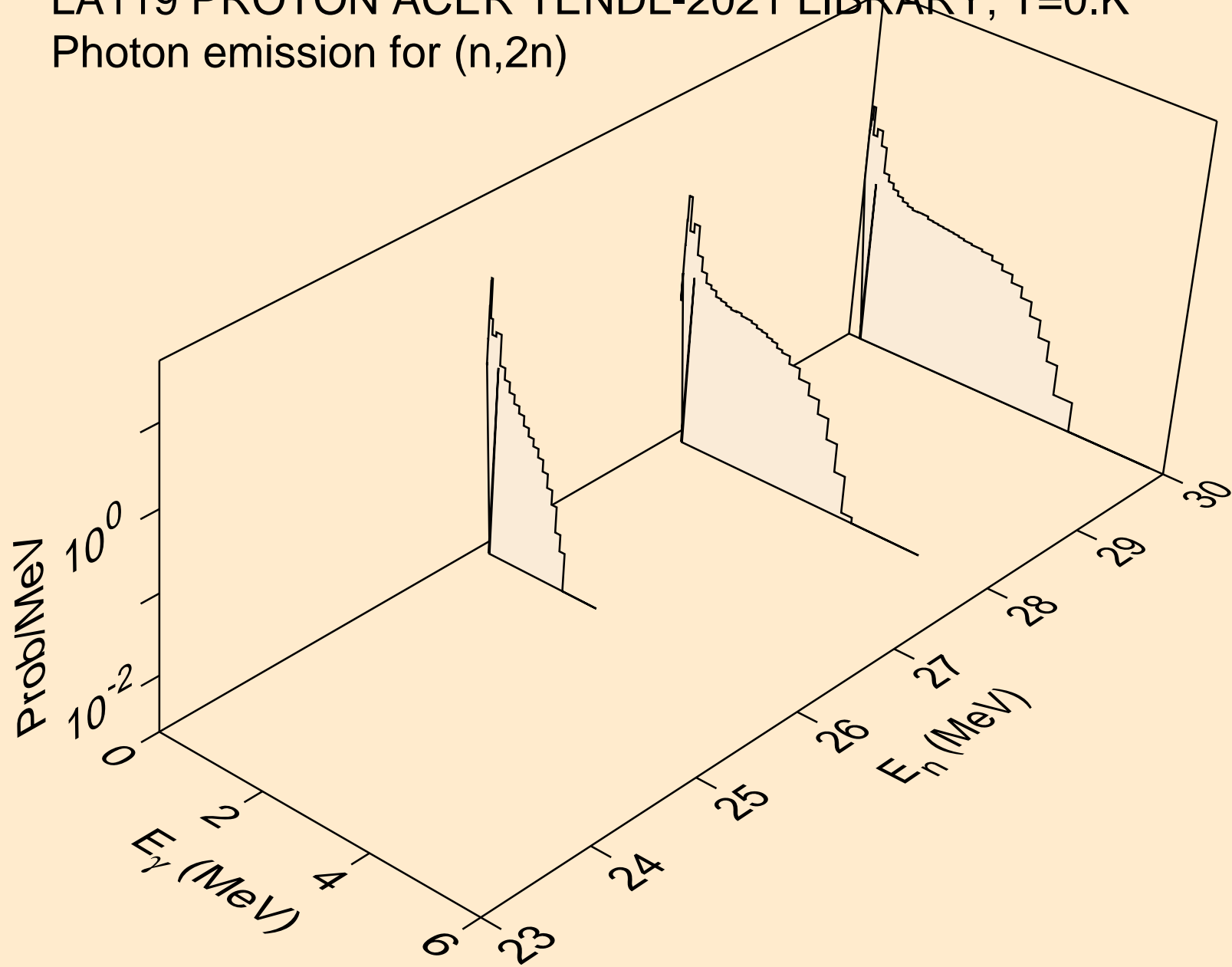

LA119 PROTON ACER TENDL-2021 LIBRARY; T=0.K  
Photon emission for (n,n\*)a

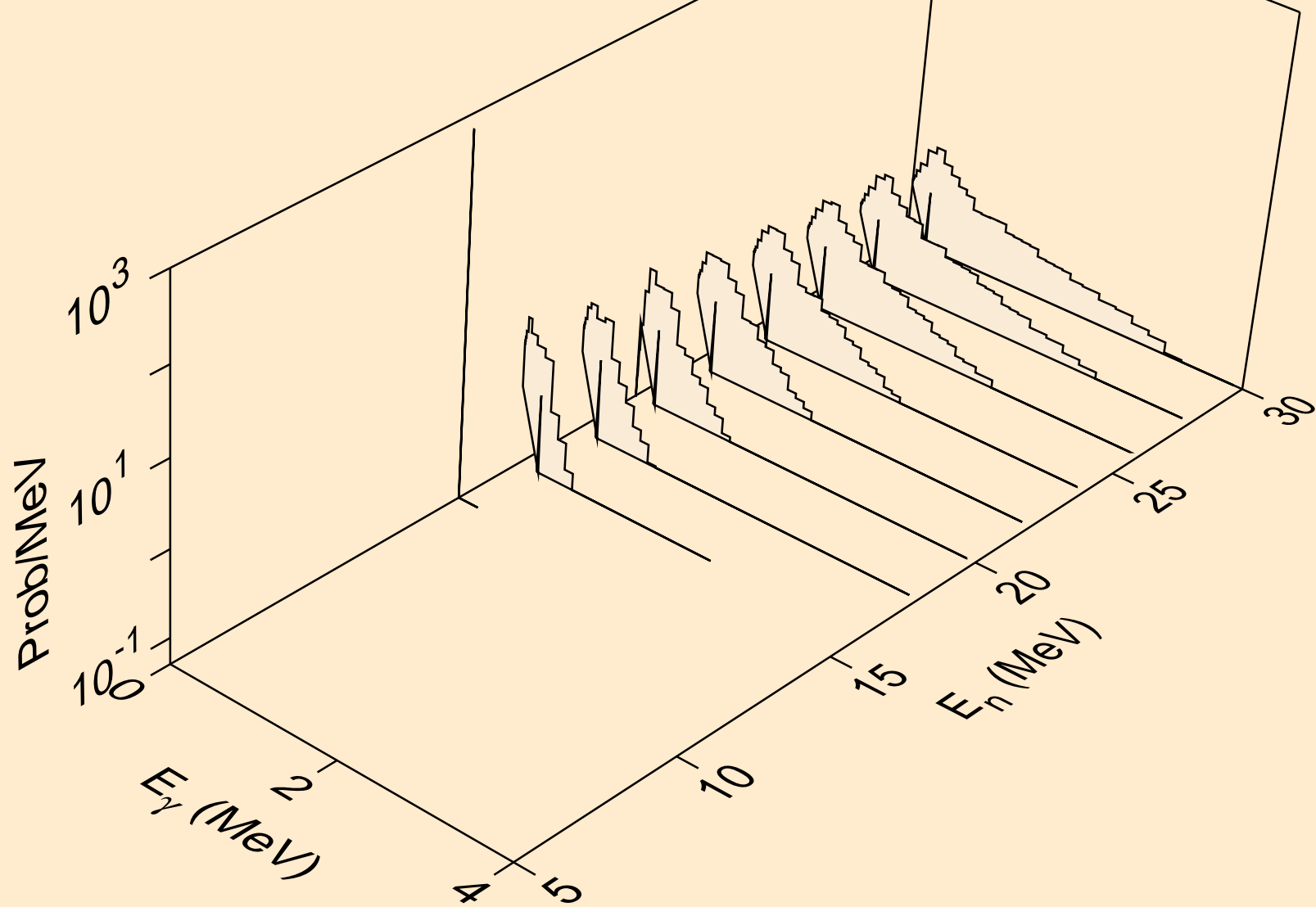

LA119 PROTON ACER TENDL-2021 LIBRARY; T=0.K  
Photon emission for (n,n\*)p

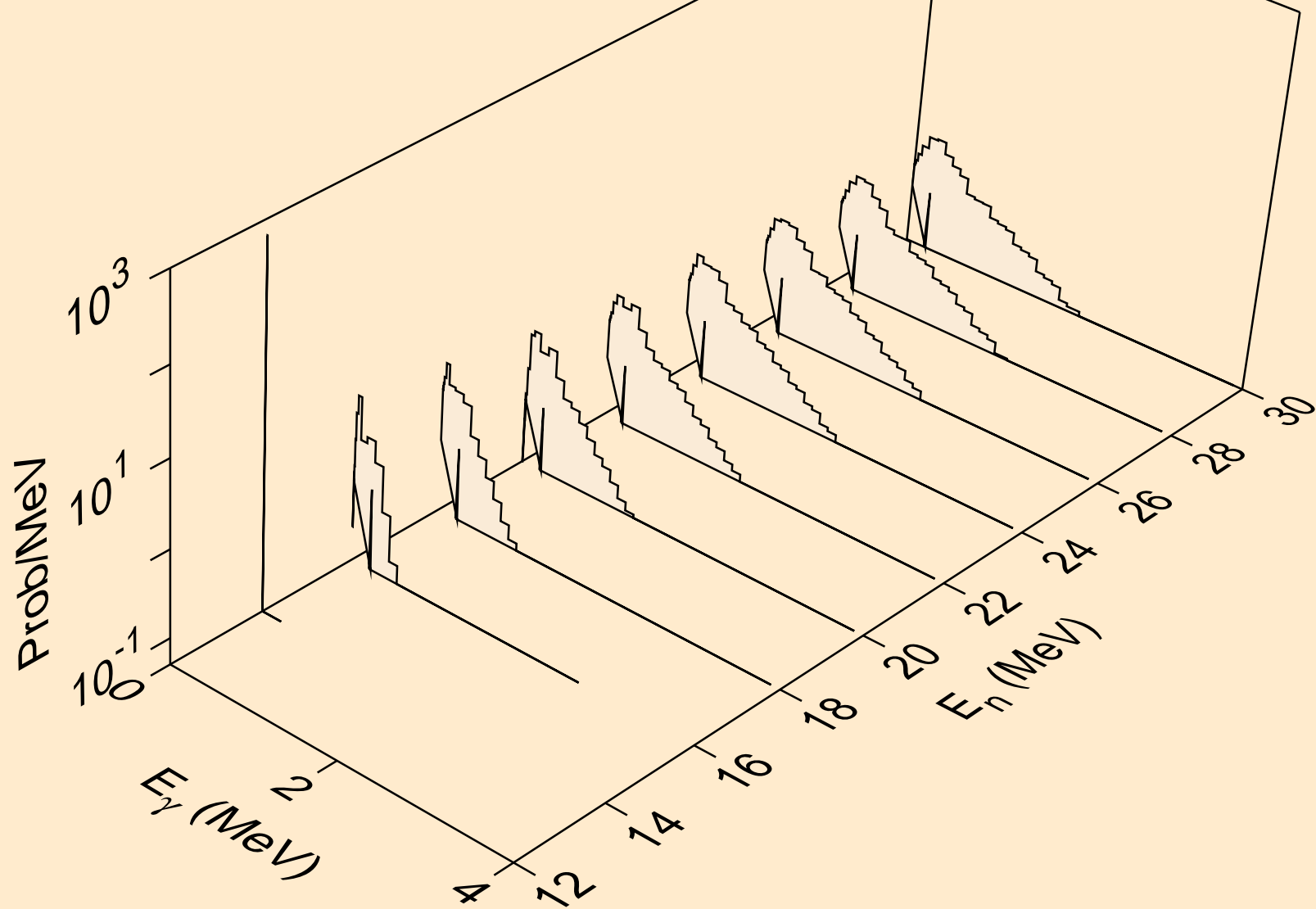



LA119 PROTON ACER TENDL-2021 LIBRARY; T=0.K  
Photon emission for (n,n\*)2a

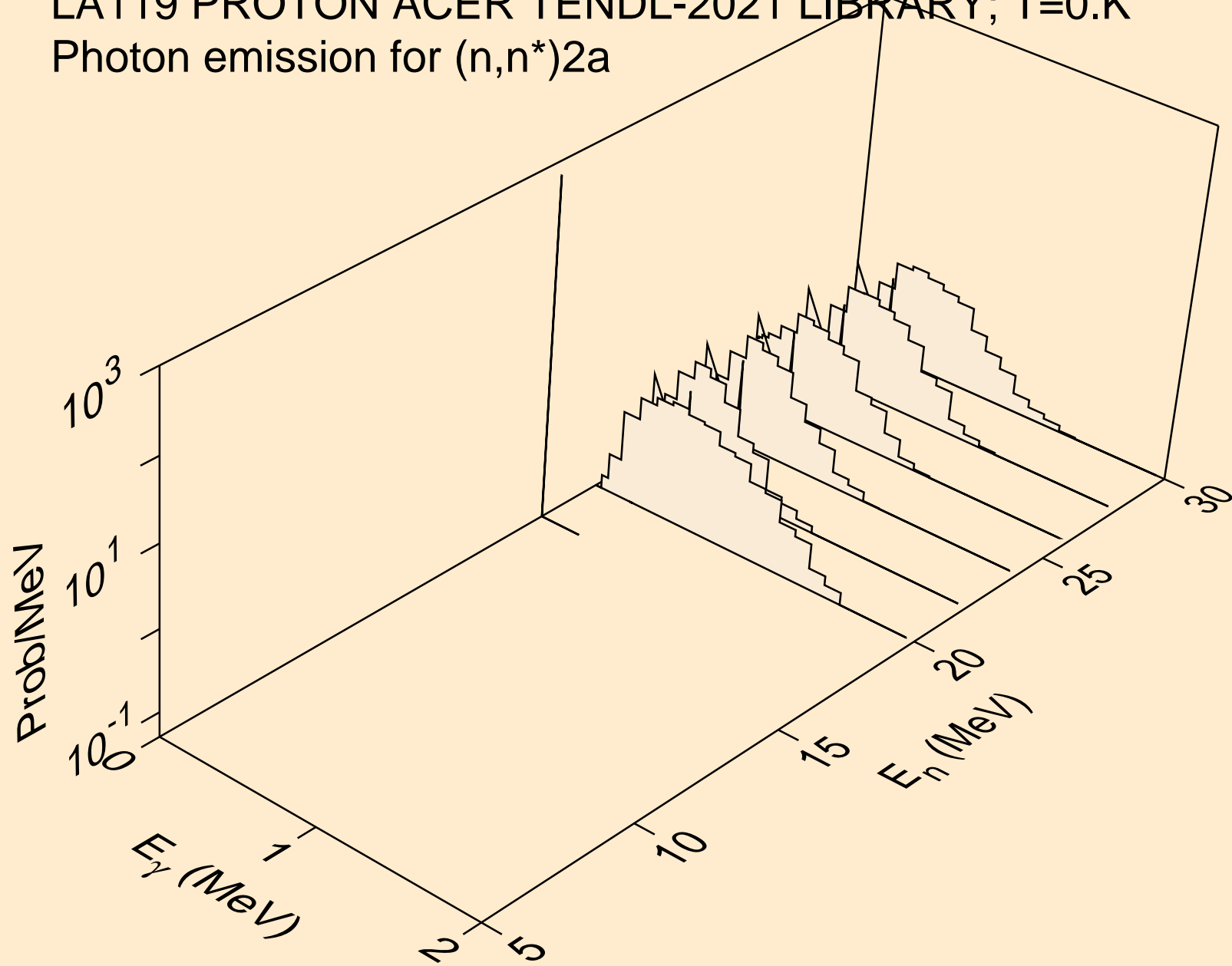

LA119 PROTON ACER TENDL-2021 LIBRARY; T=0.K  
Photon emission for (n,n\*)d

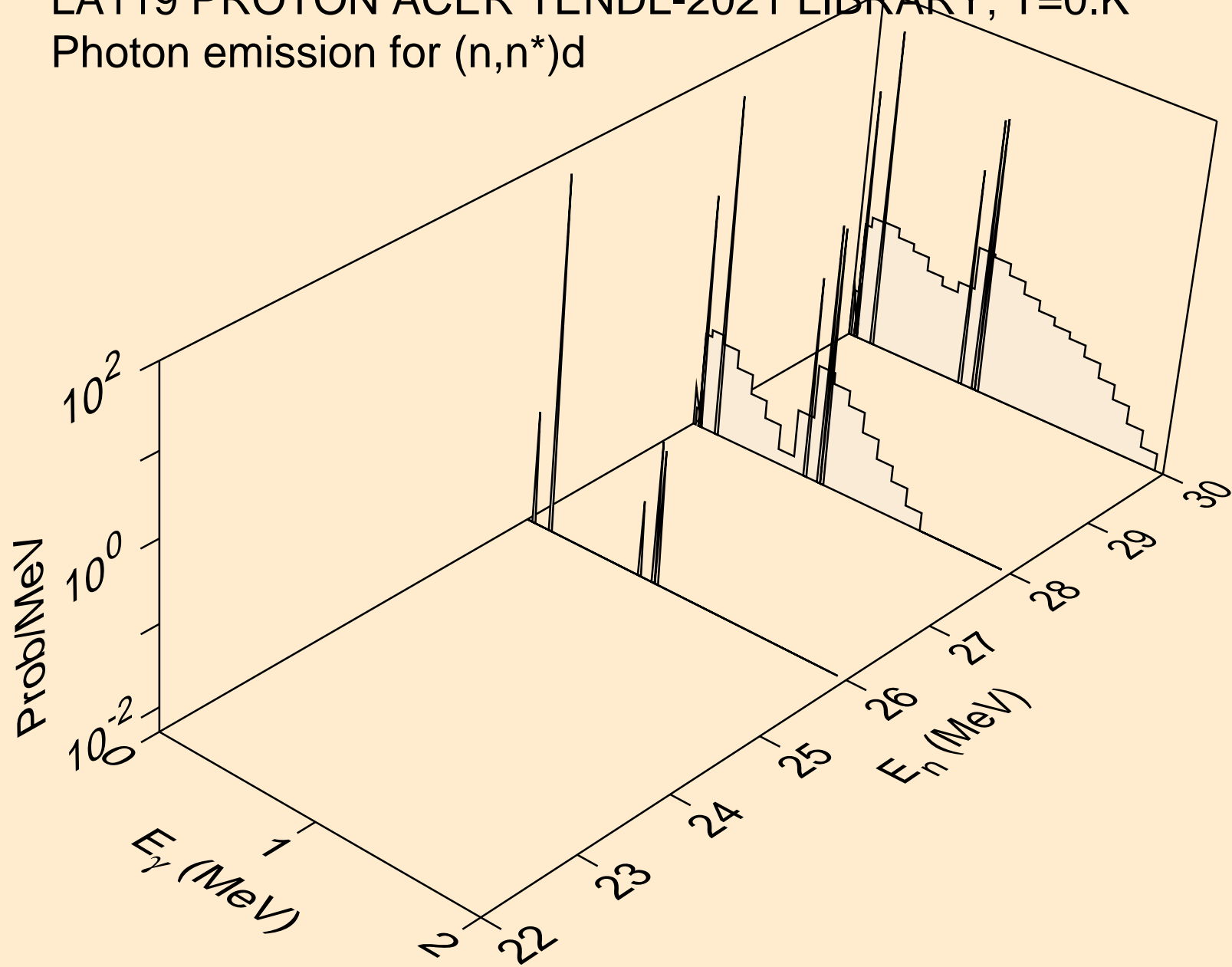

LA119 PROTON ACER TENDL-2021 LIBRARY; T=0.K  
Photon emission for (n,n\*)he3

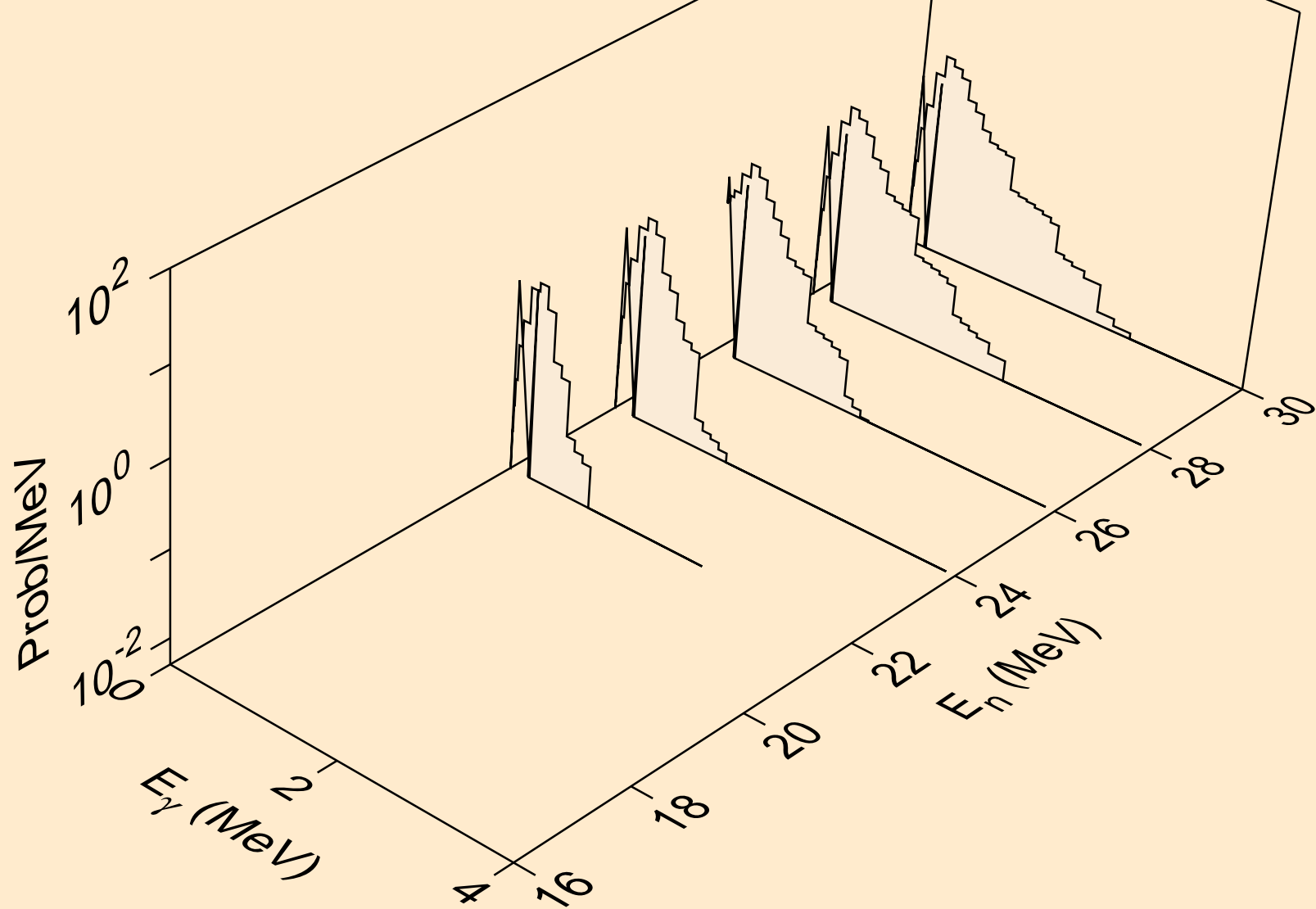

LA119 PROTON ACER TENDL-2021 LIBRARY; T=0.K  
Photon emission for (n,2np)

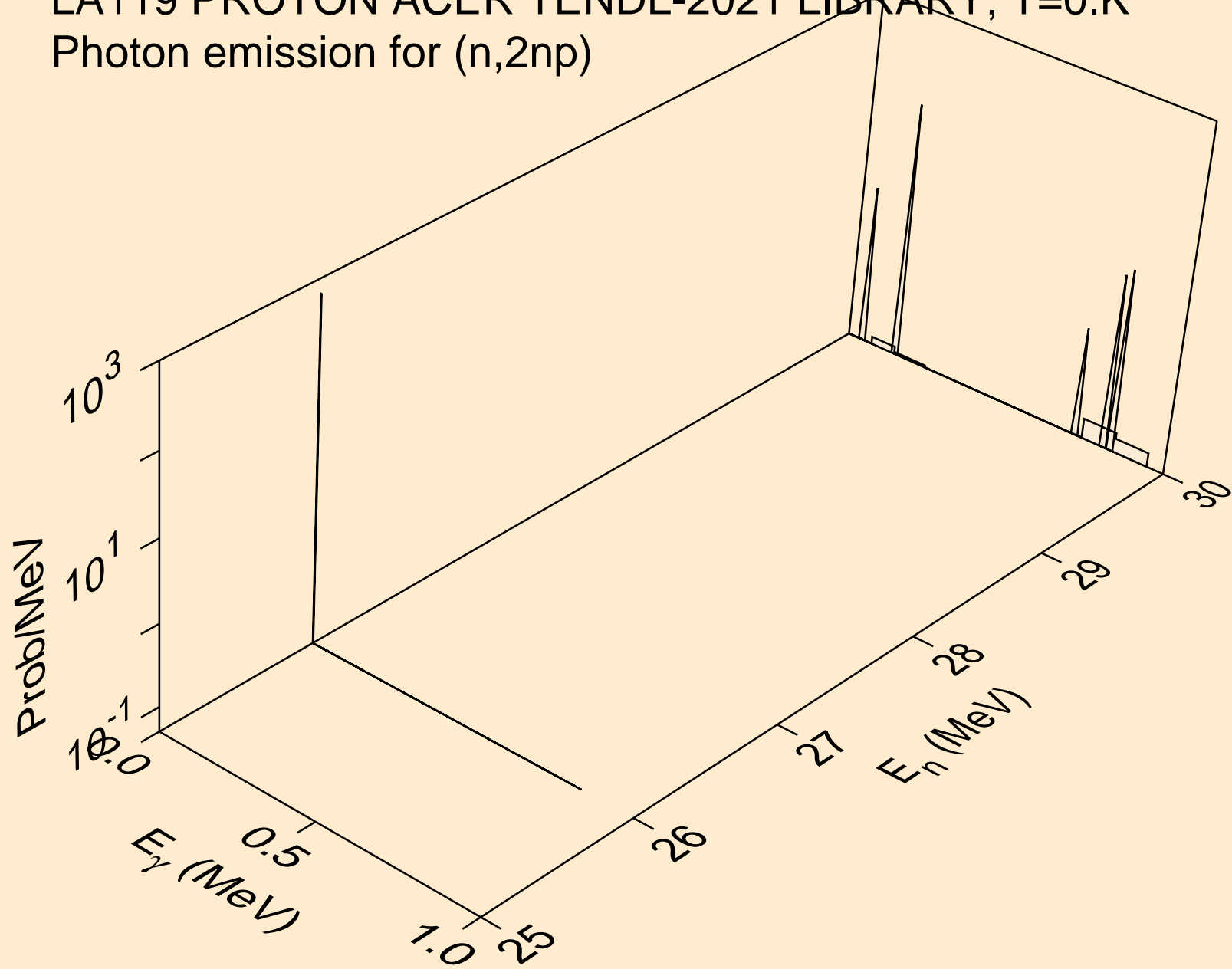

LA119 PROTON ACER TENDL-2021 LIBRARY; T=0.K  
Photon emission for (n,2np)

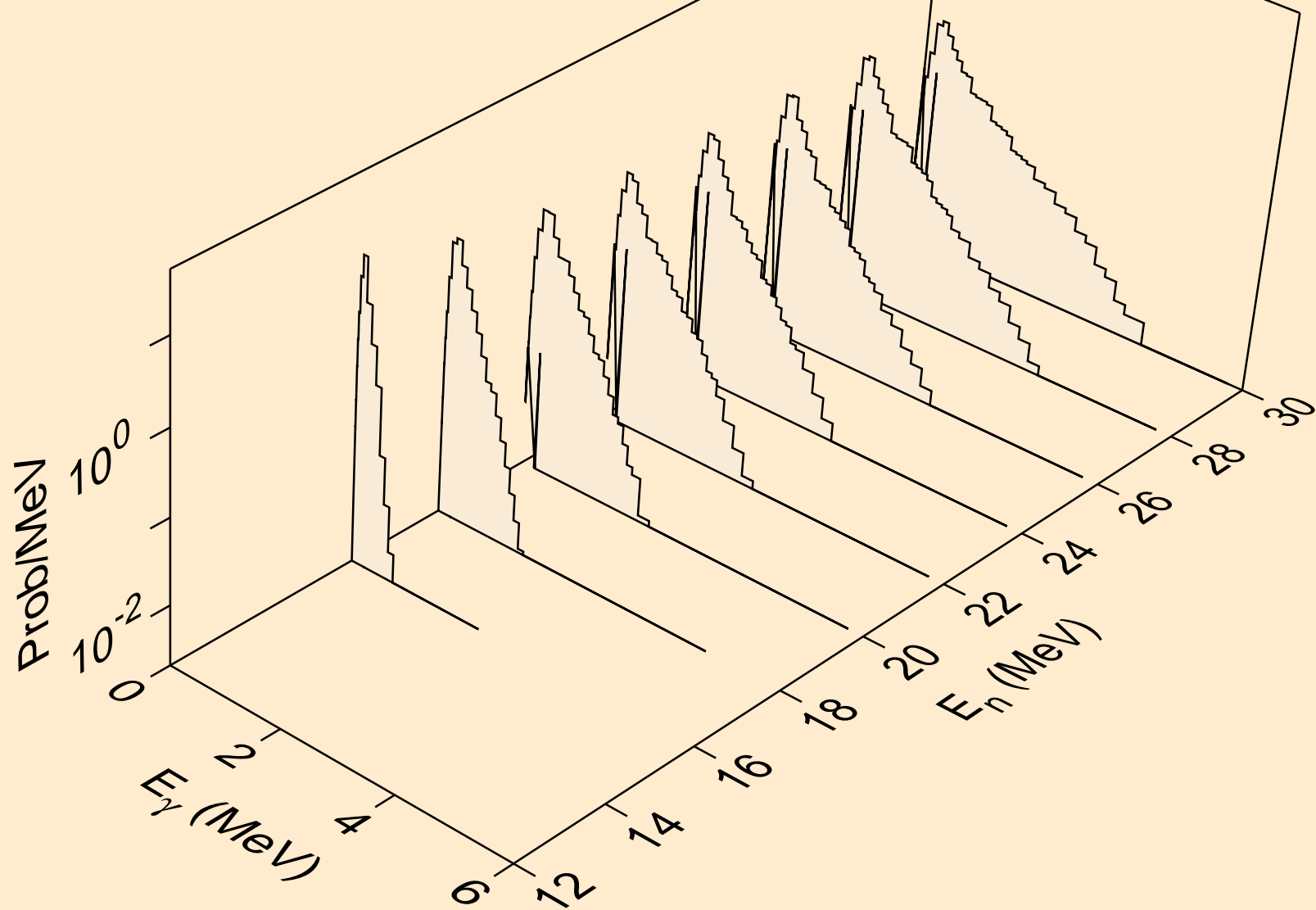

LA119 PROTON ACER TENDL-2021 LIBRARY; T=0.K  
Photon emission for (n,npa)

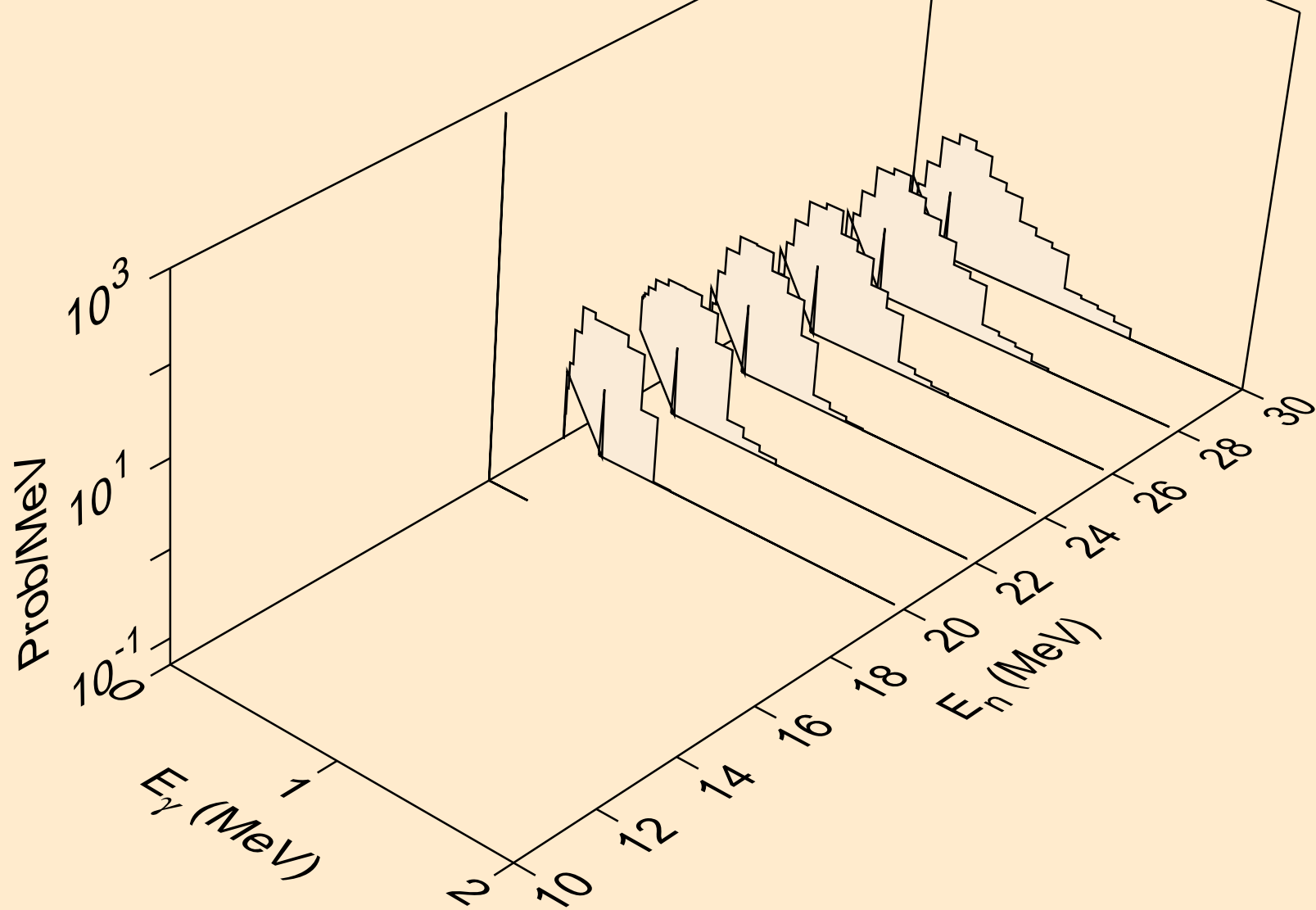

LA119 PROTON ACER TENDL-2021 LIBRARY; T=0.K  
Photon emission for (n,gma)

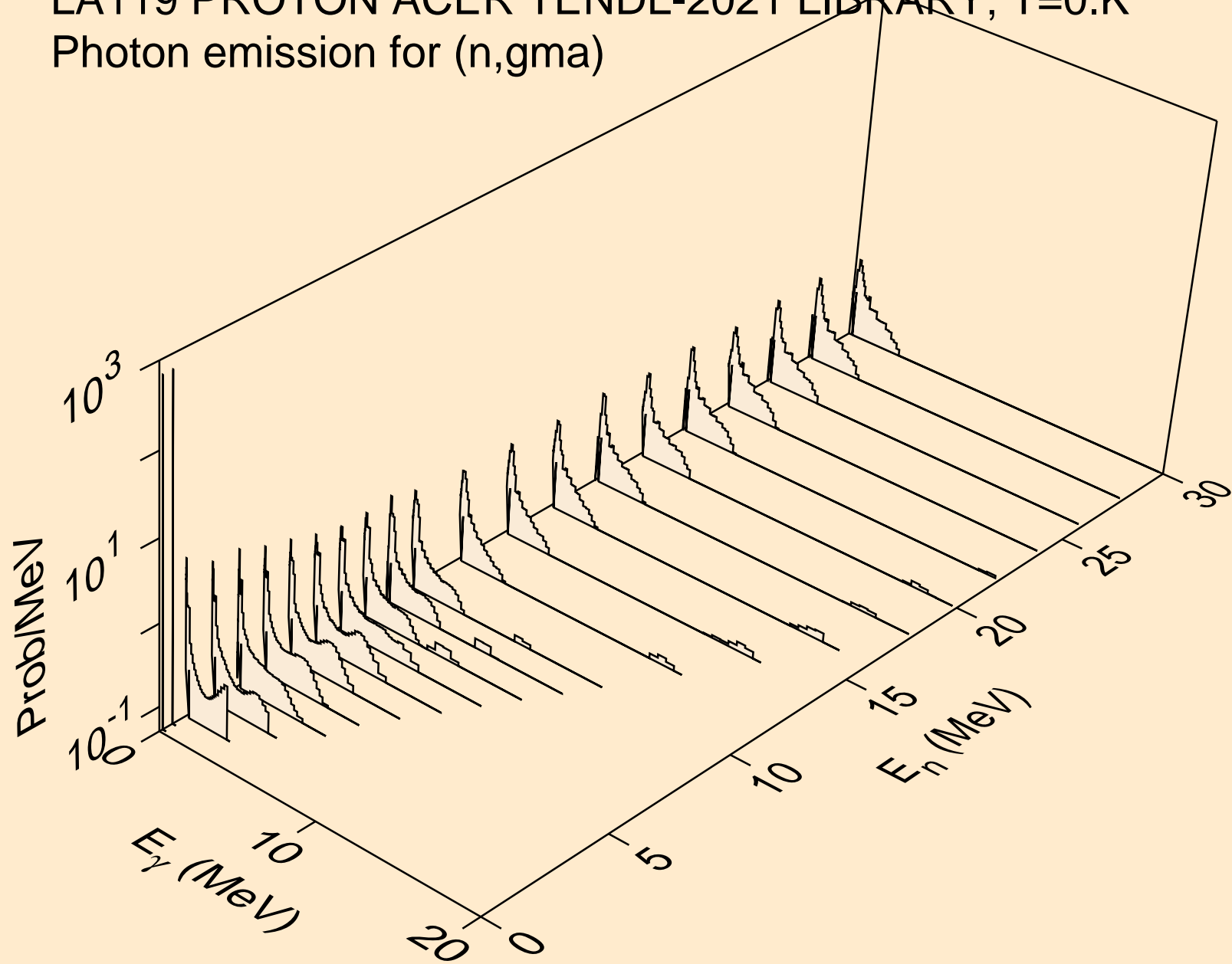

LA119 PROTON ACER TENDL-2021 LIBRARY; T=0.K  
Photon emission for inelastic

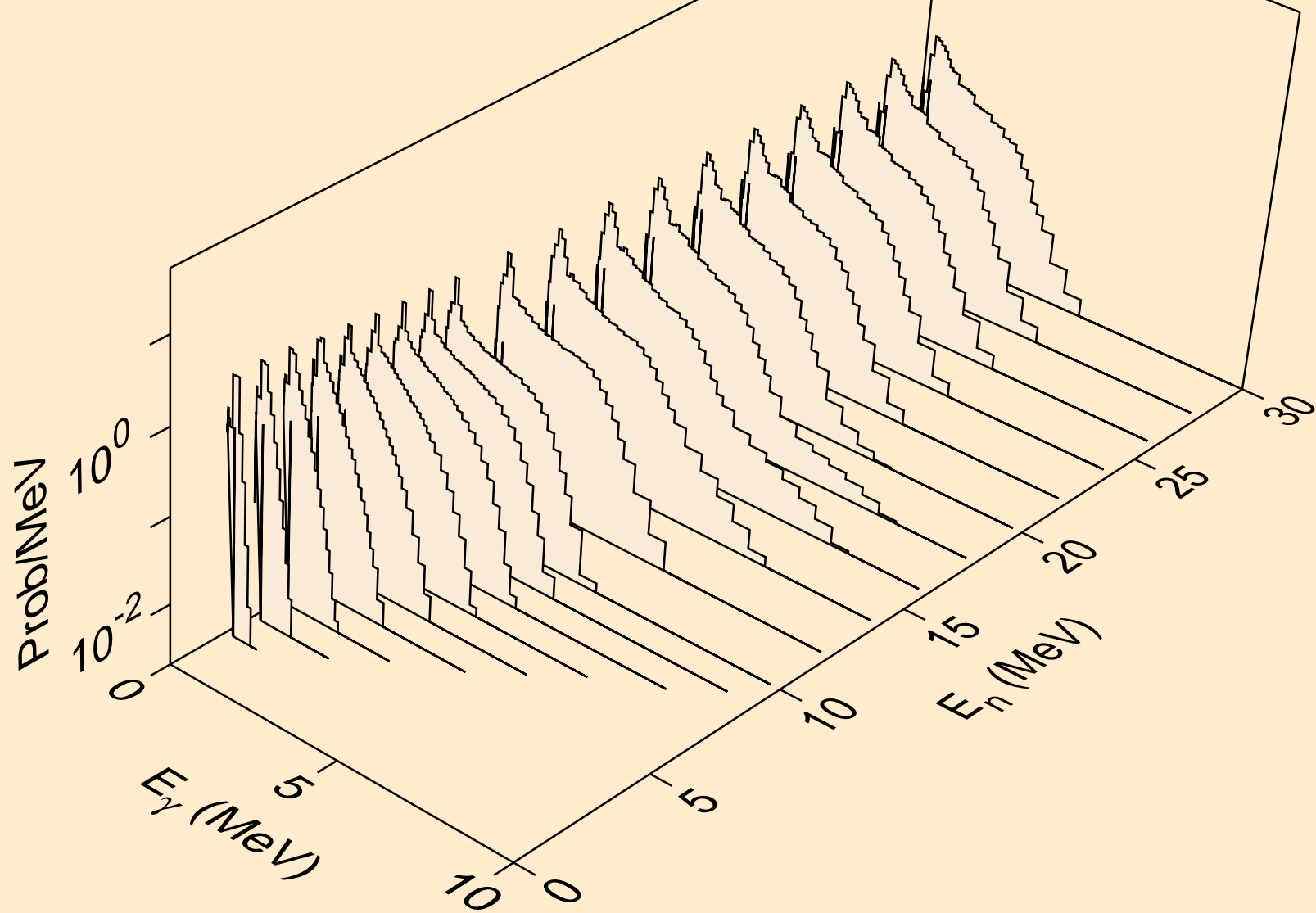



LA119 PROTON ACER TENDL-2021 LIBRARY; T=0.K  
Photon emission for (n,d)

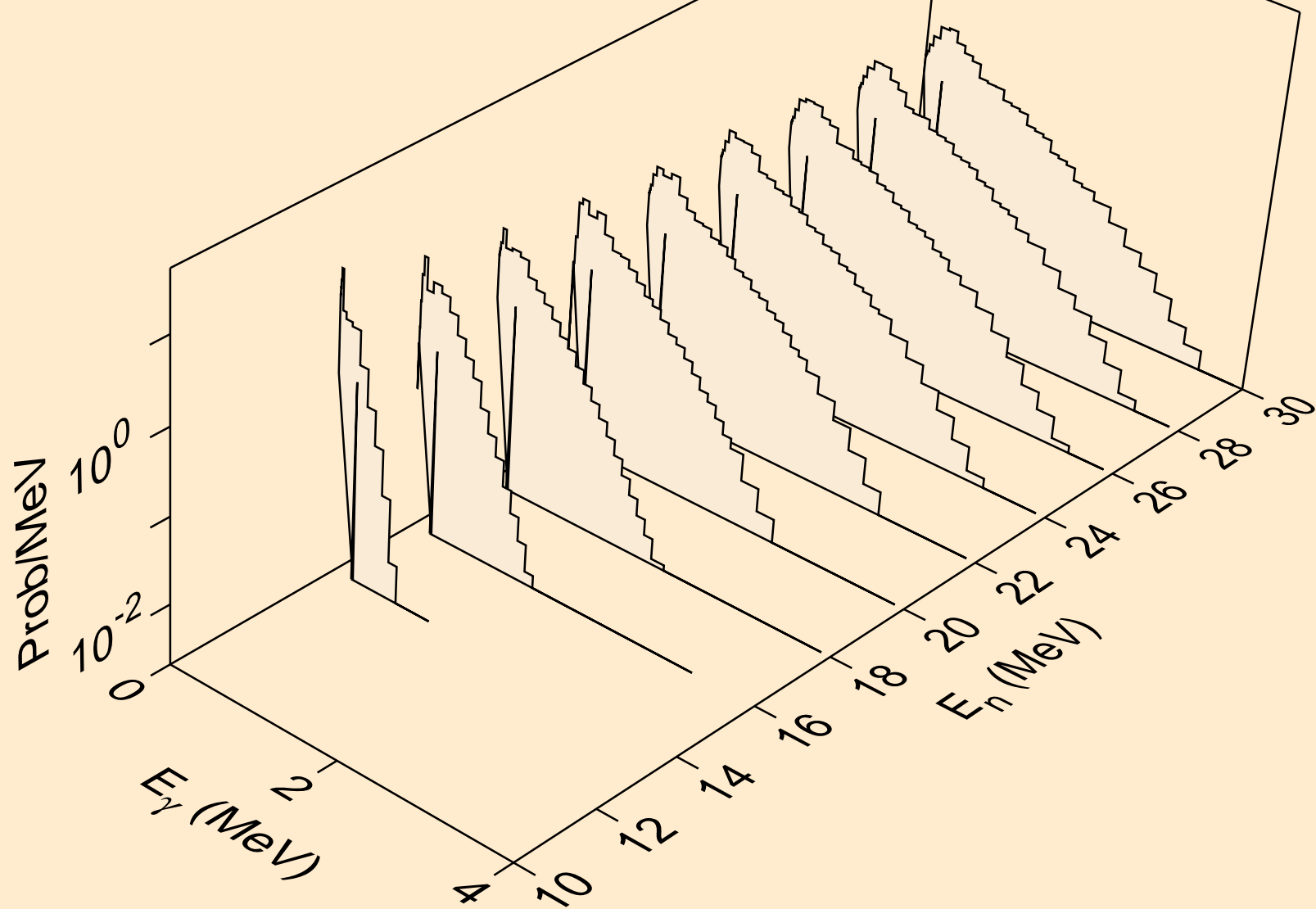

LA119 PROTON ACER TENDL-2021 LIBRARY; T=0.K  
Photon emission for (n,t)

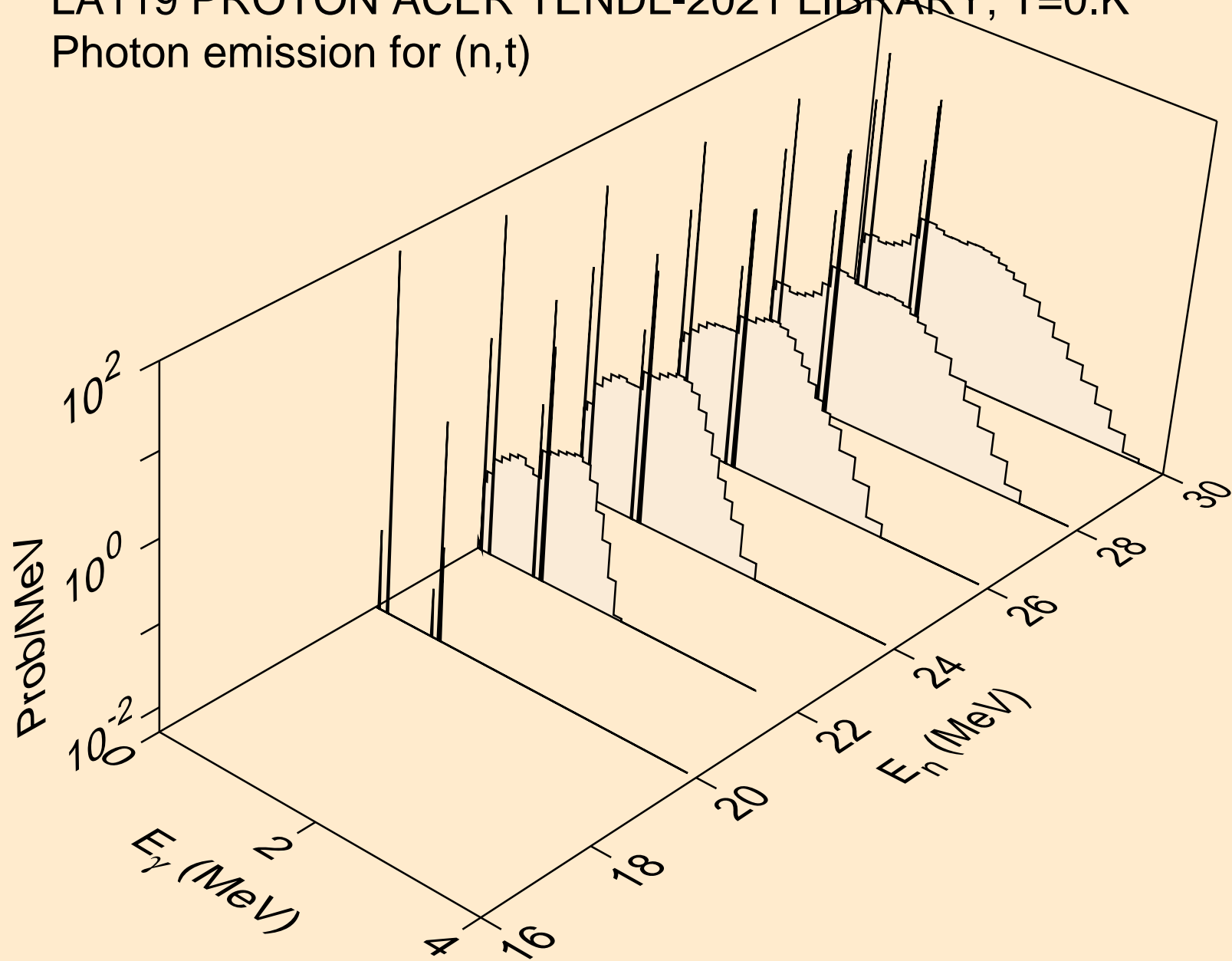

LA119 PROTON ACER TENDL-2021 LIBRARY; T=0.K  
Photon emission for (n,he3)

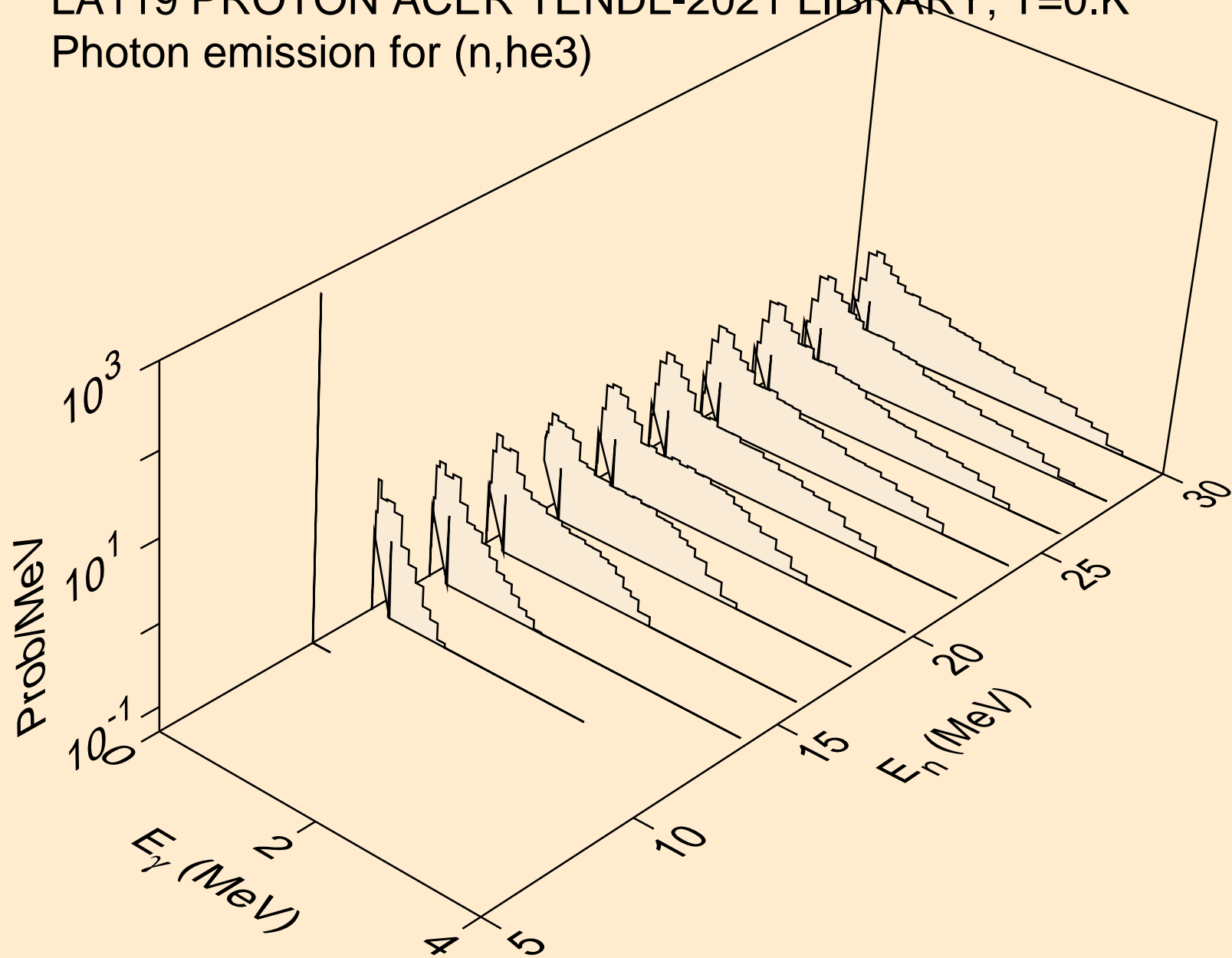

LA119 PROTON ACER TENDL-2021 LIBRARY; T=0.K  
Photon emission for (n,a)

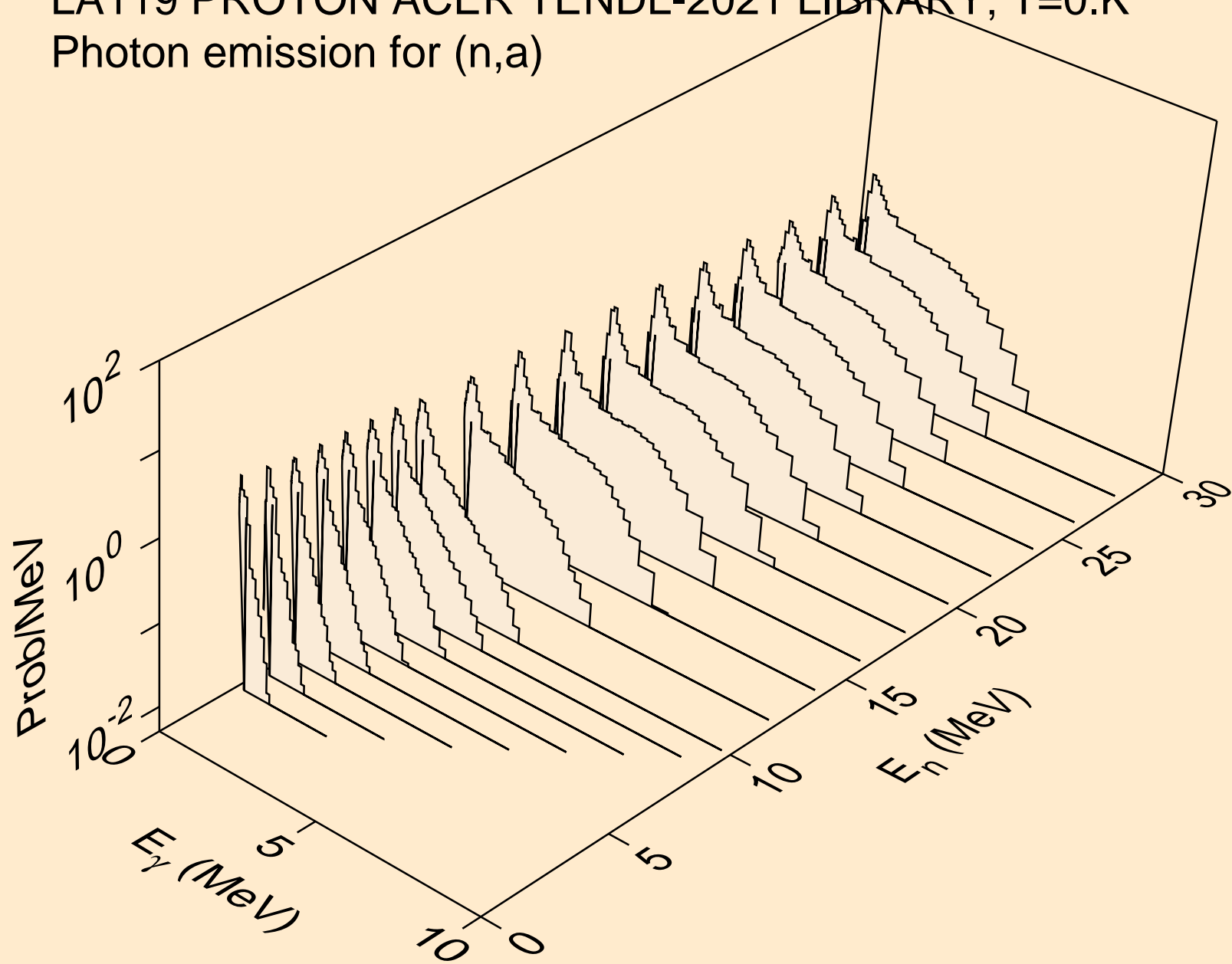

LA119 PROTON ACER TENDL-2021 LIBRARY; T=0.K  
Photon emission for (n,2a)

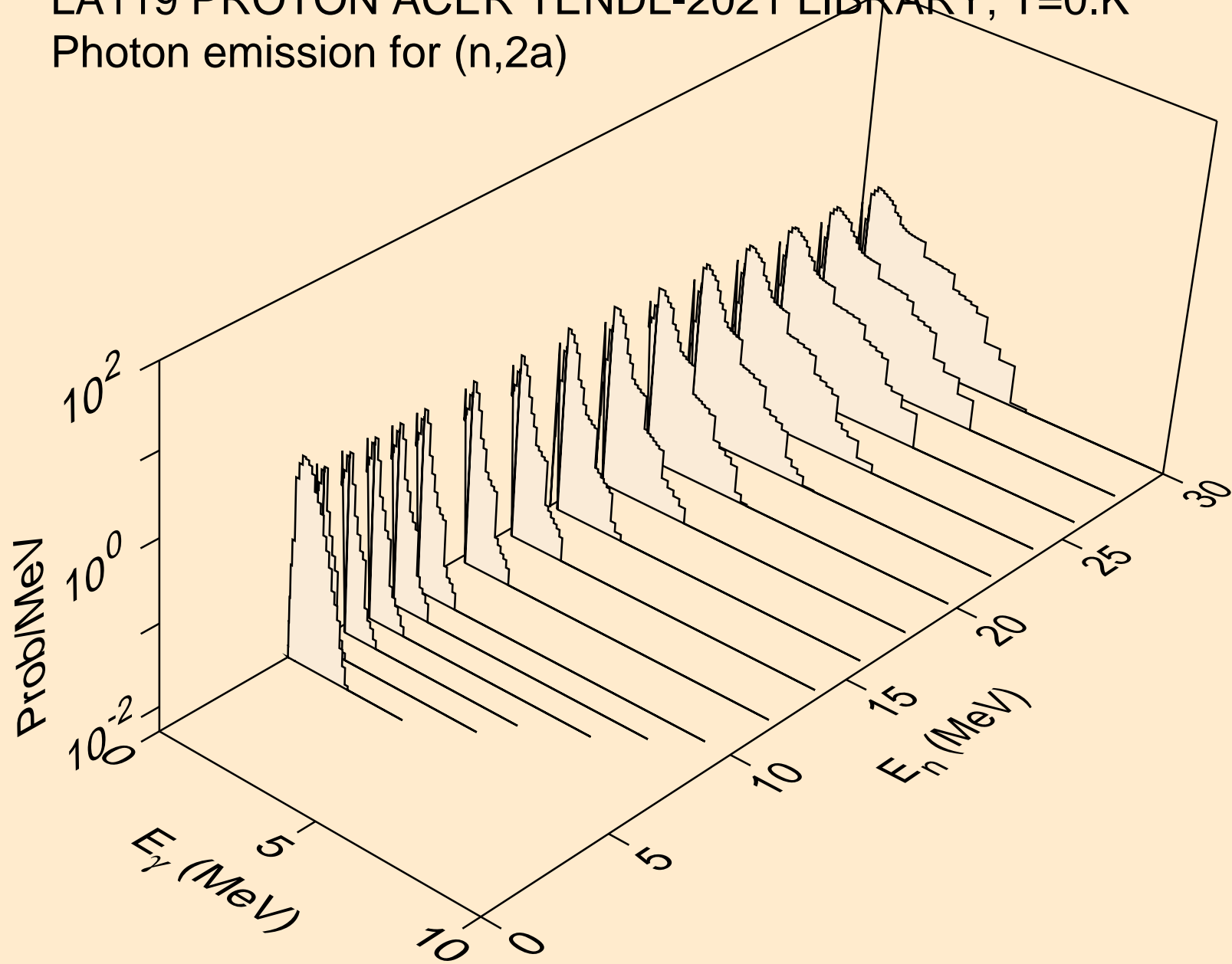

LA119 PROTON ACER TENDL-2021 LIBRARY; T=0.K  
Photon emission for (n,3a)

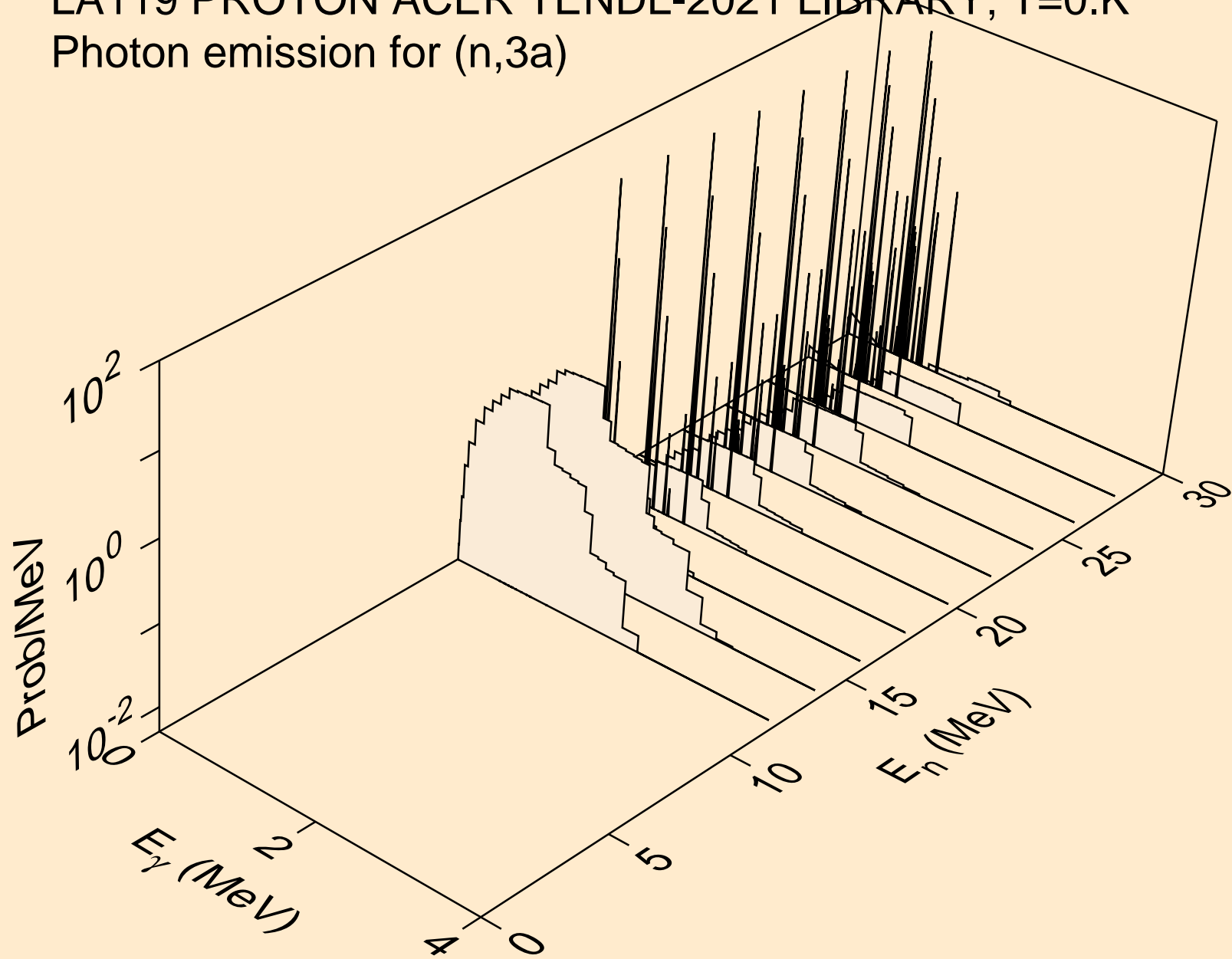

LA119 PROTON ACER TENDL-2021 LIBRARY; T=0.K  
Photon emission for (n,2p)

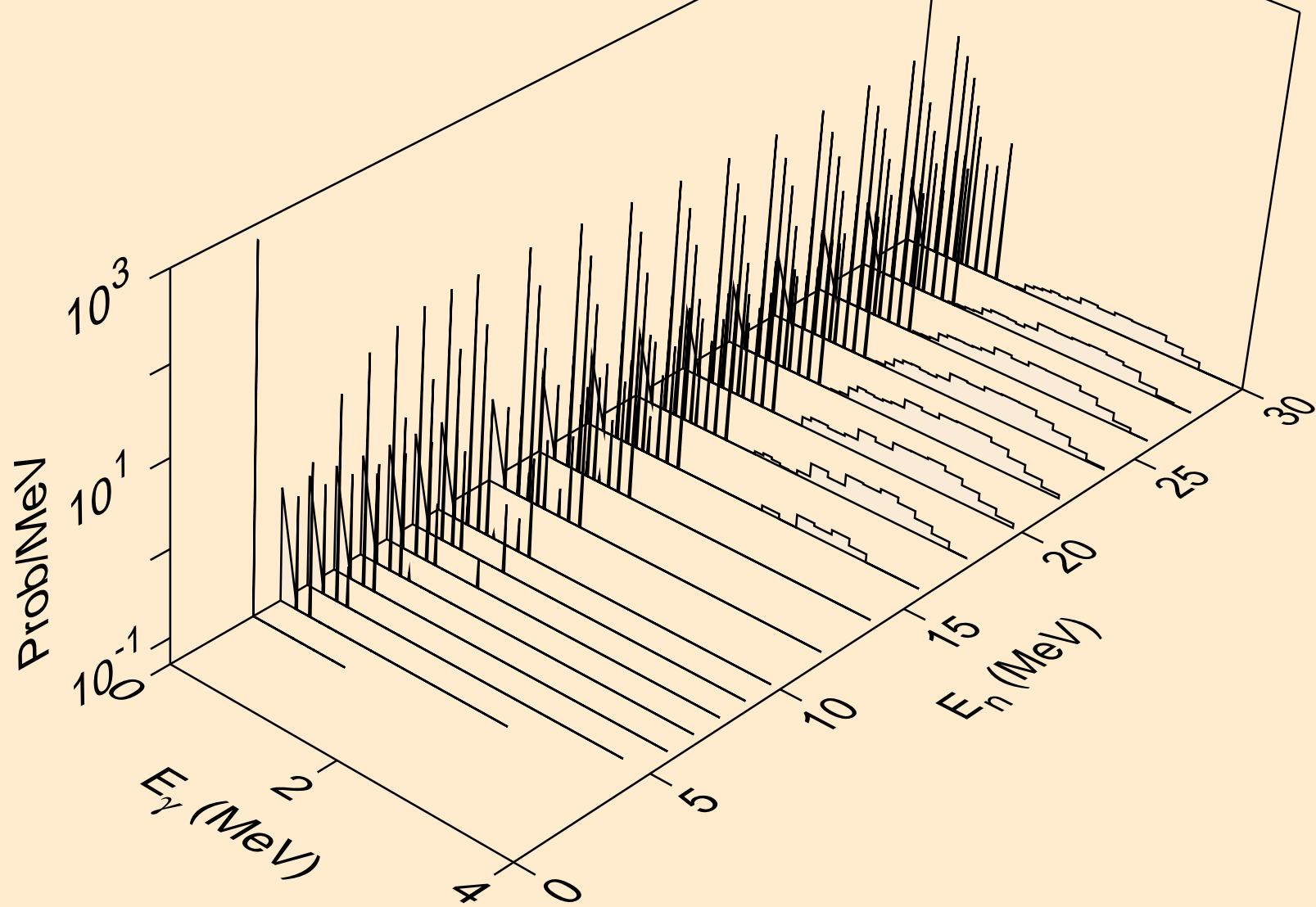

LA119 PROTON ACER TENDL-2021 LIBRARY; T=0.K  
Photon emission for (n,pa)

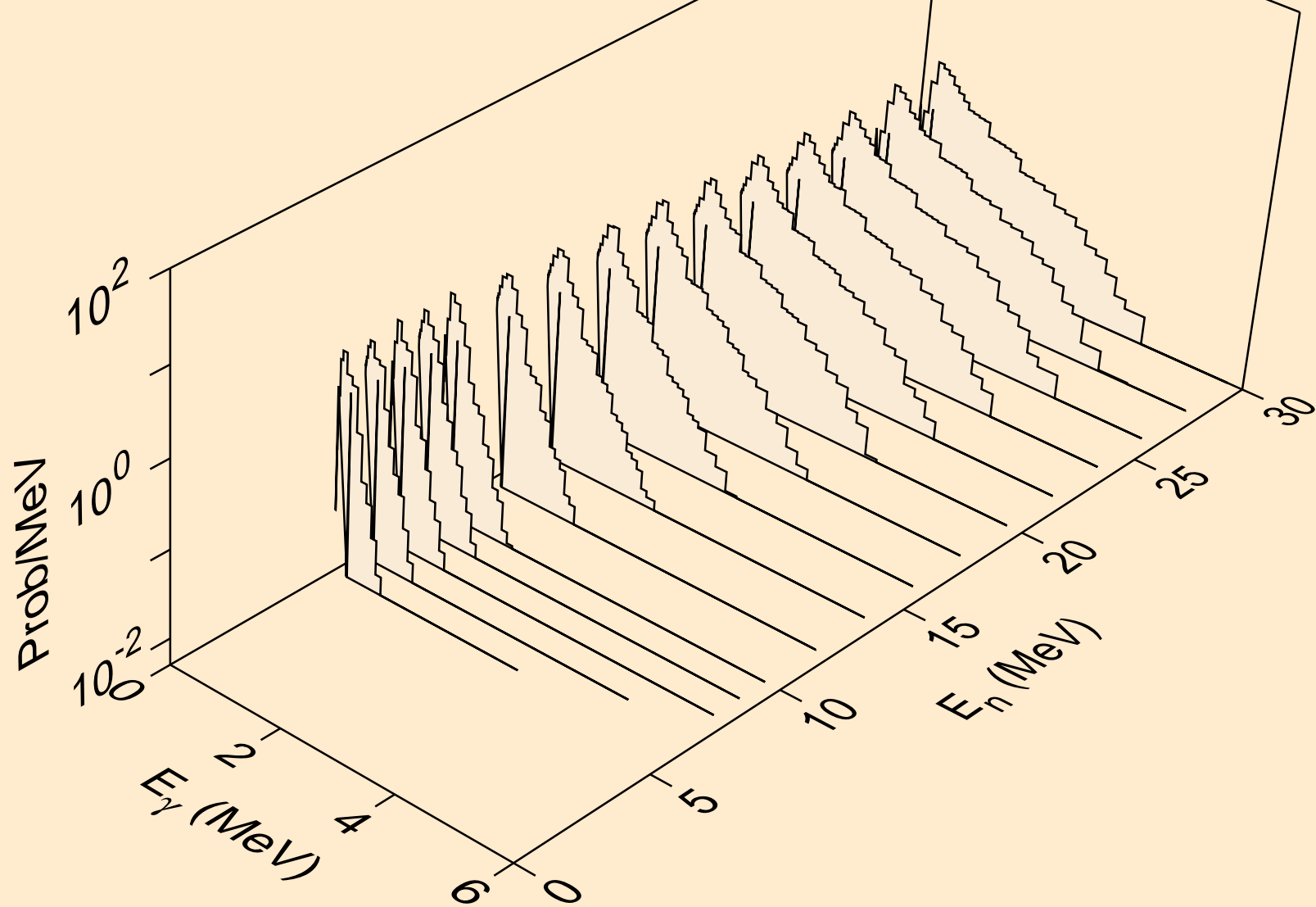



LA119 PROTON ACER TENDL-2021 LIBRARY; T=0.K  
Photon emission for (n,pd)

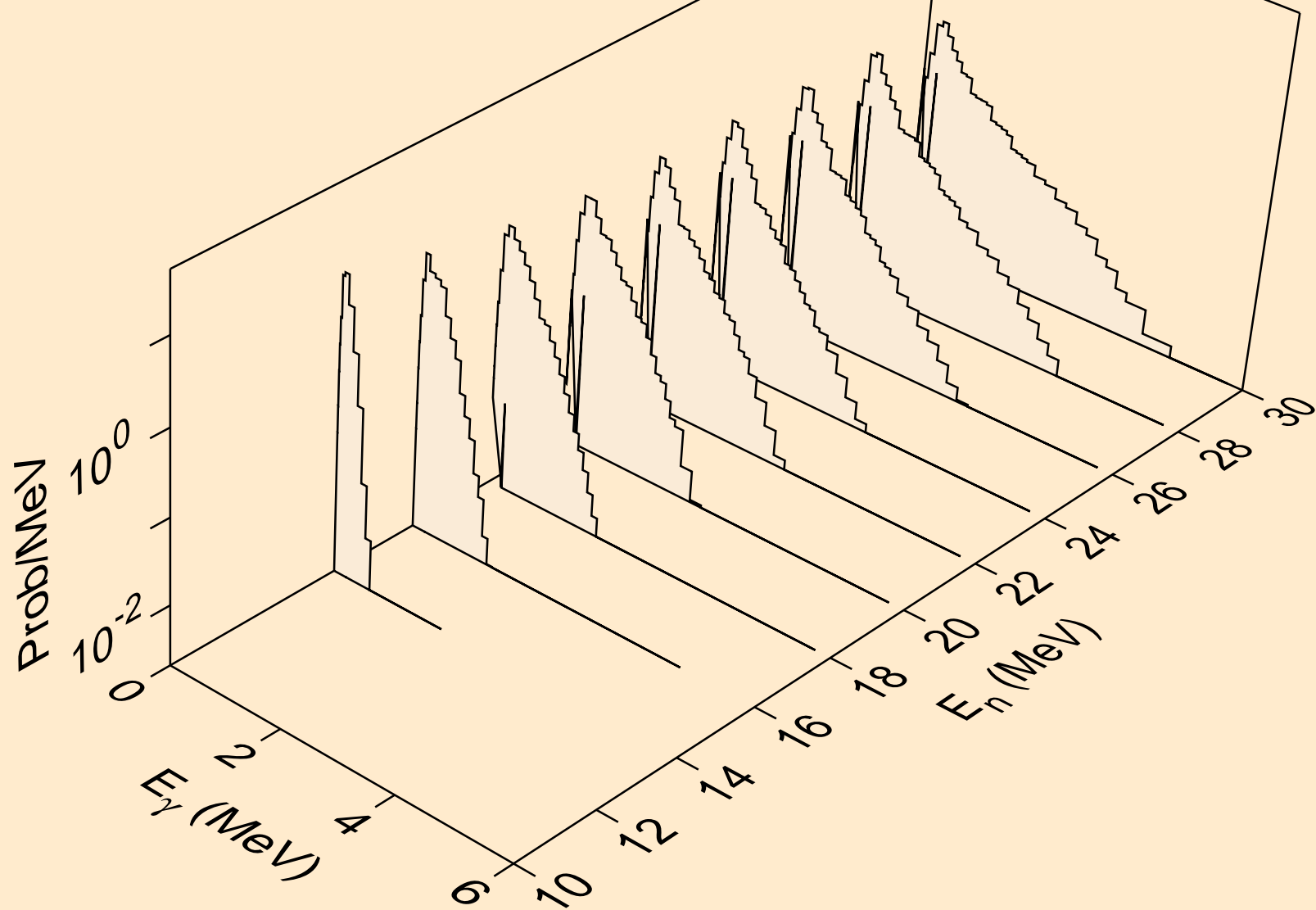

LA119 PROTON ACER TENDL-2021 LIBRARY; T=0.K  
Photon emission for (n,pt)

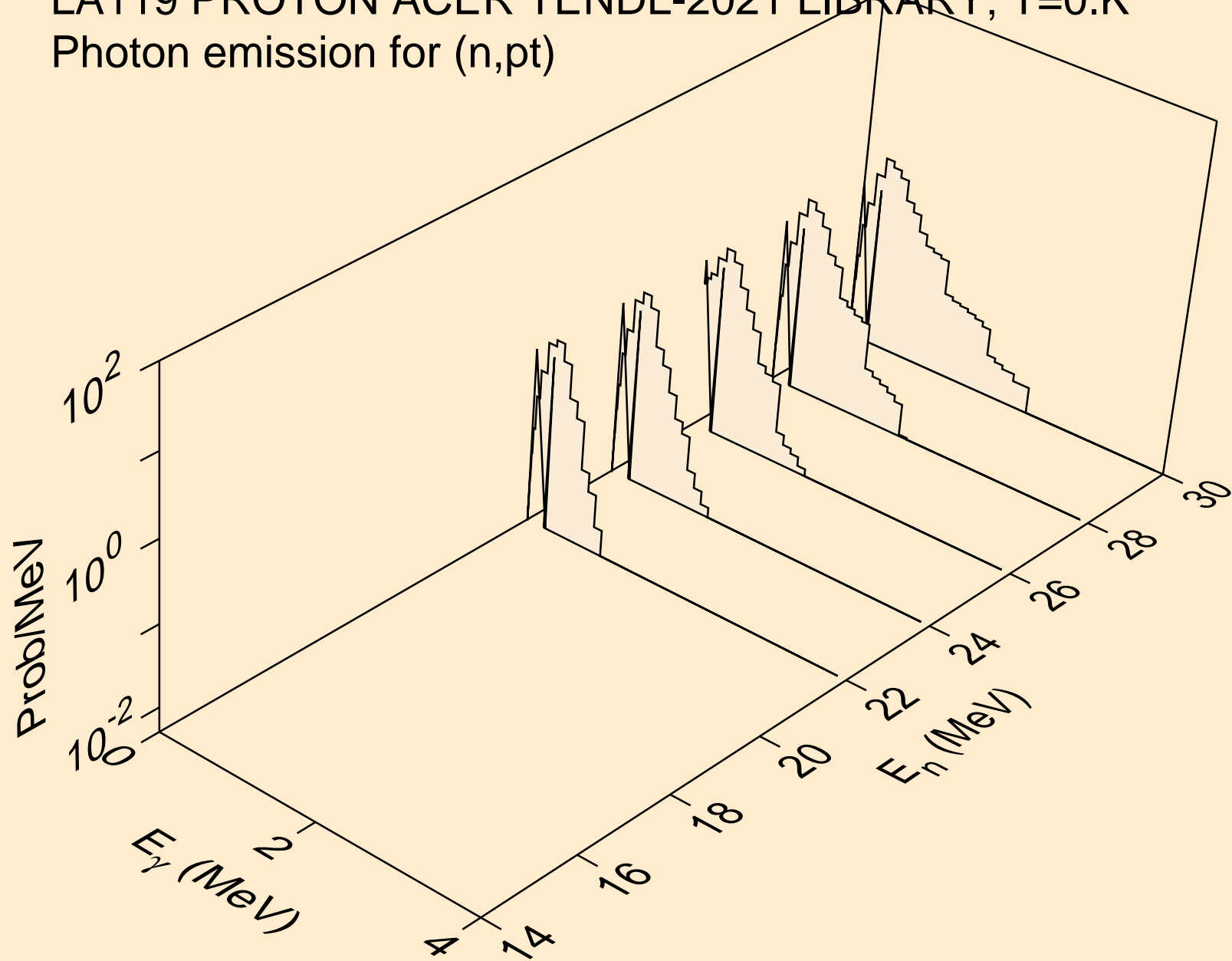

LA119 PROTON ACER TENDL-2021 LIBRARY; T=0.K  
Photon emission for (n,da)

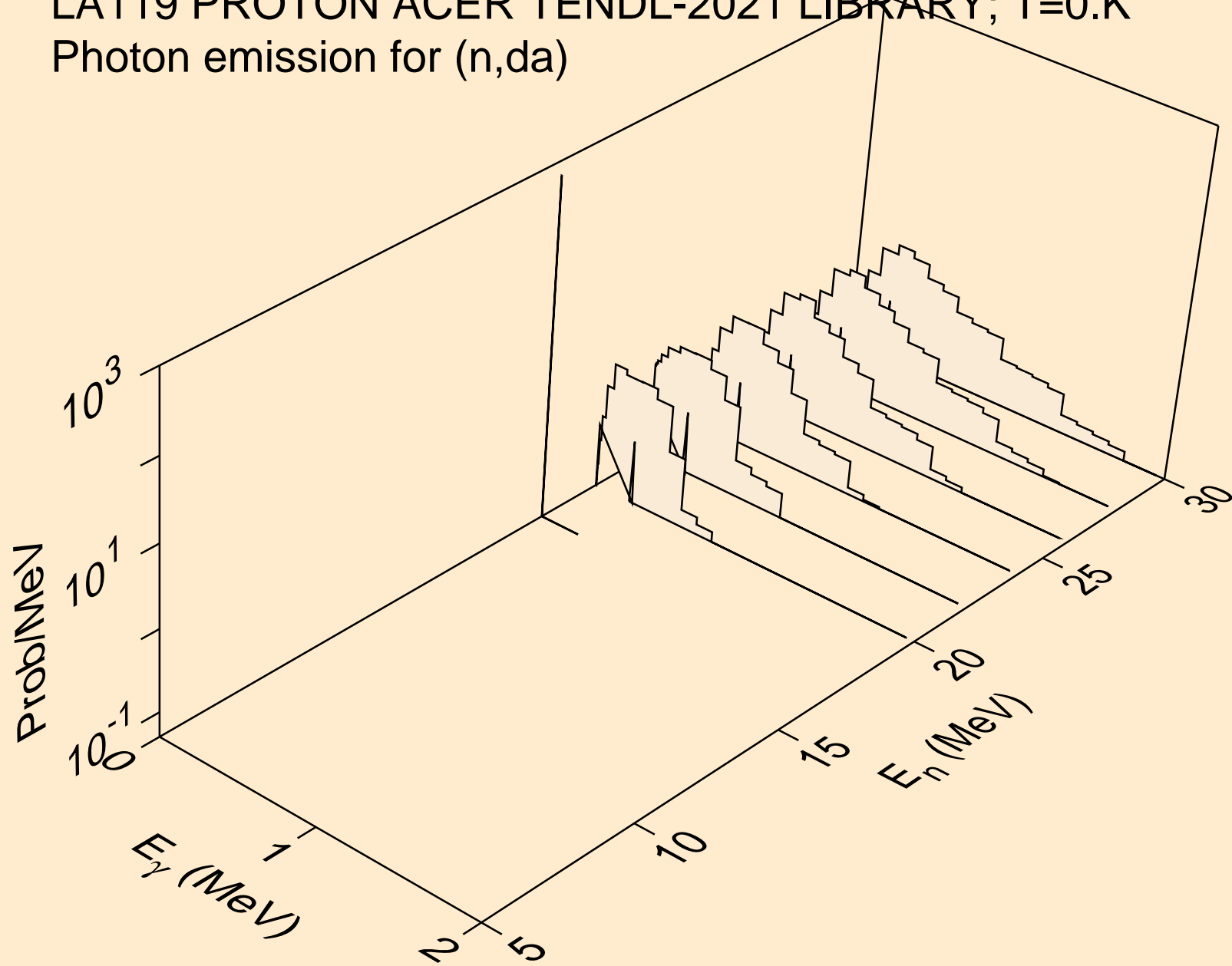

LA119 PROTON ACER TENDL-2021 LIBRARY; T=0.K  
Particle heating contributions

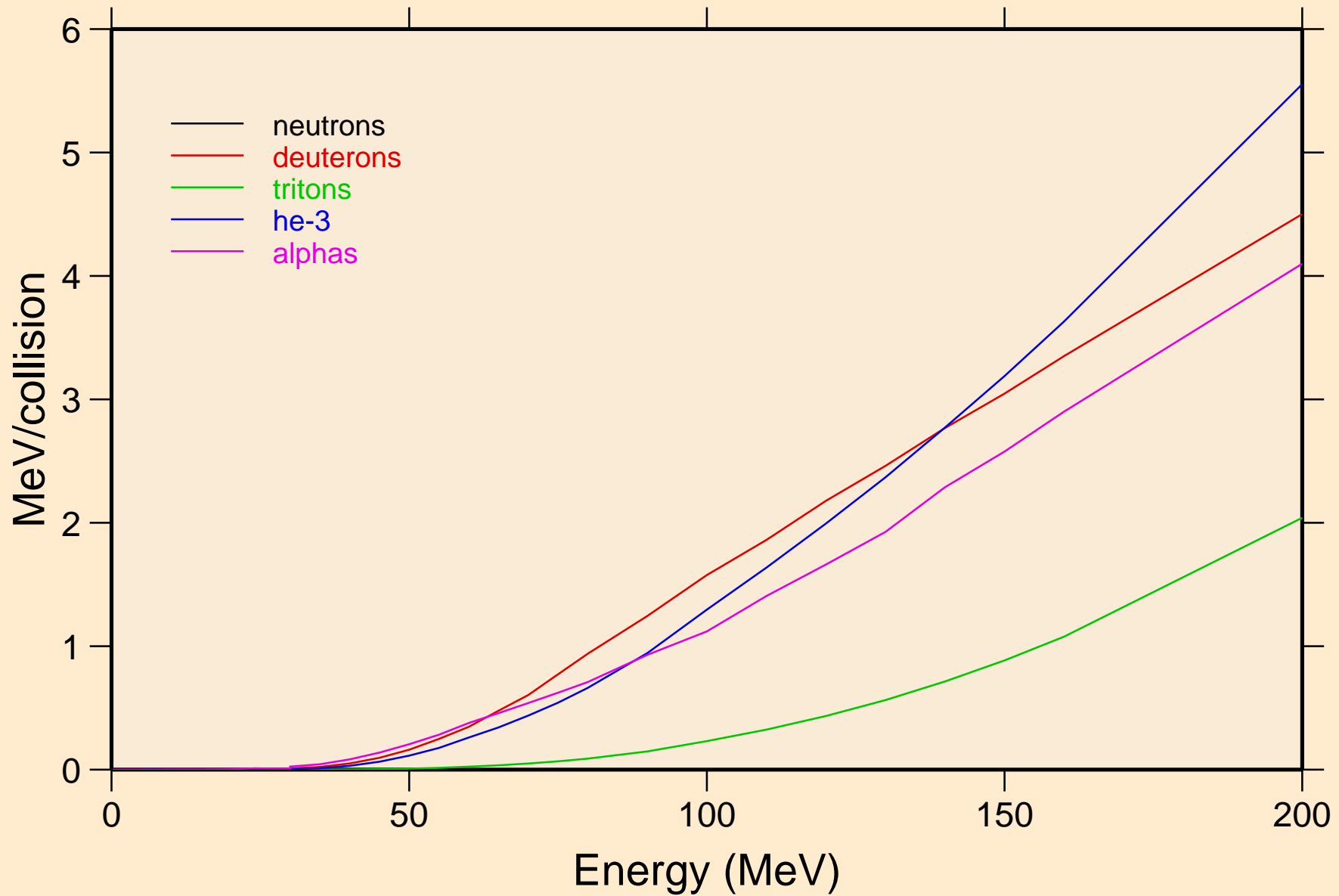

LA119 PROTON ACER TENDL-2021 LIBRARY; T=0.K  
Recoil Heating

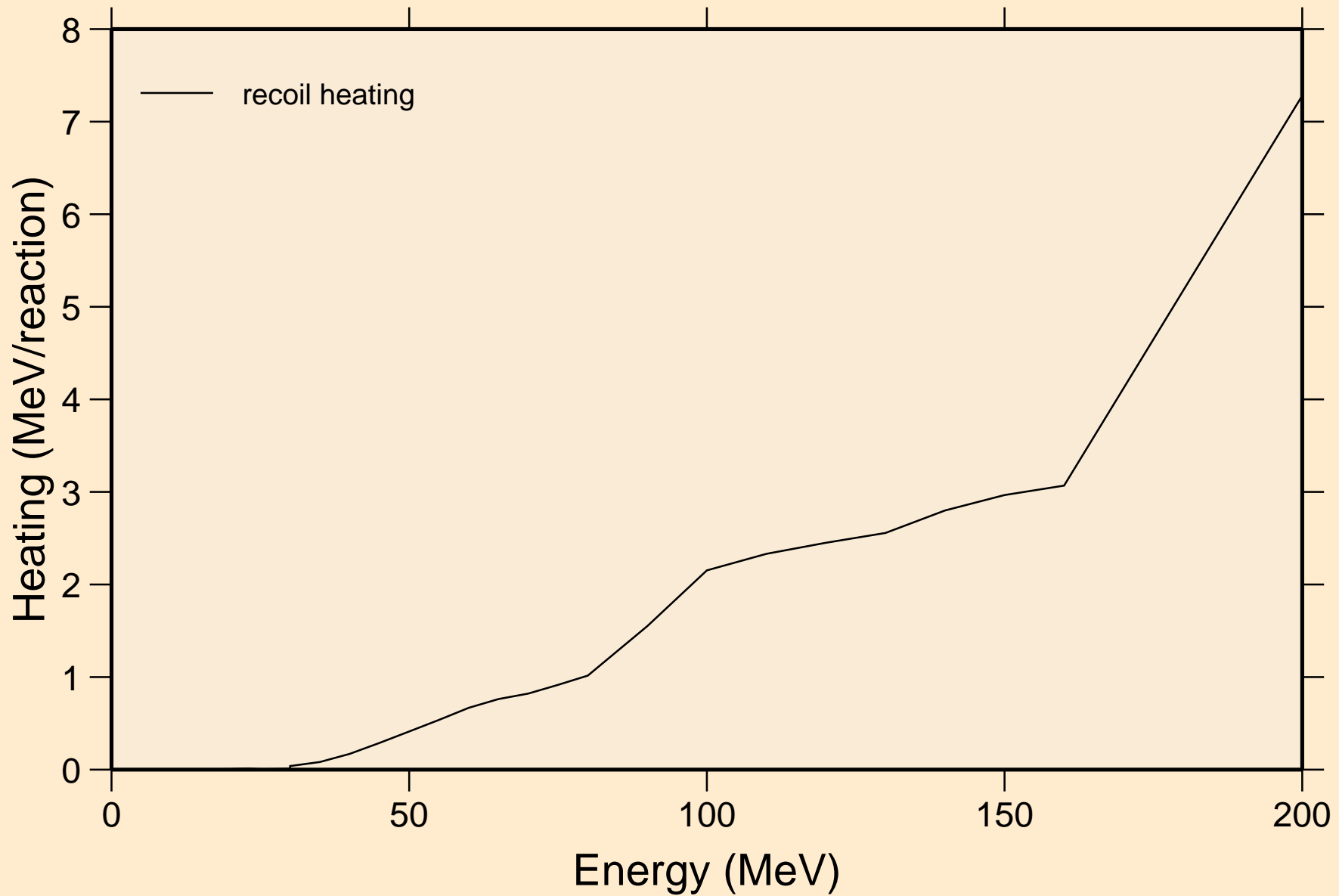

LA119 PROTON ACER TENDL-2021 LIBRARY; T=0.K  
Particle production cross sections

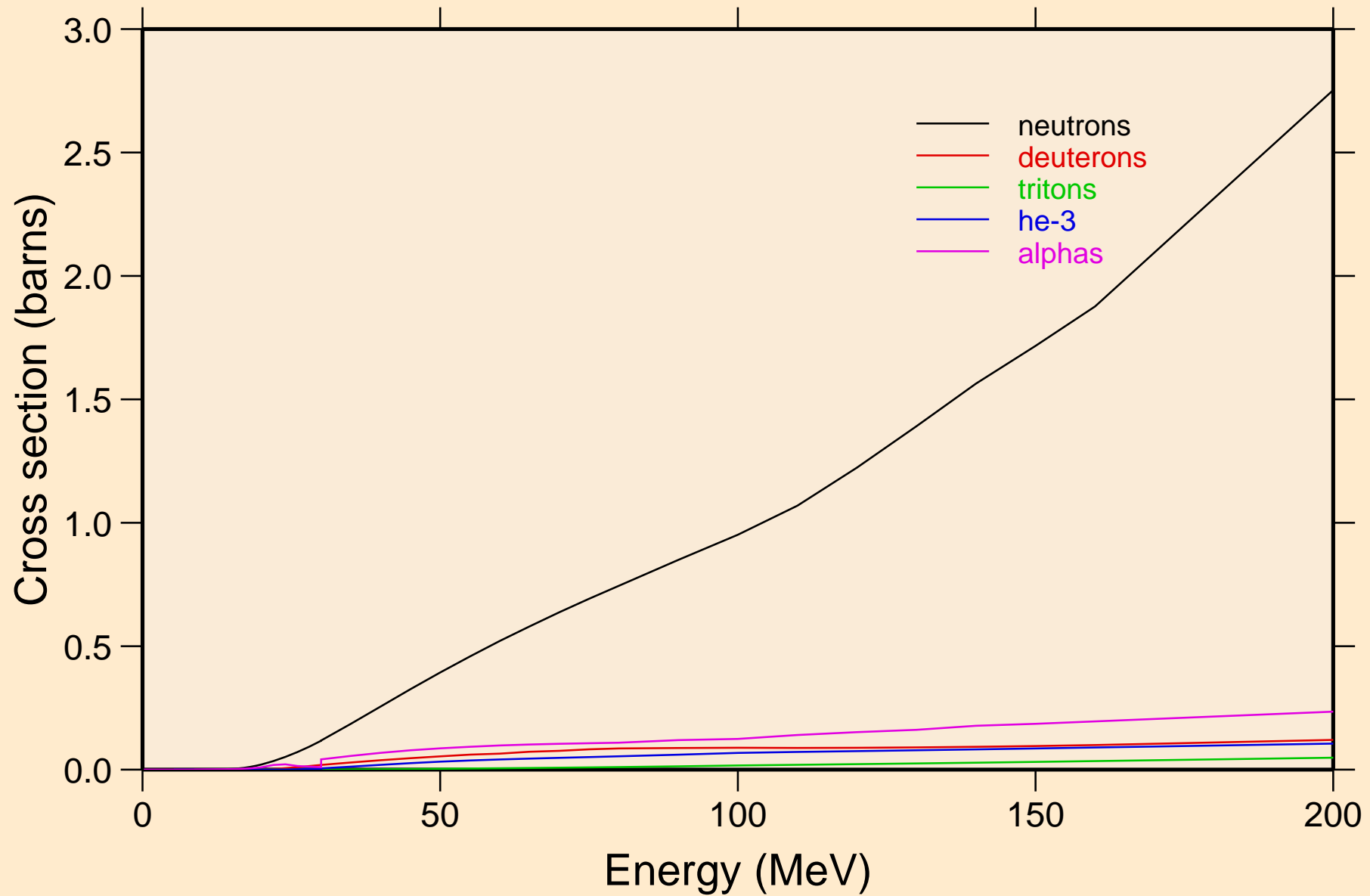

LA119 PROTON ACER TENDL-2021 LIBRARY; T=0.K  
neutrons from (p,n)

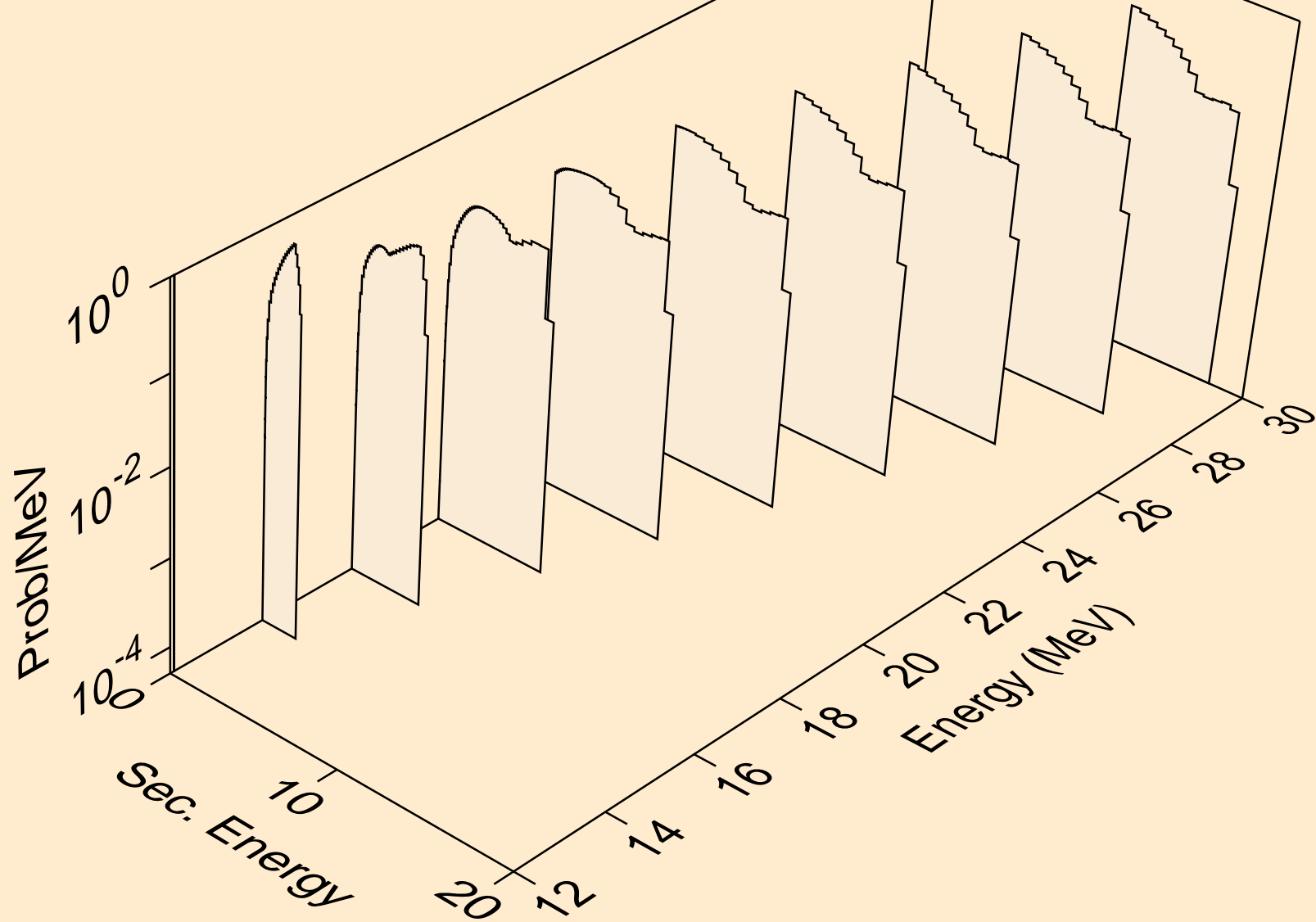

LA119 PROTON ACER TENDL-2021 LIBRARY; T=0.K  
neutrons from (p,x)

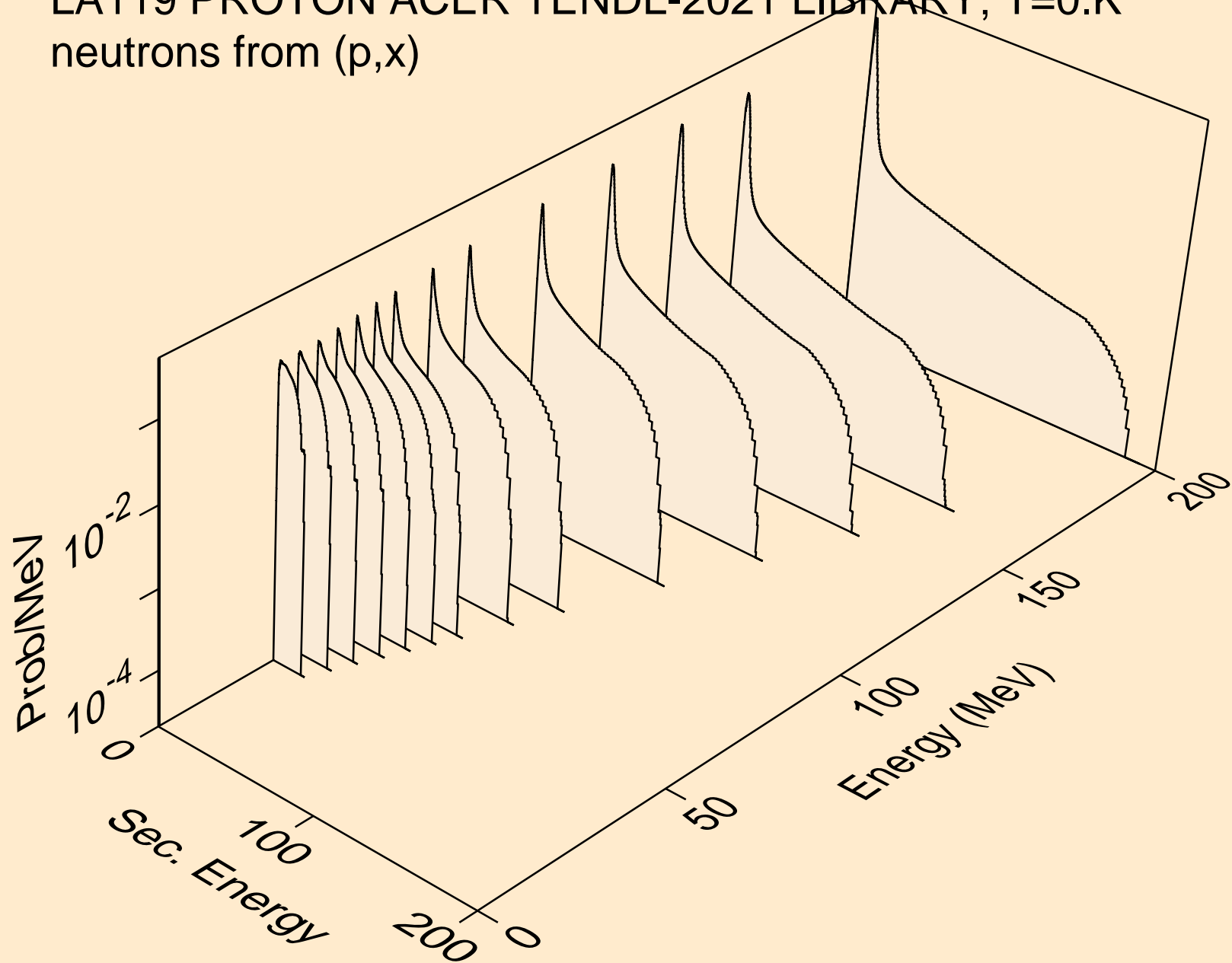



LA119 PROTON ACER TENDL-2021 LIBRARY; T=0.K  
neutrons from (p,2n)

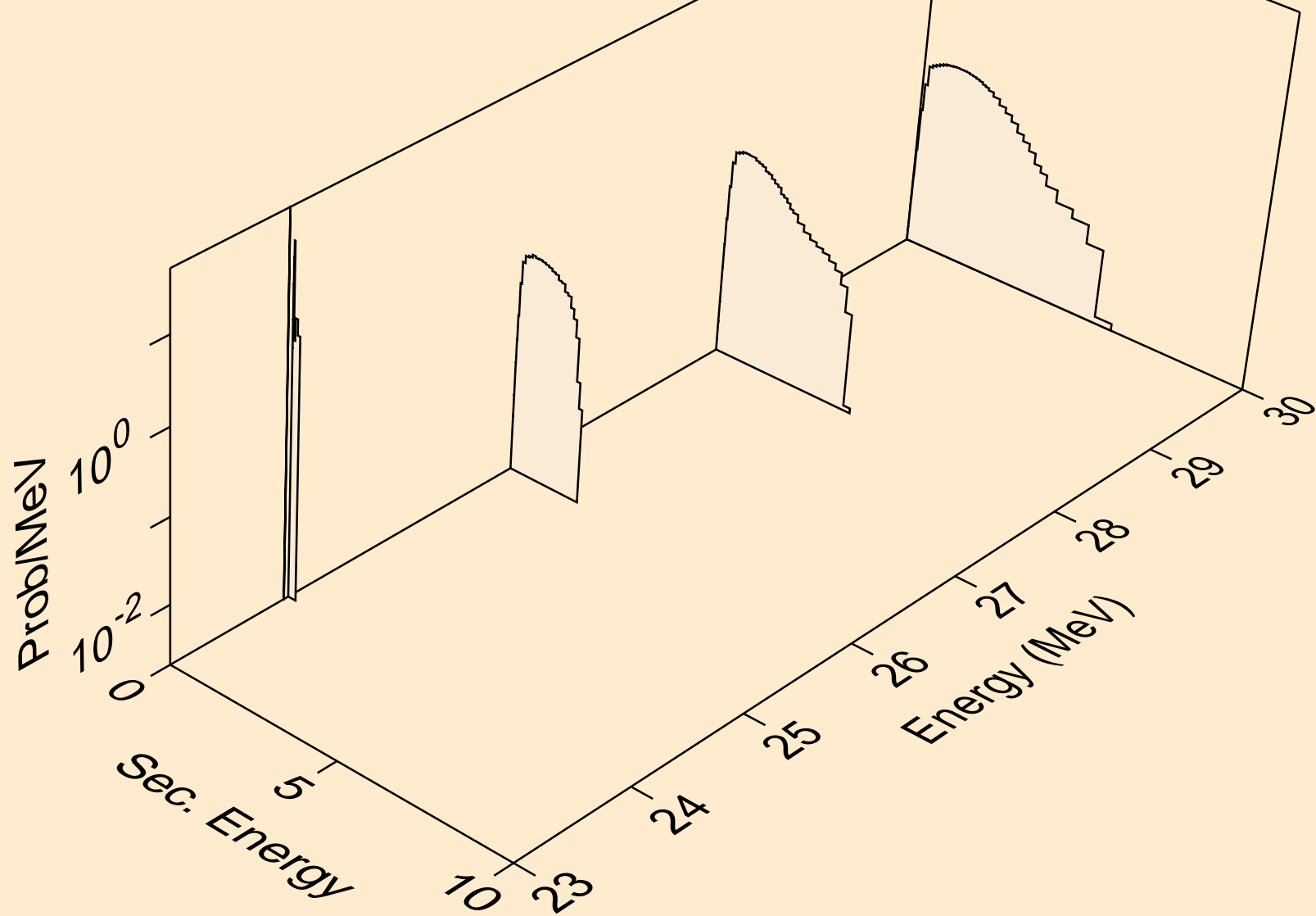

LA119 PROTON ACER TENDL-2021 LIBRARY; T=0.K  
neutrons from (p,n\*)a

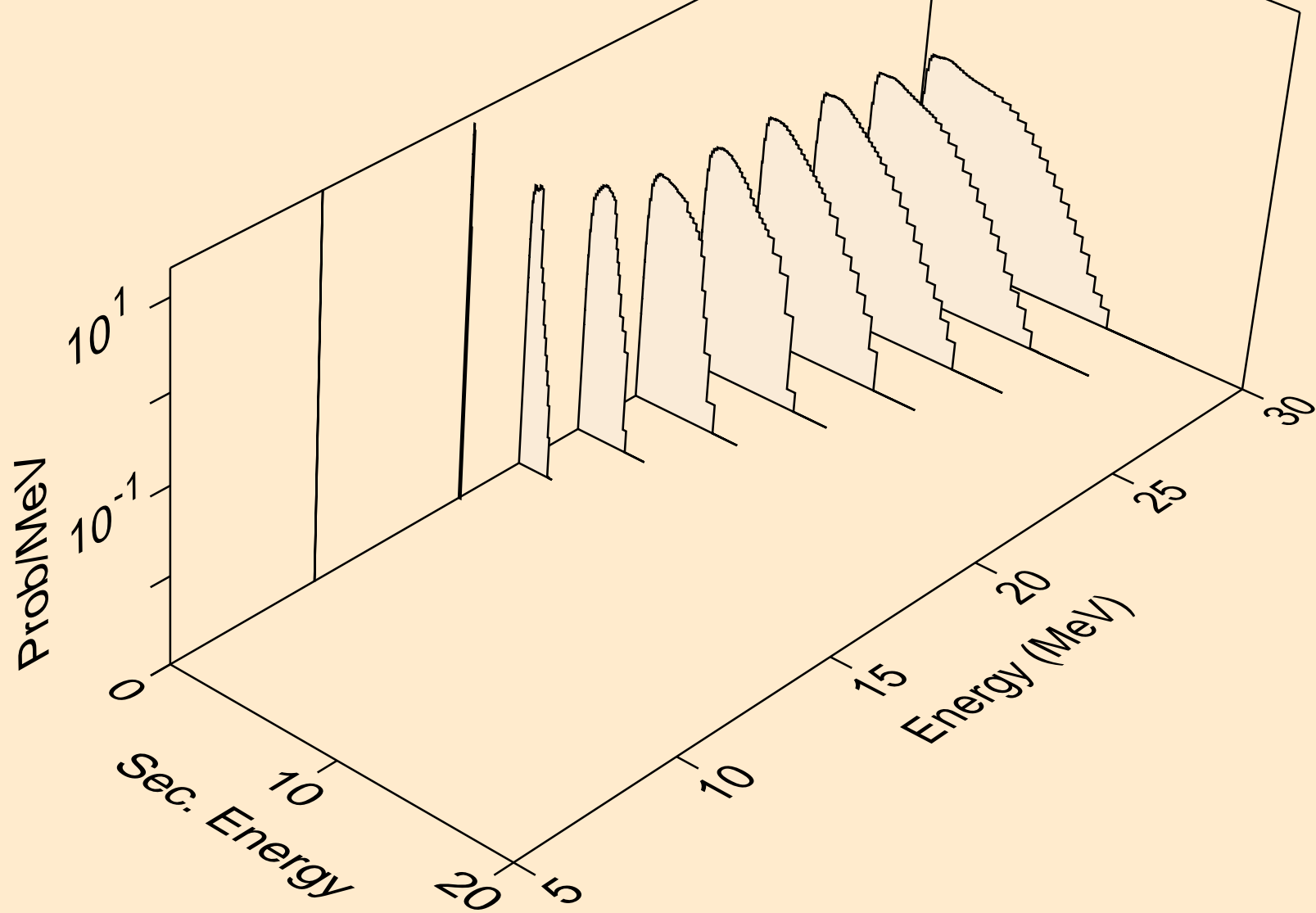

LA119 PROTON ACER TENDL-2021 LIBRARY; T=0.K  
neutrons from (p,n\*)p

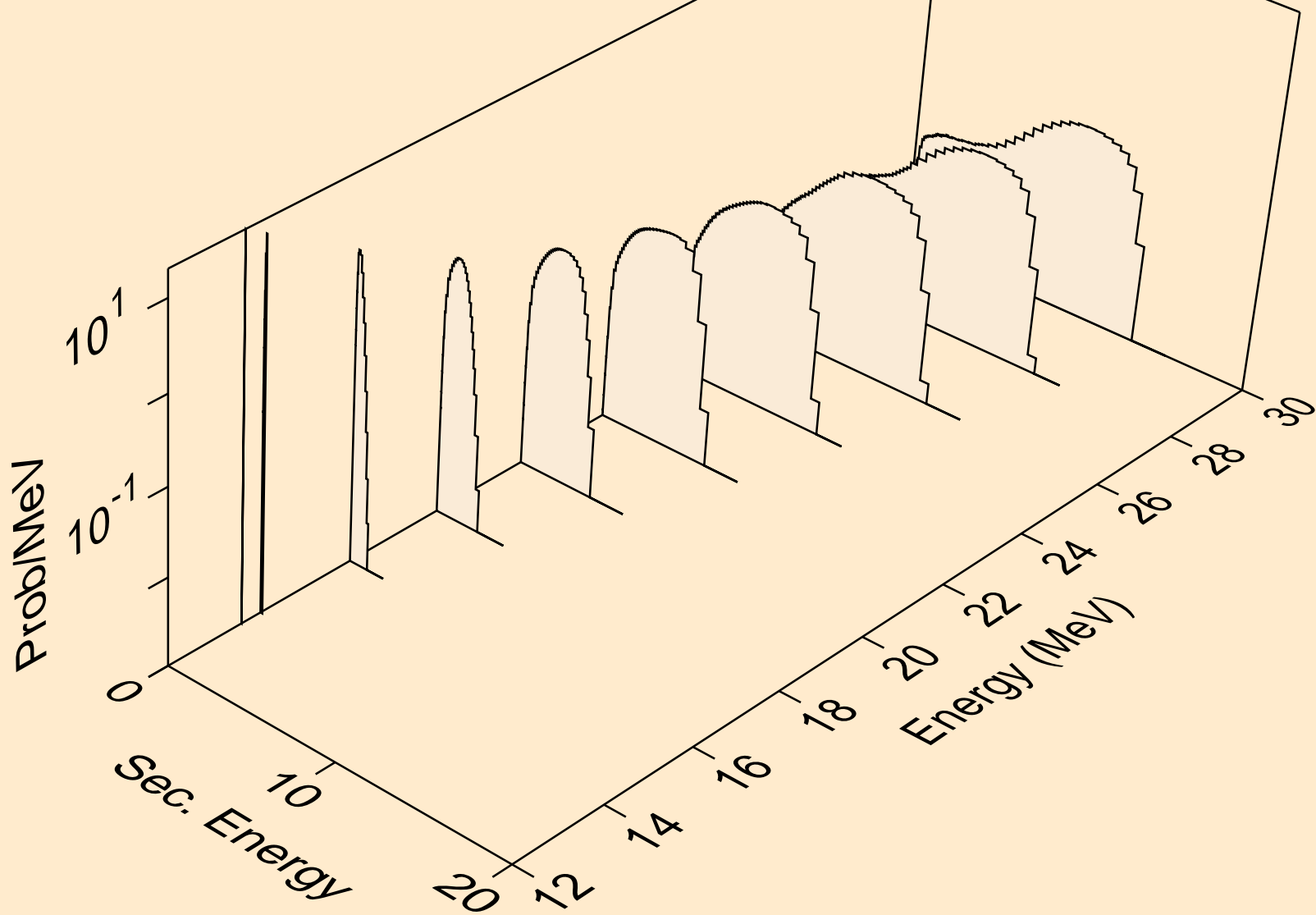

LA119 PROTON ACER TENDL-2021 LIBRARY; T=0.K  
neutrons from (p,n\*)2a

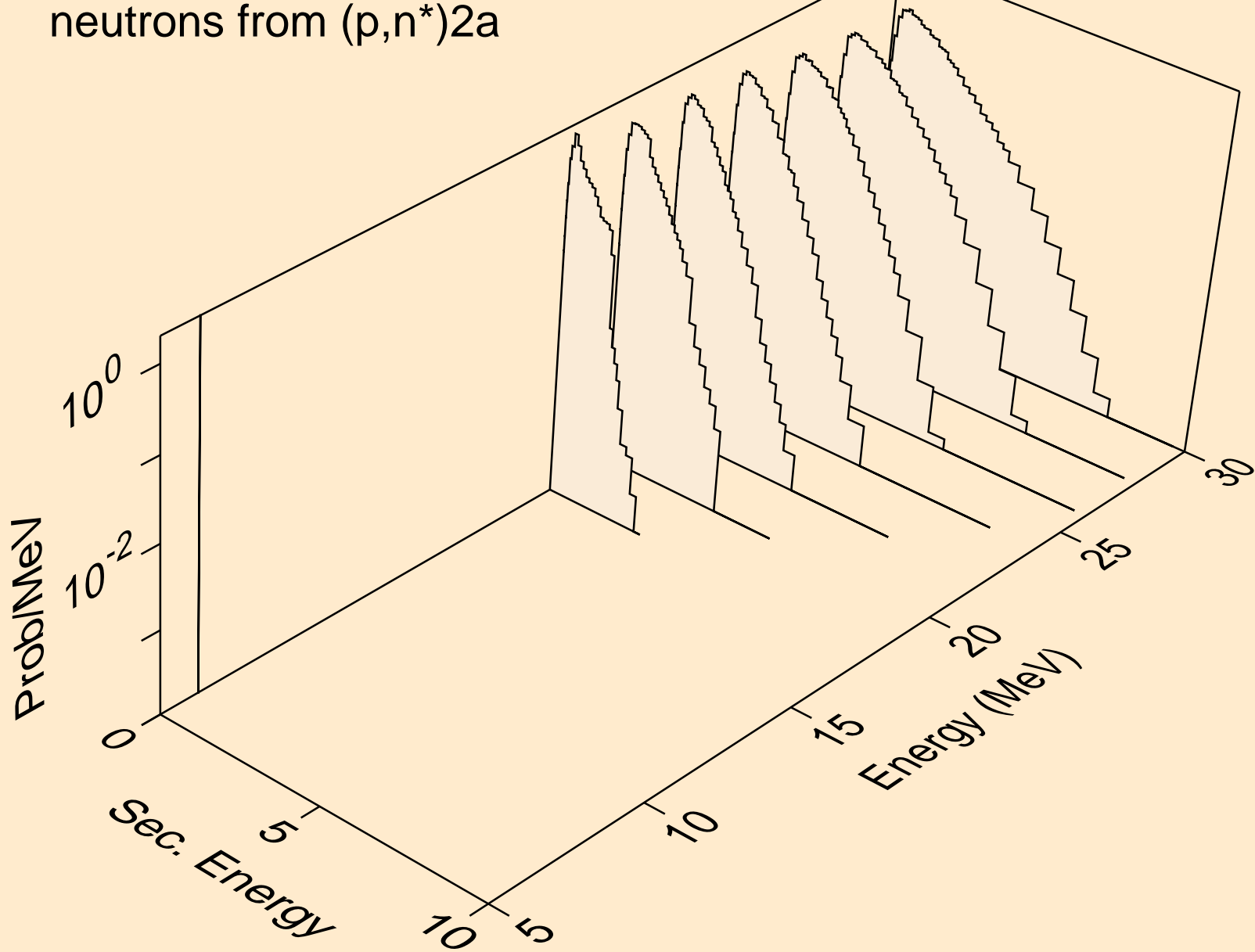

LA119 PROTON ACER TENDL-2021 LIBRARY; T=0.K  
neutrons from (p,n\*)d

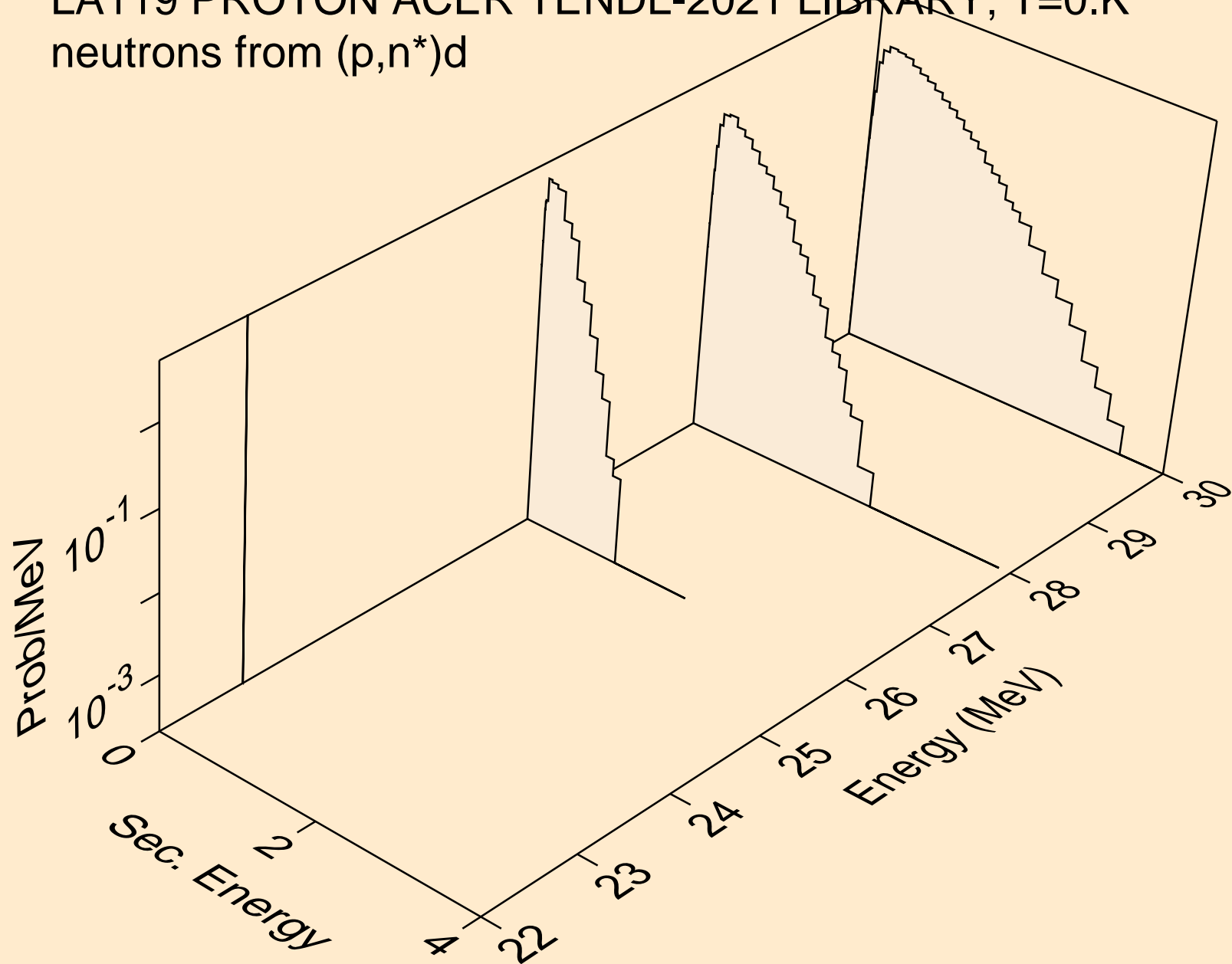

LA119 PROTON ACER TENDL-2021 LIBRARY; T=0.K  
neutrons from (p,n\*)he3

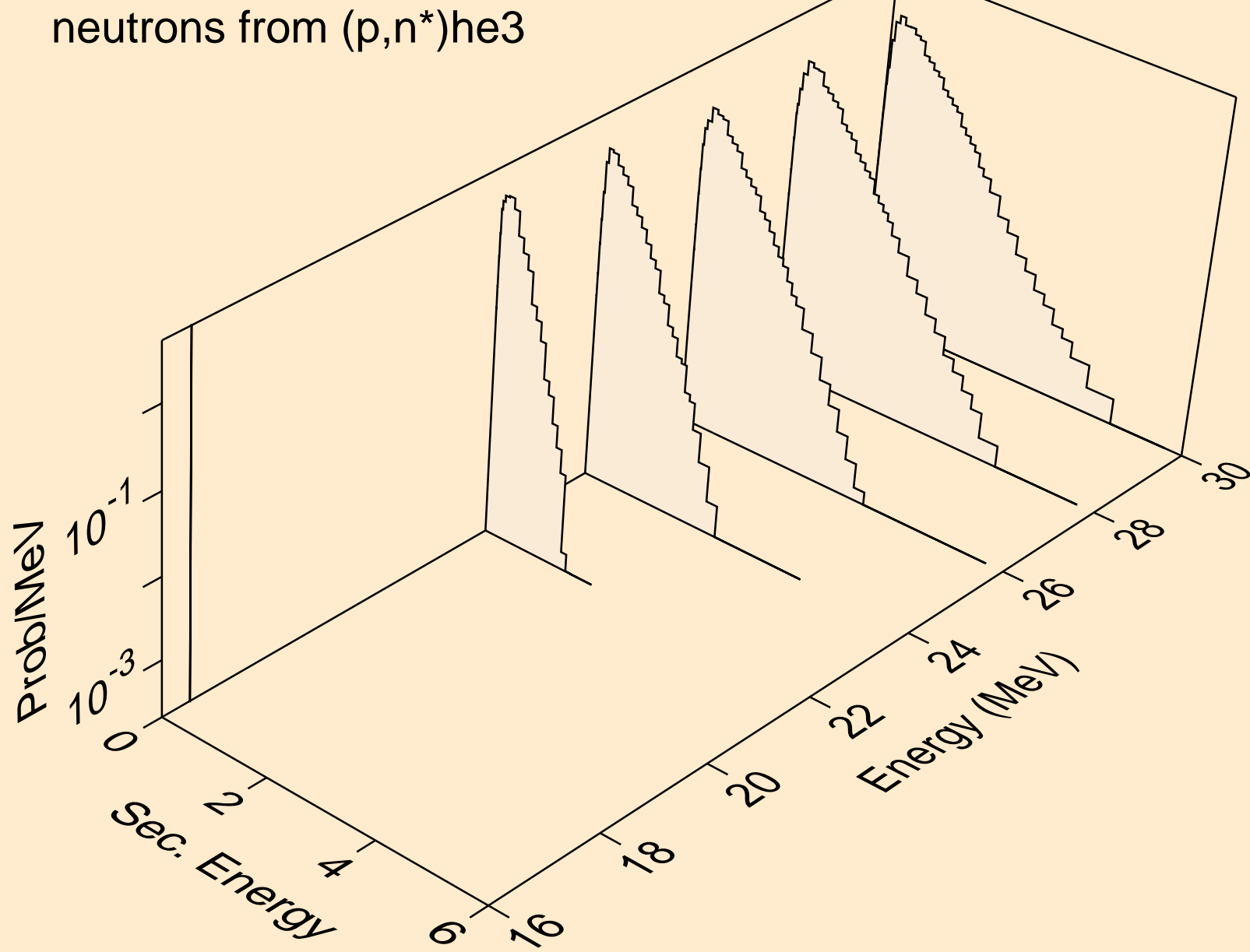

LA119 PROTON ACER TENDL-2021 LIBRARY; T=0.K  
neutrons from (p,2np)

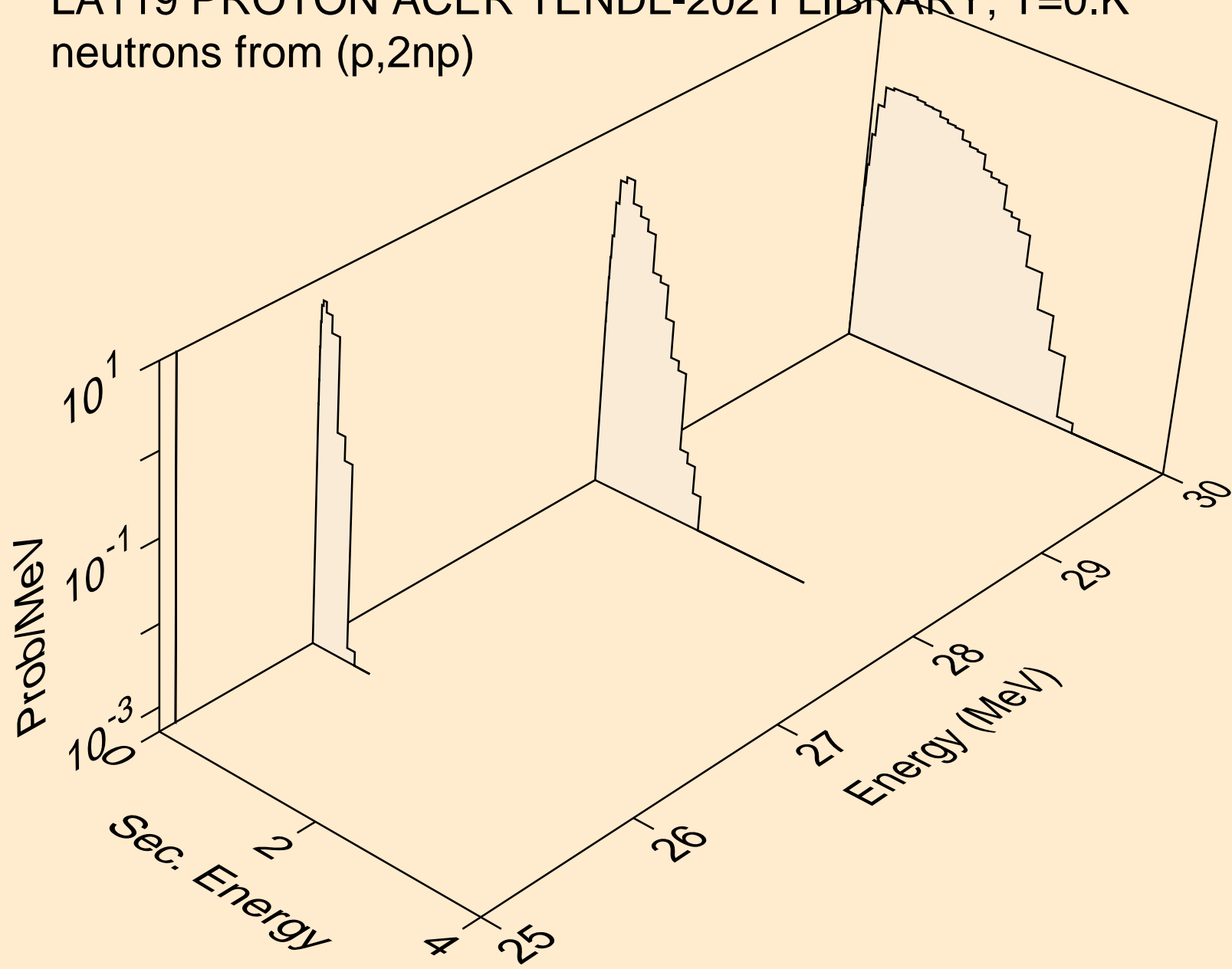

LA119 PROTON ACER TENDL-2021 LIBRARY; T=0.K  
neutrons from (p,2np)

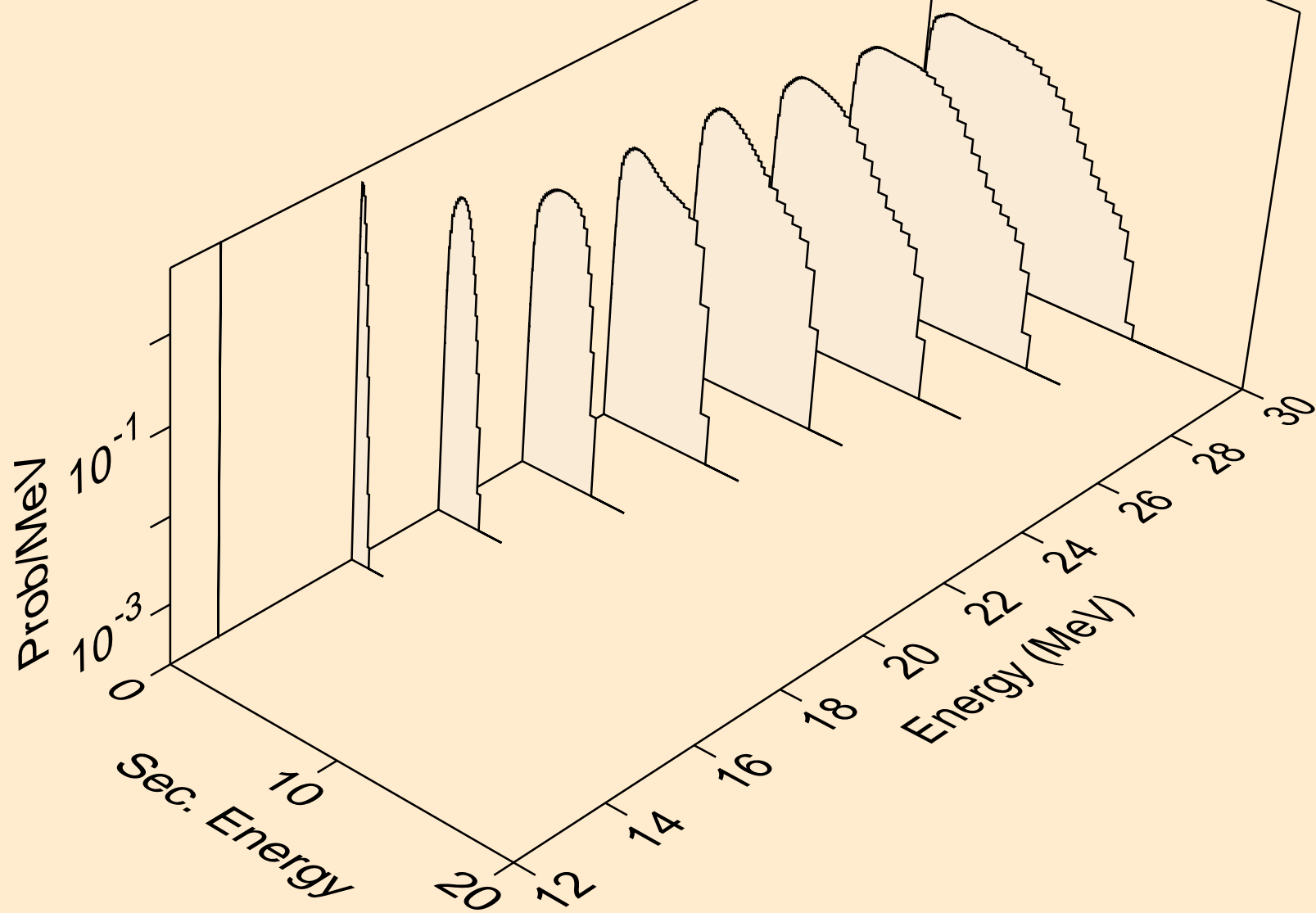



LA119 PROTON ACER TENDL-2021 LIBRARY; T=0.K  
neutrons from (p,npa)

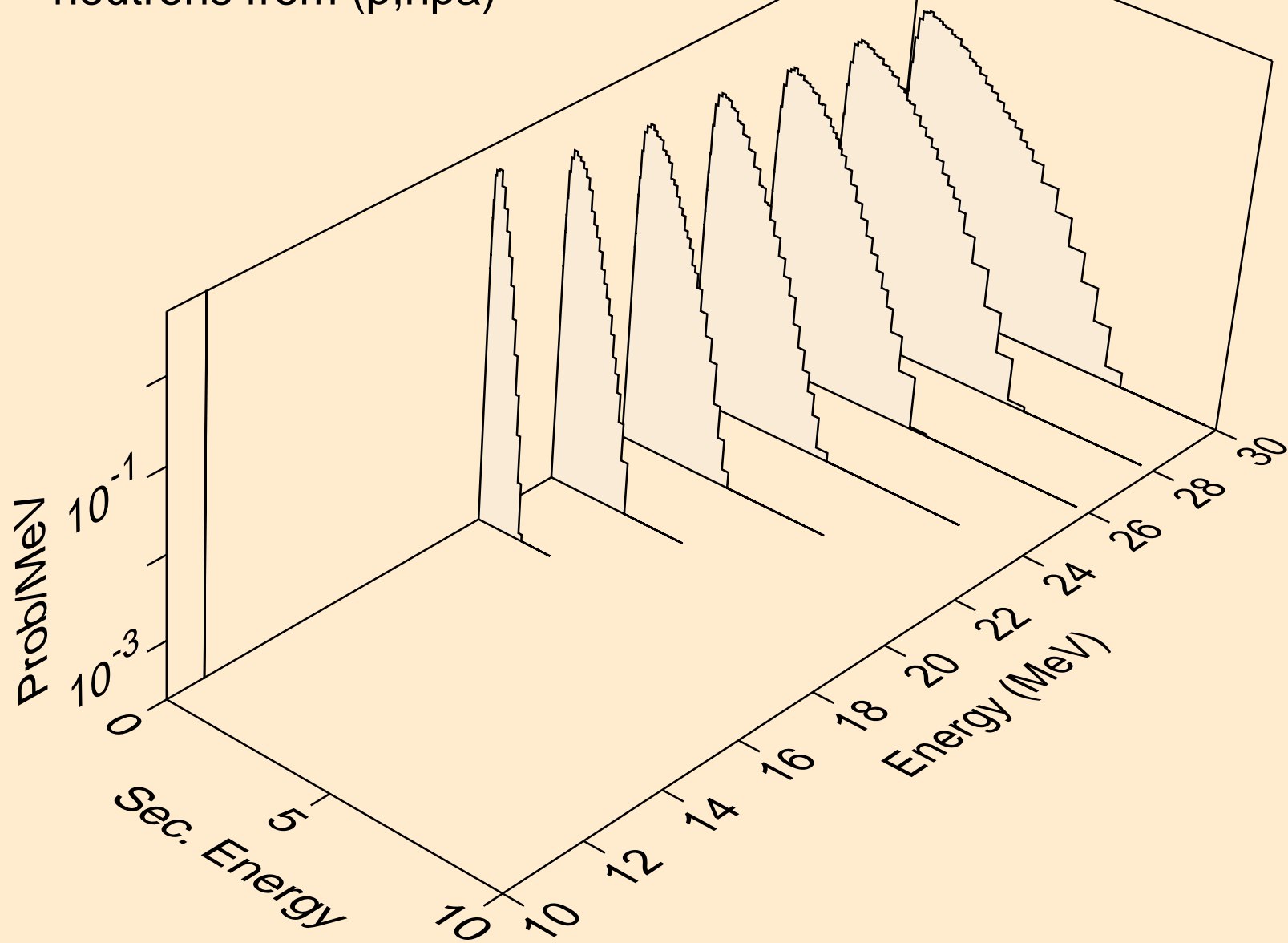

LA119 PROTON ACER TENDL-2021 LIBRARY; T=0.K  
deuterons from (p,x)

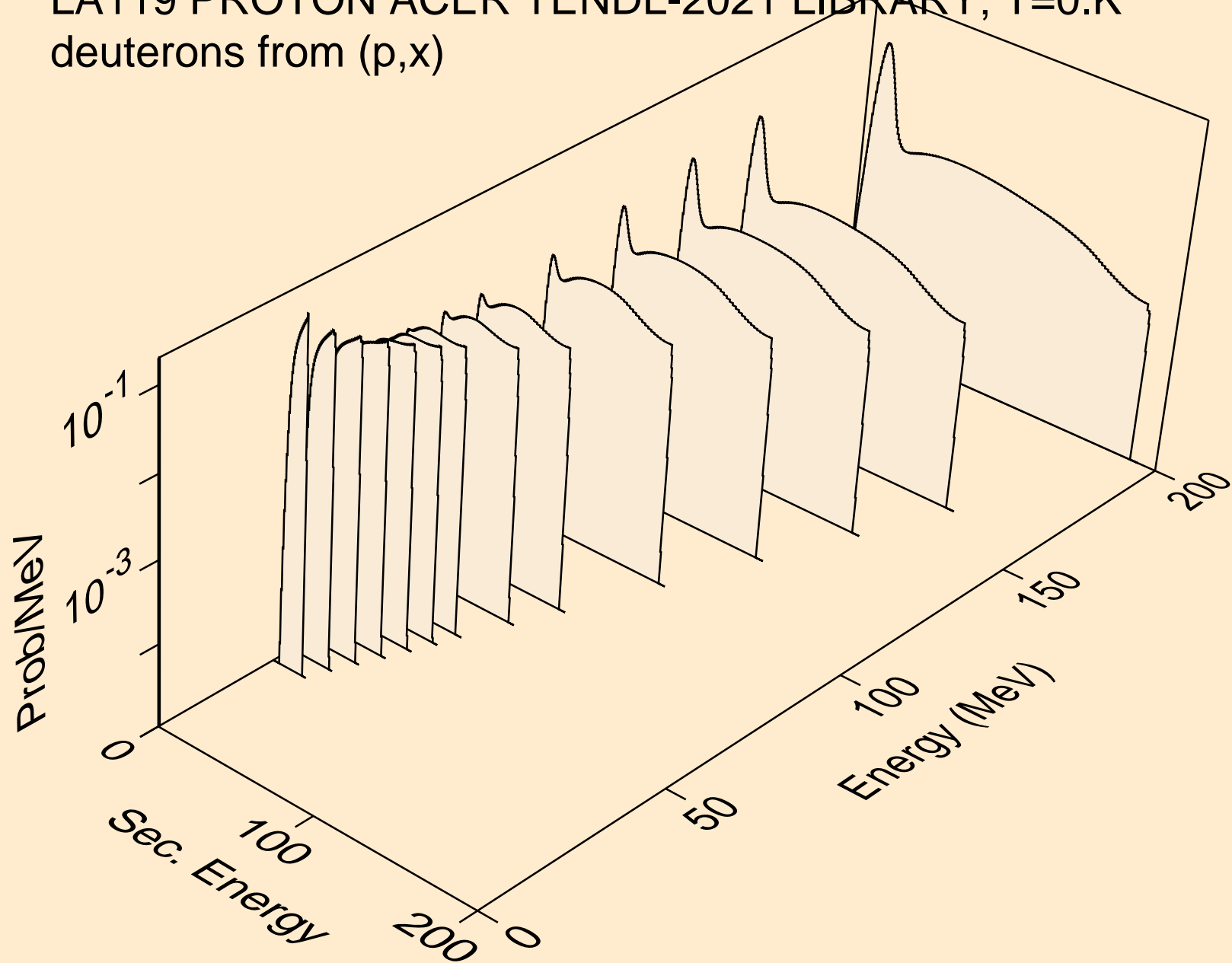

LA119 PROTON ACER TENDL-2021 LIBRARY; T=0.K  
deuterons from (p,n\*)d

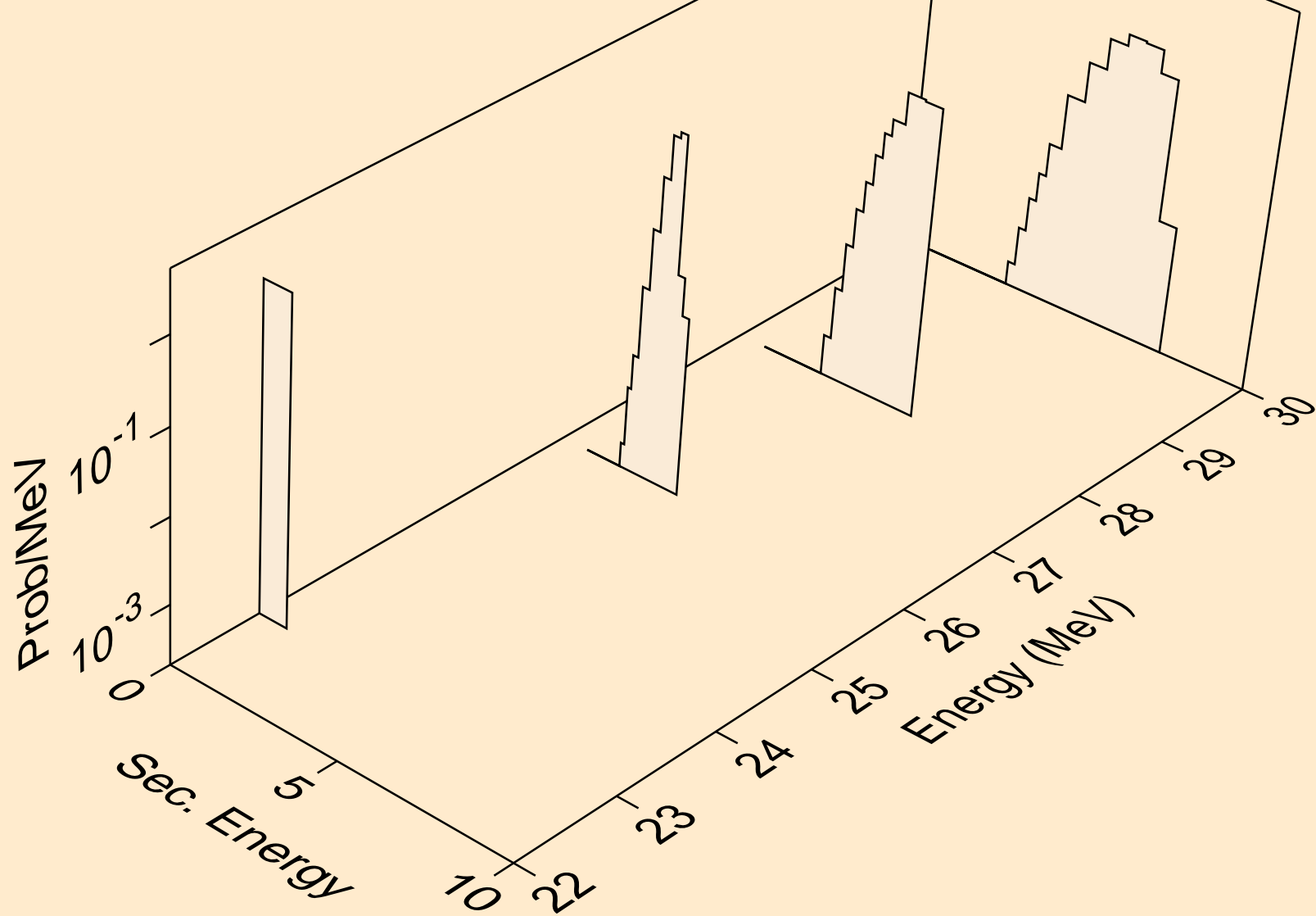

LA119 PROTON ACER TENDL-2021 LIBRARY; T=0.K  
deuterons from (p,d)

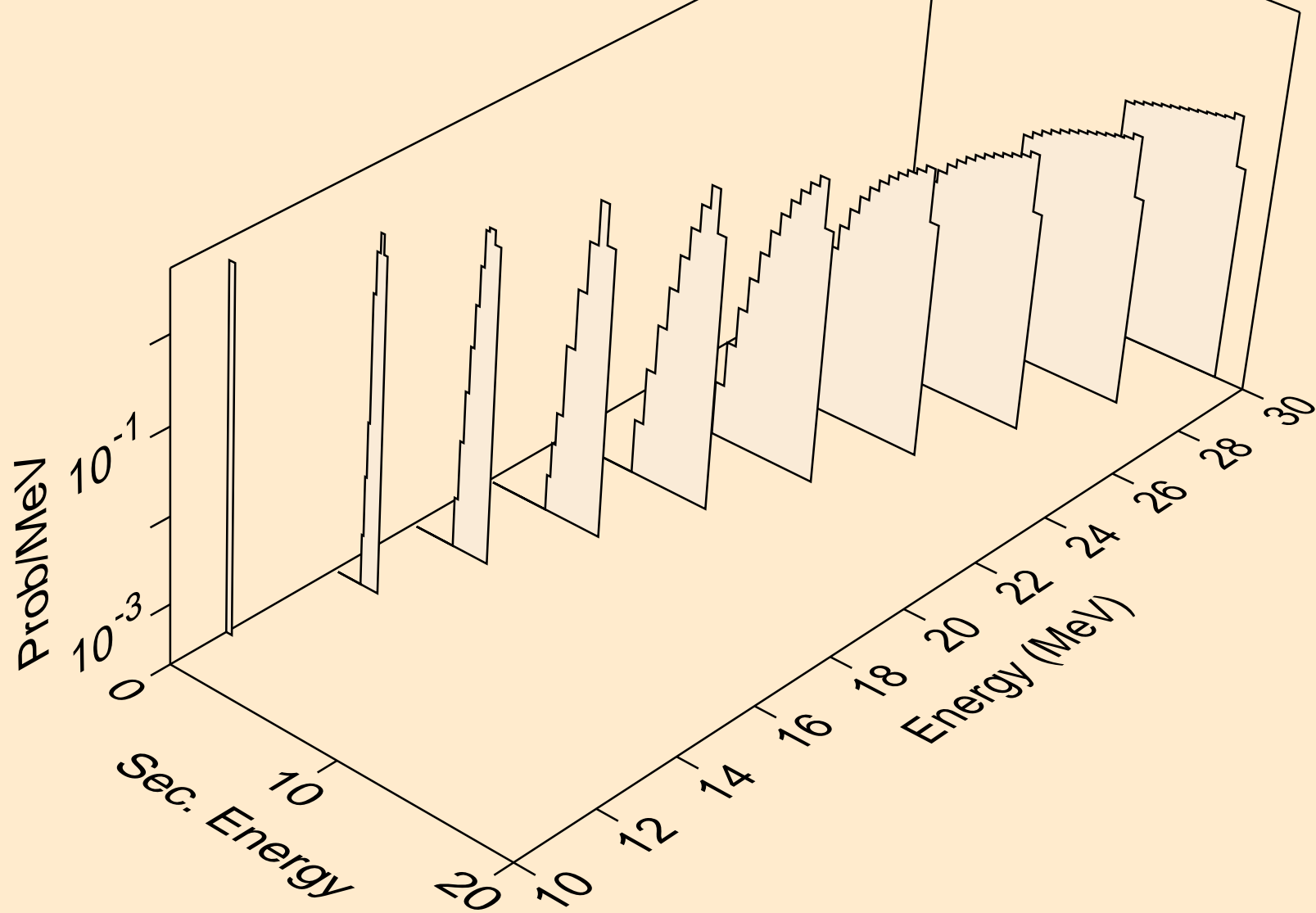

LA119 PROTON ACER TENDL-2021 LIBRARY; T=0.K  
deuterons from (p,pd)

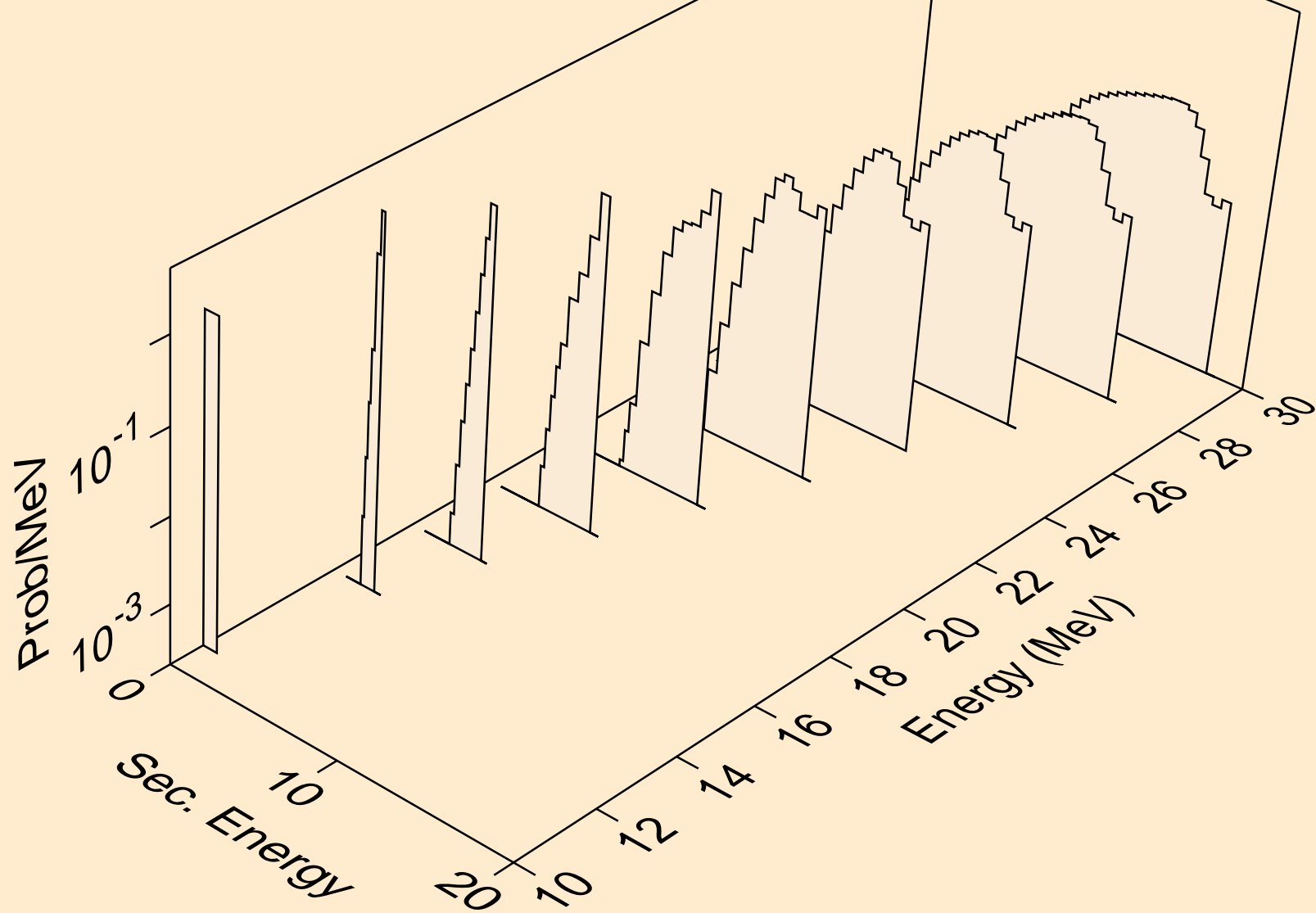

LA119 PROTON ACER TENDL-2021 LIBRARY; T=0.K  
deuterons from (p,da)

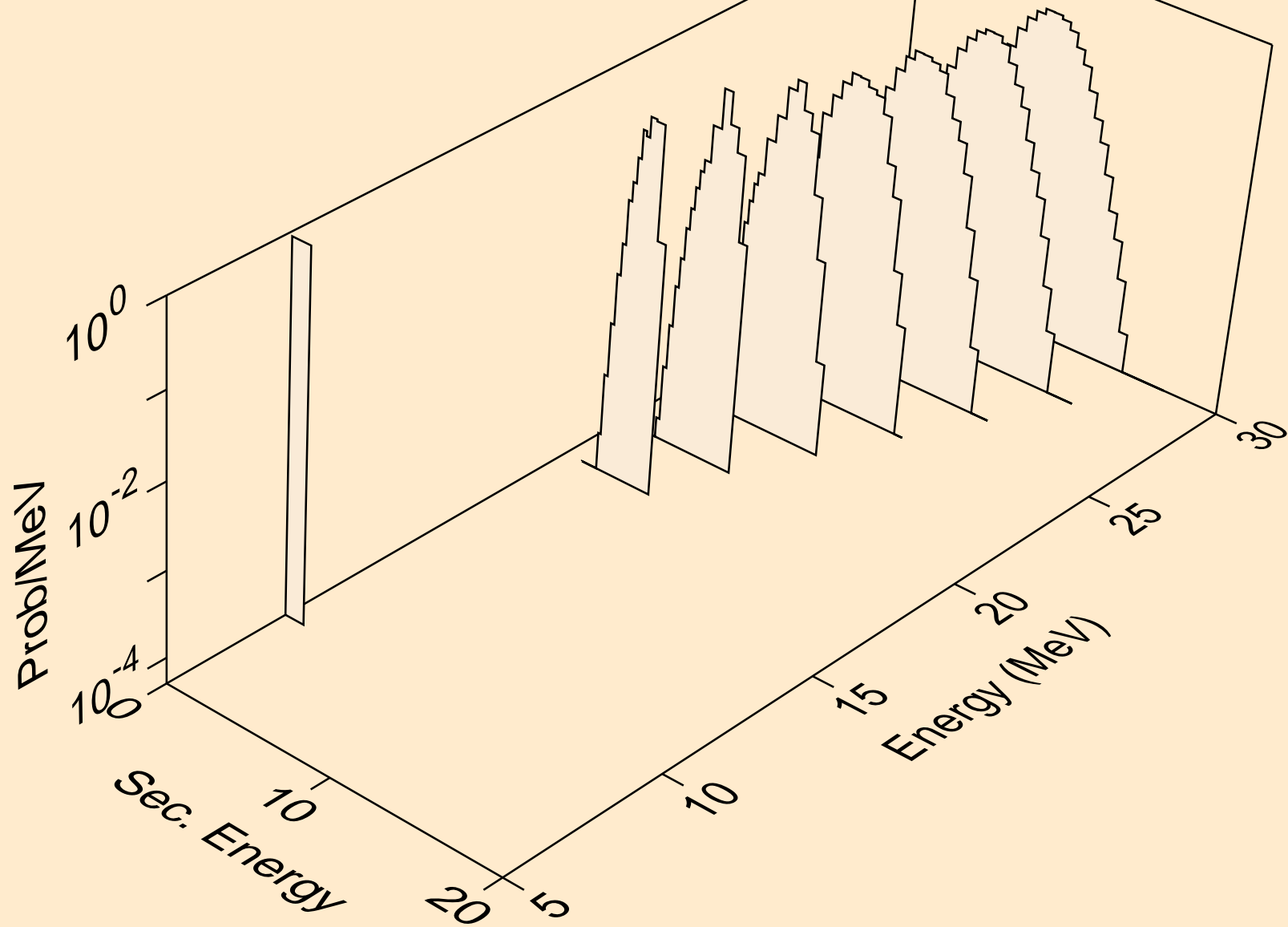

LA119 PROTON ACER TENDL-2021 LIBRARY; T=0.K  
tritons from (p,x)

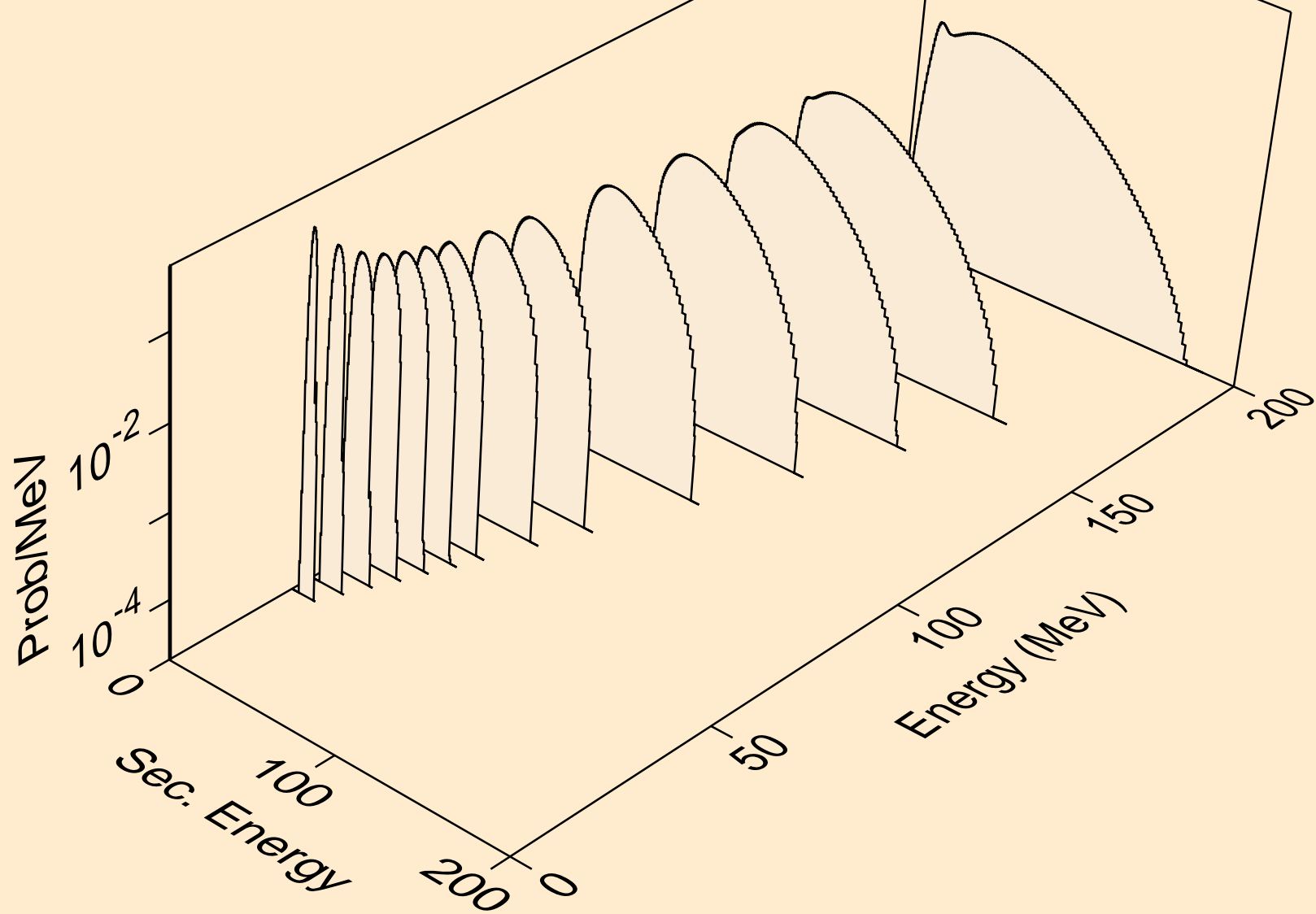

LA119 PROTON ACER TENDL-2021 LIBRARY; T=0.K  
tritons from (p,t)

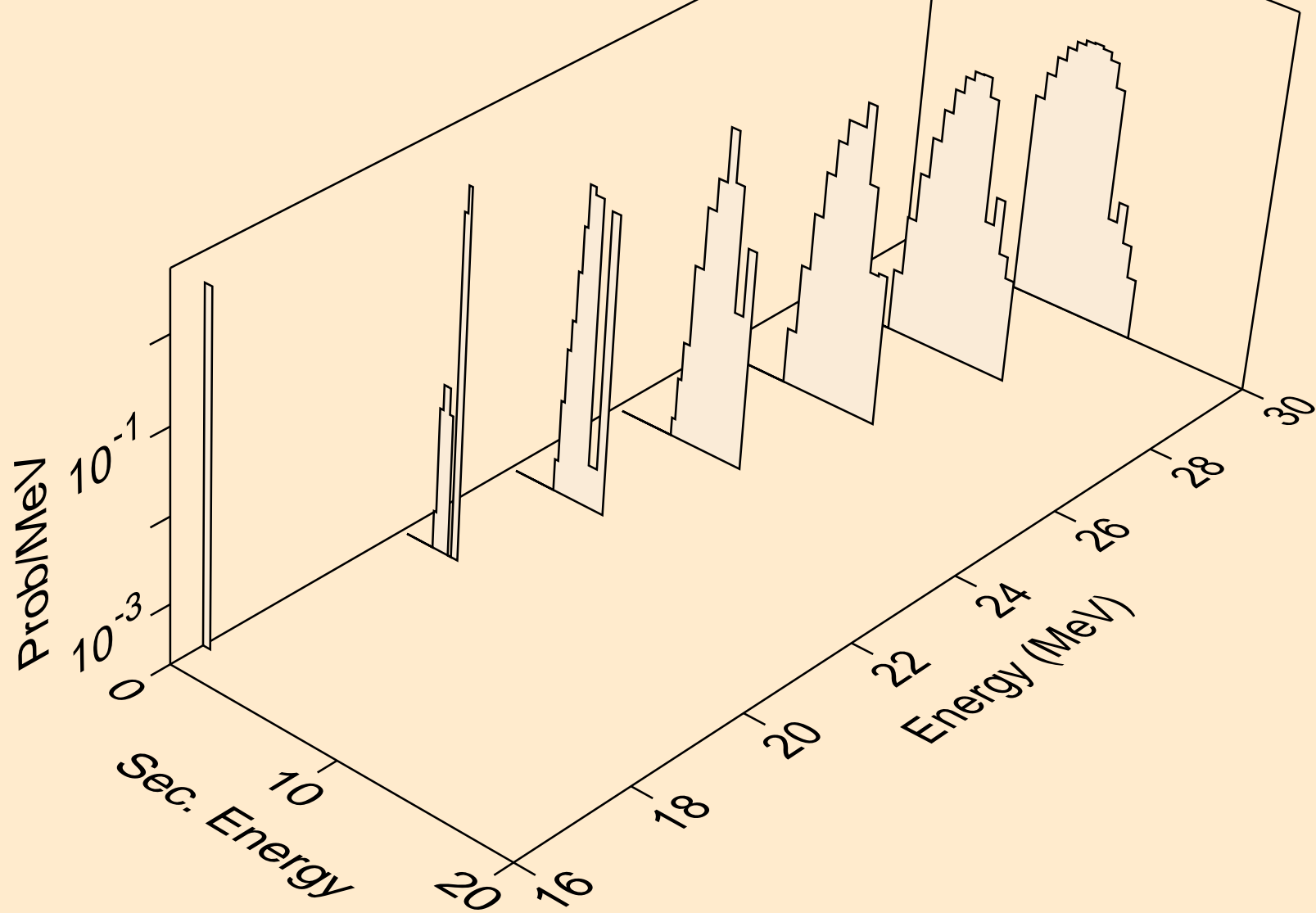



LA119 PROTON ACER TENDL-2021 LIBRARY; T=0.K  
tritons from (p,pt)

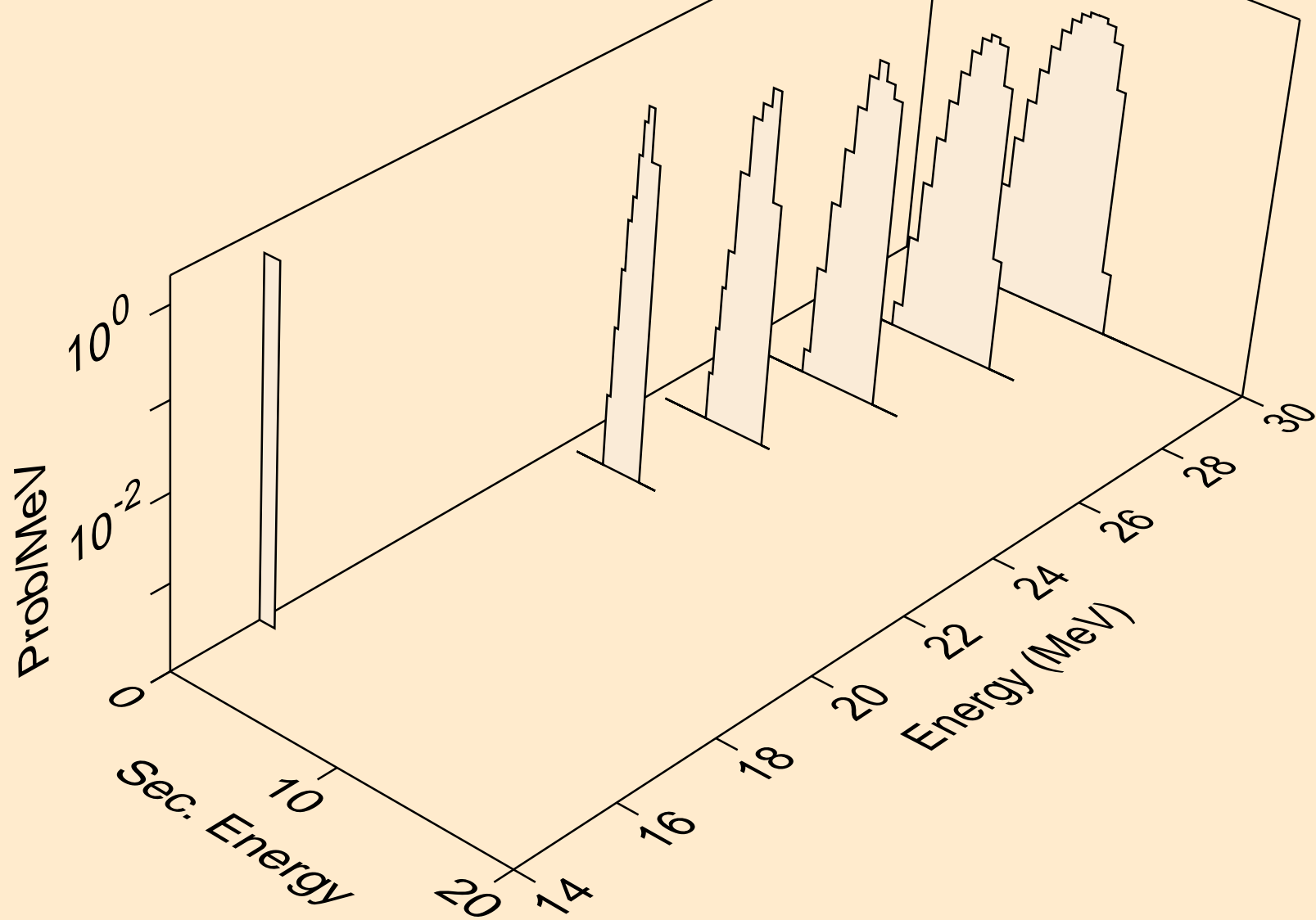

LA119 PROTON ACER TENDL-2021 LIBRARY; T=0.K  
he3s from (p,x)

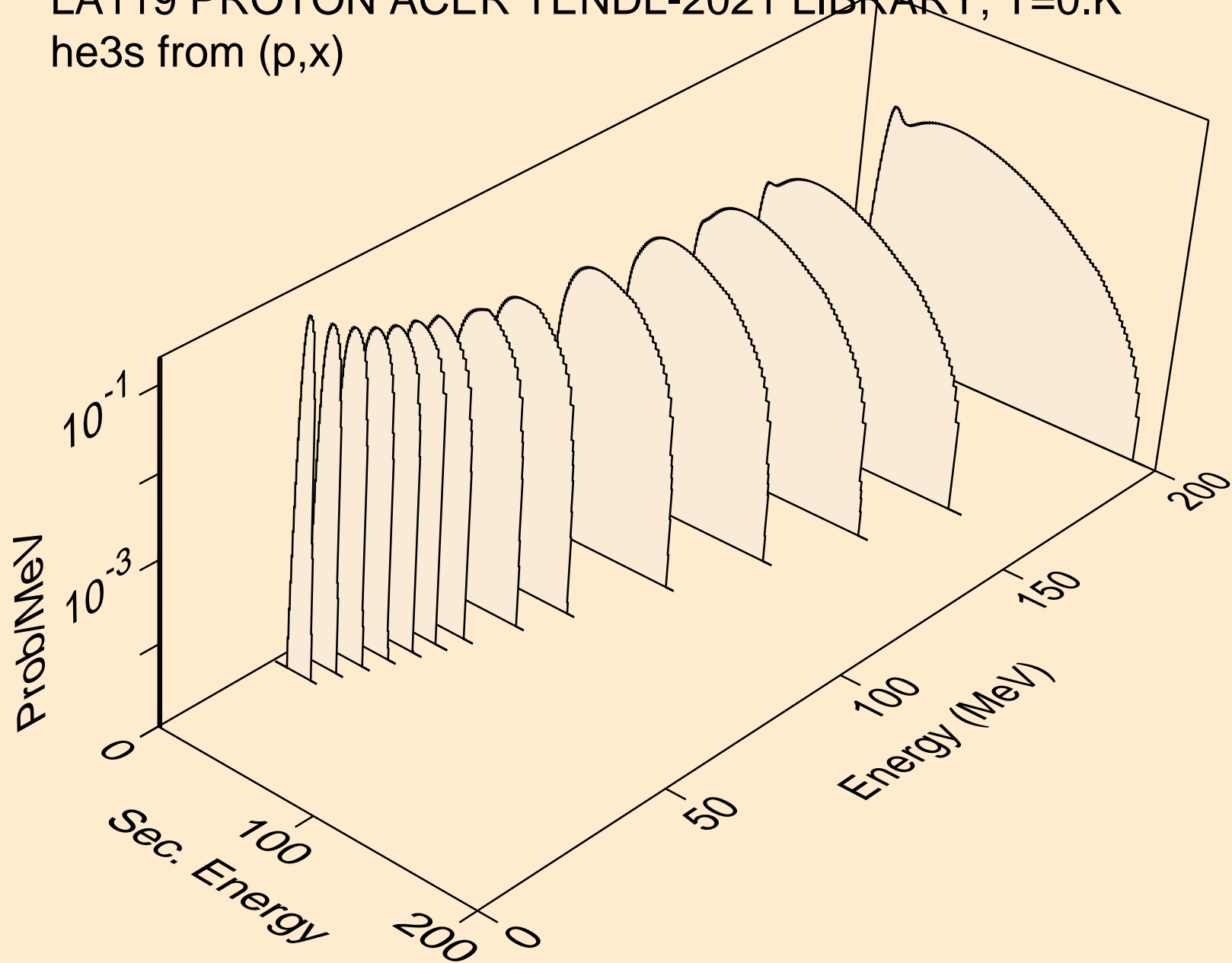

LA119 PROTON ACER TENDL-2021 LIBRARY; T=0.K  
he3s from (p,n\*)he3

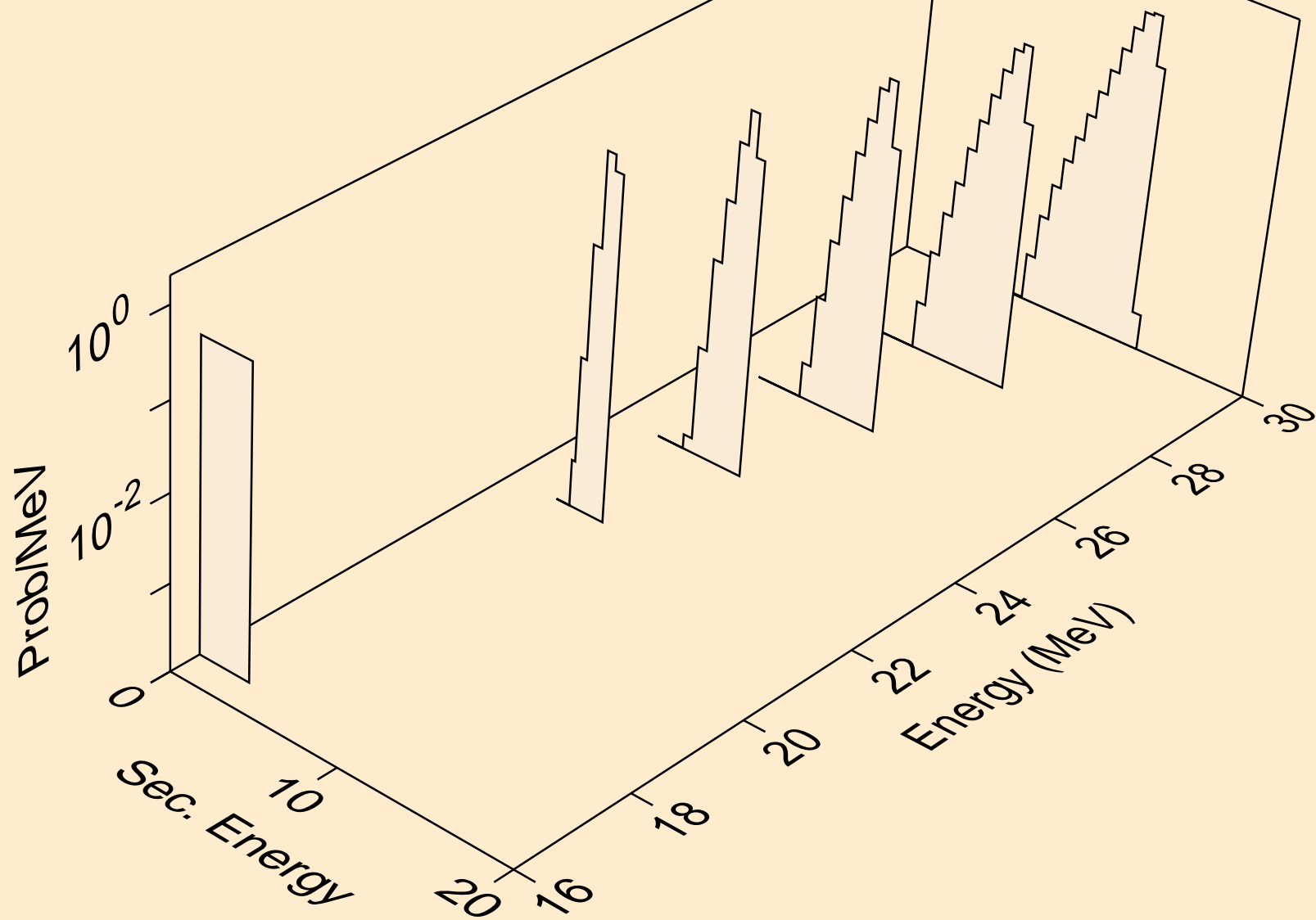

LA119 PROTON ACER TENDL-2021 LIBRARY; T=0.K  
he3s from (p,he3)

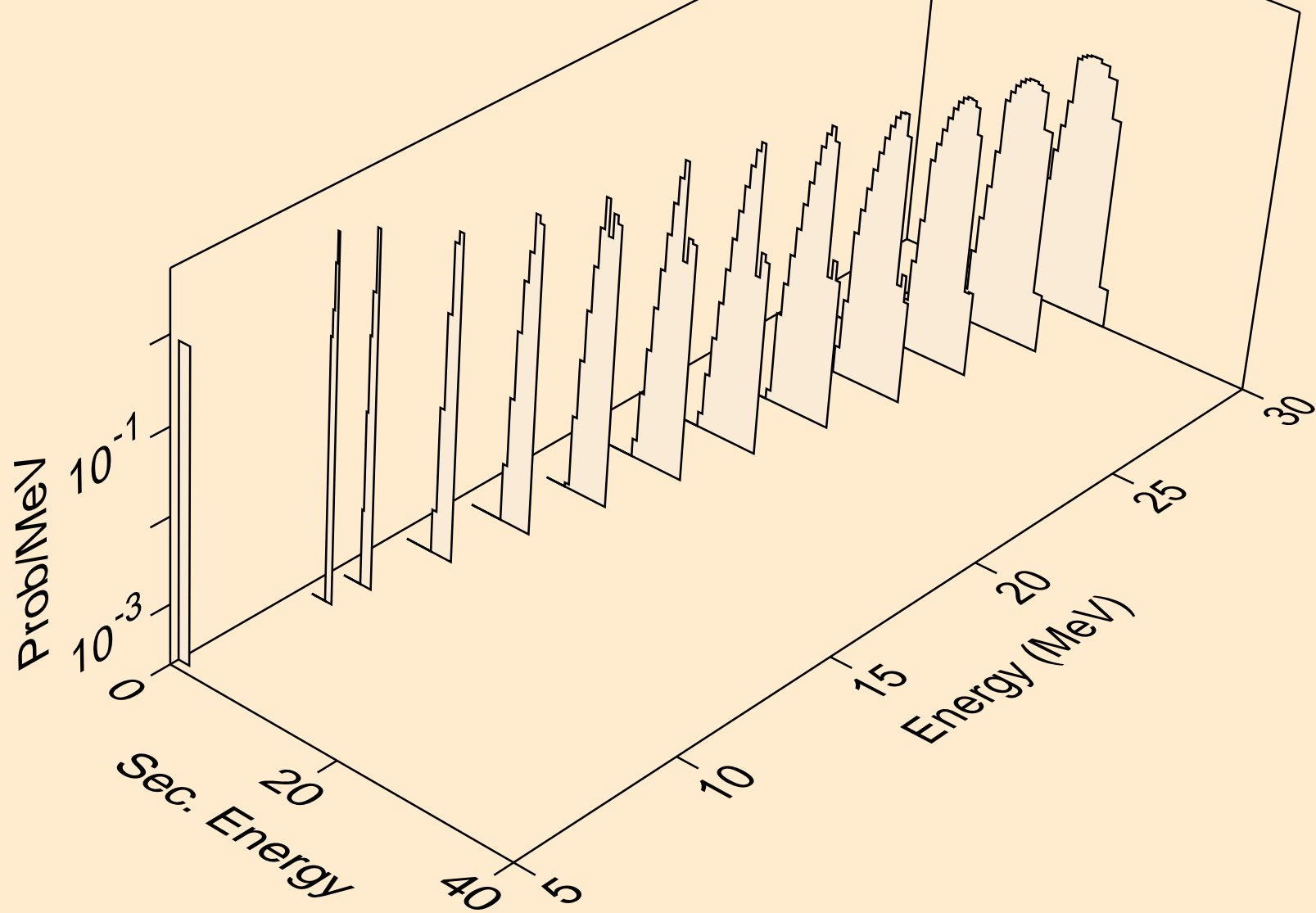

LA119 PROTON ACER TENDL-2021 LIBRARY; T=0.K  
alphas from (p,x)

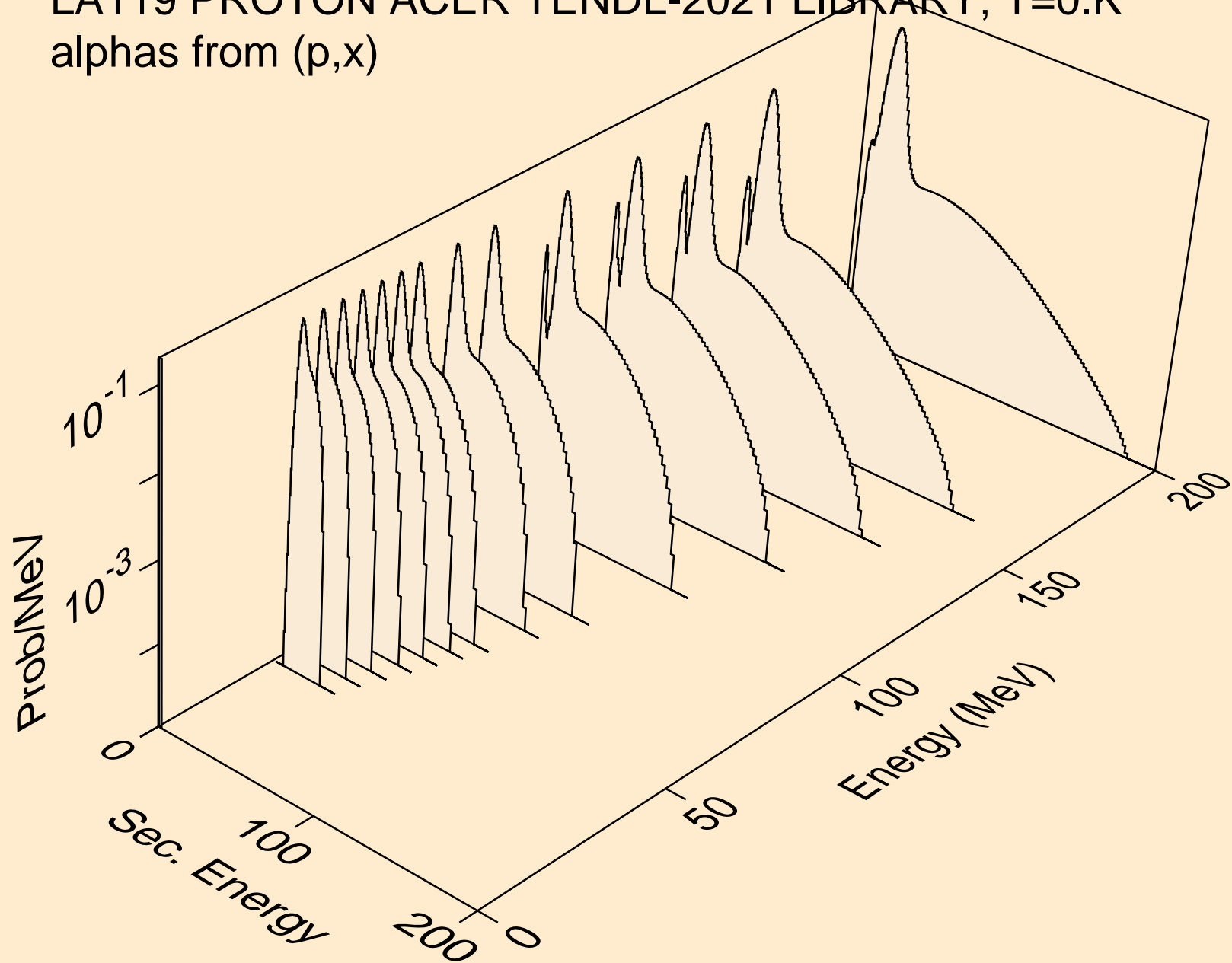

LA119 PROTON ACER TENDL-2021 LIBRARY; T=0.K  
alphas from (p,n\*)a

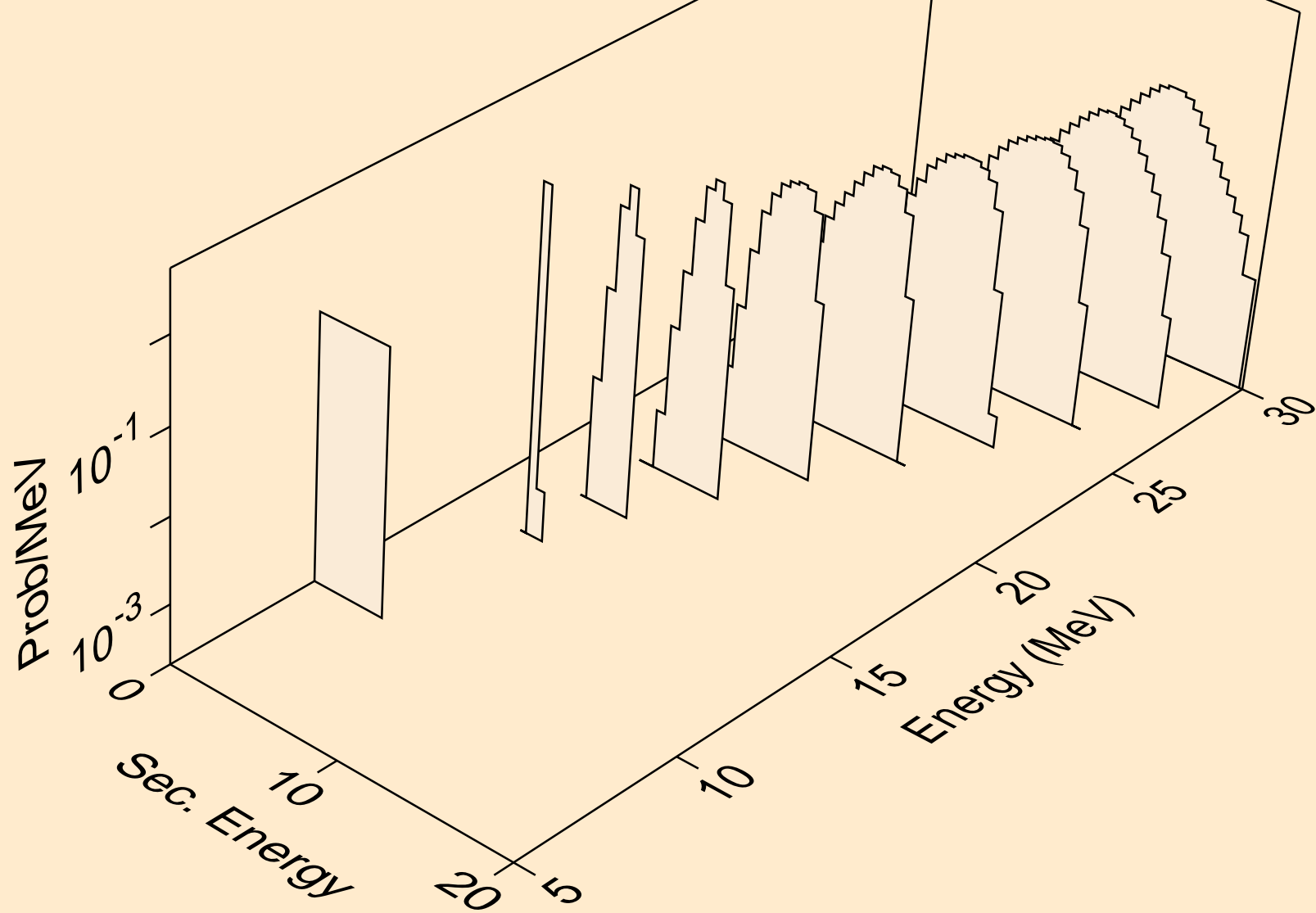

LA119 PROTON ACER TENDL-2021 LIBRARY; T=0.K  
alphas from (p,n\*)2a

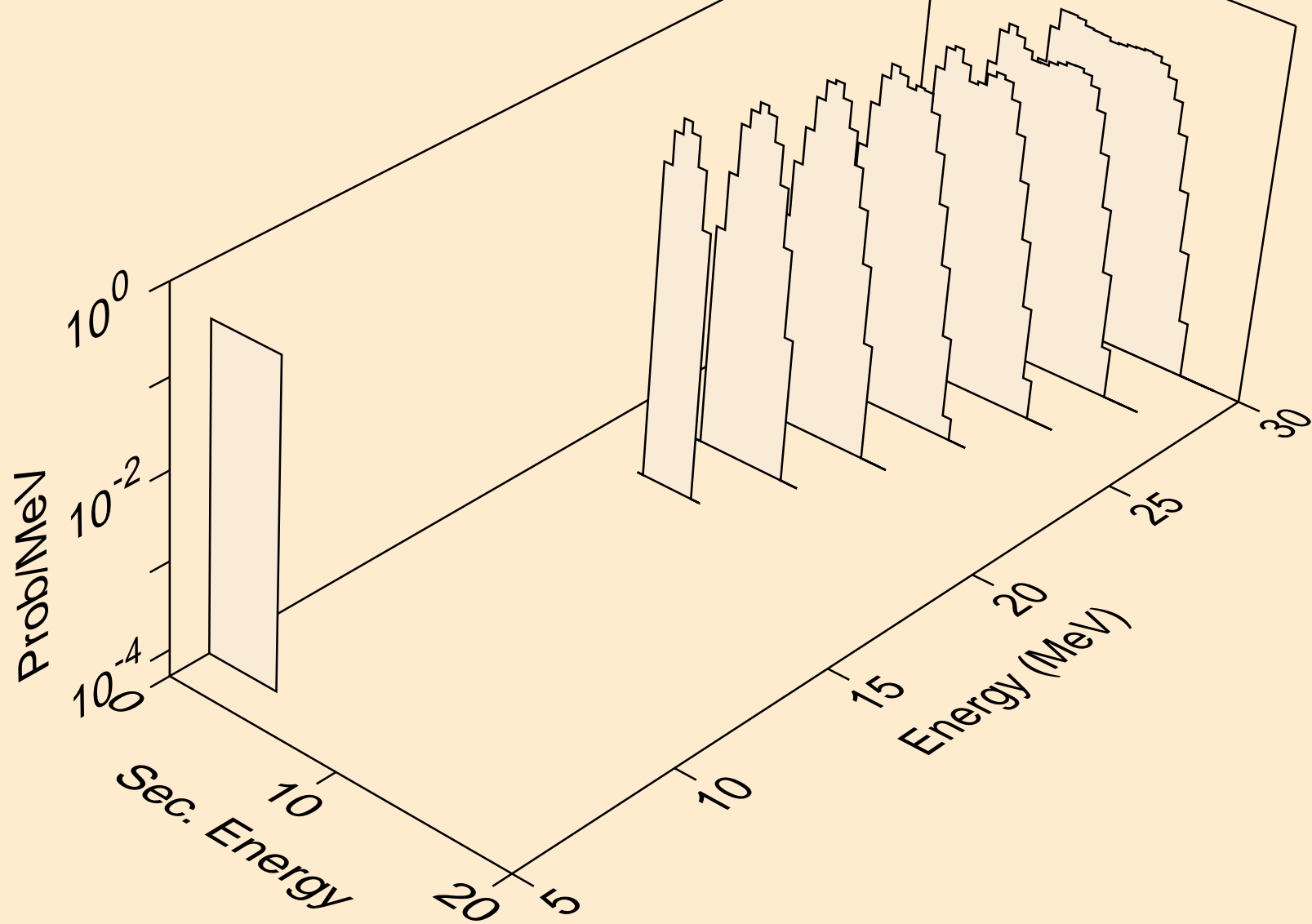

LA119 PROTON ACER TENDL-2021 LIBRARY; T=0.K  
alphas from (p,npa)

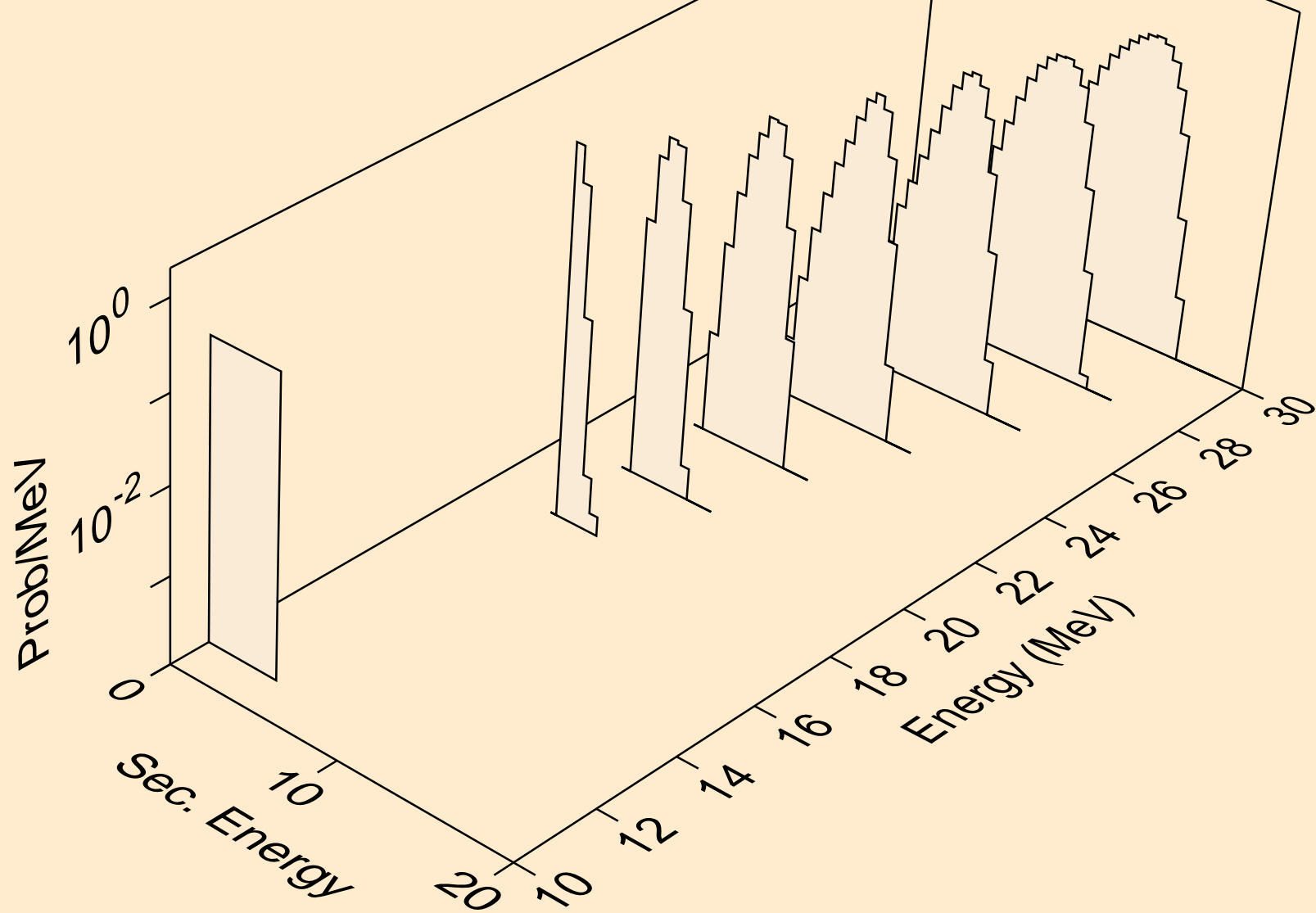



LA119 PROTON ACER TENDL-2021 LIBRARY; T=0.K  
alphas from (p,a)

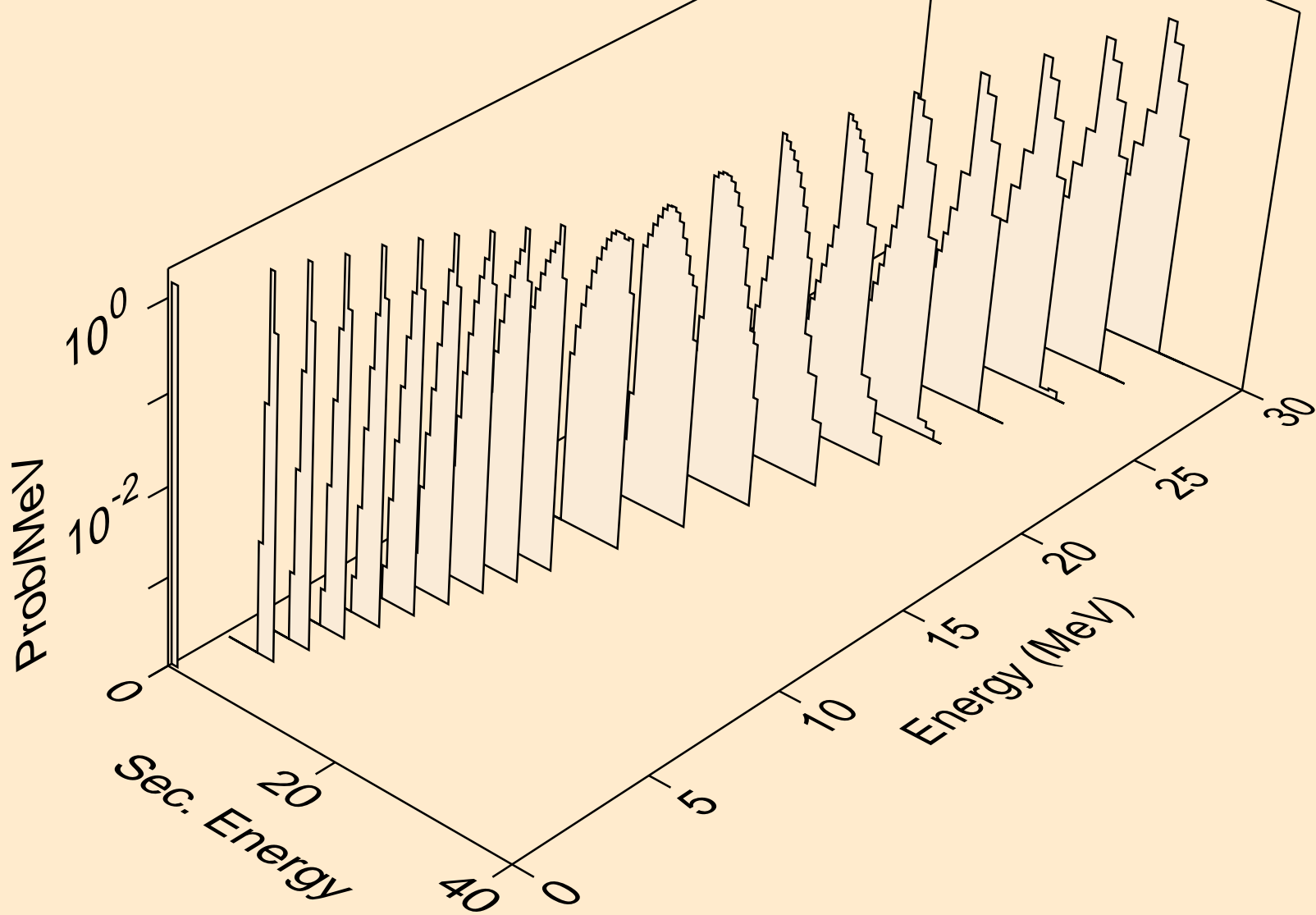

LA119 PROTON ACER TENDL-2021 LIBRARY; T=0.K  
alphas from (p,2a)

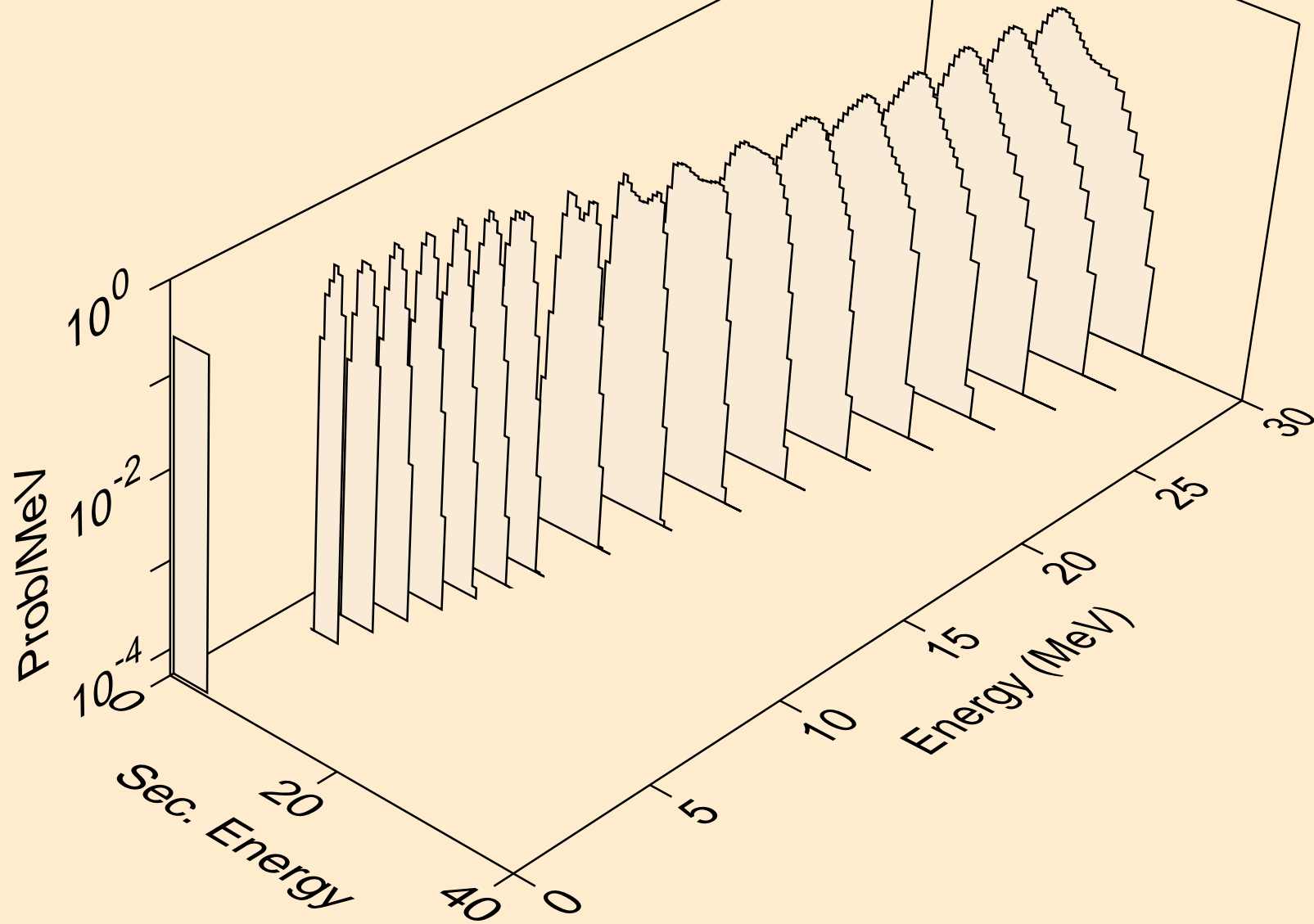

LA119 PROTON ACER TENDL-2021 LIBRARY; T=0.K  
alphas from (p,3a)

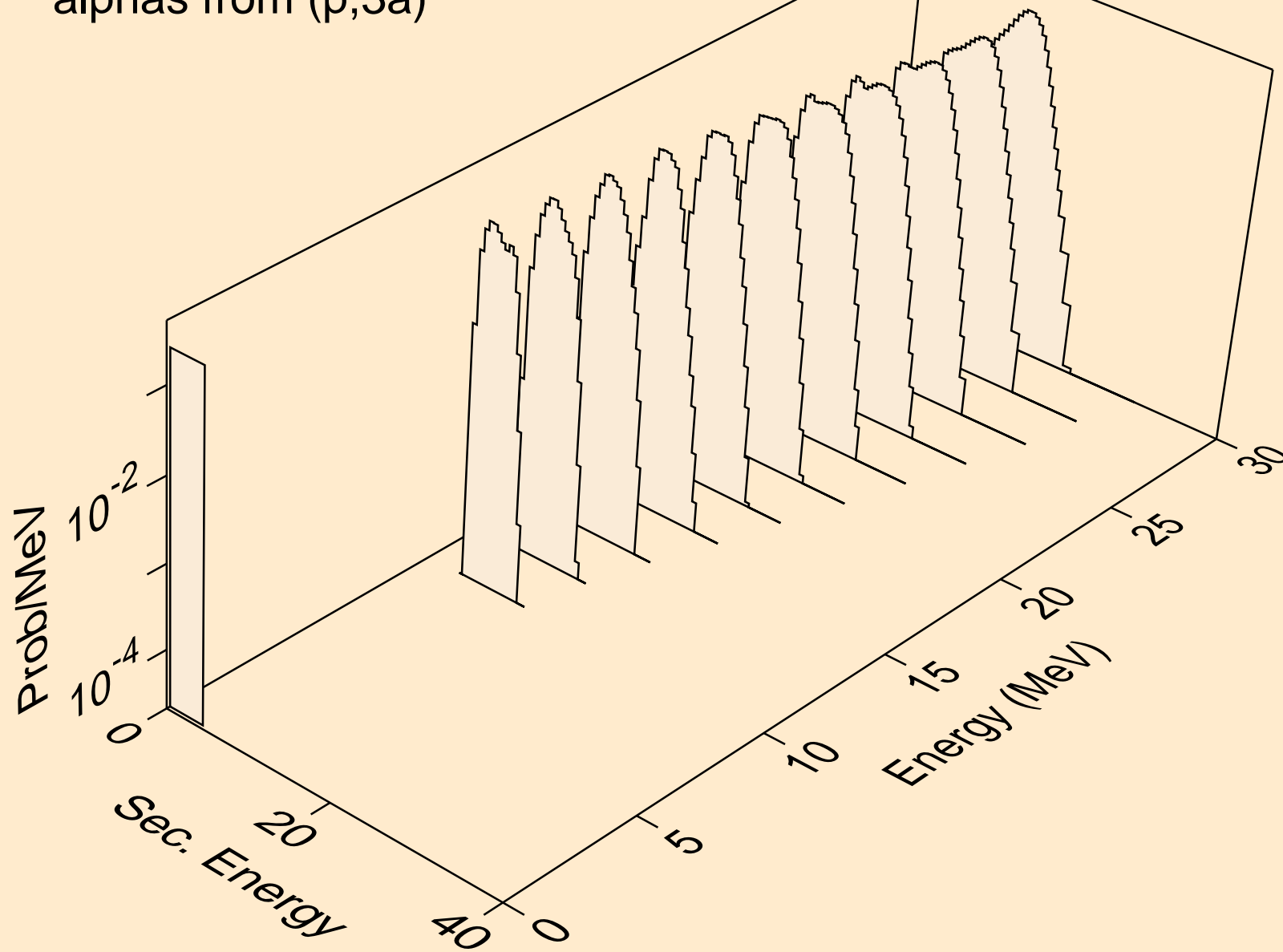

LA119 PROTON ACER TENDL-2021 LIBRARY; T=0.K  
alphas from (p,pa)

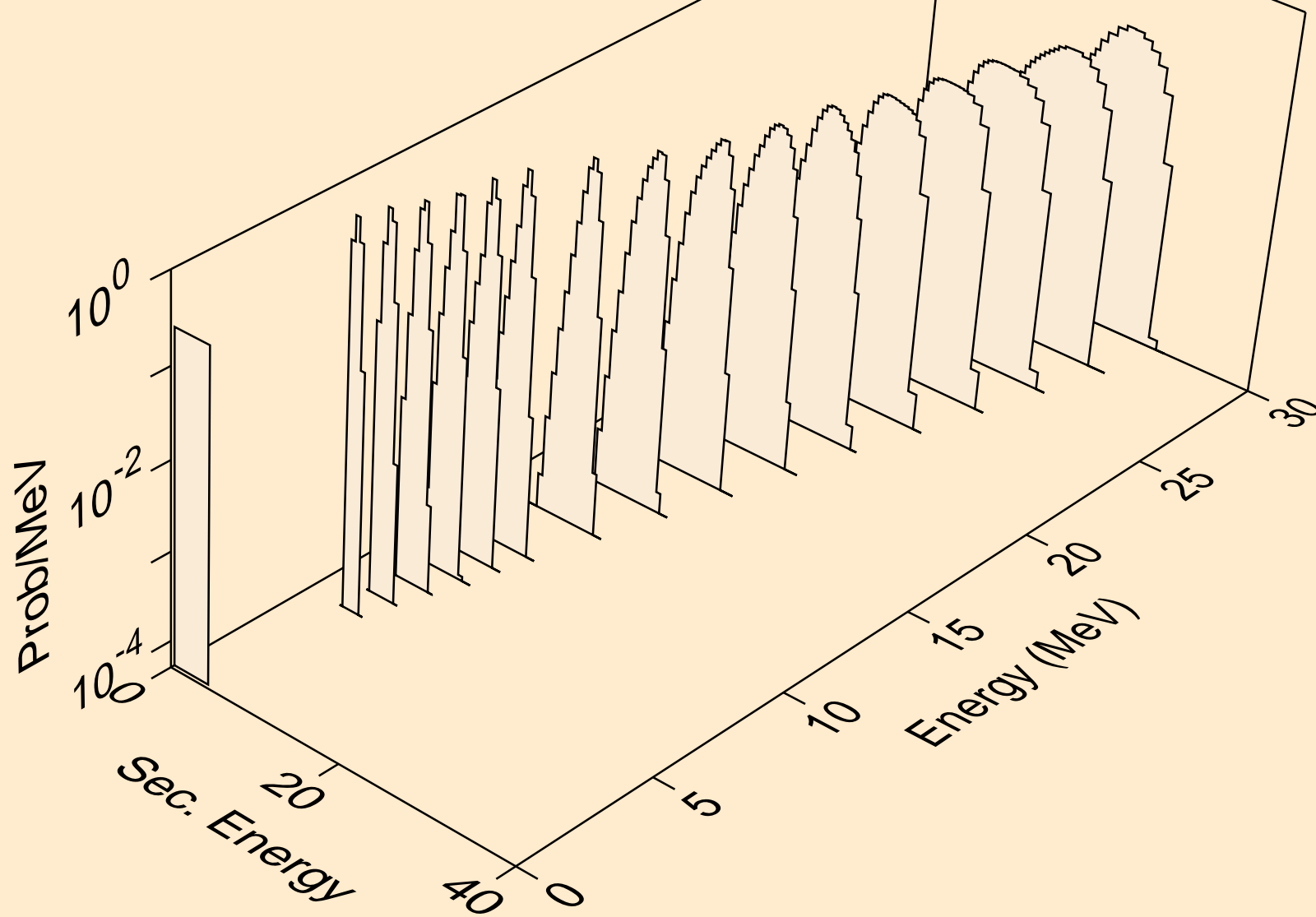

LA119 PROTON ACER TENDL-2021 LIBRARY; T=0.K  
alphas from (p,da)

