

# NO253 PROTON ACER TENDL-2021 LIBRARY; T=0.K

## Principal cross sections

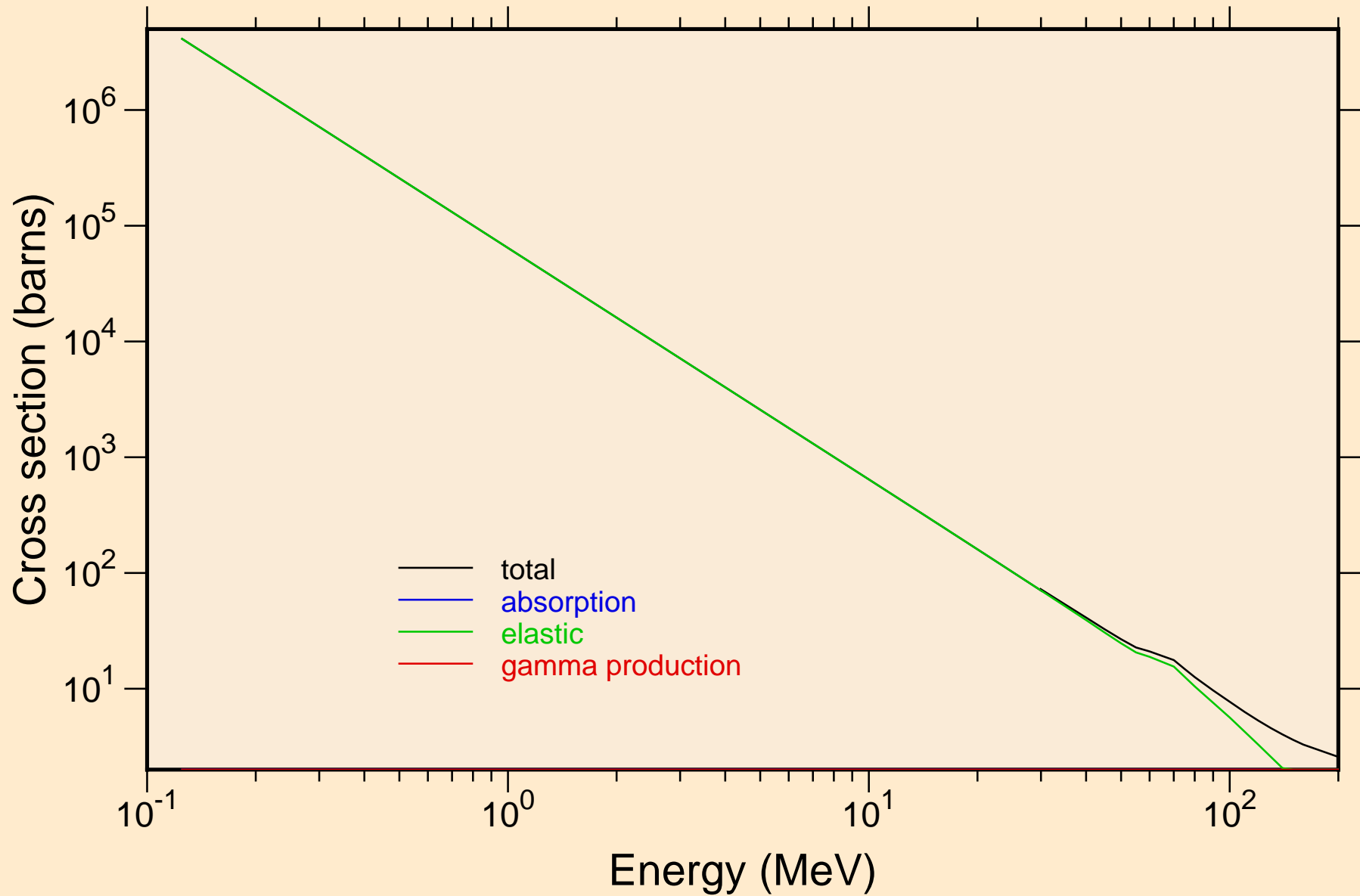

# NO253 PROTON ACER TENDL-2021 LIBRARY; T=0.K

## Heating

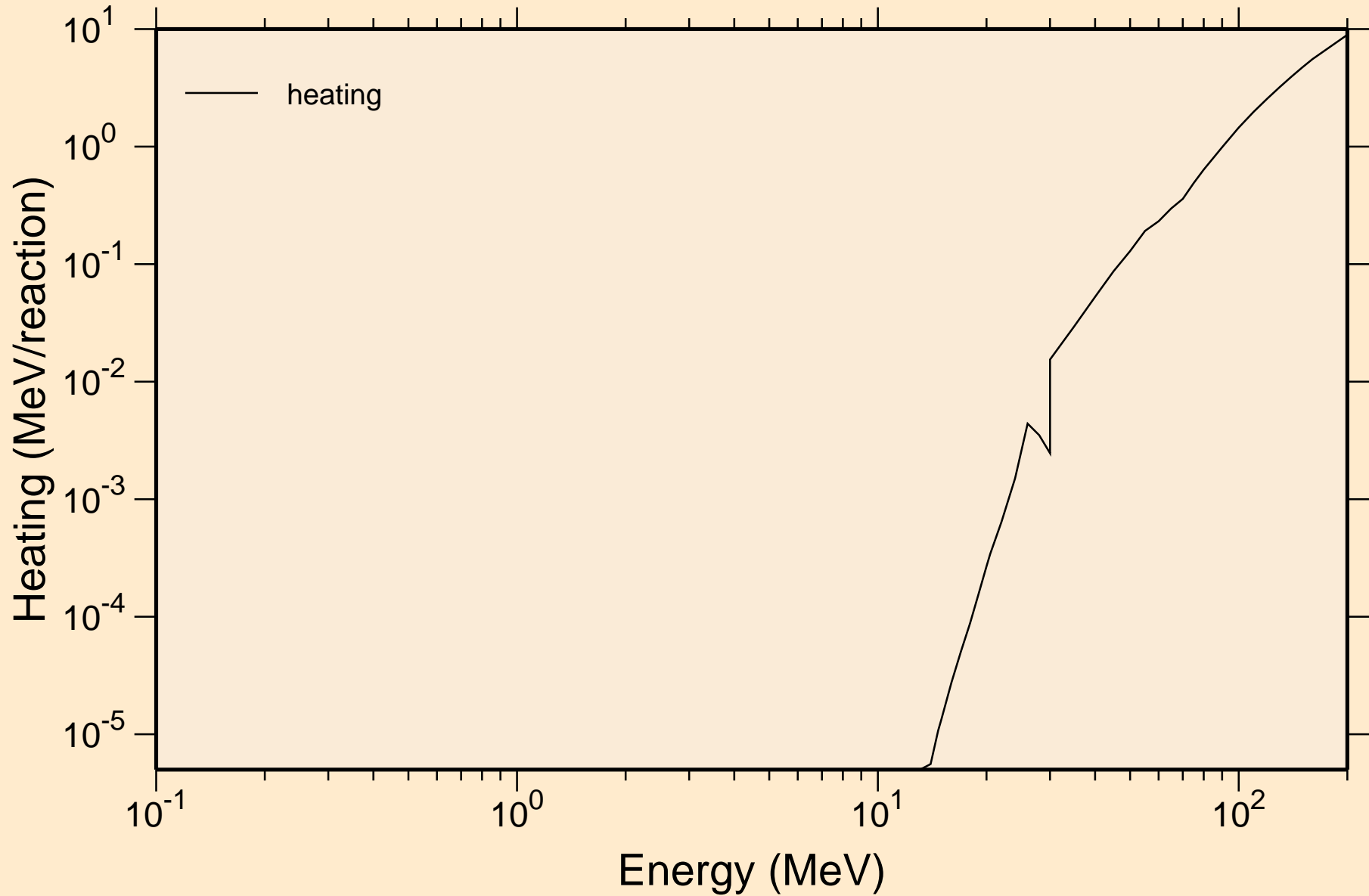

# NO253 PROTON ACER TENDL-2021 LIBRARY; T=0.K

## Principal cross sections

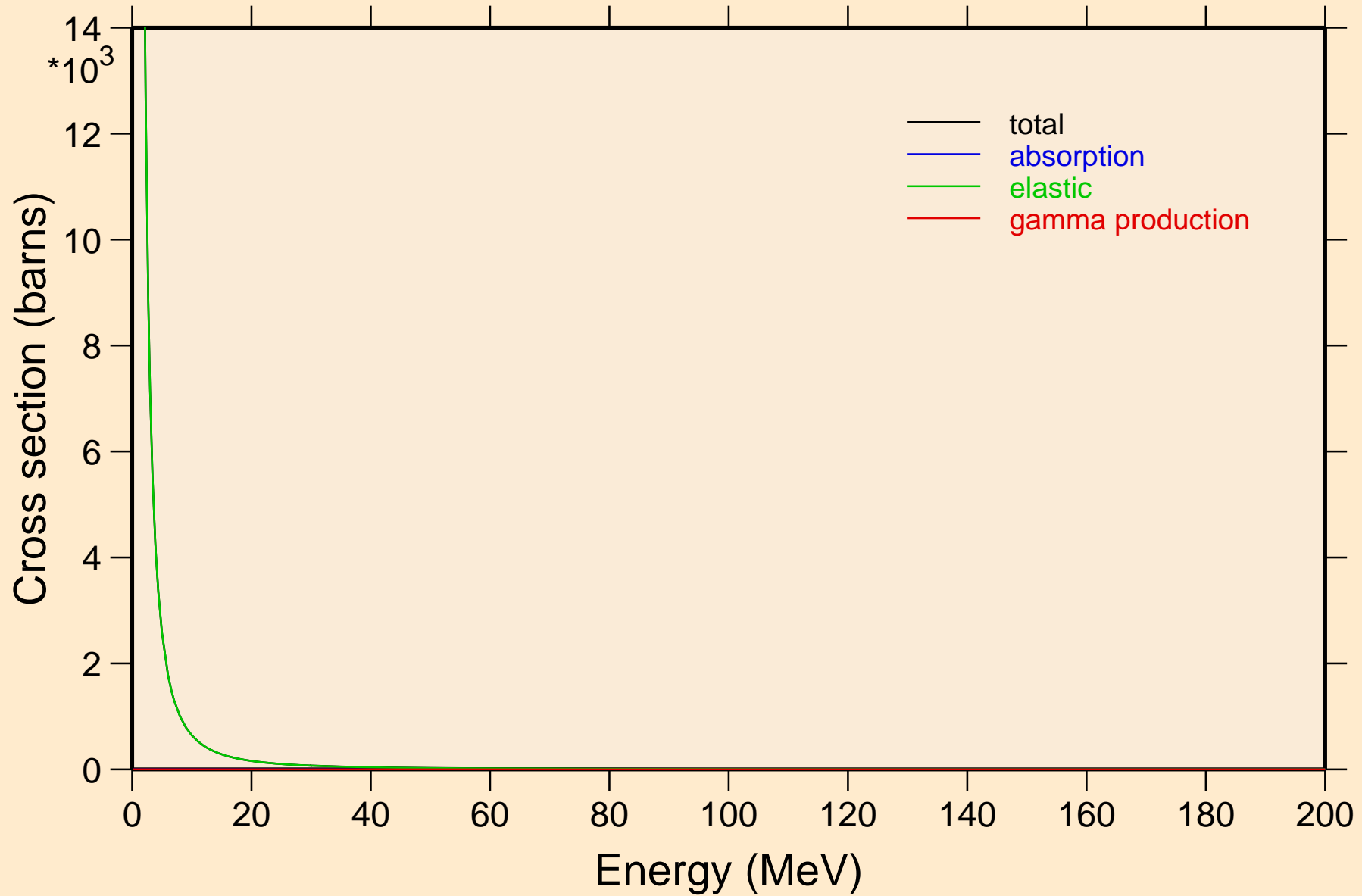

NO253 PROTON ACER TENDL-2021 LIBRARY; T=0.K

Heating

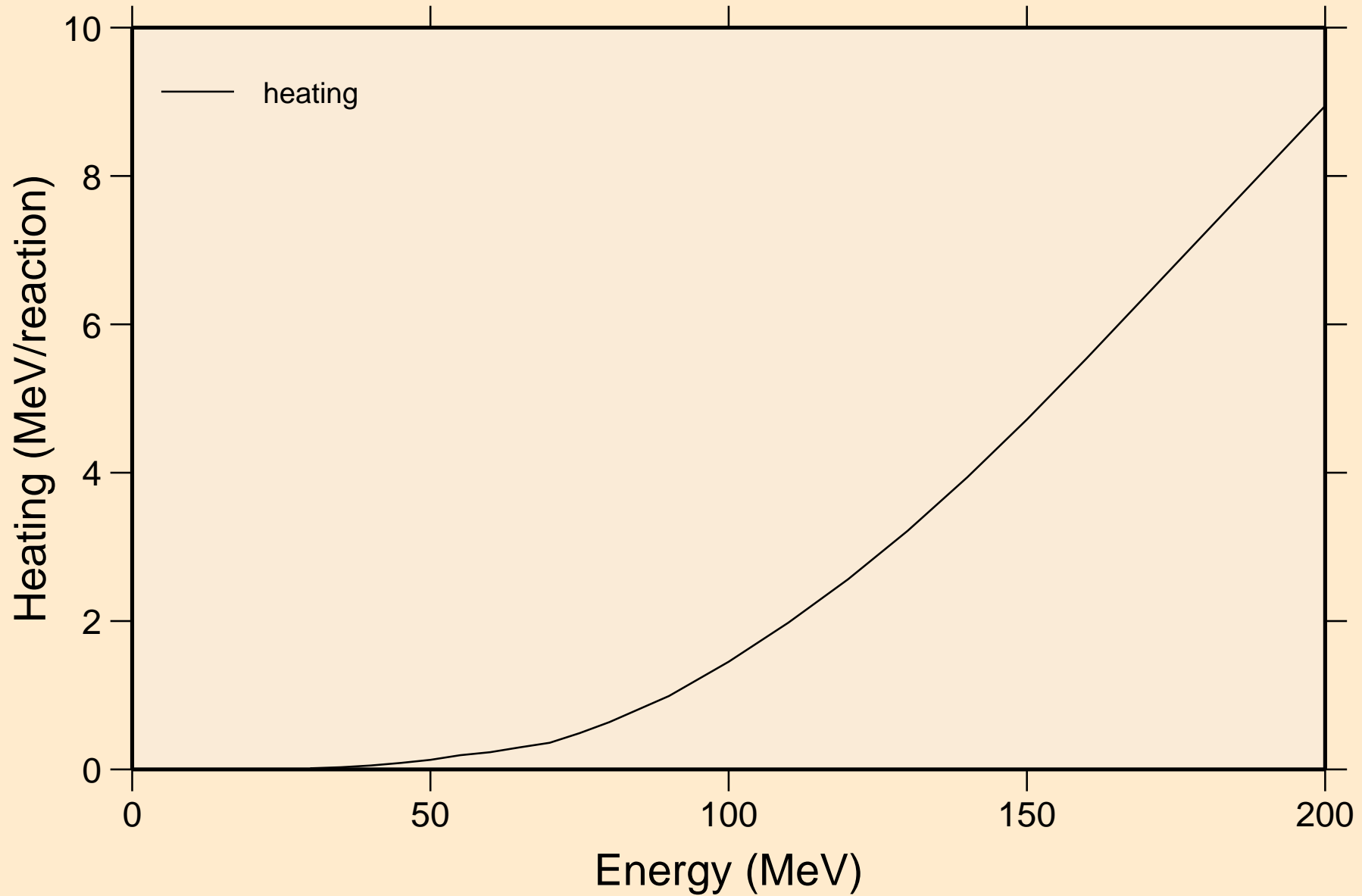

# NO253 PROTON ACER TENDL-2021 LIBRARY; T=0.K

## Threshold reactions

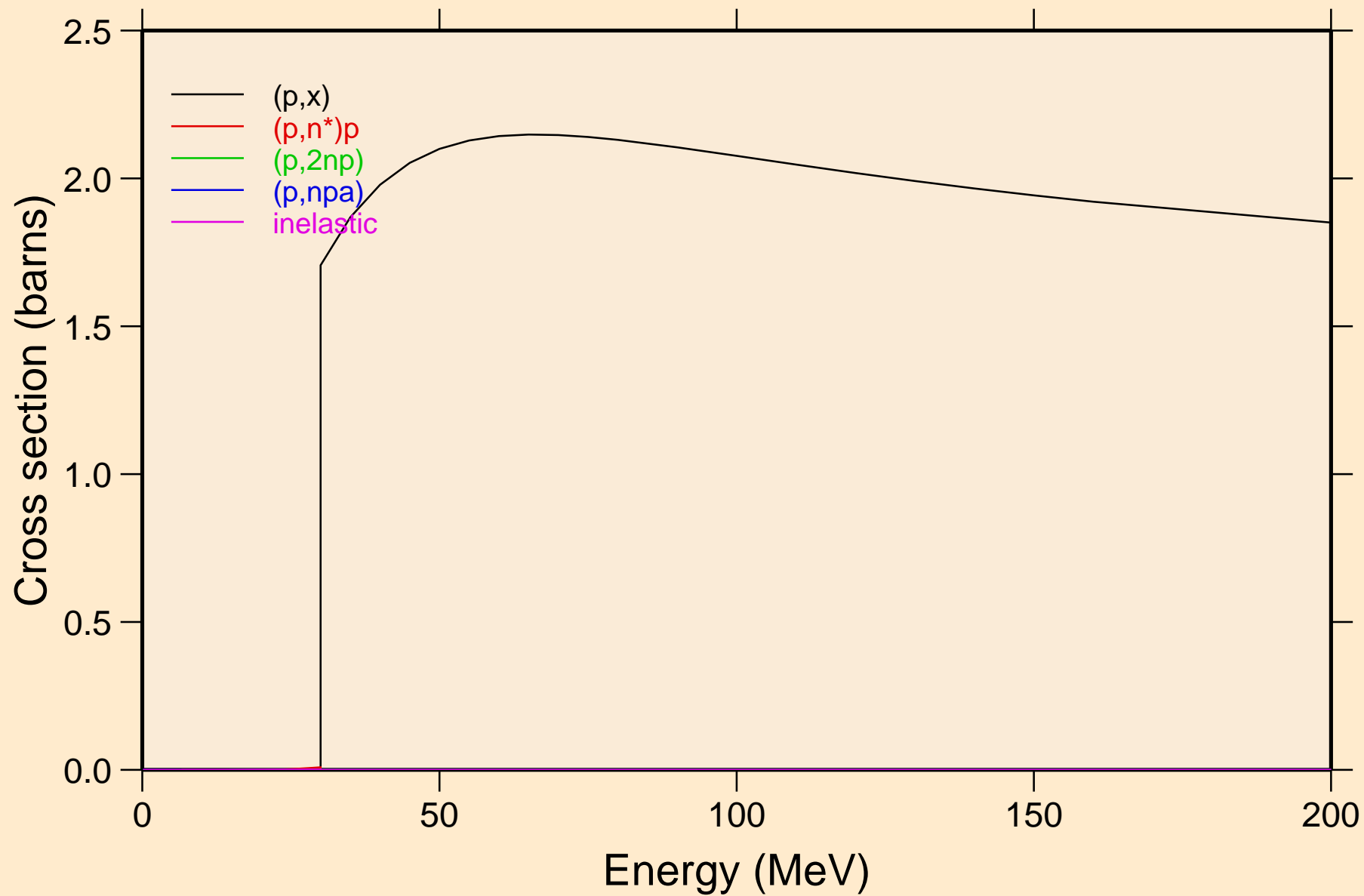

NO253 PROTON ACER TENDL-2021 LIBRARY; T=0.K  
Threshold reactions

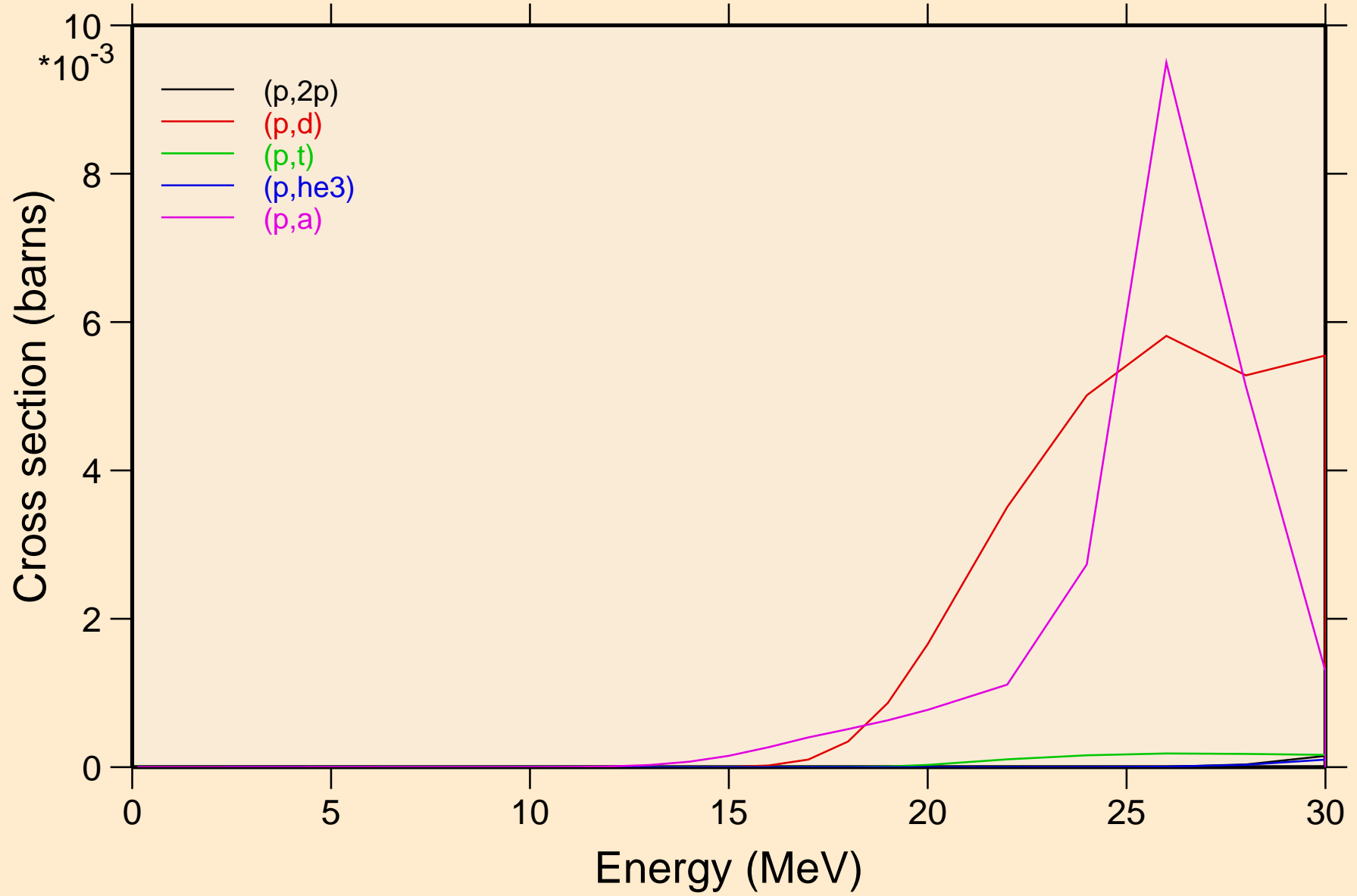

NO253 PROTON ACER TENDL-2021 LIBRARY; T=0.K  
Threshold reactions

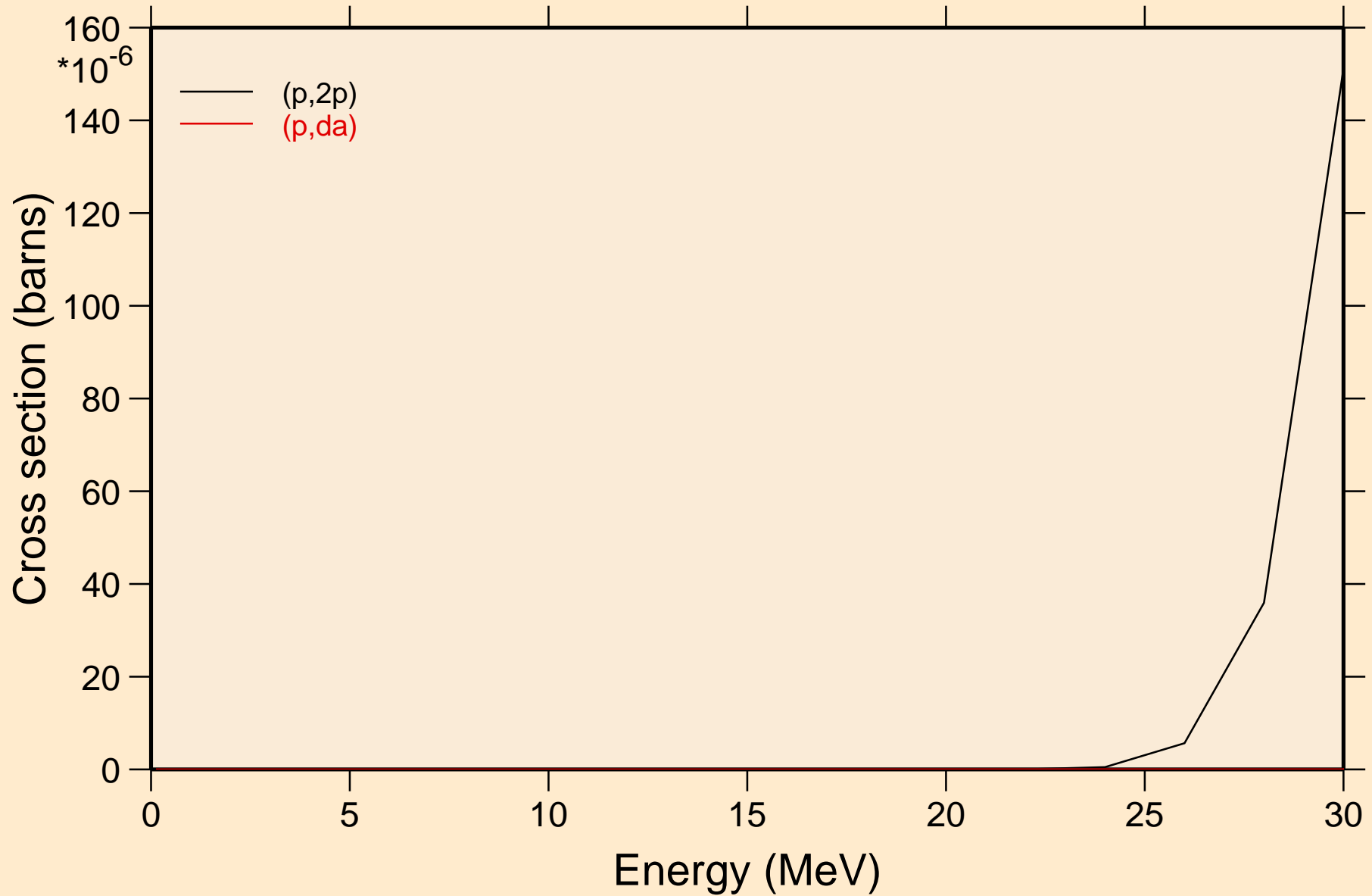

NO253 PROTON ACER TENDL-2021 LIBRARY; T=0.K  
angular distribution for elastic

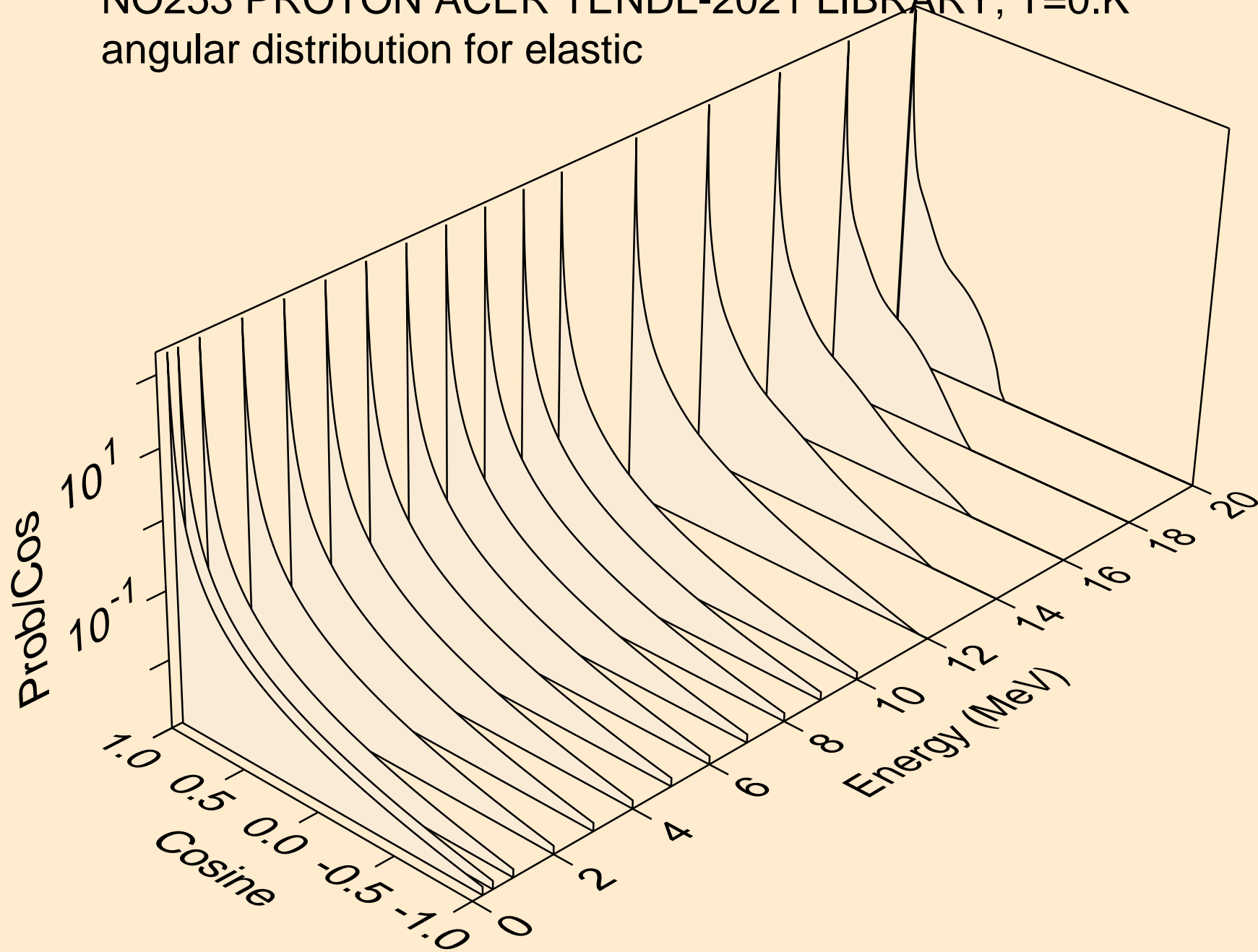



NO253 PROTON ACER TENDL-2021 LIBRARY; T=0.K  
angular distribution for elastic

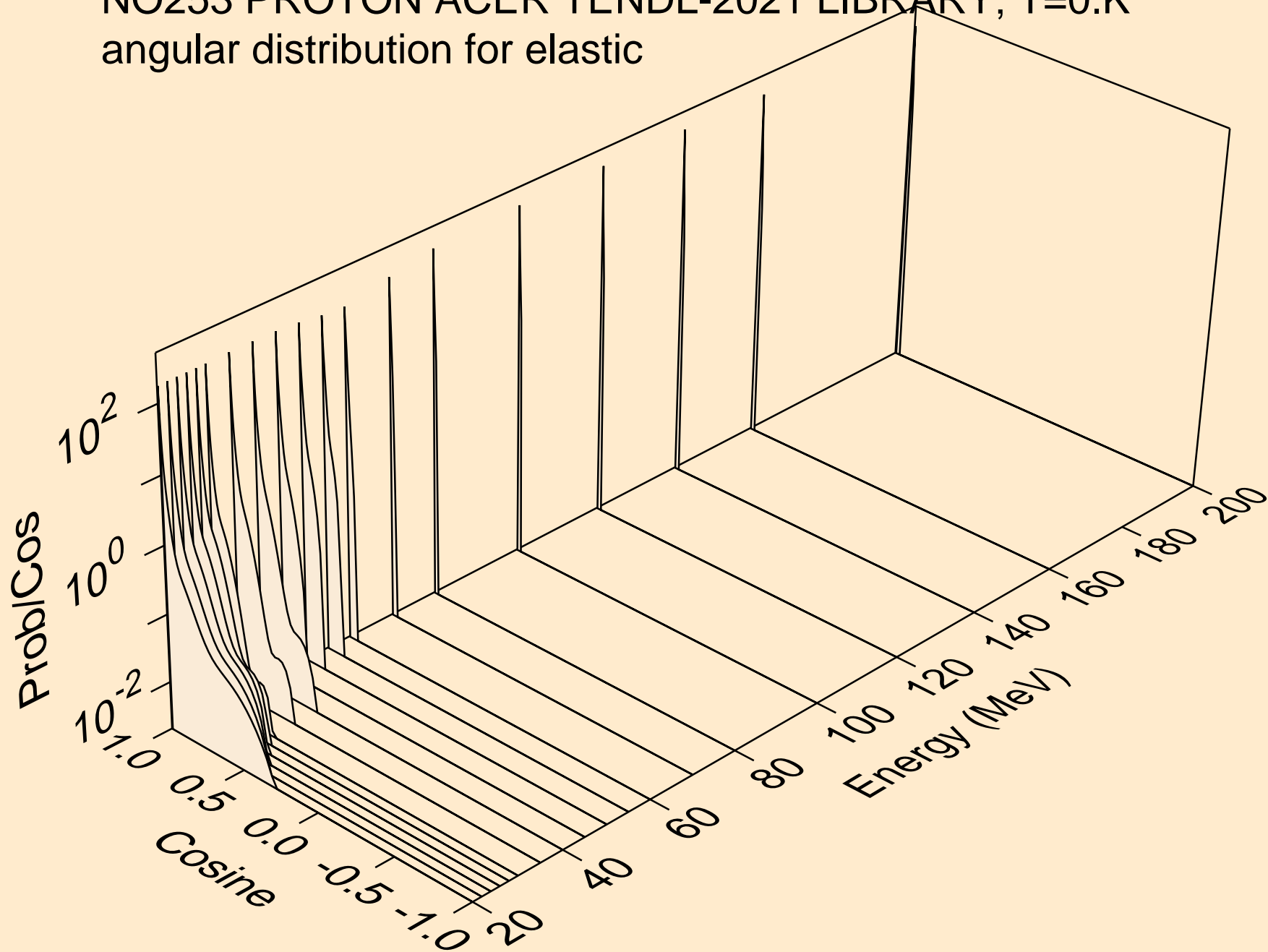

NO253 PROTON ACER TENDL-2021 LIBRARY; T=0.K  
Proton emission for (p,x)

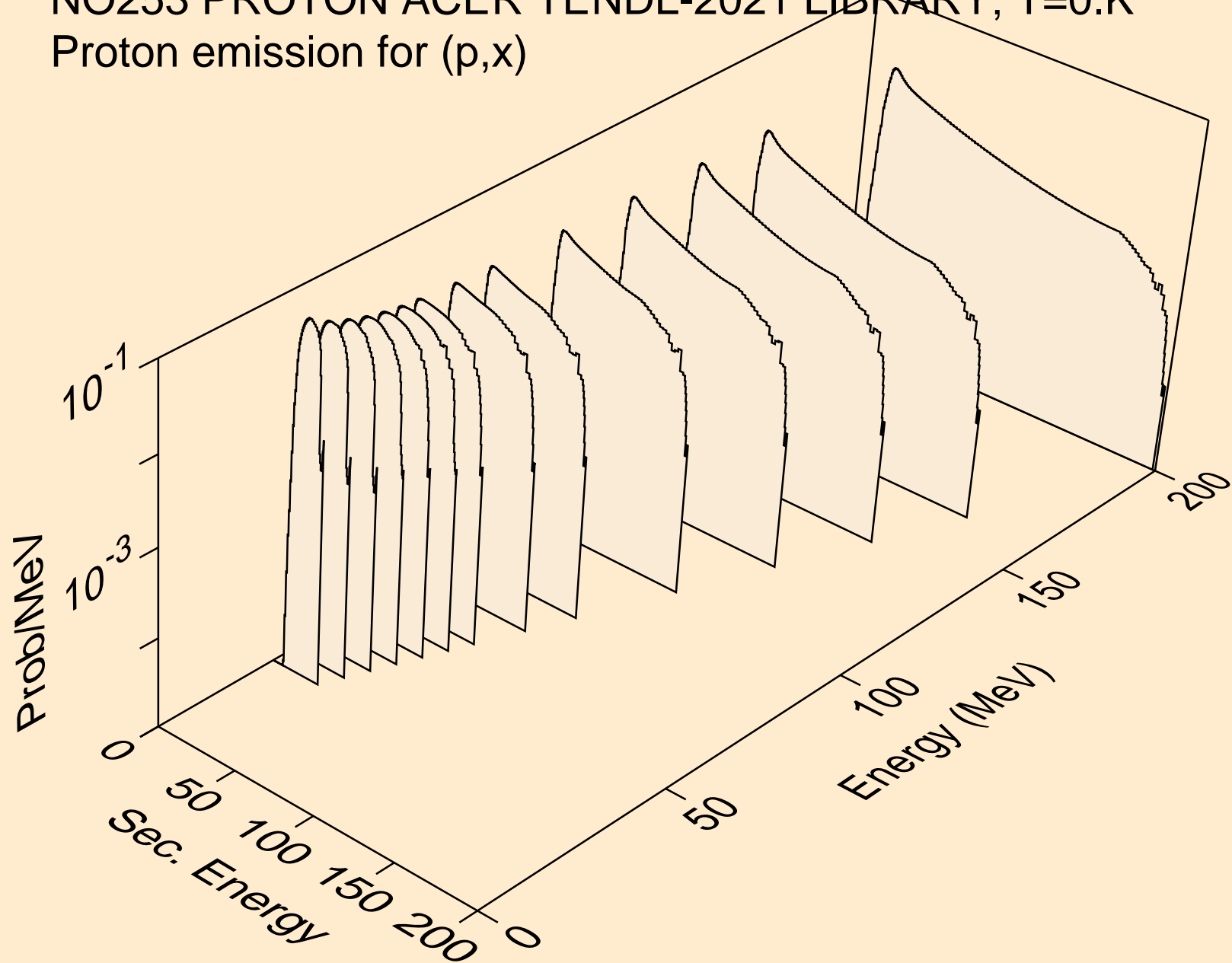

NO253 PROTON ACER TENDL-2021 LIBRARY; T=0.K  
Proton emission for (p,n\*)p

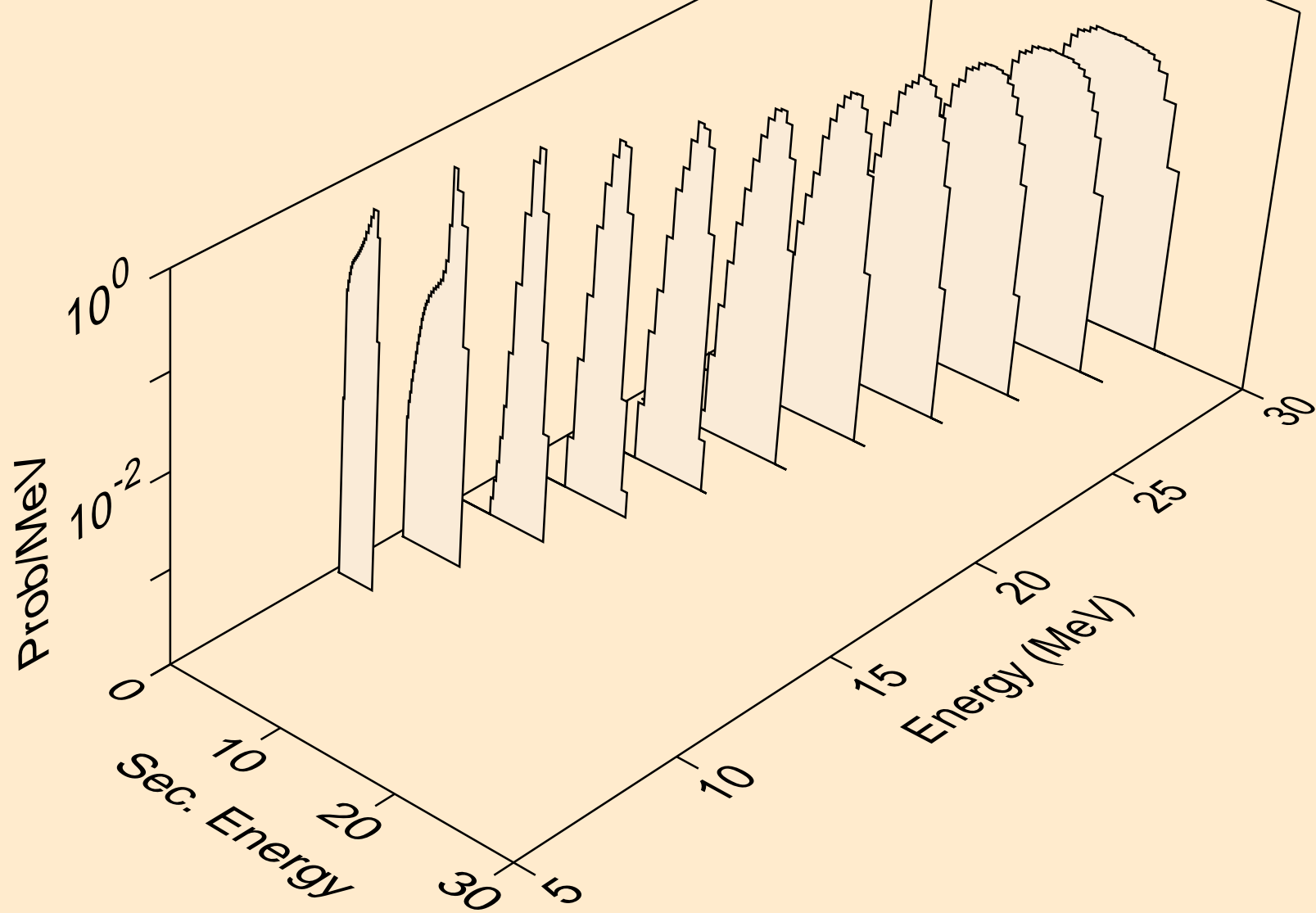

NO253 PROTON ACER TENDL-2021 LIBRARY; T=0.K  
Proton emission for (p,2np)

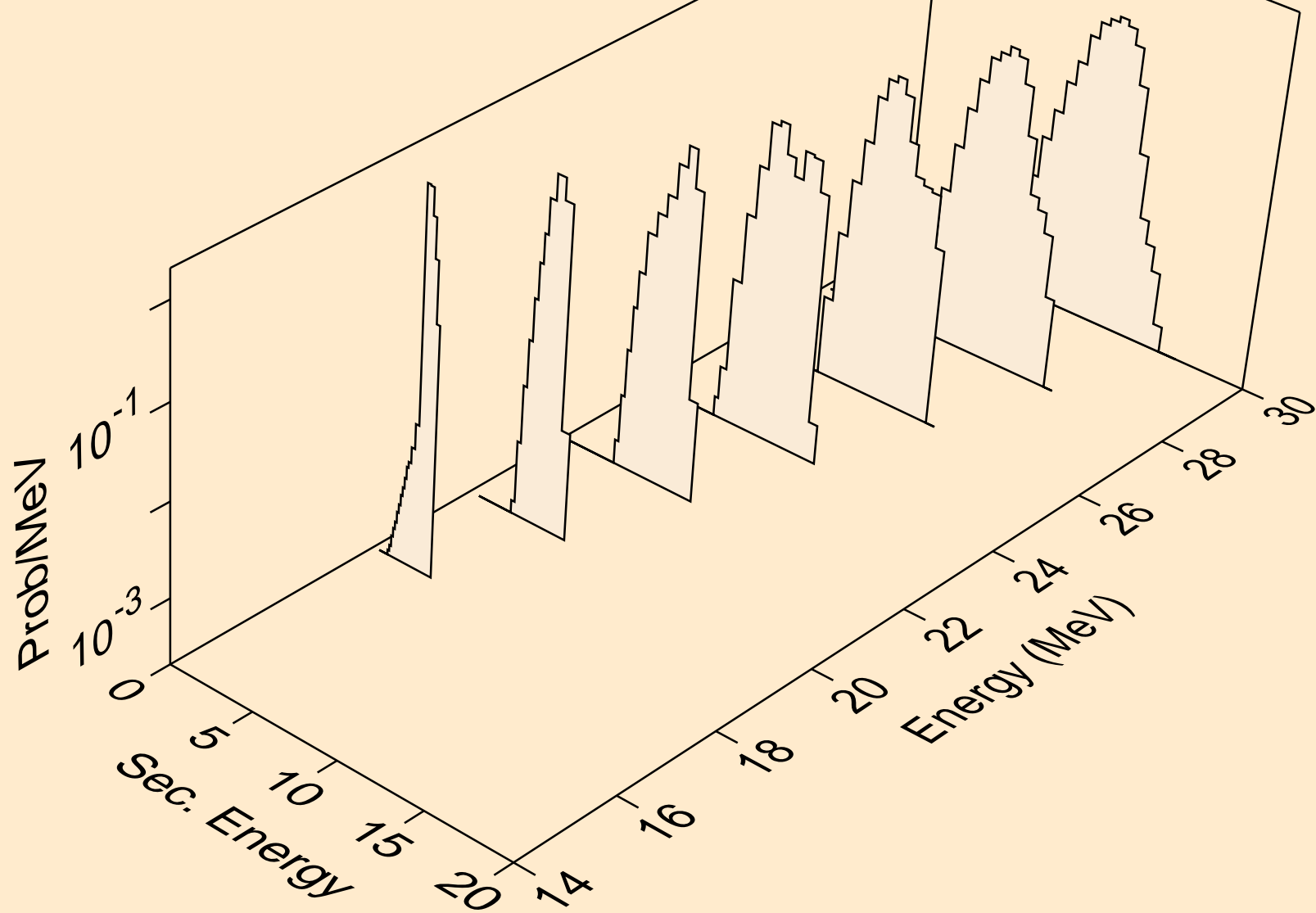

NO253 PROTON ACER TENDL-2021 LIBRARY; T=0.K  
Proton emission for (p,npa)

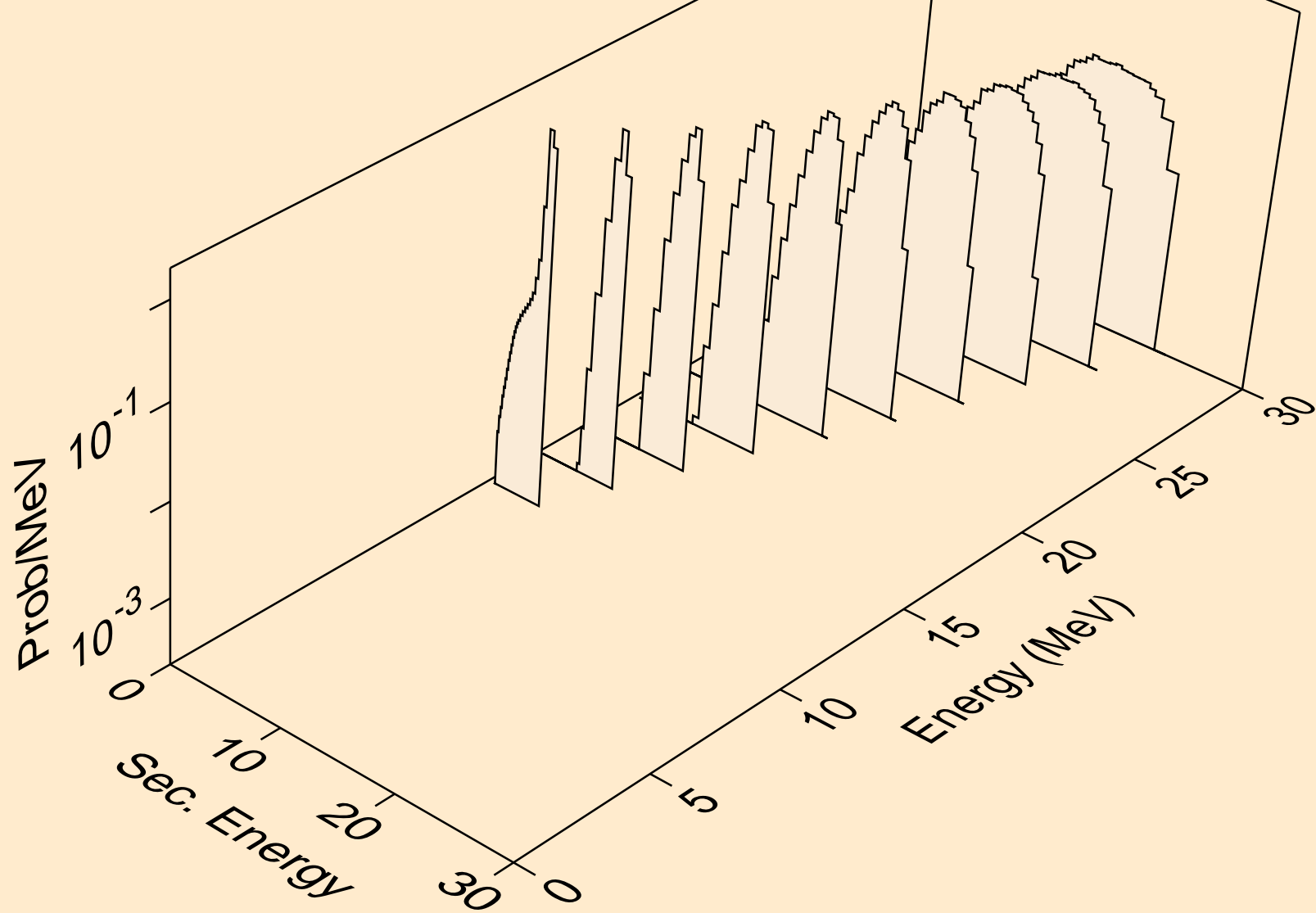

NO253 PROTON ACER TENDL-2021 LIBRARY; T=0.K  
Proton emission for inelastic

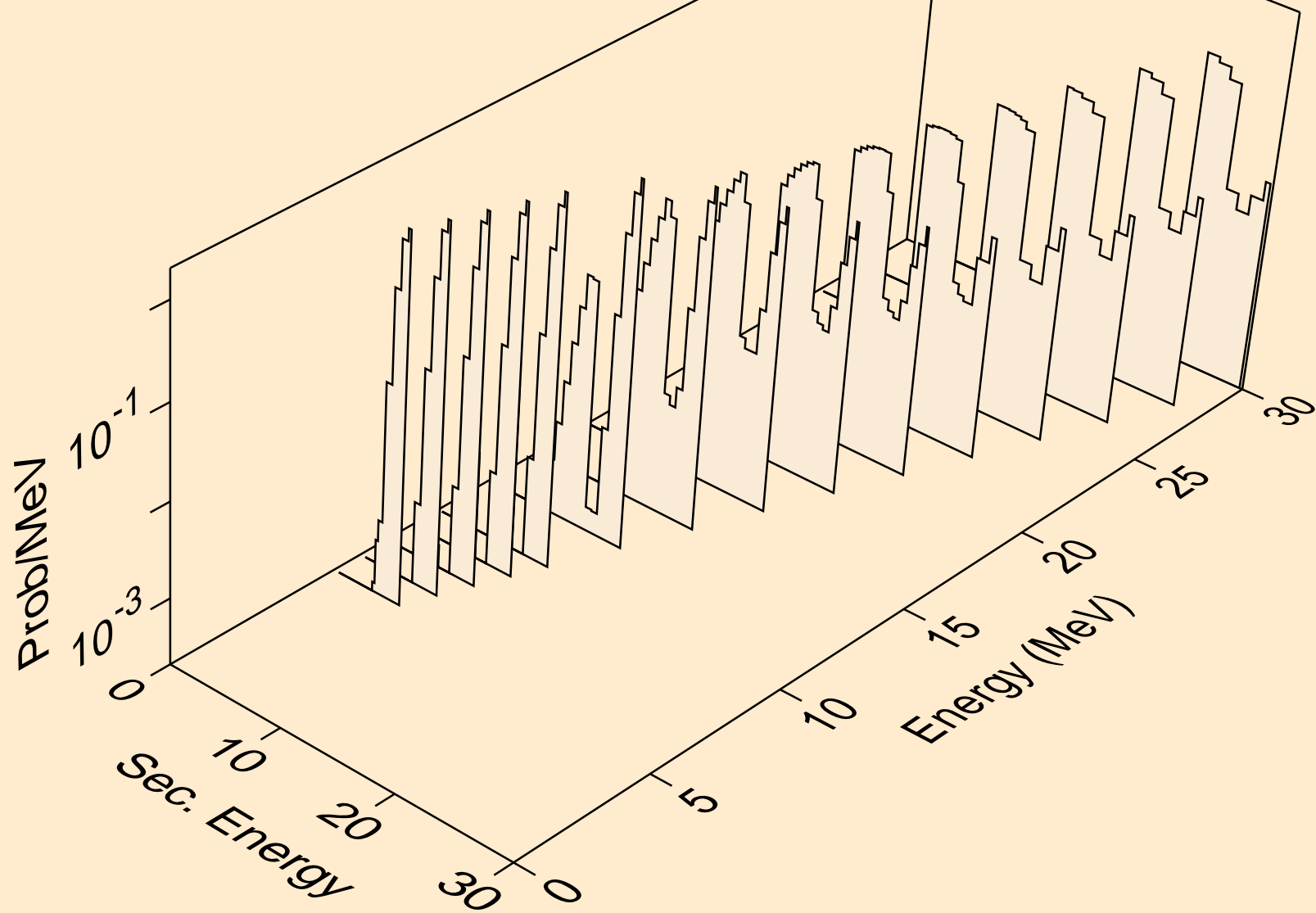

NO253 PROTON ACER TENDL-2021 LIBRARY; T=0.K  
Proton emission for (p,2p)

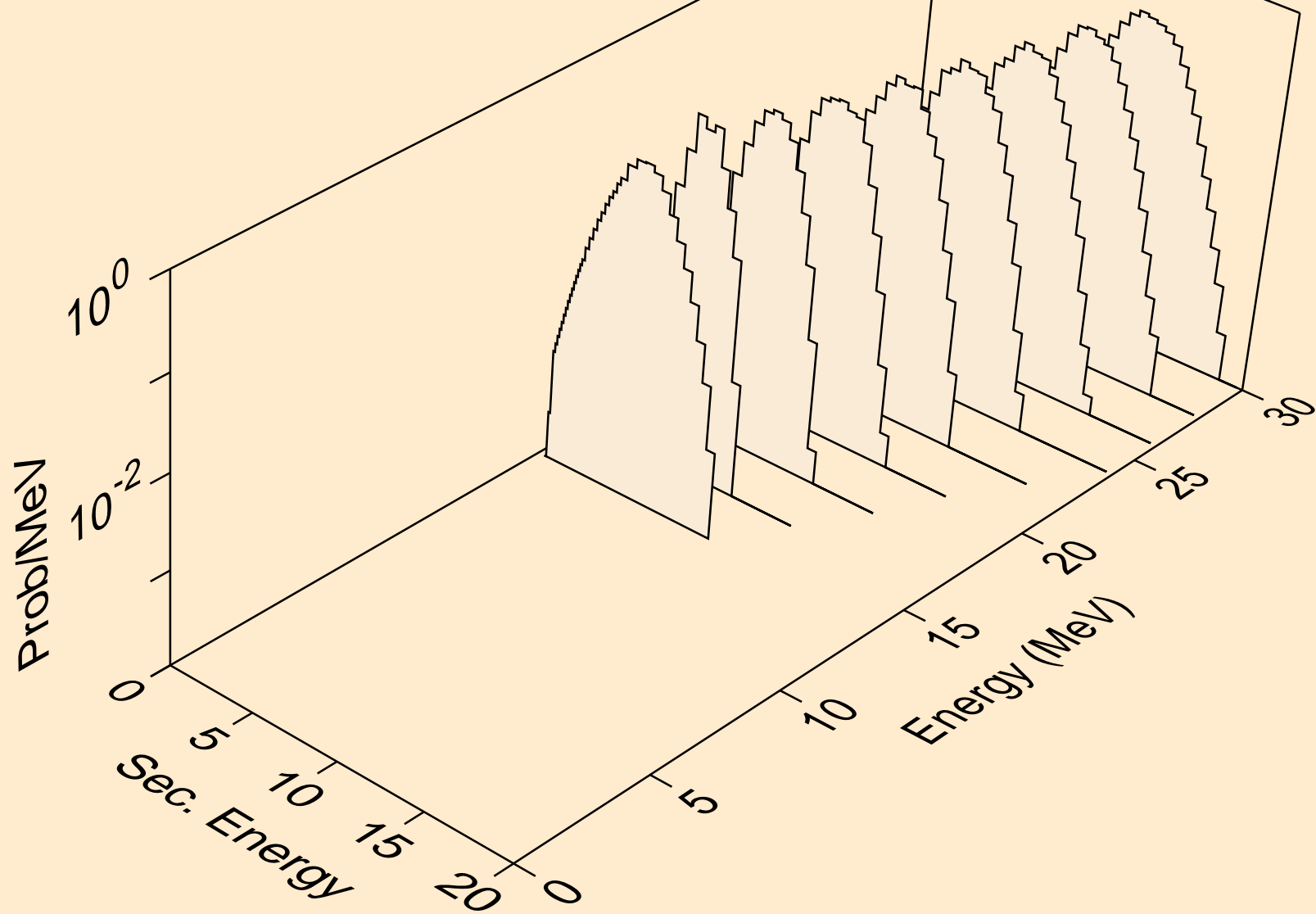

NO253 PROTON ACER TENDL-2021 LIBRARY; T=0.K  
Photon emission for (z,n)

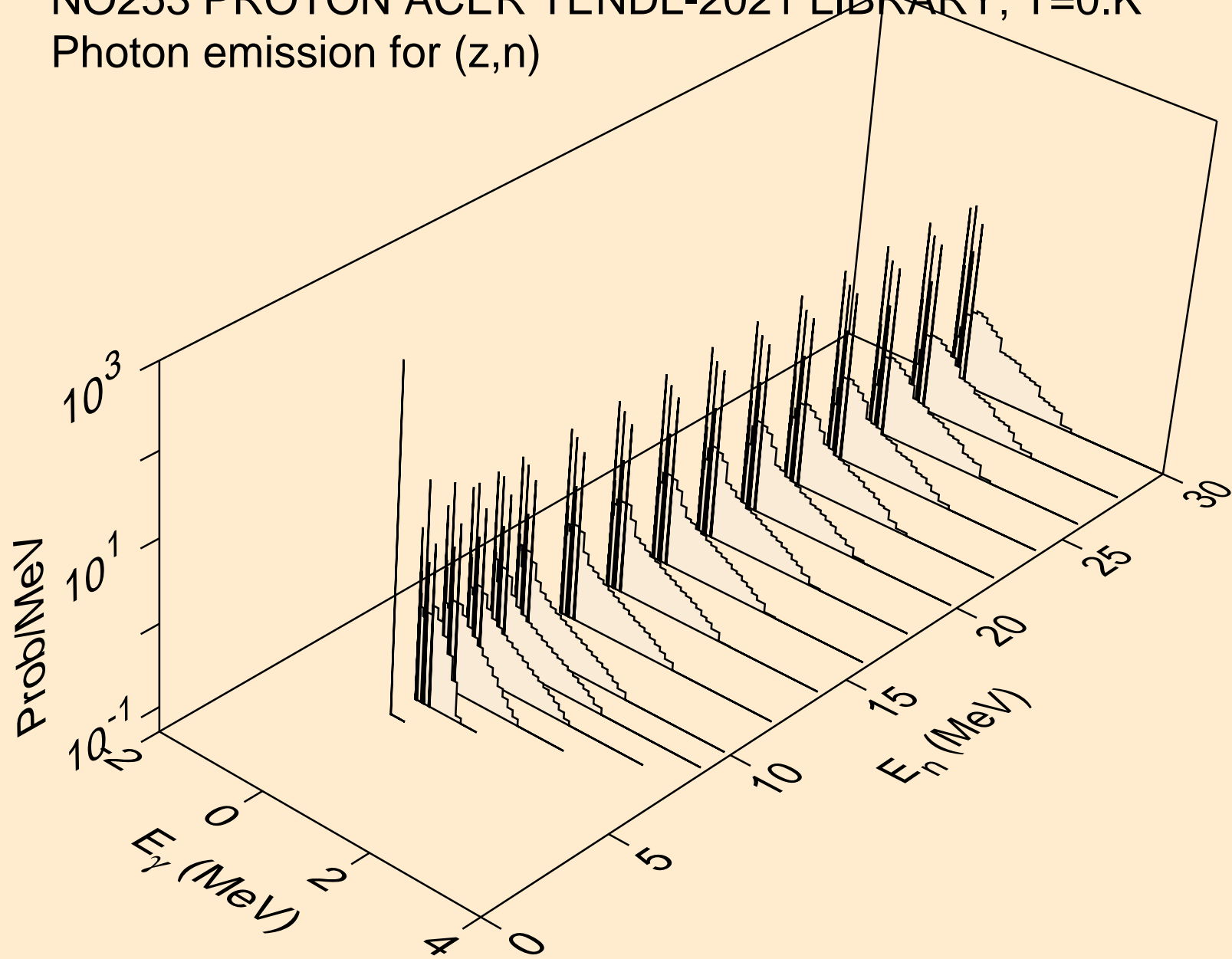



NO253 PROTON ACER TENDL-2021 LIBRARY; T=0.K  
Photon emission for (n,x)

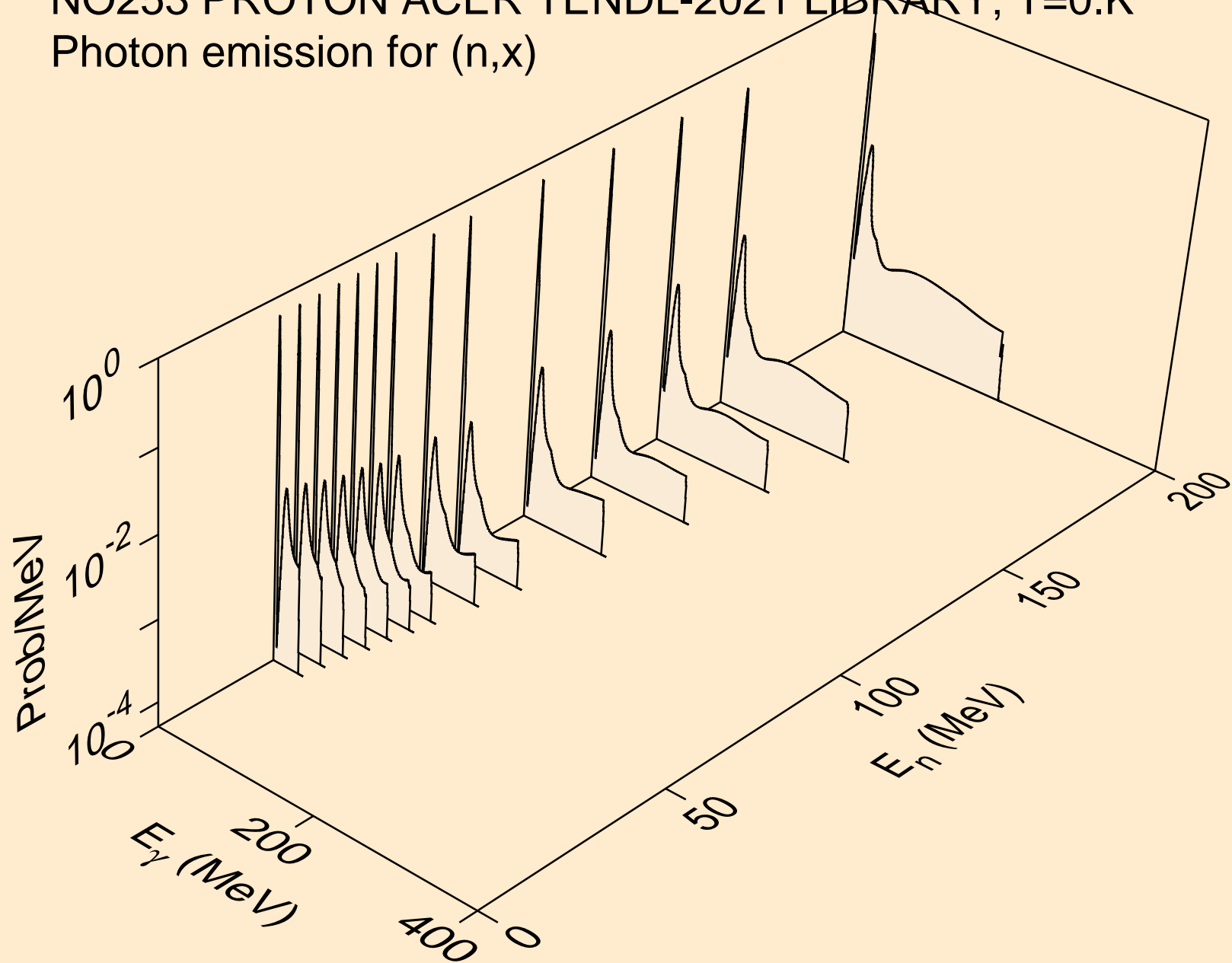

NO253 PROTON ACER TENDL-2021 LIBRARY; T=0.K  
Photon emission for (n,2n)

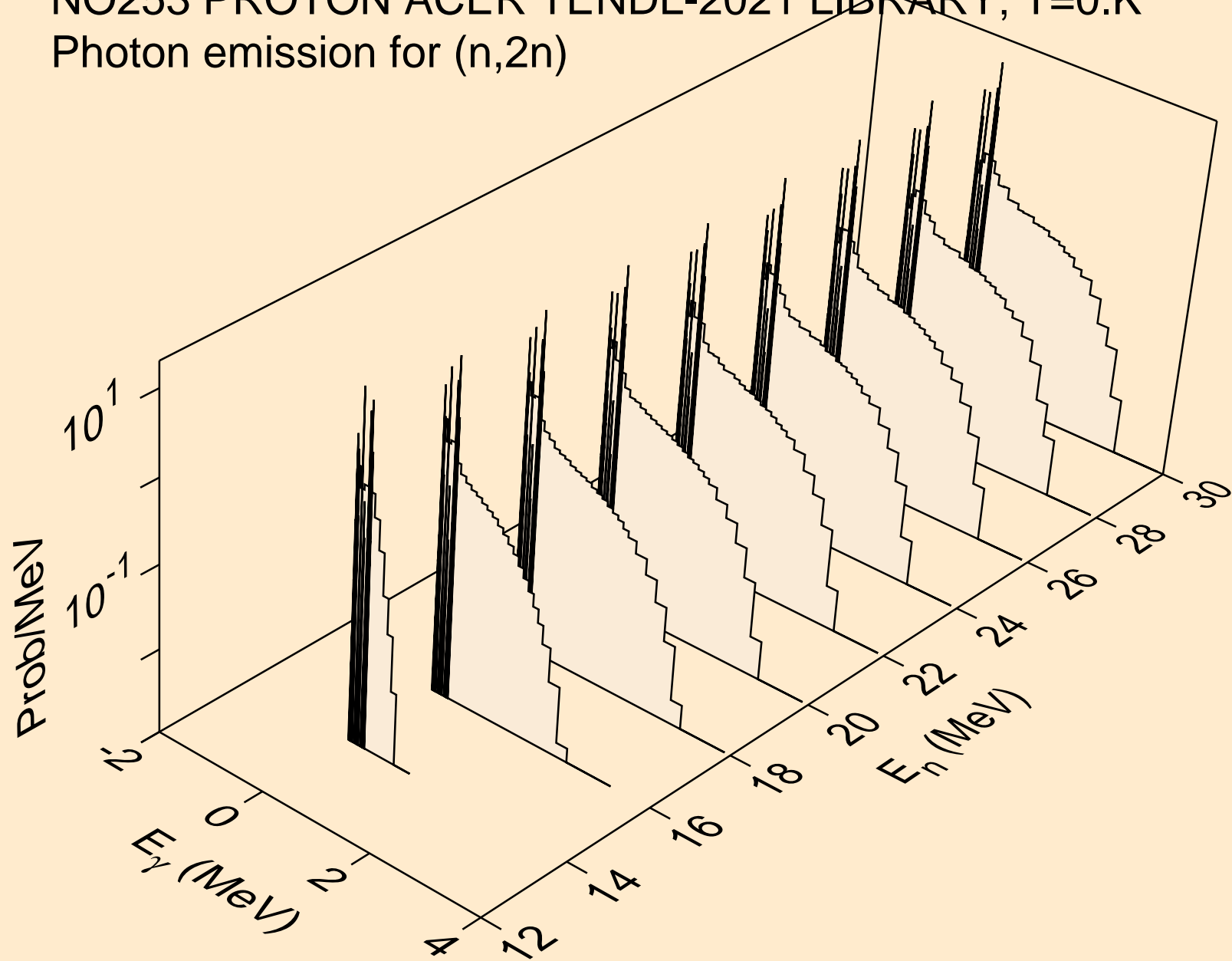

NO253 PROTON ACER TENDL-2021 LIBRARY; T=0.K  
Photon emission for (n,3n)

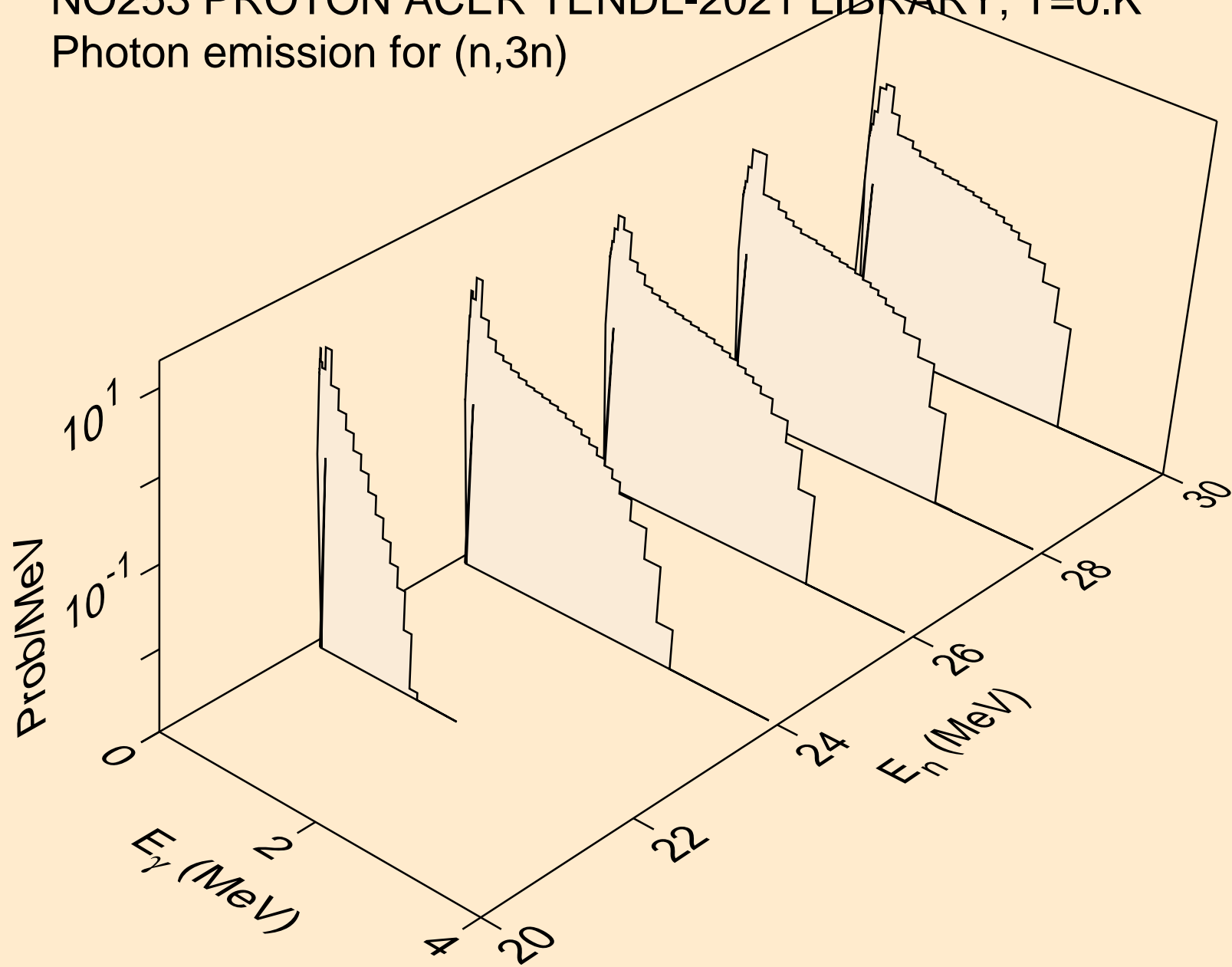

NO253 PROTON ACER TENDL-2021 LIBRARY; T=0.K  
Photon emission for (n,n\*)a

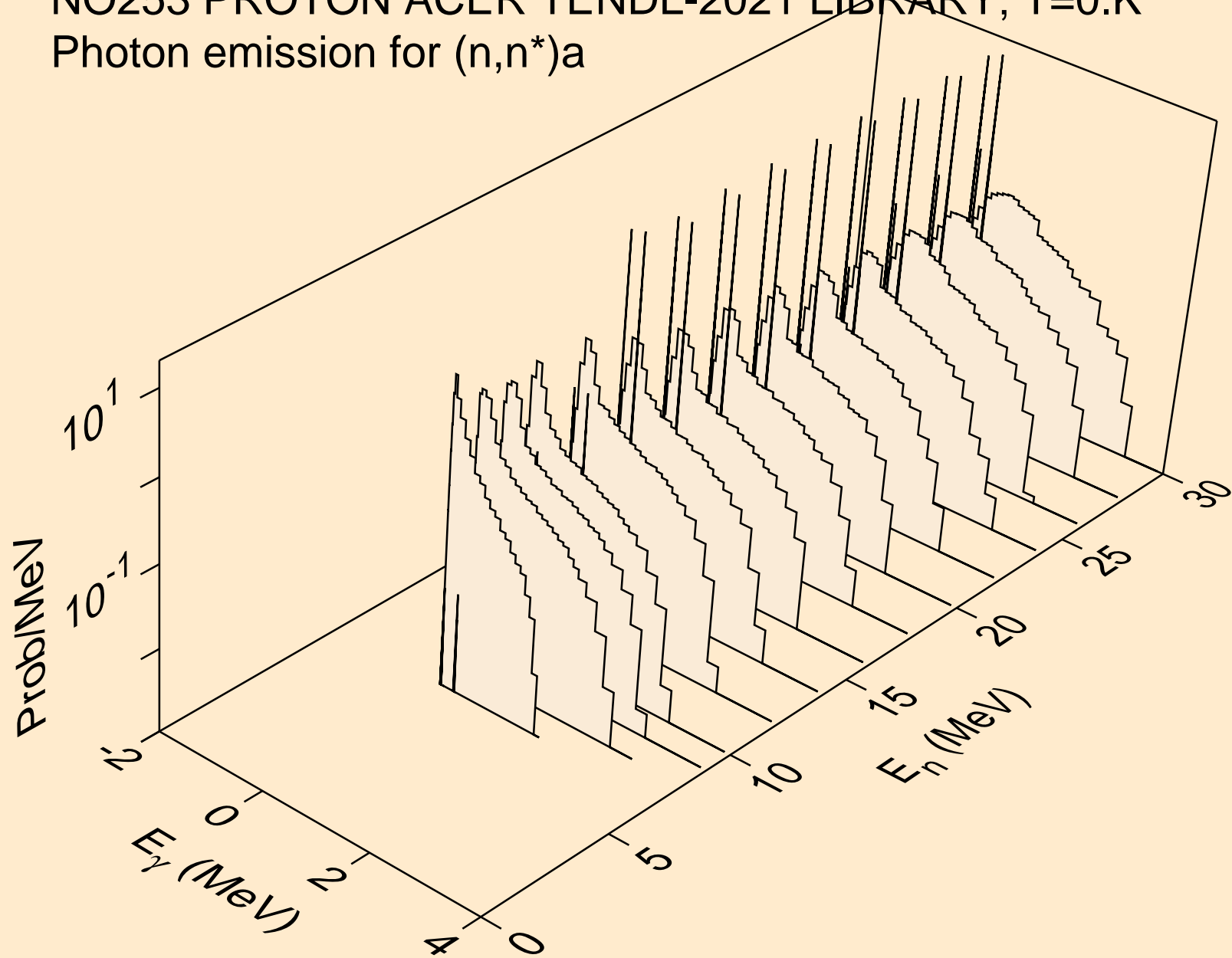

NO253 PROTON ACER TENDL-2021 LIBRARY; T=0.K  
Photon emission for (n,2n)a

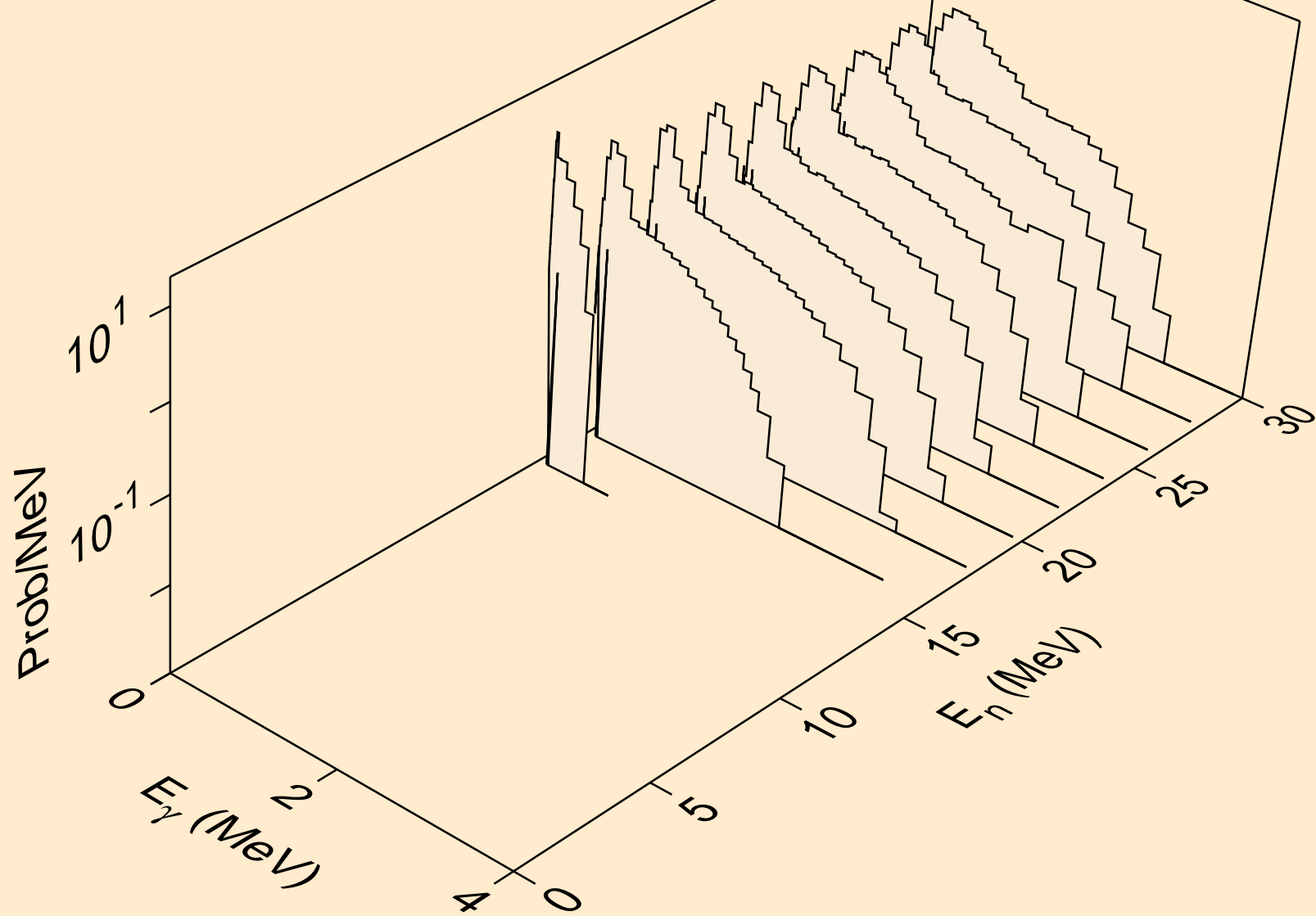

NO253 PROTON ACER TENDL-2021 LIBRARY; T=0.K  
Photon emission for (n,n\*)p

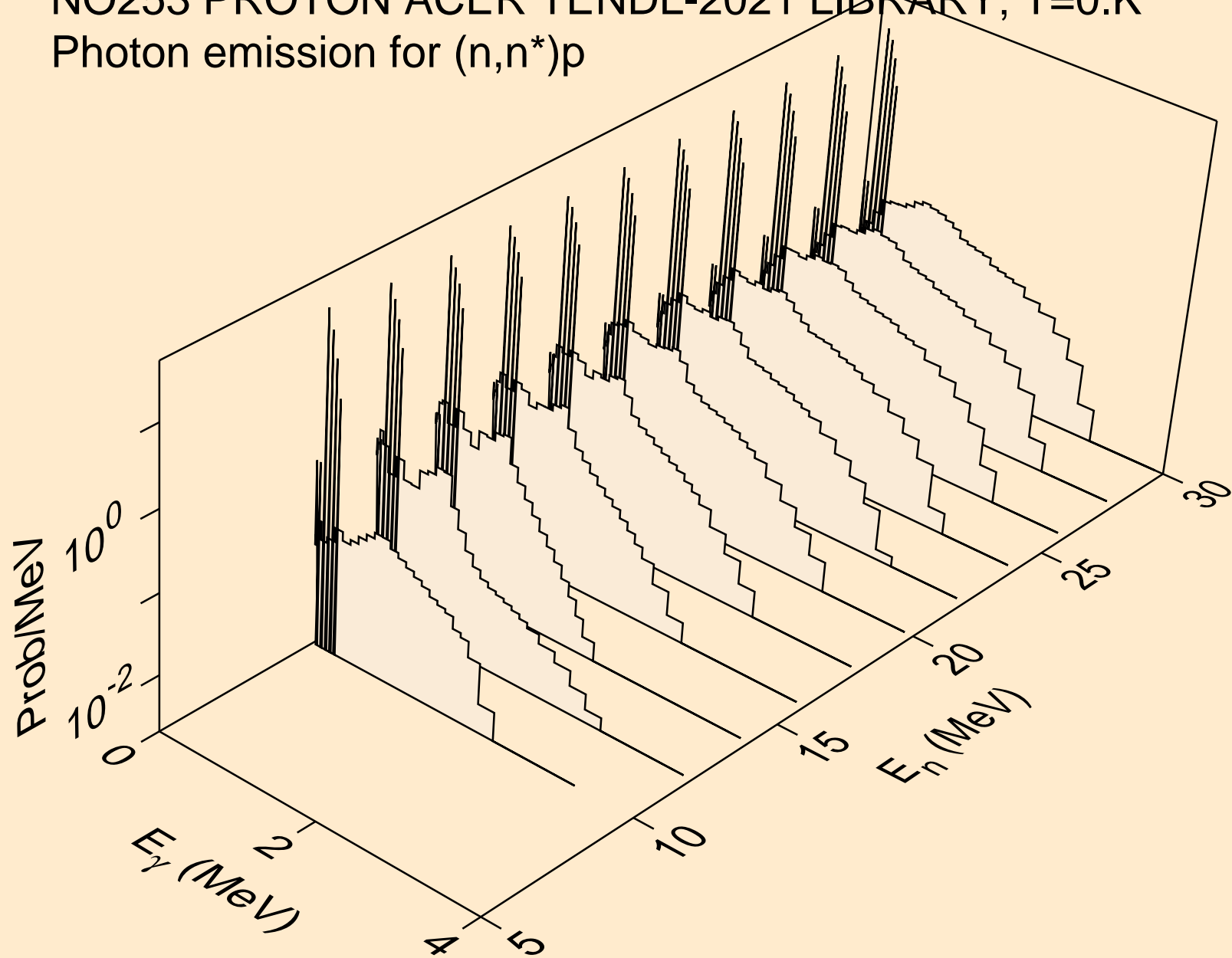

NO253 PROTON ACER TENDL-2021 LIBRARY; T=0.K  
Photon emission for (n,n\*)d

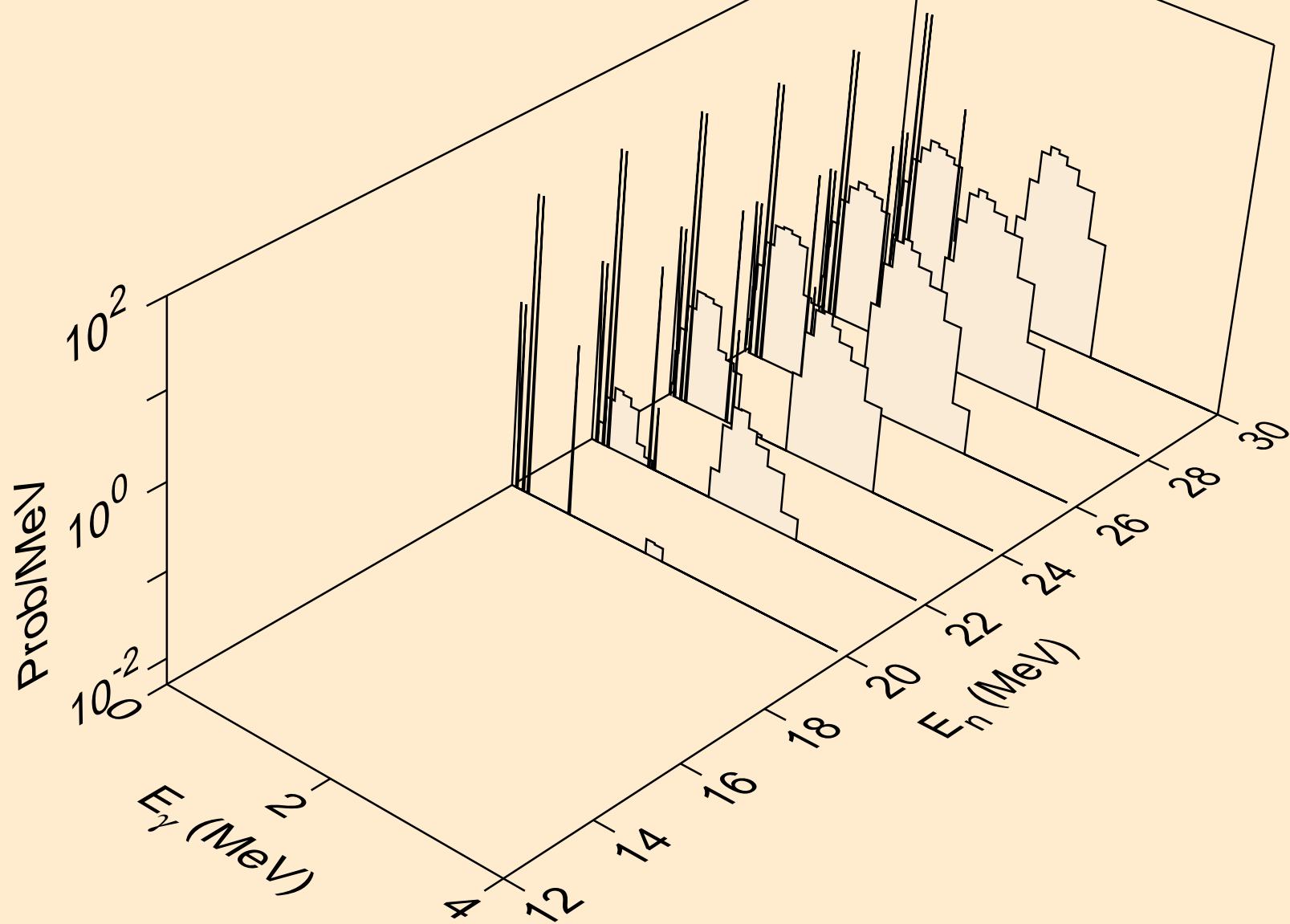

NO253 PROTON ACER TENDL-2021 LIBRARY; T=0.K  
Photon emission for (n,n\*)t

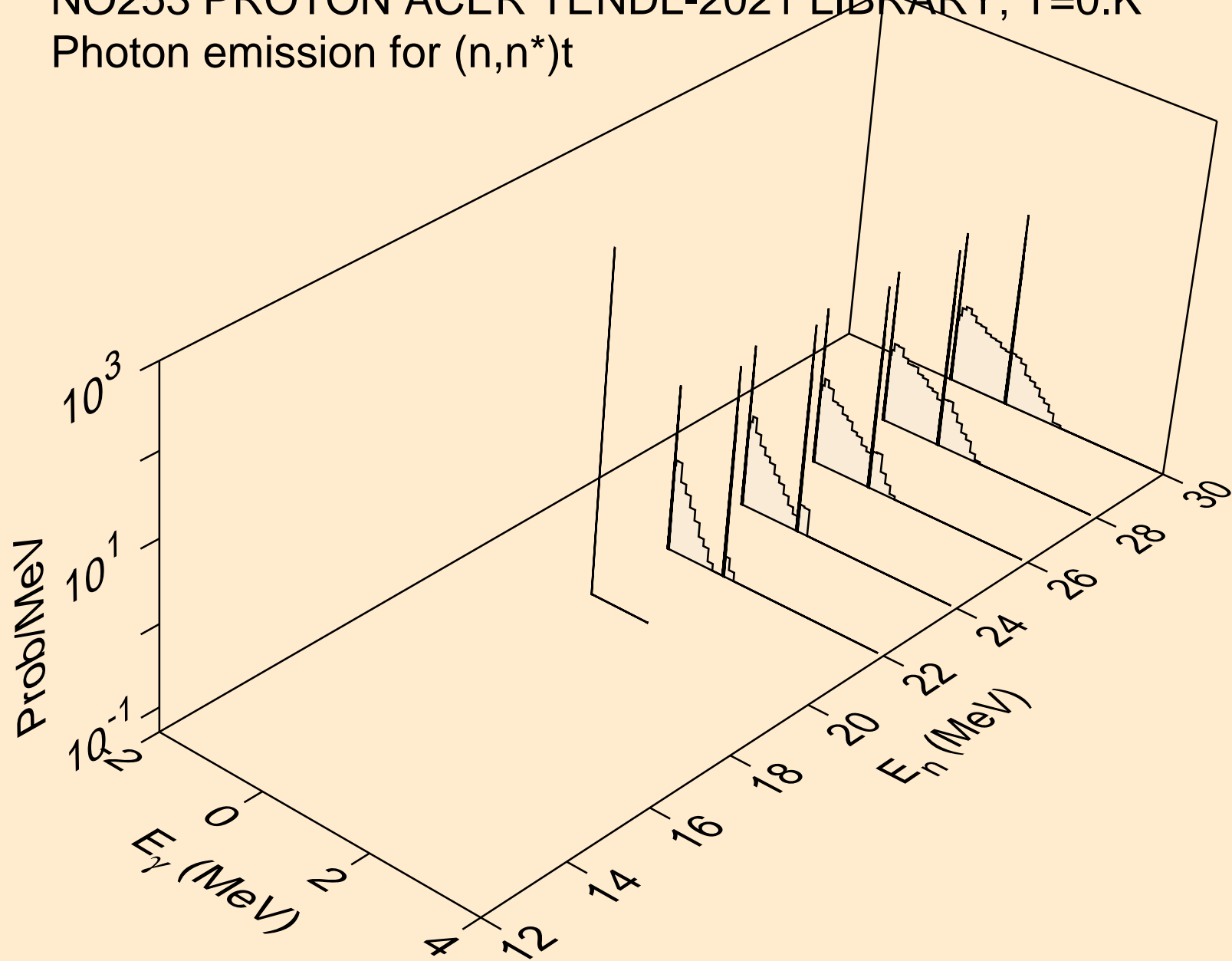



NO253 PROTON ACER TENDL-2021 LIBRARY; T=0.K  
Photon emission for (n,2np)

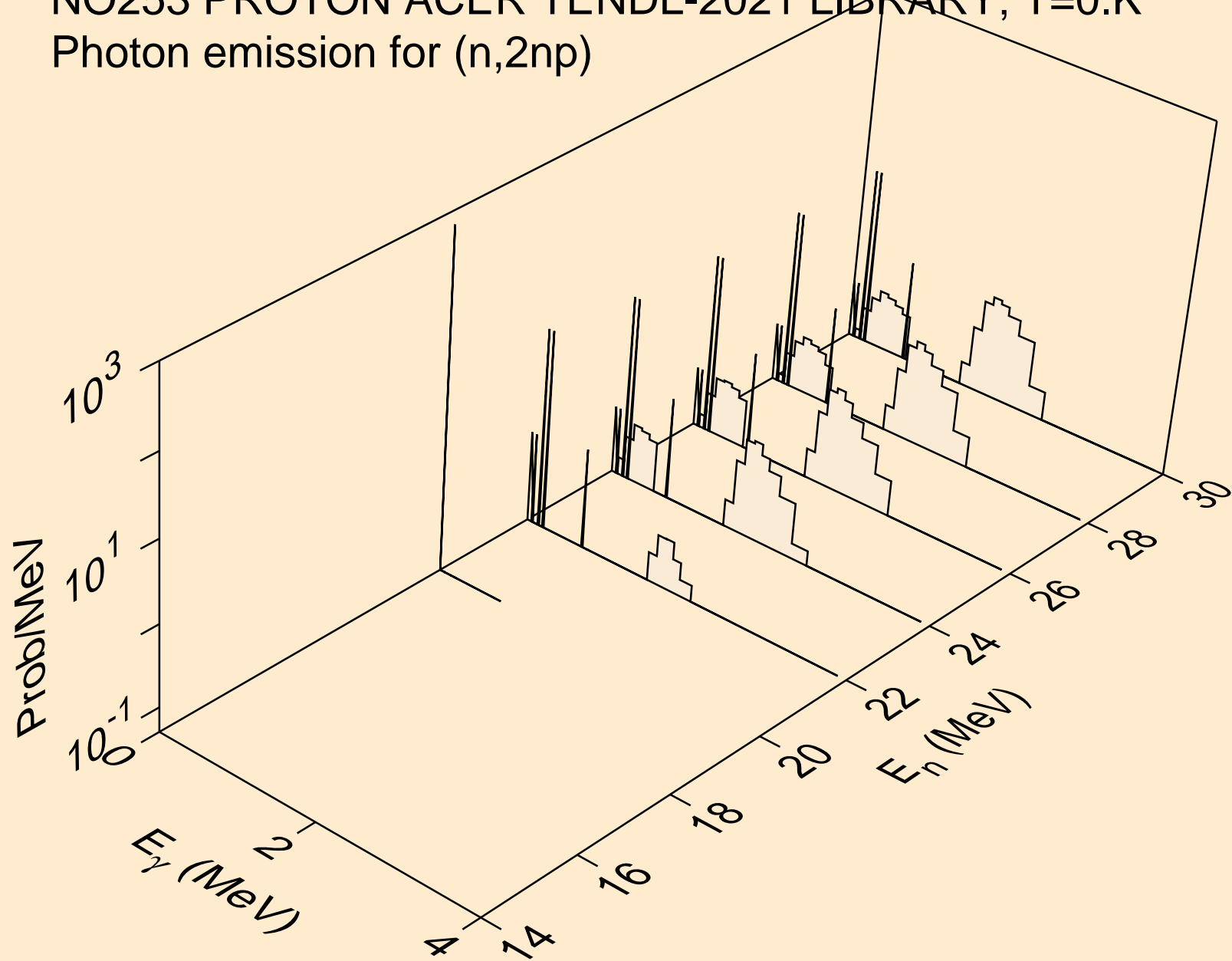

NO253 PROTON ACER TENDL-2021 LIBRARY; T=0.K  
Photon emission for (n,npa)

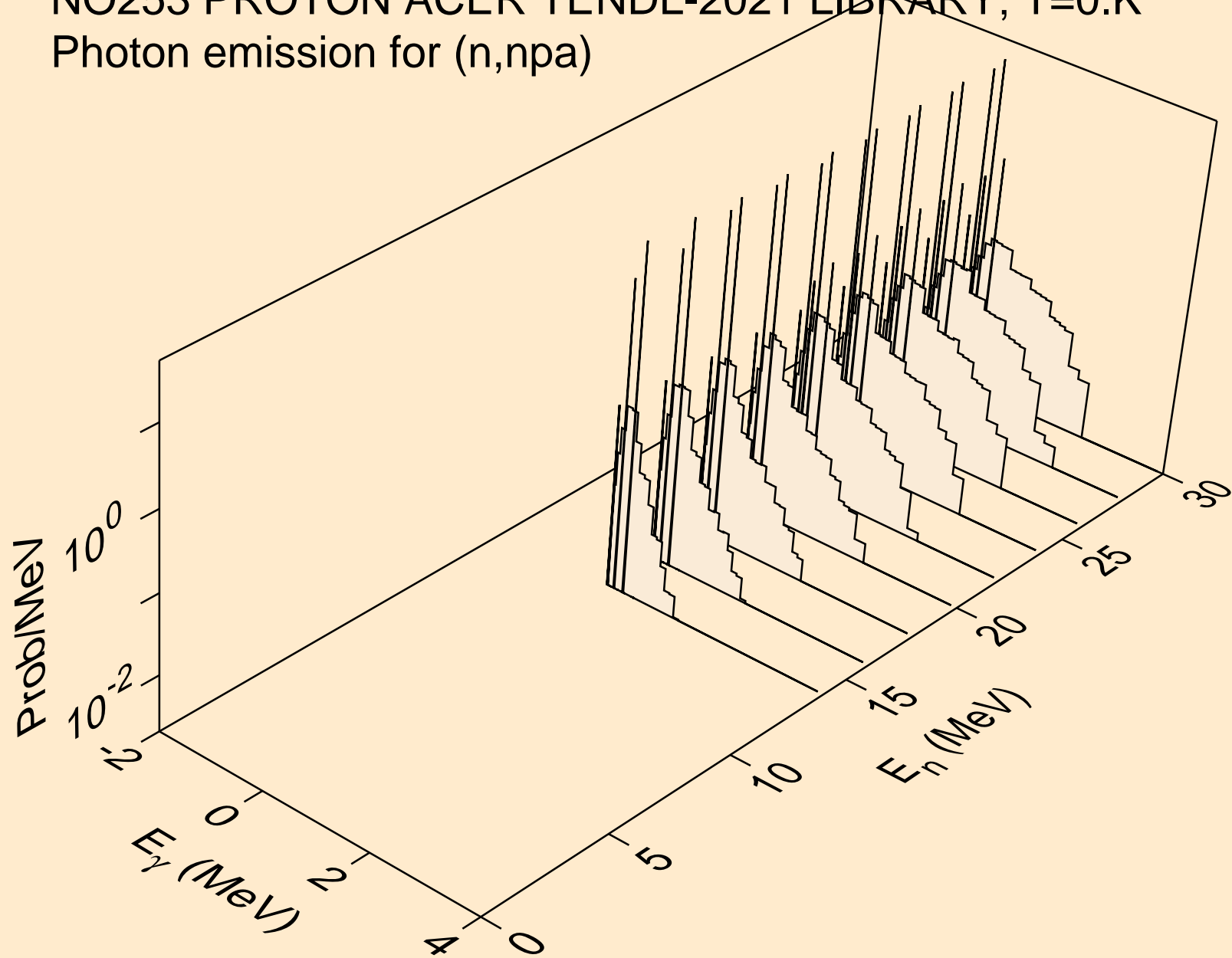

NO253 PROTON ACER TENDL-2021 LIBRARY; T=0.K  
Photon emission for (n,gma)

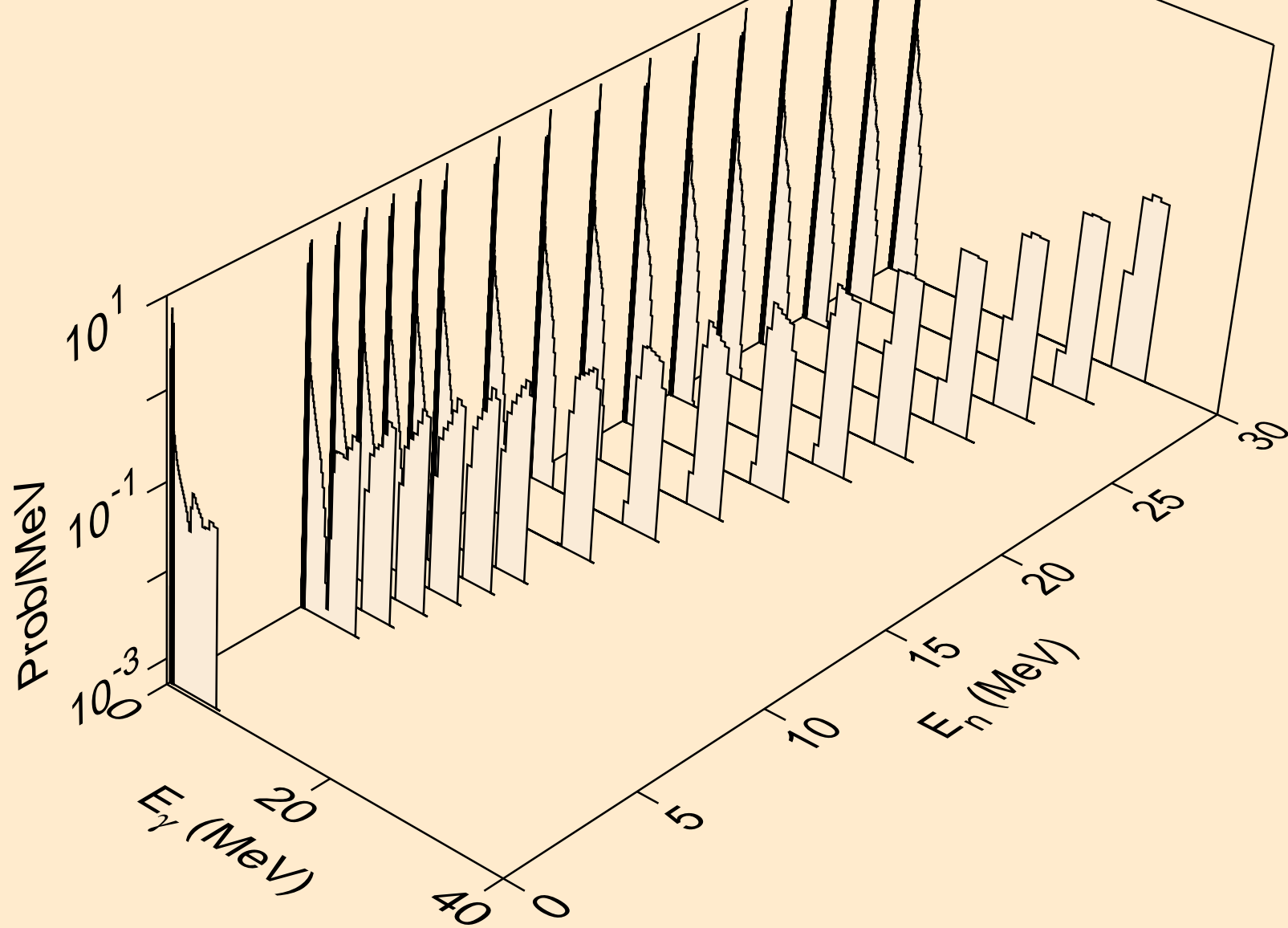

NO253 PROTON ACER TENDL-2021 LIBRARY; T=0.K  
Photon emission for inelastic

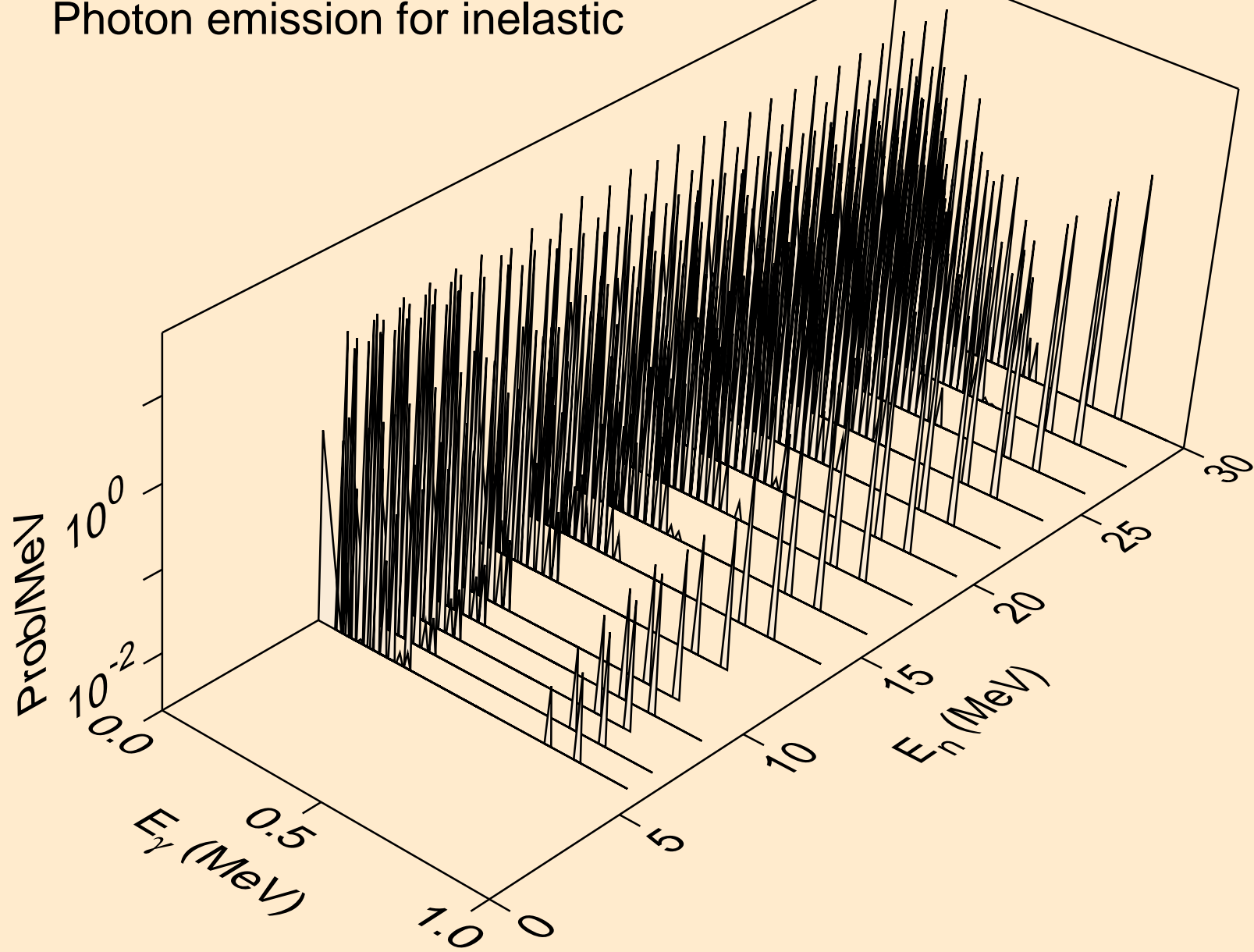

NO253 PROTON ACER TENDL-2021 LIBRARY; T=0.K  
Photon emission for (n,d)

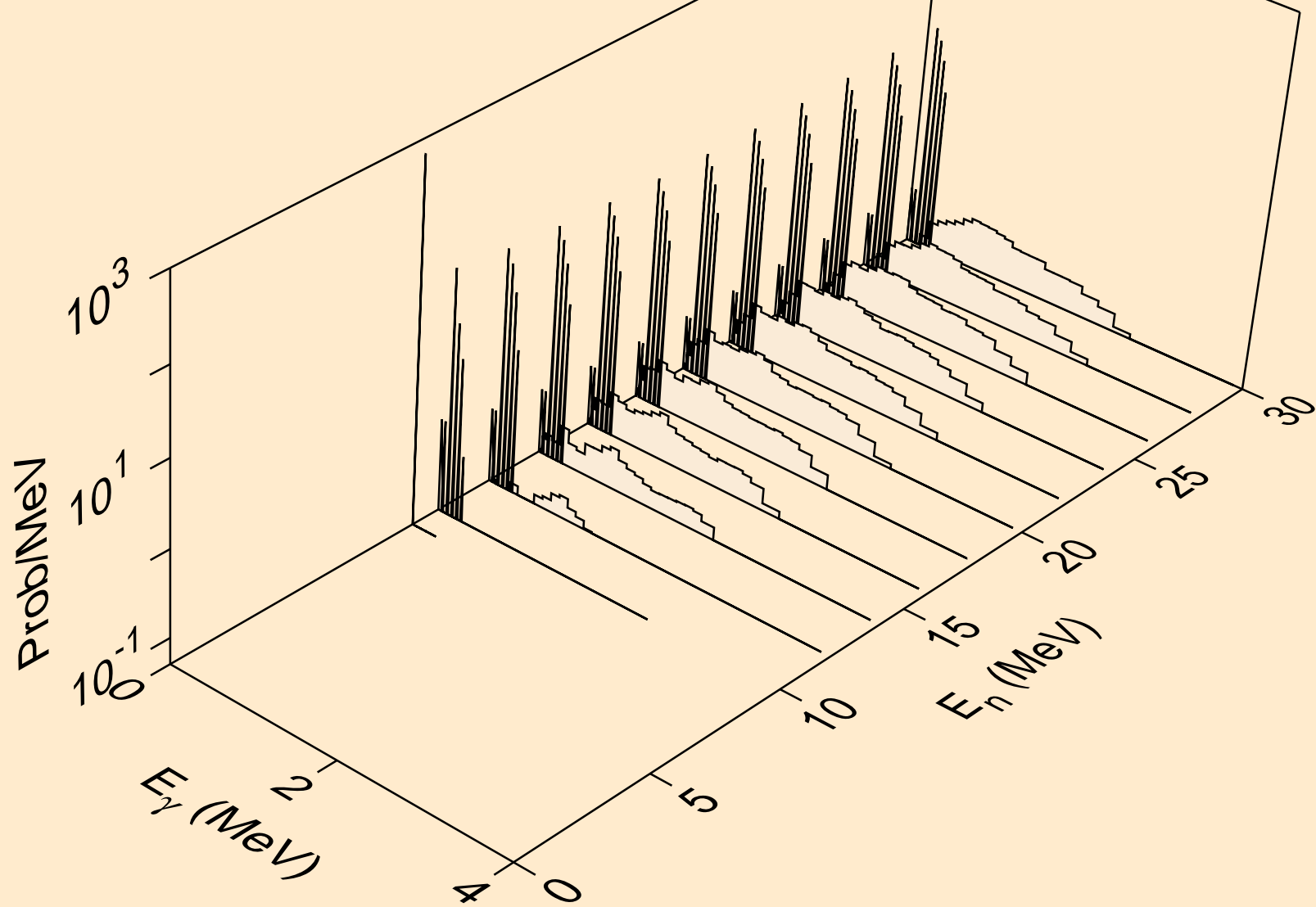

NO253 PROTON ACER TENDL-2021 LIBRARY; T=0.K  
Photon emission for (n,t)

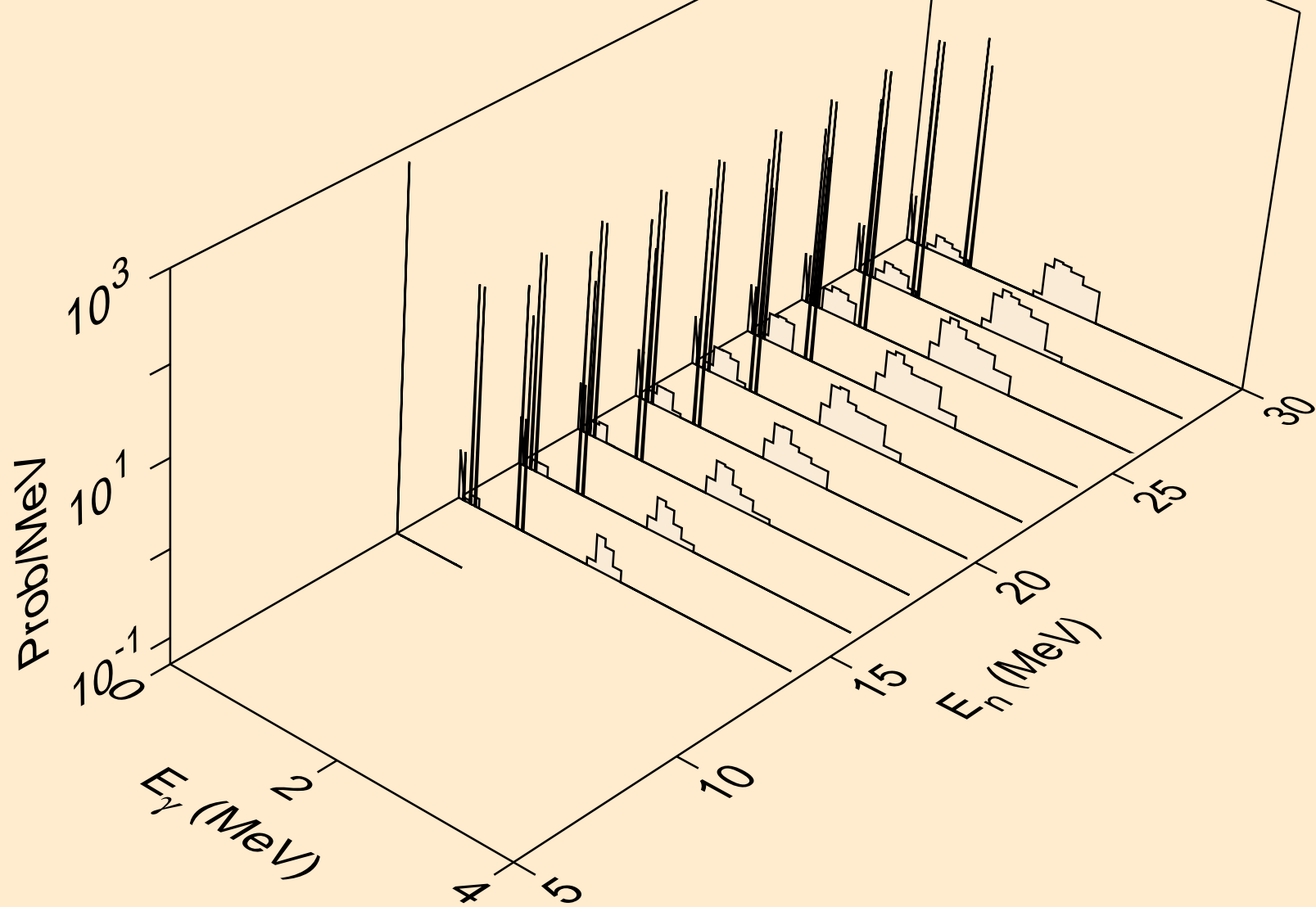

NO253 PROTON ACER TENDL-2021 LIBRARY; T=0.K  
Photon emission for (n,he3)

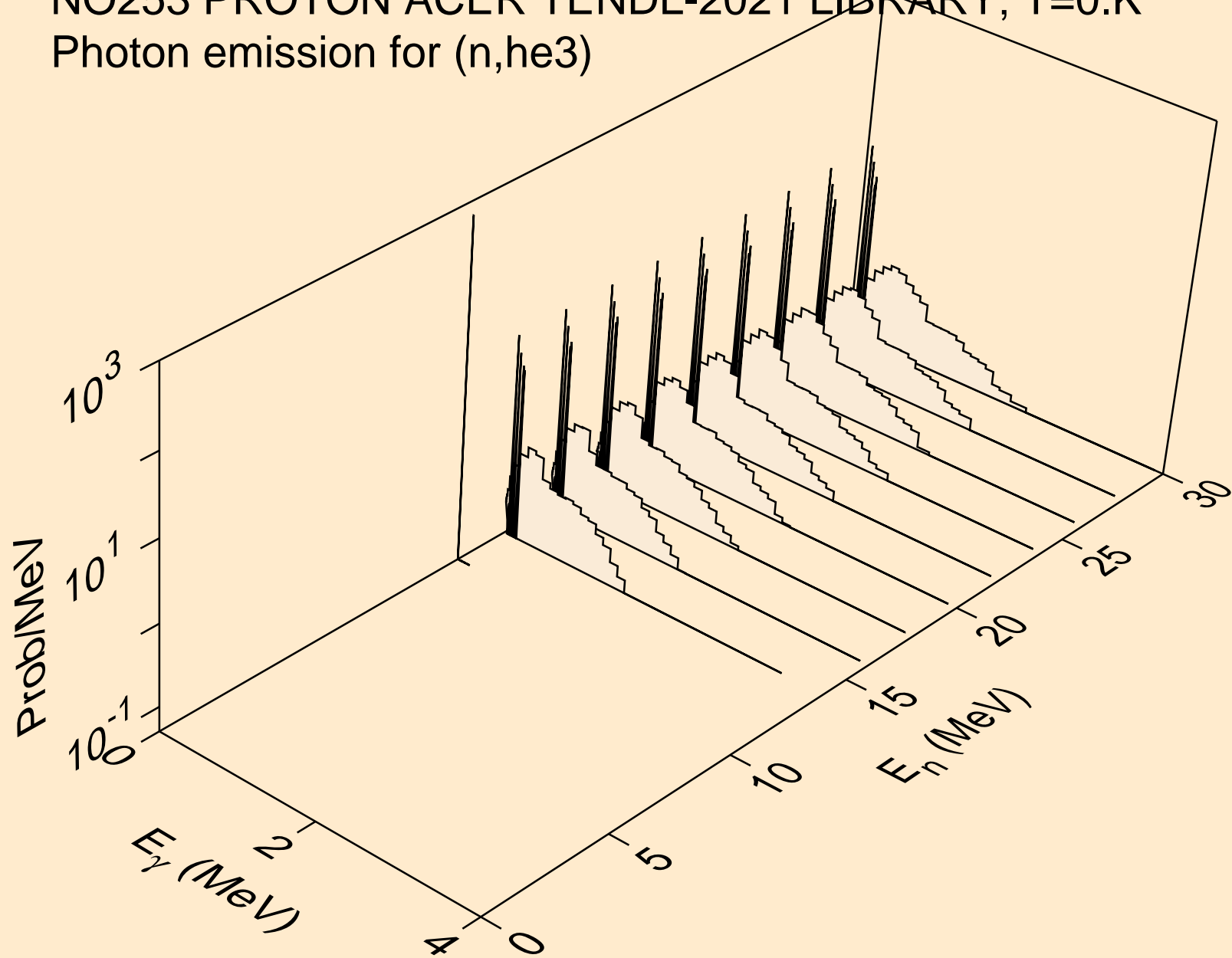

NO253 PROTON ACER TENDL-2021 LIBRARY; T=0.K  
Photon emission for (n,a)

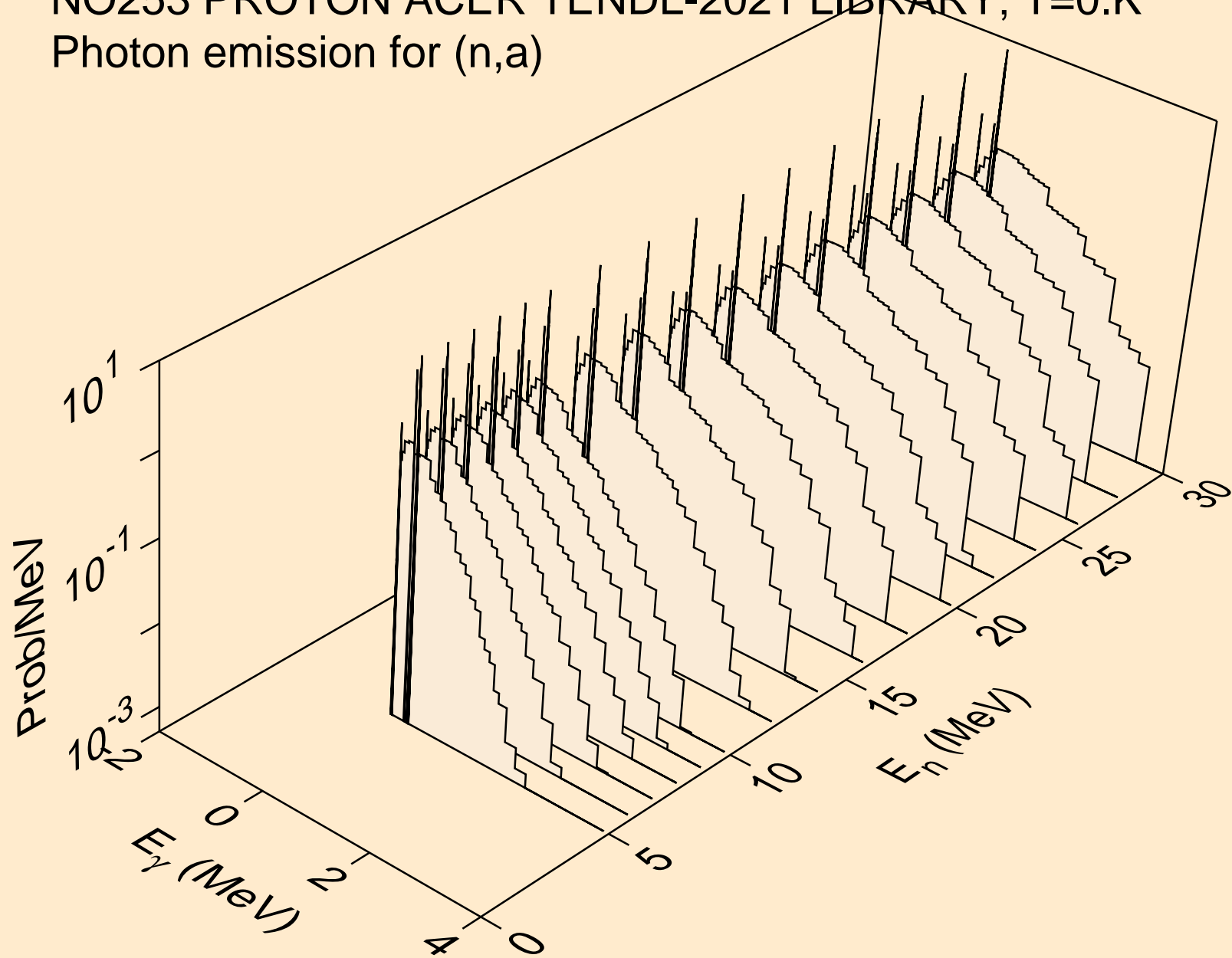



NO253 PROTON ACER TENDL-2021 LIBRARY; T=0.K  
Photon emission for (n,2p)

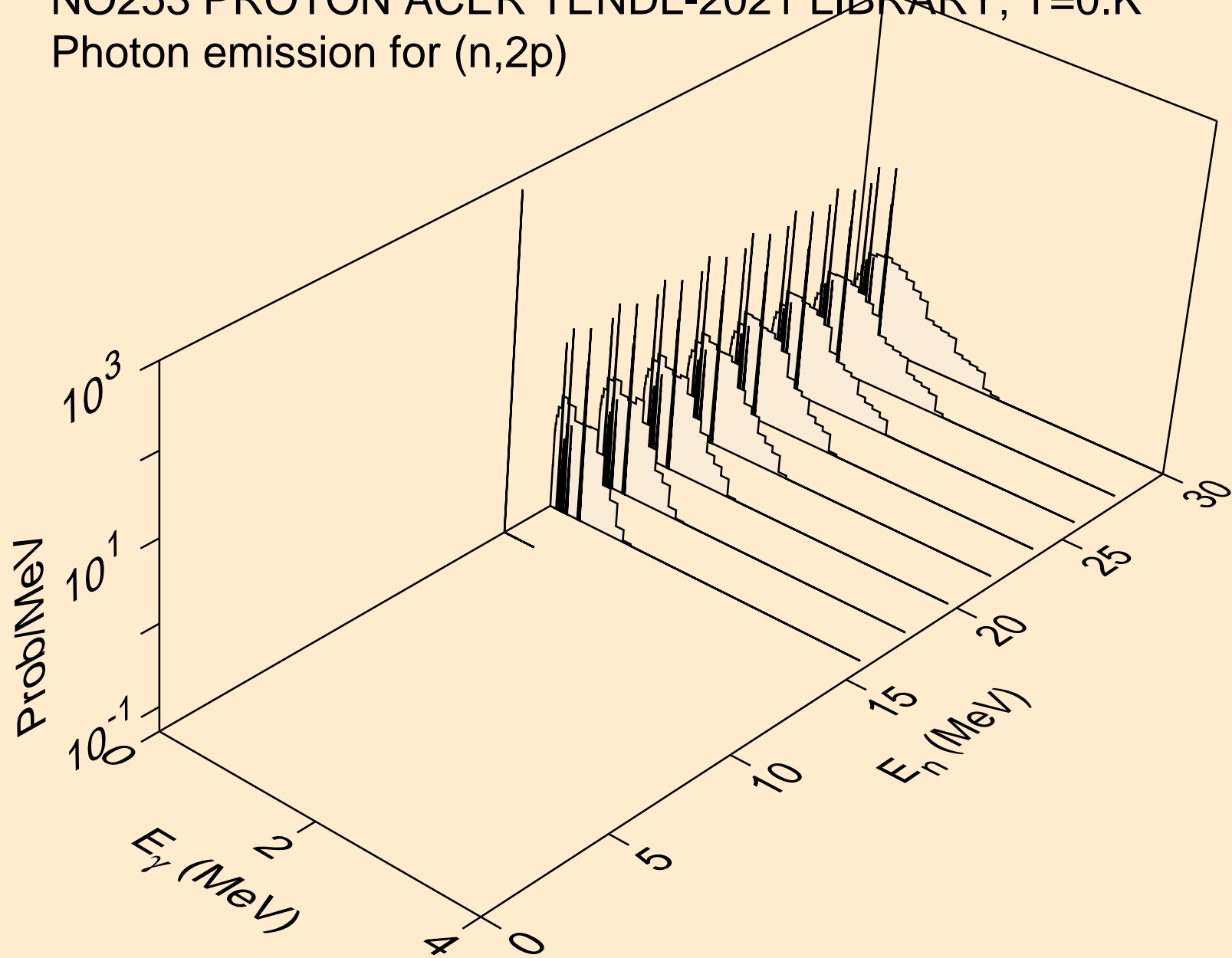

NO253 PROTON ACER TENDL-2021 LIBRARY; T=0.K  
Photon emission for (n,da)

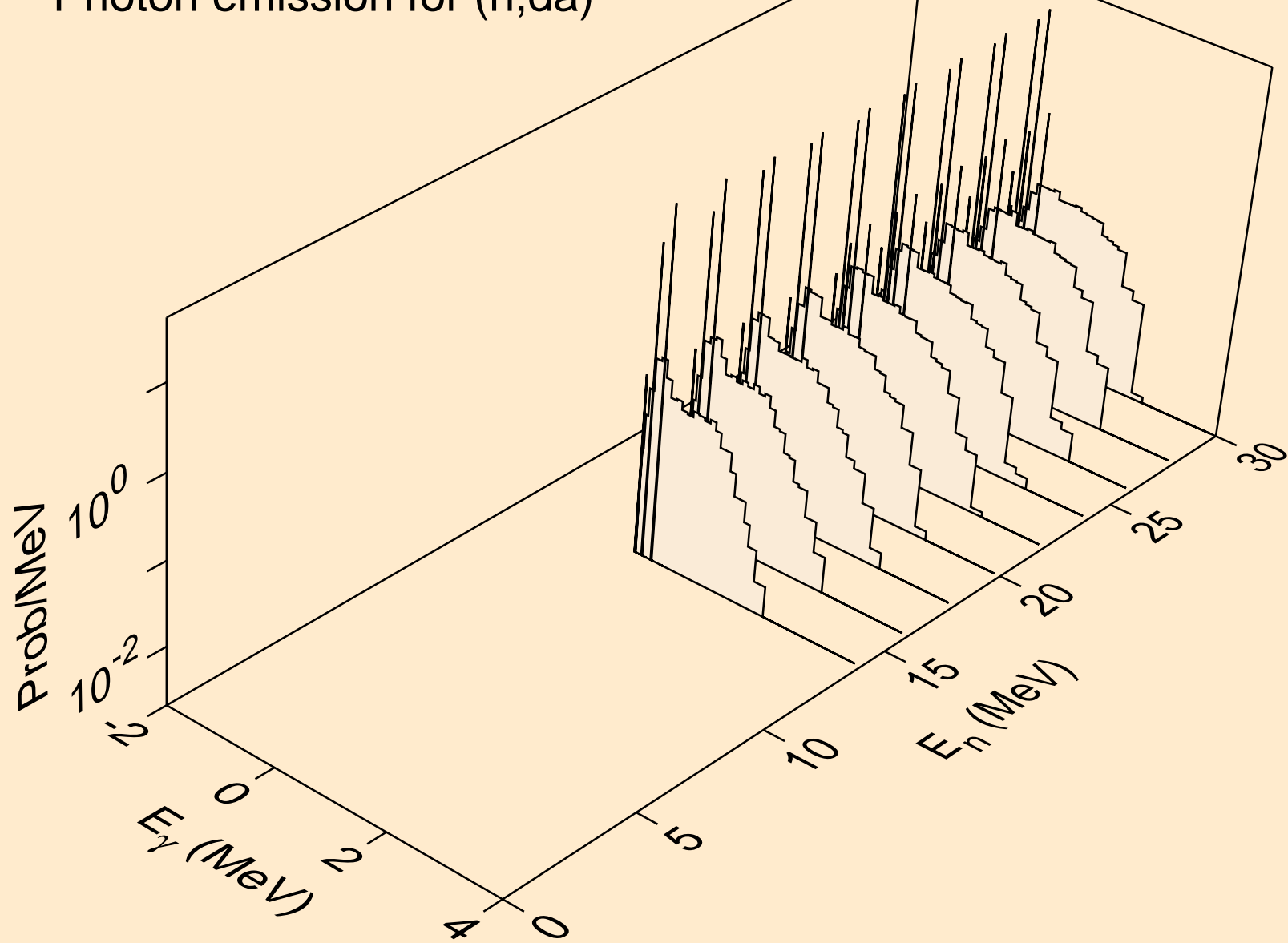

NO253 PROTON ACER TENDL-2021 LIBRARY; T=0.K  
Particle heating contributions

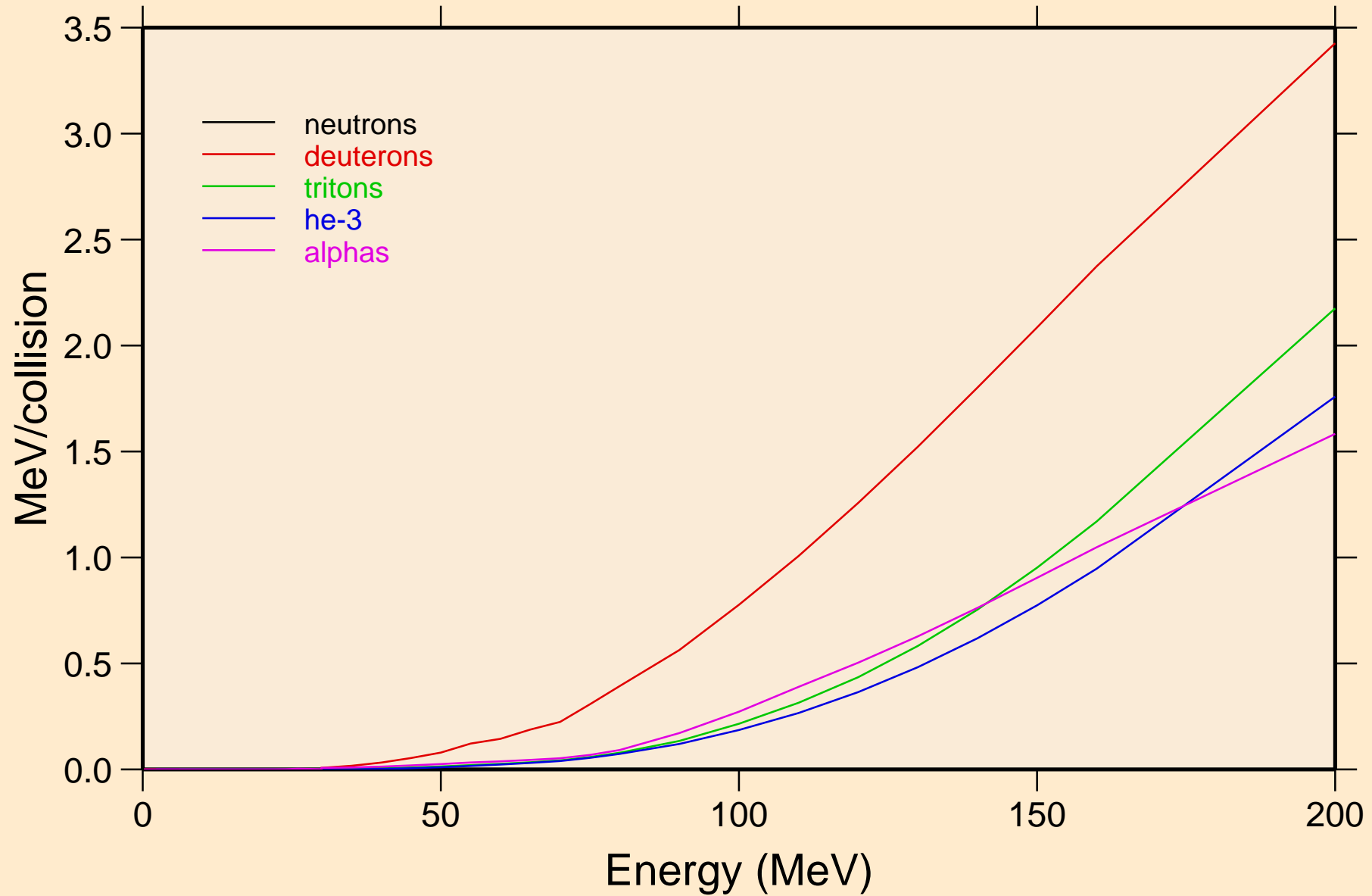

NO253 PROTON ACER TENDL-2021 LIBRARY; T=0.K  
Recoil Heating

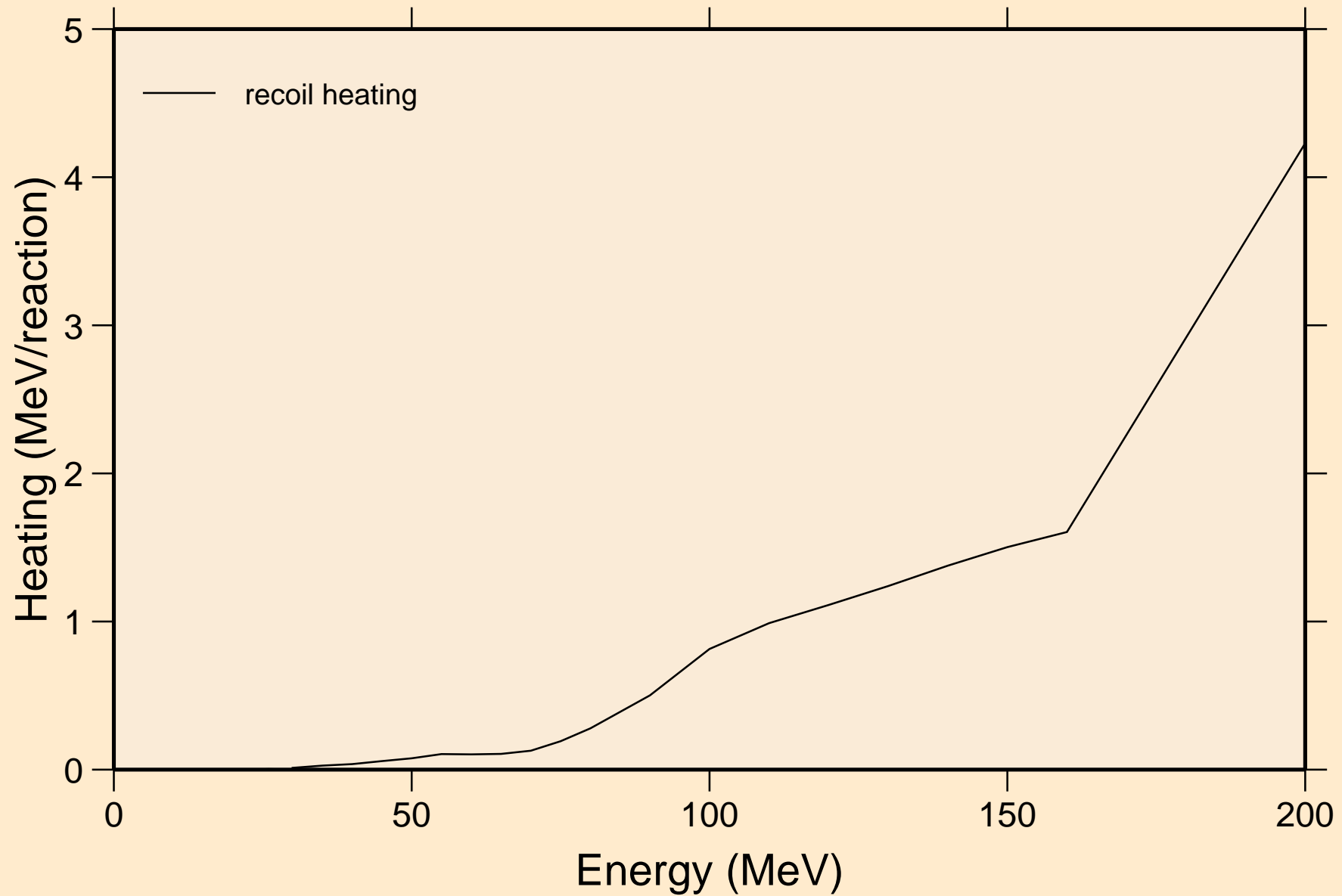

NO253 PROTON ACER TENDL-2021 LIBRARY; T=0.K  
Particle production cross sections

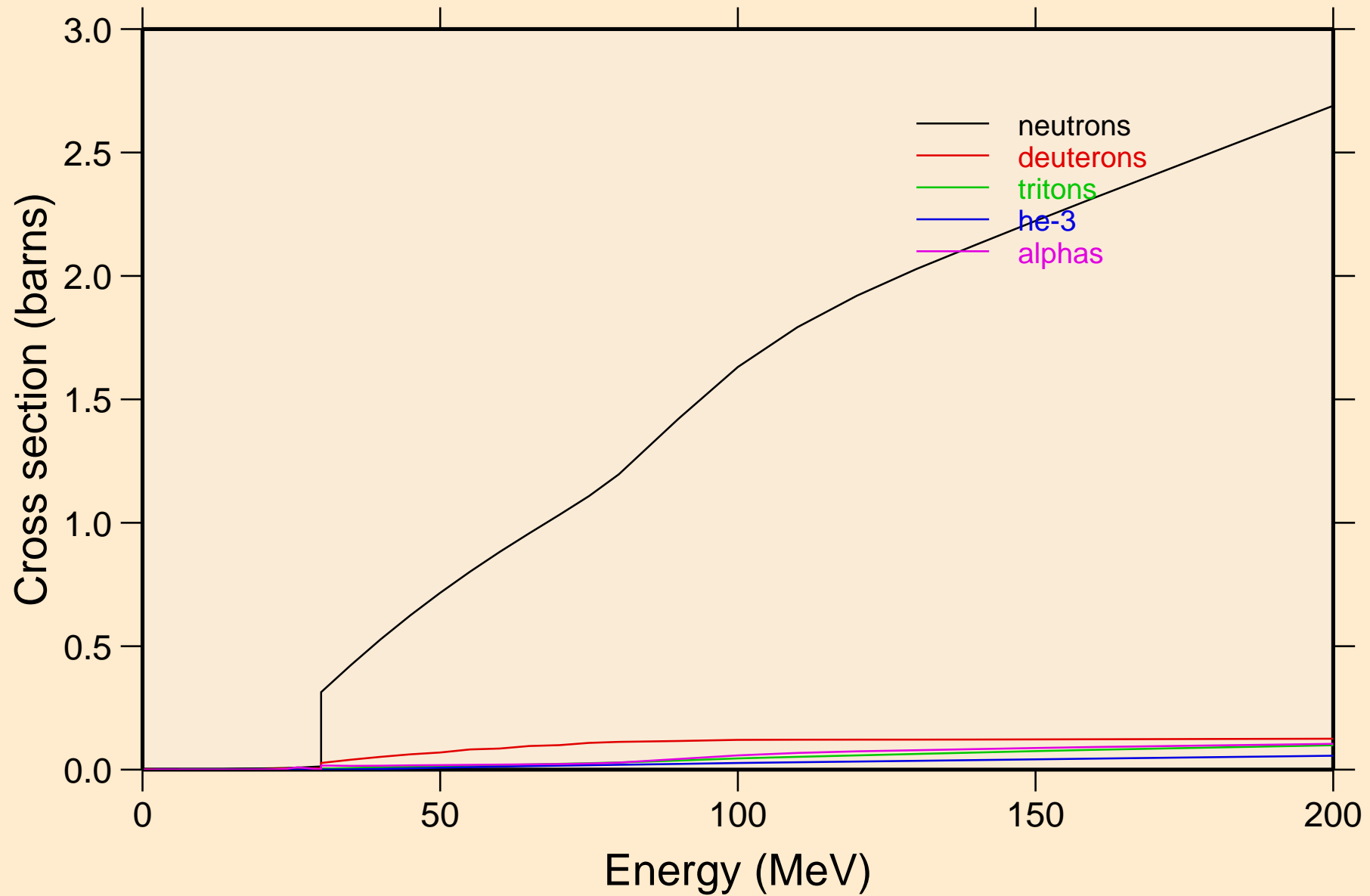

NO253 PROTON ACER TENDL-2021 LIBRARY; T=0.K  
neutrons from (p,n)

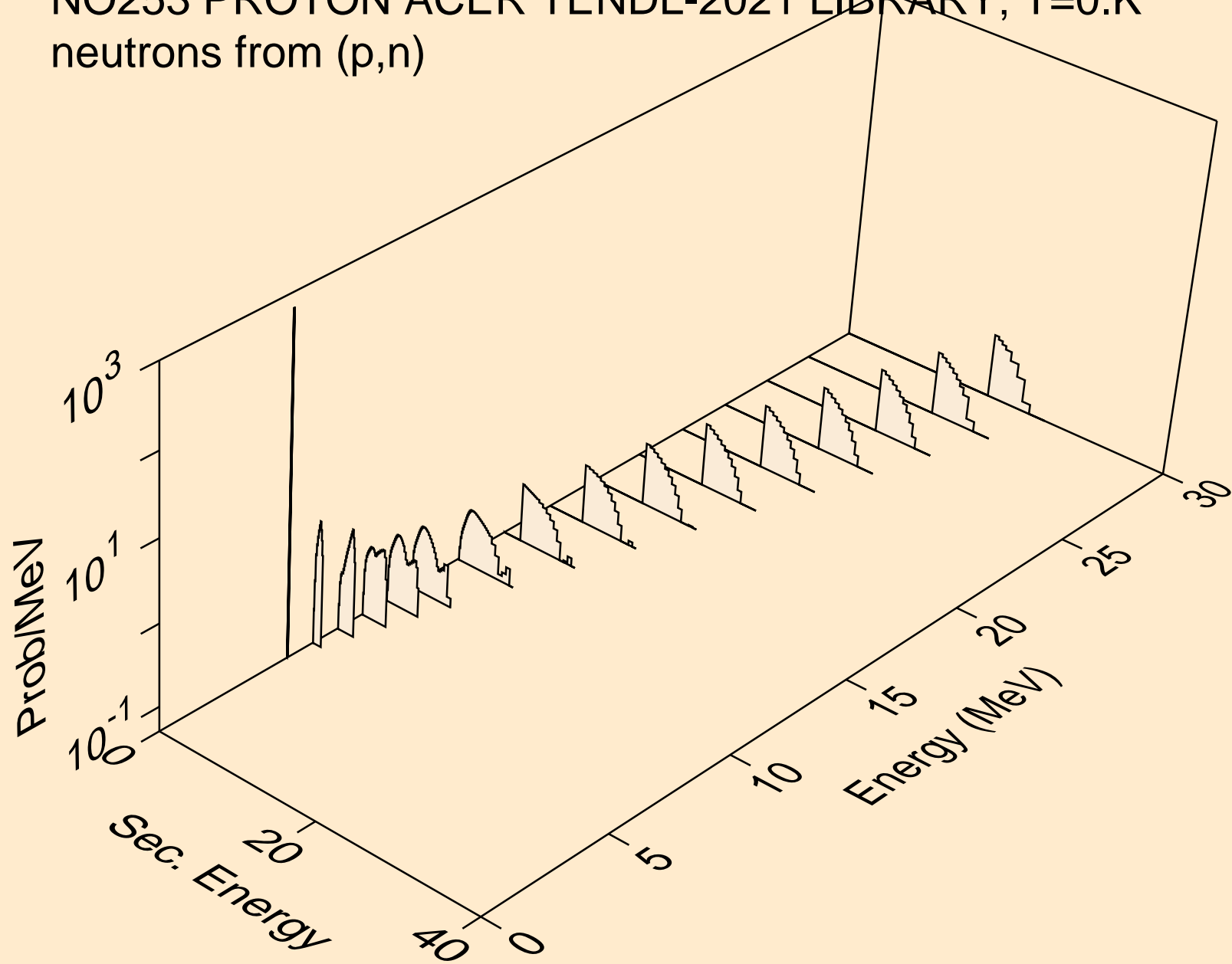

NO253 PROTON ACER TENDL-2021 LIBRARY; T=0.K  
neutrons from (p,x)

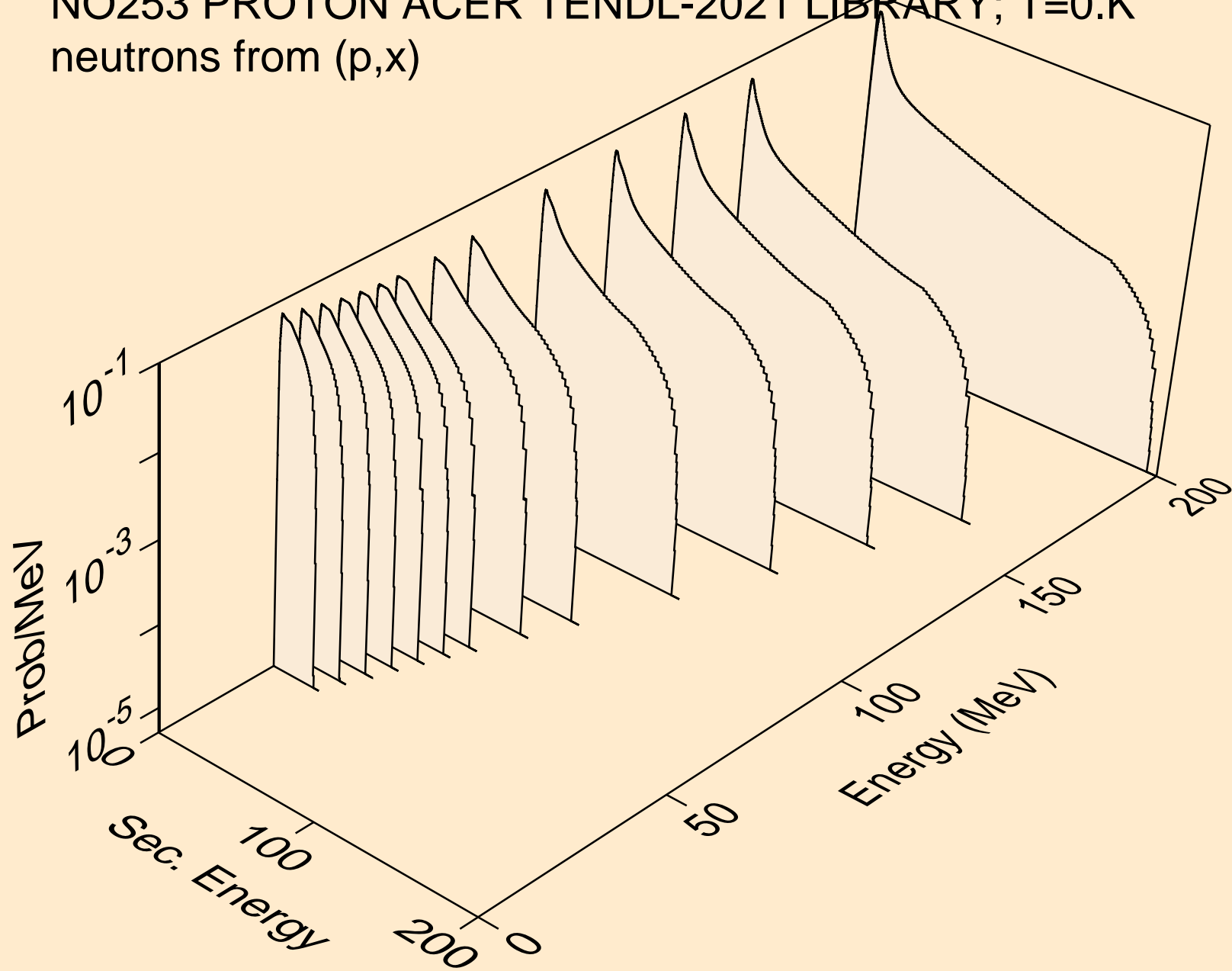

NO253 PROTON ACER TENDL-2021 LIBRARY; T=0.K  
neutrons from (p,2n)

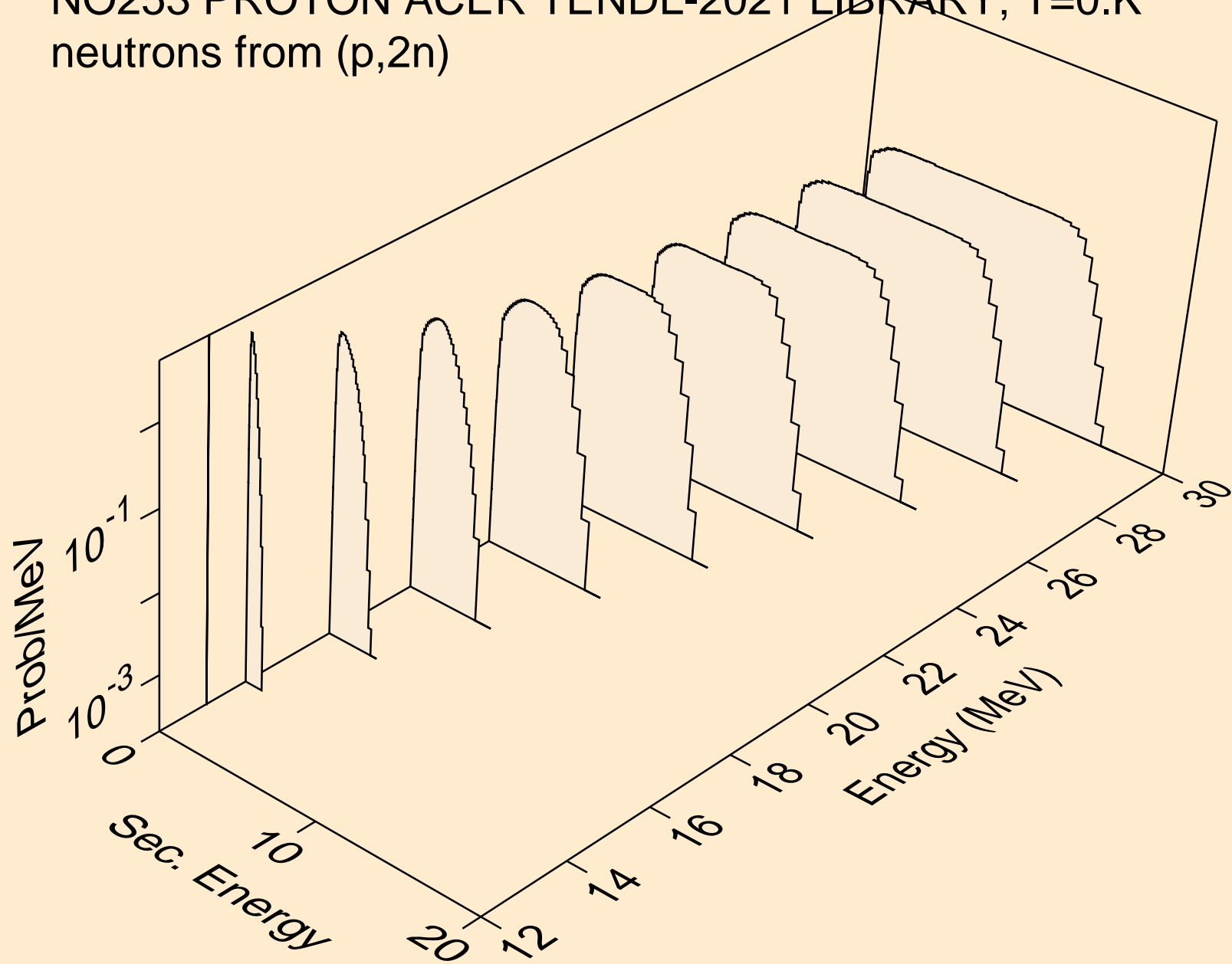



NO253 PROTON ACER TENDL-2021 LIBRARY; T=0.K  
neutrons from (p,3n)

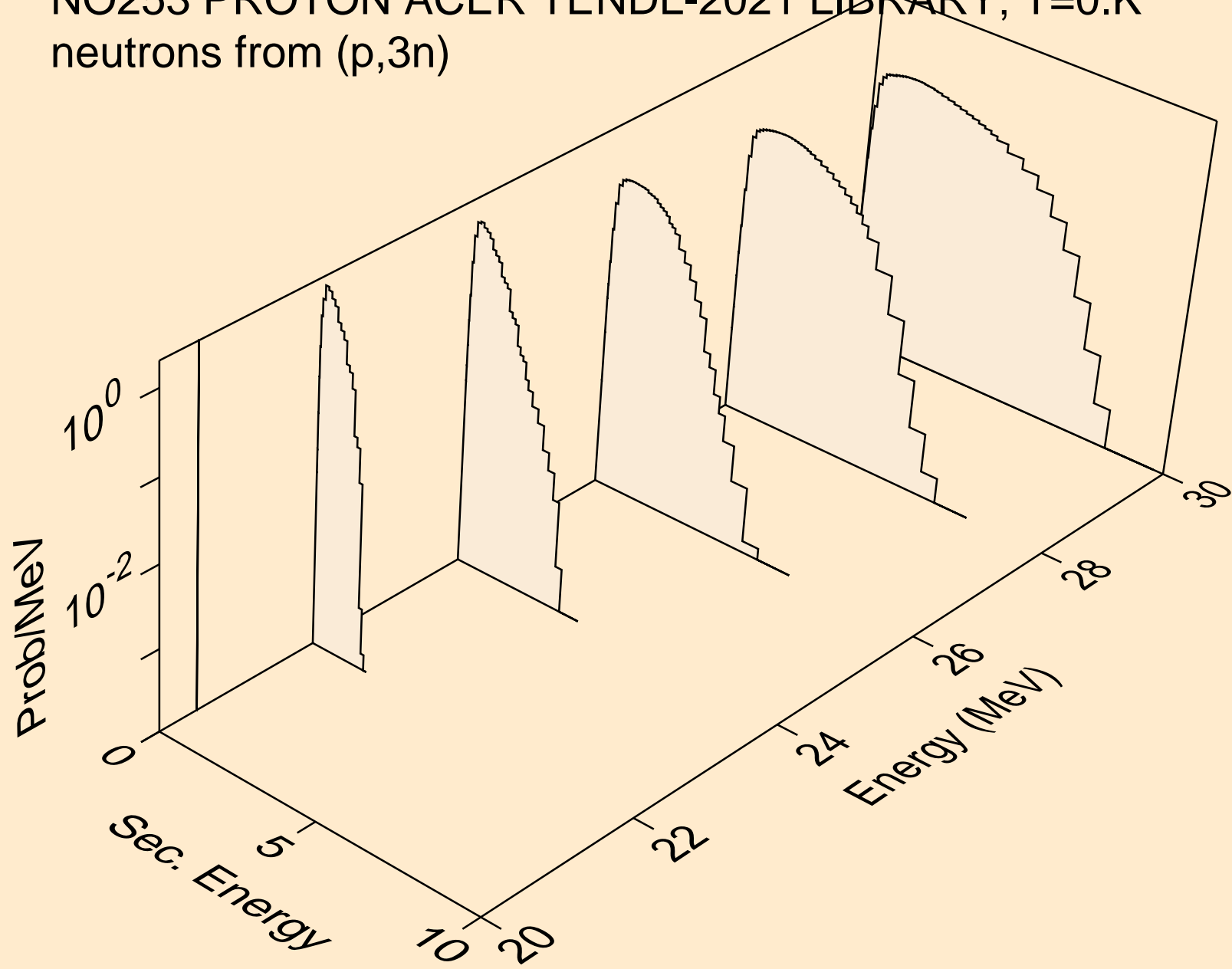

NO253 PROTON ACER TENDL-2021 LIBRARY; T=0.K  
neutrons from (p,n\*)a

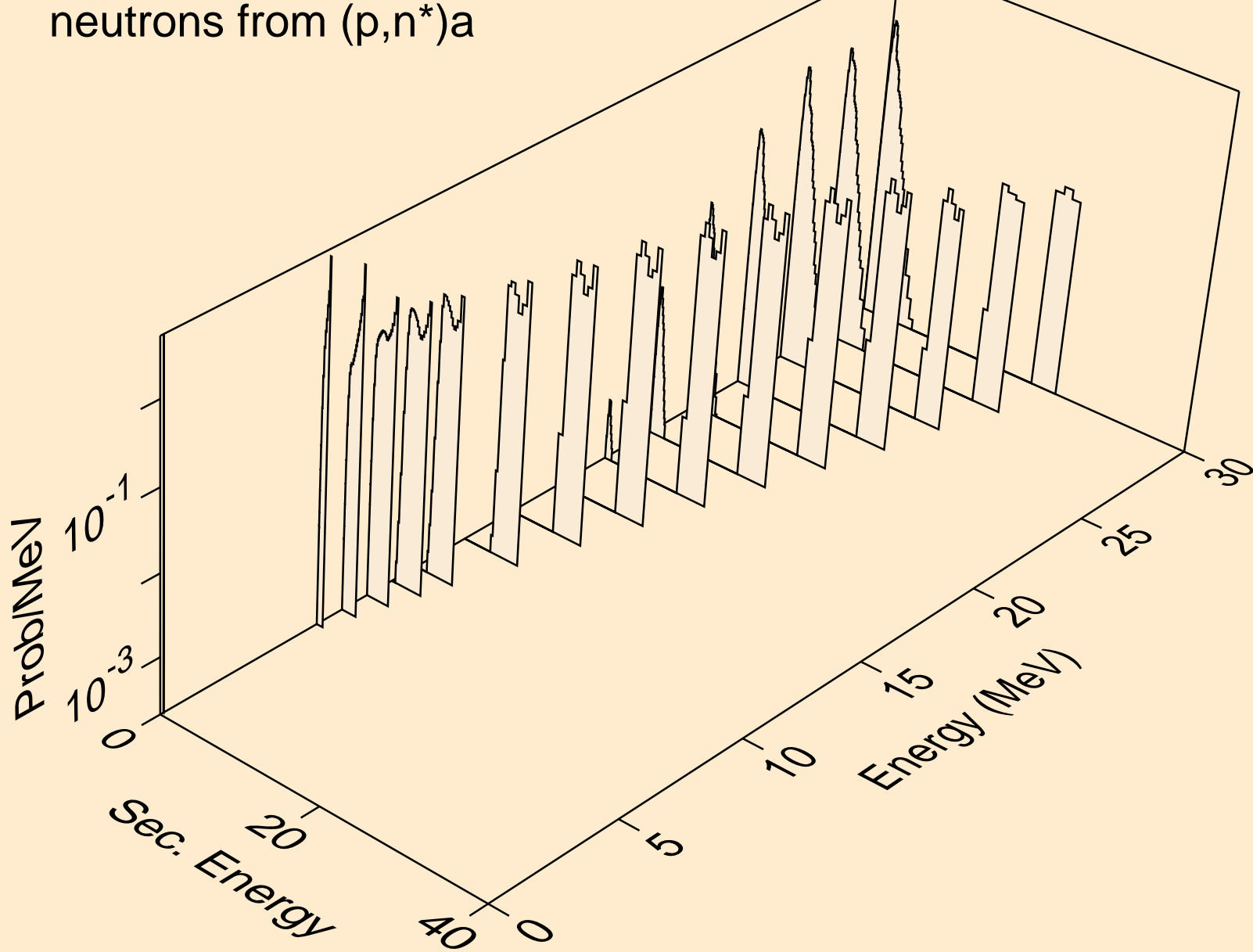

NO253 PROTON ACER TENDL-2021 LIBRARY; T=0.K  
neutrons from (p,2n)a

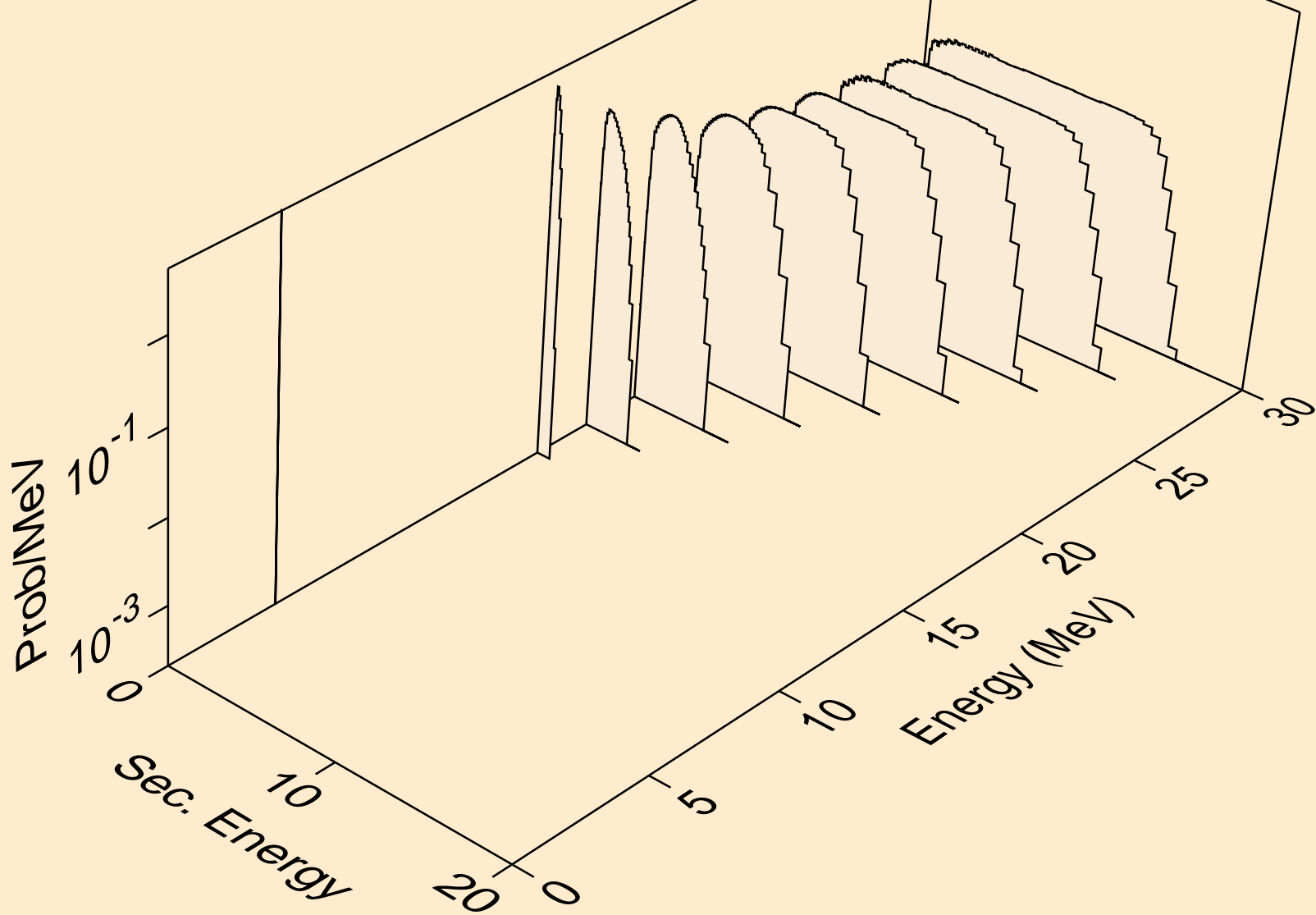

NO253 PROTON ACER TENDL-2021 LIBRARY; T=0.K  
neutrons from (p,n\*)p

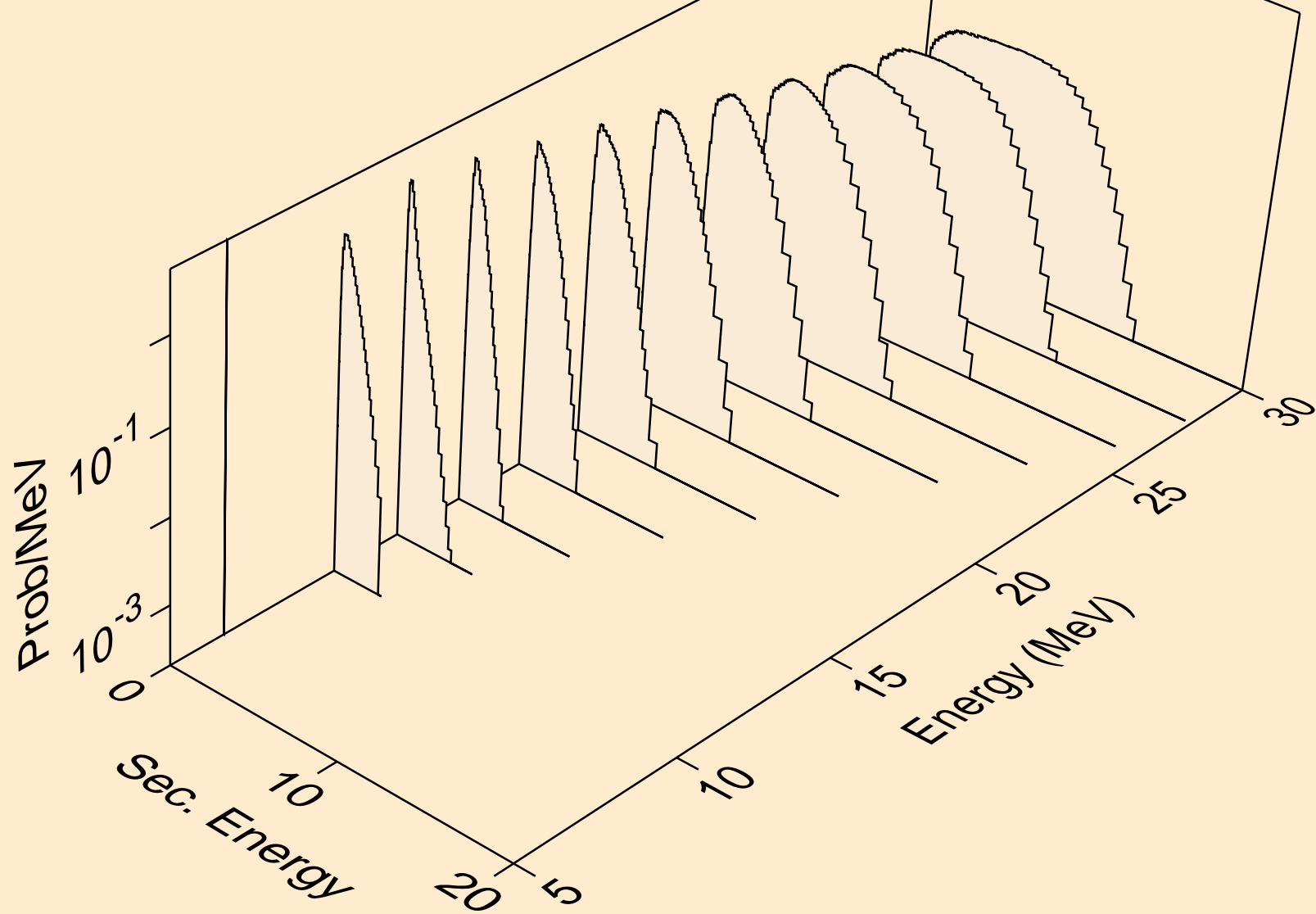

NO253 PROTON ACER TENDL-2021 LIBRARY; T=0.K  
neutrons from (p,n\*)d

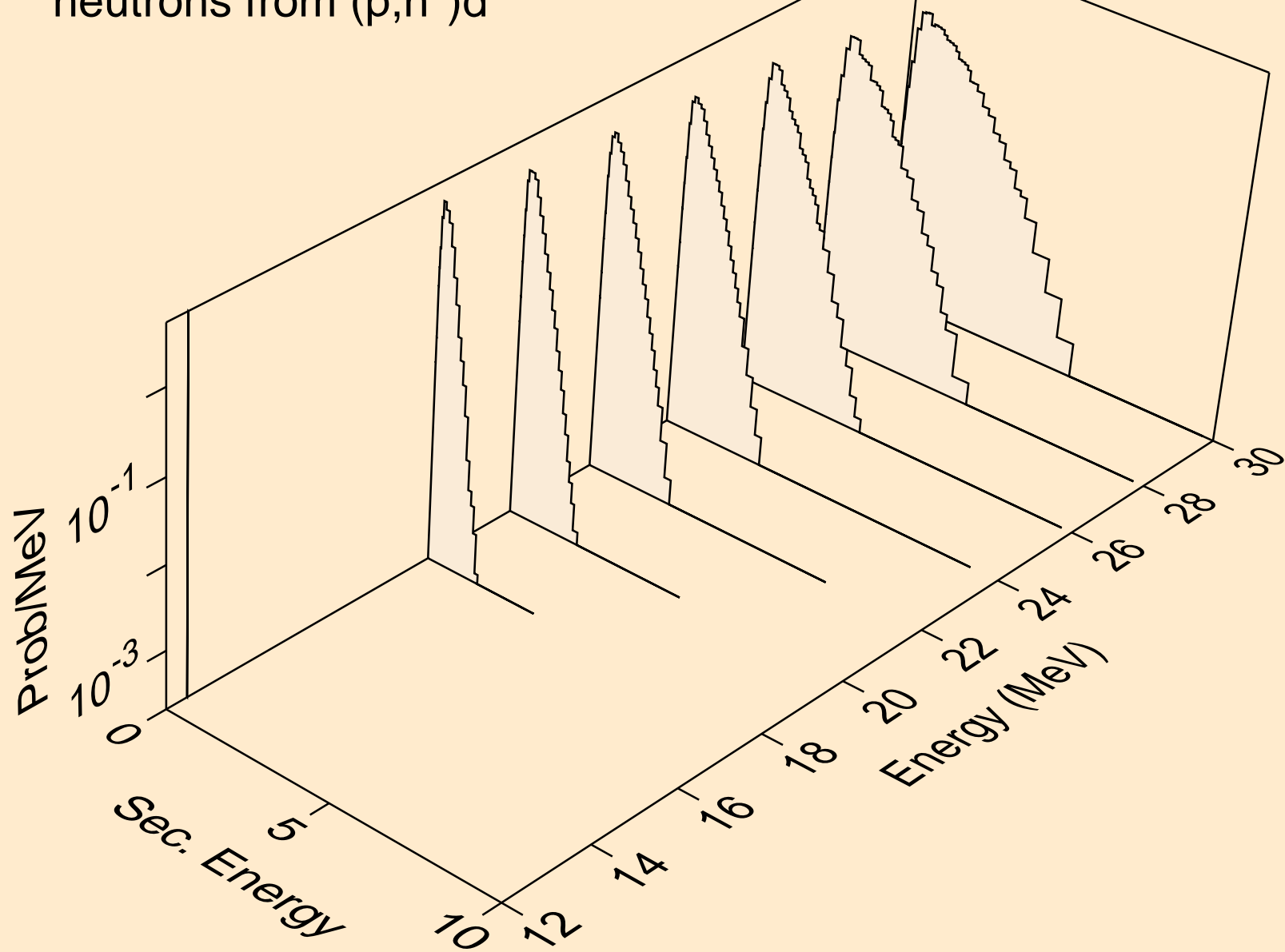

NO253 PROTON ACER TENDL-2021 LIBRARY; T=0.K  
neutrons from (p,n\*)t

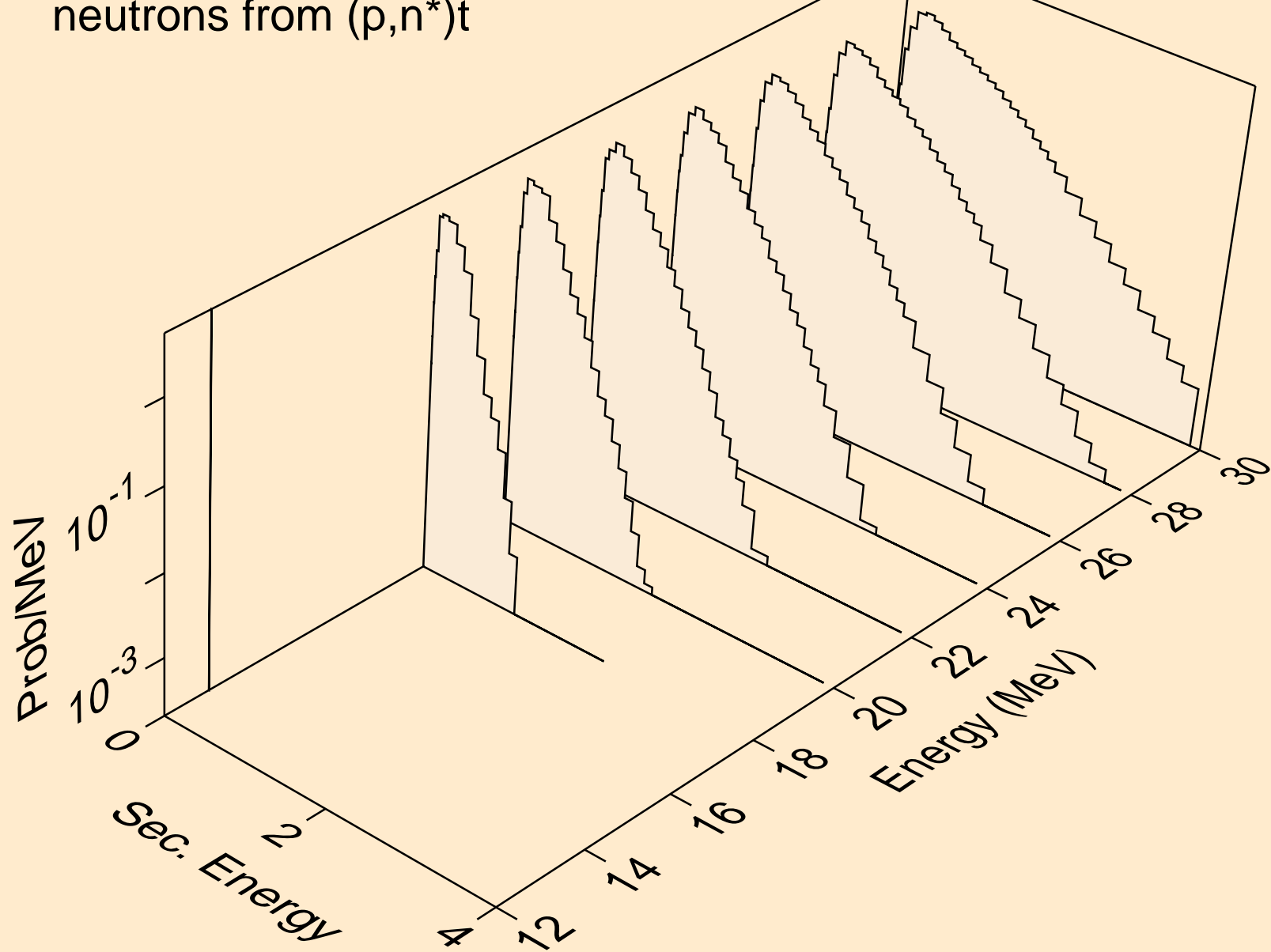

NO253 PROTON ACER TENDL-2021 LIBRARY; T=0.K  
neutrons from (p,2np)

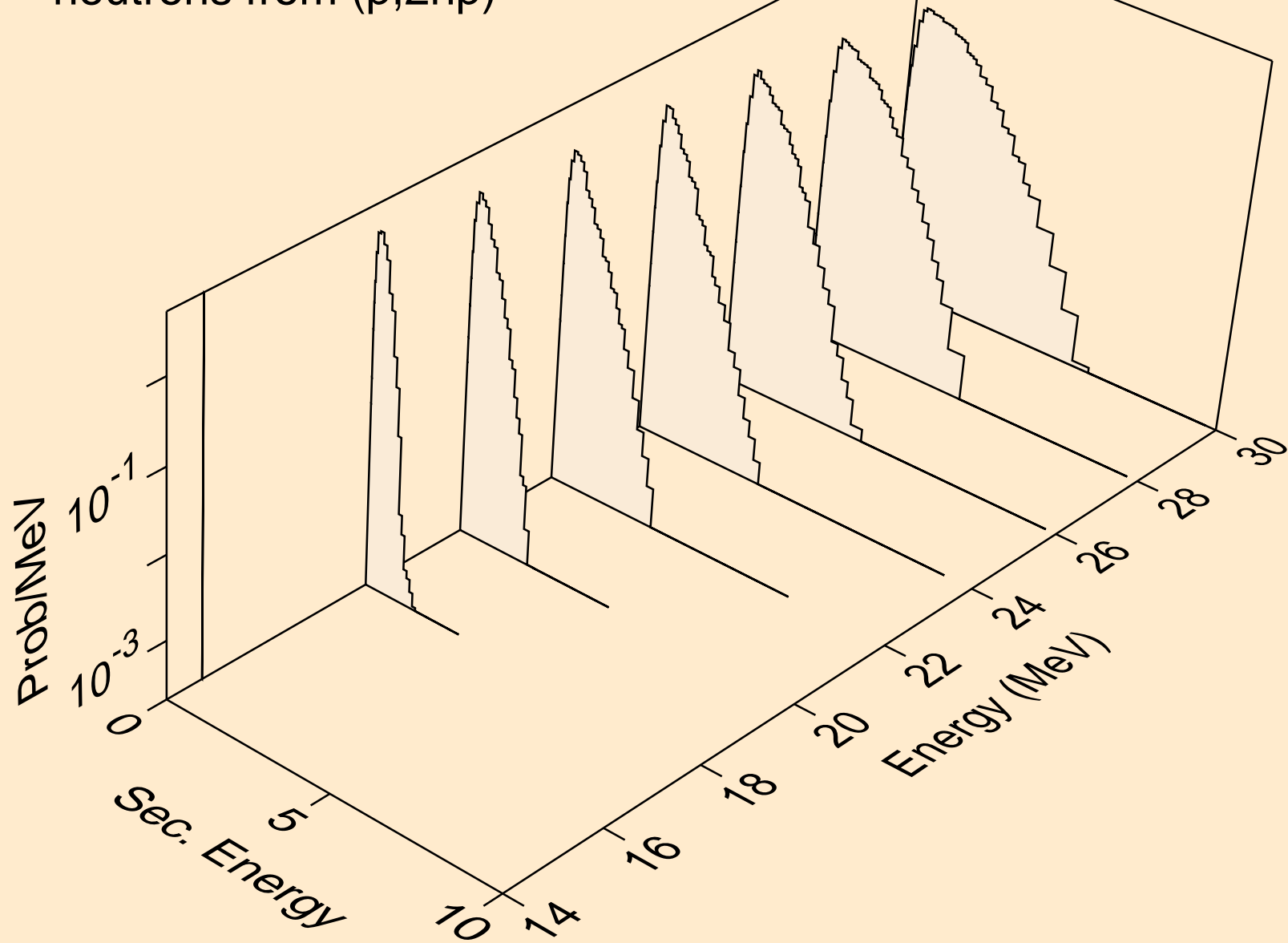

NO253 PROTON ACER TENDL-2021 LIBRARY; T=0.K  
neutrons from (p,npa)

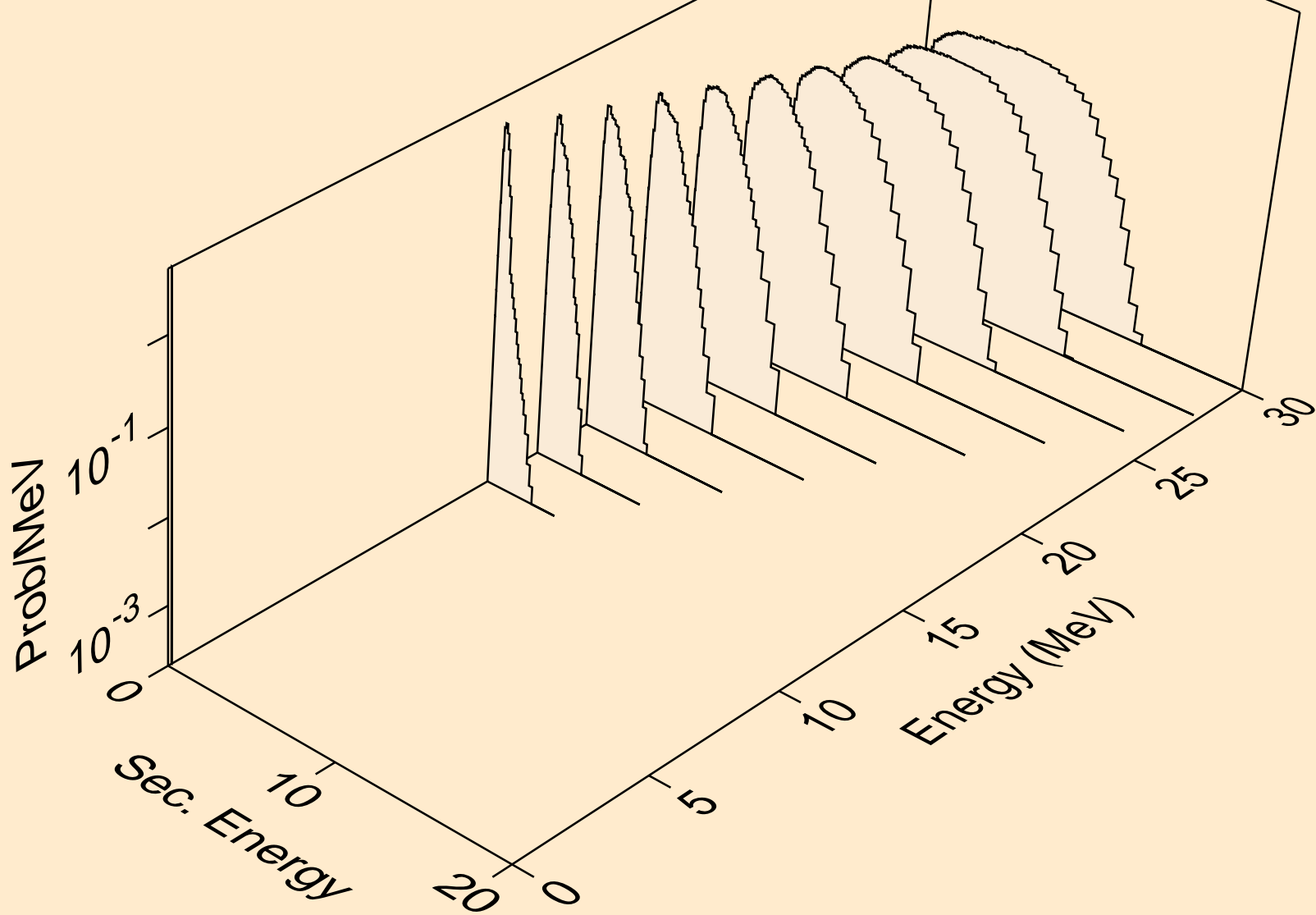



NO253 PROTON ACER TENDL-2021 LIBRARY; T=0.K  
deuterons from (p,x)

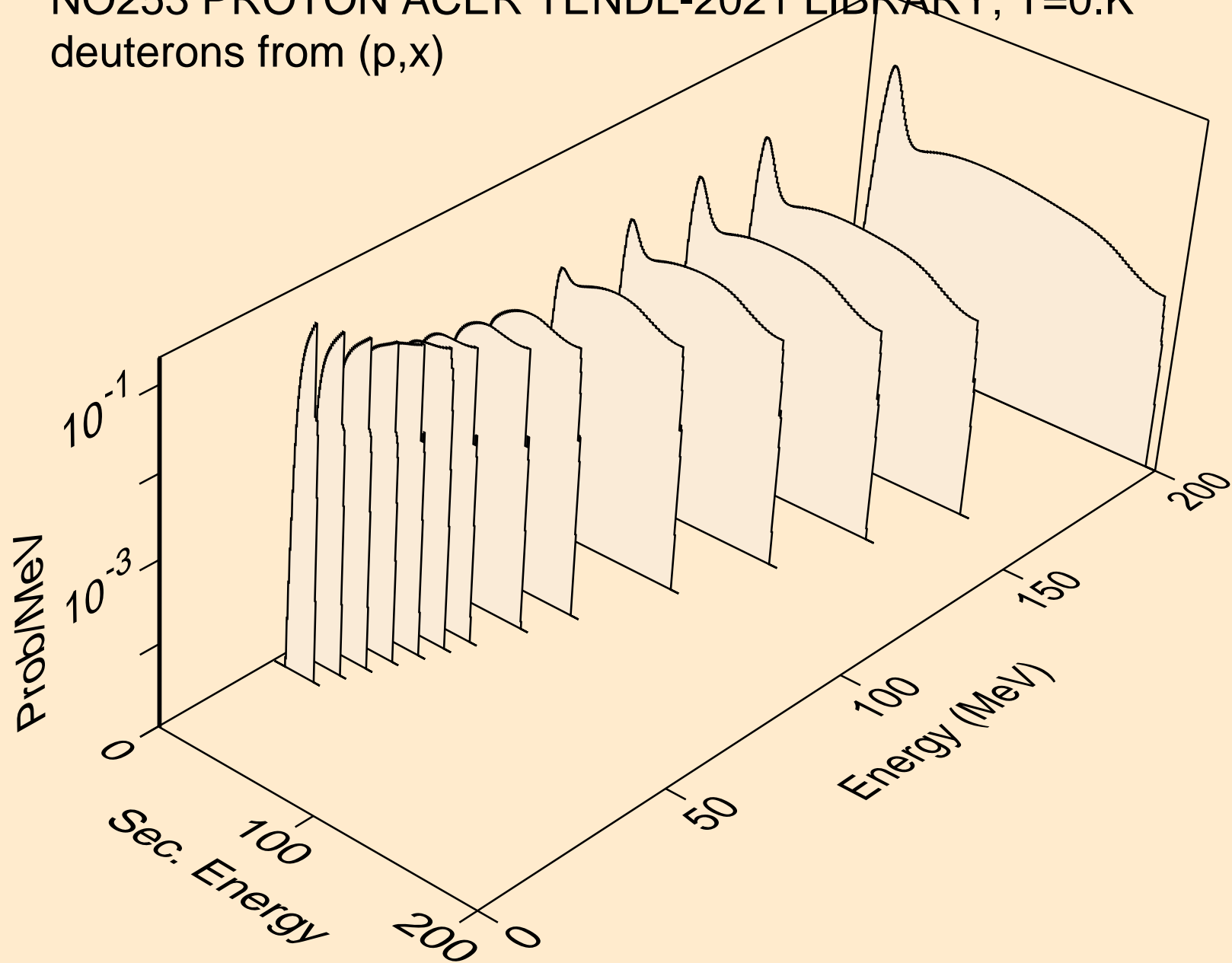

NO253 PROTON ACER TENDL-2021 LIBRARY; T=0.K  
deuterons from (p,n\*)d

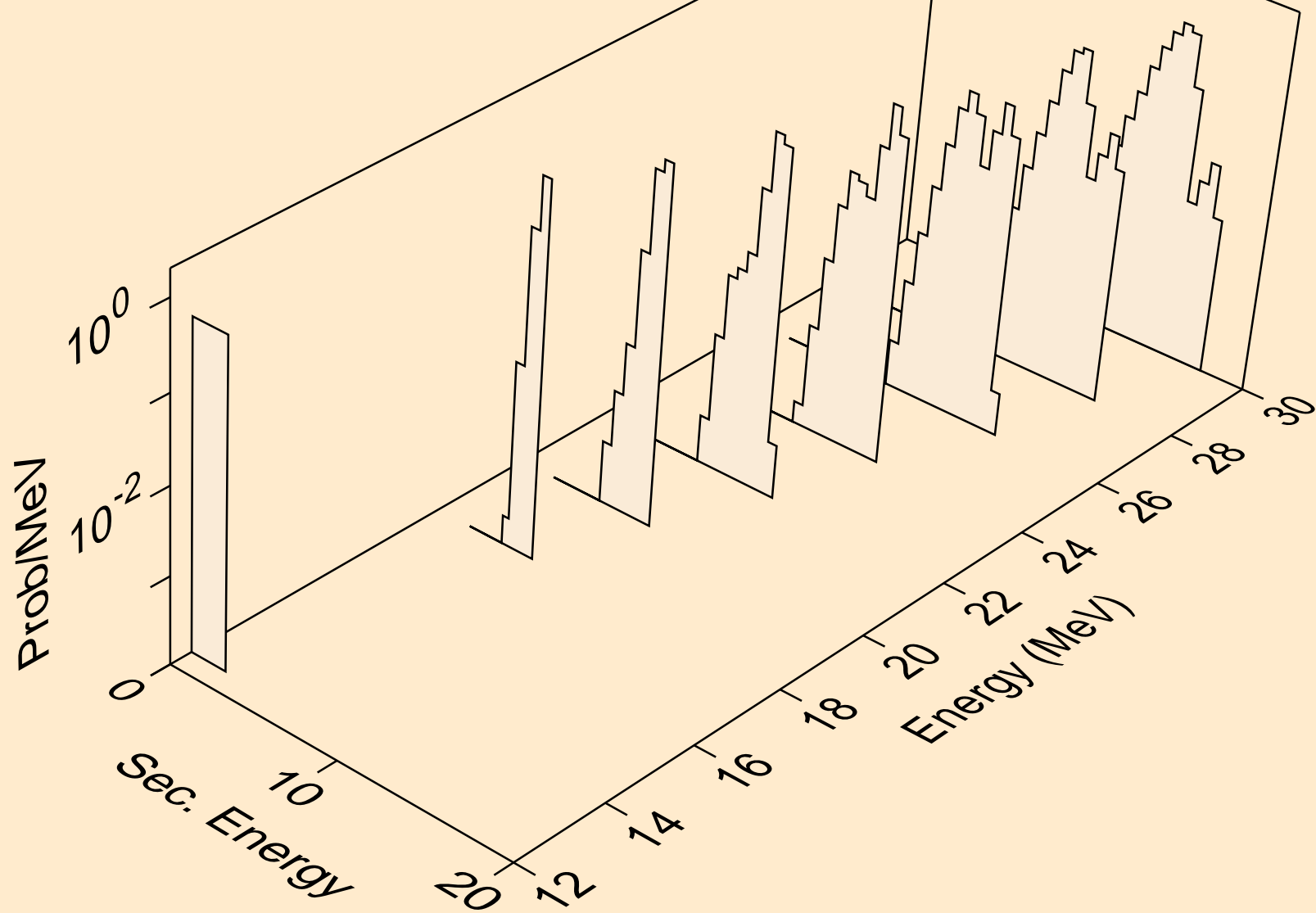

NO253 PROTON ACER TENDL-2021 LIBRARY; T=0.K  
deuterons from (p,d)

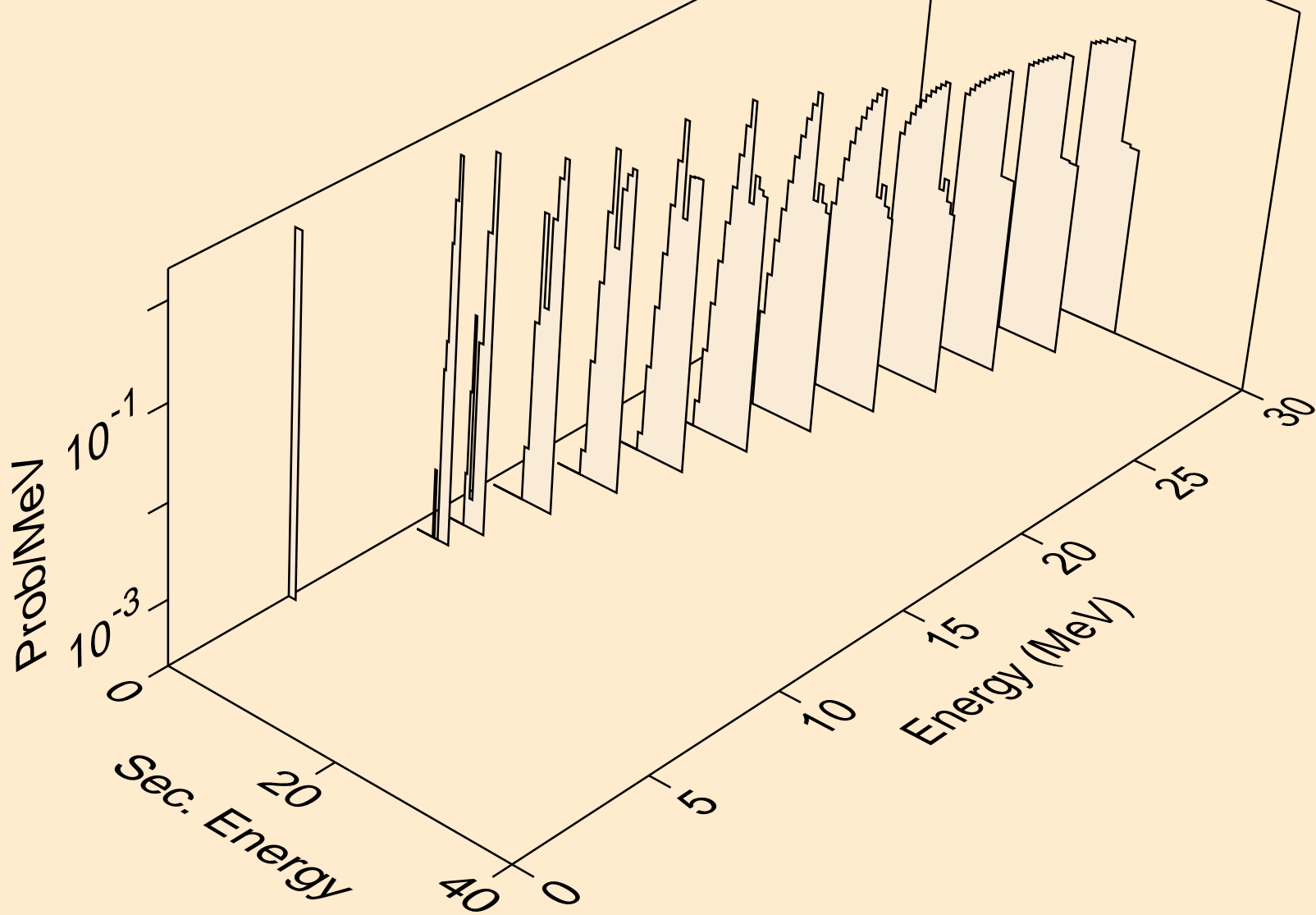

NO253 PROTON ACER TENDL-2021 LIBRARY; T=0.K  
deuterons from (p,da)

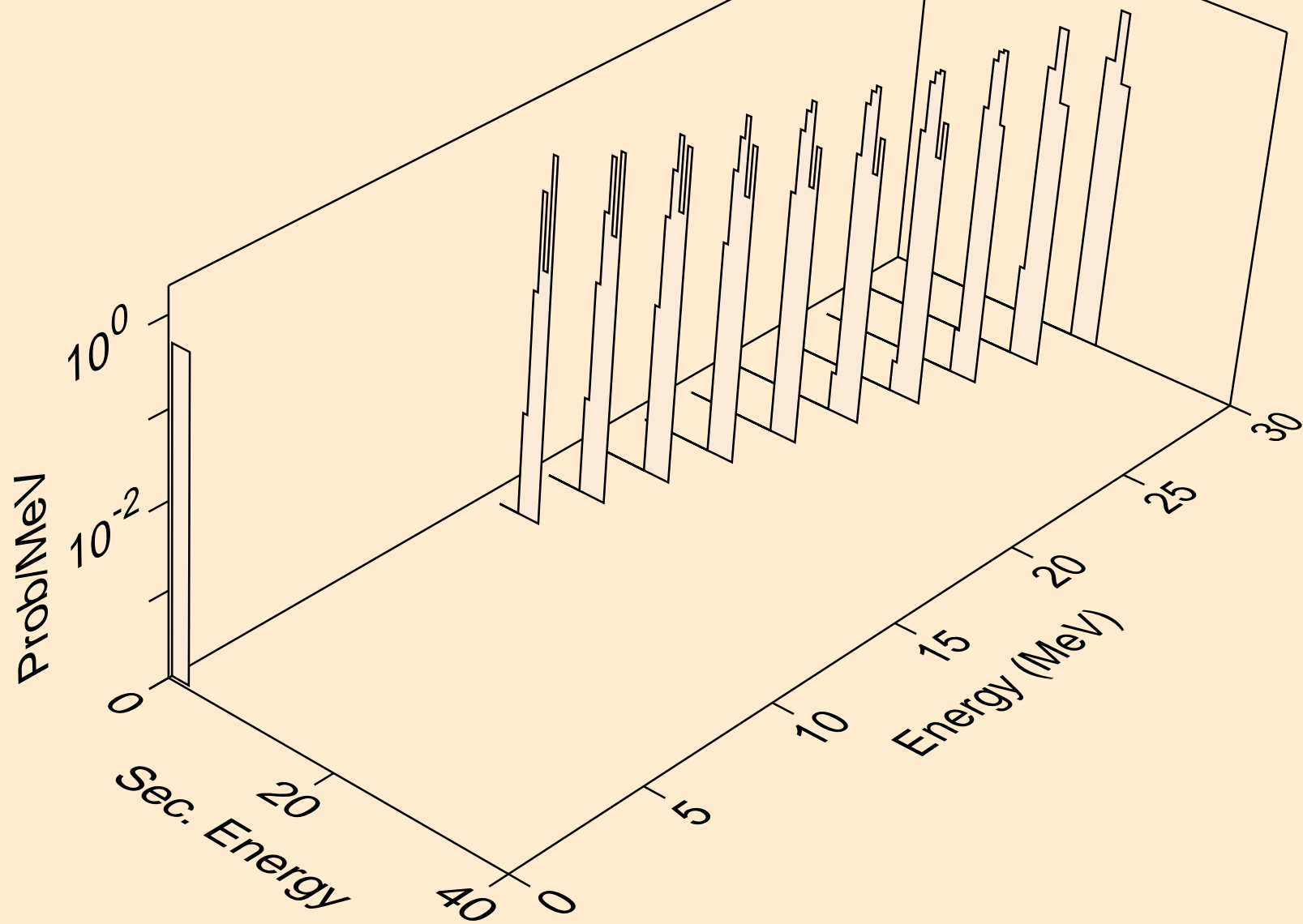

NO253 PROTON ACER TENDL-2021 LIBRARY; T=0.K  
tritons from (p,x)

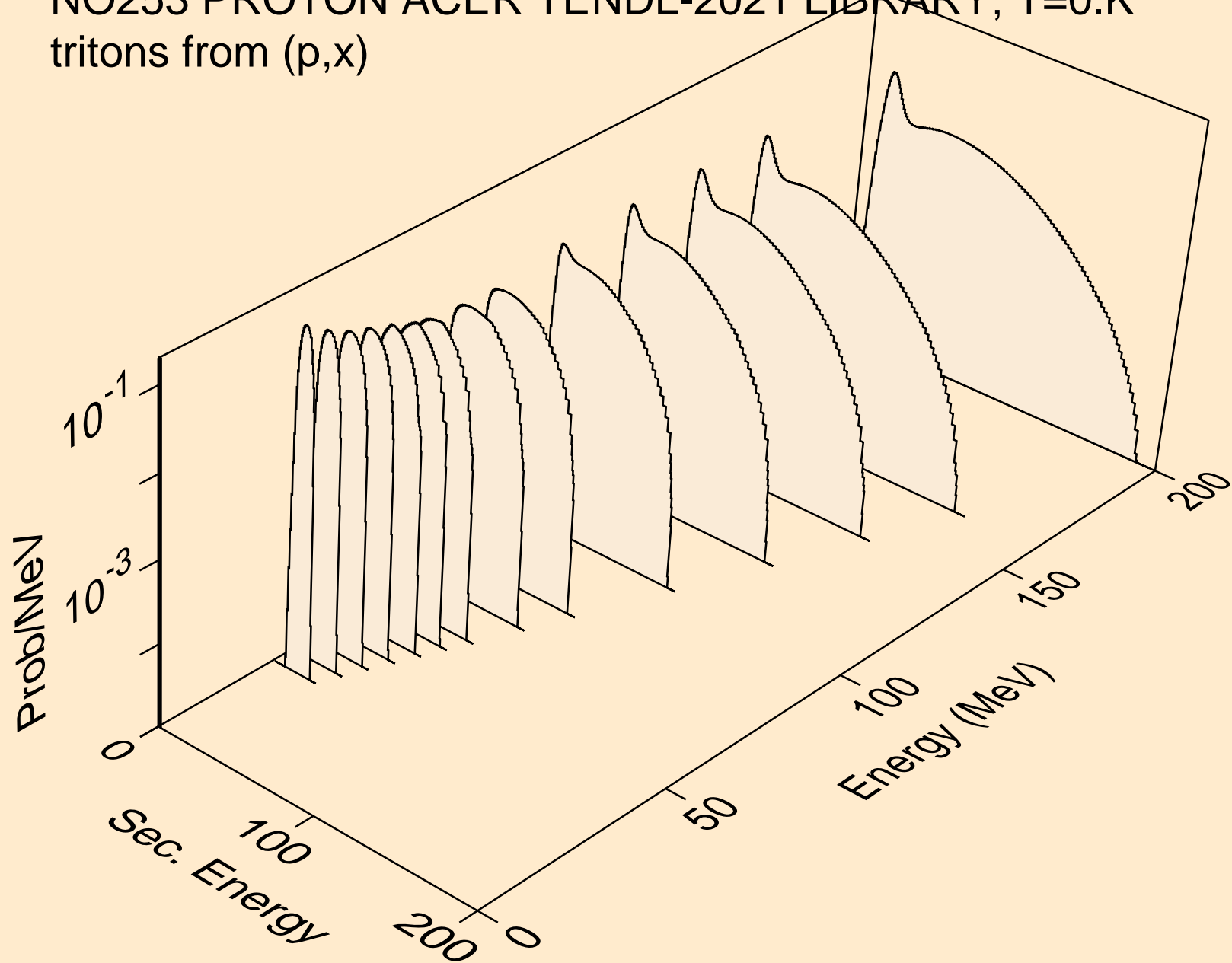

NO253 PROTON ACER TENDL-2021 LIBRARY; T=0.K  
tritons from (p,n\*)t

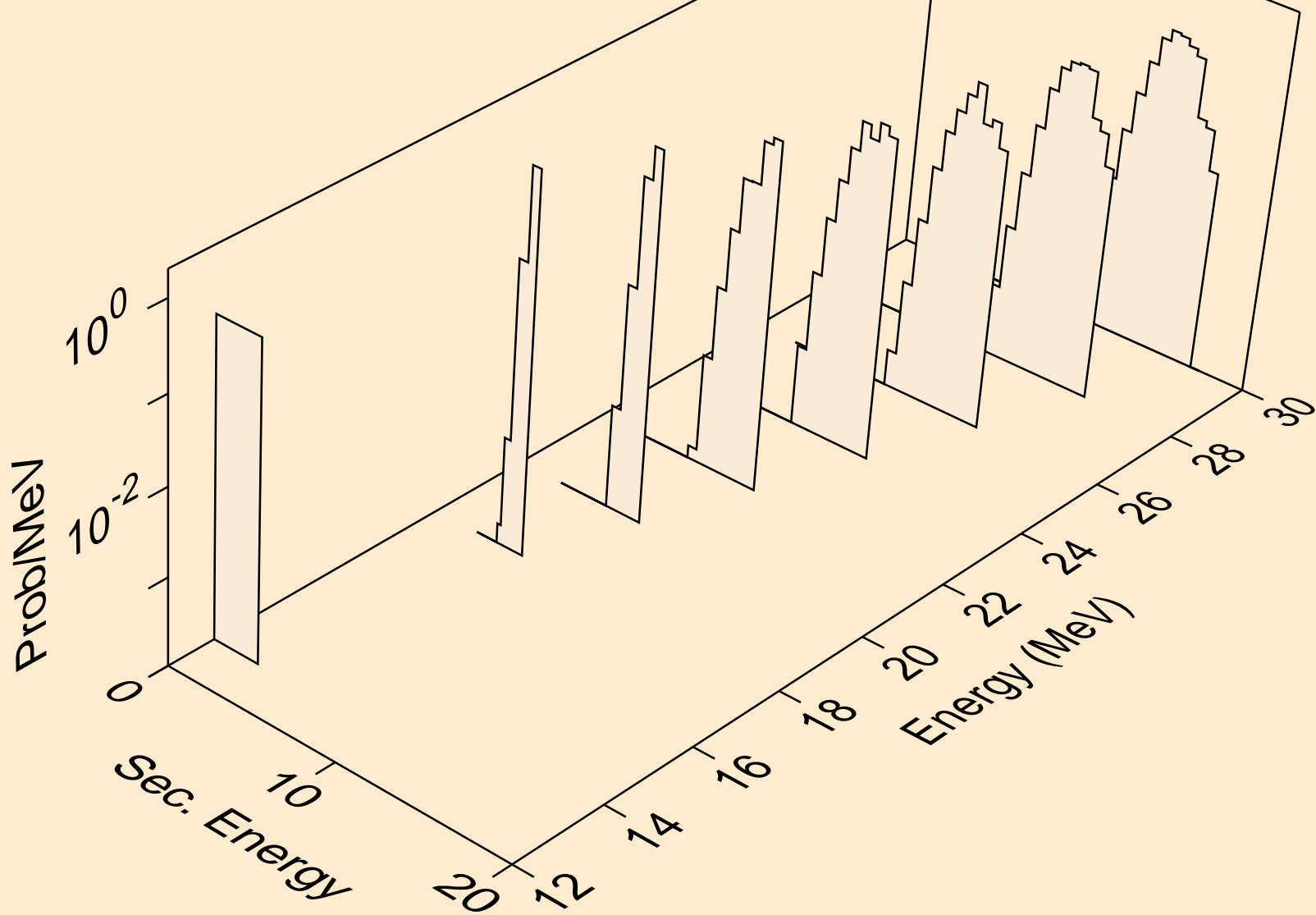

NO253 PROTON ACER TENDL-2021 LIBRARY; T=0.K  
tritons from (p,t)

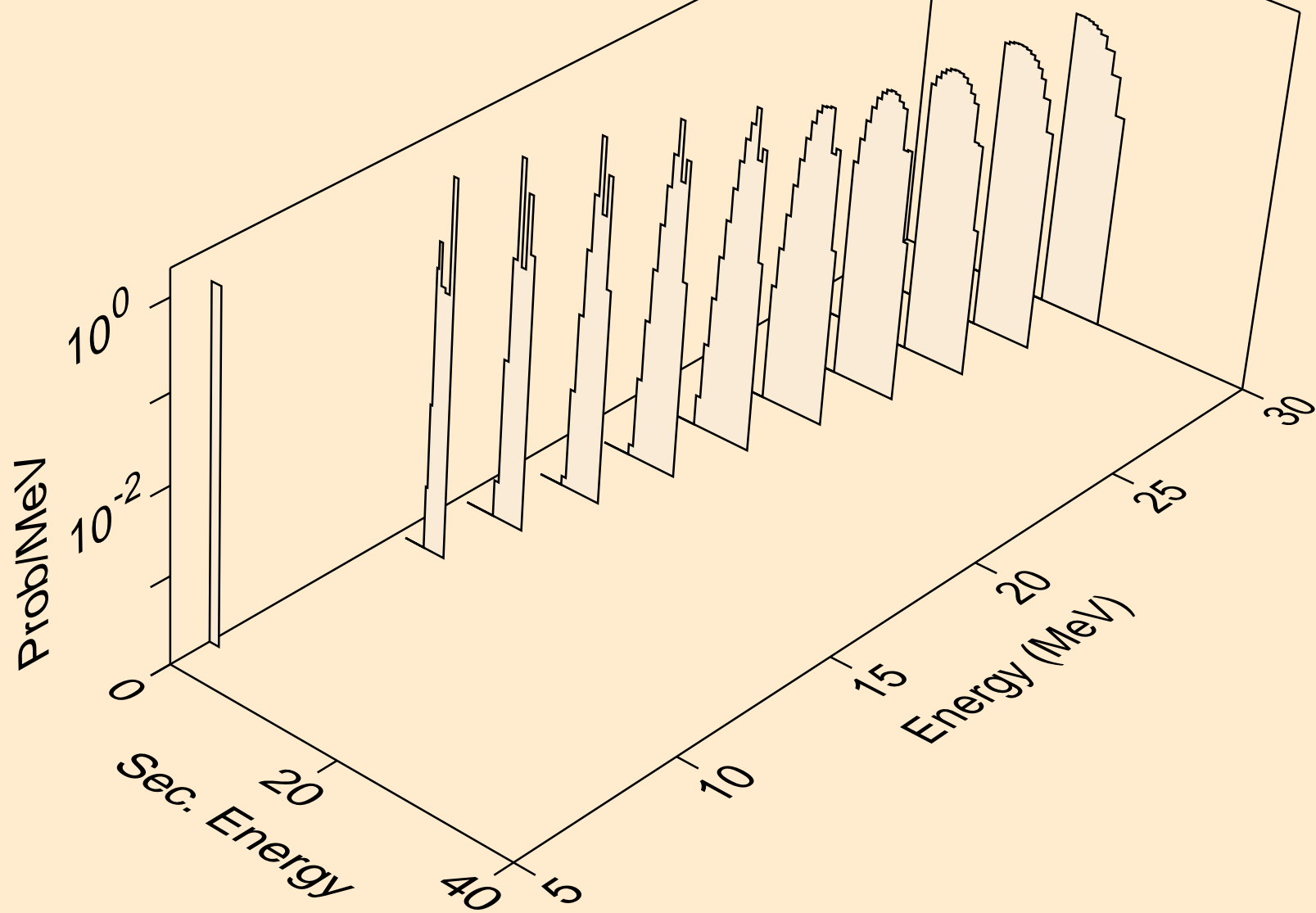

NO253 PROTON ACER TENDL-2021 LIBRARY; T=0.K  
he3s from (p,x)

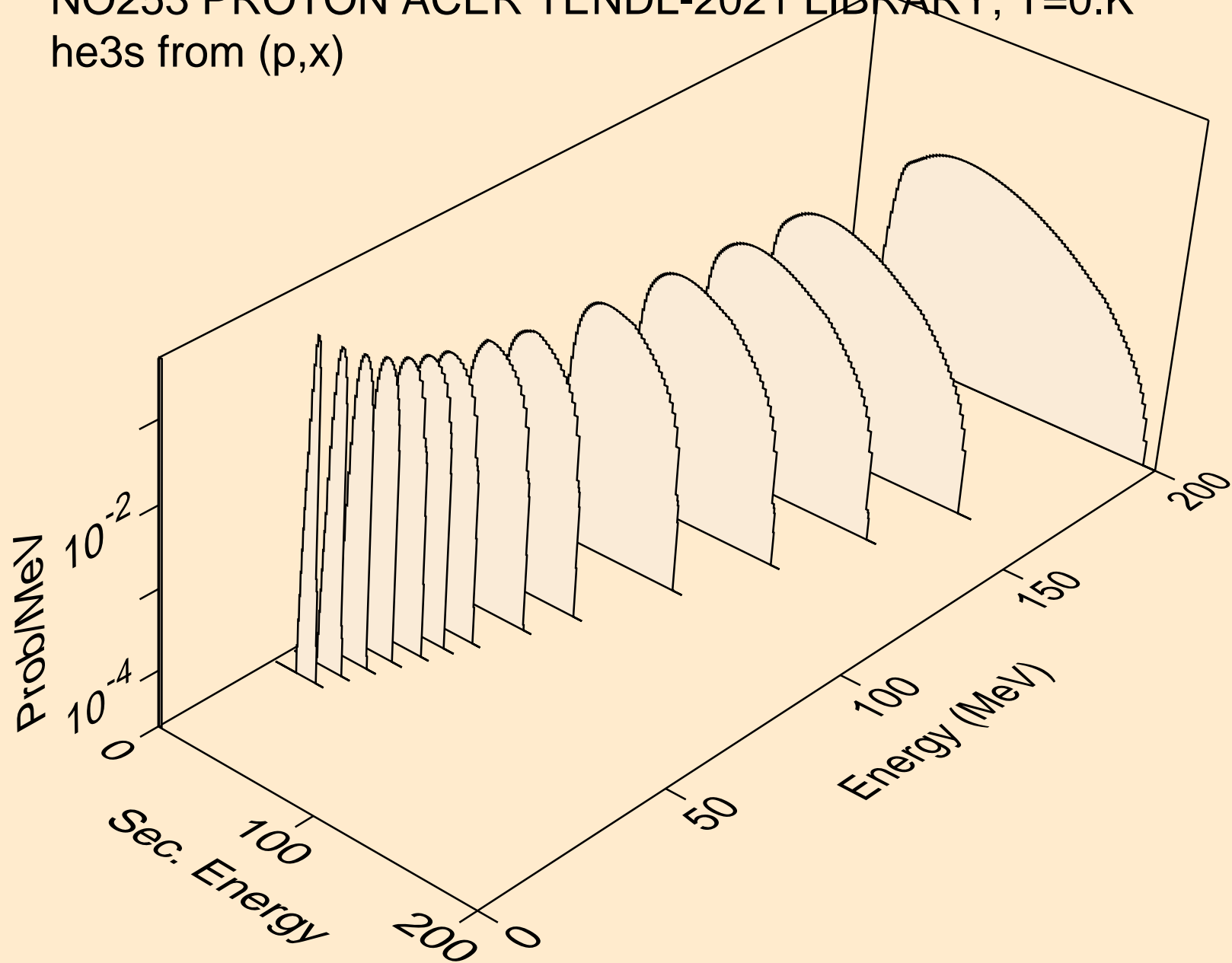



NO253 PROTON ACER TENDL-2021 LIBRARY; T=0.K  
he3s from (p,he3)

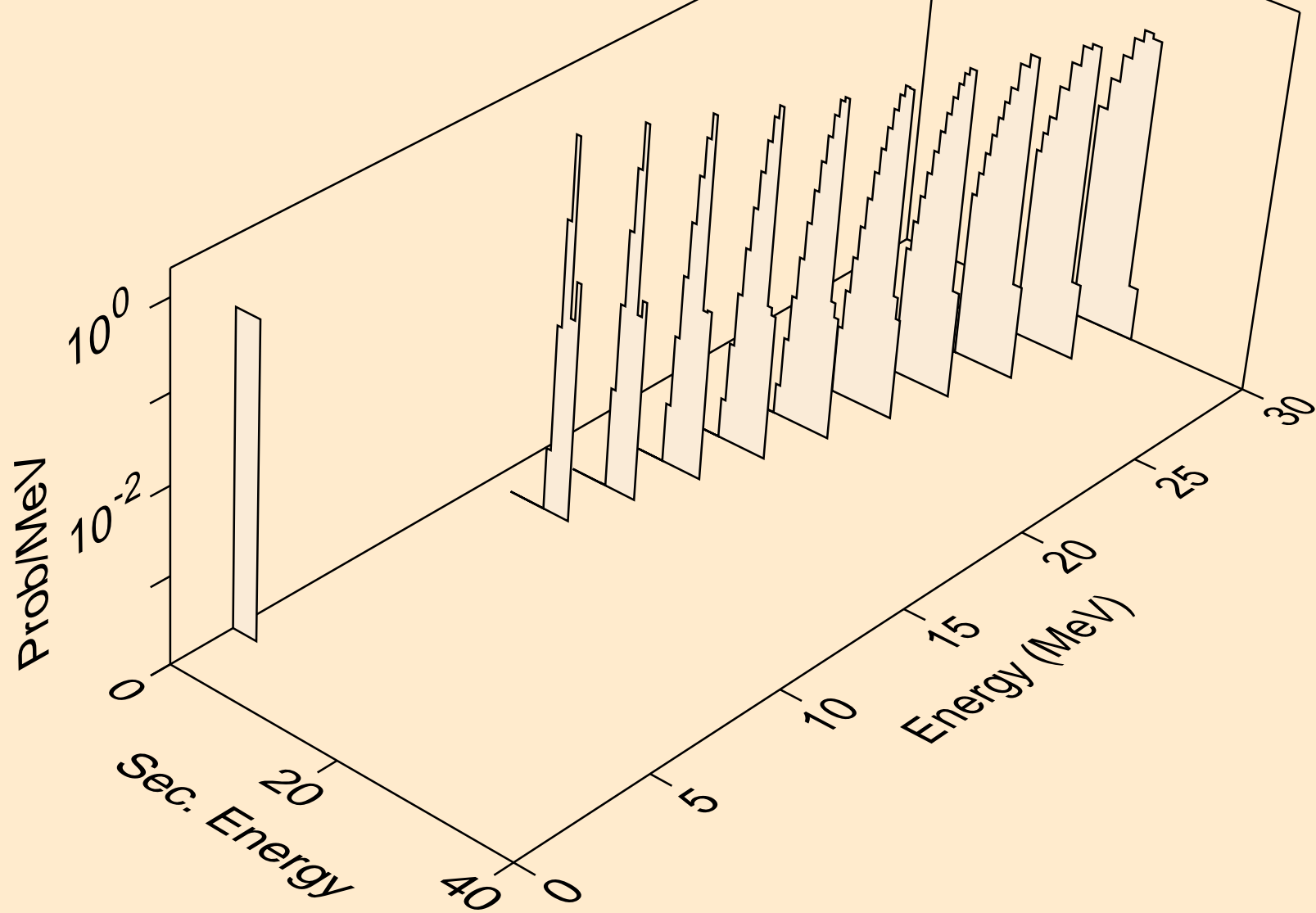

NO253 PROTON ACER TENDL-2021 LIBRARY; T=0.K  
alphas from (p,x)

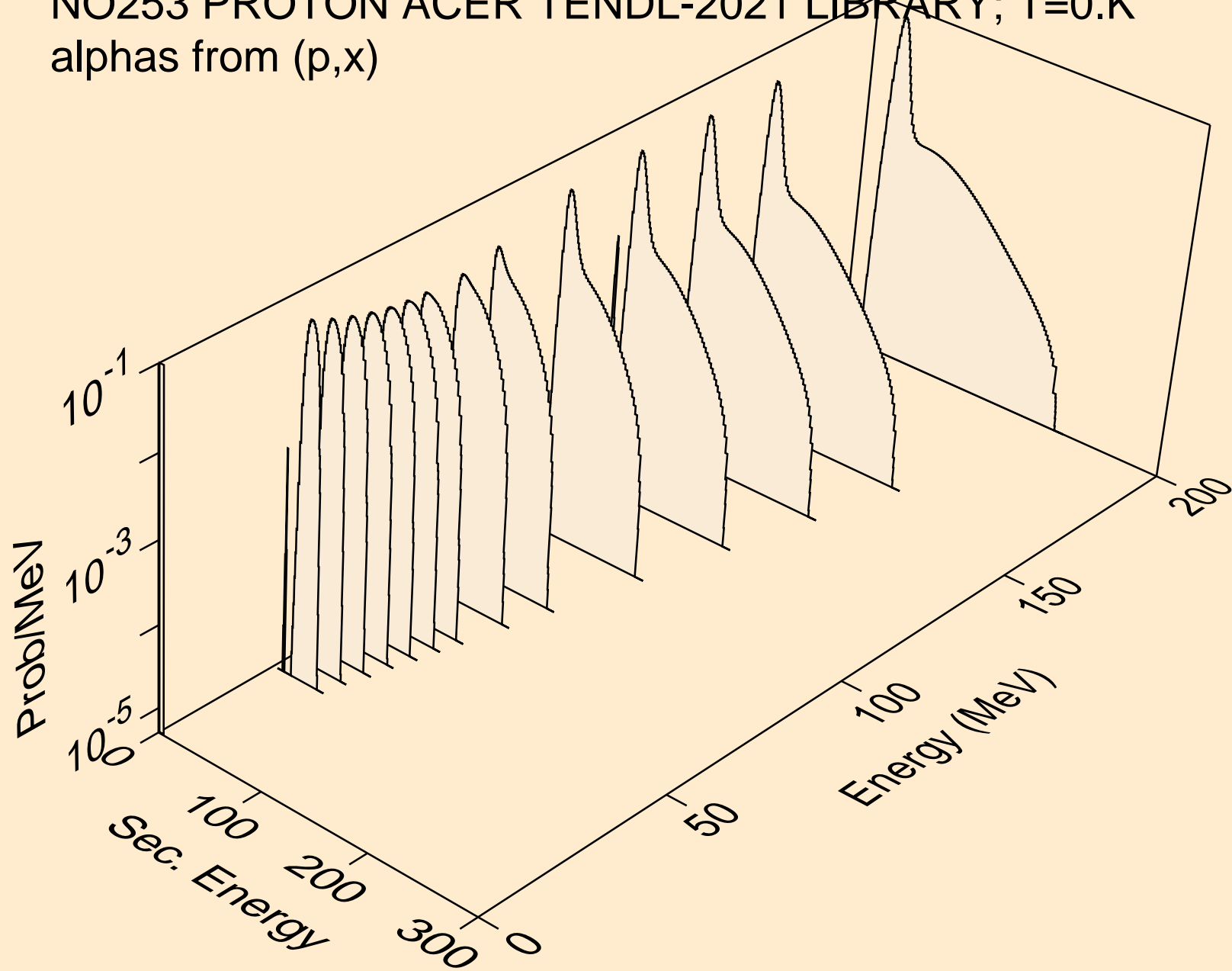

NO253 PROTON ACER TENDL-2021 LIBRARY; T=0.K  
alphas from (p,n\*)a

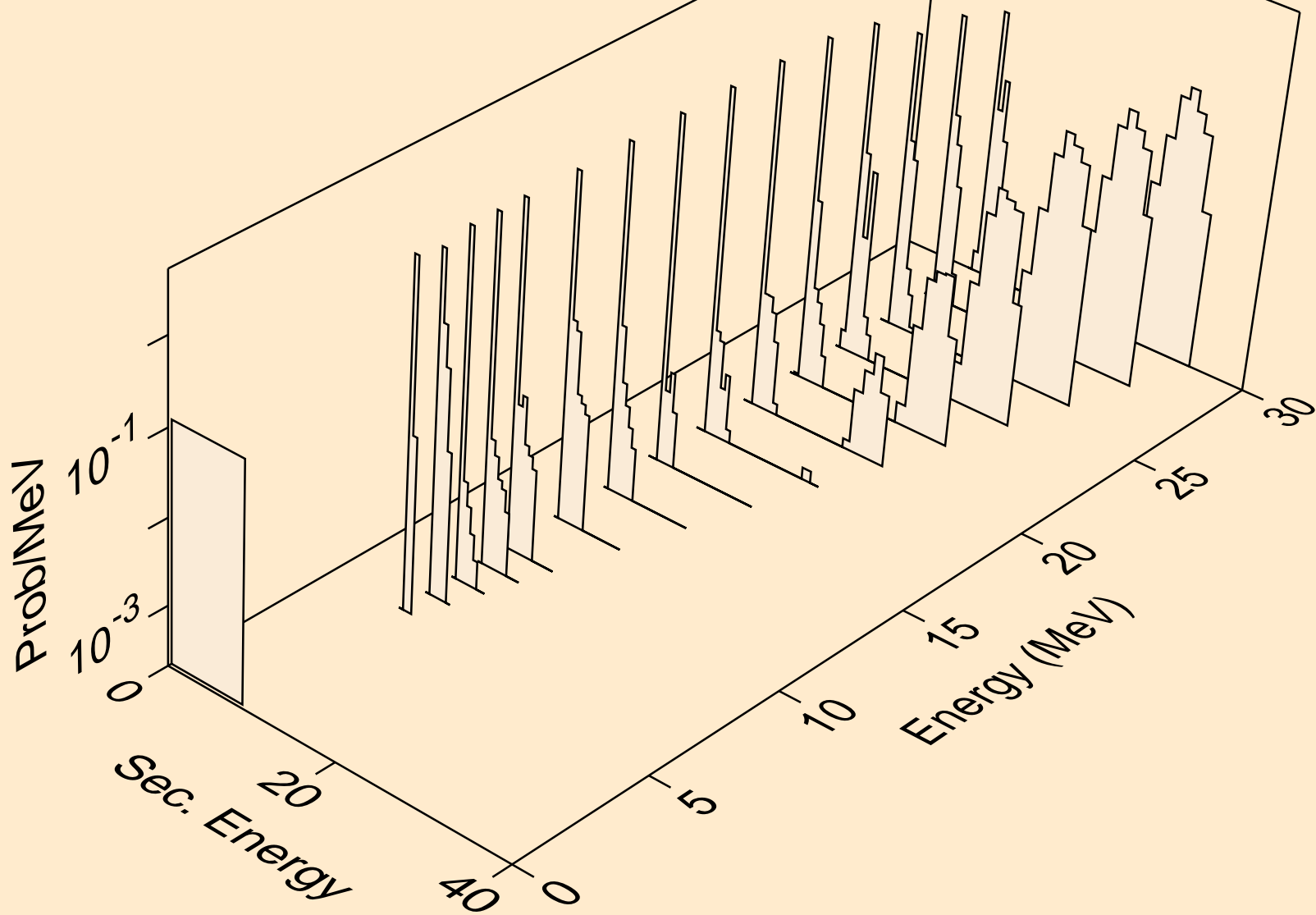

NO253 PROTON ACER TENDL-2021 LIBRARY; T=0.K  
alphas from (p,2n)a

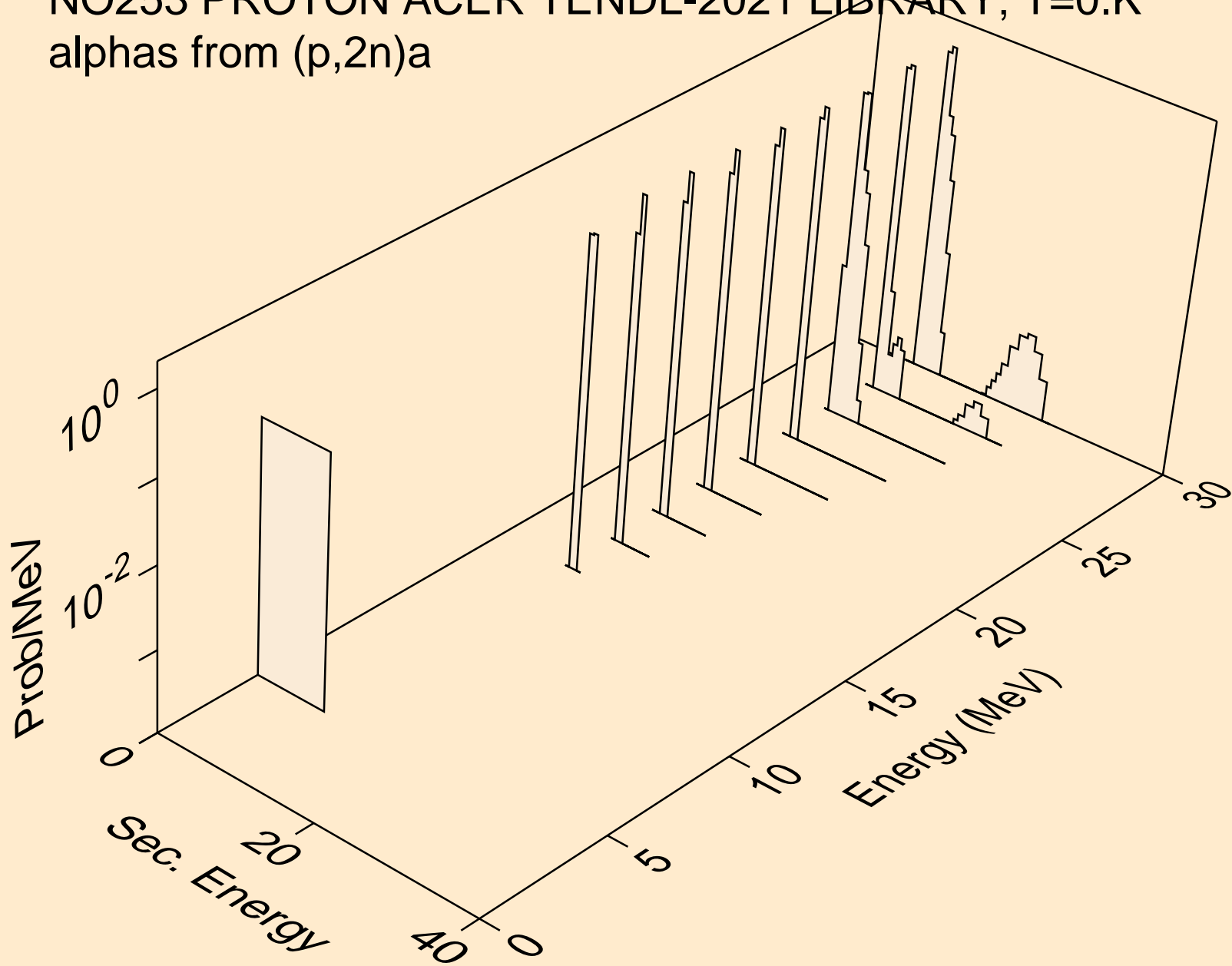

NO253 PROTON ACER TENDL-2021 LIBRARY; T=0.K  
alphas from (p,npa)

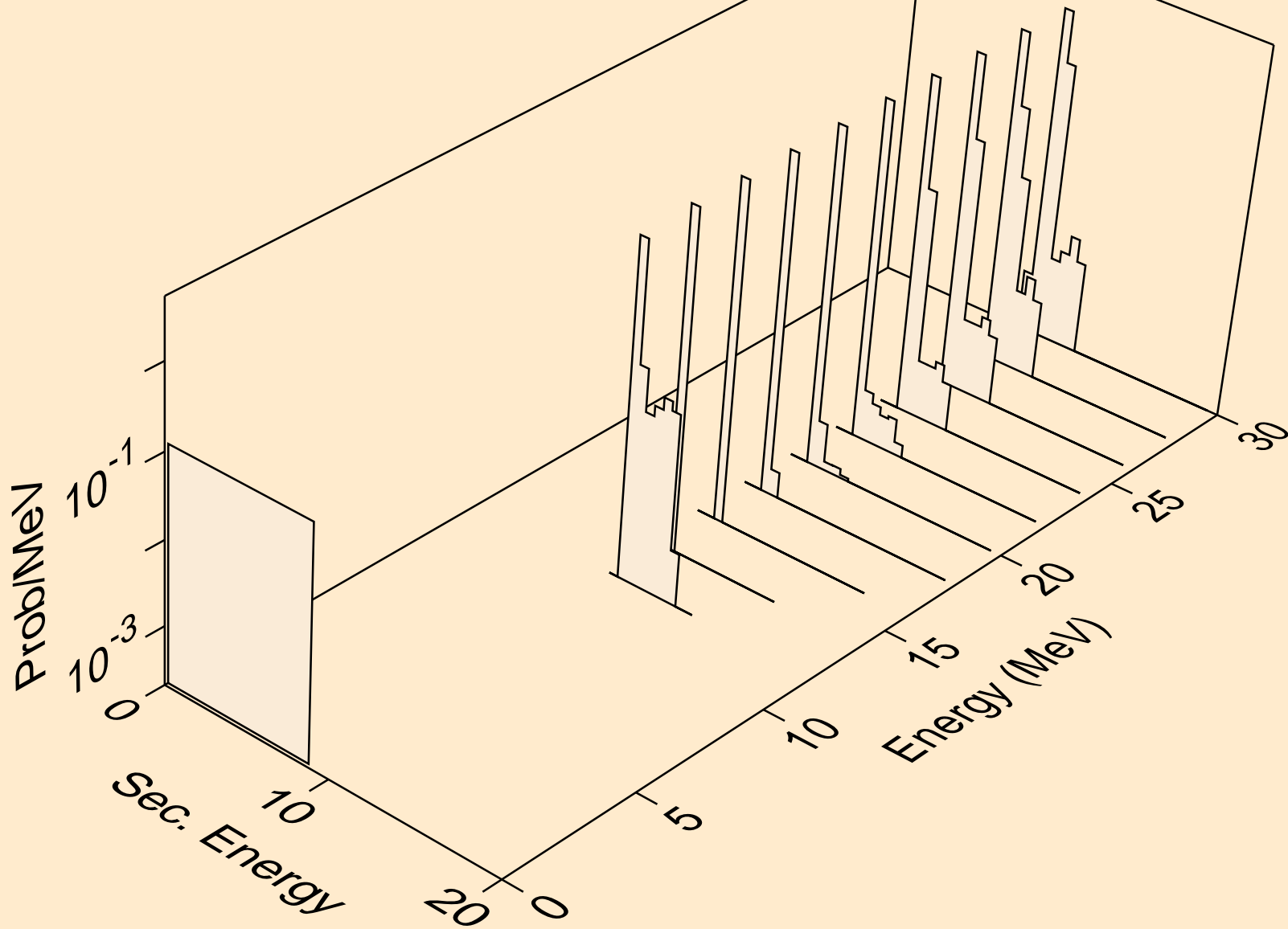

NO253 PROTON ACER TENDL-2021 LIBRARY; T=0.K  
alphas from (p,a)

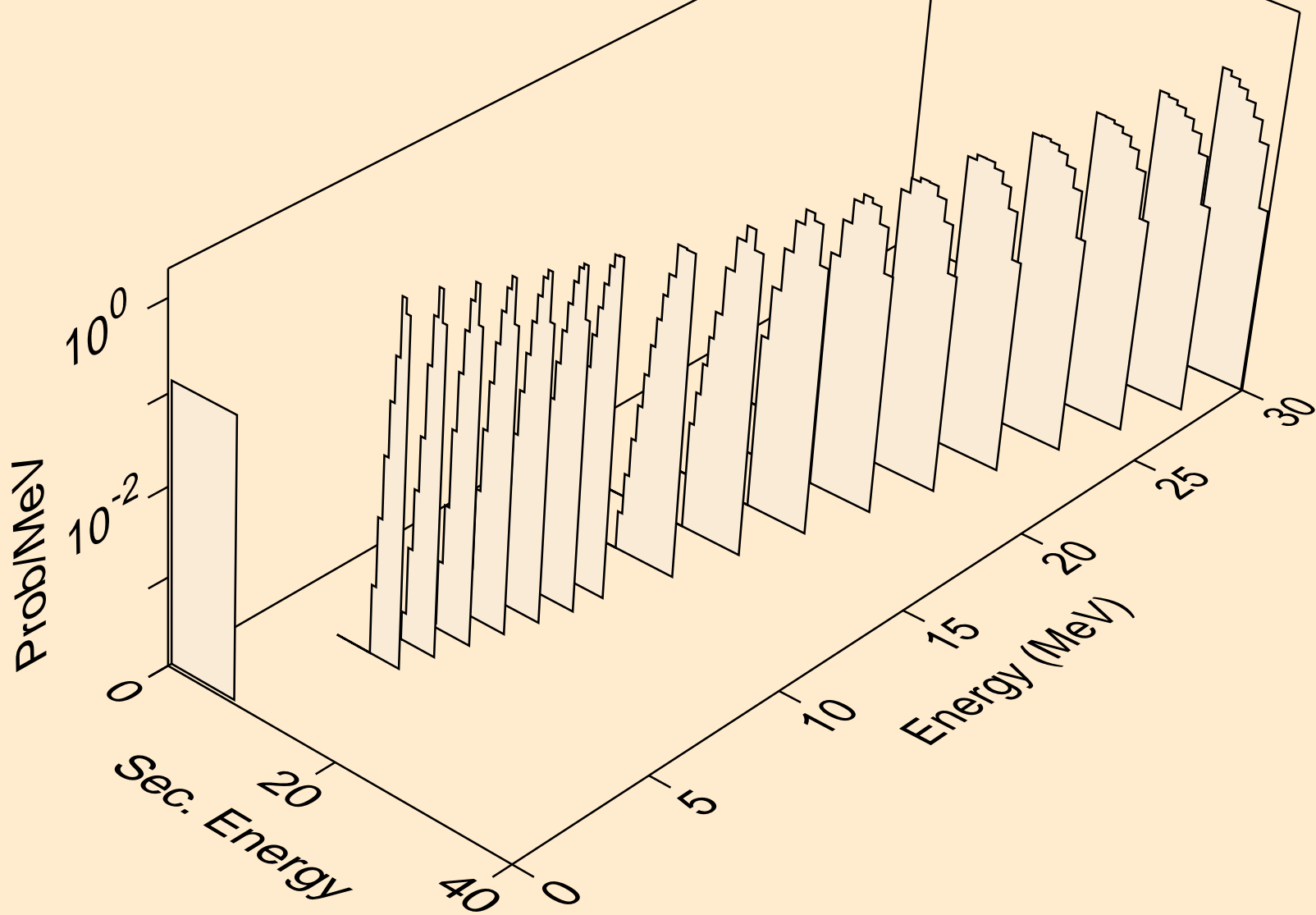

NO253 PROTON ACER TENDL-2021 LIBRARY; T=0.K  
alphas from (p,da)

