

# NP231 PROTON ACER TENDL-2021 LIBRARY; T=0.K

## Principal cross sections

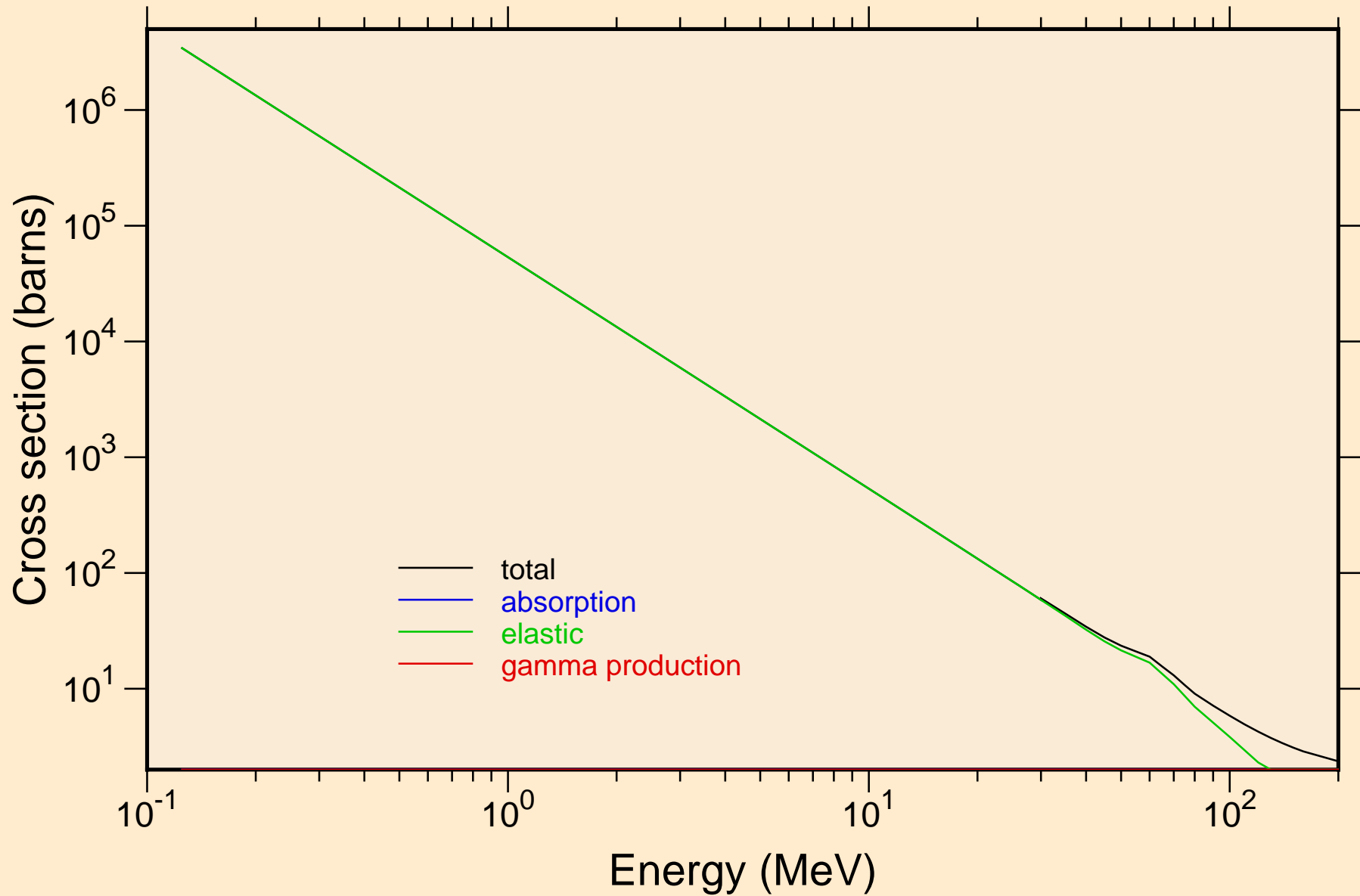

# NP231 PROTON ACER TENDL-2021 LIBRARY; T=0.K

## Heating

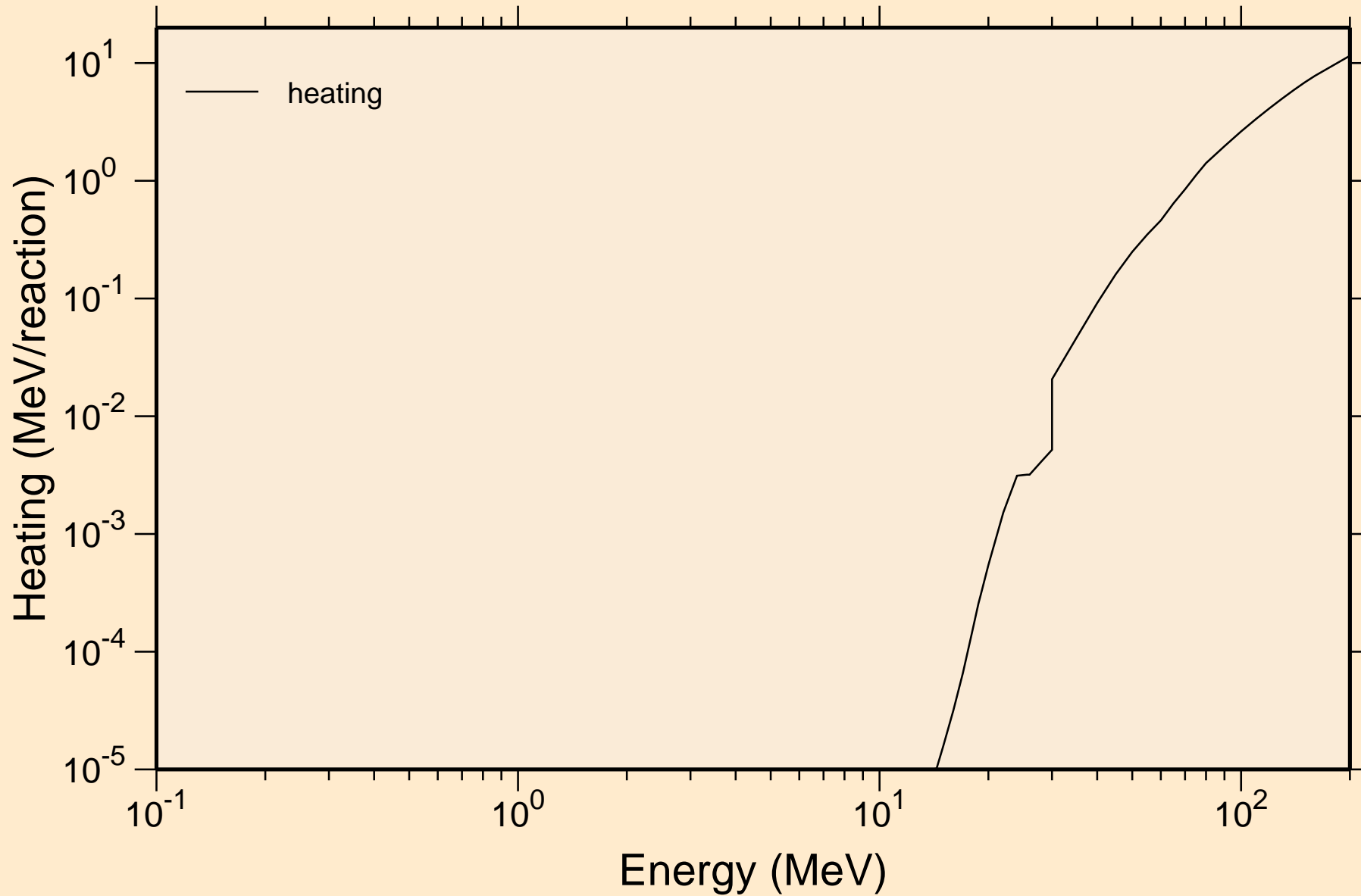

# NP231 PROTON ACER TENDL-2021 LIBRARY; T=0.K

## Principal cross sections

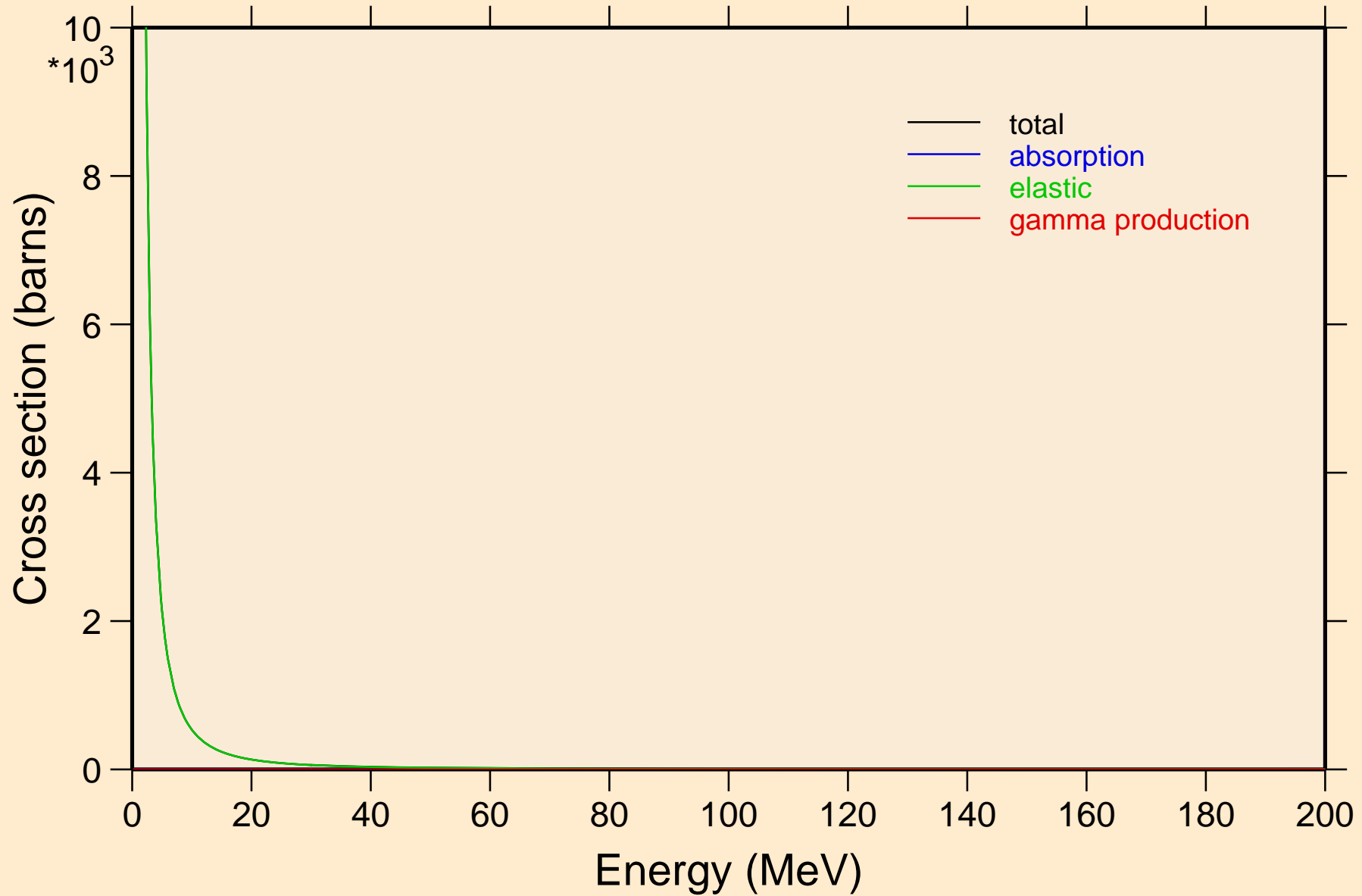

NP231 PROTON ACER TENDL-2021 LIBRARY; T=0.K

Heating

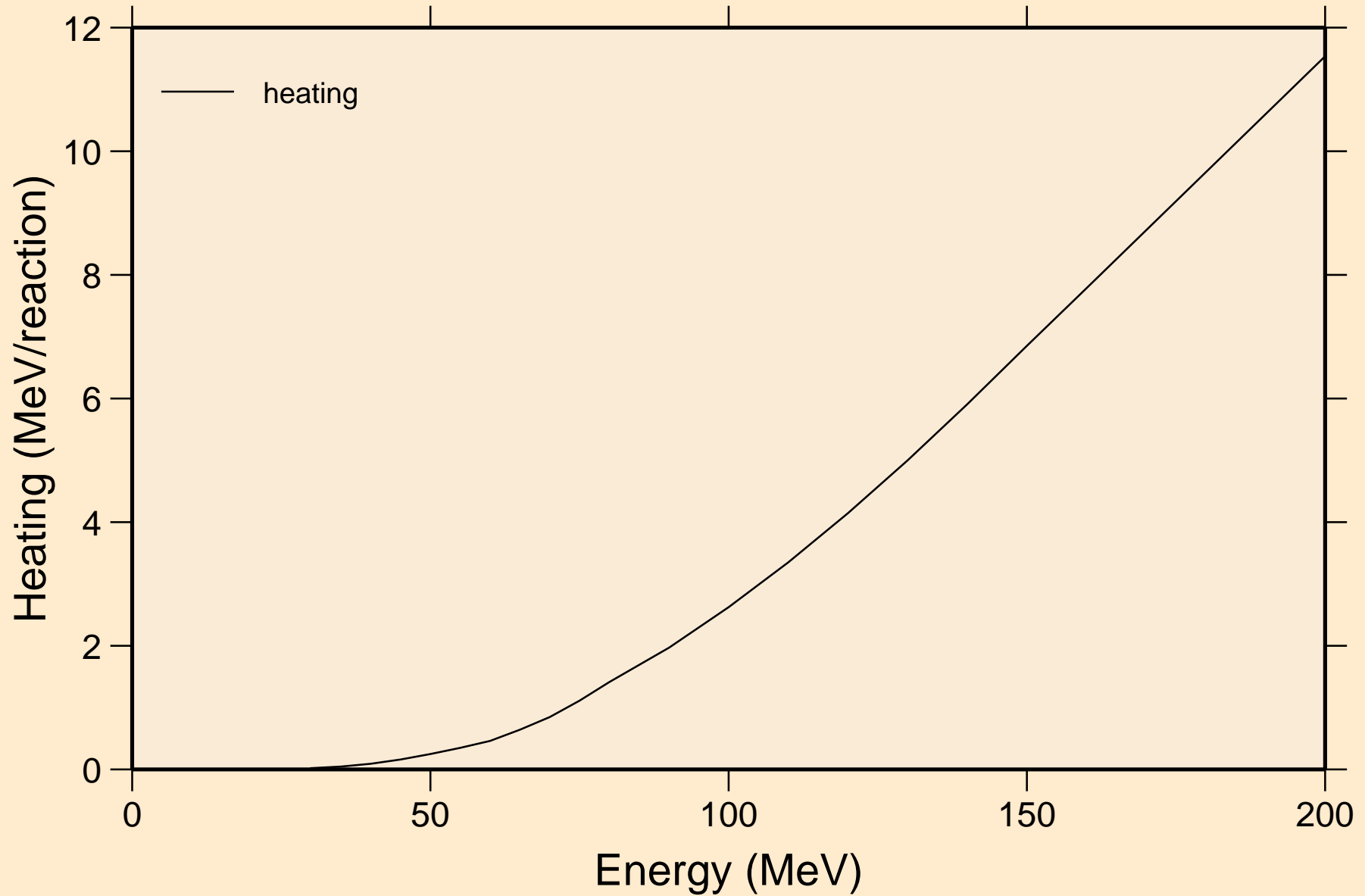

# NP231 PROTON ACER TENDL-2021 LIBRARY; T=0.K

## Threshold reactions

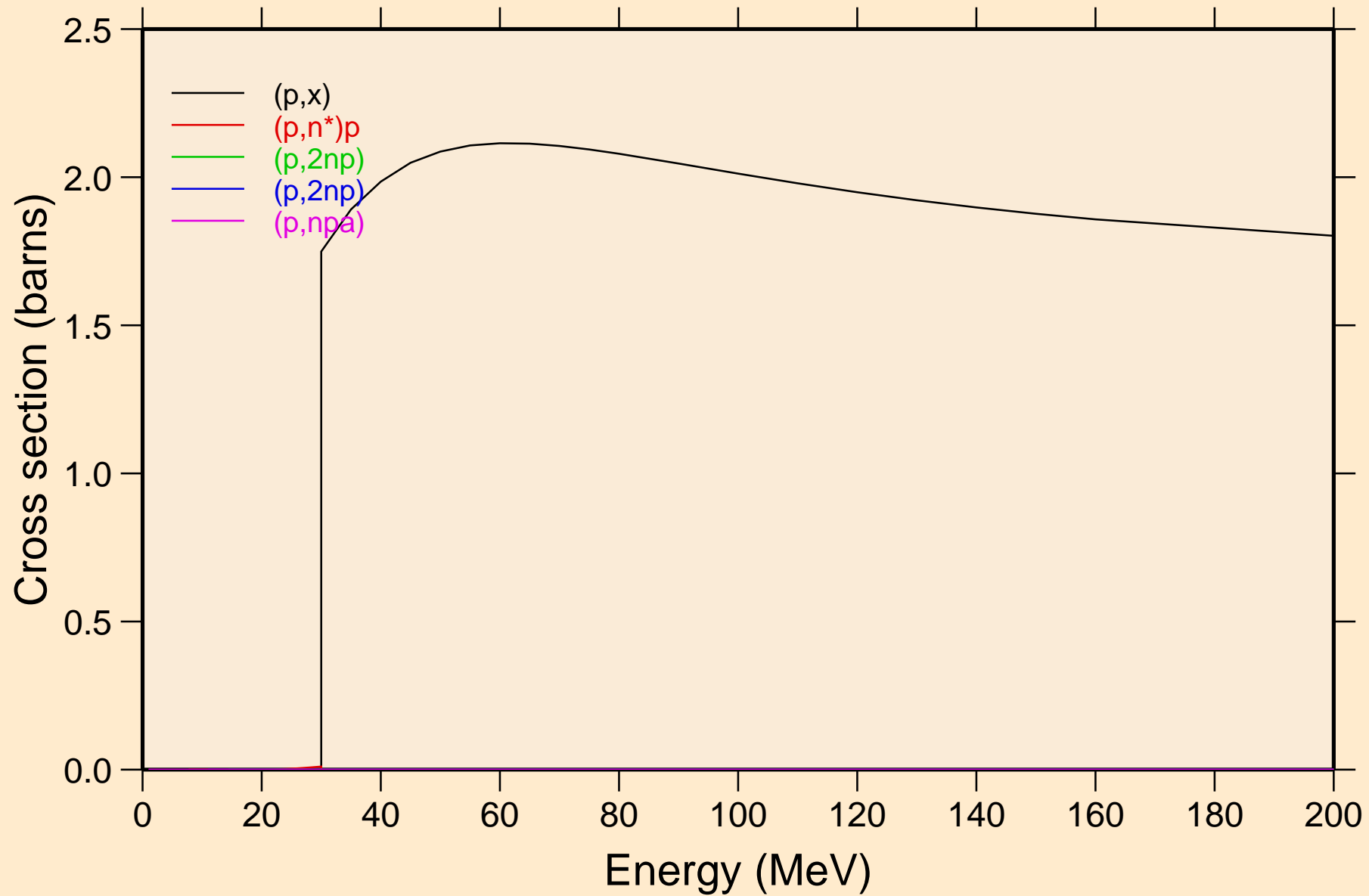

NP231 PROTON ACER TENDL-2021 LIBRARY; T=0.K  
Threshold reactions

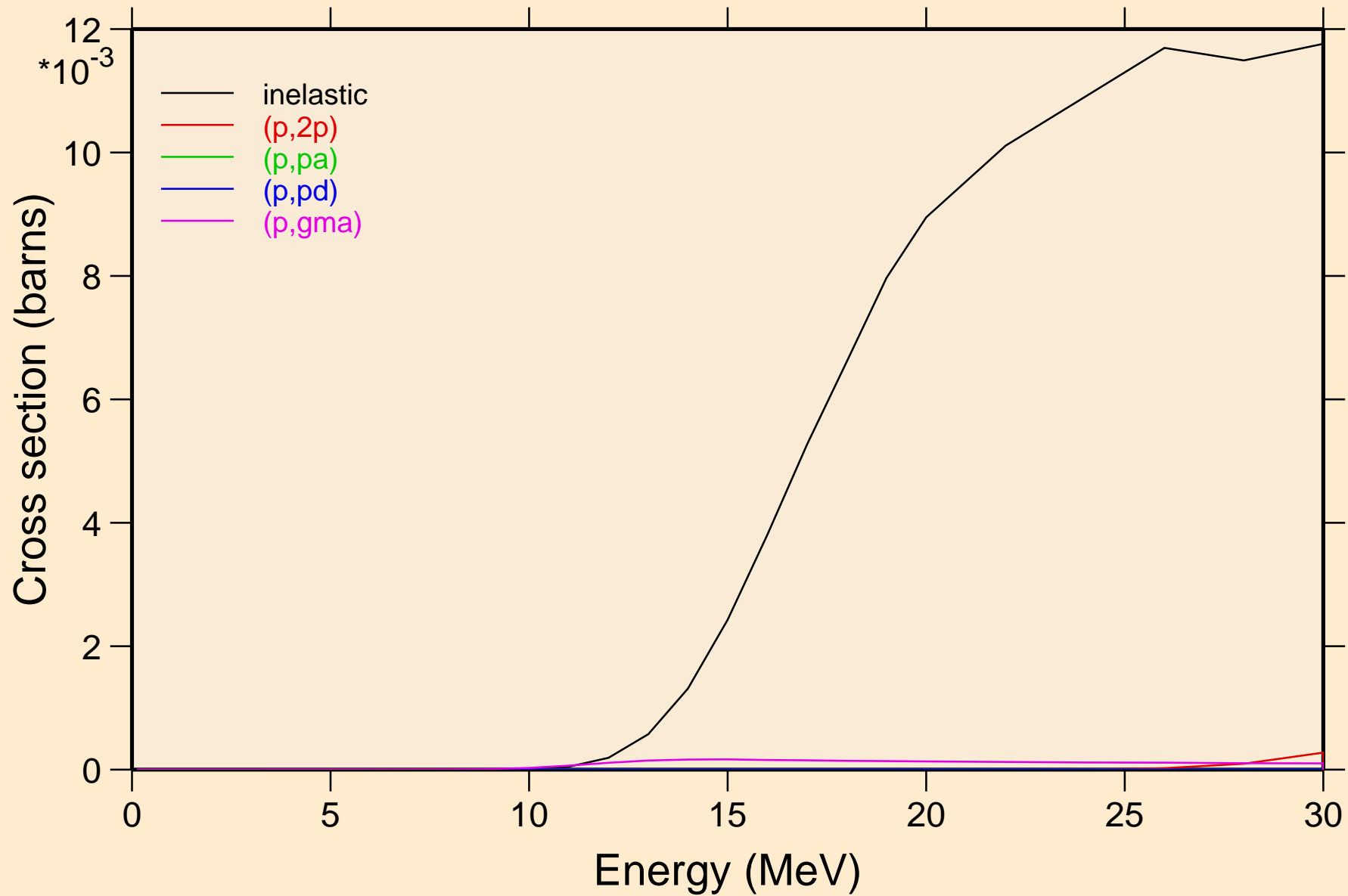

NP231 PROTON ACER TENDL-2021 LIBRARY; T=0.K  
Threshold reactions

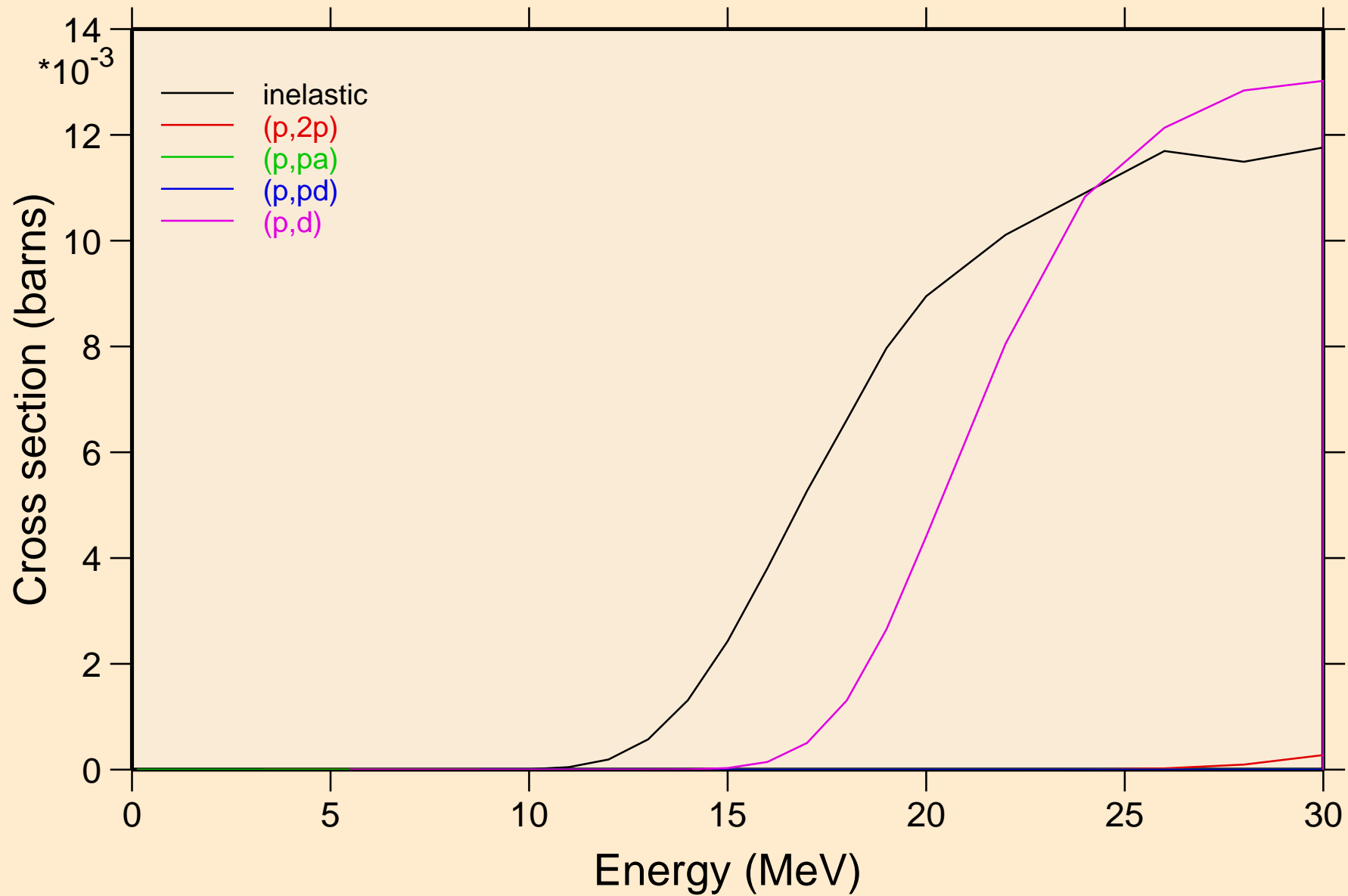

# NP231 PROTON ACER TENDL-2021 LIBRARY; T=0.K

## Threshold reactions

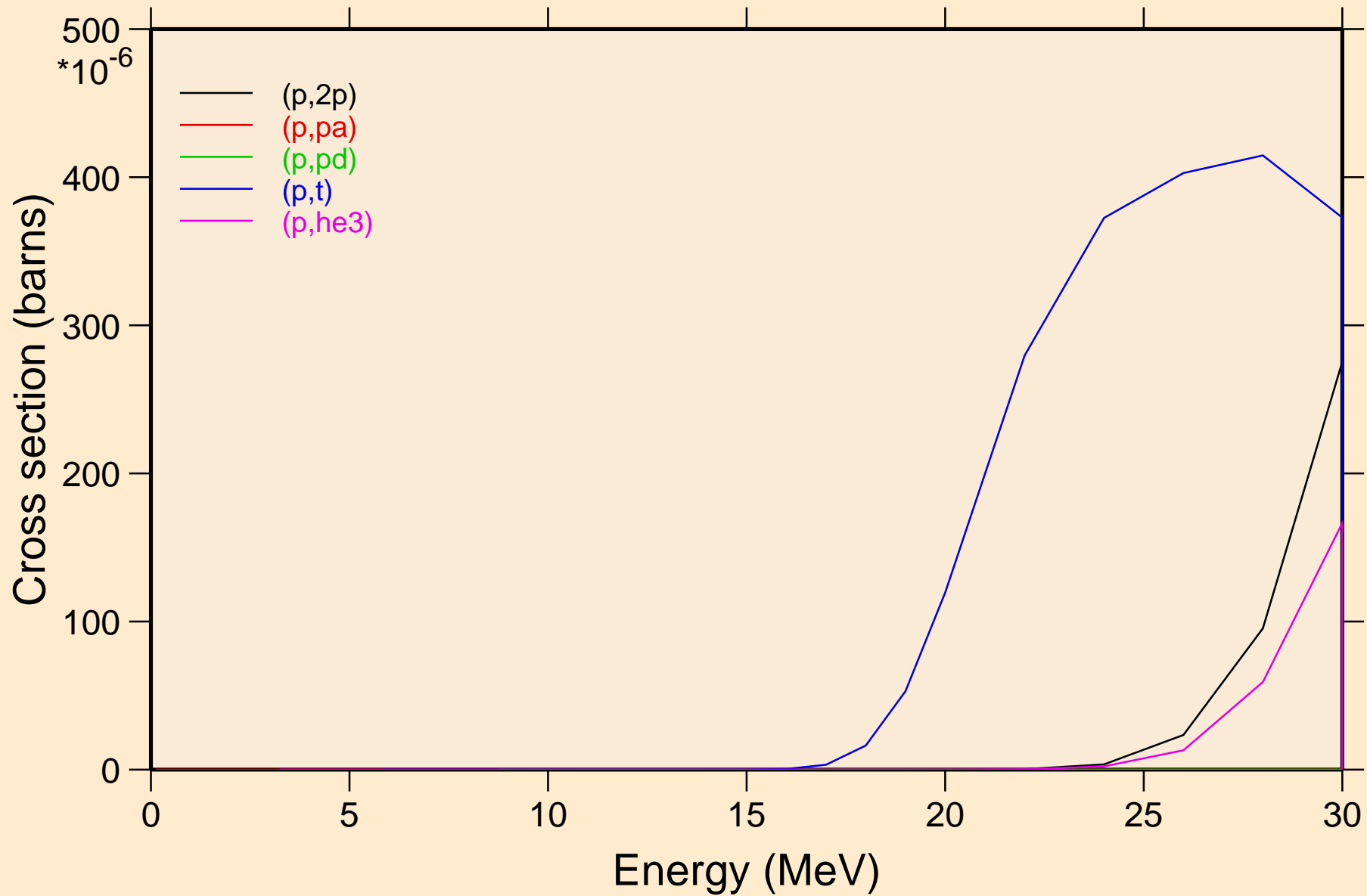



NP231 PROTON ACER TENDL-2021 LIBRARY; T=0.K  
Threshold reactions

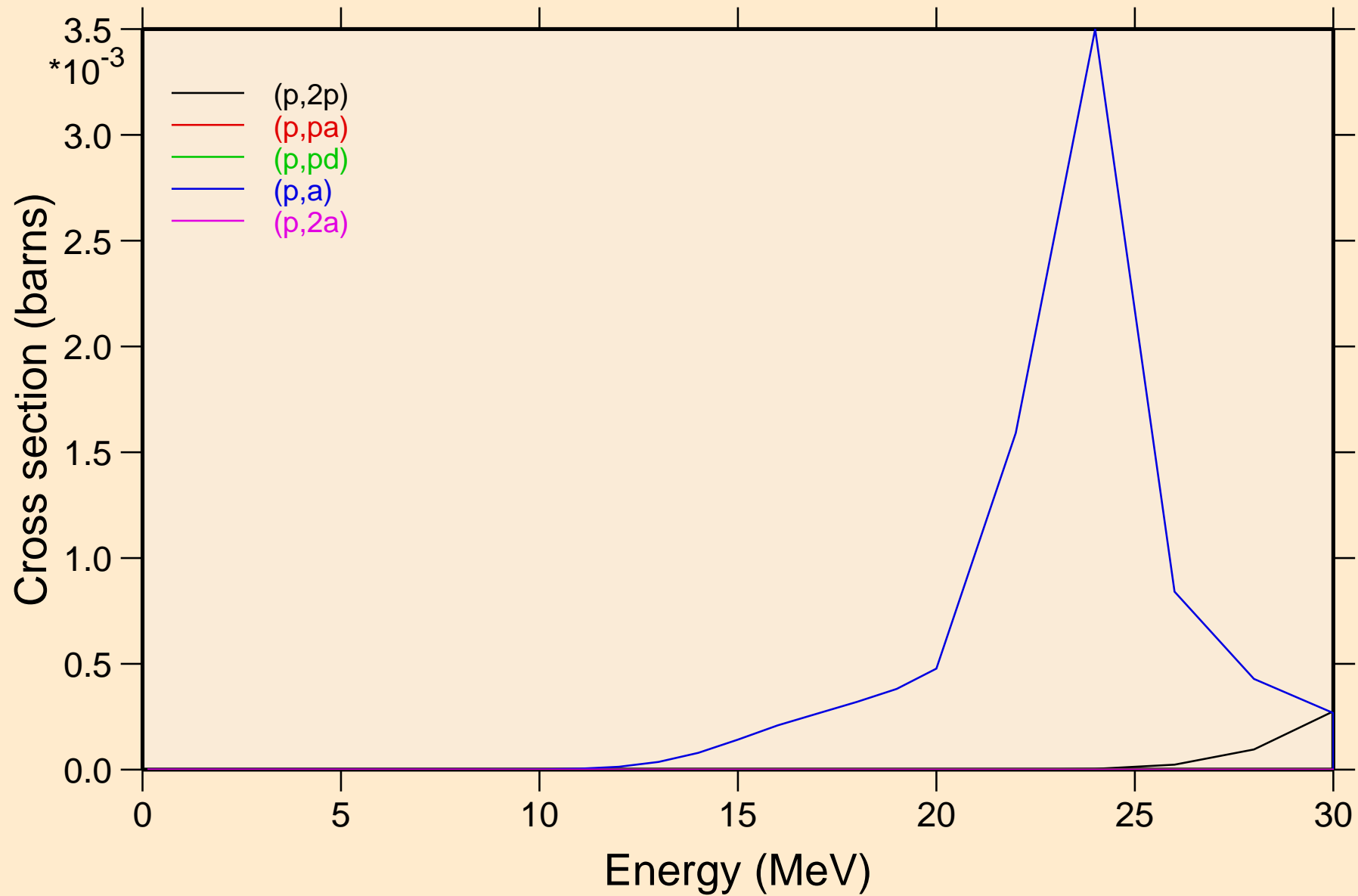

NP231 PROTON ACER TENDL-2021 LIBRARY; T=0.K  
Threshold reactions

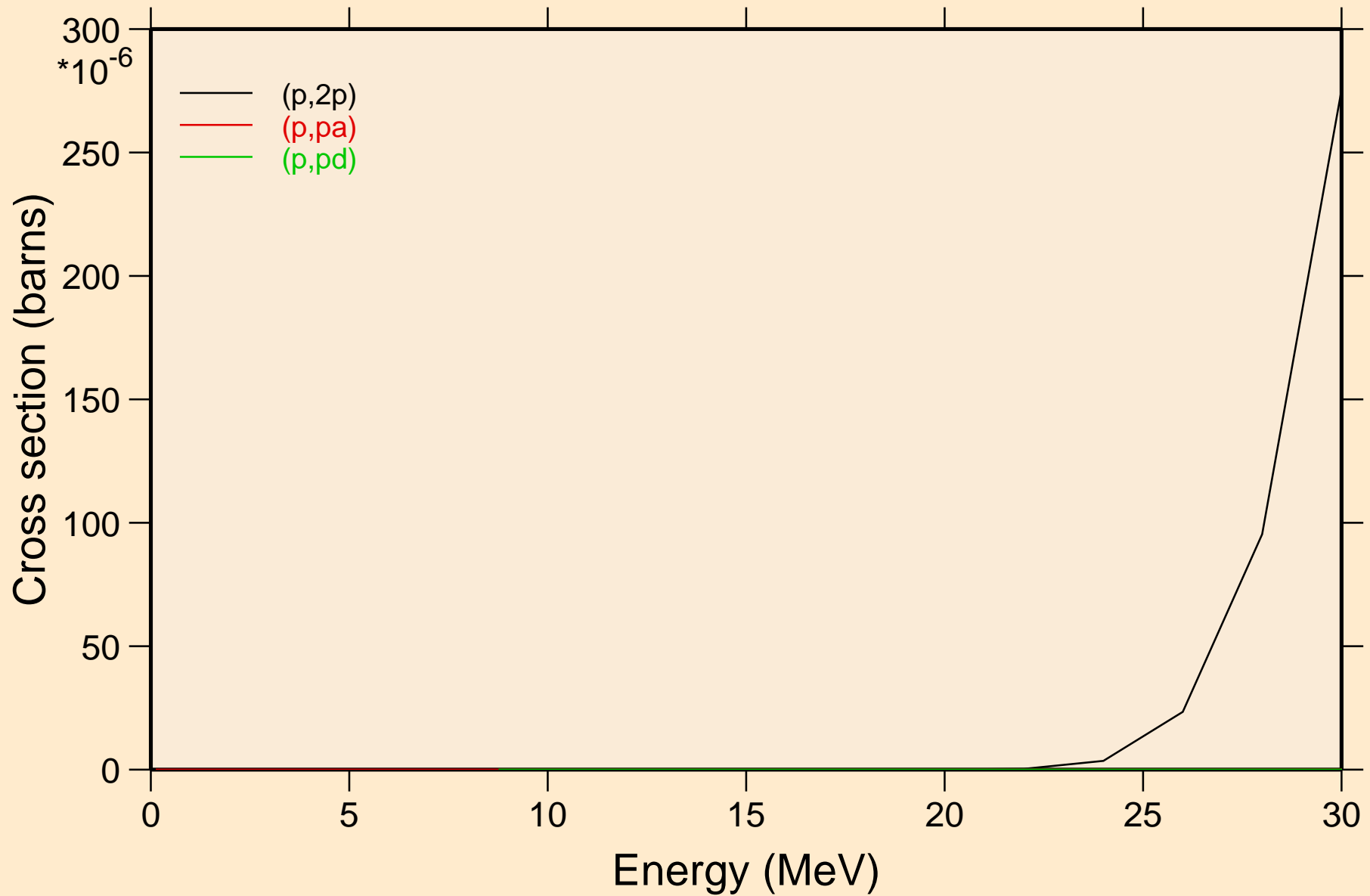

NP231 PROTON ACER TENDL-2021 LIBRARY; T=0.K  
angular distribution for elastic

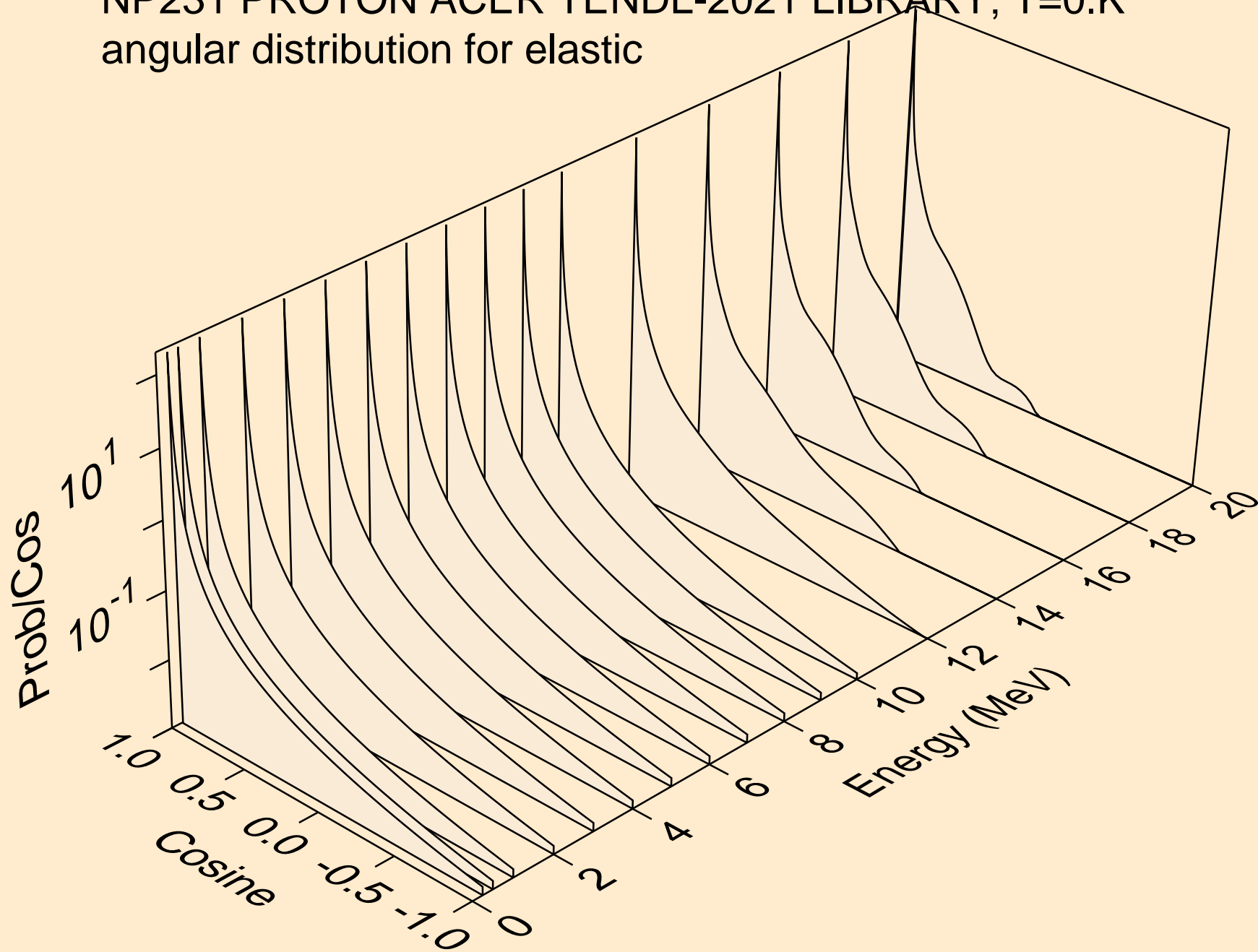

NP231 PROTON ACER TENDL-2021 LIBRARY; T=0.K  
angular distribution for elastic

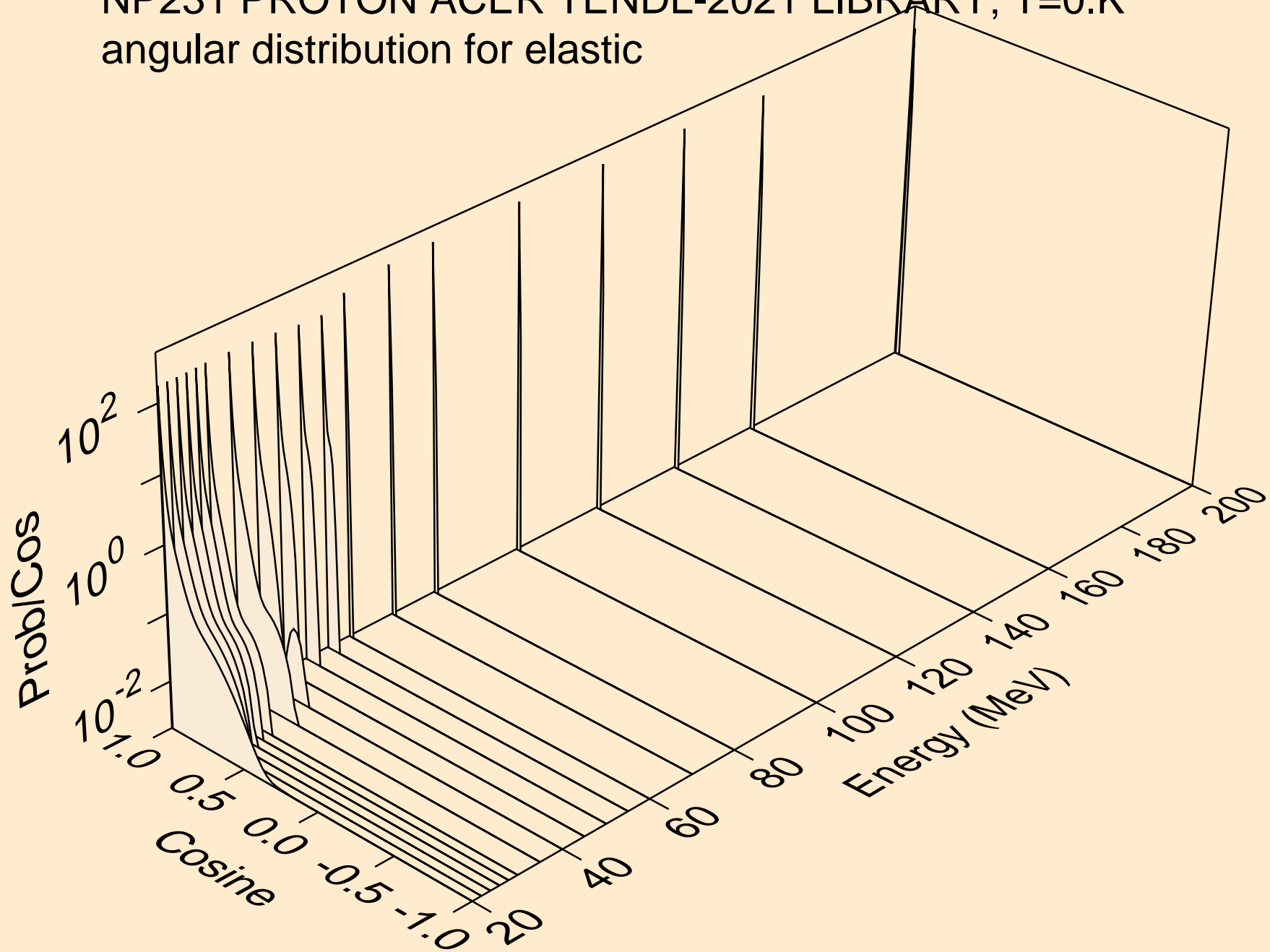

NP231 PROTON ACER TENDL-2021 LIBRARY; T=0.K  
Proton emission for (p,x)

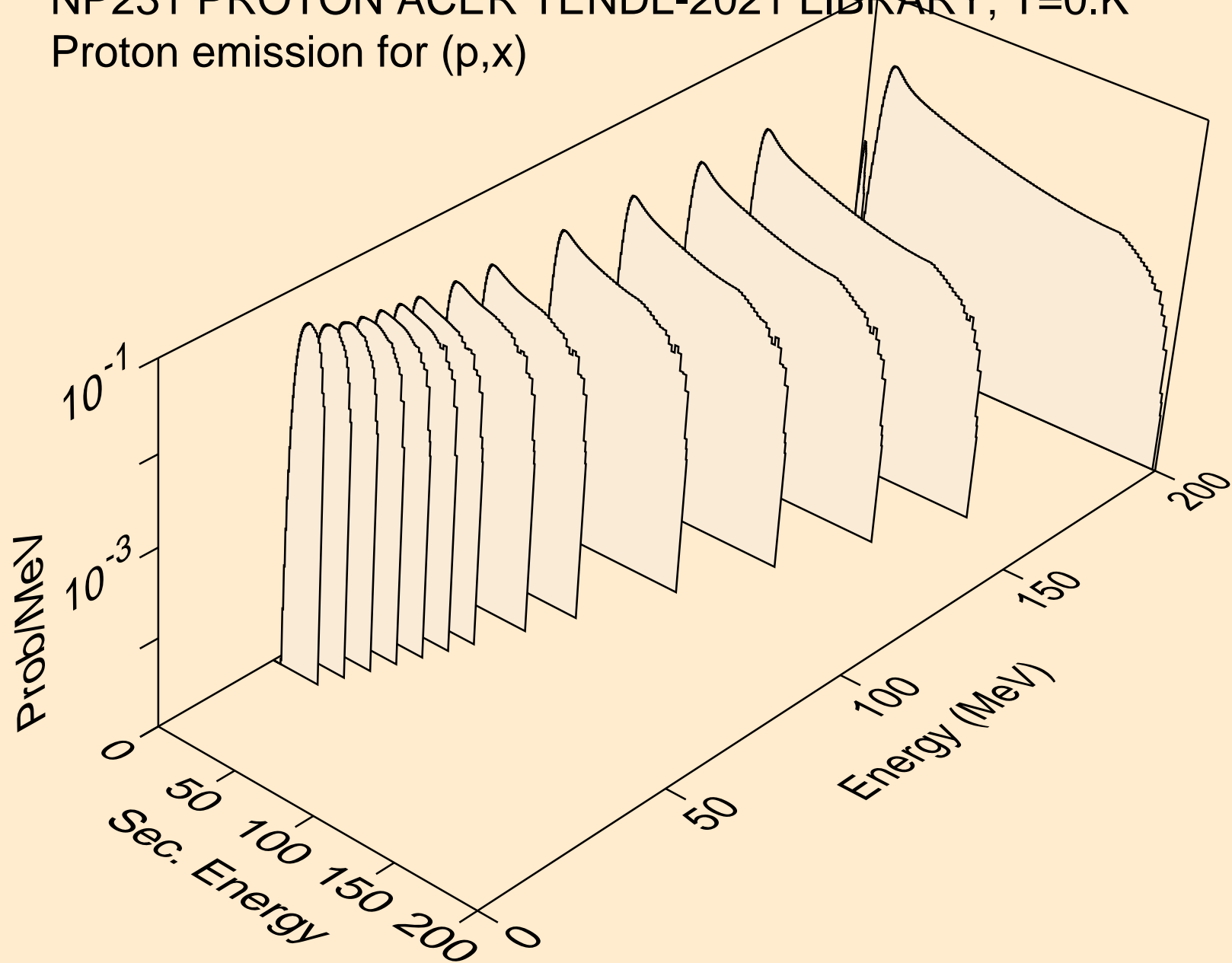

NP231 PROTON ACER TENDL-2021 LIBRARY; T=0.K  
Proton emission for (p,n\*)p

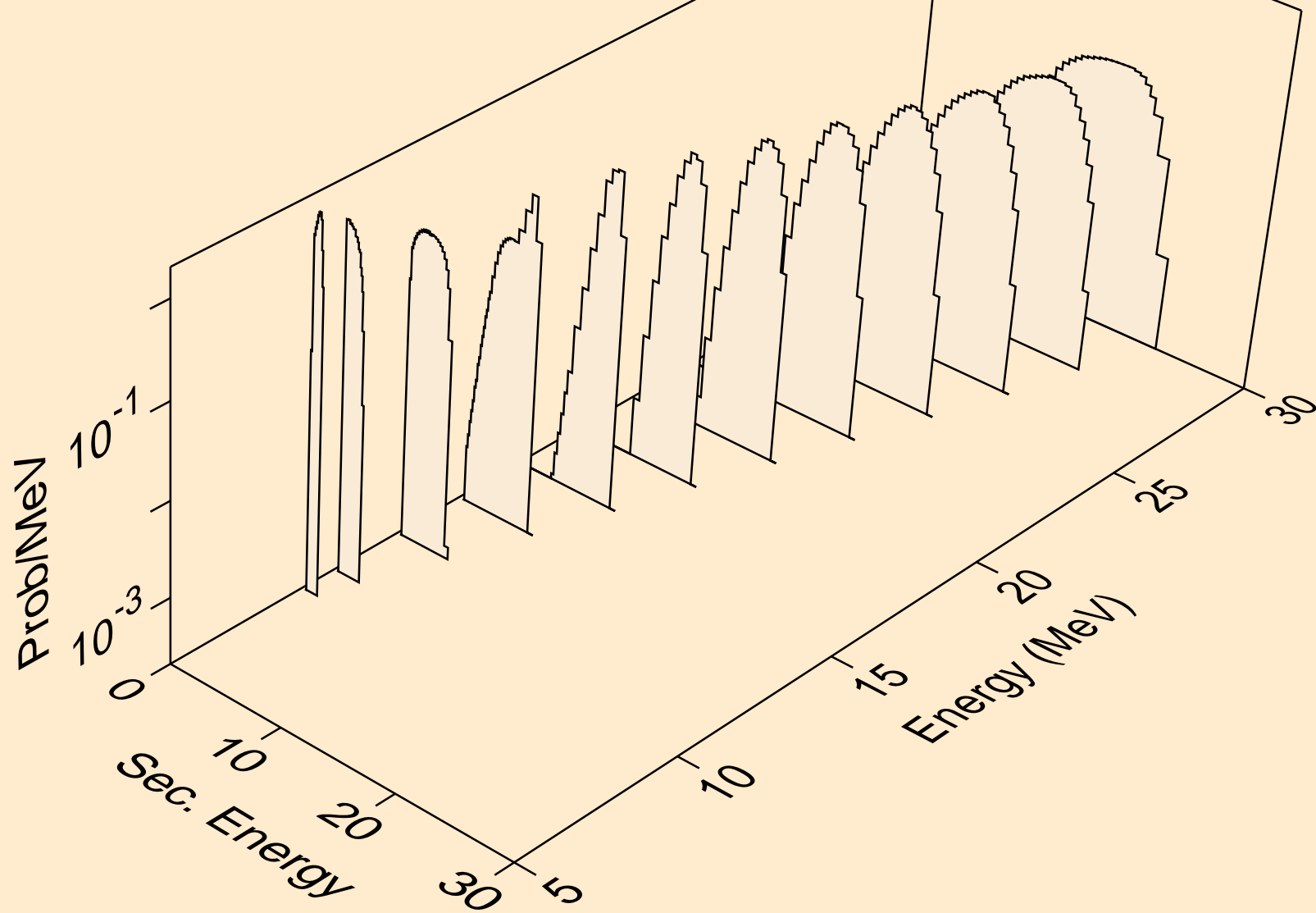

NP231 PROTON ACER TENDL-2021 LIBRARY; T=0.K  
Proton emission for (p,2np)

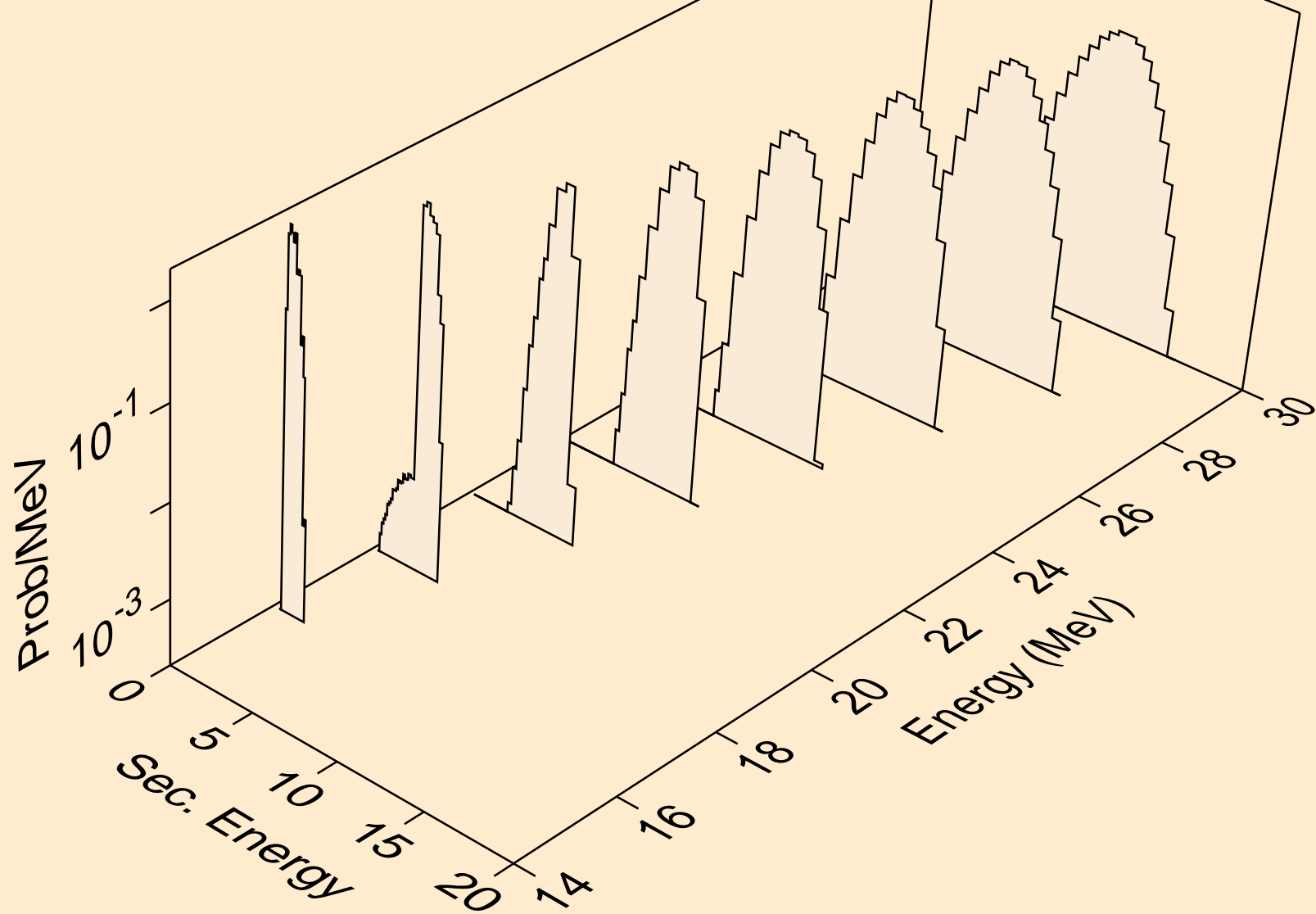

NP231 PROTON ACER TENDL-2021 LIBRARY; T=0.K  
Proton emission for (p,2np)

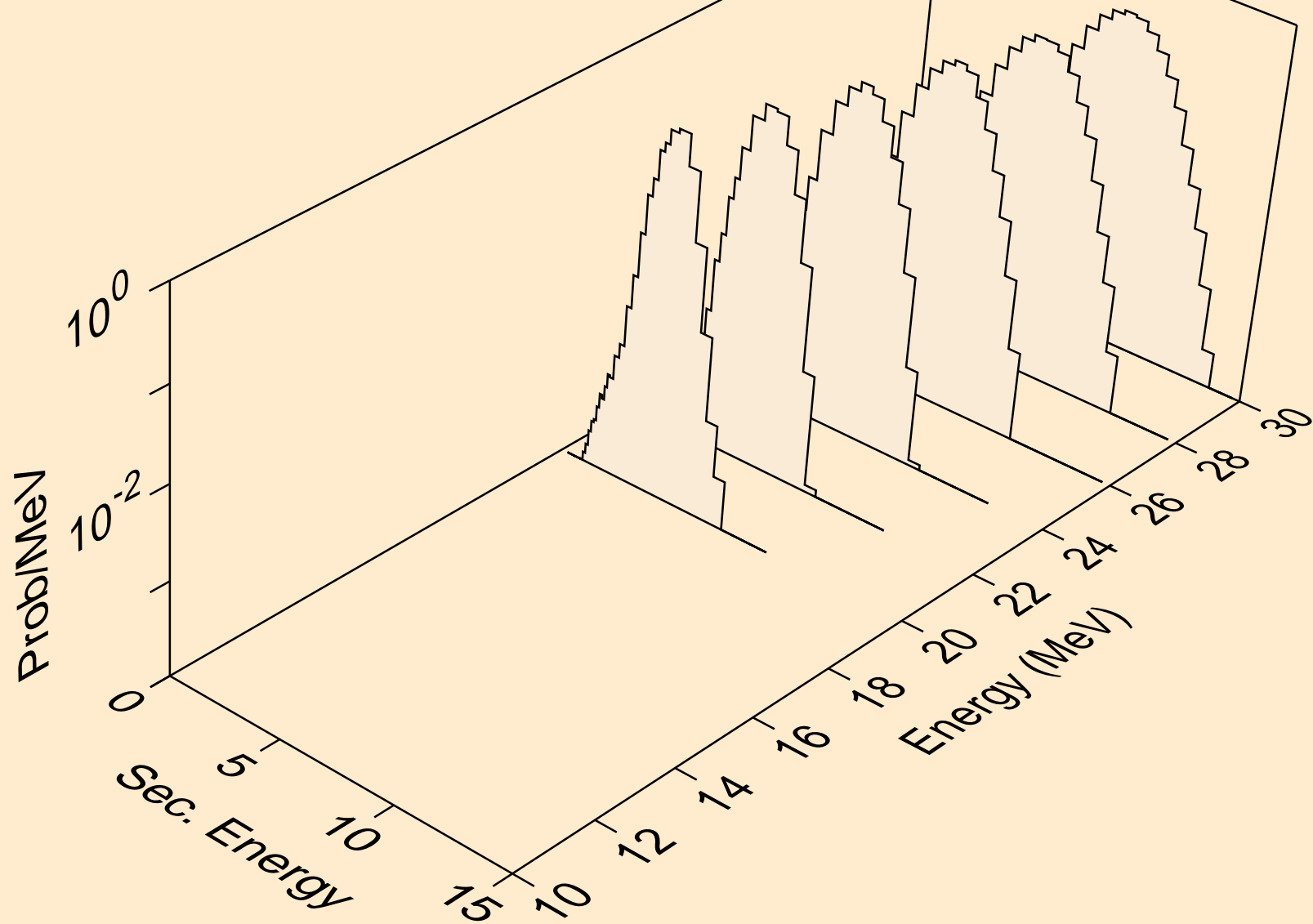



NP231 PROTON ACER TENDL-2021 LIBRARY; T=0.K  
Proton emission for (p,npa)

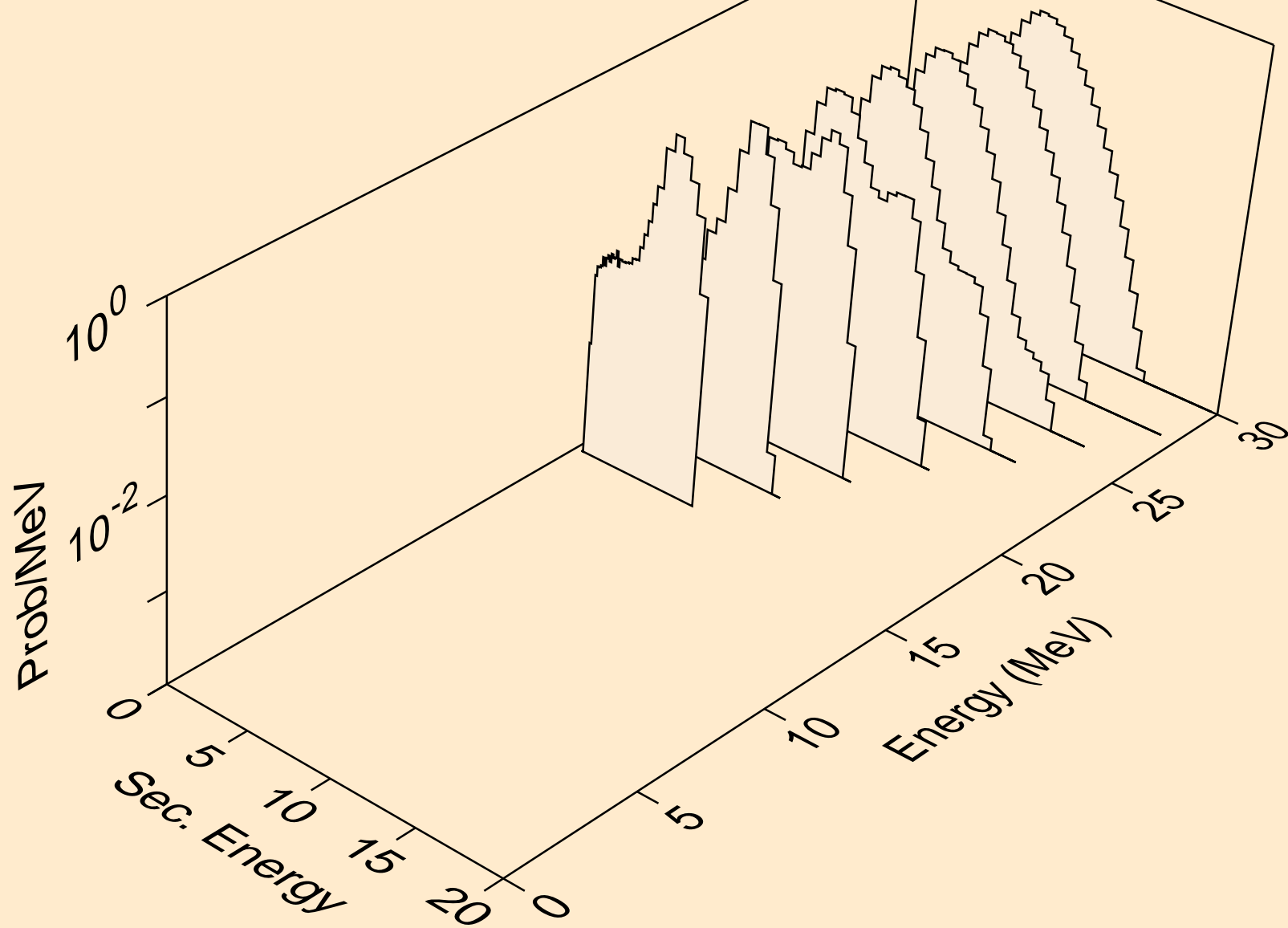

NP231 PROTON ACER TENDL-2021 LIBRARY; T=0.K  
Proton emission for inelastic

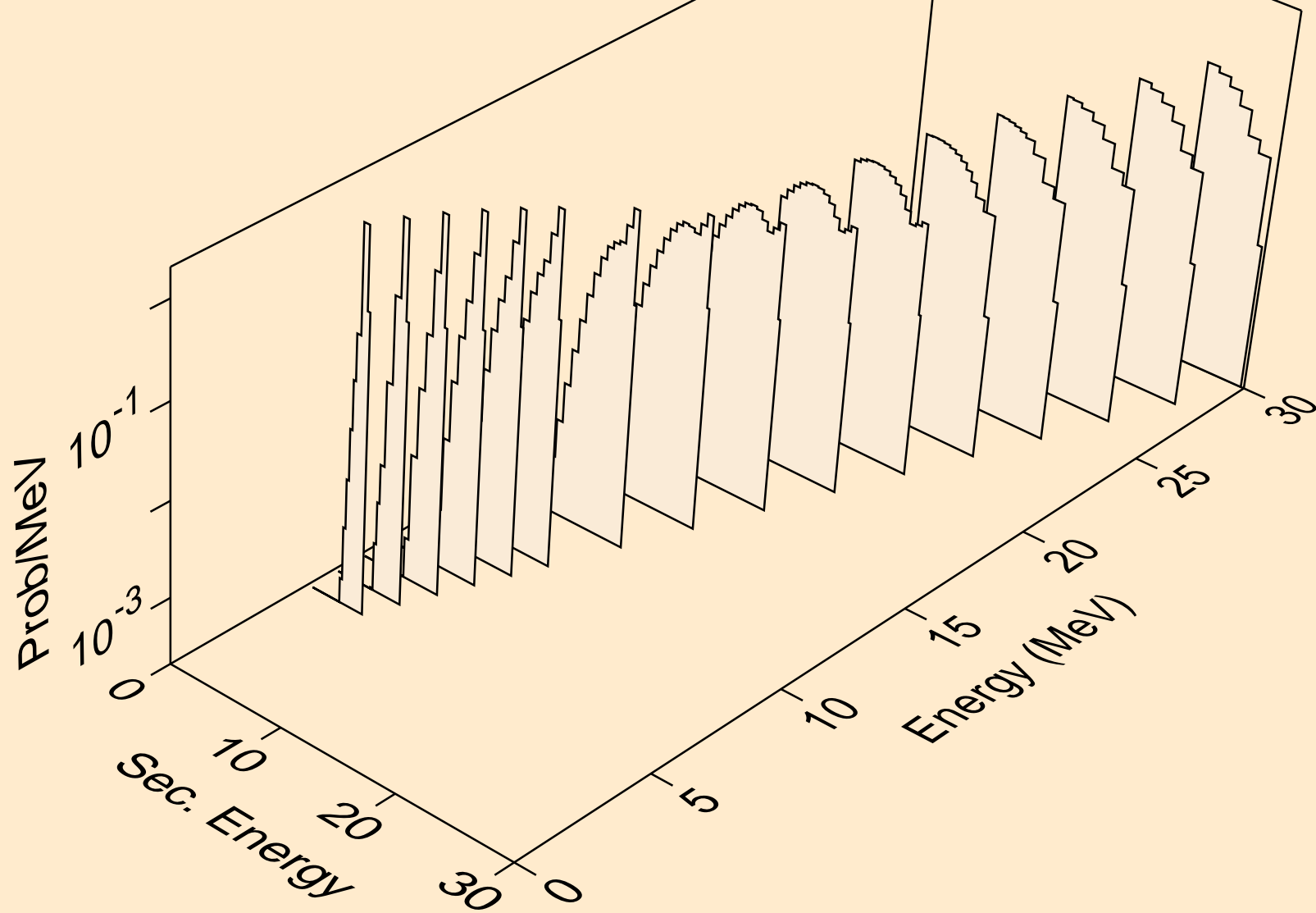

NP231 PROTON ACER TENDL-2021 LIBRARY; T=0.K  
Proton emission for (p,2p)

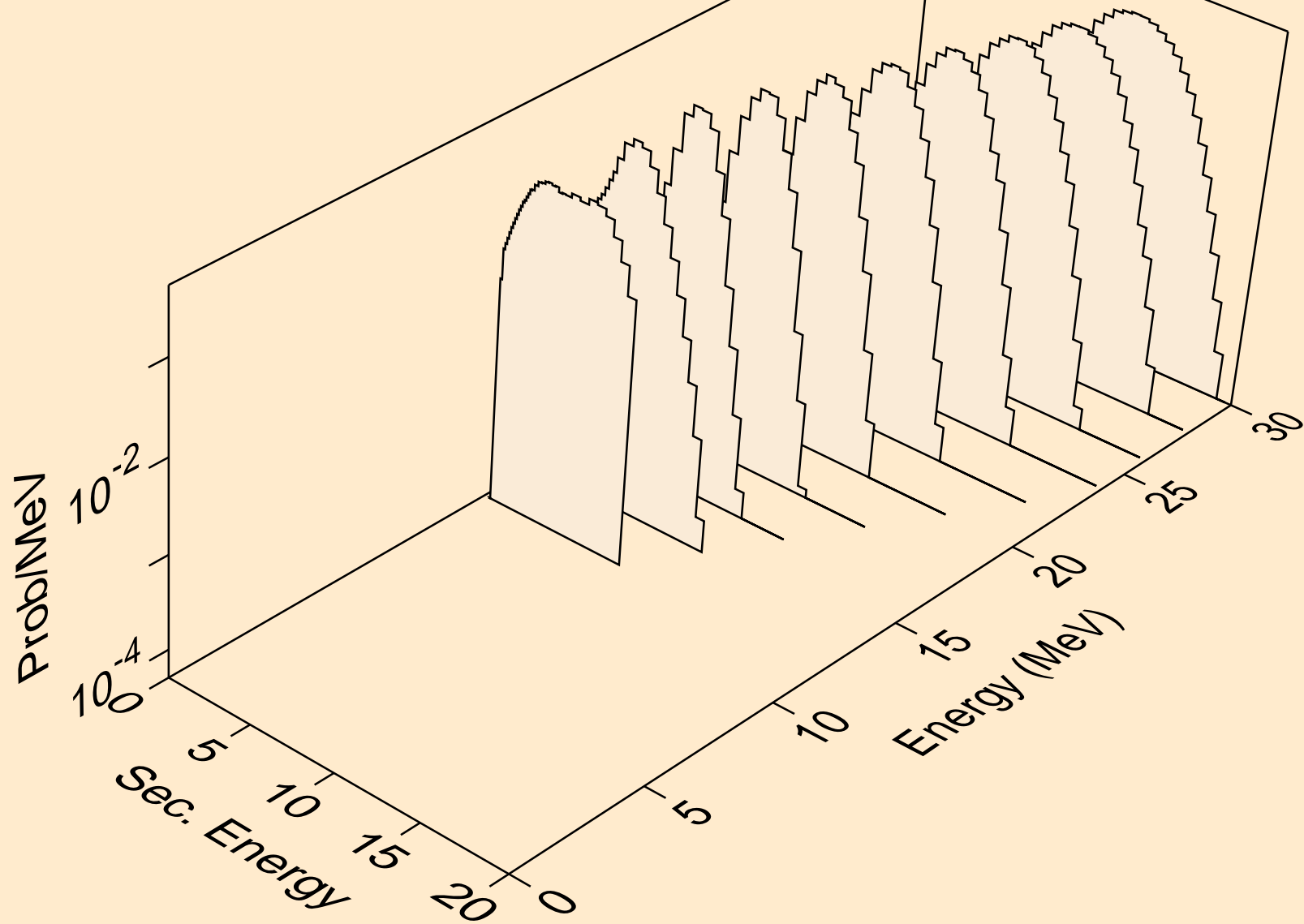

NP231 PROTON ACER TENDL-2021 LIBRARY; T=0.K  
Proton emission for (p,pa)

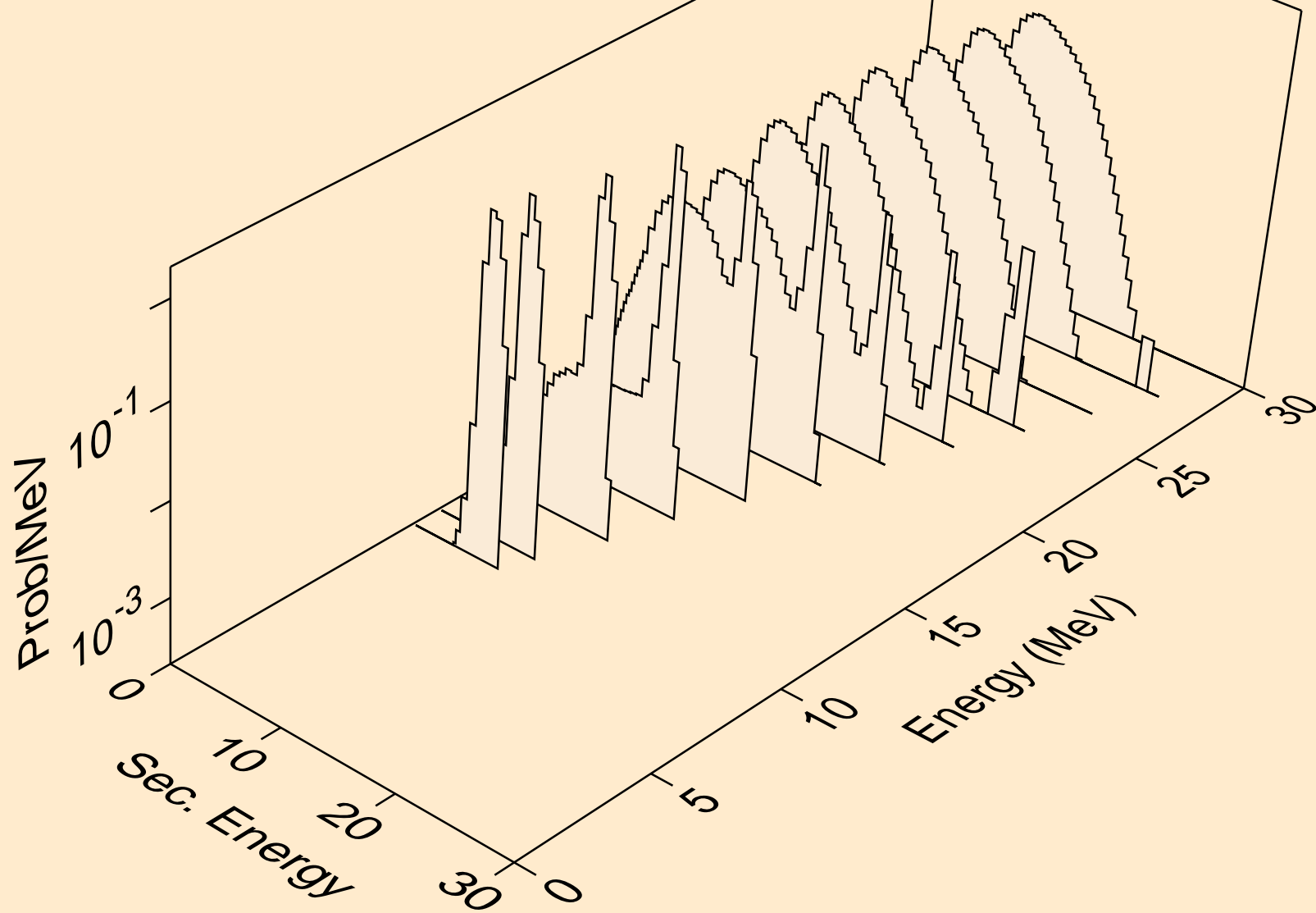

NP231 PROTON ACER TENDL-2021 LIBRARY; T=0.K  
Proton emission for (p,pd)

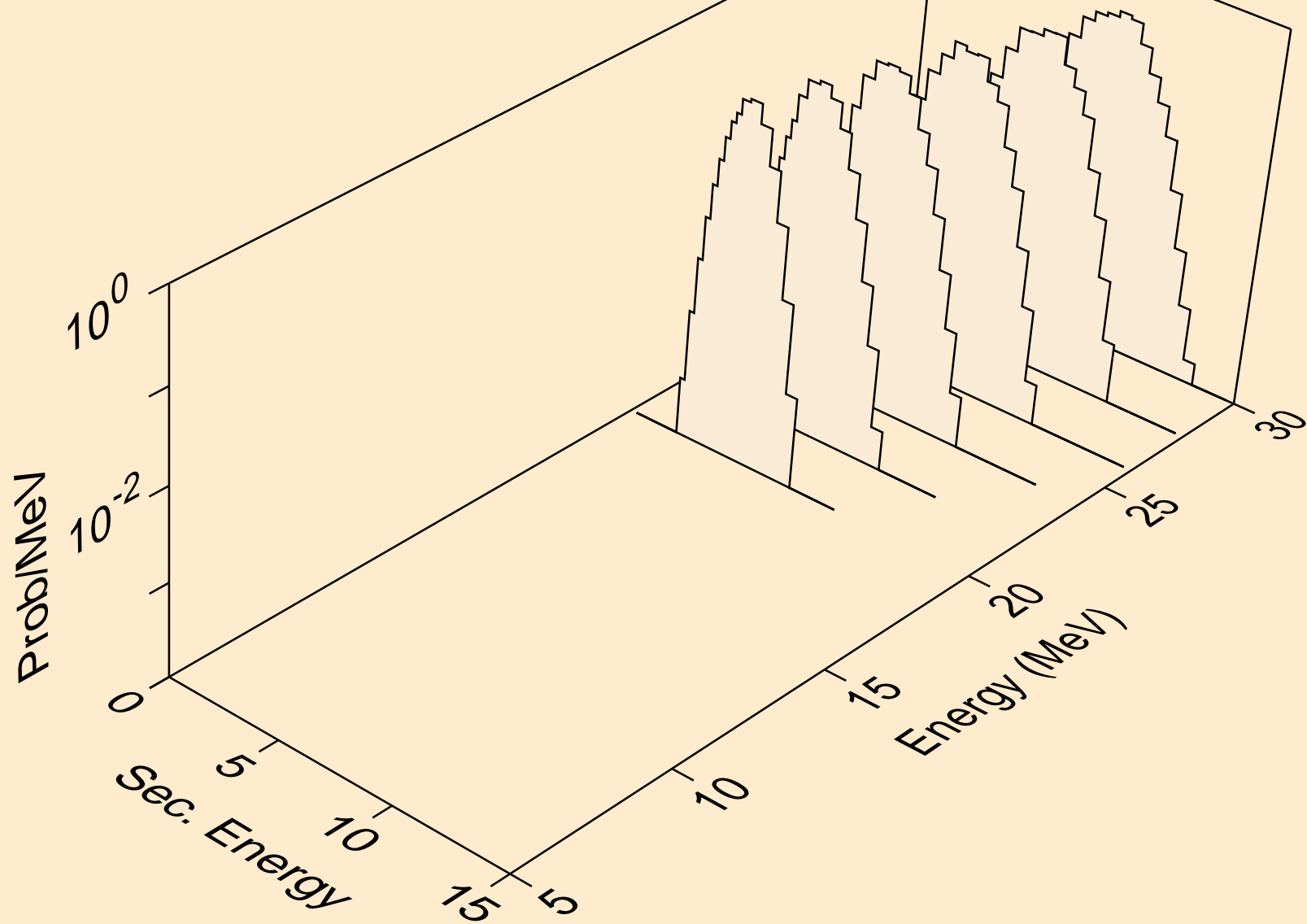

NP231 PROTON ACER TENDL-2021 LIBRARY; T=0.K  
Photon emission for (z,n)

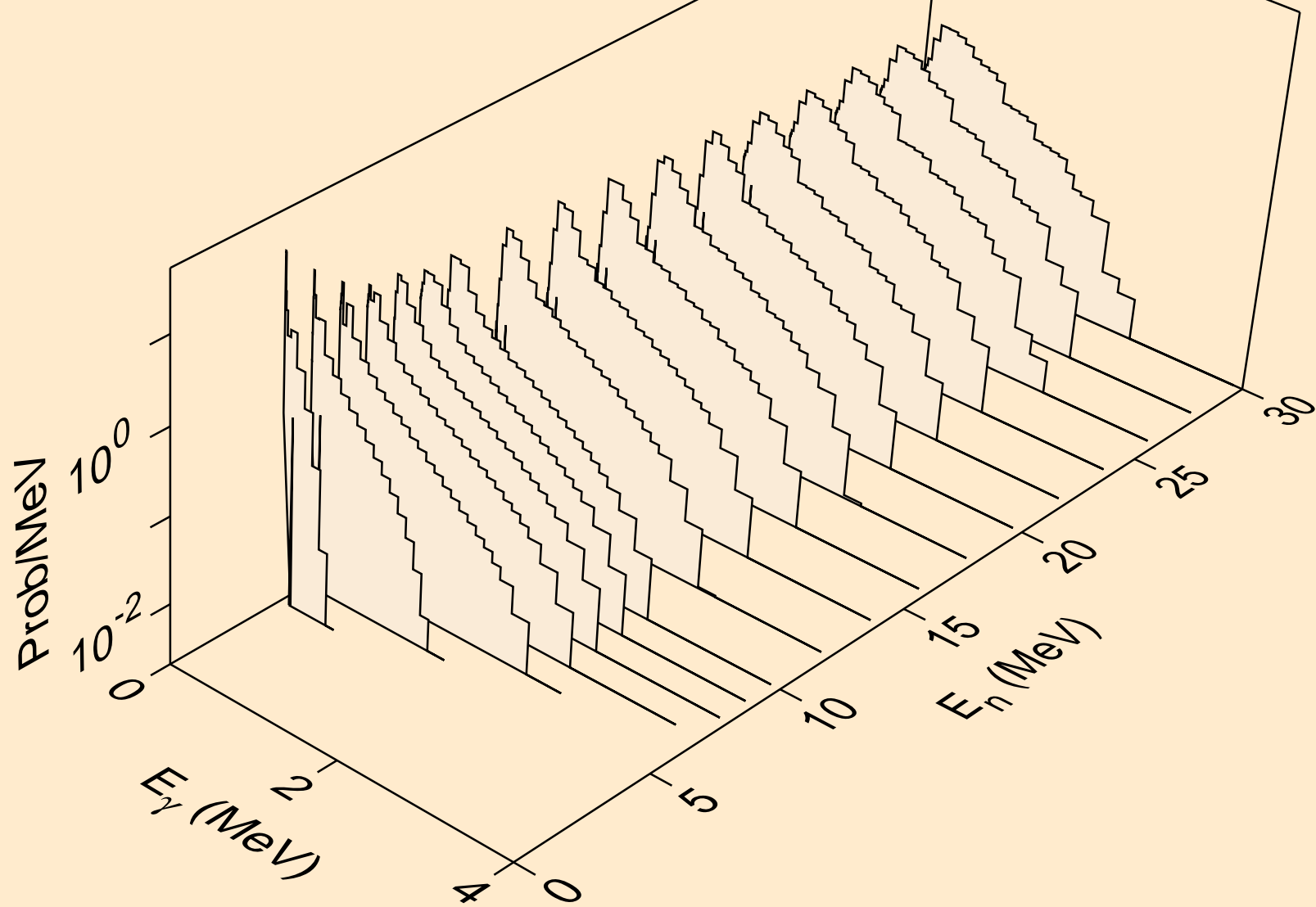

NP231 PROTON ACER TENDL-2021 LIBRARY; T=0.K  
Photon emission for (n,x)

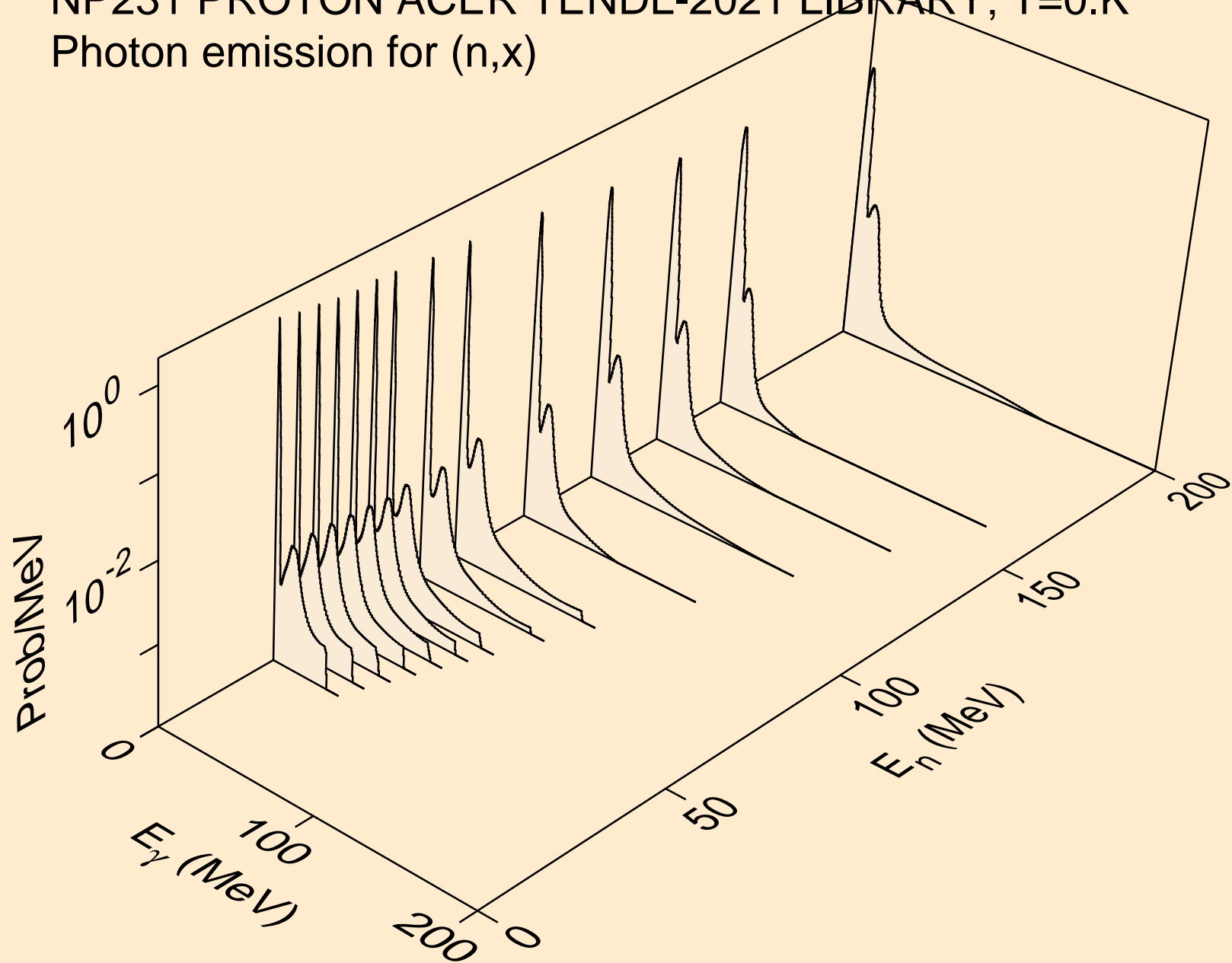

NP231 PROTON ACER TENDL-2021 LIBRARY; T=0.K  
Photon emission for (n,2n)

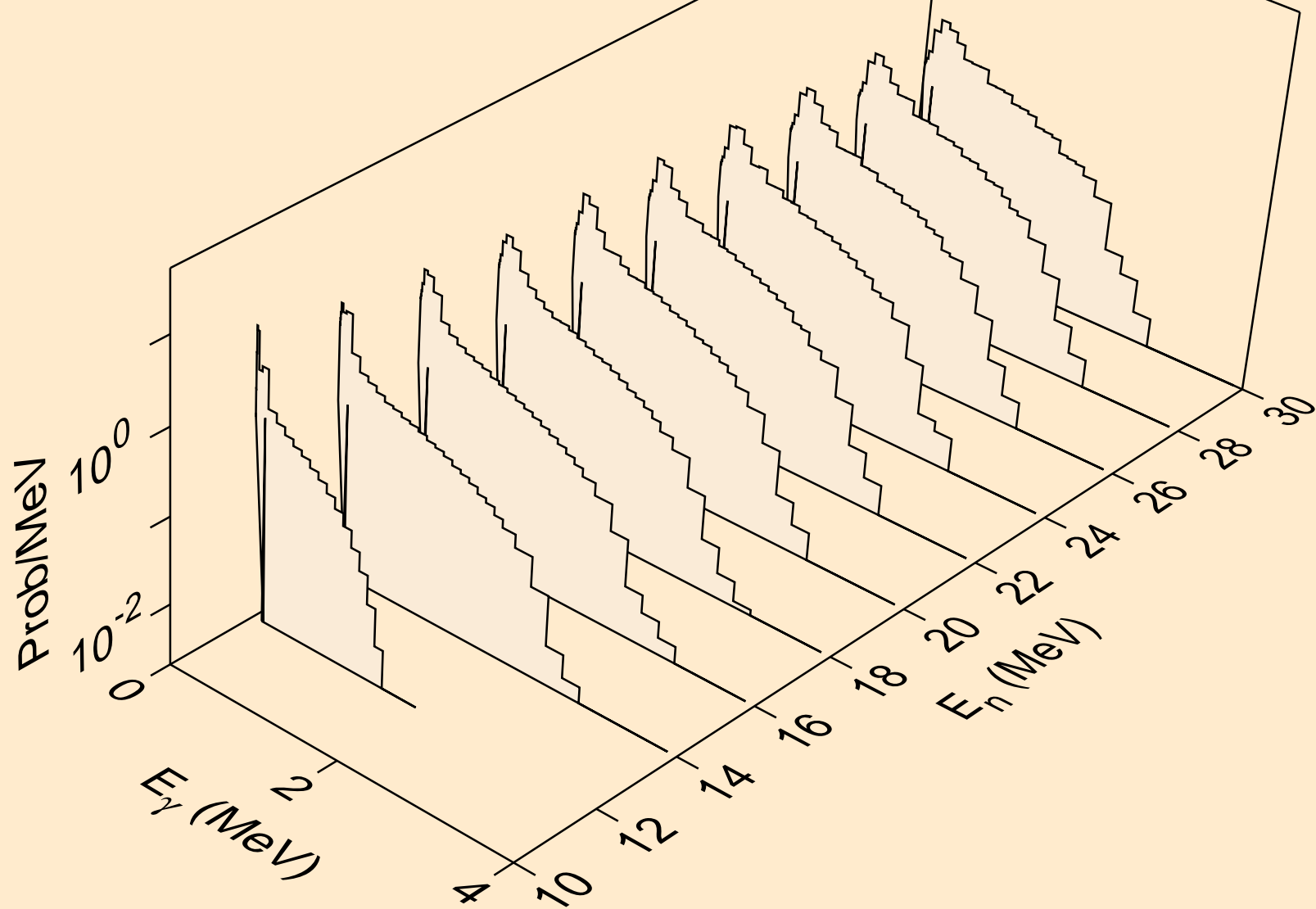



NP231 PROTON ACER TENDL-2021 LIBRARY; T=0.K  
Photon emission for (n,3n)

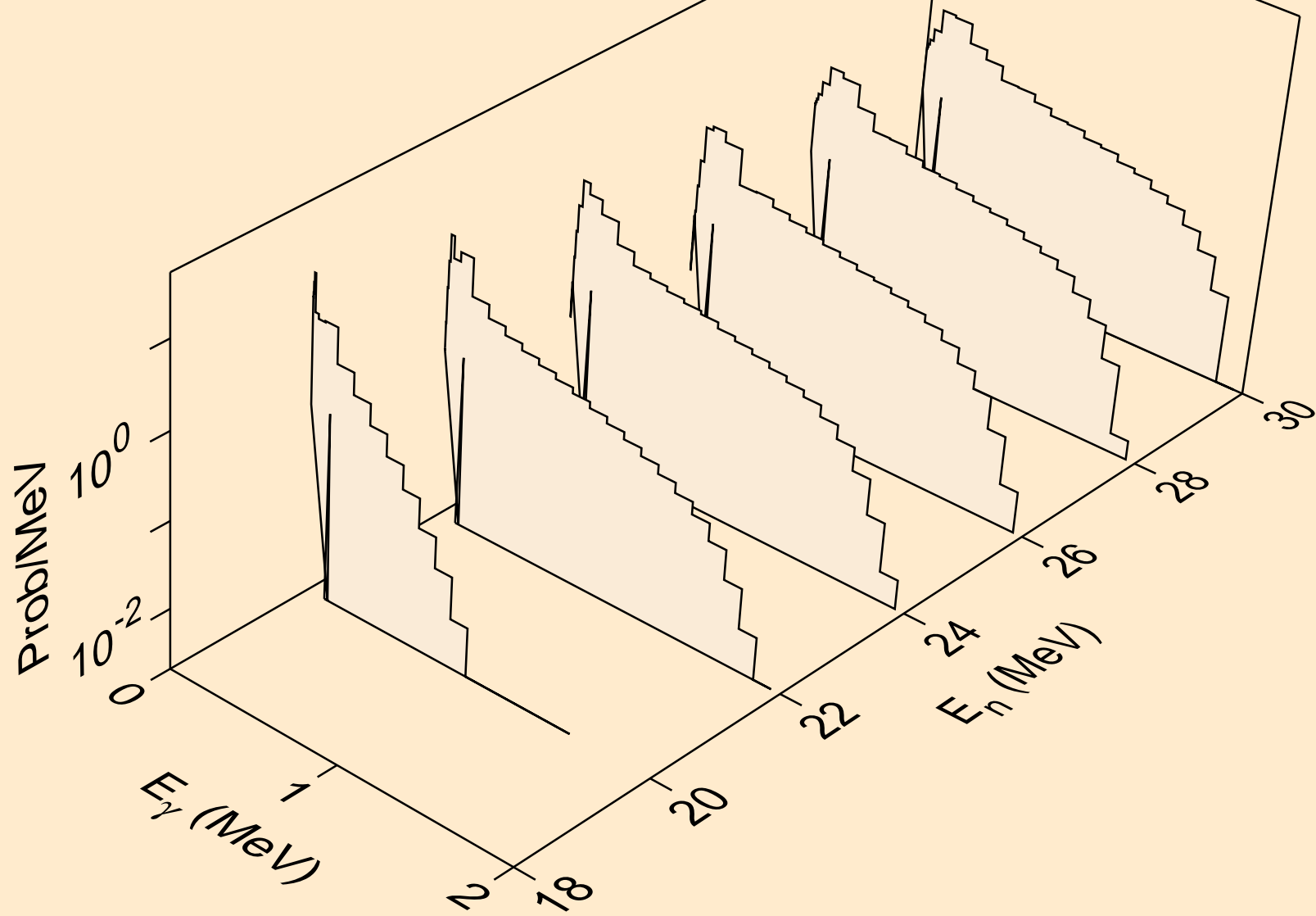

NP231 PROTON ACER TENDL-2021 LIBRARY; T=0.K  
Photon emission for (n,n\*)a

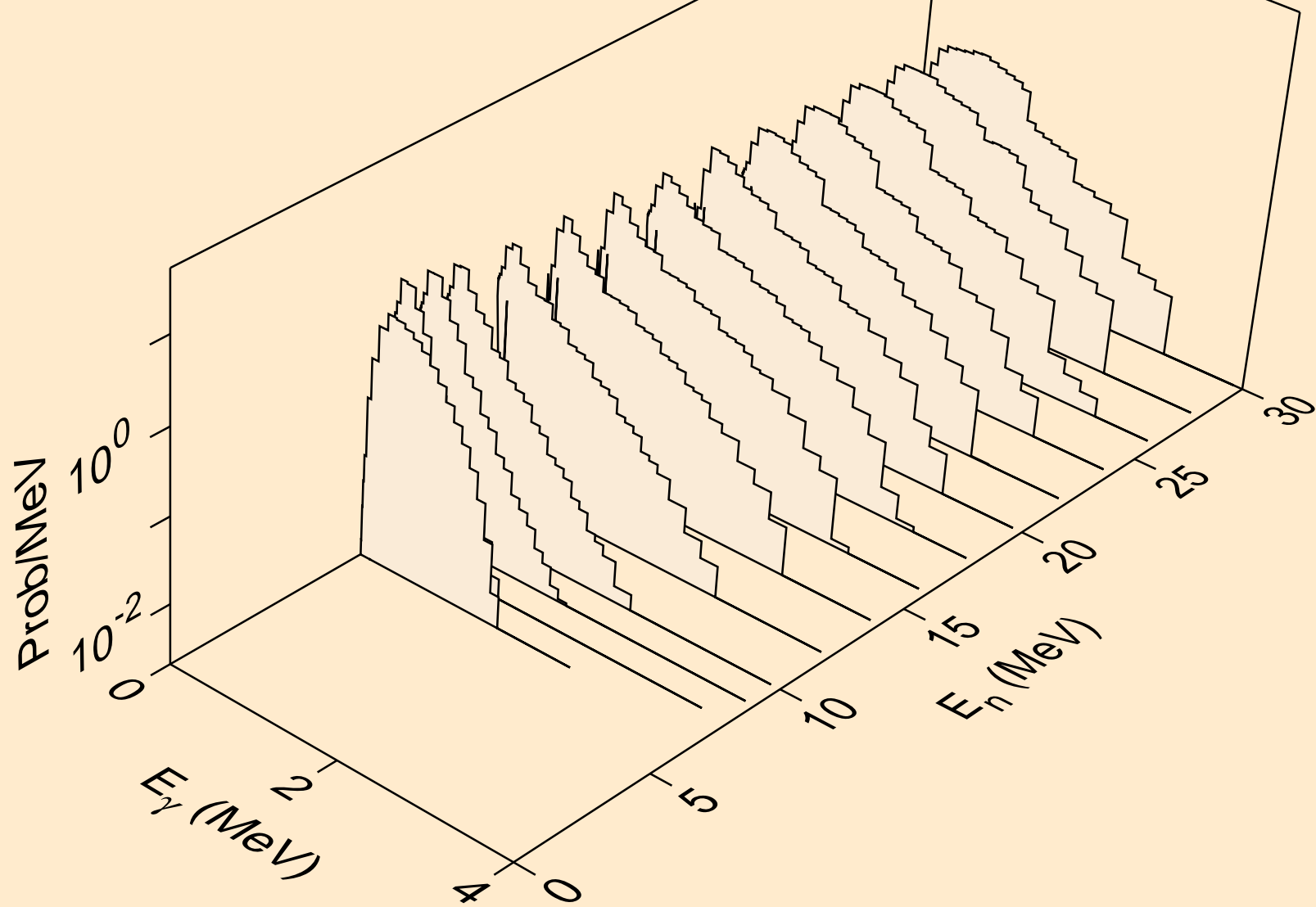

NP231 PROTON ACER TENDL-2021 LIBRARY; T=0.K  
Photon emission for (n,2n)a

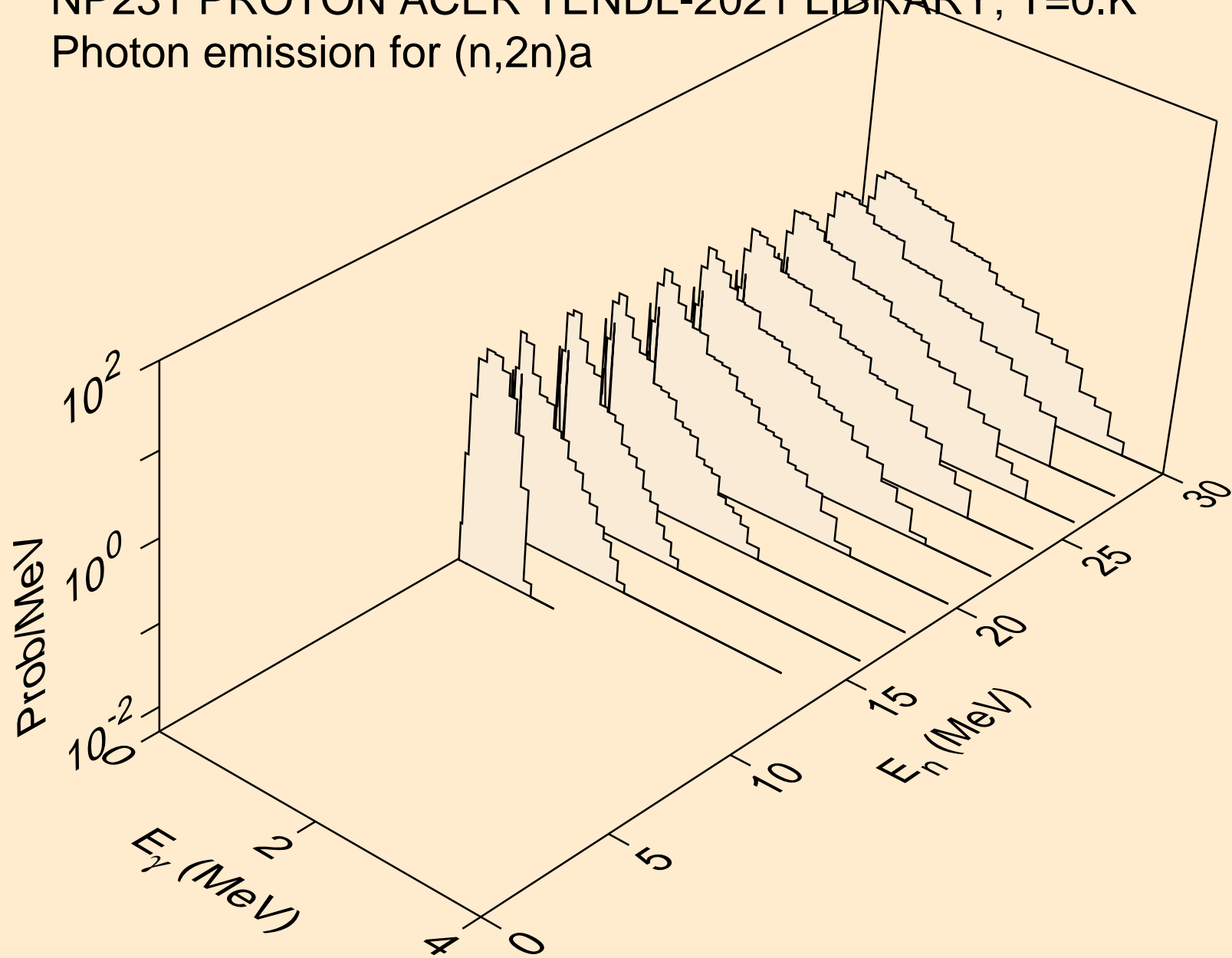

NP231 PROTON ACER TENDL-2021 LIBRARY; T=0.K  
Photon emission for (n,n\*)p

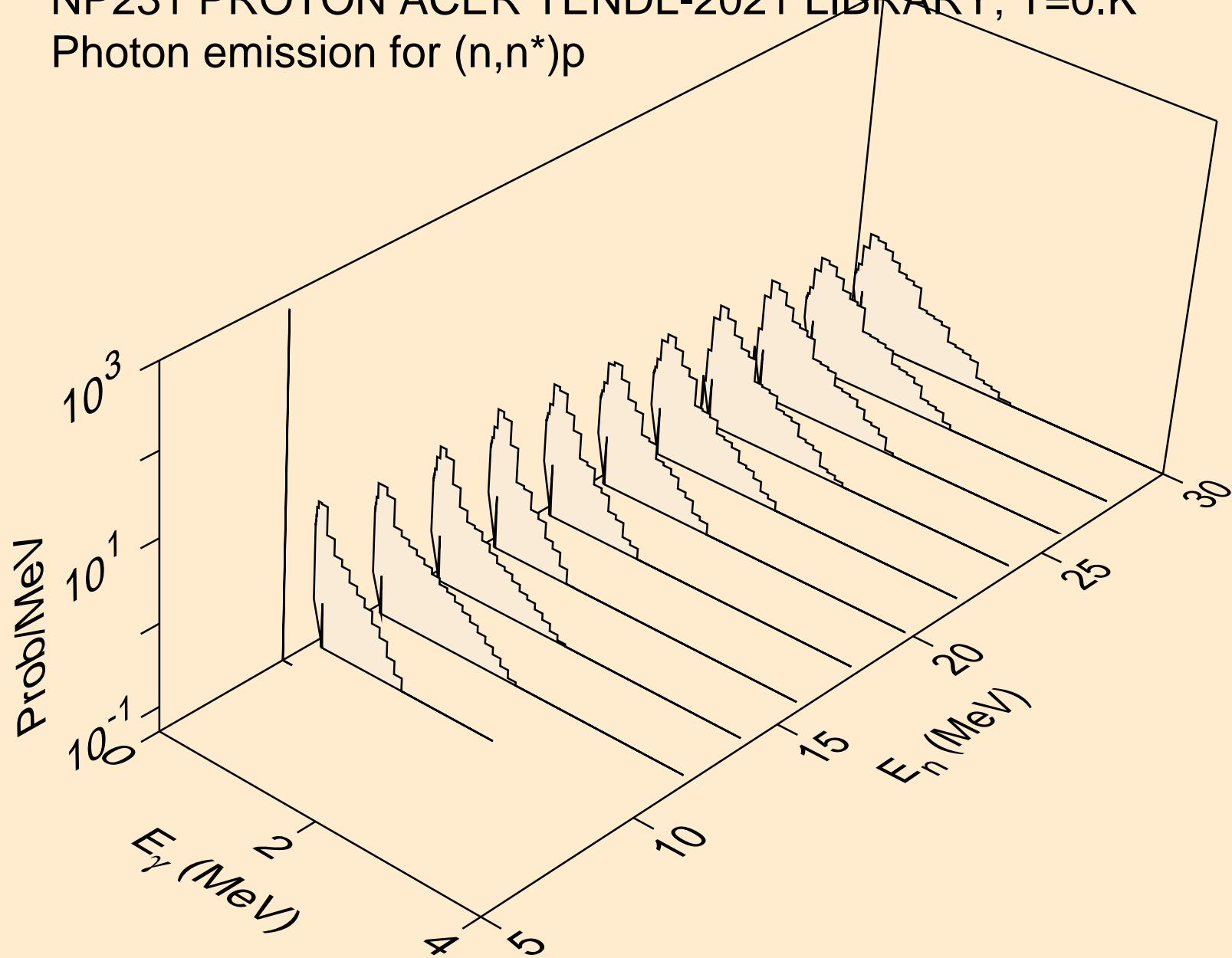

NP231 PROTON ACER TENDL-2021 LIBRARY; T=0.K  
Photon emission for (n,n\*)2a

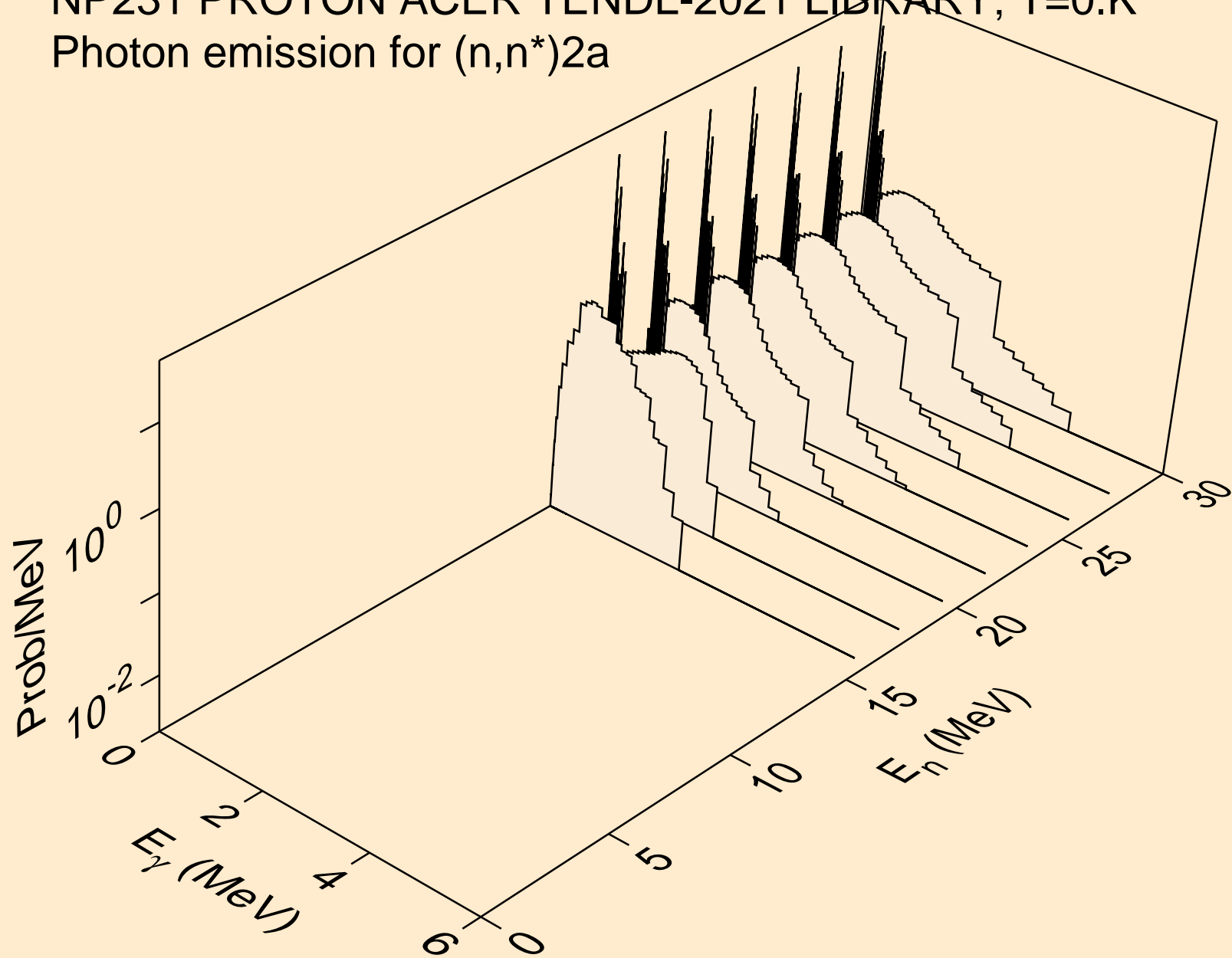

NP231 PROTON ACER TENDL-2021 LIBRARY; T=0.K  
Photon emission for (n,n\*)d

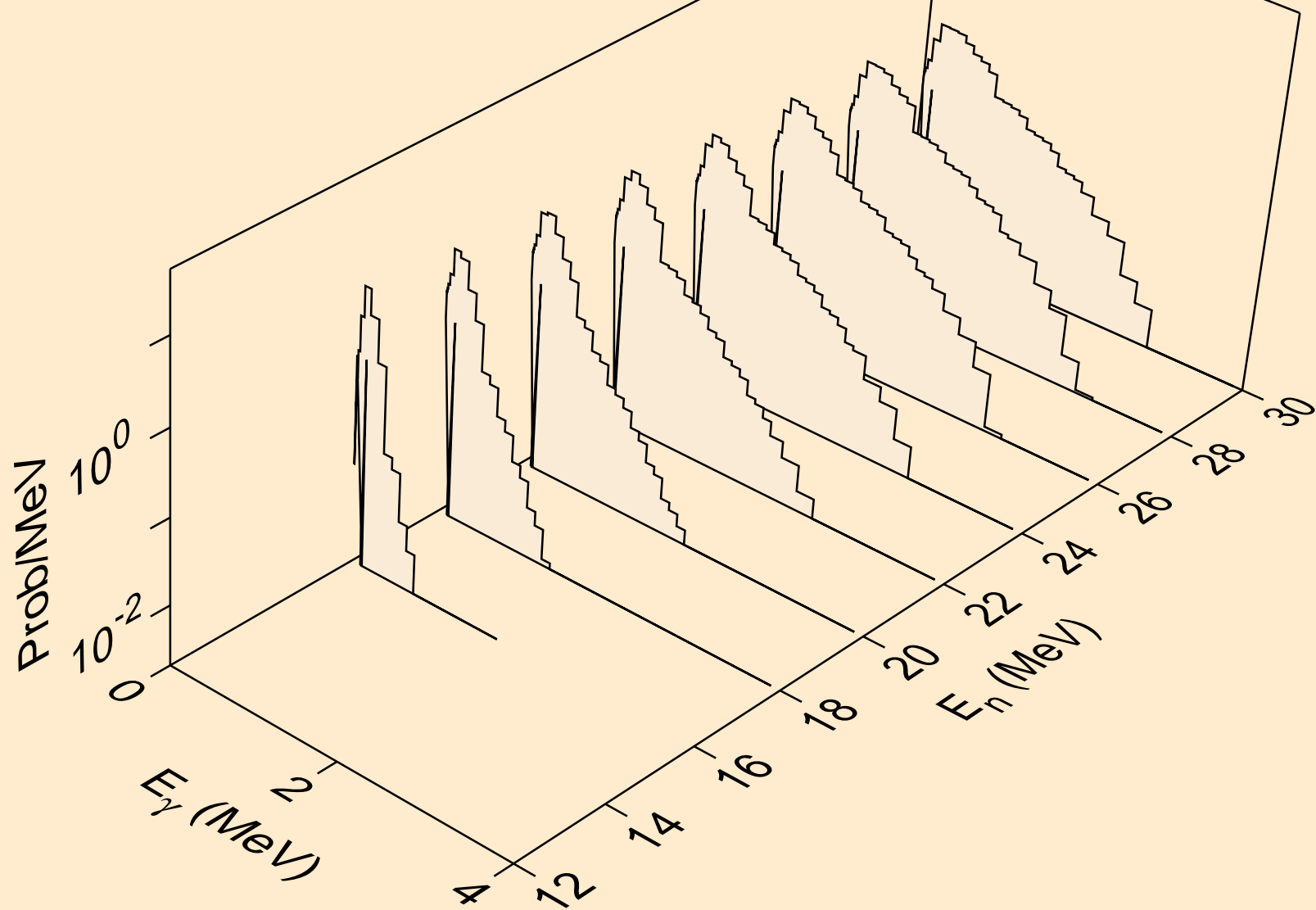

NP231 PROTON ACER TENDL-2021 LIBRARY; T=0.K  
Photon emission for (n,n\*)t

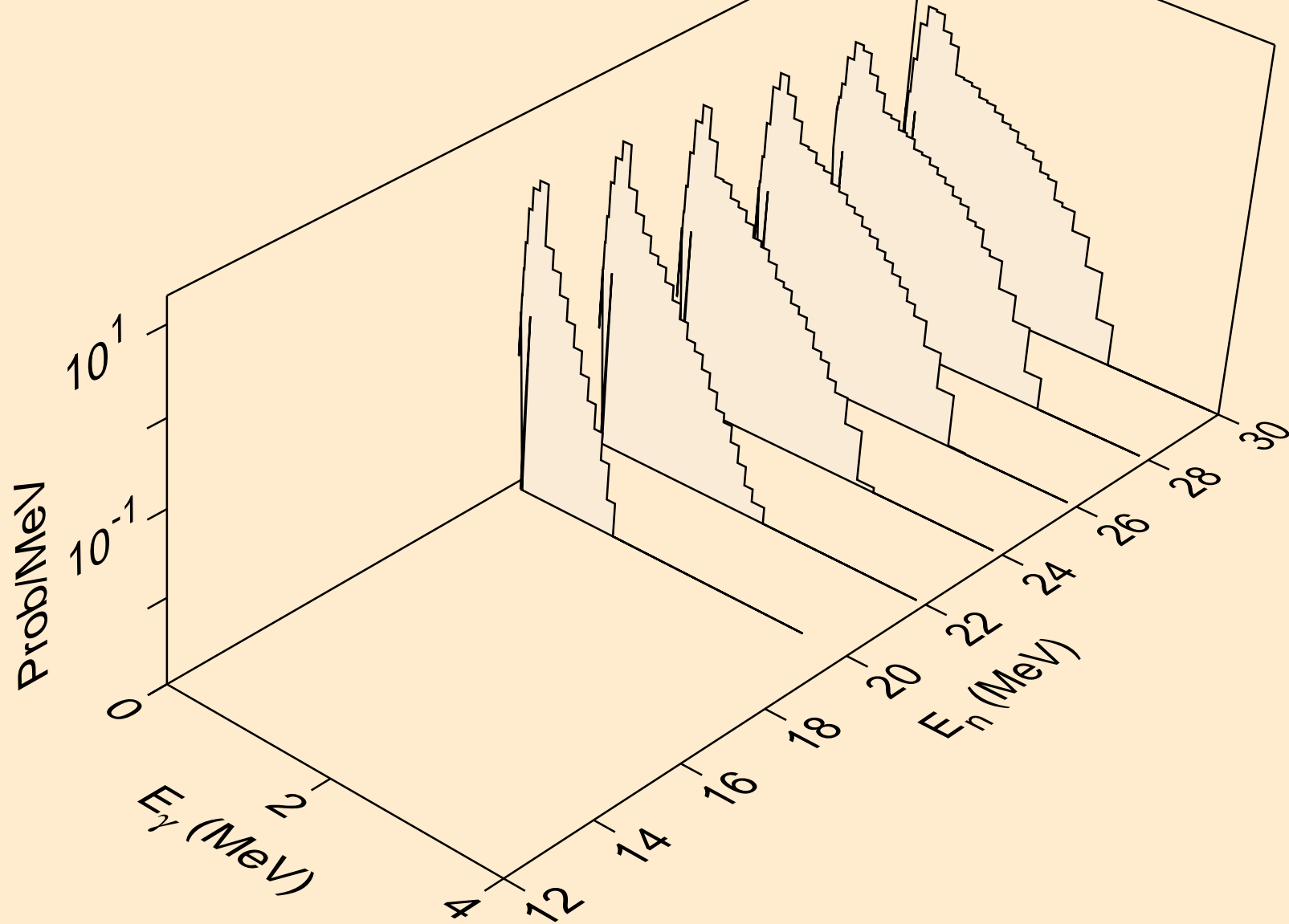

NP231 PROTON ACER TENDL-2021 LIBRARY; T=0.K  
Photon emission for (n,n\*)he3

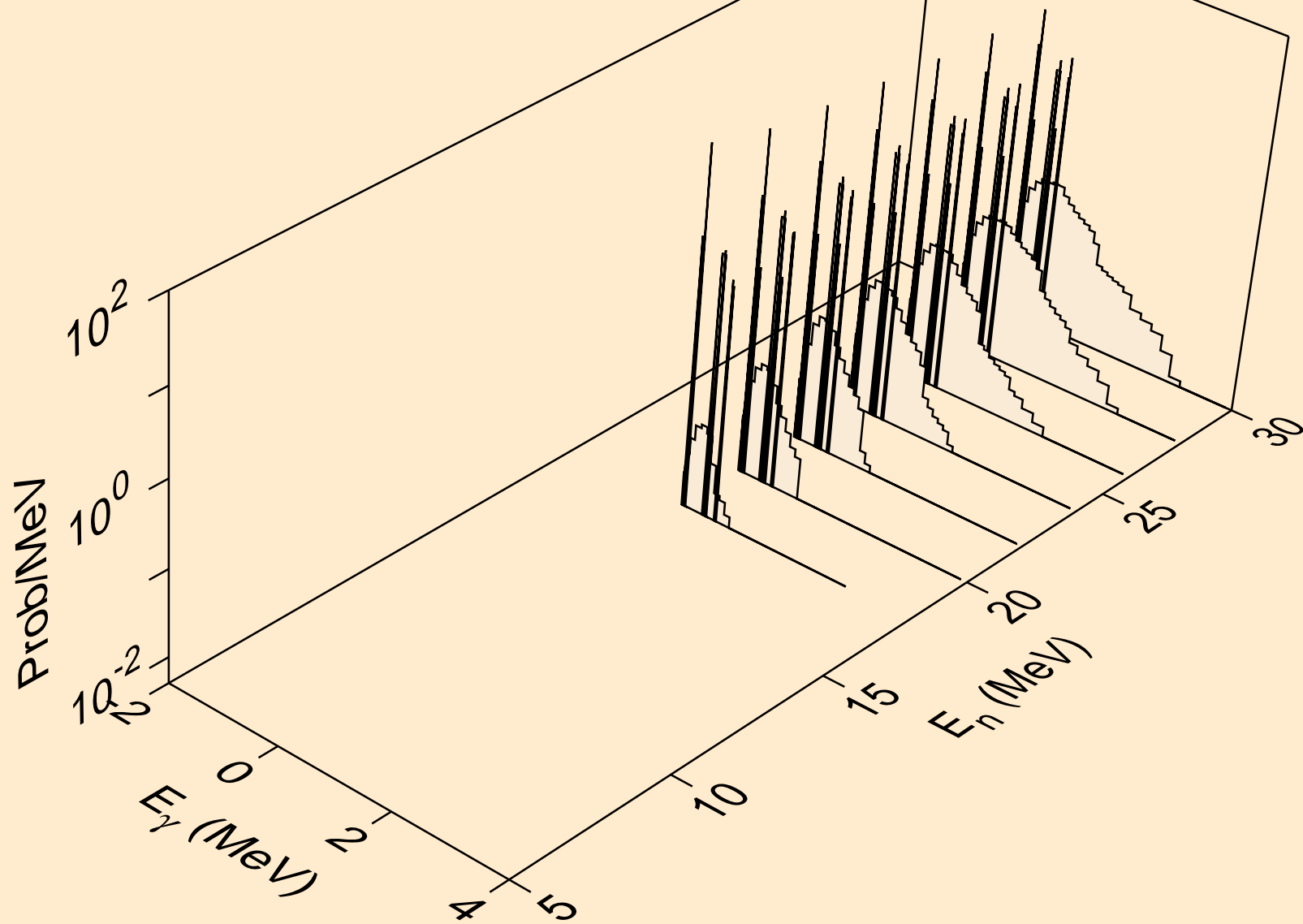



NP231 PROTON ACER TENDL-2021 LIBRARY; T=0.K  
Photon emission for (n,4n)

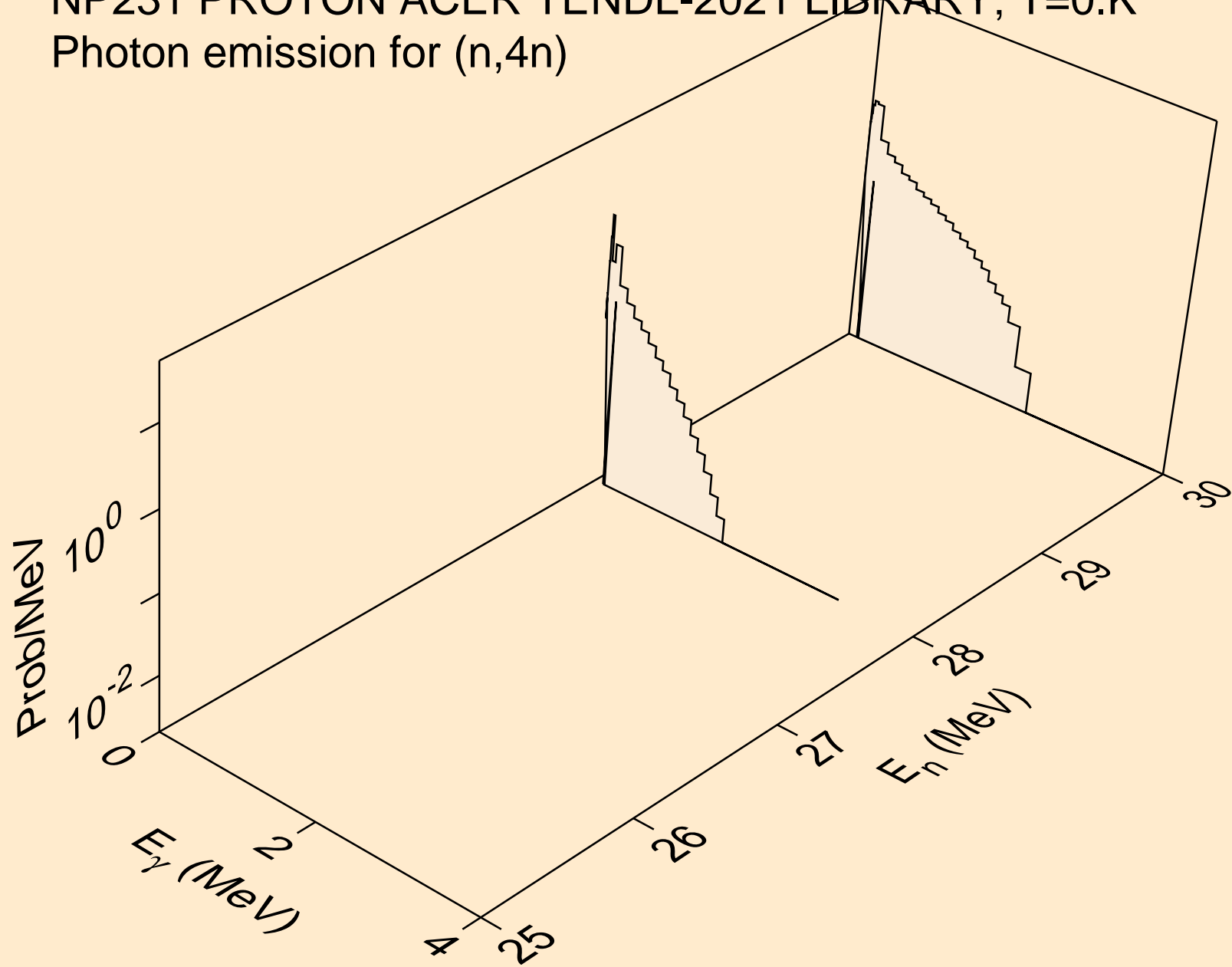

NP231 PROTON ACER TENDL-2021 LIBRARY; T=0.K  
Photon emission for (n,2np)

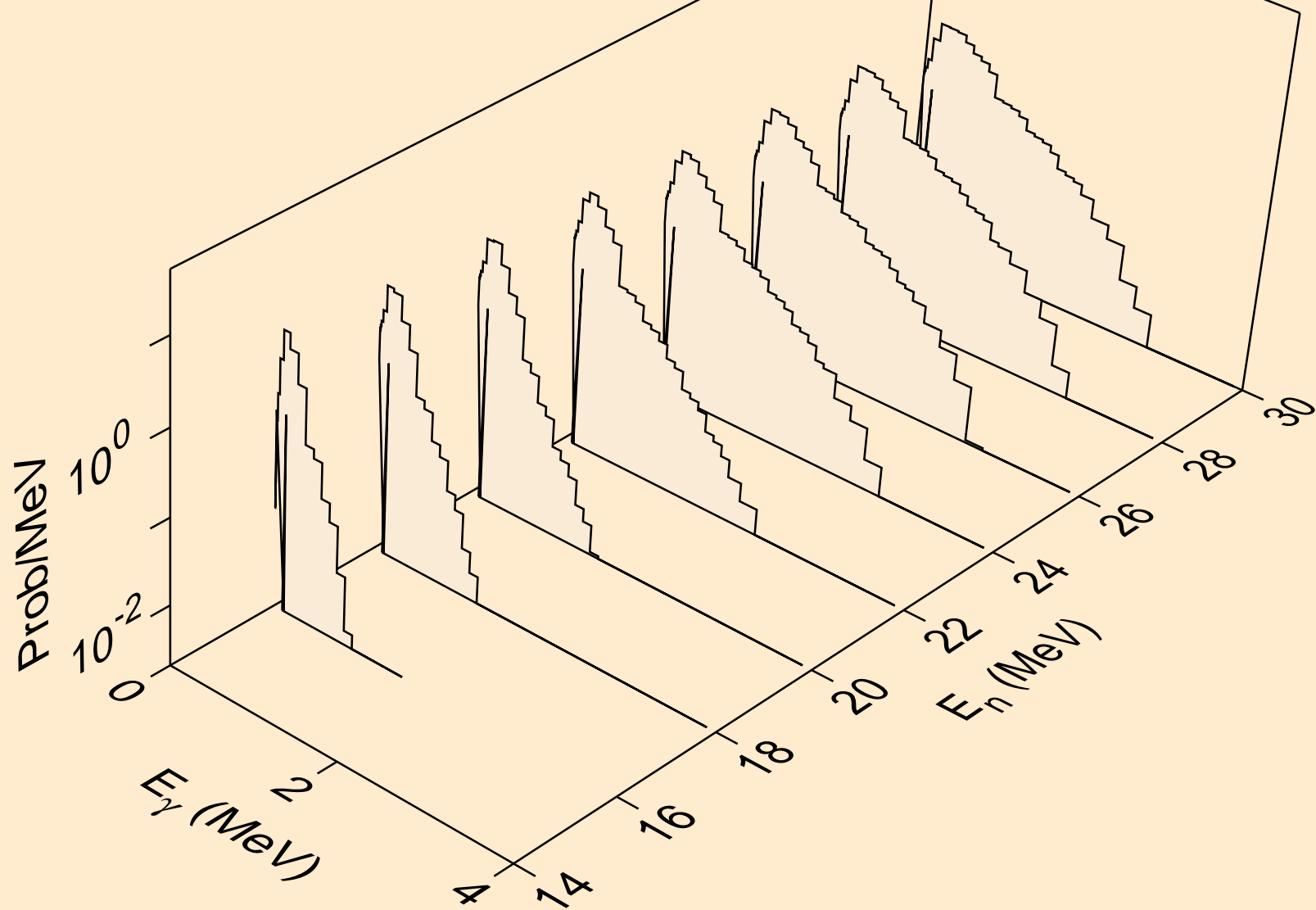

NP231 PROTON ACER TENDL-2021 LIBRARY; T=0.K  
Photon emission for (n,2np)

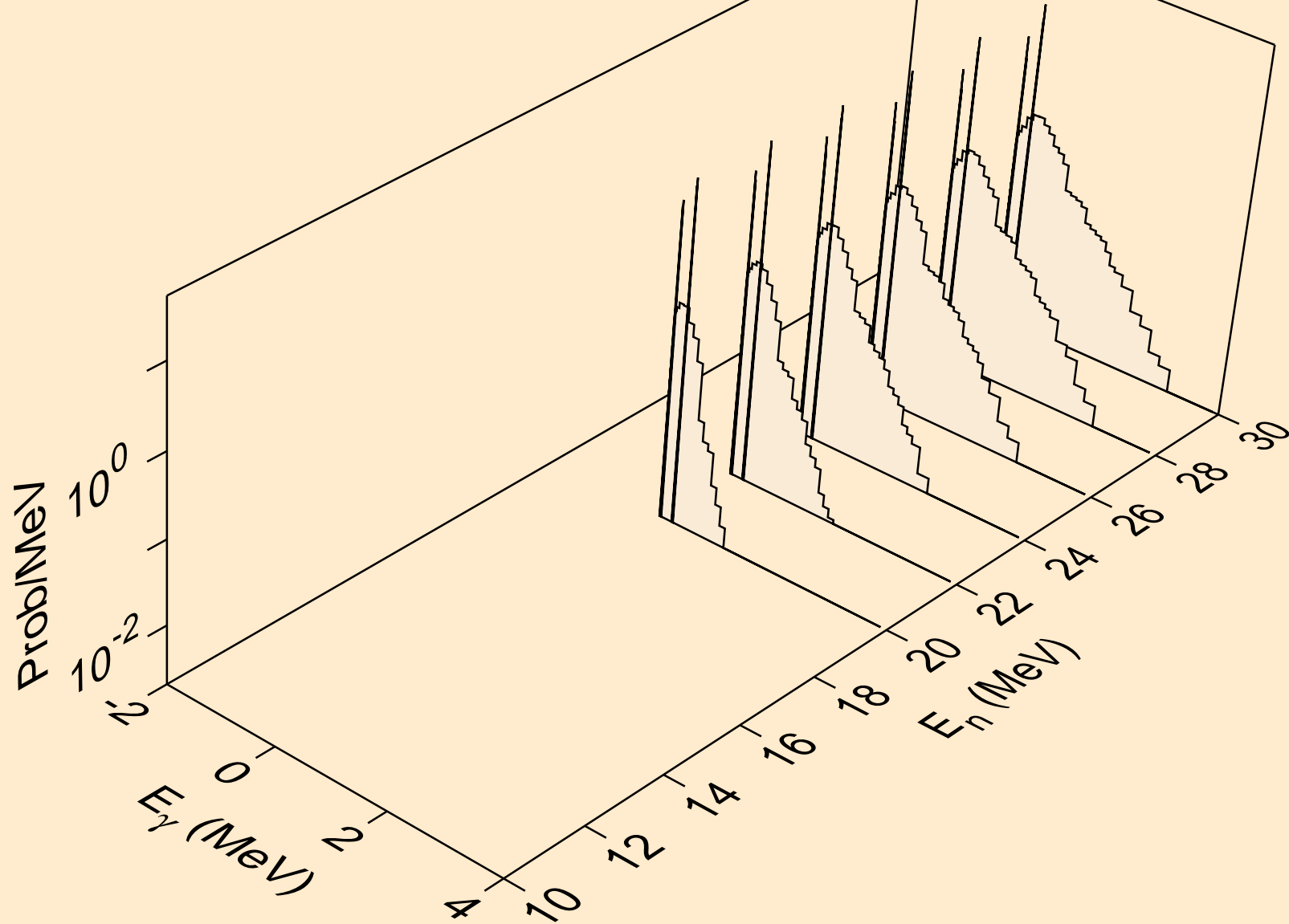

NP231 PROTON ACER TENDL-2021 LIBRARY; T=0.K  
Photon emission for (n,npa)

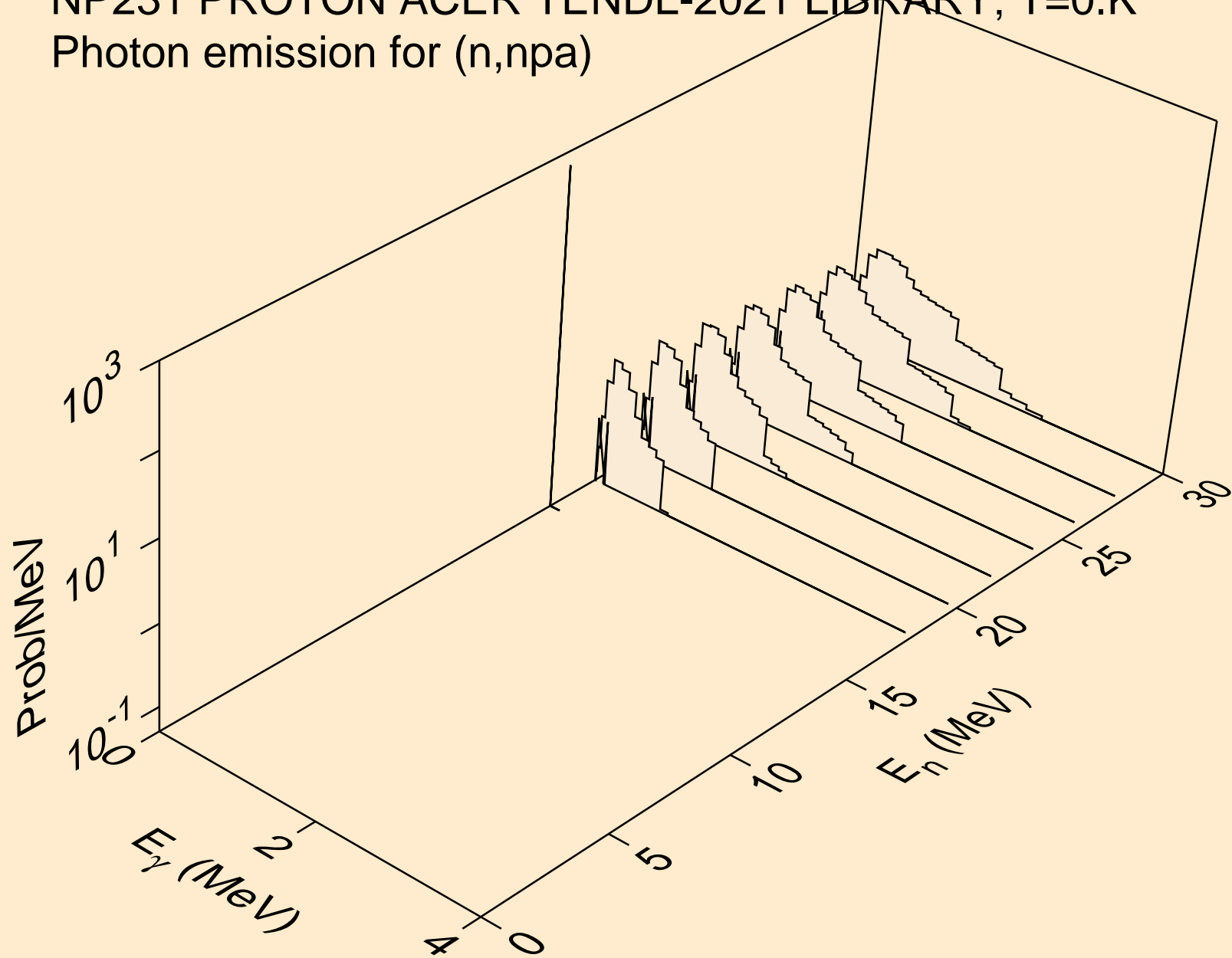

NP231 PROTON ACER TENDL-2021 LIBRARY; T=0.K  
Photon emission for (n,gma)

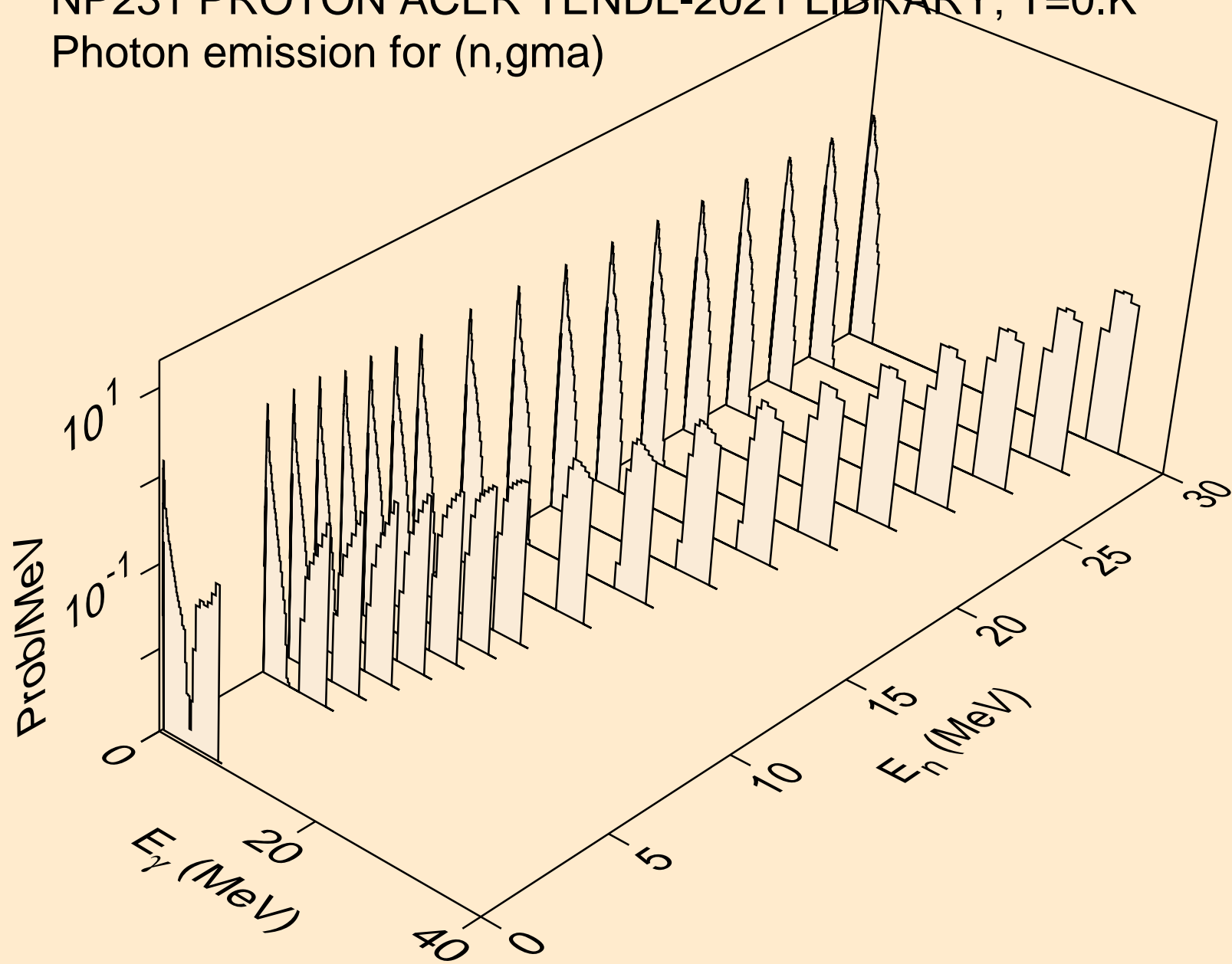

NP231 PROTON ACER TENDL-2021 LIBRARY; T=0.K  
Photon emission for inelastic

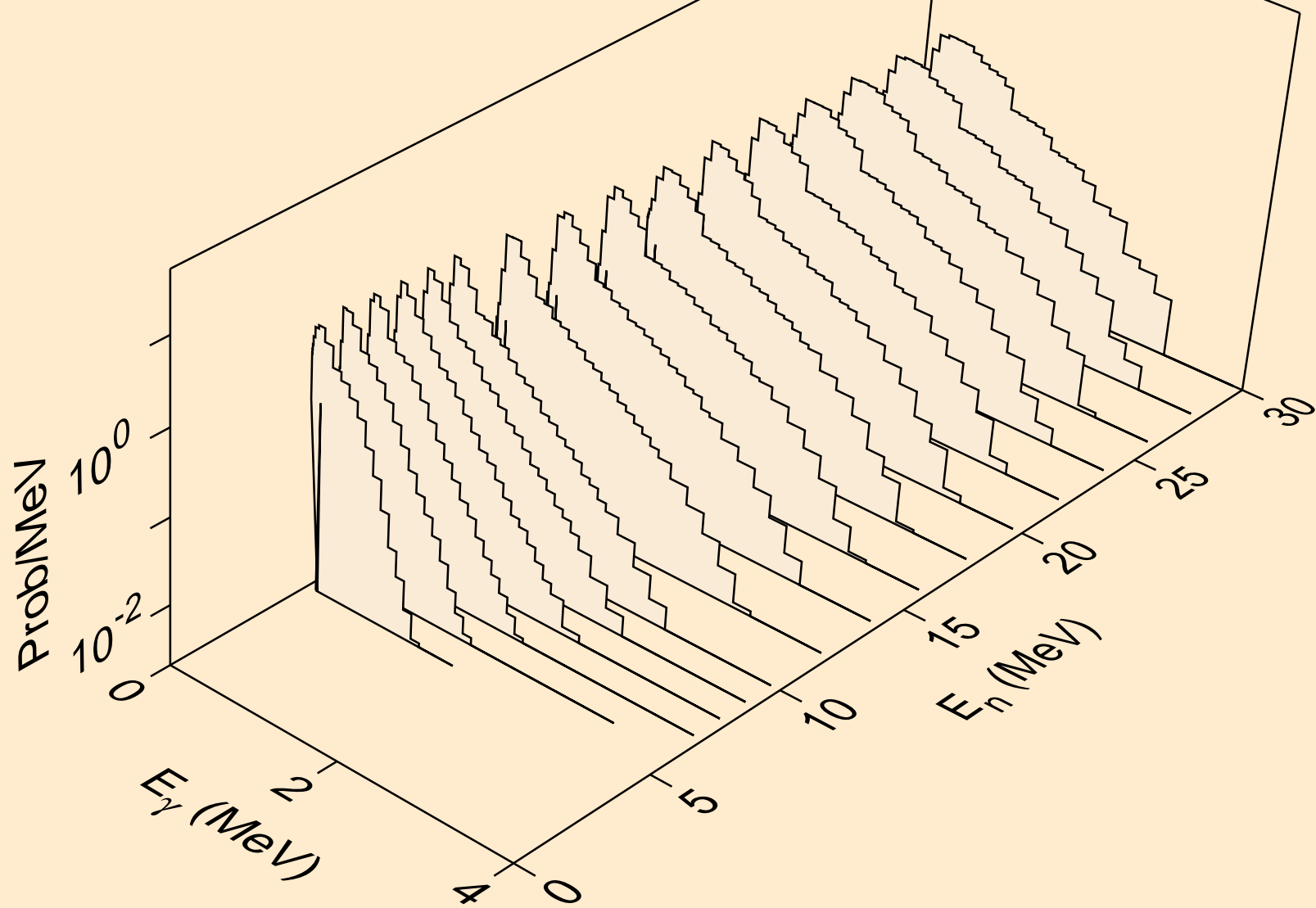

NP231 PROTON ACER TENDL-2021 LIBRARY; T=0.K  
Photon emission for (n,d)

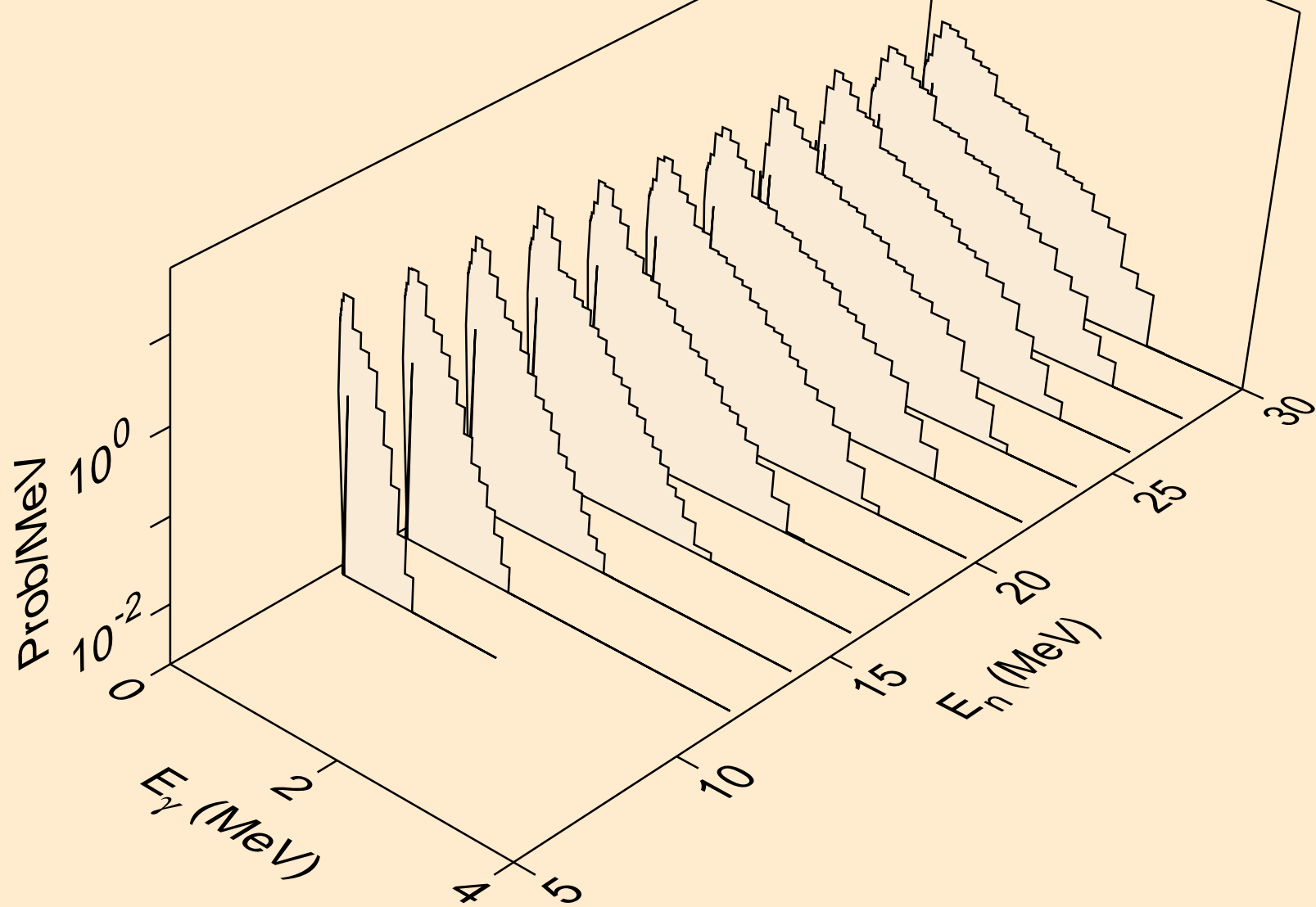

NP231 PROTON ACER TENDL-2021 LIBRARY; T=0.K  
Photon emission for (n,t)

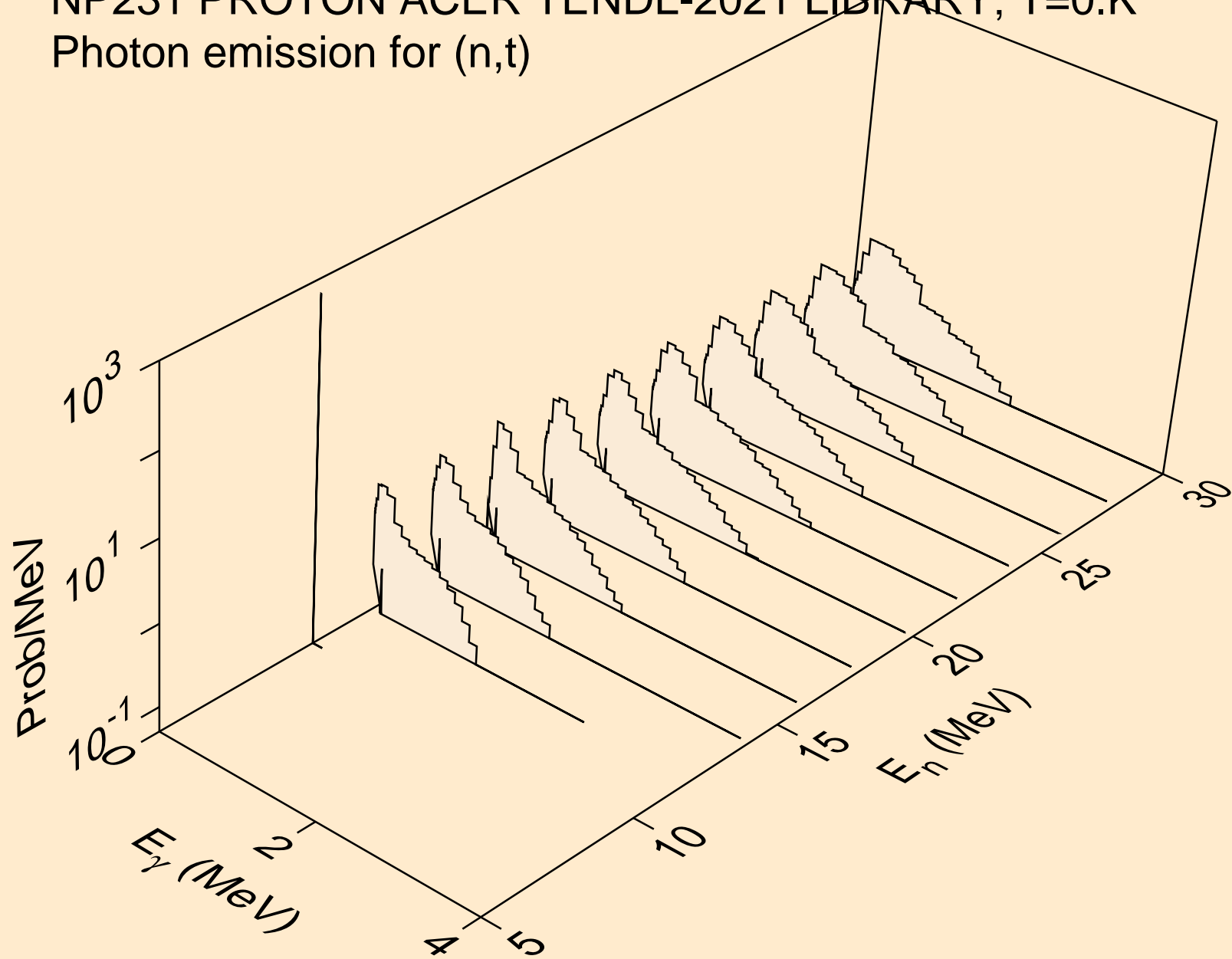



NP231 PROTON ACER TENDL-2021 LIBRARY; T=0.K  
Photon emission for (n,he3)

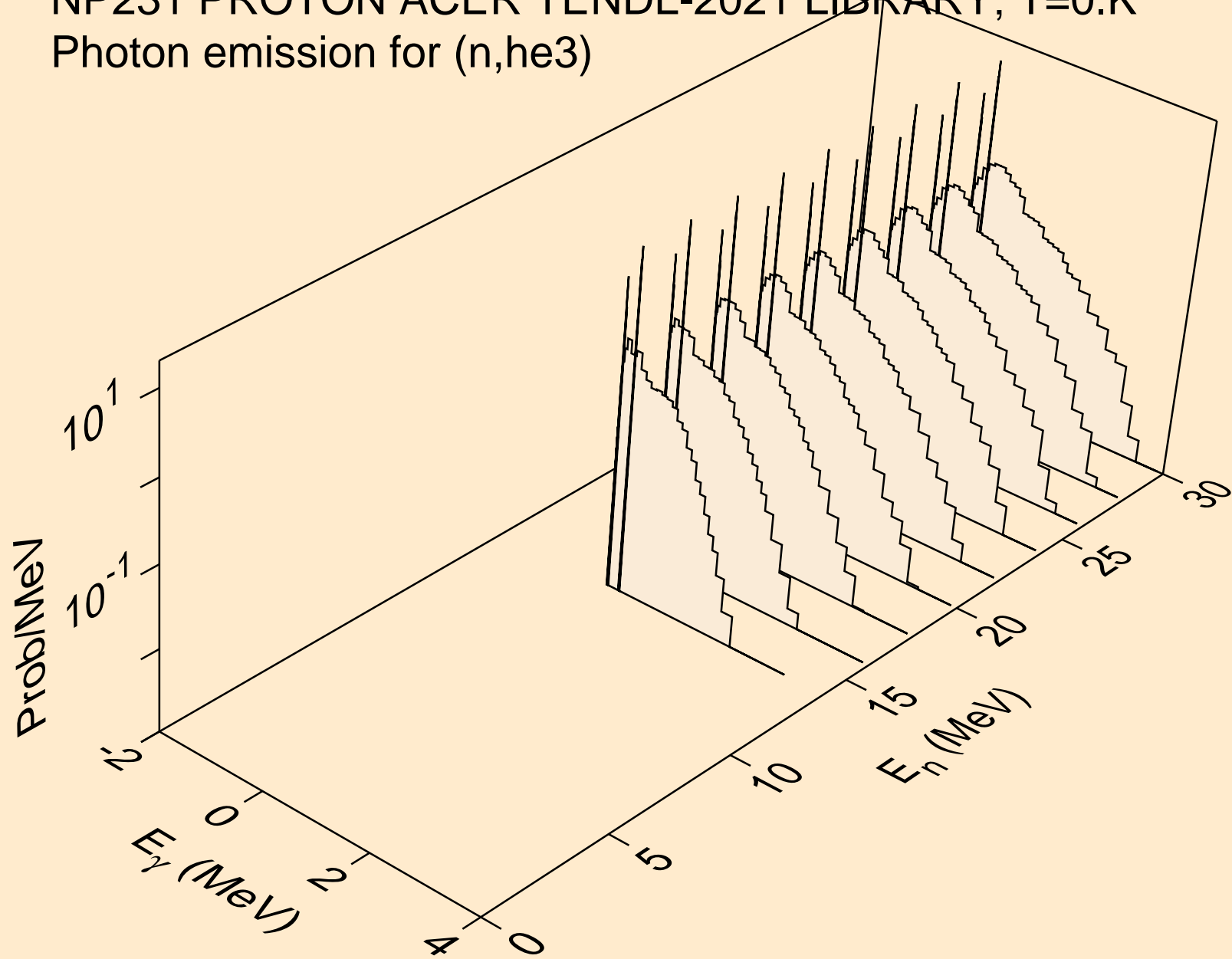

NP231 PROTON ACER TENDL-2021 LIBRARY; T=0.K  
Photon emission for (n,a)

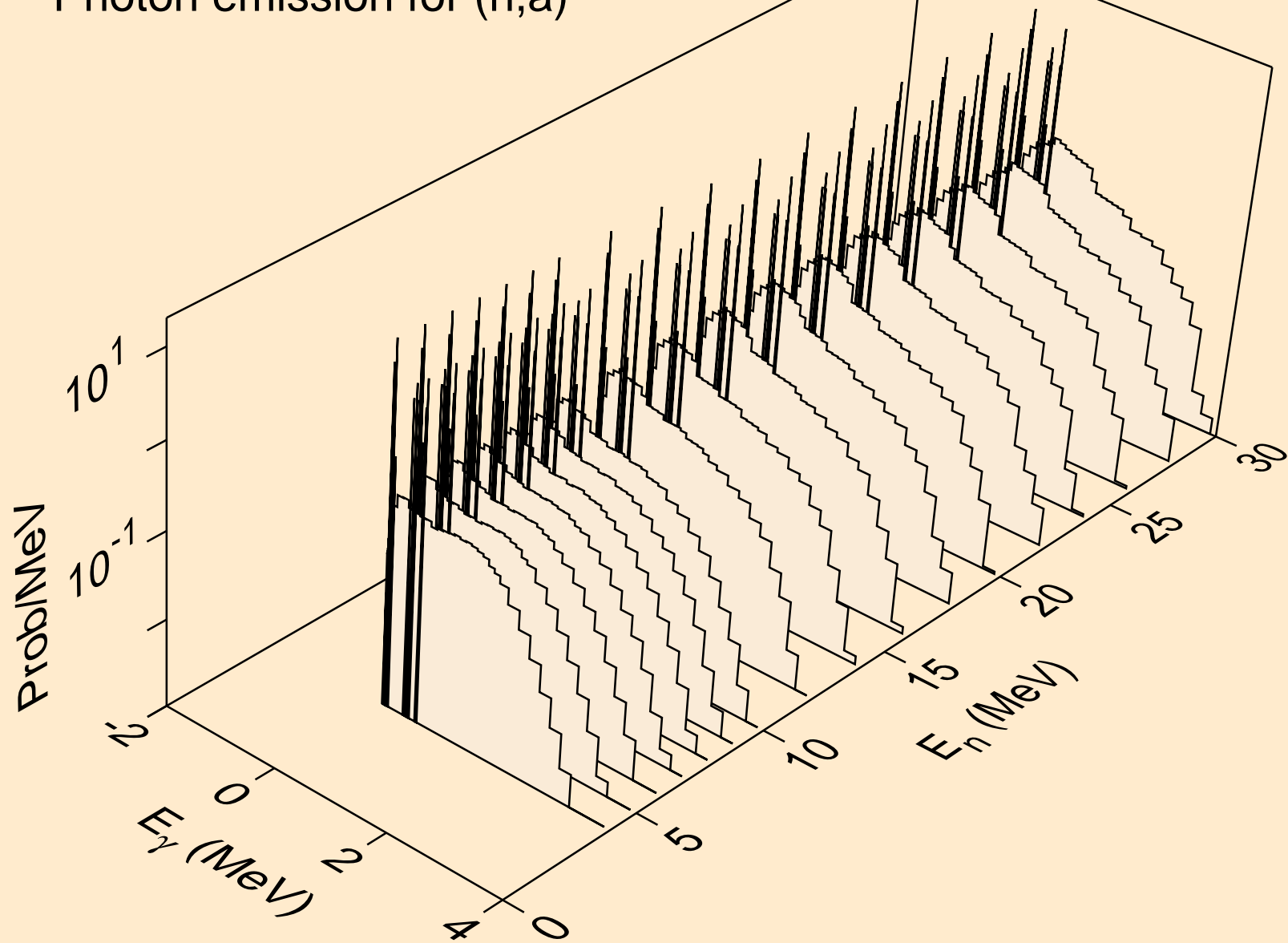

NP231 PROTON ACER TENDL-2021 LIBRARY; T=0.K  
Photon emission for (n,2a)

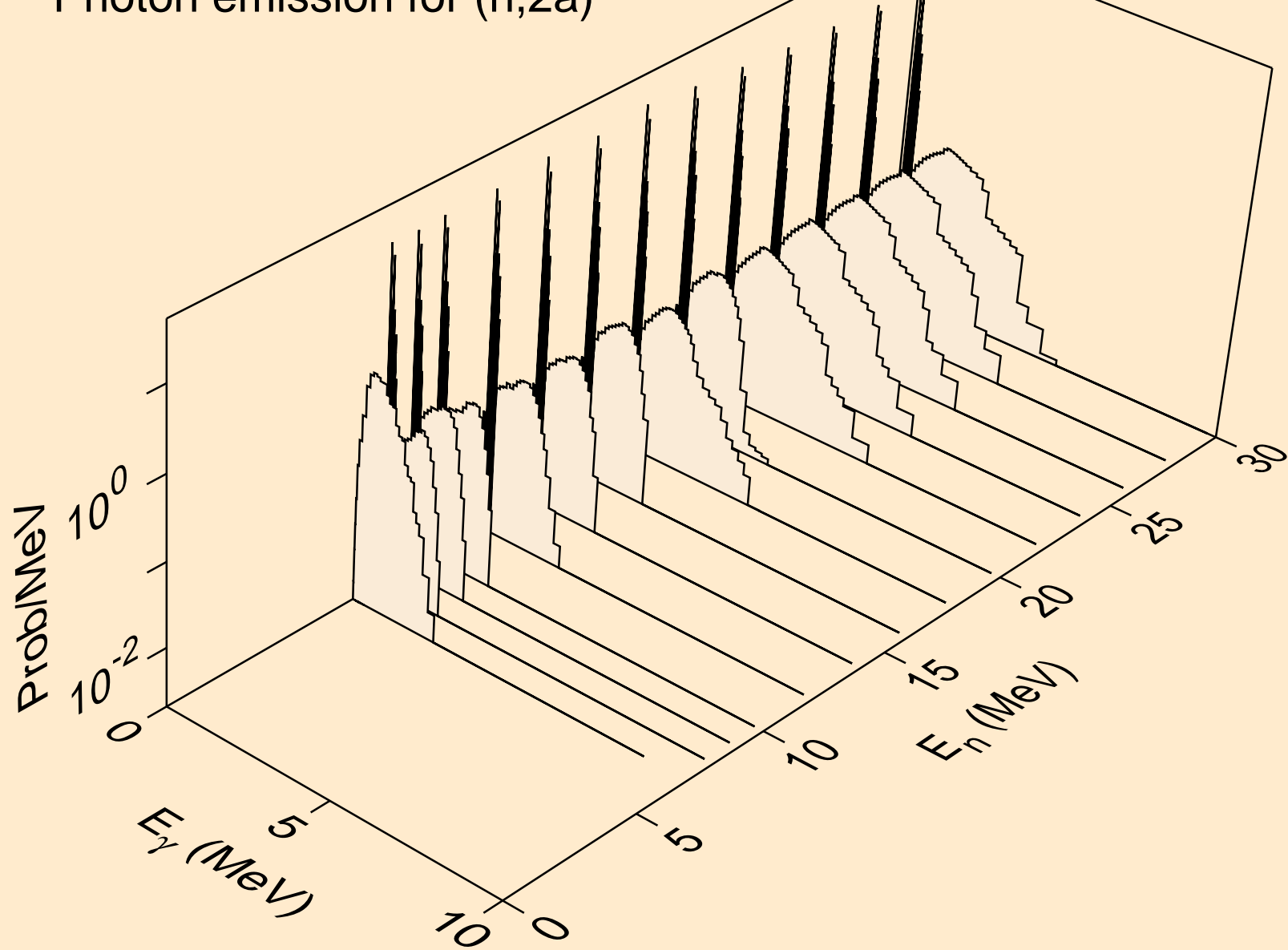

NP231 PROTON ACER TENDL-2021 LIBRARY; T=0.K  
Photon emission for (n,2p)

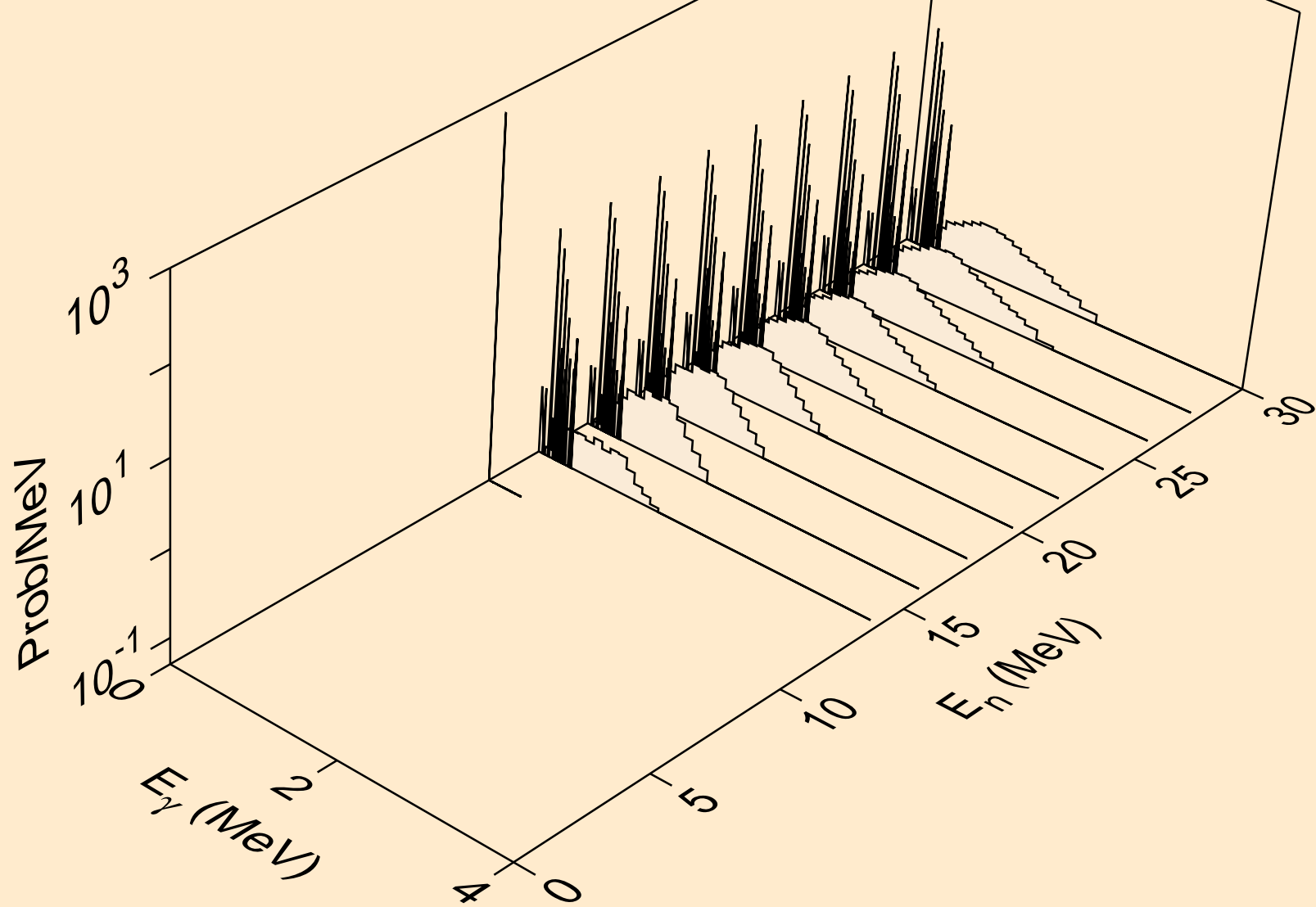

NP231 PROTON ACER TENDL-2021 LIBRARY; T=0.K  
Photon emission for (n,pa)

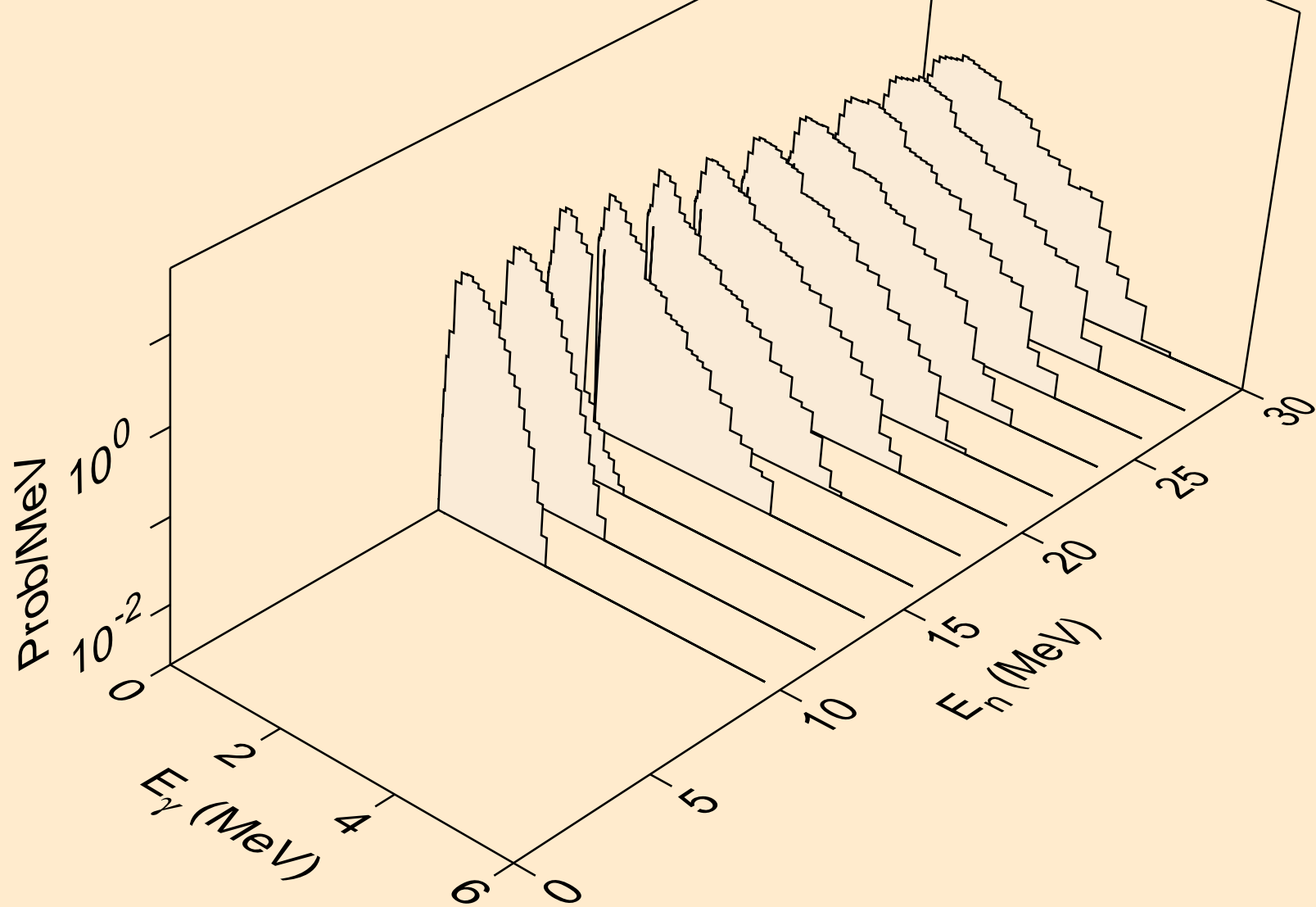

NP231 PROTON ACER TENDL-2021 LIBRARY; T=0.K  
Photon emission for (n,pd)

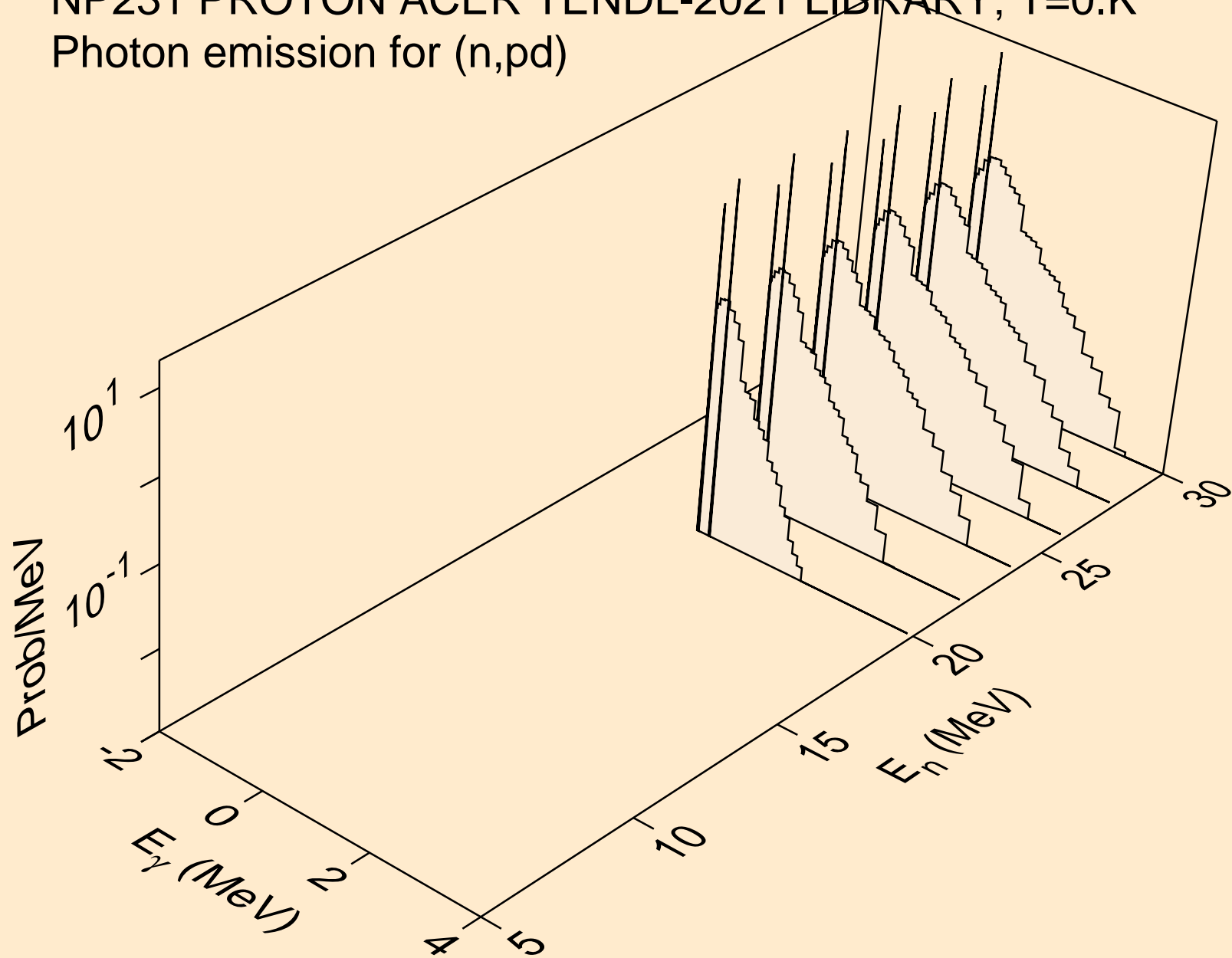

NP231 PROTON ACER TENDL-2021 LIBRARY; T=0.K  
Particle heating contributions

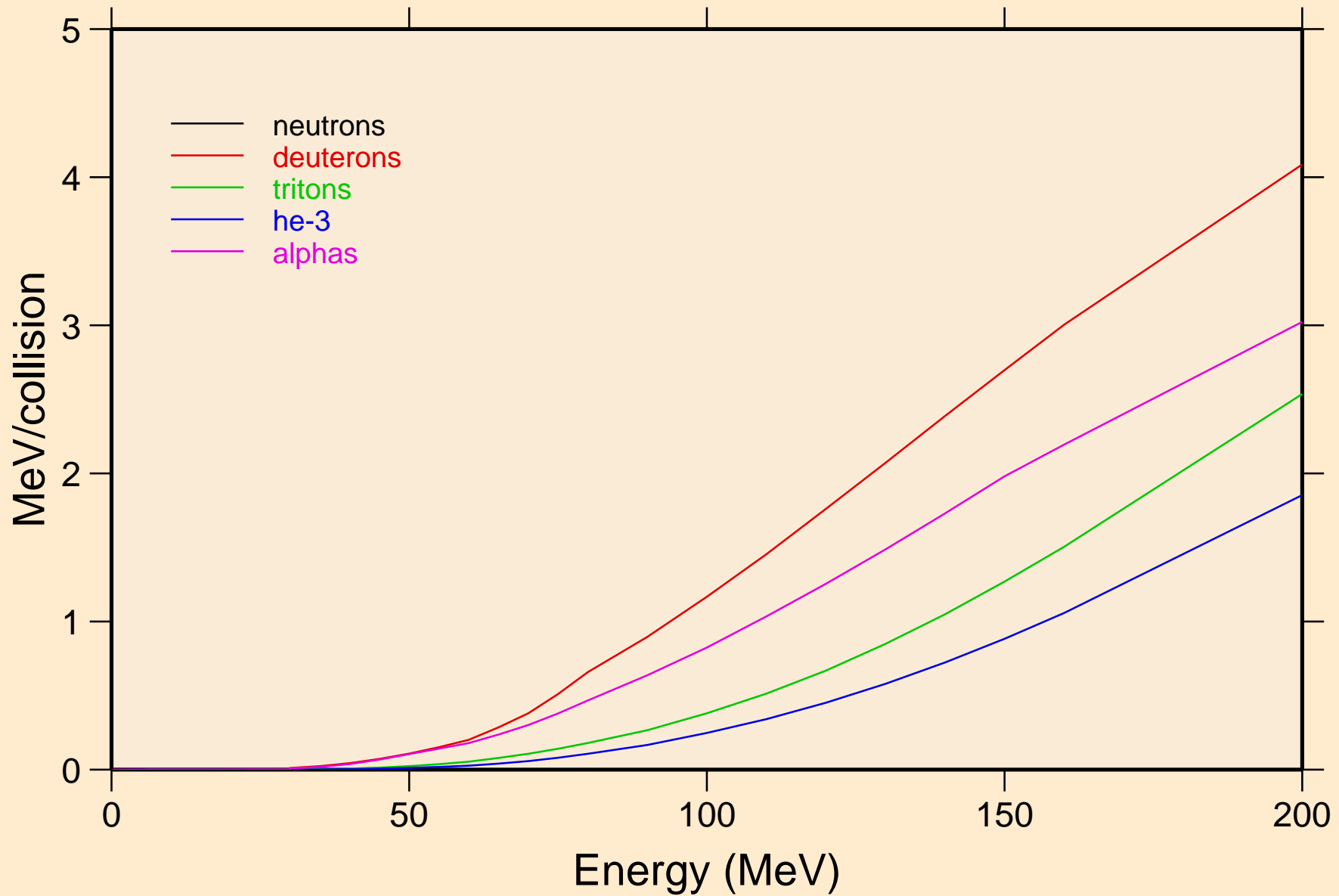

NP231 PROTON ACER TENDL-2021 LIBRARY; T=0.K  
Recoil Heating

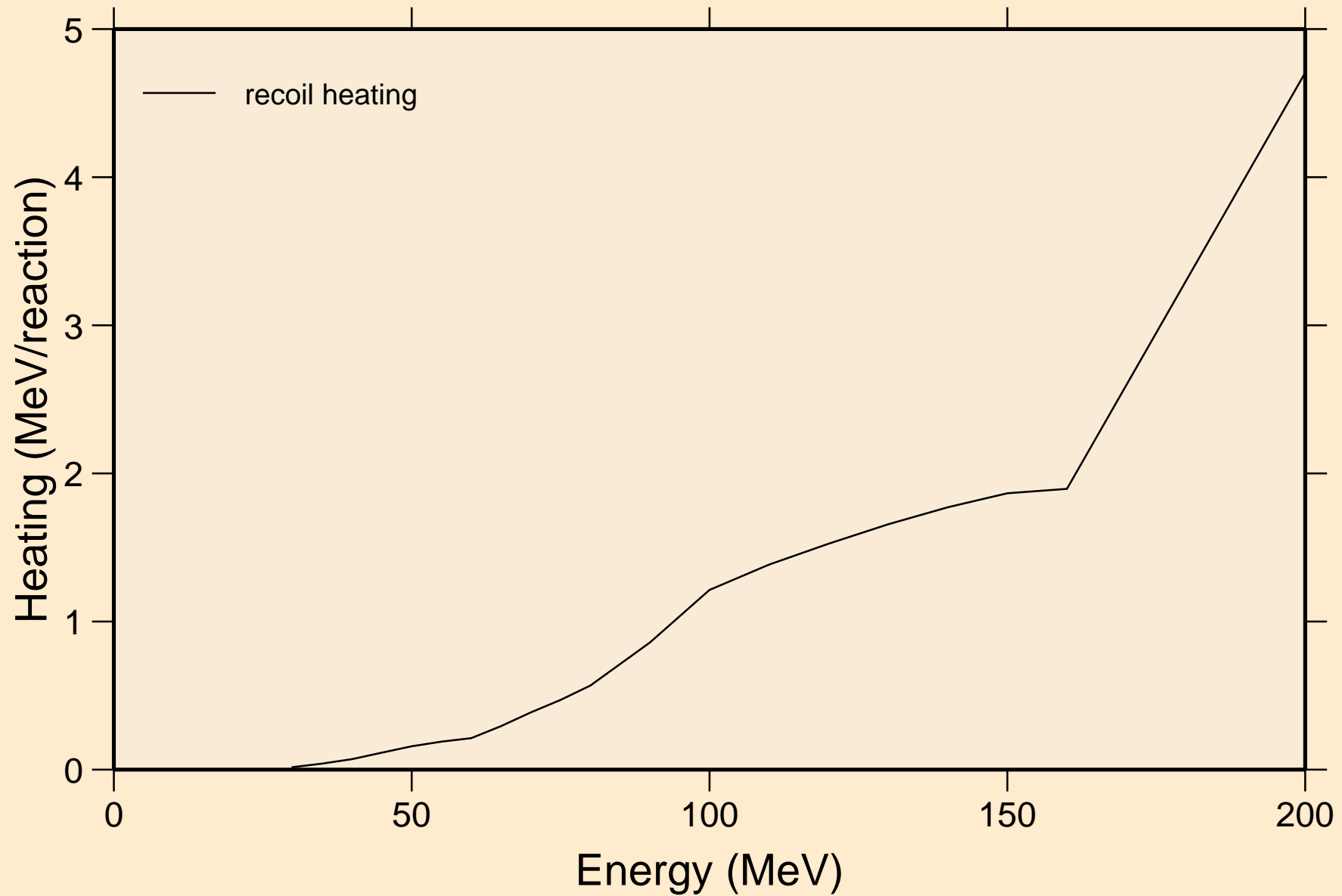



NP231 PROTON ACER TENDL-2021 LIBRARY; T=0.K  
Particle production cross sections

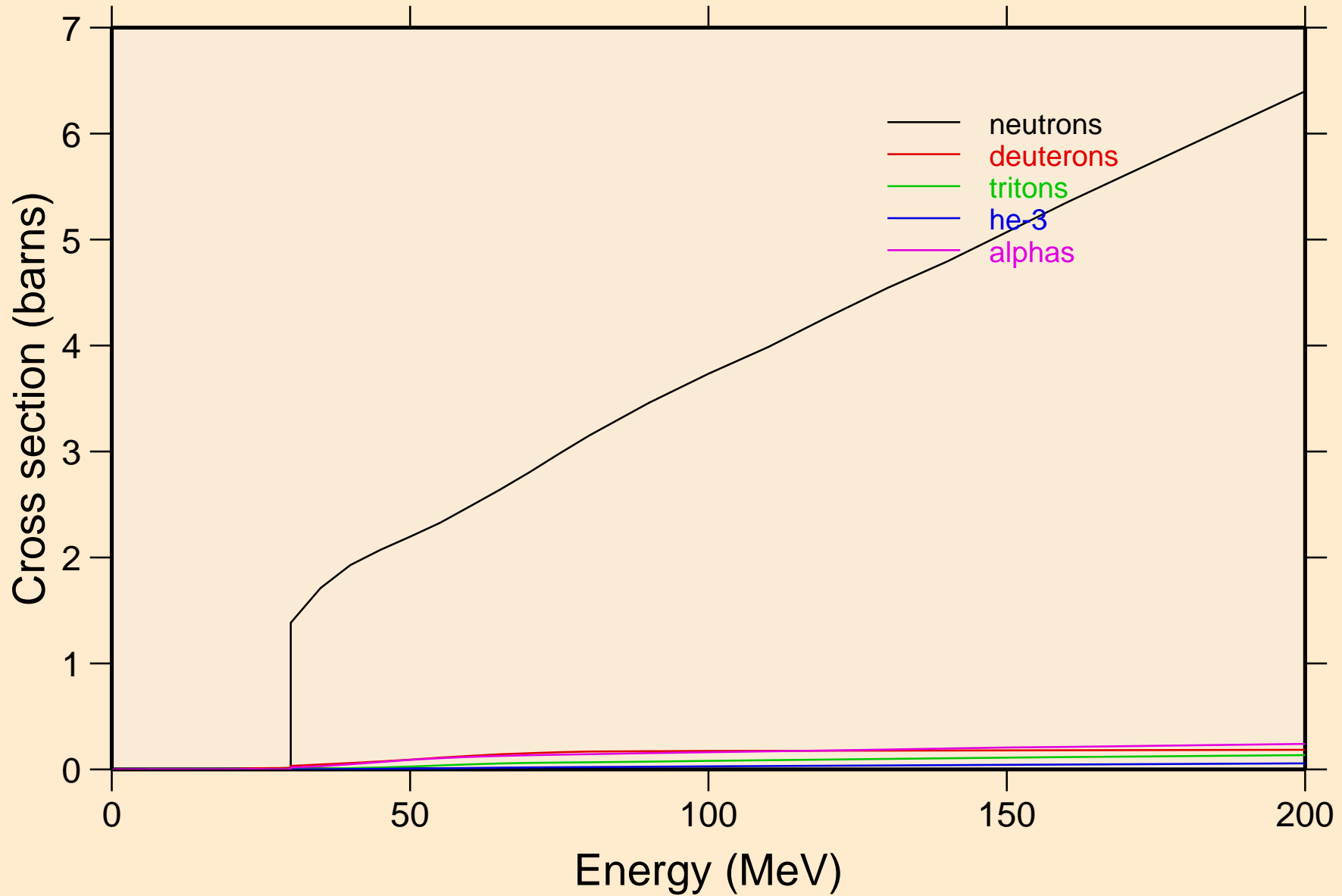

NP231 PROTON ACER TENDL-2021 LIBRARY; T=0.K  
neutrons from (p,n)

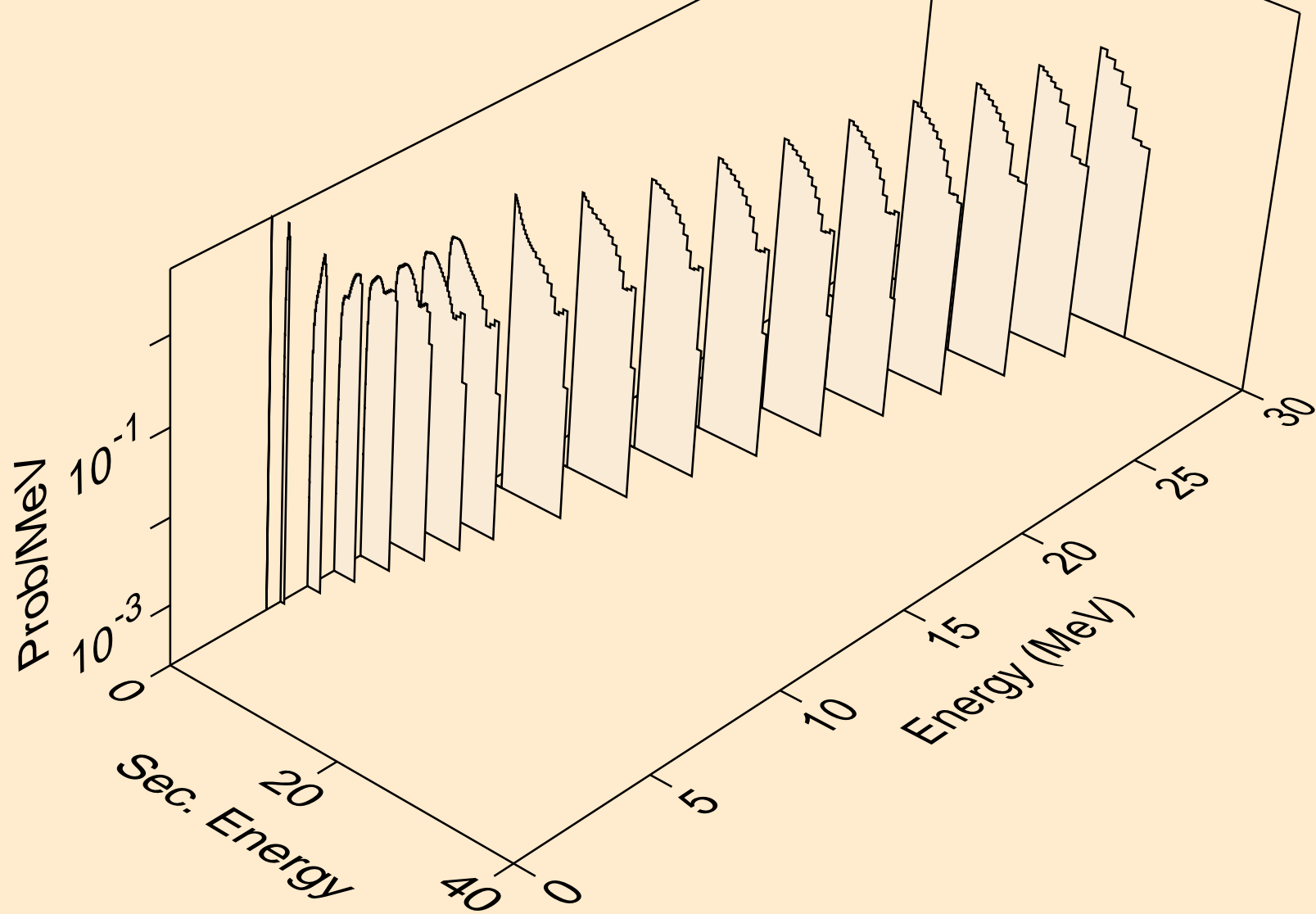

NP231 PROTON ACER TENDL-2021 LIBRARY; T=0.K  
neutrons from (p,x)

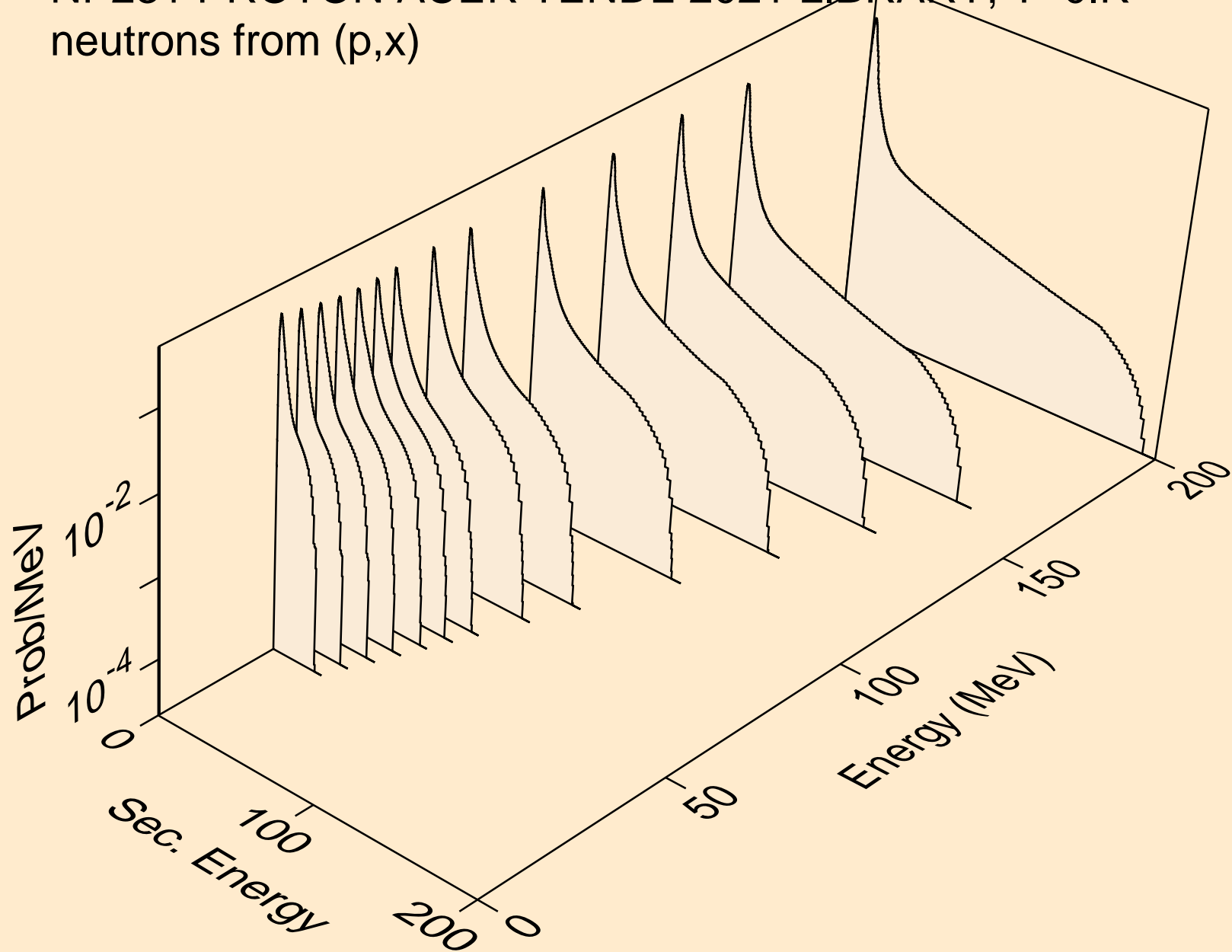

NP231 PROTON ACER TENDL-2021 LIBRARY; T=0.K  
neutrons from (p,2n)

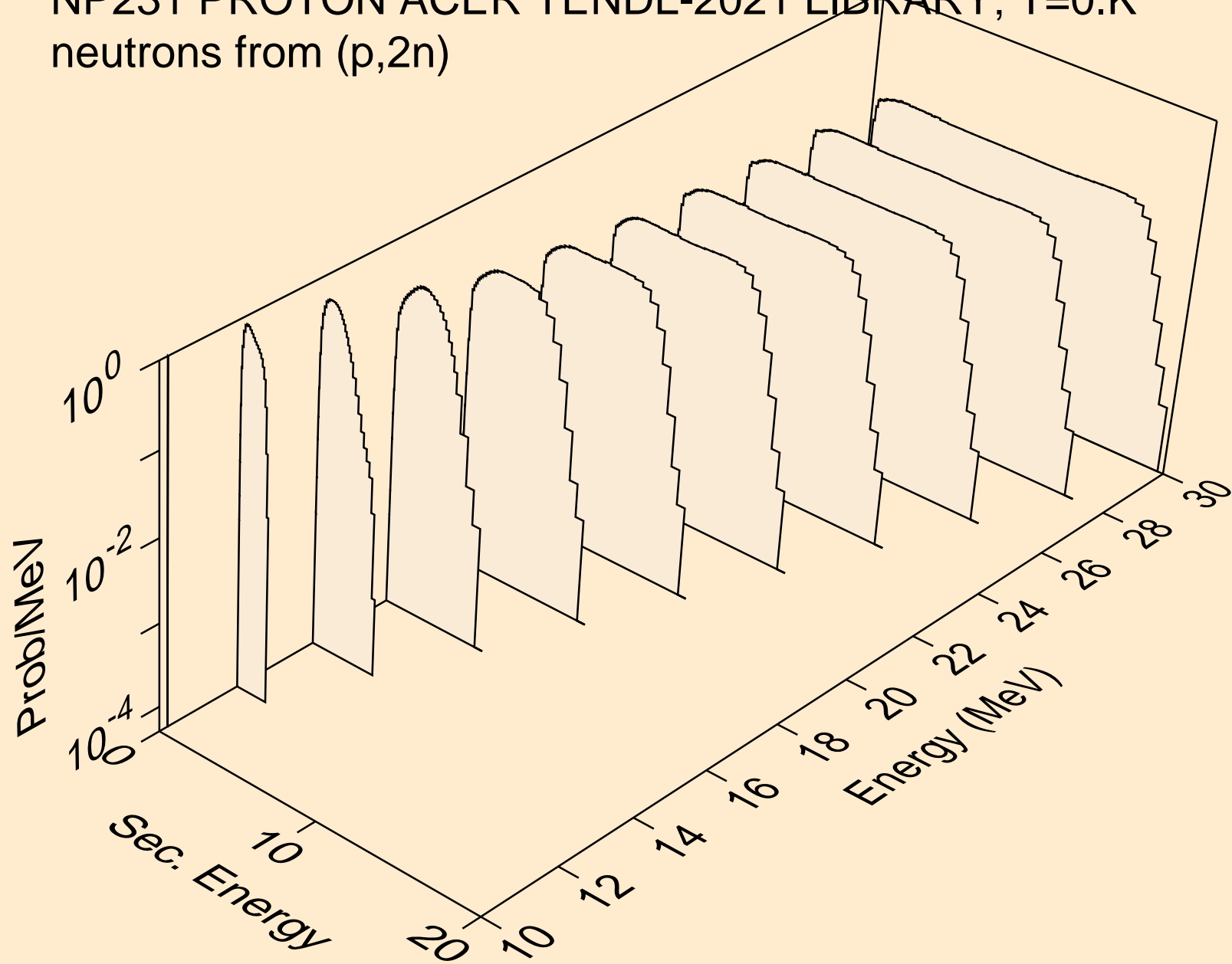

NP231 PROTON ACER TENDL-2021 LIBRARY; T=0.K  
neutrons from (p,3n)

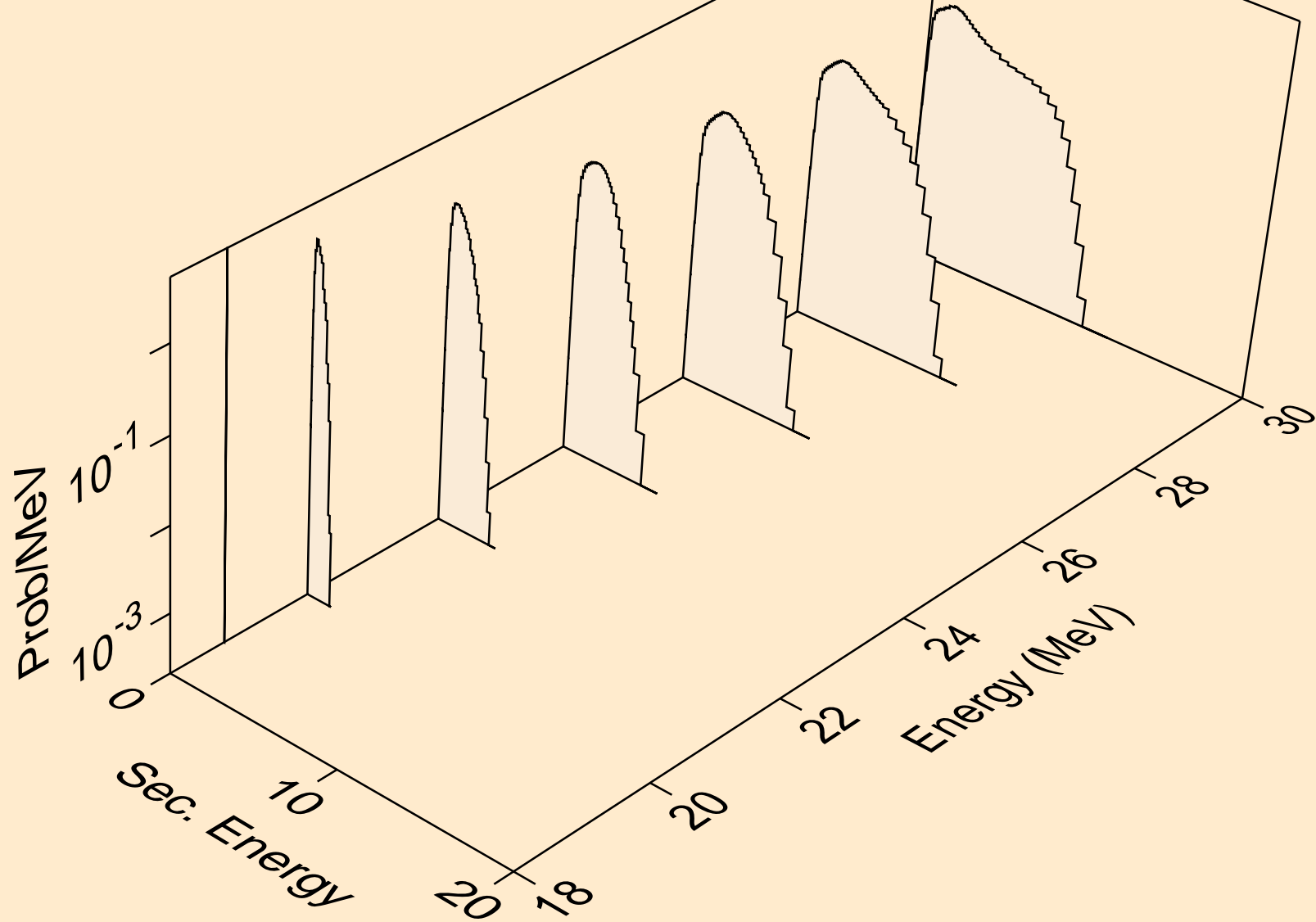

NP231 PROTON ACER TENDL-2021 LIBRARY; T=0.K  
neutrons from (p,n\*)a

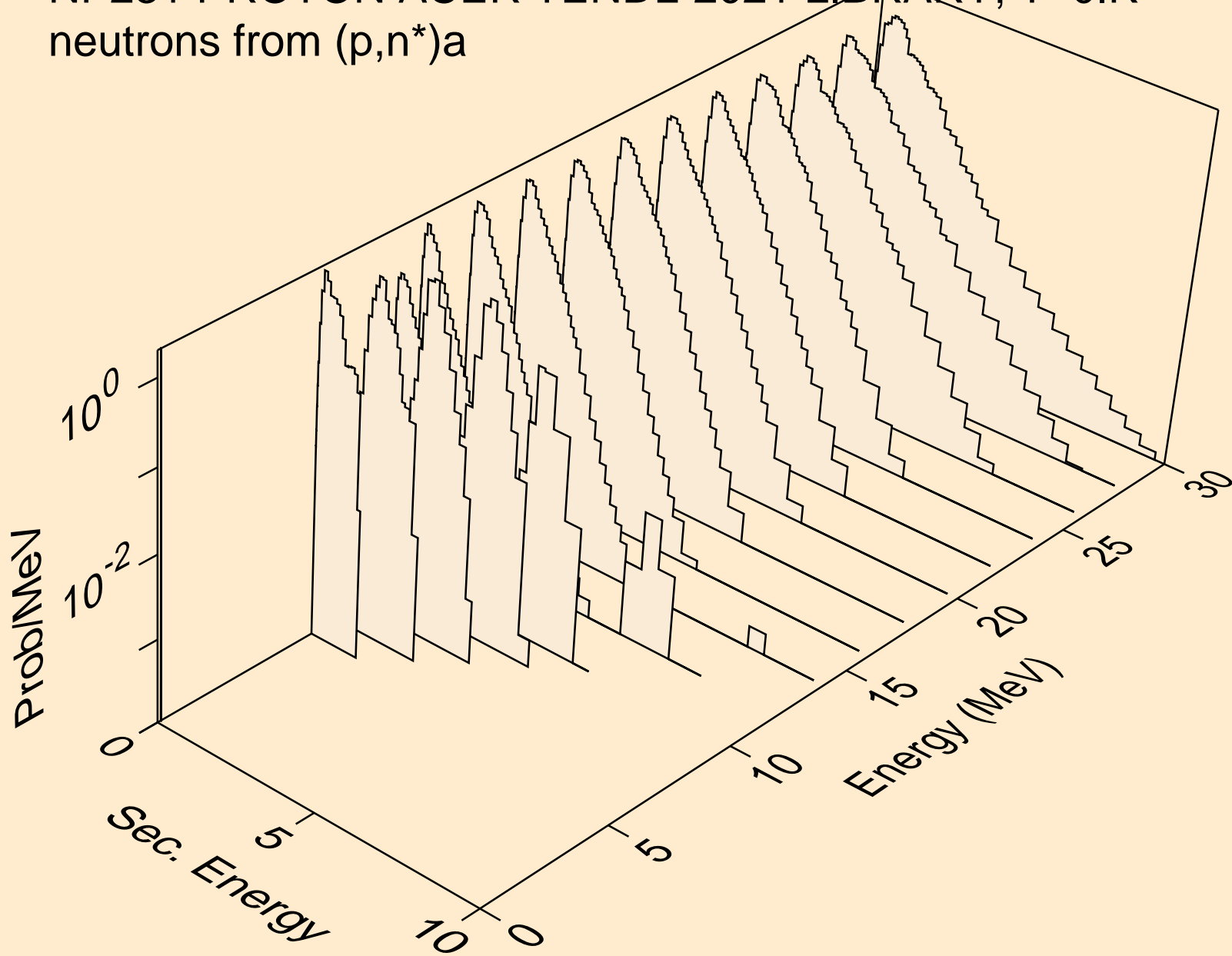

NP231 PROTON ACER TENDL-2021 LIBRARY; T=0.K  
neutrons from (p,2n)a

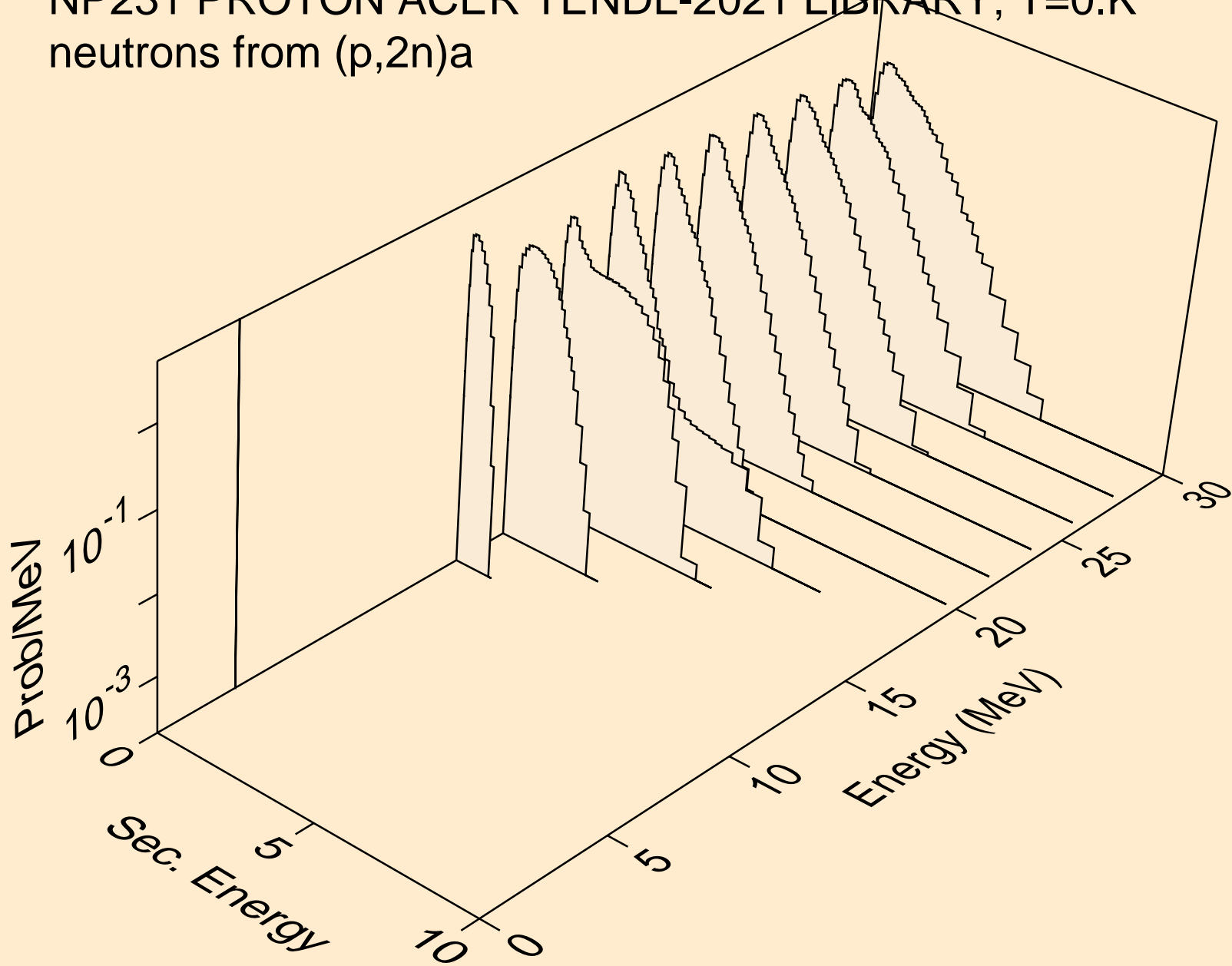

NP231 PROTON ACER TENDL-2021 LIBRARY; T=0.K  
neutrons from (p,n\*)p

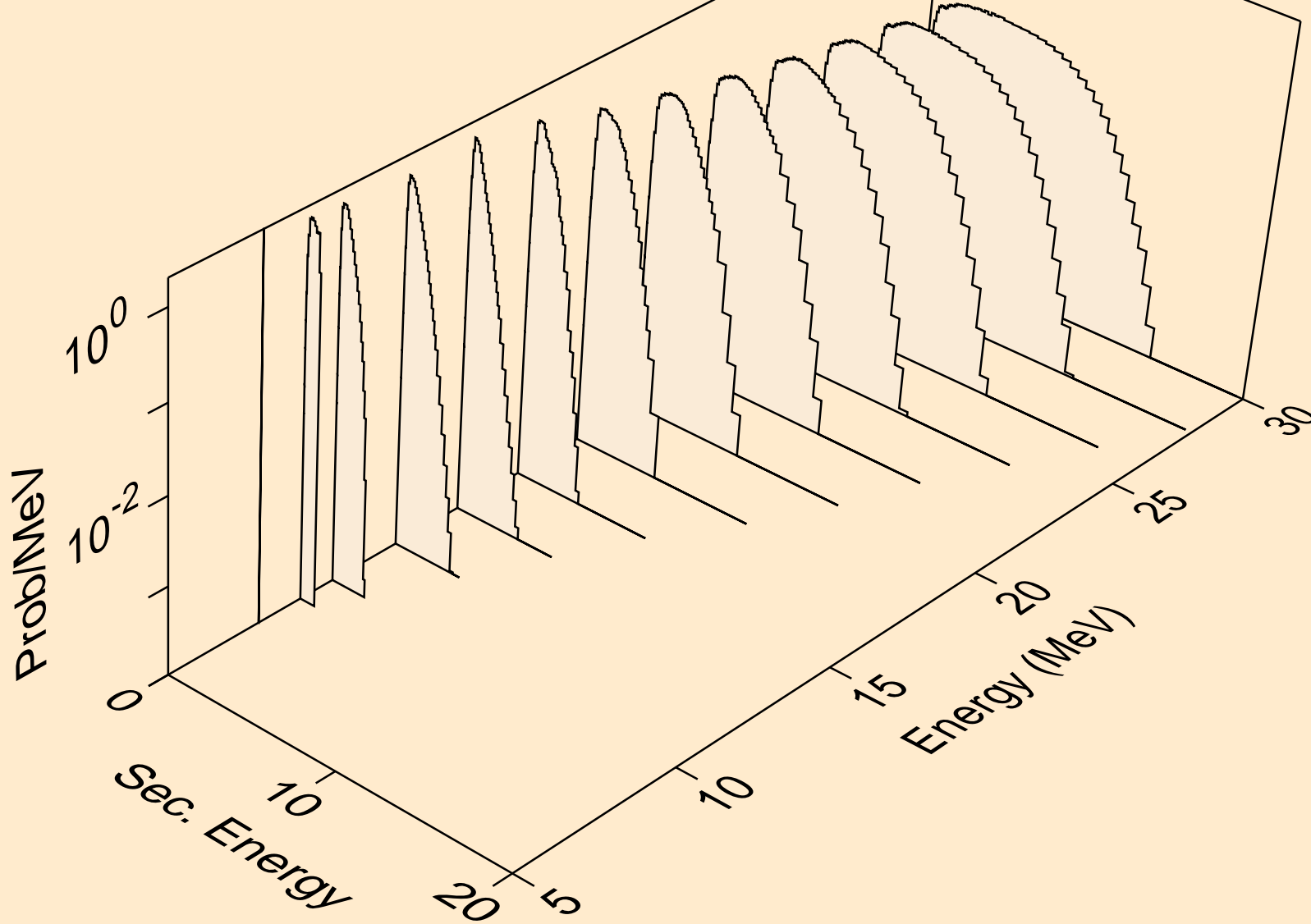



NP231 PROTON ACER TENDL-2021 LIBRARY; T=0.K  
neutrons from (p,n\*)2a

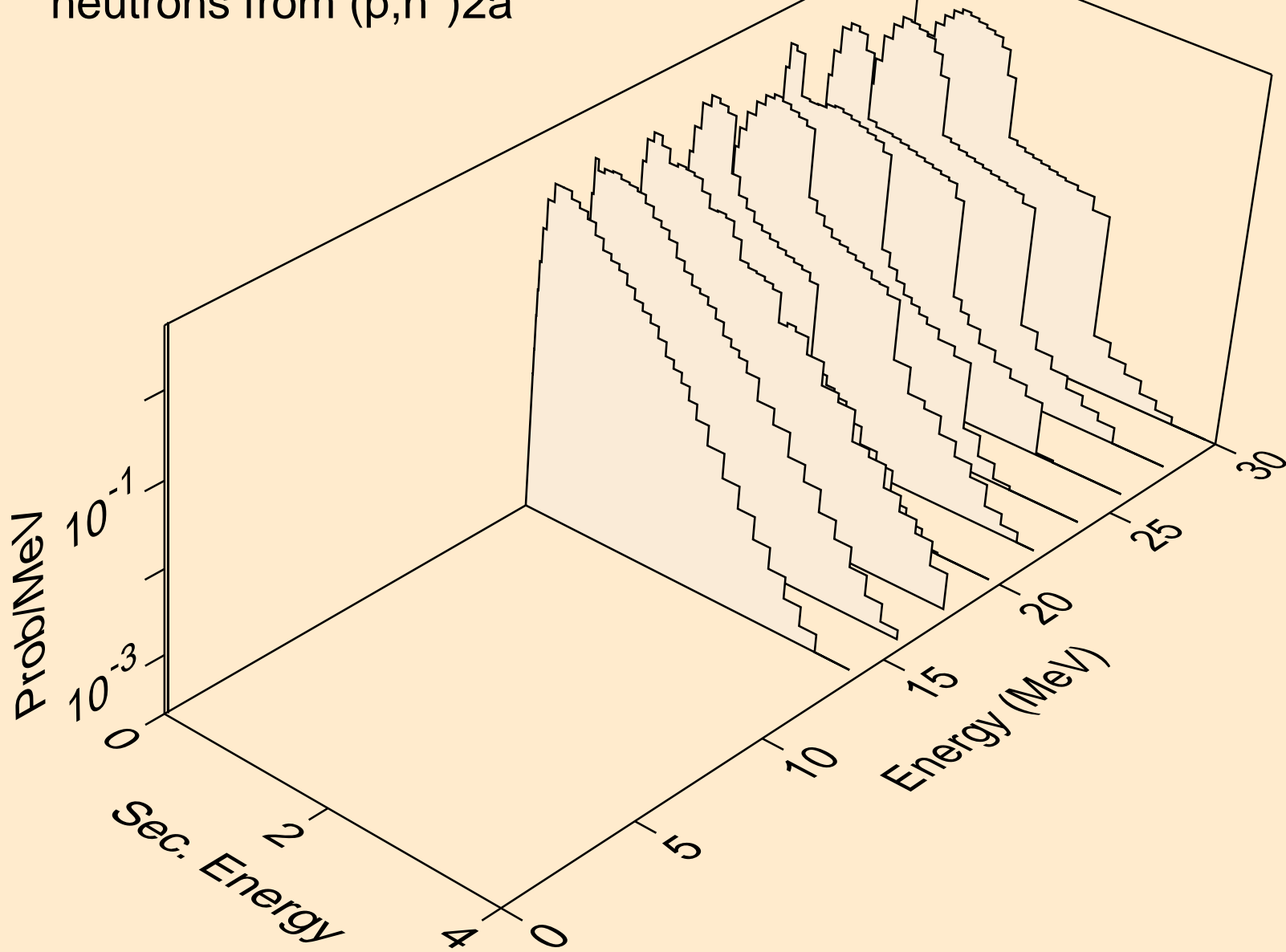

NP231 PROTON ACER TENDL-2021 LIBRARY; T=0.K  
neutrons from (p,n\*)d

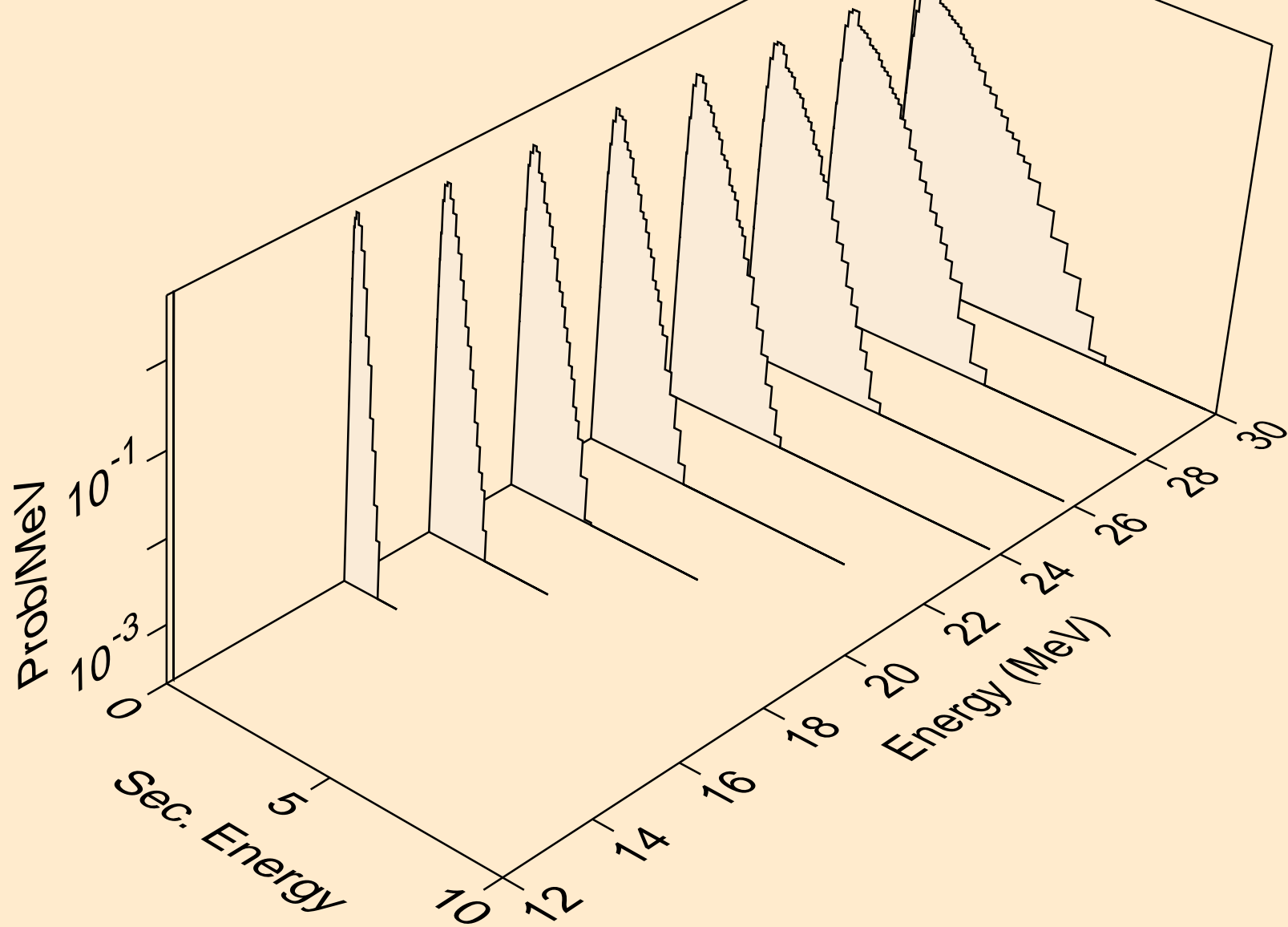

NP231 PROTON ACER TENDL-2021 LIBRARY; T=0.K  
neutrons from (p,n\*)t

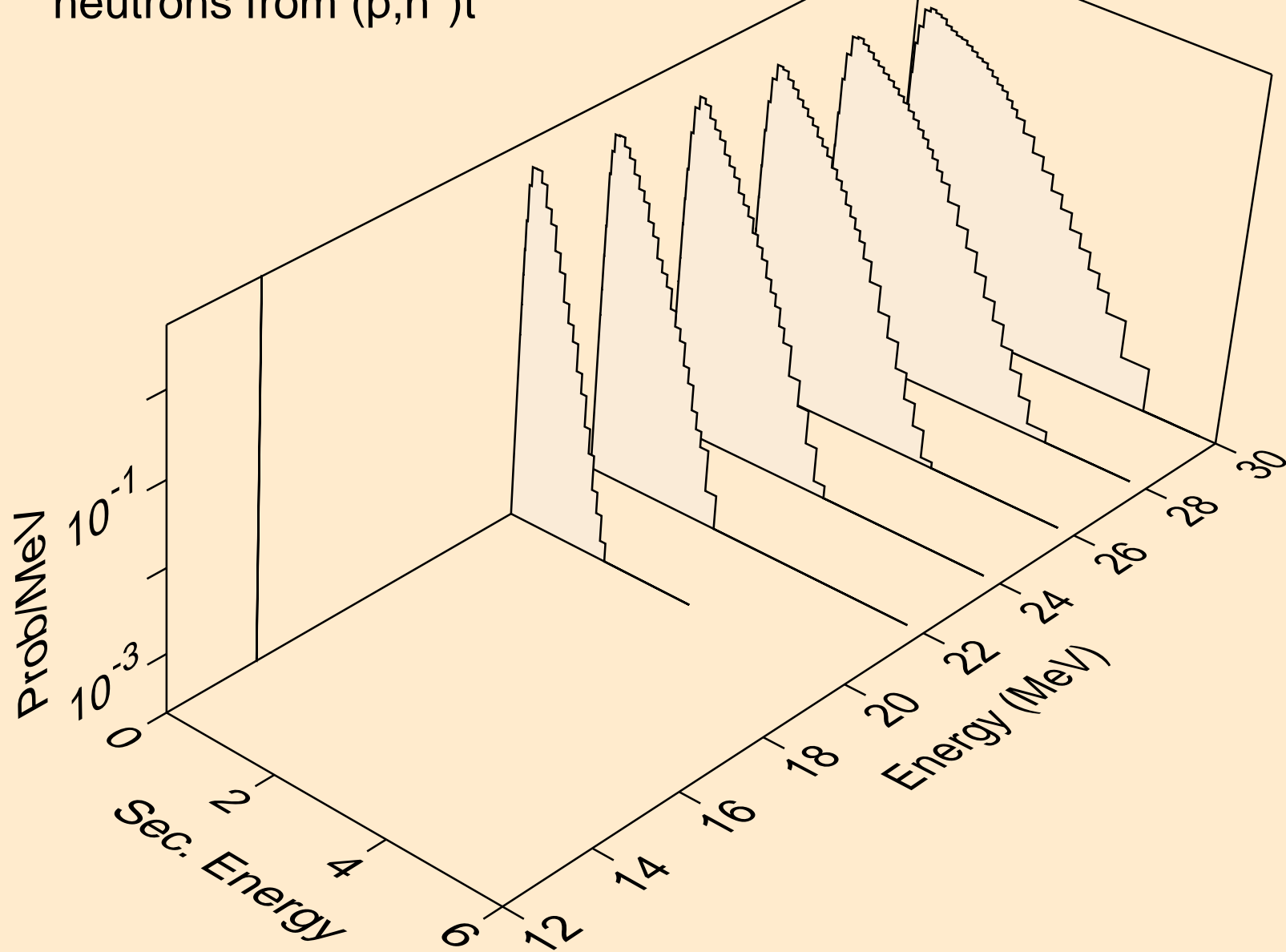

NP231 PROTON ACER TENDL-2021 LIBRARY; T=0.K  
neutrons from (p,n\*)he3

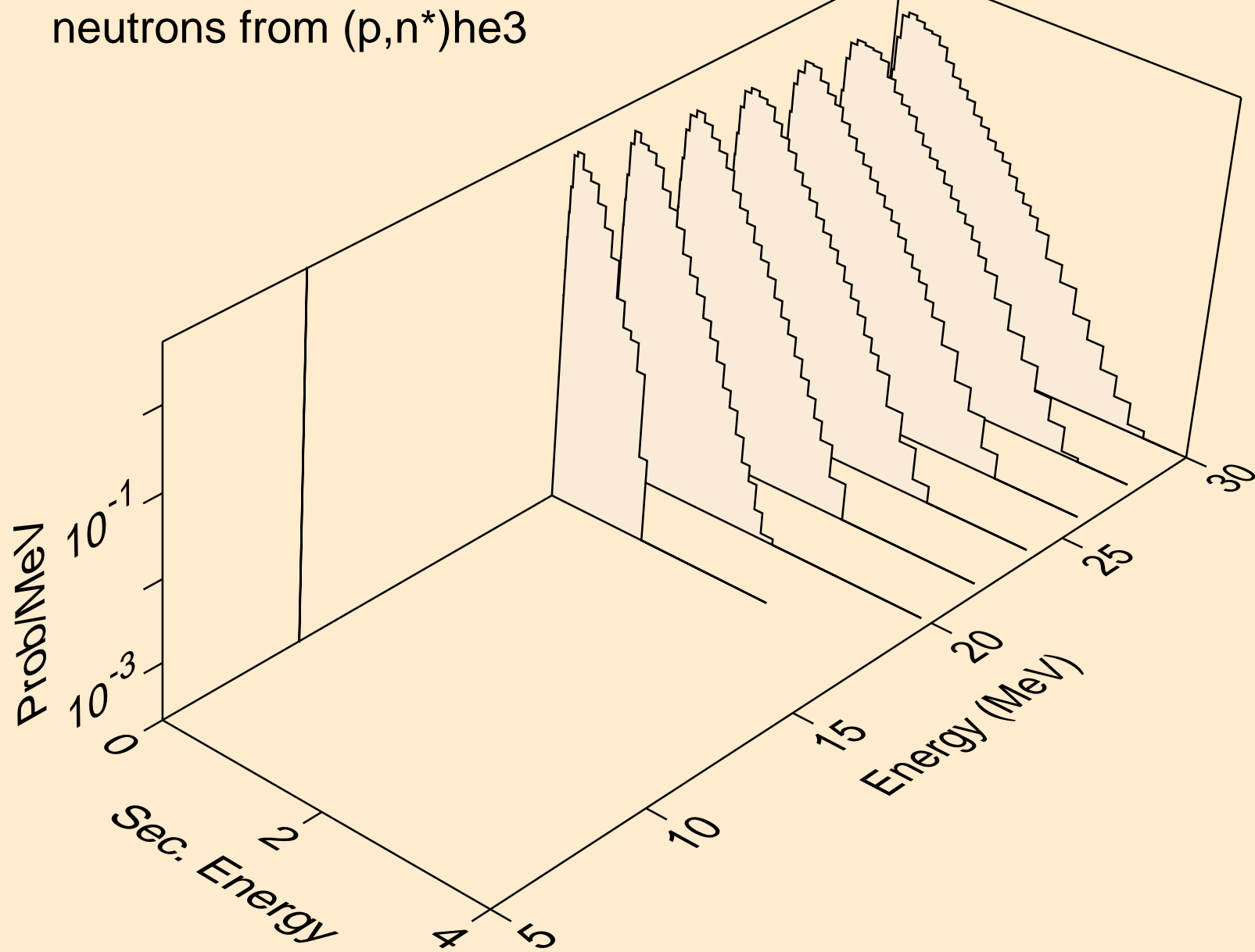

NP231 PROTON ACER TENDL-2021 LIBRARY; T=0.K  
neutrons from (p,4n)

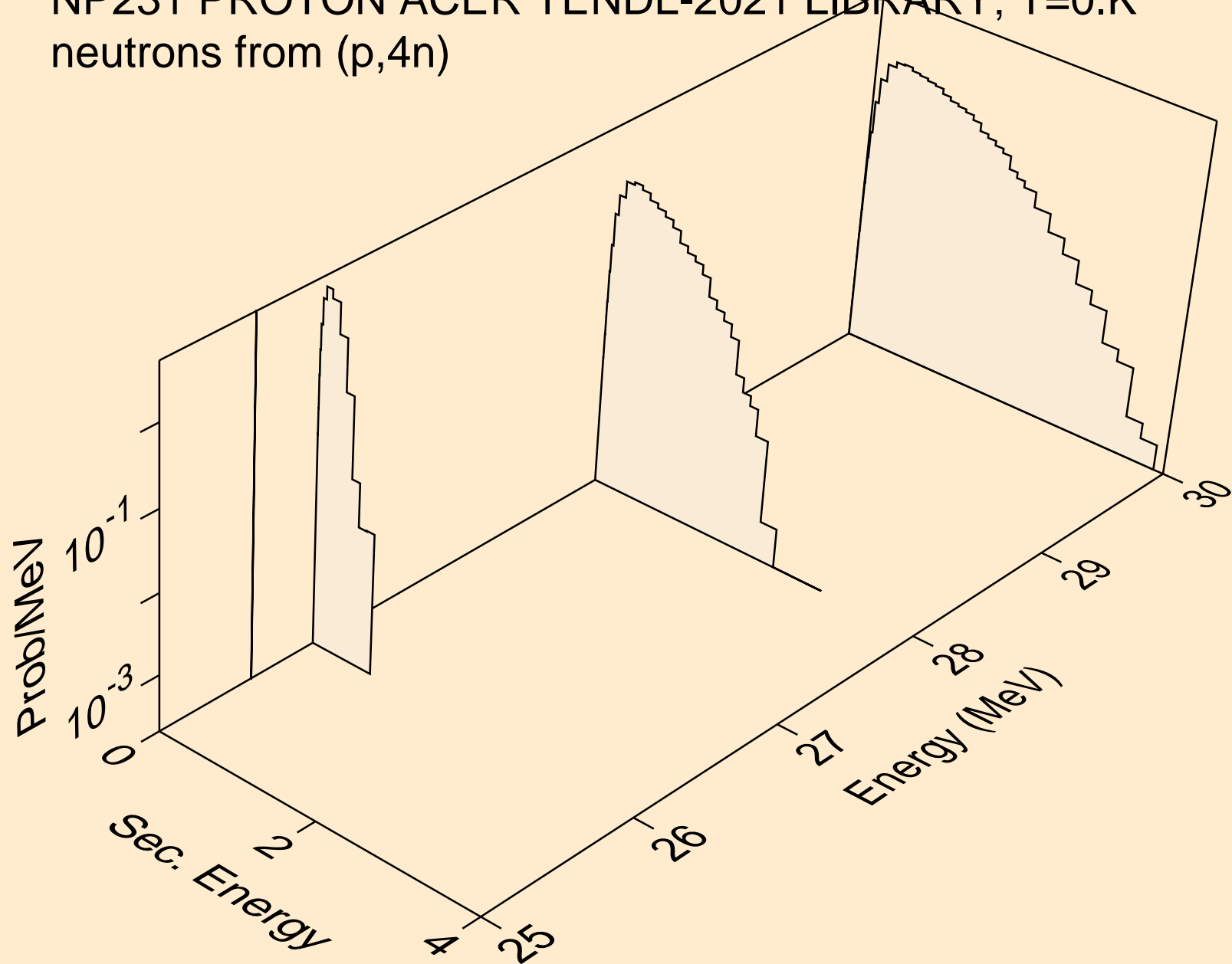

NP231 PROTON ACER TENDL-2021 LIBRARY; T=0.K  
neutrons from (p,2np)

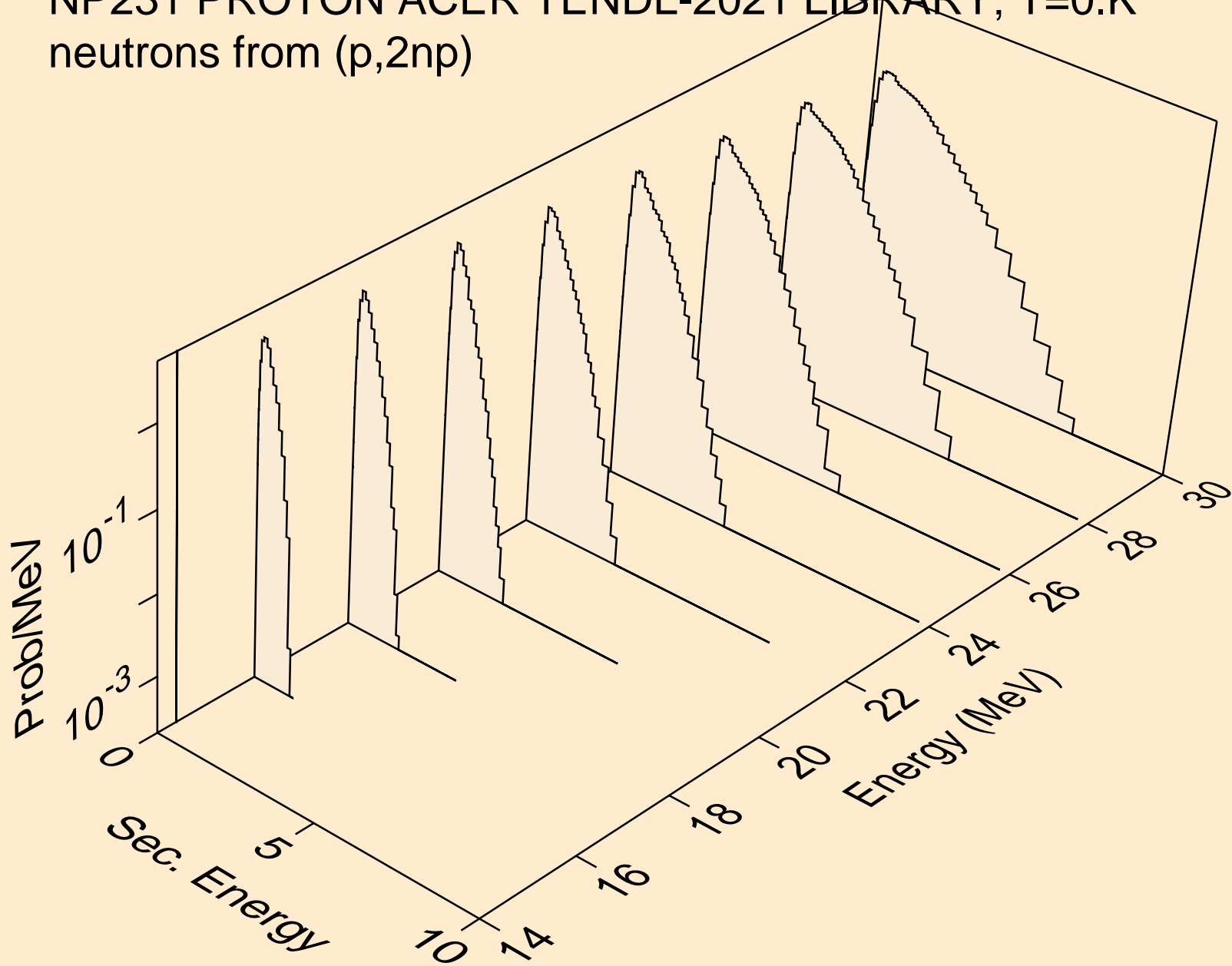

NP231 PROTON ACER TENDL-2021 LIBRARY; T=0.K  
neutrons from (p,2np)

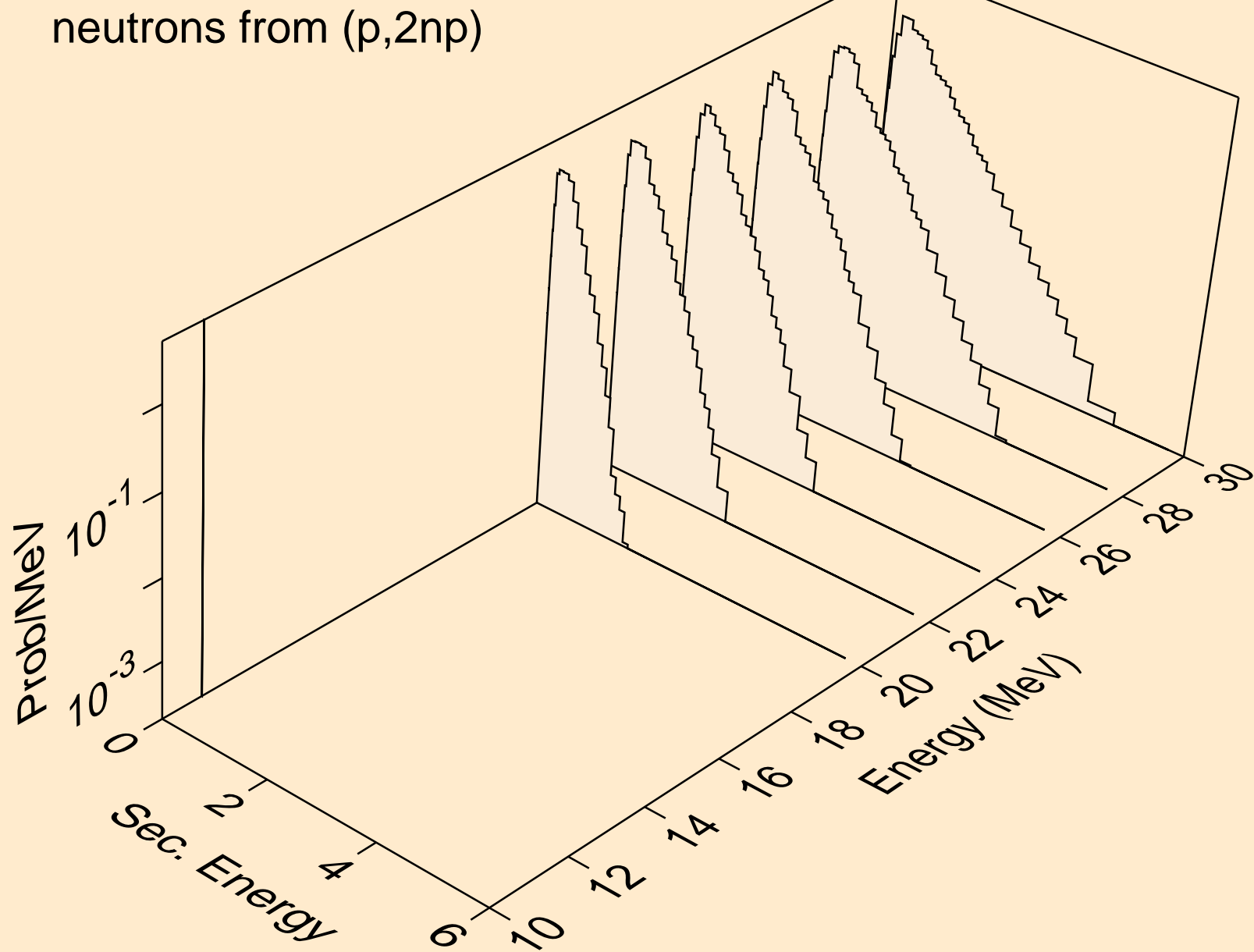

NP231 PROTON ACER TENDL-2021 LIBRARY; T=0.K  
neutrons from (p,npa)

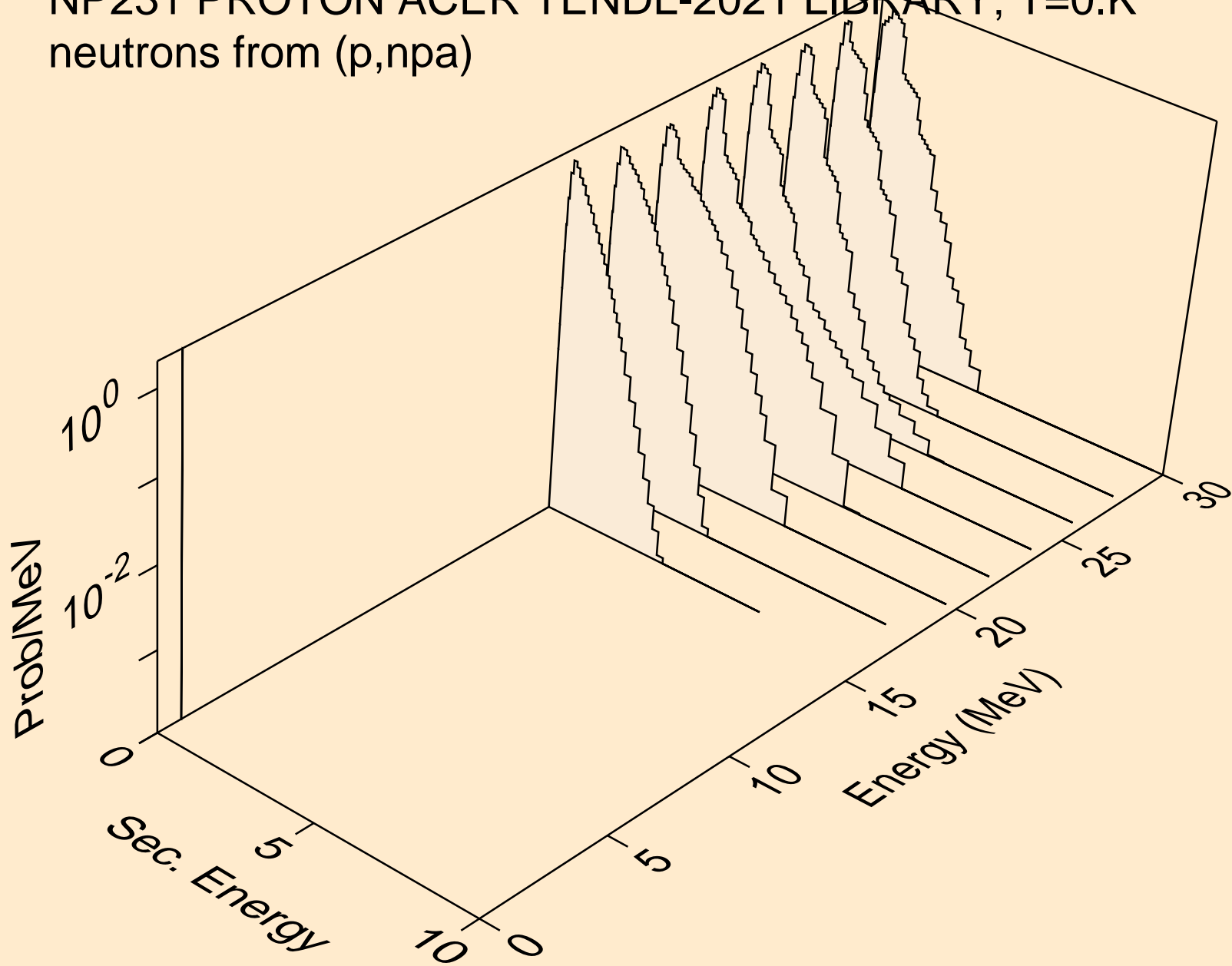



NP231 PROTON ACER TENDL-2021 LIBRARY; T=0.K  
deuterons from (p,x)

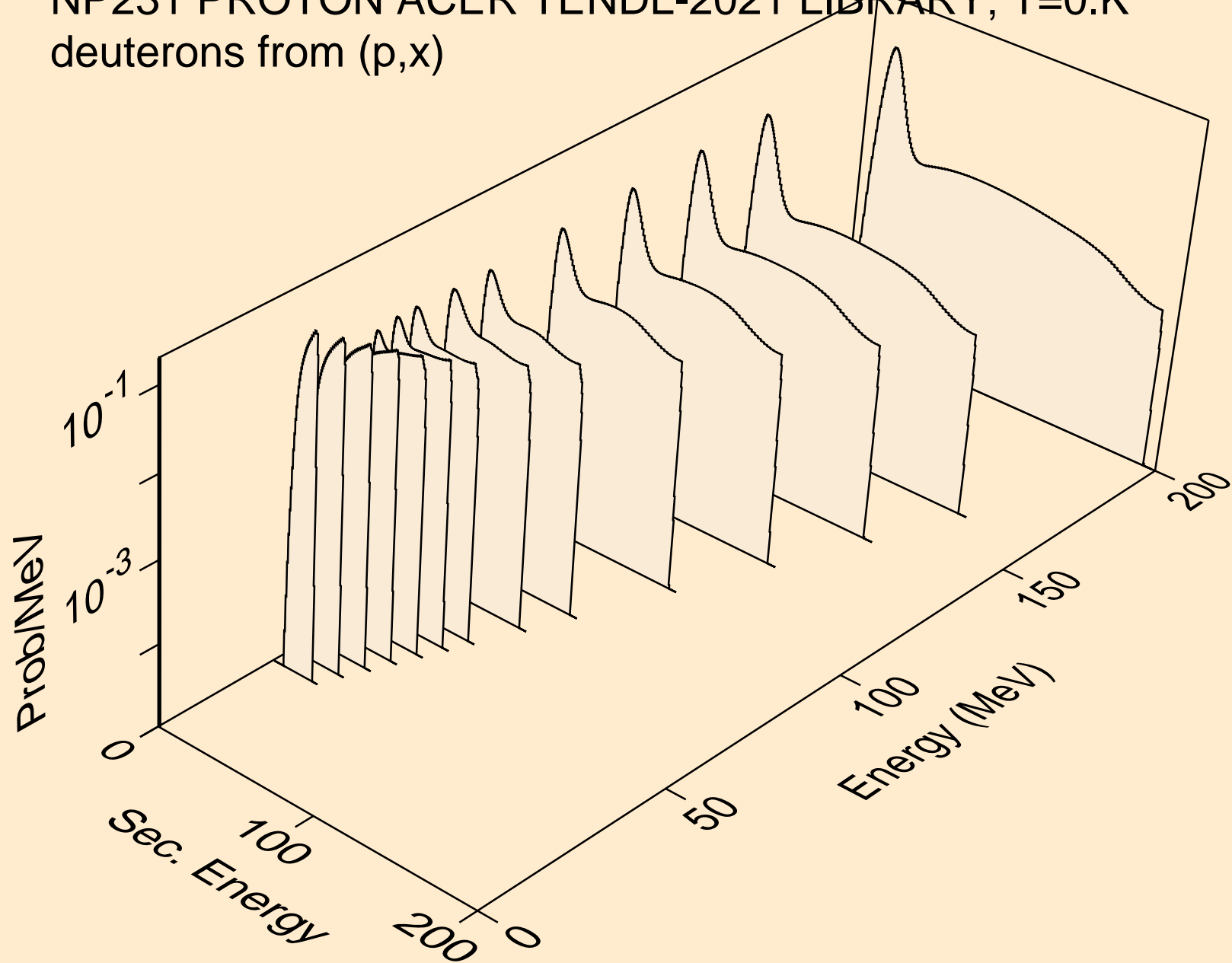

NP231 PROTON ACER TENDL-2021 LIBRARY; T=0.K  
deuterons from (p,n\*)d

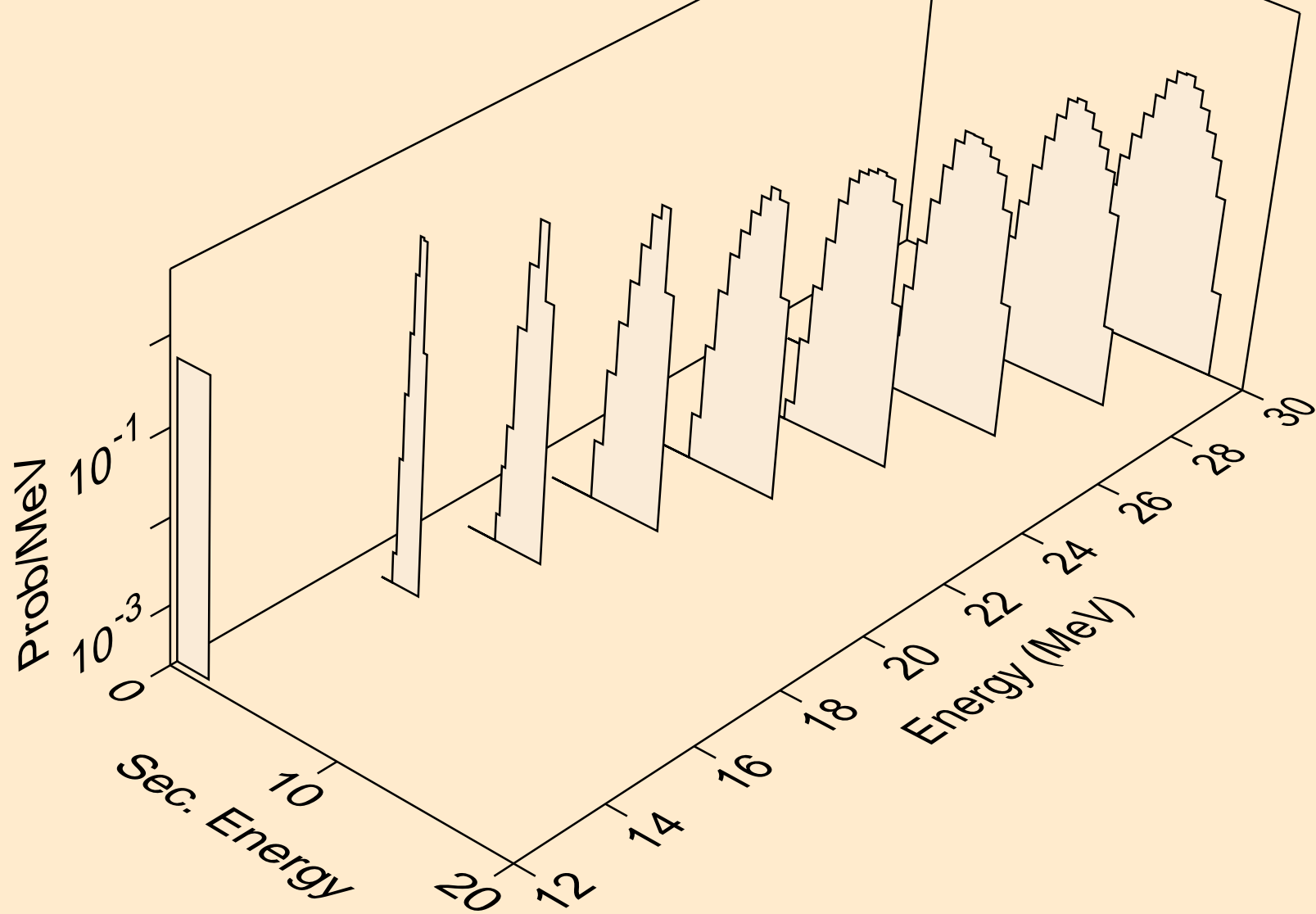

NP231 PROTON ACER TENDL-2021 LIBRARY; T=0.K  
deuterons from (p,d)

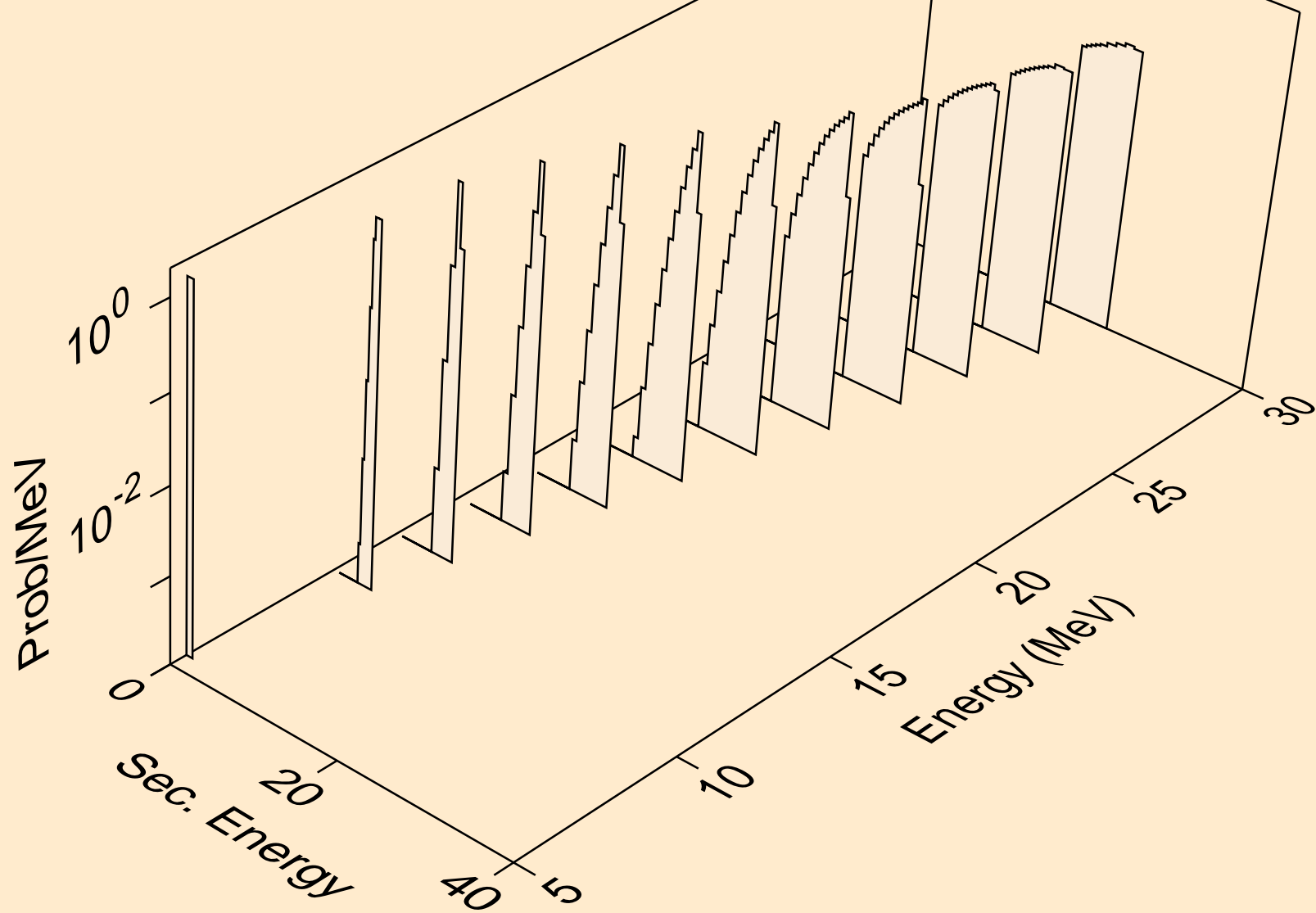

NP231 PROTON ACER TENDL-2021 LIBRARY; T=0.K  
deuterons from (p,pd)

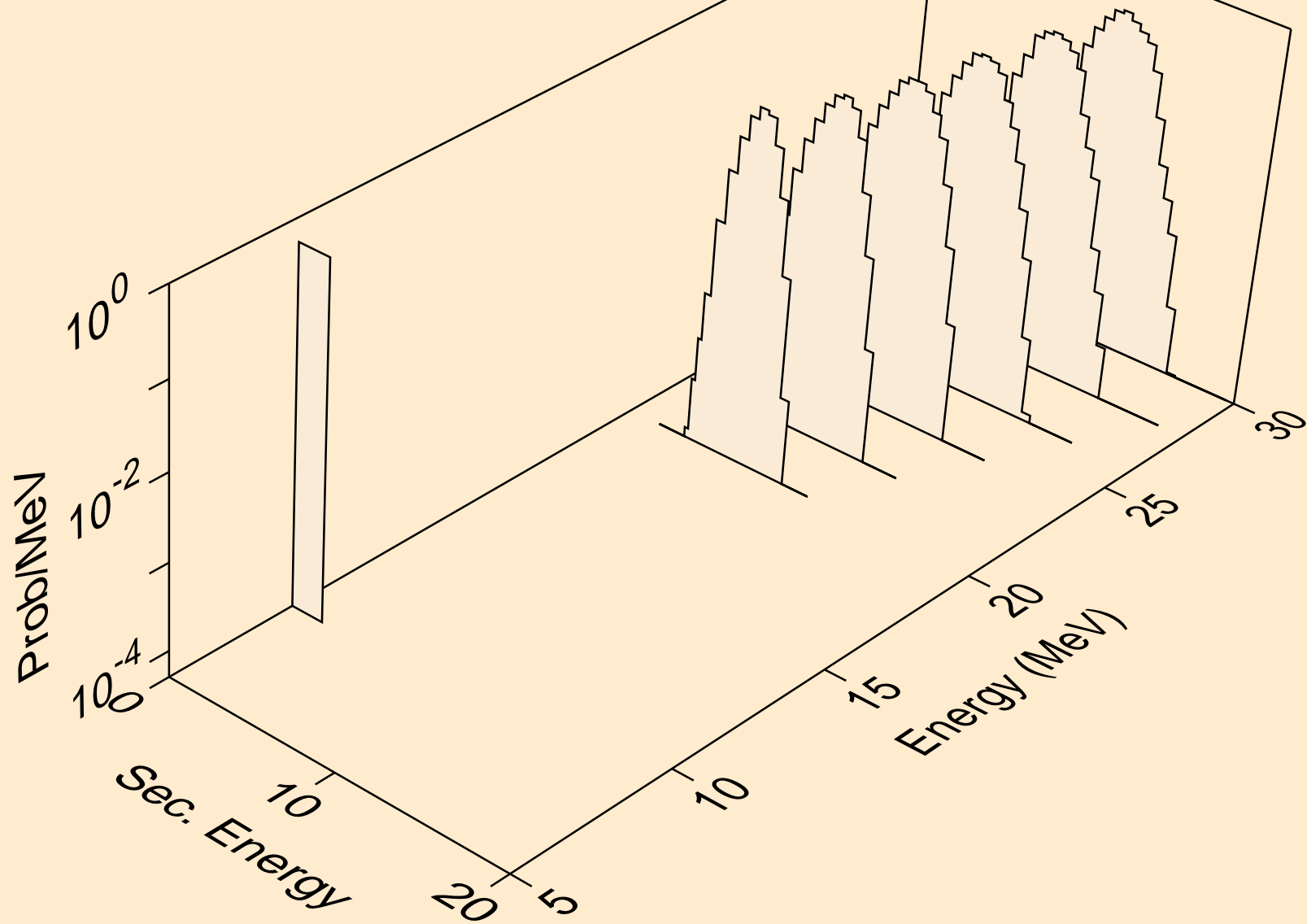

NP231 PROTON ACER TENDL-2021 LIBRARY; T=0.K  
tritons from (p,x)

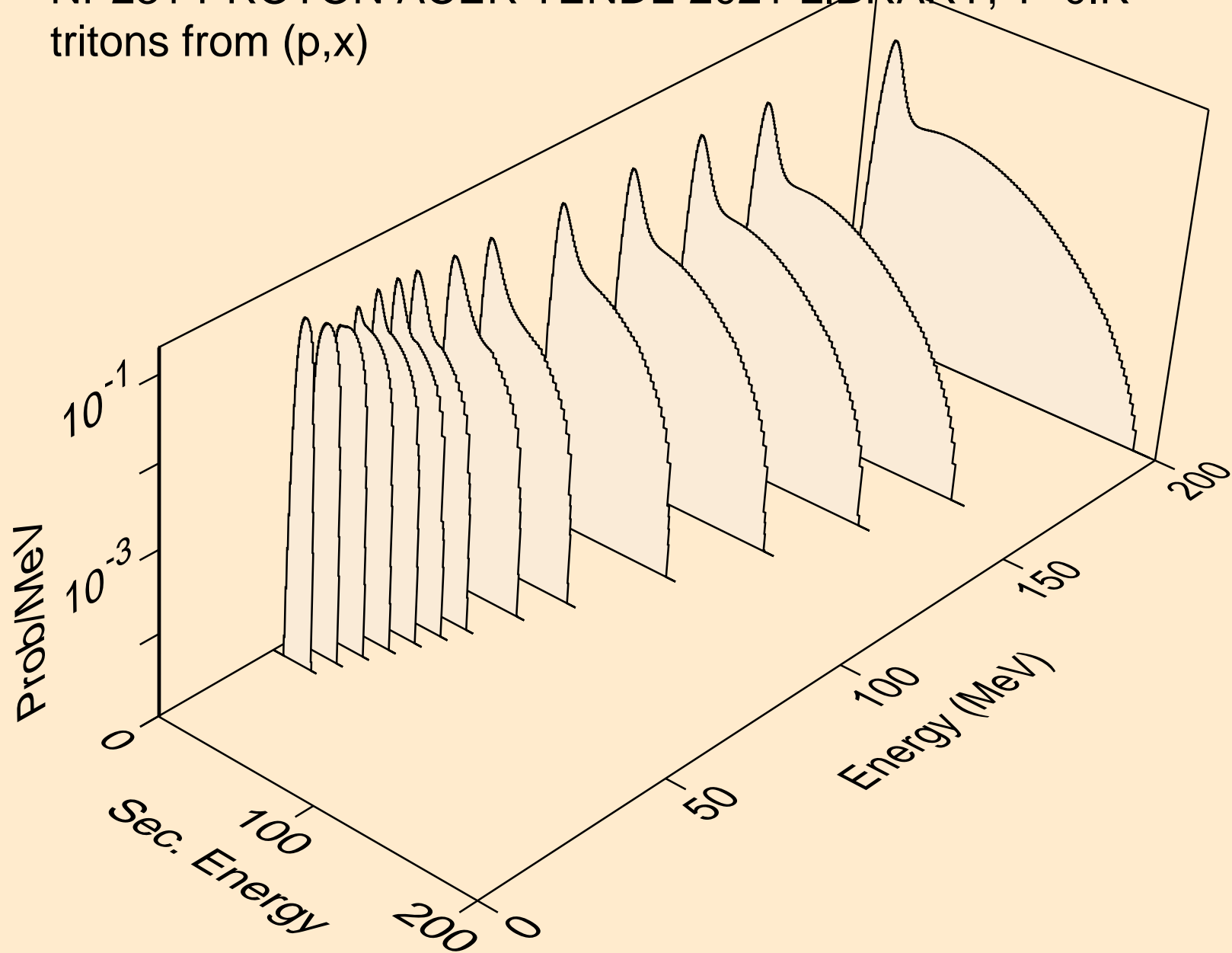

NP231 PROTON ACER TENDL-2021 LIBRARY; T=0.K  
tritons from (p,n\*)t

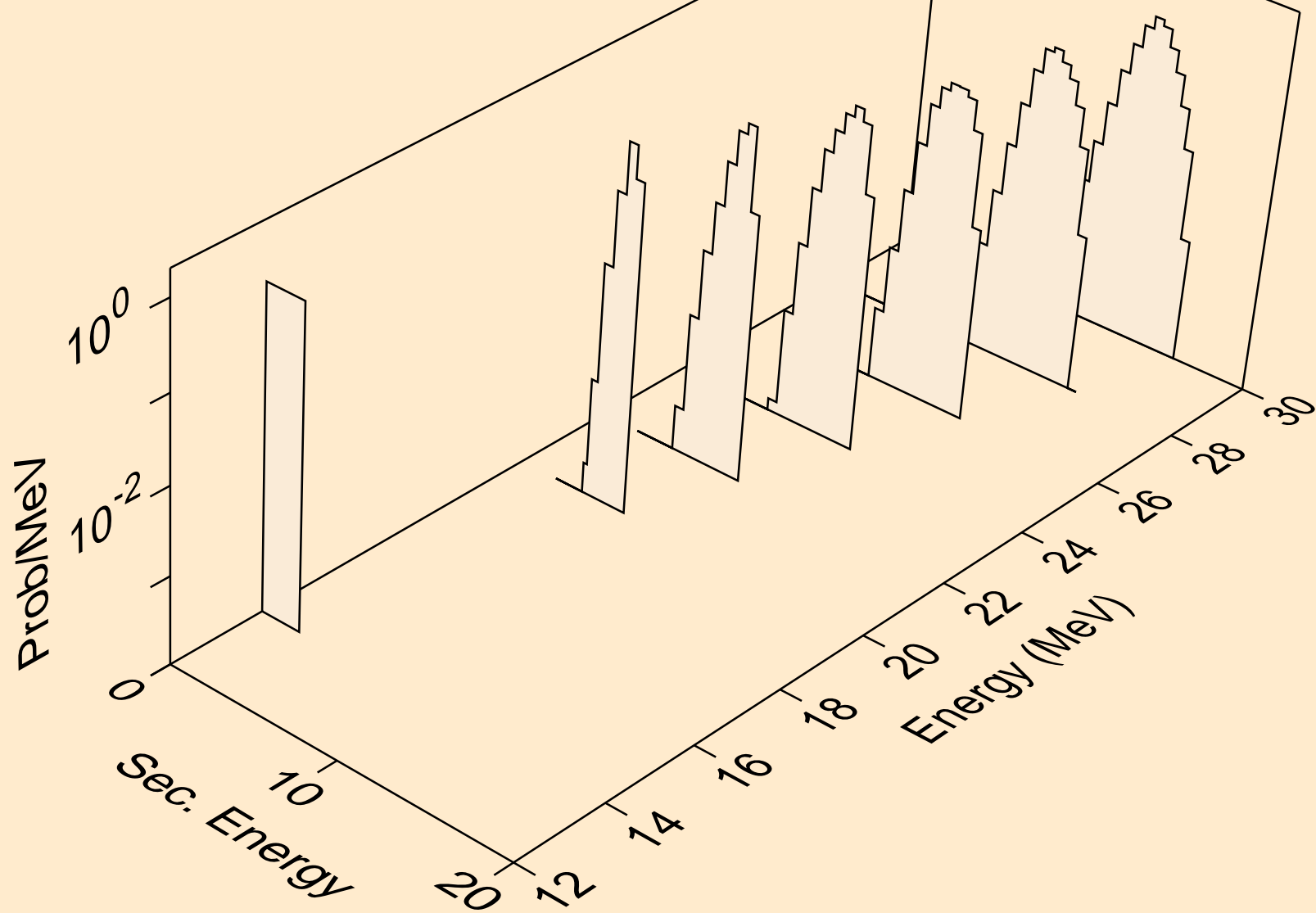

NP231 PROTON ACER TENDL-2021 LIBRARY; T=0.K  
tritons from (p,t)

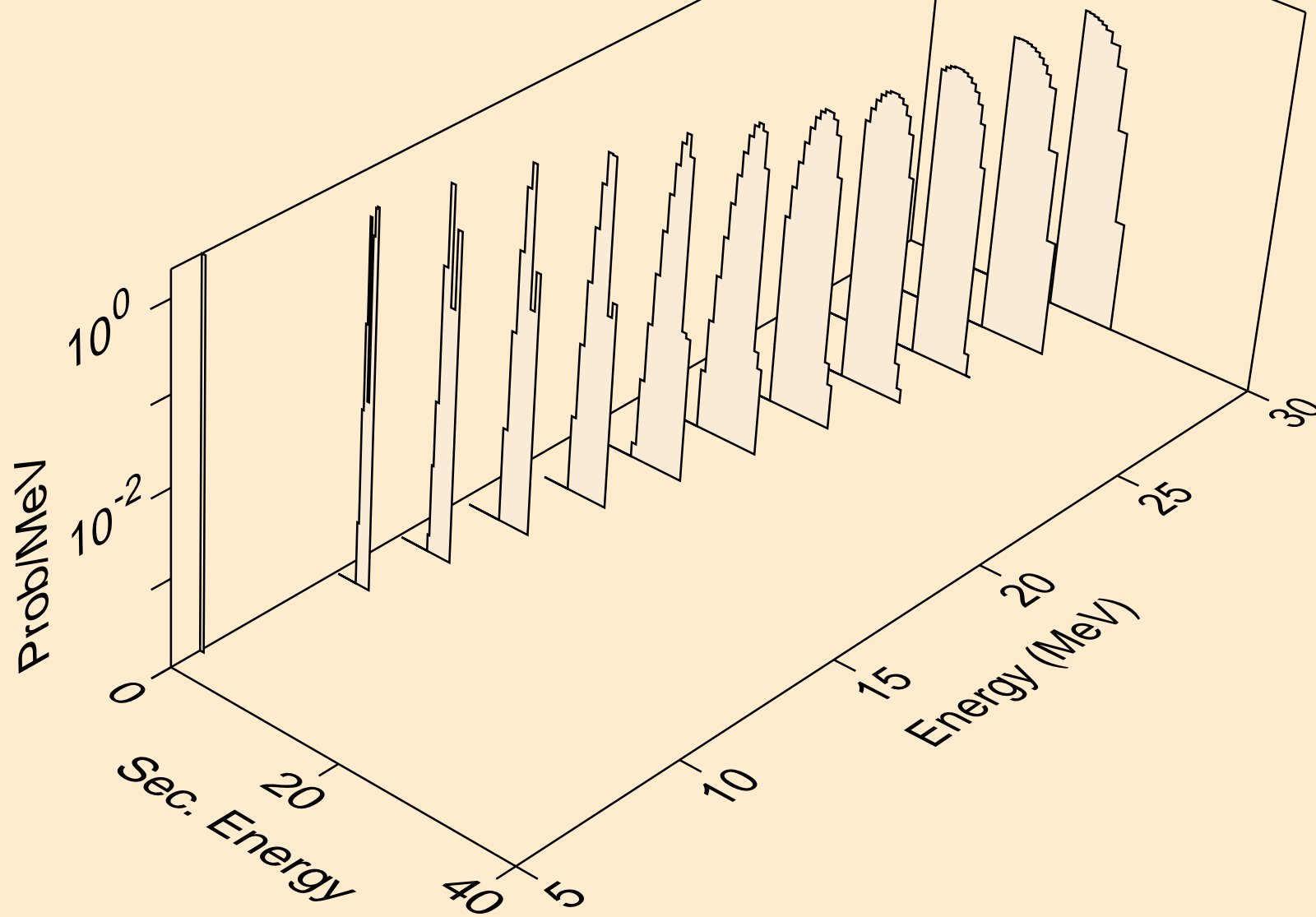

NP231 PROTON ACER TENDL-2021 LIBRARY; T=0.K  
he3s from (p,x)

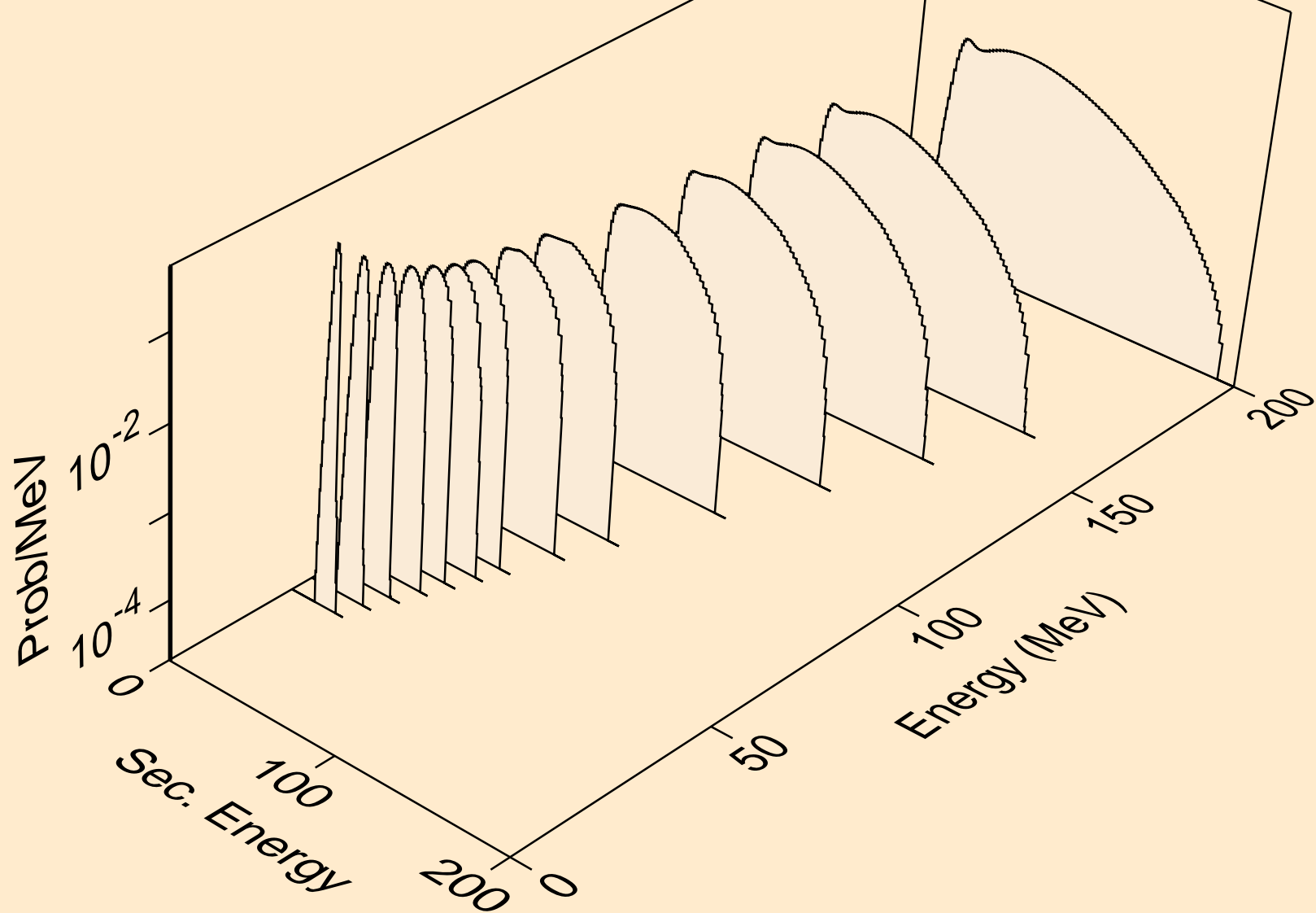



NP231 PROTON ACER TENDL-2021 LIBRARY; T=0.K  
he3s from (p,n\*)he3

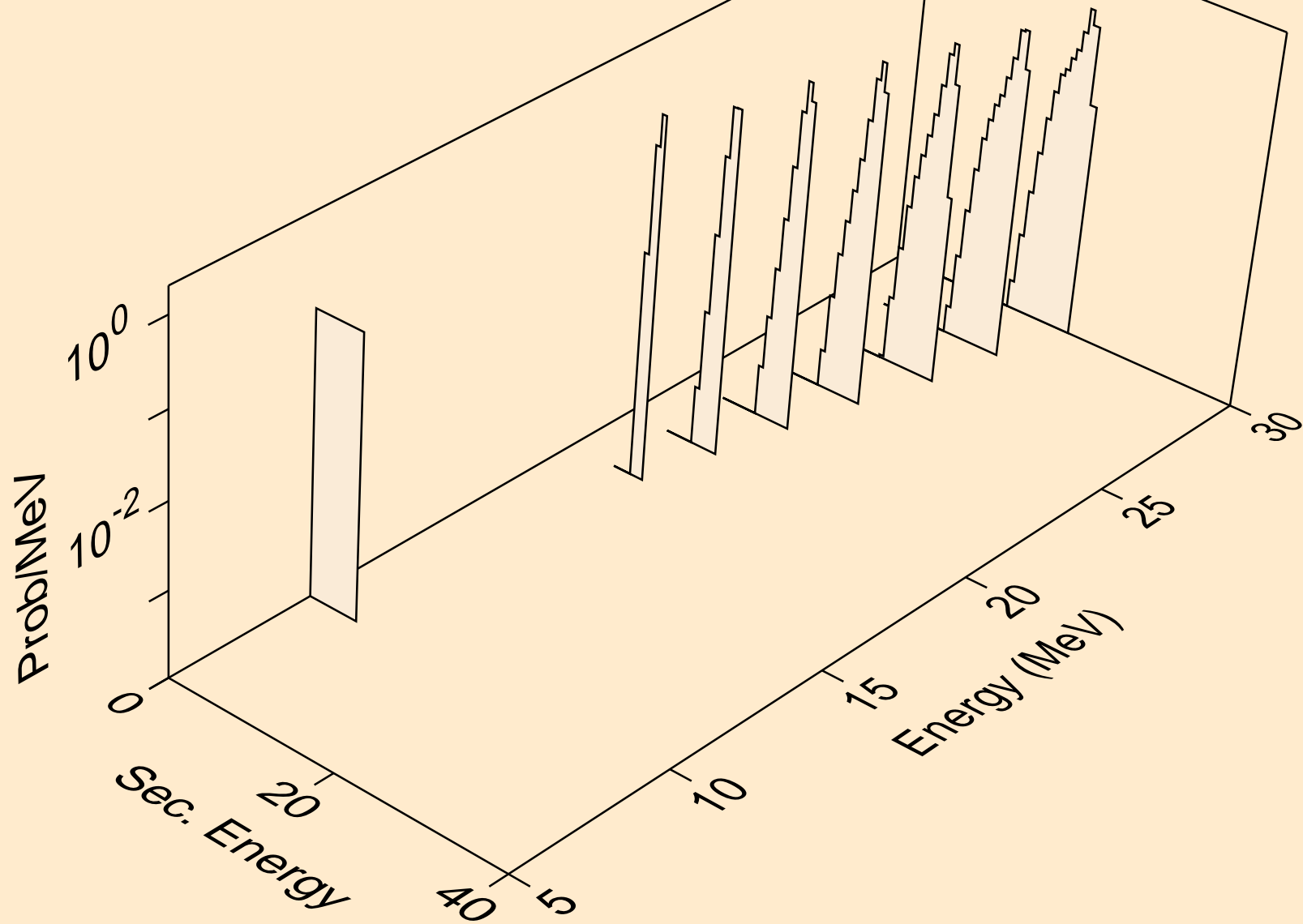

NP231 PROTON ACER TENDL-2021 LIBRARY; T=0.K  
he3s from (p,he3)

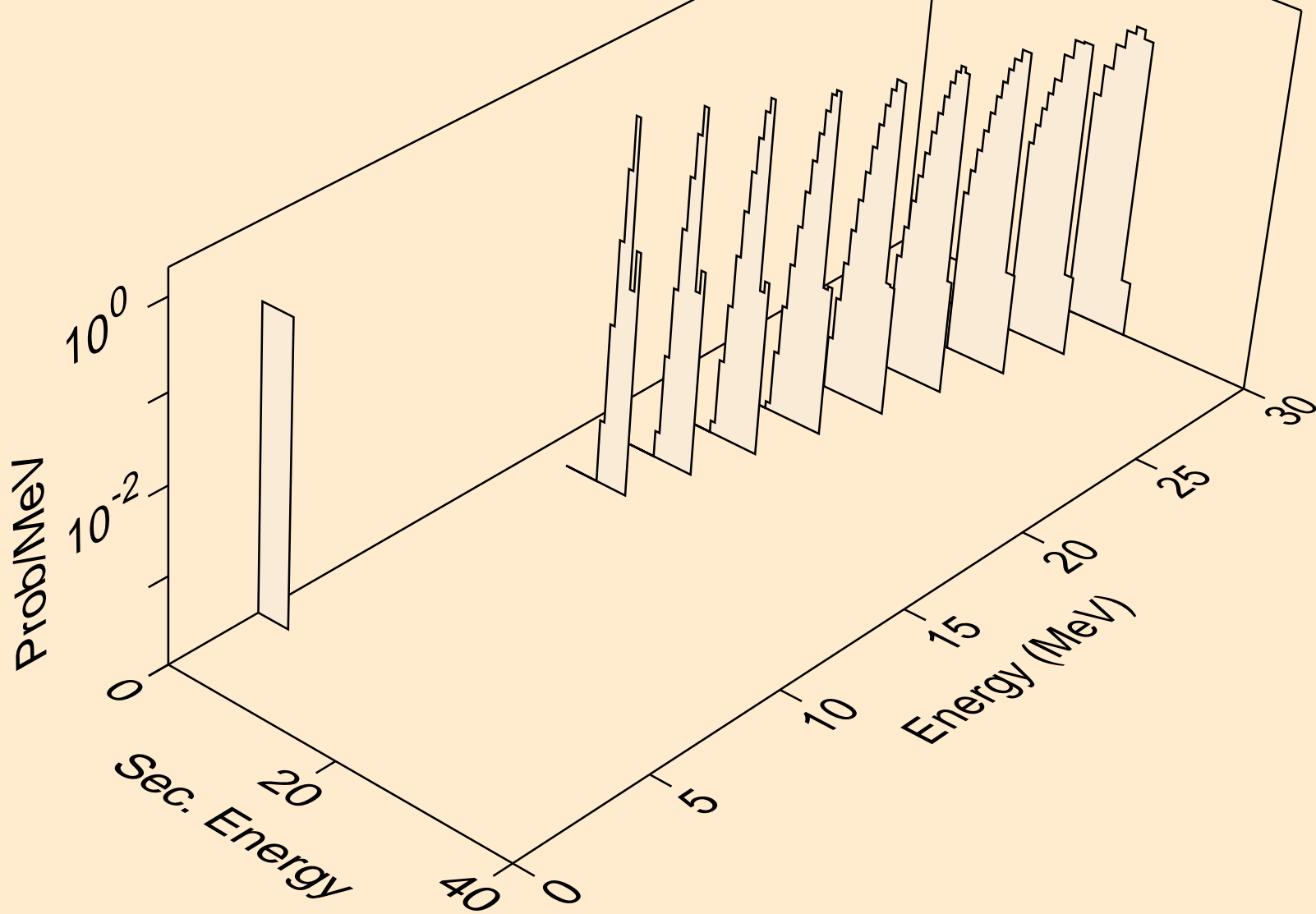

NP231 PROTON ACER TENDL-2021 LIBRARY; T=0.K  
alphas from (p,x)

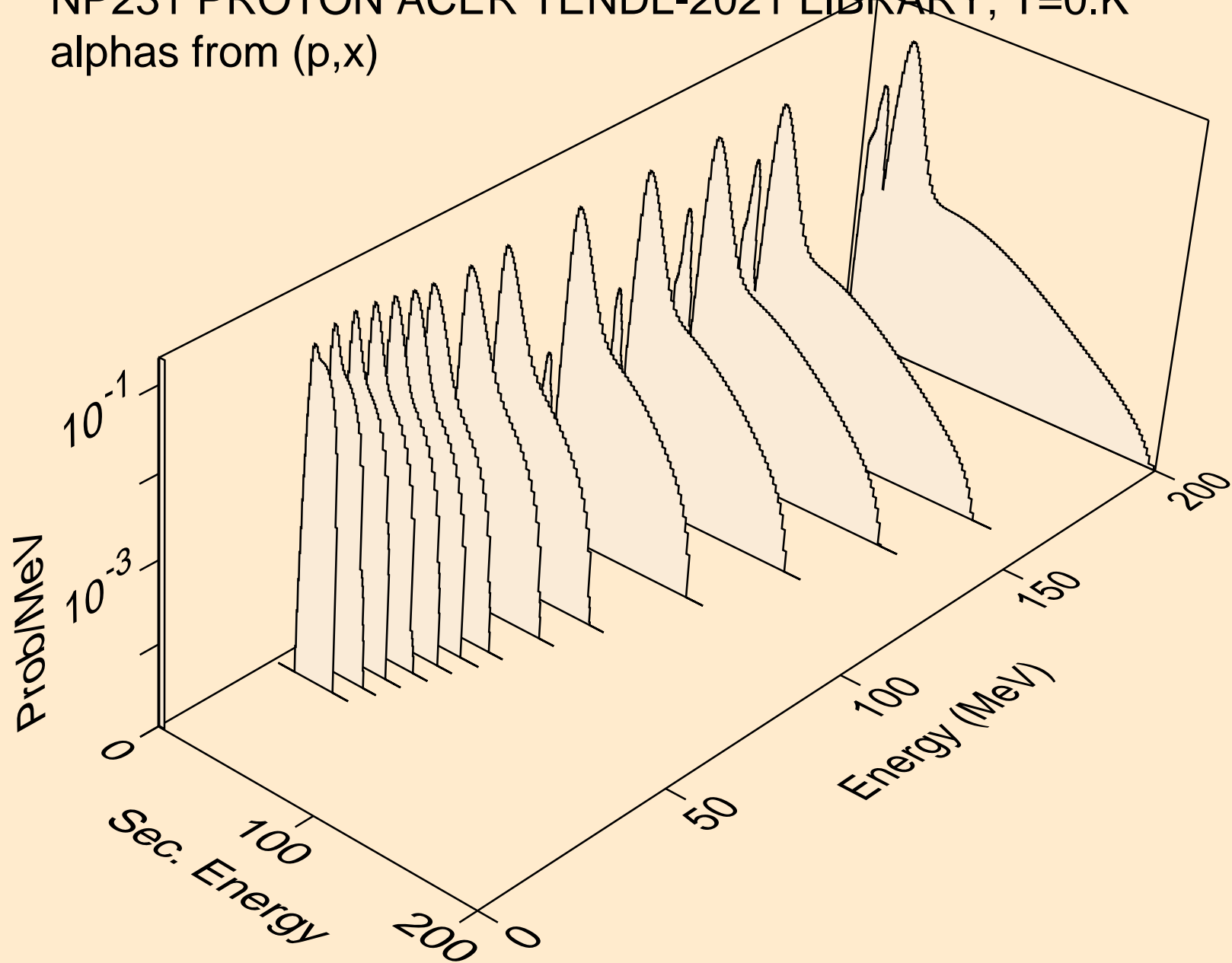

NP231 PROTON ACER TENDL-2021 LIBRARY; T=0.K  
alphas from (p,n\*)a

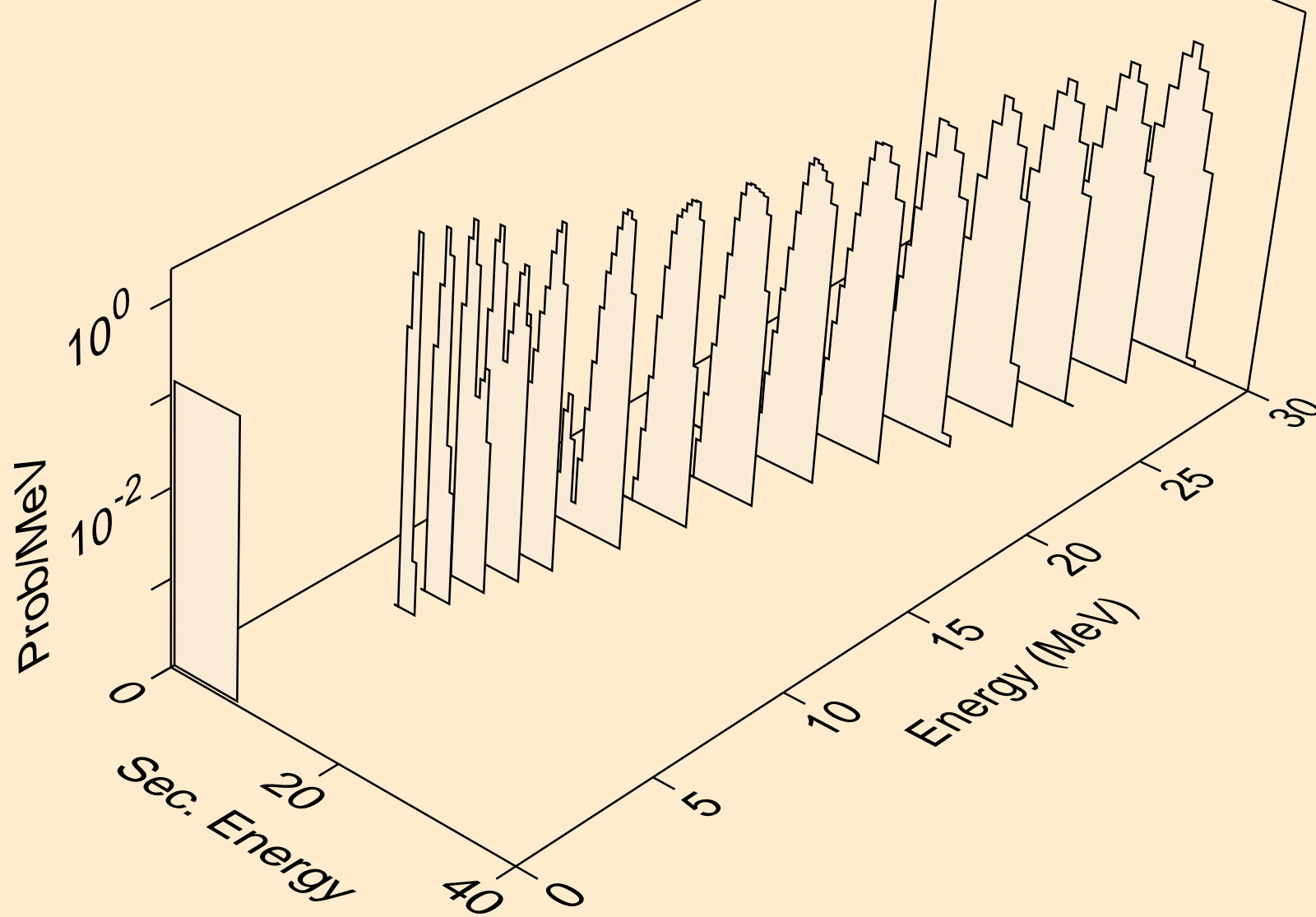

NP231 PROTON ACER TENDL-2021 LIBRARY; T=0.K  
alphas from (p,2n)a

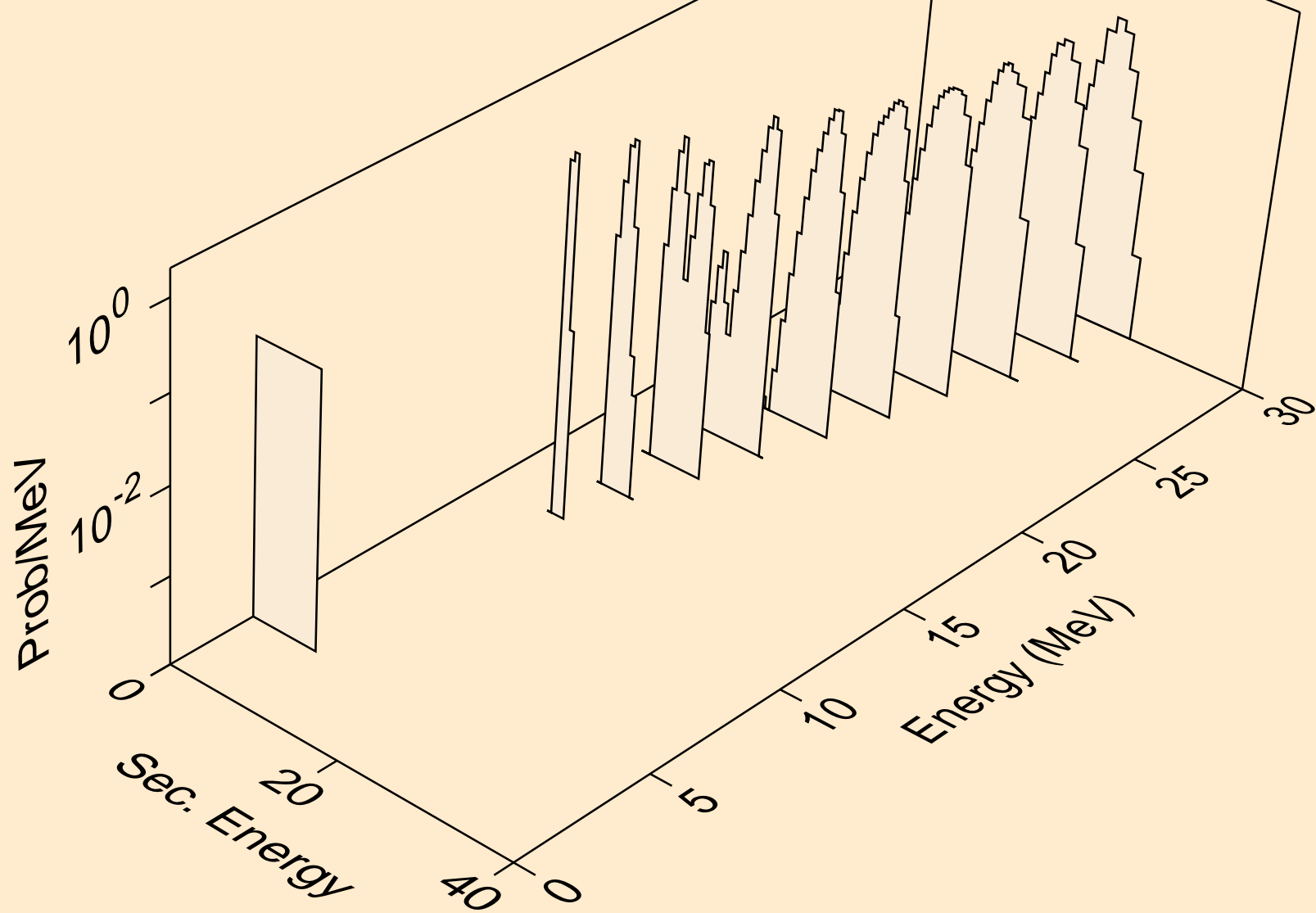

NP231 PROTON ACER TENDL-2021 LIBRARY; T=0.K  
alphas from (p,n\*)2a

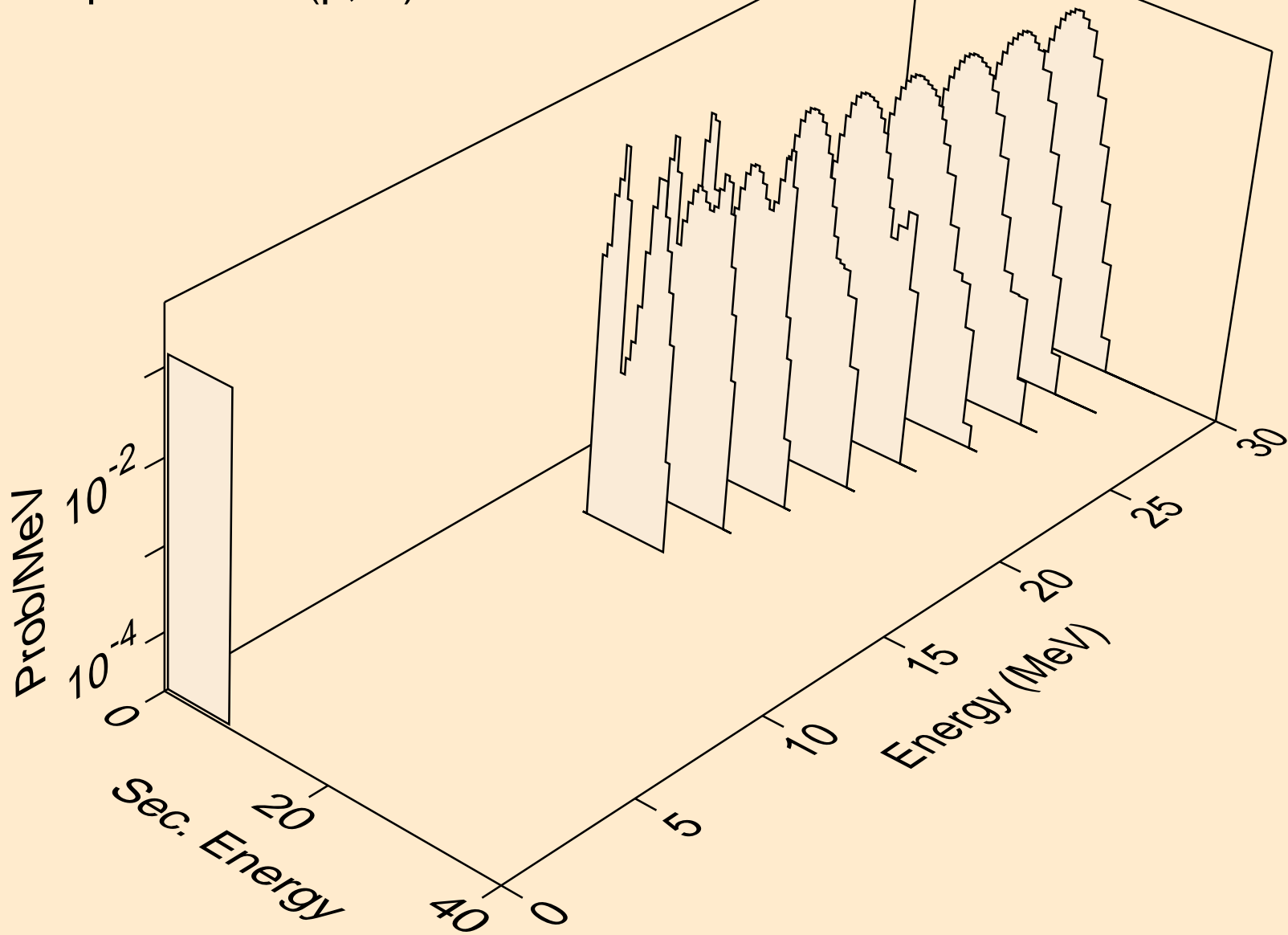

NP231 PROTON ACER TENDL-2021 LIBRARY; T=0.K  
alphas from (p,npa)

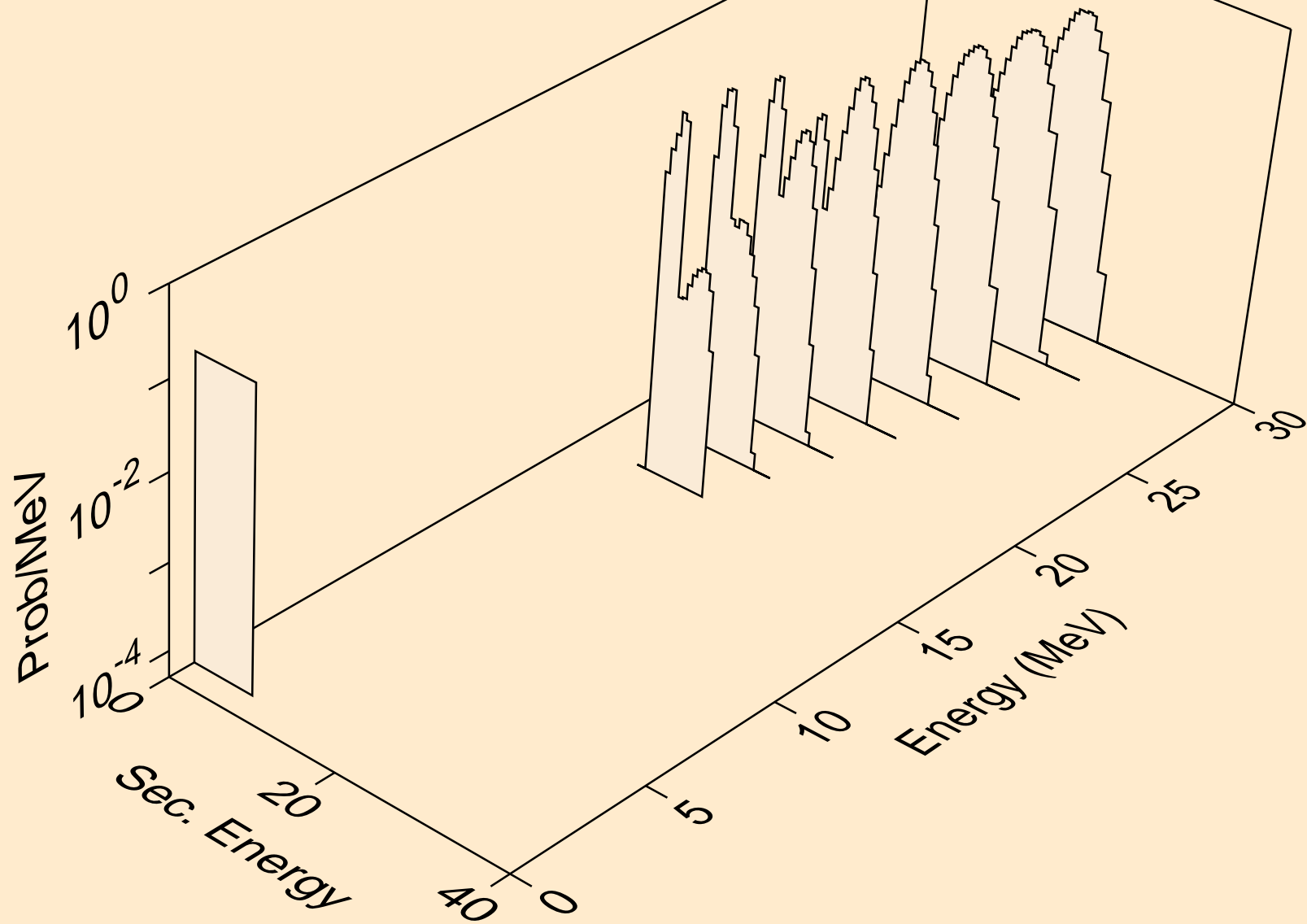

NP231 PROTON ACER TENDL-2021 LIBRARY; T=0.K  
alphas from (p,a)

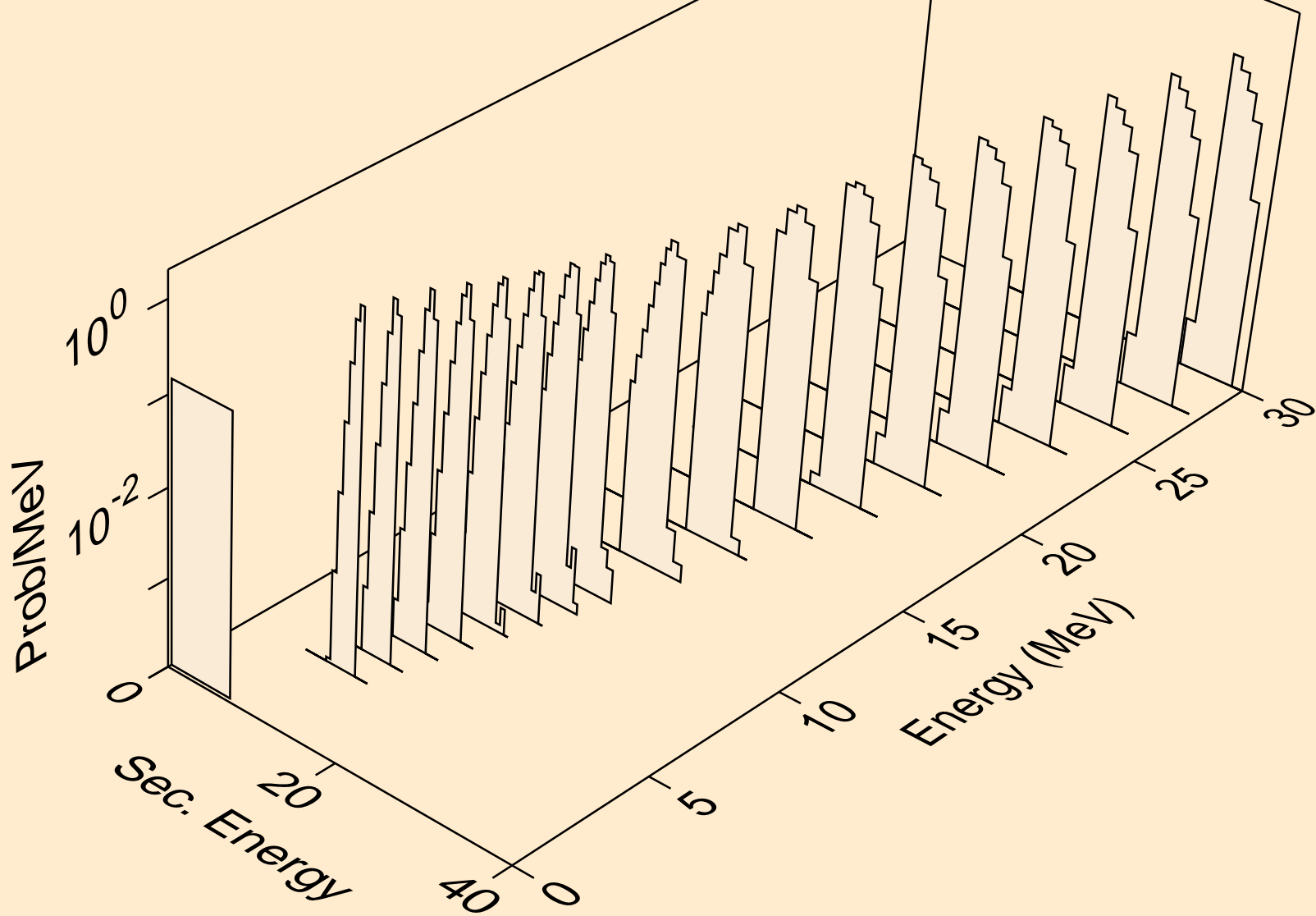



NP231 PROTON ACER TENDL-2021 LIBRARY; T=0.K  
alphas from (p,2a)

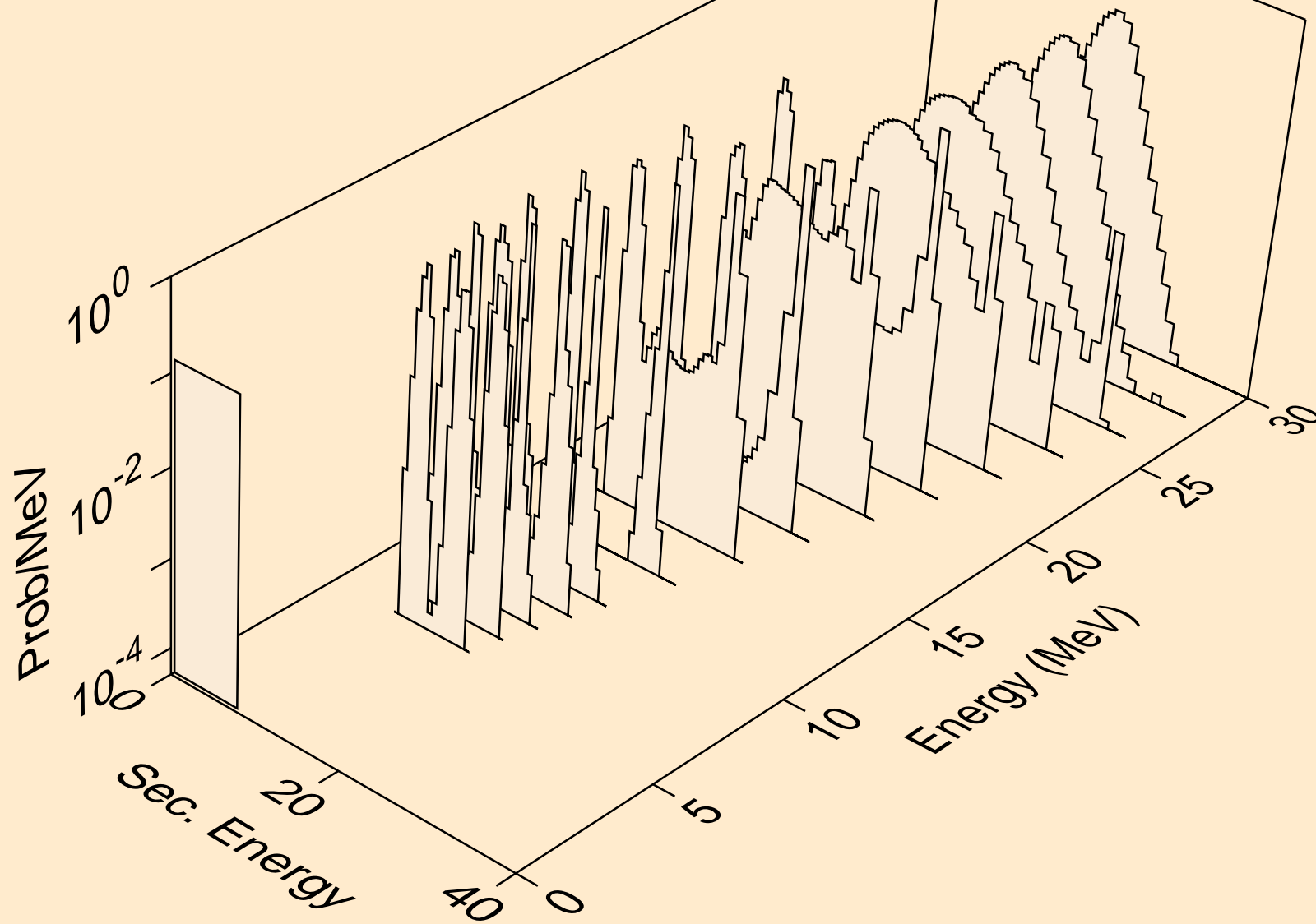

NP231 PROTON ACER TENDL-2021 LIBRARY; T=0.K  
alphas from (p,pa)

