

O020 PROTON ACER TENDL-2021 LIBRARY; T=0.K  
Principal cross sections

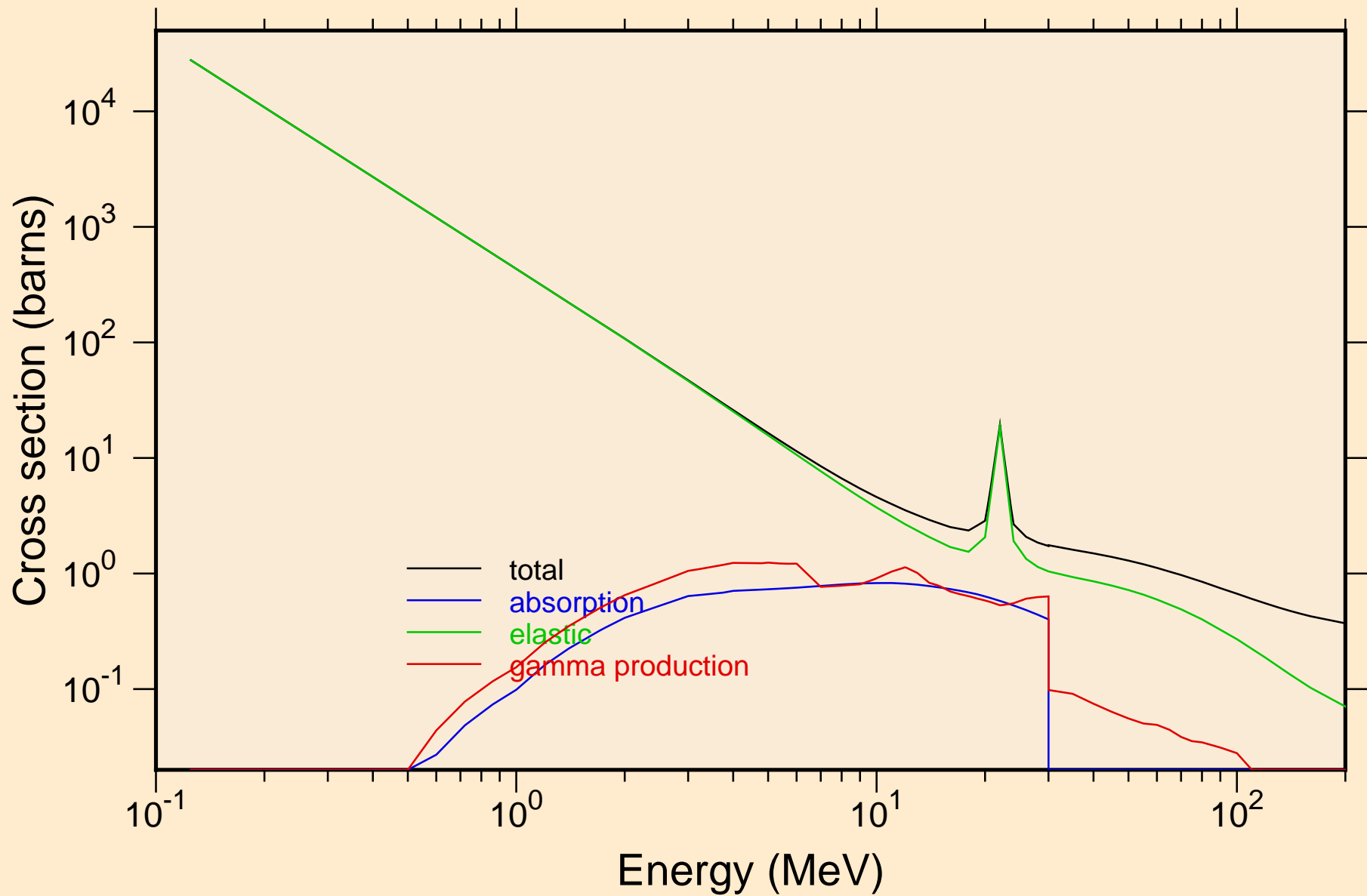

O020 PROTON ACER TENDL-2021 LIBRARY; T=0.K  
Heating

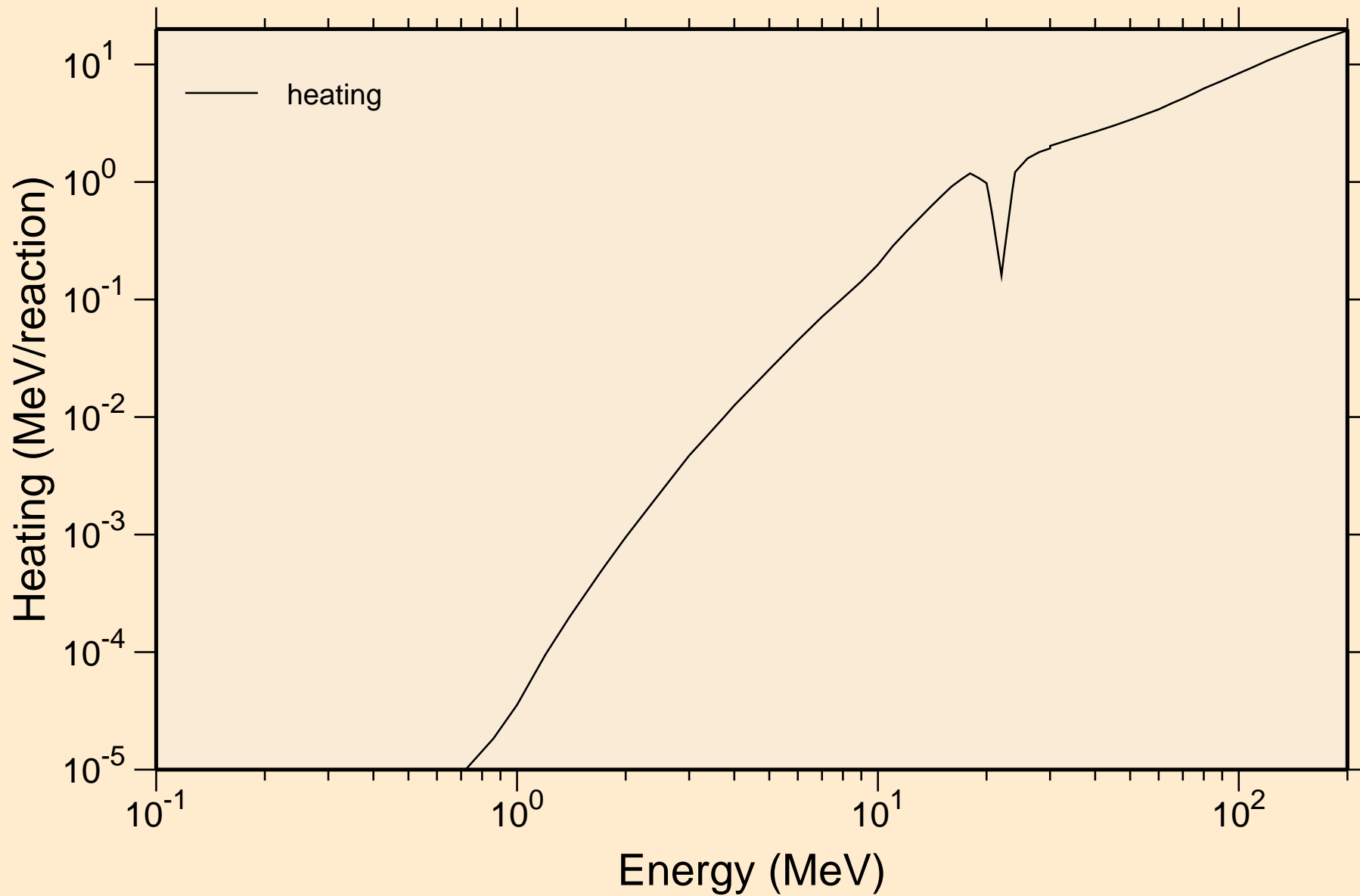

O020 PROTON ACER TENDL-2021 LIBRARY; T=0.K  
Principal cross sections

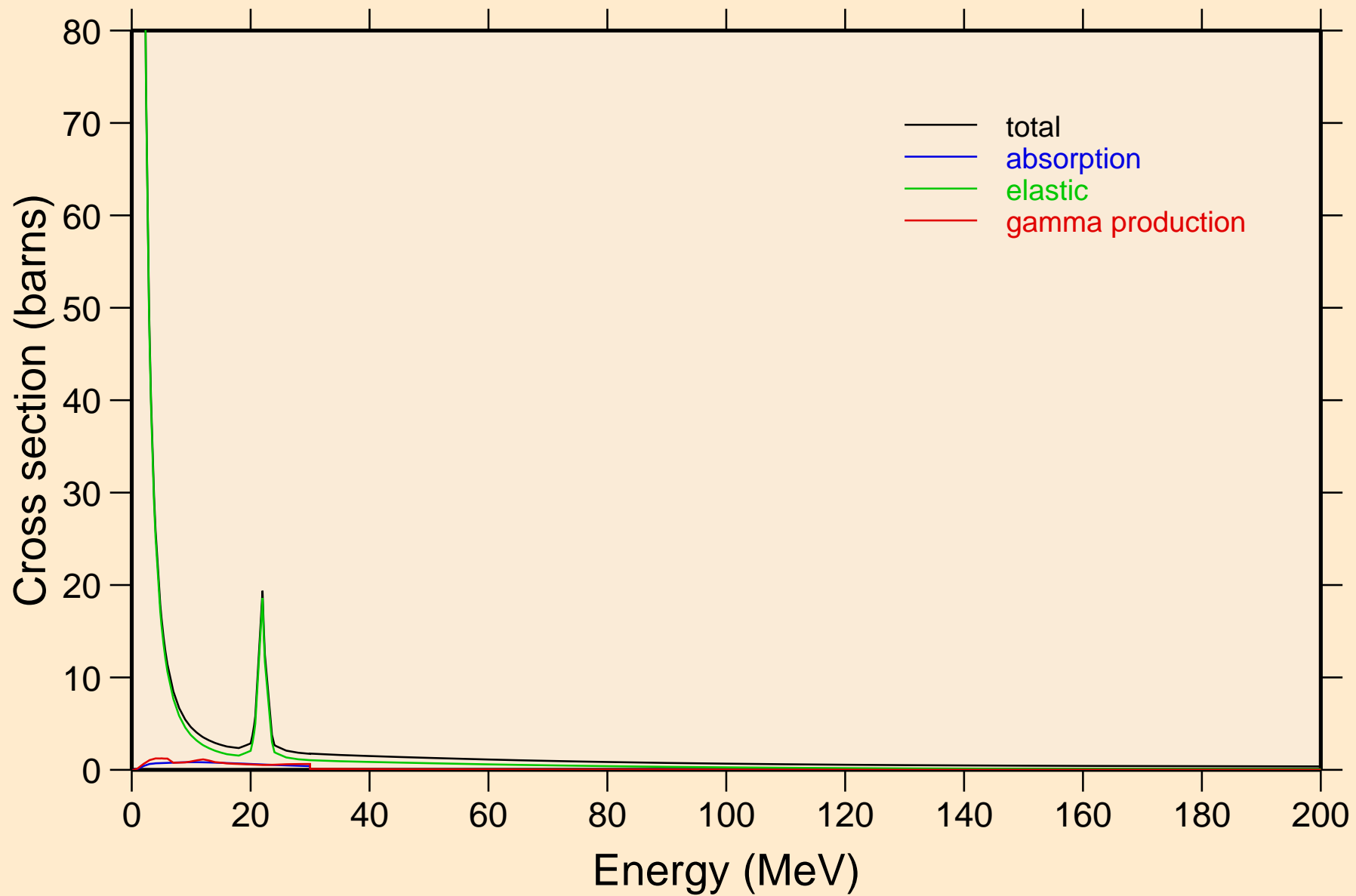

O020 PROTON ACER TENDL-2021 LIBRARY; T=0.K

Heating

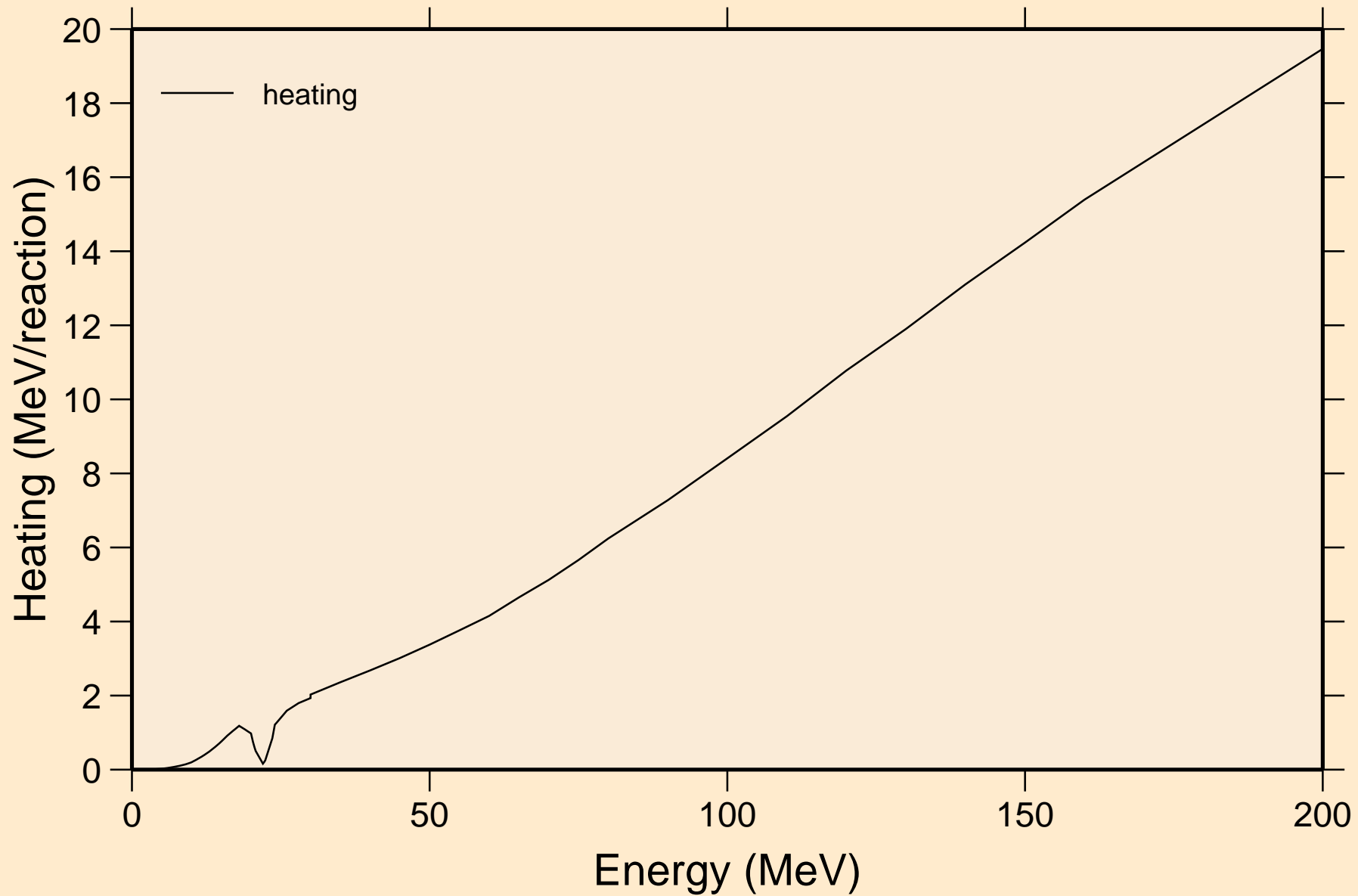

O020 PROTON ACER TENDL-2021 LIBRARY; T=0.K  
Threshold reactions

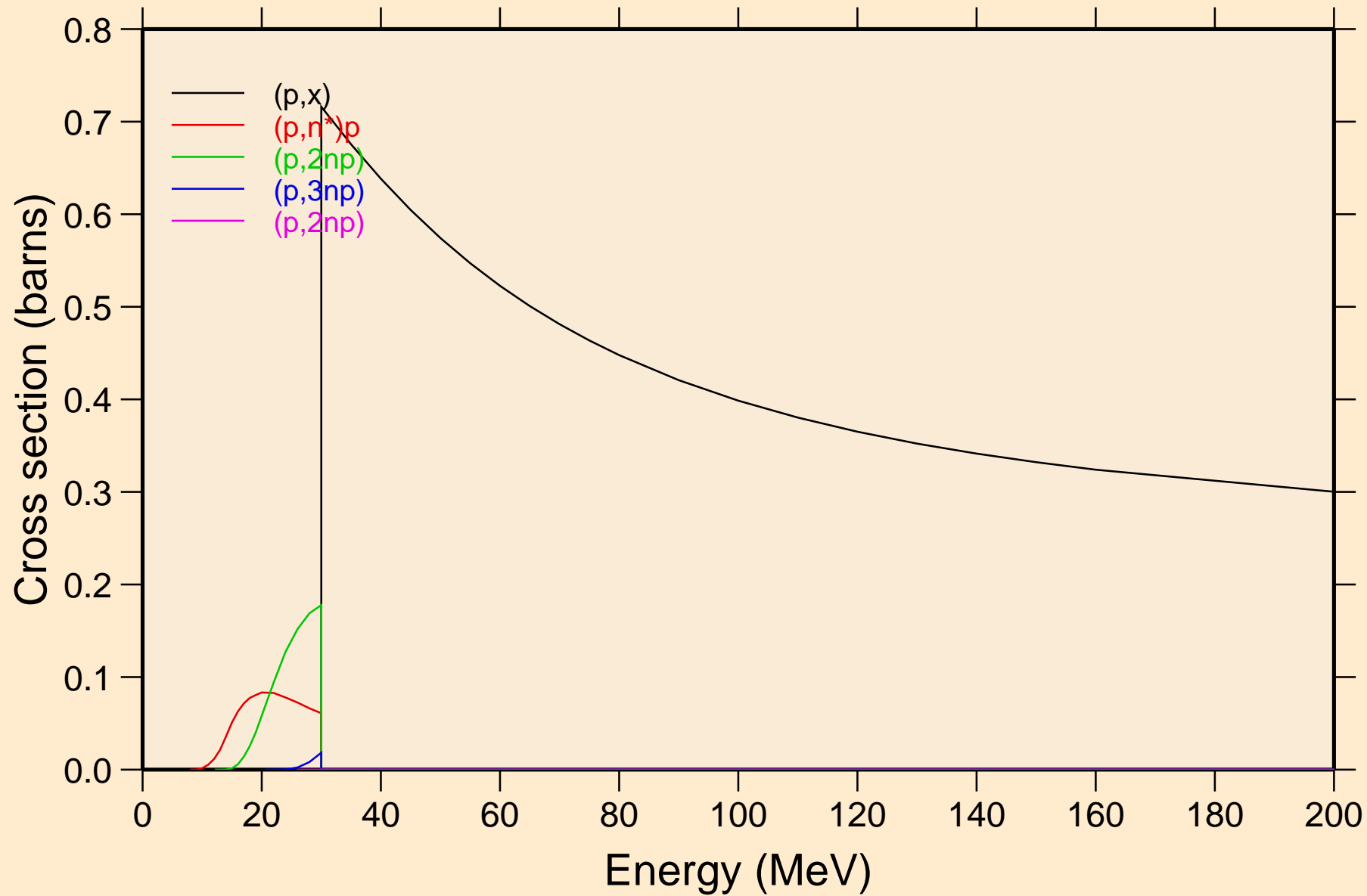

# O020 PROTON ACER TENDL-2021 LIBRARY; T=0.K

## Threshold reactions

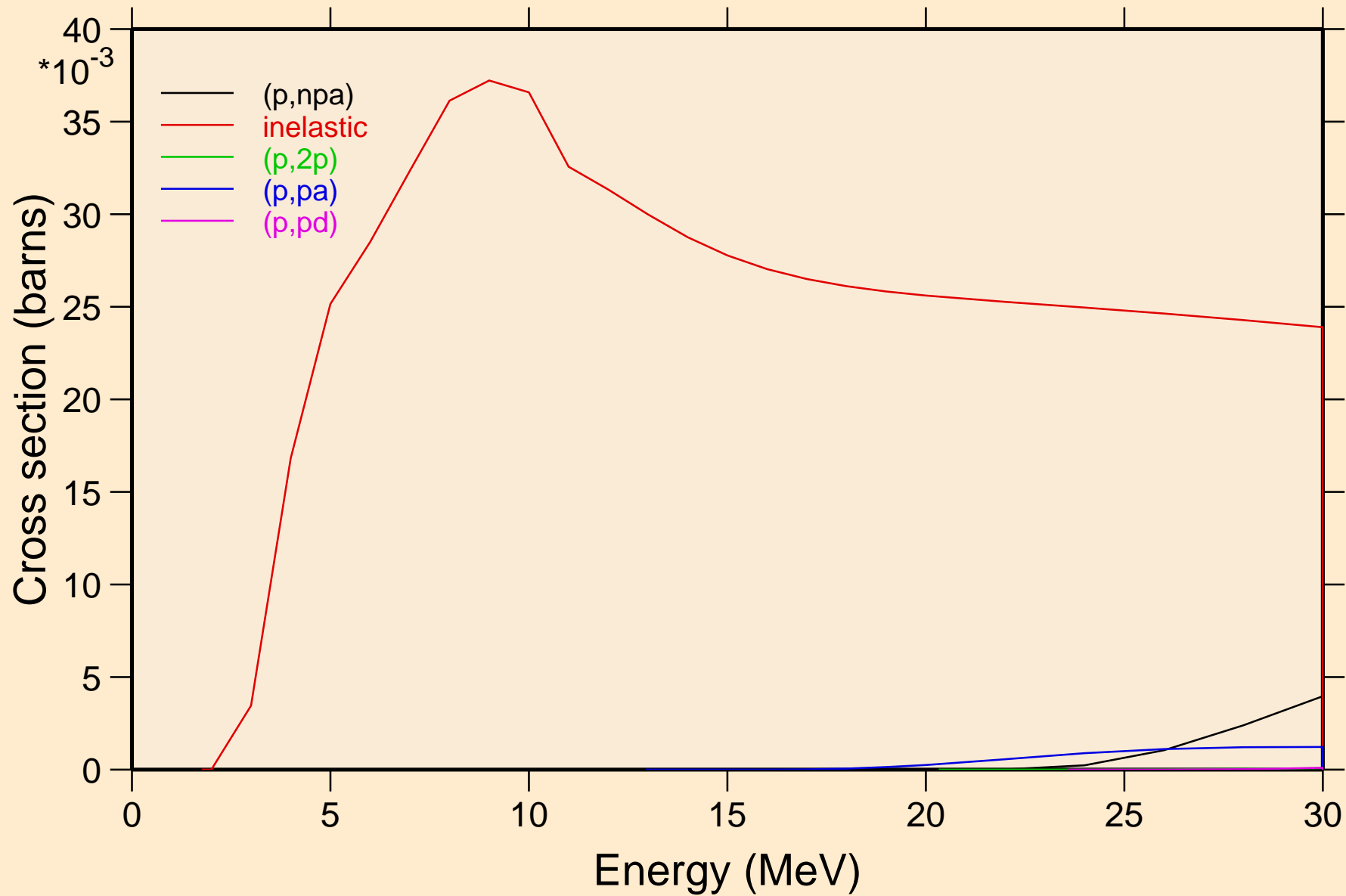

O020 PROTON ACER TENDL-2021 LIBRARY; T=0.K  
Threshold reactions

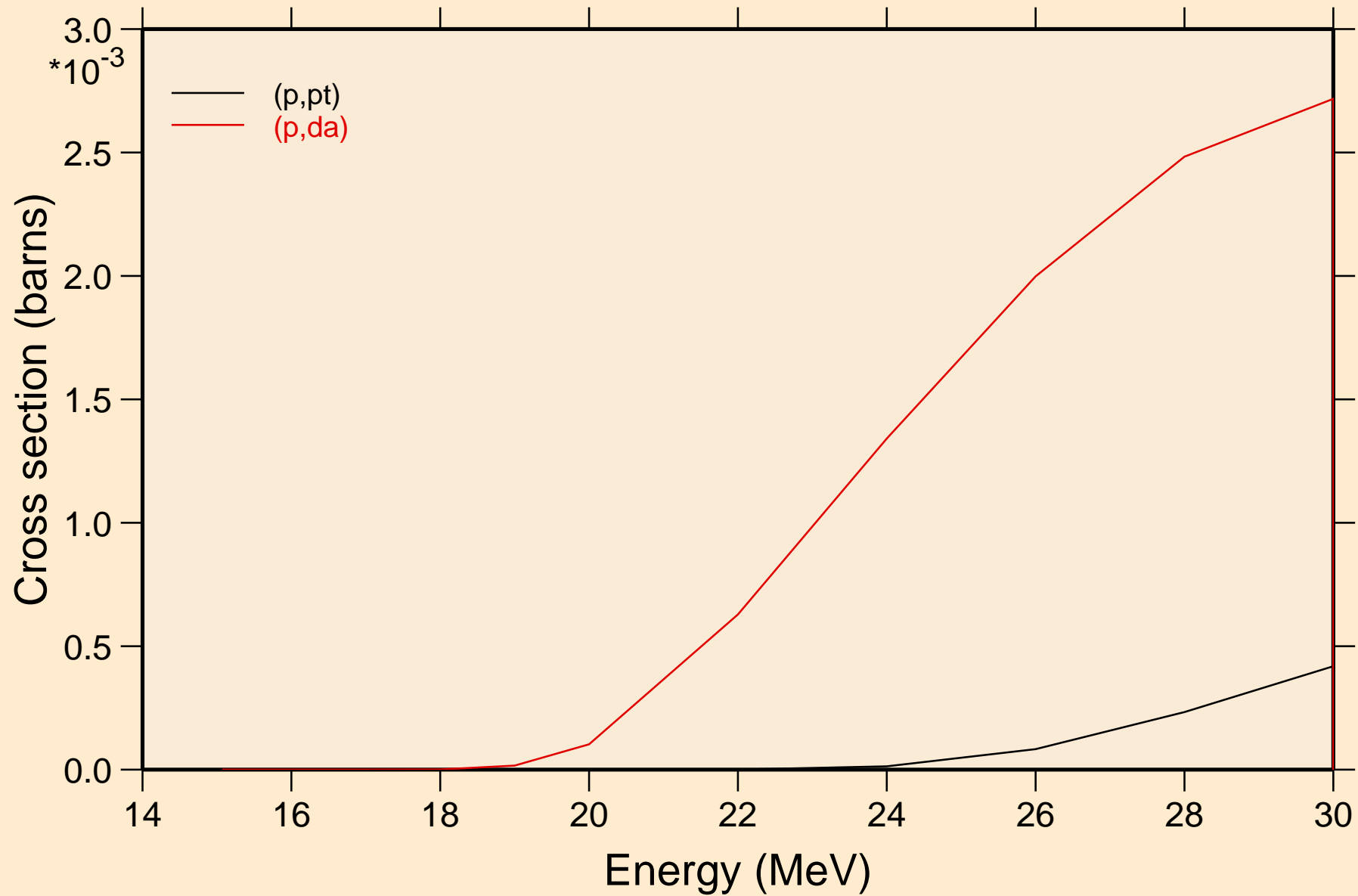

O020 PROTON ACER TENDL-2021 LIBRARY; T=0.K  
angular distribution for elastic

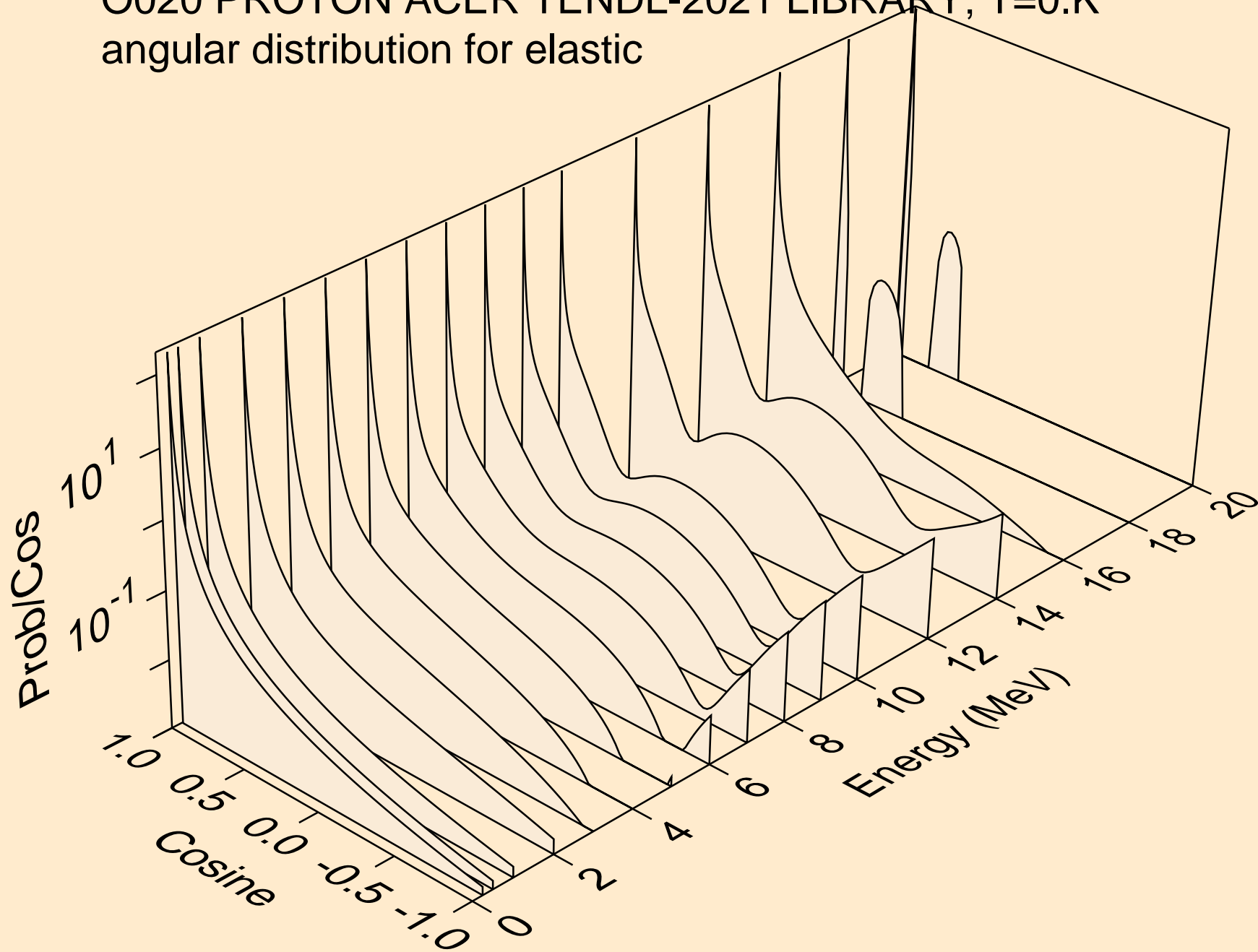



O020 PROTON ACER TENDL-2021 LIBRARY; T=0.K  
angular distribution for elastic

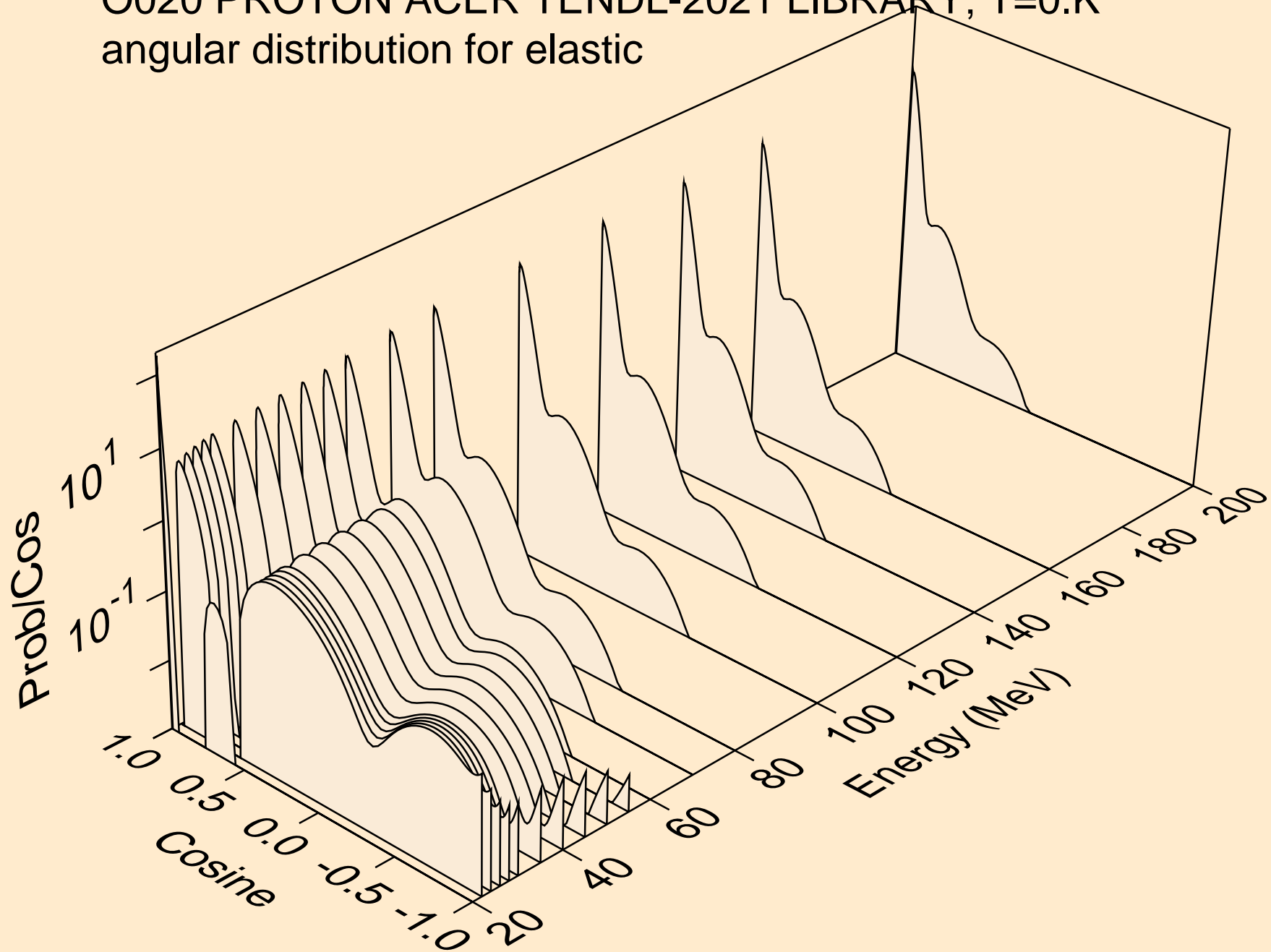

O020 PROTON ACER TENDL-2021 LIBRARY; T=0.K  
Proton emission for (p,x)

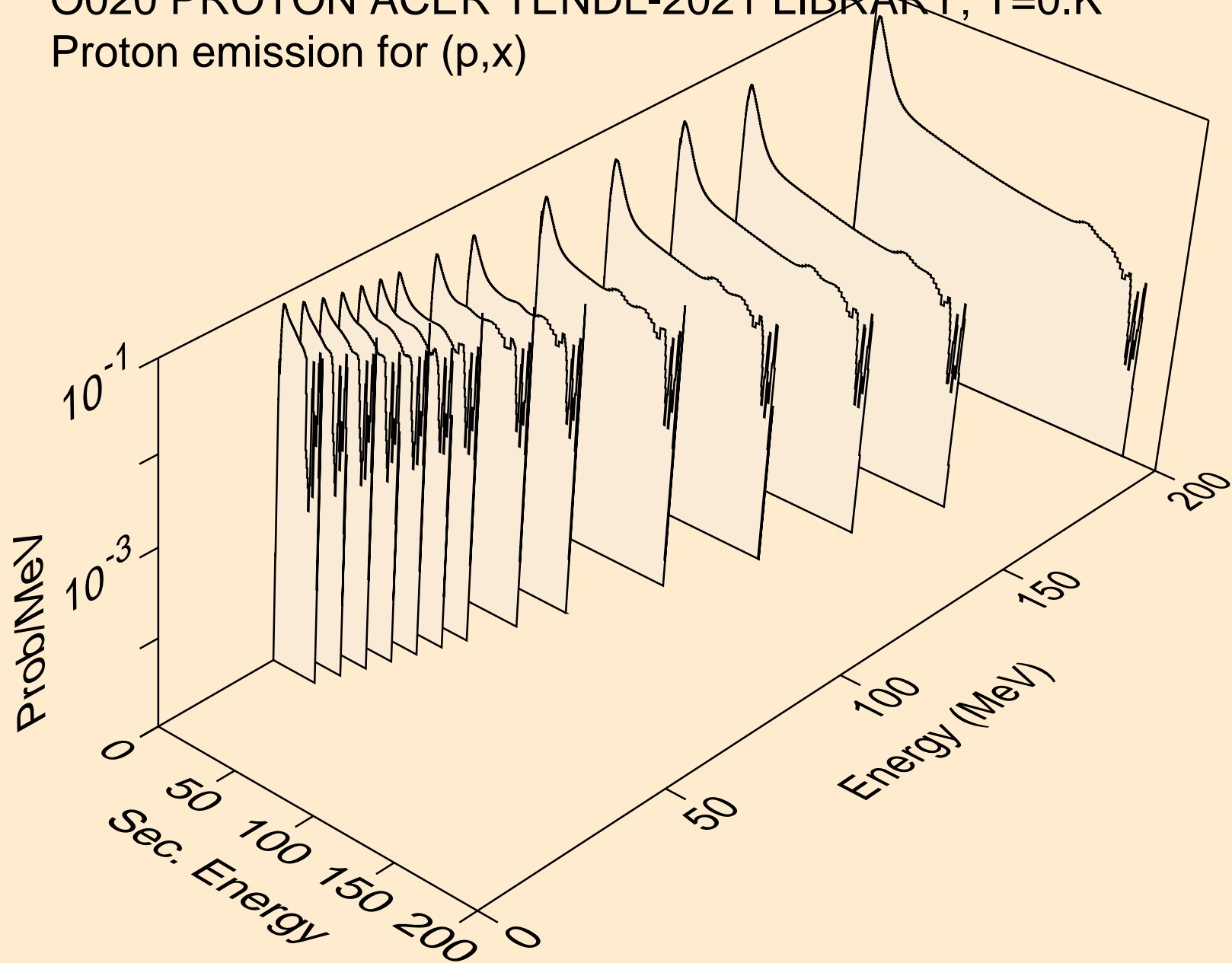

O020 PROTON ACER TENDL-2021 LIBRARY; T=0.K  
Proton emission for (p,n\*)p

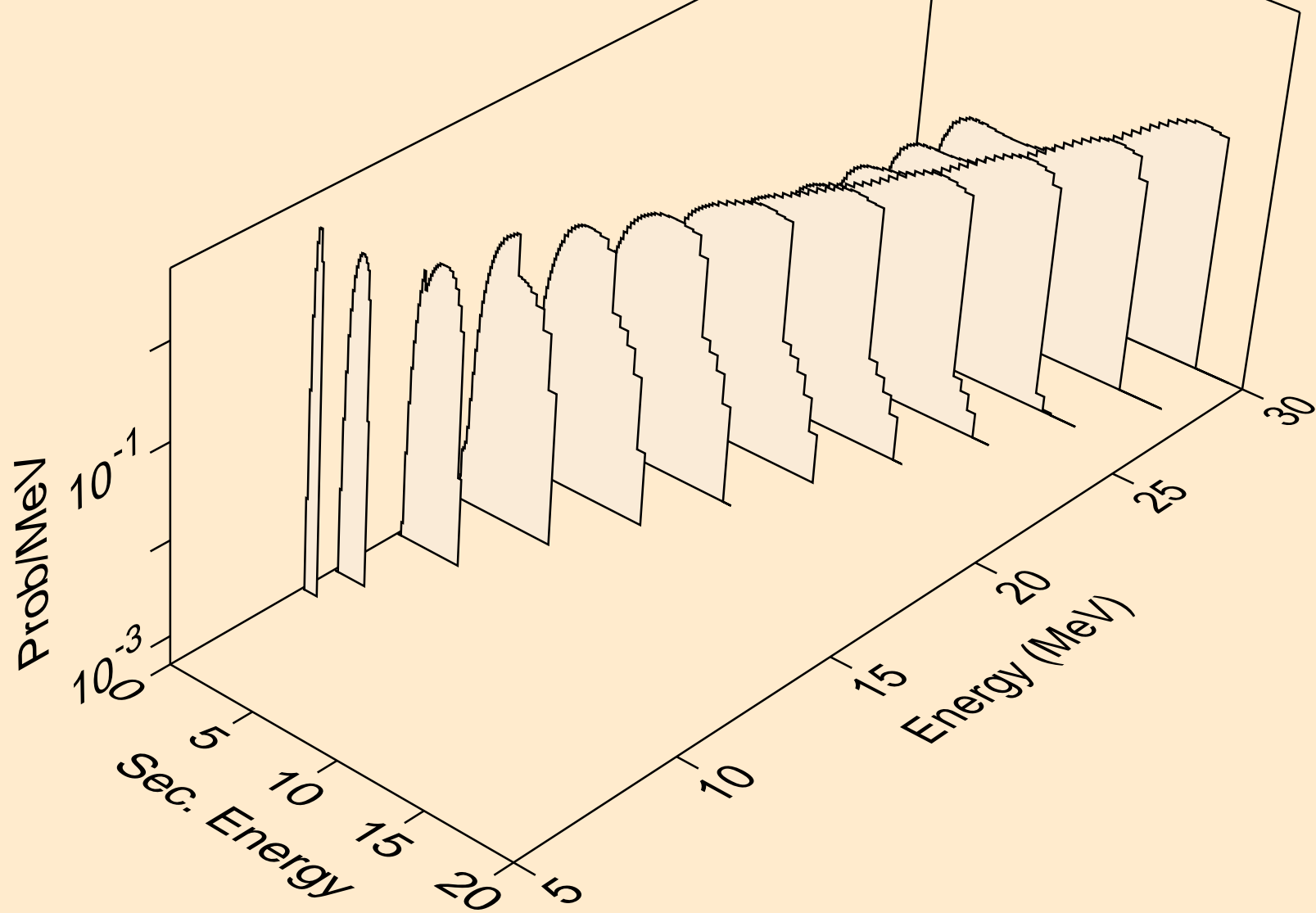

O020 PROTON ACER TENDL-2021 LIBRARY; T=0.K  
Proton emission for (p,2np)

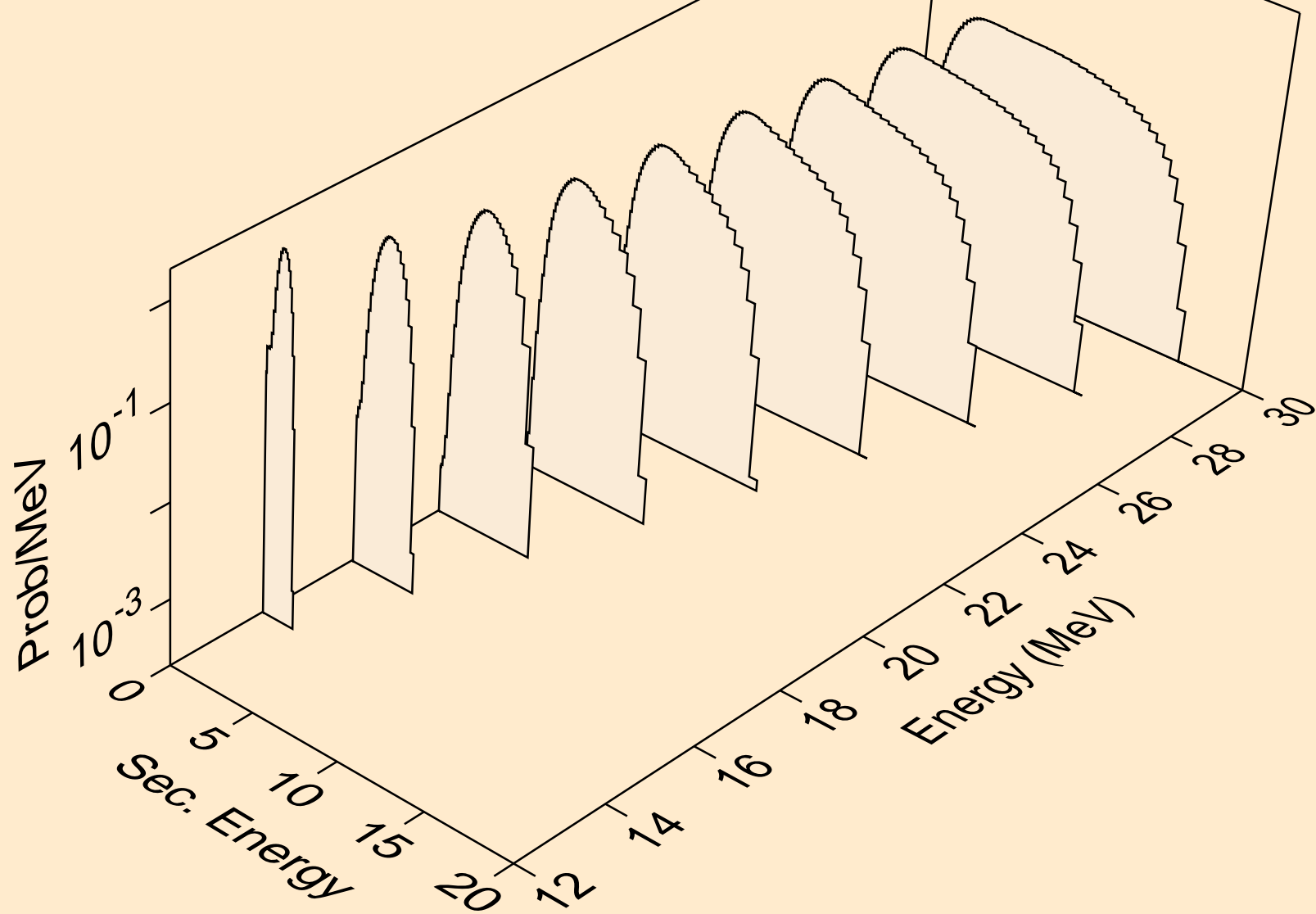

O020 PROTON ACER TENDL-2021 LIBRARY; T=0.K  
Proton emission for (p,3np)

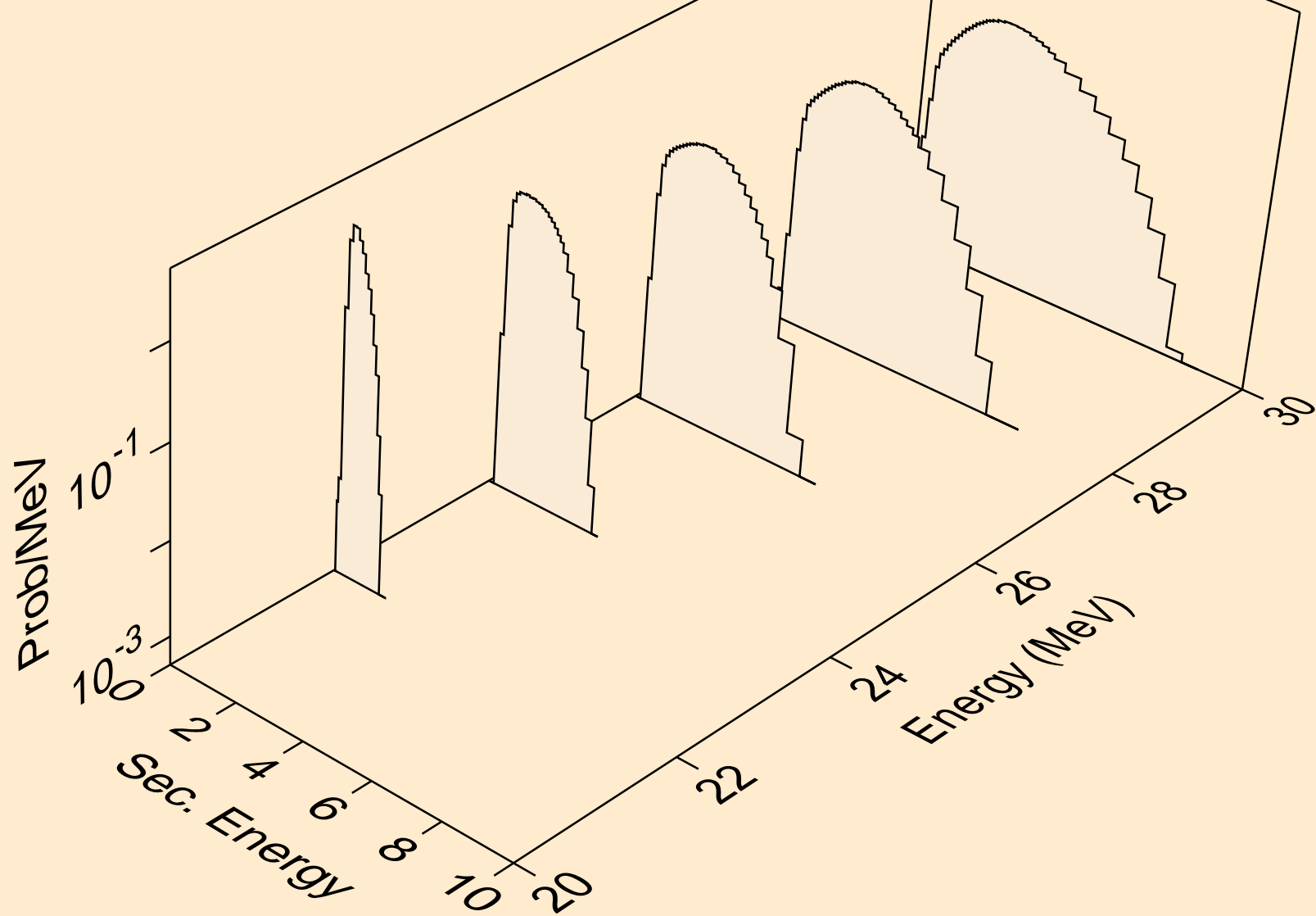

O020 PROTON ACER TENDL-2021 LIBRARY; T=0.K  
Proton emission for (p,2np)

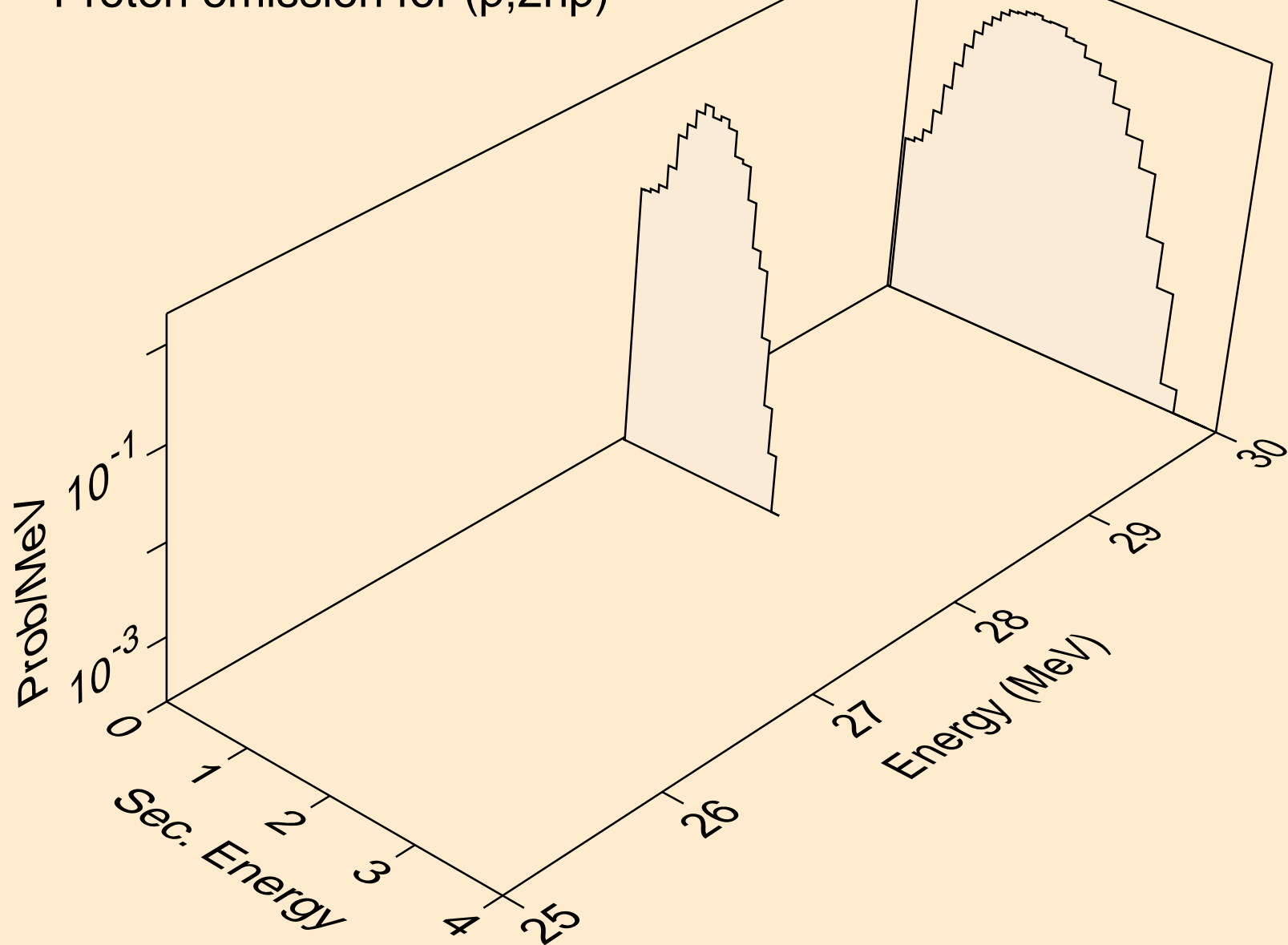

O020 PROTON ACER TENDL-2021 LIBRARY; T=0.K  
Proton emission for (p,npa)

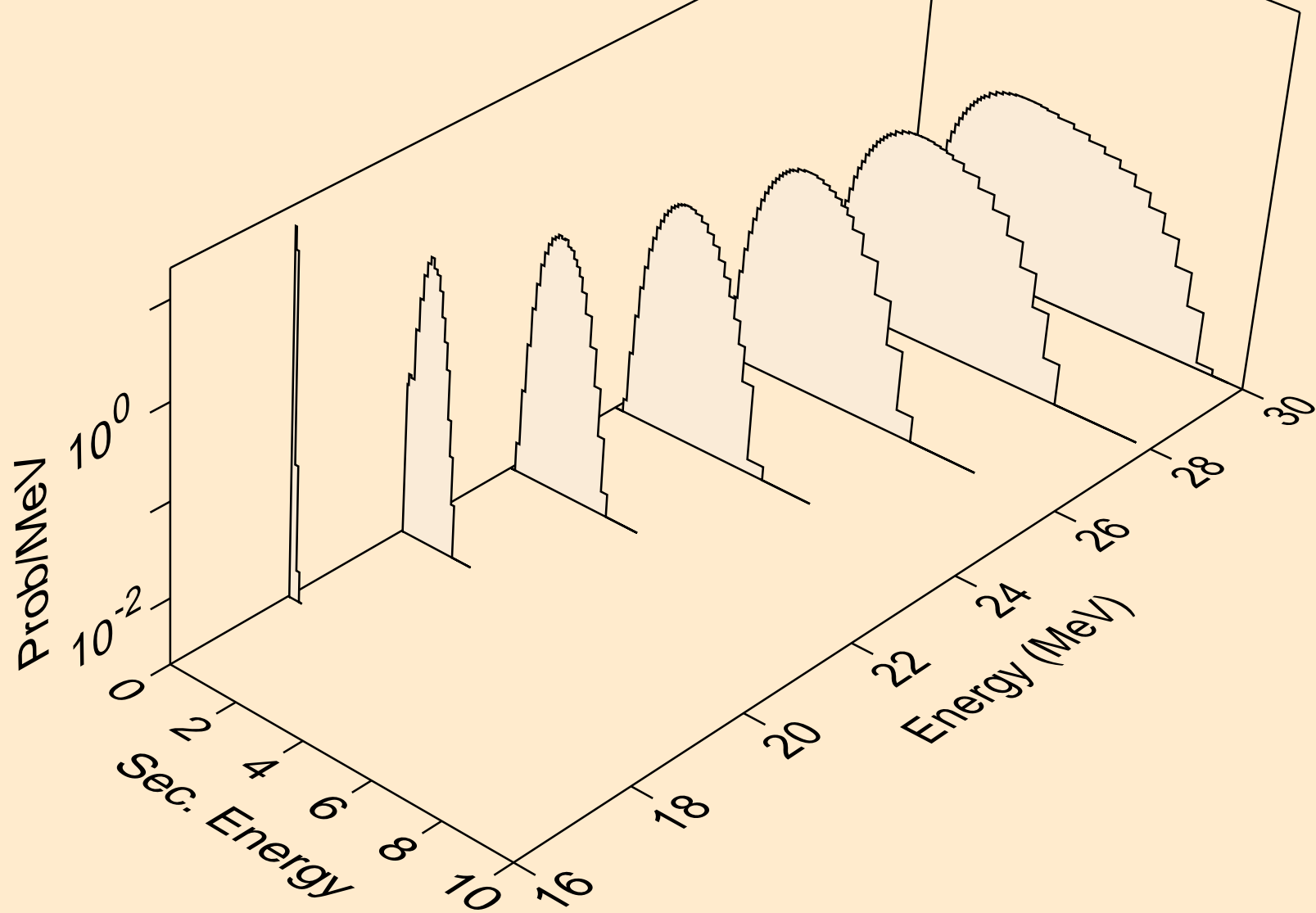

O020 PROTON ACER TENDL-2021 LIBRARY; T=0.K  
Proton emission for inelastic

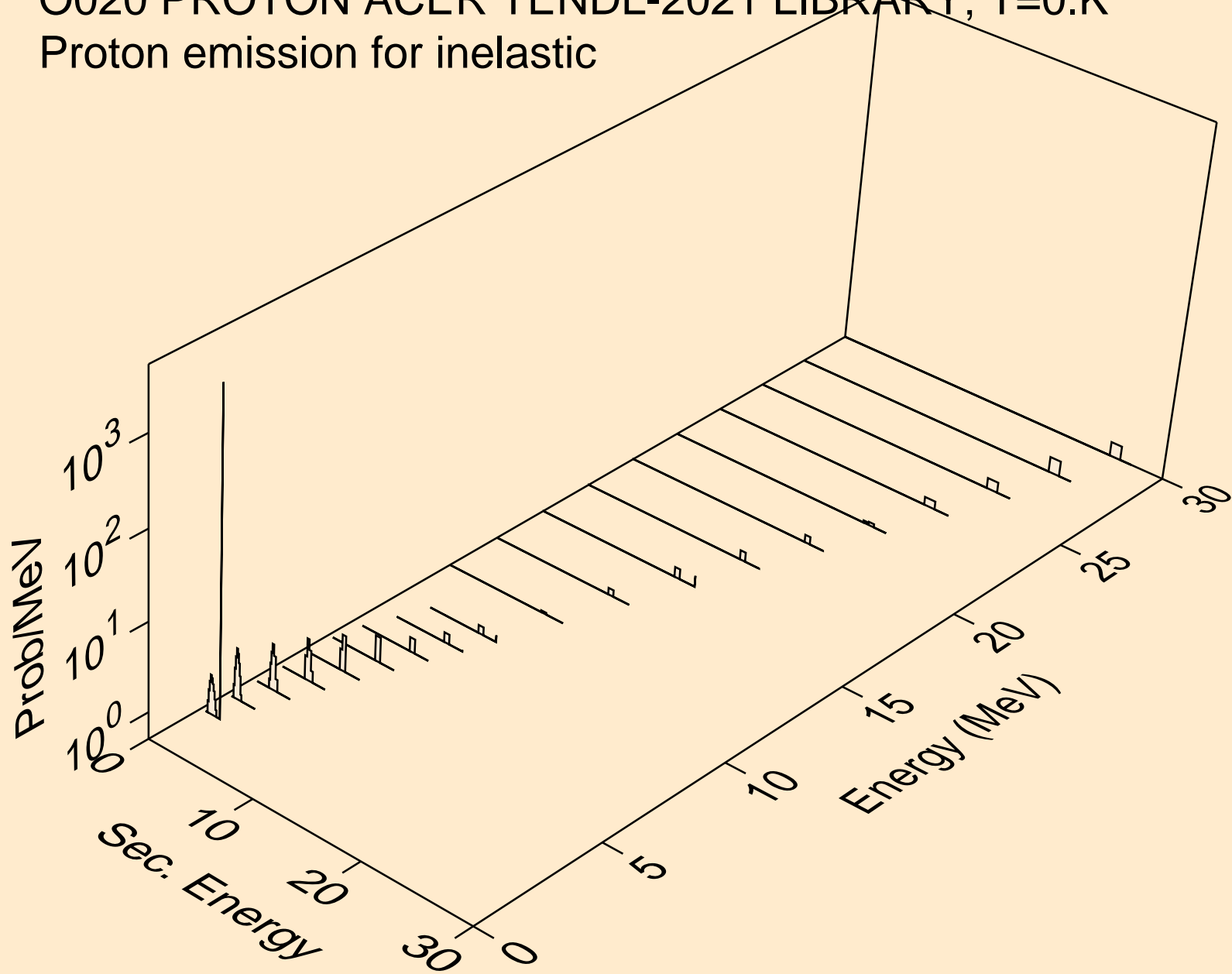



O020 PROTON ACER TENDL-2021 LIBRARY; T=0.K  
Proton emission for (p,2p)

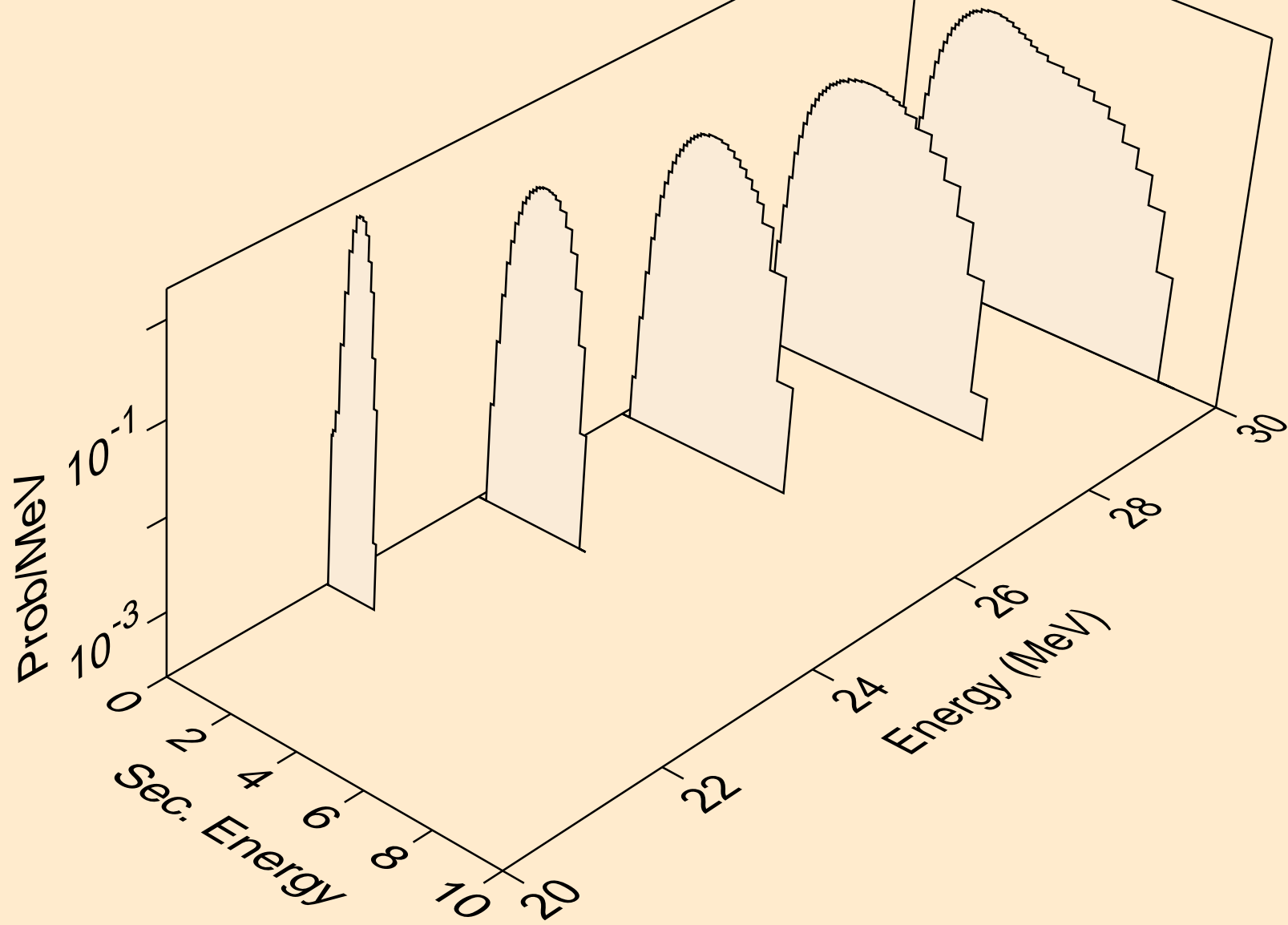

O020 PROTON ACER TENDL-2021 LIBRARY; T=0.K  
Proton emission for (p,pa)

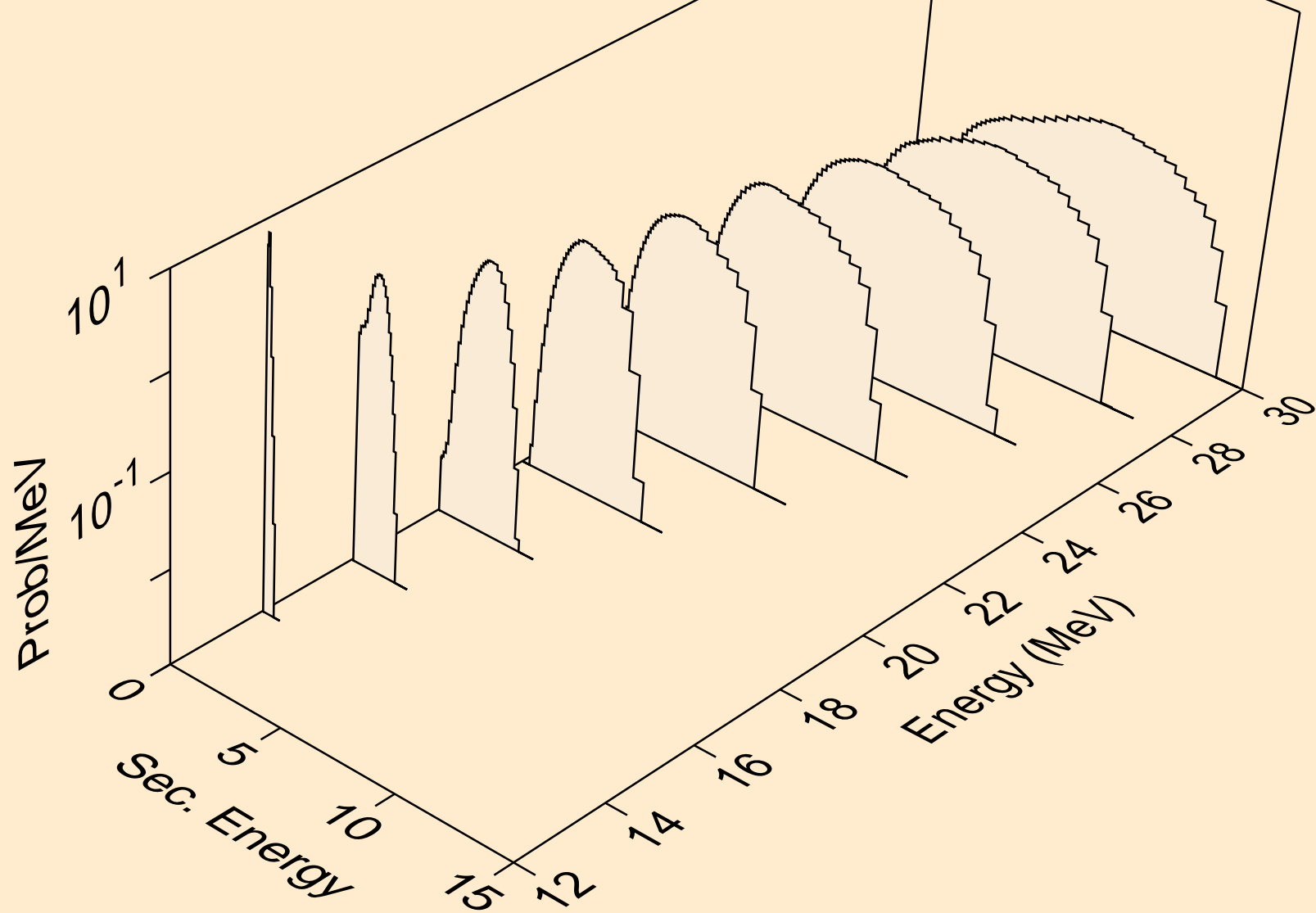

O020 PROTON ACER TENDL-2021 LIBRARY; T=0.K  
Proton emission for (p,pd)

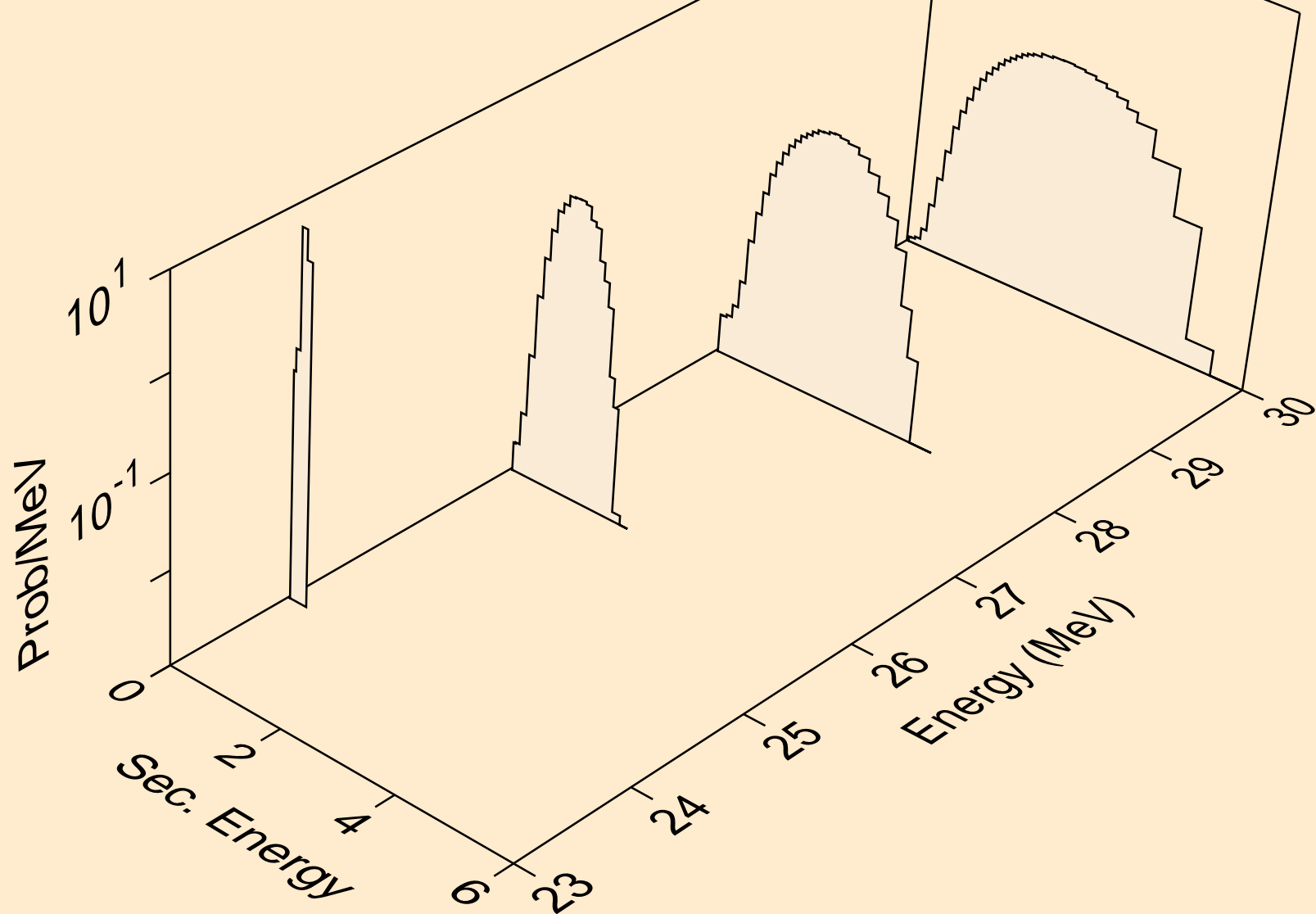

O020 PROTON ACER TENDL-2021 LIBRARY; T=0.K  
Proton emission for (p,pt)

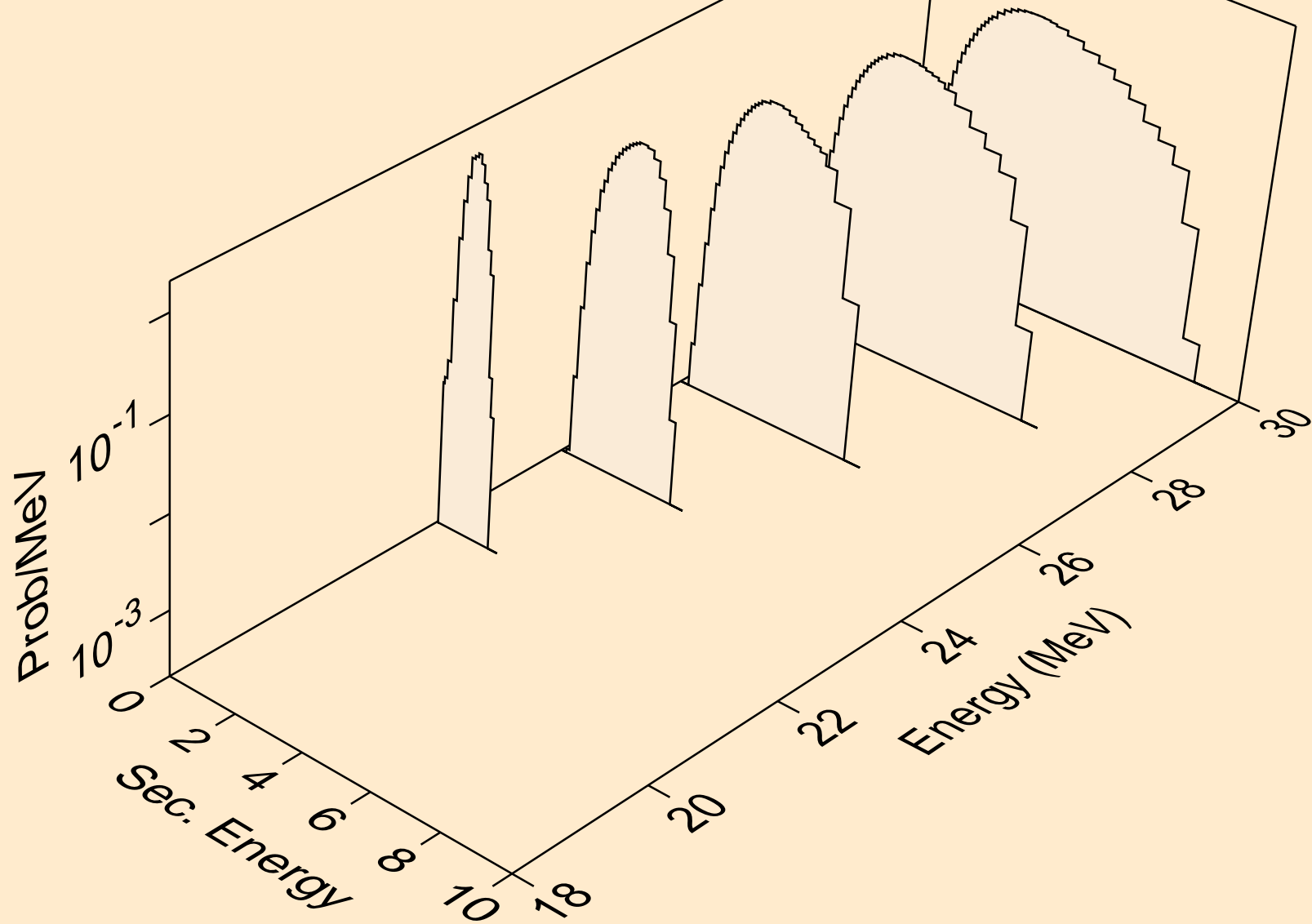

O020 PROTON ACER TENDL-2021 LIBRARY; T=0.K  
Photon emission for (z,n)

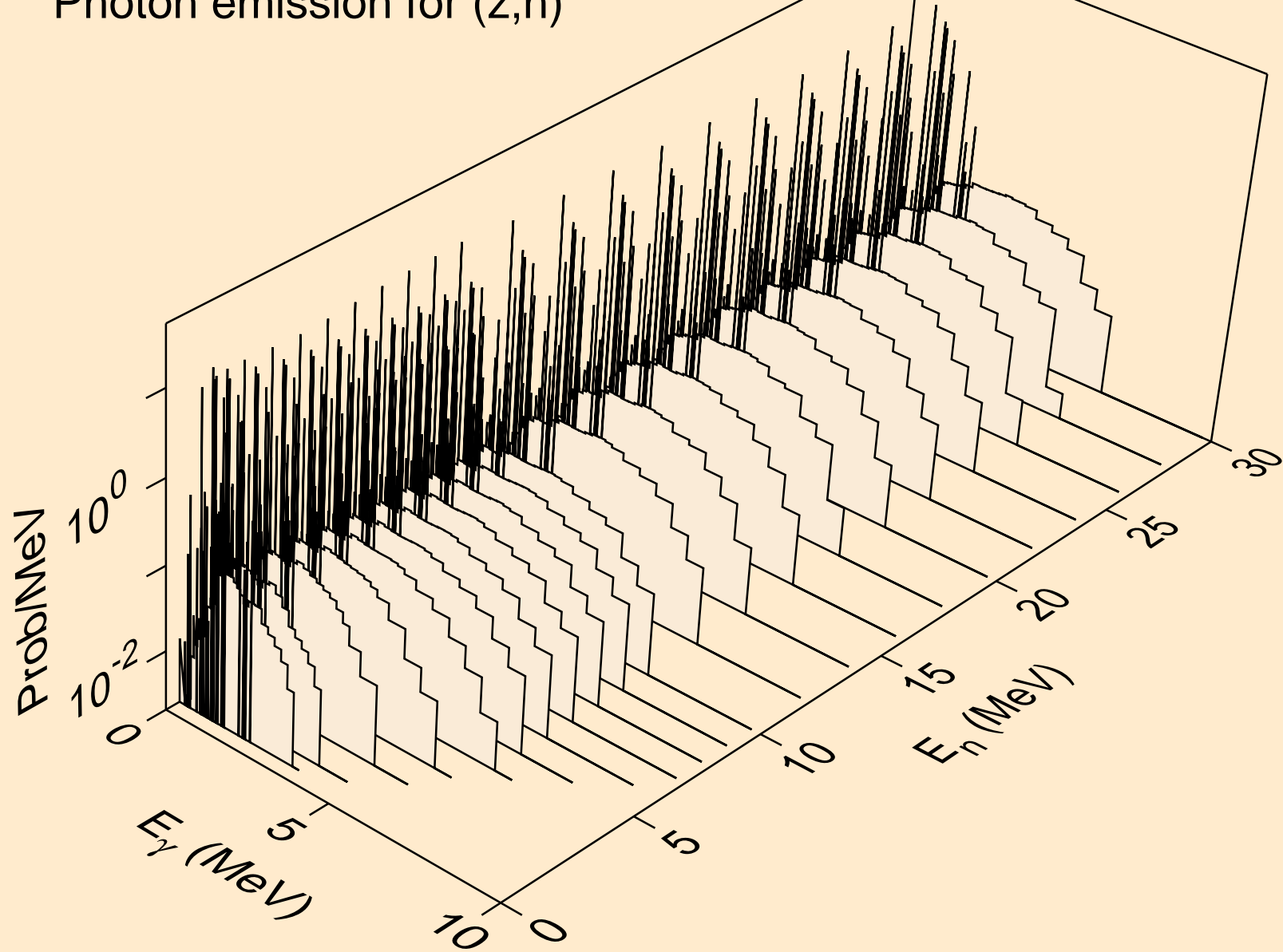

O020 PROTON ACER TENDL-2021 LIBRARY; T=0.K  
Photon emission for (n,x)

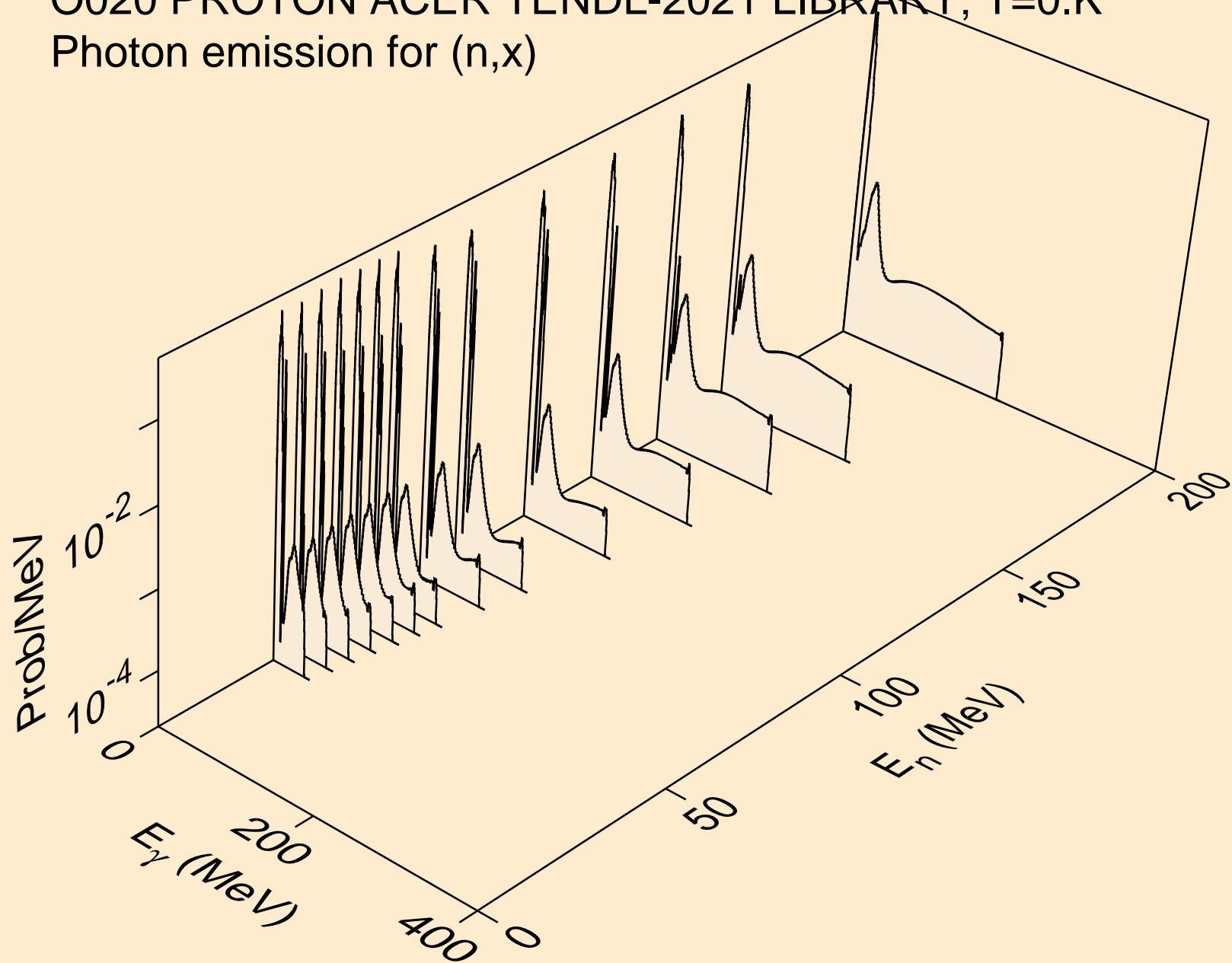

O020 PROTON ACER TENDL-2021 LIBRARY; T=0.K  
Photon emission for (n,2nd)

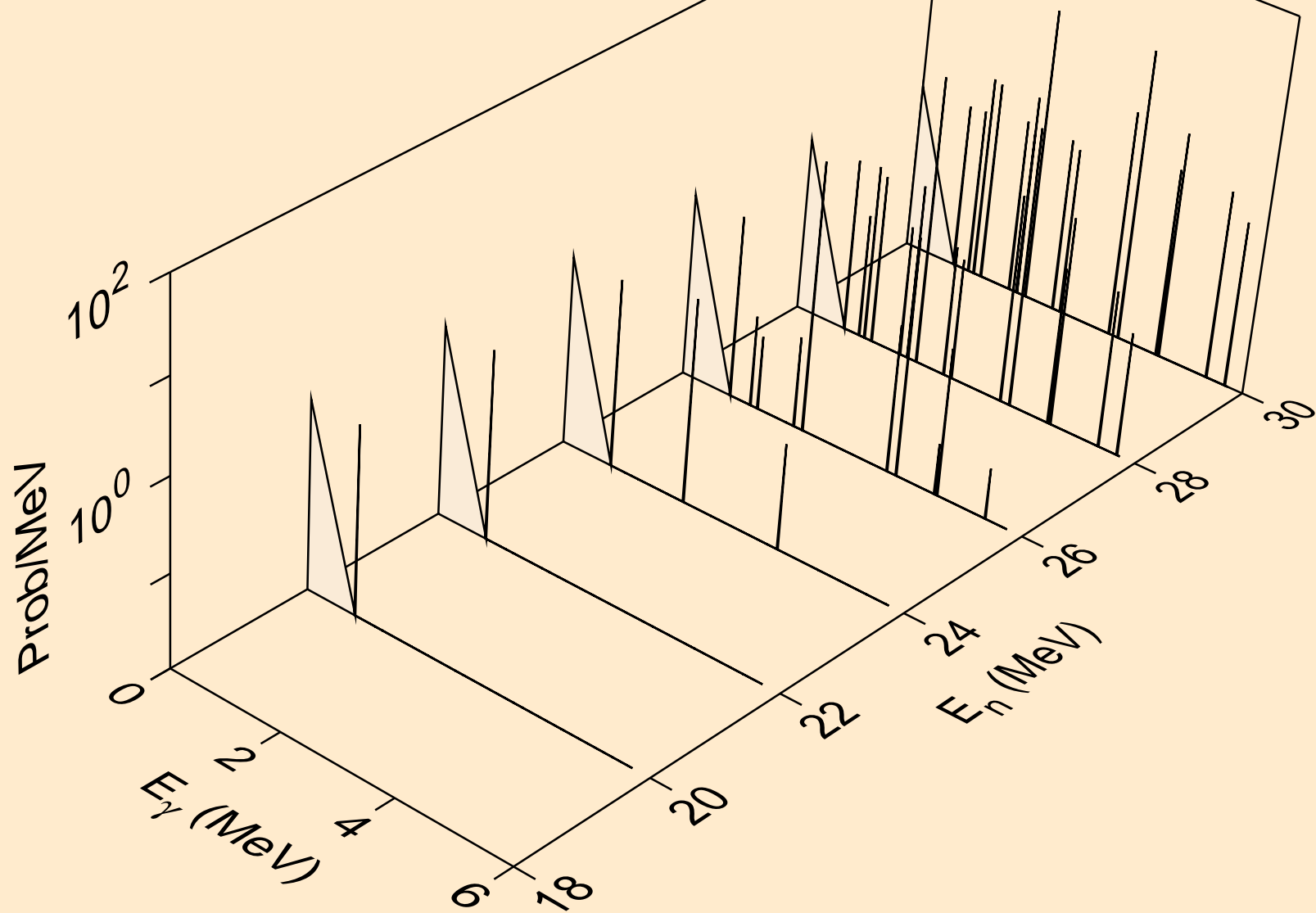

O020 PROTON ACER TENDL-2021 LIBRARY; T=0.K  
Photon emission for (n,2n)

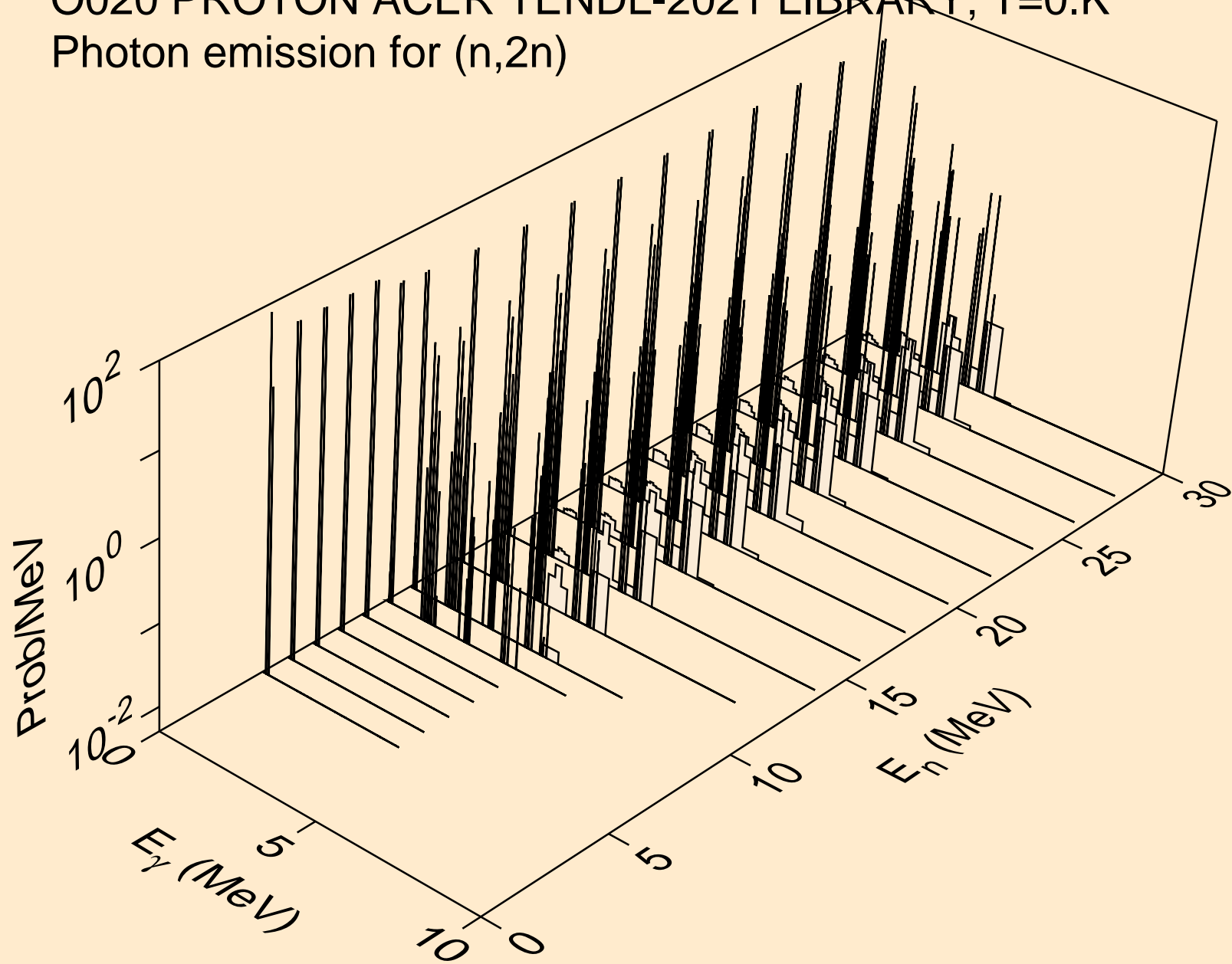



O020 PROTON ACER TENDL-2021 LIBRARY; T=0.K  
Photon emission for (n,3n)

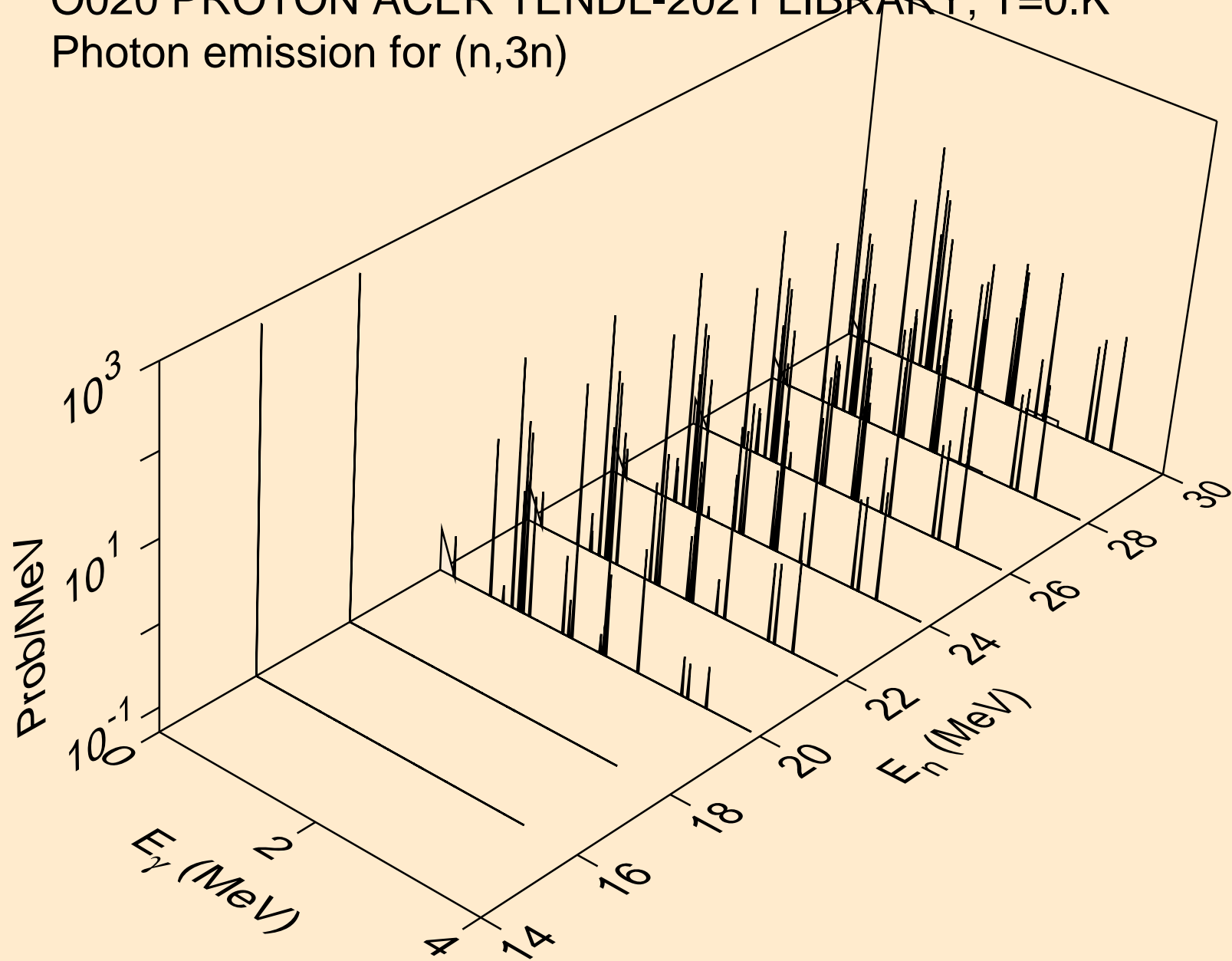

O020 PROTON ACER TENDL-2021 LIBRARY; T=0.K  
Photon emission for (n,n\*)a

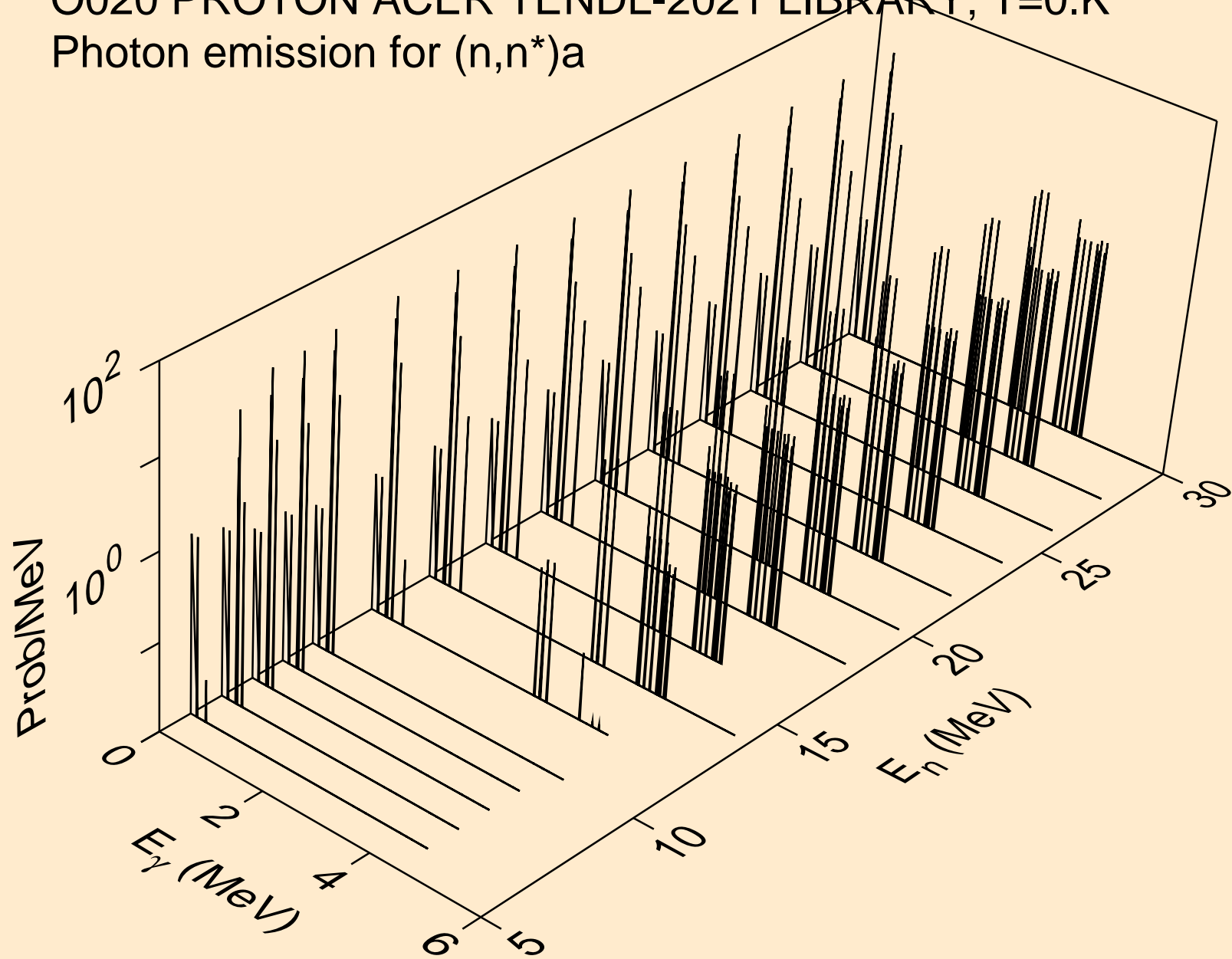

O020 PROTON ACER TENDL-2021 LIBRARY; T=0.K  
Photon emission for (n,2n)a

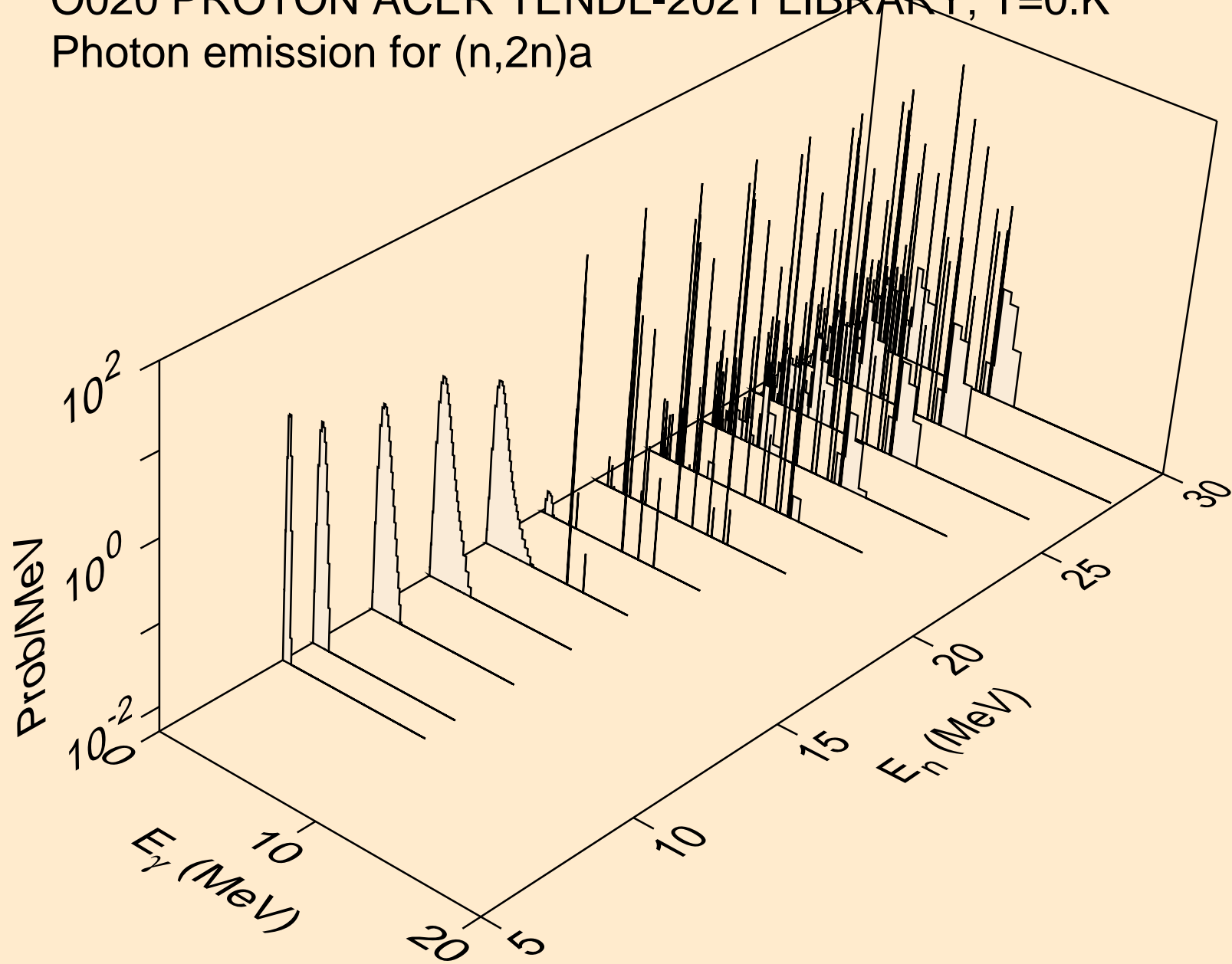

O020 PROTON ACER TENDL-2021 LIBRARY; T=0.K  
Photon emission for (n,3n)a

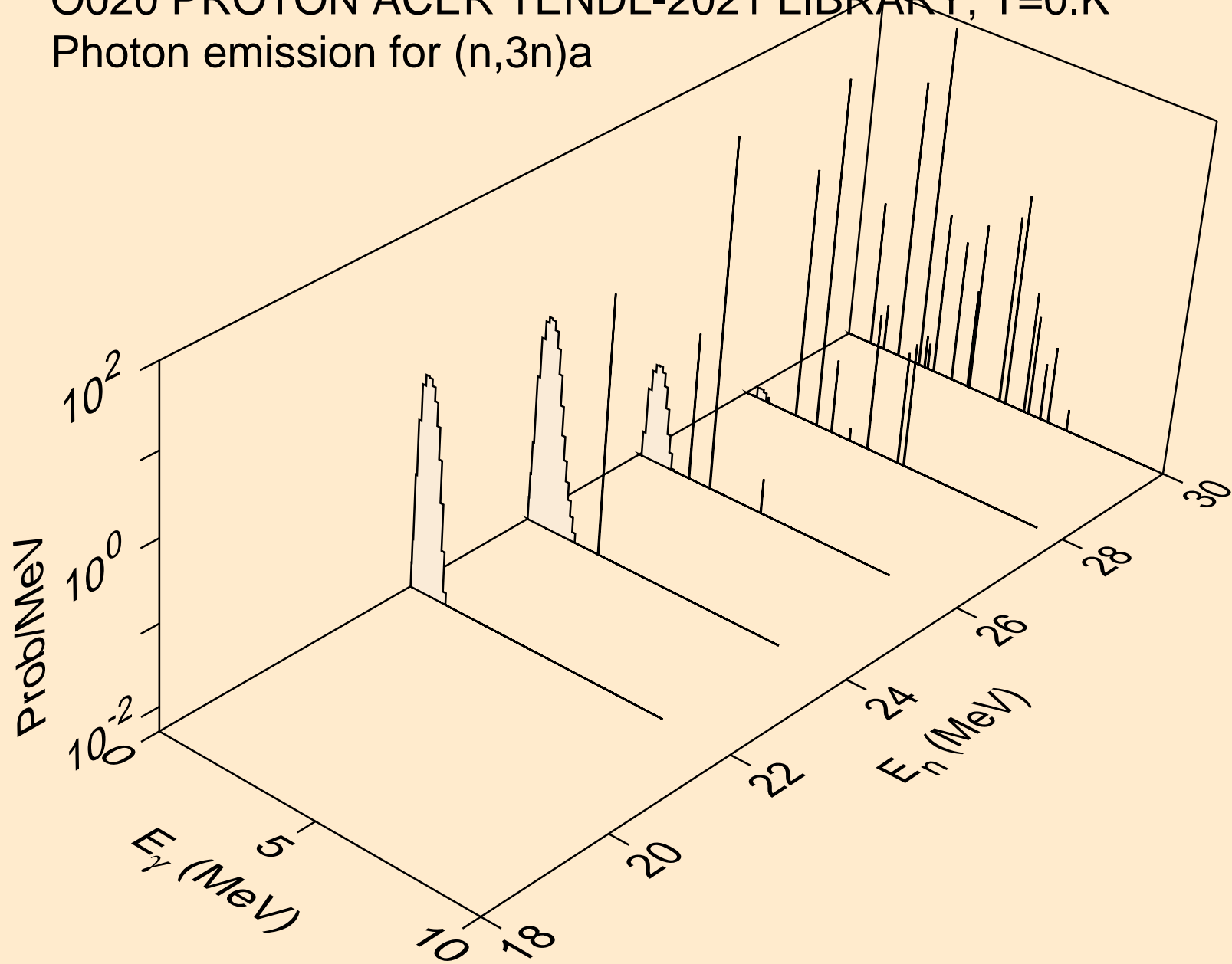

O020 PROTON ACER TENDL-2021 LIBRARY; T=0.K  
Photon emission for (n,n\*)p

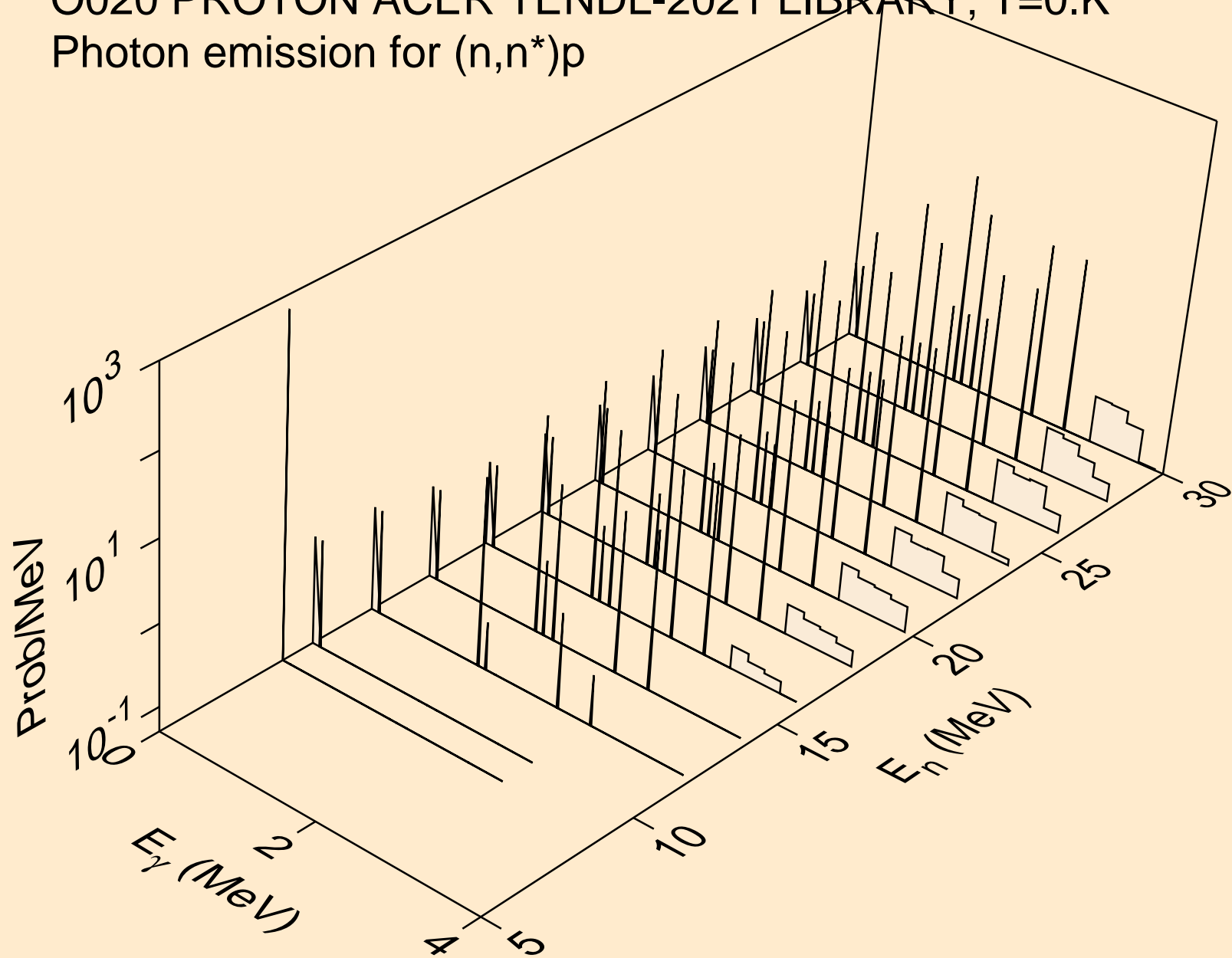

O020 PROTON ACER TENDL-2021 LIBRARY; T=0.K  
Photon emission for (n,n\*)2a

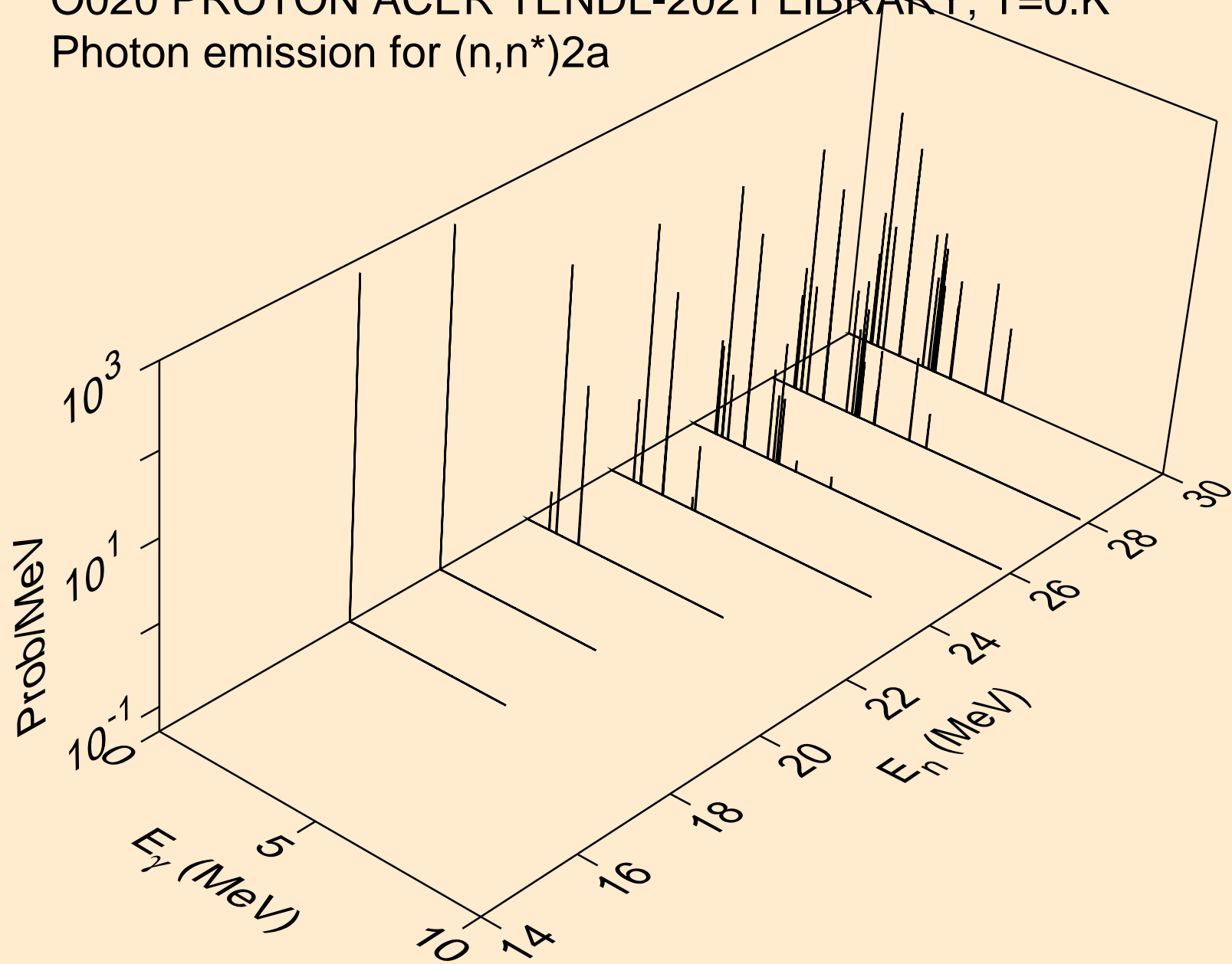

O020 PROTON ACER TENDL-2021 LIBRARY; T=0.K  
Photon emission for (n,2n)2a

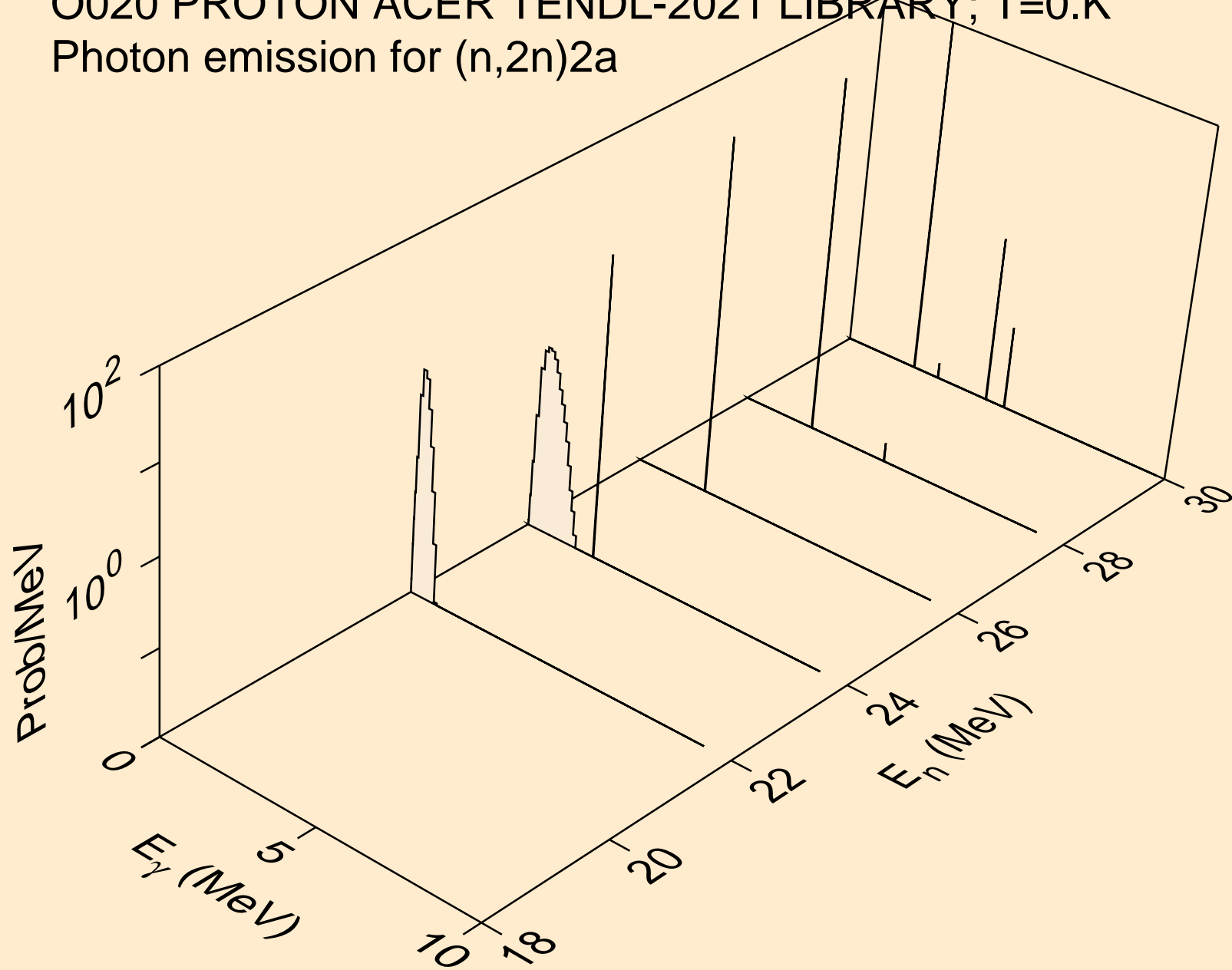

O020 PROTON ACER TENDL-2021 LIBRARY; T=0.K  
Photon emission for (n,n\*)d

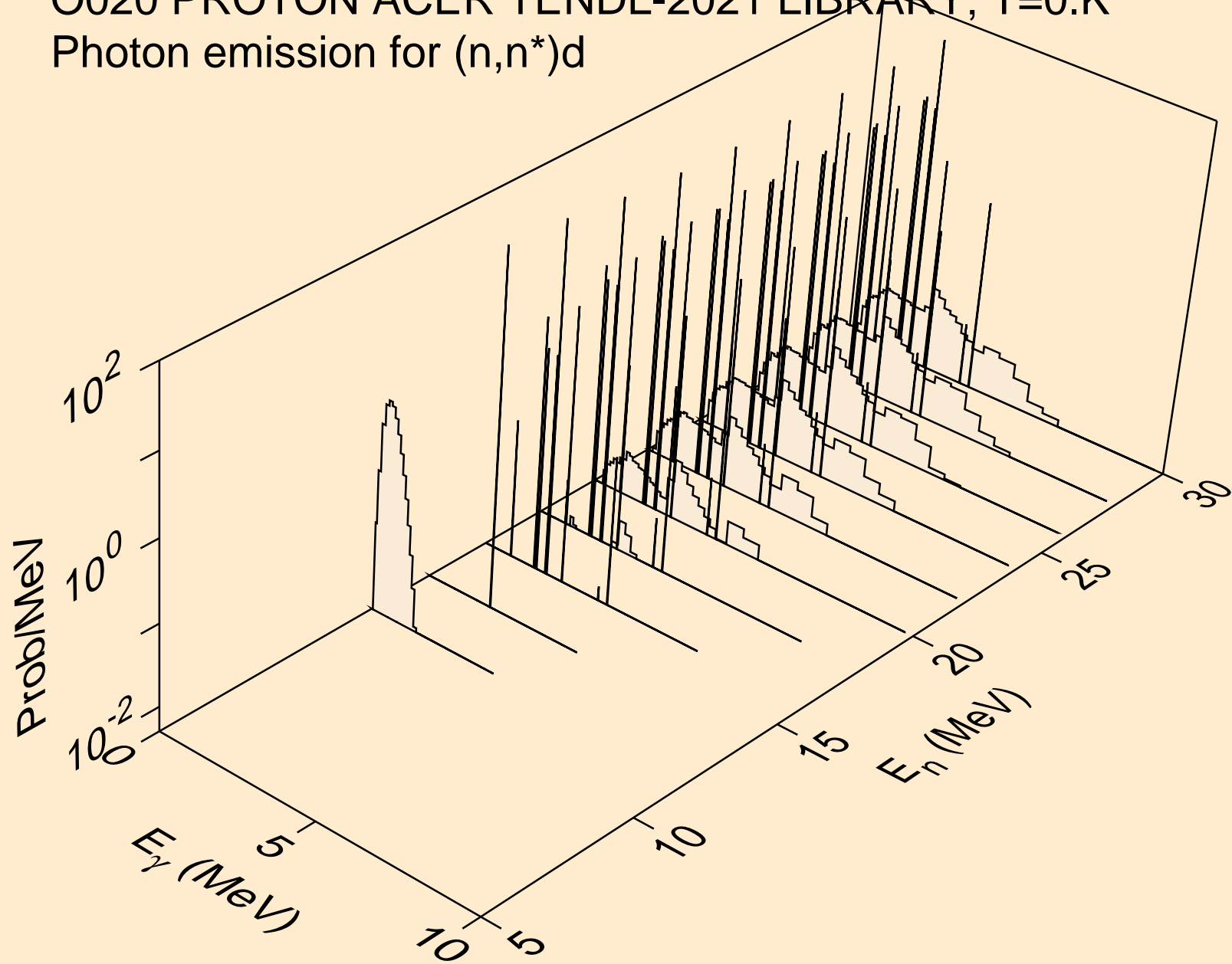



O020 PROTON ACER TENDL-2021 LIBRARY; T=0.K  
Photon emission for (n,n\*)t

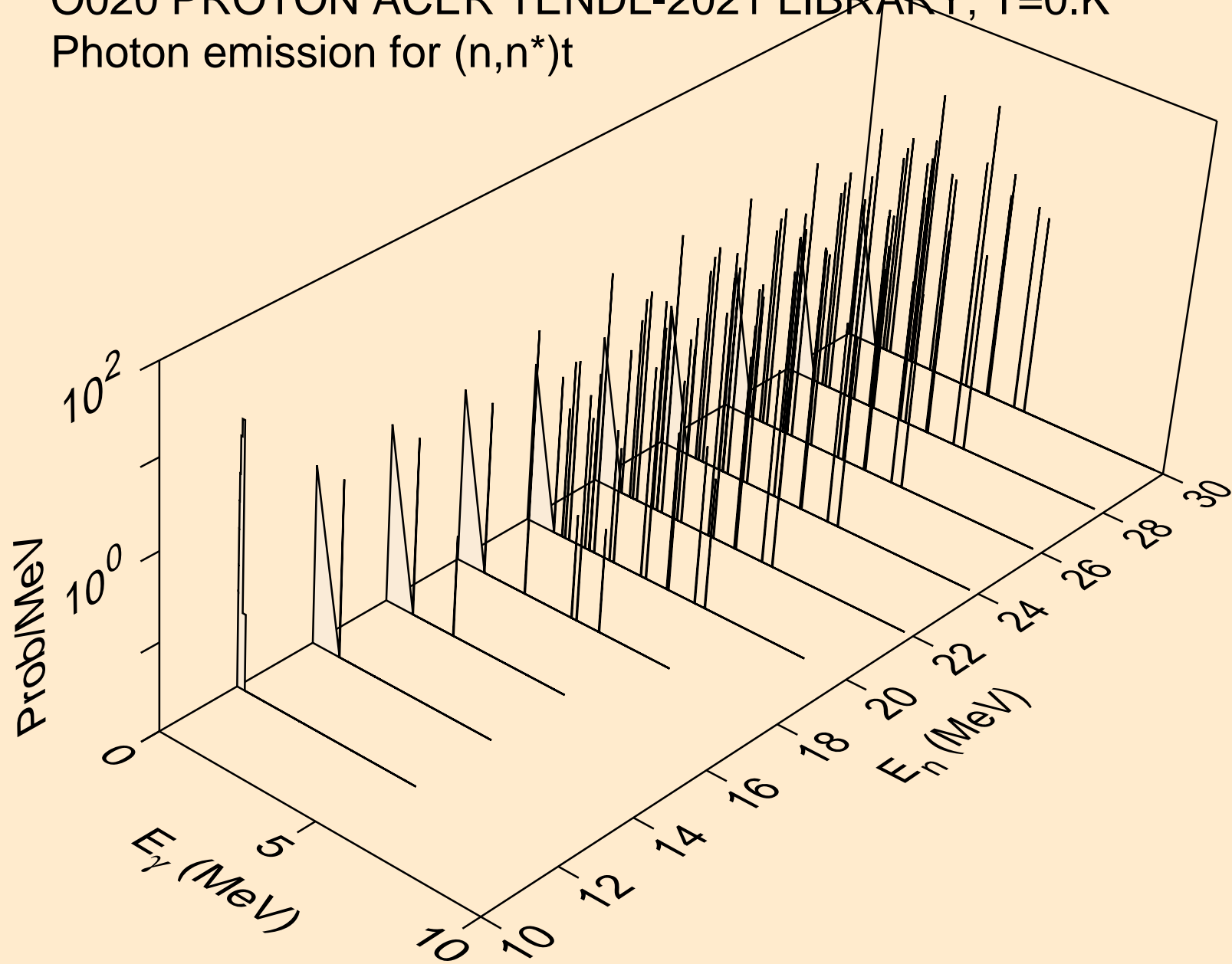

O020 PROTON ACER TENDL-2021 LIBRARY; T=0.K  
Photon emission for (n,n\*)he3

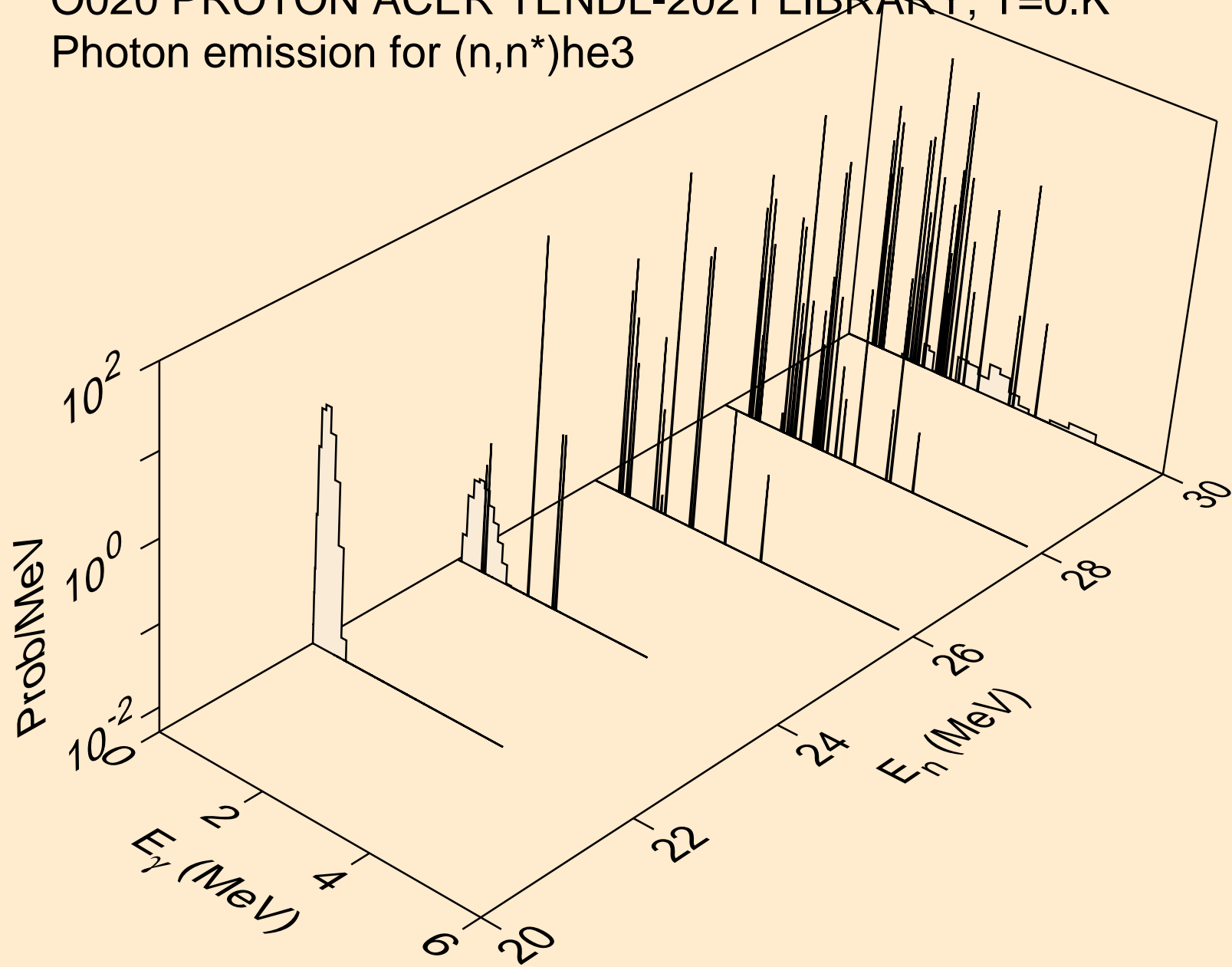

O020 PROTON ACER TENDL-2021 LIBRARY; T=0.K  
Photon emission for (n,4n)

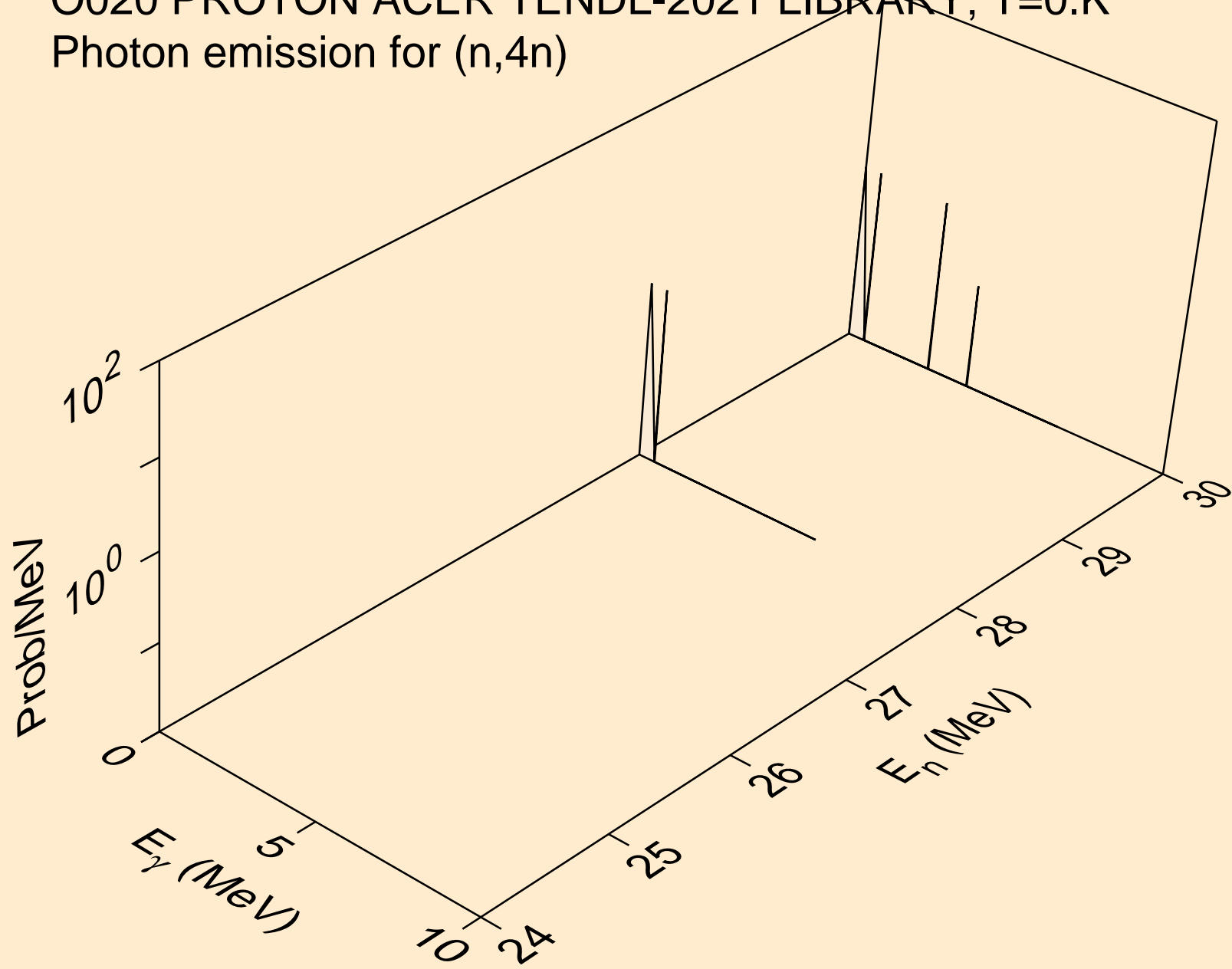

O020 PROTON ACER TENDL-2021 LIBRARY; T=0.K  
Photon emission for (n,2np)

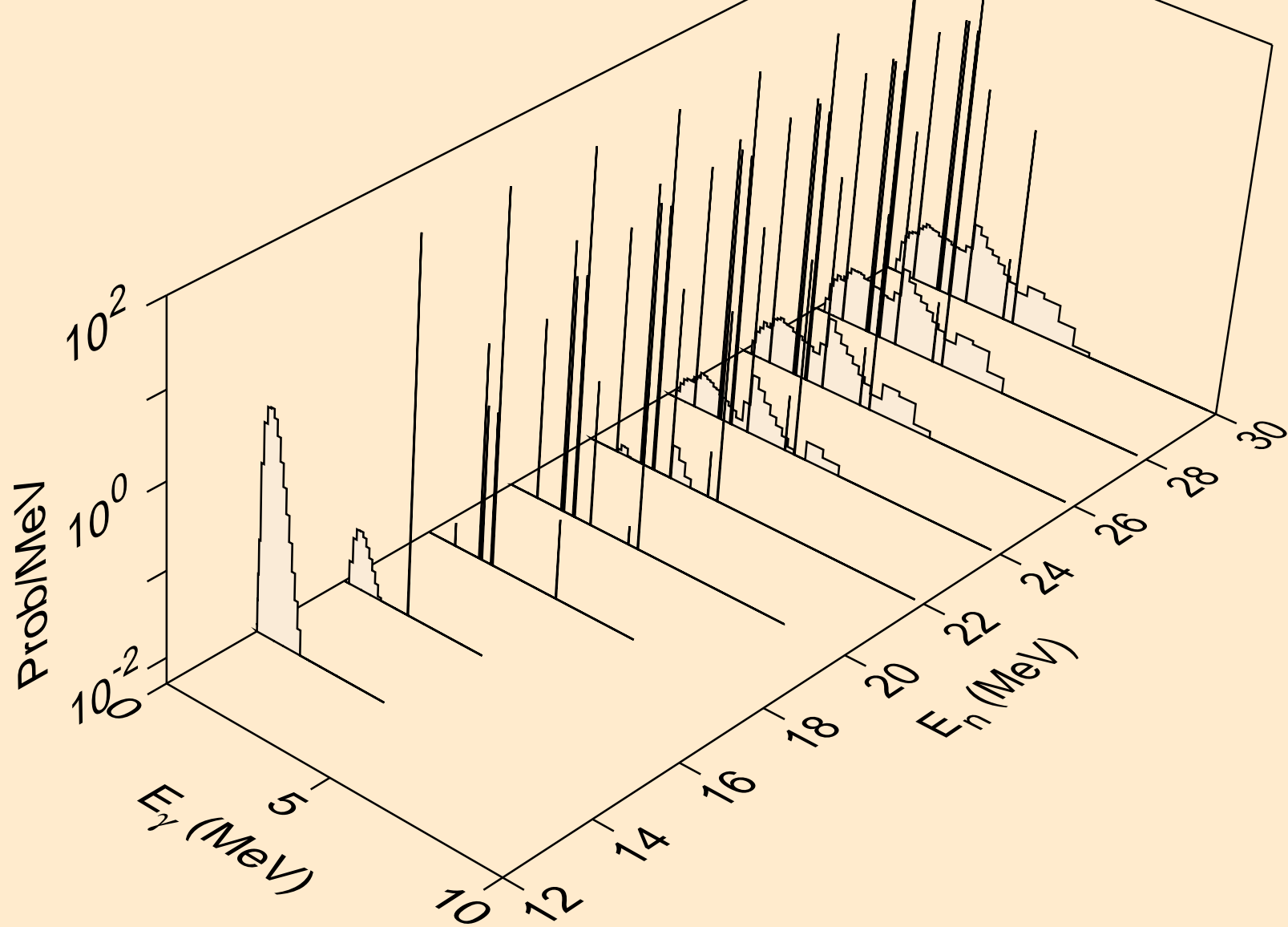

O020 PROTON ACER TENDL-2021 LIBRARY; T=0.K  
Photon emission for (n,3np)

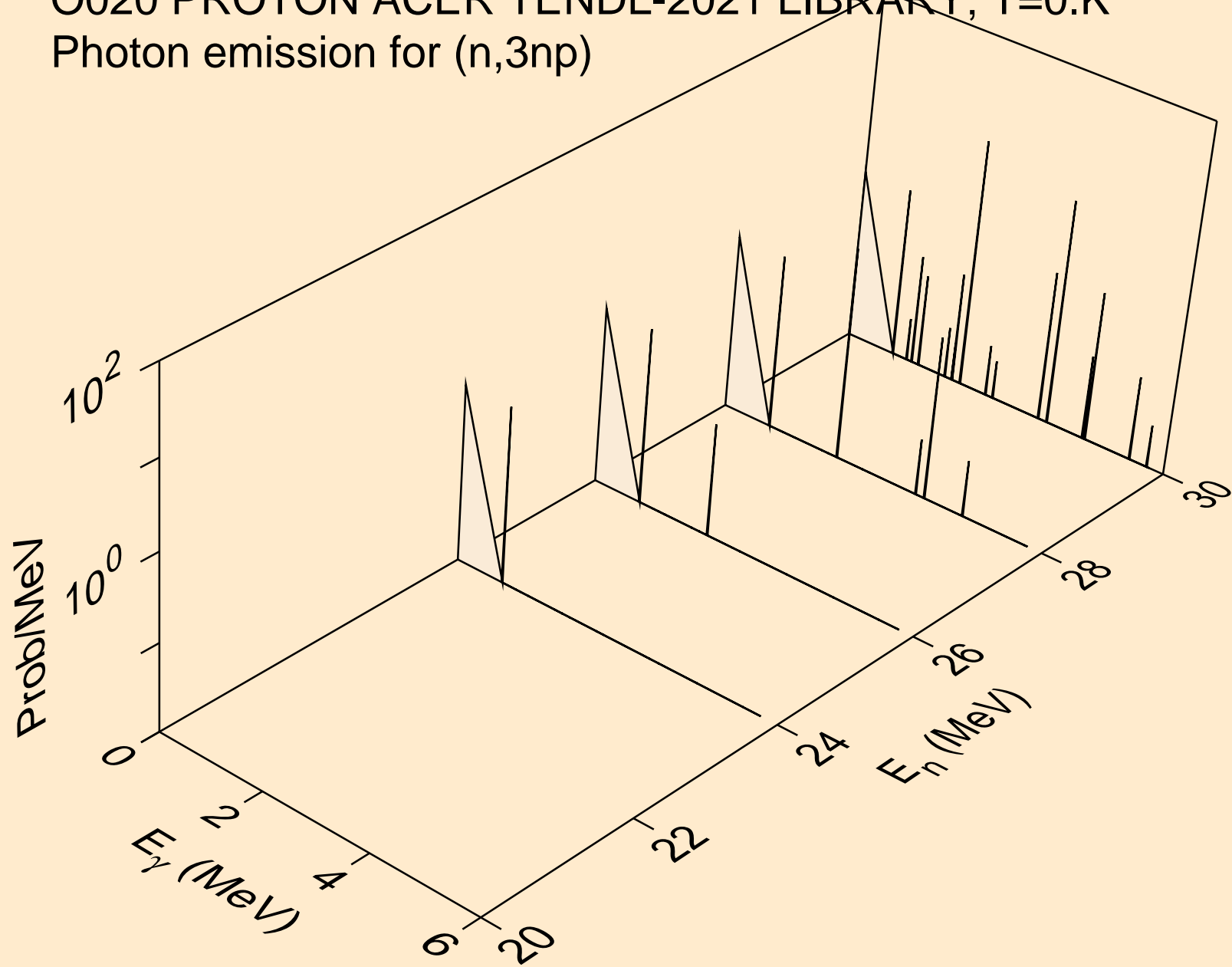

O020 PROTON ACER TENDL-2021 LIBRARY; T=0.K  
Photon emission for (n,2np)

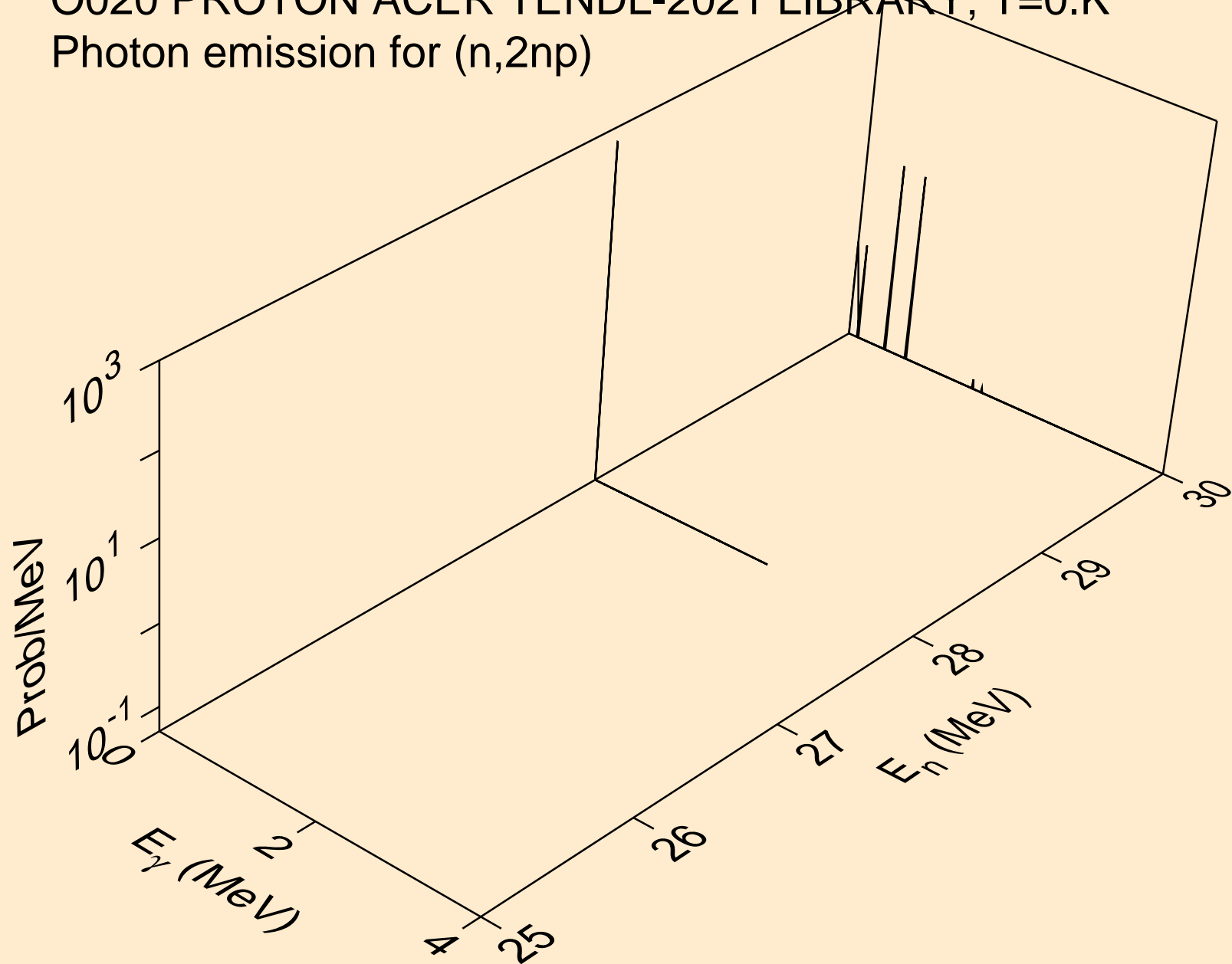

O020 PROTON ACER TENDL-2021 LIBRARY; T=0.K  
Photon emission for (n,npa)

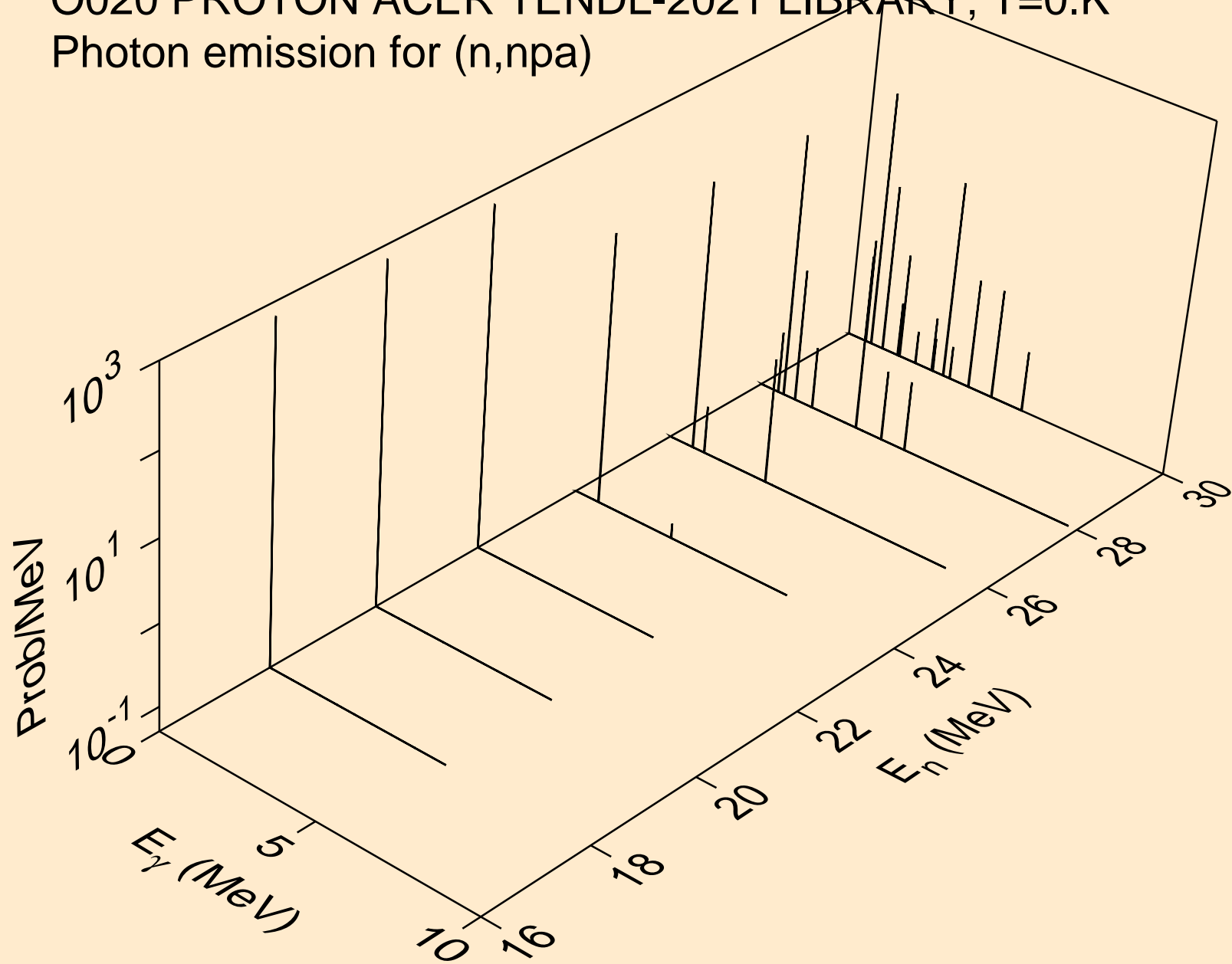

O020 PROTON ACER TENDL-2021 LIBRARY; T=0.K  
Photon emission for (n,gma)

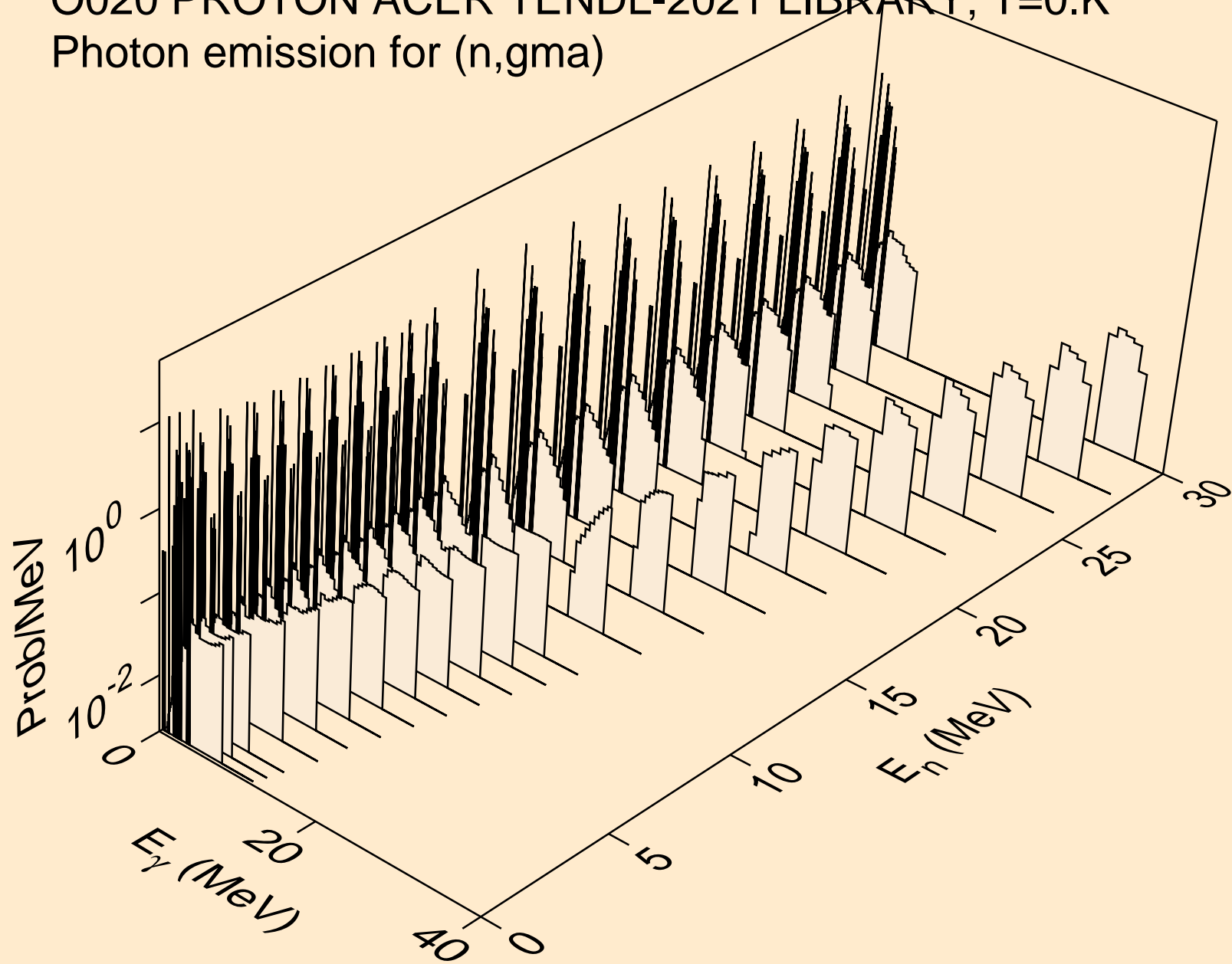



O020 PROTON ACER TENDL-2021 LIBRARY; T=0.K  
Photon emission for inelastic

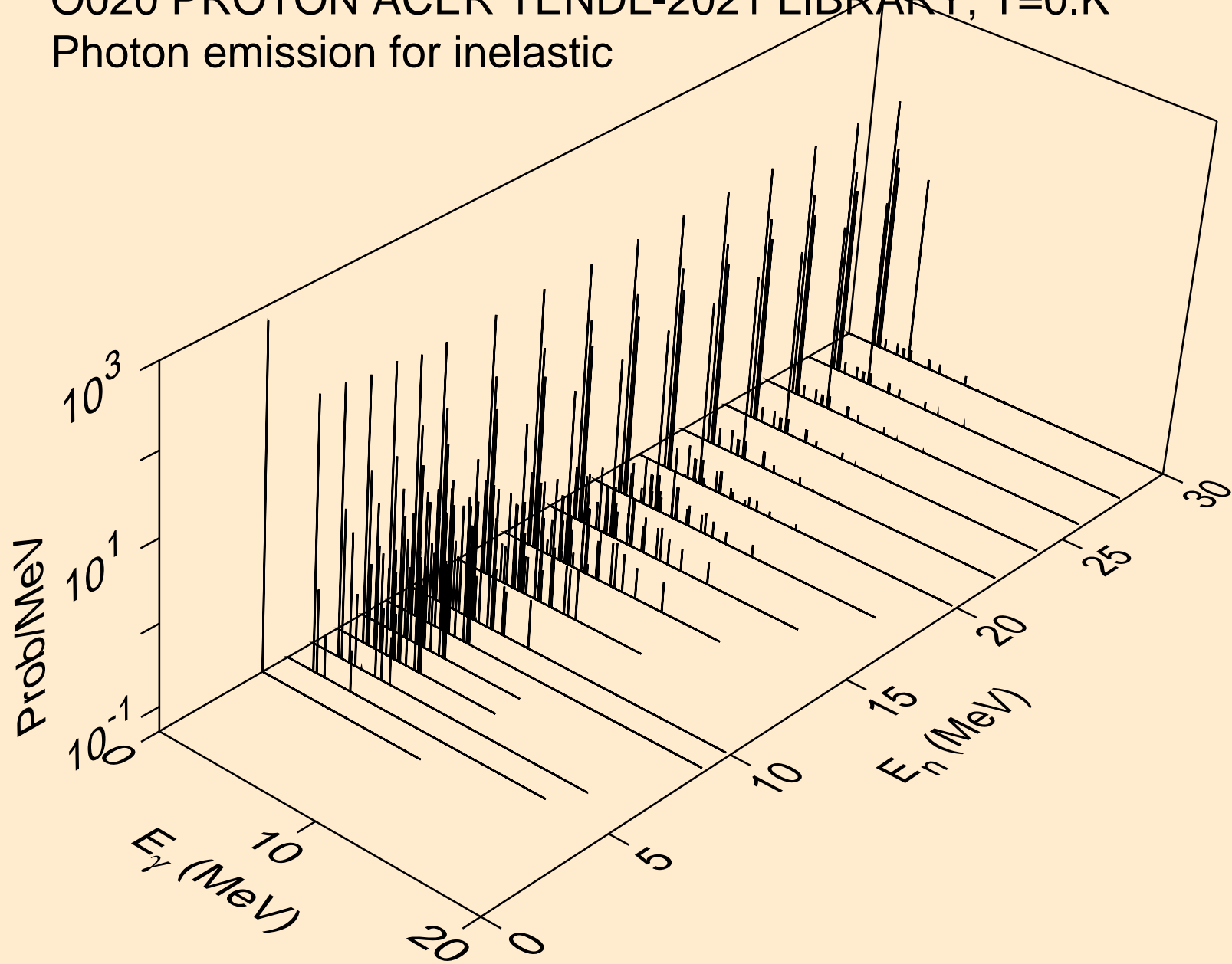

O020 PROTON ACER TENDL-2021 LIBRARY; T=0.K  
Photon emission for (n,d)

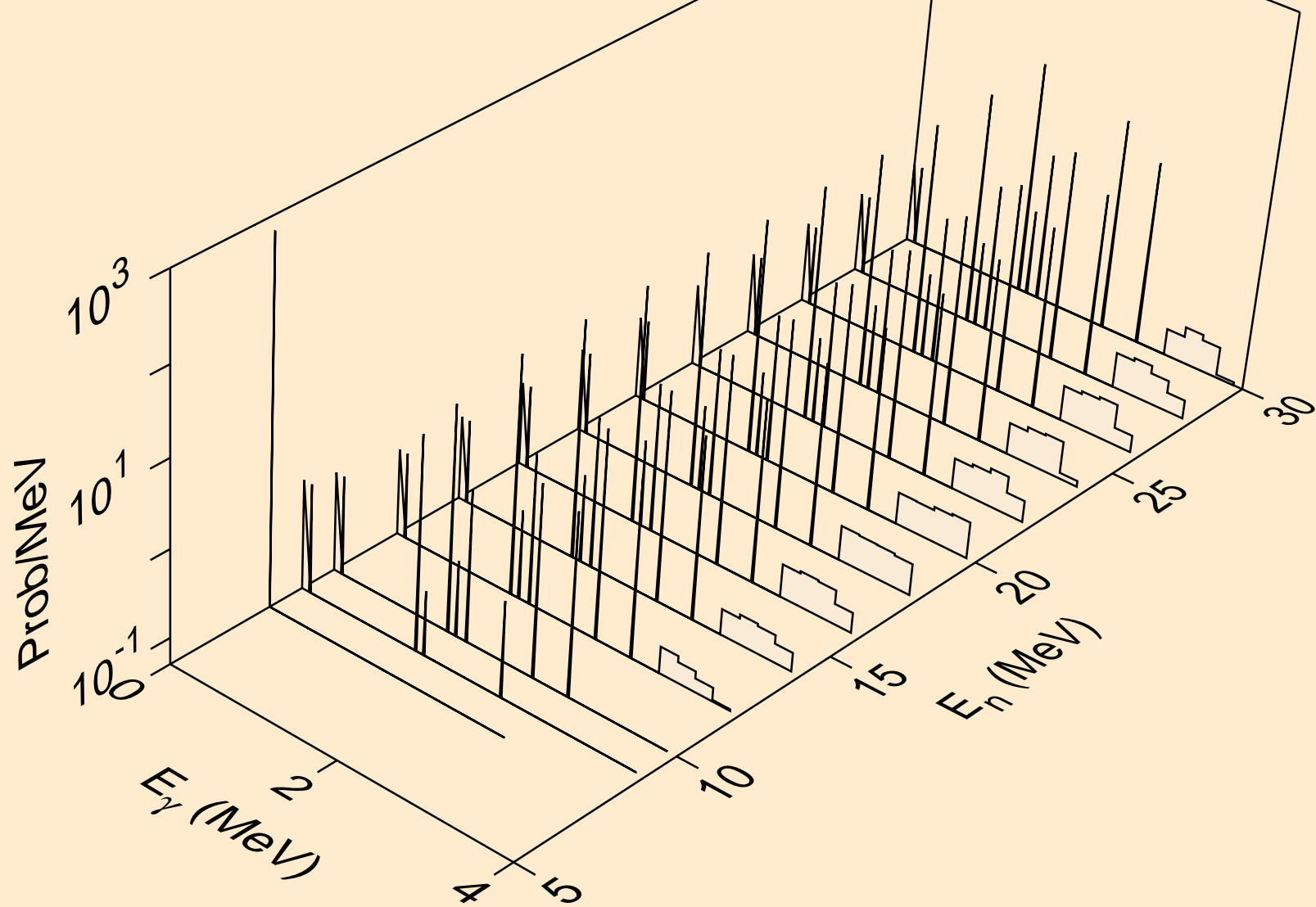

O020 PROTON ACER TENDL-2021 LIBRARY; T=0.K  
Photon emission for (n,t)

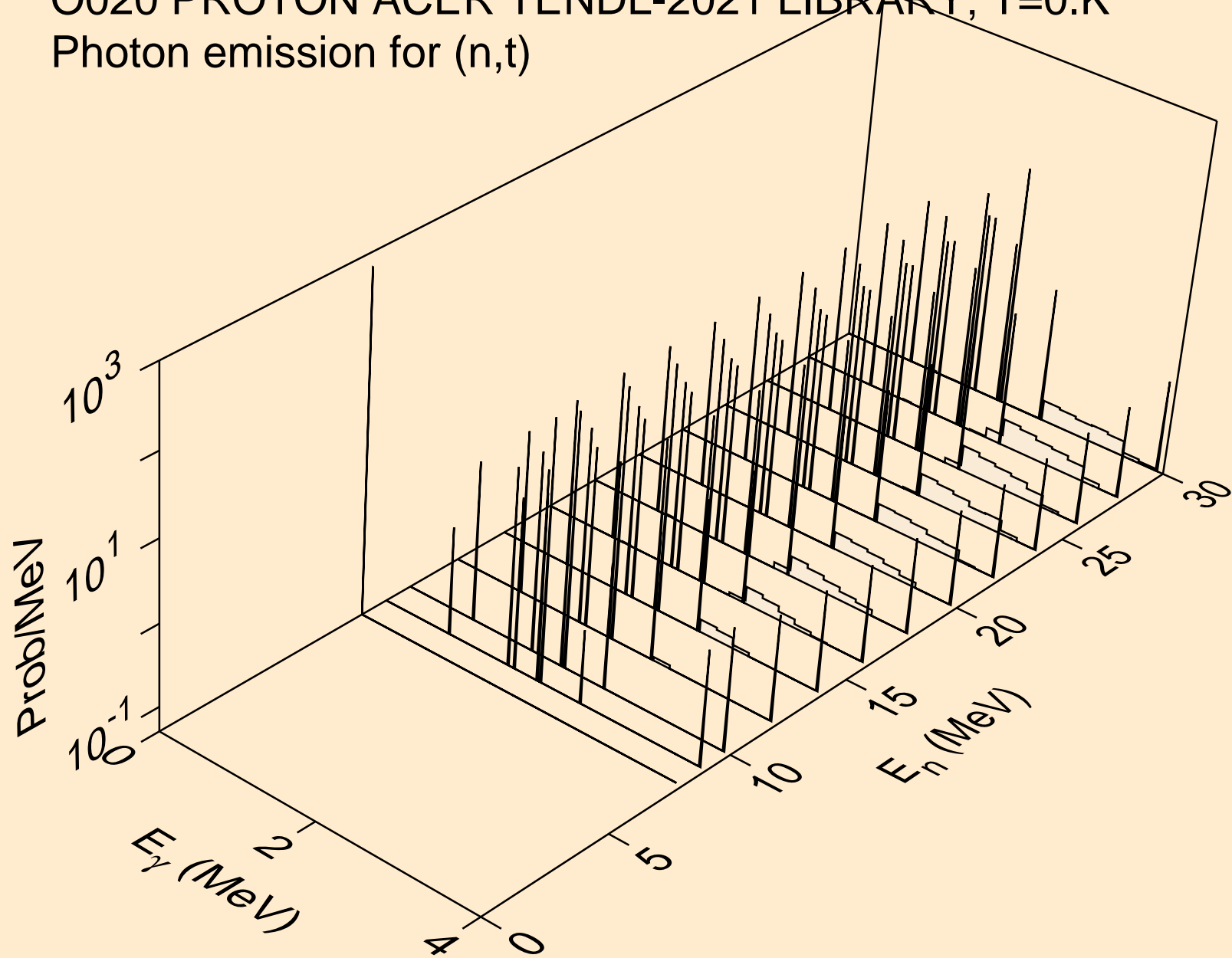

O020 PROTON ACER TENDL-2021 LIBRARY; T=0.K  
Photon emission for (n,he3)

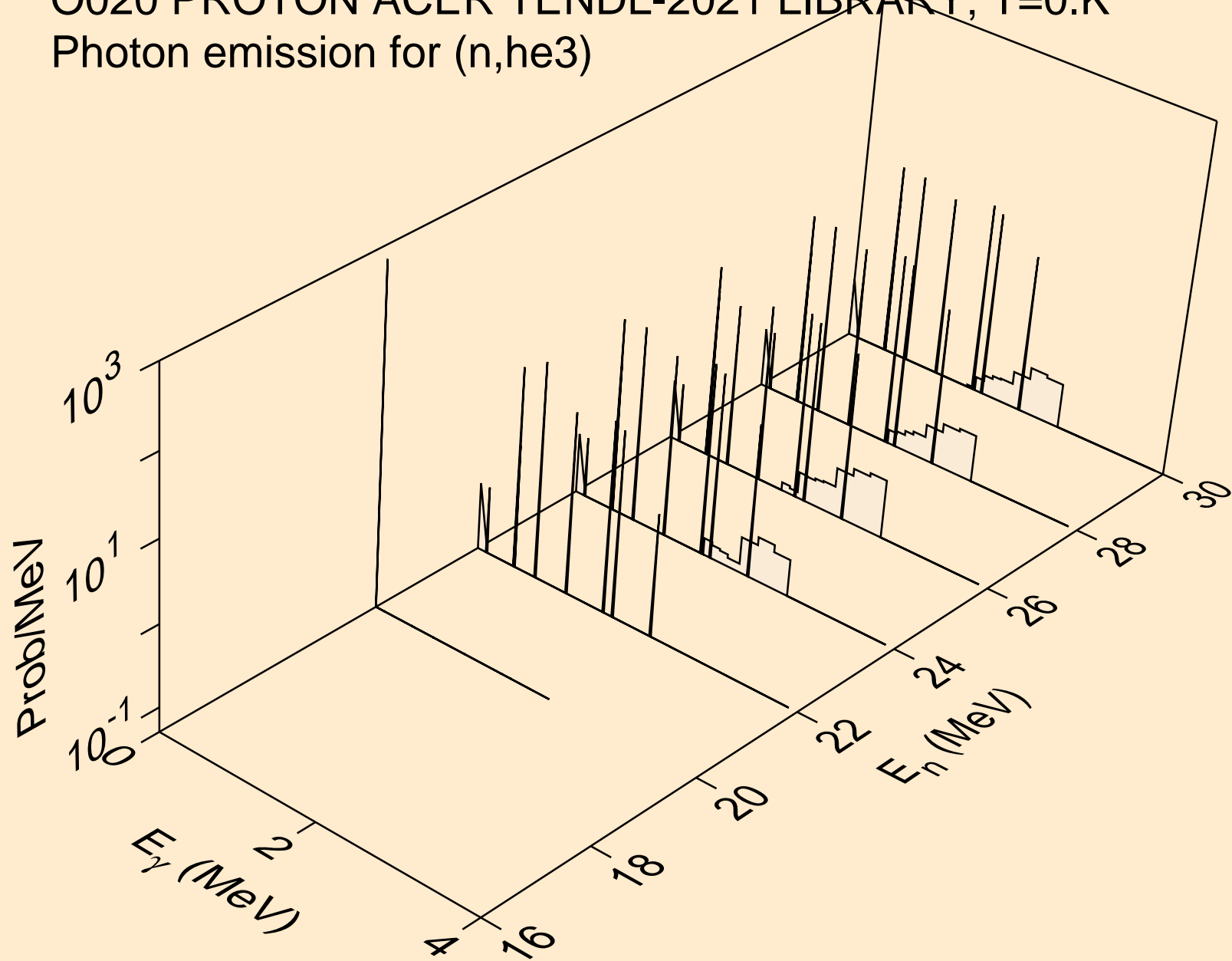

O020 PROTON ACER TENDL-2021 LIBRARY; T=0.K  
Photon emission for (n,a)

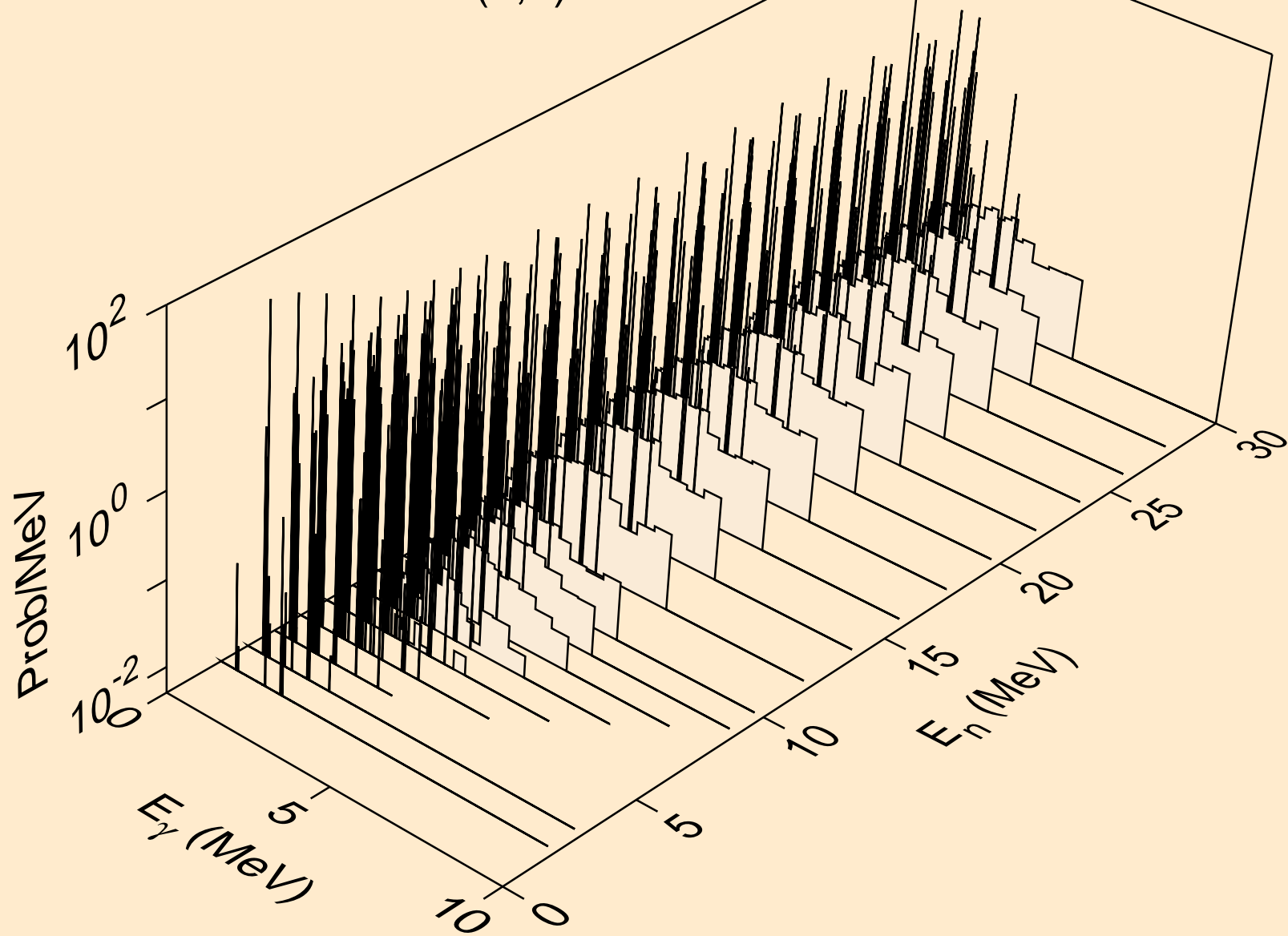

O020 PROTON ACER TENDL-2021 LIBRARY; T=0.K  
Photon emission for (n,2a)

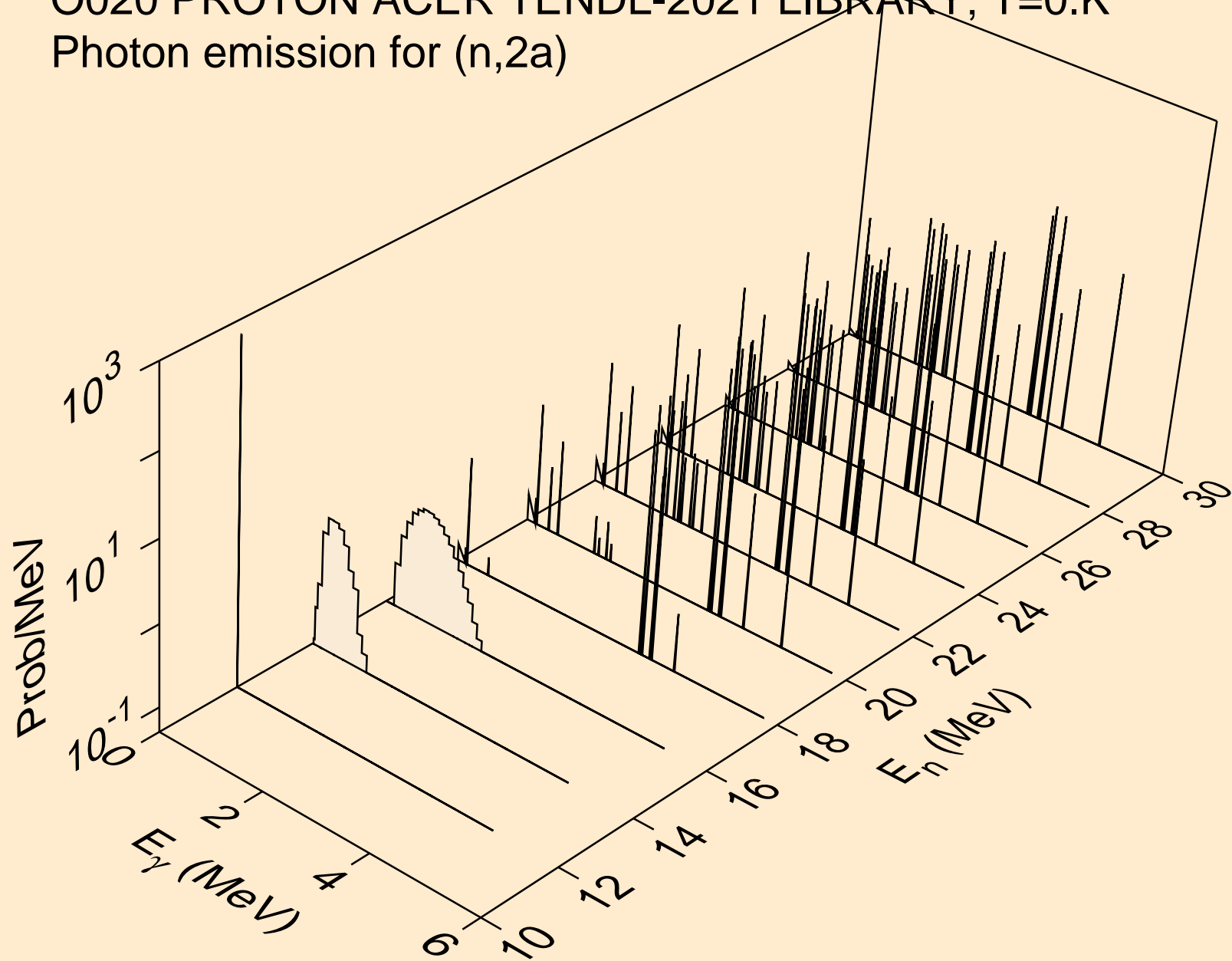

O020 PROTON ACER TENDL-2021 LIBRARY; T=0.K  
Photon emission for (n,3a)

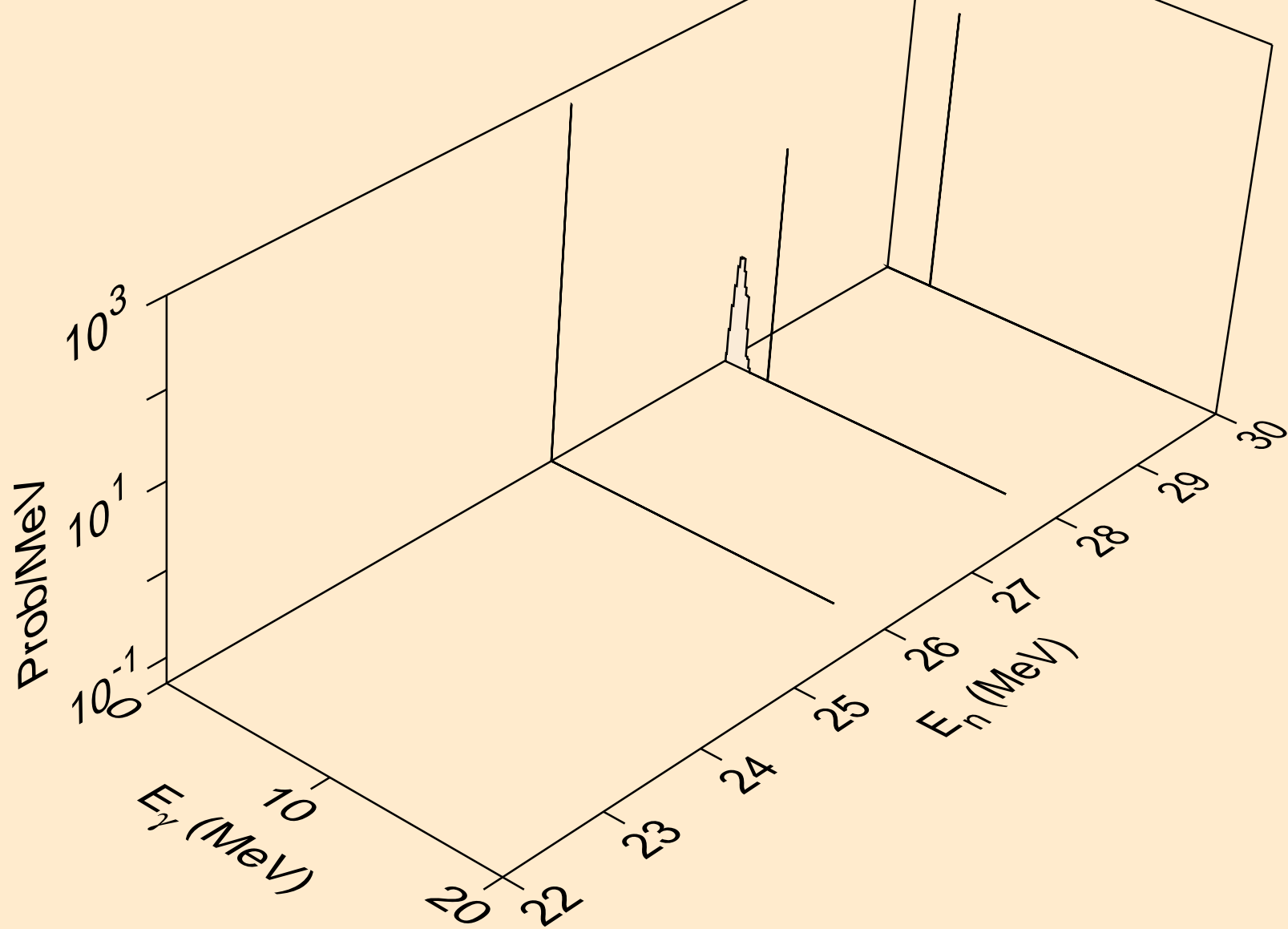

O020 PROTON ACER TENDL-2021 LIBRARY; T=0.K  
Photon emission for (n,2p)

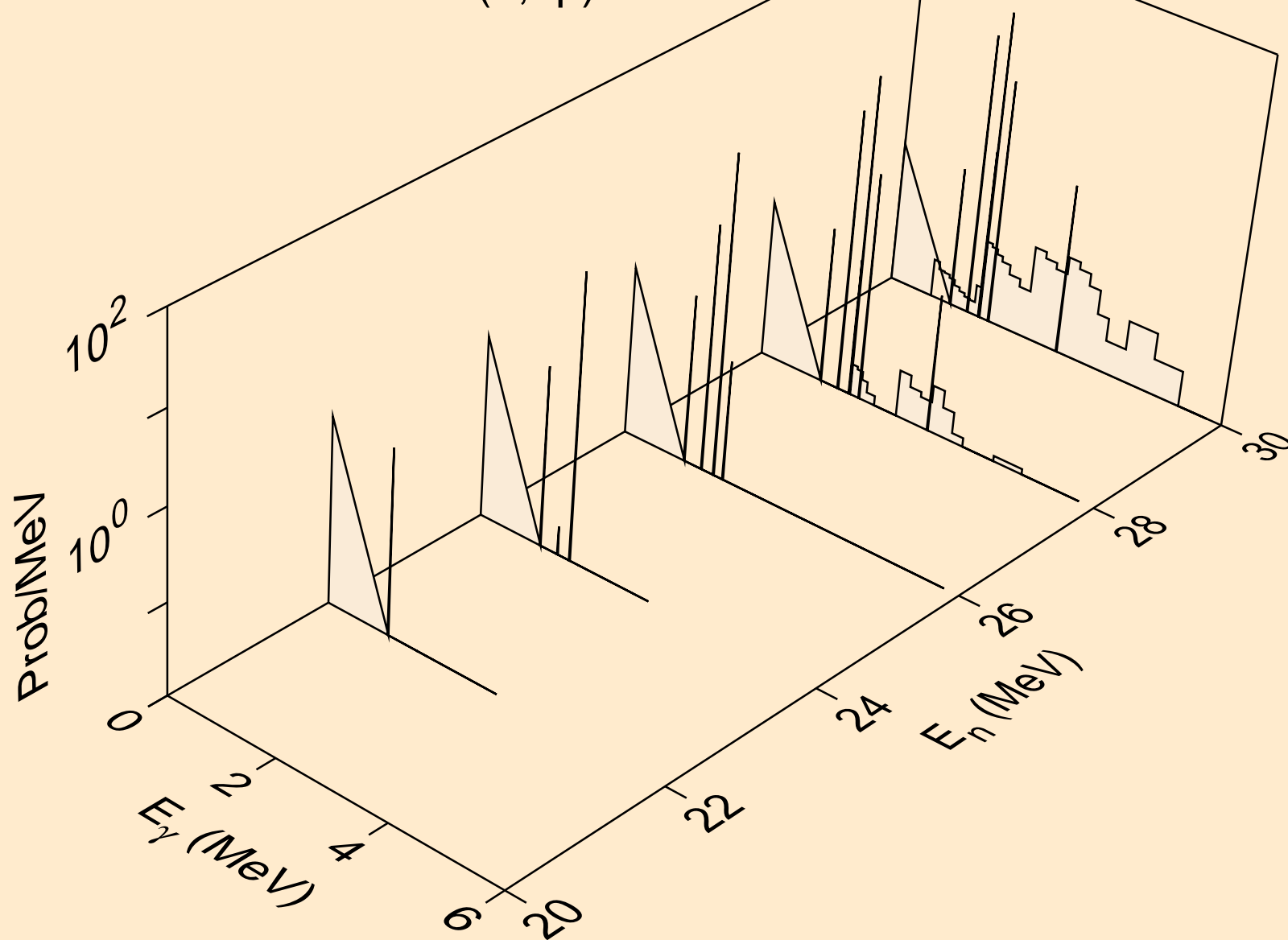



O020 PROTON ACER TENDL-2021 LIBRARY; T=0.K  
Photon emission for (n,pa)

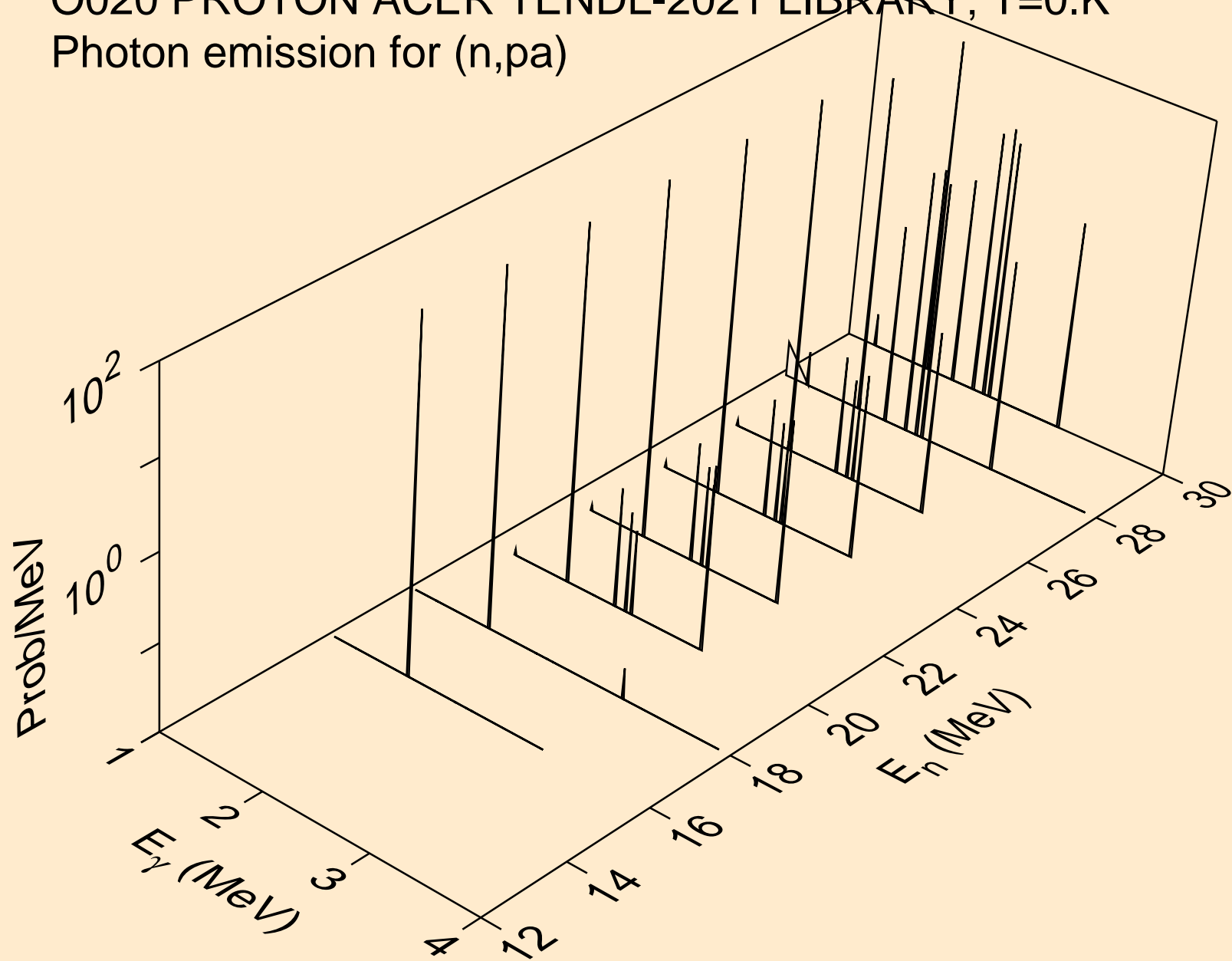

O020 PROTON ACER TENDL-2021 LIBRARY; T=0.K  
Photon emission for (n,t2a)

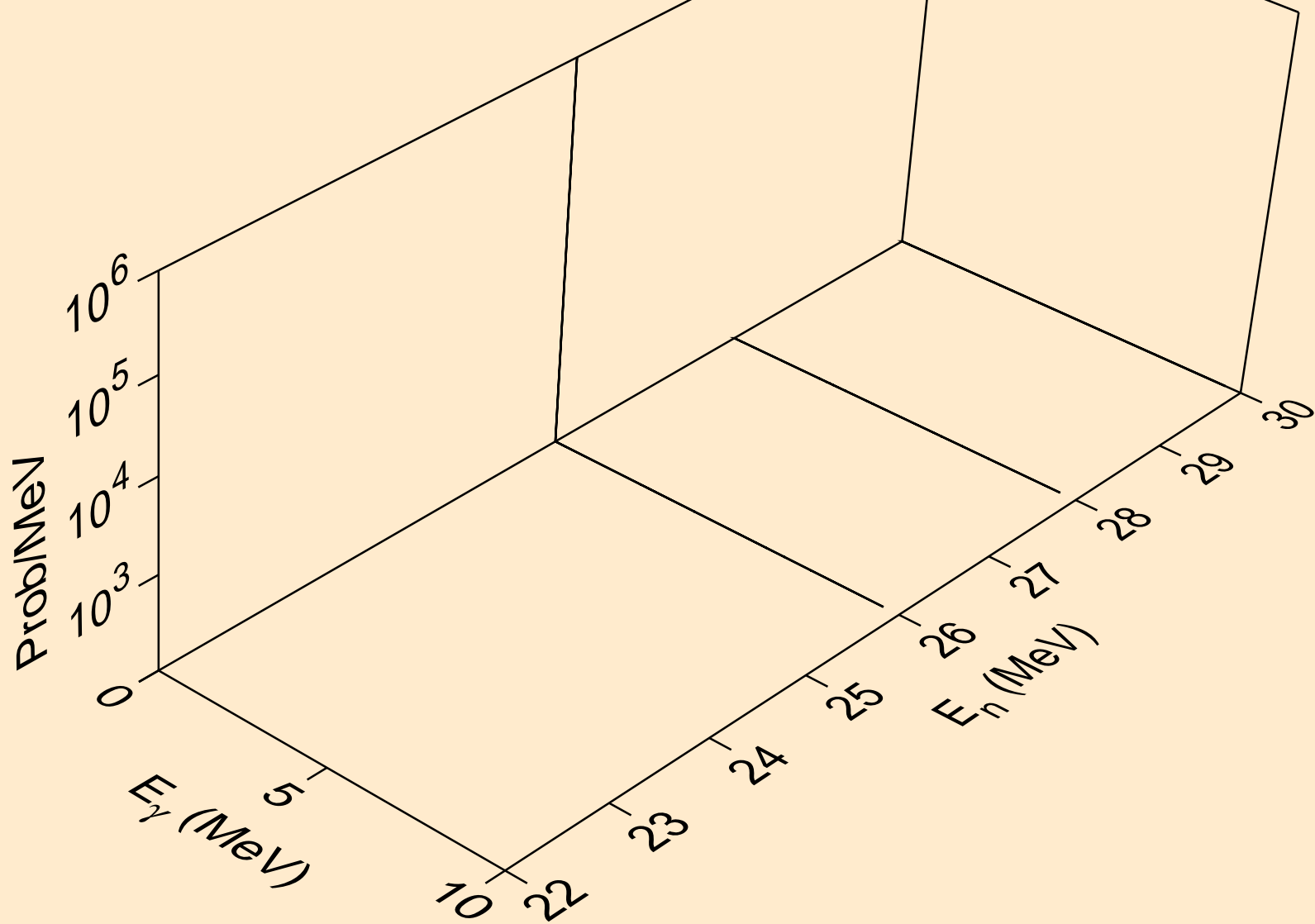

O020 PROTON ACER TENDL-2021 LIBRARY; T=0.K  
Photon emission for (n,pd)

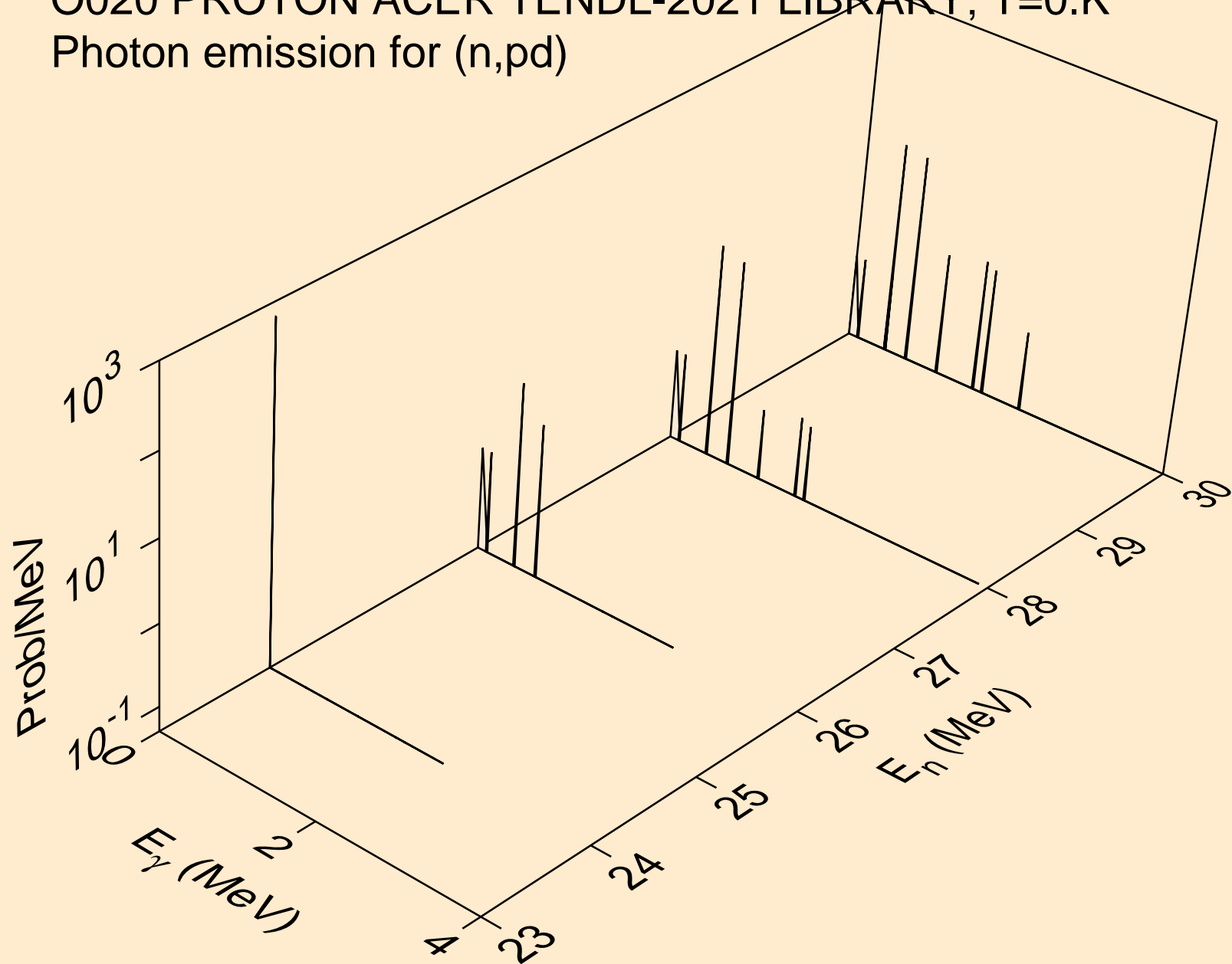

O020 PROTON ACER TENDL-2021 LIBRARY; T=0.K  
Photon emission for (n,pt)

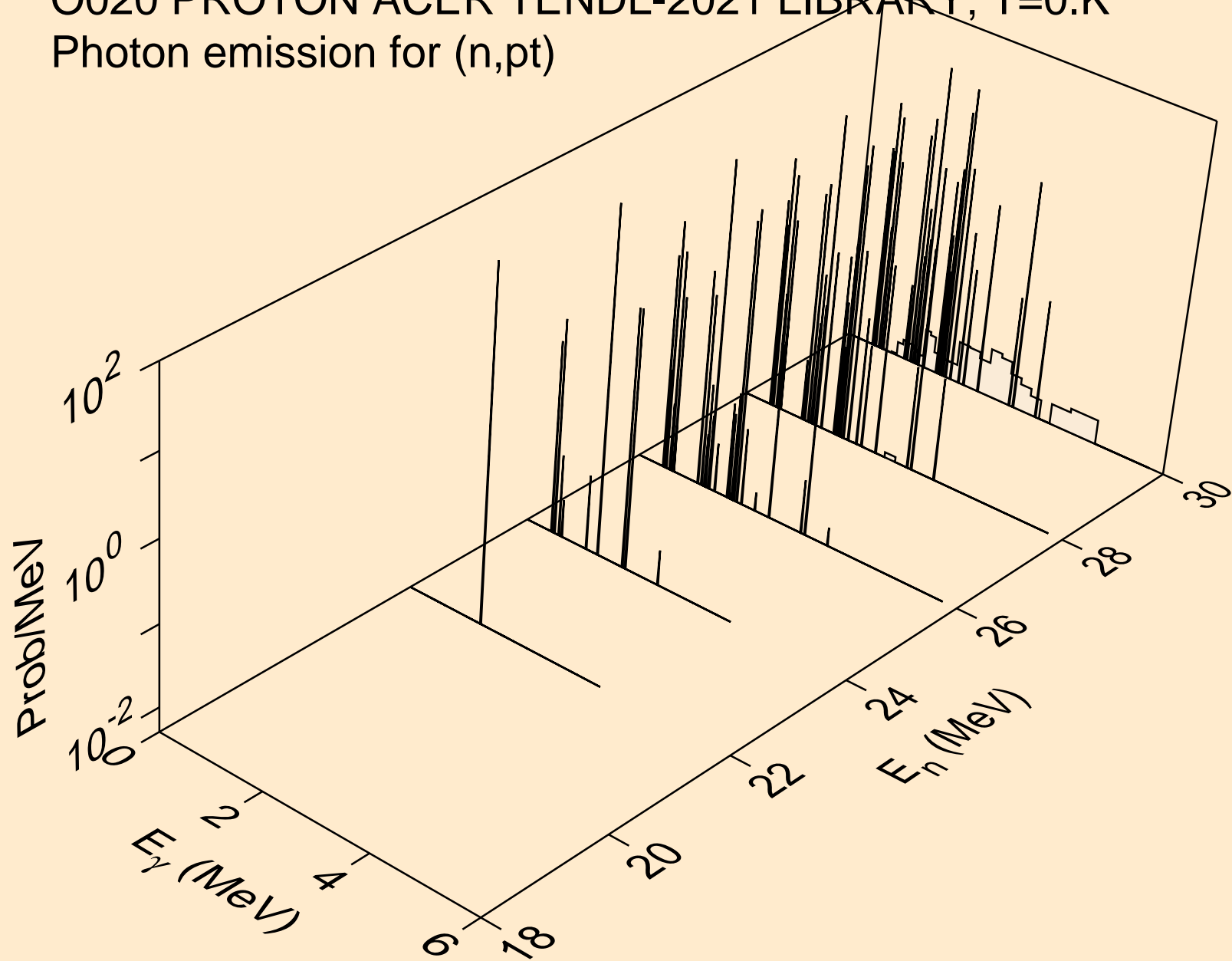

O020 PROTON ACER TENDL-2021 LIBRARY; T=0.K  
Photon emission for (n,da)

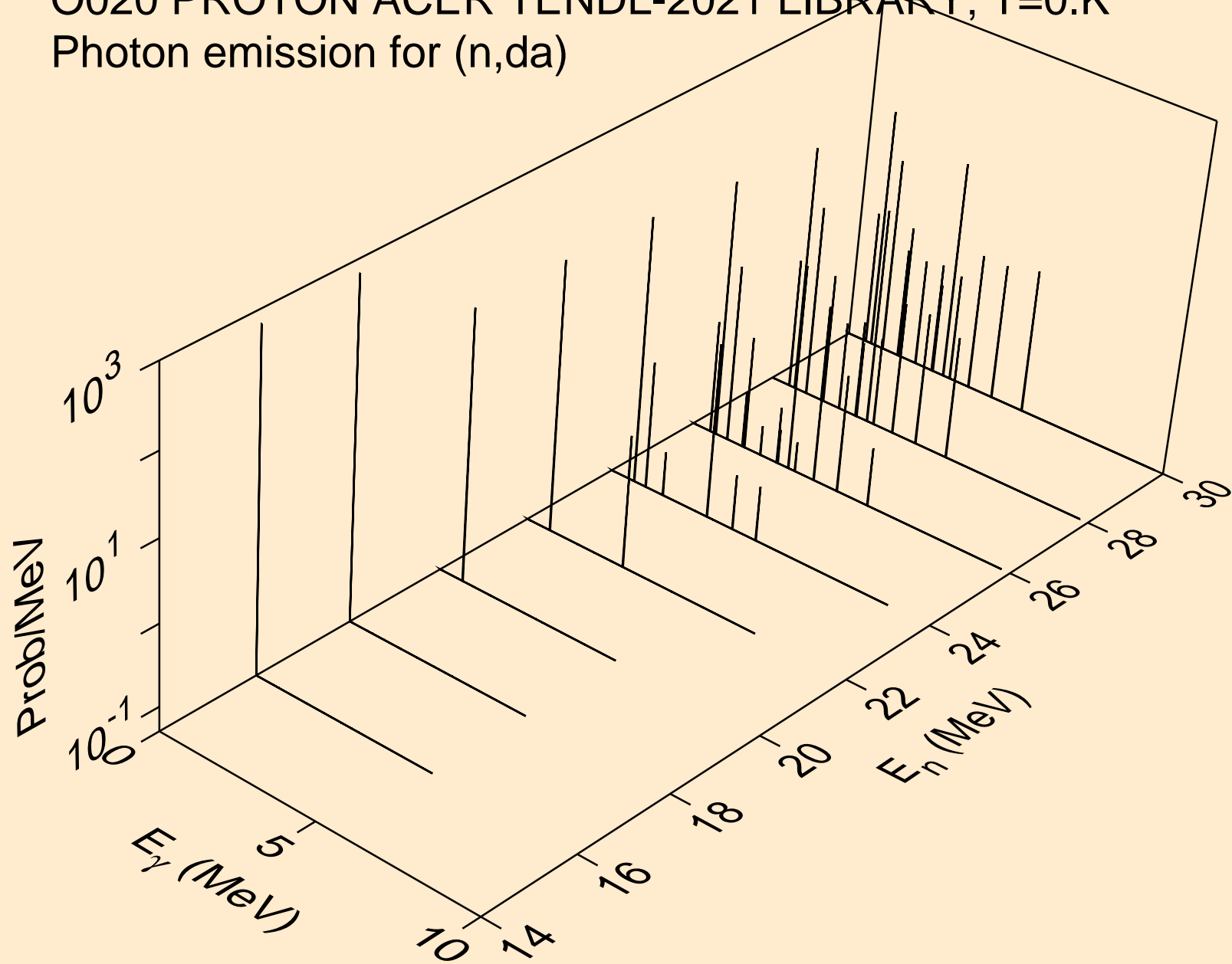

O020 PROTON ACER TENDL-2021 LIBRARY; T=0.K  
Particle heating contributions

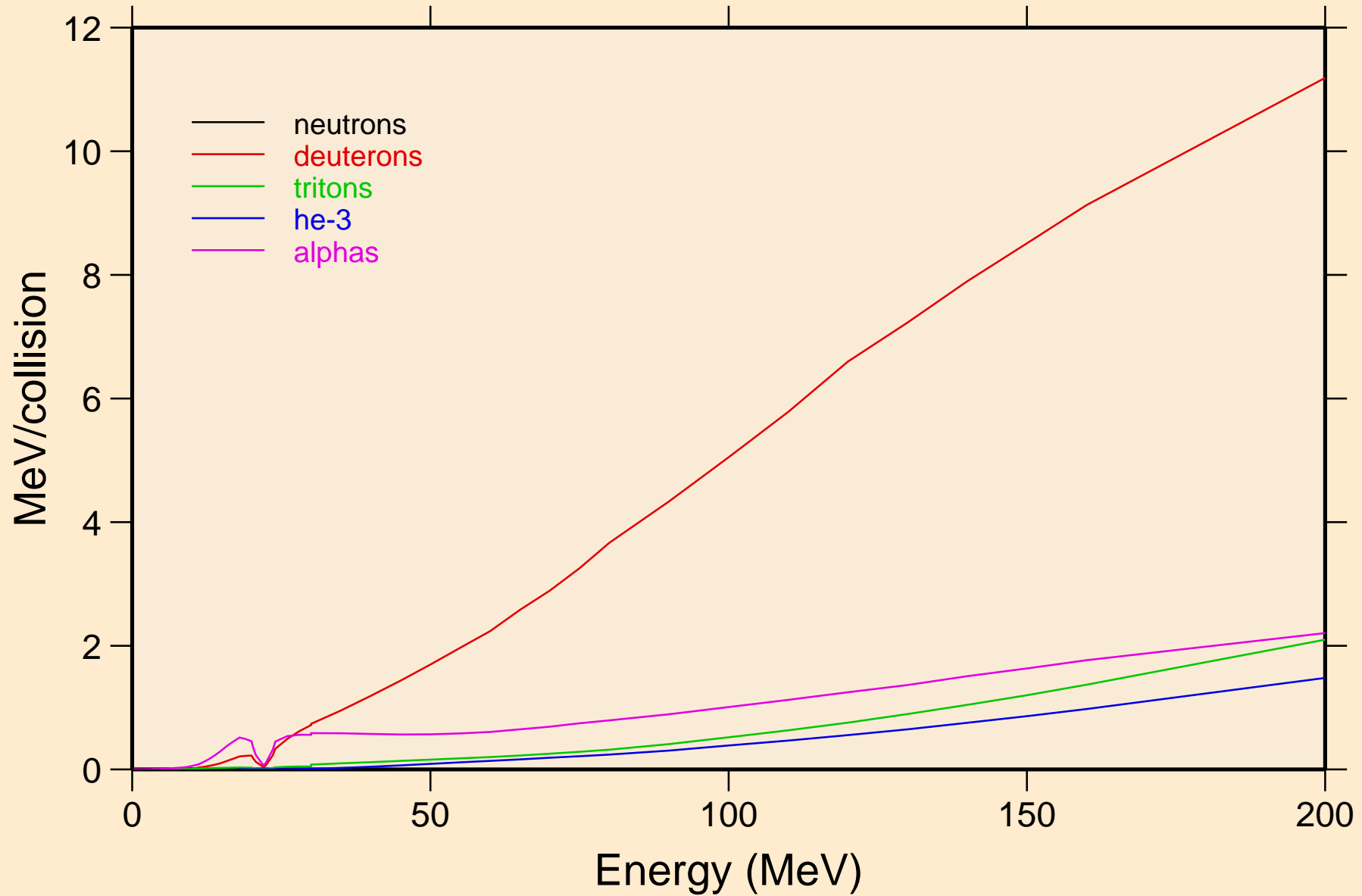

O020 PROTON ACER TENDL-2021 LIBRARY; T=0.K  
Recoil Heating

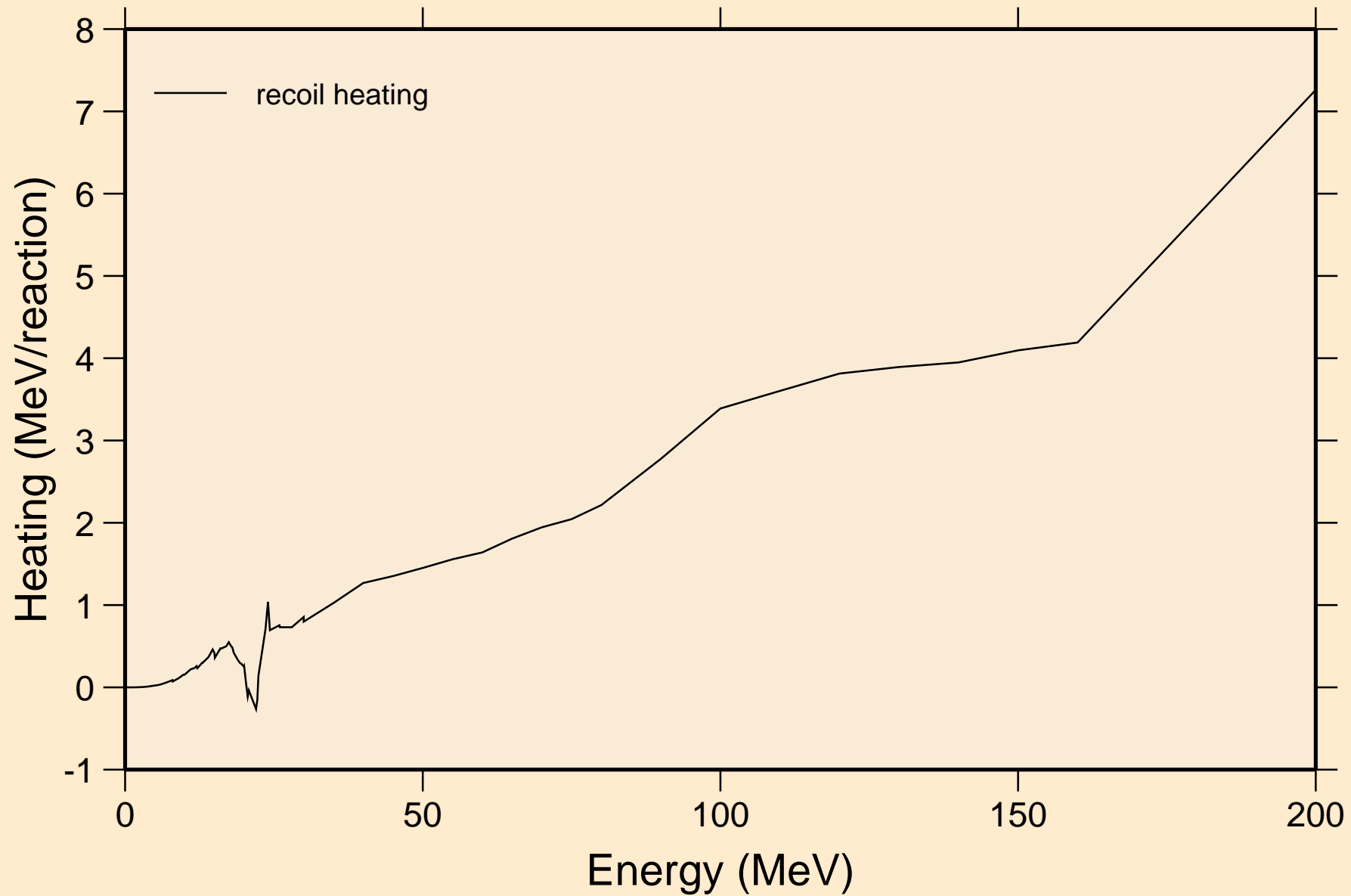

O020 PROTON ACER TENDL-2021 LIBRARY; T=0.K  
Particle production cross sections

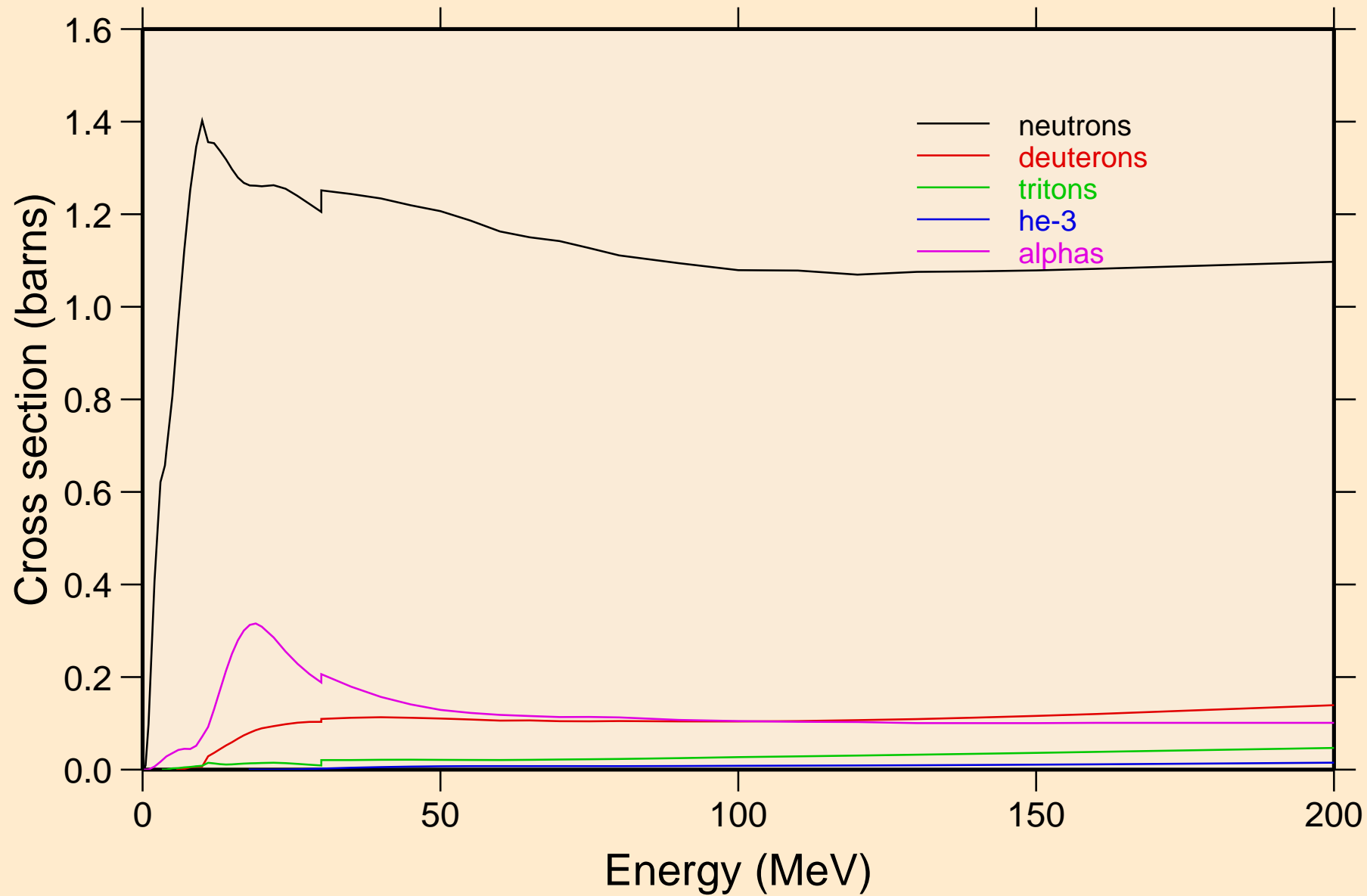



O020 PROTON ACER TENDL-2021 LIBRARY; T=0.K  
neutrons from (p,n)

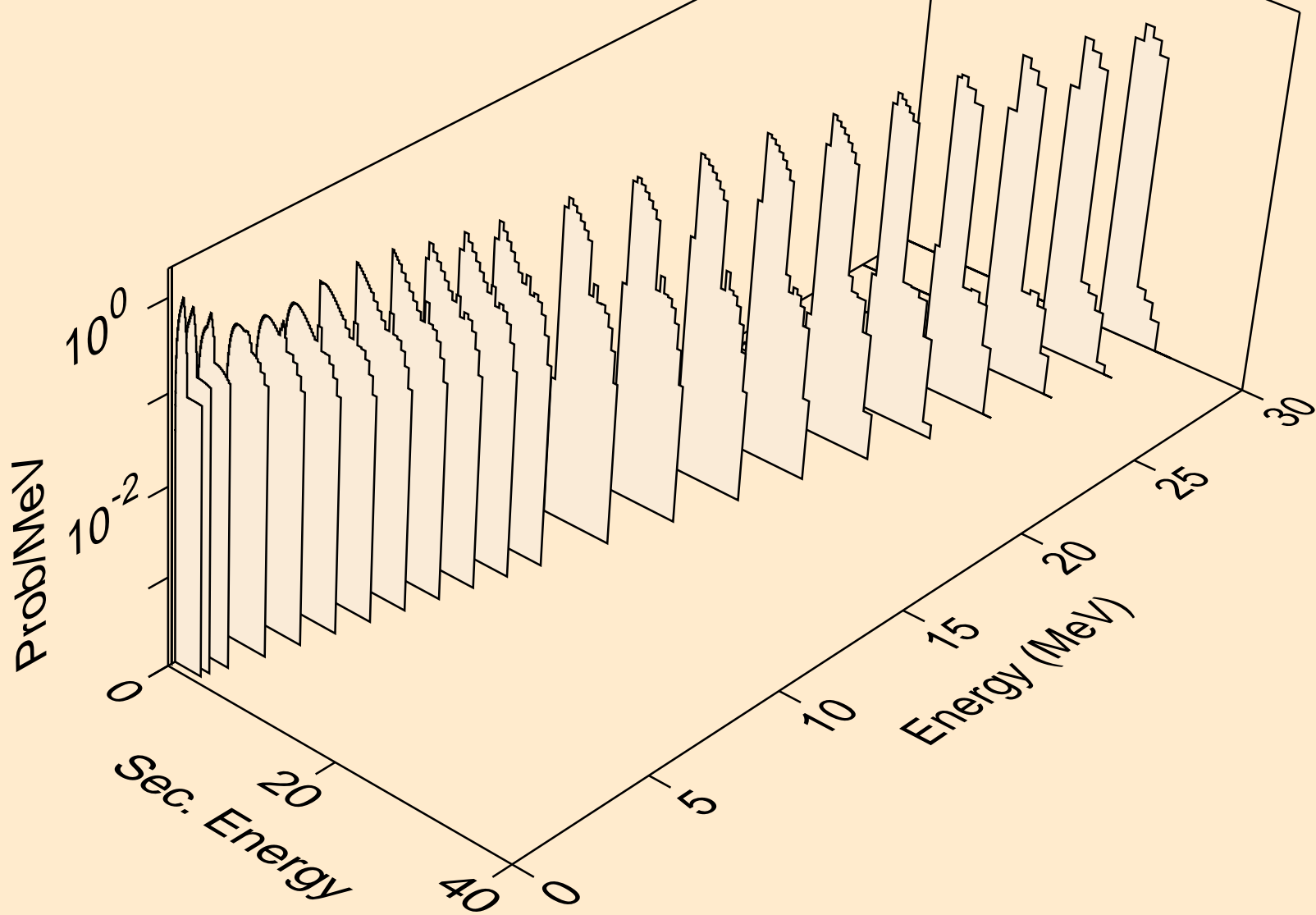

O020 PROTON ACER TENDL-2021 LIBRARY; T=0.K  
neutrons from (p,x)

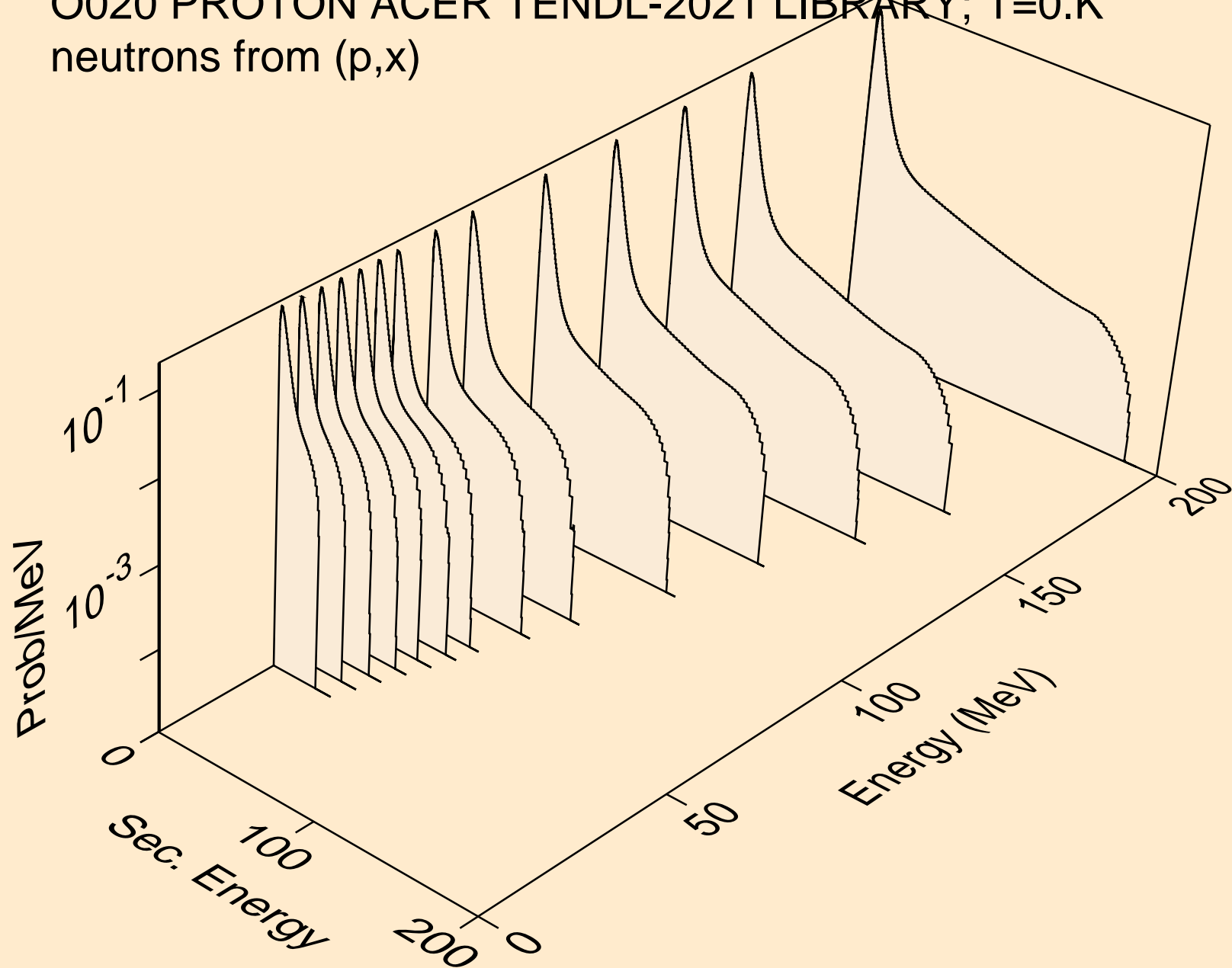

O020 PROTON ACER TENDL-2021 LIBRARY; T=0.K  
neutrons from (p,2nd)

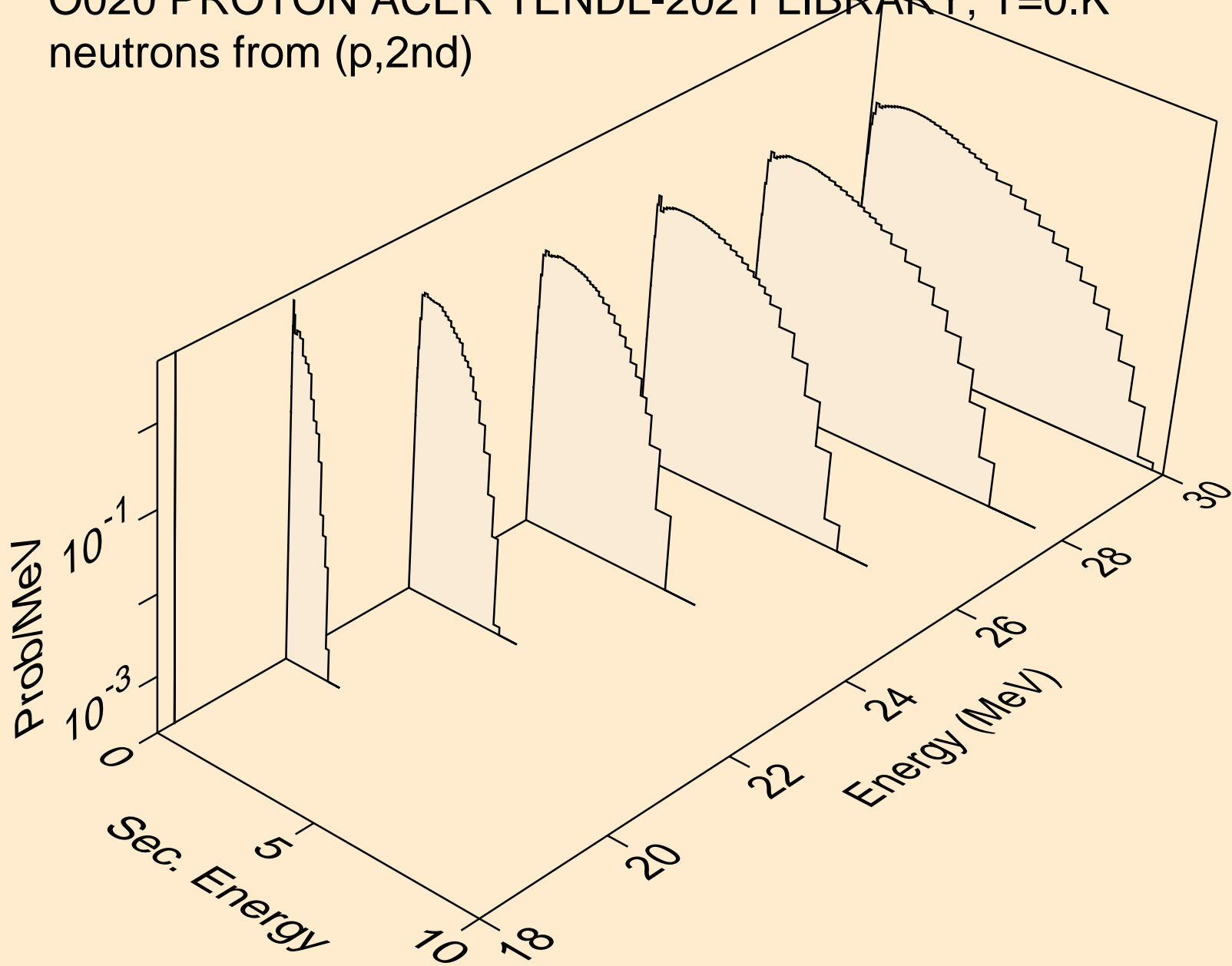

O020 PROTON ACER TENDL-2021 LIBRARY; T=0.K  
neutrons from (p,2n)

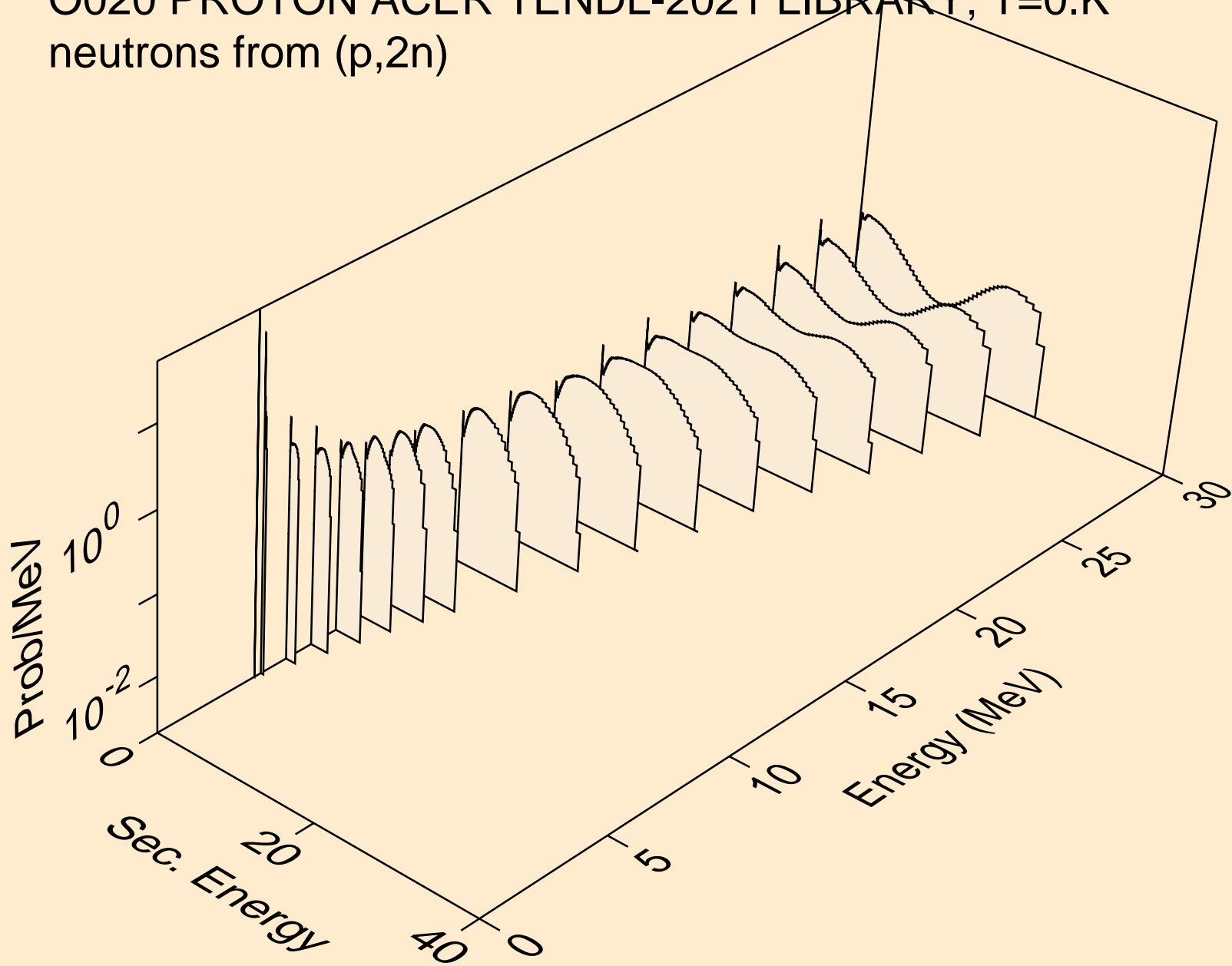

O020 PROTON ACER TENDL-2021 LIBRARY; T=0.K  
neutrons from (p,3n)

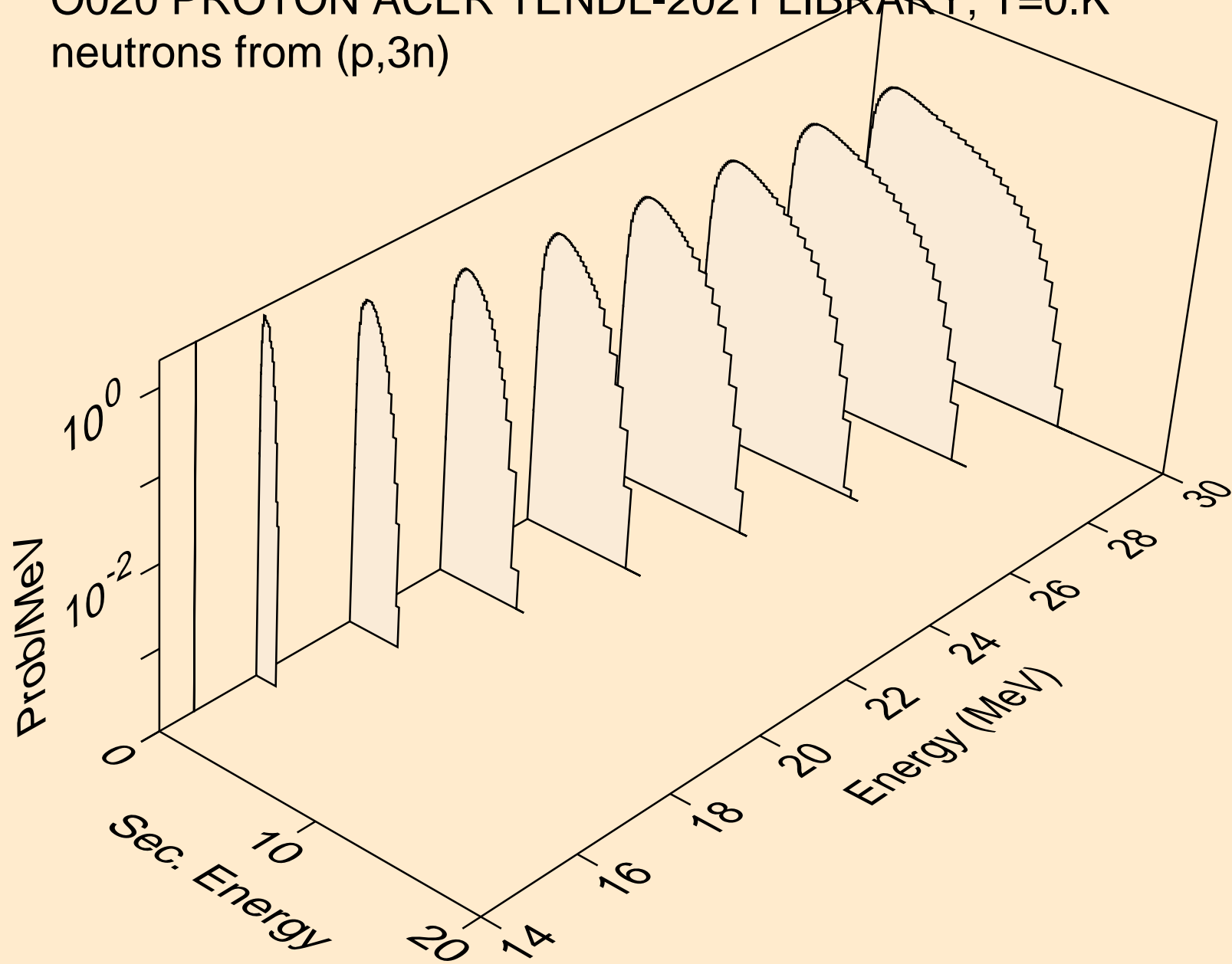

O020 PROTON ACER TENDL-2021 LIBRARY; T=0.K  
neutrons from (p,n\*)a

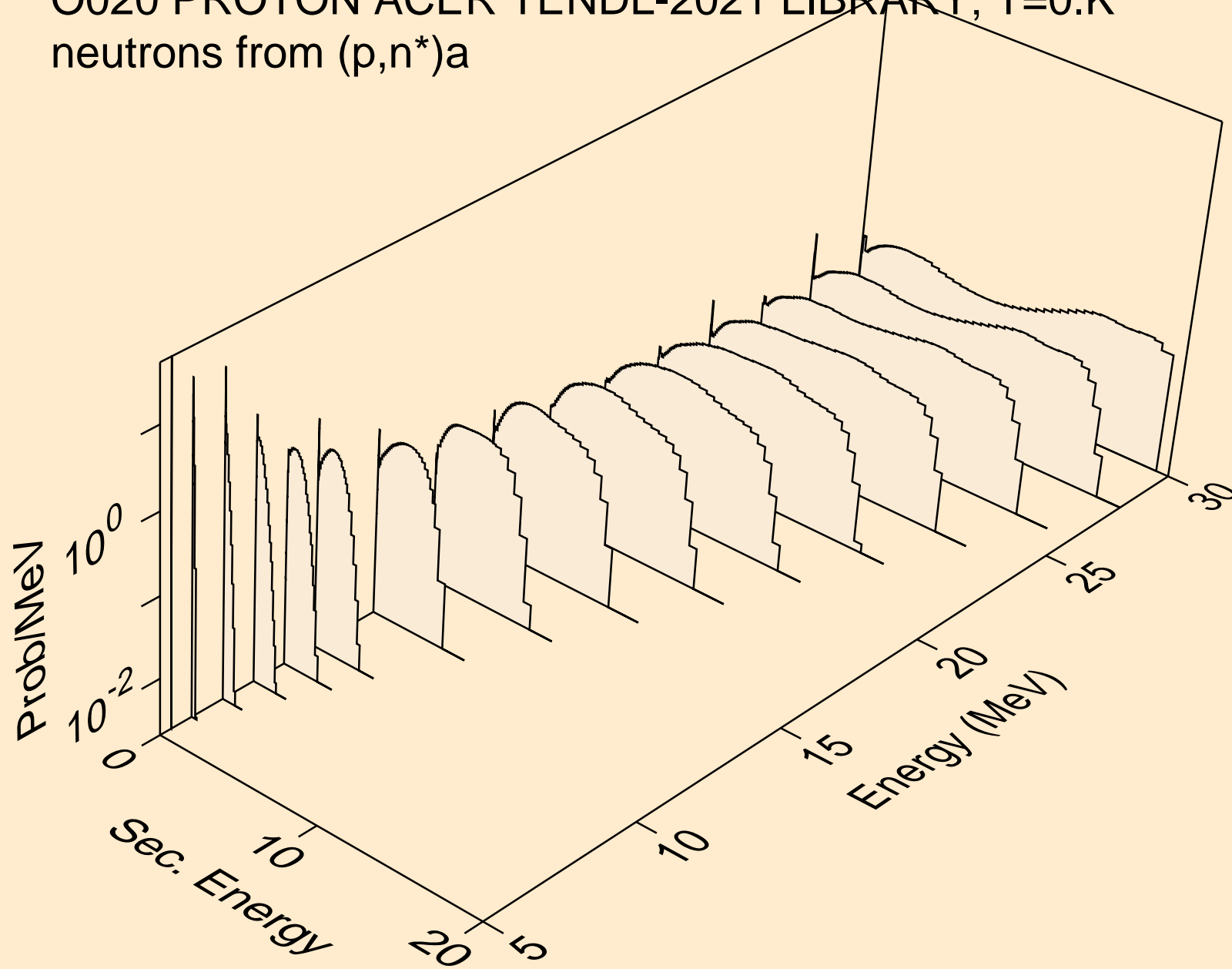

O020 PROTON ACER TENDL-2021 LIBRARY; T=0.K  
neutrons from (p,2n)a

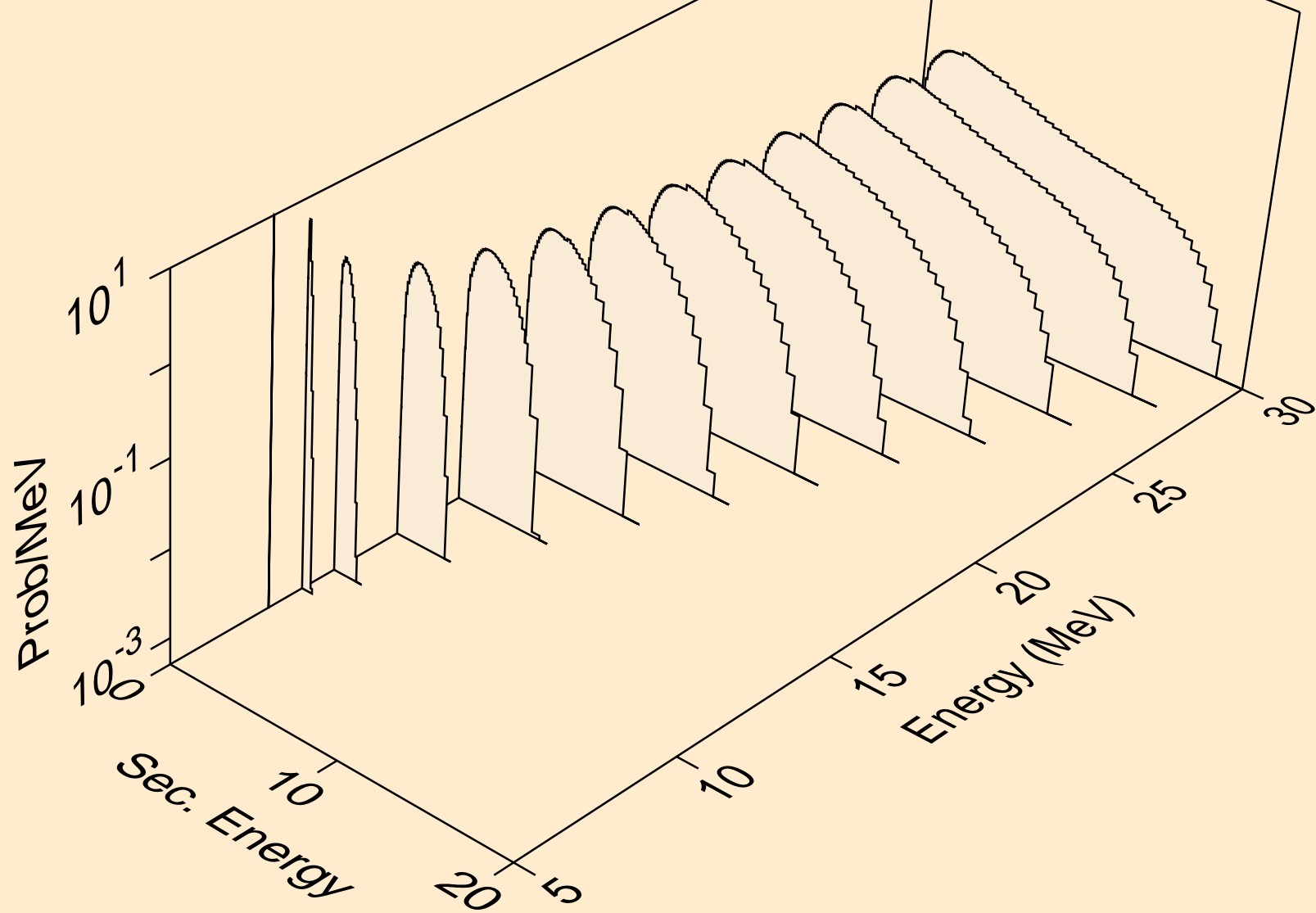

O020 PROTON ACER TENDL-2021 LIBRARY; T=0.K  
neutrons from (p,3n)a

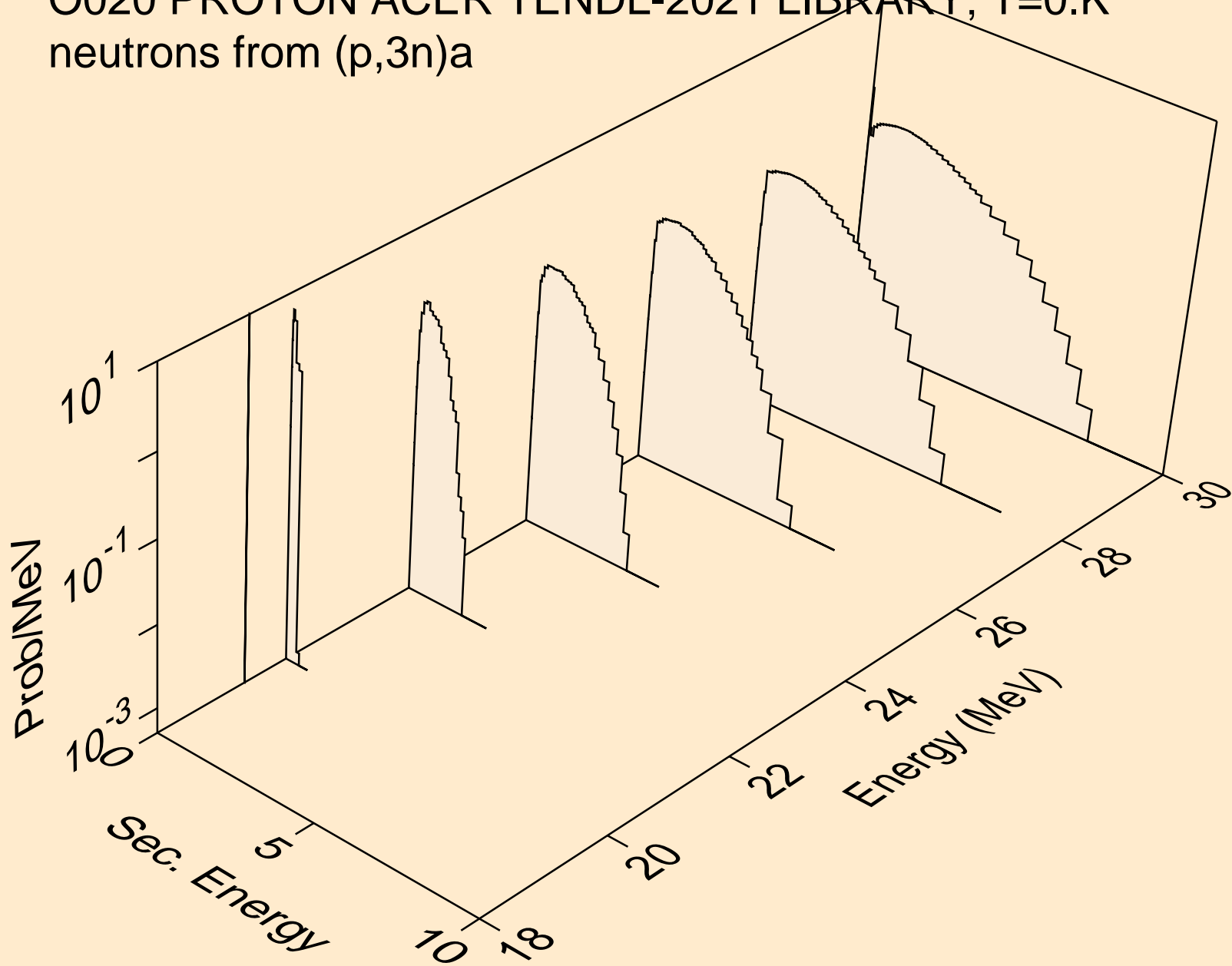



O020 PROTON ACER TENDL-2021 LIBRARY; T=0.K  
neutrons from (p,n\*)p

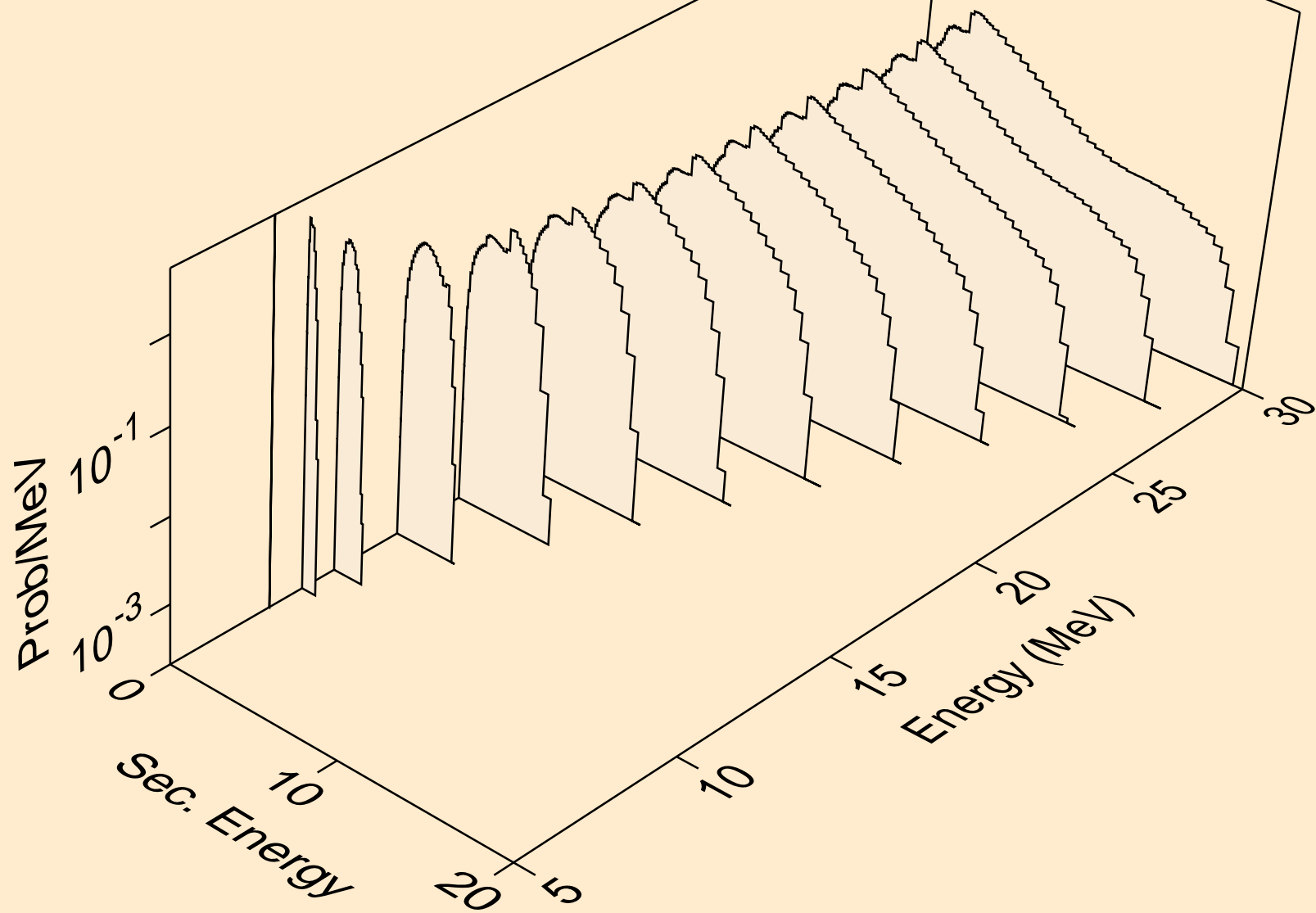

O020 PROTON ACER TENDL-2021 LIBRARY; T=0.K  
neutrons from (p,n\*)2a

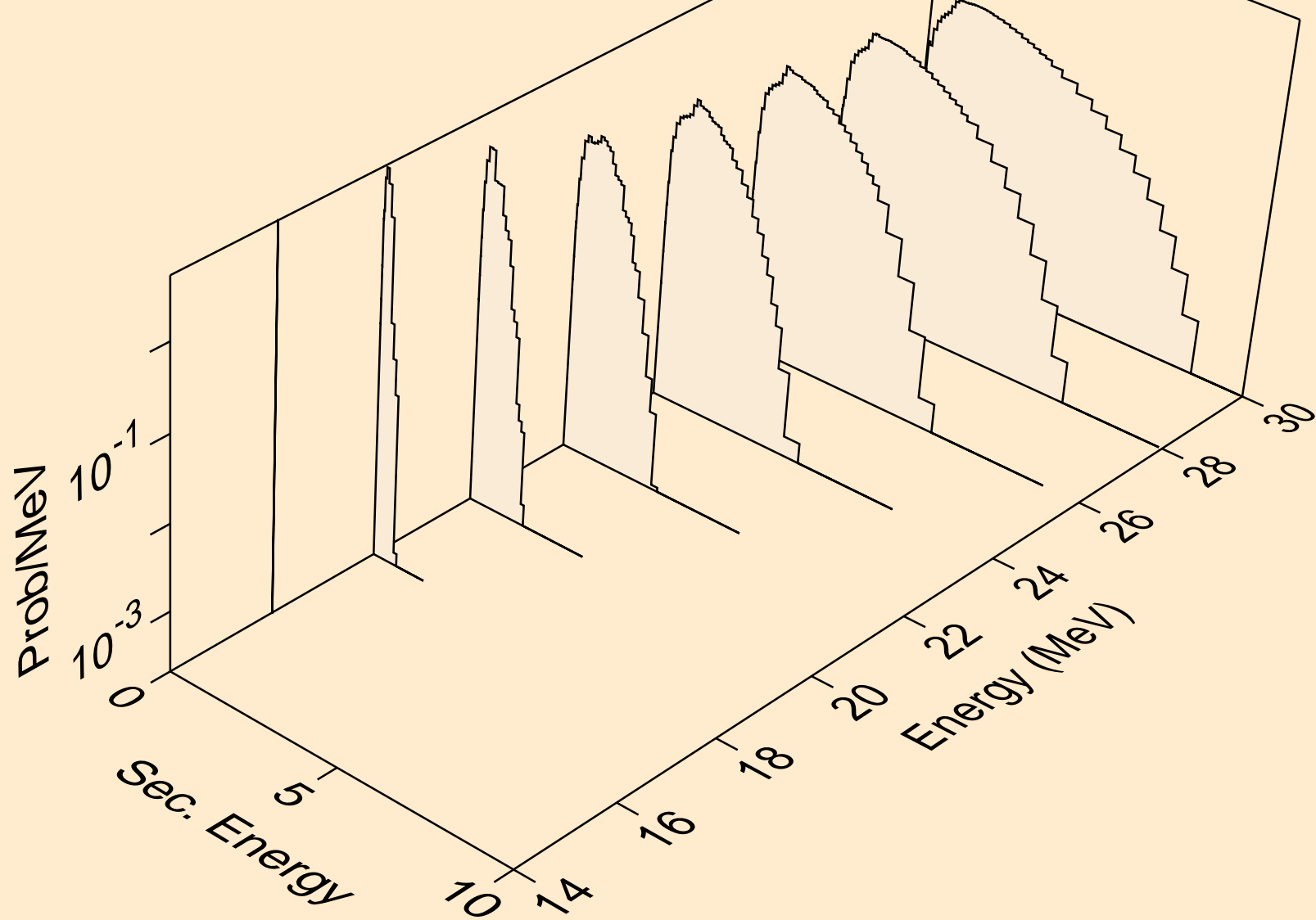

O020 PROTON ACER TENDL-2021 LIBRARY; T=0.K  
neutrons from (p,2n)2a

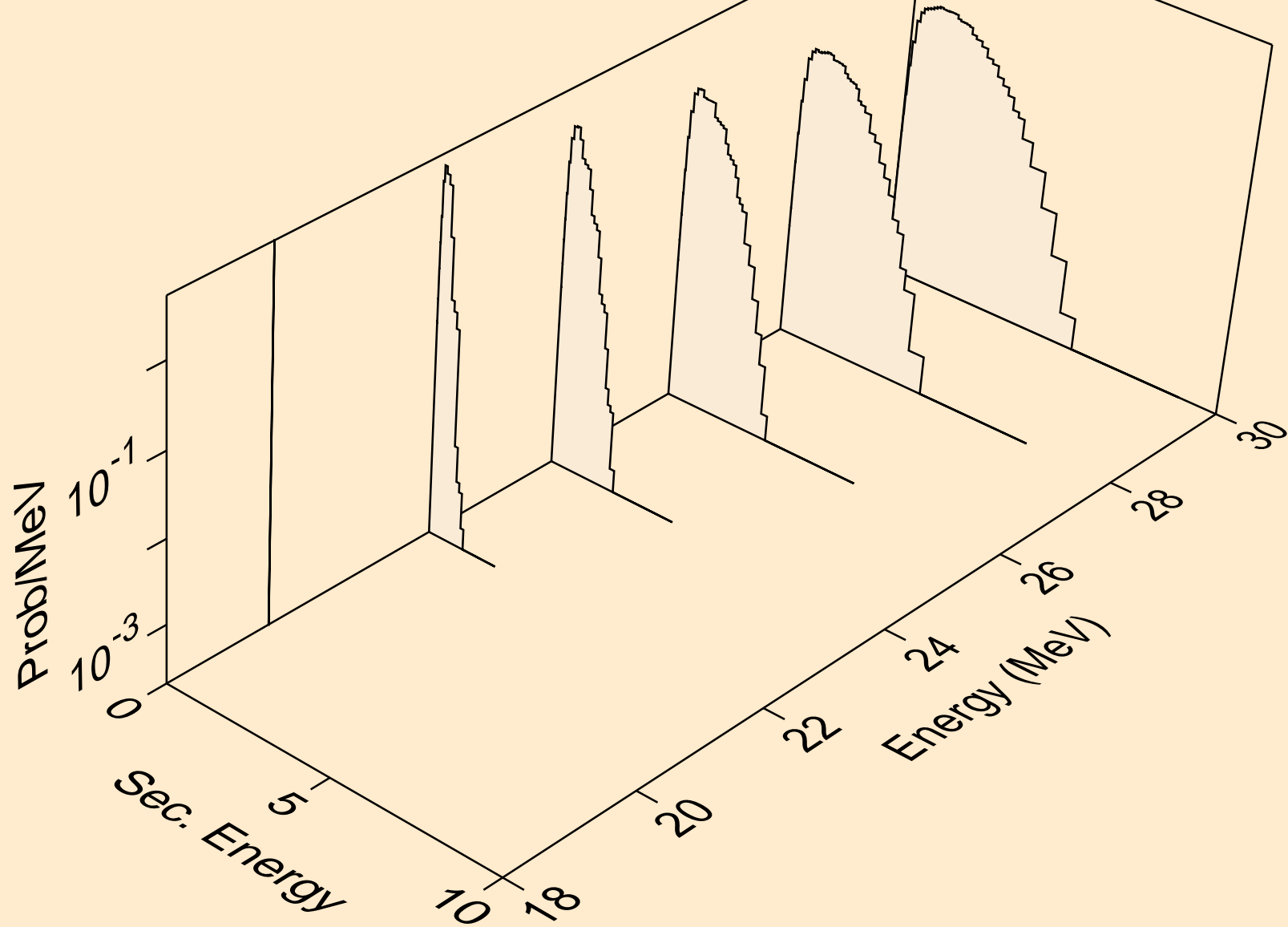

O020 PROTON ACER TENDL-2021 LIBRARY; T=0.K  
neutrons from (p,n\*)d

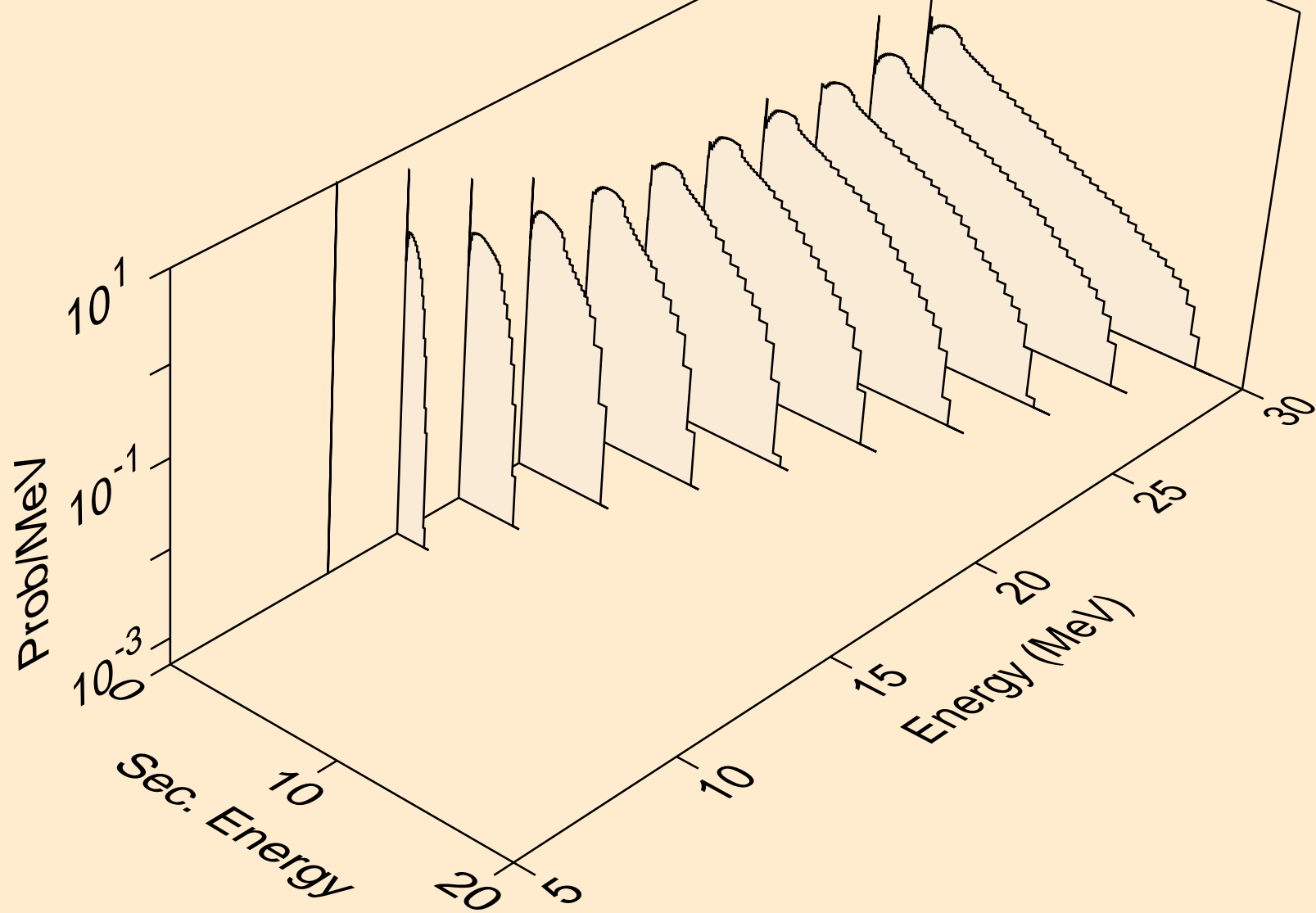

O020 PROTON ACER TENDL-2021 LIBRARY; T=0.K  
neutrons from (p,n\*)t

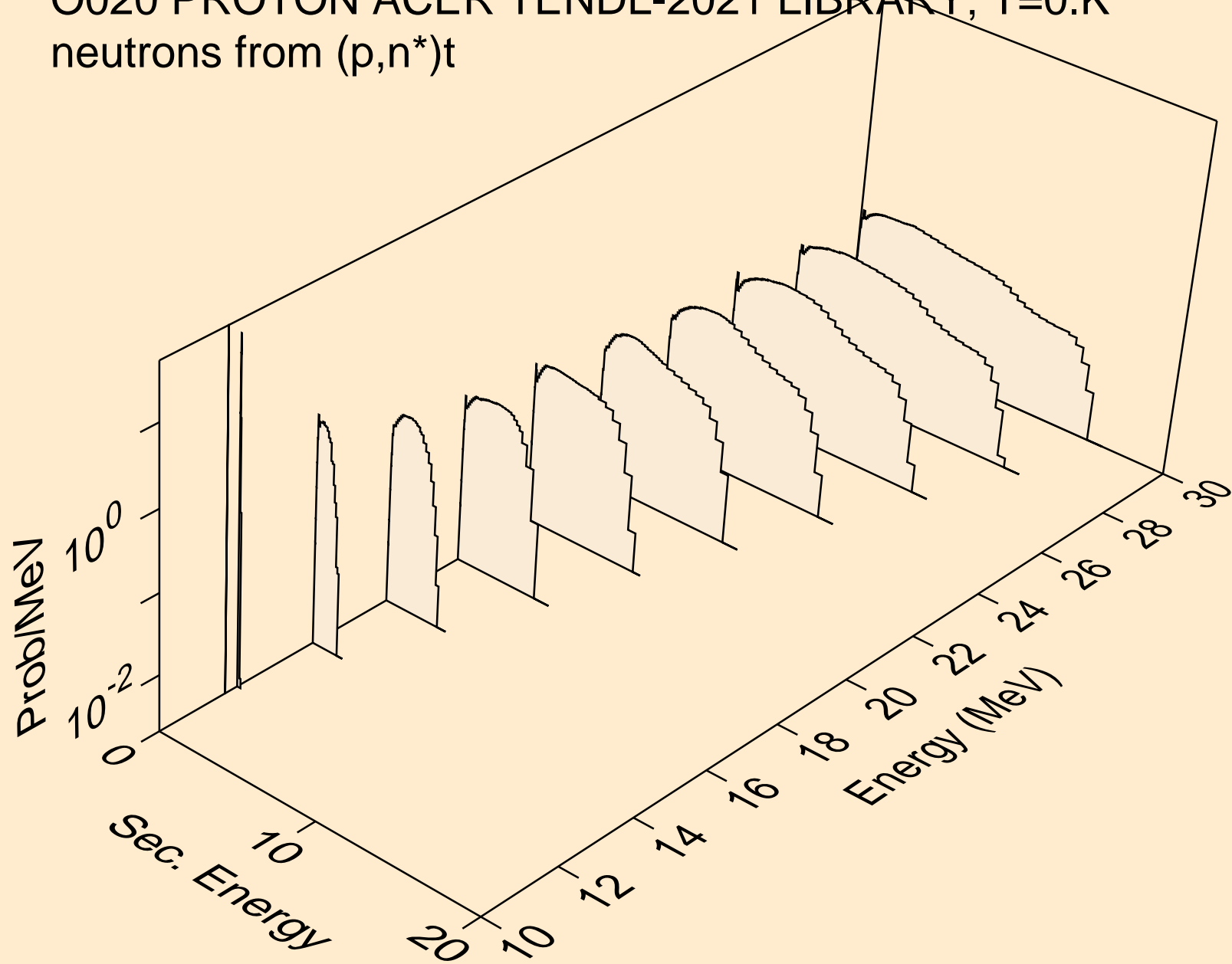

O020 PROTON ACER TENDL-2021 LIBRARY; T=0.K  
neutrons from (p,n\*)he3

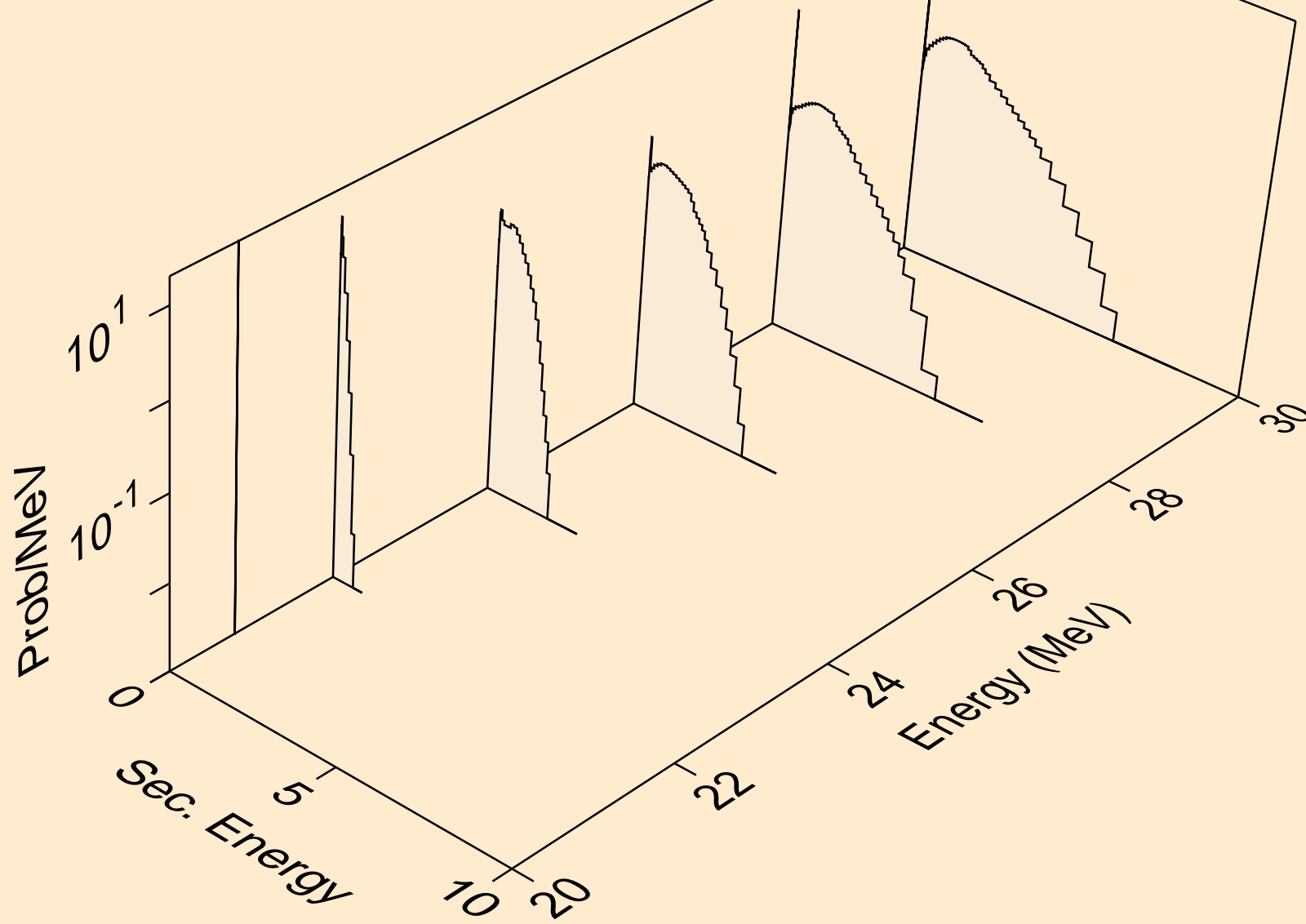

O020 PROTON ACER TENDL-2021 LIBRARY; T=0.K  
neutrons from (p,4n)

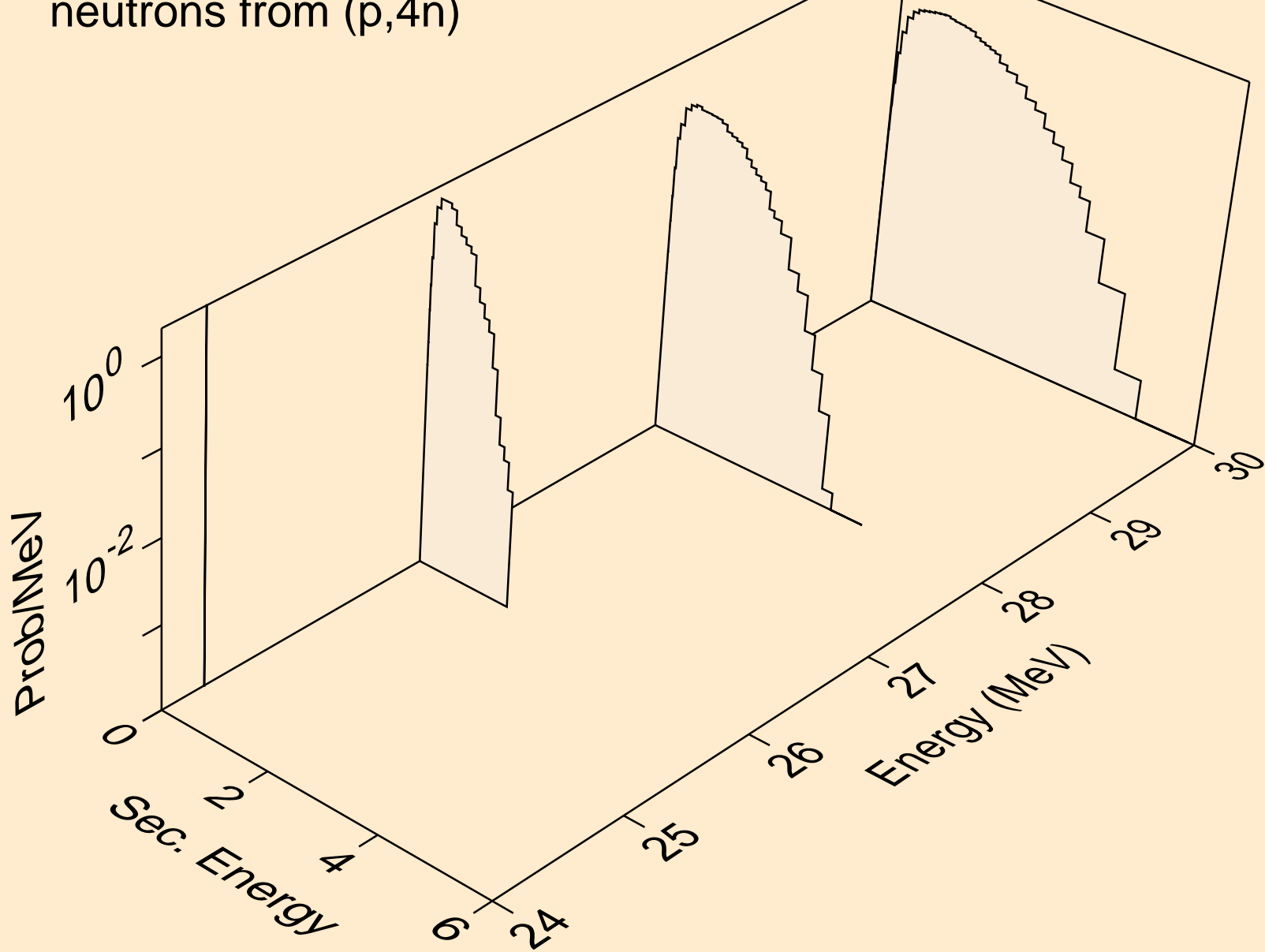

O020 PROTON ACER TENDL-2021 LIBRARY; T=0.K  
neutrons from (p,2np)

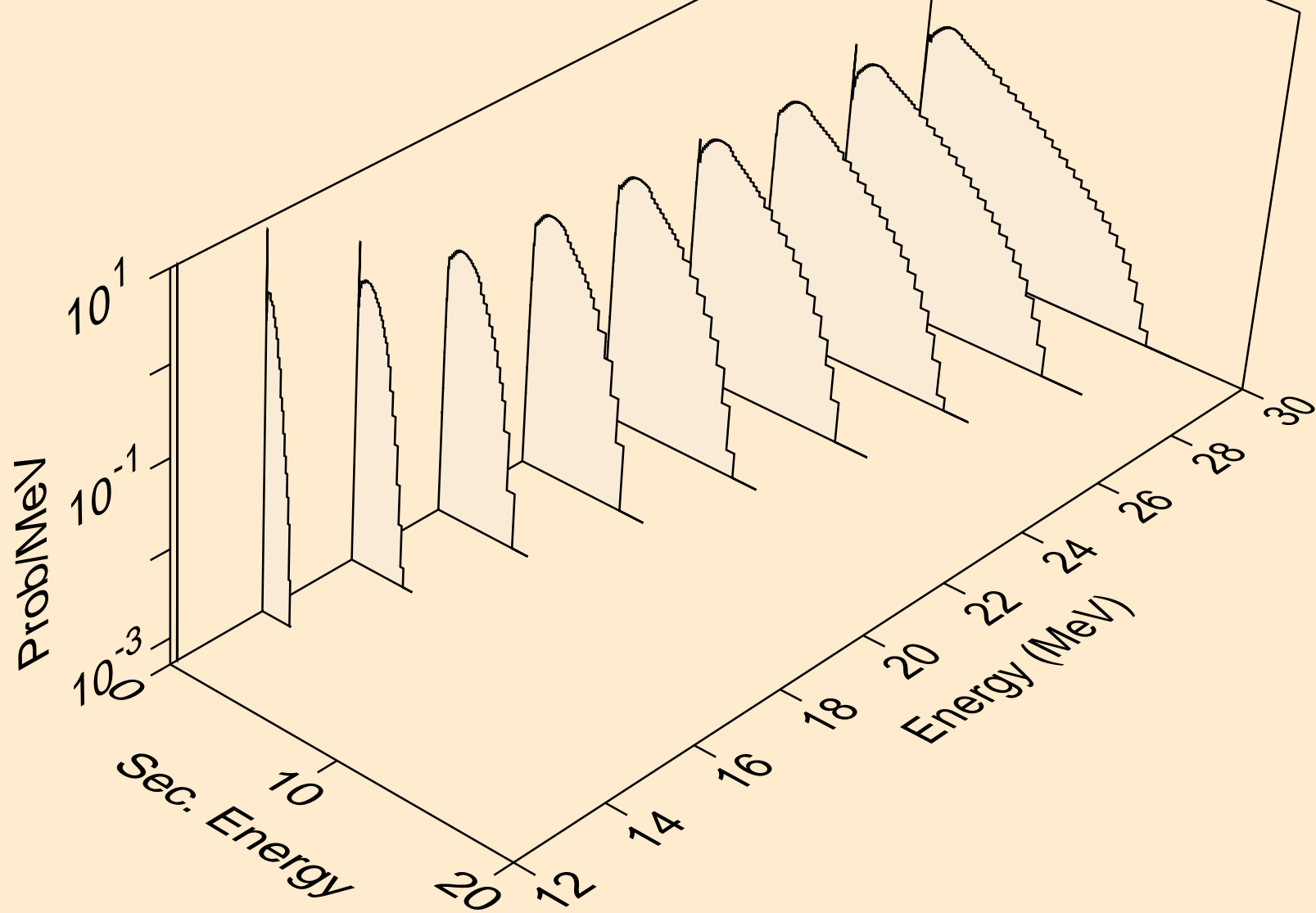



O020 PROTON ACER TENDL-2021 LIBRARY; T=0.K  
neutrons from (p,3np)

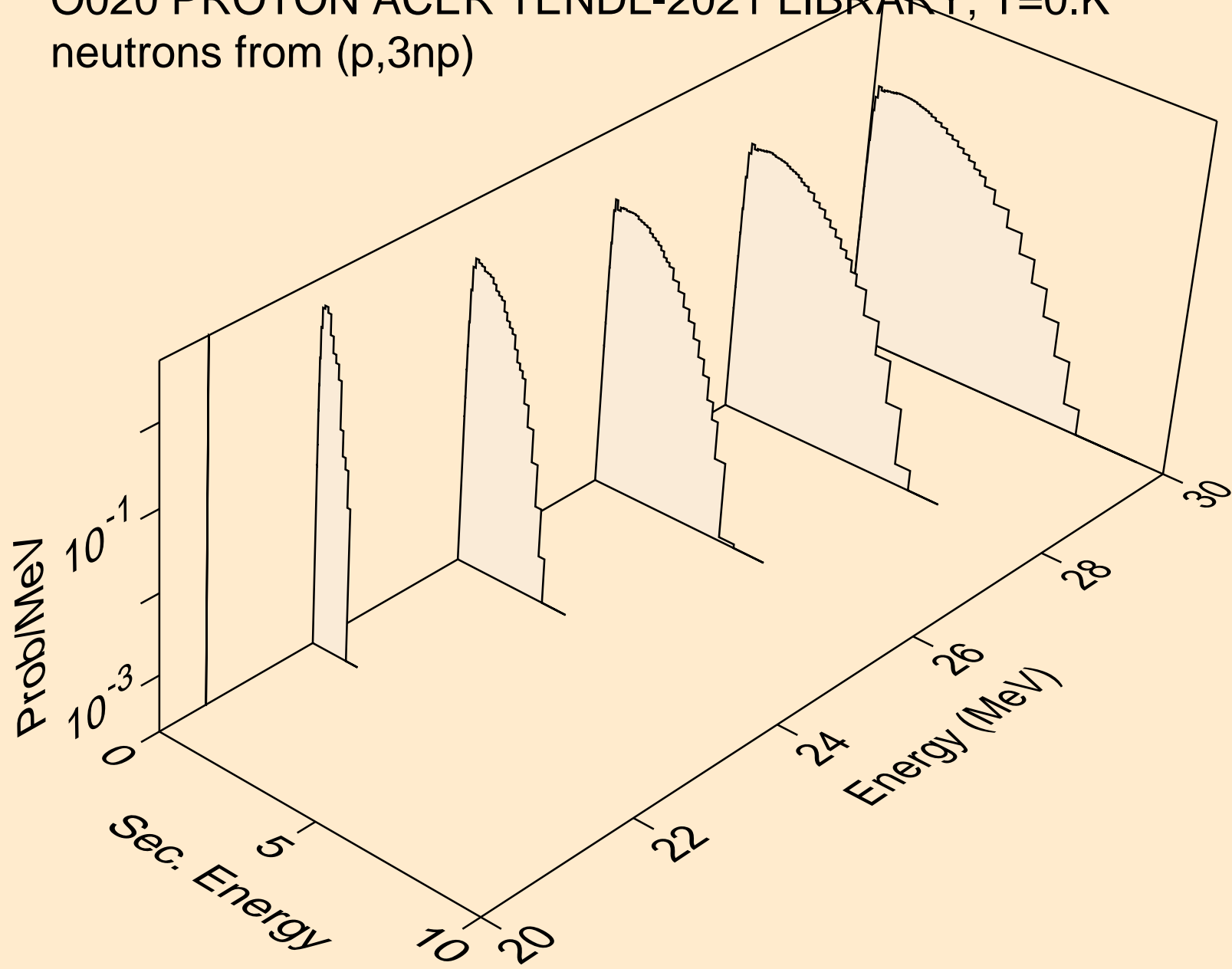

O020 PROTON ACER TENDL-2021 LIBRARY; T=0.K  
neutrons from (p,2np)

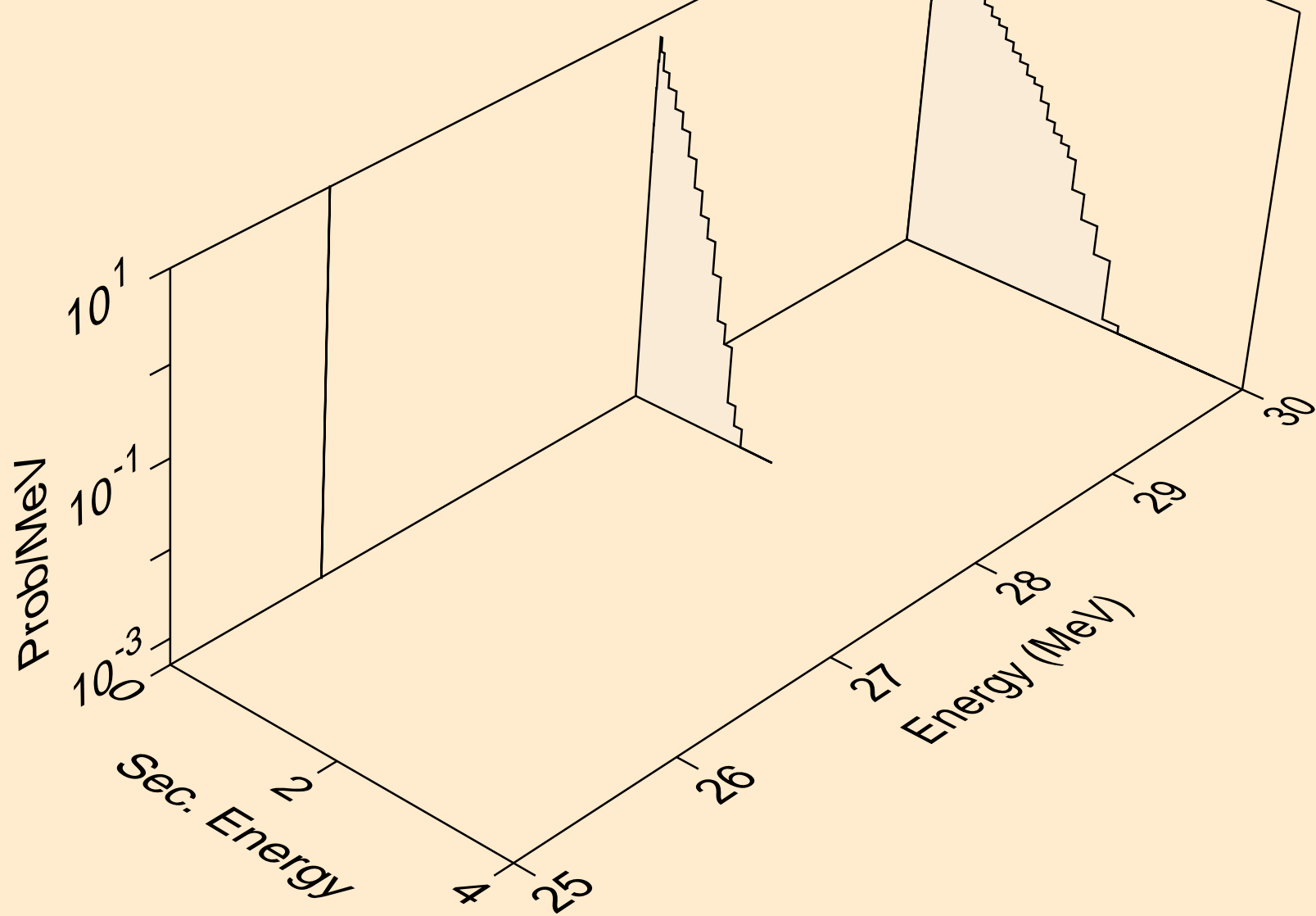

O020 PROTON ACER TENDL-2021 LIBRARY; T=0.K  
neutrons from (p,npa)

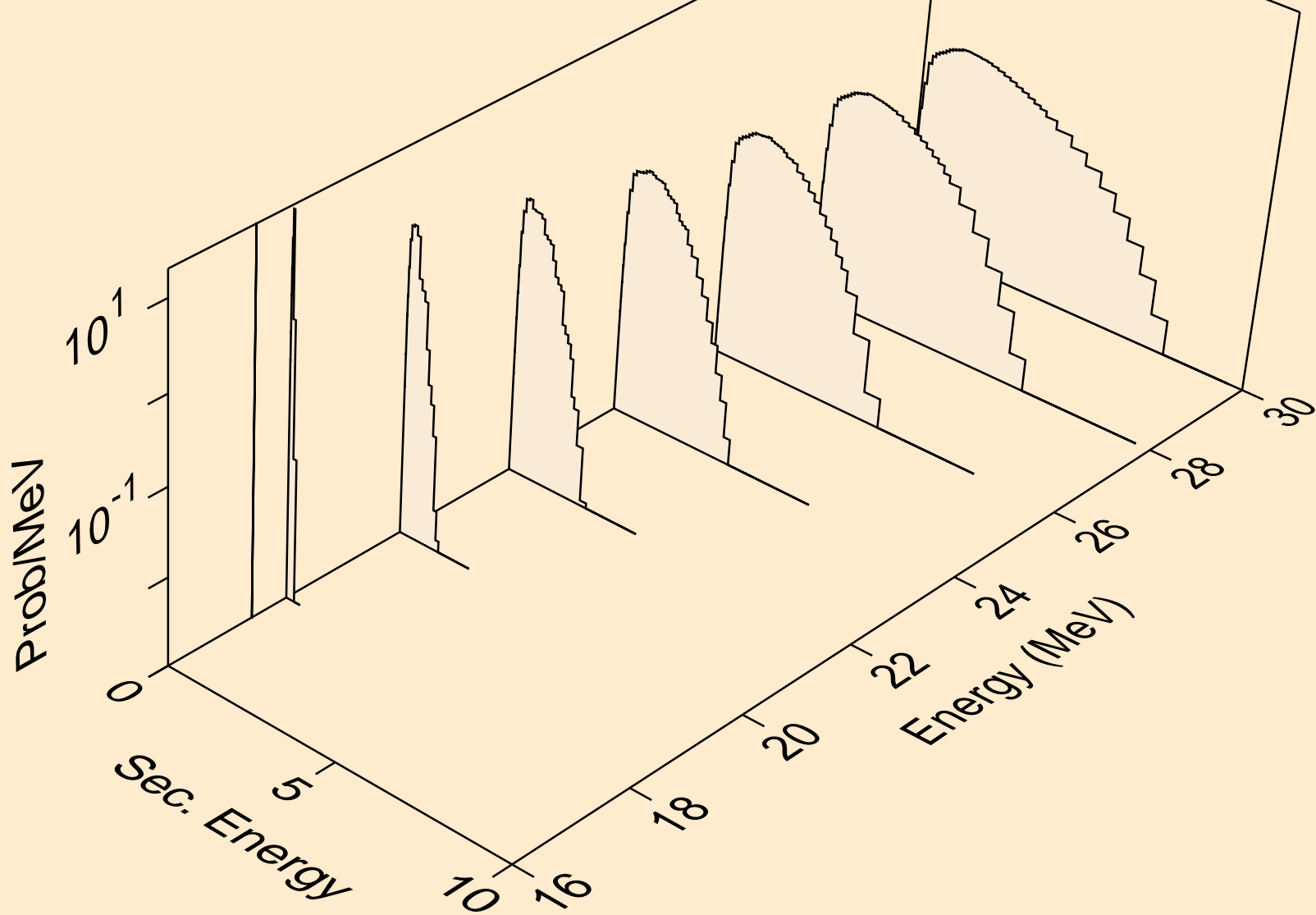

O020 PROTON ACER TENDL-2021 LIBRARY; T=0.K  
deuterons from (p,x)

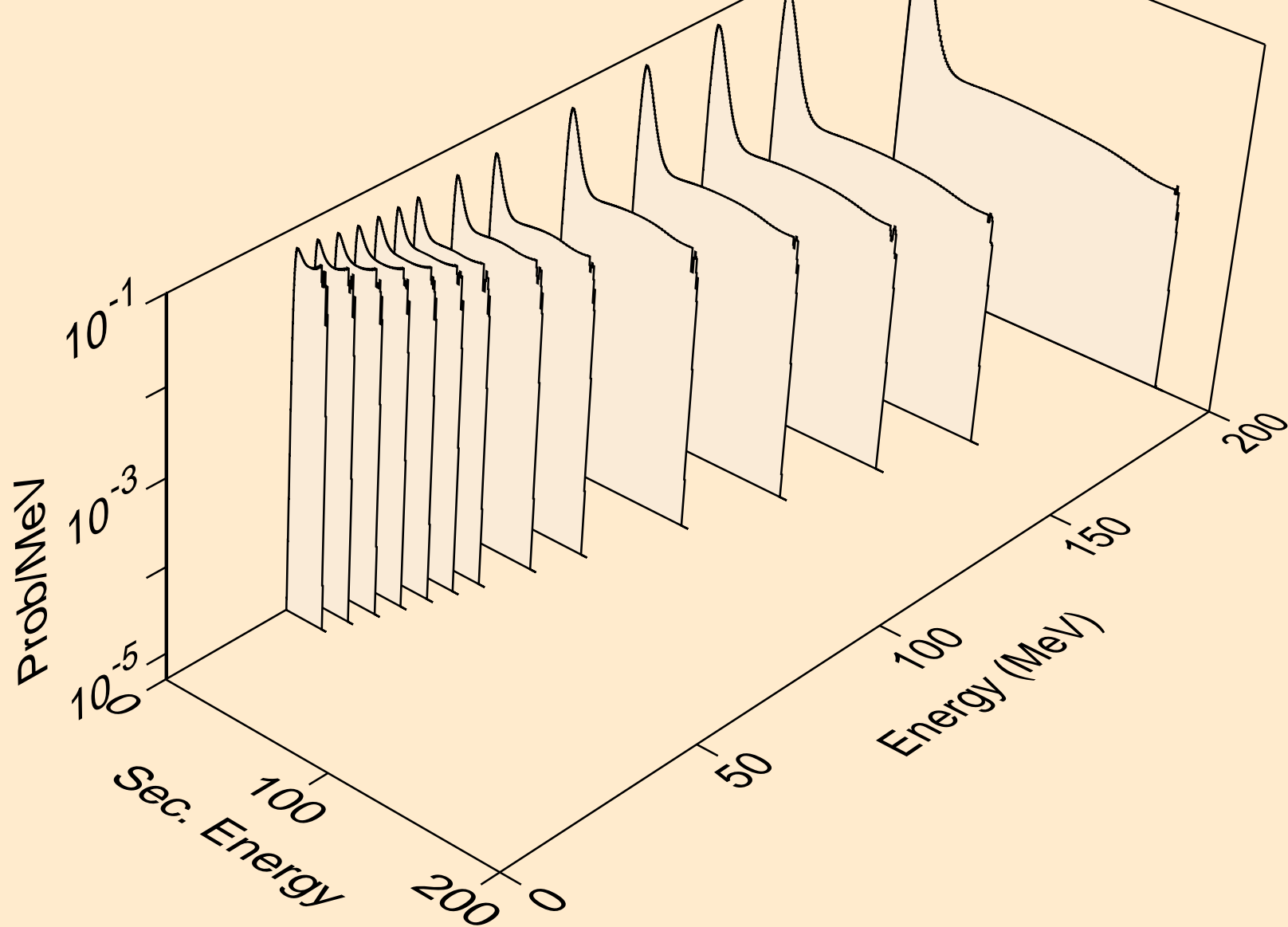

O020 PROTON ACER TENDL-2021 LIBRARY; T=0.K  
deuterons from (p,2nd)

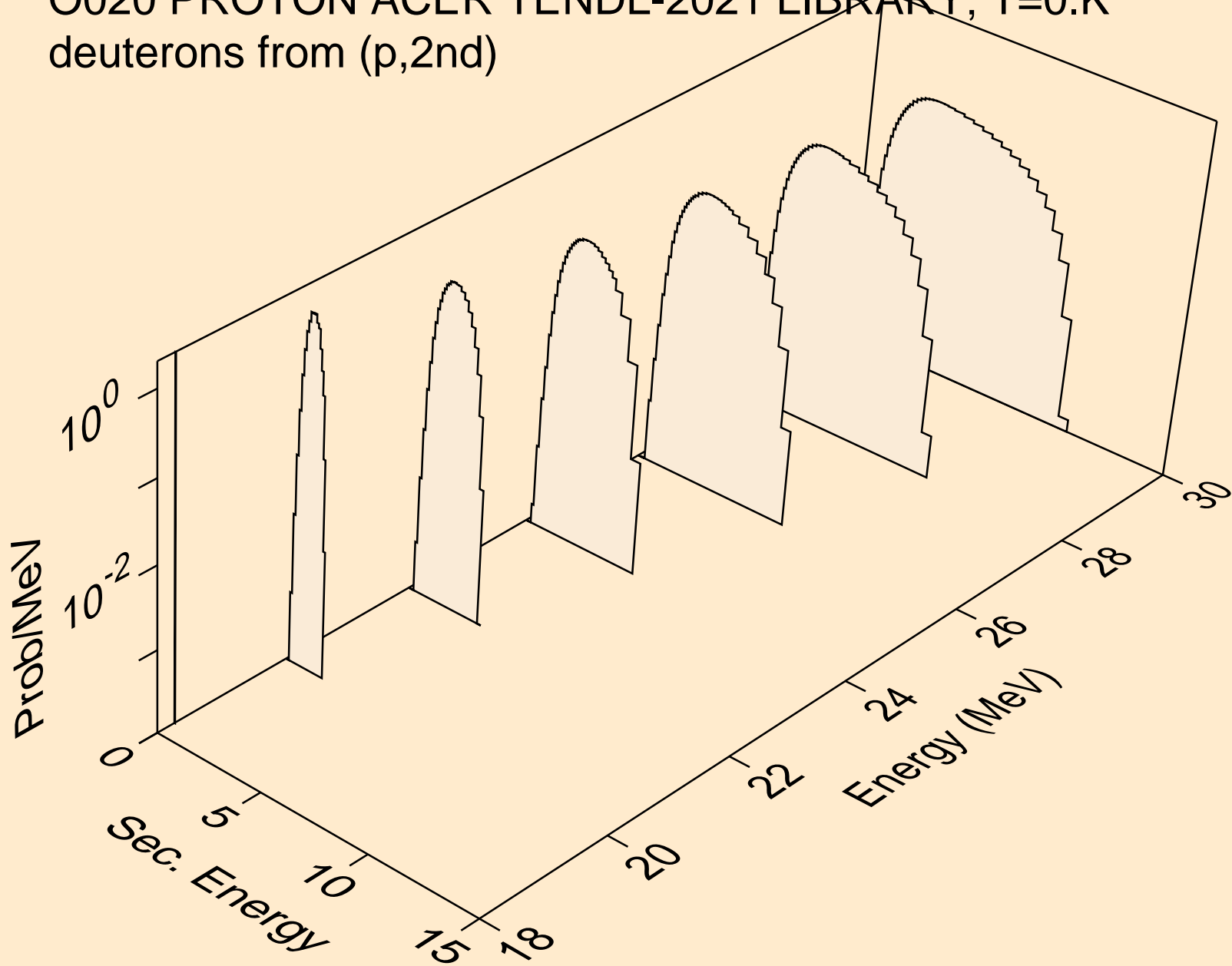

O020 PROTON ACER TENDL-2021 LIBRARY; T=0.K  
deuterons from (p,n\*)d

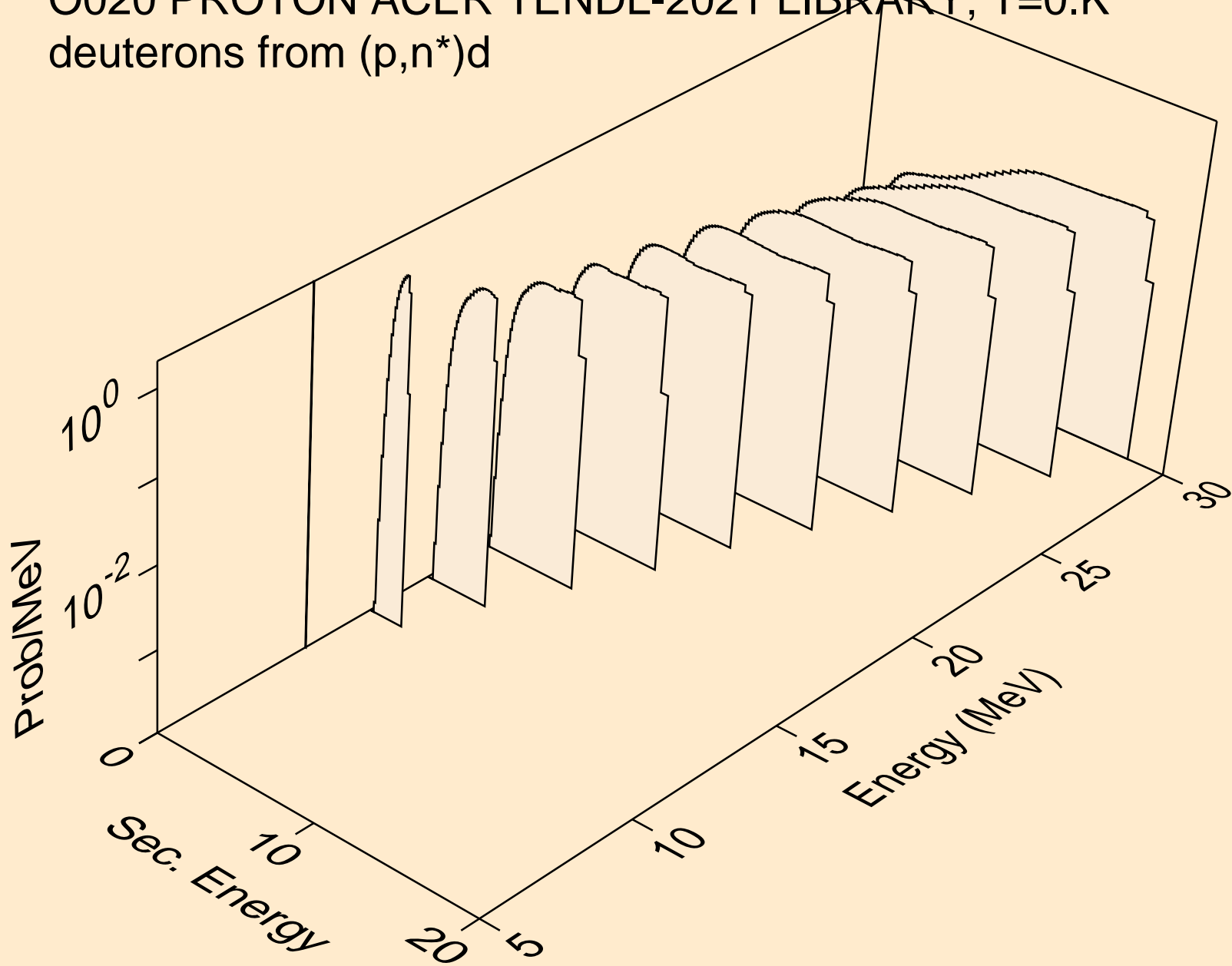

O020 PROTON ACER TENDL-2021 LIBRARY; T=0.K  
deuterons from (p,d)

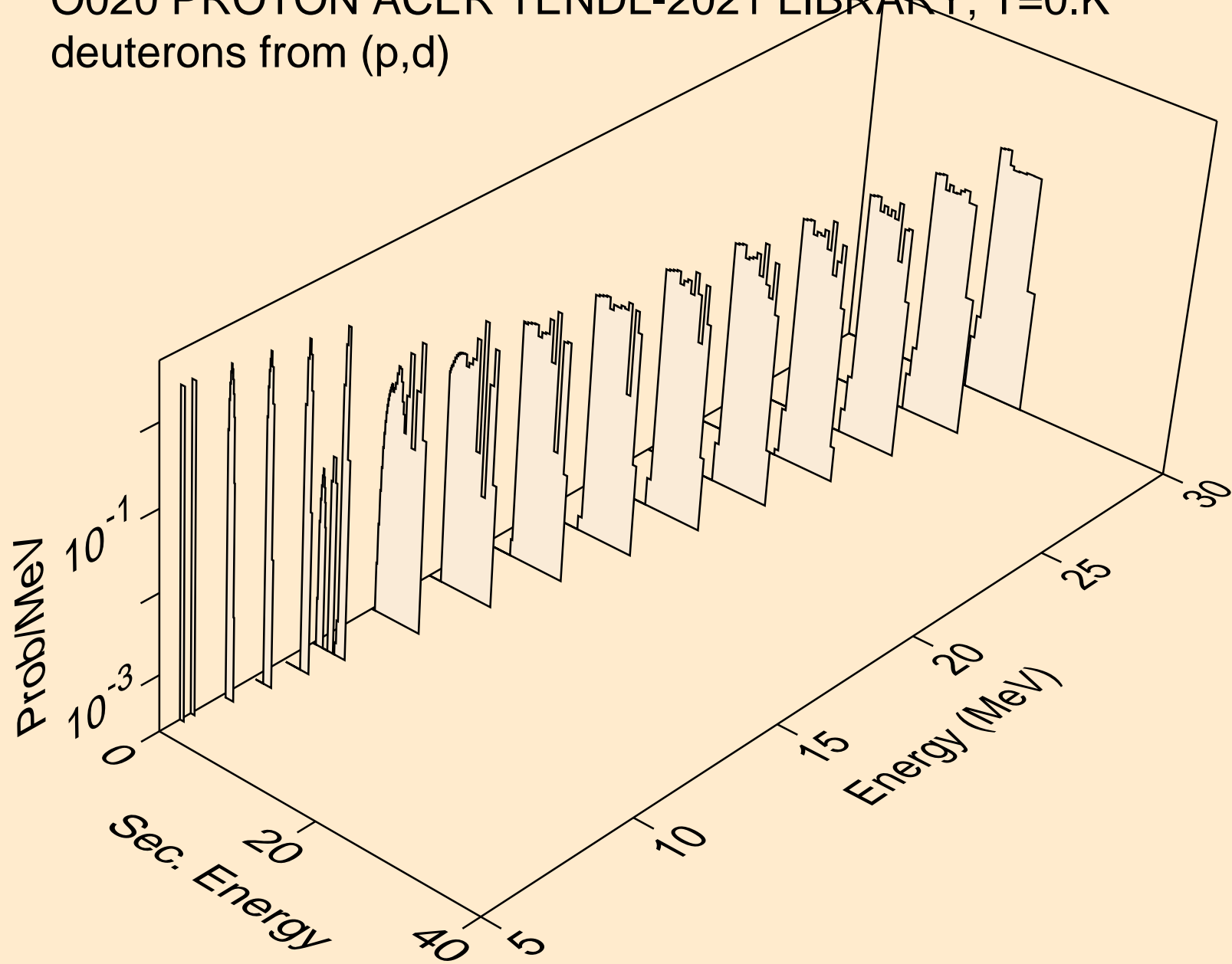

O020 PROTON ACER TENDL-2021 LIBRARY; T=0.K  
deuterons from (p,pd)

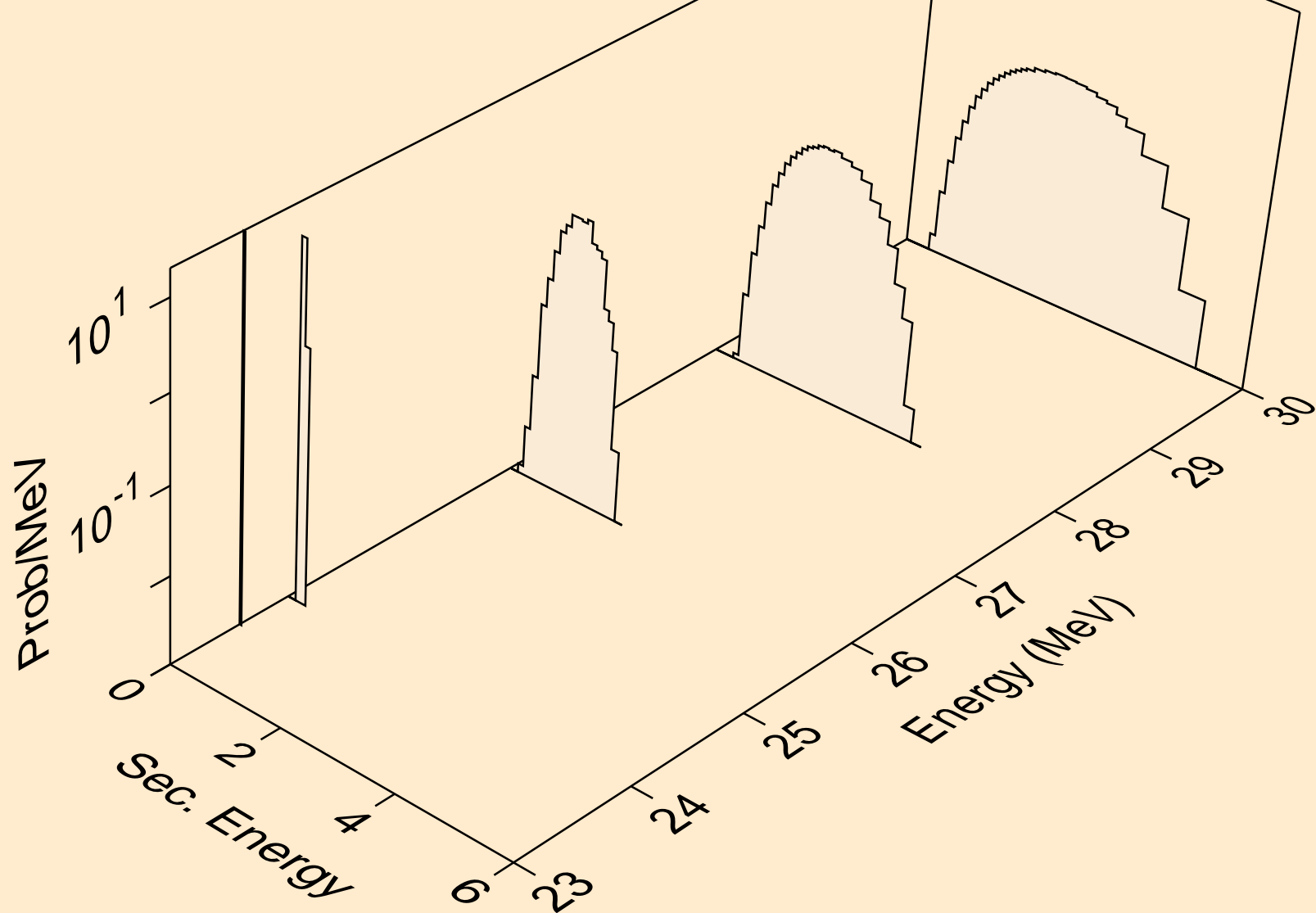



O020 PROTON ACER TENDL-2021 LIBRARY; T=0.K  
deuterons from (p,da)

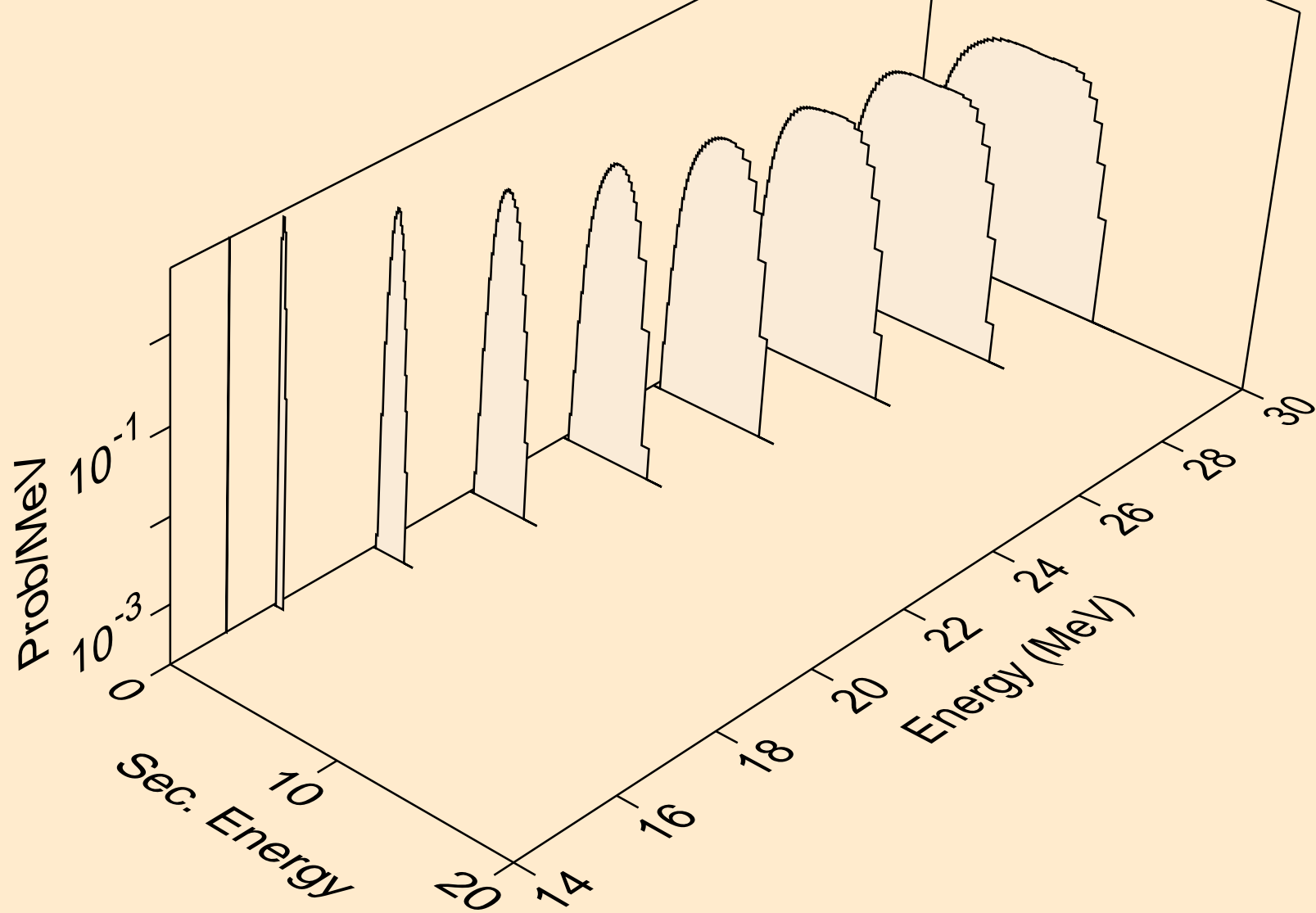

O020 PROTON ACER TENDL-2021 LIBRARY; T=0.K  
tritons from (p,x)

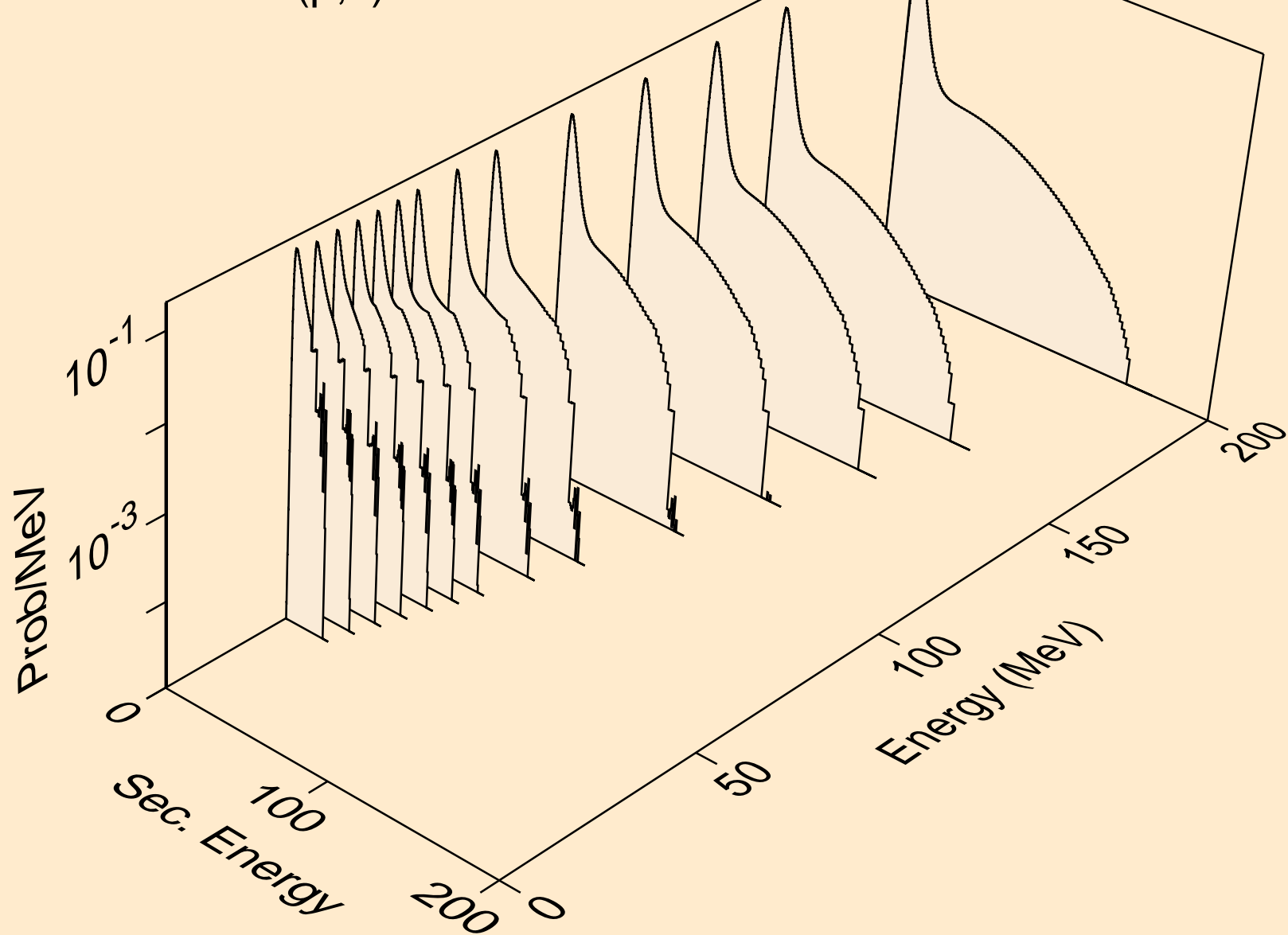

O020 PROTON ACER TENDL-2021 LIBRARY; T=0.K  
tritons from (p,n\*)t

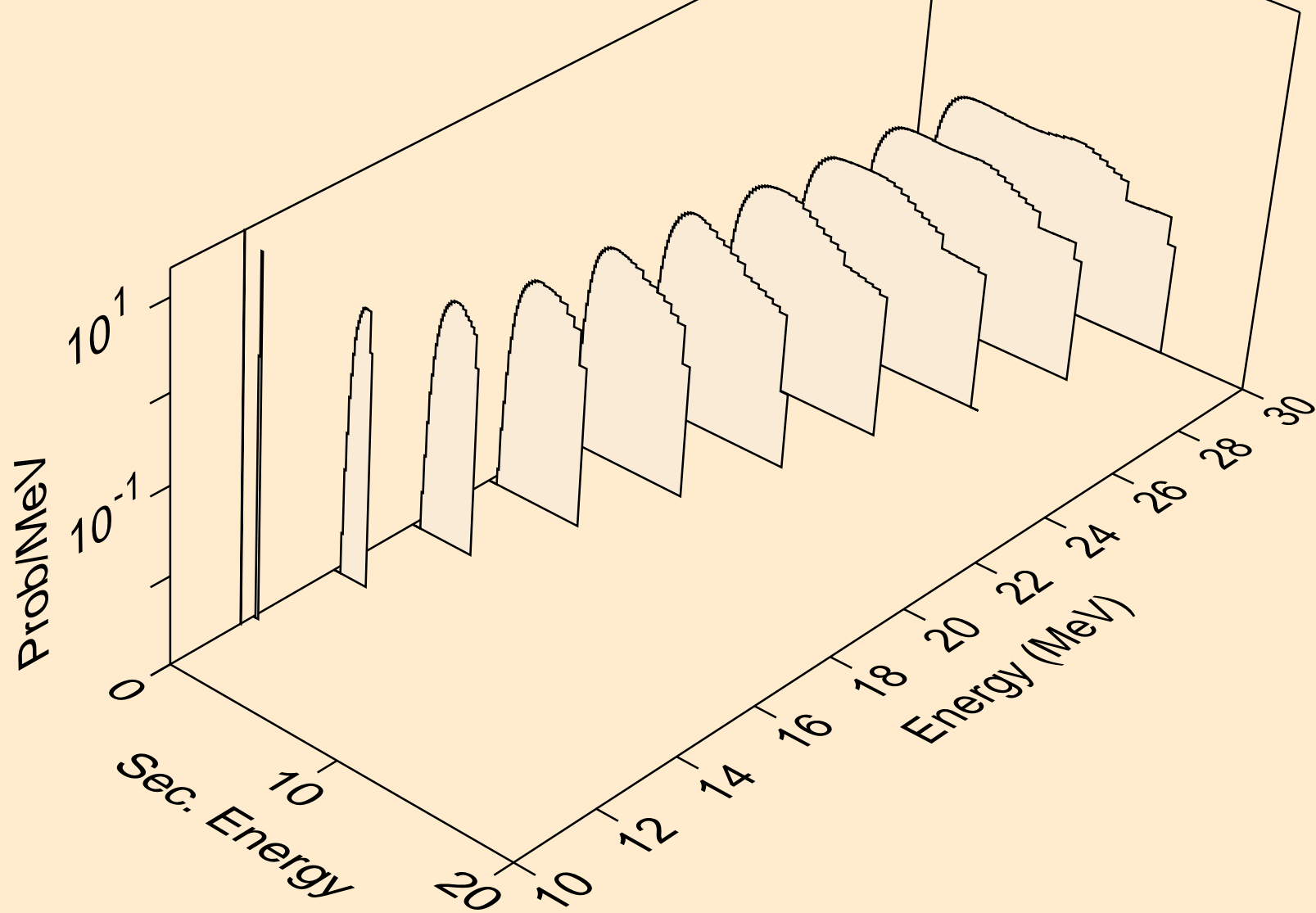

O020 PROTON ACER TENDL-2021 LIBRARY; T=0.K  
tritons from (p,t)

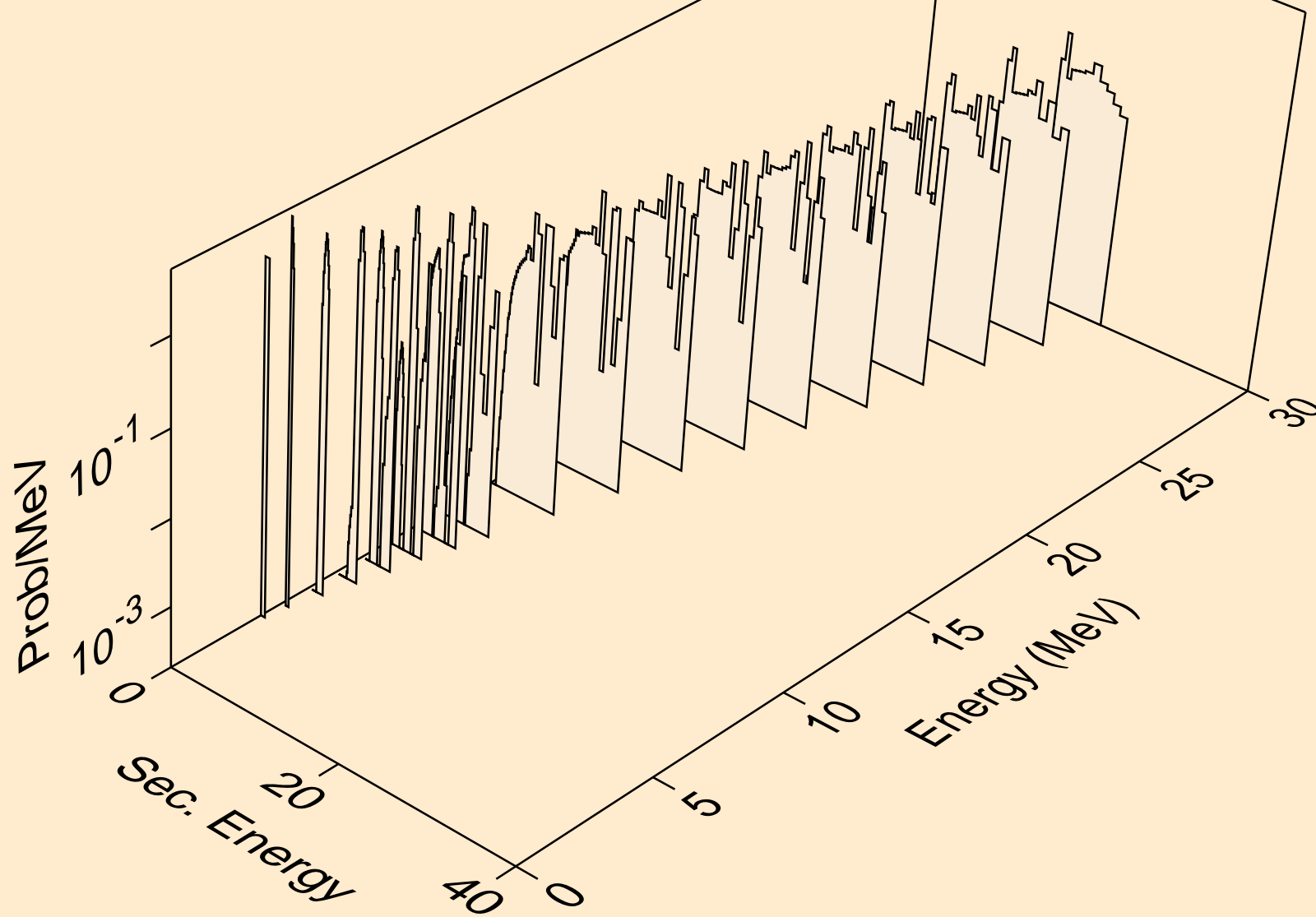

O020 PROTON ACER TENDL-2021 LIBRARY; T=0.K  
tritons from (p,t2a)

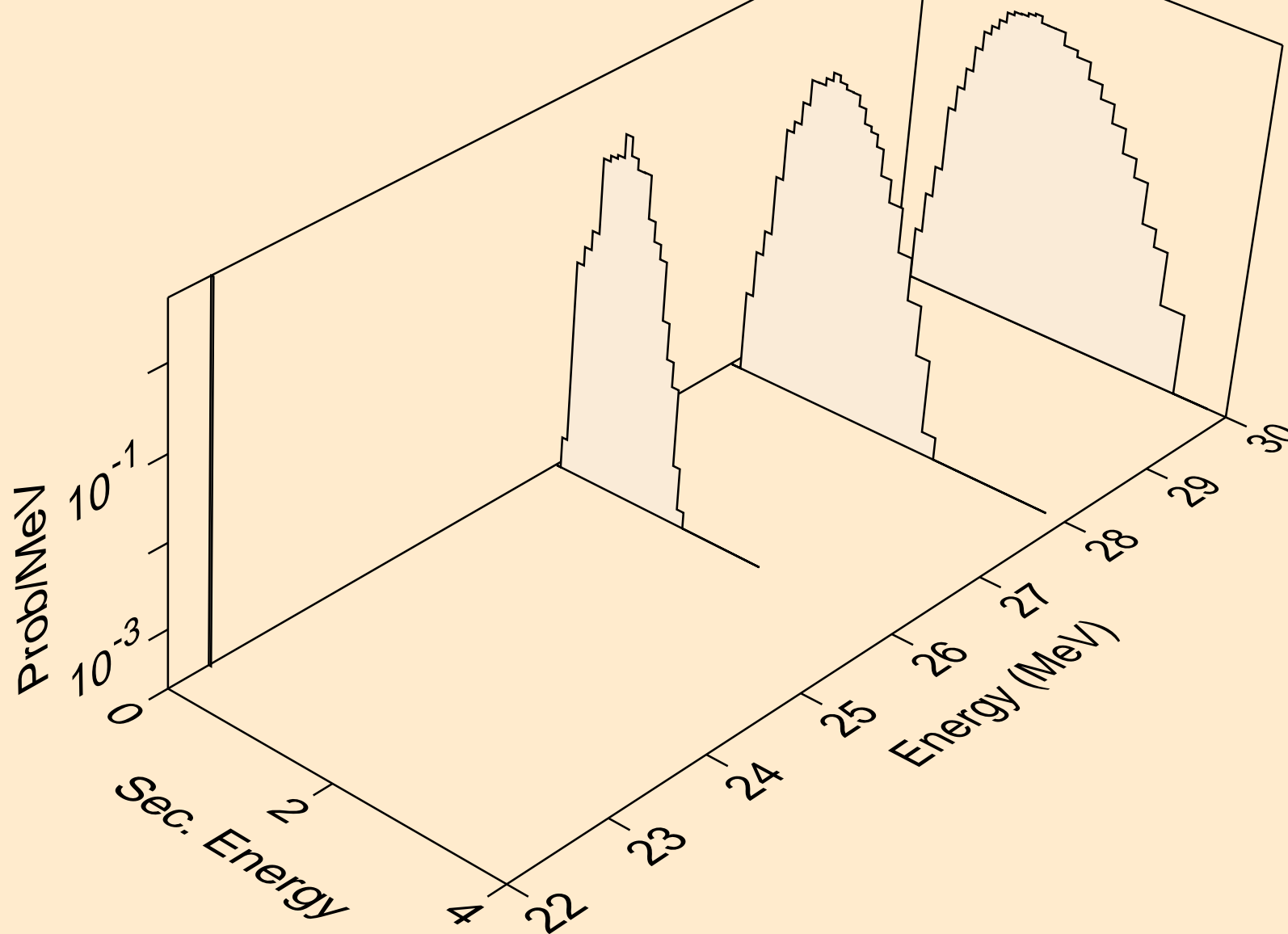

O020 PROTON ACER TENDL-2021 LIBRARY; T=0.K  
tritons from (p,pt)

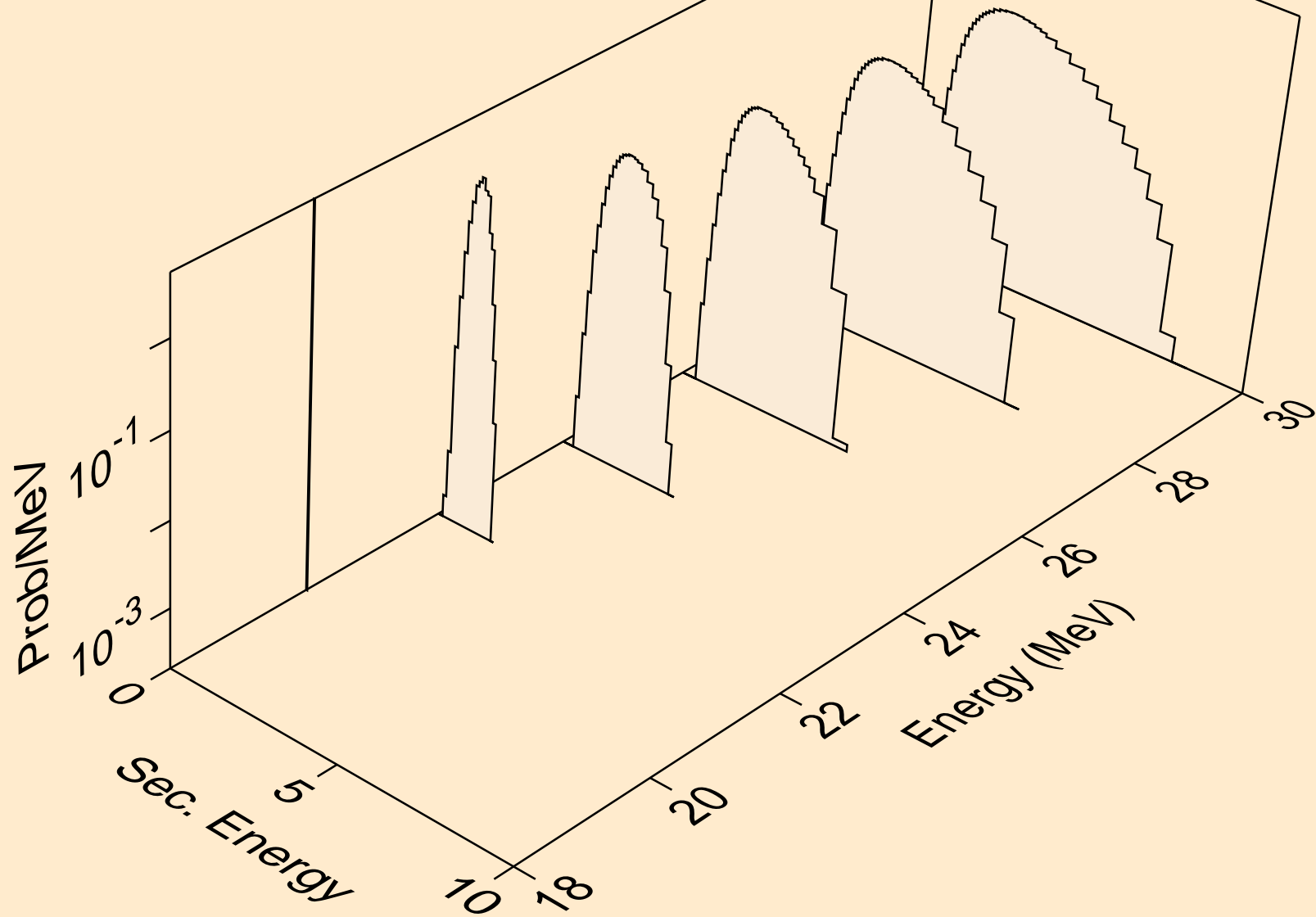

O020 PROTON ACER TENDL-2021 LIBRARY; T=0.K  
he3s from (p,x)

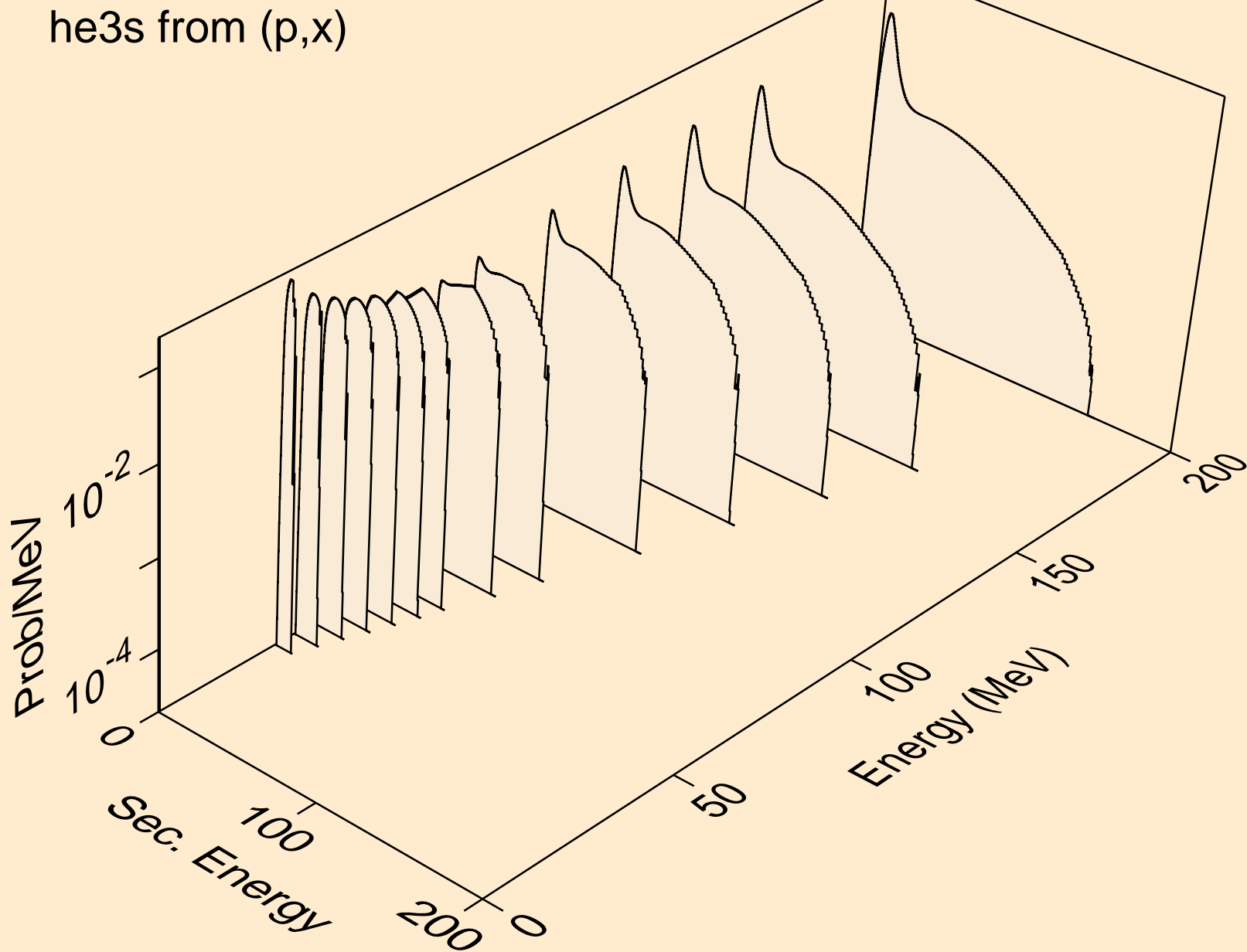

O020 PROTON ACER TENDL-2021 LIBRARY; T=0.K  
he3s from (p,n\*)he3

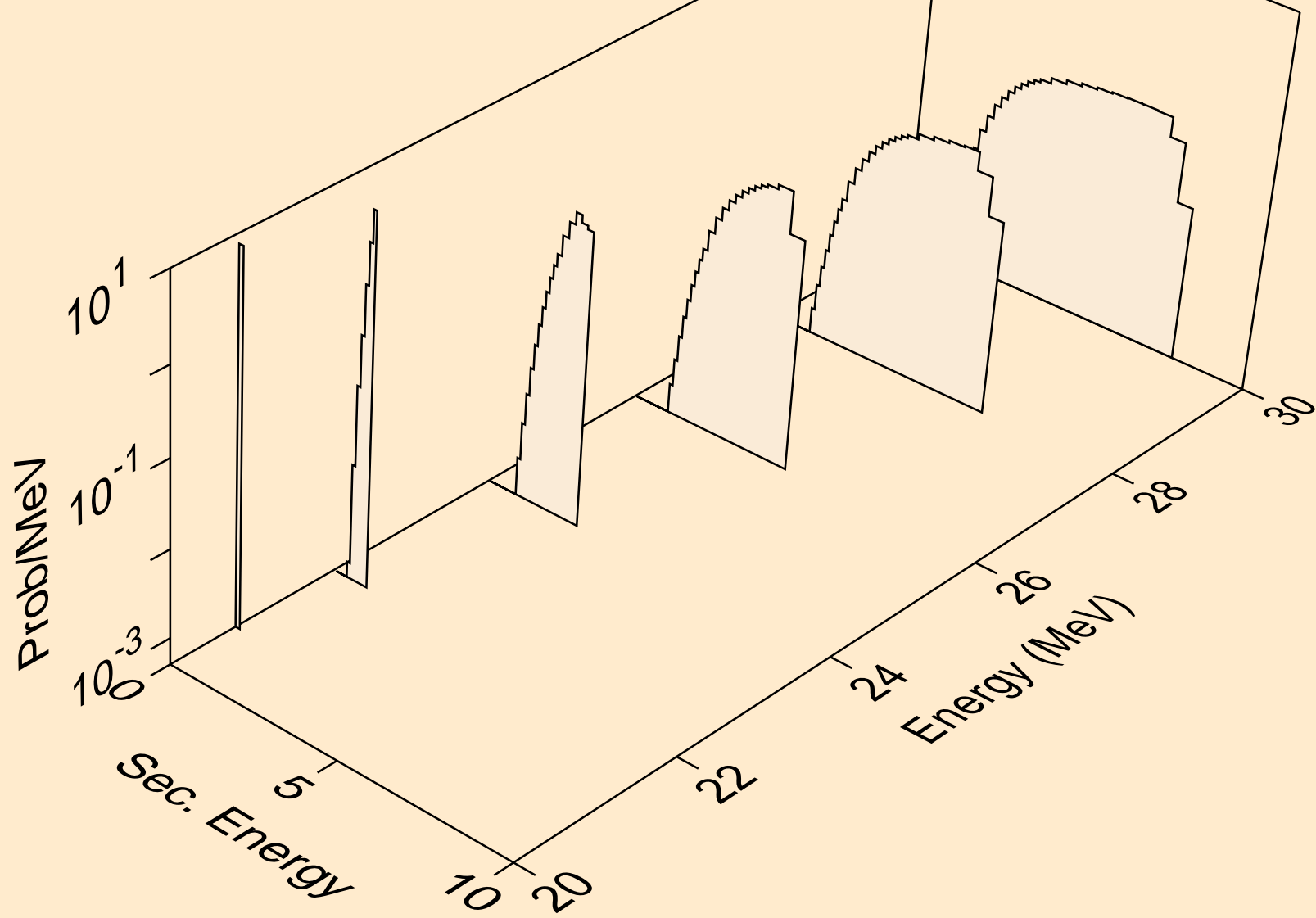



O020 PROTON ACER TENDL-2021 LIBRARY; T=0.K  
he3s from (p,he3)

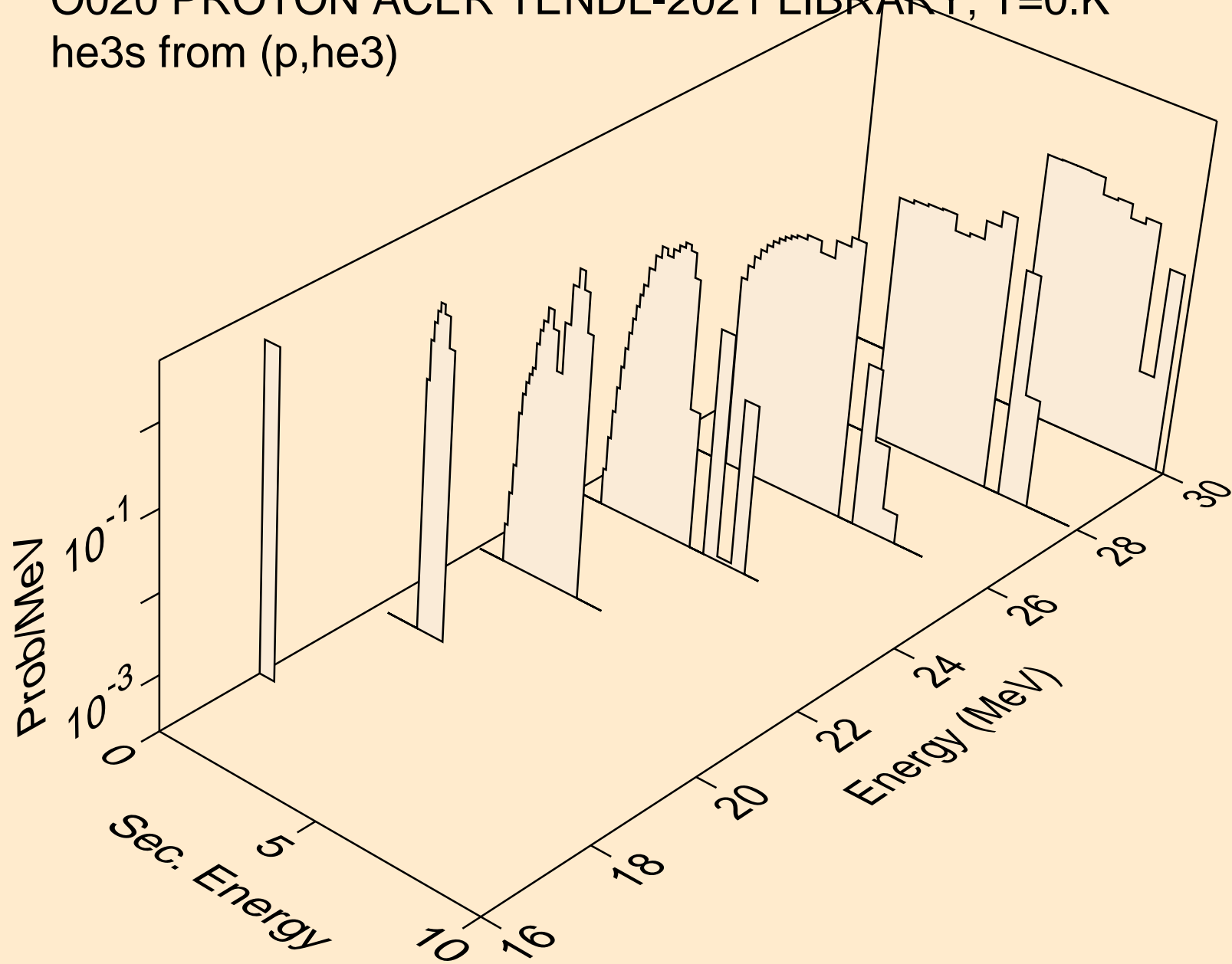

O020 PROTON ACER TENDL-2021 LIBRARY; T=0.K  
alphas from (p,x)

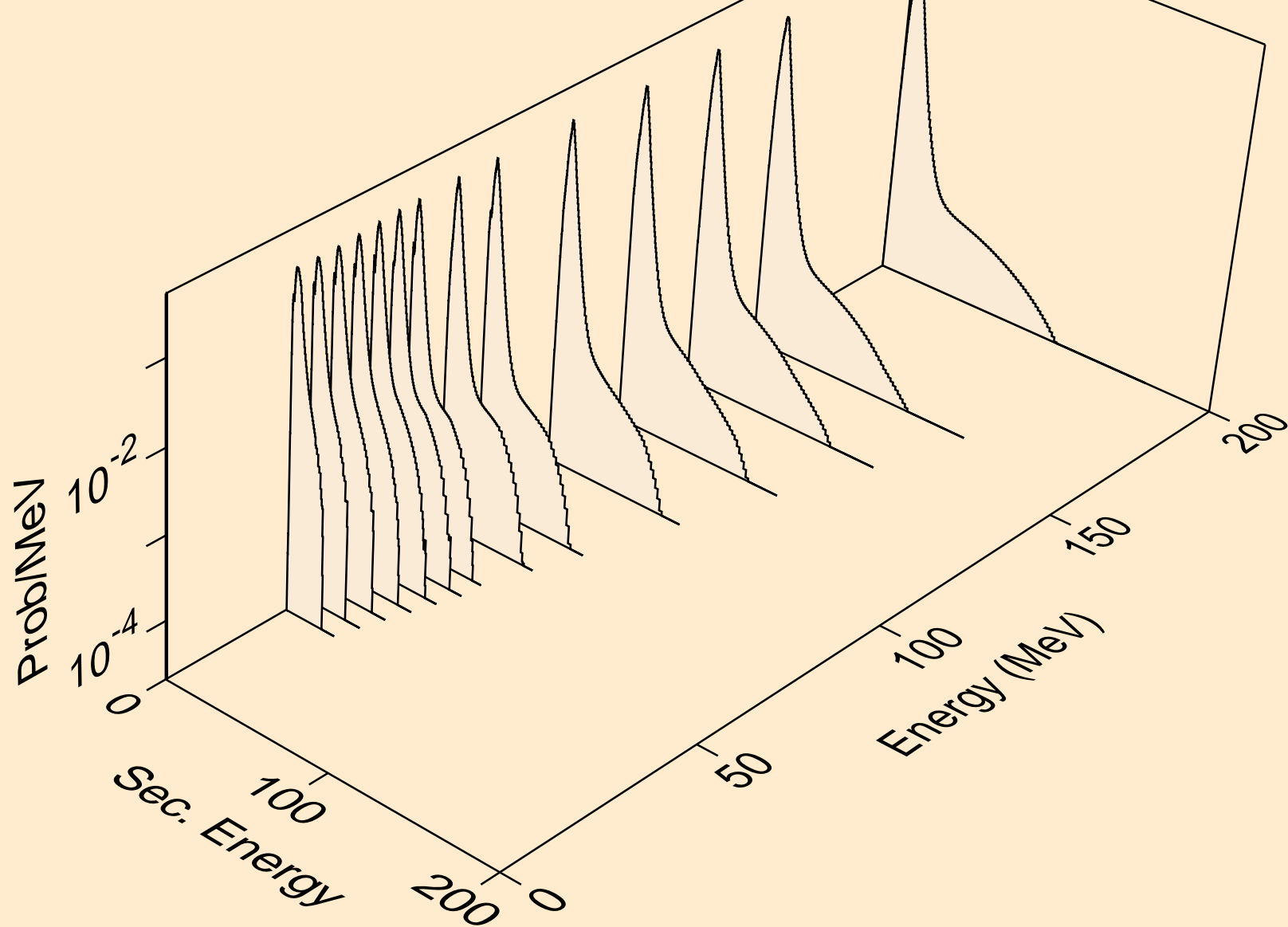

O020 PROTON ACER TENDL-2021 LIBRARY; T=0.K  
alphas from (p,n\*)a

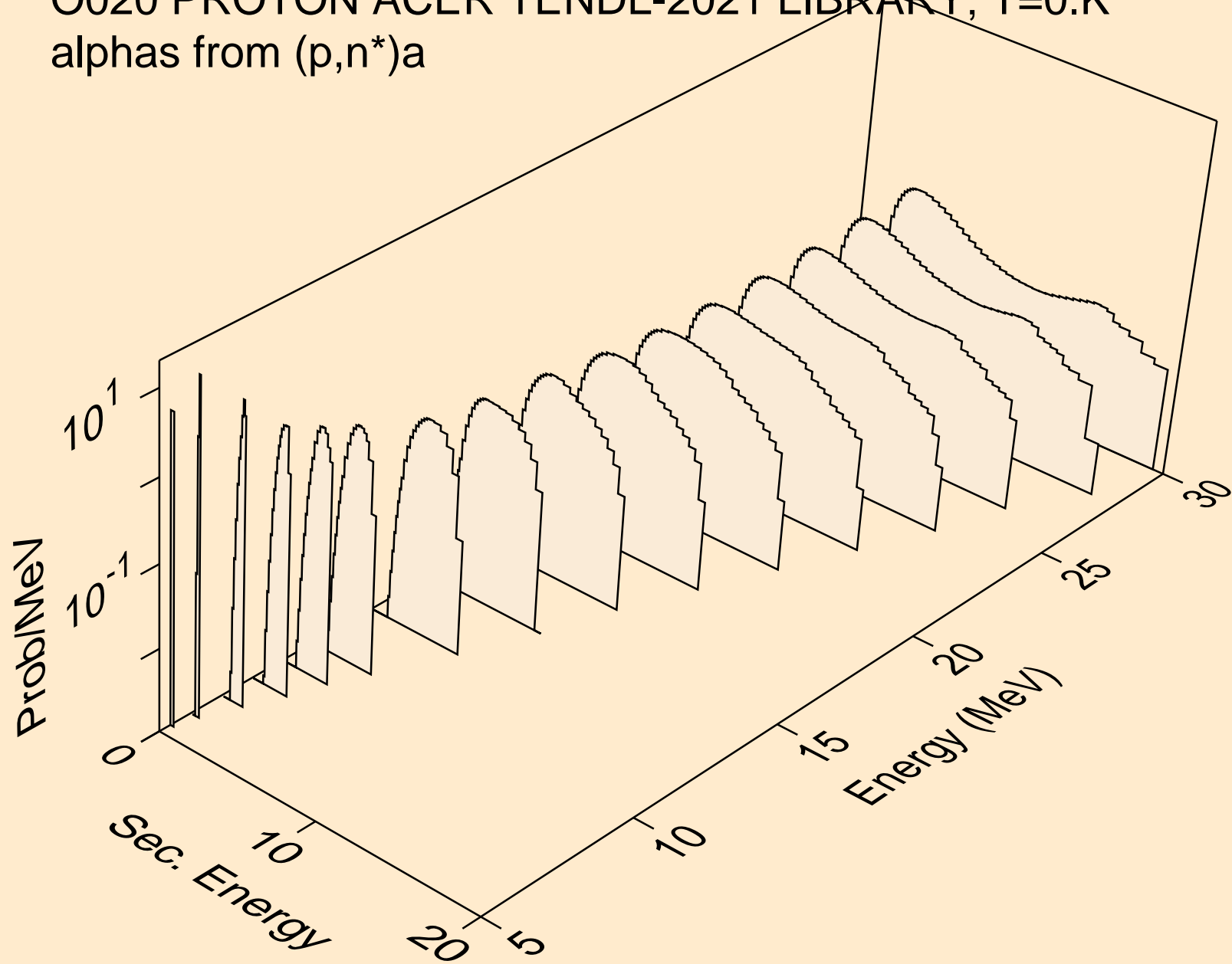

O020 PROTON ACER TENDL-2021 LIBRARY; T=0.K  
alphas from (p,2n)a

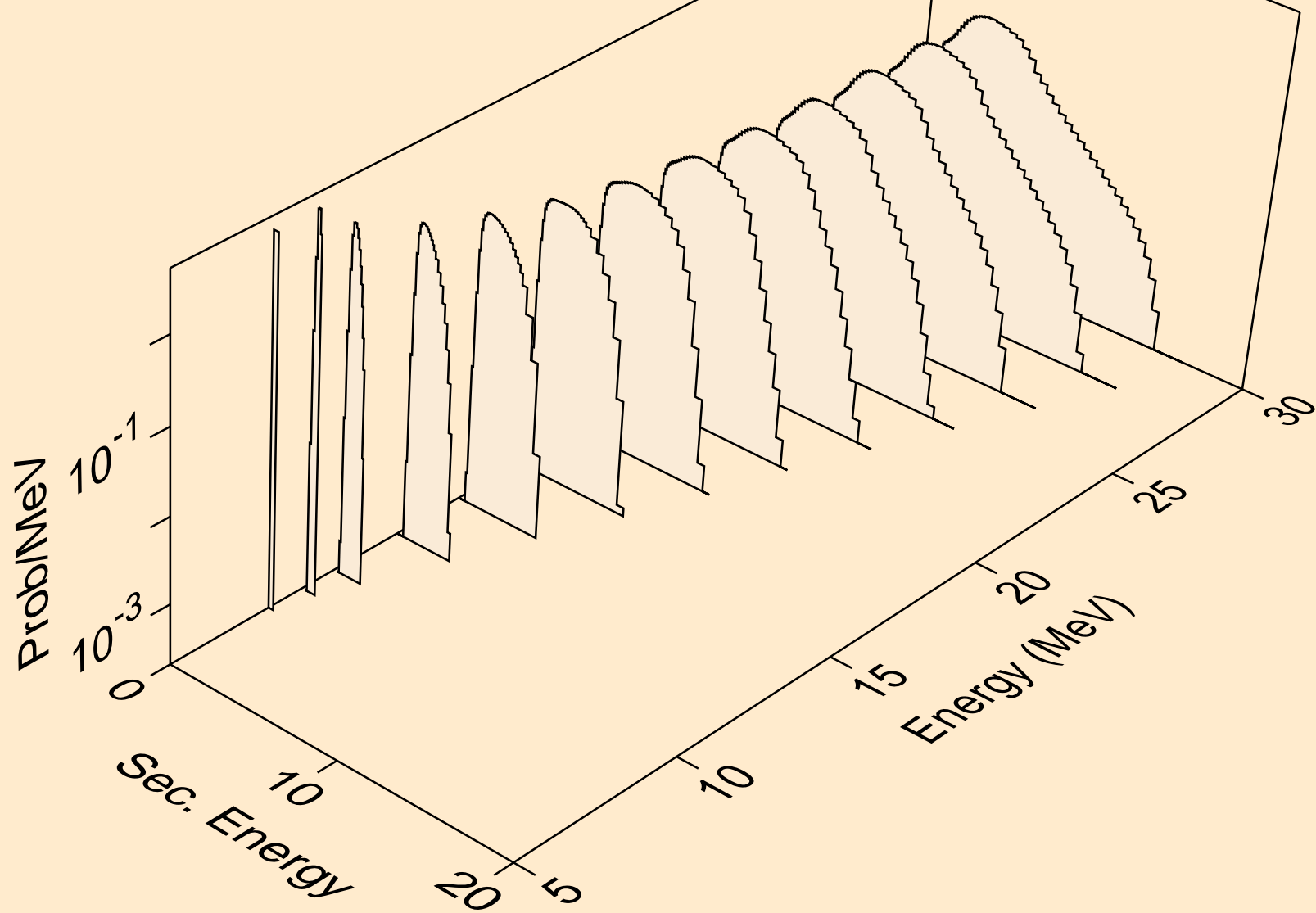

O020 PROTON ACER TENDL-2021 LIBRARY; T=0.K  
alphas from (p,3n)a

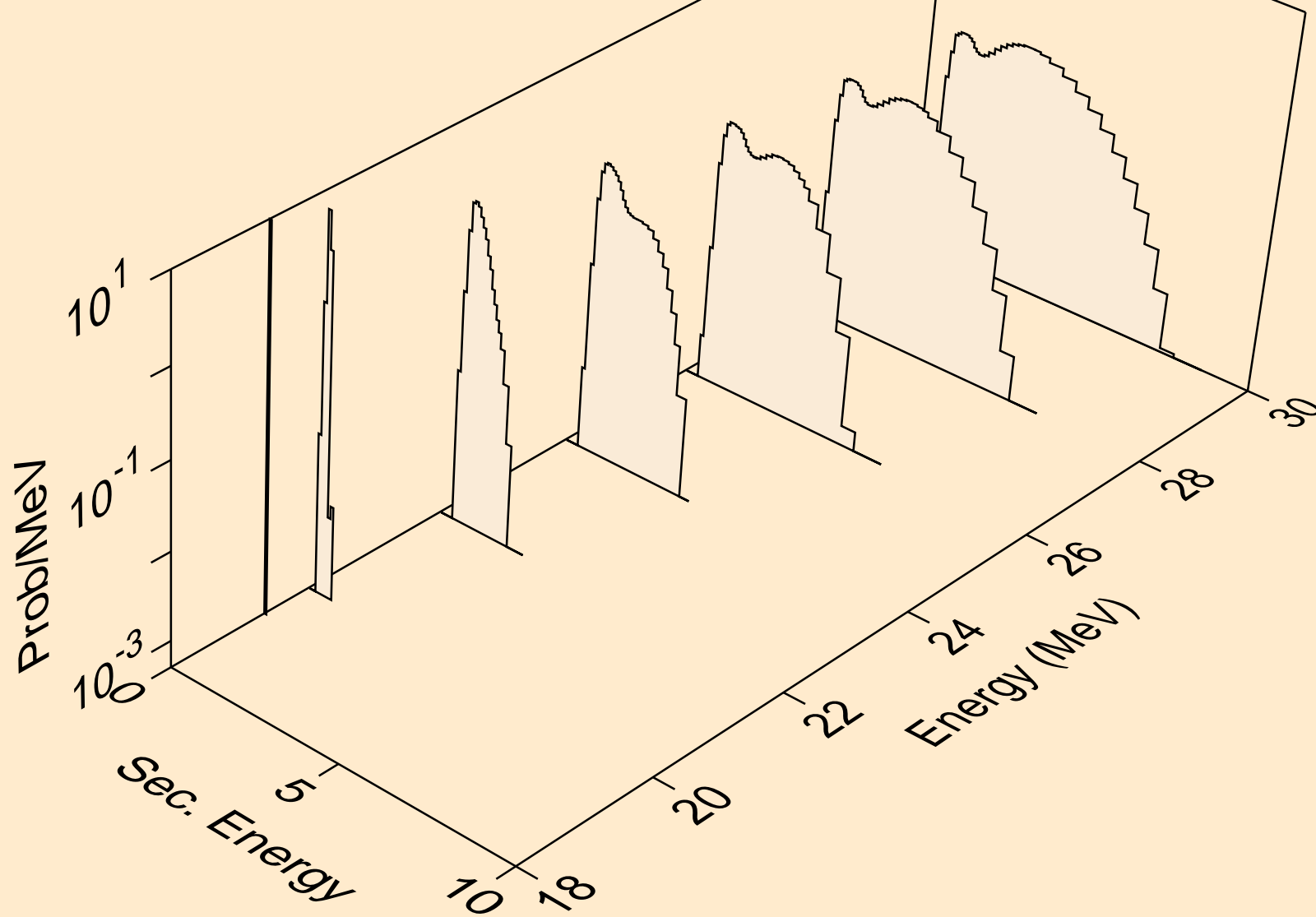

O020 PROTON ACER TENDL-2021 LIBRARY; T=0.K  
alphas from (p,n\*)2a

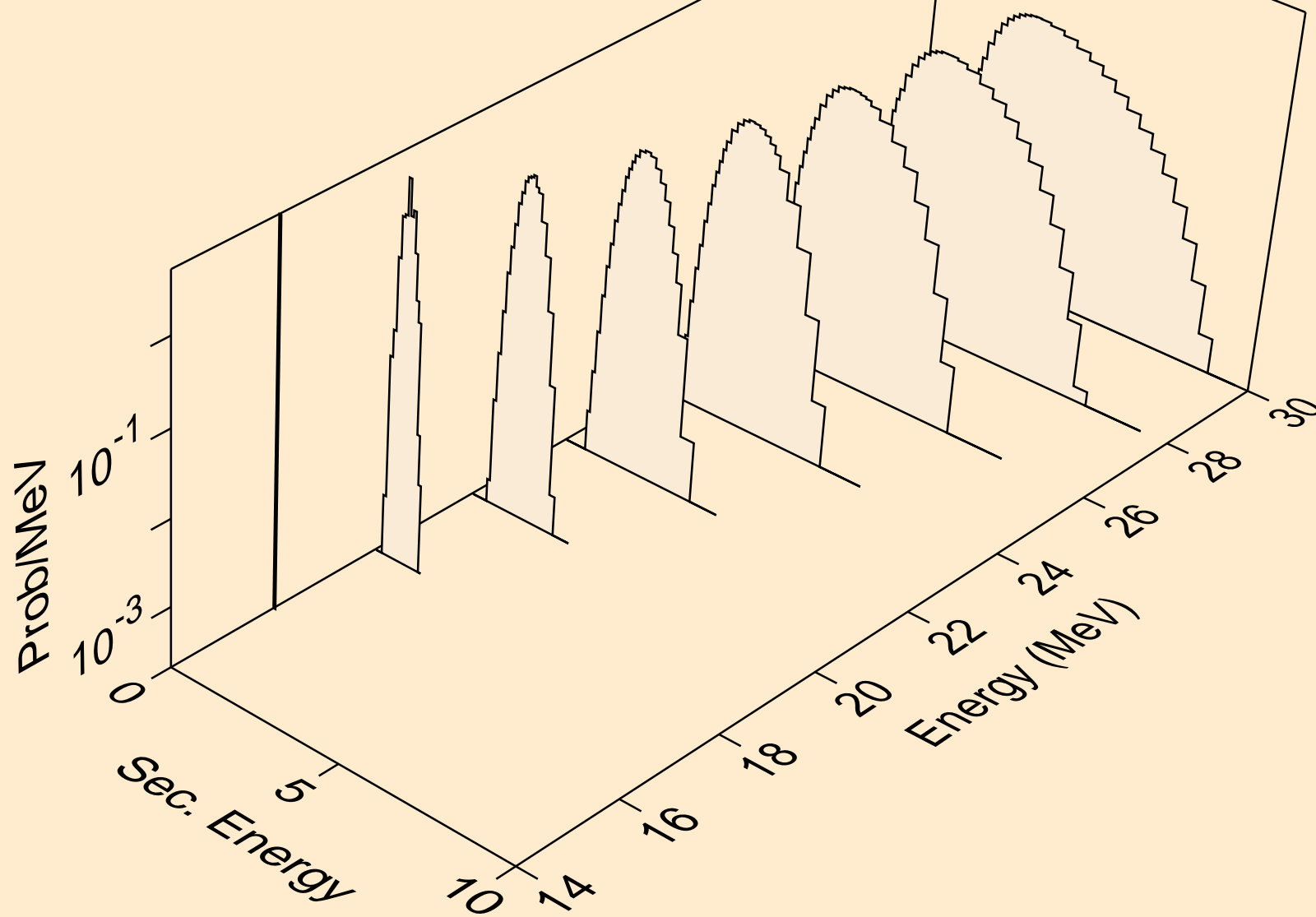

O020 PROTON ACER TENDL-2021 LIBRARY; T=0.K  
alphas from (p,2n)2a

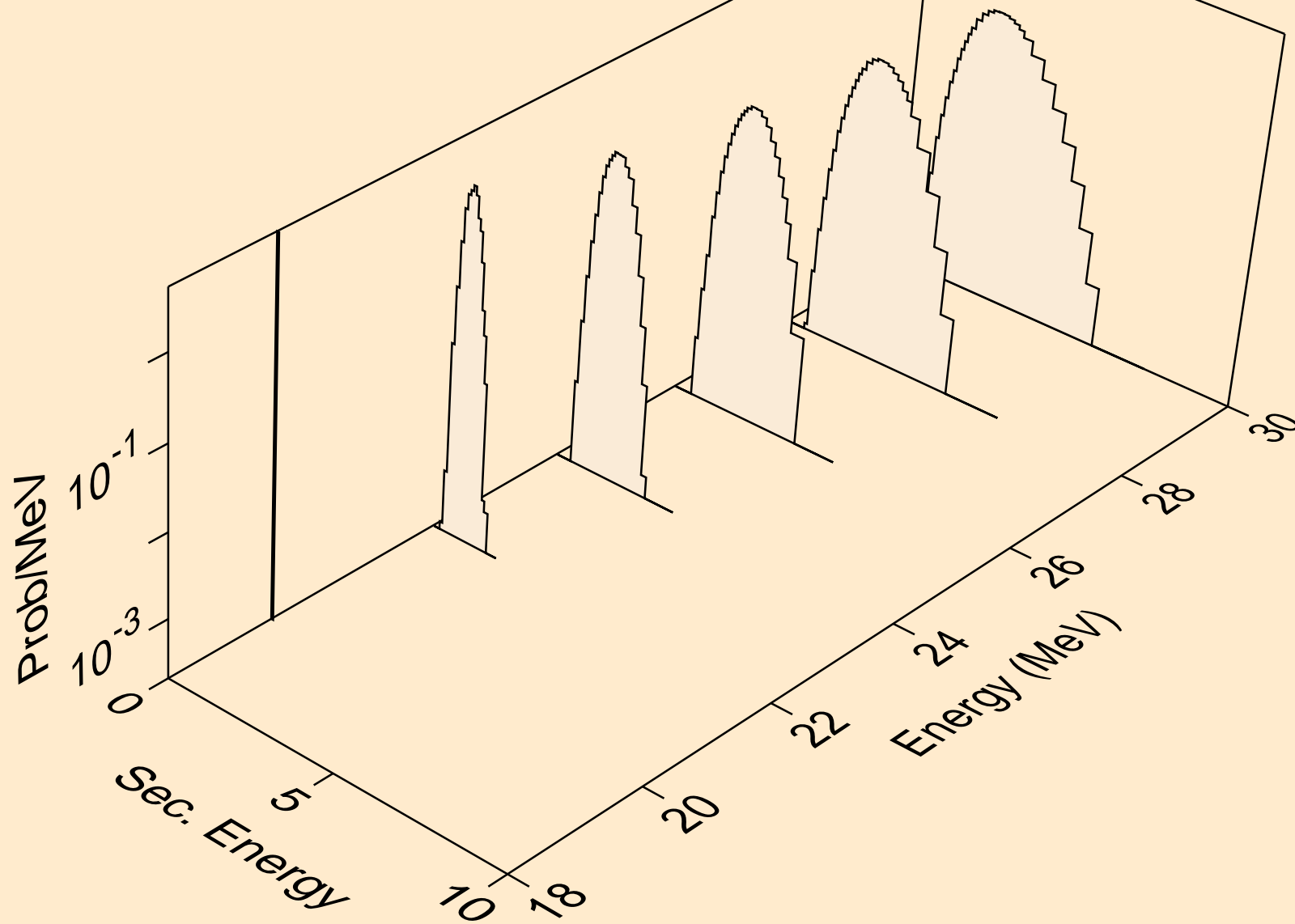

O020 PROTON ACER TENDL-2021 LIBRARY; T=0.K  
alphas from (p,npa)

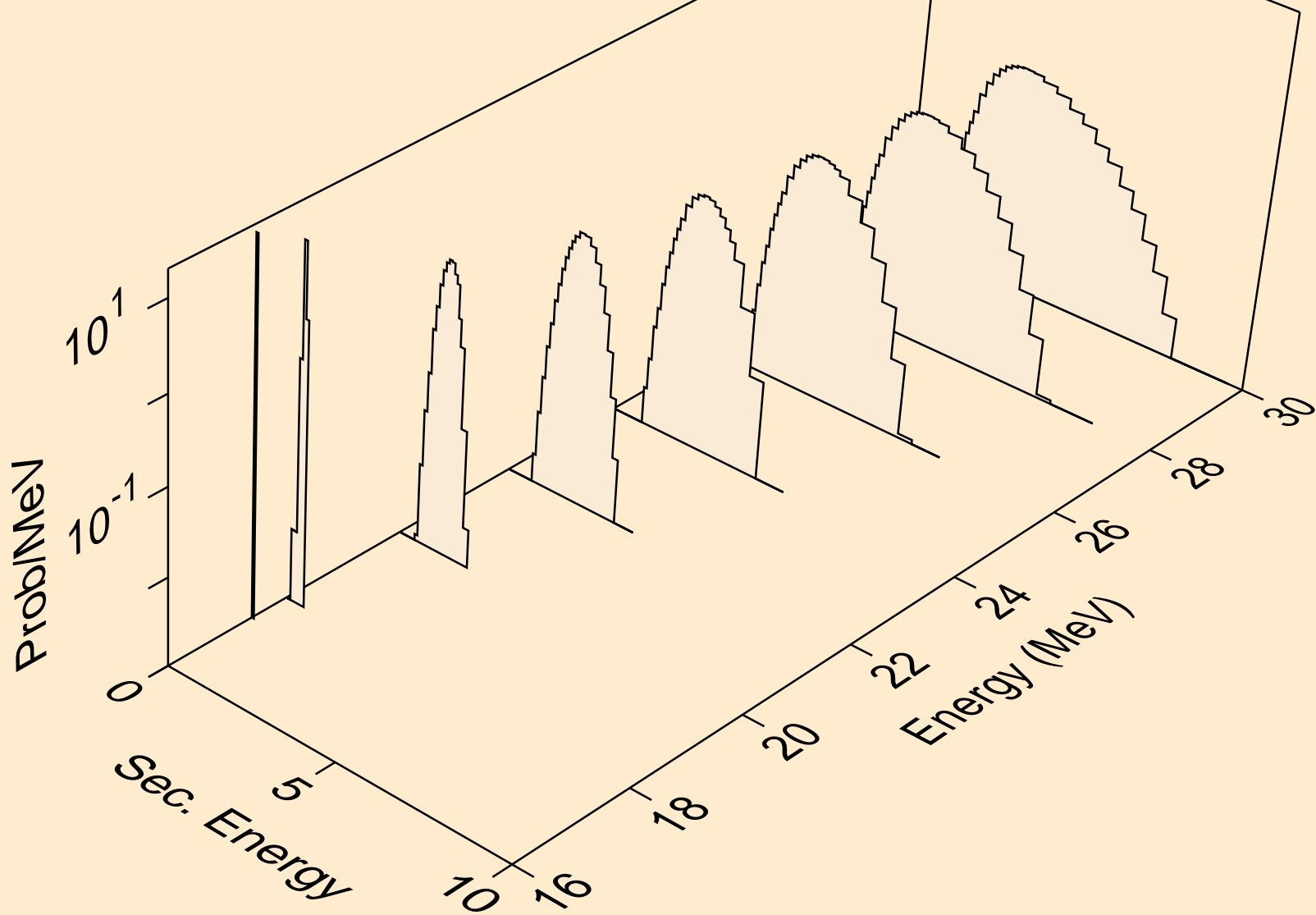



O020 PROTON ACER TENDL-2021 LIBRARY; T=0.K  
alphas from (p,a)

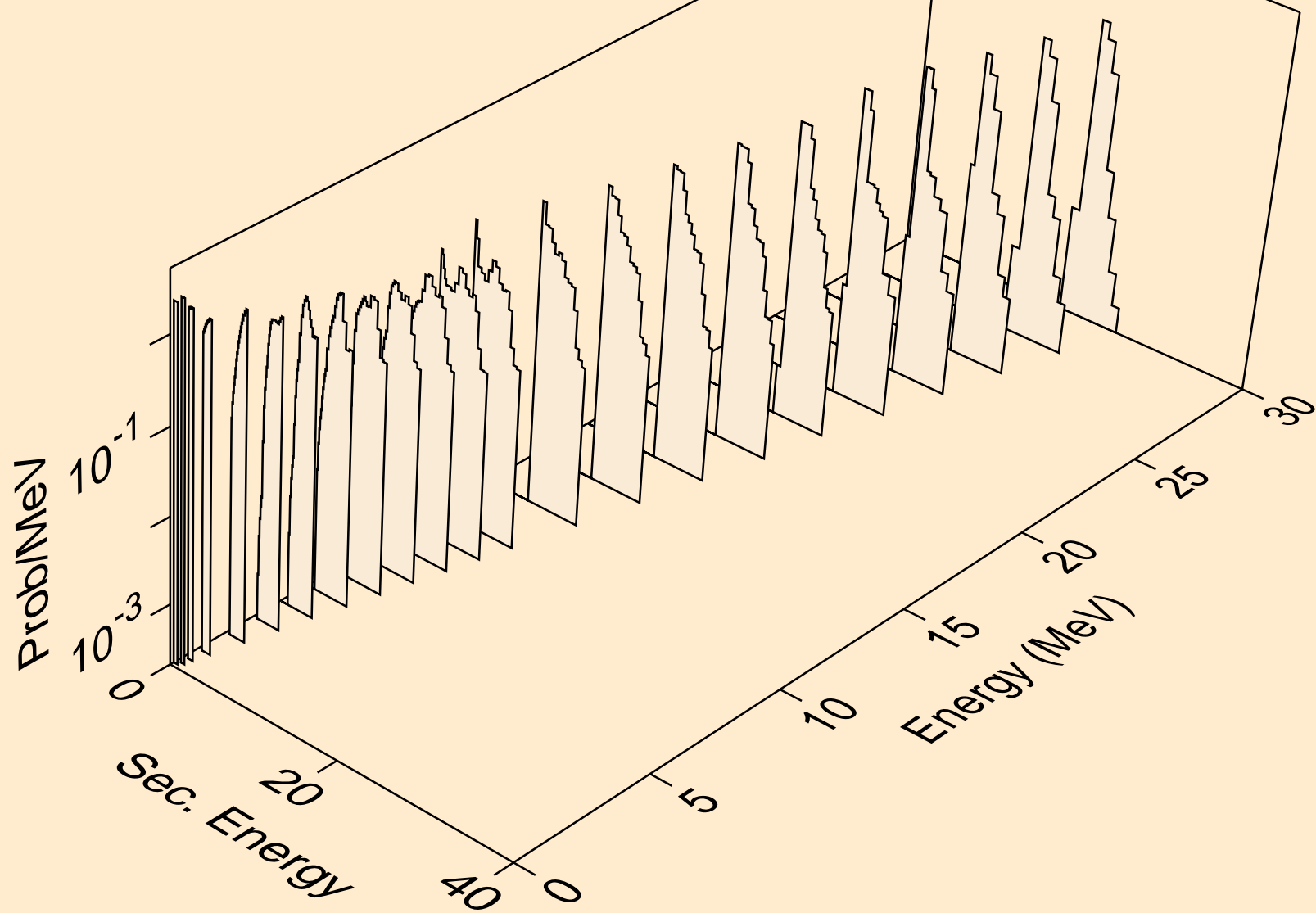

O020 PROTON ACER TENDL-2021 LIBRARY; T=0.K  
alphas from (p,2a)

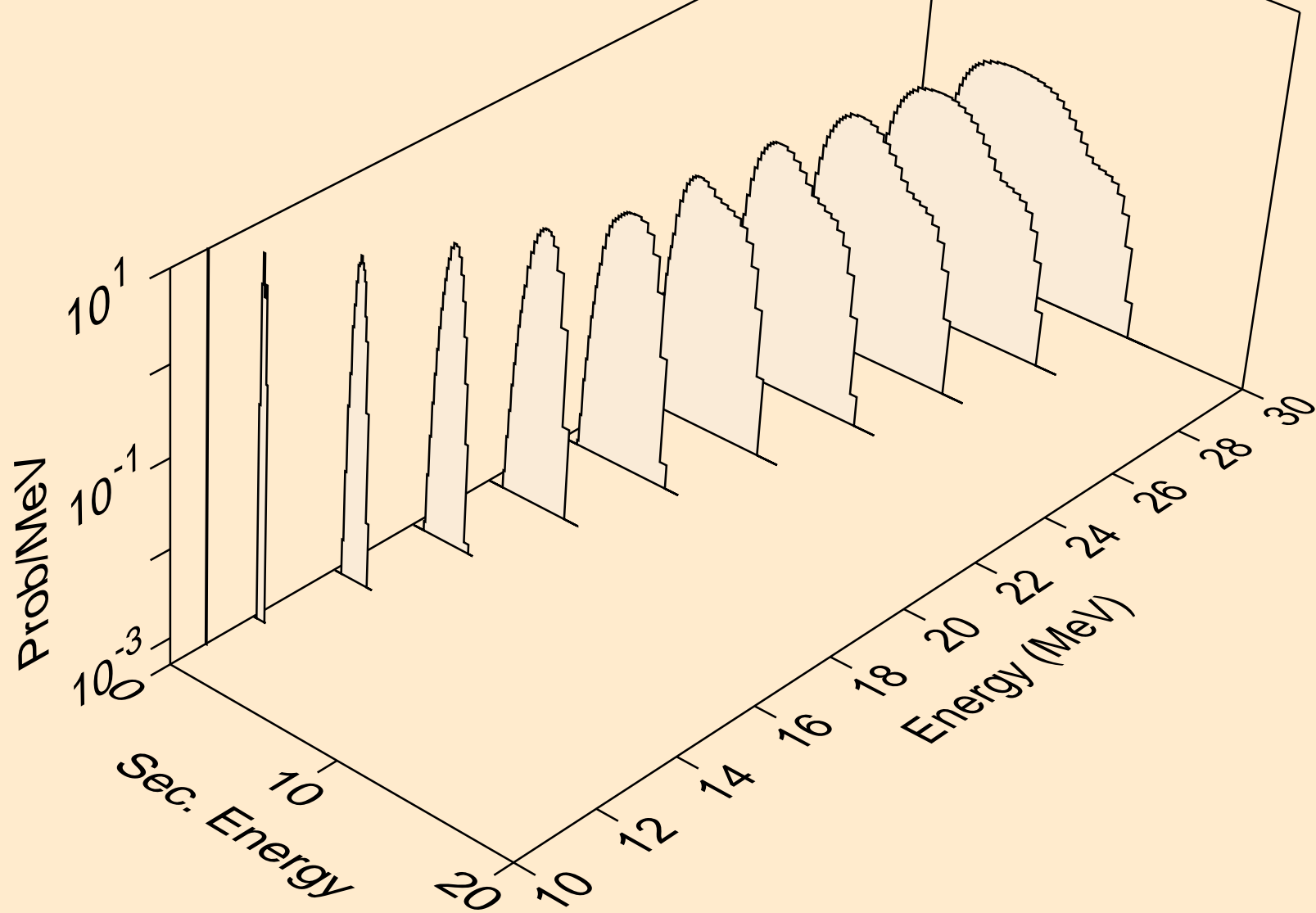

O020 PROTON ACER TENDL-2021 LIBRARY; T=0.K  
alphas from (p,3a)

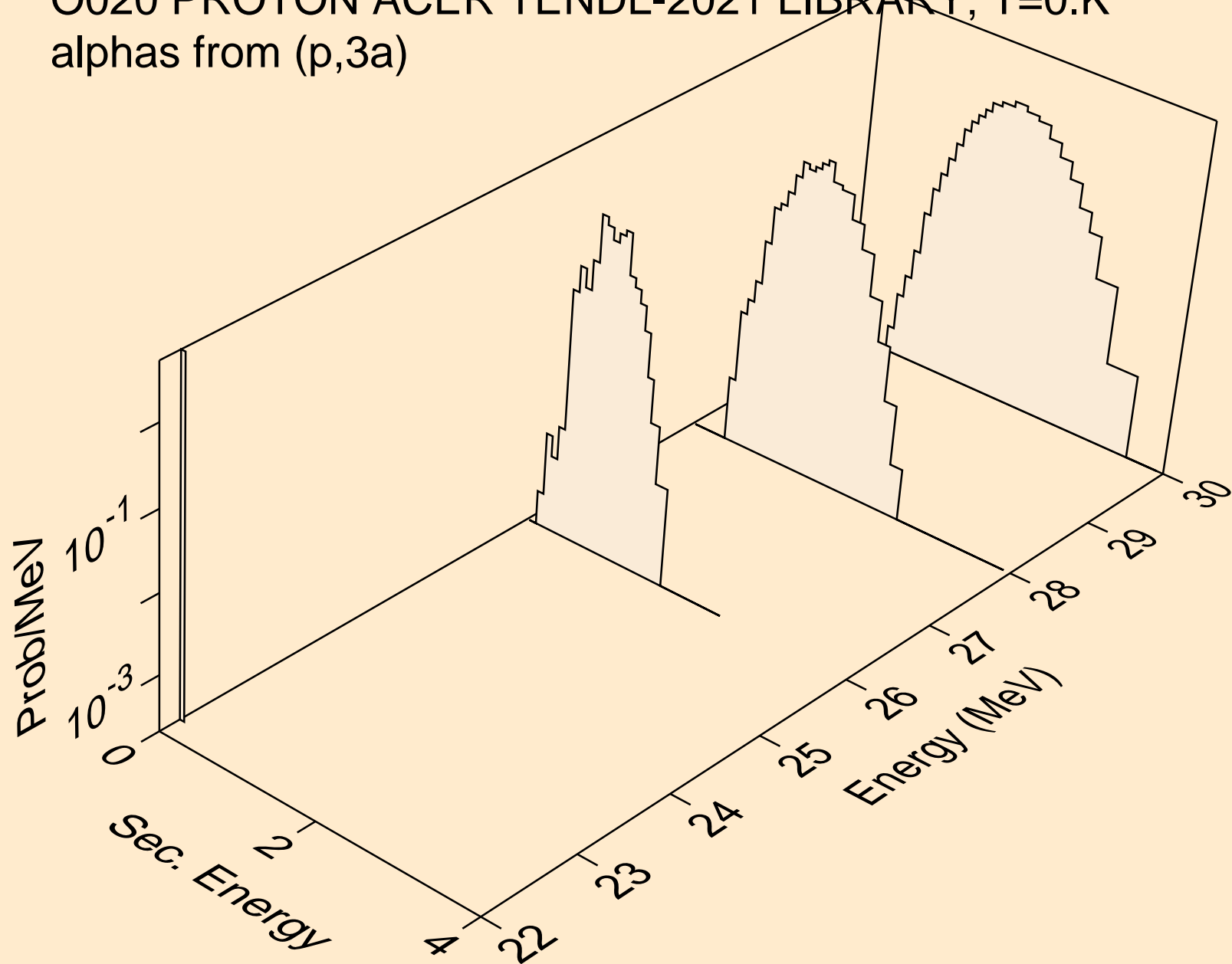

O020 PROTON ACER TENDL-2021 LIBRARY; T=0.K  
alphas from (p,pa)

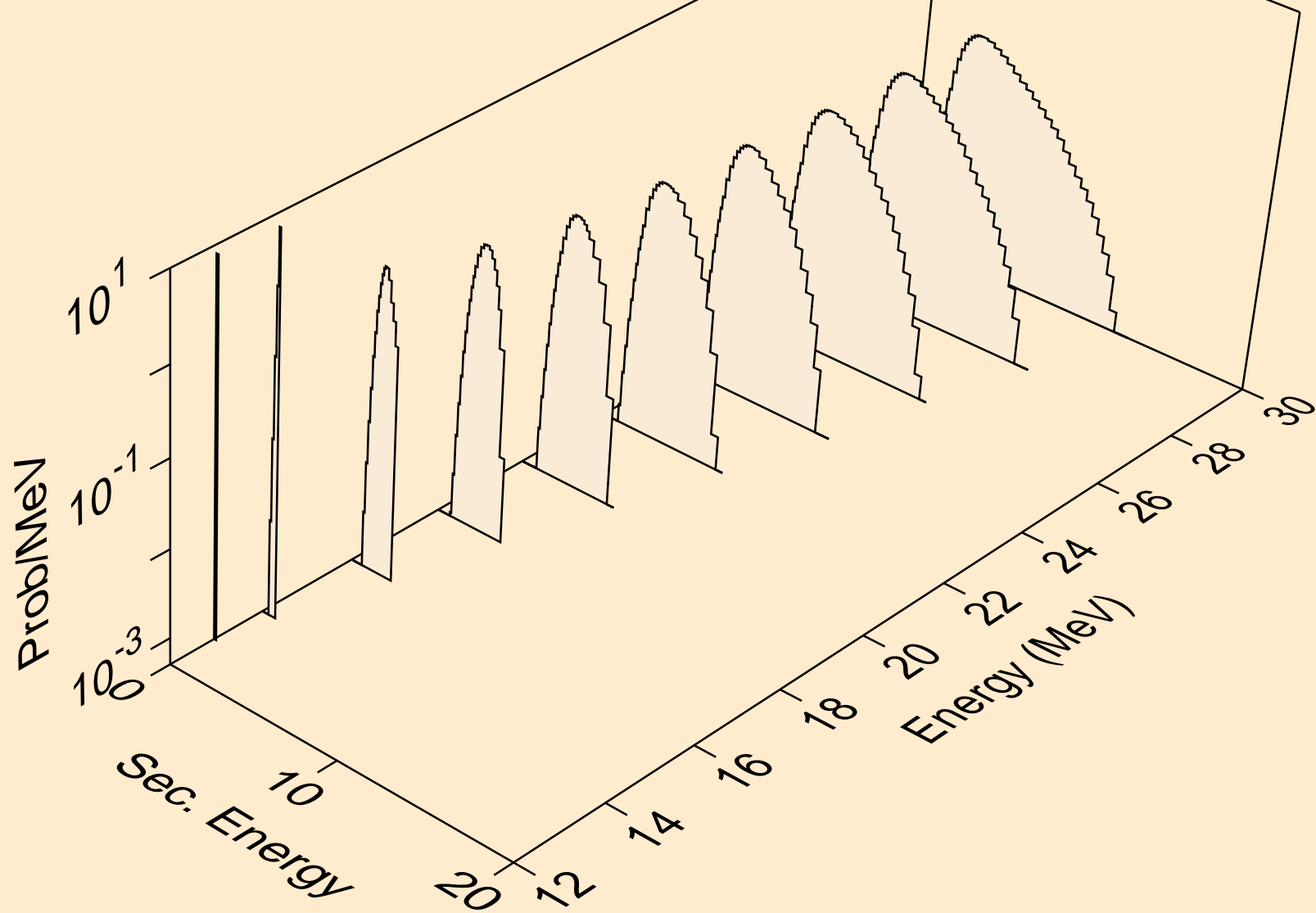

O020 PROTON ACER TENDL-2021 LIBRARY; T=0.K  
alphas from (p,t2a)

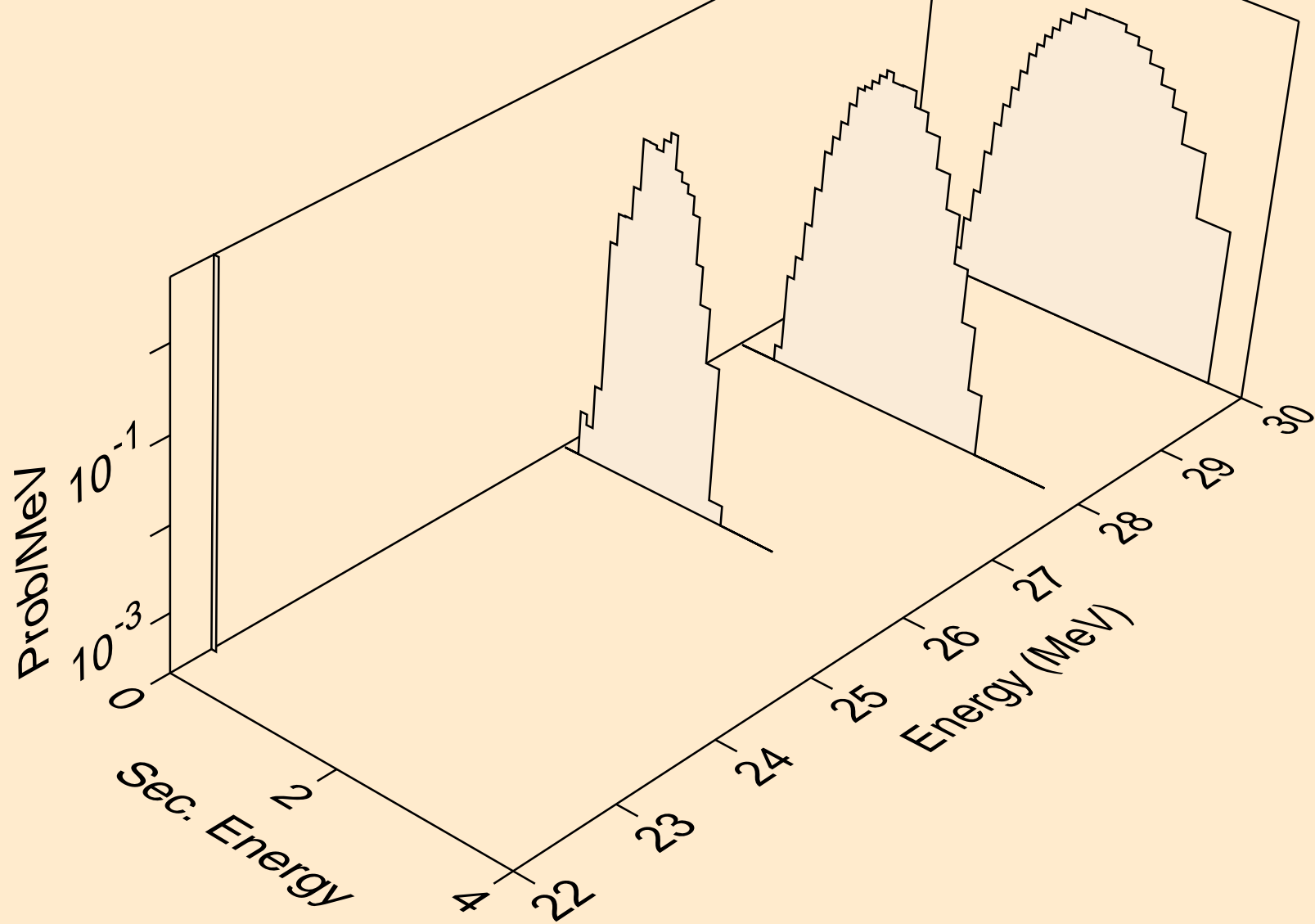

O020 PROTON ACER TENDL-2021 LIBRARY; T=0.K  
alphas from (p,da)

