

# OS186 PROTON ACER TENDL-2021 LIBRARY; T=0.K

## Principal cross sections

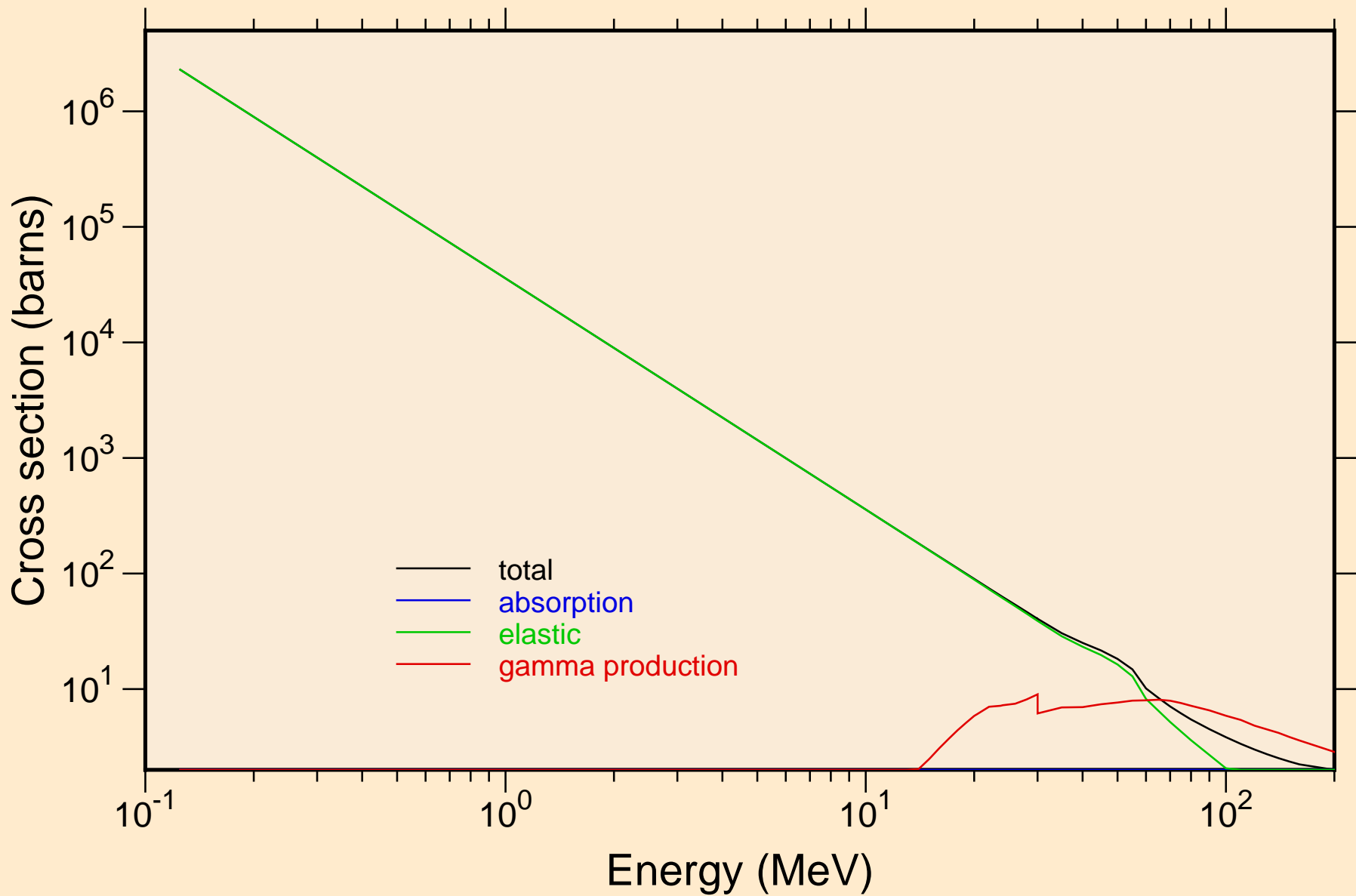

# OS186 PROTON ACER TENDL-2021 LIBRARY; T=0.K

## Heating

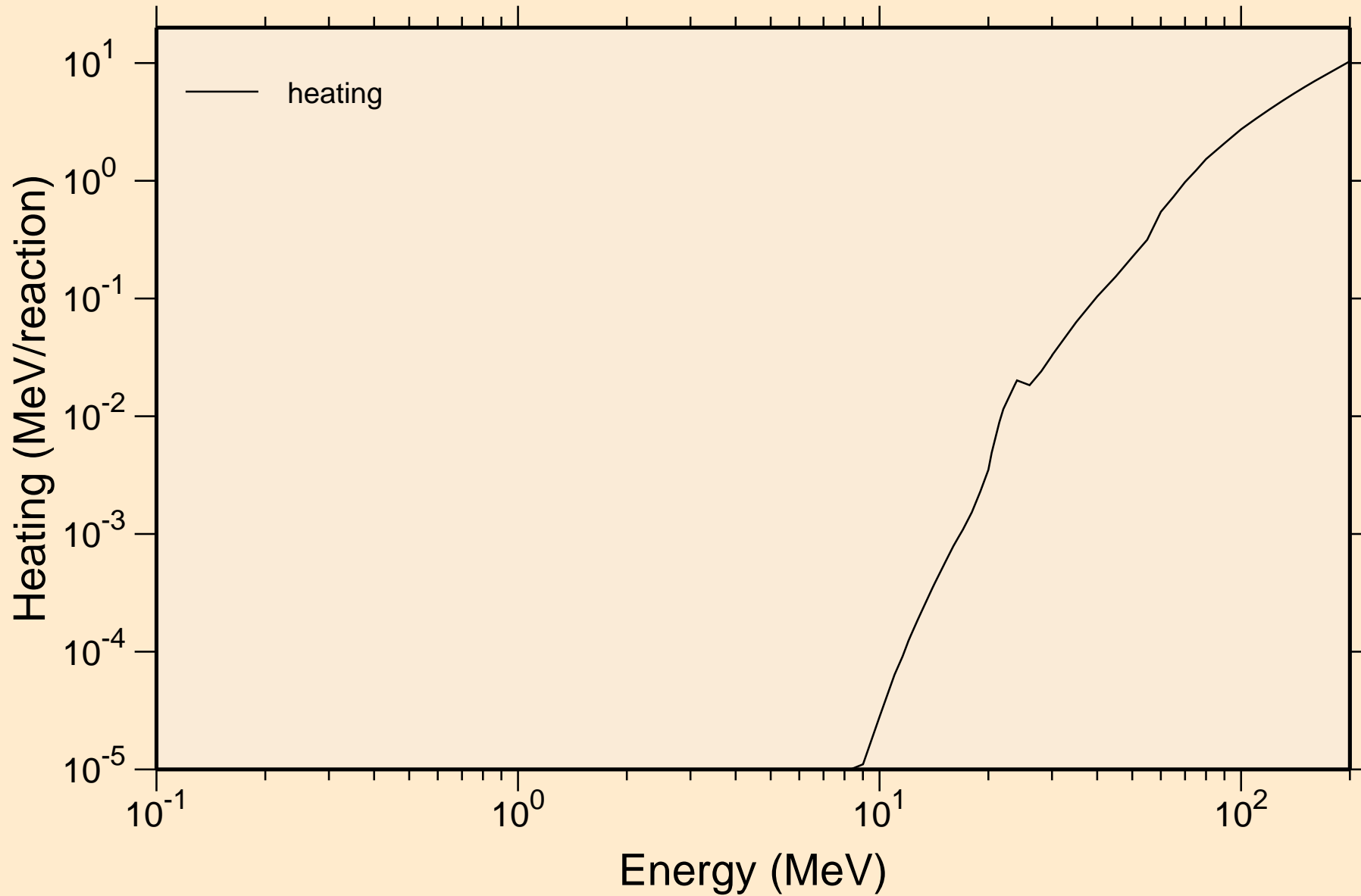

# OS186 PROTON ACER TENDL-2021 LIBRARY; T=0.K

## Principal cross sections

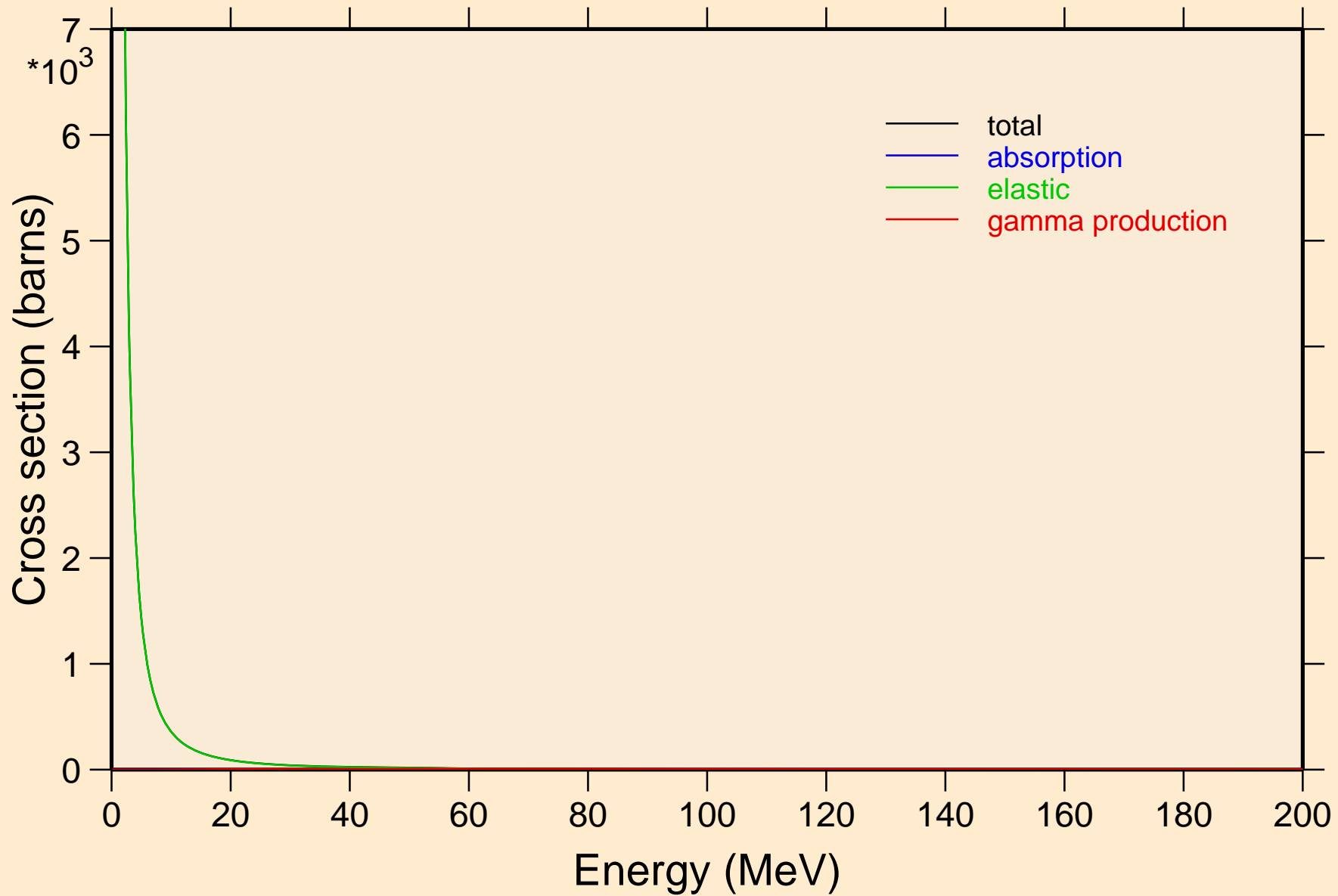

# OS186 PROTON ACER TENDL-2021 LIBRARY; T=0.K

## Heating

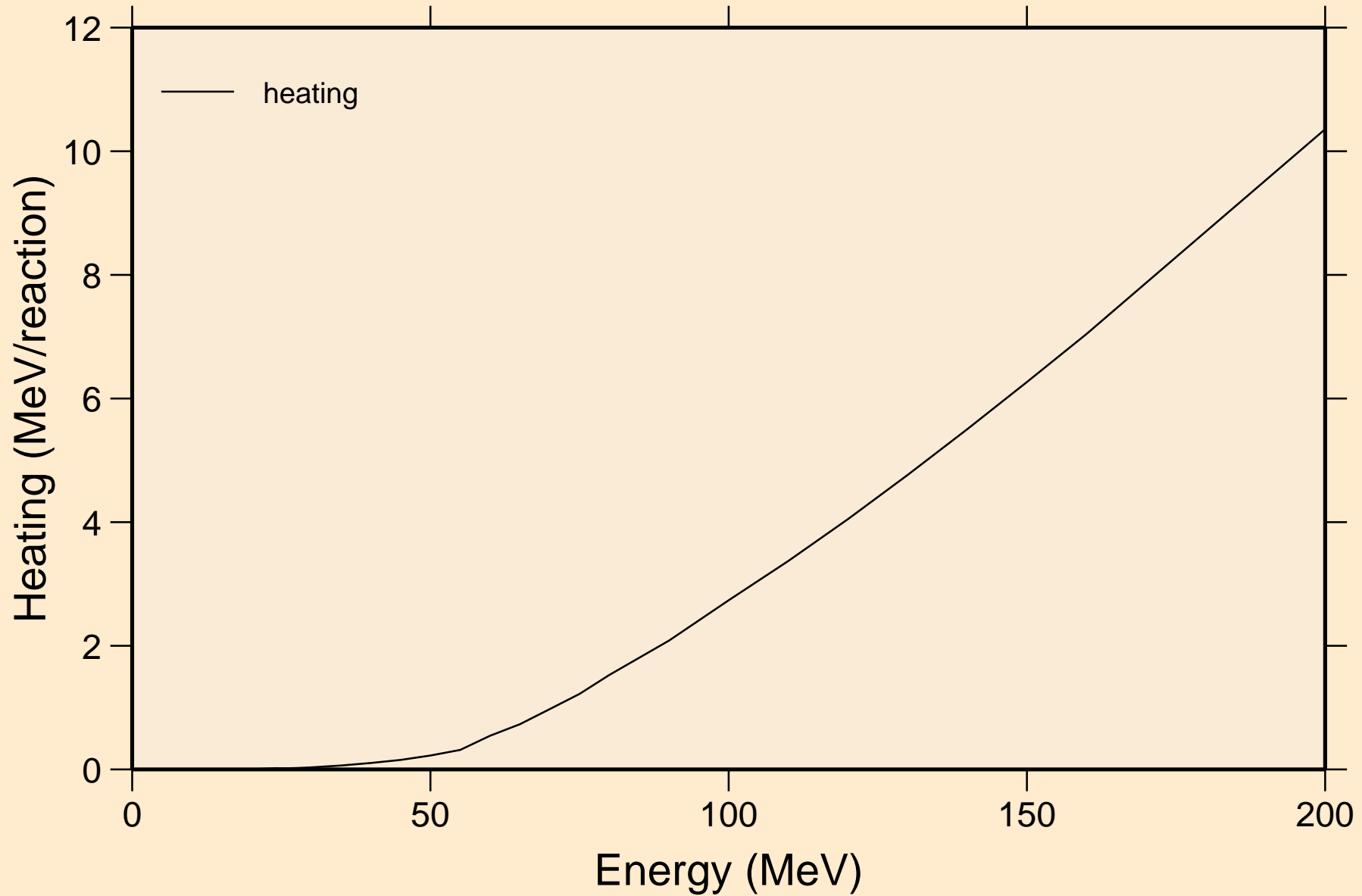

# OS186 PROTON ACER TENDL-2021 LIBRARY; T=0.K

## Threshold reactions

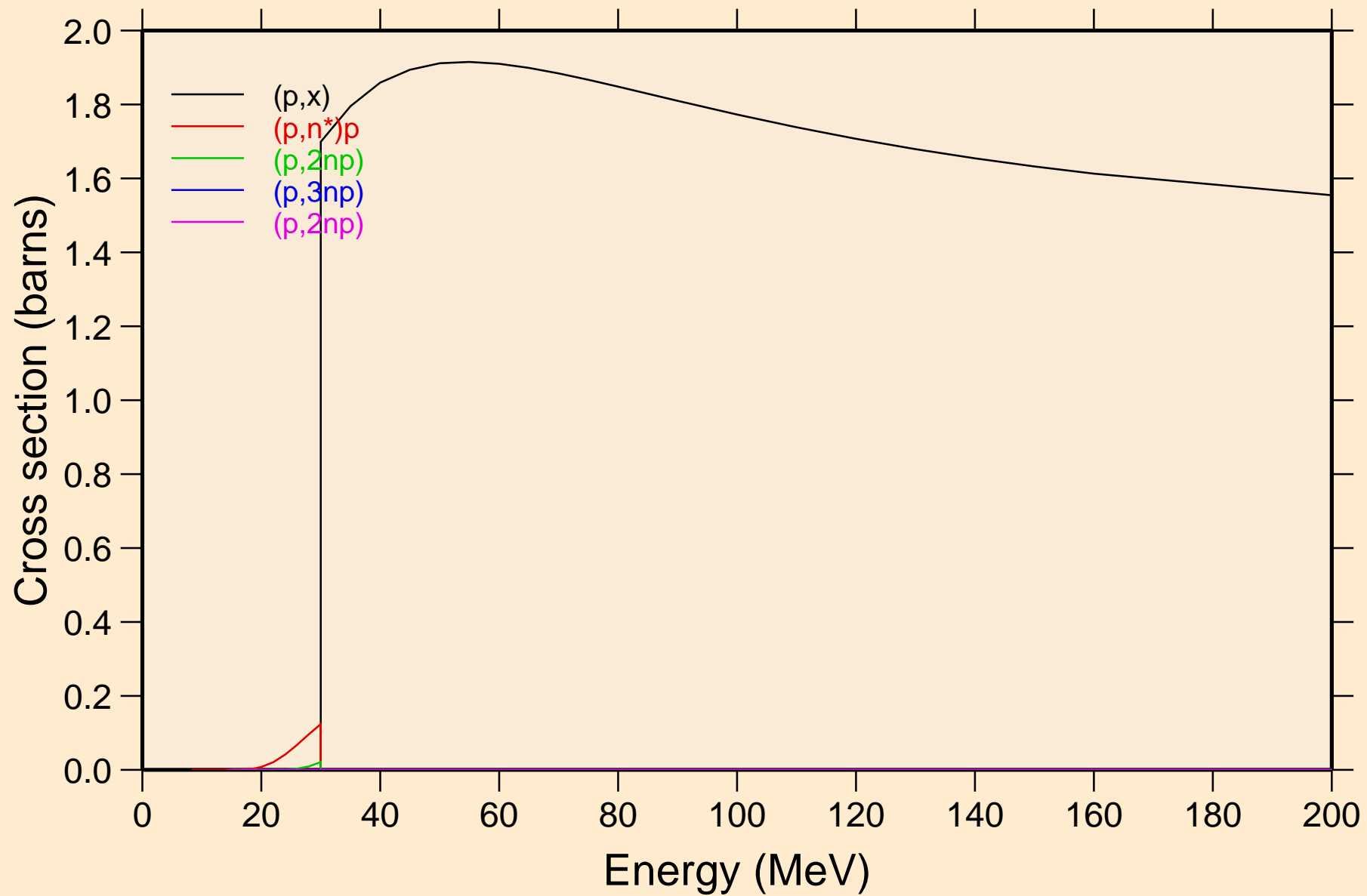

OS186 PROTON ACER TENDL-2021 LIBRARY; T=0.K  
Threshold reactions

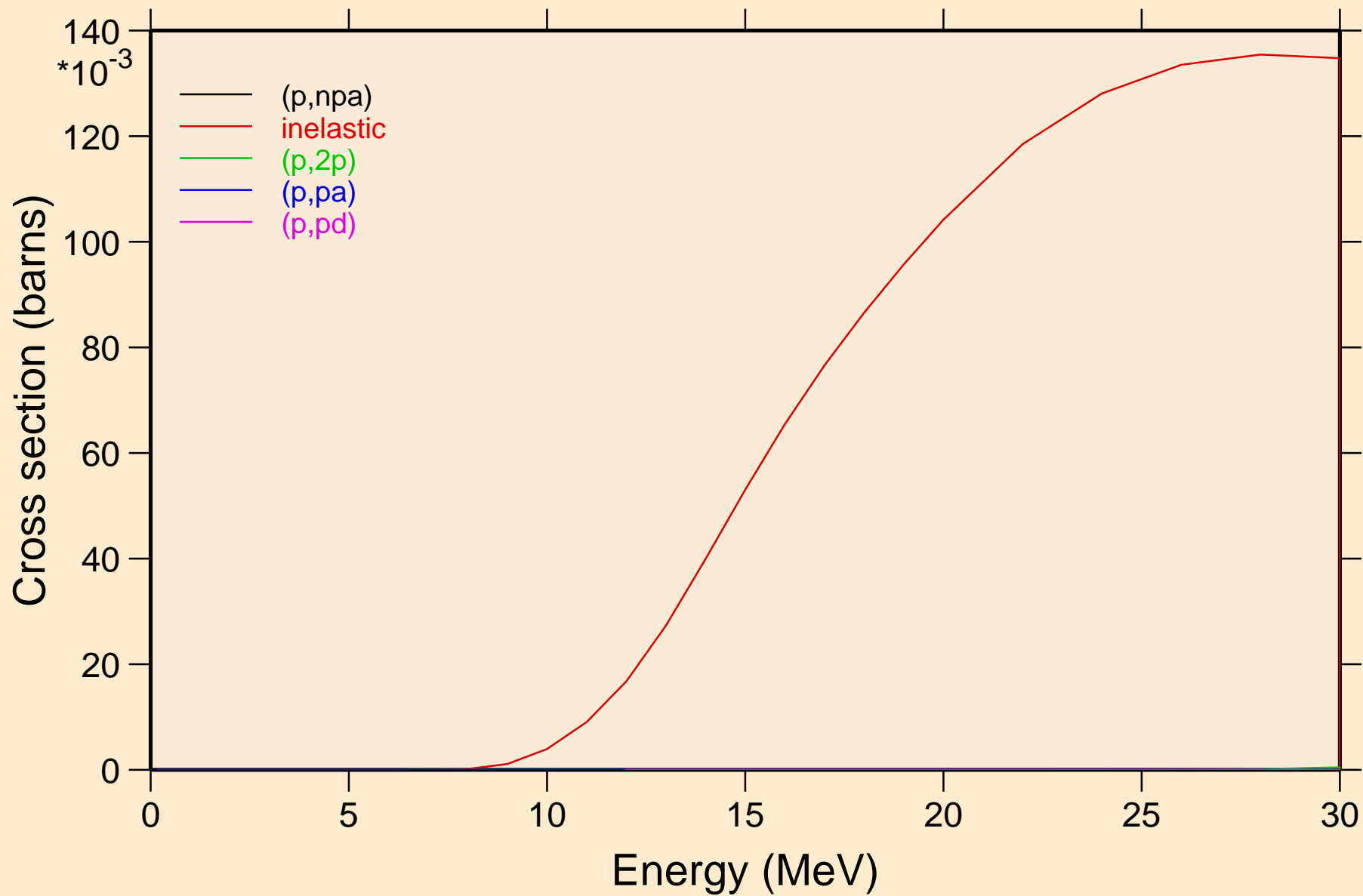

OS186 PROTON ACER TENDL-2021 LIBRARY; T=0.K  
Threshold reactions

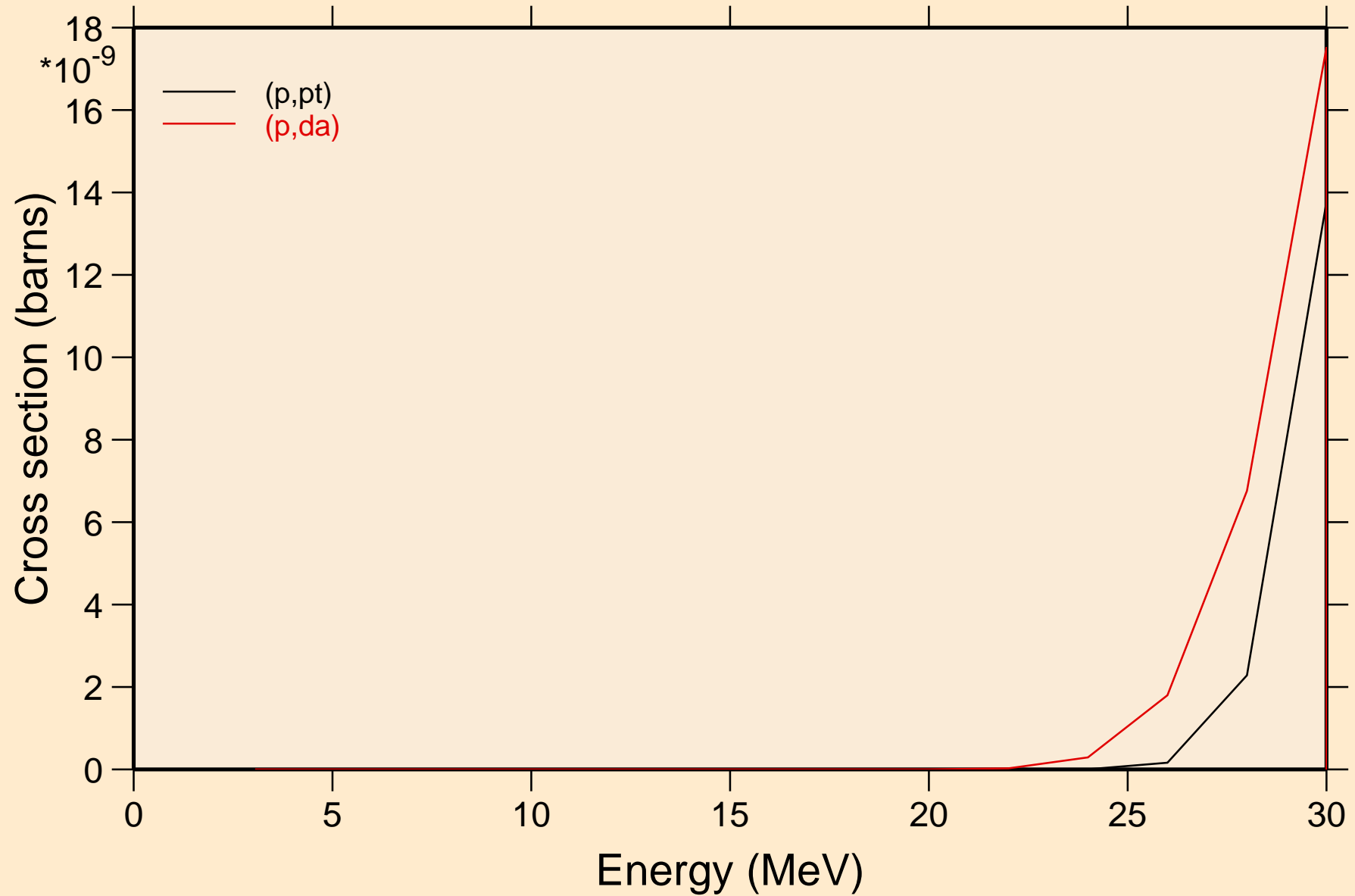

OS186 PROTON ACER TENDL-2021 LIBRARY; T=0.K  
angular distribution for elastic

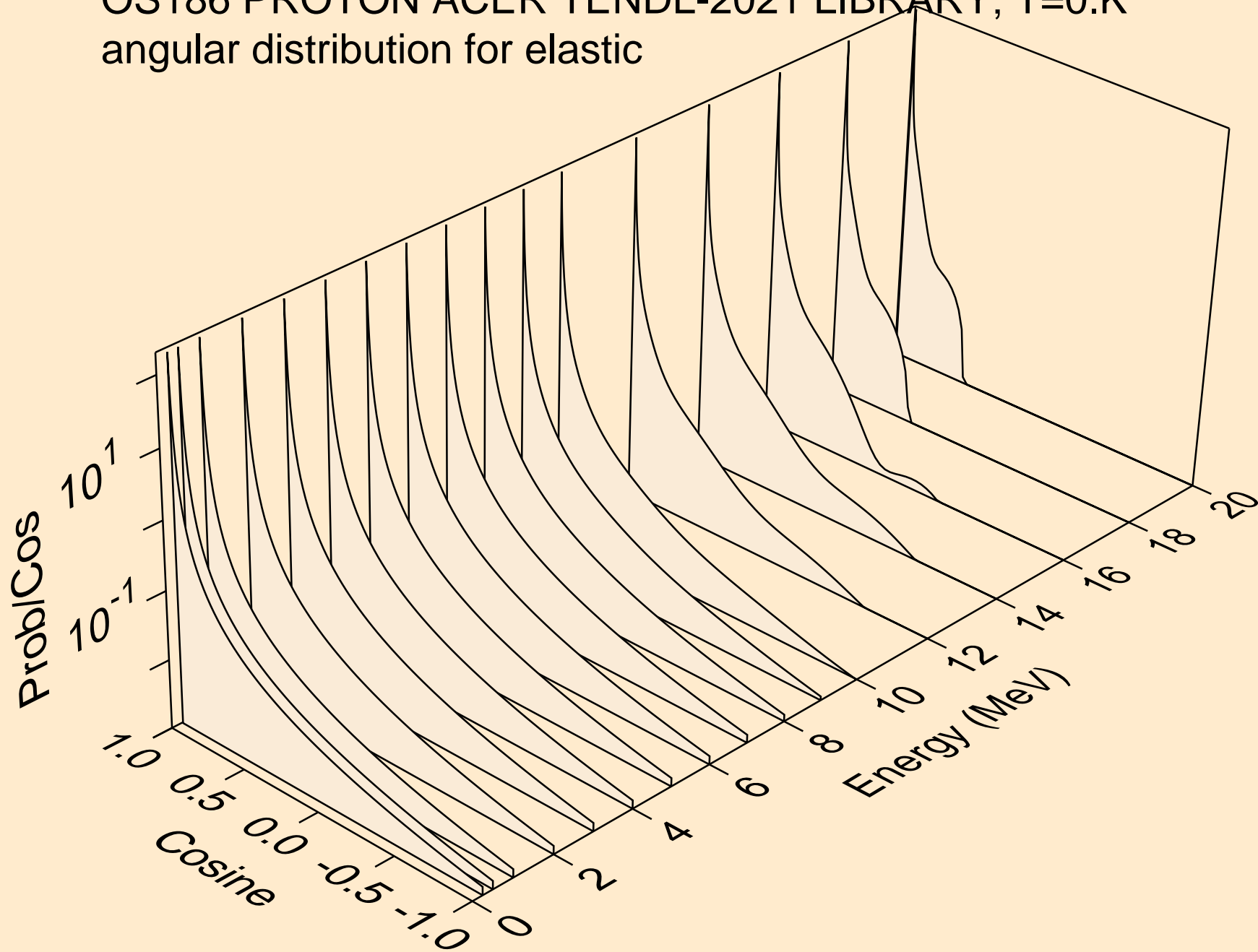



OS186 PROTON ACER TENDL-2021 LIBRARY; T=0.K  
angular distribution for elastic

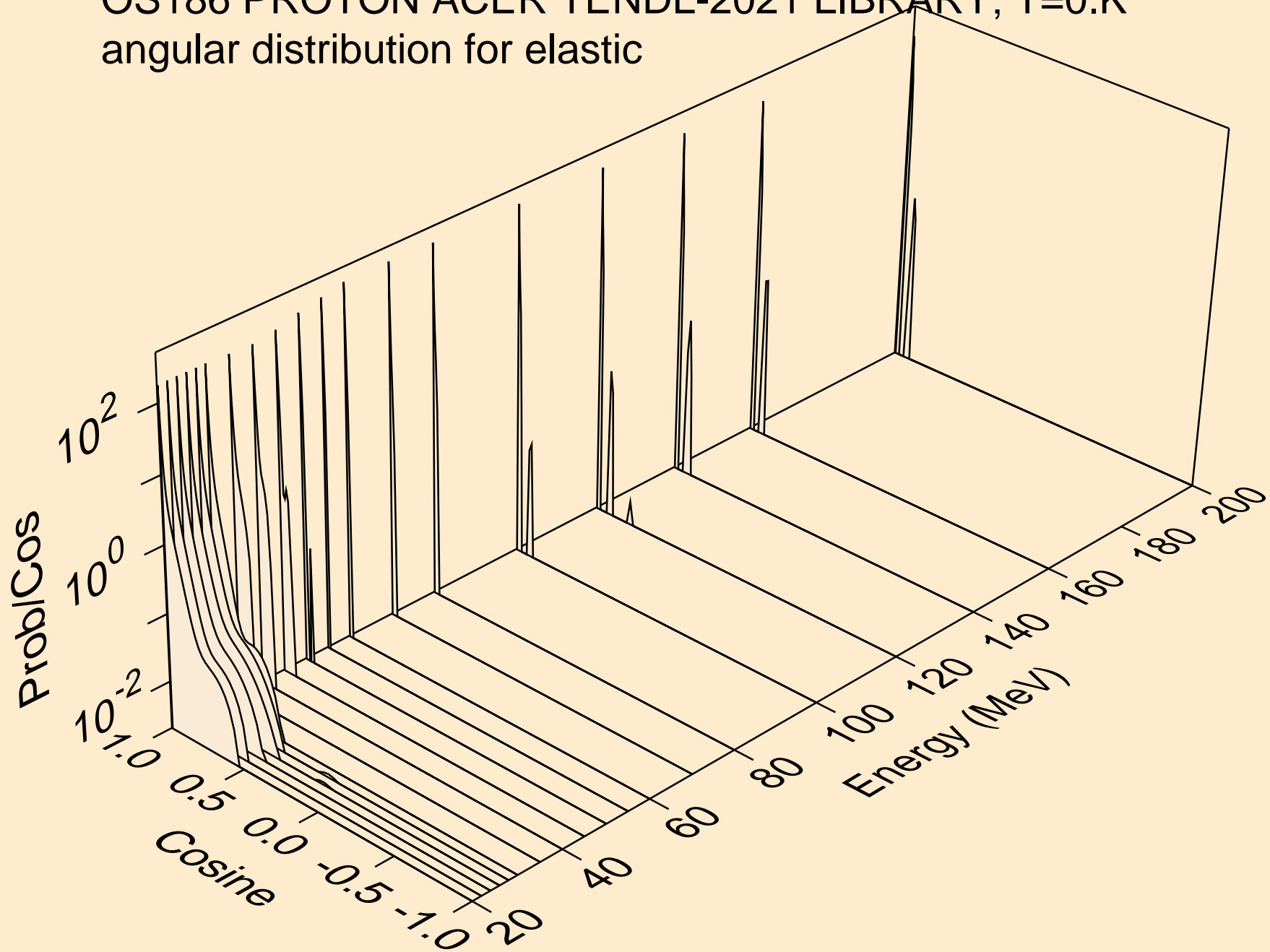

OS186 PROTON ACER TENDL-2021 LIBRARY; T=0.K  
Proton emission for (p,x)

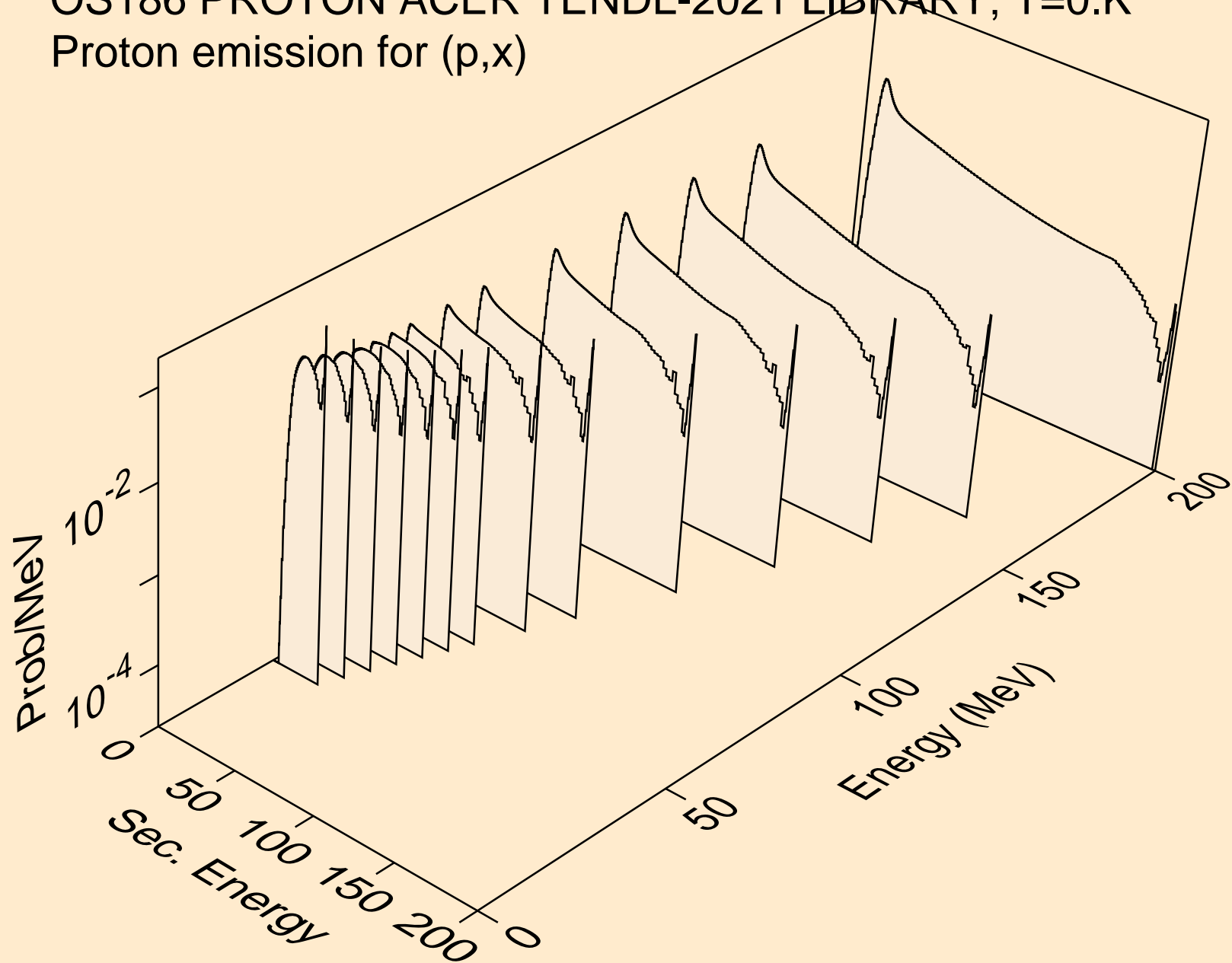

OS186 PROTON ACER TENDL-2021 LIBRARY; T=0.K  
Proton emission for (p,n\*)p

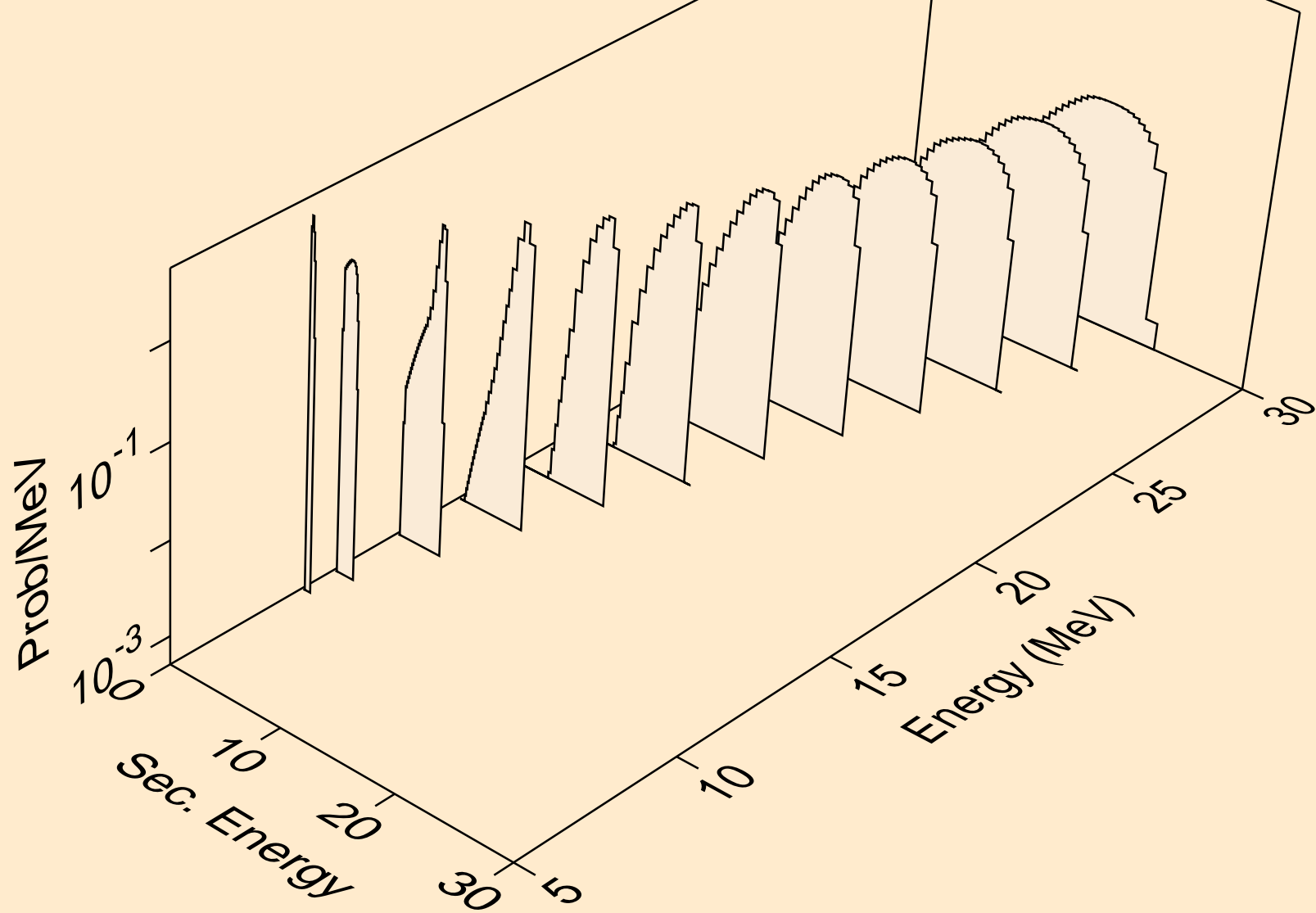

OS186 PROTON ACER TENDL-2021 LIBRARY; T=0.K  
Proton emission for (p,2np)

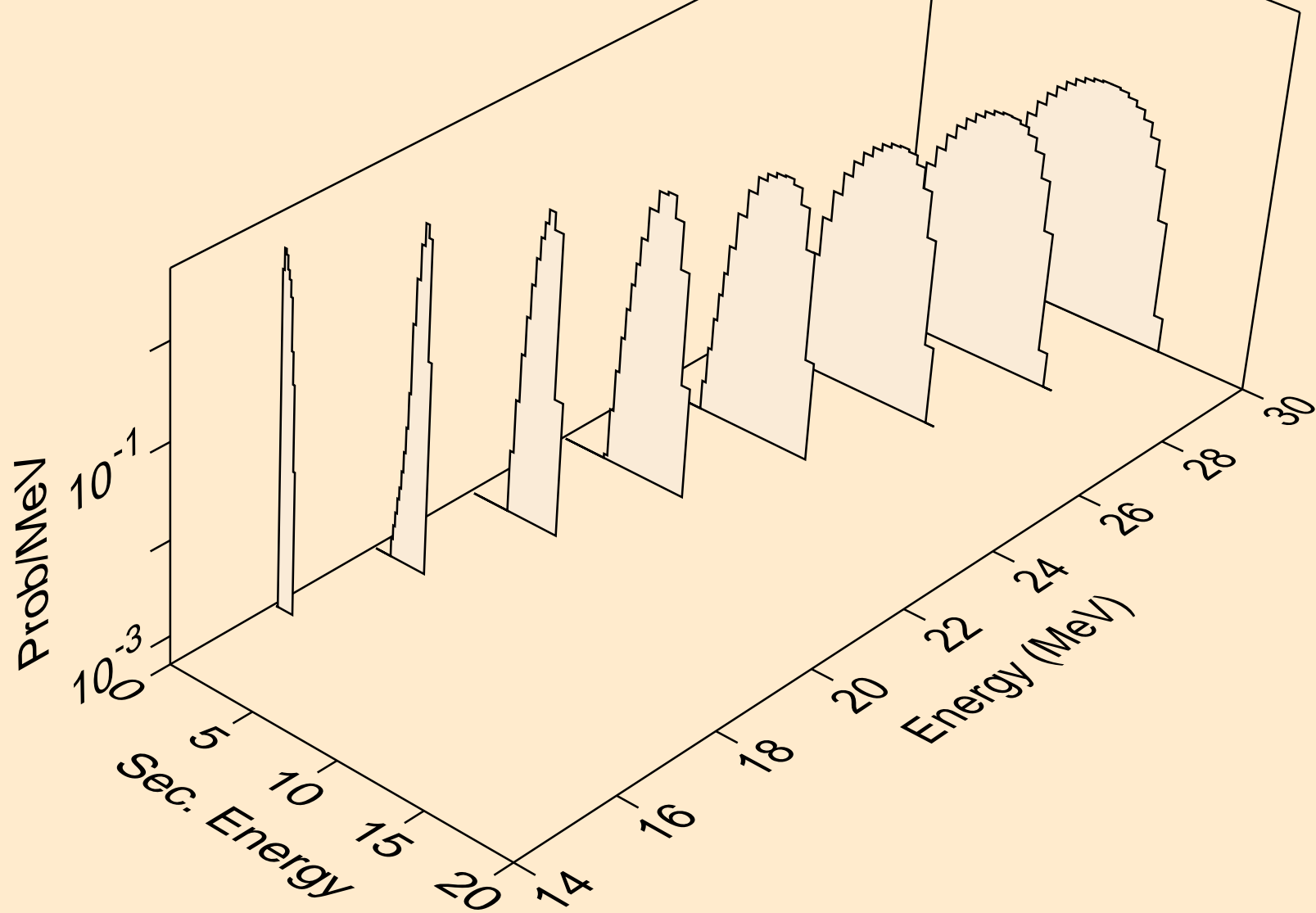

OS186 PROTON ACER TENDL-2021 LIBRARY; T=0.K  
Proton emission for (p,3np)

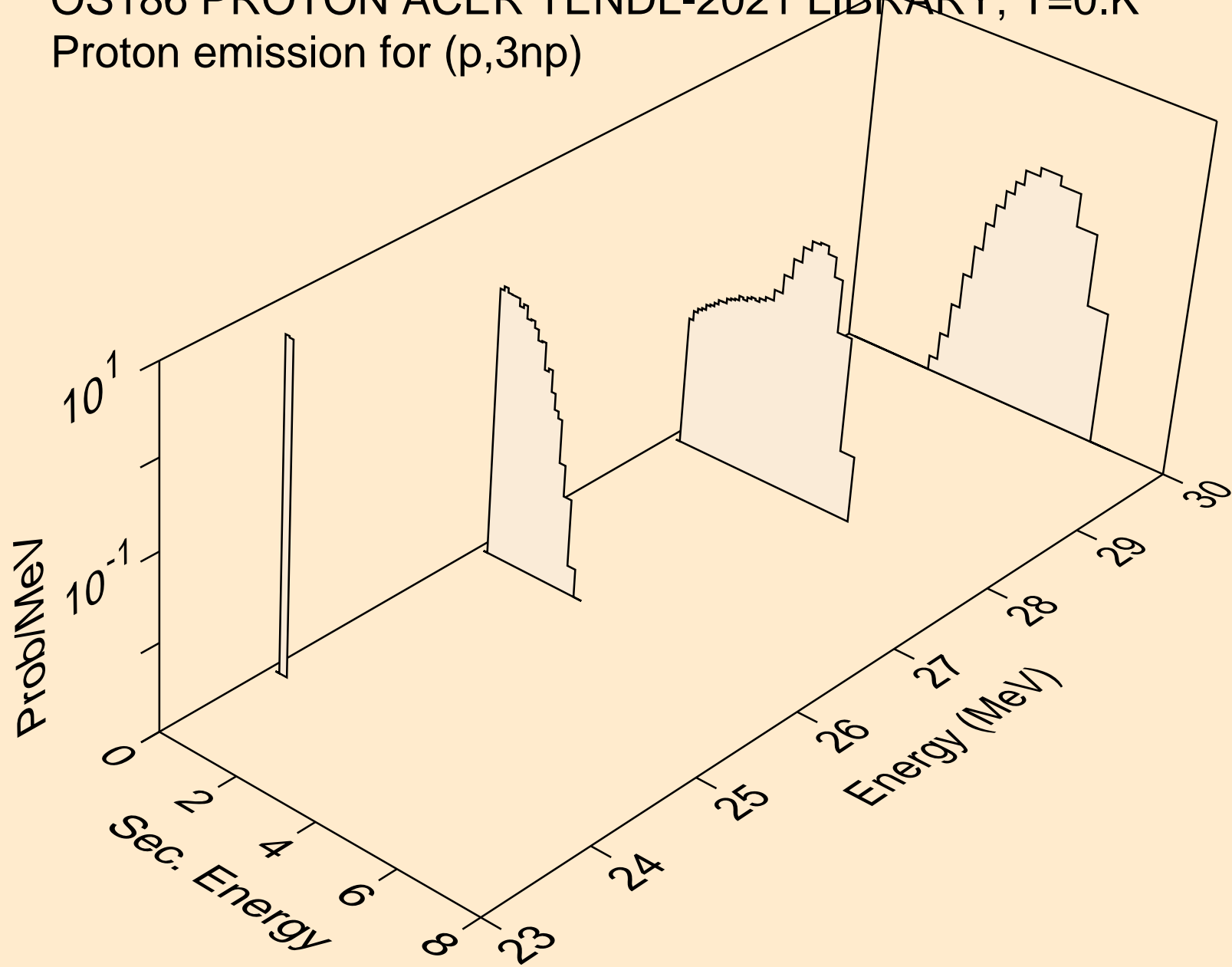

OS186 PROTON ACER TENDL-2021 LIBRARY; T=0.K  
Proton emission for (p,2np)

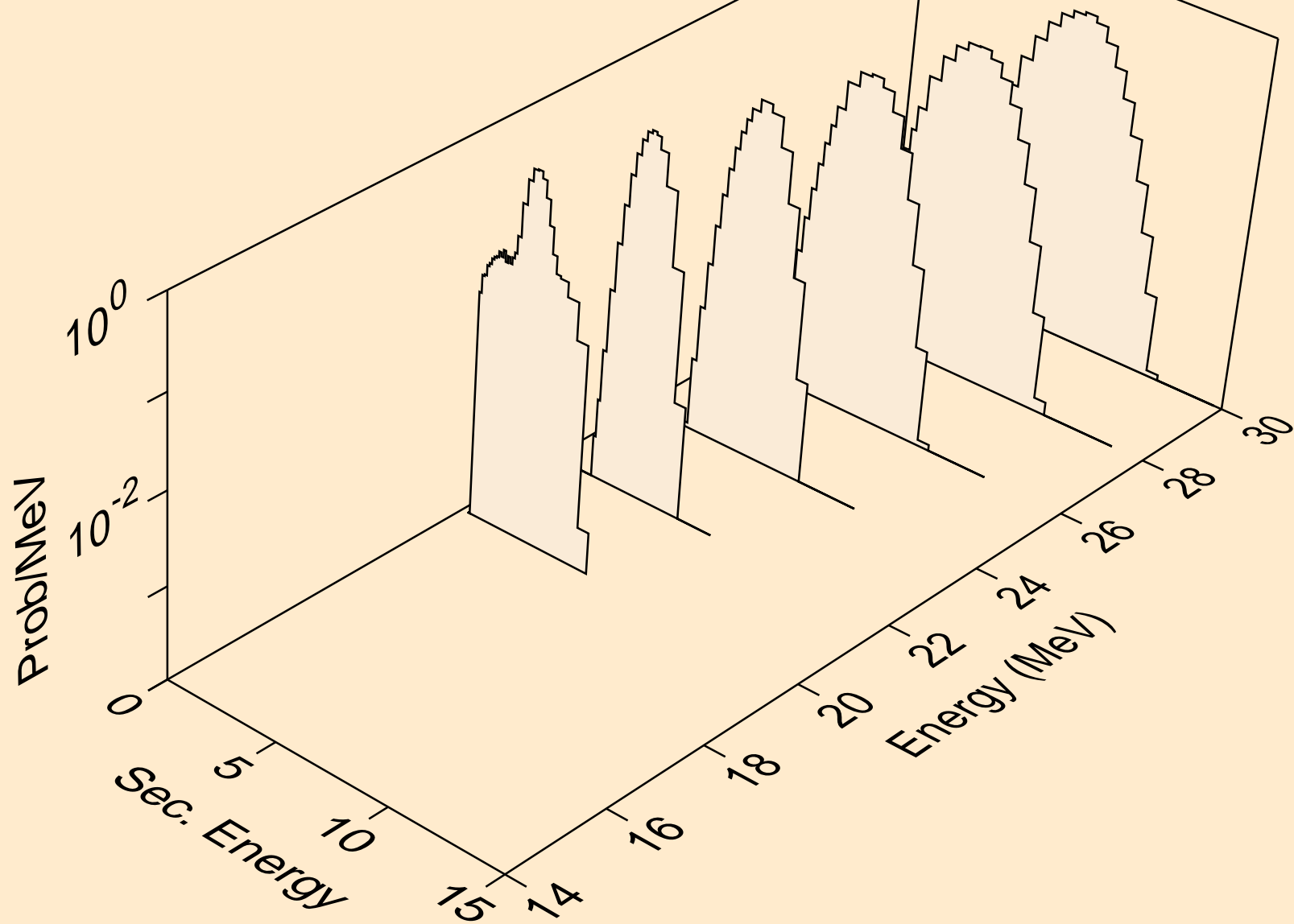

OS186 PROTON ACER TENDL-2021 LIBRARY; T=0.K  
Proton emission for (p,npa)

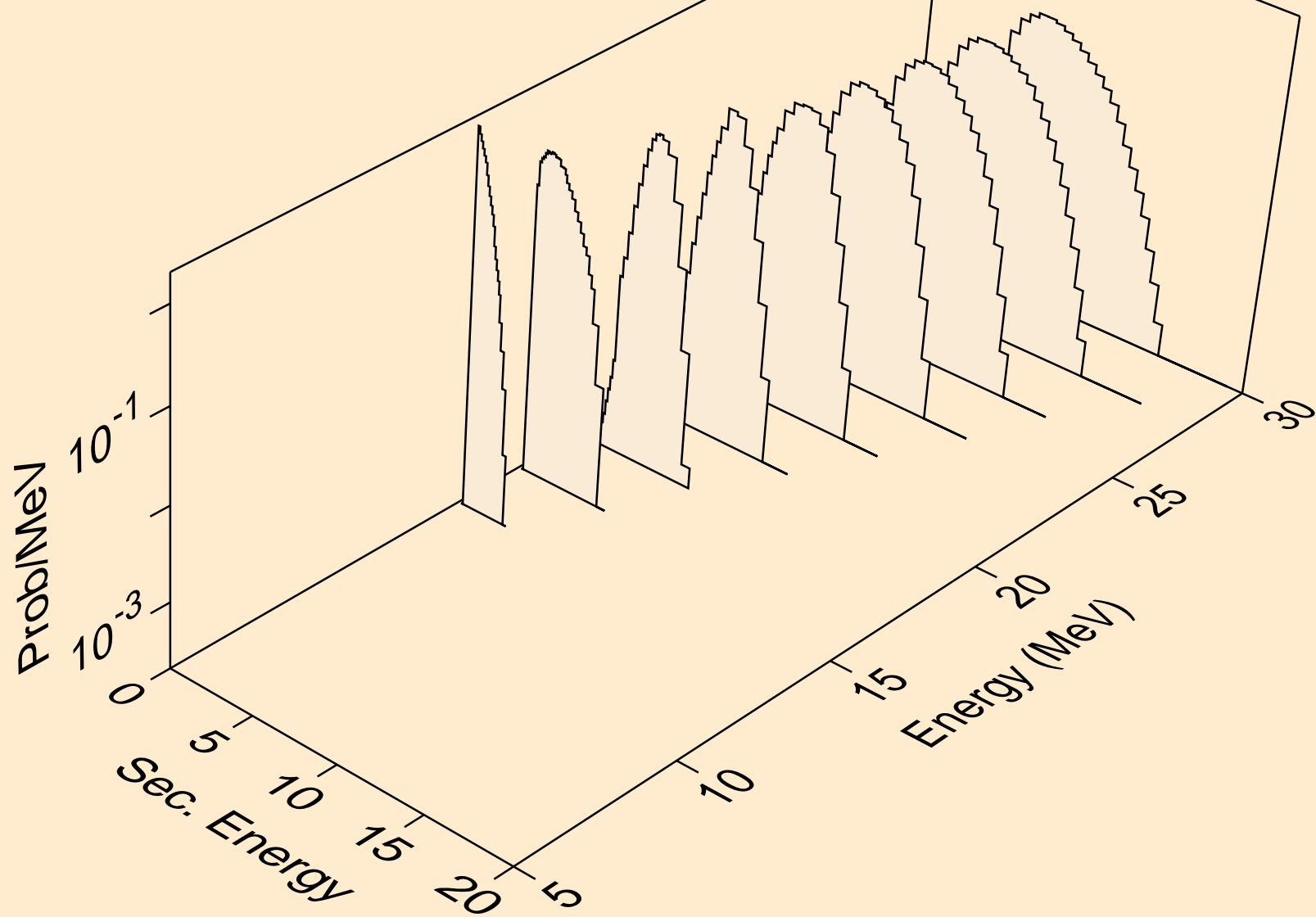

OS186 PROTON ACER TENDL-2021 LIBRARY; T=0.K  
Proton emission for inelastic

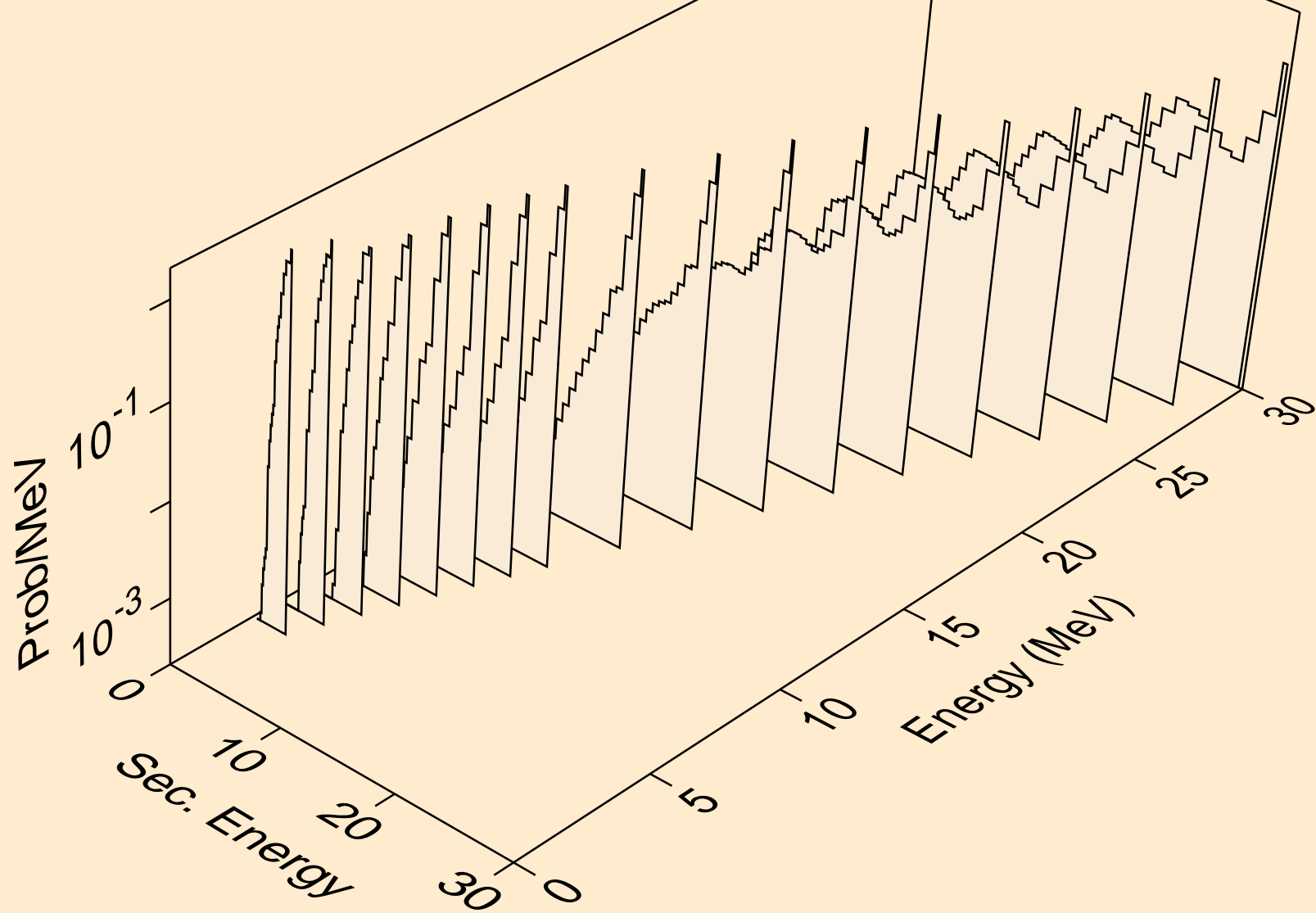



OS186 PROTON ACER TENDL-2021 LIBRARY; T=0.K  
Proton emission for (p,2p)

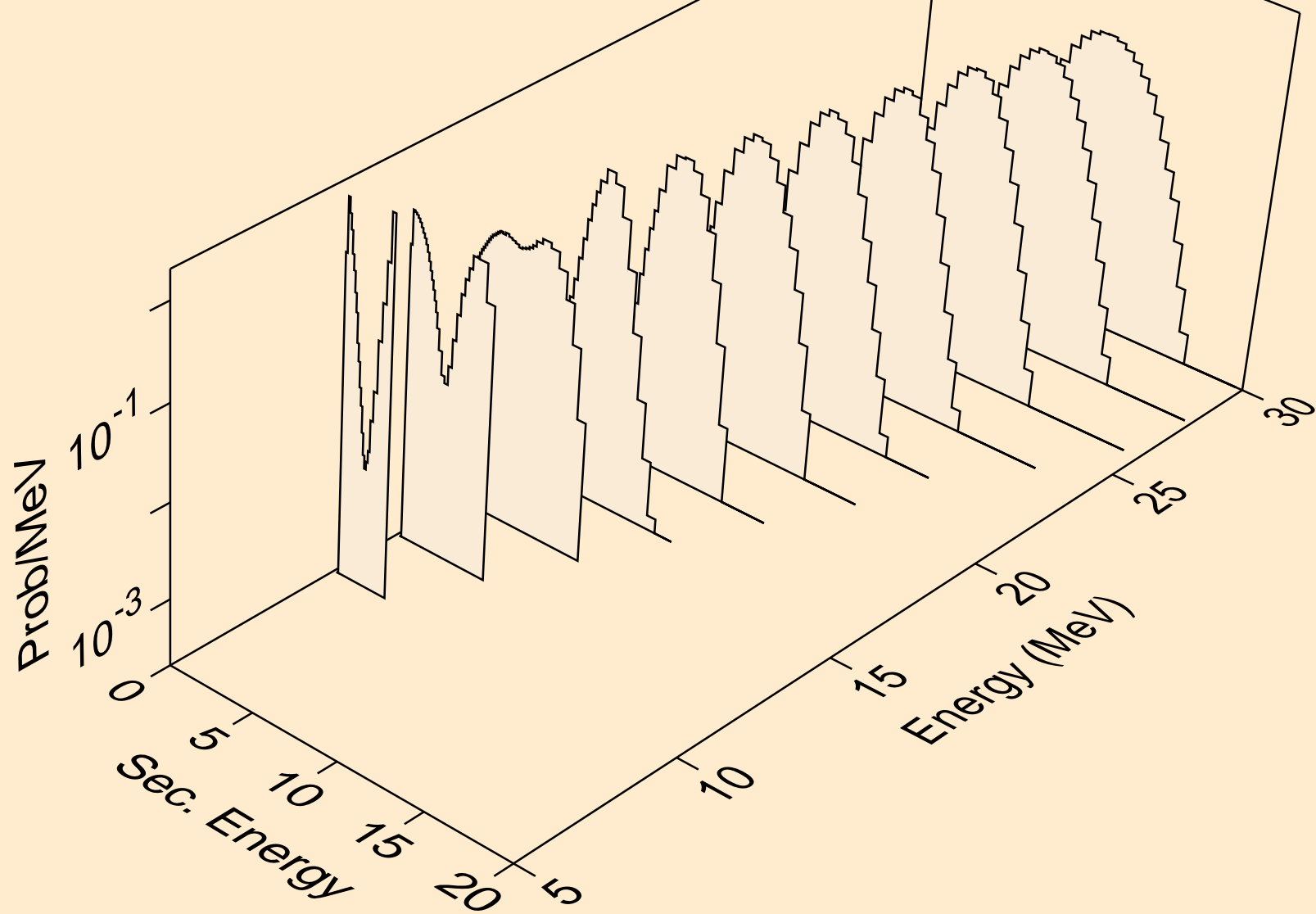

OS186 PROTON ACER TENDL-2021 LIBRARY; T=0.K  
Proton emission for (p,pa)

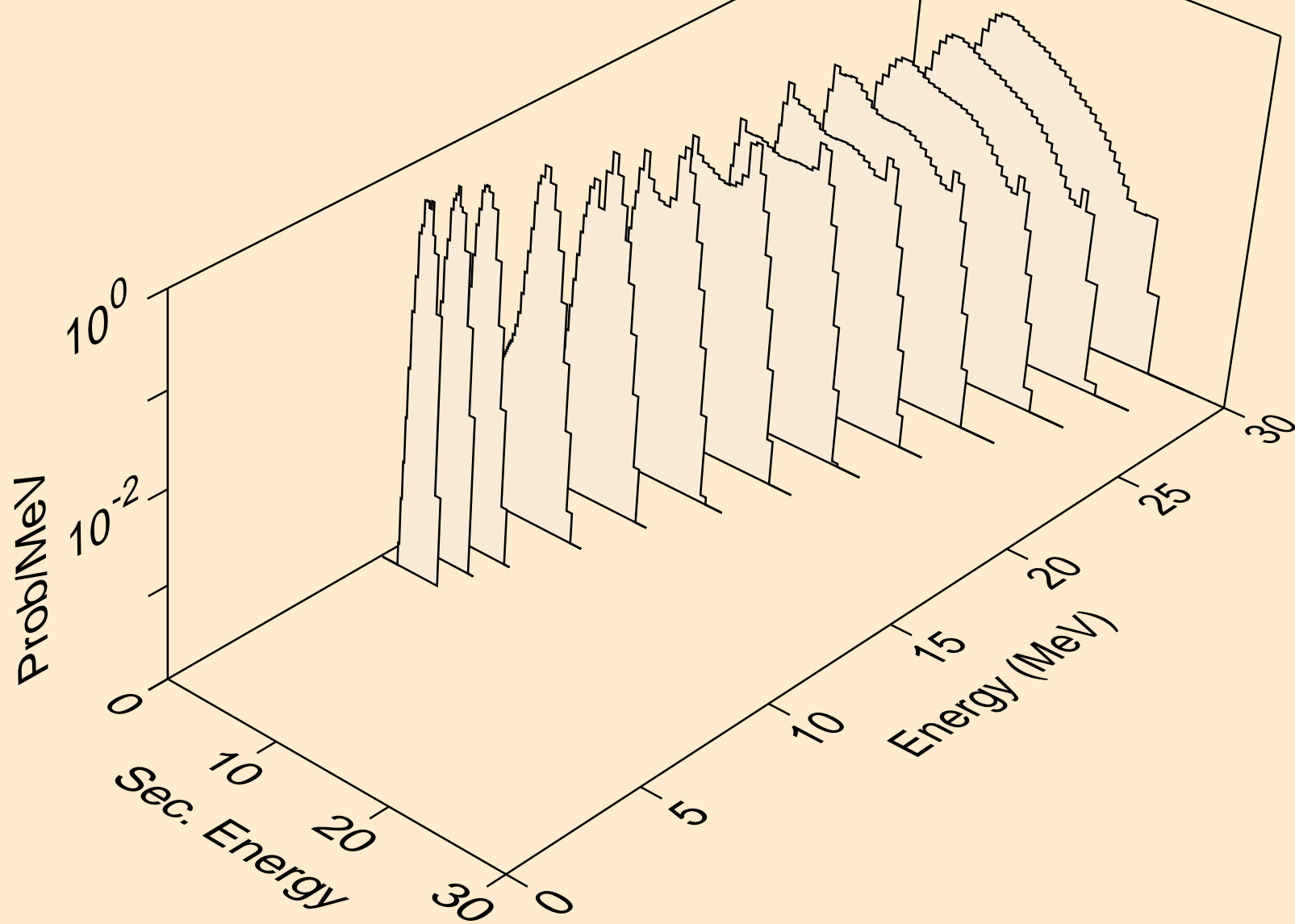

OS186 PROTON ACER TENDL-2021 LIBRARY; T=0.K  
Proton emission for (p,pd)

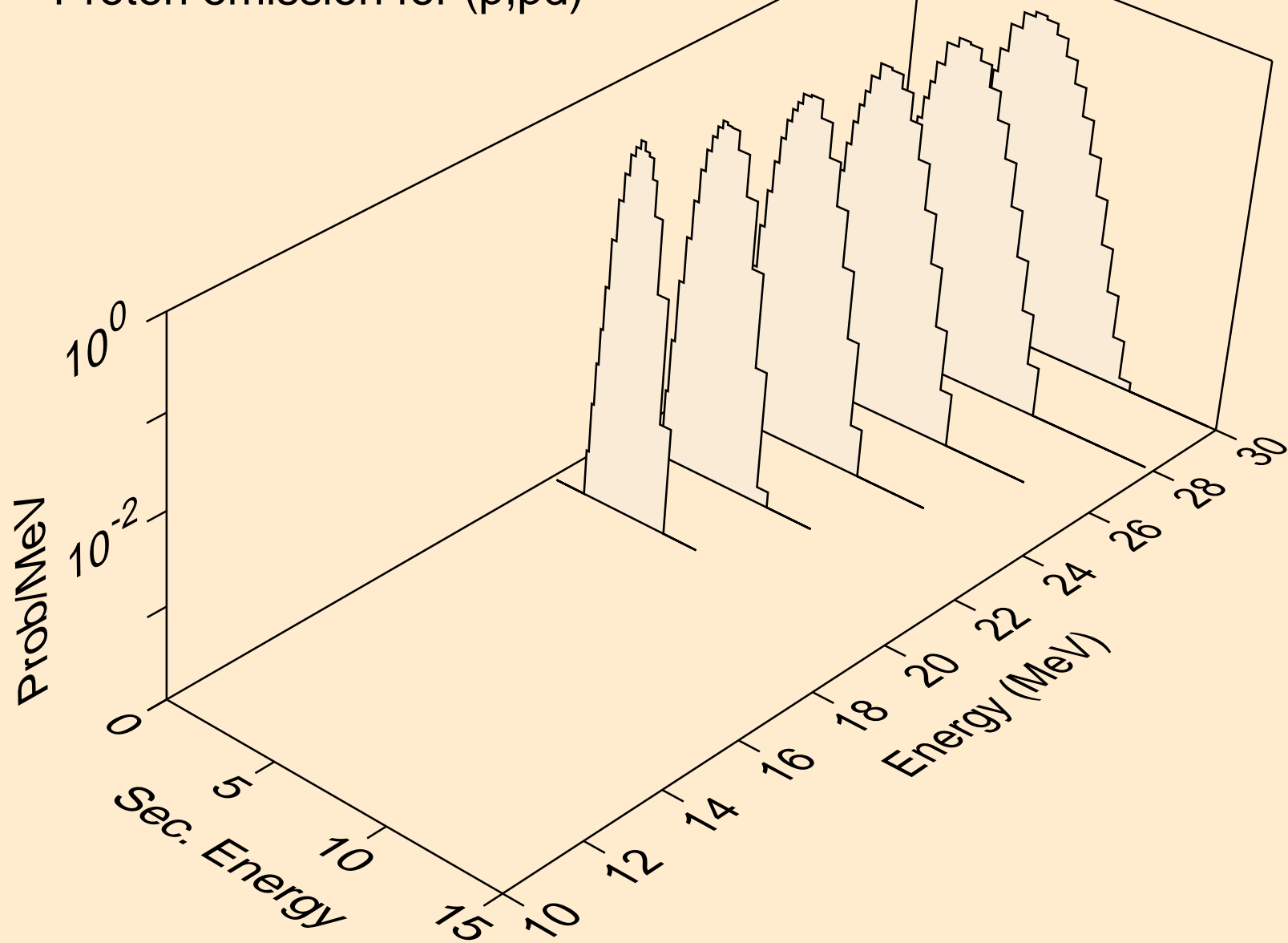

OS186 PROTON ACER TENDL-2021 LIBRARY; T=0.K  
Proton emission for (p,pt)

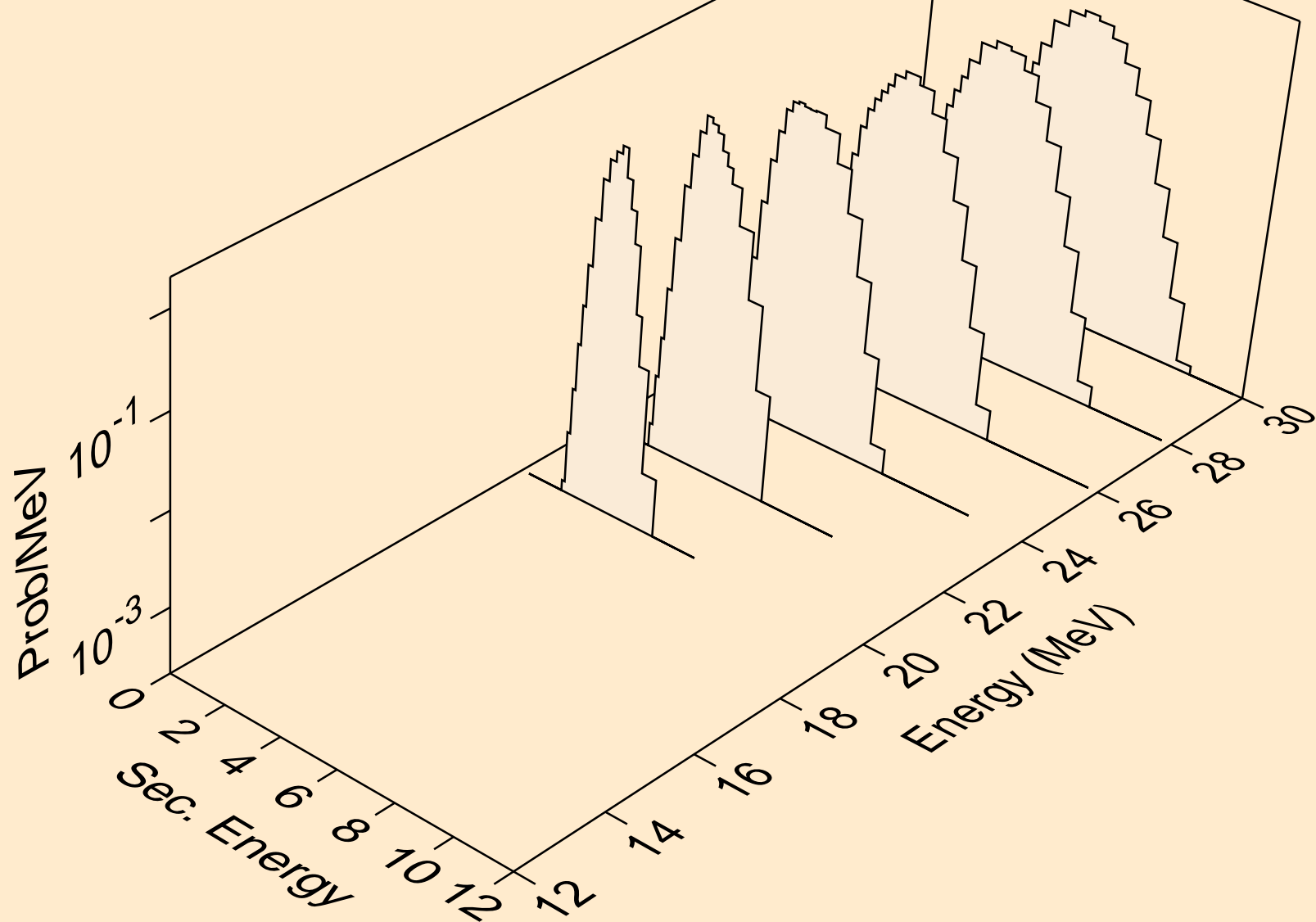

OS186 PROTON ACER TENDL-2021 LIBRARY; T=0.K  
Photon emission for (z,n)

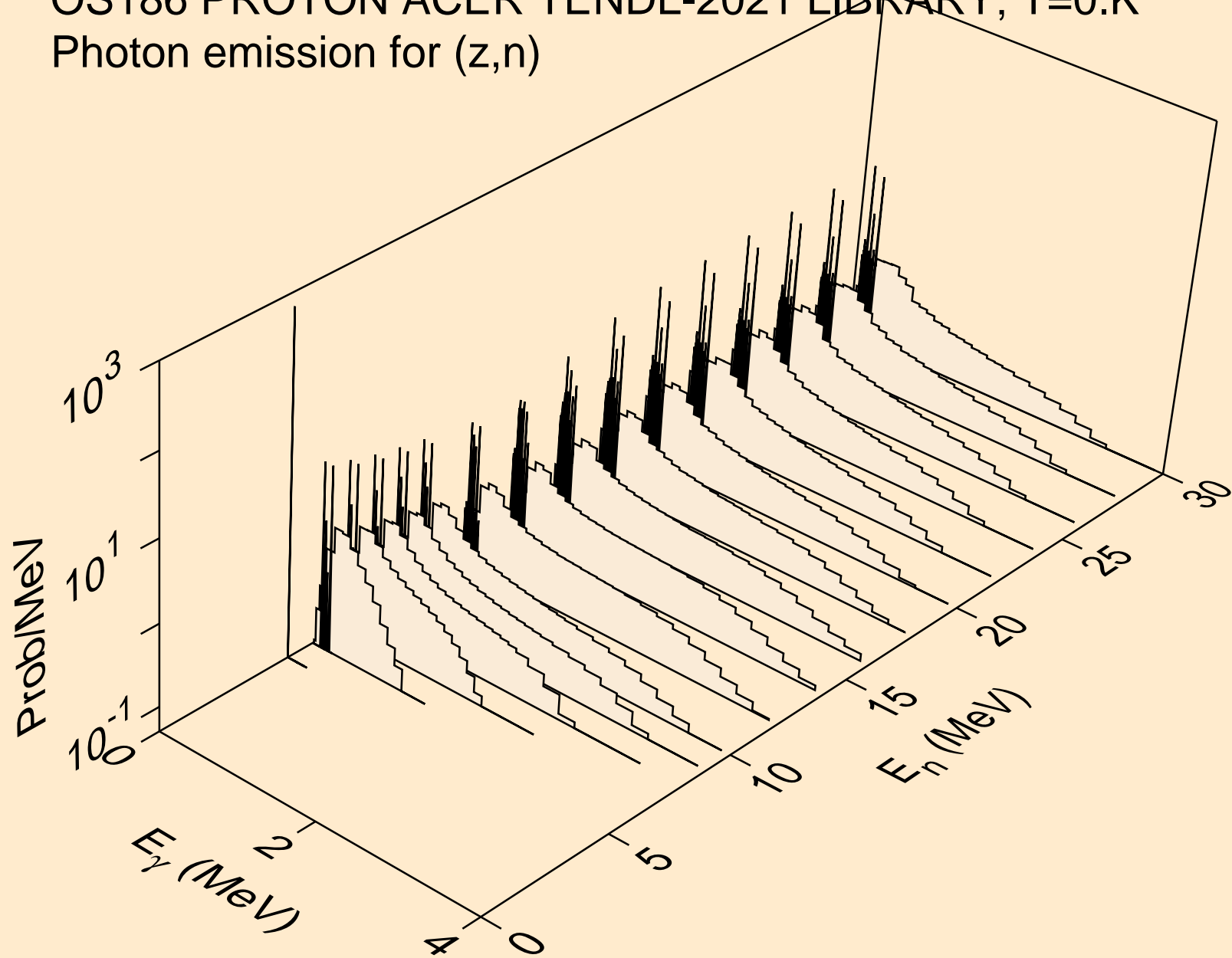

OS186 PROTON ACER TENDL-2021 LIBRARY; T=0.K  
Photon emission for (n,x)

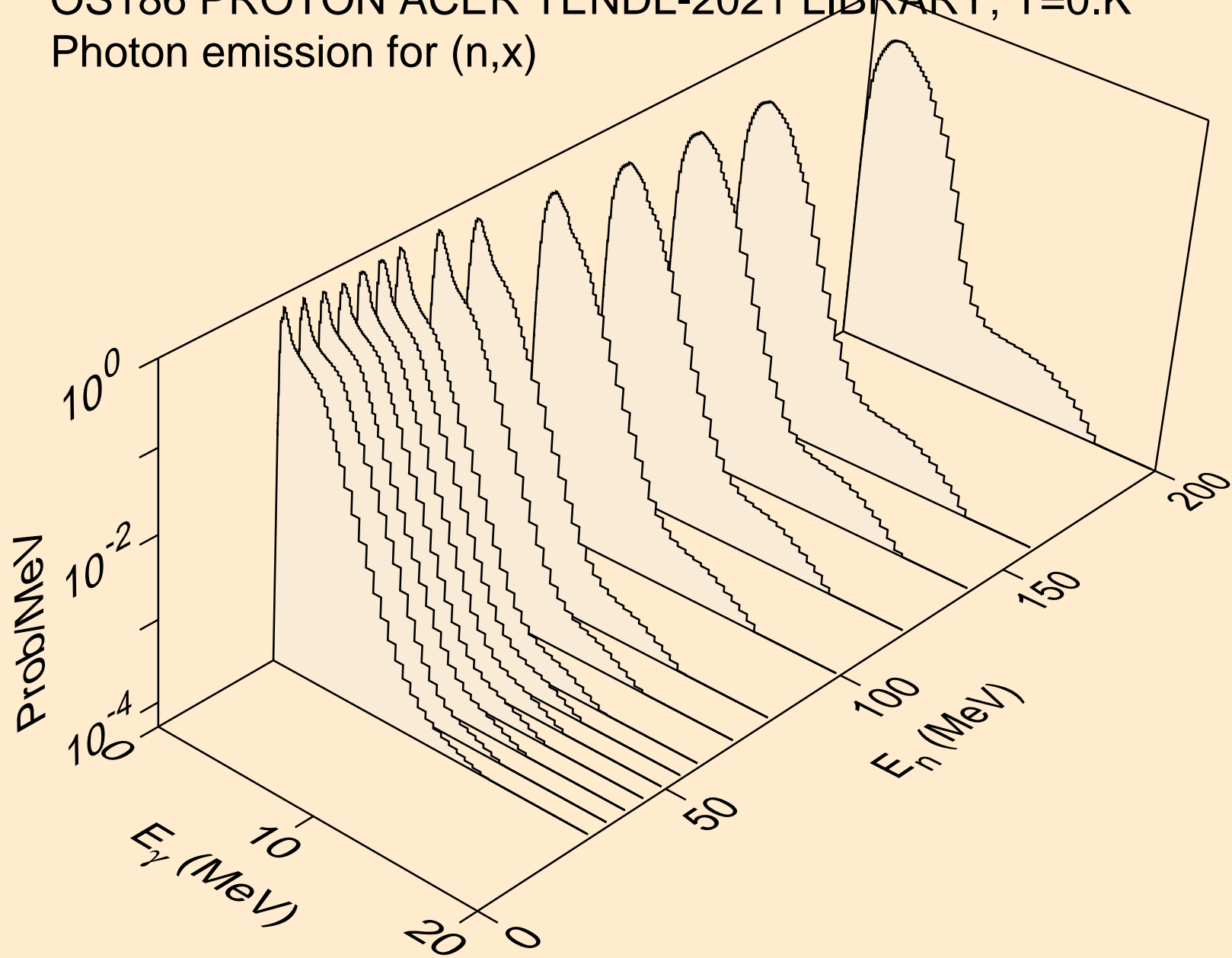

OS186 PROTON ACER TENDL-2021 LIBRARY; T=0.K  
Photon emission for (n,2nd)

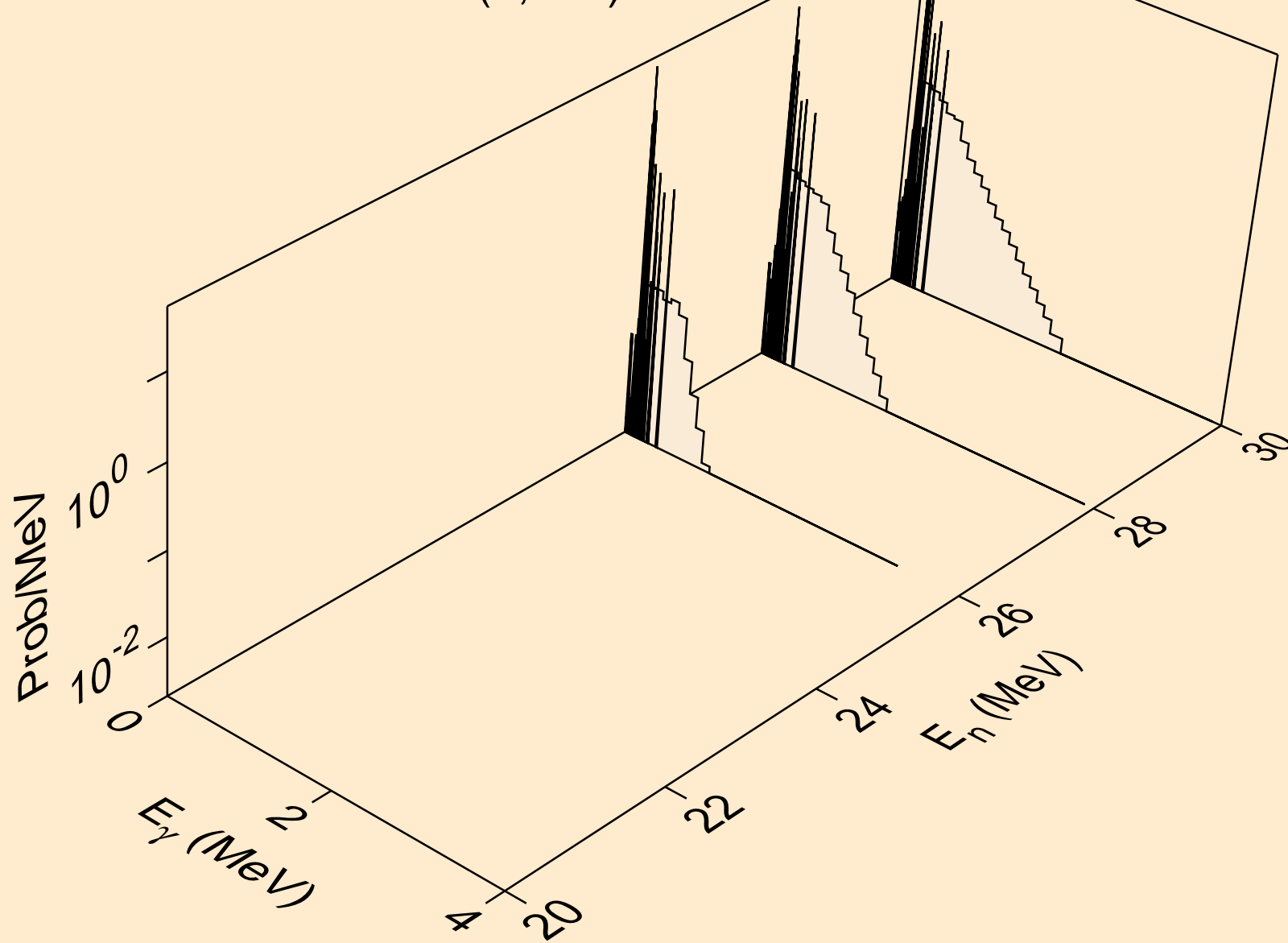

OS186 PROTON ACER TENDL-2021 LIBRARY; T=0.K  
Photon emission for (n,2n)

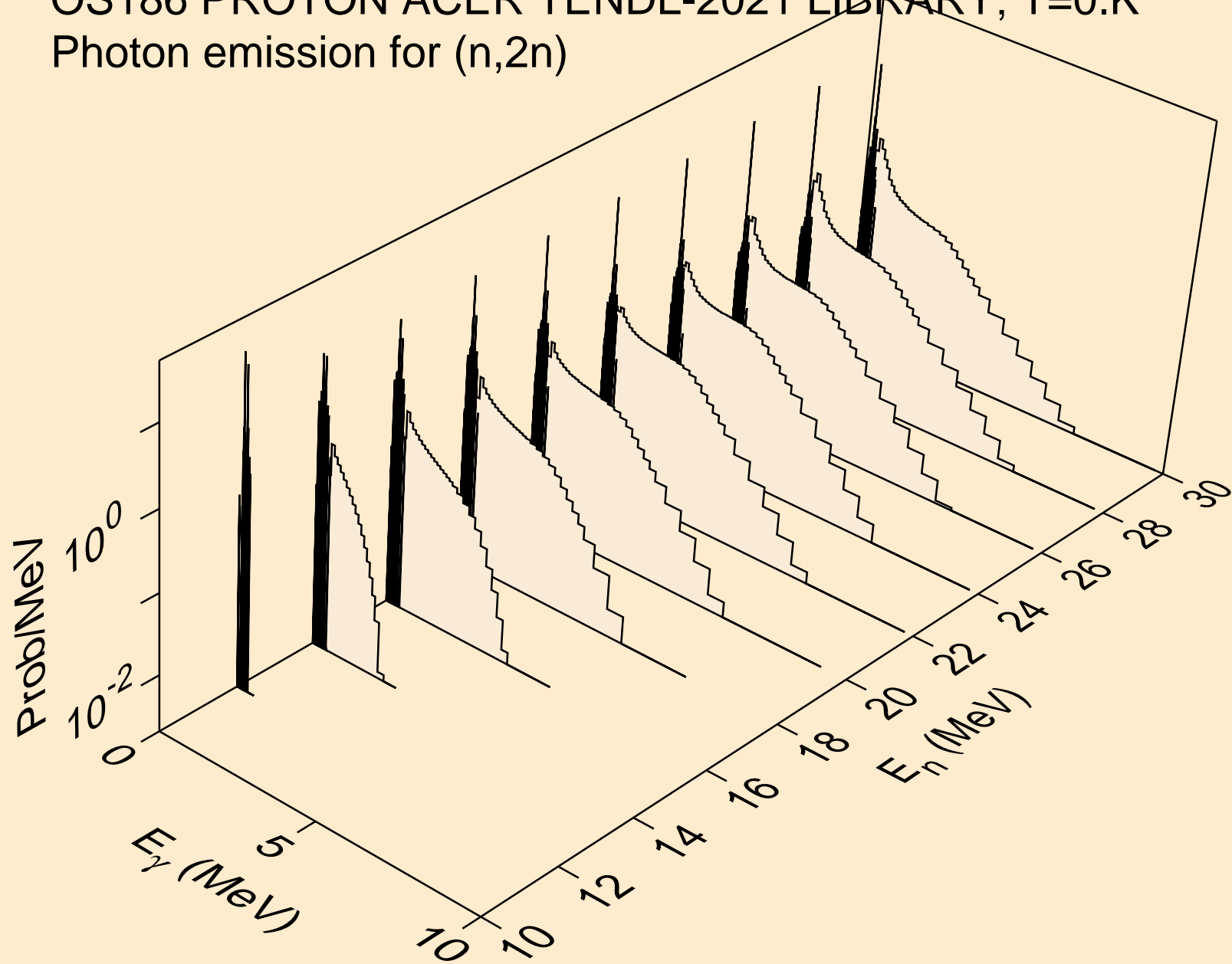



OS186 PROTON ACER TENDL-2021 LIBRARY; T=0.K  
Photon emission for (n,3n)

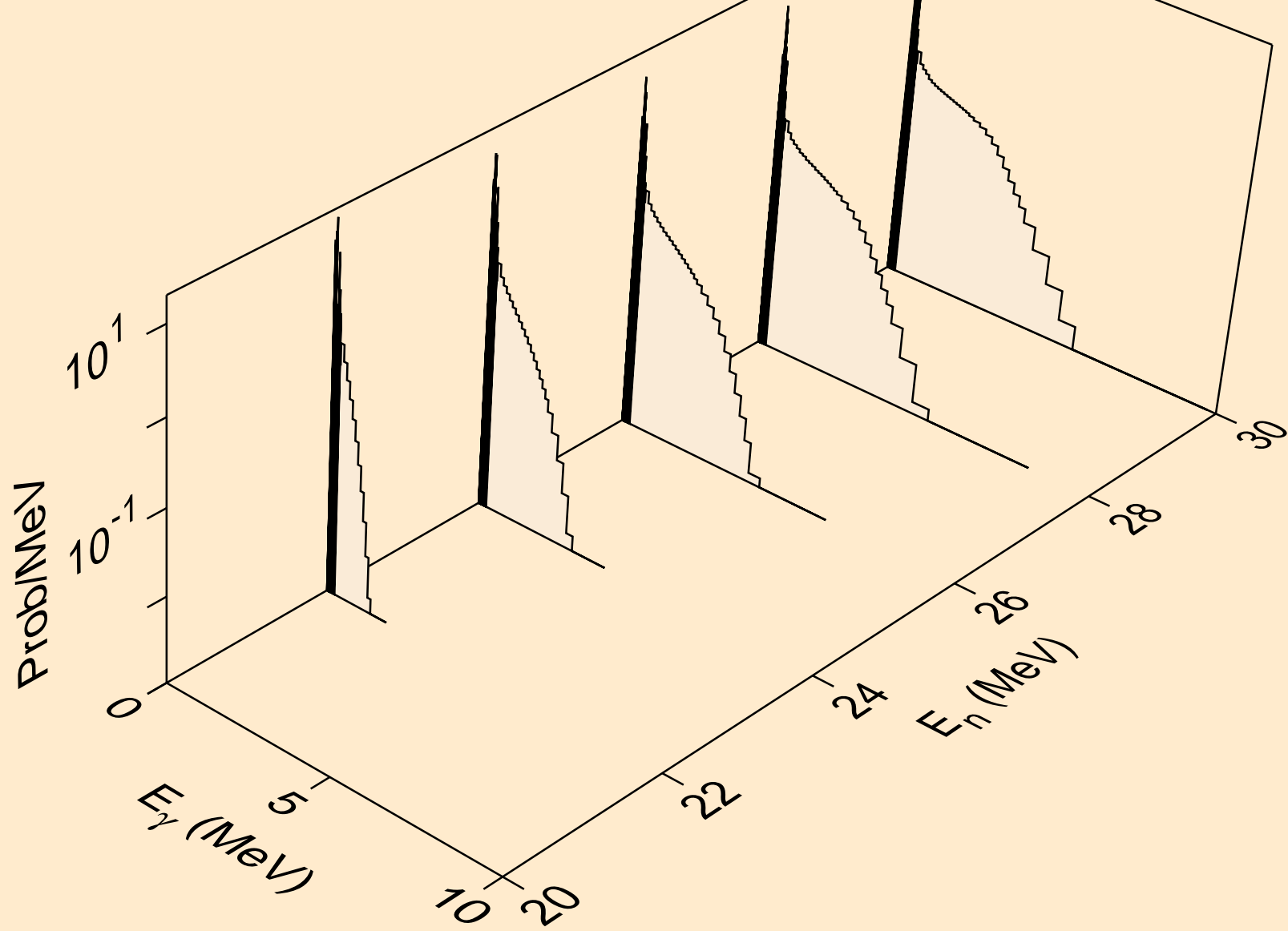

OS186 PROTON ACER TENDL-2021 LIBRARY; T=0.K  
Photon emission for (n,n\*)a

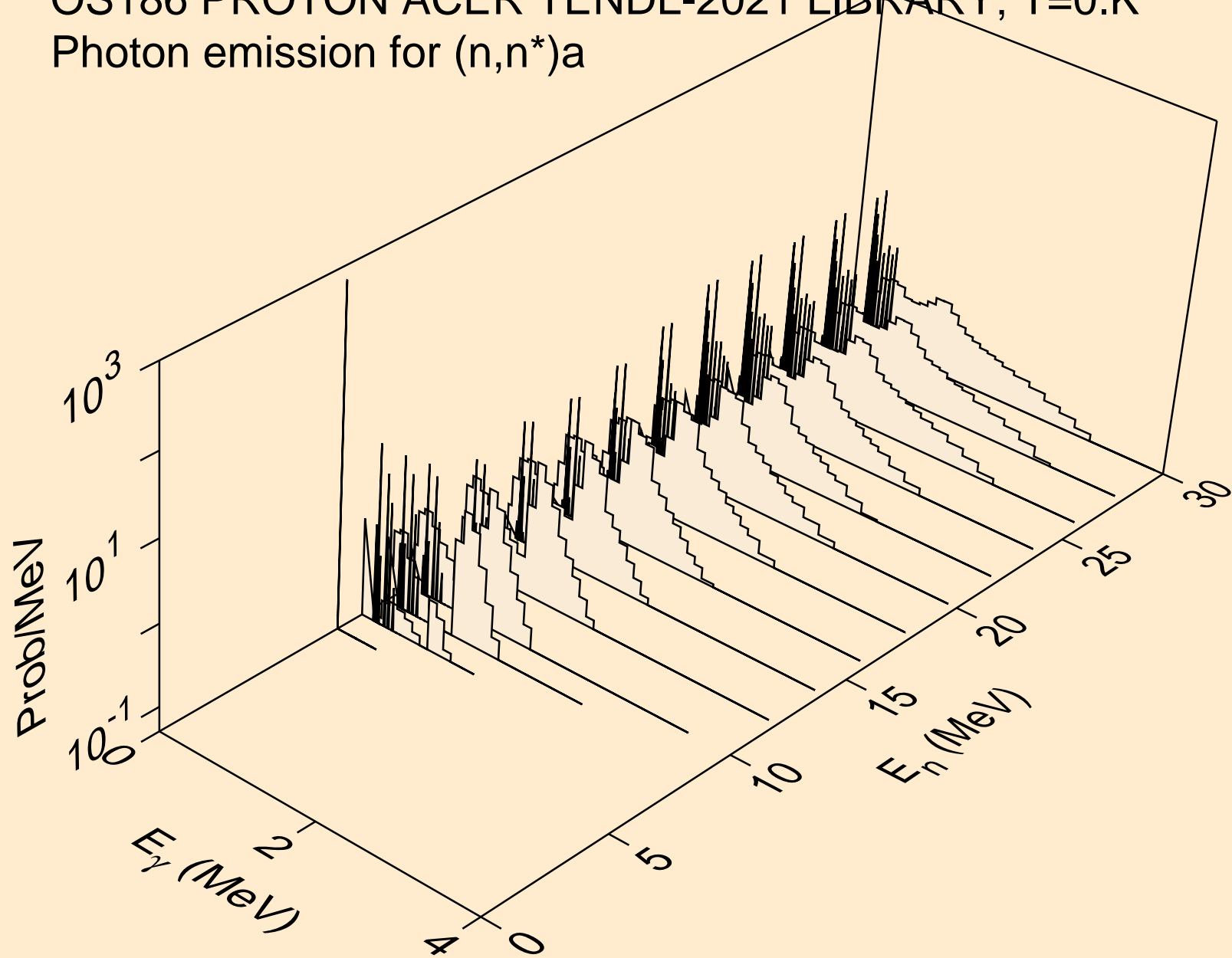

OS186 PROTON ACER TENDL-2021 LIBRARY; T=0.K  
Photon emission for (n,2n) $\alpha$

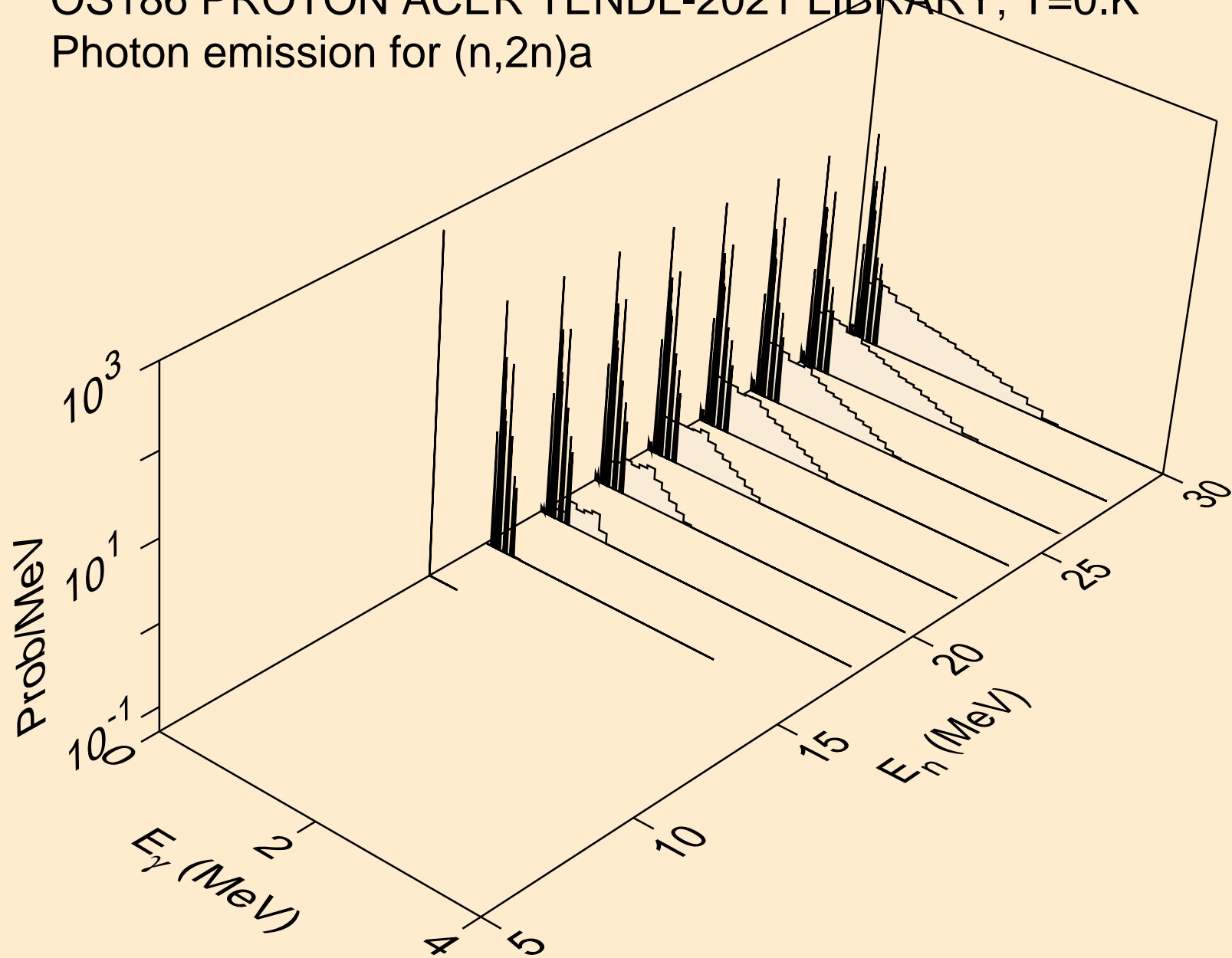

OS186 PROTON ACER TENDL-2021 LIBRARY; T=0.K  
Photon emission for (n,3n)a

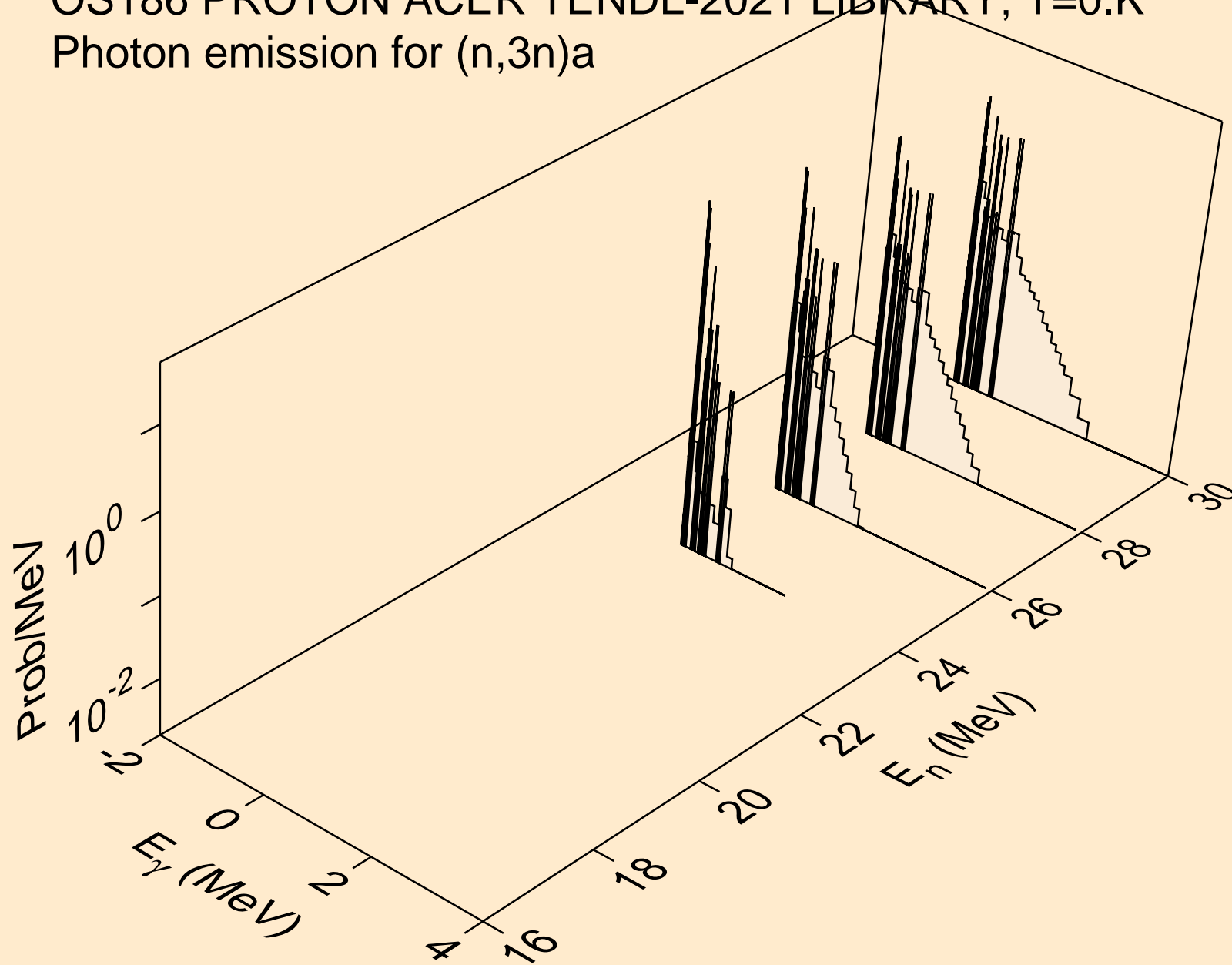

OS186 PROTON ACER TENDL-2021 LIBRARY; T=0.K  
Photon emission for (n,n\*)p

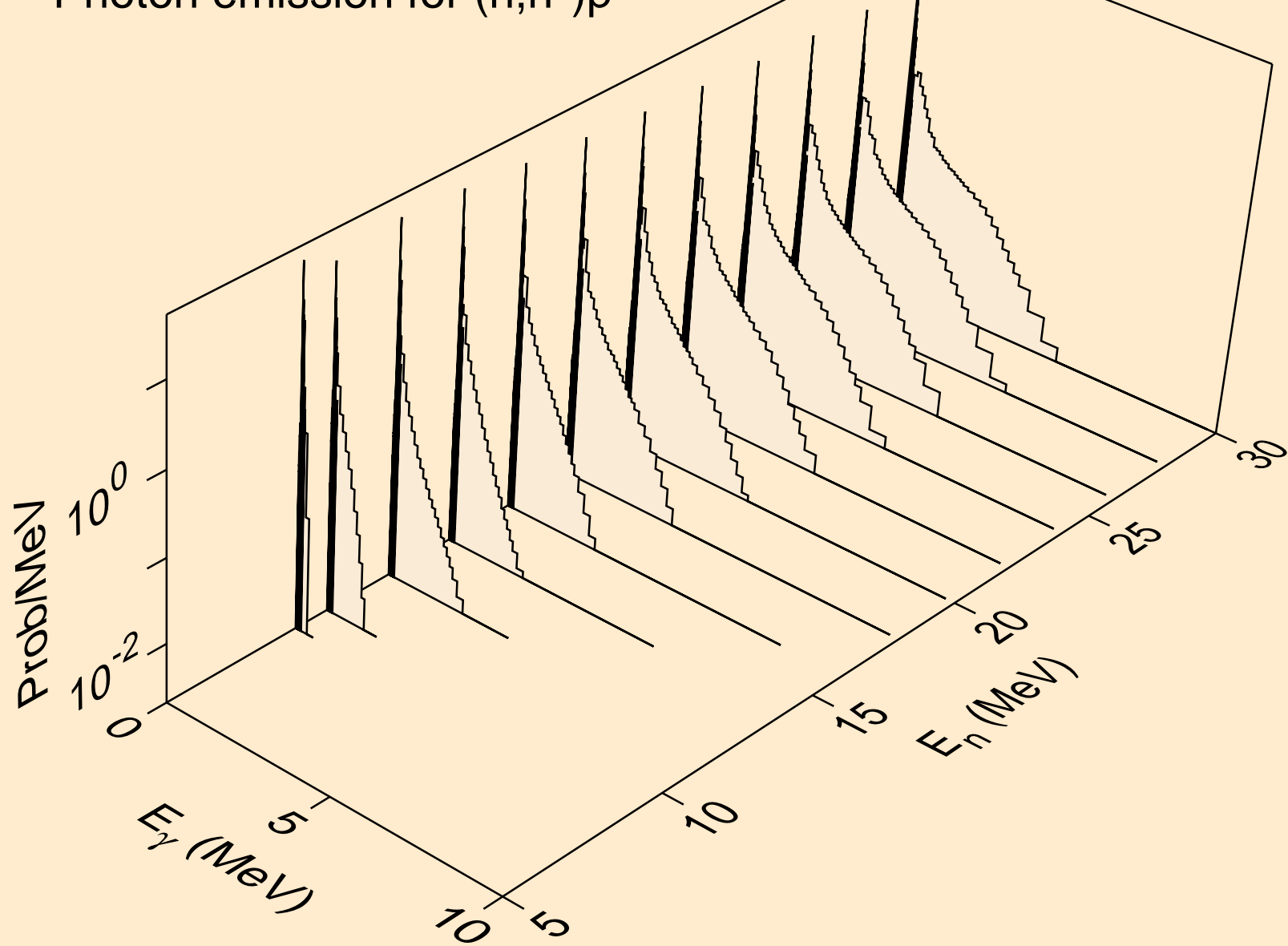

OS186 PROTON ACER TENDL-2021 LIBRARY; T=0.K  
Photon emission for (n,n\*)2a

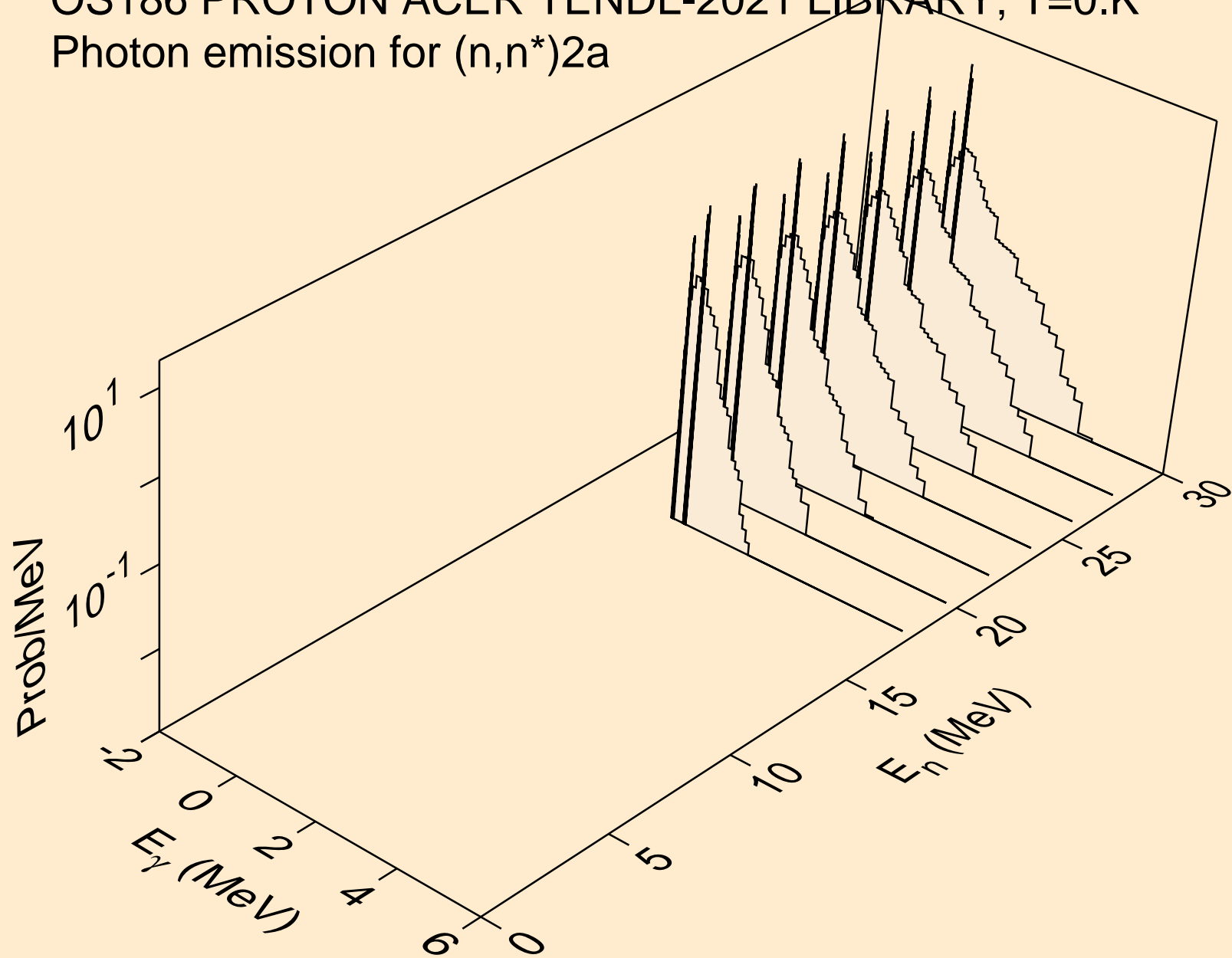

OS186 PROTON ACER TENDL-2021 LIBRARY; T=0.K  
Photon emission for (n,n\*)d

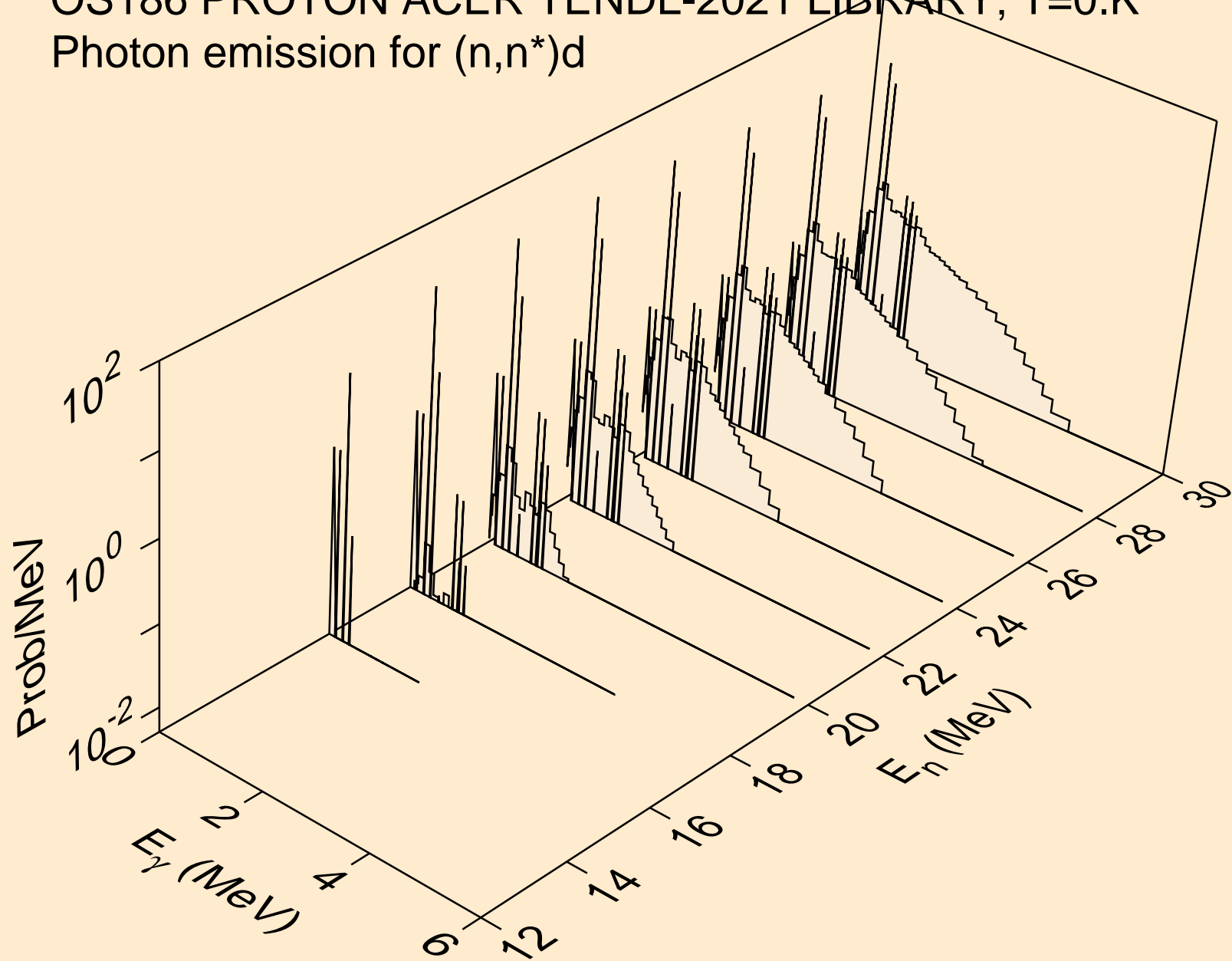

OS186 PROTON ACER TENDL-2021 LIBRARY; T=0.K  
Photon emission for (n,n\*)t

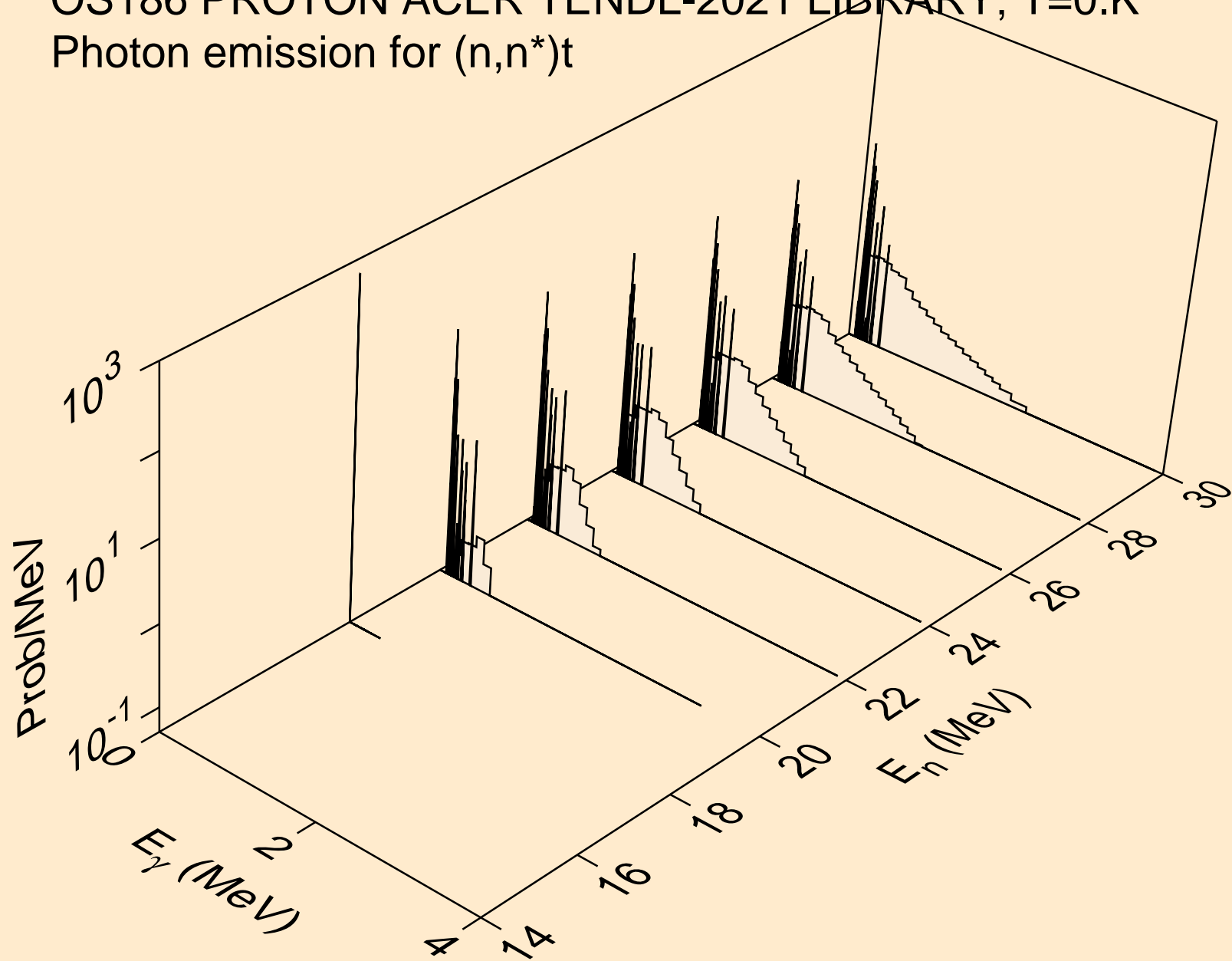



OS186 PROTON ACER TENDL-2021 LIBRARY; T=0.K  
Photon emission for (n,n\*)he3

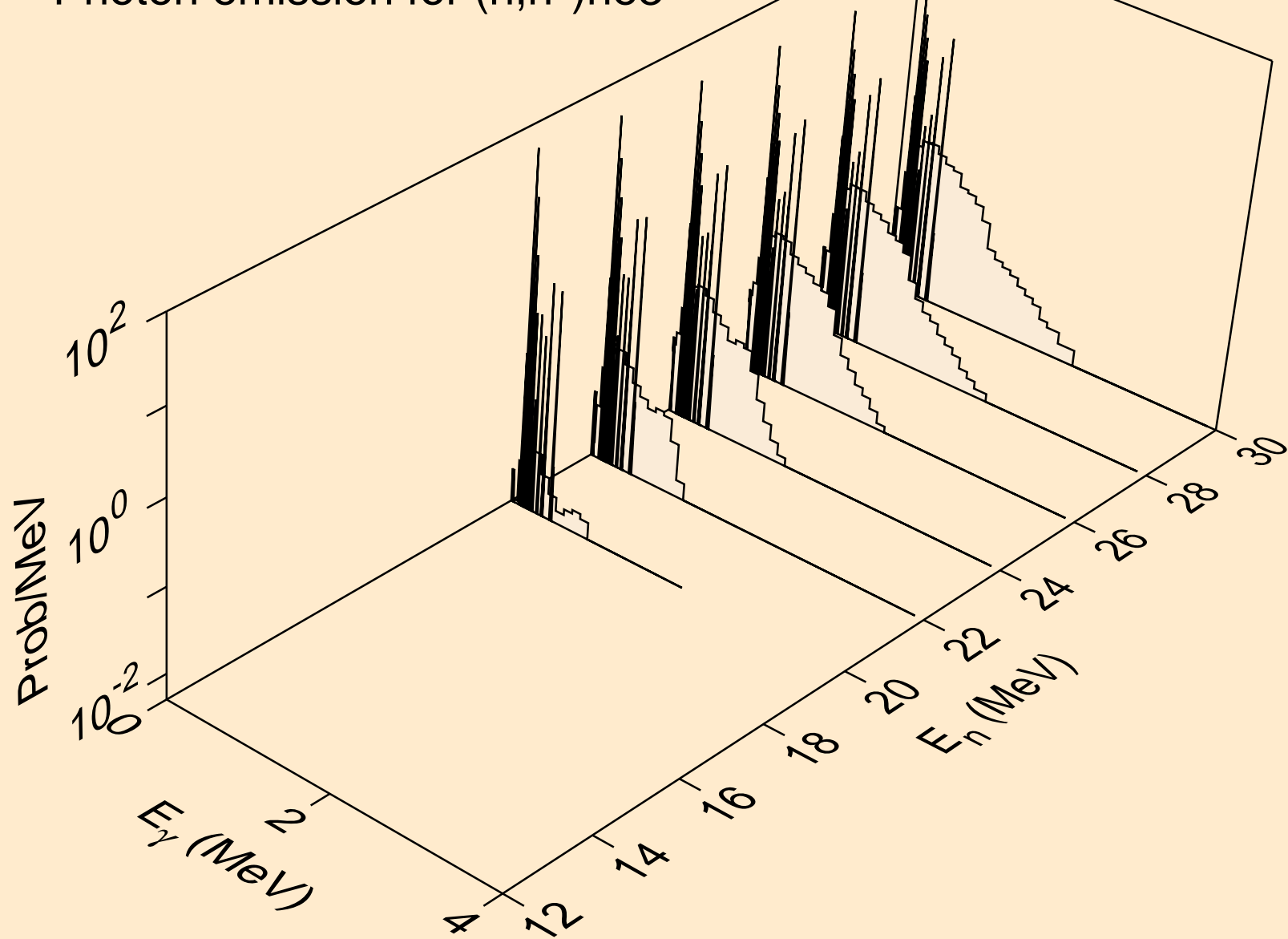

OS186 PROTON ACER TENDL-2021 LIBRARY; T=0.K  
Photon emission for (n,4n)

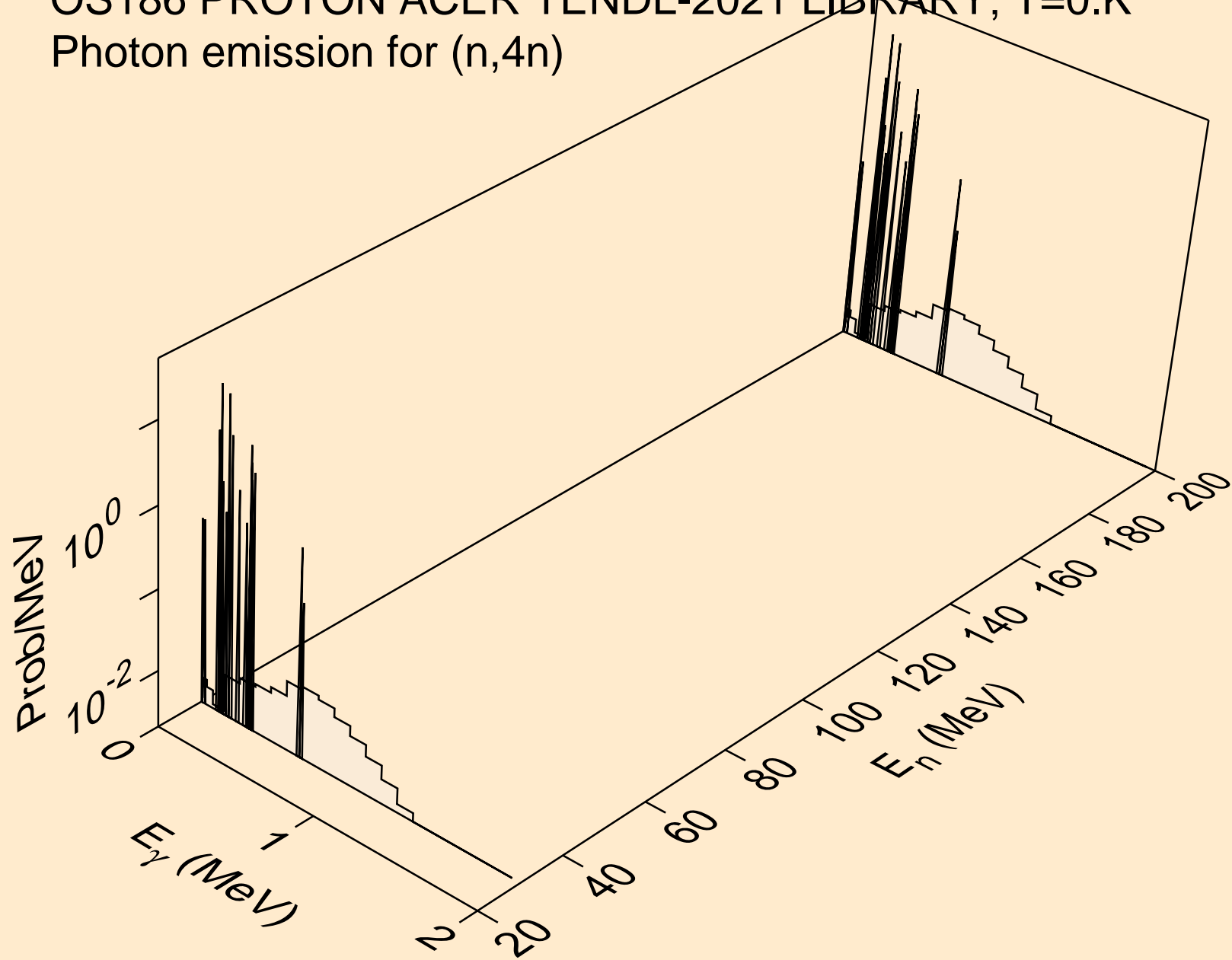

OS186 PROTON ACER TENDL-2021 LIBRARY; T=0.K  
Photon emission for (n,2np)

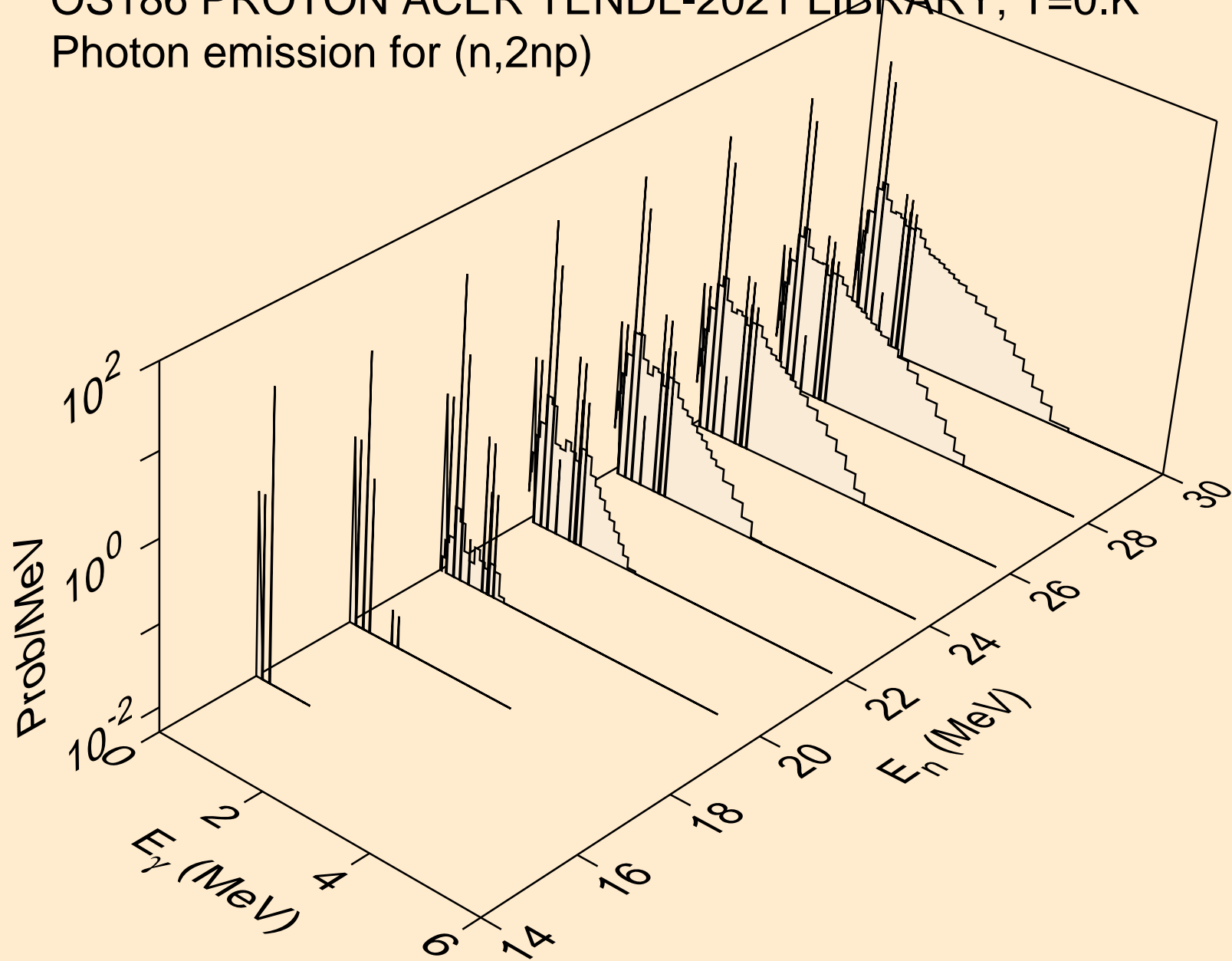

OS186 PROTON ACER TENDL-2021 LIBRARY; T=0.K  
Photon emission for (n,3np)

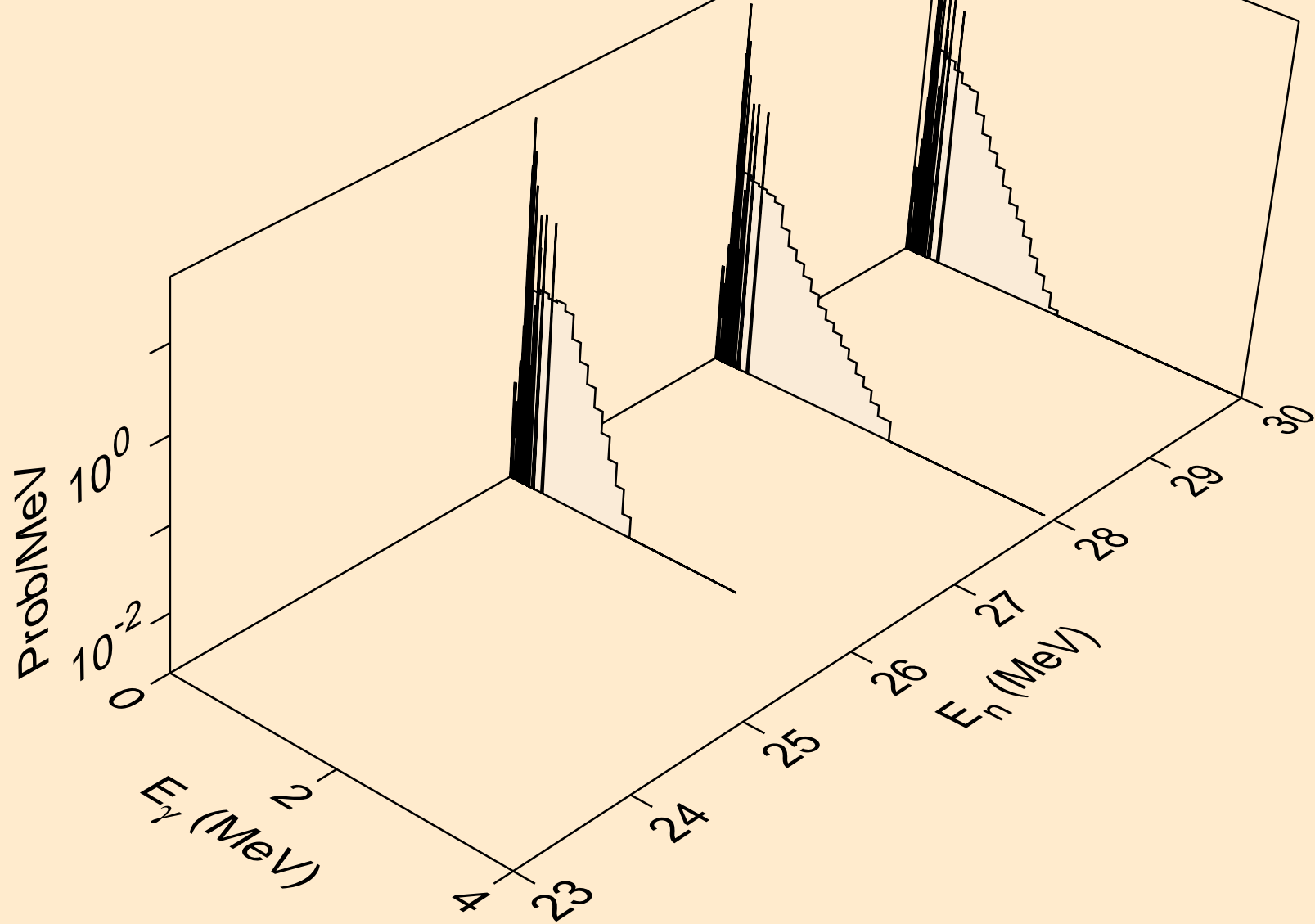

OS186 PROTON ACER TENDL-2021 LIBRARY; T=0.K  
Photon emission for (n,2np)

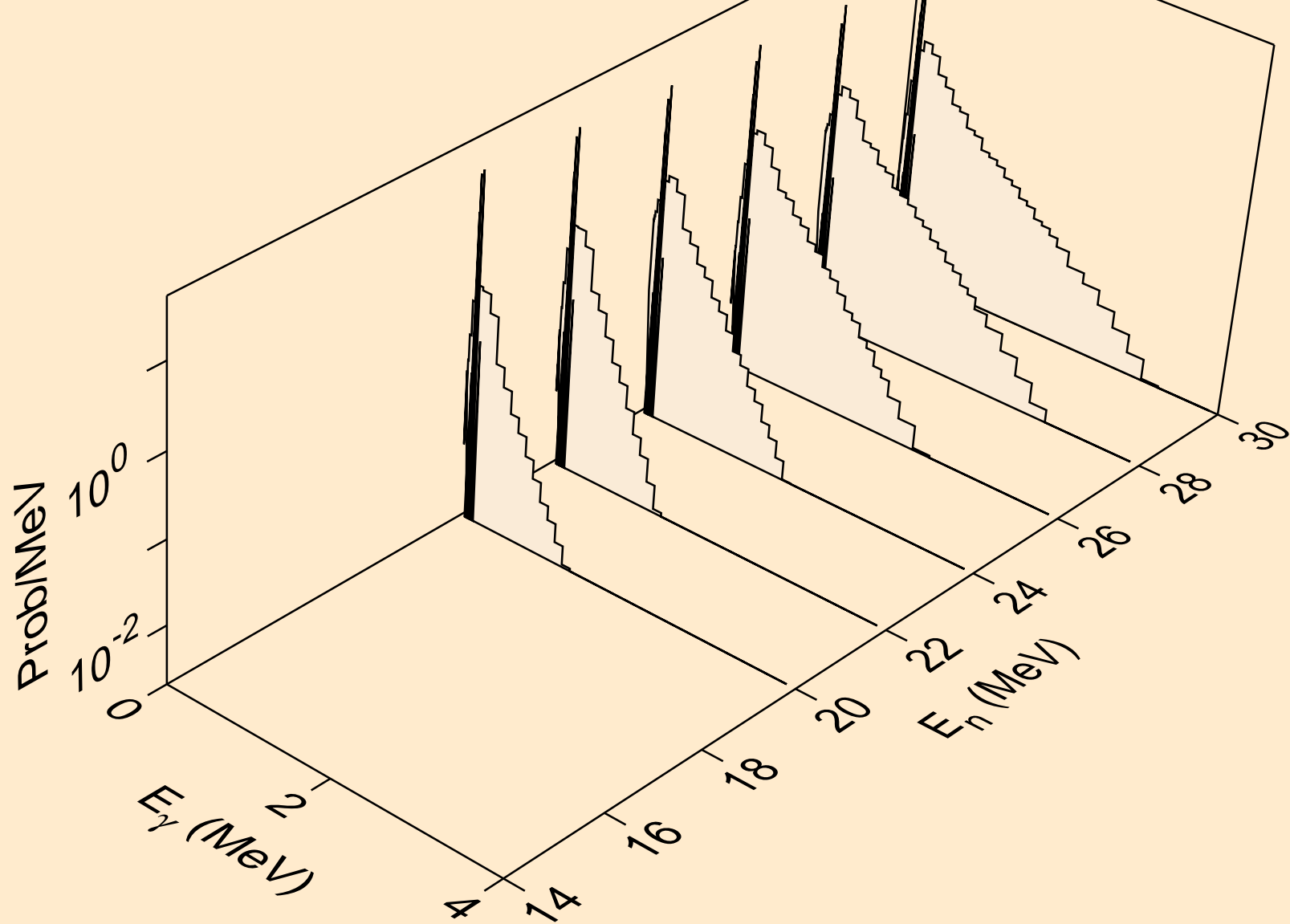

OS186 PROTON ACER TENDL-2021 LIBRARY; T=0.K  
Photon emission for (n,npa)

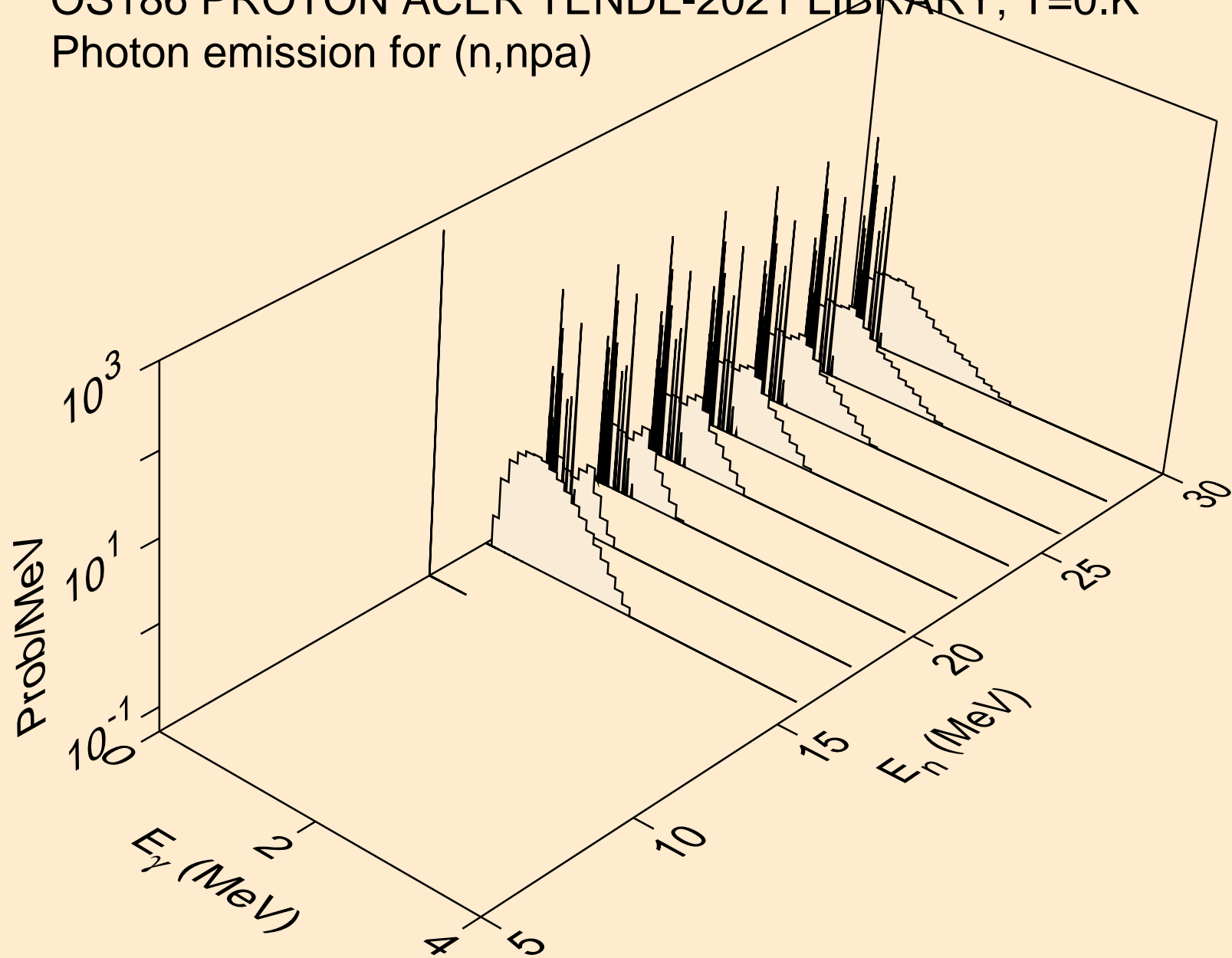

OS186 PROTON ACER TENDL-2021 LIBRARY; T=0.K  
Photon emission for (n,gma)

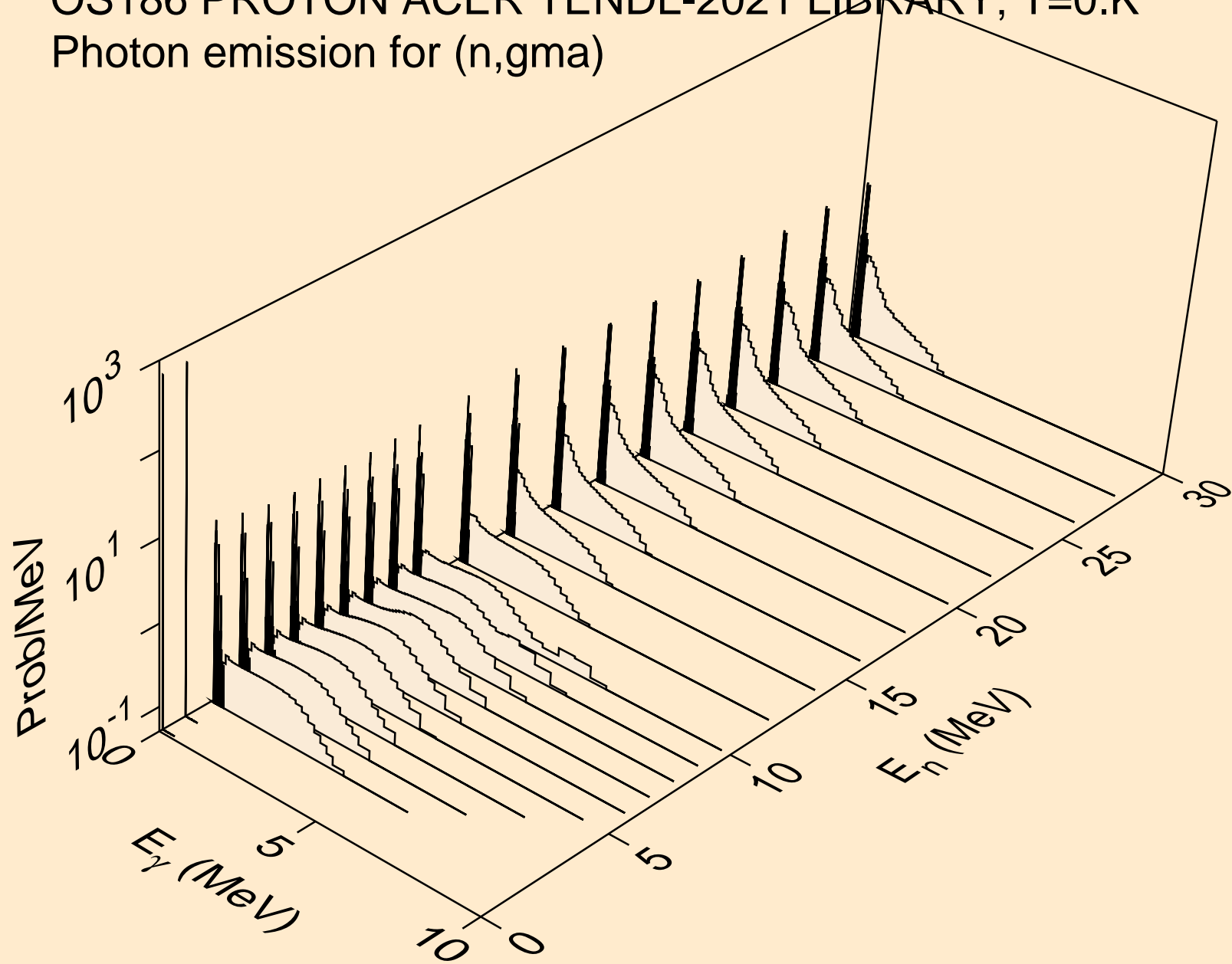

OS186 PROTON ACER TENDL-2021 LIBRARY; T=0.K  
Photon emission for inelastic

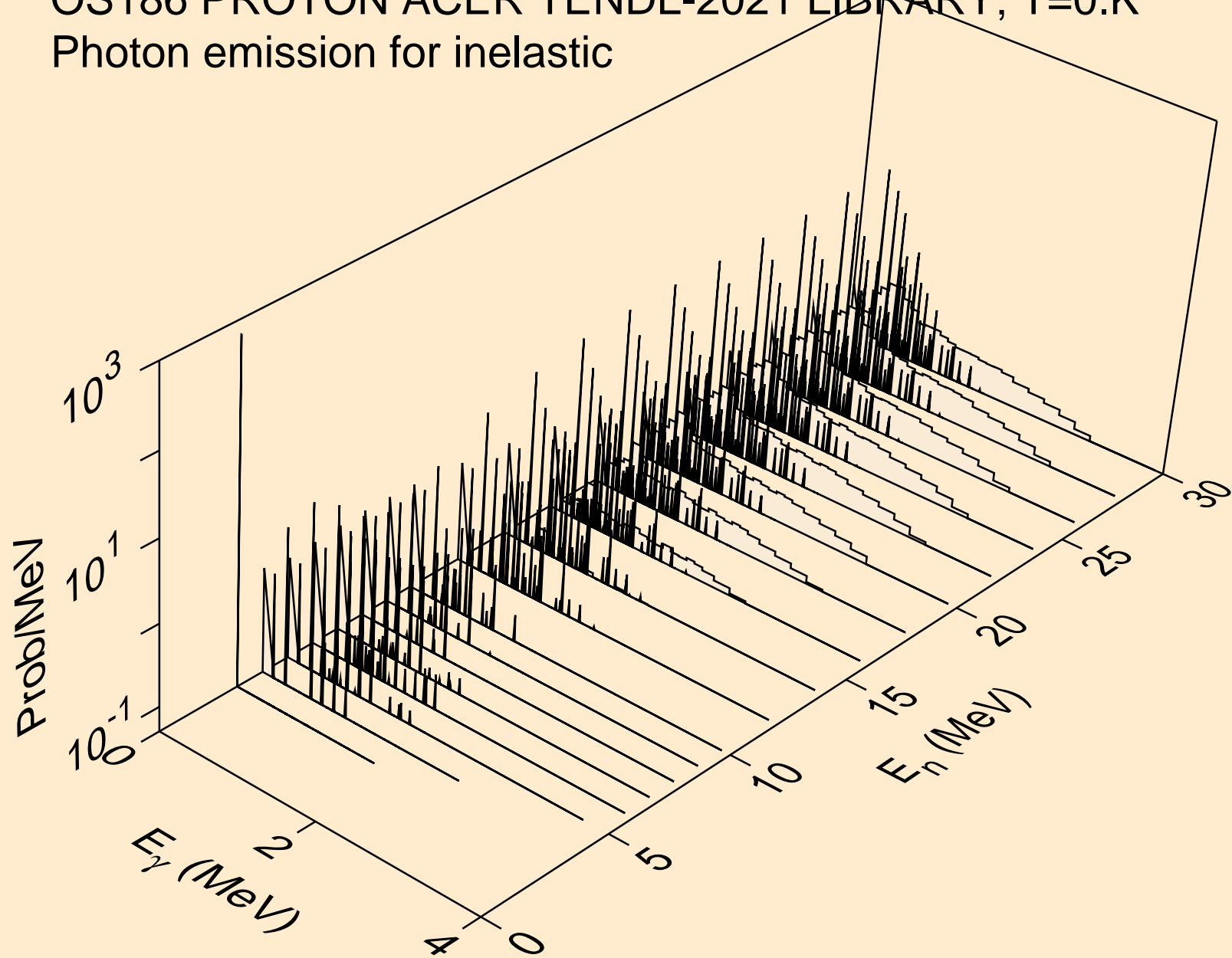



OS186 PROTON ACER TENDL-2021 LIBRARY; T=0.K  
Photon emission for (n,d)

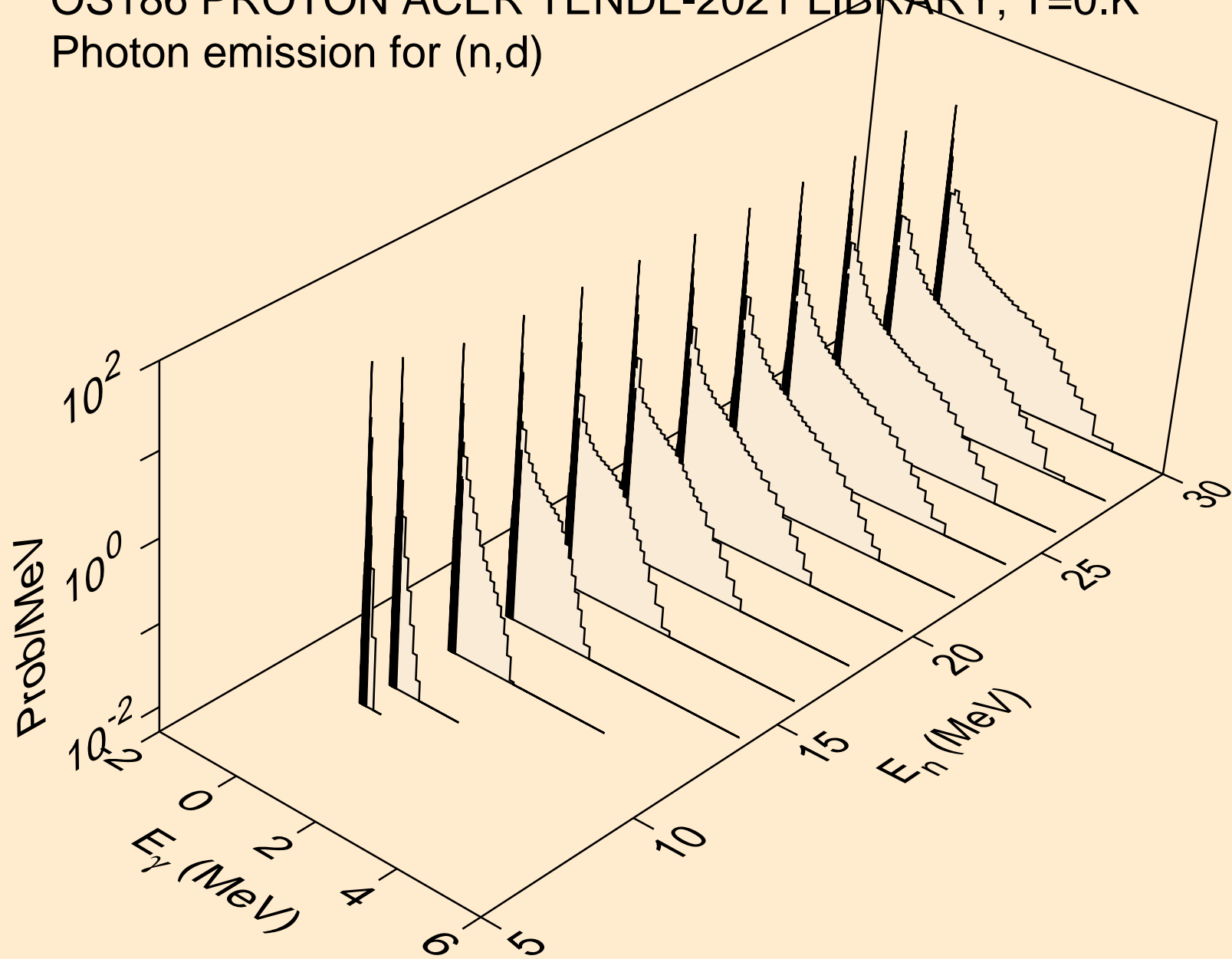

OS186 PROTON ACER TENDL-2021 LIBRARY; T=0.K  
Photon emission for (n,t)

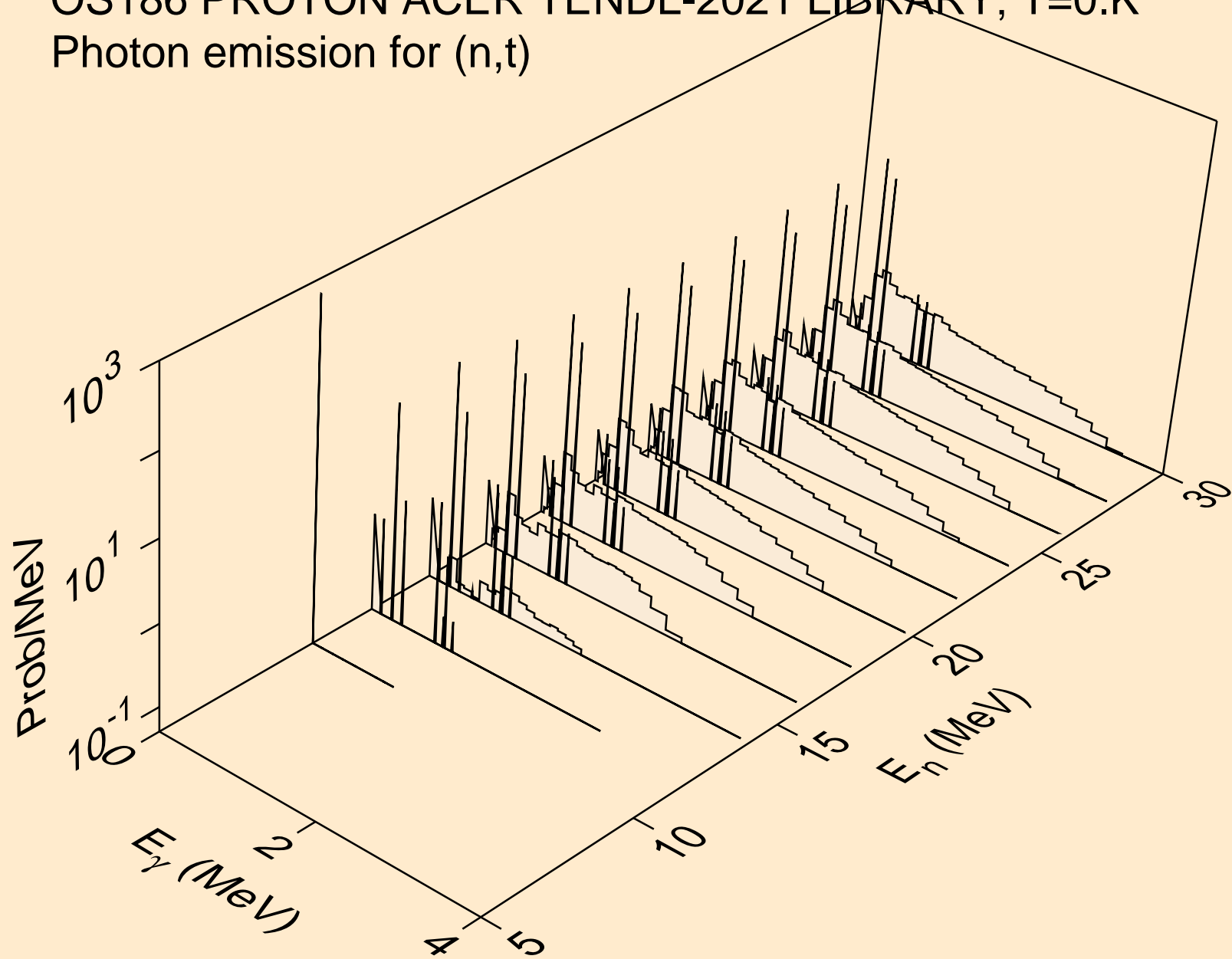

OS186 PROTON ACER TENDL-2021 LIBRARY; T=0.K  
Photon emission for (n,he3)

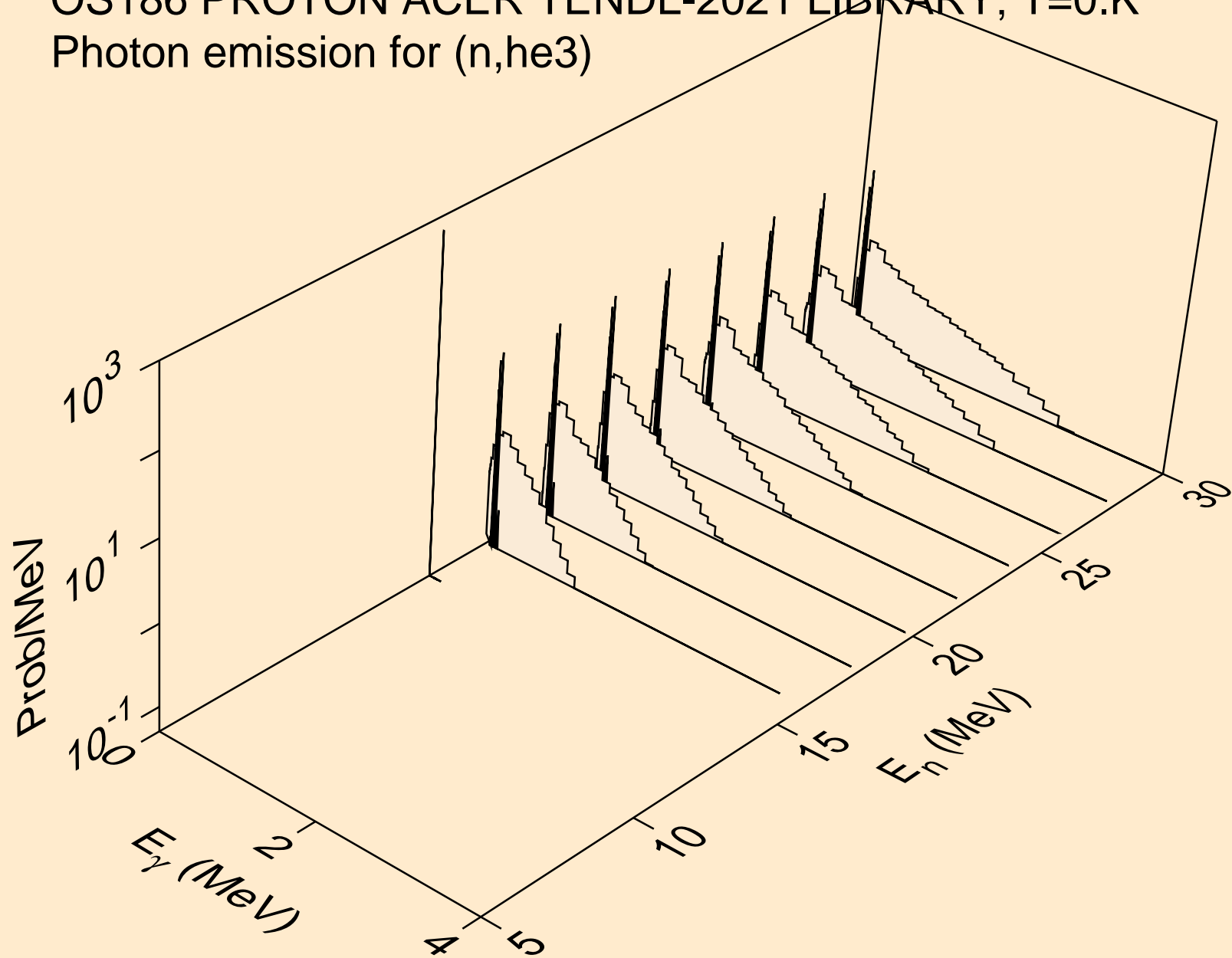

OS186 PROTON ACER TENDL-2021 LIBRARY; T=0.K  
Photon emission for (n,a)

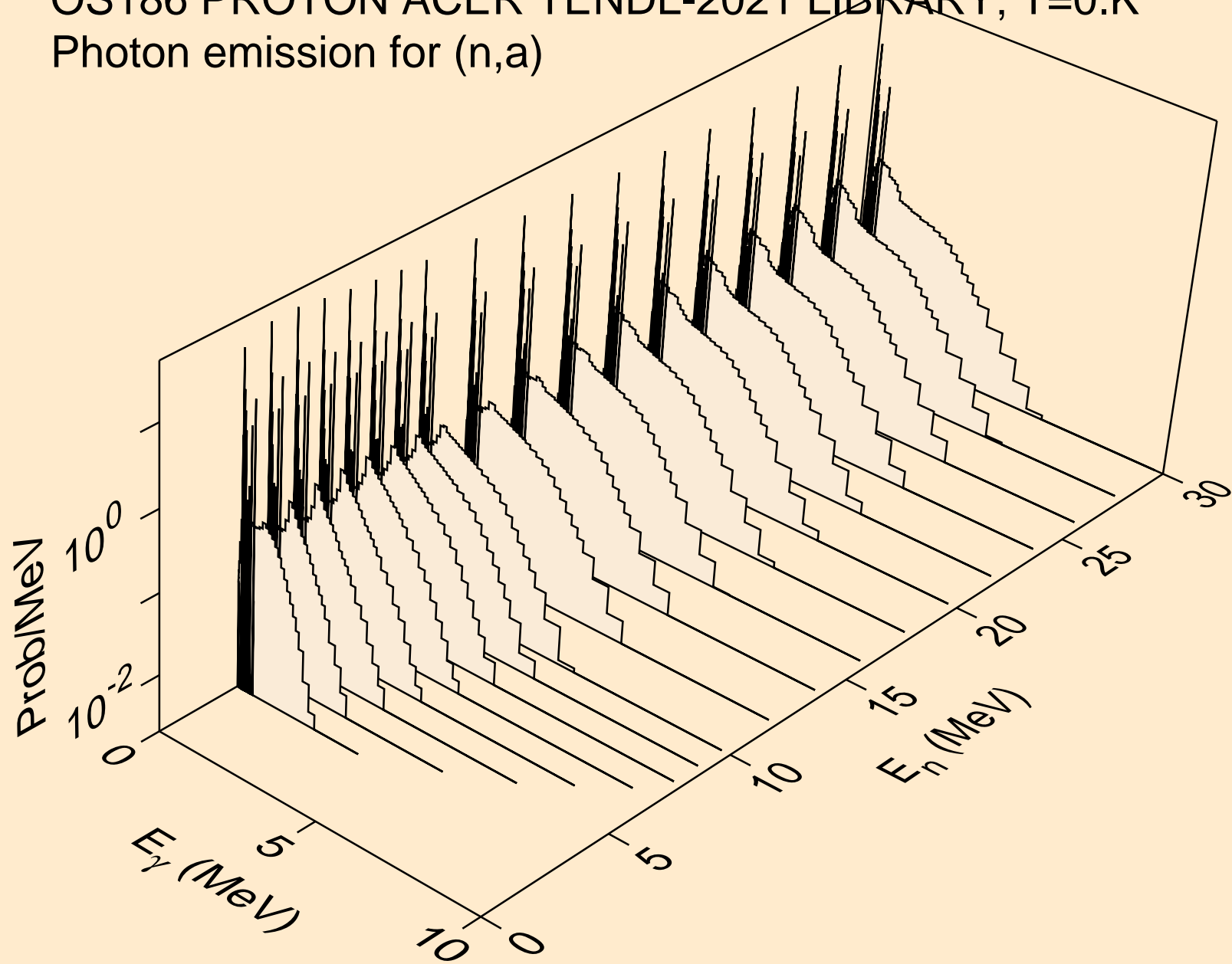

OS186 PROTON ACER TENDL-2021 LIBRARY; T=0.K  
Photon emission for (n,2a)

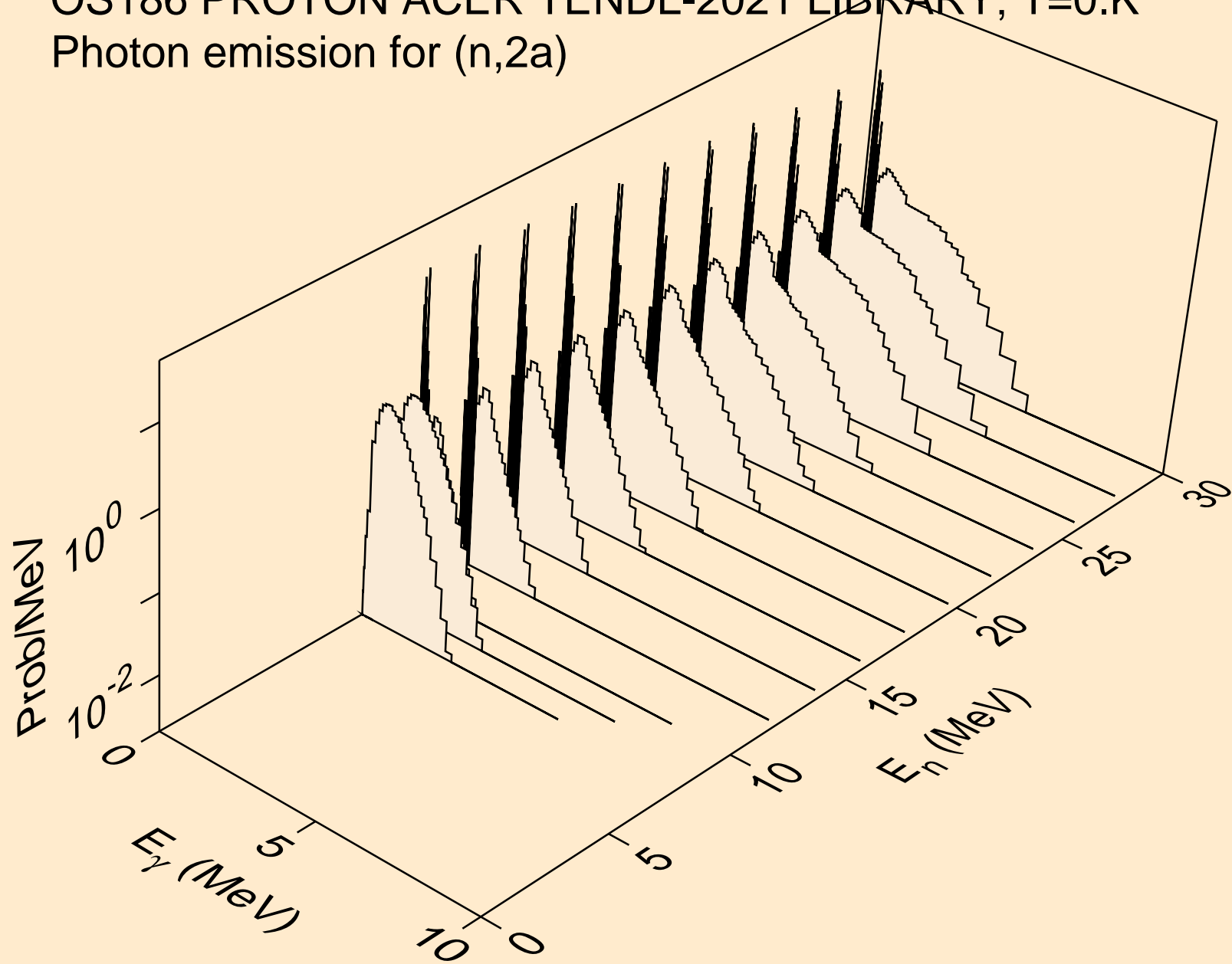

OS186 PROTON ACER TENDL-2021 LIBRARY; T=0.K  
Photon emission for (n,2p)

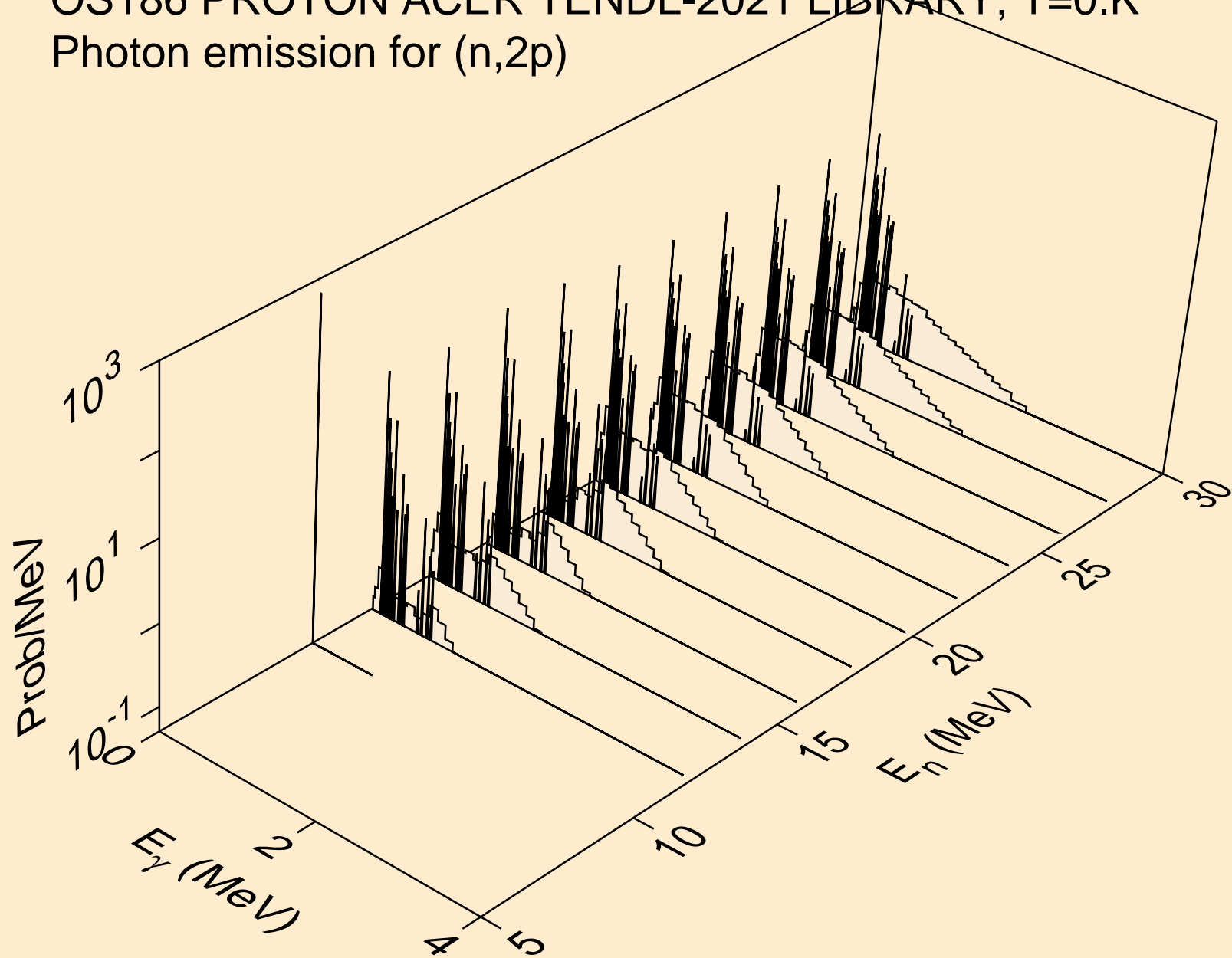

OS186 PROTON ACER TENDL-2021 LIBRARY; T=0.K  
Photon emission for (n,pa)

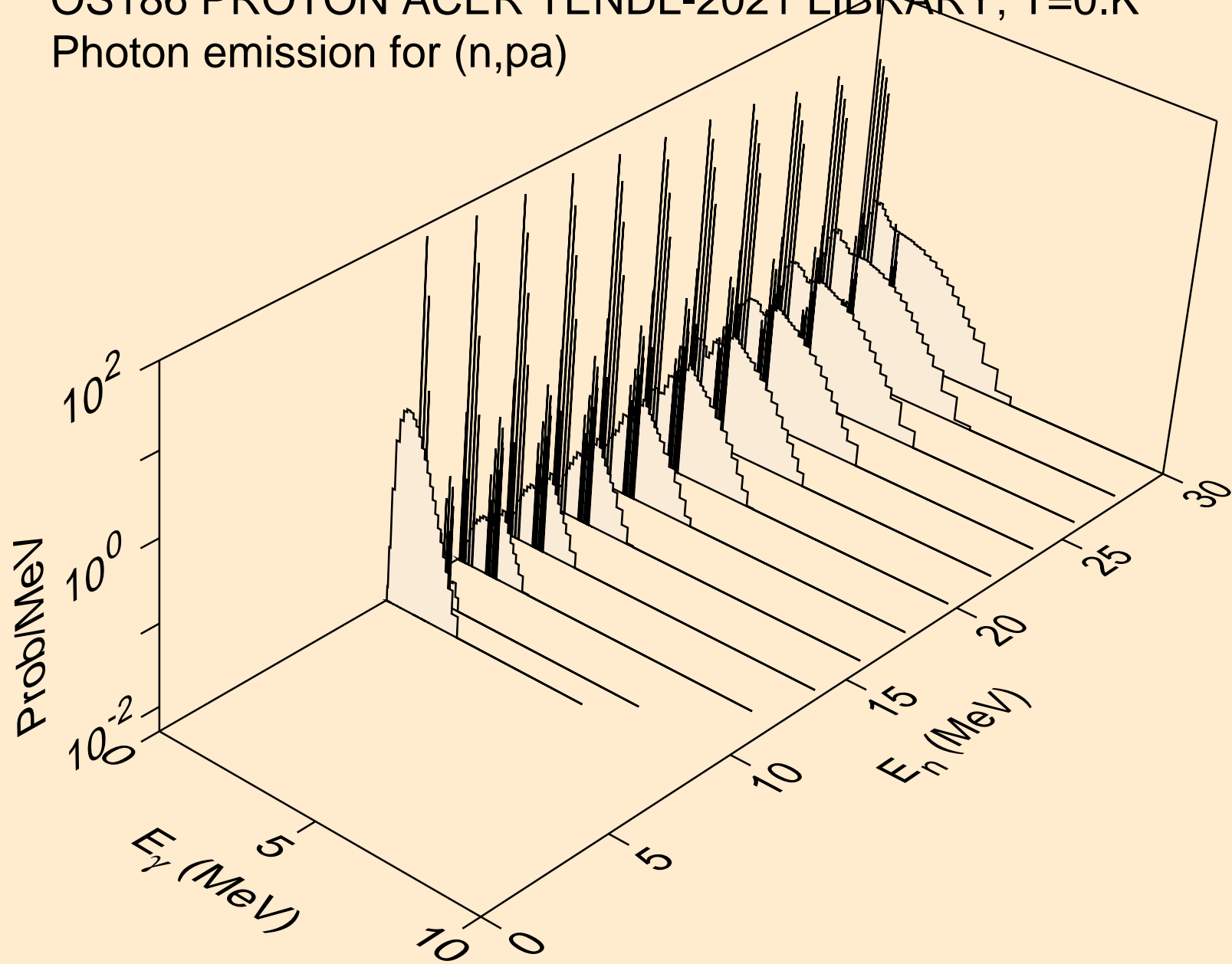

OS186 PROTON ACER TENDL-2021 LIBRARY; T=0.K  
Photon emission for (n,pd)

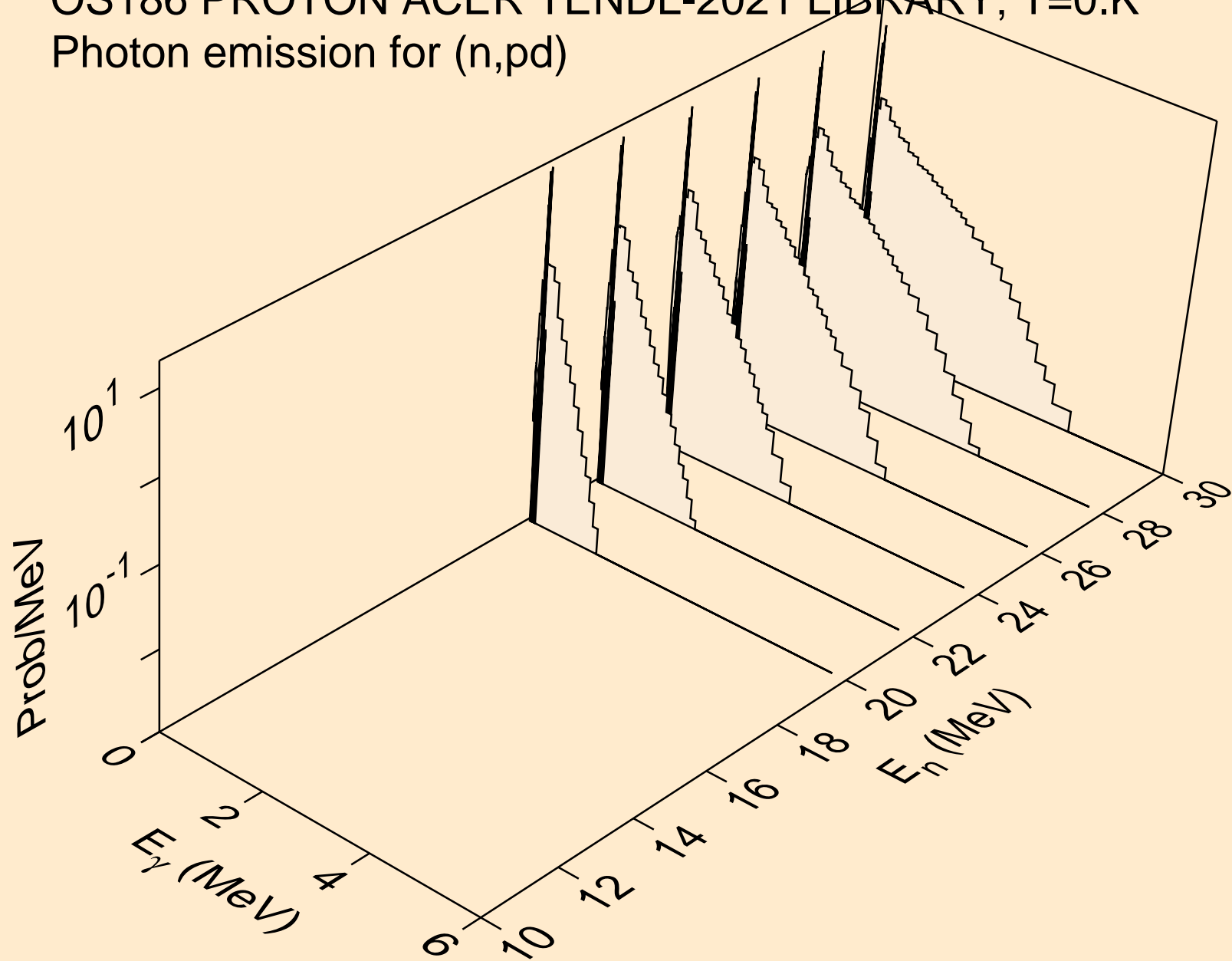



OS186 PROTON ACER TENDL-2021 LIBRARY; T=0.K  
Photon emission for (n,pt)

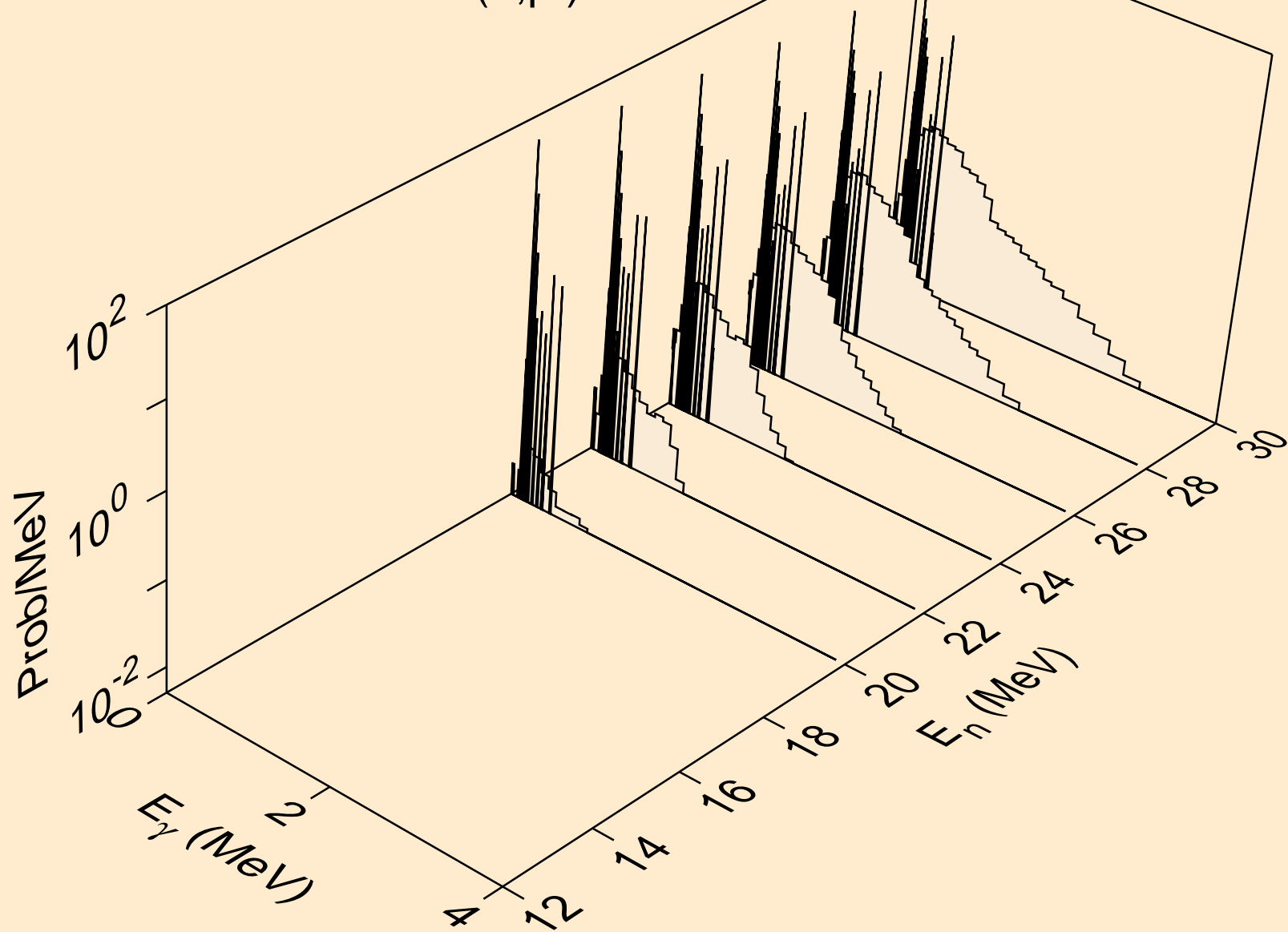

OS186 PROTON ACER TENDL-2021 LIBRARY; T=0.K  
Photon emission for (n,da)

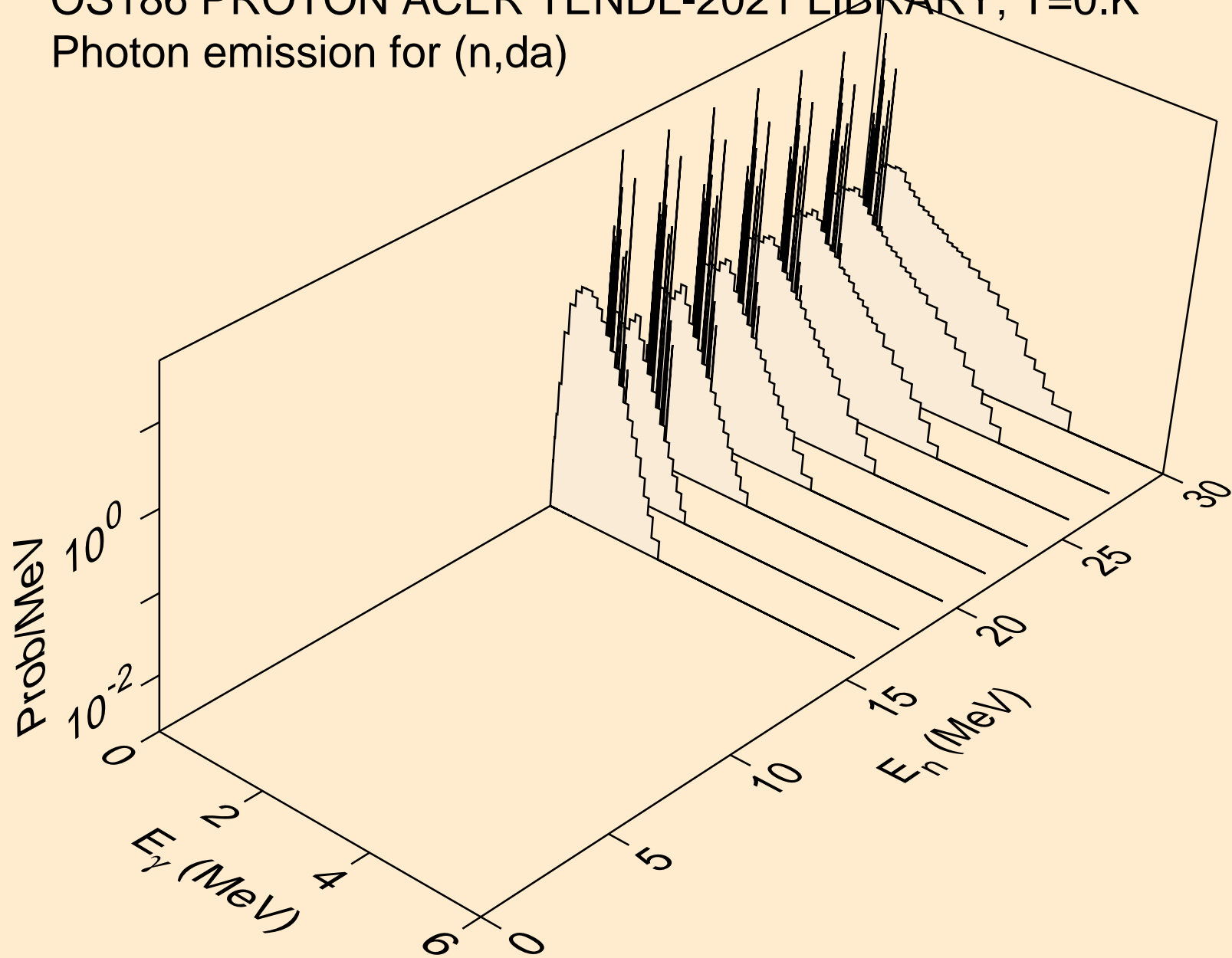

# OS186 PROTON ACER TENDL-2021 LIBRARY; T=0.K

## Particle heating contributions

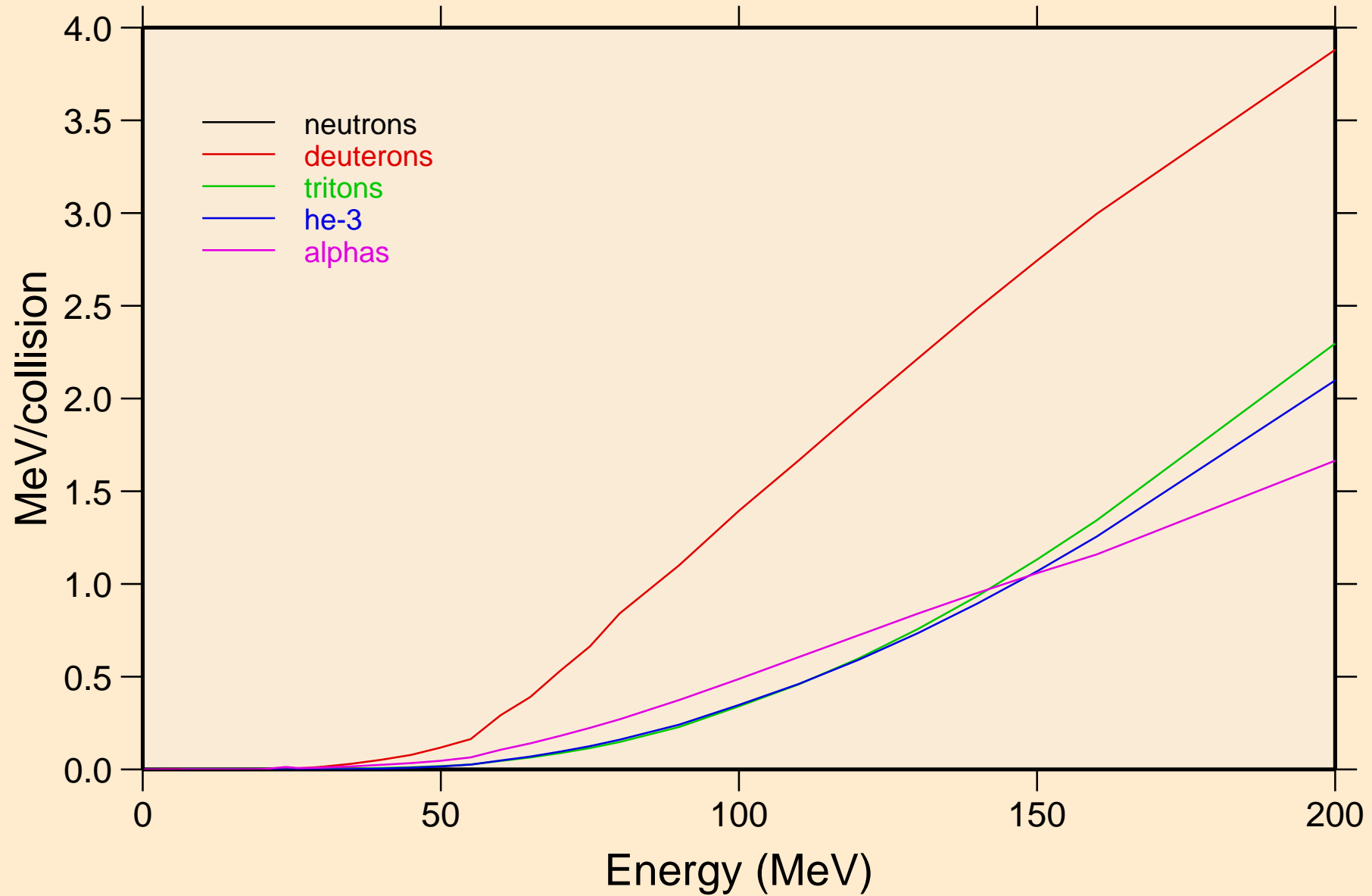

OS186 PROTON ACER TENDL-2021 LIBRARY; T=0.K  
Recoil Heating

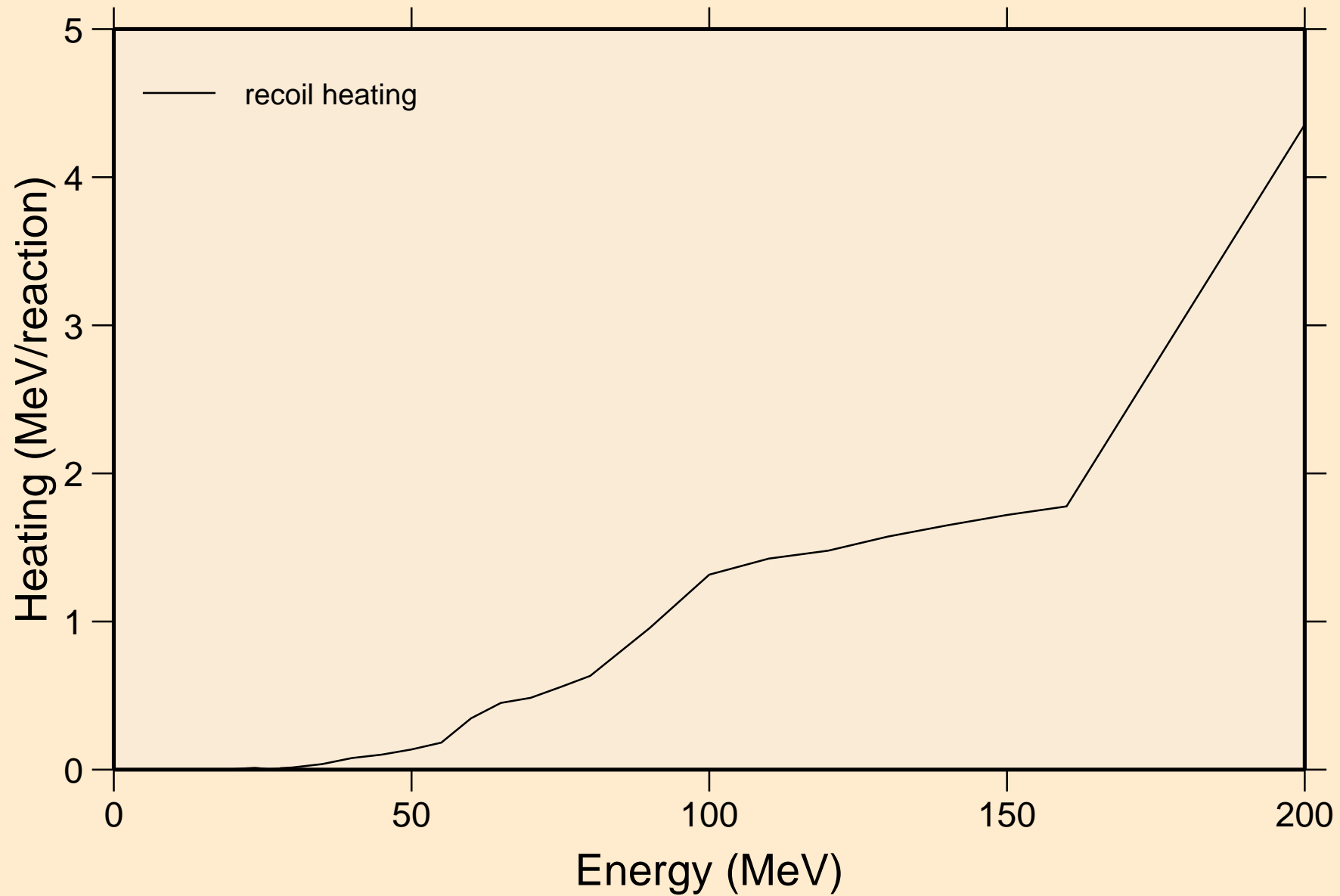

OS186 PROTON ACER TENDL-2021 LIBRARY; T=0.K  
Particle production cross sections

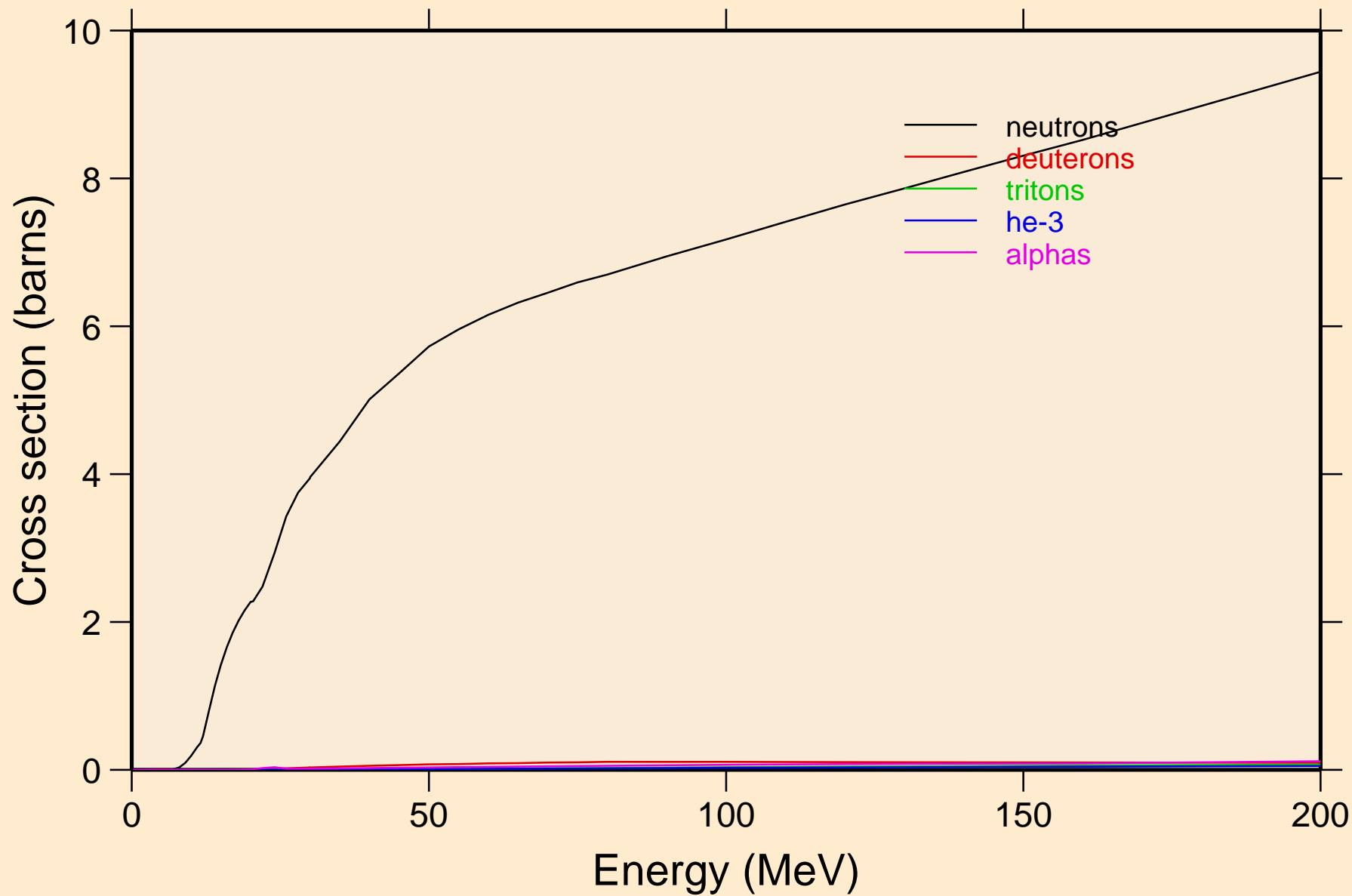

OS186 PROTON ACER TENDL-2021 LIBRARY; T=0.K  
neutrons from (p,n)

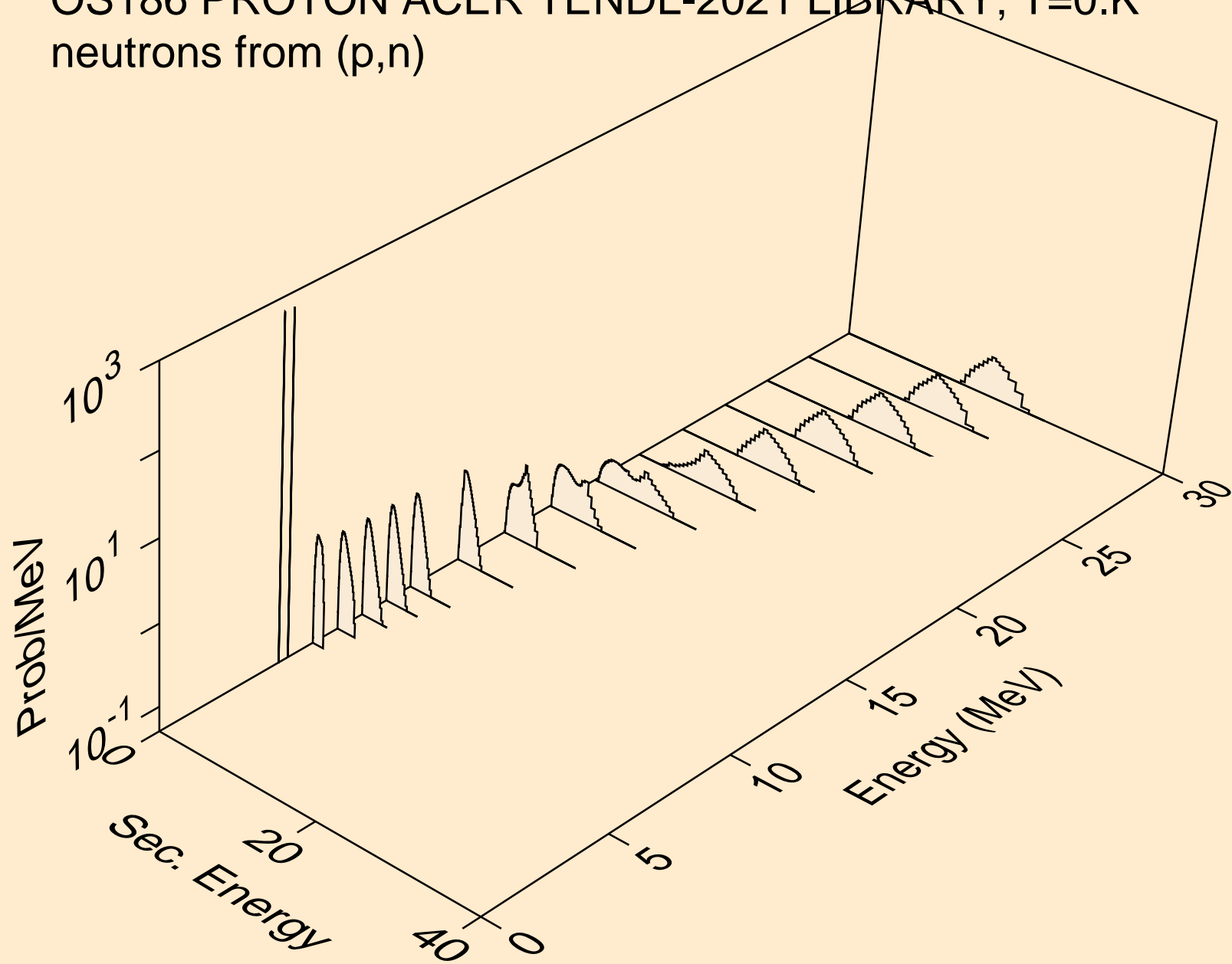

OS186 PROTON ACER TENDL-2021 LIBRARY; T=0.K  
neutrons from (p,x)

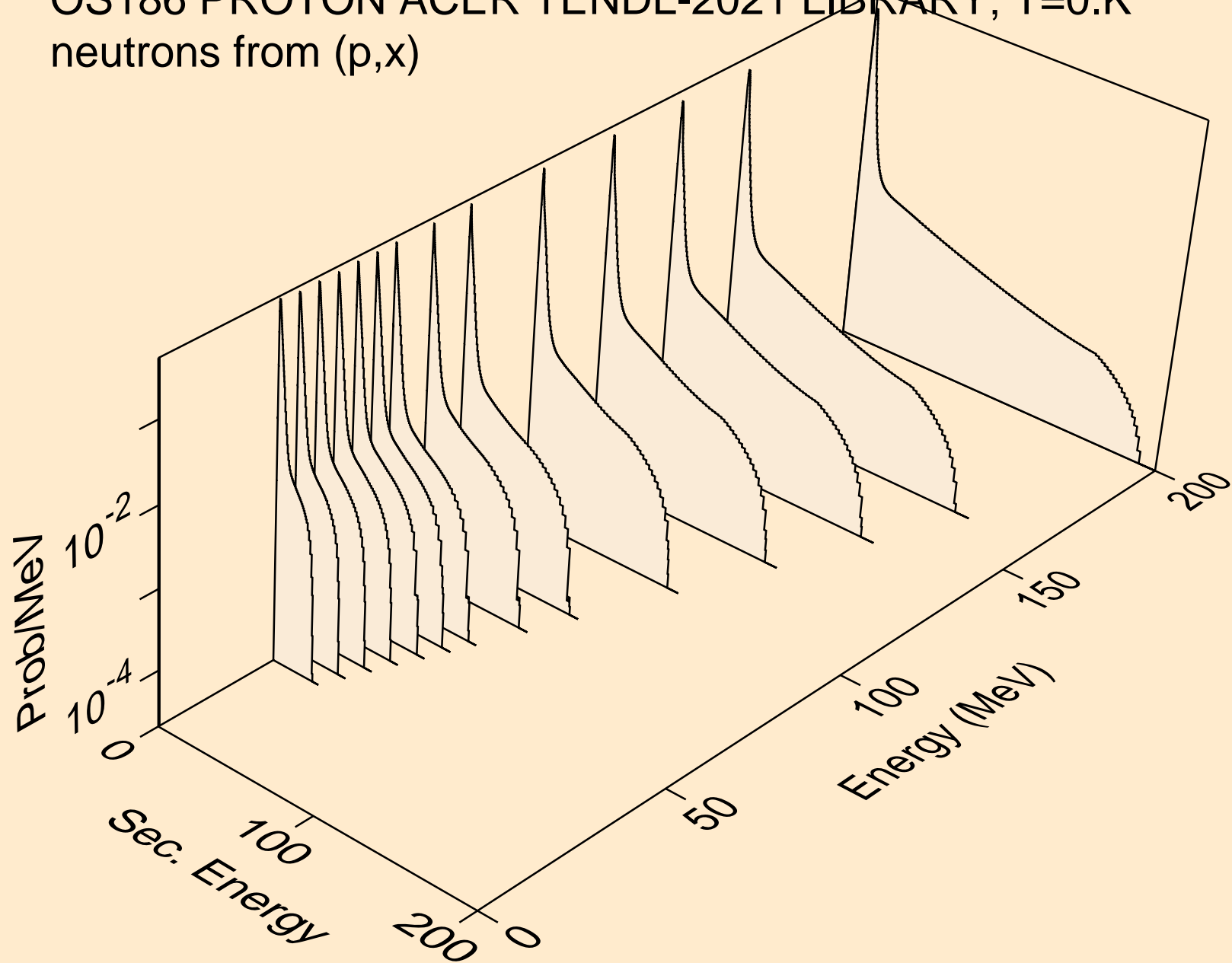

OS186 PROTON ACER TENDL-2021 LIBRARY; T=0.K  
neutrons from (p,2nd)

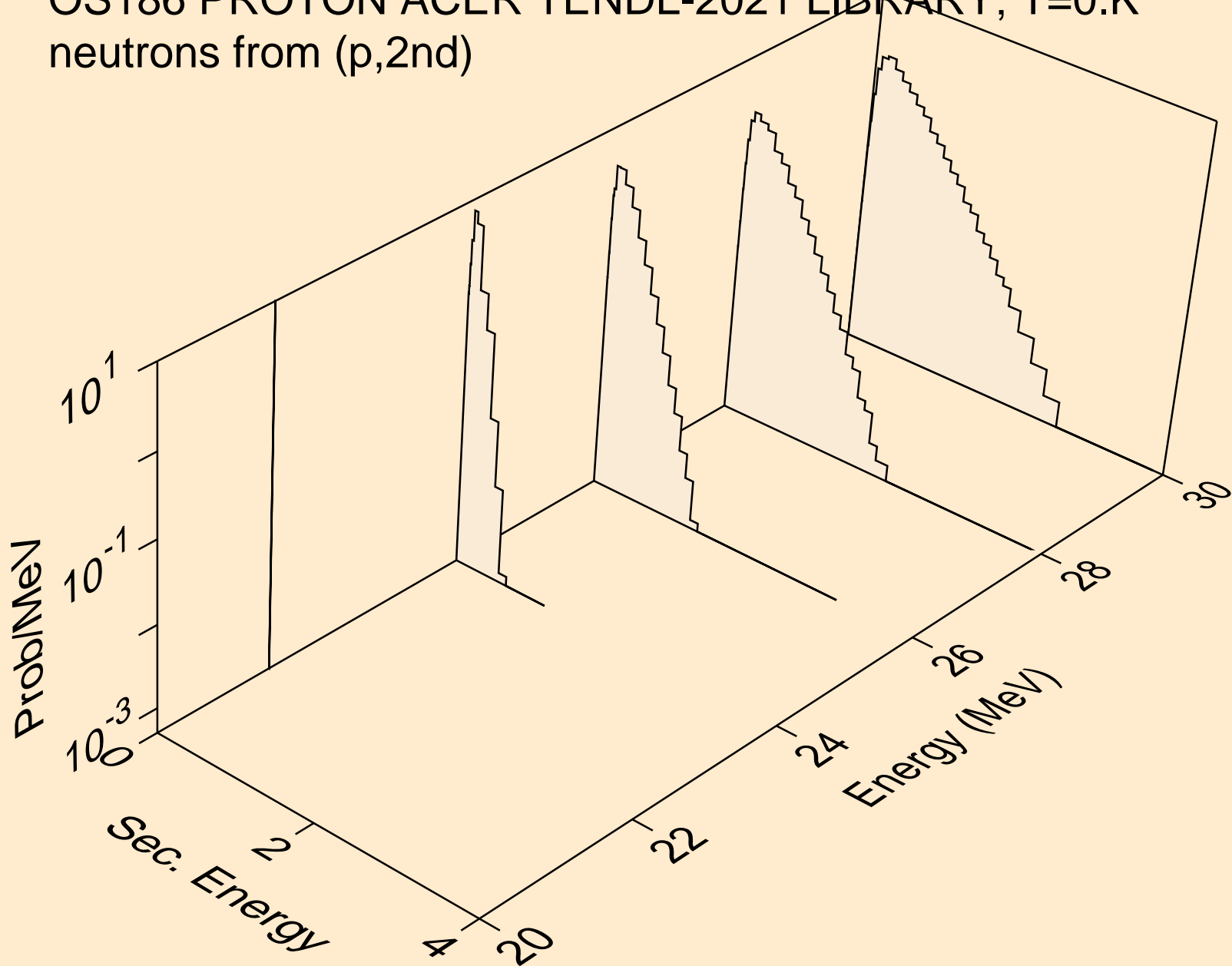



OS186 PROTON ACER TENDL-2021 LIBRARY; T=0.K  
neutrons from (p,2n)

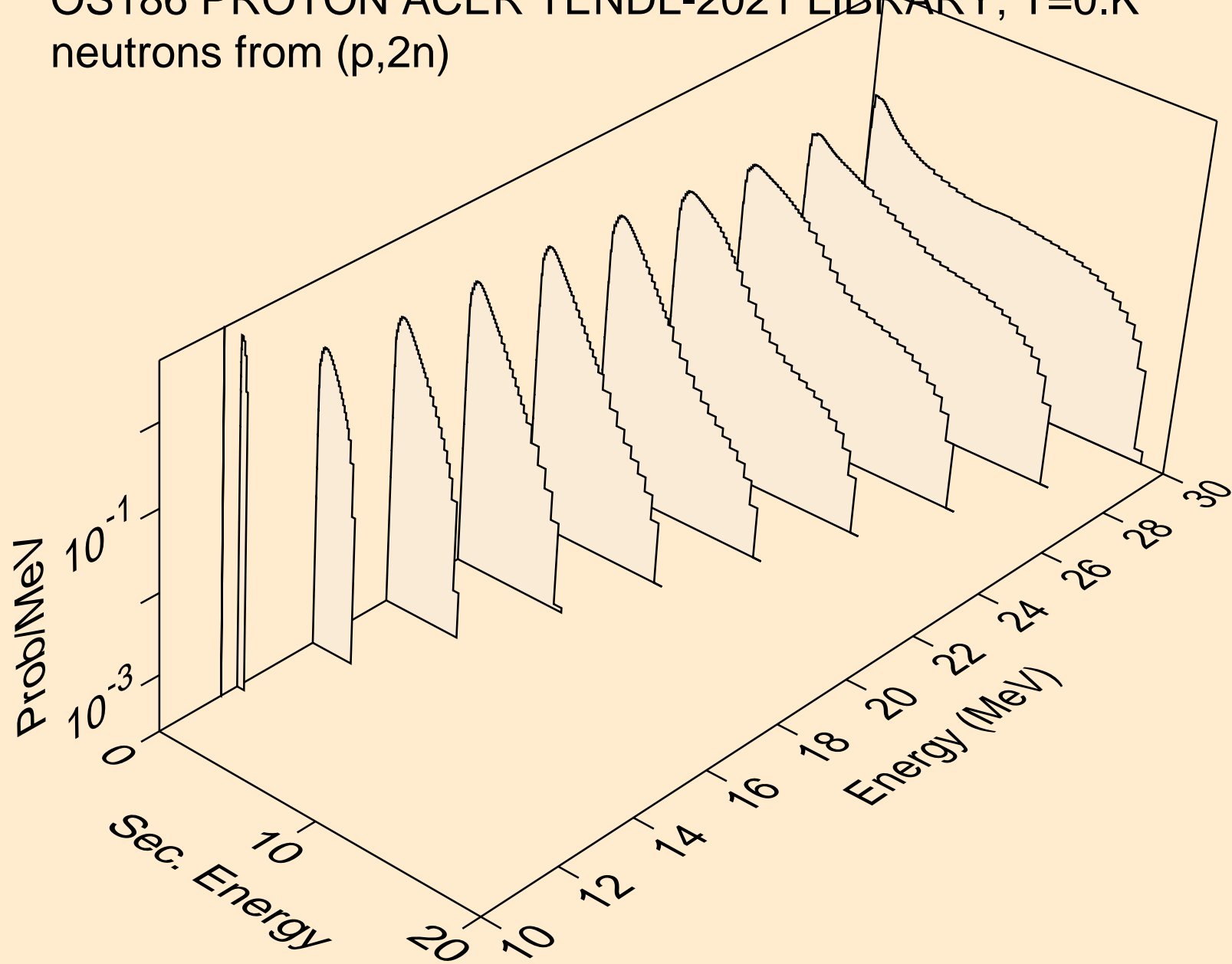

OS186 PROTON ACER TENDL-2021 LIBRARY; T=0.K  
neutrons from (p,3n)

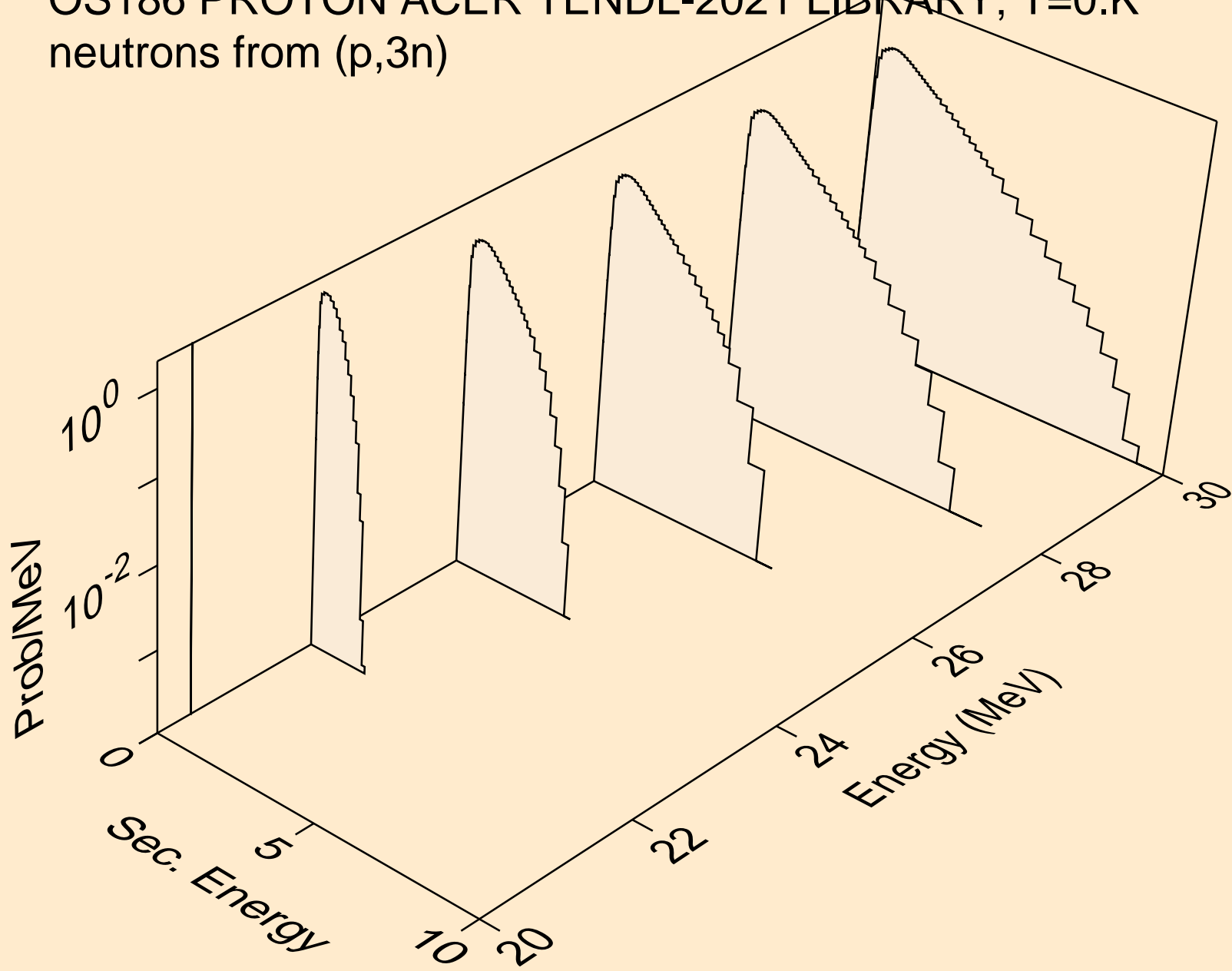

OS186 PROTON ACER TENDL-2021 LIBRARY; T=0.K  
neutrons from (p,n\*)a

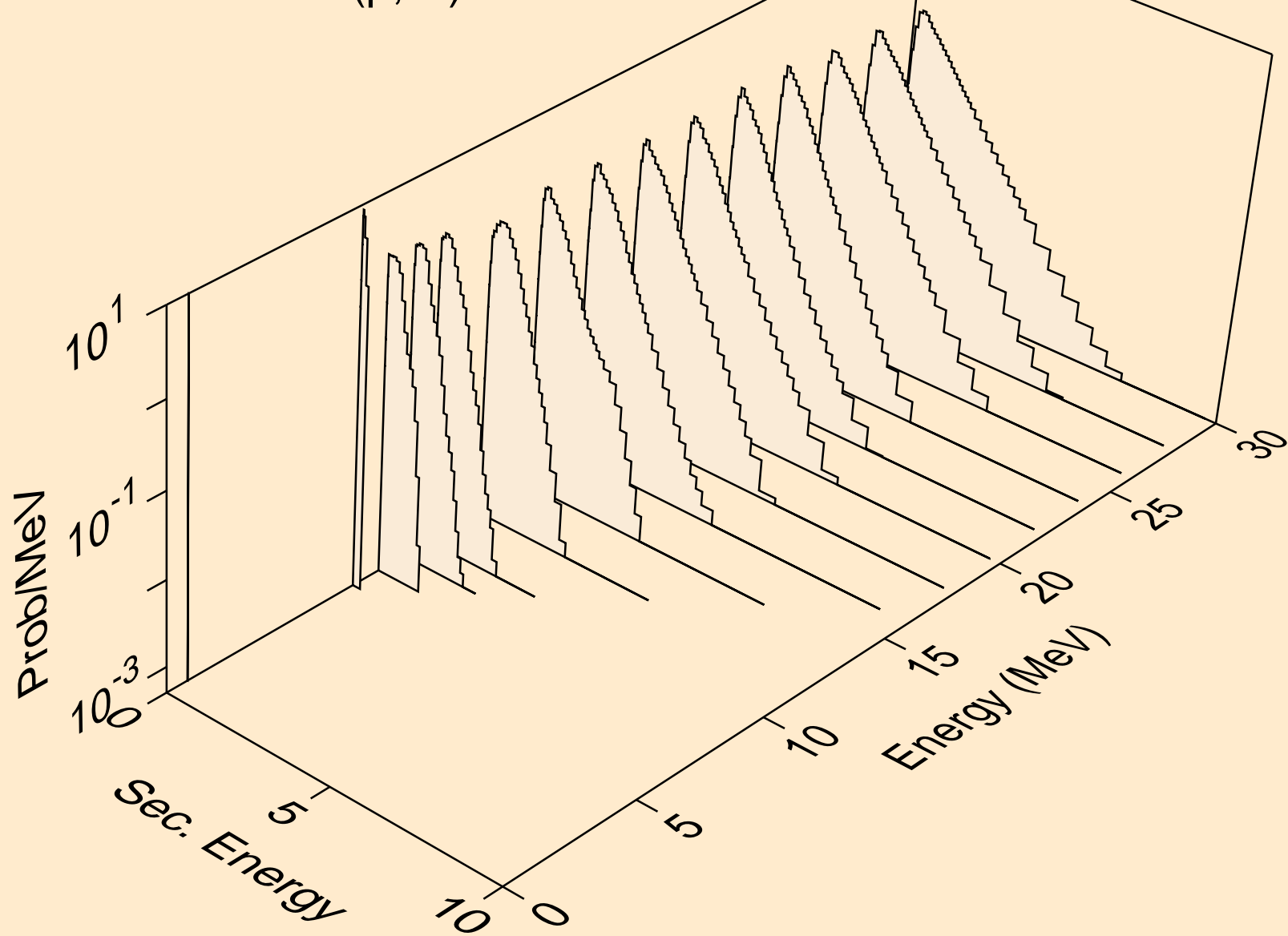

OS186 PROTON ACER TENDL-2021 LIBRARY; T=0.K  
neutrons from (p,2n)a

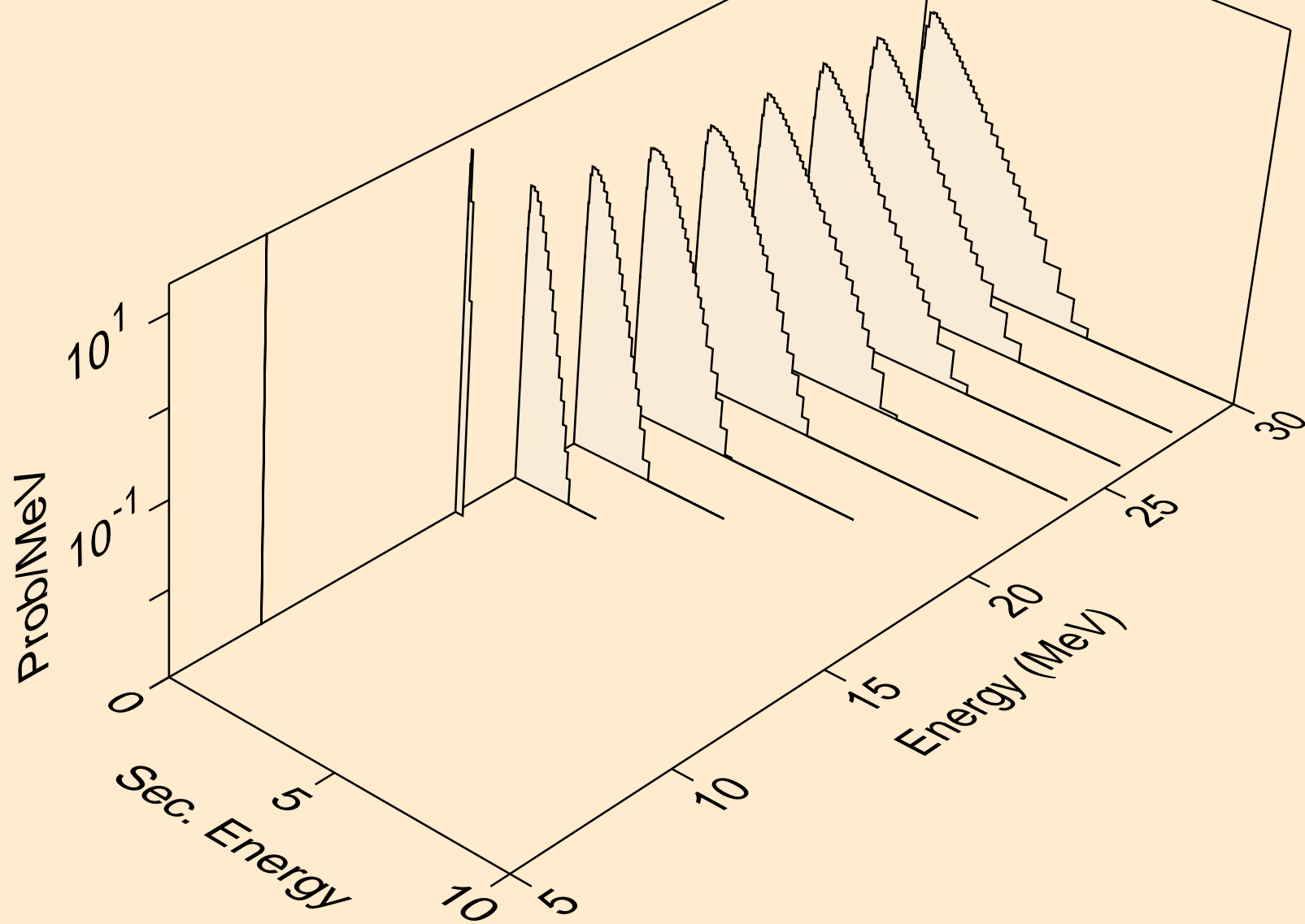

OS186 PROTON ACER TENDL-2021 LIBRARY; T=0.K  
neutrons from (p,3n)a

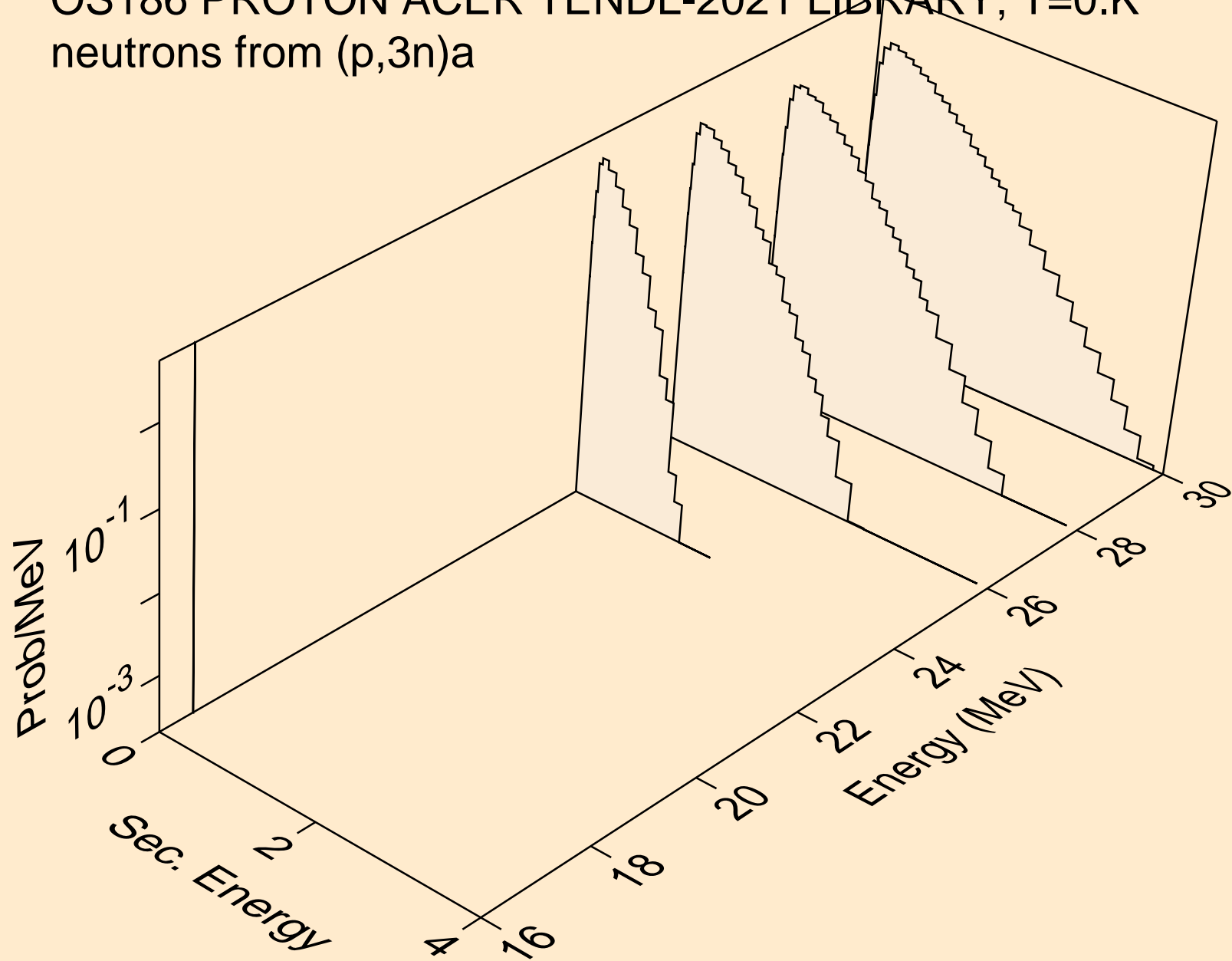

OS186 PROTON ACER TENDL-2021 LIBRARY; T=0.K  
neutrons from (p,n\*)p

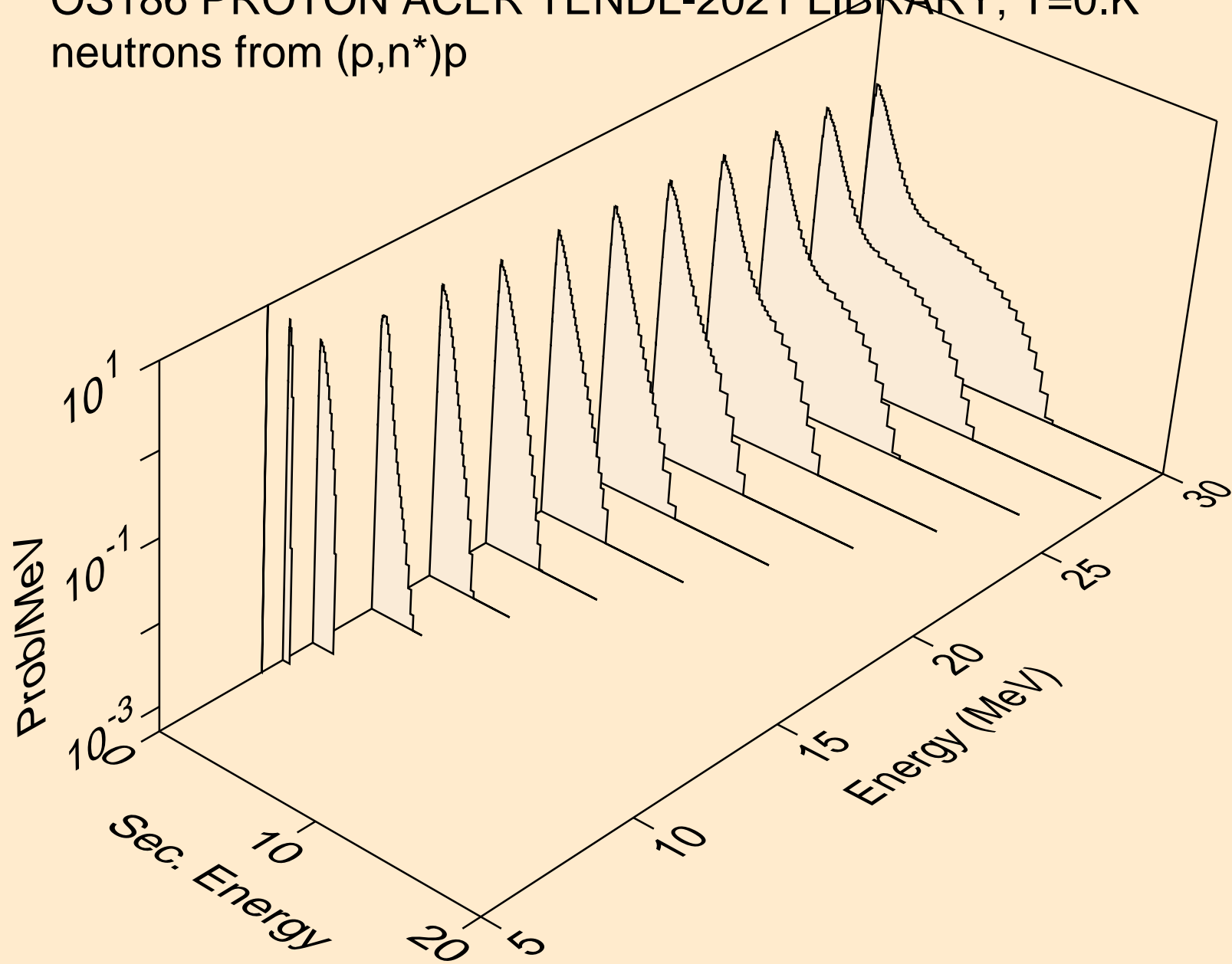

OS186 PROTON ACER TENDL-2021 LIBRARY; T=0.K  
neutrons from (p,n\*)2a

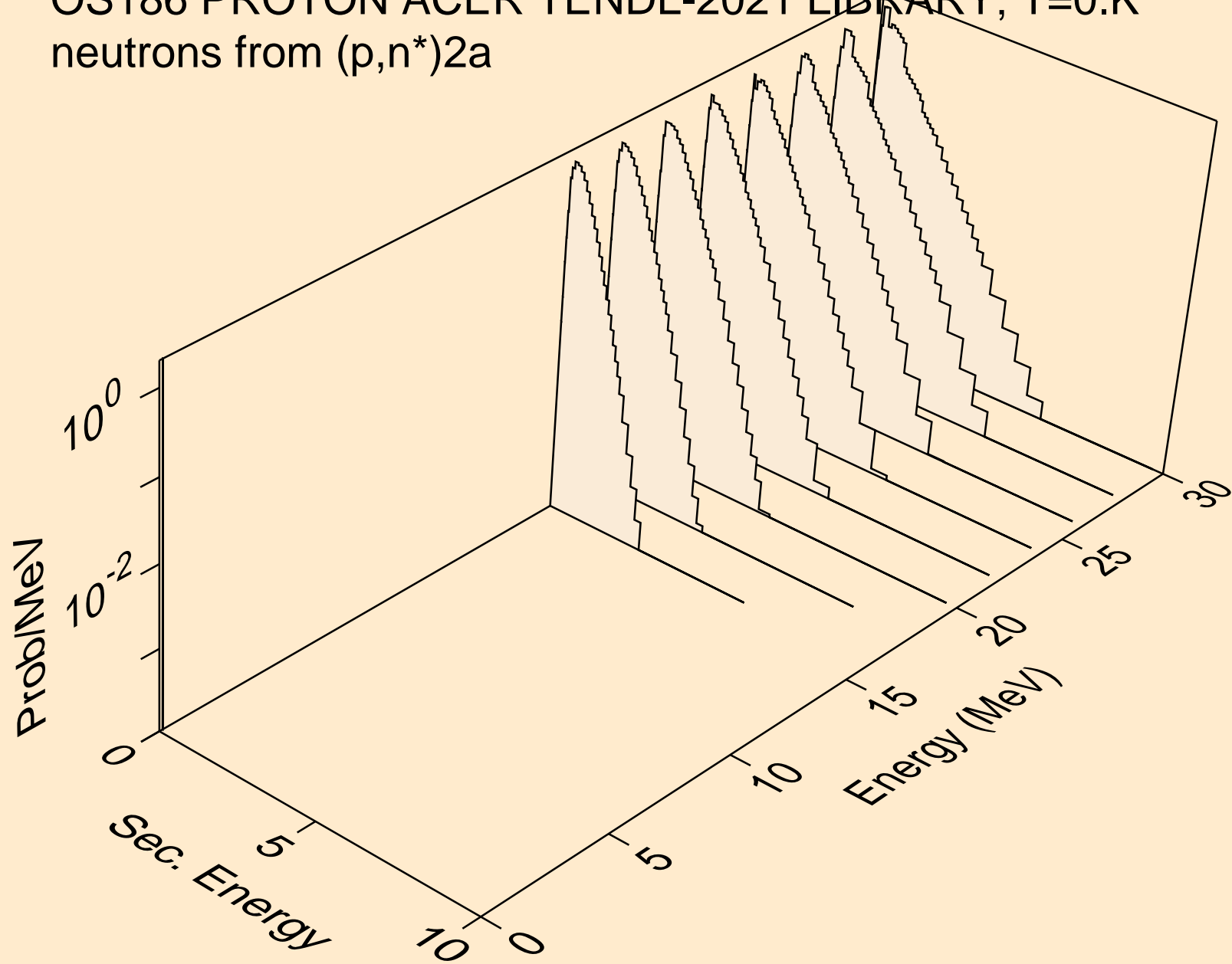

OS186 PROTON ACER TENDL-2021 LIBRARY; T=0.K  
neutrons from (p,n\*)d

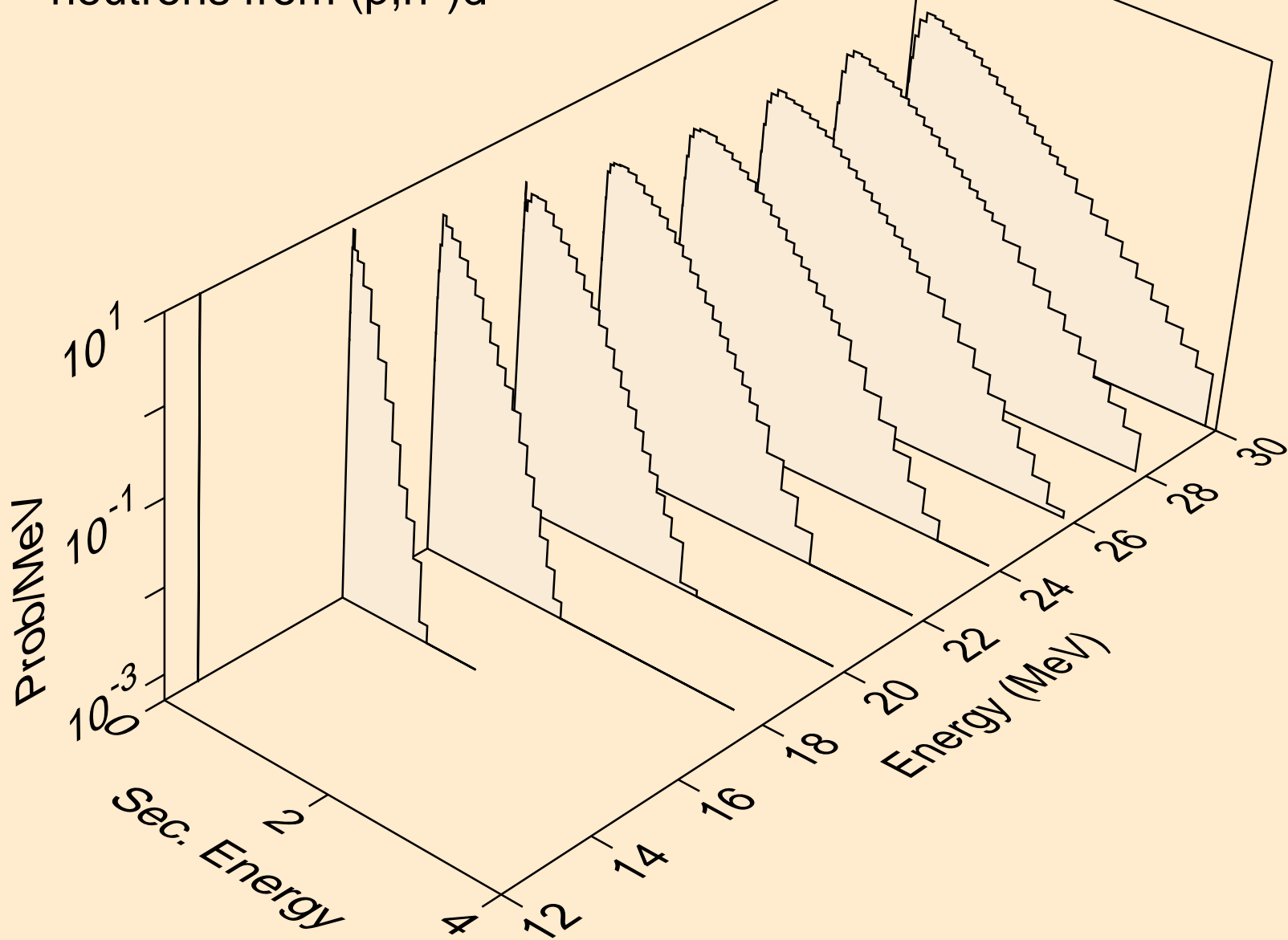



OS186 PROTON ACER TENDL-2021 LIBRARY; T=0.K  
neutrons from (p,n\*)t

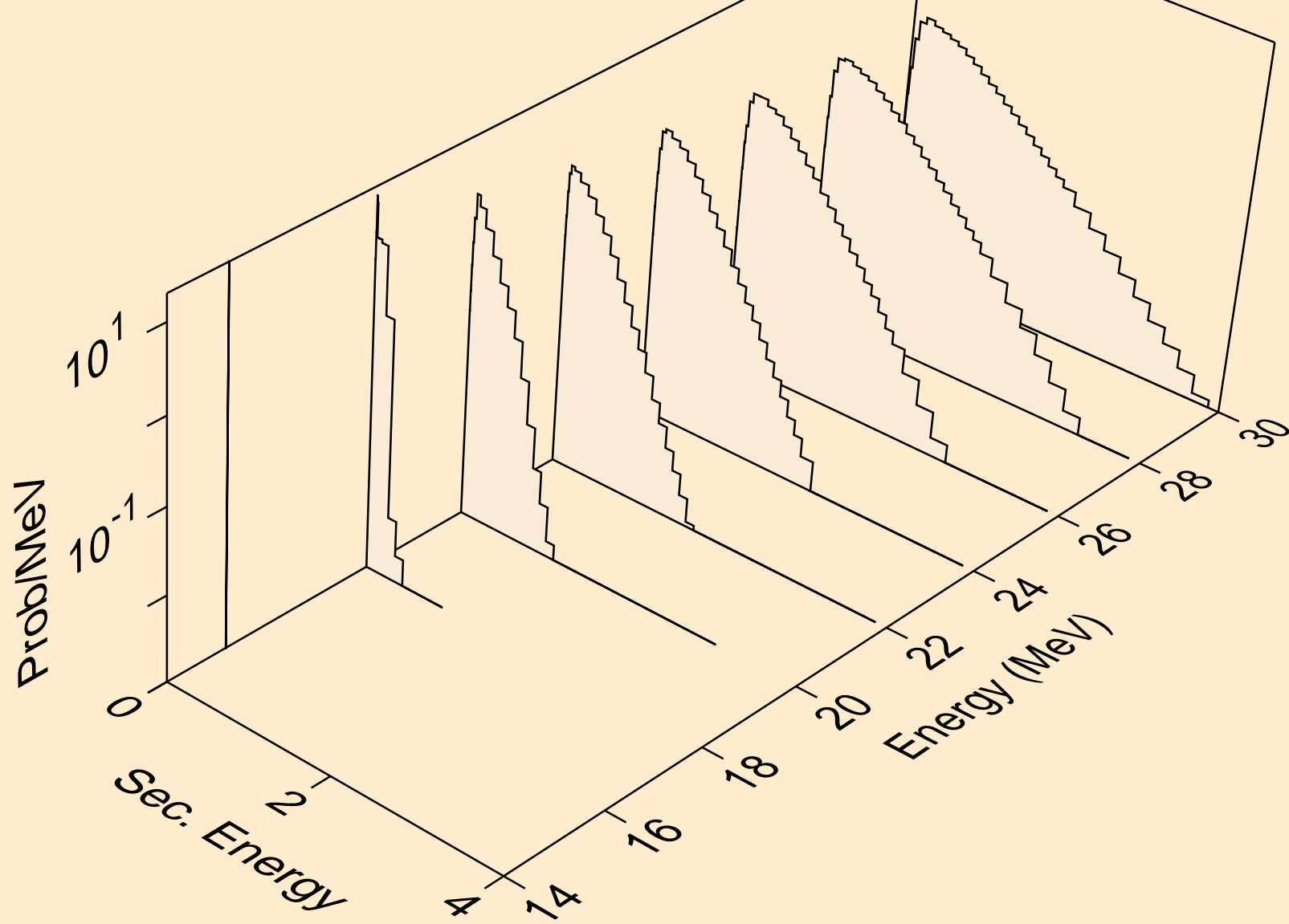

OS186 PROTON ACER TENDL-2021 LIBRARY; T=0.K  
neutrons from (p,n\*)he3

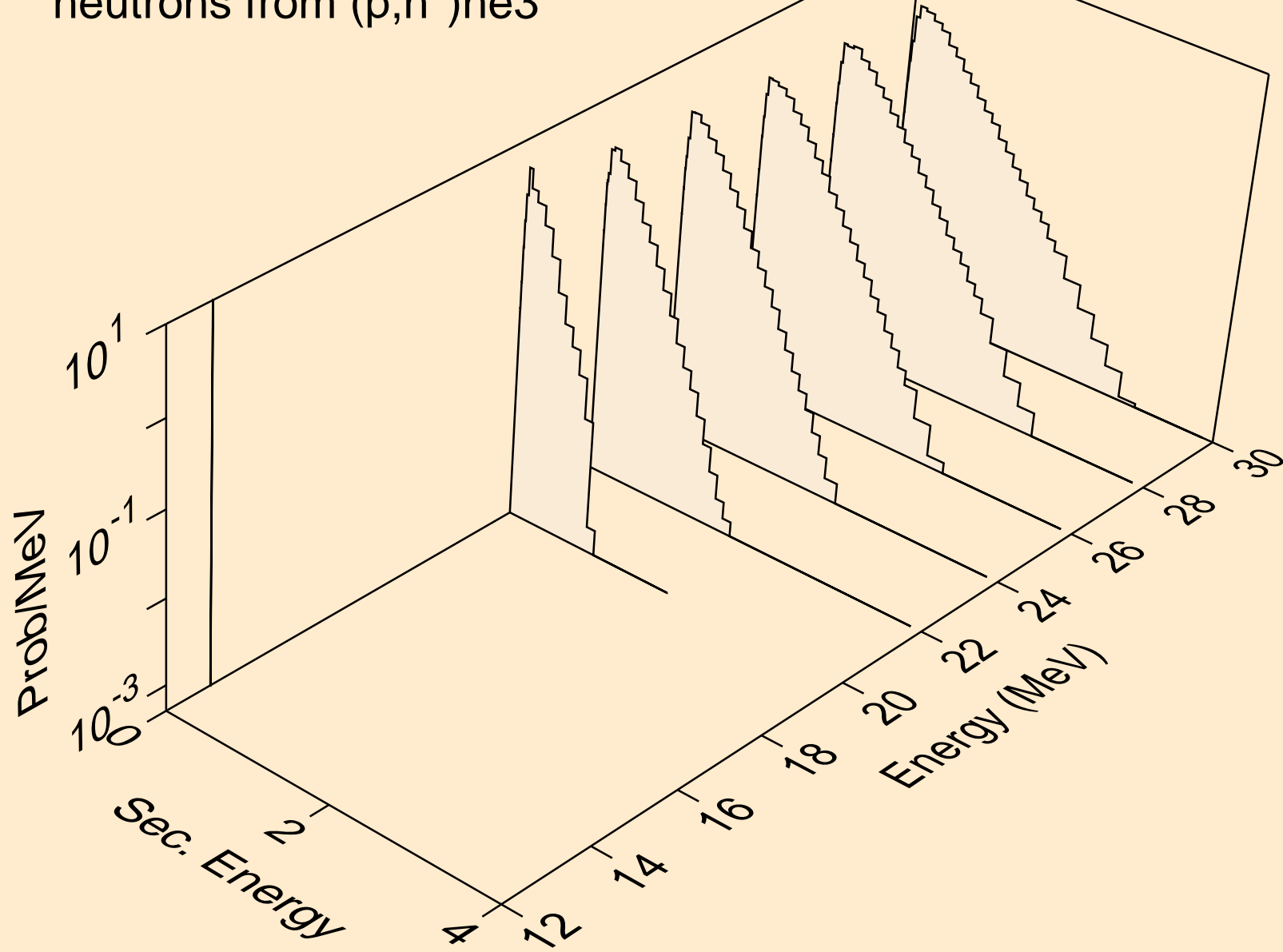

OS186 PROTON ACER TENDL-2021 LIBRARY; T=0.K  
neutrons from (p,4n)

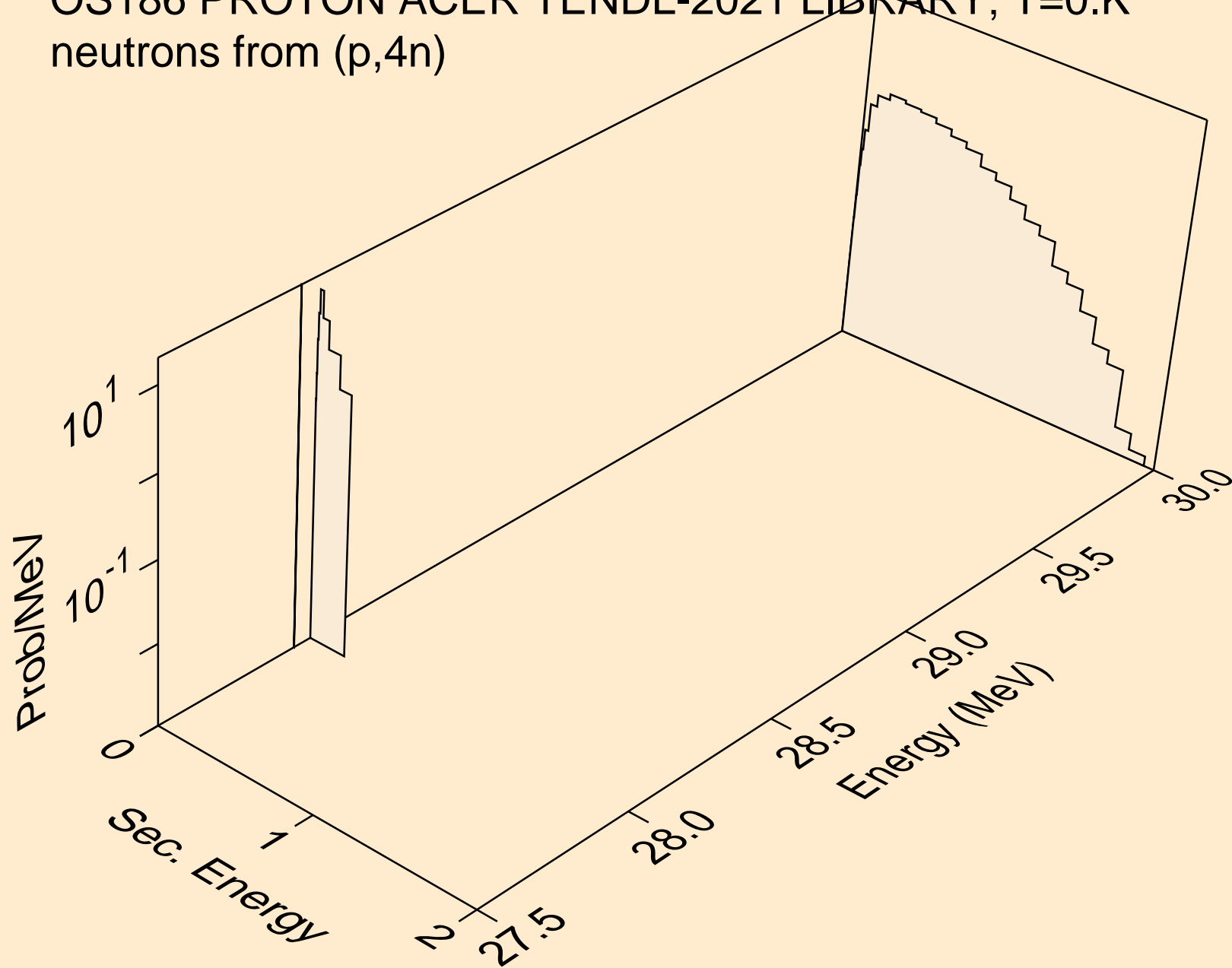

OS186 PROTON ACER TENDL-2021 LIBRARY; T=0.K  
neutrons from (p,2np)

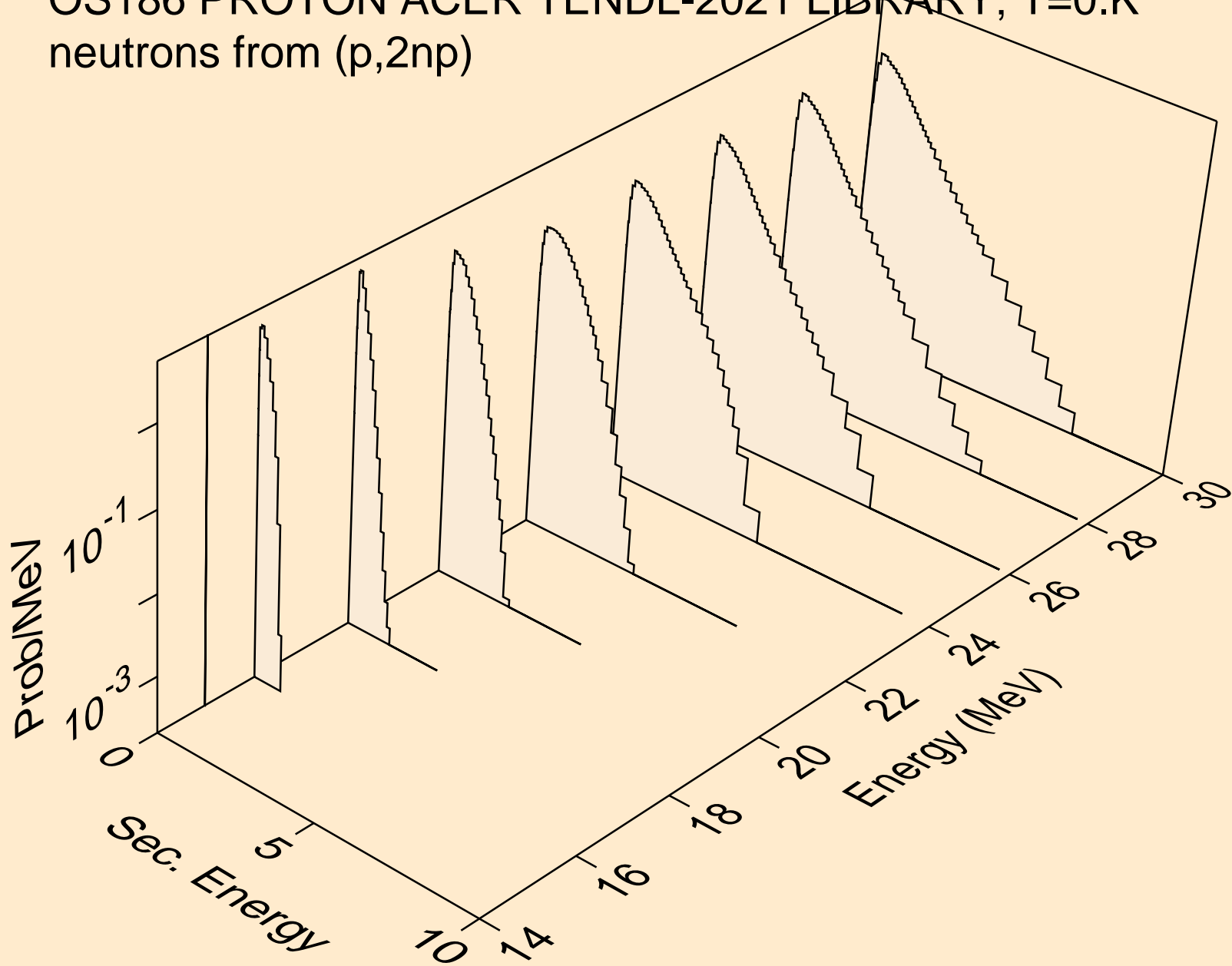

OS186 PROTON ACER TENDL-2021 LIBRARY; T=0.K  
neutrons from (p,3np)

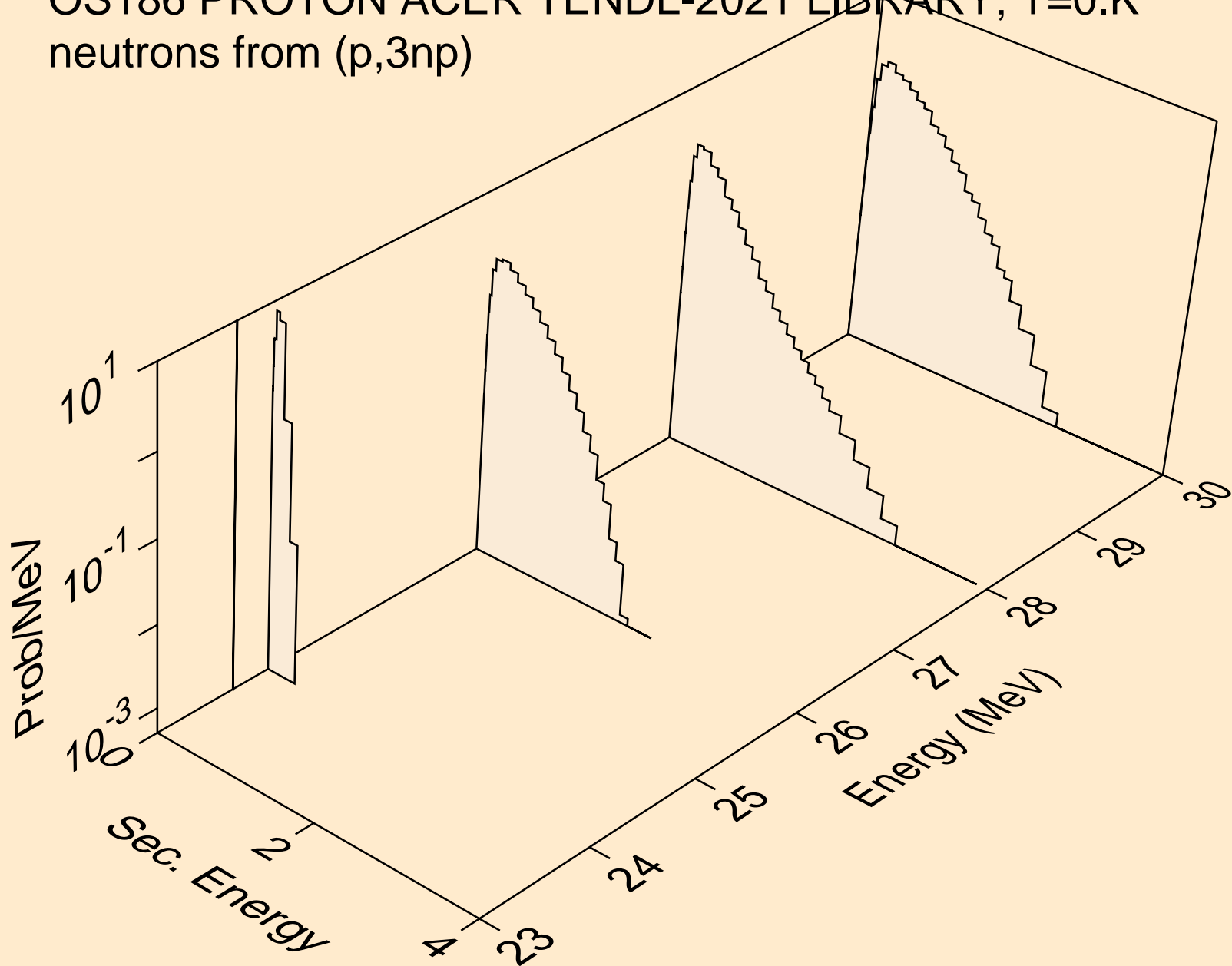

OS186 PROTON ACER TENDL-2021 LIBRARY; T=0.K  
neutrons from (p,2np)

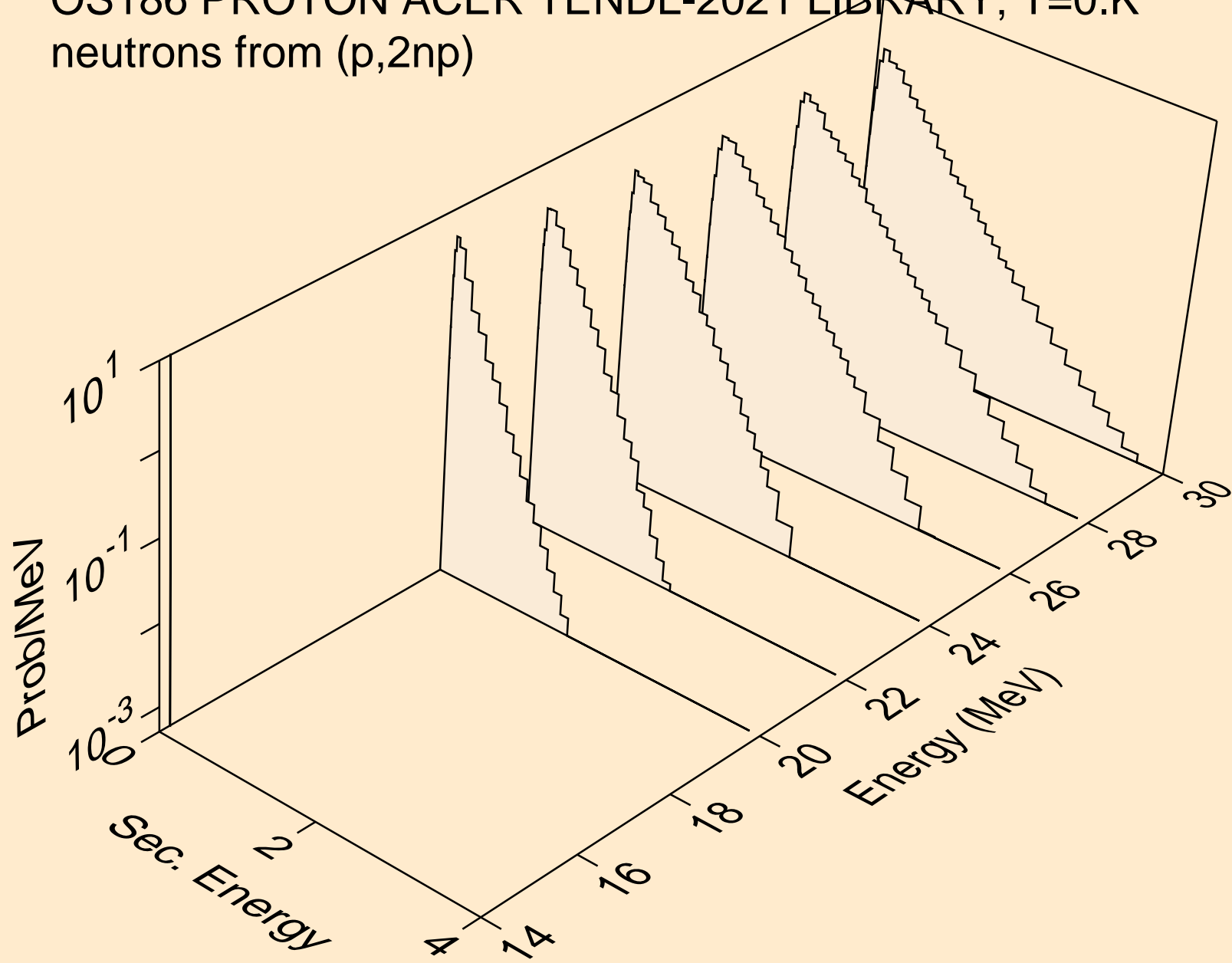

OS186 PROTON ACER TENDL-2021 LIBRARY; T=0.K  
neutrons from (p,npa)

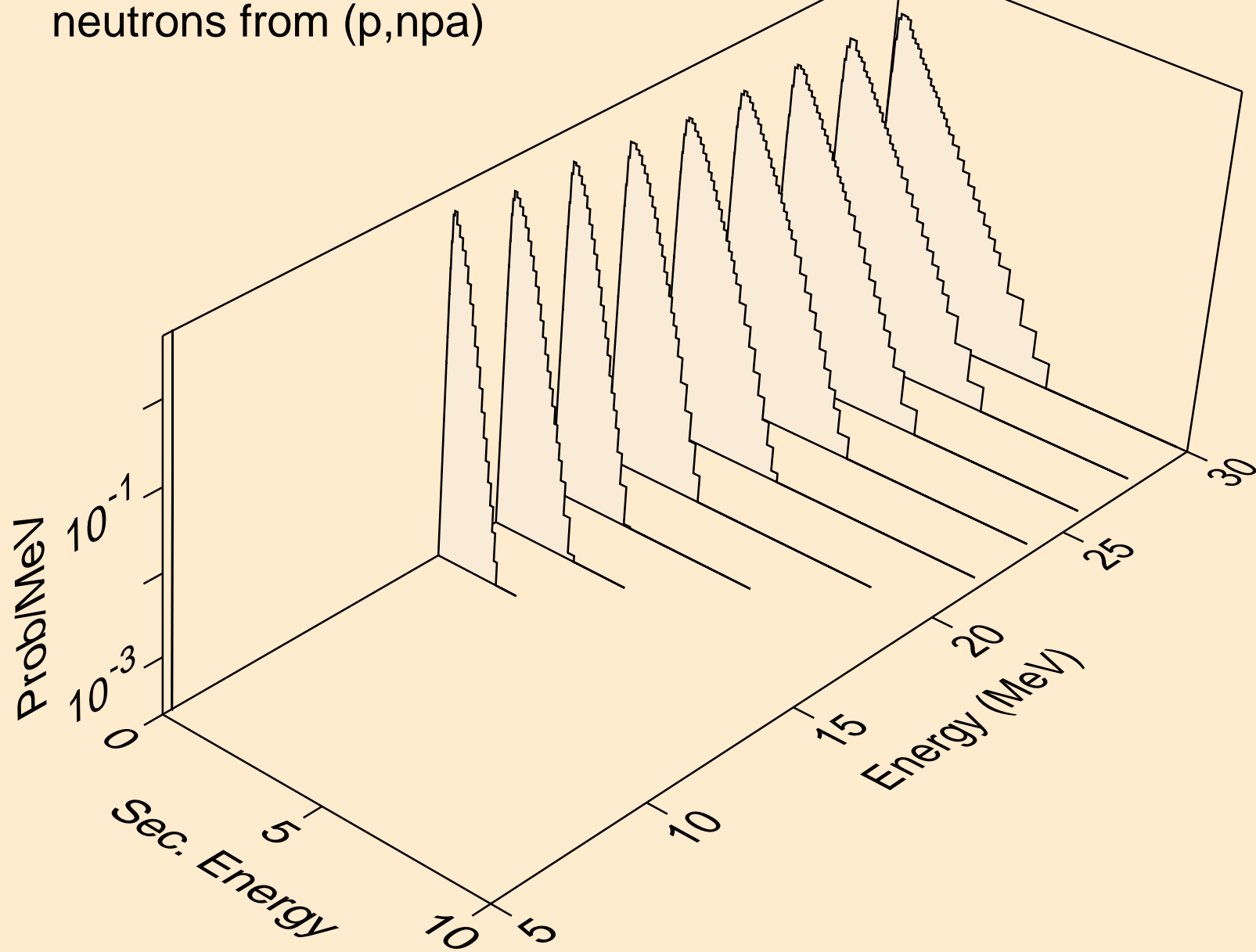

OS186 PROTON ACER TENDL-2021 LIBRARY; T=0.K  
deuterons from (p,x)

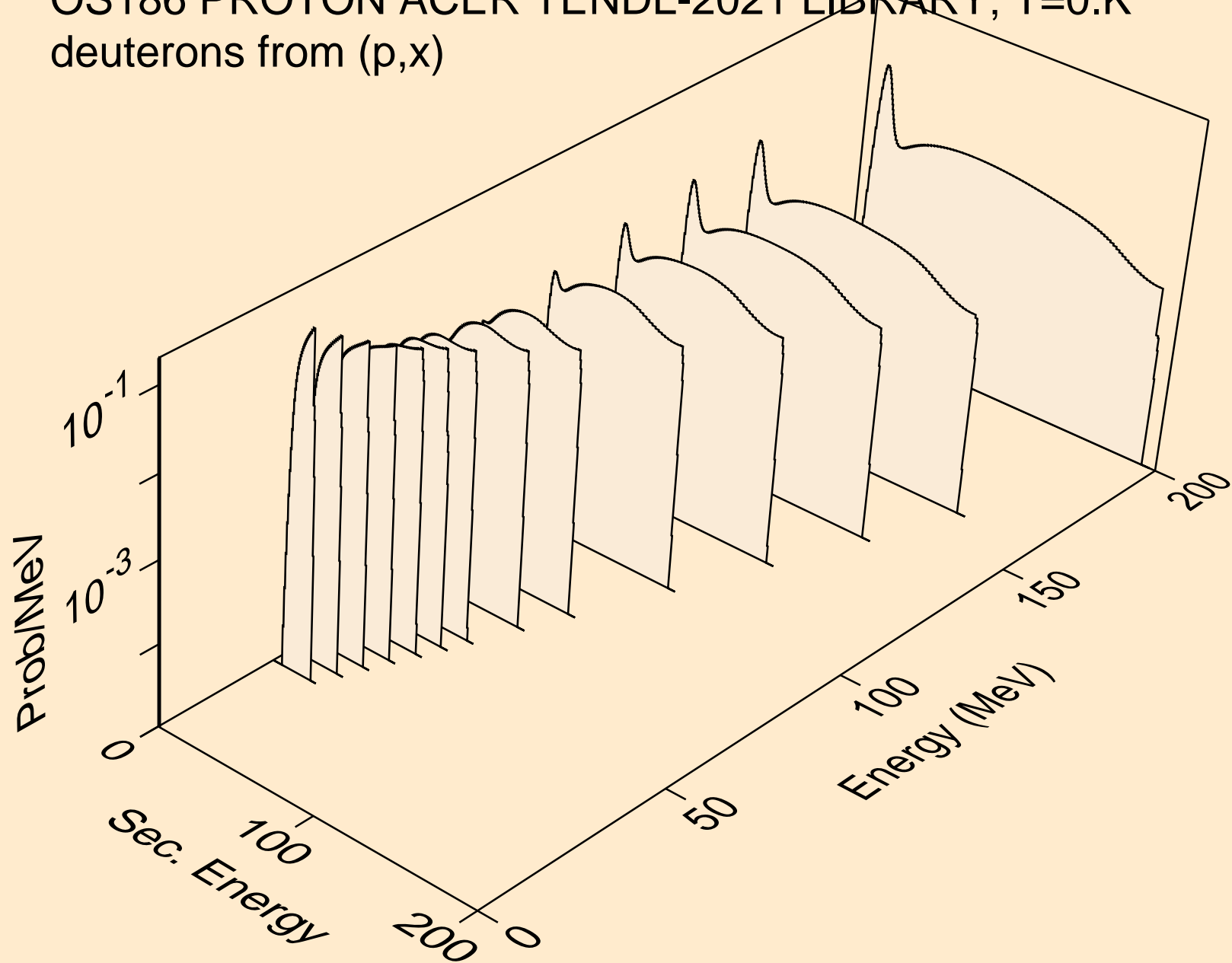



OS186 PROTON ACER TENDL-2021 LIBRARY; T=0.K  
deuterons from (p,2nd)

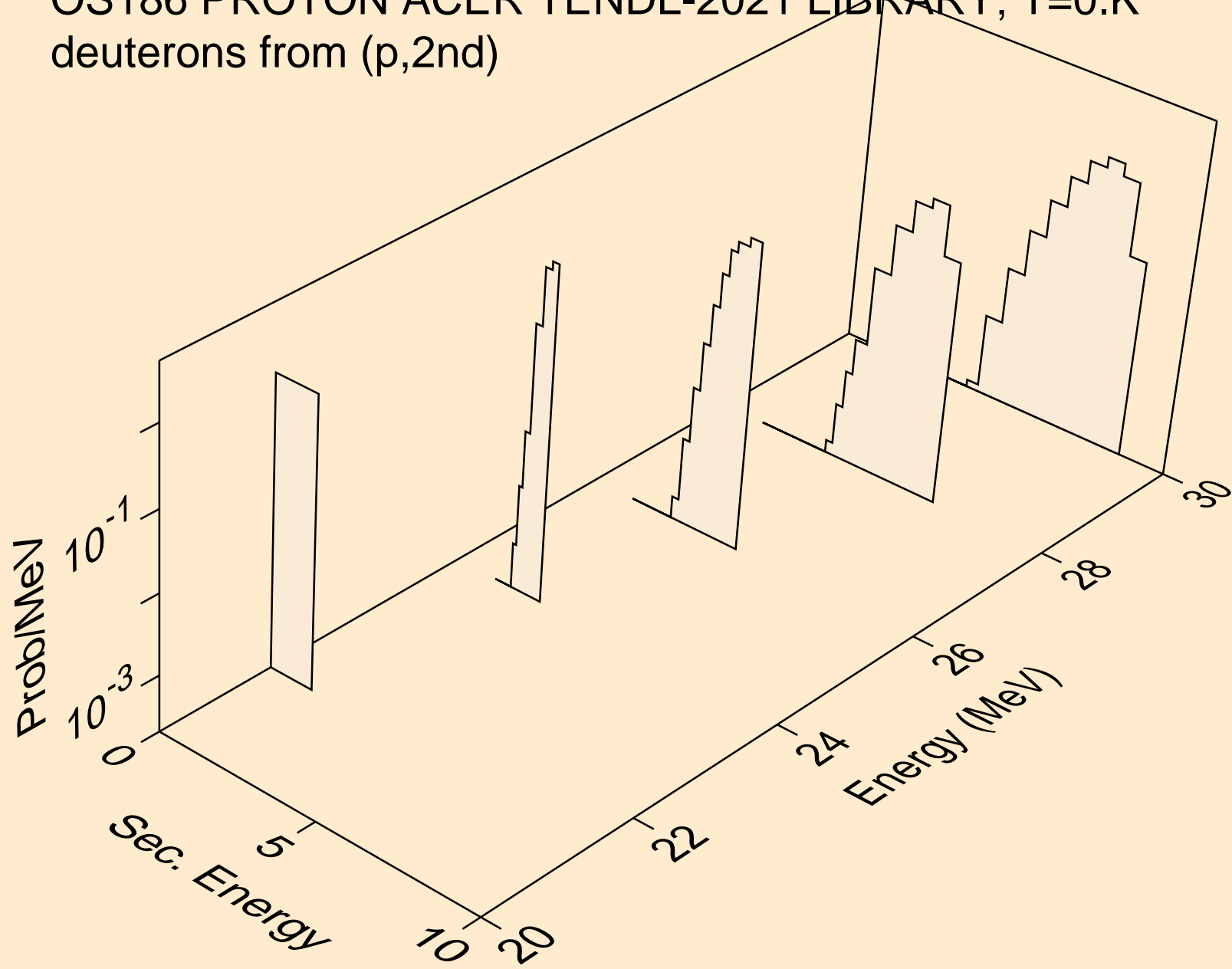

OS186 PROTON ACER TENDL-2021 LIBRARY; T=0.K  
deuterons from (p,n\*)d

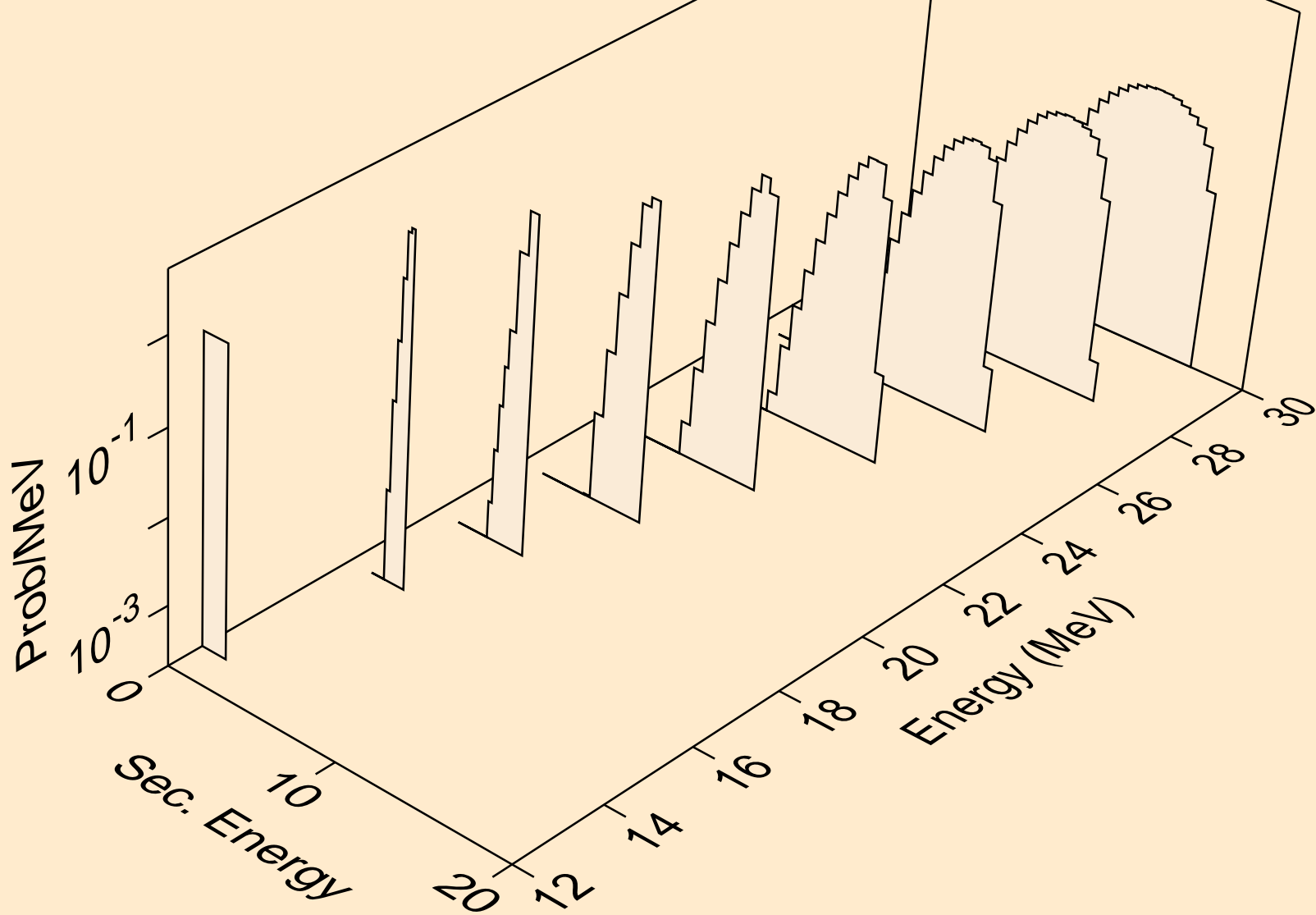

OS186 PROTON ACER TENDL-2021 LIBRARY; T=0.K  
deuterons from (p,d)

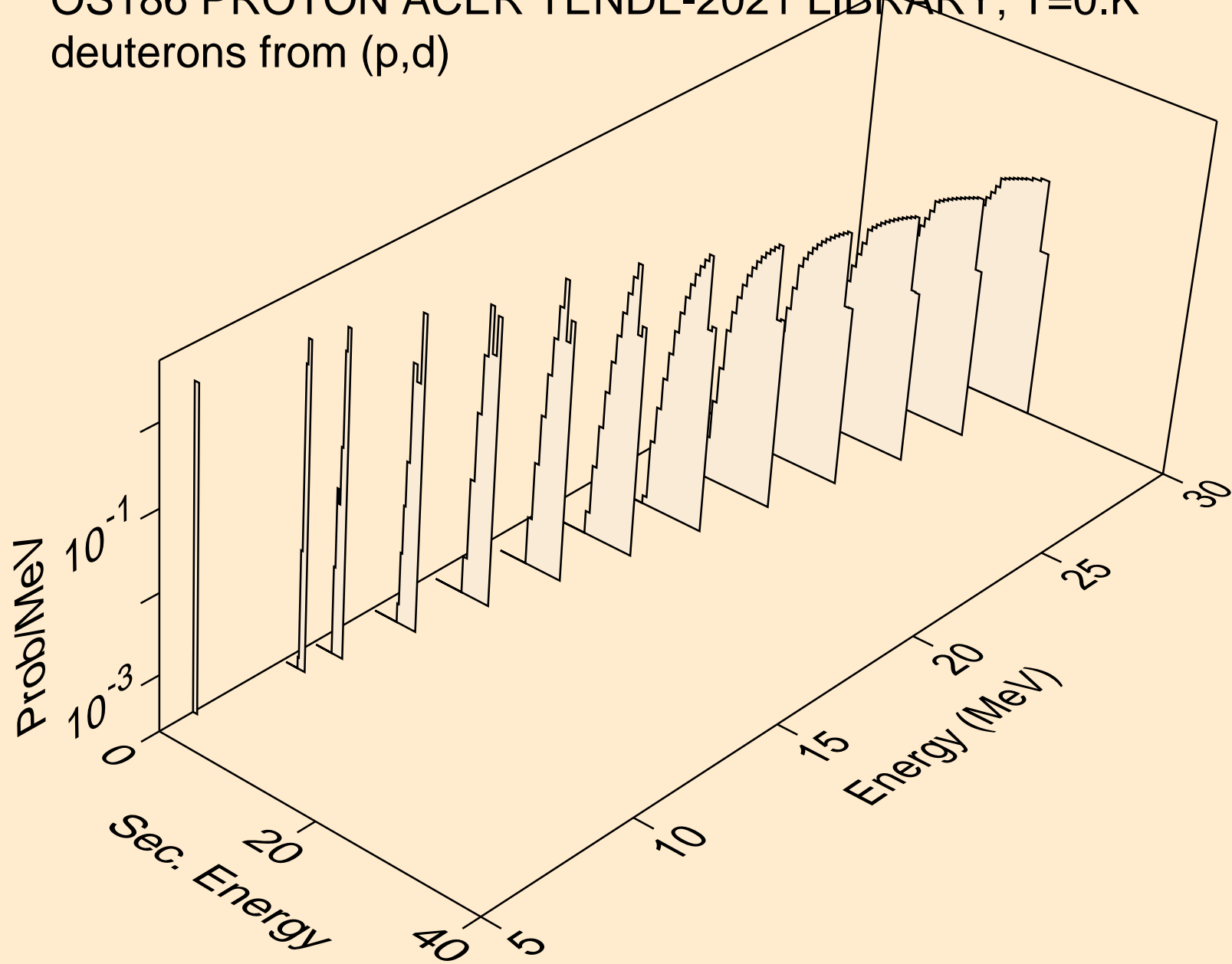

OS186 PROTON ACER TENDL-2021 LIBRARY; T=0.K  
deuterons from (p,pd)

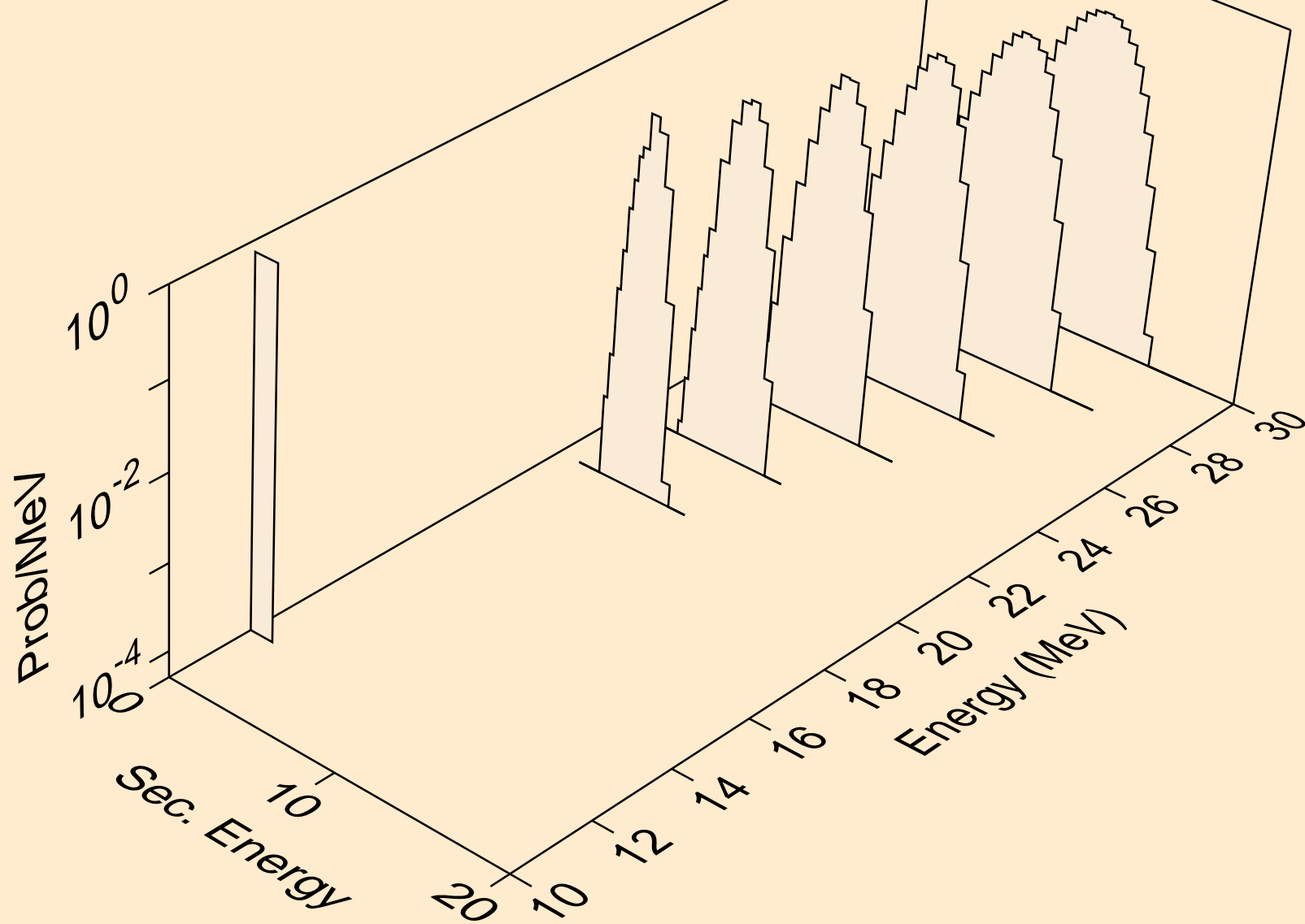

OS186 PROTON ACER TENDL-2021 LIBRARY; T=0.K  
deuterons from (p,da)

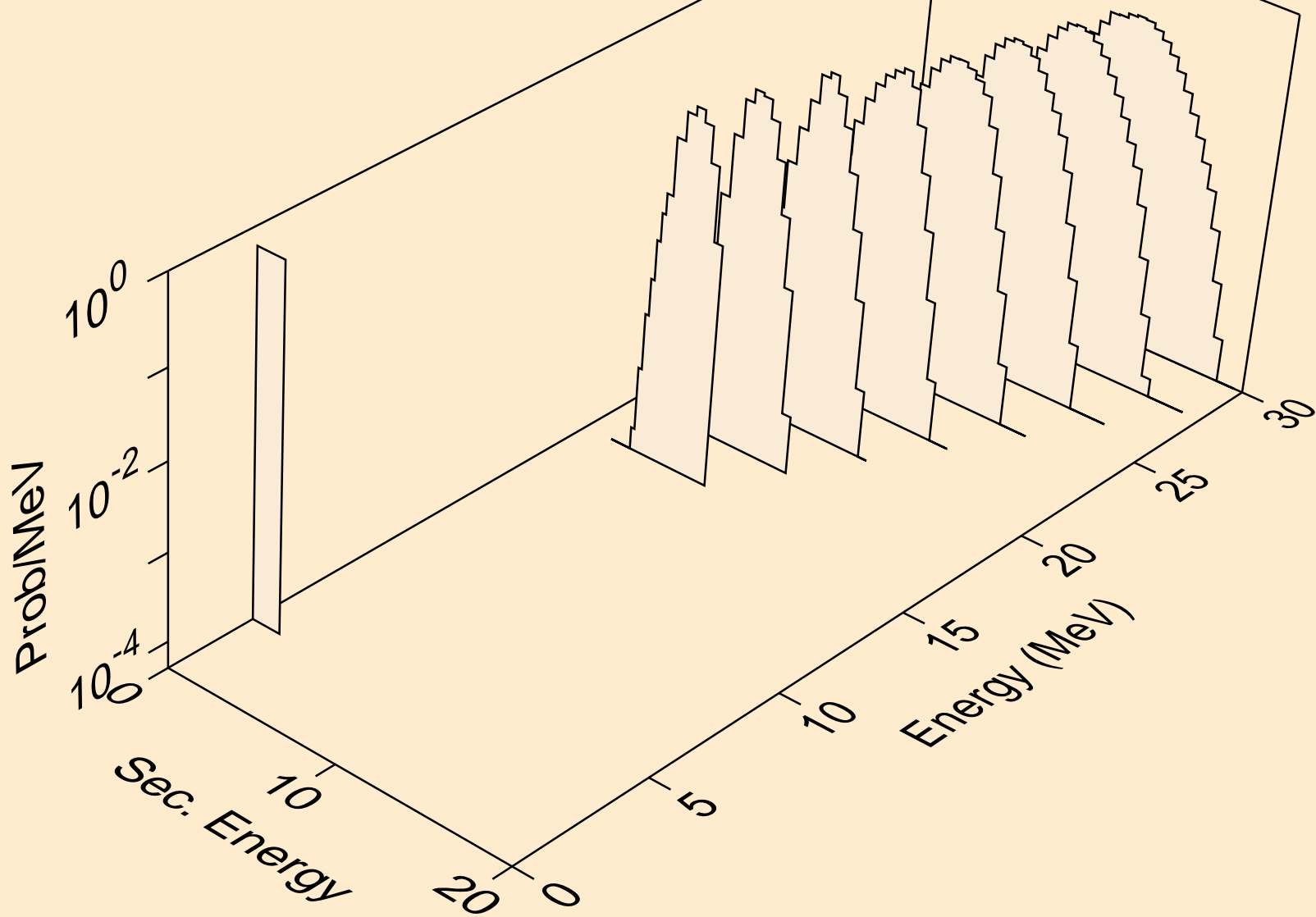

OS186 PROTON ACER TENDL-2021 LIBRARY; T=0.K  
tritons from (p,x)

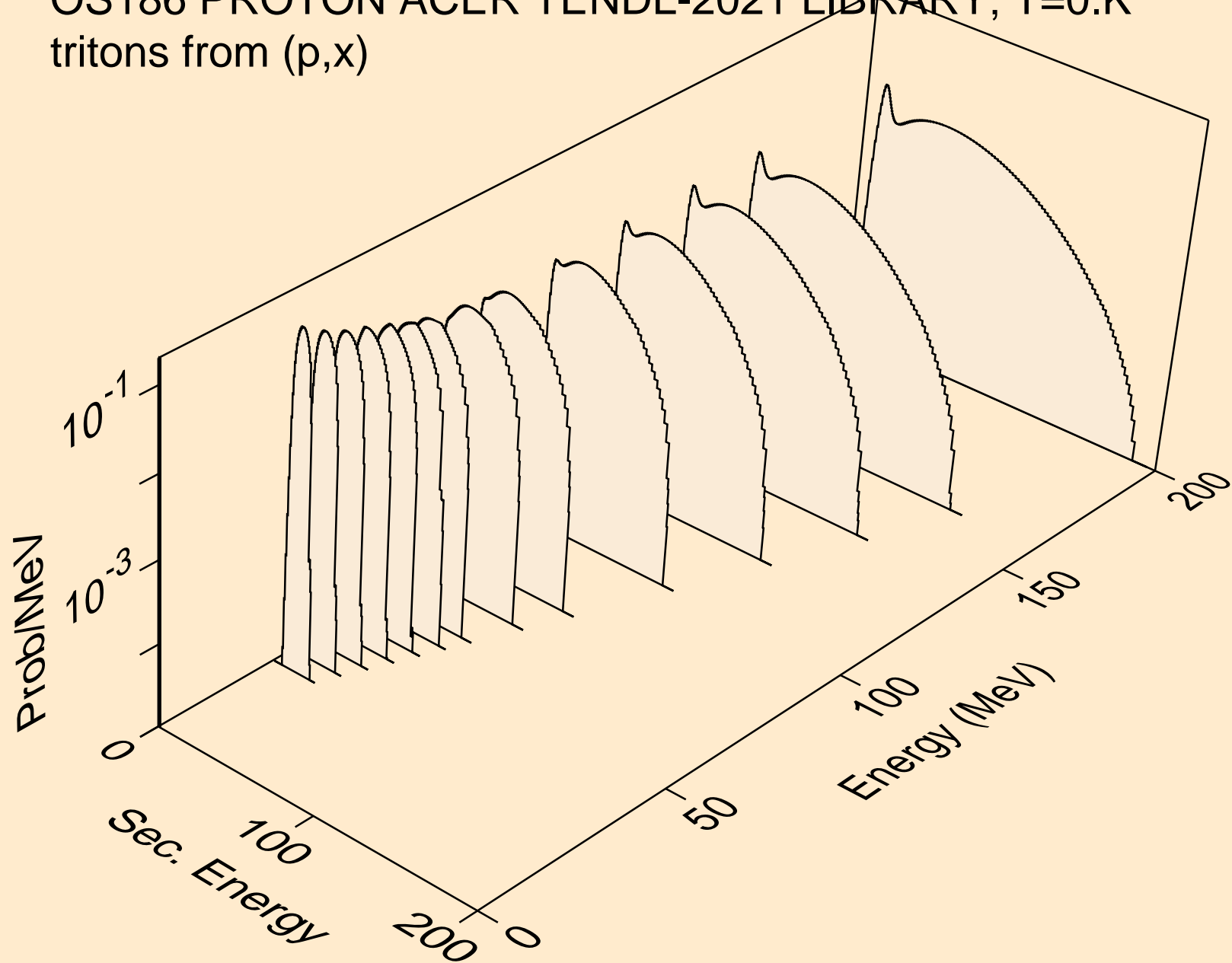

OS186 PROTON ACER TENDL-2021 LIBRARY; T=0.K  
tritons from (p,n\*)t

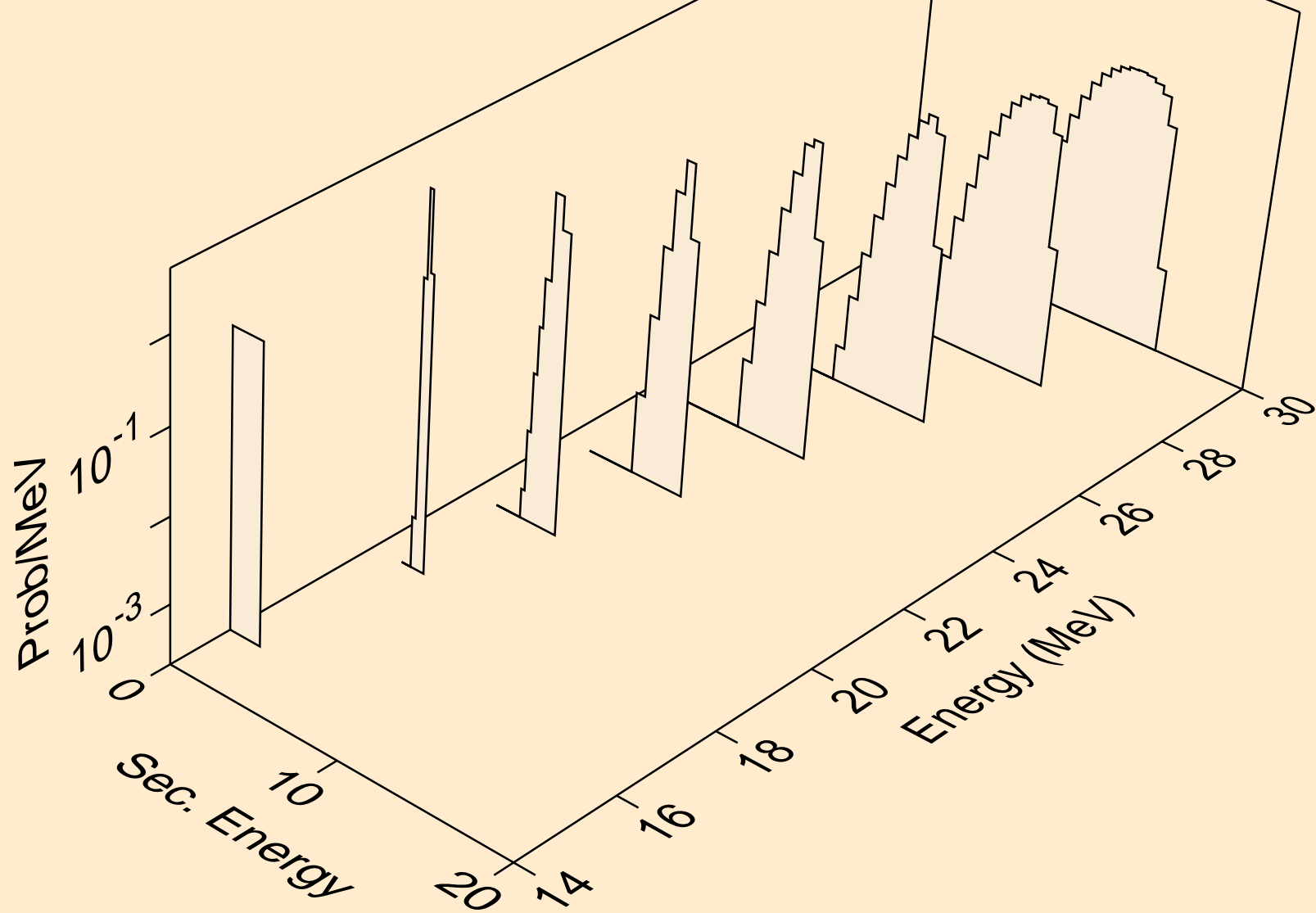

OS186 PROTON ACER TENDL-2021 LIBRARY; T=0.K  
tritons from (p,t)

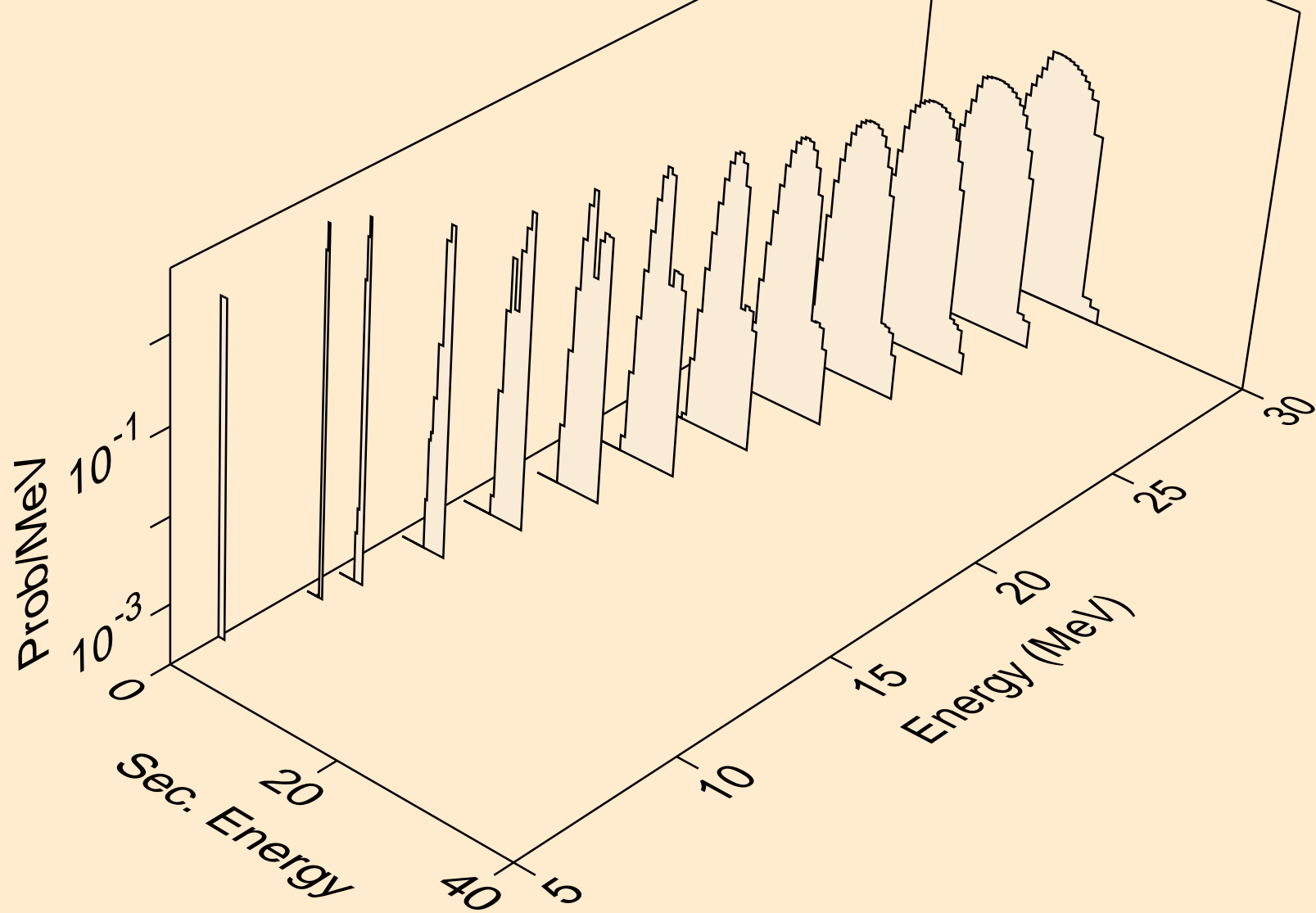



OS186 PROTON ACER TENDL-2021 LIBRARY; T=0.K  
tritons from (p,pt)

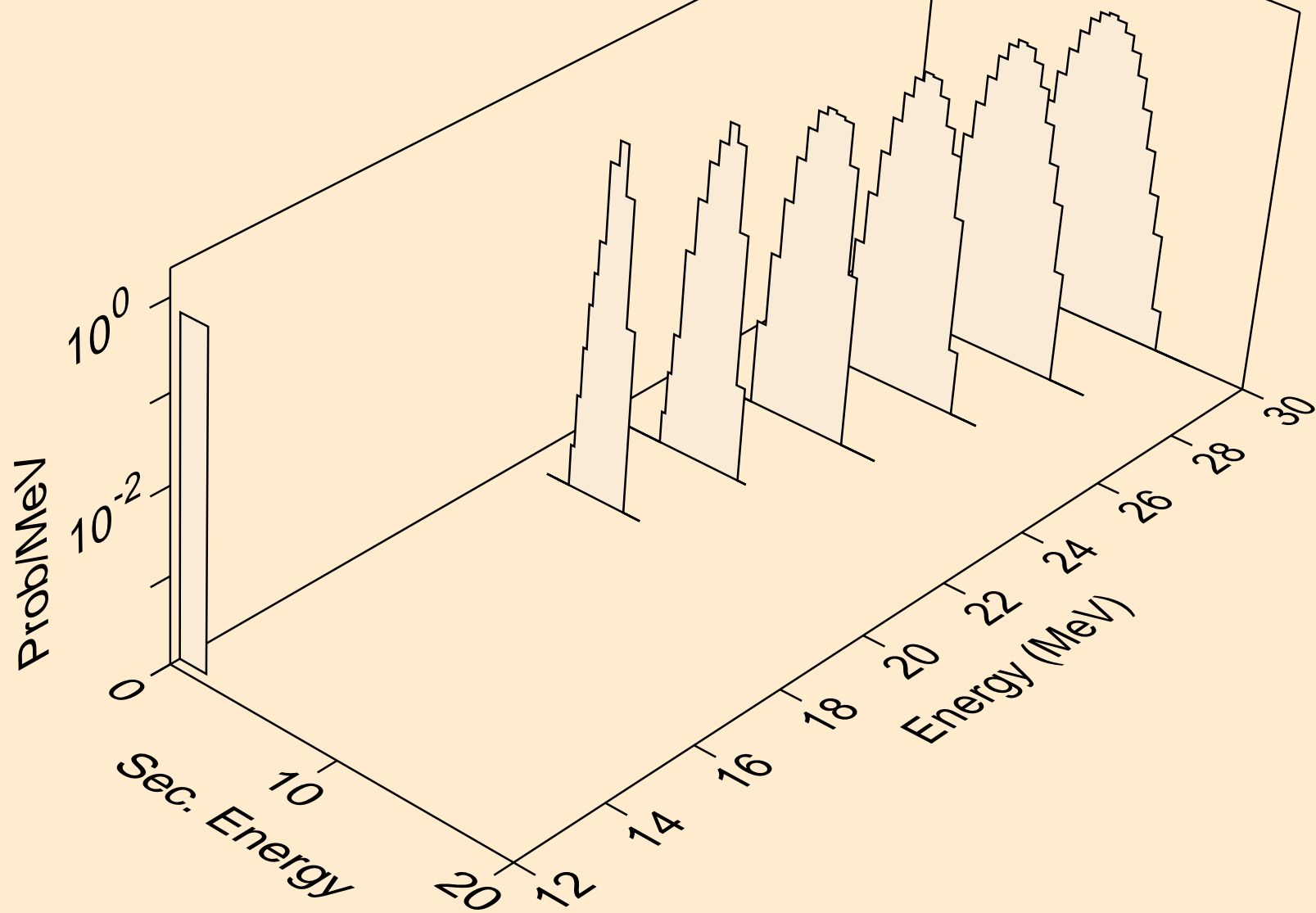

OS186 PROTON ACER TENDL-2021 LIBRARY; T=0.K  
he3s from (p,x)

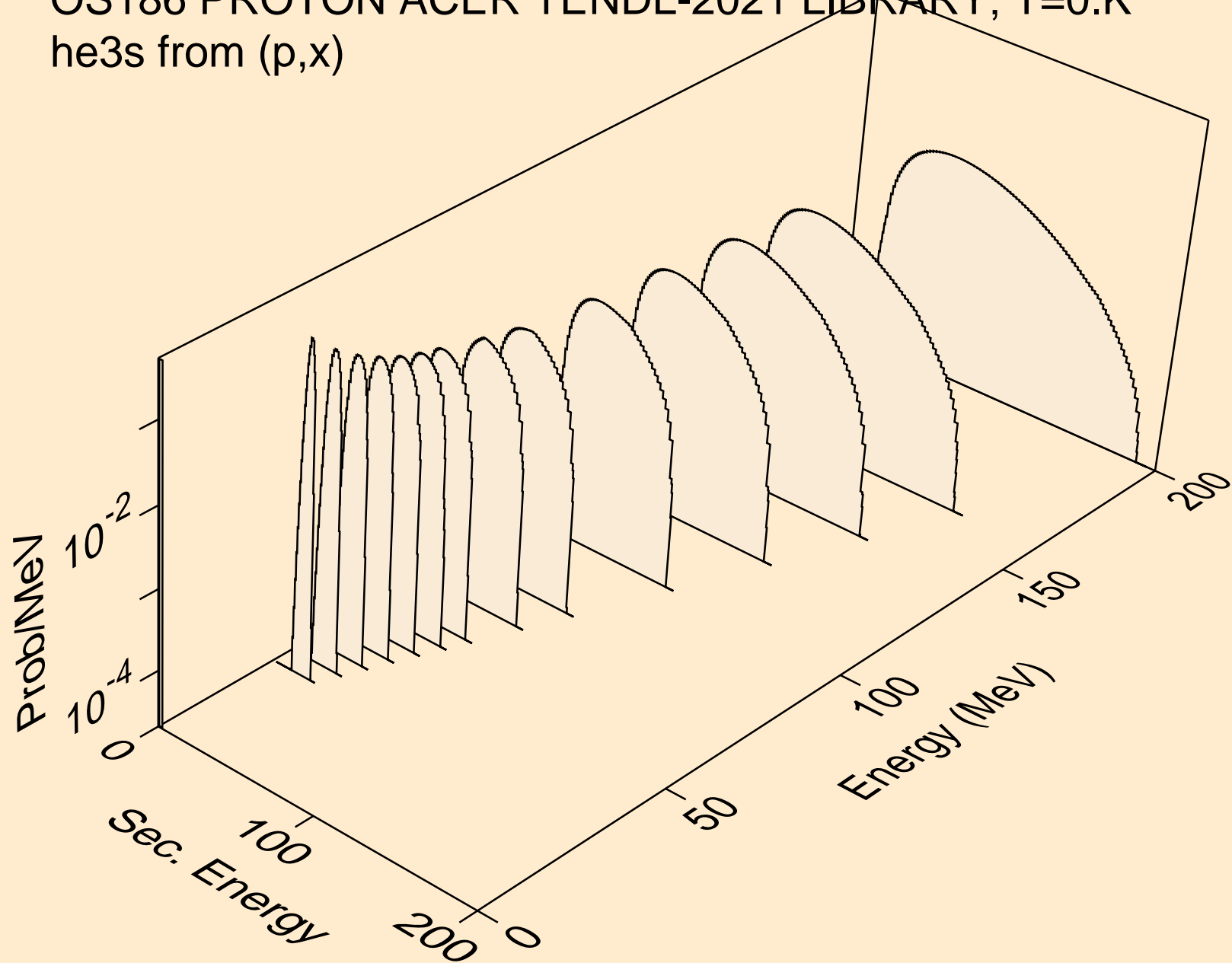

OS186 PROTON ACER TENDL-2021 LIBRARY; T=0.K  
he3s from (p,n\*)he3

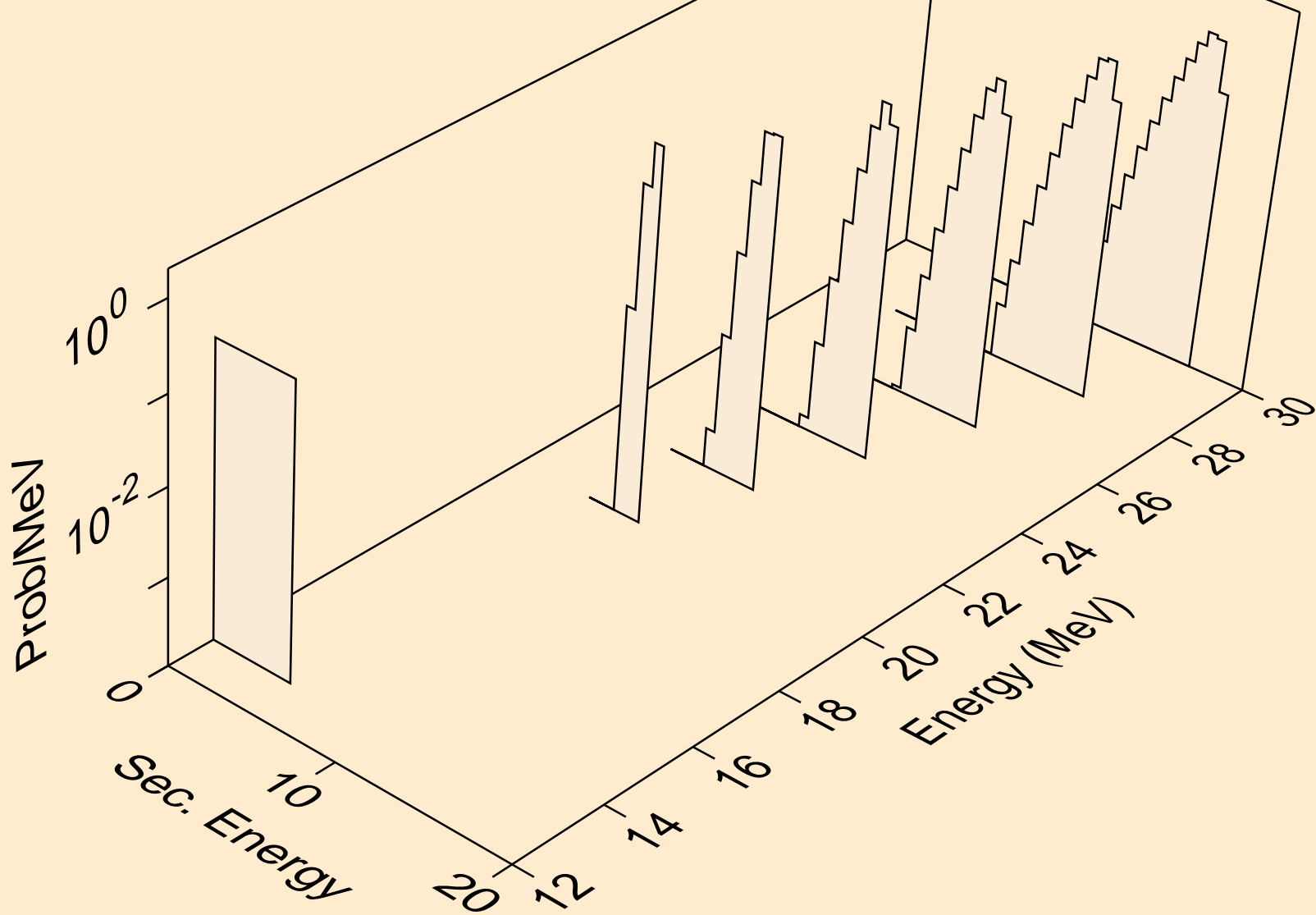

OS186 PROTON ACER TENDL-2021 LIBRARY; T=0.K  
he3s from (p,he3)

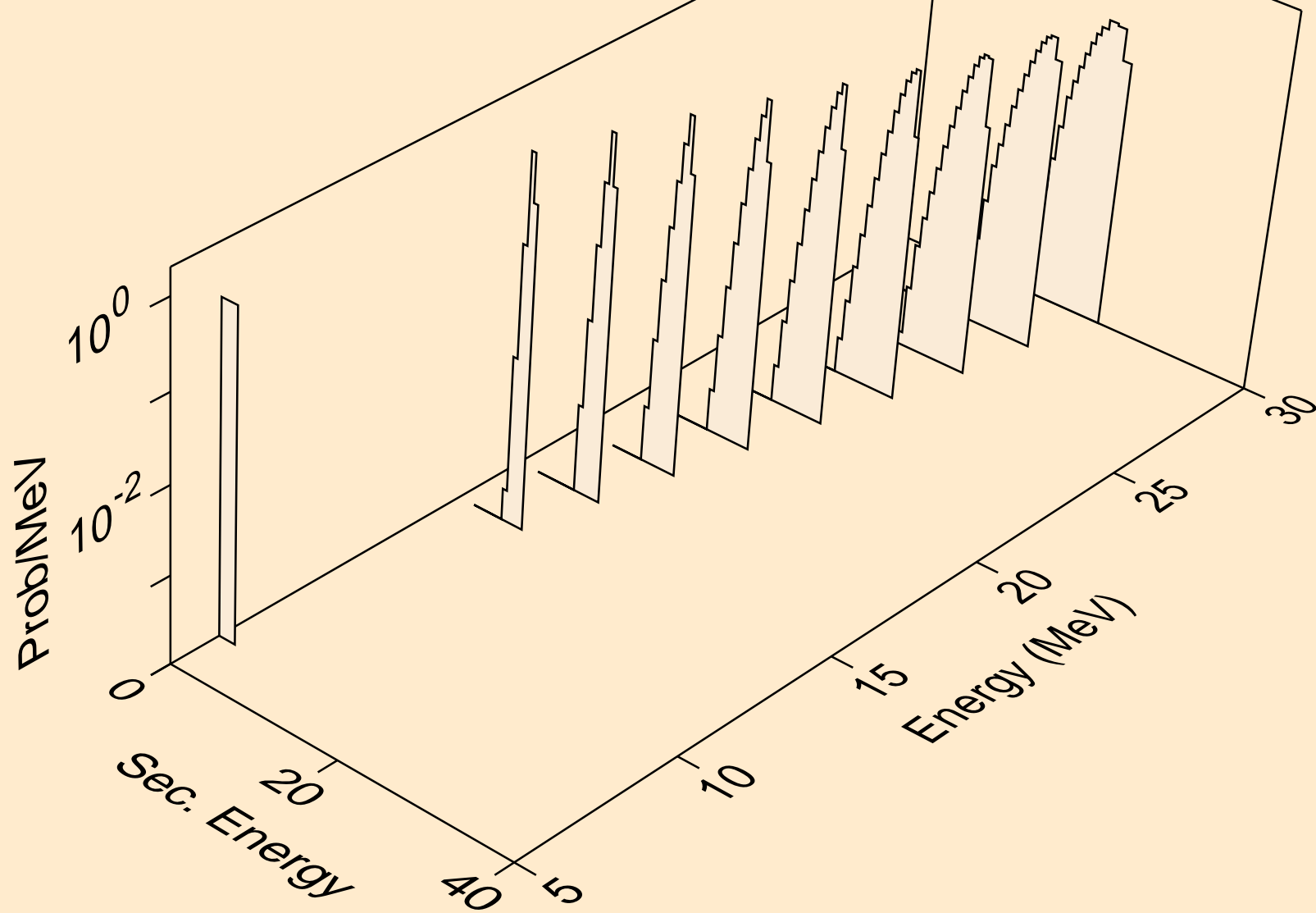

OS186 PROTON ACER TENDL-2021 LIBRARY; T=0.K  
alphas from (p,x)

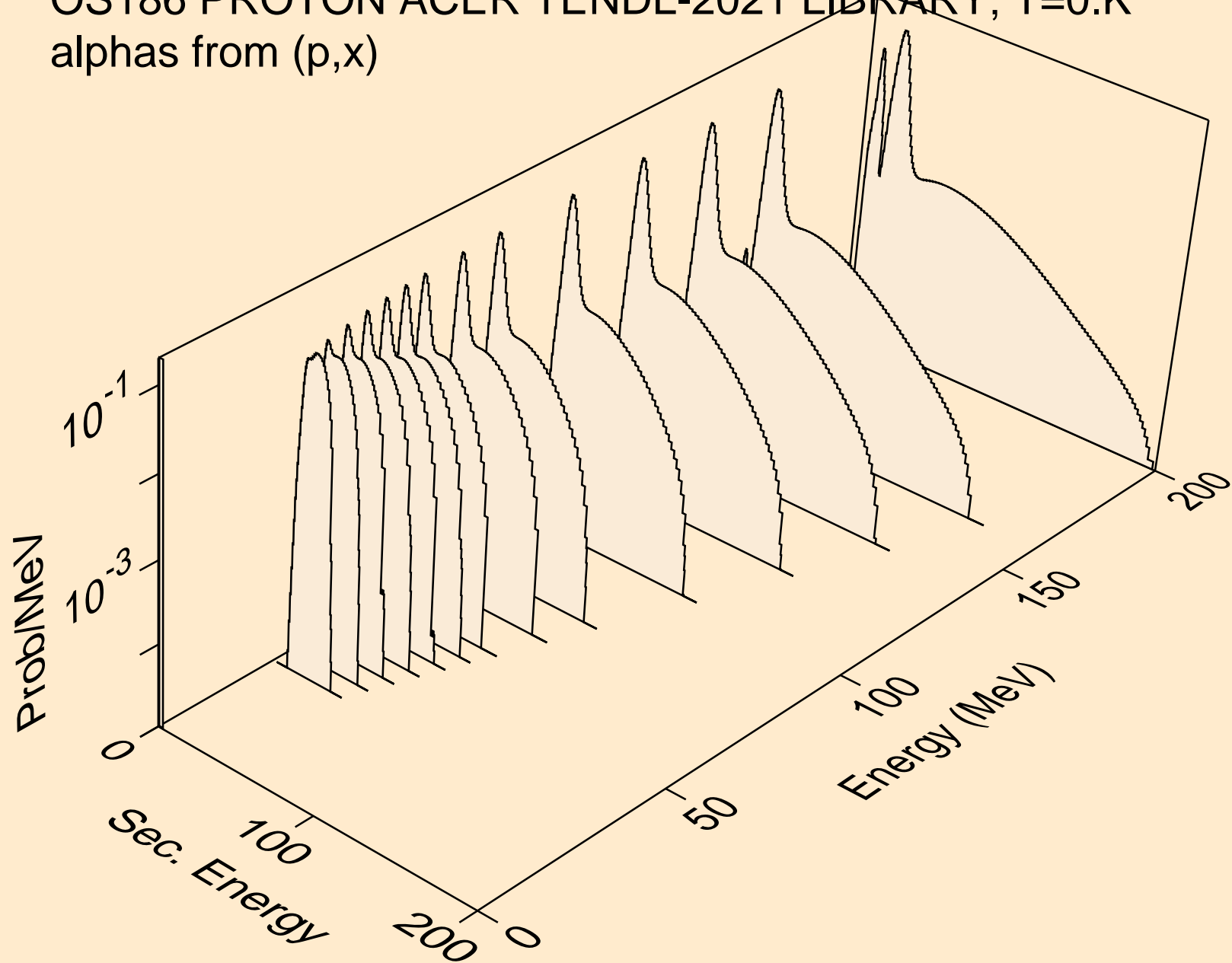

OS186 PROTON ACER TENDL-2021 LIBRARY; T=0.K  
alphas from (p,n\*)a

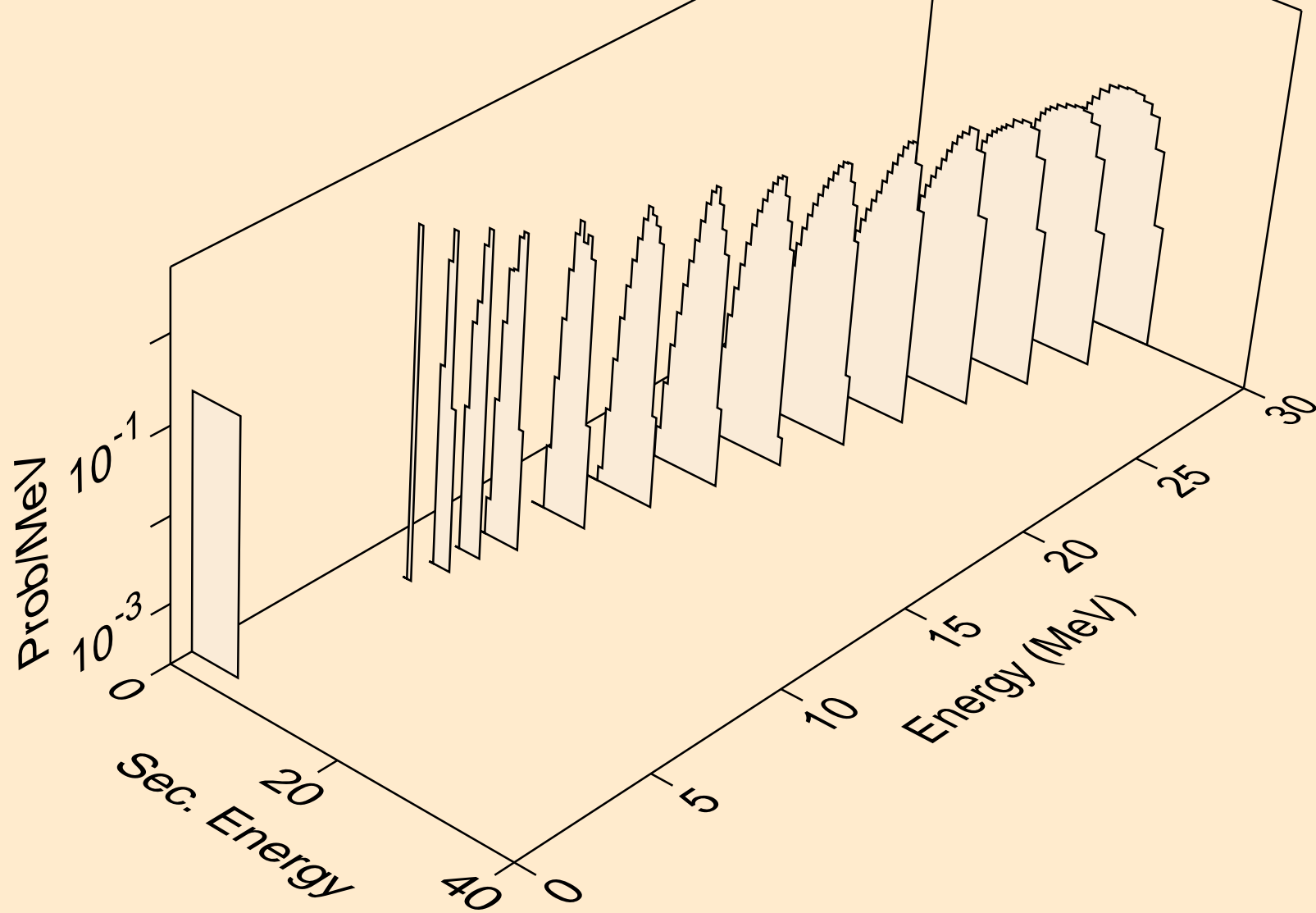

OS186 PROTON ACER TENDL-2021 LIBRARY; T=0.K  
alphas from (p,2n)a

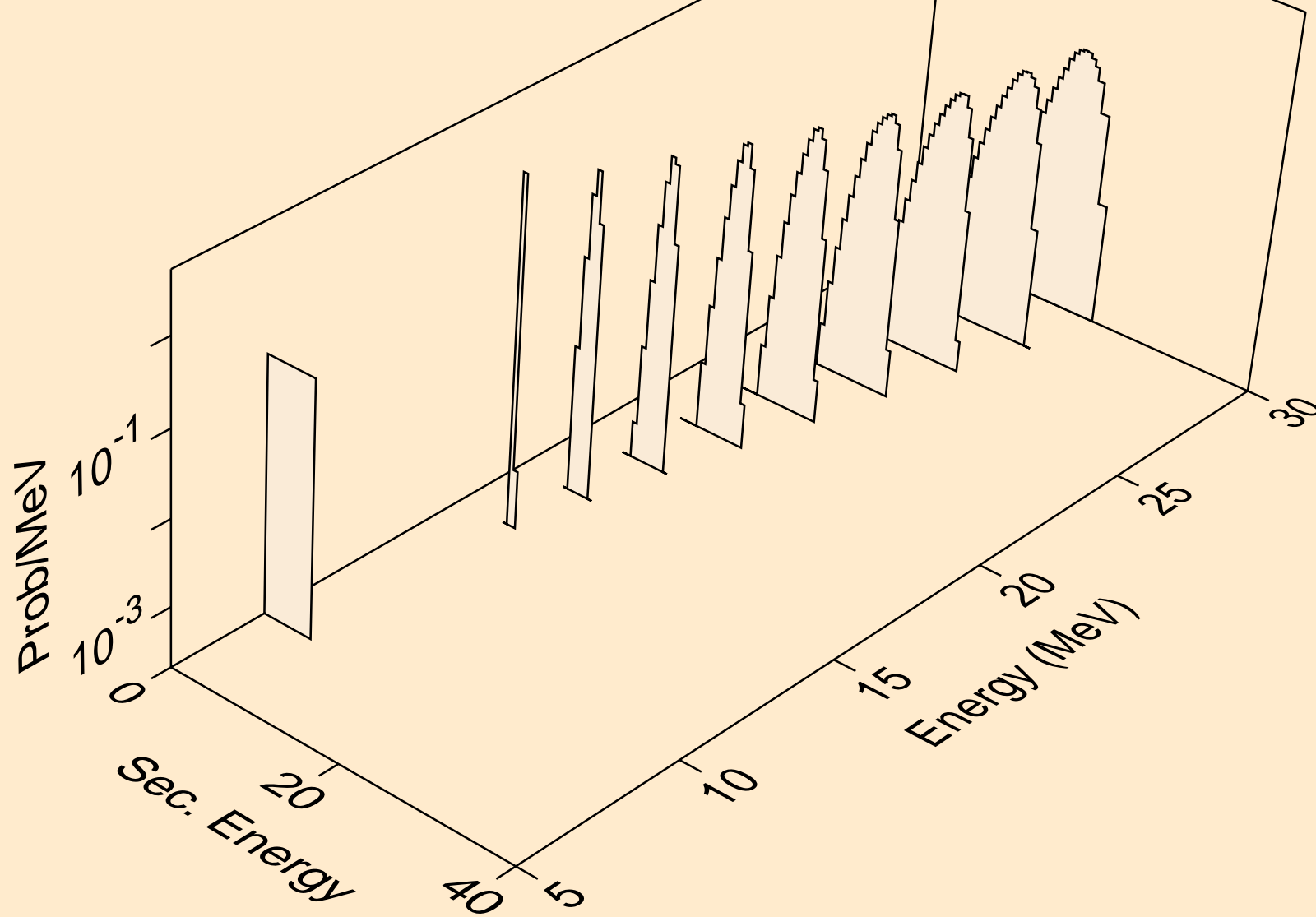

OS186 PROTON ACER TENDL-2021 LIBRARY; T=0.K  
alphas from (p,3n)a

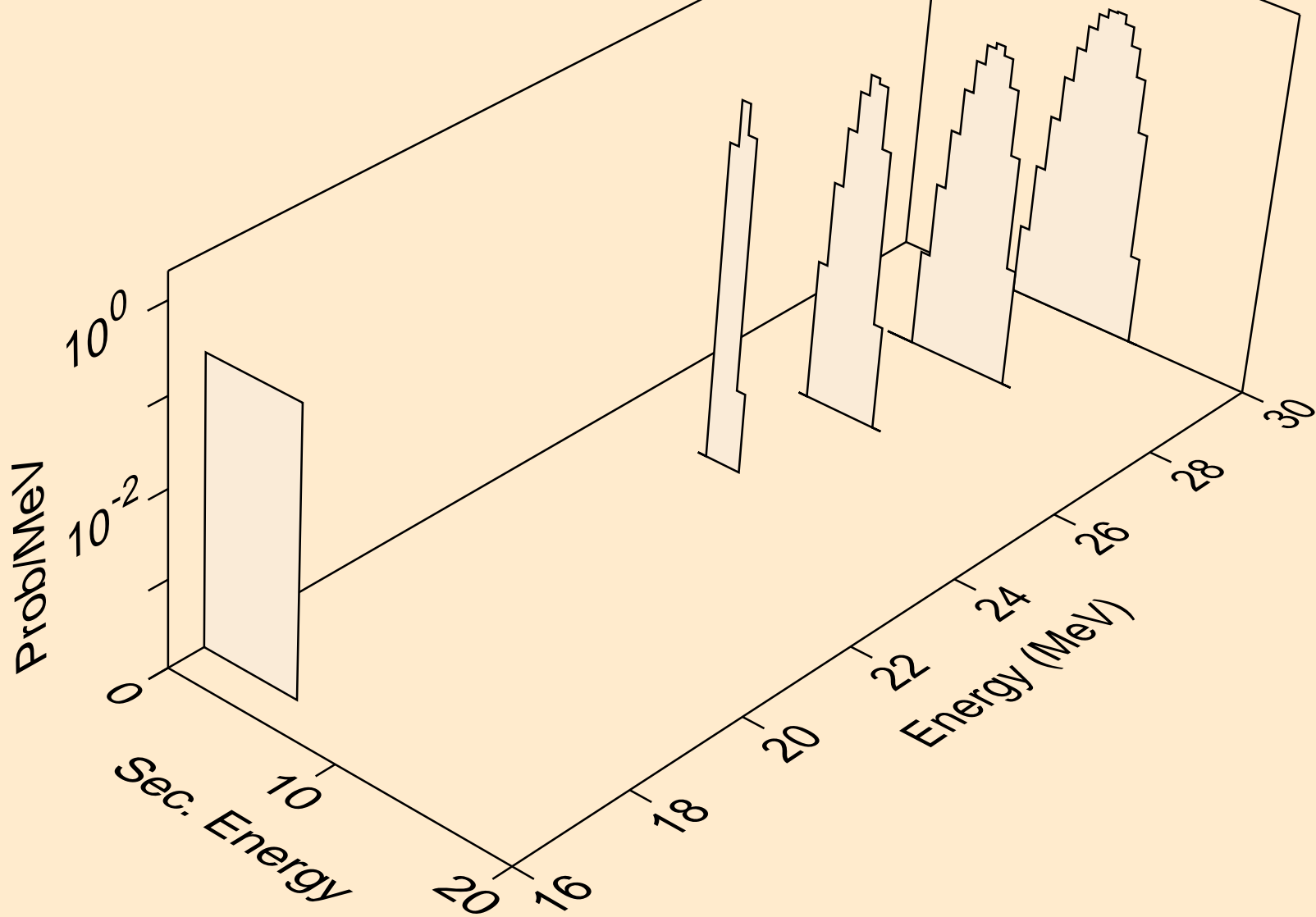



OS186 PROTON ACER TENDL-2021 LIBRARY; T=0.K  
alphas from (p,n\*)2a

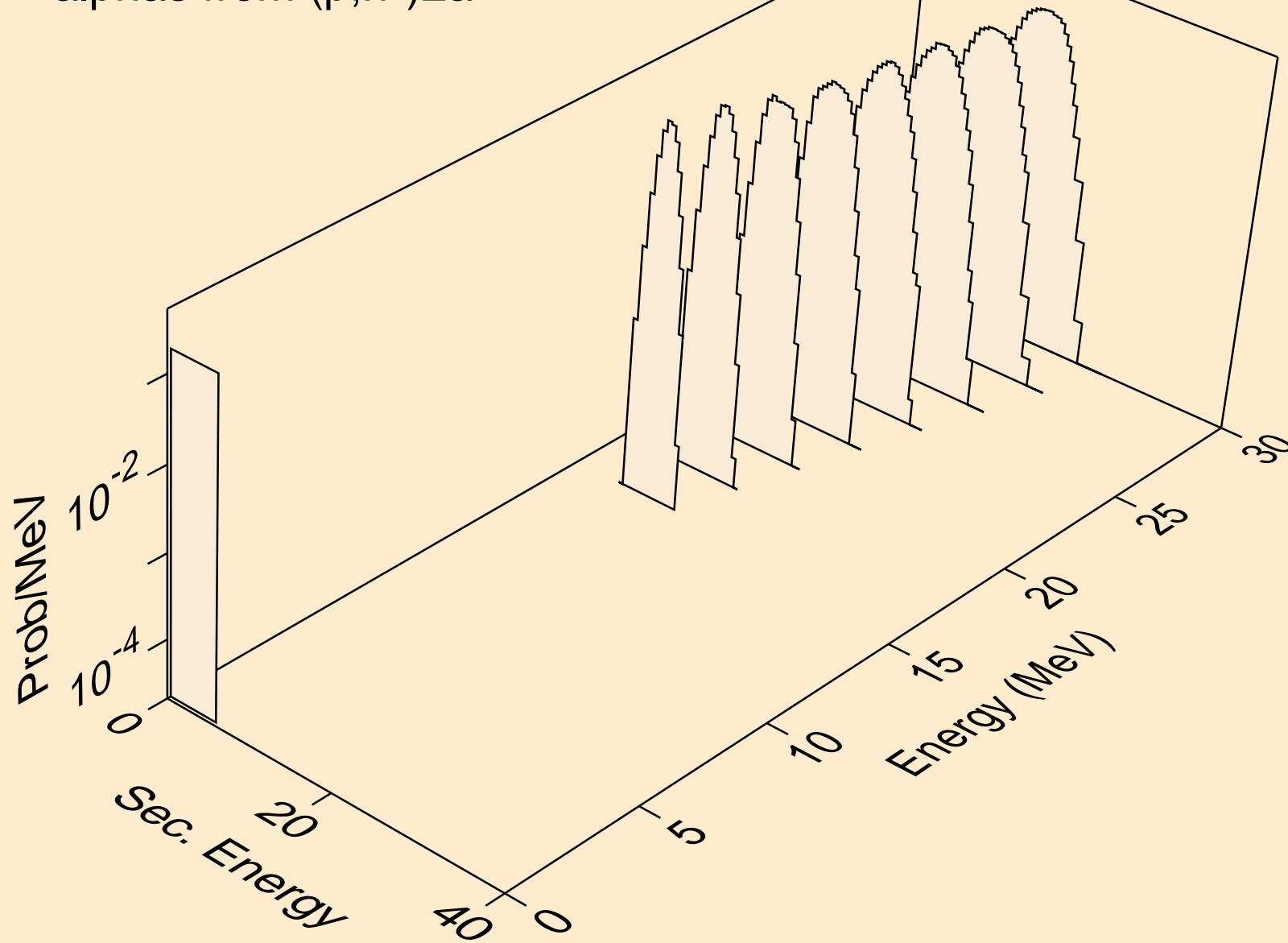

OS186 PROTON ACER TENDL-2021 LIBRARY; T=0.K  
alphas from (p,npa)

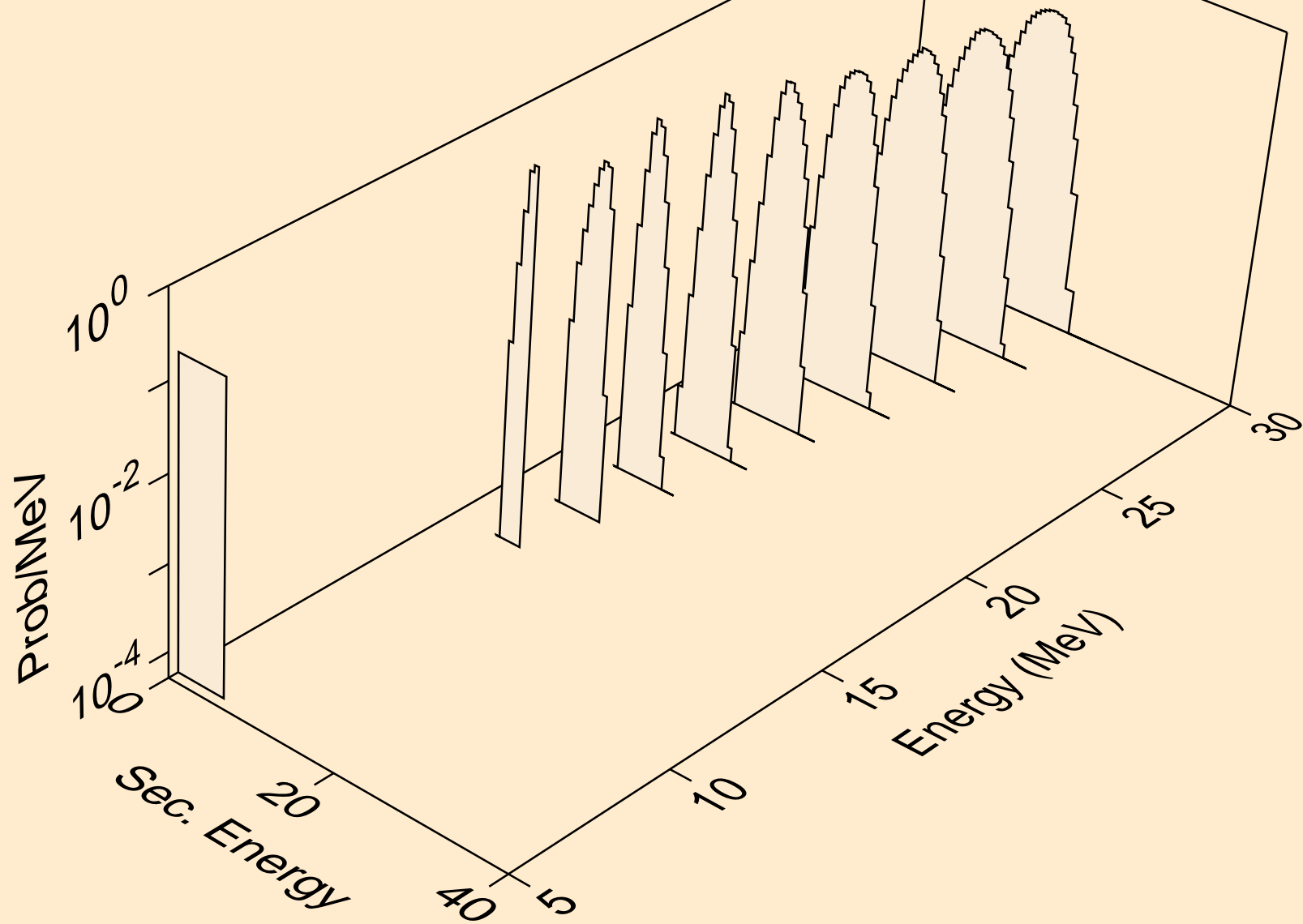

OS186 PROTON ACER TENDL-2021 LIBRARY; T=0.K  
alphas from (p,a)

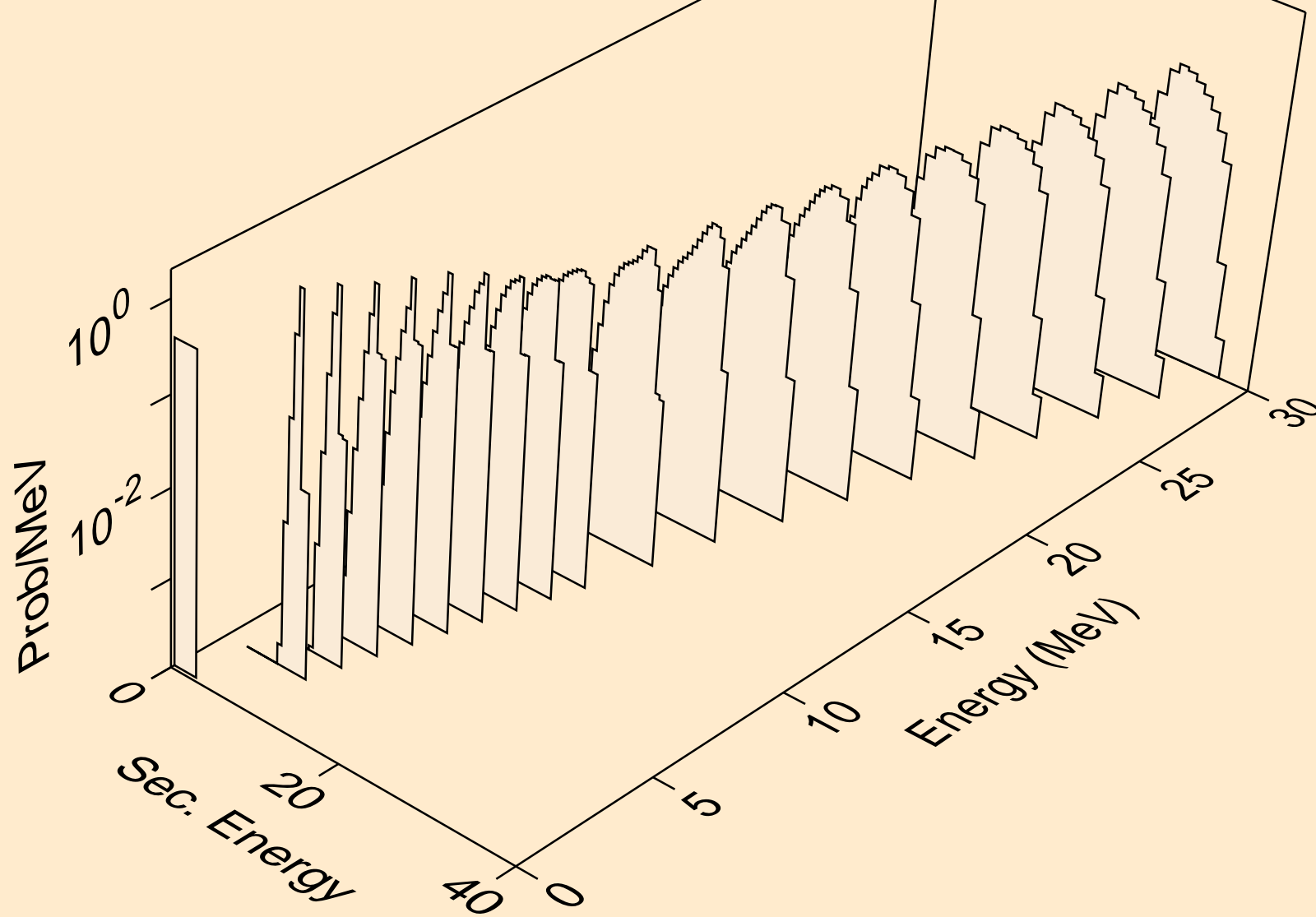

OS186 PROTON ACER TENDL-2021 LIBRARY; T=0.K  
alphas from (p,2a)

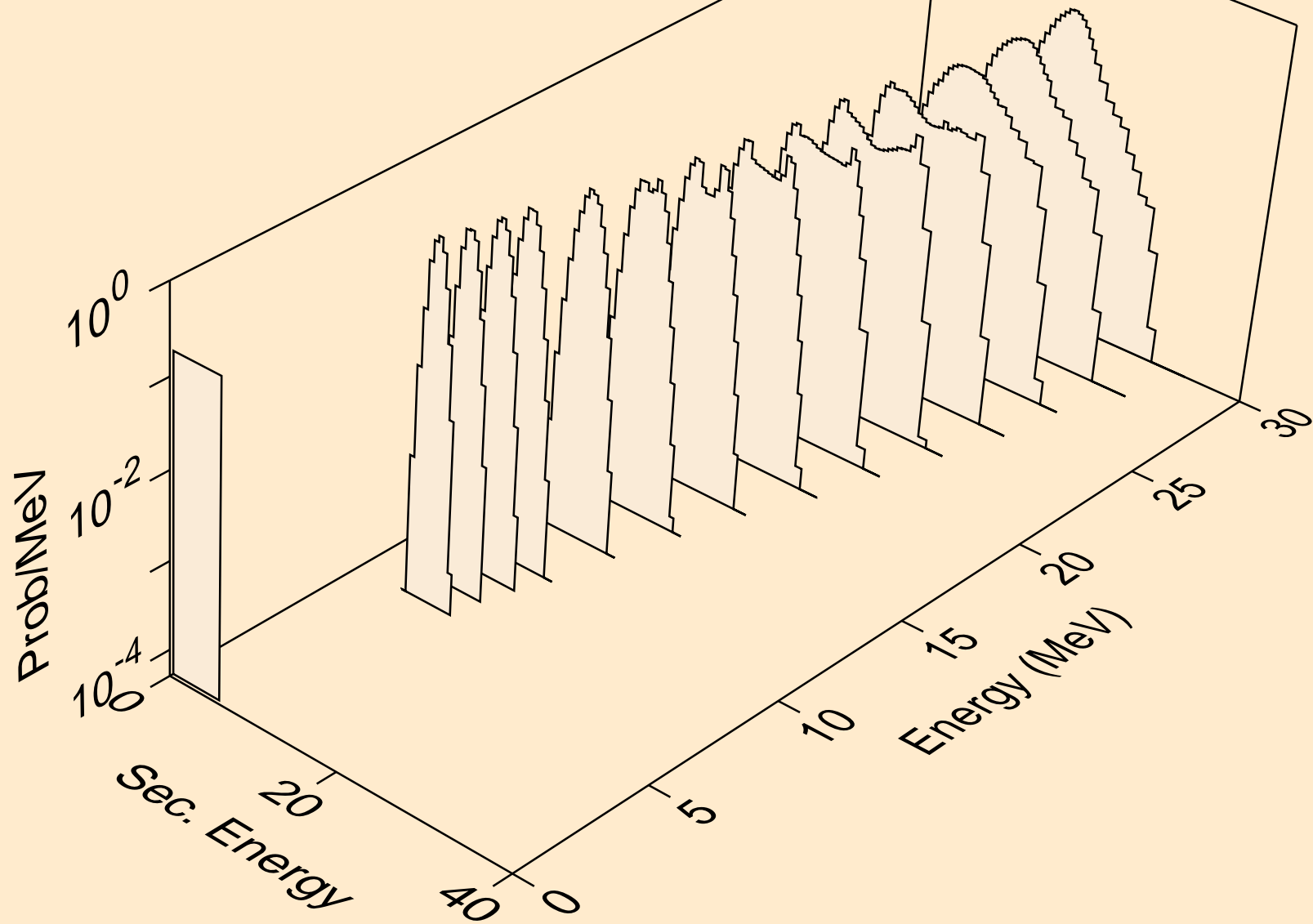

OS186 PROTON ACER TENDL-2021 LIBRARY; T=0.K  
alphas from (p,pa)

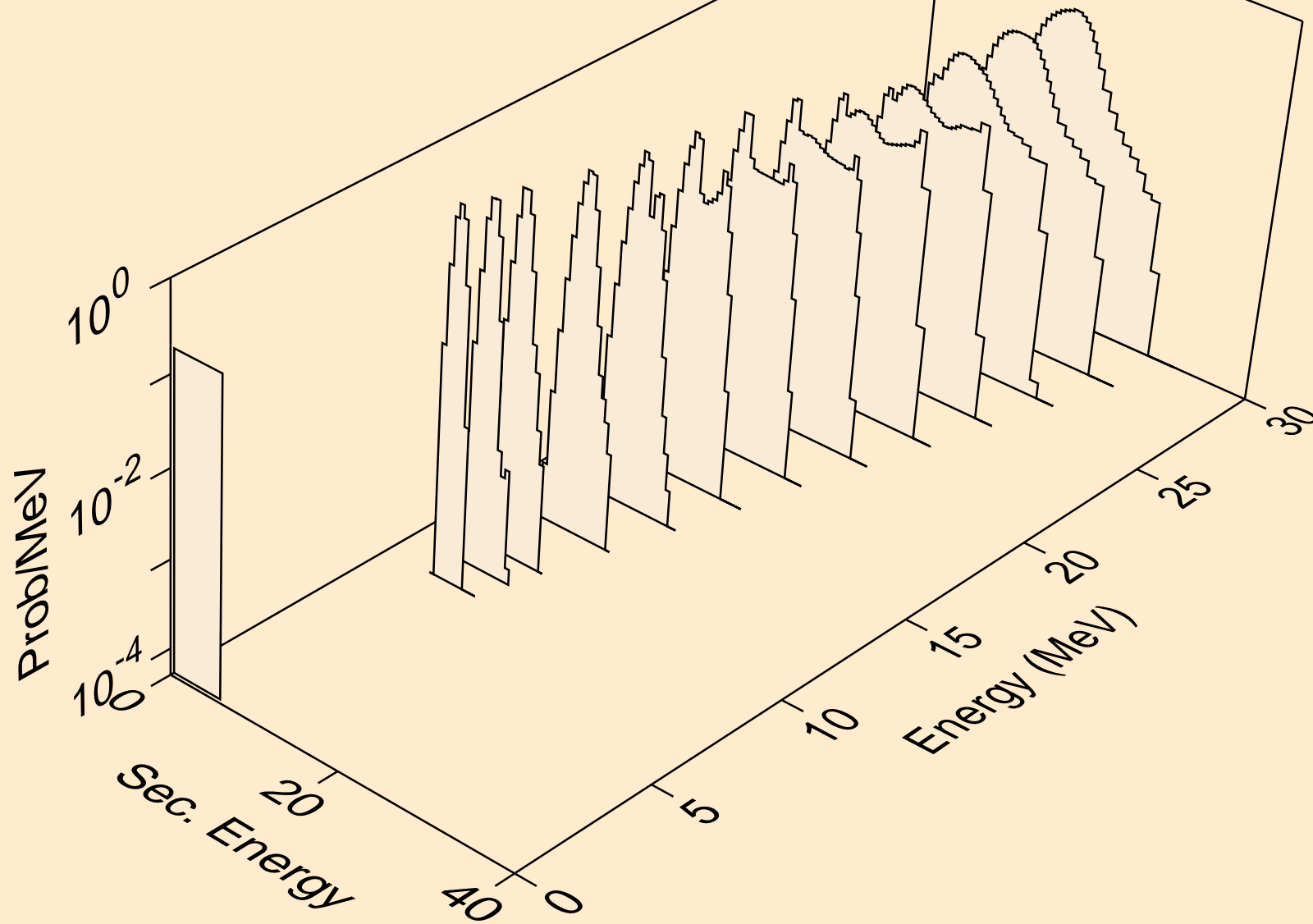

OS186 PROTON ACER TENDL-2021 LIBRARY; T=0.K  
alphas from (p,da)

