

PA241 PROTON ACER TENDL-2021 LIBRARY; T=0.K  
Principal cross sections

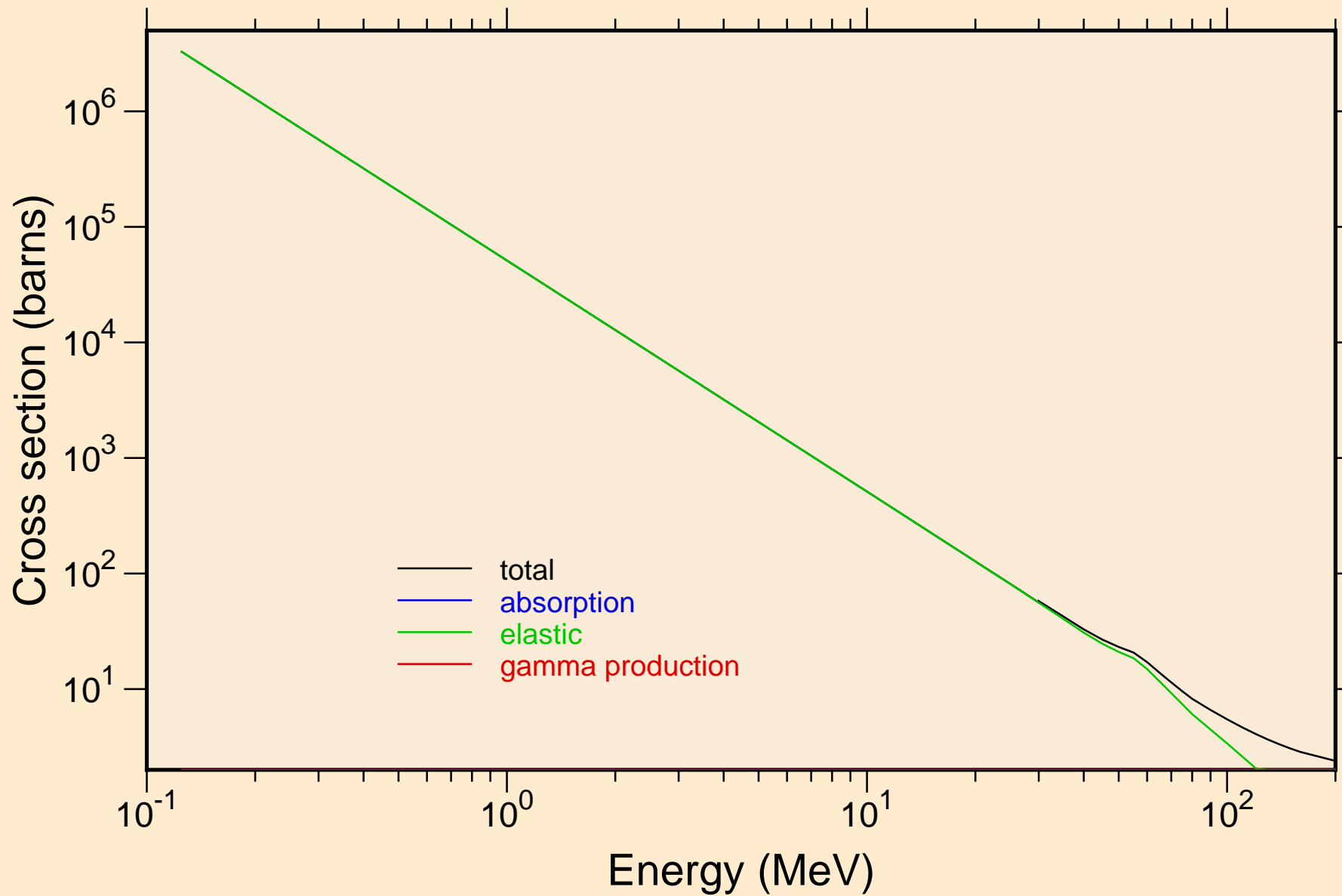

PA241 PROTON ACER TENDL-2021 LIBRARY; T=0.K

Heating

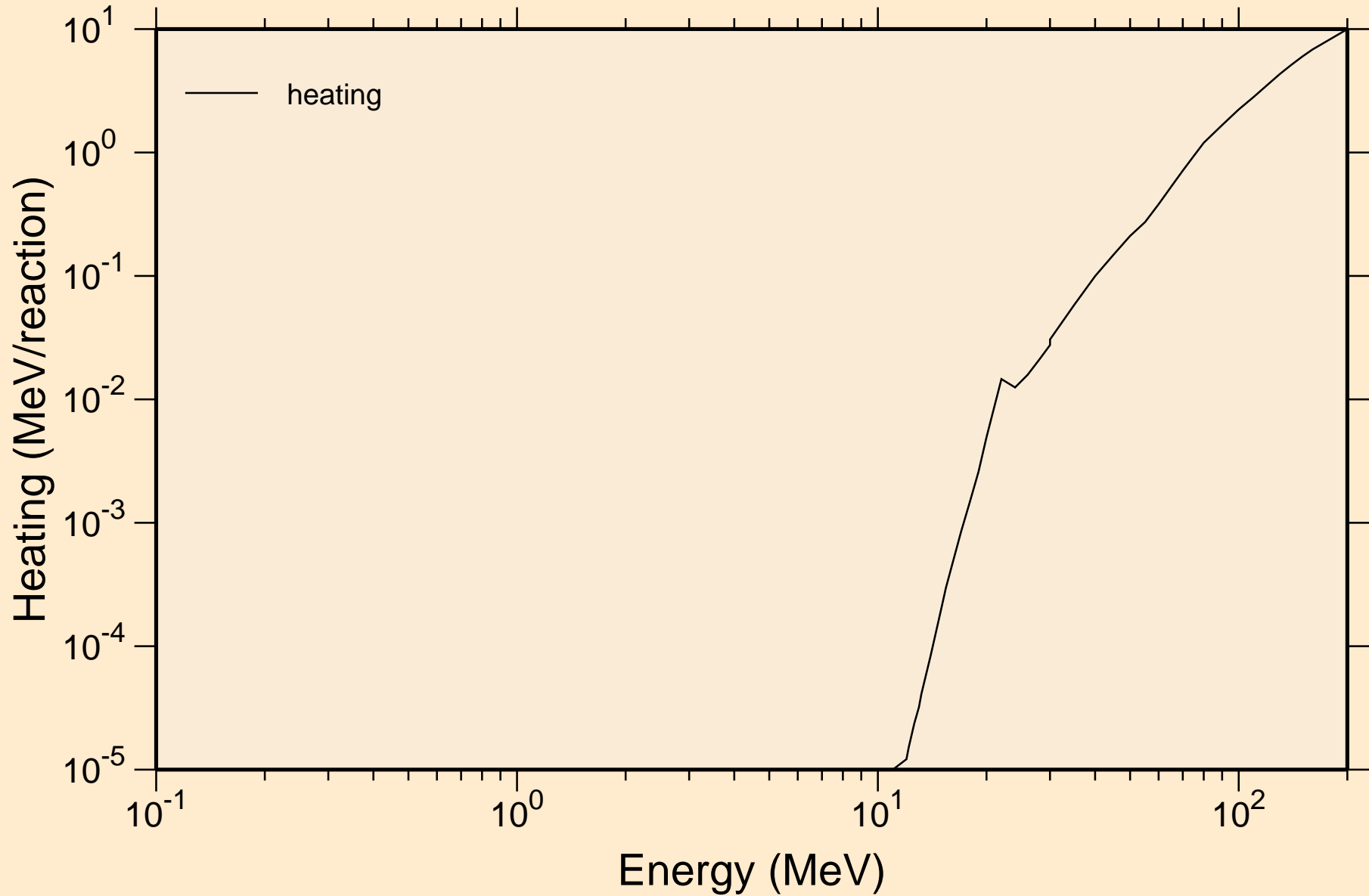

# PA241 PROTON ACER TENDL-2021 LIBRARY; T=0.K

## Principal cross sections

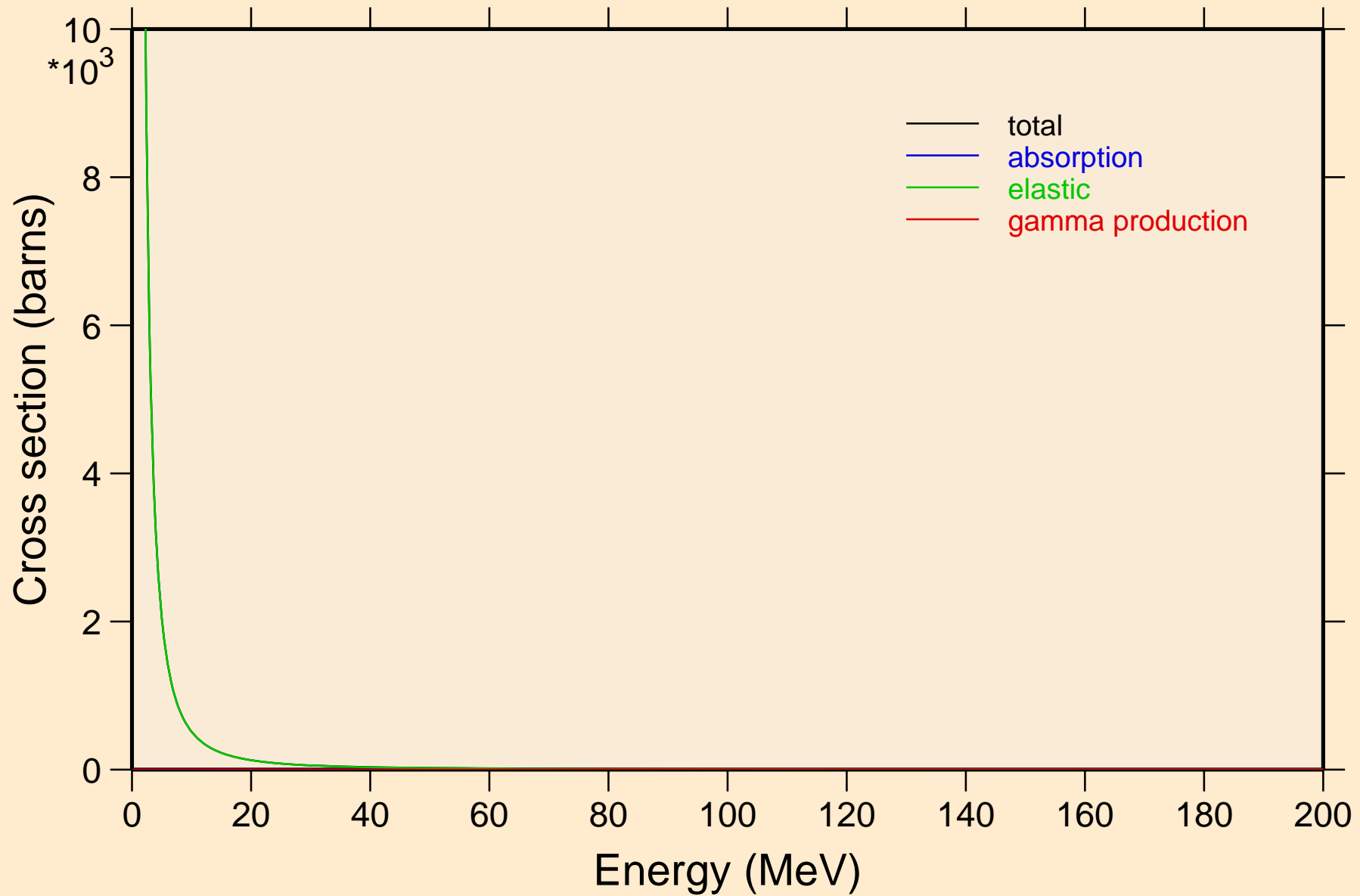

PA241 PROTON ACER TENDL-2021 LIBRARY; T=0.K

Heating

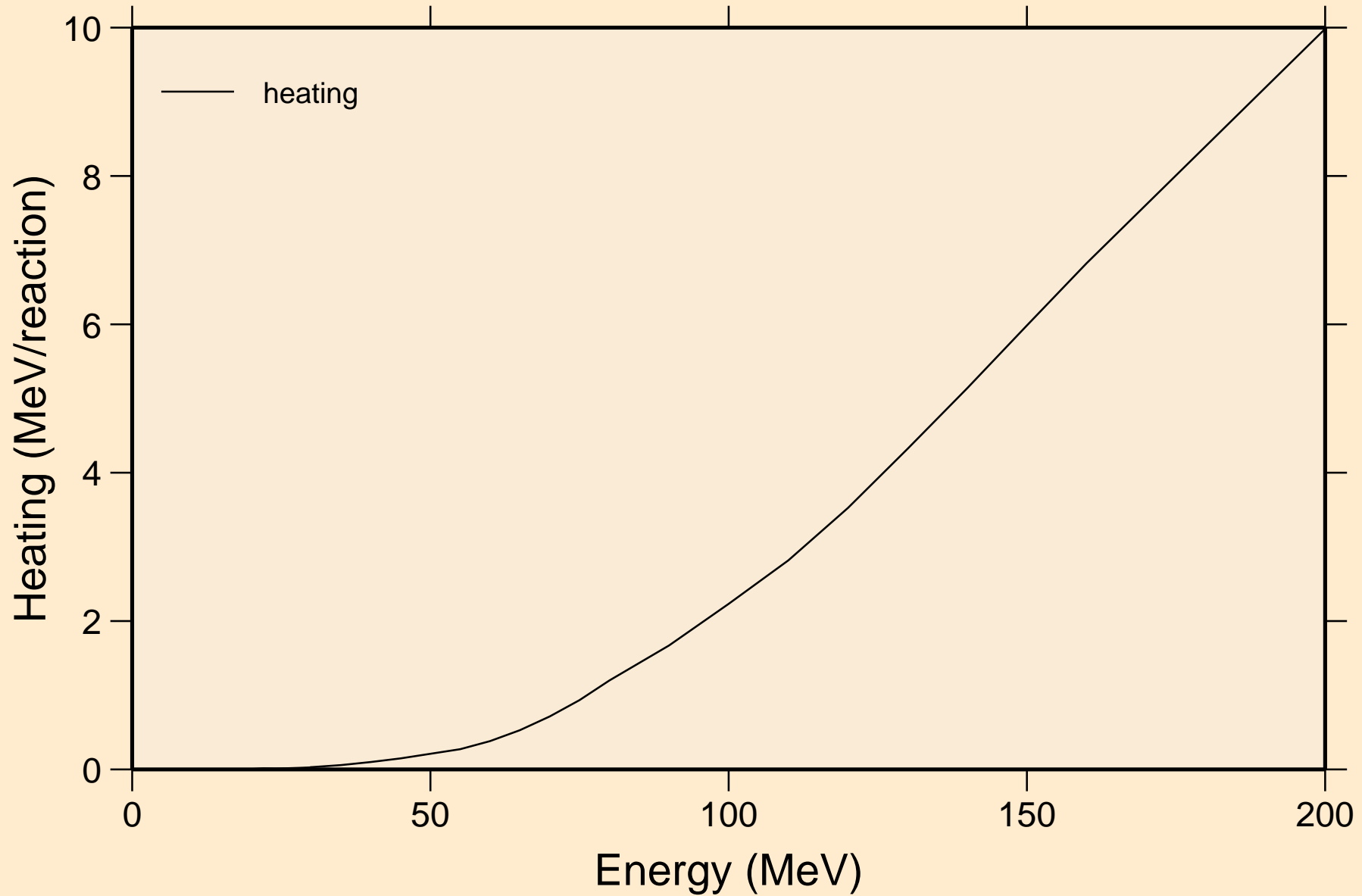

PA241 PROTON ACER TENDL-2021 LIBRARY; T=0.K  
Threshold reactions

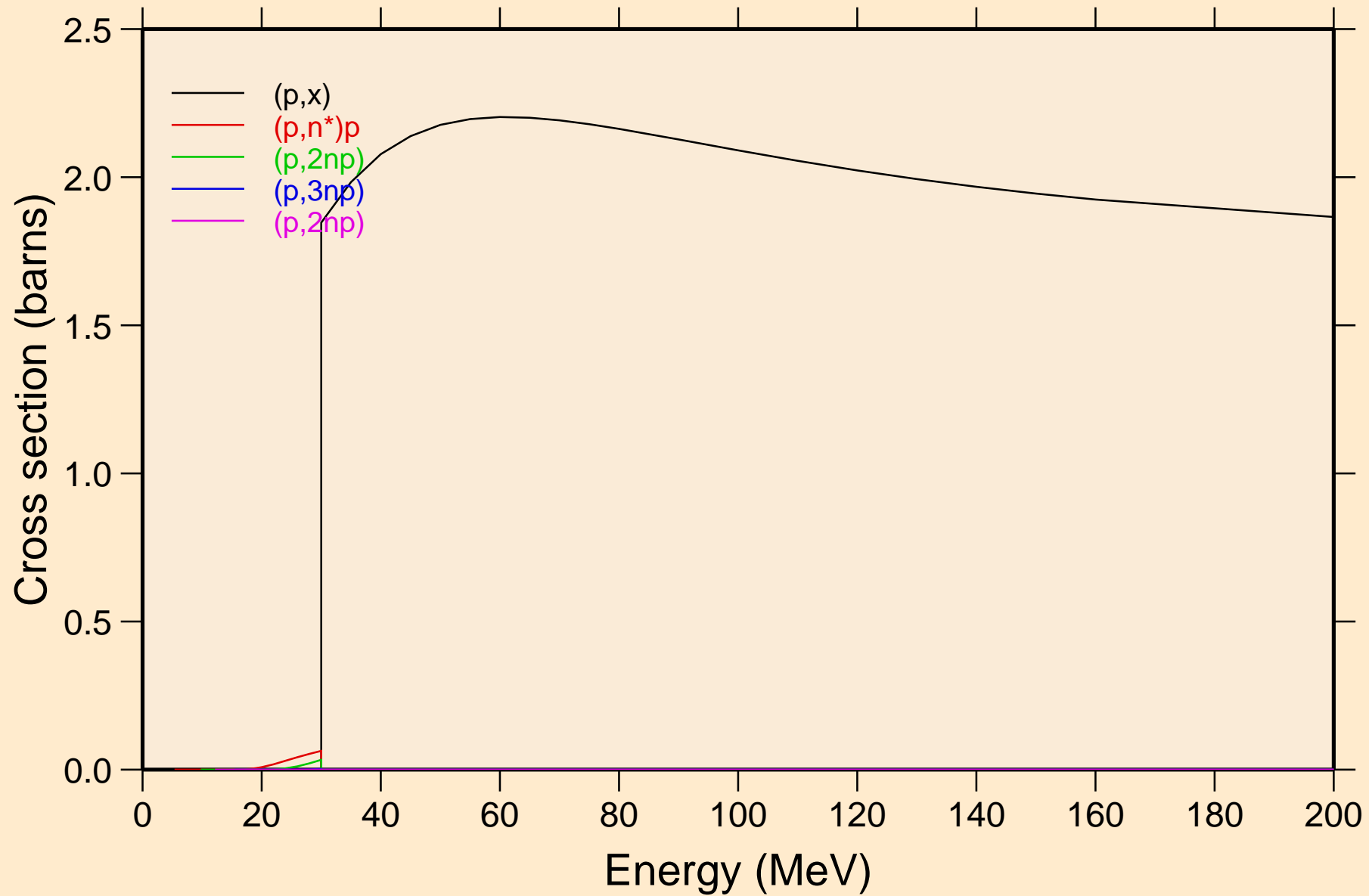

PA241 PROTON ACER TENDL-2021 LIBRARY; T=0.K  
Threshold reactions

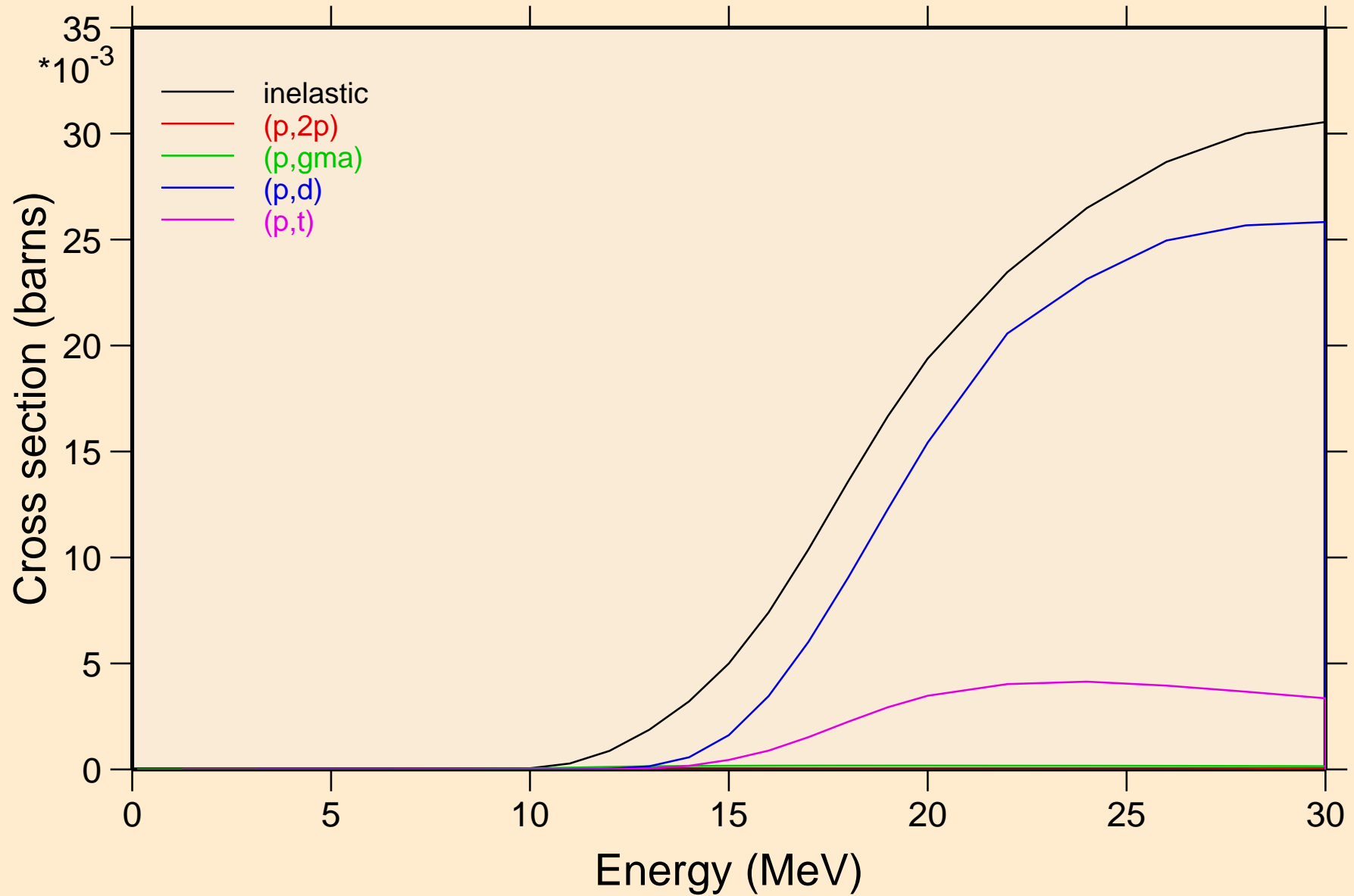

PA241 PROTON ACER TENDL-2021 LIBRARY; T=0.K  
Threshold reactions

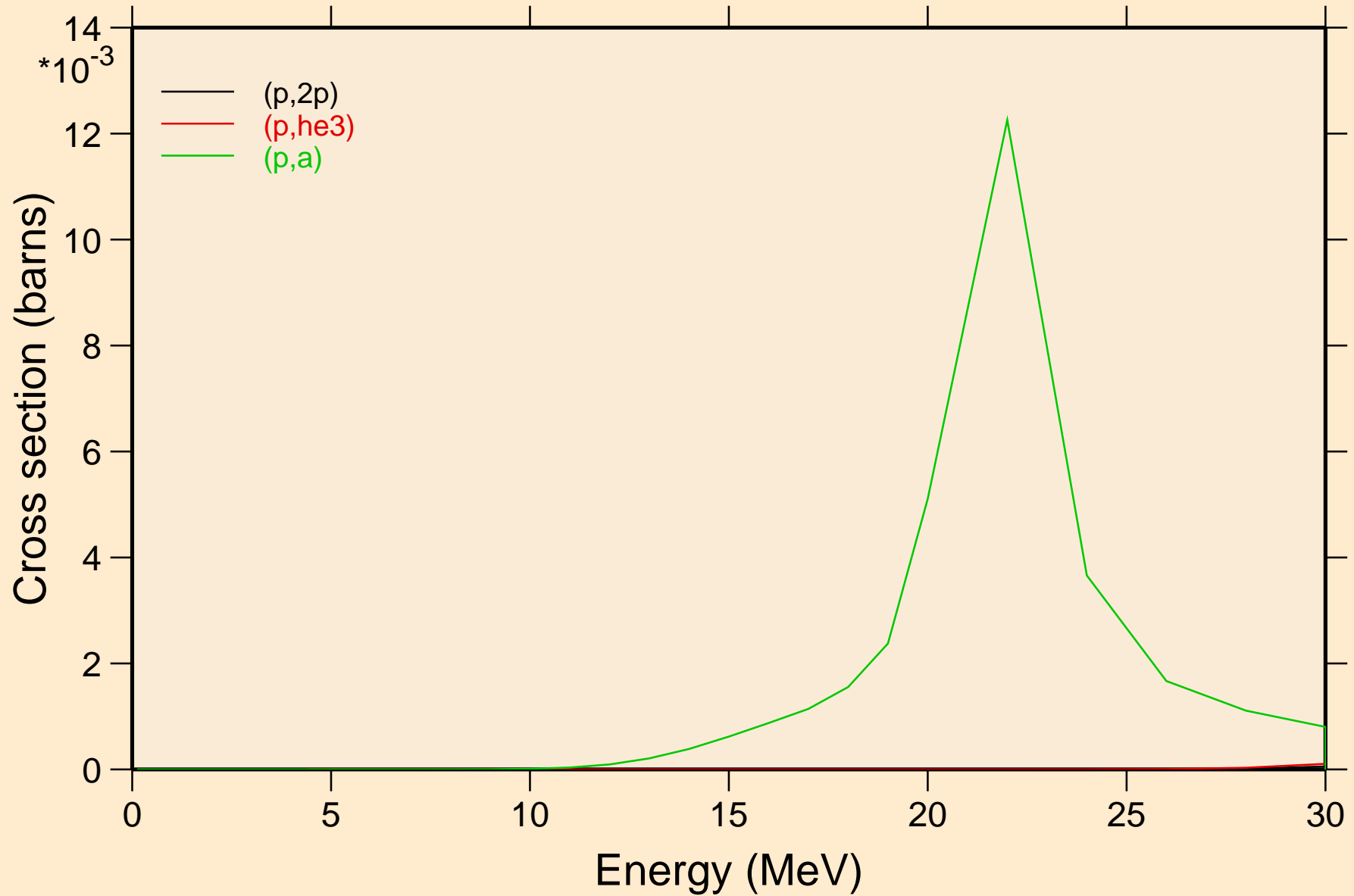

PA241 PROTON ACER TENDL-2021 LIBRARY; T=0.K  
Threshold reactions

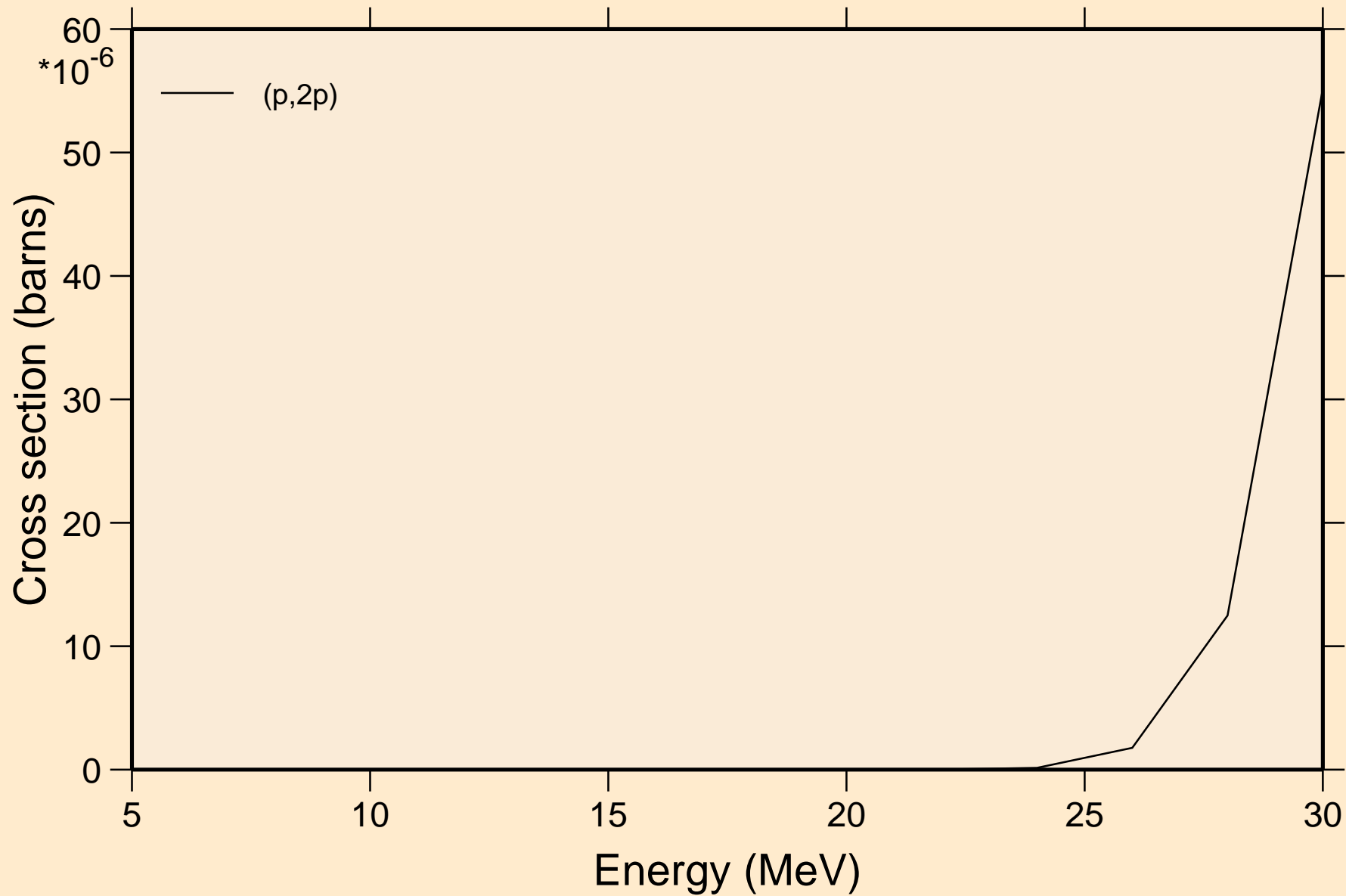



PA241 PROTON ACER TENDL-2021 LIBRARY; T=0.K  
angular distribution for elastic

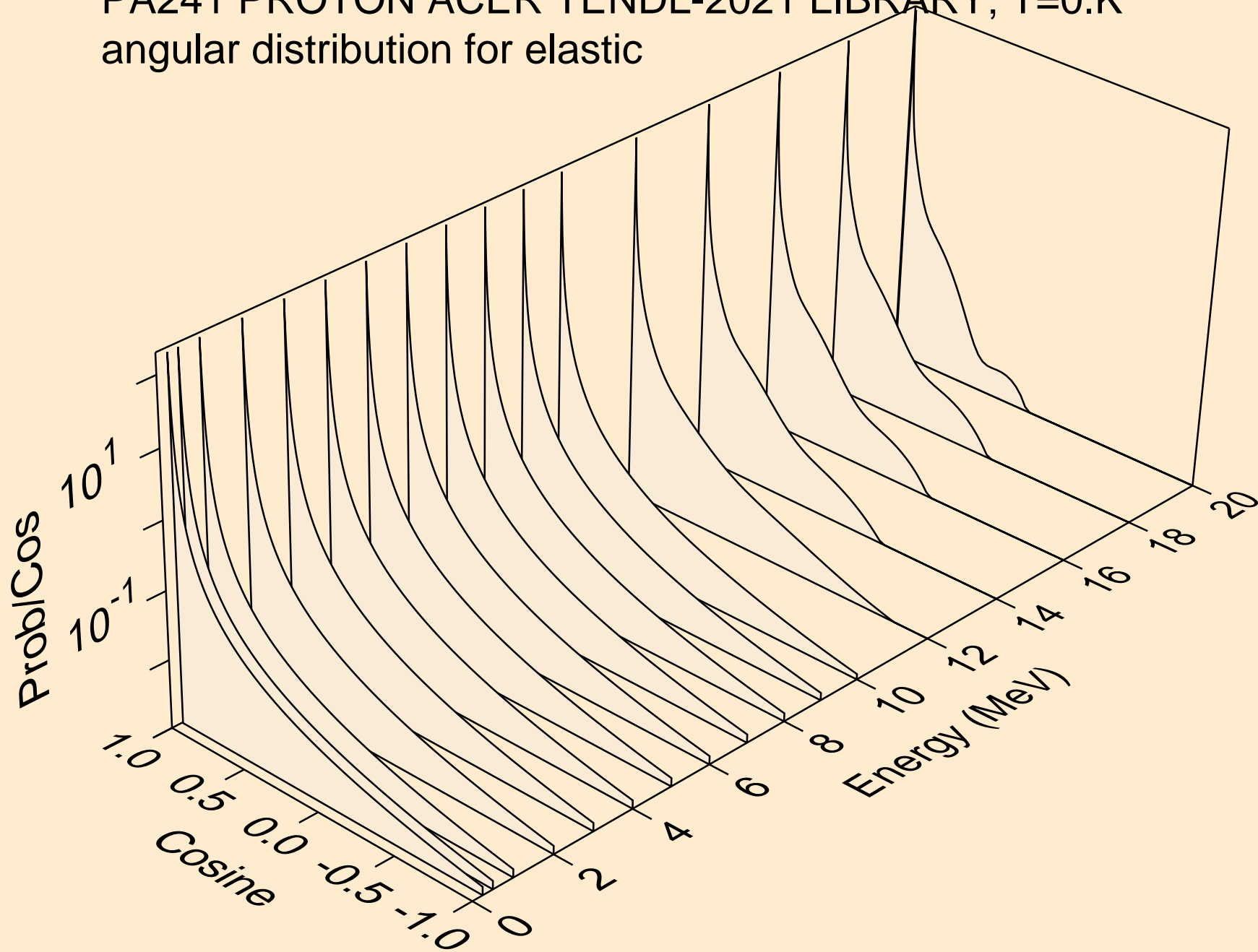

PA241 PROTON ACER TENDL-2021 LIBRARY; T=0.K  
angular distribution for elastic

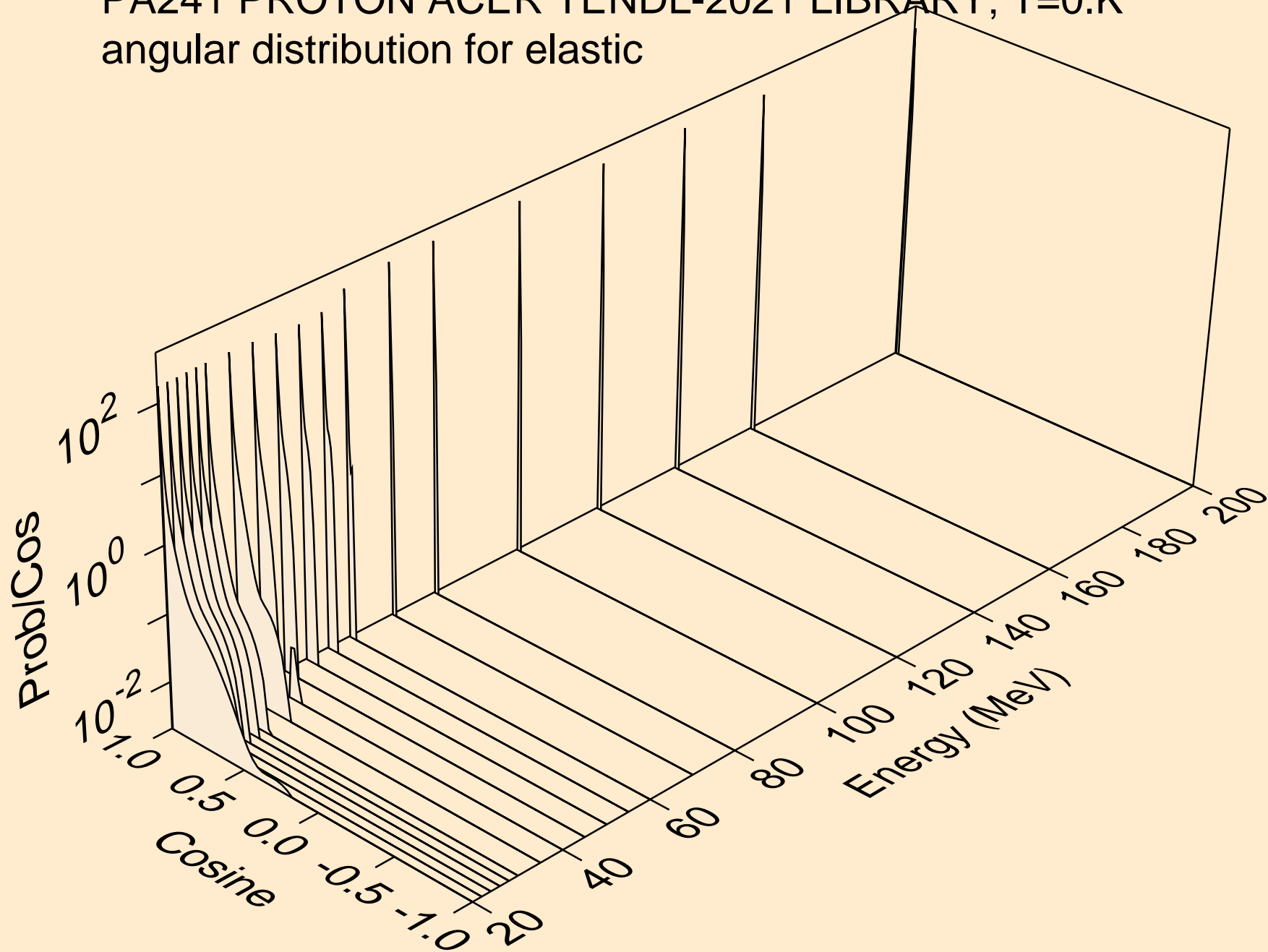

PA241 PROTON ACER TENDL-2021 LIBRARY; T=0.K  
Proton emission for (p,x)

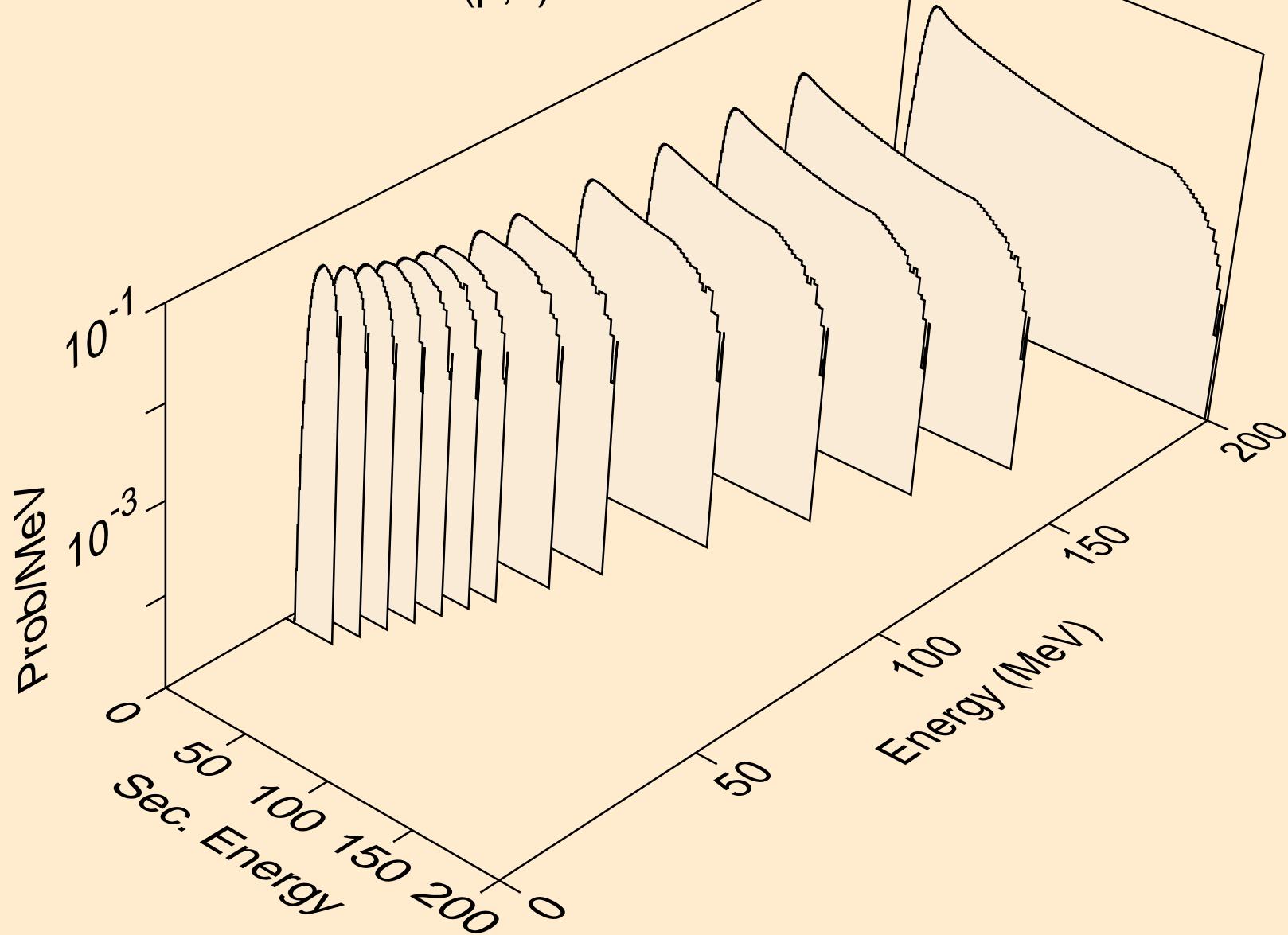

PA241 PROTON ACER TENDL-2021 LIBRARY; T=0.K  
Proton emission for (p,n\*)p

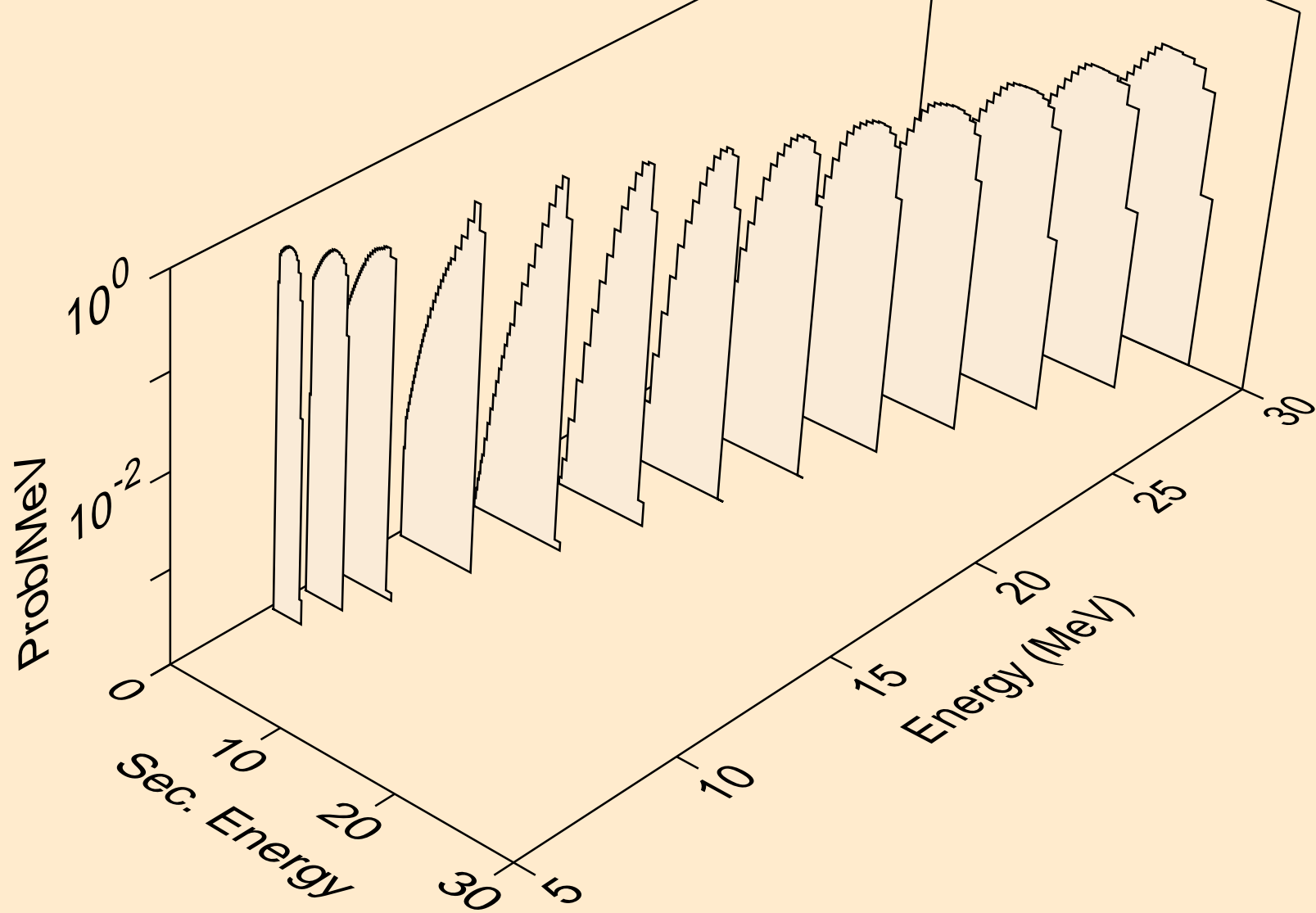

PA241 PROTON ACER TENDL-2021 LIBRARY; T=0.K  
Proton emission for (p,2np)

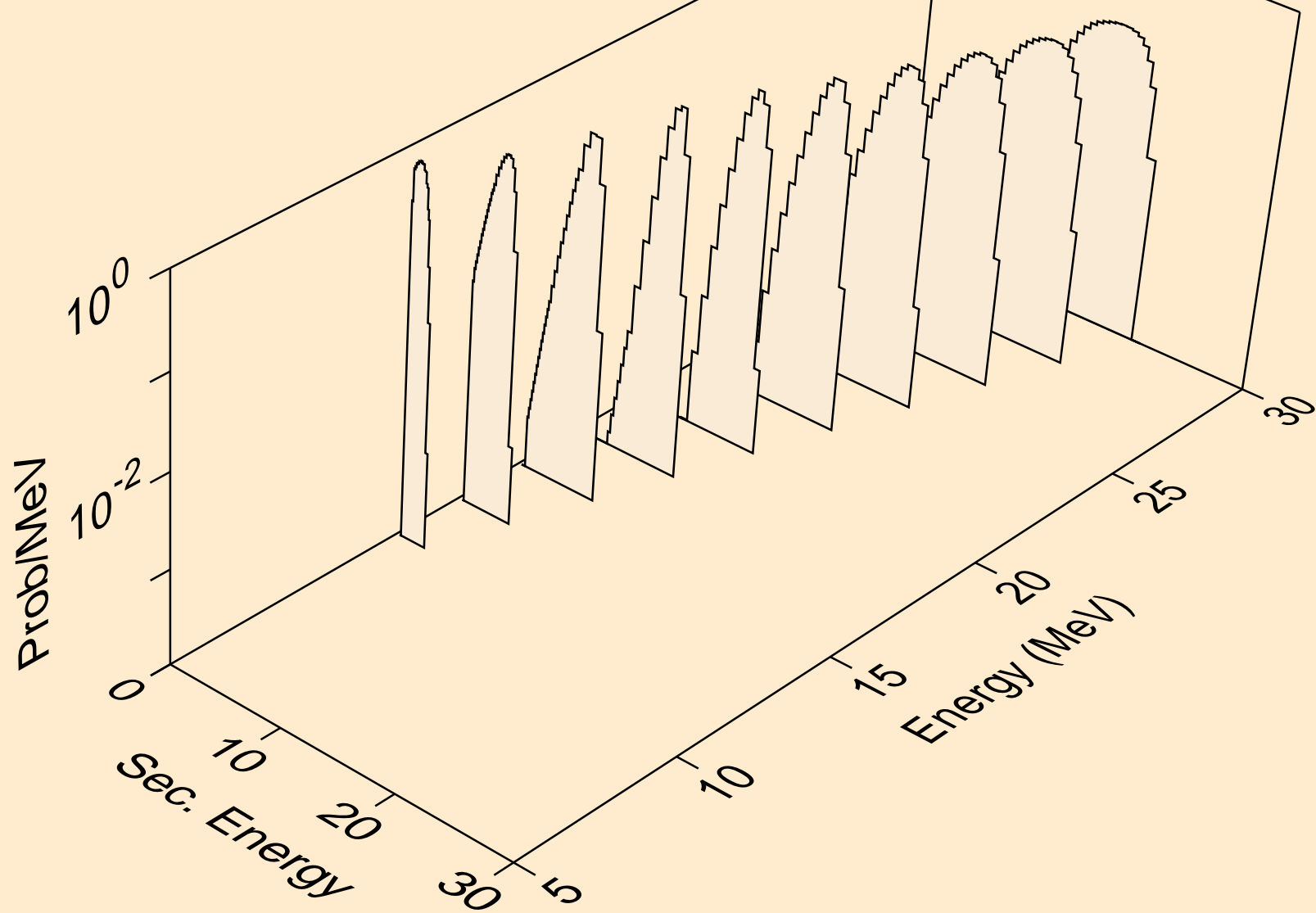

PA241 PROTON ACER TENDL-2021 LIBRARY; T=0.K  
Proton emission for (p,3np)

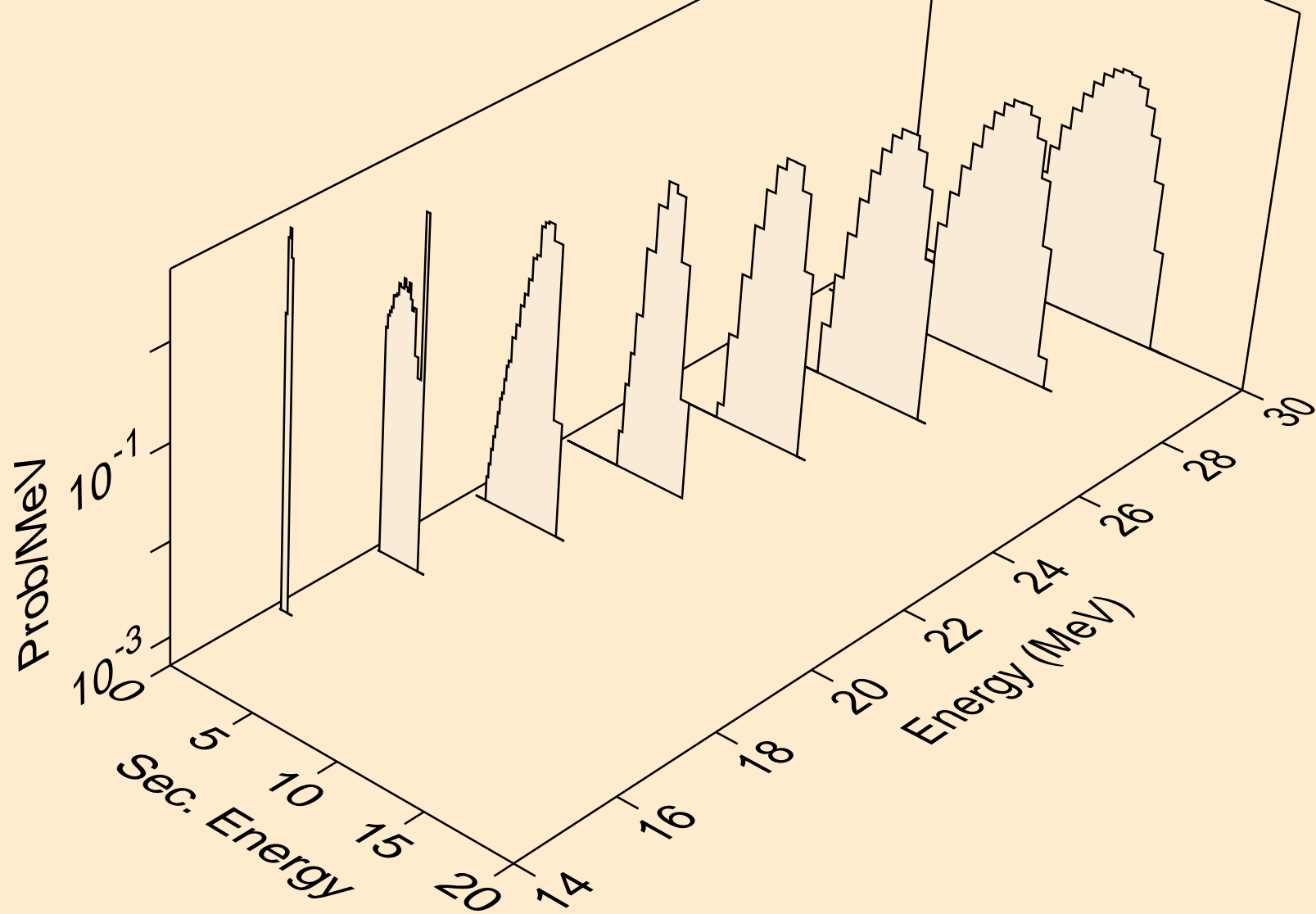

PA241 PROTON ACER TENDL-2021 LIBRARY; T=0.K  
Proton emission for (p,2np)

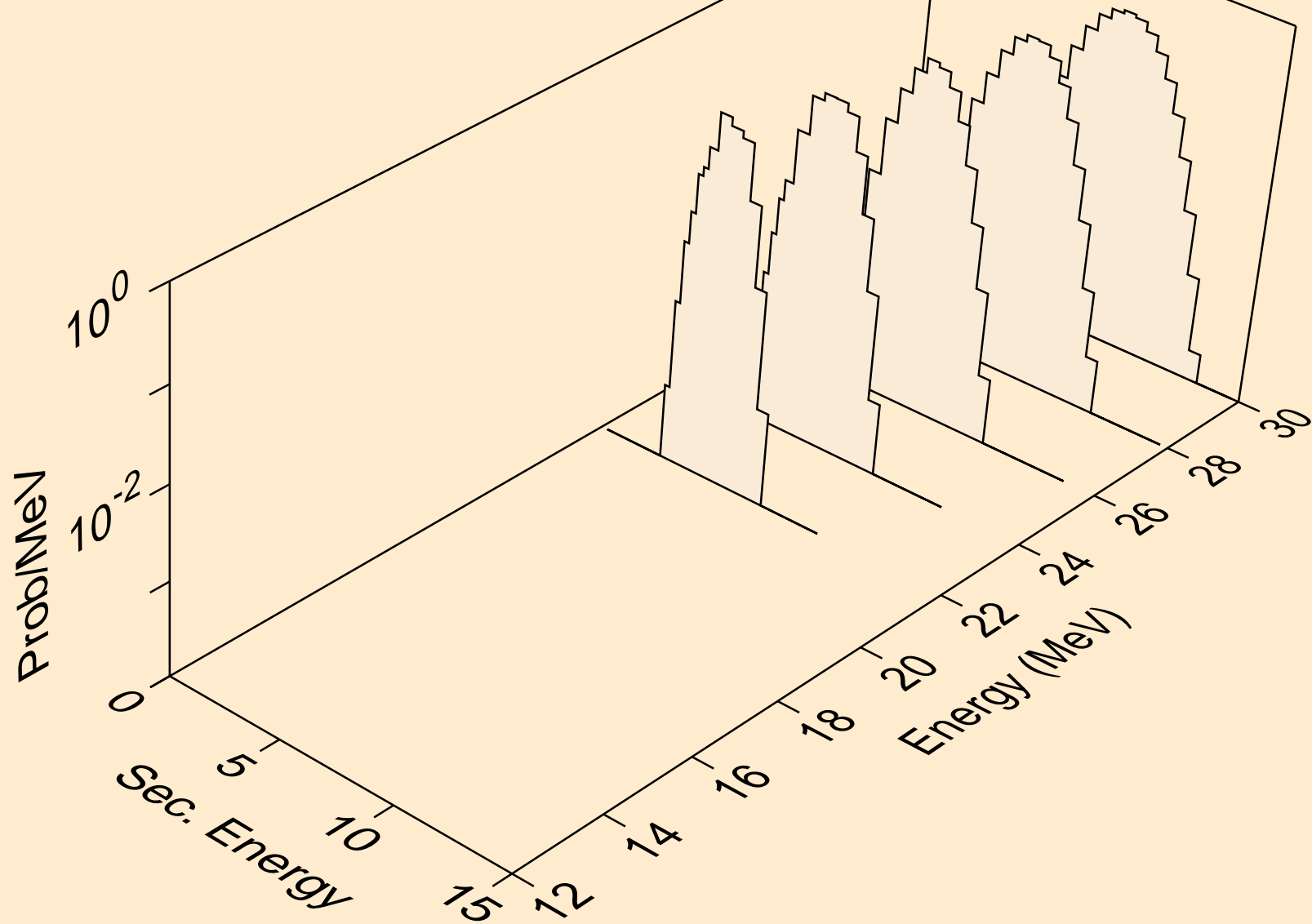

PA241 PROTON ACER TENDL-2021 LIBRARY; T=0.K  
Proton emission for inelastic

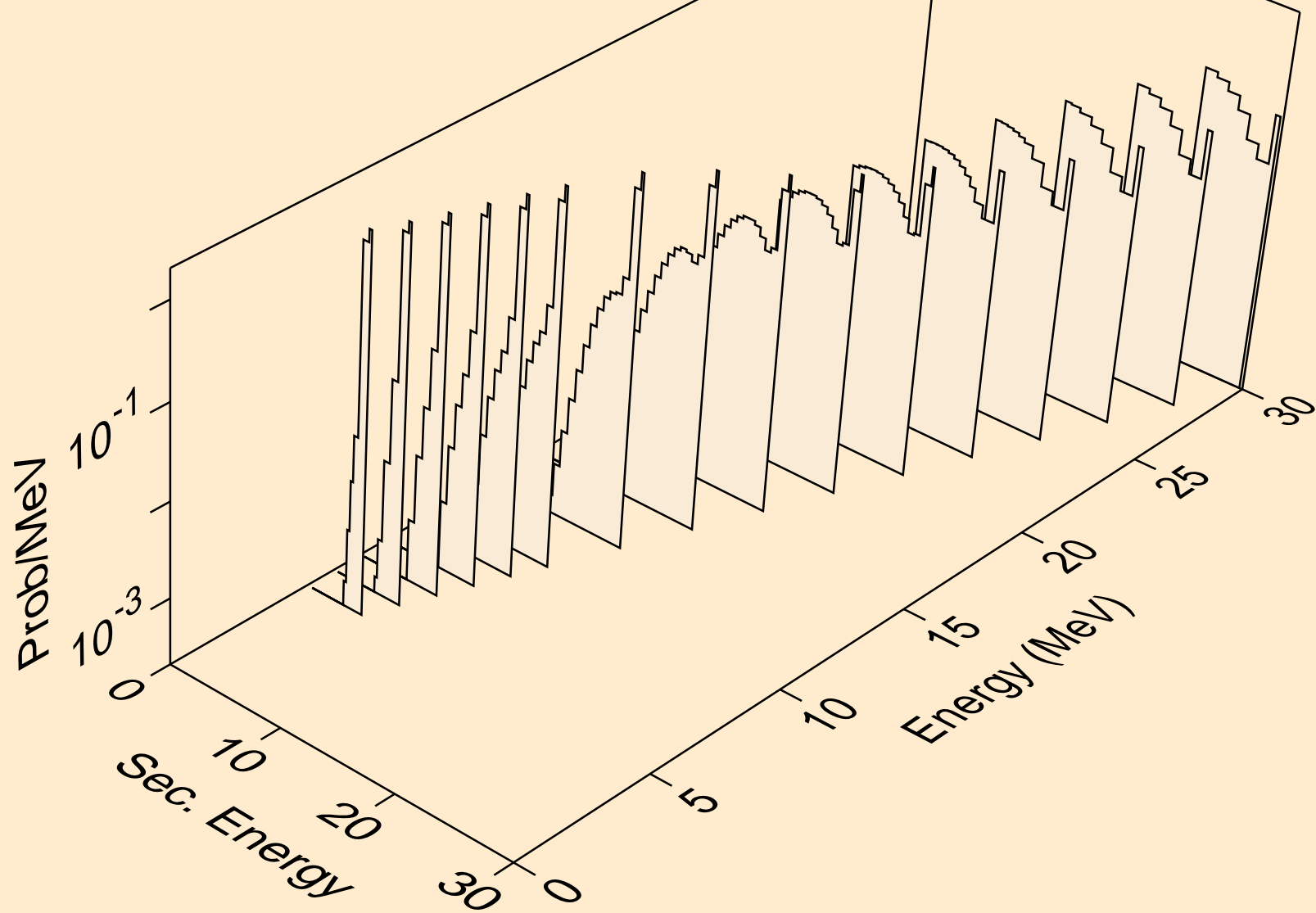



PA241 PROTON ACER TENDL-2021 LIBRARY; T=0.K  
Proton emission for (p,2p)

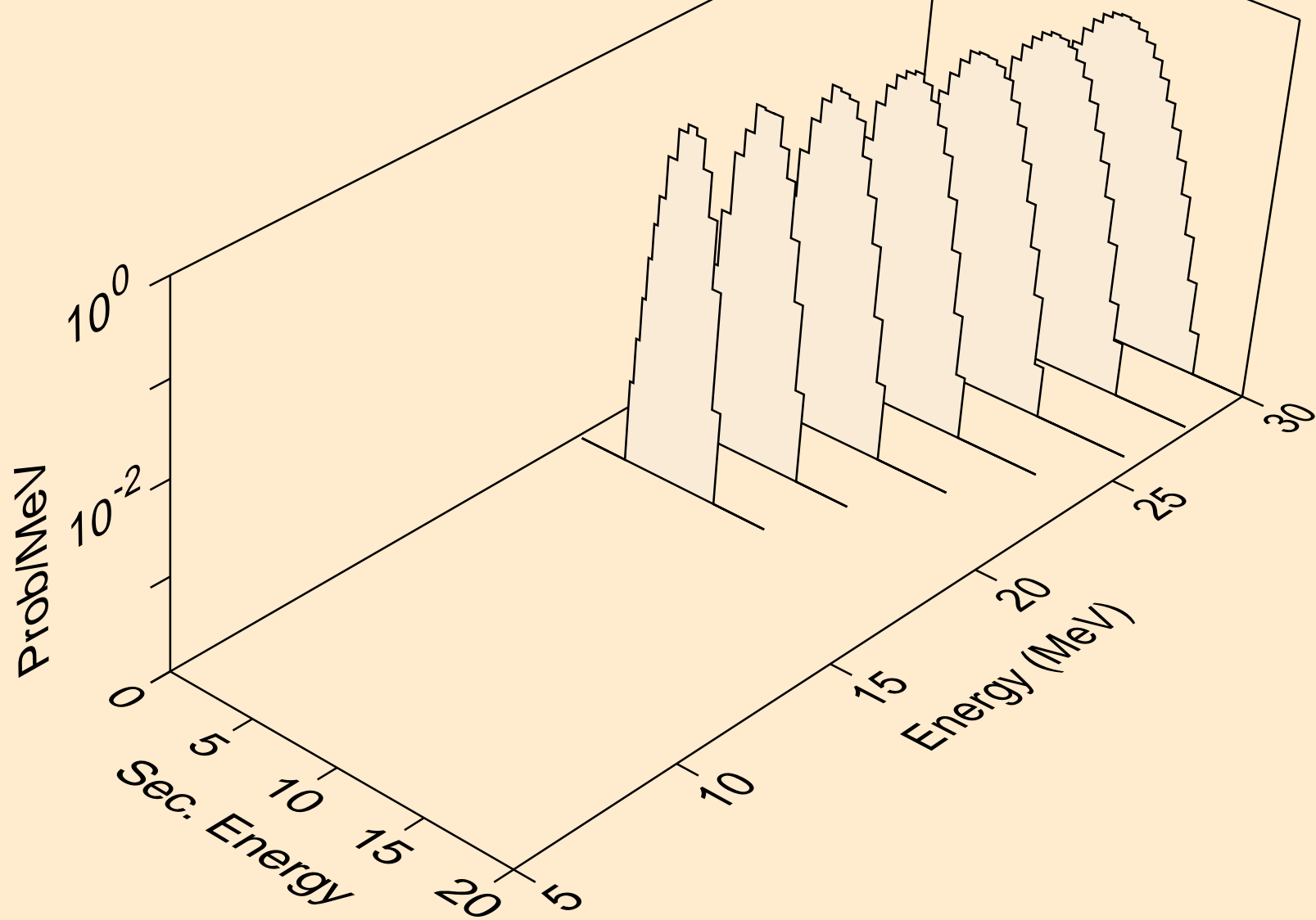

PA241 PROTON ACER TENDL-2021 LIBRARY; T=0.K  
Photon emission for (z,n)

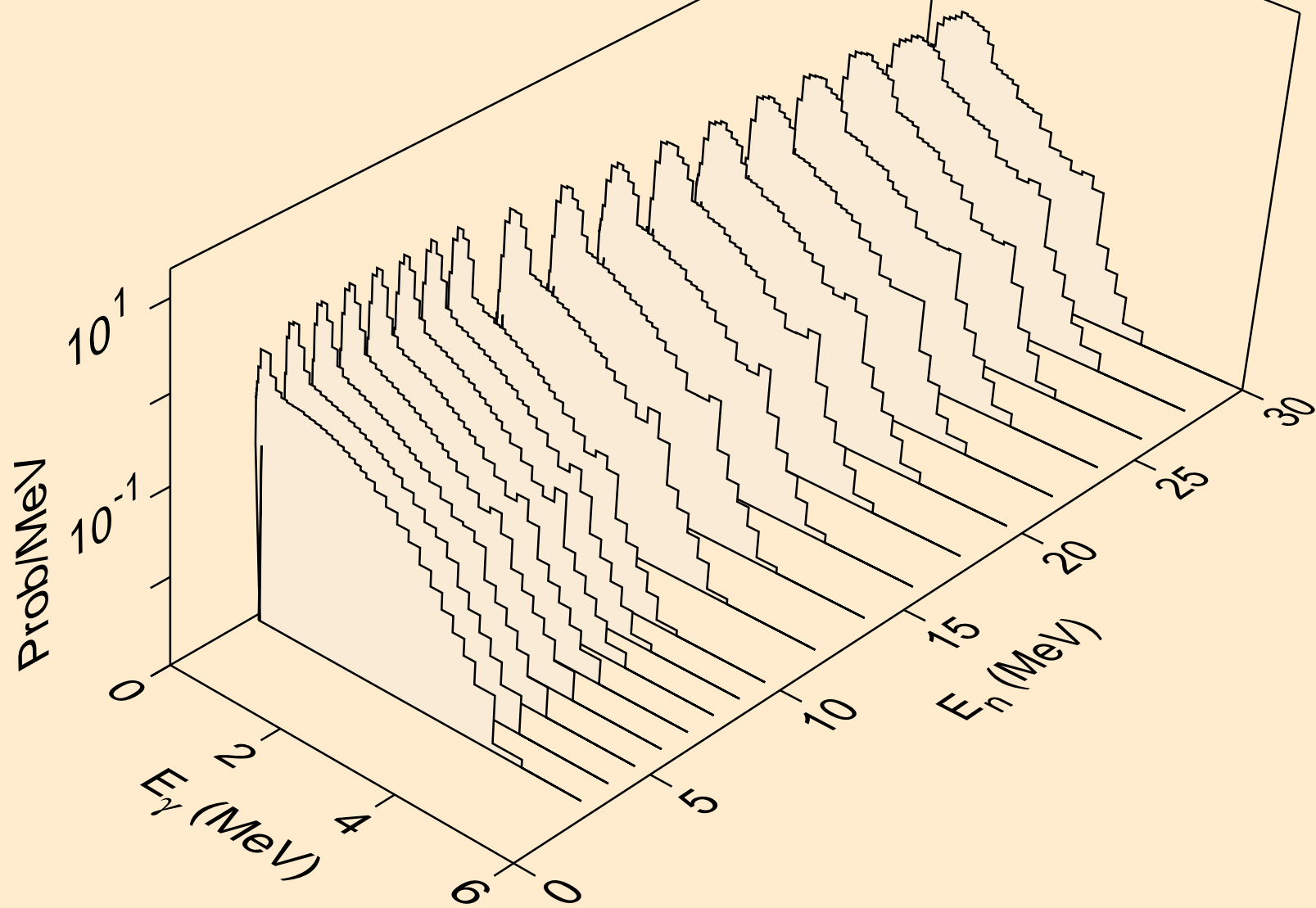

PA241 PROTON ACER TENDL-2021 LIBRARY; T=0.K  
Photon emission for (n,x)

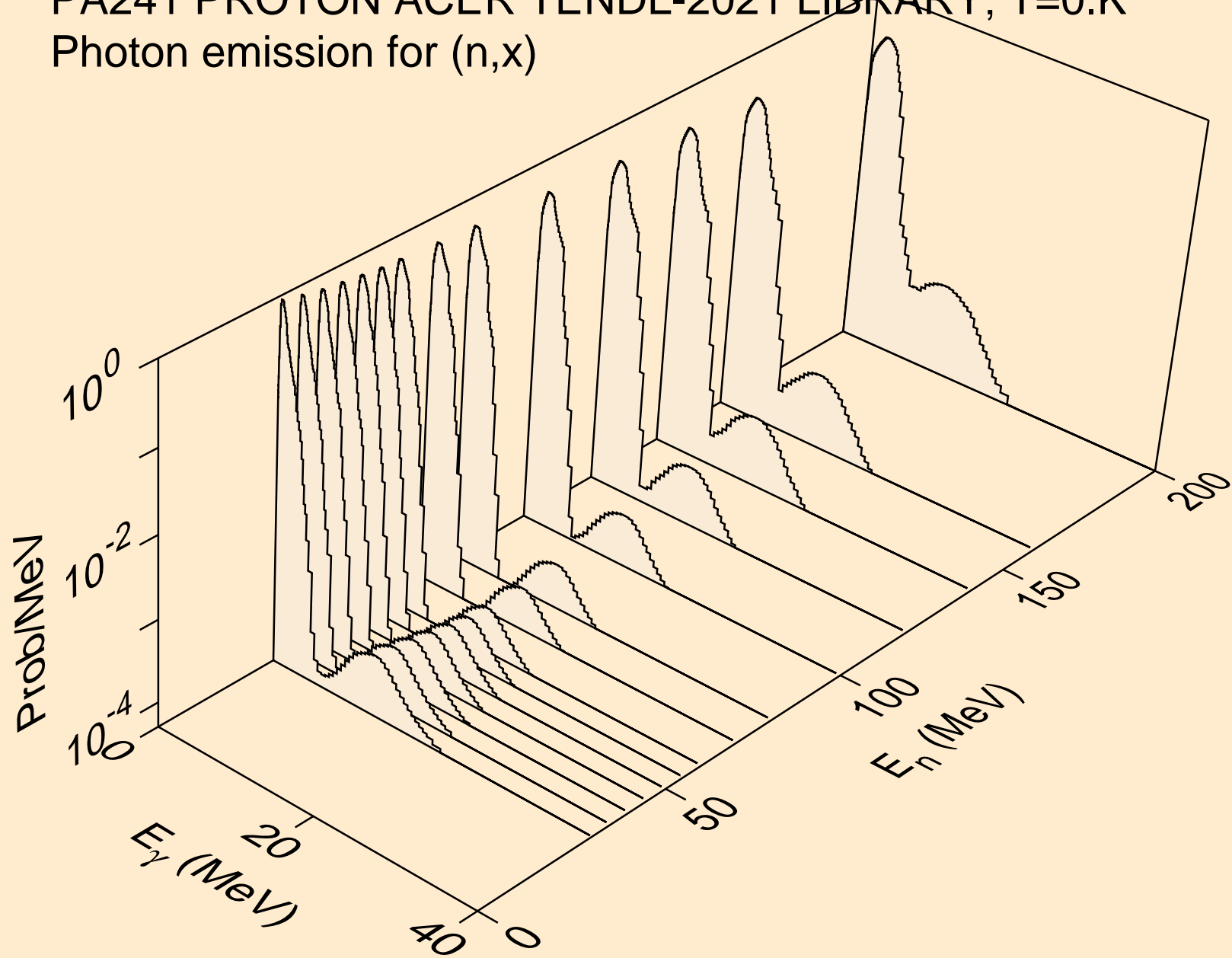

PA241 PROTON ACER TENDL-2021 LIBRARY; T=0.K  
Photon emission for (n,2nd)

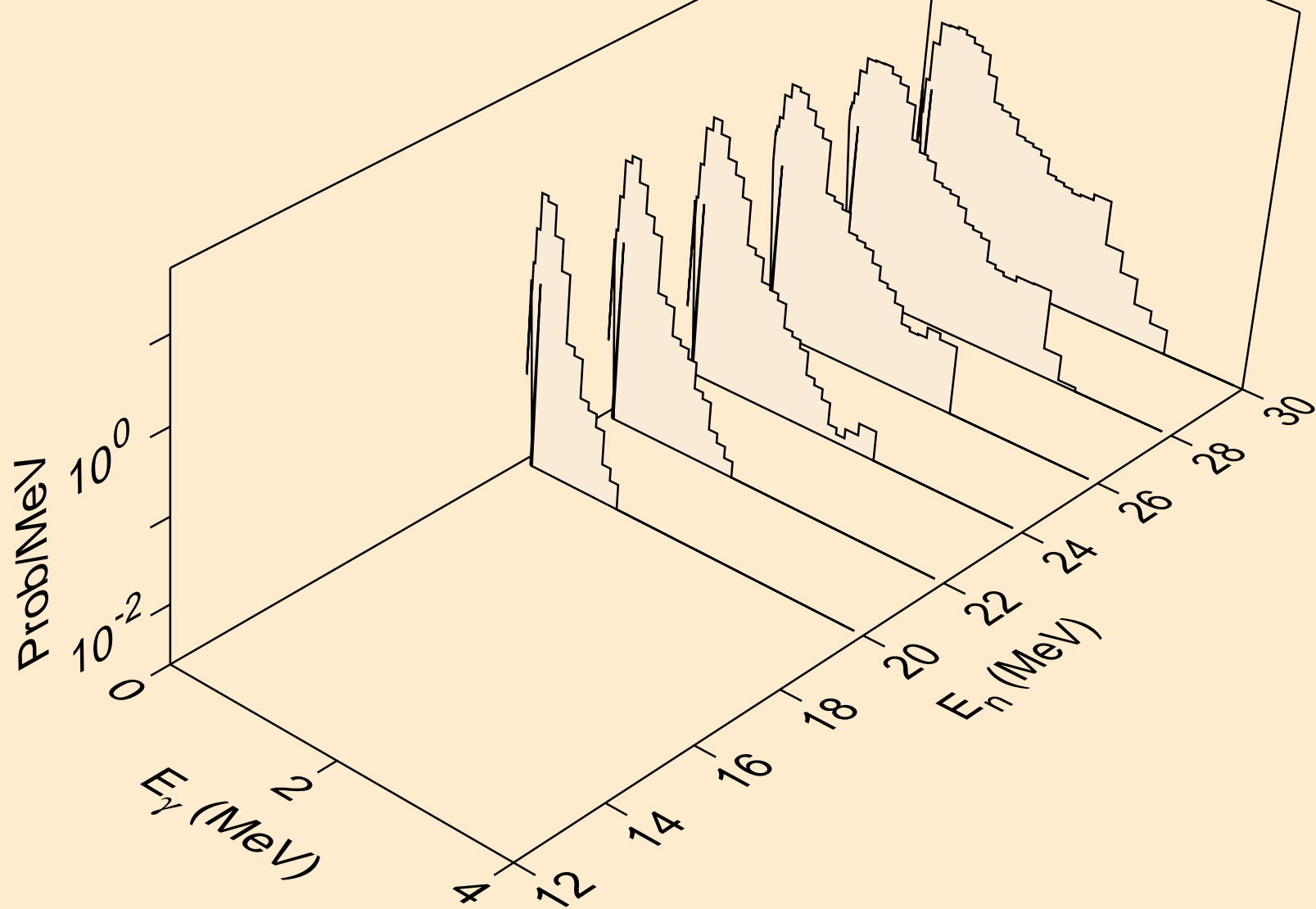

PA241 PROTON ACER TENDL-2021 LIBRARY; T=0.K  
Photon emission for (n,2n)

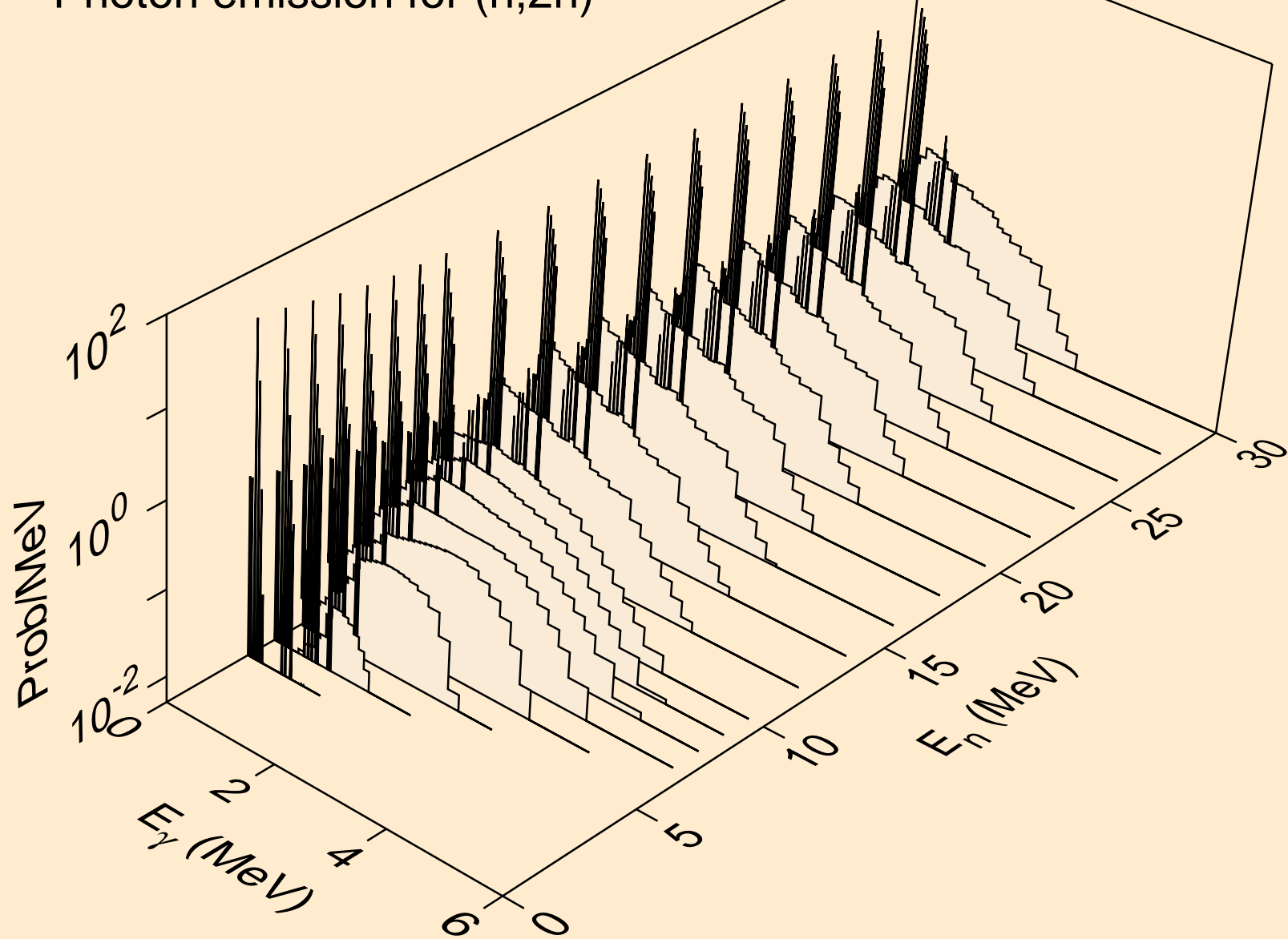

PA241 PROTON ACER TENDL-2021 LIBRARY; T=0.K  
Photon emission for (n,3n)

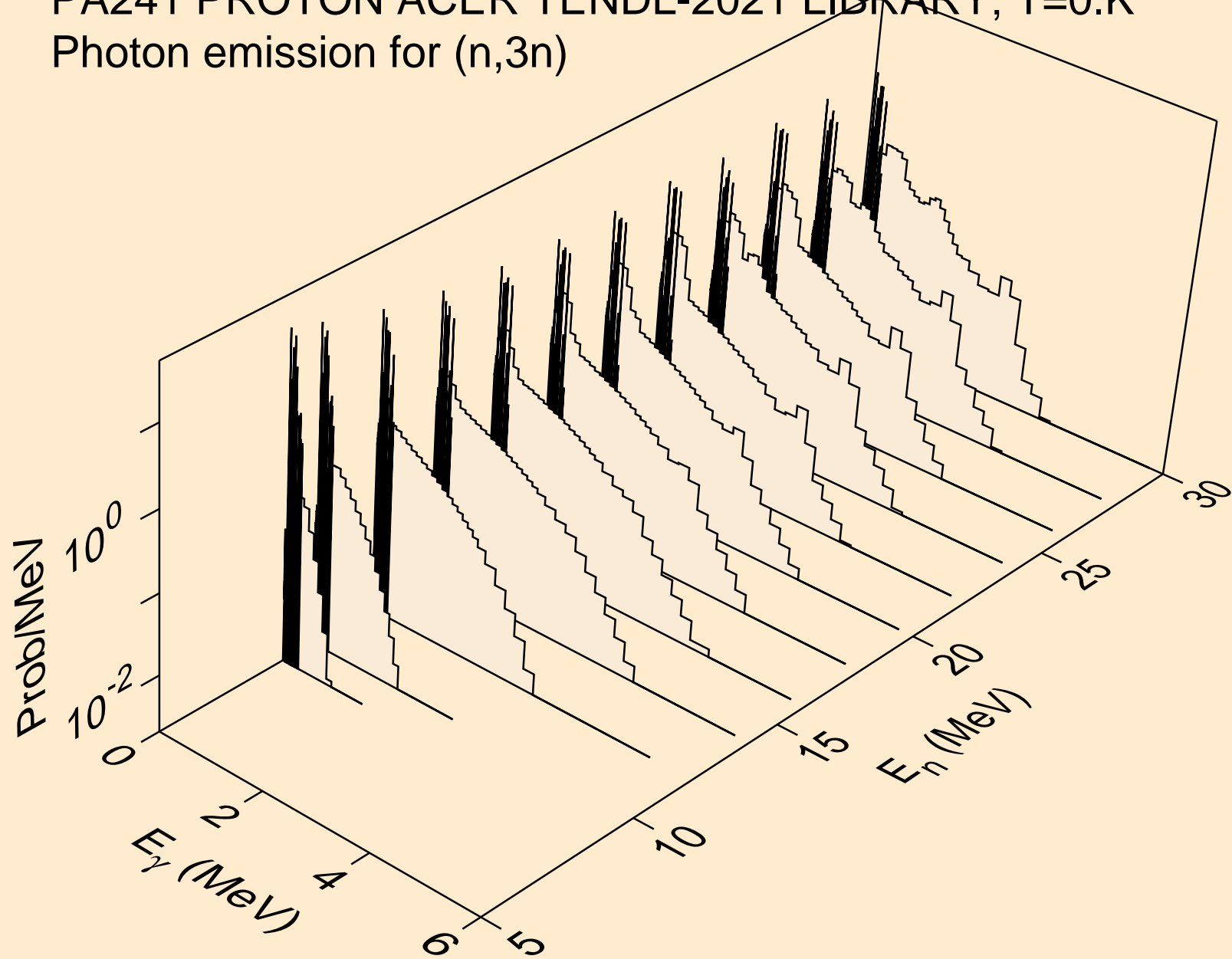

PA241 PROTON ACER TENDL-2021 LIBRARY; T=0.K  
Photon emission for (n,n\*)a

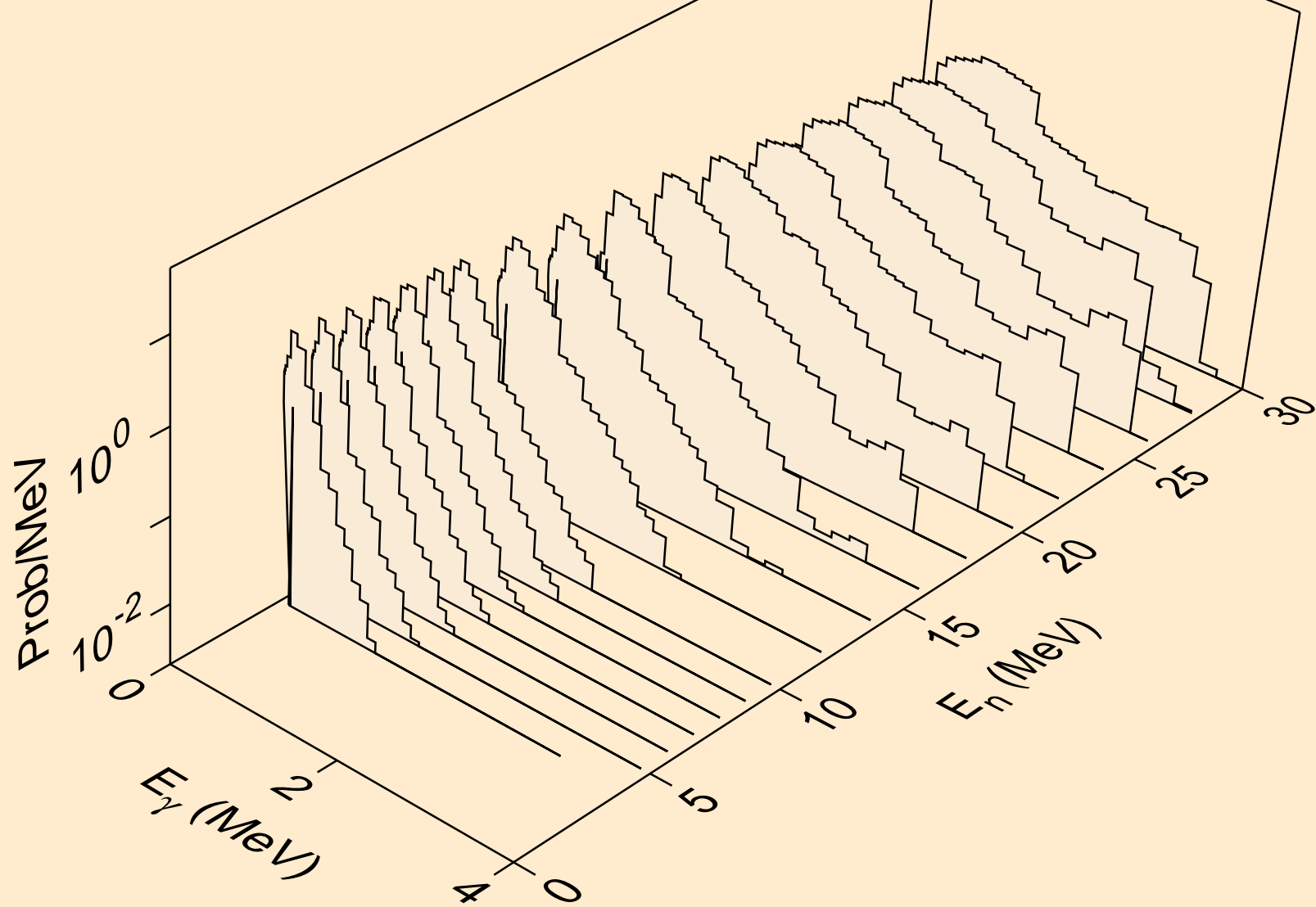

PA241 PROTON ACER TENDL-2021 LIBRARY; T=0.K  
Photon emission for (n,2n)a

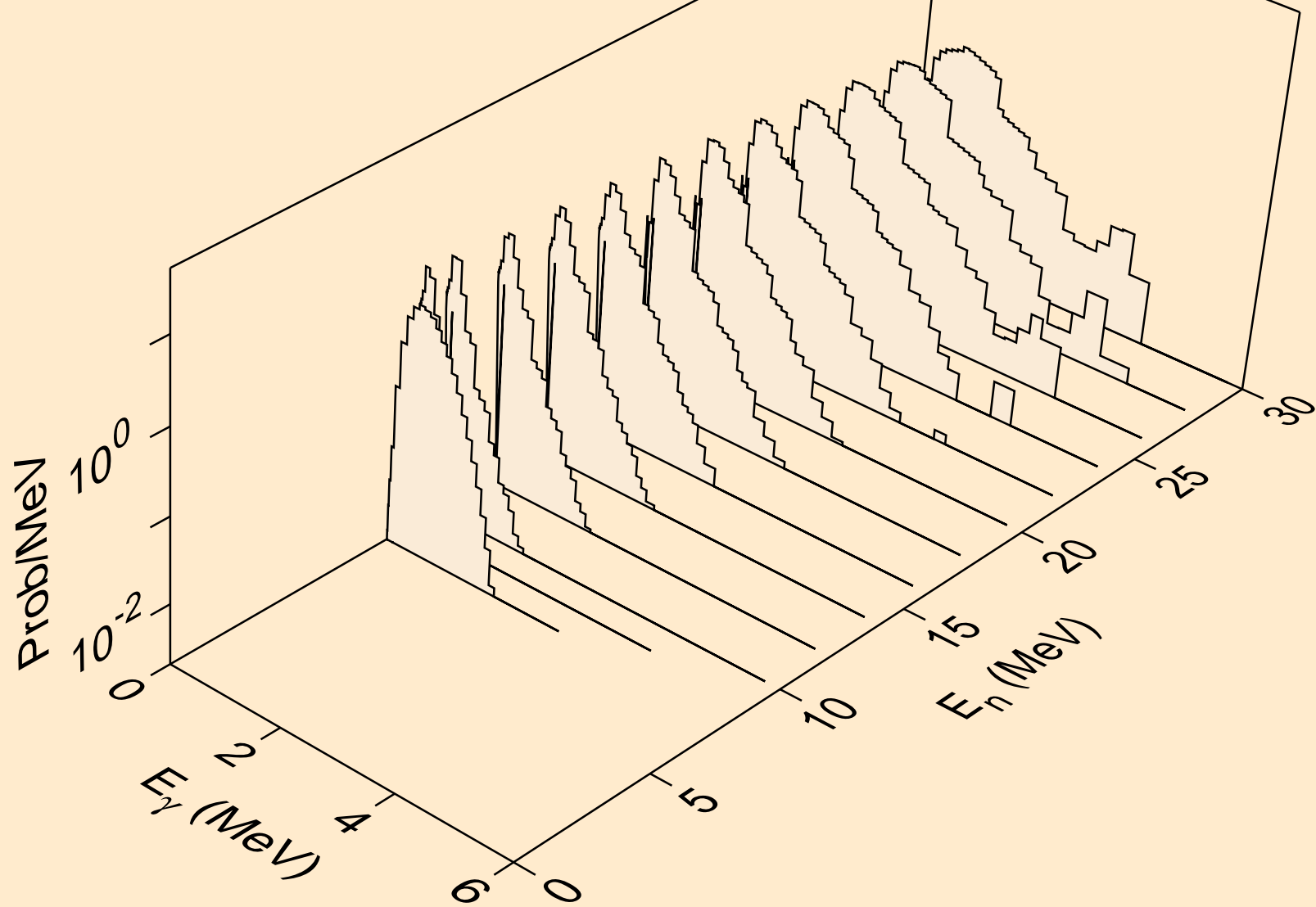



PA241 PROTON ACER TENDL-2021 LIBRARY; T=0.K  
Photon emission for (n,3n)a

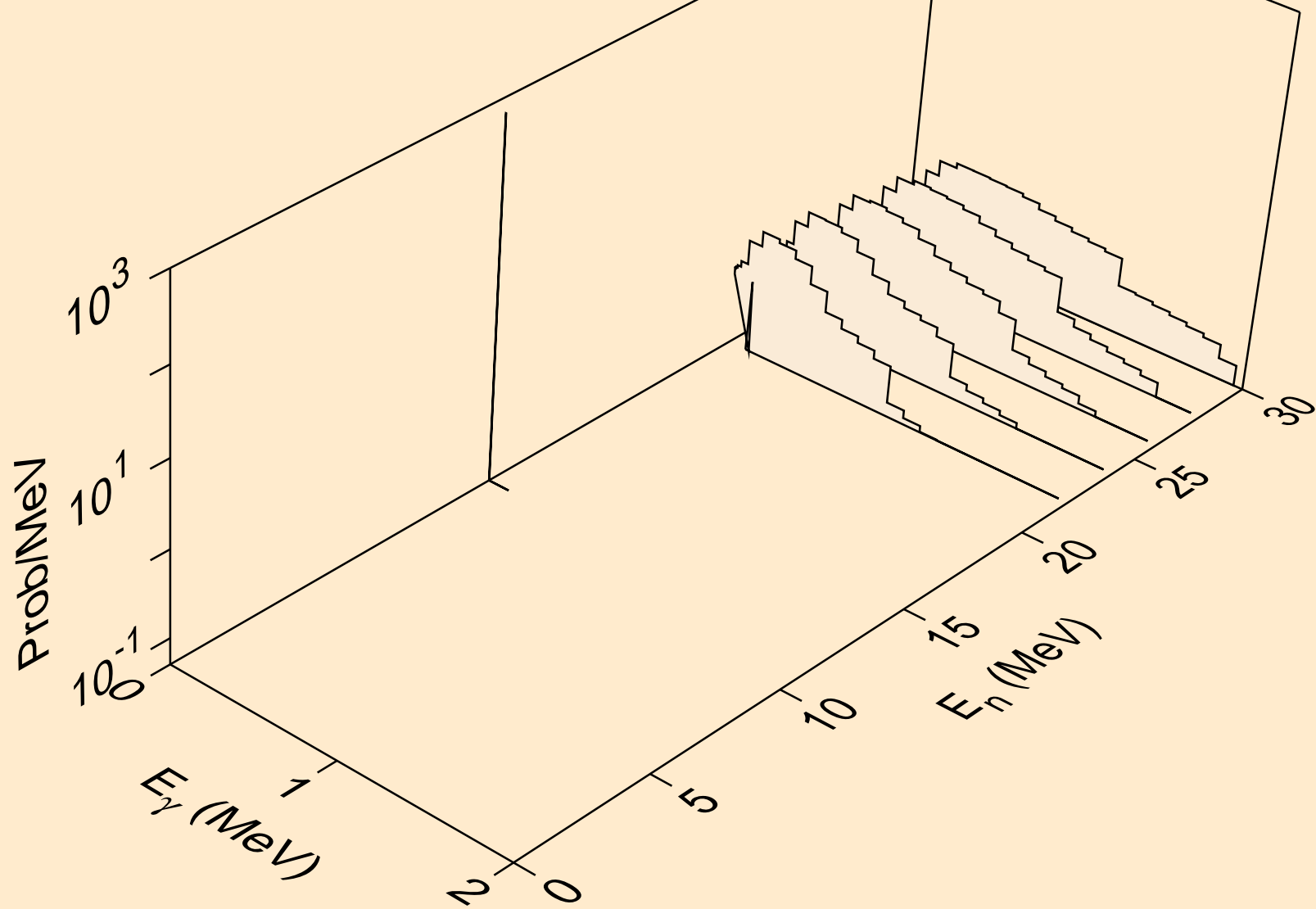

PA241 PROTON ACER TENDL-2021 LIBRARY; T=0.K  
Photon emission for (n,n\*)p

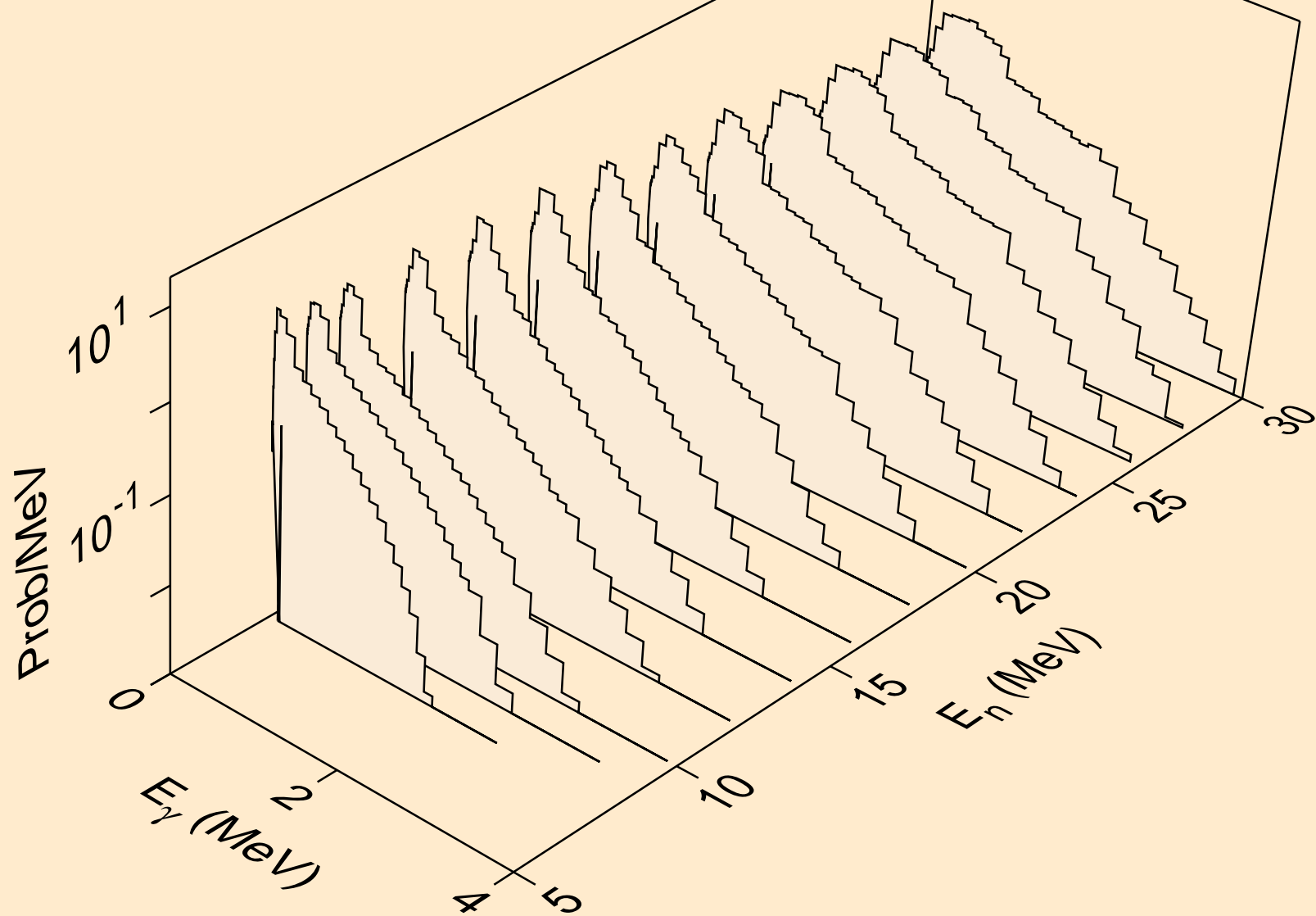

PA241 PROTON ACER TENDL-2021 LIBRARY; T=0.K  
Photon emission for (n,n\*)d

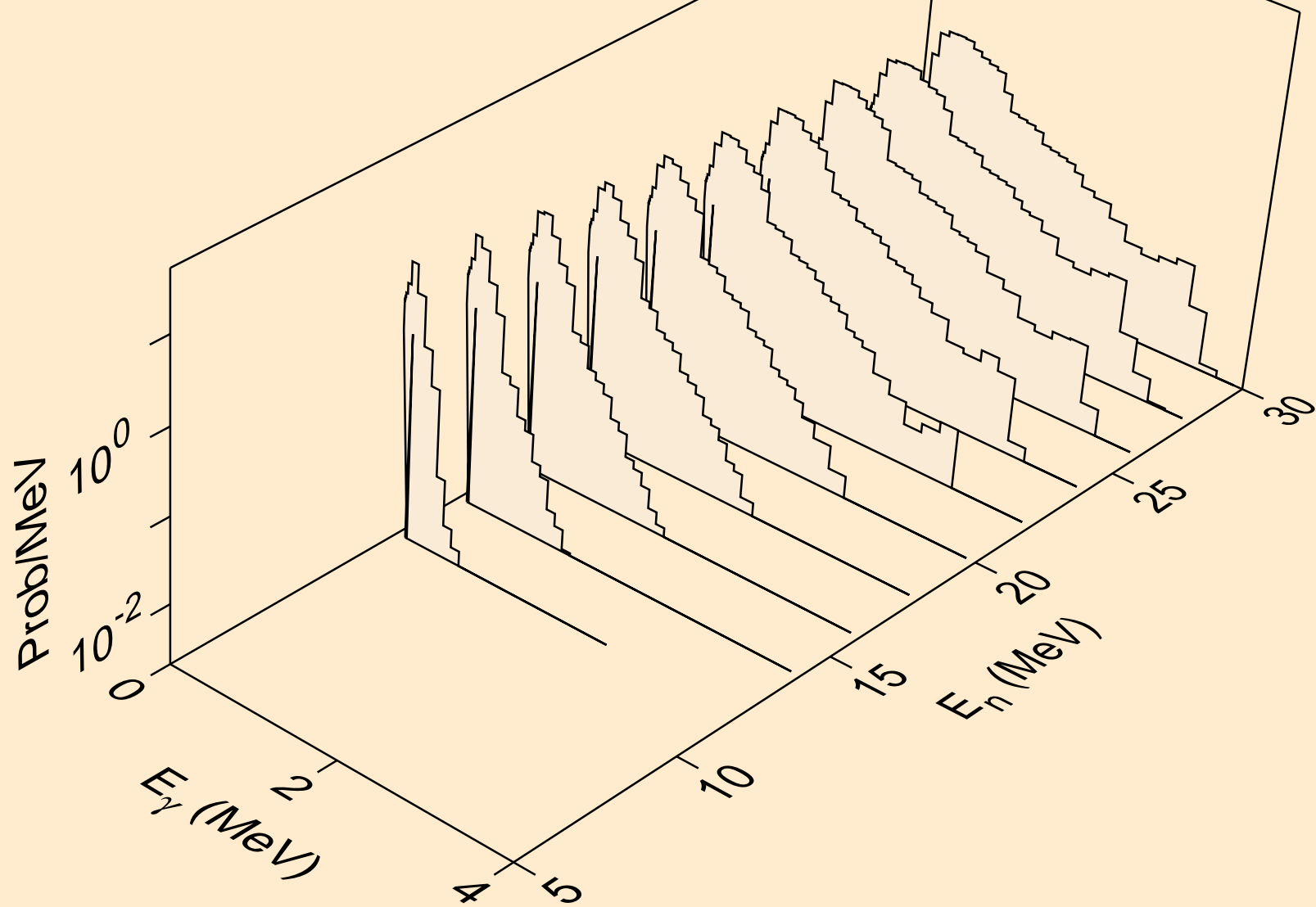

PA241 PROTON ACER TENDL-2021 LIBRARY; T=0.K  
Photon emission for (n,n\*)t

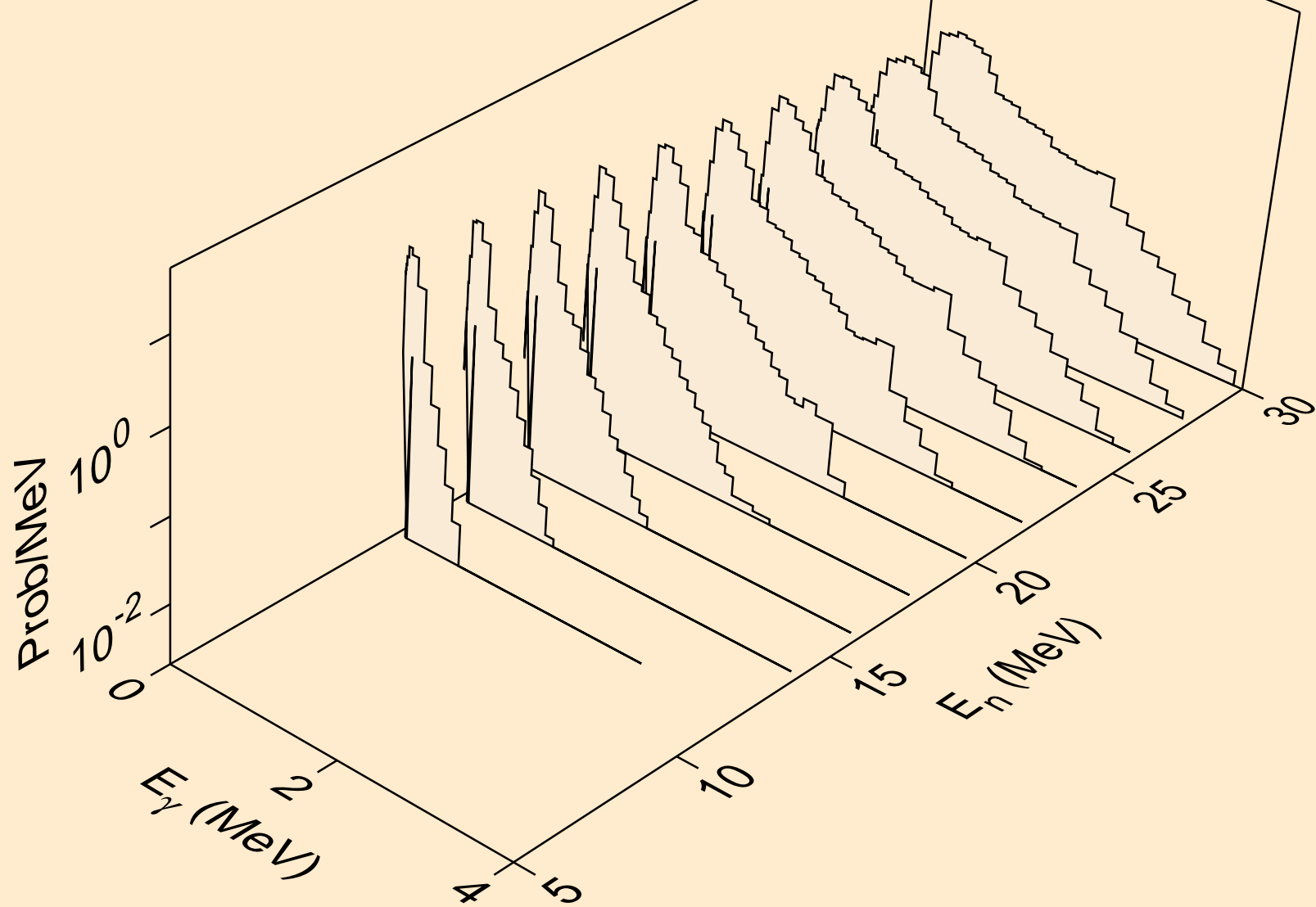

PA241 PROTON ACER TENDL-2021 LIBRARY; T=0.K  
Photon emission for (n,n\*)he3

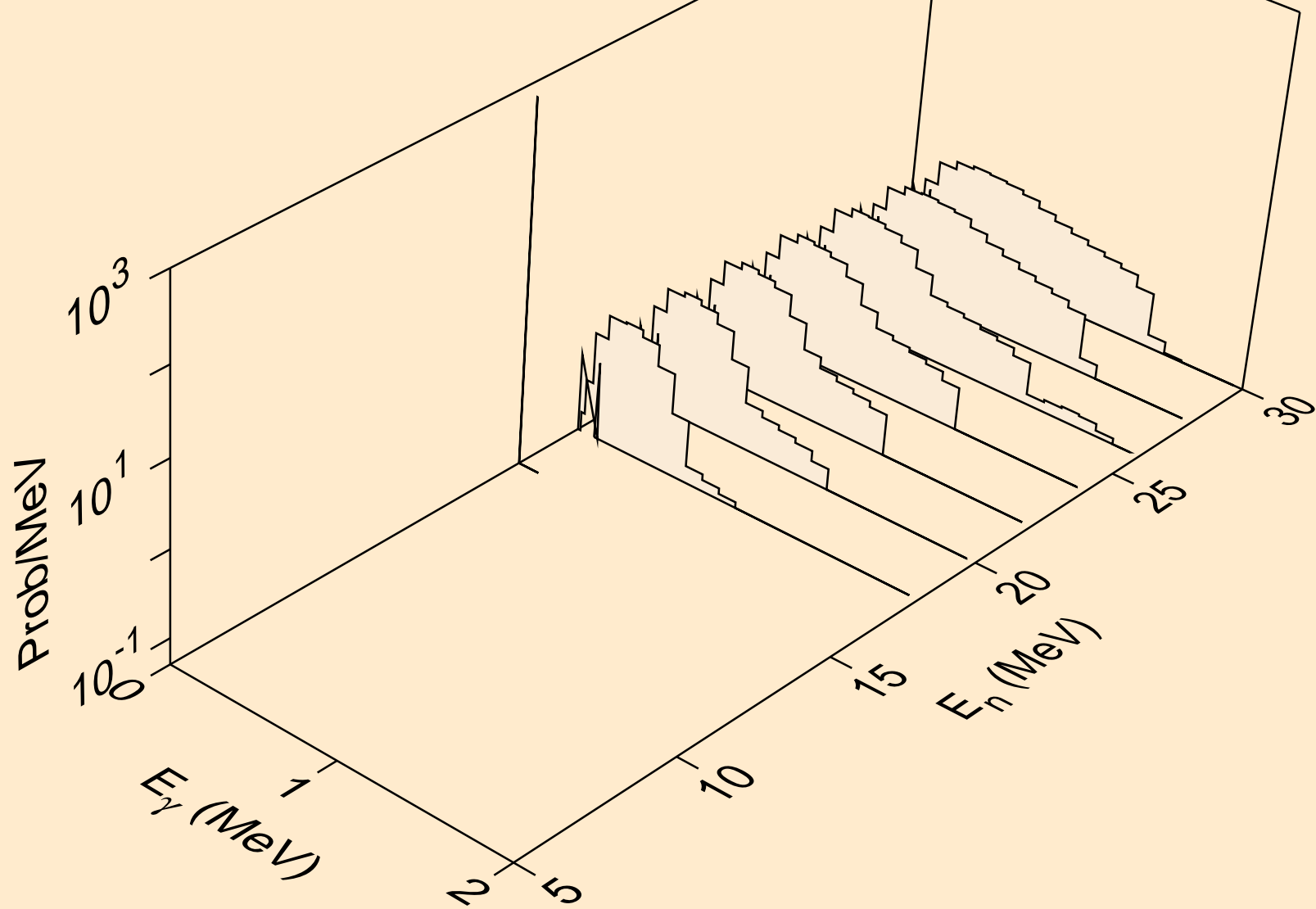

PA241 PROTON ACER TENDL-2021 LIBRARY; T=0.K  
Photon emission for (n,4n)

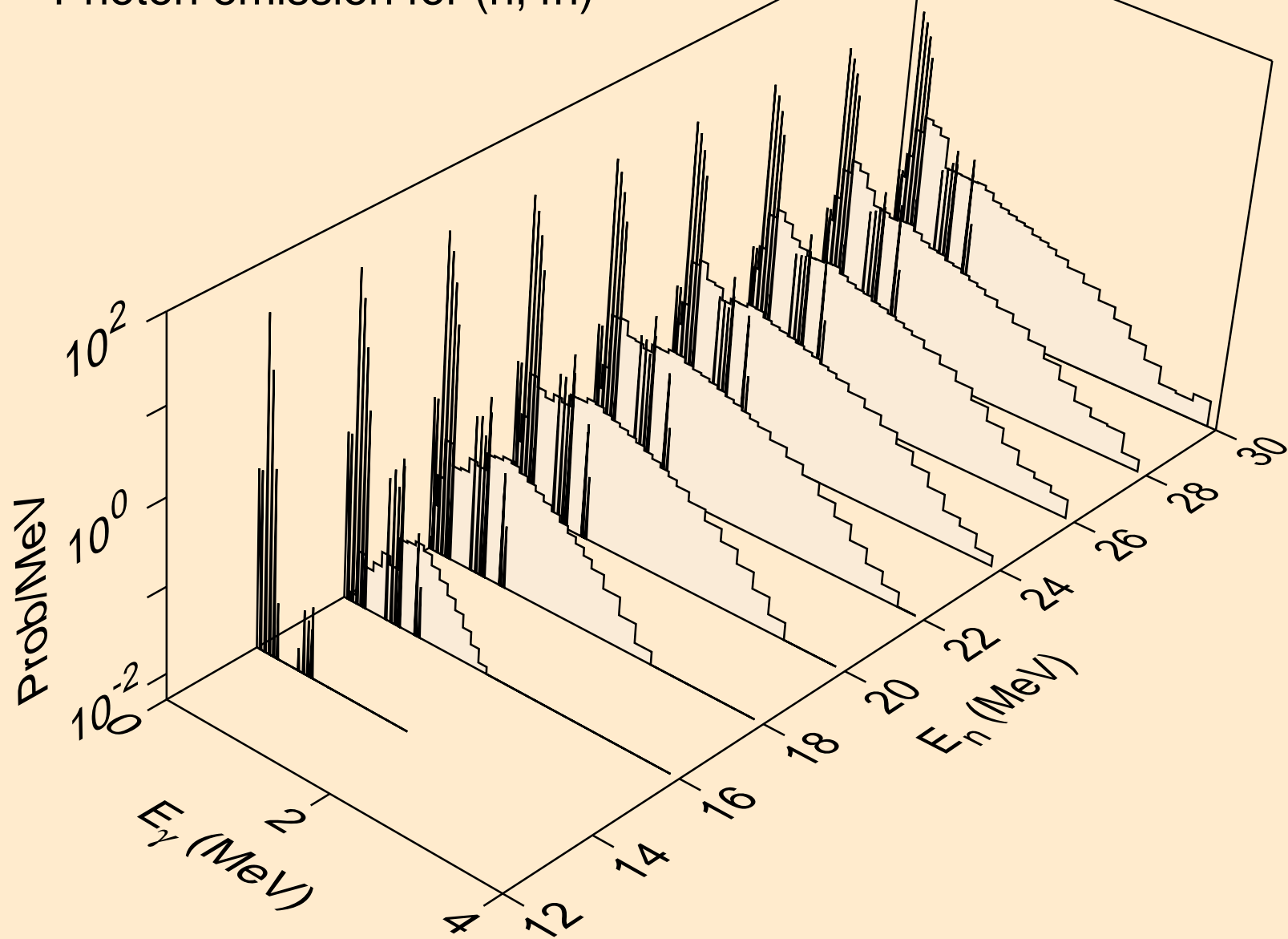

PA241 PROTON ACER TENDL-2021 LIBRARY; T=0.K  
Photon emission for (n,2np)

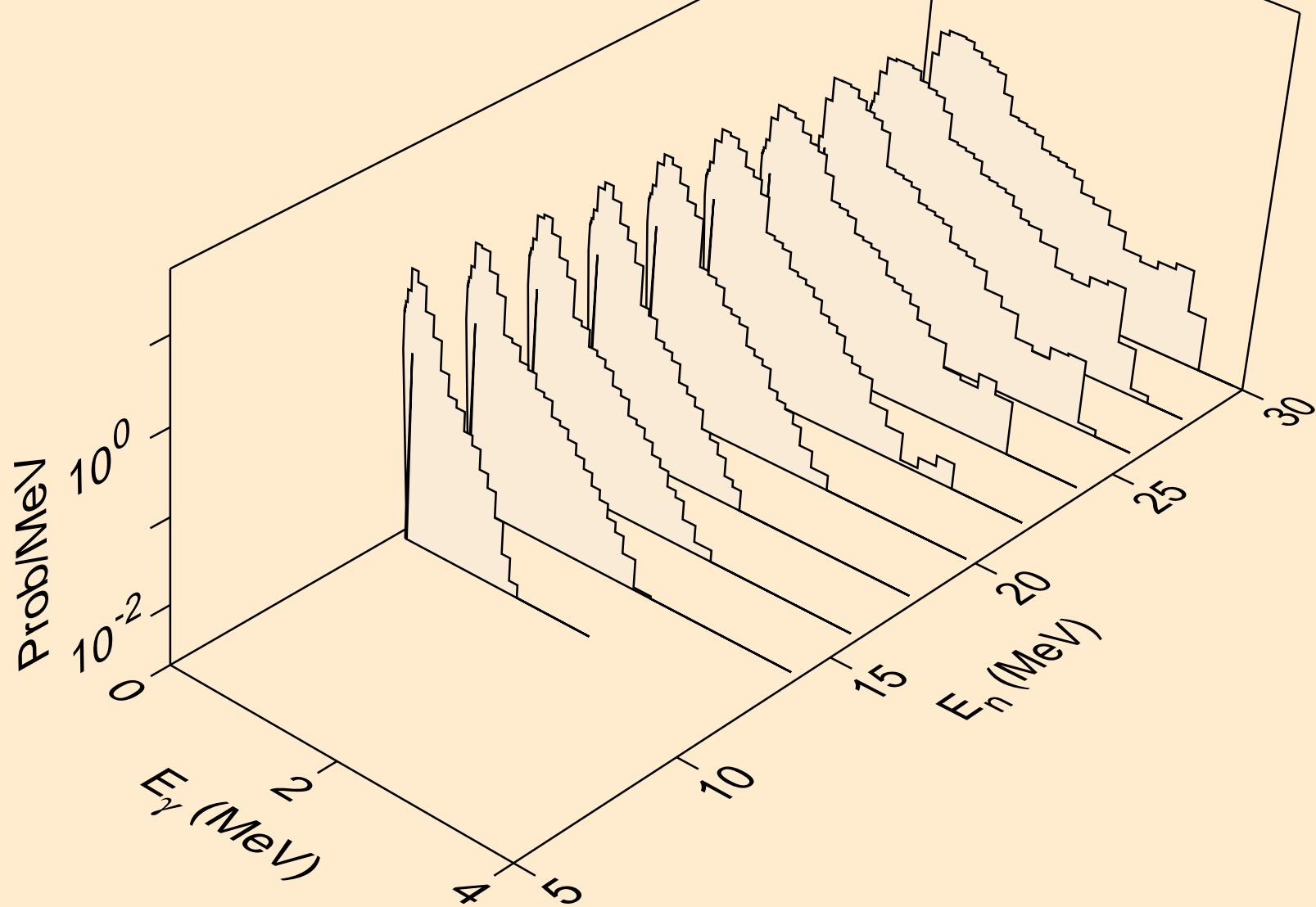

PA241 PROTON ACER TENDL-2021 LIBRARY; T=0.K  
Photon emission for (n,3np)

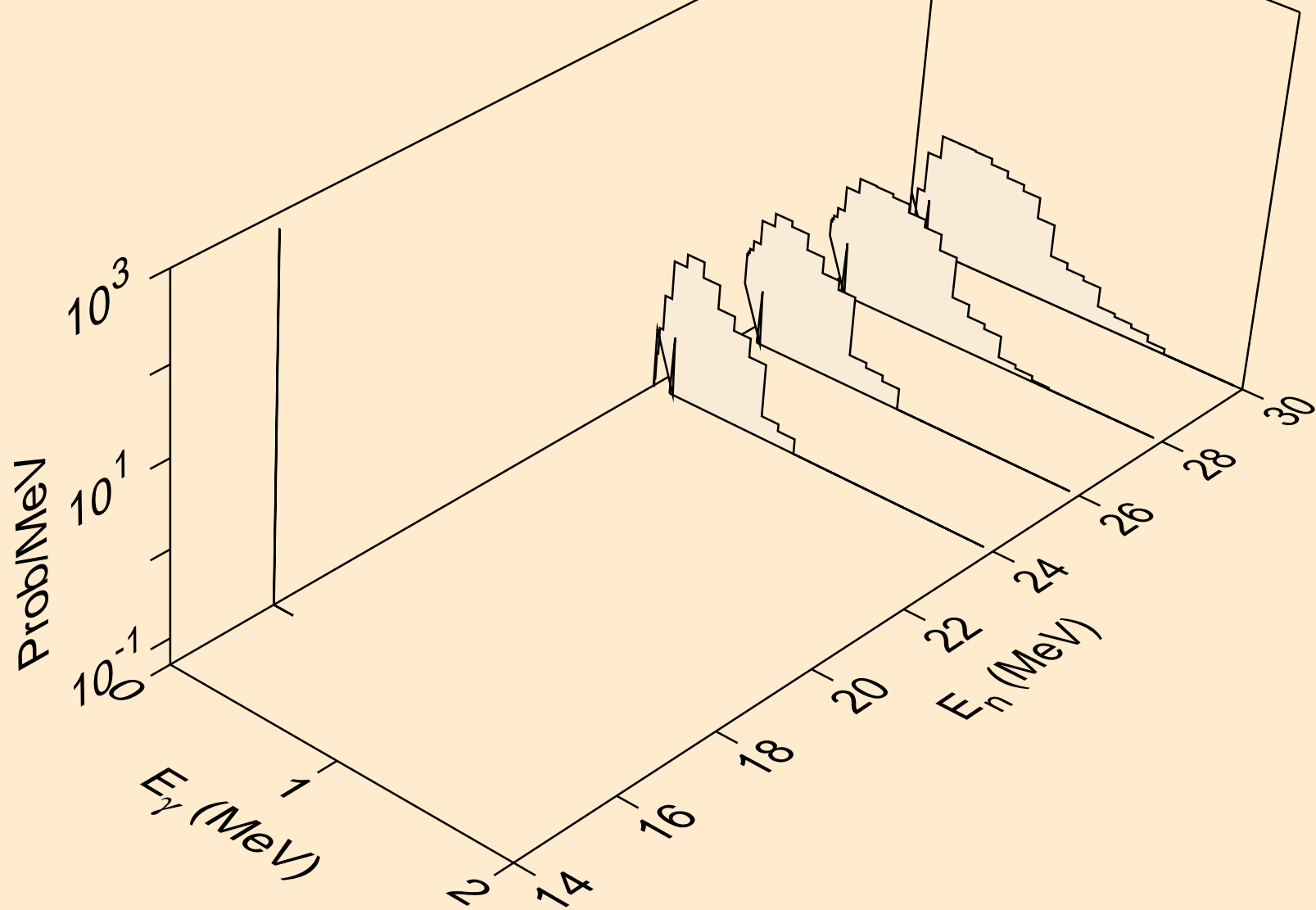



PA241 PROTON ACER TENDL-2021 LIBRARY; T=0.K  
Photon emission for (n,2np)

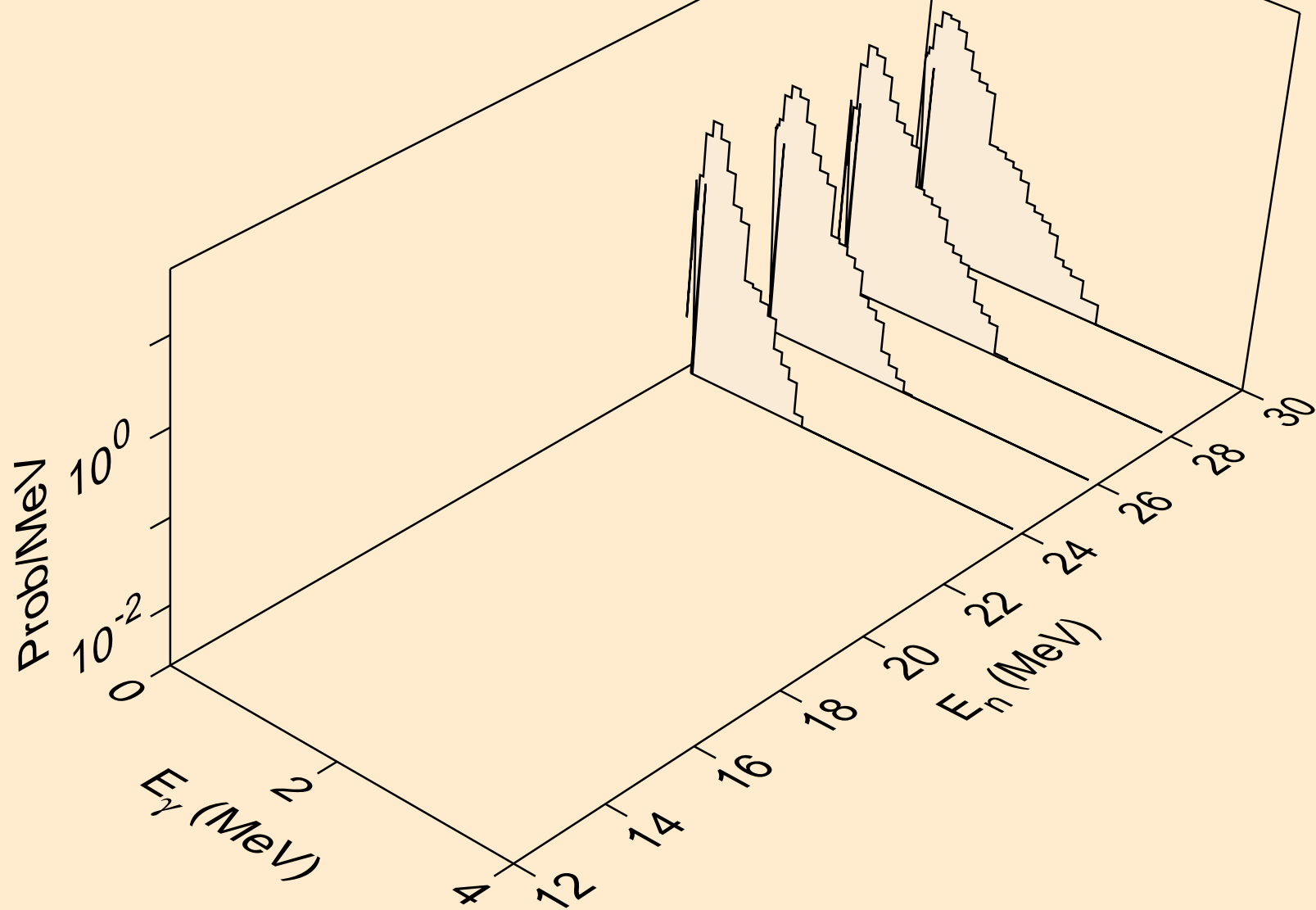

PA241 PROTON ACER TENDL-2021 LIBRARY; T=0.K  
Photon emission for (n,gma)

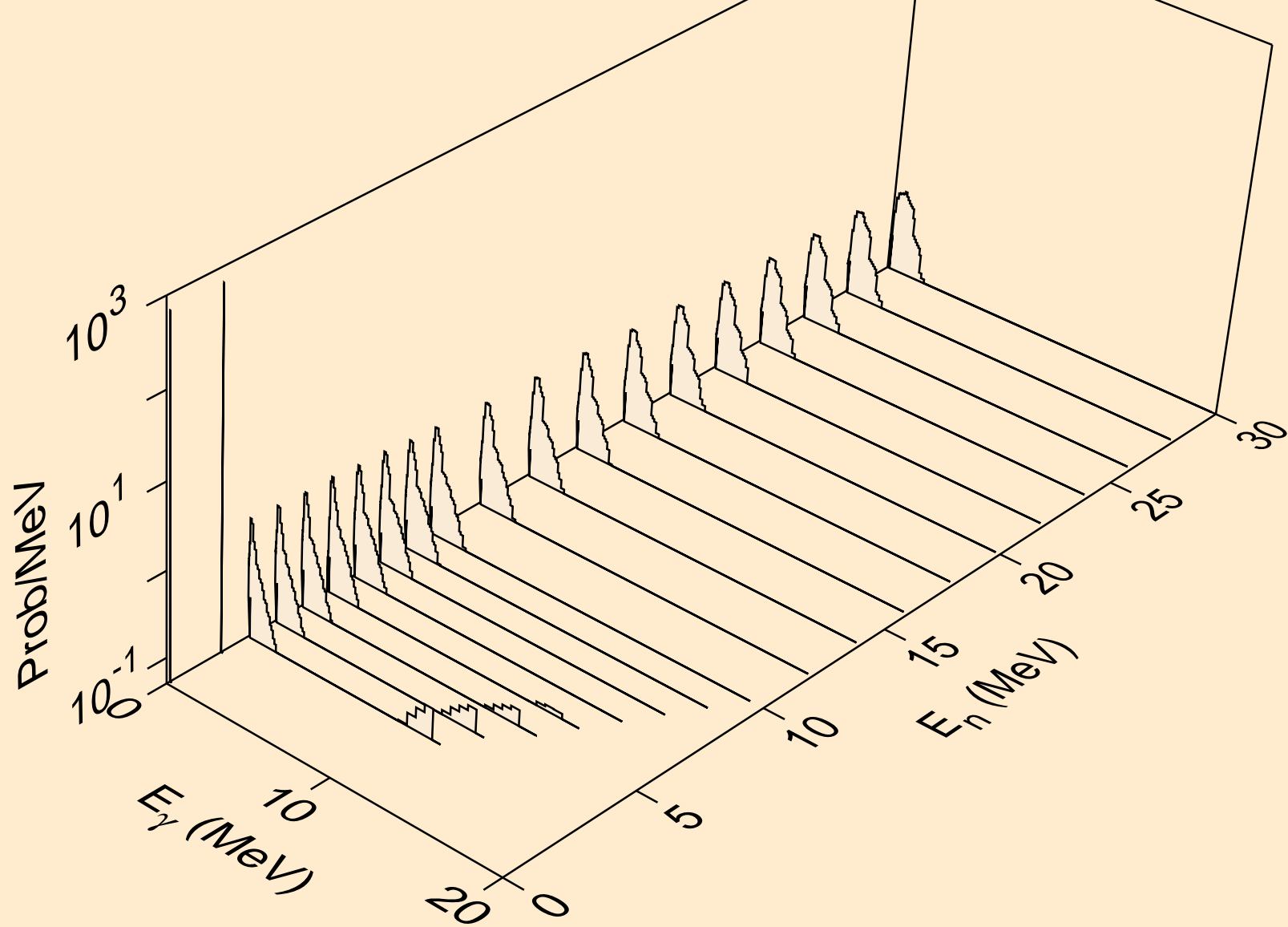

PA241 PROTON ACER TENDL-2021 LIBRARY; T=0.K  
Photon emission for inelastic

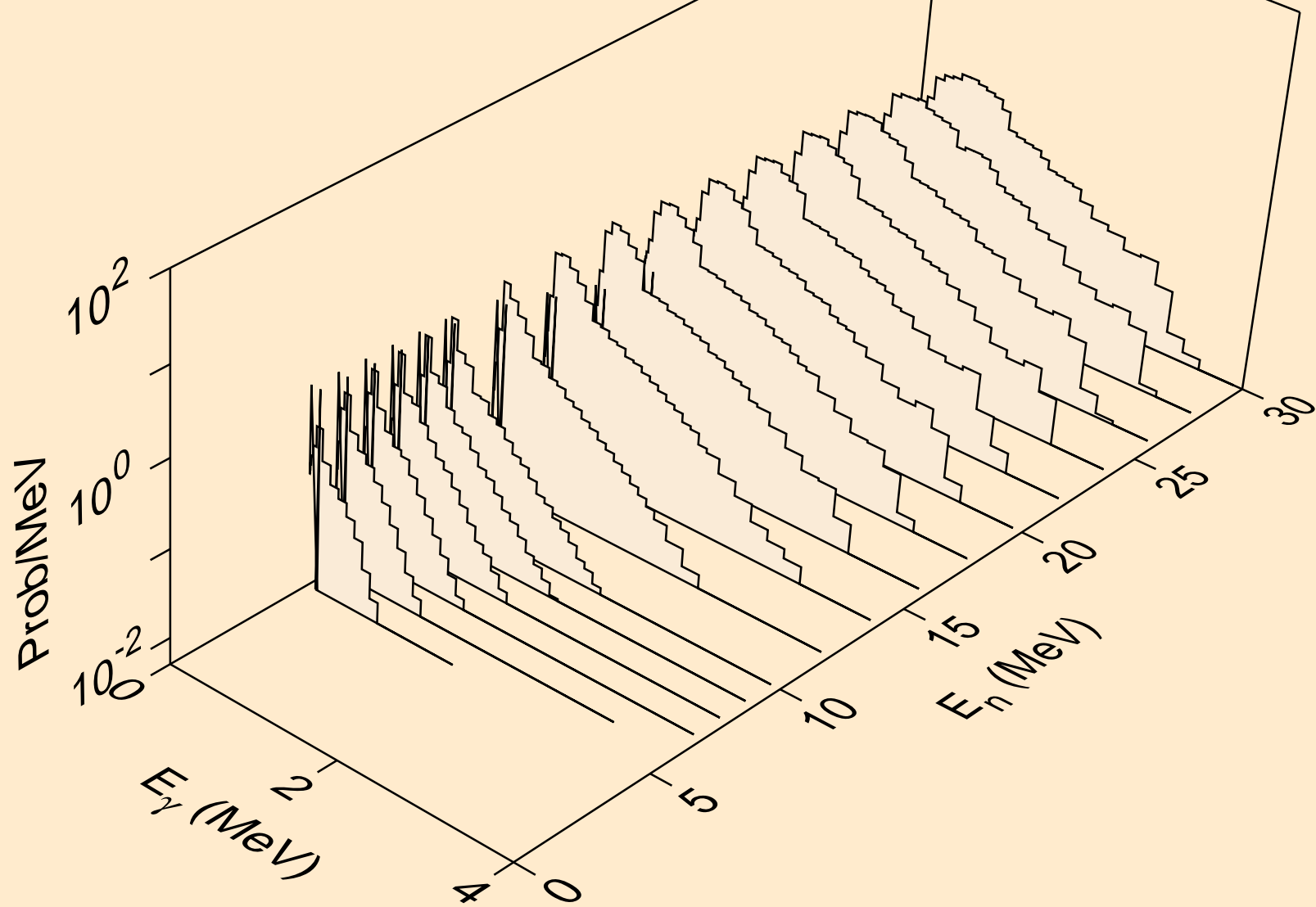

PA241 PROTON ACER TENDL-2021 LIBRARY; T=0.K  
Photon emission for (n,d)

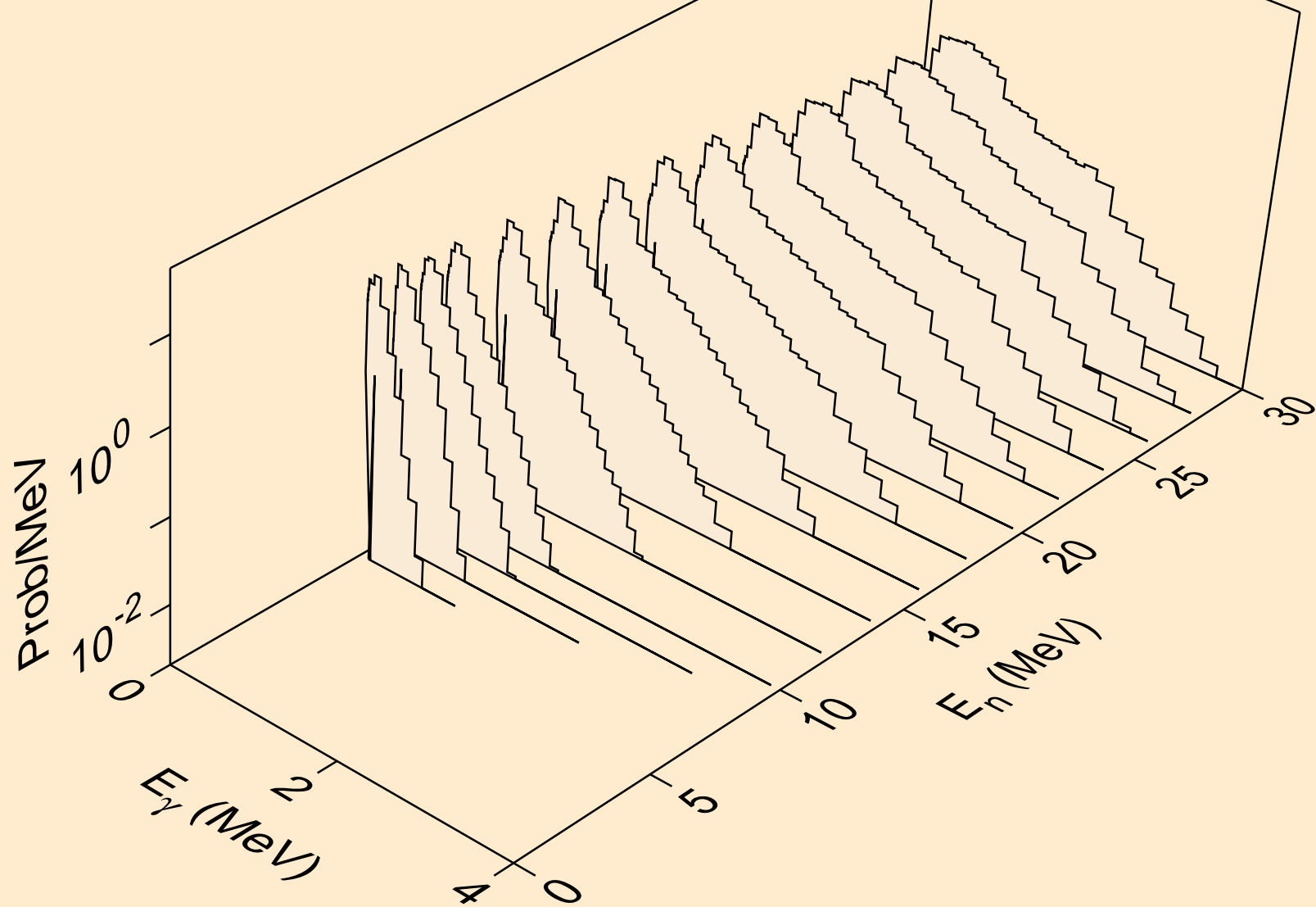

PA241 PROTON ACER TENDL-2021 LIBRARY; T=0.K  
Photon emission for (n,t)

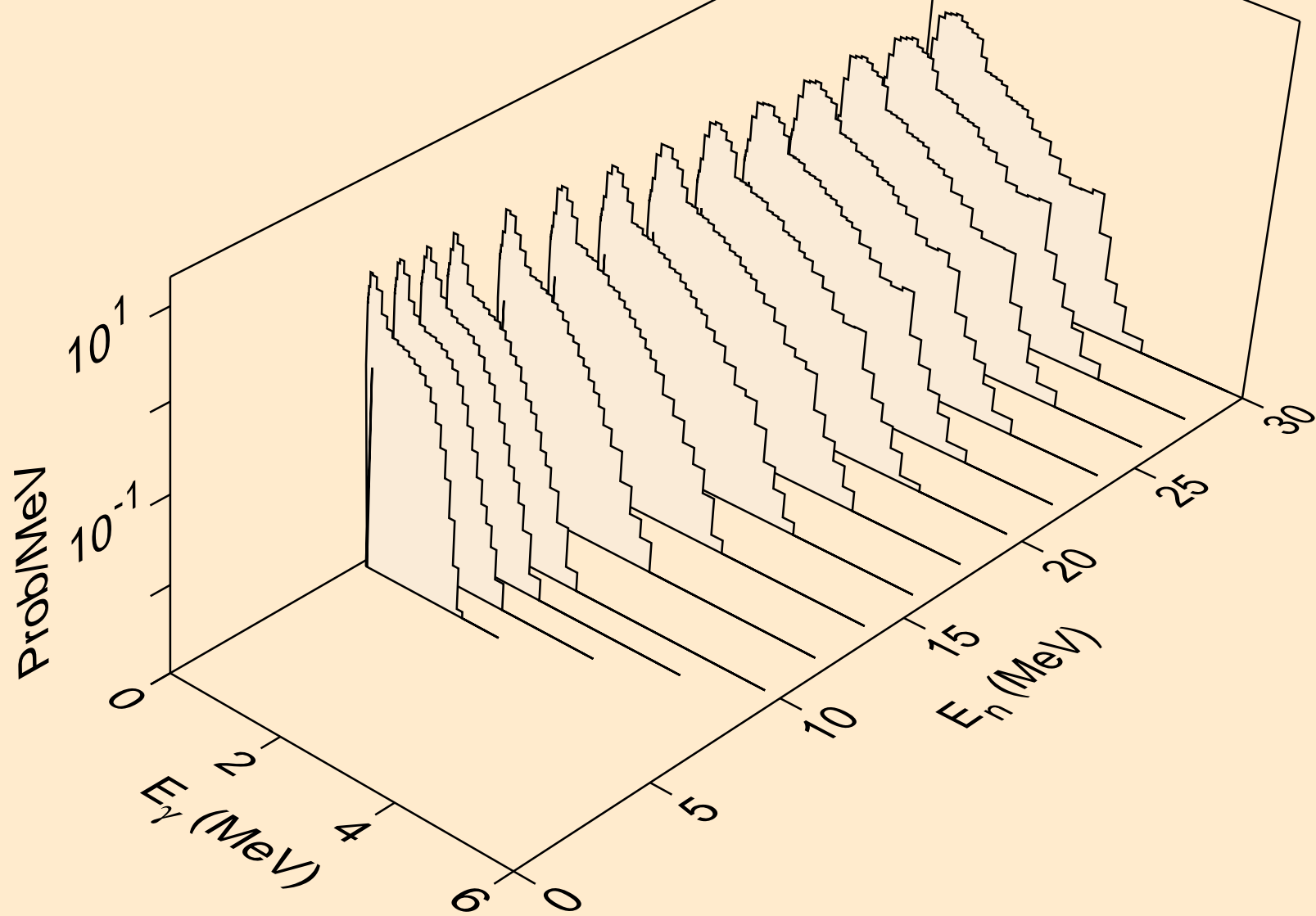

PA241 PROTON ACER TENDL-2021 LIBRARY; T=0.K  
Photon emission for (n,he3)

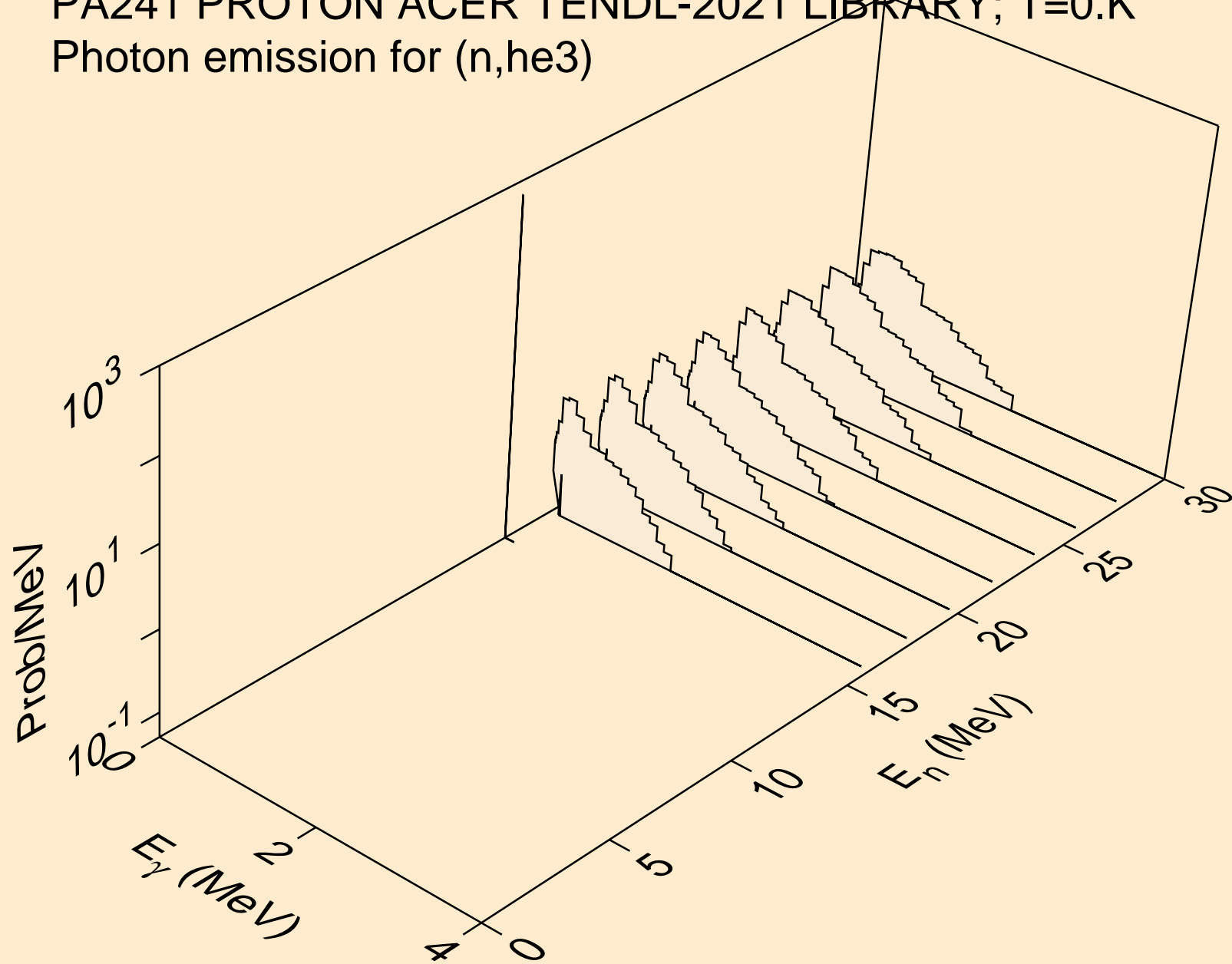

PA241 PROTON ACER TENDL-2021 LIBRARY; T=0.K  
Photon emission for (n,a)

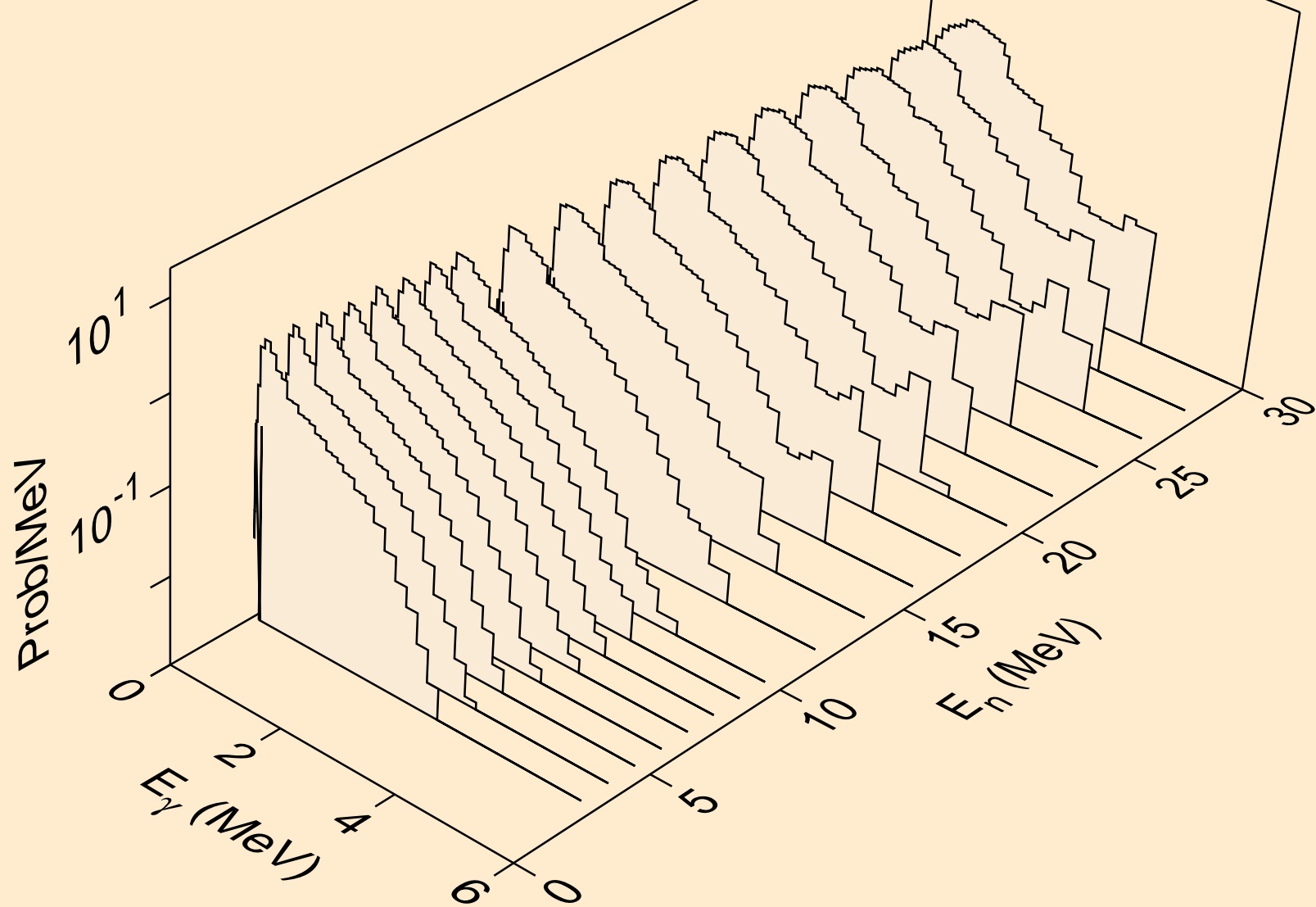

PA241 PROTON ACER TENDL-2021 LIBRARY; T=0.K  
Photon emission for (n,2p)

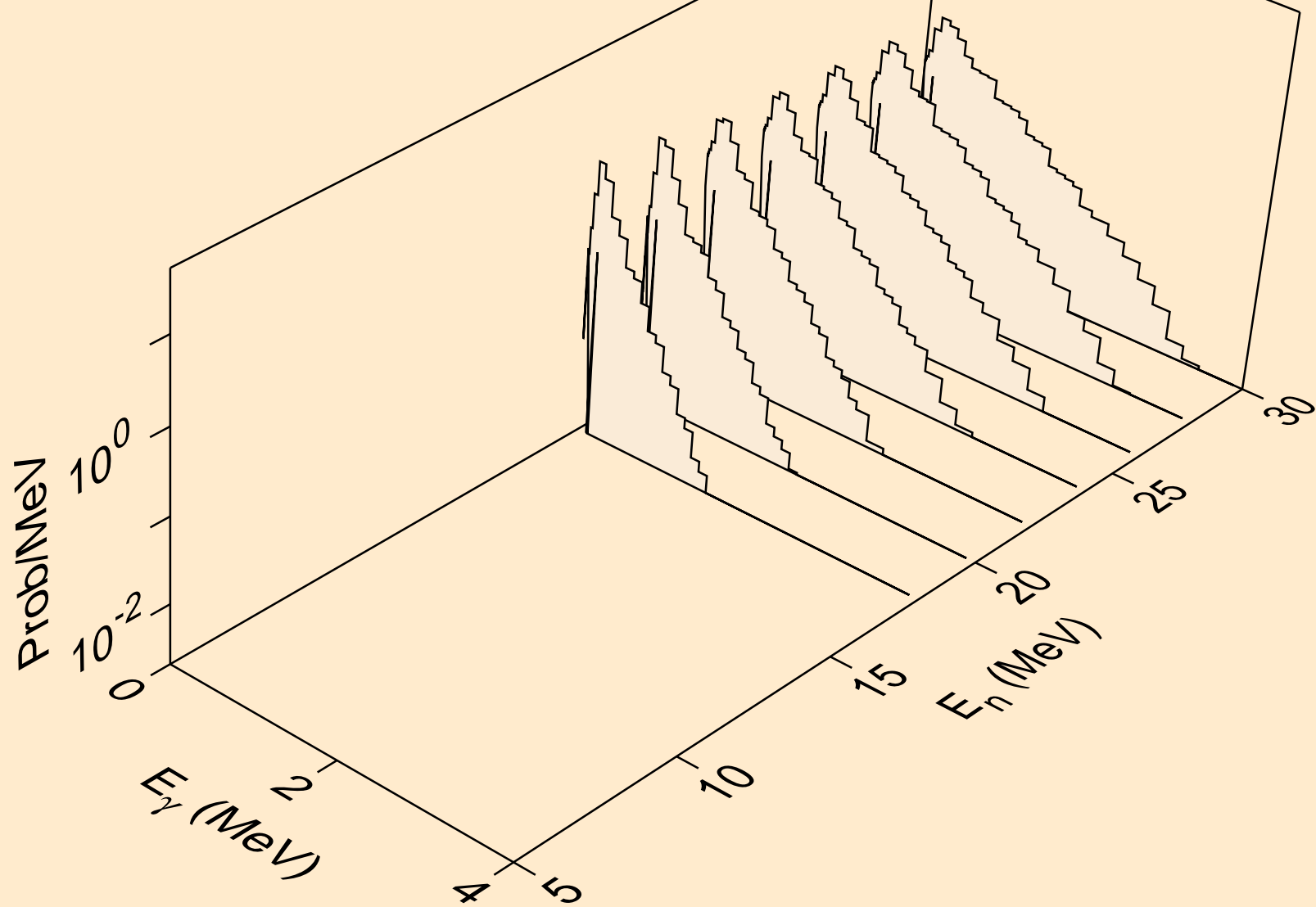



PA241 PROTON ACER TENDL-2021 LIBRARY; T=0.K  
Particle heating contributions

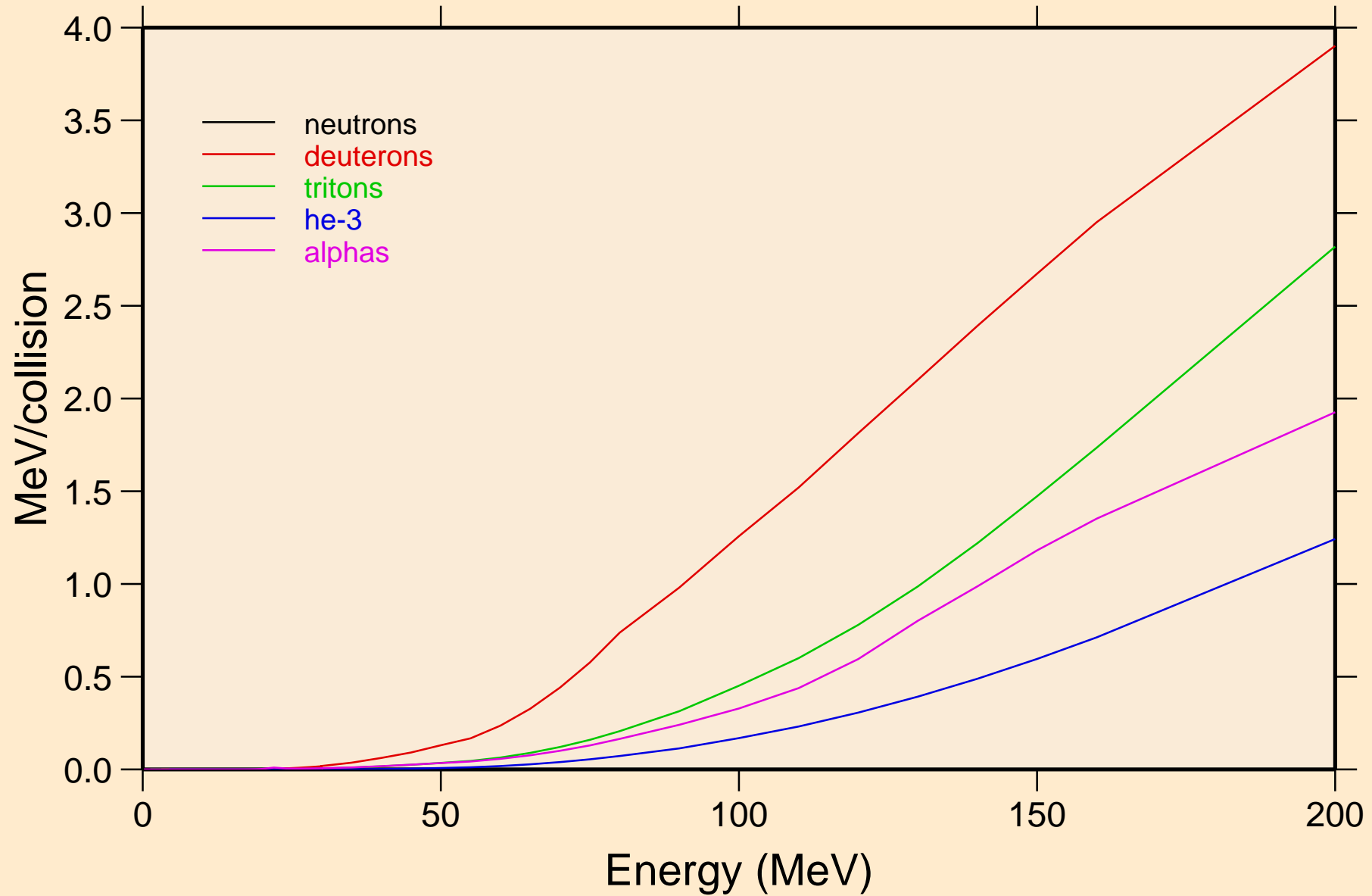

PA241 PROTON ACER TENDL-2021 LIBRARY; T=0.K  
Recoil Heating

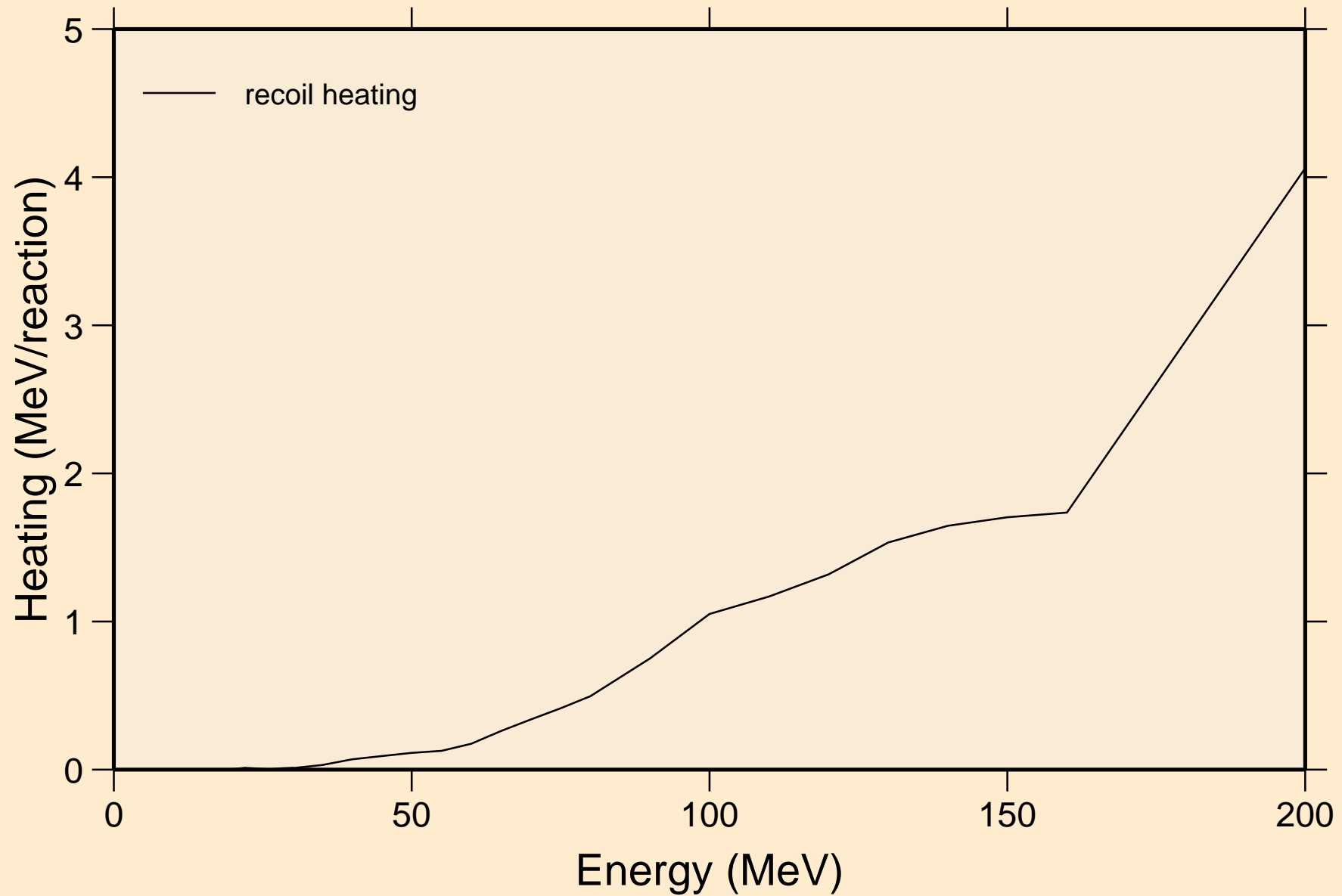

PA241 PROTON ACER TENDL-2021 LIBRARY; T=0.K  
Particle production cross sections

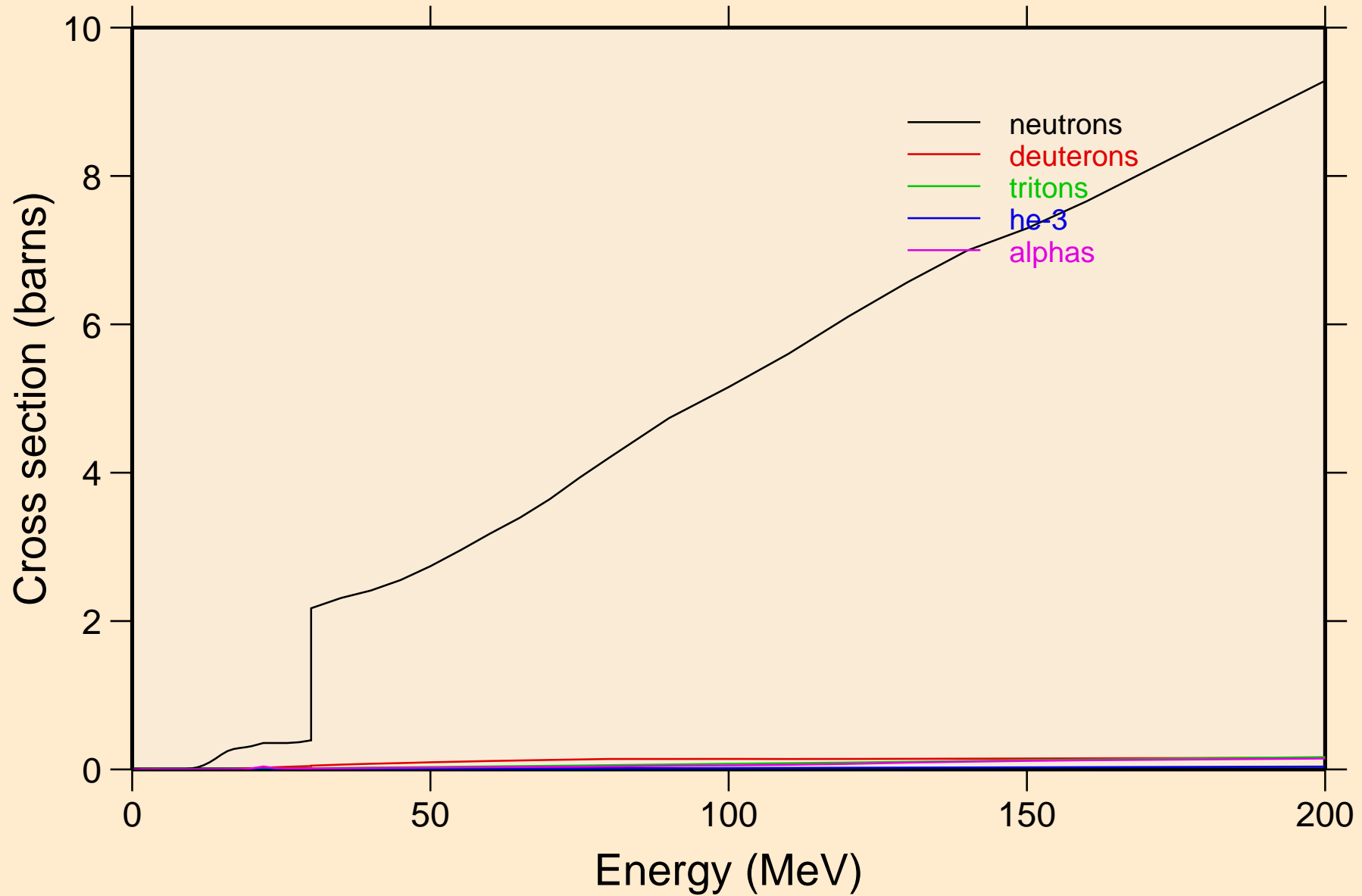

PA241 PROTON ACER TENDL-2021 LIBRARY; T=0.K  
neutrons from (p,n)

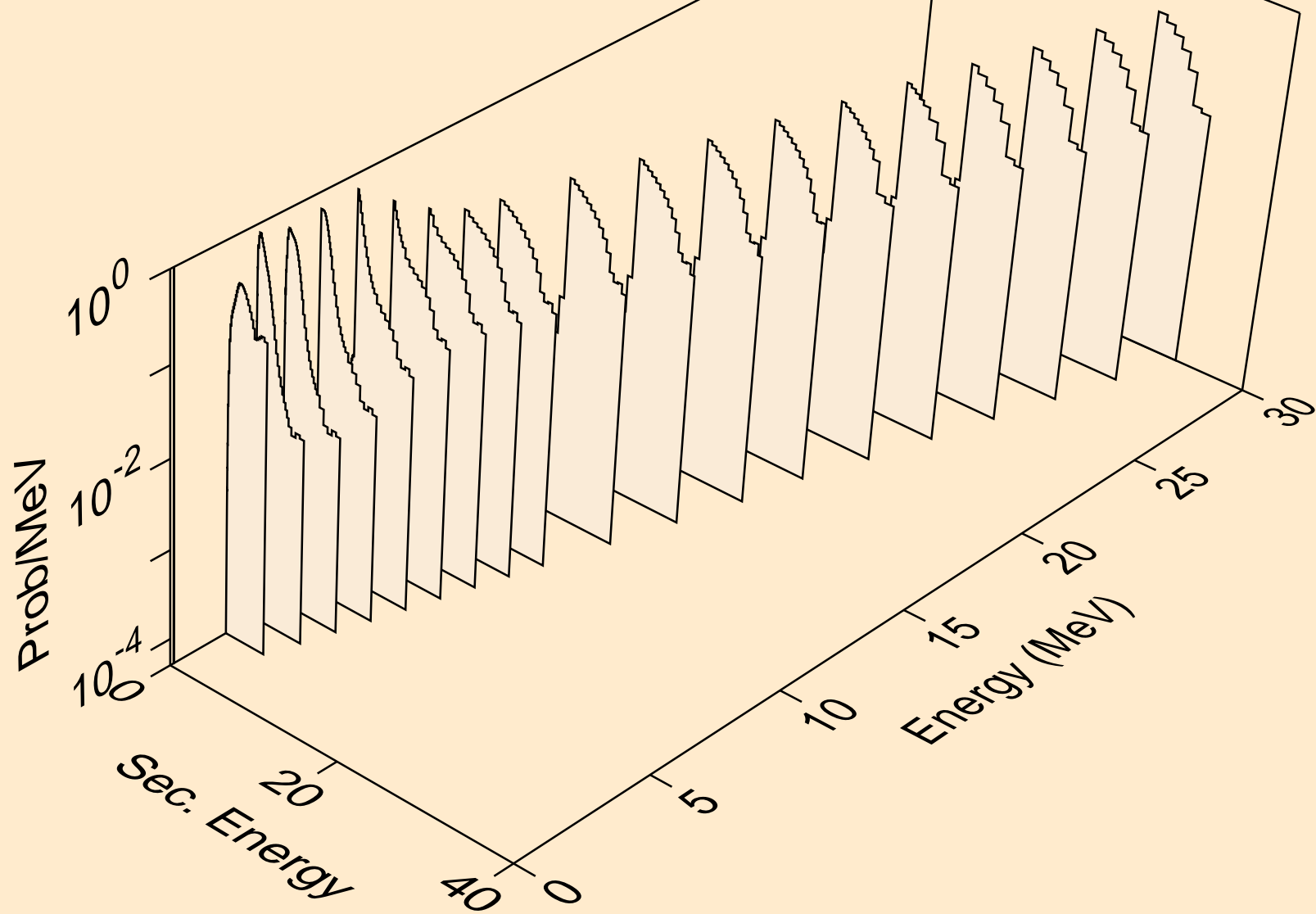

PA241 PROTON ACER TENDL-2021 LIBRARY; T=0.K  
neutrons from (p,x)

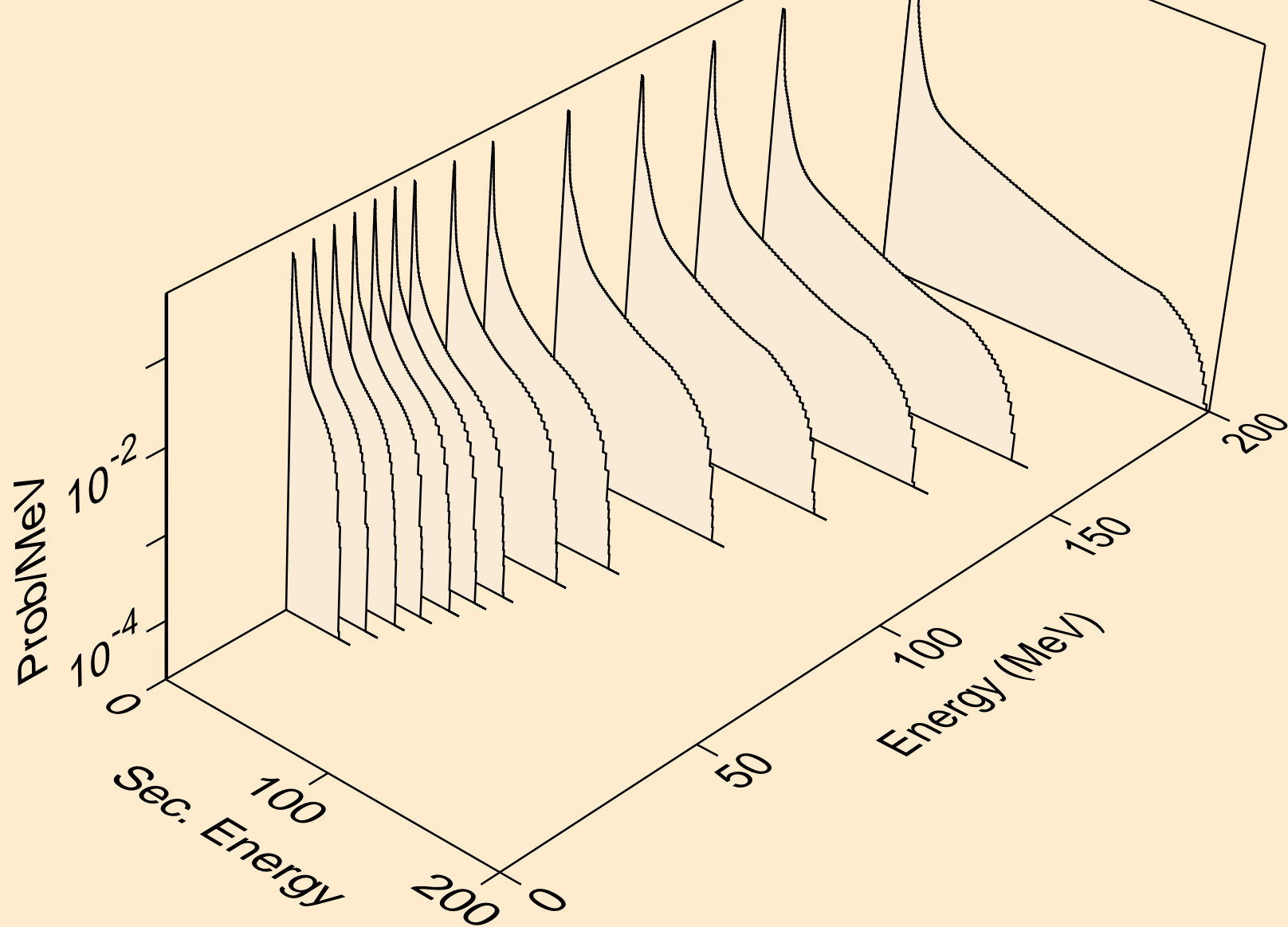

PA241 PROTON ACER TENDL-2021 LIBRARY; T=0.K  
neutrons from (p,2nd)

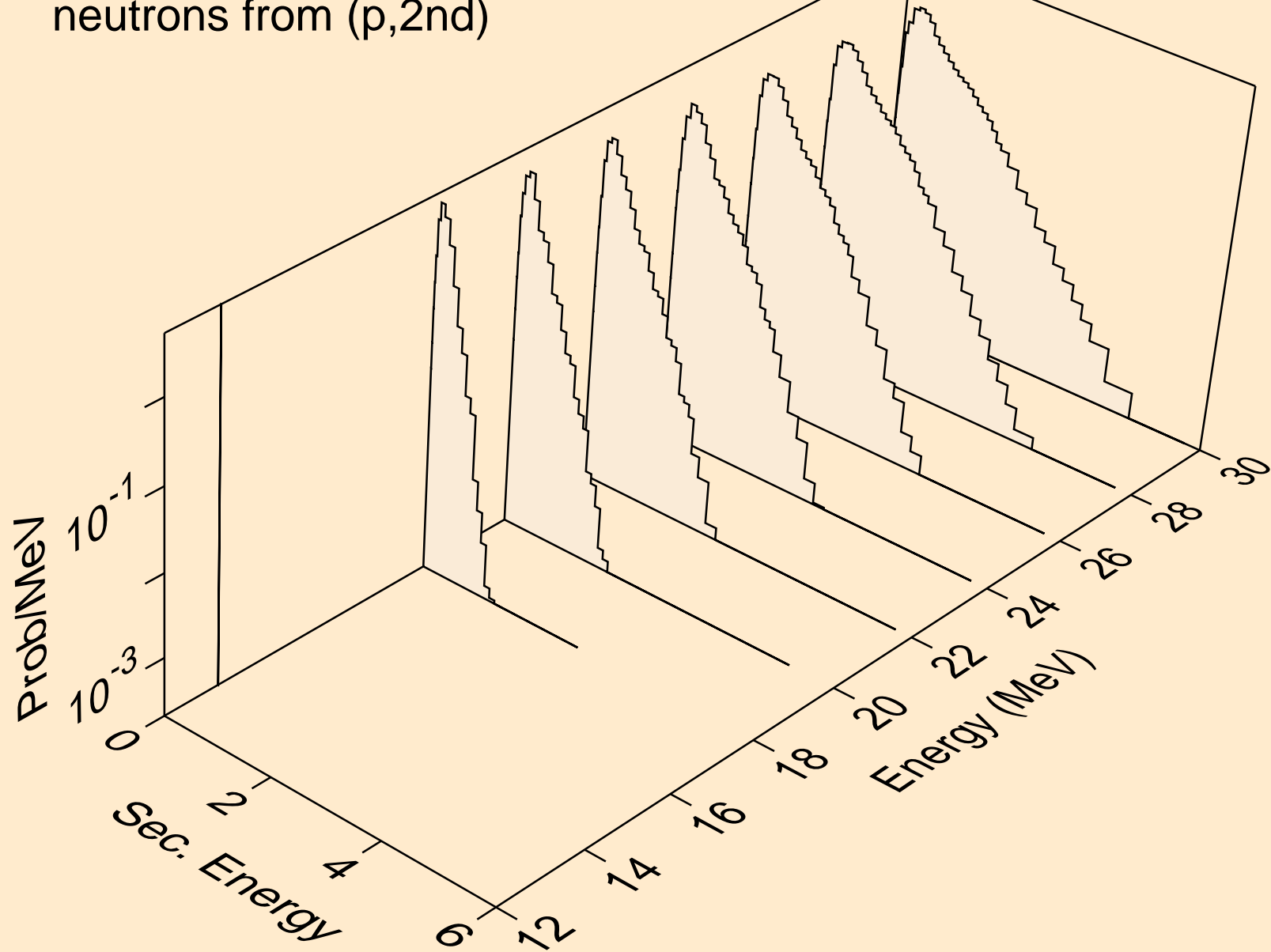

PA241 PROTON ACER TENDL-2021 LIBRARY; T=0.K  
neutrons from (p,2n)

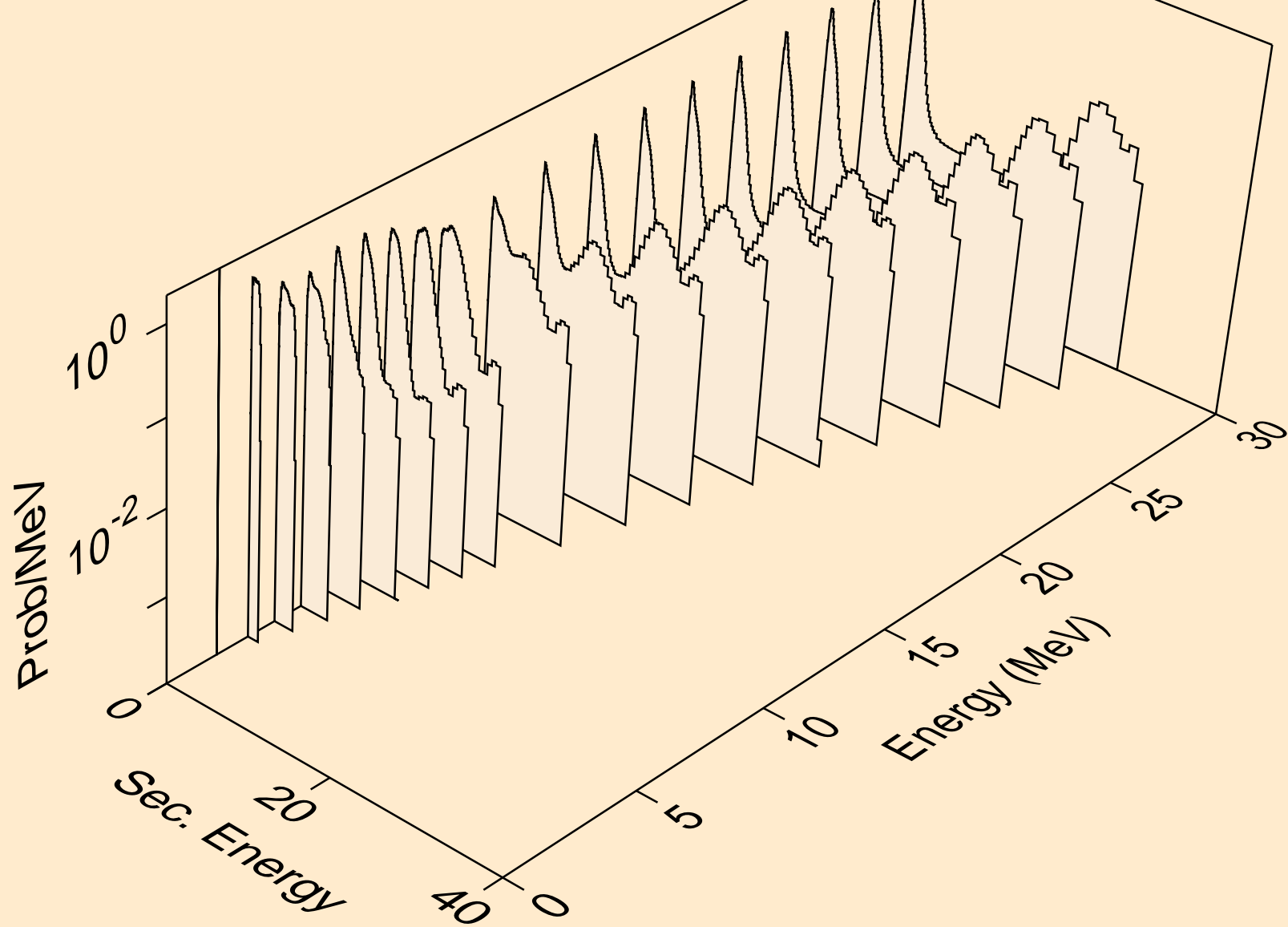

PA241 PROTON ACER TENDL-2021 LIBRARY; T=0.K  
neutrons from (p,3n)

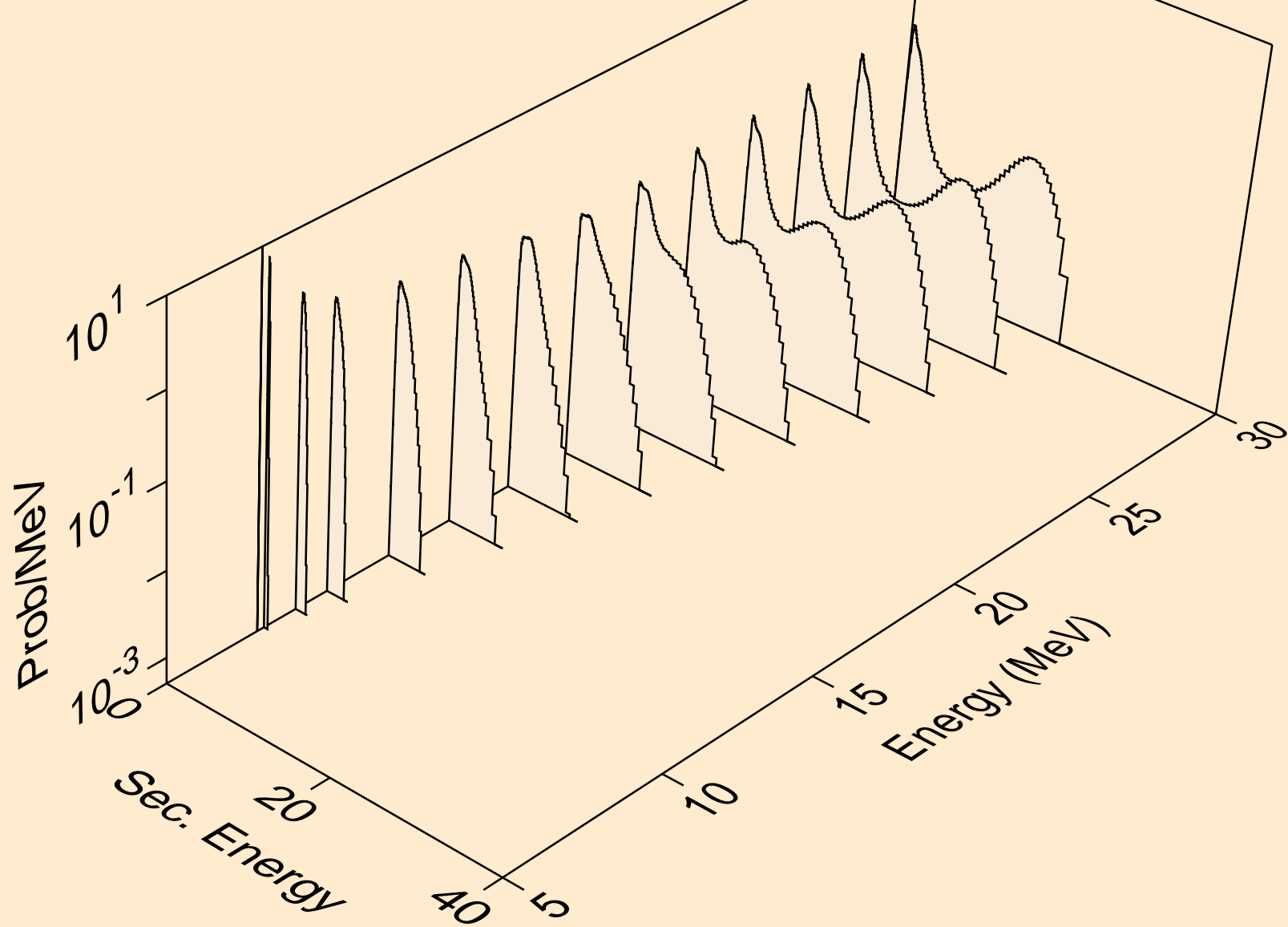



PA241 PROTON ACER TENDL-2021 LIBRARY; T=0.K  
neutrons from (p,n\*)a

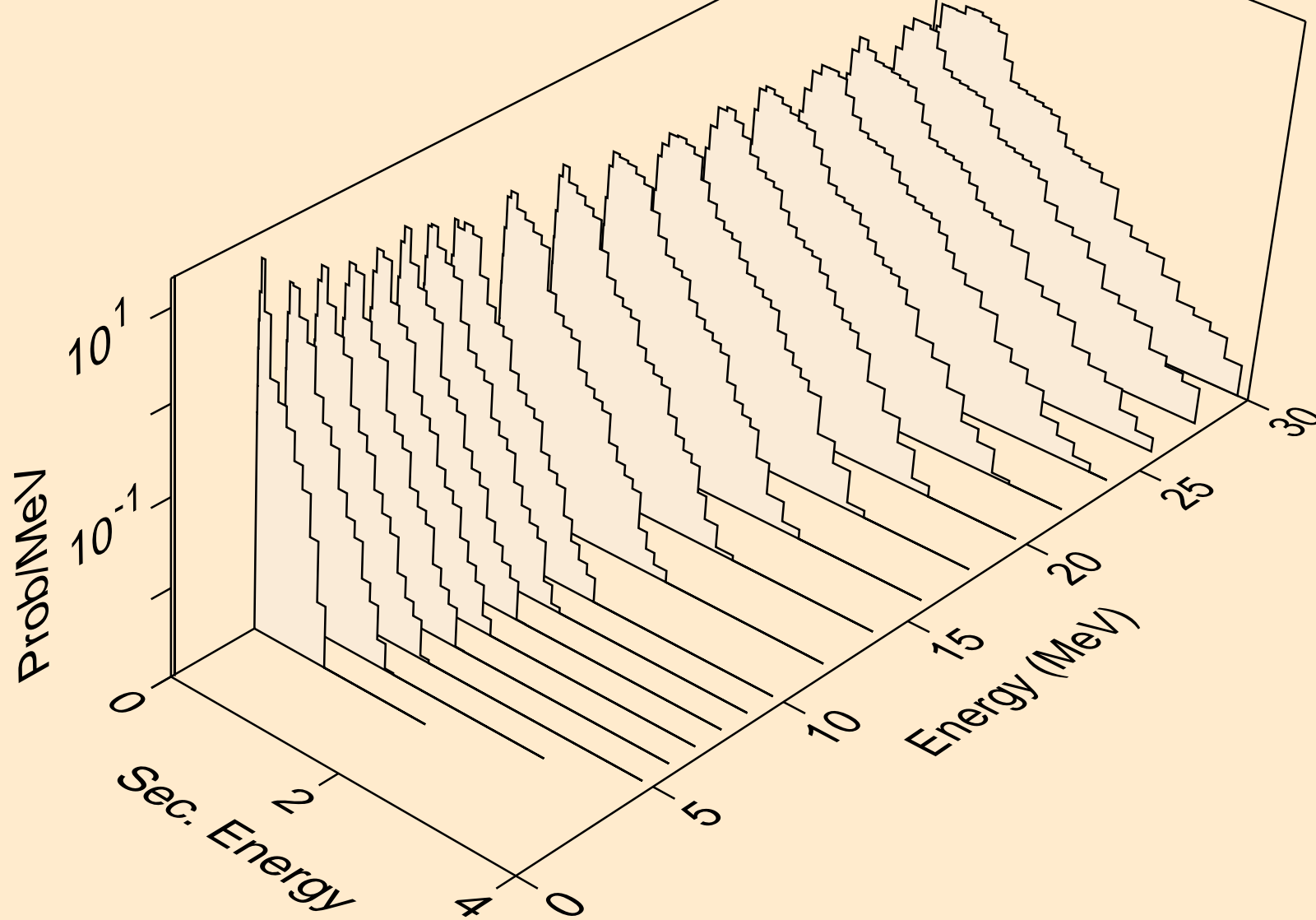

PA241 PROTON ACER TENDL-2021 LIBRARY; T=0.K  
neutrons from (p,2n)a

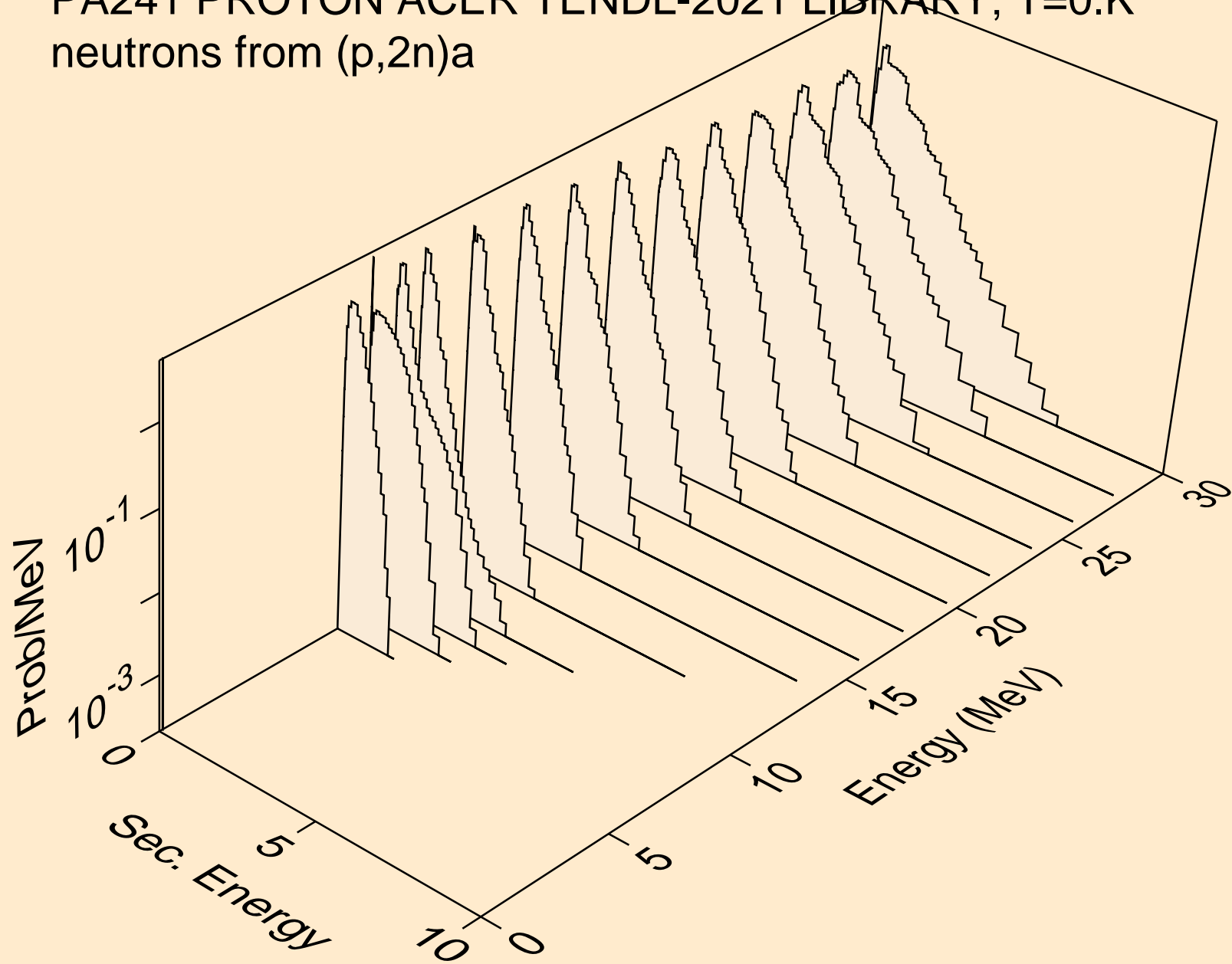

PA241 PROTON ACER TENDL-2021 LIBRARY; T=0.K  
neutrons from (p,3n)a

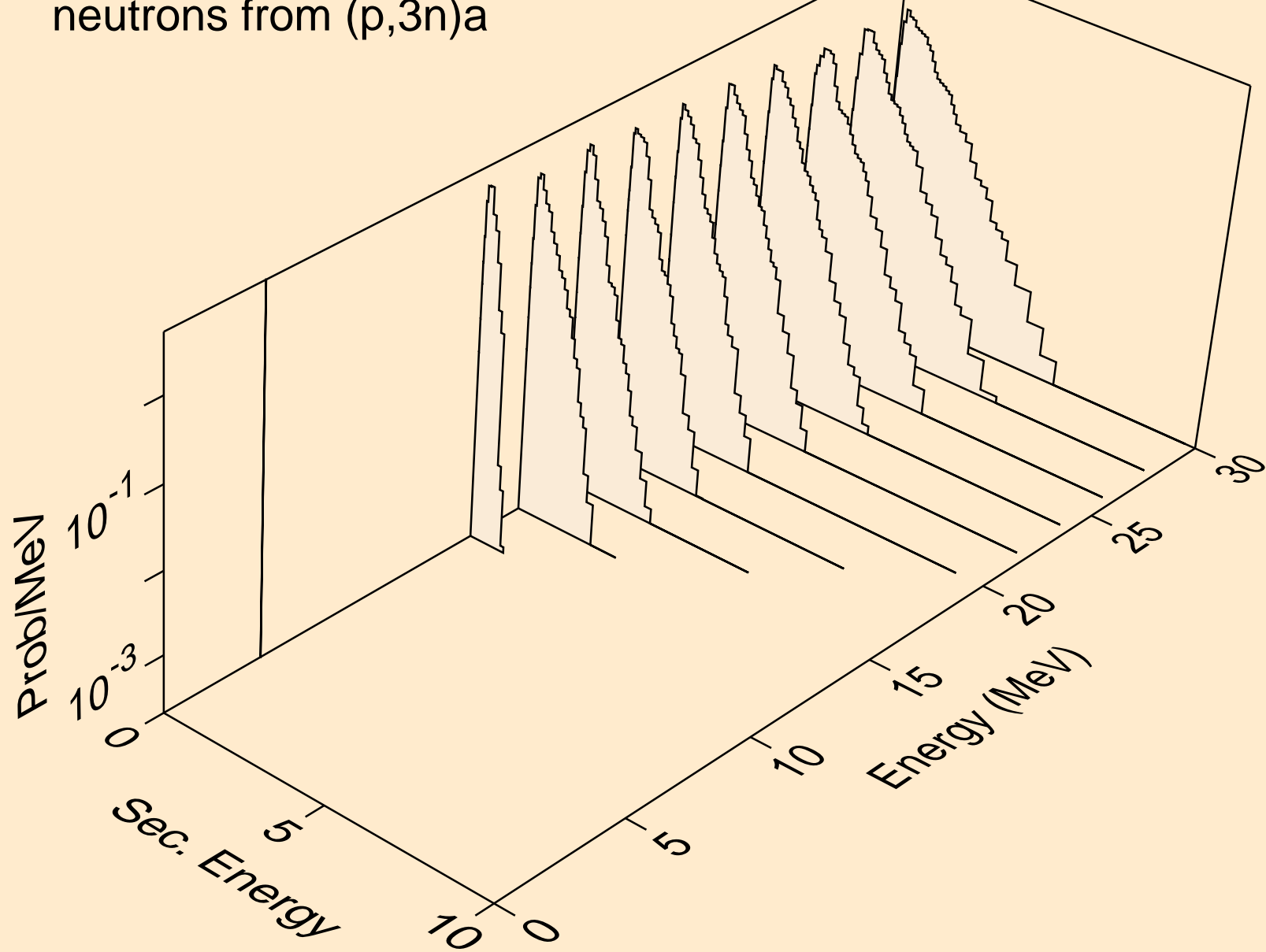

PA241 PROTON ACER TENDL-2021 LIBRARY; T=0.K  
neutrons from (p,n\*)p

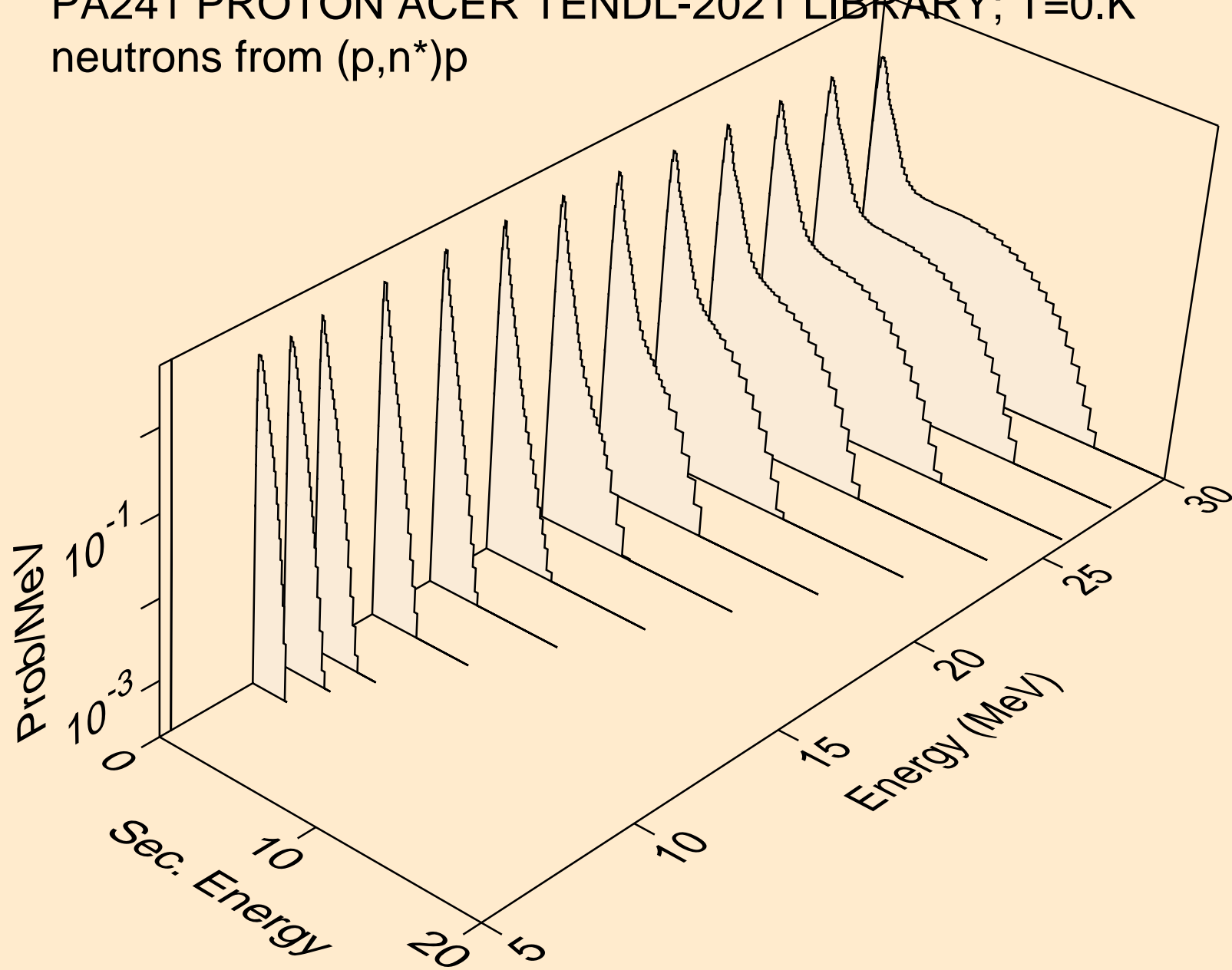

PA241 PROTON ACER TENDL-2021 LIBRARY; T=0.K  
neutrons from (p,n\*)d

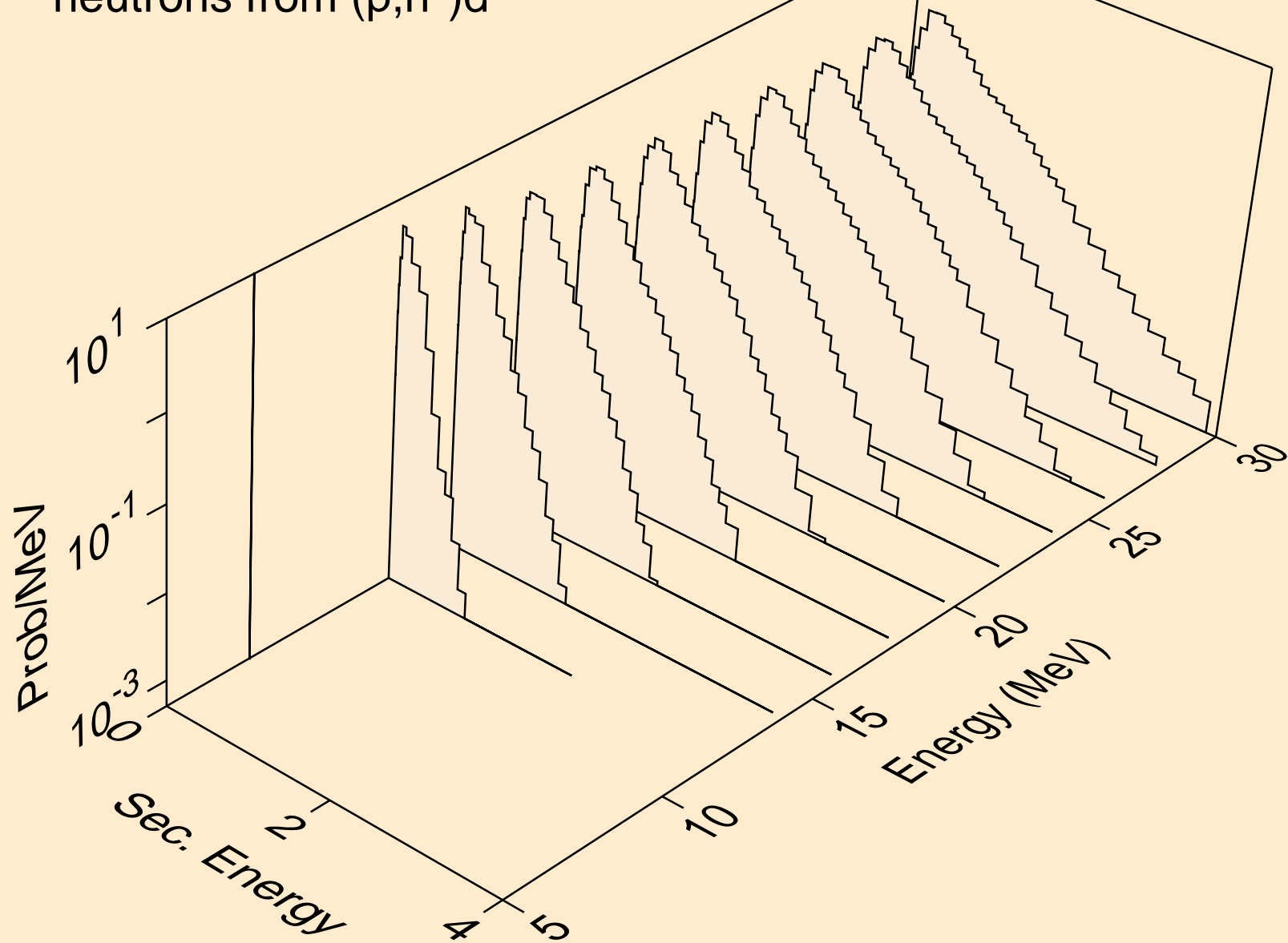

PA241 PROTON ACER TENDL-2021 LIBRARY; T=0.K  
neutrons from (p,n\*)t

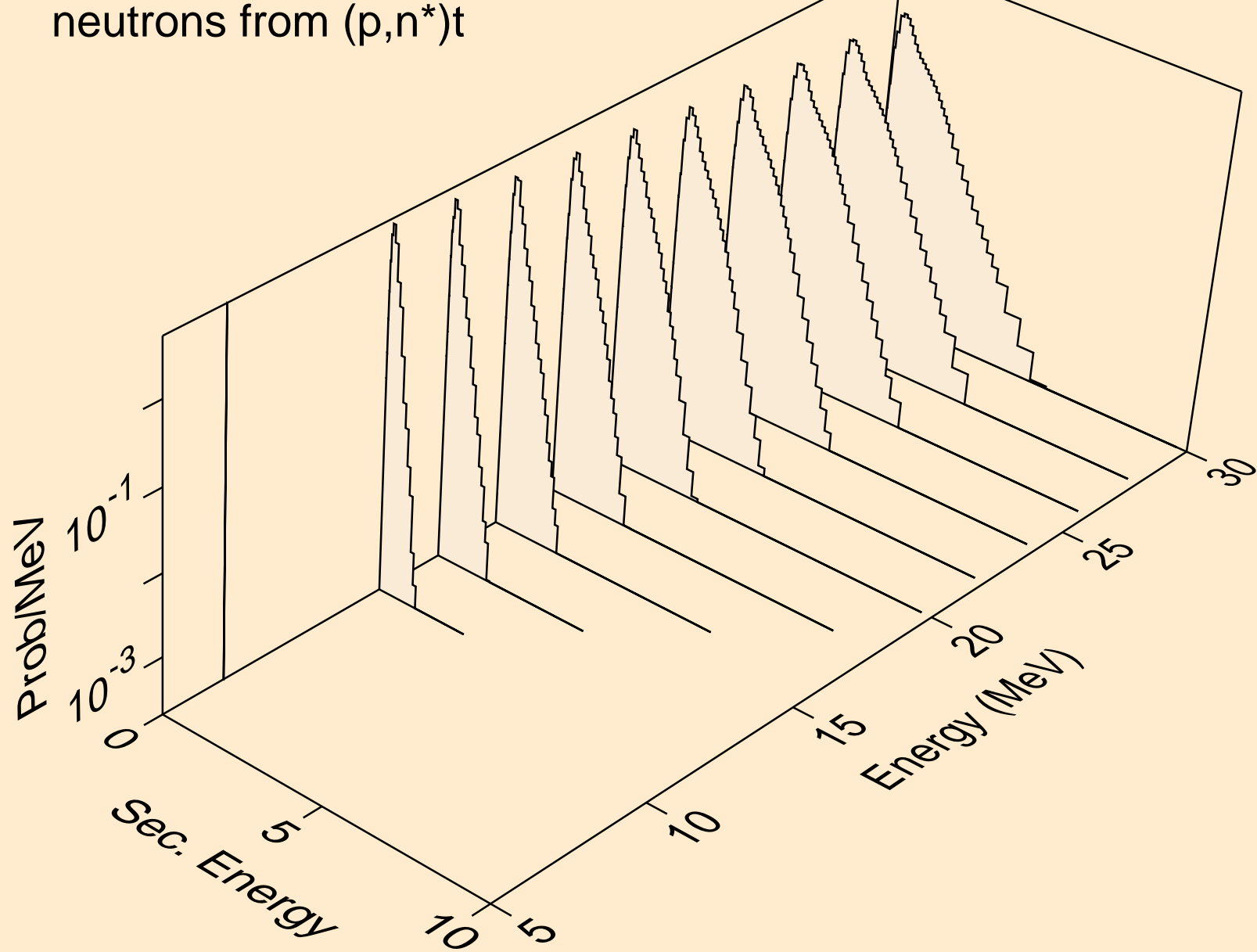

PA241 PROTON ACER TENDL-2021 LIBRARY; T=0.K  
neutrons from (p,n\*)he3

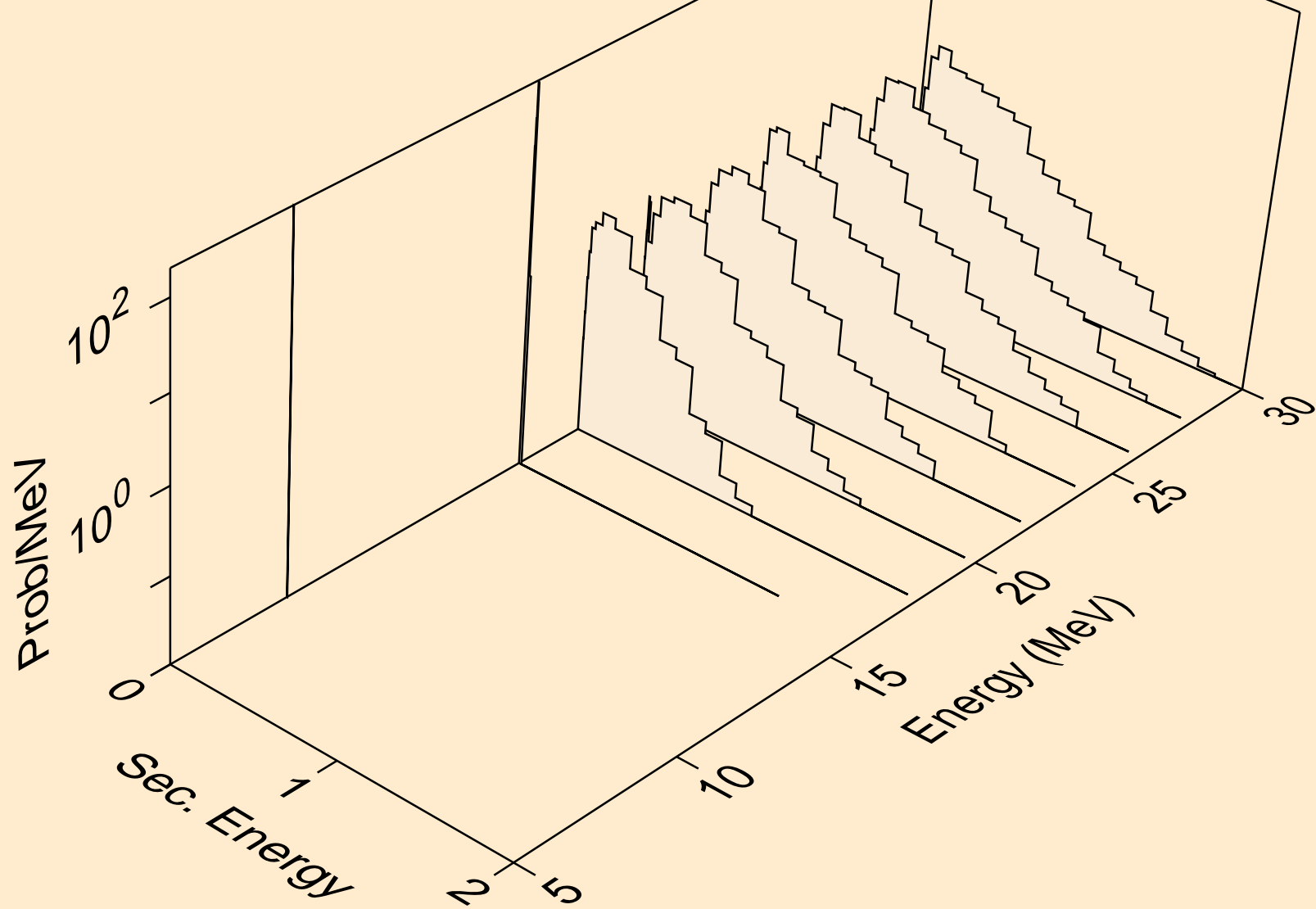

PA241 PROTON ACER TENDL-2021 LIBRARY; T=0.K  
neutrons from (p,4n)

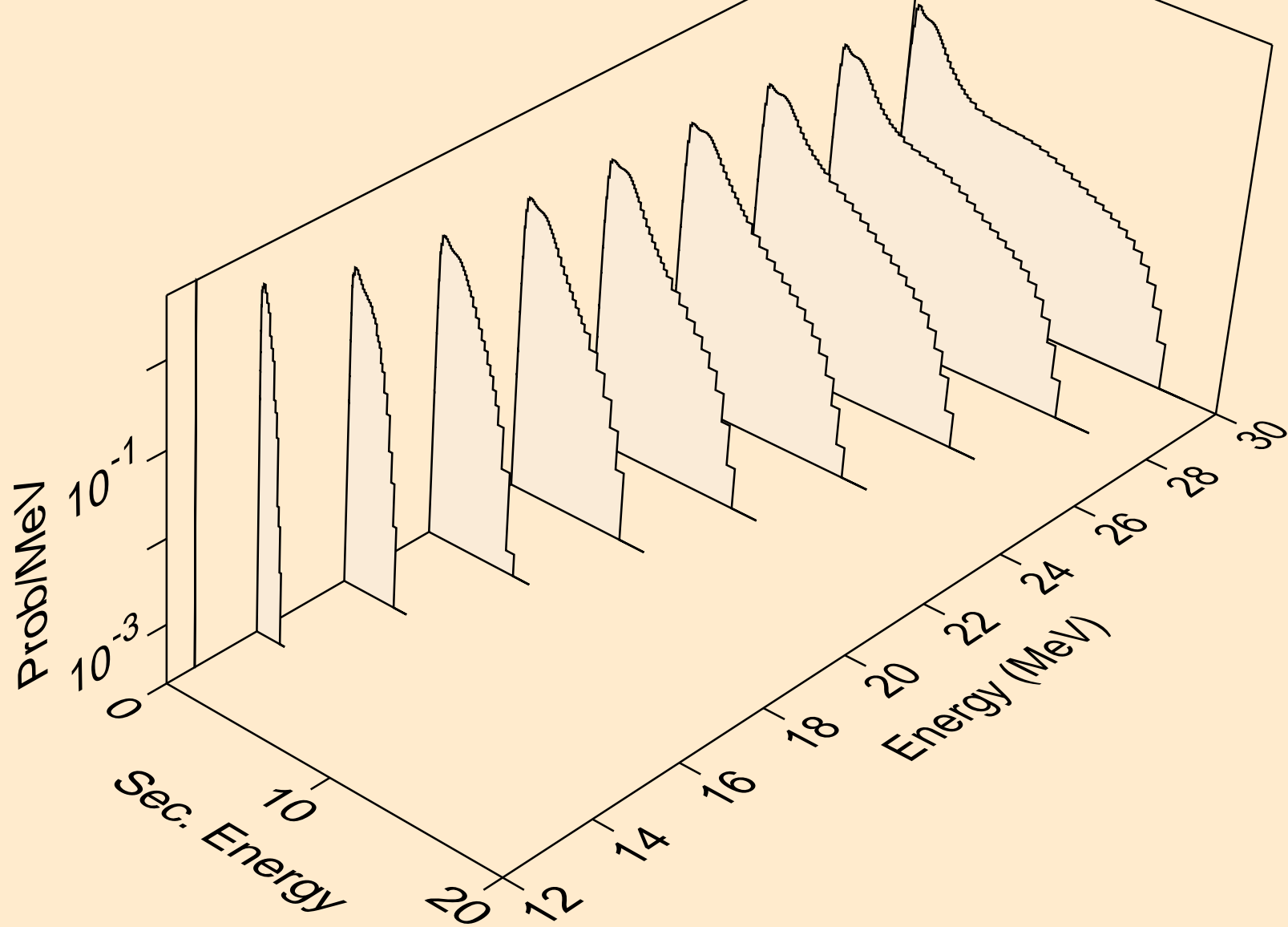



PA241 PROTON ACER TENDL-2021 LIBRARY; T=0.K  
neutrons from (p,2np)

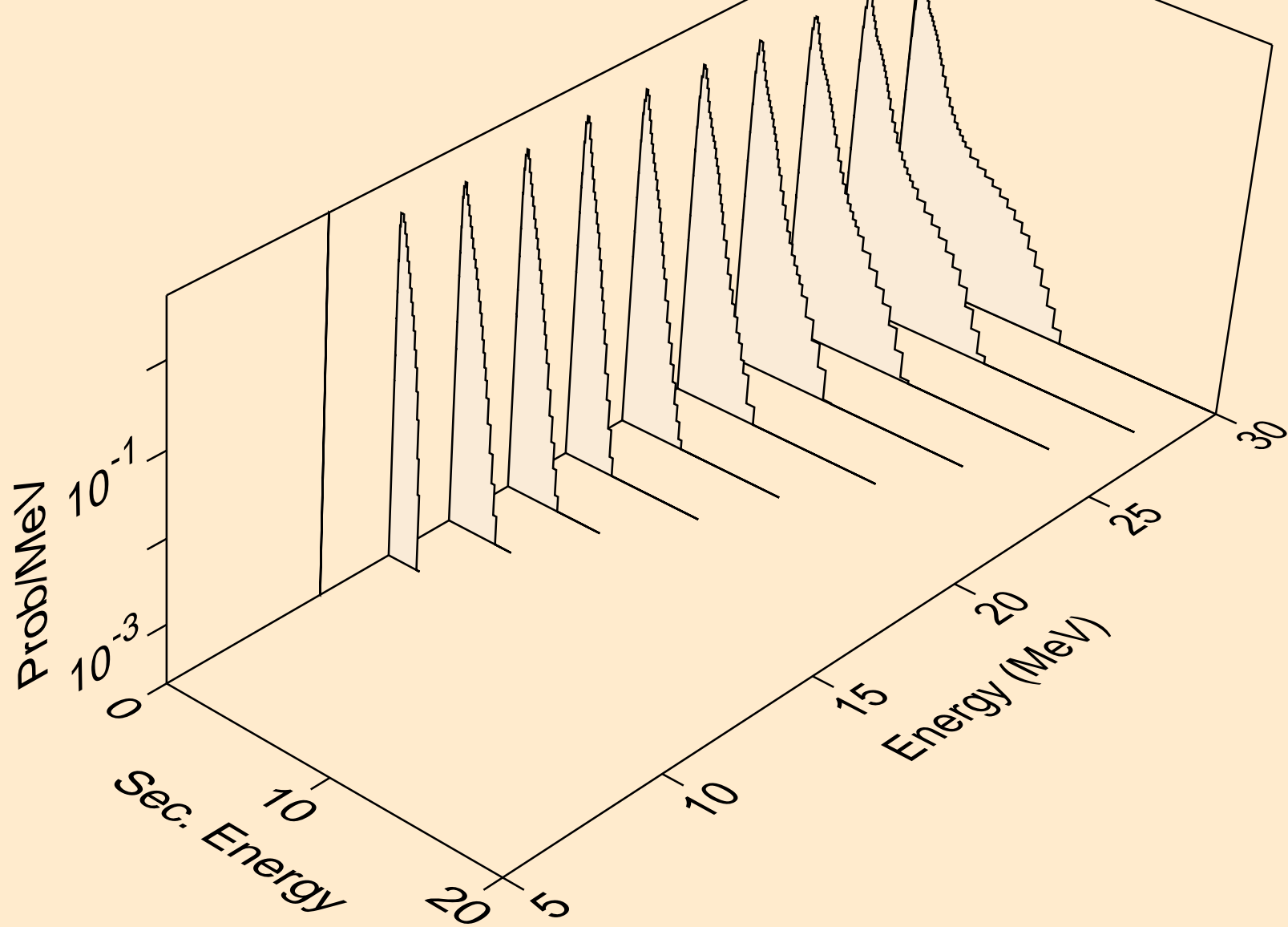

PA241 PROTON ACER TENDL-2021 LIBRARY; T=0.K  
neutrons from (p,3np)

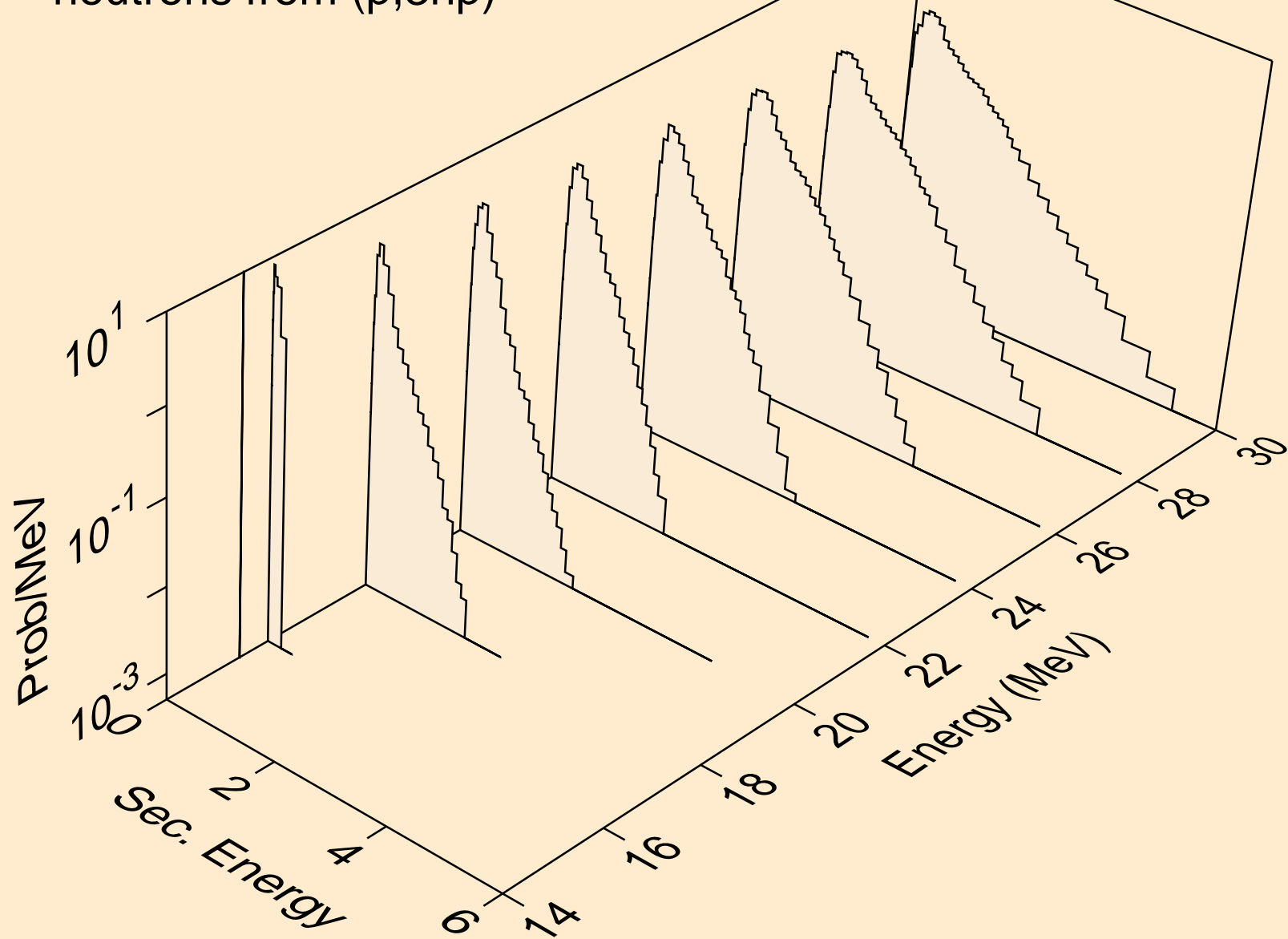

PA241 PROTON ACER TENDL-2021 LIBRARY; T=0.K  
neutrons from (p,2np)

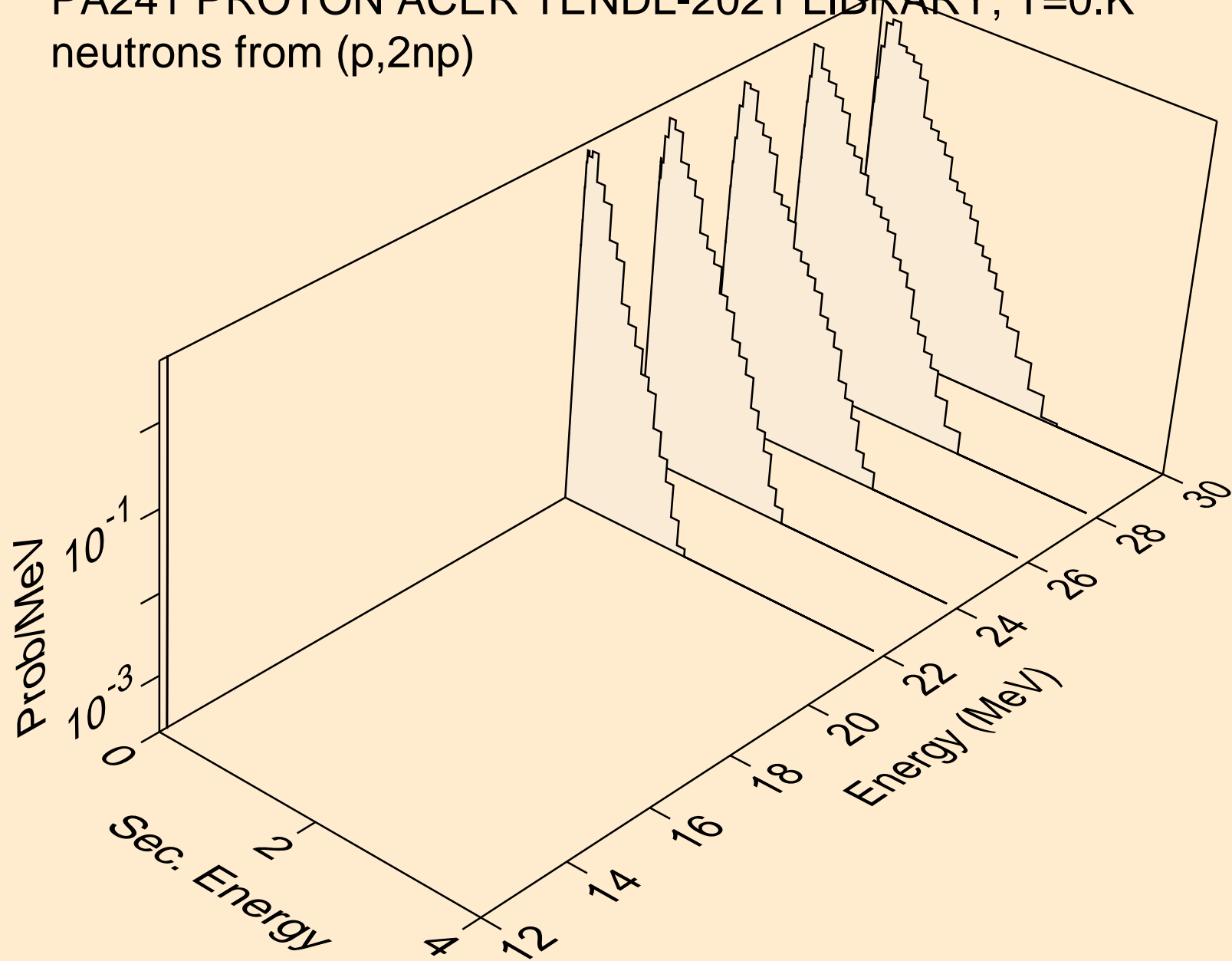

PA241 PROTON ACER TENDL-2021 LIBRARY; T=0.K  
deuterons from (p,x)

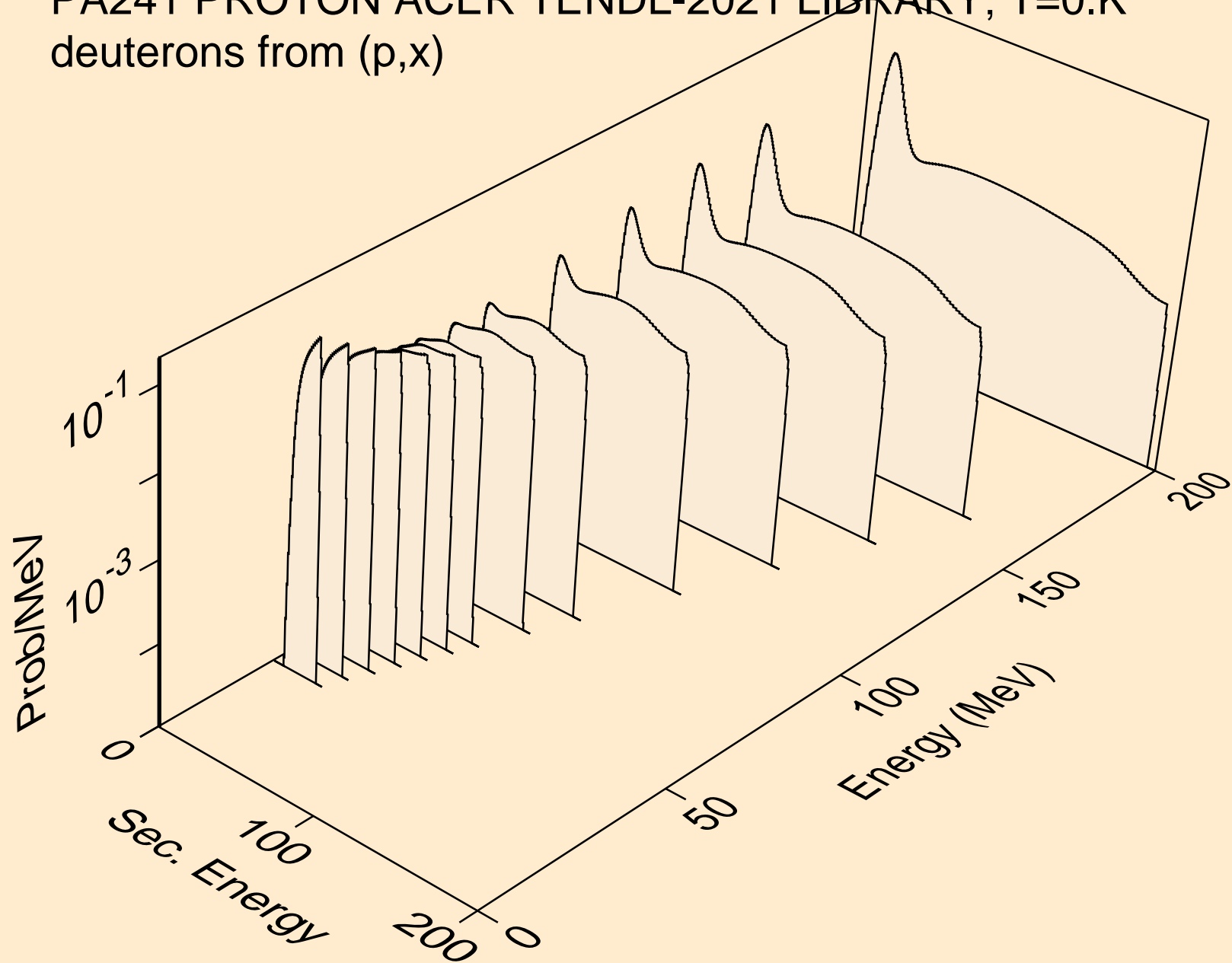

PA241 PROTON ACER TENDL-2021 LIBRARY; T=0.K  
deuterons from (p,2nd)

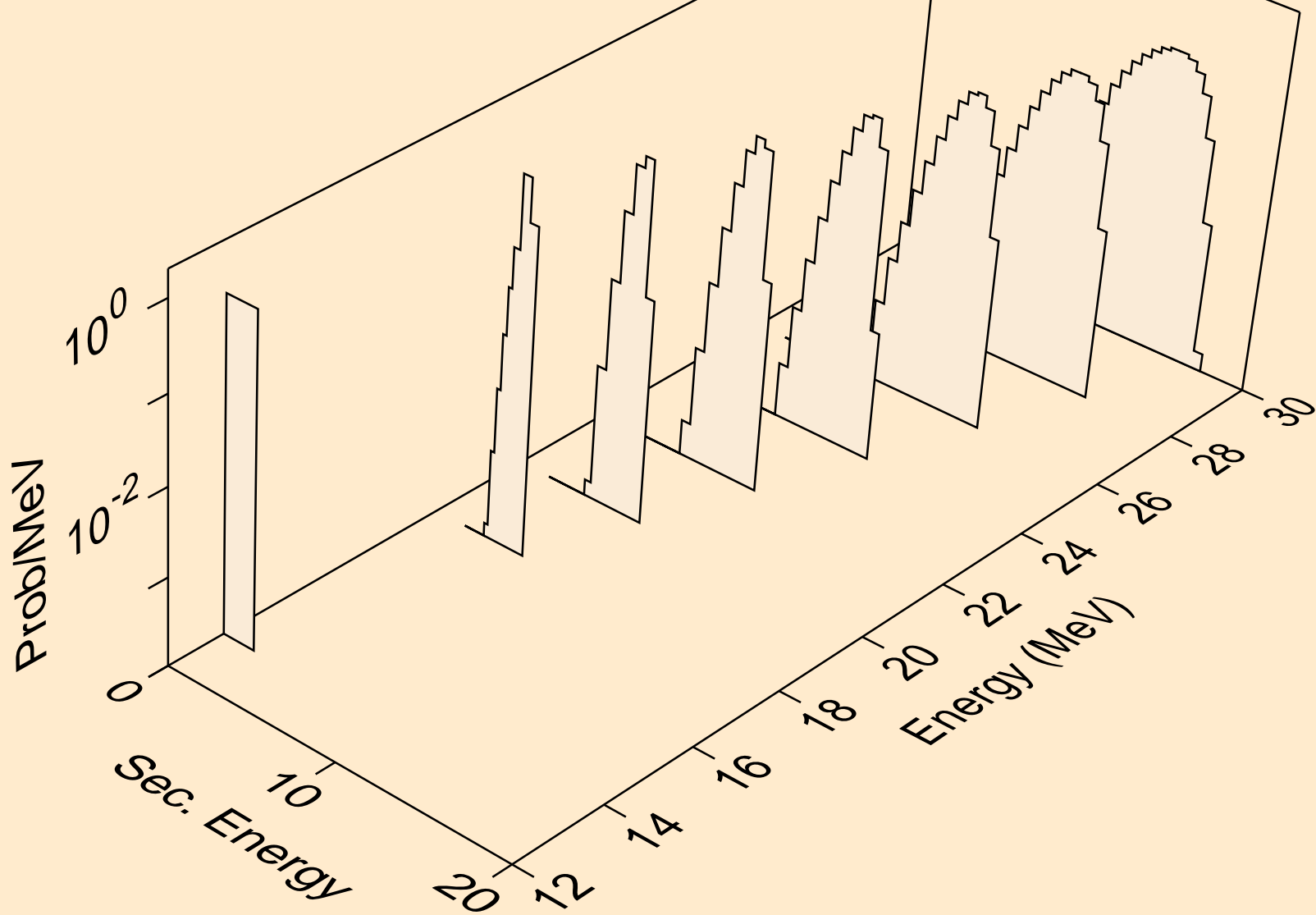

PA241 PROTON ACER TENDL-2021 LIBRARY; T=0.K  
deuterons from (p,n\*)d

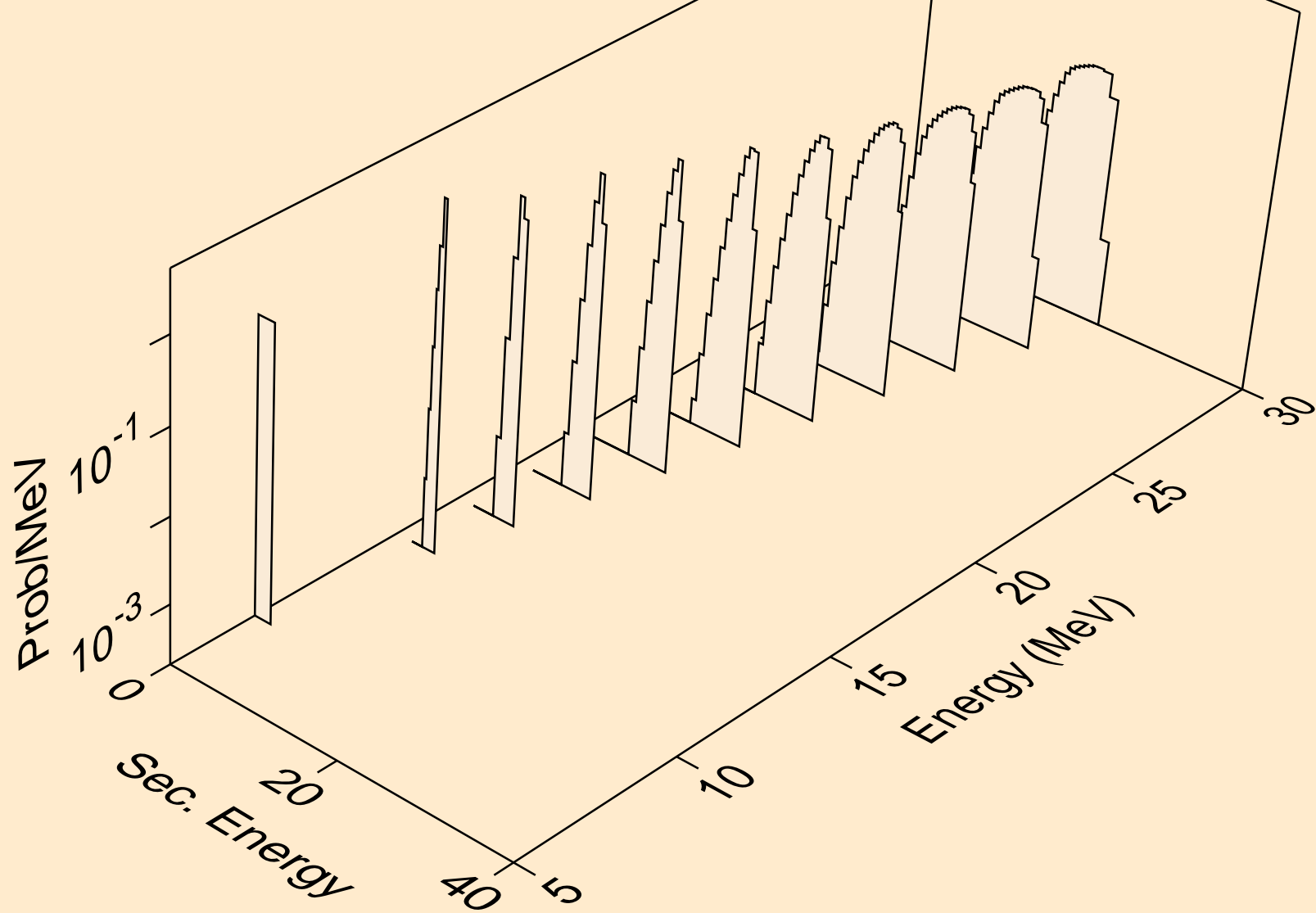

PA241 PROTON ACER TENDL-2021 LIBRARY; T=0.K  
deuterons from (p,d)

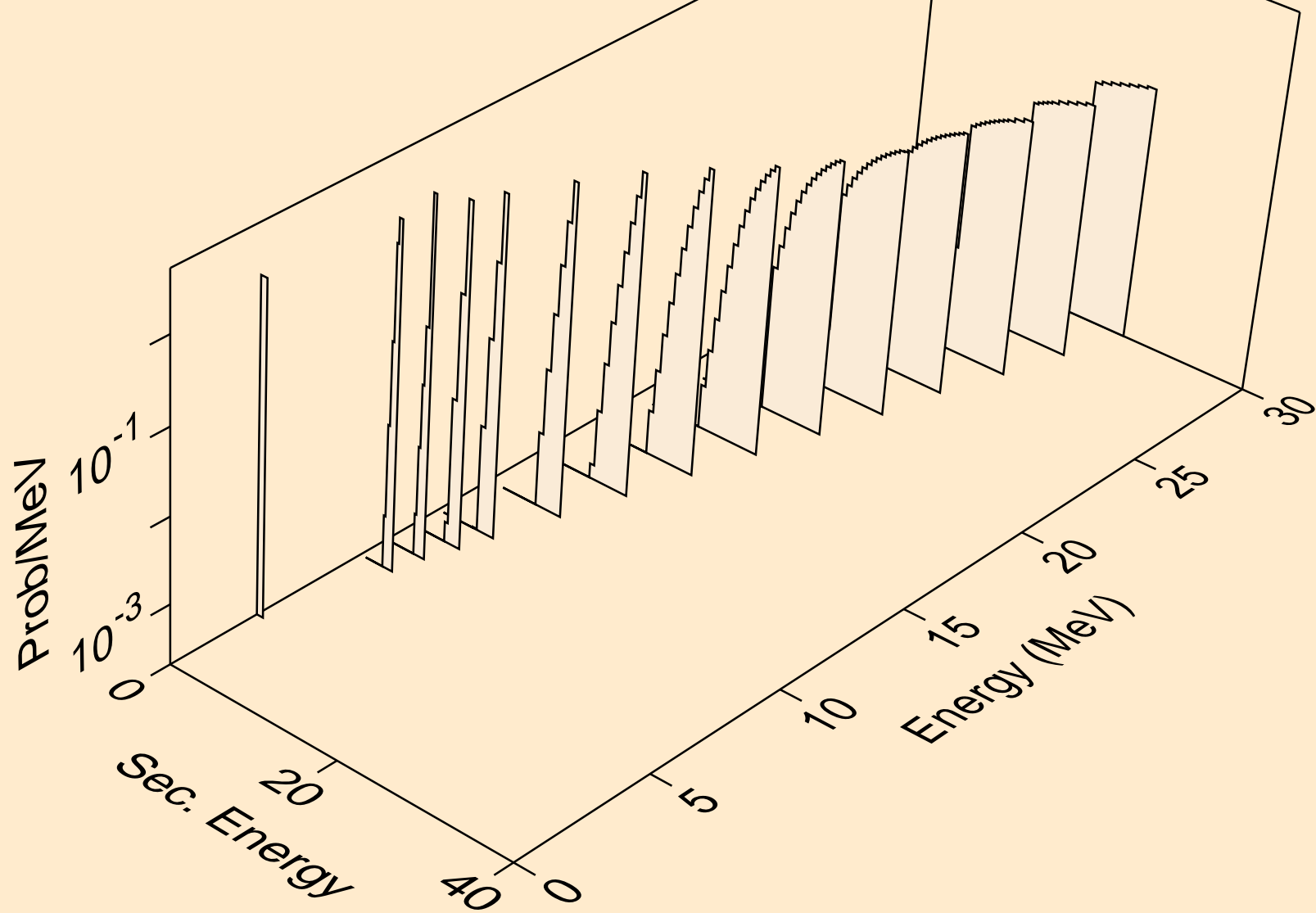

PA241 PROTON ACER TENDL-2021 LIBRARY; T=0.K  
tritons from (p,x)

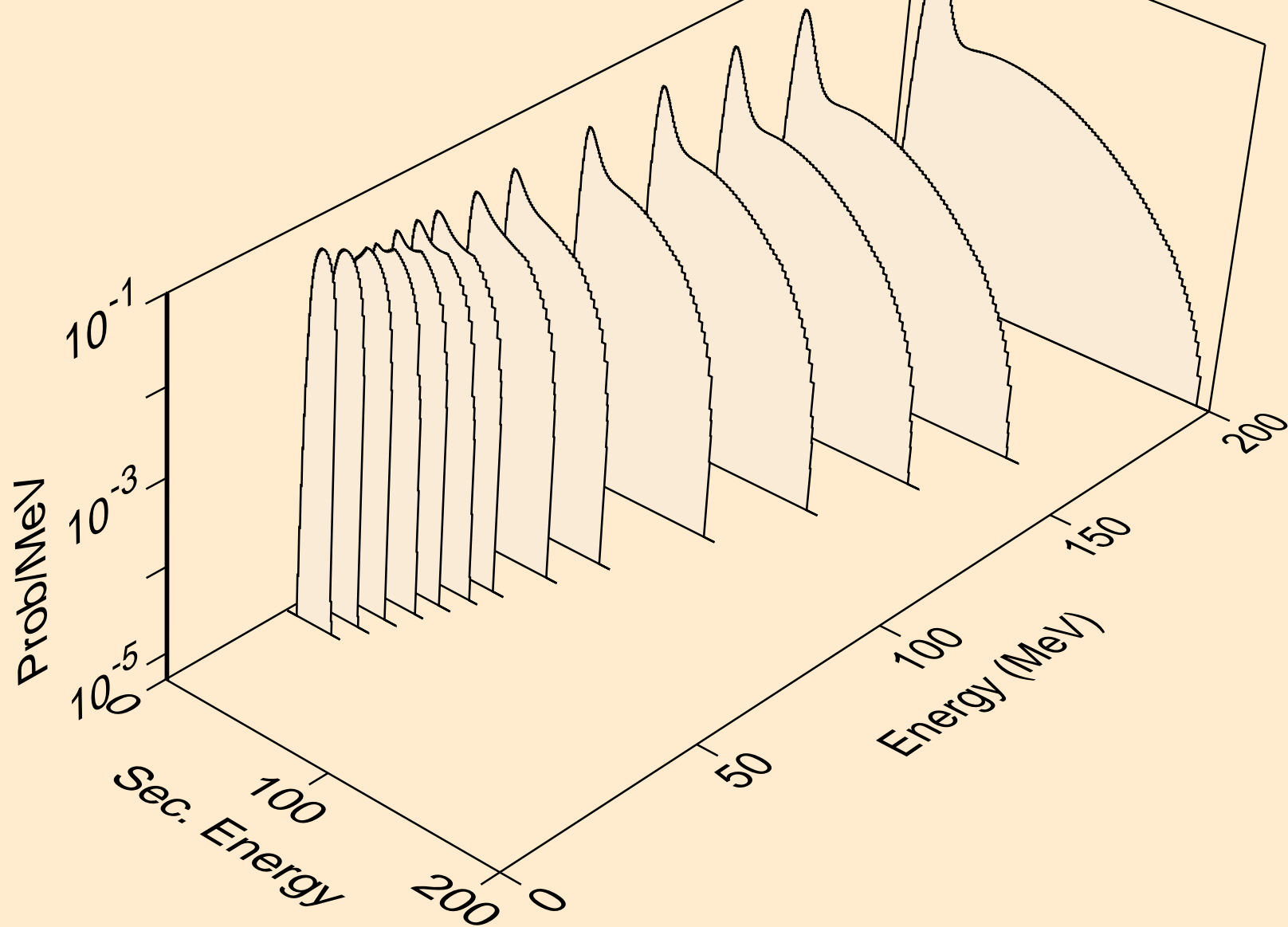



PA241 PROTON ACER TENDL-2021 LIBRARY; T=0.K  
tritons from (p,n\*)t

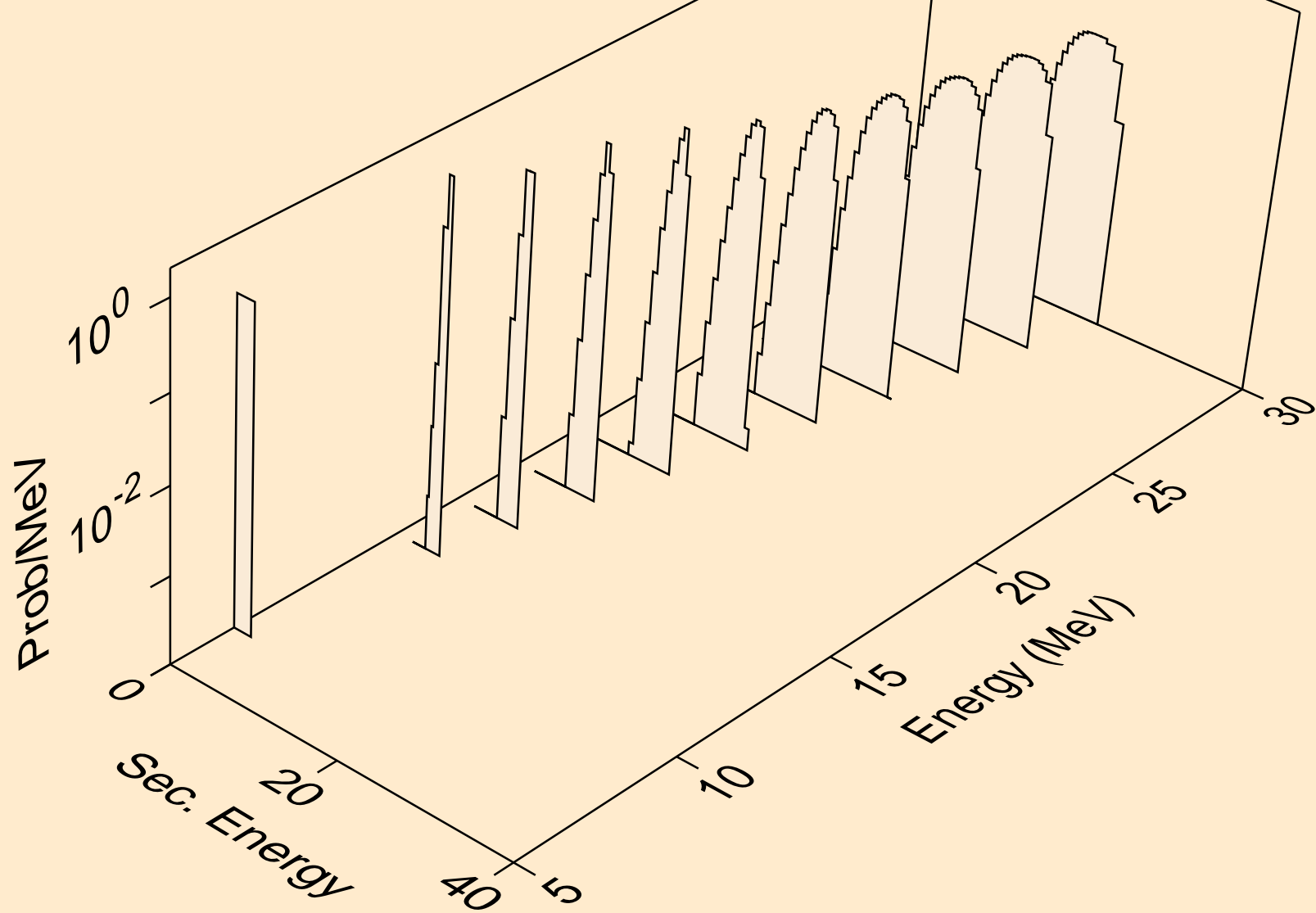

PA241 PROTON ACER TENDL-2021 LIBRARY; T=0.K  
tritons from (p,t)

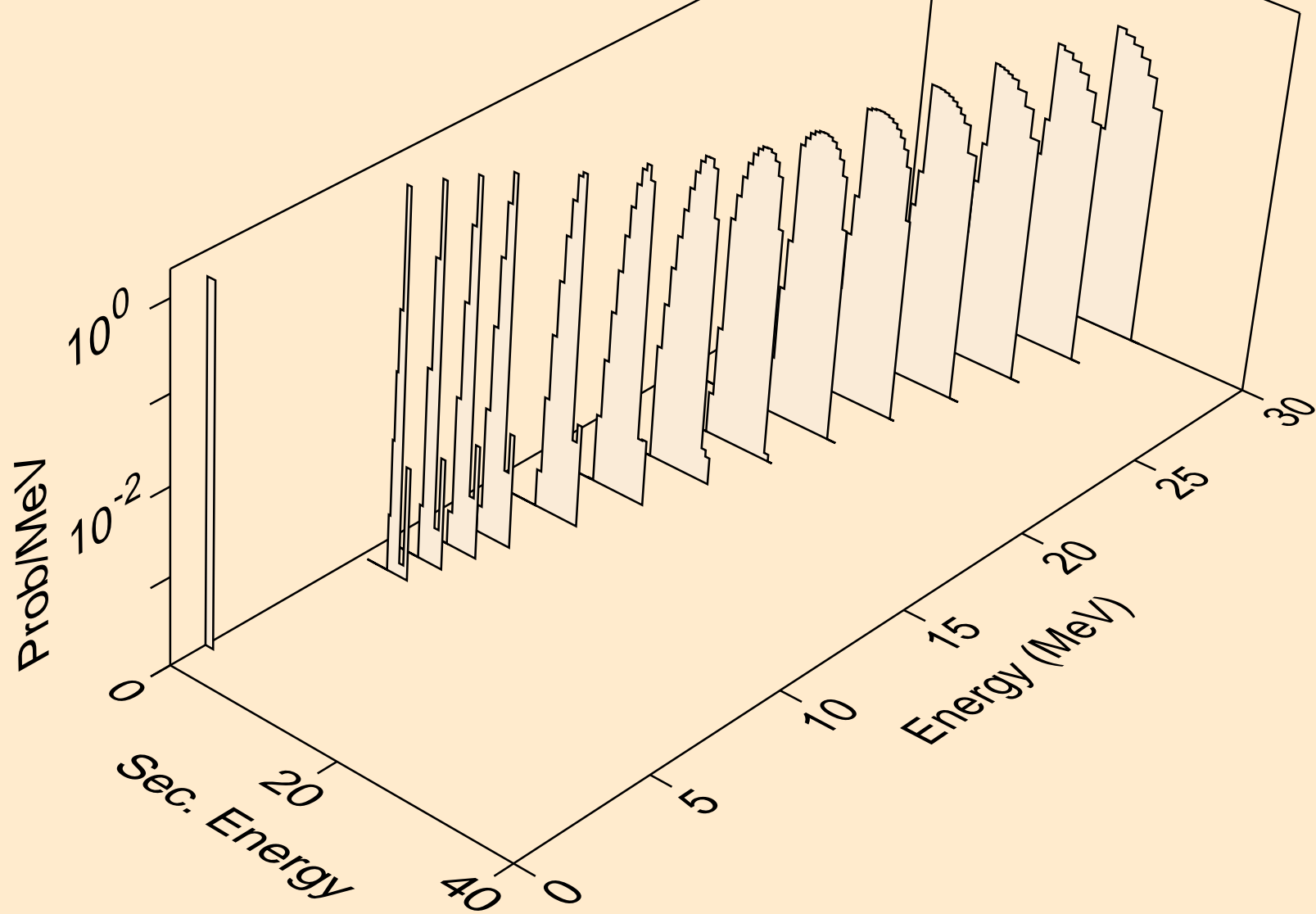

PA241 PROTON ACER TENDL-2021 LIBRARY; T=0.K  
he3s from (p,x)

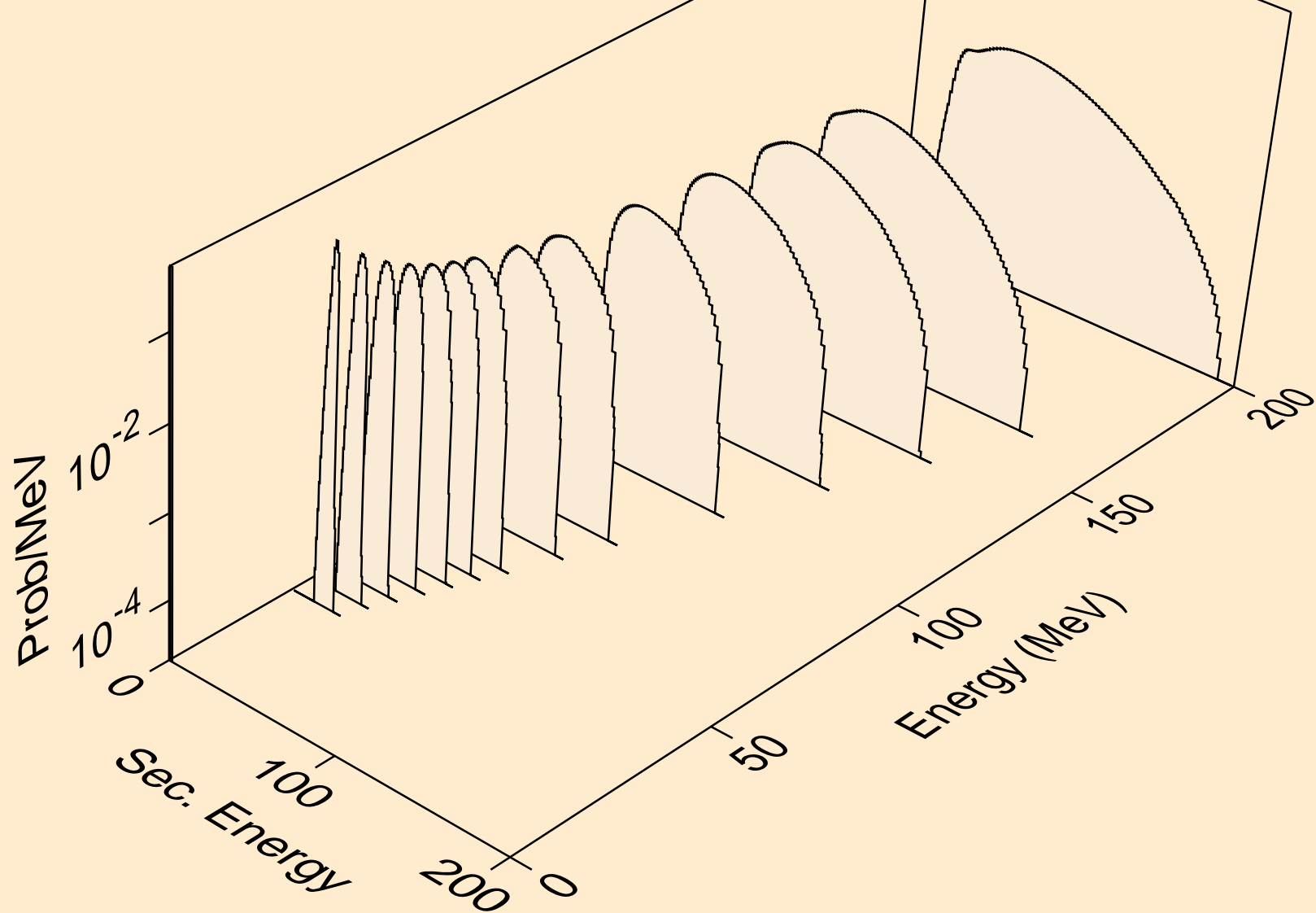

PA241 PROTON ACER TENDL-2021 LIBRARY; T=0.K  
he3s from (p,n\*)he3

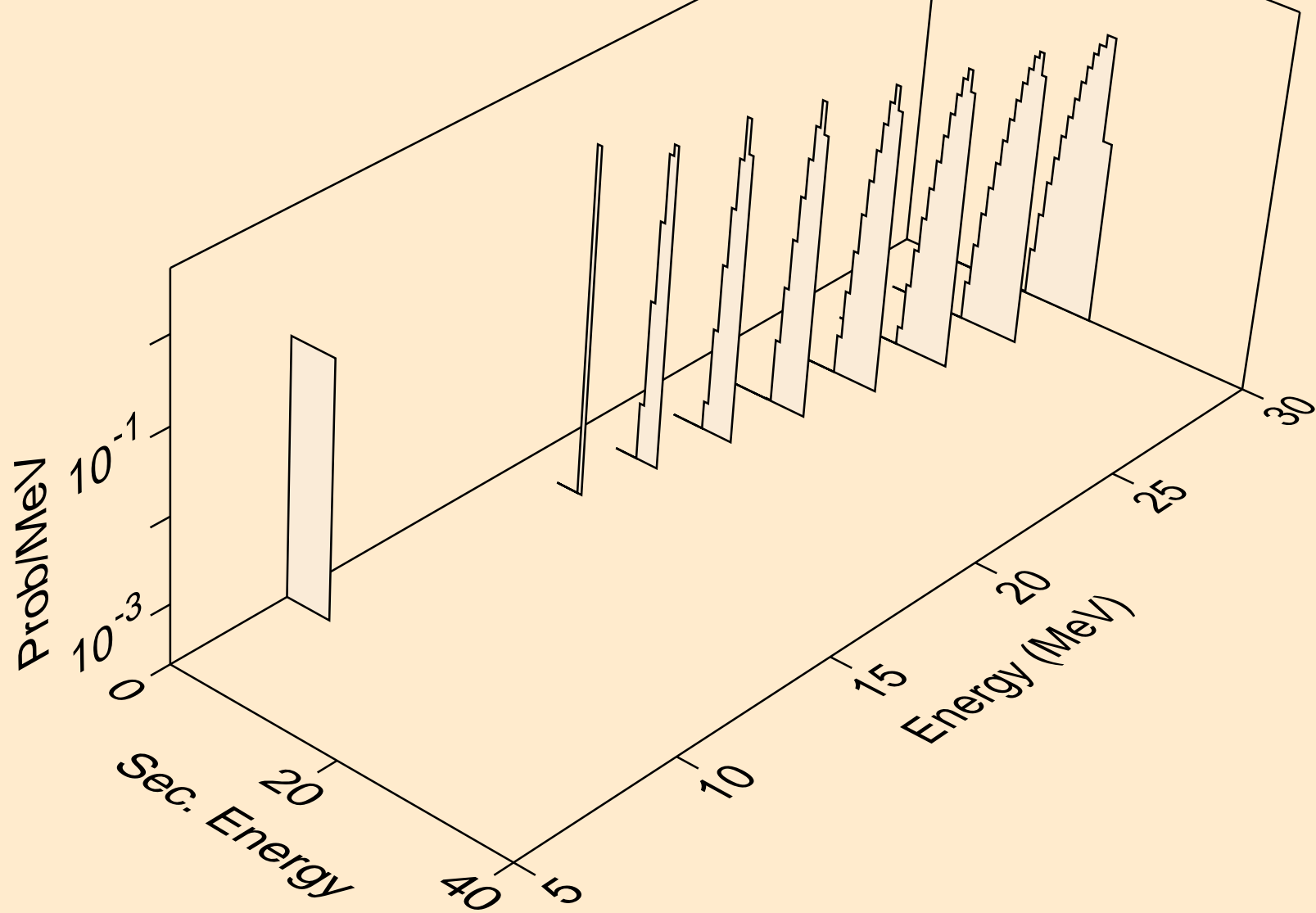

PA241 PROTON ACER TENDL-2021 LIBRARY; T=0.K  
he3s from (p,he3)

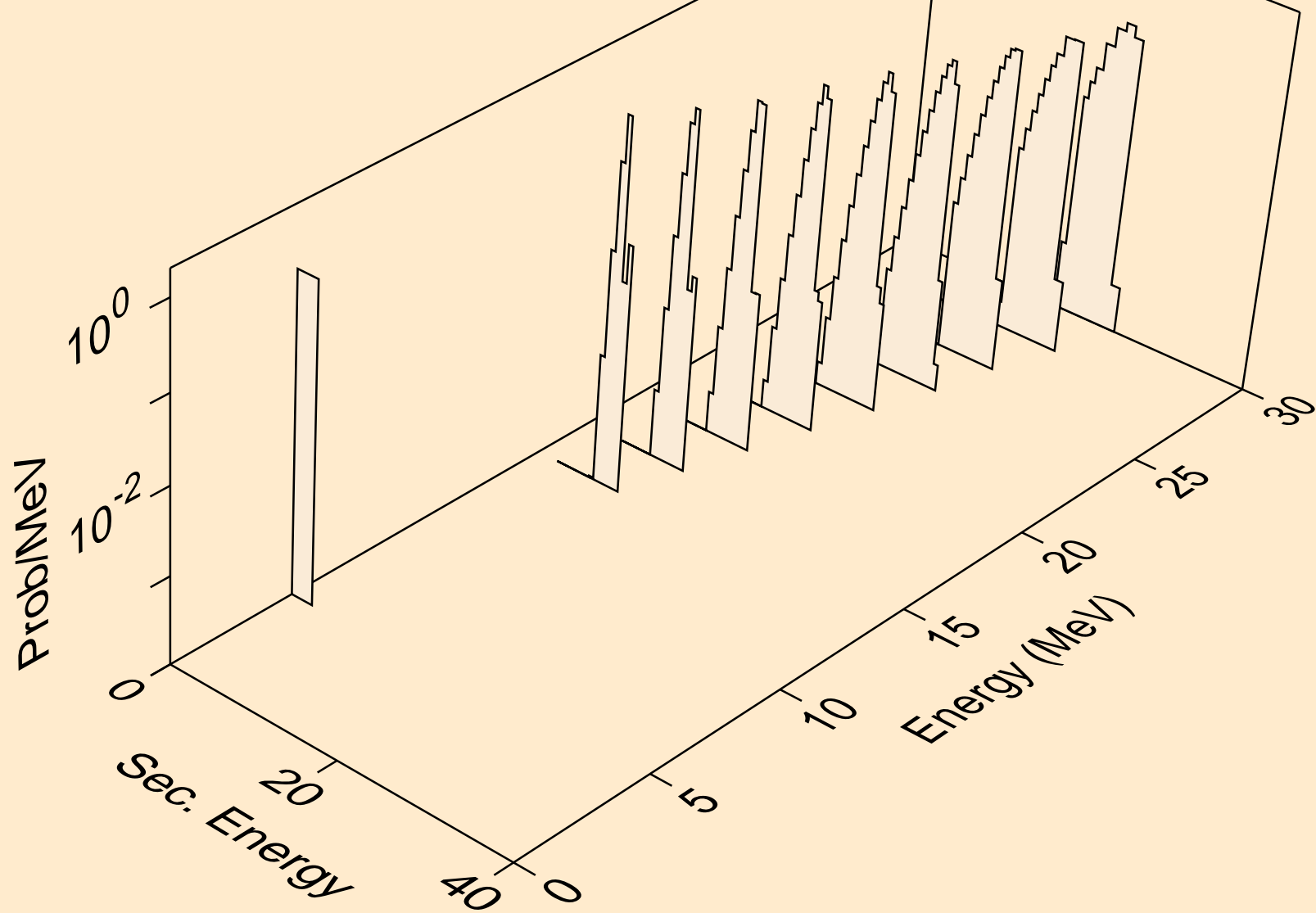

PA241 PROTON ACER TENDL-2021 LIBRARY; T=0.K  
alphas from (p,x)

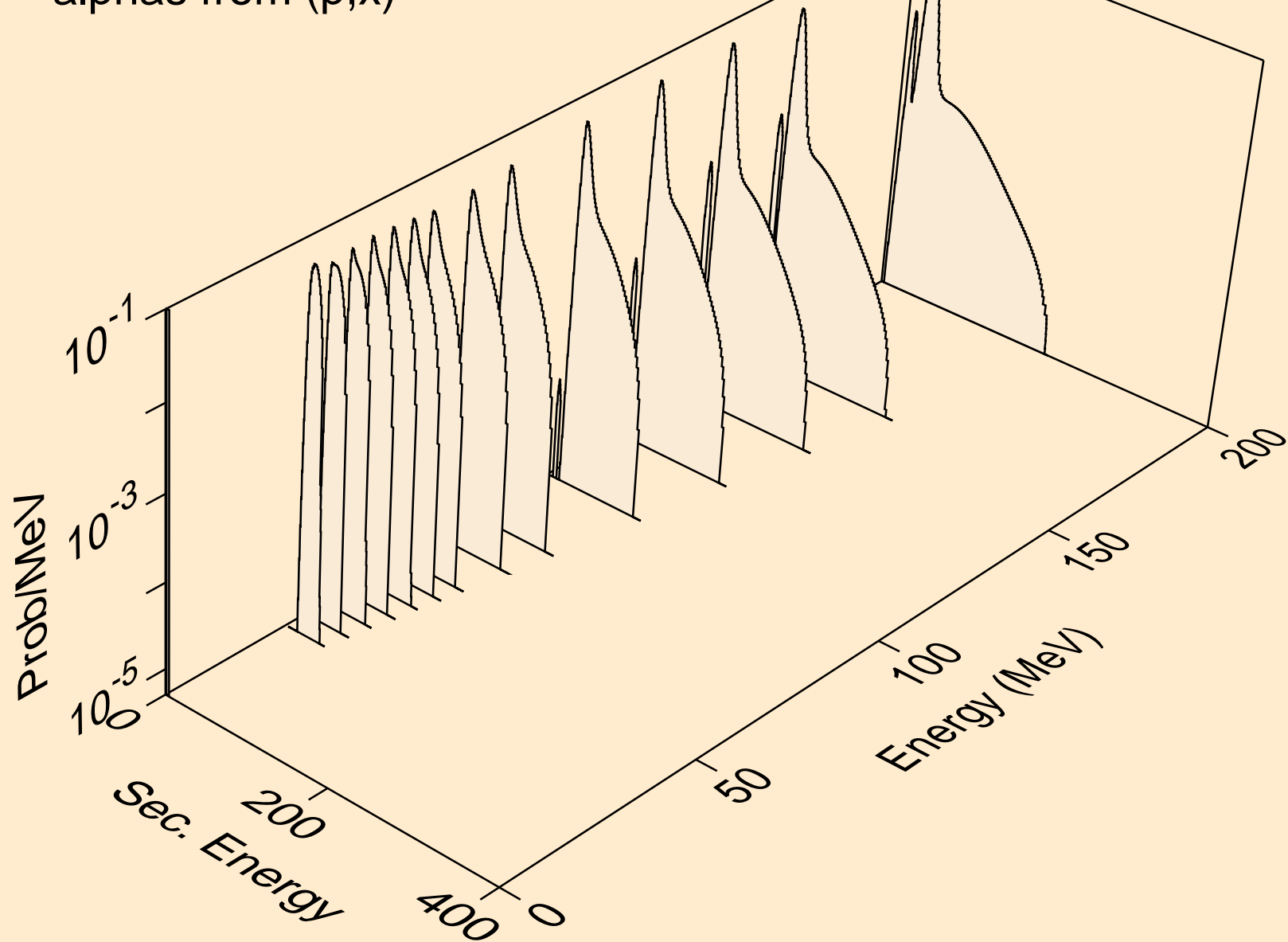

PA241 PROTON ACER TENDL-2021 LIBRARY; T=0.K  
alphas from (p,n\*)a

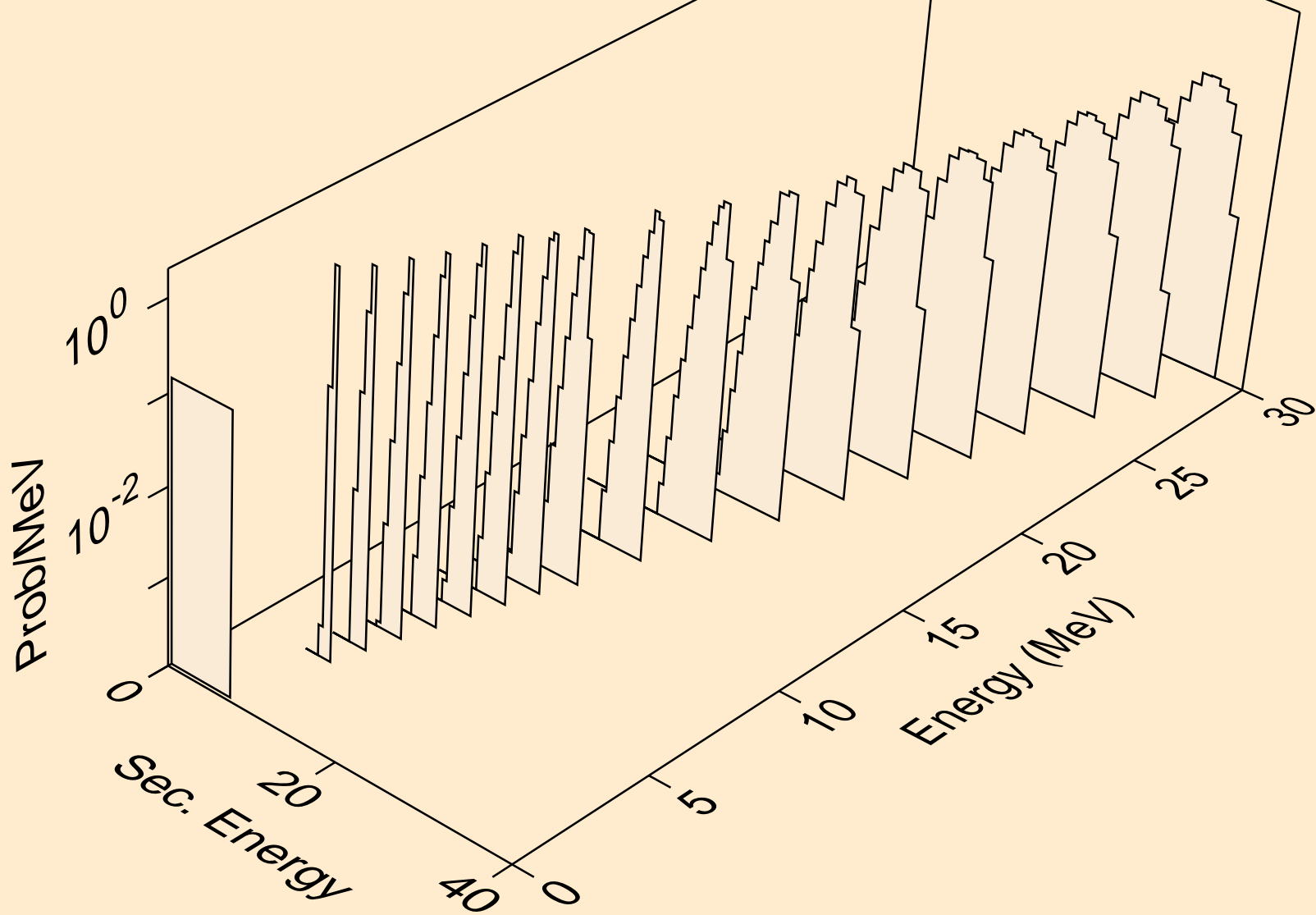

PA241 PROTON ACER TENDL-2021 LIBRARY; T=0.K  
alphas from (p,2n)a

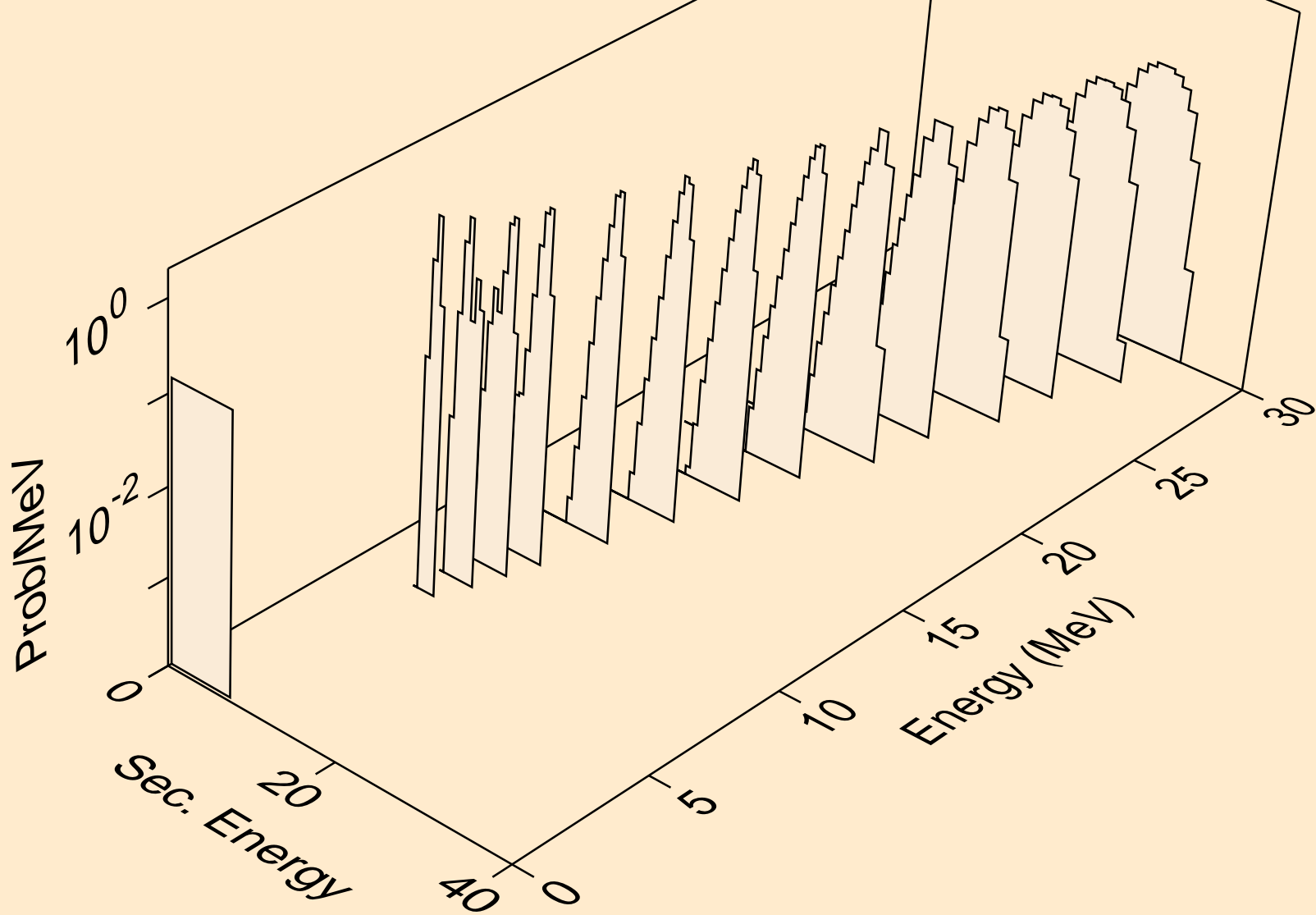



PA241 PROTON ACER TENDL-2021 LIBRARY; T=0.K  
alphas from (p,3n)a

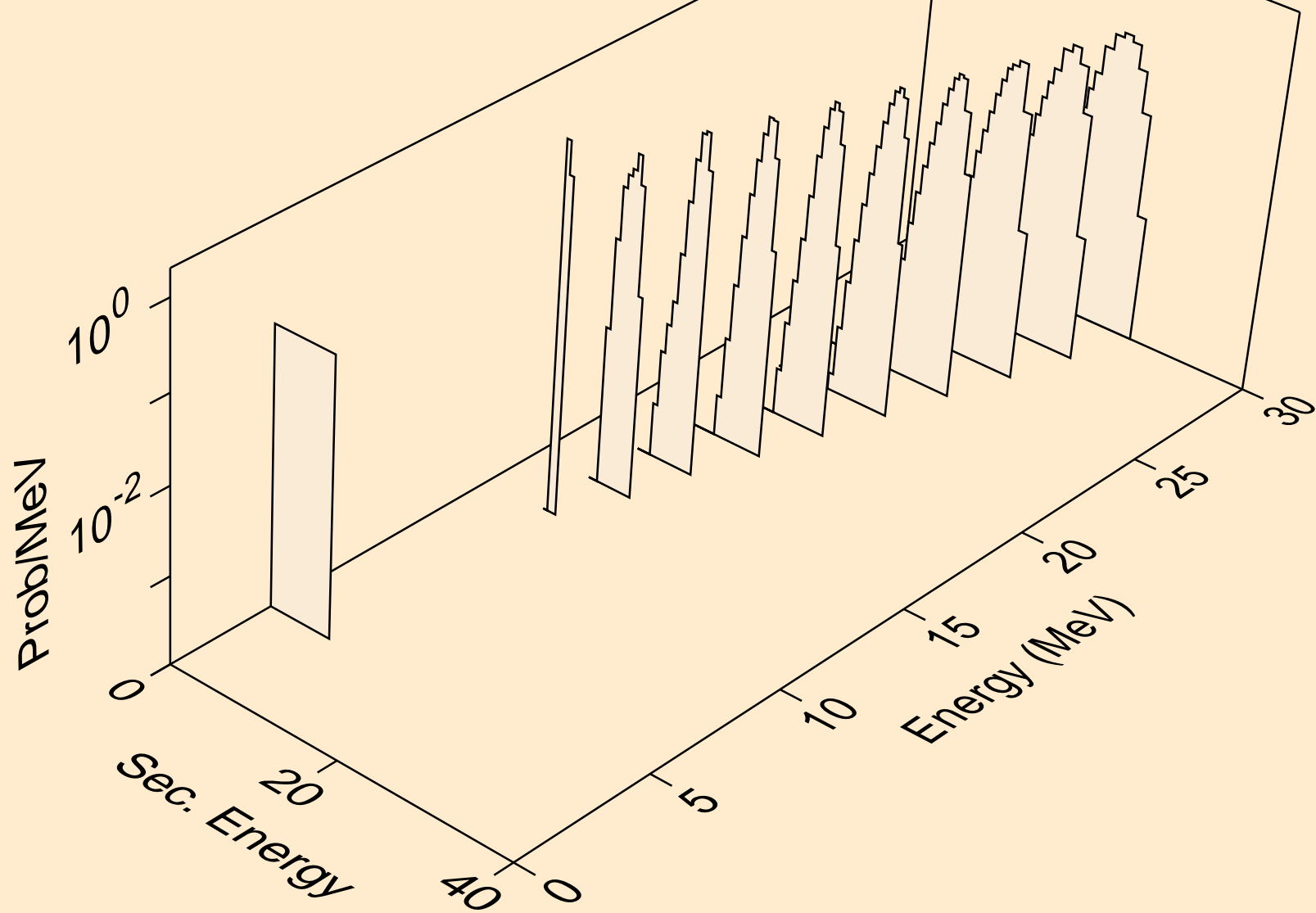

PA241 PROTON ACER TENDL-2021 LIBRARY; T=0.K  
alphas from (p,a)

