

PD117 PROTON ACER TENDL-2021 LIBRARY; T=0.K  
Principal cross sections

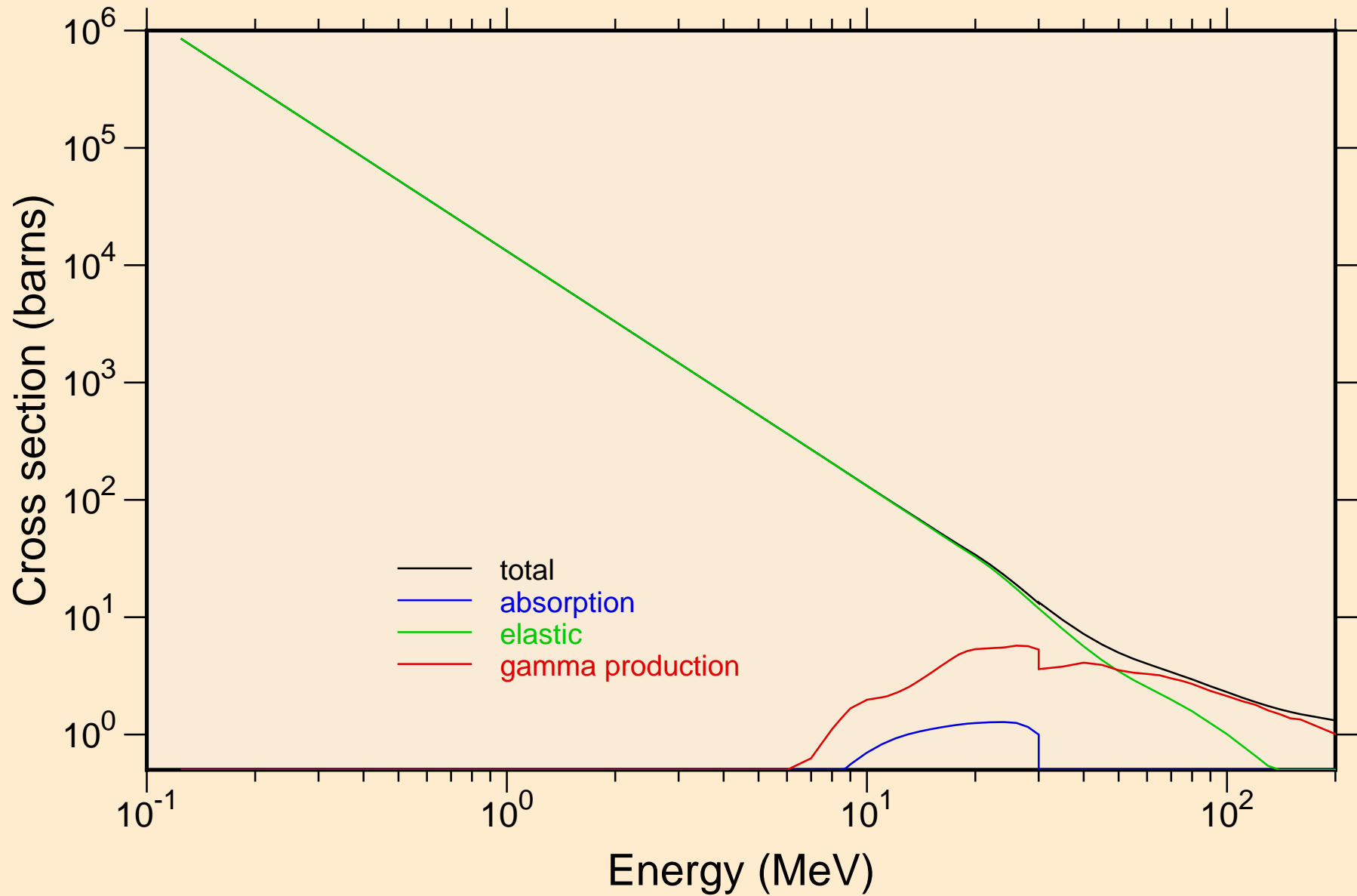

# PD117 PROTON ACER TENDL-2021 LIBRARY; T=0.K

## Heating

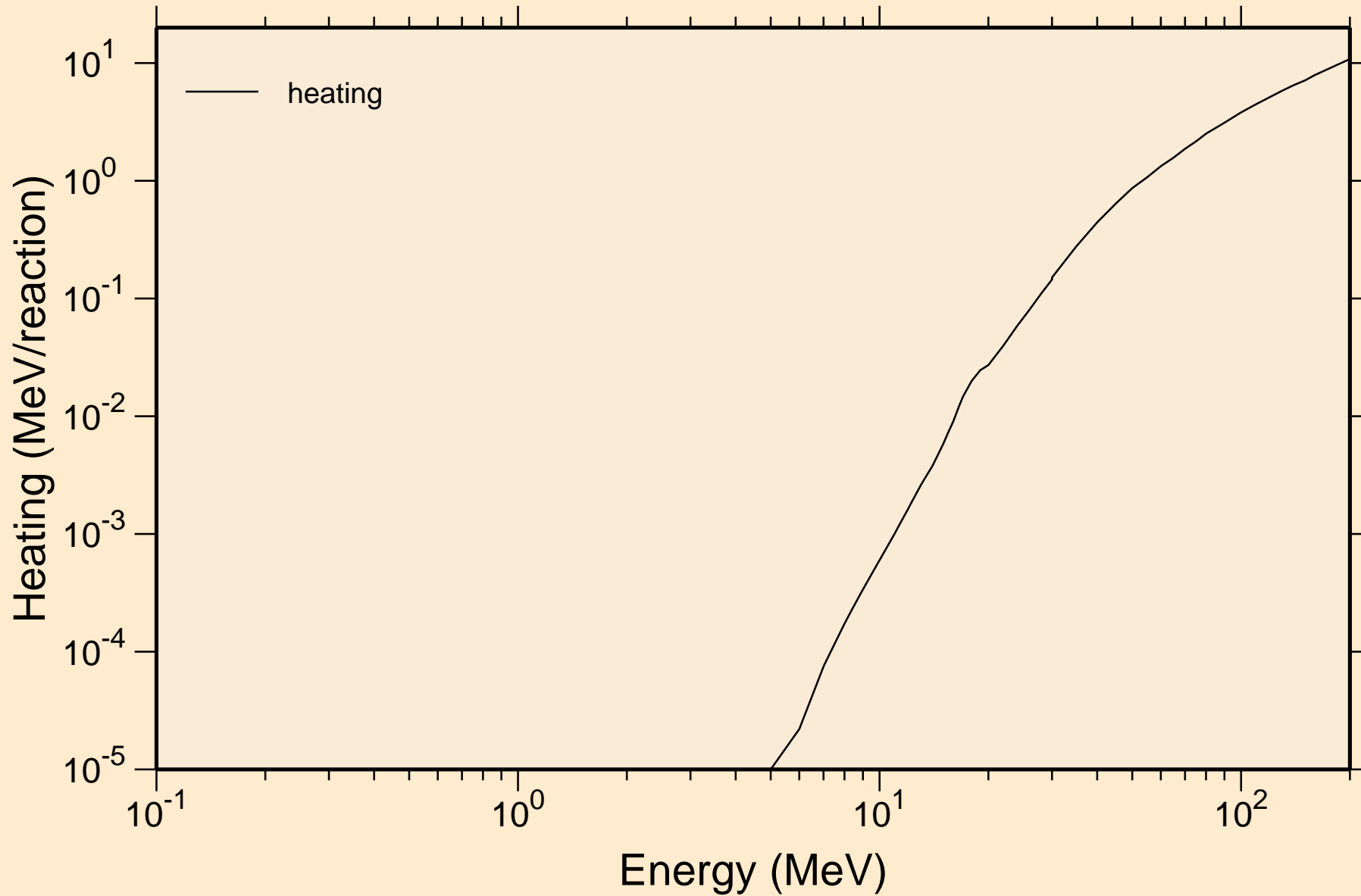

# PD117 PROTON ACER TENDL-2021 LIBRARY; T=0.K

## Principal cross sections

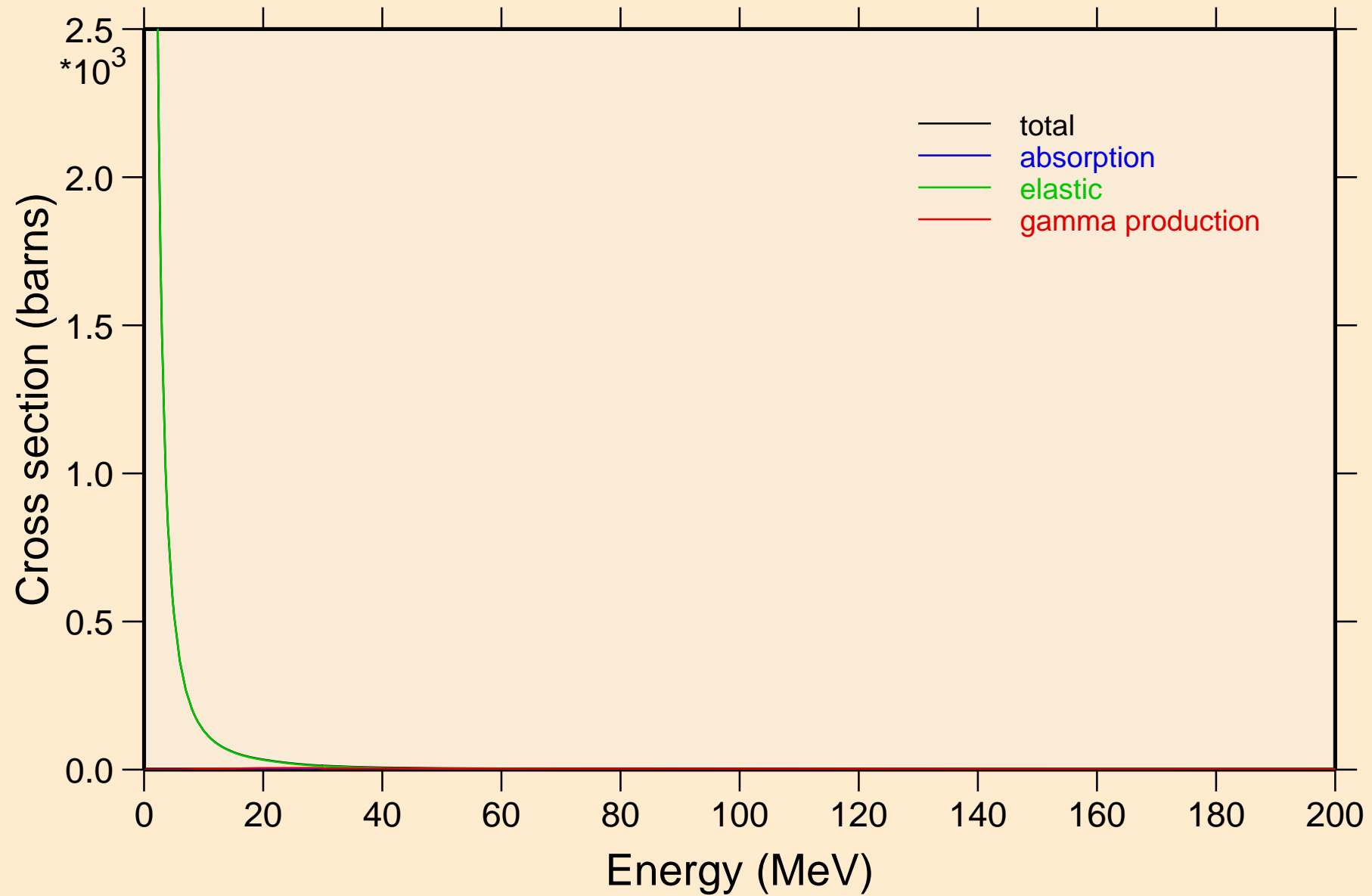

PD117 PROTON ACER TENDL-2021 LIBRARY; T=0.K

Heating

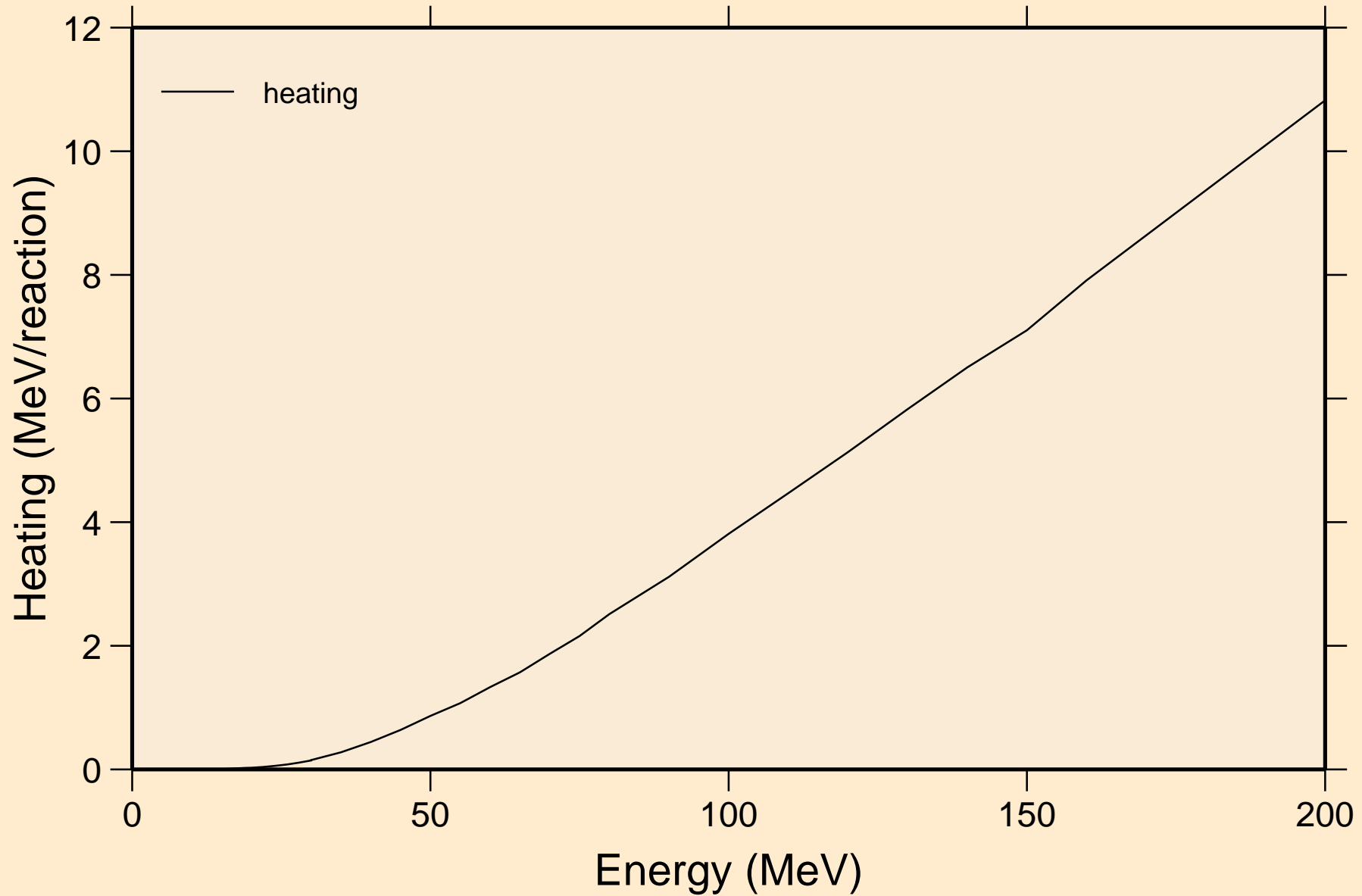

PD117 PROTON ACER TENDL-2021 LIBRARY; T=0.K  
Threshold reactions

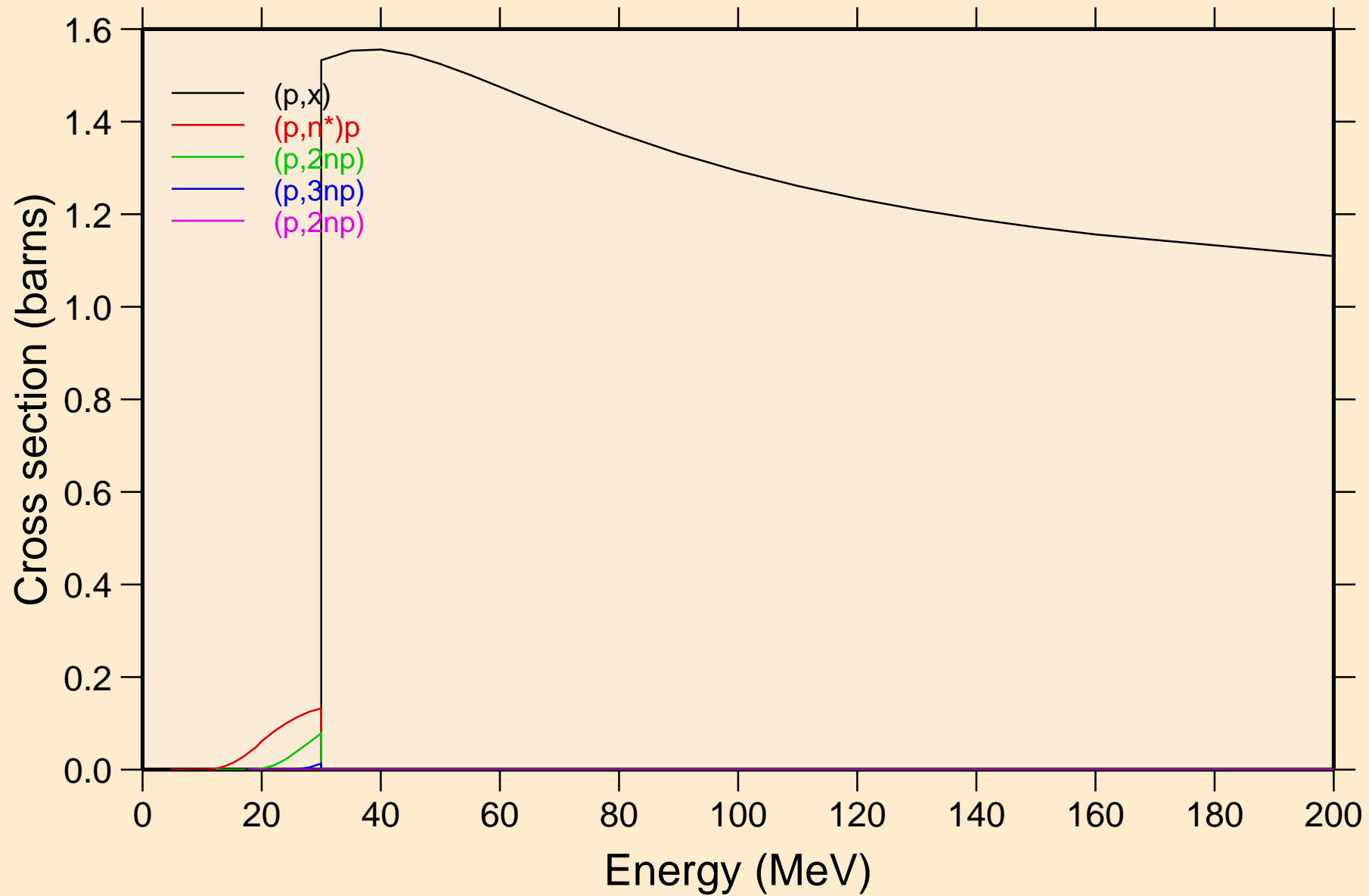

PD117 PROTON ACER TENDL-2021 LIBRARY; T=0.K  
Threshold reactions

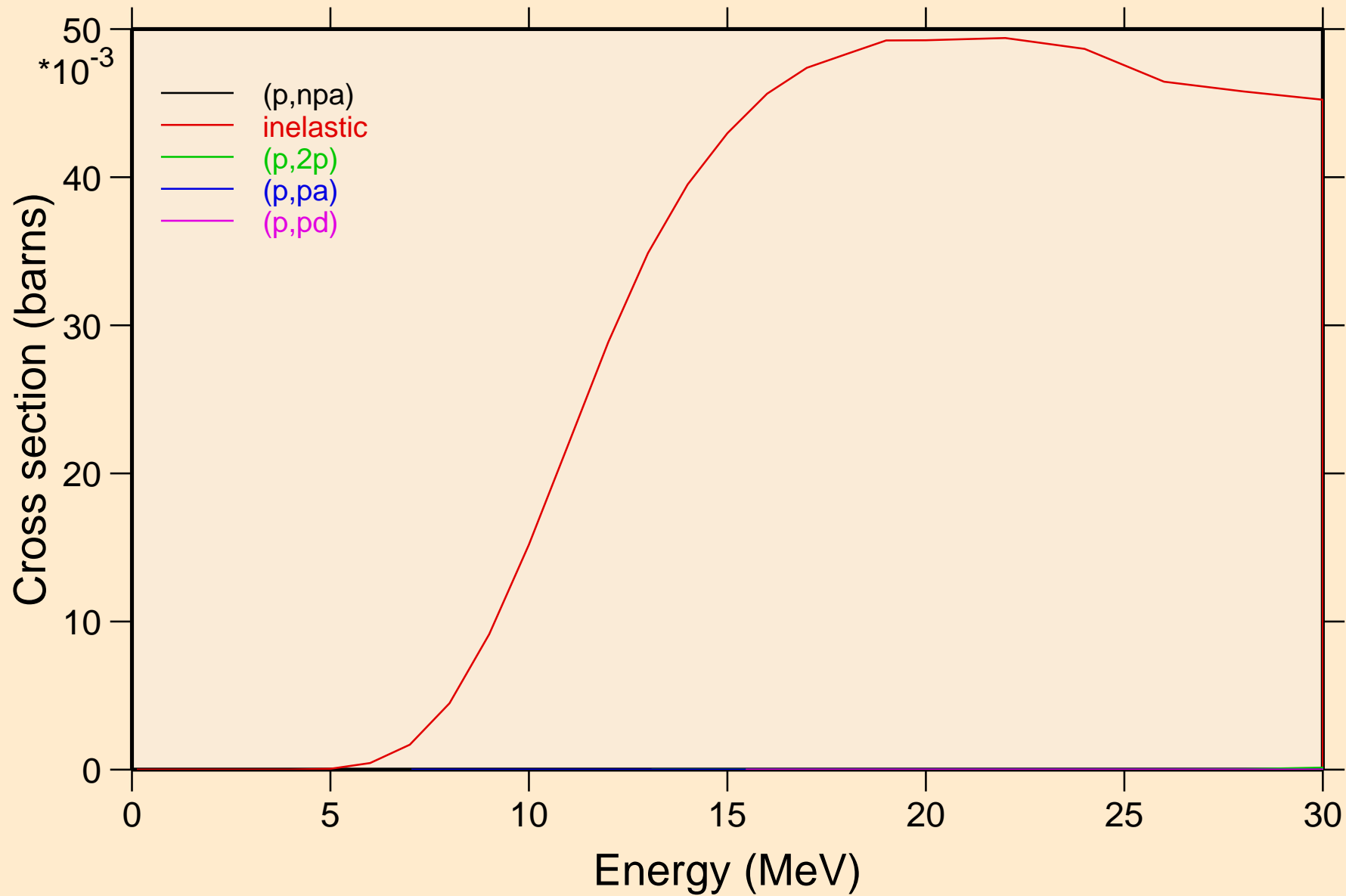

PD117 PROTON ACER TENDL-2021 LIBRARY; T=0.K  
angular distribution for elastic

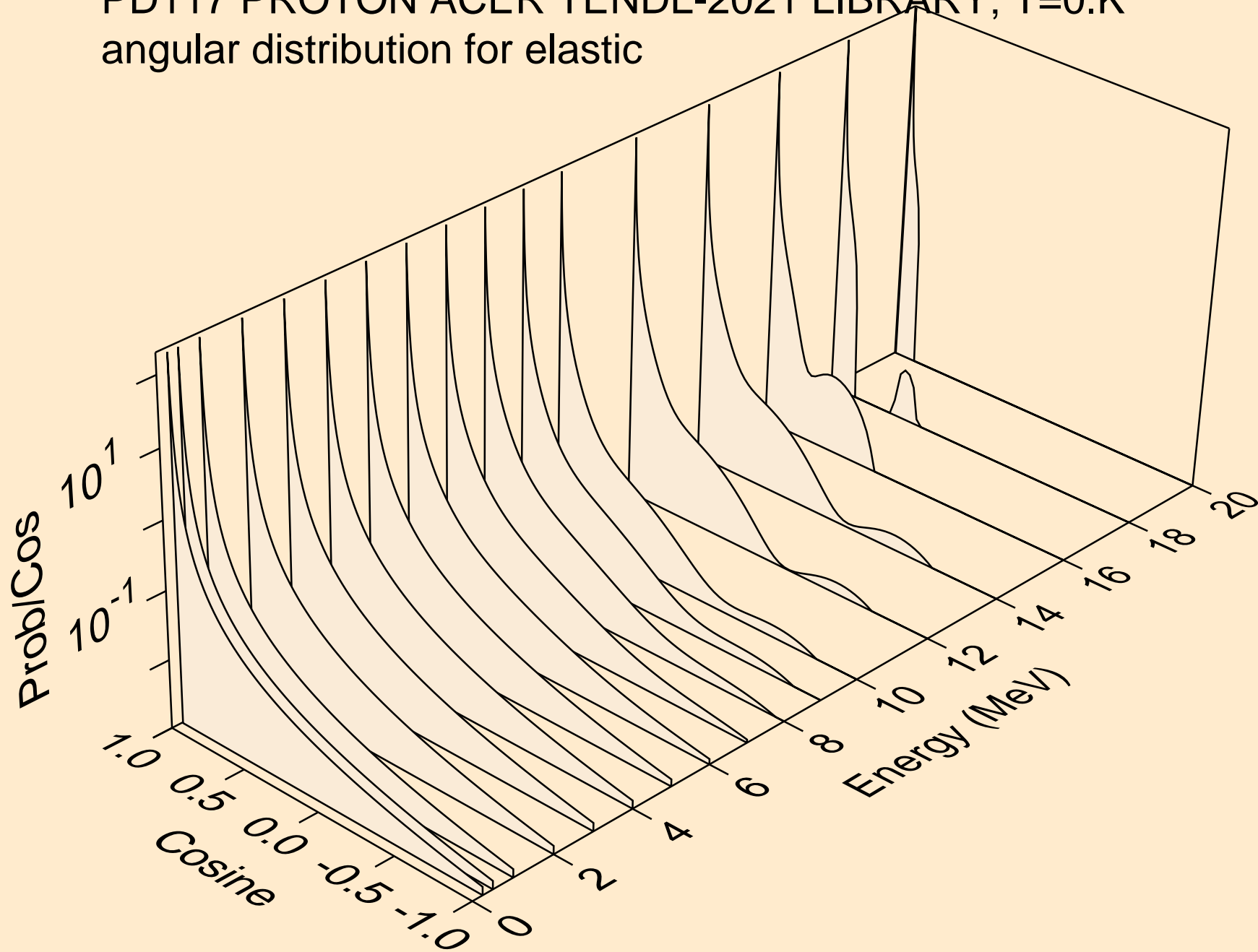

PD117 PROTON ACER TENDL-2021 LIBRARY; T=0.K  
angular distribution for elastic

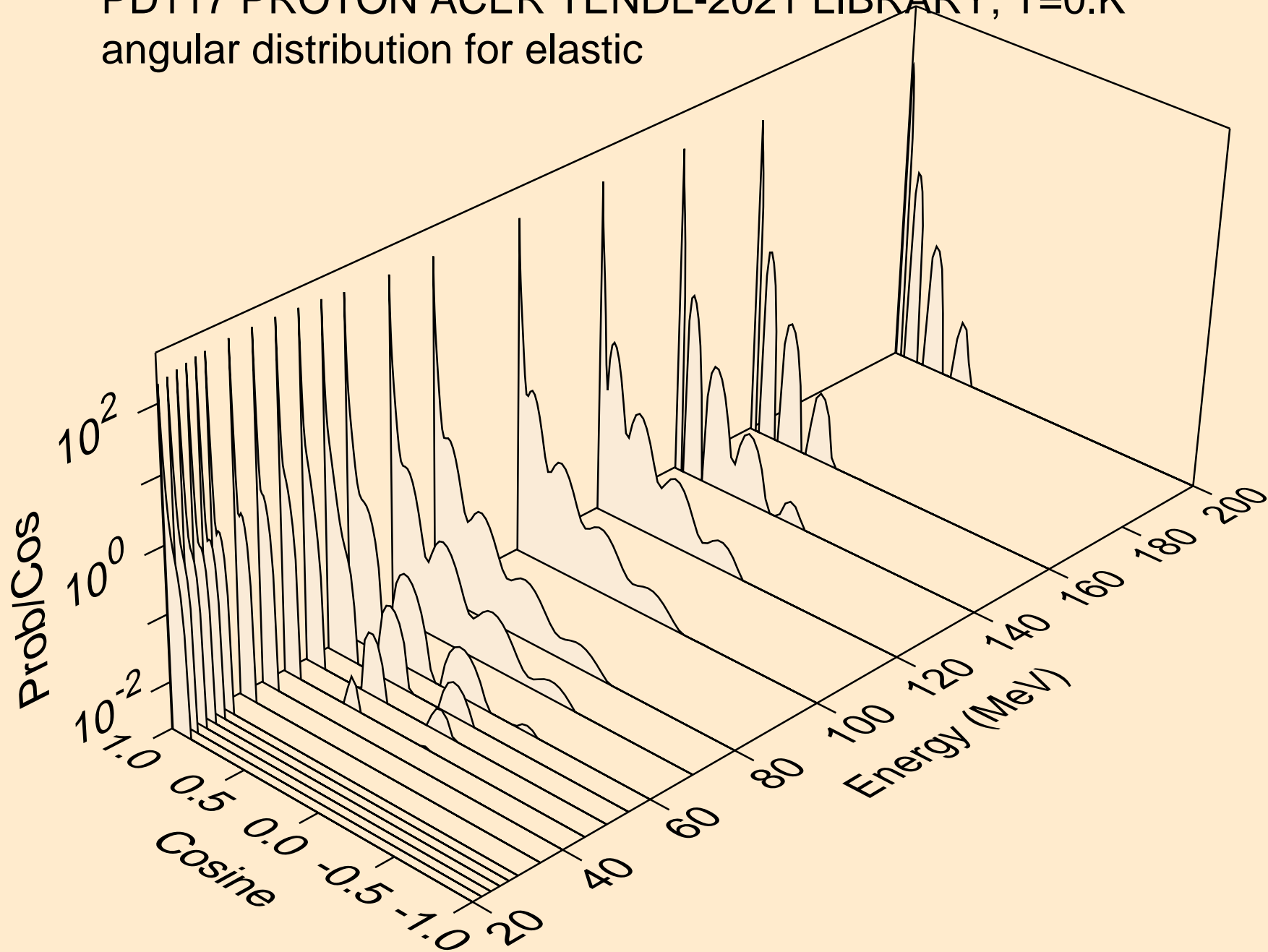



PD117 PROTON ACER TENDL-2021 LIBRARY; T=0.K  
Proton emission for (p,x)

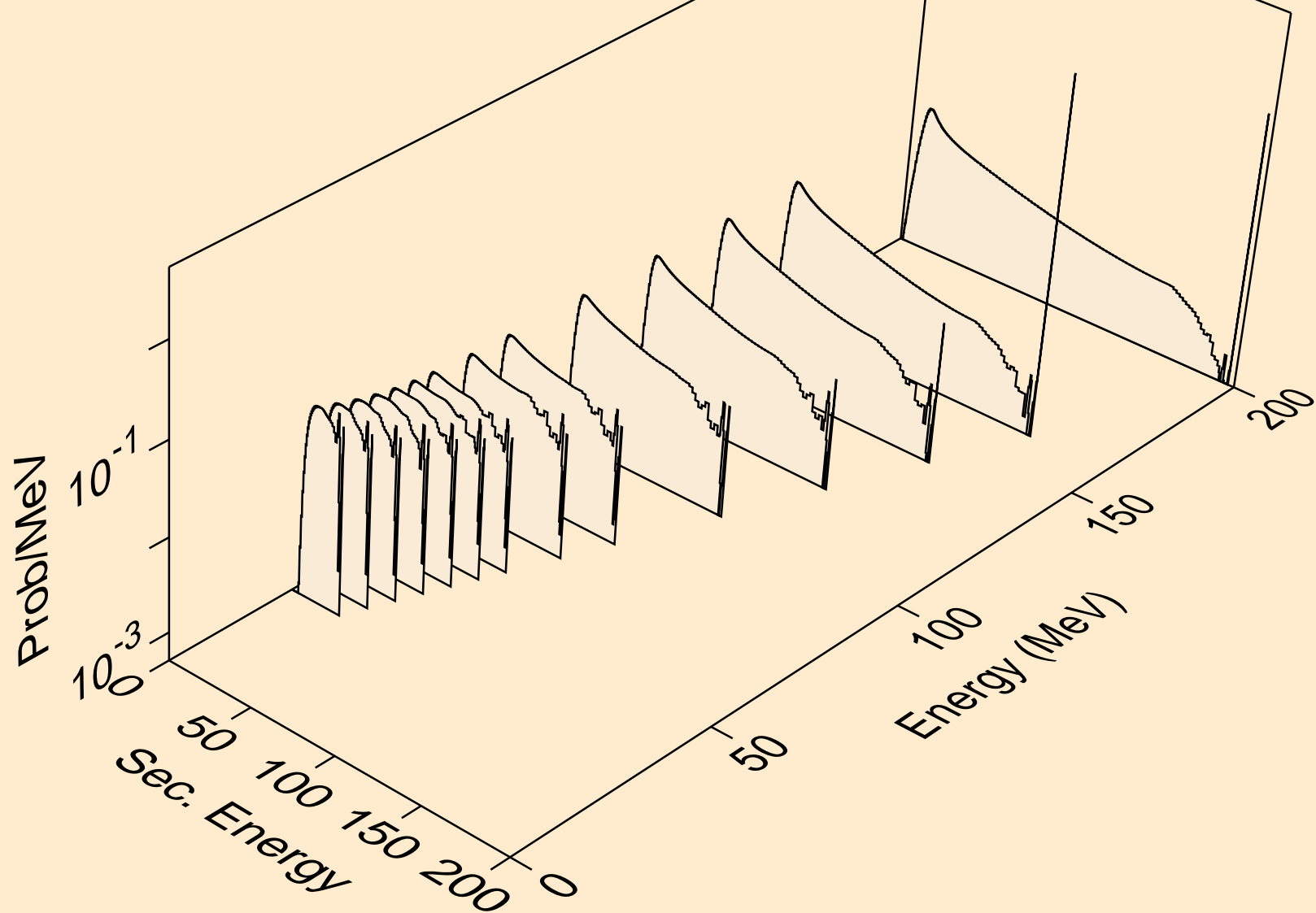

PD117 PROTON ACER TENDL-2021 LIBRARY; T=0.K  
Proton emission for (p,n\*)p

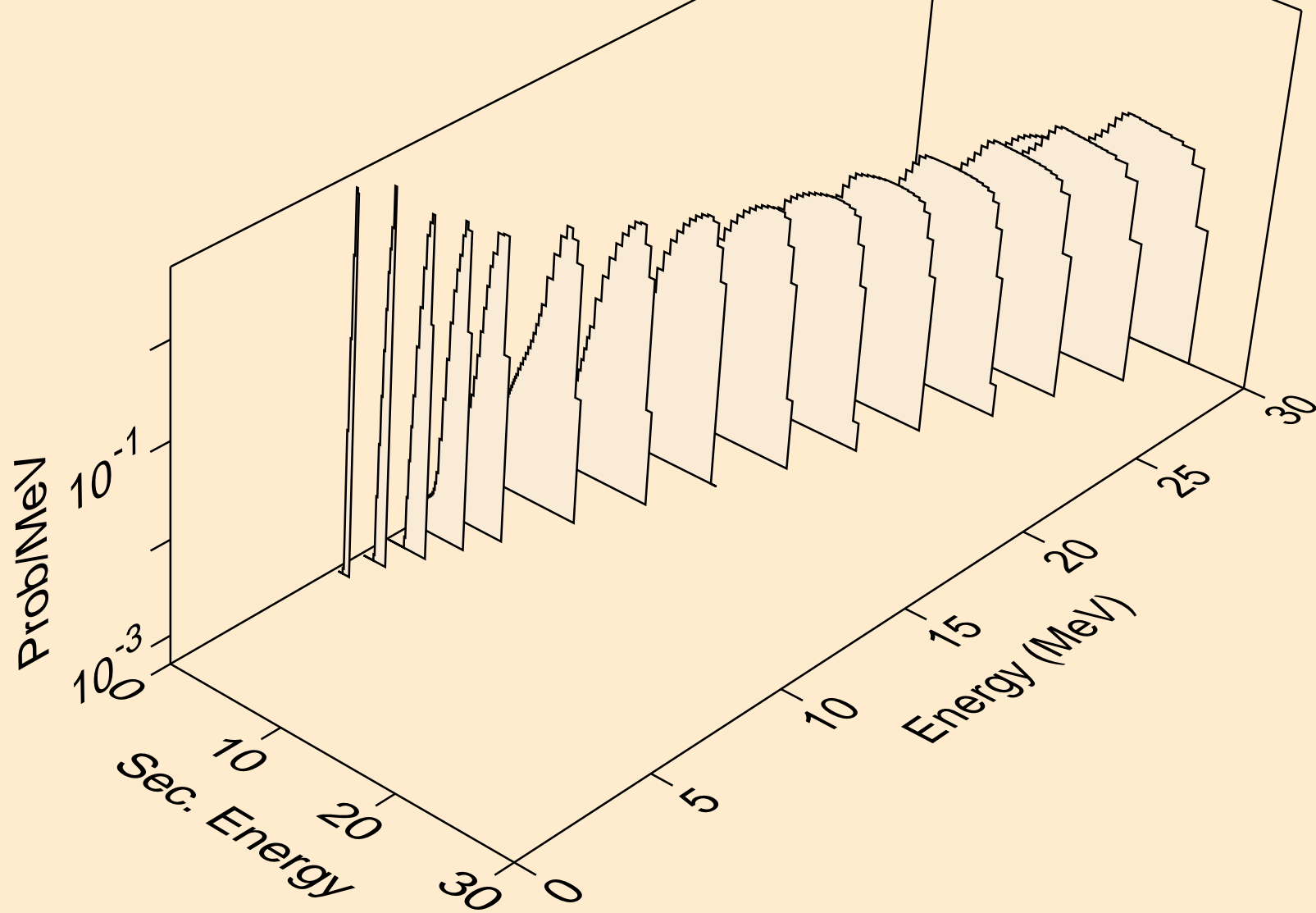

PD117 PROTON ACER TENDL-2021 LIBRARY; T=0.K  
Proton emission for (p,2np)

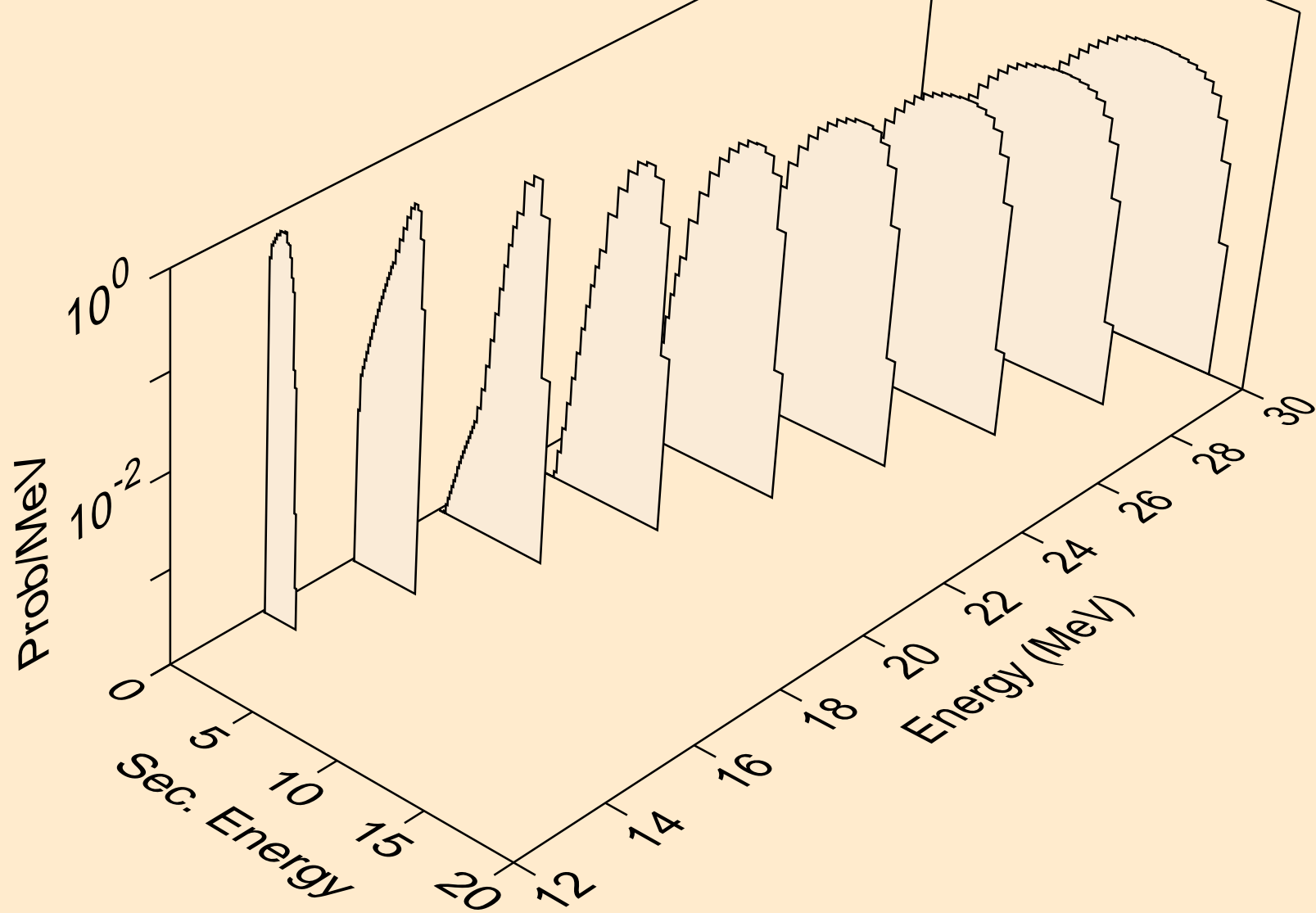

PD117 PROTON ACER TENDL-2021 LIBRARY; T=0.K  
Proton emission for (p,3np)

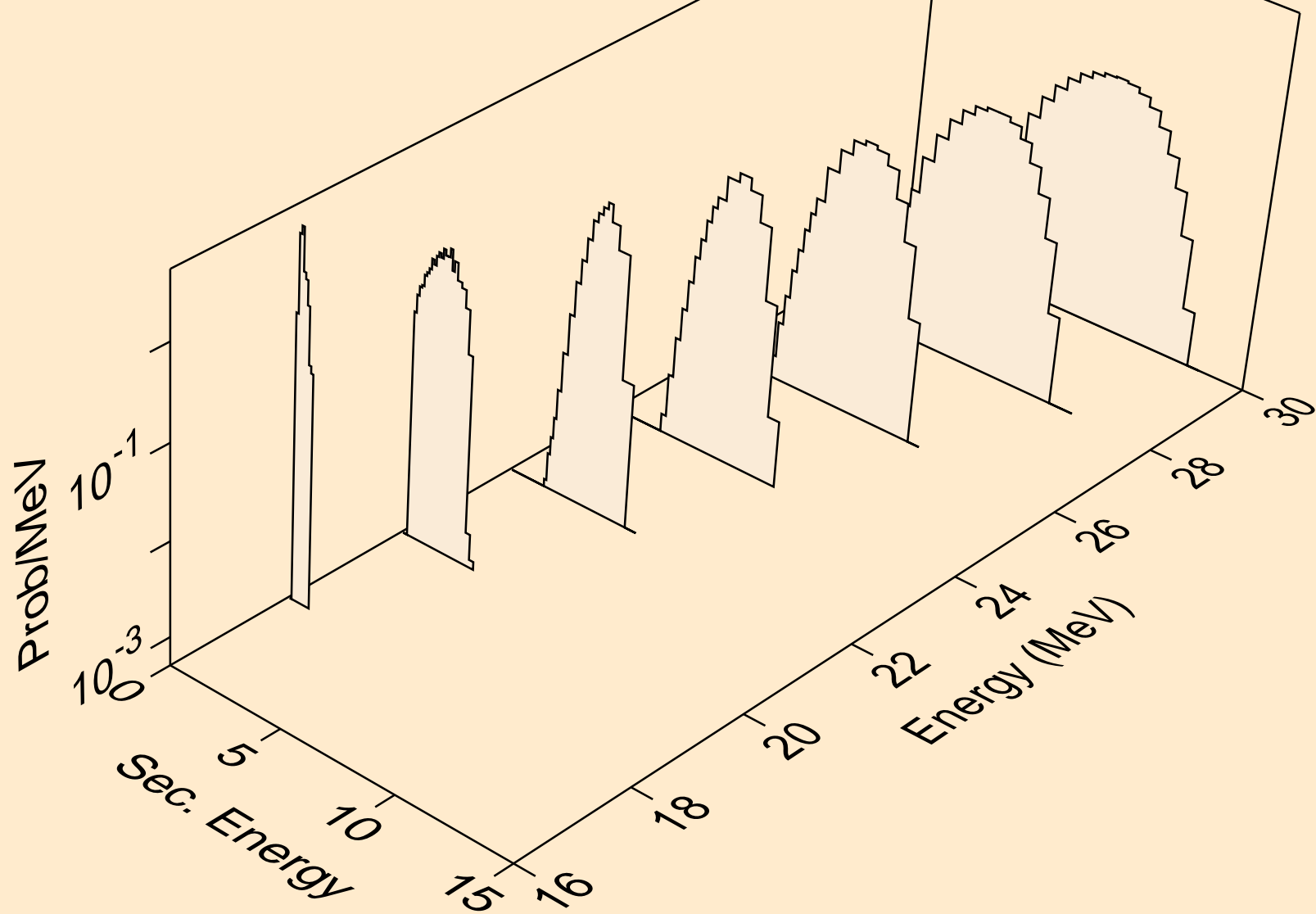

PD117 PROTON ACER TENDL-2021 LIBRARY; T=0.K  
Proton emission for (p,2np)

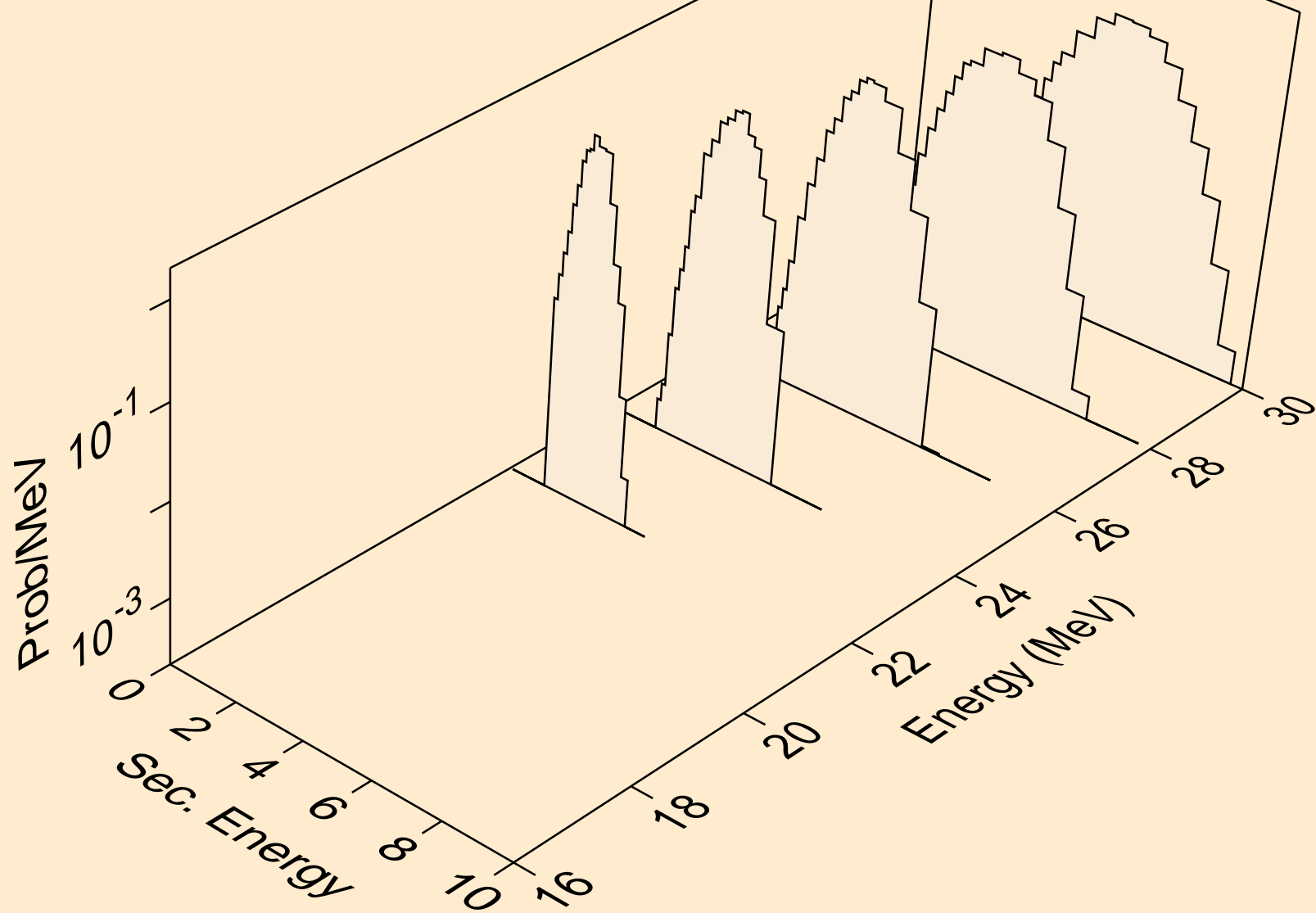

PD117 PROTON ACER TENDL-2021 LIBRARY; T=0.K  
Proton emission for (p,npa)

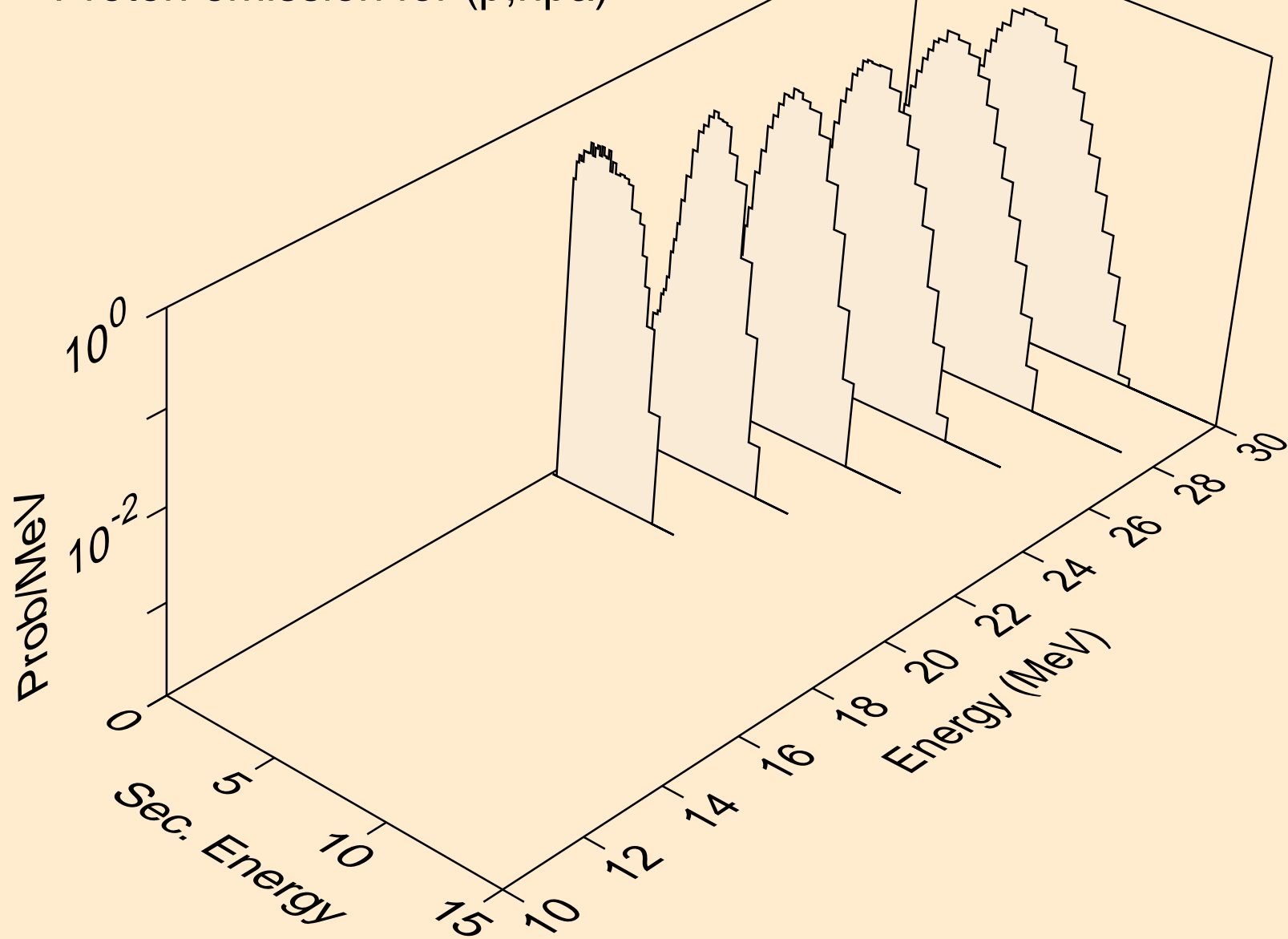

PD117 PROTON ACER TENDL-2021 LIBRARY; T=0.K  
Proton emission for inelastic

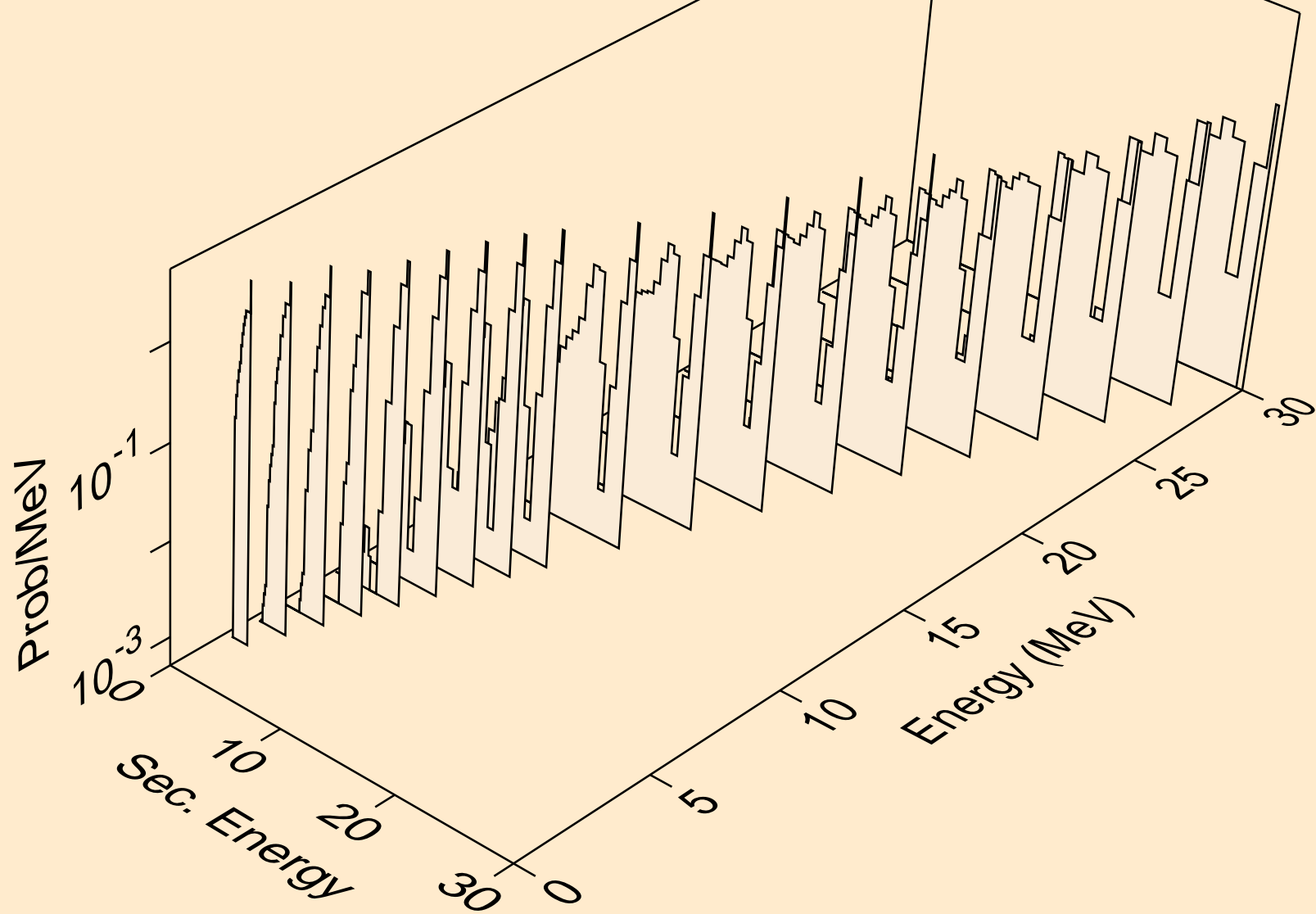

PD117 PROTON ACER TENDL-2021 LIBRARY; T=0.K  
Proton emission for (p,2p)

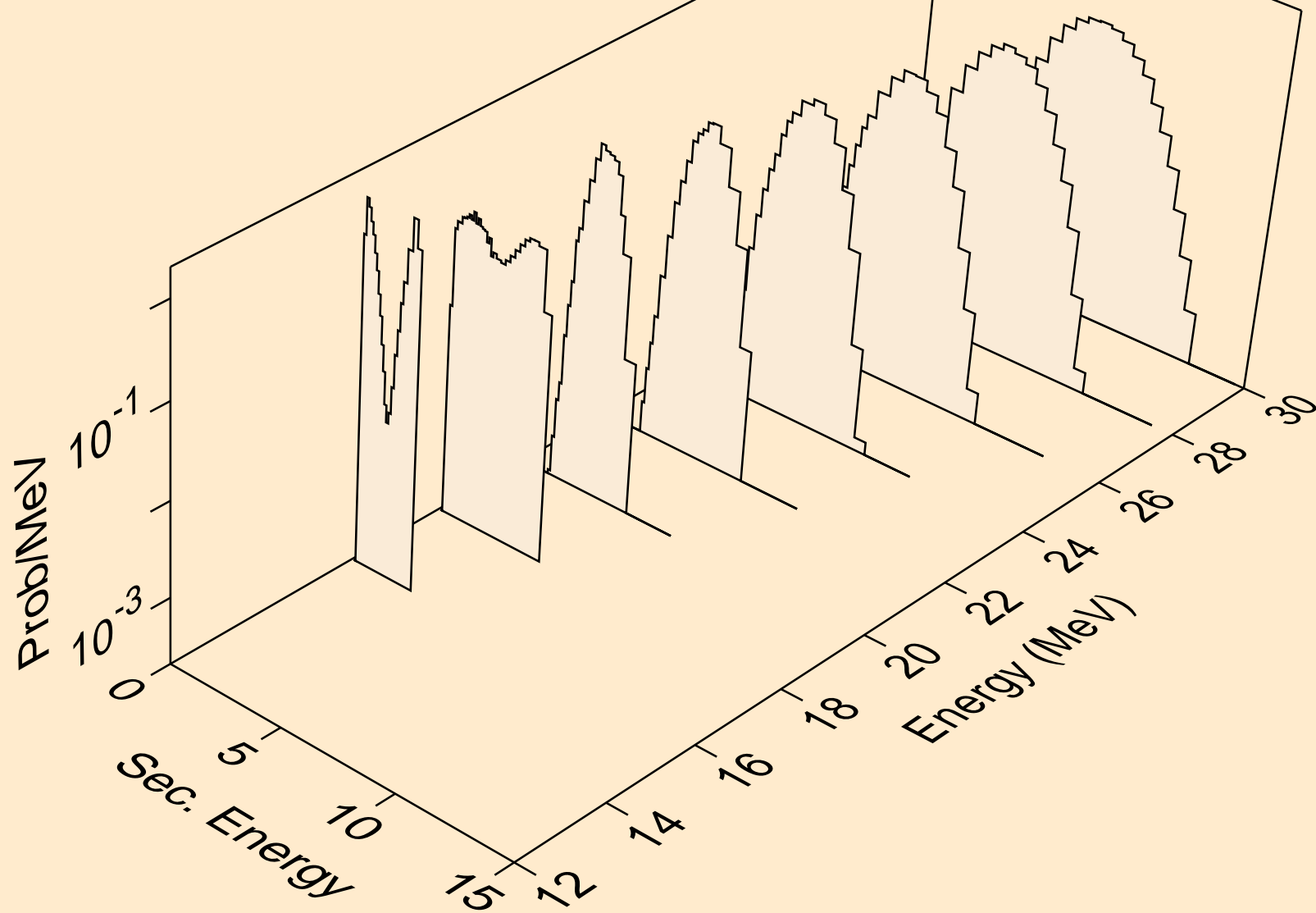



PD117 PROTON ACER TENDL-2021 LIBRARY; T=0.K  
Proton emission for (p,pa)

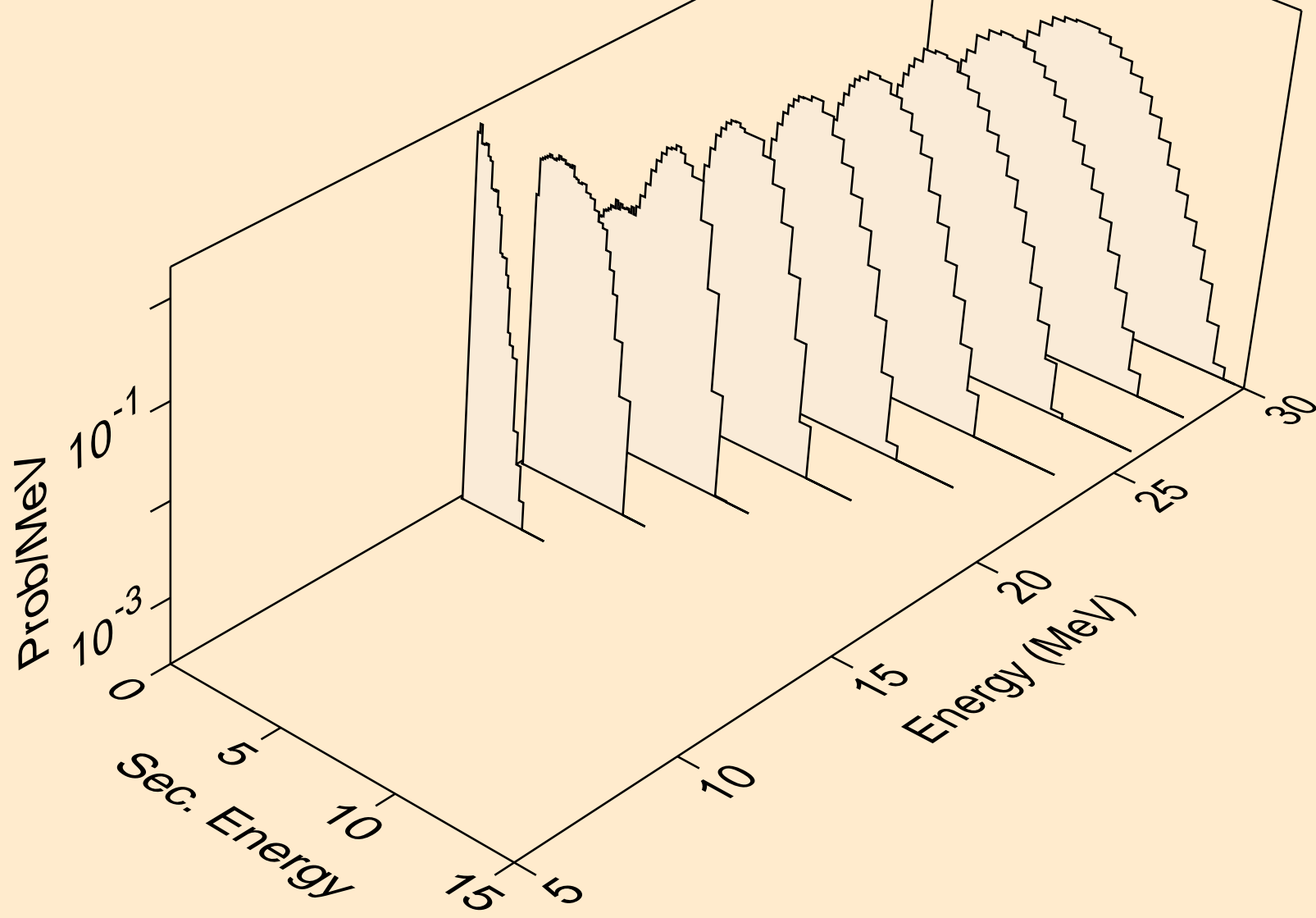

PD117 PROTON ACER TENDL-2021 LIBRARY; T=0.K  
Proton emission for (p,pd)

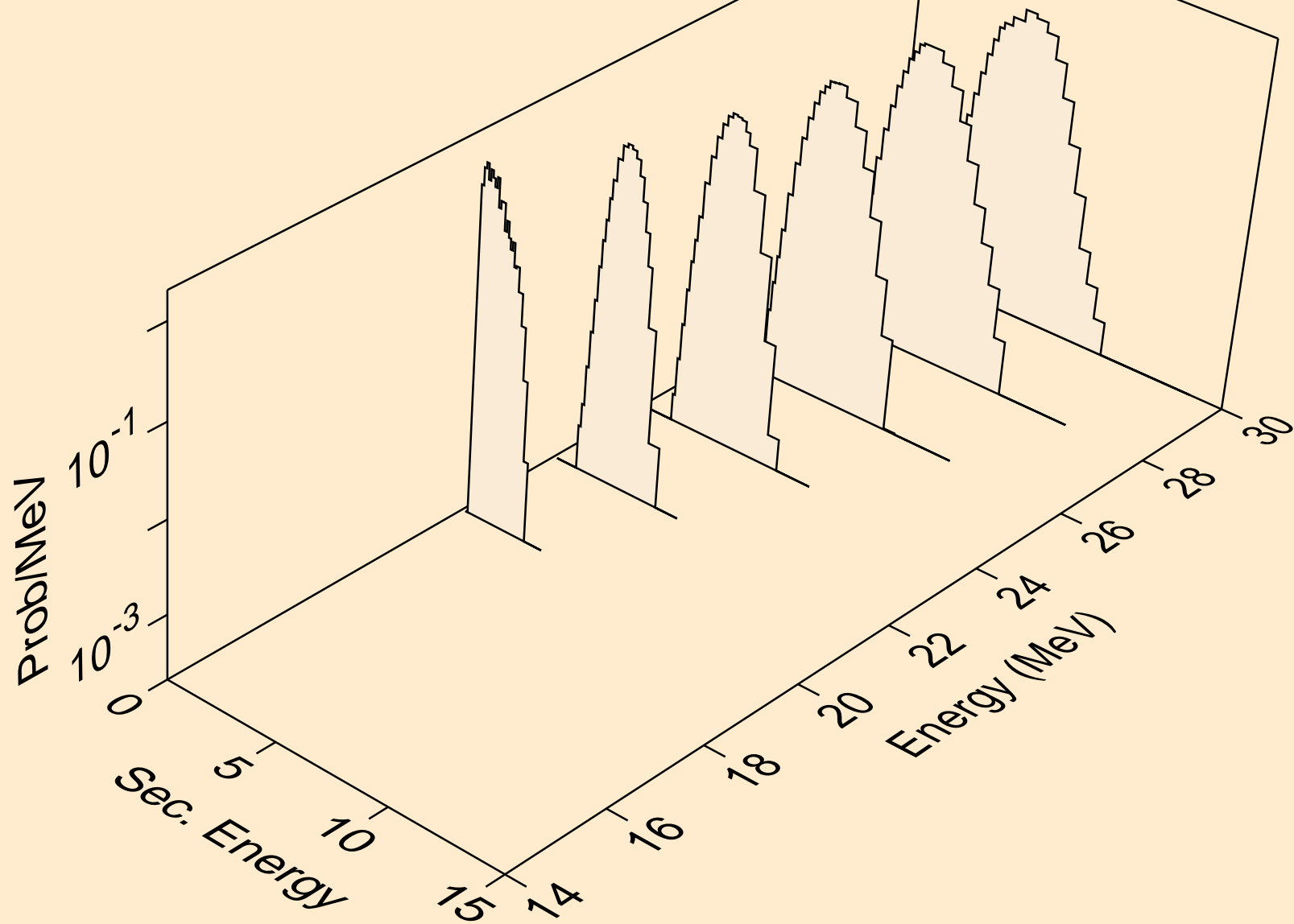

PD117 PROTON ACER TENDL-2021 LIBRARY; T=0.K  
Photon emission for (z,n)

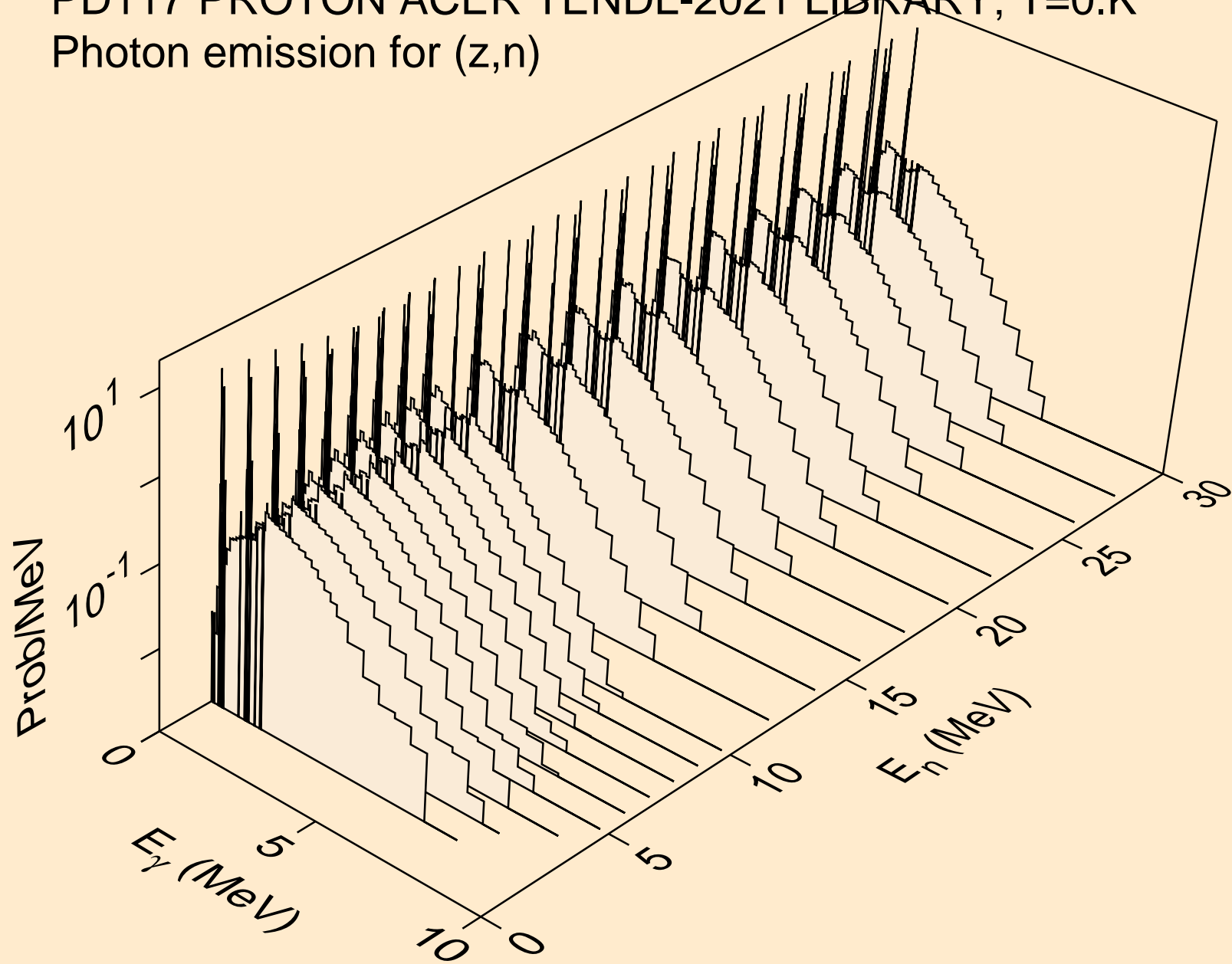

PD117 PROTON ACER TENDL-2021 LIBRARY; T=0.K  
Photon emission for (n,x)

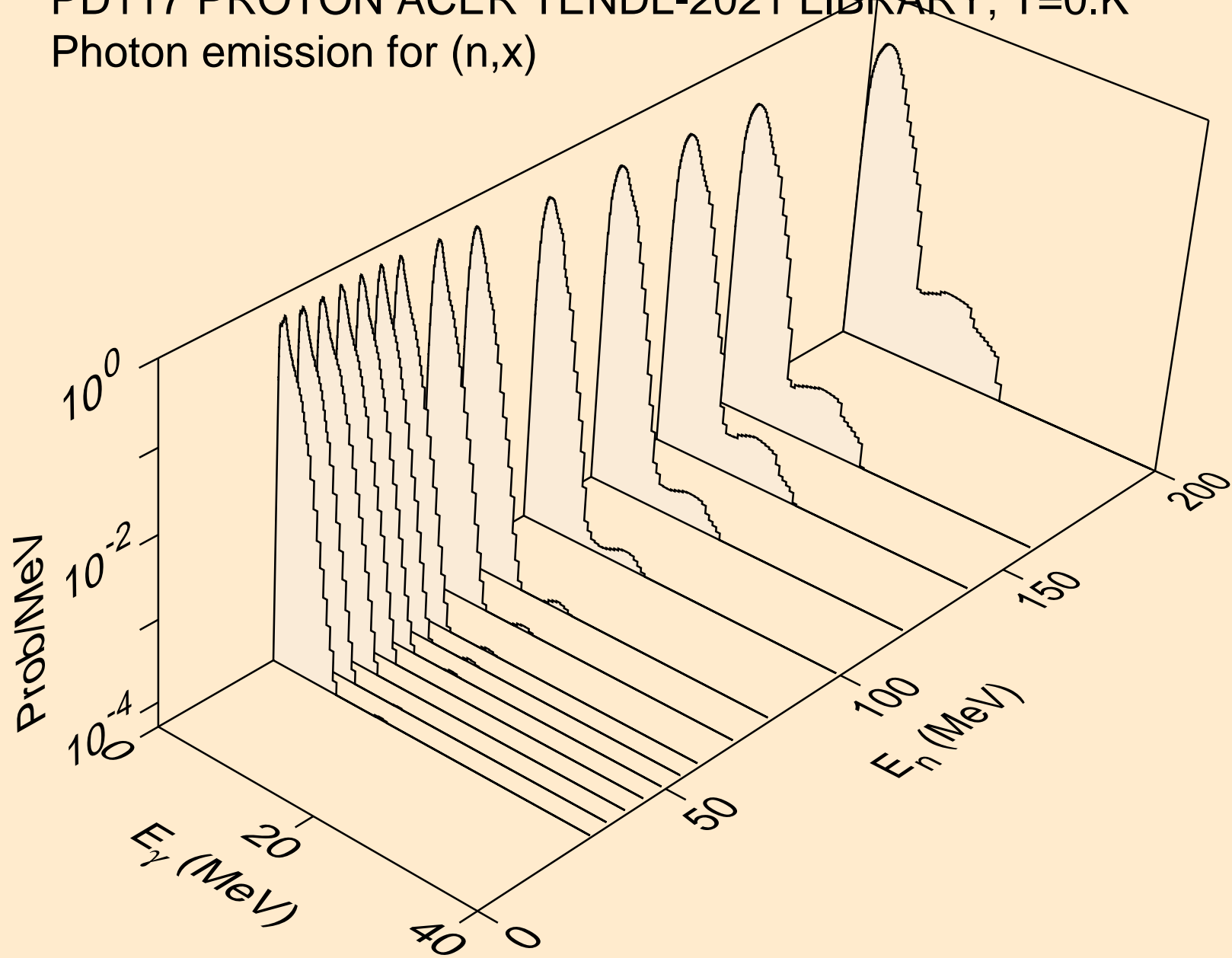

PD117 PROTON ACER TENDL-2021 LIBRARY; T=0.K  
Photon emission for (n,2nd)

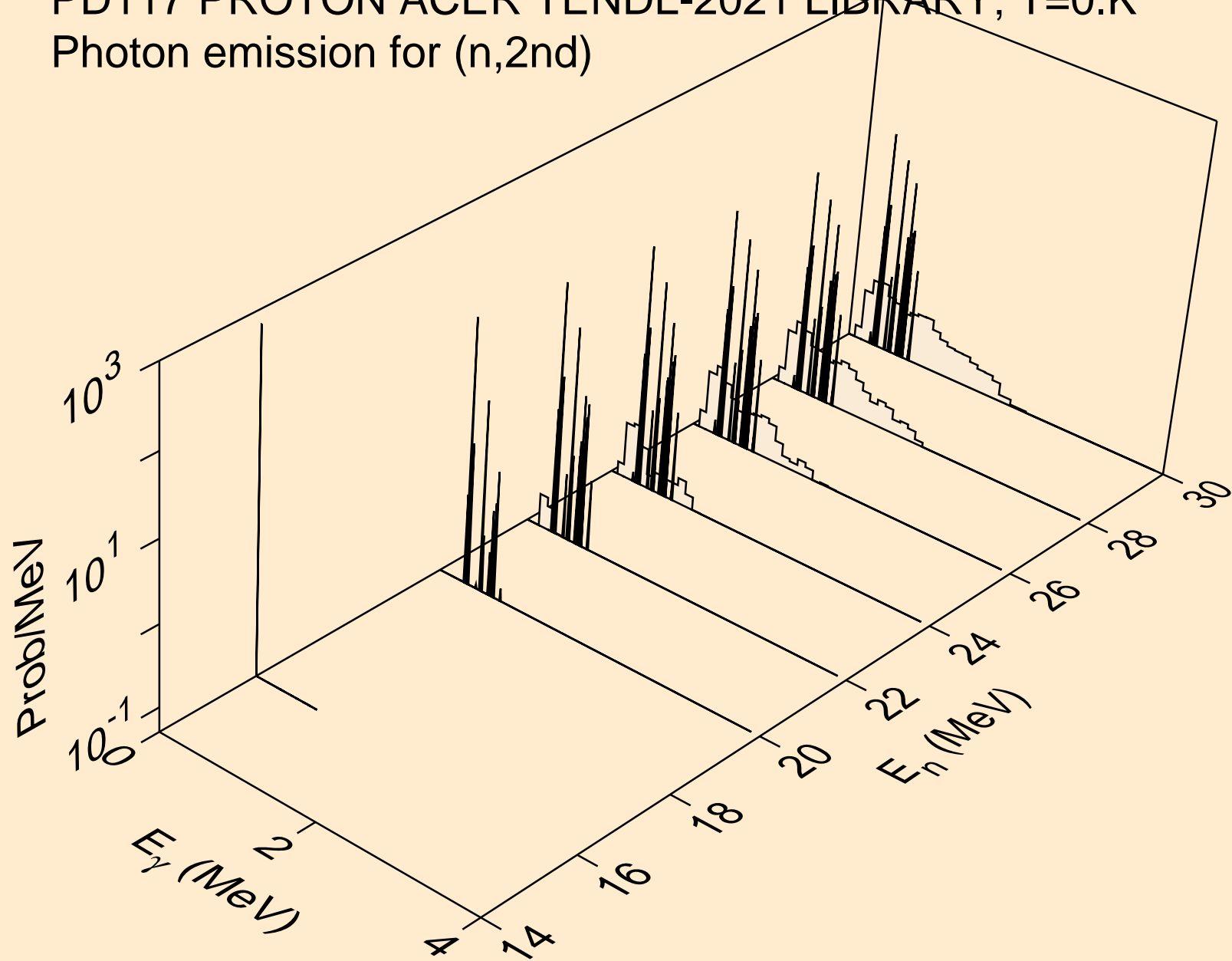

PD117 PROTON ACER TENDL-2021 LIBRARY; T=0.K  
Photon emission for (n,2n)

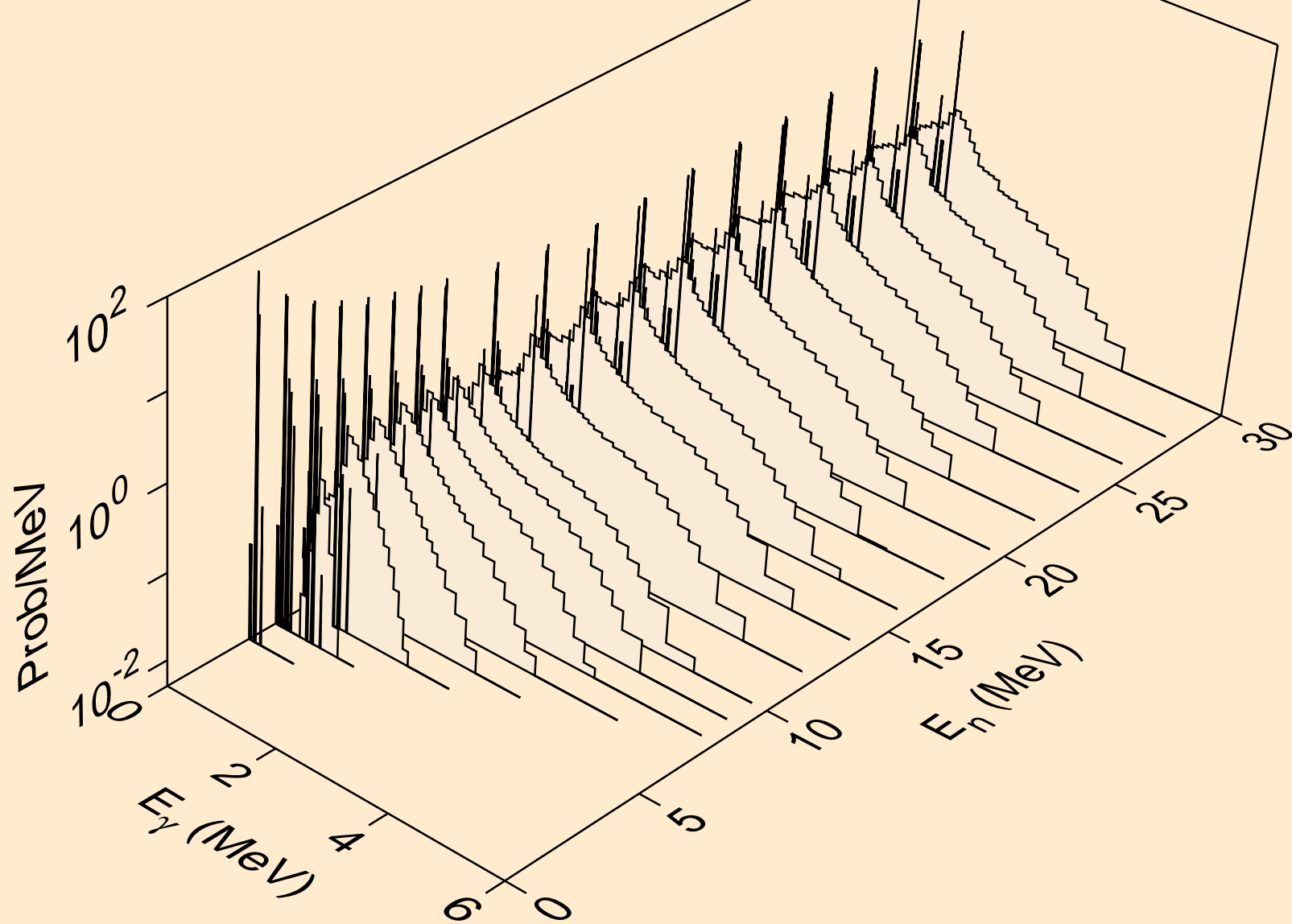

PD117 PROTON ACER TENDL-2021 LIBRARY; T=0.K  
Photon emission for (n,3n)

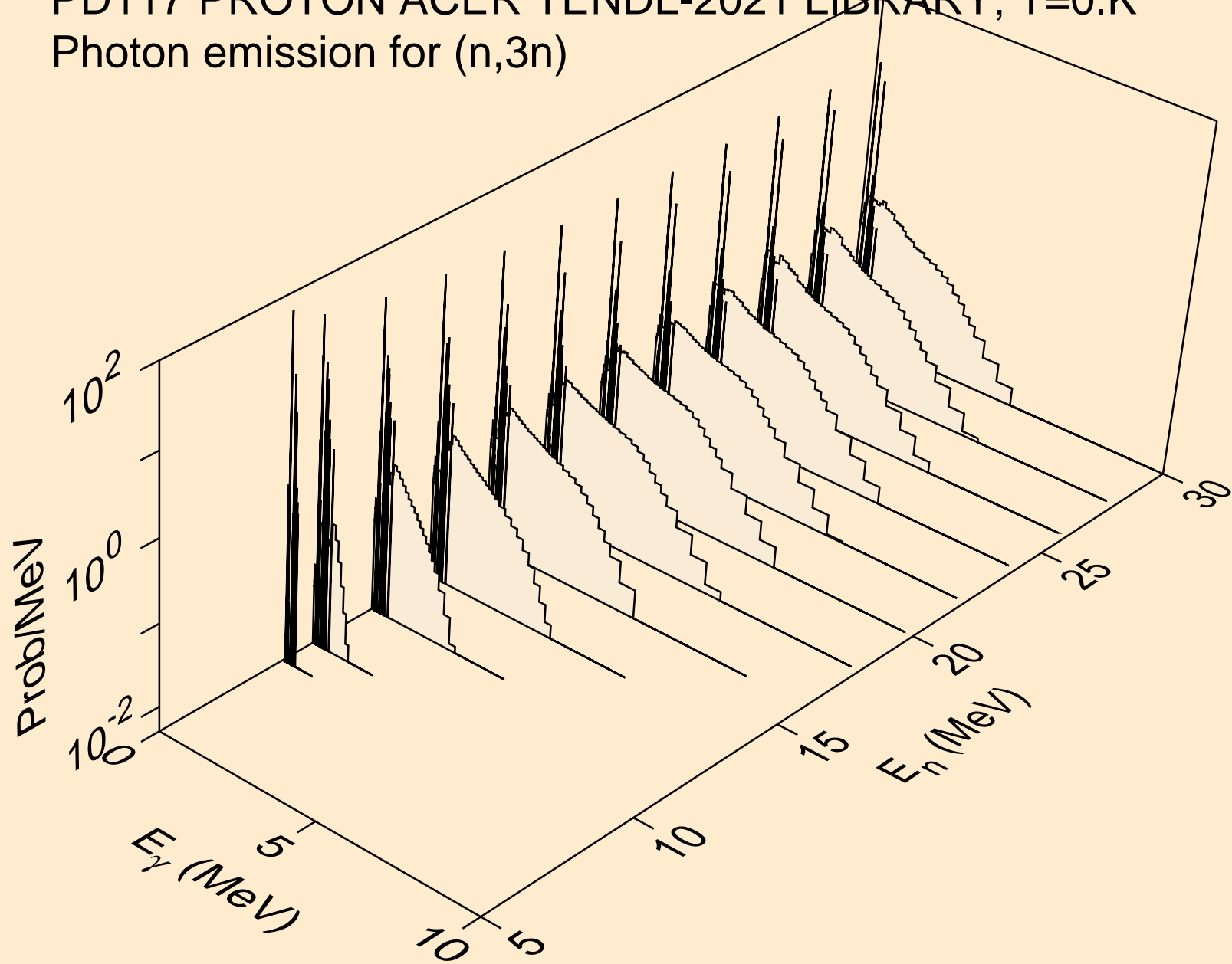

PD117 PROTON ACER TENDL-2021 LIBRARY; T=0.K  
Photon emission for (n,n\*)a

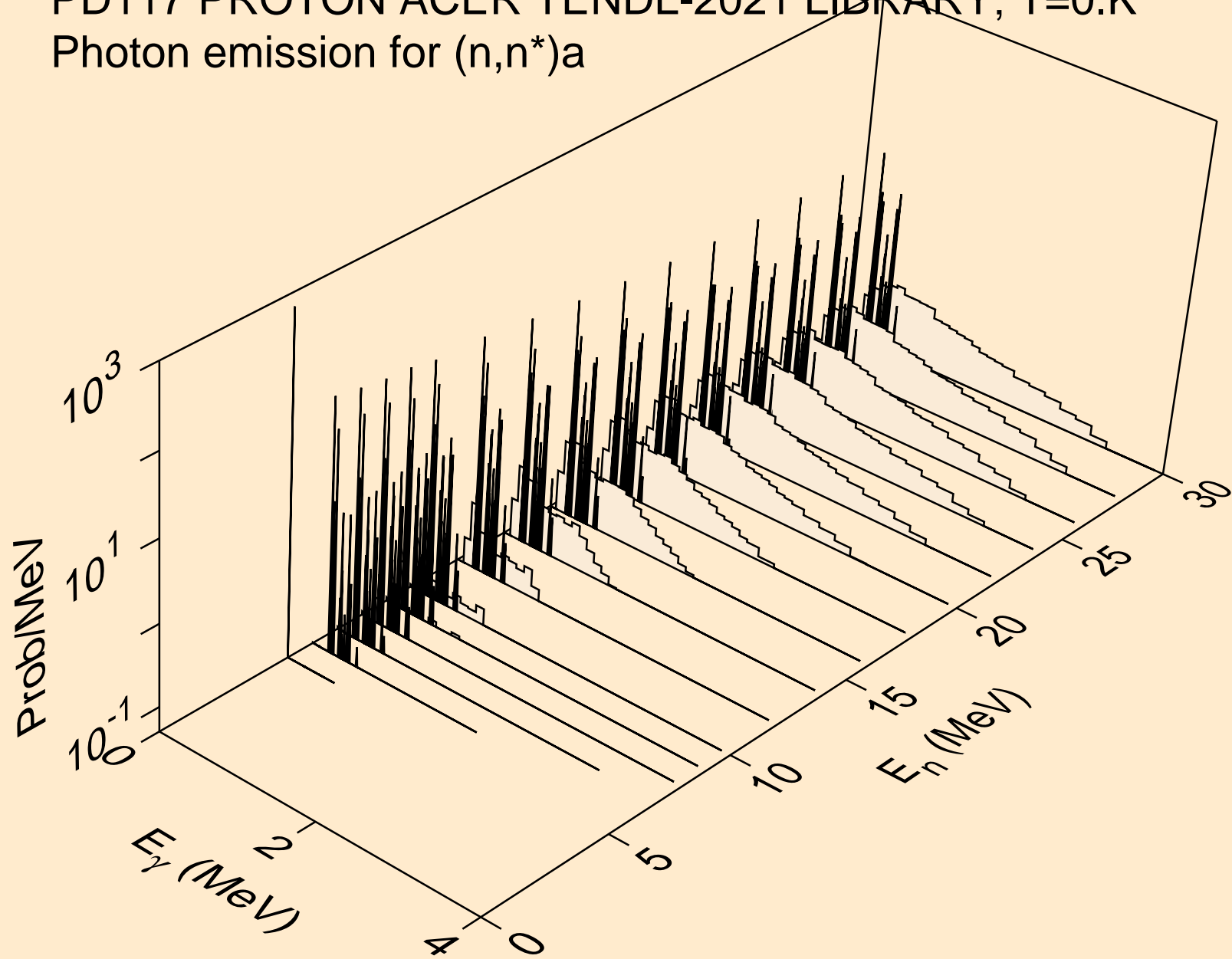



PD117 PROTON ACER TENDL-2021 LIBRARY; T=0.K  
Photon emission for (n,2n)a

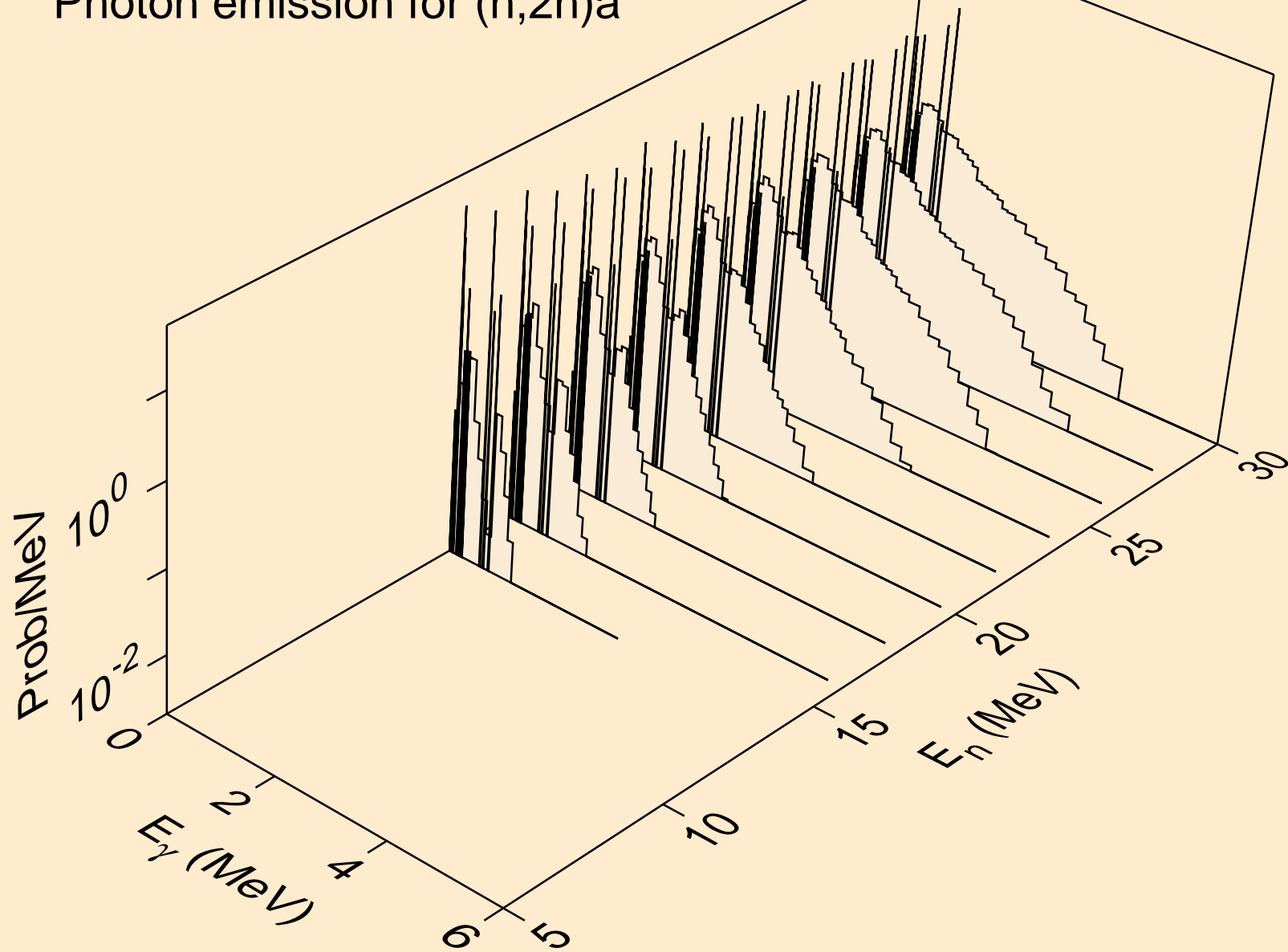

PD117 PROTON ACER TENDL-2021 LIBRARY; T=0.K  
Photon emission for (n,3n)a

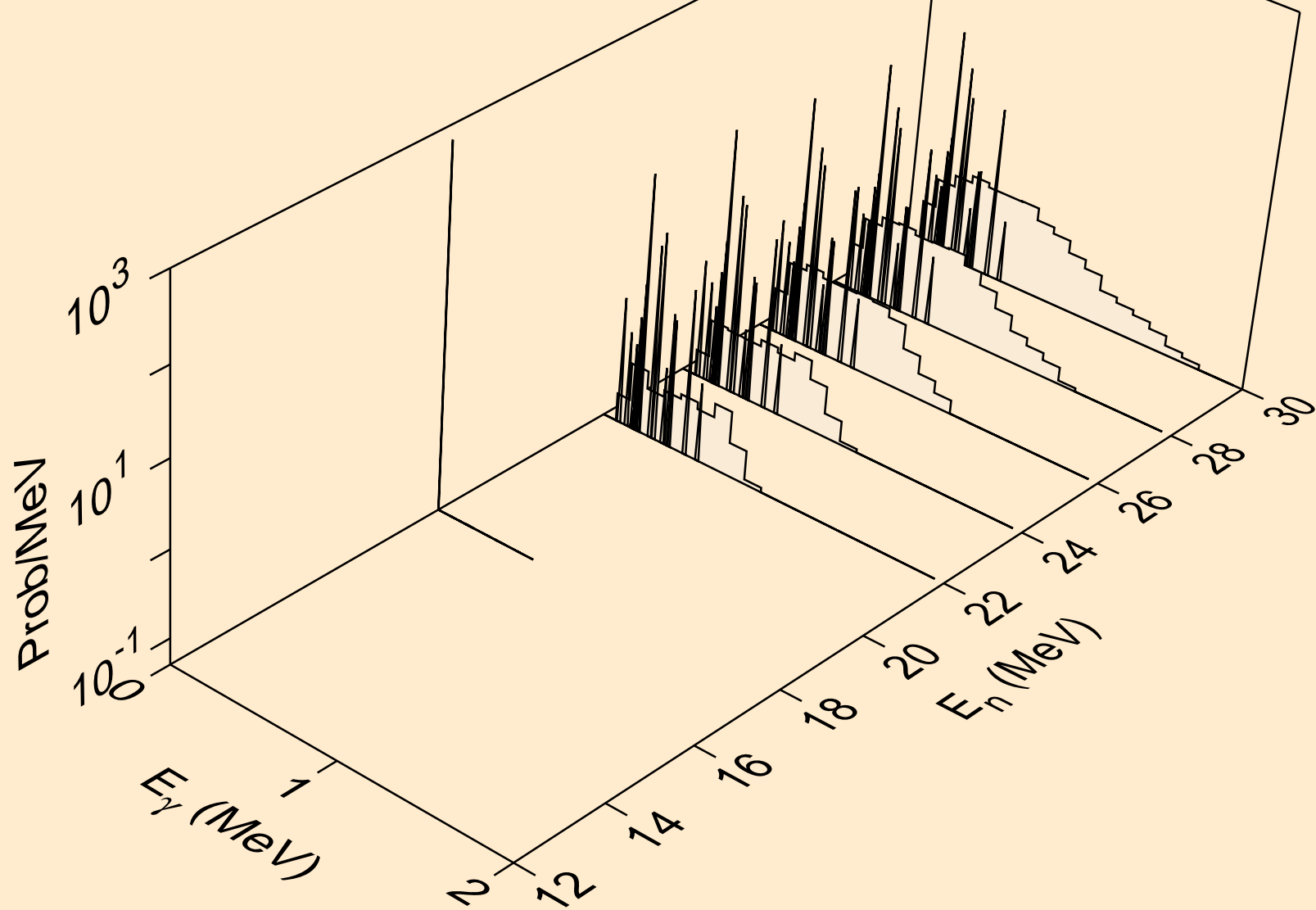

PD117 PROTON ACER TENDL-2021 LIBRARY; T=0.K  
Photon emission for (n,n\*)p

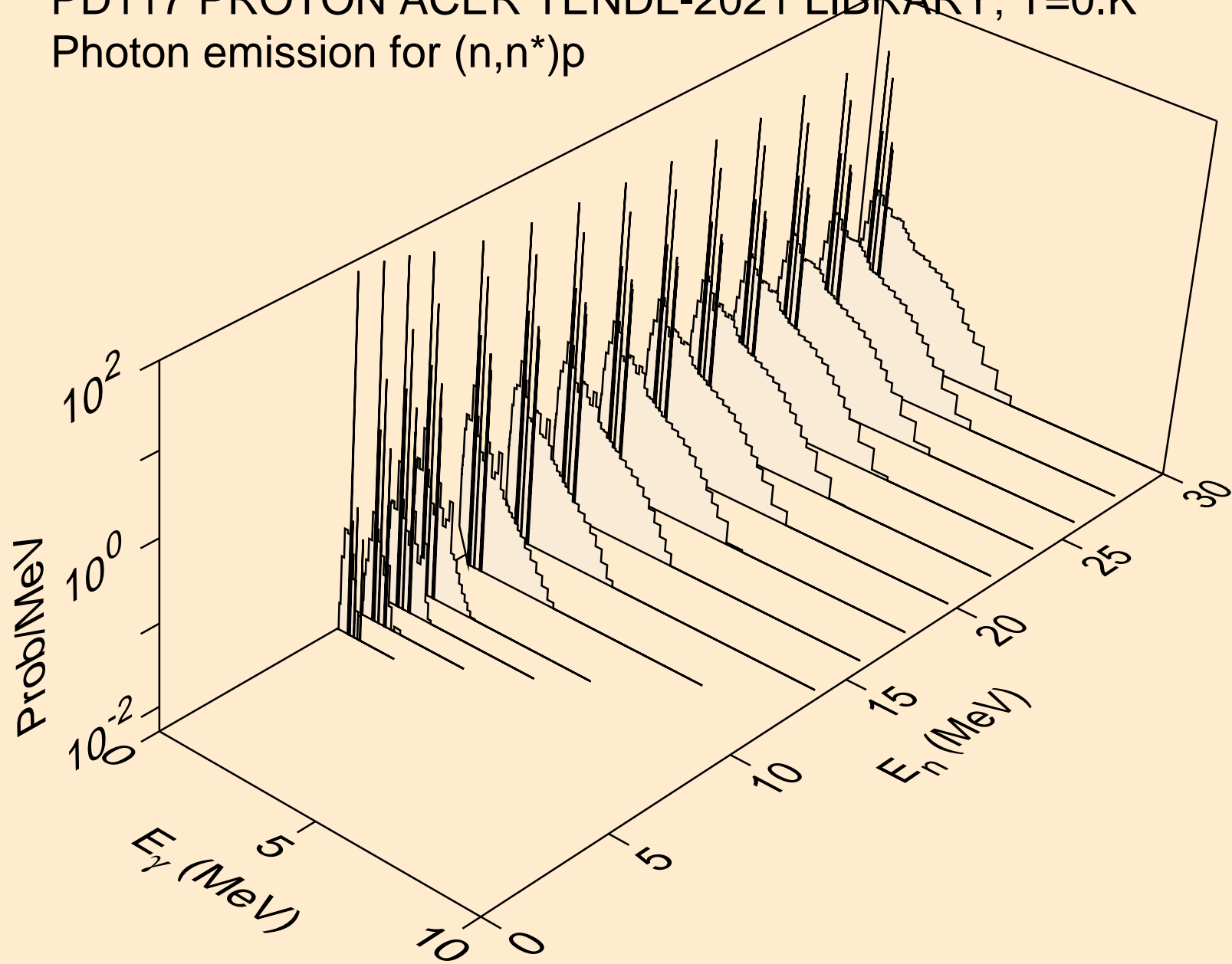

PD117 PROTON ACER TENDL-2021 LIBRARY; T=0.K  
Photon emission for (n,n\*)d

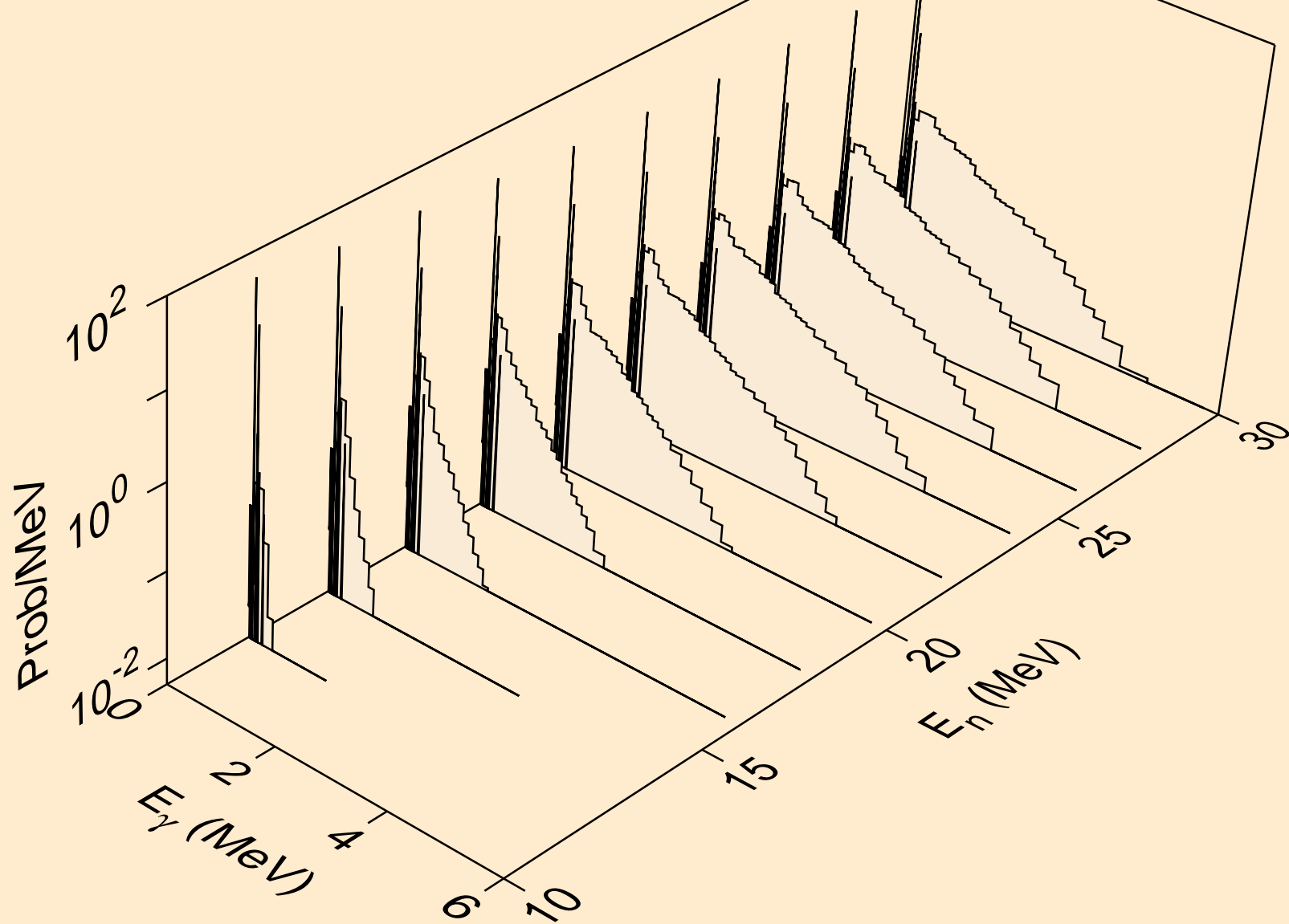

PD117 PROTON ACER TENDL-2021 LIBRARY; T=0.K  
Photon emission for (n,n\*)t

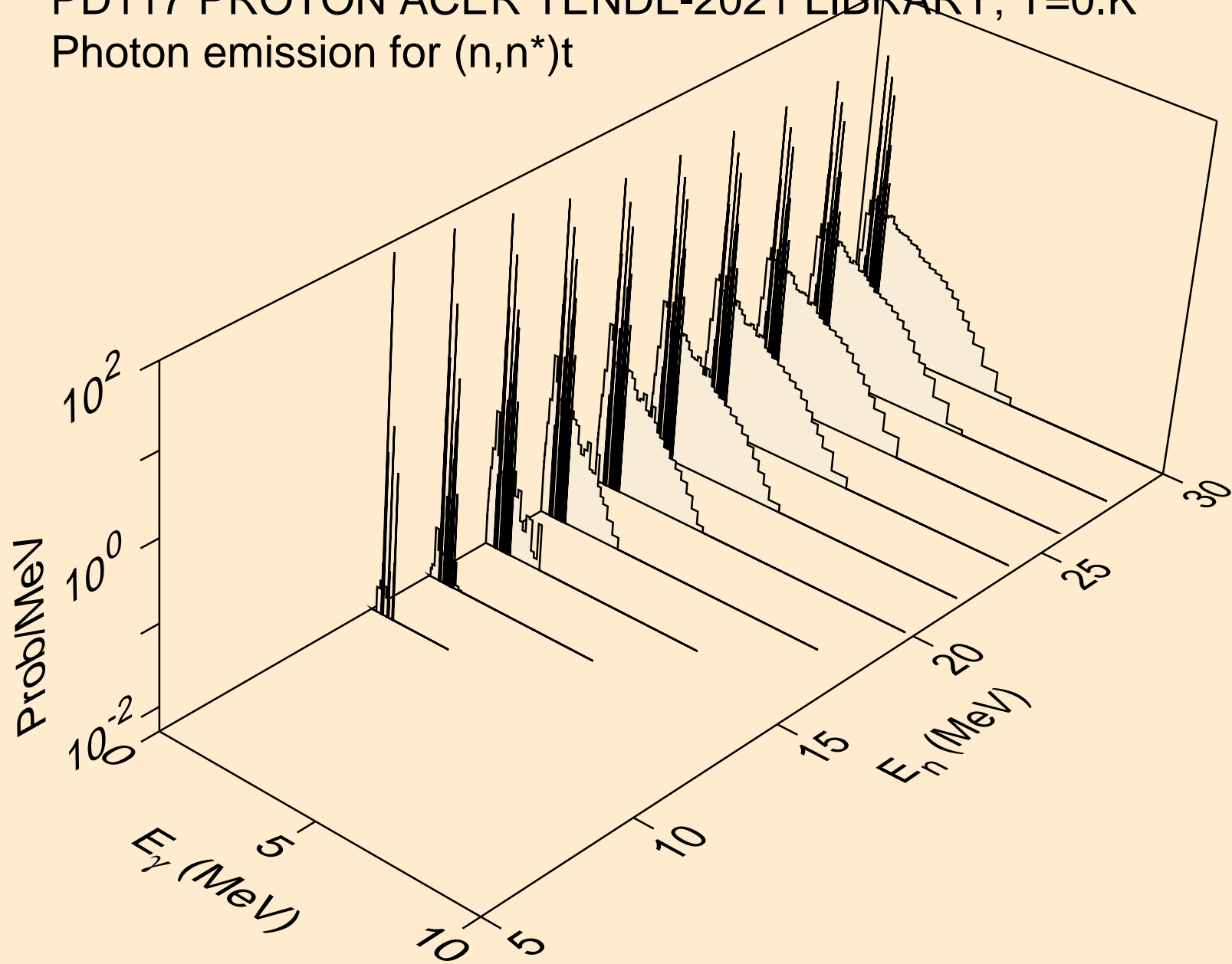

PD117 PROTON ACER TENDL-2021 LIBRARY; T=0.K  
Photon emission for (n,n\*)he3

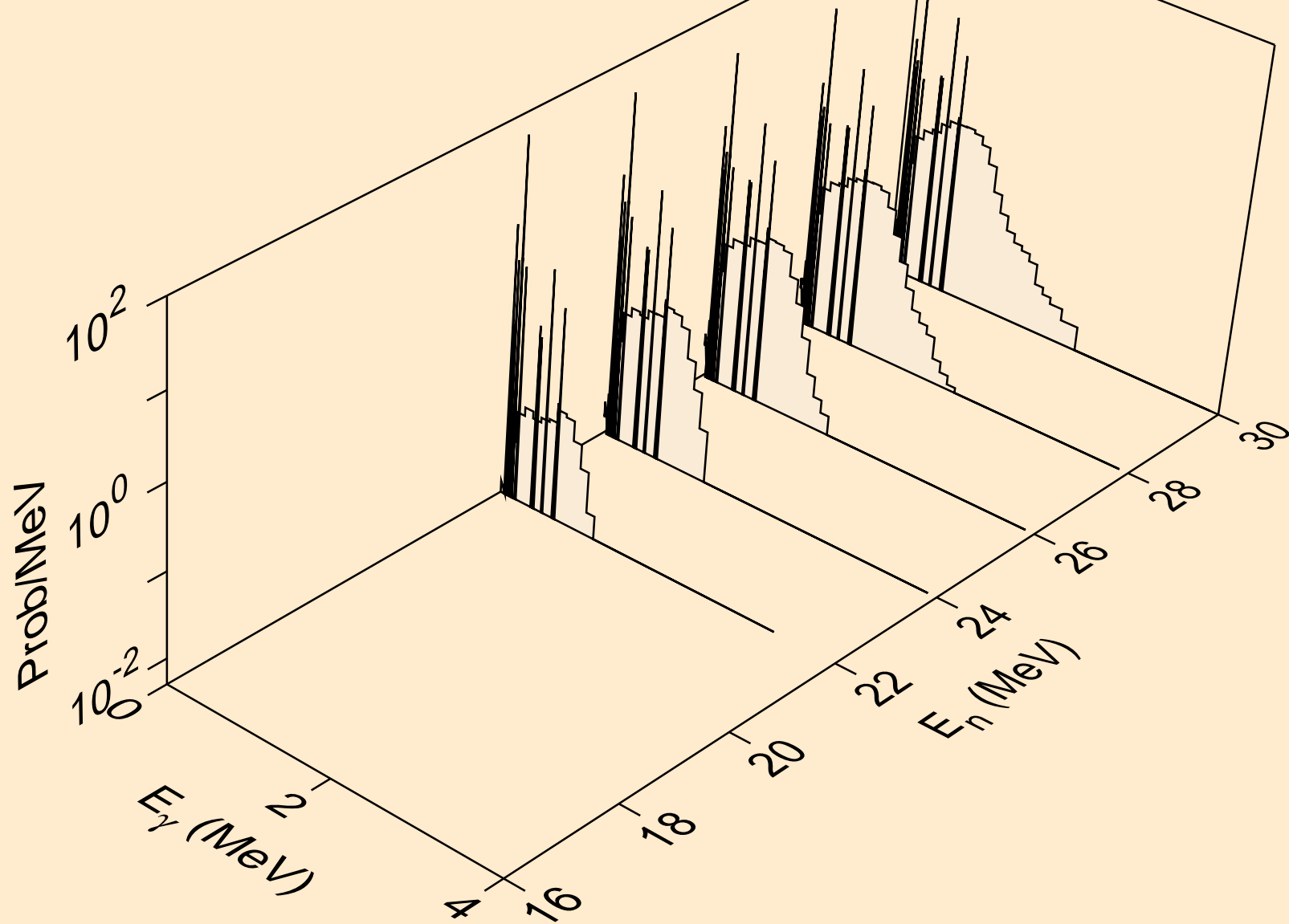

PD117 PROTON ACER TENDL-2021 LIBRARY; T=0.K  
Photon emission for (n,4n)

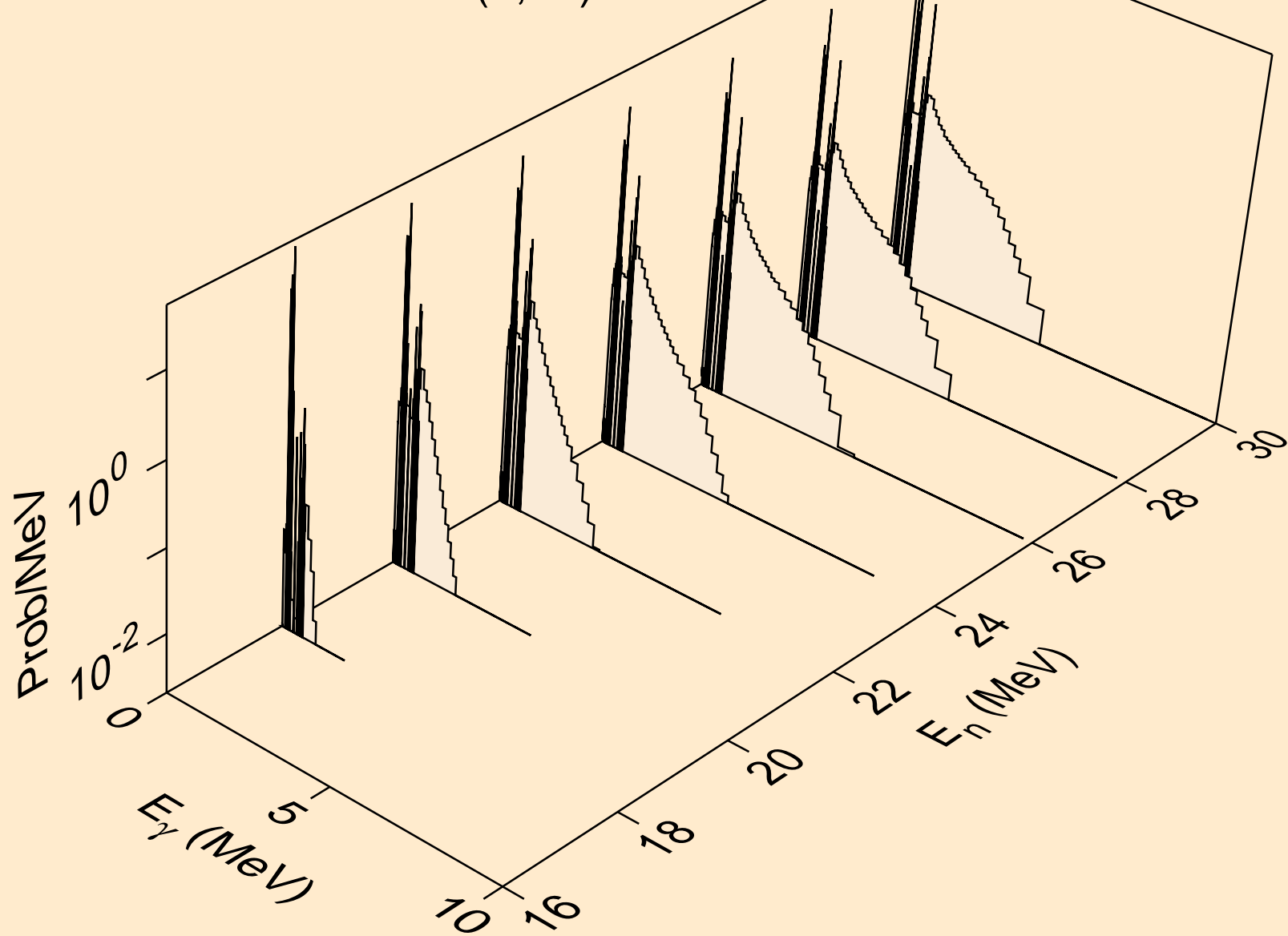

PD117 PROTON ACER TENDL-2021 LIBRARY; T=0.K  
Photon emission for (n,2np)

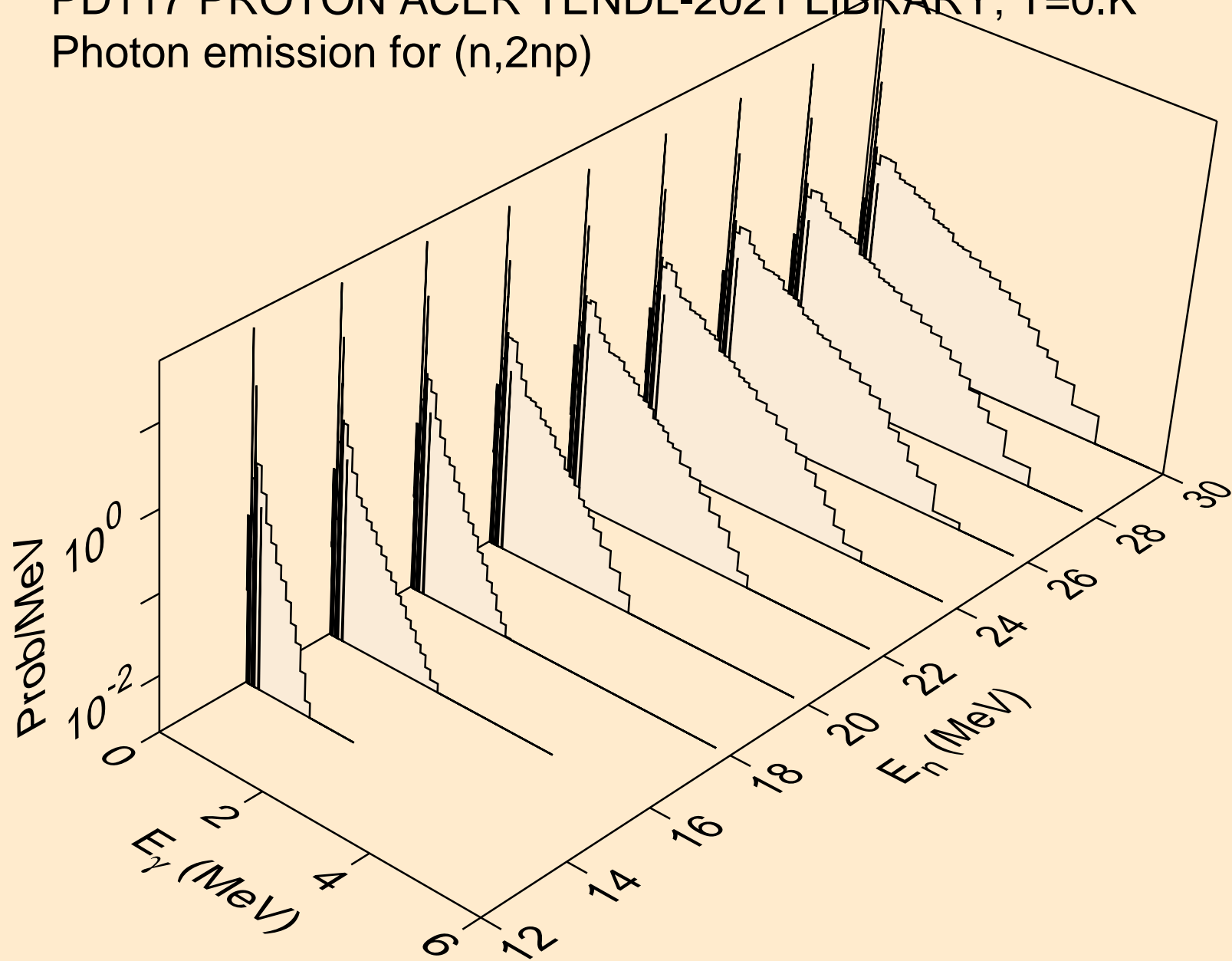



PD117 PROTON ACER TENDL-2021 LIBRARY; T=0.K  
Photon emission for (n,3np)

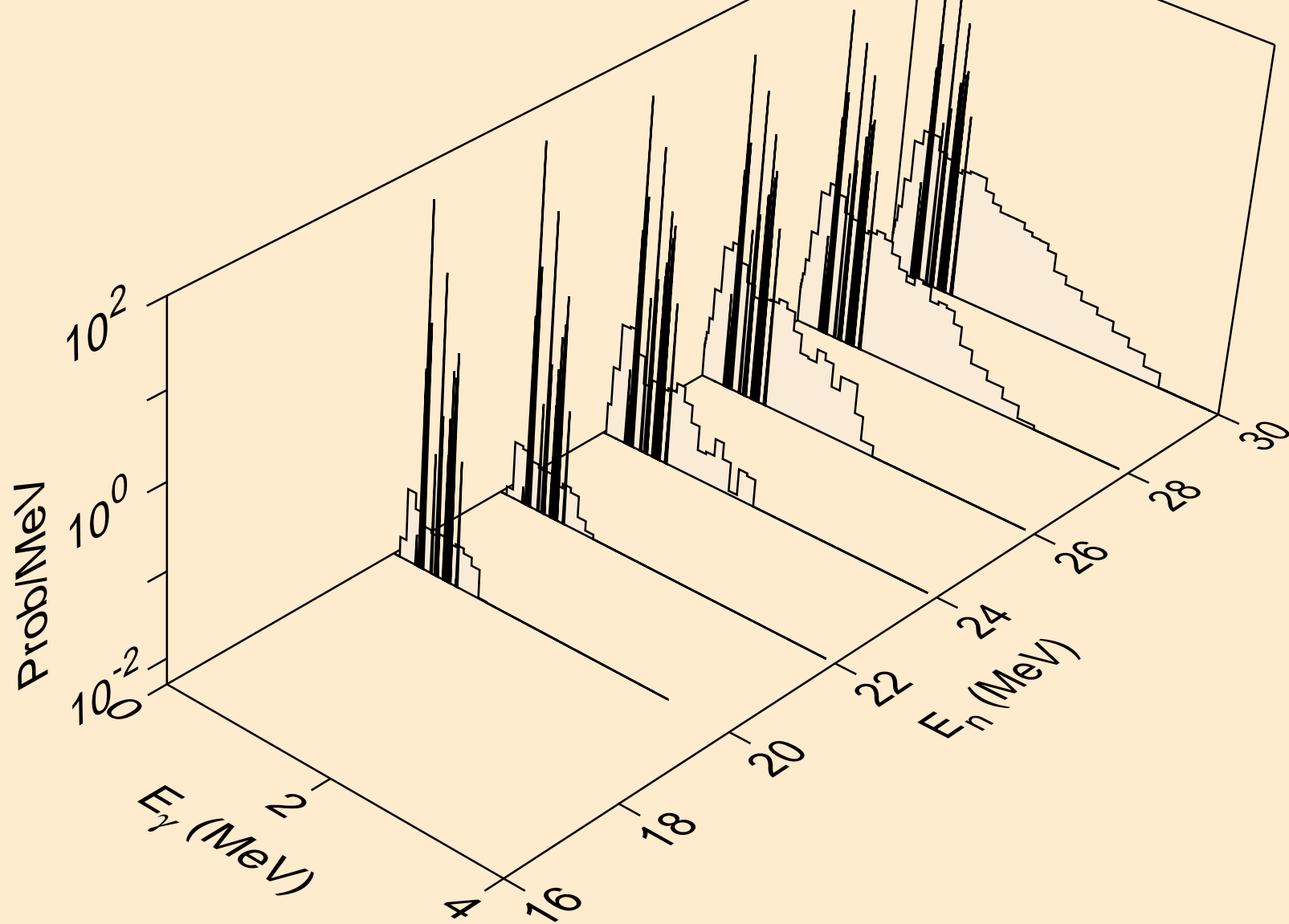

PD117 PROTON ACER TENDL-2021 LIBRARY; T=0.K  
Photon emission for (n,2np)

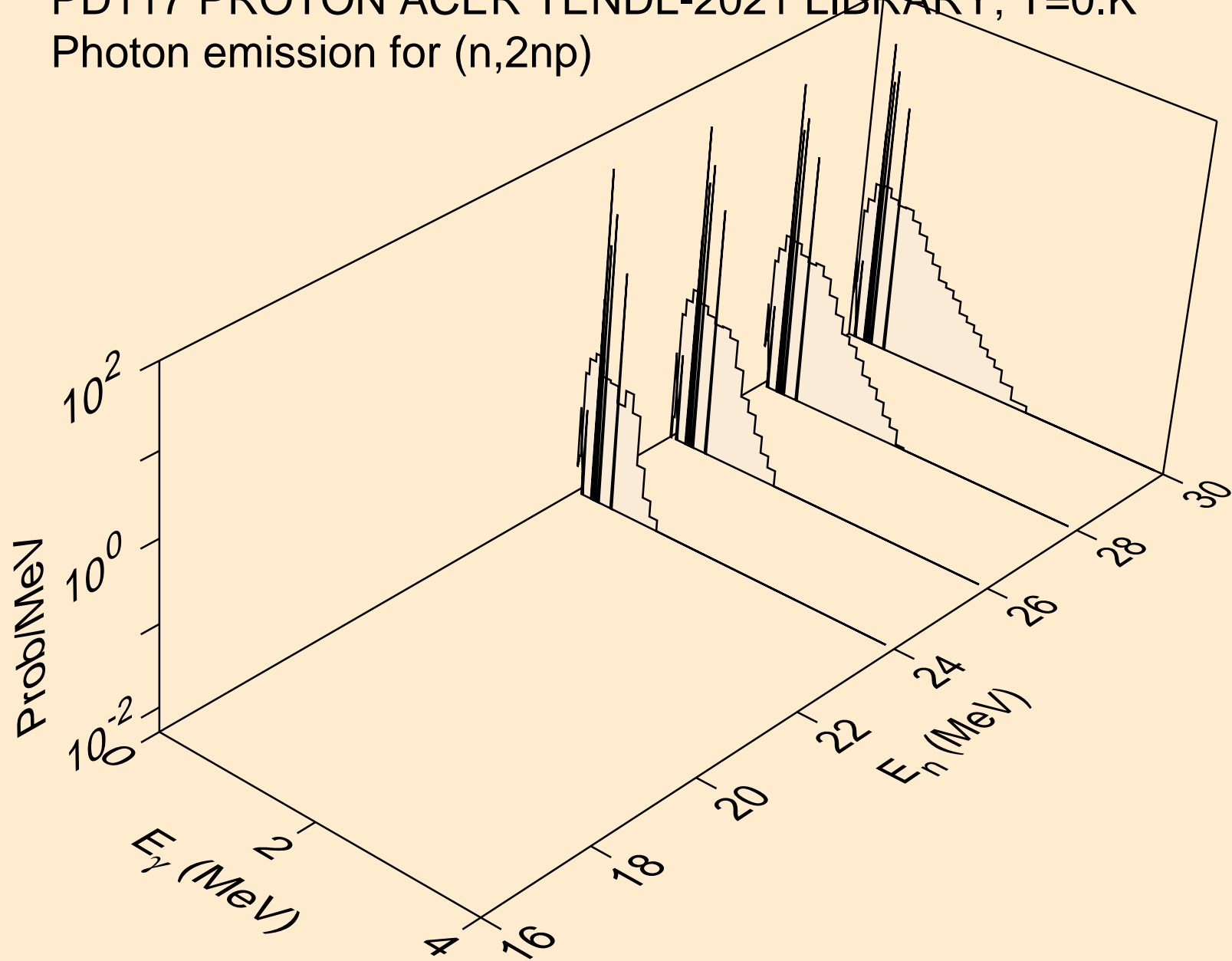

PD117 PROTON ACER TENDL-2021 LIBRARY; T=0.K  
Photon emission for (n,npa)

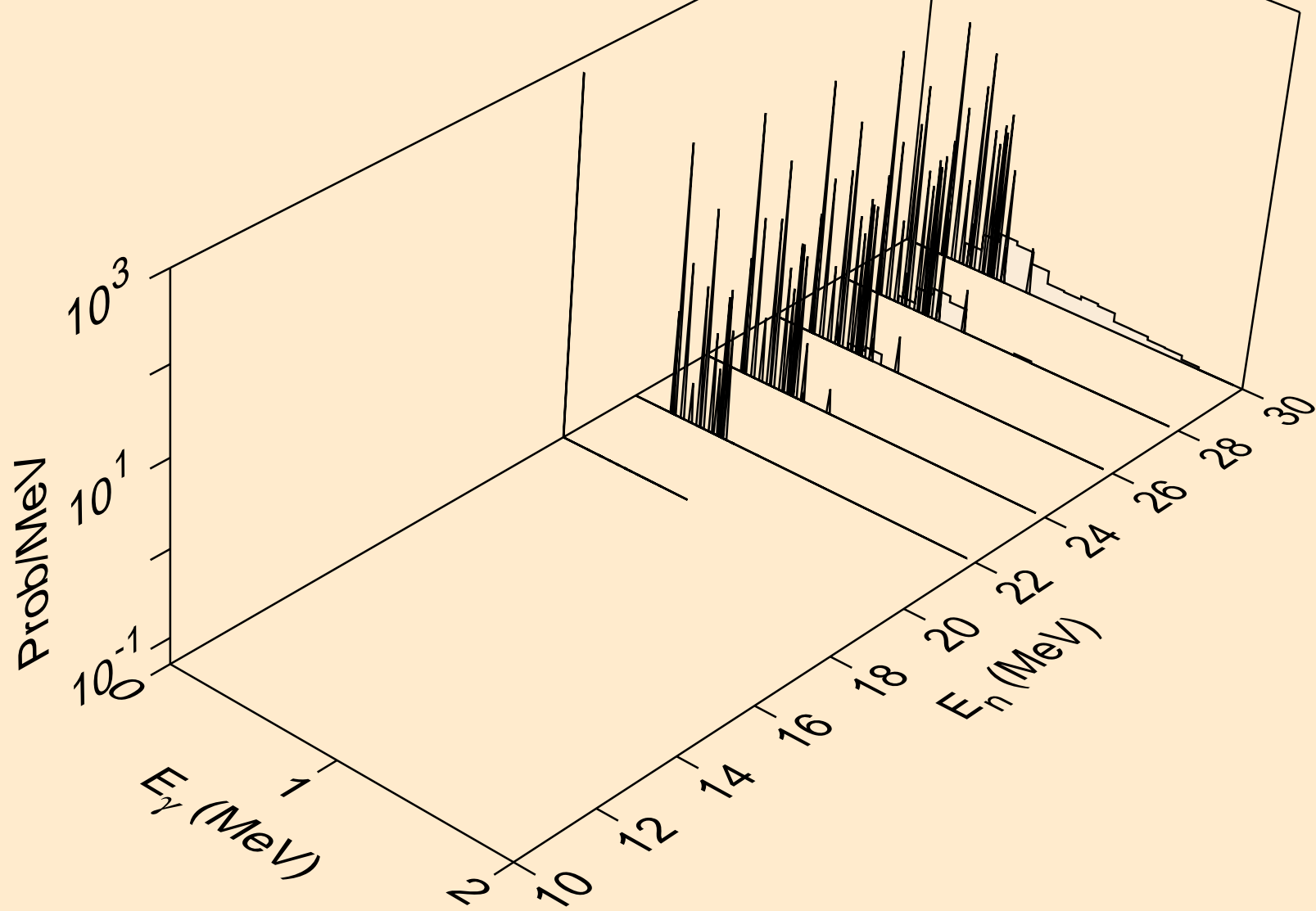

PD117 PROTON ACER TENDL-2021 LIBRARY; T=0.K  
Photon emission for (n,gma)

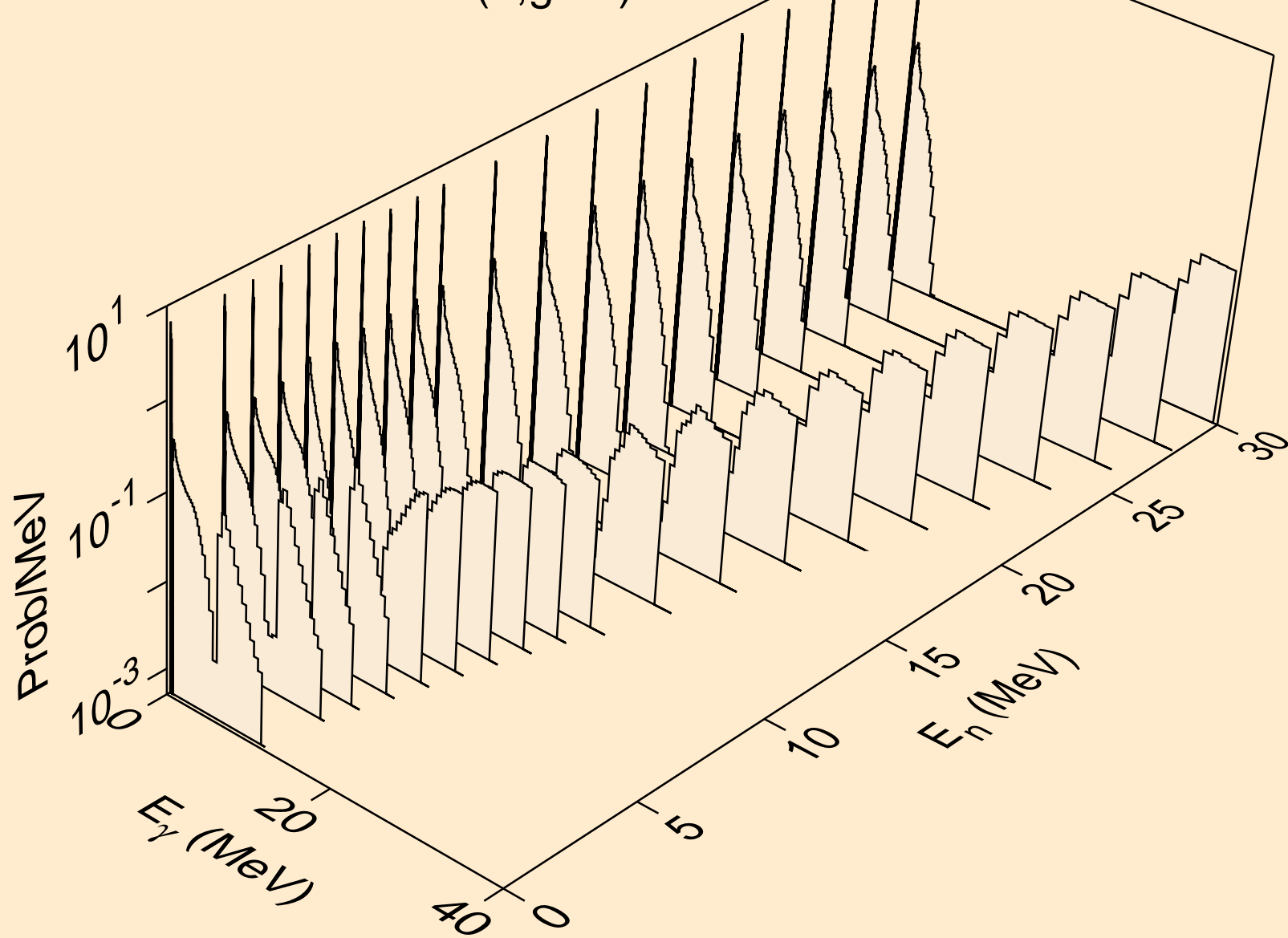

PD117 PROTON ACER TENDL-2021 LIBRARY; T=0.K  
Photon emission for inelastic

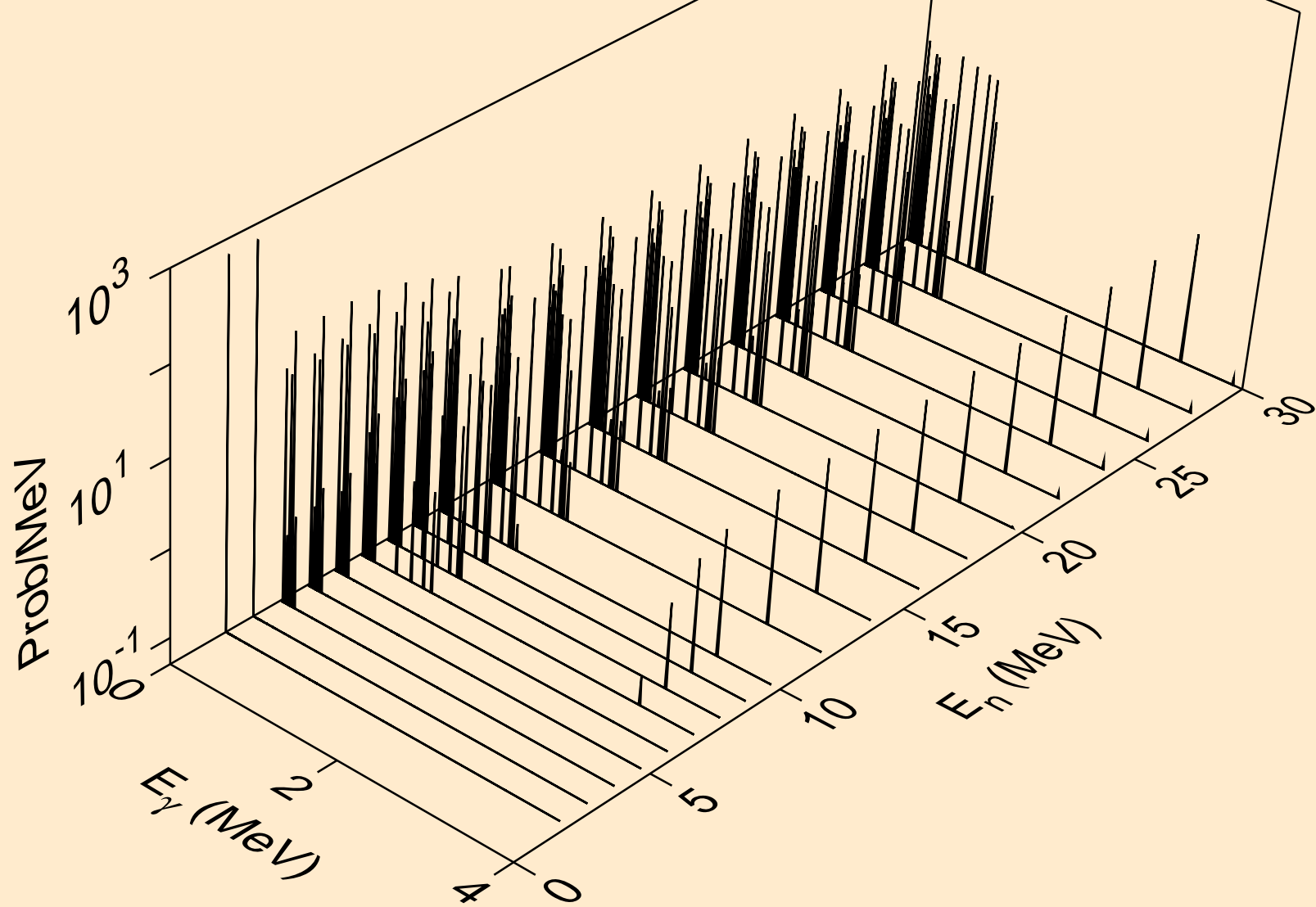

PD117 PROTON ACER TENDL-2021 LIBRARY; T=0.K  
Photon emission for (n,d)

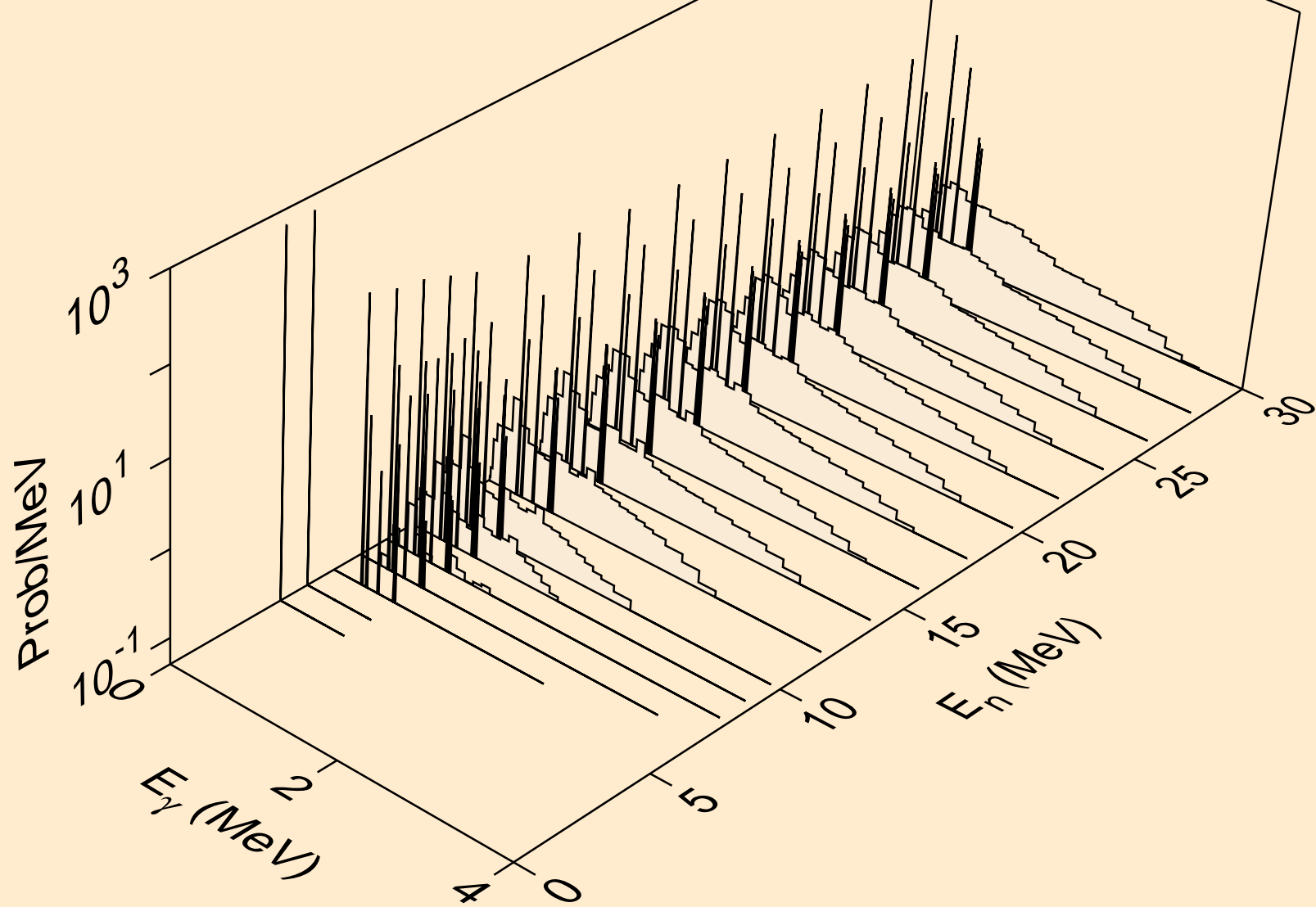

PD117 PROTON ACER TENDL-2021 LIBRARY; T=0.K  
Photon emission for (n,t)

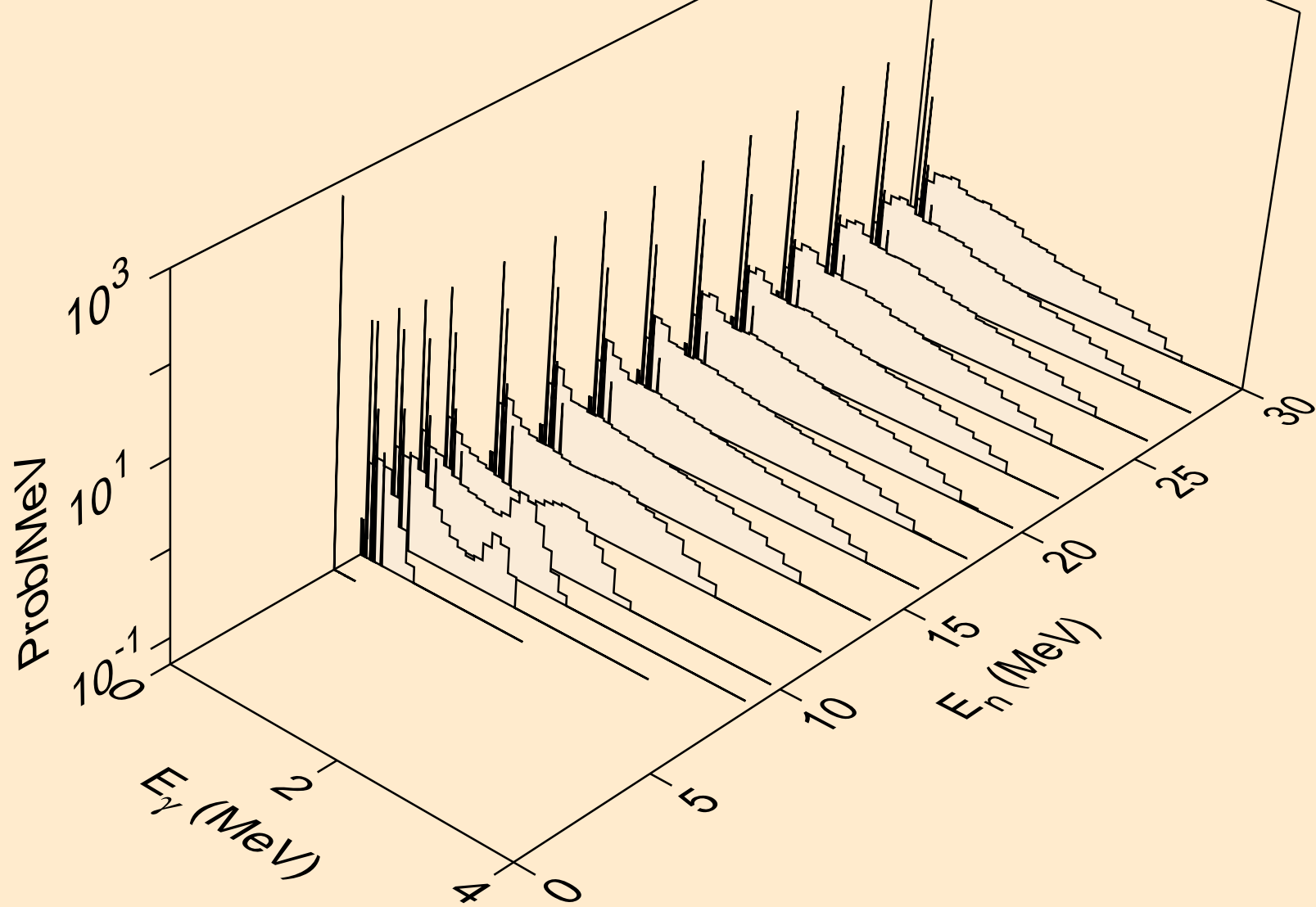

PD117 PROTON ACER TENDL-2021 LIBRARY; T=0.K  
Photon emission for (n,he3)

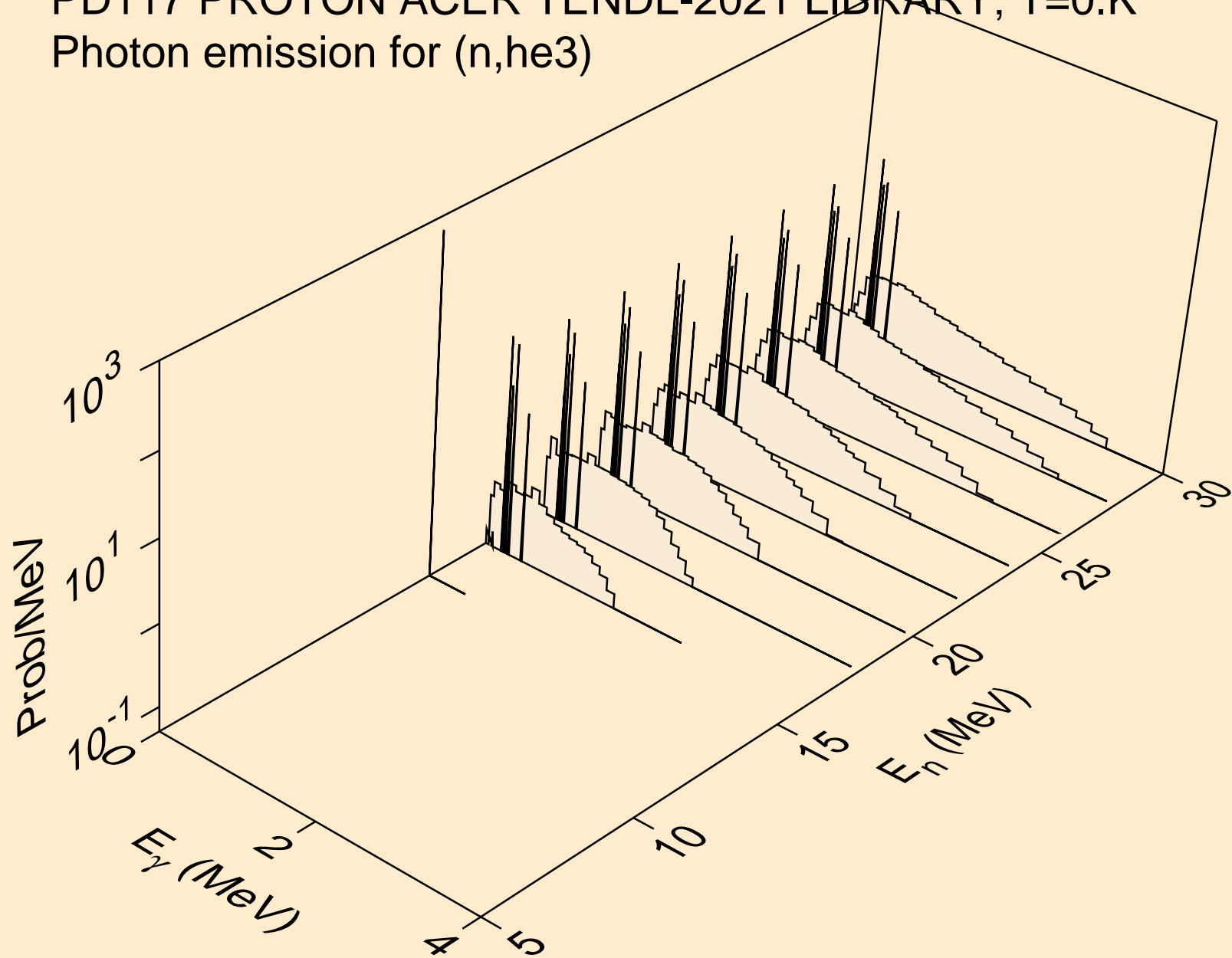



PD117 PROTON ACER TENDL-2021 LIBRARY; T=0.K  
Photon emission for (n,a)

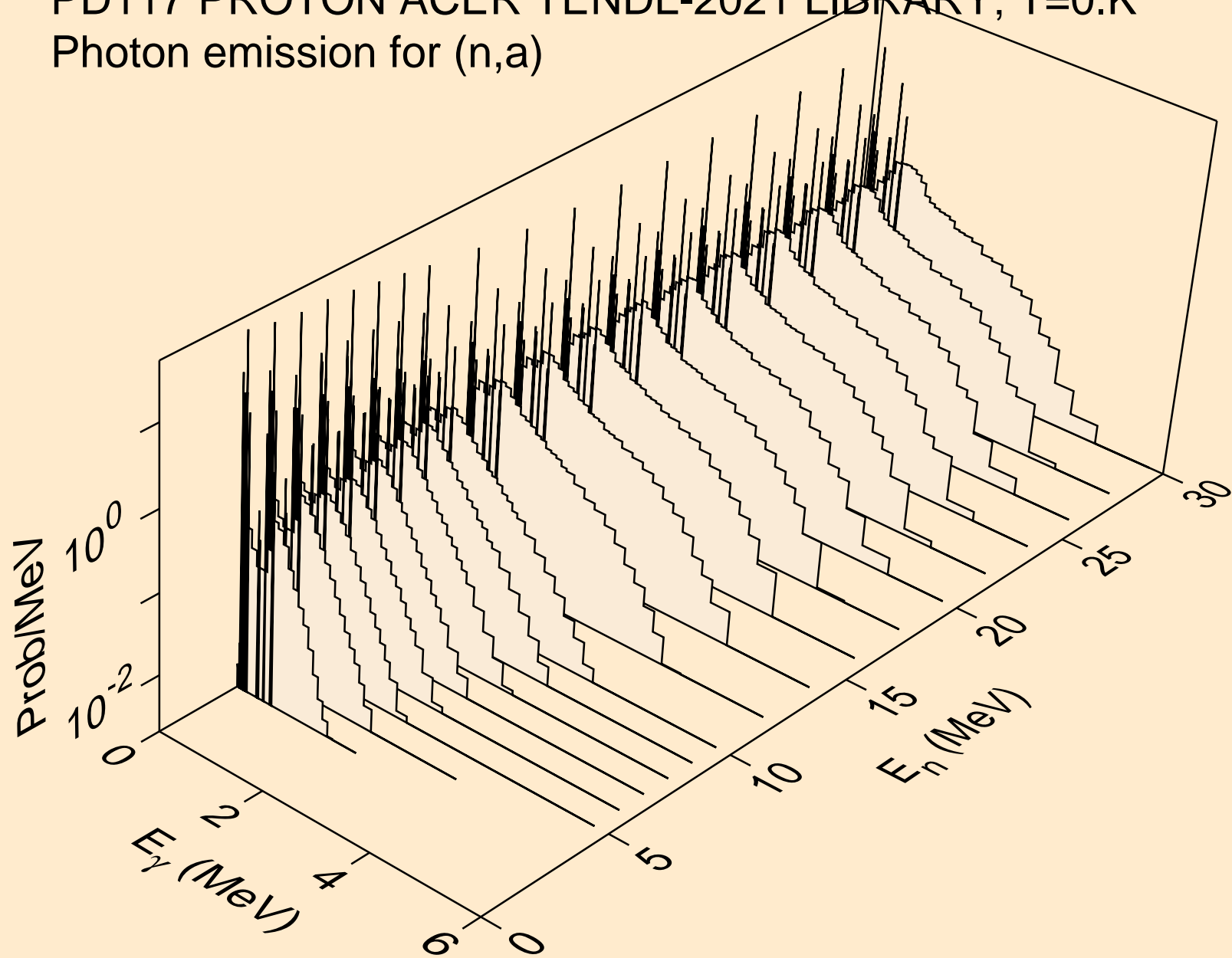

PD117 PROTON ACER TENDL-2021 LIBRARY; T=0.K  
Photon emission for (n,2p)

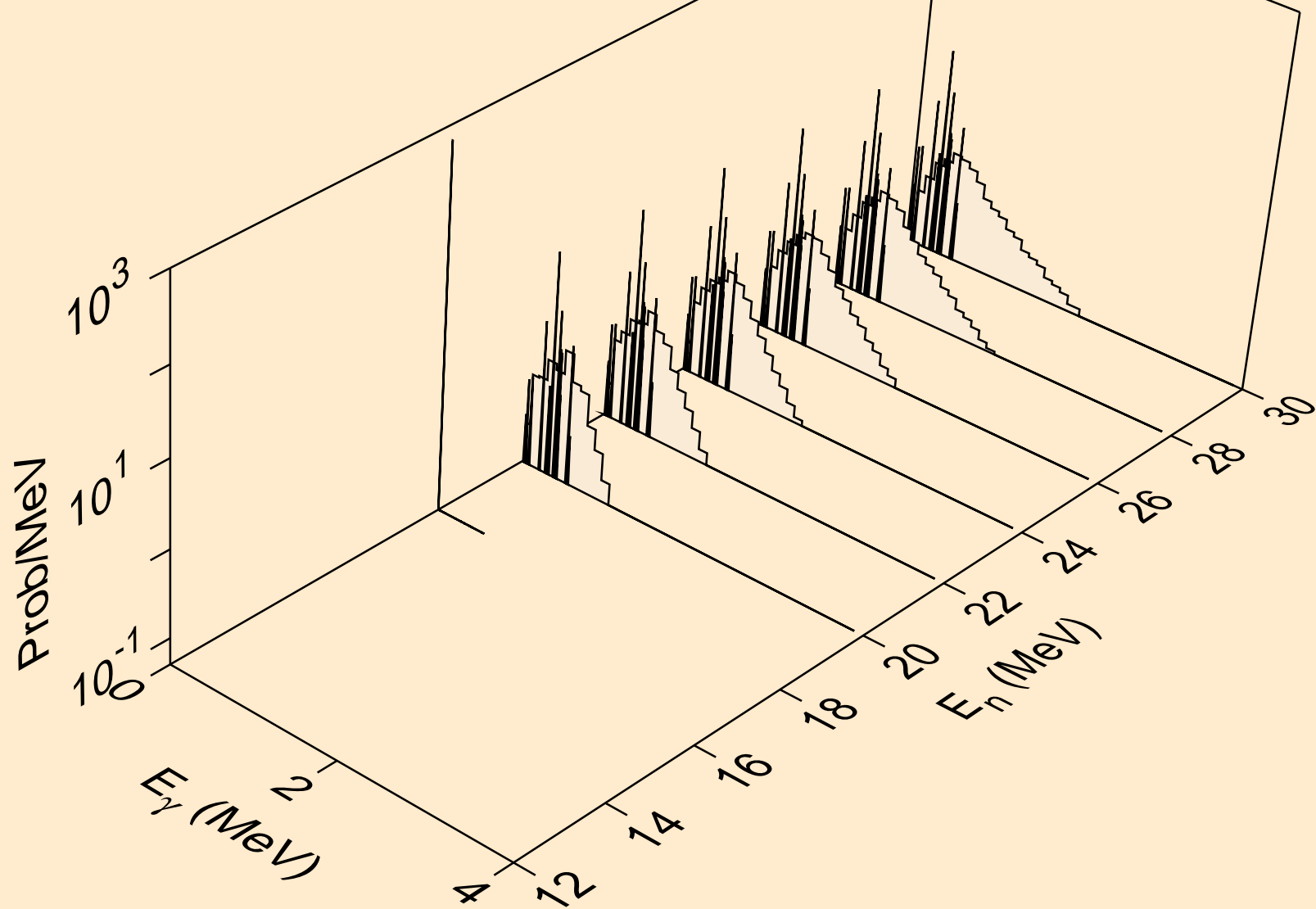

PD117 PROTON ACER TENDL-2021 LIBRARY; T=0.K  
Photon emission for (n,pa)

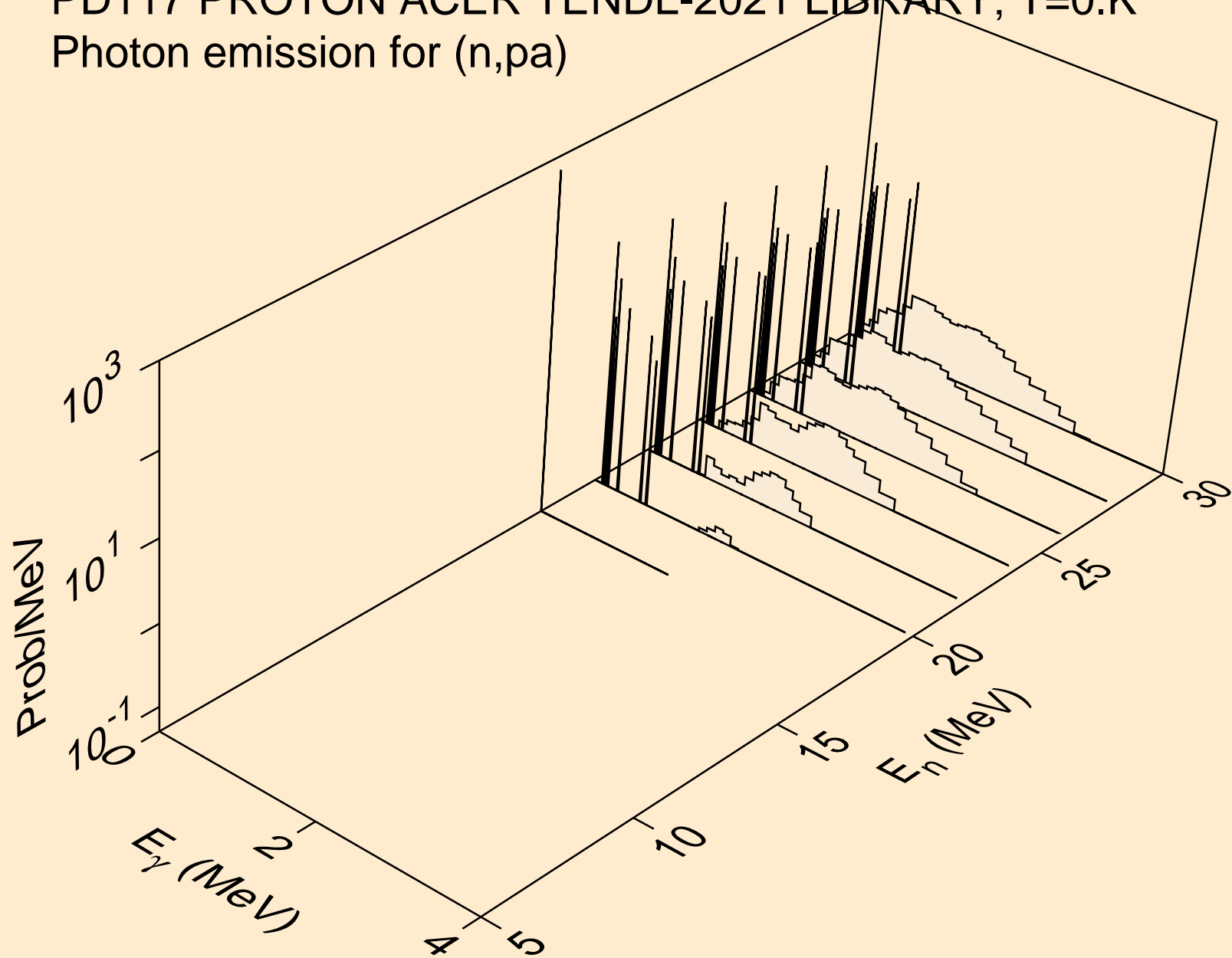

PD117 PROTON ACER TENDL-2021 LIBRARY; T=0.K  
Photon emission for (n,pd)

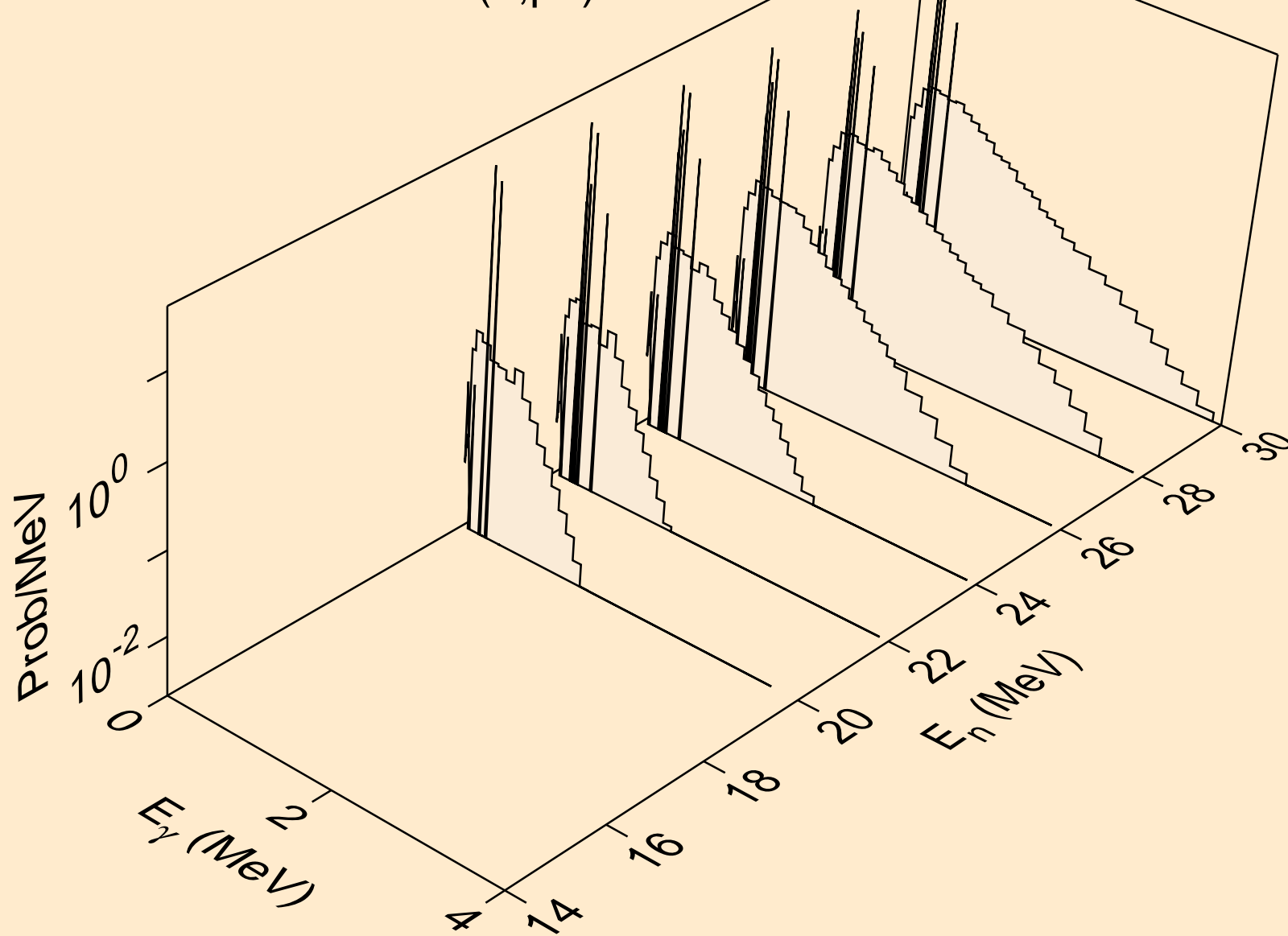

PD117 PROTON ACER TENDL-2021 LIBRARY; T=0.K  
Particle heating contributions

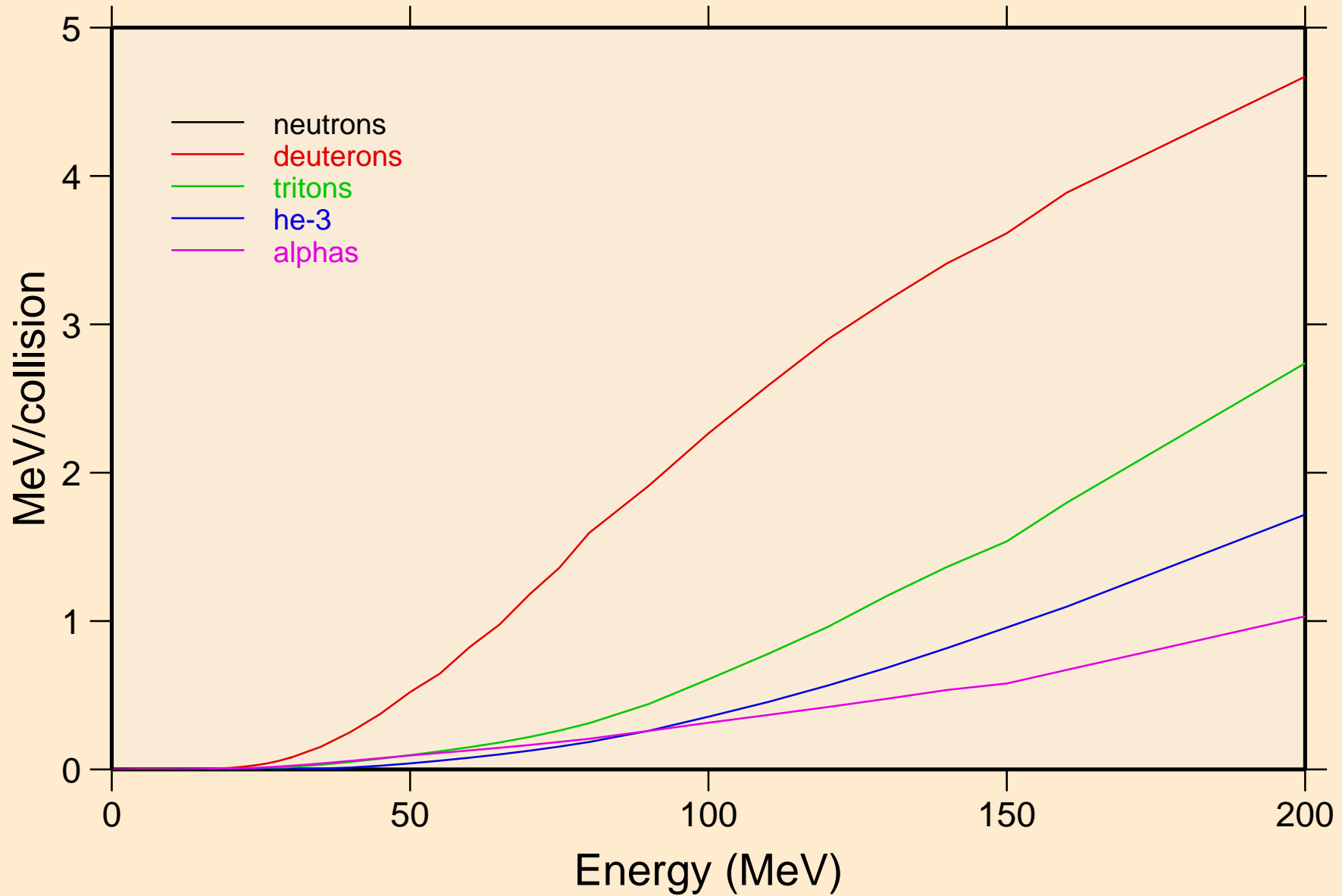

PD117 PROTON ACER TENDL-2021 LIBRARY; T=0.K  
Recoil Heating

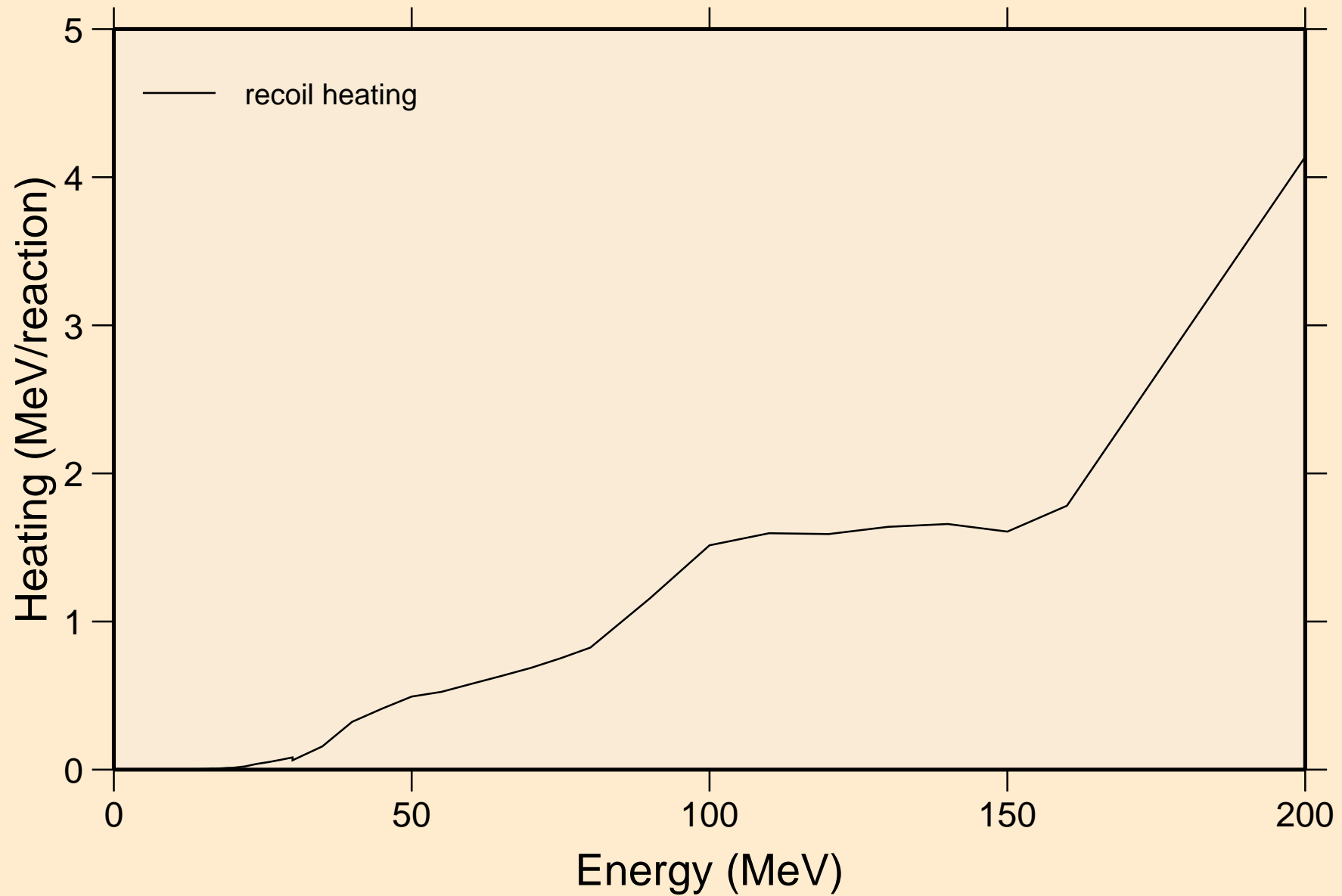

PD117 PROTON ACER TENDL-2021 LIBRARY; T=0.K  
Particle production cross sections

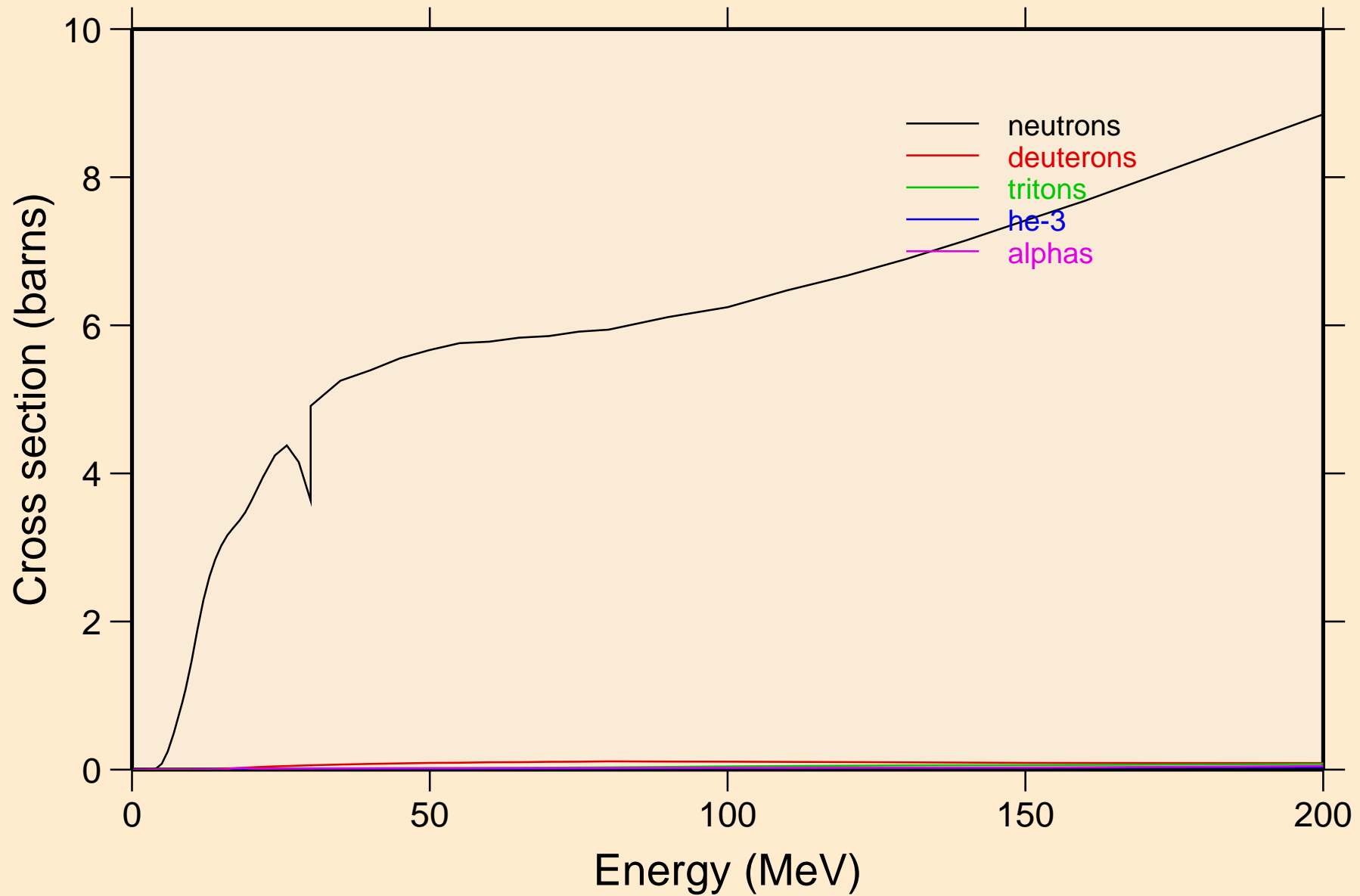

PD117 PROTON ACER TENDL-2021 LIBRARY; T=0.K  
neutrons from (p,n)

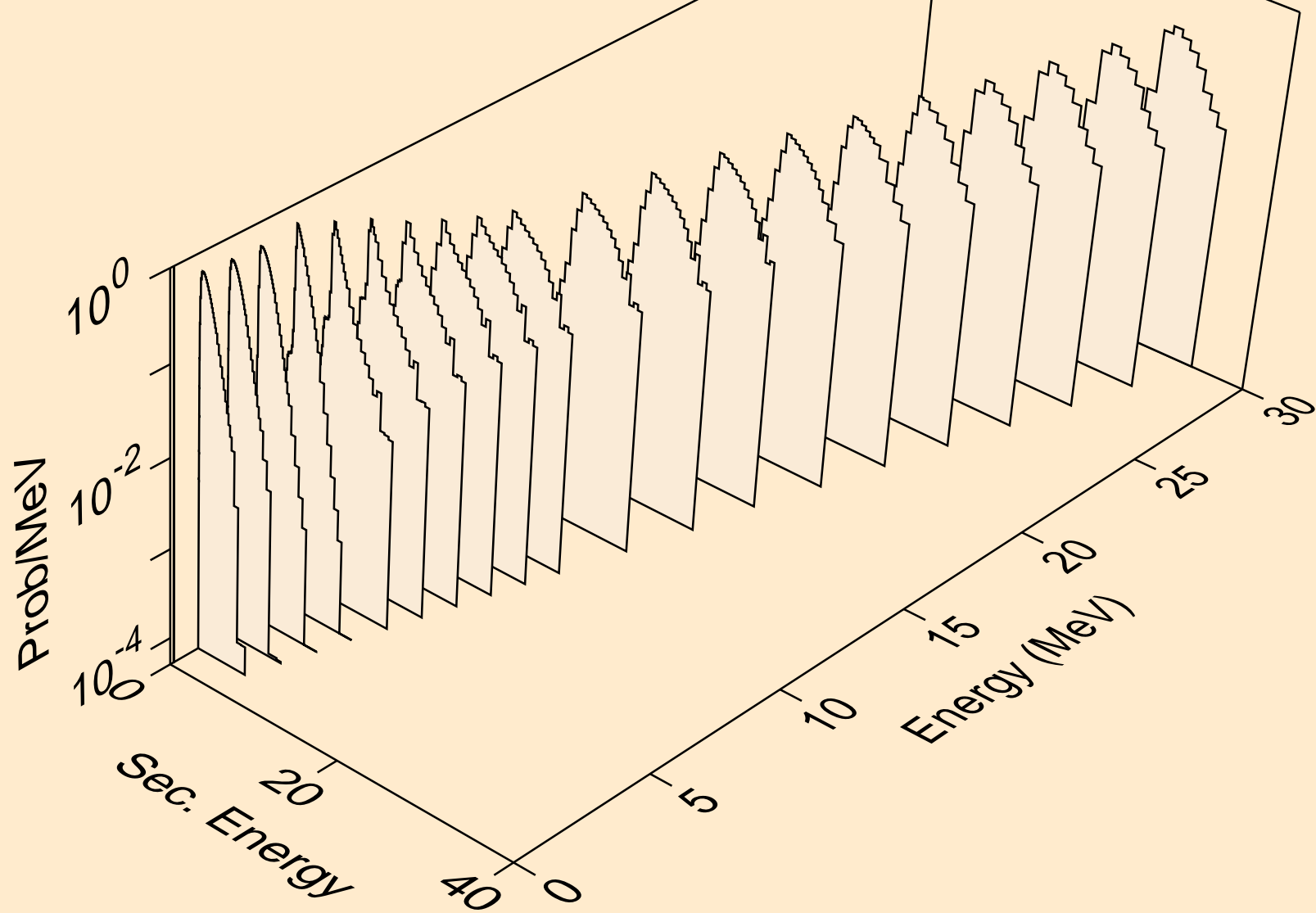



PD117 PROTON ACER TENDL-2021 LIBRARY; T=0.K  
neutrons from (p,x)

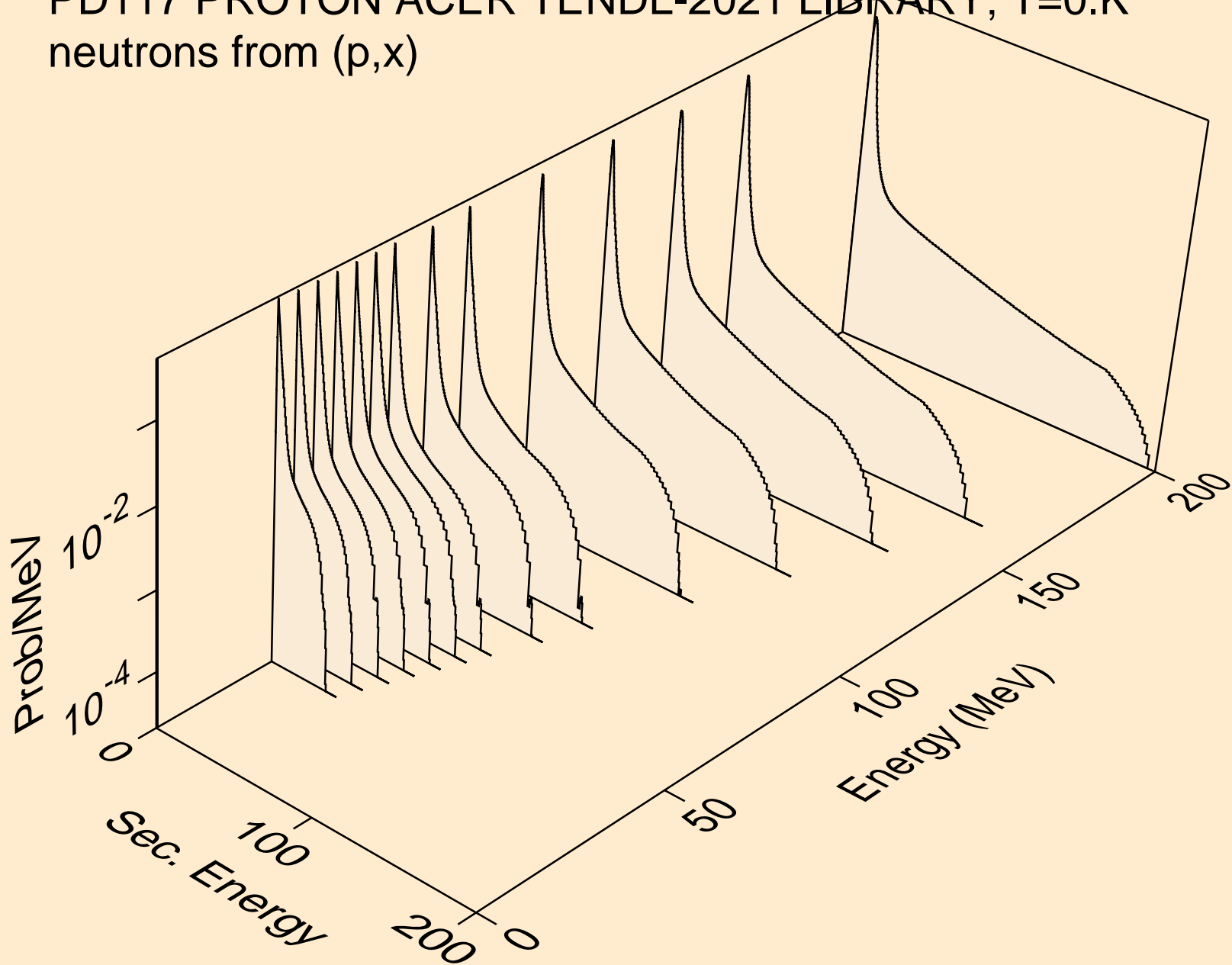

PD117 PROTON ACER TENDL-2021 LIBRARY; T=0.K  
neutrons from (p,2nd)

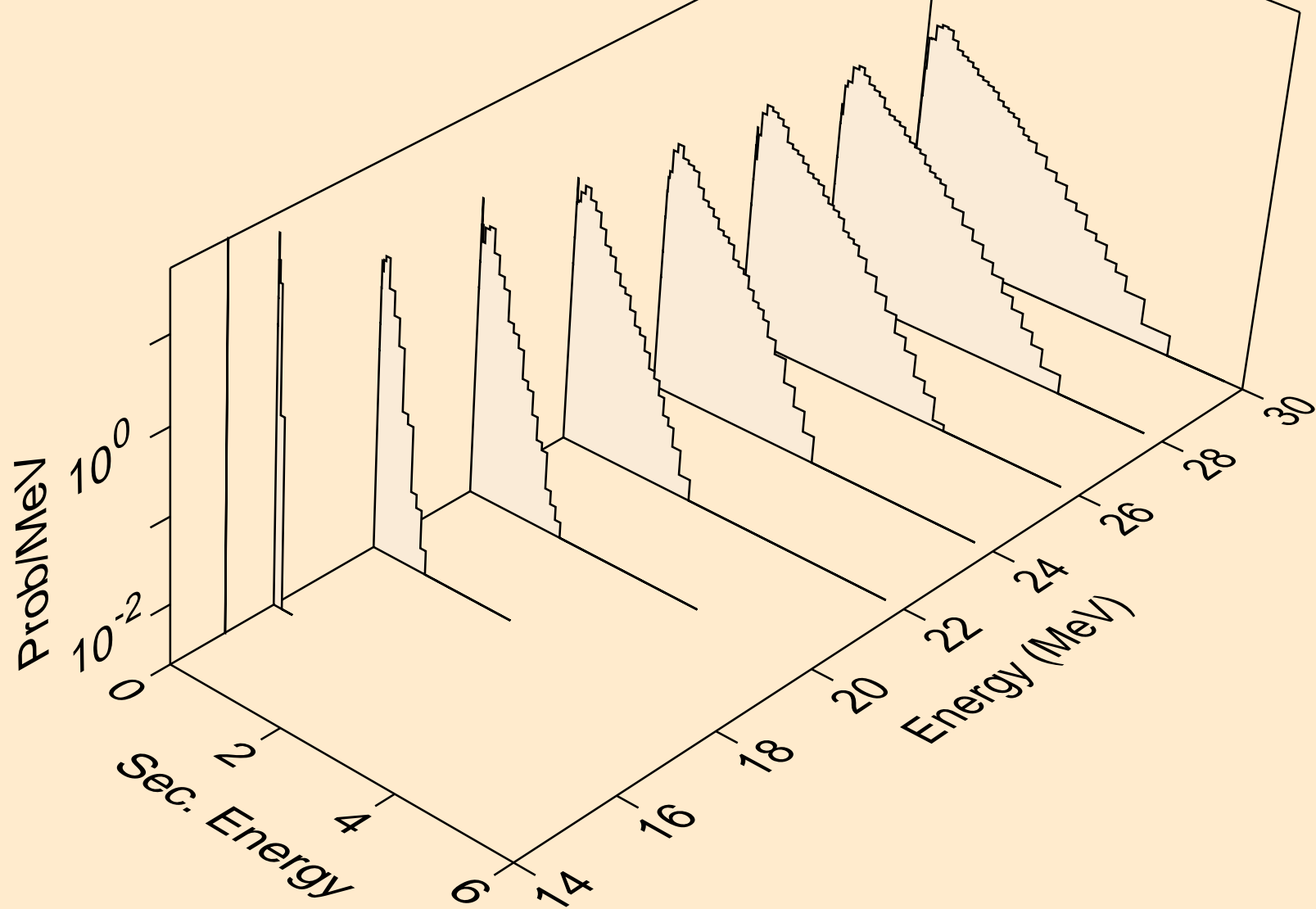

PD117 PROTON ACER TENDL-2021 LIBRARY; T=0.K  
neutrons from (p,2n)

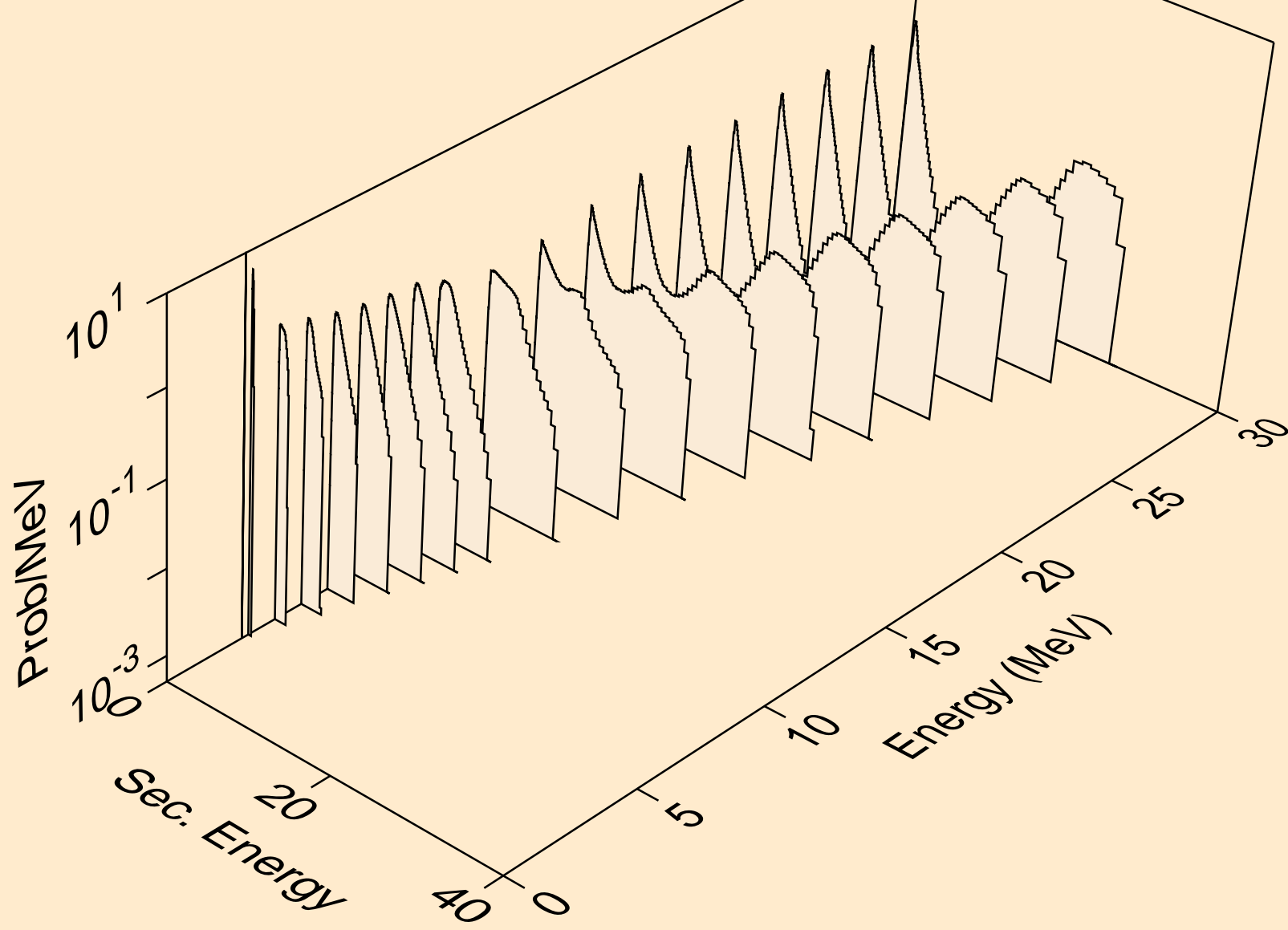

PD117 PROTON ACER TENDL-2021 LIBRARY; T=0.K  
neutrons from (p,3n)

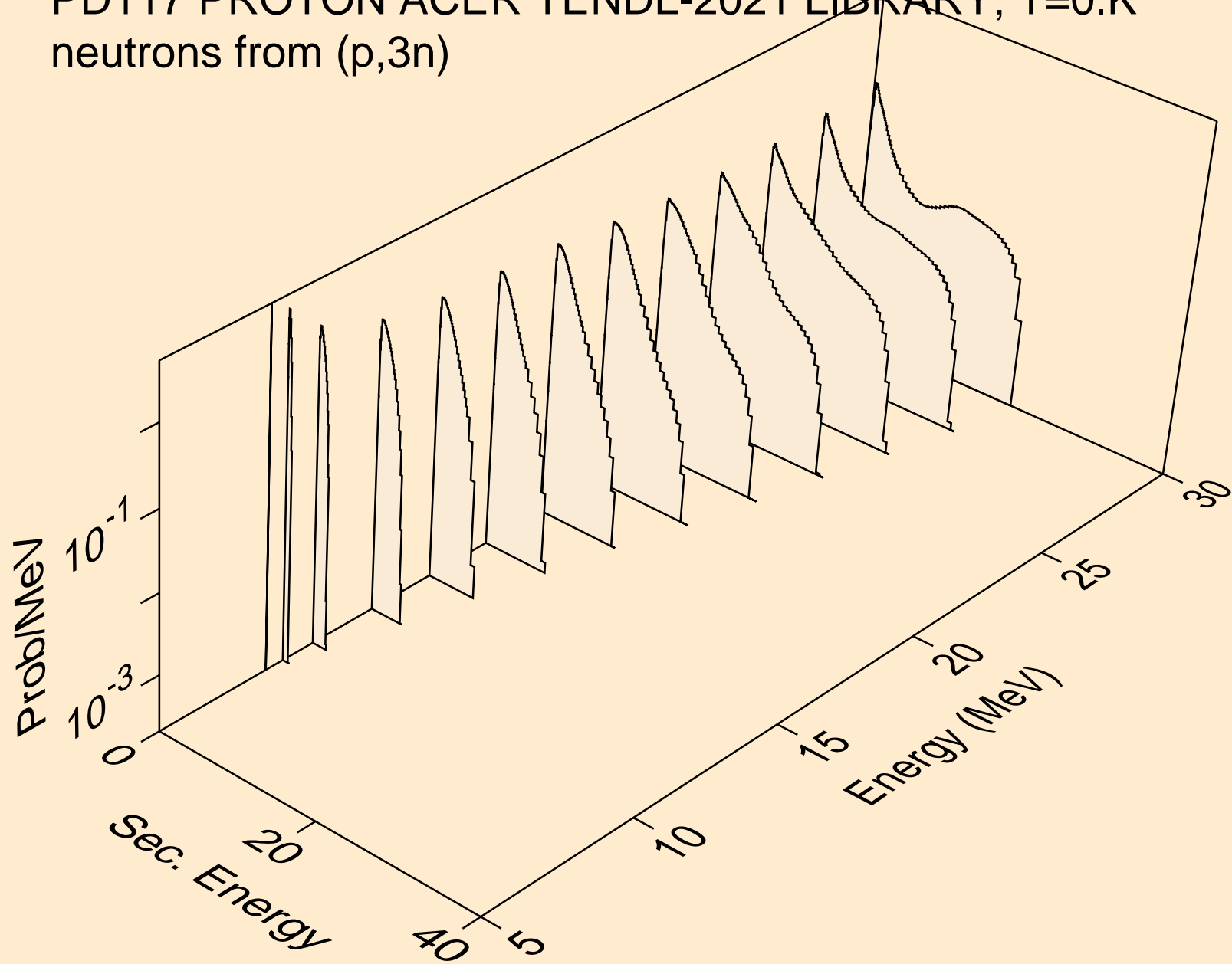

PD117 PROTON ACER TENDL-2021 LIBRARY; T=0.K  
neutrons from (p,n\*)a

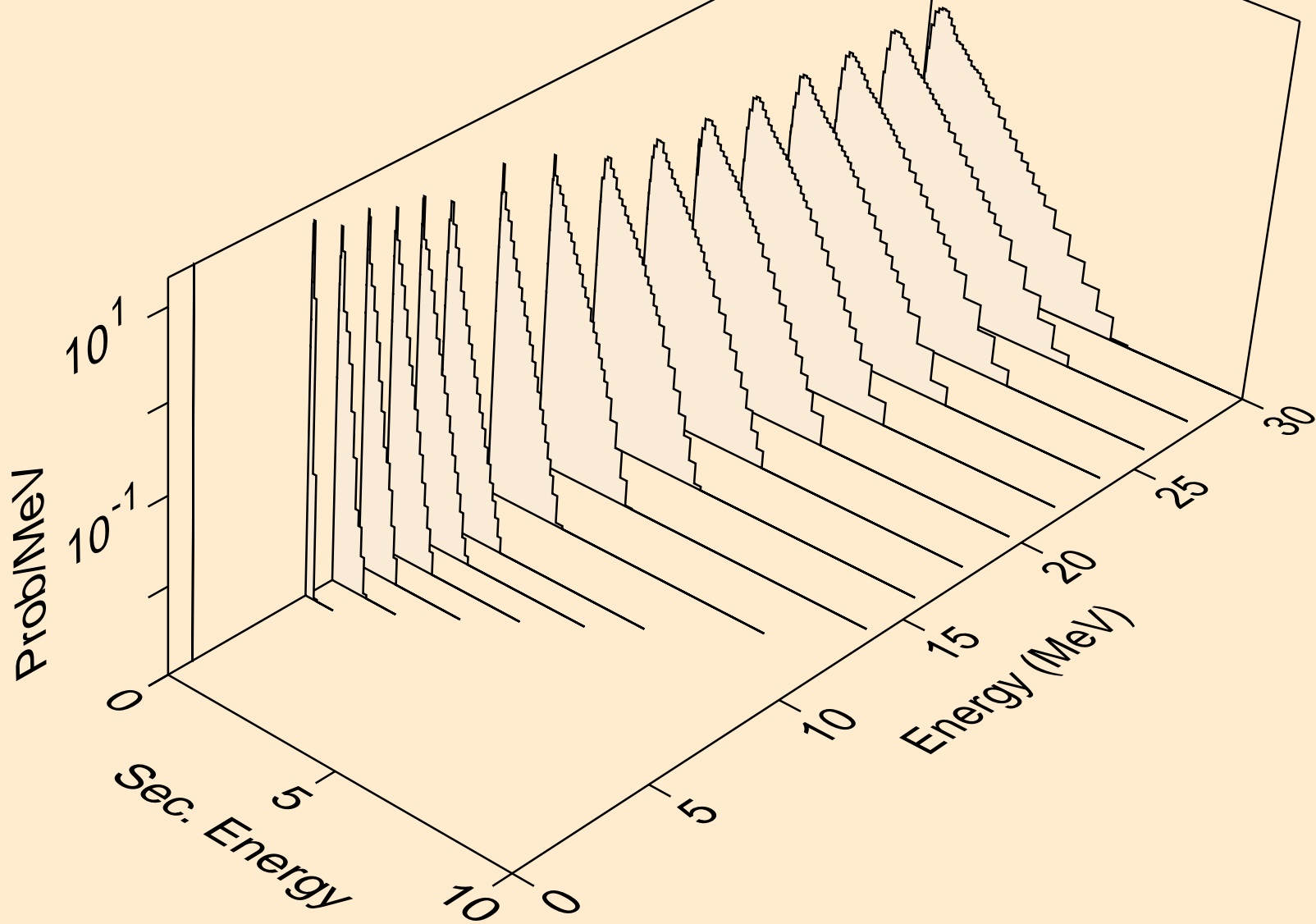

PD117 PROTON ACER TENDL-2021 LIBRARY; T=0.K  
neutrons from (p,2n)a

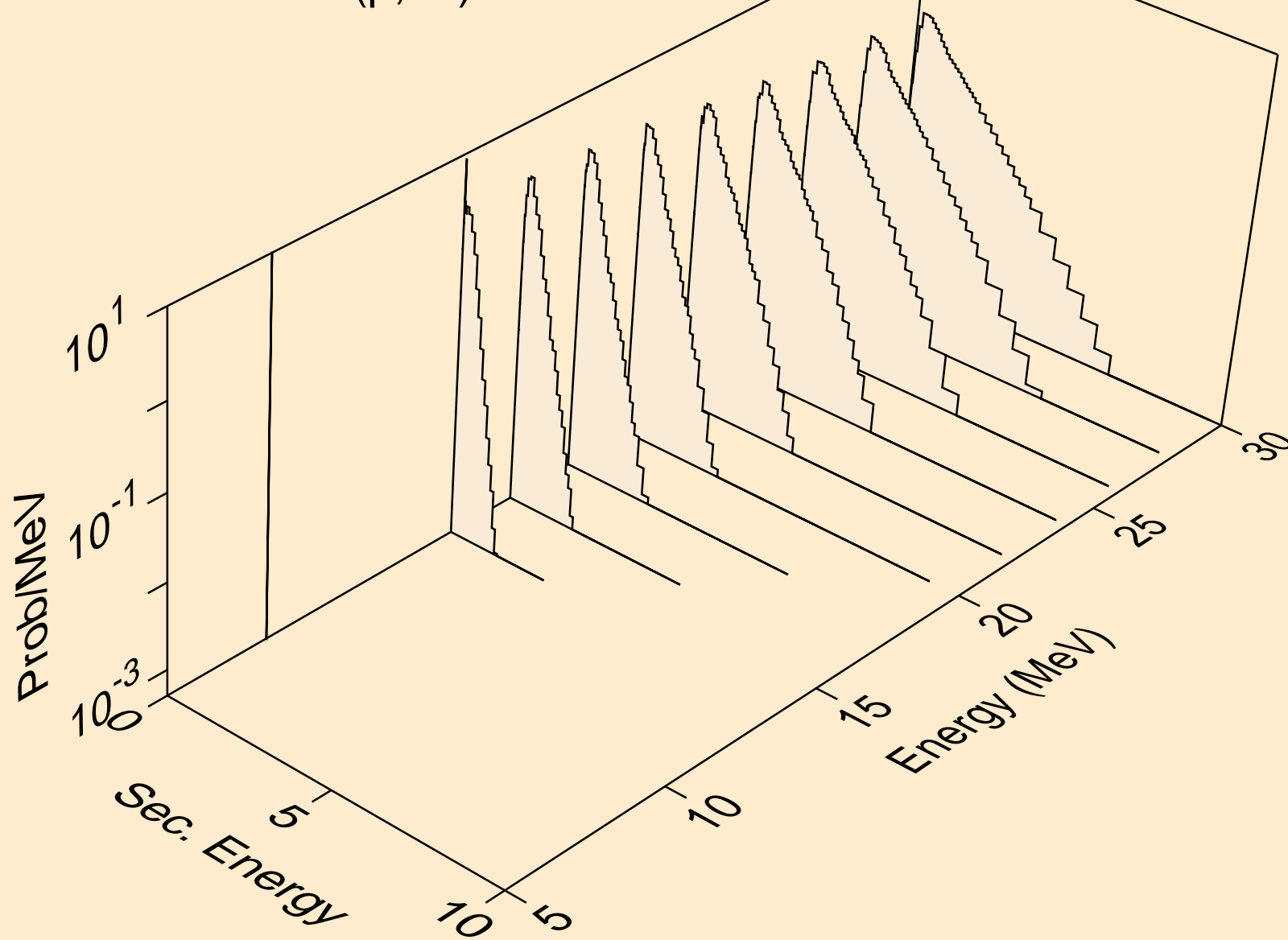

PD117 PROTON ACER TENDL-2021 LIBRARY; T=0.K  
neutrons from (p,3n)a

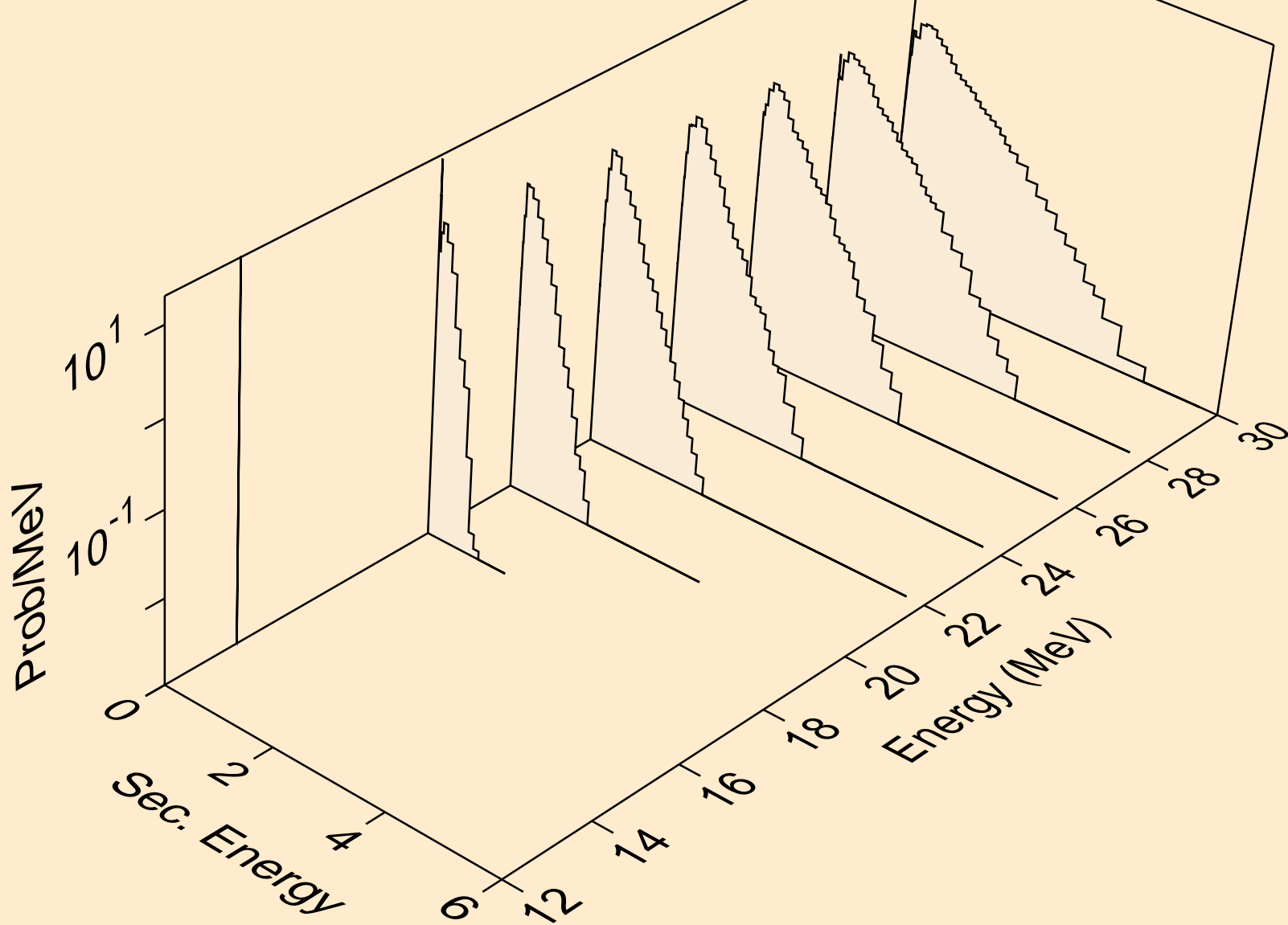

PD117 PROTON ACER TENDL-2021 LIBRARY; T=0.K  
neutrons from (p,n\*)p

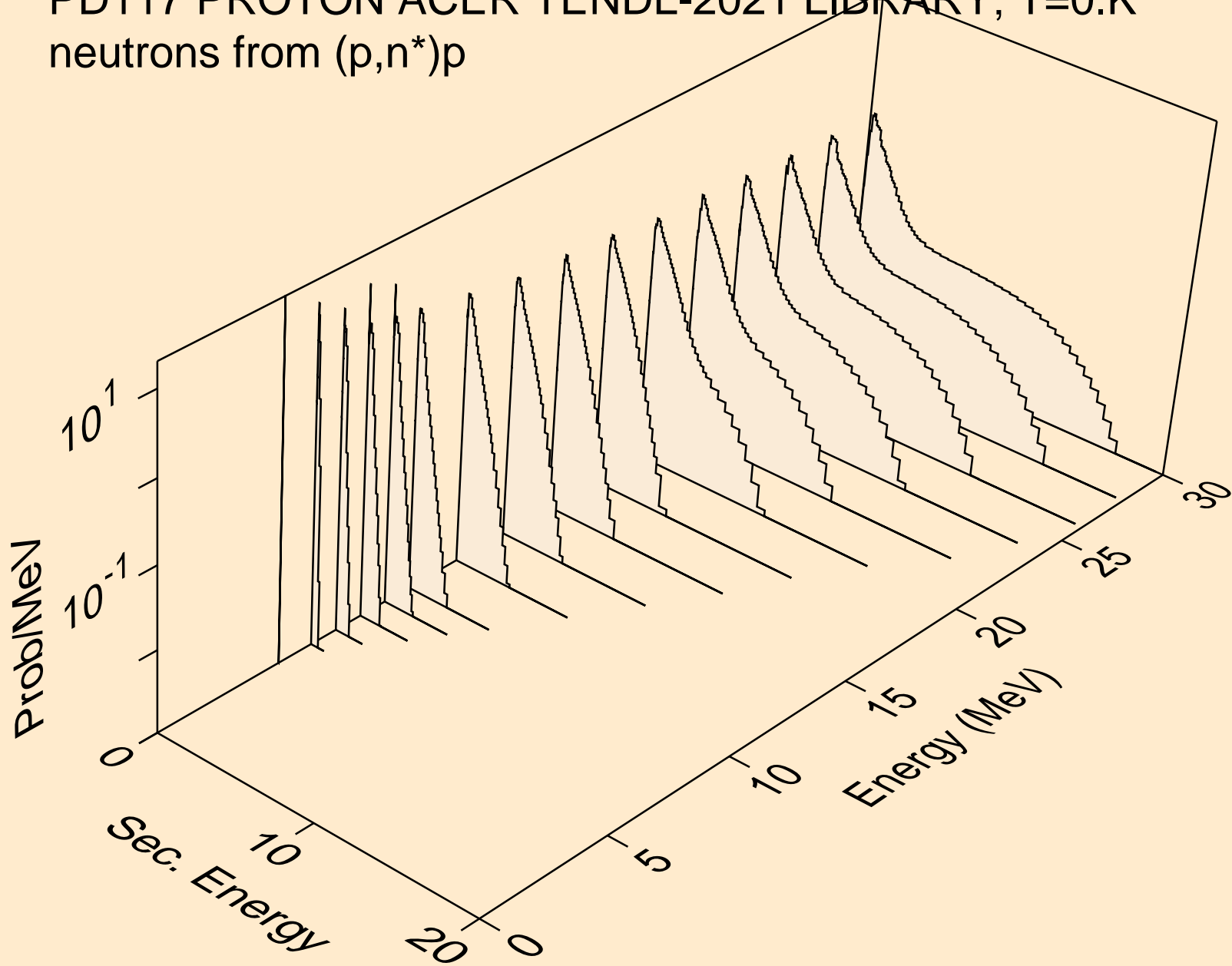



PD117 PROTON ACER TENDL-2021 LIBRARY; T=0.K  
neutrons from (p,n\*)d

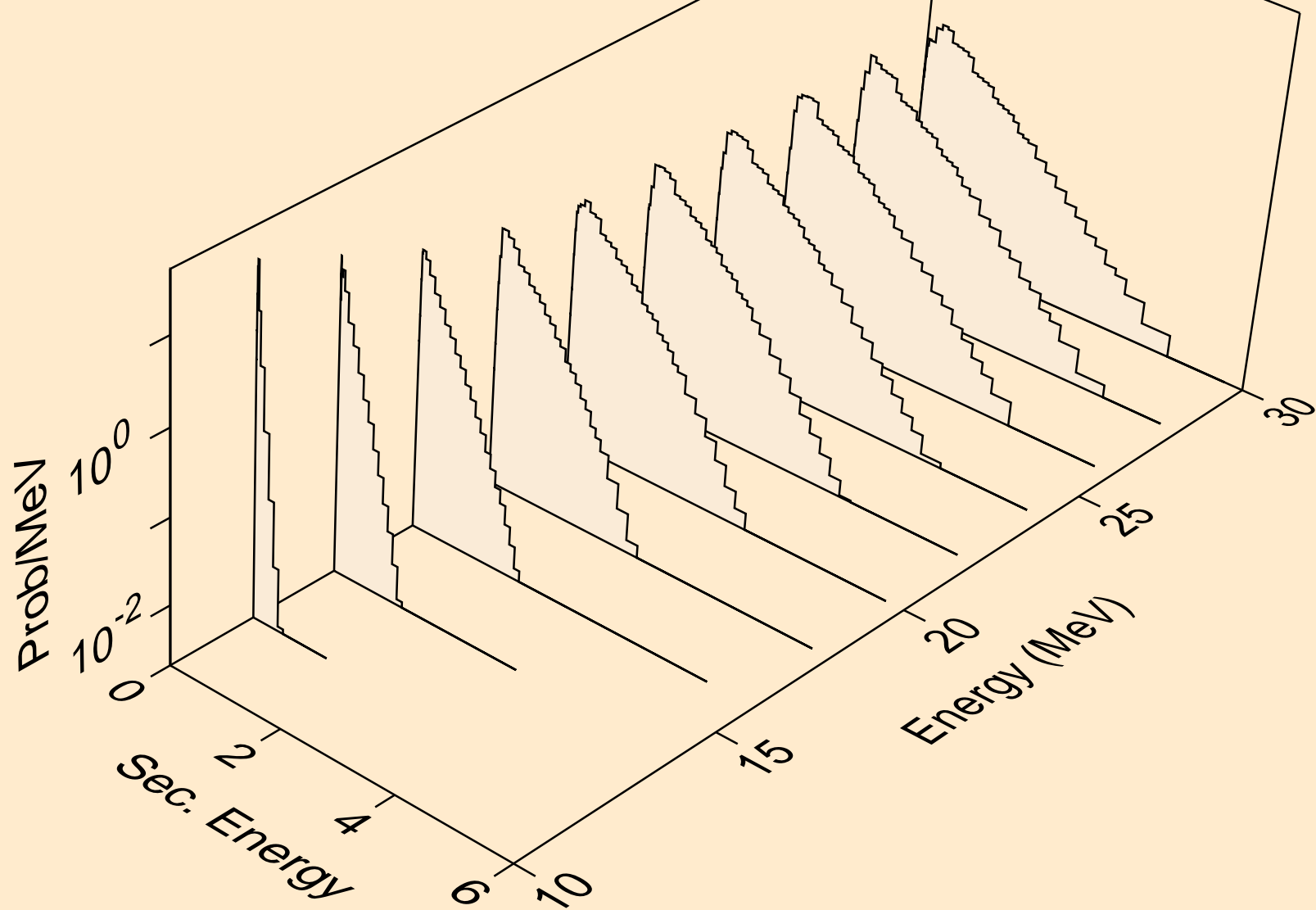

PD117 PROTON ACER TENDL-2021 LIBRARY; T=0.K  
neutrons from (p,n\*)t

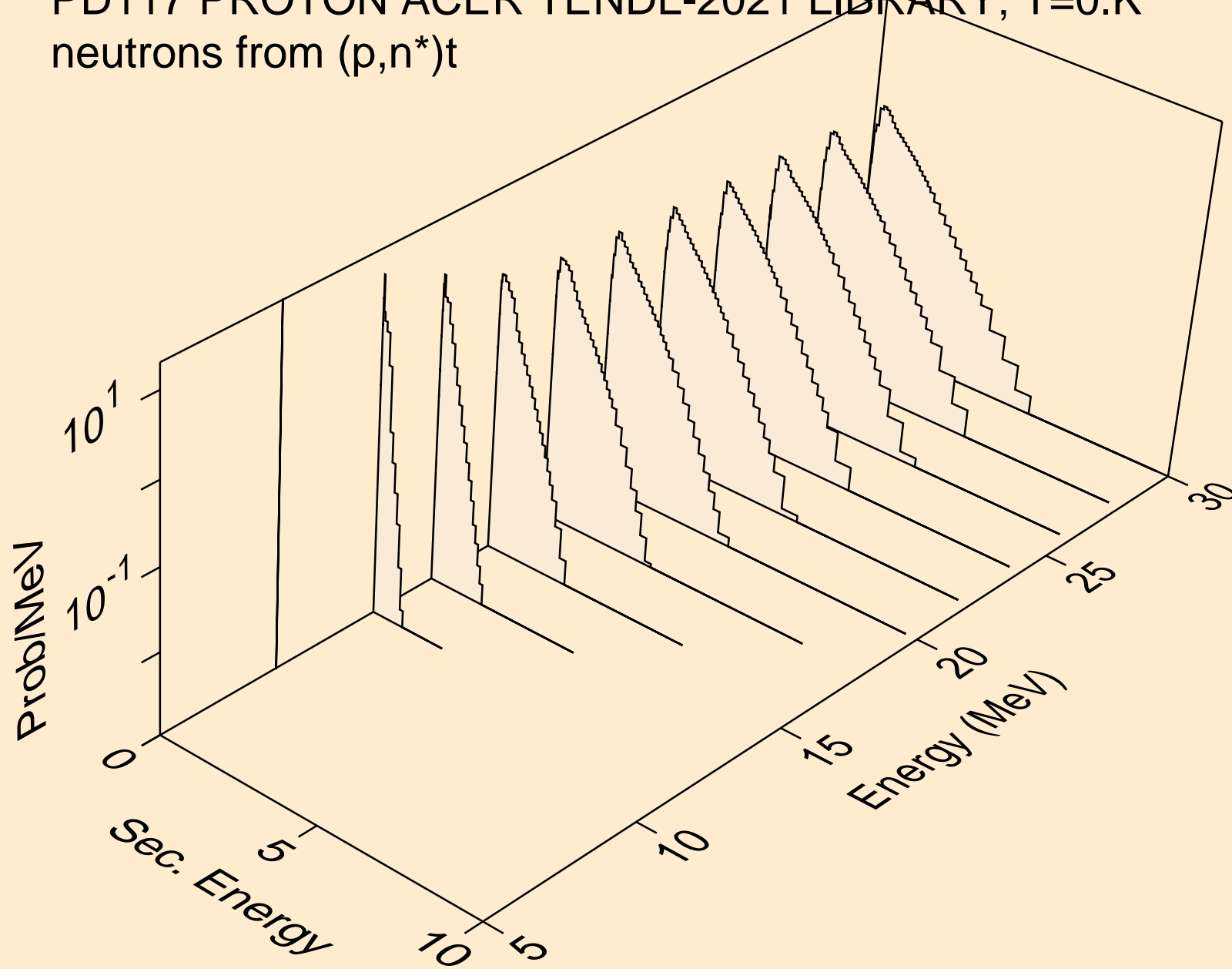

PD117 PROTON ACER TENDL-2021 LIBRARY; T=0.K  
neutrons from (p,n\*)he3

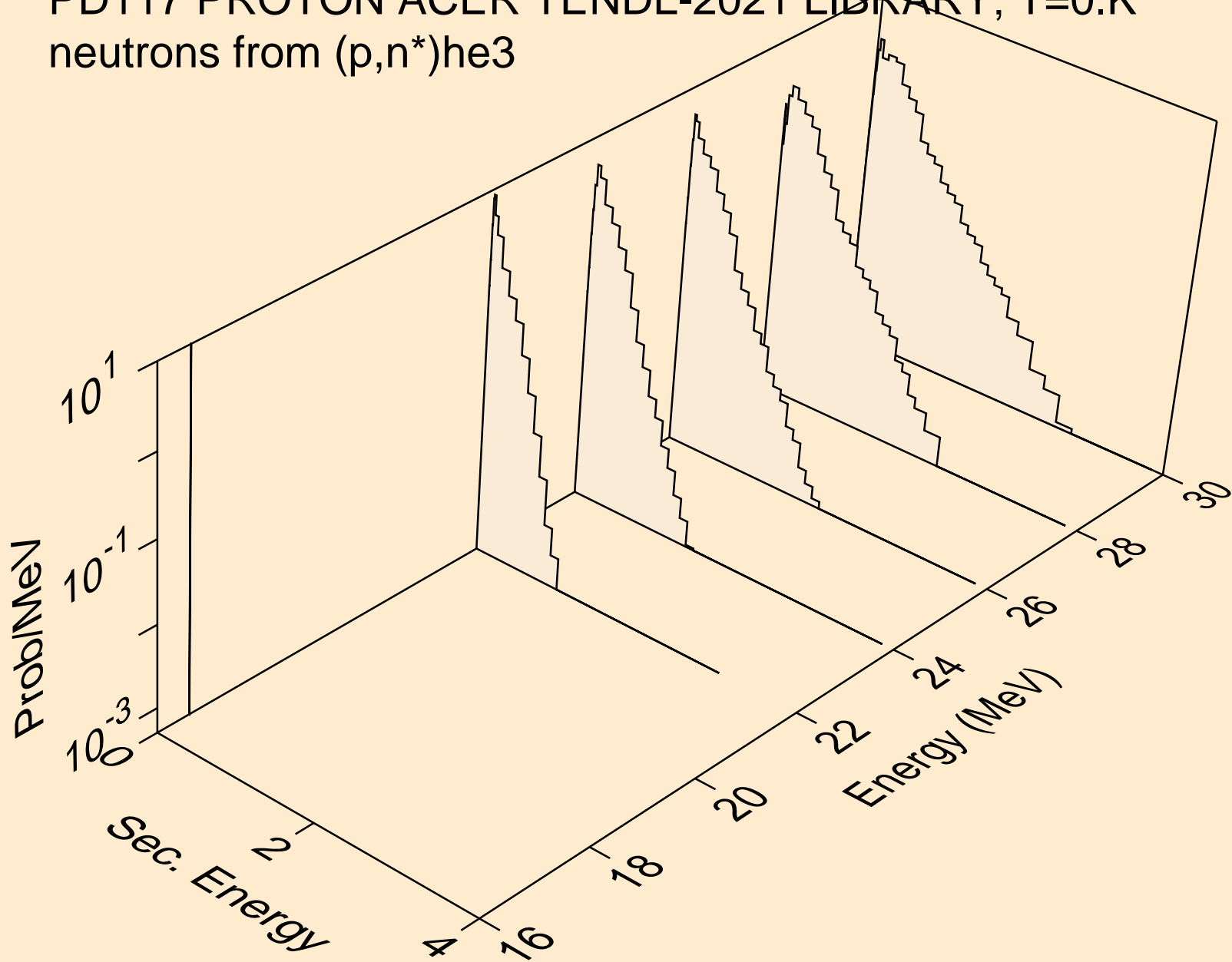

PD117 PROTON ACER TENDL-2021 LIBRARY; T=0.K  
neutrons from (p,4n)

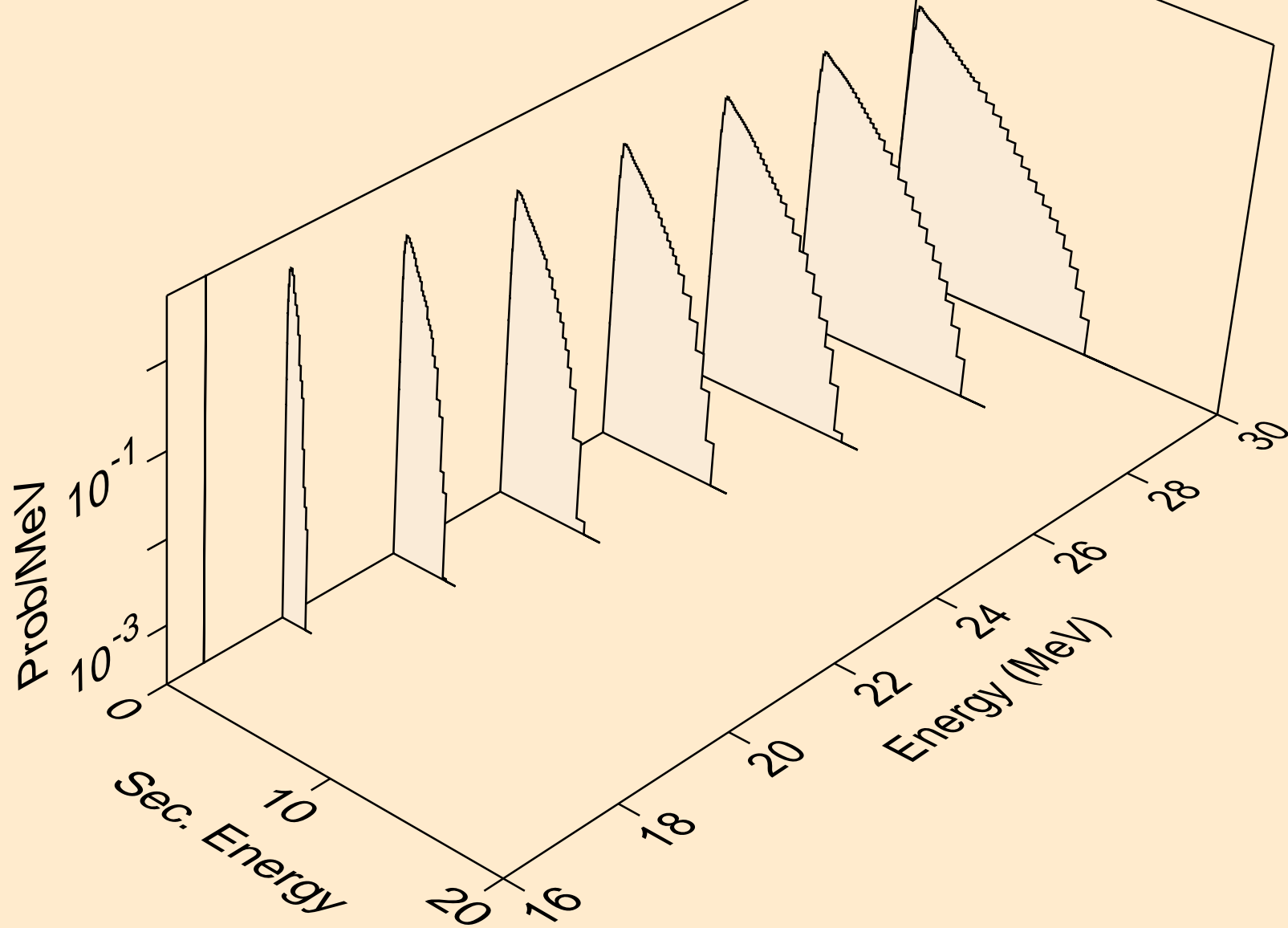

PD117 PROTON ACER TENDL-2021 LIBRARY; T=0.K  
neutrons from (p,2np)

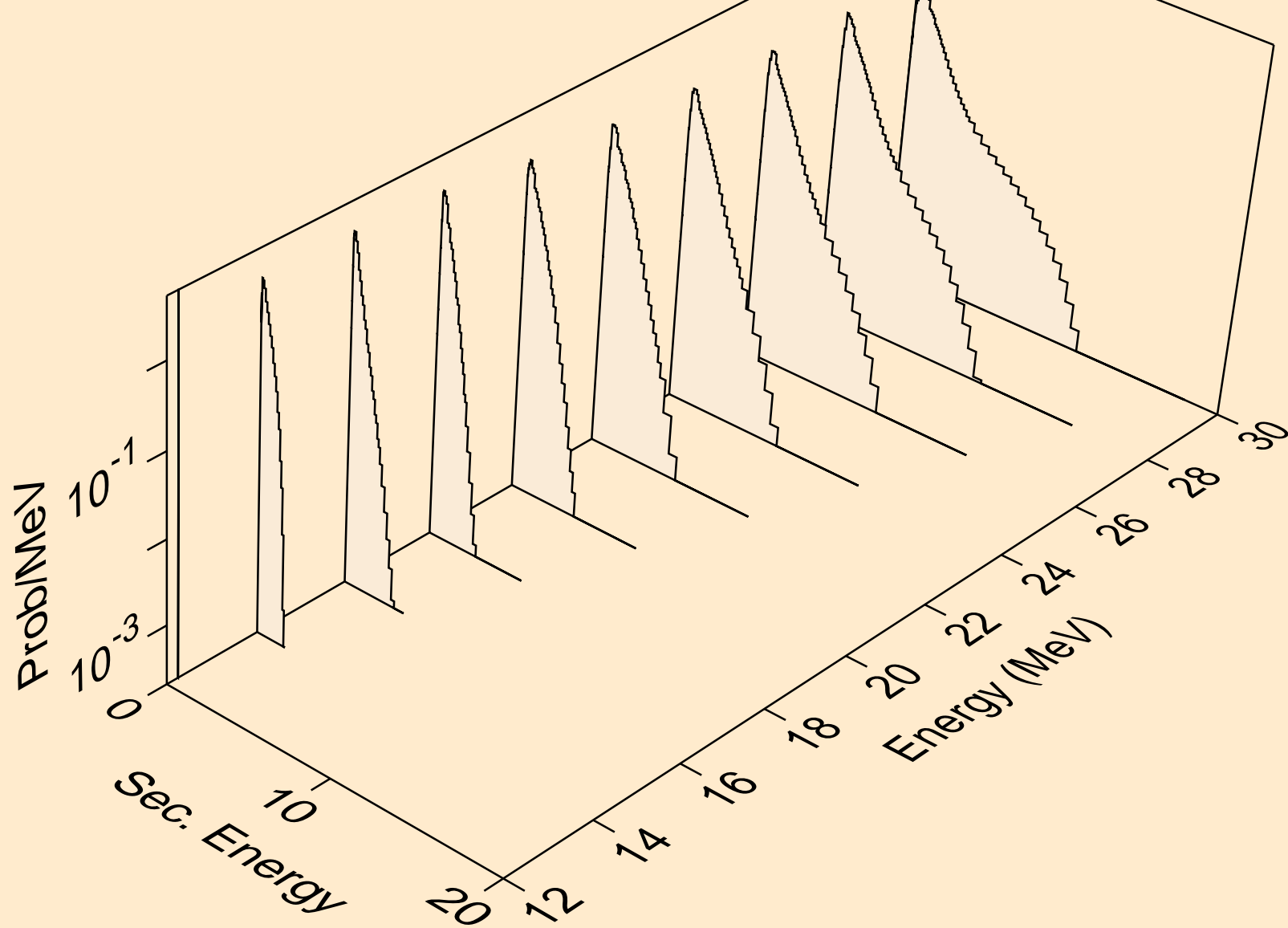

PD117 PROTON ACER TENDL-2021 LIBRARY; T=0.K  
neutrons from (p,3np)

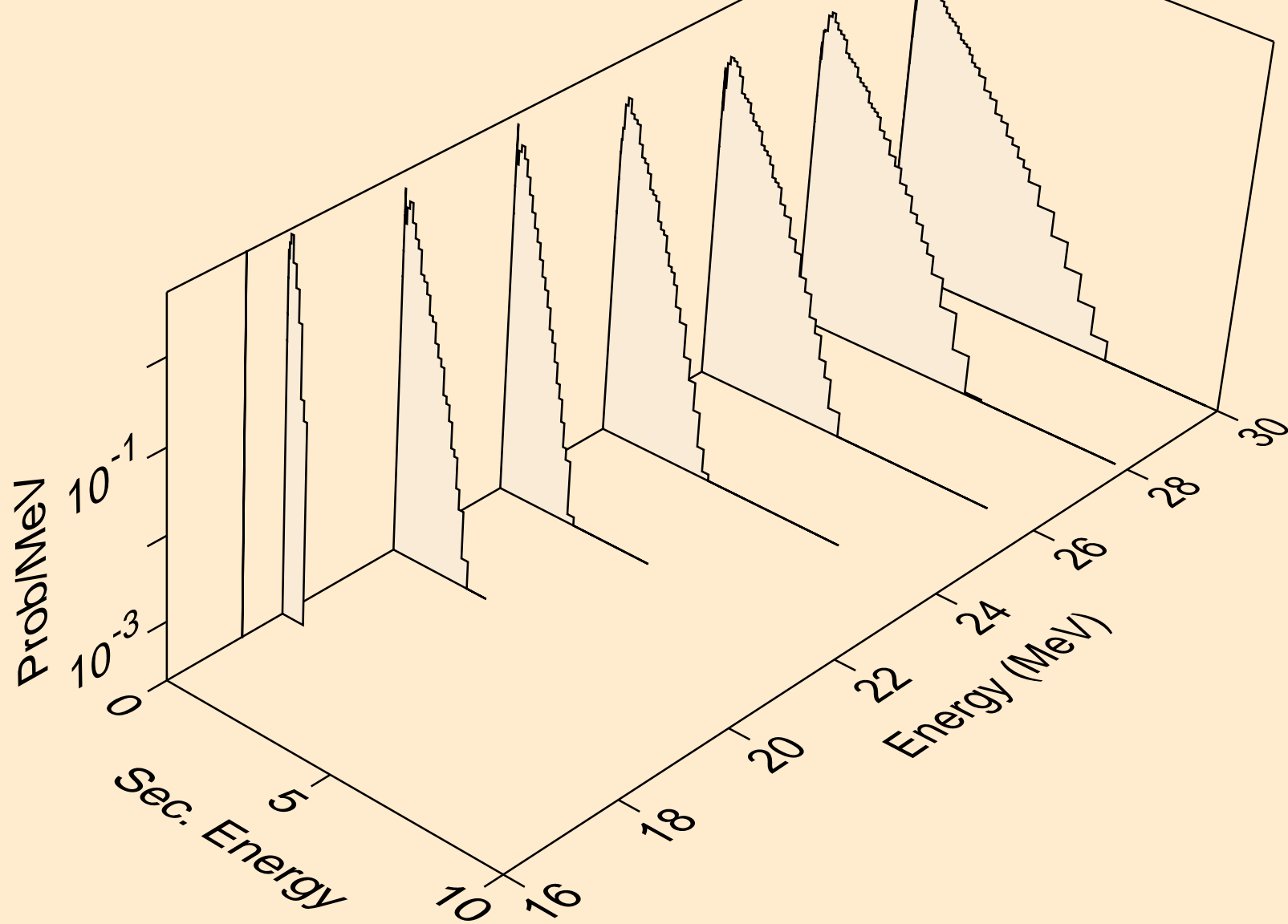

PD117 PROTON ACER TENDL-2021 LIBRARY; T=0.K  
neutrons from (p,2np)

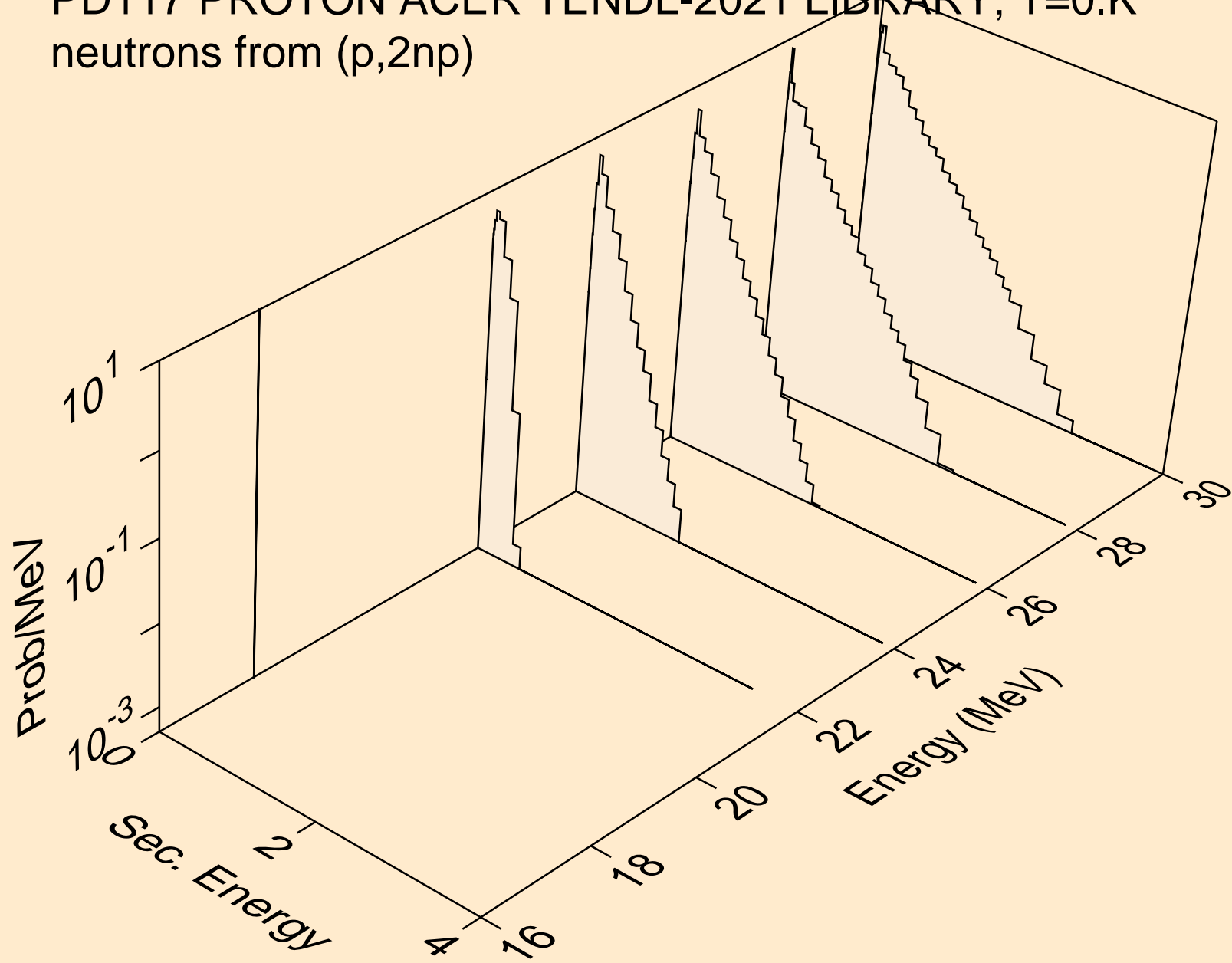

PD117 PROTON ACER TENDL-2021 LIBRARY; T=0.K  
neutrons from (p,npa)

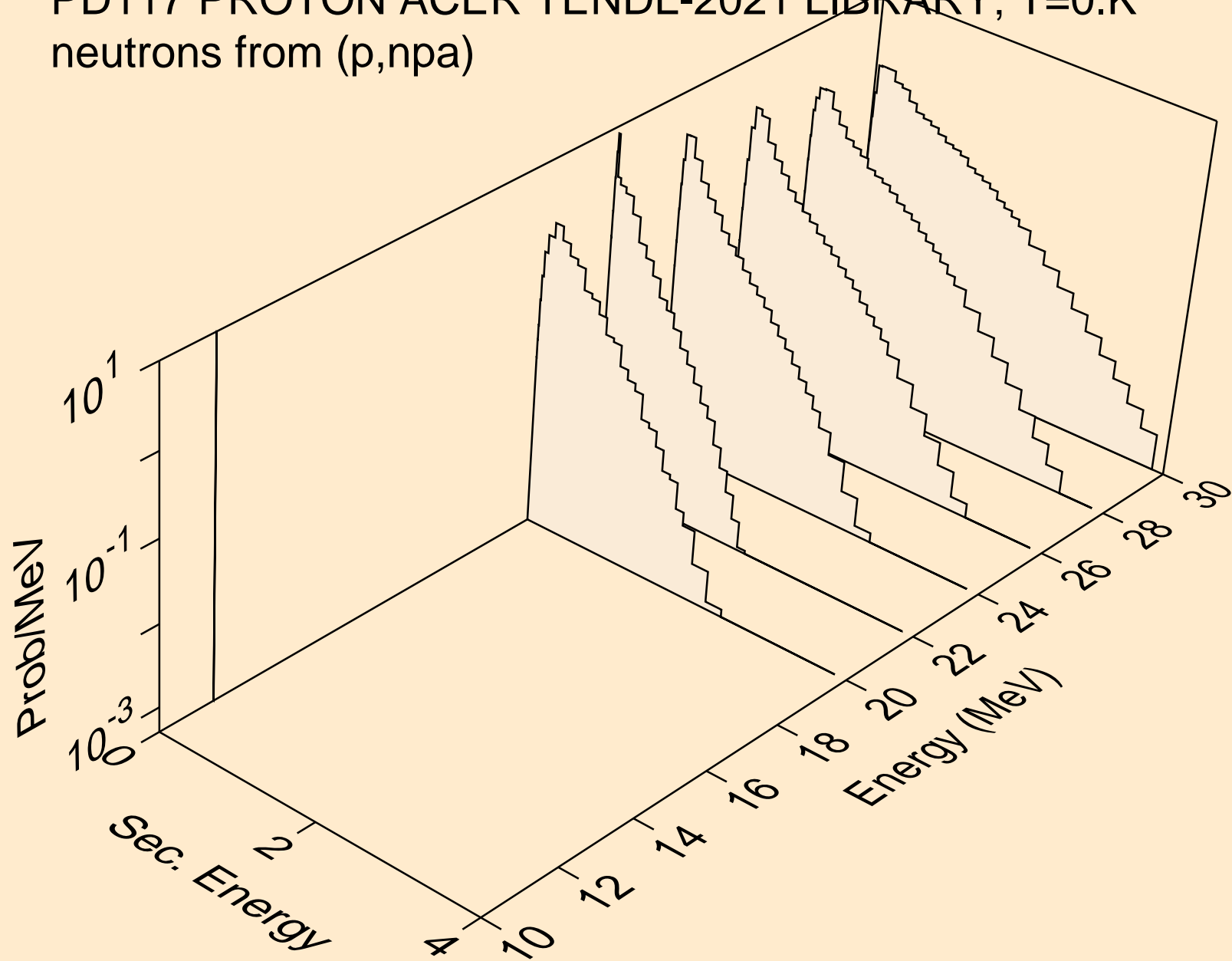



PD117 PROTON ACER TENDL-2021 LIBRARY; T=0.K  
deuterons from (p,x)

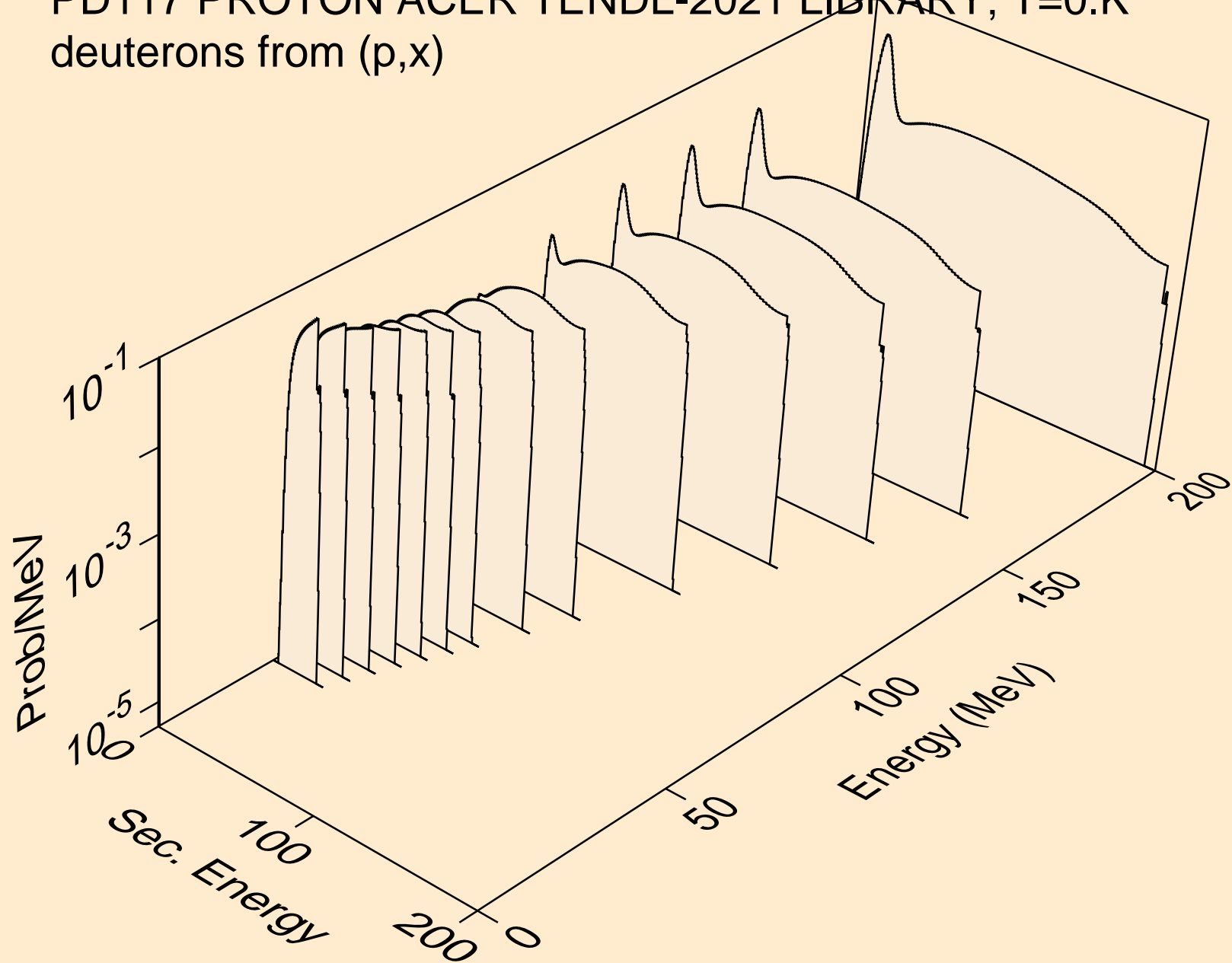

PD117 PROTON ACER TENDL-2021 LIBRARY; T=0.K  
deuterons from (p,2nd)

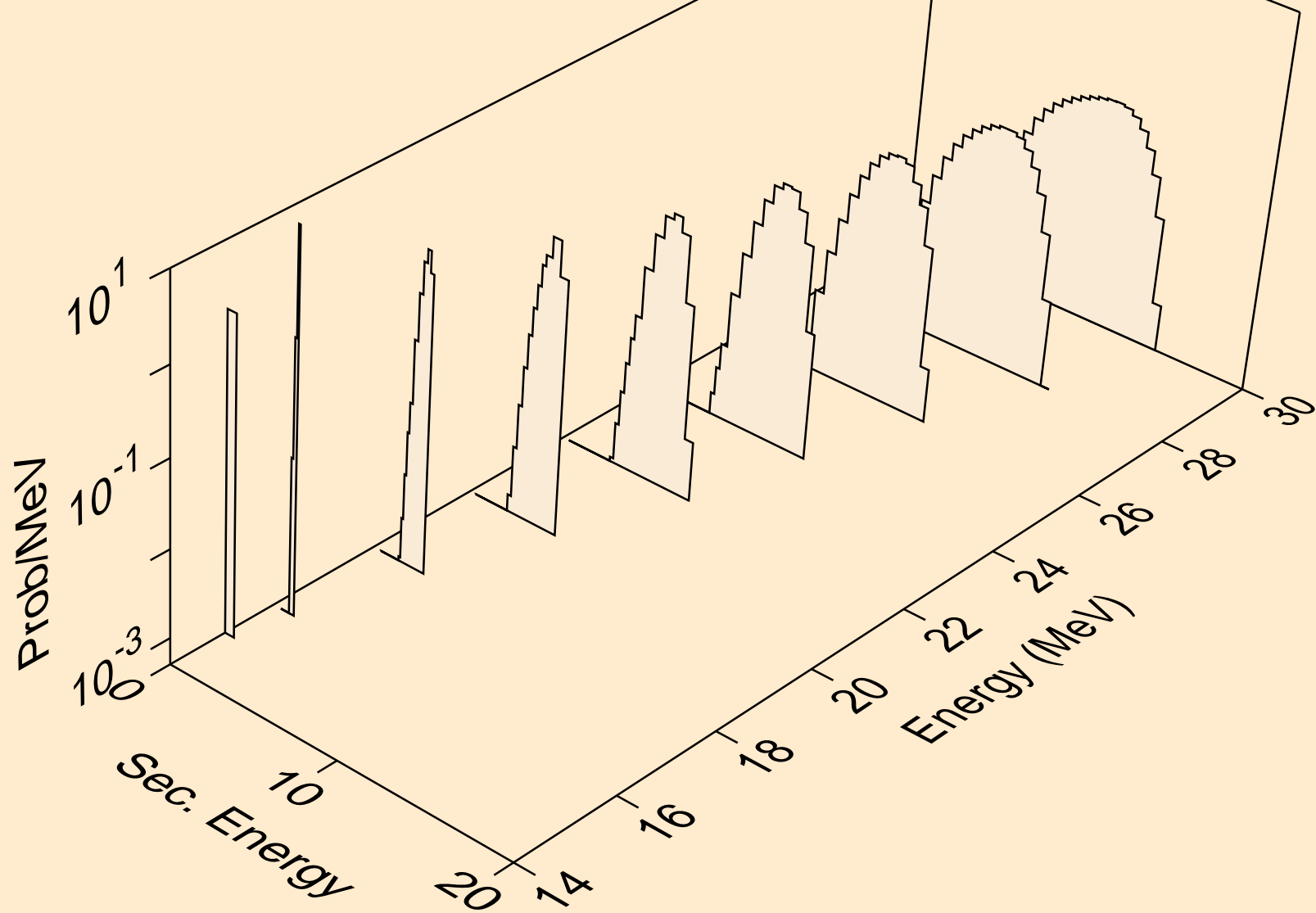

PD117 PROTON ACER TENDL-2021 LIBRARY; T=0.K  
deuterons from (p,n\*)d

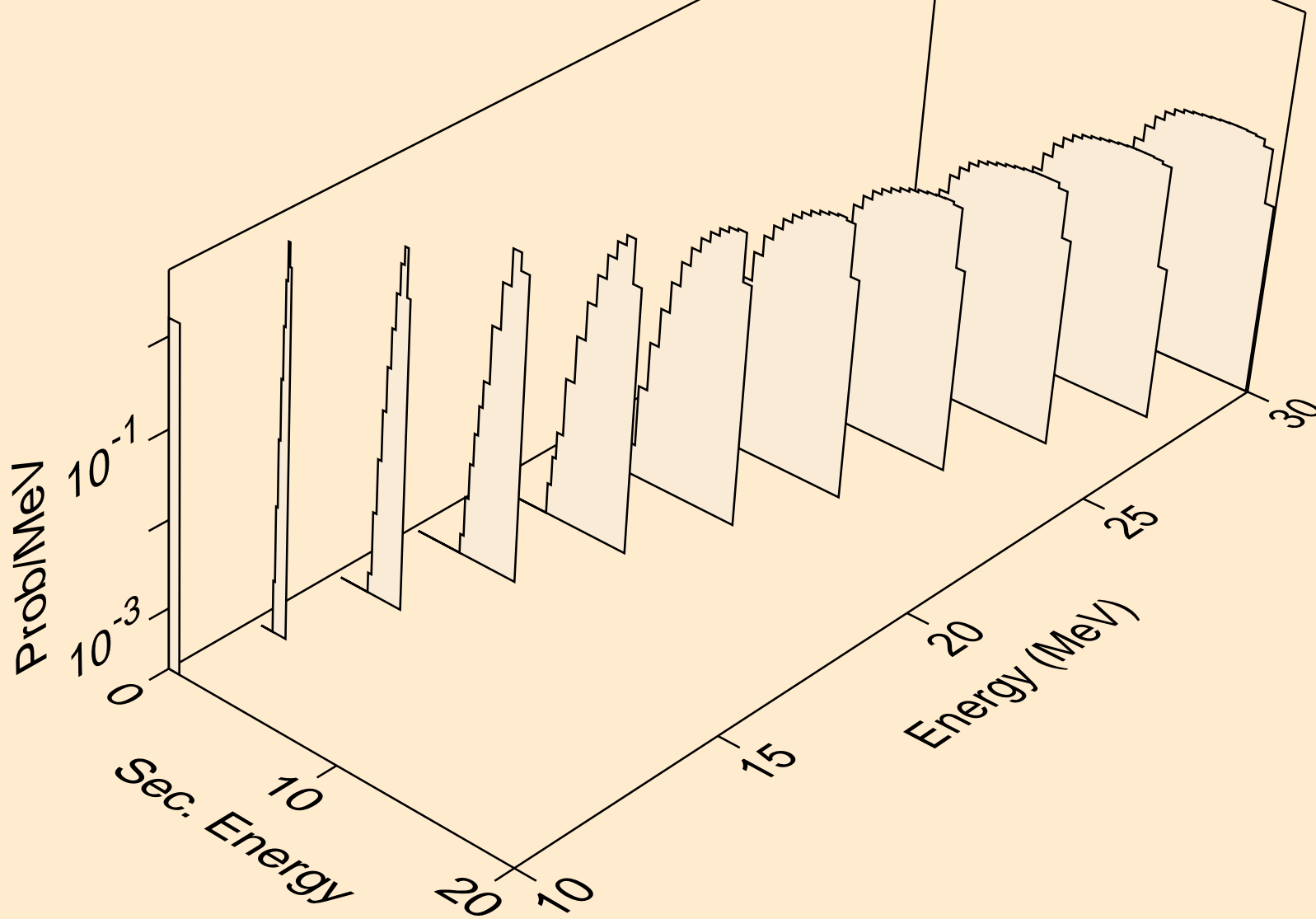

PD117 PROTON ACER TENDL-2021 LIBRARY; T=0.K  
deuterons from (p,d)

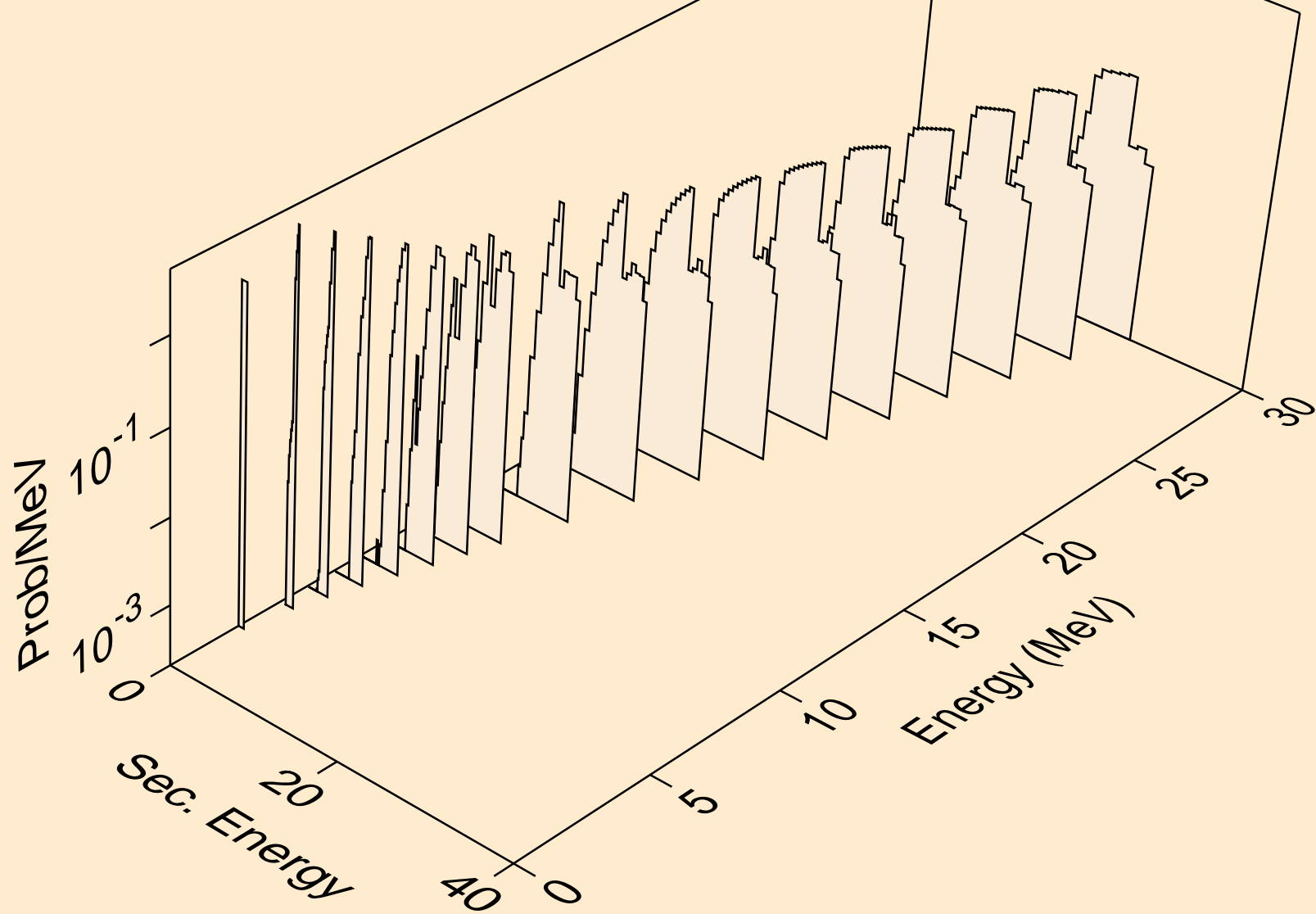

PD117 PROTON ACER TENDL-2021 LIBRARY; T=0.K  
deuterons from (p,pd)

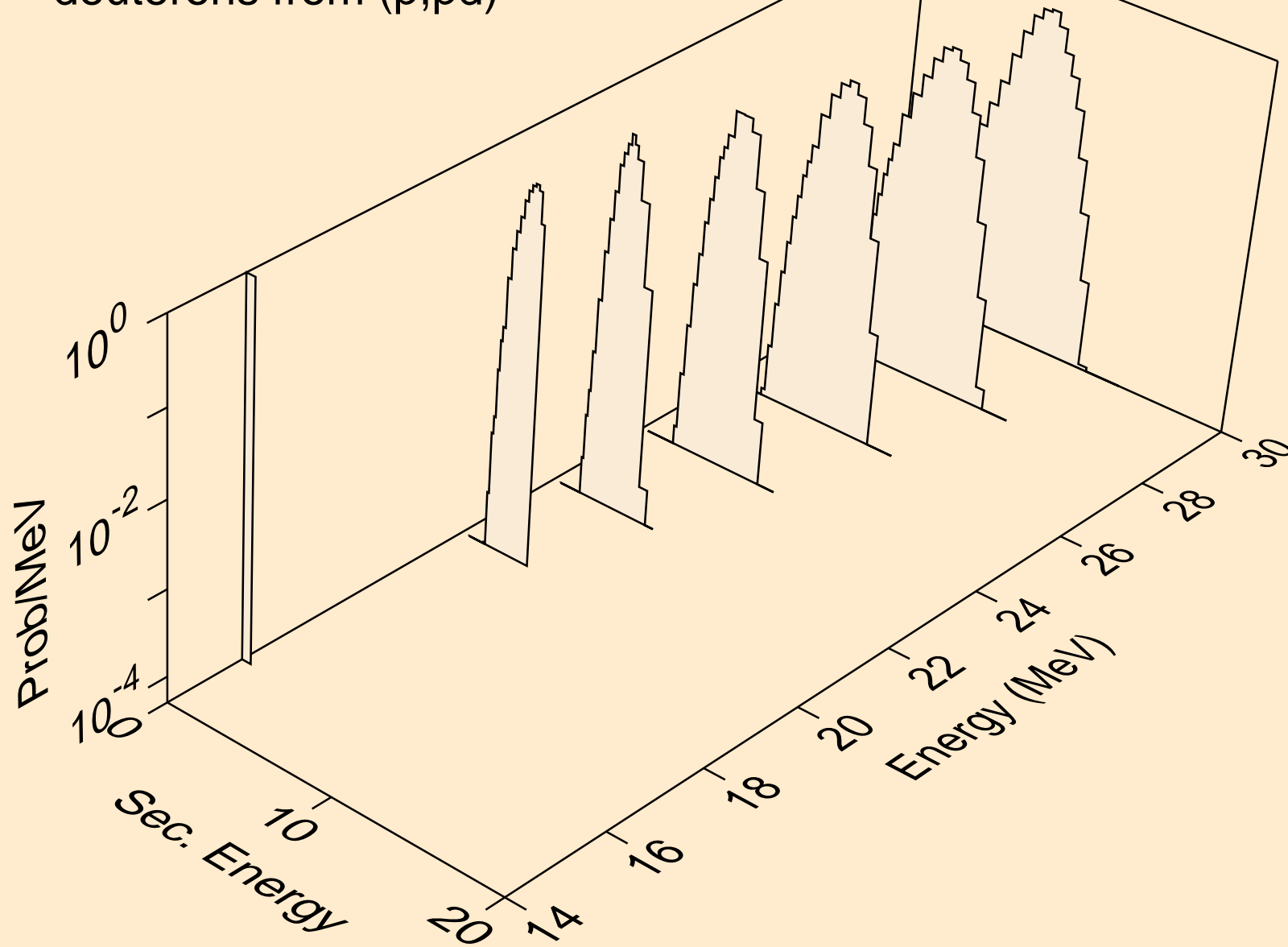

PD117 PROTON ACER TENDL-2021 LIBRARY; T=0.K  
tritons from (p,x)

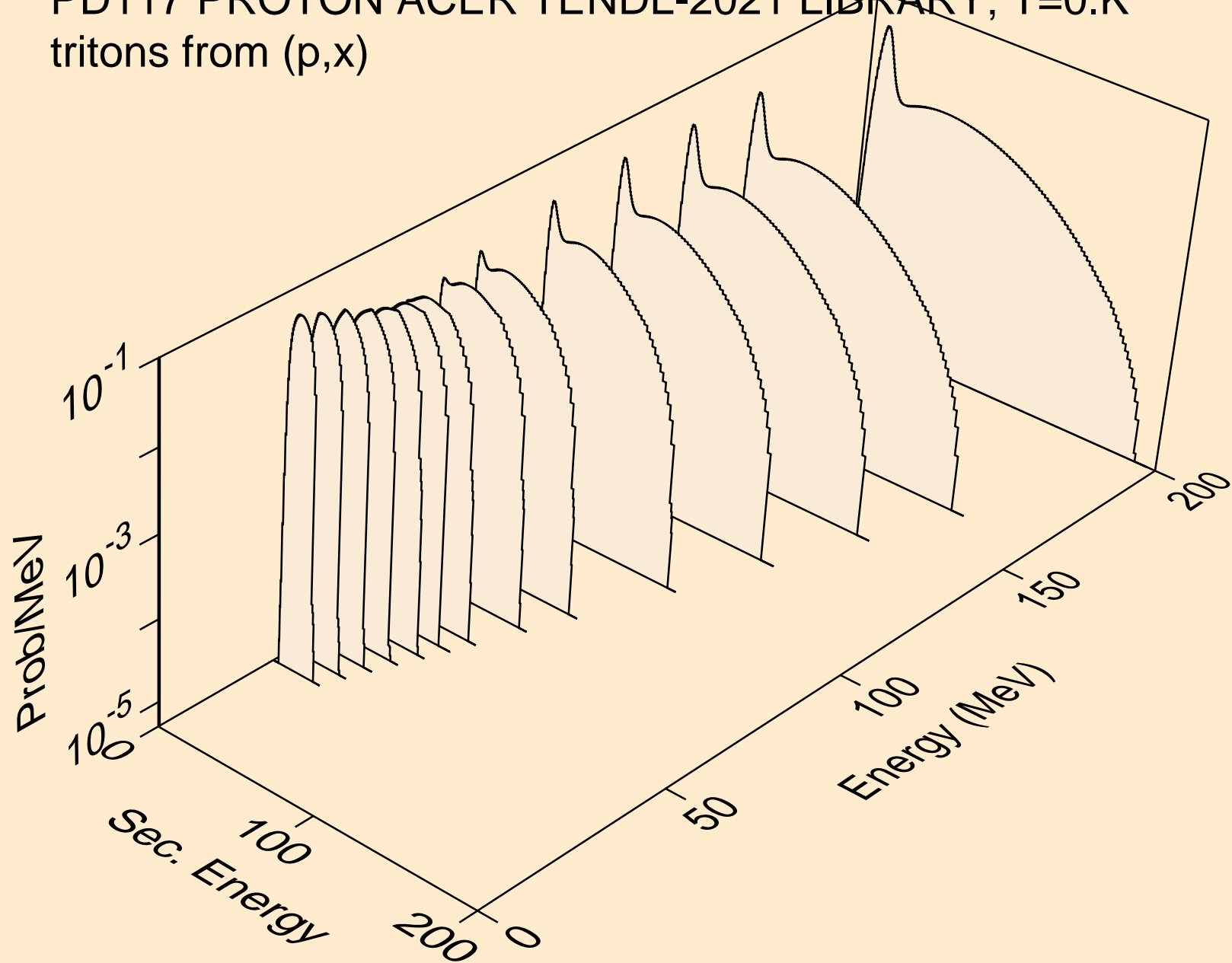

PD117 PROTON ACER TENDL-2021 LIBRARY; T=0.K  
tritons from (p,n\*)t

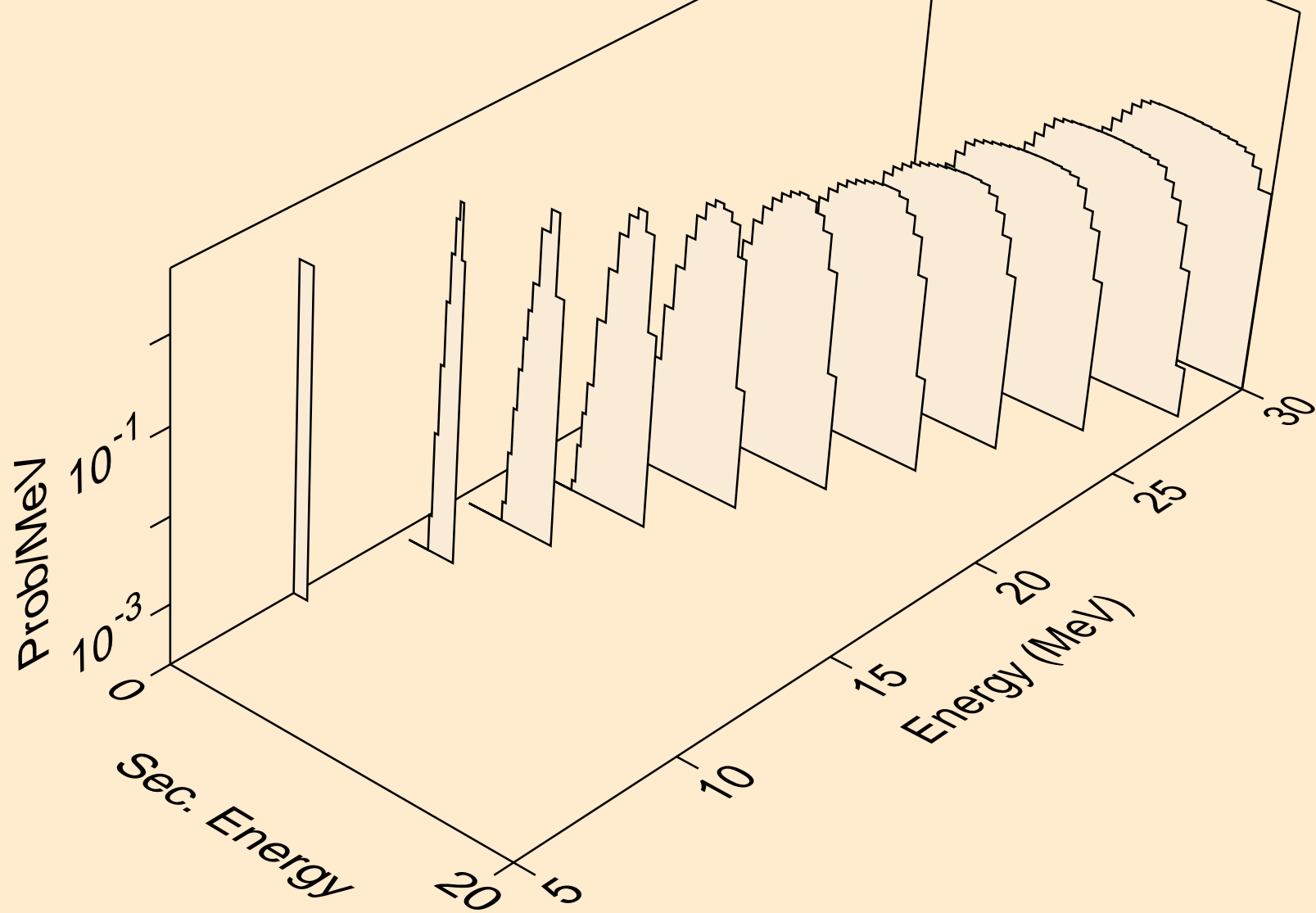

PD117 PROTON ACER TENDL-2021 LIBRARY; T=0.K  
tritons from (p,t)

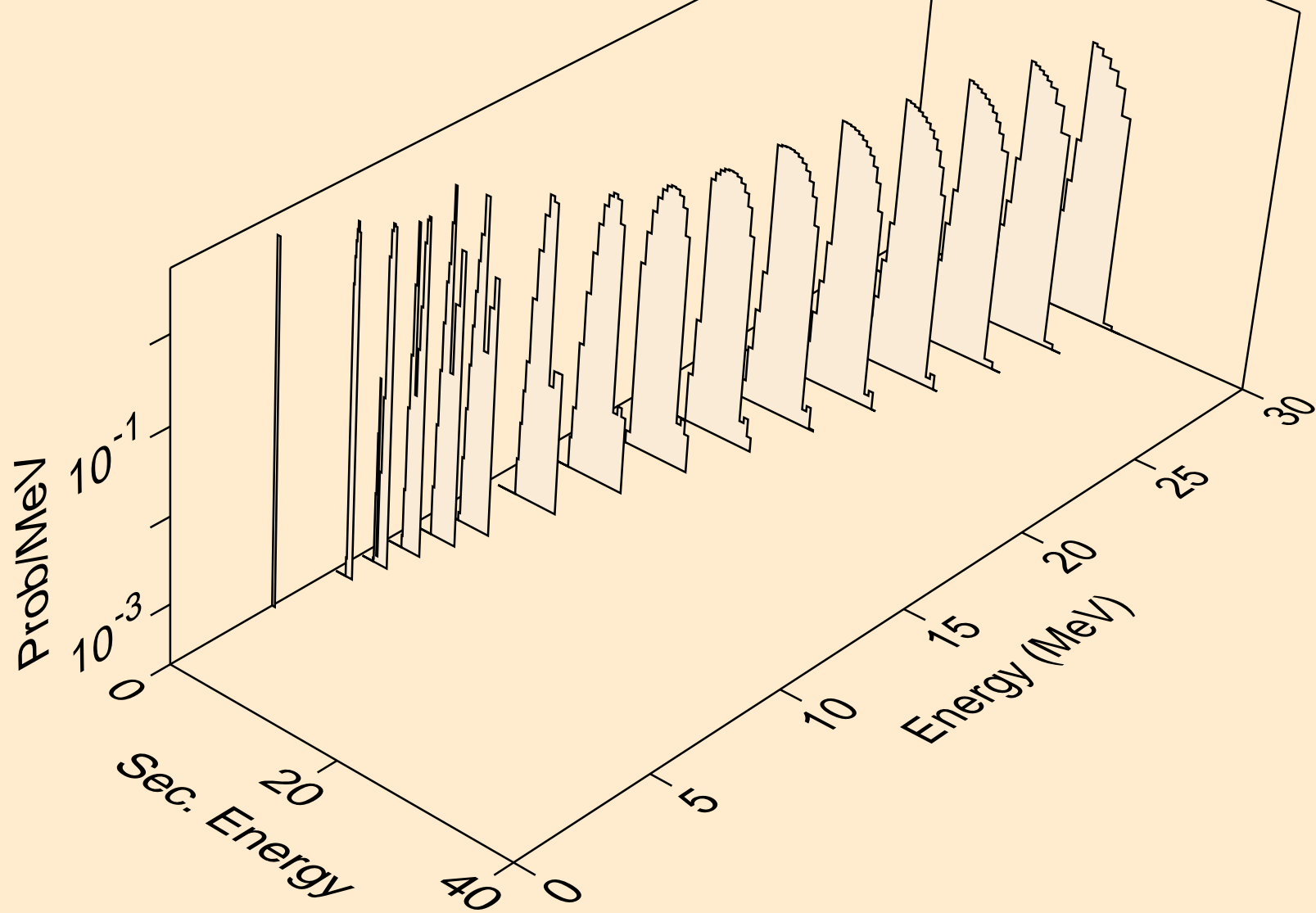



PD117 PROTON ACER TENDL-2021 LIBRARY; T=0.K  
he3s from (p,x)

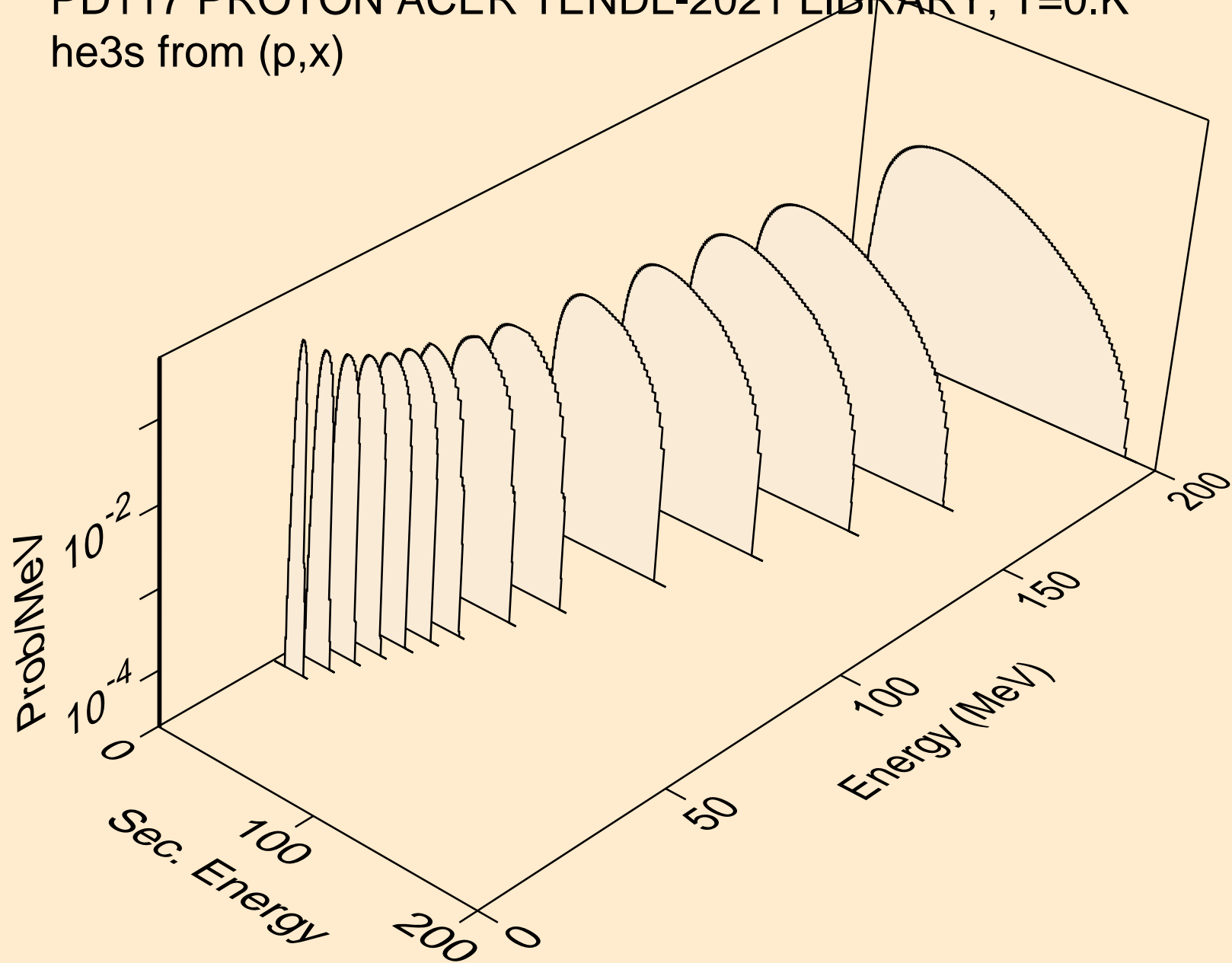

PD117 PROTON ACER TENDL-2021 LIBRARY; T=0.K  
he3s from (p,n\*)he3

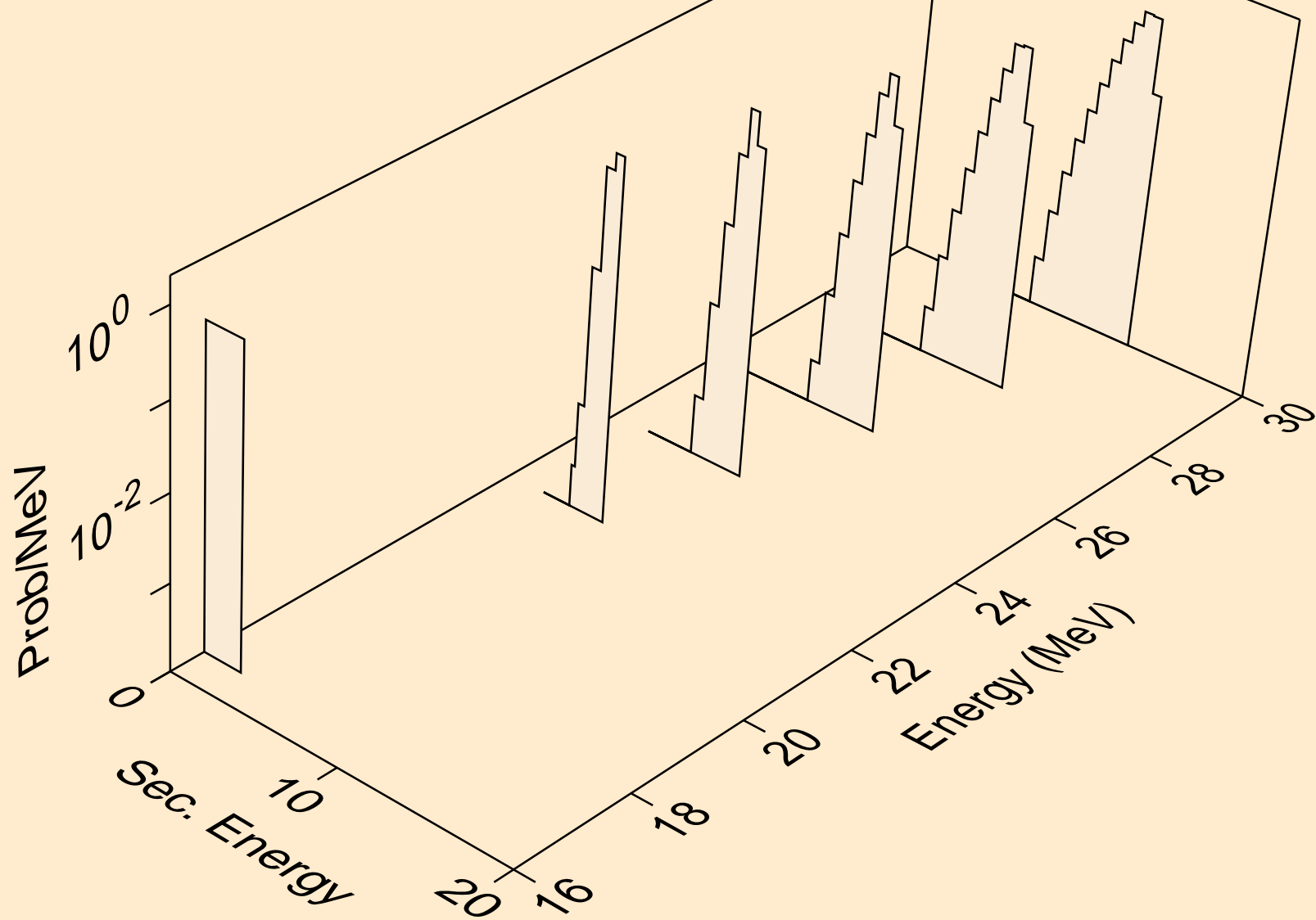

PD117 PROTON ACER TENDL-2021 LIBRARY; T=0.K  
he3s from (p,he3)

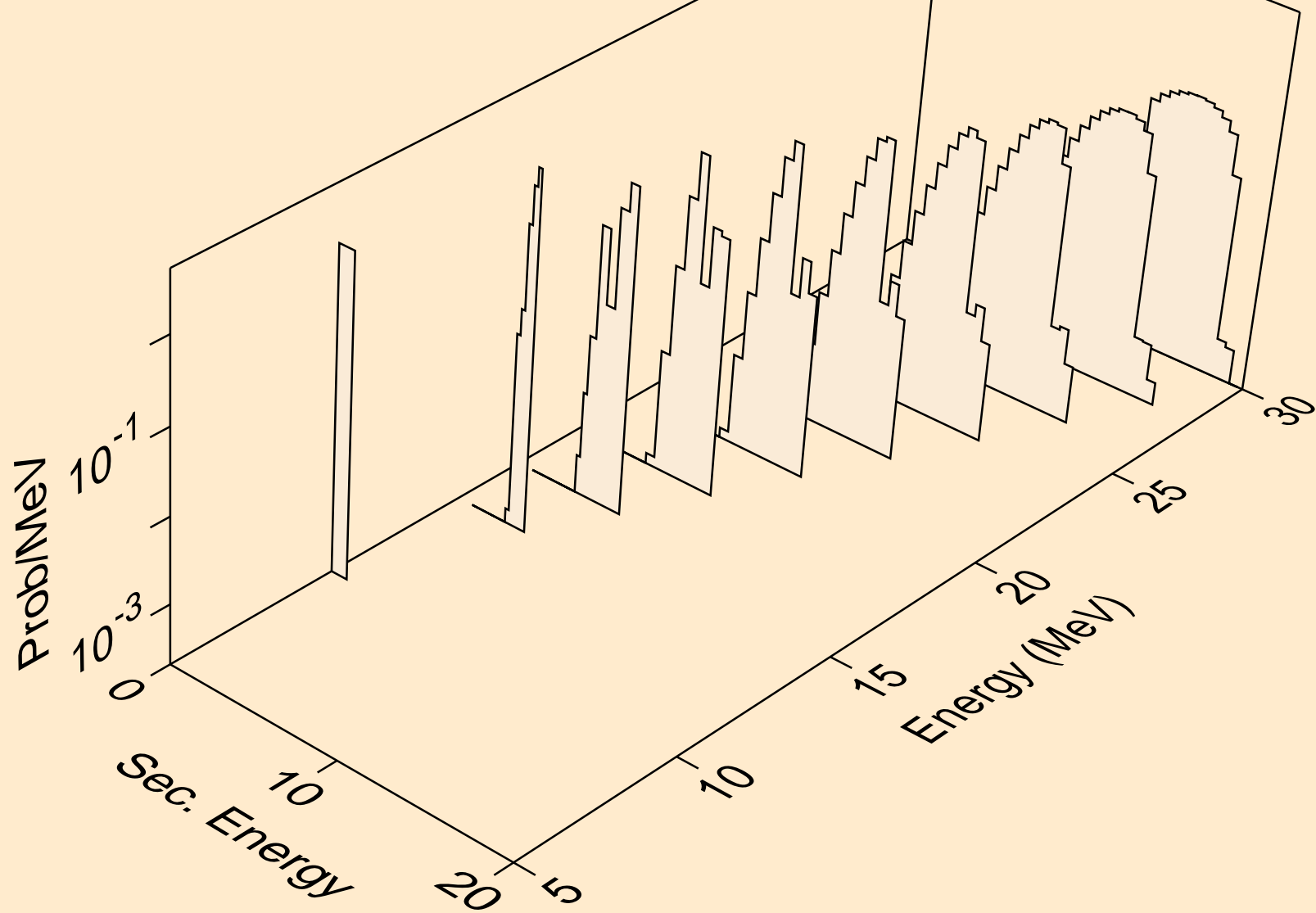

PD117 PROTON ACER TENDL-2021 LIBRARY; T=0.K  
alphas from (p,x)

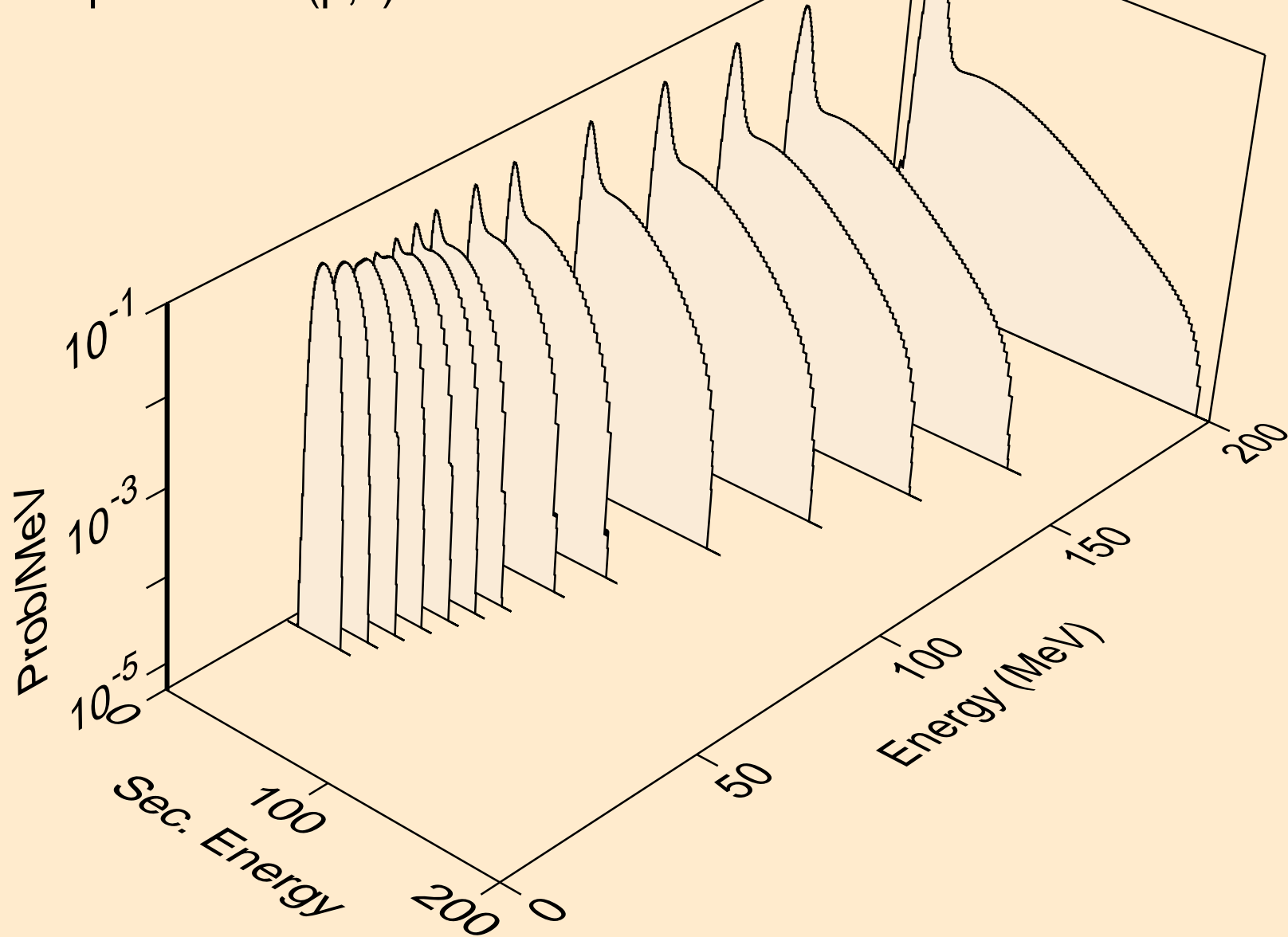

PD117 PROTON ACER TENDL-2021 LIBRARY; T=0.K  
alphas from (p,n\*)a

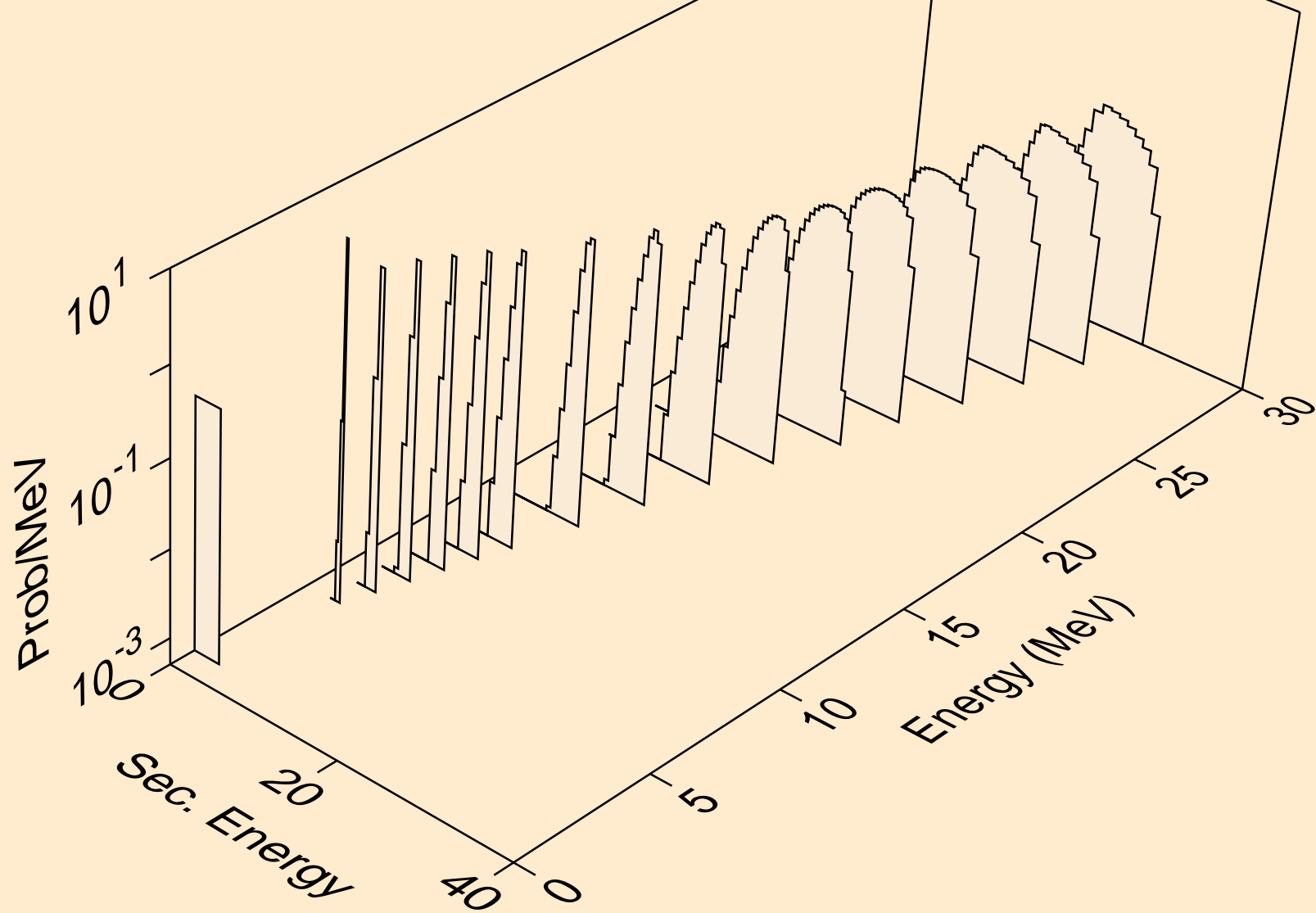

PD117 PROTON ACER TENDL-2021 LIBRARY; T=0.K  
alphas from (p,2n)a

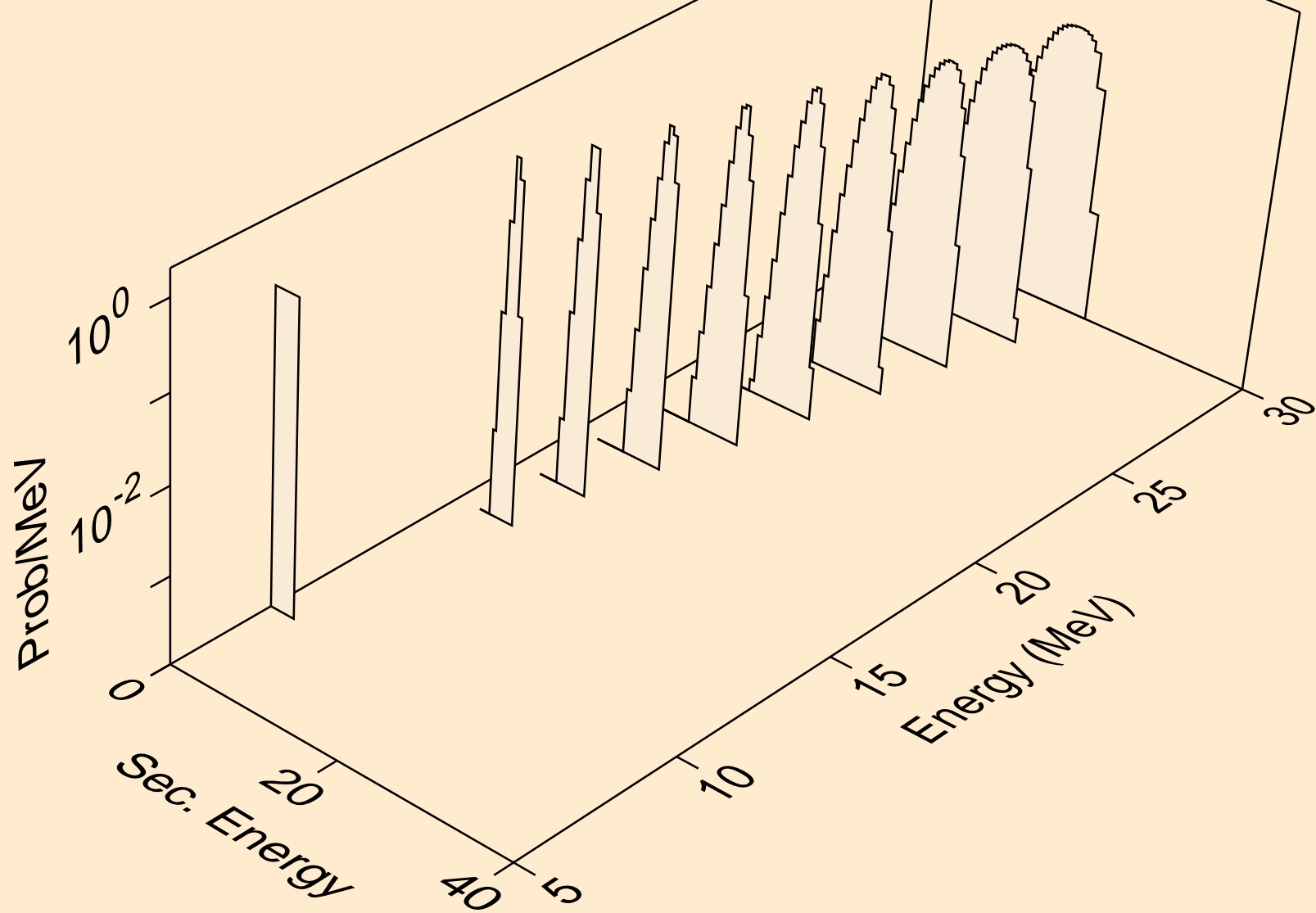

PD117 PROTON ACER TENDL-2021 LIBRARY; T=0.K  
alphas from (p,3n)a

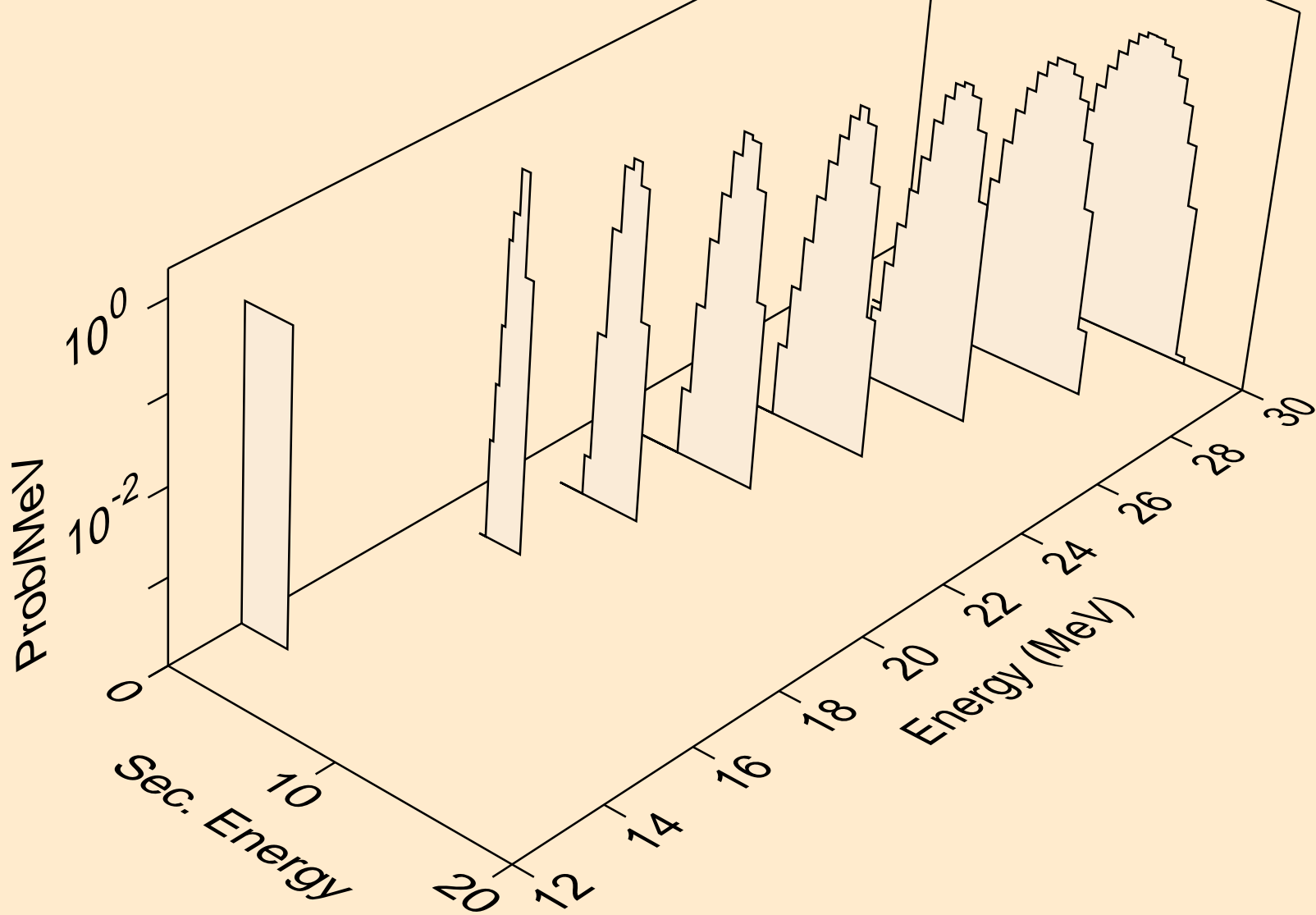

PD117 PROTON ACER TENDL-2021 LIBRARY; T=0.K  
alphas from (p,npa)

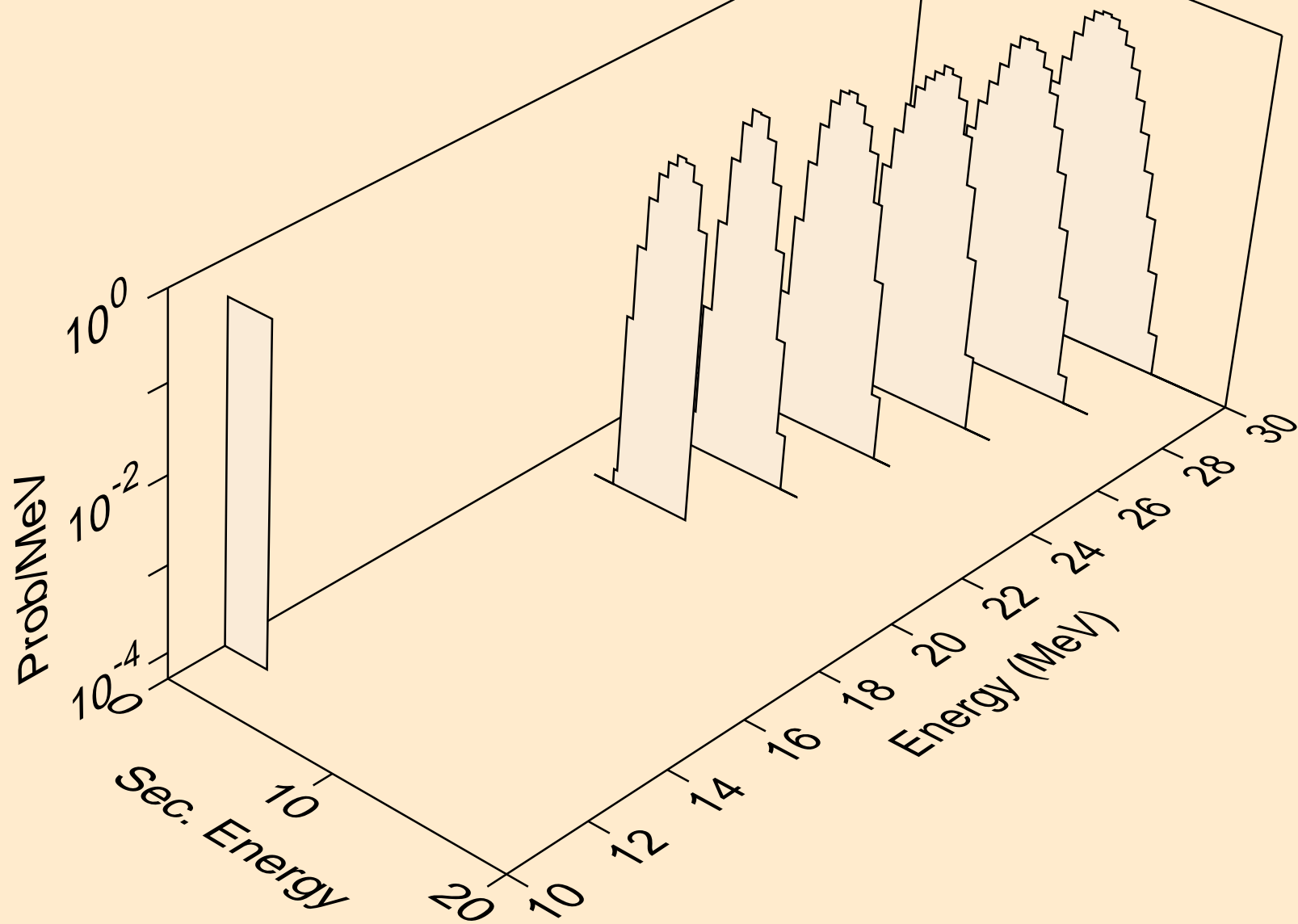



PD117 PROTON ACER TENDL-2021 LIBRARY; T=0.K  
alphas from (p,a)

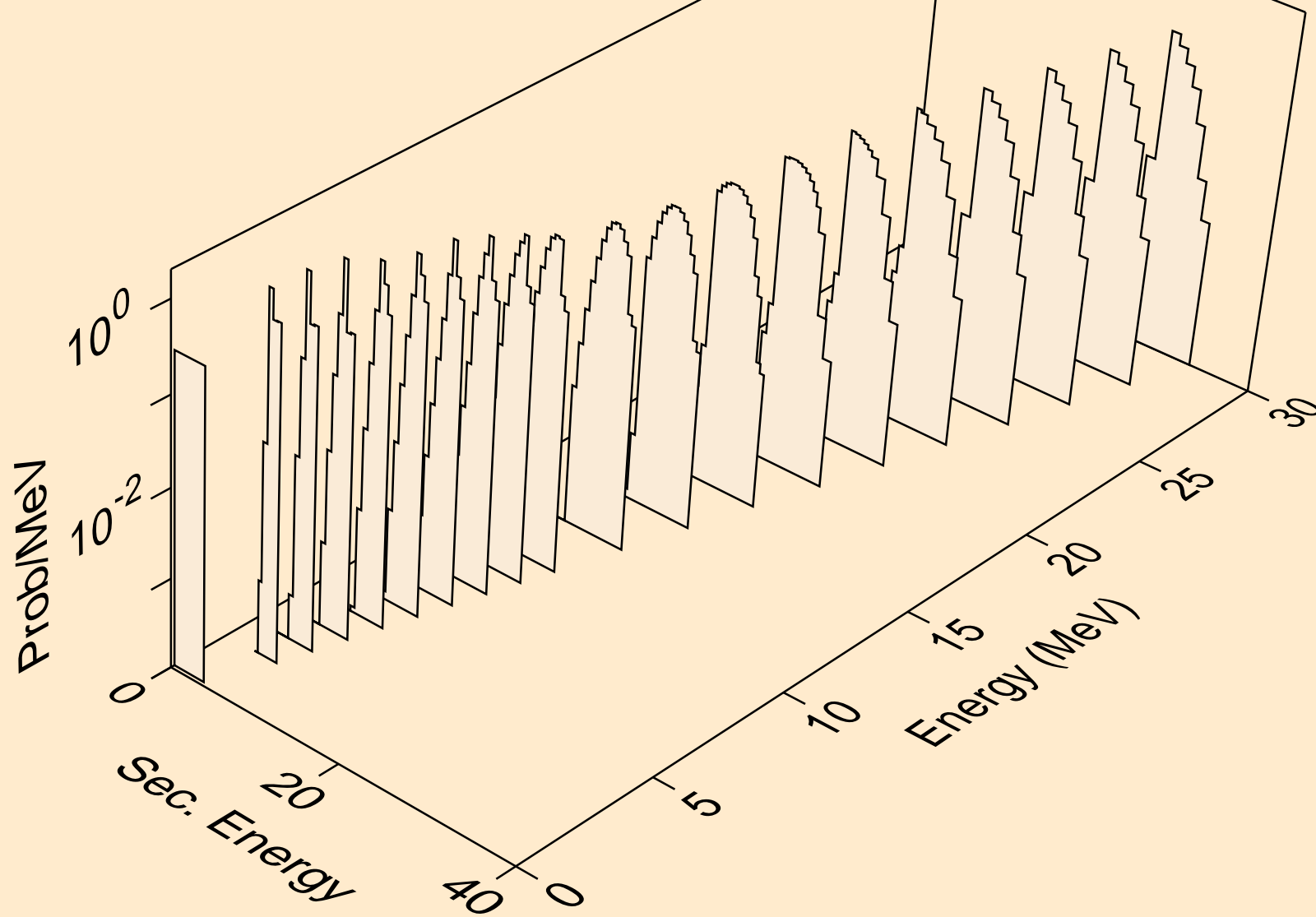

PD117 PROTON ACER TENDL-2021 LIBRARY; T=0.K  
alphas from (p,pa)

