

PR141 PROTON ACER TENDL-2021 LIBRARY; T=0.K  
Principal cross sections

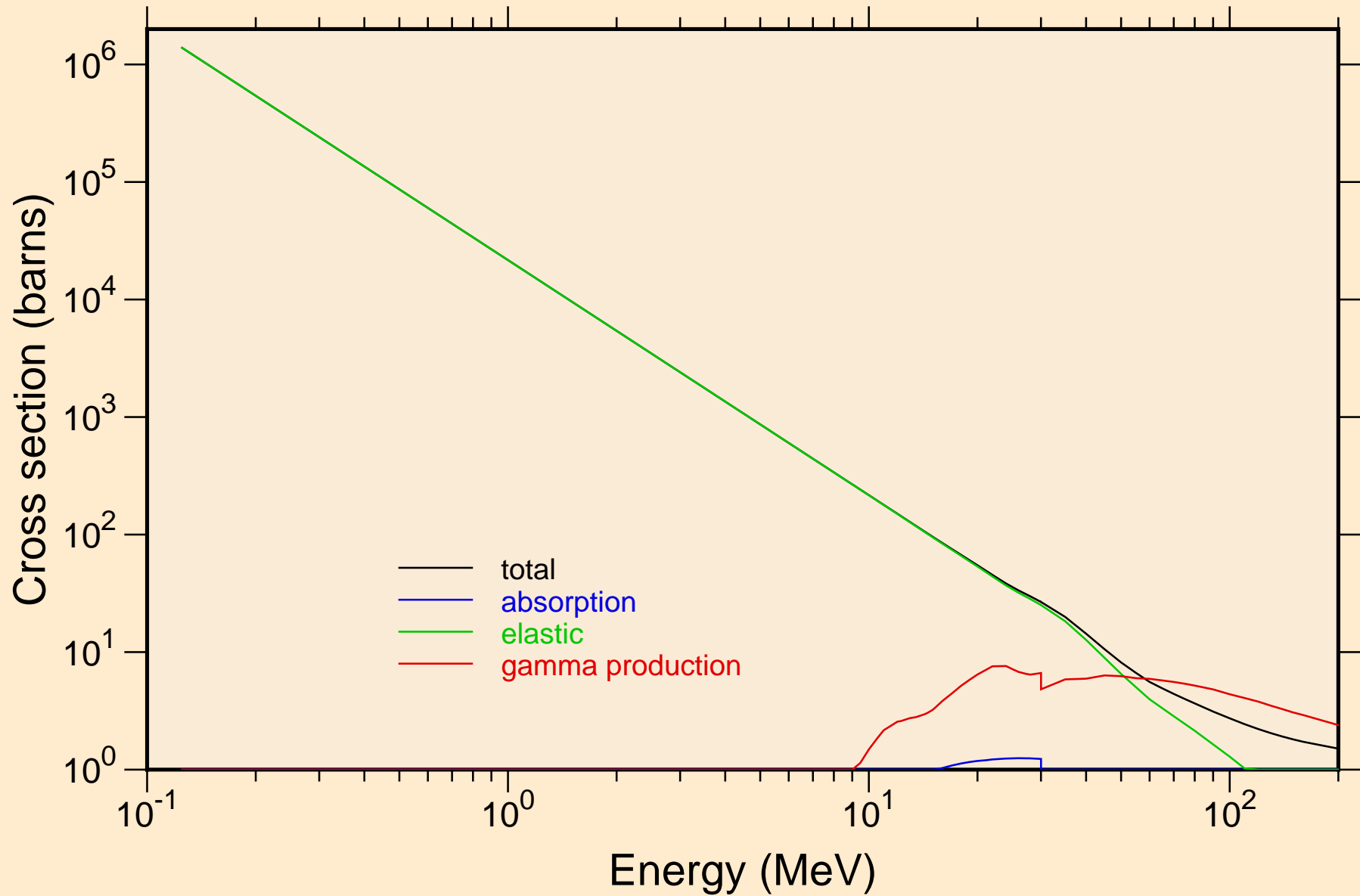

PR141 PROTON ACER TENDL-2021 LIBRARY; T=0.K  
Heating

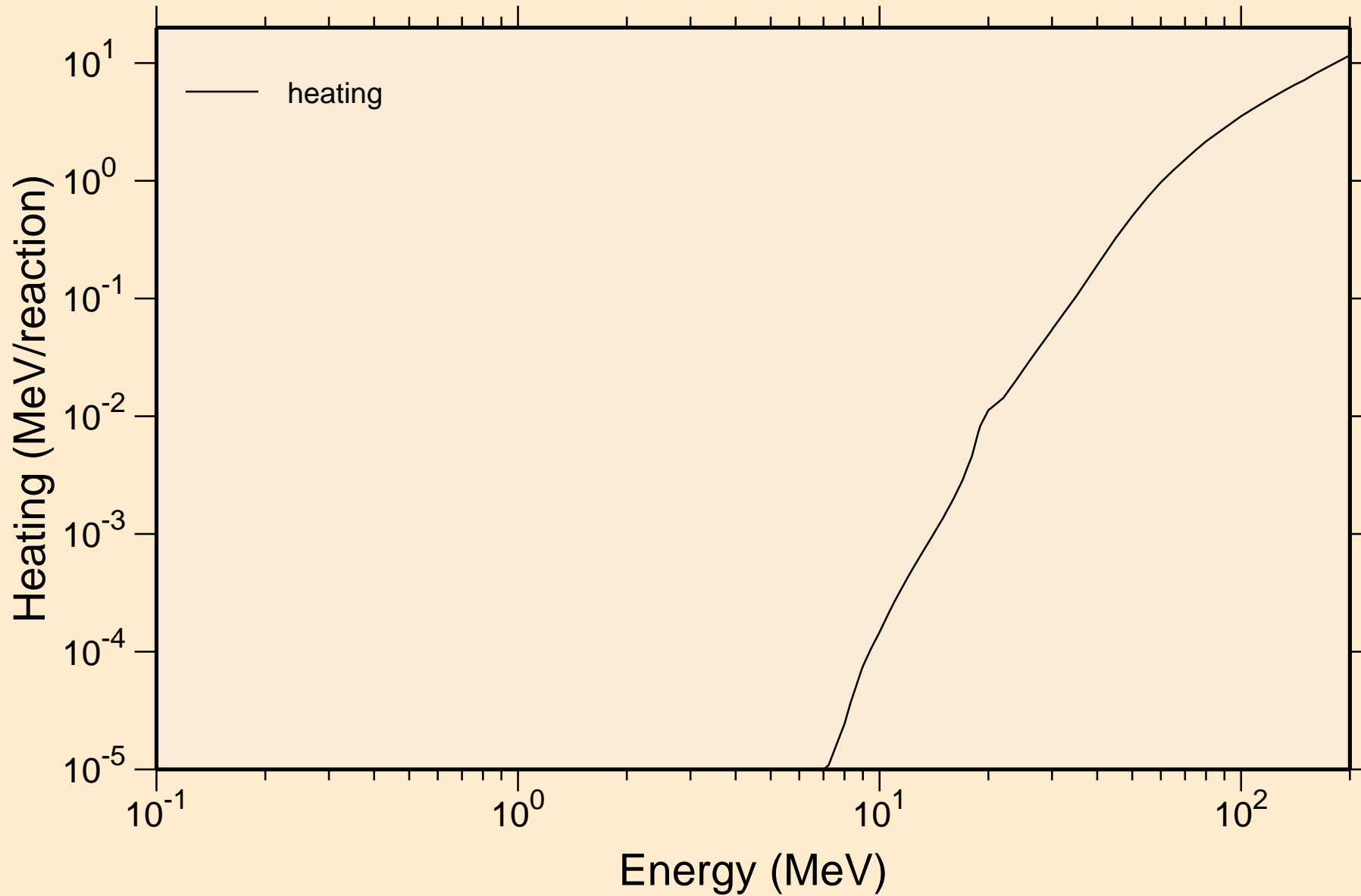

# PR141 PROTON ACER TENDL-2021 LIBRARY; T=0.K

## Principal cross sections

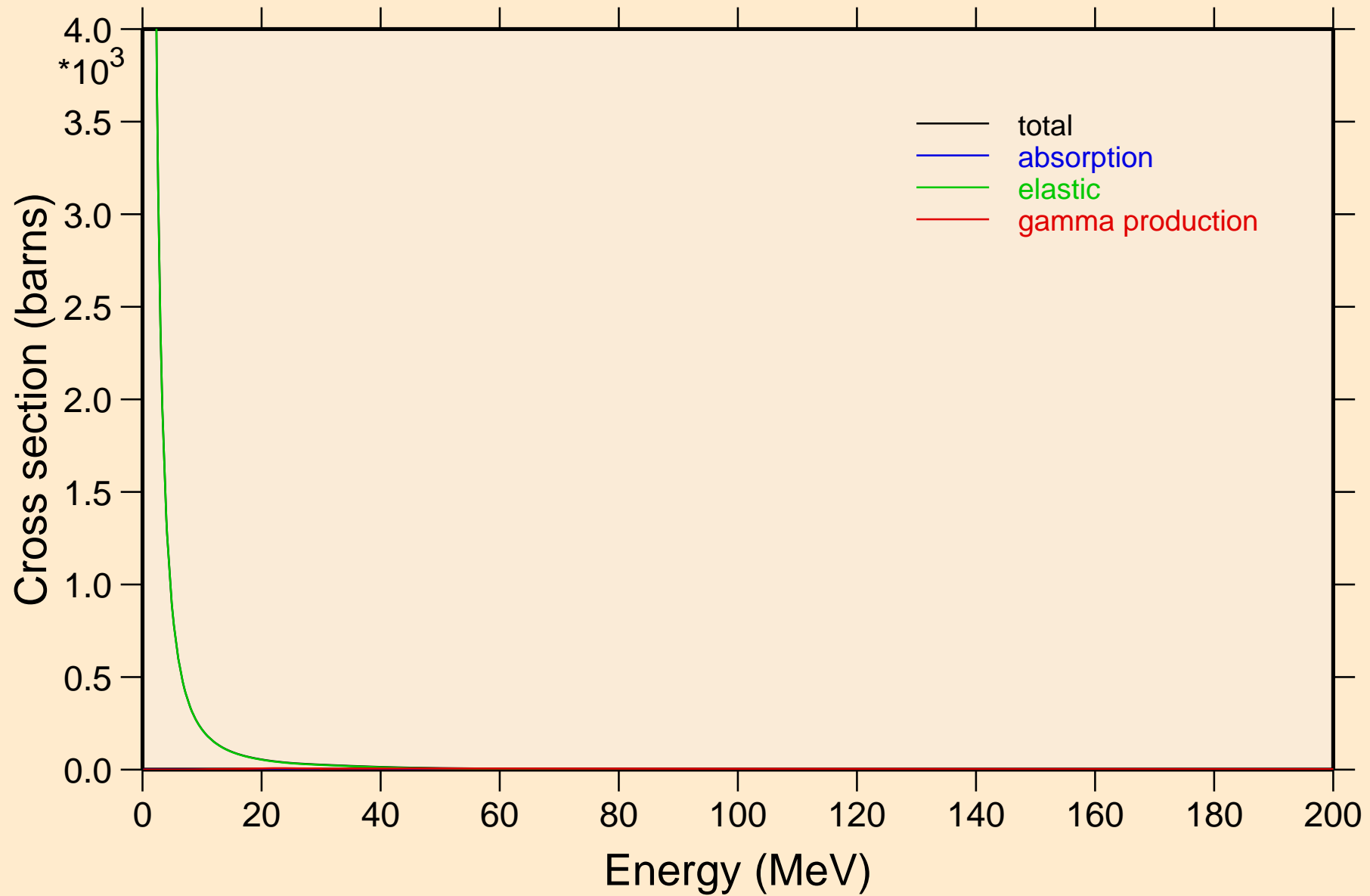

PR141 PROTON ACER TENDL-2021 LIBRARY; T=0.K

Heating

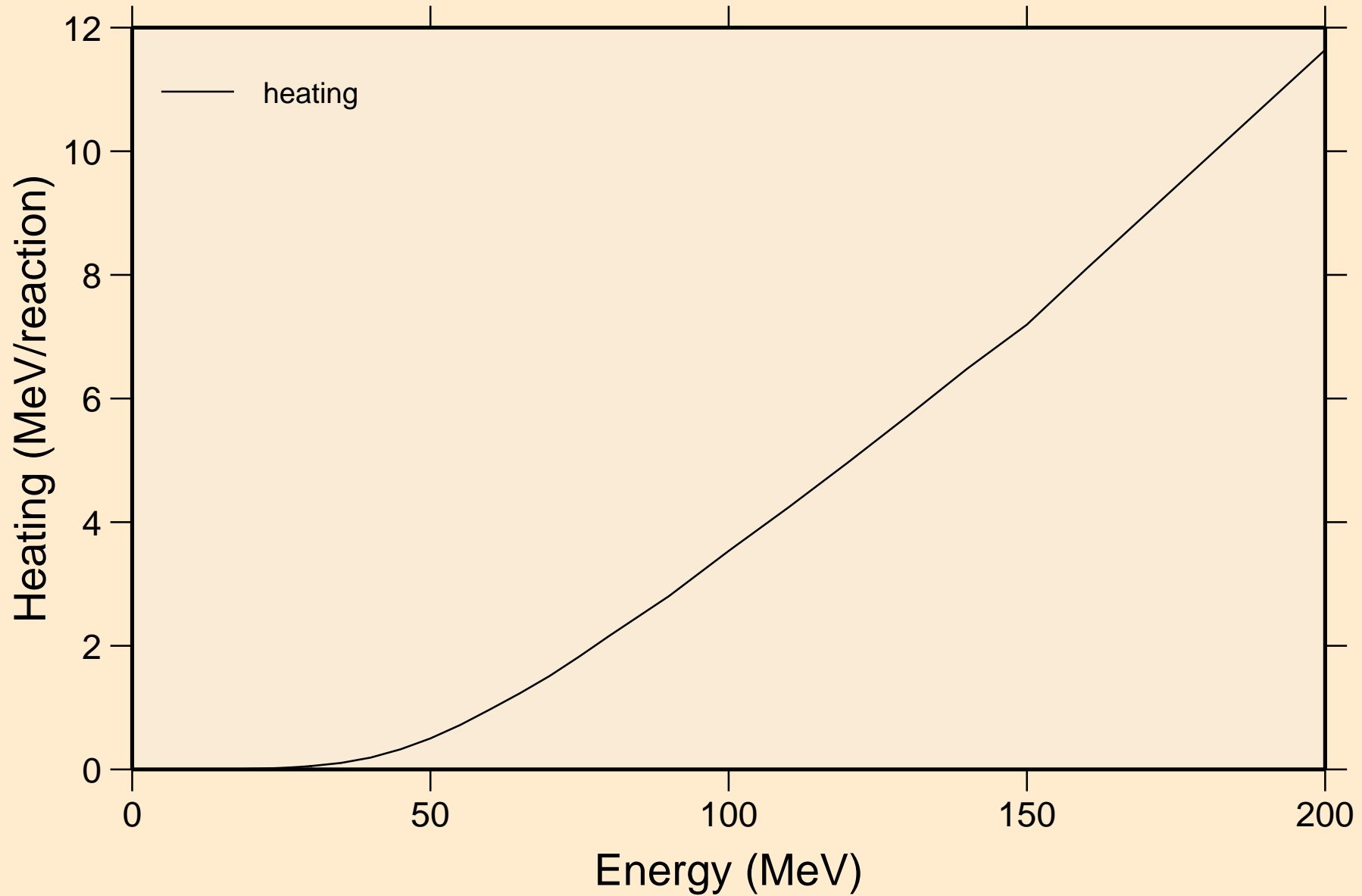

PR141 PROTON ACER TENDL-2021 LIBRARY; T=0.K  
Threshold reactions

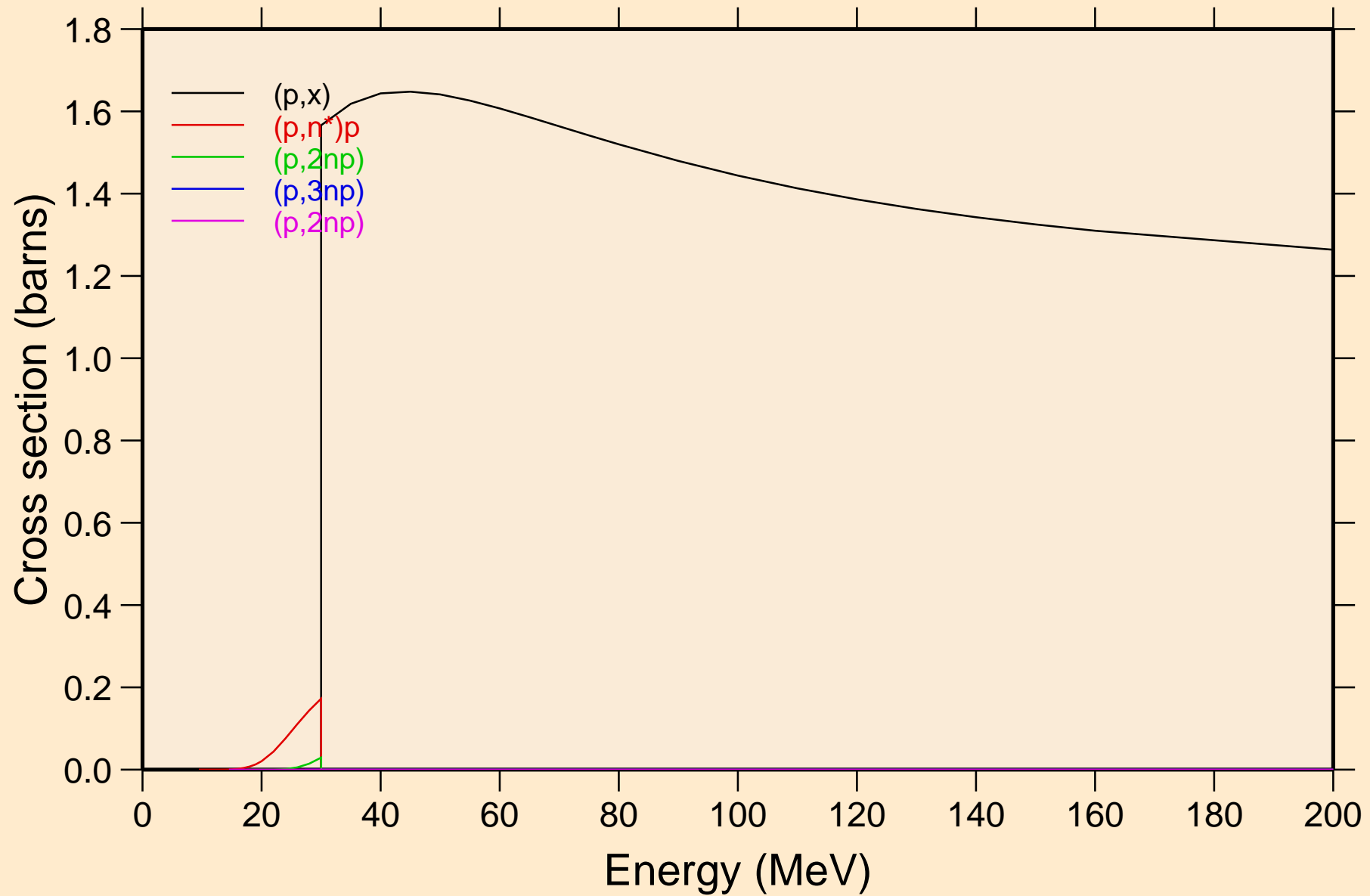

PR141 PROTON ACER TENDL-2021 LIBRARY; T=0.K  
Threshold reactions

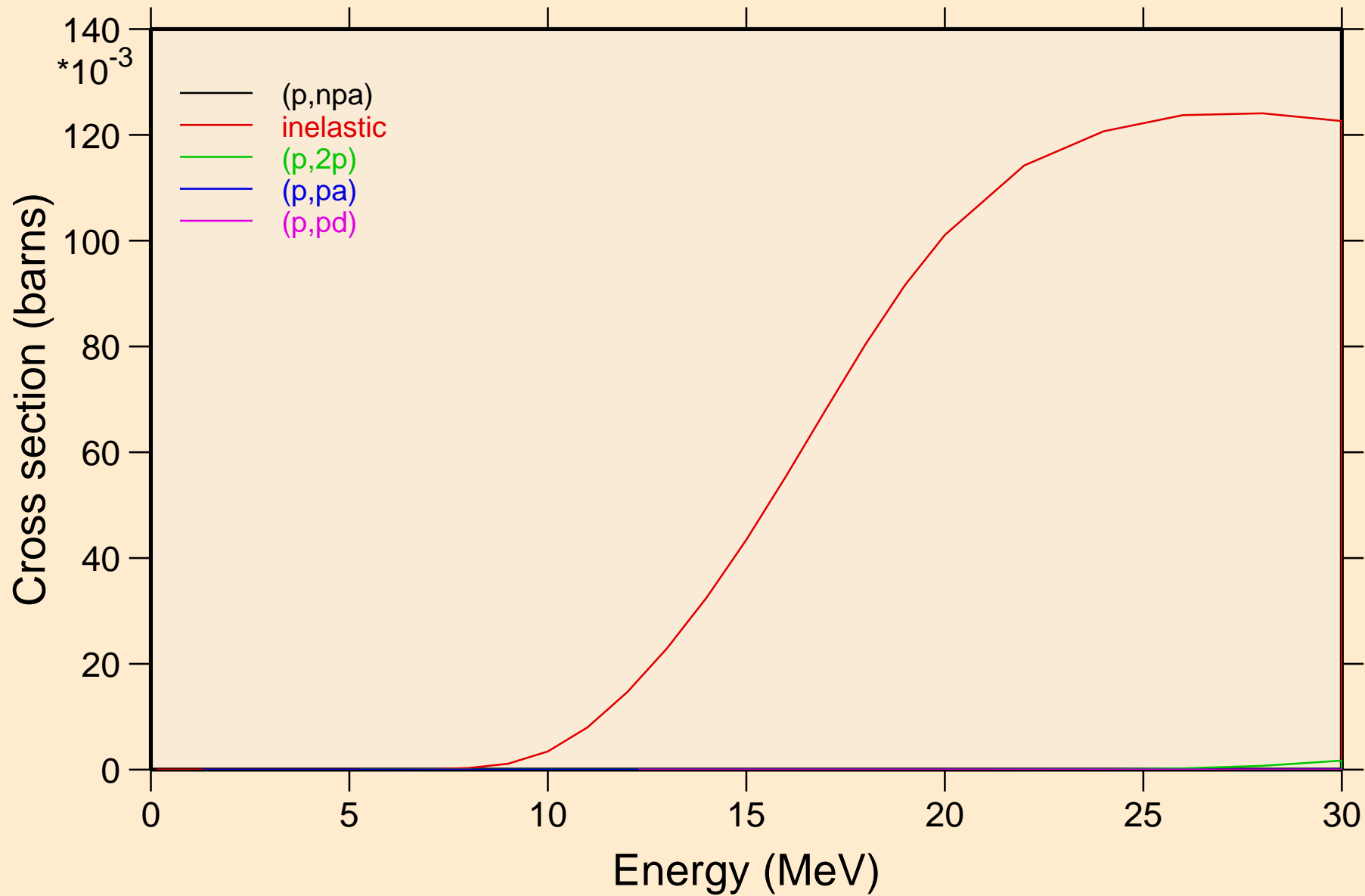

PR141 PROTON ACER TENDL-2021 LIBRARY; T=0.K  
Threshold reactions

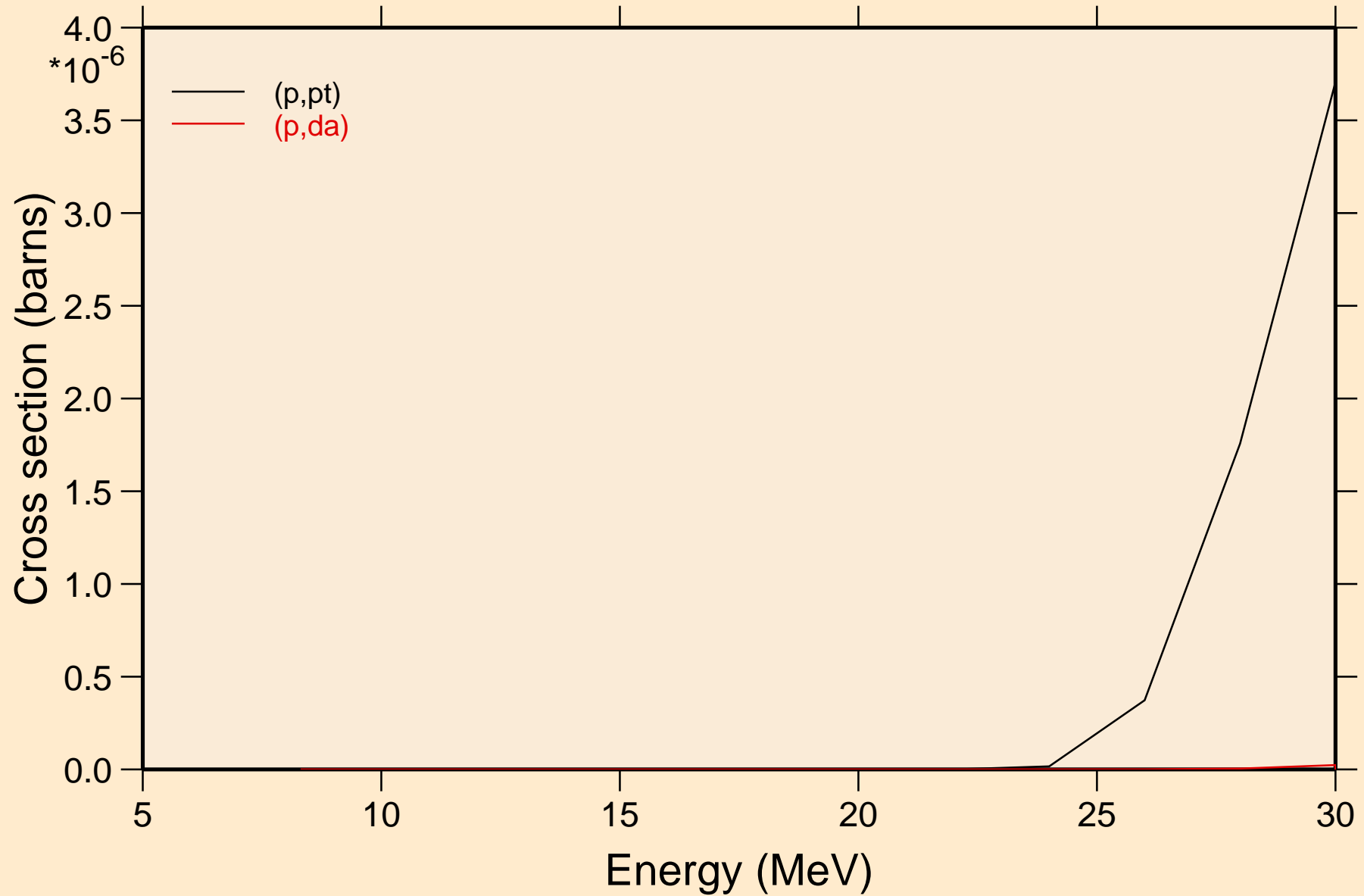

PR141 PROTON ACER TENDL-2021 LIBRARY; T=0.K  
angular distribution for elastic

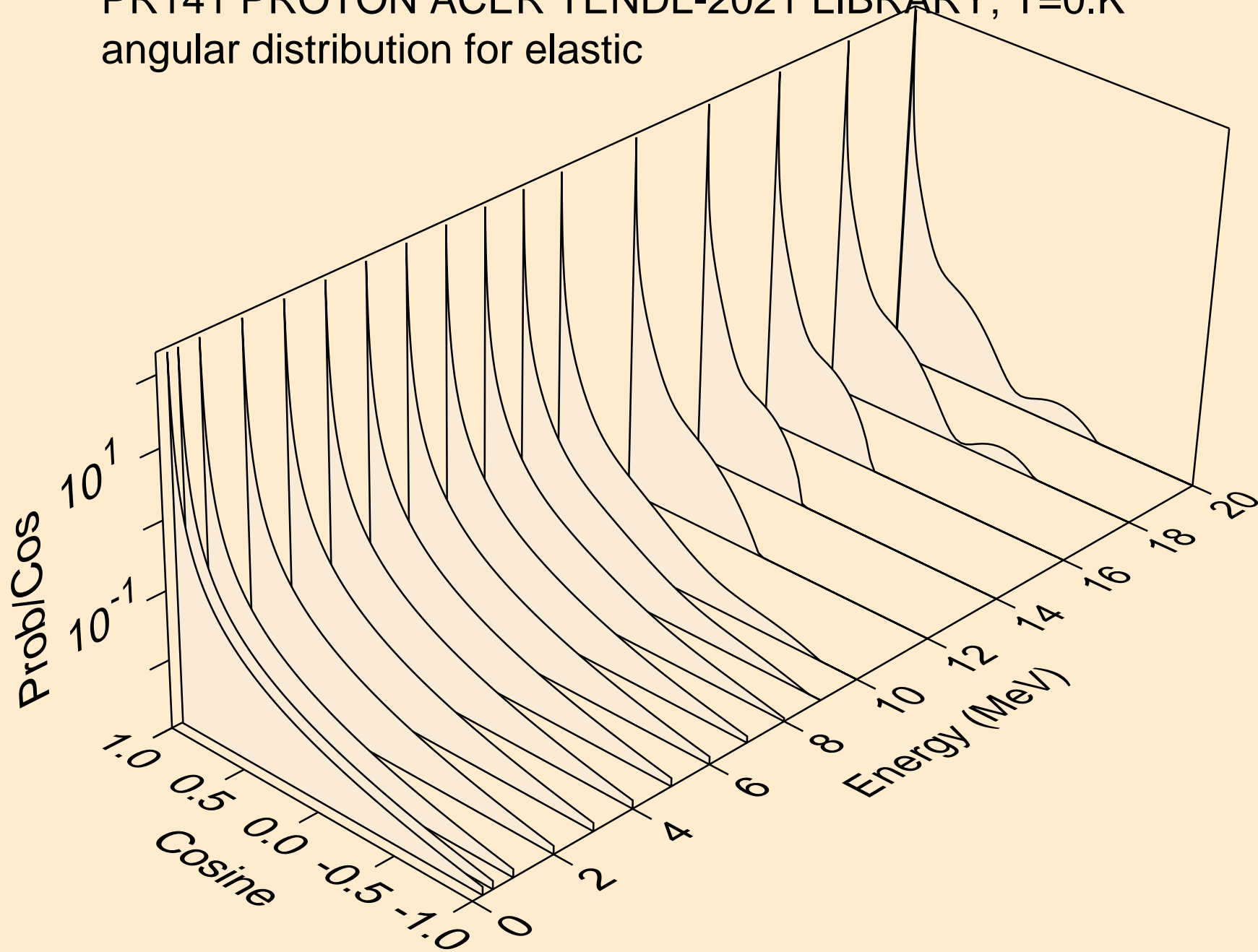



PR141 PROTON ACER TENDL-2021 LIBRARY; T=0.K  
angular distribution for elastic

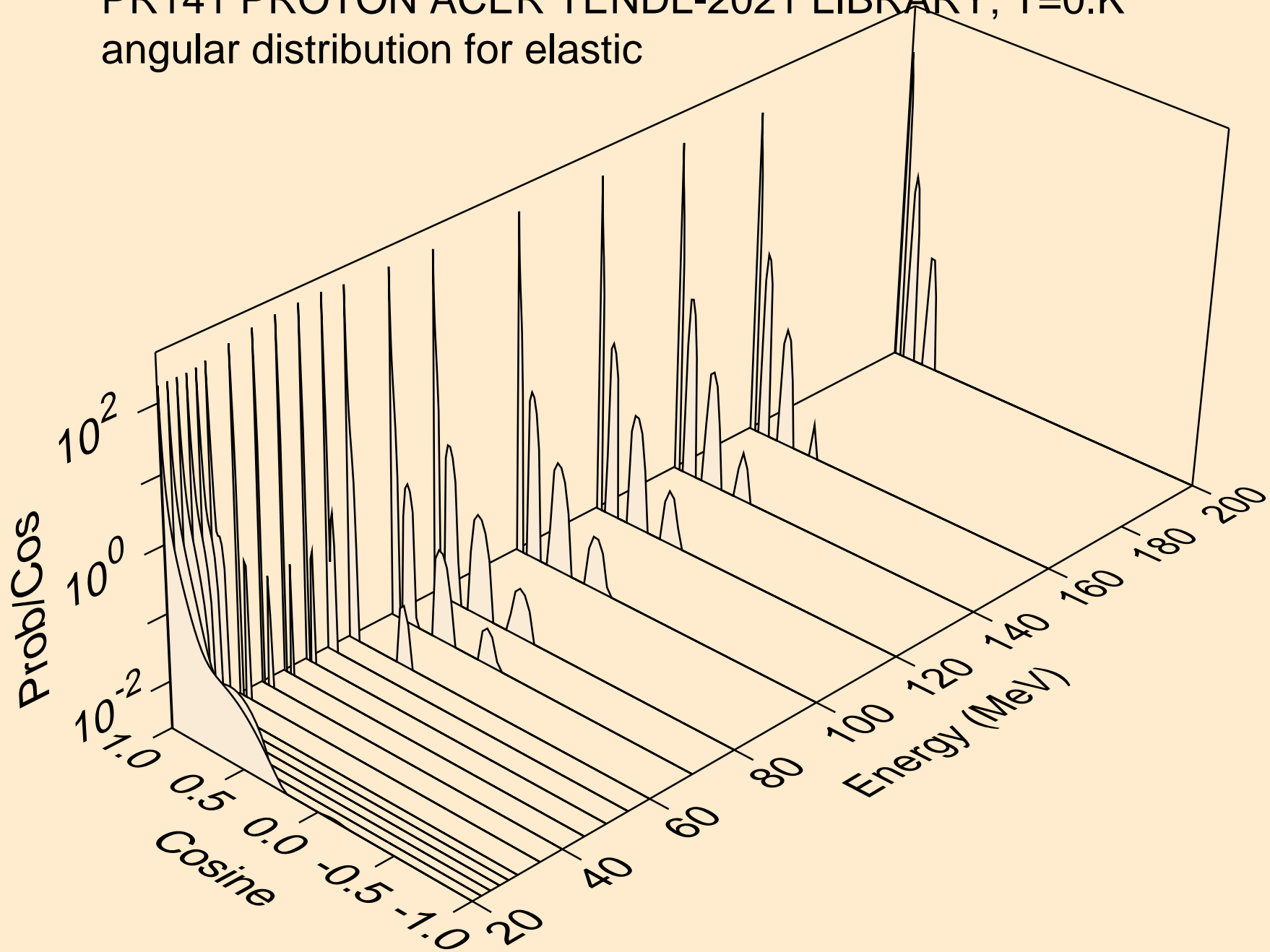

PR141 PROTON ACER TENDL-2021 LIBRARY; T=0.K  
Proton emission for (p,x)

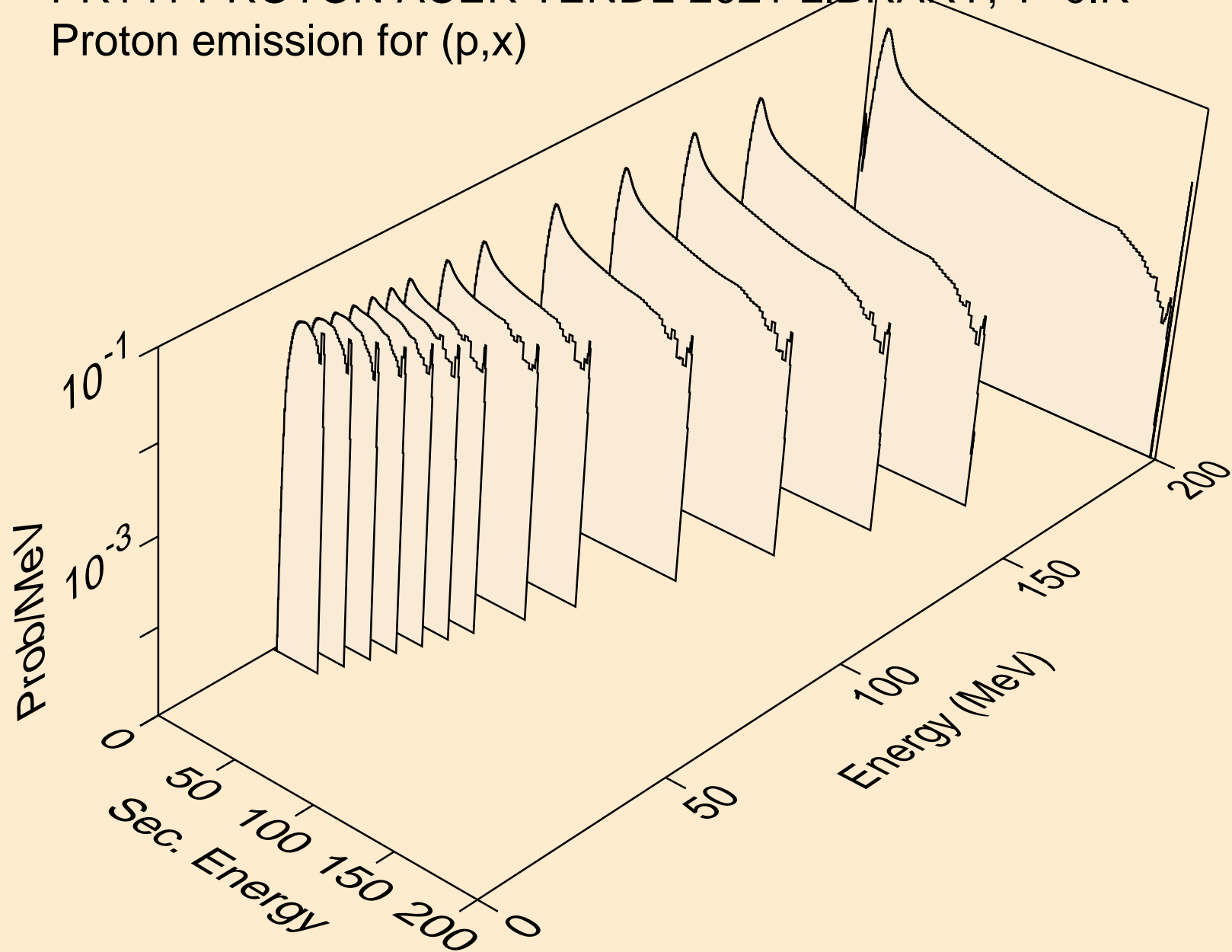

PR141 PROTON ACER TENDL-2021 LIBRARY; T=0.K  
Proton emission for (p,n\*)p

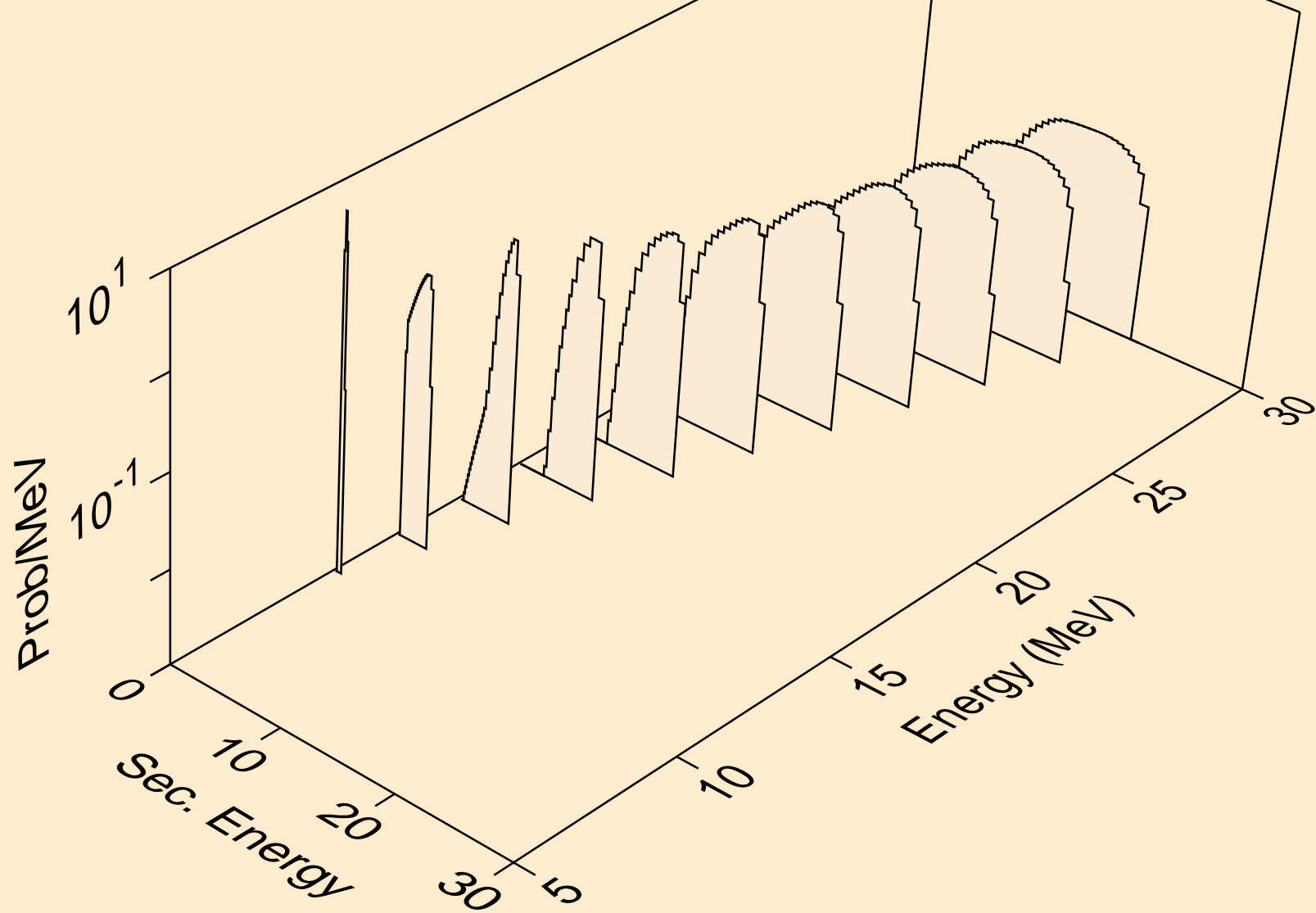

PR141 PROTON ACER TENDL-2021 LIBRARY; T=0.K  
Proton emission for (p,2np)

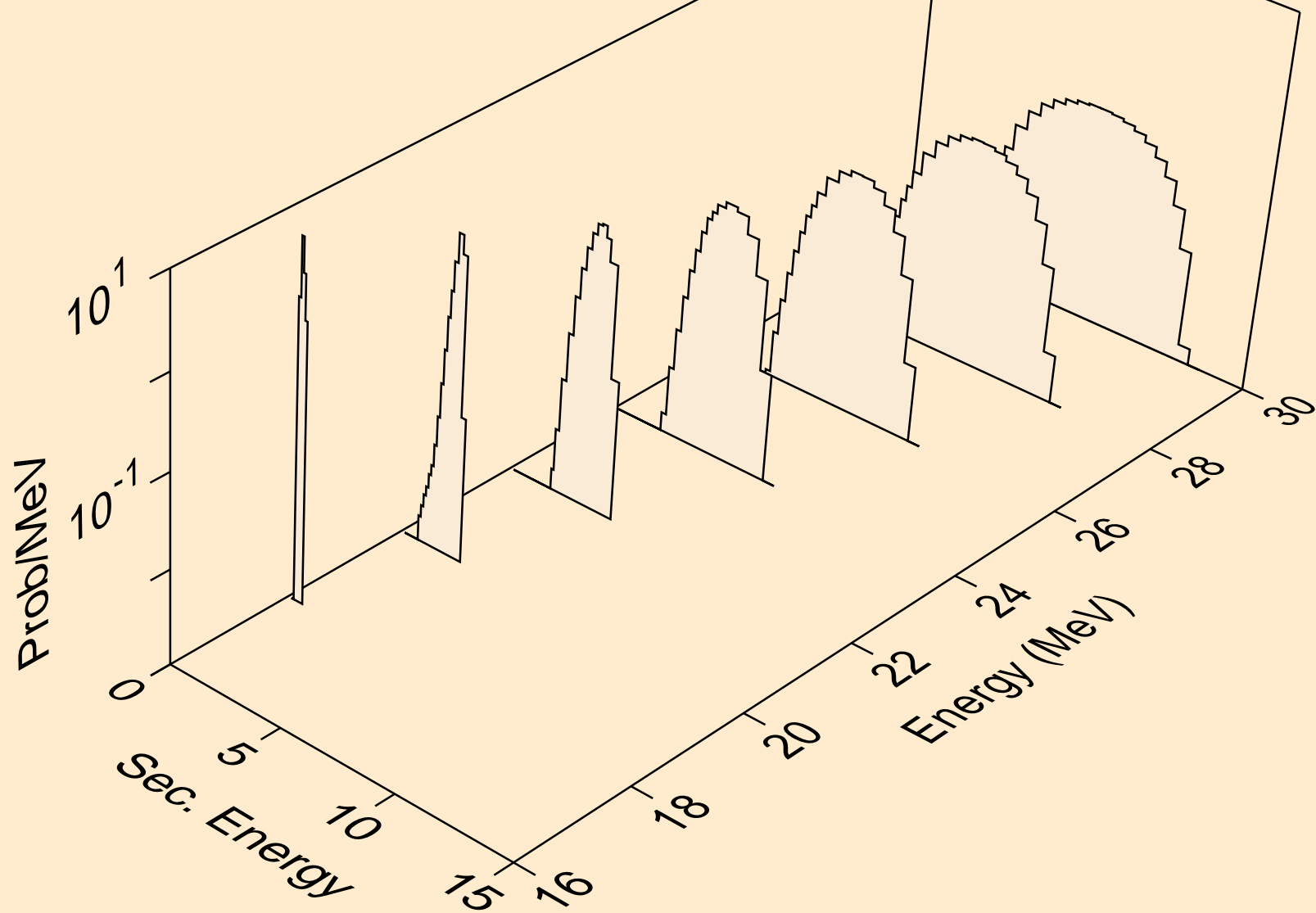

PR141 PROTON ACER TENDL-2021 LIBRARY; T=0.K  
Proton emission for (p,3np)

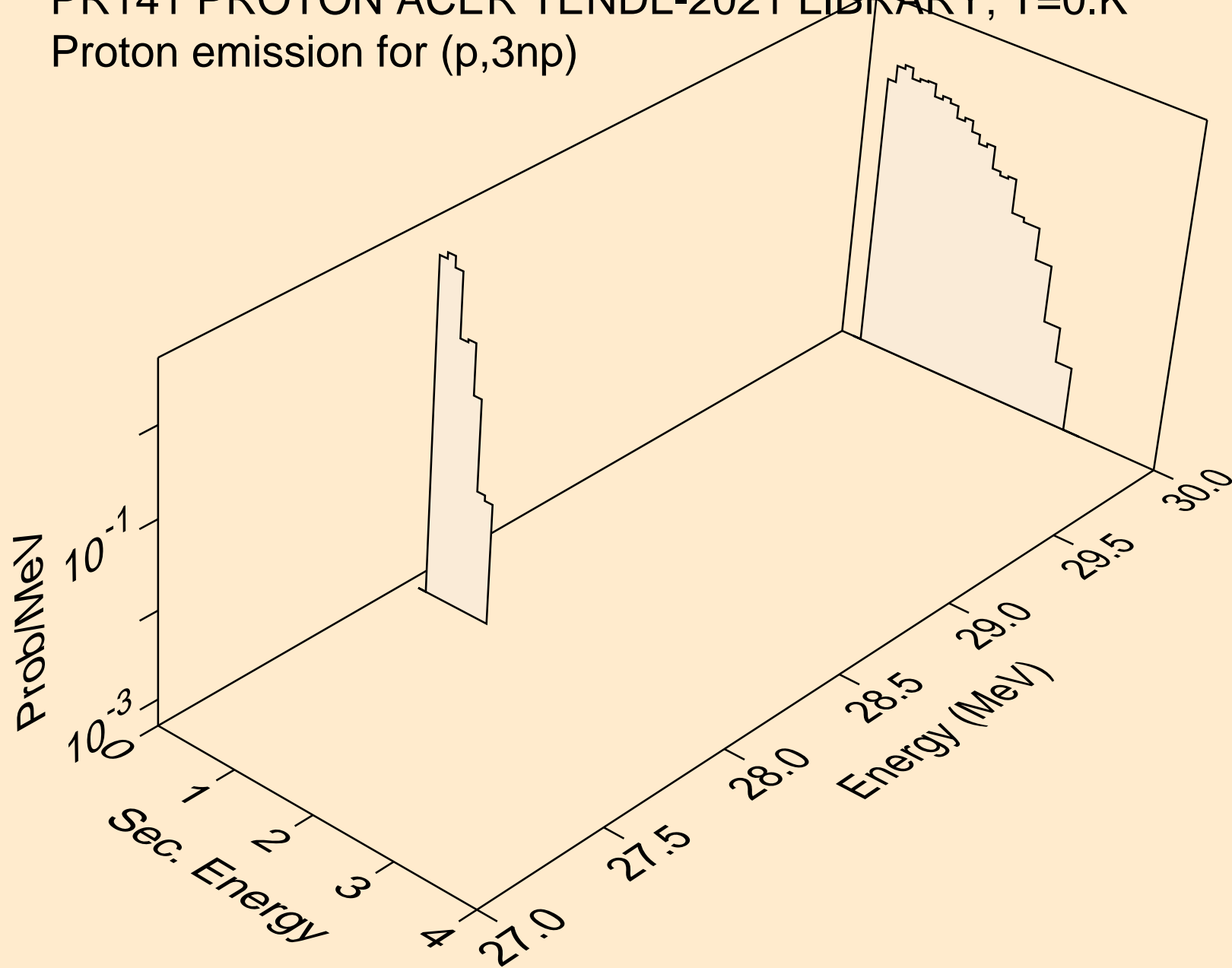

PR141 PROTON ACER TENDL-2021 LIBRARY; T=0.K  
Proton emission for (p,2np)

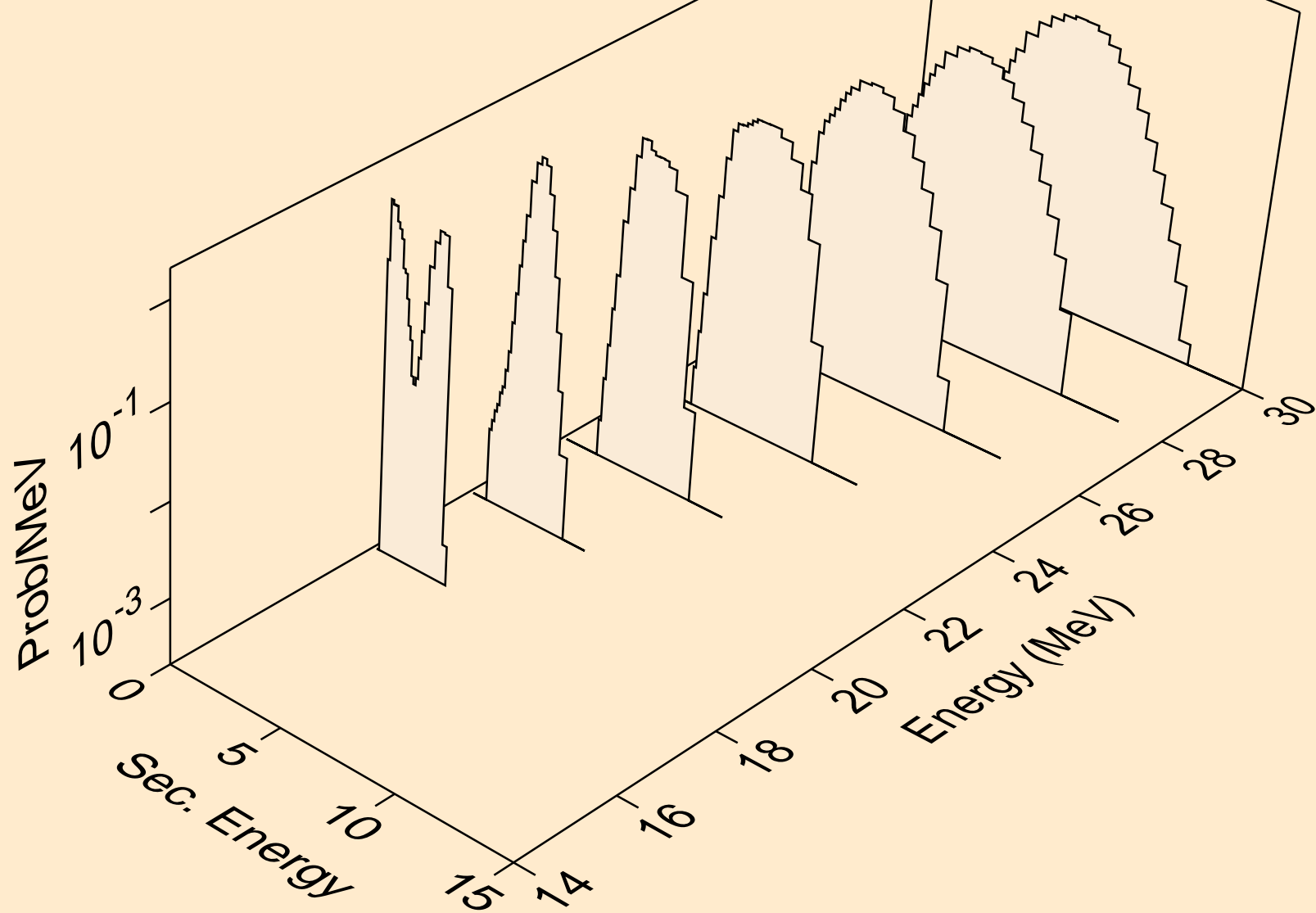

PR141 PROTON ACER TENDL-2021 LIBRARY; T=0.K  
Proton emission for (p,npa)

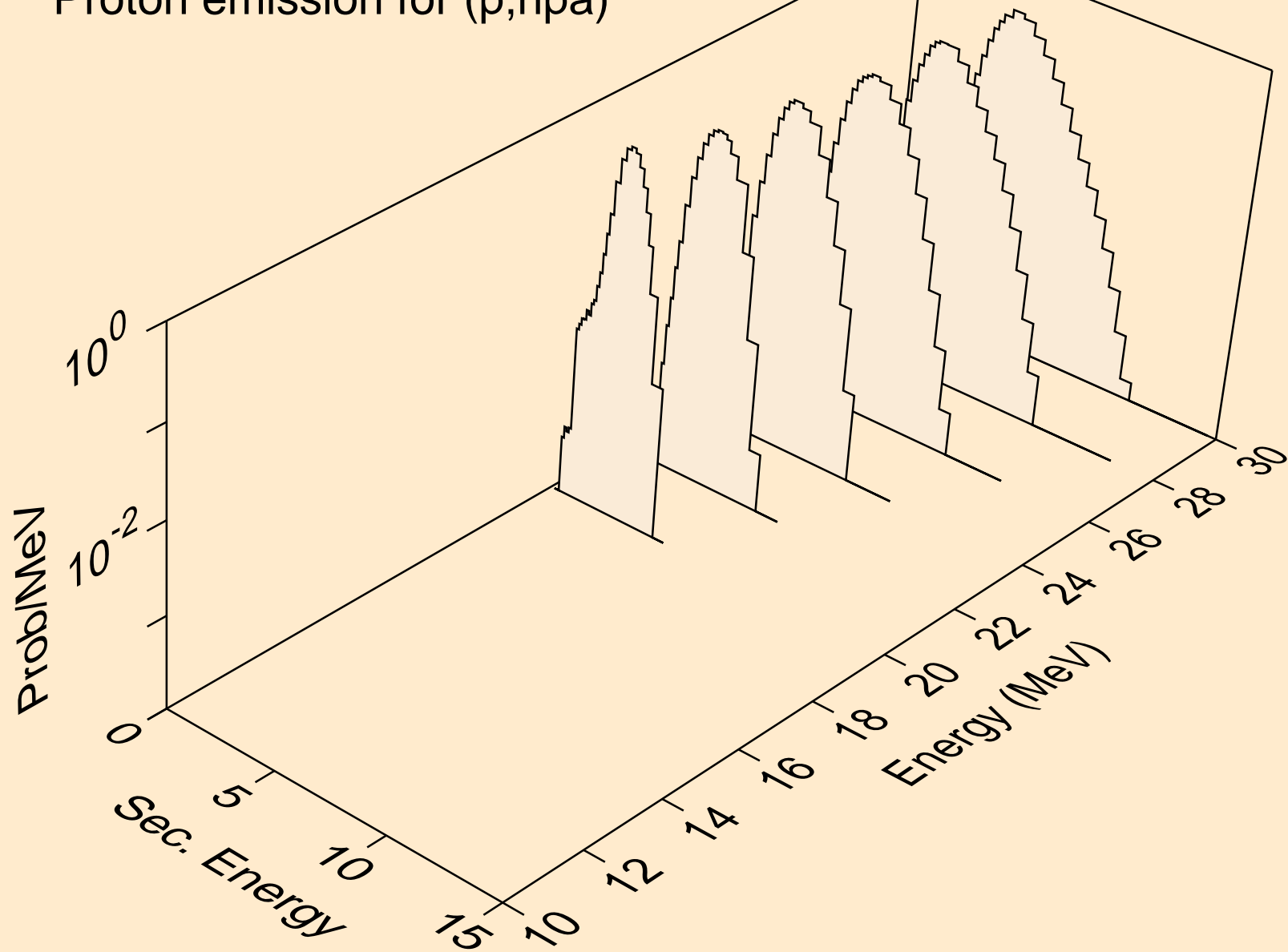

PR141 PROTON ACER TENDL-2021 LIBRARY; T=0.K  
Proton emission for inelastic

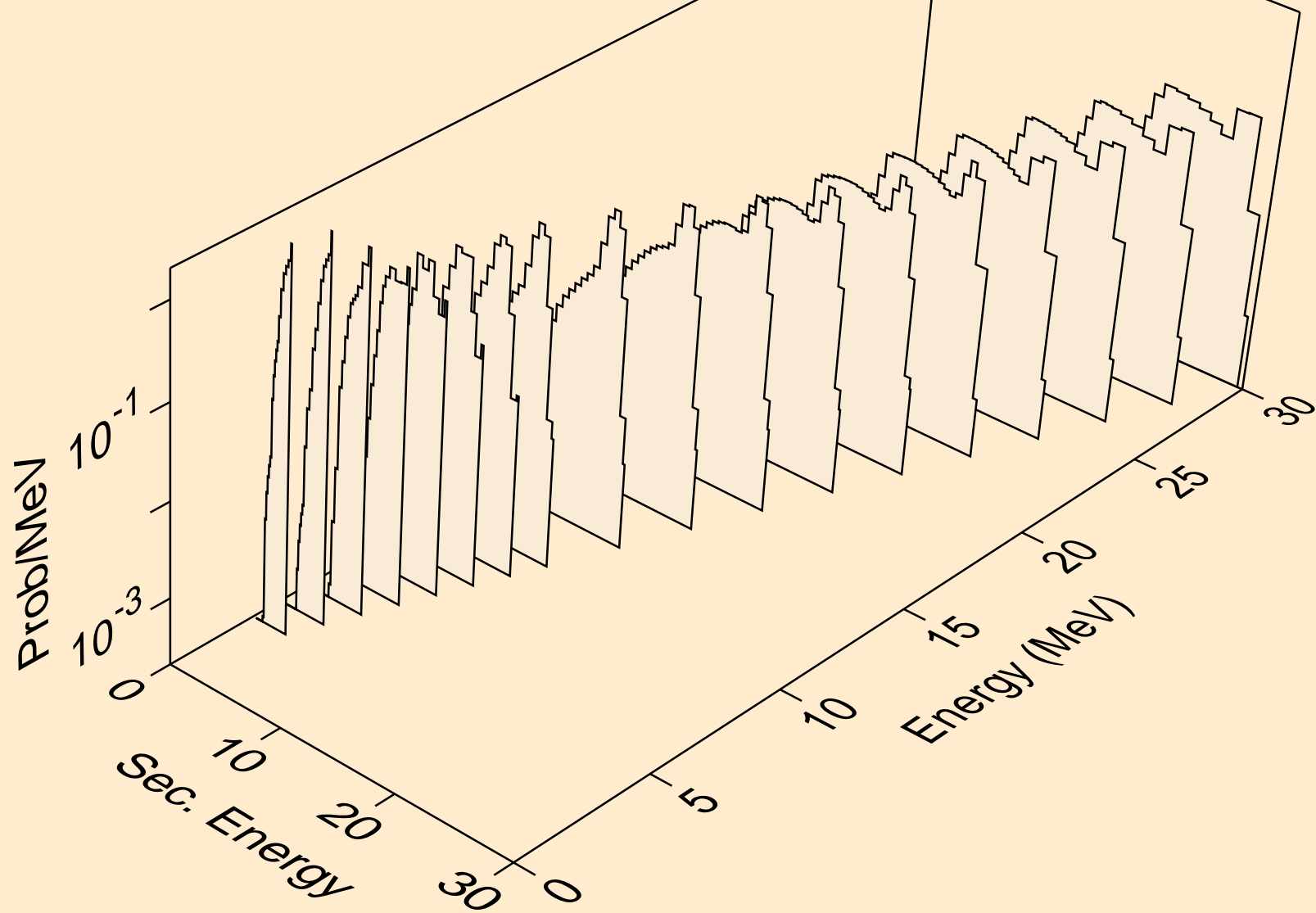



PR141 PROTON ACER TENDL-2021 LIBRARY; T=0.K  
Proton emission for (p,2p)

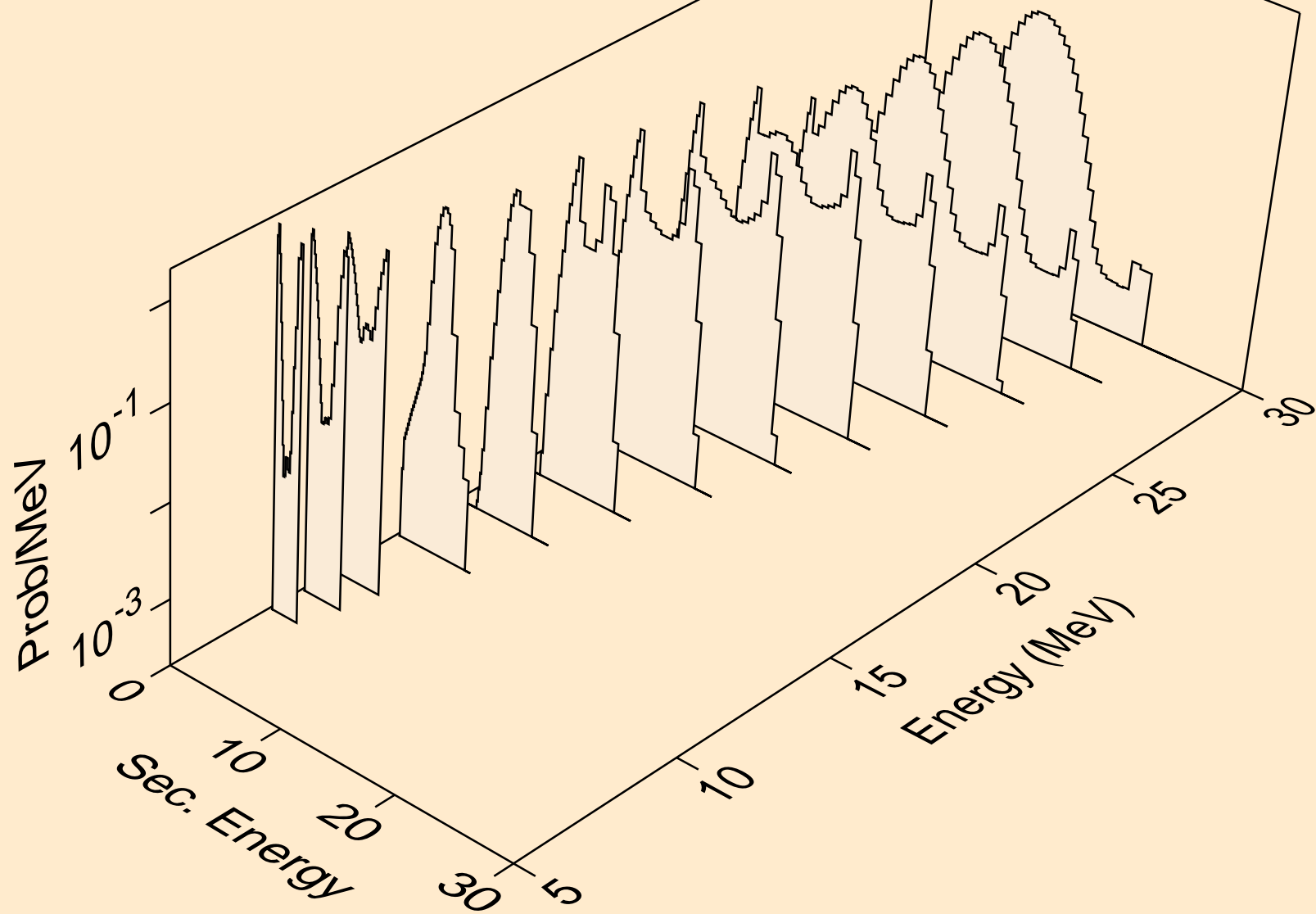

PR141 PROTON ACER TENDL-2021 LIBRARY; T=0.K  
Proton emission for (p,pa)

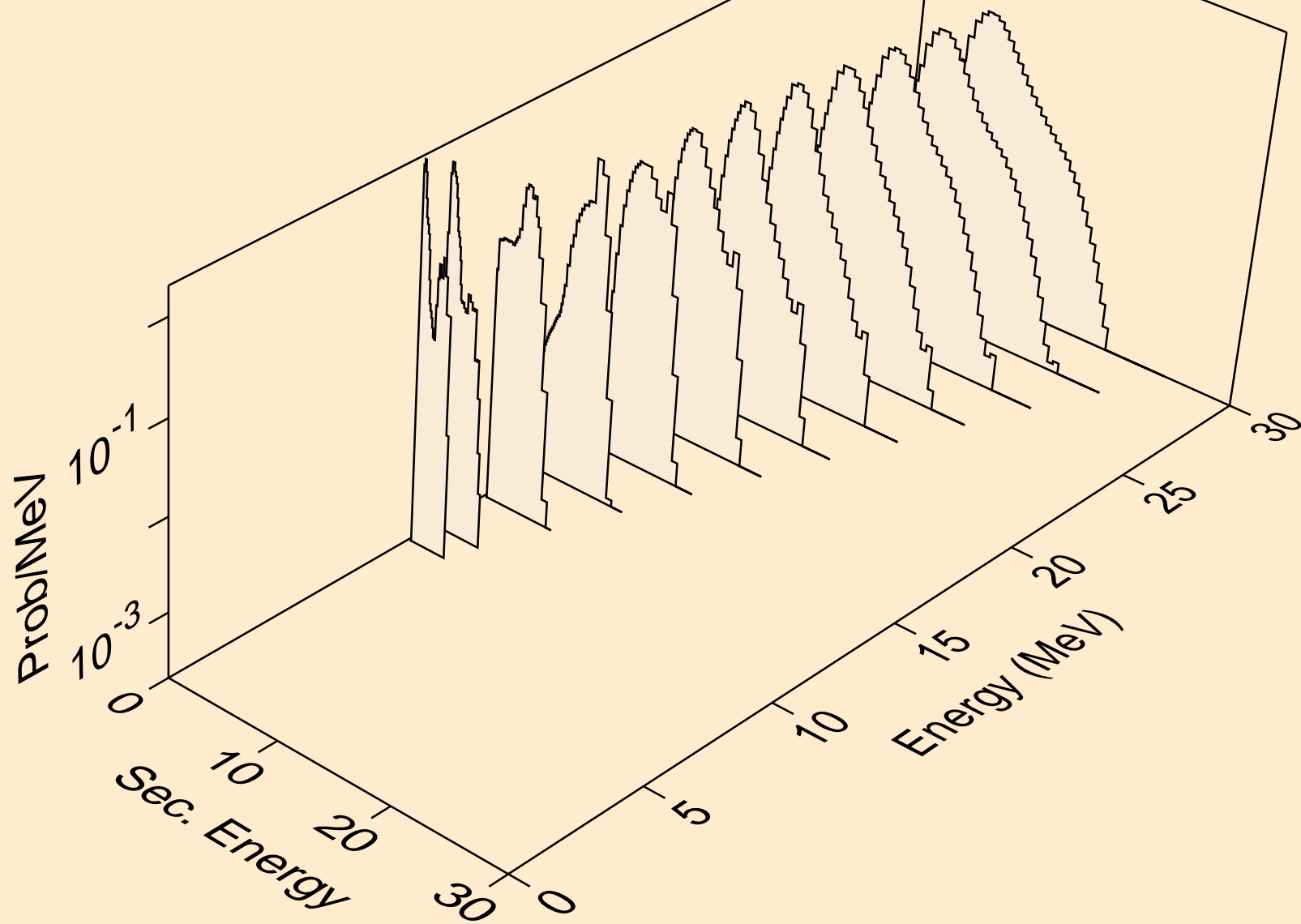

PR141 PROTON ACER TENDL-2021 LIBRARY; T=0.K  
Proton emission for (p,pd)

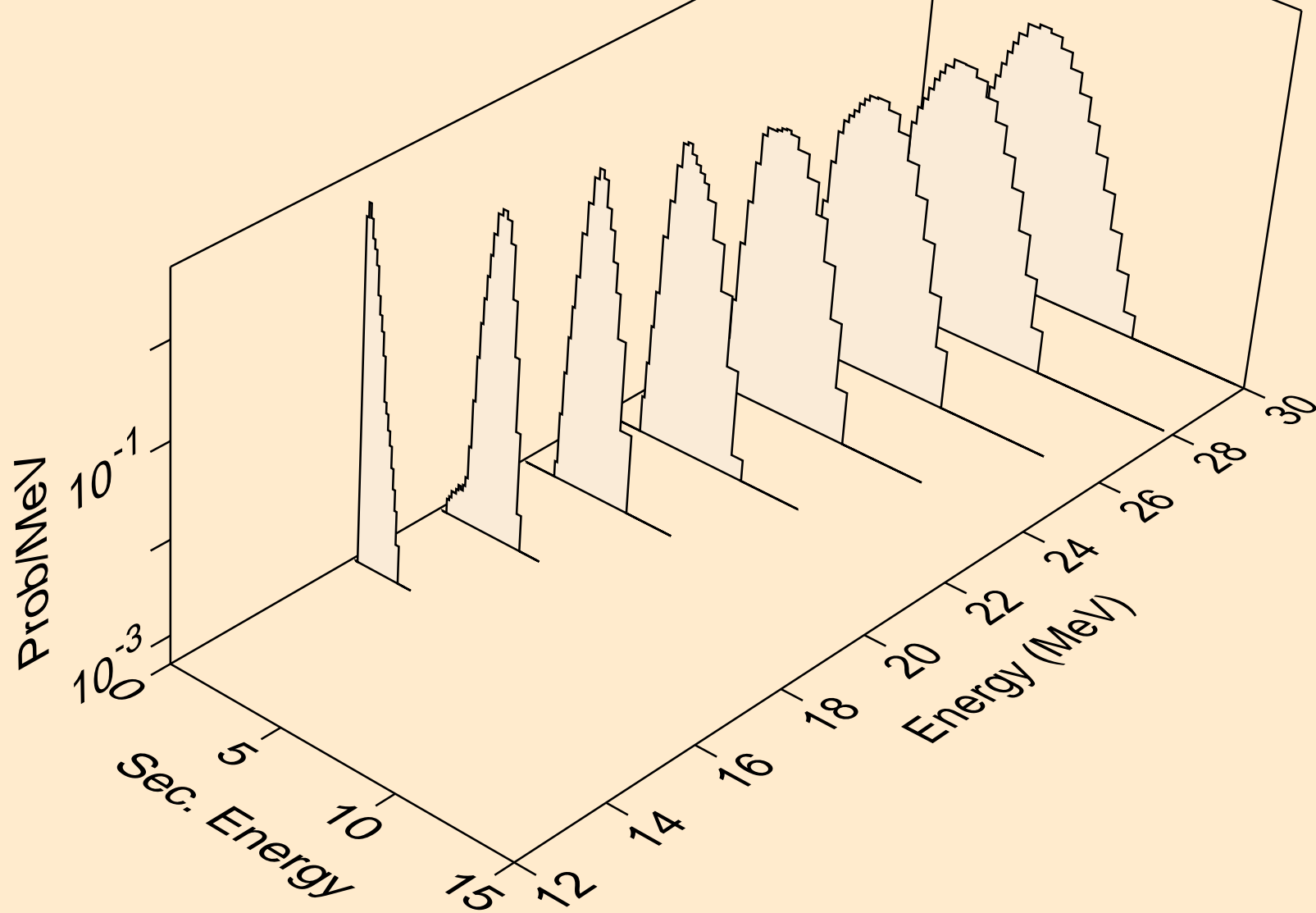

PR141 PROTON ACER TENDL-2021 LIBRARY; T=0.K  
Proton emission for (p,pt)

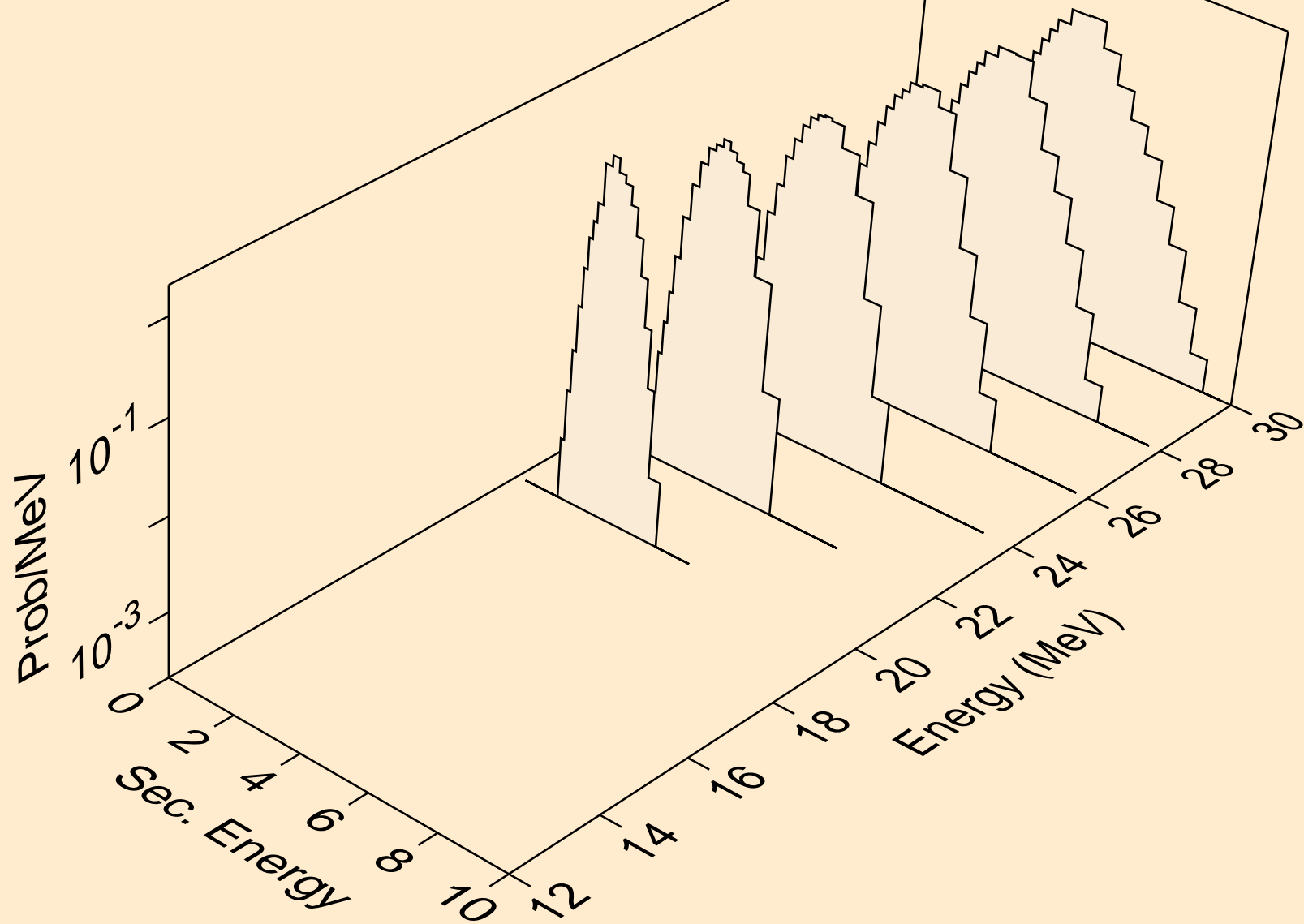

PR141 PROTON ACER TENDL-2021 LIBRARY; T=0.K  
Photon emission for (z,n)

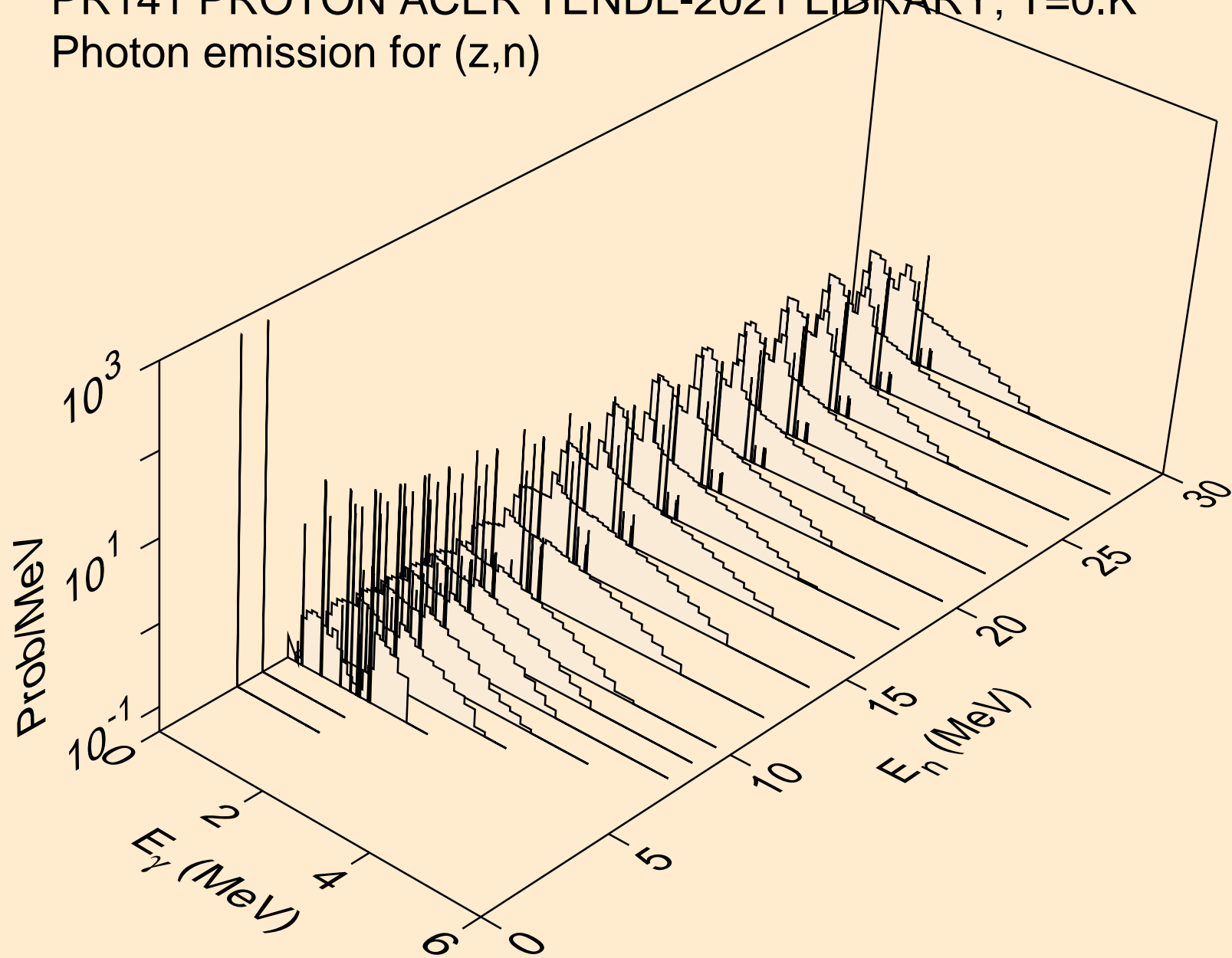

PR141 PROTON ACER TENDL-2021 LIBRARY; T=0.K  
Photon emission for (n,x)

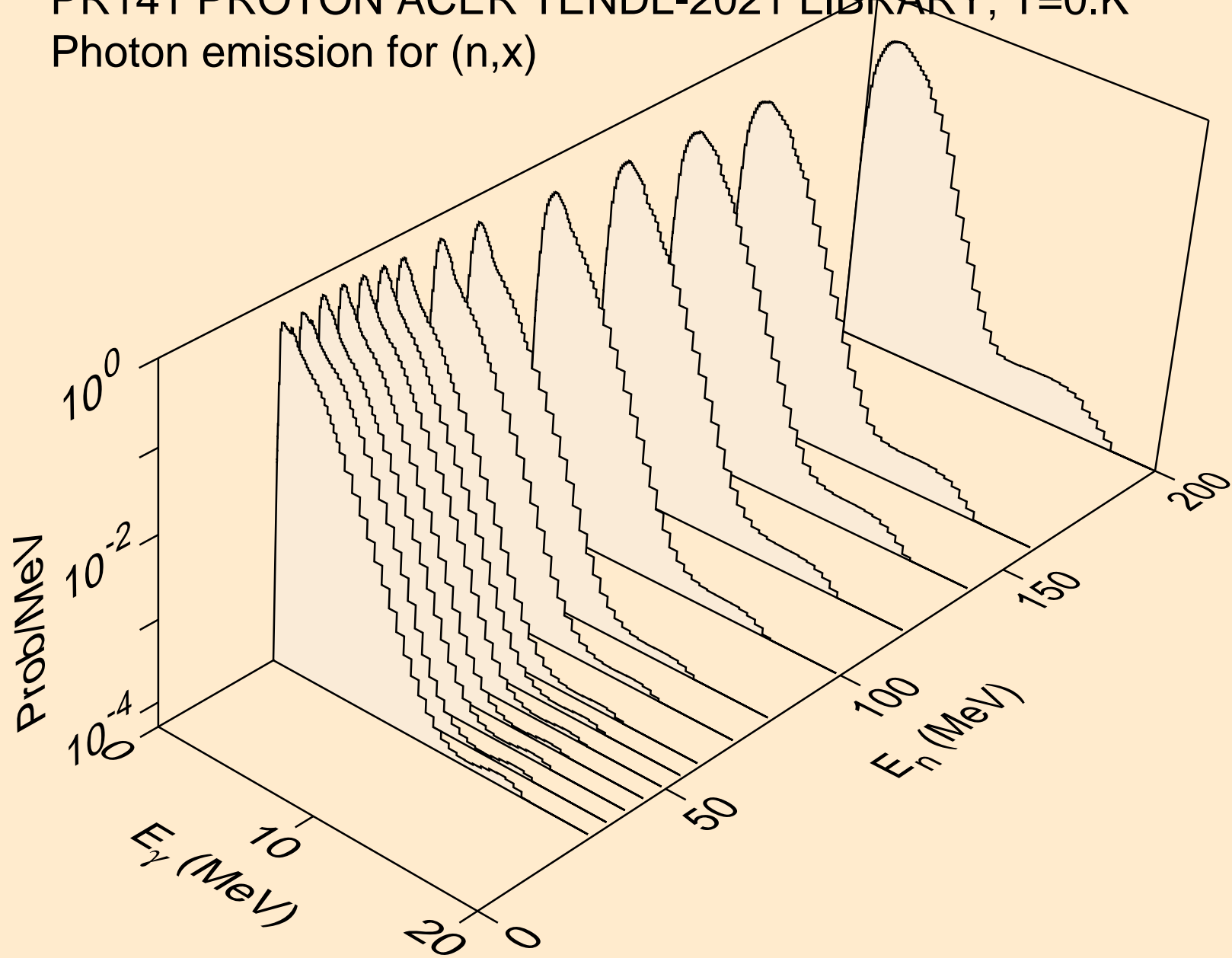

PR141 PROTON ACER TENDL-2021 LIBRARY; T=0.K  
Photon emission for (n,2nd)

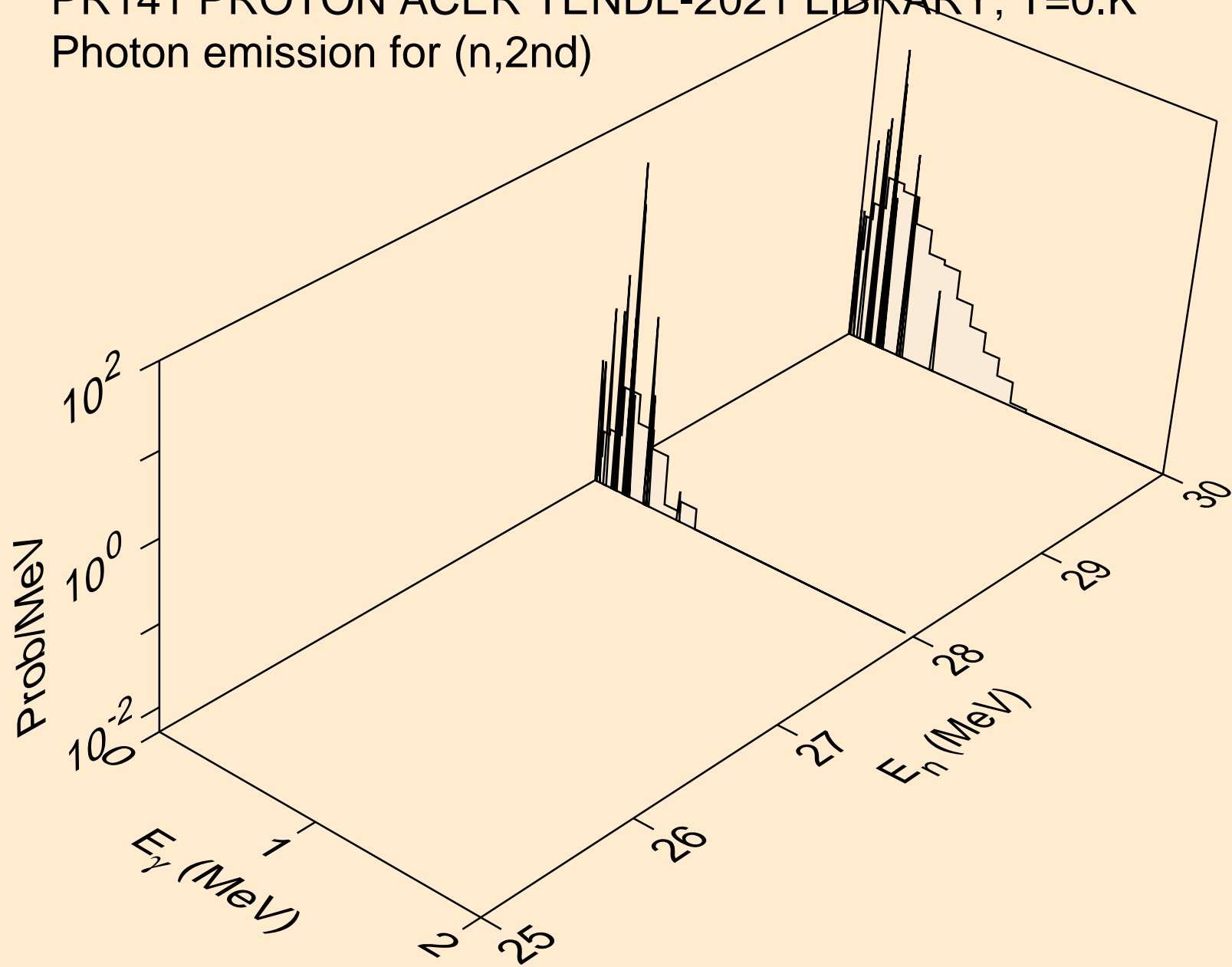

PR141 PROTON ACER TENDL-2021 LIBRARY; T=0.K  
Photon emission for (n,2n)

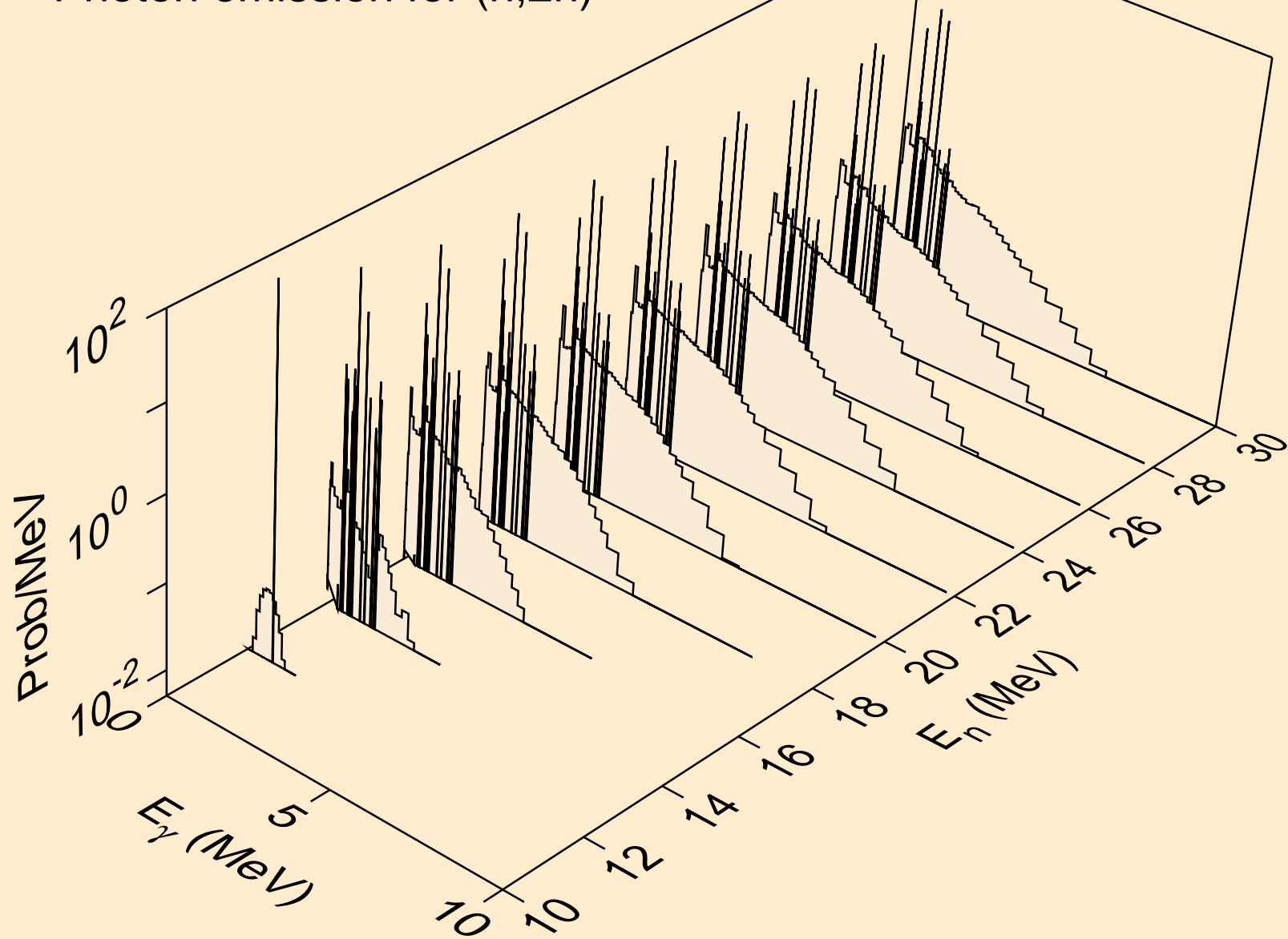



PR141 PROTON ACER TENDL-2021 LIBRARY; T=0.K  
Photon emission for (n,3n)

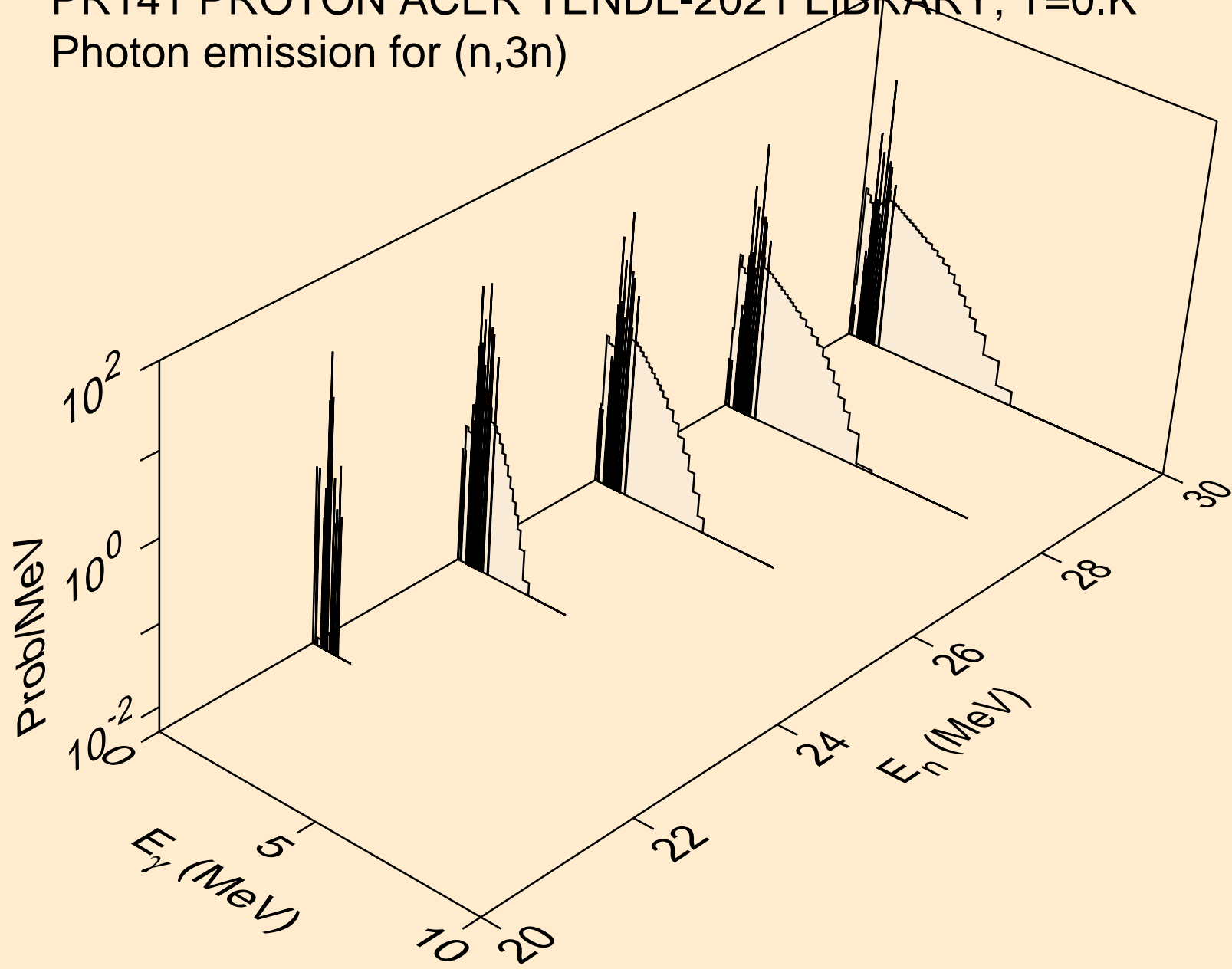

PR141 PROTON ACER TENDL-2021 LIBRARY; T=0.K  
Photon emission for (n,n\*)a

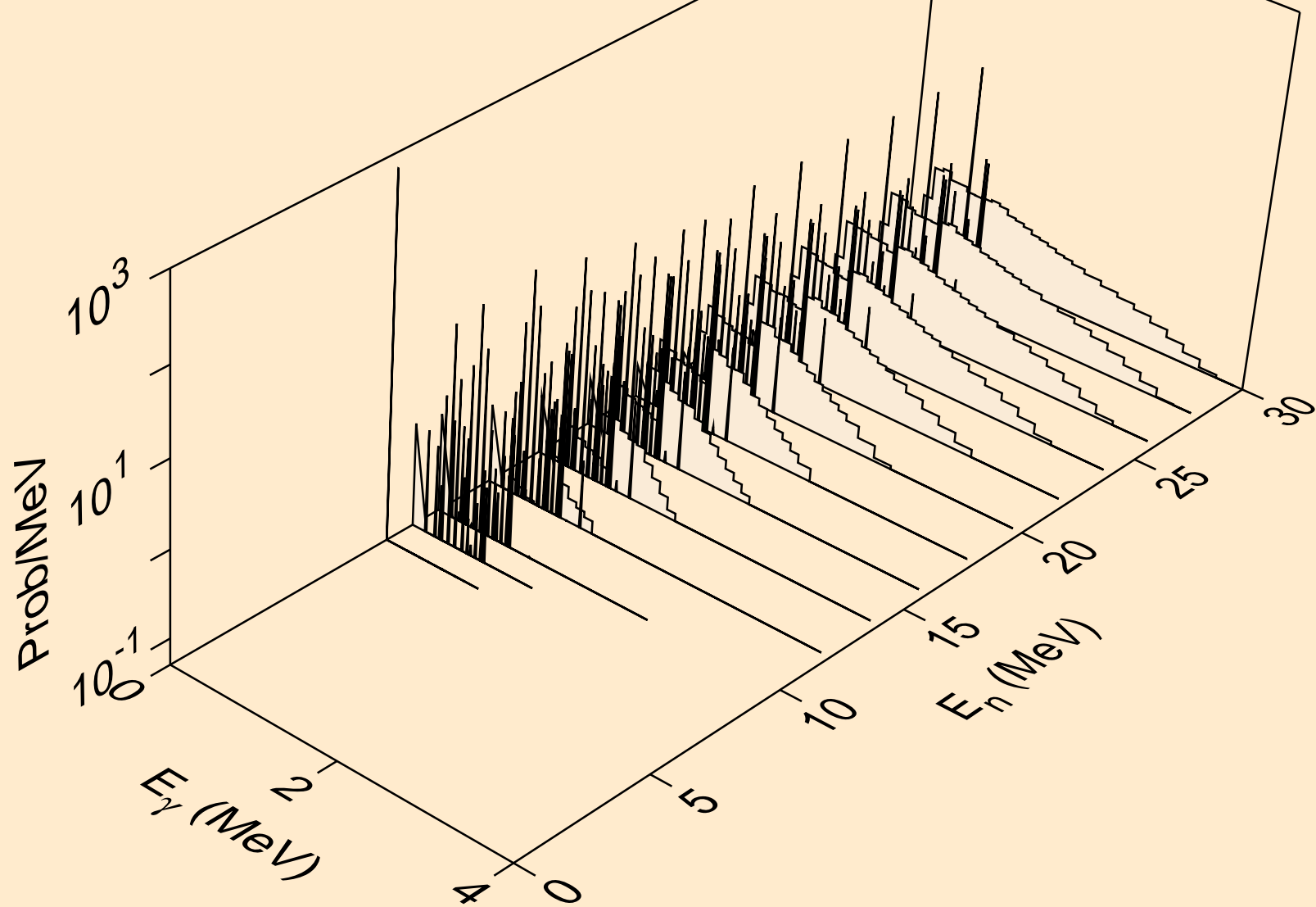

PR141 PROTON ACER TENDL-2021 LIBRARY; T=0.K  
Photon emission for (n,2n)a

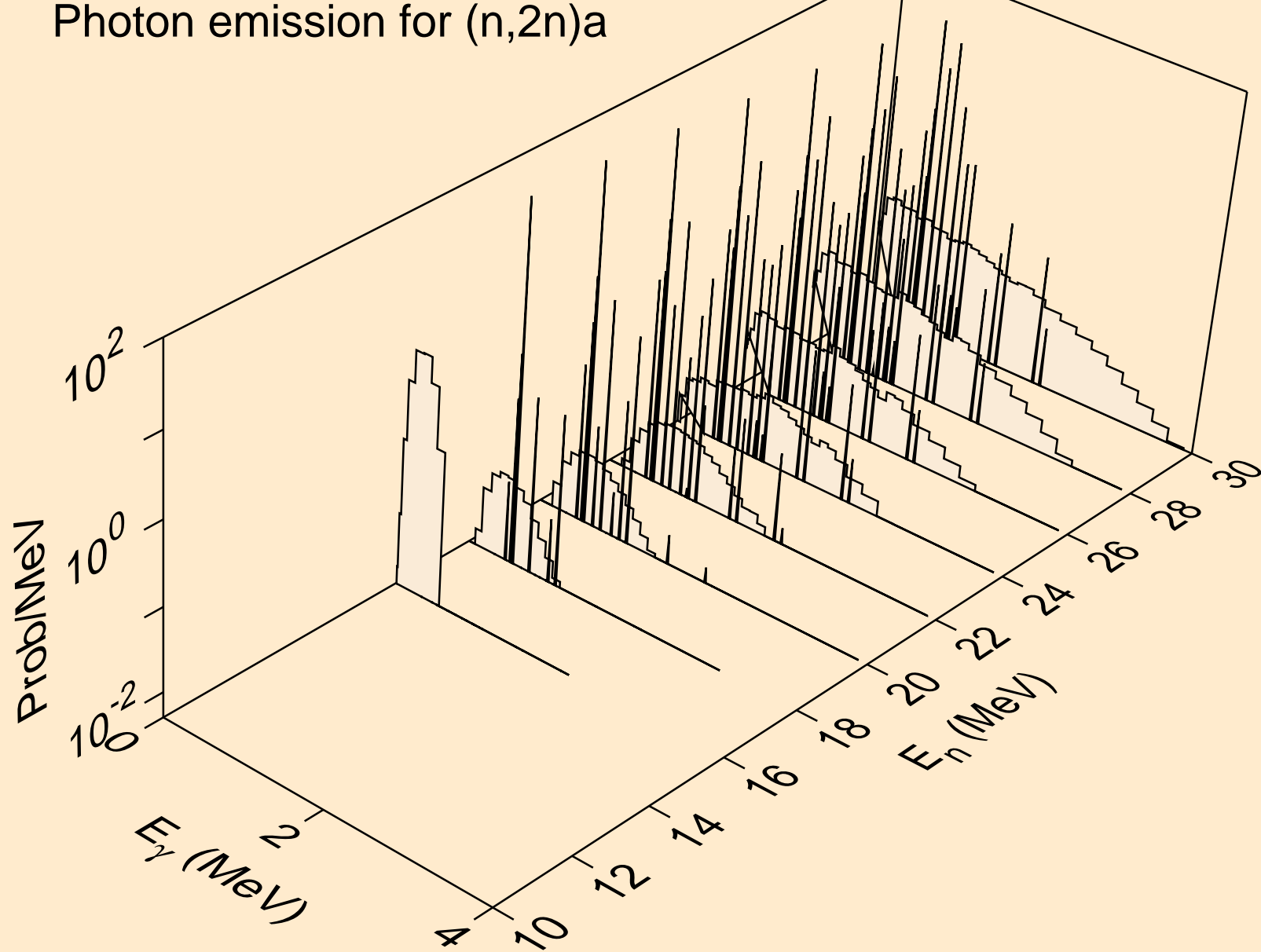

PR141 PROTON ACER TENDL-2021 LIBRARY; T=0.K  
Photon emission for (n,3n)a

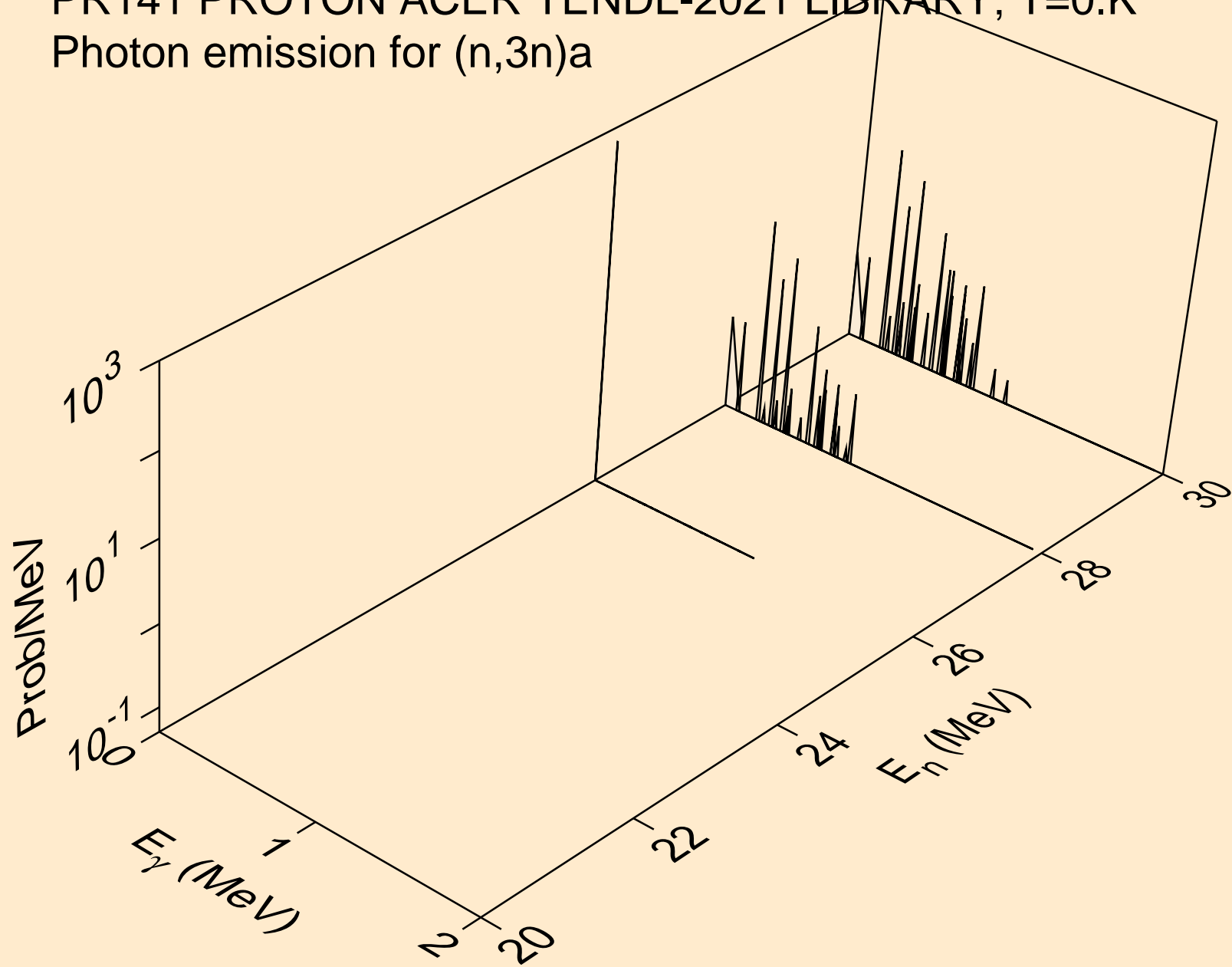

PR141 PROTON ACER TENDL-2021 LIBRARY; T=0.K  
Photon emission for (n,n\*)p

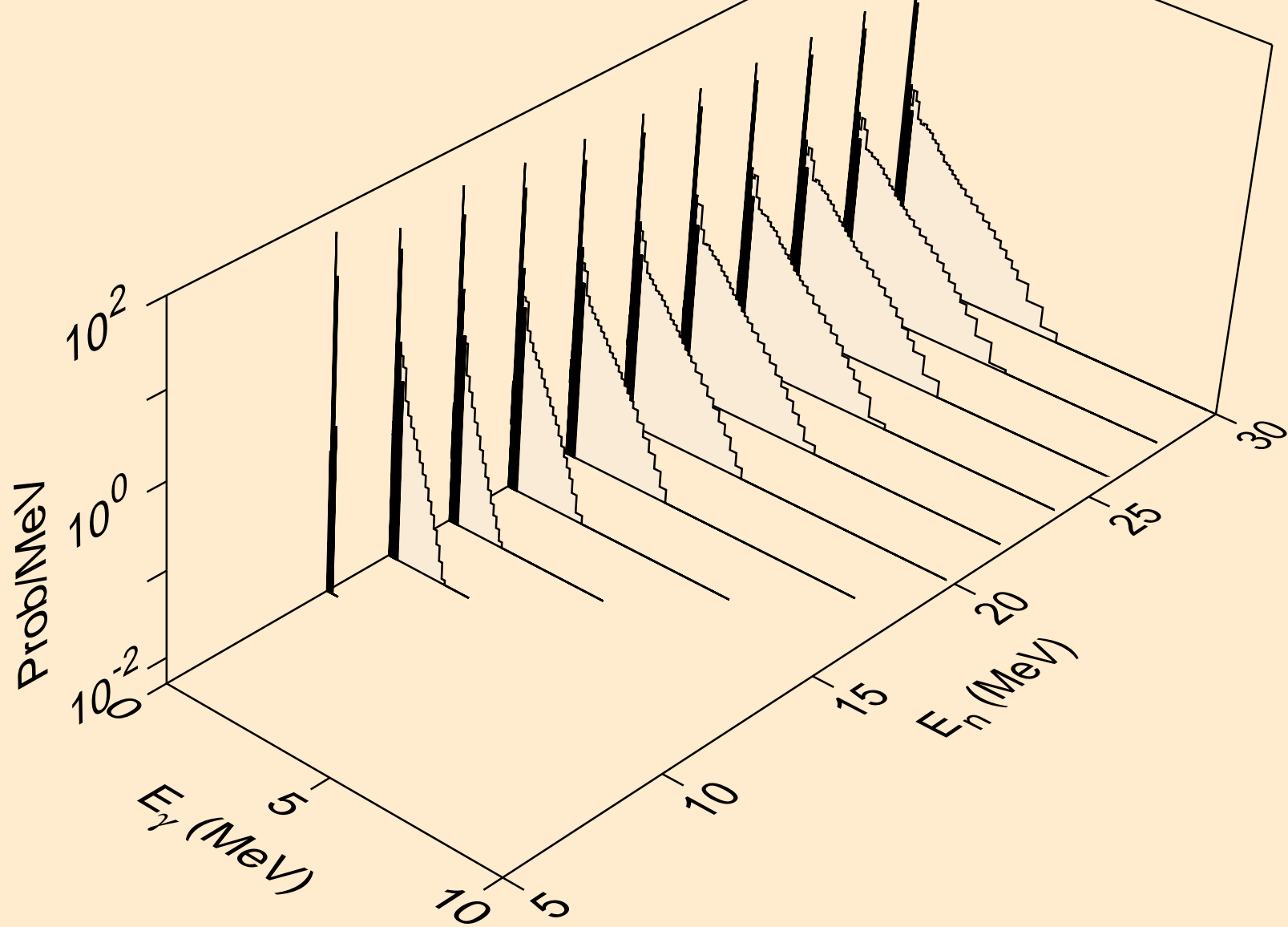

PR141 PROTON ACER TENDL-2021 LIBRARY; T=0.K  
Photon emission for (n,n\*)2a

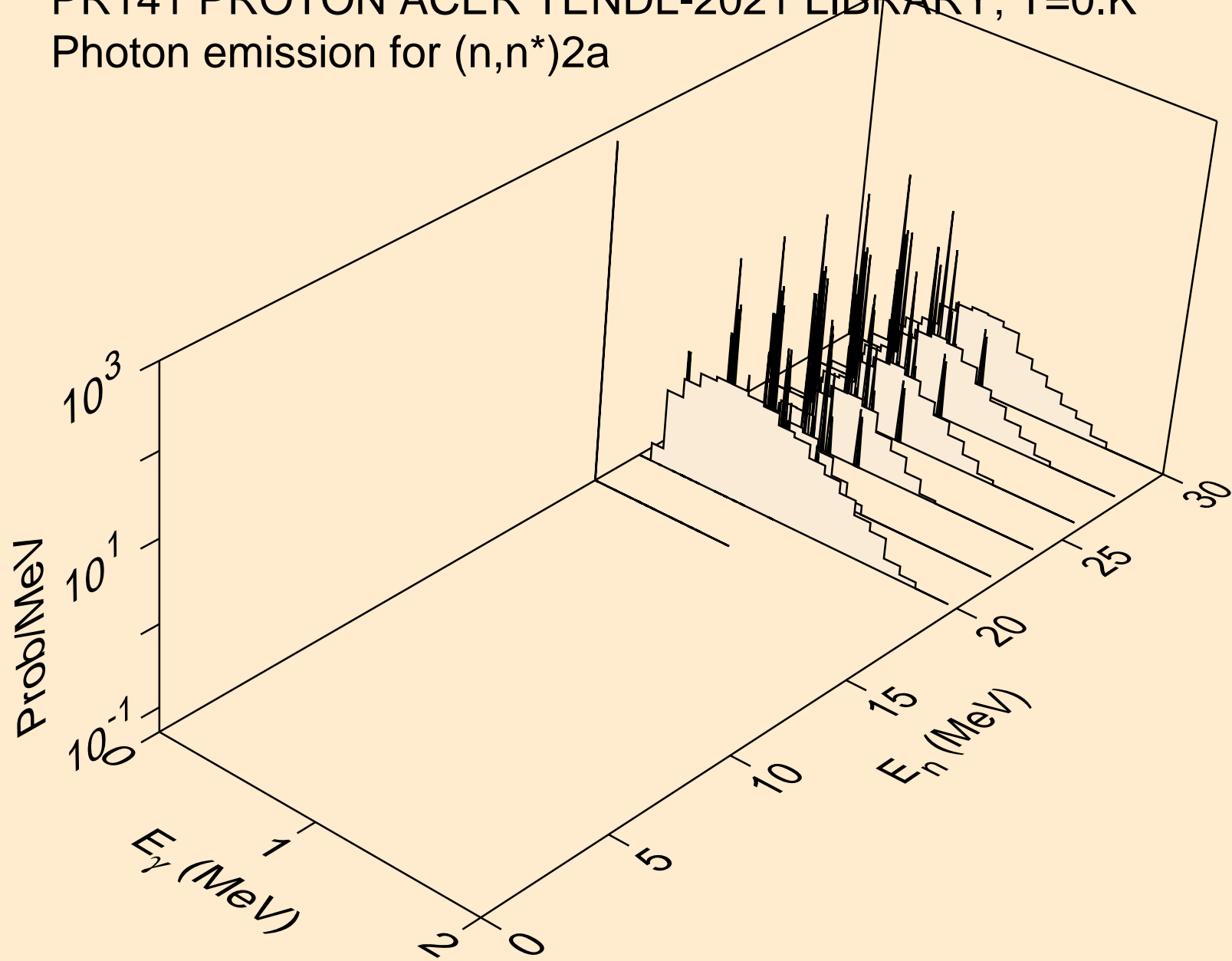

PR141 PROTON ACER TENDL-2021 LIBRARY; T=0.K  
Photon emission for (n,n\*)d

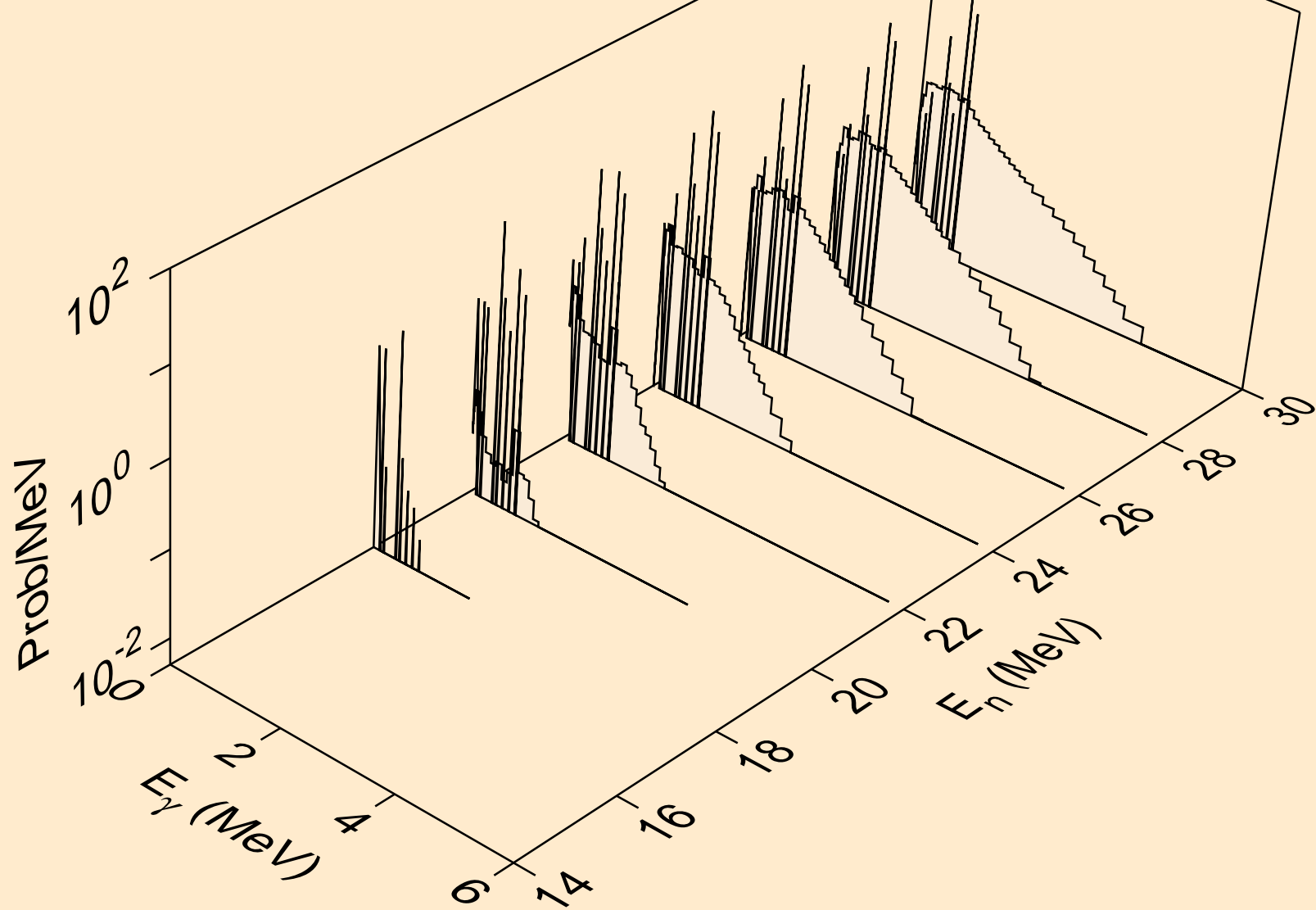

PR141 PROTON ACER TENDL-2021 LIBRARY; T=0.K  
Photon emission for (n,n\*)t

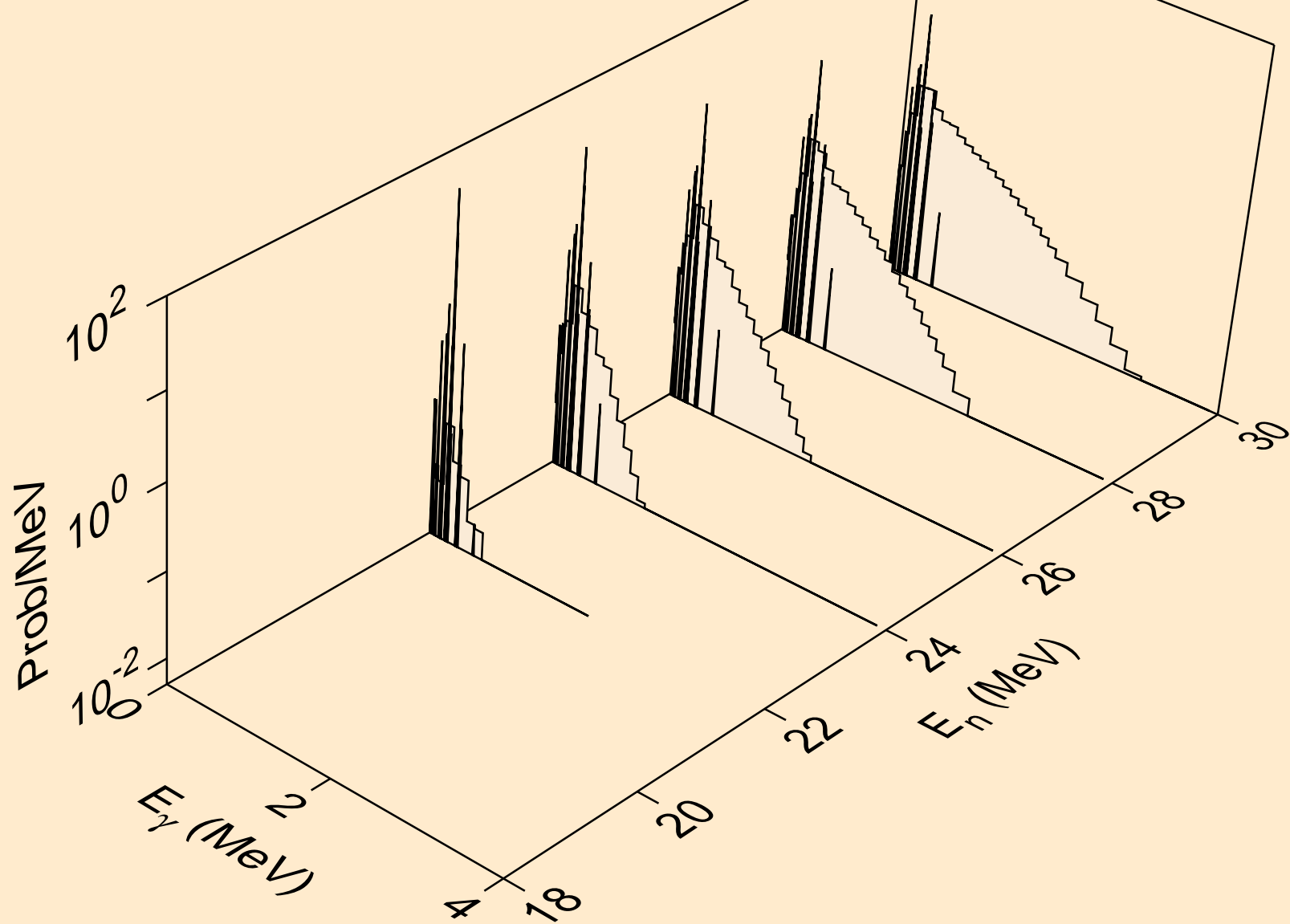



PR141 PROTON ACER TENDL-2021 LIBRARY; T=0.K  
Photon emission for (n,n\*)he3

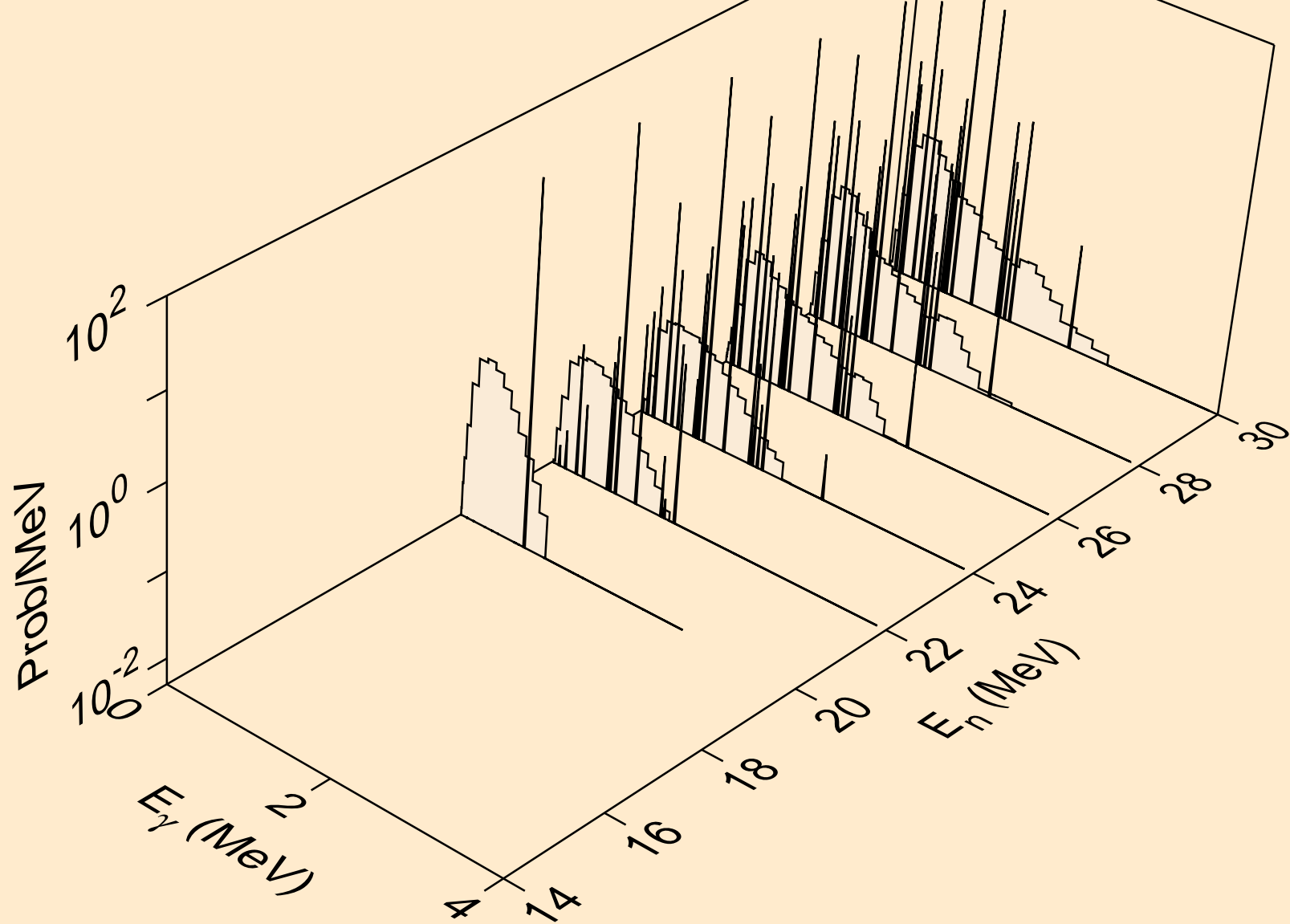

PR141 PROTON ACER TENDL-2021 LIBRARY; T=0.K  
Photon emission for (n,2np)

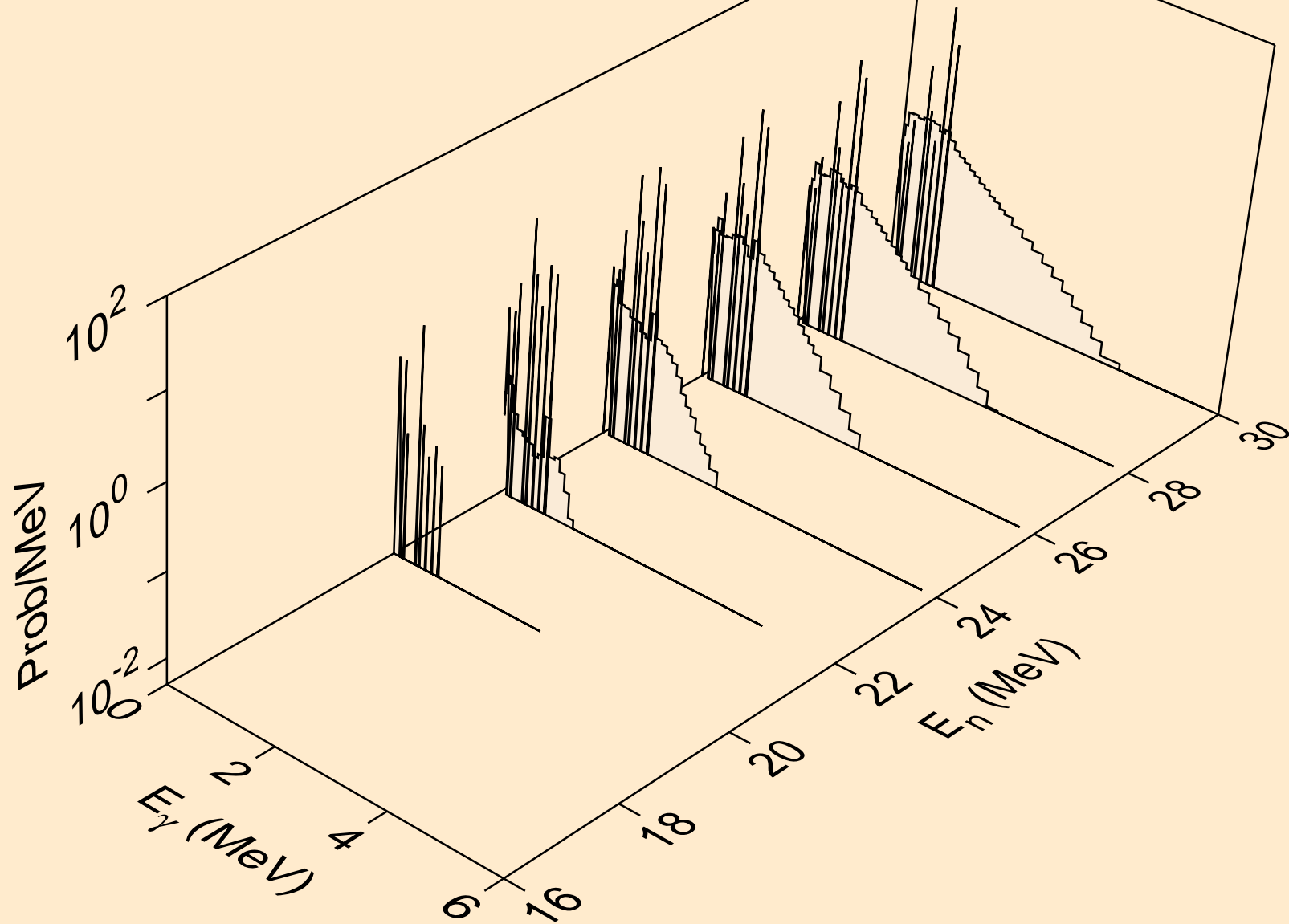

PR141 PROTON ACER TENDL-2021 LIBRARY; T=0.K  
Photon emission for (n,3np)

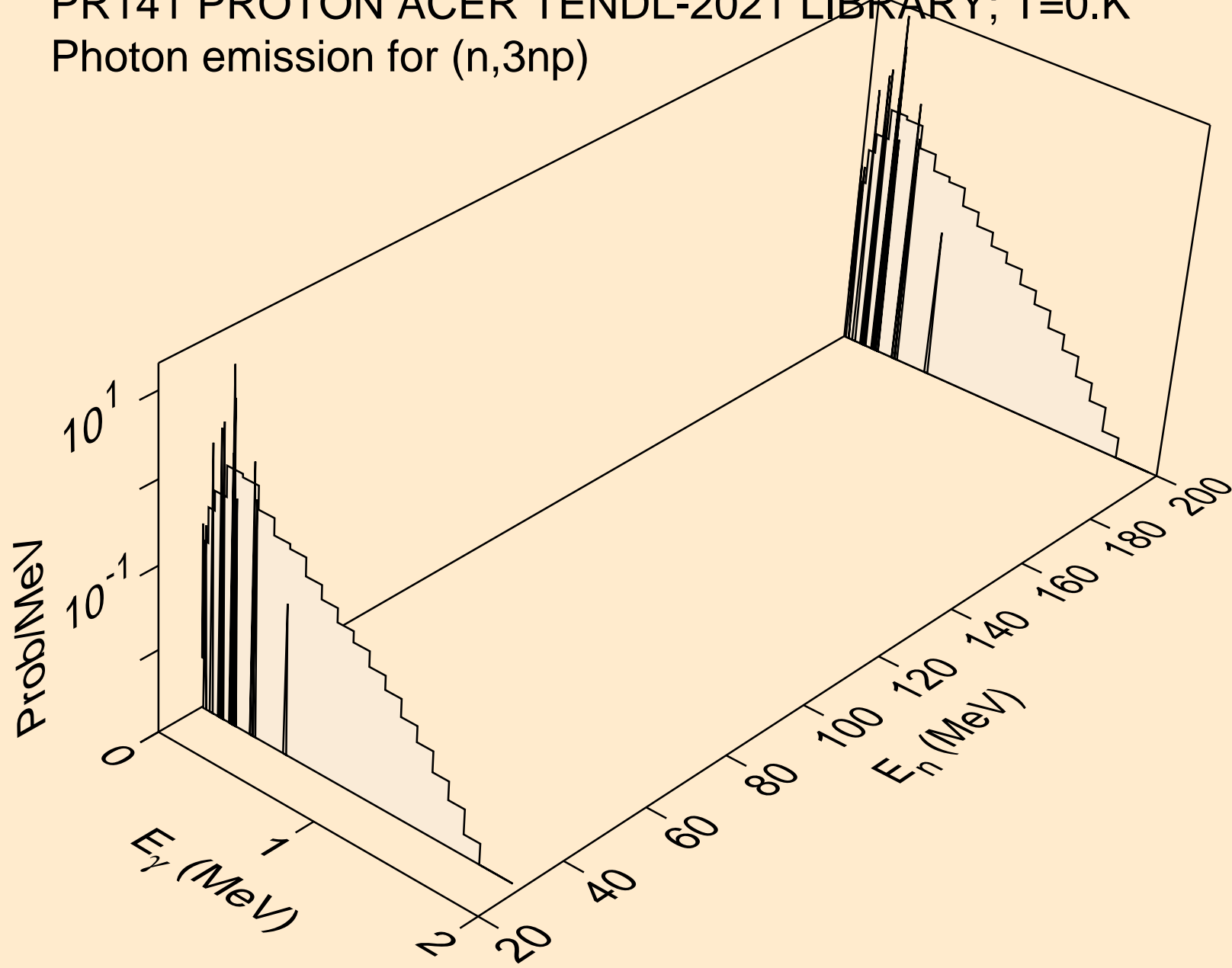

PR141 PROTON ACER TENDL-2021 LIBRARY; T=0.K  
Photon emission for (n,2np)

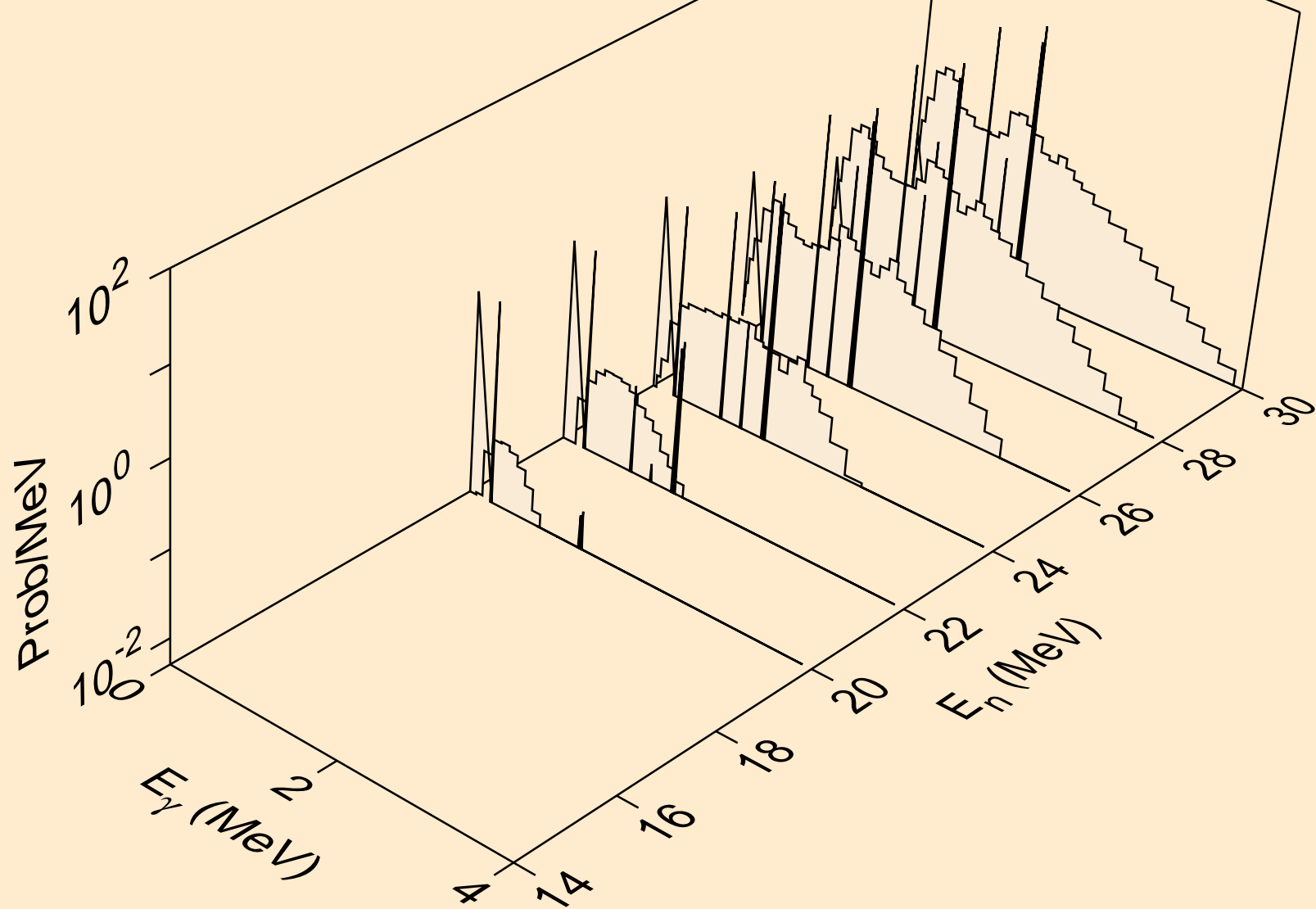

PR141 PROTON ACER TENDL-2021 LIBRARY; T=0.K  
Photon emission for (n,npa)

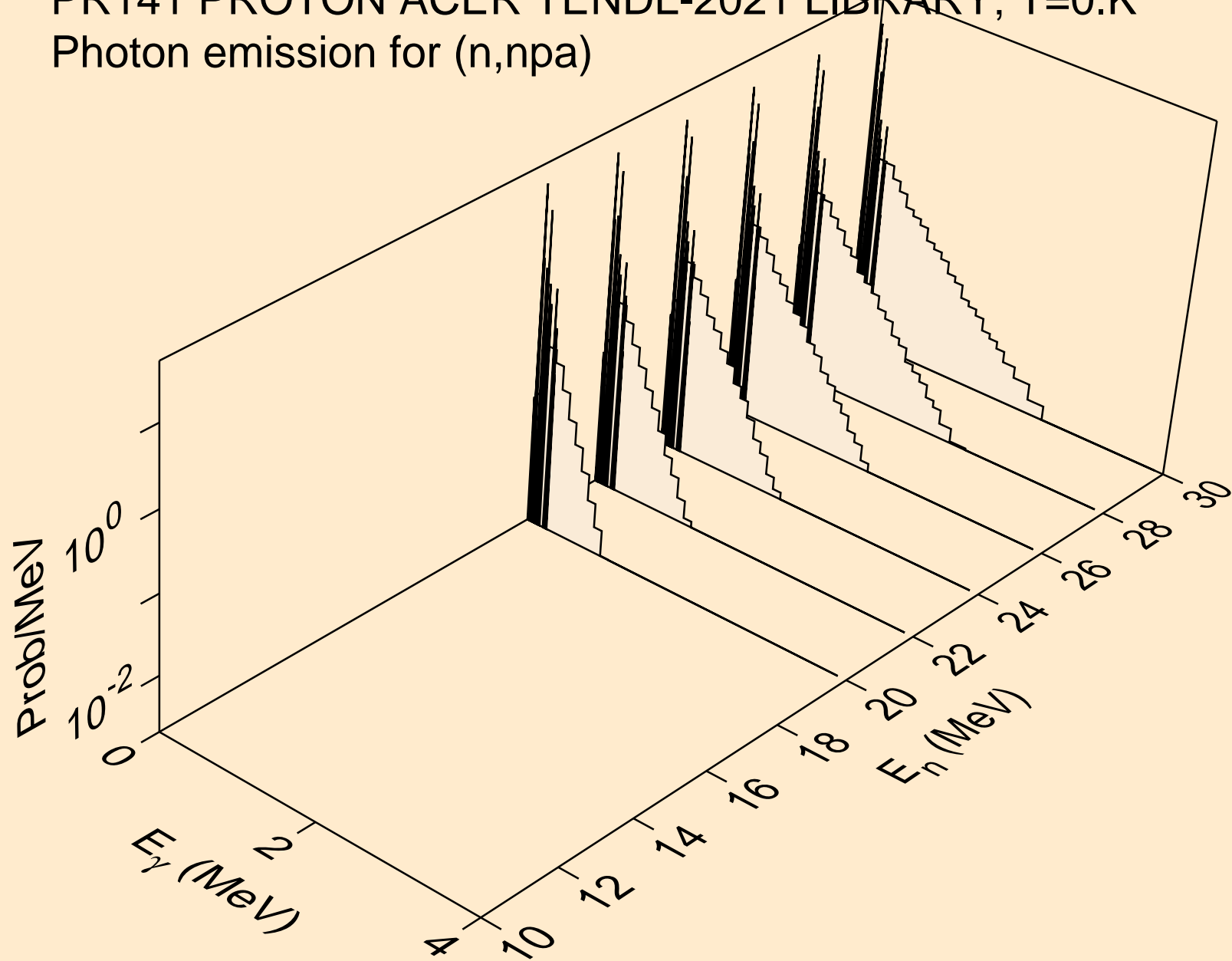

PR141 PROTON ACER TENDL-2021 LIBRARY; T=0.K  
Photon emission for (n,gma)

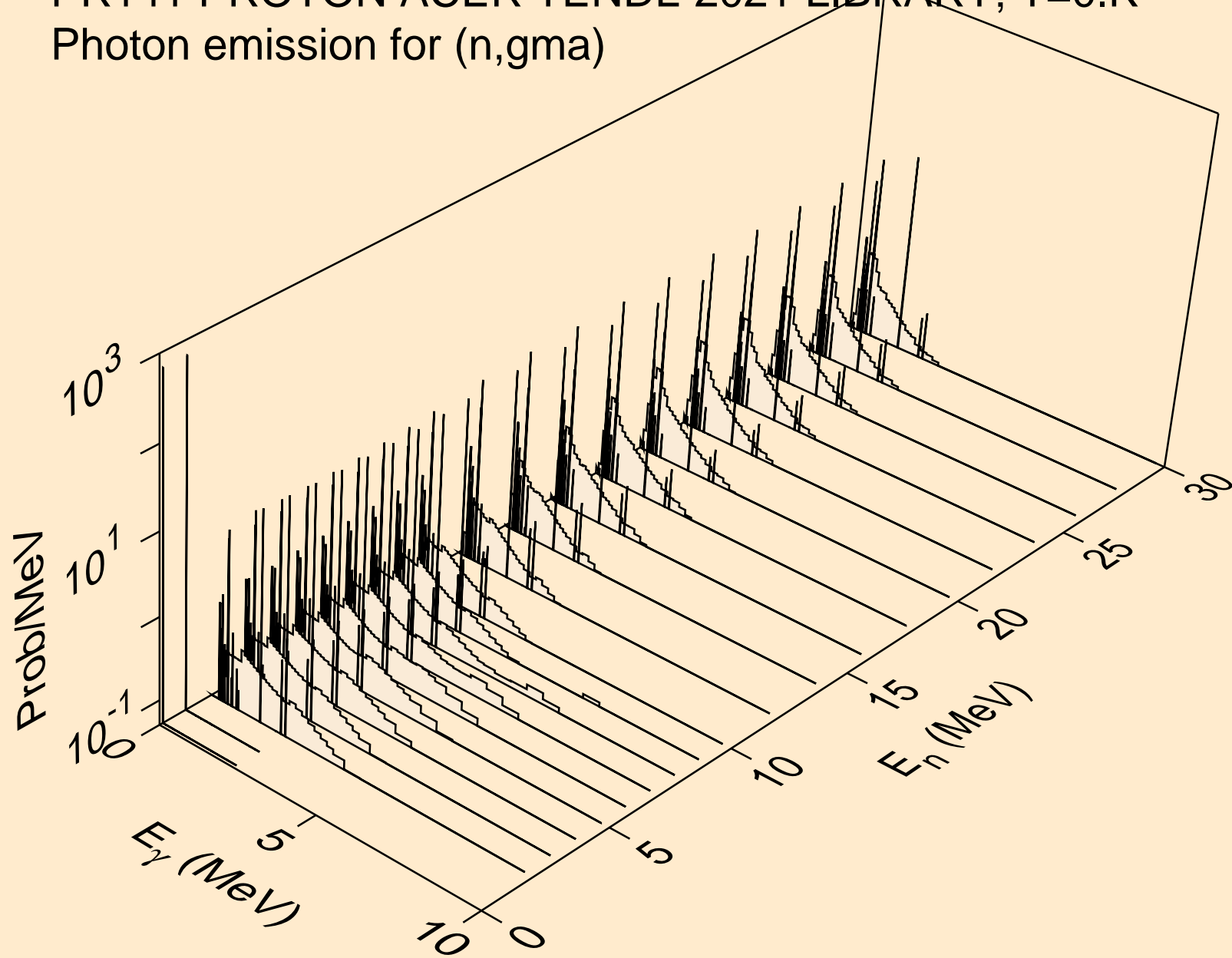

PR141 PROTON ACER TENDL-2021 LIBRARY; T=0.K  
Photon emission for inelastic

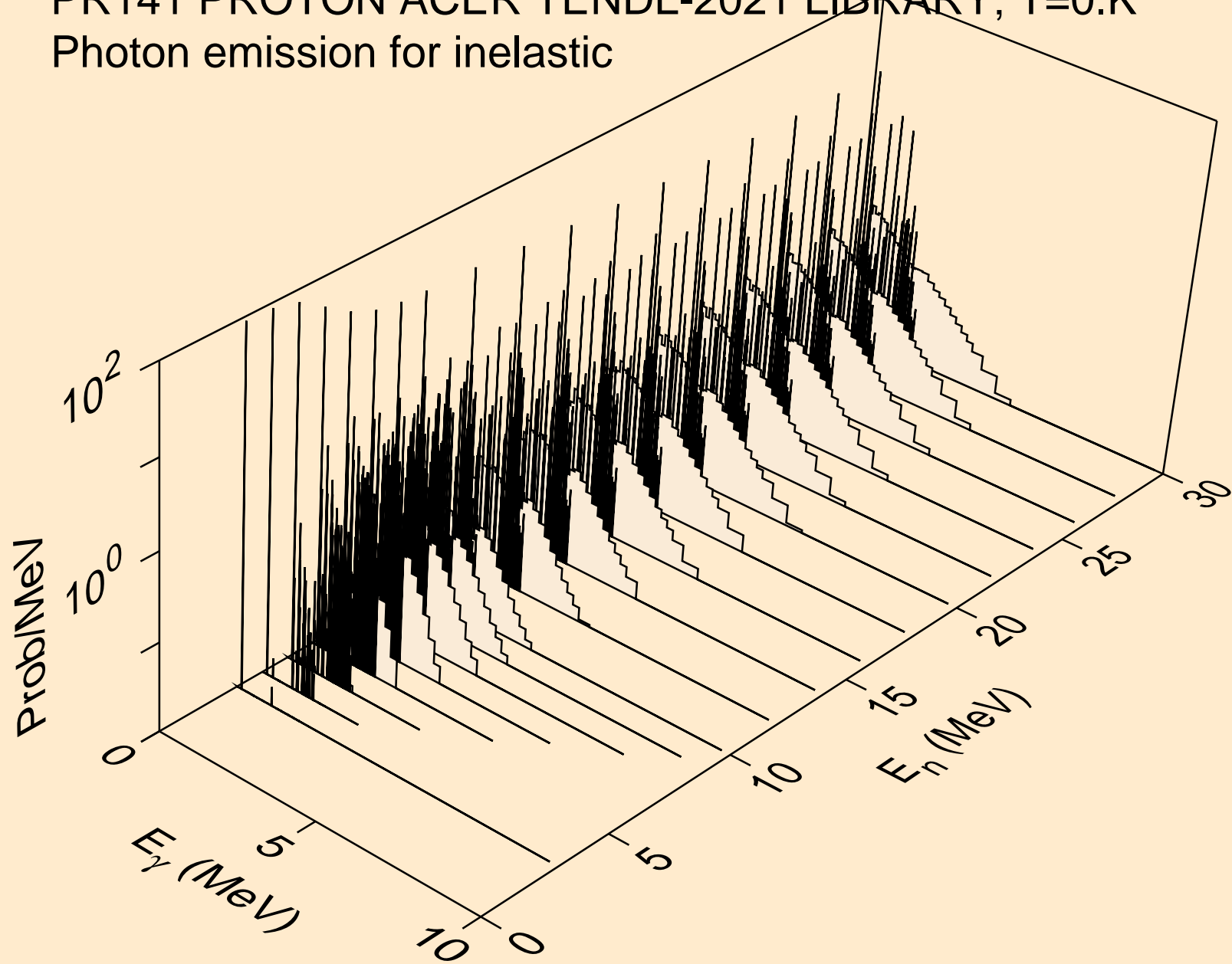

PR141 PROTON ACER TENDL-2021 LIBRARY; T=0.K  
Photon emission for (n,d)

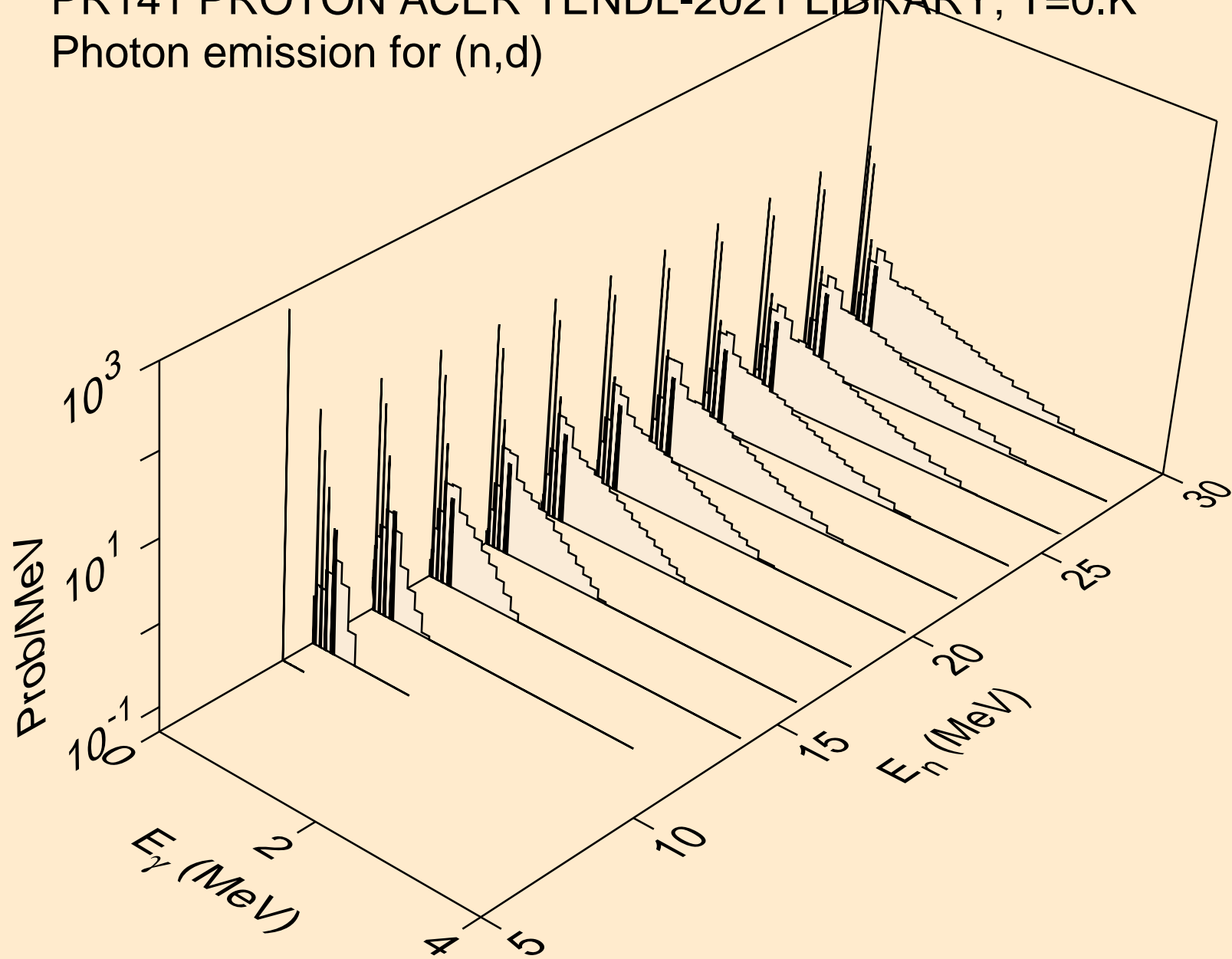



PR141 PROTON ACER TENDL-2021 LIBRARY; T=0.K  
Photon emission for (n,t)

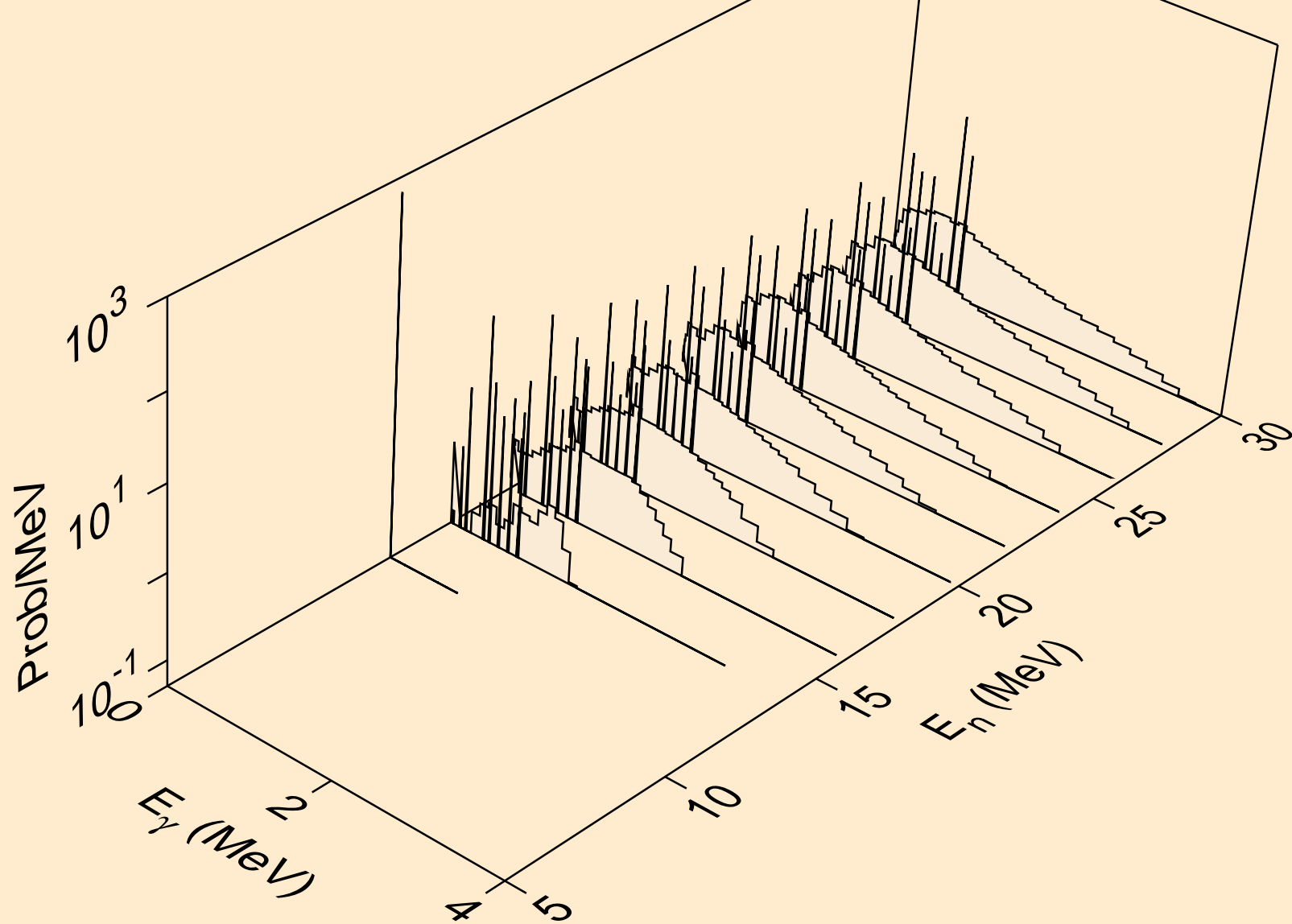

PR141 PROTON ACER TENDL-2021 LIBRARY; T=0.K  
Photon emission for (n,he3)

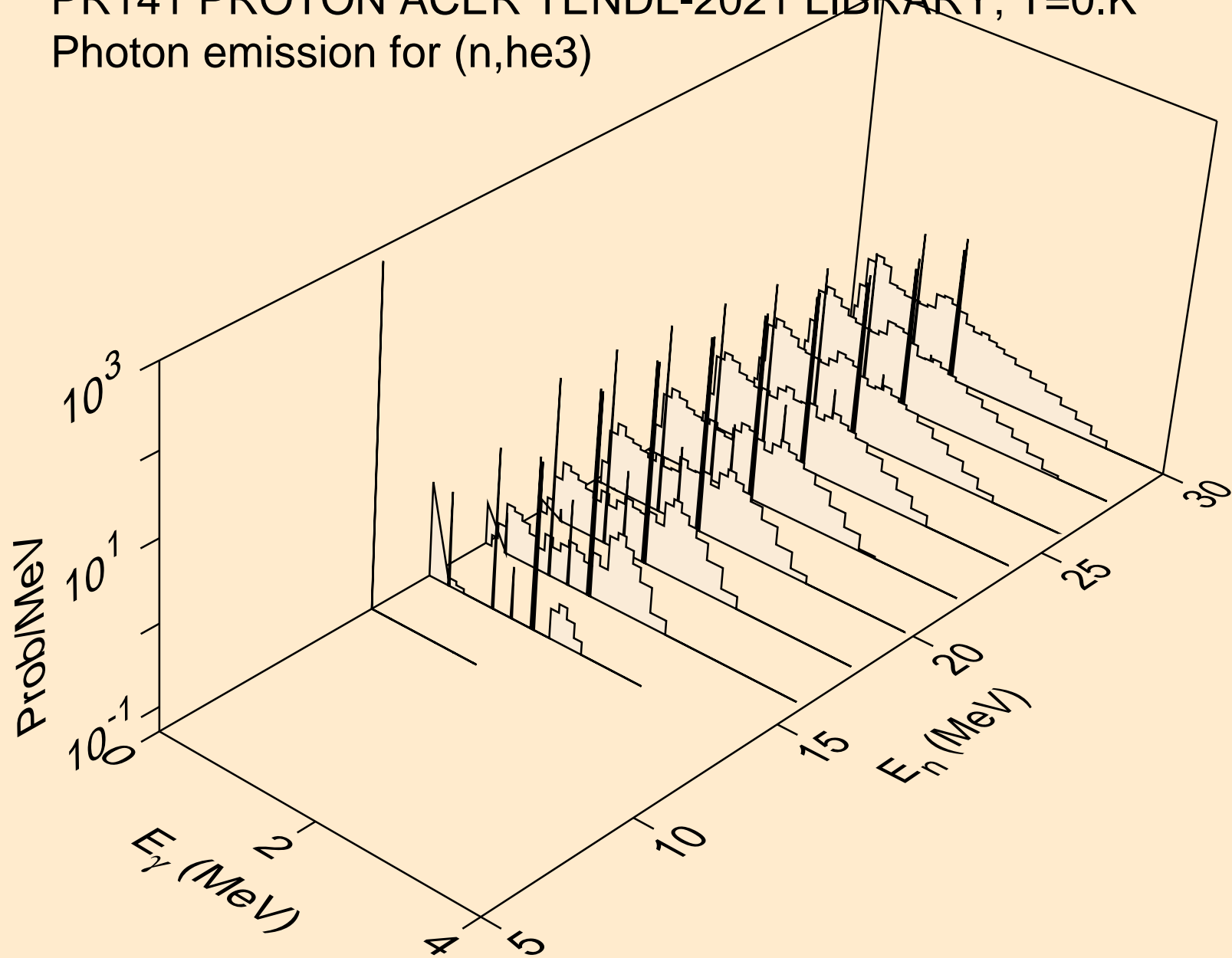

PR141 PROTON ACER TENDL-2021 LIBRARY; T=0.K  
Photon emission for (n,a)

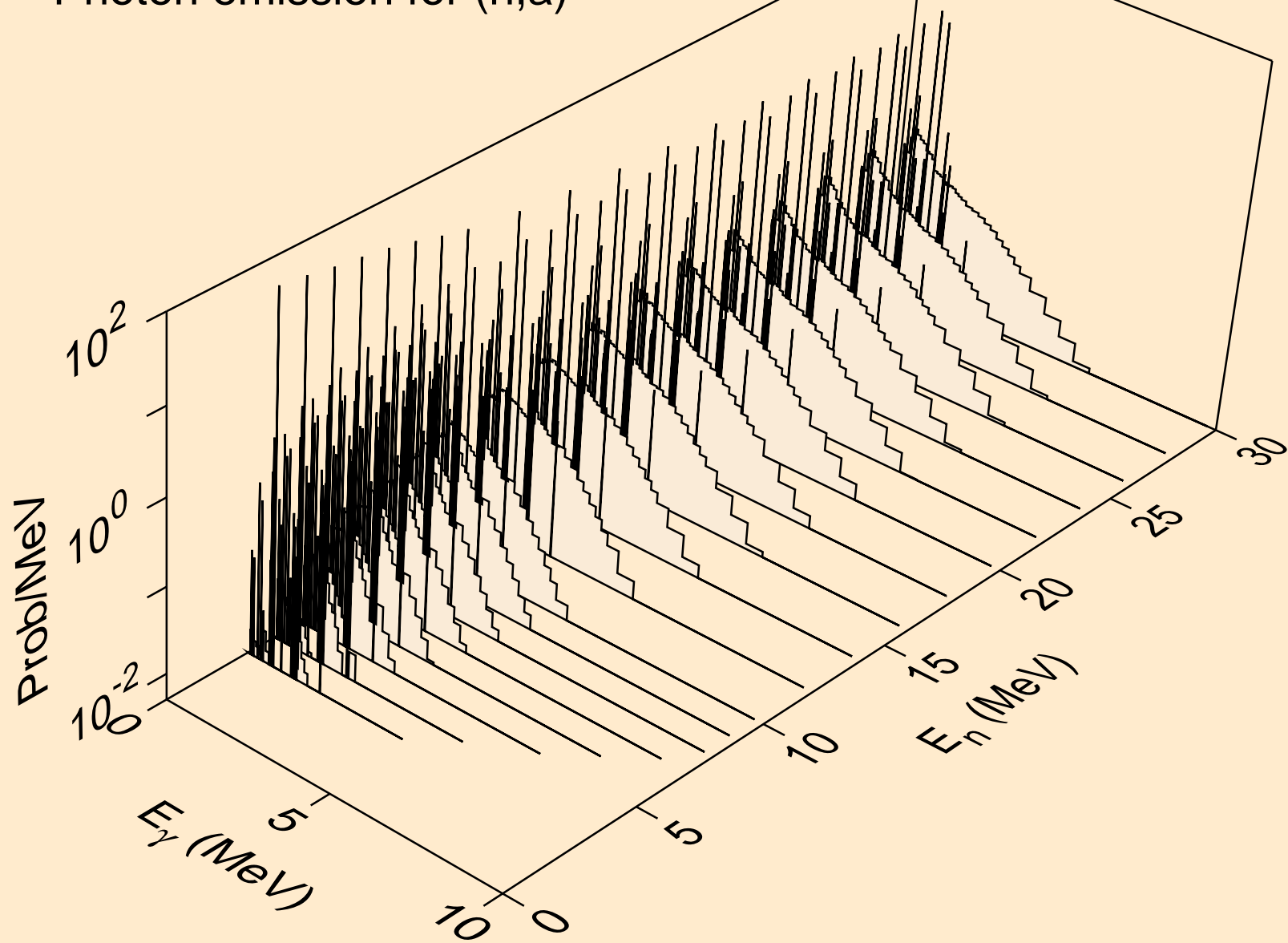

PR141 PROTON ACER TENDL-2021 LIBRARY; T=0.K  
Photon emission for (n,2a)

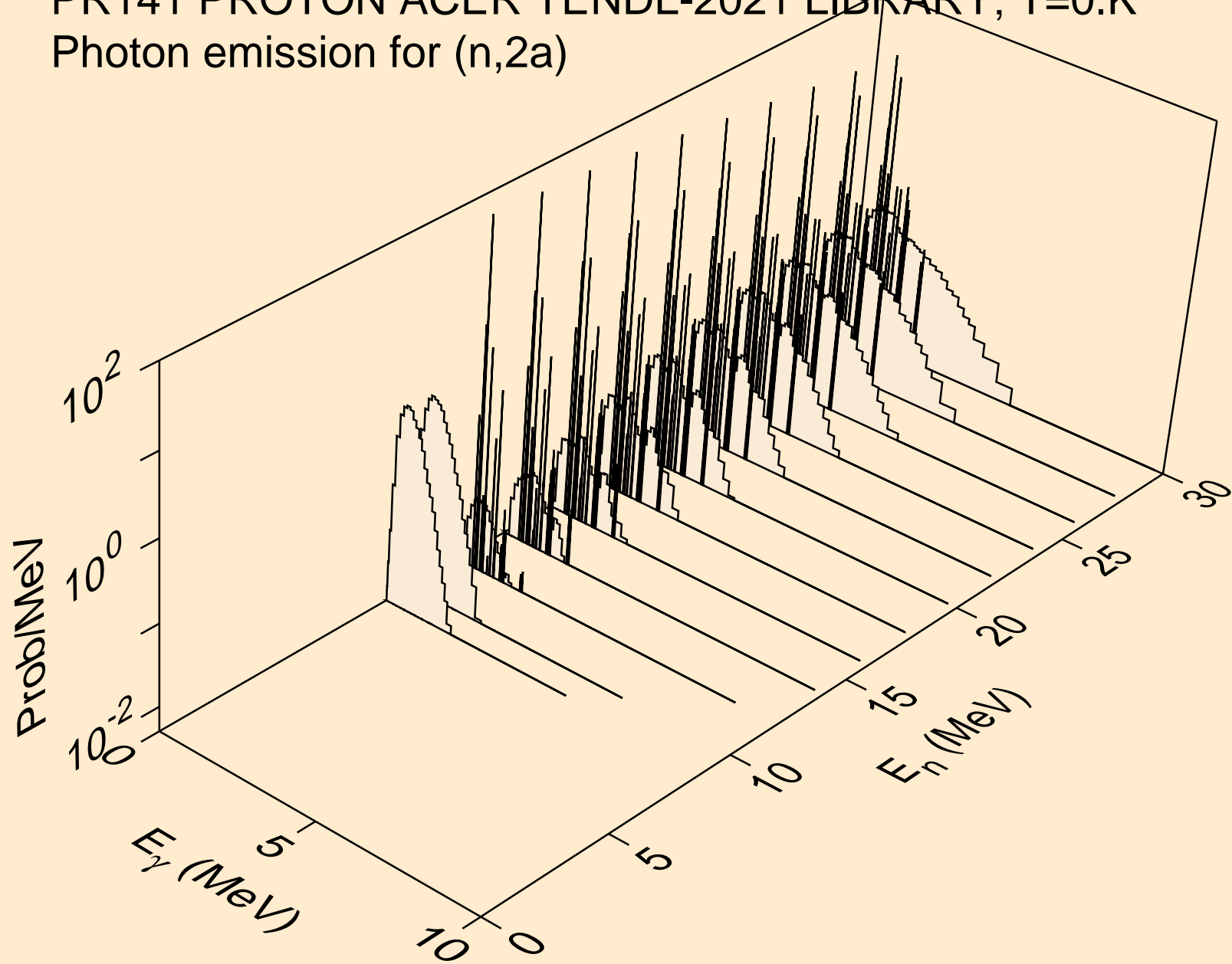

PR141 PROTON ACER TENDL-2021 LIBRARY; T=0.K  
Photon emission for (n,2p)

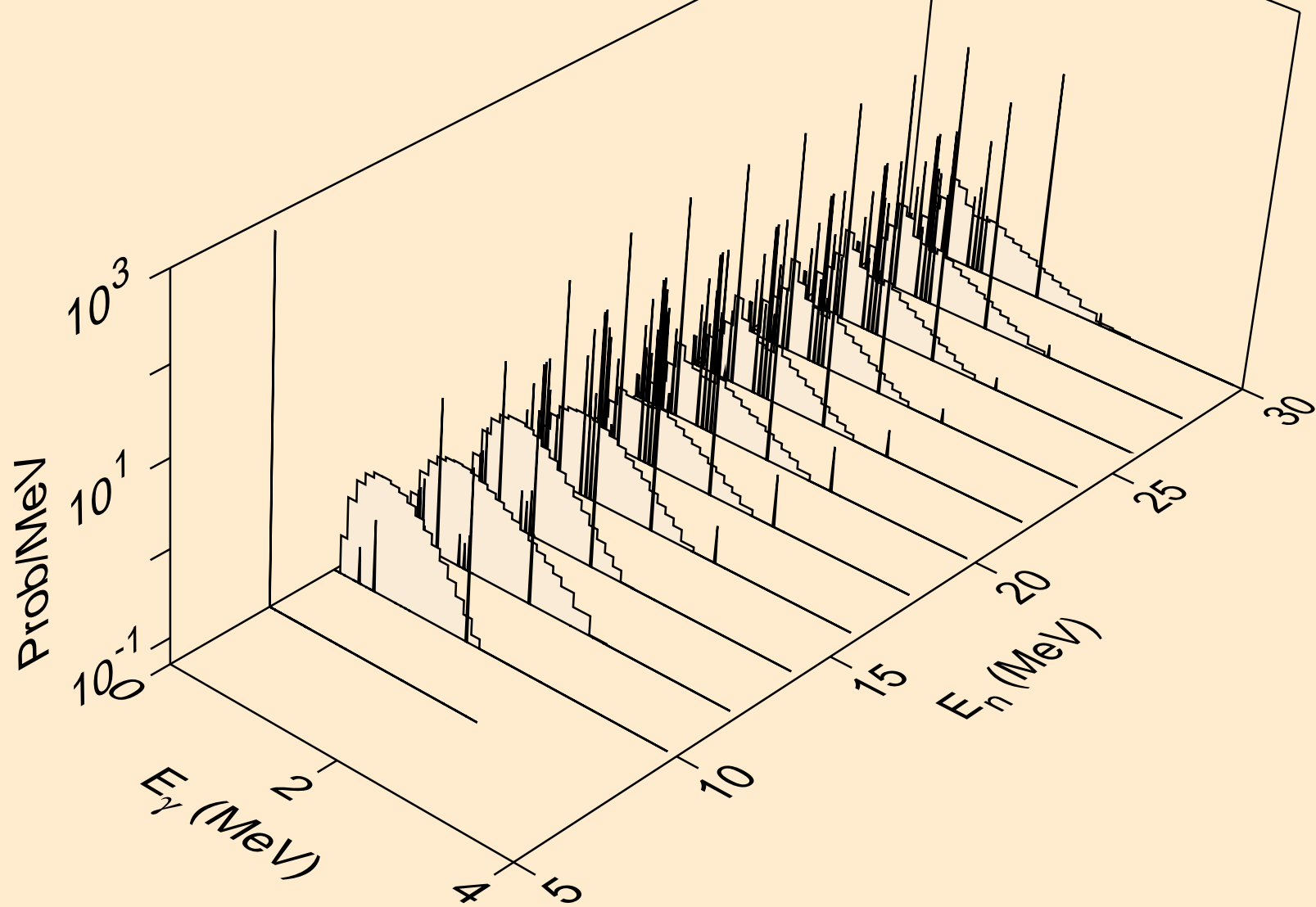

PR141 PROTON ACER TENDL-2021 LIBRARY; T=0.K  
Photon emission for (n,pa)

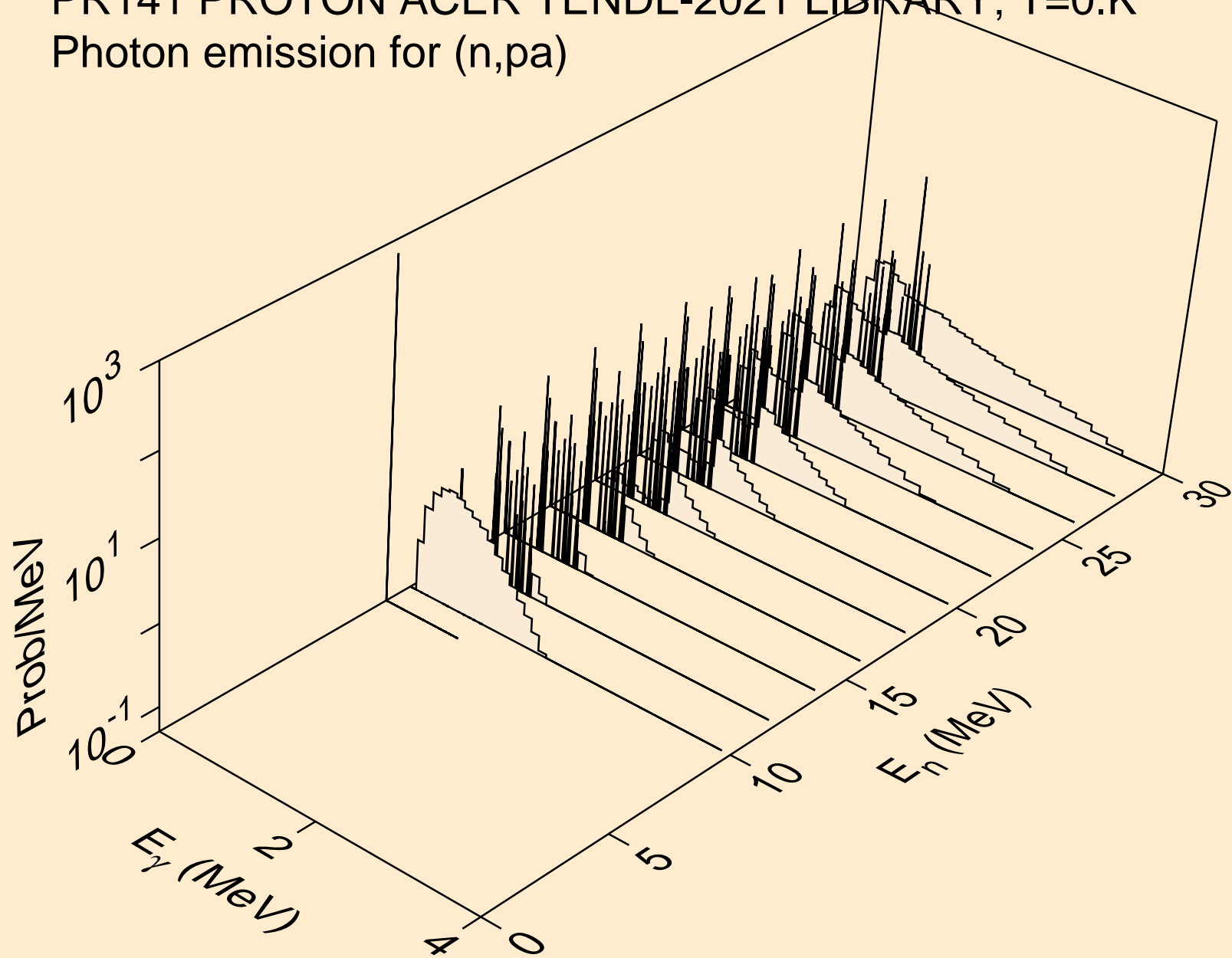

PR141 PROTON ACER TENDL-2021 LIBRARY; T=0.K  
Photon emission for (n,pd)

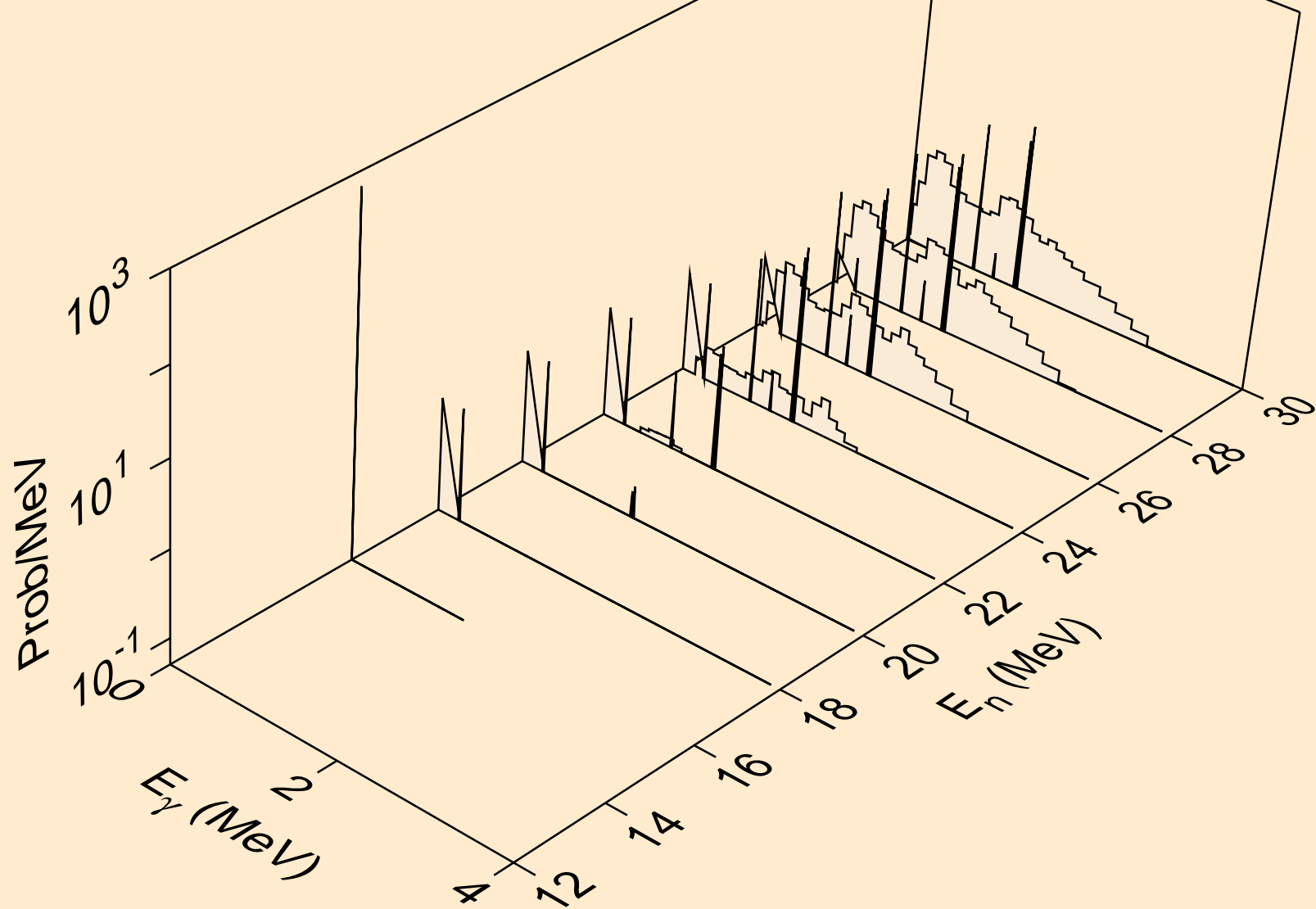

PR141 PROTON ACER TENDL-2021 LIBRARY; T=0.K  
Photon emission for (n,pt)

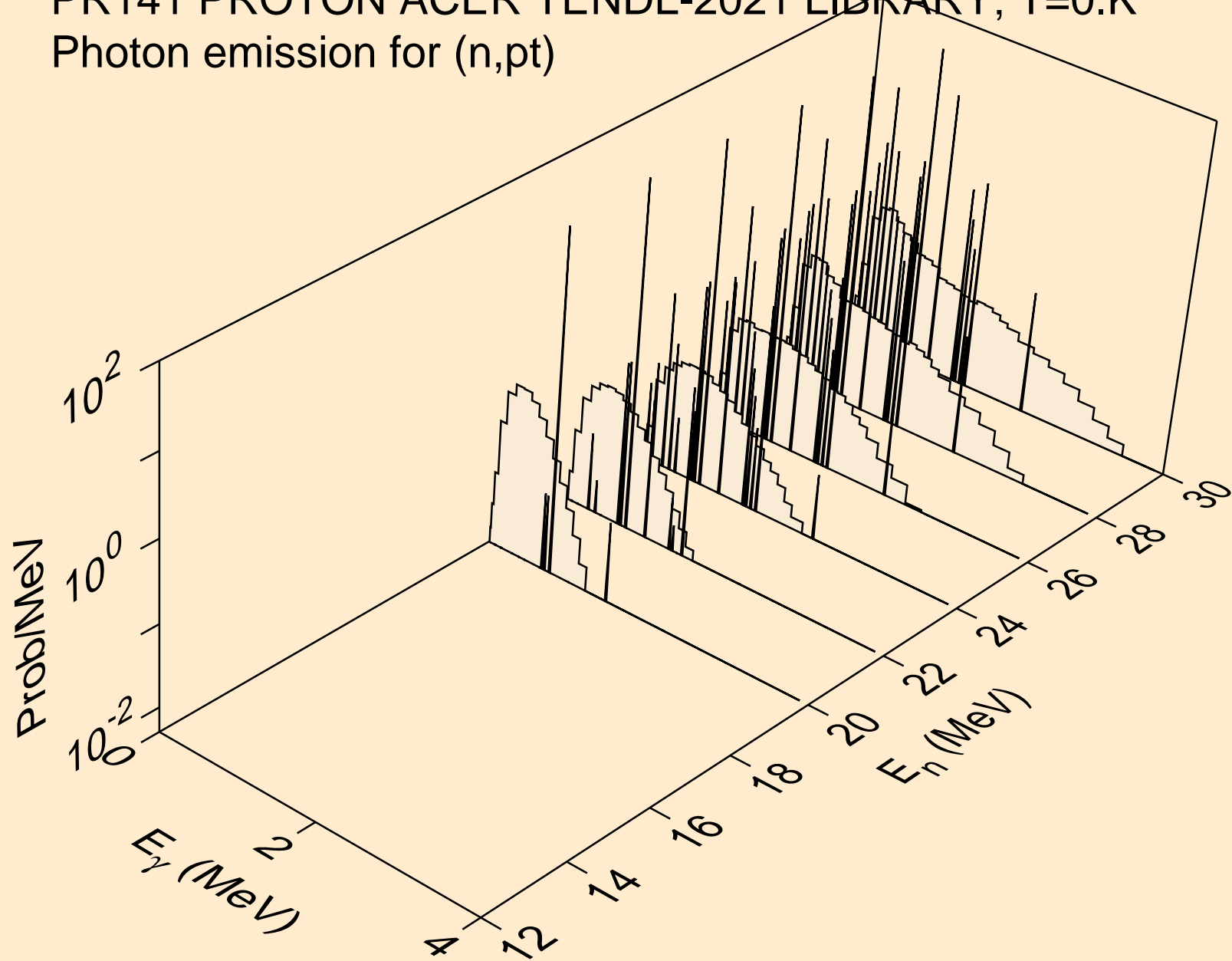



PR141 PROTON ACER TENDL-2021 LIBRARY; T=0.K  
Photon emission for (n,da)

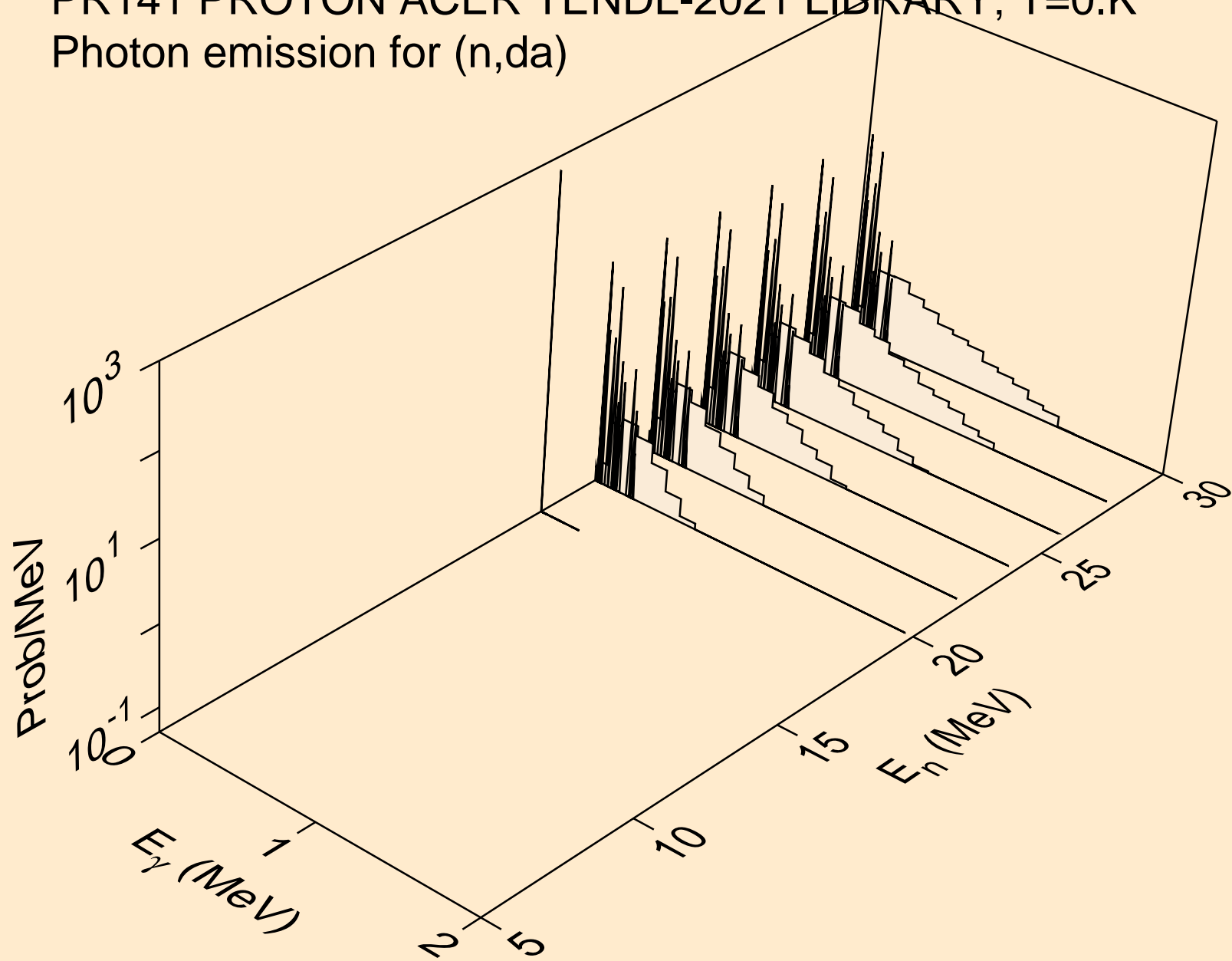

PR141 PROTON ACER TENDL-2021 LIBRARY; T=0.K  
Particle heating contributions

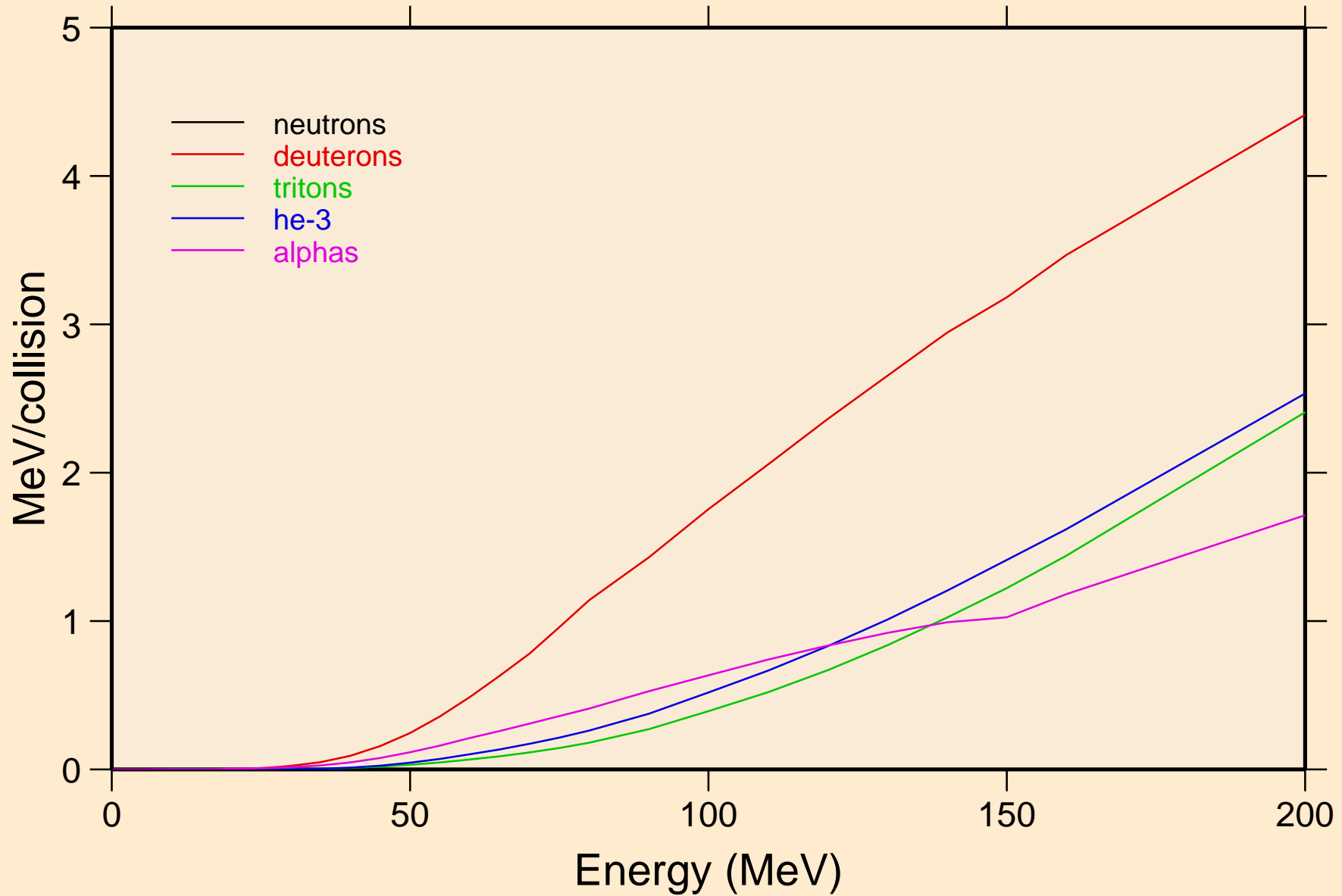

PR141 PROTON ACER TENDL-2021 LIBRARY; T=0.K  
Recoil Heating

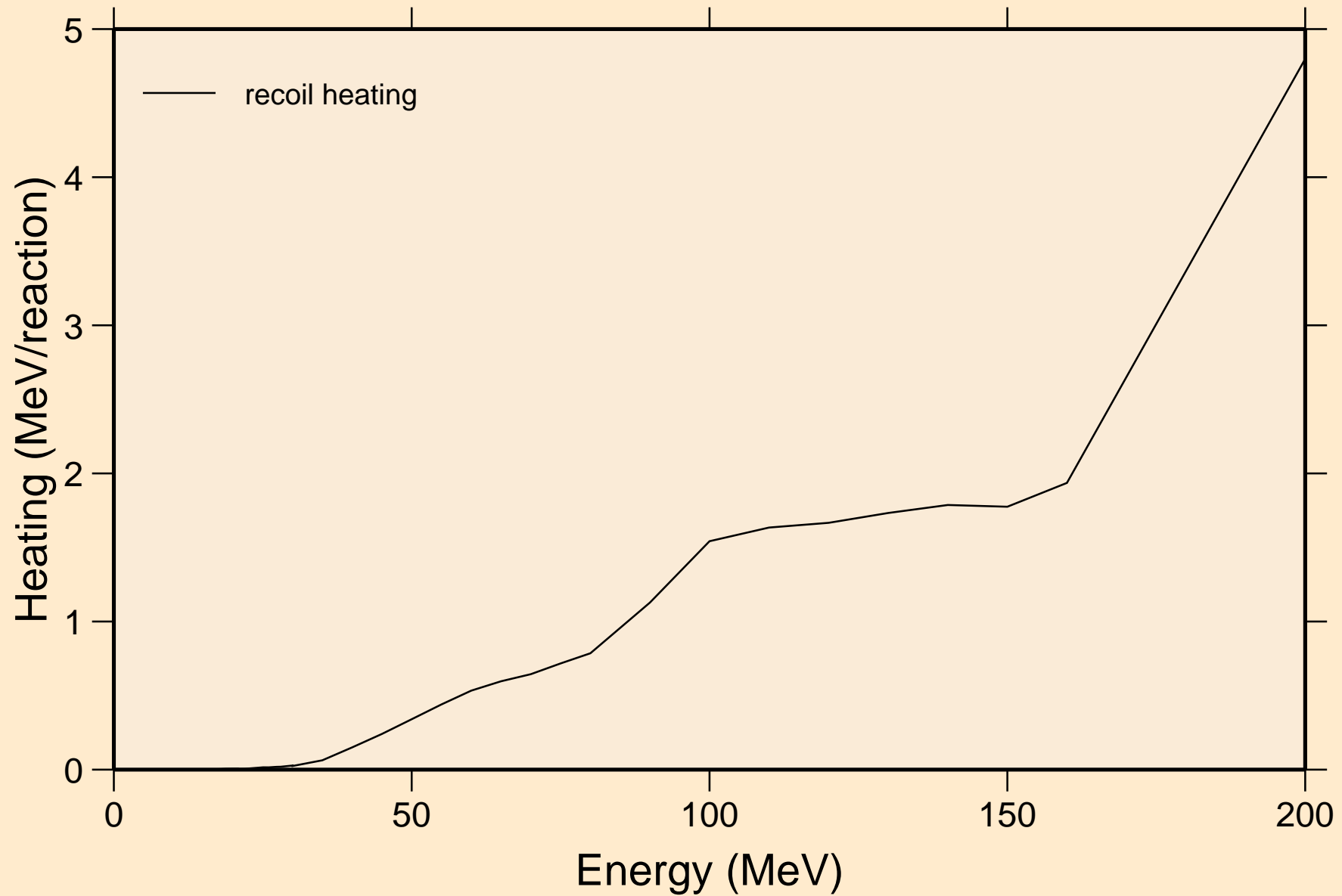

PR141 PROTON ACER TENDL-2021 LIBRARY; T=0.K  
Particle production cross sections

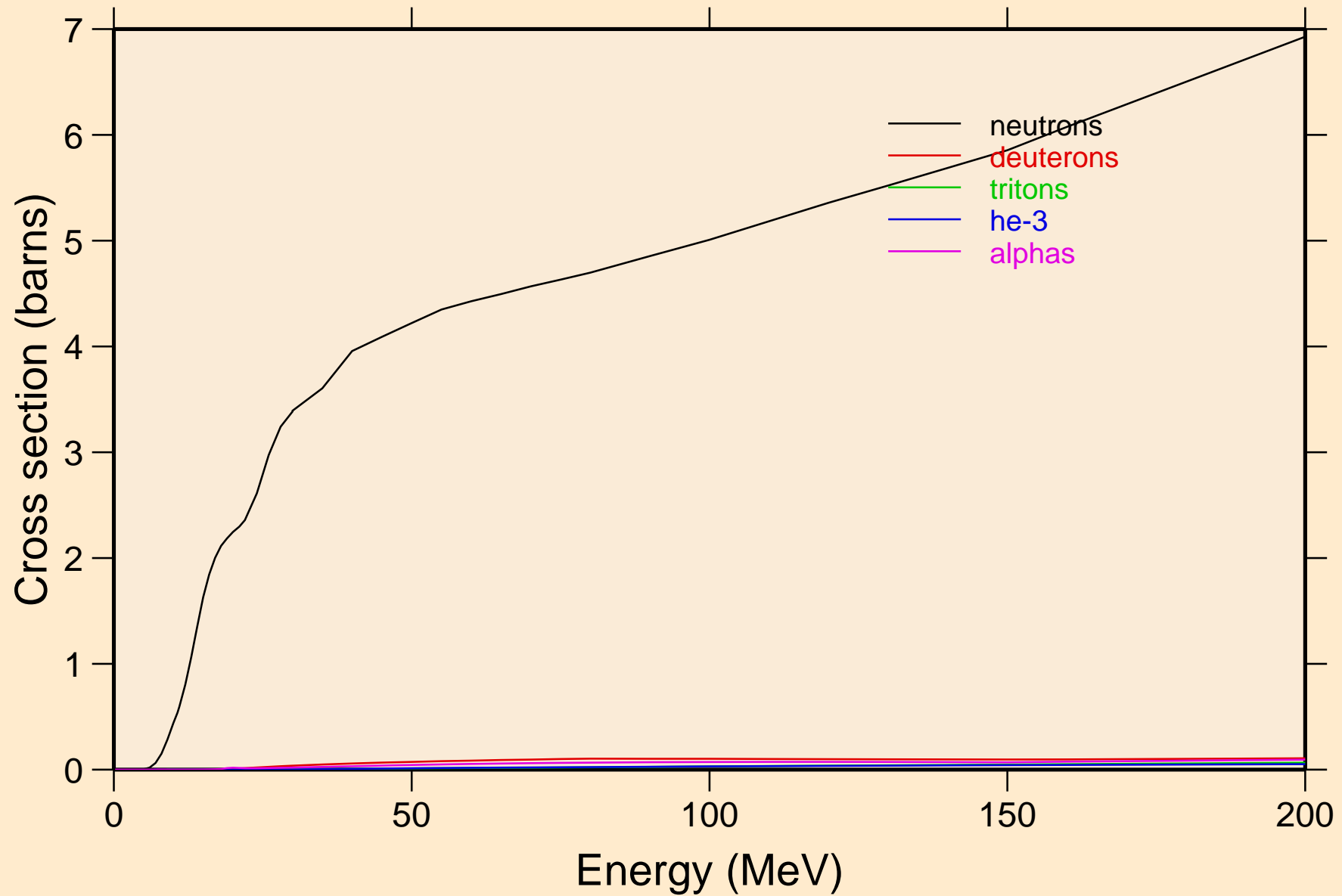

PR141 PROTON ACER TENDL-2021 LIBRARY; T=0.K  
neutrons from (p,n)

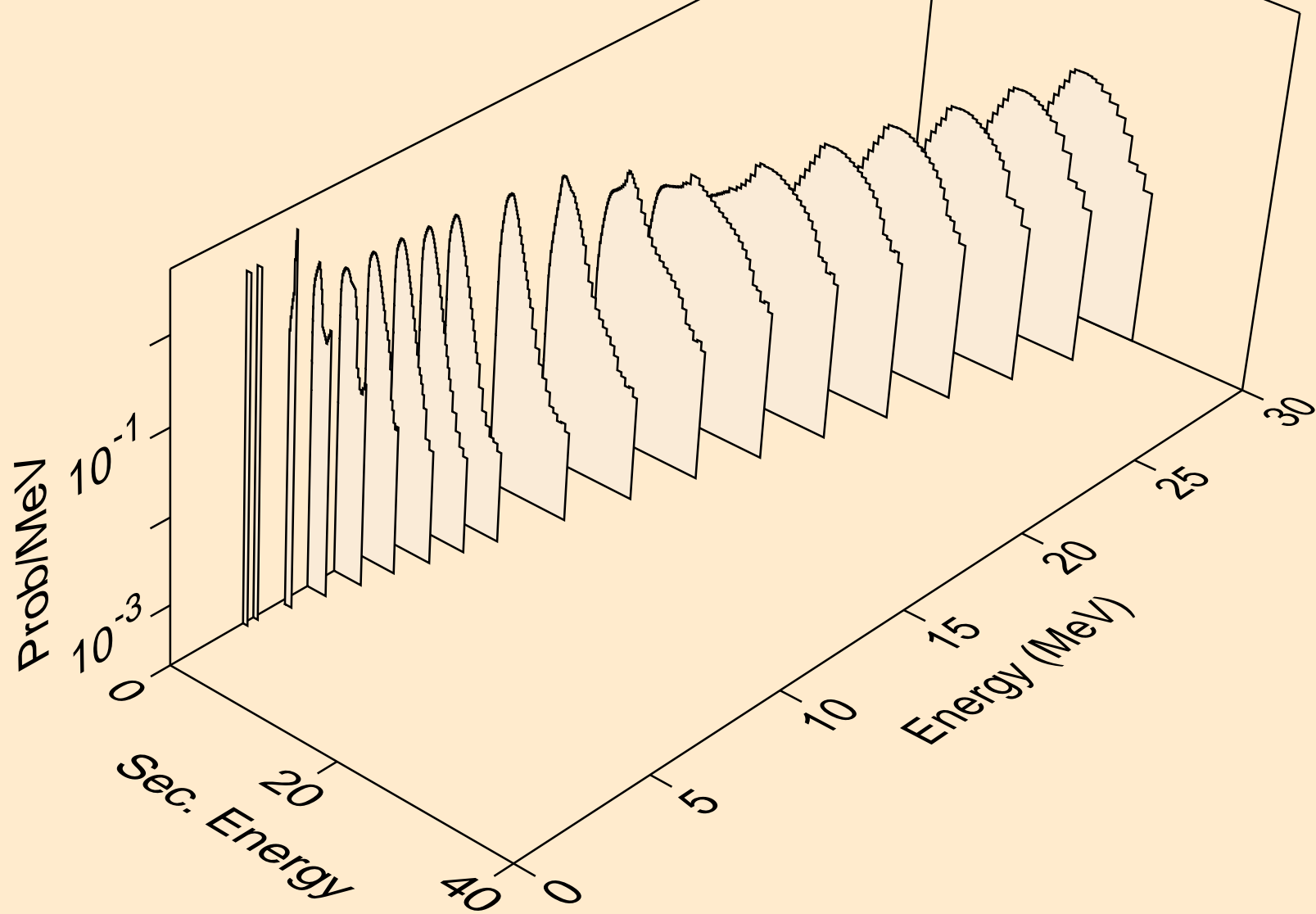

PR141 PROTON ACER TENDL-2021 LIBRARY; T=0.K  
neutrons from (p,x)

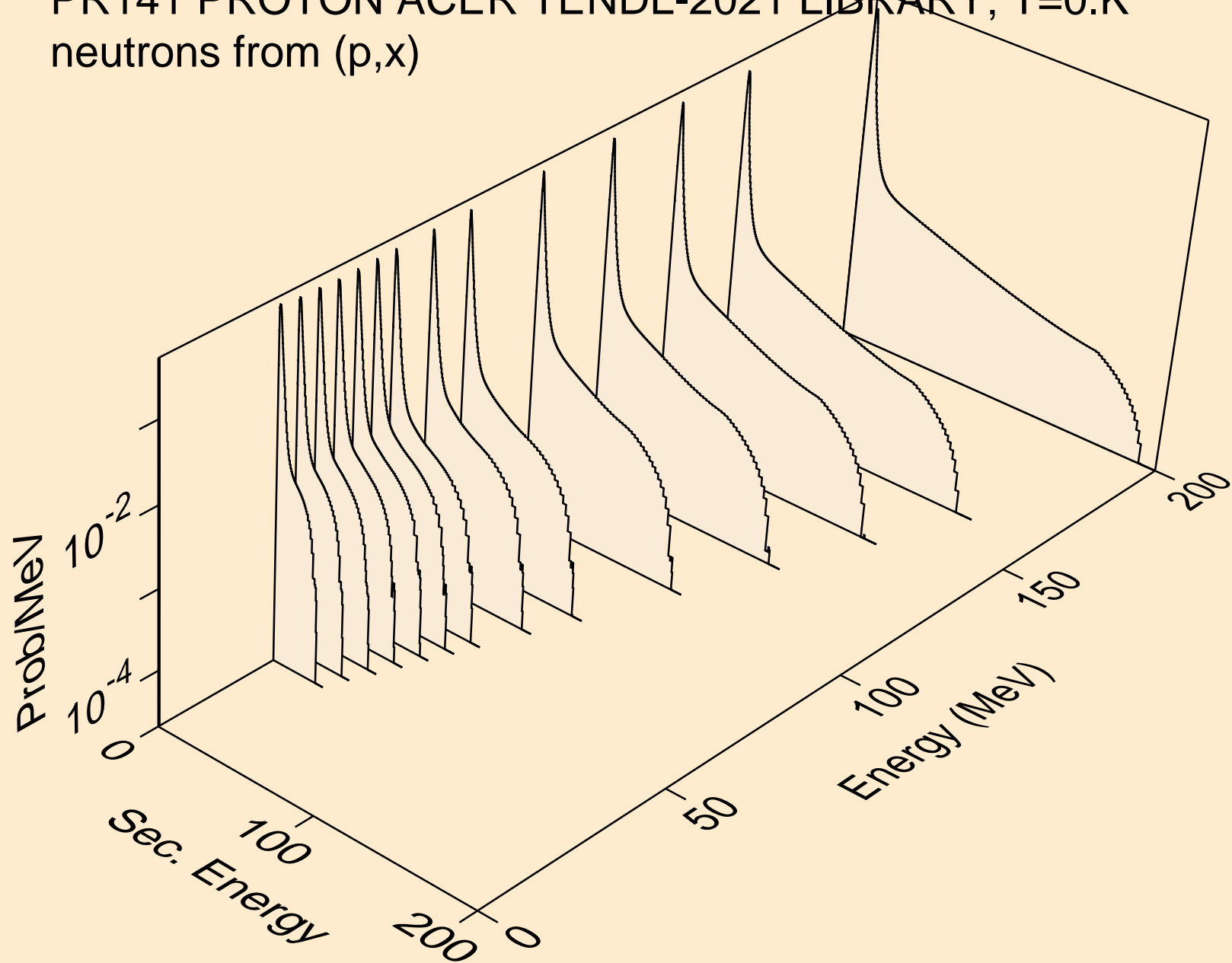

PR141 PROTON ACER TENDL-2021 LIBRARY; T=0.K  
neutrons from (p,2nd)

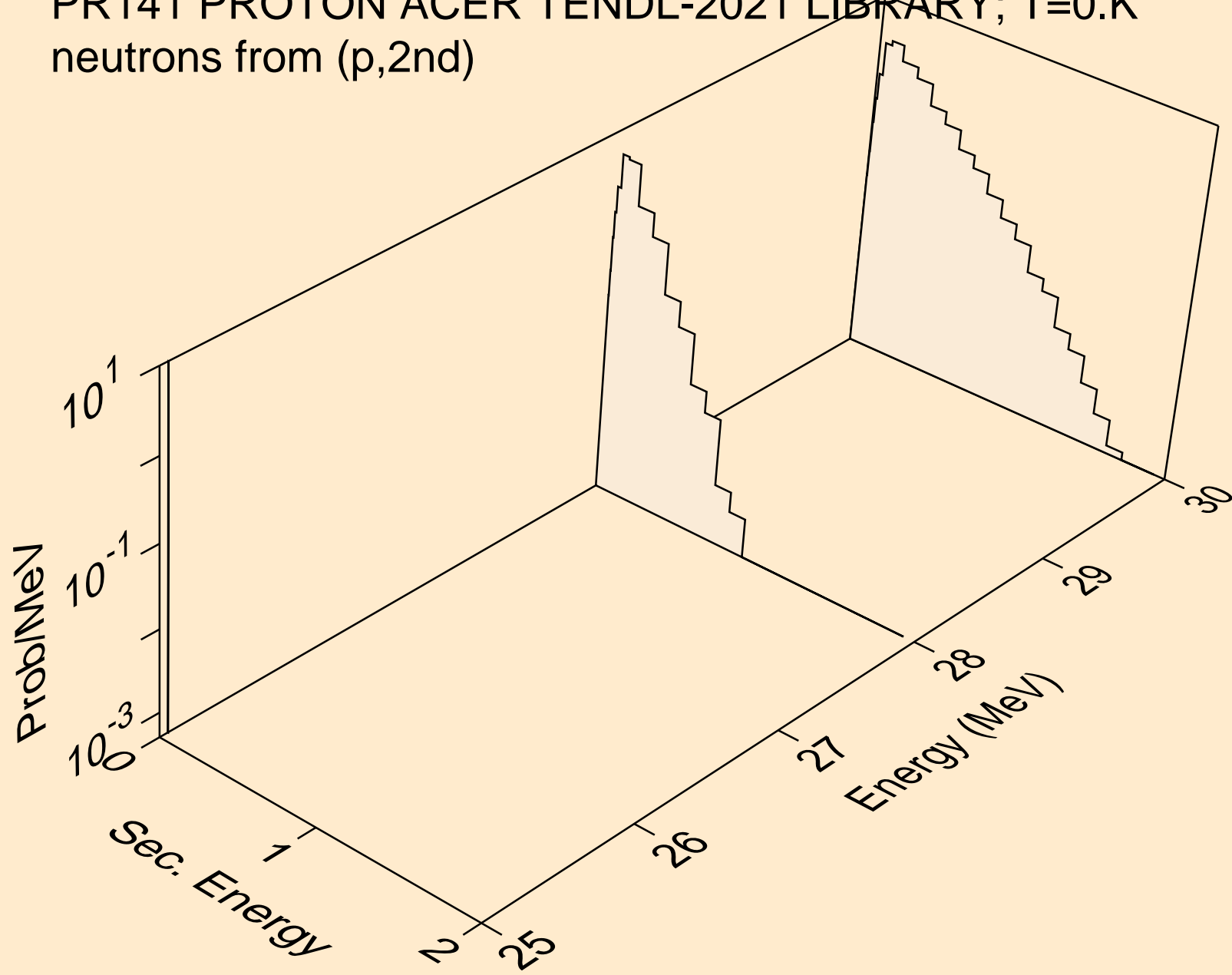

PR141 PROTON ACER TENDL-2021 LIBRARY; T=0.K  
neutrons from (p,2n)

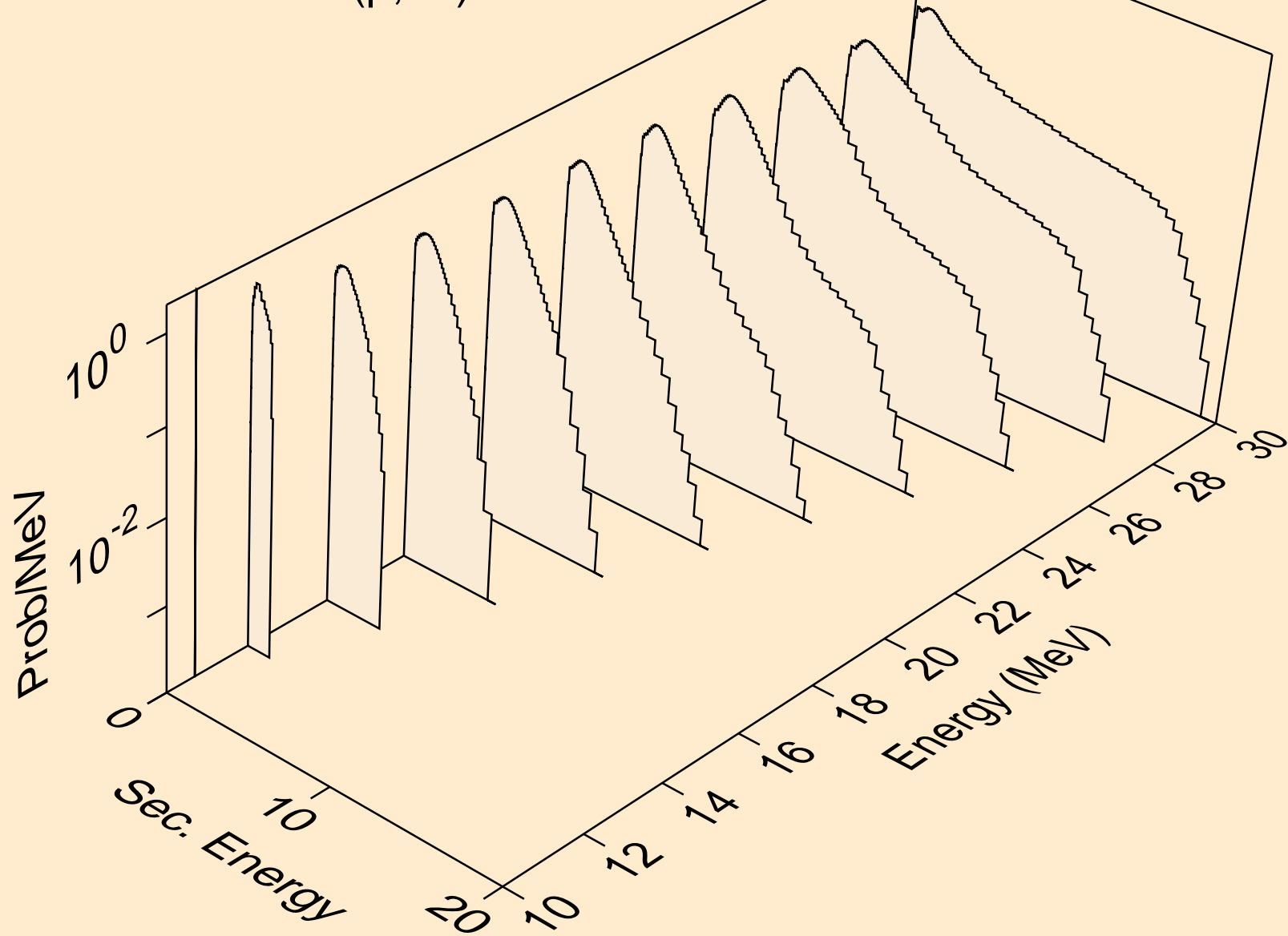



PR141 PROTON ACER TENDL-2021 LIBRARY; T=0.K  
neutrons from (p,3n)

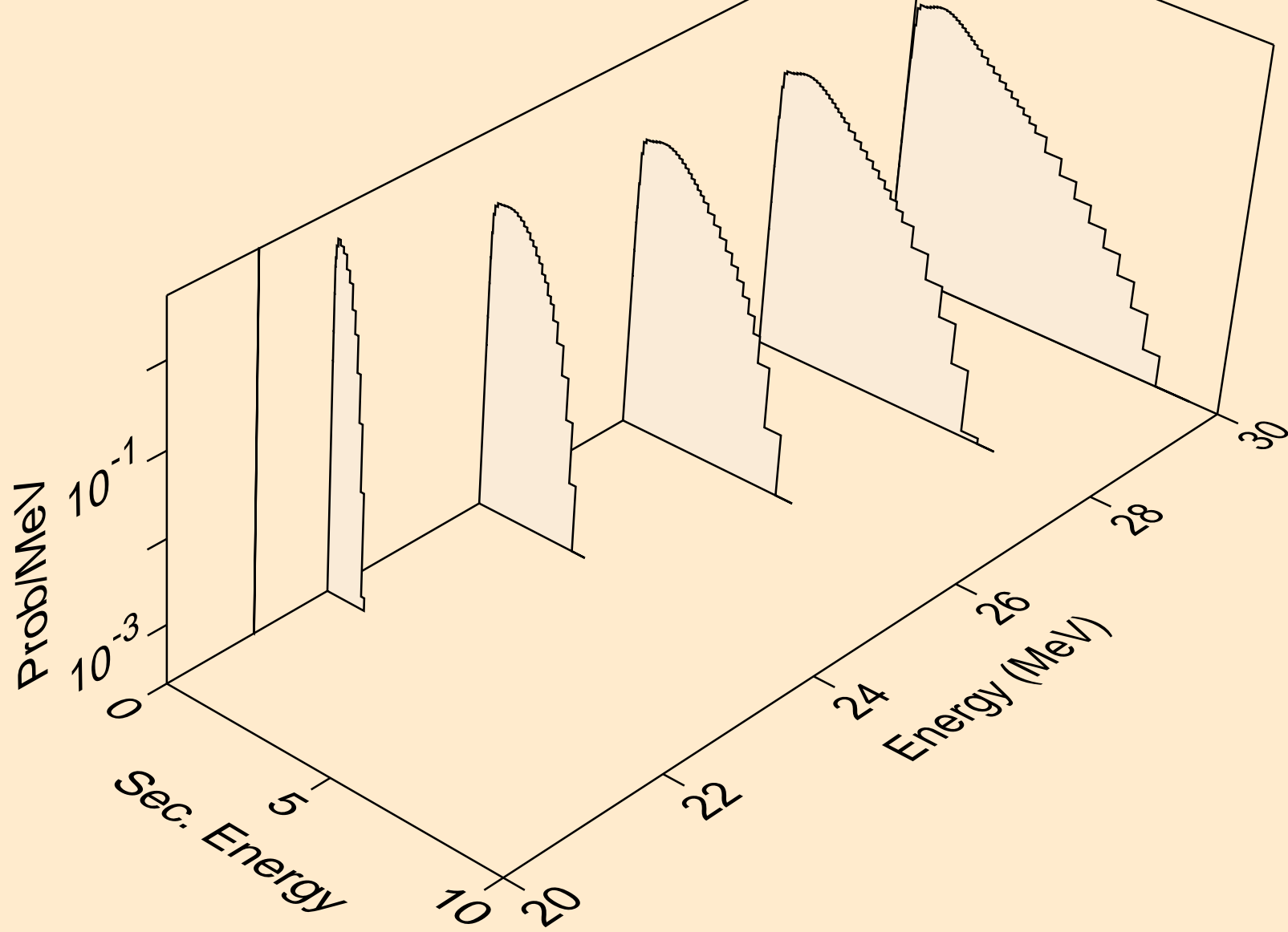

PR141 PROTON ACER TENDL-2021 LIBRARY; T=0.K  
neutrons from (p,n\*)a

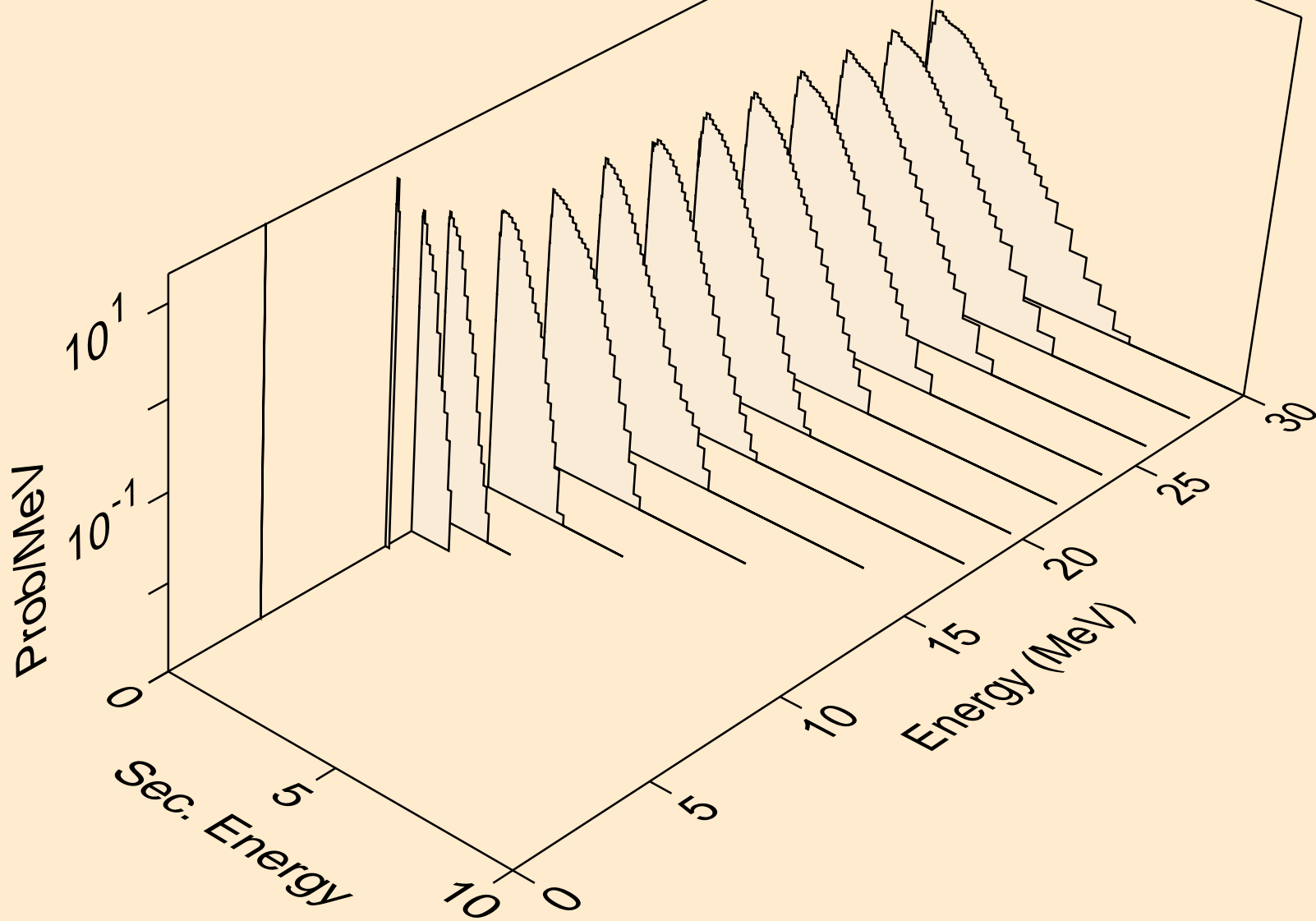

PR141 PROTON ACER TENDL-2021 LIBRARY; T=0.K  
neutrons from (p,2n)a

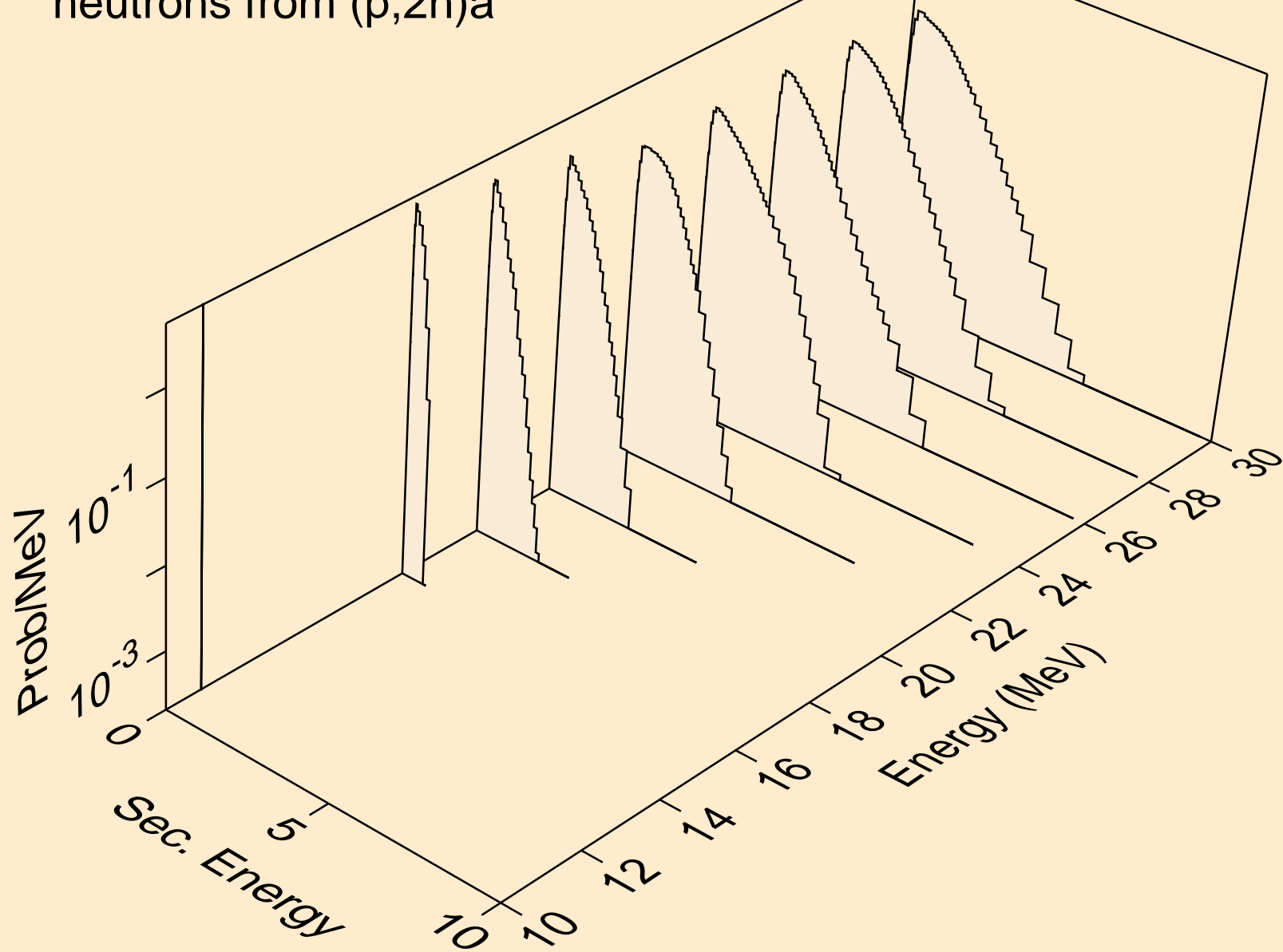

PR141 PROTON ACER TENDL-2021 LIBRARY; T=0.K  
neutrons from (p,3n)a

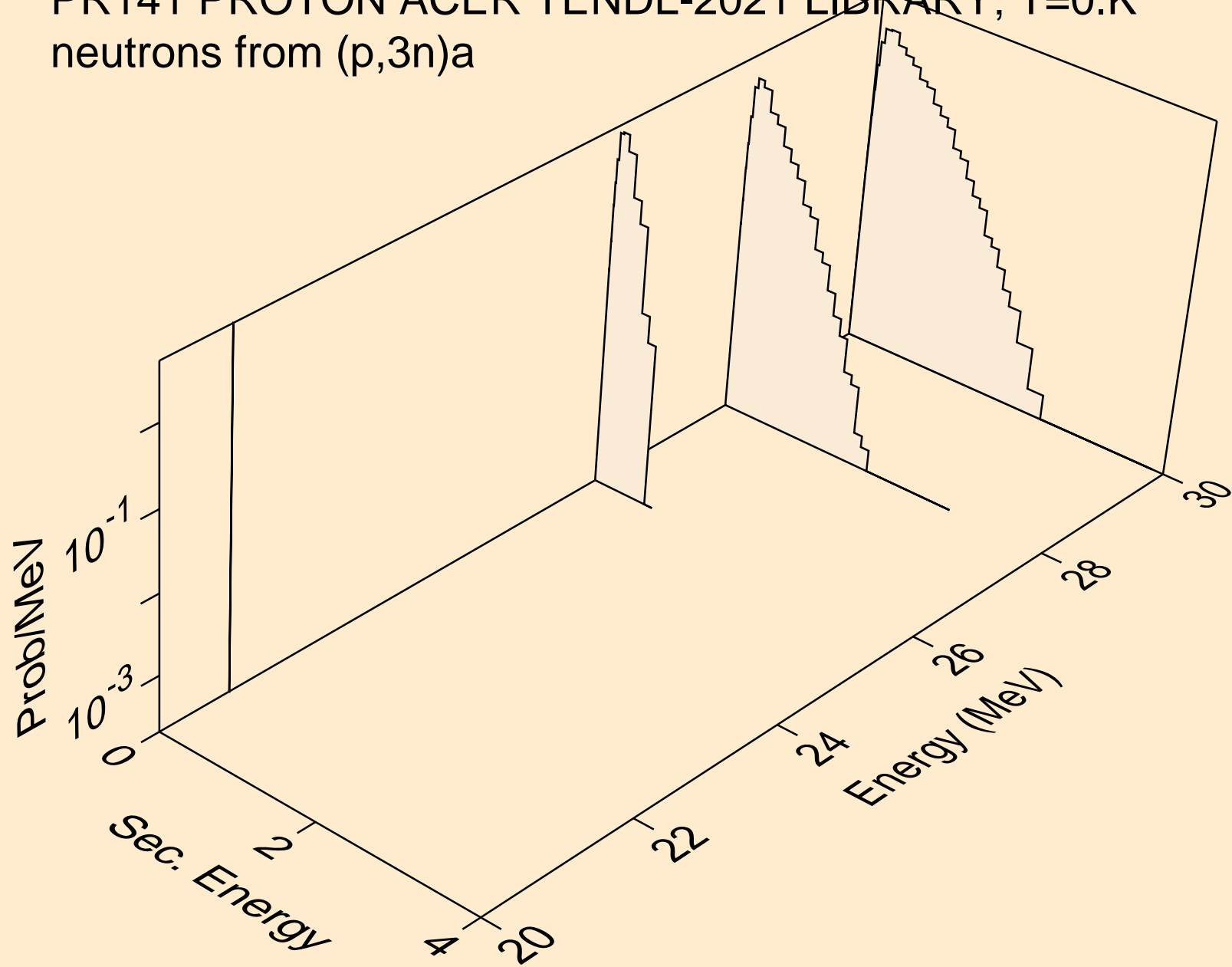

PR141 PROTON ACER TENDL-2021 LIBRARY; T=0.K  
neutrons from (p,n\*)p

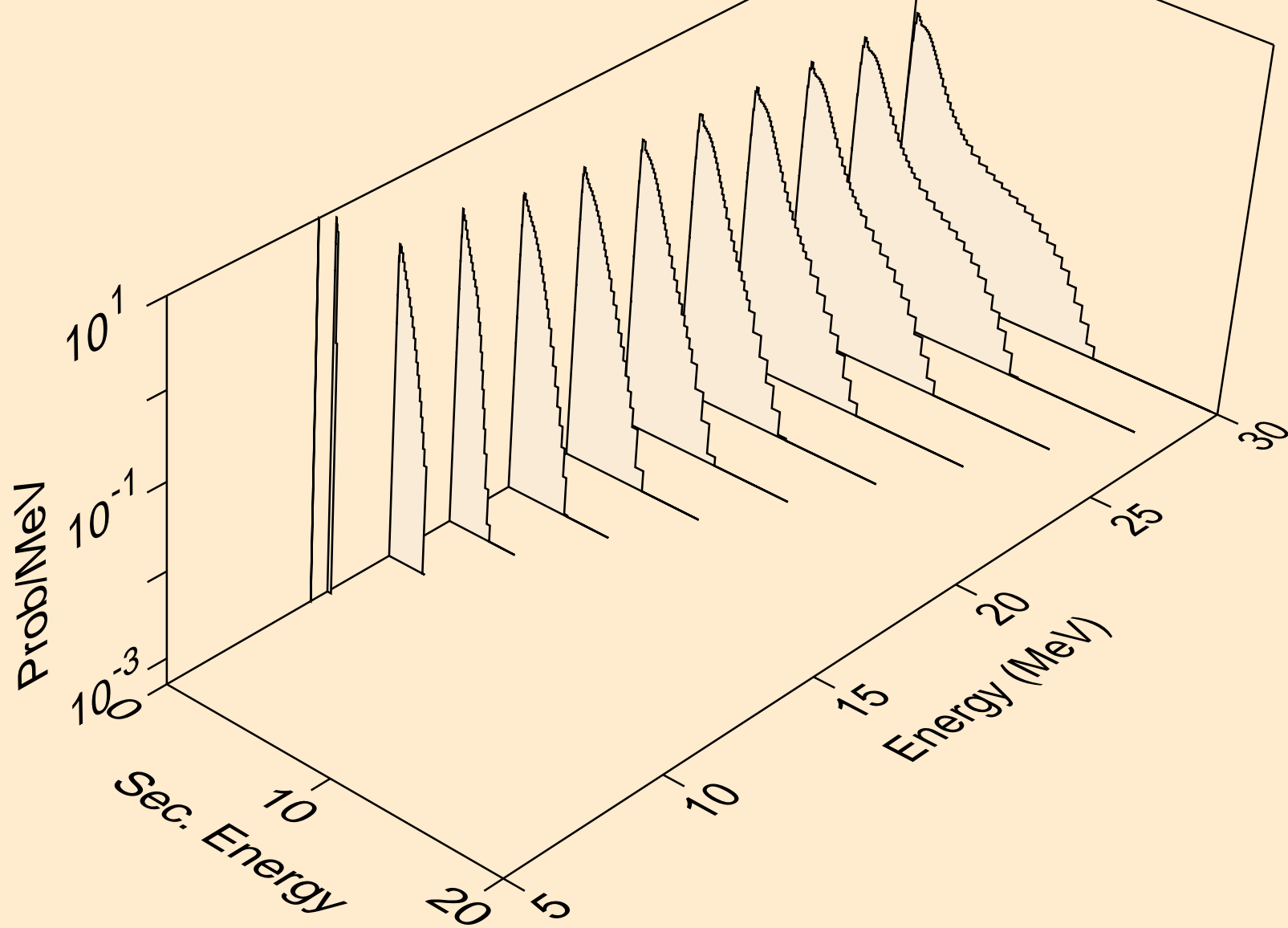

PR141 PROTON ACER TENDL-2021 LIBRARY; T=0.K  
neutrons from (p,n\*)2a

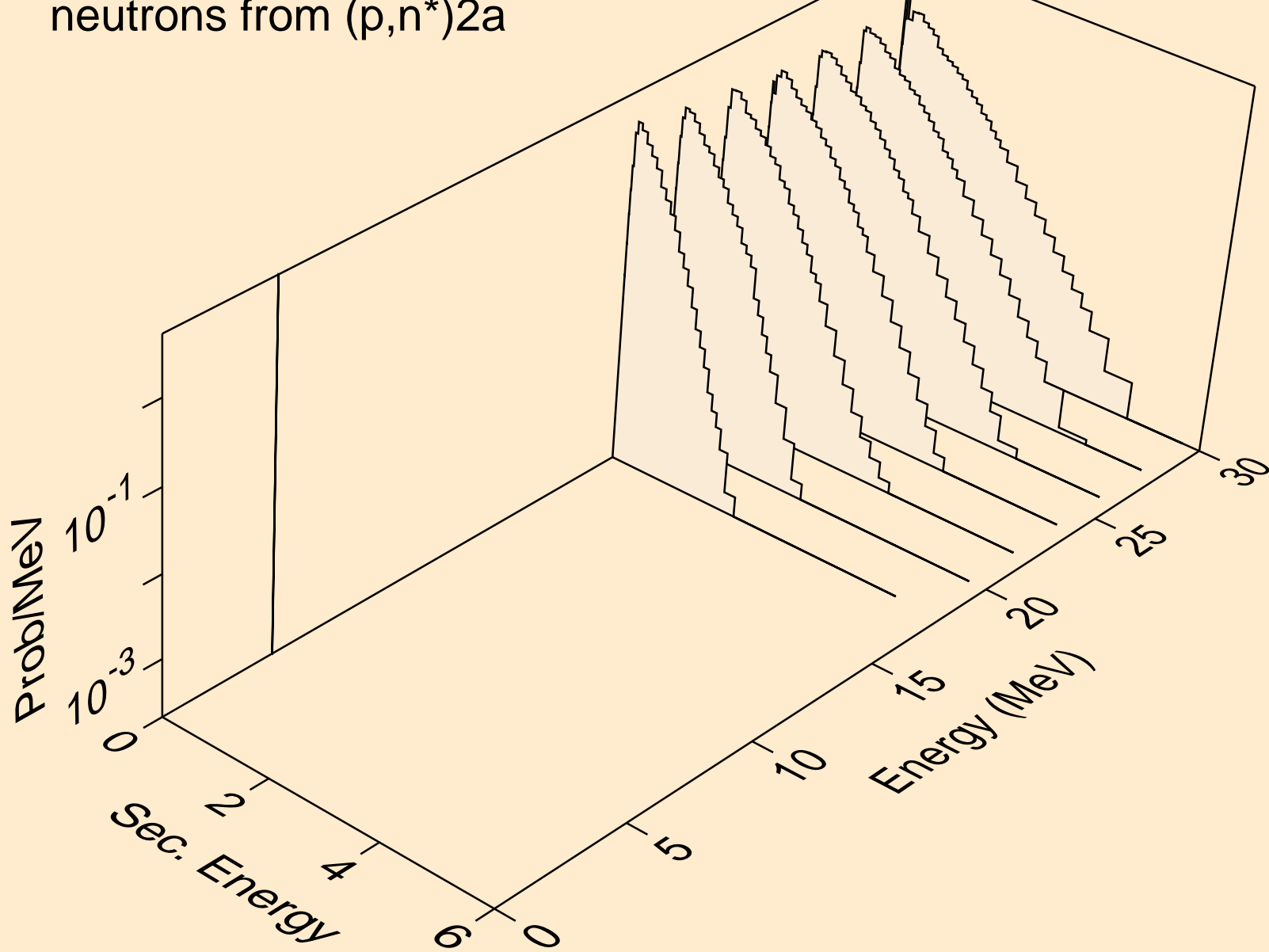

PR141 PROTON ACER TENDL-2021 LIBRARY; T=0.K  
neutrons from (p,n\*)d

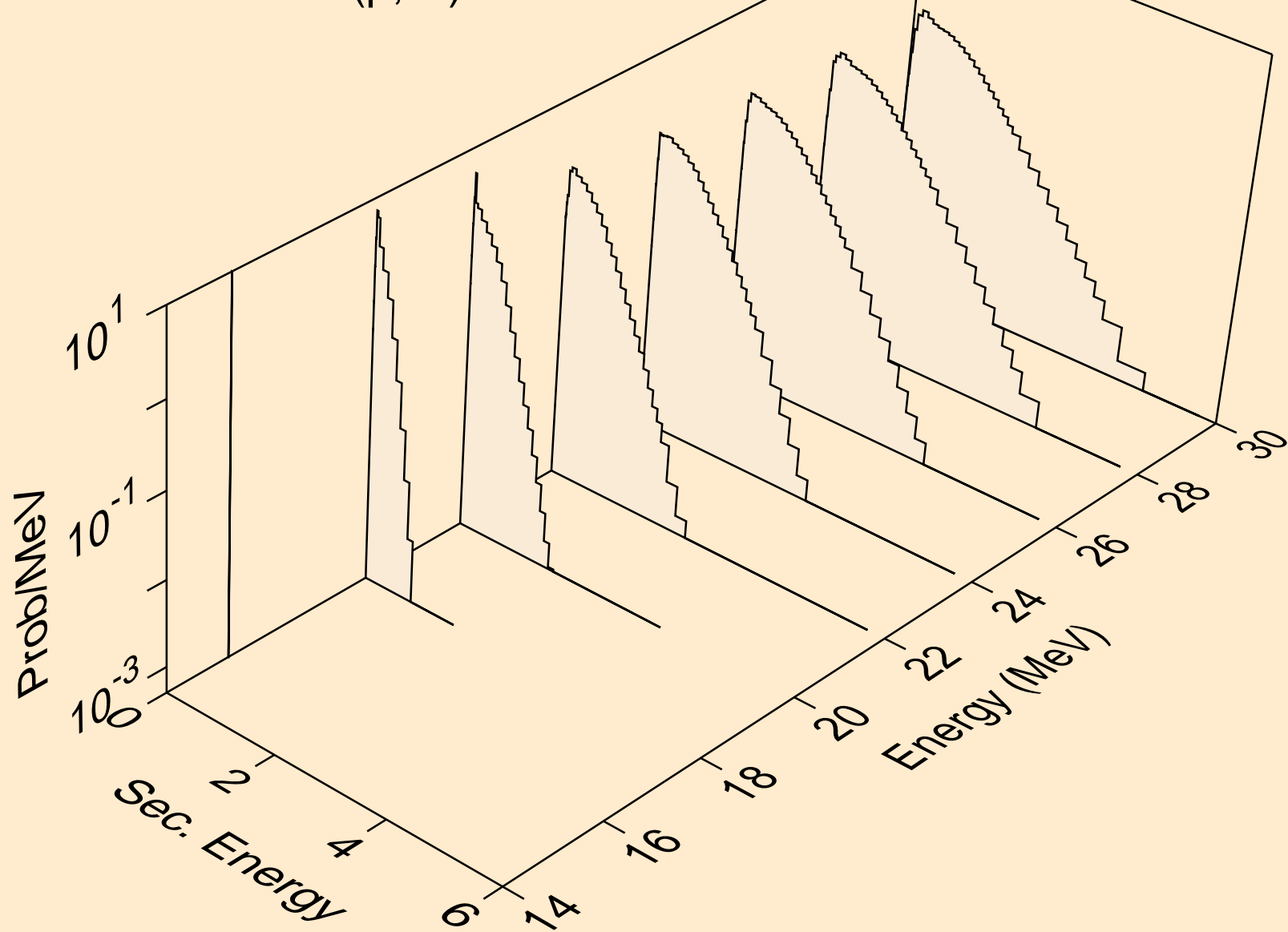

PR141 PROTON ACER TENDL-2021 LIBRARY; T=0.K  
neutrons from (p,n\*)t

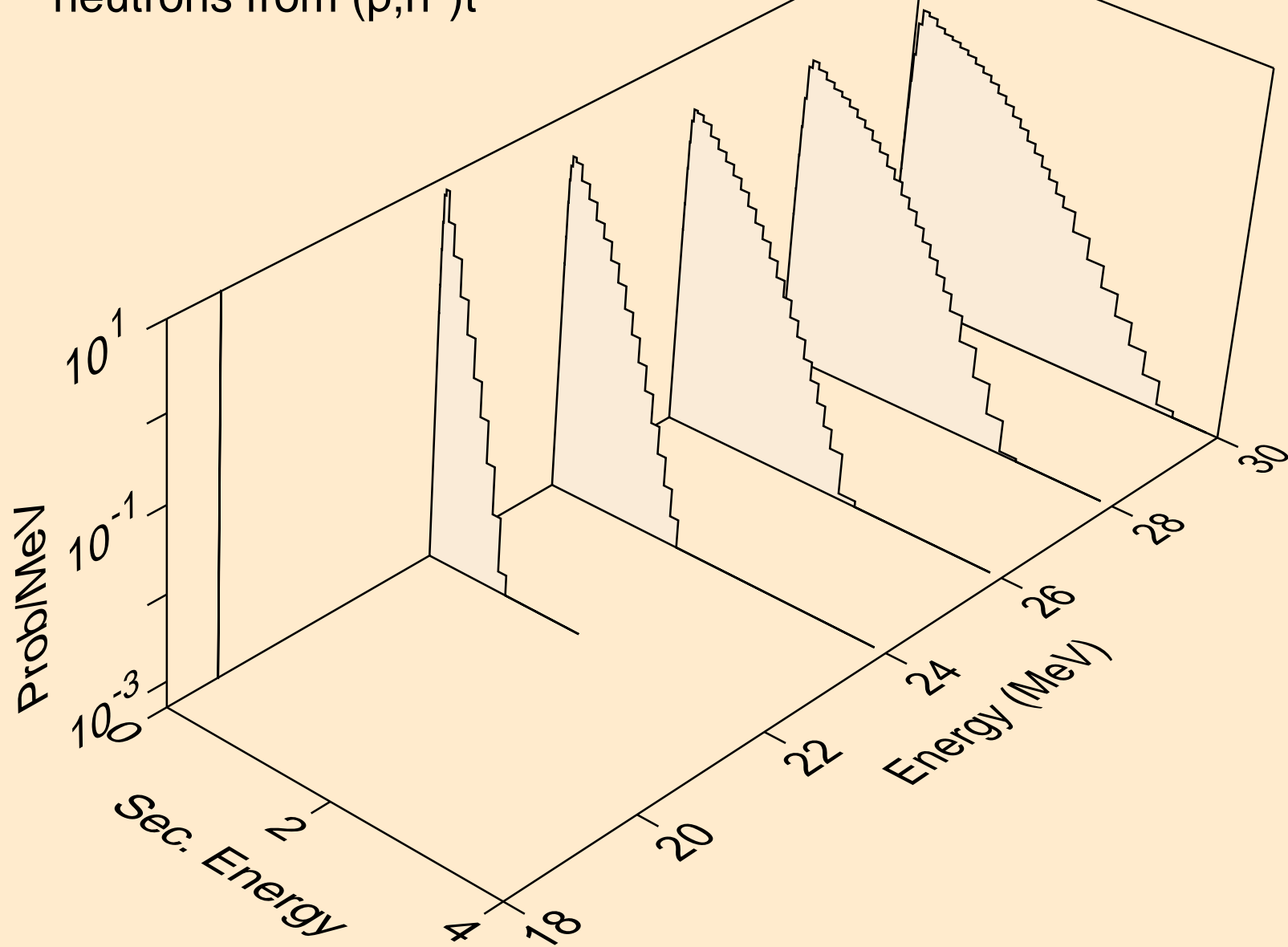



PR141 PROTON ACER TENDL-2021 LIBRARY; T=0.K  
neutrons from (p,n\*)he3

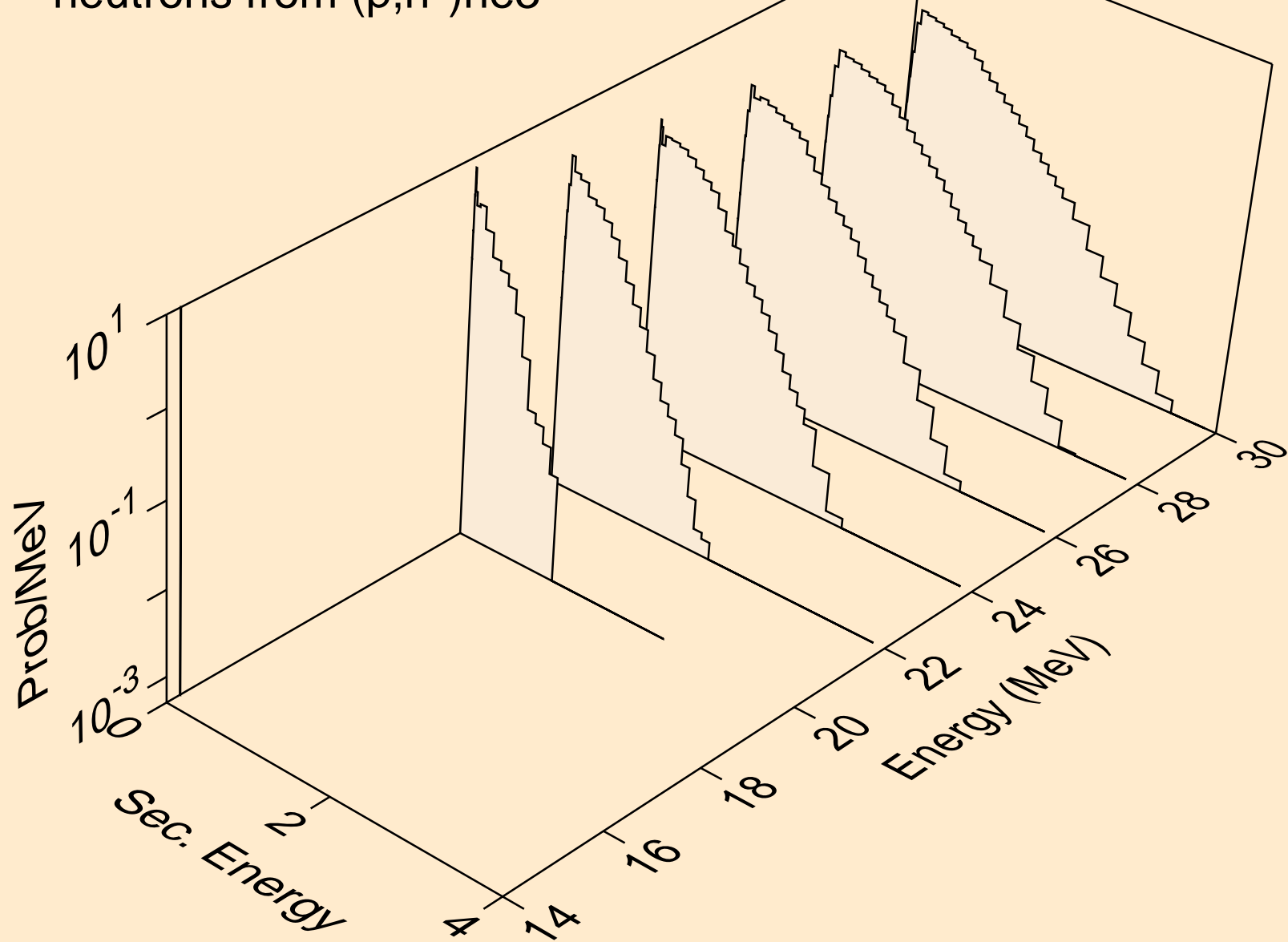

PR141 PROTON ACER TENDL-2021 LIBRARY; T=0.K  
neutrons from (p,2np)

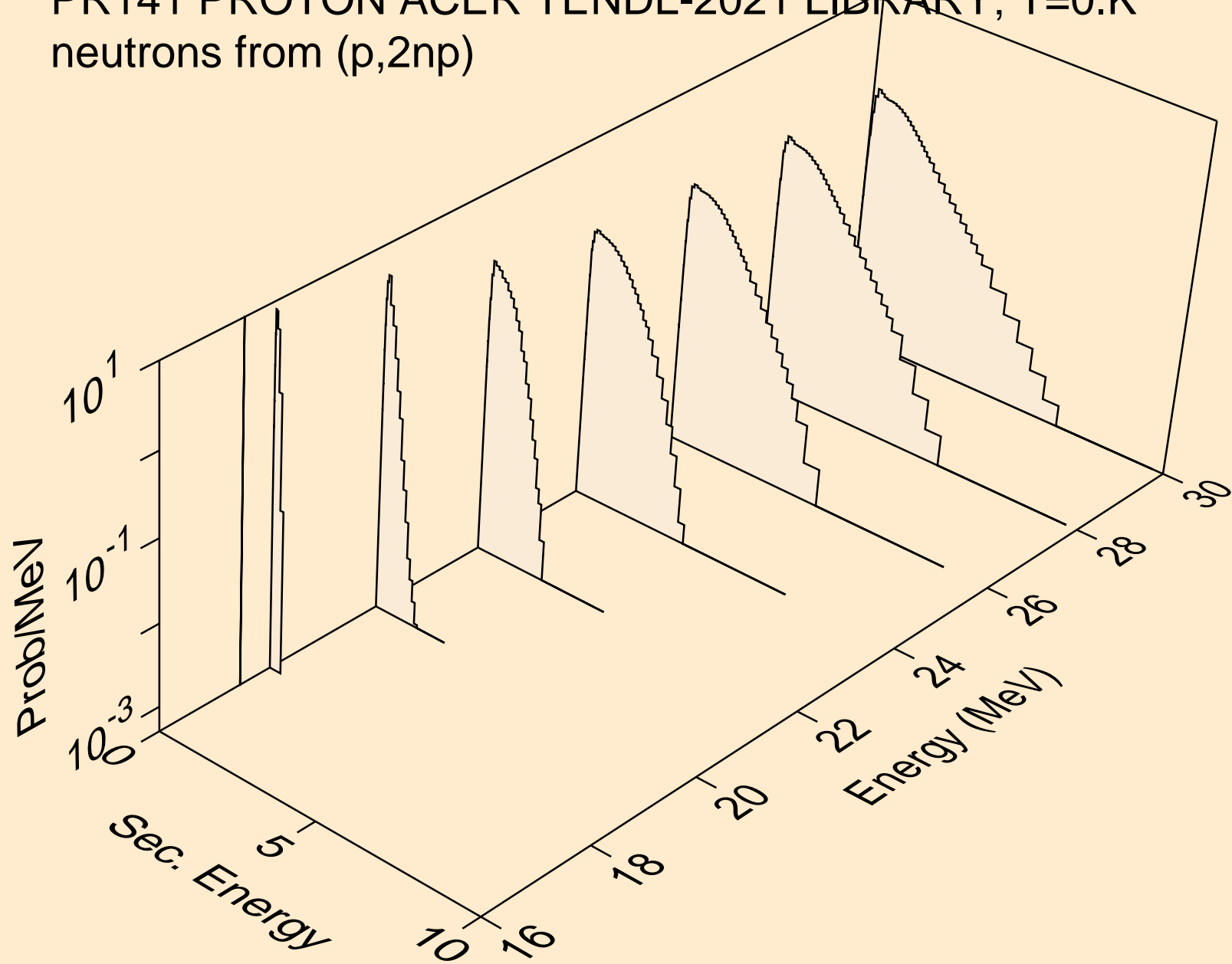

PR141 PROTON ACER TENDL-2021 LIBRARY; T=0.K  
neutrons from (p,3np)

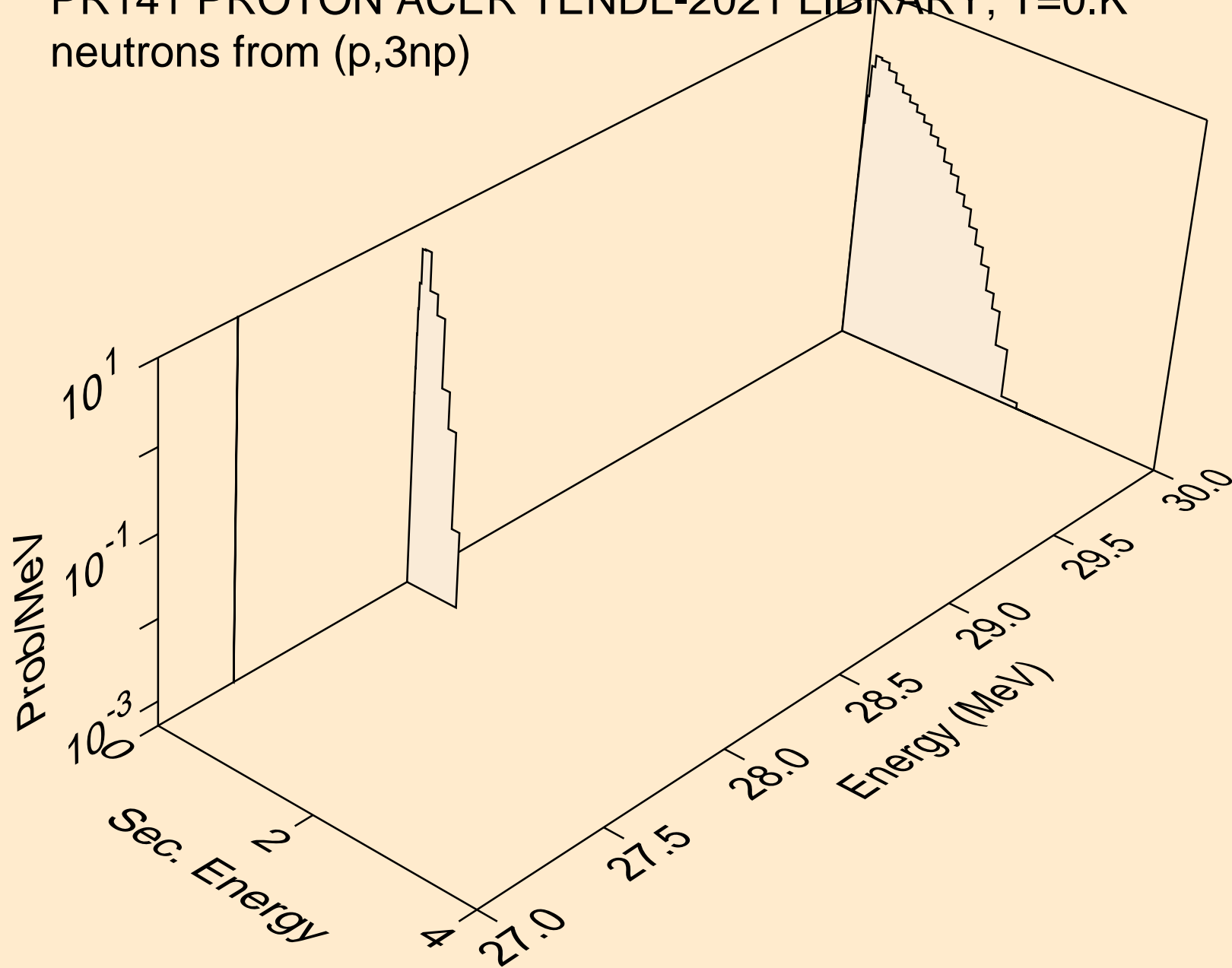

PR141 PROTON ACER TENDL-2021 LIBRARY; T=0.K  
neutrons from (p,2np)

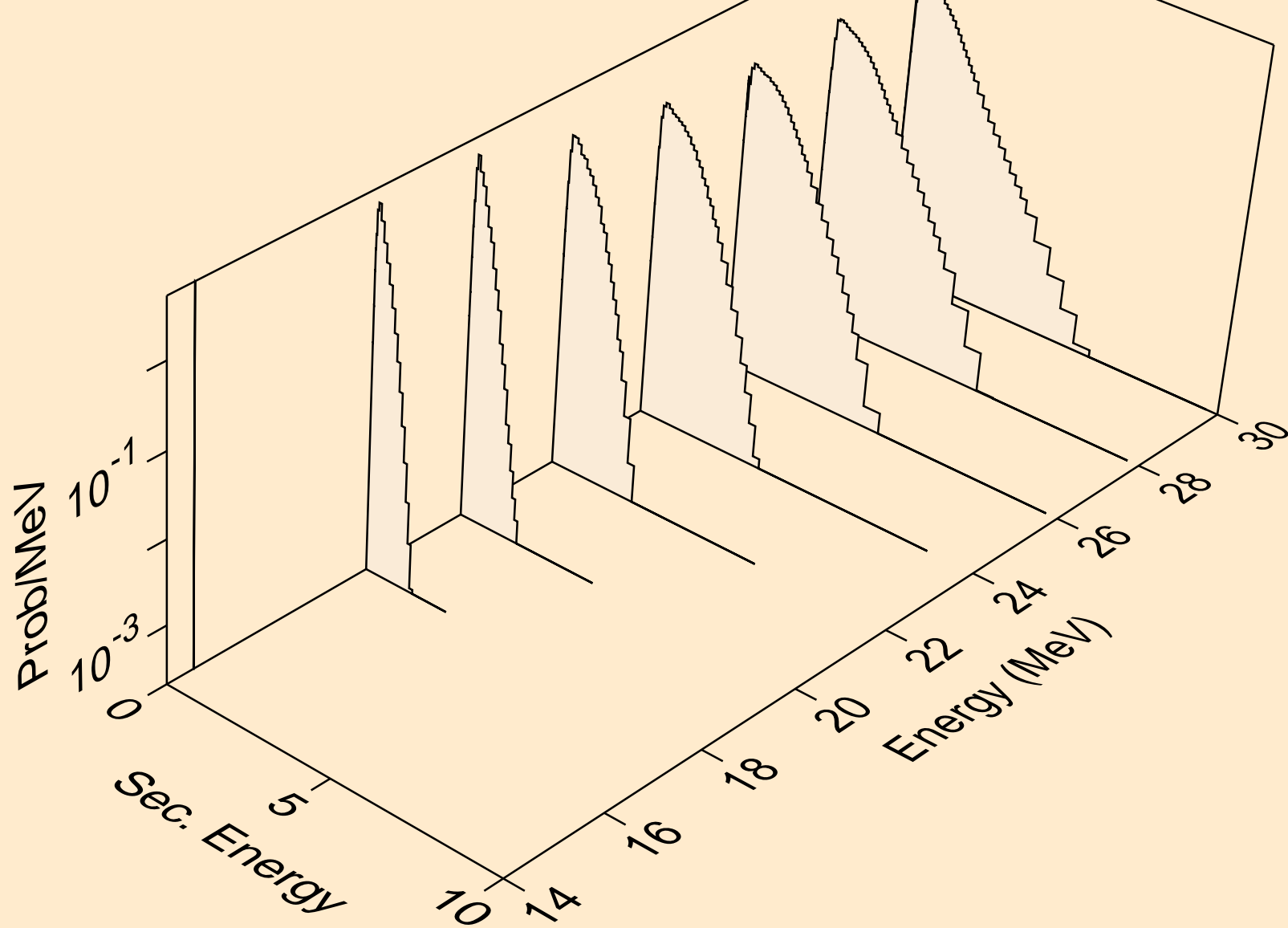

PR141 PROTON ACER TENDL-2021 LIBRARY; T=0.K  
neutrons from (p,npa)

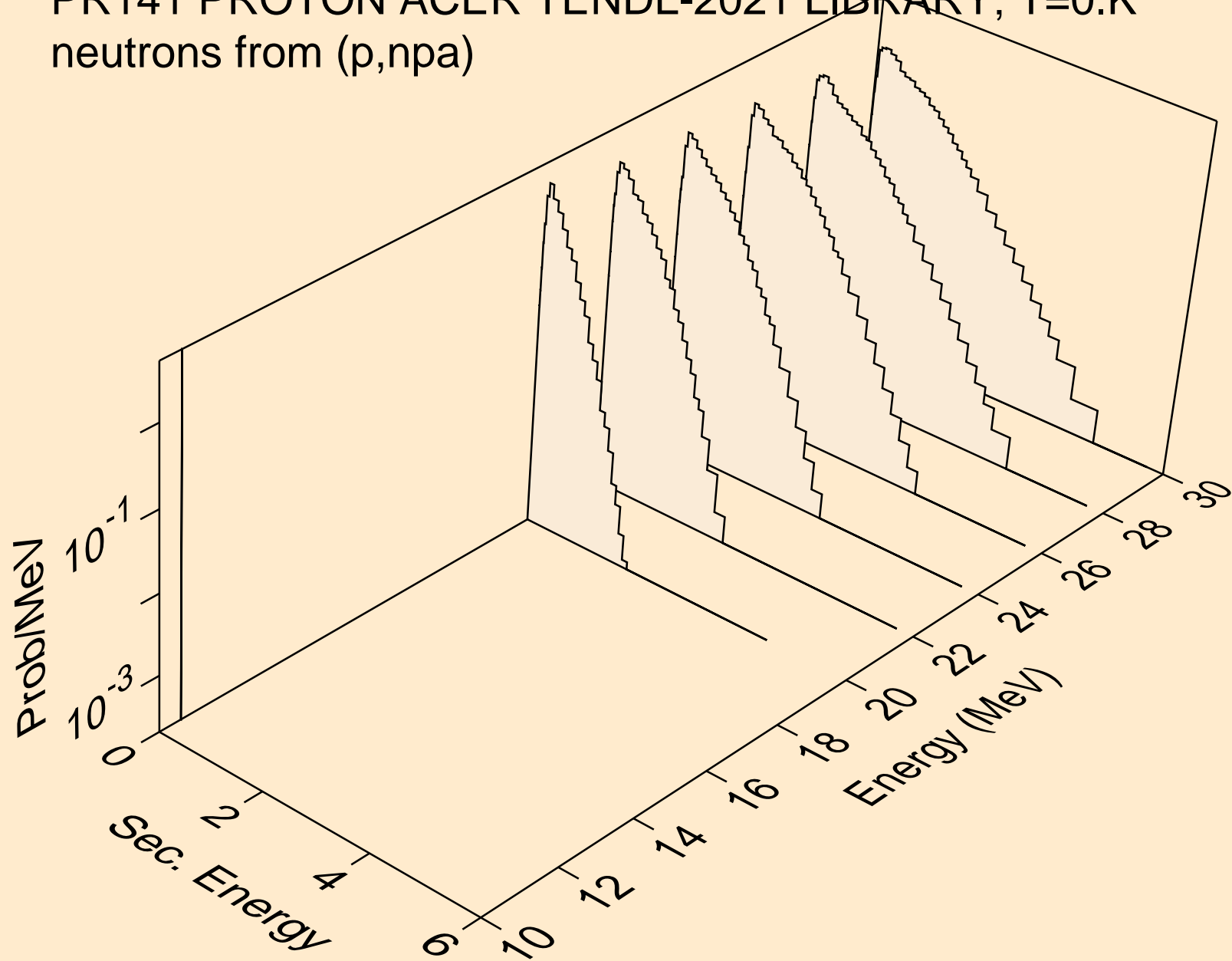

PR141 PROTON ACER TENDL-2021 LIBRARY; T=0.K  
deuterons from (p,x)

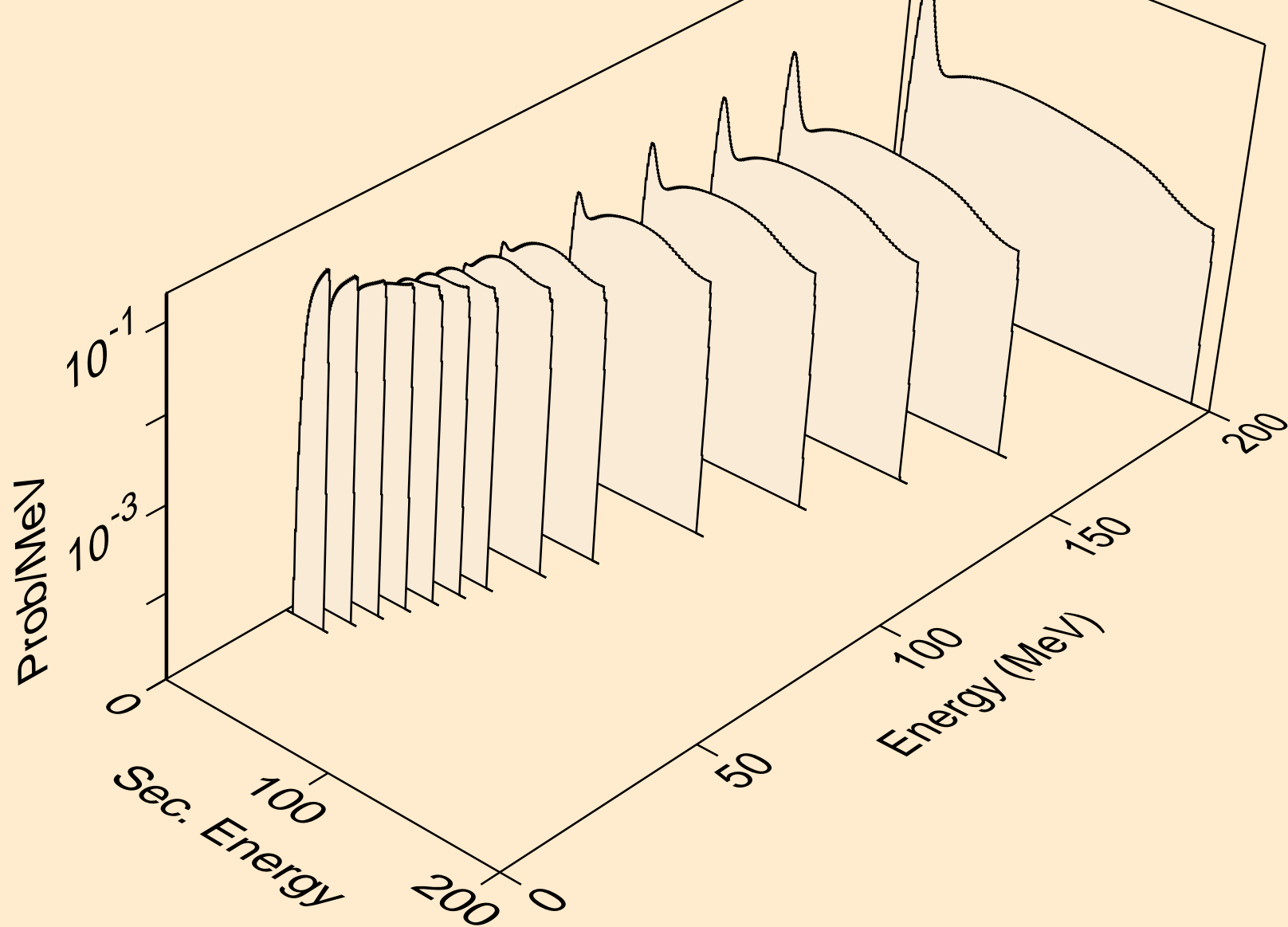

PR141 PROTON ACER TENDL-2021 LIBRARY; T=0.K  
deuterons from (p,2nd)

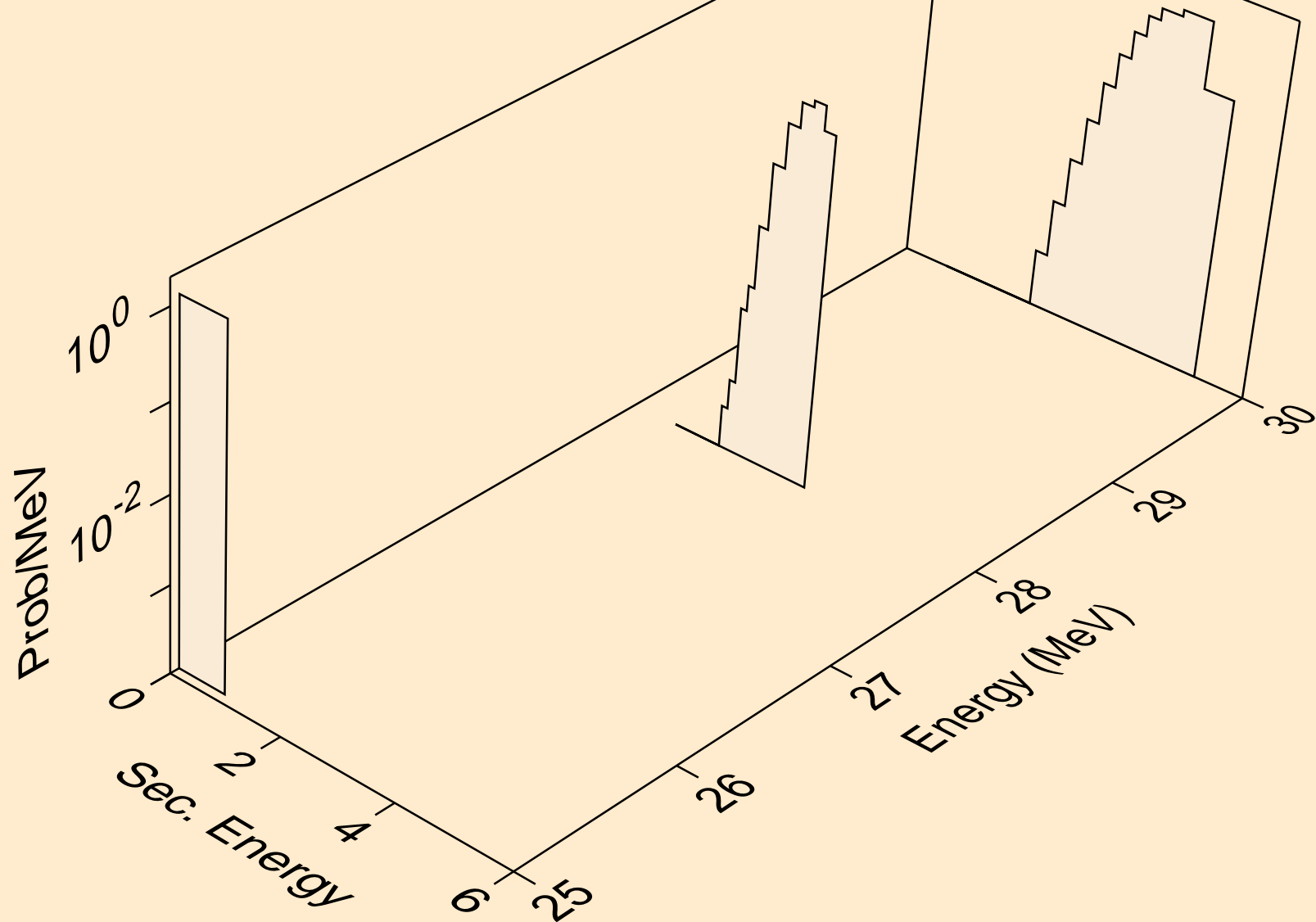

PR141 PROTON ACER TENDL-2021 LIBRARY; T=0.K  
deuterons from (p,n\*)d

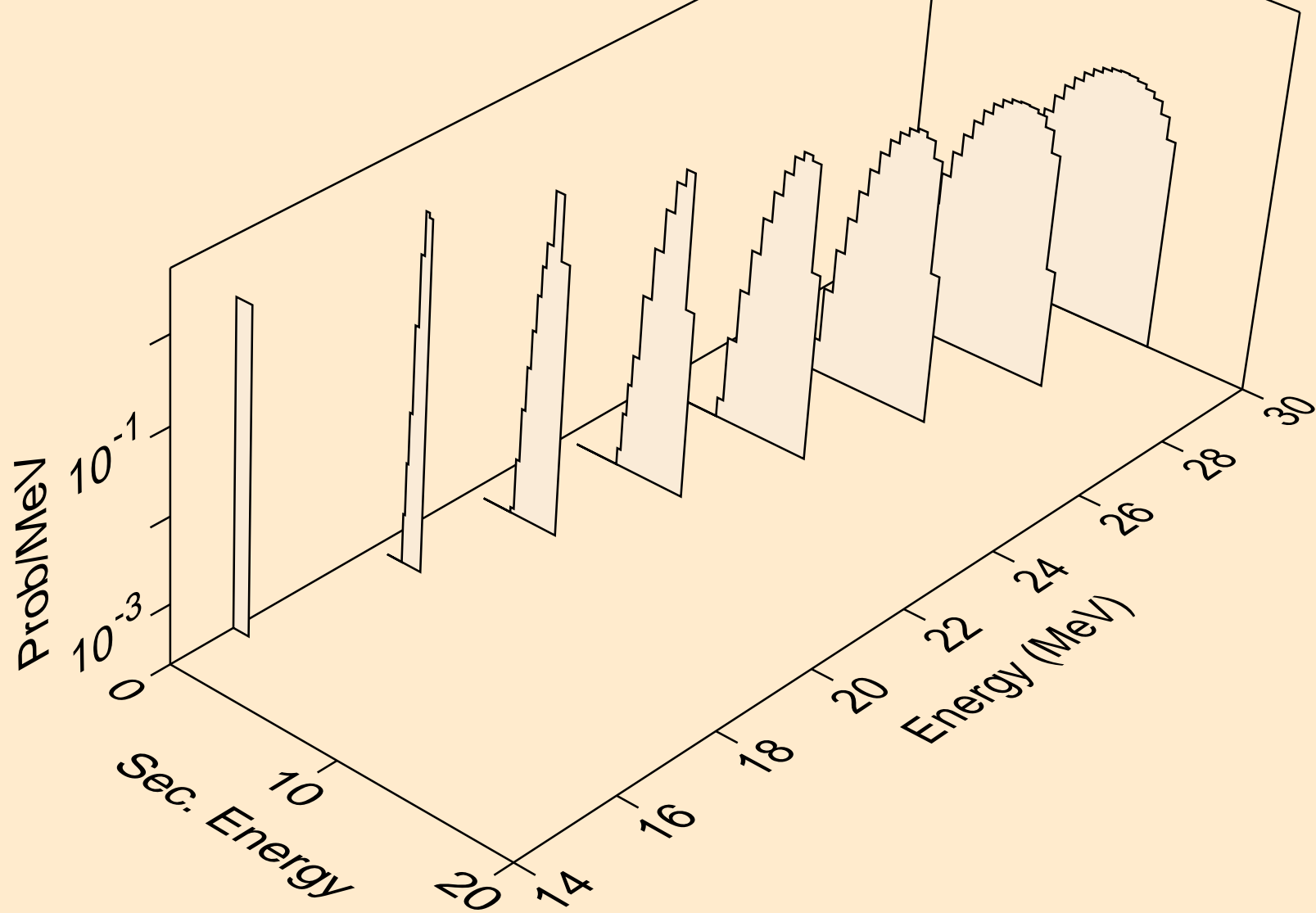



PR141 PROTON ACER TENDL-2021 LIBRARY; T=0.K  
deuterons from (p,d)

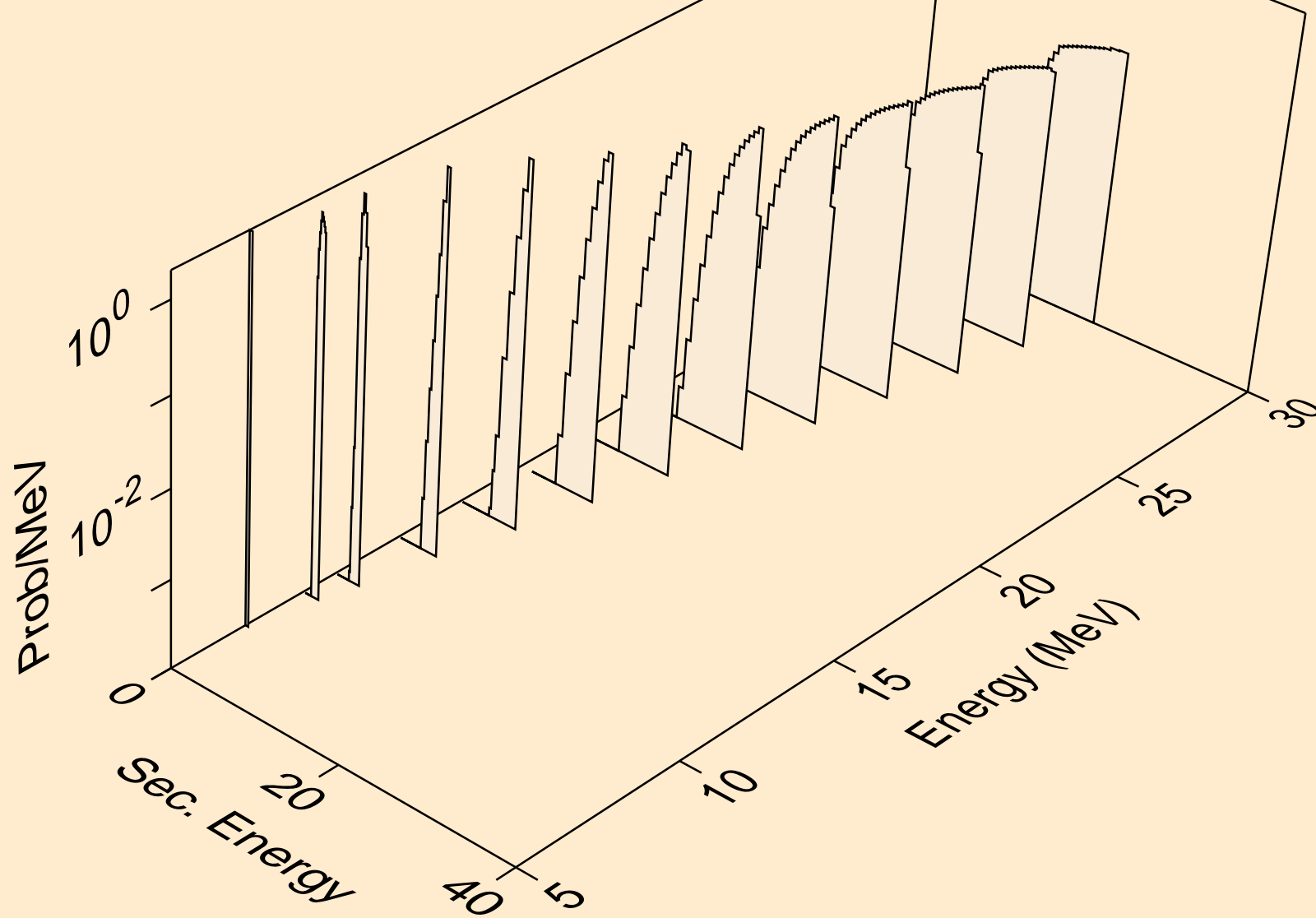

PR141 PROTON ACER TENDL-2021 LIBRARY; T=0.K  
deuterons from (p,pd)

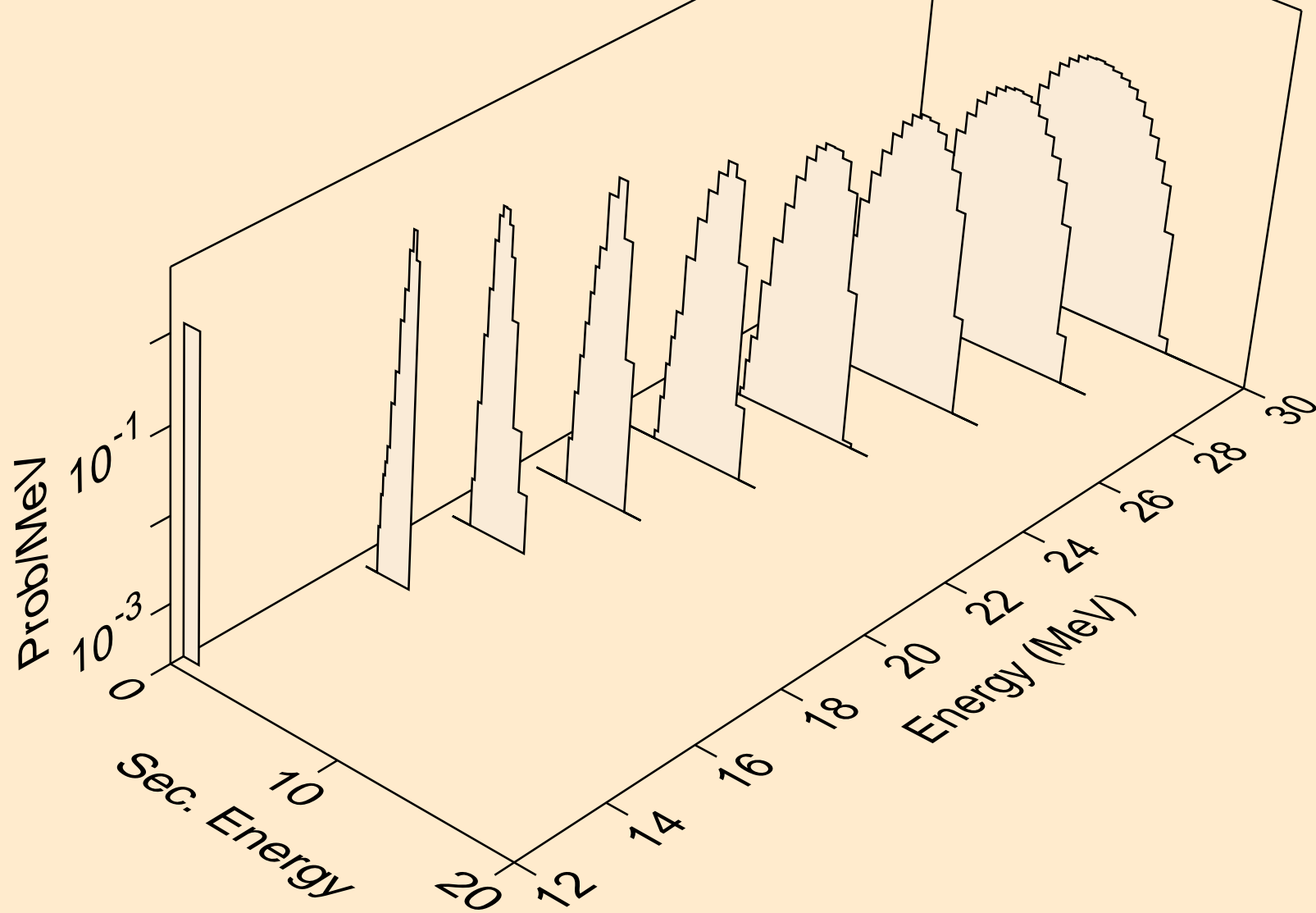

PR141 PROTON ACER TENDL-2021 LIBRARY; T=0.K  
deuterons from (p,da)

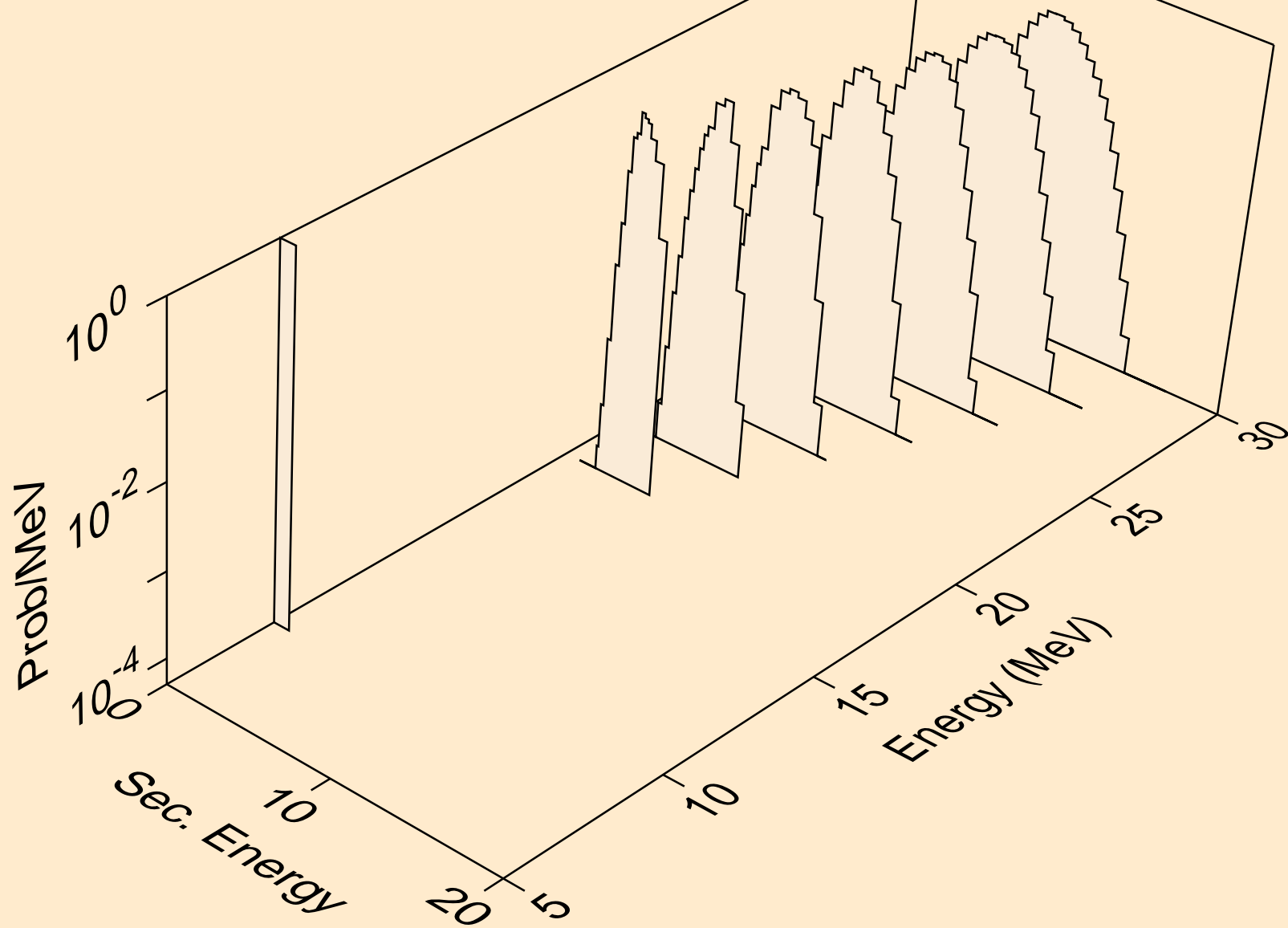

PR141 PROTON ACER TENDL-2021 LIBRARY; T=0.K  
tritons from (p,x)

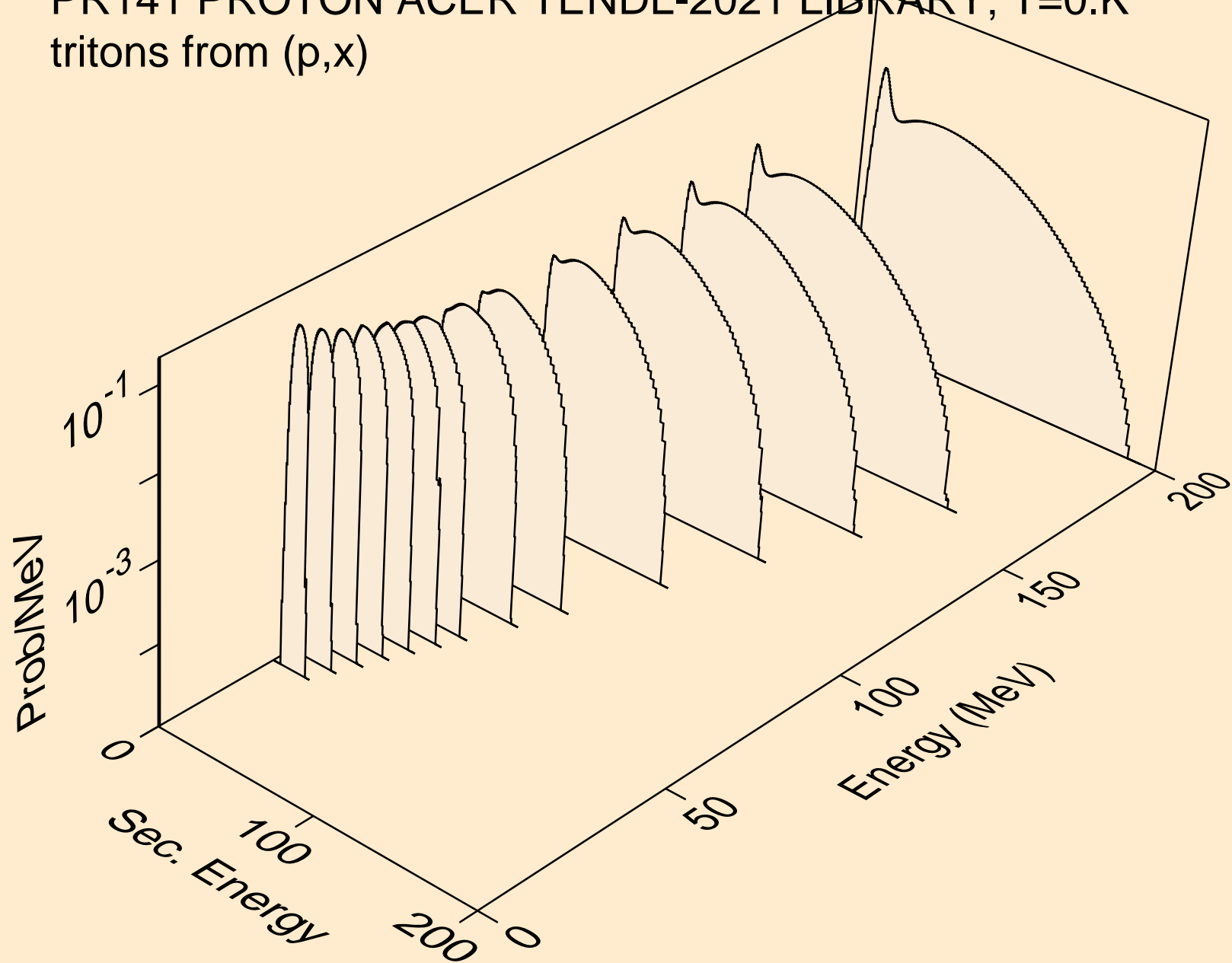

PR141 PROTON ACER TENDL-2021 LIBRARY; T=0.K  
tritons from (p,n\*)t

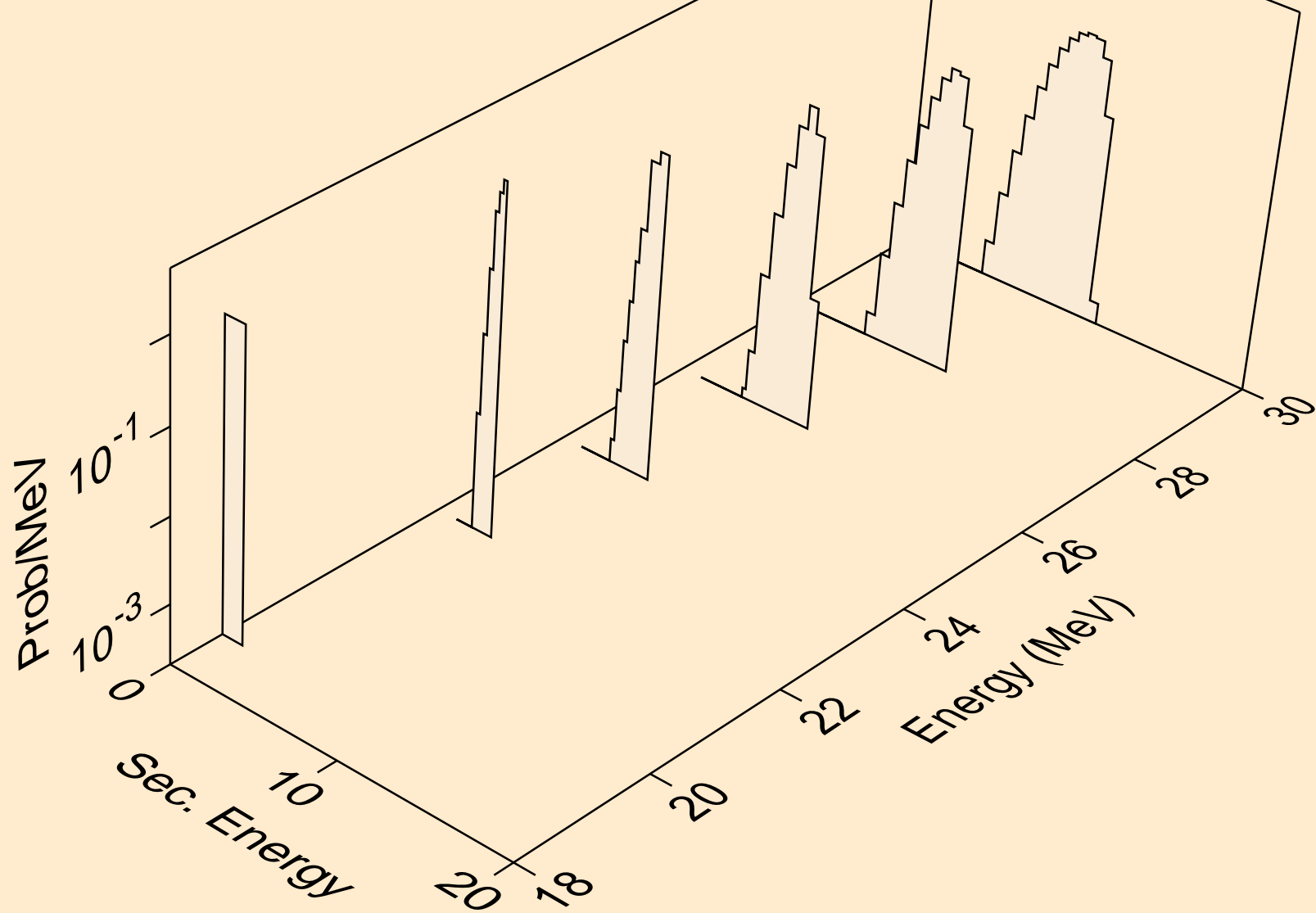

PR141 PROTON ACER TENDL-2021 LIBRARY; T=0.K  
tritons from (p,t)

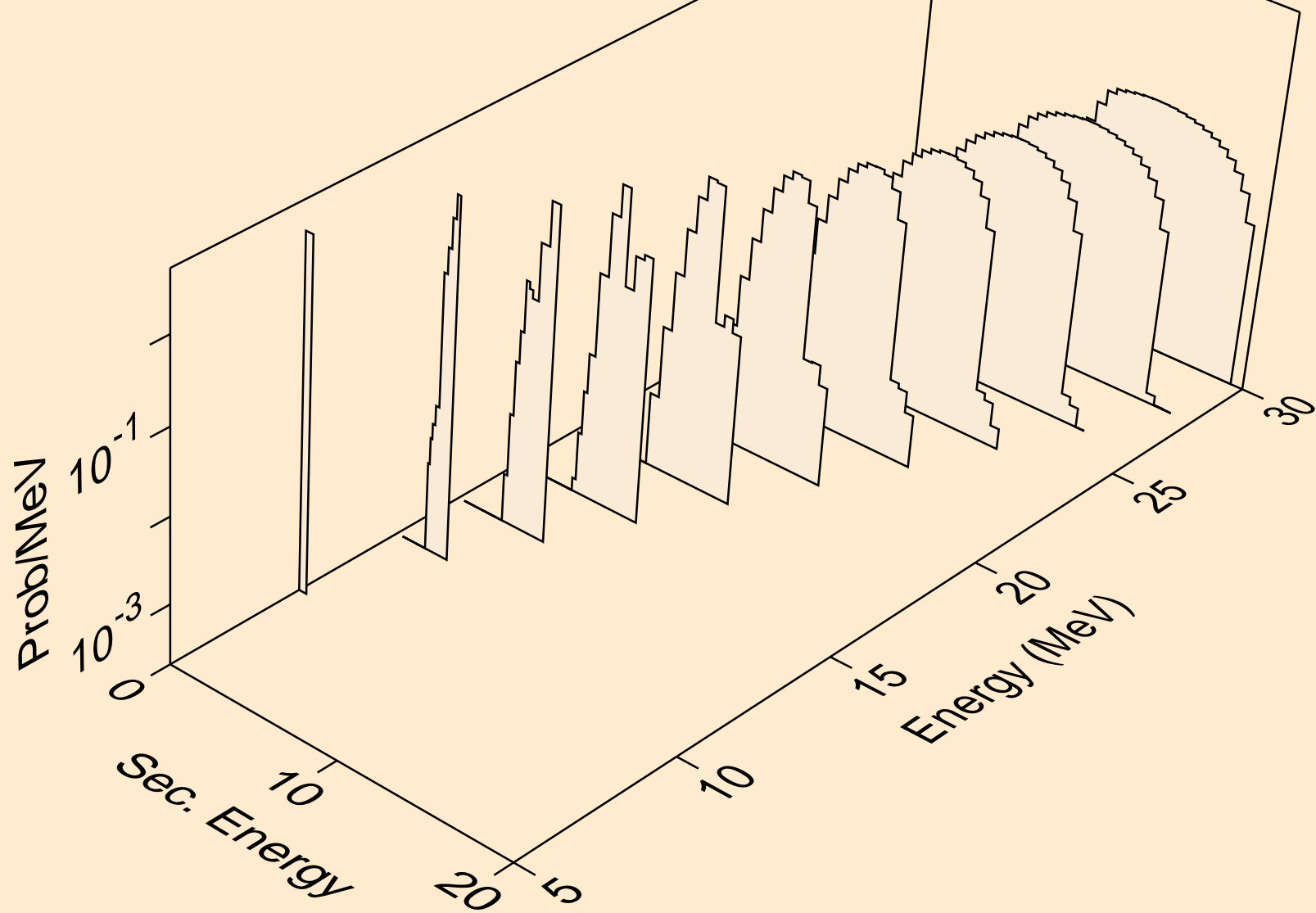

PR141 PROTON ACER TENDL-2021 LIBRARY; T=0.K  
tritons from (p,pt)

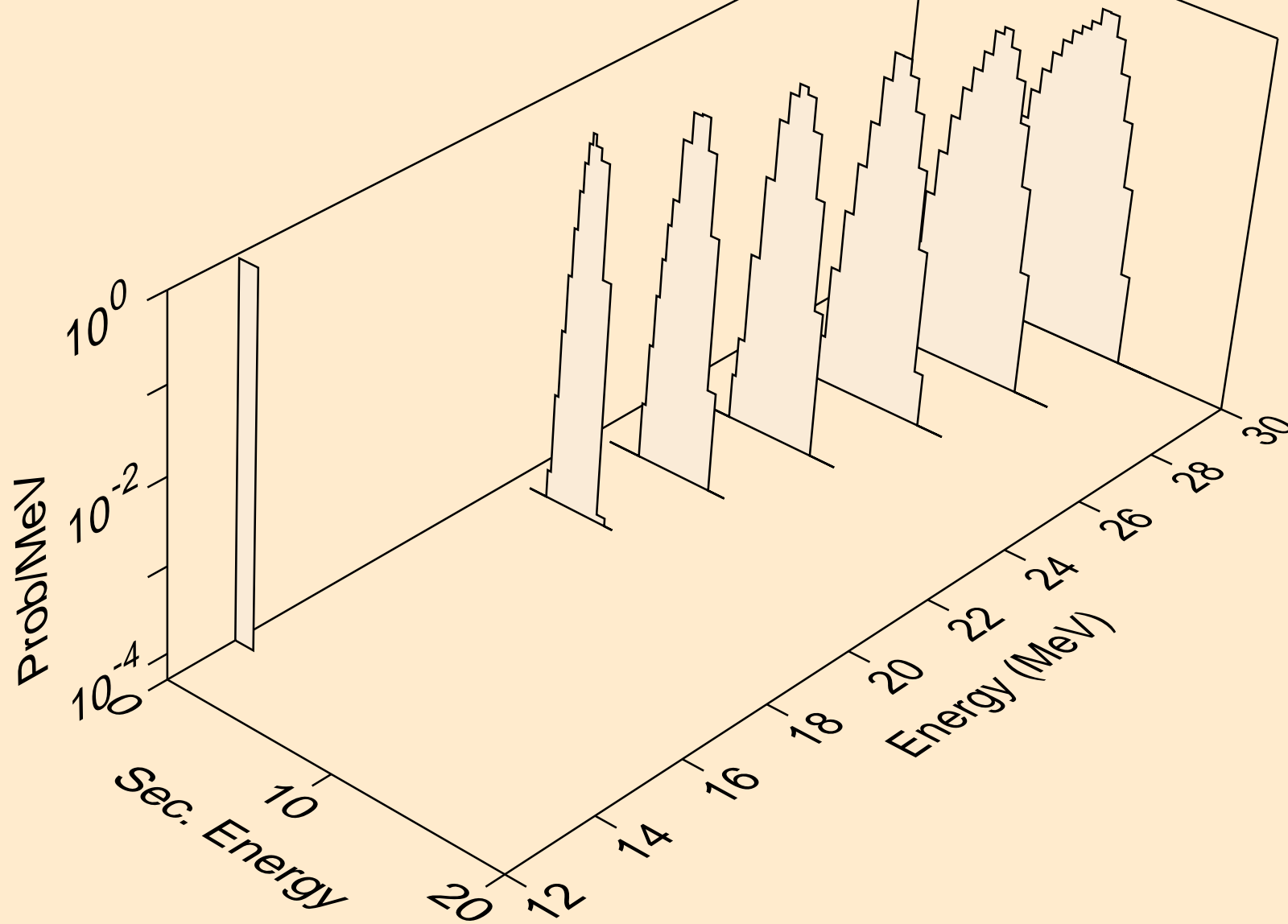

PR141 PROTON ACER TENDL-2021 LIBRARY; T=0.K  
he3s from (p,x)

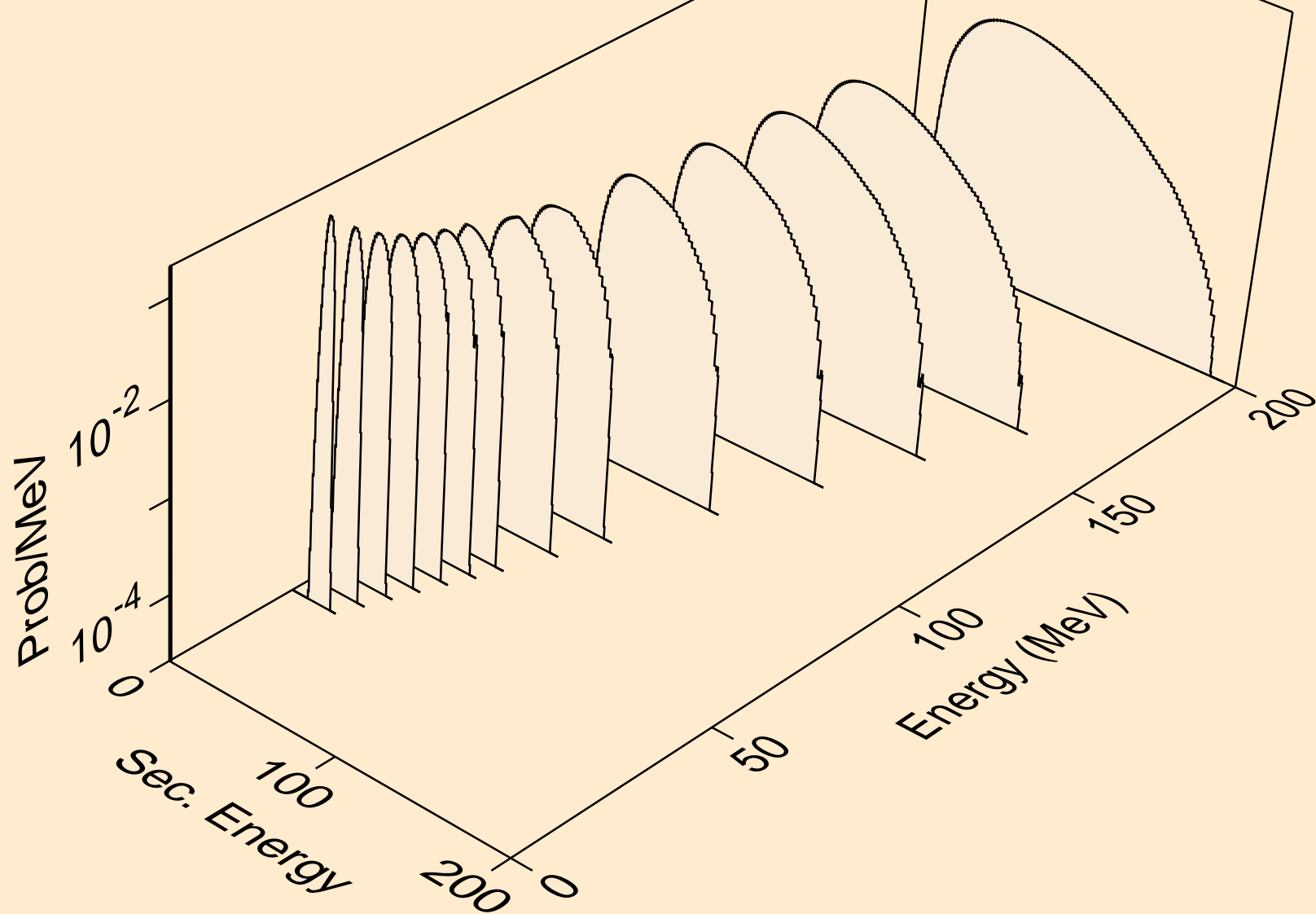



PR141 PROTON ACER TENDL-2021 LIBRARY; T=0.K  
he3s from (p,n\*)he3

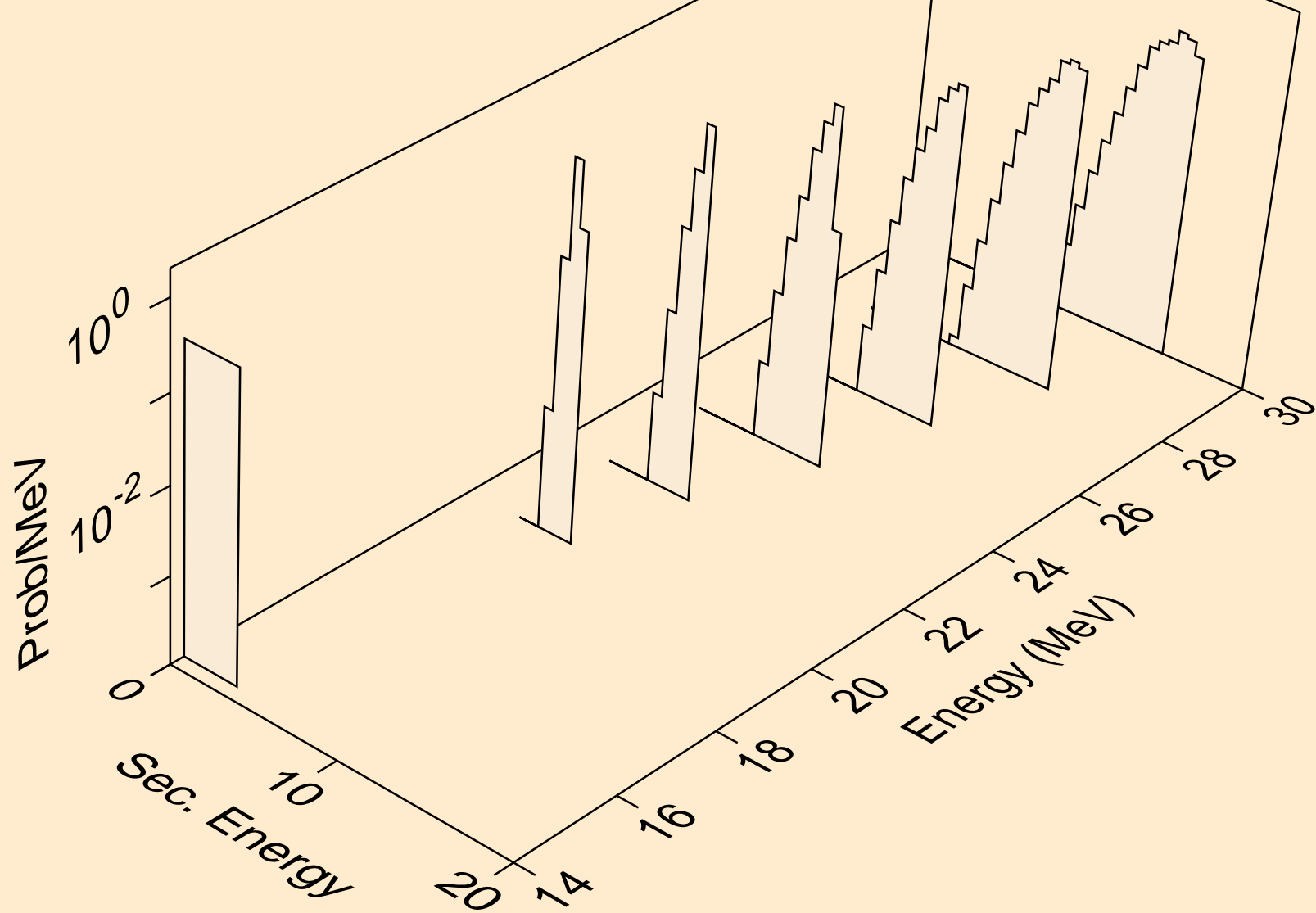

PR141 PROTON ACER TENDL-2021 LIBRARY; T=0.K  
he3s from (p,he3)

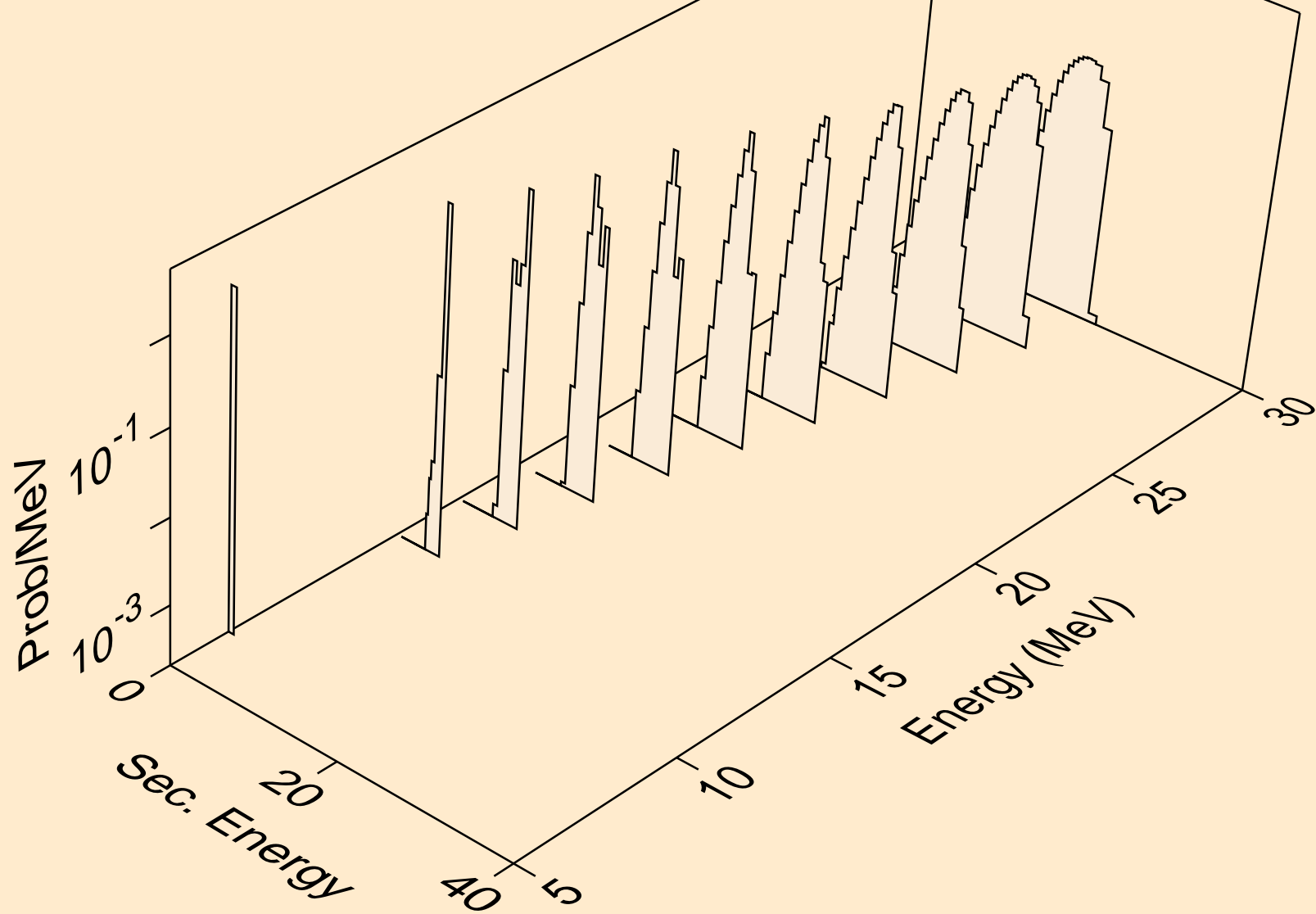

PR141 PROTON ACER TENDL-2021 LIBRARY; T=0.K  
alphas from (p,x)

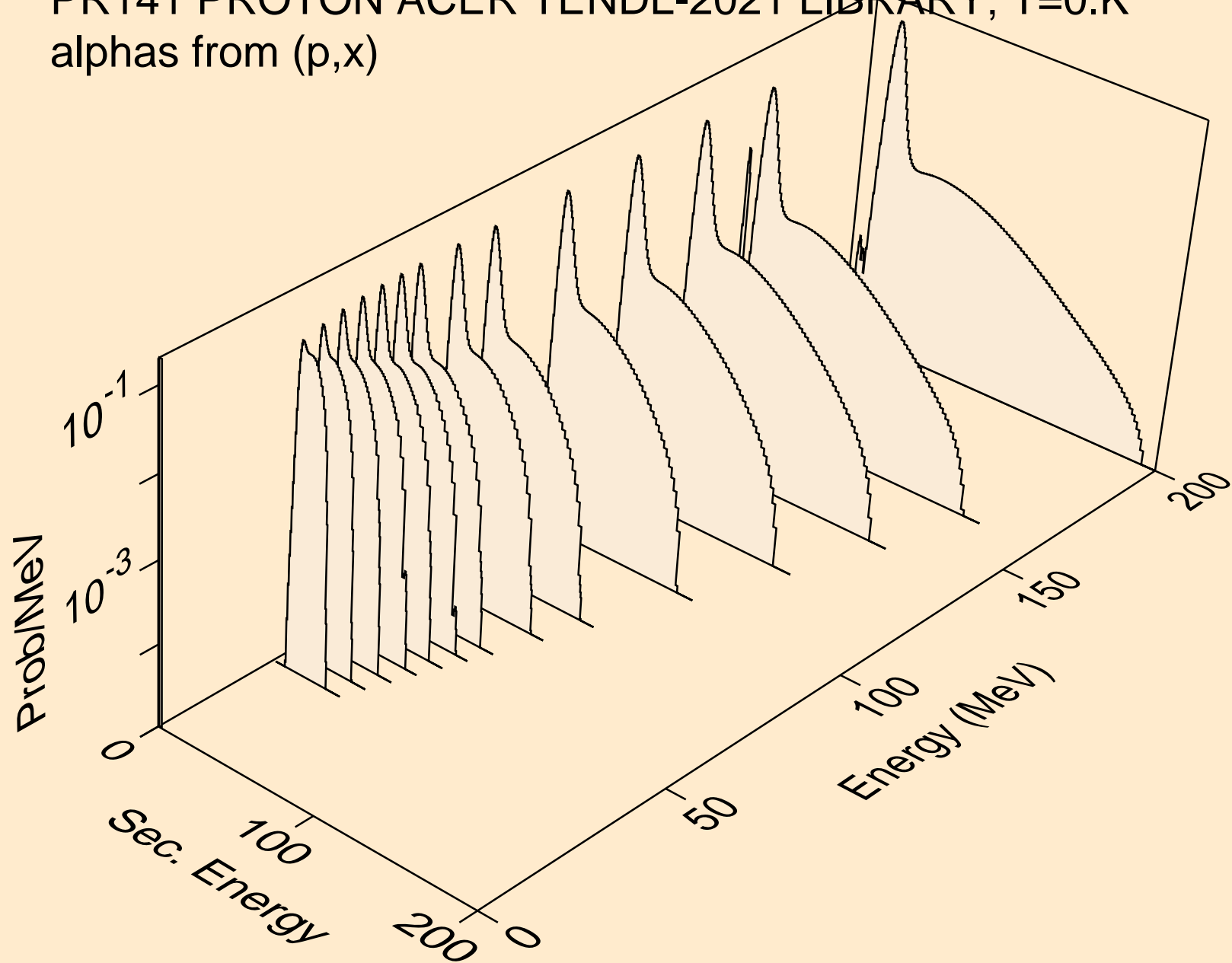

PR141 PROTON ACER TENDL-2021 LIBRARY; T=0.K  
alphas from (p,n\*)a

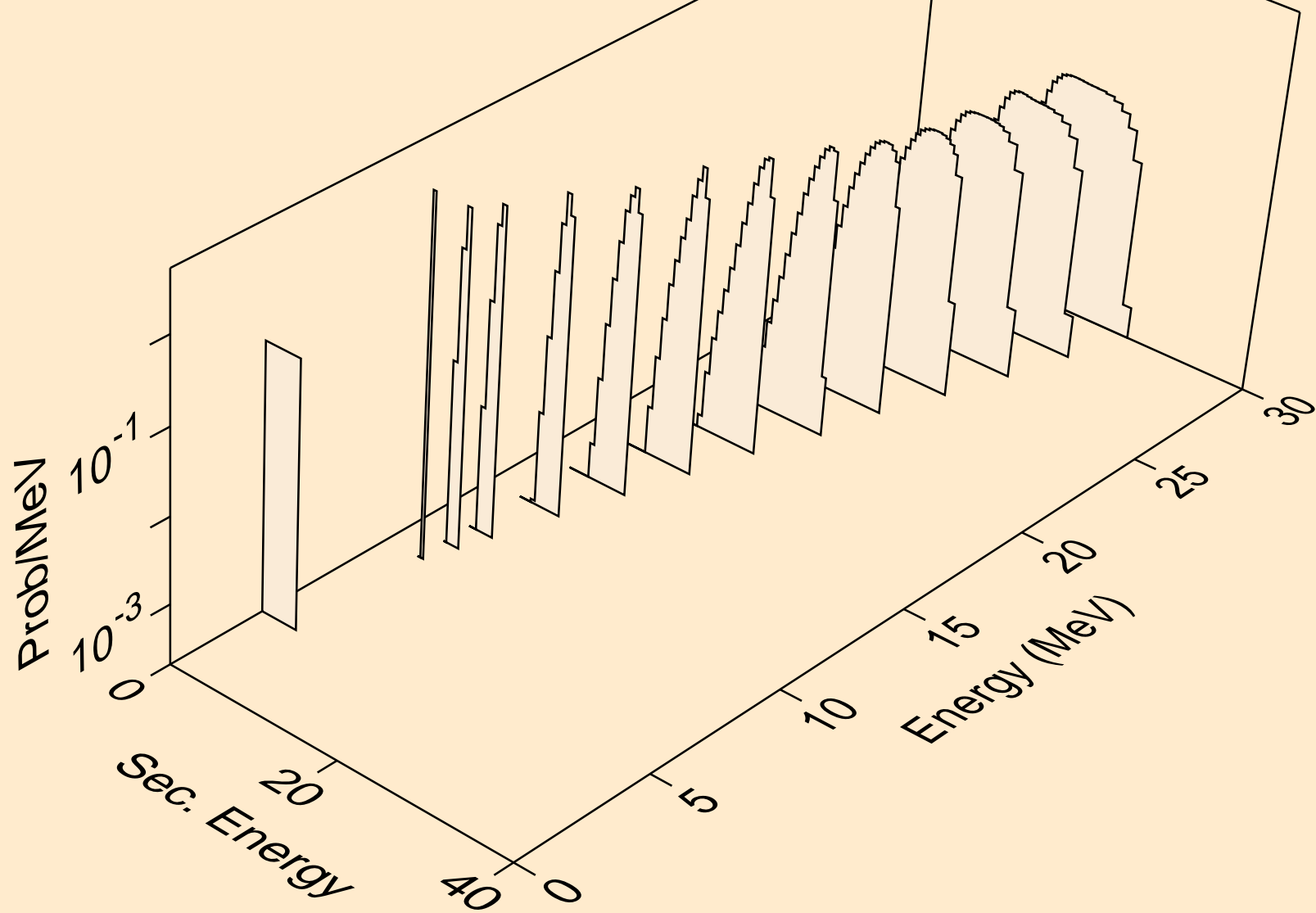

PR141 PROTON ACER TENDL-2021 LIBRARY; T=0.K  
alphas from (p,2n)a

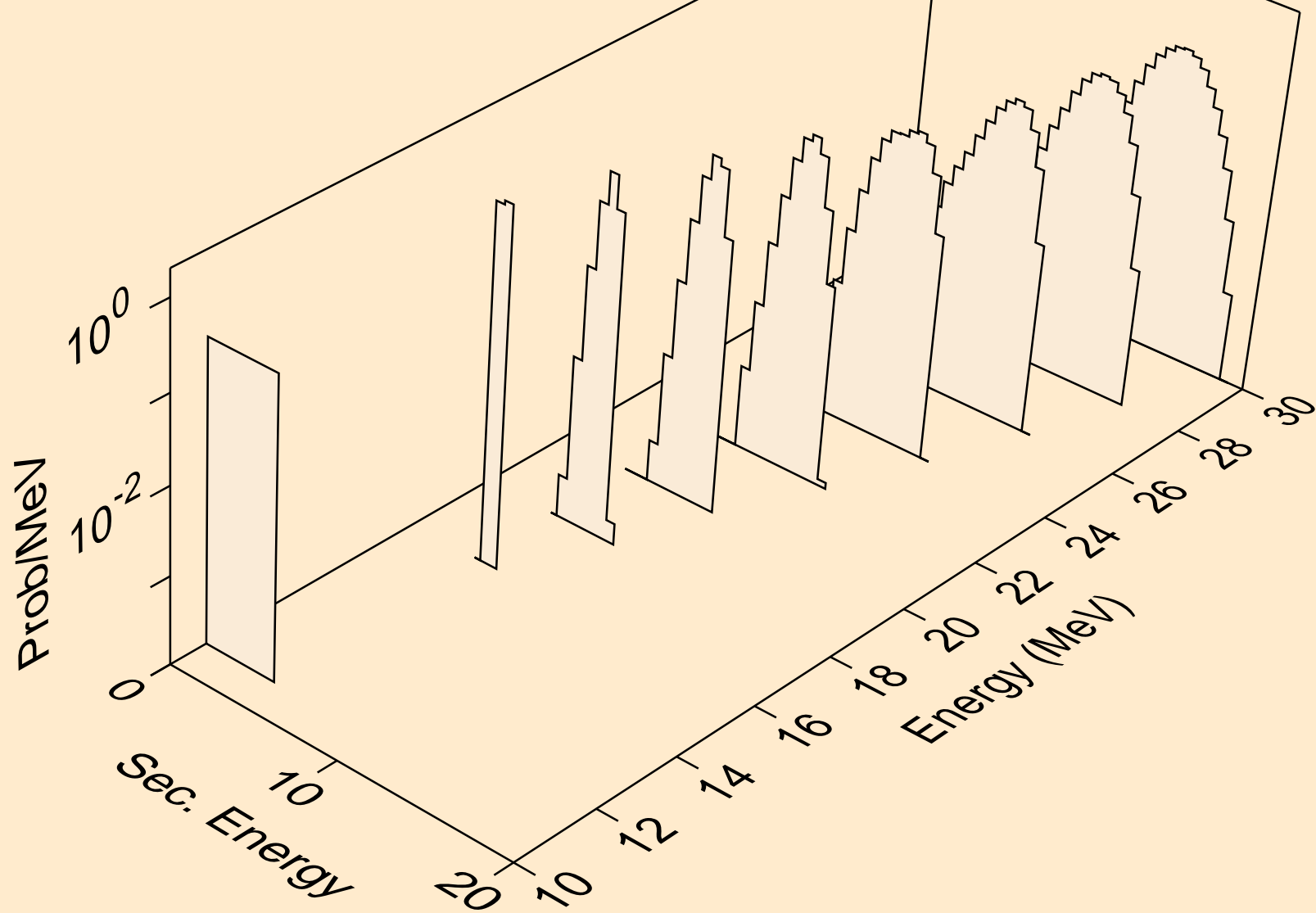

PR141 PROTON ACER TENDL-2021 LIBRARY; T=0.K  
alphas from (p,3n)a

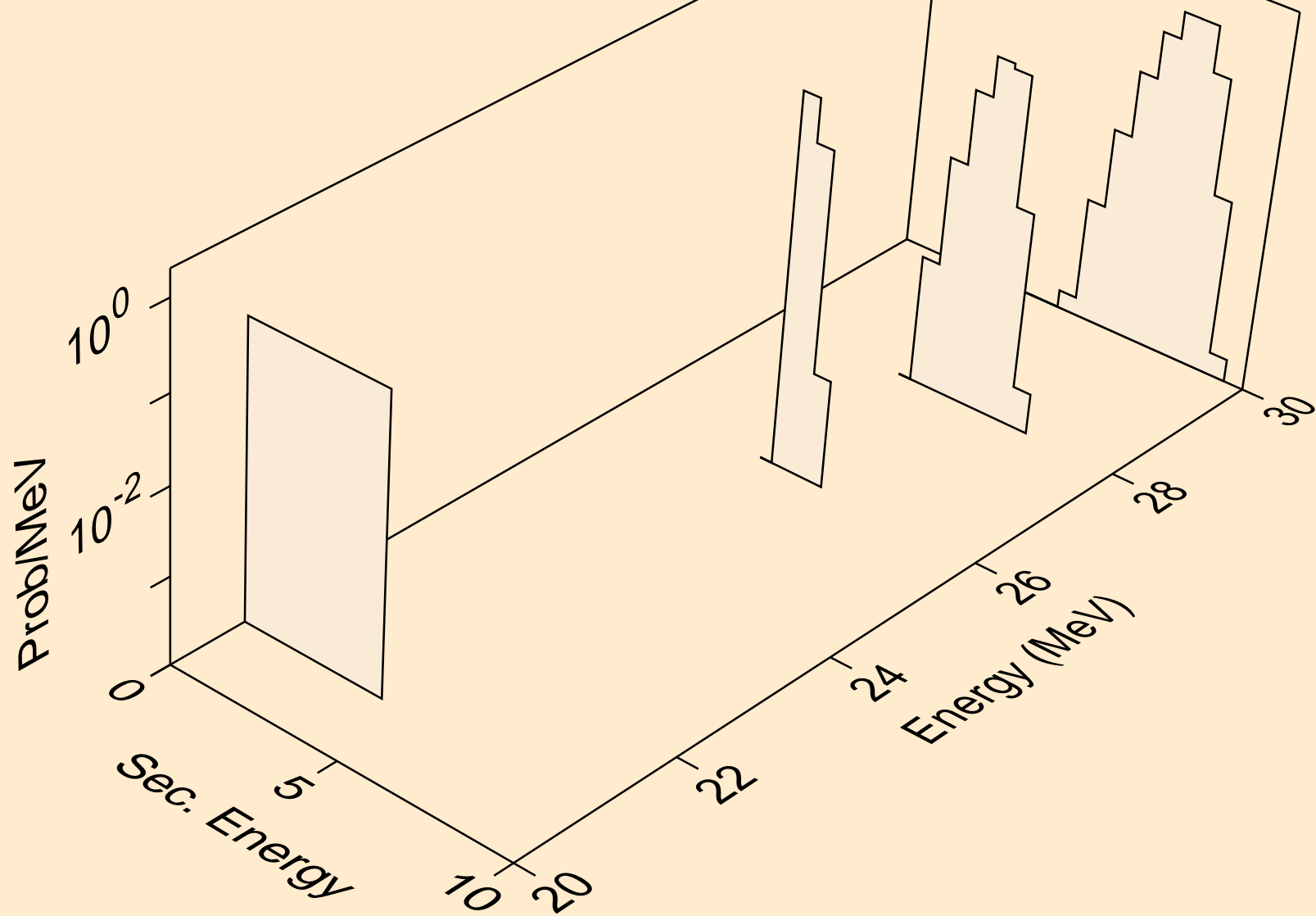

PR141 PROTON ACER TENDL-2021 LIBRARY; T=0.K  
alphas from (p,n\*)2a

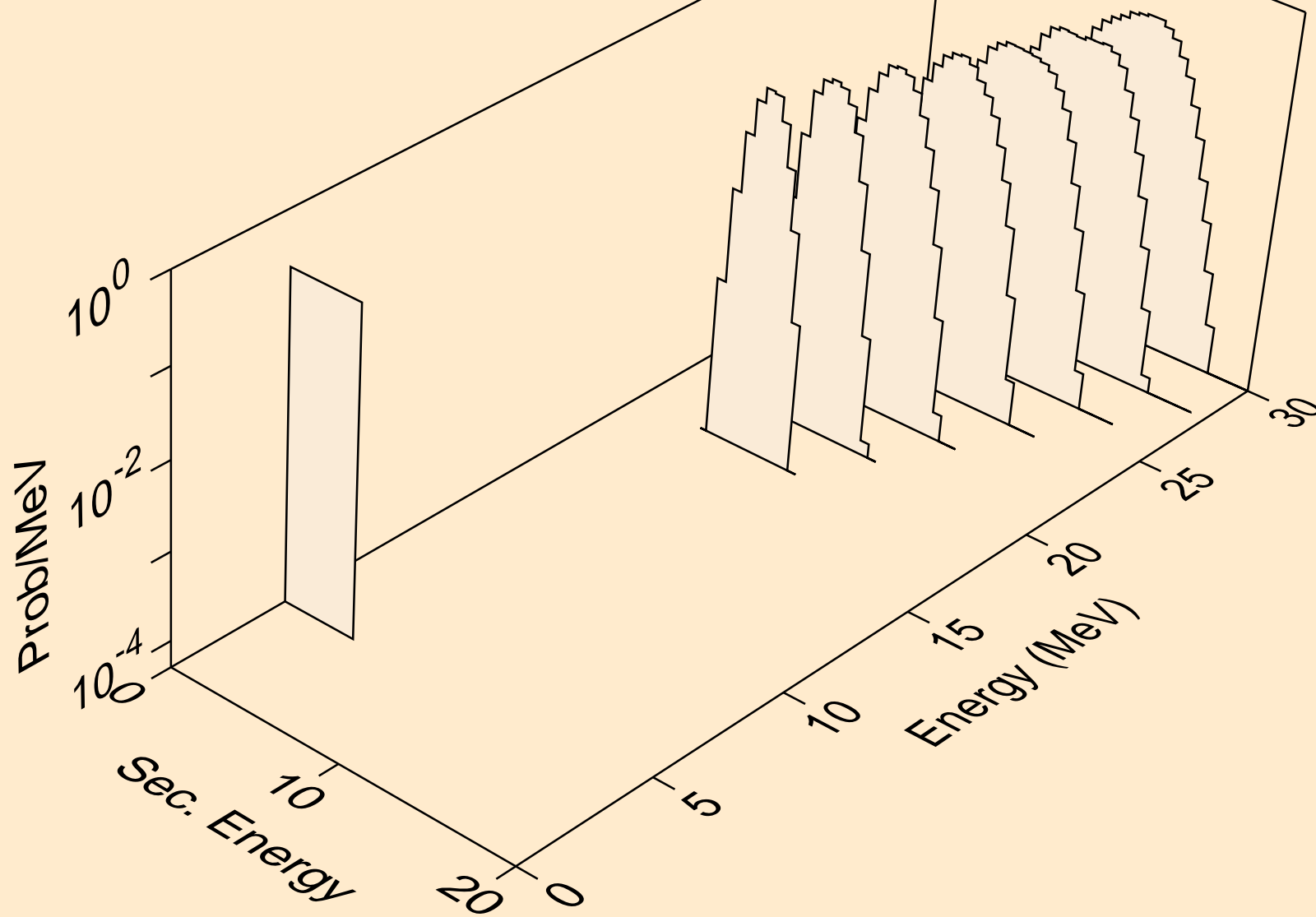

PR141 PROTON ACER TENDL-2021 LIBRARY; T=0.K  
alphas from (p,npa)

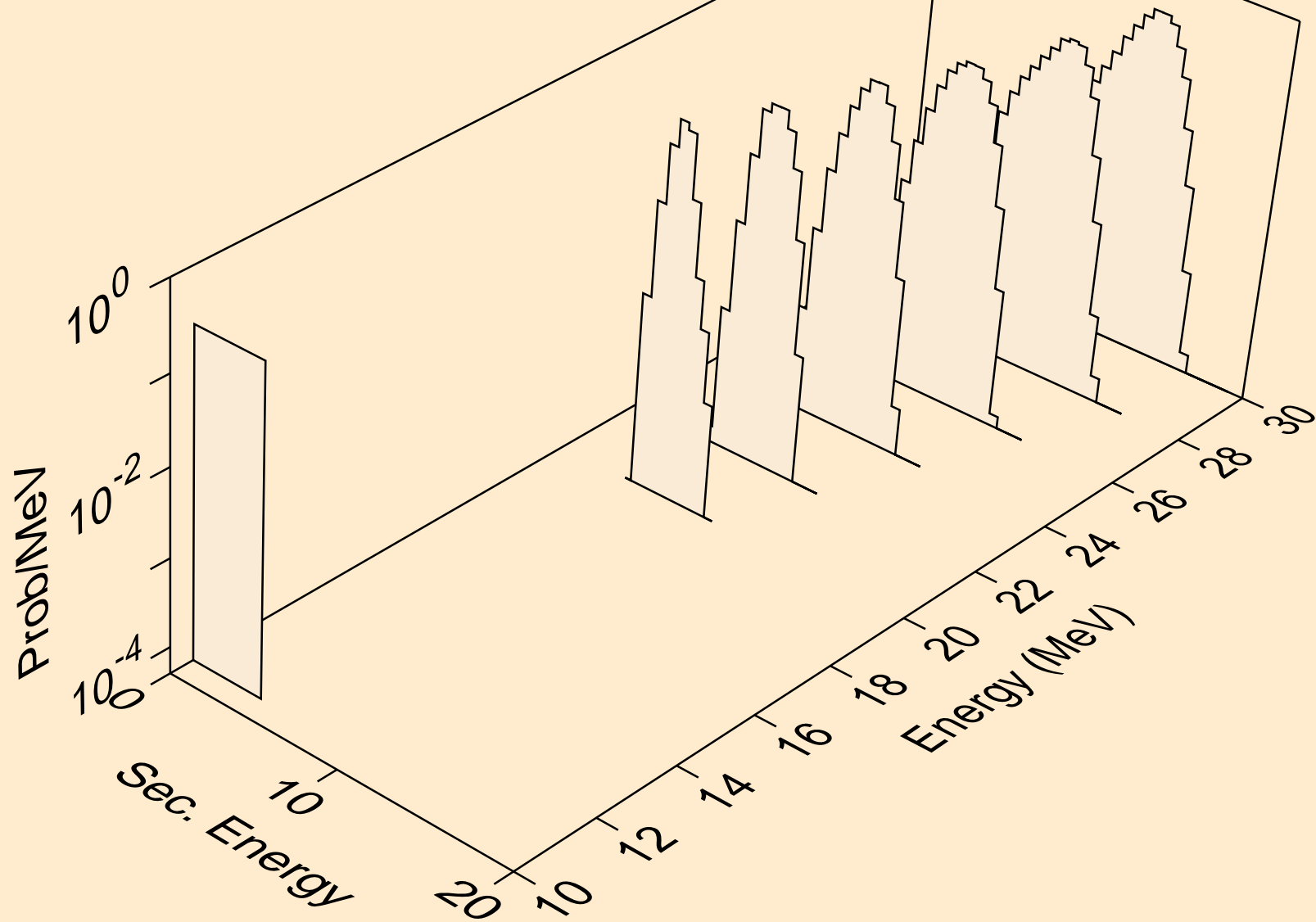



PR141 PROTON ACER TENDL-2021 LIBRARY; T=0.K  
alphas from (p,a)

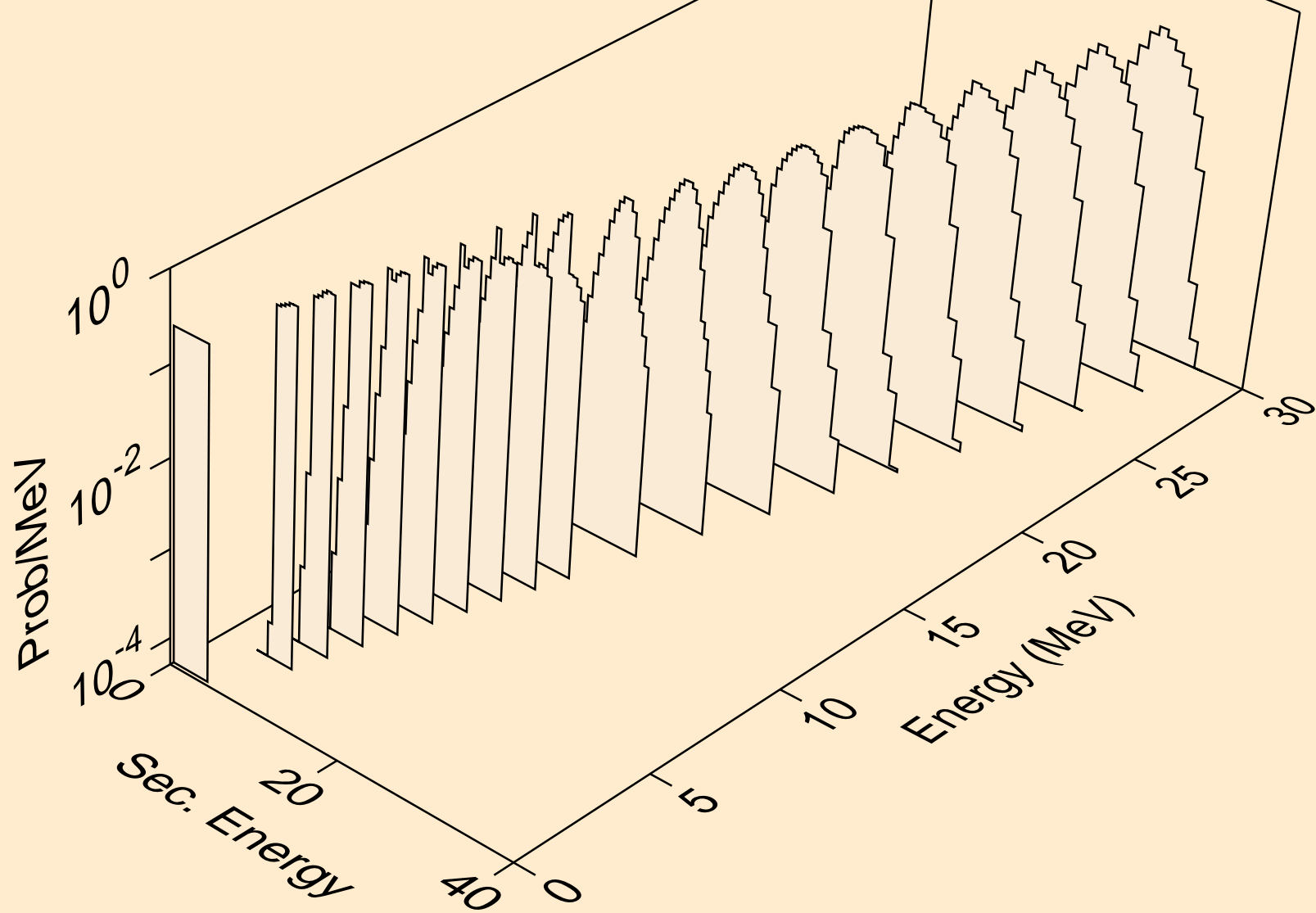

PR141 PROTON ACER TENDL-2021 LIBRARY; T=0.K  
alphas from (p,2a)

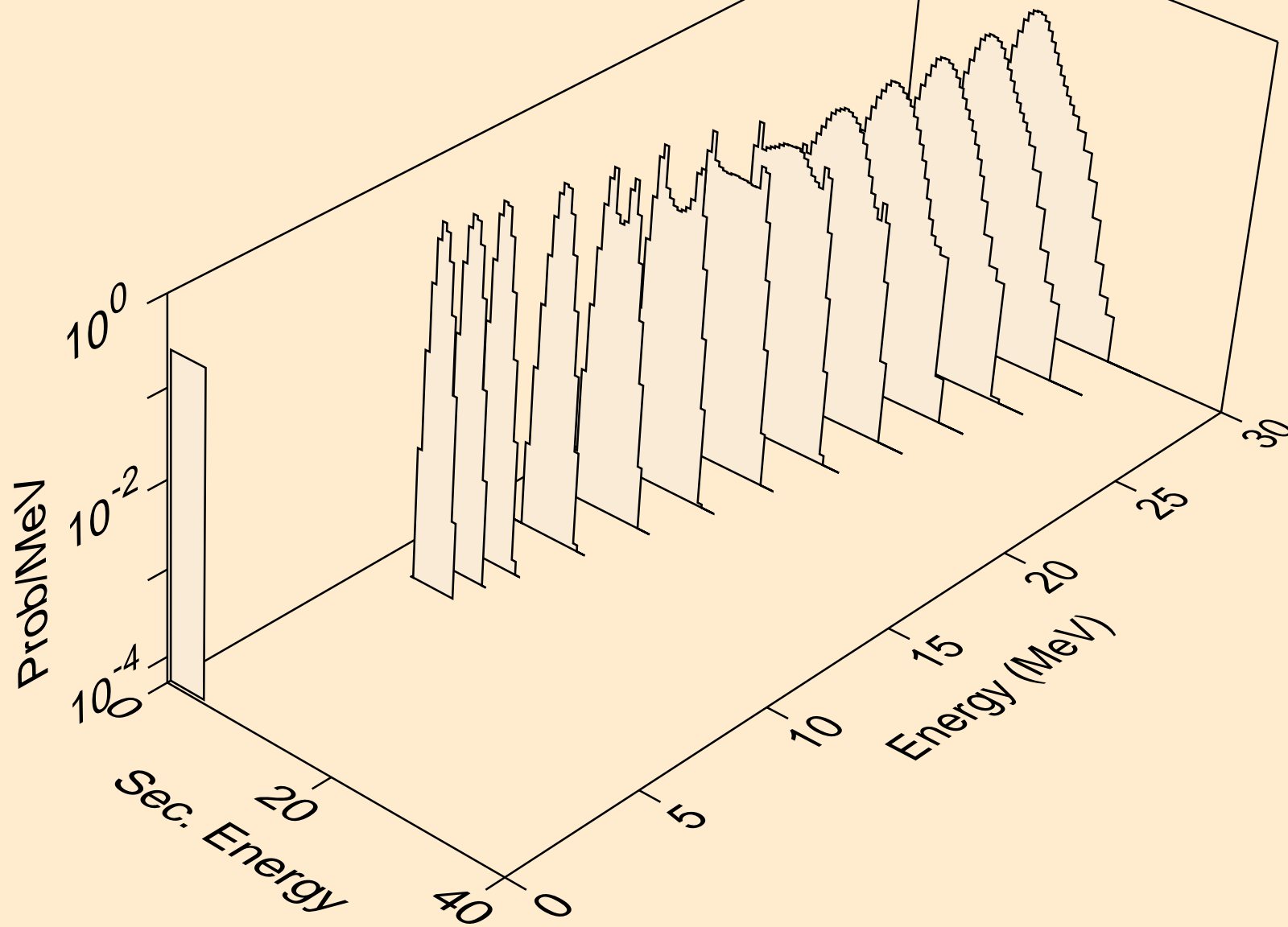

PR141 PROTON ACER TENDL-2021 LIBRARY; T=0.K  
alphas from (p,pa)

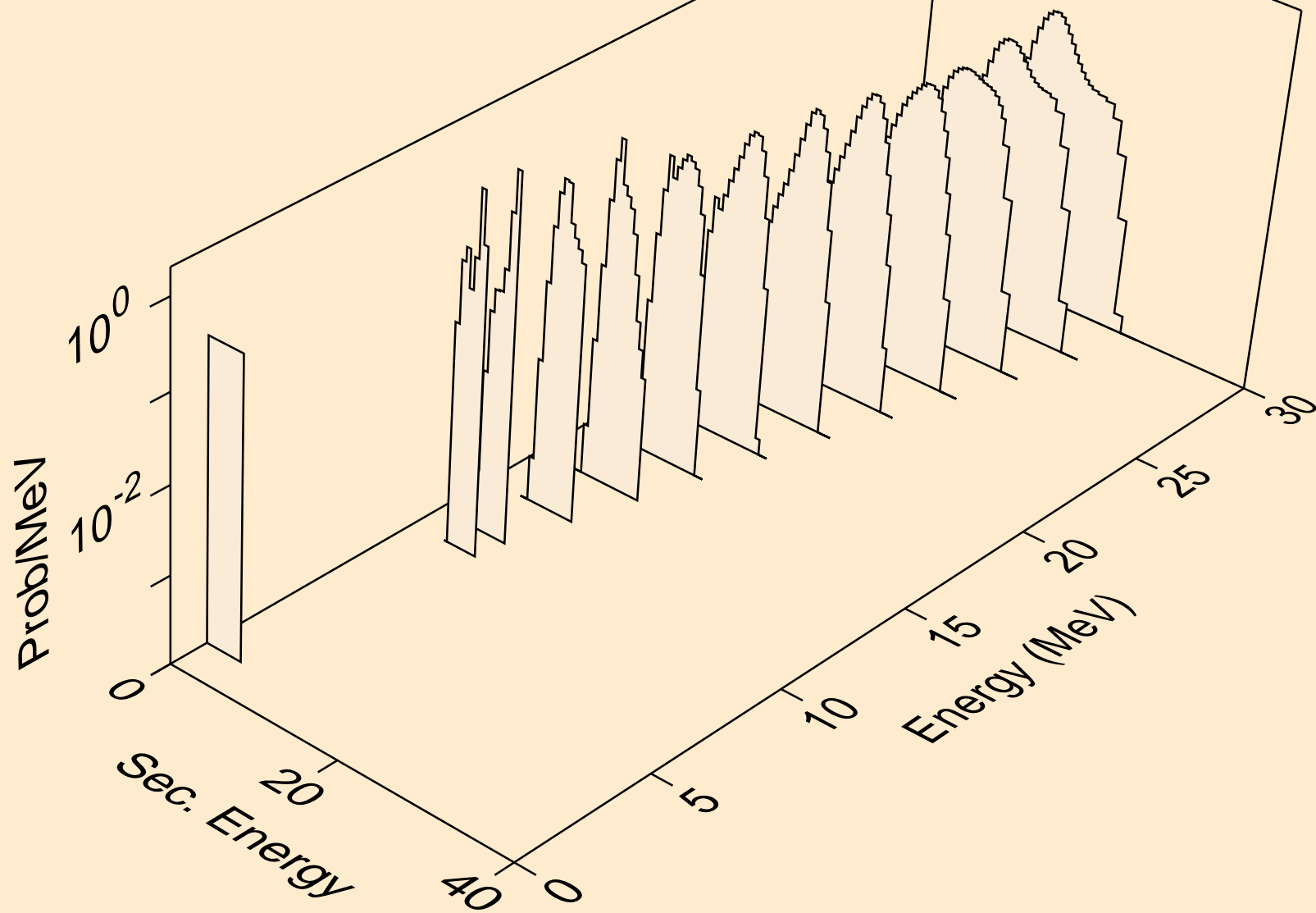

PR141 PROTON ACER TENDL-2021 LIBRARY; T=0.K  
alphas from (p,da)

