

PR144 PROTON ACER TENDL-2021 LIBRARY; T=0.K  
Principal cross sections

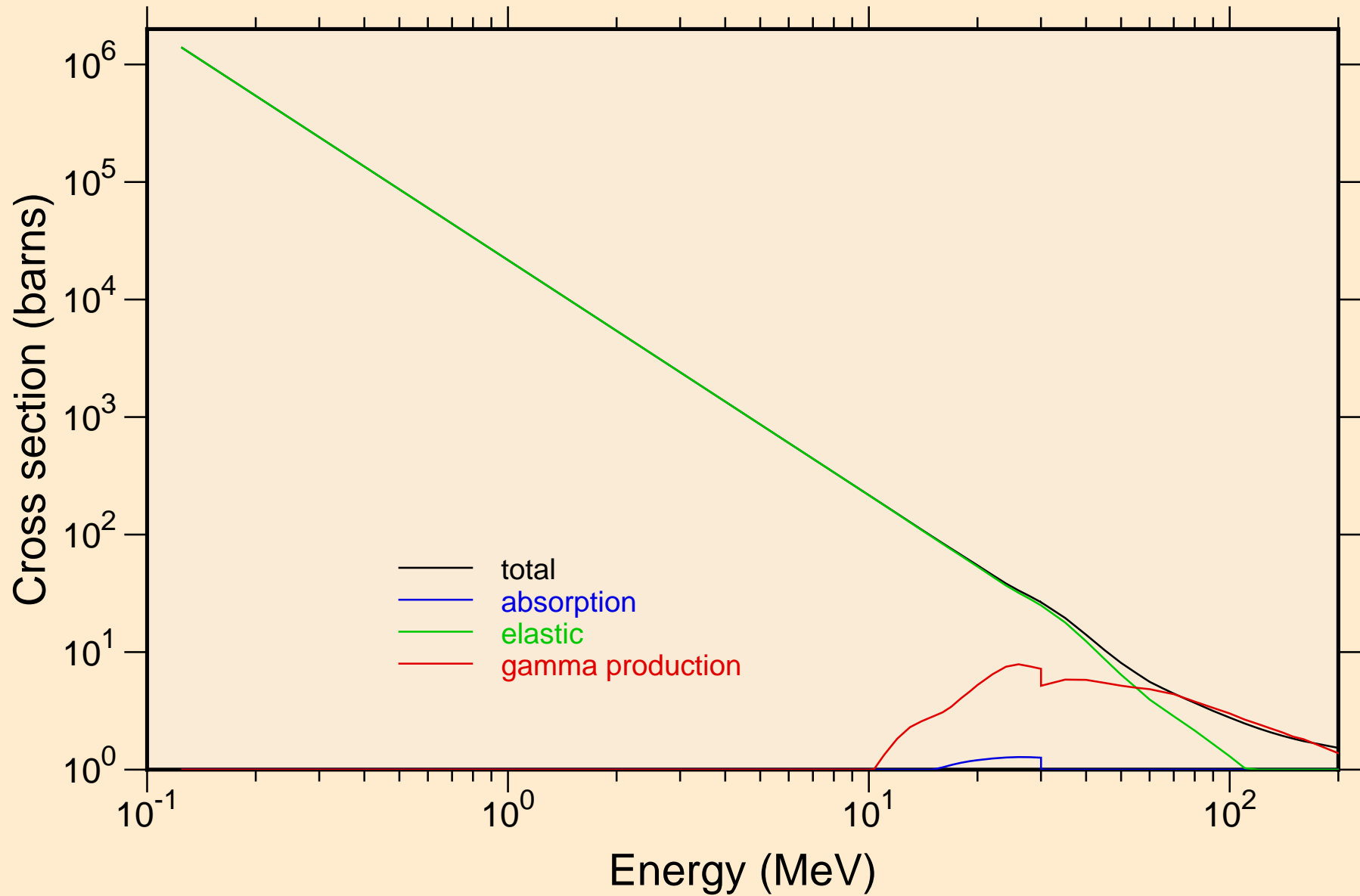

PR144 PROTON ACER TENDL-2021 LIBRARY; T=0.K  
Heating

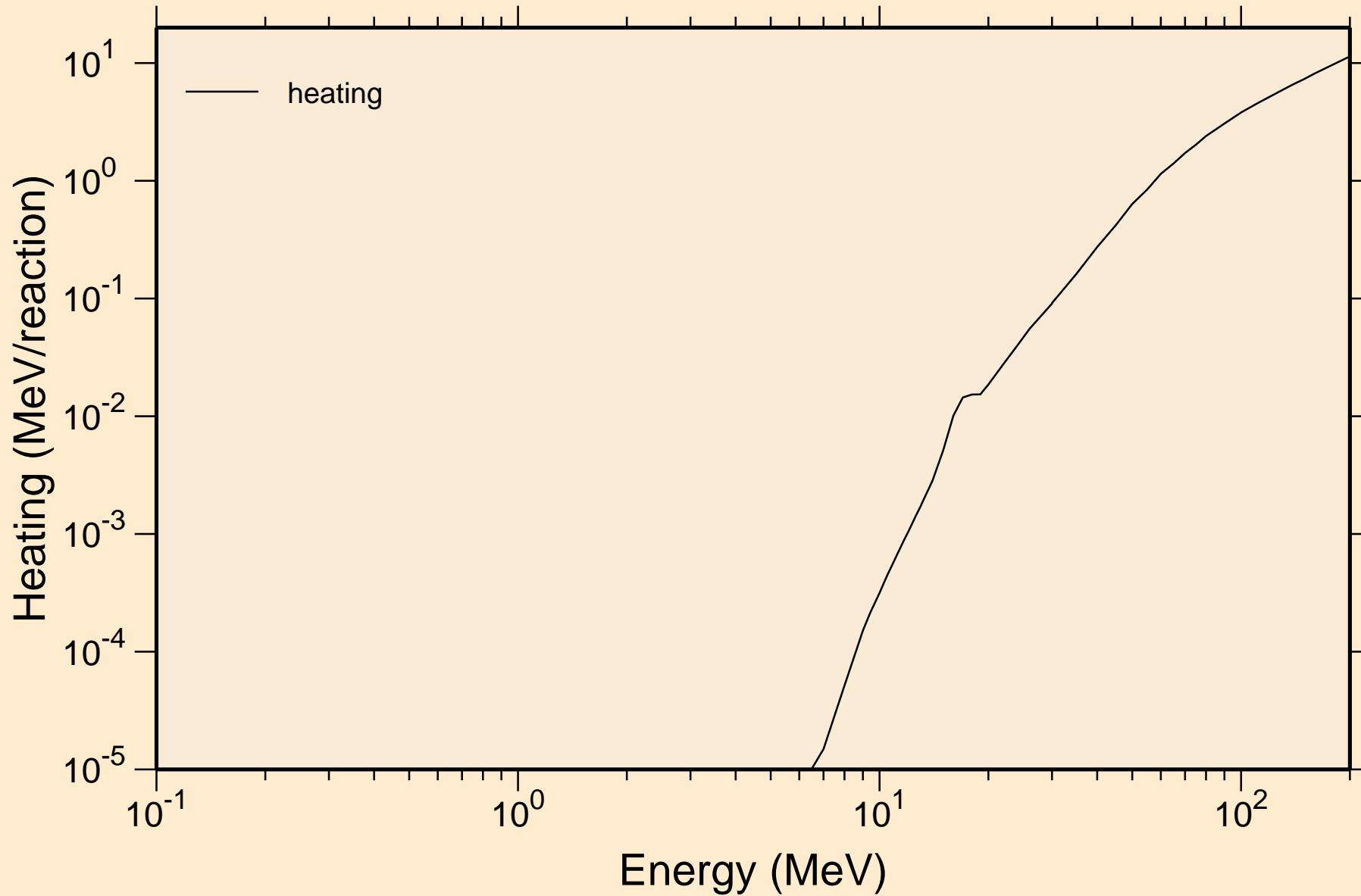

# PR144 PROTON ACER TENDL-2021 LIBRARY; T=0.K

## Principal cross sections

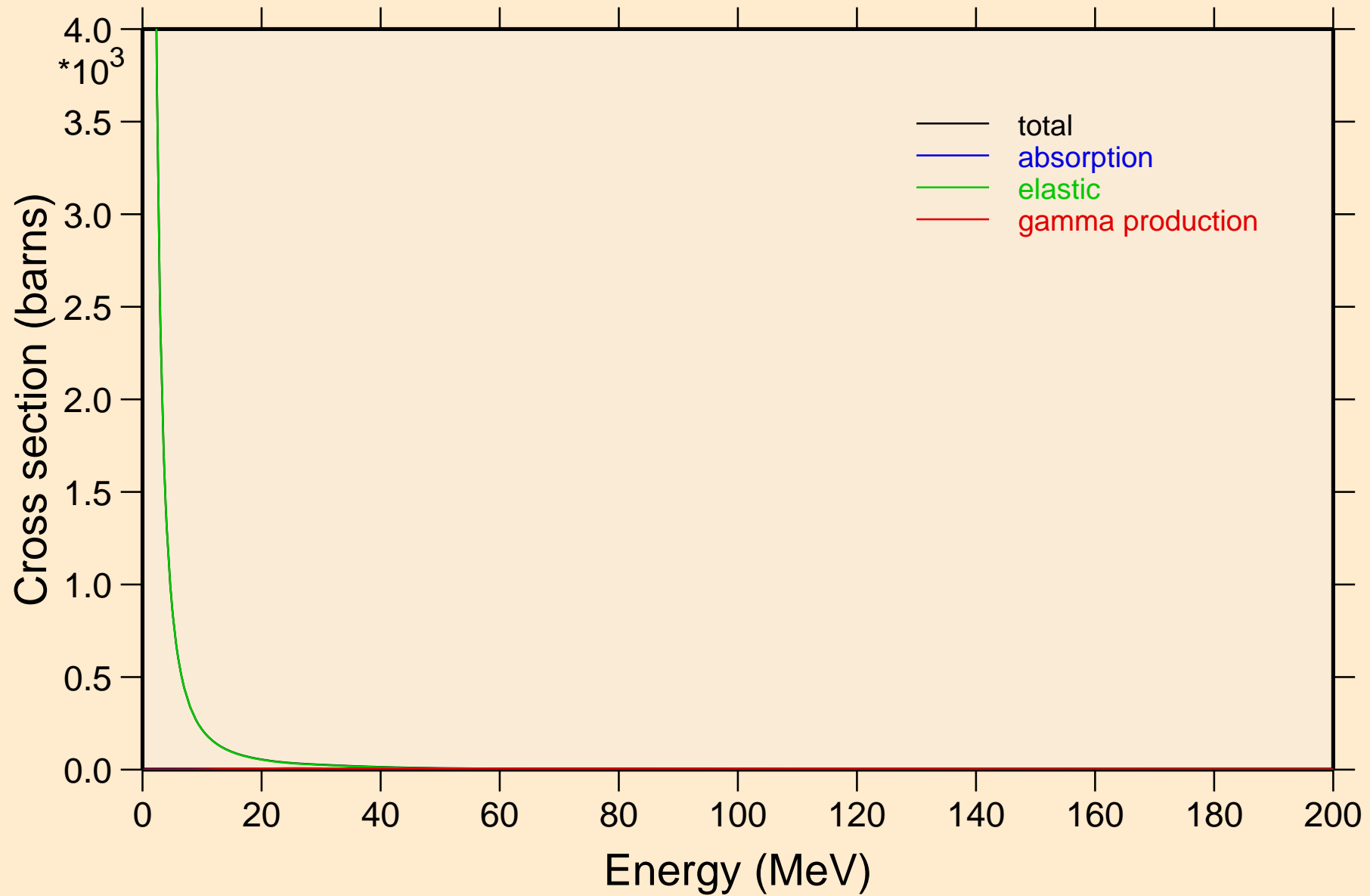

PR144 PROTON ACER TENDL-2021 LIBRARY; T=0.K

Heating

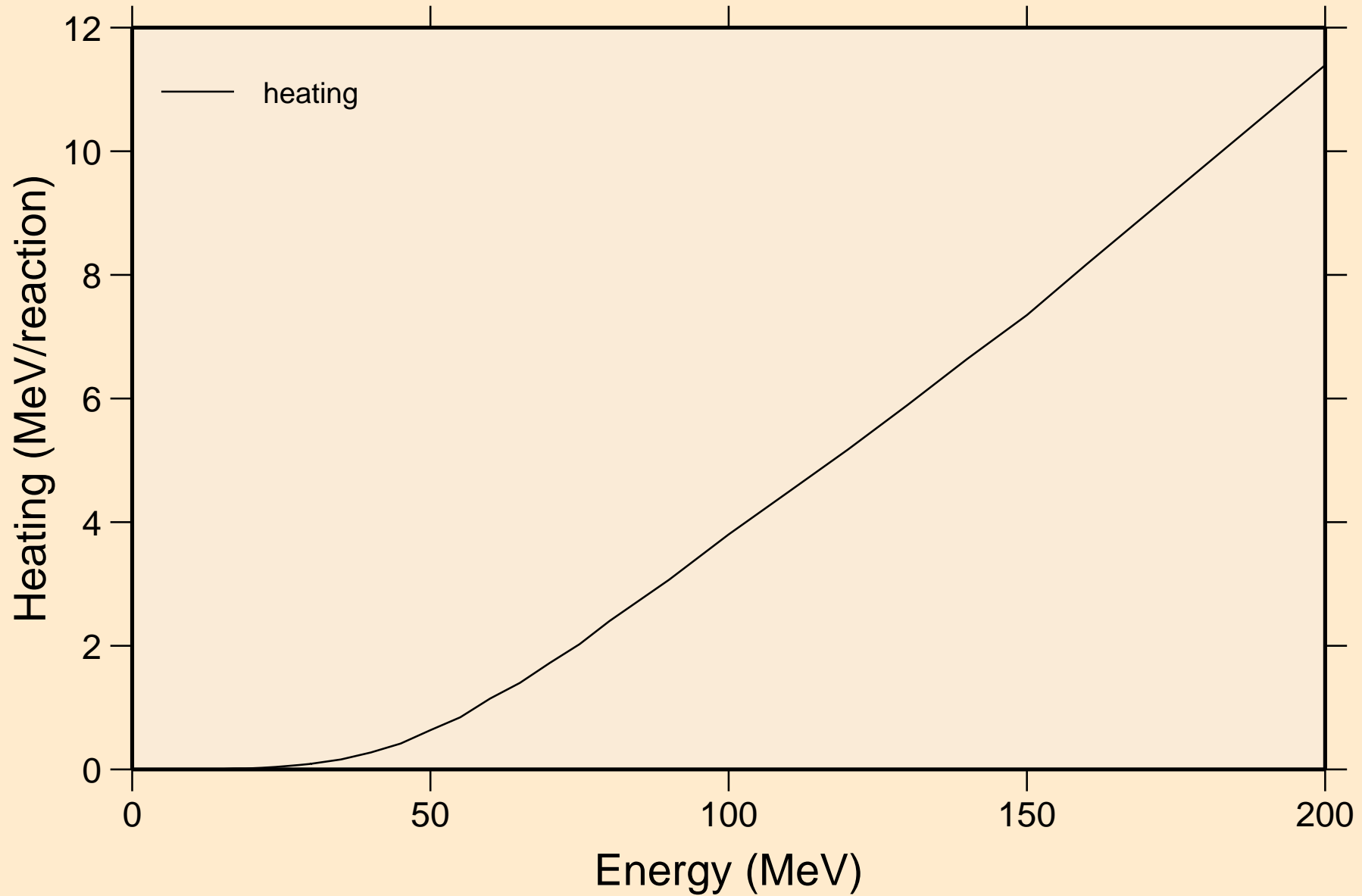

PR144 PROTON ACER TENDL-2021 LIBRARY; T=0.K  
Threshold reactions

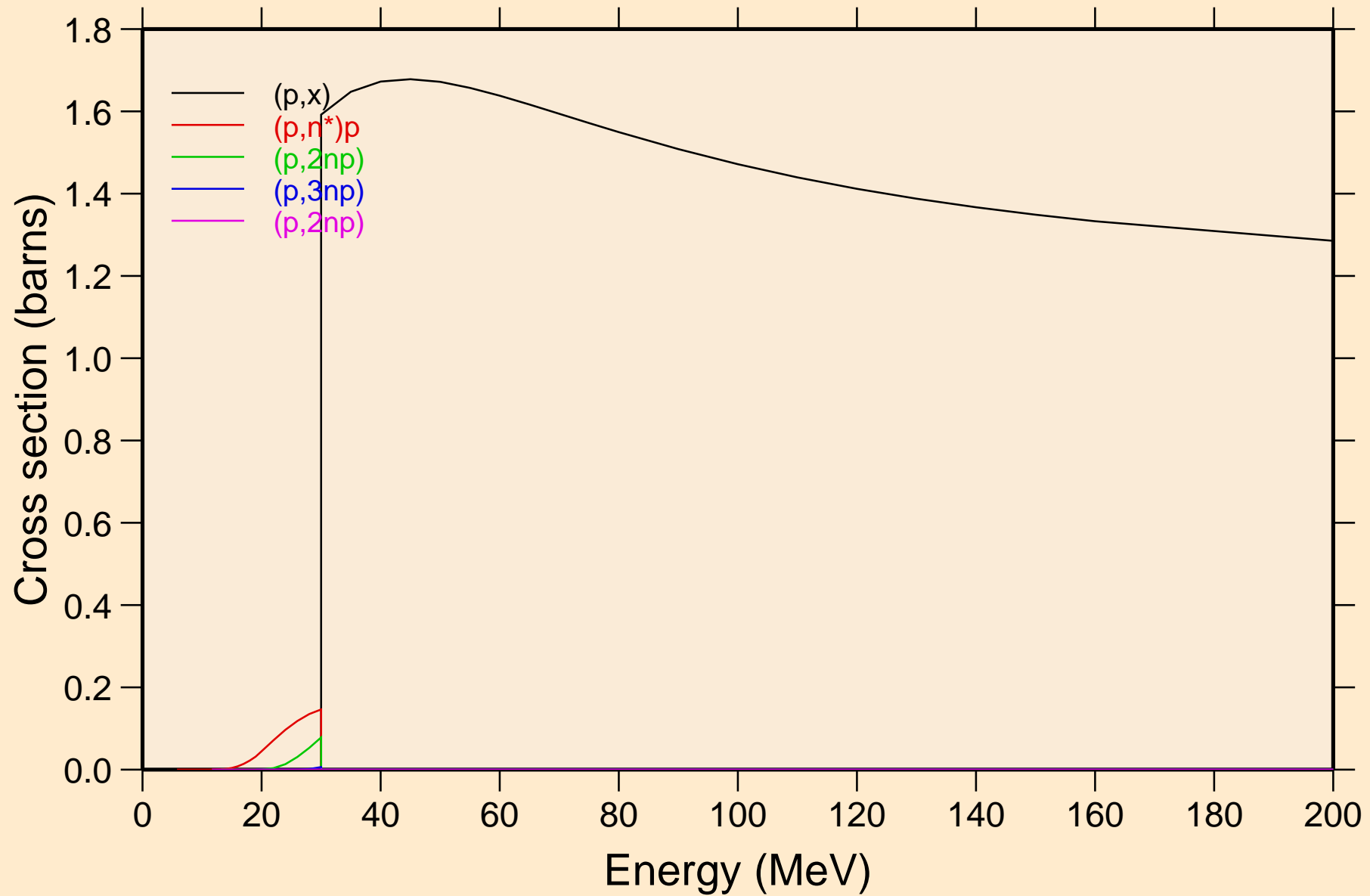

PR144 PROTON ACER TENDL-2021 LIBRARY; T=0.K  
Threshold reactions

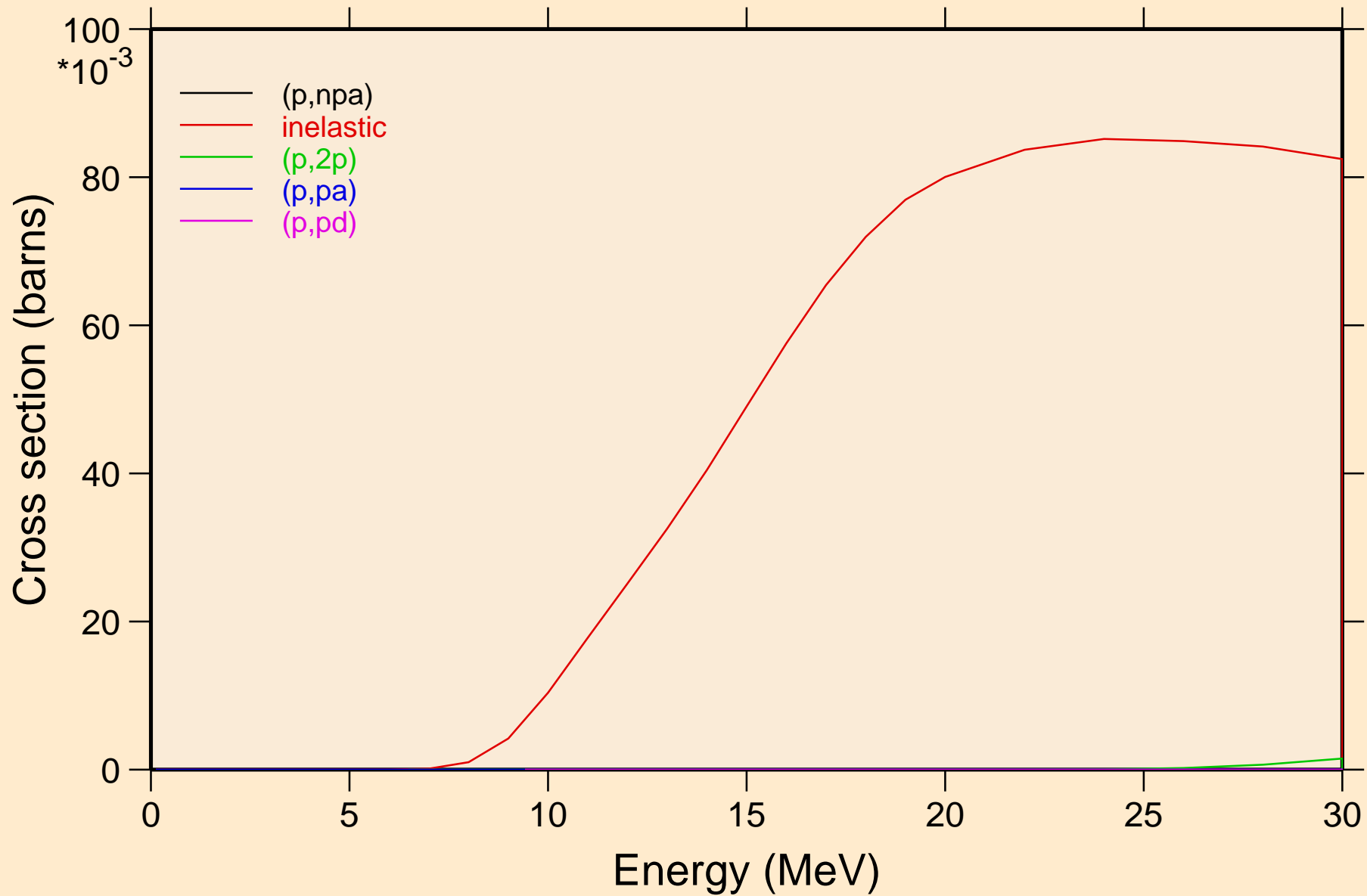

PR144 PROTON ACER TENDL-2021 LIBRARY; T=0.K  
Threshold reactions

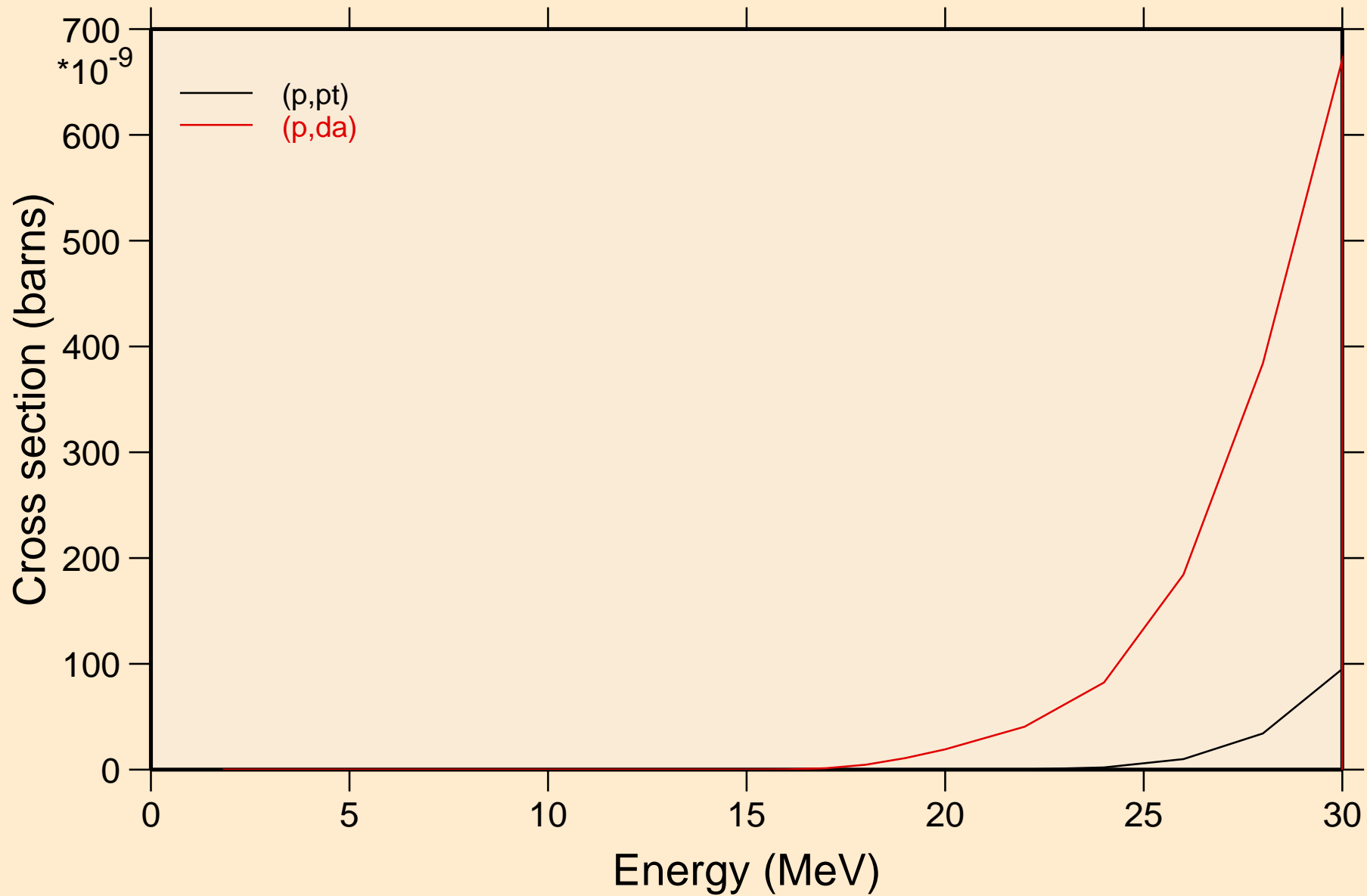

PR144 PROTON ACER TENDL-2021 LIBRARY; T=0.K  
angular distribution for elastic

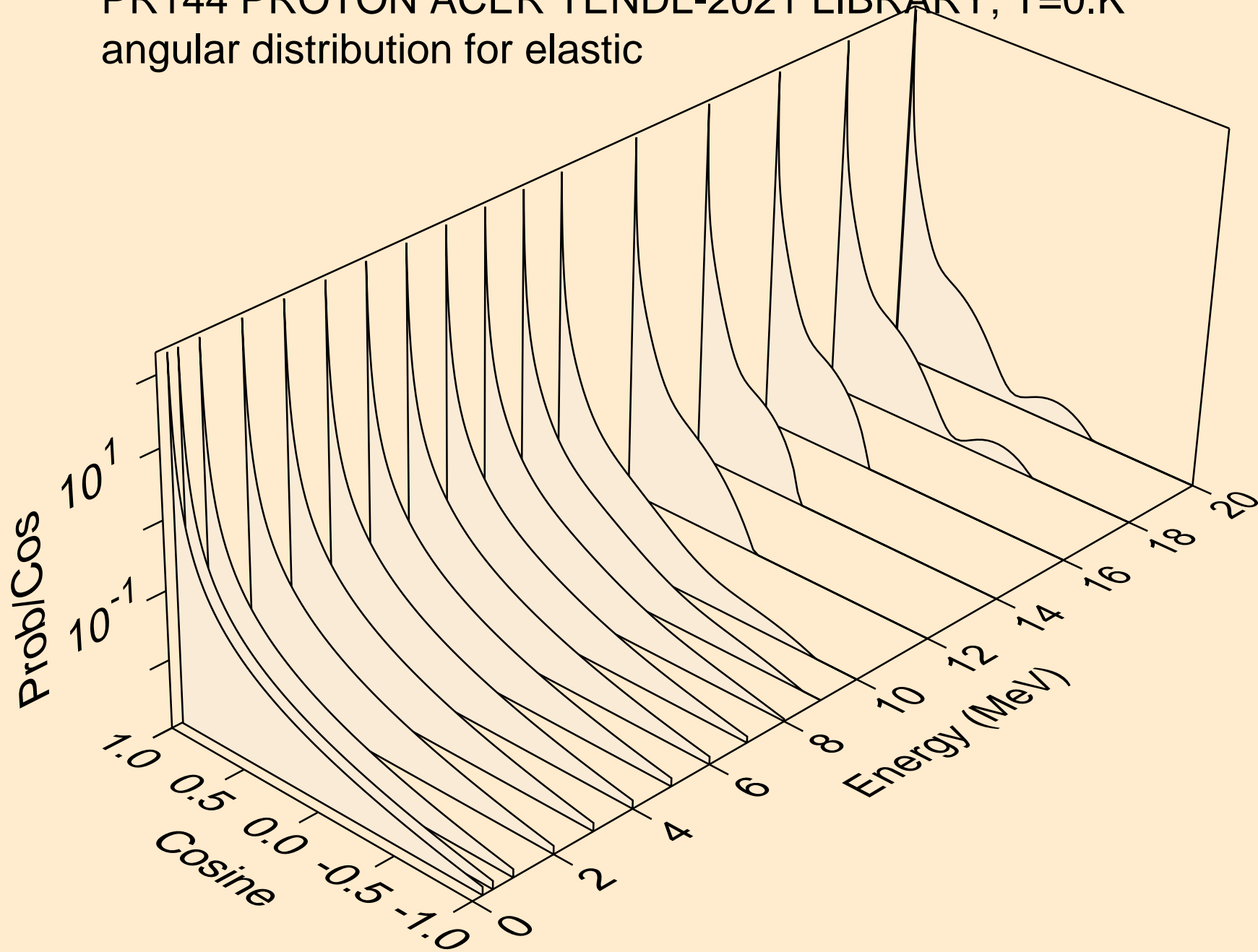



PR144 PROTON ACER TENDL-2021 LIBRARY; T=0.K  
angular distribution for elastic

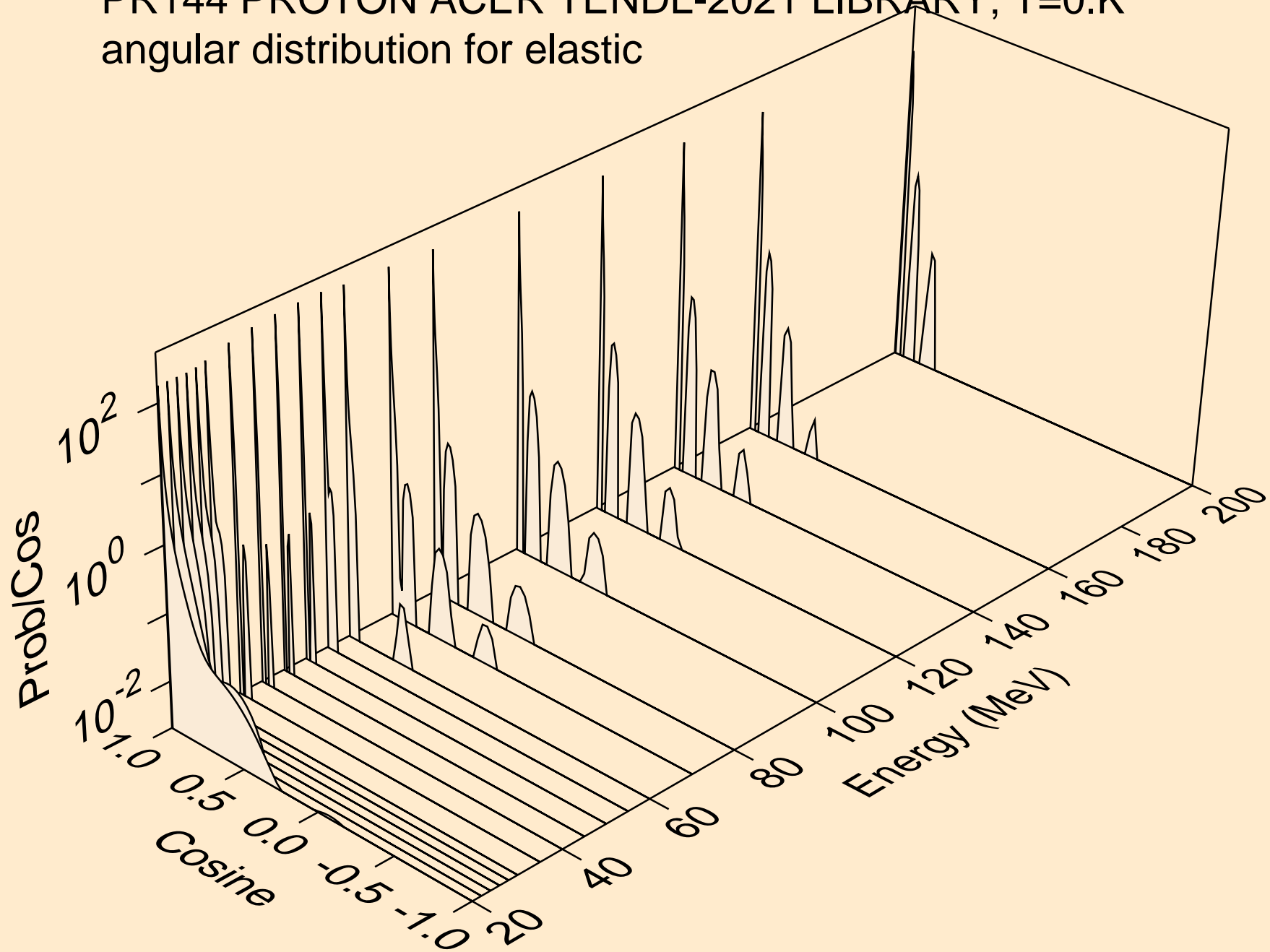

PR144 PROTON ACER TENDL-2021 LIBRARY; T=0.K  
Proton emission for (p,x)

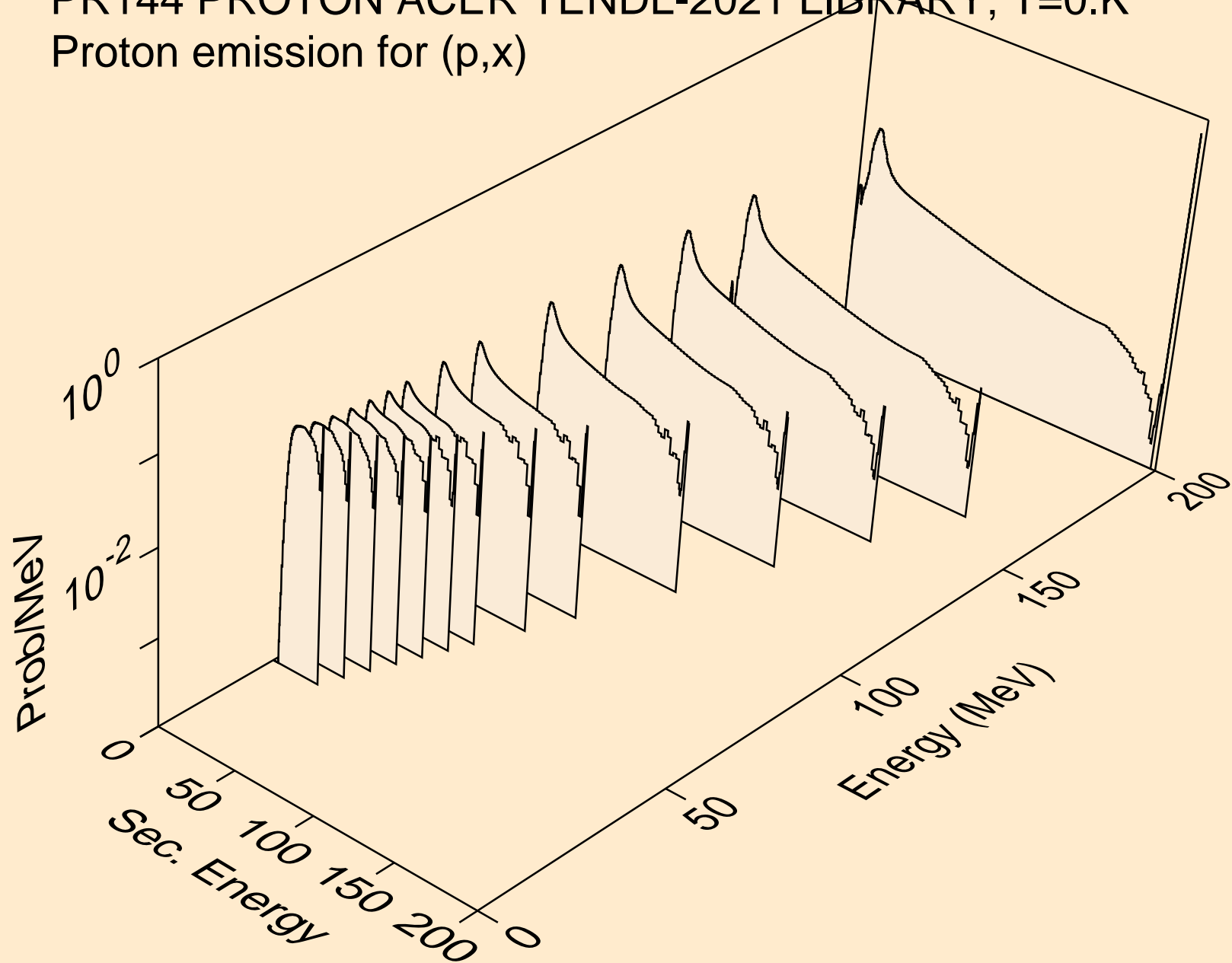

PR144 PROTON ACER TENDL-2021 LIBRARY; T=0.K  
Proton emission for (p,n\*)p

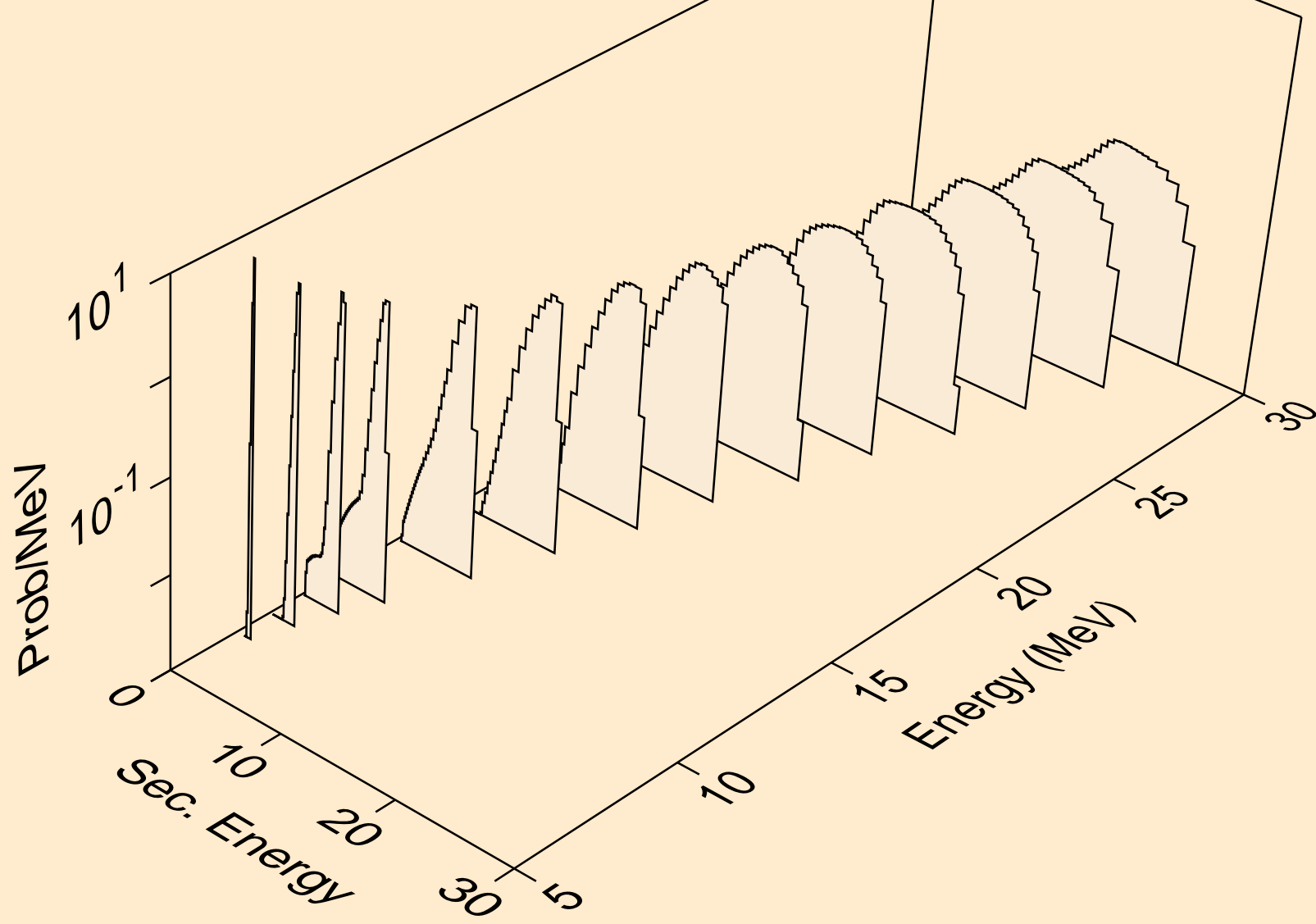

PR144 PROTON ACER TENDL-2021 LIBRARY; T=0.K  
Proton emission for (p,2np)

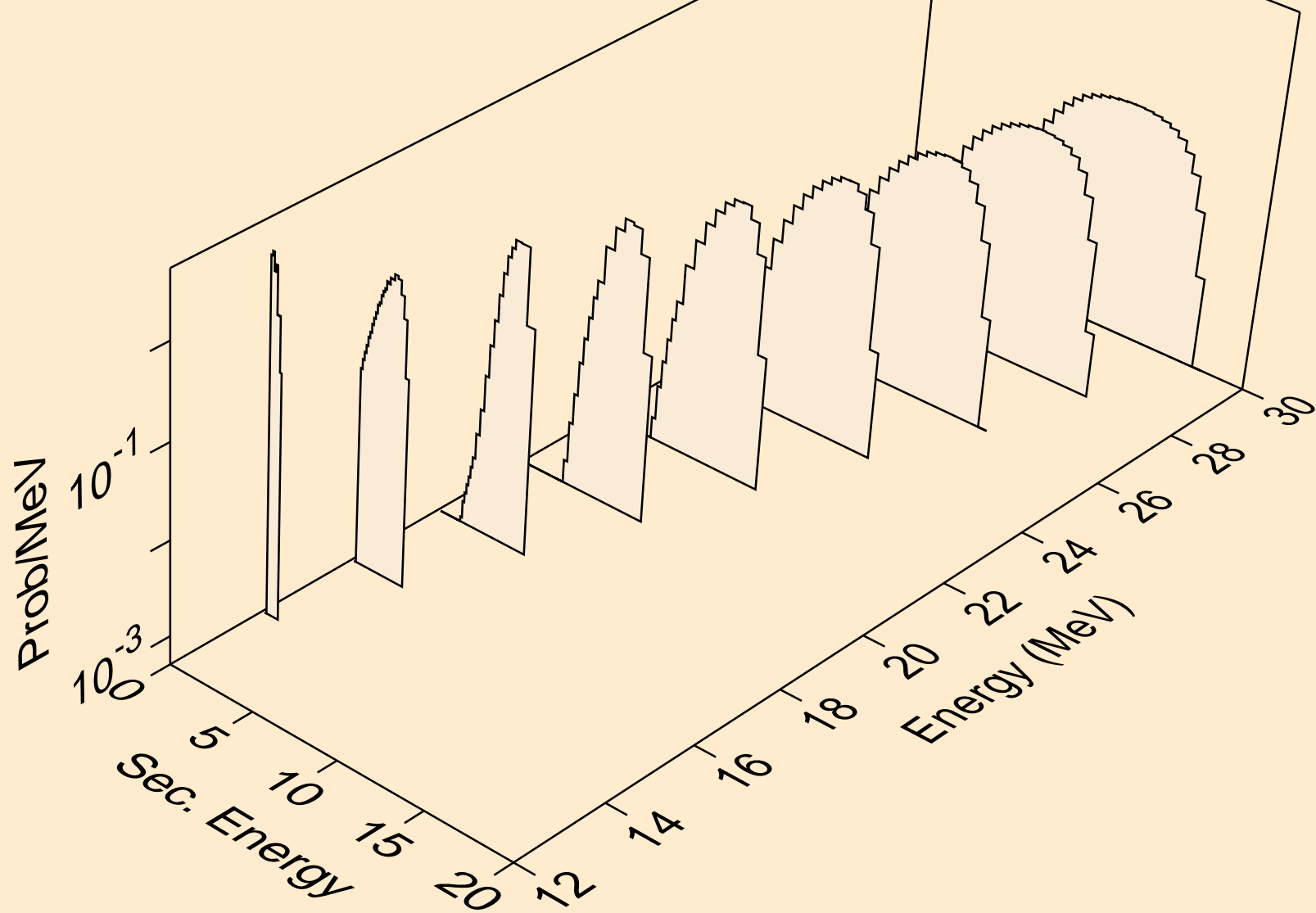

PR144 PROTON ACER TENDL-2021 LIBRARY; T=0.K  
Proton emission for (p,3np)

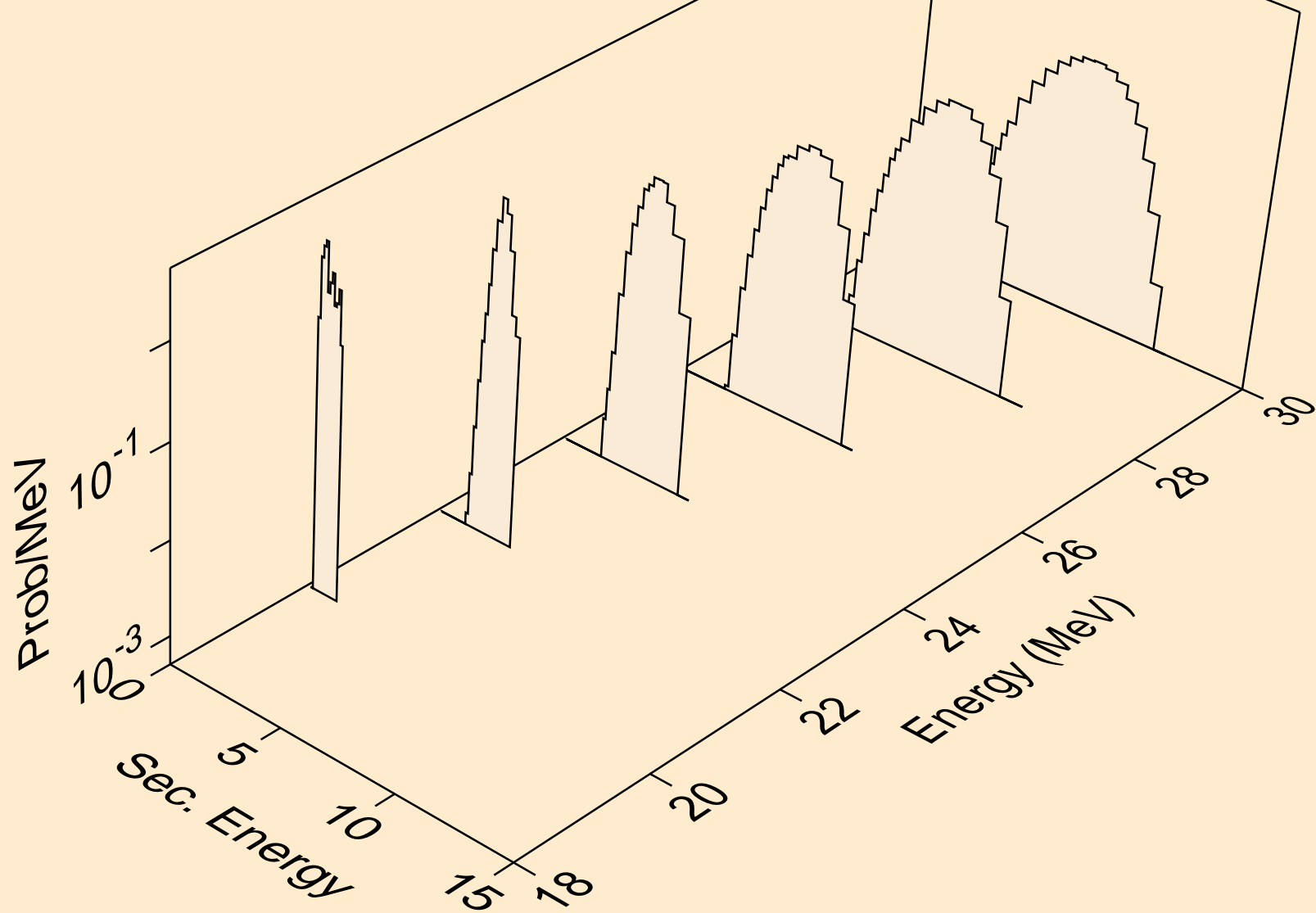

PR144 PROTON ACER TENDL-2021 LIBRARY; T=0.K  
Proton emission for (p,2np)

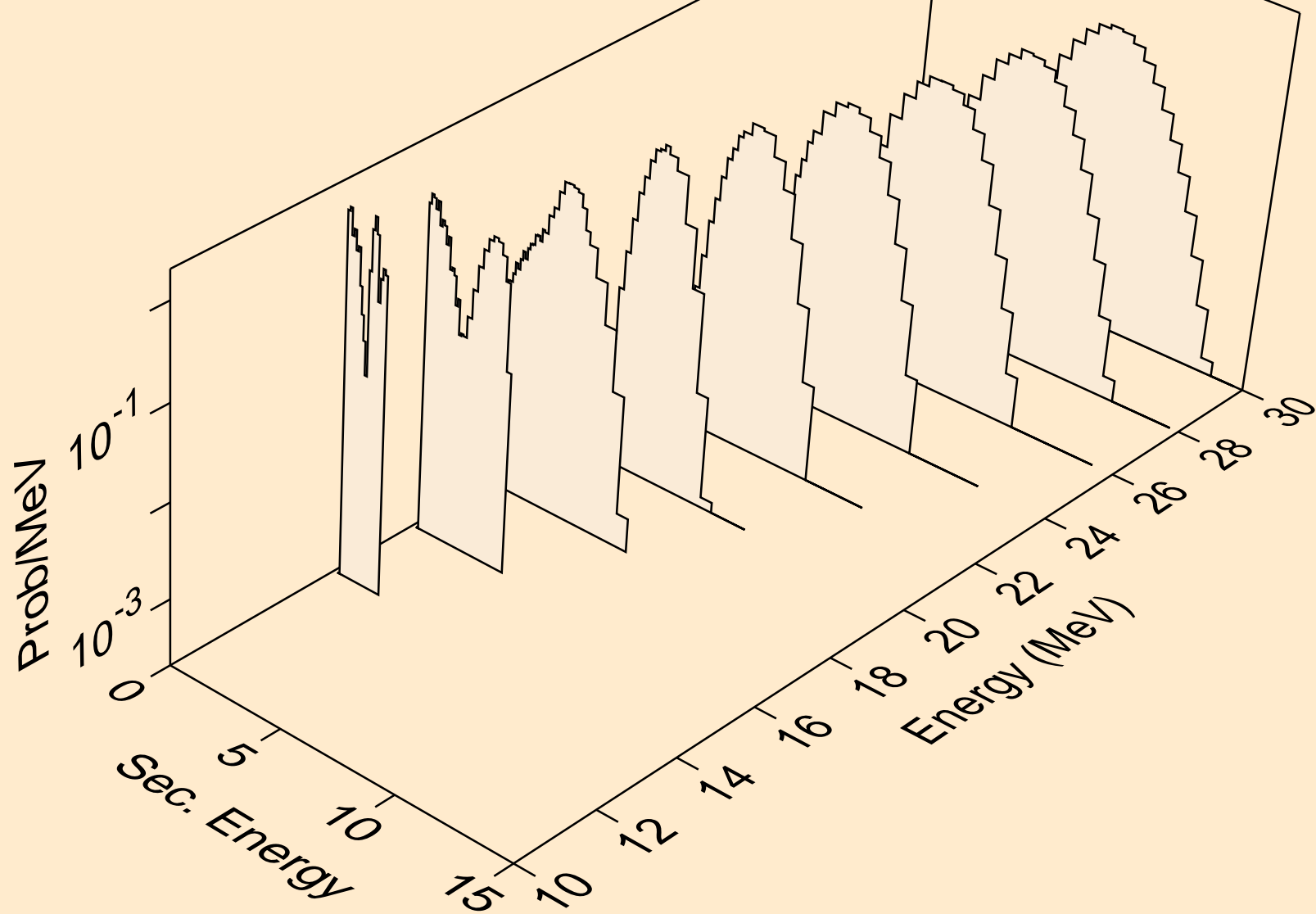

PR144 PROTON ACER TENDL-2021 LIBRARY; T=0.K  
Proton emission for (p,npa)

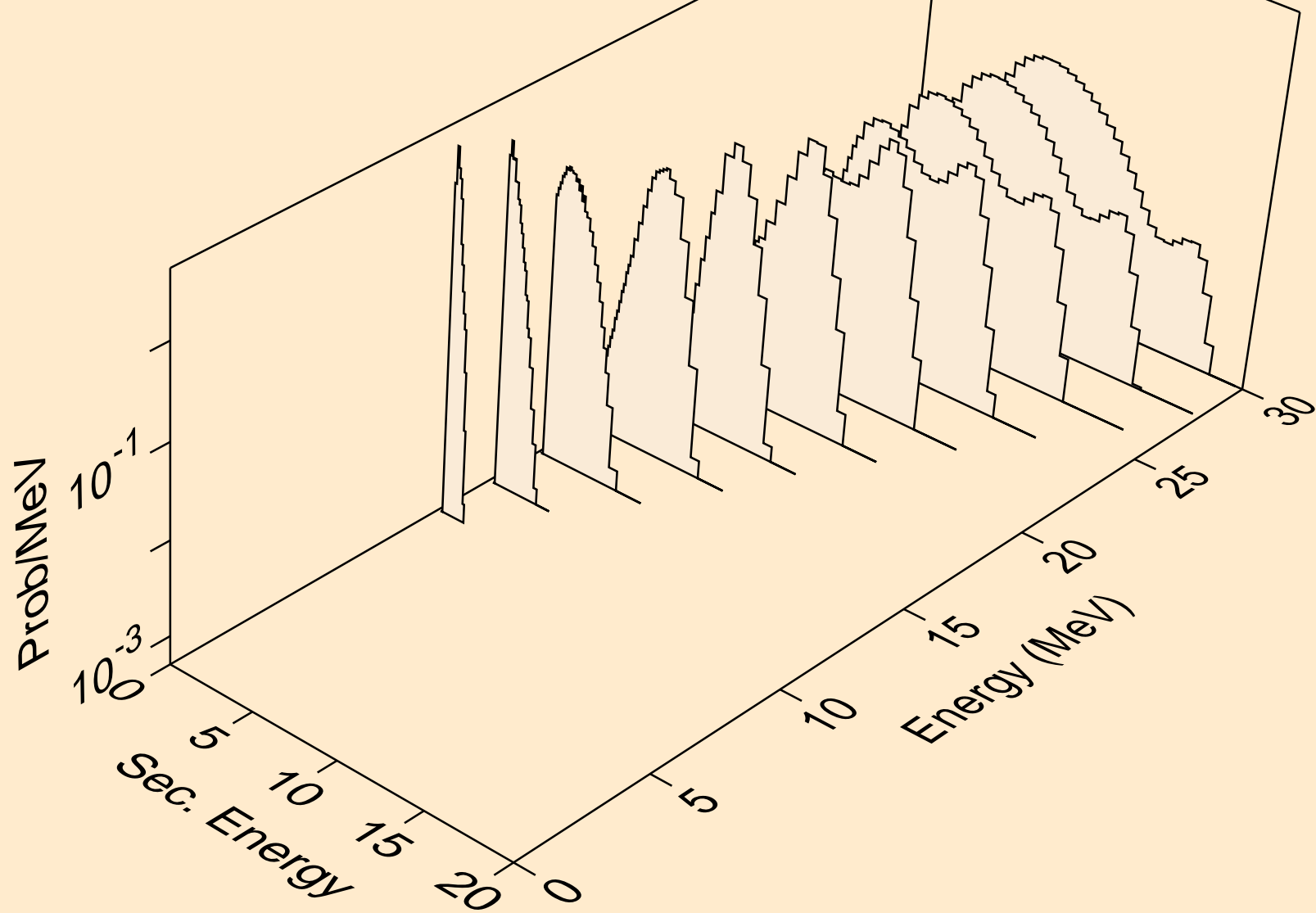

PR144 PROTON ACER TENDL-2021 LIBRARY; T=0.K  
Proton emission for inelastic

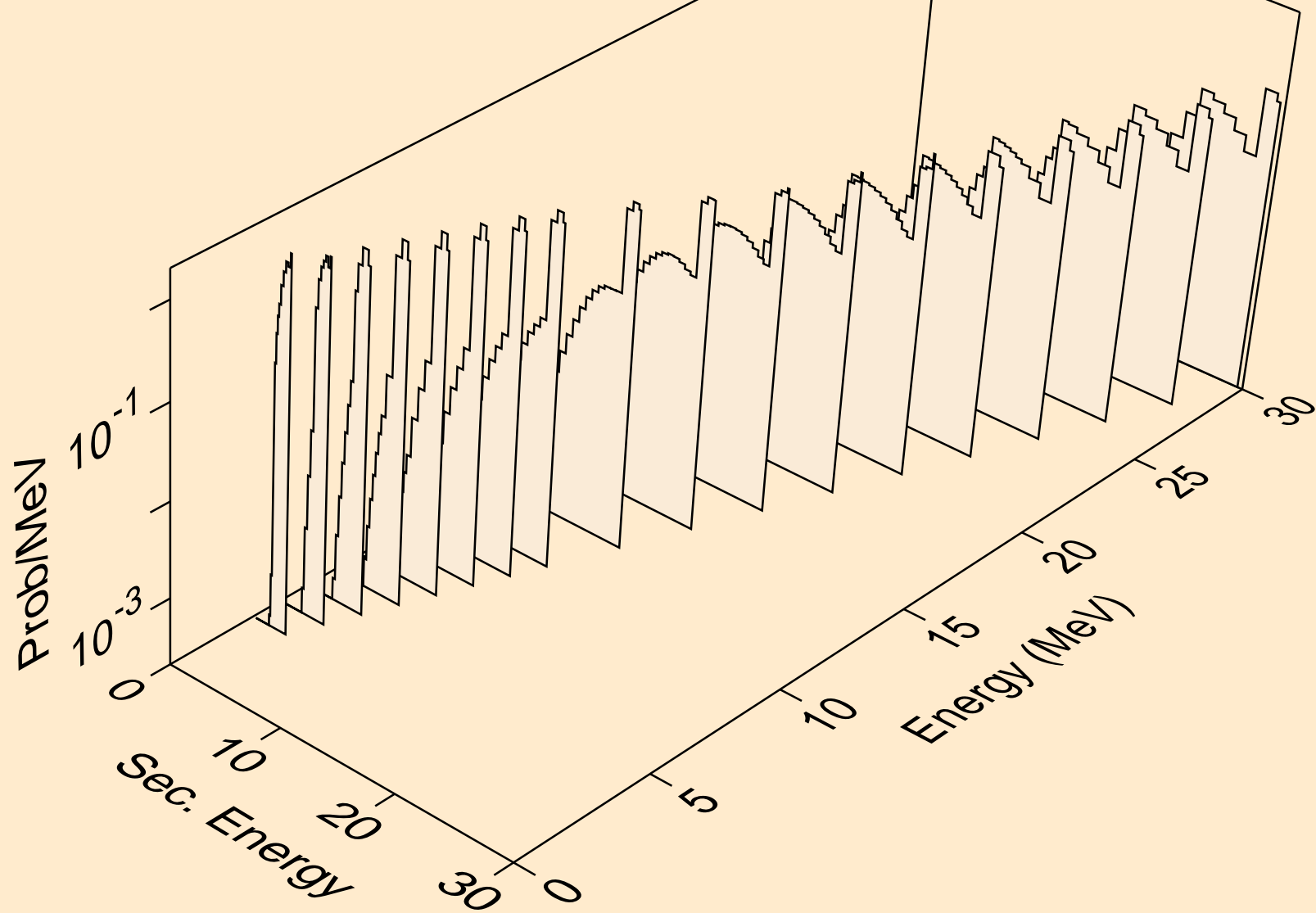



PR144 PROTON ACER TENDL-2021 LIBRARY; T=0.K  
Proton emission for (p,2p)

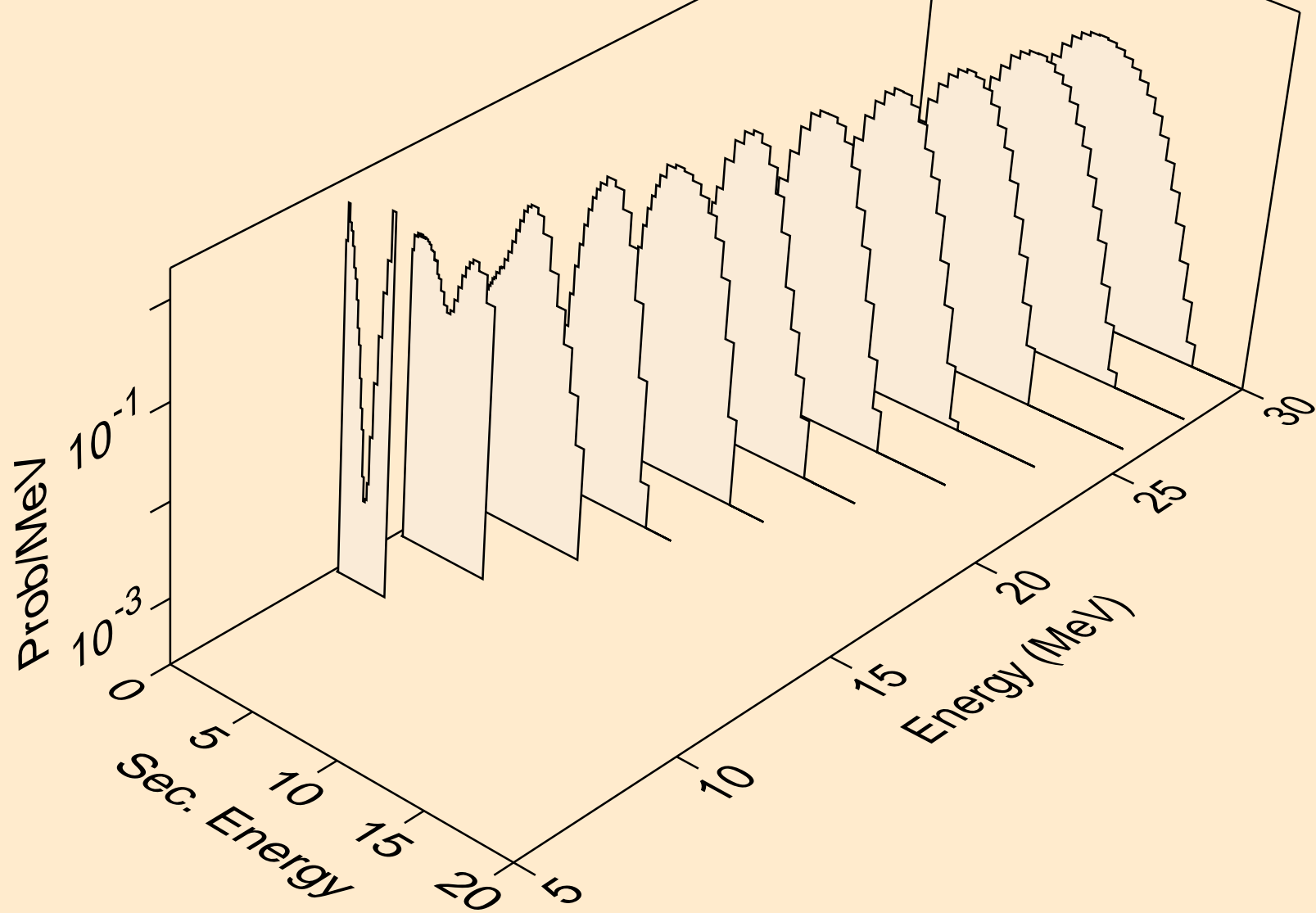

PR144 PROTON ACER TENDL-2021 LIBRARY; T=0.K  
Proton emission for (p,pa)

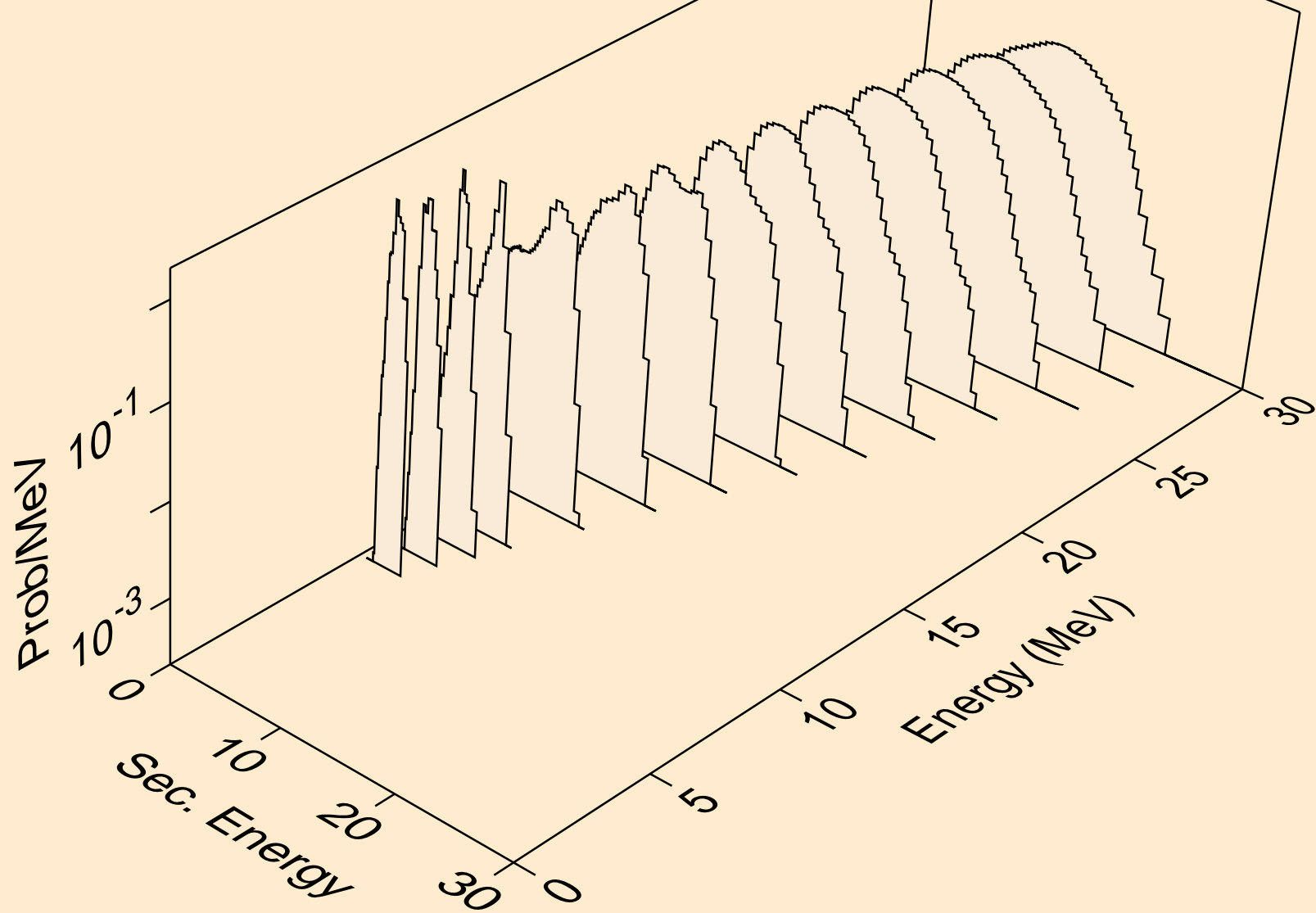

PR144 PROTON ACER TENDL-2021 LIBRARY; T=0.K  
Proton emission for (p,pd)

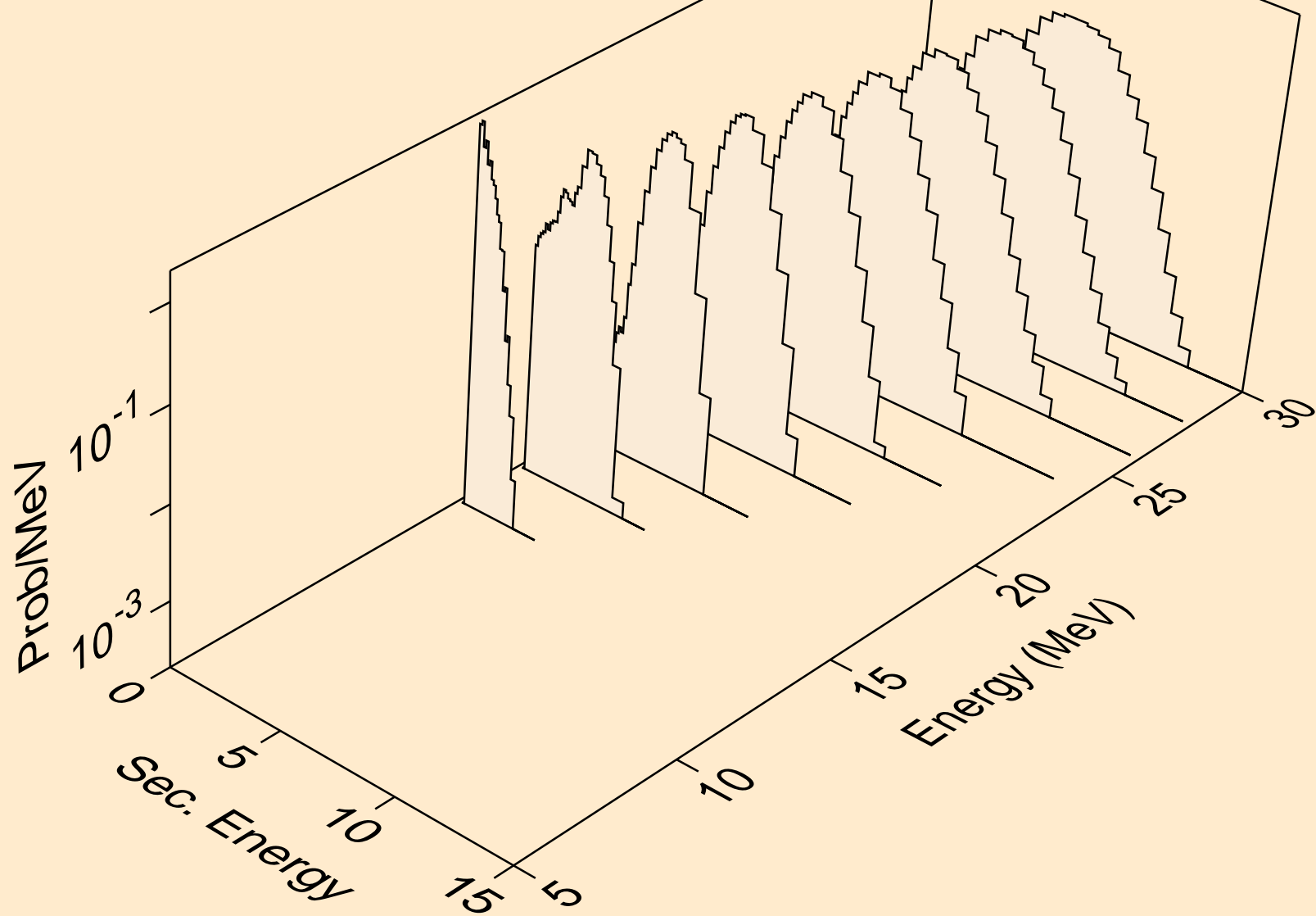

PR144 PROTON ACER TENDL-2021 LIBRARY; T=0.K  
Proton emission for (p,pt)

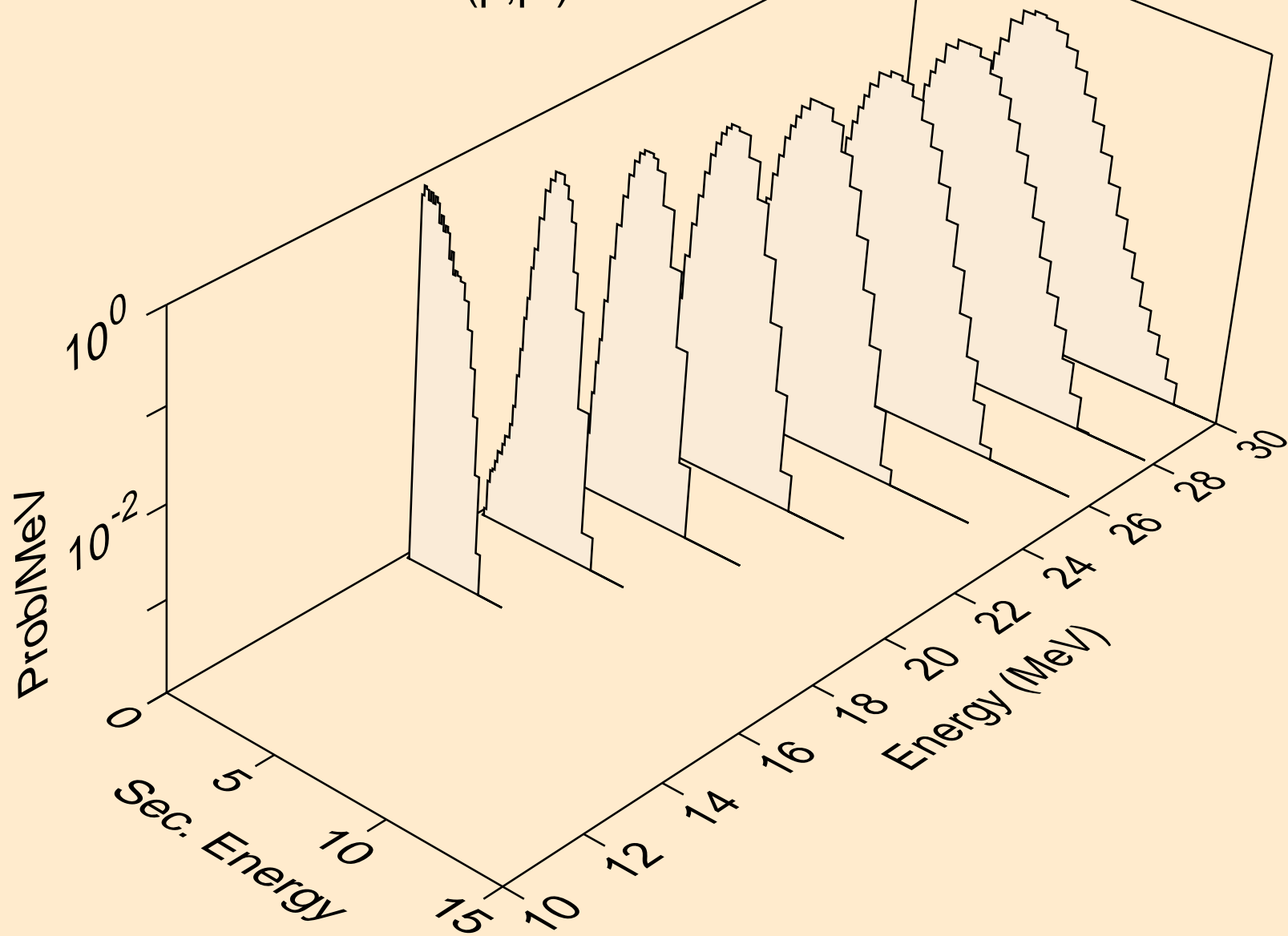

PR144 PROTON ACER TENDL-2021 LIBRARY; T=0.K  
Photon emission for (z,n)

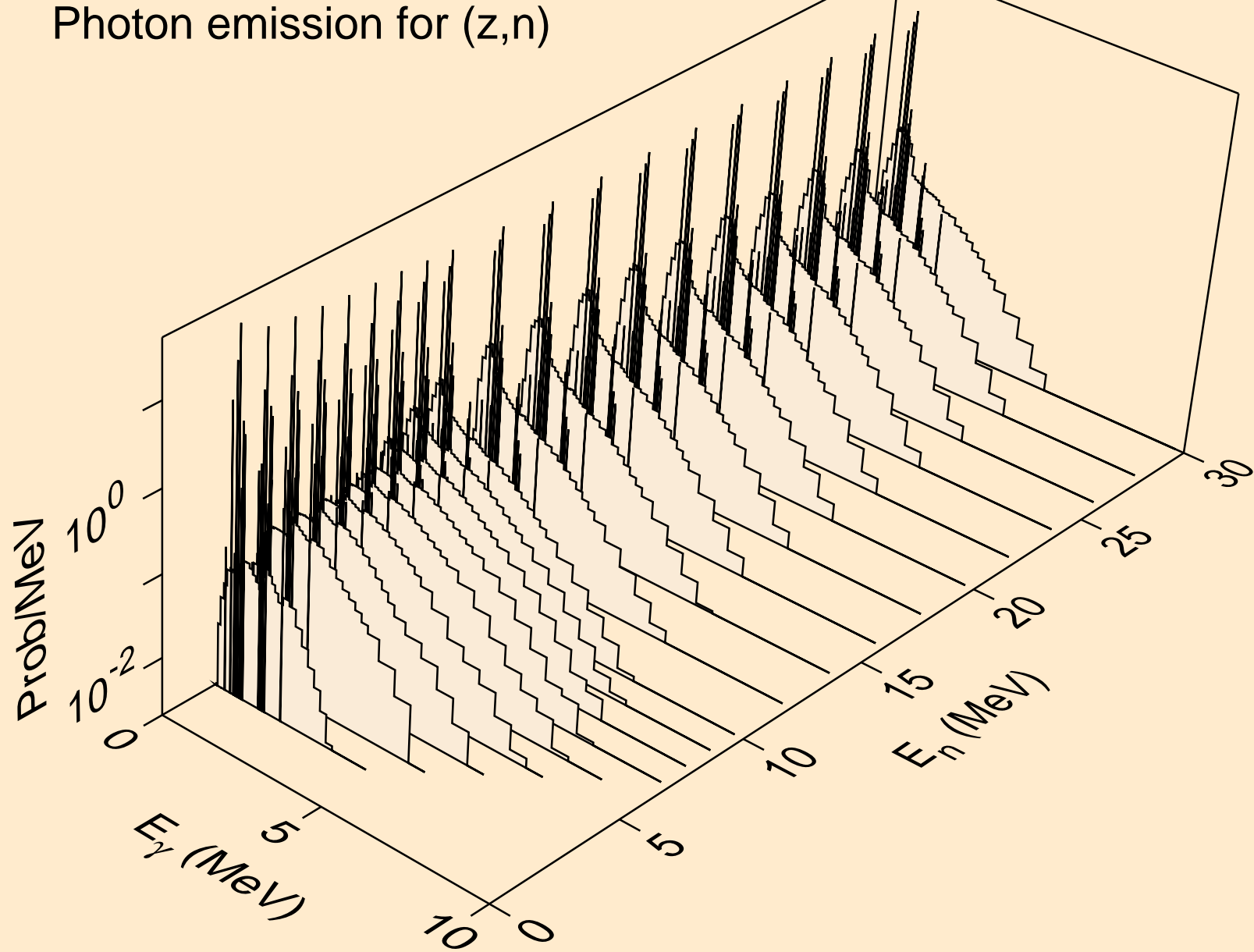

PR144 PROTON ACER TENDL-2021 LIBRARY; T=0.K  
Photon emission for (n,x)

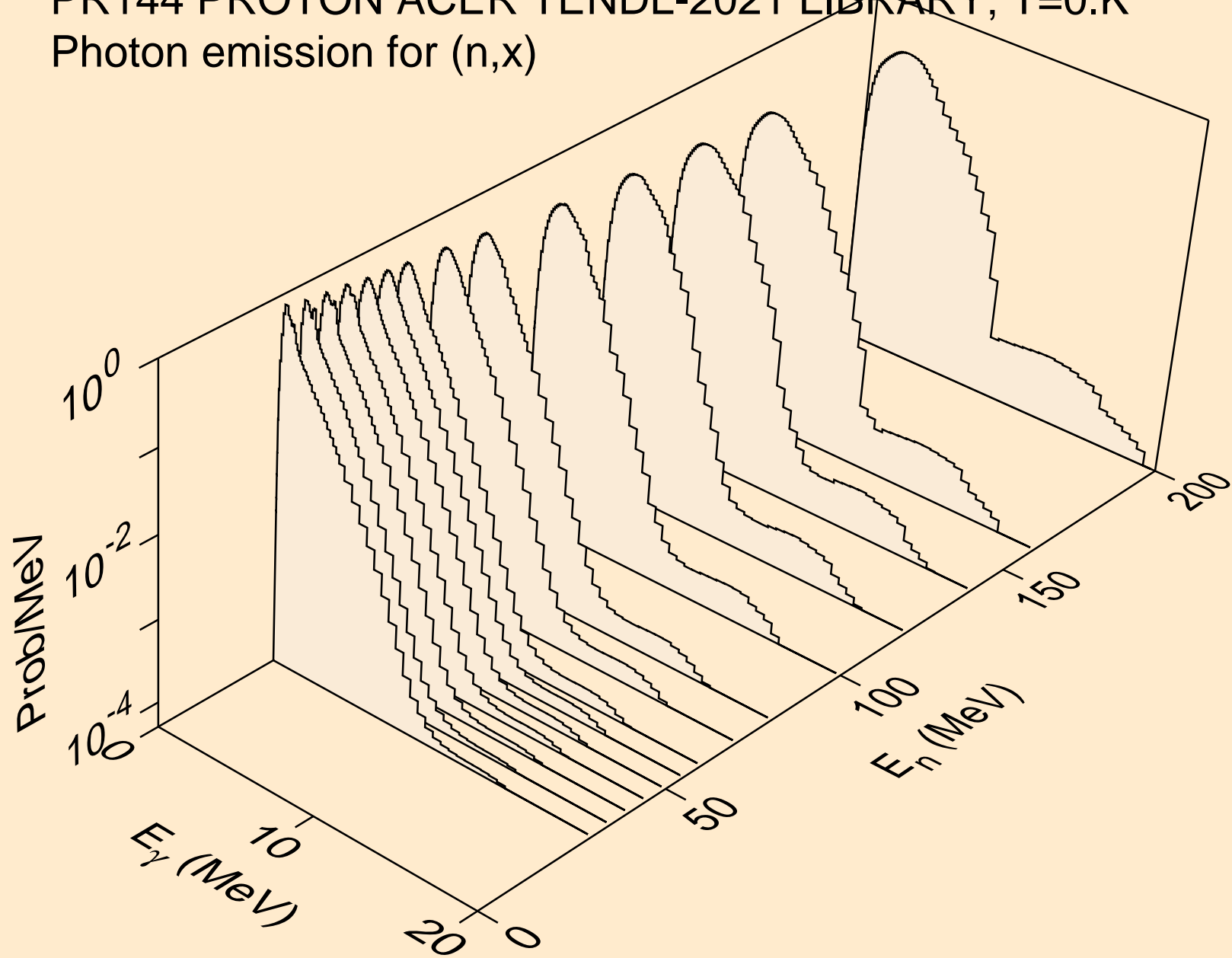

PR144 PROTON ACER TENDL-2021 LIBRARY; T=0.K  
Photon emission for (n,2nd)

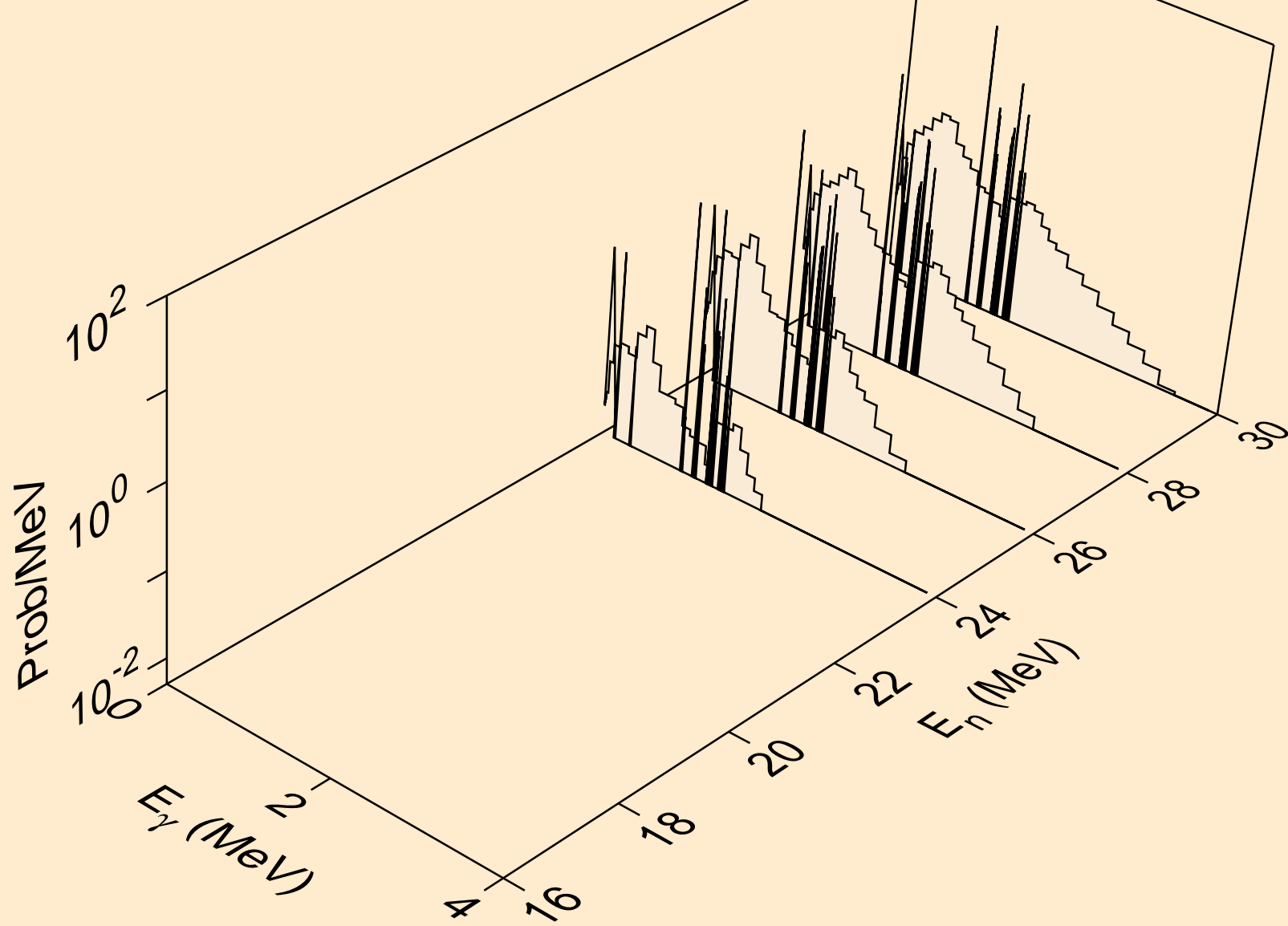

PR144 PROTON ACER TENDL-2021 LIBRARY; T=0.K  
Photon emission for (n,2n)

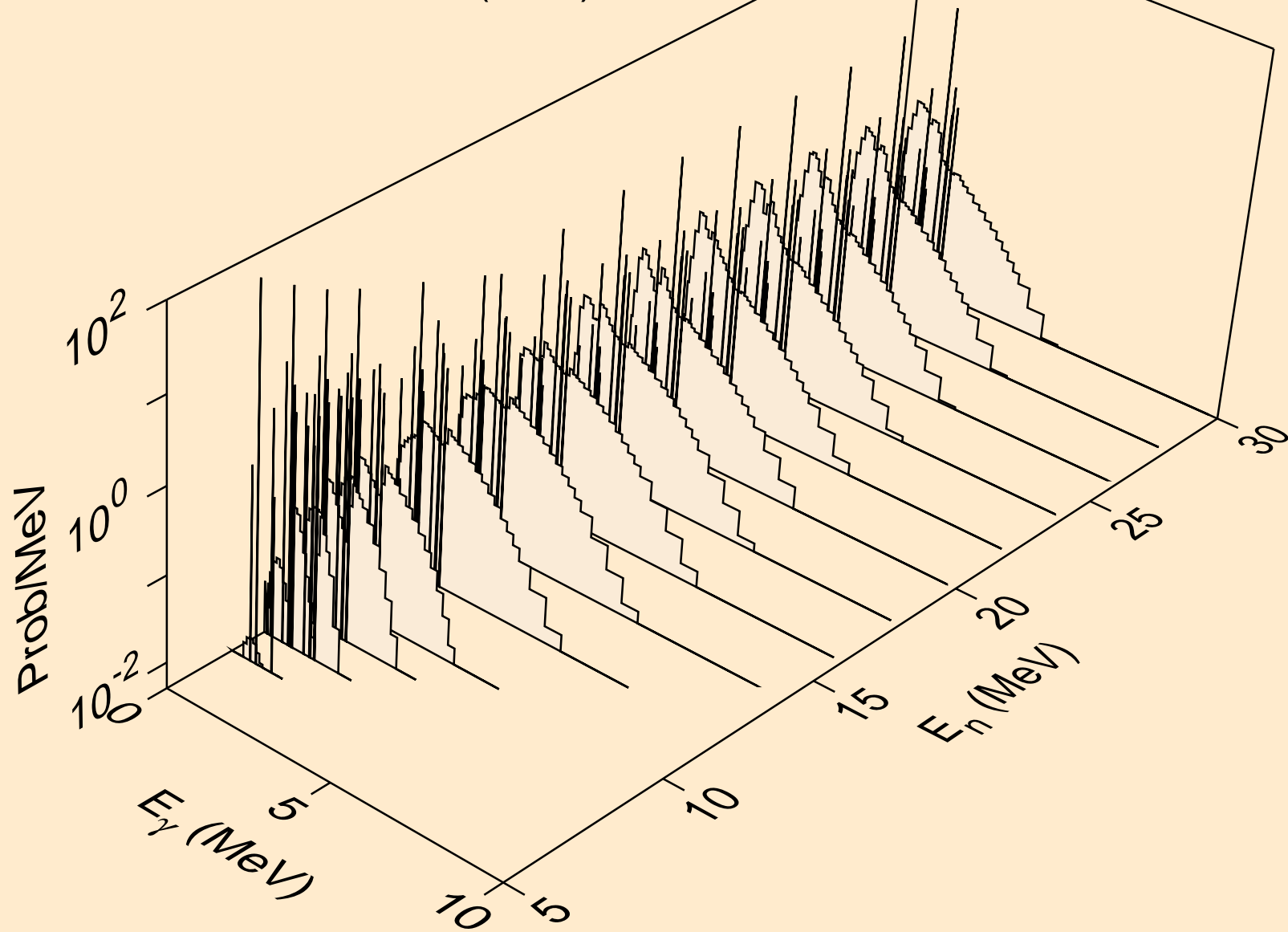



PR144 PROTON ACER TENDL-2021 LIBRARY; T=0.K  
Photon emission for (n,3n)

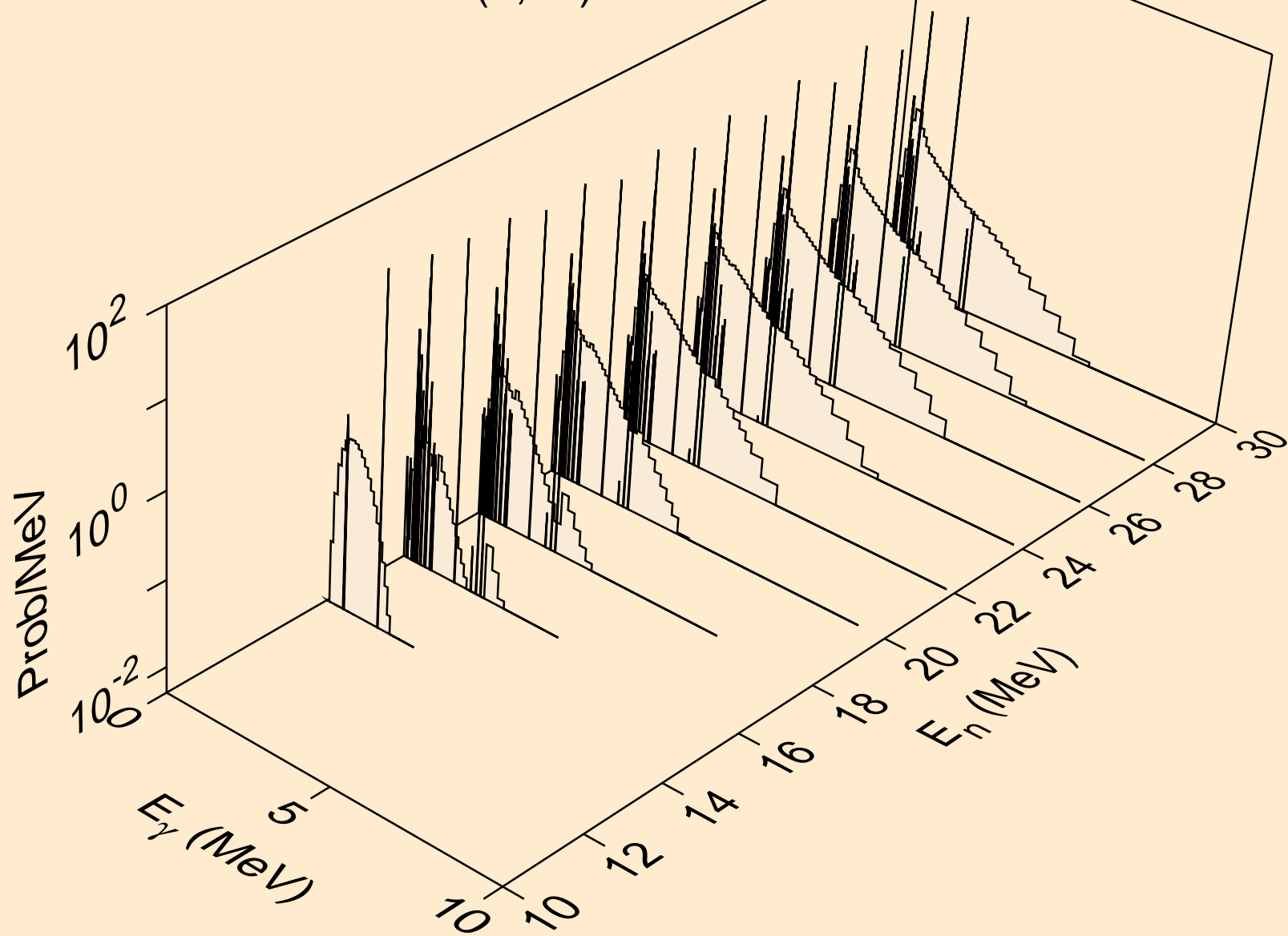

PR144 PROTON ACER TENDL-2021 LIBRARY; T=0.K  
Photon emission for (n,n\*)a

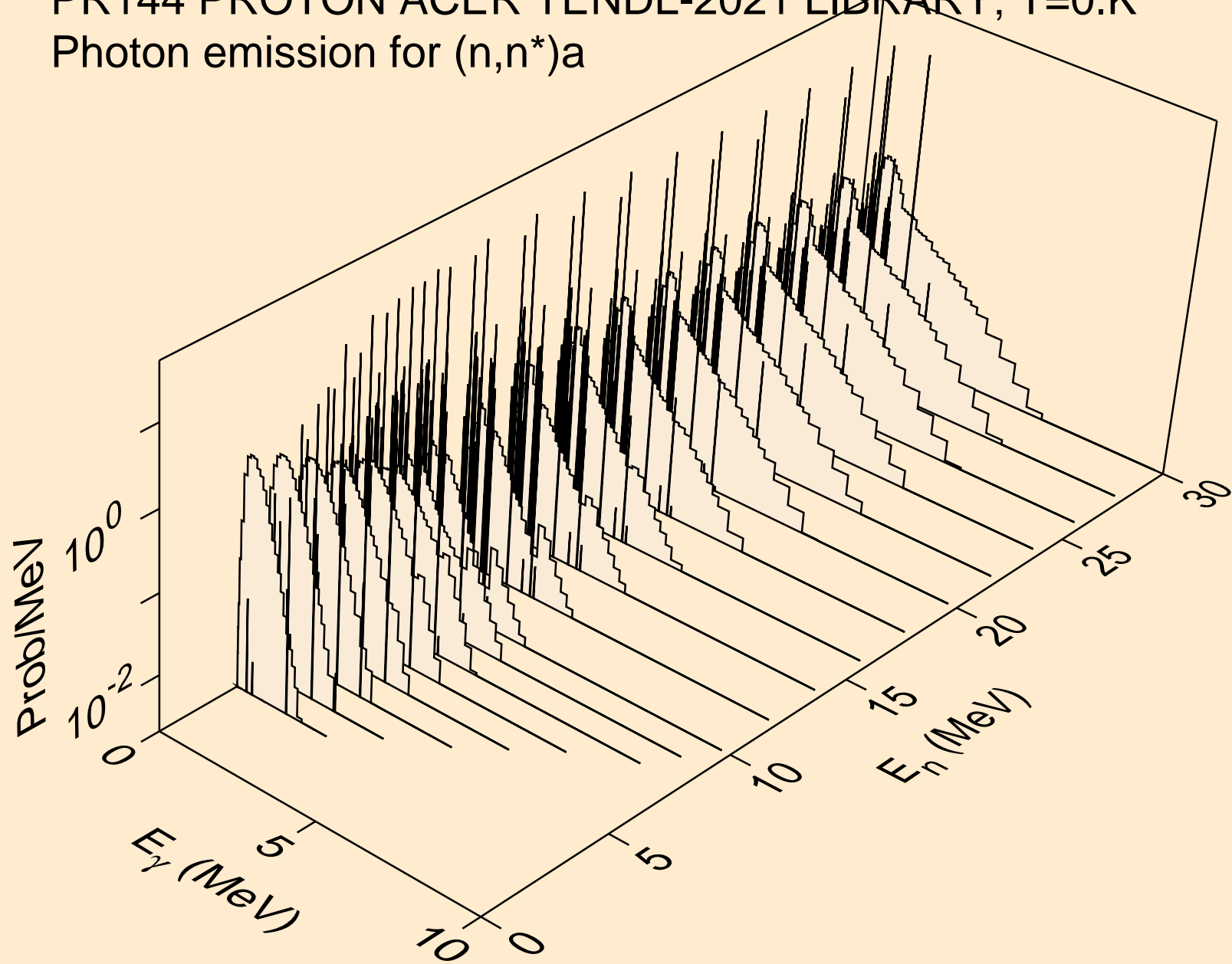

PR144 PROTON ACER TENDL-2021 LIBRARY; T=0.K  
Photon emission for (n,2n)a

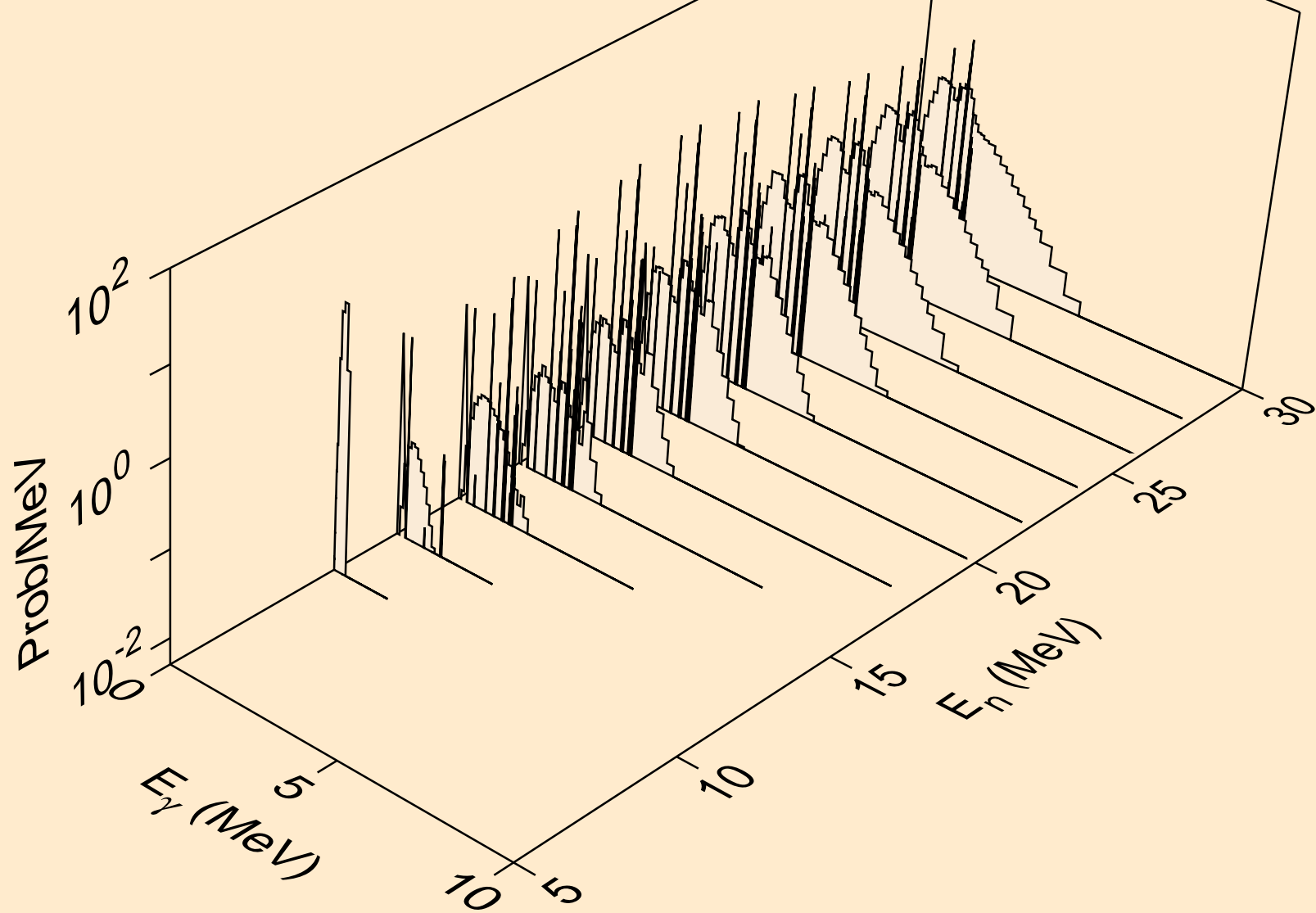

PR144 PROTON ACER TENDL-2021 LIBRARY; T=0.K  
Photon emission for (n,3n)a

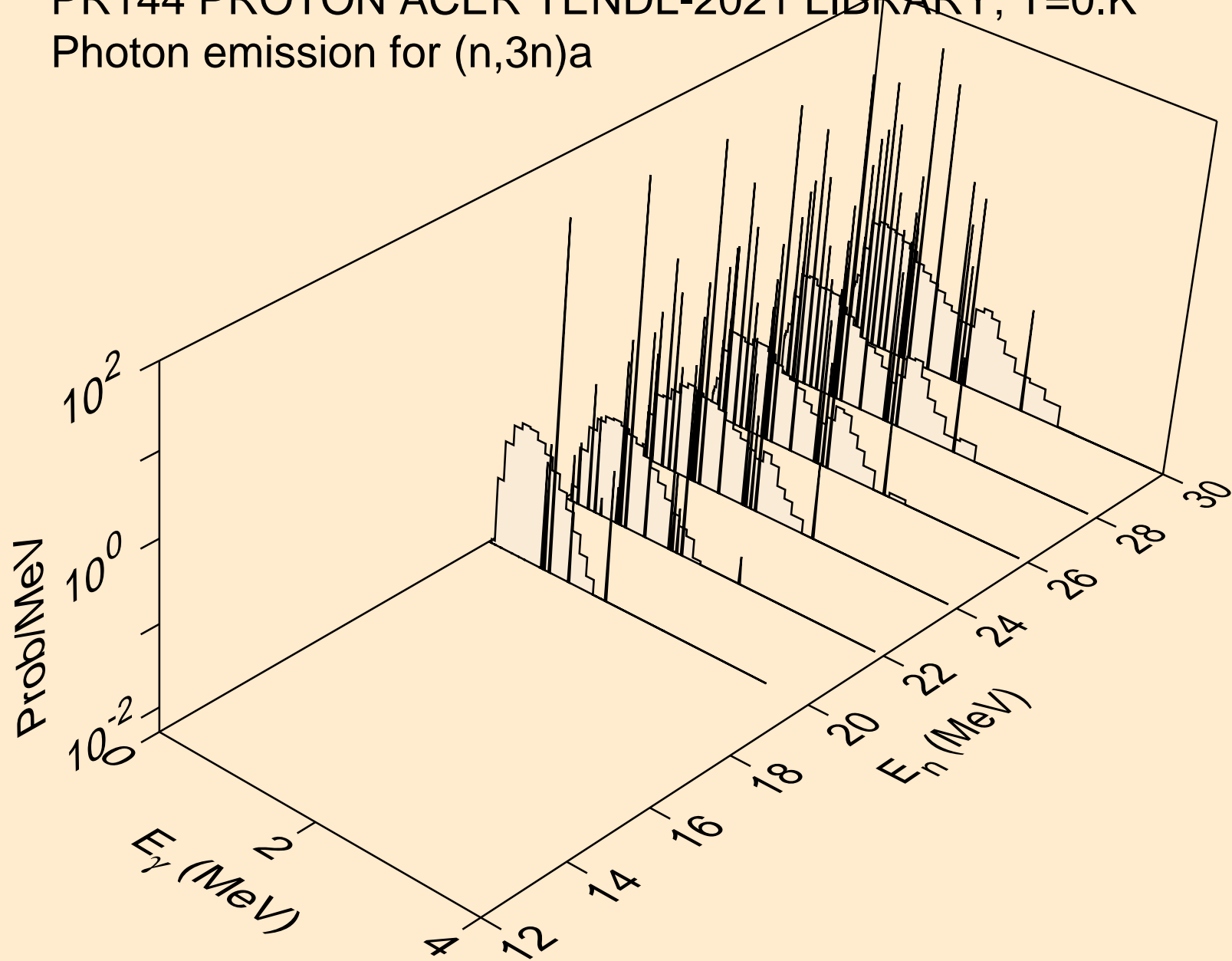

PR144 PROTON ACER TENDL-2021 LIBRARY; T=0.K  
Photon emission for (n,n\*)p

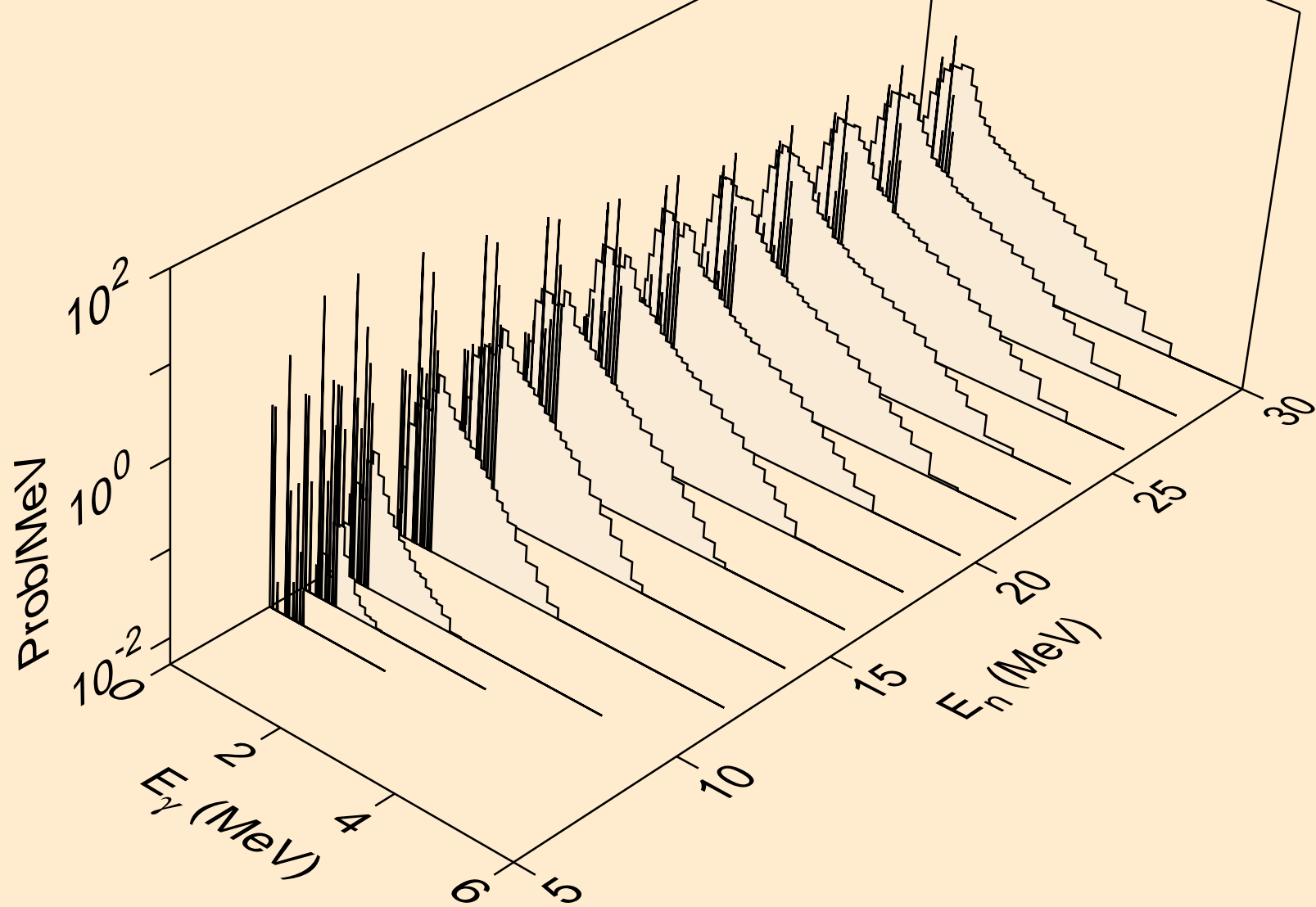

PR144 PROTON ACER TENDL-2021 LIBRARY; T=0.K  
Photon emission for (n,n\*)2a

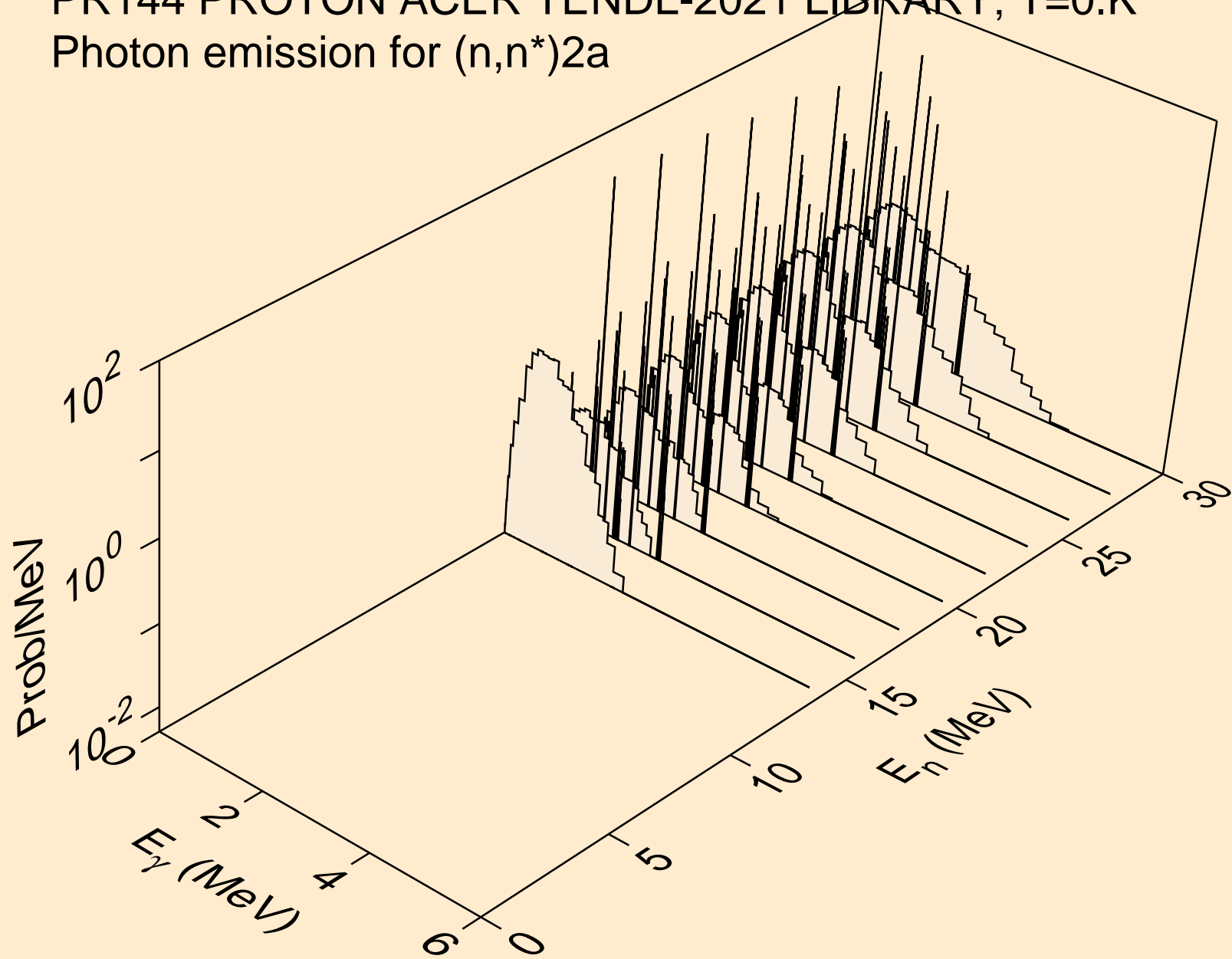

PR144 PROTON ACER TENDL-2021 LIBRARY; T=0.K  
Photon emission for (n,n\*)d

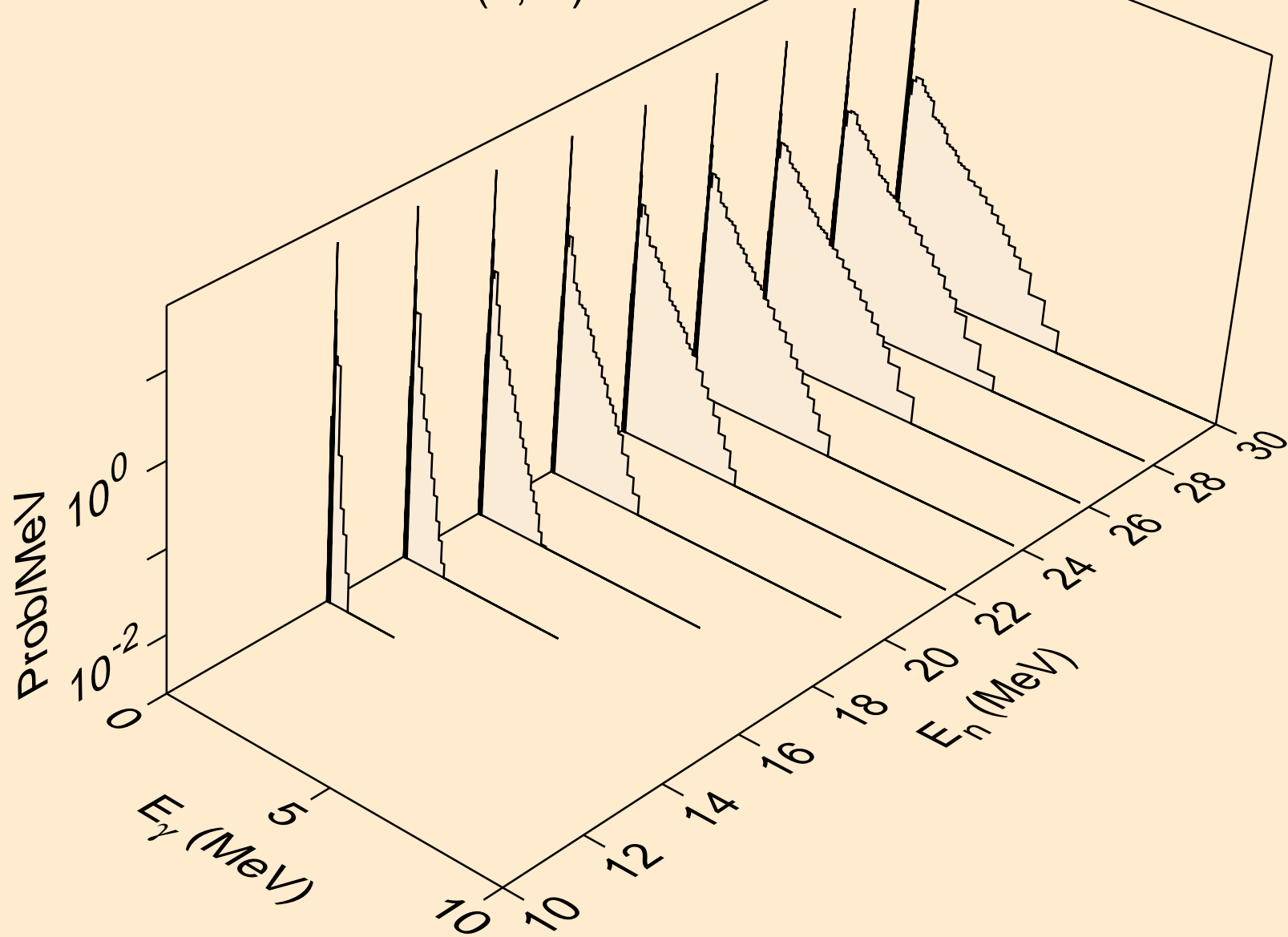

PR144 PROTON ACER TENDL-2021 LIBRARY; T=0.K  
Photon emission for (n,n\*)t

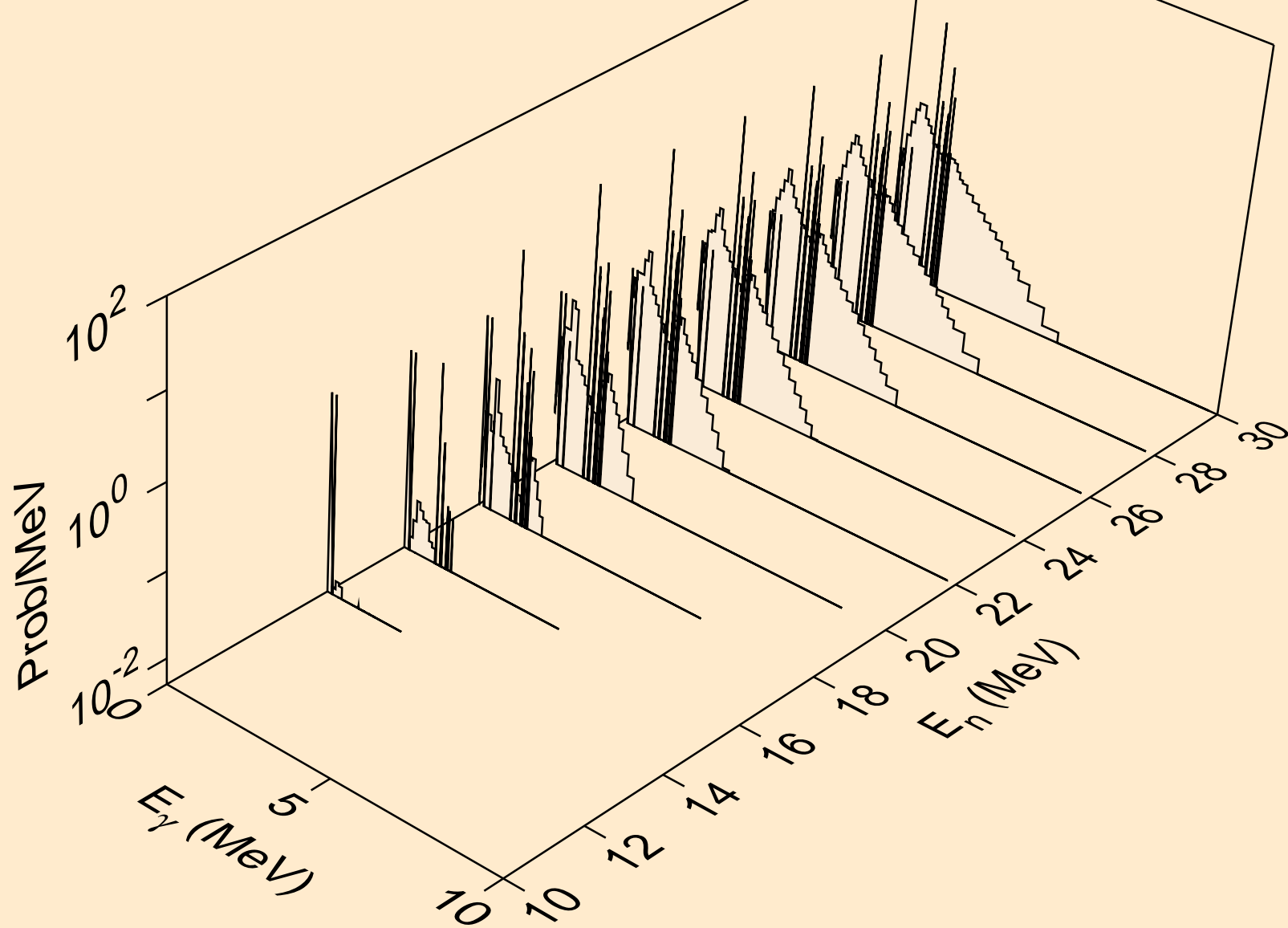



PR144 PROTON ACER TENDL-2021 LIBRARY; T=0.K  
Photon emission for (n,n\*)he3

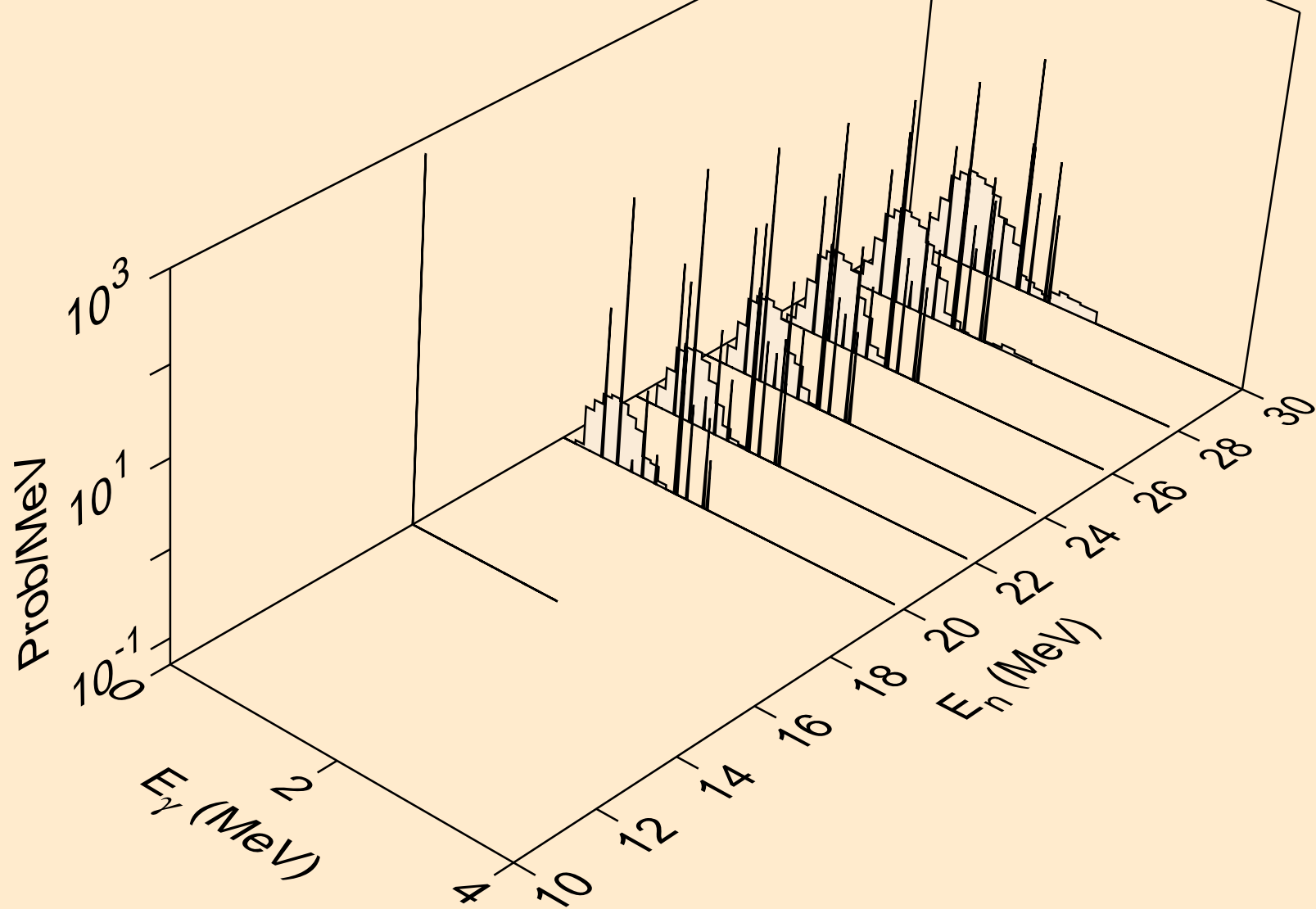

PR144 PROTON ACER TENDL-2021 LIBRARY; T=0.K  
Photon emission for (n,4n)

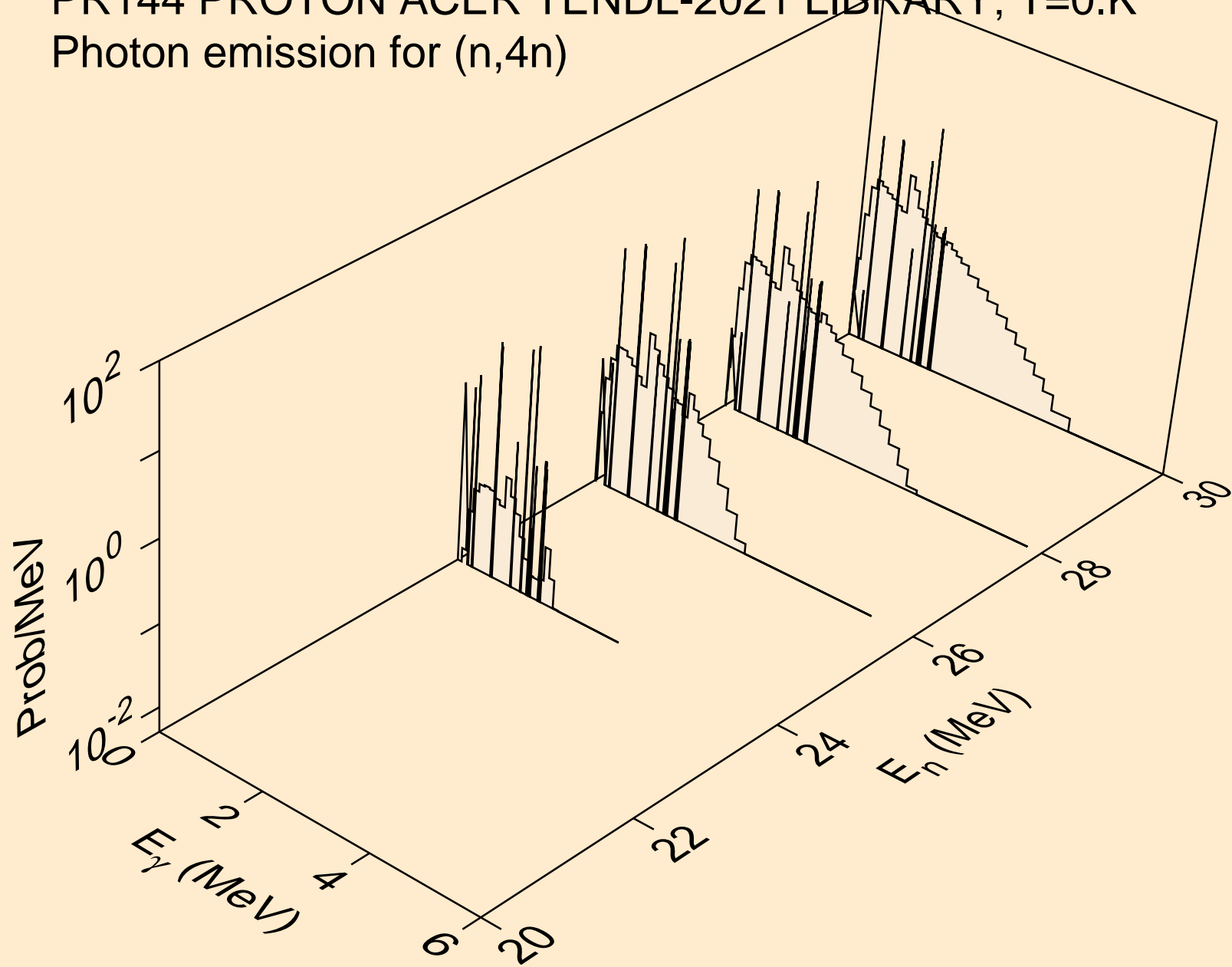

PR144 PROTON ACER TENDL-2021 LIBRARY; T=0.K  
Photon emission for (n,2np)

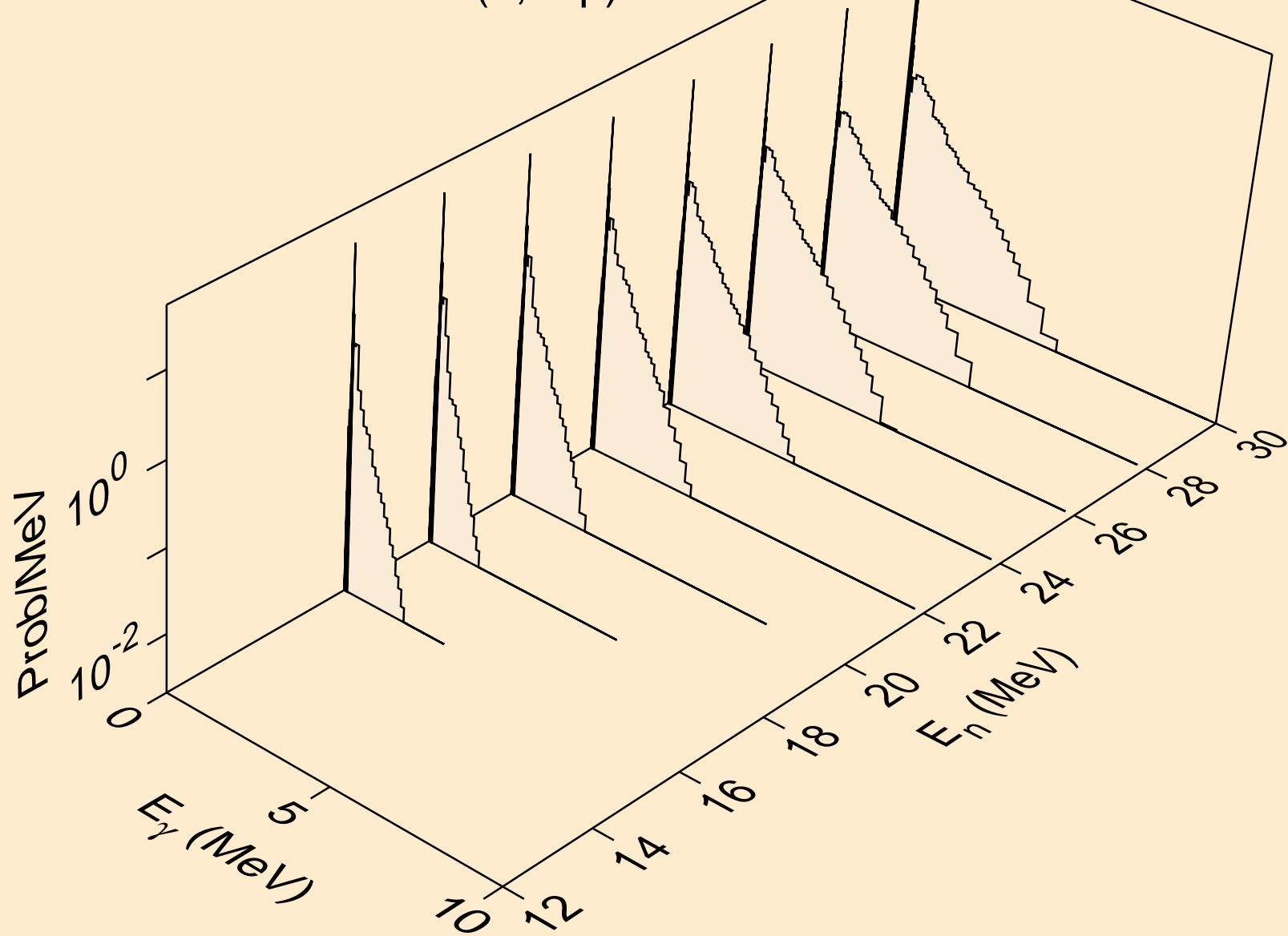

PR144 PROTON ACER TENDL-2021 LIBRARY; T=0.K  
Photon emission for (n,3np)

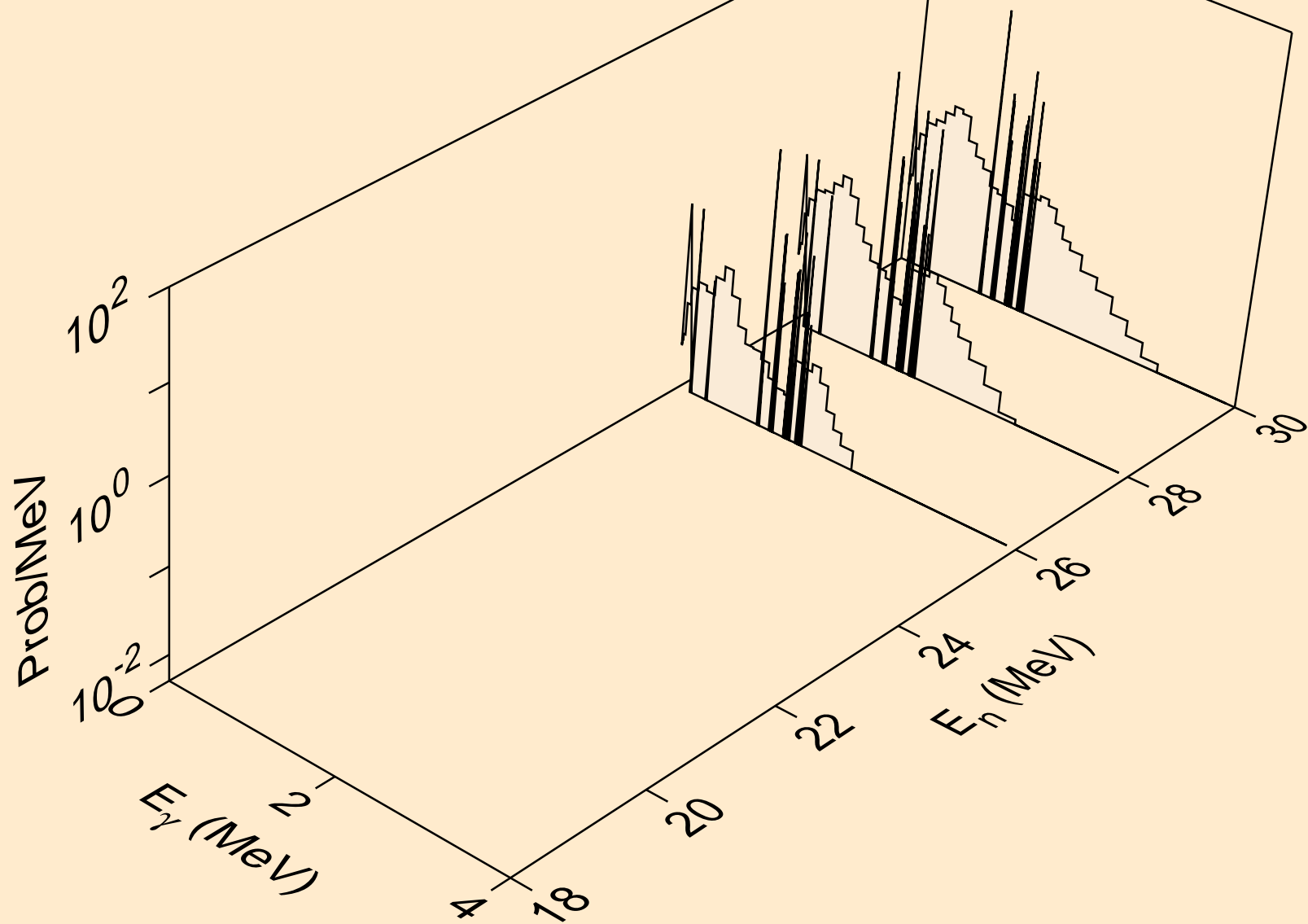

PR144 PROTON ACER TENDL-2021 LIBRARY; T=0.K  
Photon emission for (n,2np)

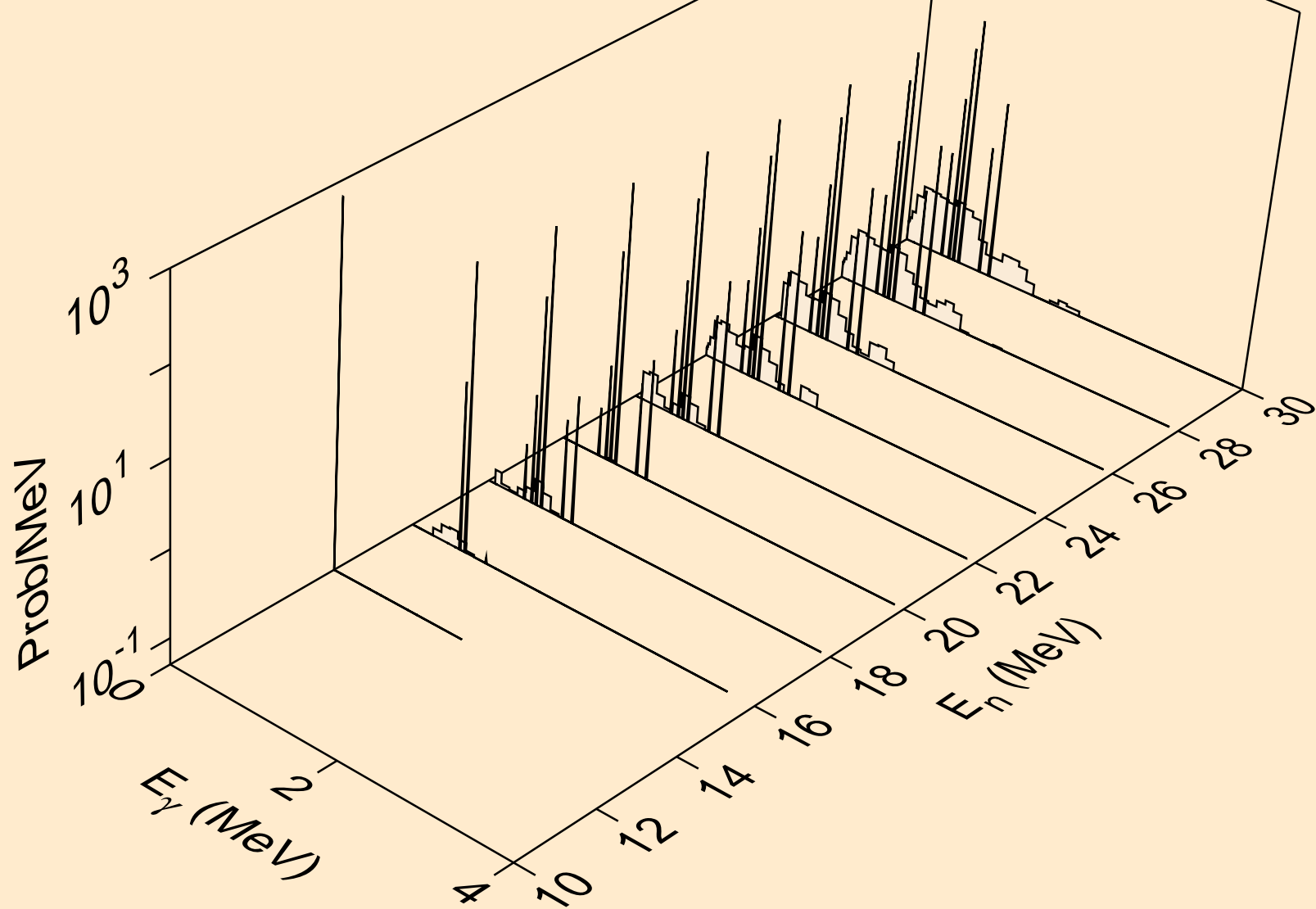

PR144 PROTON ACER TENDL-2021 LIBRARY; T=0.K  
Photon emission for (n,npa)

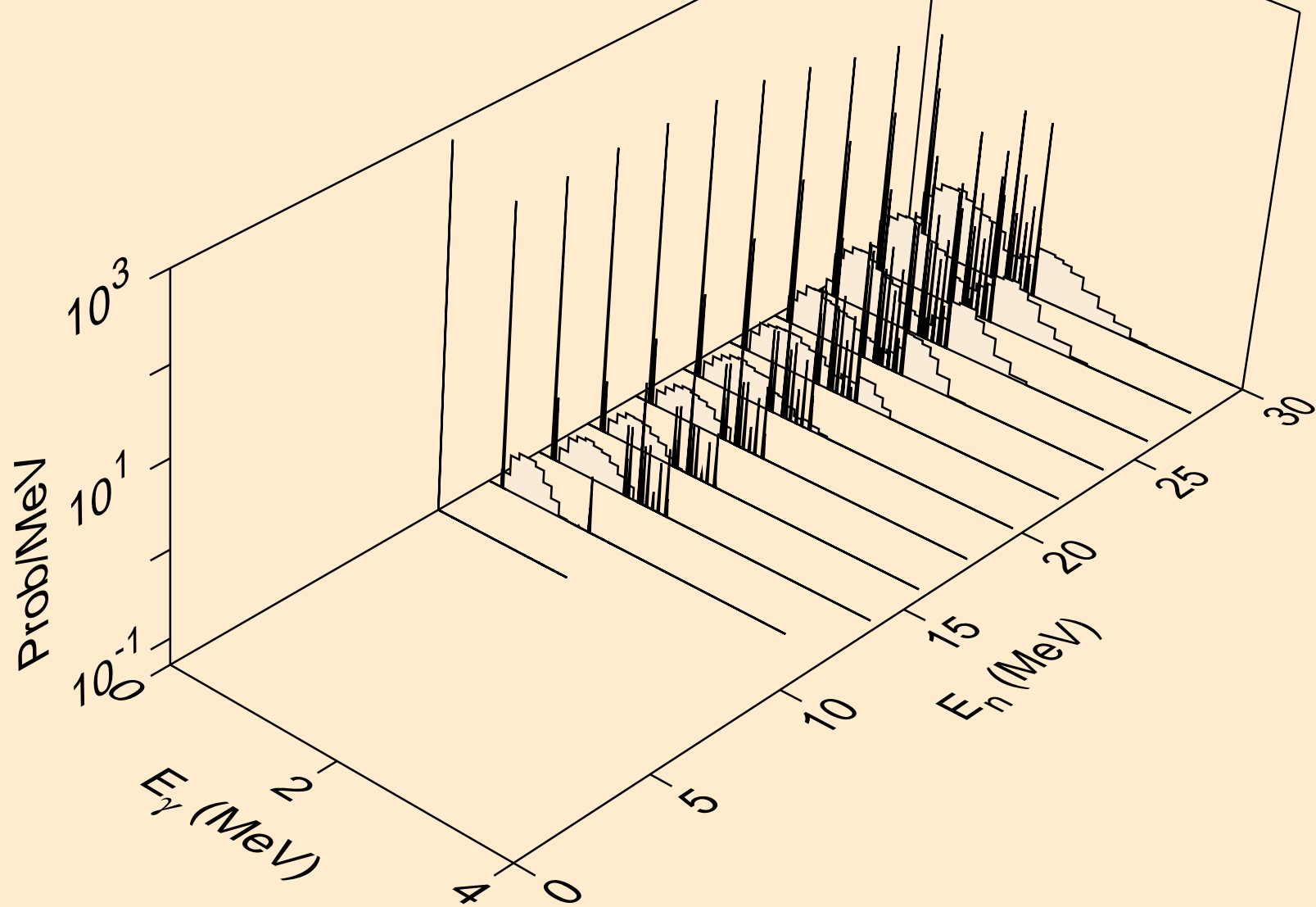

PR144 PROTON ACER TENDL-2021 LIBRARY; T=0.K  
Photon emission for (n,gma)

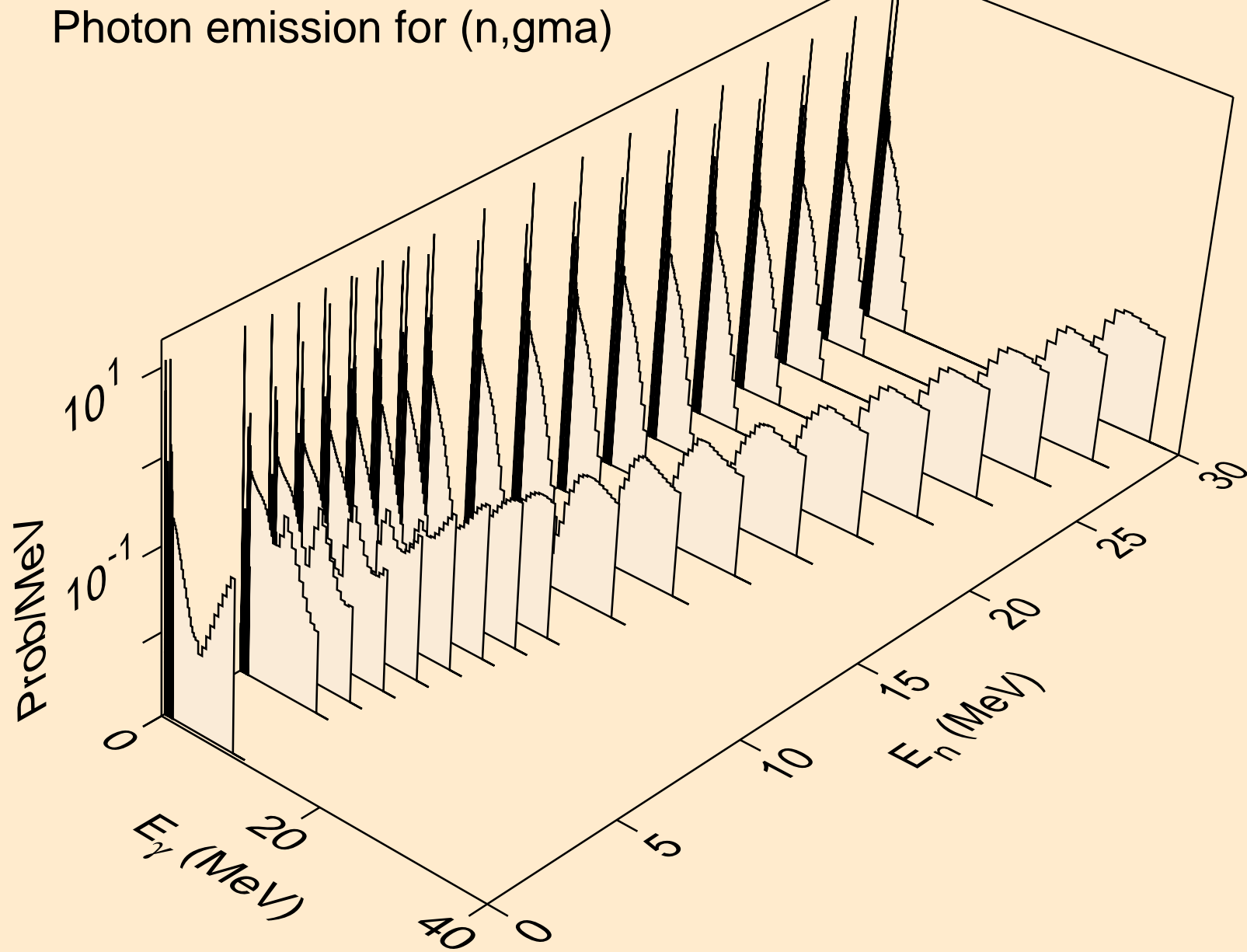

PR144 PROTON ACER TENDL-2021 LIBRARY; T=0.K  
Photon emission for inelastic

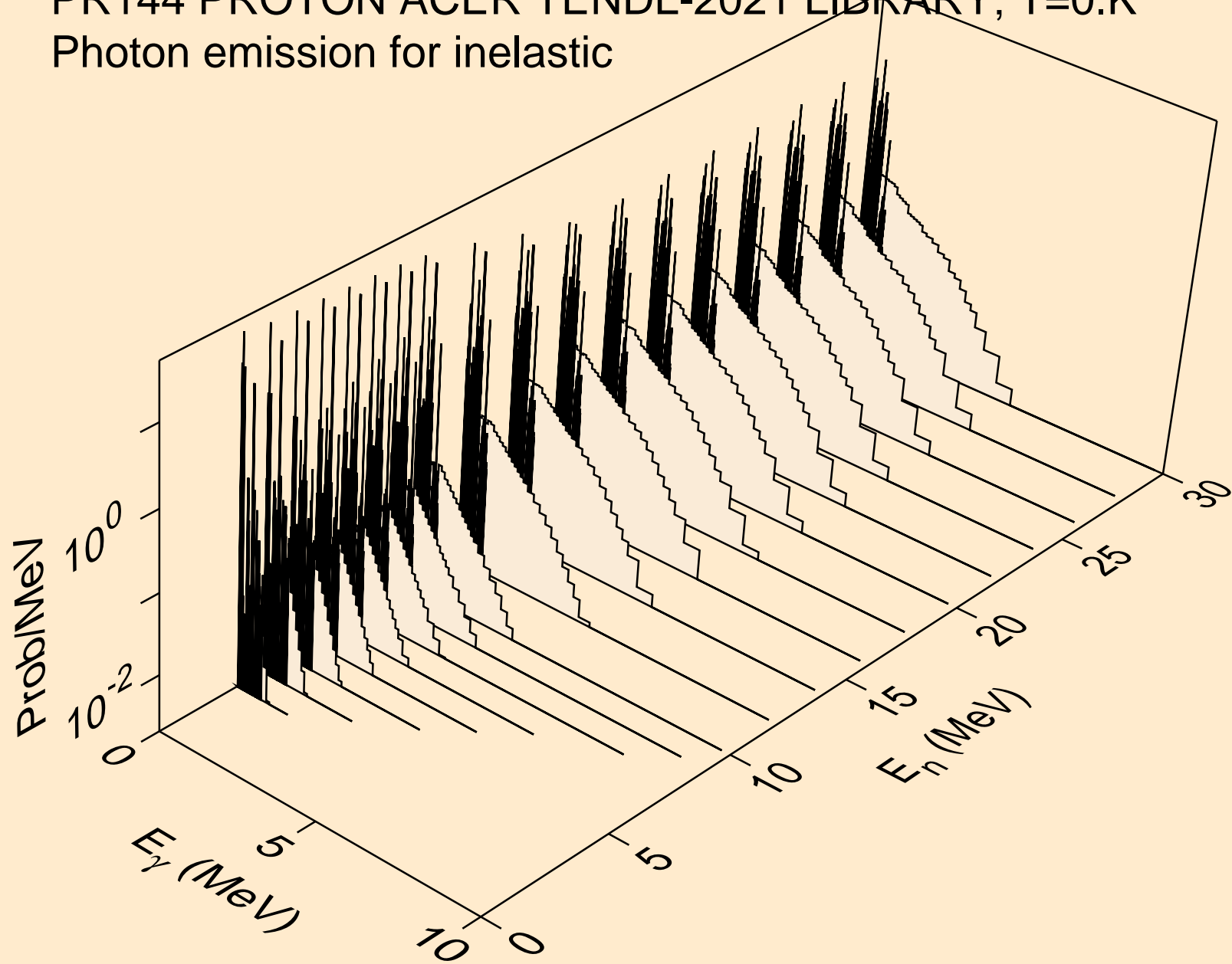



PR144 PROTON ACER TENDL-2021 LIBRARY; T=0.K  
Photon emission for (n,d)

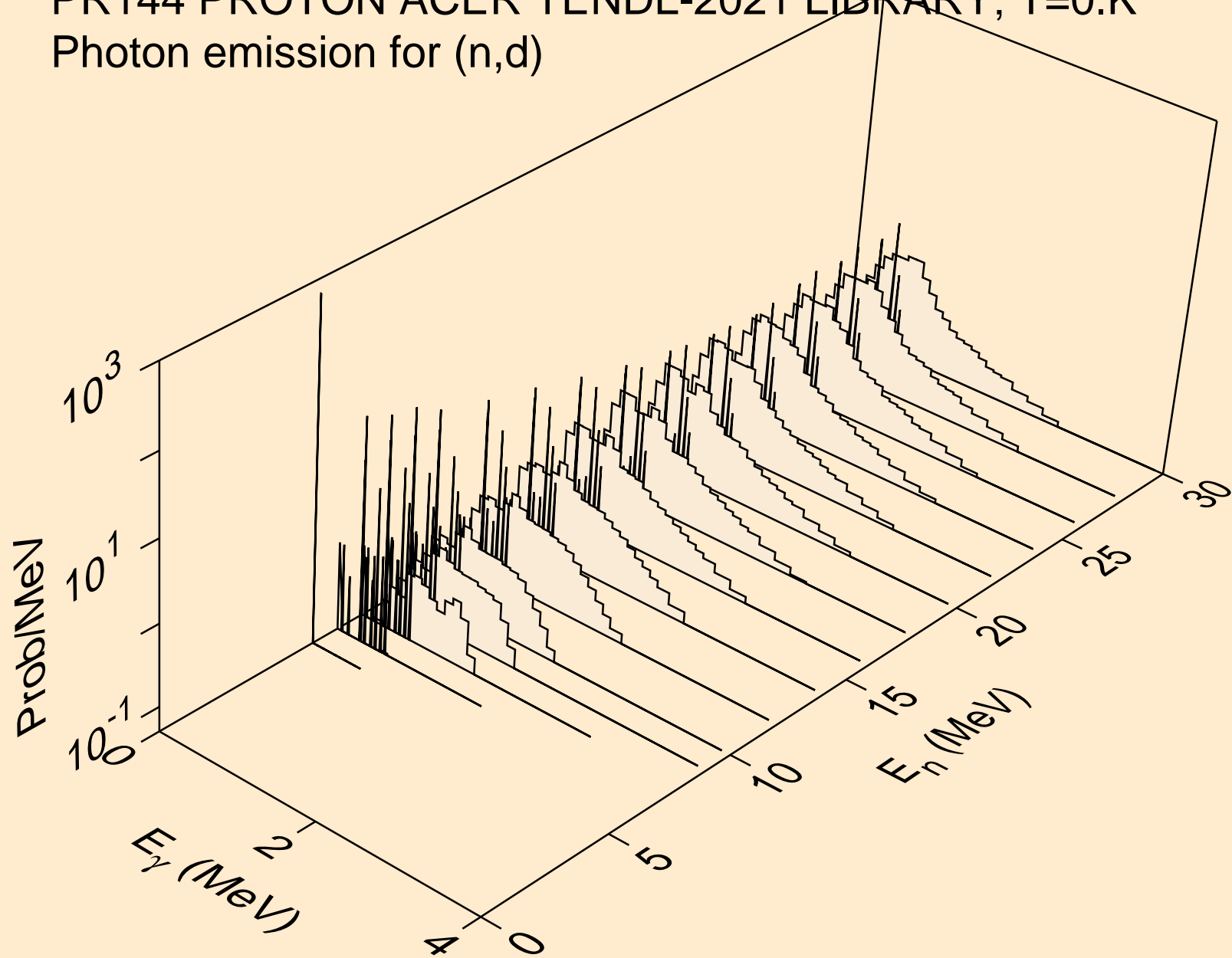

PR144 PROTON ACER TENDL-2021 LIBRARY; T=0.K  
Photon emission for (n,t)

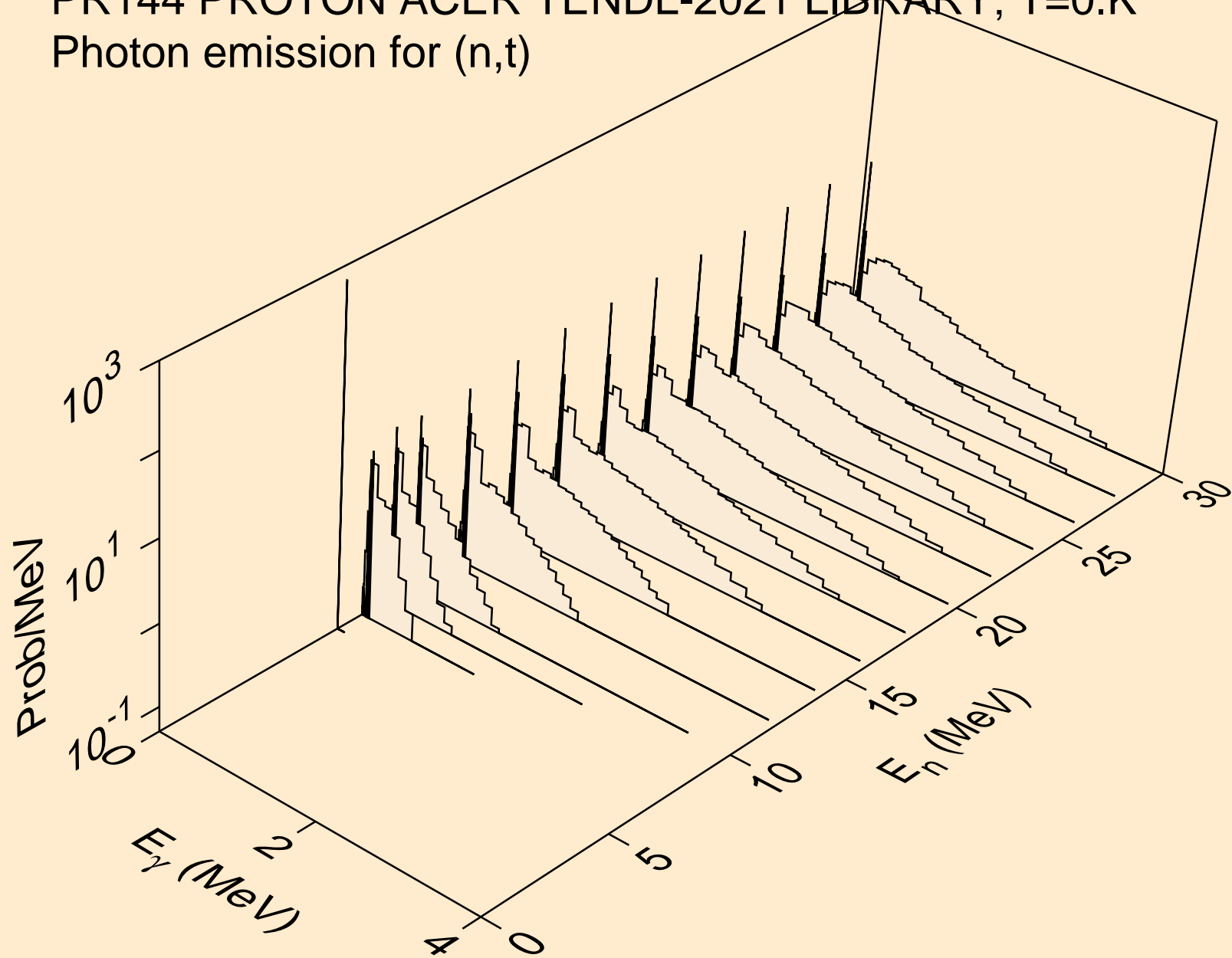

PR144 PROTON ACER TENDL-2021 LIBRARY; T=0.K  
Photon emission for (n,he3)

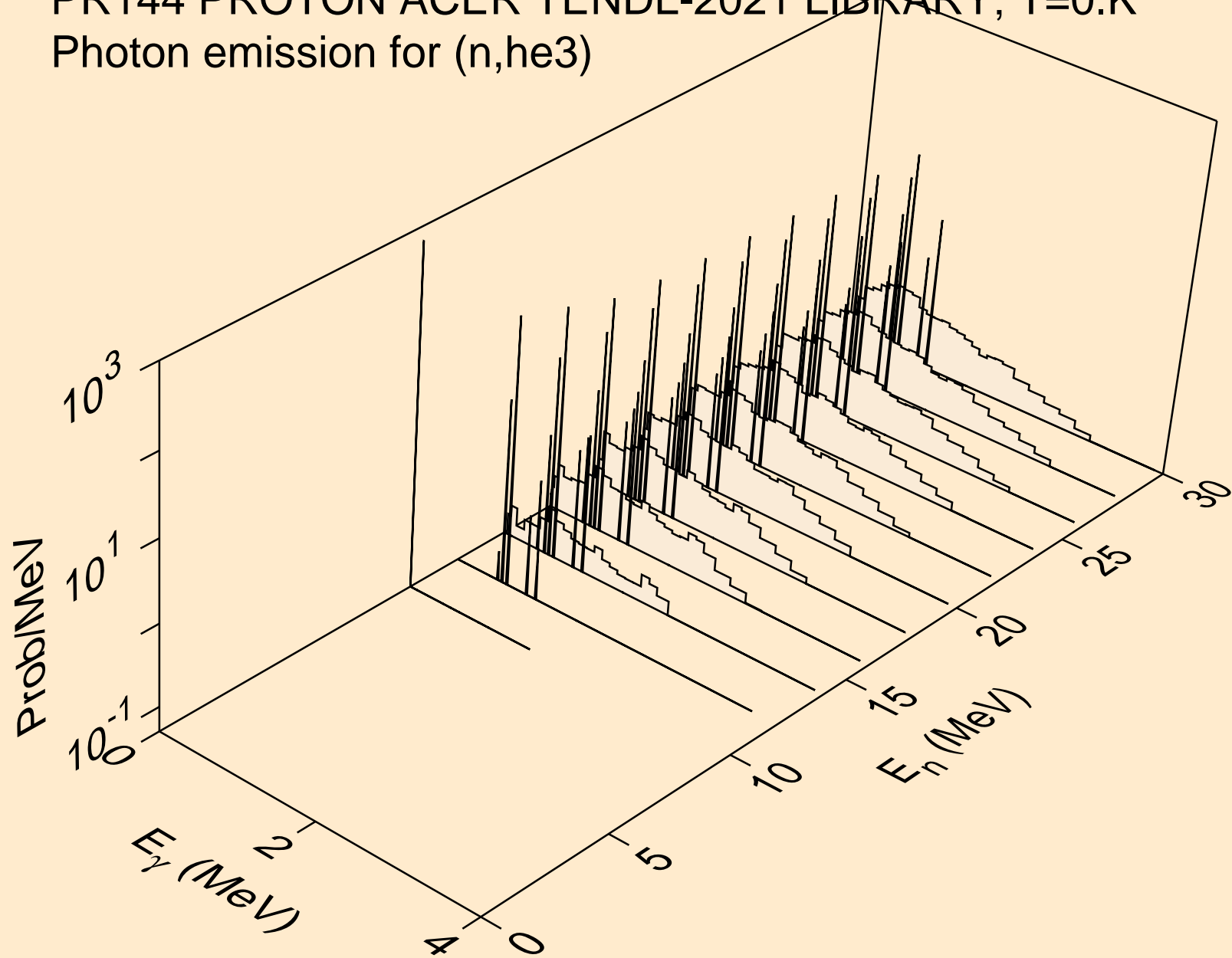

PR144 PROTON ACER TENDL-2021 LIBRARY; T=0.K  
Photon emission for (n,a)

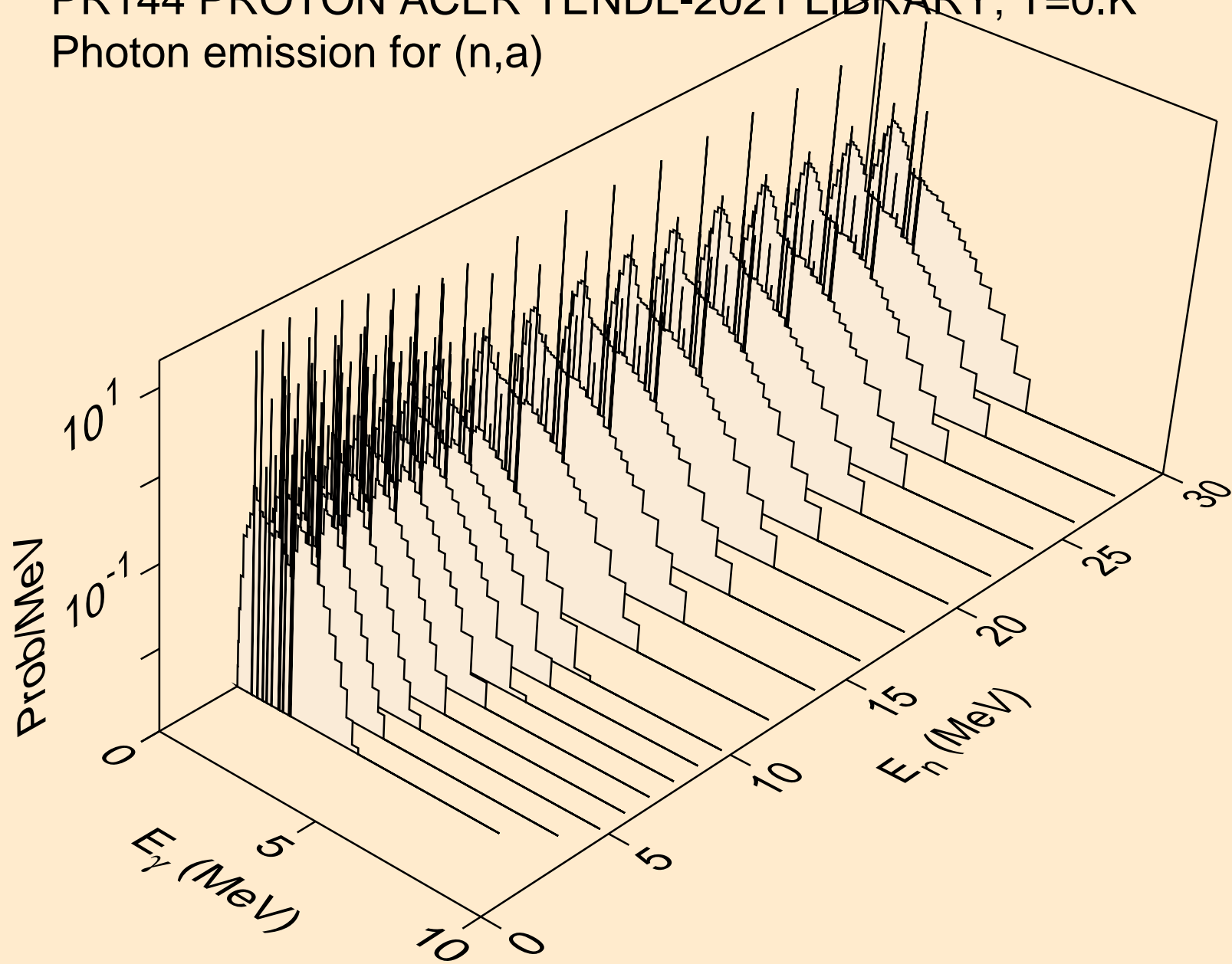

PR144 PROTON ACER TENDL-2021 LIBRARY; T=0.K  
Photon emission for (n,2a)

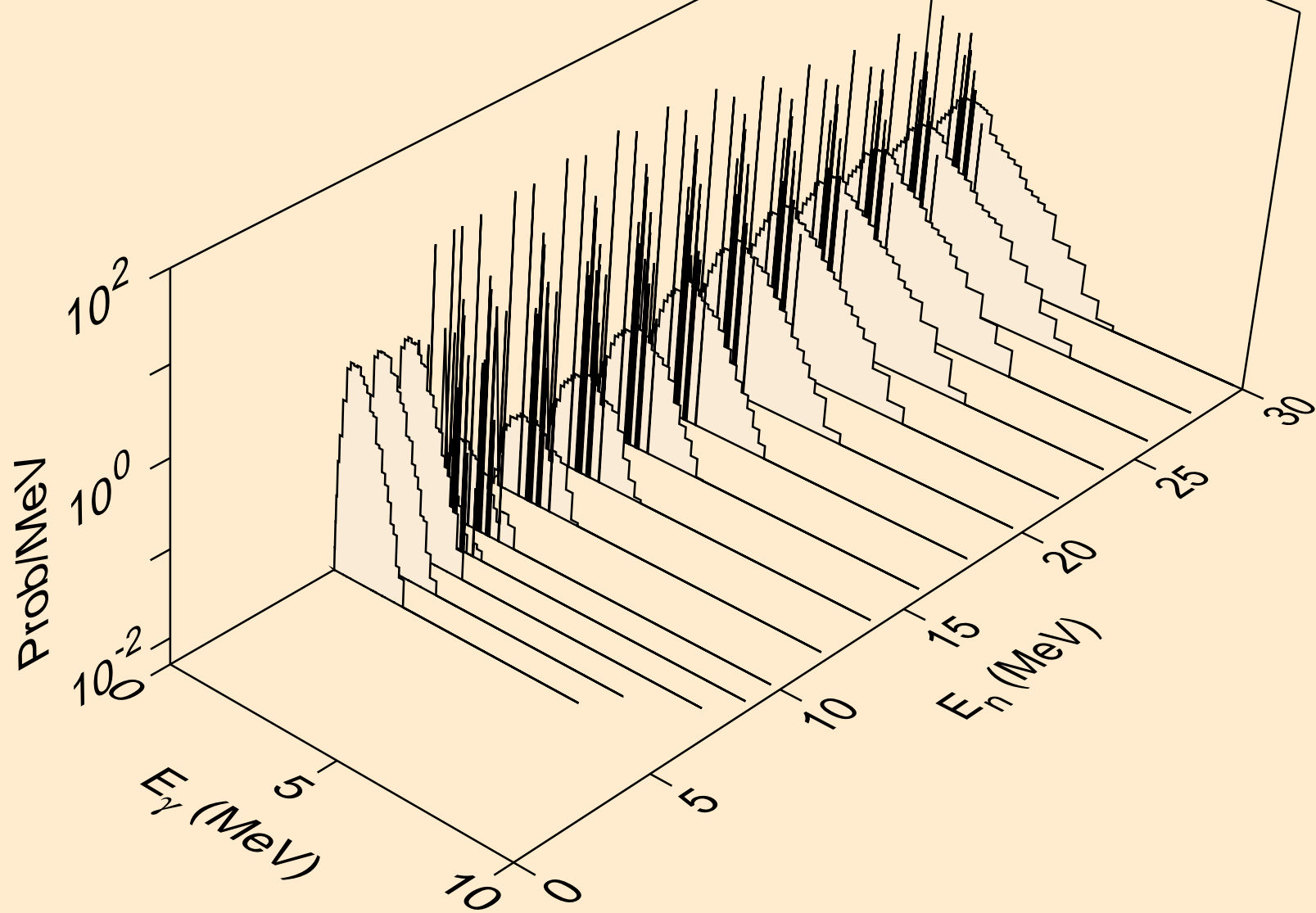

PR144 PROTON ACER TENDL-2021 LIBRARY; T=0.K  
Photon emission for (n,2p)

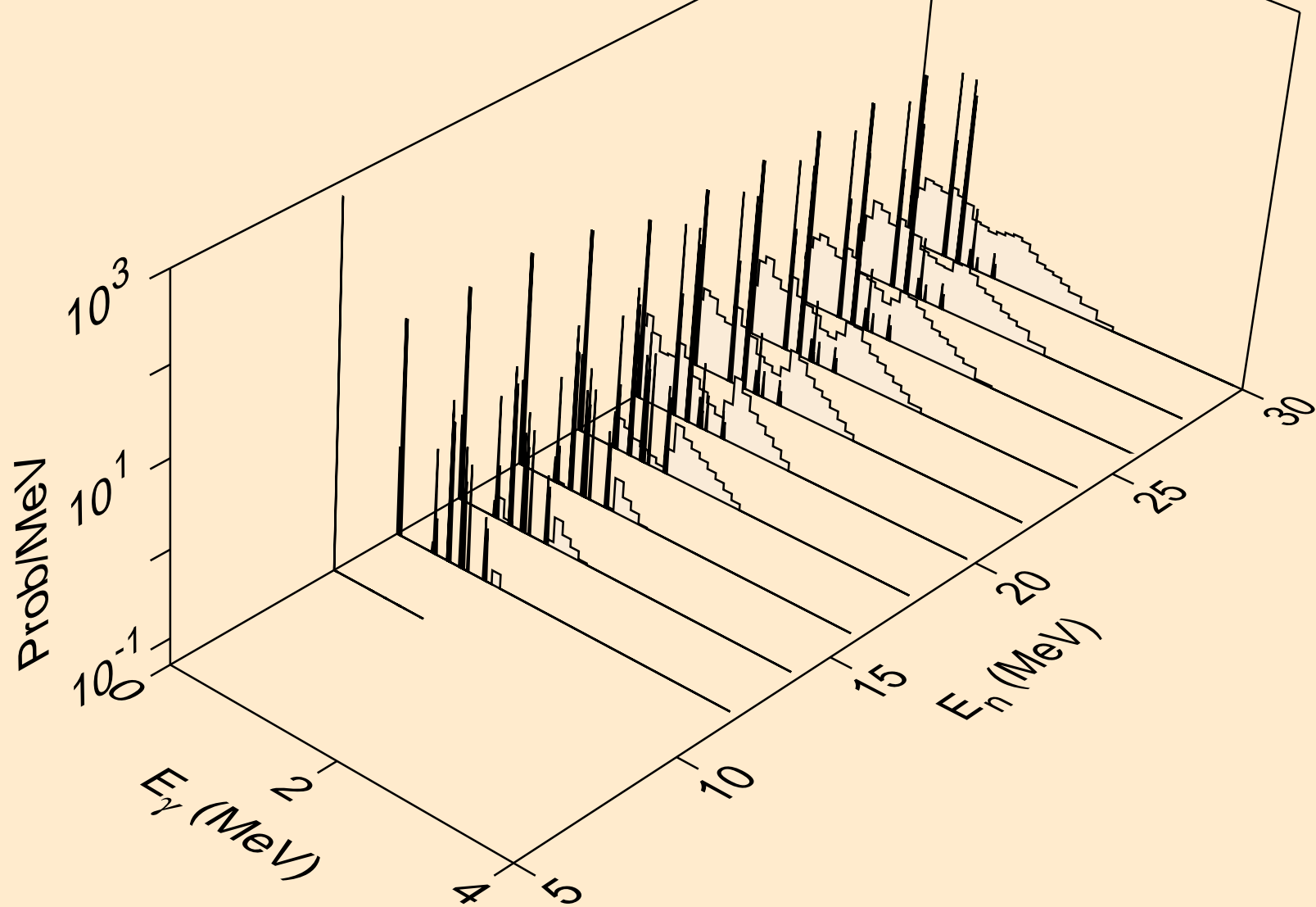

PR144 PROTON ACER TENDL-2021 LIBRARY; T=0.K  
Photon emission for (n,pa)

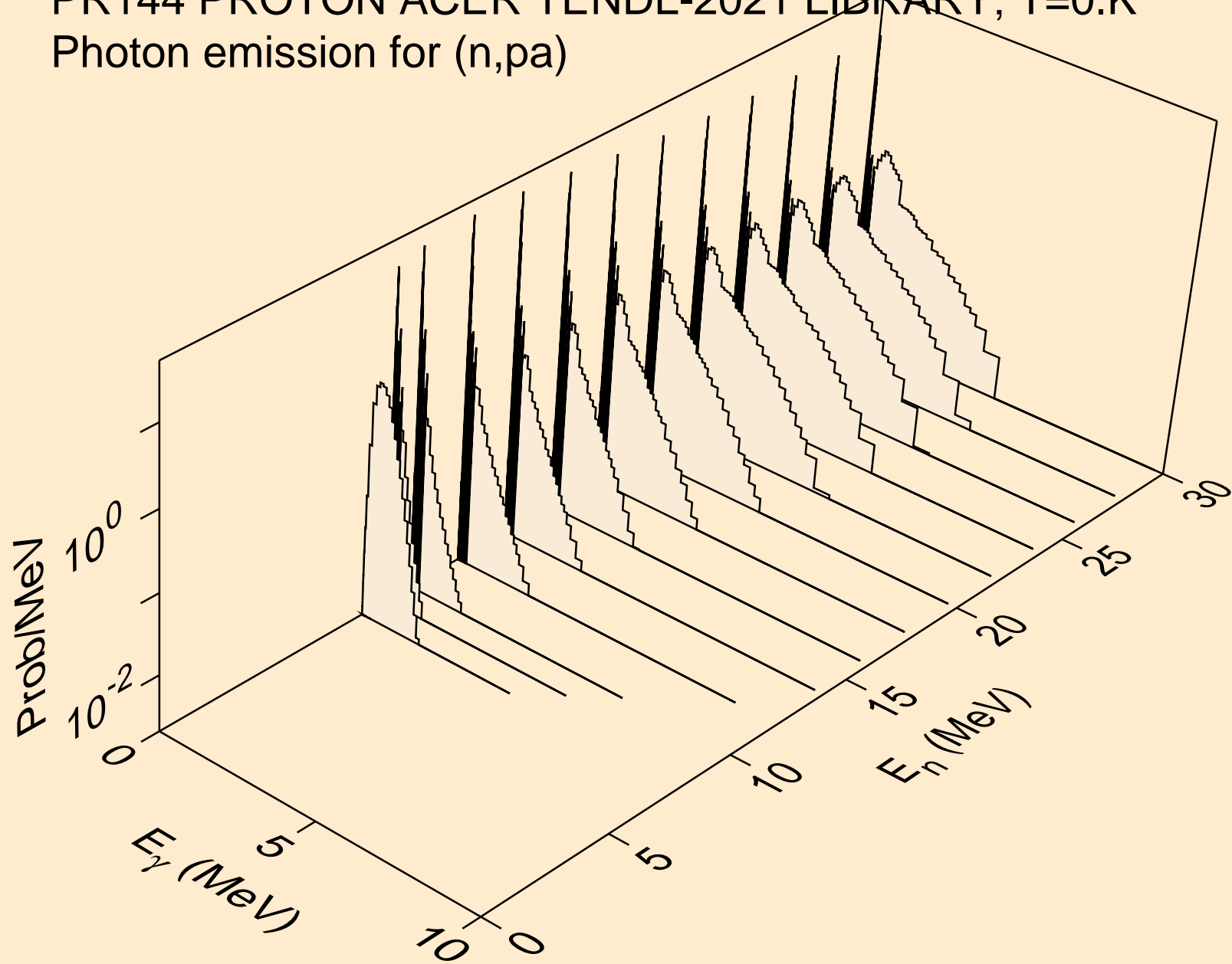

PR144 PROTON ACER TENDL-2021 LIBRARY; T=0.K  
Photon emission for (n,pd)

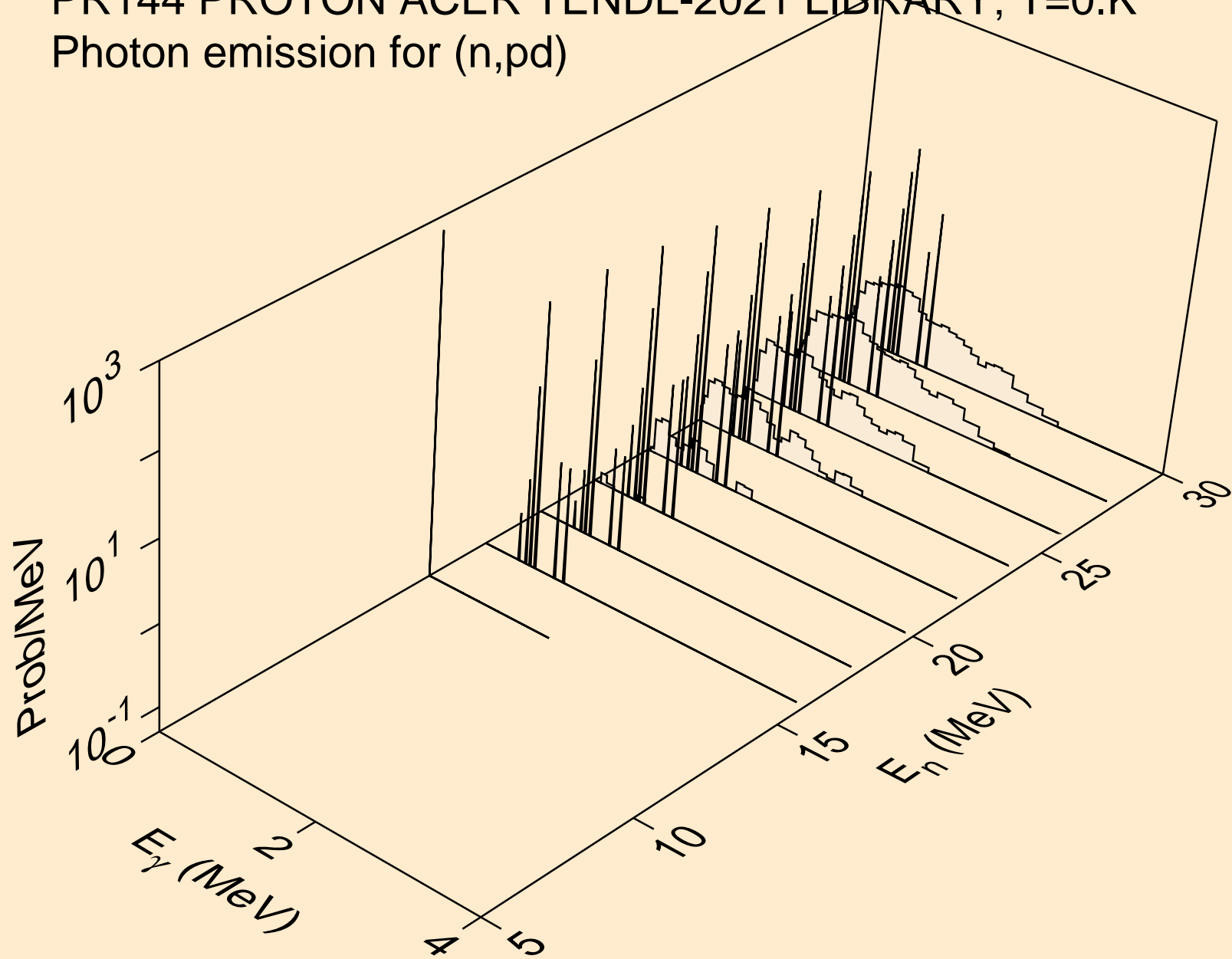



PR144 PROTON ACER TENDL-2021 LIBRARY; T=0.K  
Photon emission for (n,pt)

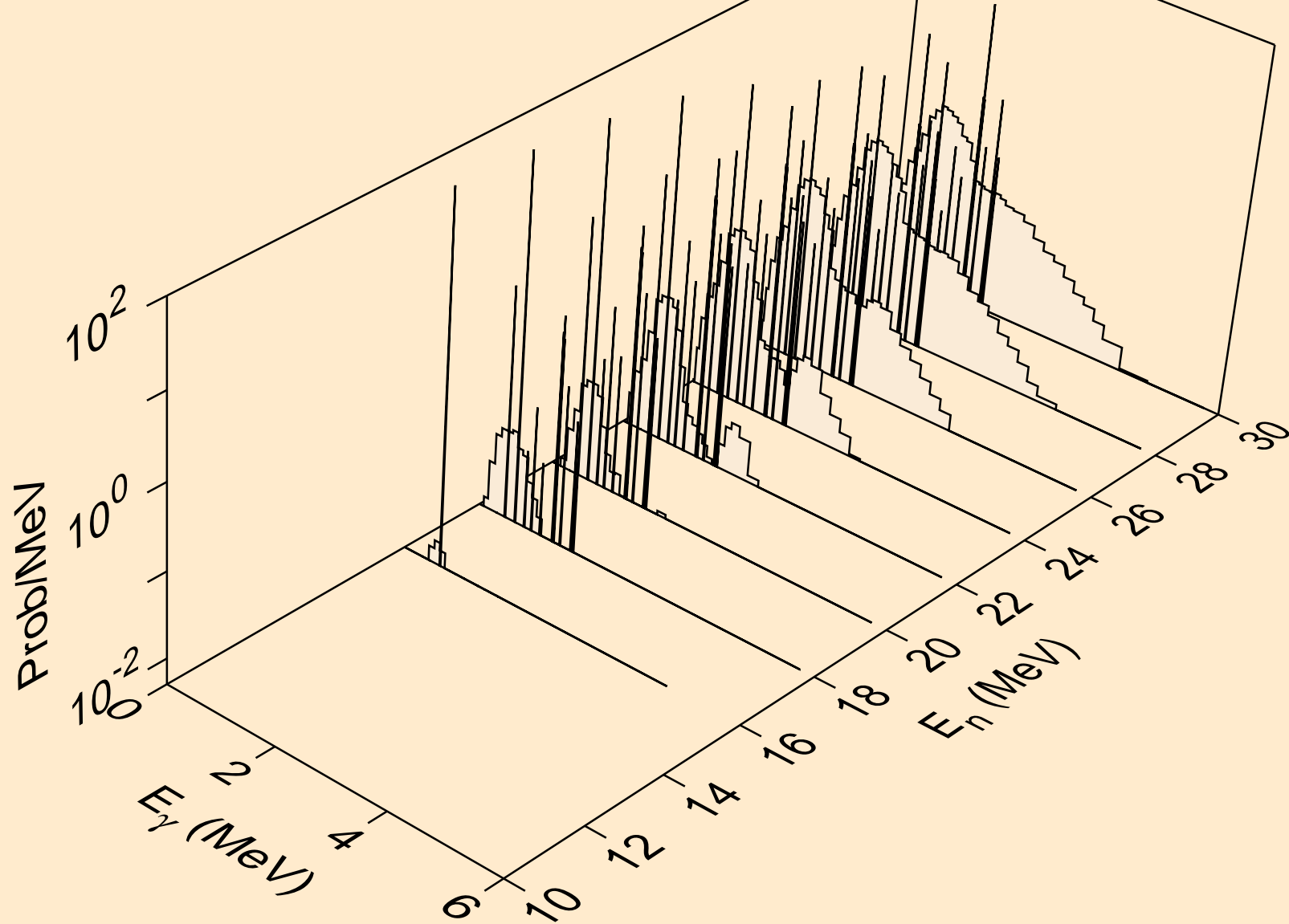

PR144 PROTON ACER TENDL-2021 LIBRARY; T=0.K  
Photon emission for (n,da)

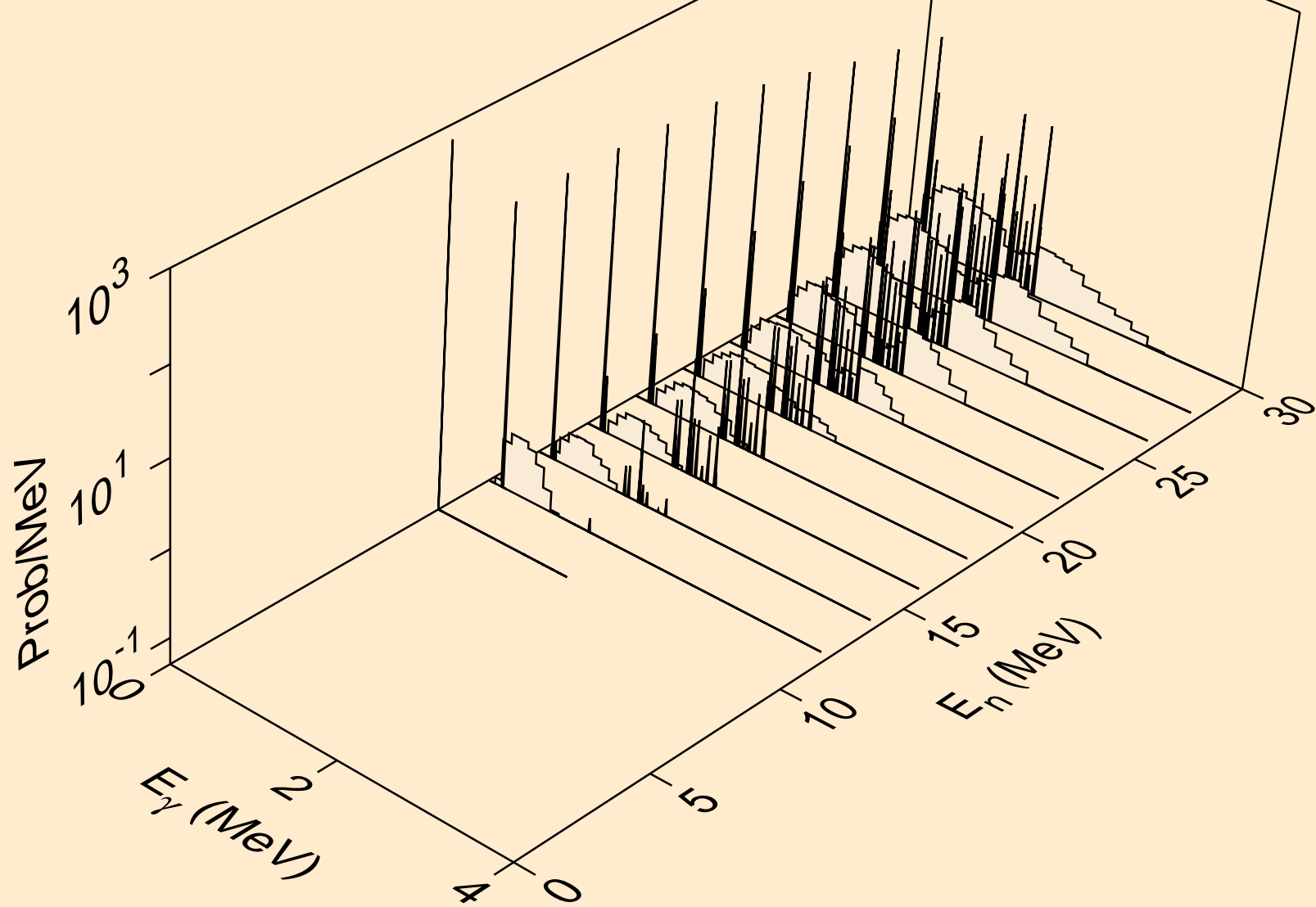

PR144 PROTON ACER TENDL-2021 LIBRARY; T=0.K  
Particle heating contributions

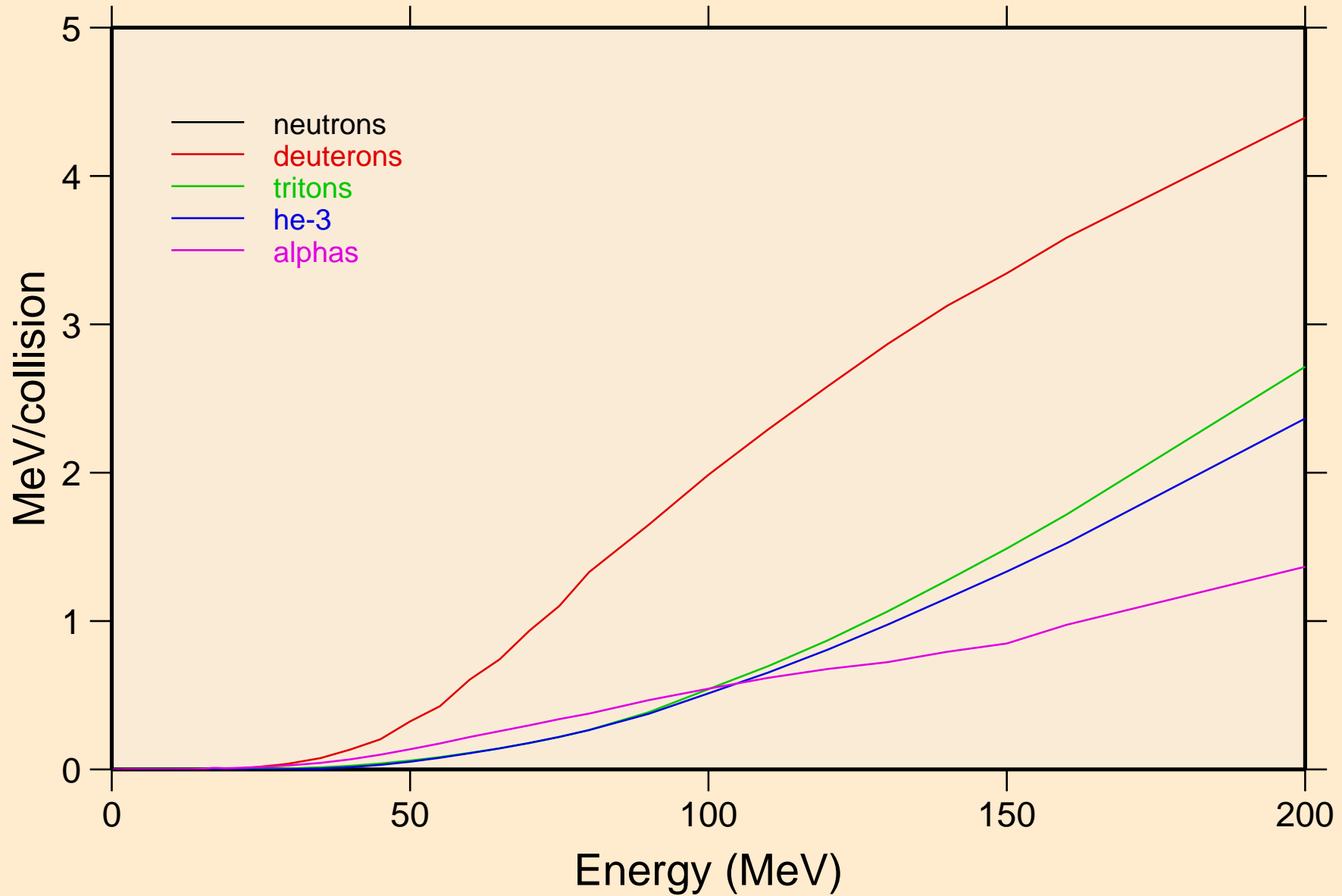

PR144 PROTON ACER TENDL-2021 LIBRARY; T=0.K  
Recoil Heating

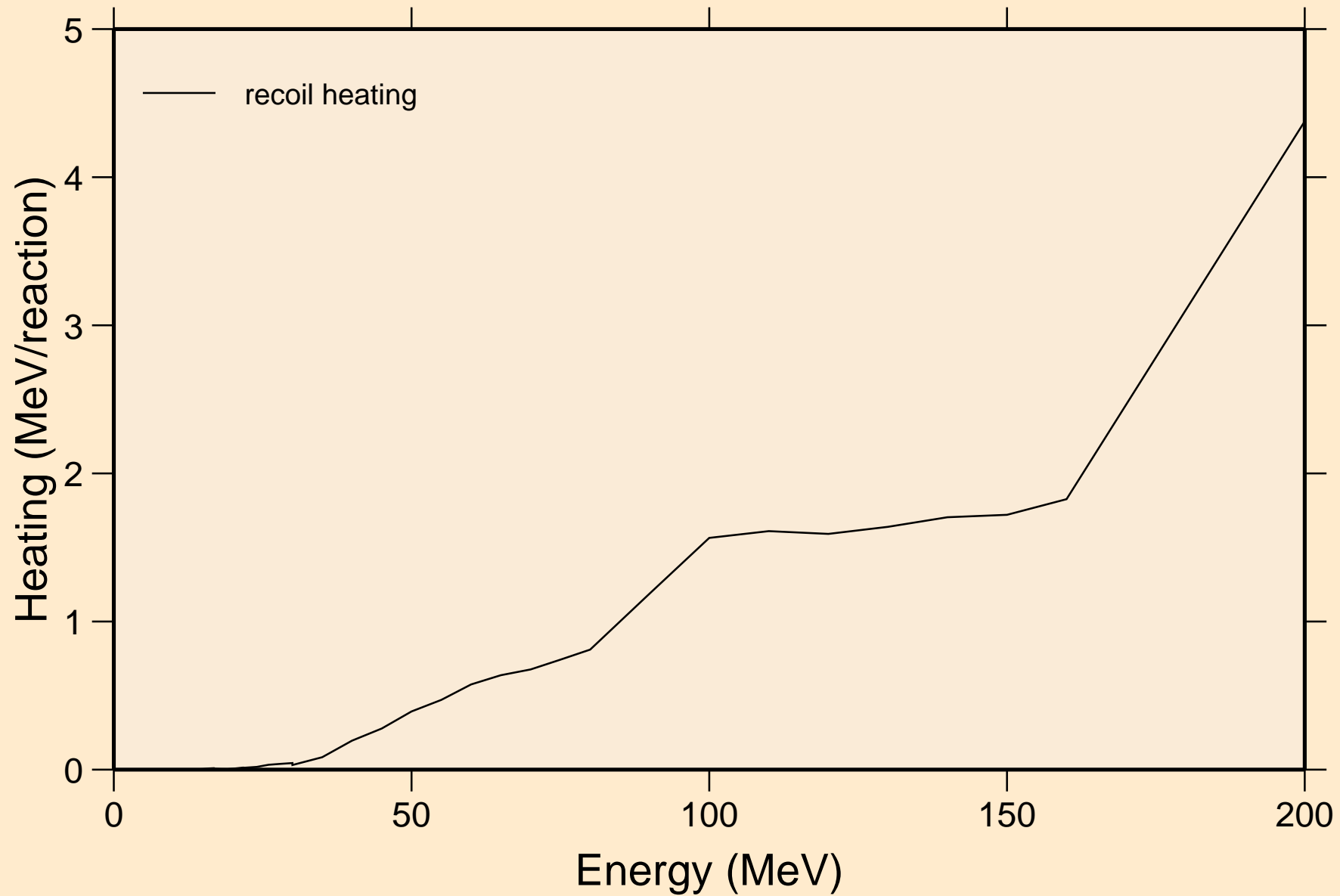

PR144 PROTON ACER TENDL-2021 LIBRARY; T=0.K  
Particle production cross sections

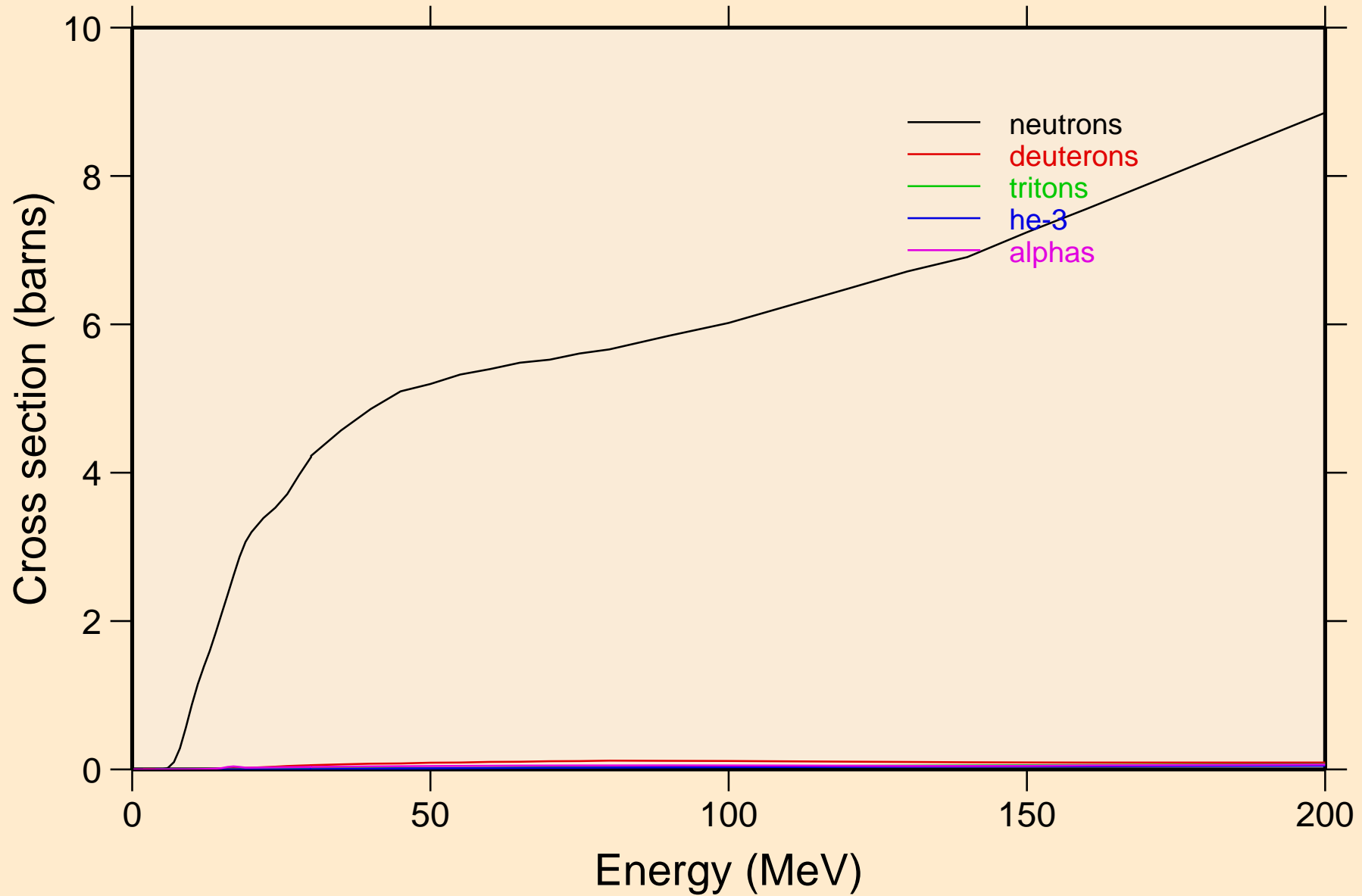

PR144 PROTON ACER TENDL-2021 LIBRARY; T=0.K  
neutrons from (p,n)

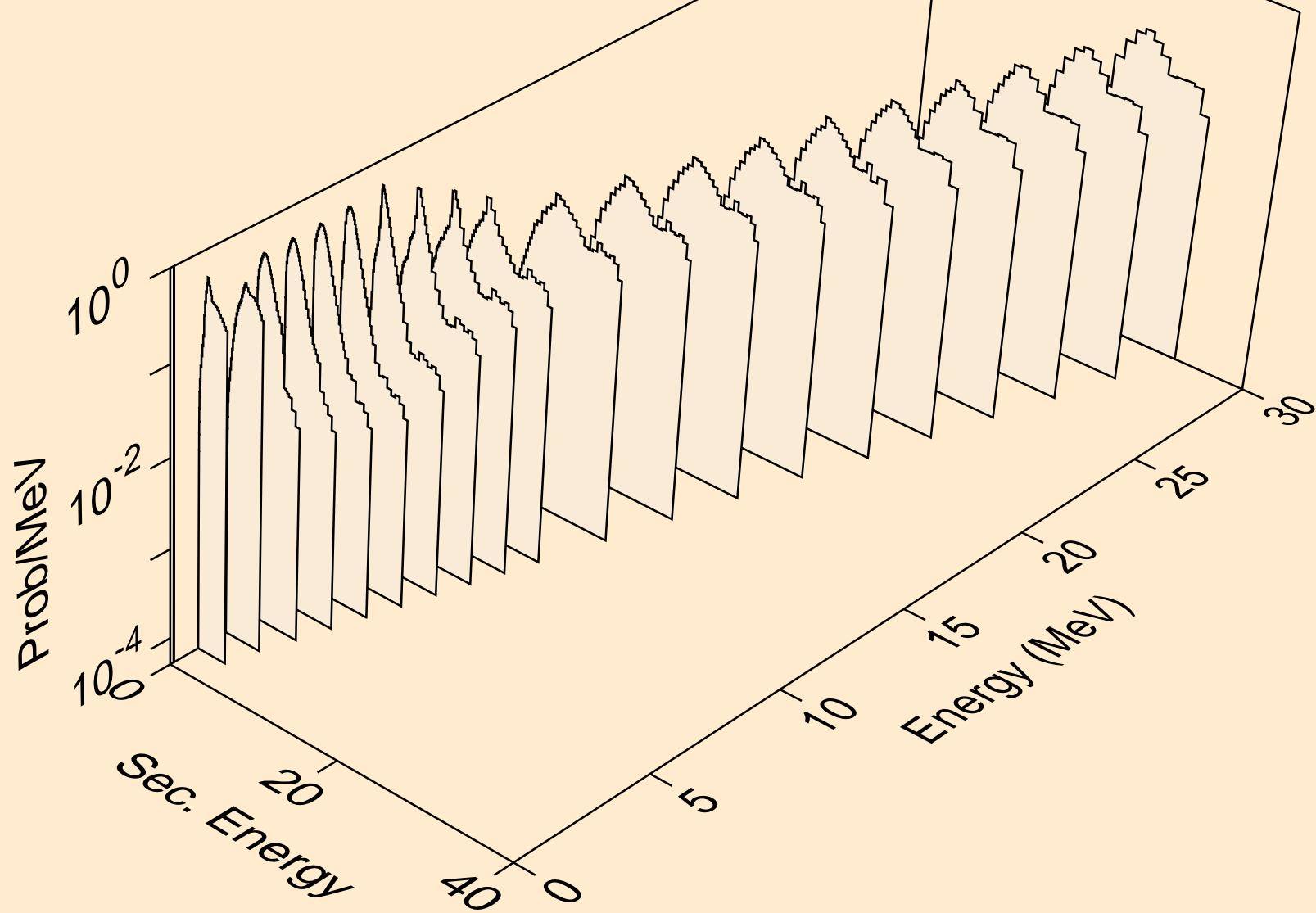

PR144 PROTON ACER TENDL-2021 LIBRARY; T=0.K  
neutrons from (p,x)

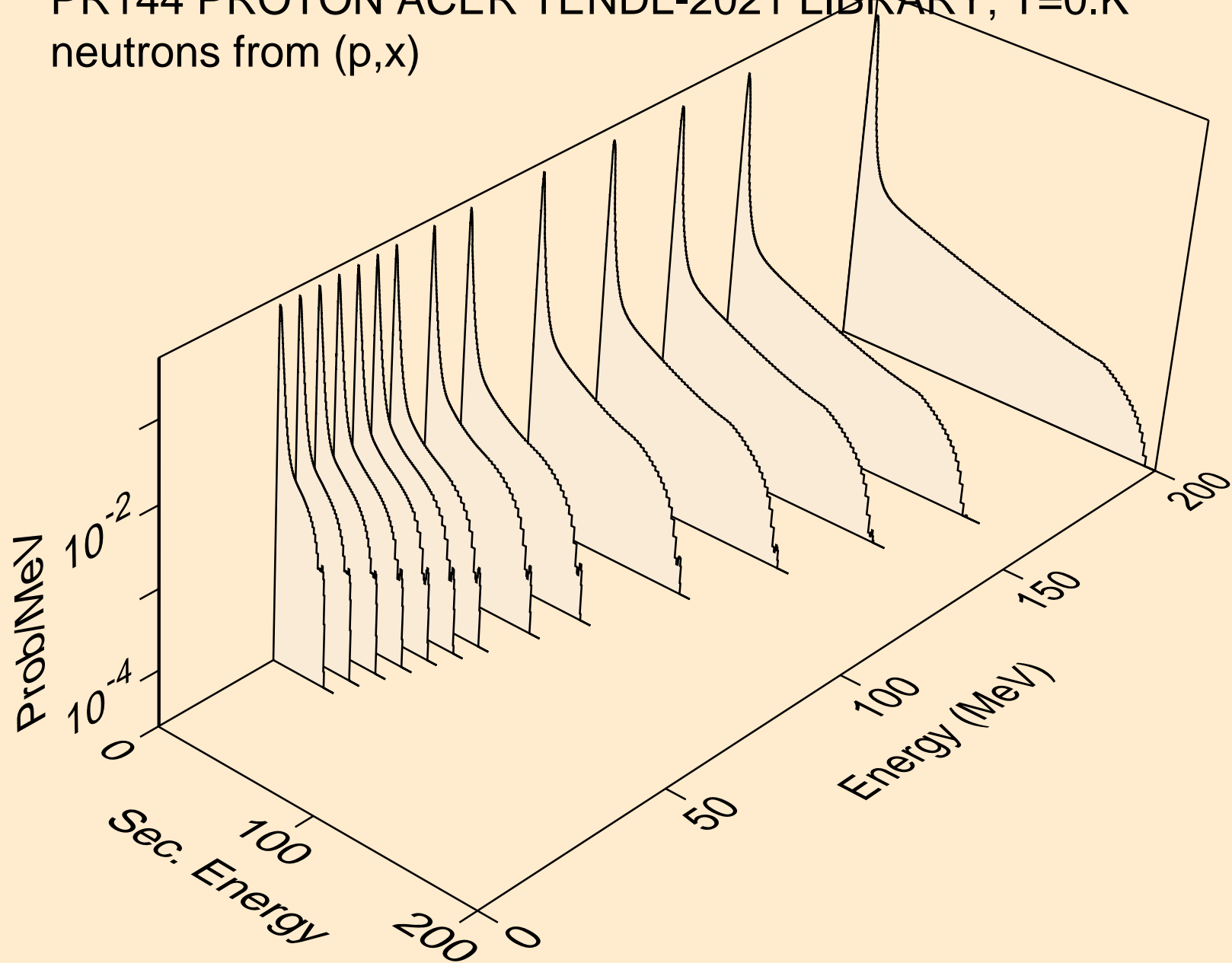

PR144 PROTON ACER TENDL-2021 LIBRARY; T=0.K  
neutrons from (p,2nd)

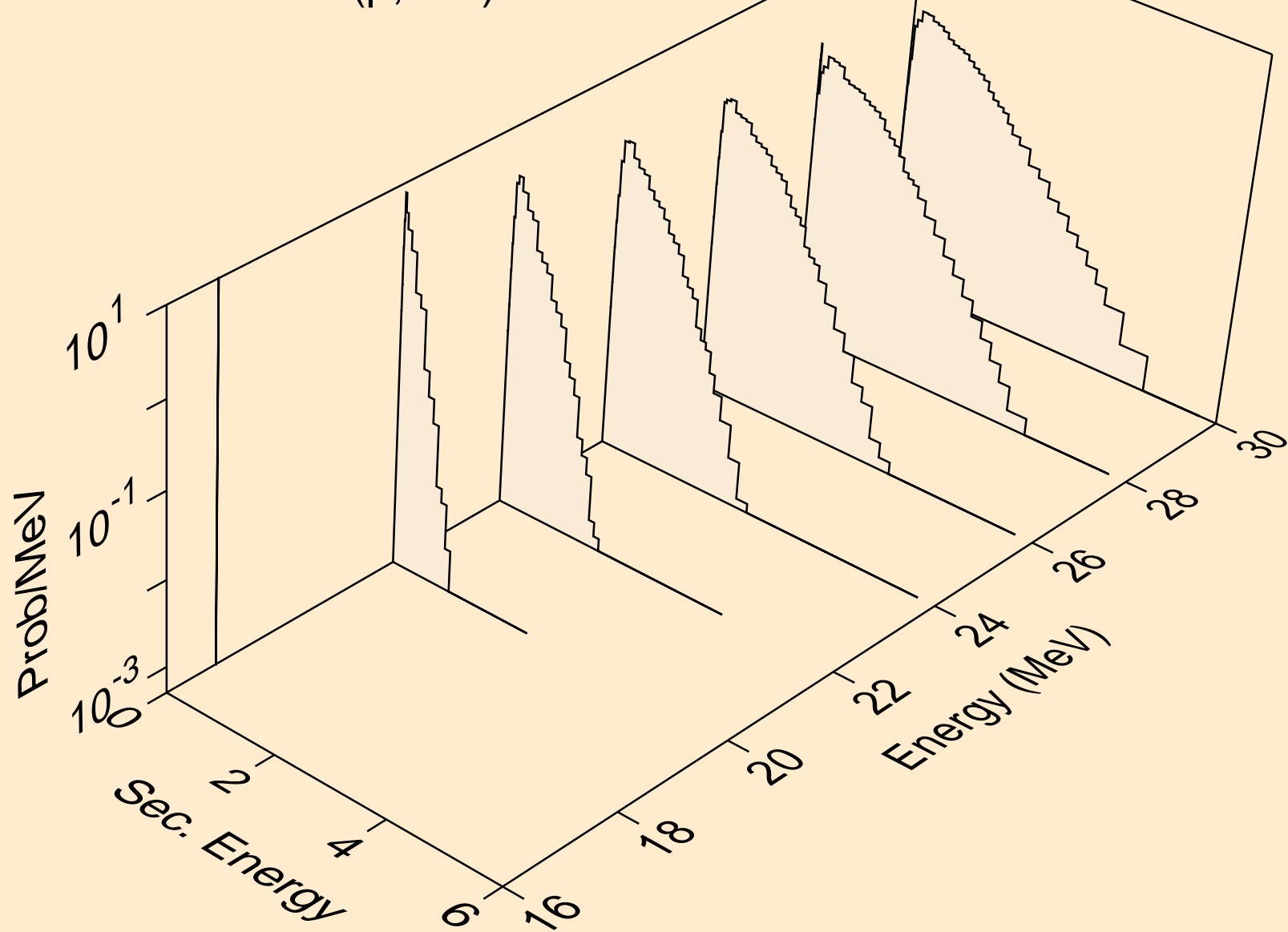



PR144 PROTON ACER TENDL-2021 LIBRARY; T=0.K  
neutrons from (p,2n)

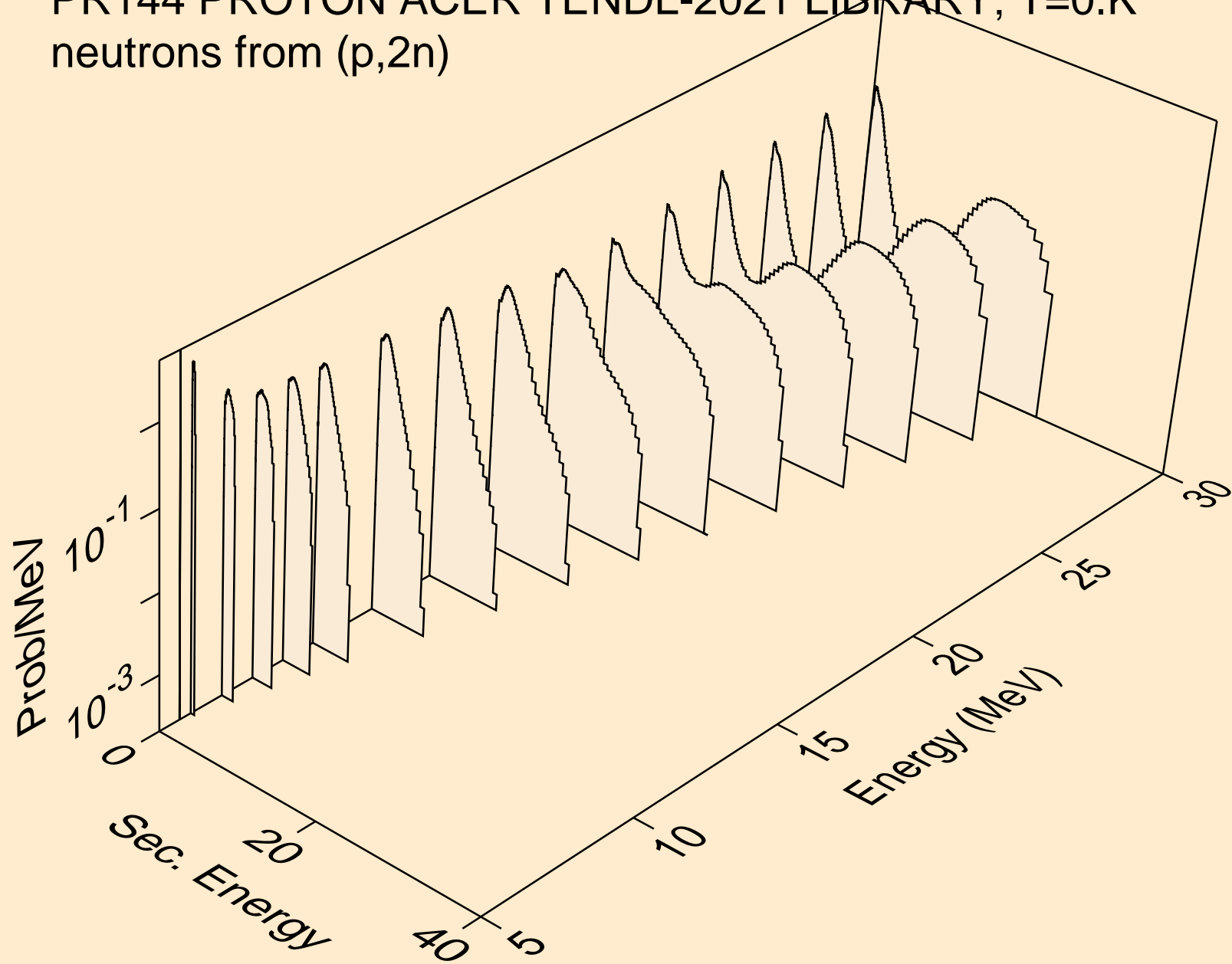

PR144 PROTON ACER TENDL-2021 LIBRARY; T=0.K  
neutrons from (p,3n)

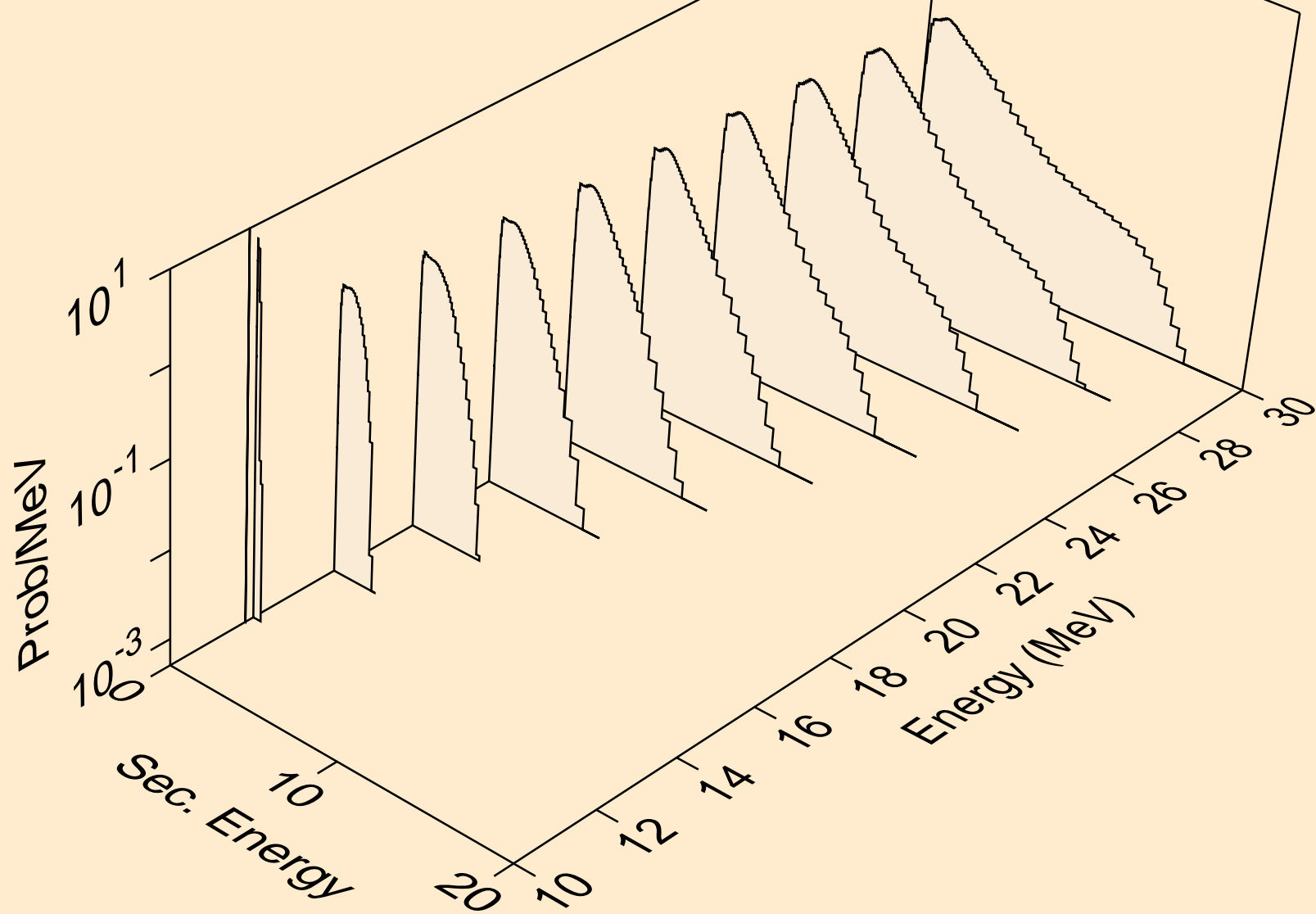

PR144 PROTON ACER TENDL-2021 LIBRARY; T=0.K  
neutrons from (p,n\*)a

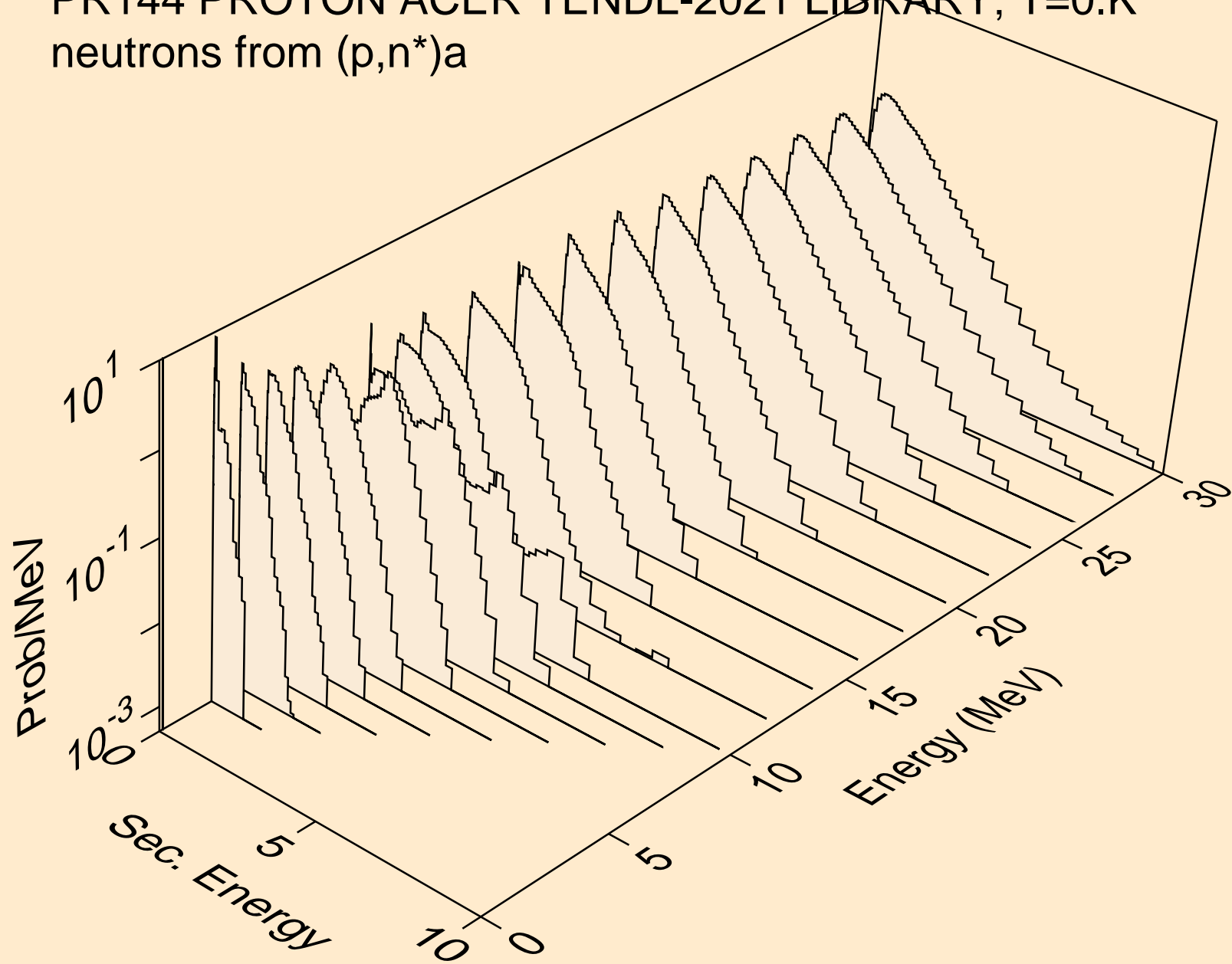

PR144 PROTON ACER TENDL-2021 LIBRARY; T=0.K  
neutrons from (p,2n)a

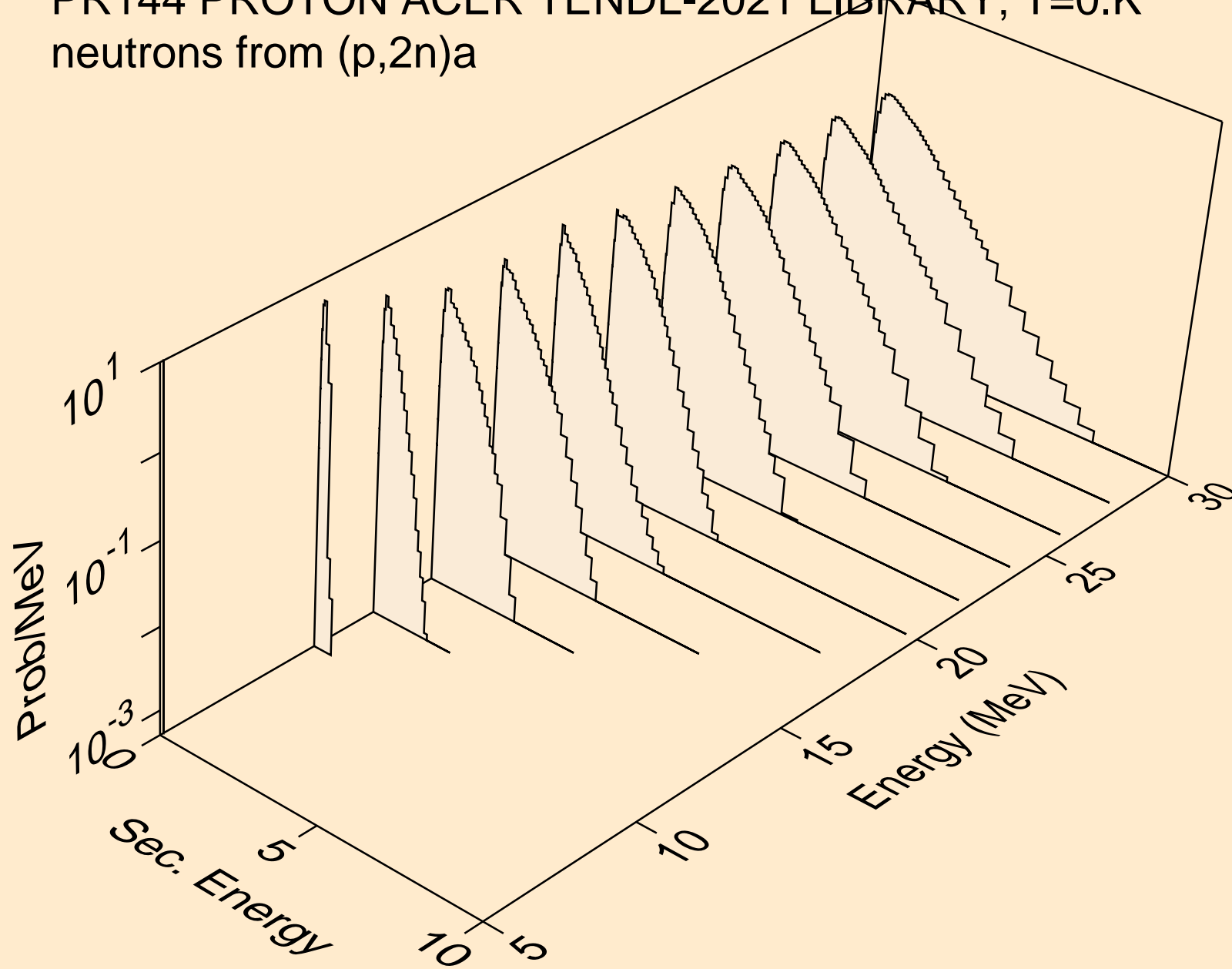

PR144 PROTON ACER TENDL-2021 LIBRARY; T=0.K  
neutrons from (p,3n)a

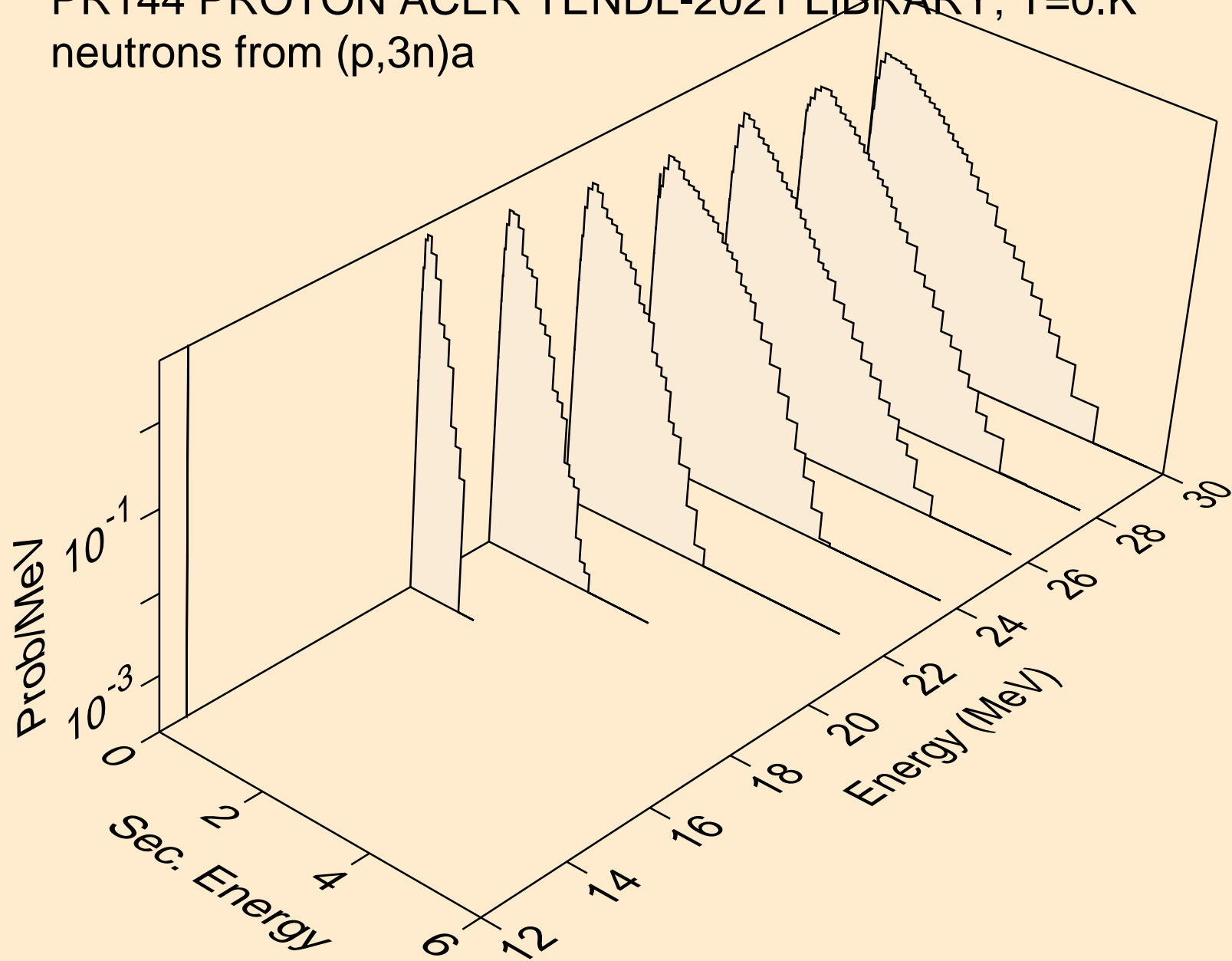

PR144 PROTON ACER TENDL-2021 LIBRARY; T=0.K  
neutrons from (p,n\*)p

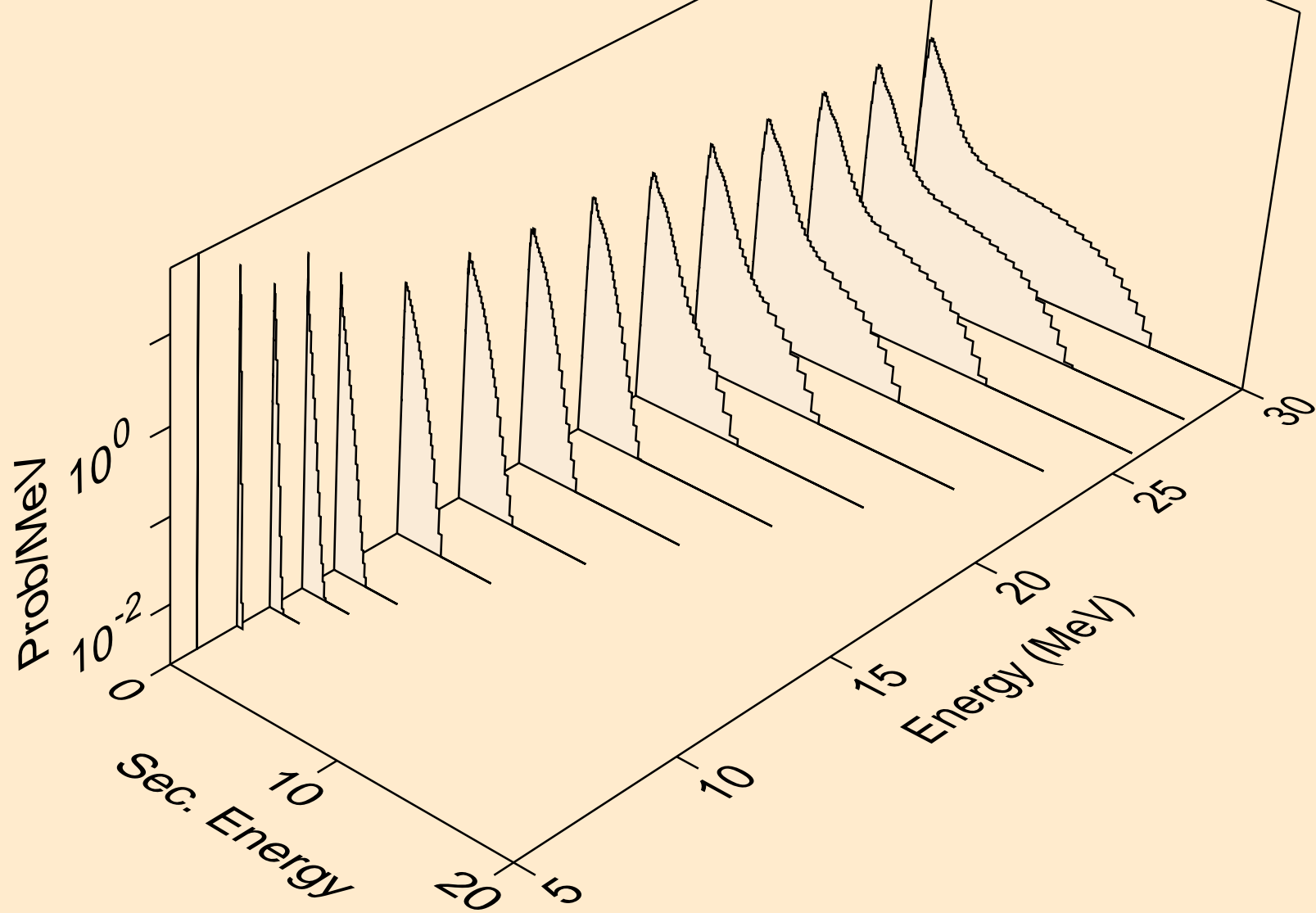

PR144 PROTON ACER TENDL-2021 LIBRARY; T=0.K  
neutrons from (p,n\*)2a

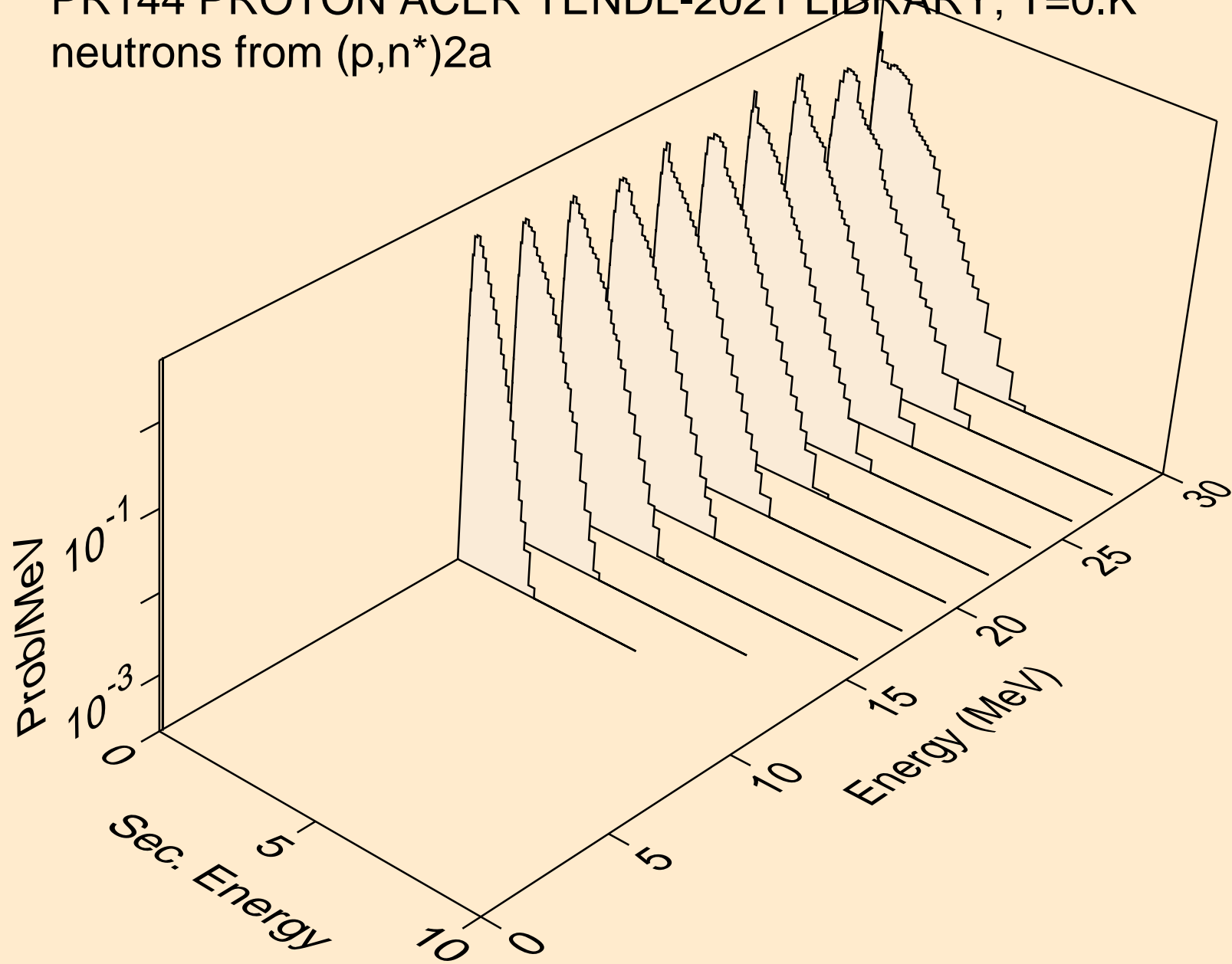

PR144 PROTON ACER TENDL-2021 LIBRARY; T=0.K  
neutrons from (p,n\*)d

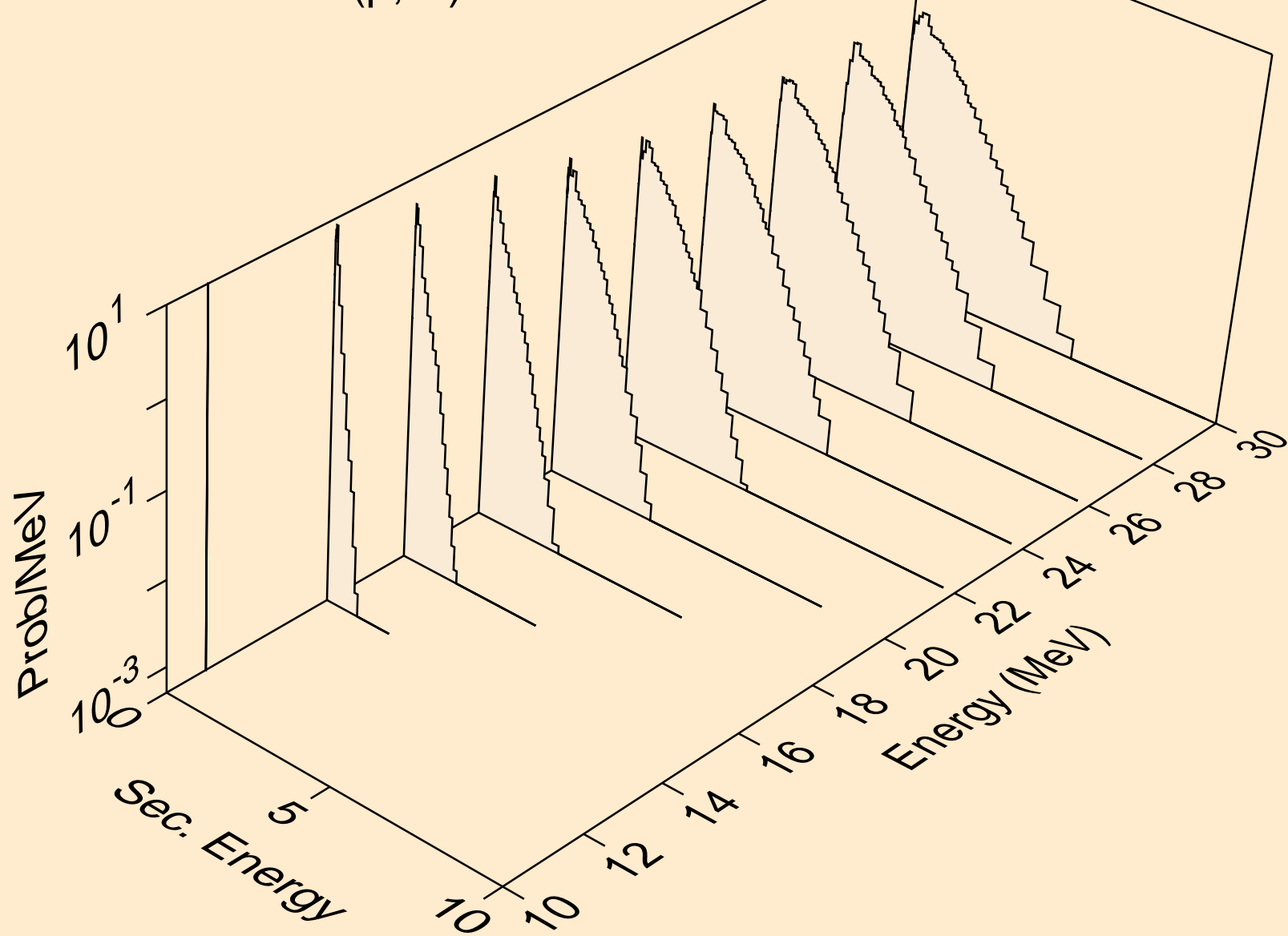



PR144 PROTON ACER TENDL-2021 LIBRARY; T=0.K  
neutrons from (p,n\*)t

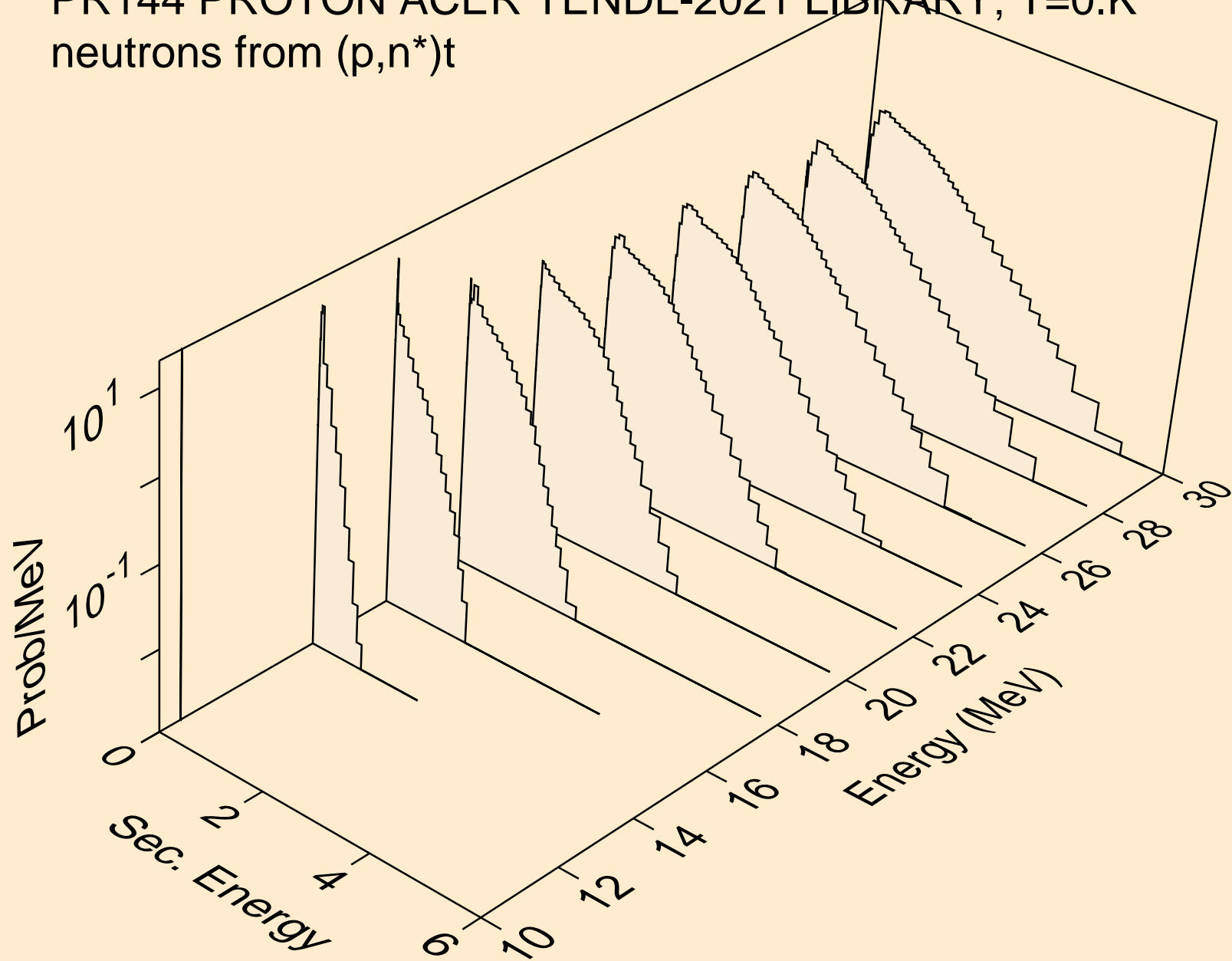

PR144 PROTON ACER TENDL-2021 LIBRARY; T=0.K  
neutrons from (p,n\*)he3

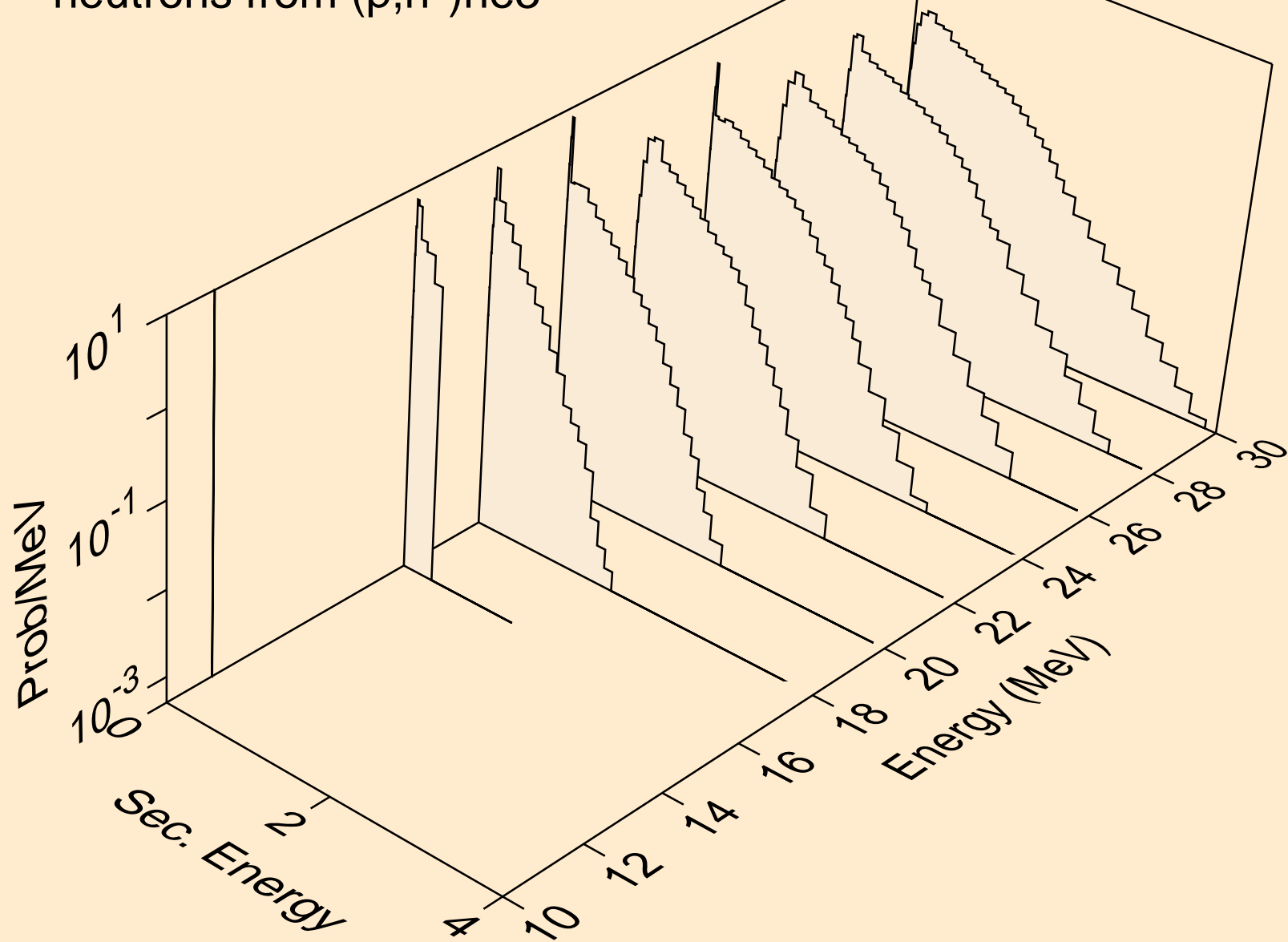

PR144 PROTON ACER TENDL-2021 LIBRARY; T=0.K  
neutrons from (p,4n)

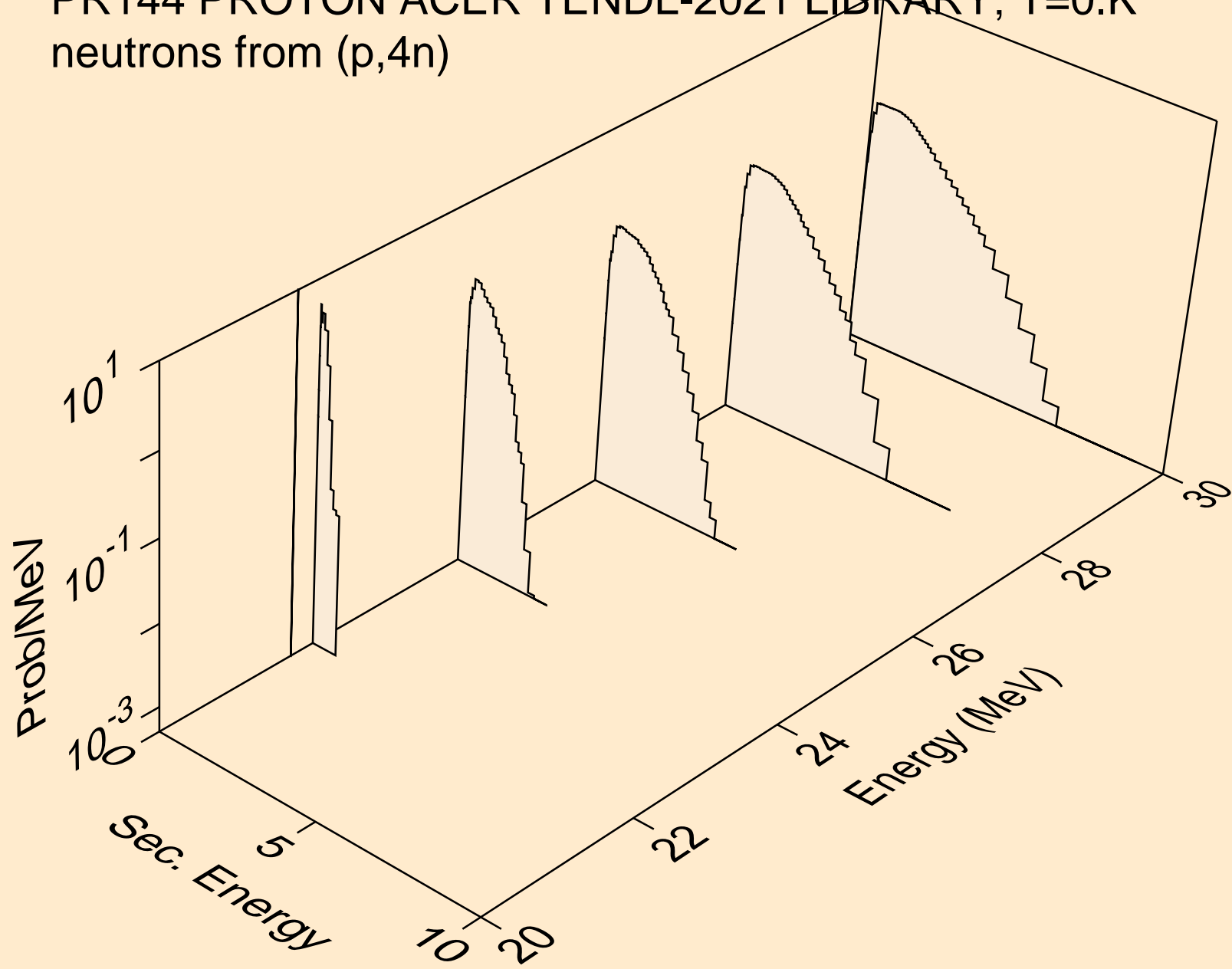

PR144 PROTON ACER TENDL-2021 LIBRARY; T=0.K  
neutrons from (p,2np)

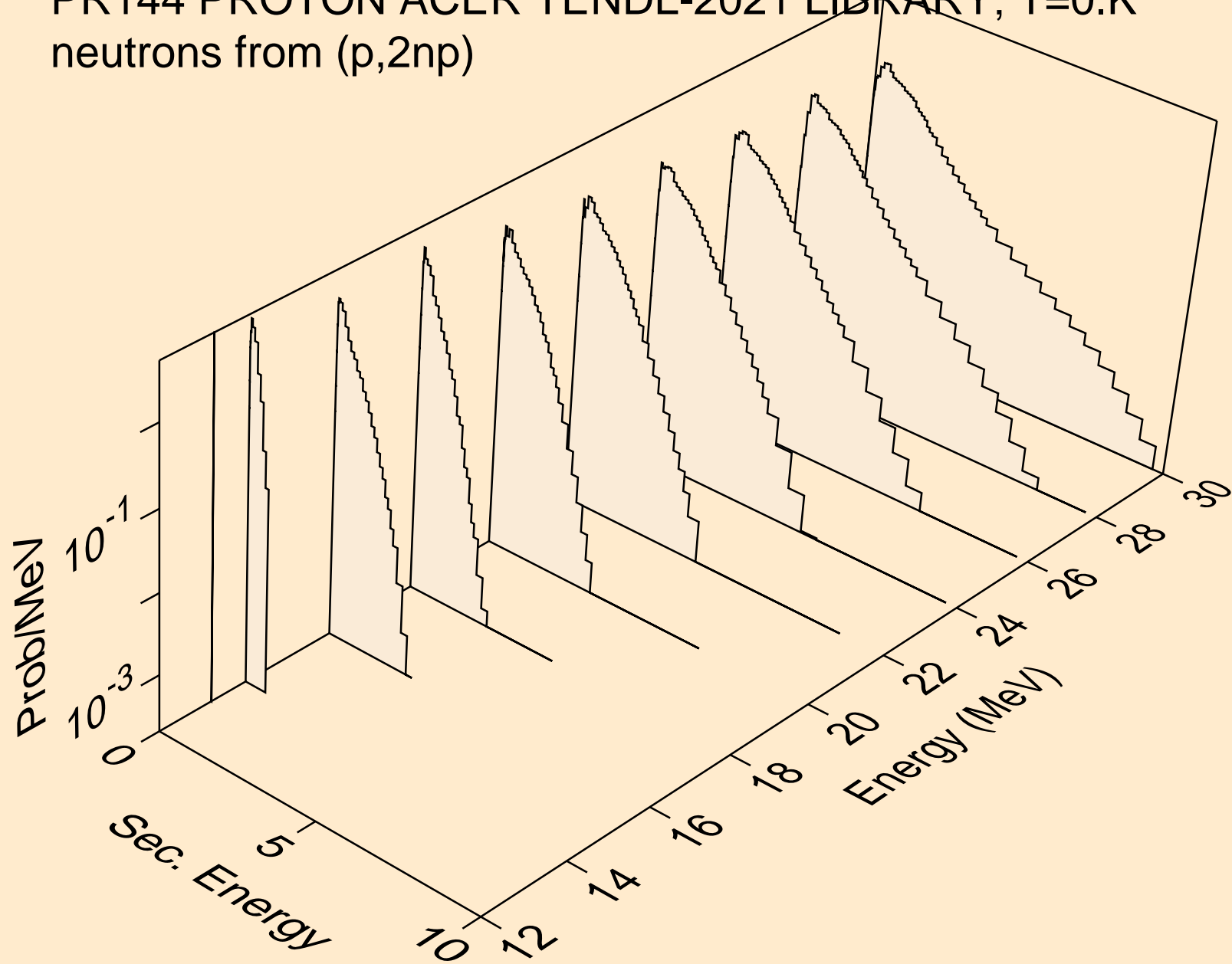

PR144 PROTON ACER TENDL-2021 LIBRARY; T=0.K  
neutrons from (p,3np)

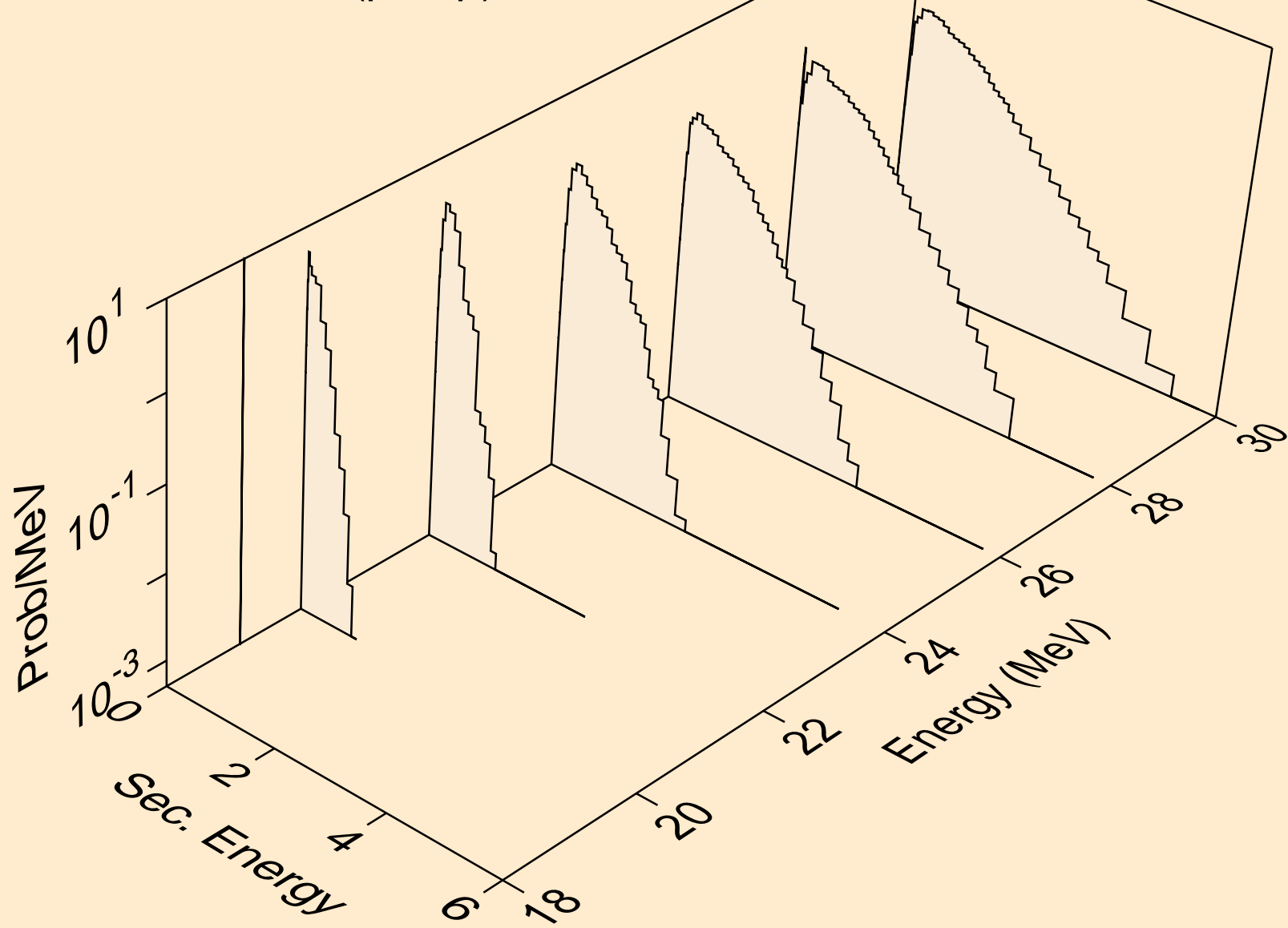

PR144 PROTON ACER TENDL-2021 LIBRARY; T=0.K  
neutrons from (p,2np)

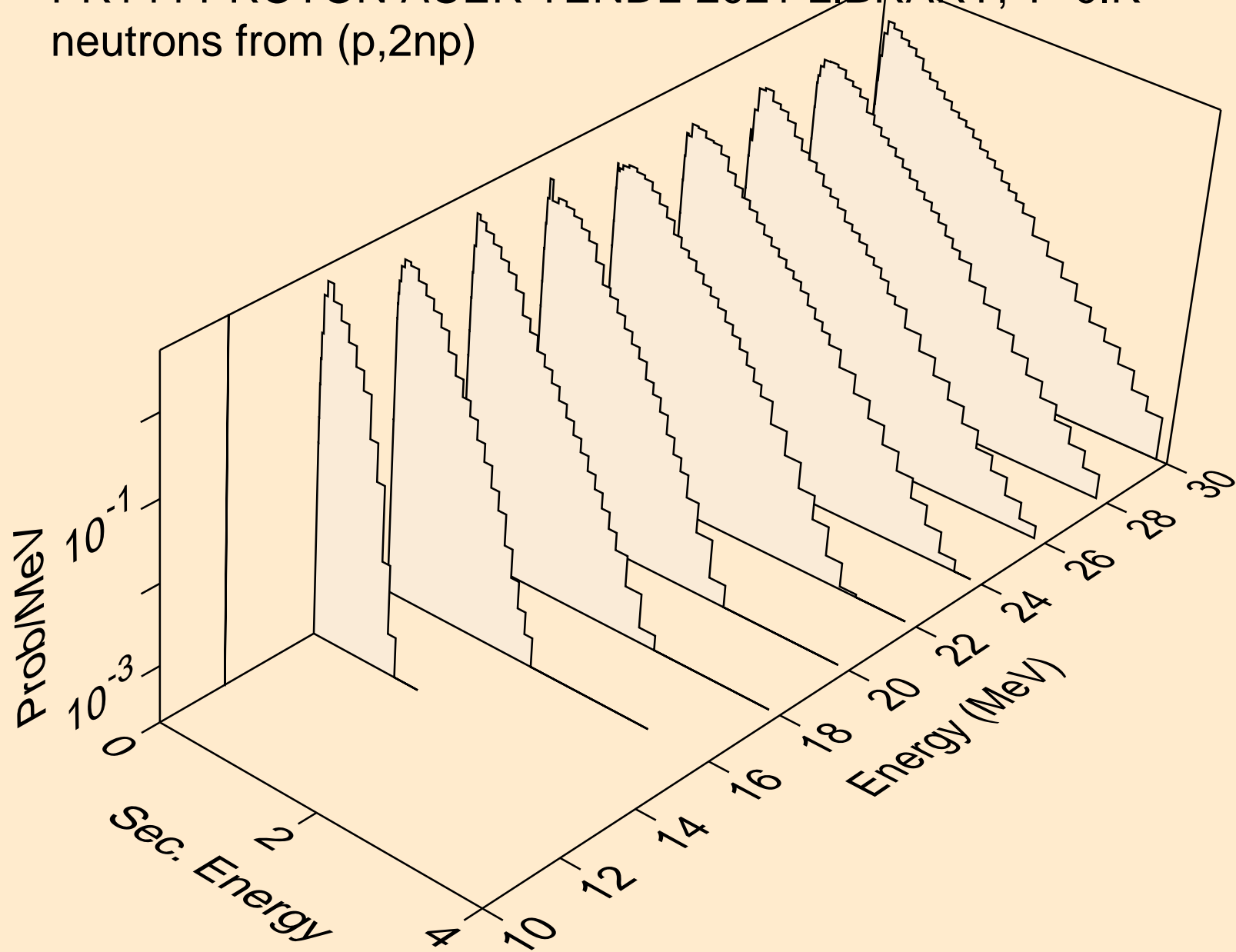

PR144 PROTON ACER TENDL-2021 LIBRARY; T=0.K  
neutrons from (p,npa)

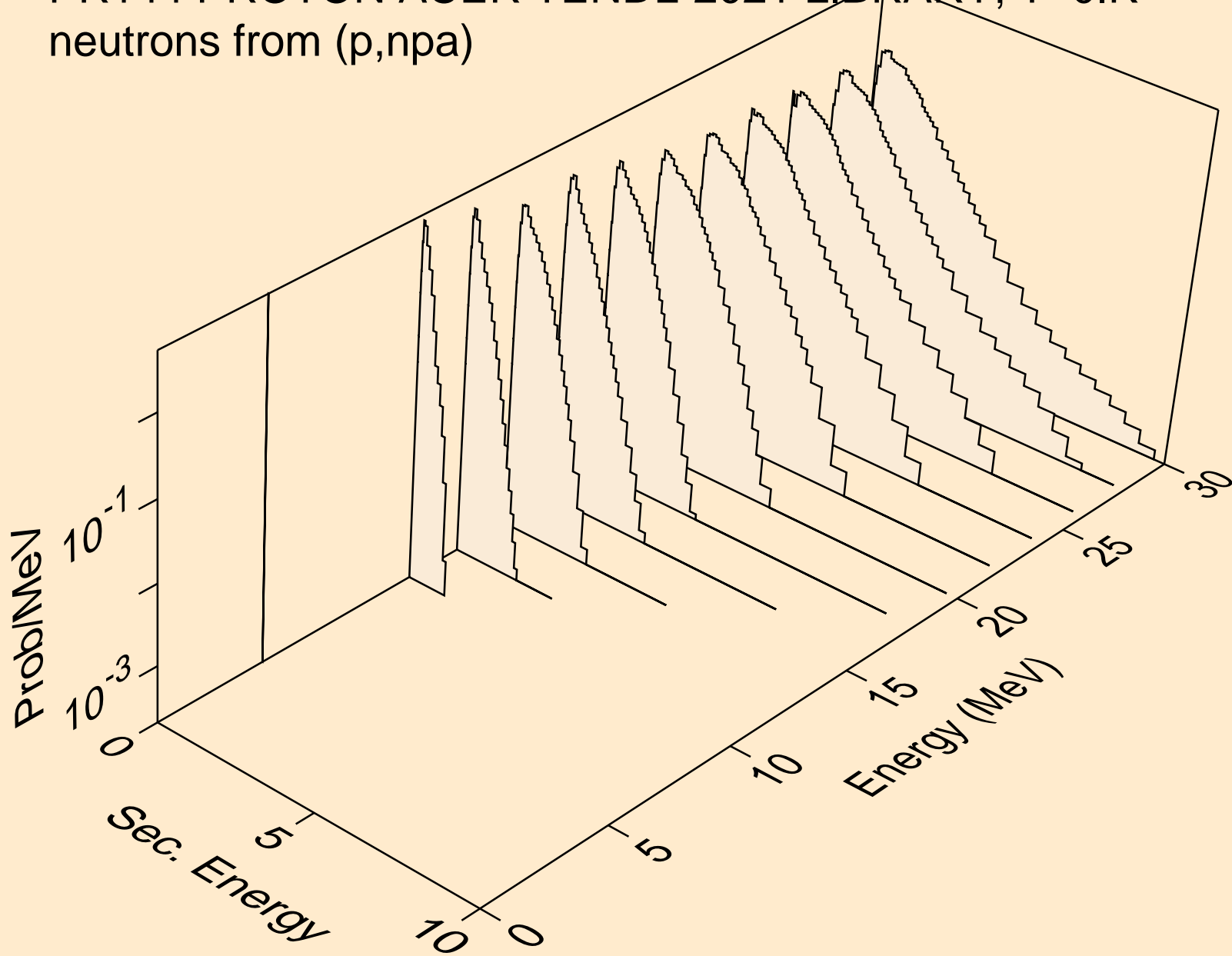

PR144 PROTON ACER TENDL-2021 LIBRARY; T=0.K  
deuterons from (p,x)

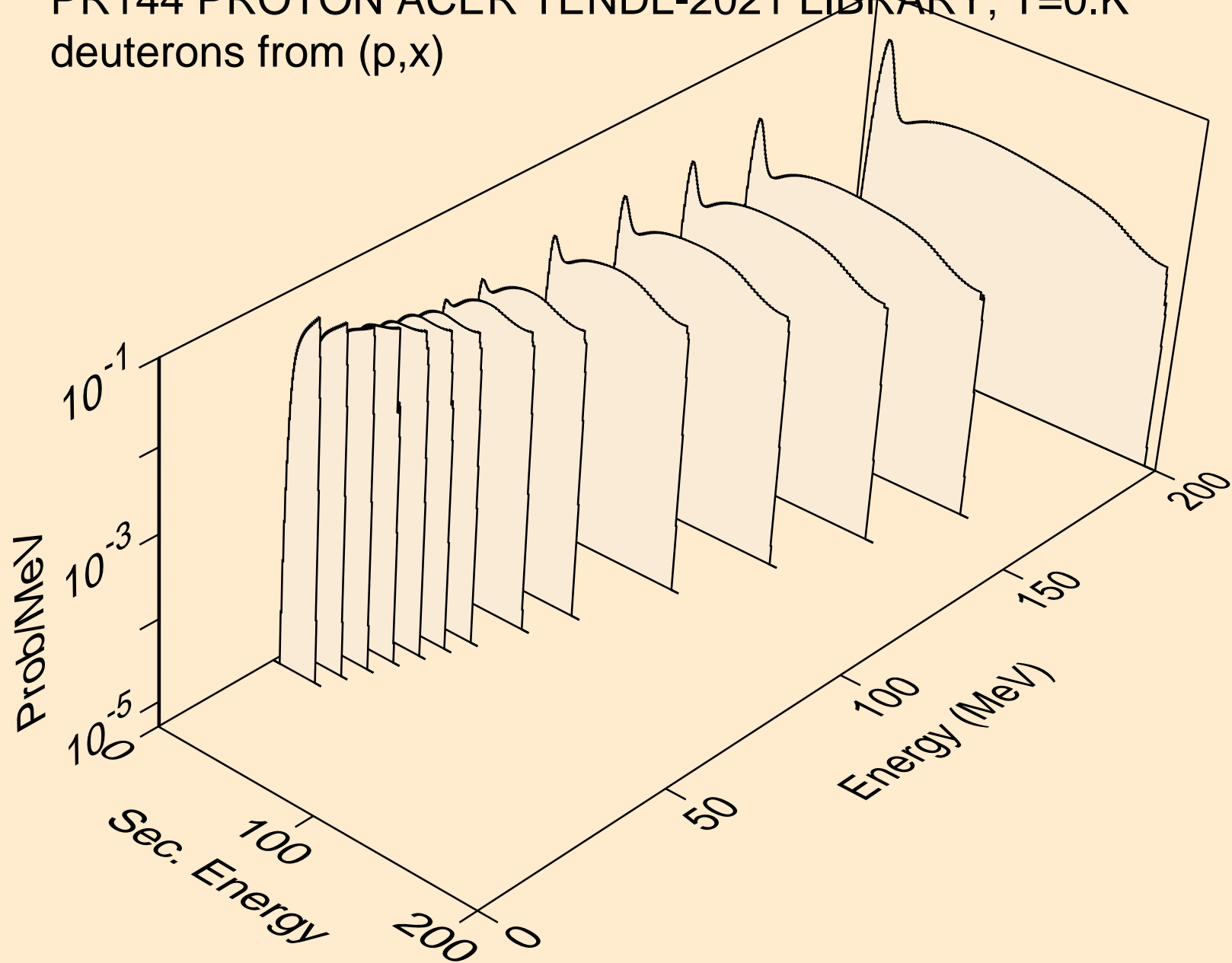



PR144 PROTON ACER TENDL-2021 LIBRARY; T=0.K  
deuterons from (p,2nd)

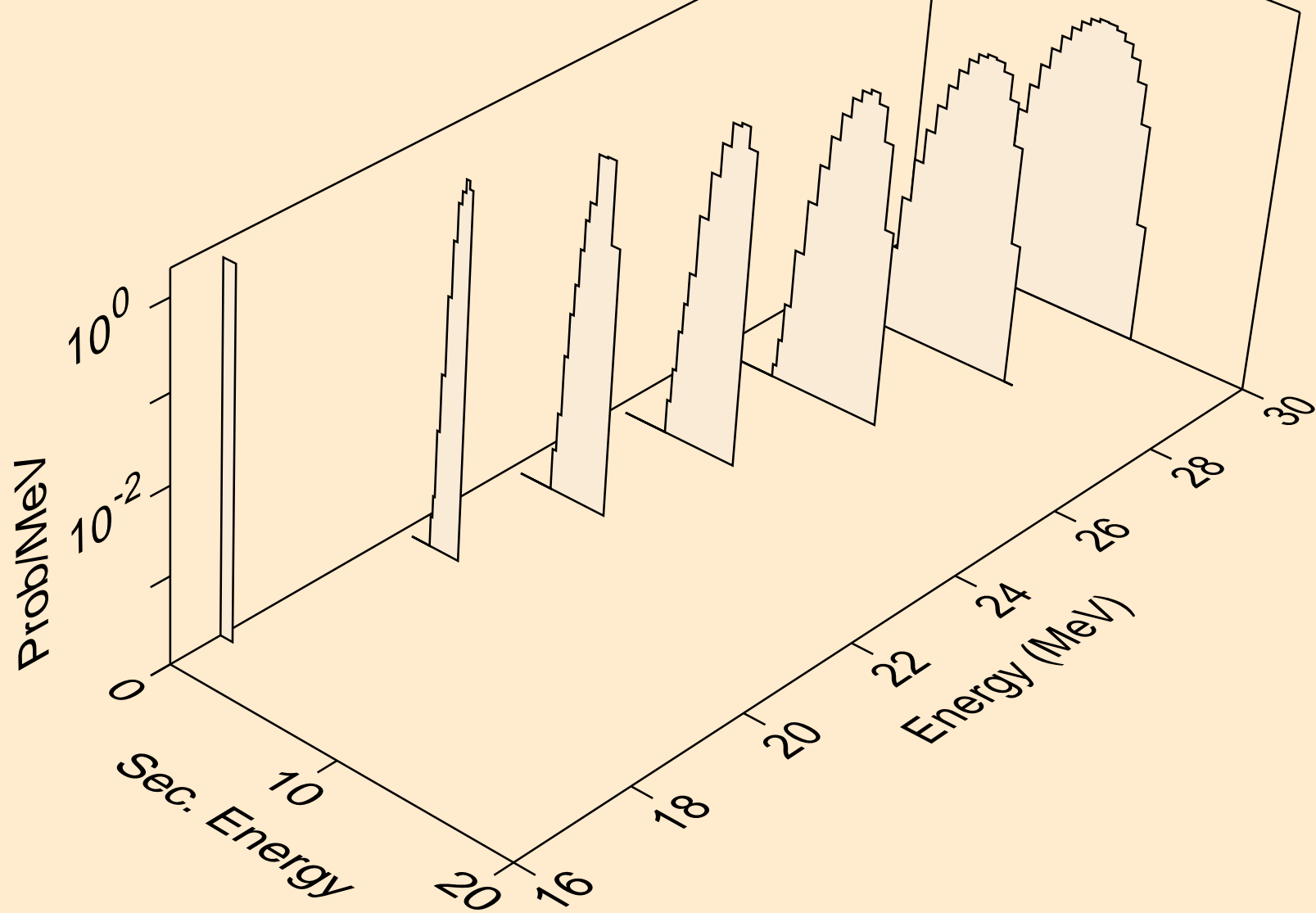

PR144 PROTON ACER TENDL-2021 LIBRARY; T=0.K  
deuterons from (p,n\*)d

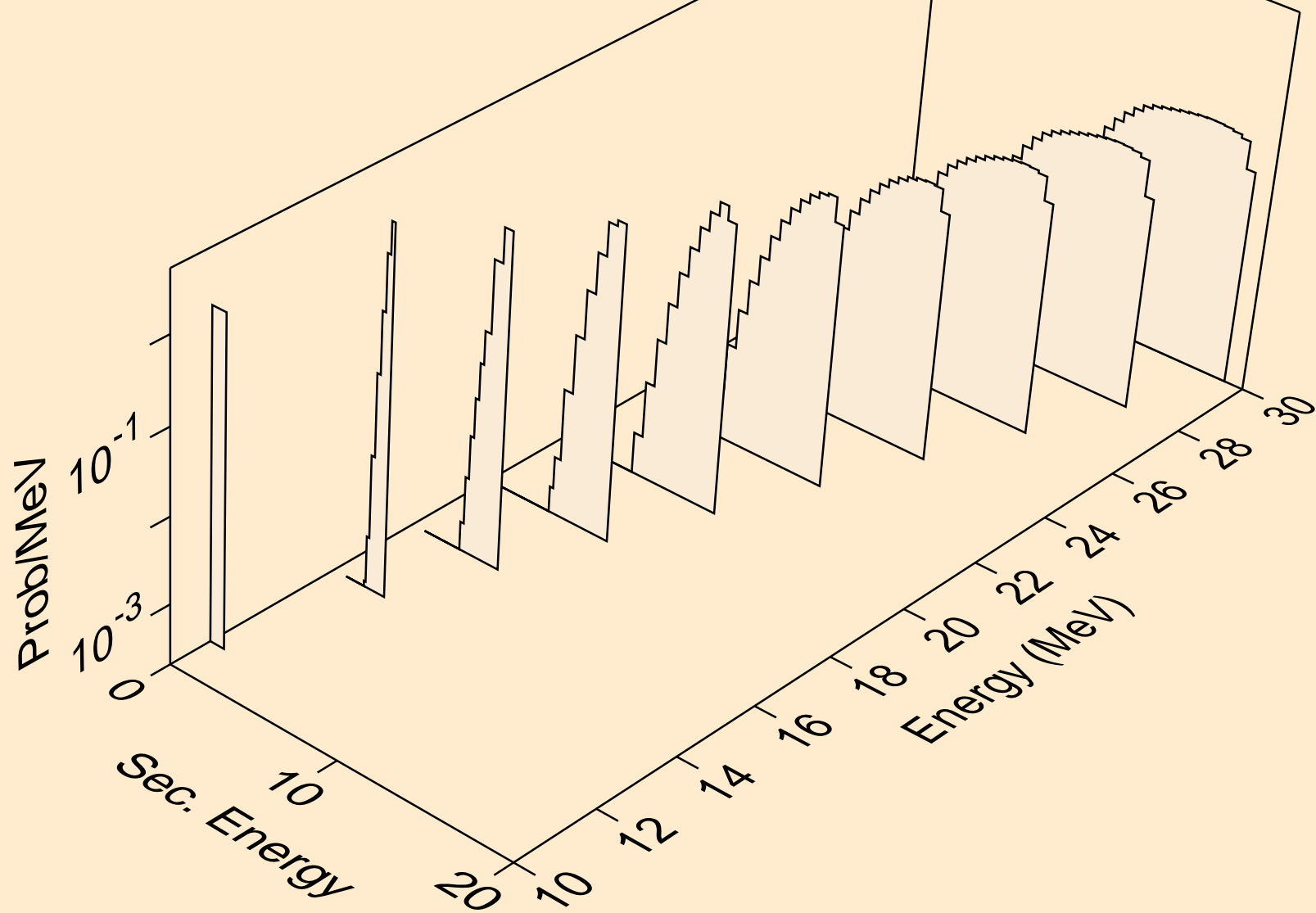

PR144 PROTON ACER TENDL-2021 LIBRARY; T=0.K  
deuterons from (p,d)

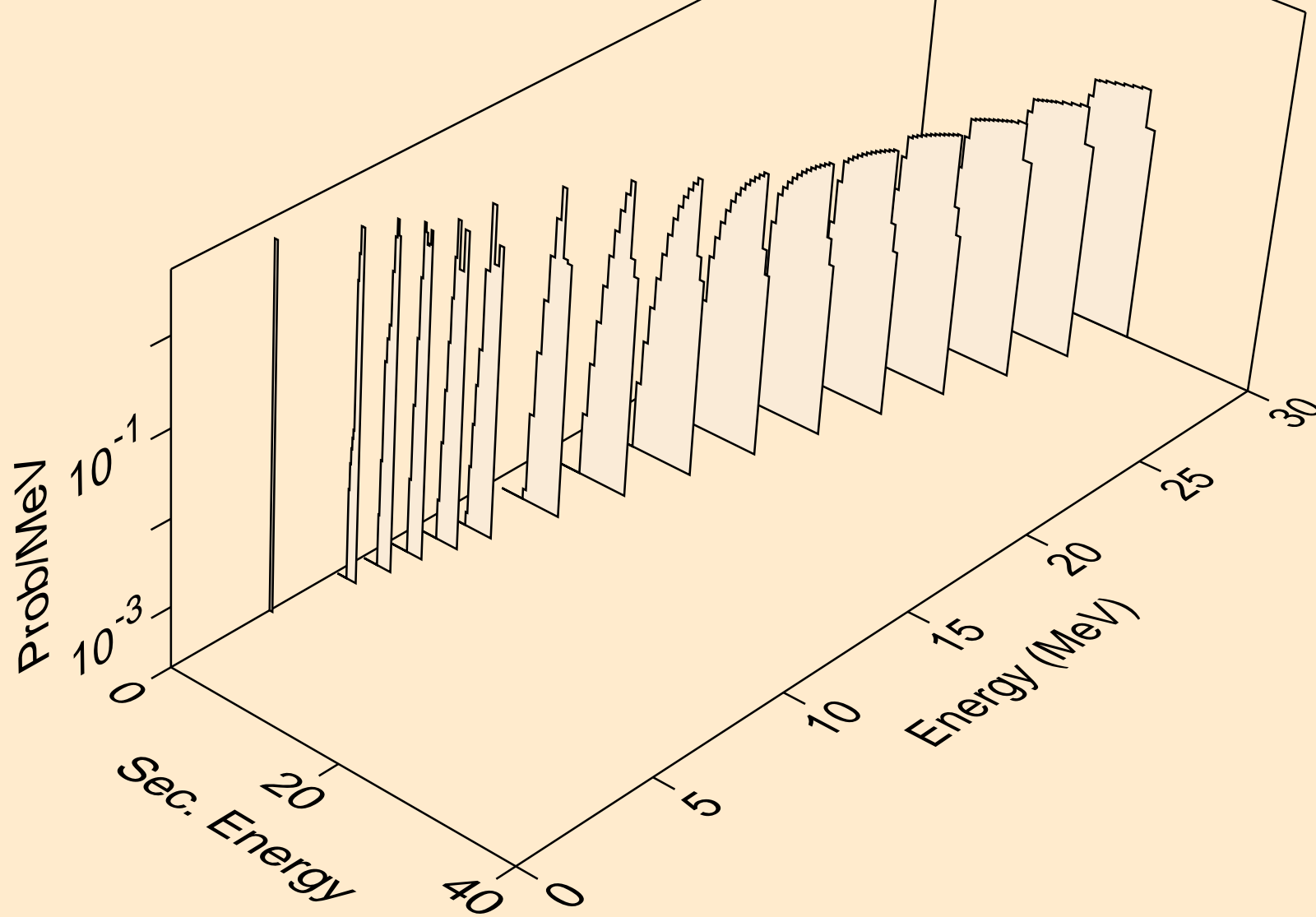

PR144 PROTON ACER TENDL-2021 LIBRARY; T=0.K  
deuterons from (p,pd)

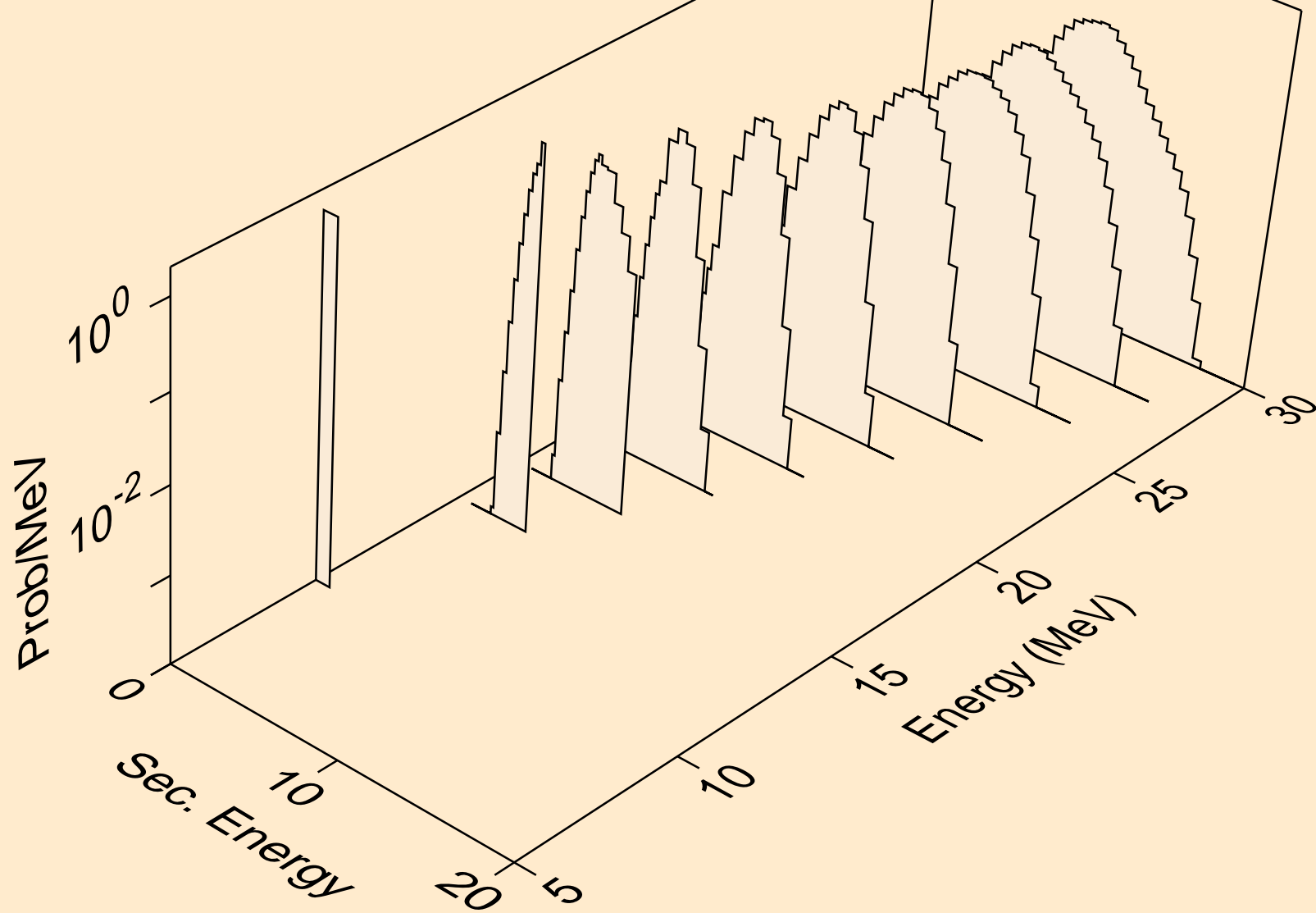

PR144 PROTON ACER TENDL-2021 LIBRARY; T=0.K  
deuterons from (p,da)

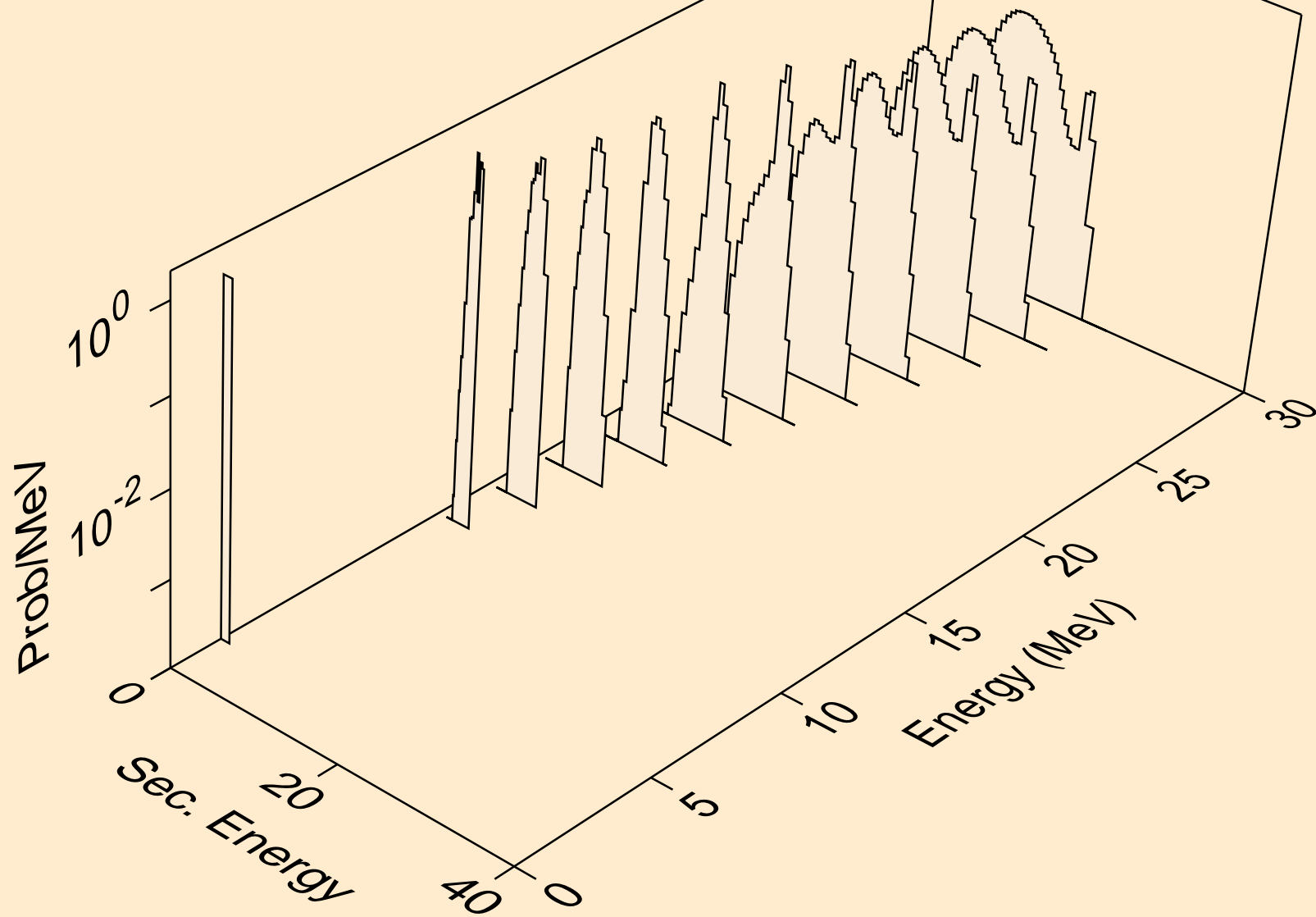

PR144 PROTON ACER TENDL-2021 LIBRARY; T=0.K  
tritons from (p,x)

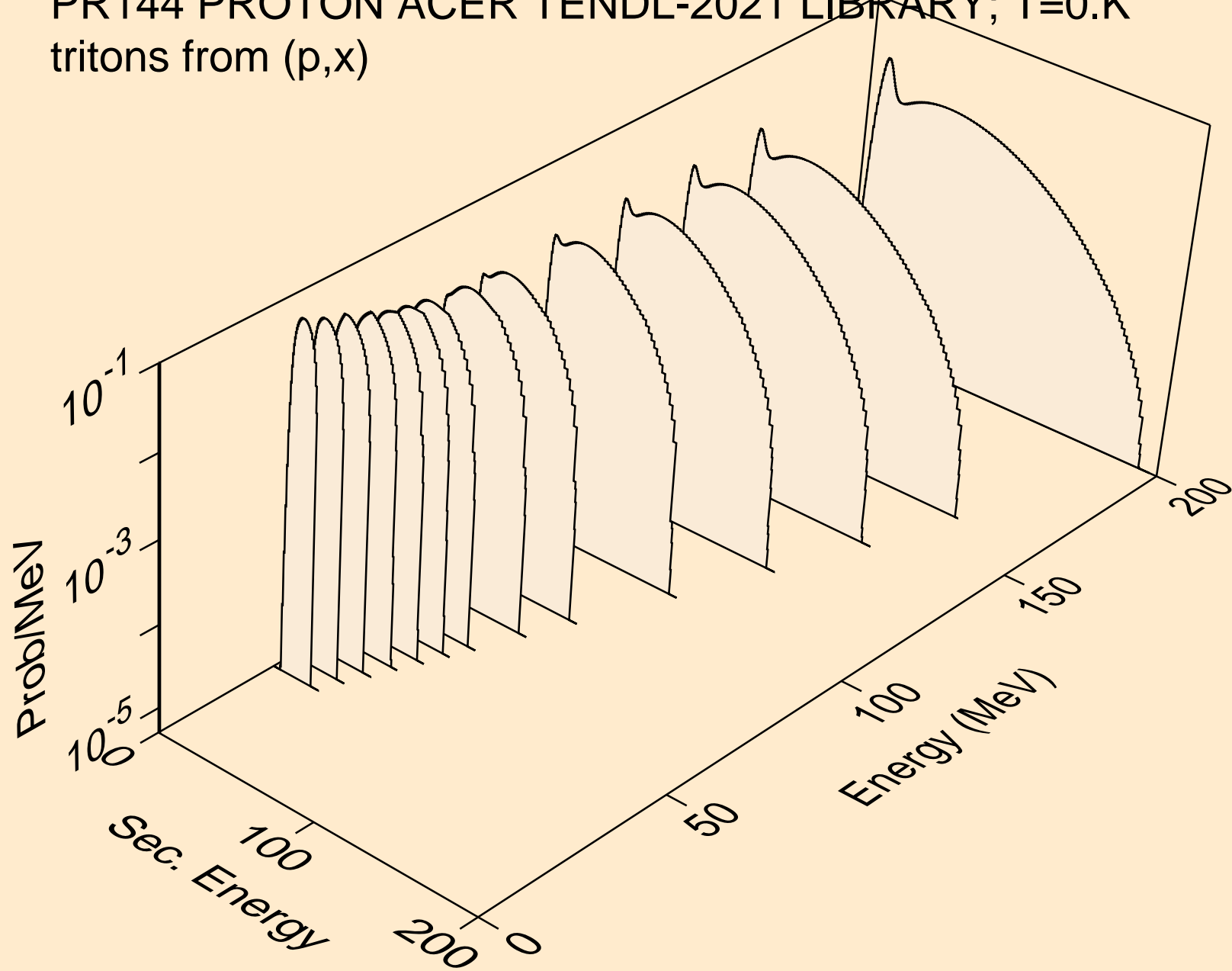

PR144 PROTON ACER TENDL-2021 LIBRARY; T=0.K  
tritons from (p,n\*)t

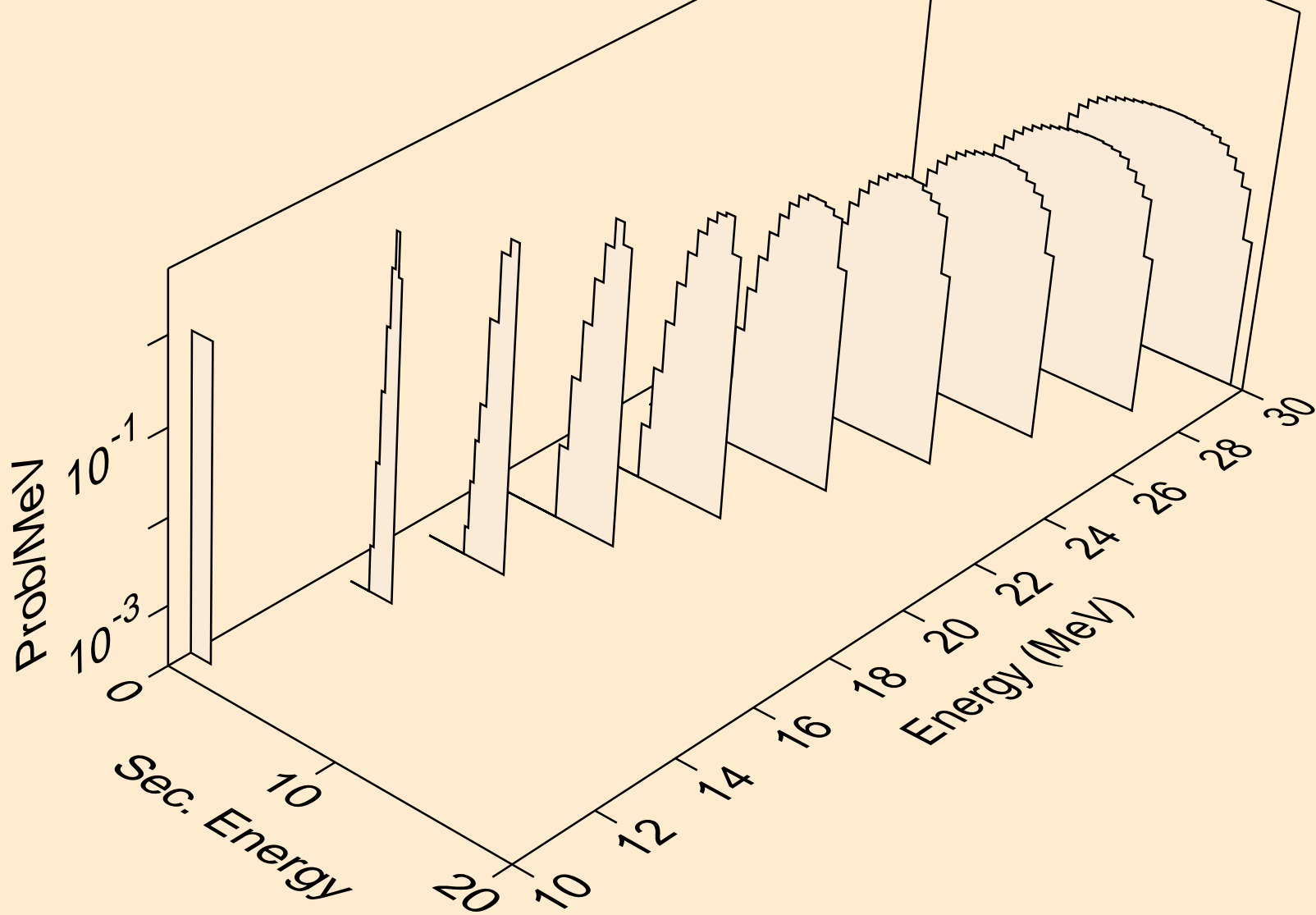

PR144 PROTON ACER TENDL-2021 LIBRARY; T=0.K  
tritons from (p,t)

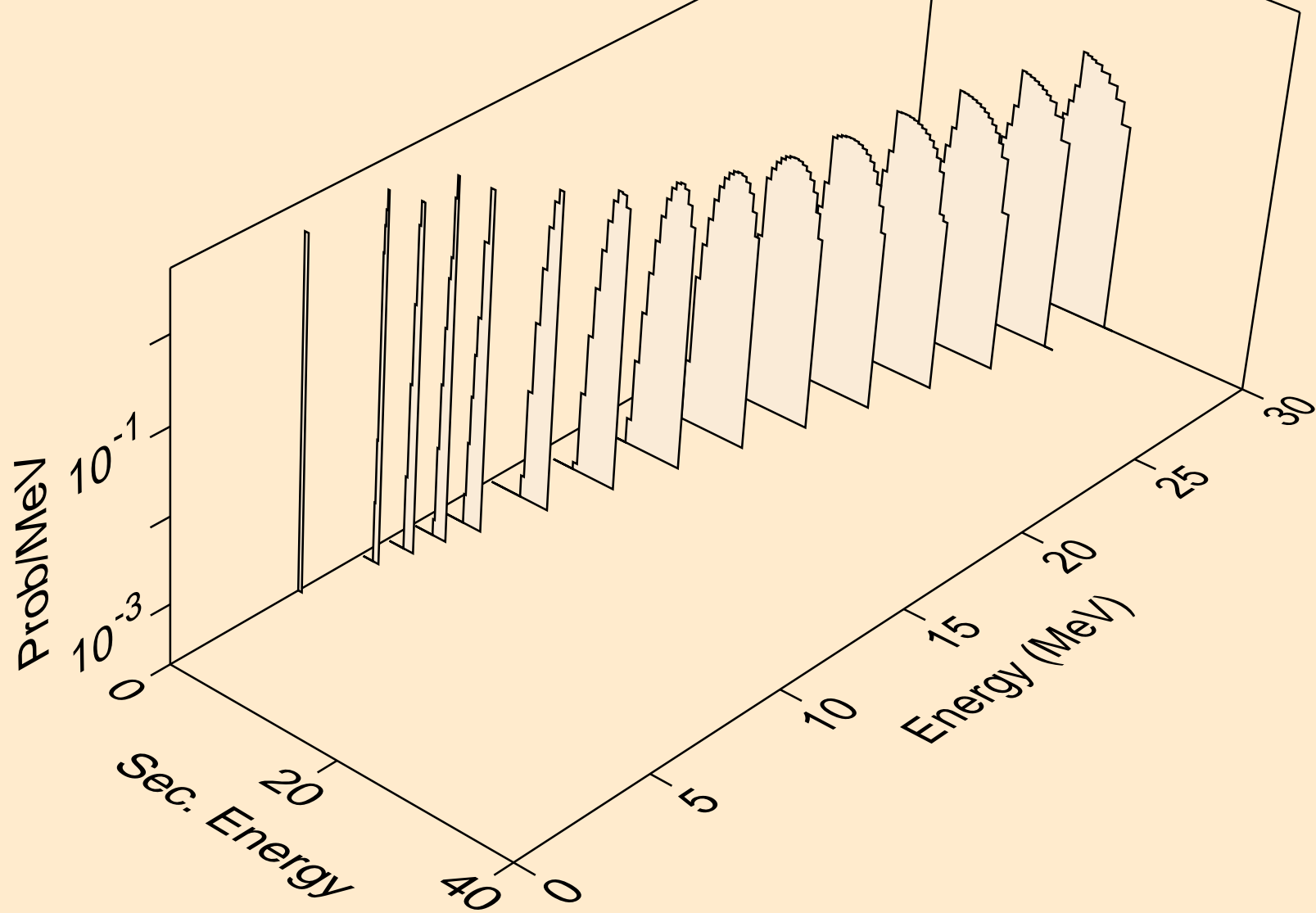



PR144 PROTON ACER TENDL-2021 LIBRARY; T=0.K  
tritons from (p,pt)

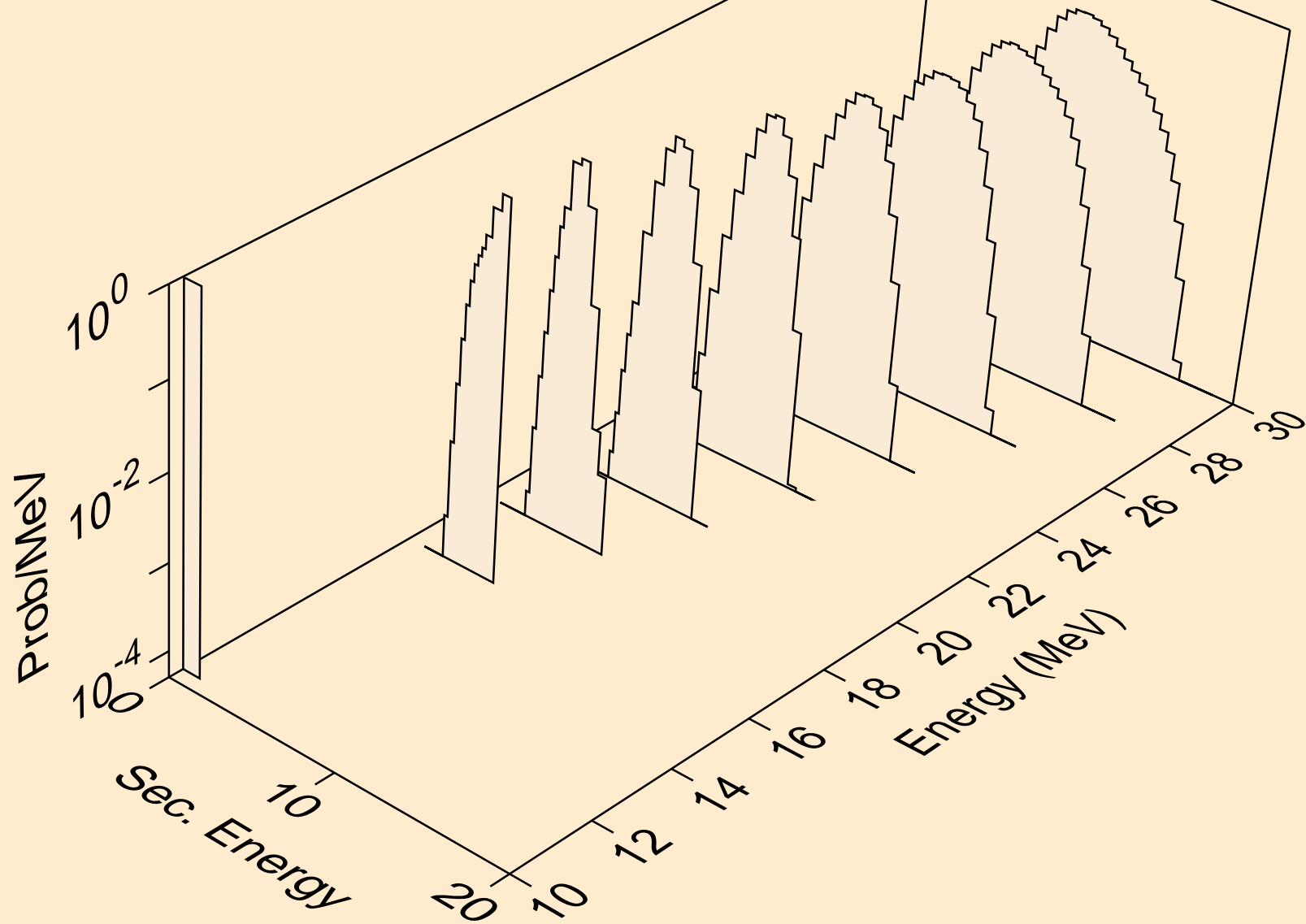

PR144 PROTON ACER TENDL-2021 LIBRARY; T=0.K  
he3s from (p,x)

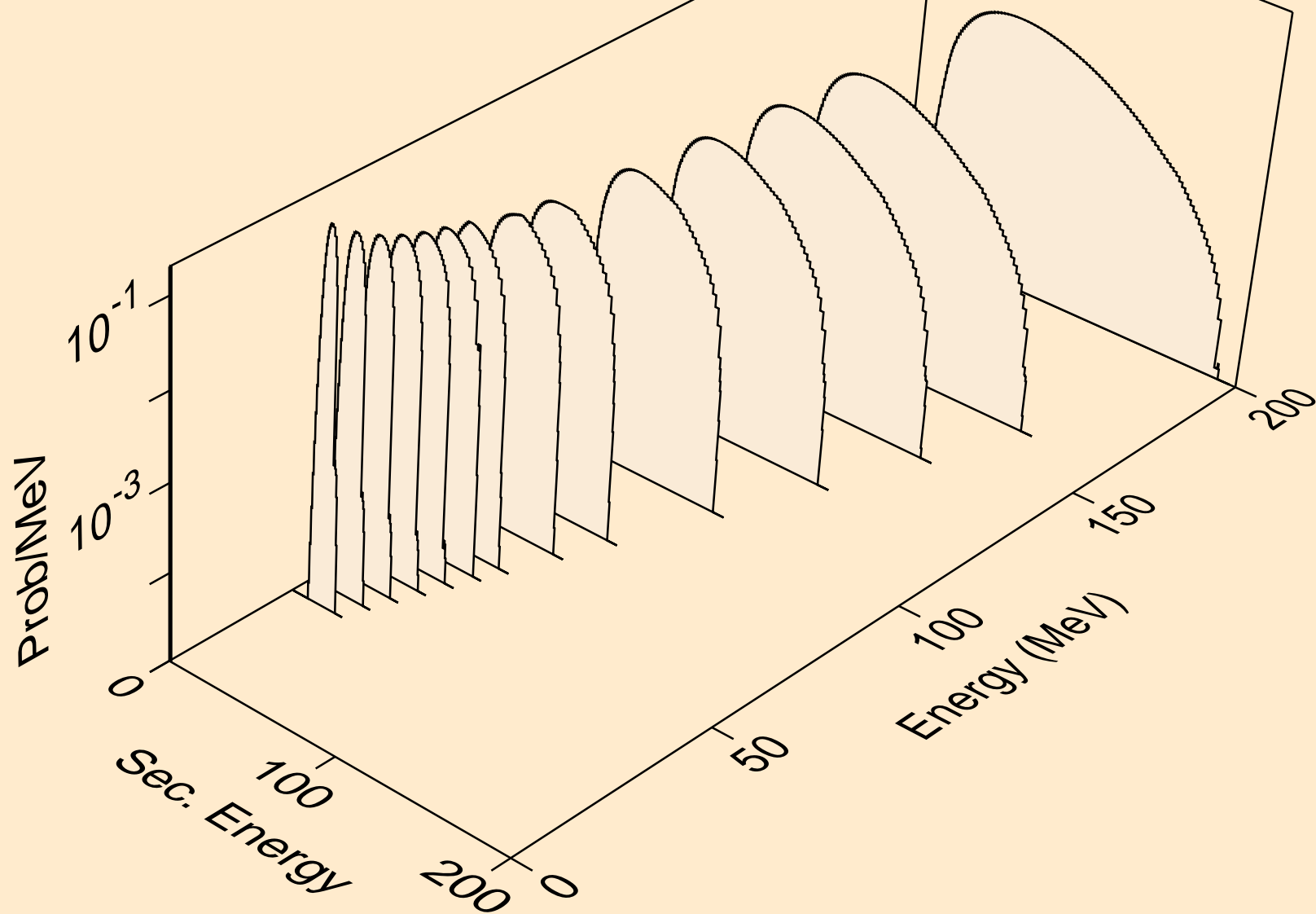

PR144 PROTON ACER TENDL-2021 LIBRARY; T=0.K  
he3s from (p,n\*)he3

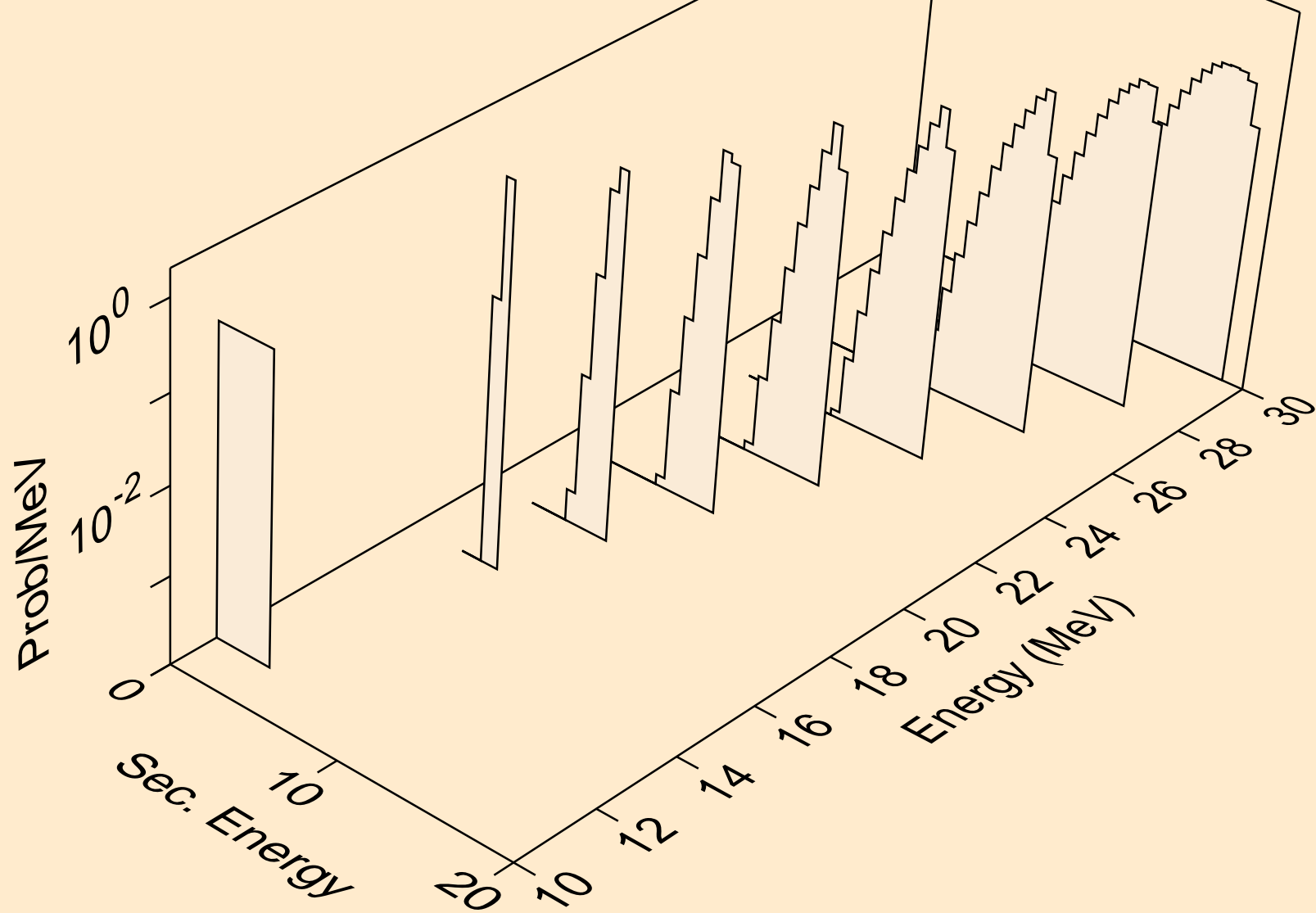

PR144 PROTON ACER TENDL-2021 LIBRARY; T=0.K  
he3s from (p,he3)

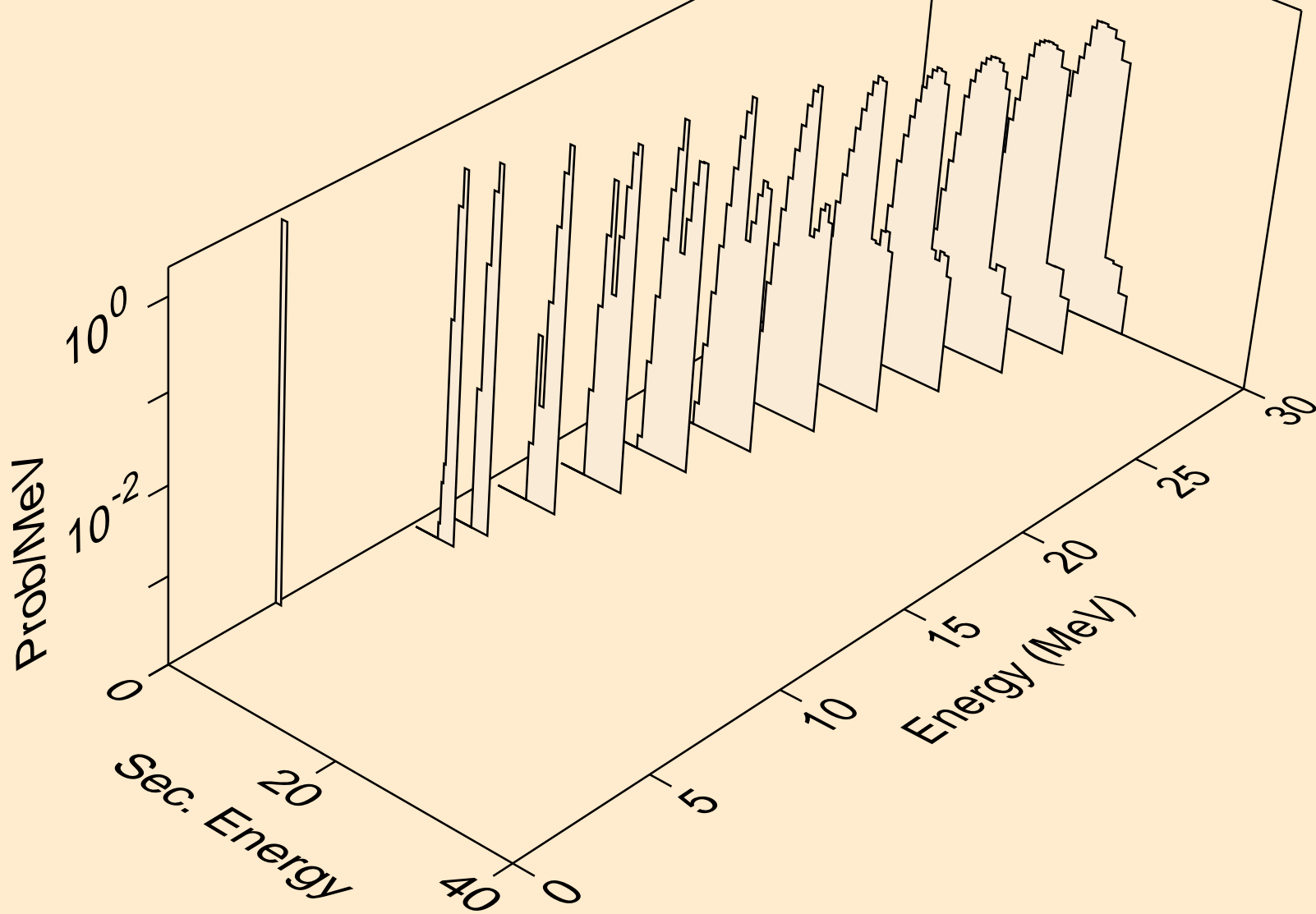

PR144 PROTON ACER TENDL-2021 LIBRARY; T=0.K  
alphas from (p,x)

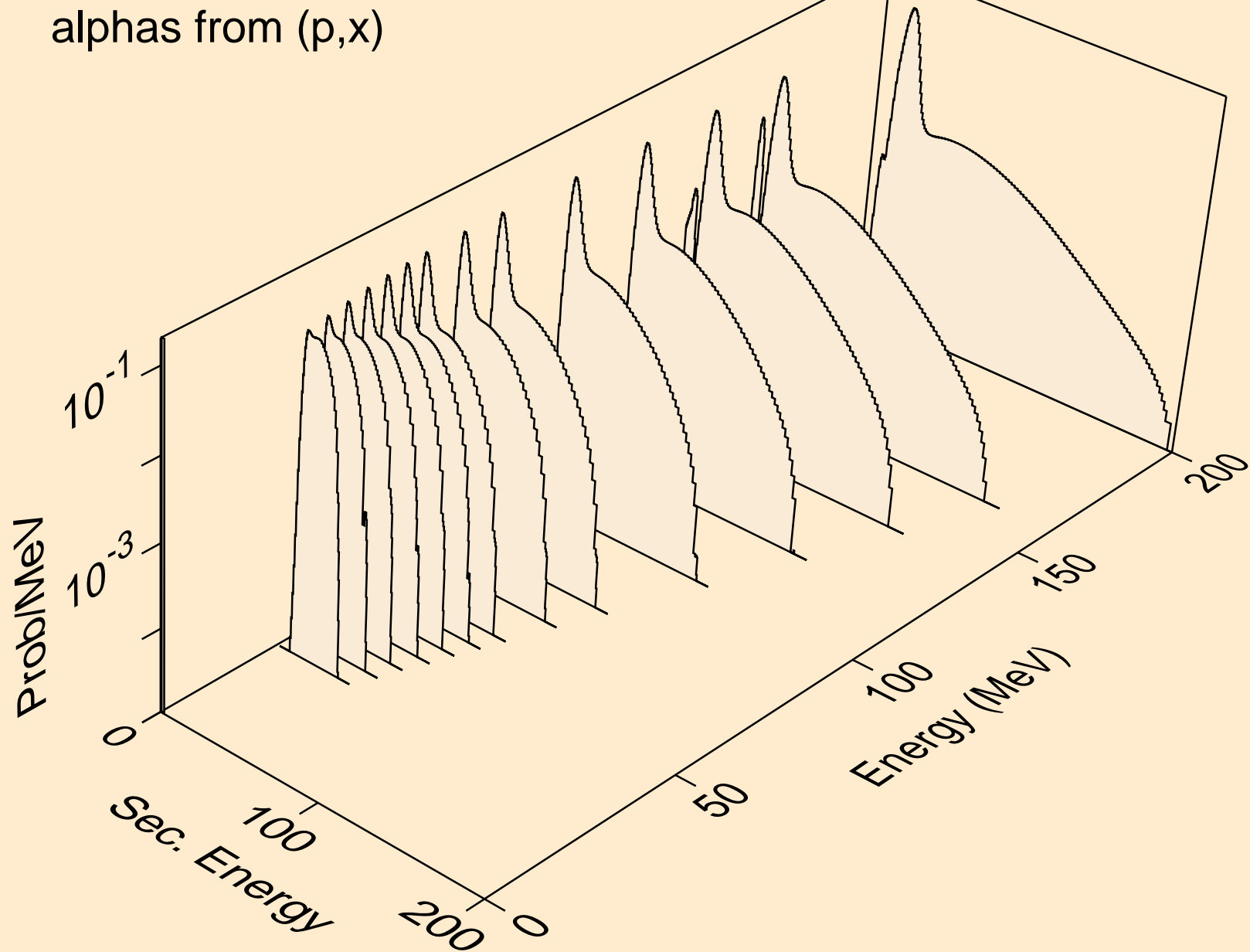

PR144 PROTON ACER TENDL-2021 LIBRARY; T=0.K  
alphas from (p,n\*)a

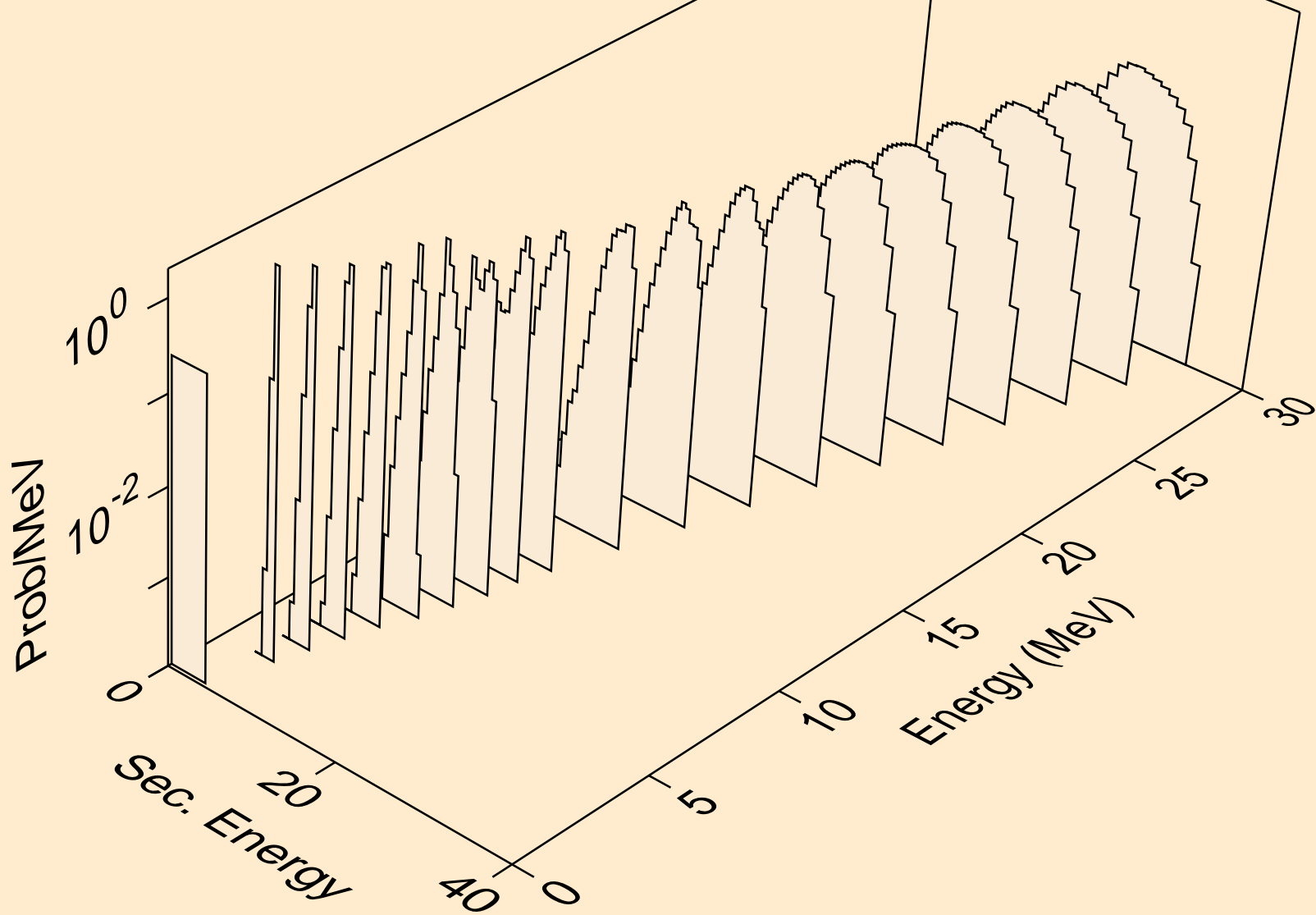

PR144 PROTON ACER TENDL-2021 LIBRARY; T=0.K  
alphas from (p,2n)a

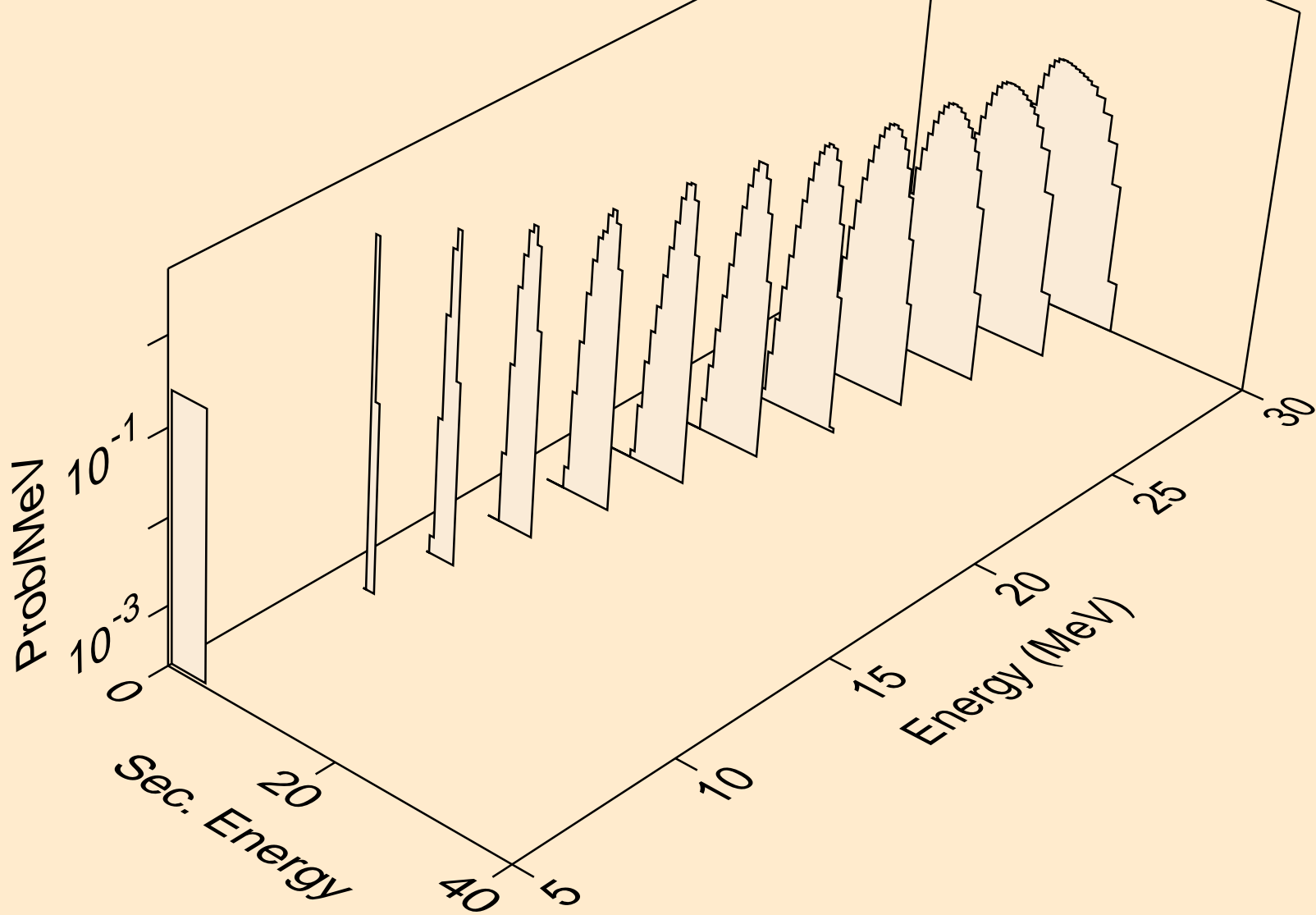

PR144 PROTON ACER TENDL-2021 LIBRARY; T=0.K  
alphas from (p,3n)a

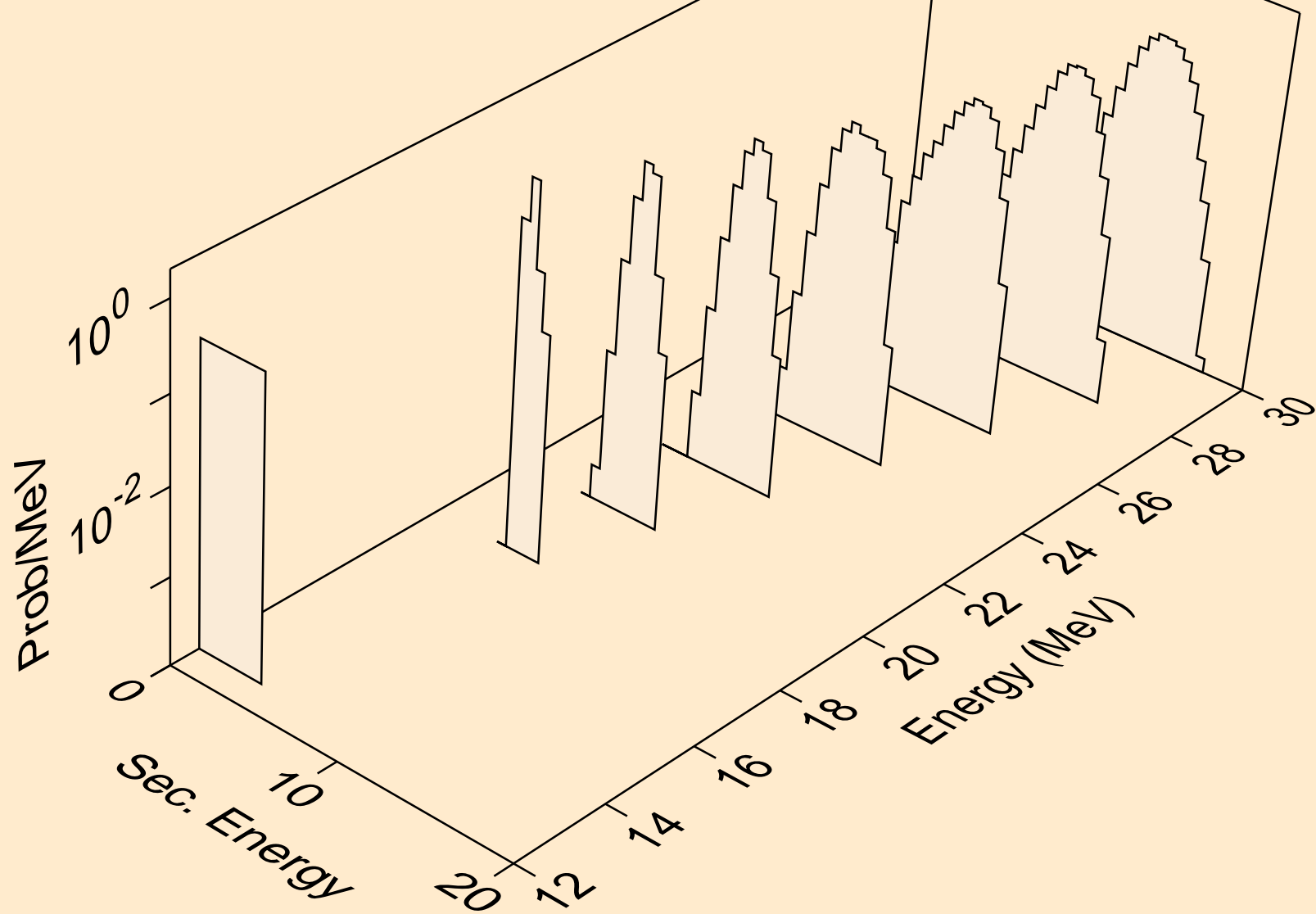



PR144 PROTON ACER TENDL-2021 LIBRARY; T=0.K  
alphas from (p,n\*)2a

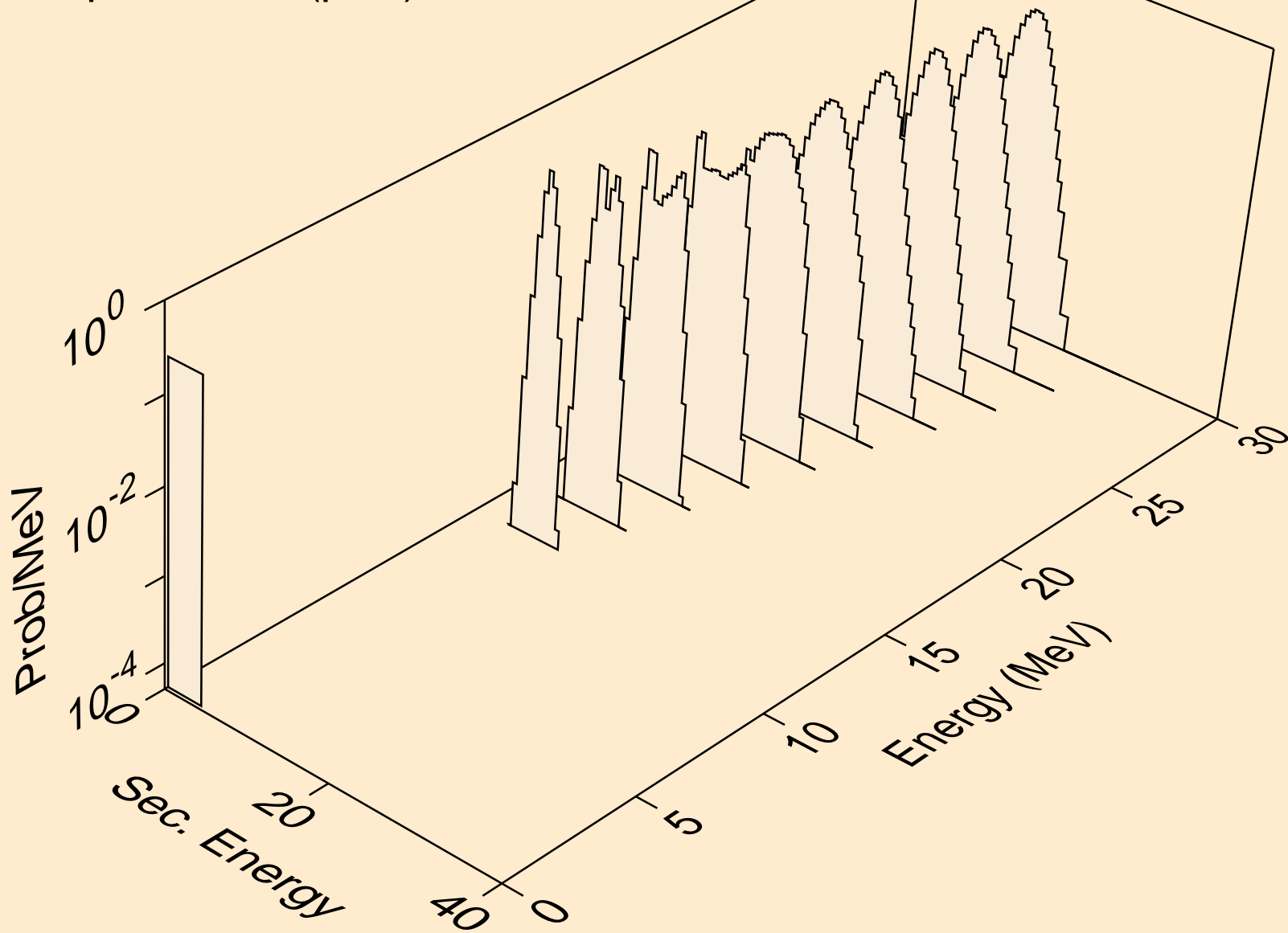

PR144 PROTON ACER TENDL-2021 LIBRARY; T=0.K  
alphas from (p,npa)

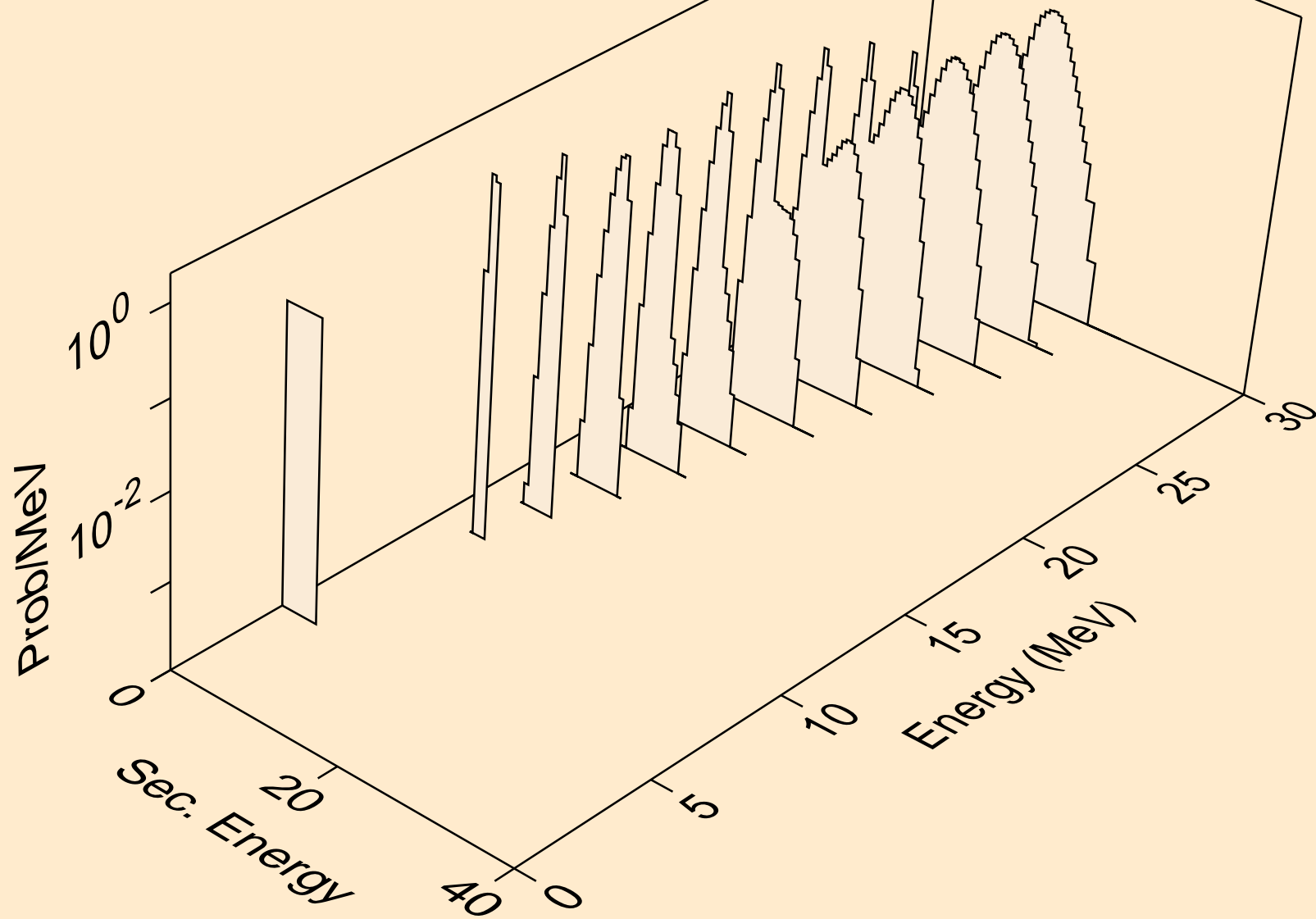

PR144 PROTON ACER TENDL-2021 LIBRARY; T=0.K  
alphas from (p,a)

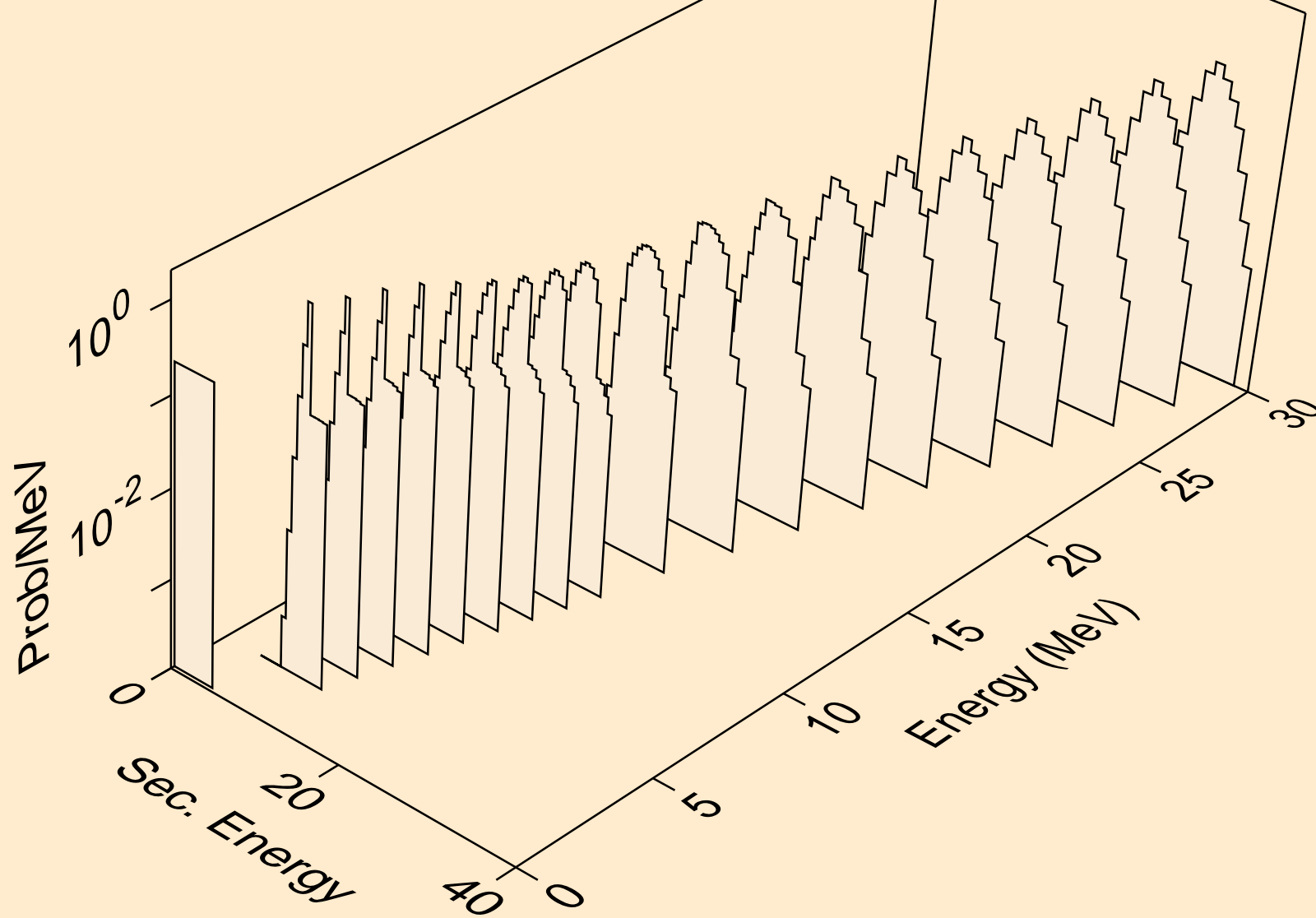

PR144 PROTON ACER TENDL-2021 LIBRARY; T=0.K  
alphas from (p,2a)

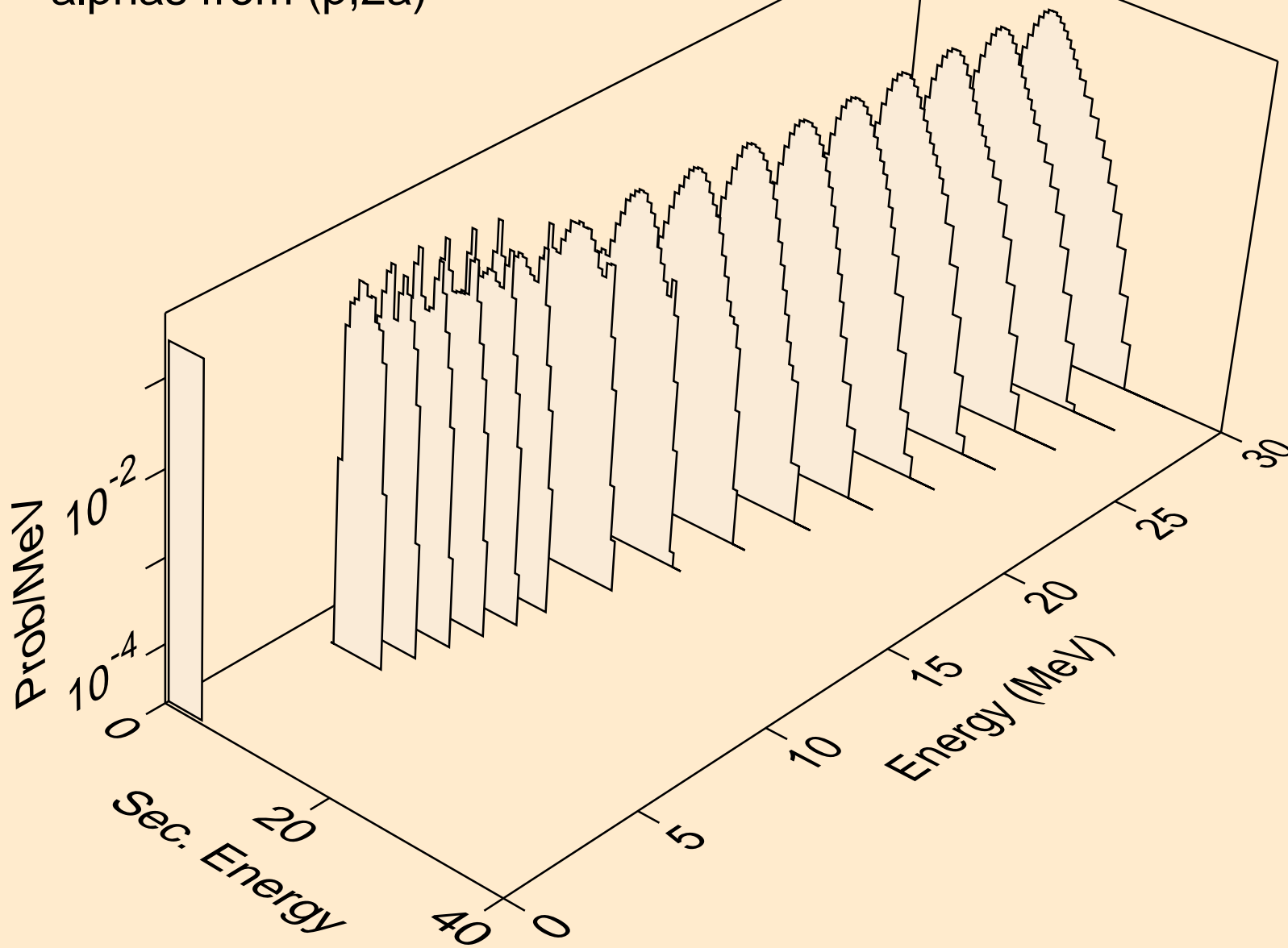

PR144 PROTON ACER TENDL-2021 LIBRARY; T=0.K  
alphas from (p,pa)

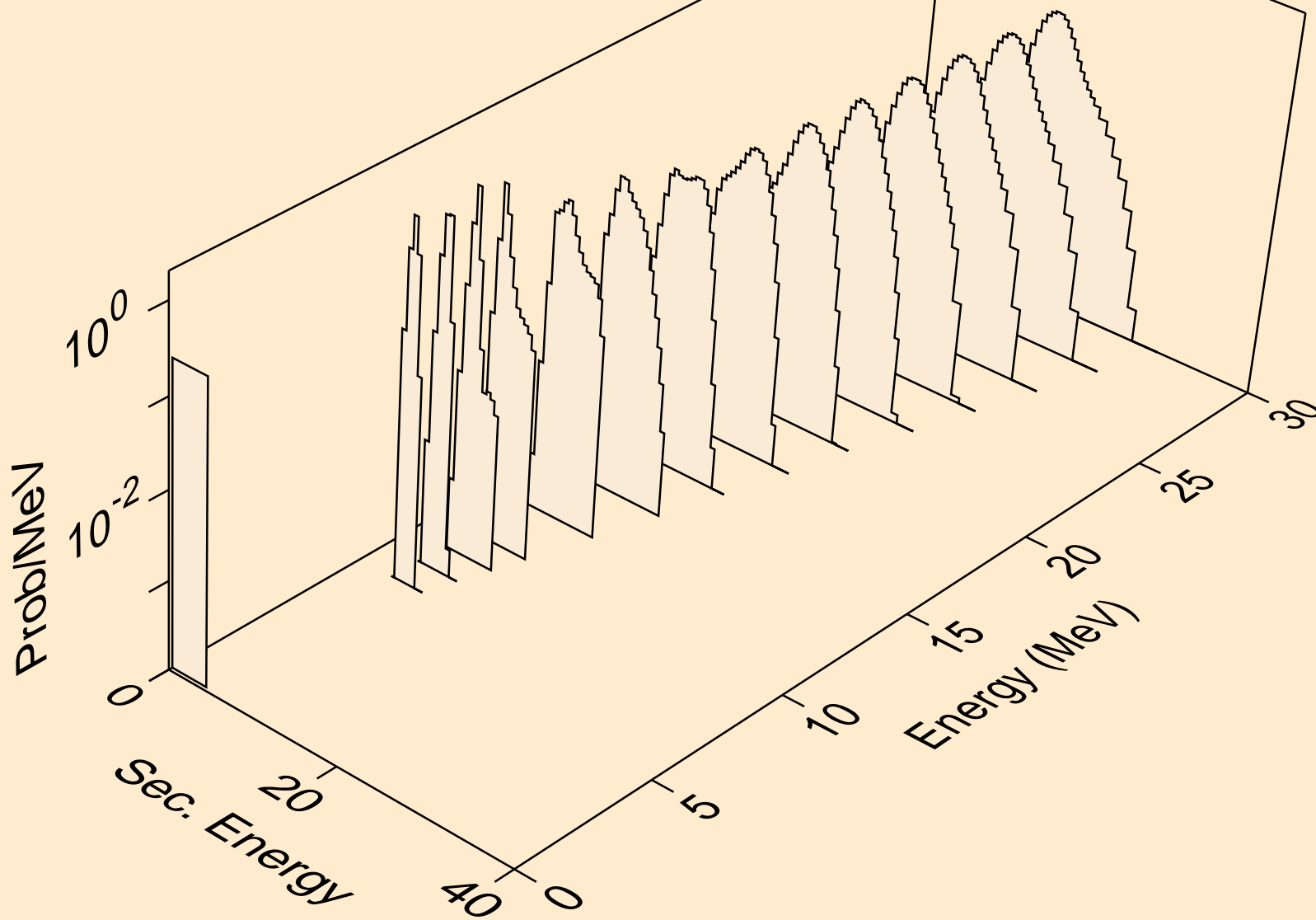

PR144 PROTON ACER TENDL-2021 LIBRARY; T=0.K  
alphas from (p,da)

