

PT181 PROTON ACER TENDL-2021 LIBRARY; T=0.K  
Principal cross sections

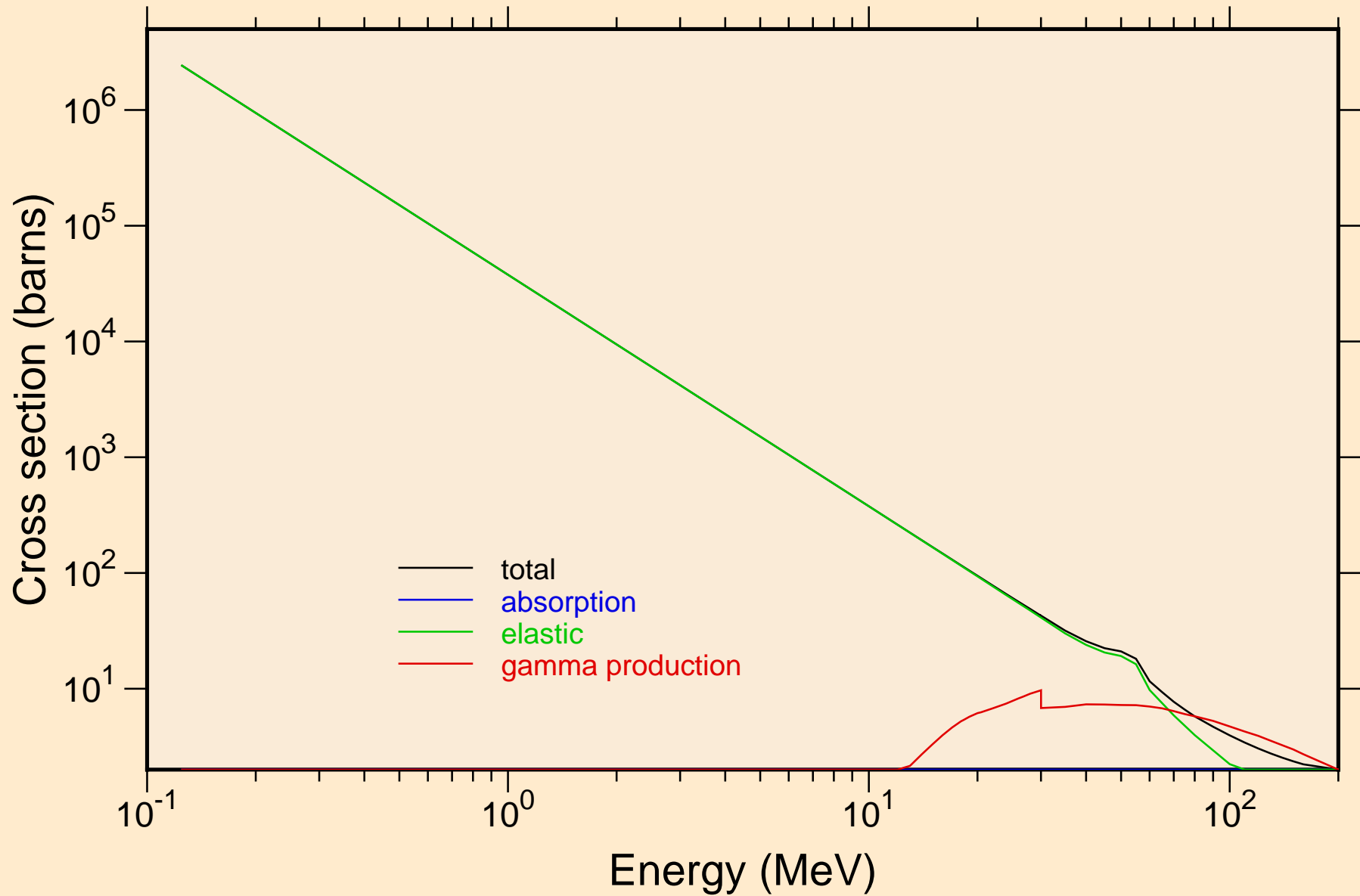

PT181 PROTON ACER TENDL-2021 LIBRARY; T=0.K  
Heating

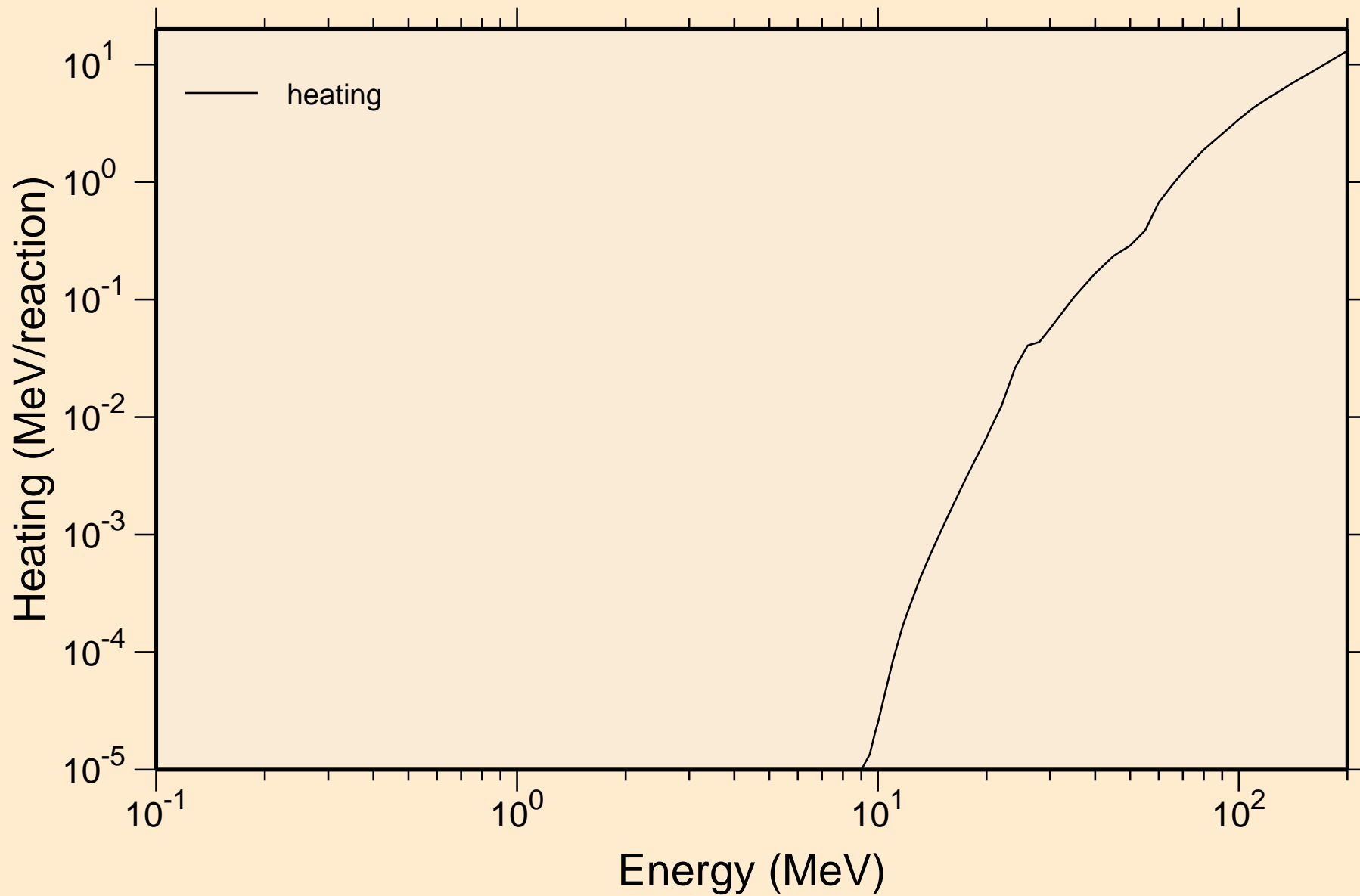

# PT181 PROTON ACER TENDL-2021 LIBRARY; T=0.K

## Principal cross sections

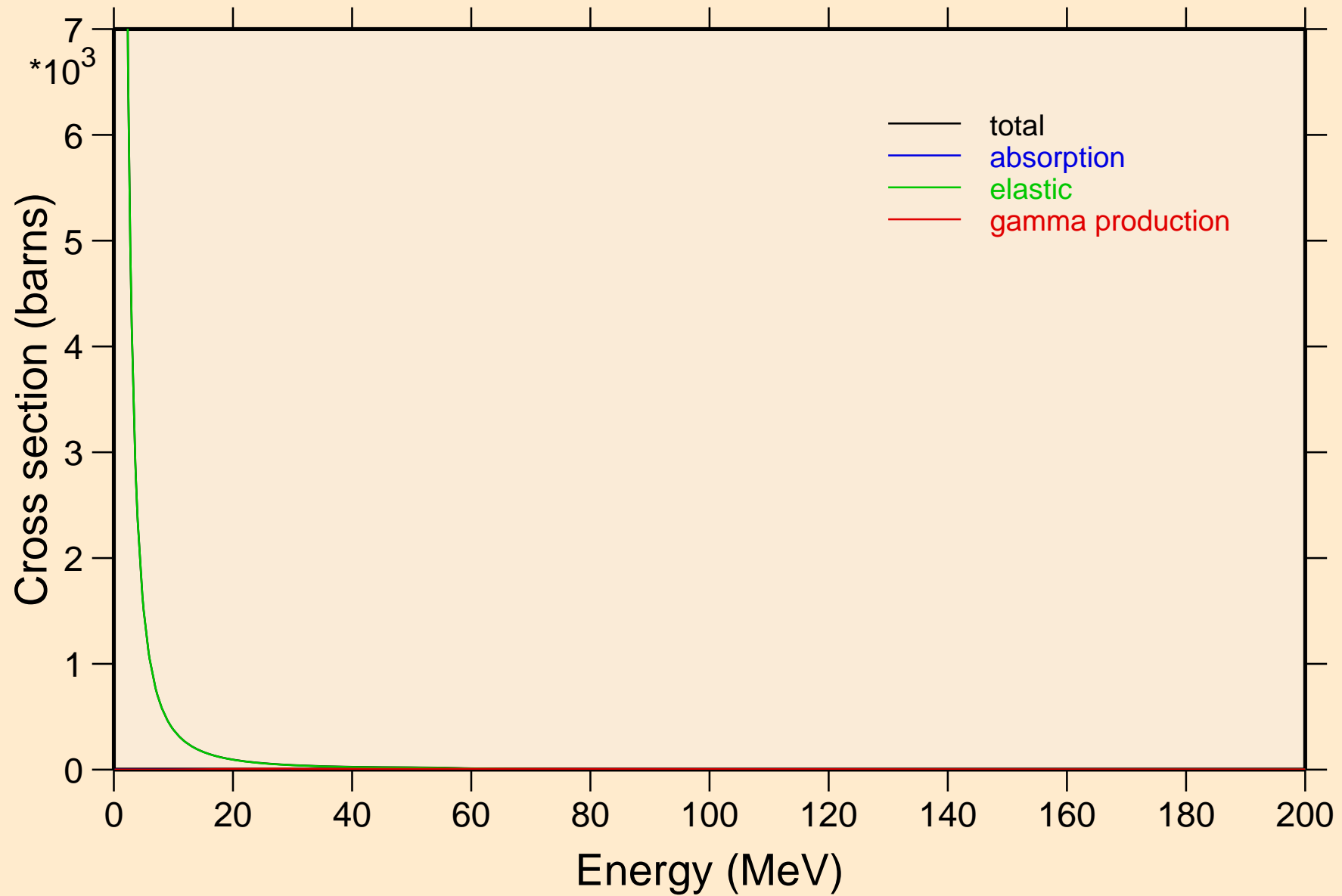

PT181 PROTON ACER TENDL-2021 LIBRARY; T=0.K

Heating

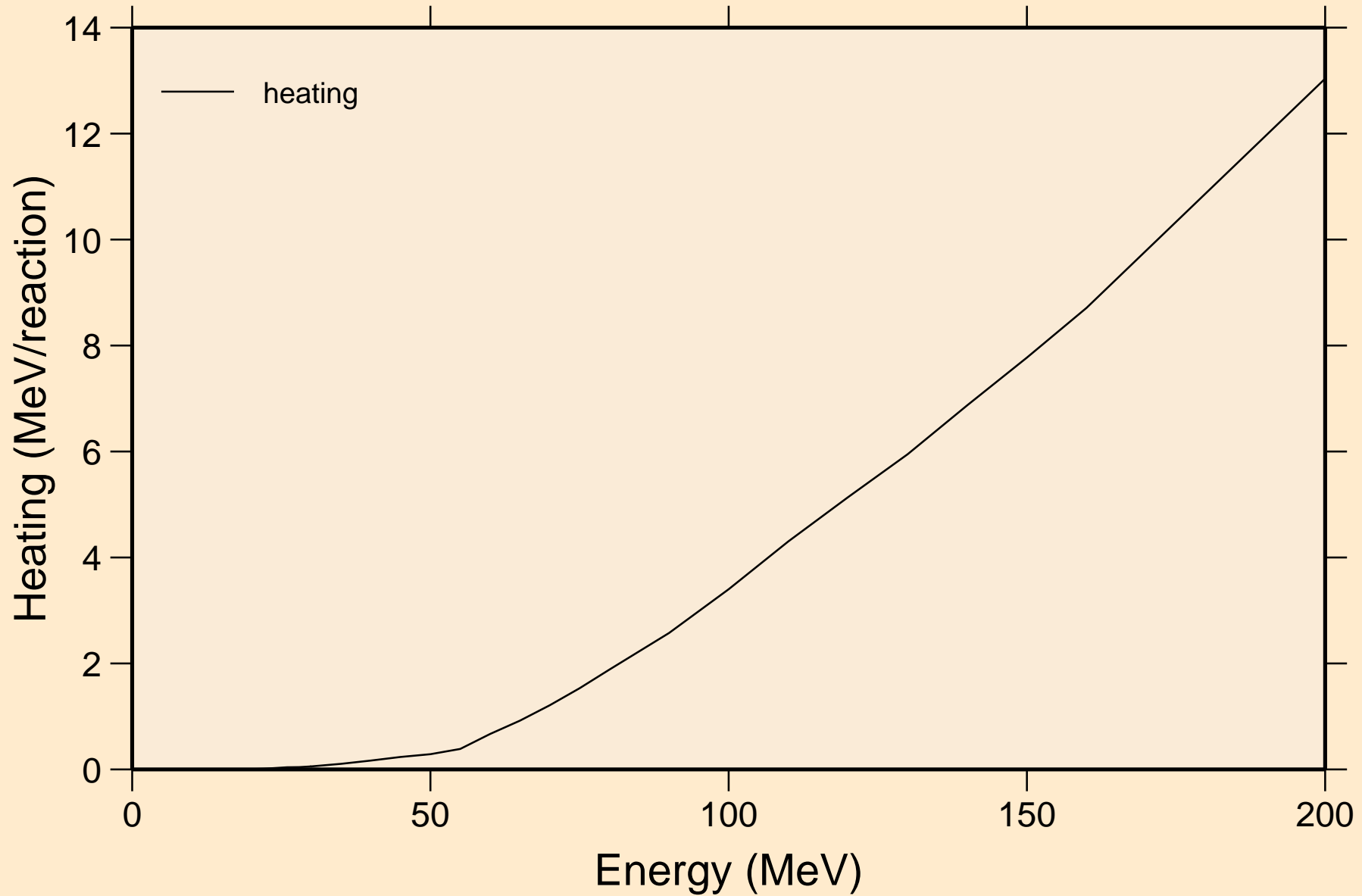

PT181 PROTON ACER TENDL-2021 LIBRARY; T=0.K  
Threshold reactions

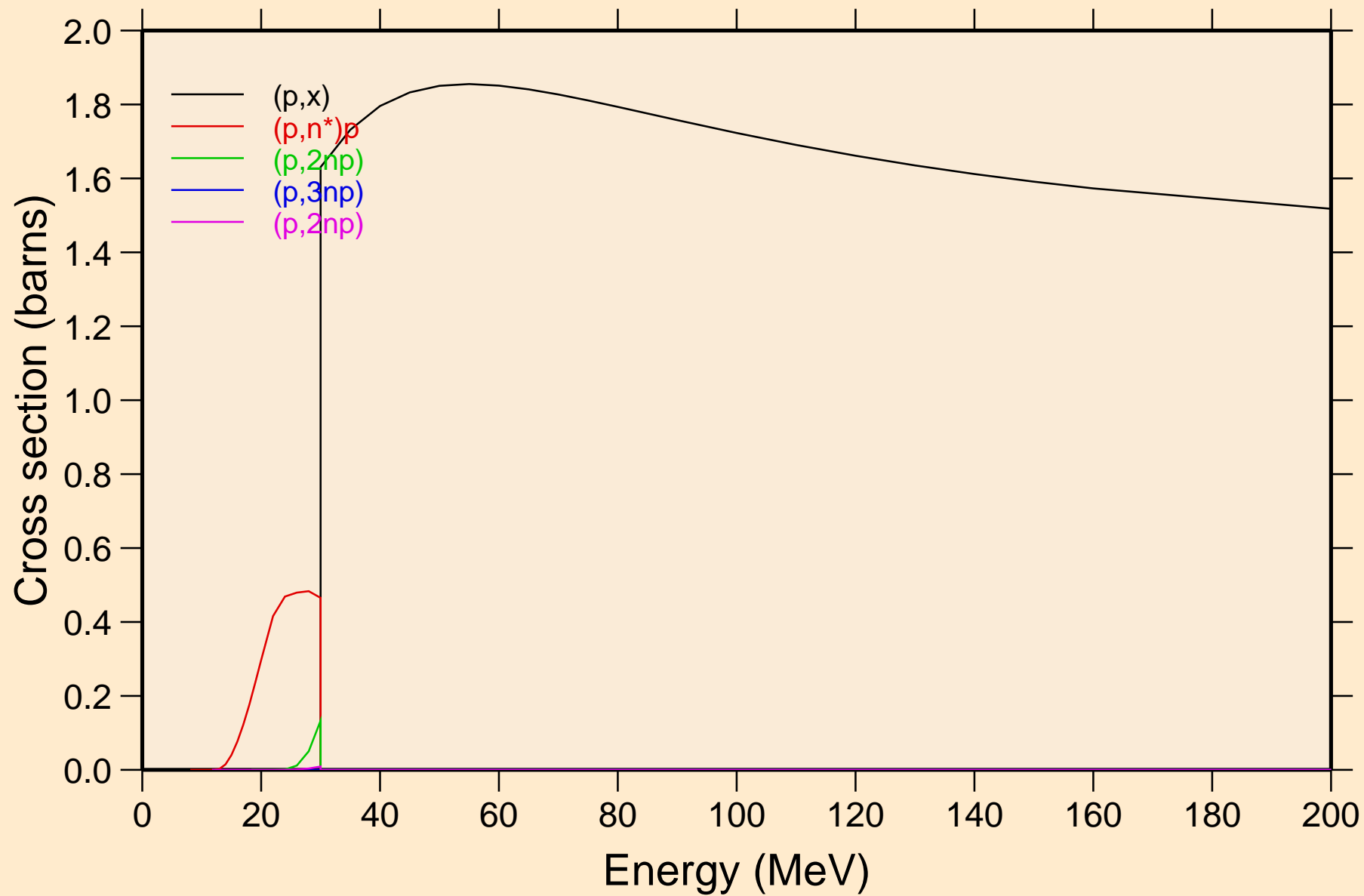

PT181 PROTON ACER TENDL-2021 LIBRARY; T=0.K  
Threshold reactions

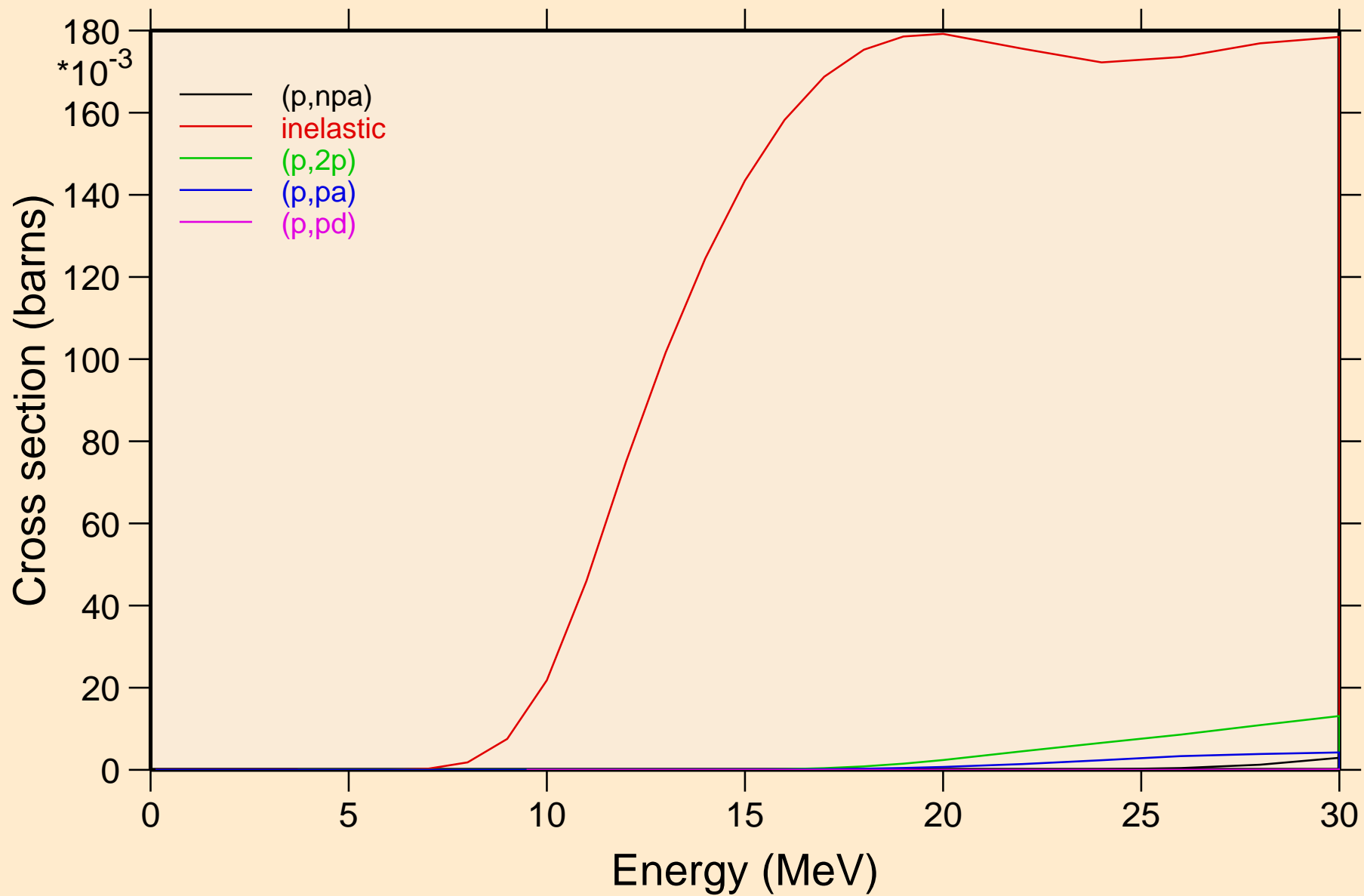

PT181 PROTON ACER TENDL-2021 LIBRARY; T=0.K  
Threshold reactions

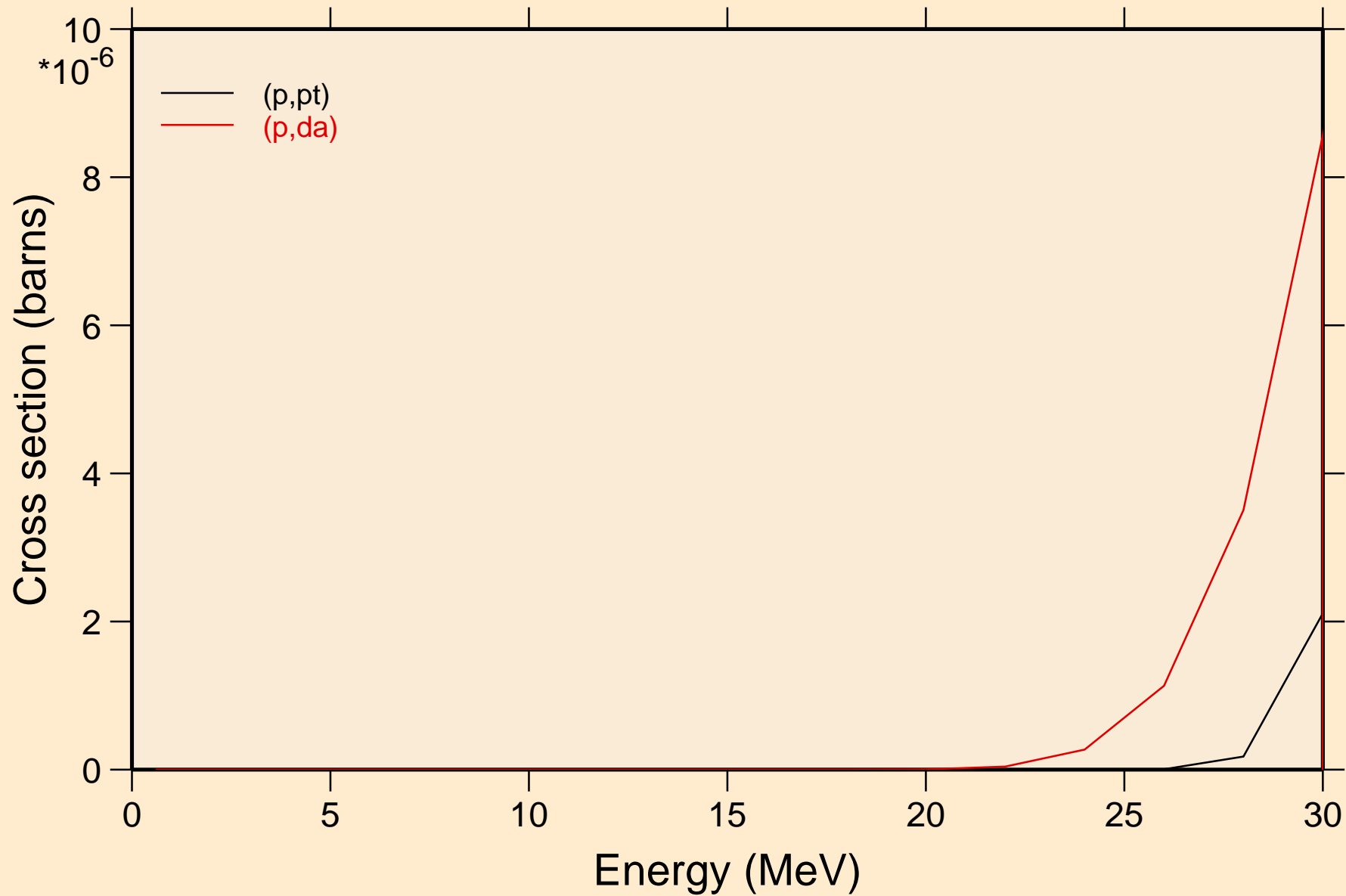

PT181 PROTON ACER TENDL-2021 LIBRARY; T=0.K  
angular distribution for elastic

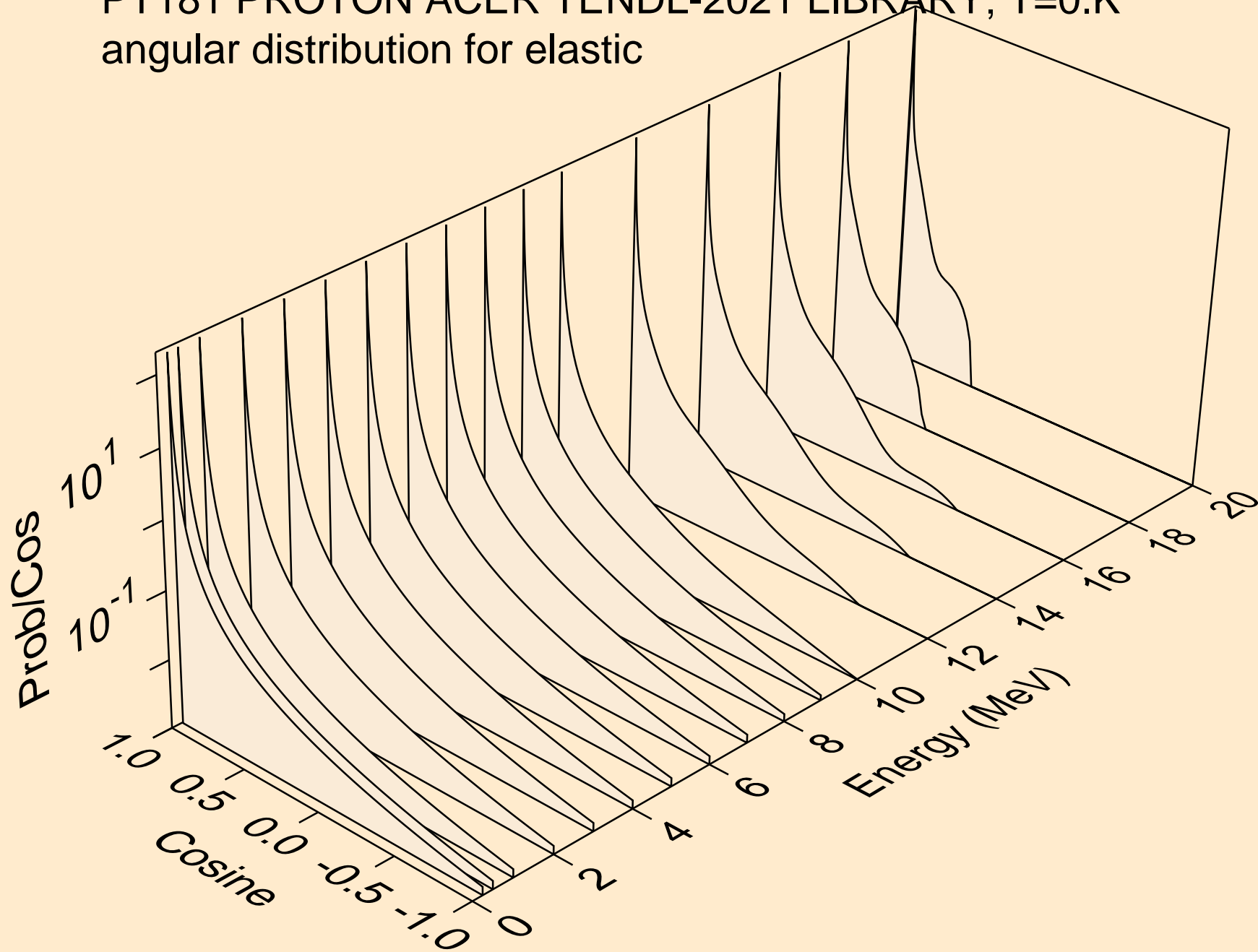



PT181 PROTON ACER TENDL-2021 LIBRARY; T=0.K  
angular distribution for elastic

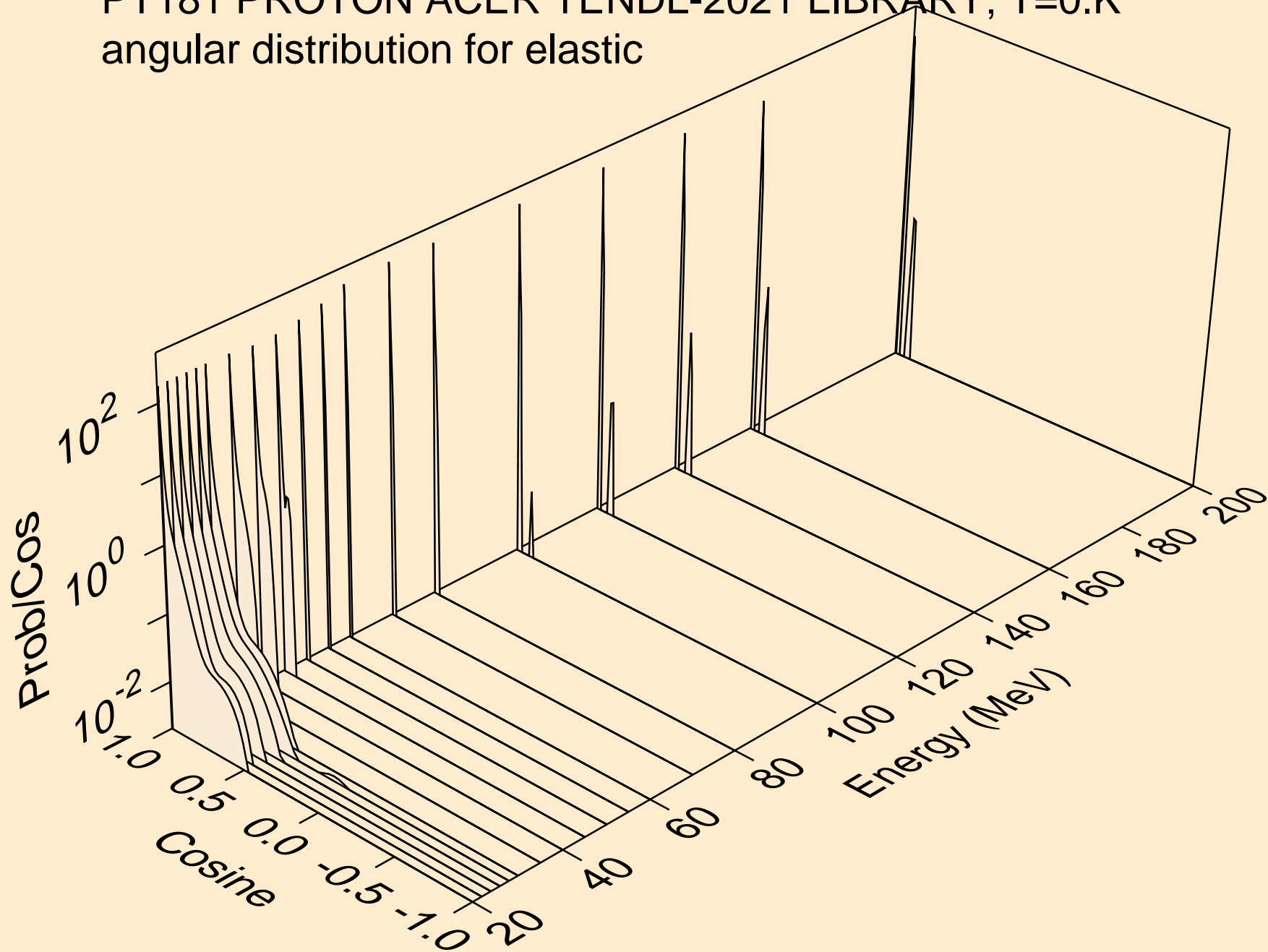

PT181 PROTON ACER TENDL-2021 LIBRARY; T=0.K  
Proton emission for (p,x)

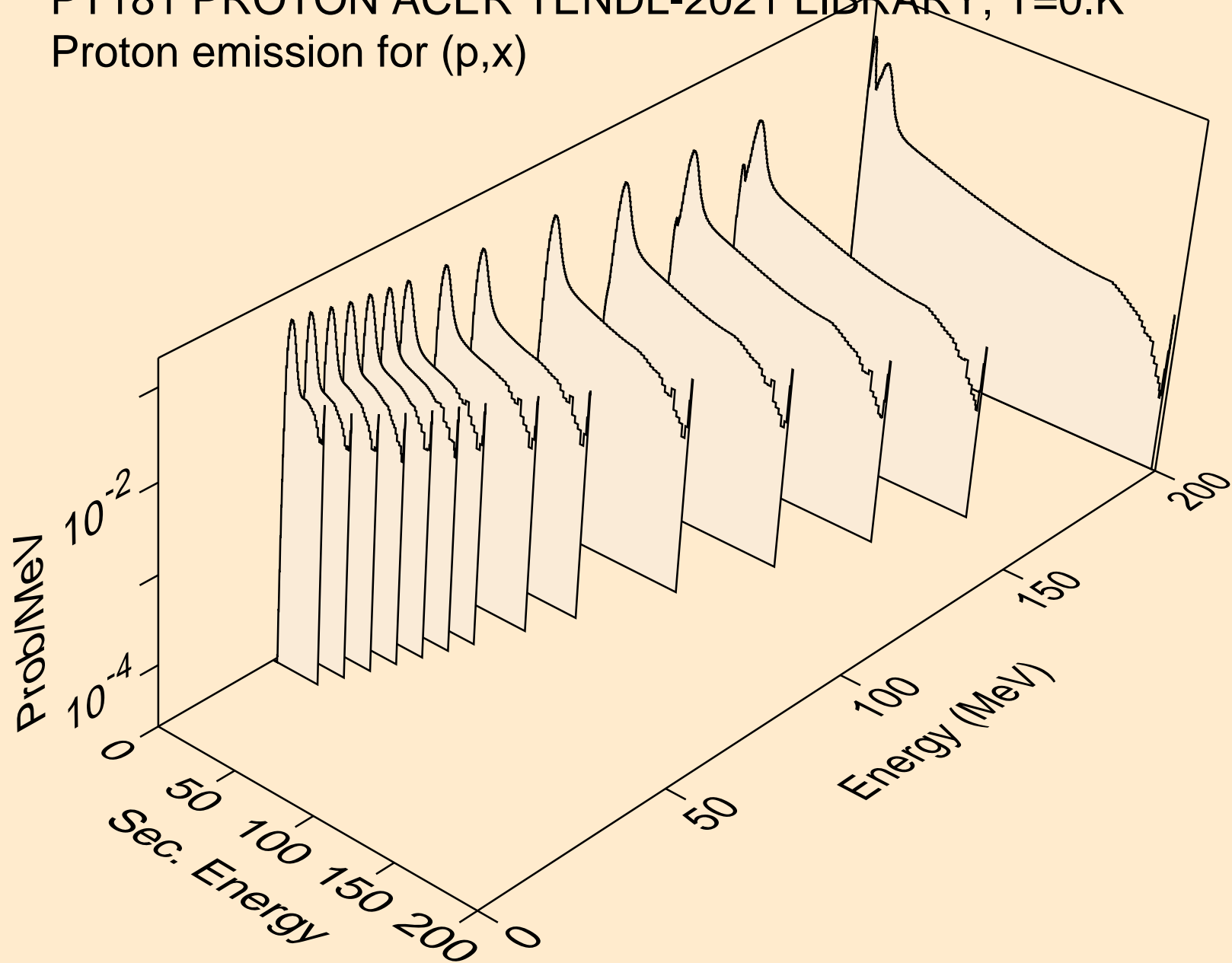

PT181 PROTON ACER TENDL-2021 LIBRARY; T=0.K  
Proton emission for (p,n\*)p

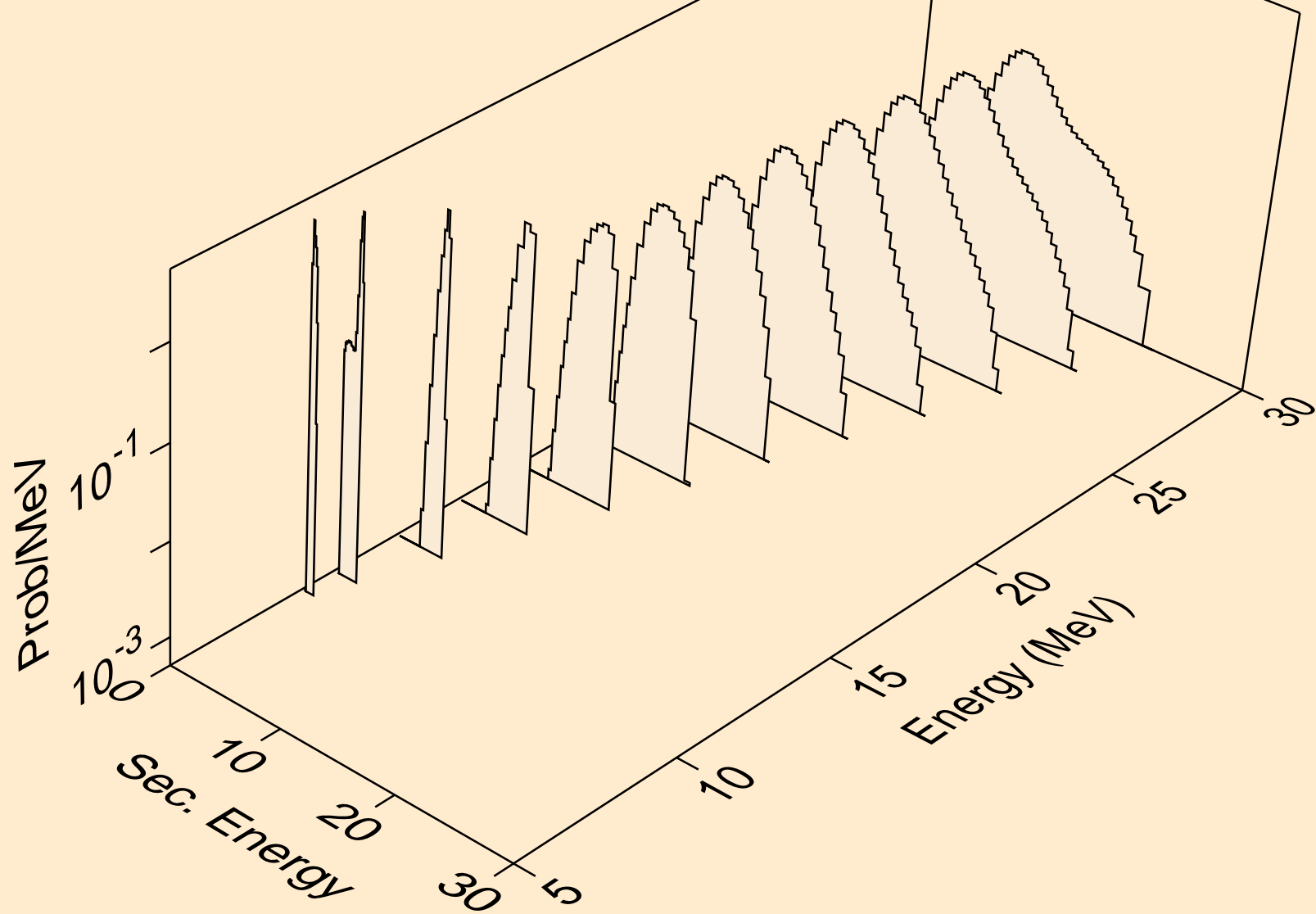

PT181 PROTON ACER TENDL-2021 LIBRARY; T=0.K  
Proton emission for (p,2np)

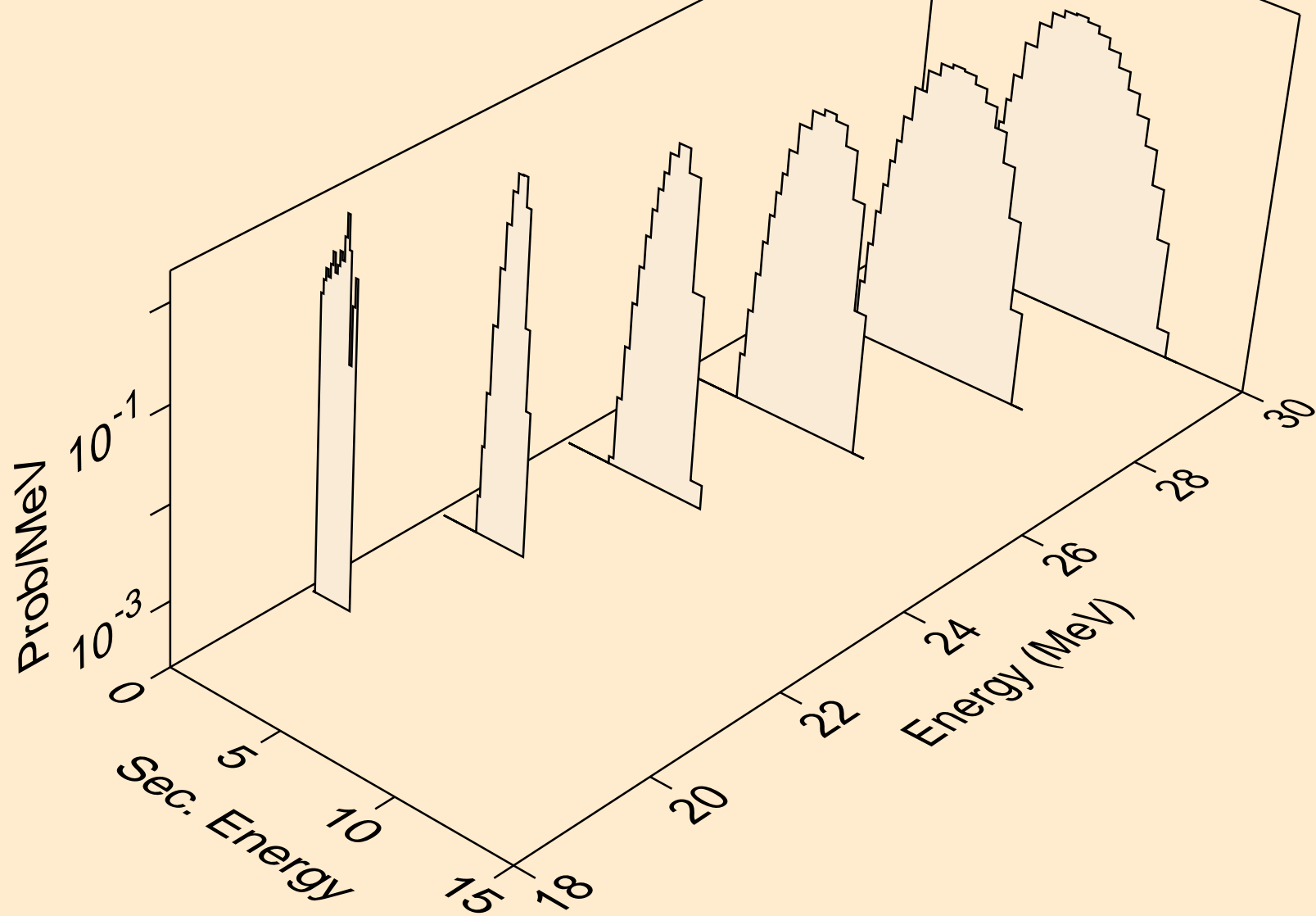

PT181 PROTON ACER TENDL-2021 LIBRARY; T=0.K  
Proton emission for (p,3np)

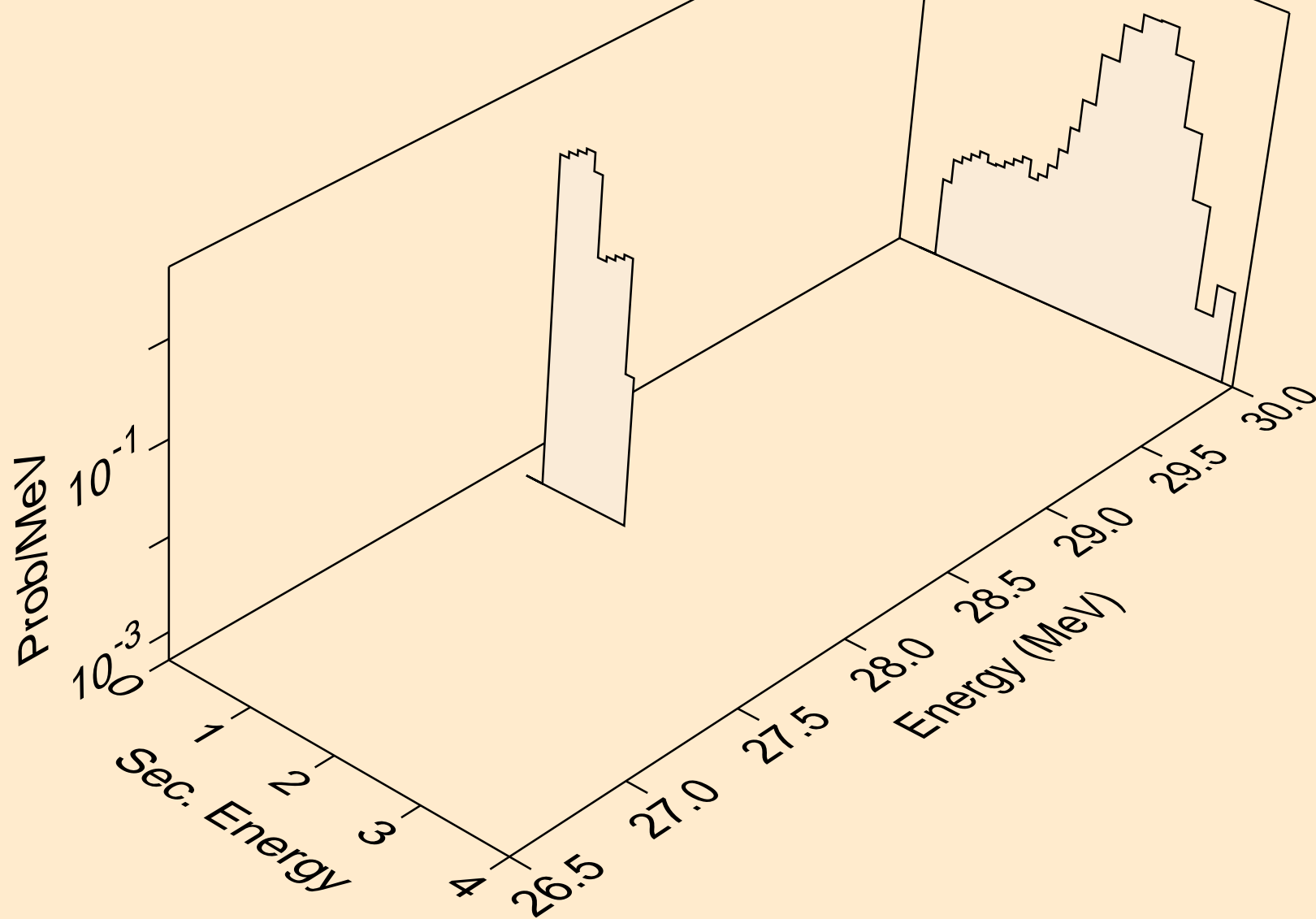

PT181 PROTON ACER TENDL-2021 LIBRARY; T=0.K  
Proton emission for (p,2np)

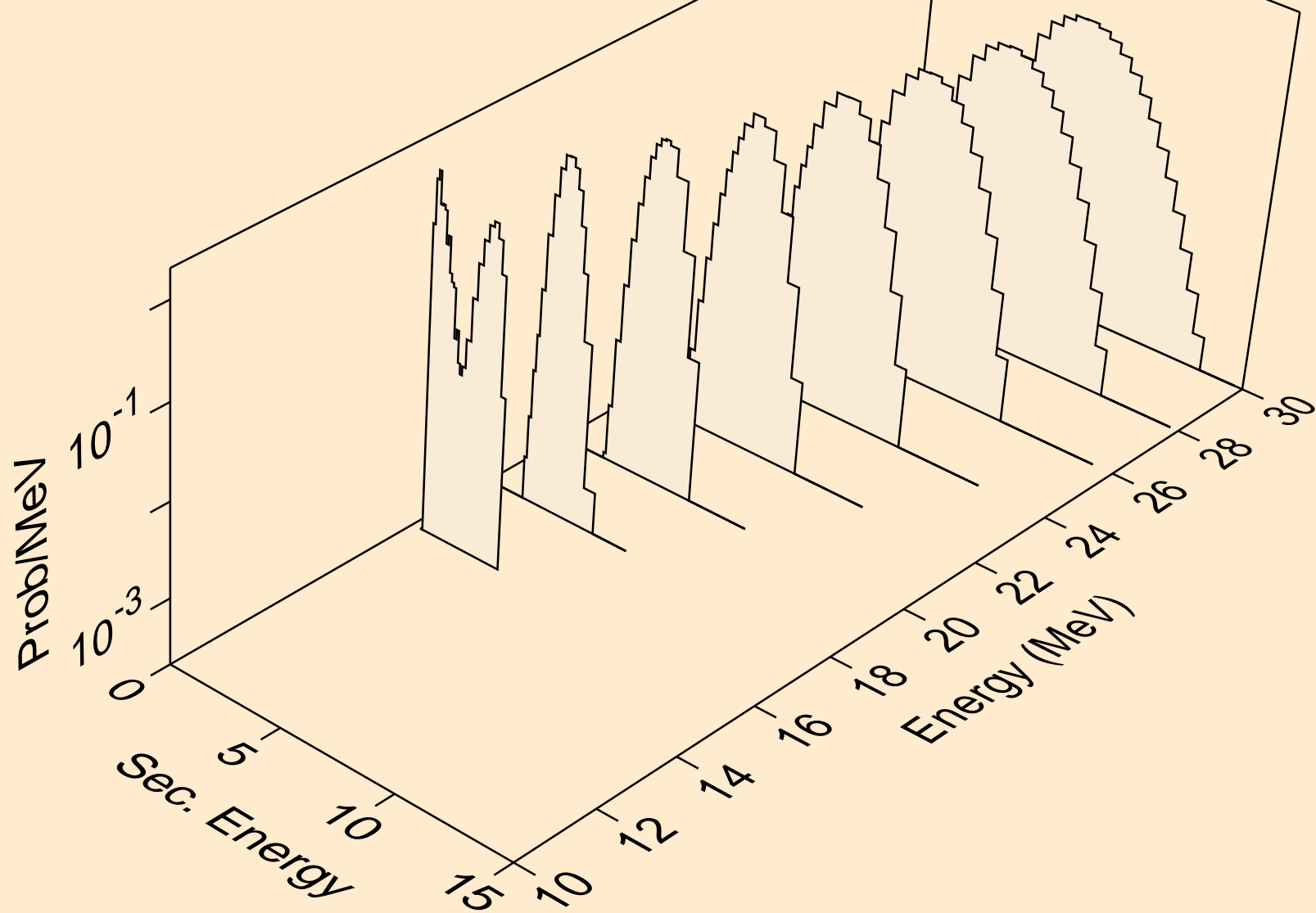

PT181 PROTON ACER TENDL-2021 LIBRARY; T=0.K  
Proton emission for (p,npa)

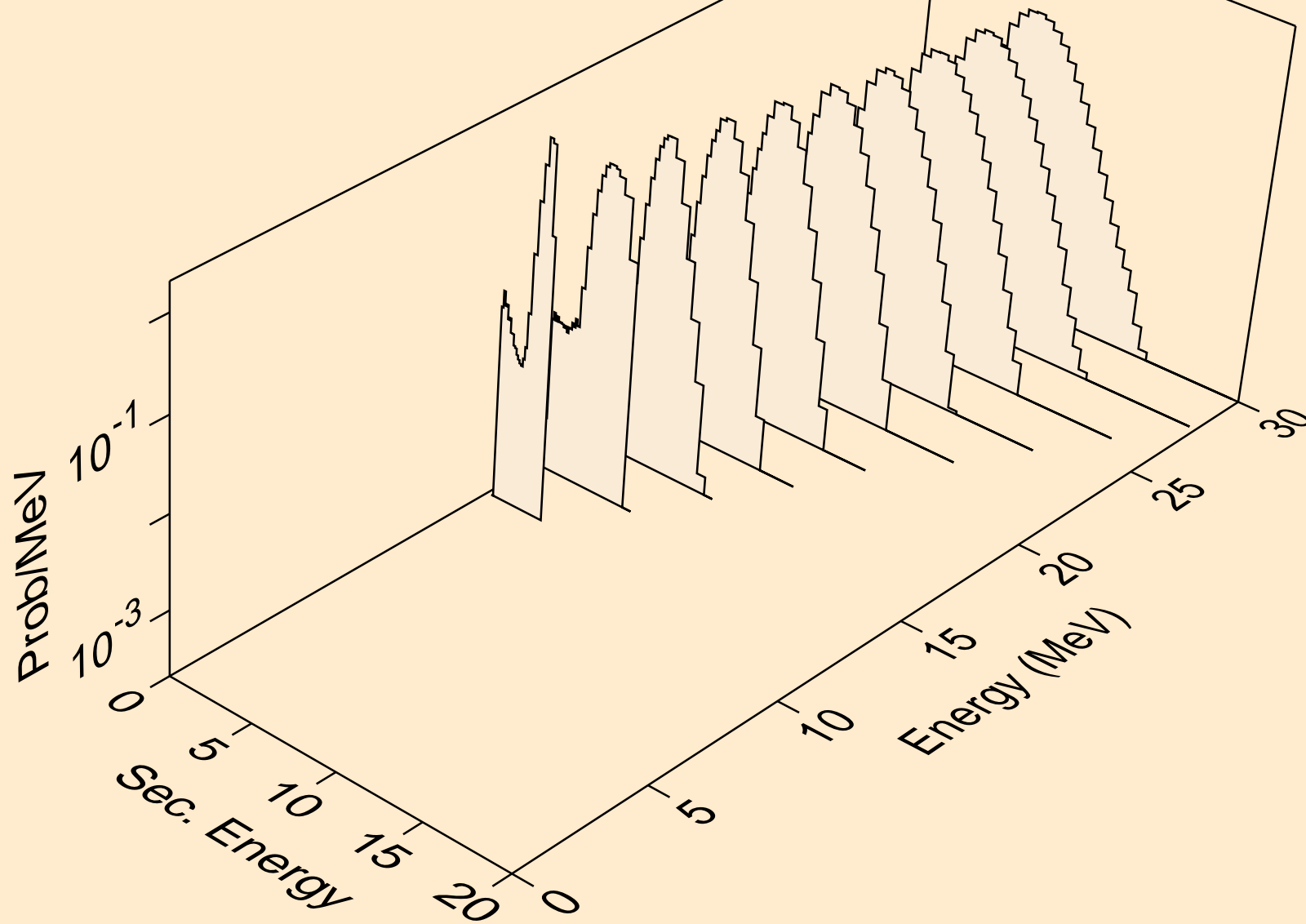

PT181 PROTON ACER TENDL-2021 LIBRARY; T=0.K  
Proton emission for inelastic

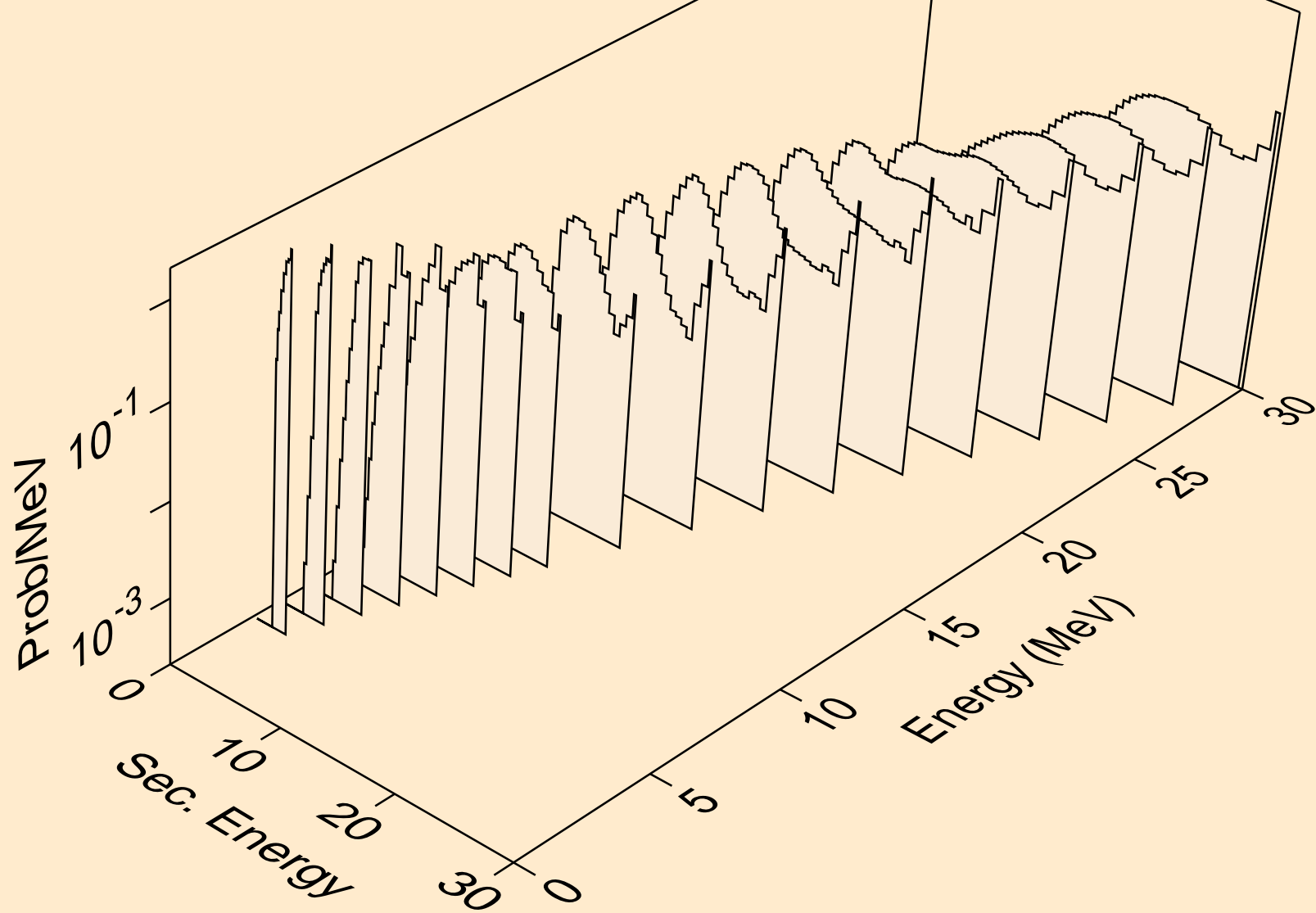



PT181 PROTON ACER TENDL-2021 LIBRARY; T=0.K  
Proton emission for (p,2p)

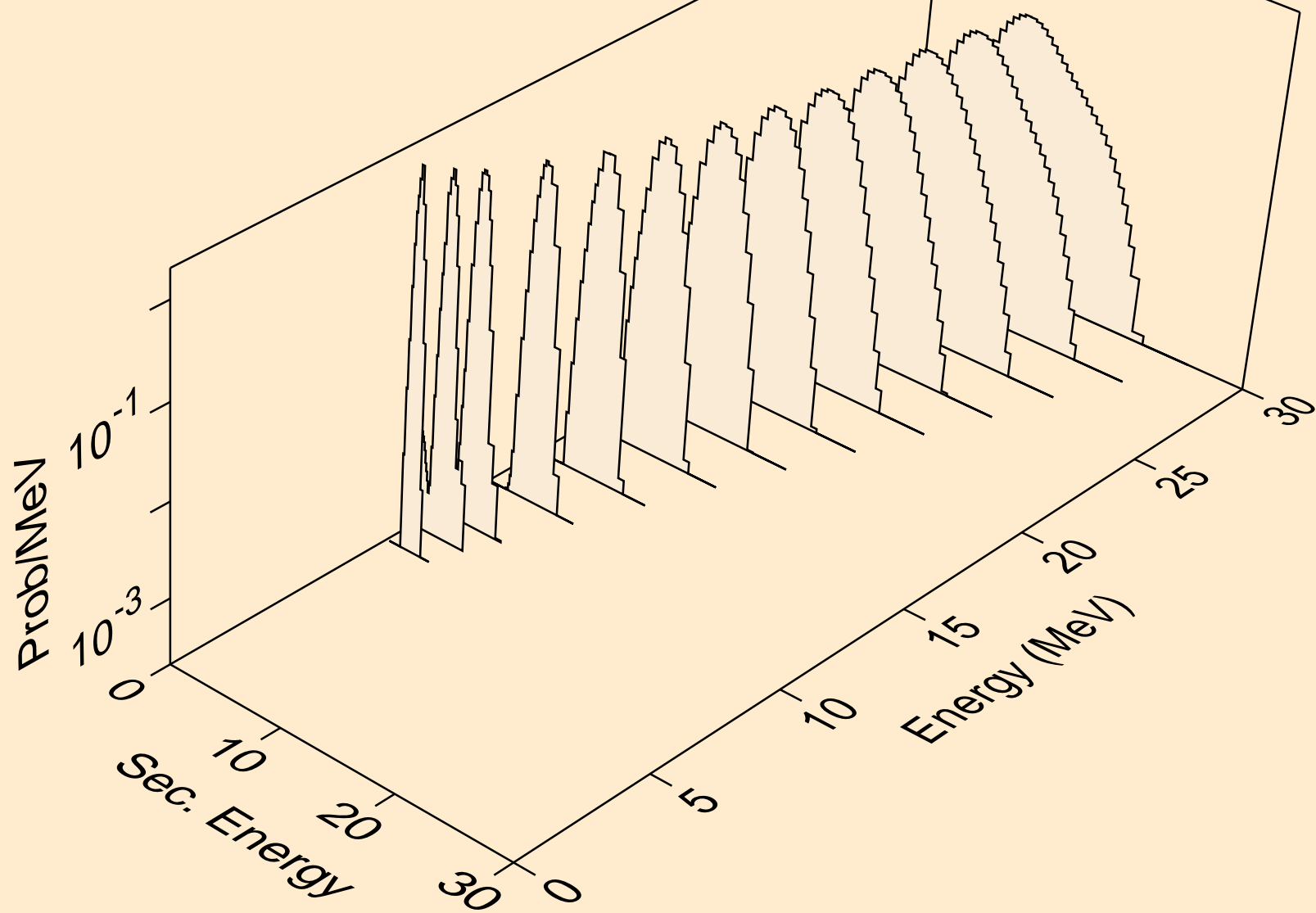

PT181 PROTON ACER TENDL-2021 LIBRARY; T=0.K  
Proton emission for (p,pa)

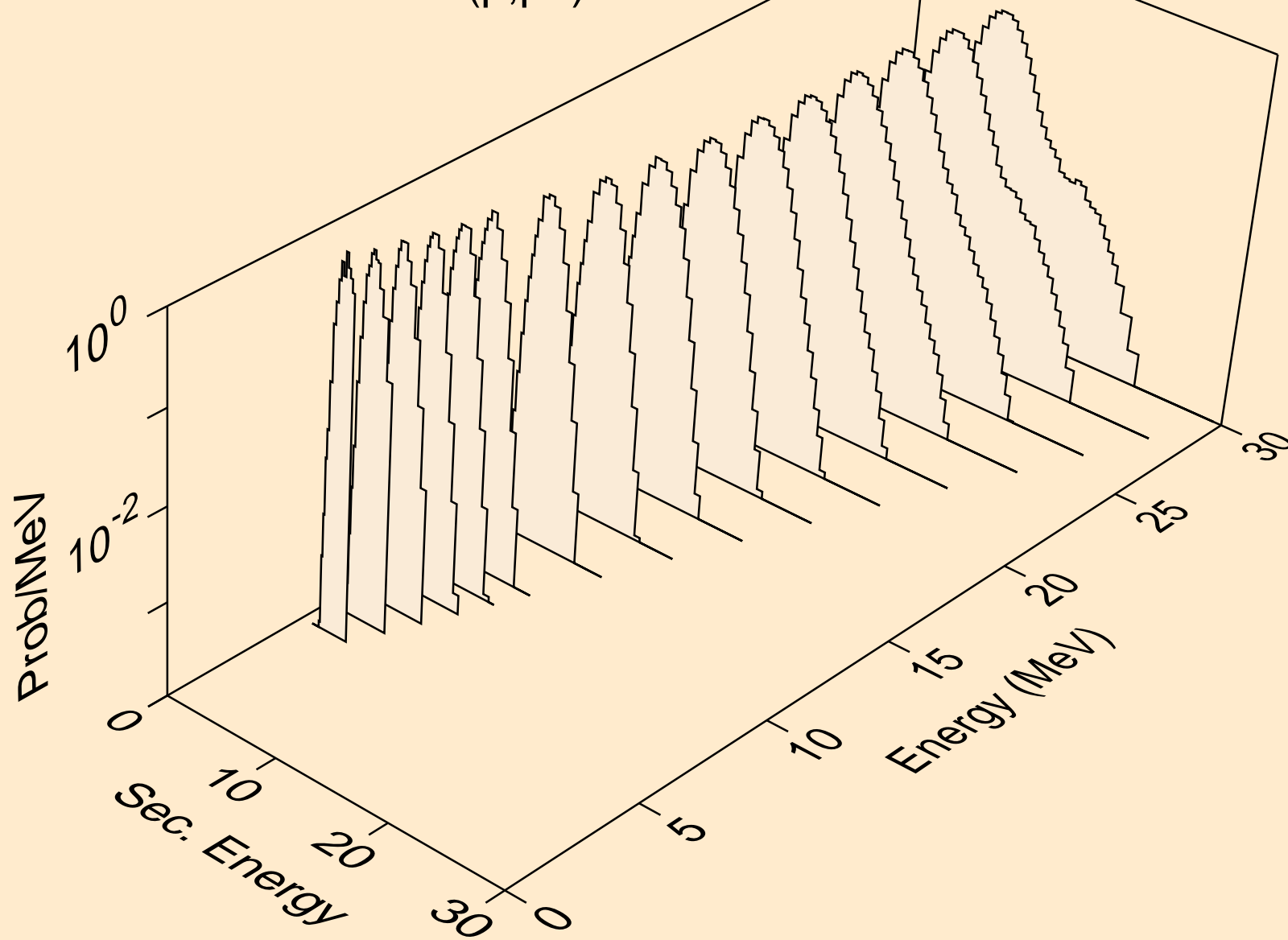

PT181 PROTON ACER TENDL-2021 LIBRARY; T=0.K  
Proton emission for (p,pd)

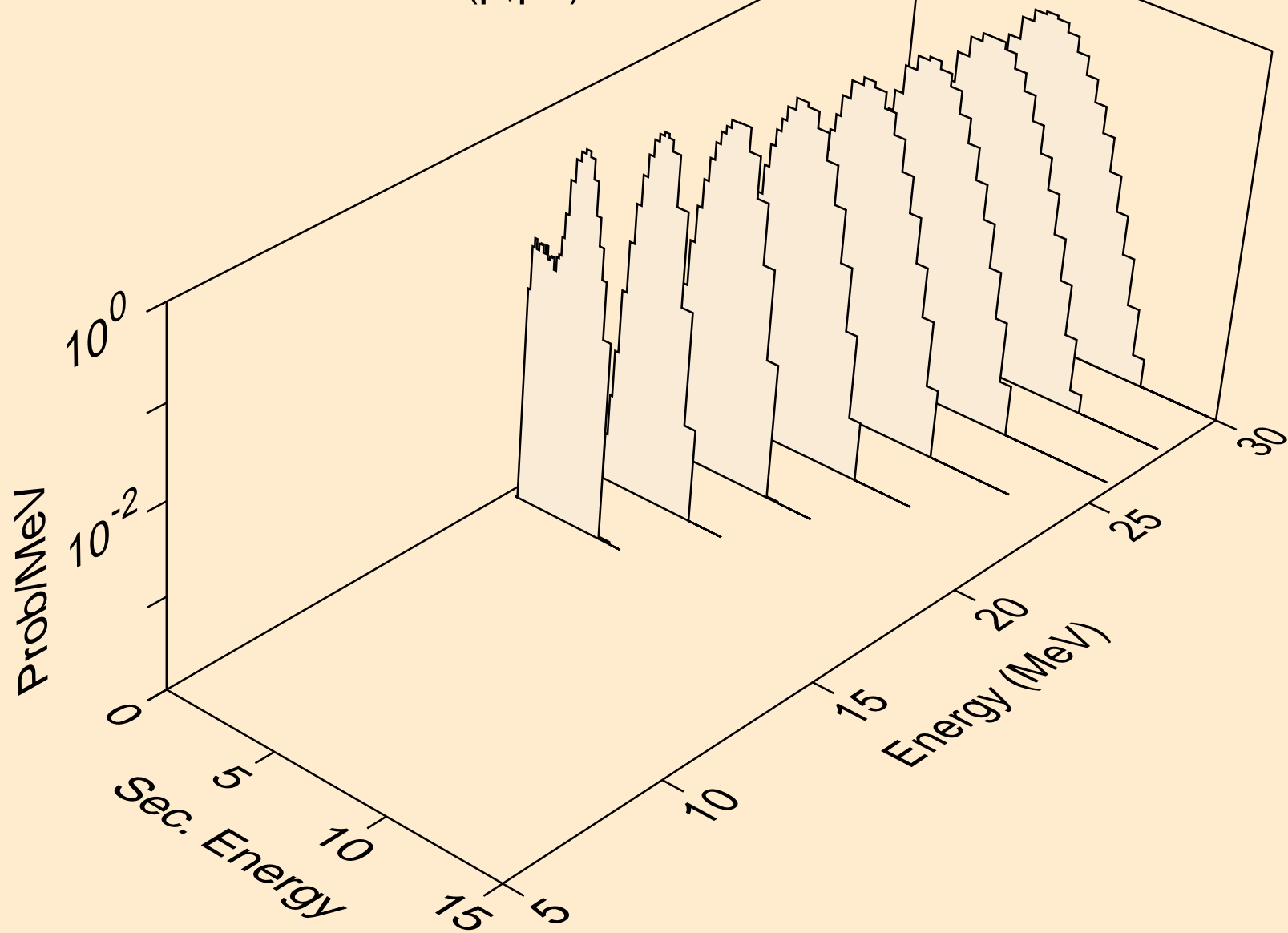

PT181 PROTON ACER TENDL-2021 LIBRARY; T=0.K  
Proton emission for (p,pt)

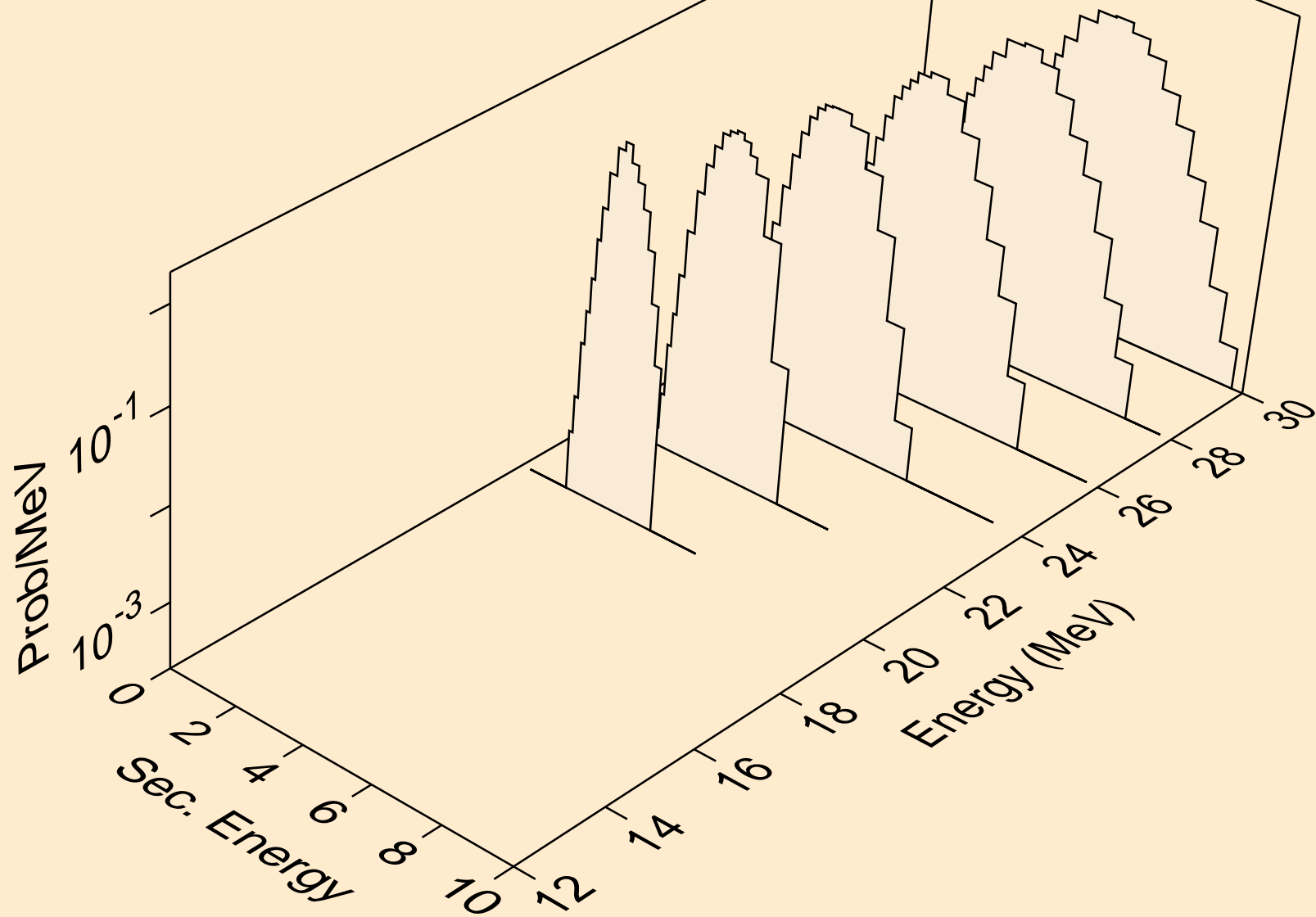

PT181 PROTON ACER TENDL-2021 LIBRARY; T=0.K  
Photon emission for (z,n)

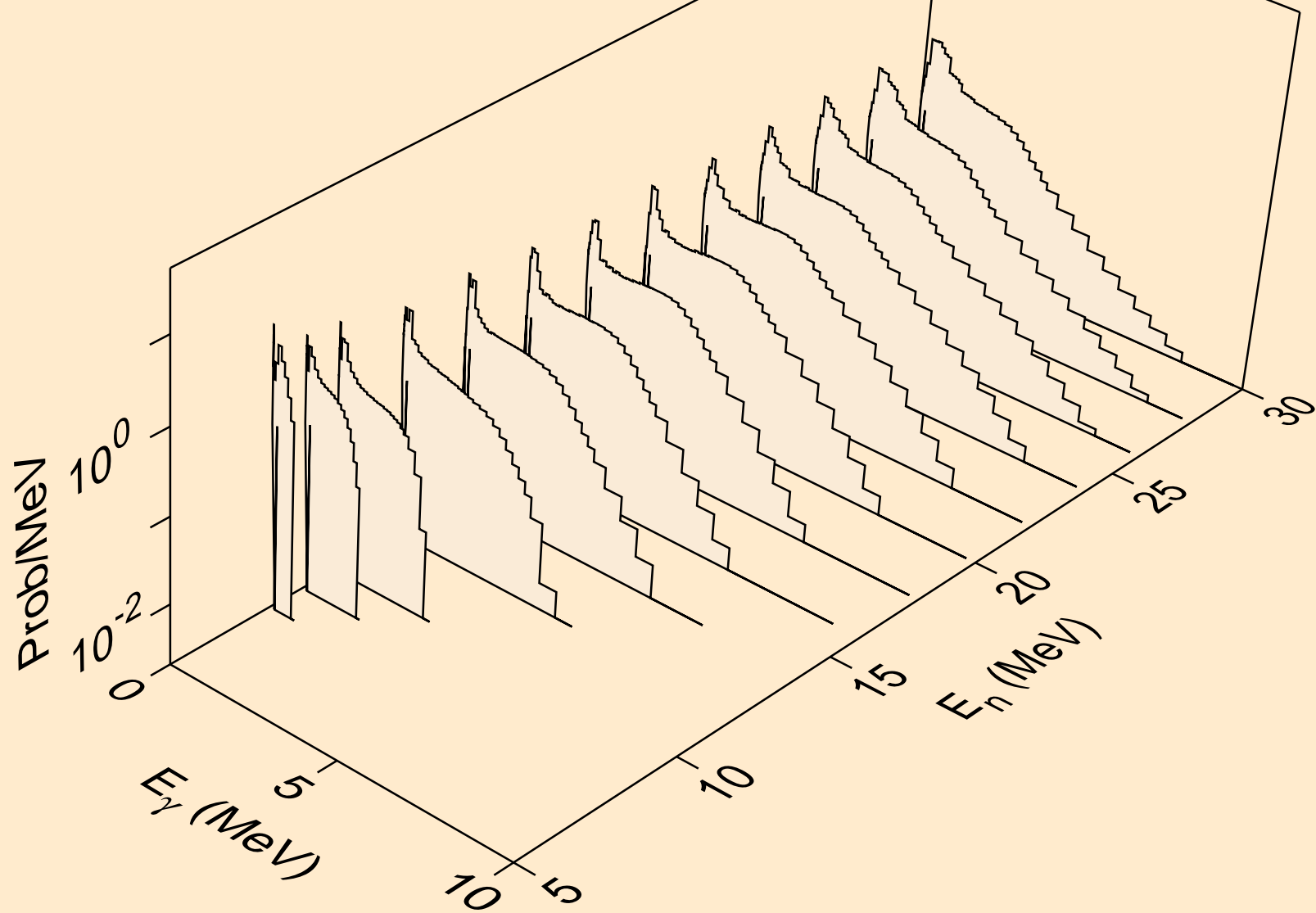

PT181 PROTON ACER TENDL-2021 LIBRARY; T=0.K  
Photon emission for (n,x)

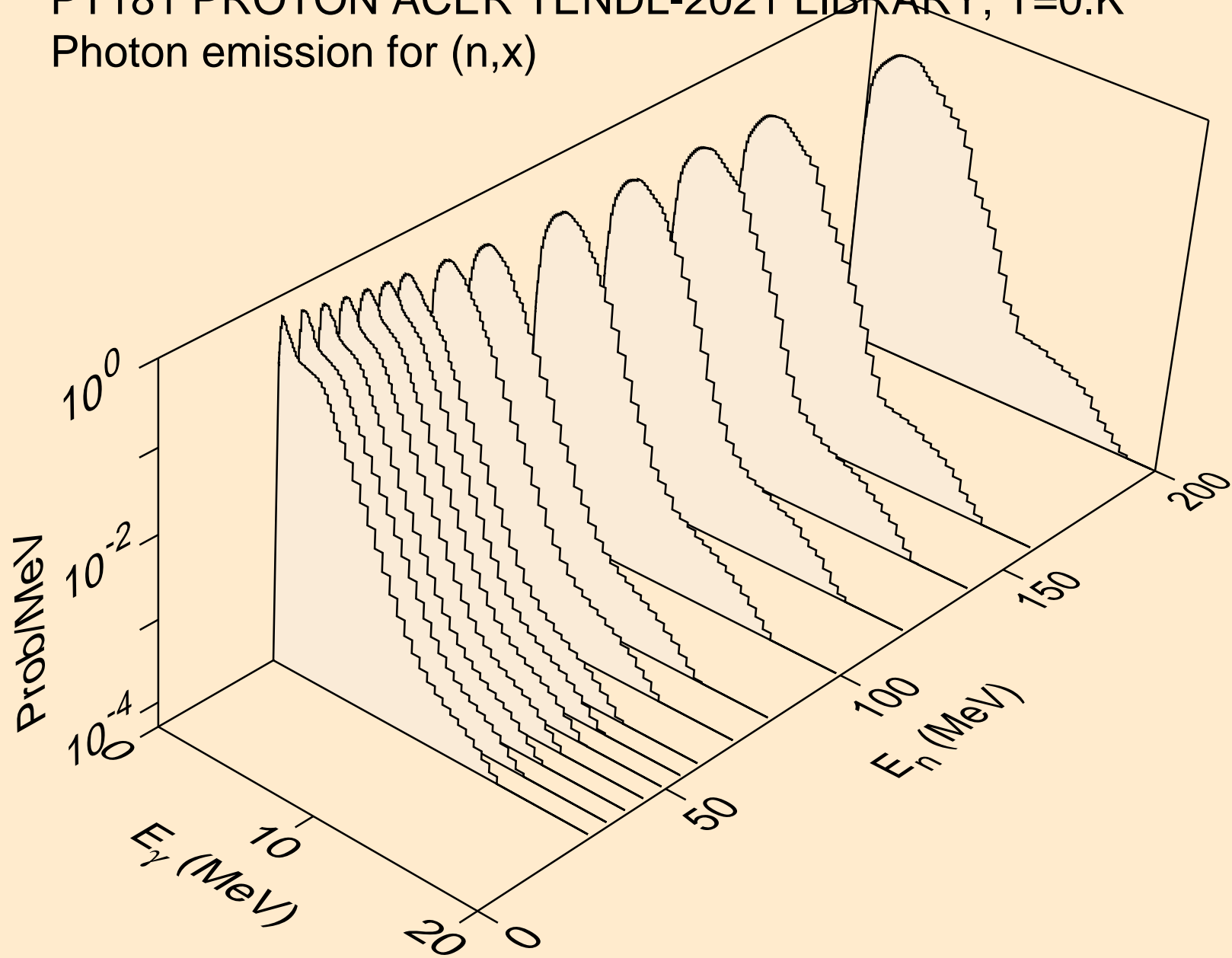

PT181 PROTON ACER TENDL-2021 LIBRARY; T=0.K  
Photon emission for (n,2n)

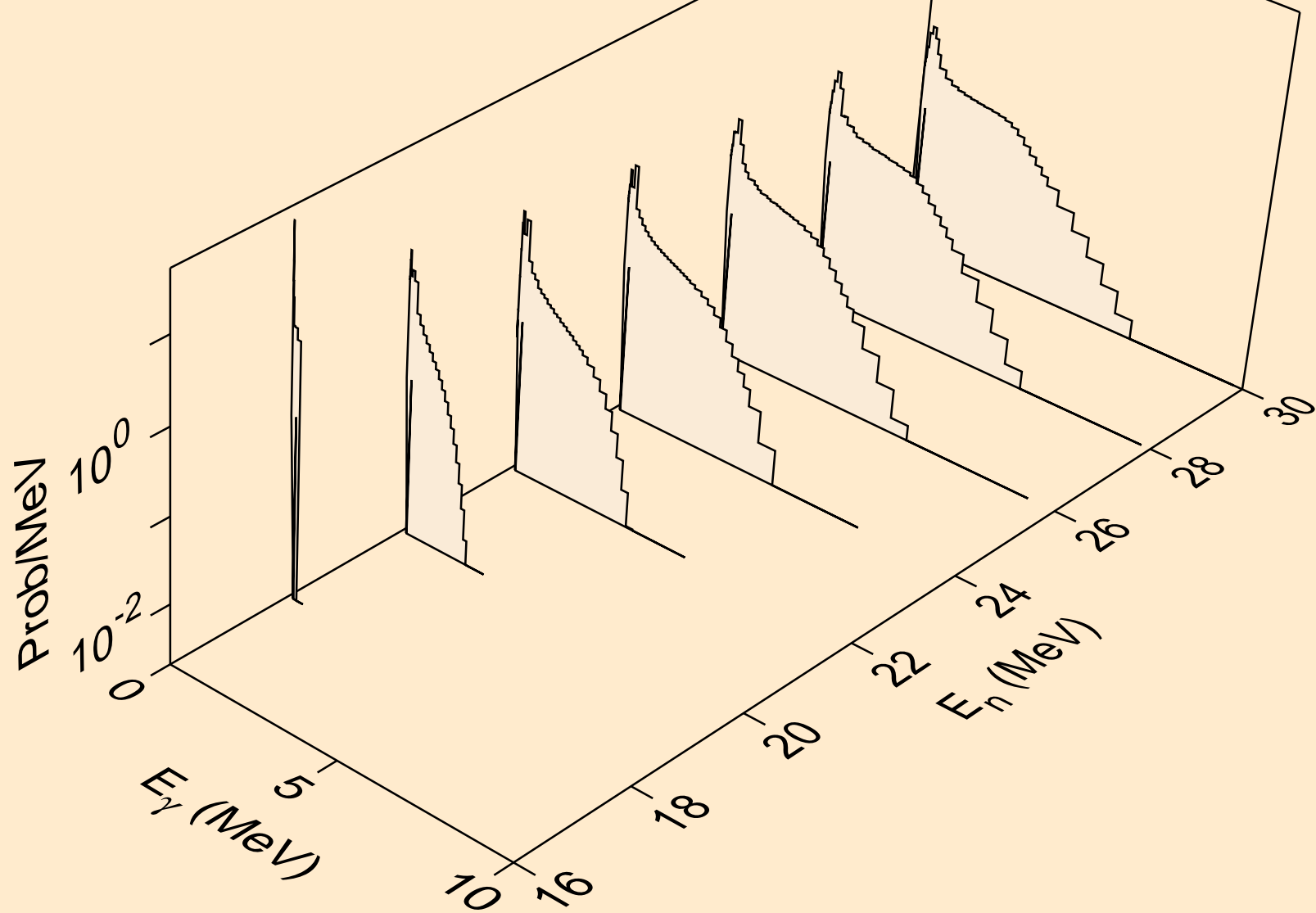

PT181 PROTON ACER TENDL-2021 LIBRARY; T=0.K  
Photon emission for (n,3n)

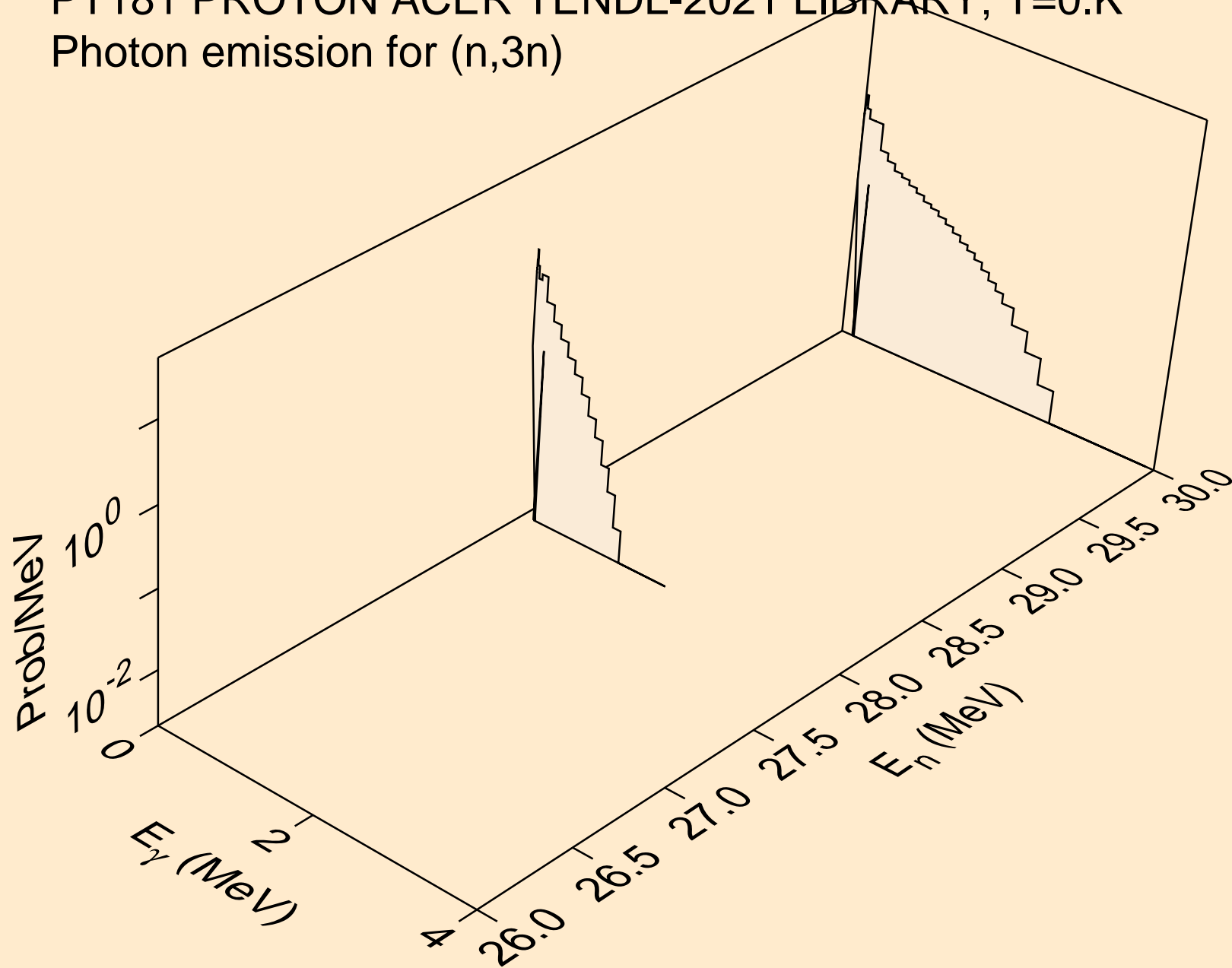



PT181 PROTON ACER TENDL-2021 LIBRARY; T=0.K  
Photon emission for (n,n\*)a

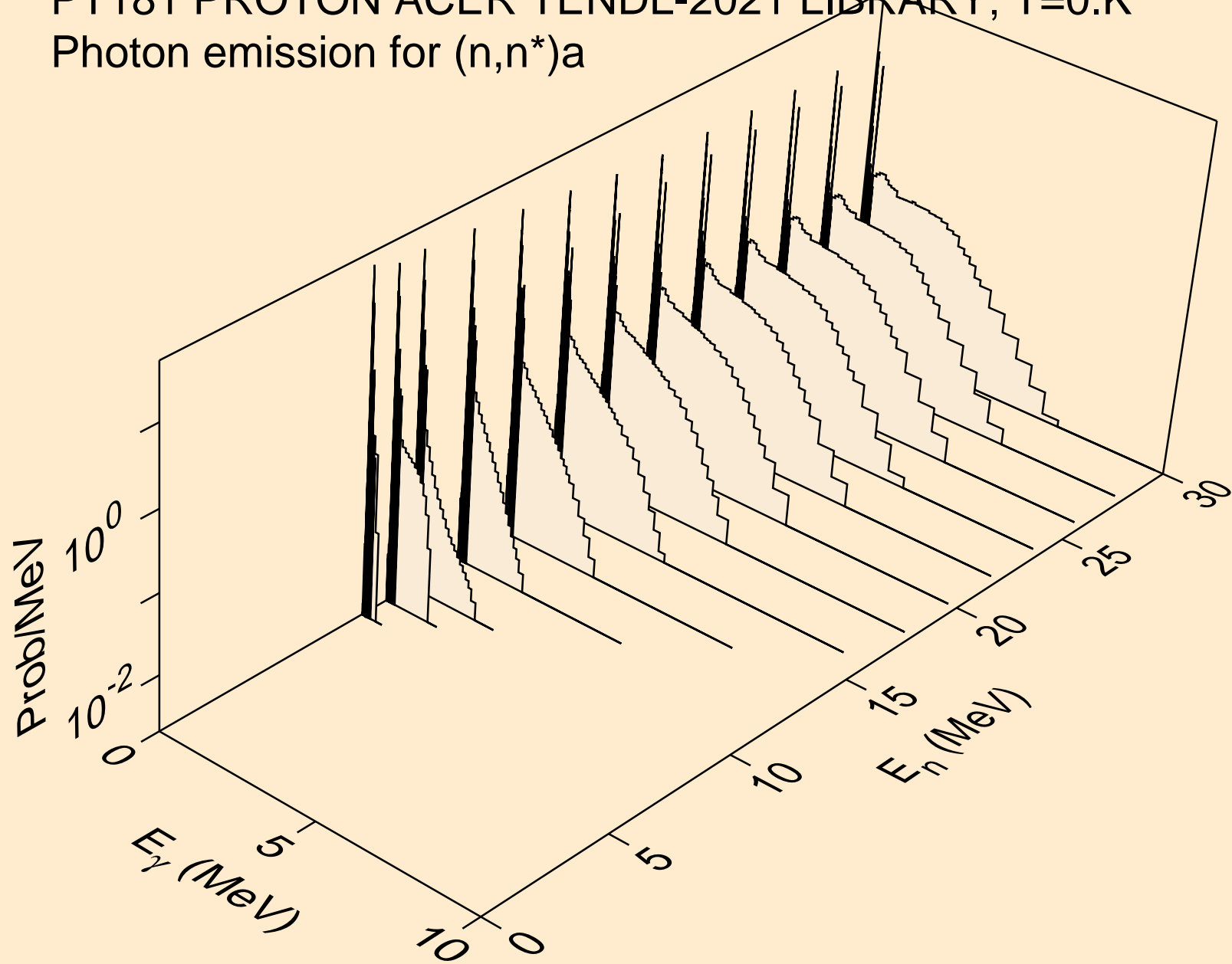

PT181 PROTON ACER TENDL-2021 LIBRARY; T=0.K  
Photon emission for (n,2n)a

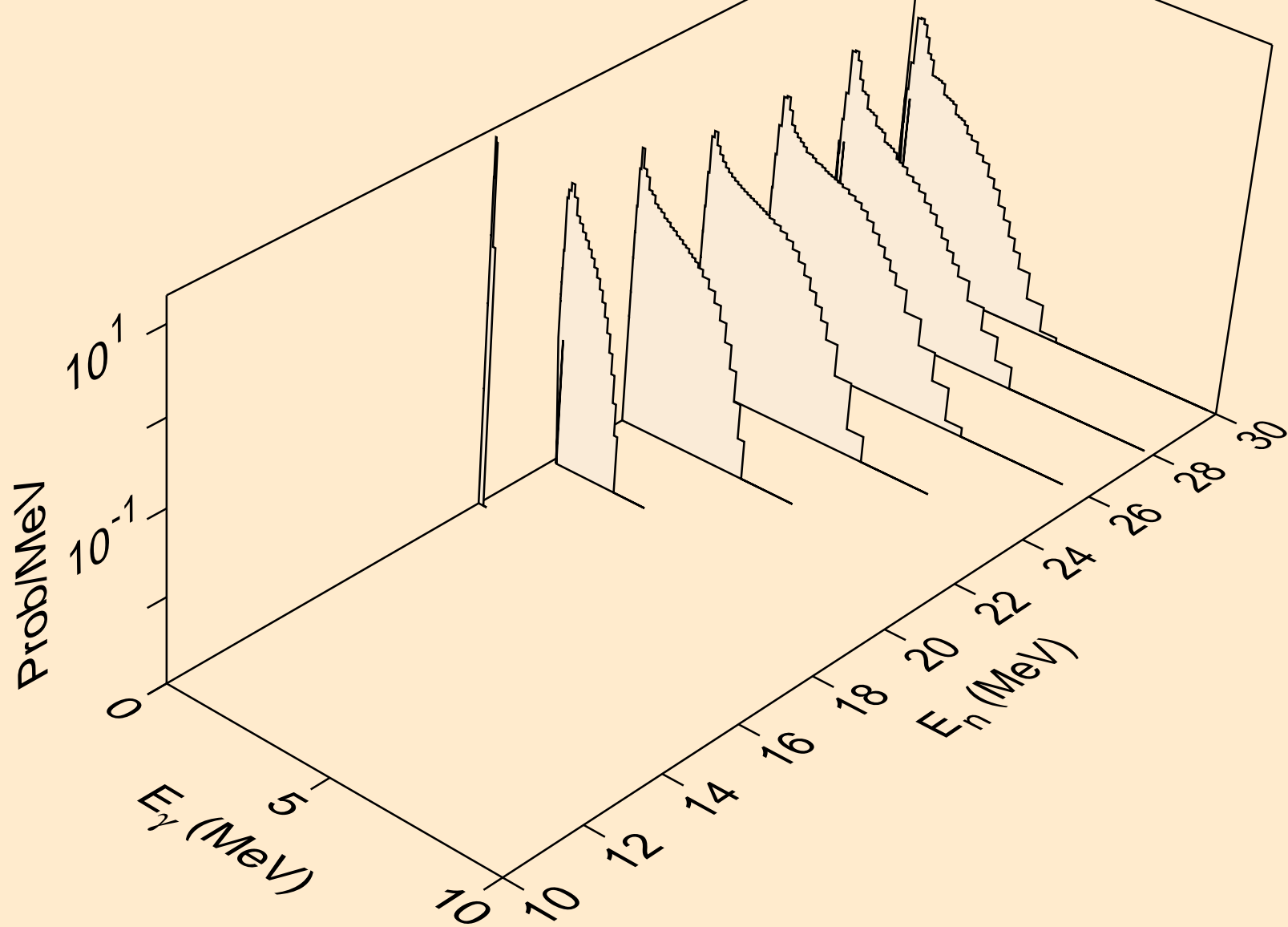

PT181 PROTON ACER TENDL-2021 LIBRARY; T=0.K  
Photon emission for (n,3n)a

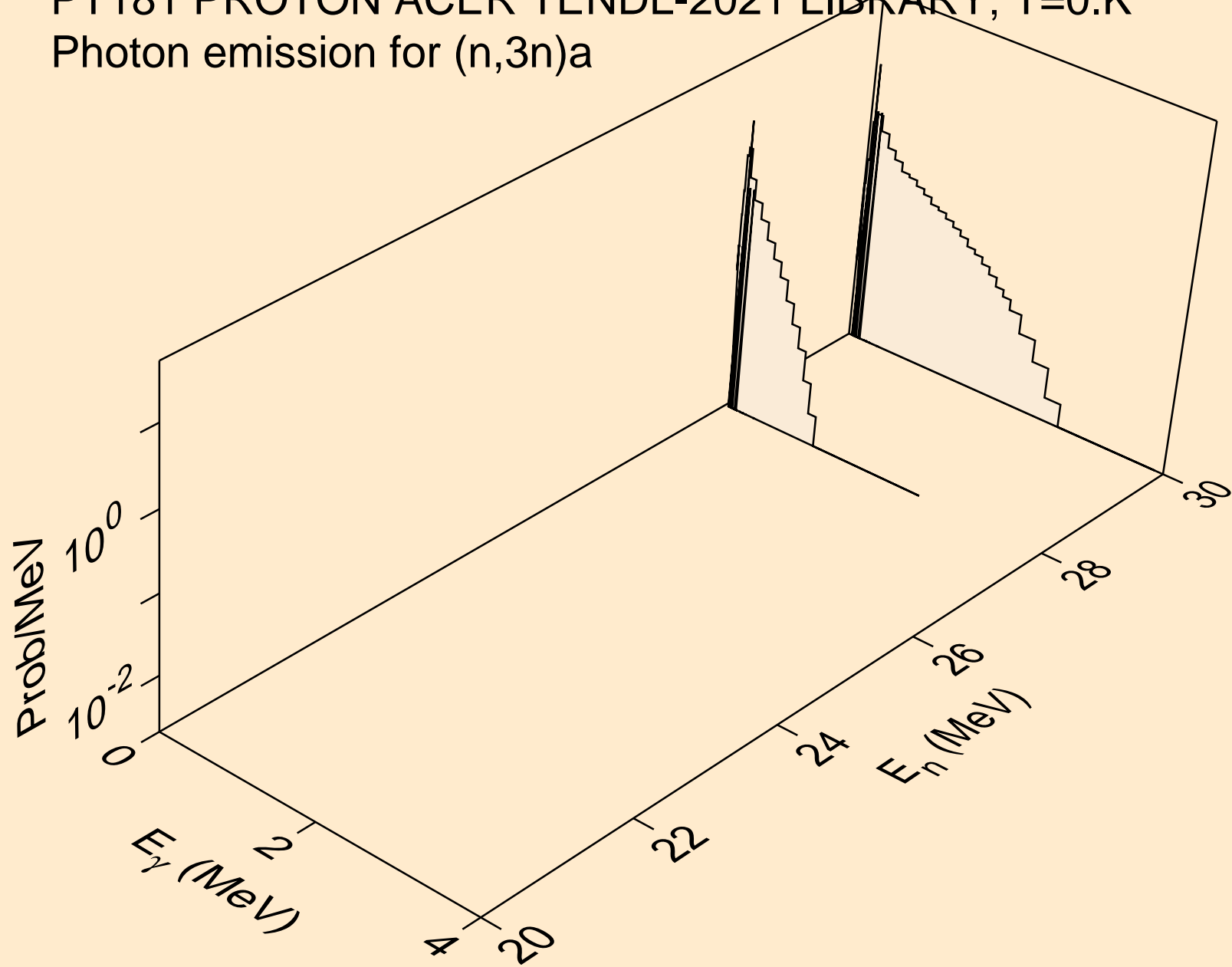

PT181 PROTON ACER TENDL-2021 LIBRARY; T=0.K  
Photon emission for (n,n\*)p

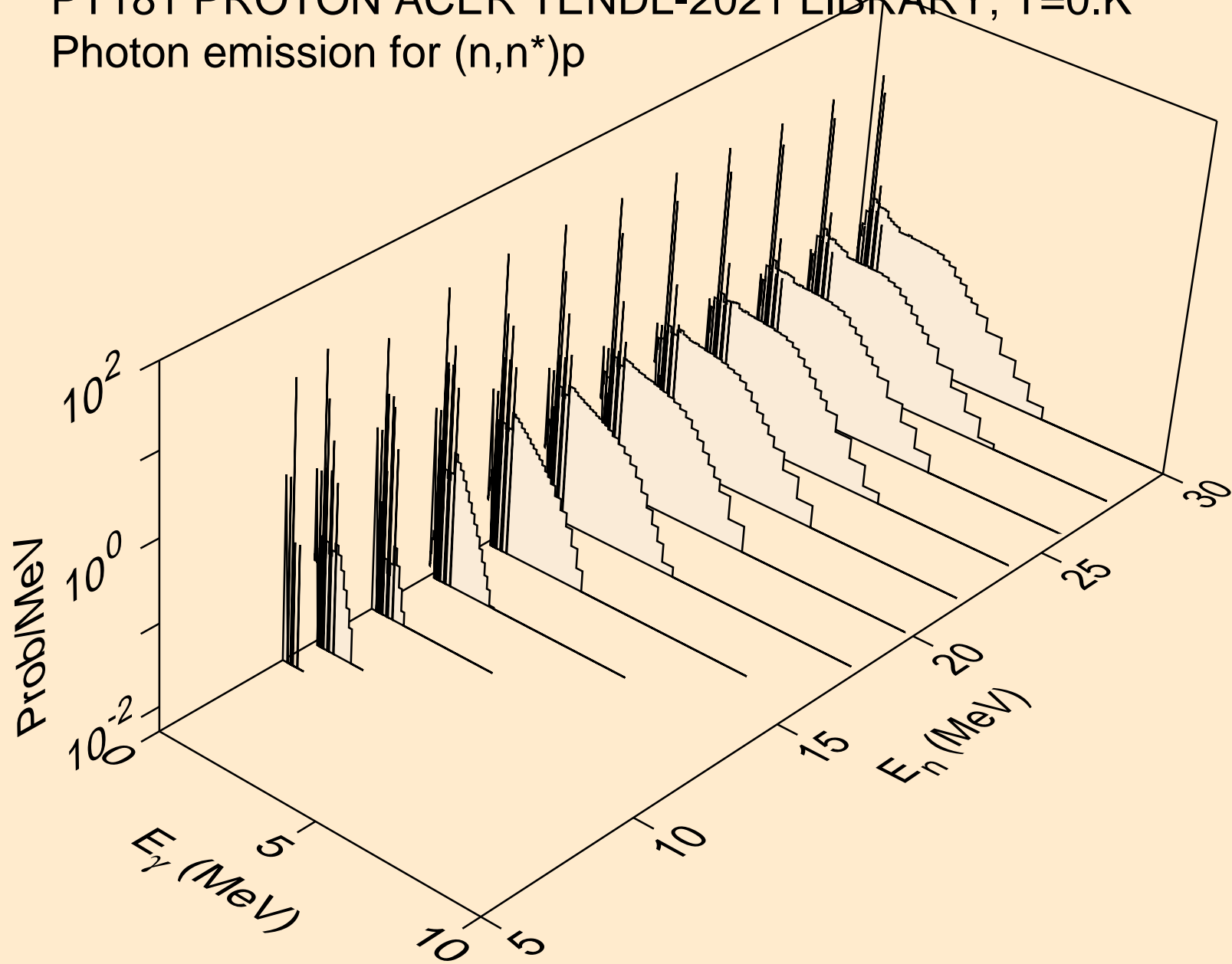

PT181 PROTON ACER TENDL-2021 LIBRARY; T=0.K  
Photon emission for (n,n\*)2a

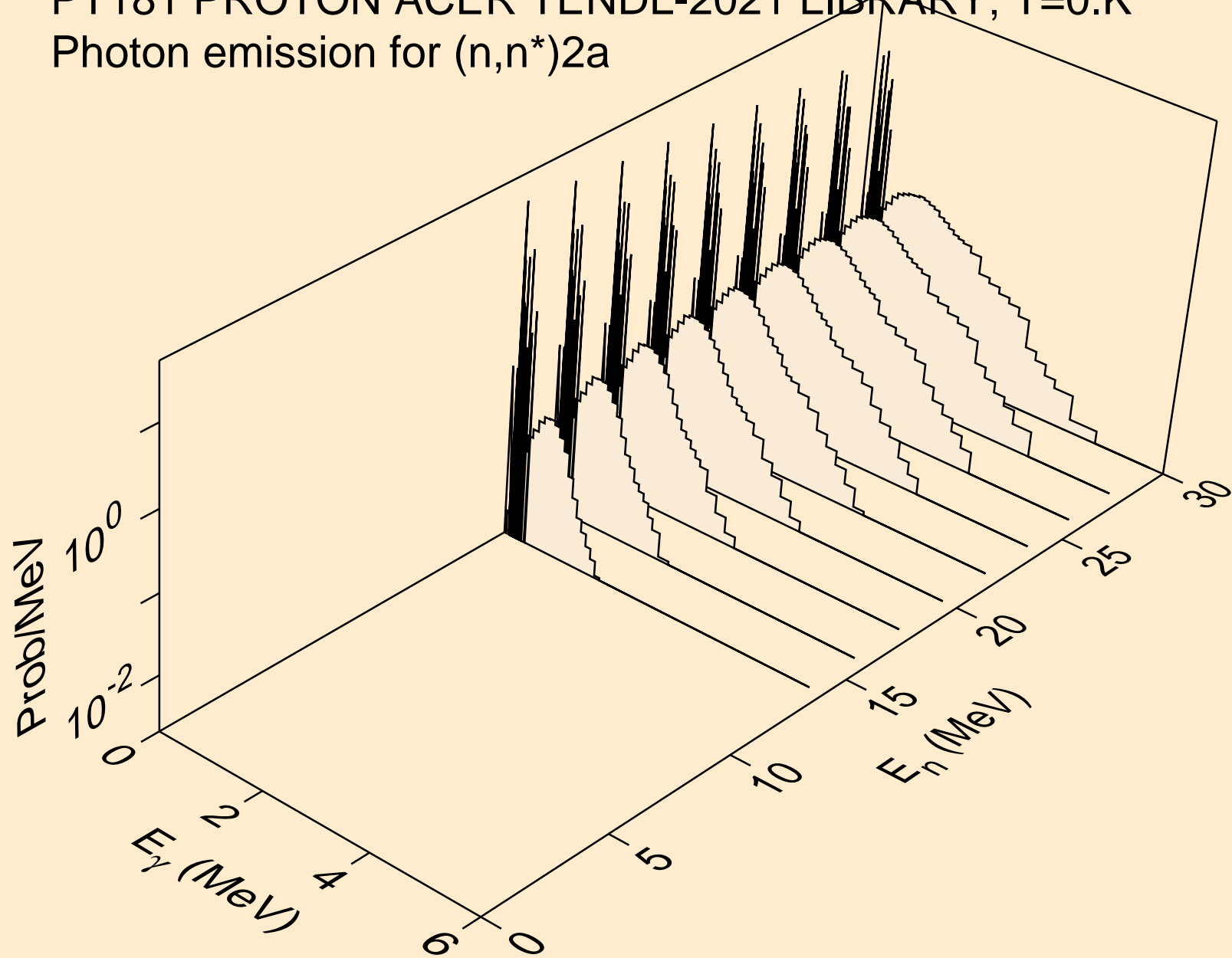

PT181 PROTON ACER TENDL-2021 LIBRARY; T=0.K  
Photon emission for (n,n\*)d

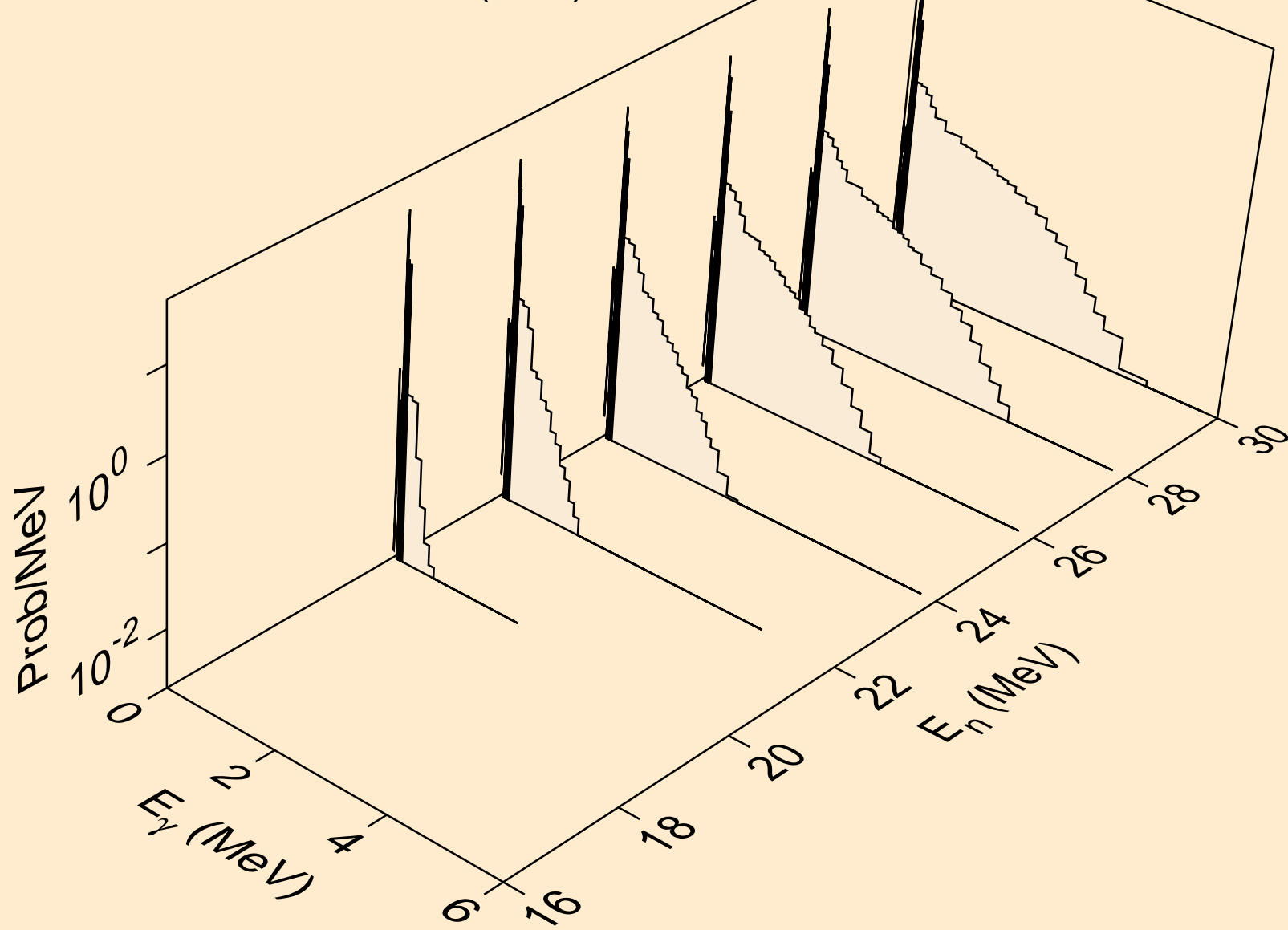

PT181 PROTON ACER TENDL-2021 LIBRARY; T=0.K  
Photon emission for (n,n\*)t

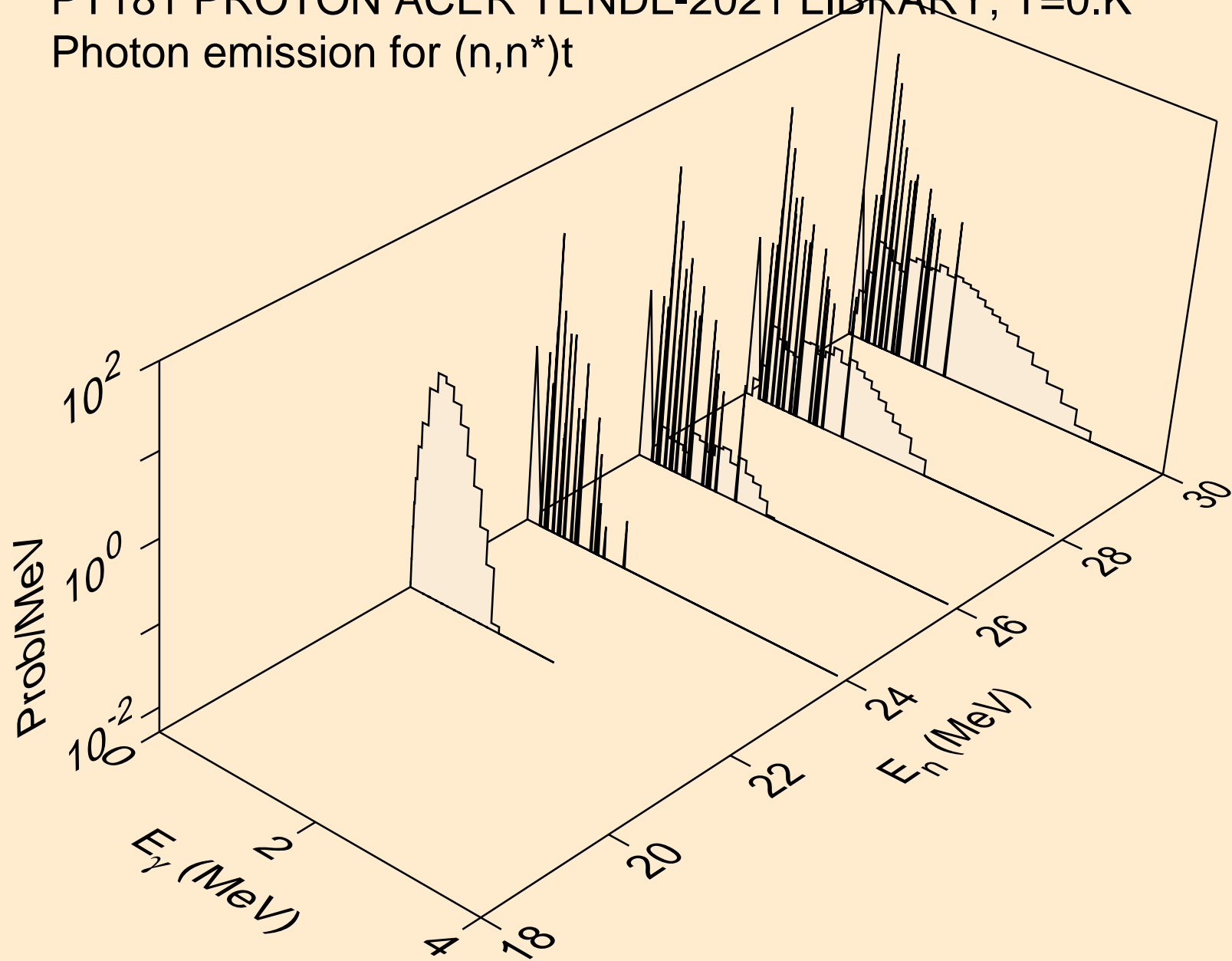

PT181 PROTON ACER TENDL-2021 LIBRARY; T=0.K  
Photon emission for (n,n\*)he3

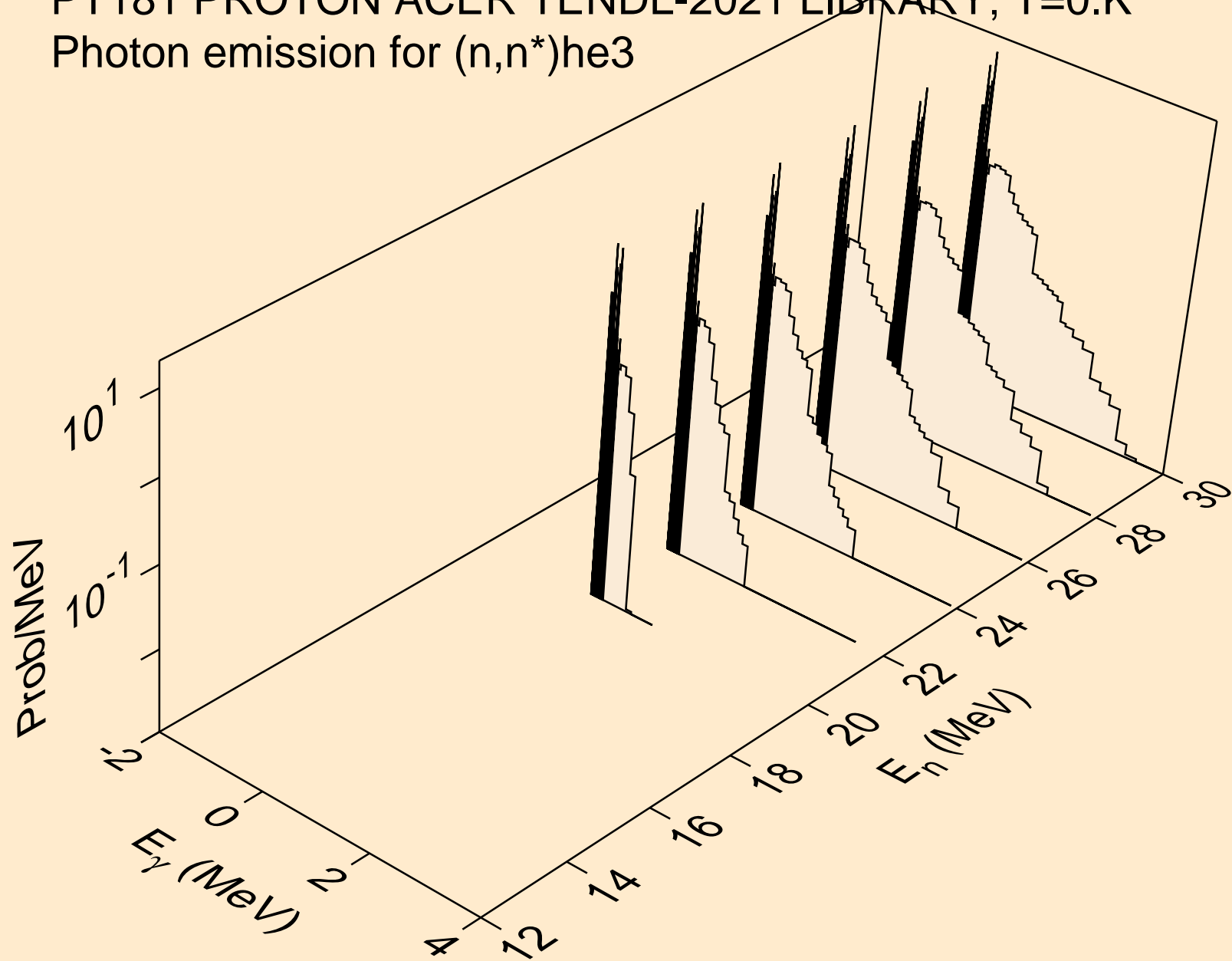



PT181 PROTON ACER TENDL-2021 LIBRARY; T=0.K  
Photon emission for (n,2np)

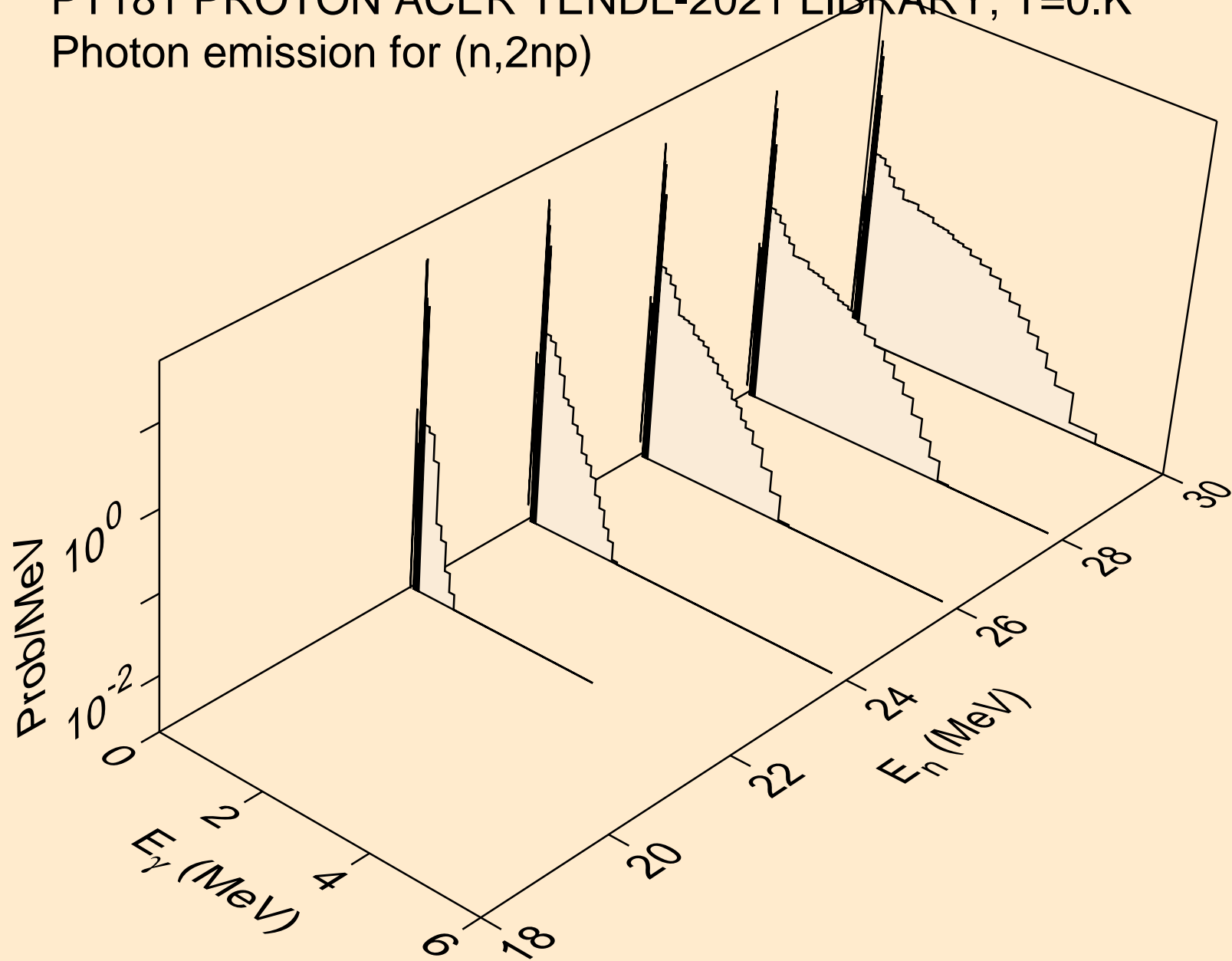

PT181 PROTON ACER TENDL-2021 LIBRARY; T=0.K  
Photon emission for (n,3np)

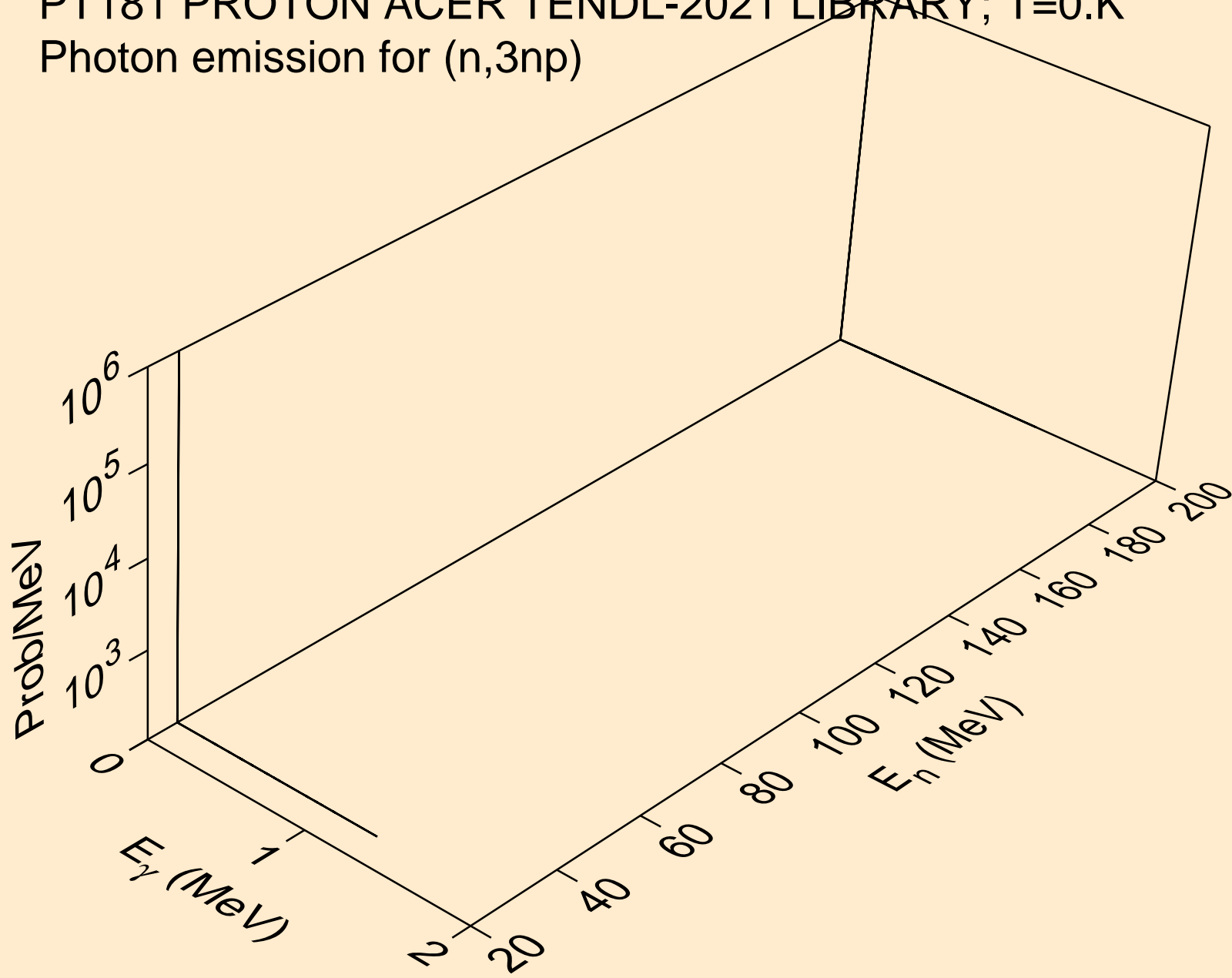

PT181 PROTON ACER TENDL-2021 LIBRARY; T=0.K  
Photon emission for (n,2np)

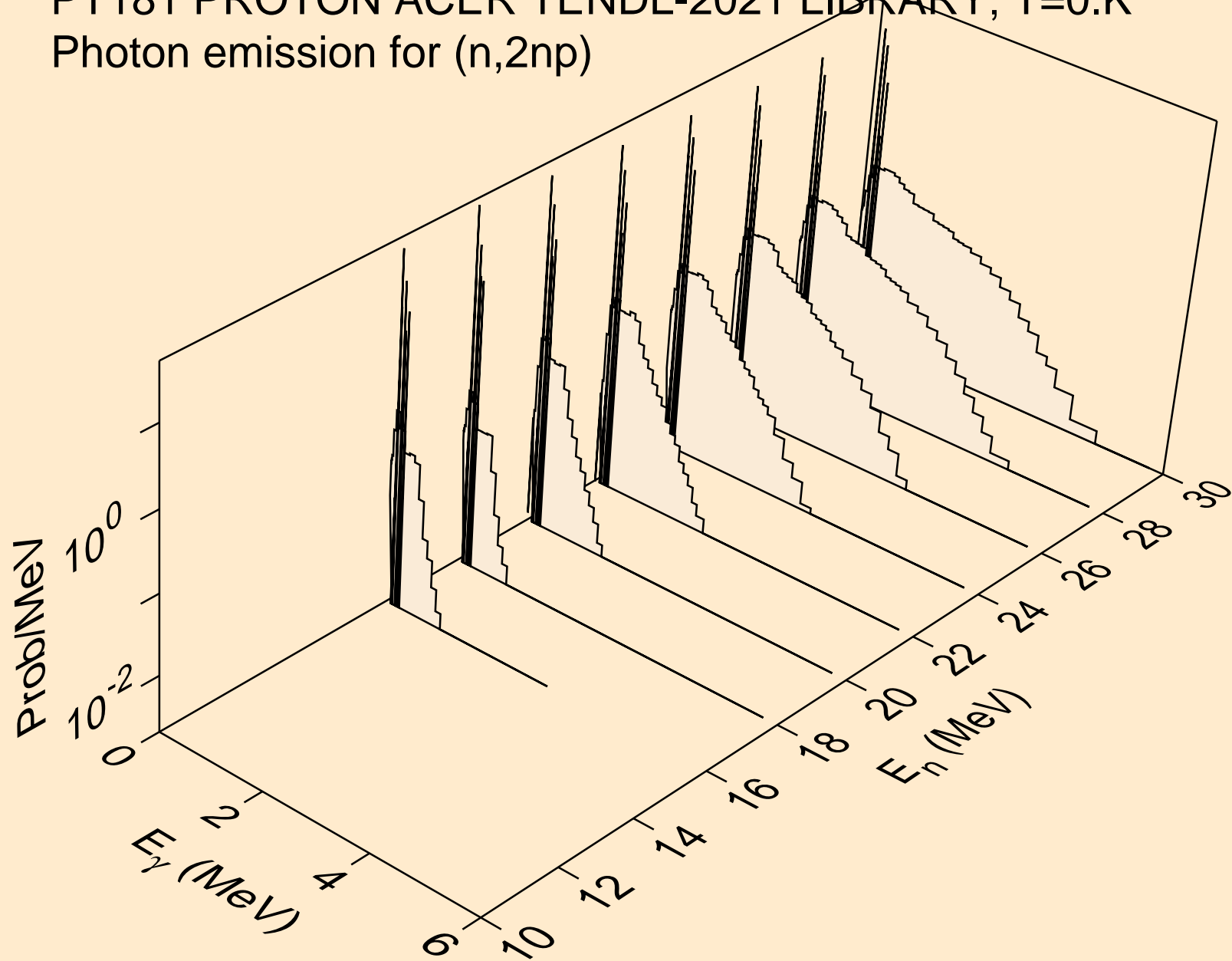

PT181 PROTON ACER TENDL-2021 LIBRARY; T=0.K  
Photon emission for (n,npa)

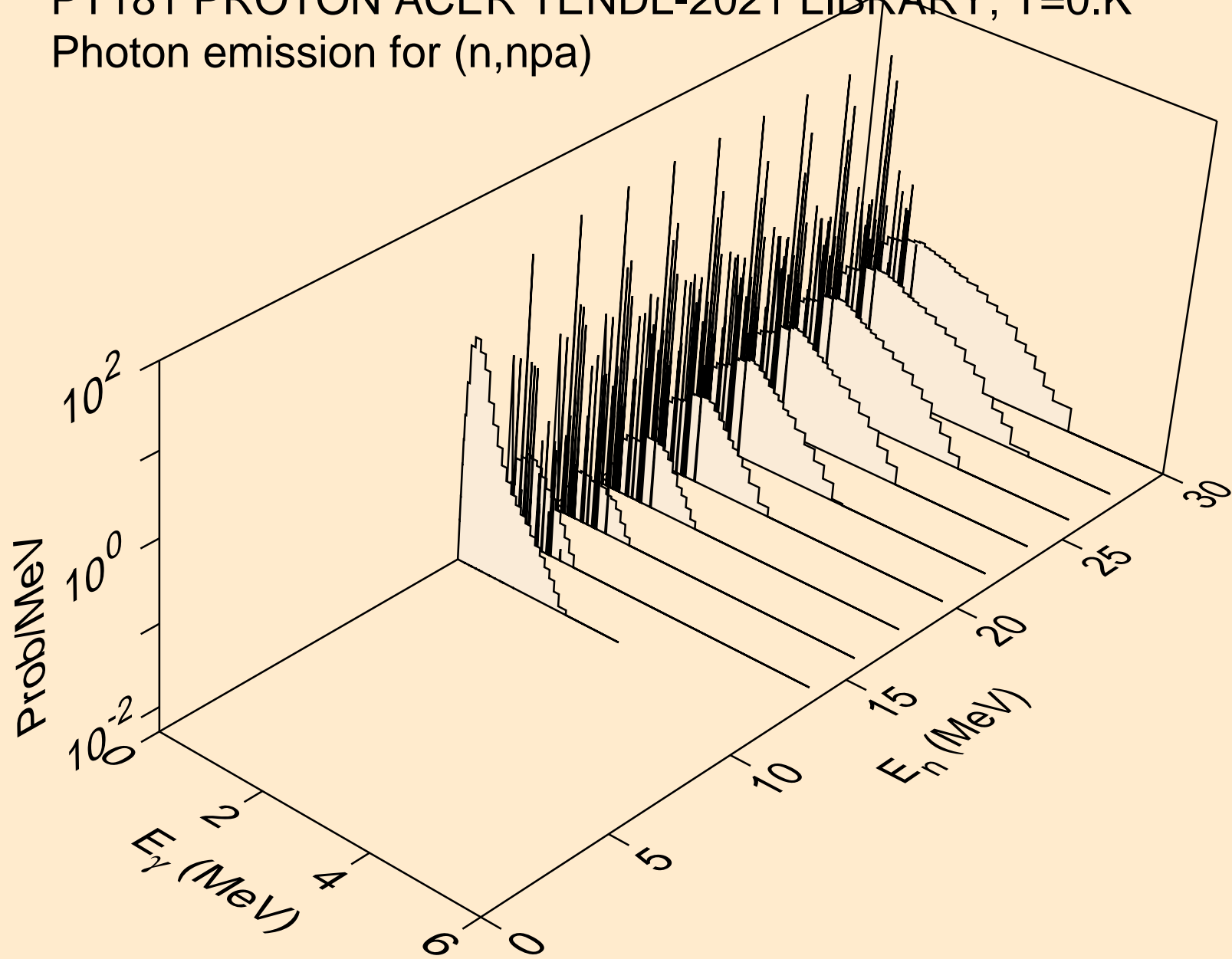

PT181 PROTON ACER TENDL-2021 LIBRARY; T=0.K  
Photon emission for (n,gma)

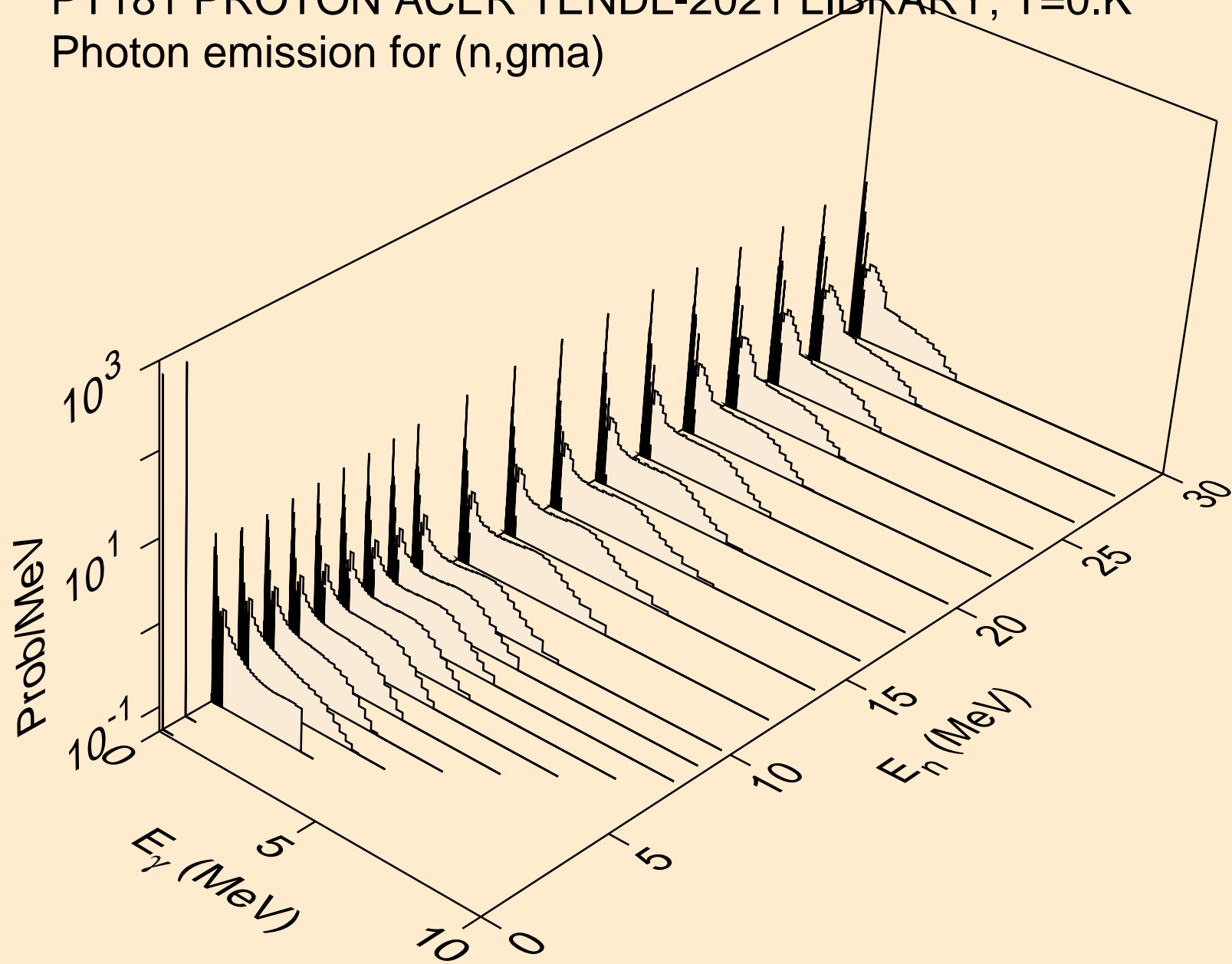

PT181 PROTON ACER TENDL-2021 LIBRARY; T=0.K  
Photon emission for inelastic

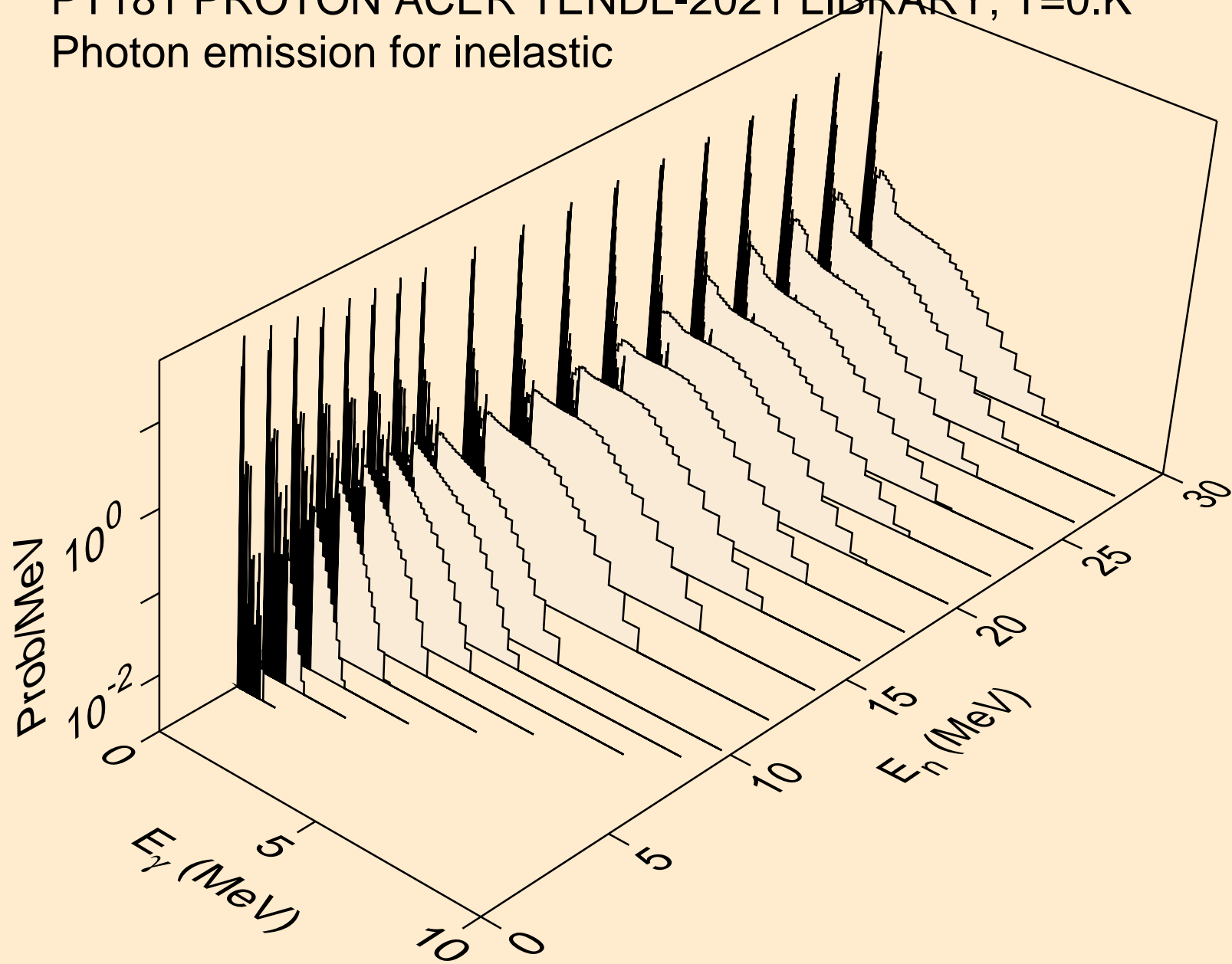

PT181 PROTON ACER TENDL-2021 LIBRARY; T=0.K  
Photon emission for (n,d)

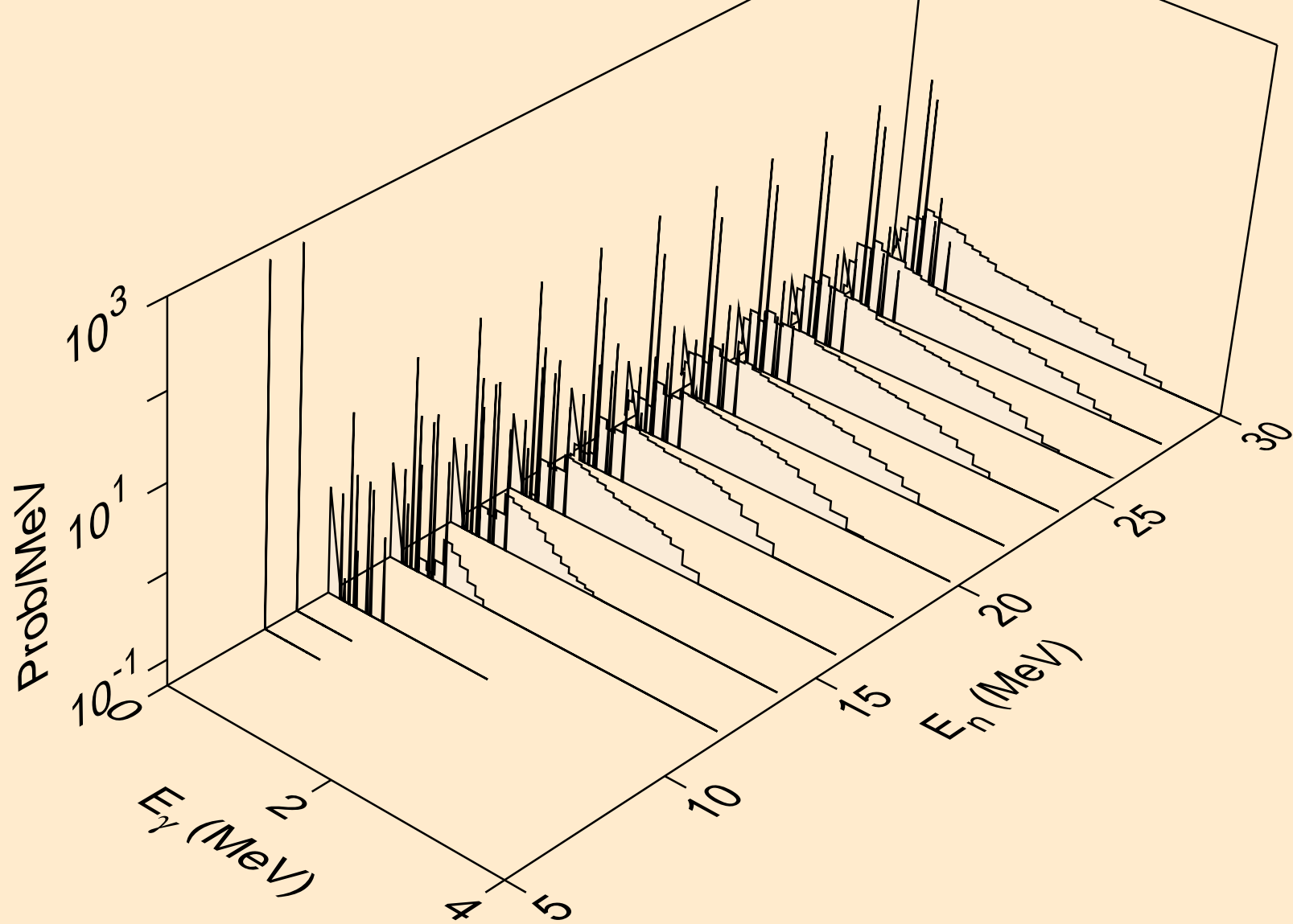

PT181 PROTON ACER TENDL-2021 LIBRARY; T=0.K  
Photon emission for (n,t)

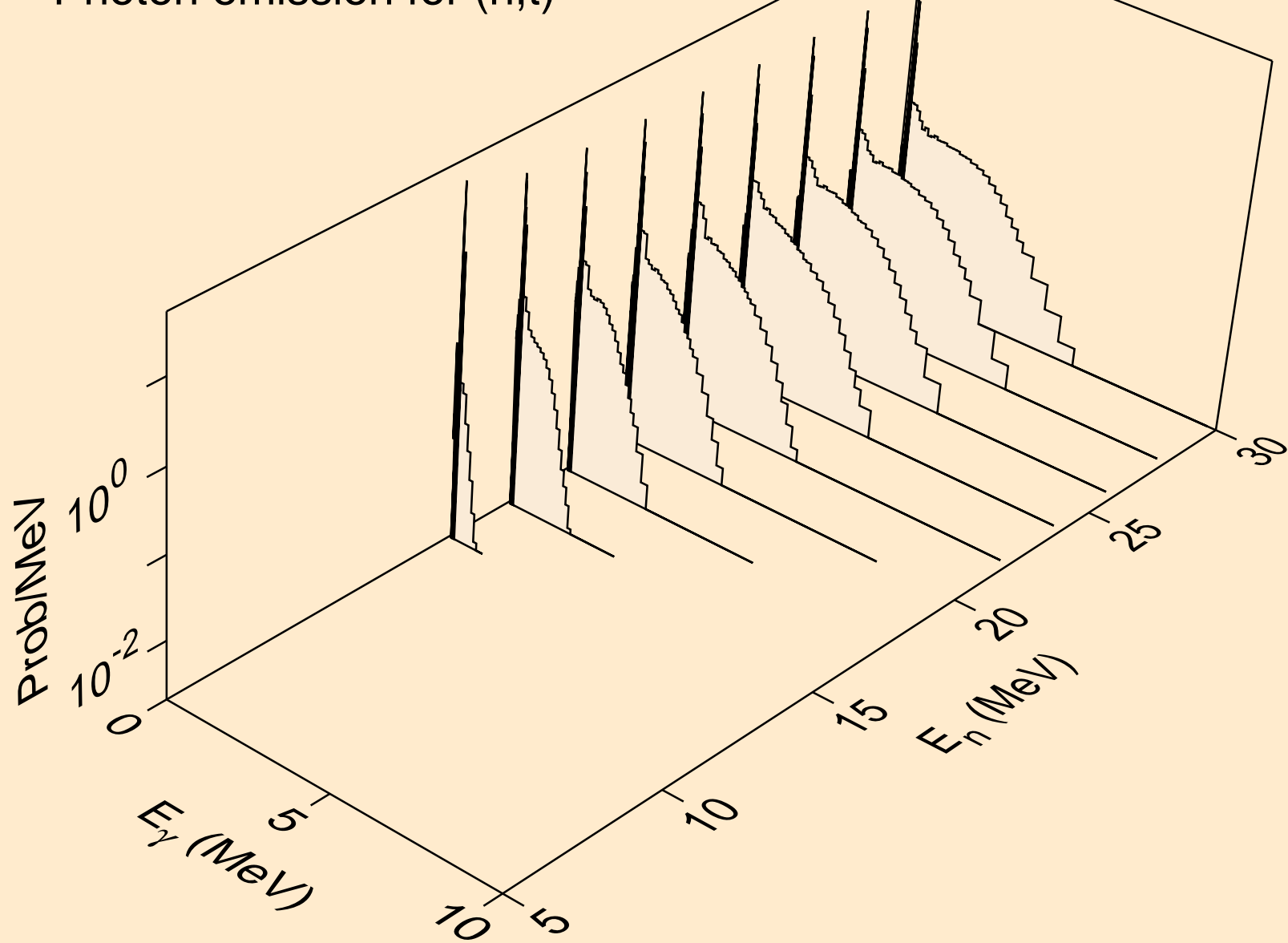



PT181 PROTON ACER TENDL-2021 LIBRARY; T=0.K  
Photon emission for (n,he3)

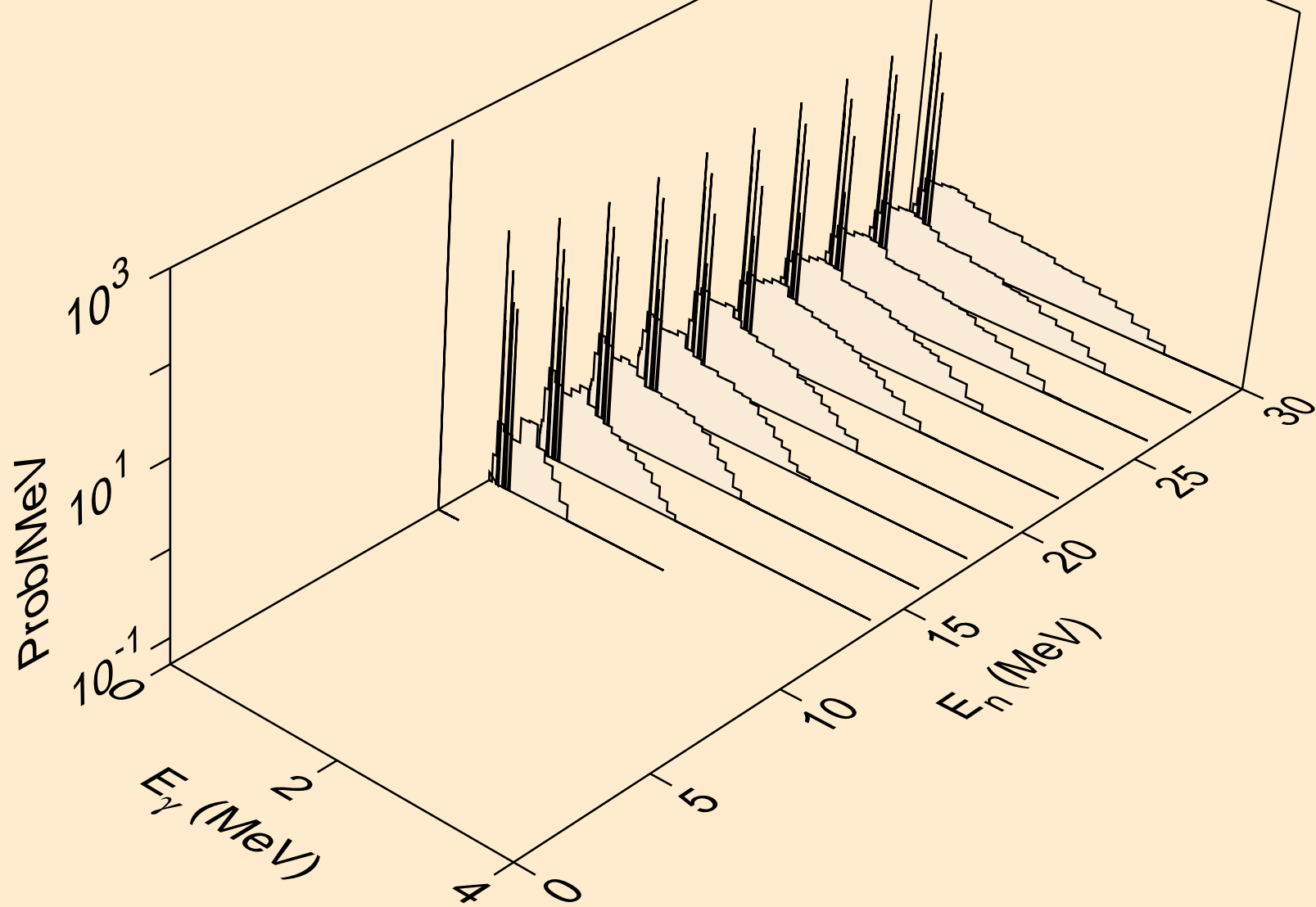

PT181 PROTON ACER TENDL-2021 LIBRARY; T=0.K  
Photon emission for (n,a)

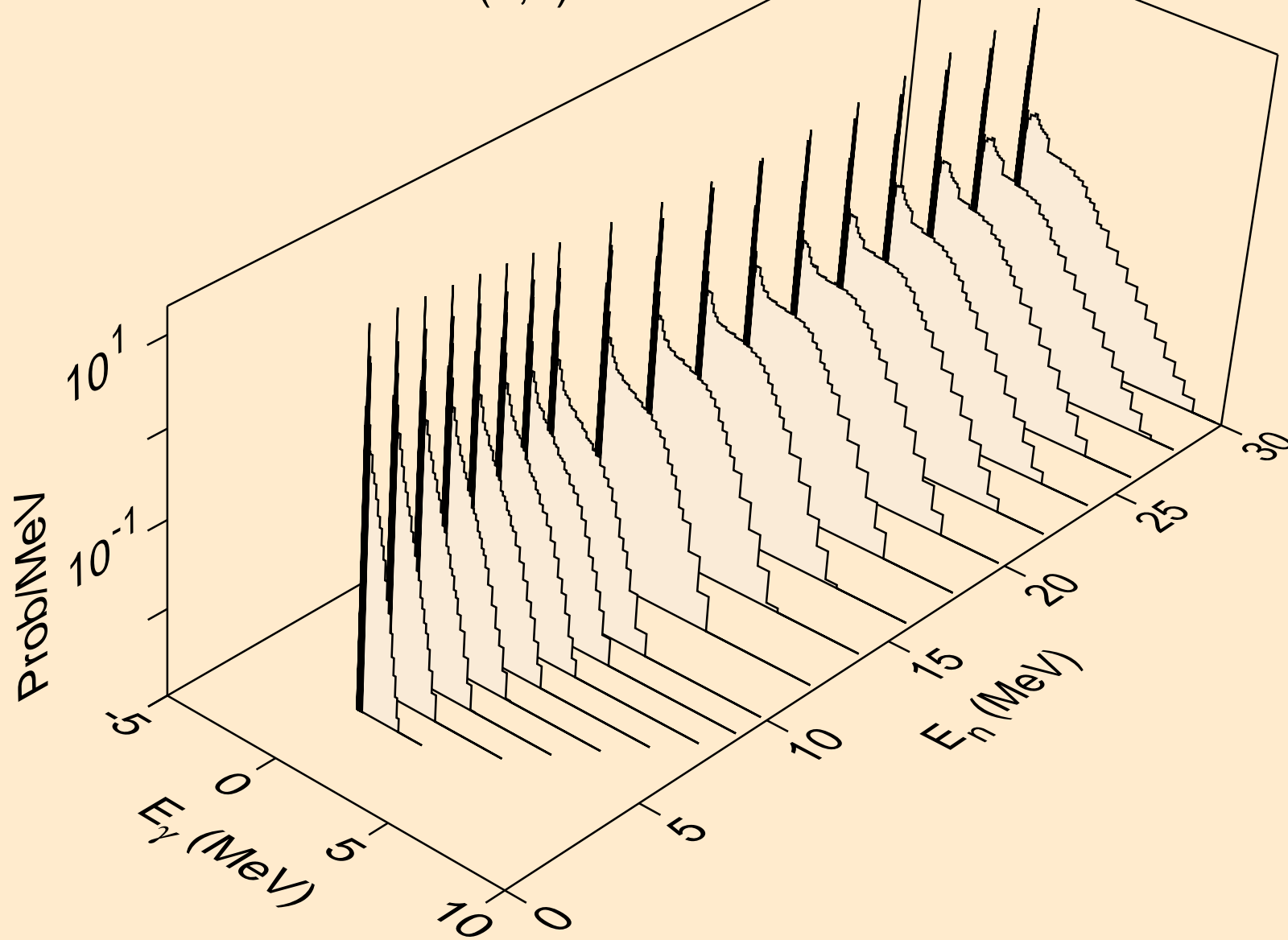

PT181 PROTON ACER TENDL-2021 LIBRARY; T=0.K  
Photon emission for (n,2a)

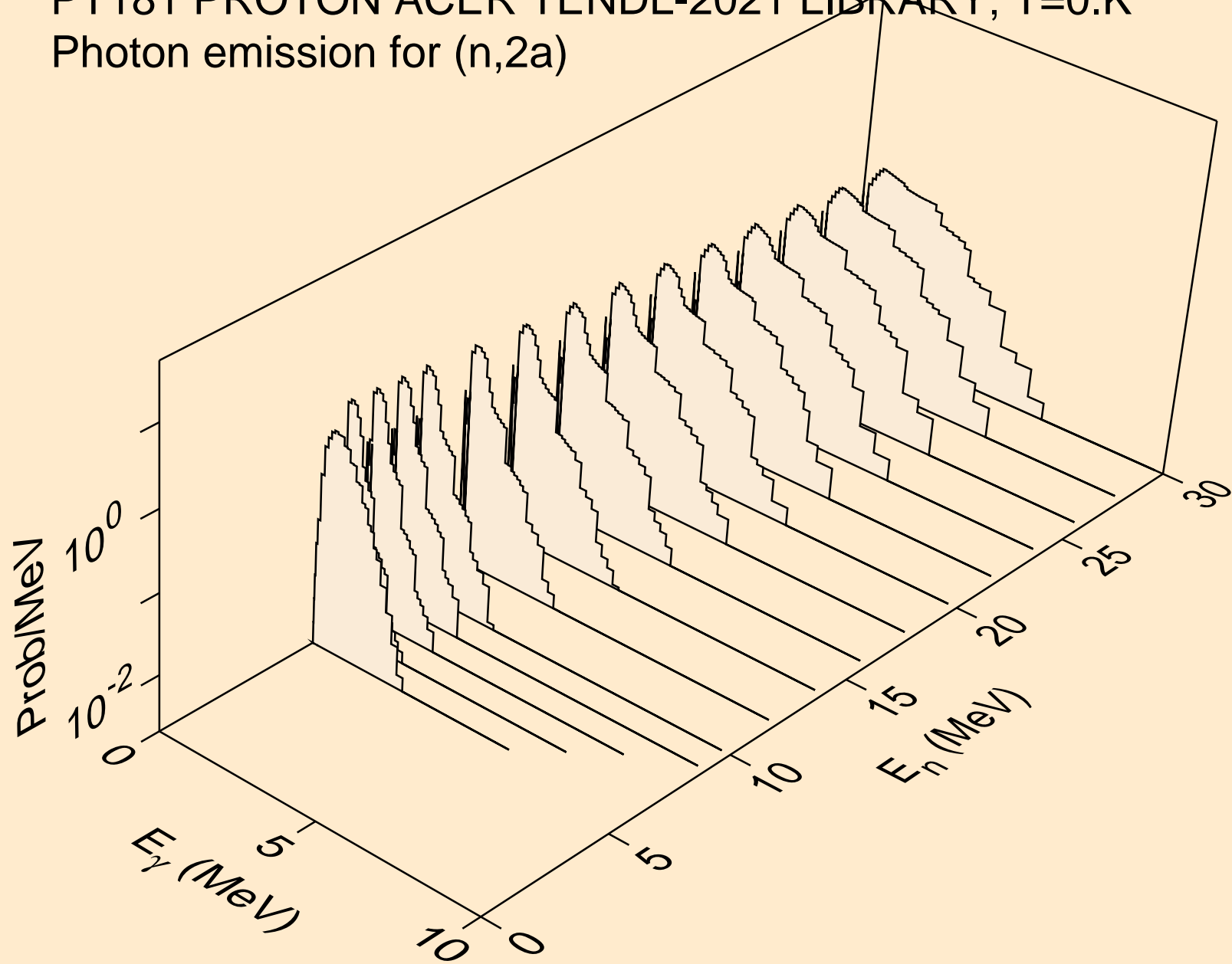

PT181 PROTON ACER TENDL-2021 LIBRARY; T=0.K  
Photon emission for (n,2p)

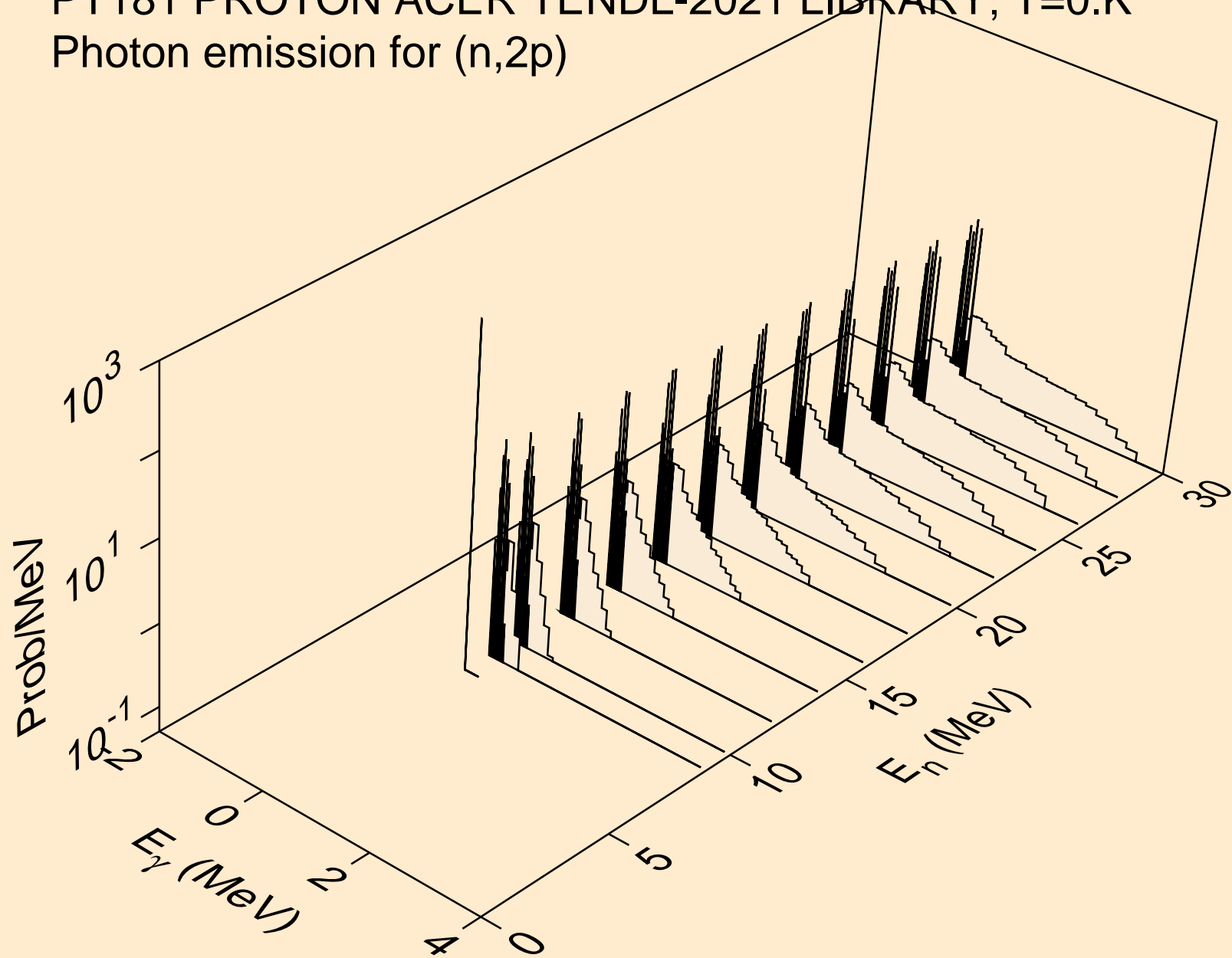

PT181 PROTON ACER TENDL-2021 LIBRARY; T=0.K  
Photon emission for (n,pa)

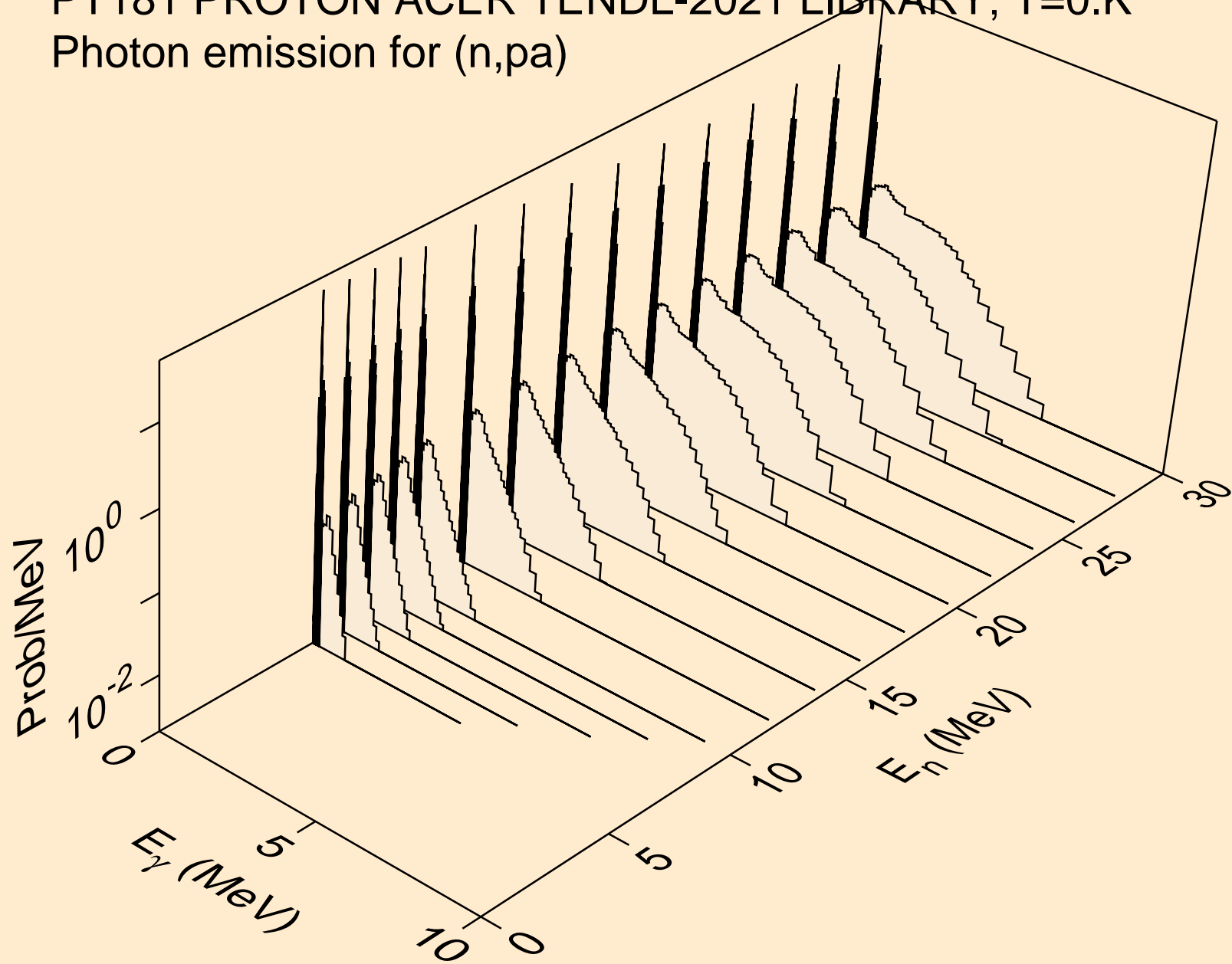

PT181 PROTON ACER TENDL-2021 LIBRARY; T=0.K  
Photon emission for (n,pd)

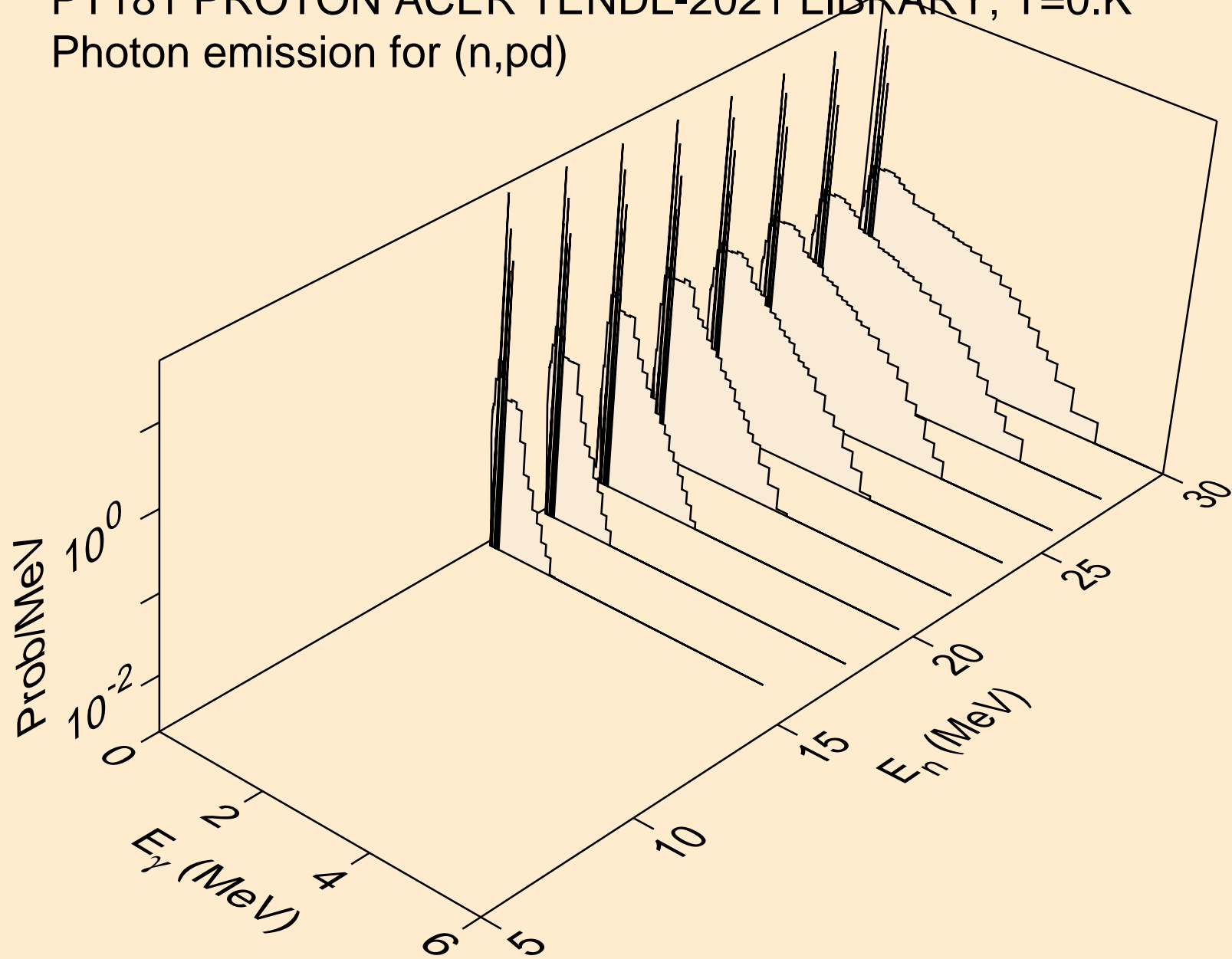

PT181 PROTON ACER TENDL-2021 LIBRARY; T=0.K  
Photon emission for (n,pt)

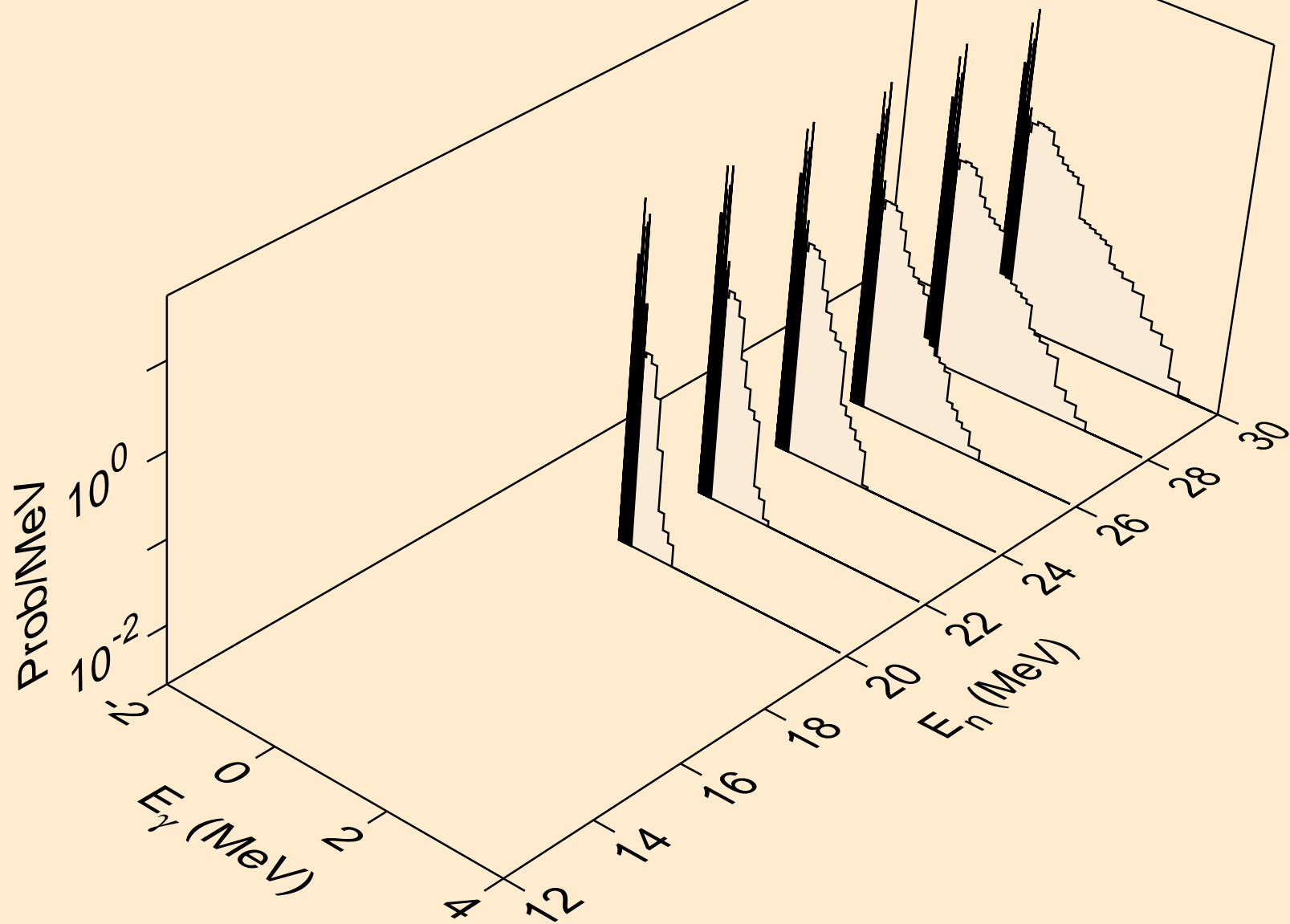

PT181 PROTON ACER TENDL-2021 LIBRARY; T=0.K  
Photon emission for (n,da)

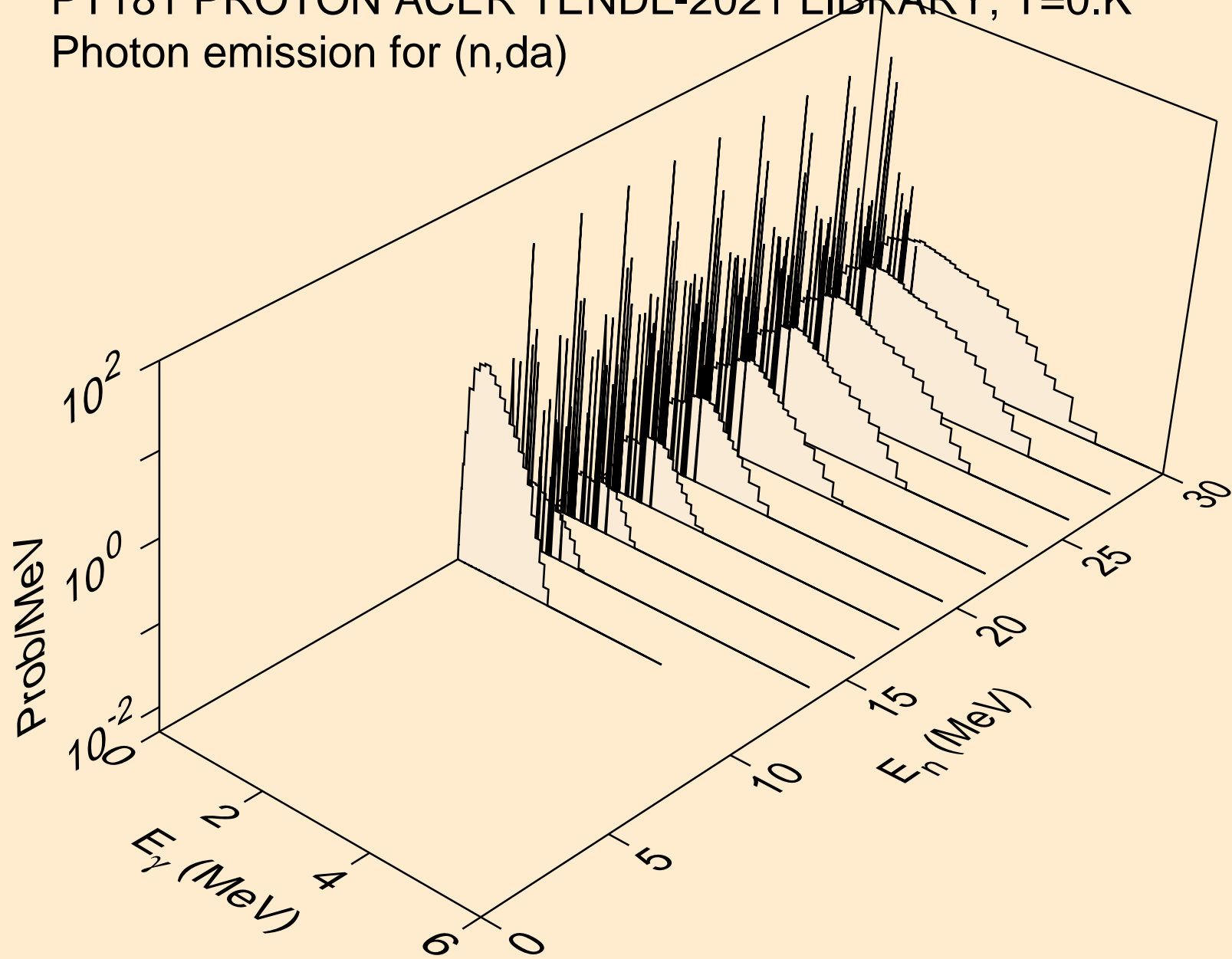



PT181 PROTON ACER TENDL-2021 LIBRARY; T=0.K  
Particle heating contributions

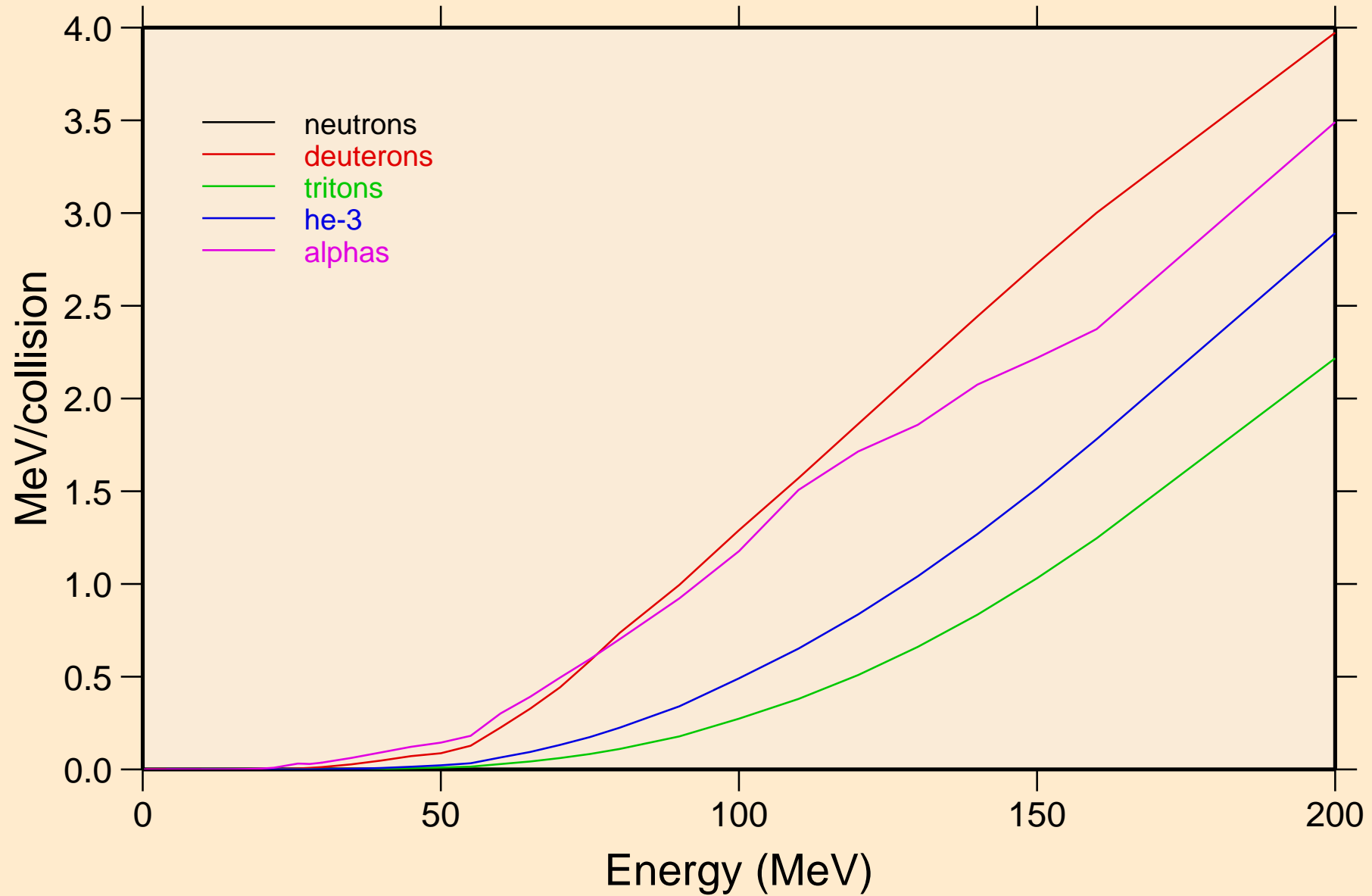

PT181 PROTON ACER TENDL-2021 LIBRARY; T=0.K  
Recoil Heating

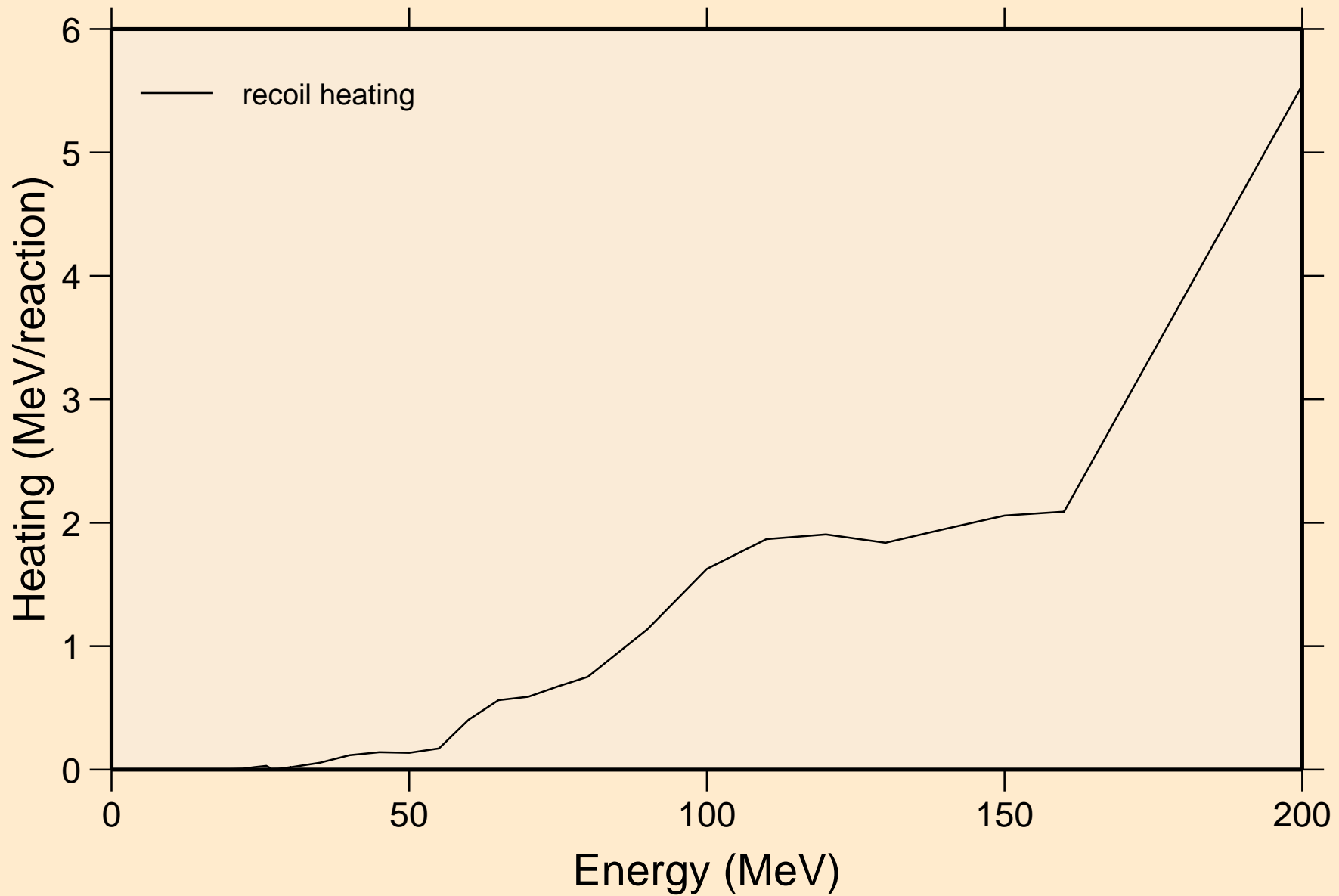

PT181 PROTON ACER TENDL-2021 LIBRARY; T=0.K  
Particle production cross sections

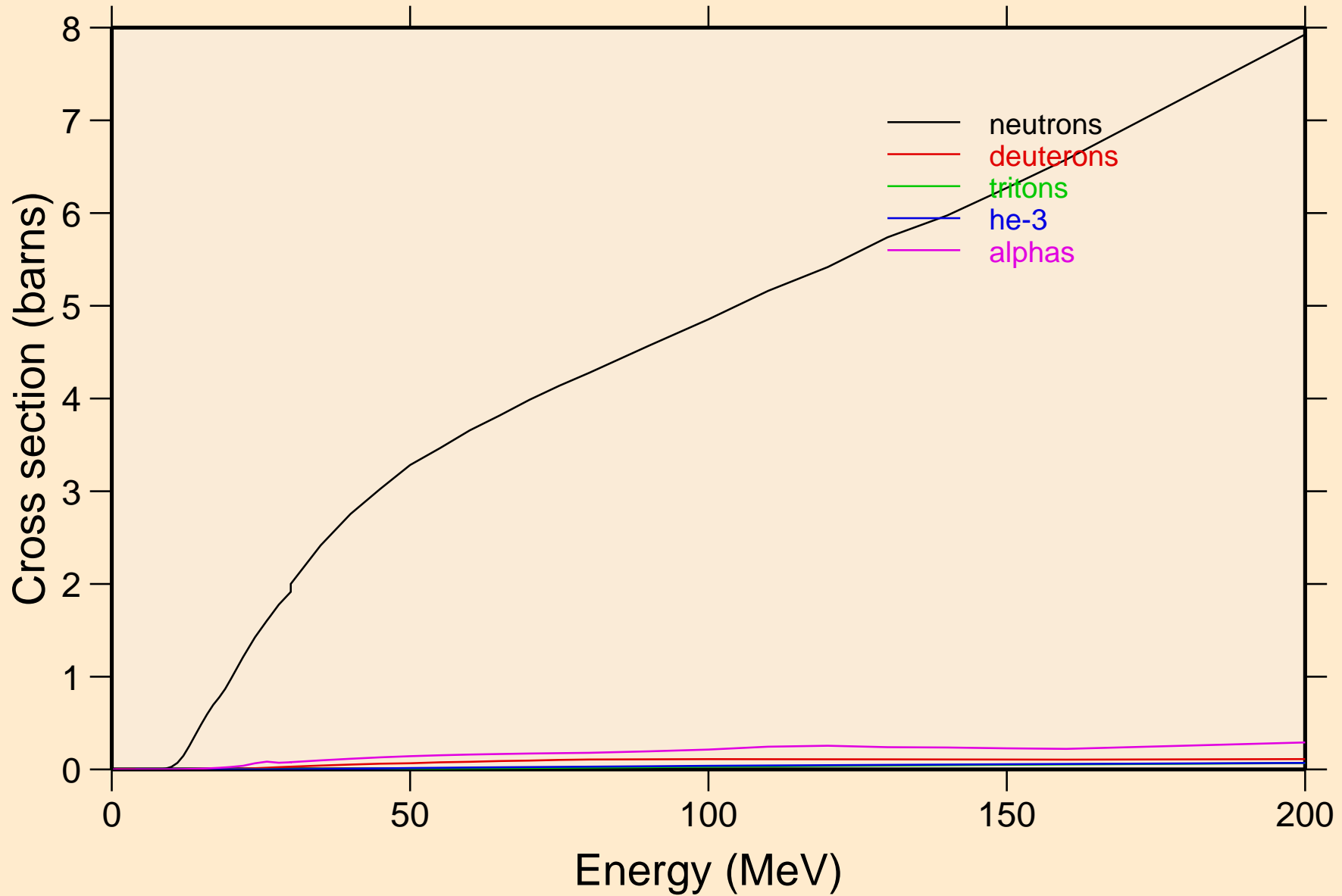

PT181 PROTON ACER TENDL-2021 LIBRARY; T=0.K  
neutrons from (p,n)

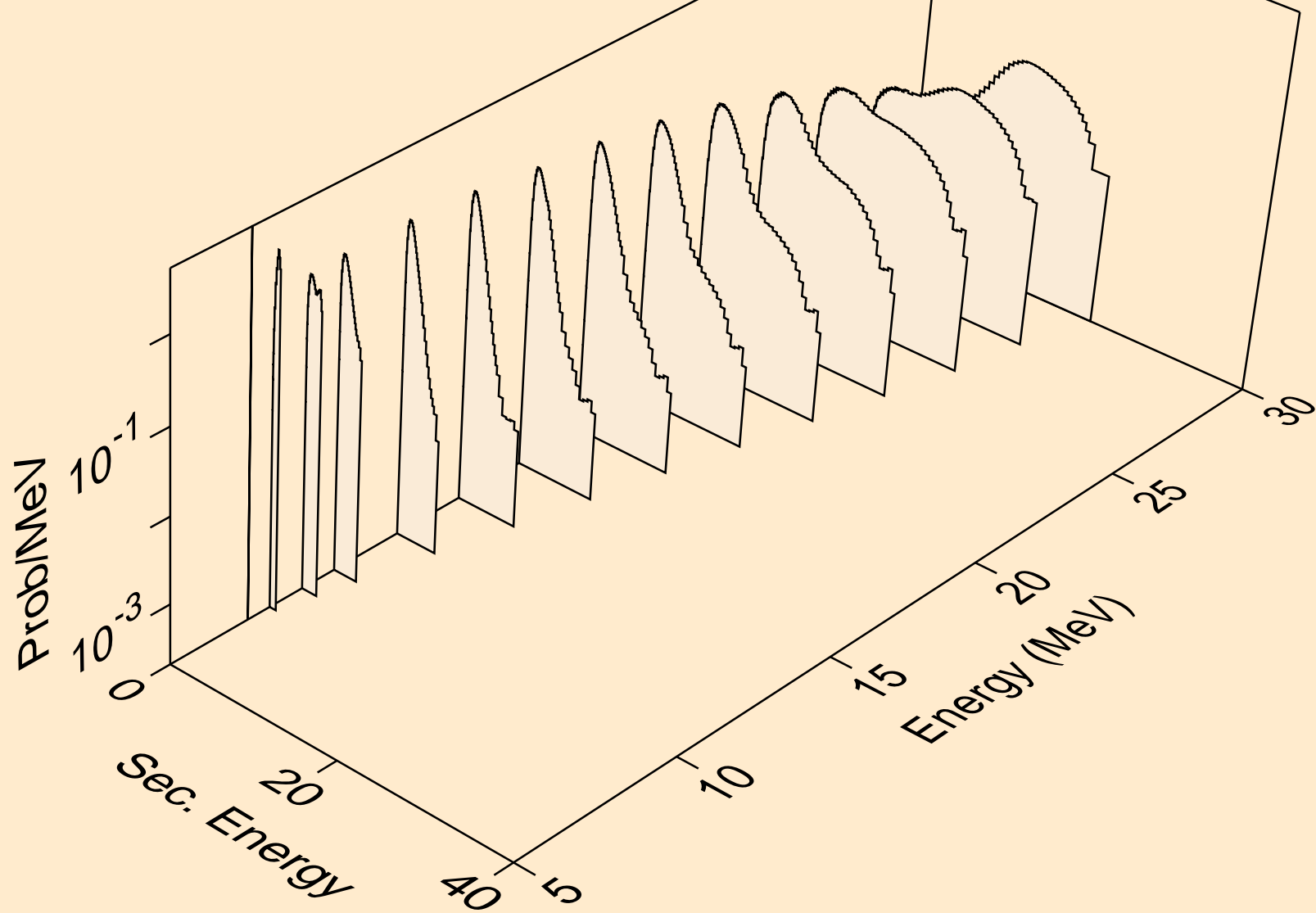

PT181 PROTON ACER TENDL-2021 LIBRARY; T=0.K  
neutrons from (p,x)

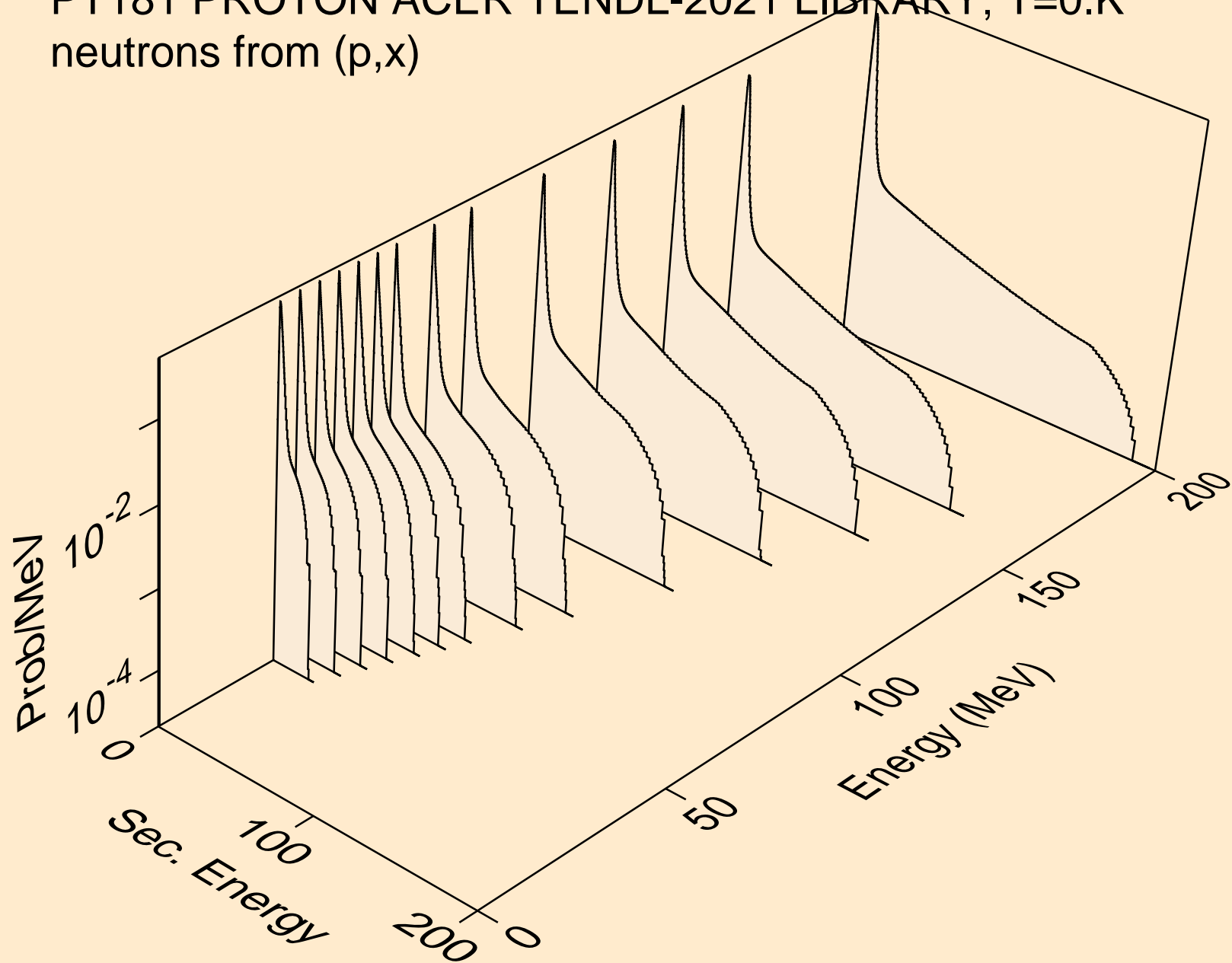

PT181 PROTON ACER TENDL-2021 LIBRARY; T=0.K  
neutrons from (p,2n)

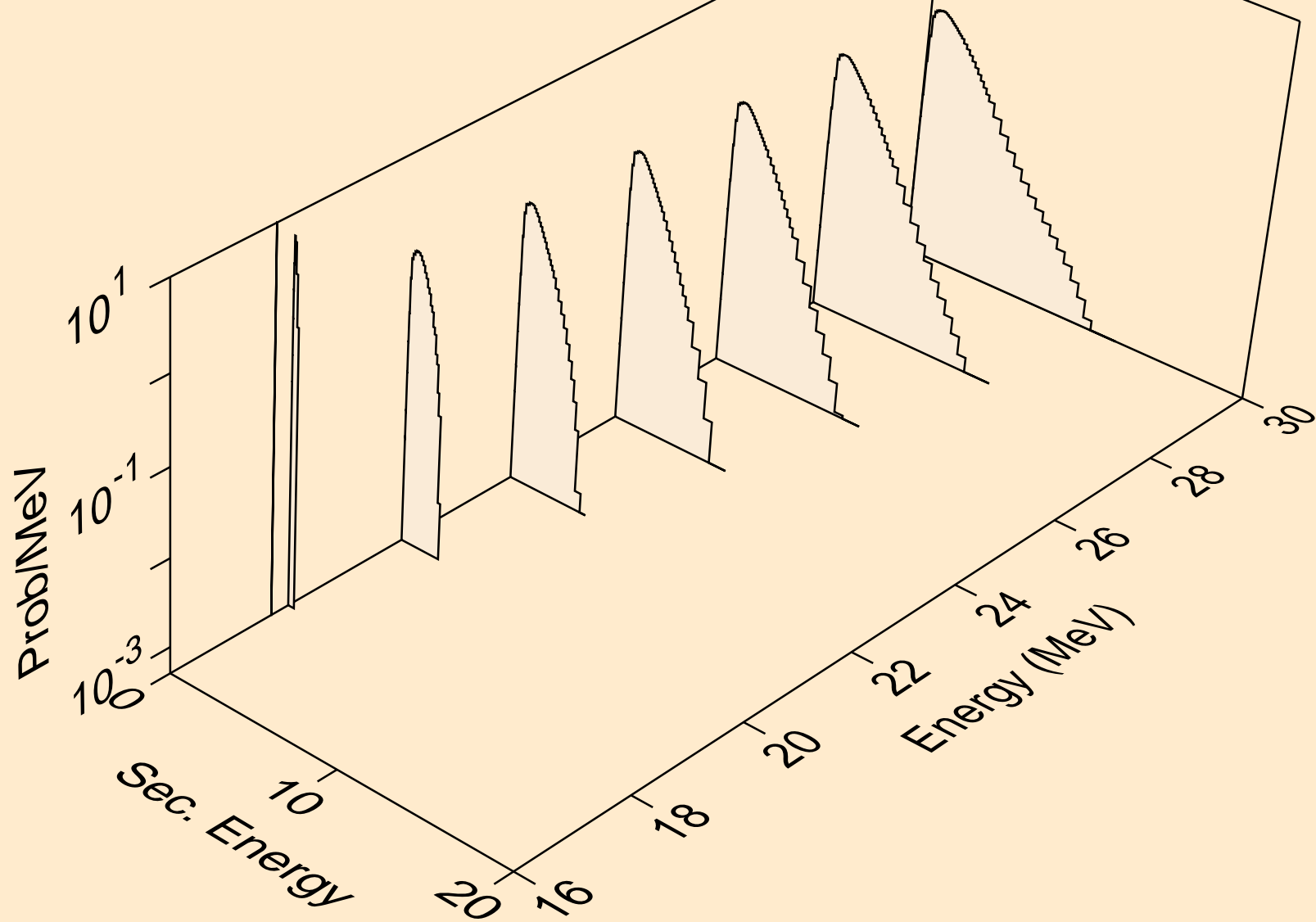

PT181 PROTON ACER TENDL-2021 LIBRARY; T=0.K  
neutrons from (p,3n)

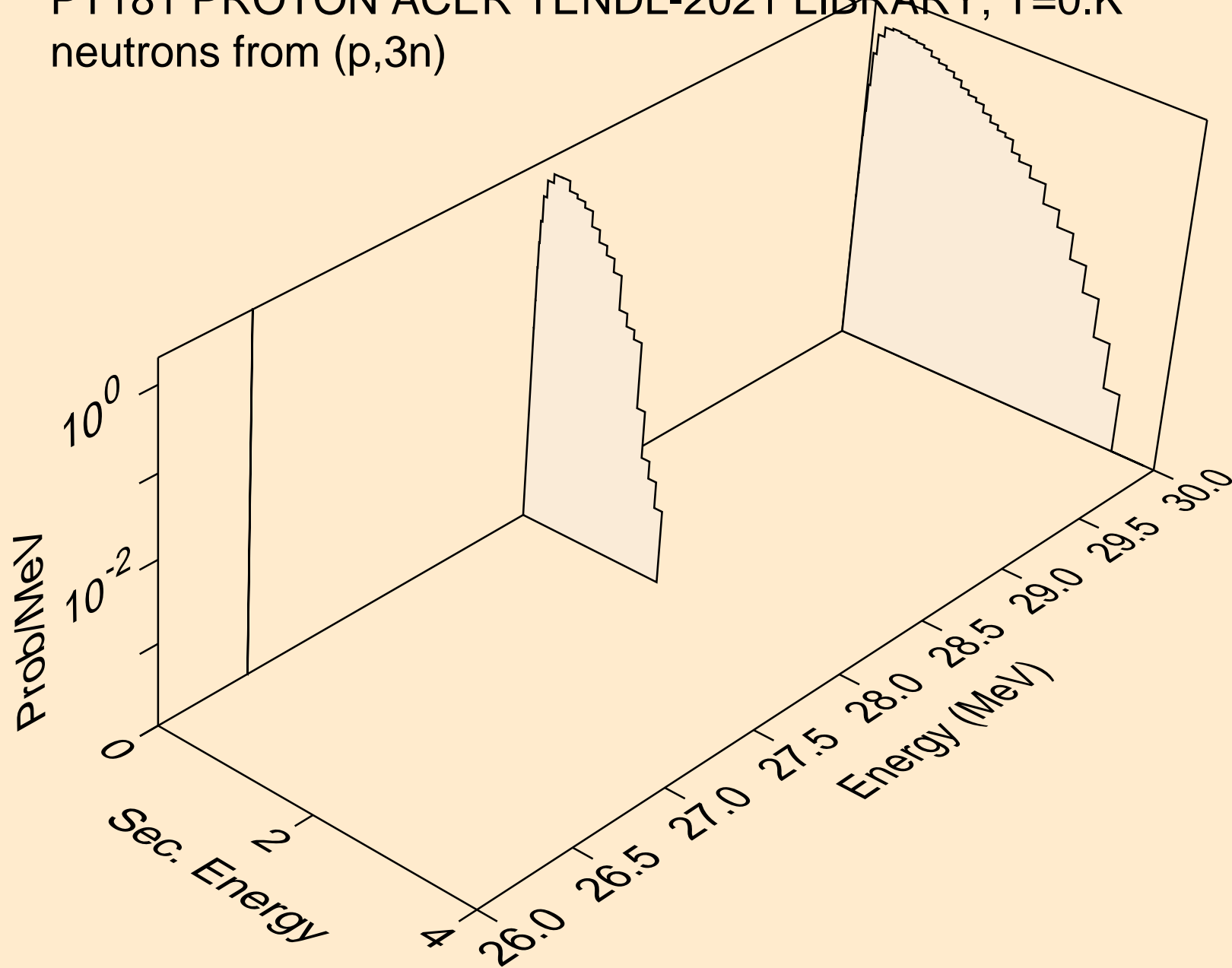

PT181 PROTON ACER TENDL-2021 LIBRARY; T=0.K  
neutrons from (p,n\*)a

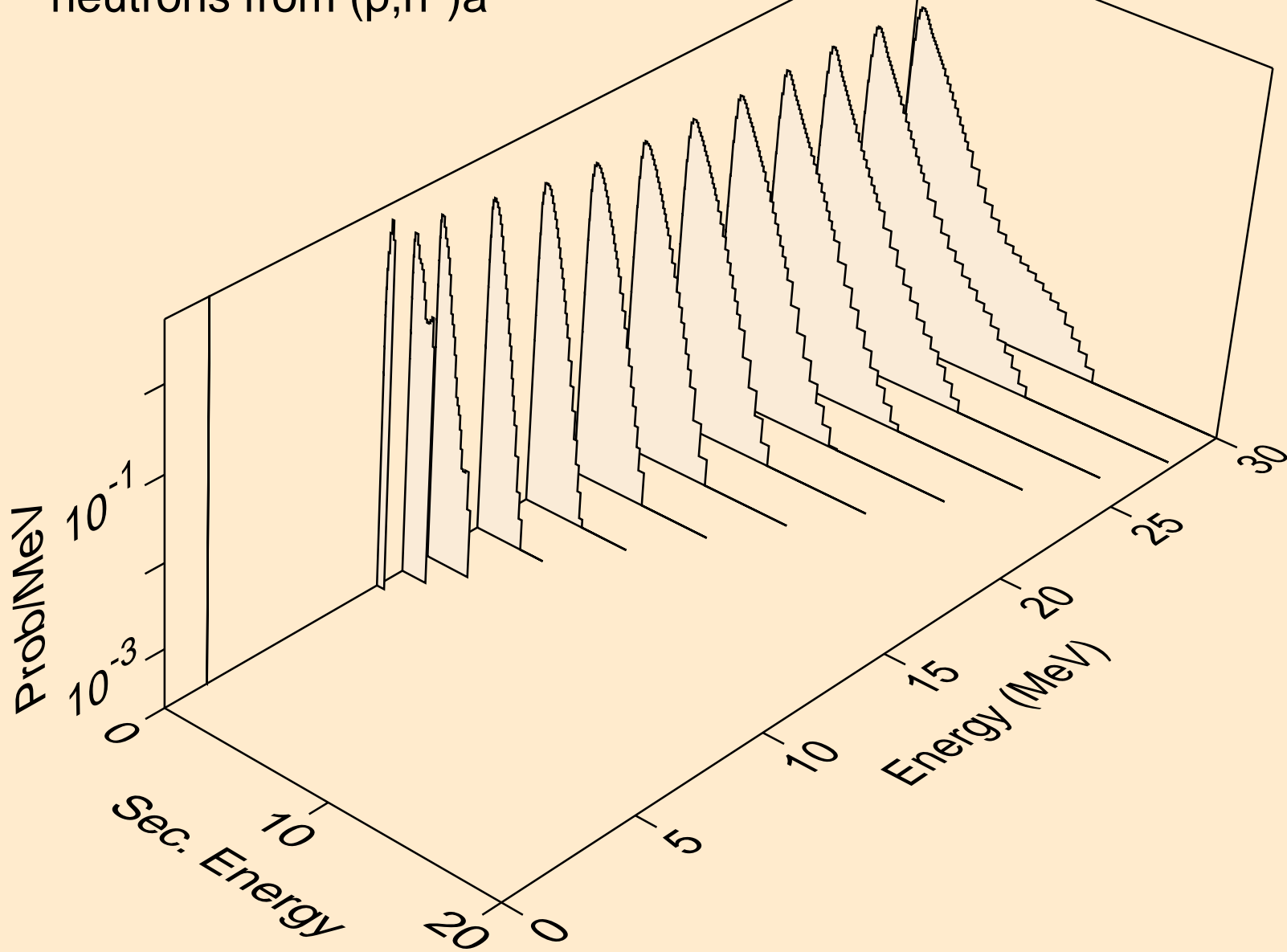



PT181 PROTON ACER TENDL-2021 LIBRARY; T=0.K  
neutrons from (p,2n)a

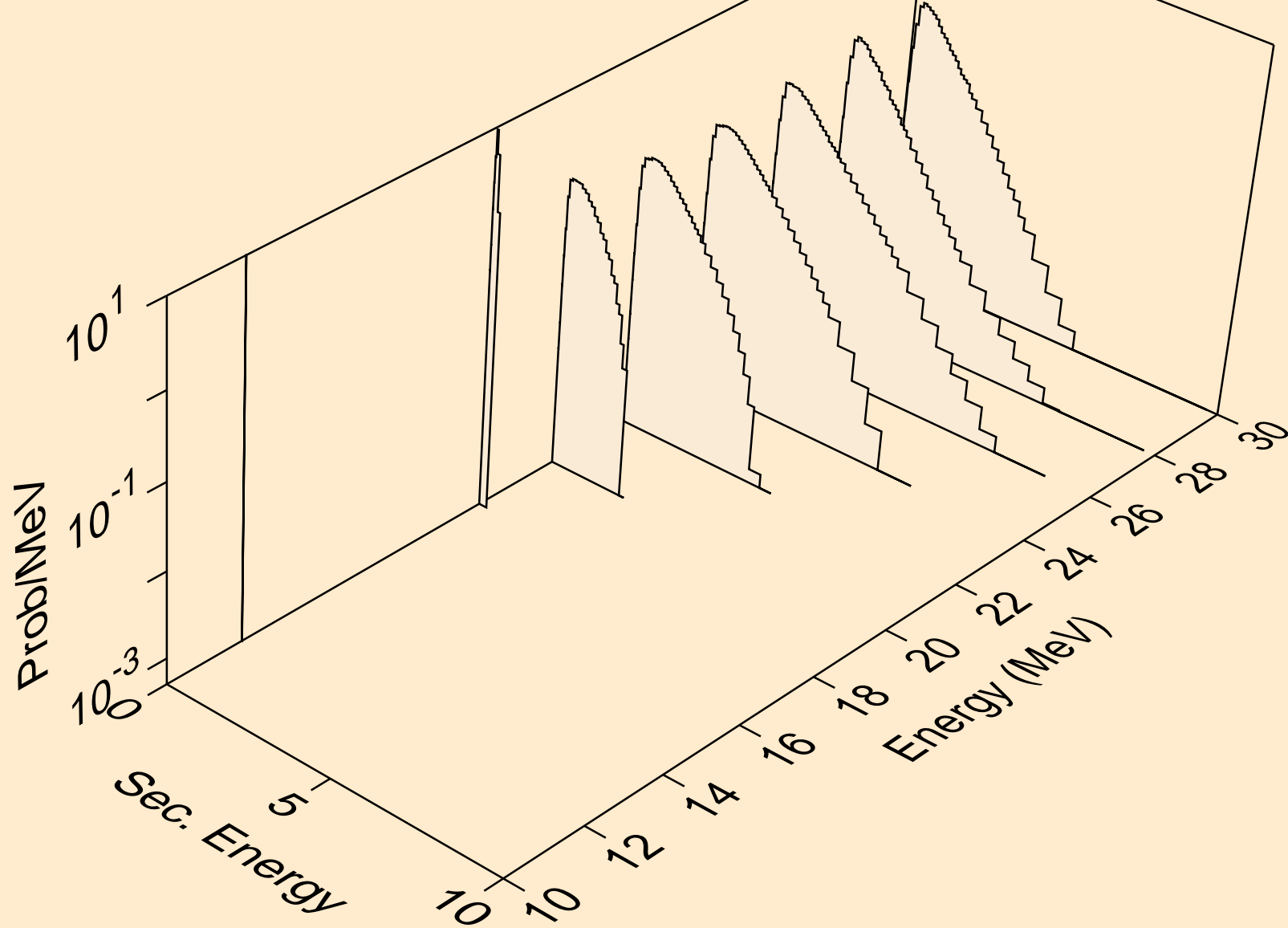

PT181 PROTON ACER TENDL-2021 LIBRARY; T=0.K  
neutrons from (p,3n)a

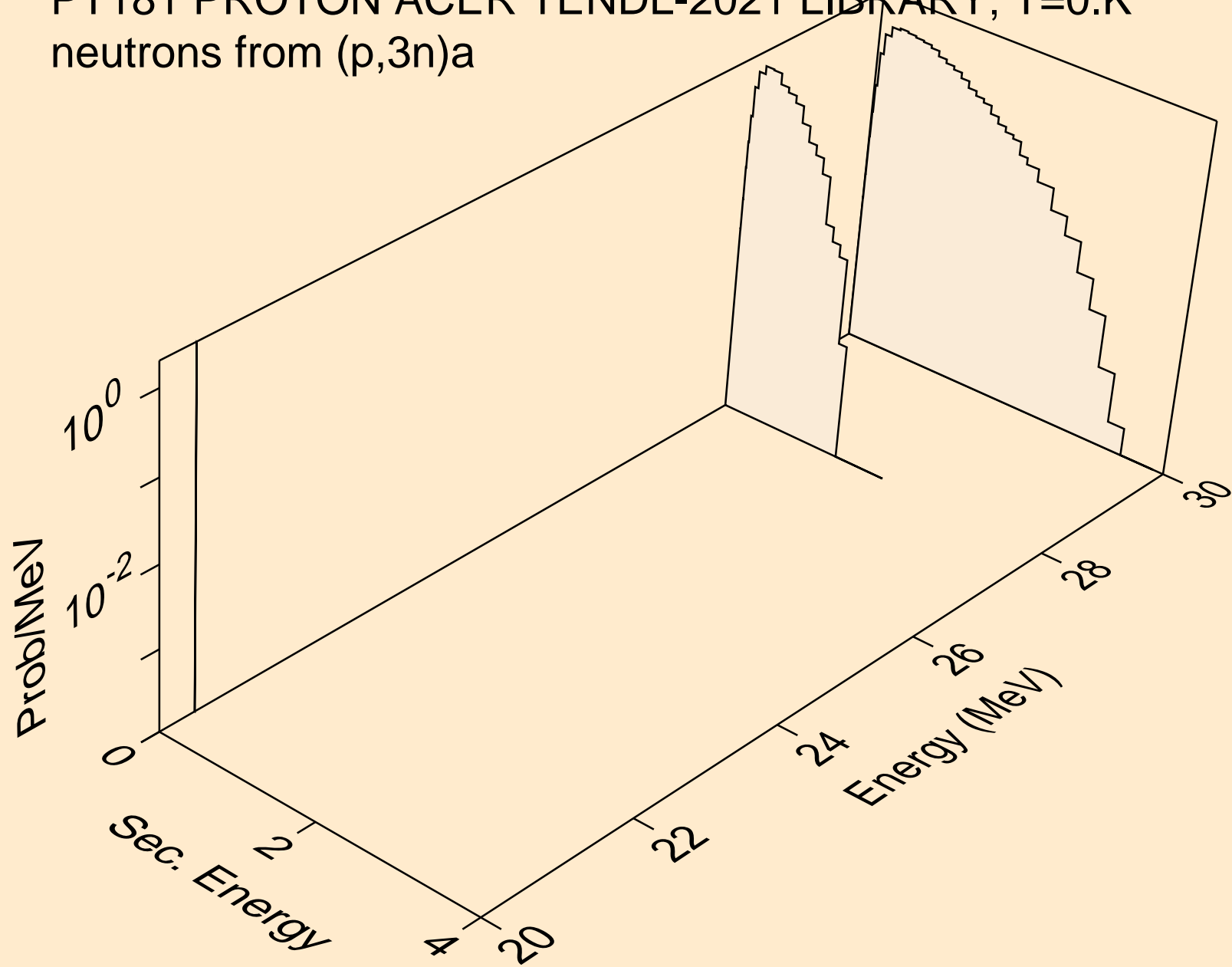

PT181 PROTON ACER TENDL-2021 LIBRARY; T=0.K  
neutrons from (p,n\*)p

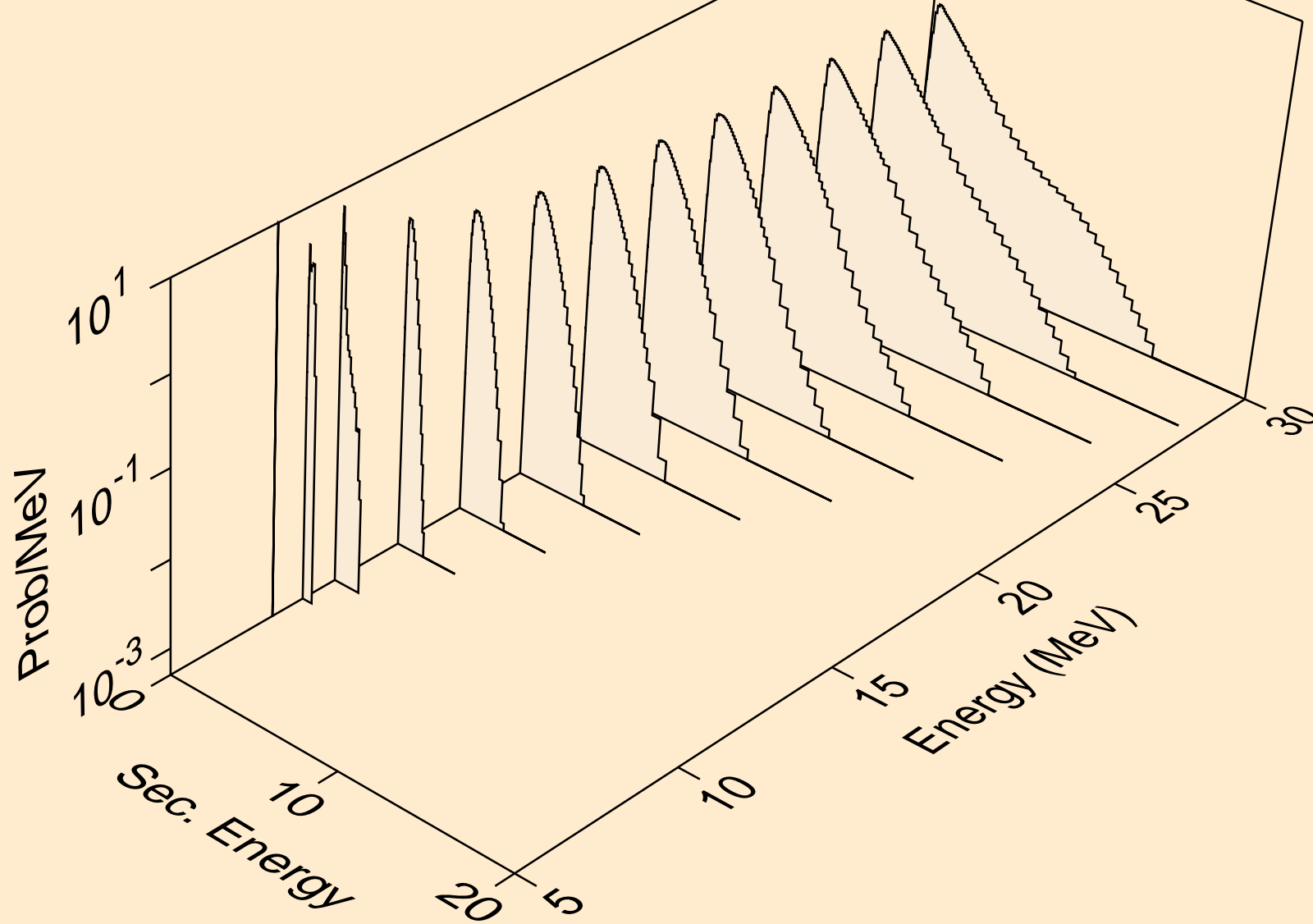

PT181 PROTON ACER TENDL-2021 LIBRARY; T=0.K  
neutrons from (p,n\*)2a

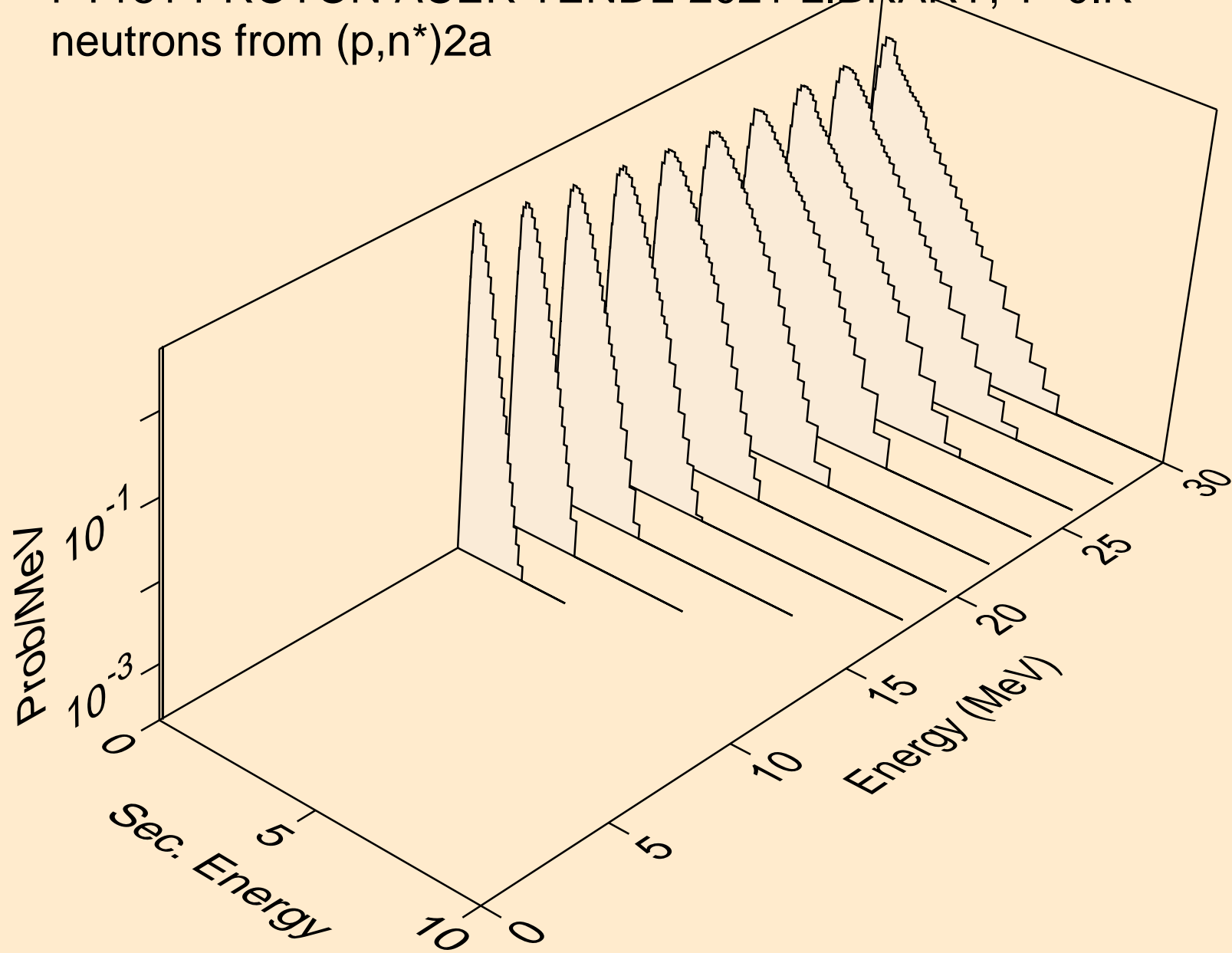

PT181 PROTON ACER TENDL-2021 LIBRARY; T=0.K  
neutrons from (p,n\*)d

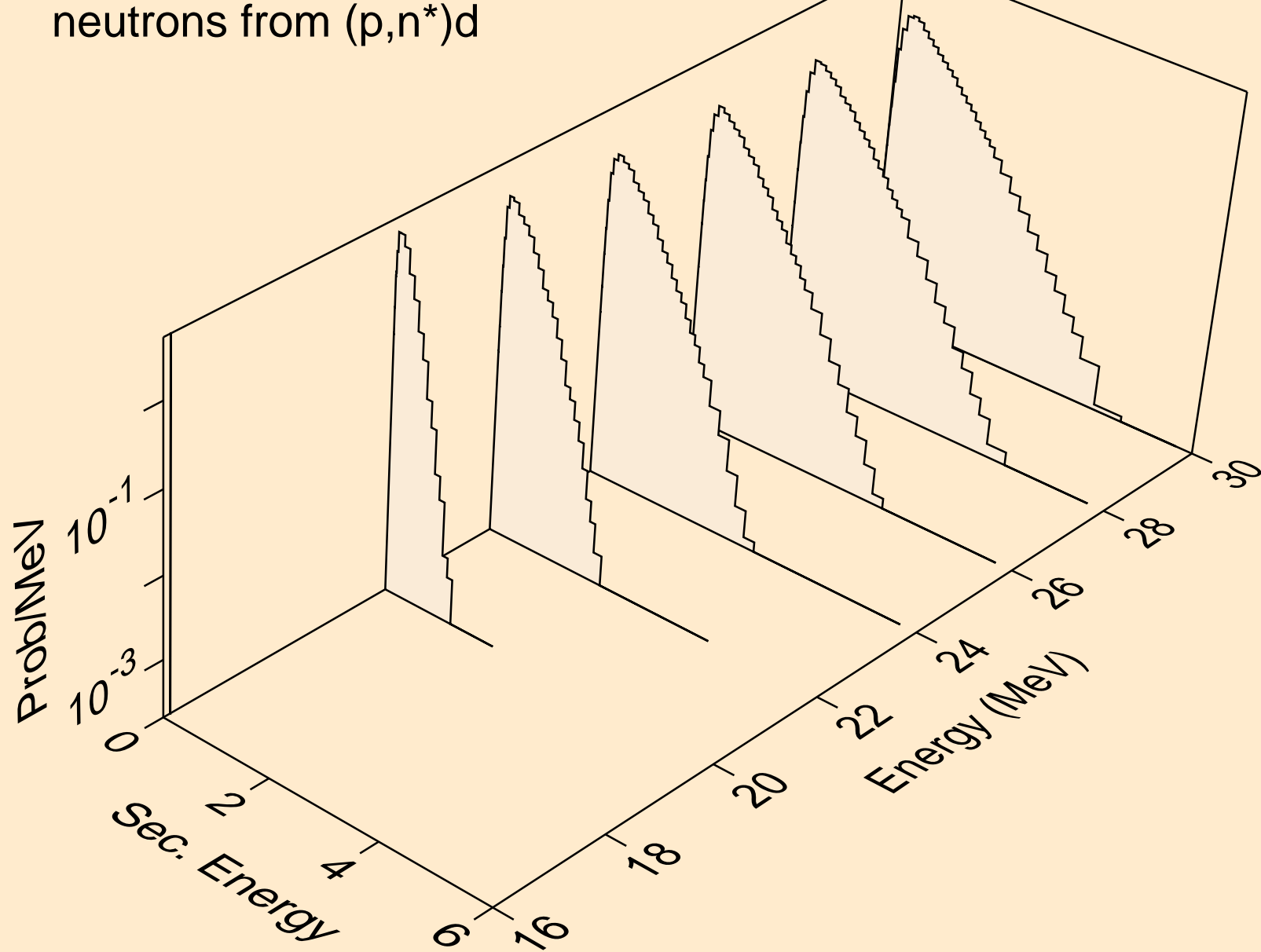

PT181 PROTON ACER TENDL-2021 LIBRARY; T=0.K  
neutrons from (p,n\*)t

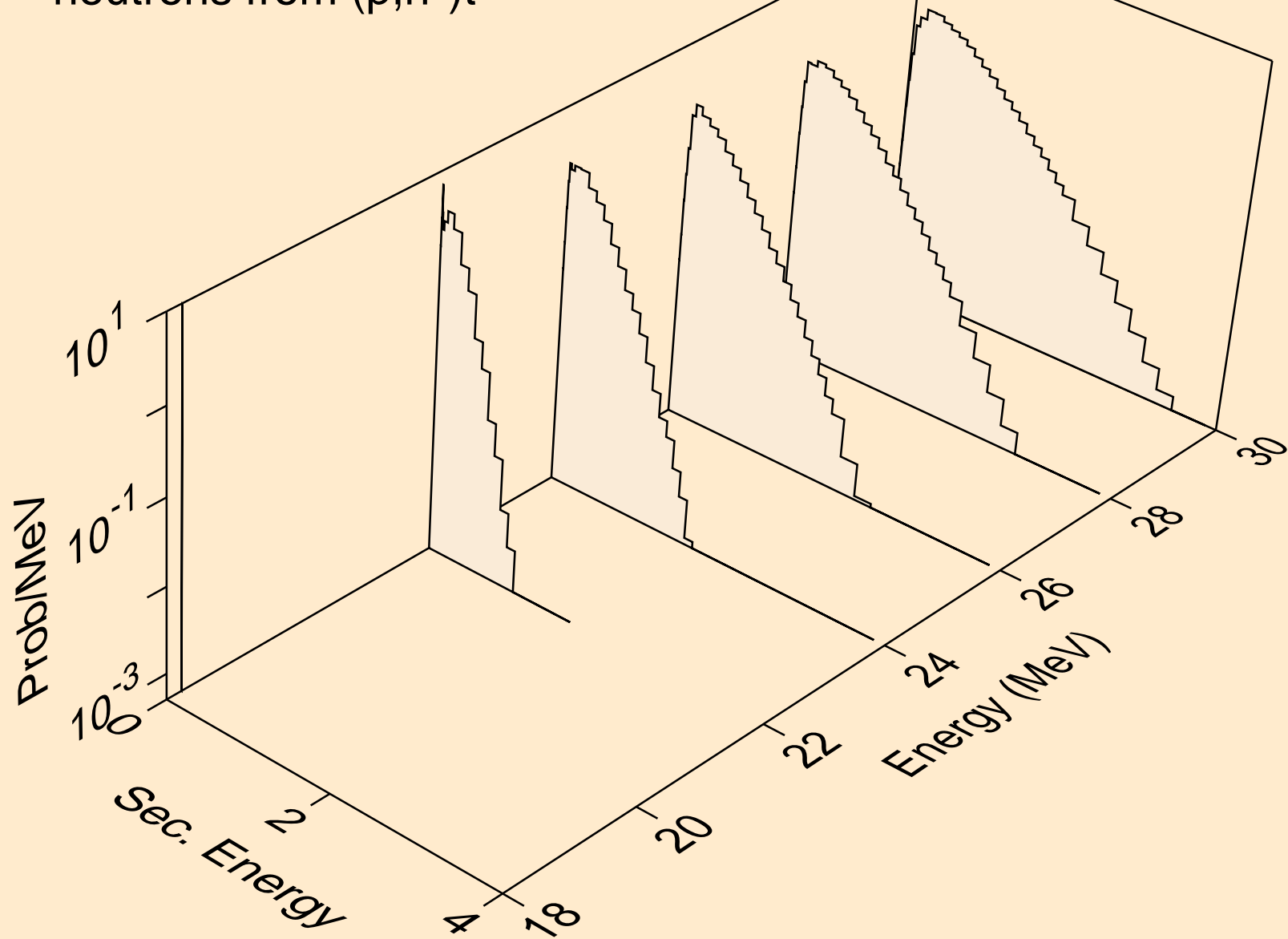

PT181 PROTON ACER TENDL-2021 LIBRARY; T=0.K  
neutrons from (p,n\*)he3

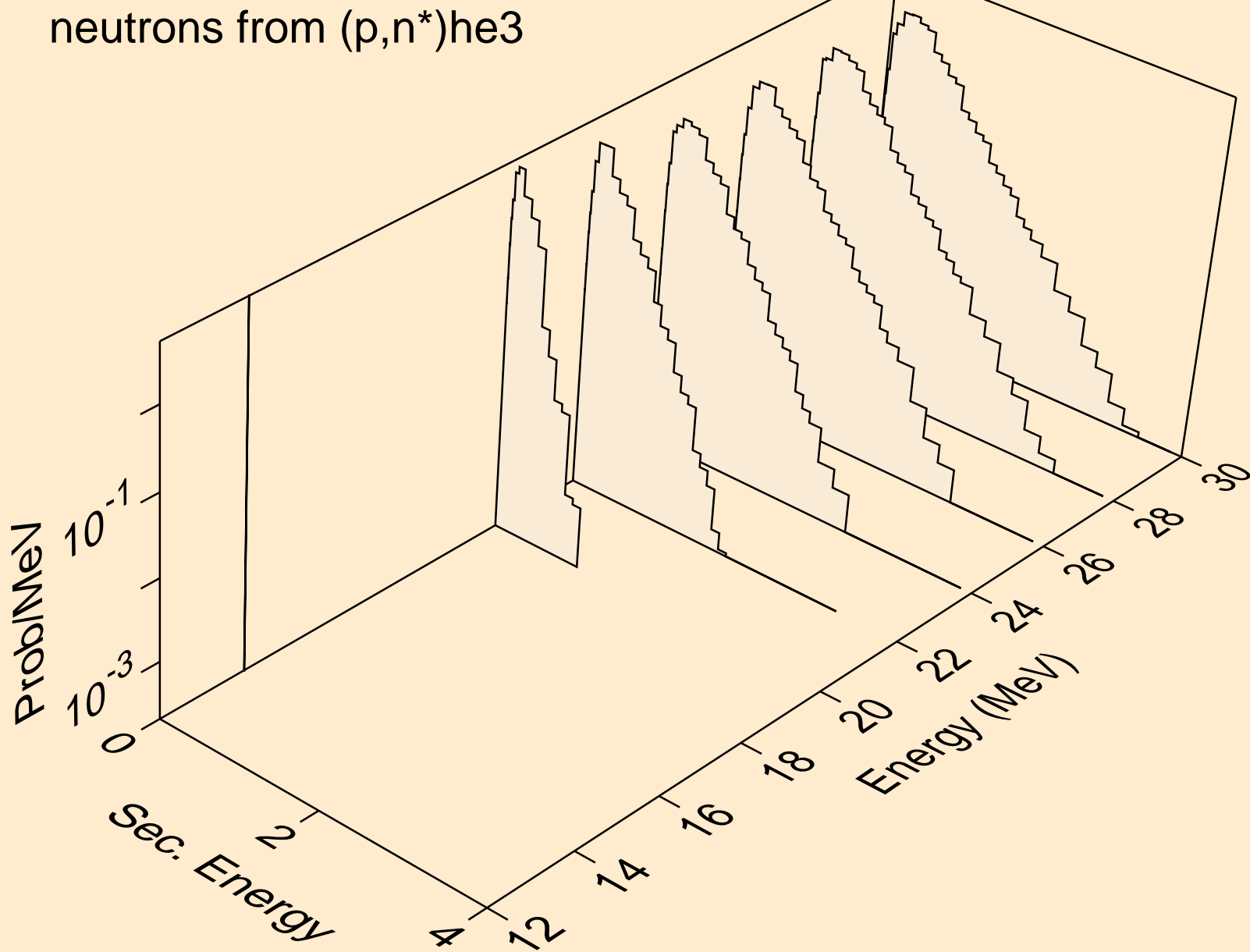

PT181 PROTON ACER TENDL-2021 LIBRARY; T=0.K  
neutrons from (p,2np)

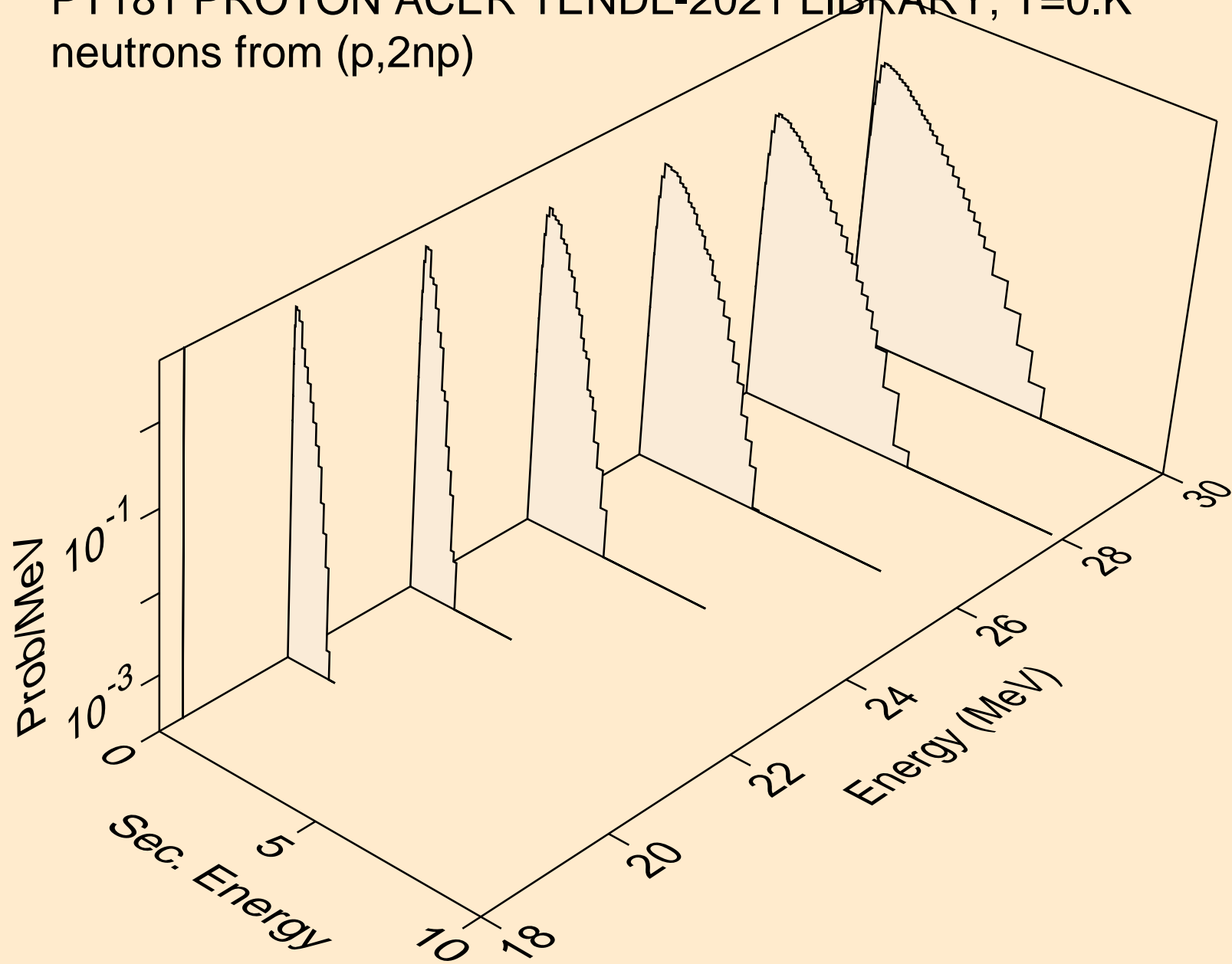



PT181 PROTON ACER TENDL-2021 LIBRARY; T=0.K  
neutrons from (p,3np)

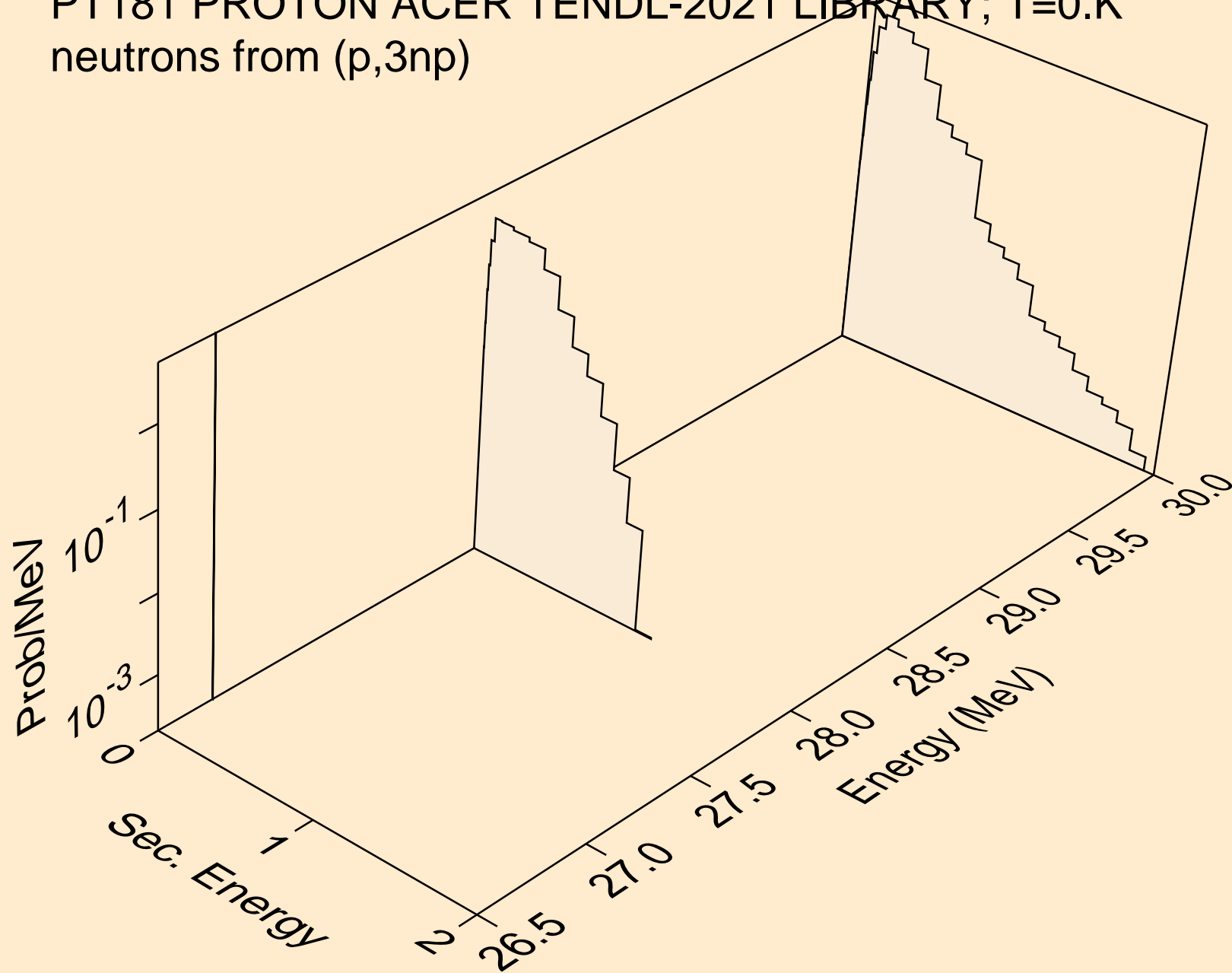

PT181 PROTON ACER TENDL-2021 LIBRARY; T=0.K  
neutrons from (p,2np)

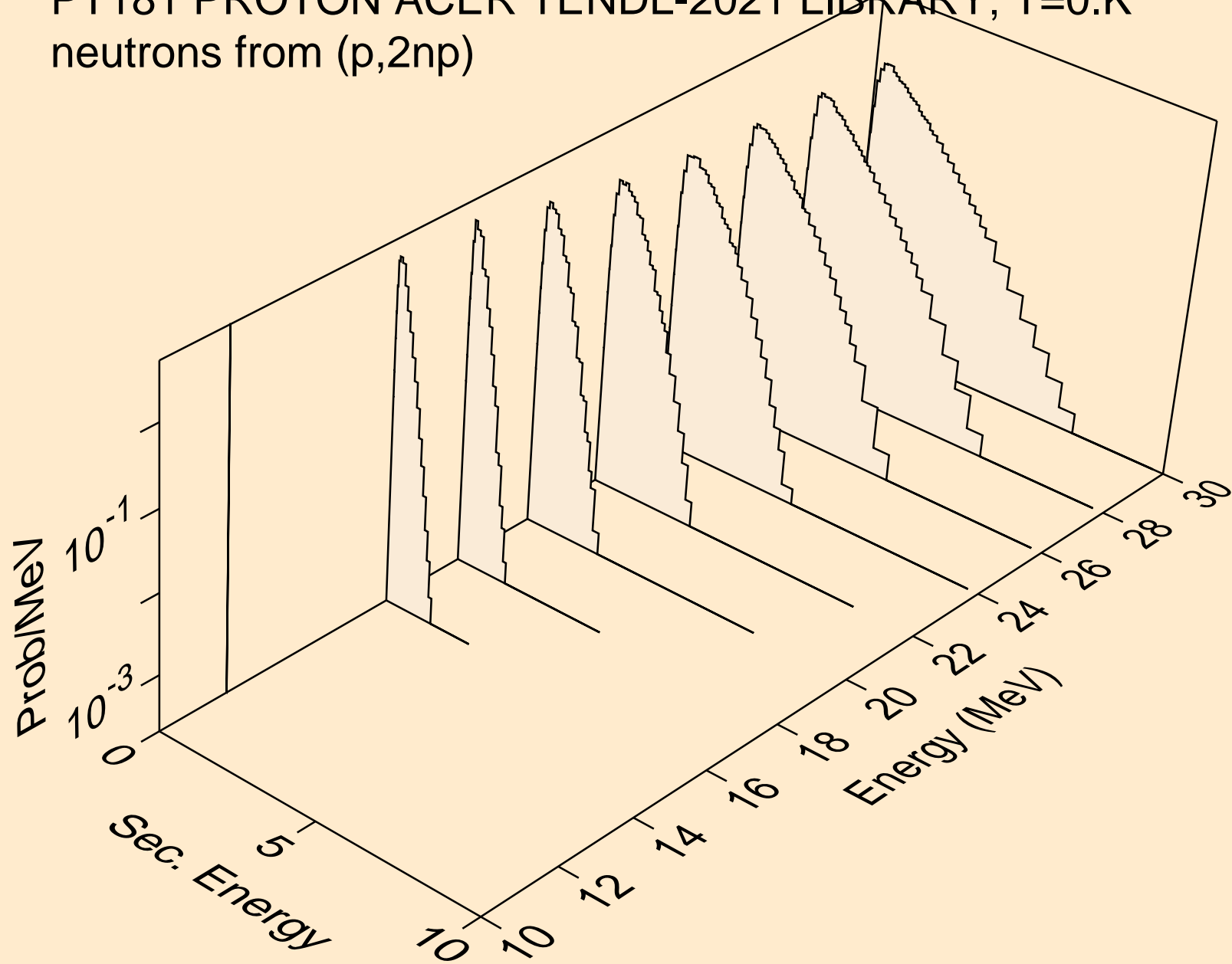

PT181 PROTON ACER TENDL-2021 LIBRARY; T=0.K  
neutrons from (p,npa)

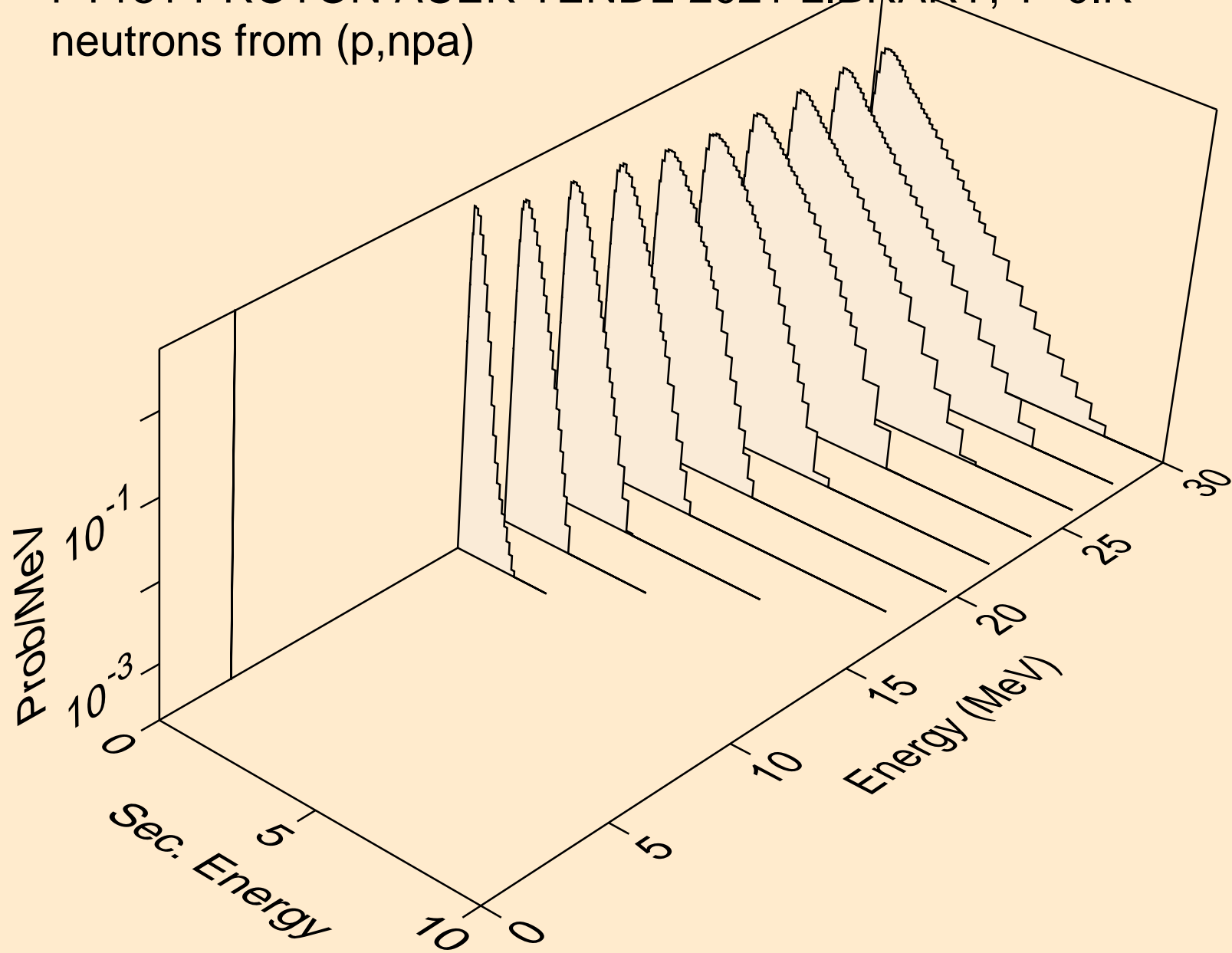

PT181 PROTON ACER TENDL-2021 LIBRARY; T=0.K  
deuterons from (p,x)

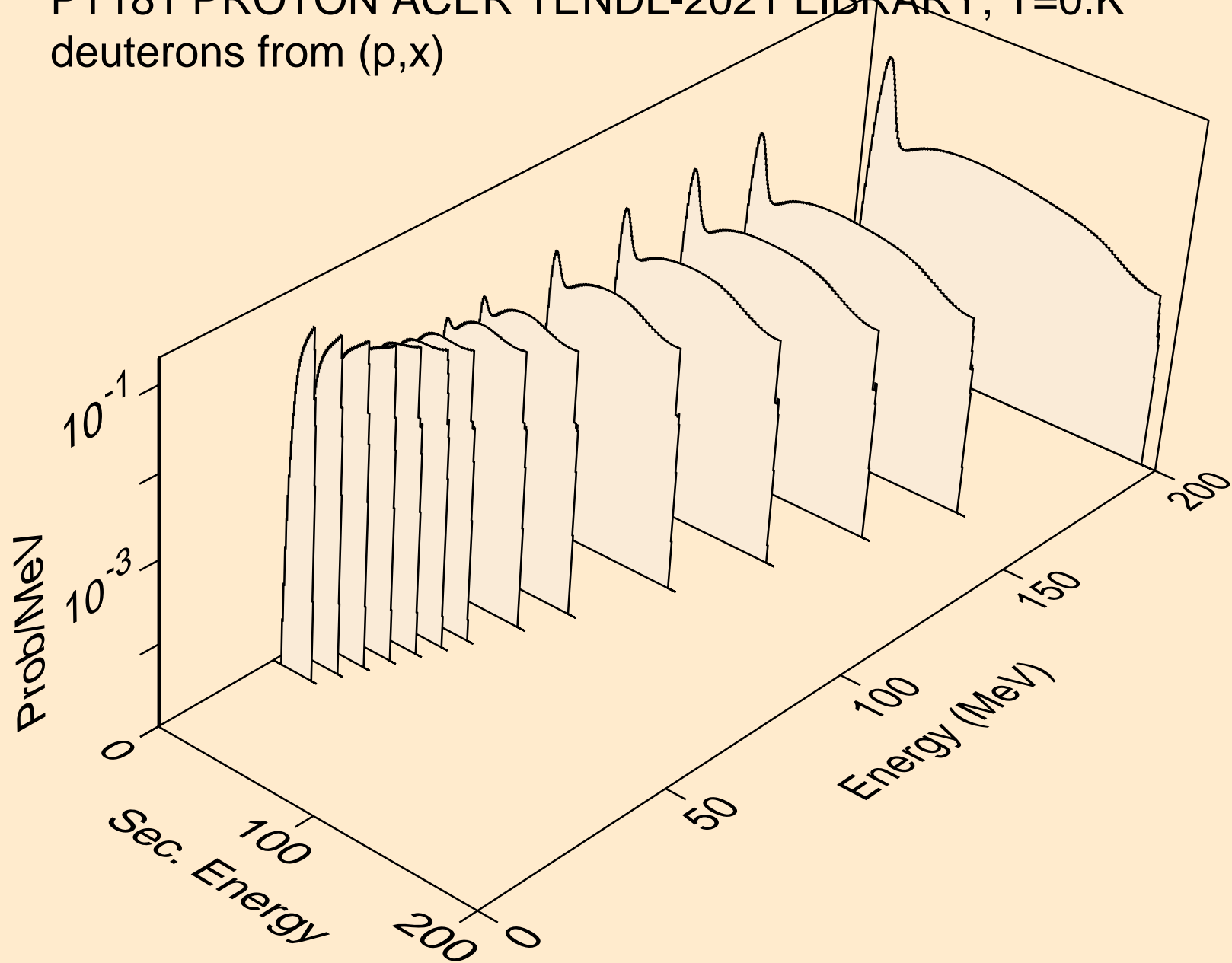

PT181 PROTON ACER TENDL-2021 LIBRARY; T=0.K  
deuterons from (p,n\*)d

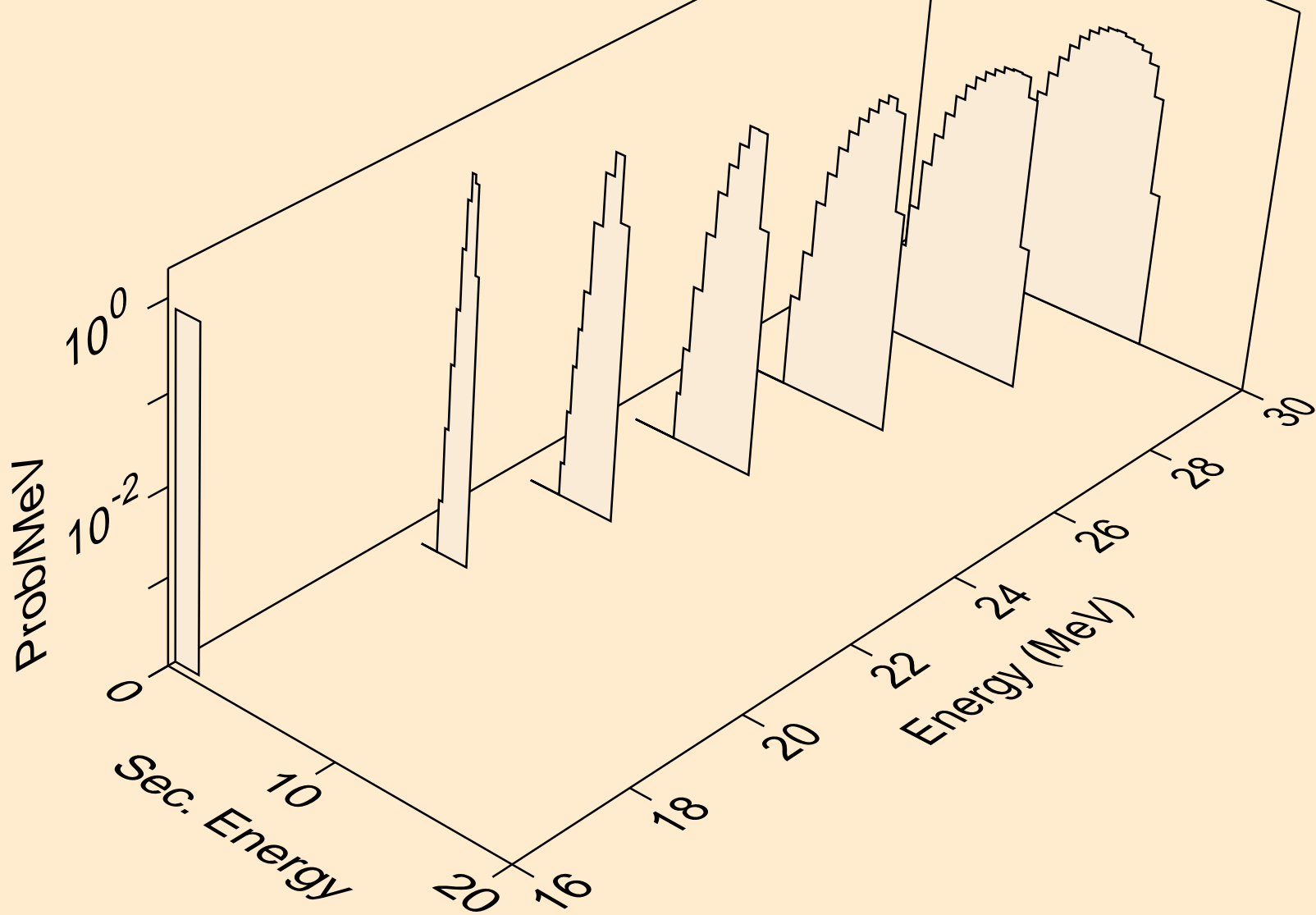

PT181 PROTON ACER TENDL-2021 LIBRARY; T=0.K  
deuterons from (p,d)

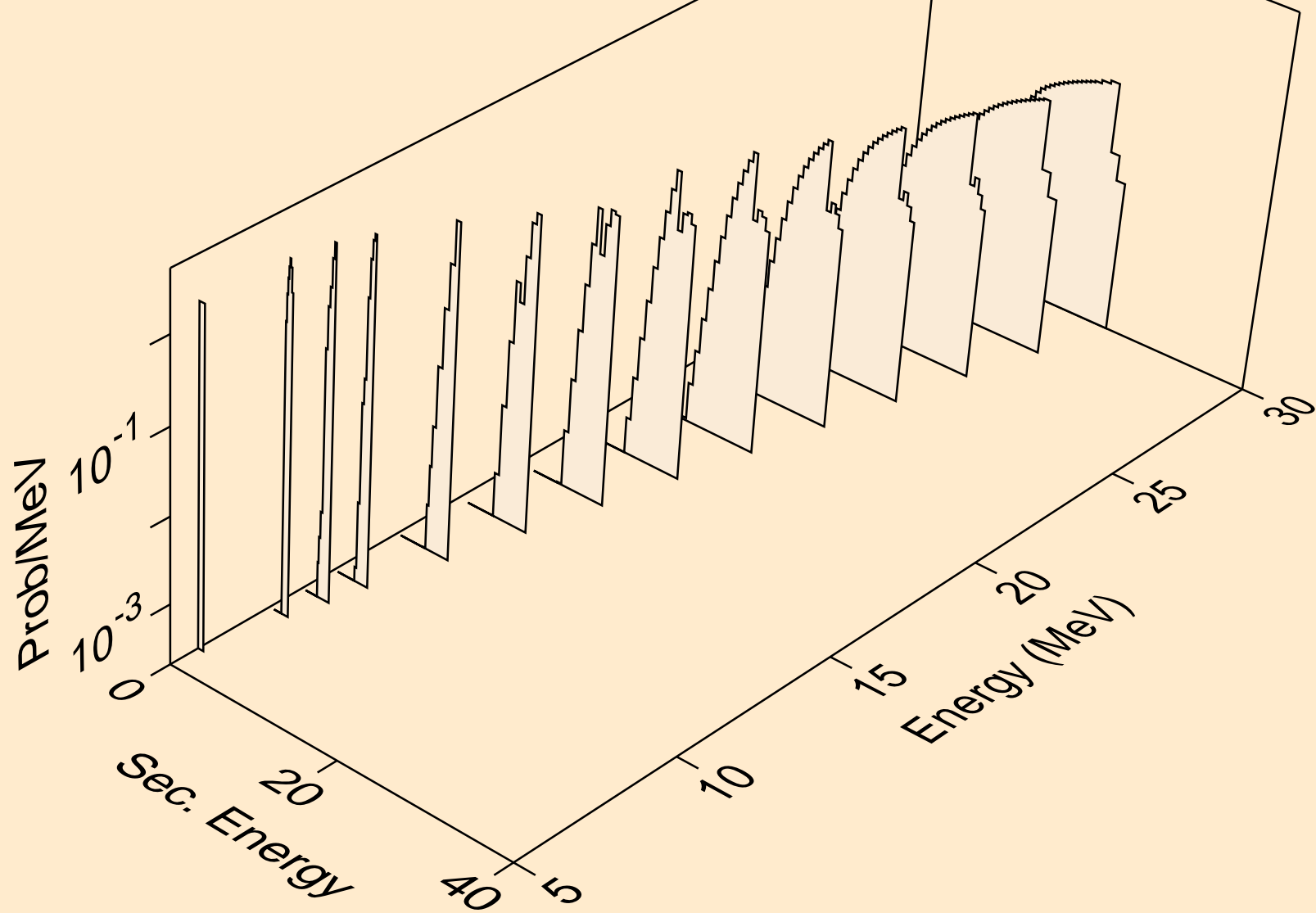

PT181 PROTON ACER TENDL-2021 LIBRARY; T=0.K  
deuterons from (p,pd)

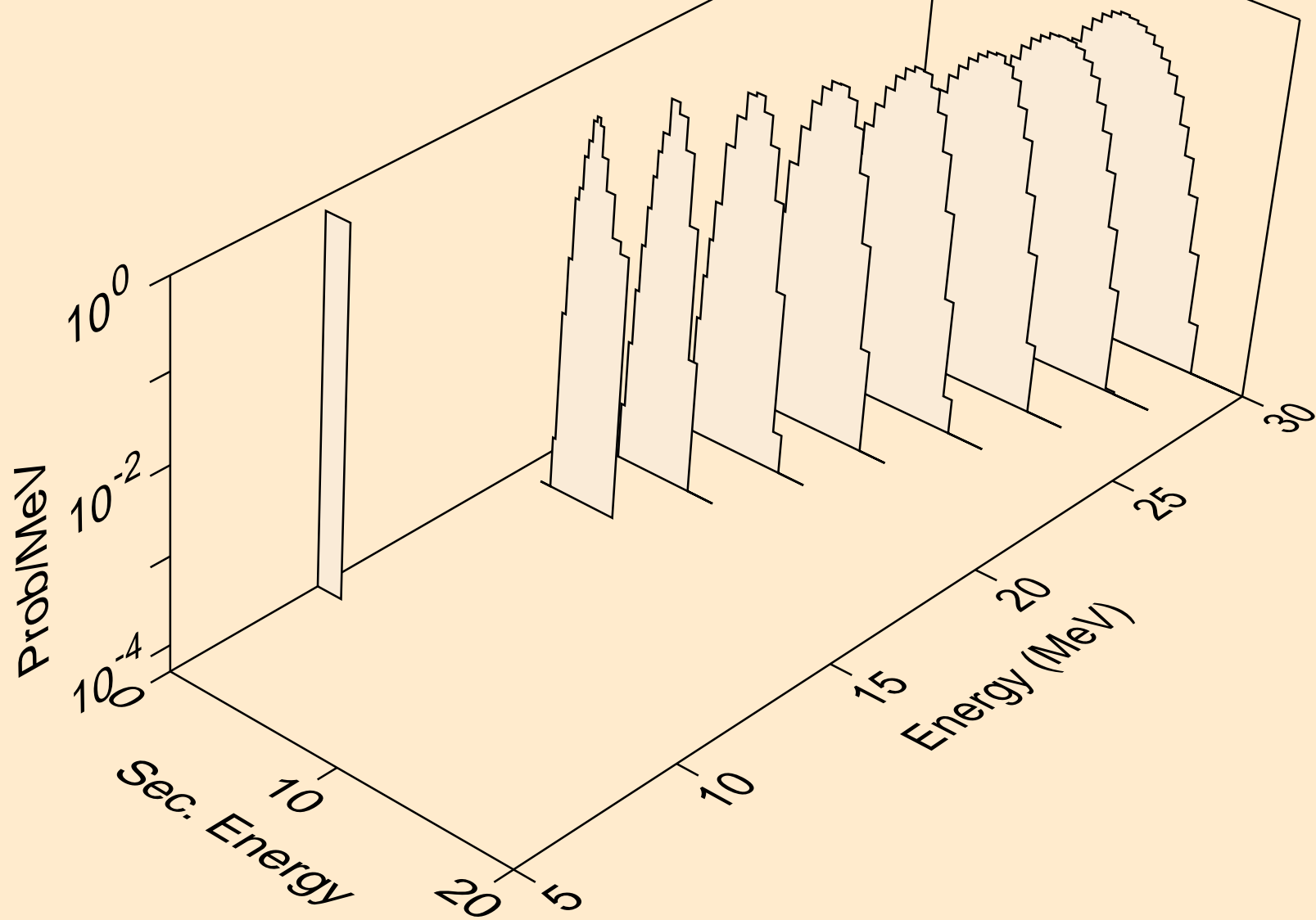

PT181 PROTON ACER TENDL-2021 LIBRARY; T=0.K  
deuterons from (p,da)

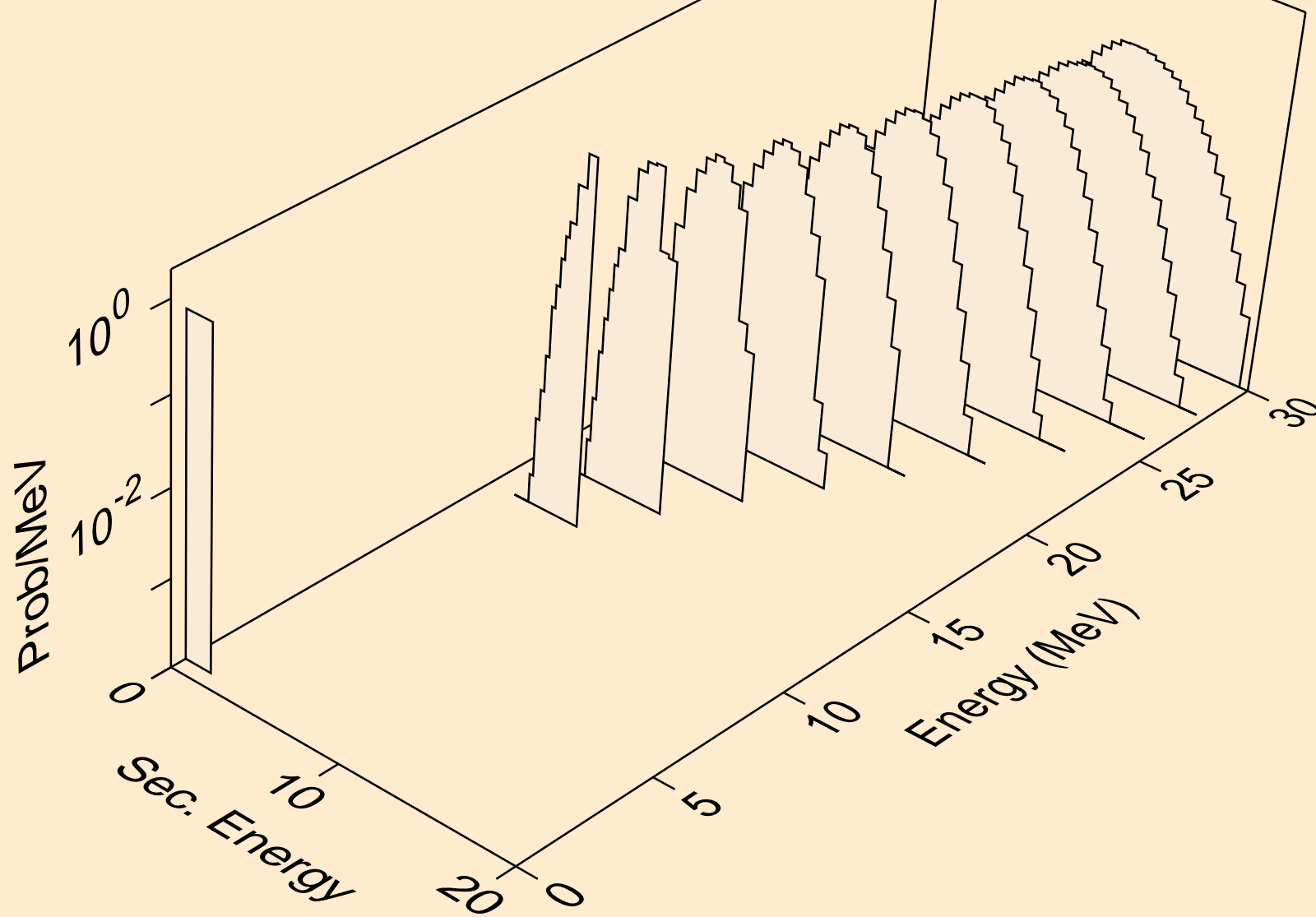



PT181 PROTON ACER TENDL-2021 LIBRARY; T=0.K  
tritons from (p,x)

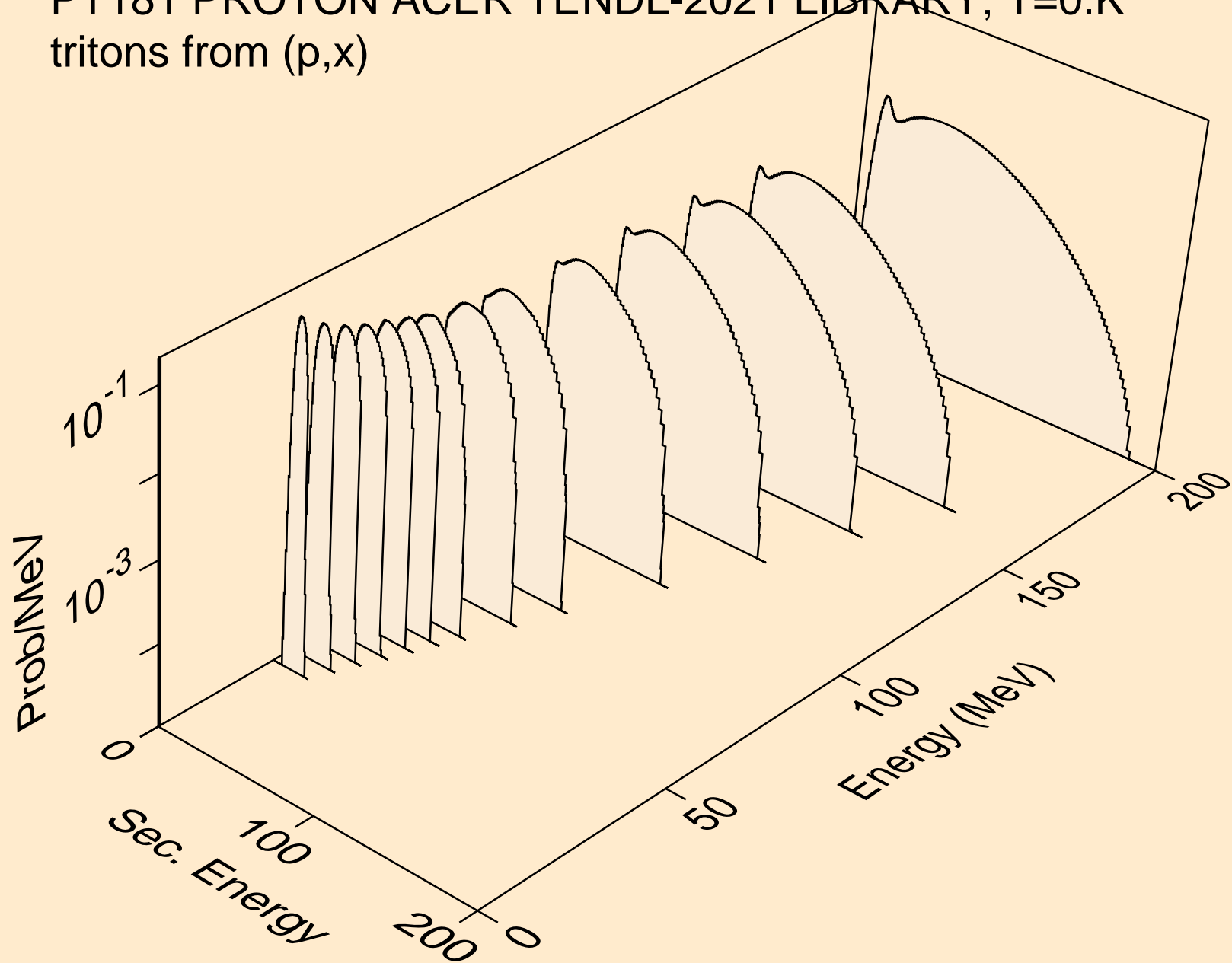

PT181 PROTON ACER TENDL-2021 LIBRARY; T=0.K  
tritons from (p,n\*)t

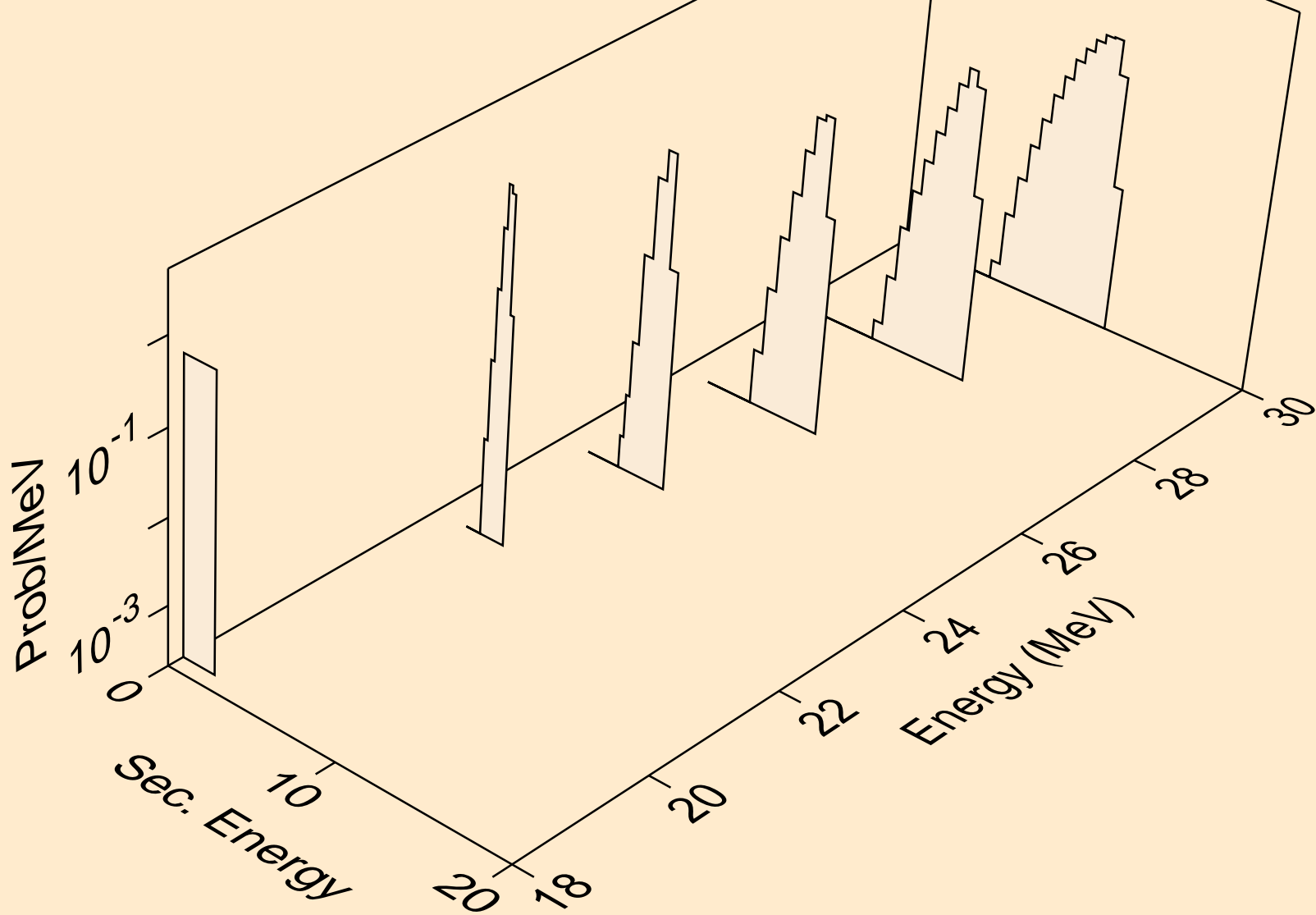

PT181 PROTON ACER TENDL-2021 LIBRARY; T=0.K  
tritons from (p,t)

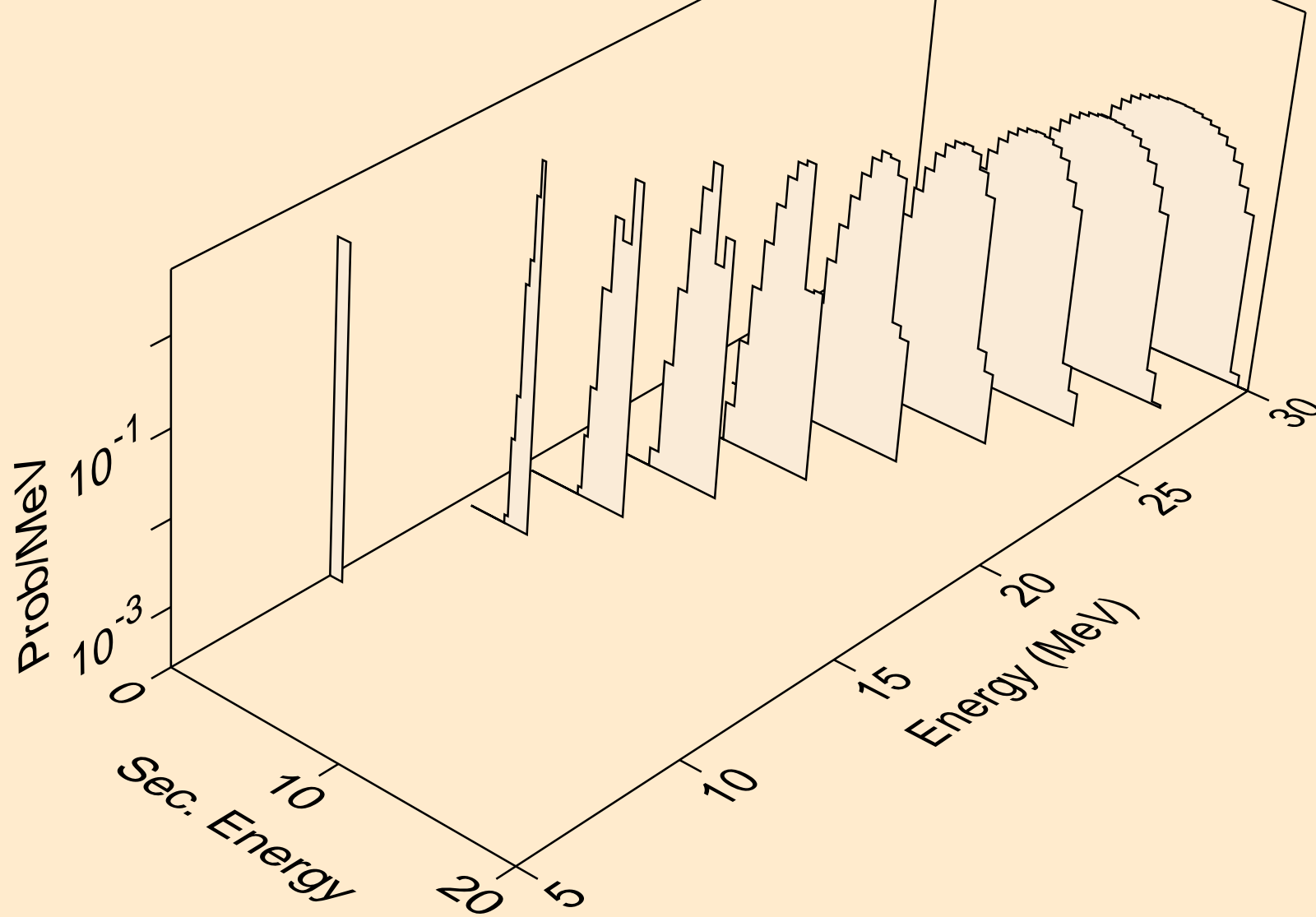

PT181 PROTON ACER TENDL-2021 LIBRARY; T=0.K  
tritons from (p,pt)

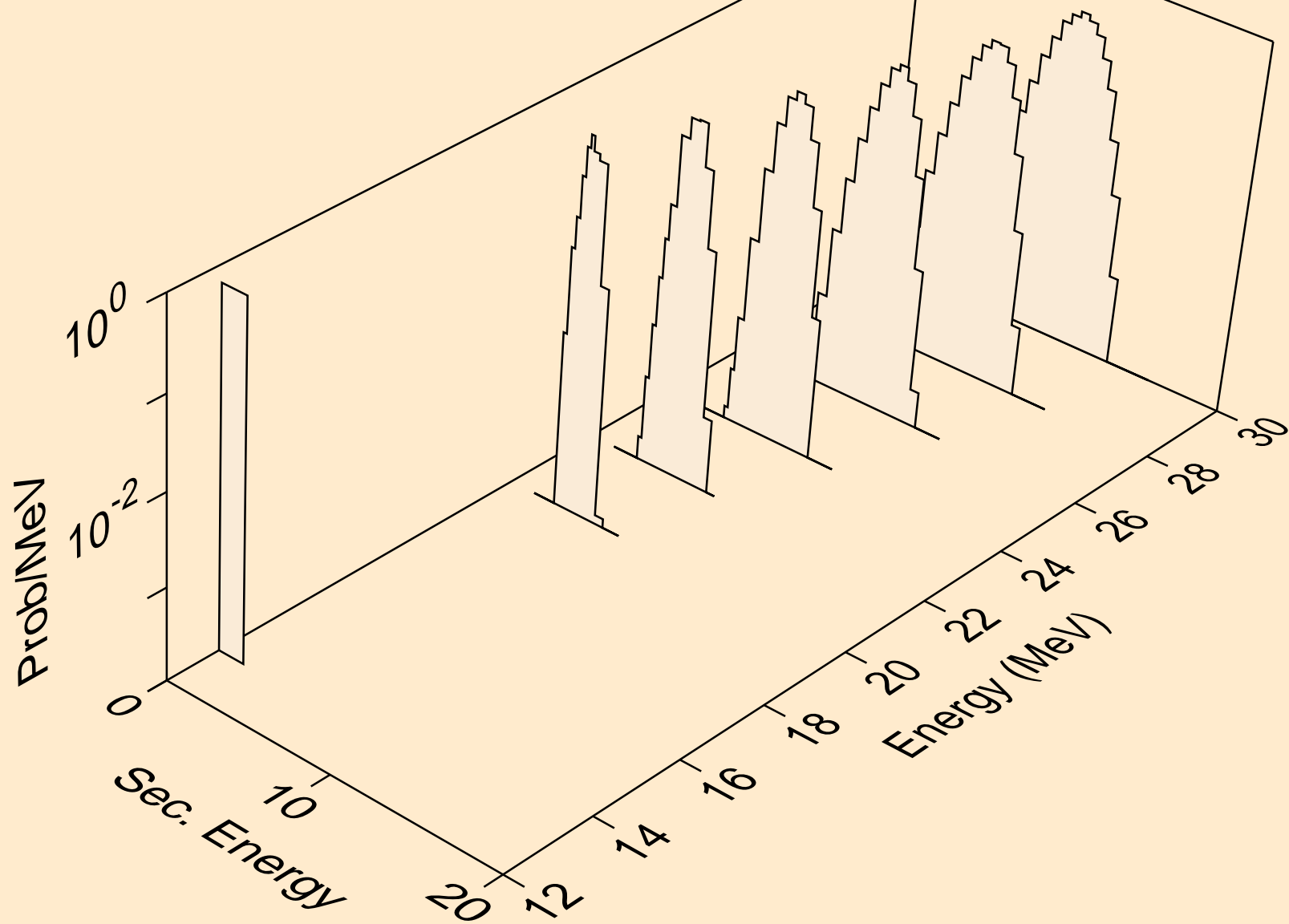

PT181 PROTON ACER TENDL-2021 LIBRARY; T=0.K  
he3s from (p,x)

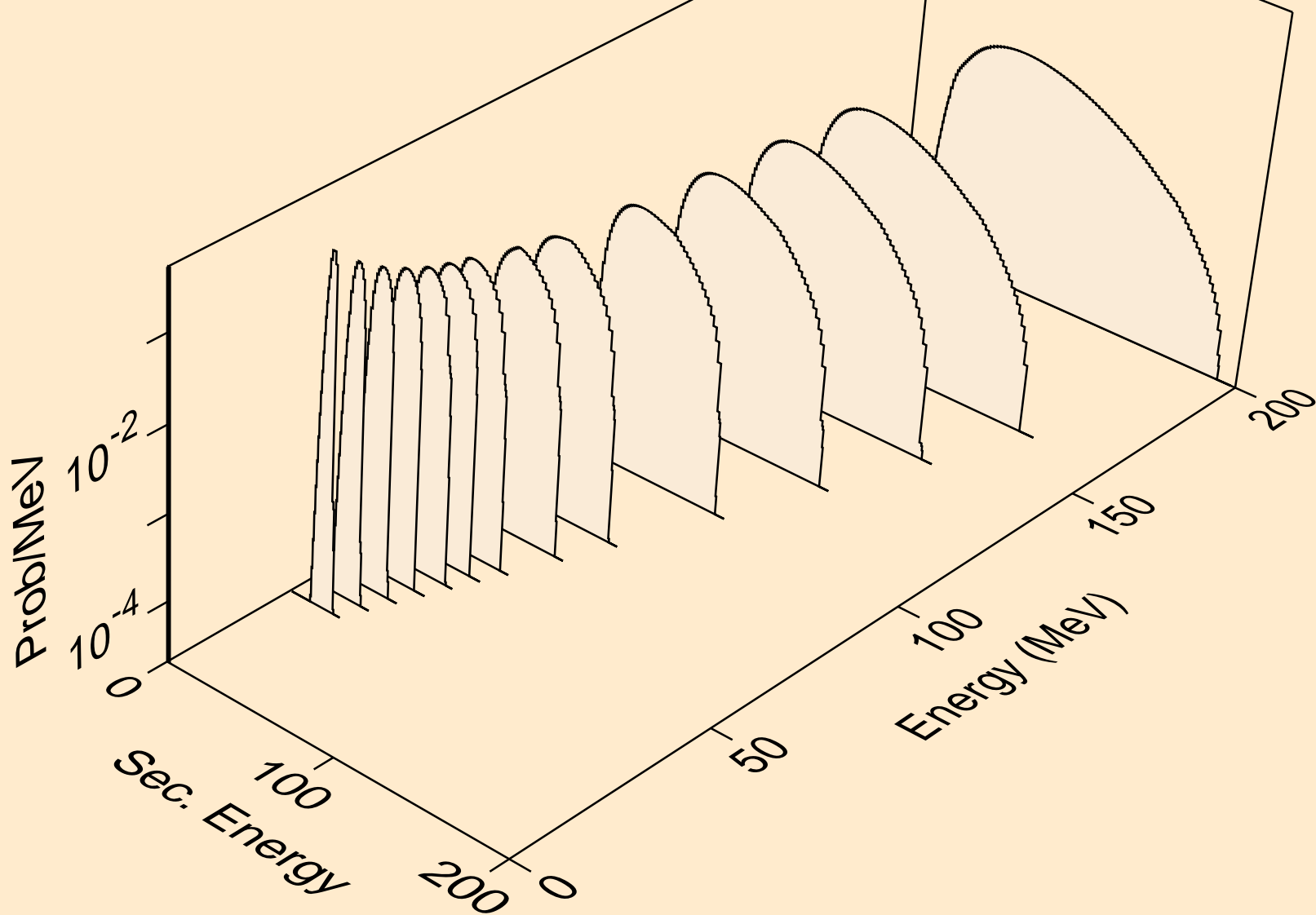

PT181 PROTON ACER TENDL-2021 LIBRARY; T=0.K  
he3s from (p,n\*)he3

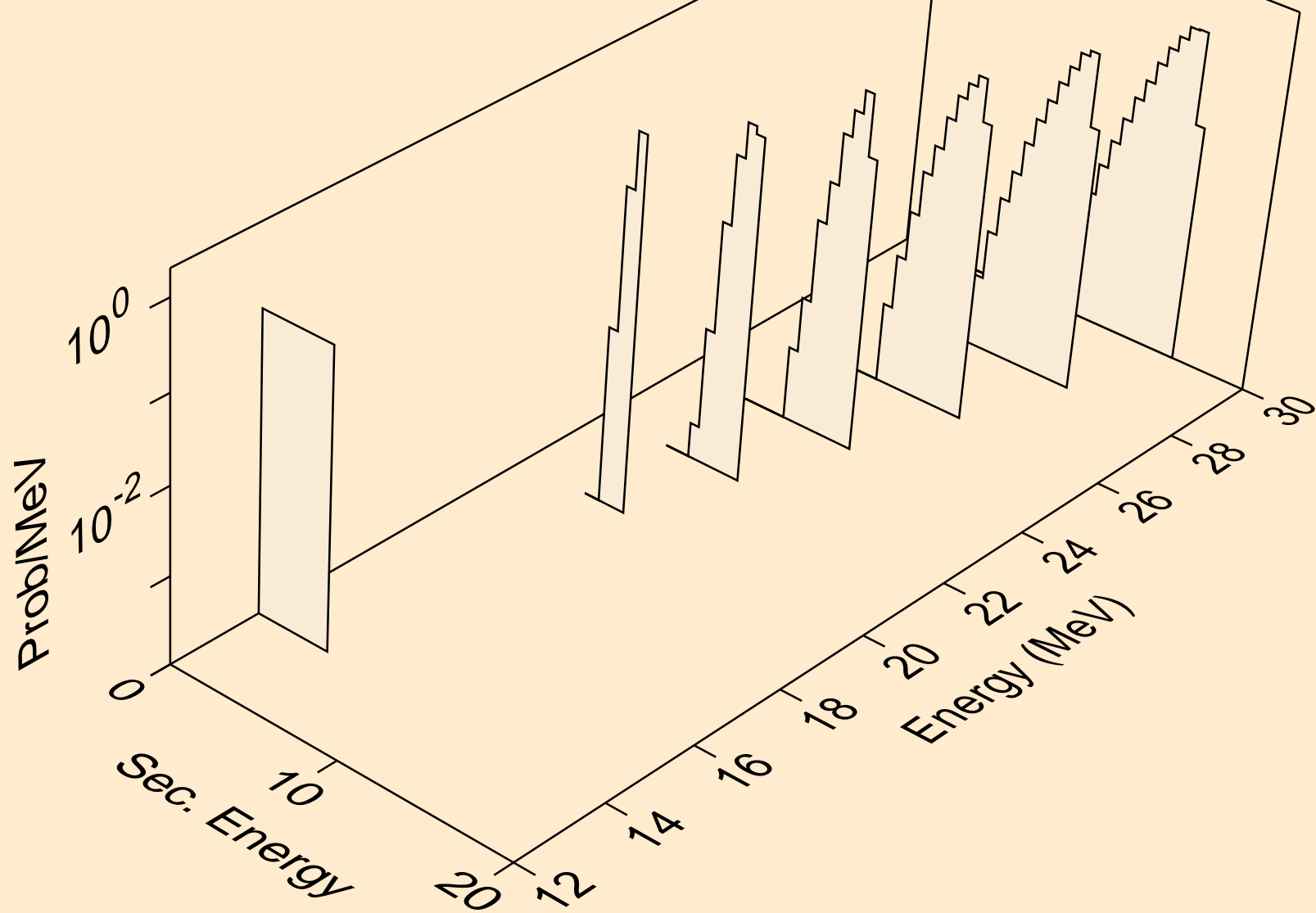

PT181 PROTON ACER TENDL-2021 LIBRARY; T=0.K  
he3s from (p,he3)

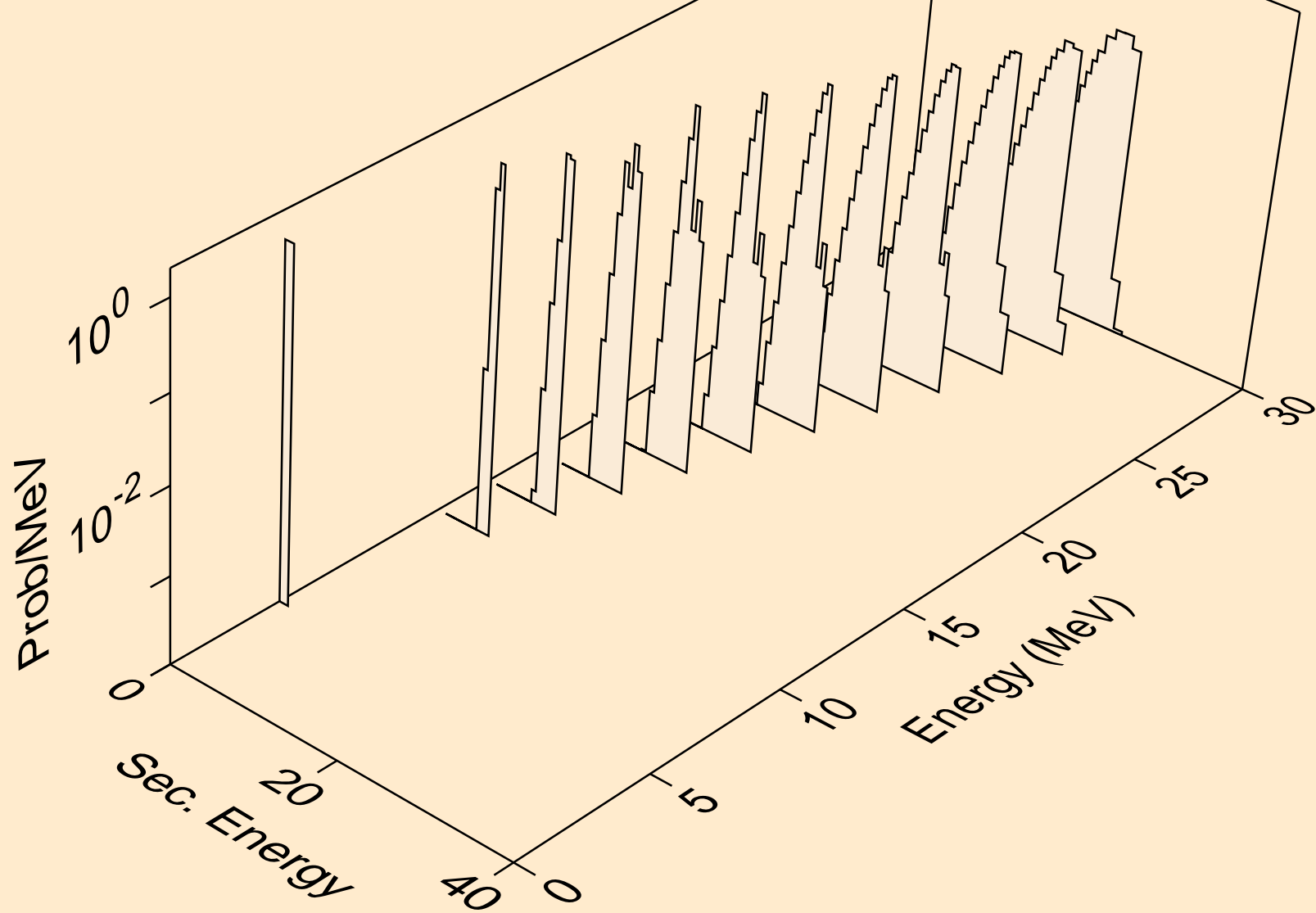

PT181 PROTON ACER TENDL-2021 LIBRARY; T=0.K  
alphas from (p,x)

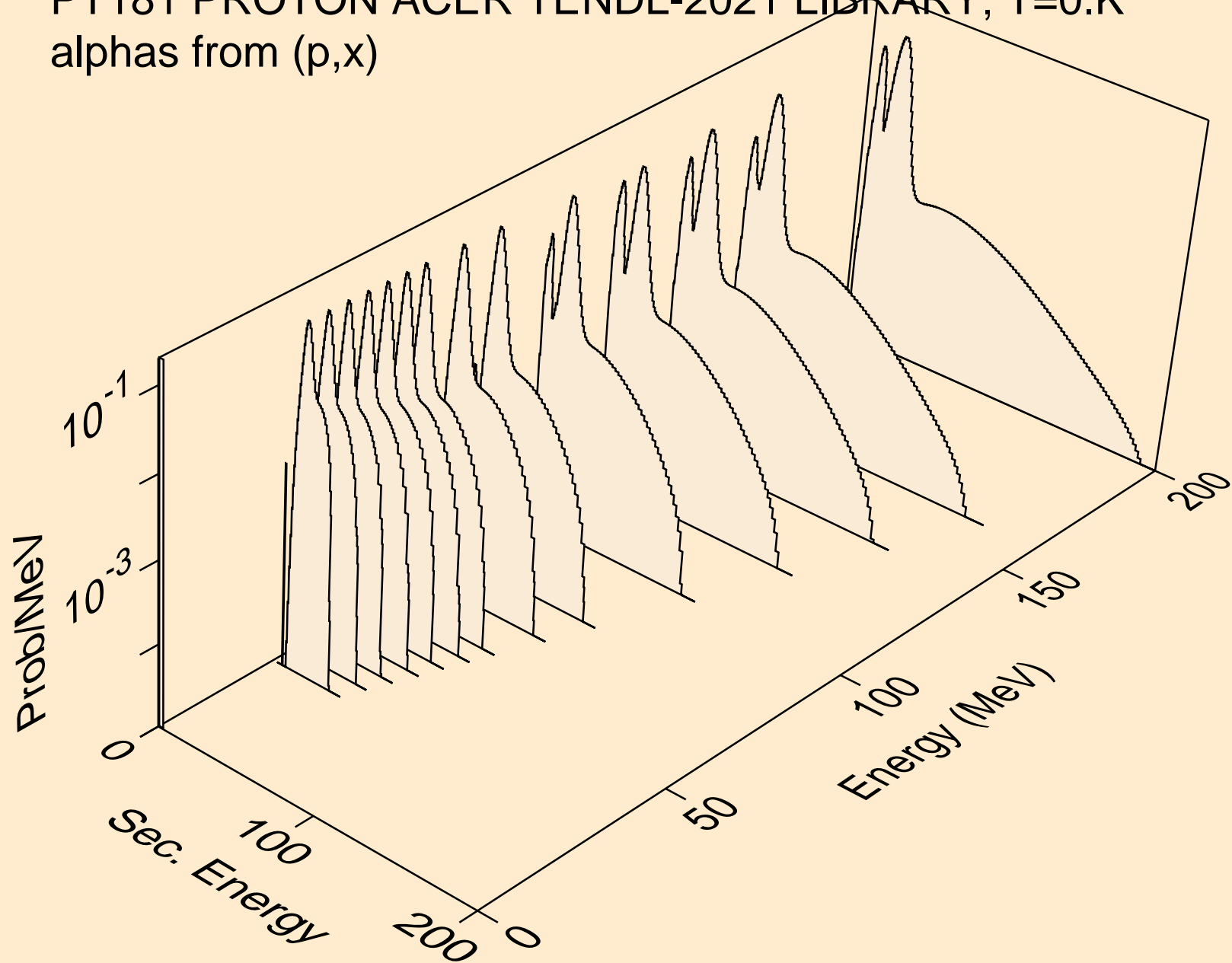



PT181 PROTON ACER TENDL-2021 LIBRARY; T=0.K  
alphas from (p,n\*)a

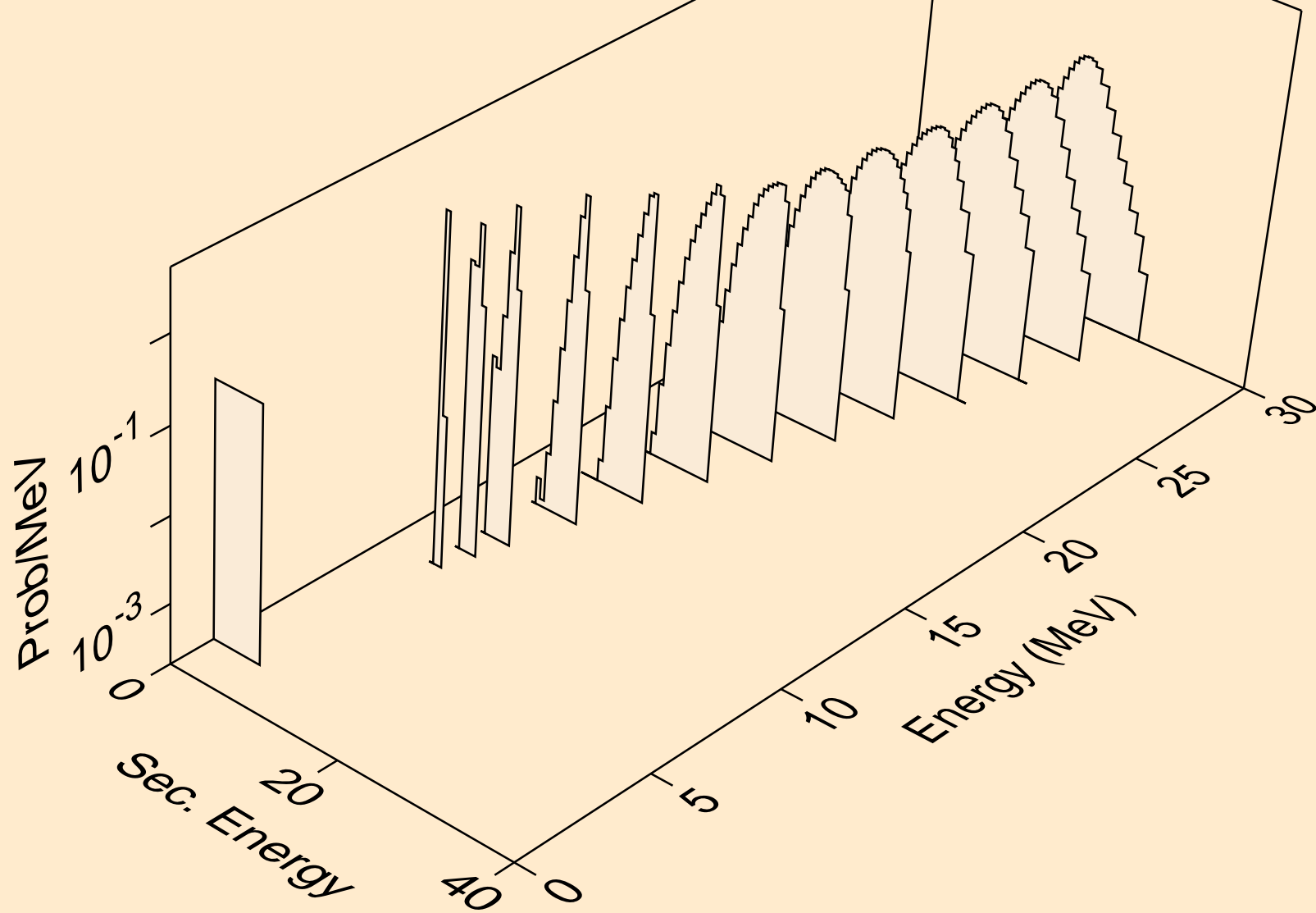

PT181 PROTON ACER TENDL-2021 LIBRARY; T=0.K  
alphas from (p,2n)a

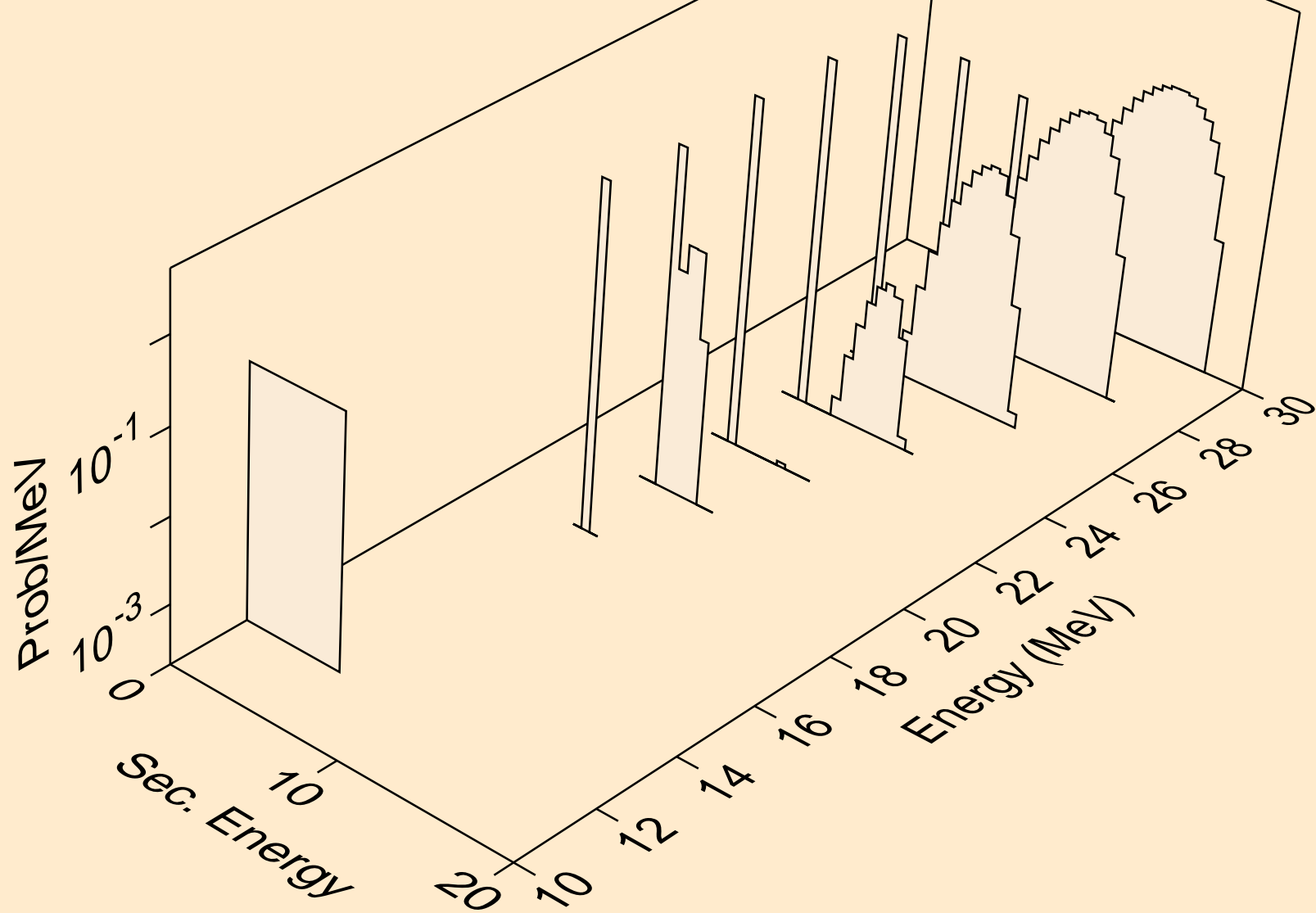

PT181 PROTON ACER TENDL-2021 LIBRARY; T=0.K  
alphas from (p,3n)a

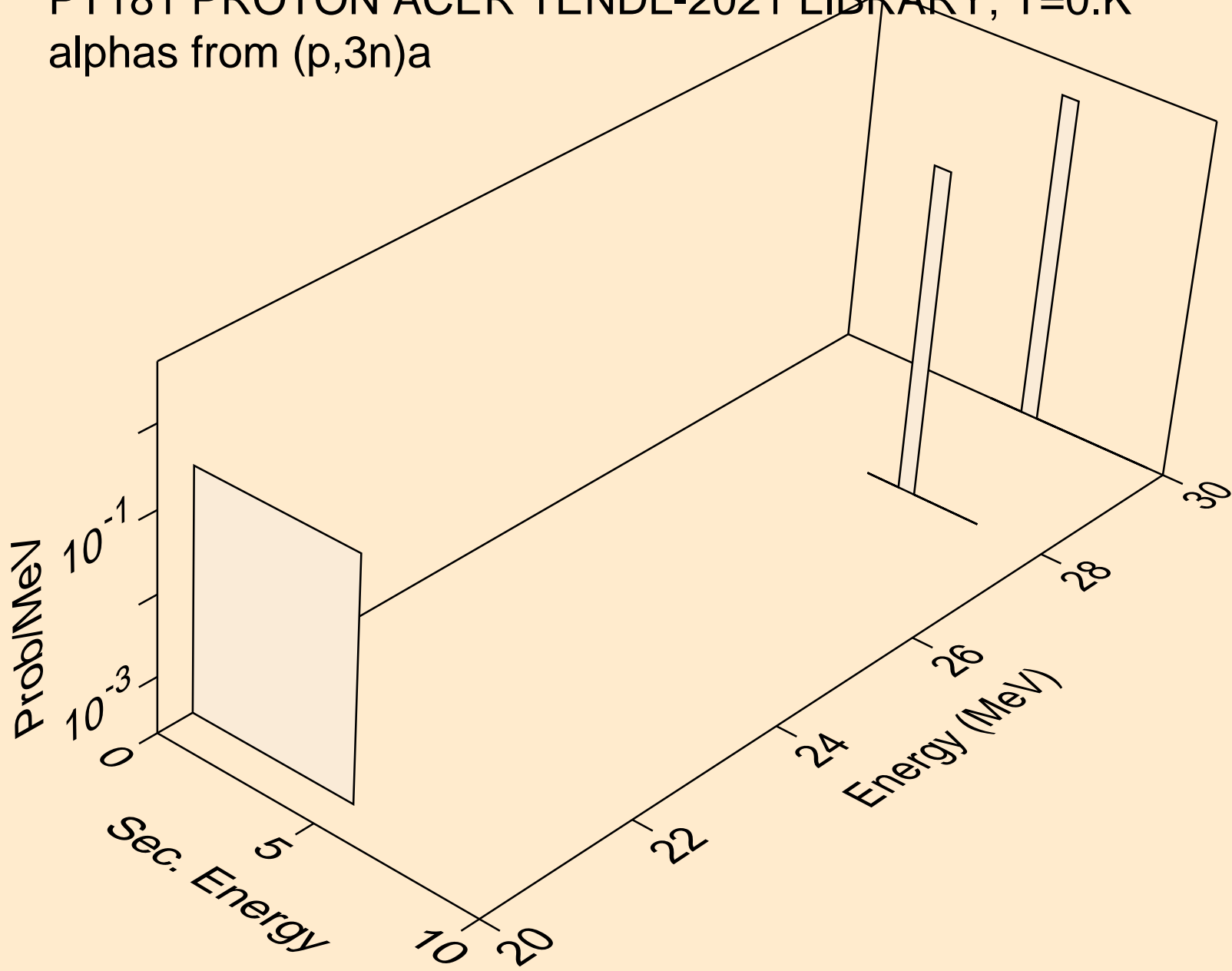

PT181 PROTON ACER TENDL-2021 LIBRARY; T=0.K  
alphas from (p,n\*)2a

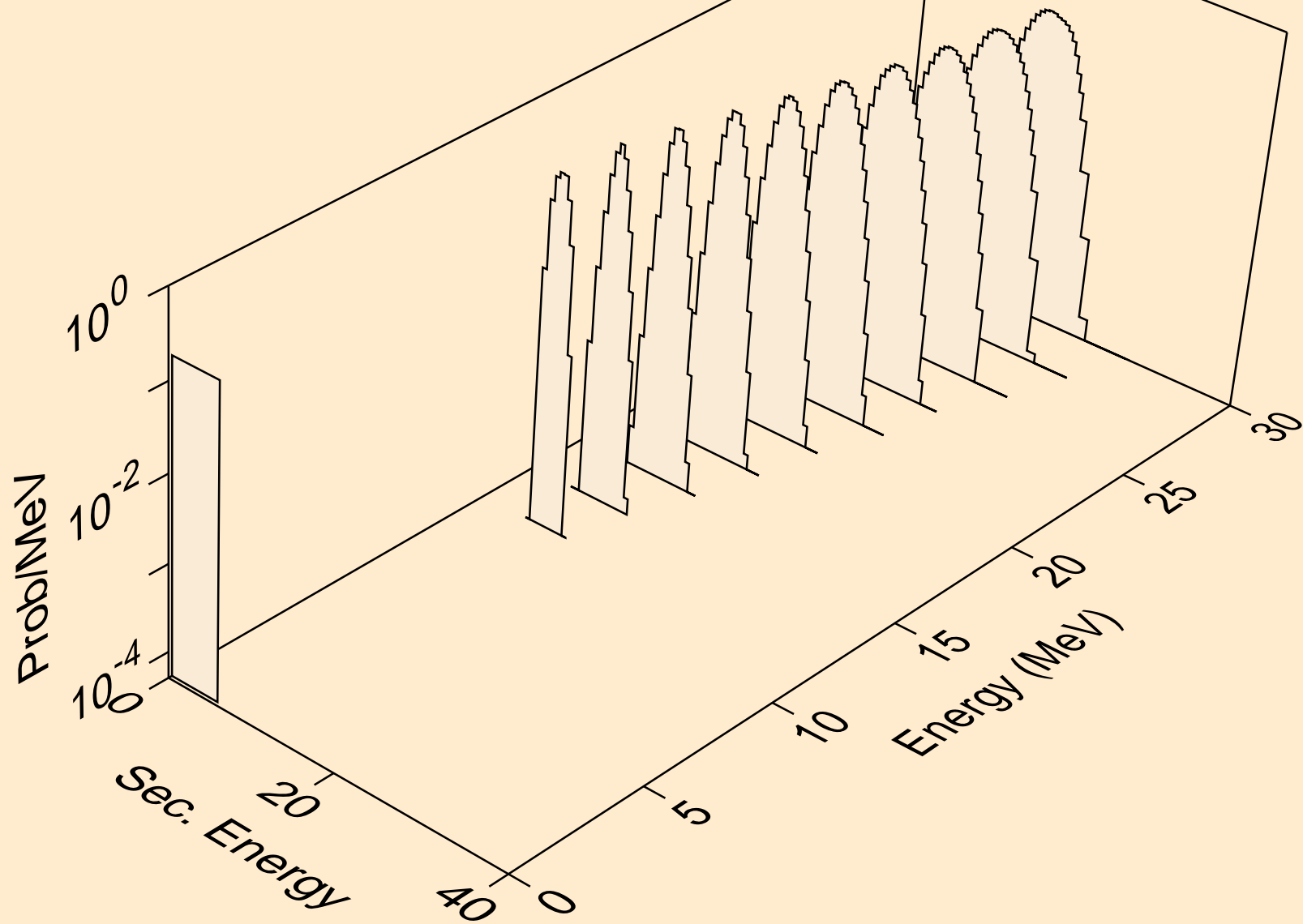

PT181 PROTON ACER TENDL-2021 LIBRARY; T=0.K  
alphas from (p,npa)

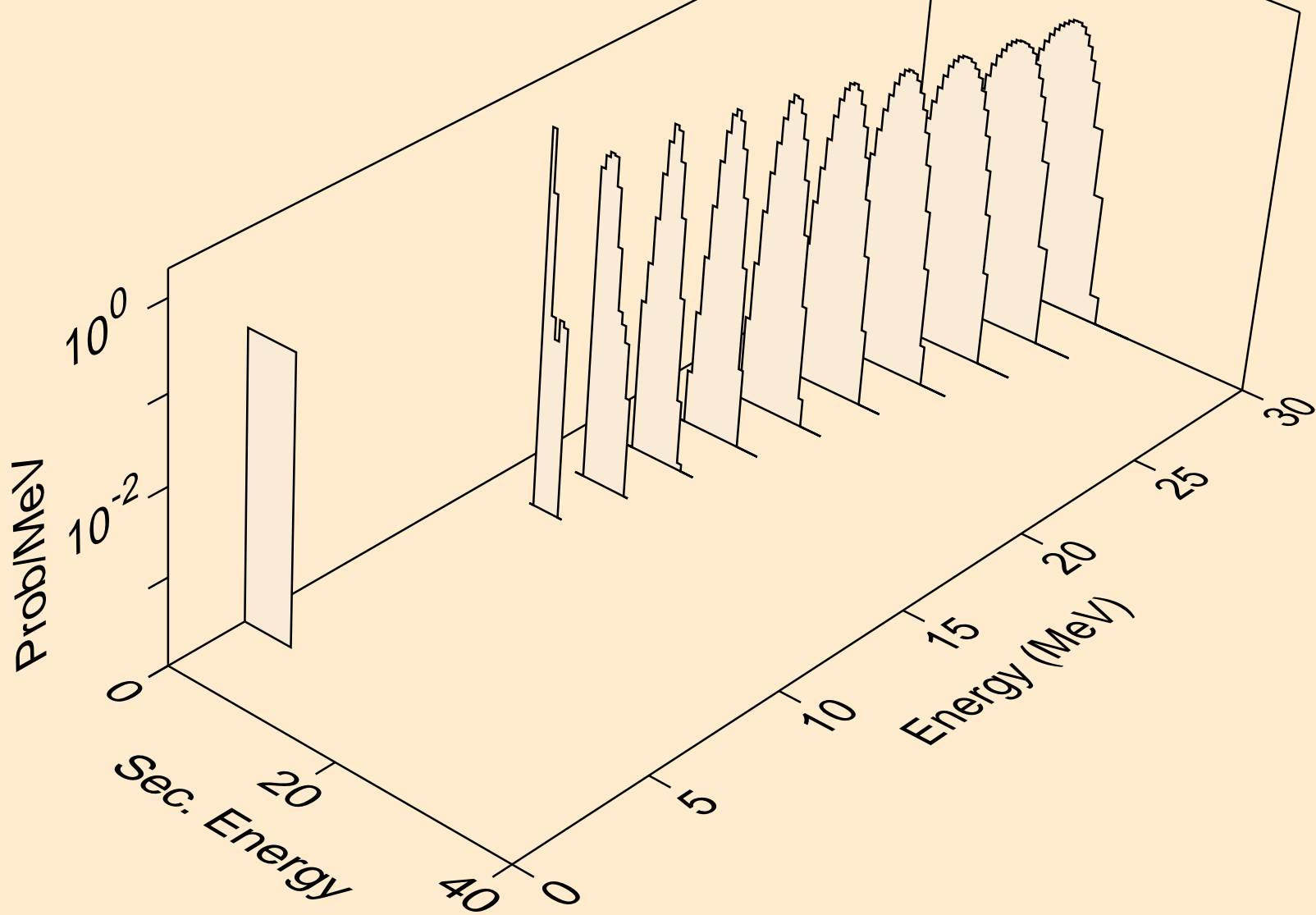

PT181 PROTON ACER TENDL-2021 LIBRARY; T=0.K  
alphas from (p,a)

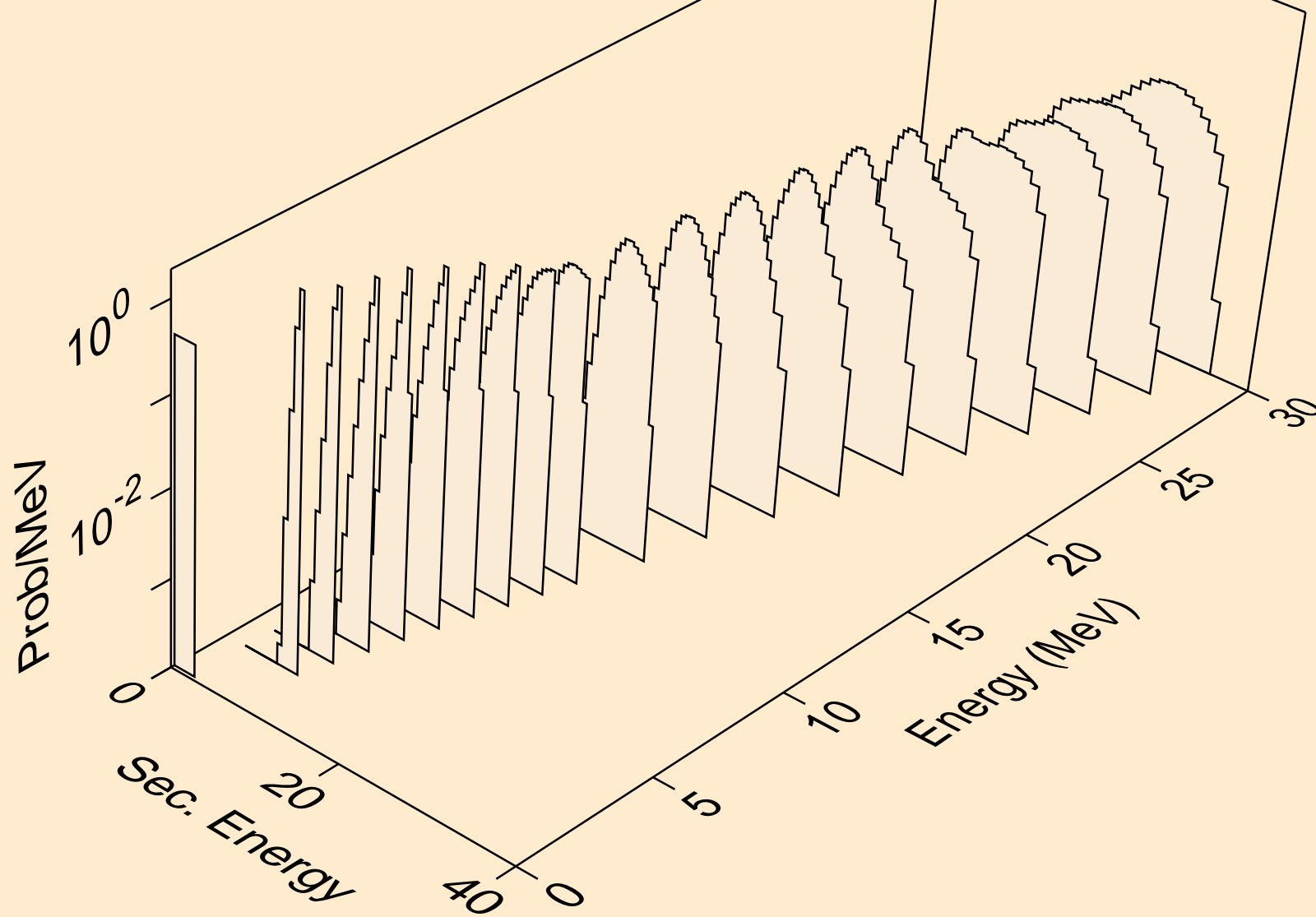

PT181 PROTON ACER TENDL-2021 LIBRARY; T=0.K  
alphas from (p,2a)

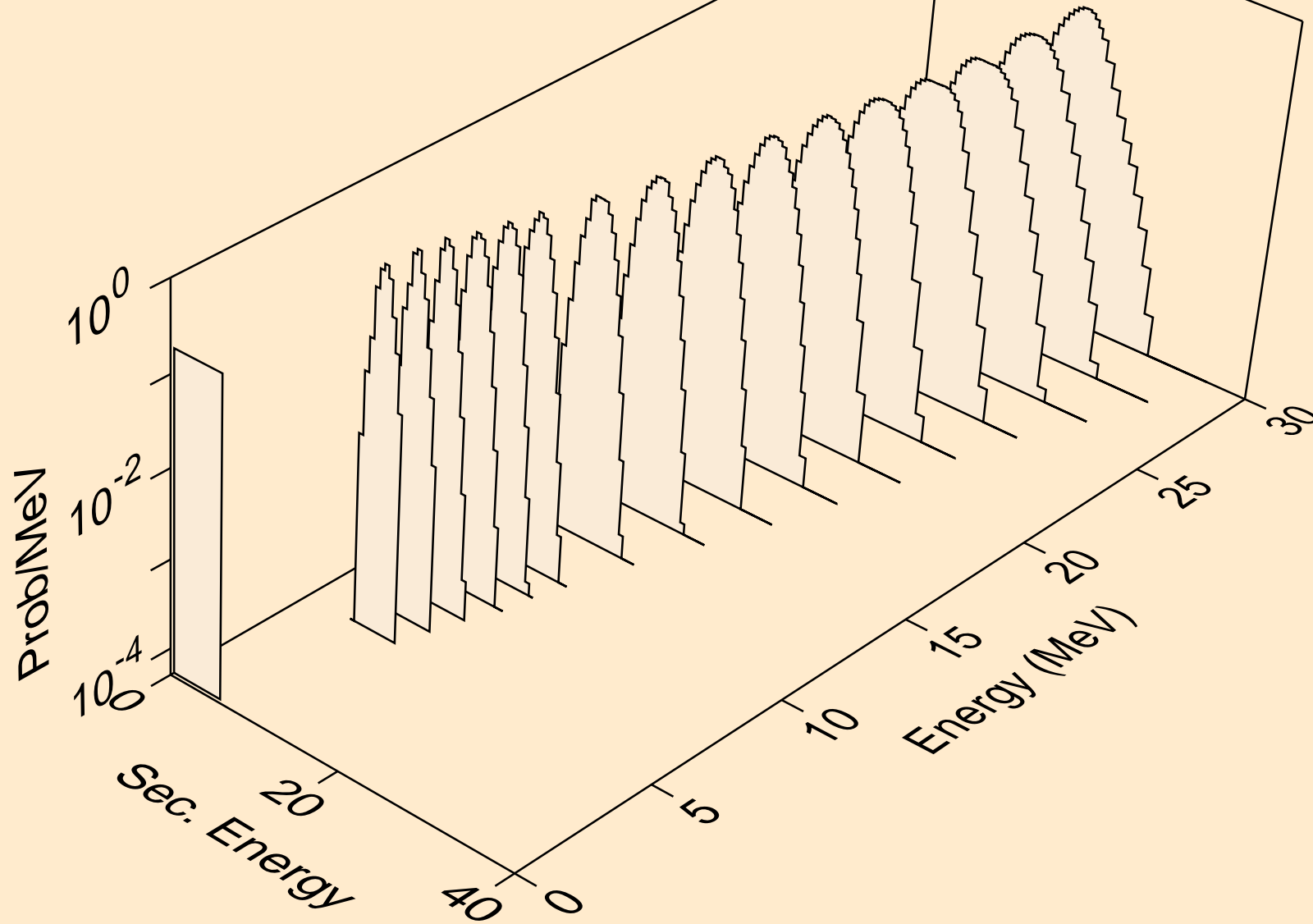

PT181 PROTON ACER TENDL-2021 LIBRARY; T=0.K  
alphas from (p,pa)

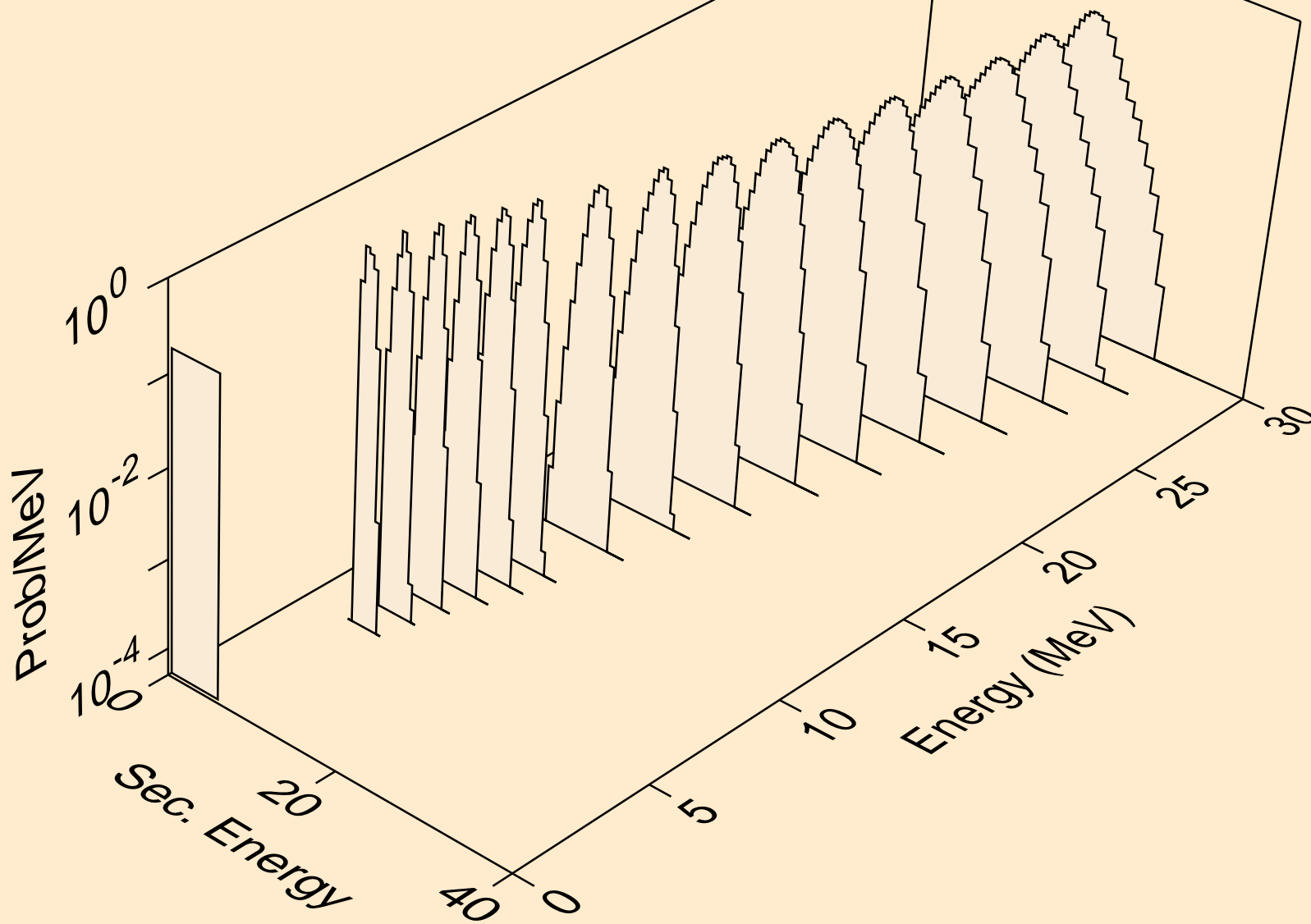



PT181 PROTON ACER TENDL-2021 LIBRARY; T=0.K  
alphas from (p,da)

