

RA208 PROTON ACER TENDL-2021 LIBRARY; T=0.K
Principal cross sections

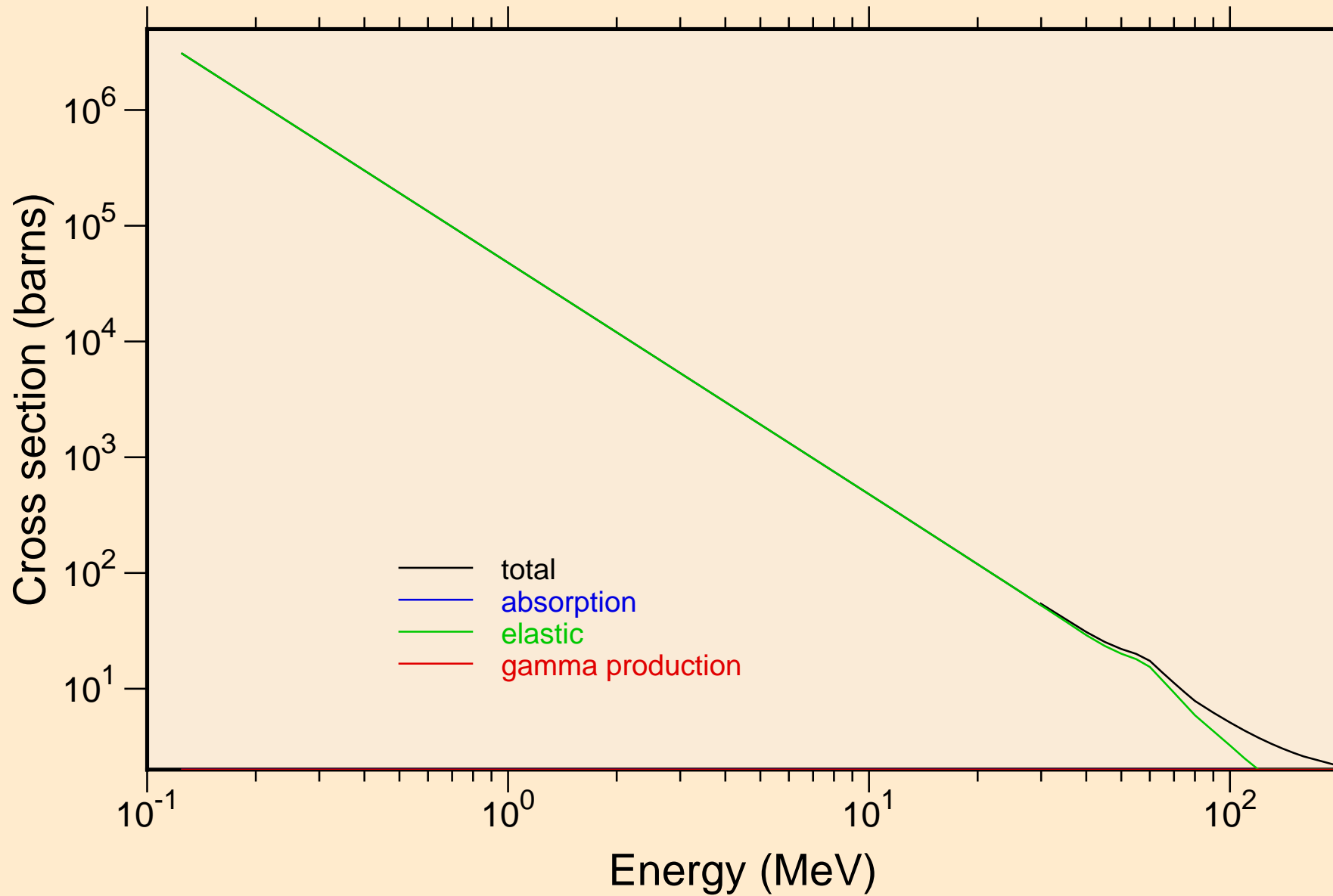

RA208 PROTON ACER TENDL-2021 LIBRARY; T=0.K

Heating

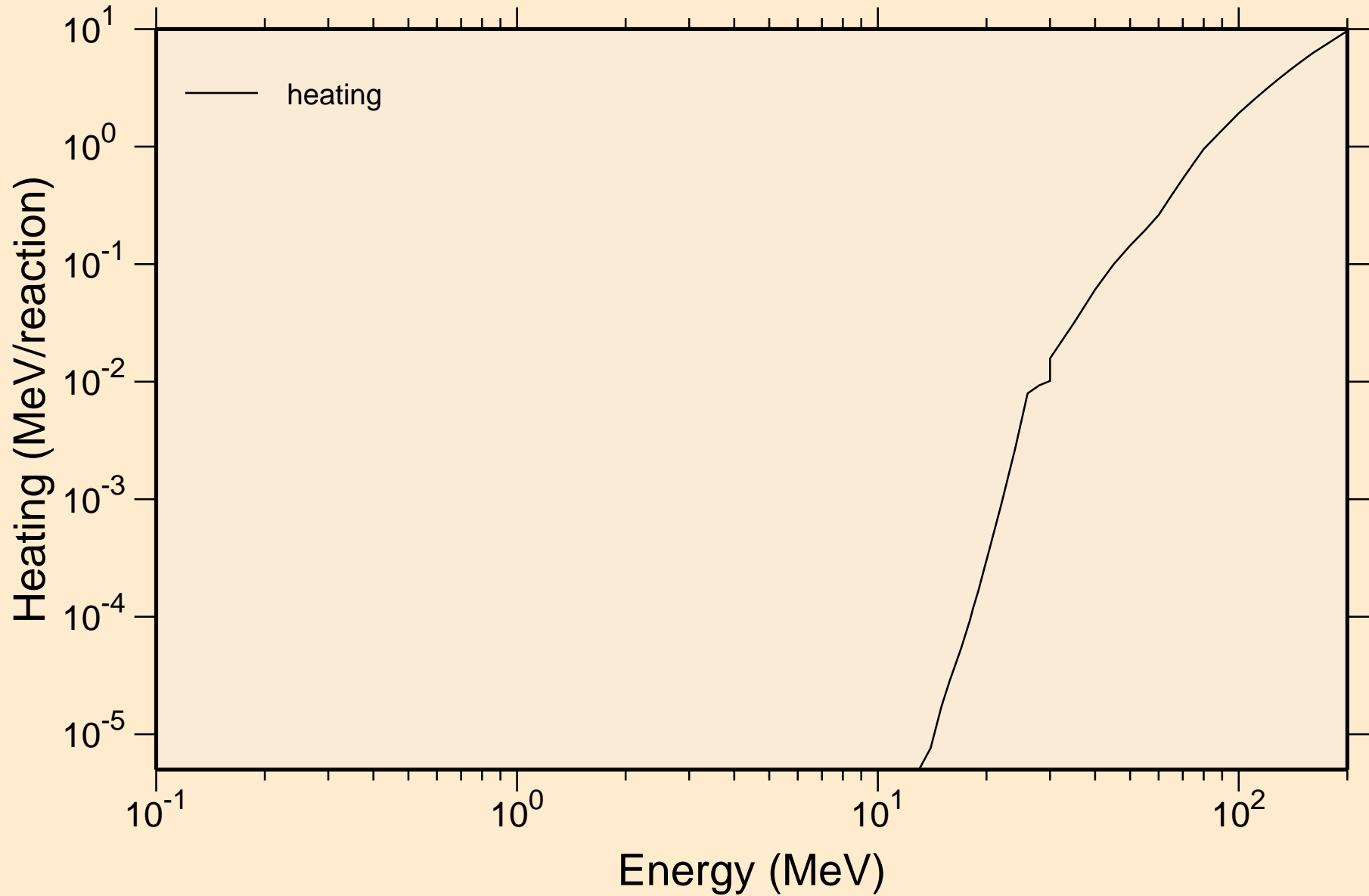

RA208 PROTON ACER TENDL-2021 LIBRARY; T=0.K

Principal cross sections

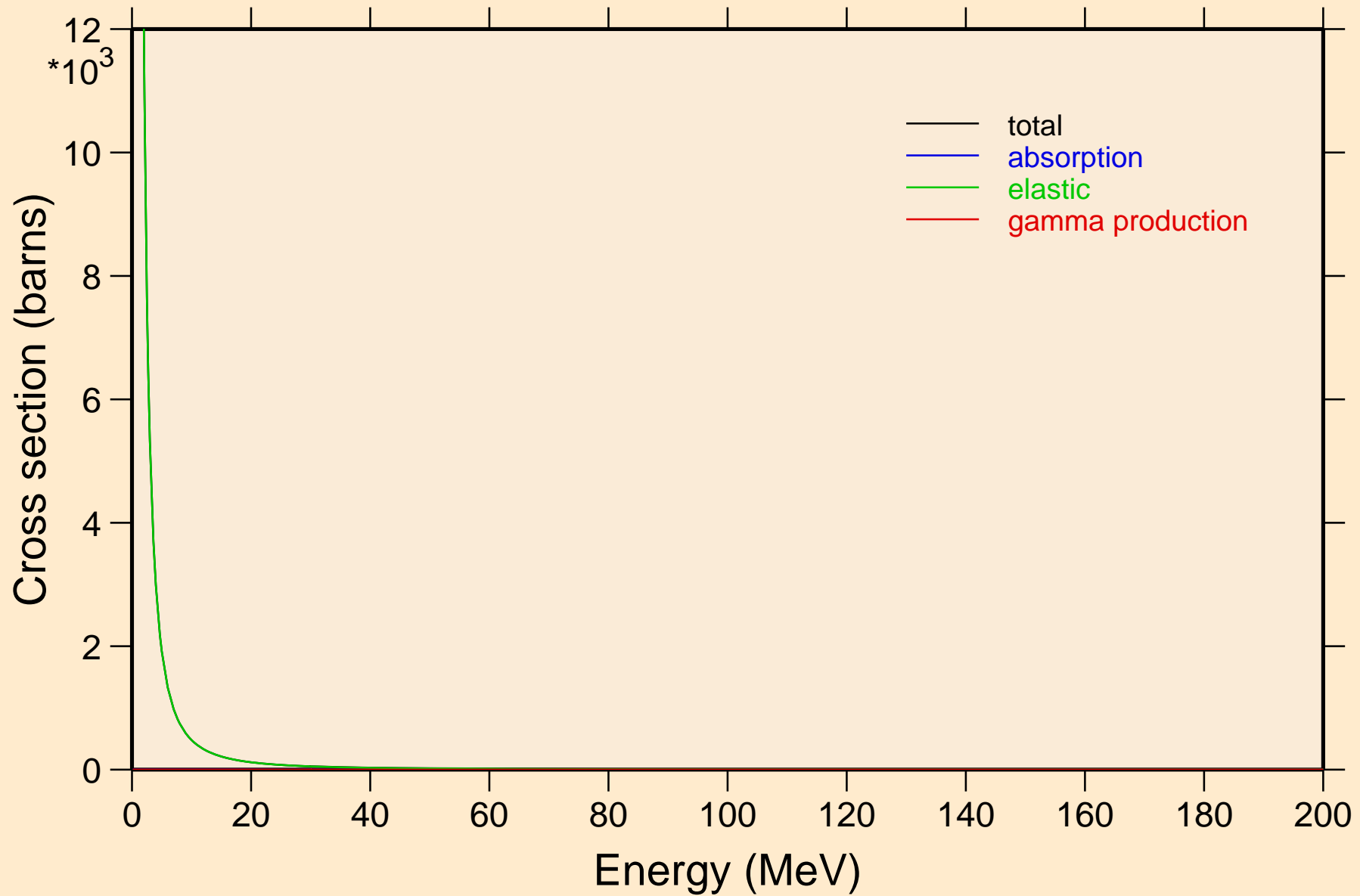

RA208 PROTON ACER TENDL-2021 LIBRARY; T=0.K

Heating

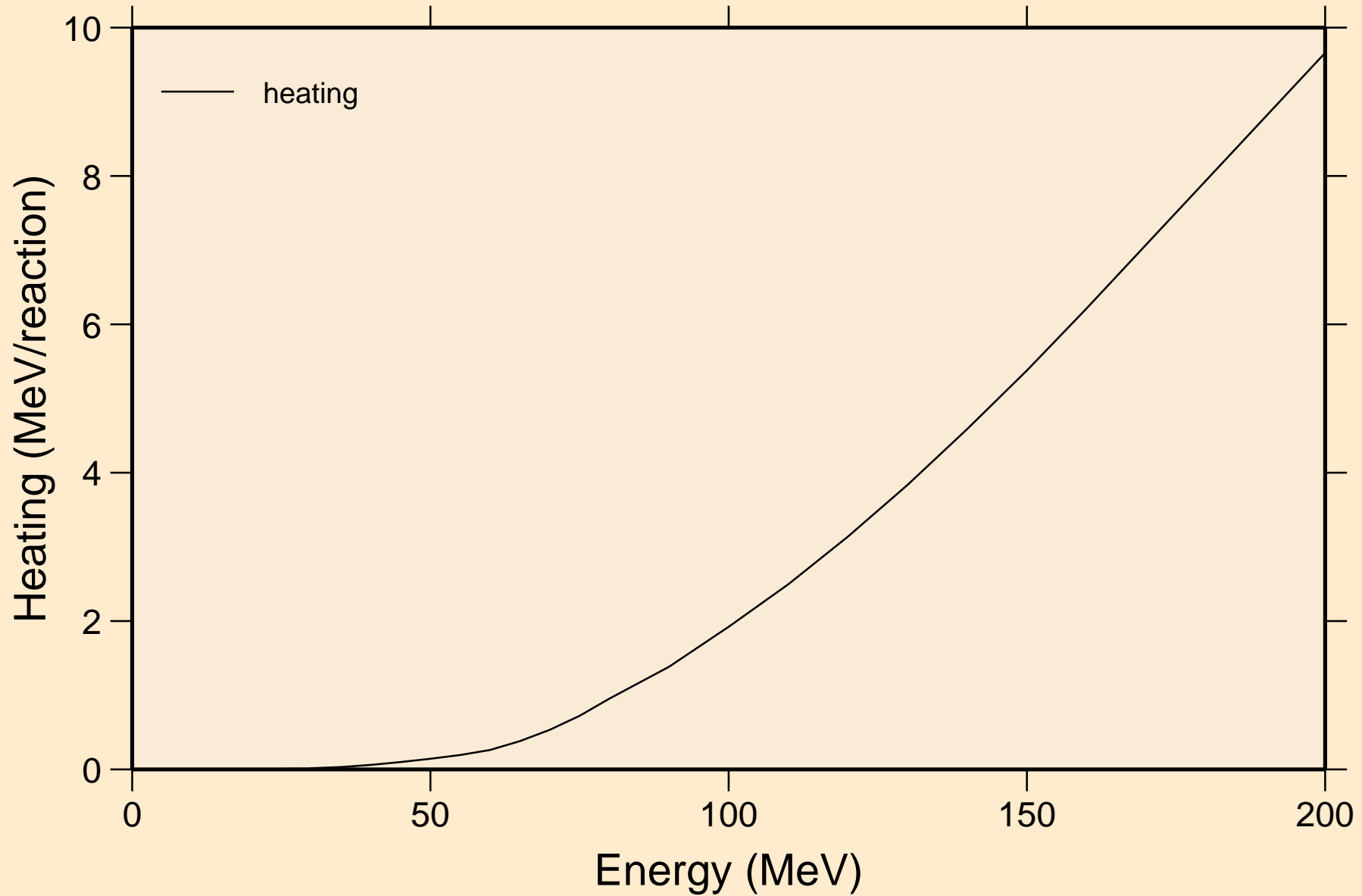

RA208 PROTON ACER TENDL-2021 LIBRARY; T=0.K

Threshold reactions

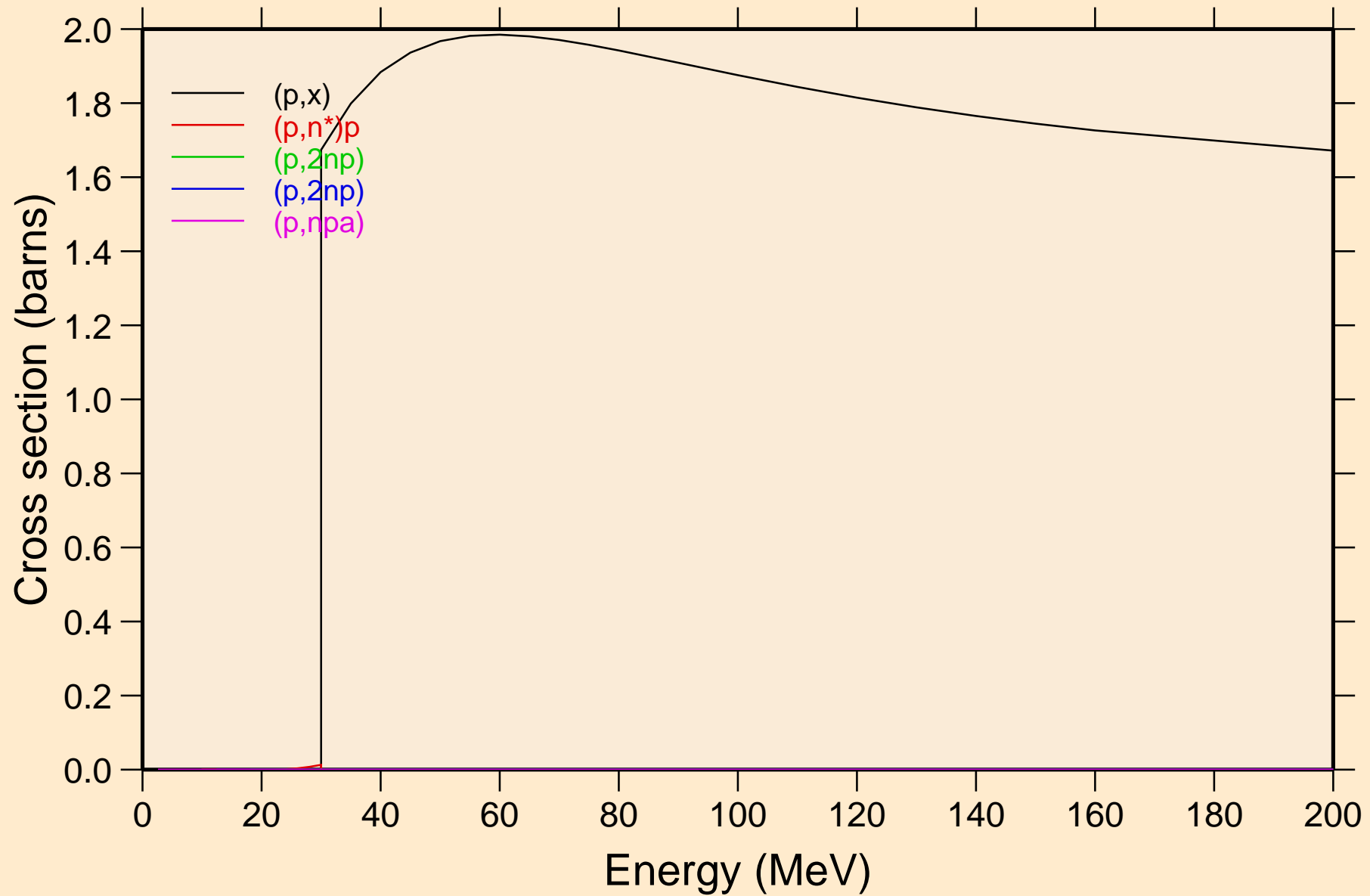

RA208 PROTON ACER TENDL-2021 LIBRARY; T=0.K
Threshold reactions

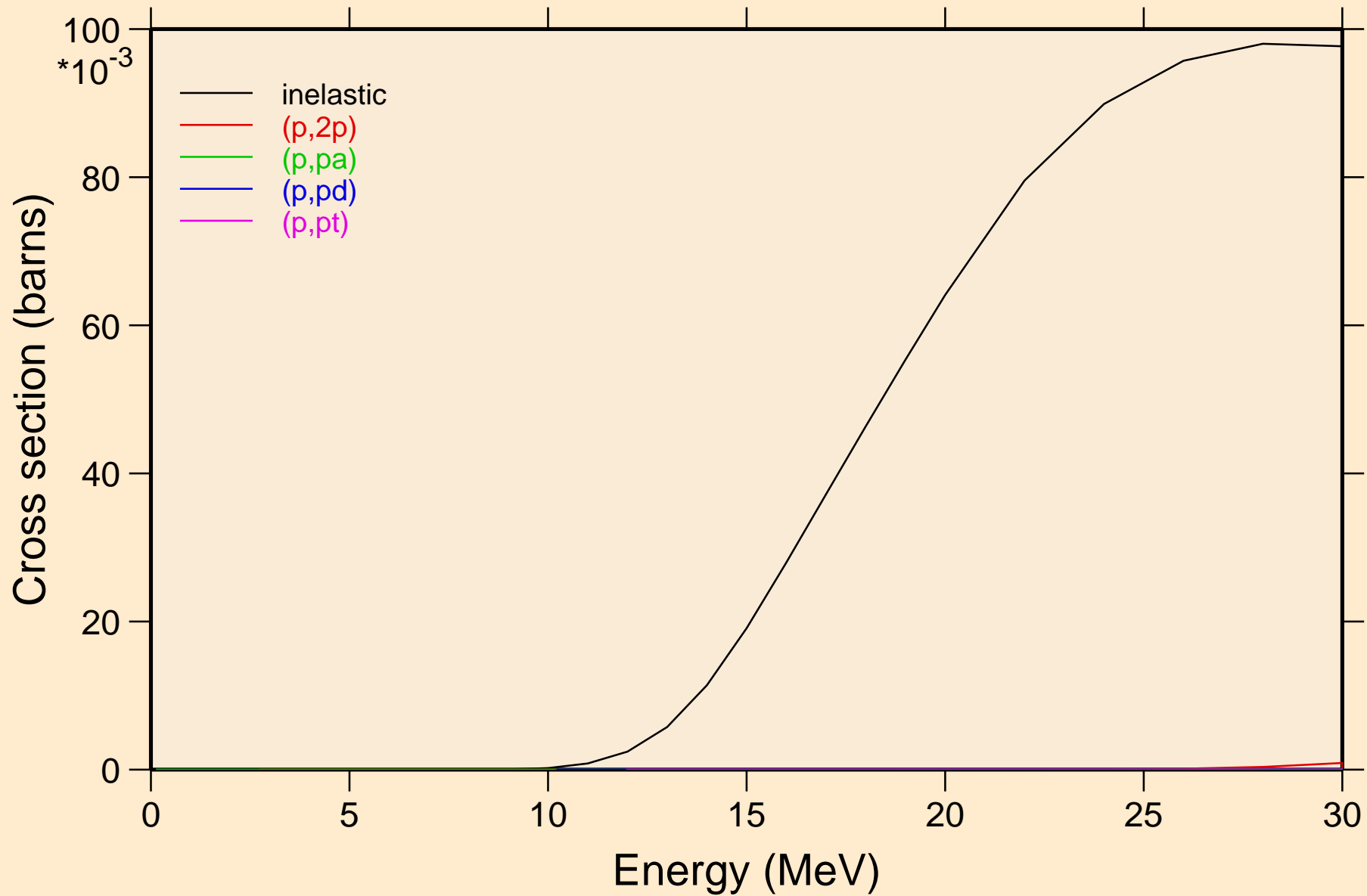

RA208 PROTON ACER TENDL-2021 LIBRARY; T=0.K
Threshold reactions

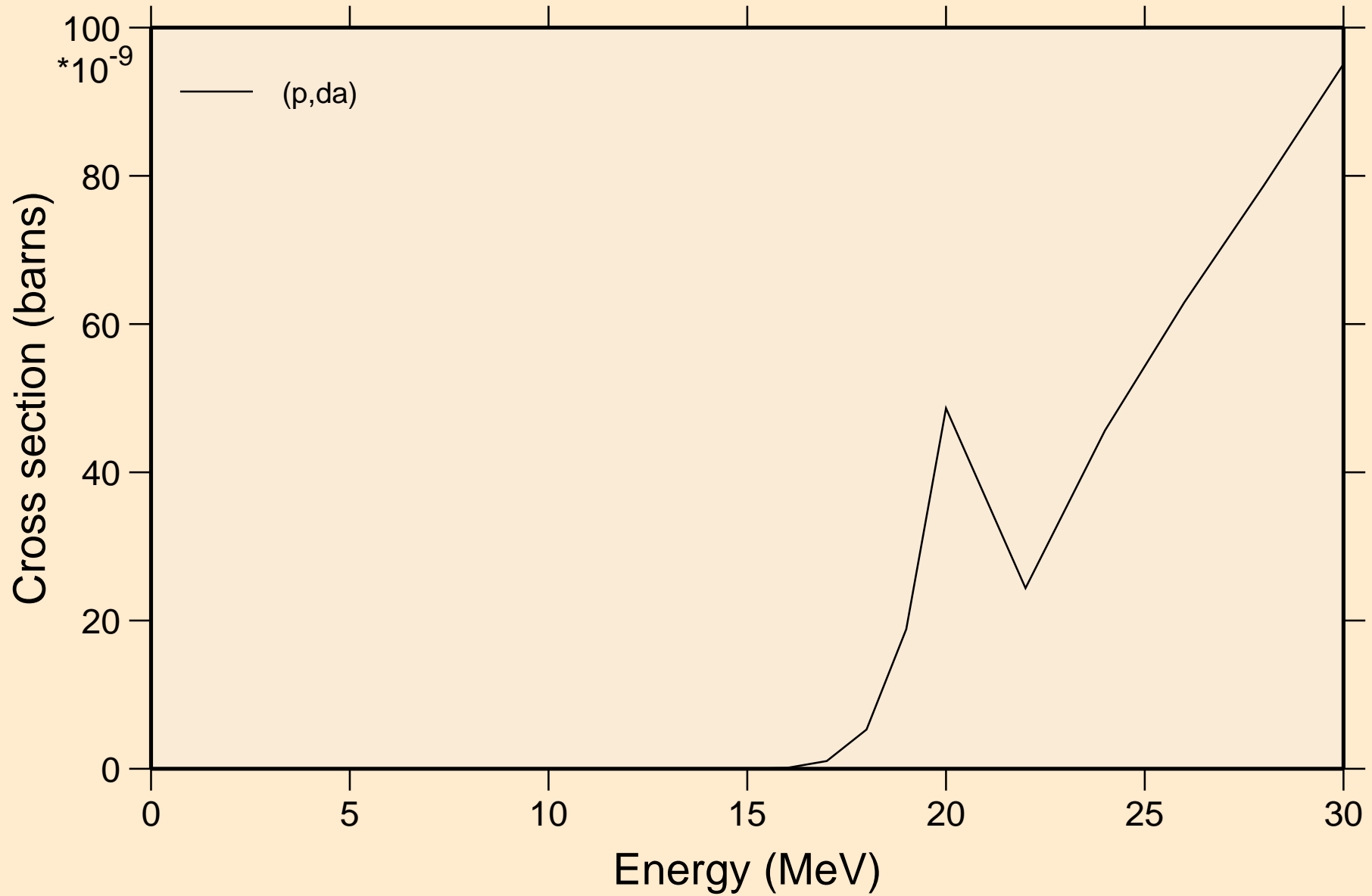

RA208 PROTON ACER TENDL-2021 LIBRARY; T=0.K
angular distribution for elastic

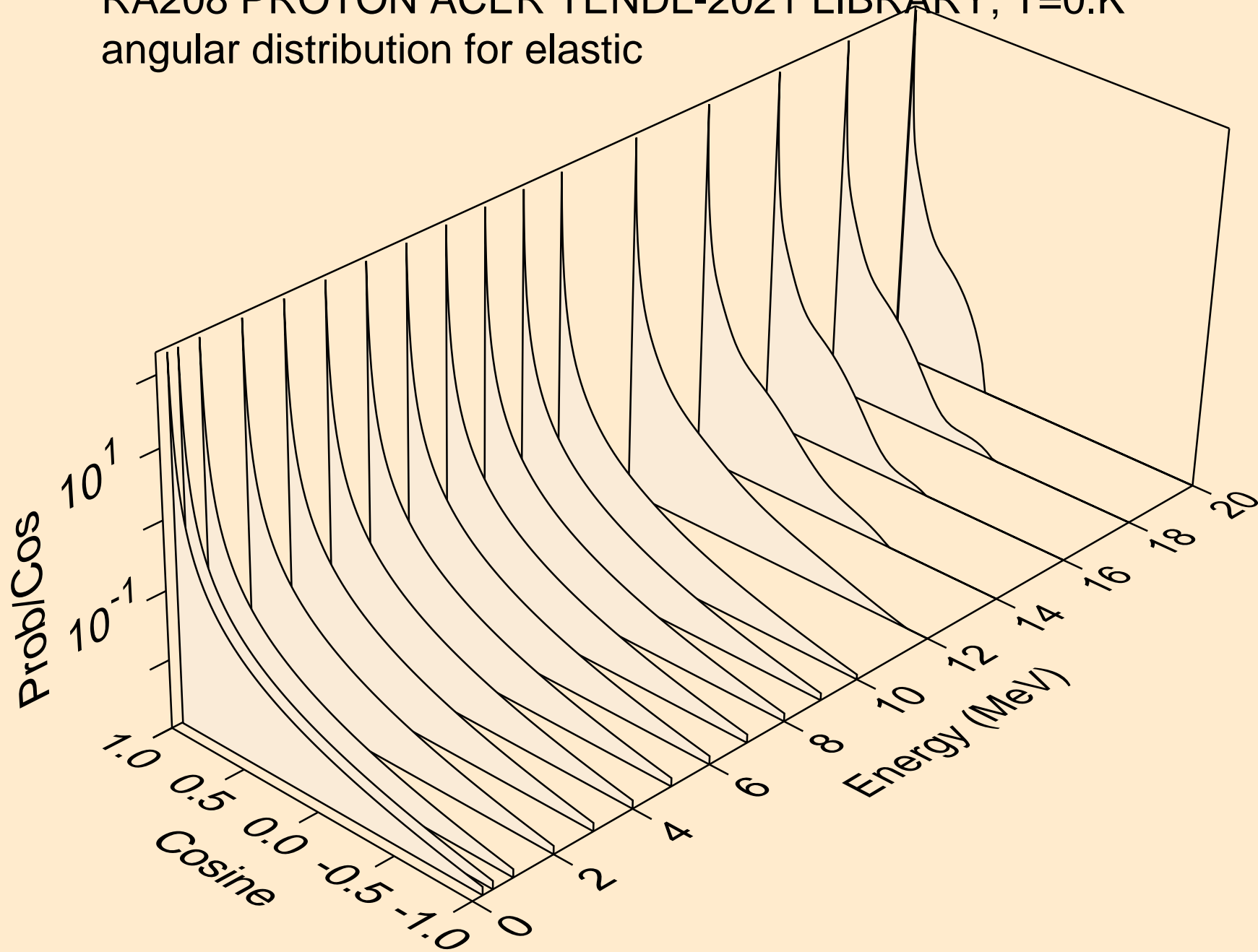

RA208 PROTON ACER TENDL-2021 LIBRARY; T=0.K
angular distribution for elastic

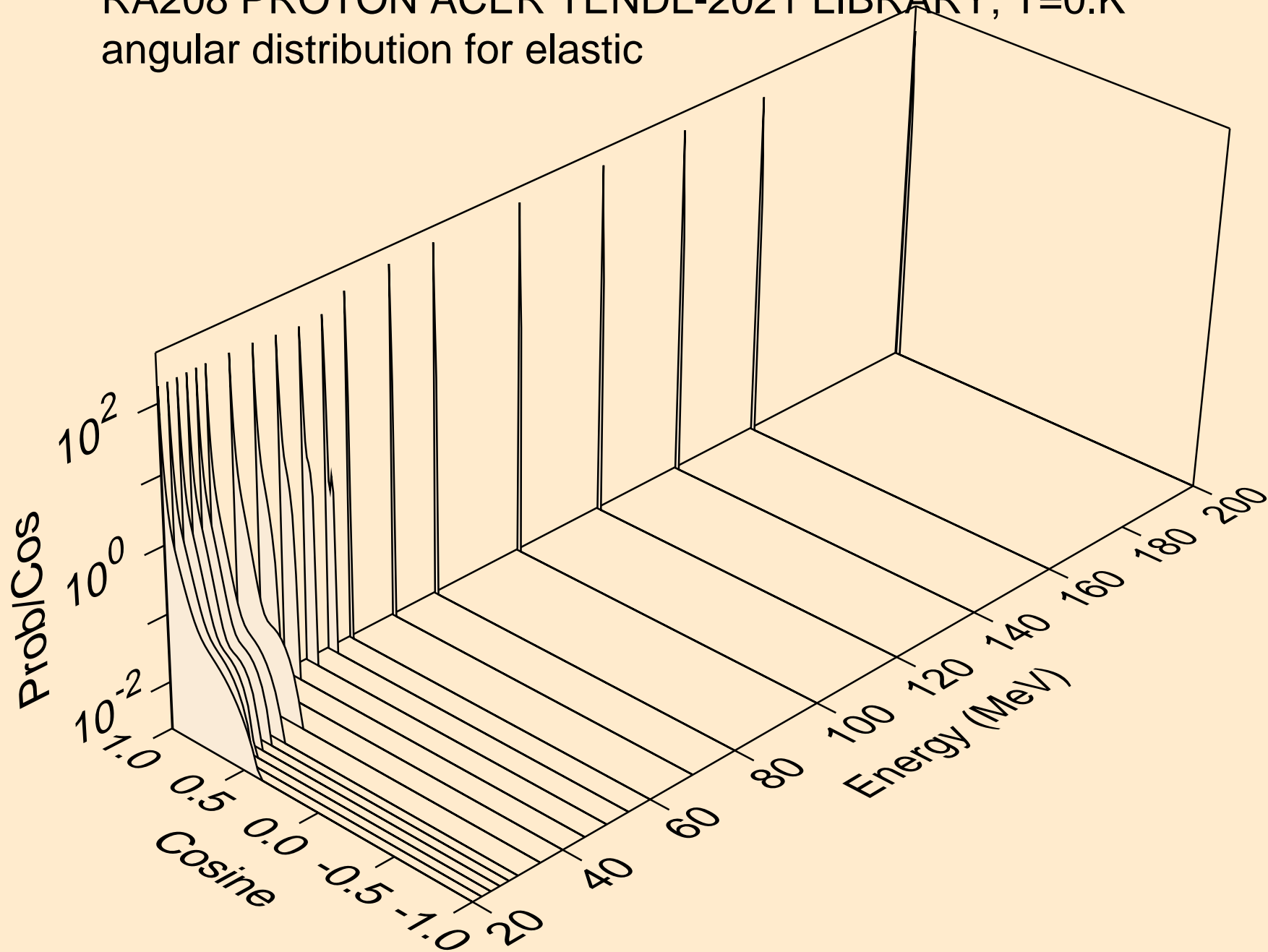

RA208 PROTON ACER TENDL-2021 LIBRARY; T=0.K
Proton emission for (p,x)

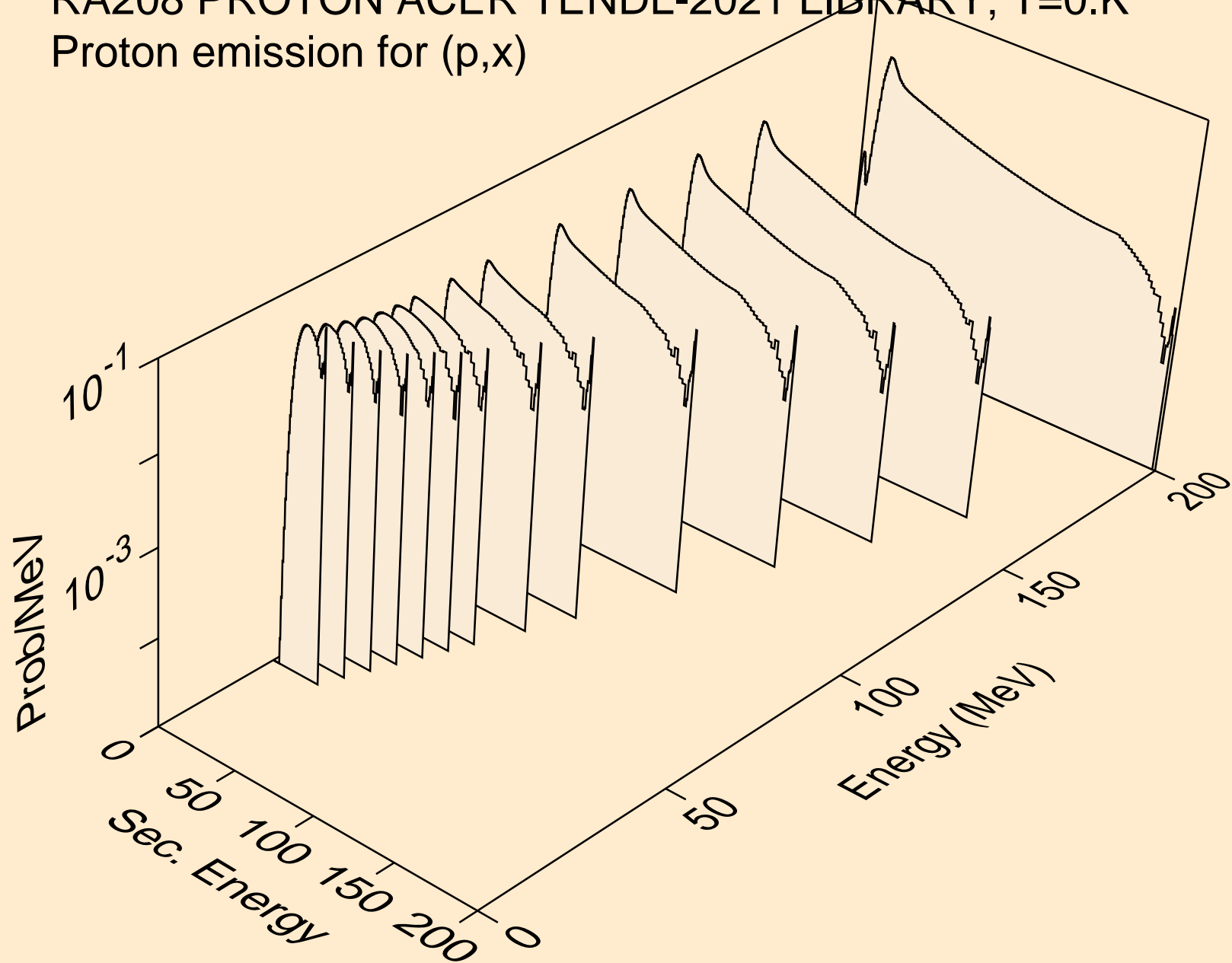

RA208 PROTON ACER TENDL-2021 LIBRARY; T=0.K
Proton emission for (p,n*)p

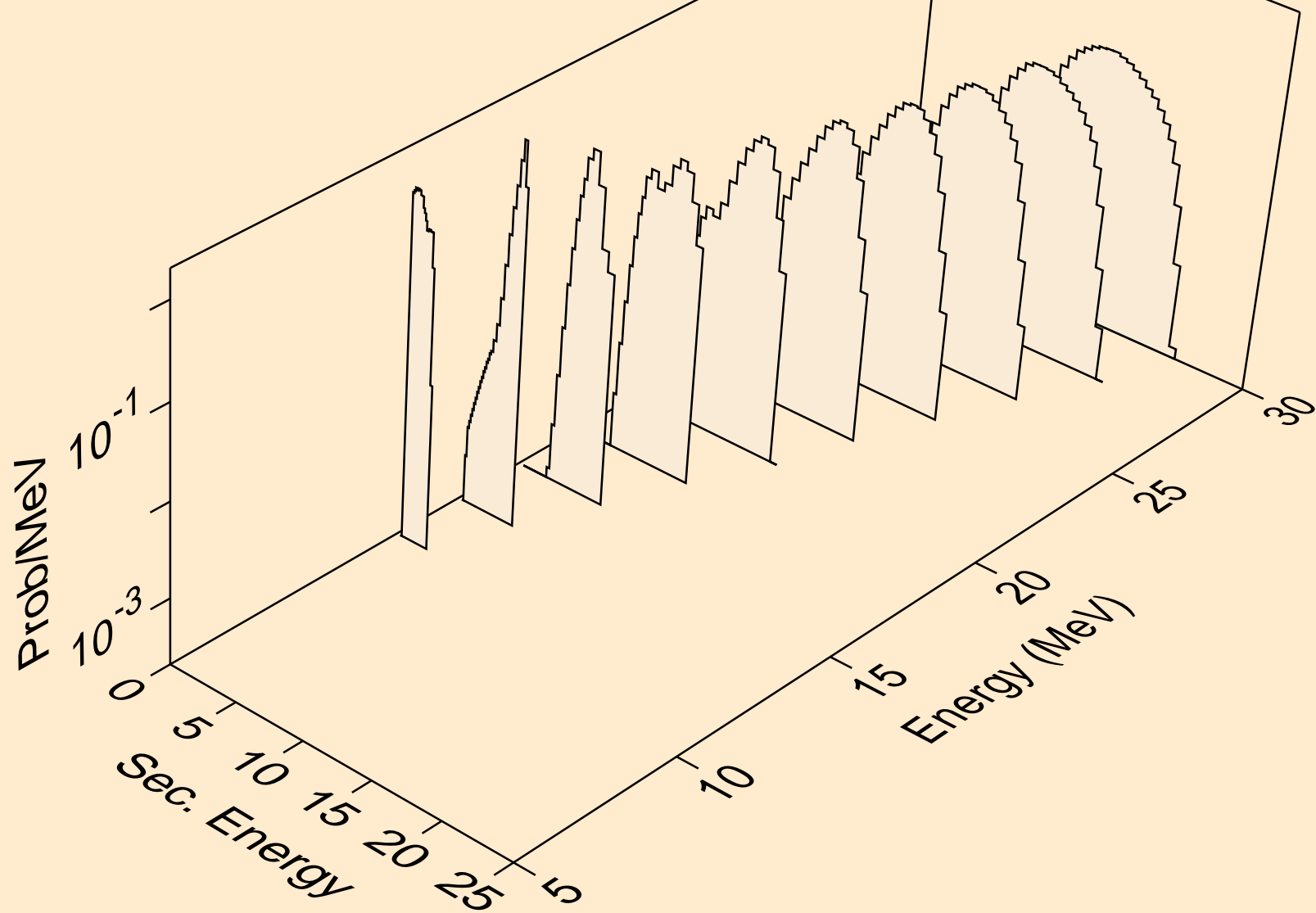

RA208 PROTON ACER TENDL-2021 LIBRARY; T=0.K
Proton emission for (p,2np)

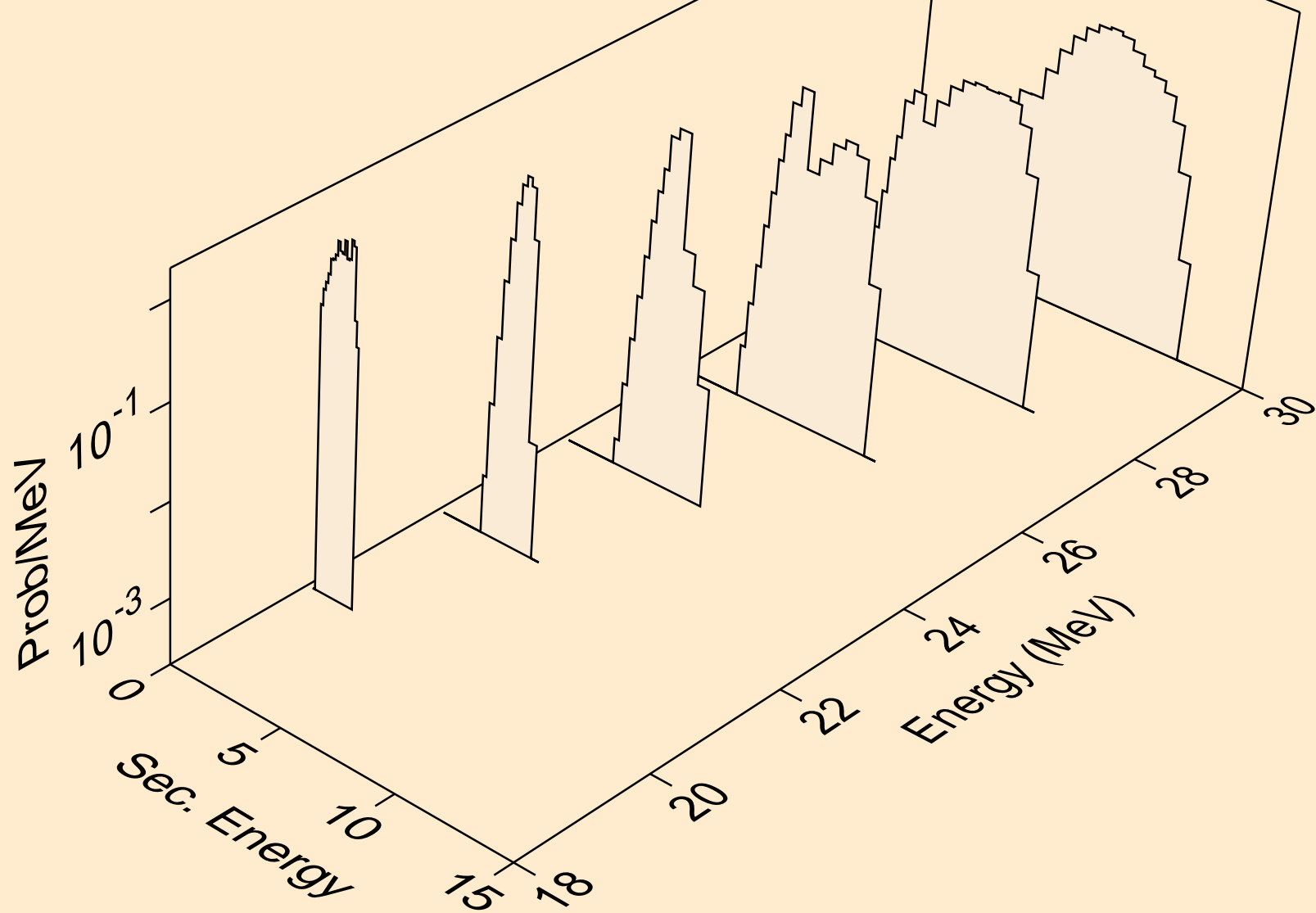

RA208 PROTON ACER TENDL-2021 LIBRARY; T=0.K
Proton emission for (p,2np)

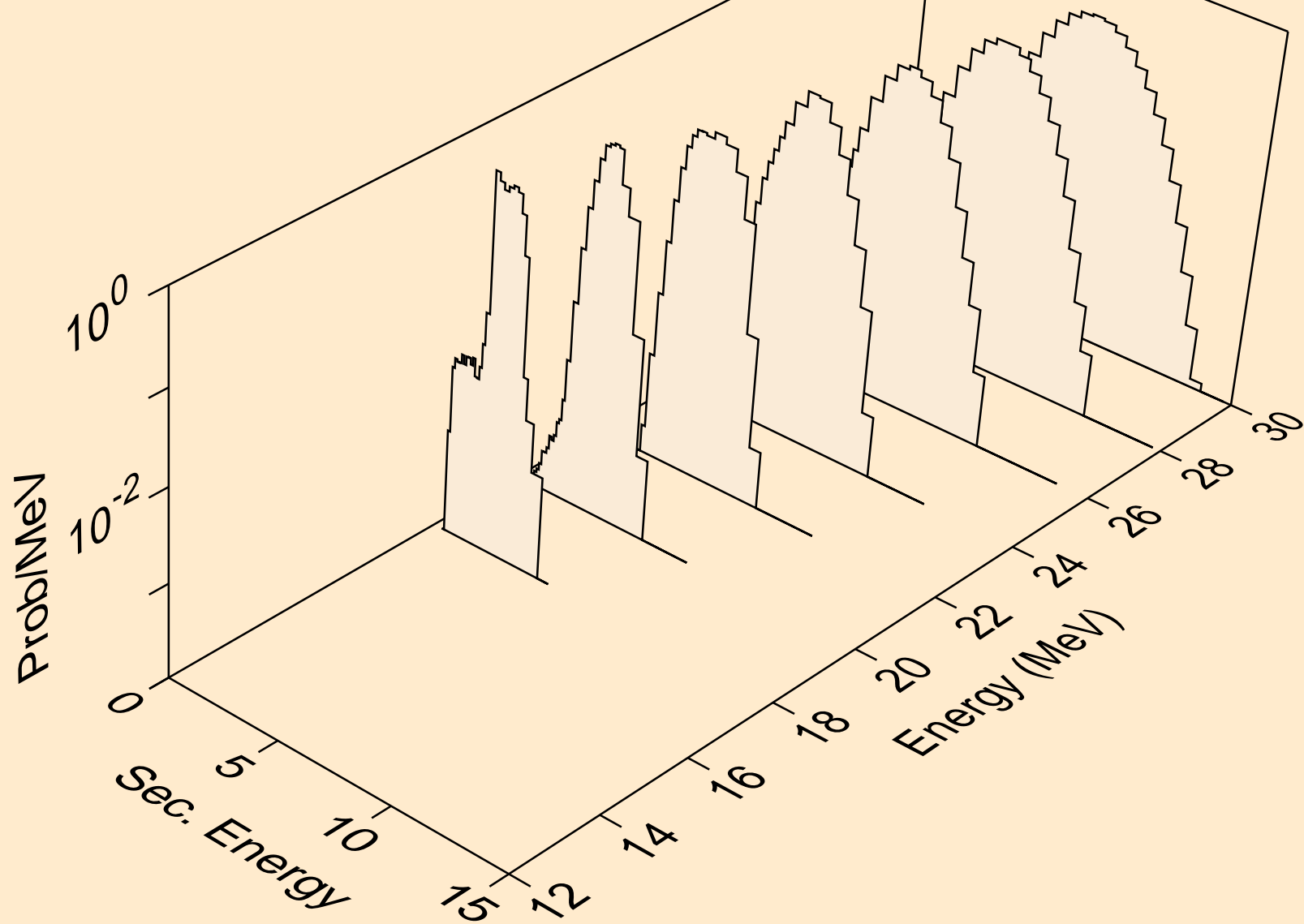

RA208 PROTON ACER TENDL-2021 LIBRARY; T=0.K
Proton emission for (p,npa)

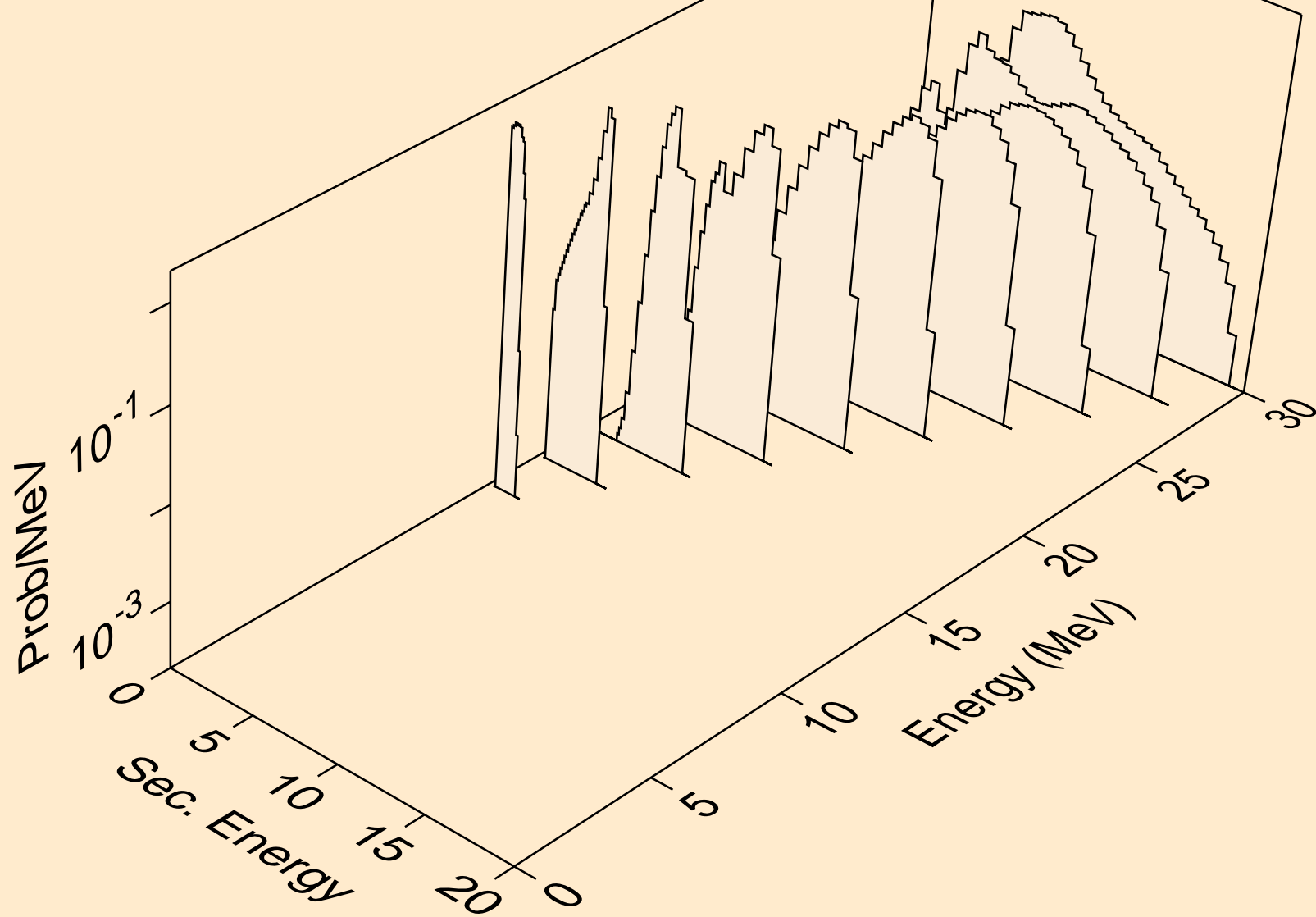

RA208 PROTON ACER TENDL-2021 LIBRARY; T=0.K
Proton emission for inelastic

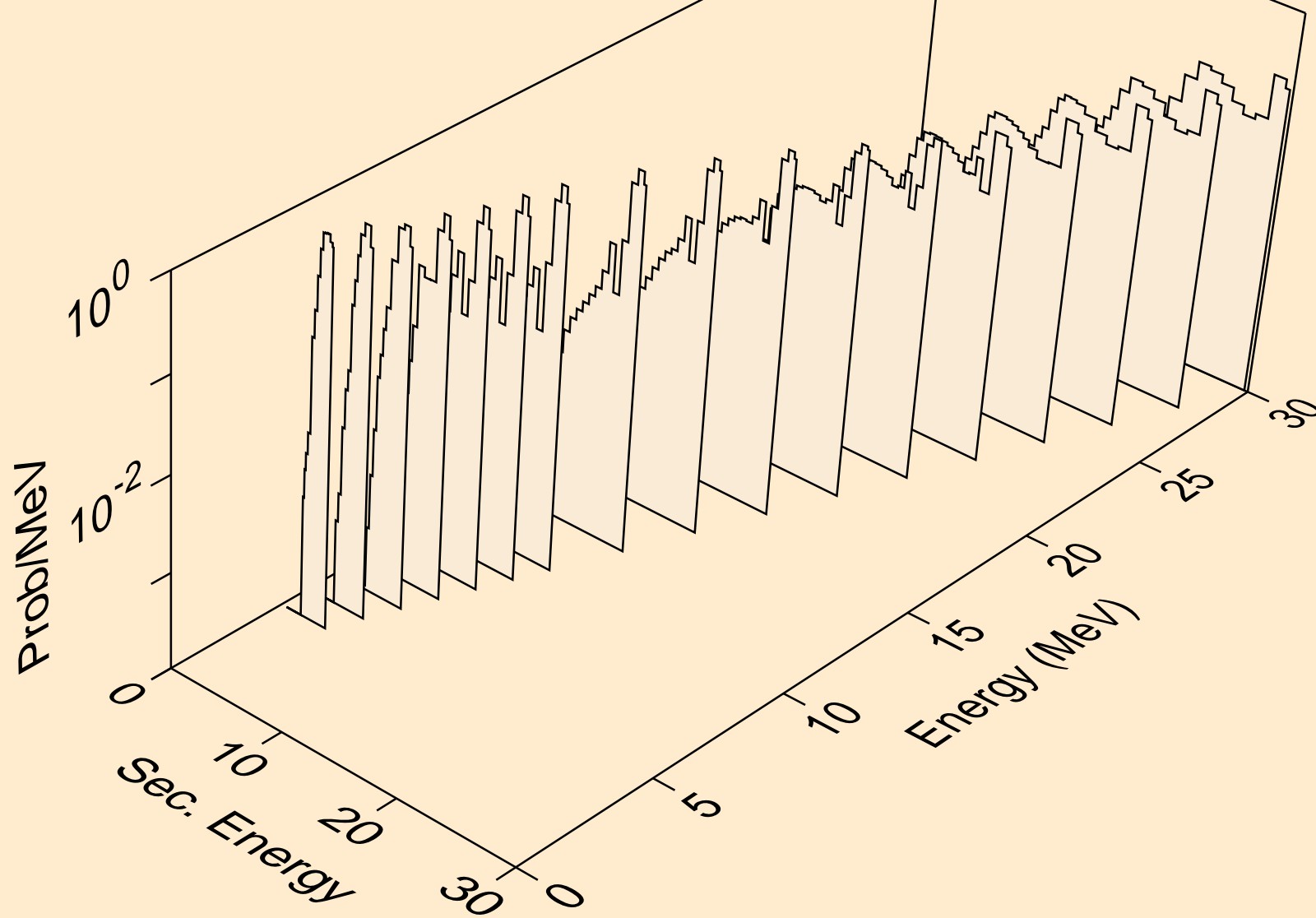

RA208 PROTON ACER TENDL-2021 LIBRARY; T=0.K
Proton emission for (p,2p)

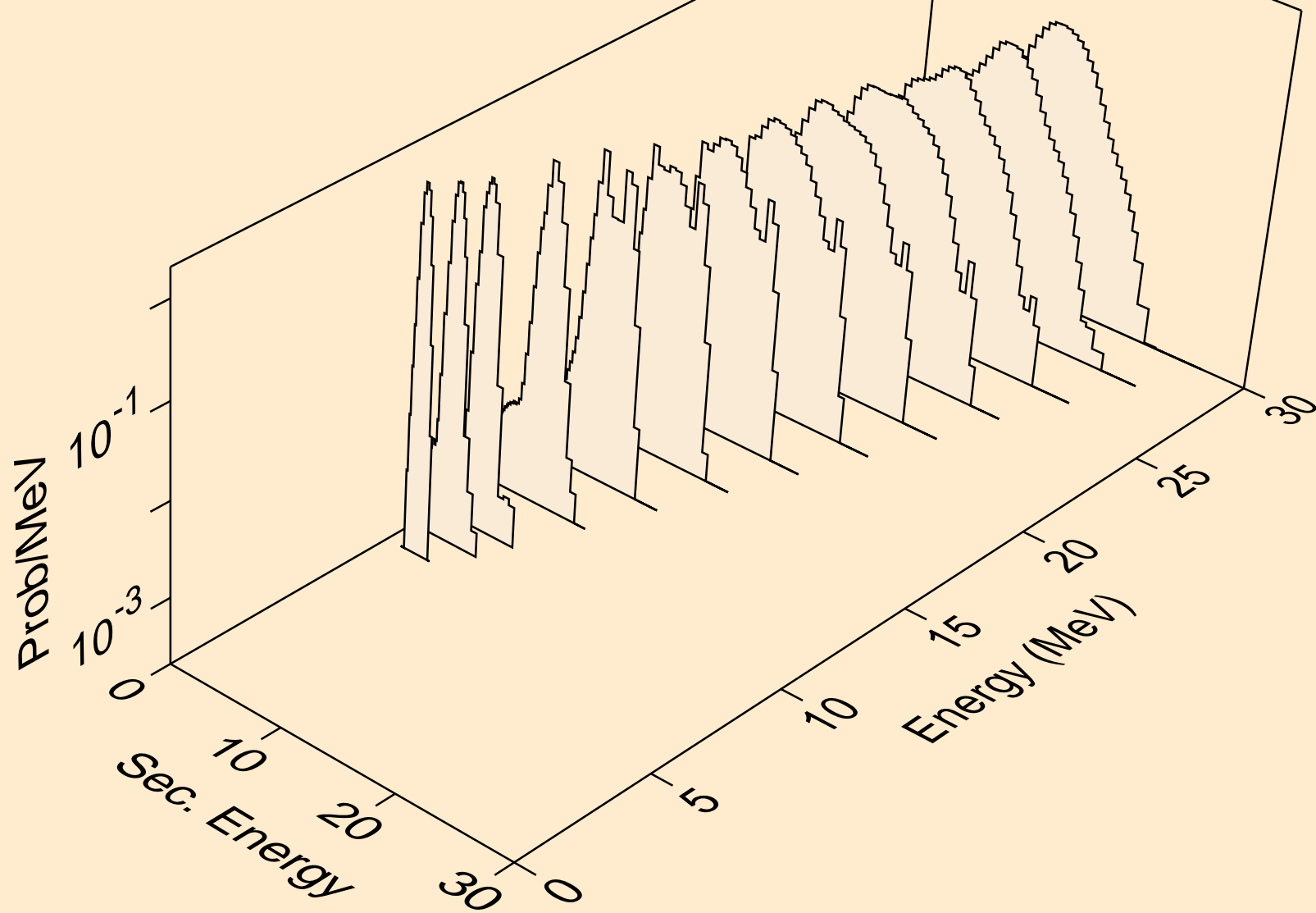

RA208 PROTON ACER TENDL-2021 LIBRARY; T=0.K
Proton emission for (p,pa)

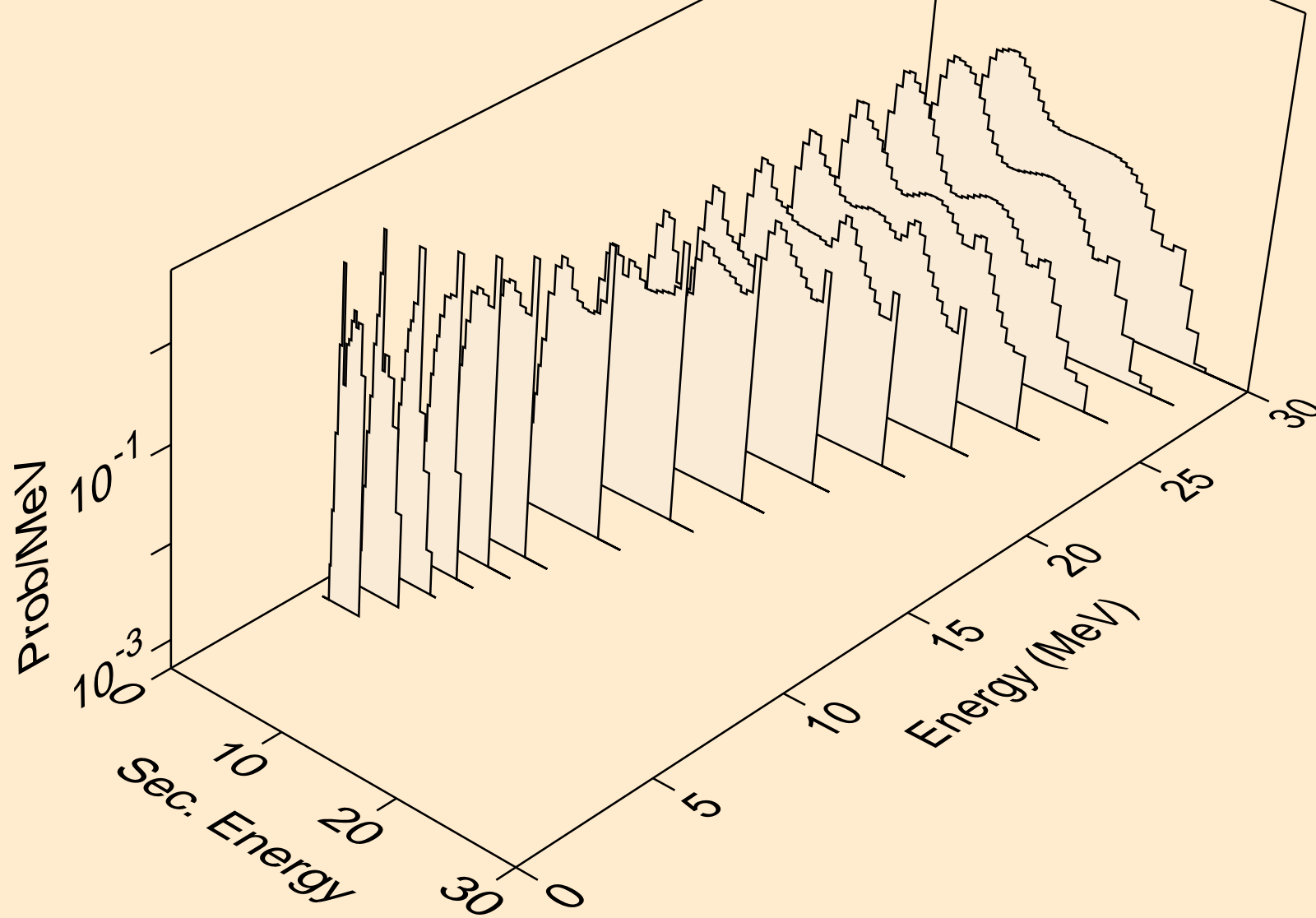

RA208 PROTON ACER TENDL-2021 LIBRARY; T=0.K
Proton emission for (p,pd)

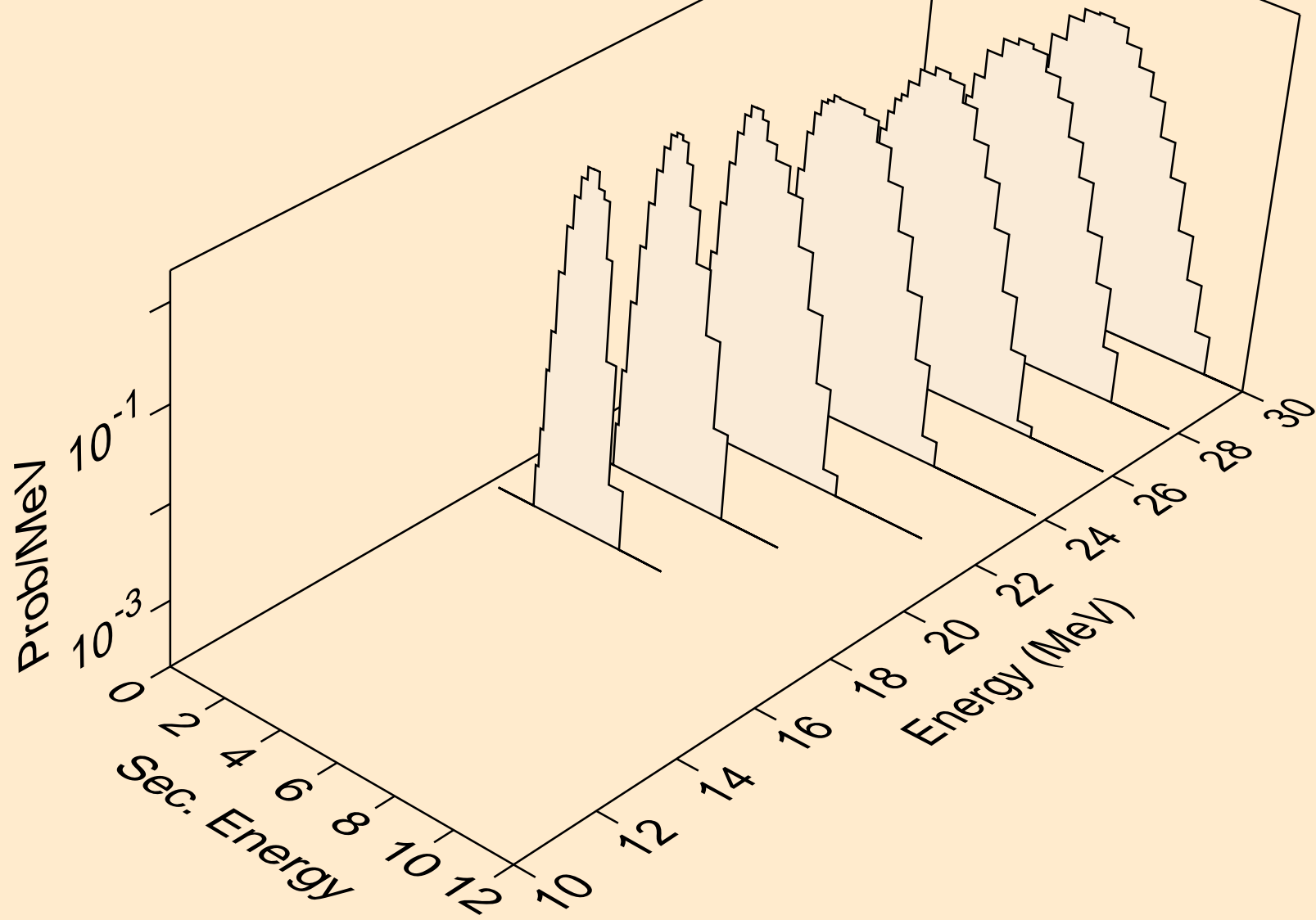

RA208 PROTON ACER TENDL-2021 LIBRARY; T=0.K

Proton emission for (p,pt)

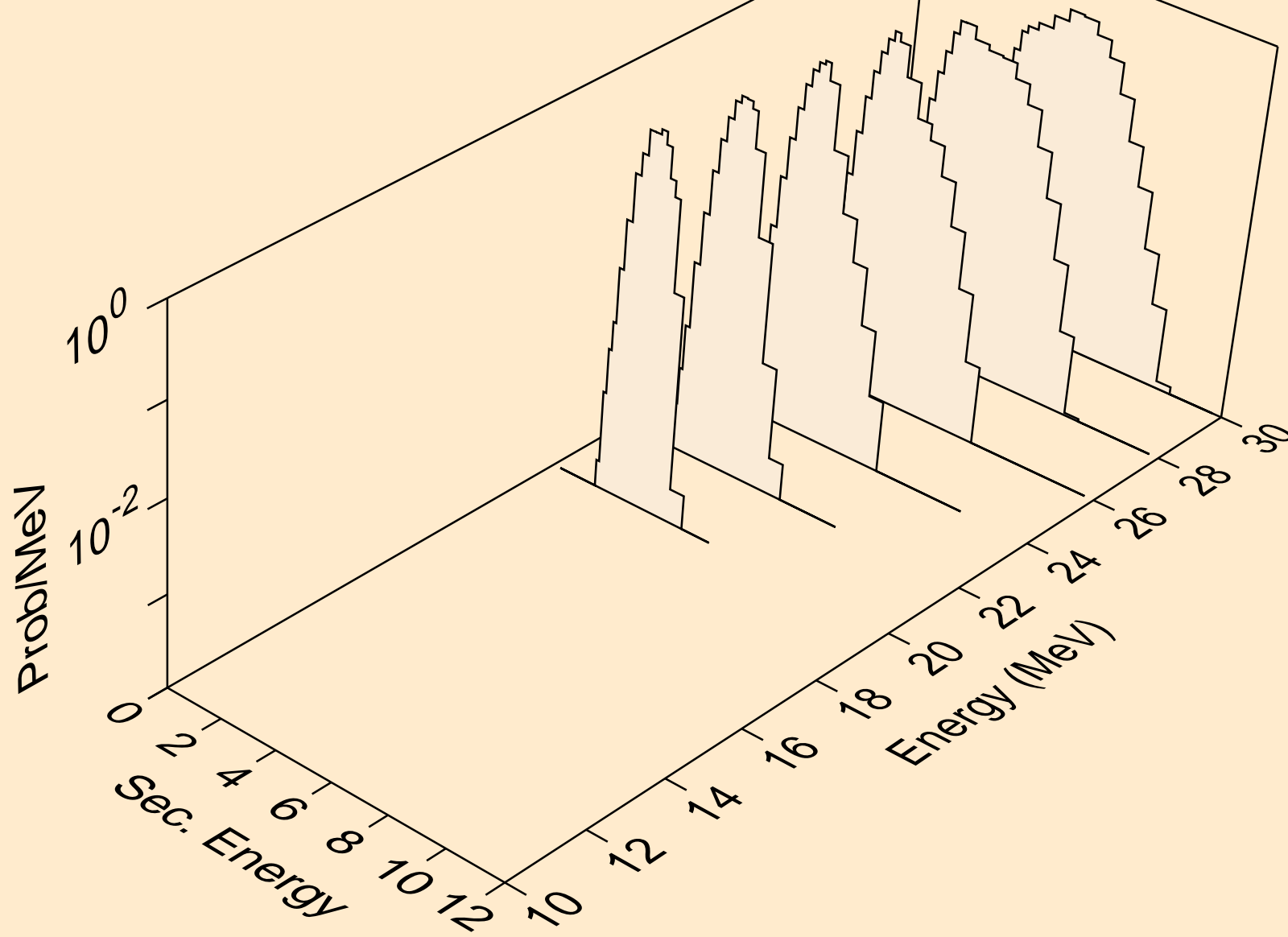

RA208 PROTON ACER TENDL-2021 LIBRARY; T=0.K
Photon emission for (z,n)

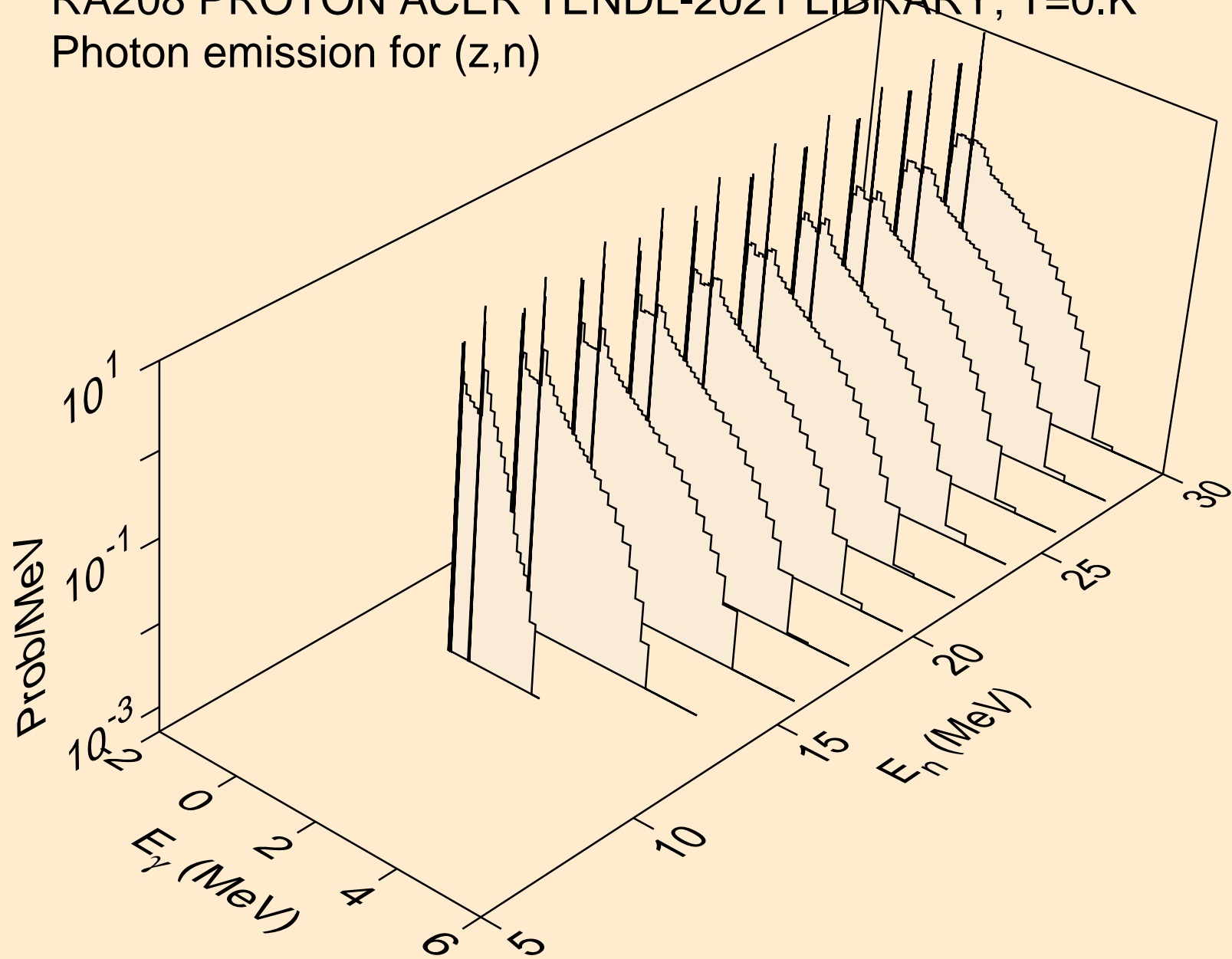

RA208 PROTON ACER TENDL-2021 LIBRARY; T=0.K
Photon emission for (n,x)

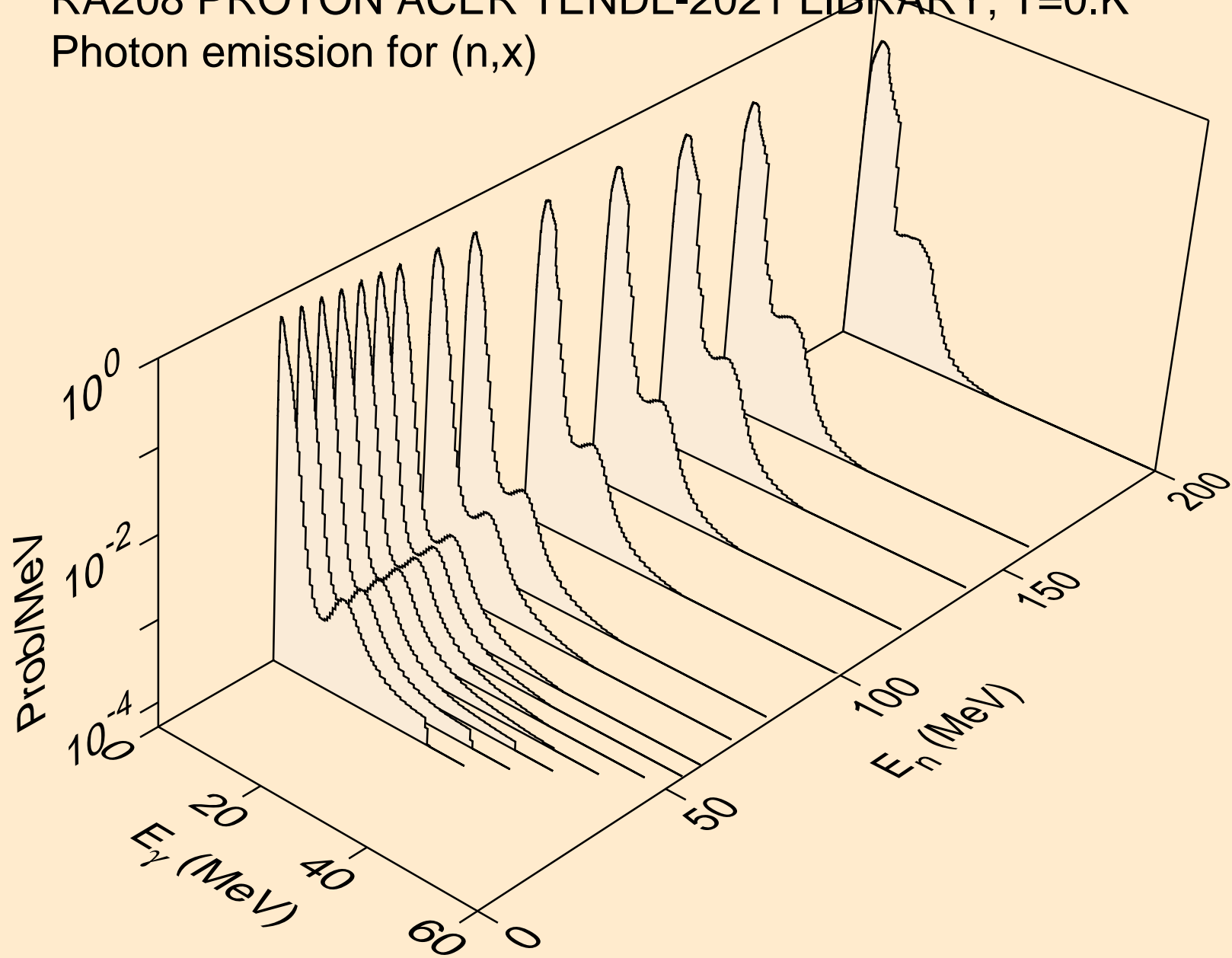

RA208 PROTON ACER TENDL-2021 LIBRARY; T=0.K
Photon emission for (n,2n)

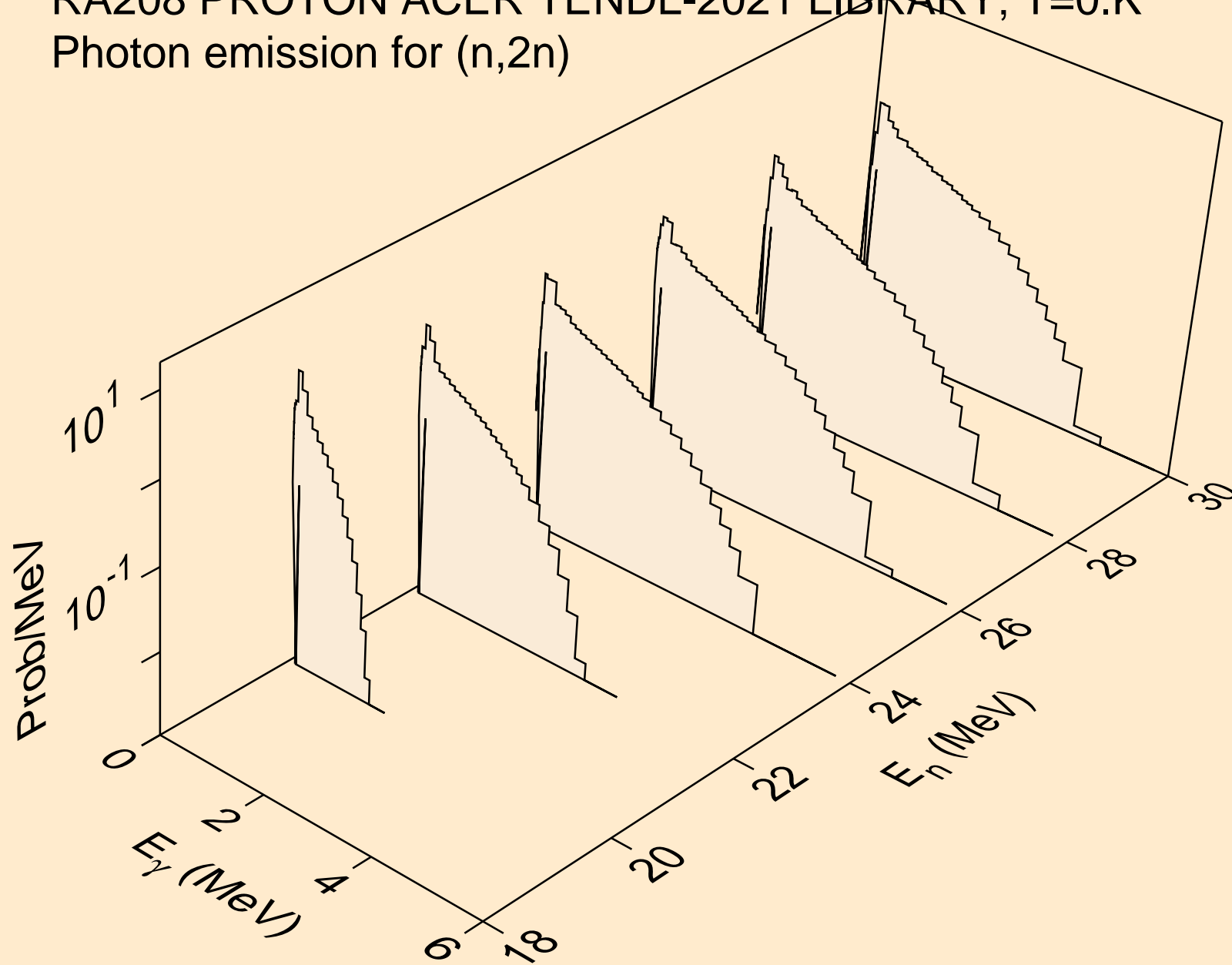

RA208 PROTON ACER TENDL-2021 LIBRARY; T=0.K
Photon emission for (n,n*)a

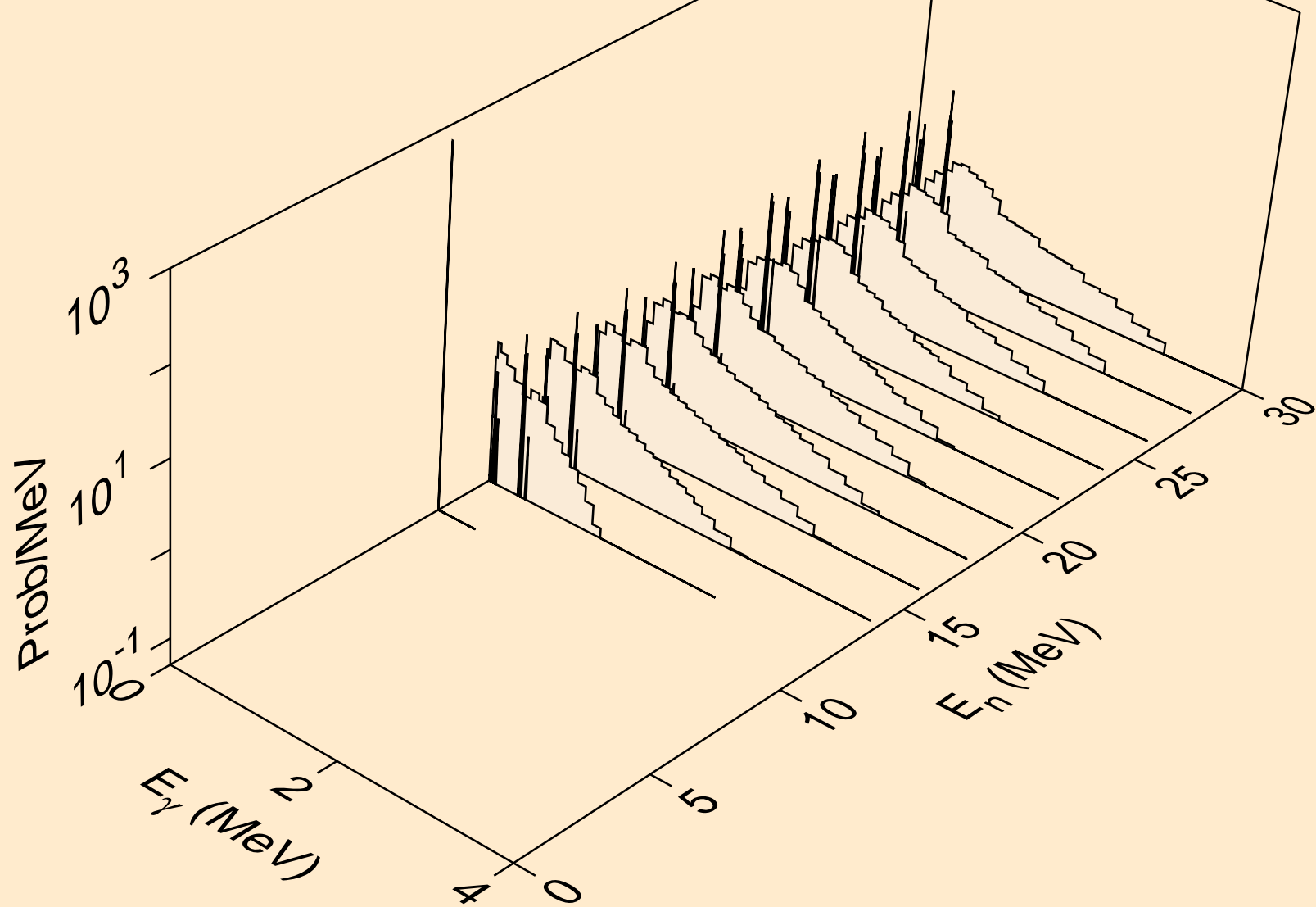

RA208 PROTON ACER TENDL-2021 LIBRARY; T=0.K
Photon emission for (n,2n)a

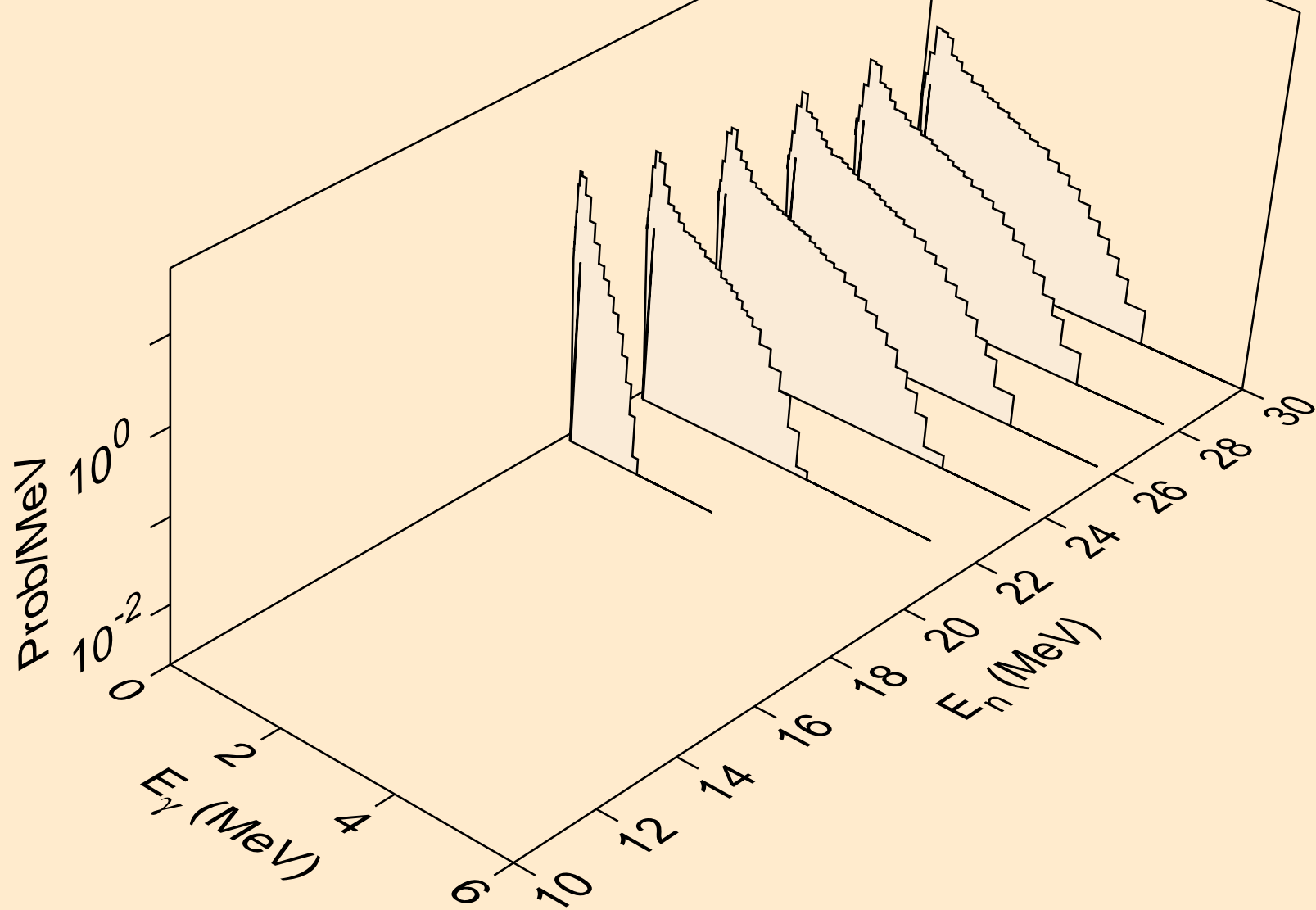

RA208 PROTON ACER TENDL-2021 LIBRARY; T=0.K
Photon emission for (n,n*)p

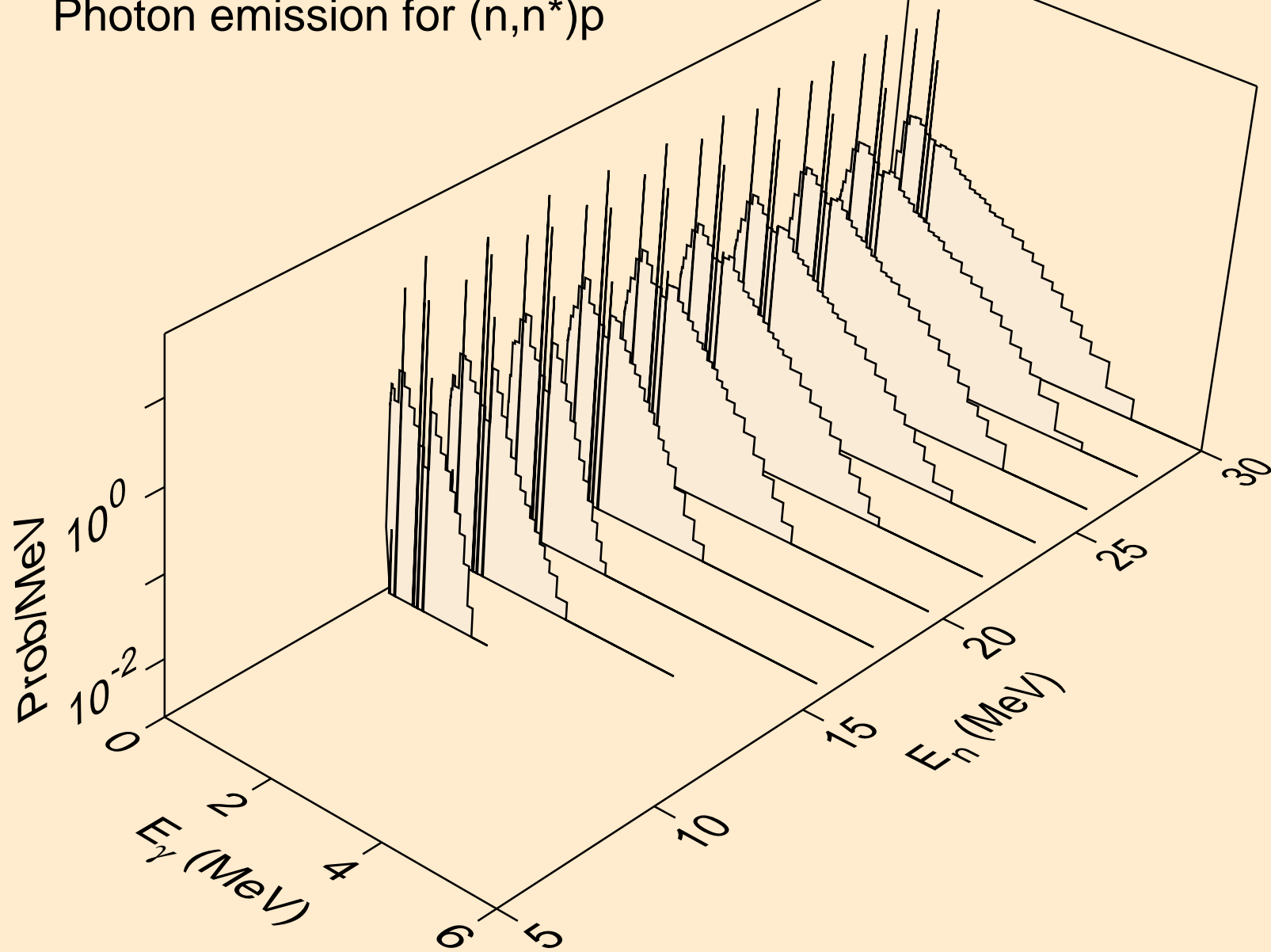

RA208 PROTON ACER TENDL-2021 LIBRARY; T=0.K
Photon emission for (n,n*)2a

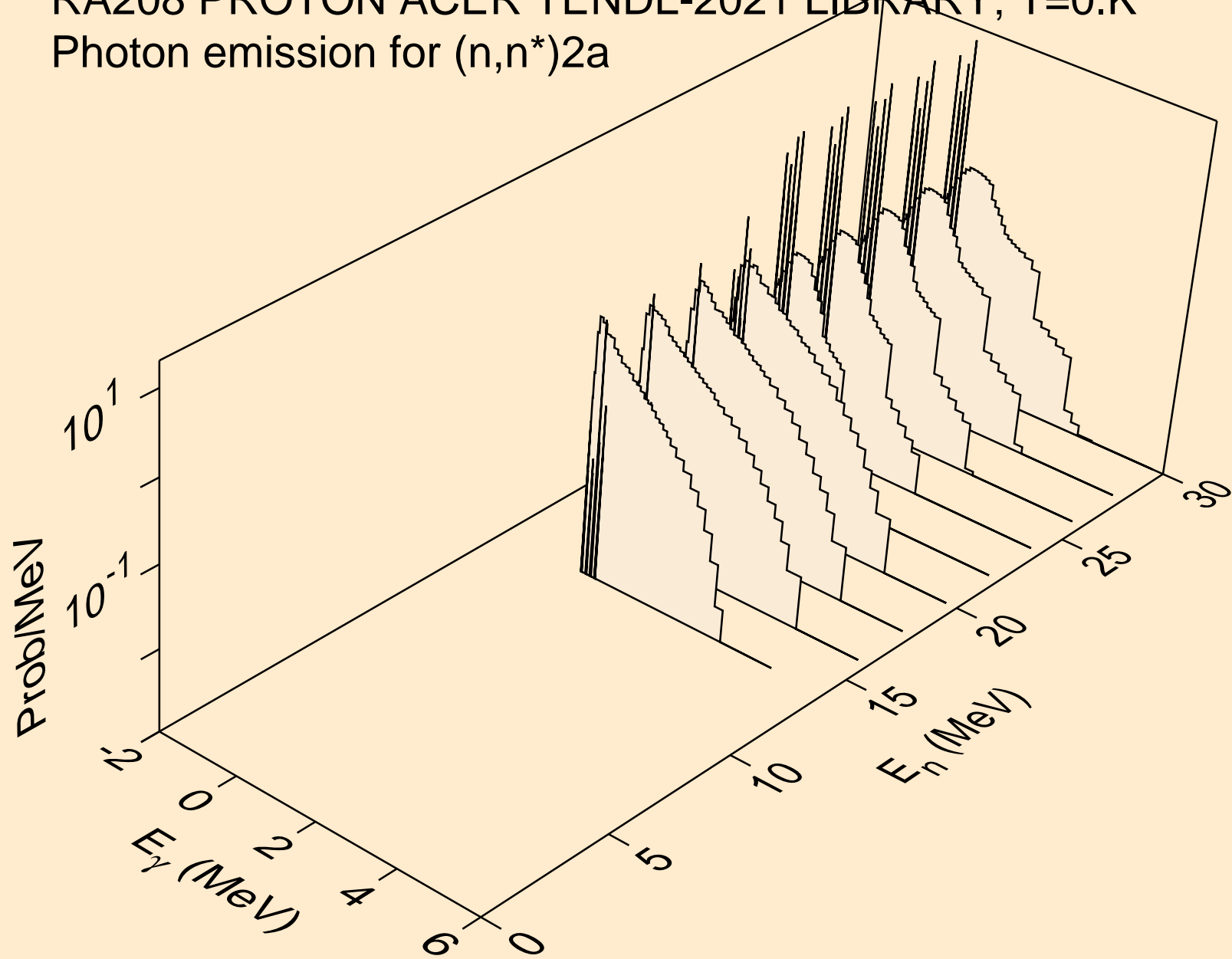

RA208 PROTON ACER TENDL-2021 LIBRARY; T=0.K
Photon emission for (n,n*)d

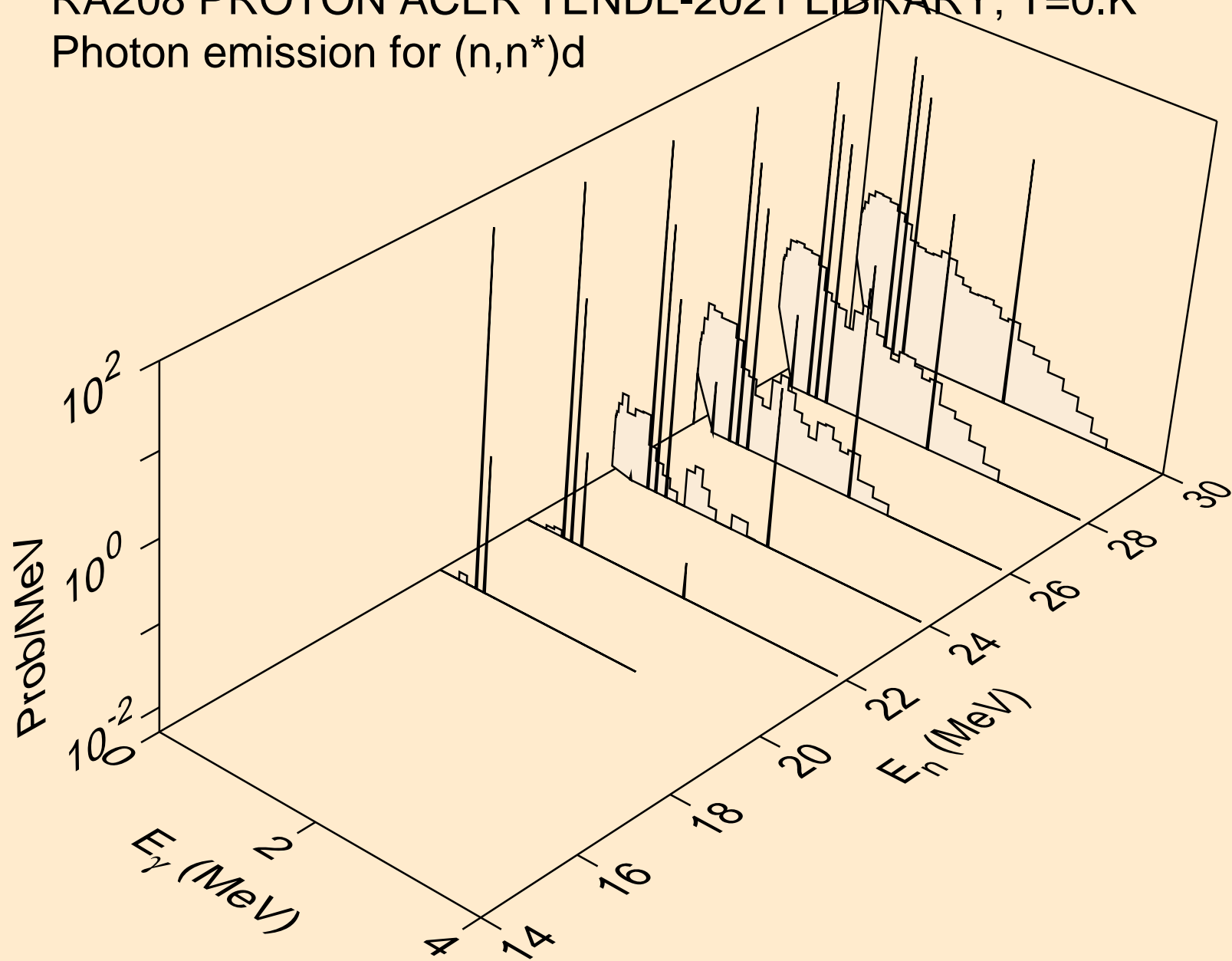

RA208 PROTON ACER TENDL-2021 LIBRARY; T=0.K
Photon emission for (n,n*)t

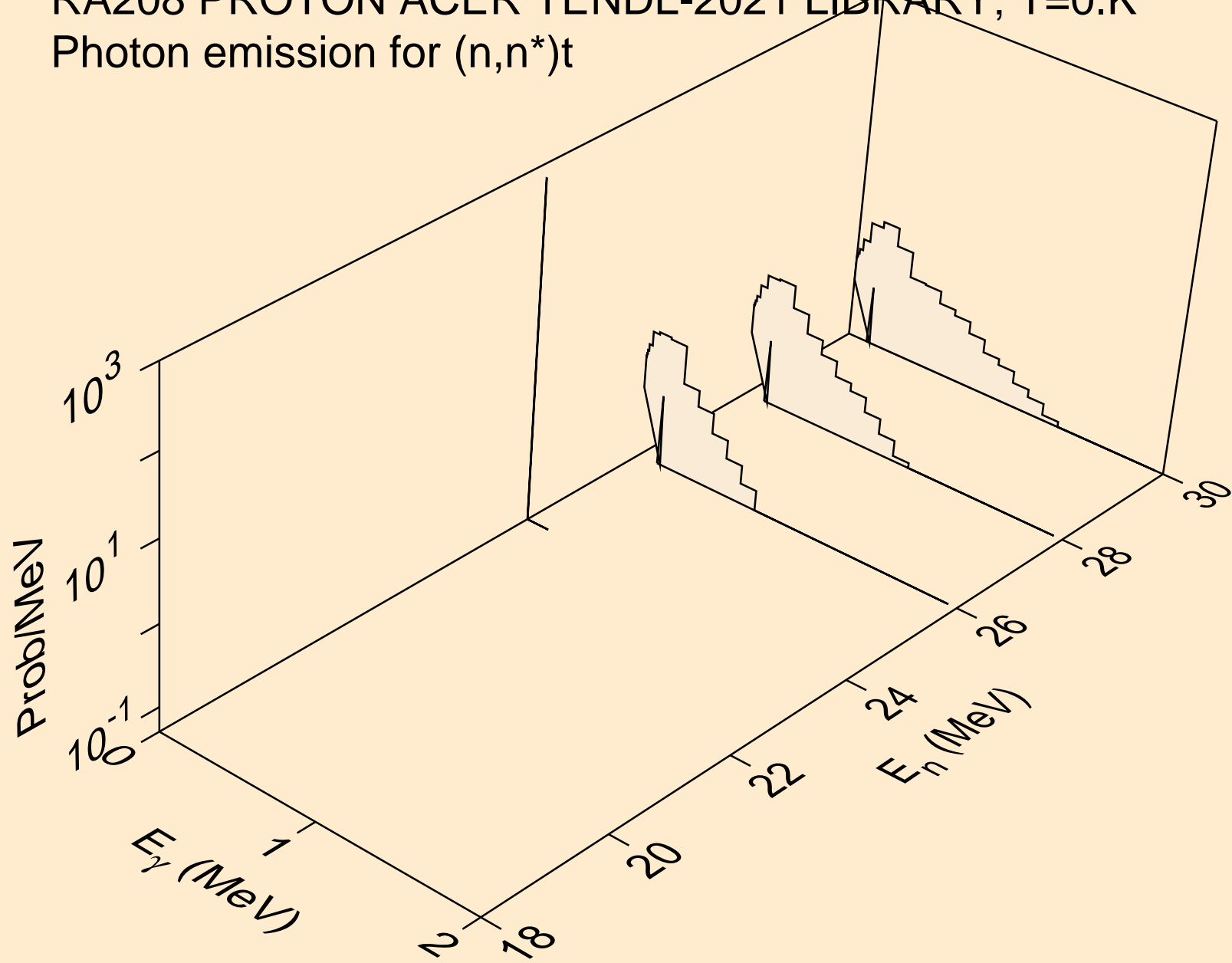

RA208 PROTON ACER TENDL-2021 LIBRARY; T=0.K
Photon emission for (n,n*)he3

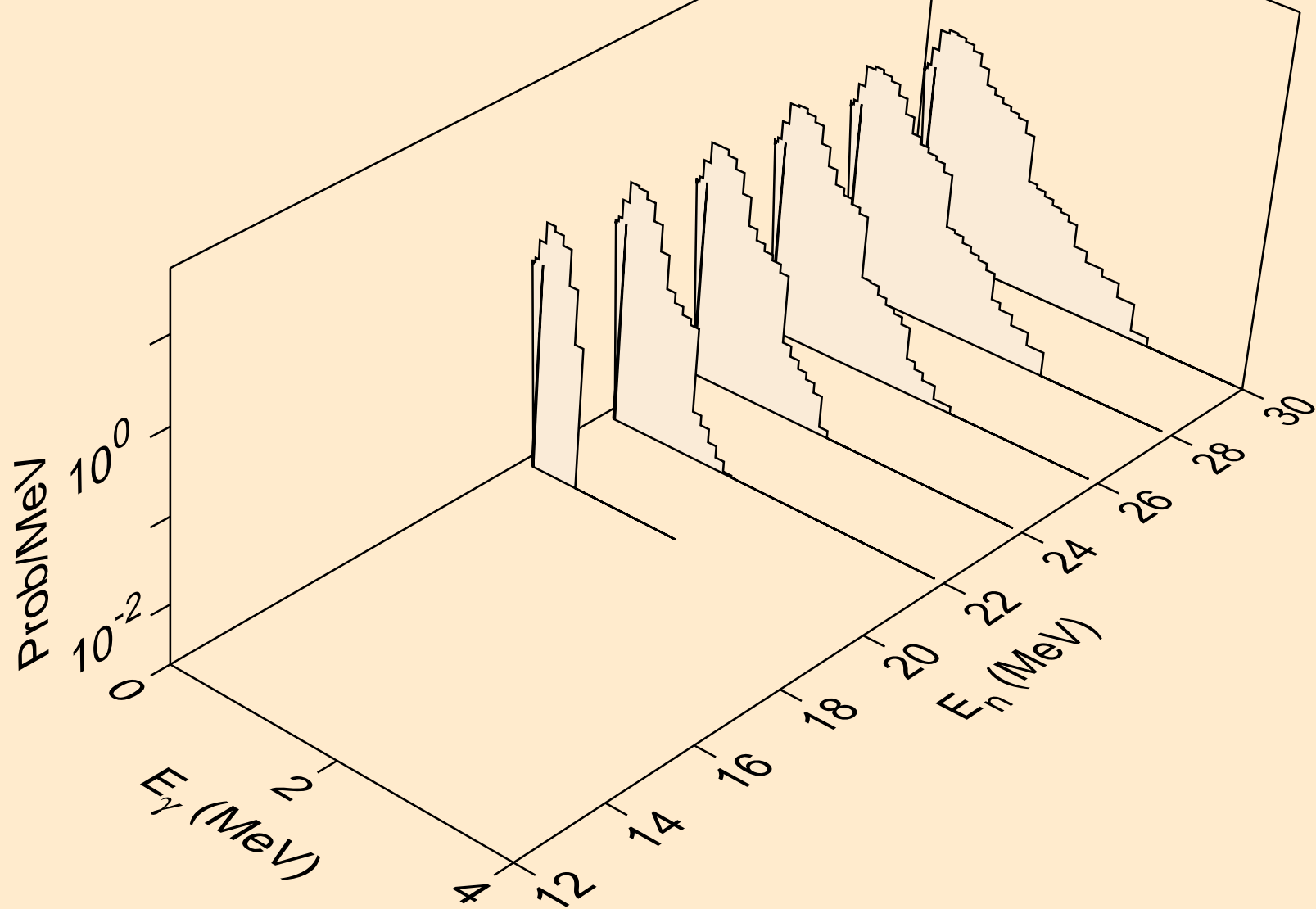

RA208 PROTON ACER TENDL-2021 LIBRARY; T=0.K
Photon emission for (n,2np)

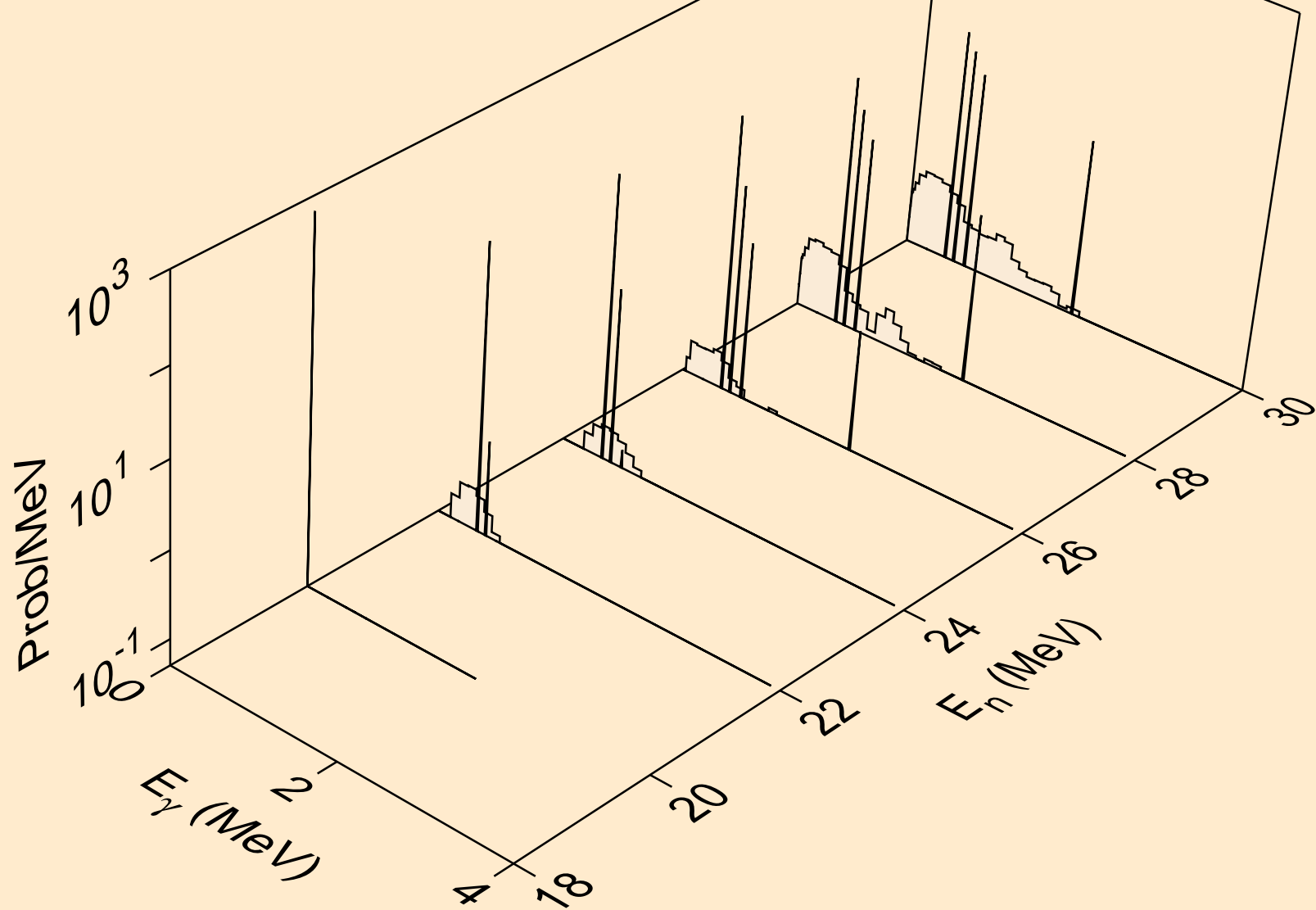

RA208 PROTON ACER TENDL-2021 LIBRARY; T=0.K
Photon emission for (n,2np)

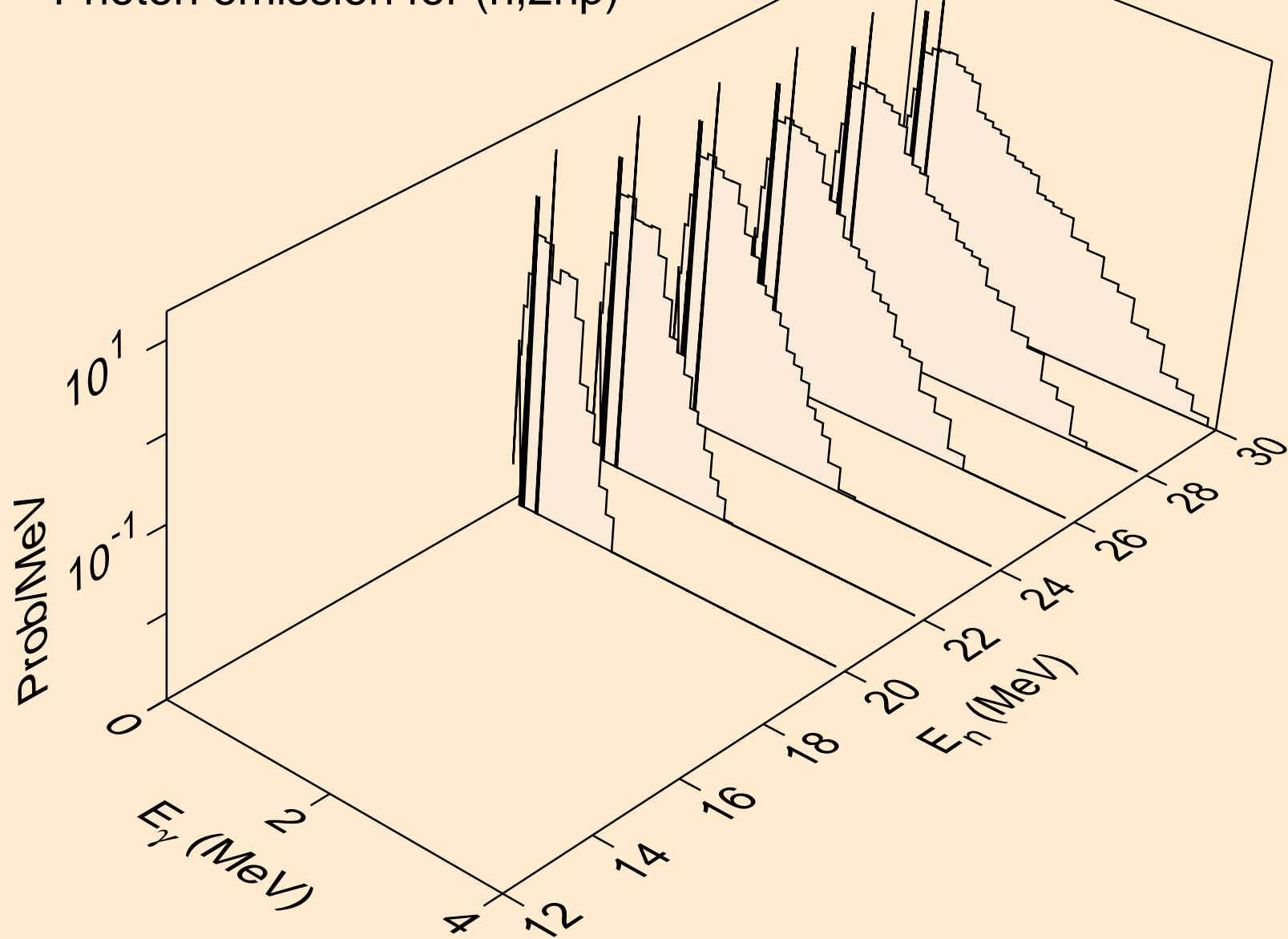

RA208 PROTON ACER TENDL-2021 LIBRARY; T=0.K
Photon emission for (n,npa)

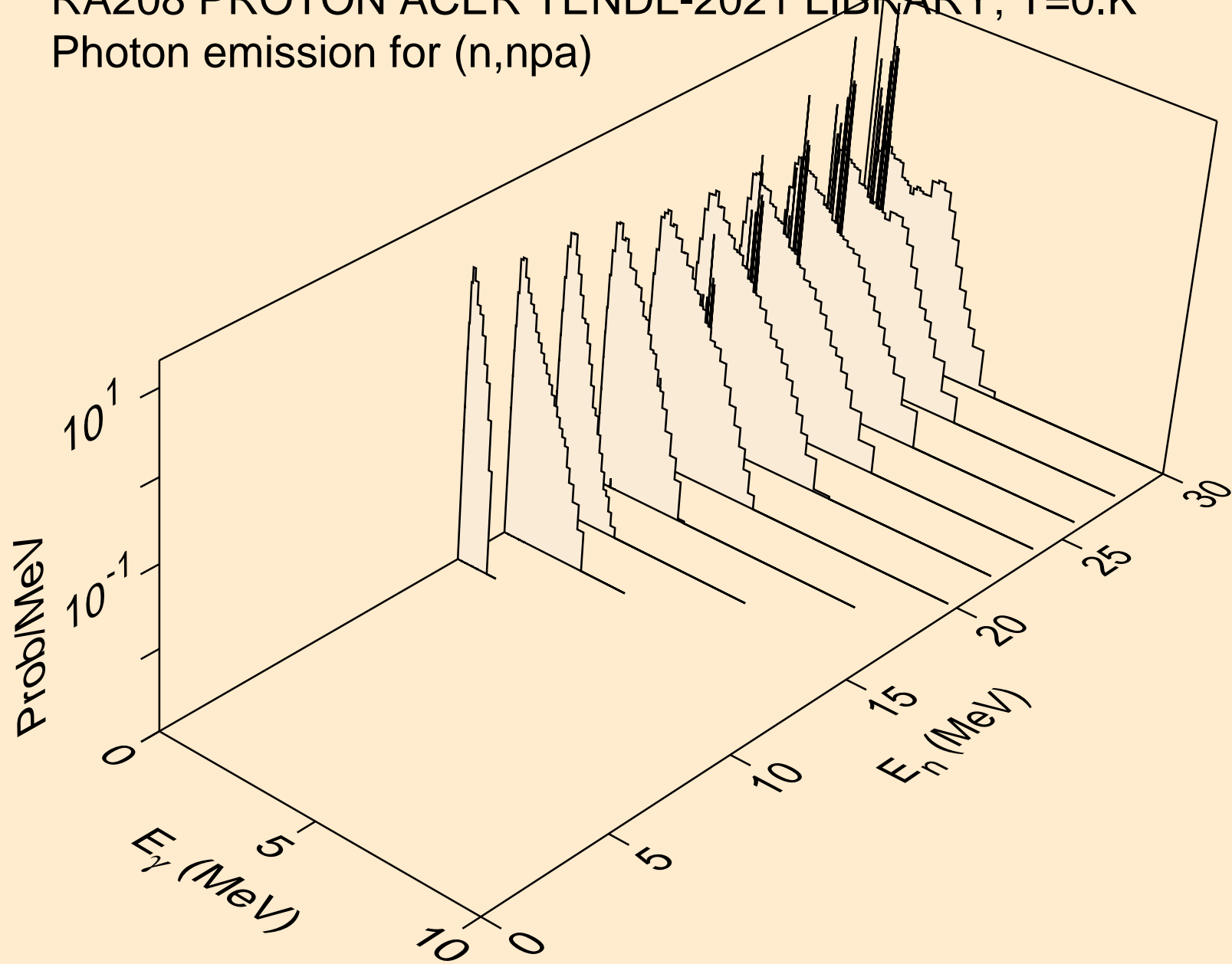

RA208 PROTON ACER TENDL-2021 LIBRARY; T=0.K
Photon emission for (n,gma)

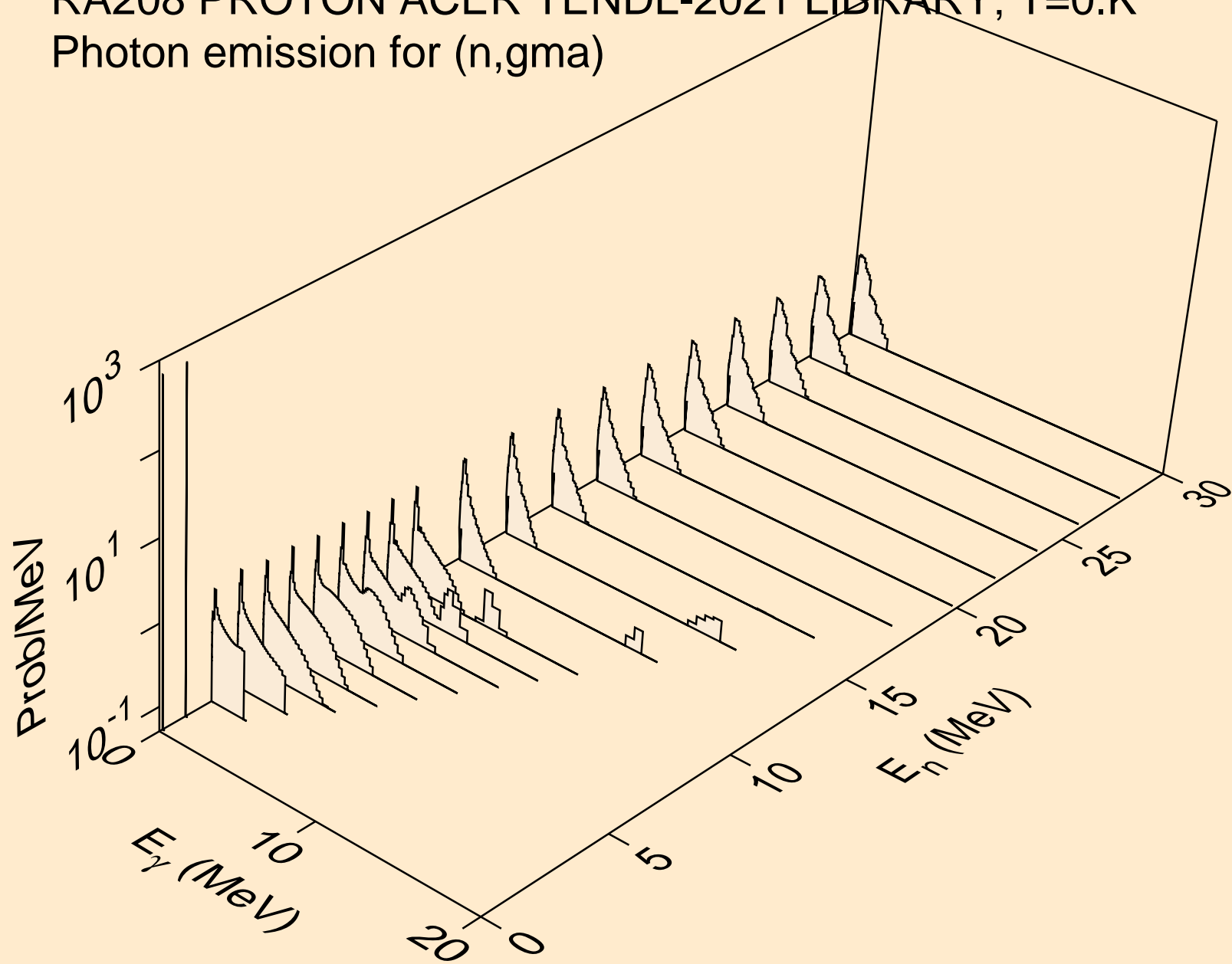

RA208 PROTON ACER TENDL-2021 LIBRARY; T=0.K
Photon emission for inelastic

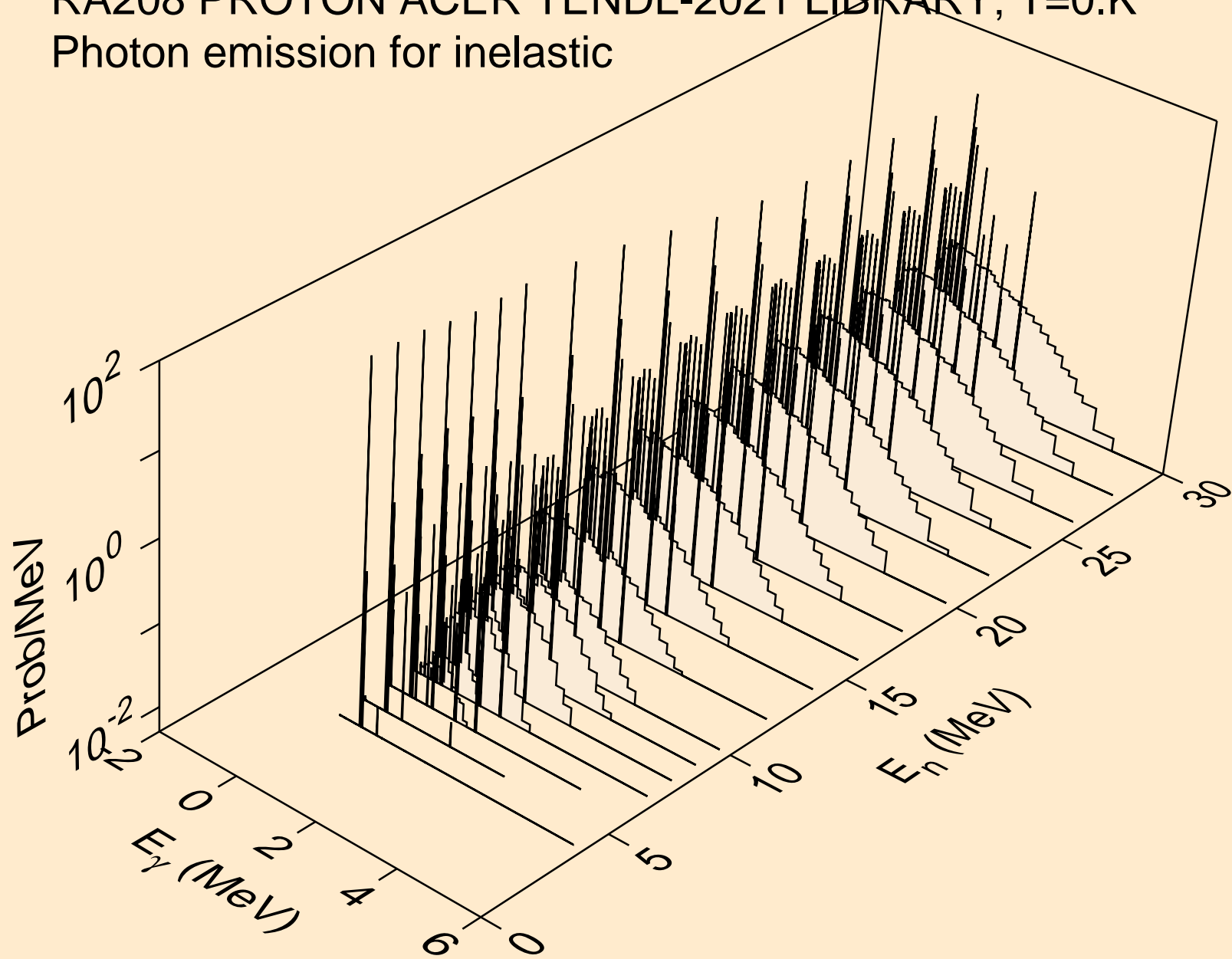

RA208 PROTON ACER TENDL-2021 LIBRARY; T=0.K
Photon emission for (n,d)

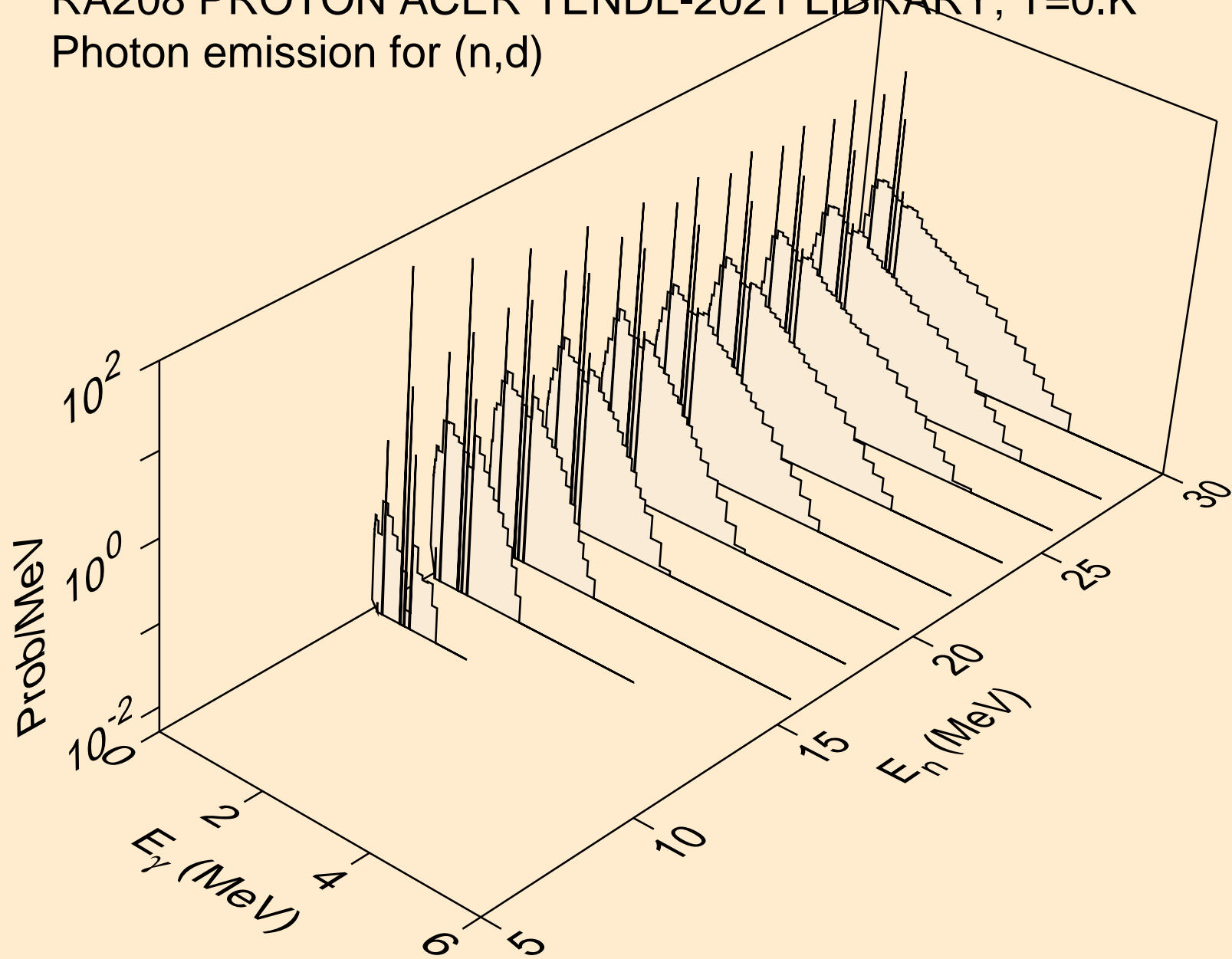

RA208 PROTON ACER TENDL-2021 LIBRARY; T=0.K
Photon emission for (n,t)

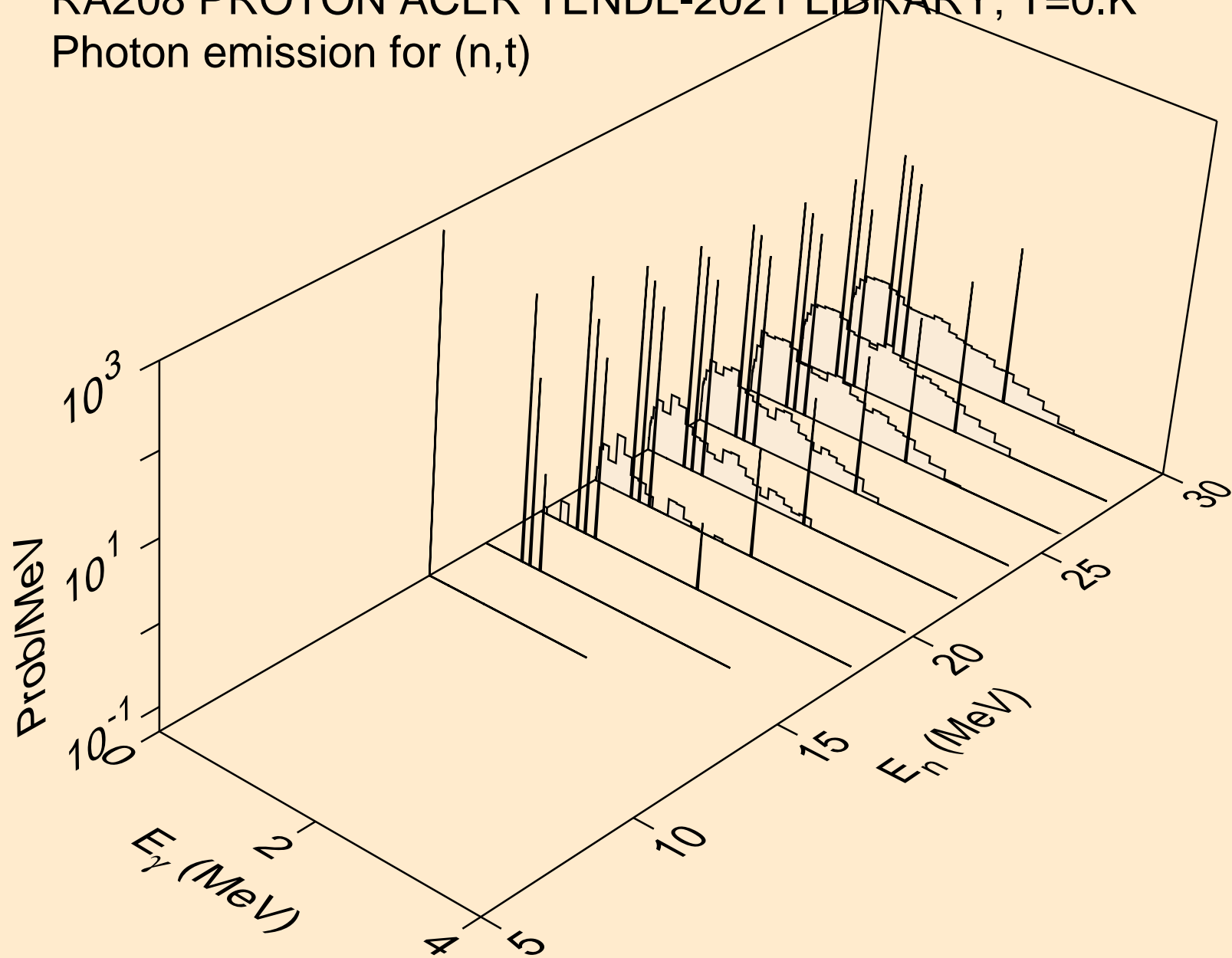

RA208 PROTON ACER TENDL-2021 LIBRARY; T=0.K
Photon emission for (n,he3)

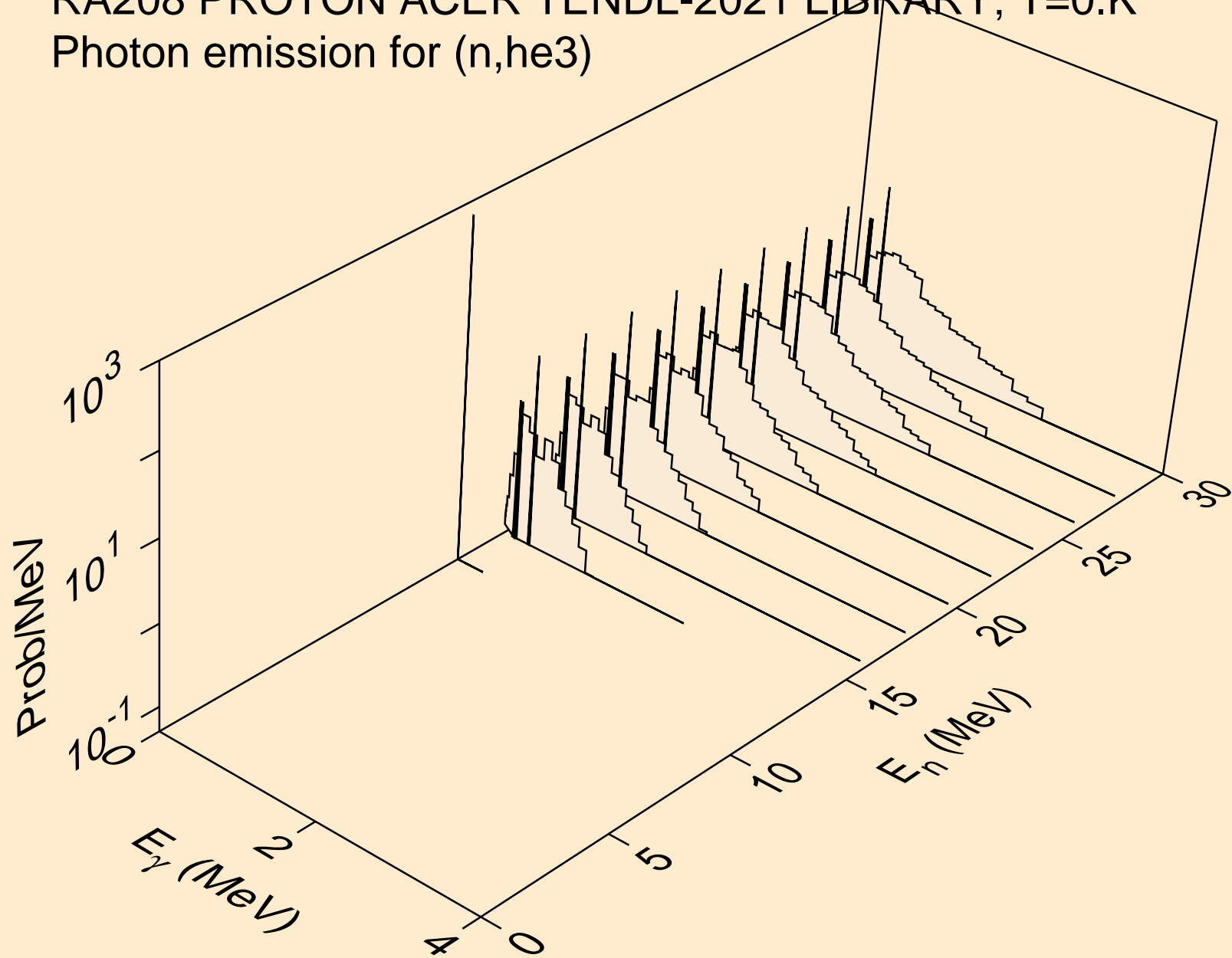

RA208 PROTON ACER TENDL-2021 LIBRARY; T=0.K
Photon emission for (n,a)

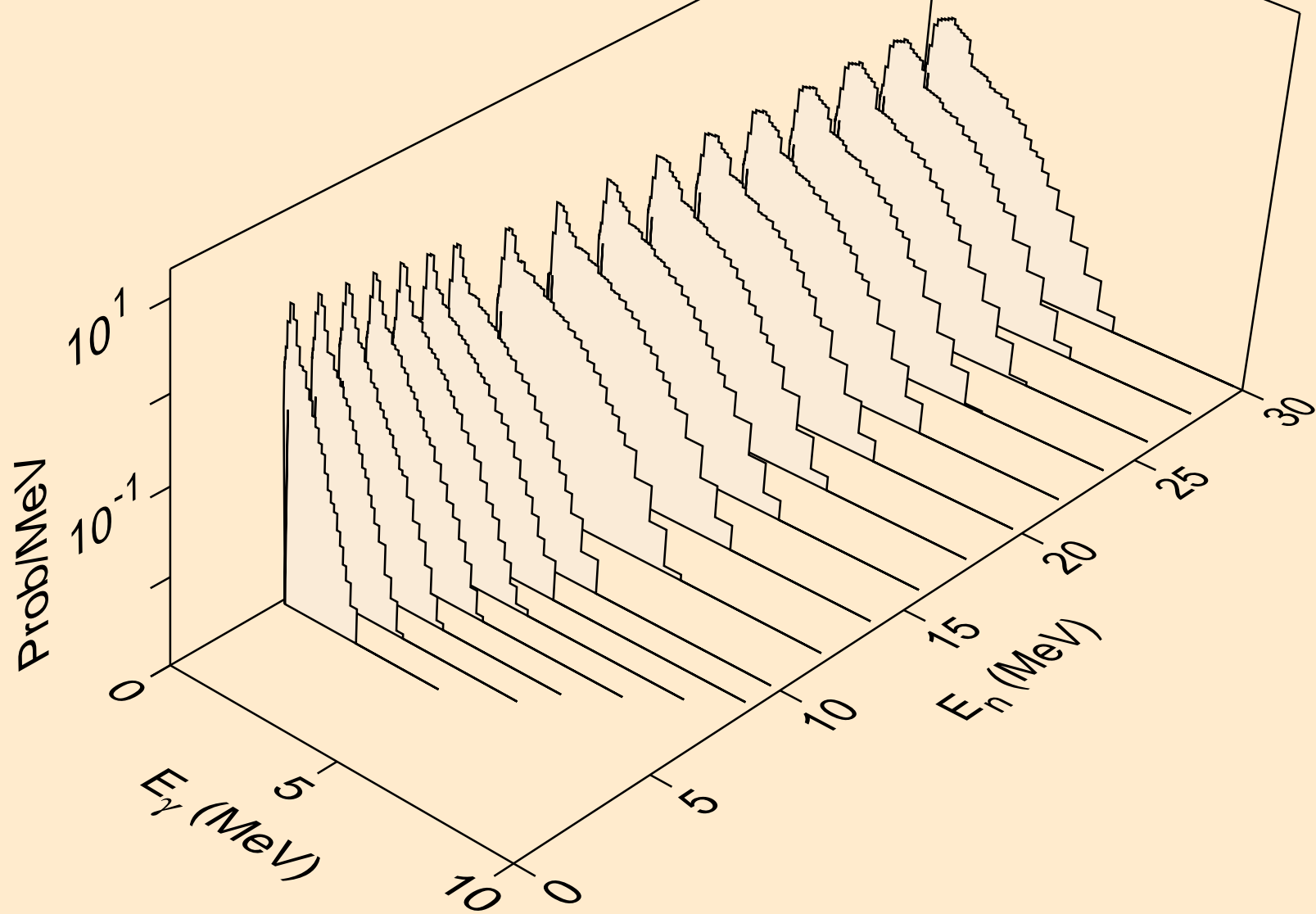

RA208 PROTON ACER TENDL-2021 LIBRARY; T=0.K
Photon emission for (n,2a)

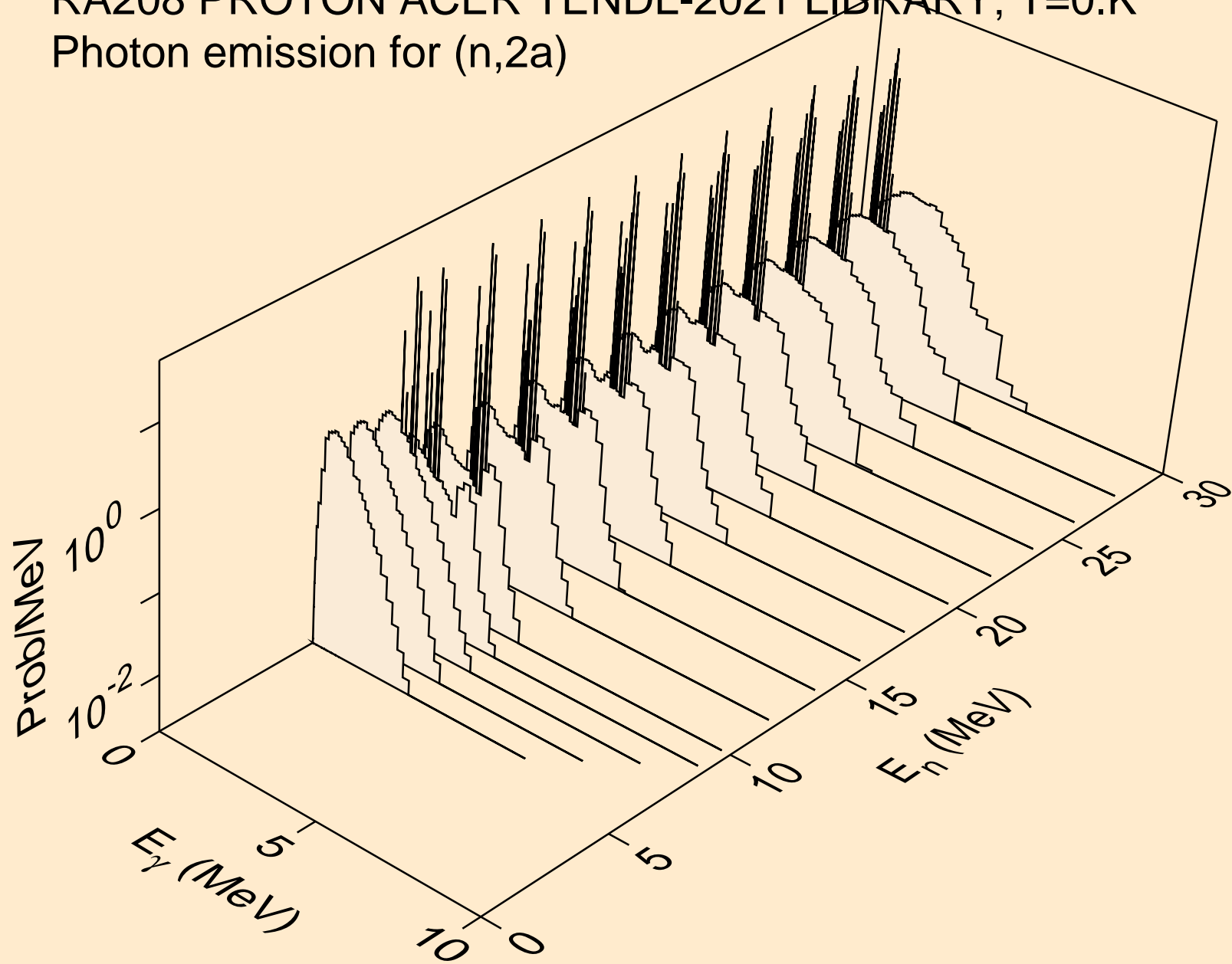

RA208 PROTON ACER TENDL-2021 LIBRARY; T=0.K
Photon emission for (n,2p)

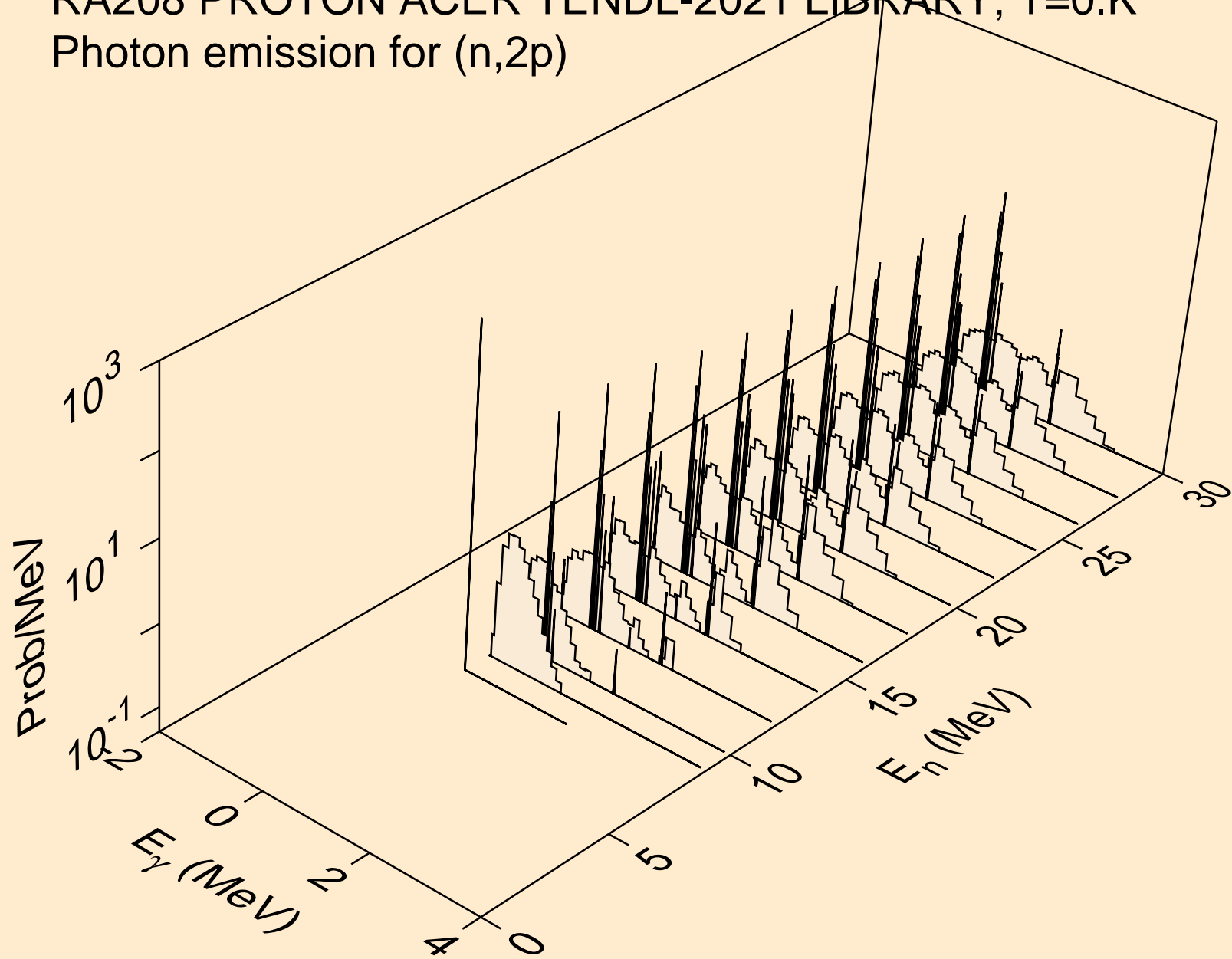

RA208 PROTON ACER TENDL-2021 LIBRARY; T=0.K
Photon emission for (n,pa)

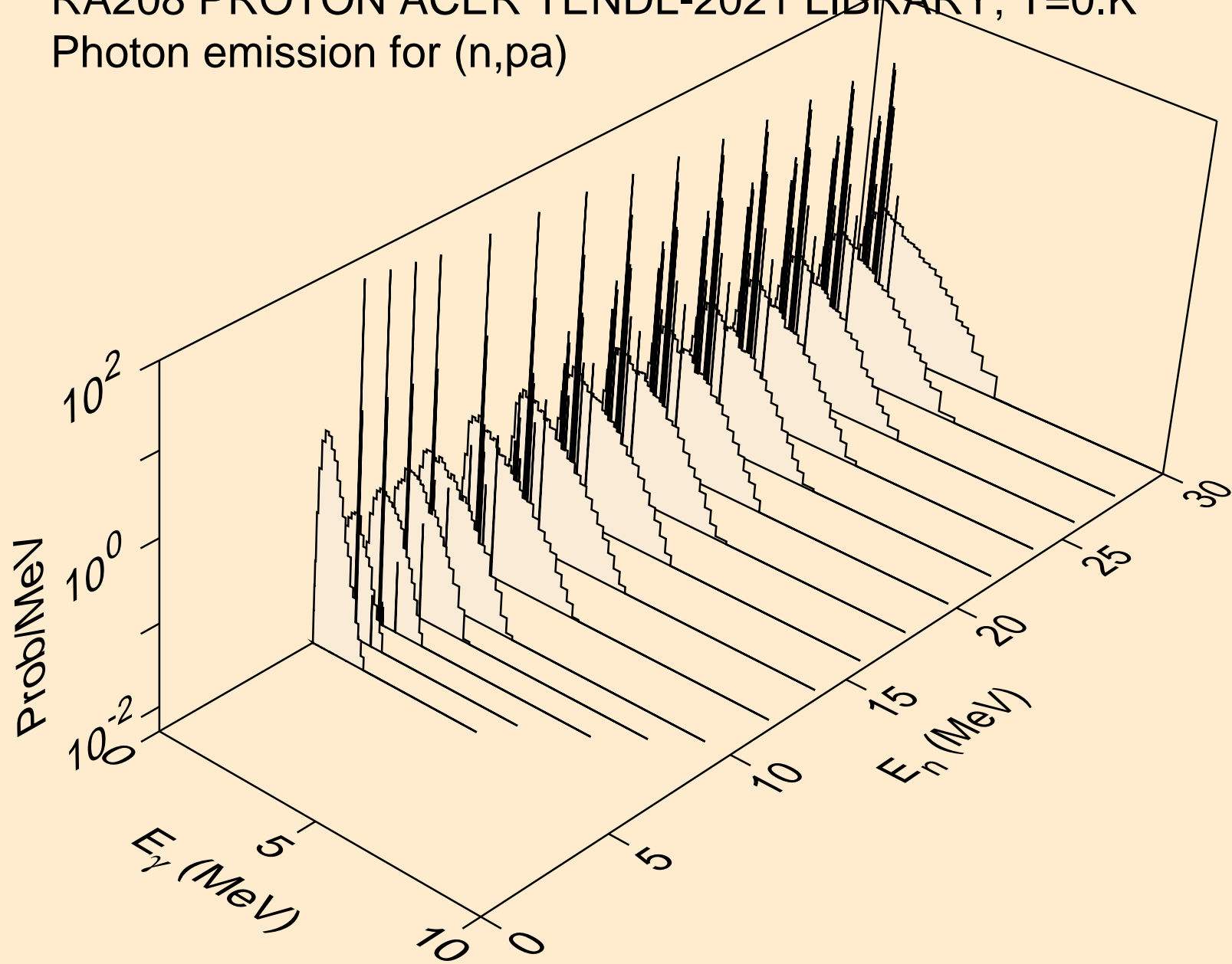

RA208 PROTON ACER TENDL-2021 LIBRARY; T=0.K
Photon emission for (n,pd)

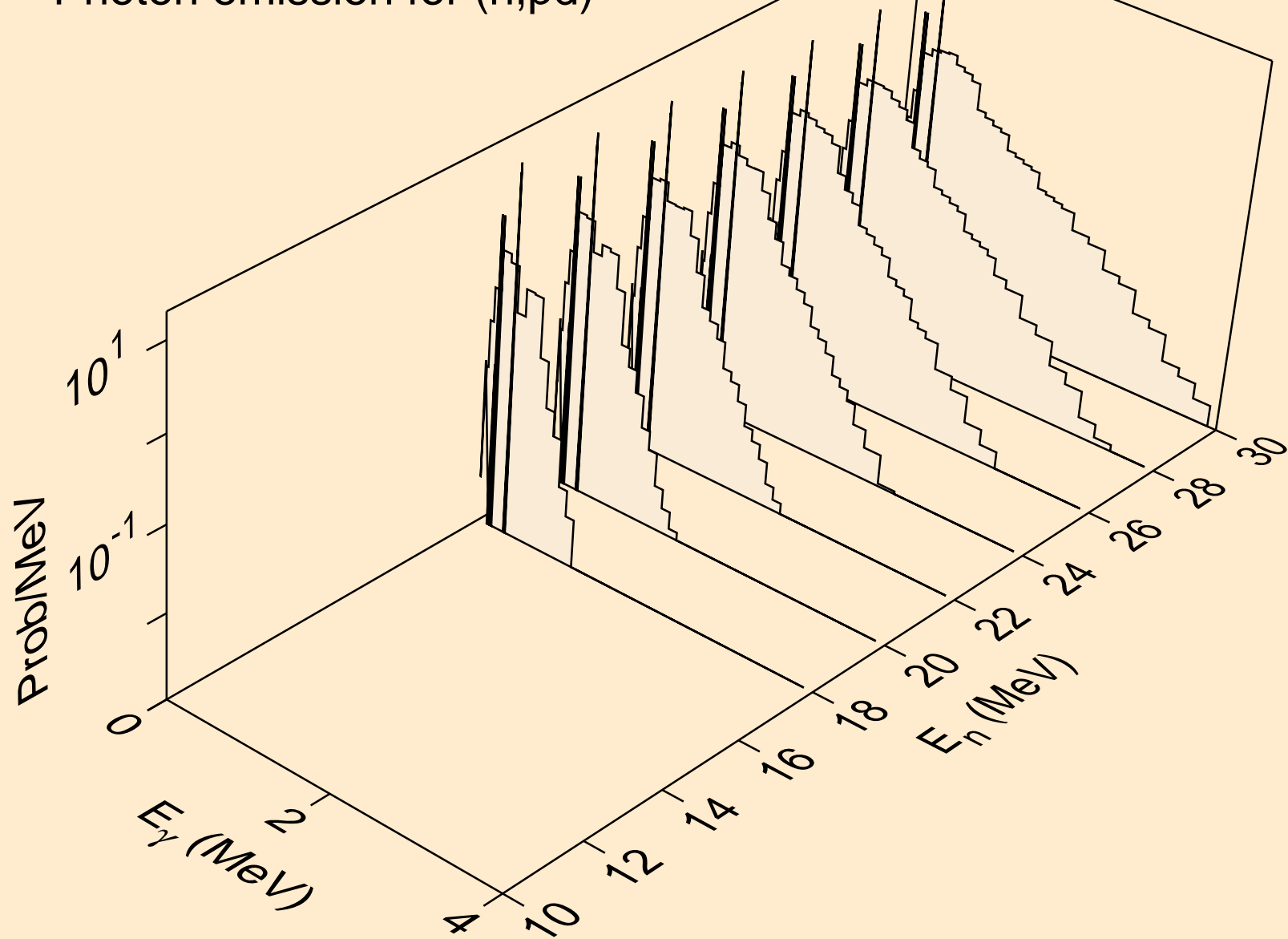

RA208 PROTON ACER TENDL-2021 LIBRARY; T=0.K
Photon emission for (n,pt)

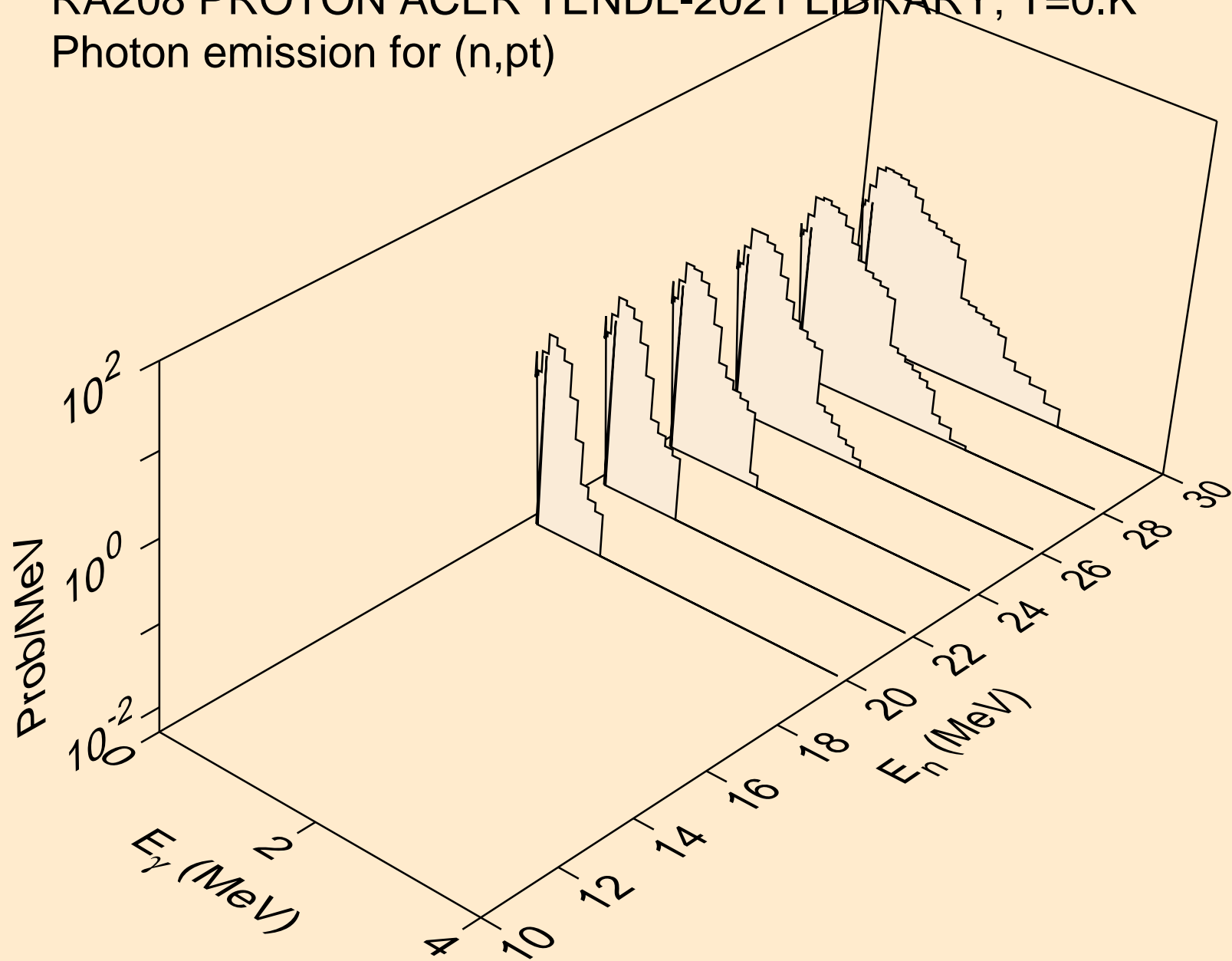

RA208 PROTON ACER TENDL-2021 LIBRARY; T=0.K
Photon emission for (n,da)

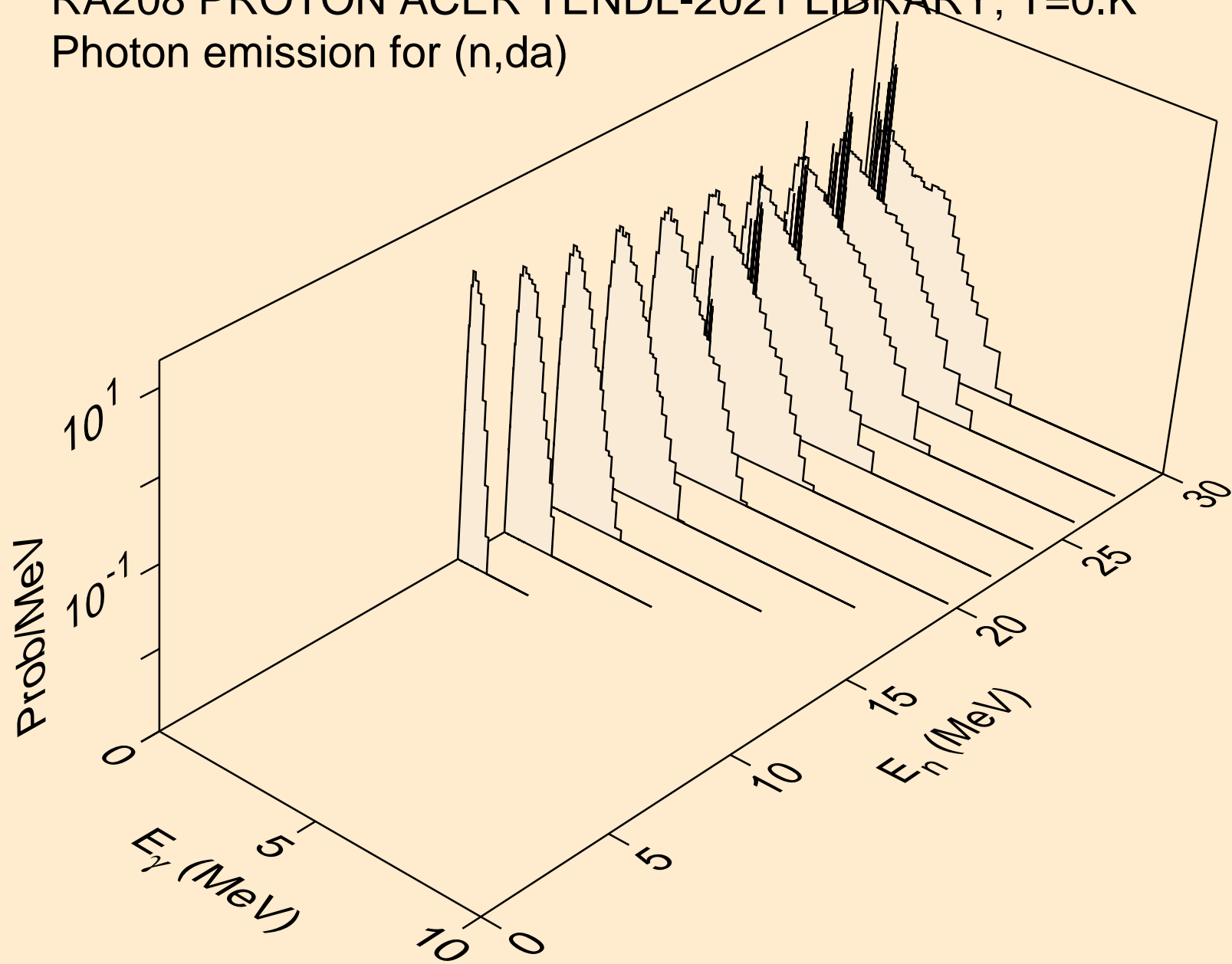

RA208 PROTON ACER TENDL-2021 LIBRARY; T=0.K
Particle heating contributions

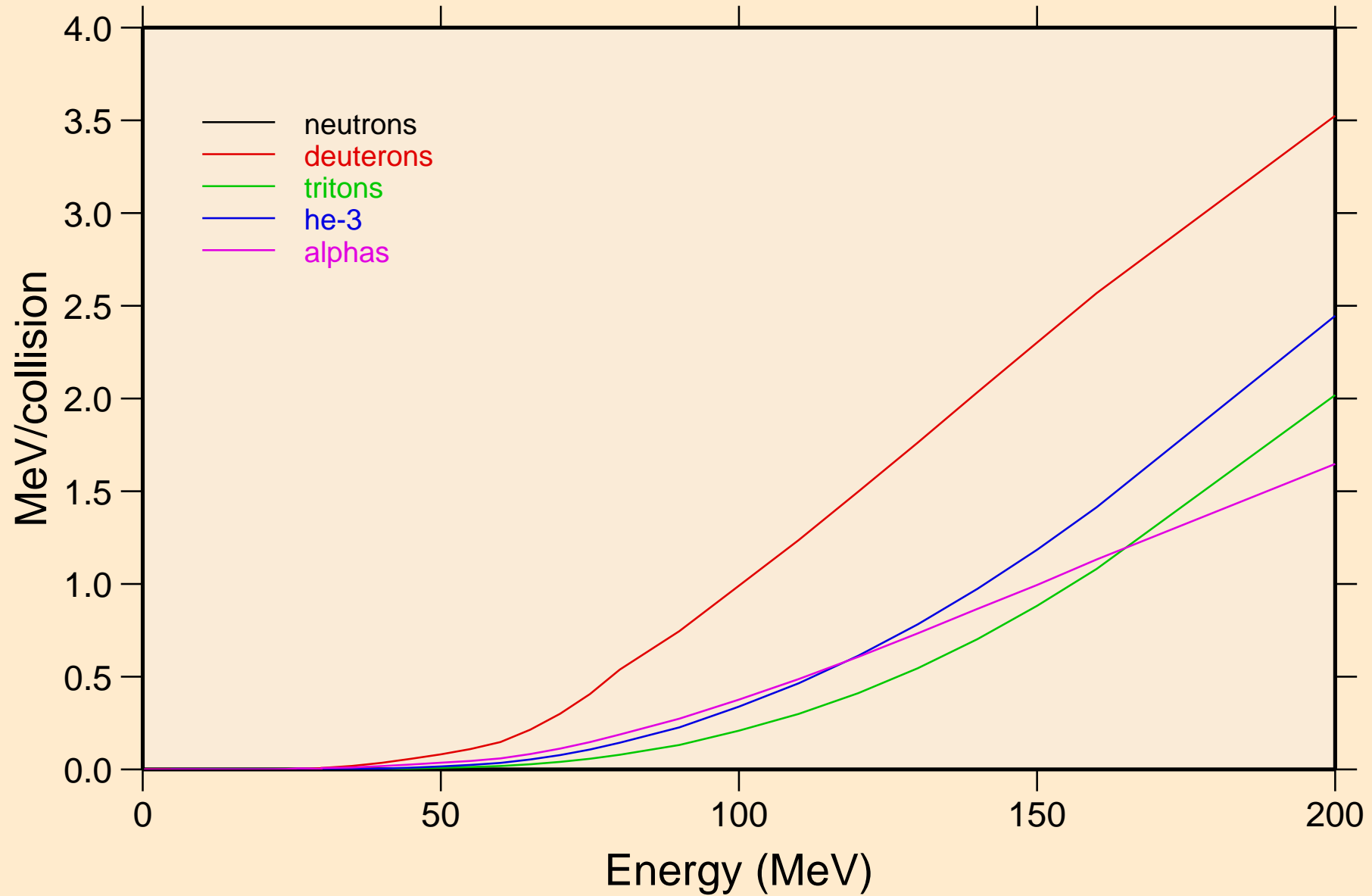

RA208 PROTON ACER TENDL-2021 LIBRARY; T=0.K
Recoil Heating

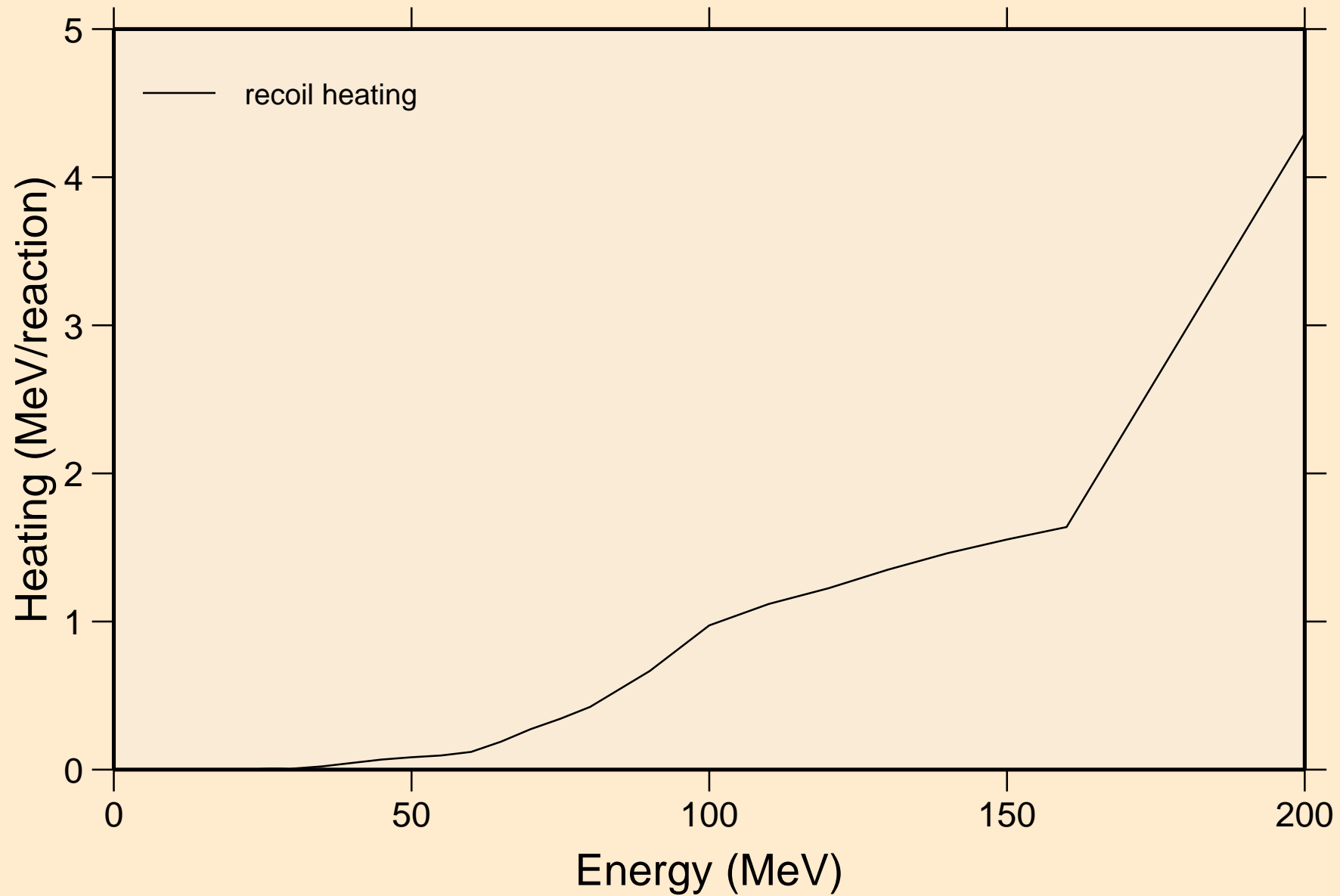

RA208 PROTON ACER TENDL-2021 LIBRARY; T=0.K

Particle production cross sections

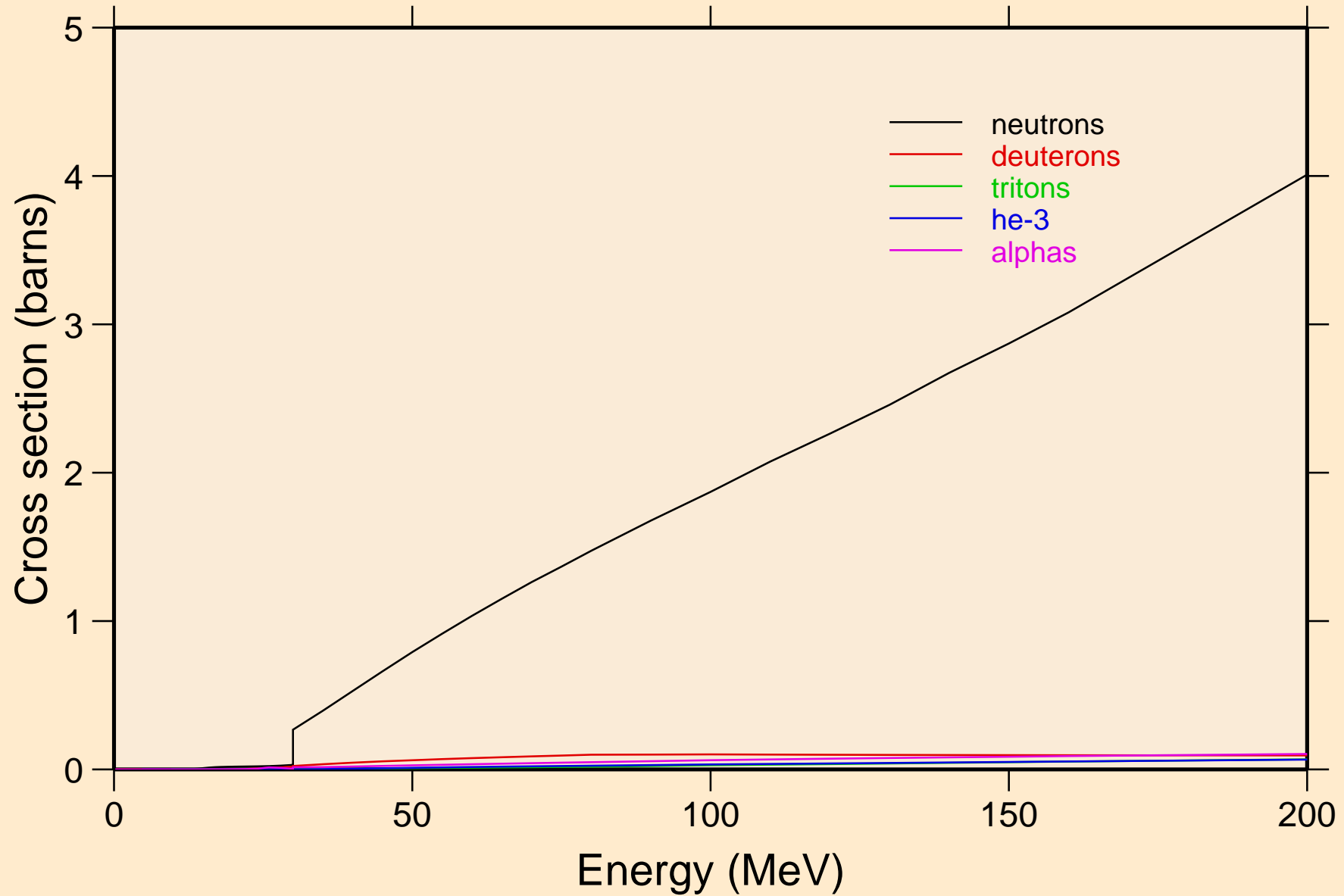

RA208 PROTON ACER TENDL-2021 LIBRARY; T=0.K
neutrons from (p,n)

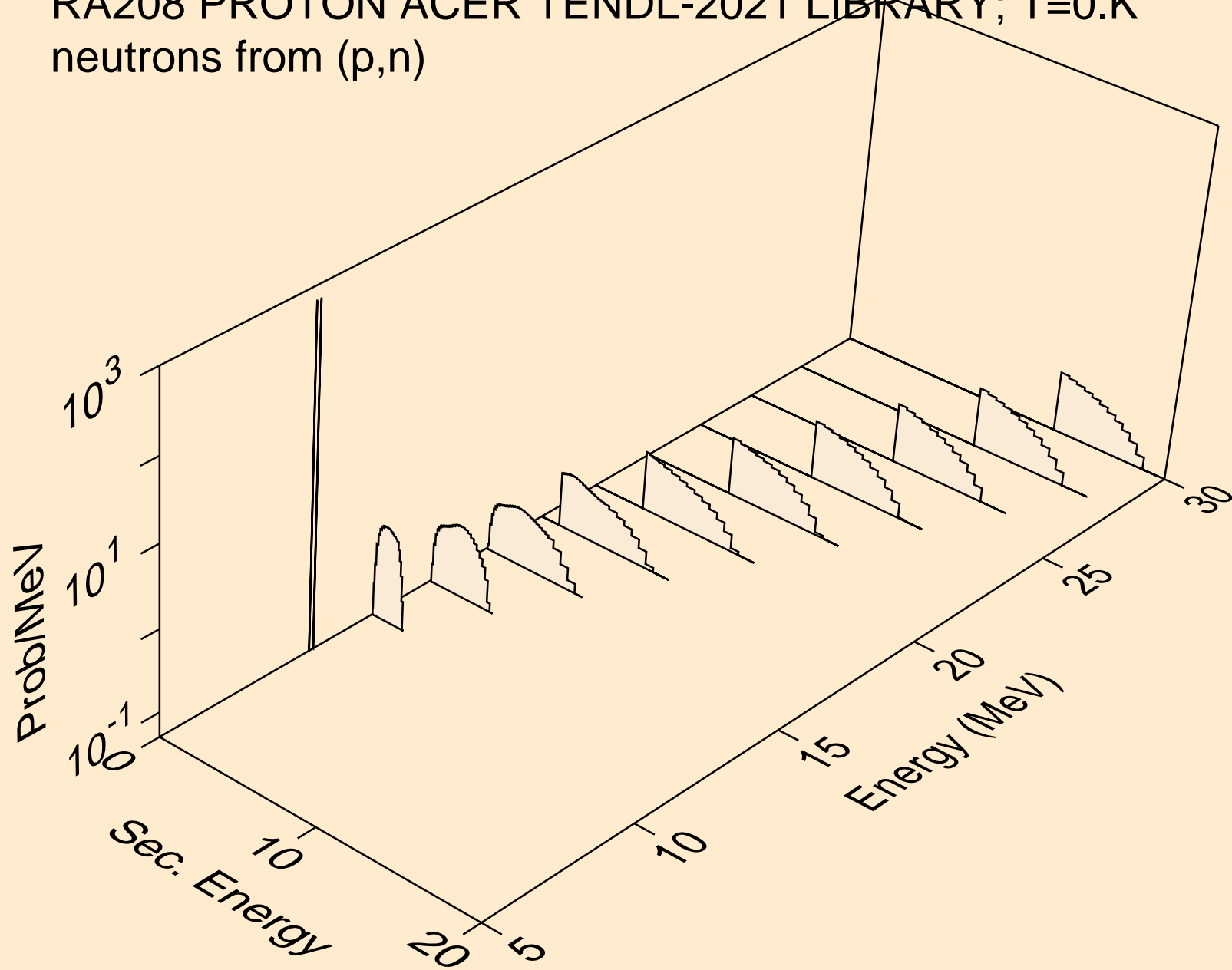

RA208 PROTON ACER TENDL-2021 LIBRARY; T=0.K
neutrons from (p,x)

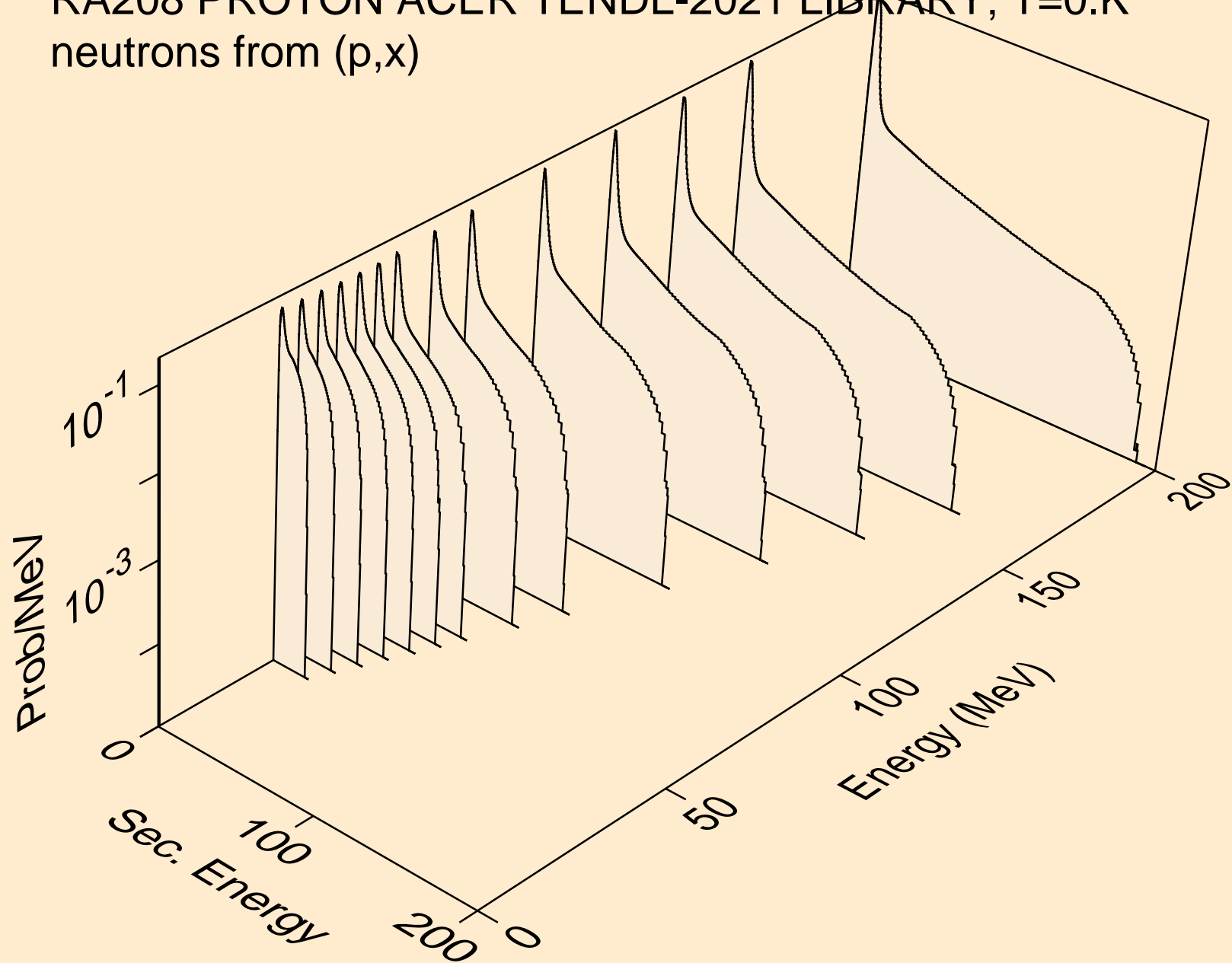

RA208 PROTON ACER TENDL-2021 LIBRARY; T=0.K
neutrons from (p,2n)

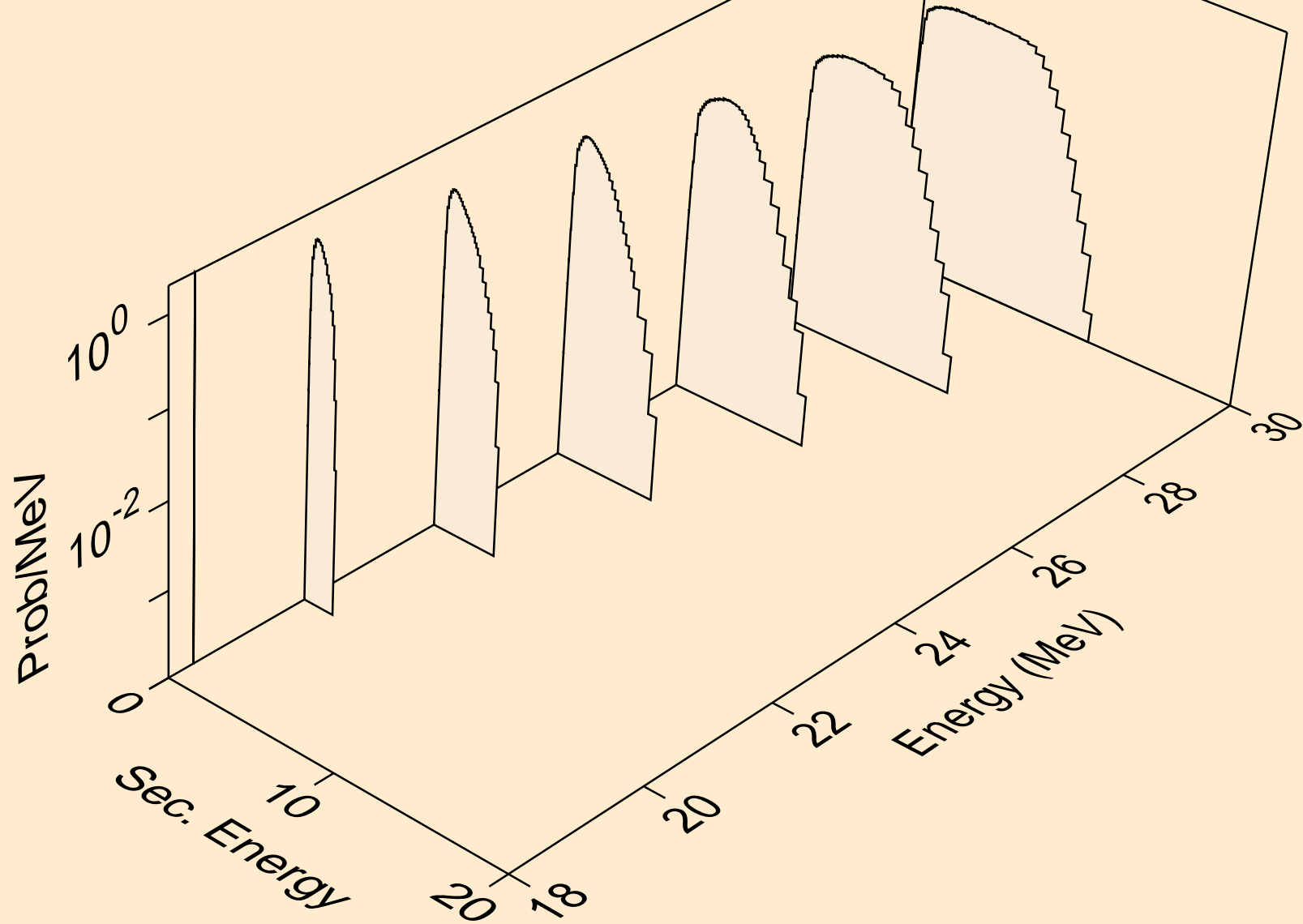

RA208 PROTON ACER TENDL-2021 LIBRARY; T=0.K
neutrons from (p,n*)a

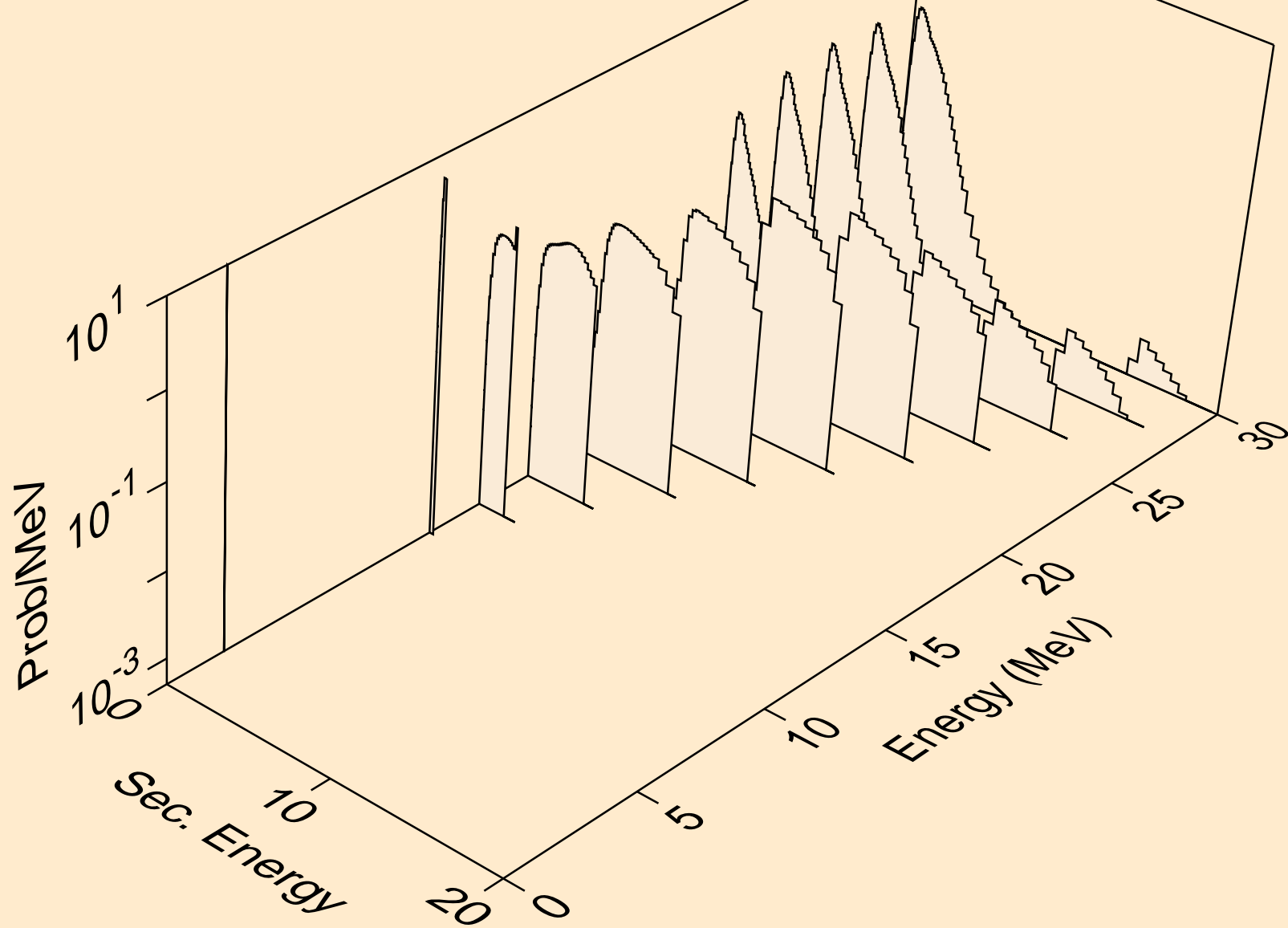

RA208 PROTON ACER TENDL-2021 LIBRARY; T=0.K
neutrons from (p,2n)a

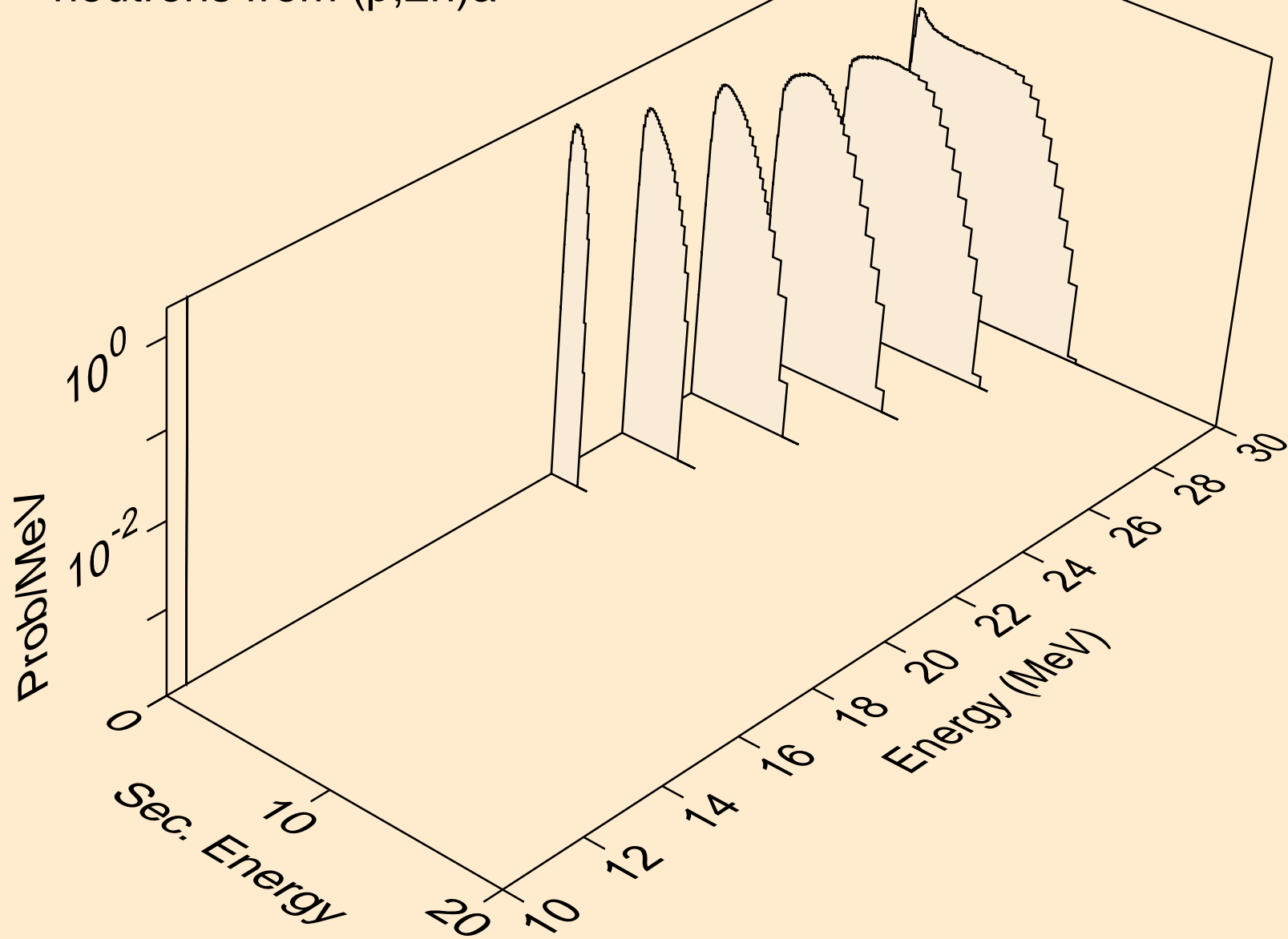

RA208 PROTON ACER TENDL-2021 LIBRARY; T=0.K
neutrons from (p,n*)p

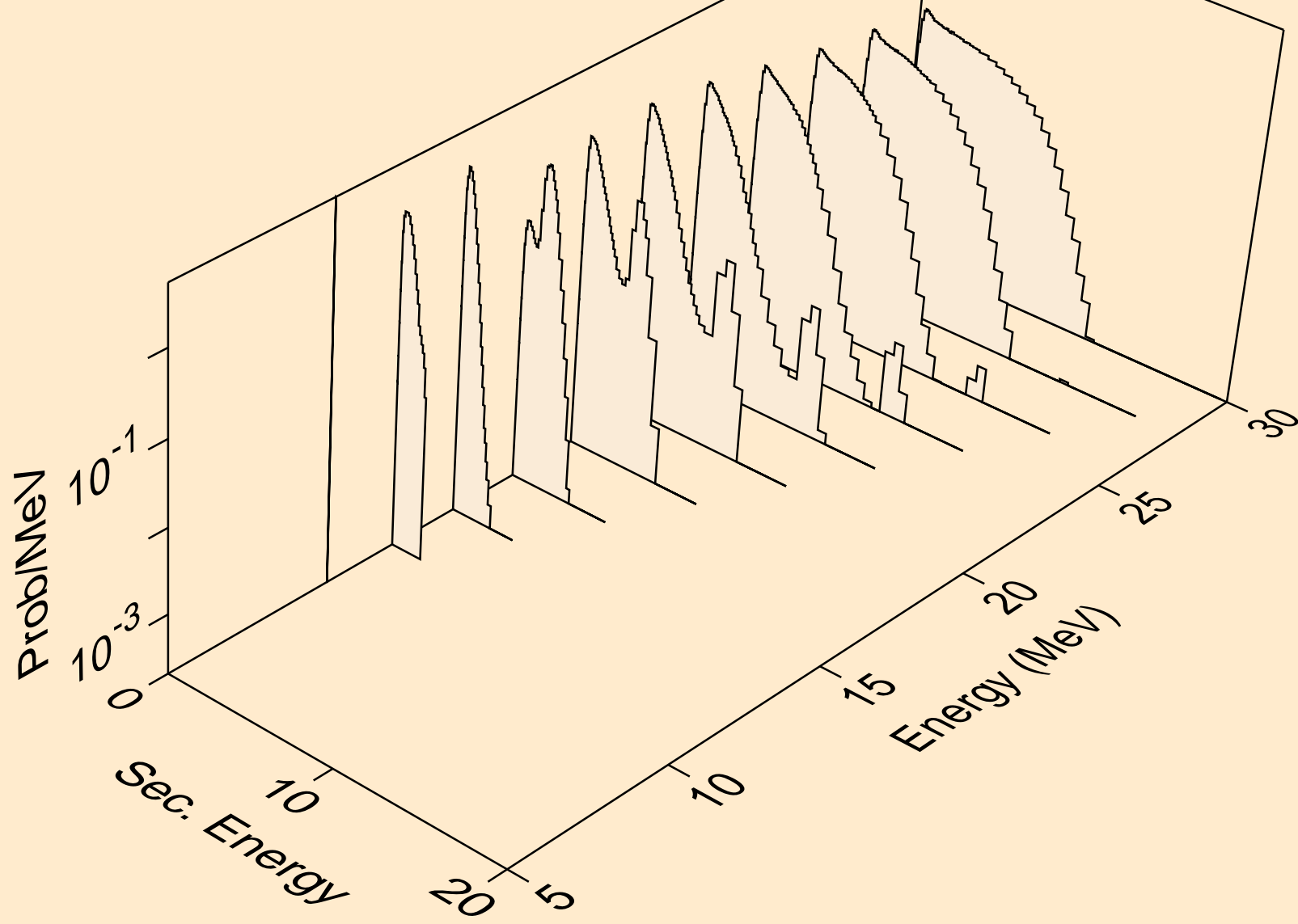

RA208 PROTON ACER TENDL-2021 LIBRARY; T=0.K
neutrons from (p,n*)2a

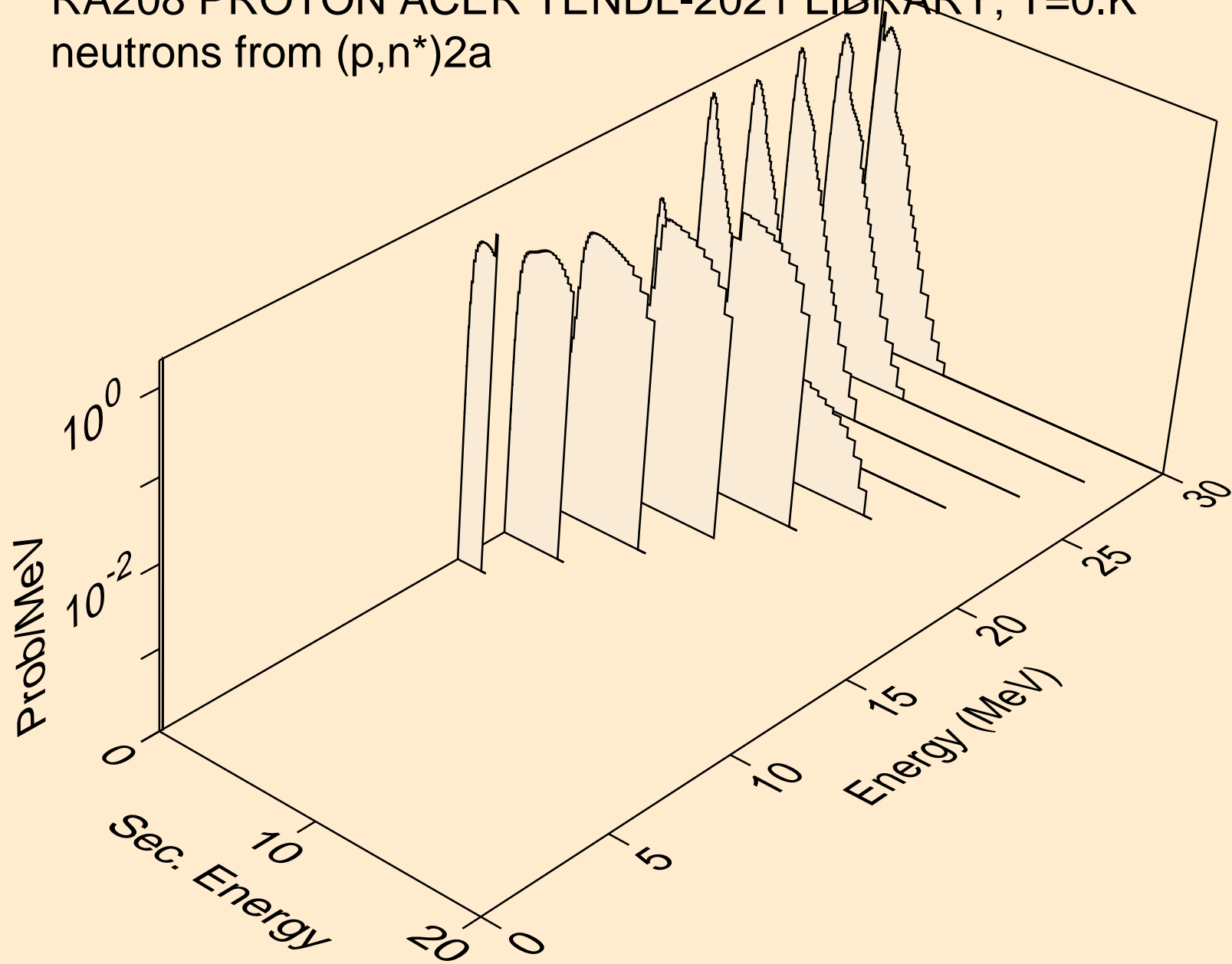

RA208 PROTON ACER TENDL-2021 LIBRARY; T=0.K
neutrons from (p,n*)d

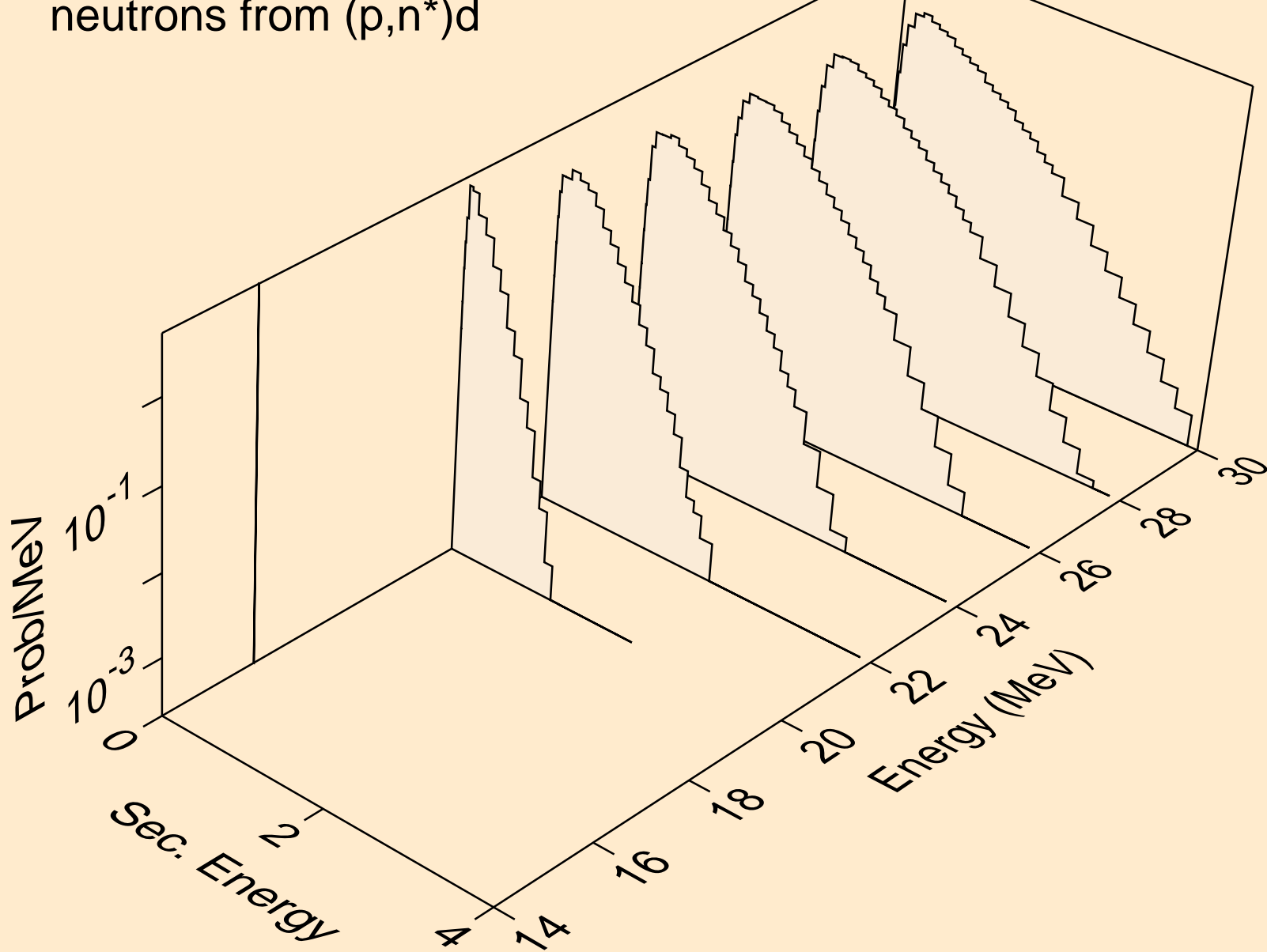

RA208 PROTON ACER TENDL-2021 LIBRARY; T=0.K
neutrons from (p,n*)t

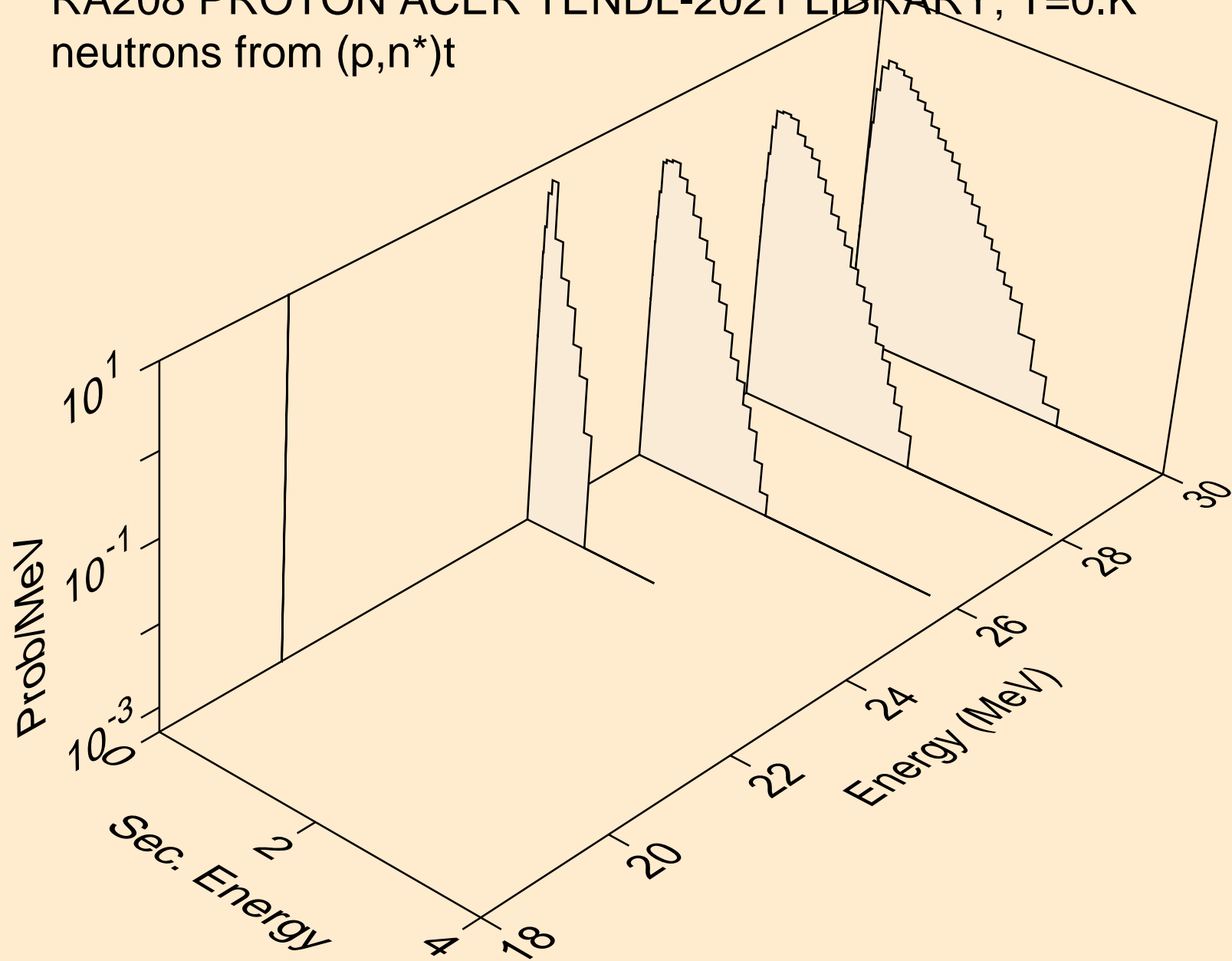

RA208 PROTON ACER TENDL-2021 LIBRARY; T=0.K
neutrons from (p,n*)he3

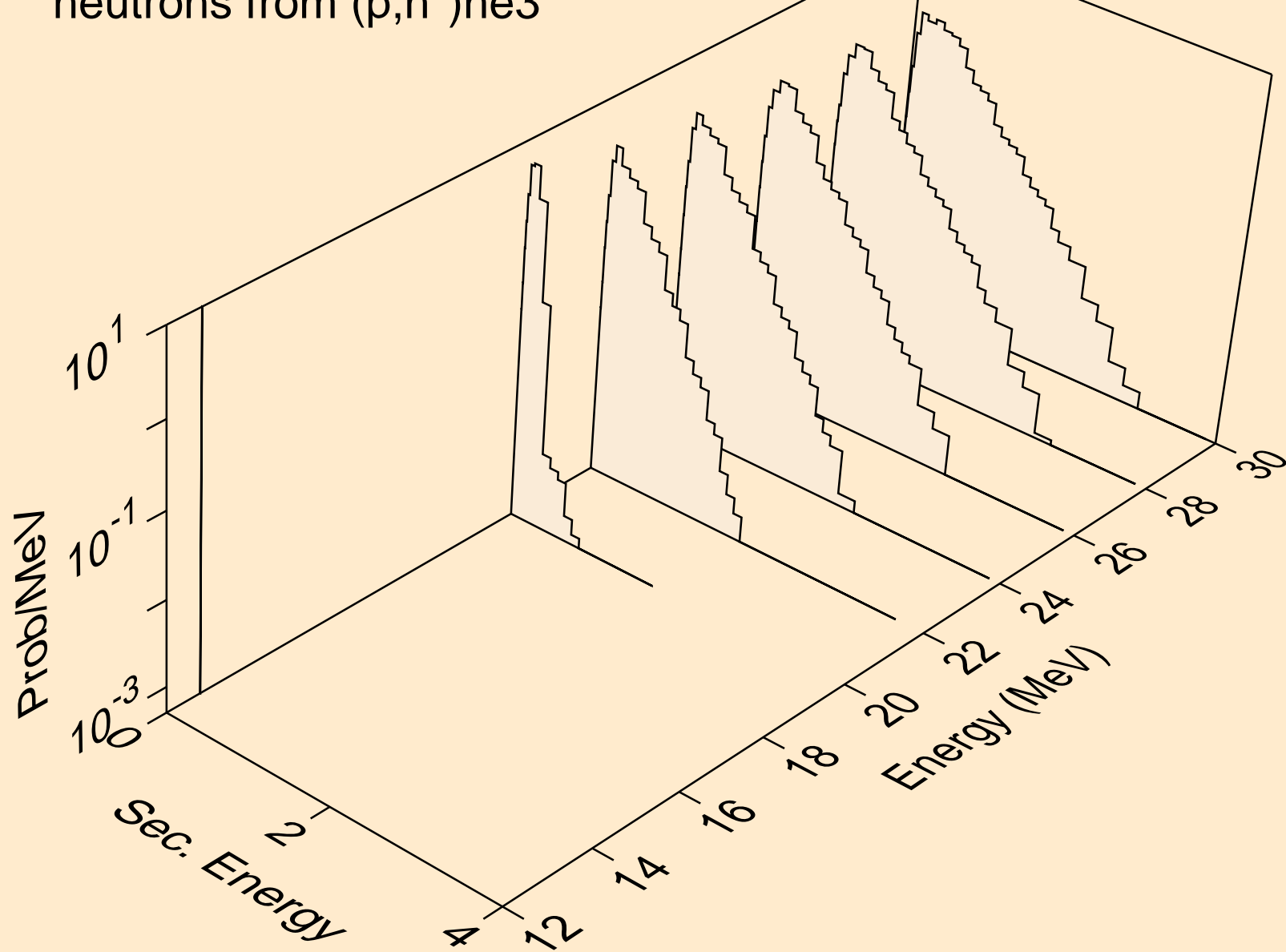

RA208 PROTON ACER TENDL-2021 LIBRARY; T=0.K
neutrons from (p,2np)

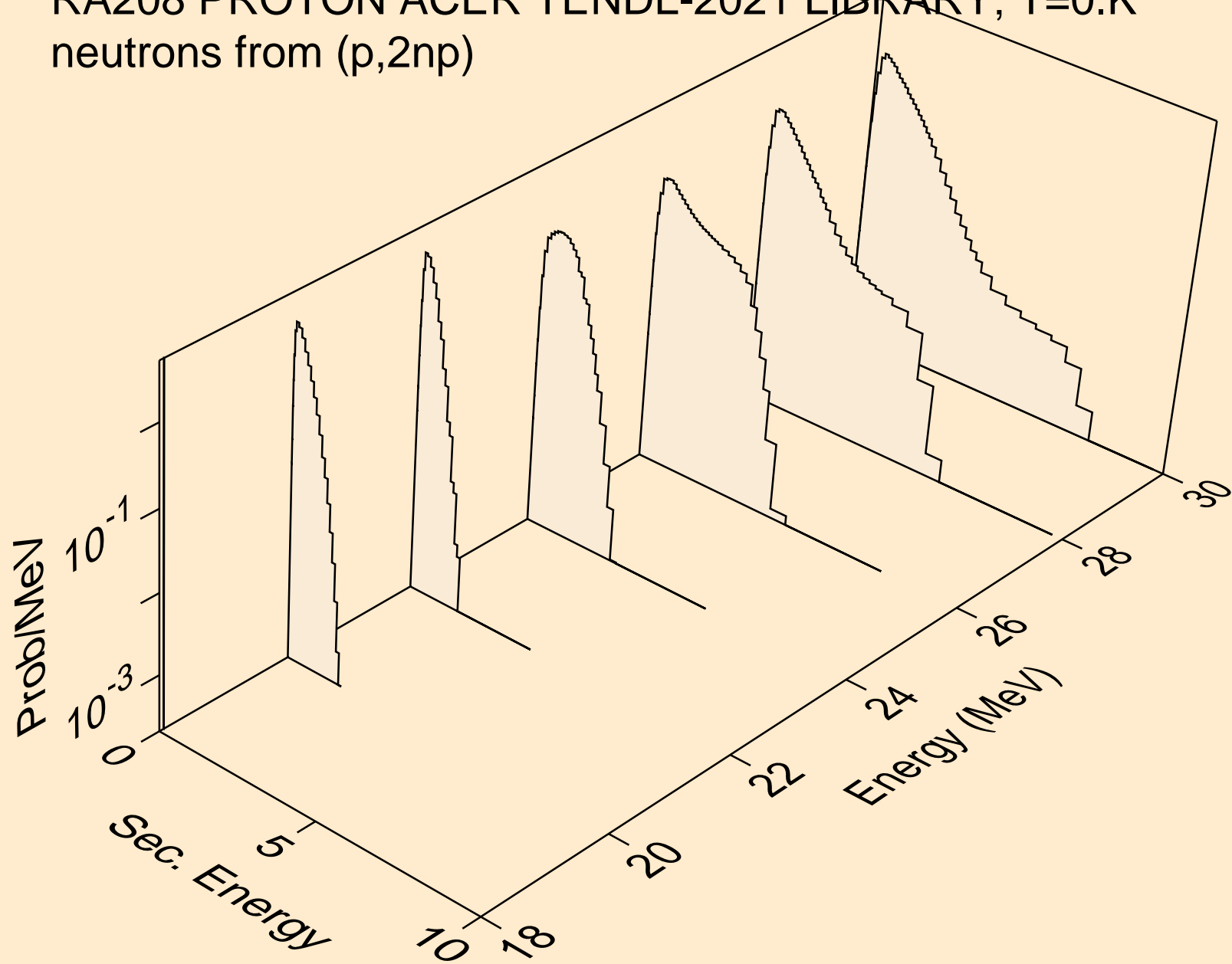

RA208 PROTON ACER TENDL-2021 LIBRARY; T=0.K
neutrons from (p,2np)

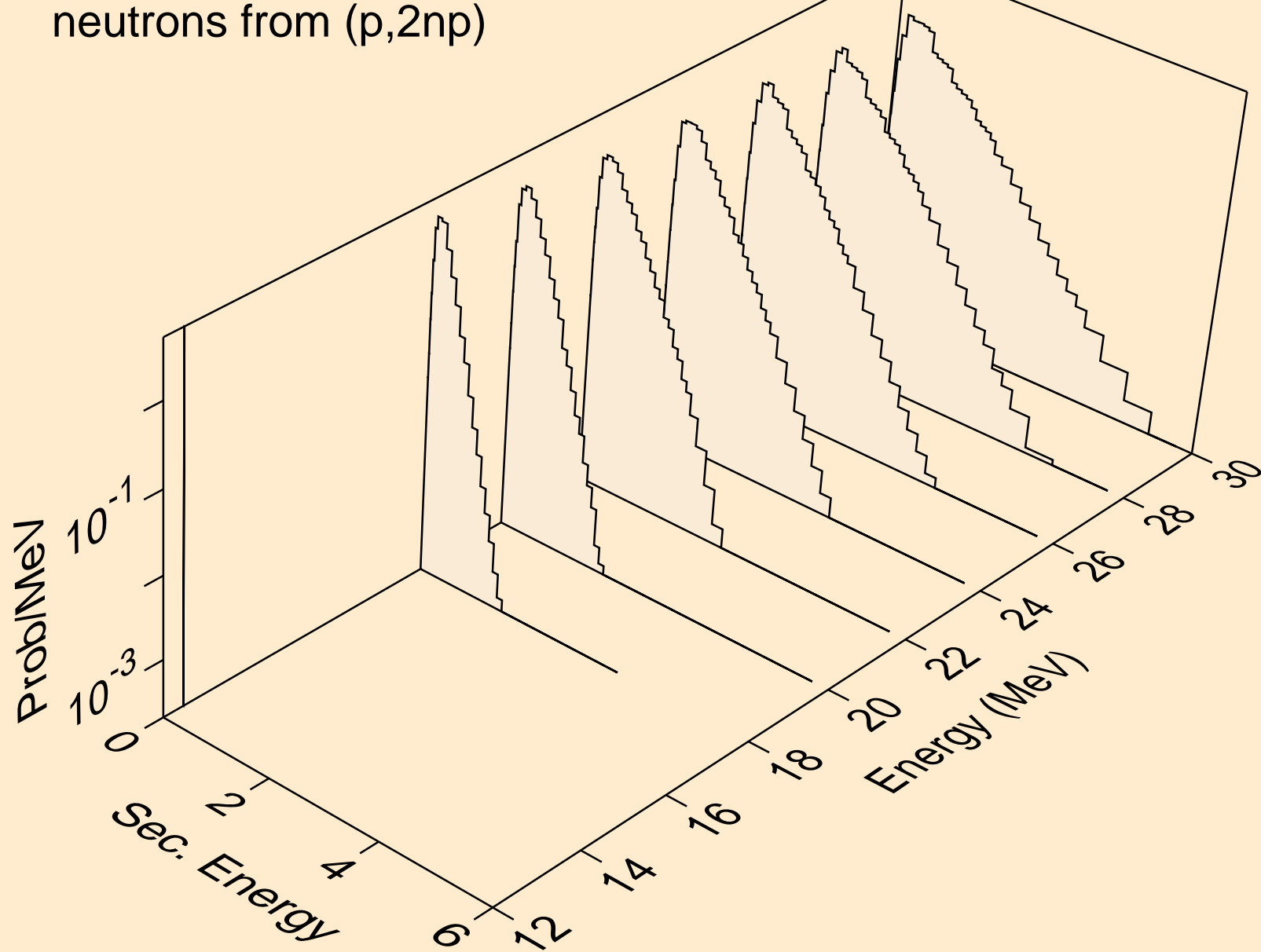

RA208 PROTON ACER TENDL-2021 LIBRARY; T=0.K
neutrons from (p,npa)

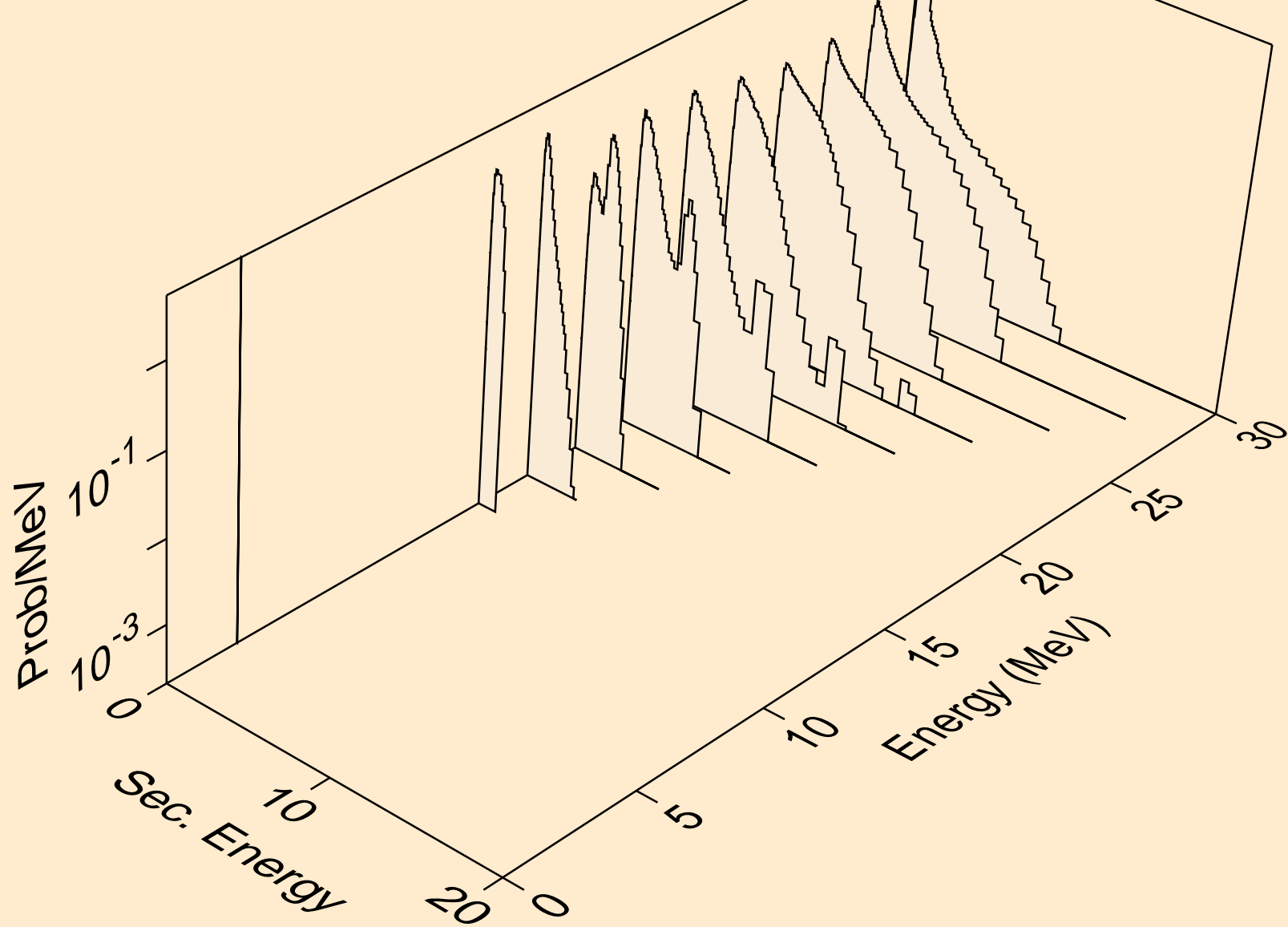

RA208 PROTON ACER TENDL-2021 LIBRARY; T=0.K
deuterons from (p,x)

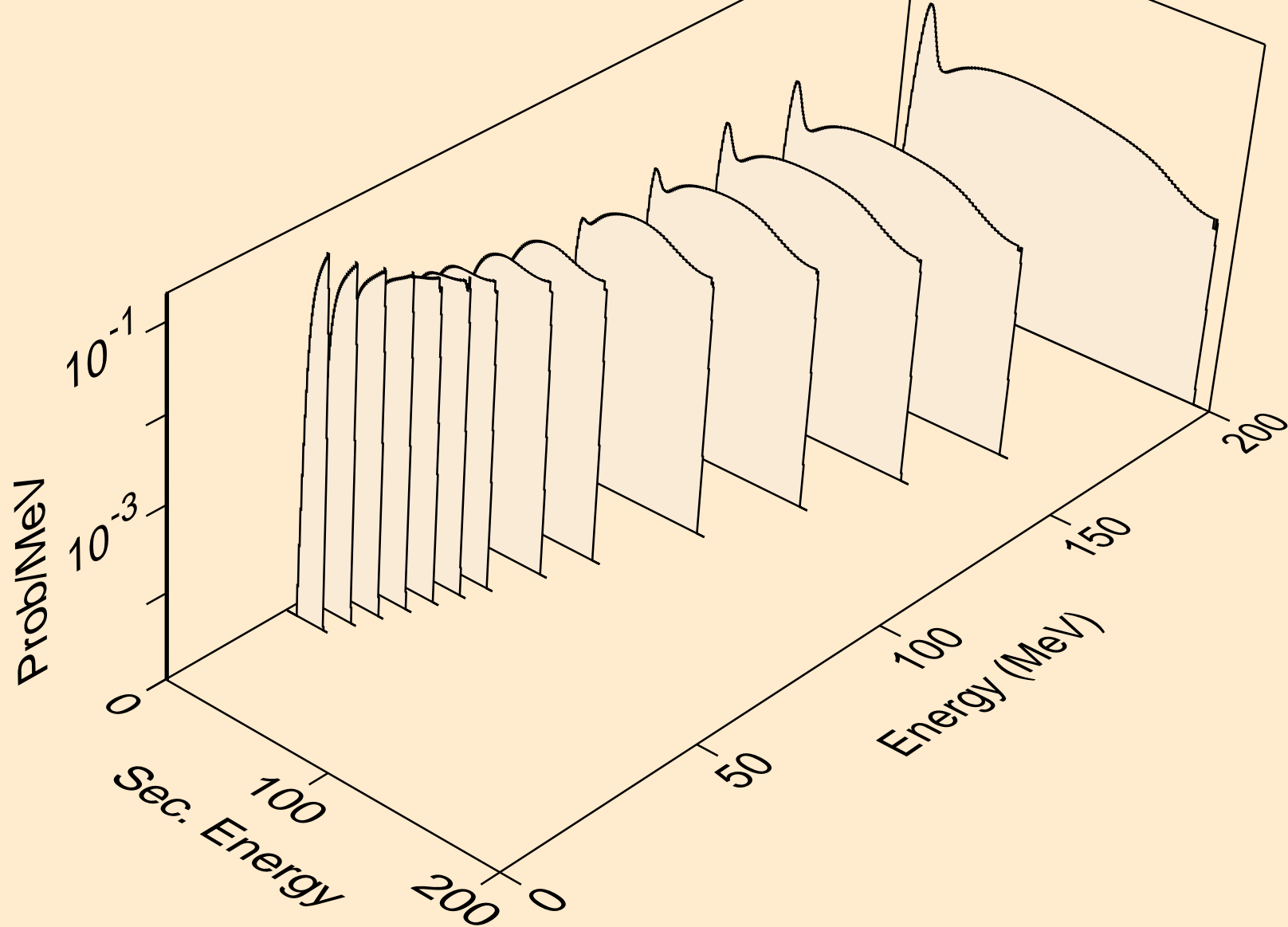

RA208 PROTON ACER TENDL-2021 LIBRARY; T=0.K
deuterons from (p,n*)d

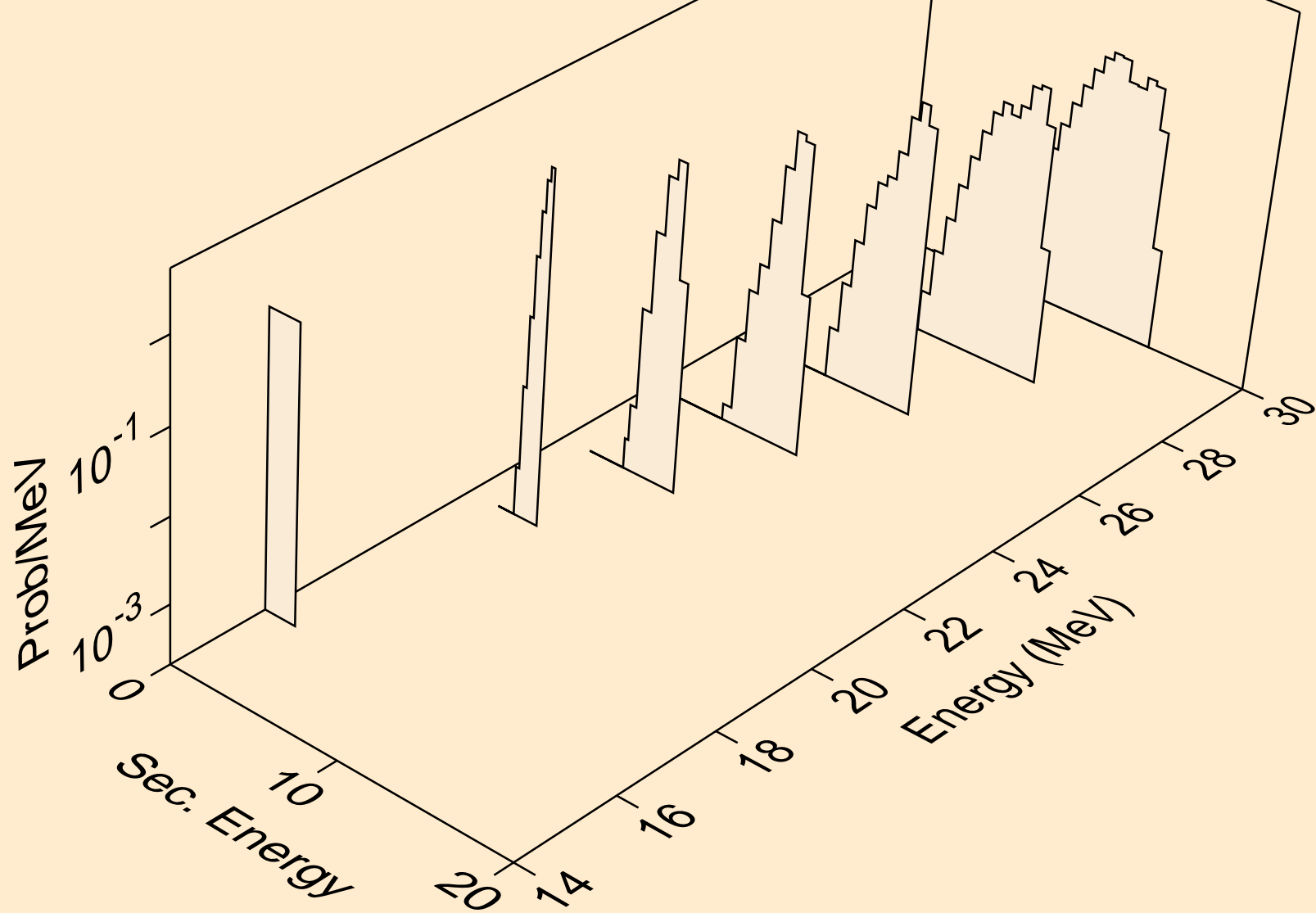

RA208 PROTON ACER TENDL-2021 LIBRARY; T=0.K
deuterons from (p,d)

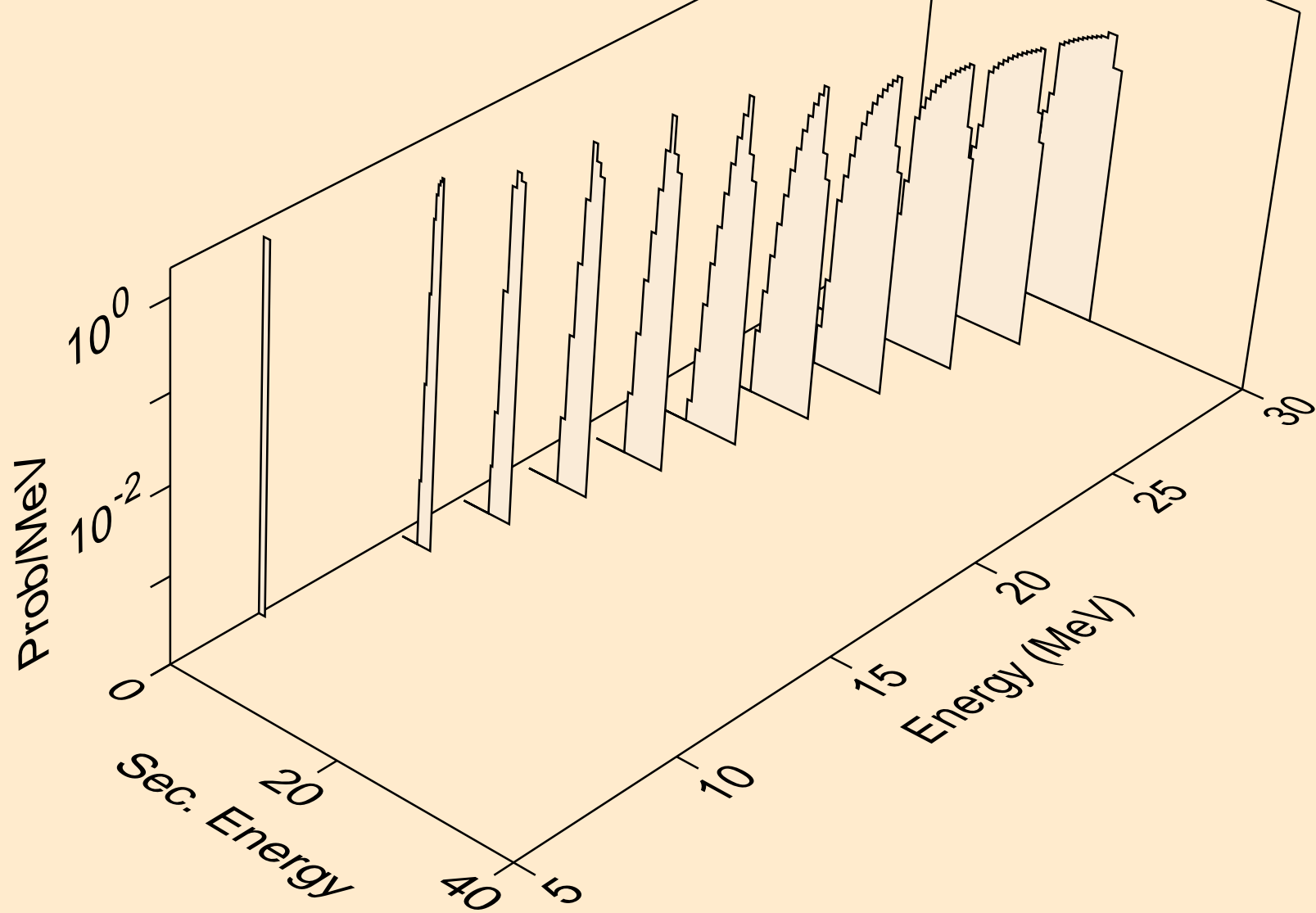

RA208 PROTON ACER TENDL-2021 LIBRARY; T=0.K
deuterons from (p,pd)

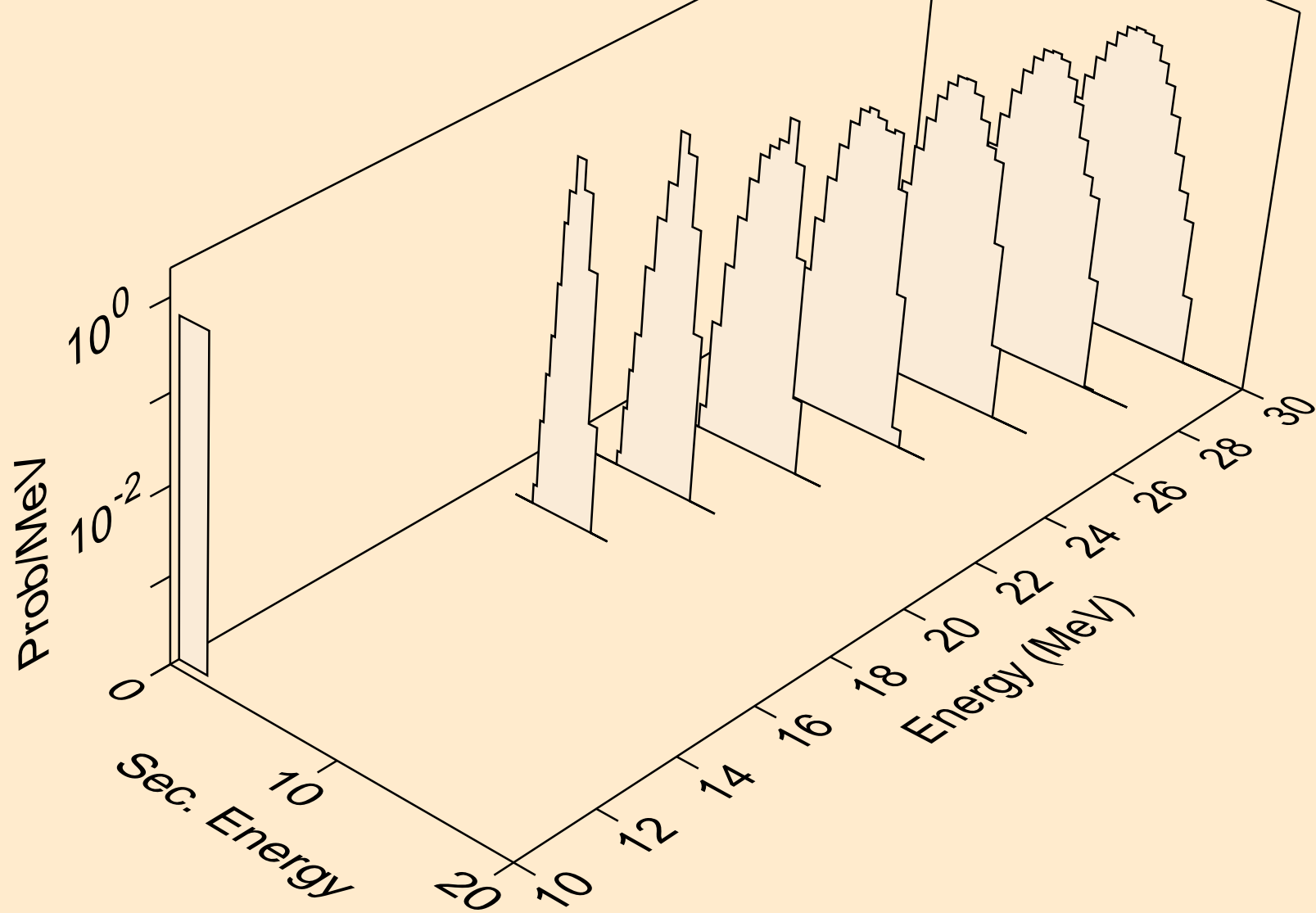

RA208 PROTON ACER TENDL-2021 LIBRARY; T=0.K
deuterons from (p,da)

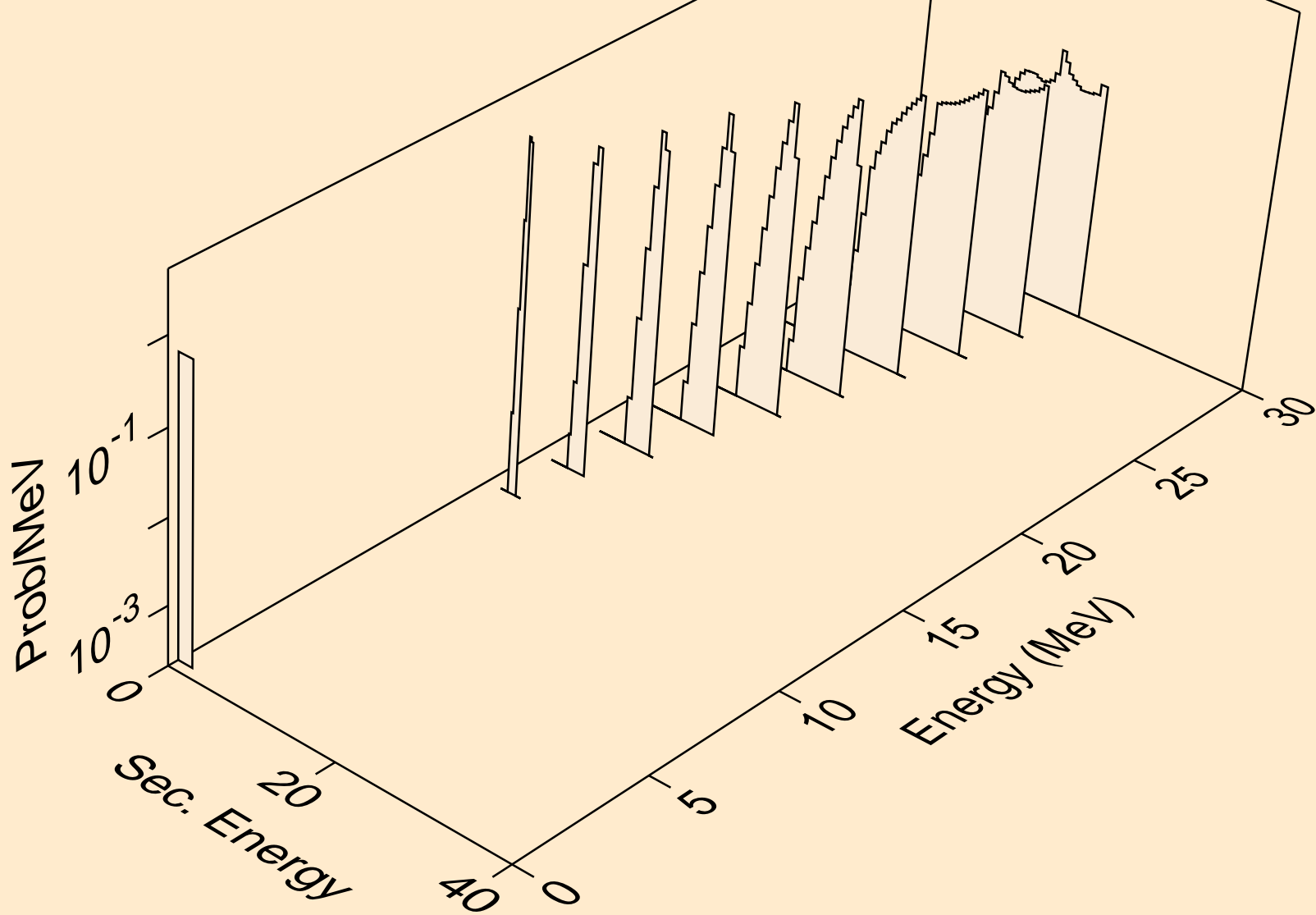

RA208 PROTON ACER TENDL-2021 LIBRARY; T=0.K
tritons from (p,x)

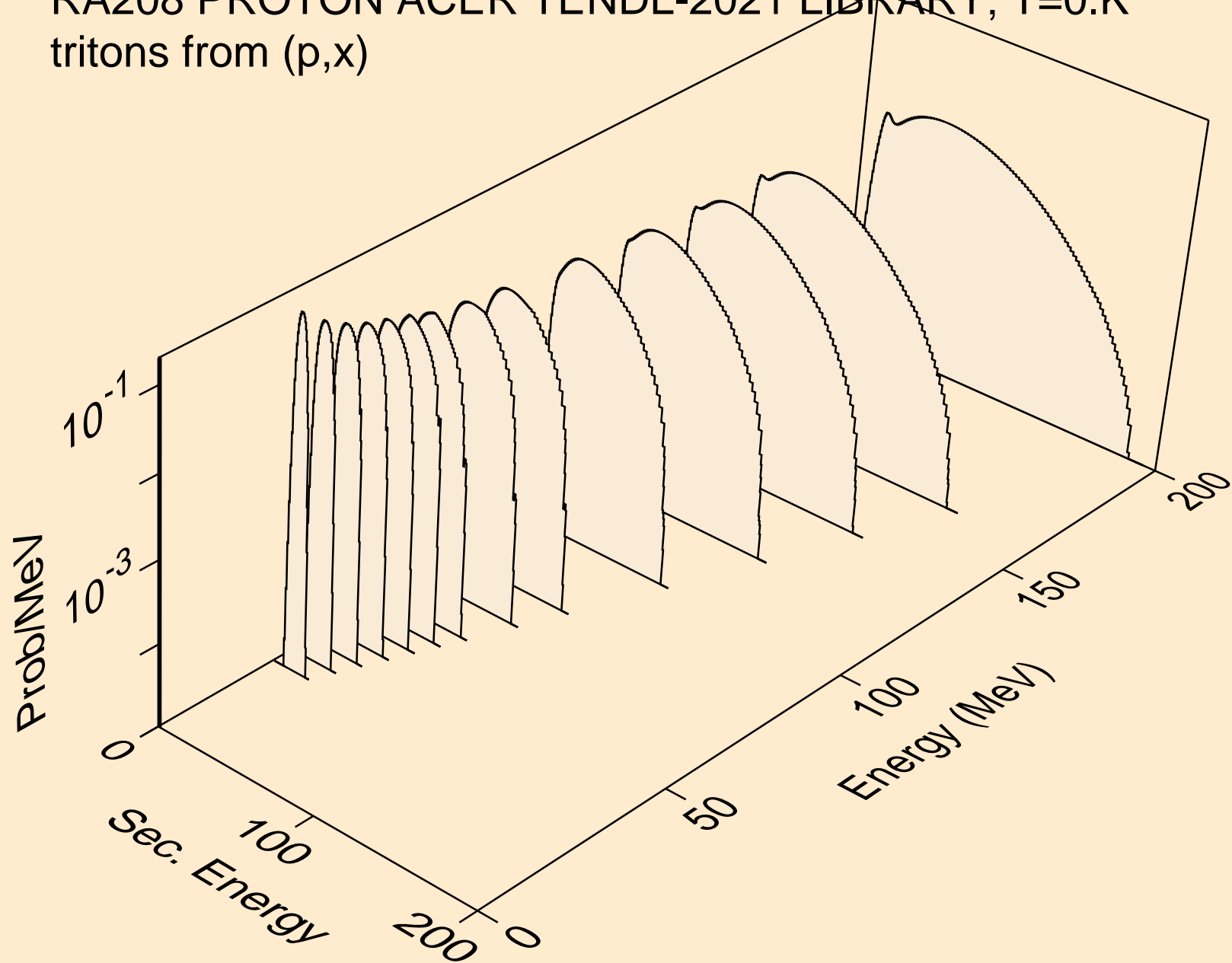

RA208 PROTON ACER TENDL-2021 LIBRARY; T=0.K
tritons from (p,n*)t

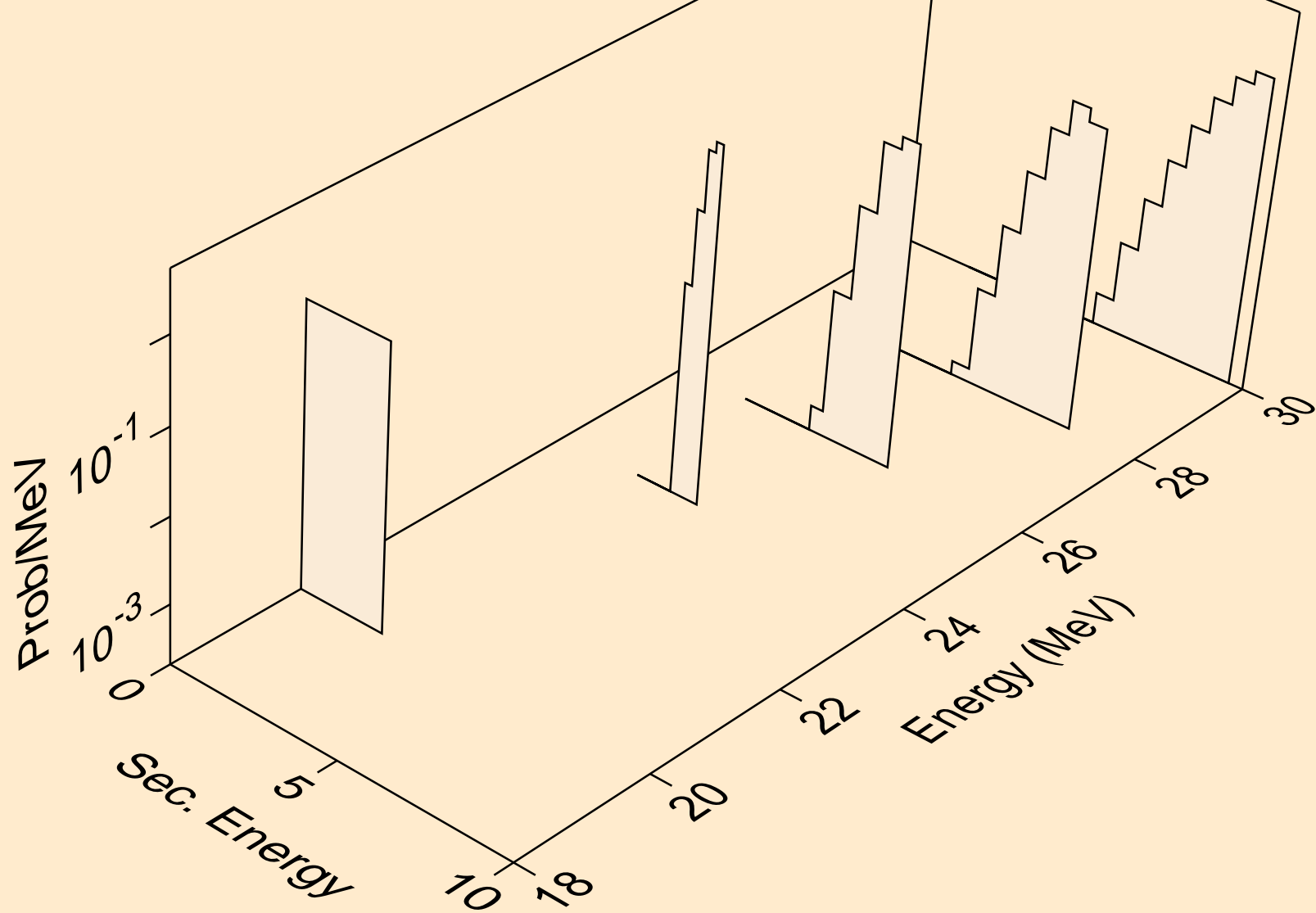

RA208 PROTON ACER TENDL-2021 LIBRARY; T=0.K
tritons from (p,t)

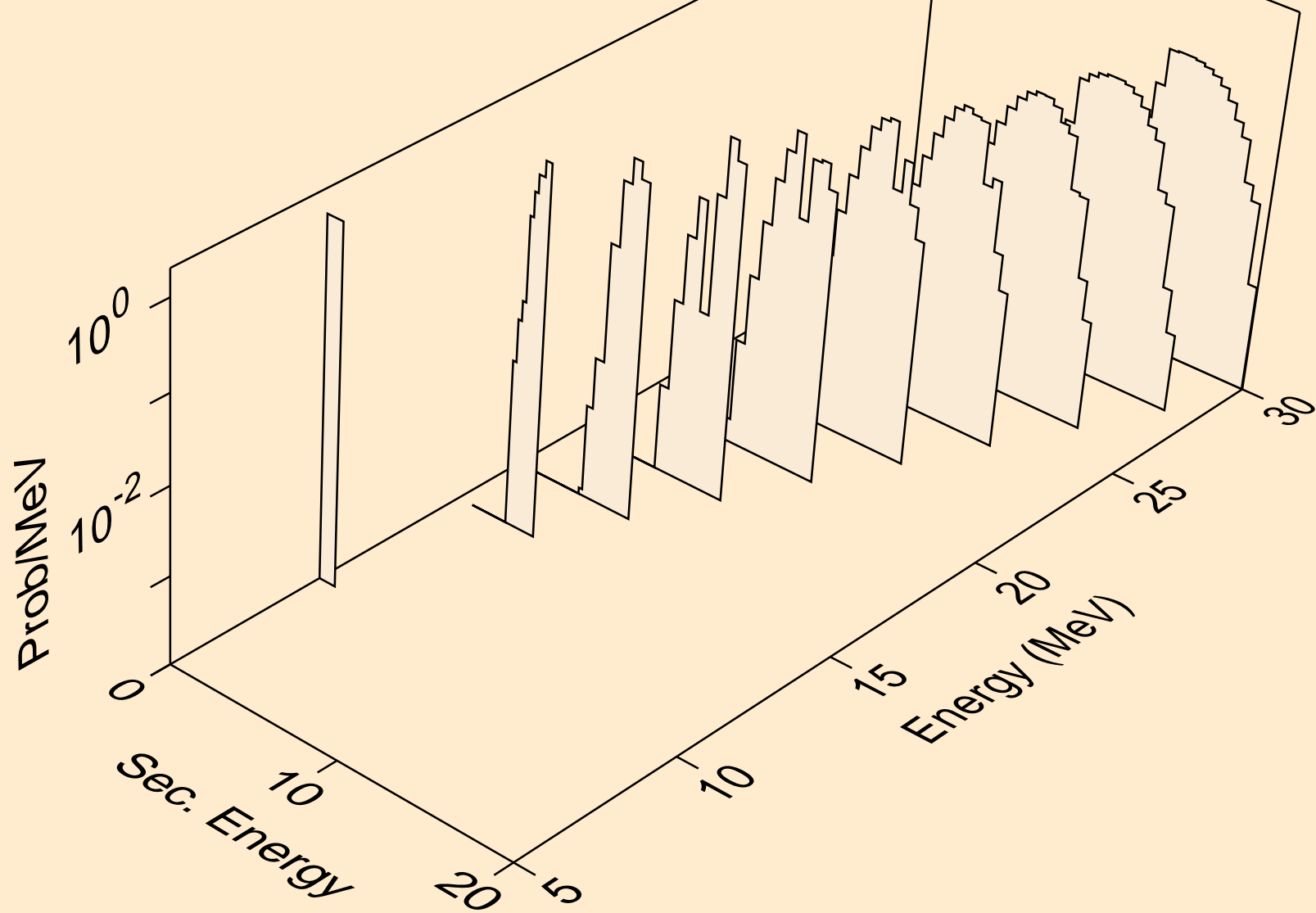

RA208 PROTON ACER TENDL-2021 LIBRARY; T=0.K
tritons from (p,pt)

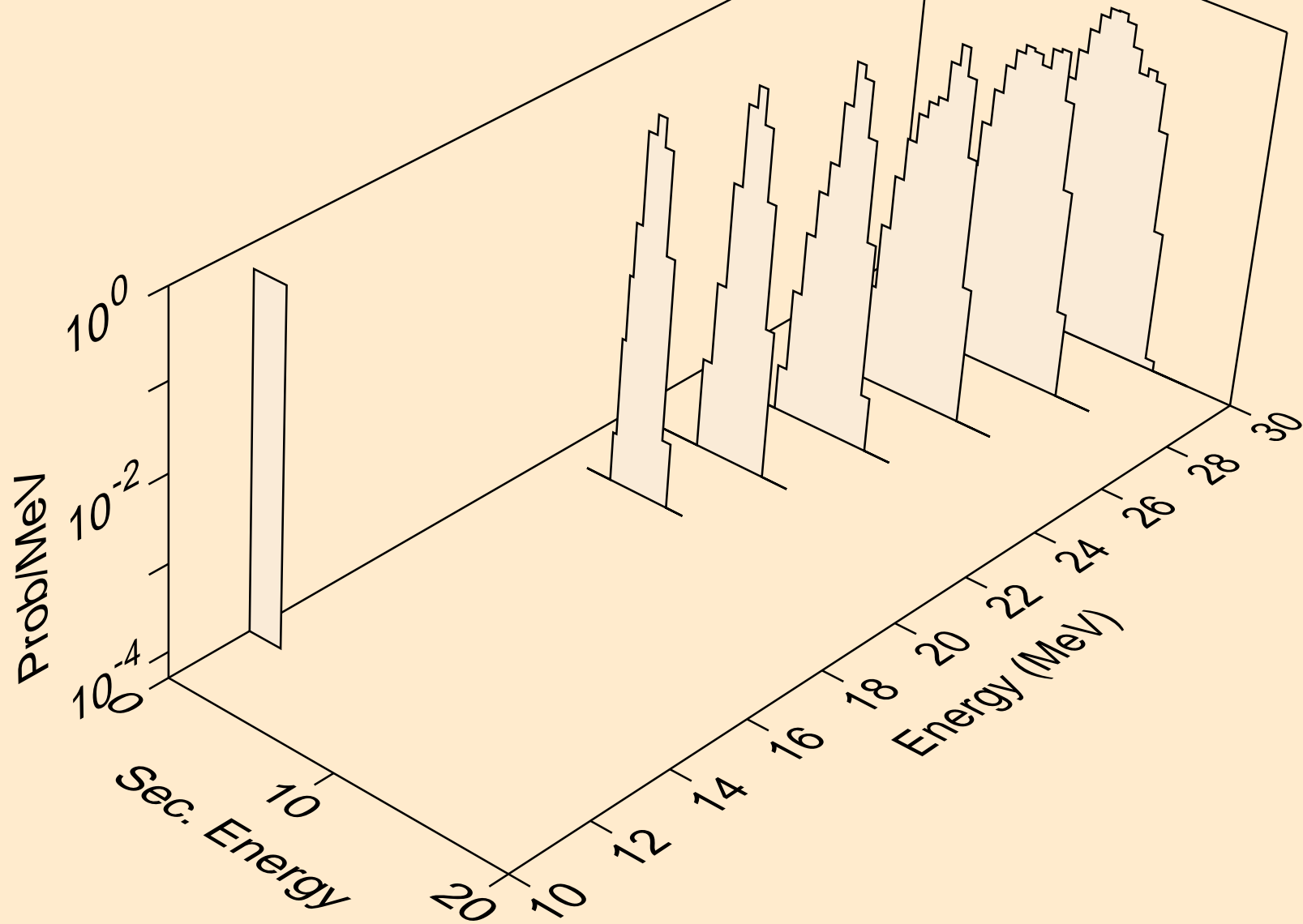

RA208 PROTON ACER TENDL-2021 LIBRARY; T=0.K
he3s from (p,x)

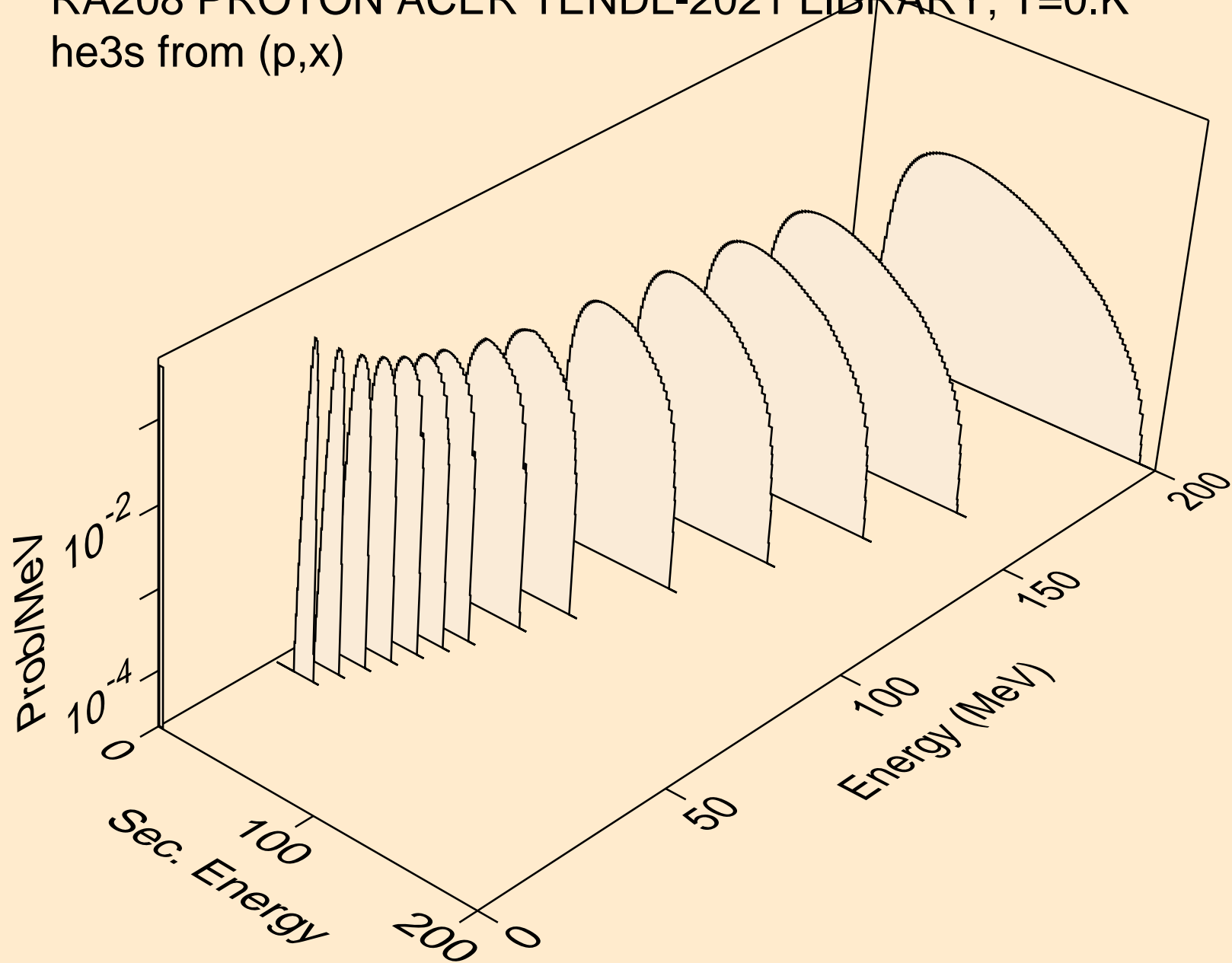

RA208 PROTON ACER TENDL-2021 LIBRARY; T=0.K
he3s from (p,n*)he3

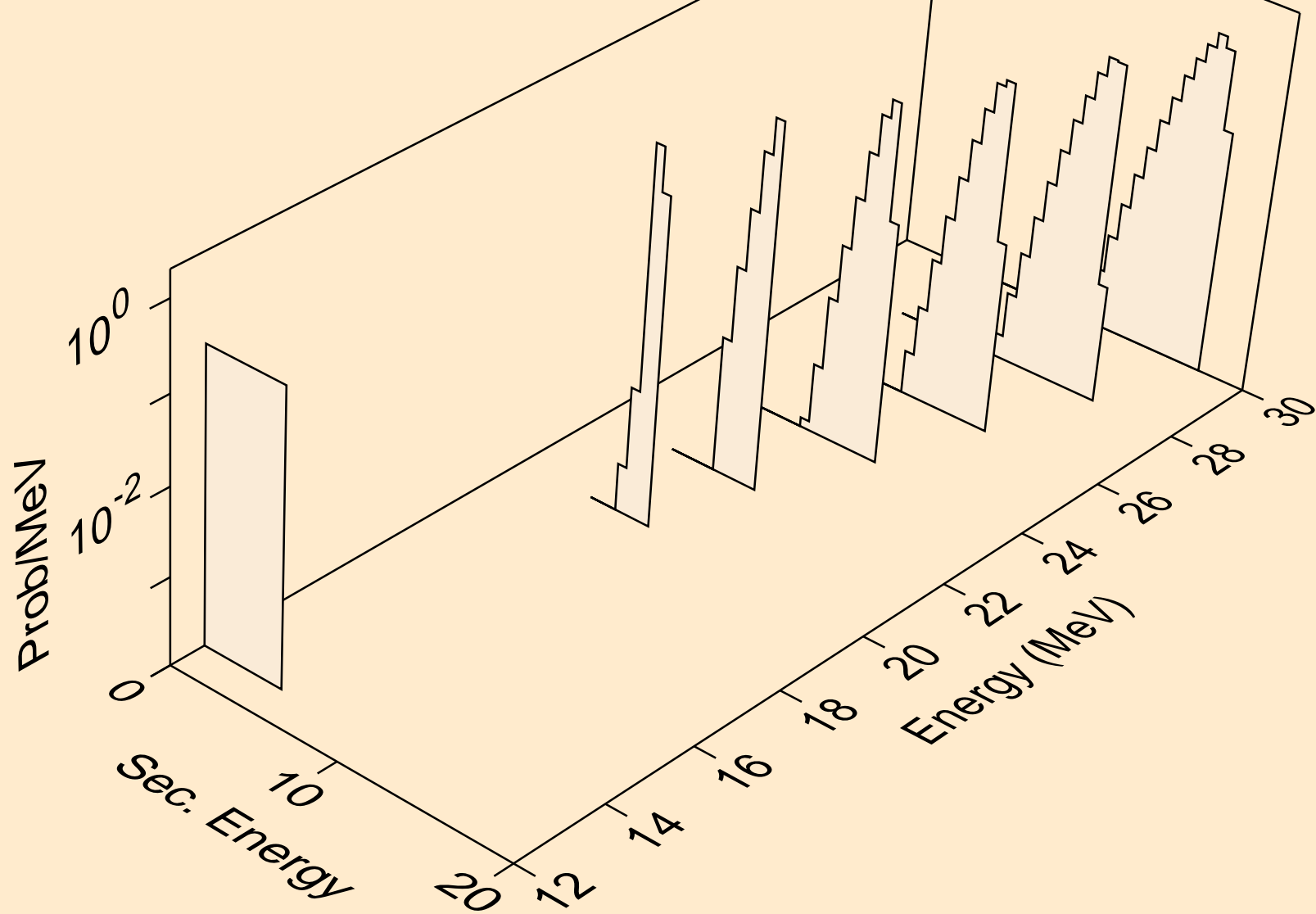

RA208 PROTON ACER TENDL-2021 LIBRARY; T=0.K
he3s from (p,he3)

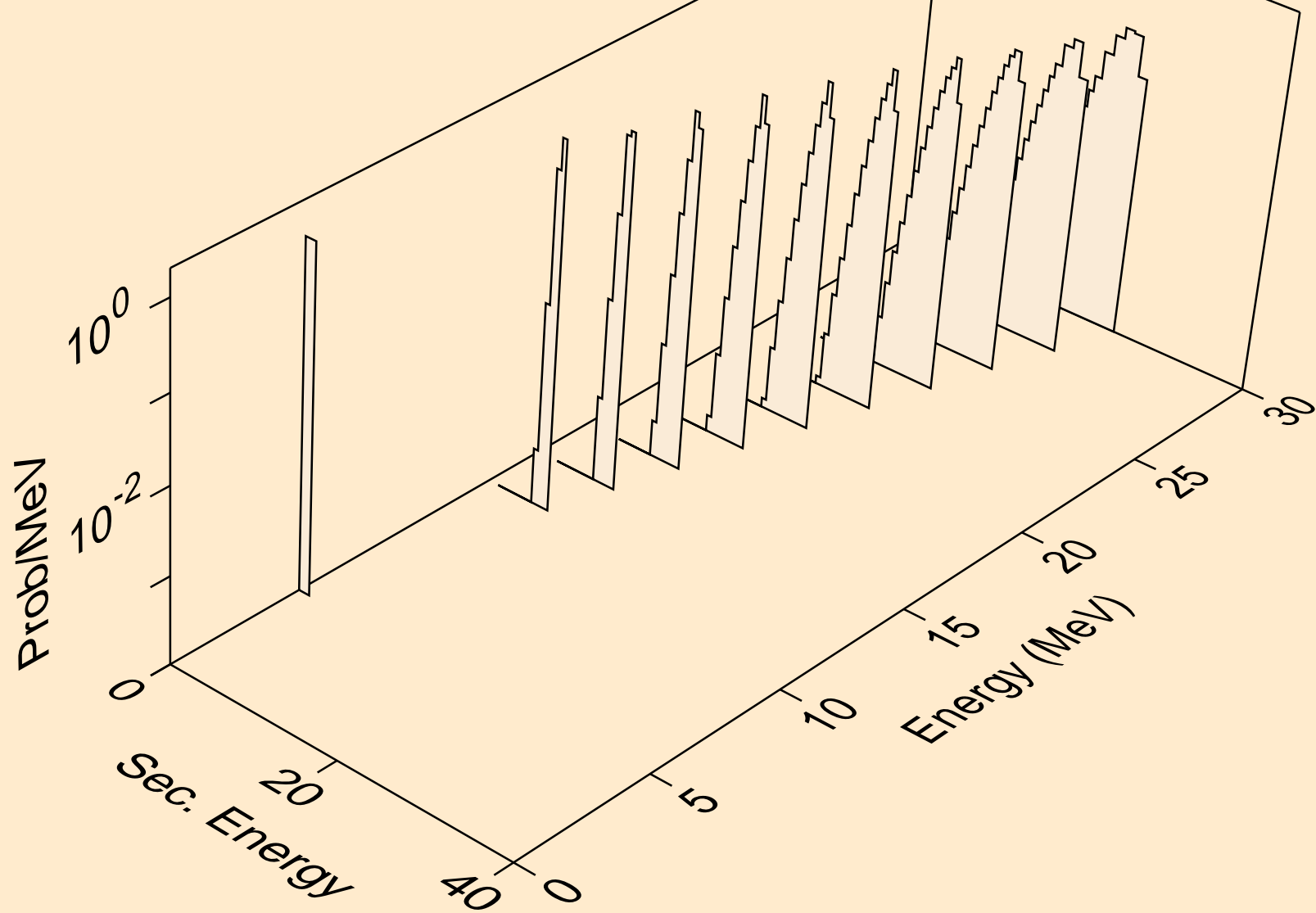

RA208 PROTON ACER TENDL-2021 LIBRARY; T=0.K
alphas from (p,x)

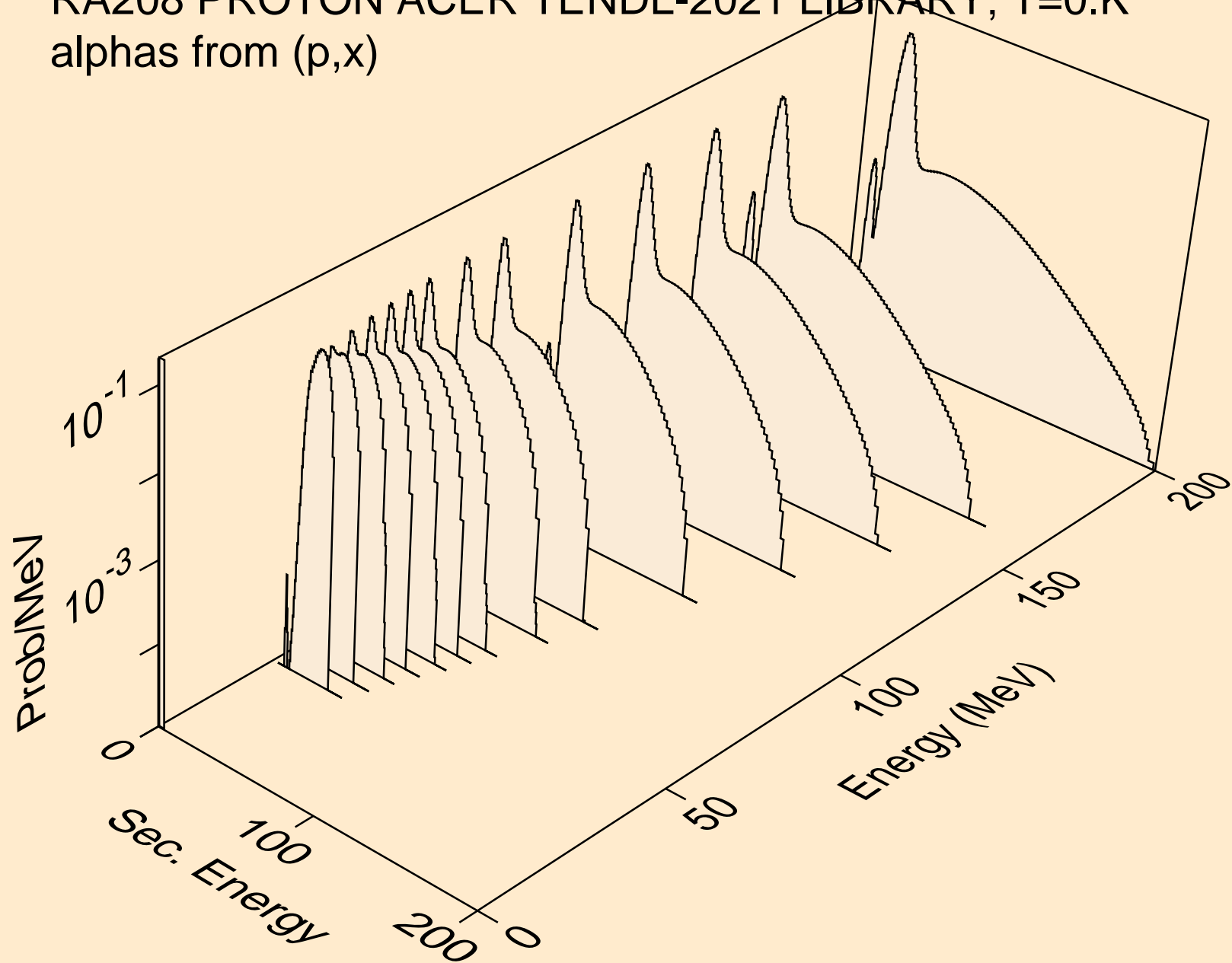

RA208 PROTON ACER TENDL-2021 LIBRARY; T=0.K
alphas from (p,n*)a

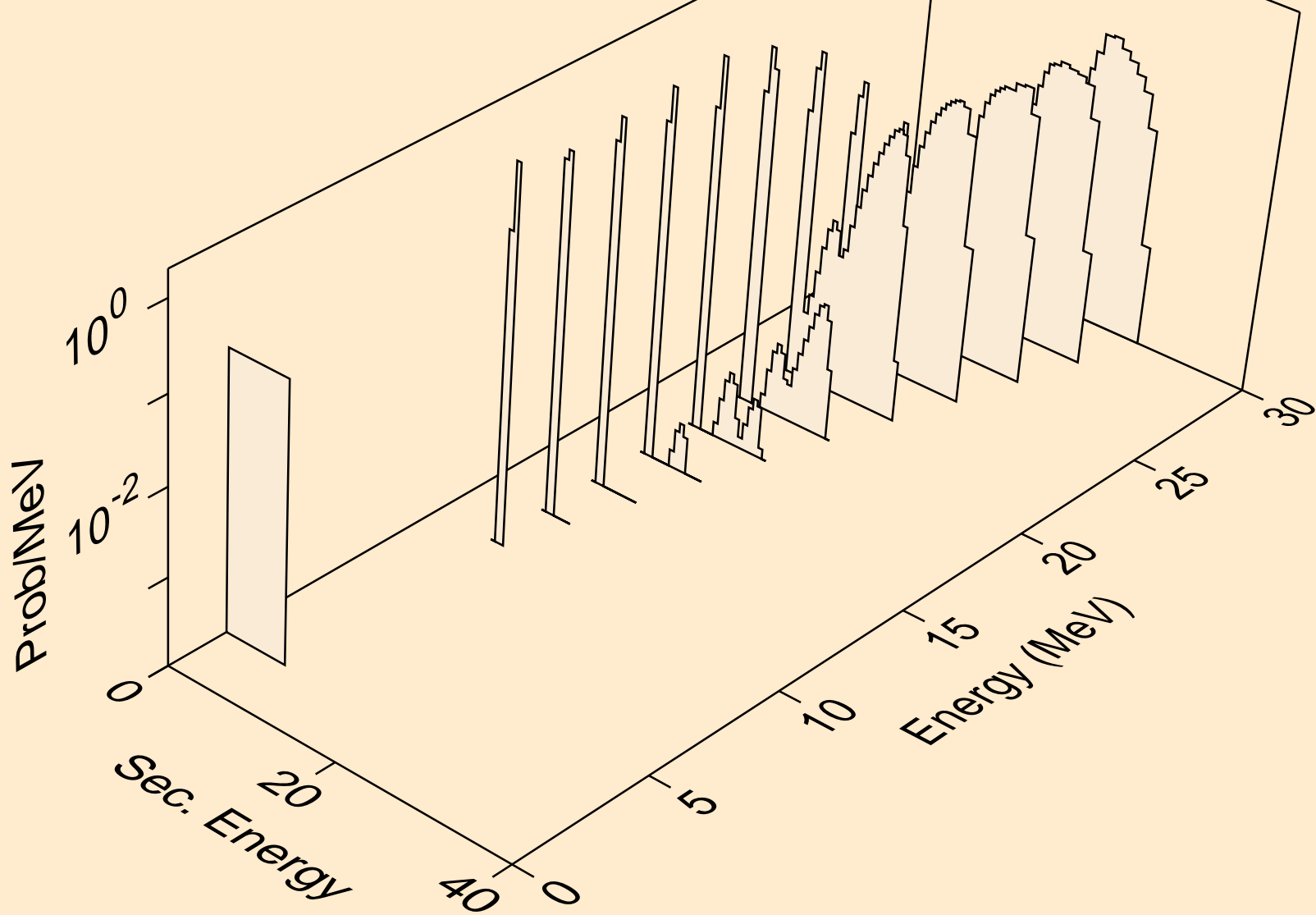

RA208 PROTON ACER TENDL-2021 LIBRARY; T=0.K
alphas from (p,2n)a

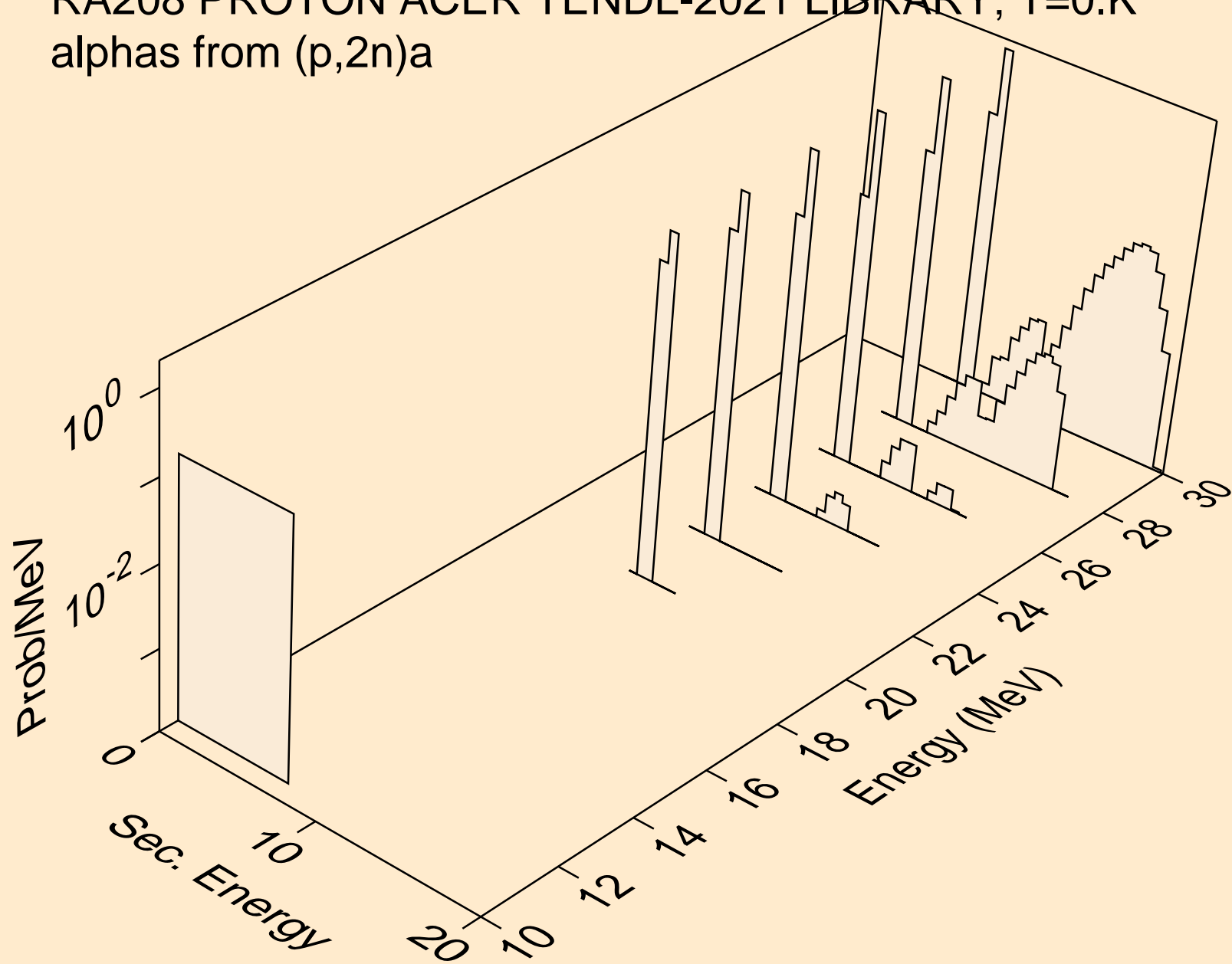

RA208 PROTON ACER TENDL-2021 LIBRARY; T=0.K
alphas from (p,n*)2a

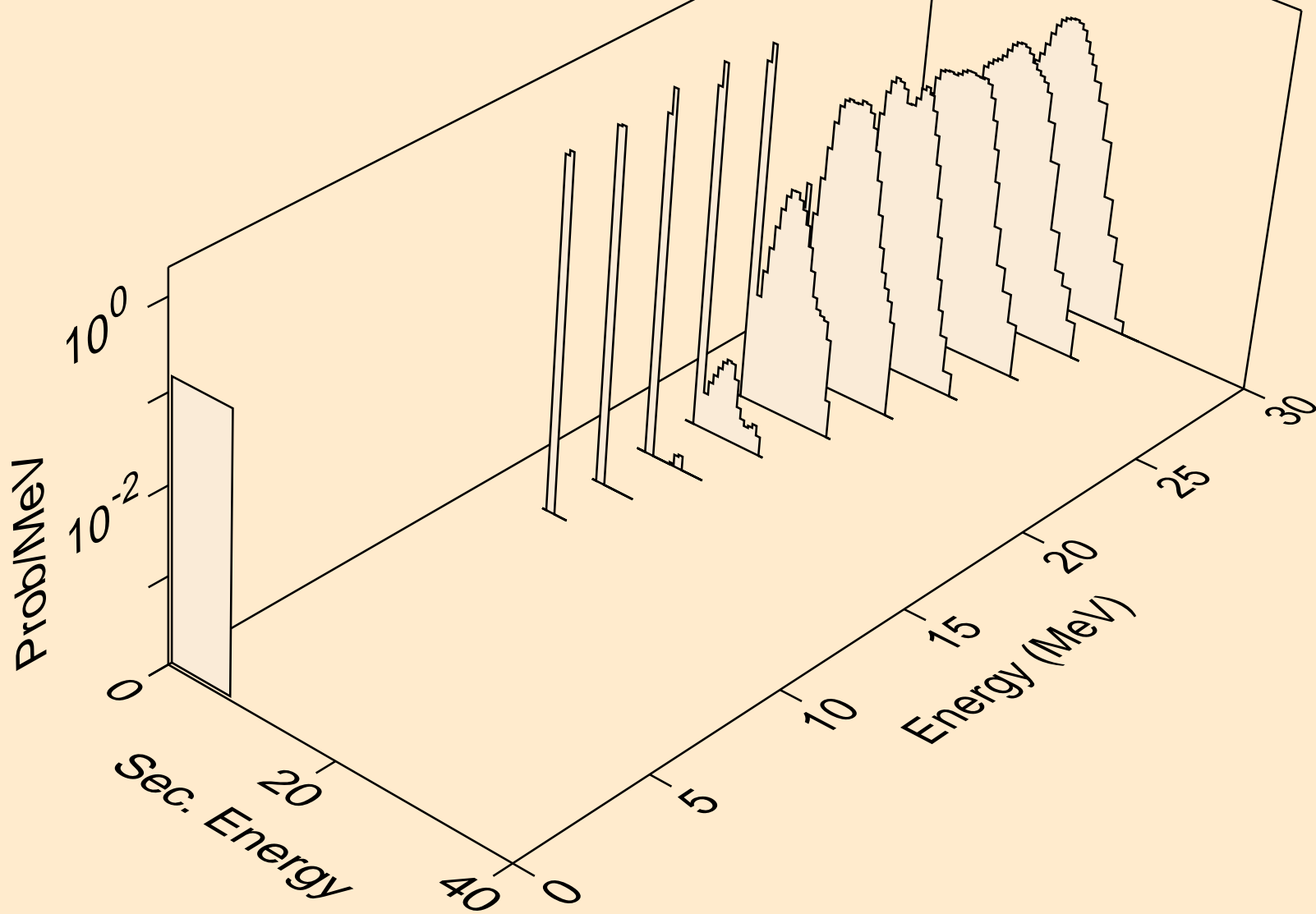

RA208 PROTON ACER TENDL-2021 LIBRARY; T=0.K
alphas from (p,npa)

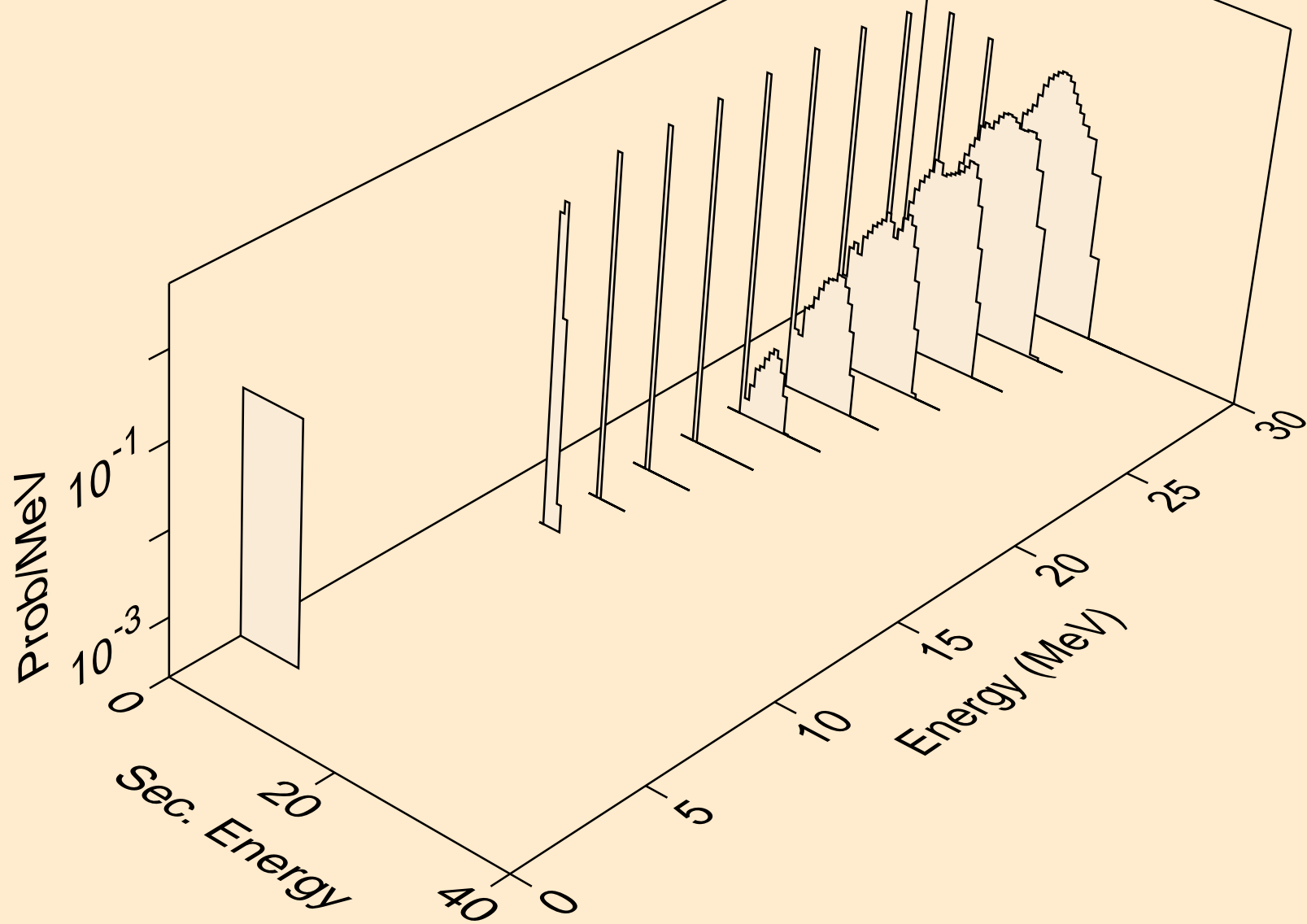

RA208 PROTON ACER TENDL-2021 LIBRARY; T=0.K
alphas from (p,a)

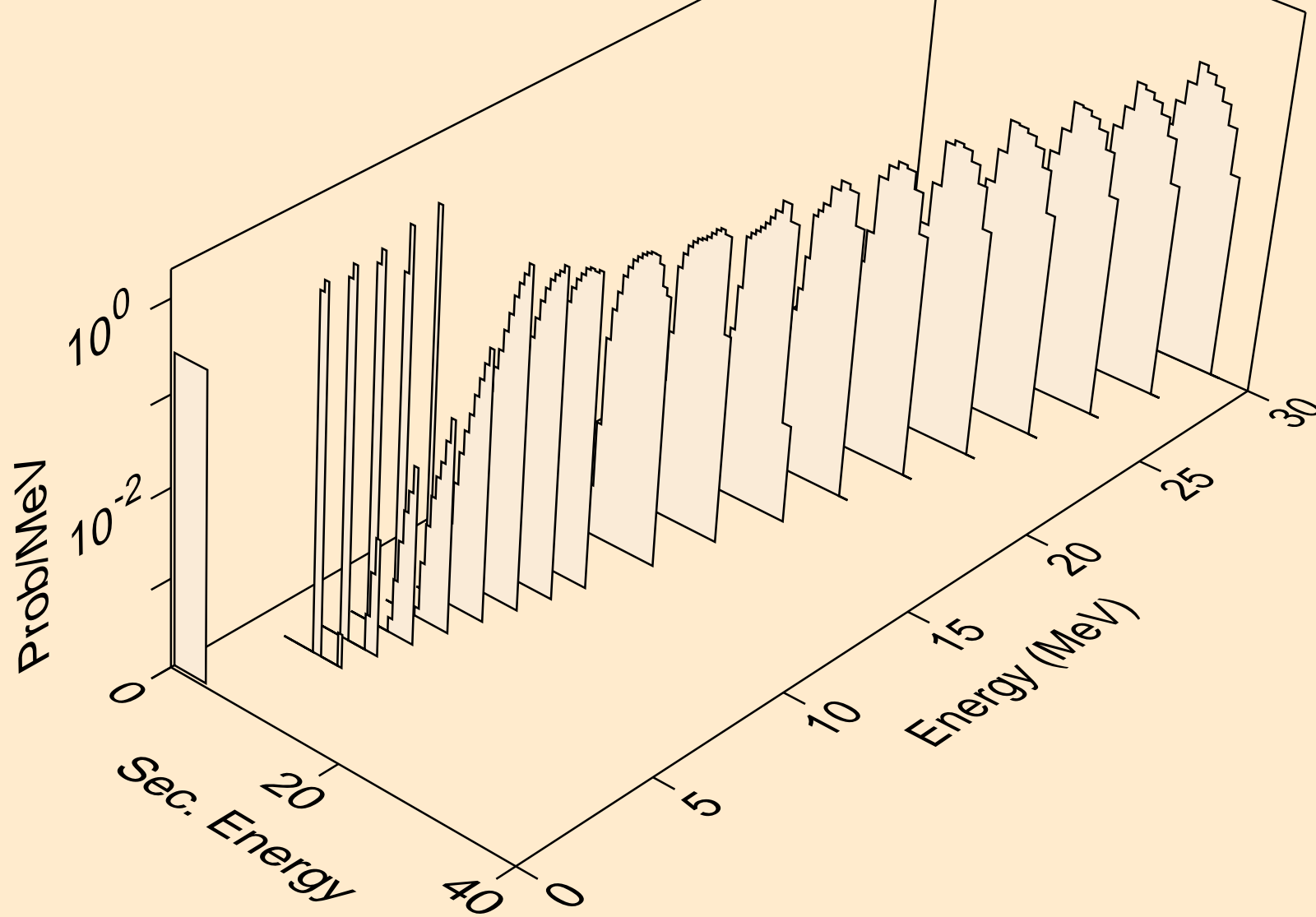

RA208 PROTON ACER TENDL-2021 LIBRARY; T=0.K
alphas from (p,2a)

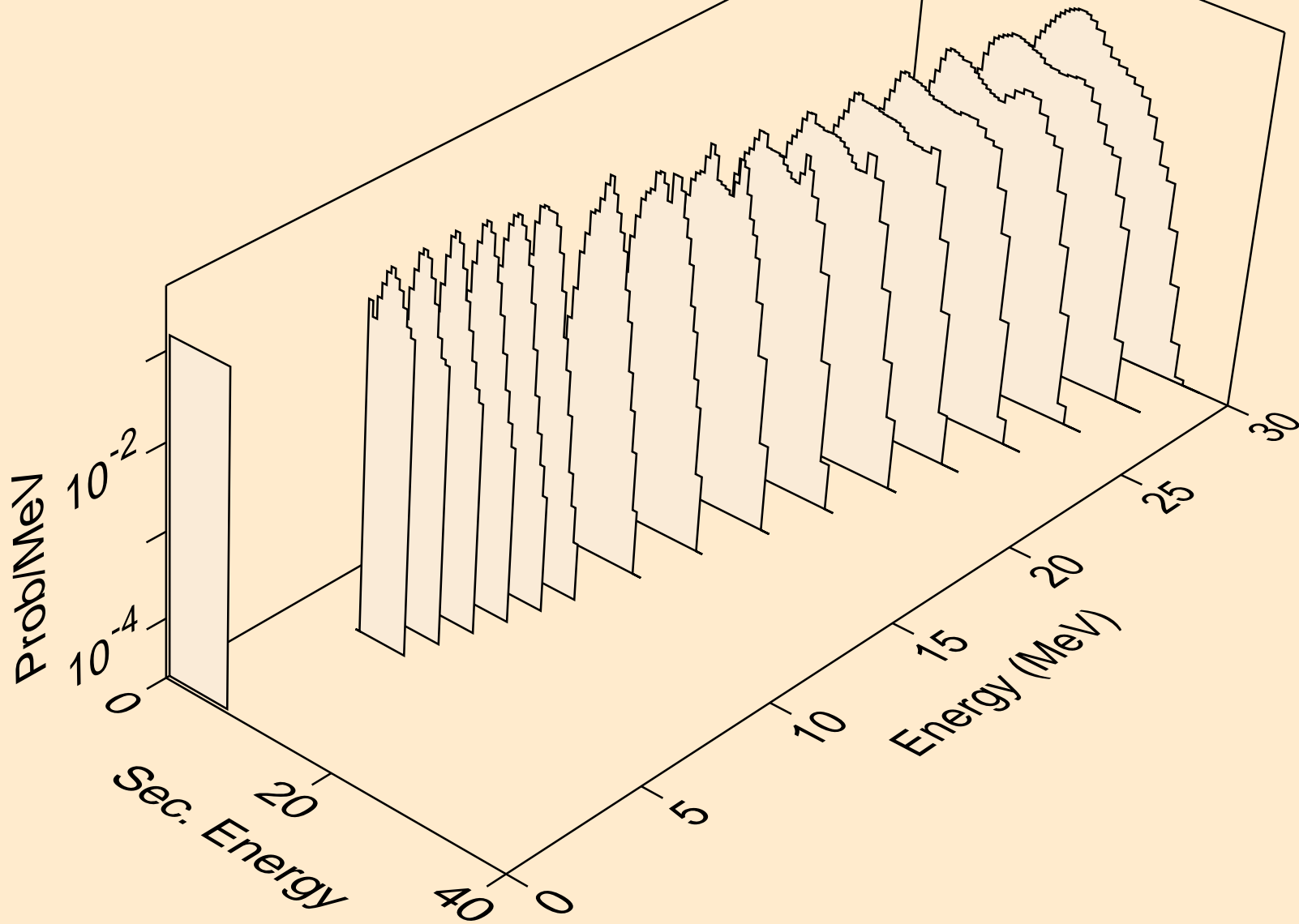

RA208 PROTON ACER TENDL-2021 LIBRARY; T=0.K
alphas from (p,pa)

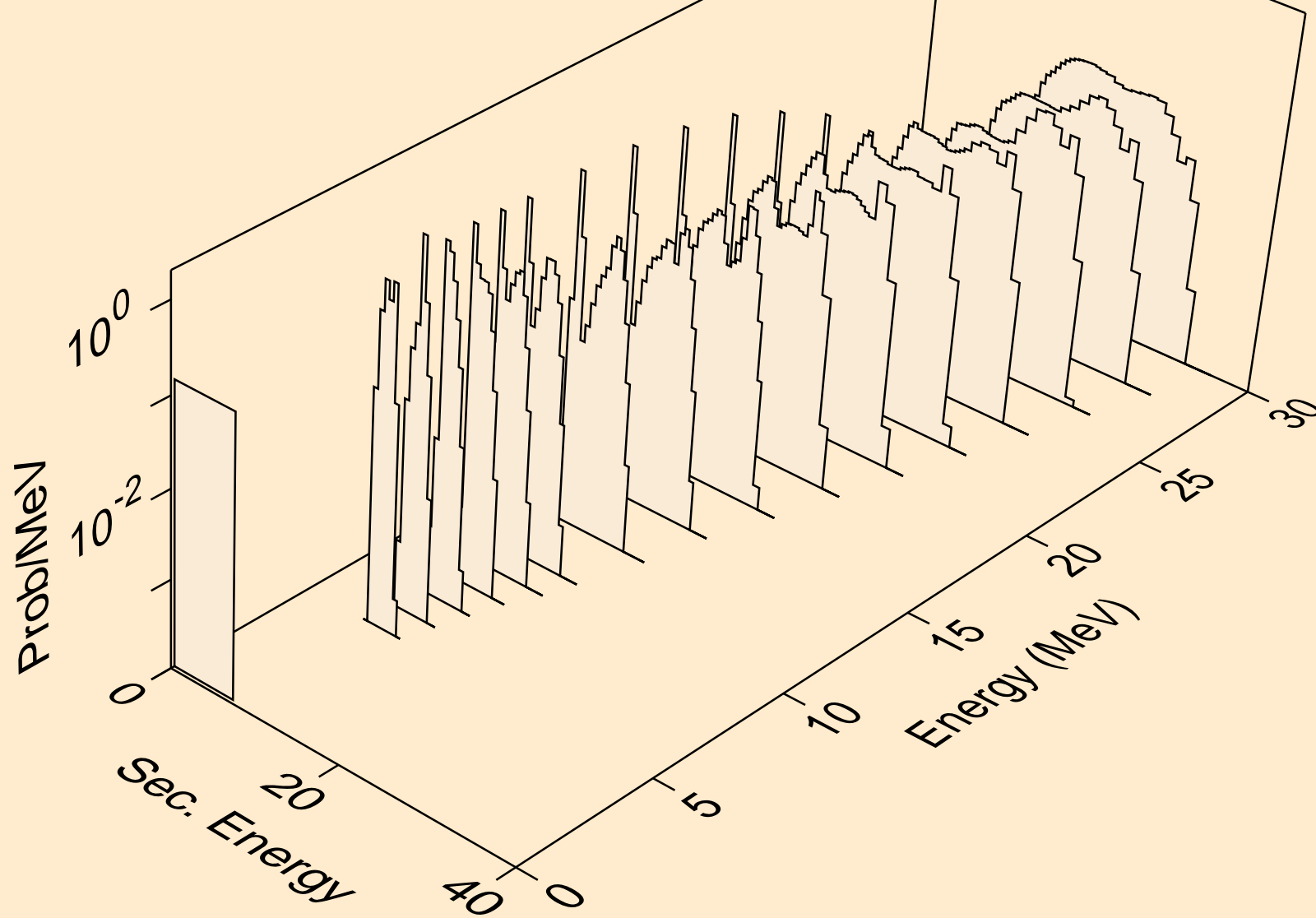

RA208 PROTON ACER TENDL-2021 LIBRARY; T=0.K
alphas from (p,da)

