

# RA226 PROTON ACER TENDL-2021 LIBRARY; T=0.K

## Principal cross sections

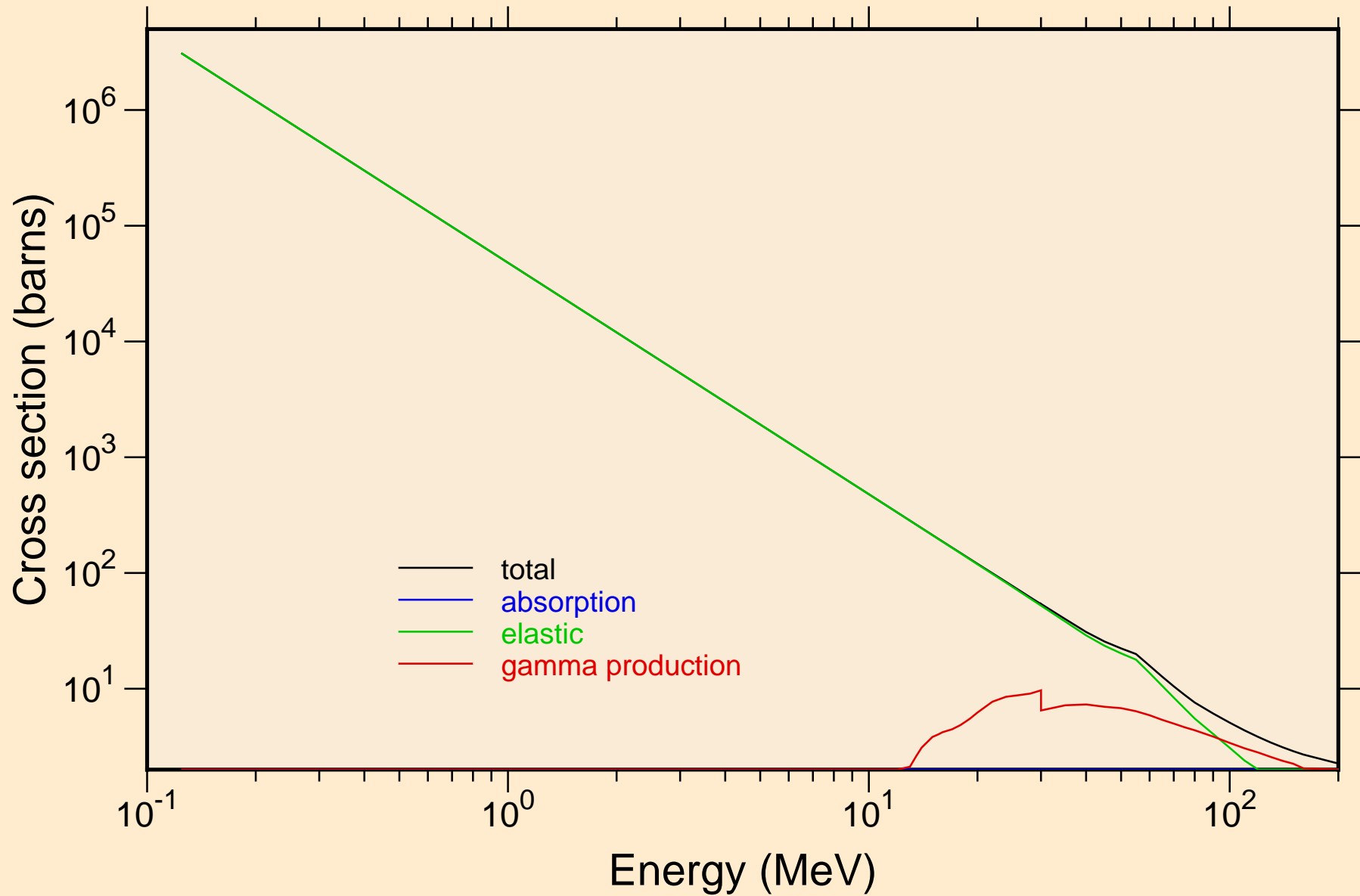

# RA226 PROTON ACER TENDL-2021 LIBRARY; T=0.K

## Heating

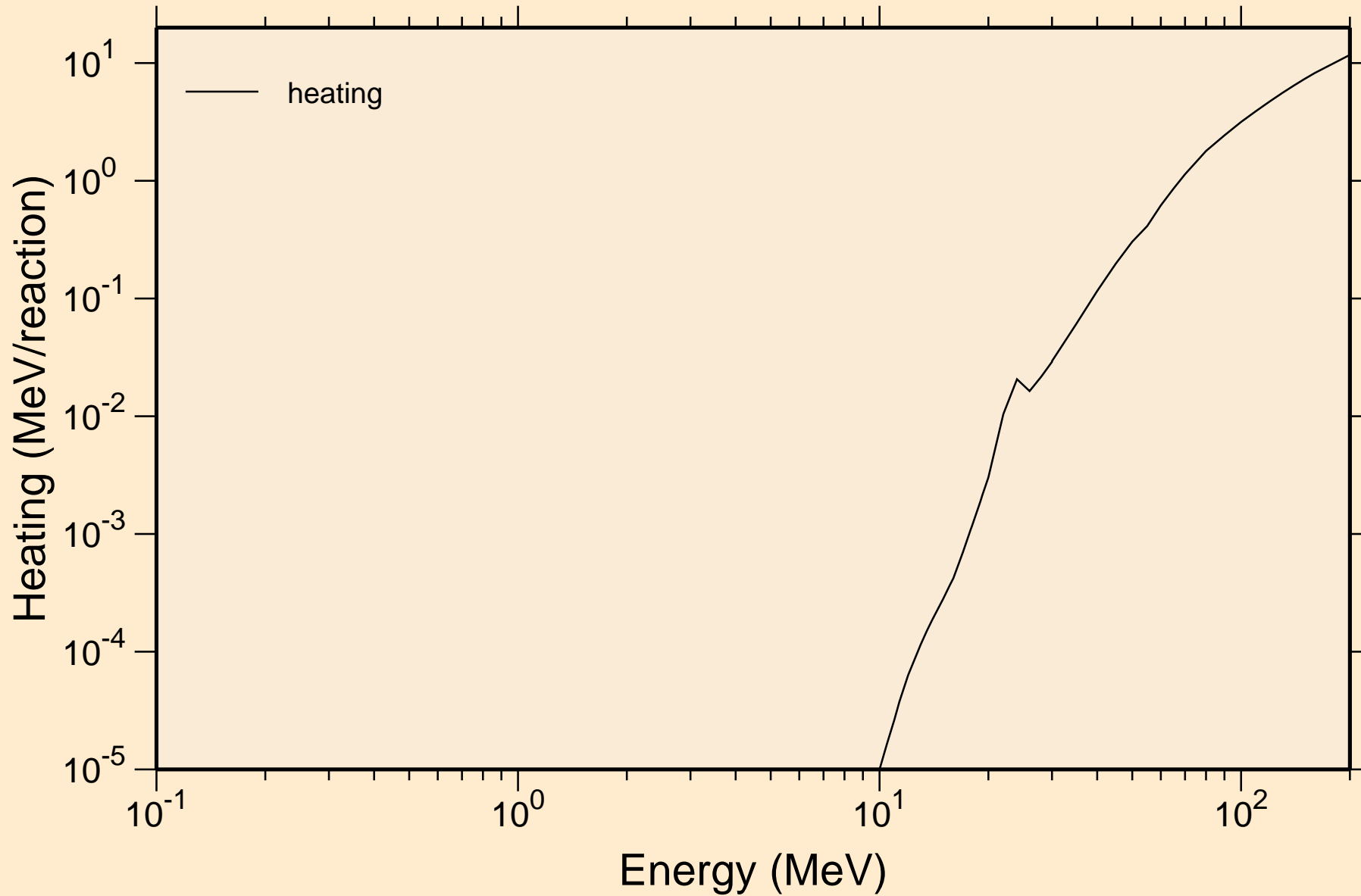

# RA226 PROTON ACER TENDL-2021 LIBRARY; T=0.K

## Principal cross sections

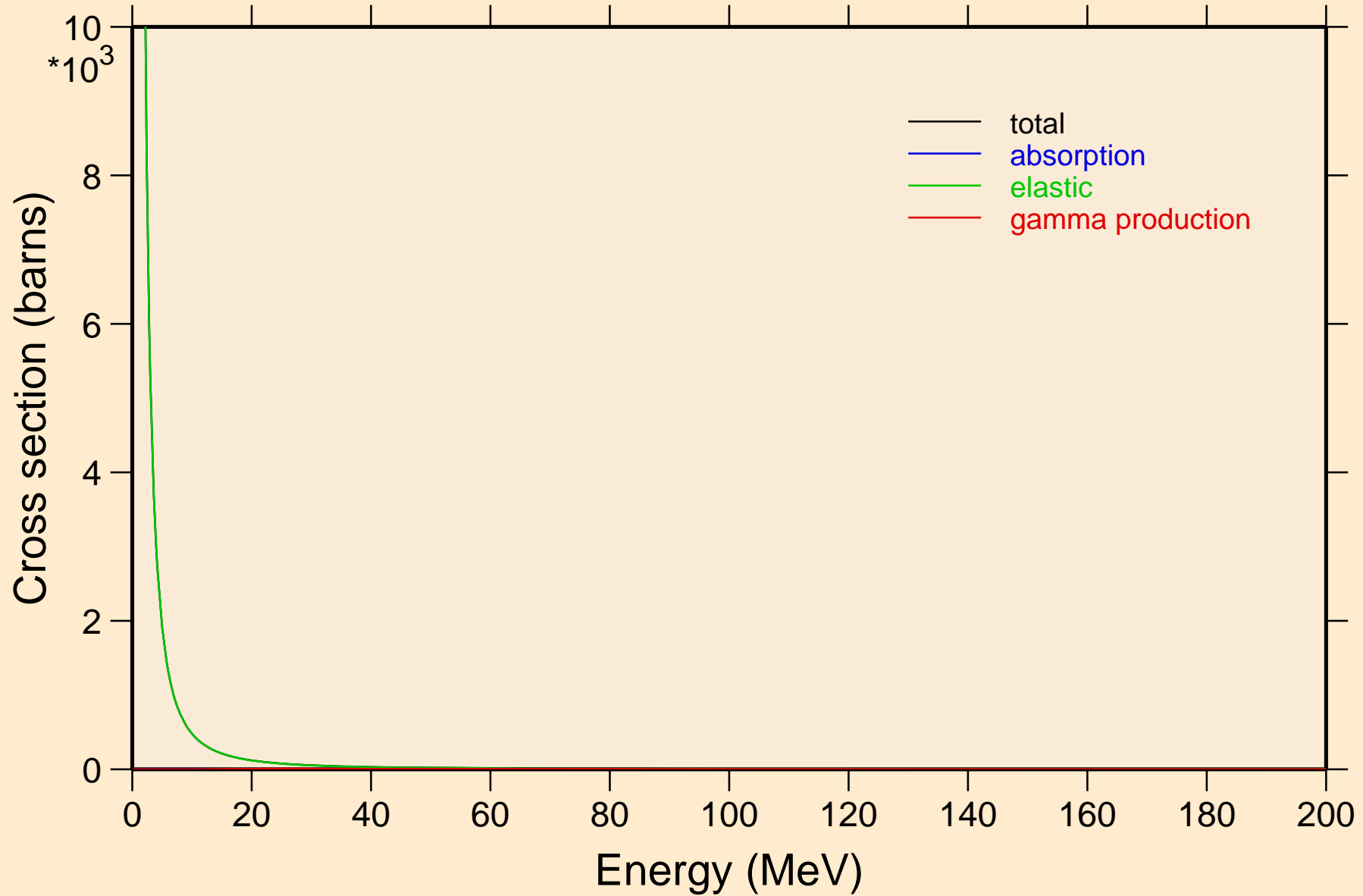

RA226 PROTON ACER TENDL-2021 LIBRARY; T=0.K

Heating

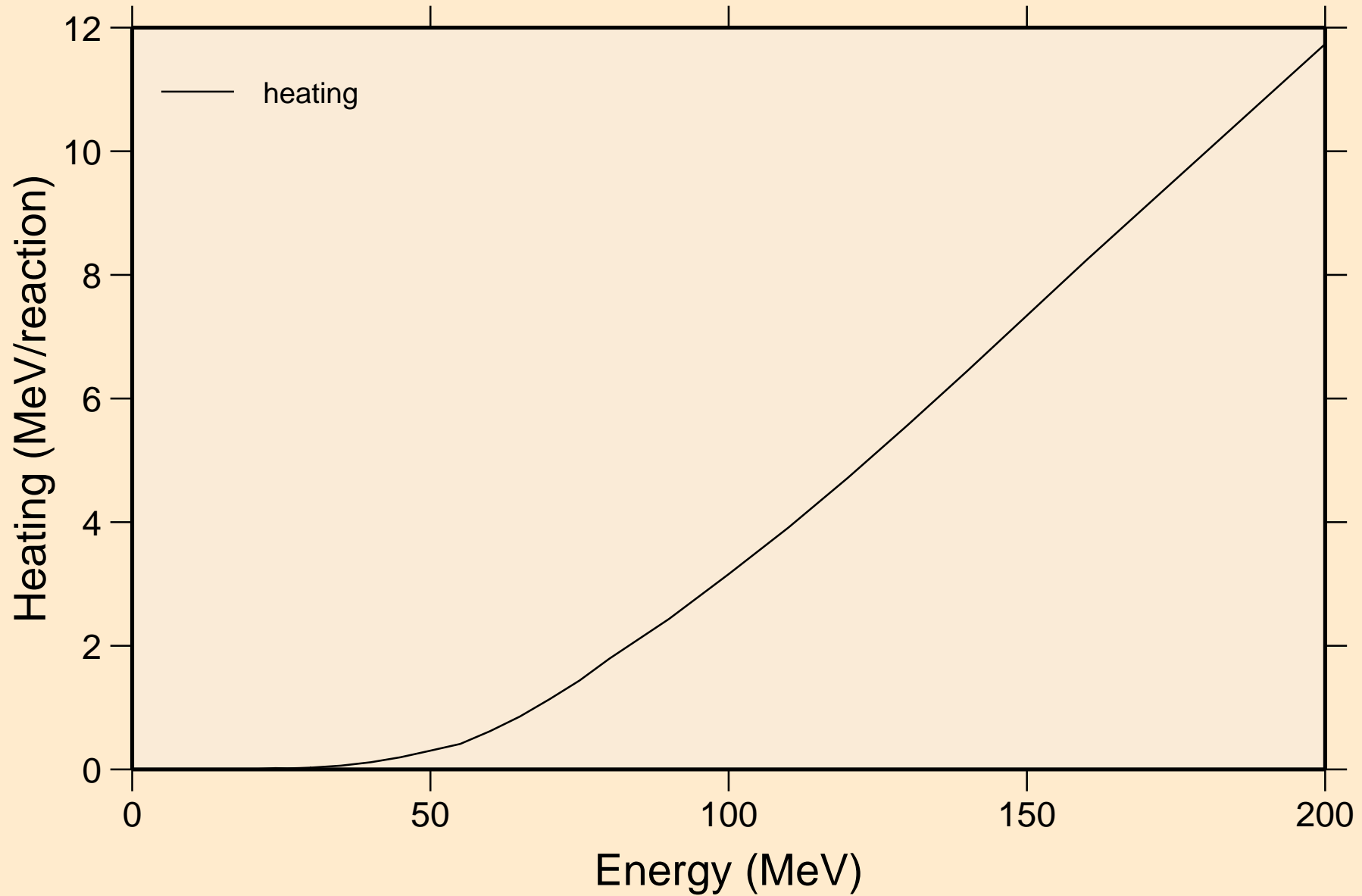

RA226 PROTON ACER TENDL-2021 LIBRARY; T=0.K  
Threshold reactions

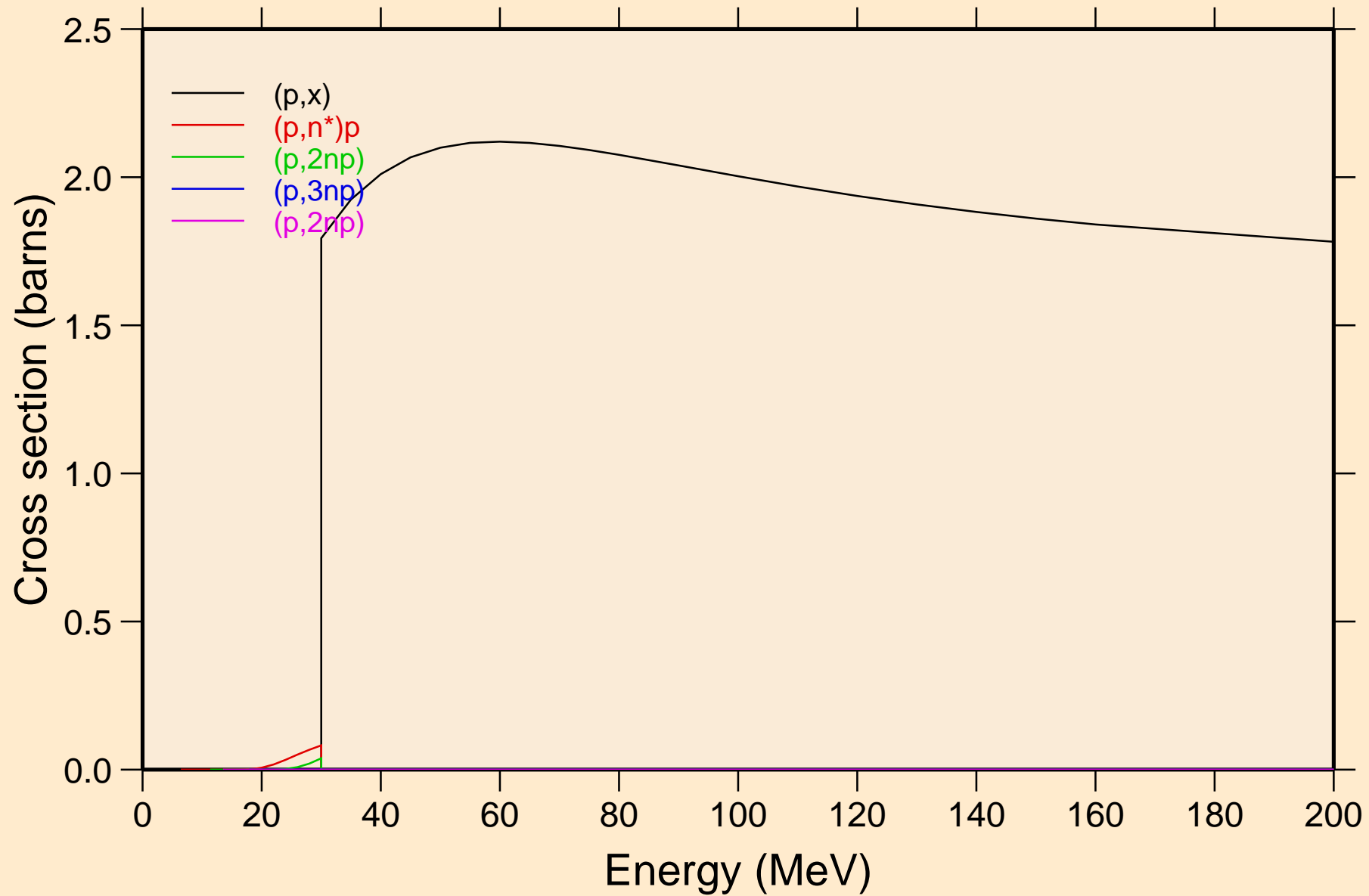

RA226 PROTON ACER TENDL-2021 LIBRARY; T=0.K  
Threshold reactions

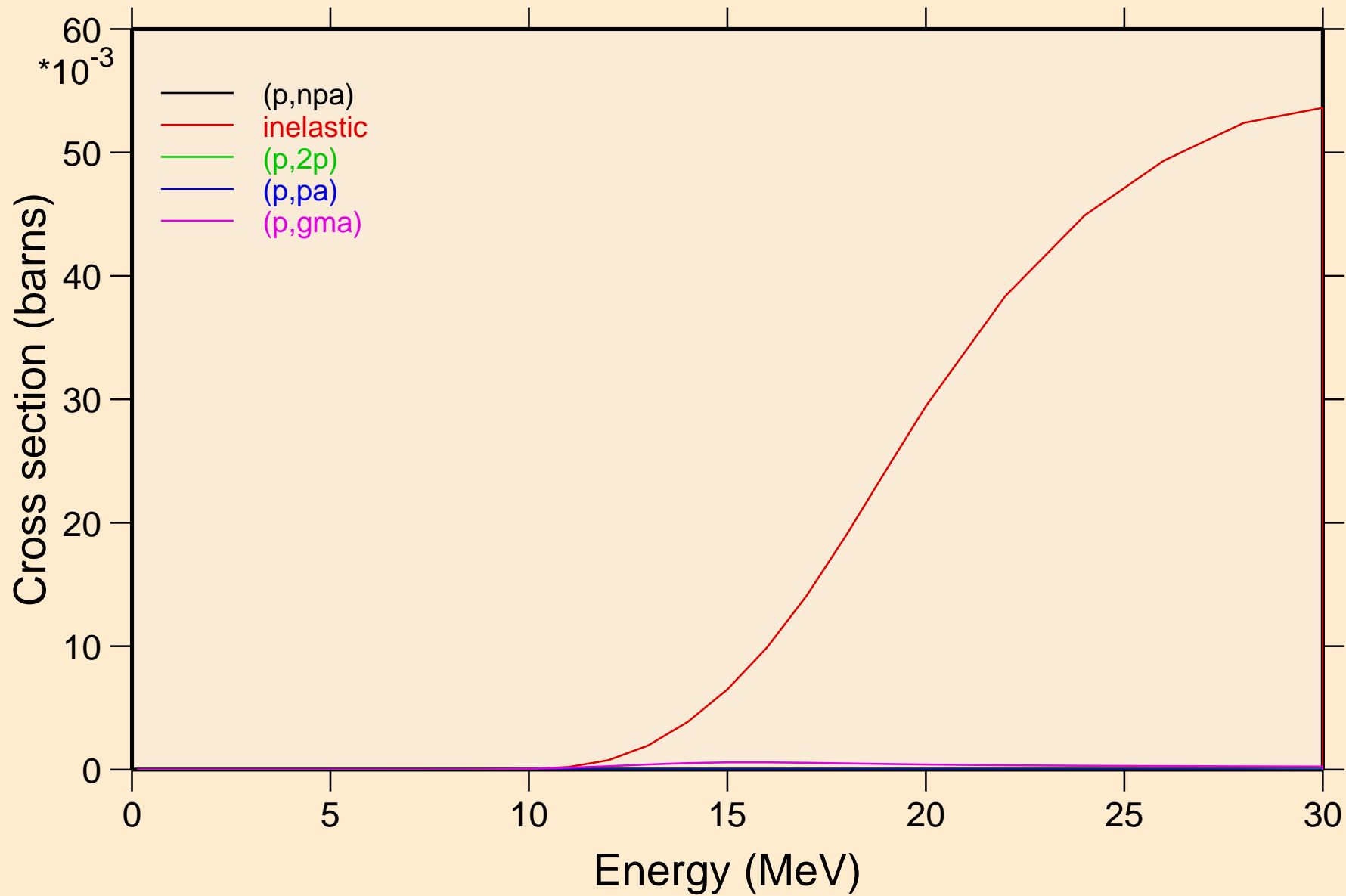

RA226 PROTON ACER TENDL-2021 LIBRARY; T=0.K  
Threshold reactions

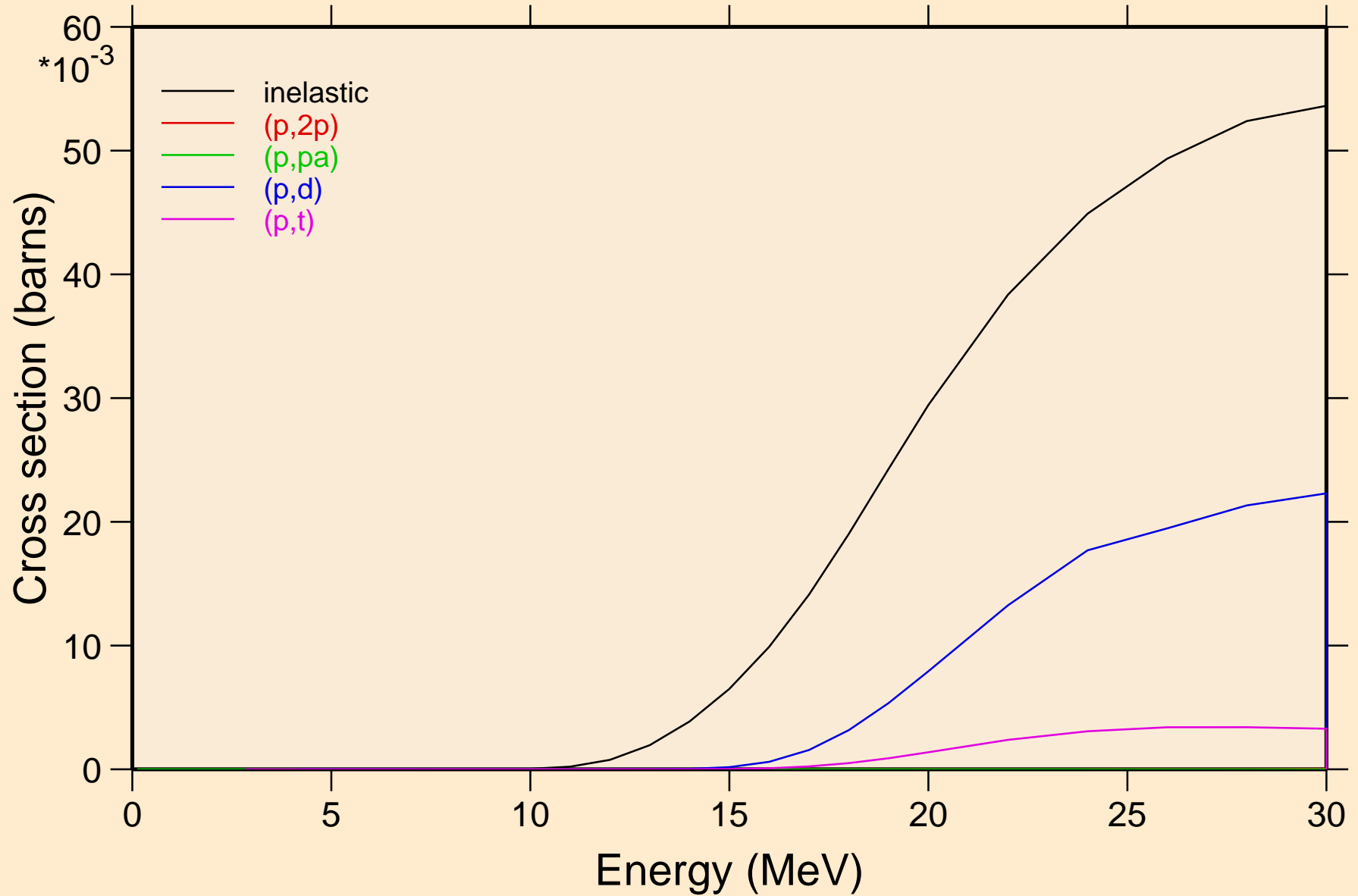

RA226 PROTON ACER TENDL-2021 LIBRARY; T=0.K  
Threshold reactions

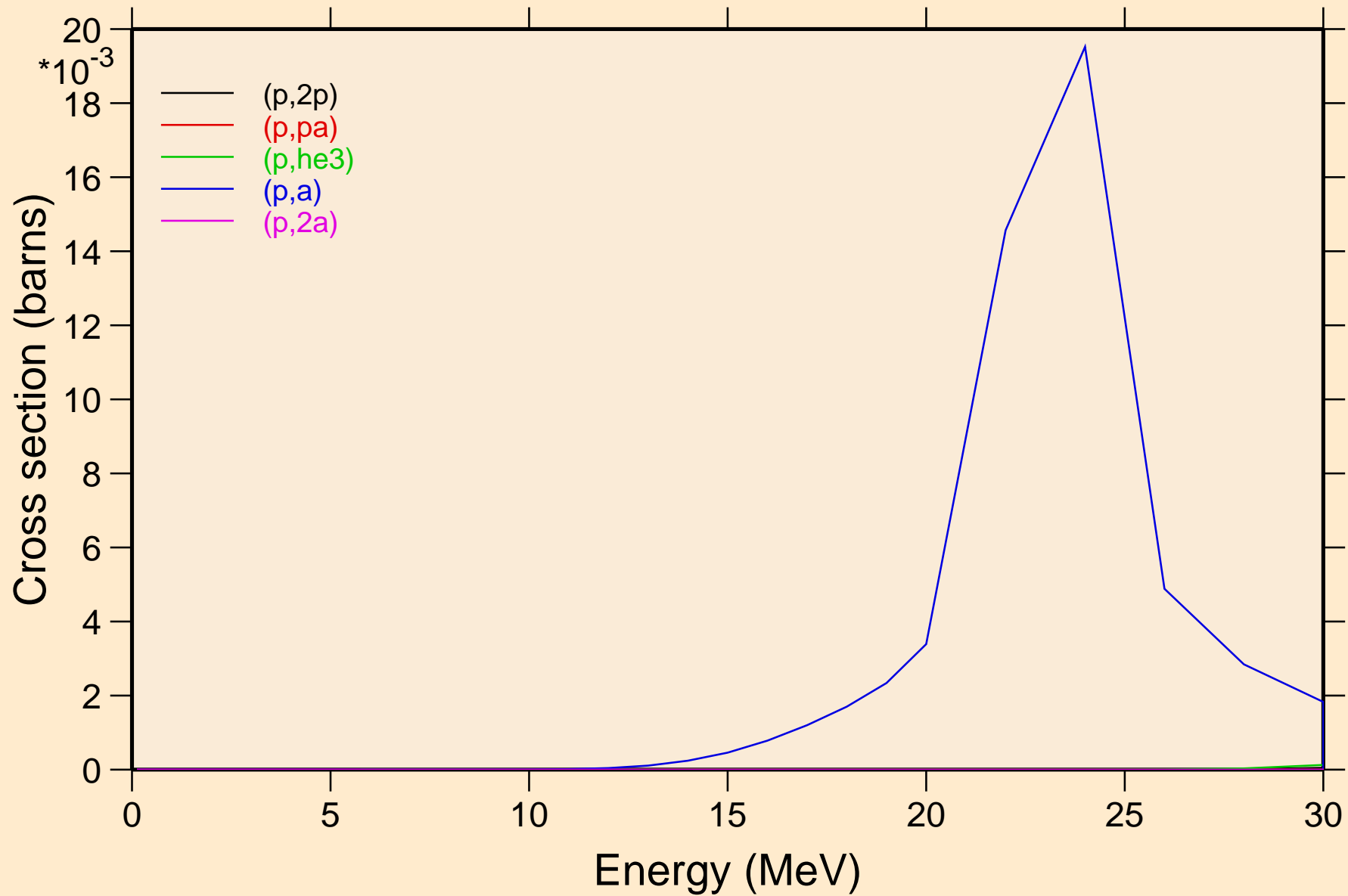



RA226 PROTON ACER TENDL-2021 LIBRARY; T=0.K  
Threshold reactions

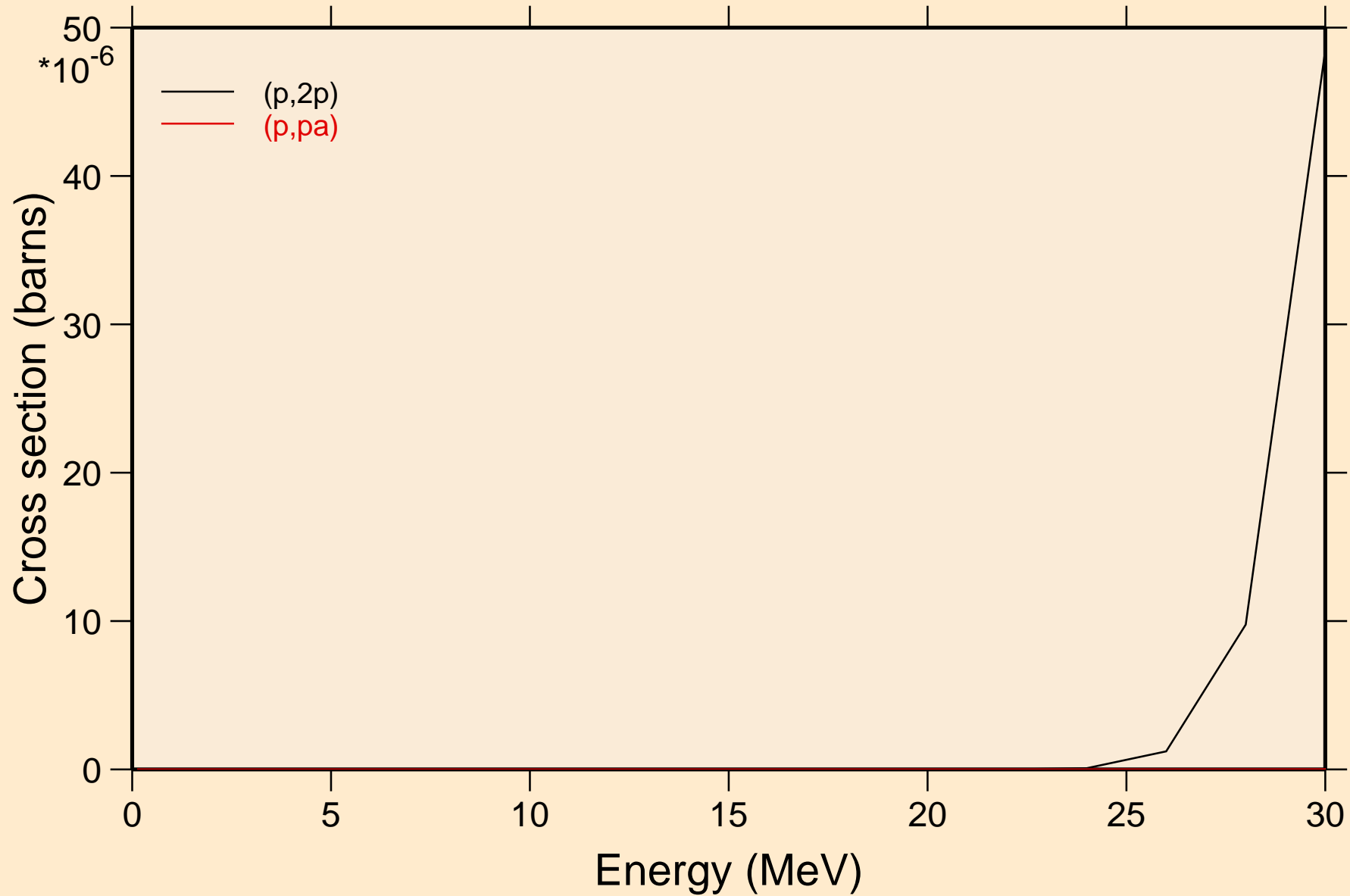

RA226 PROTON ACER TENDL-2021 LIBRARY; T=0.K  
angular distribution for elastic

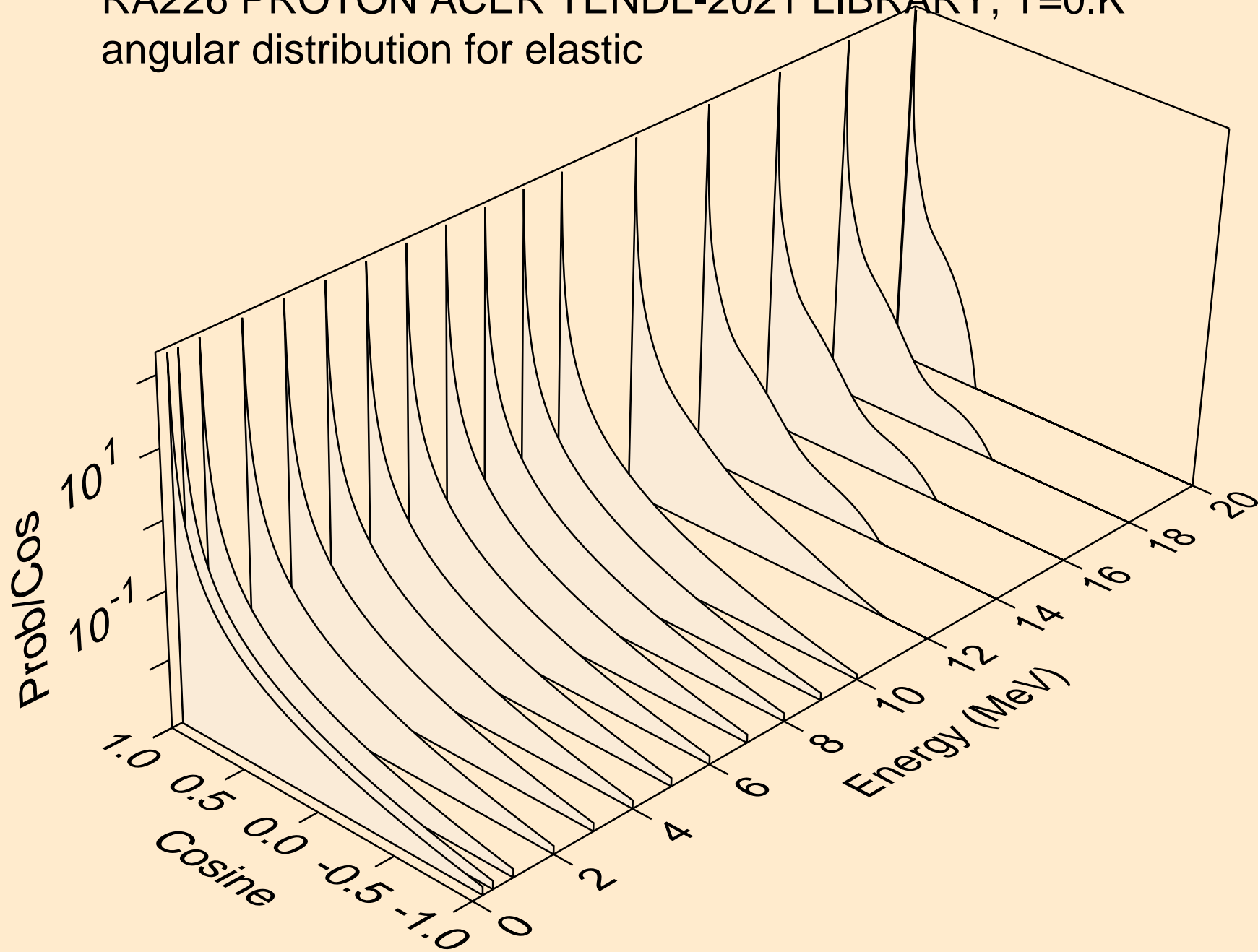

RA226 PROTON ACER TENDL-2021 LIBRARY; T=0.K  
angular distribution for elastic

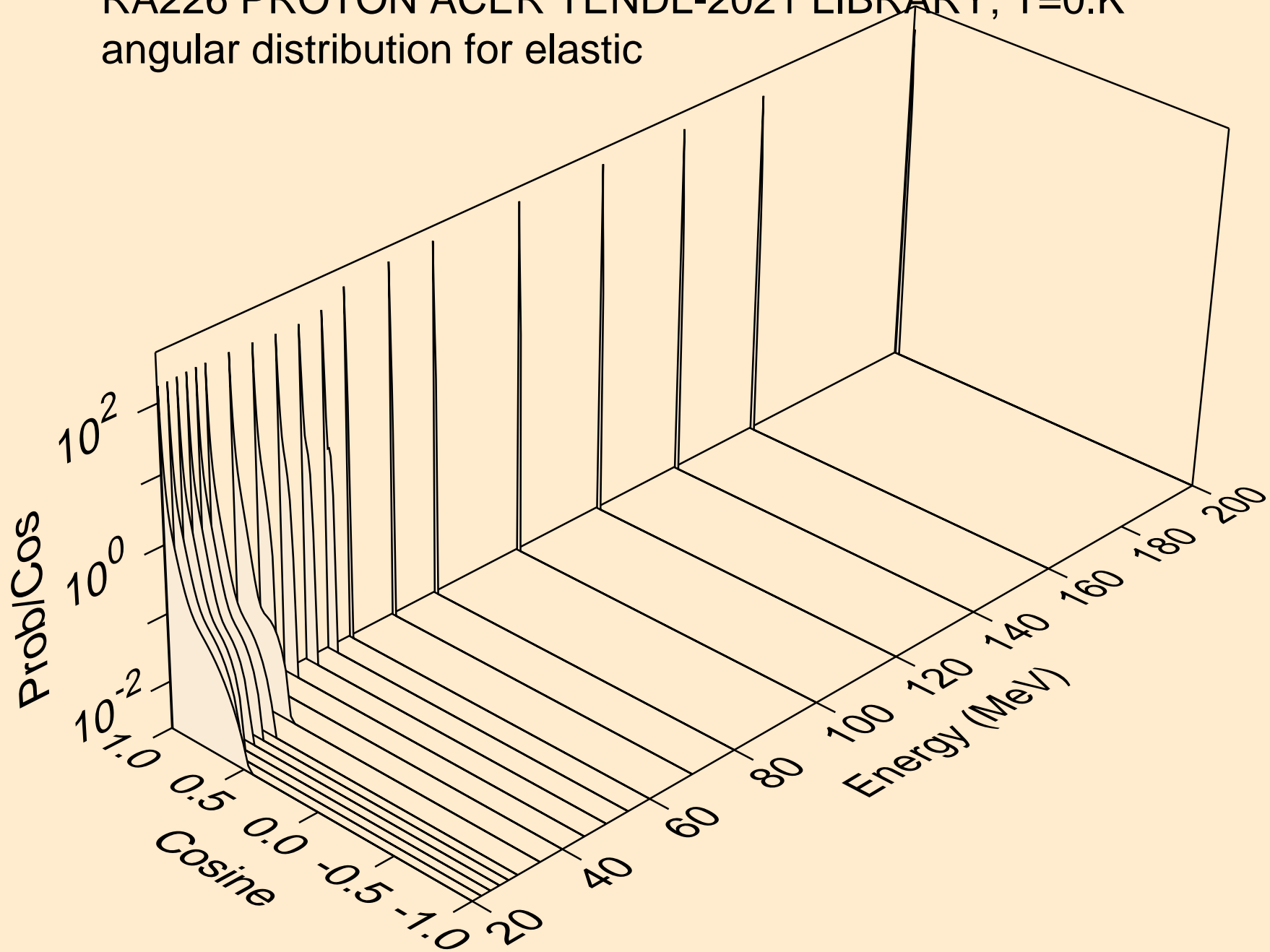

RA226 PROTON ACER TENDL-2021 LIBRARY; T=0.K  
Proton emission for (p,x)

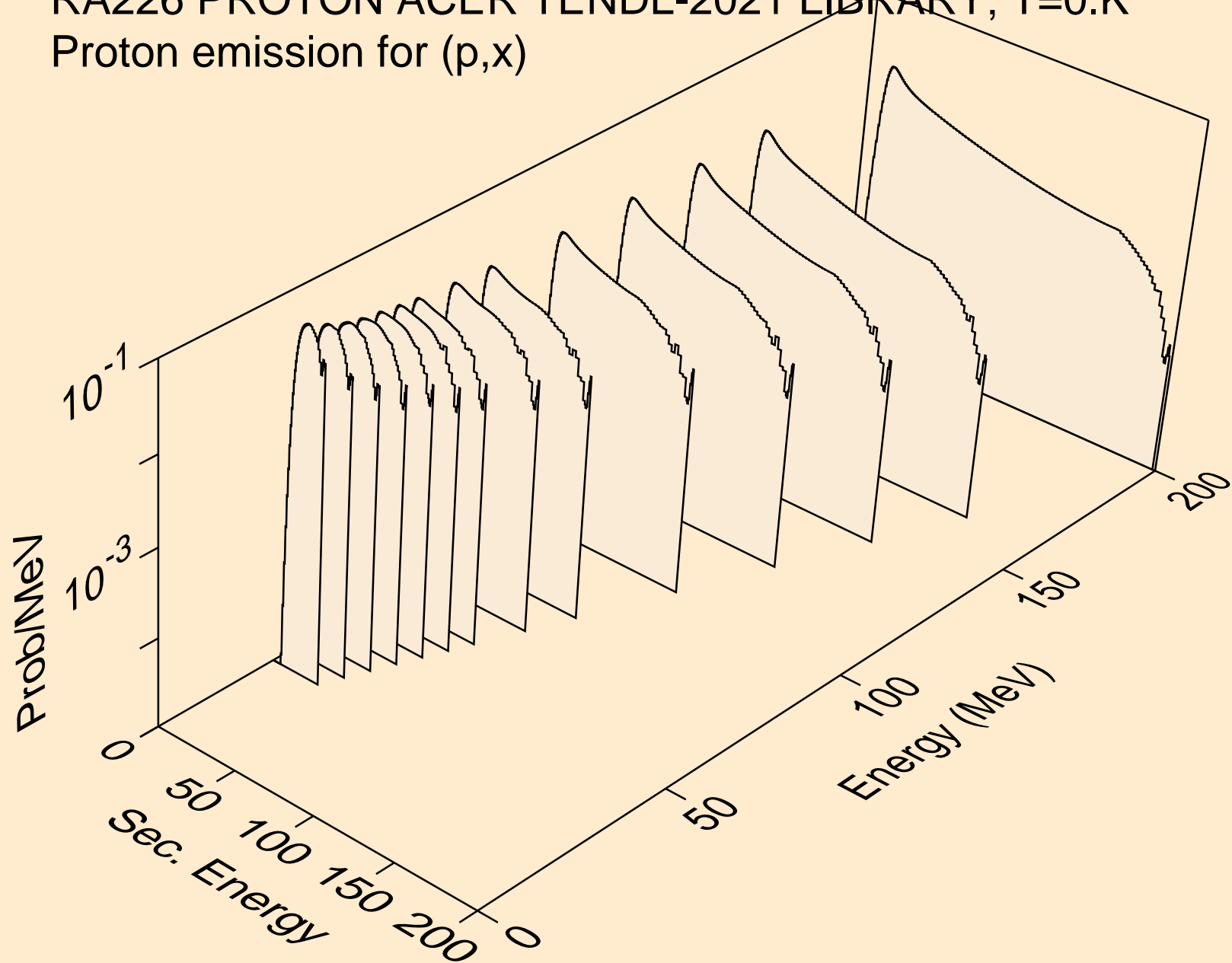

RA226 PROTON ACER TENDL-2021 LIBRARY; T=0.K  
Proton emission for (p,n\*)p

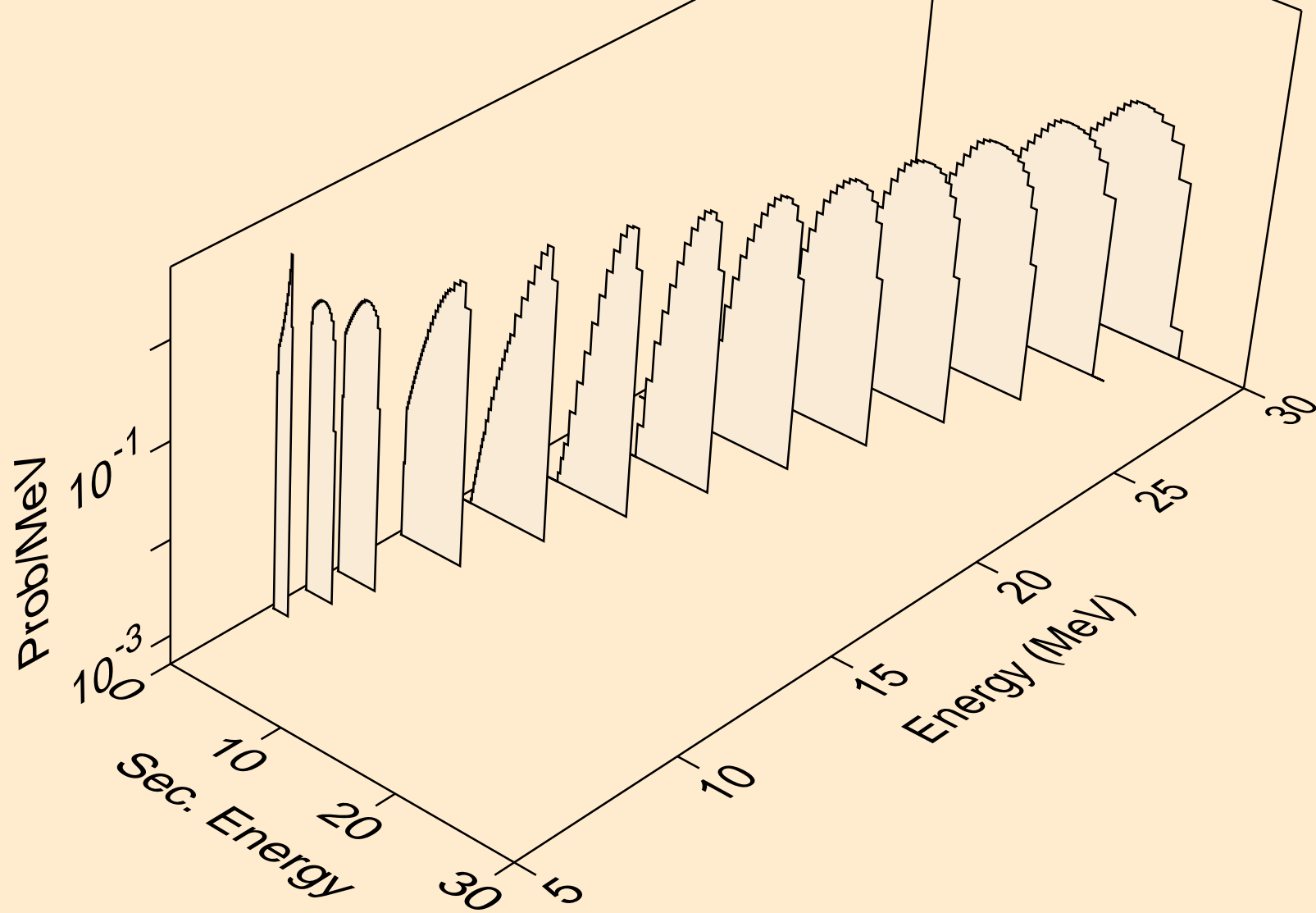

RA226 PROTON ACER TENDL-2021 LIBRARY; T=0.K  
Proton emission for (p,2np)

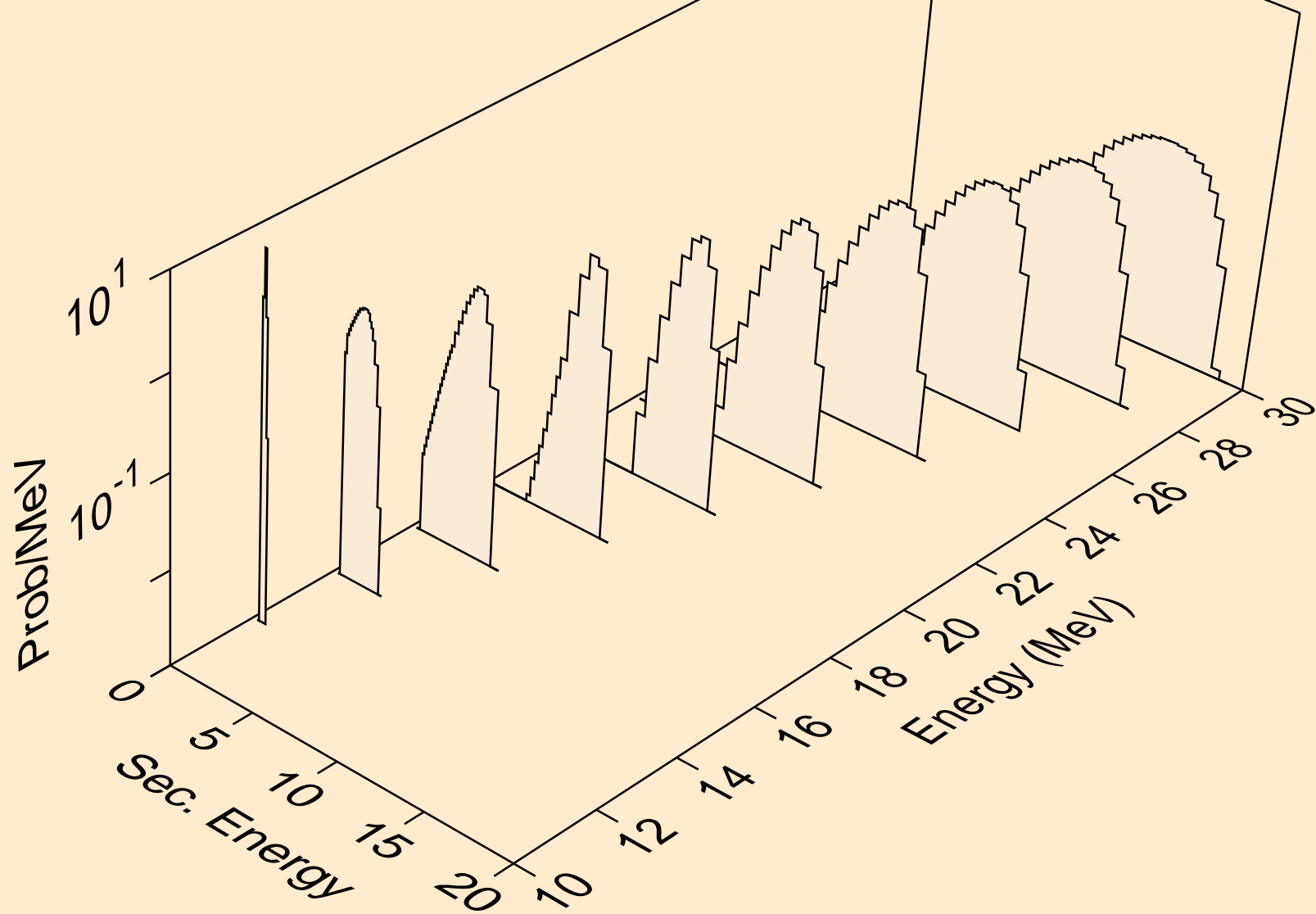

RA226 PROTON ACER TENDL-2021 LIBRARY; T=0.K  
Proton emission for (p,3np)

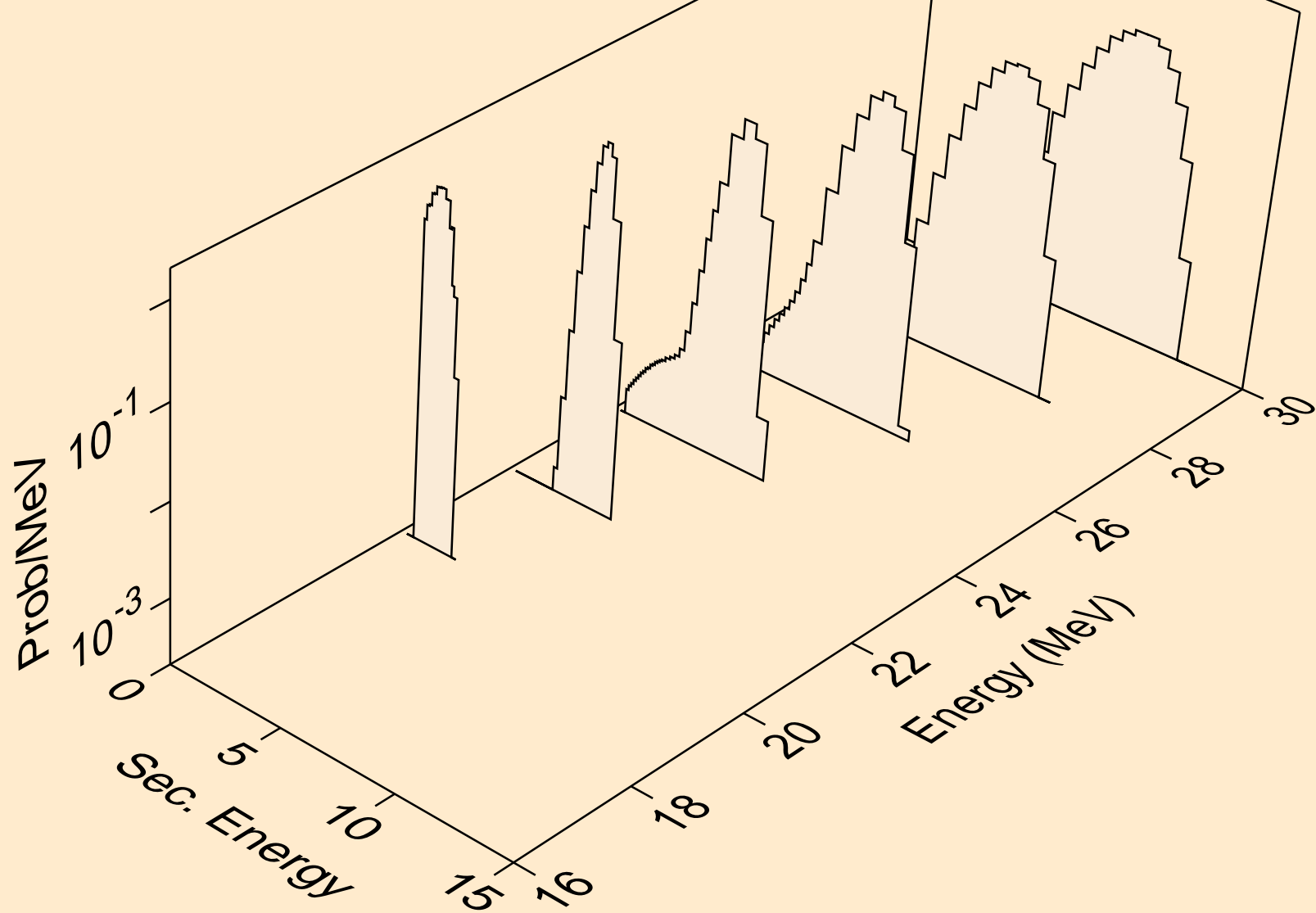

RA226 PROTON ACER TENDL-2021 LIBRARY; T=0.K  
Proton emission for (p,2np)

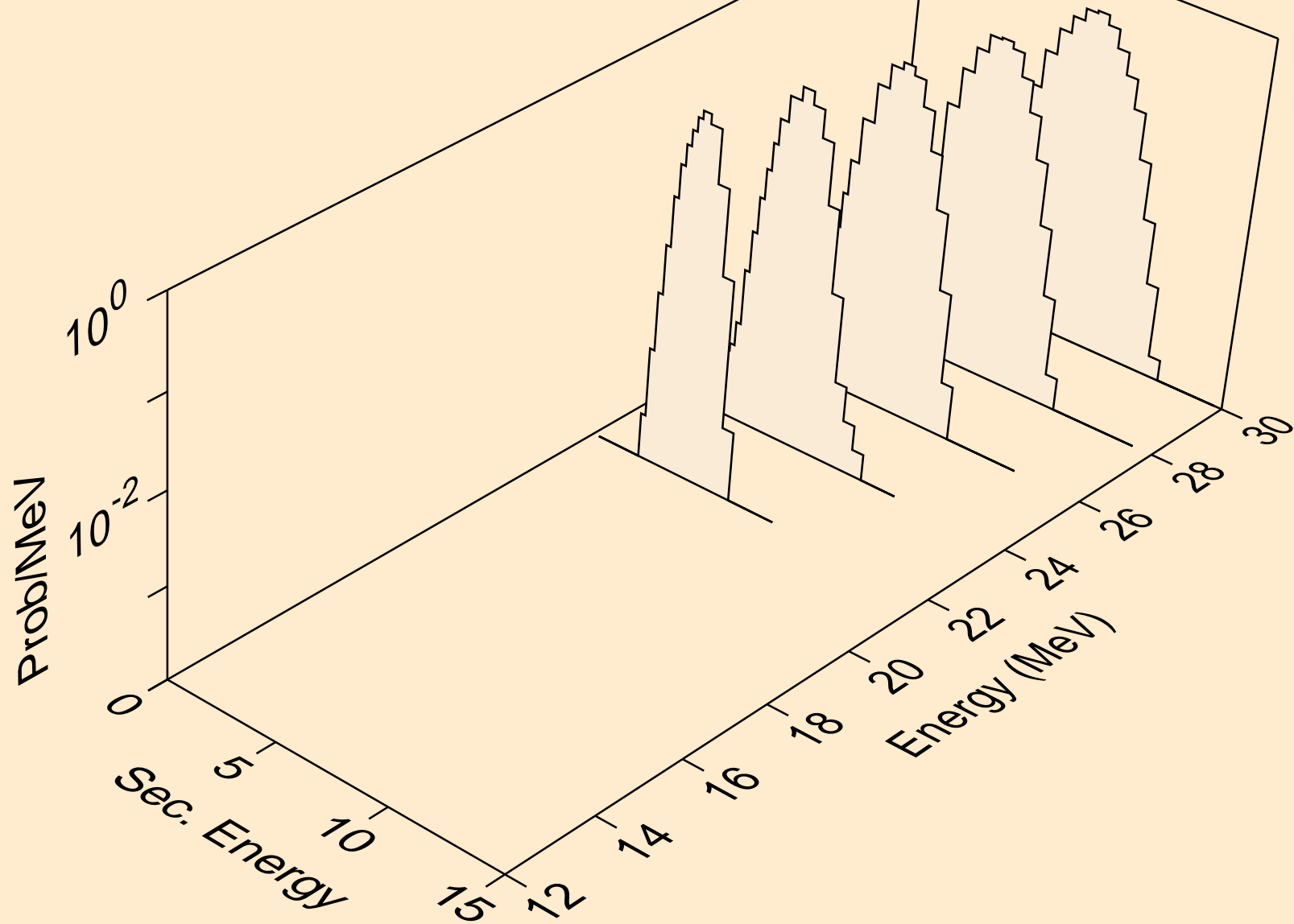



RA226 PROTON ACER TENDL-2021 LIBRARY; T=0.K  
Proton emission for (p,npa)

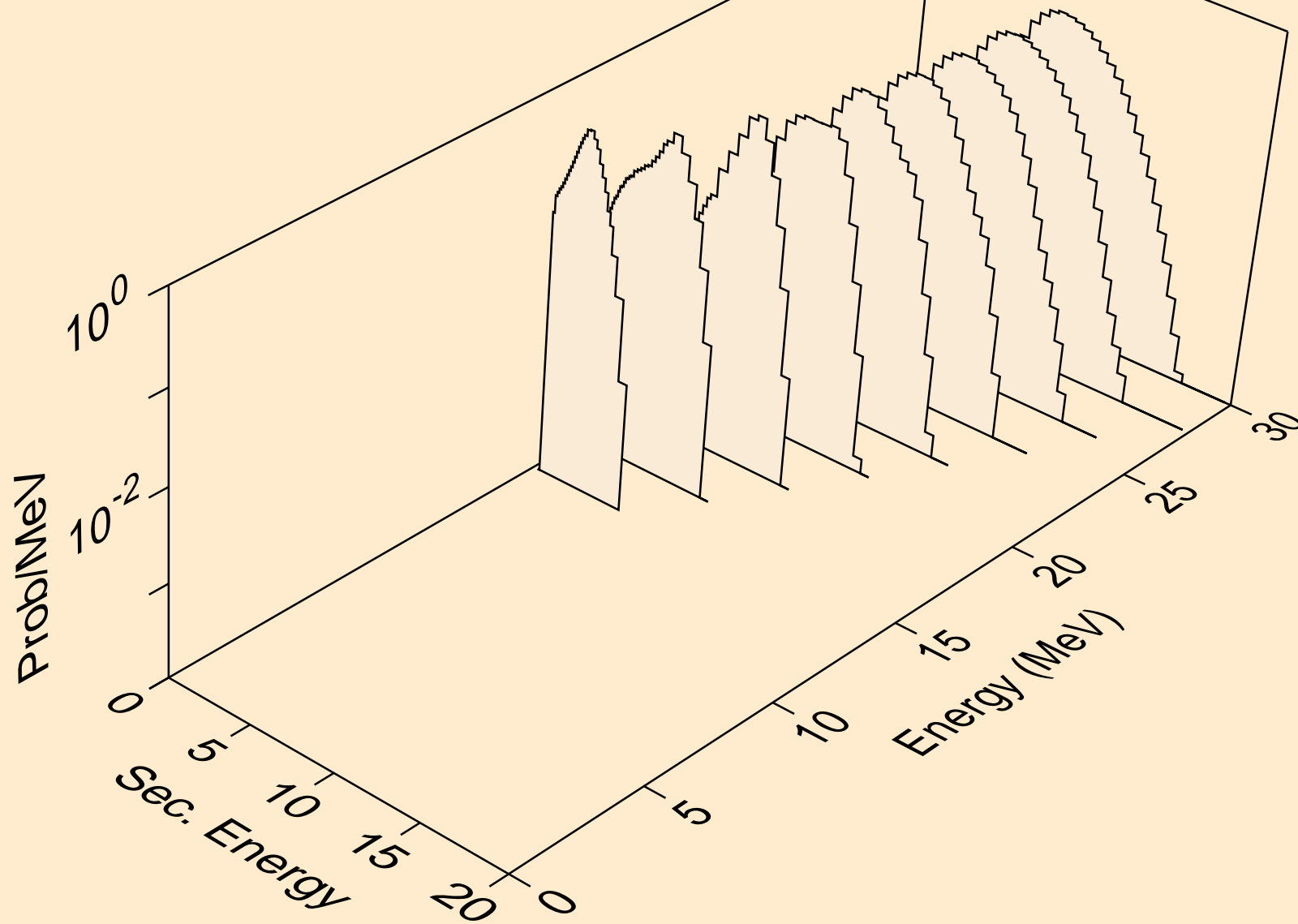

RA226 PROTON ACER TENDL-2021 LIBRARY; T=0.K  
Proton emission for inelastic

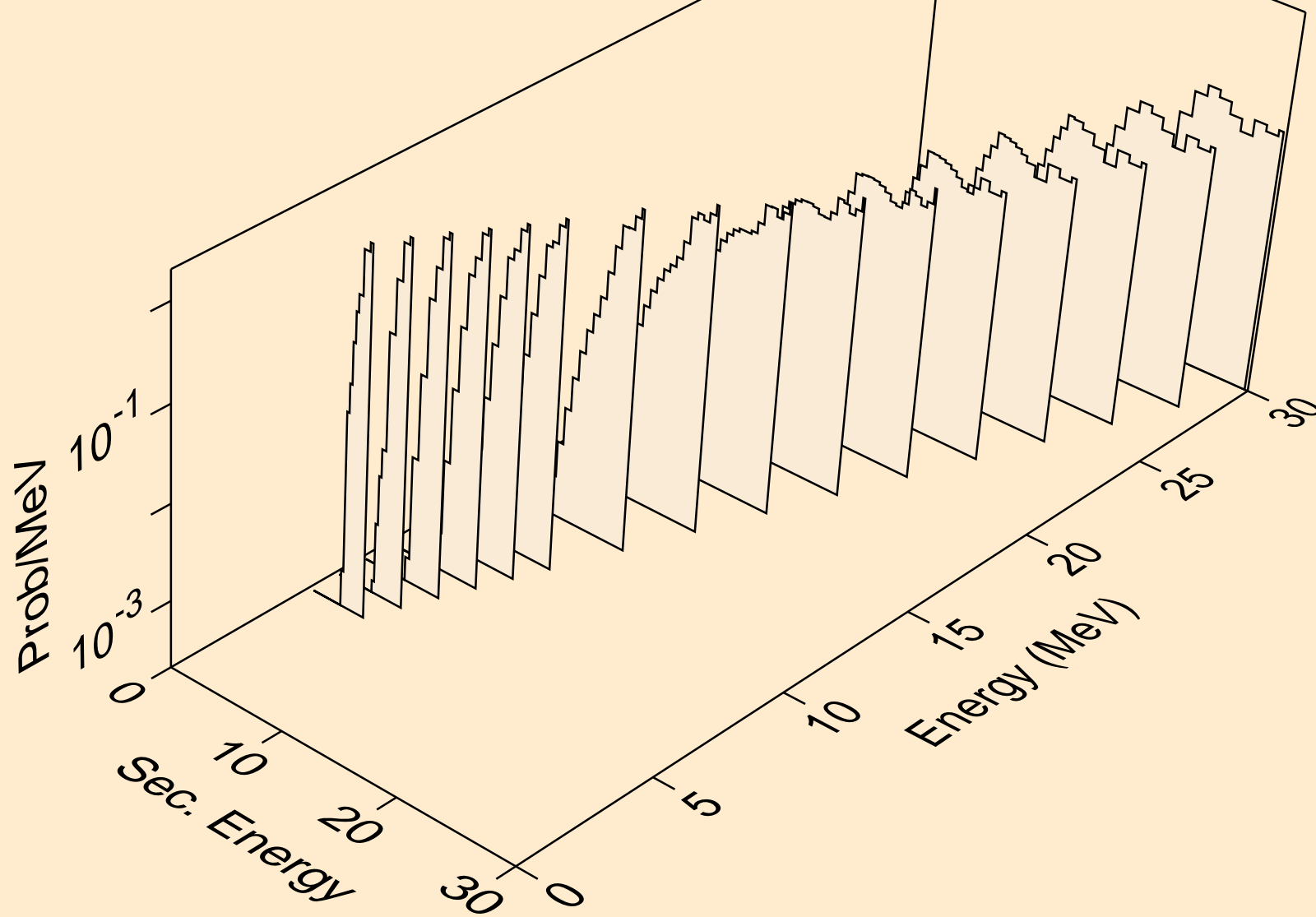

RA226 PROTON ACER TENDL-2021 LIBRARY; T=0.K  
Proton emission for (p,2p)

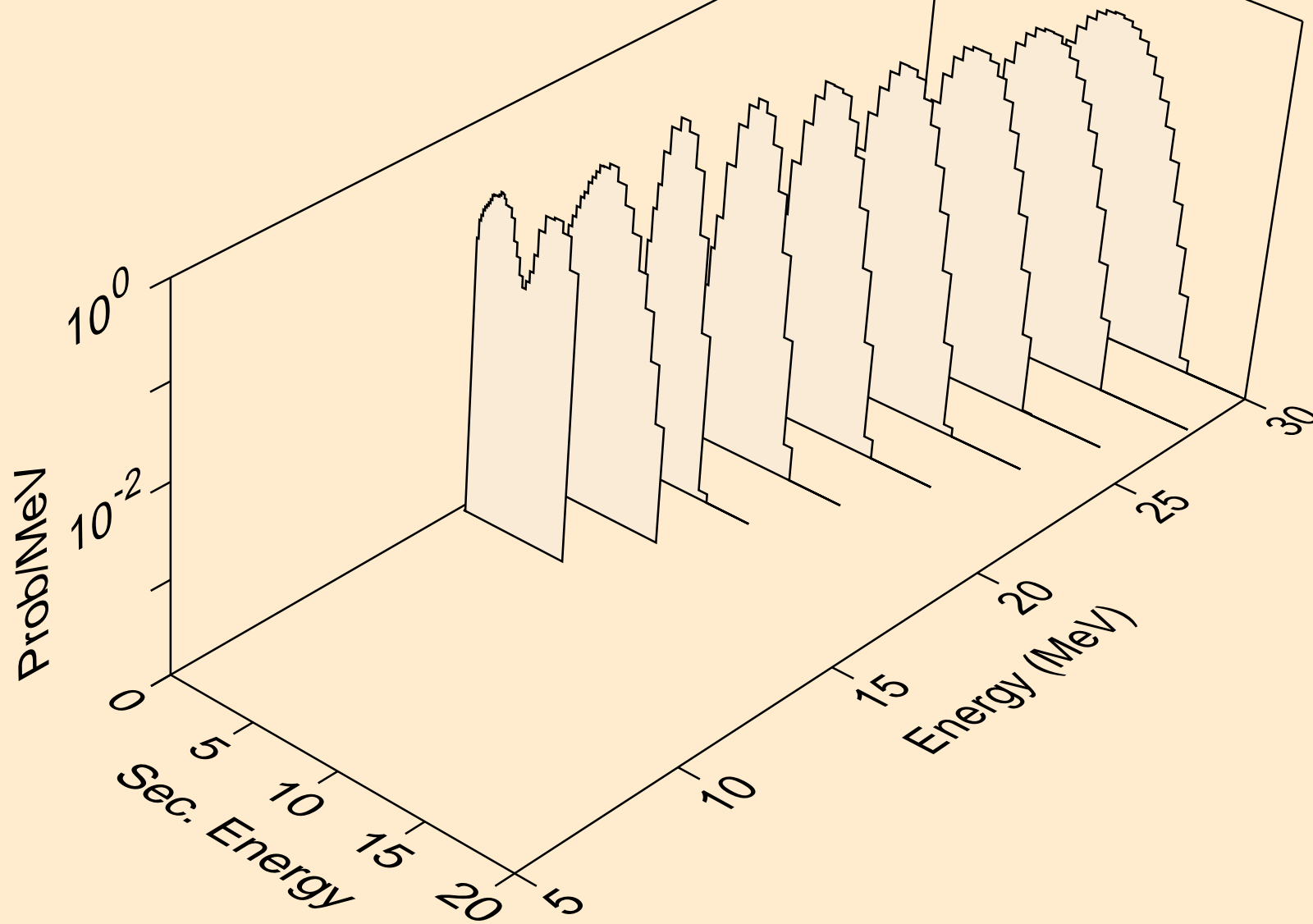

RA226 PROTON ACER TENDL-2021 LIBRARY; T=0.K  
Proton emission for (p,pa)

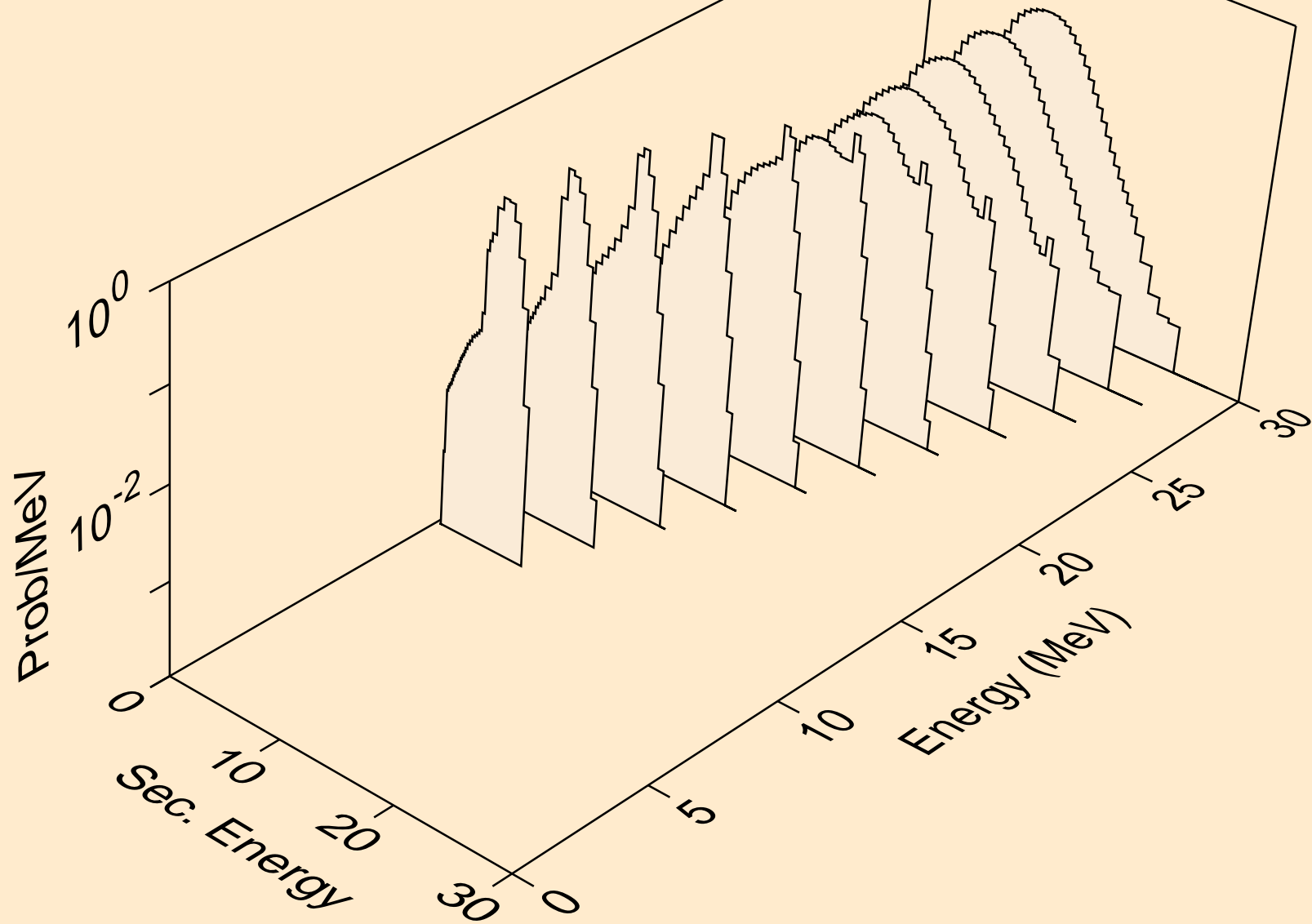

RA226 PROTON ACER TENDL-2021 LIBRARY; T=0.K  
Photon emission for (z,n)

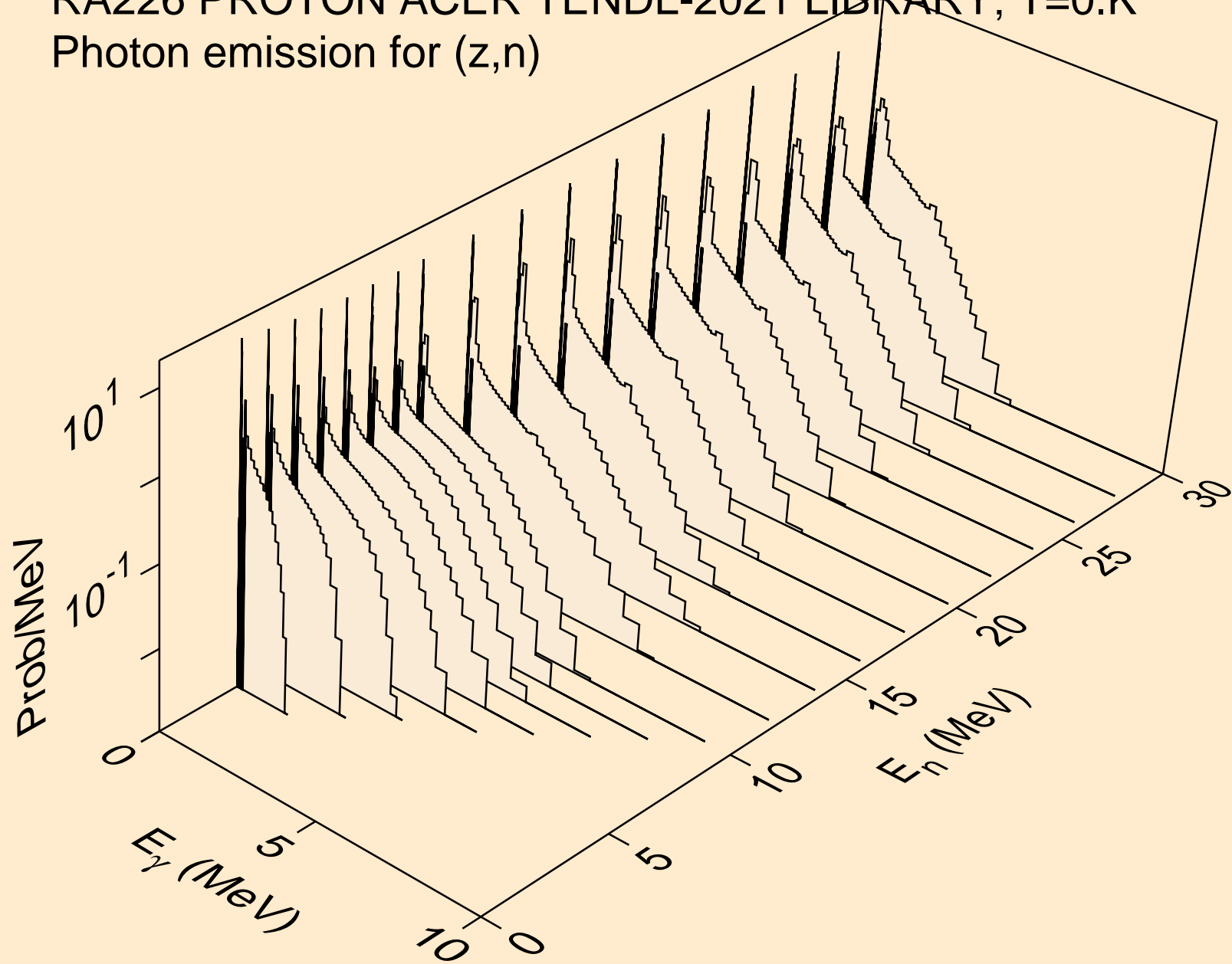

RA226 PROTON ACER TENDL-2021 LIBRARY; T=0.K  
Photon emission for (n,x)

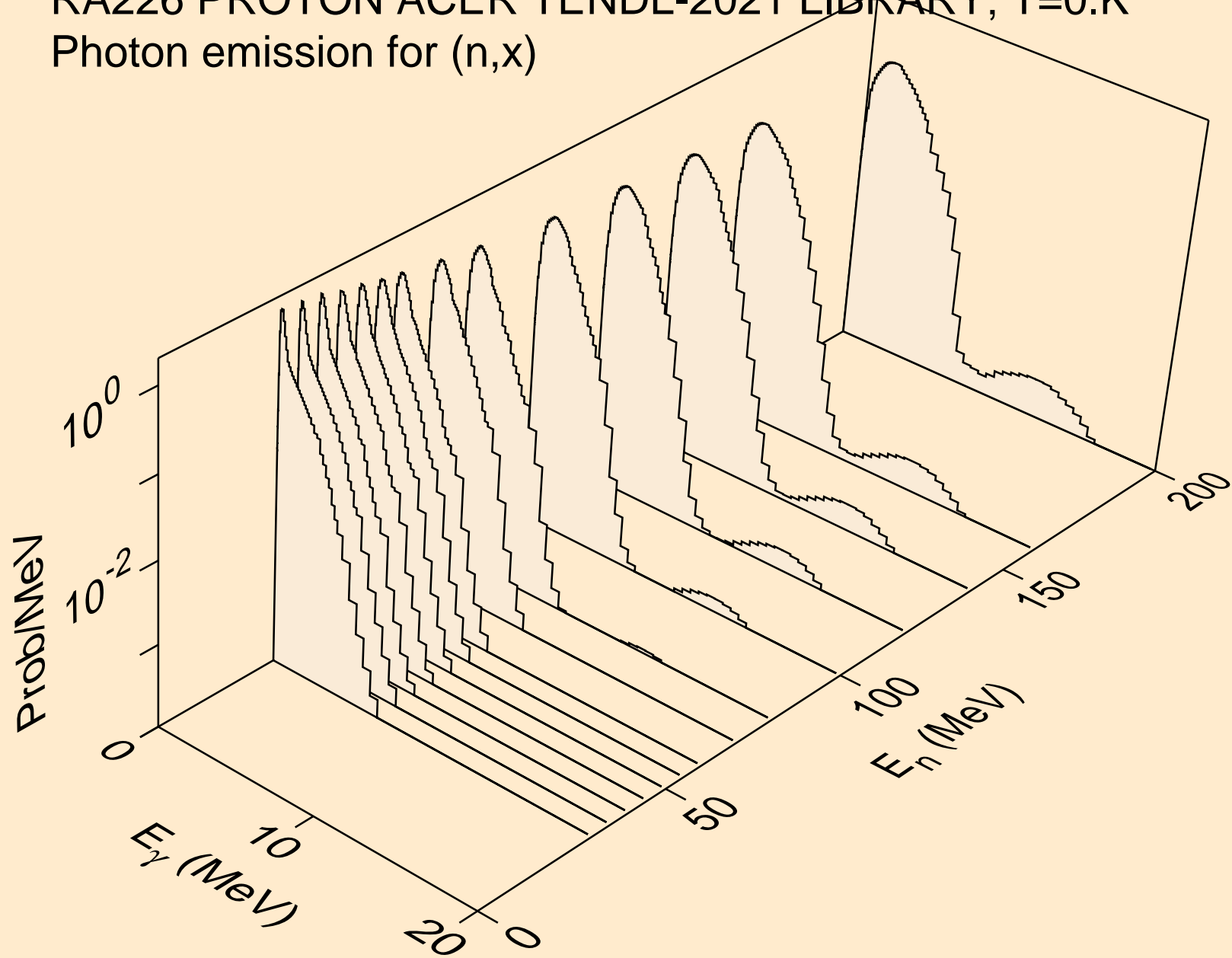

RA226 PROTON ACER TENDL-2021 LIBRARY; T=0.K  
Photon emission for (n,2nd)

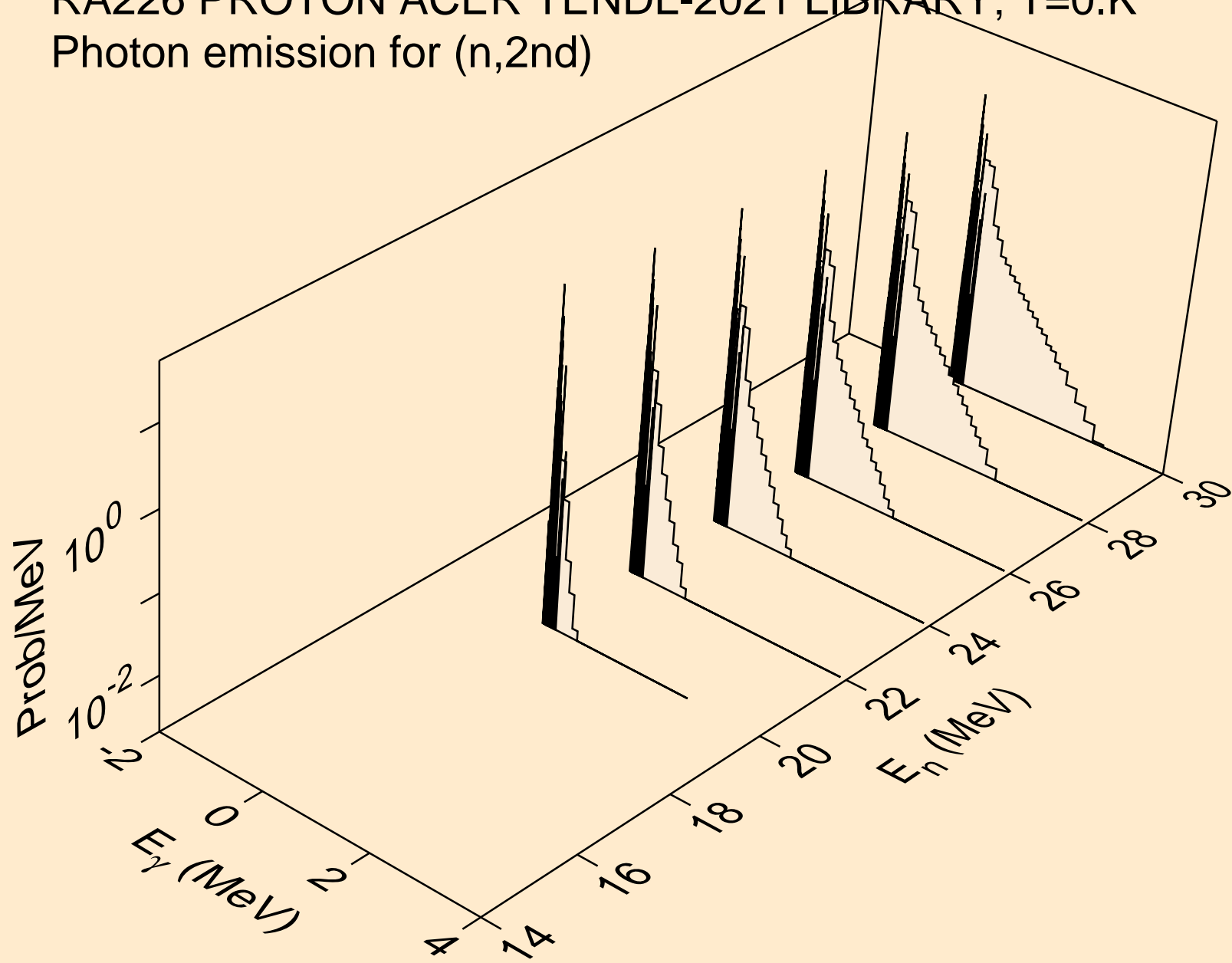

RA226 PROTON ACER TENDL-2021 LIBRARY; T=0.K  
Photon emission for (n,2n)

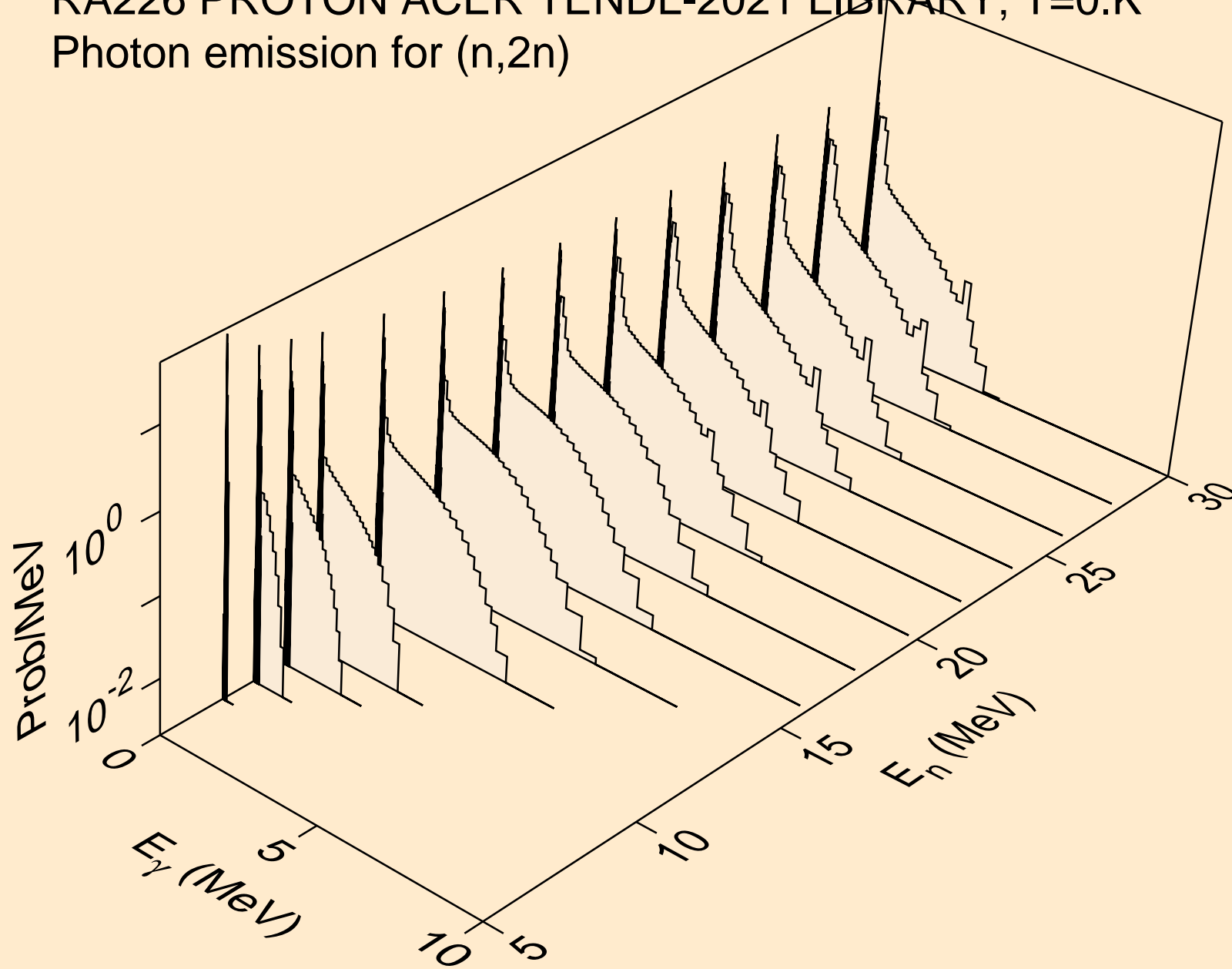



RA226 PROTON ACER TENDL-2021 LIBRARY; T=0.K  
Photon emission for (n,3n)

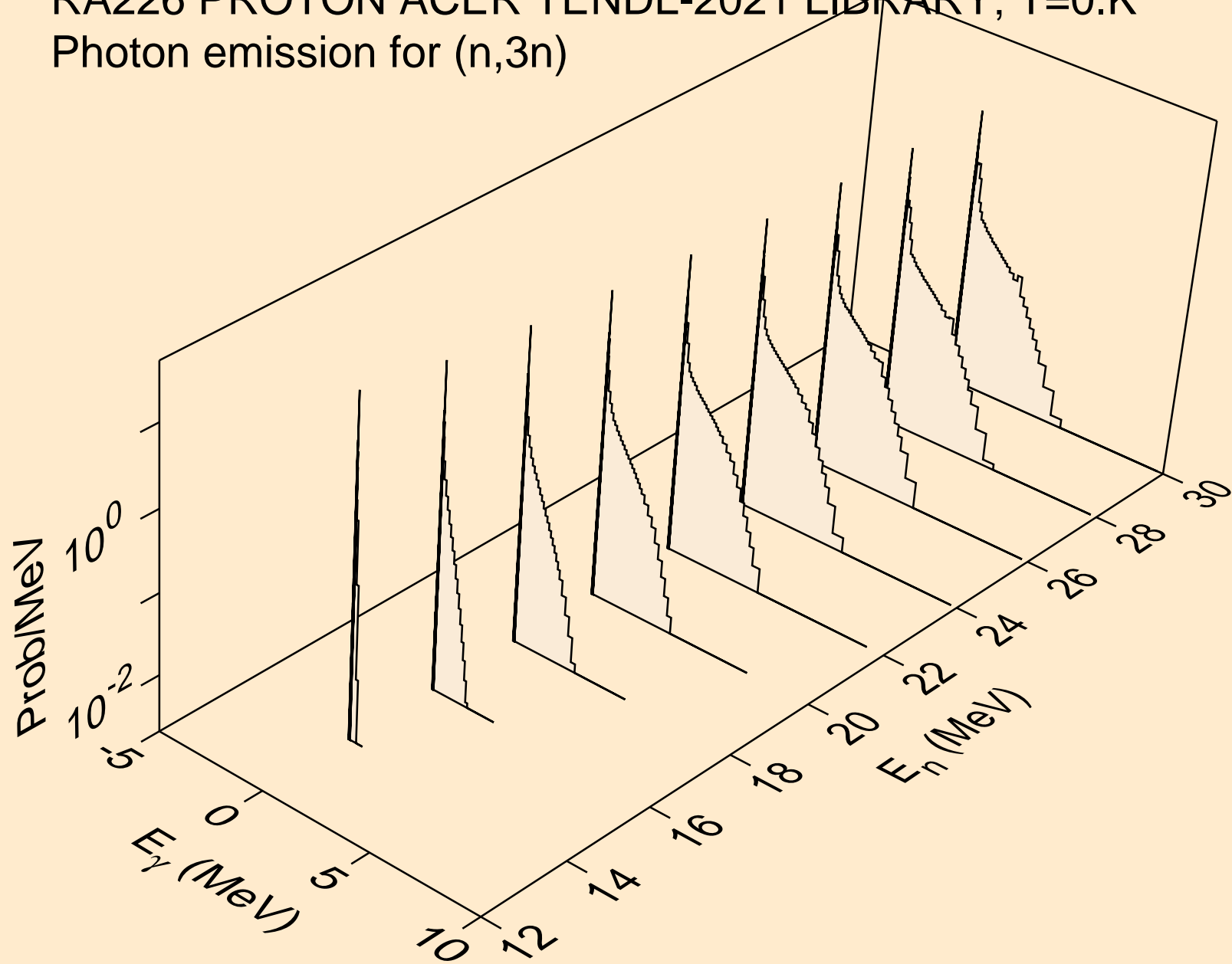

RA226 PROTON ACER TENDL-2021 LIBRARY; T=0.K  
Photon emission for (n,n\*)a

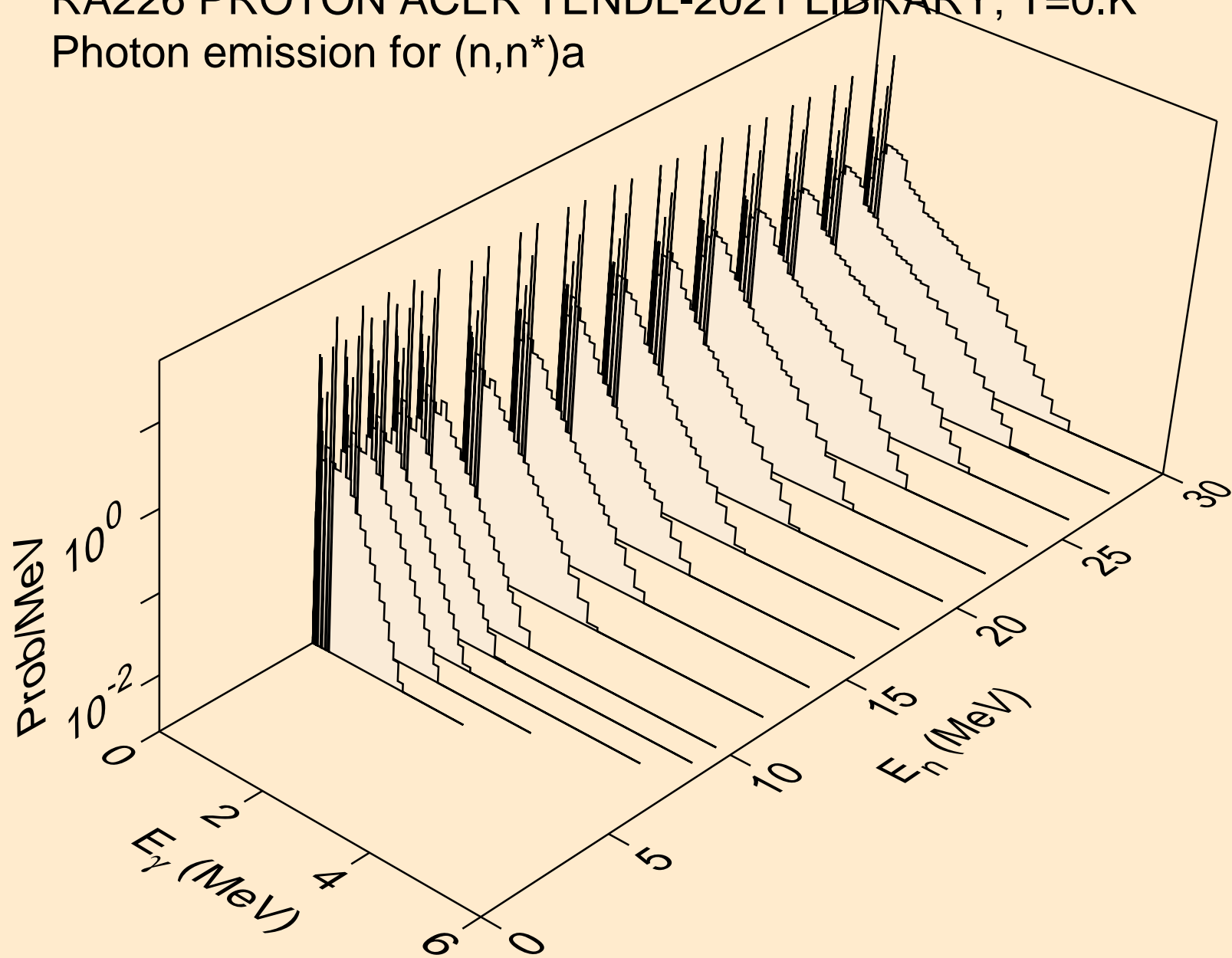

RA226 PROTON ACER TENDL-2021 LIBRARY; T=0.K  
Photon emission for (n,2n)a

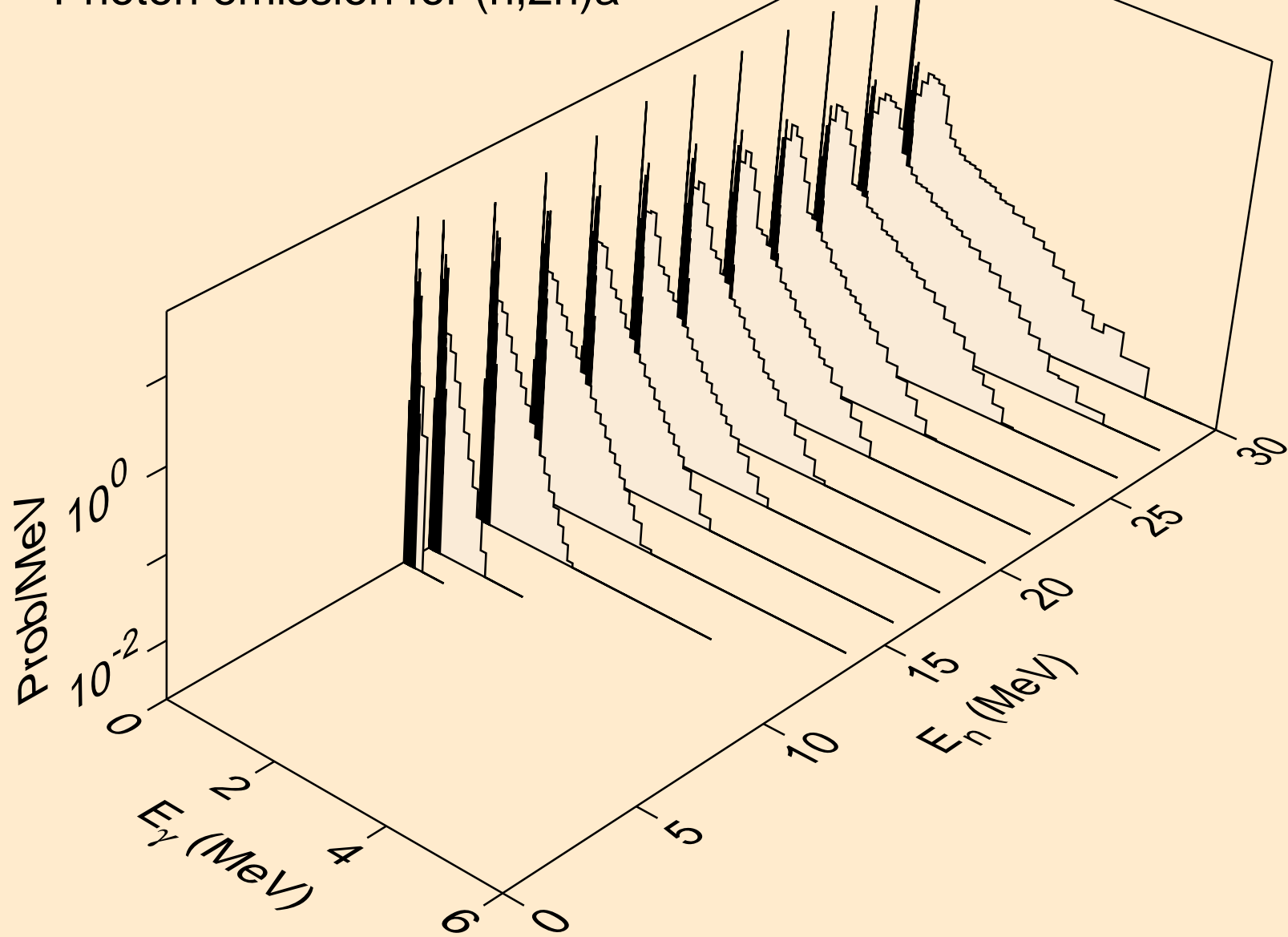

RA226 PROTON ACER TENDL-2021 LIBRARY; T=0.K  
Photon emission for (n,3n)a

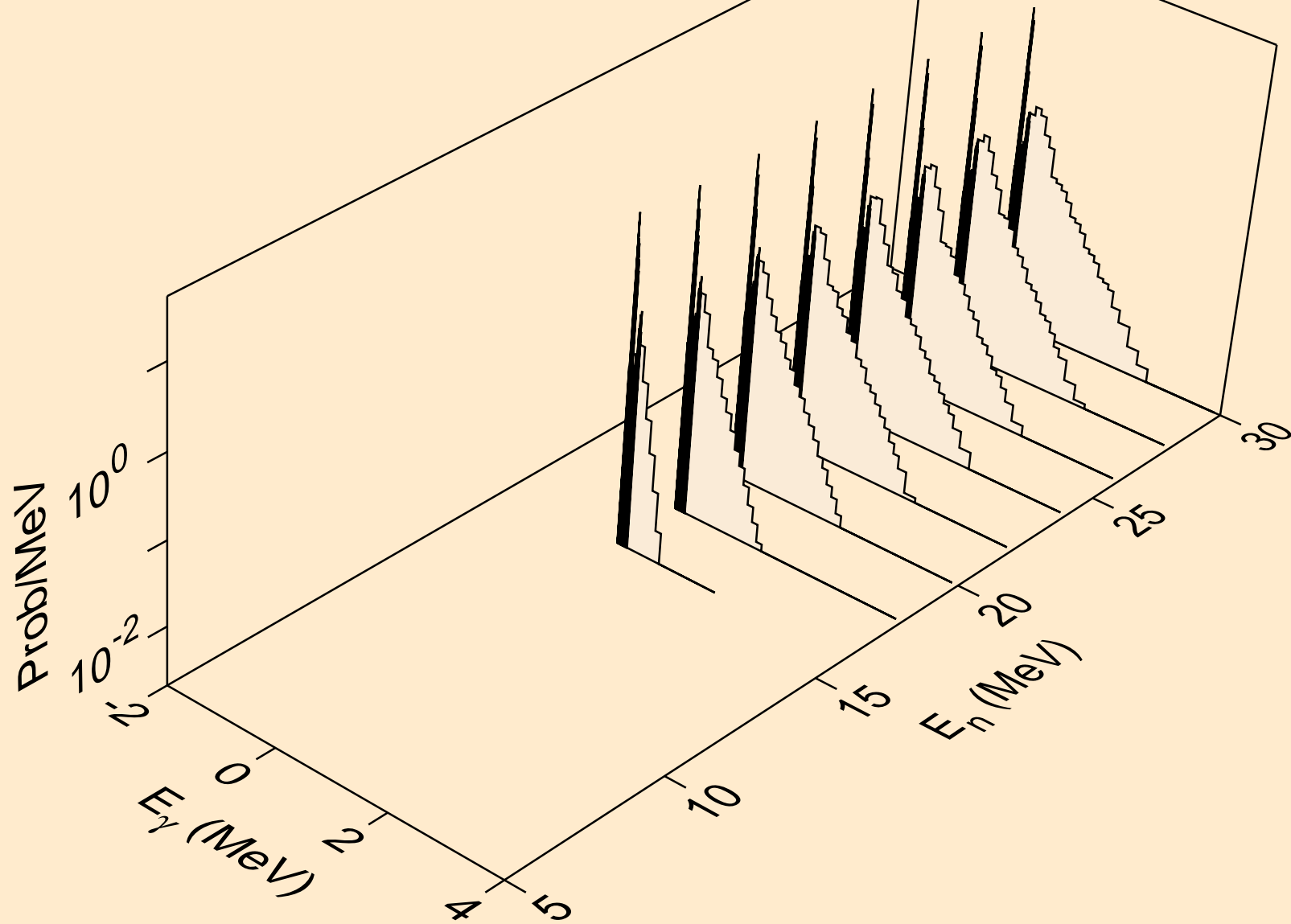

RA226 PROTON ACER TENDL-2021 LIBRARY; T=0.K  
Photon emission for (n,n\*)p

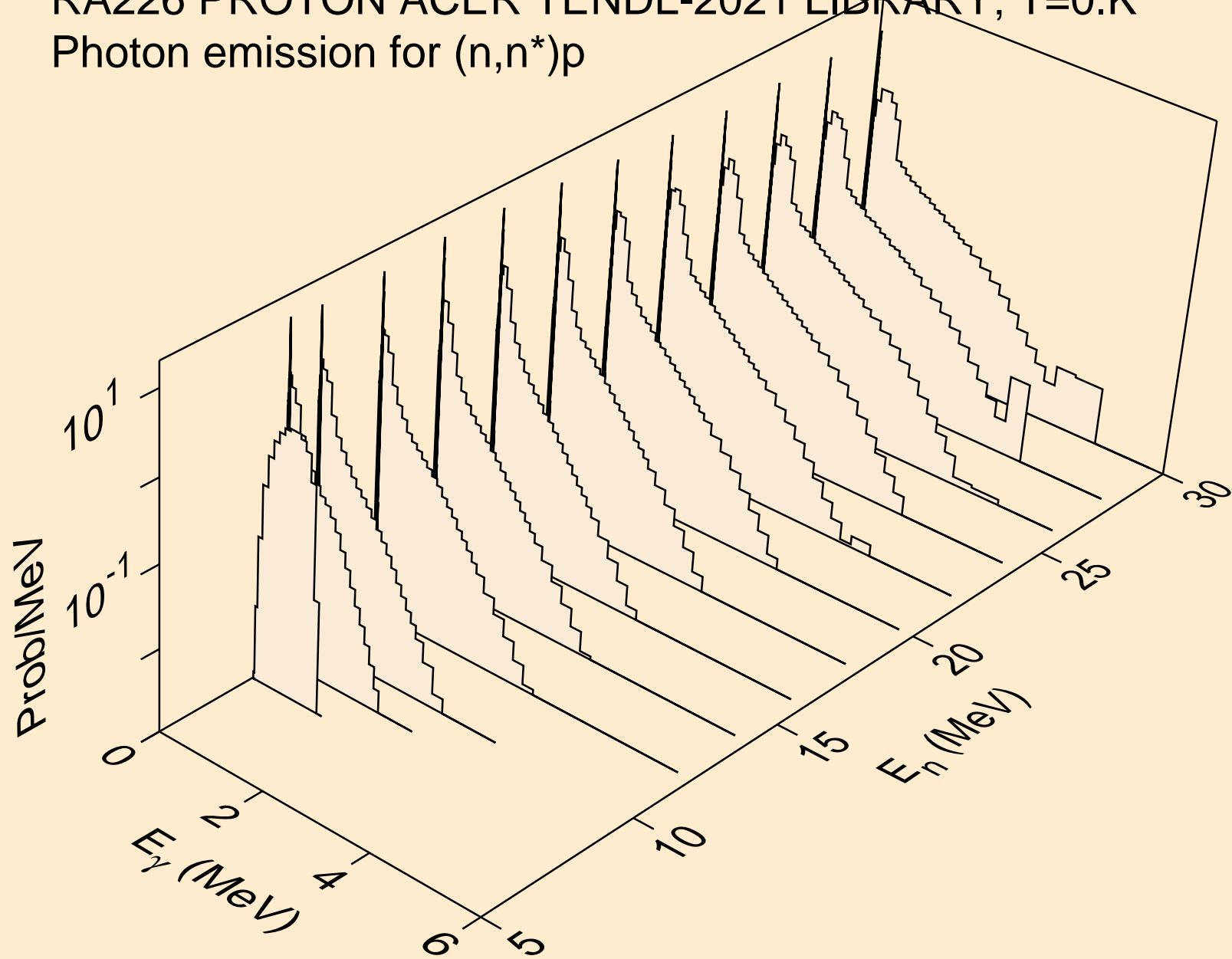

RA226 PROTON ACER TENDL-2021 LIBRARY; T=0.K  
Photon emission for (n,n\*)2a

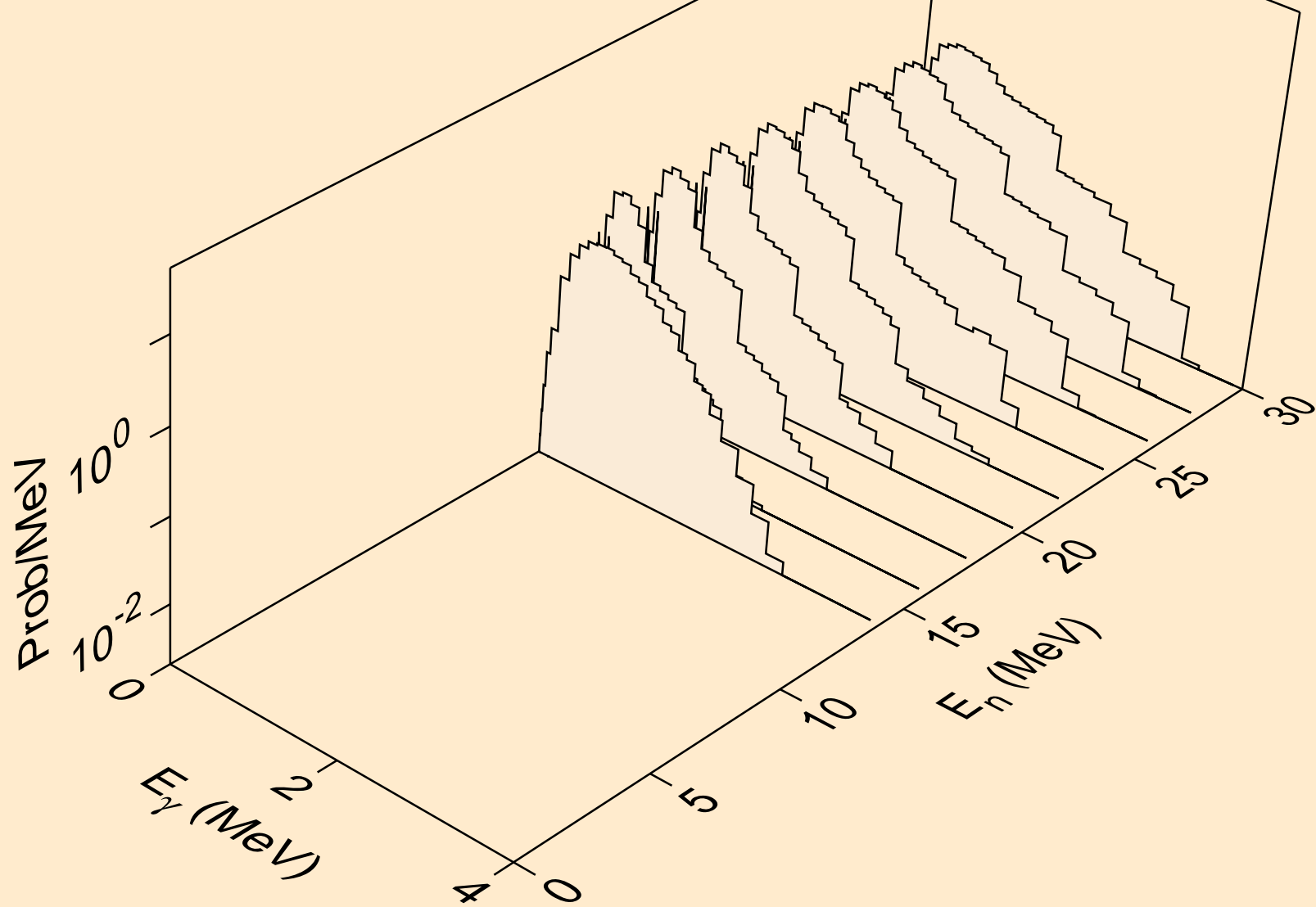

RA226 PROTON ACER TENDL-2021 LIBRARY; T=0.K  
Photon emission for (n,2n)2a

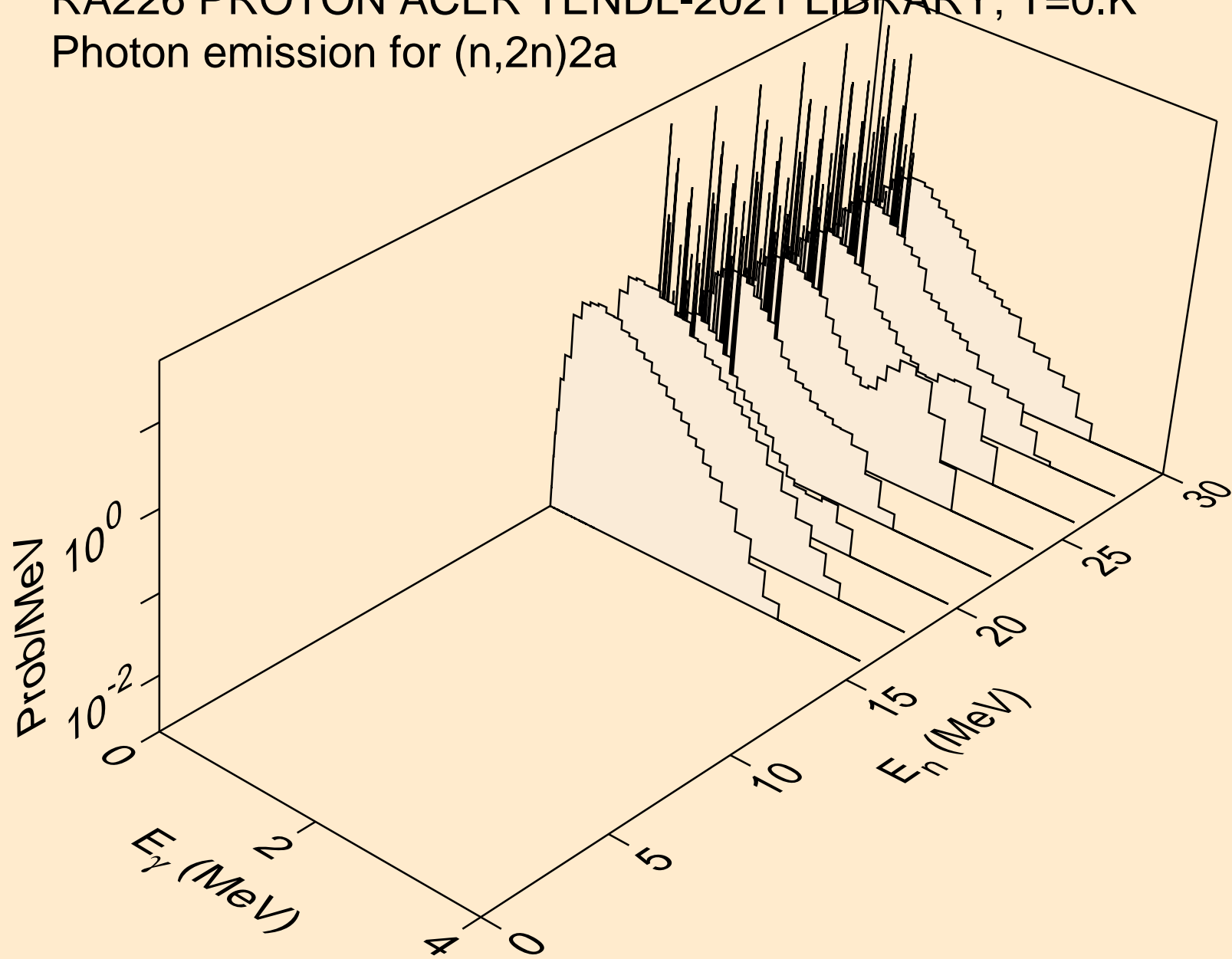

RA226 PROTON ACER TENDL-2021 LIBRARY; T=0.K  
Photon emission for (n,n\*)d

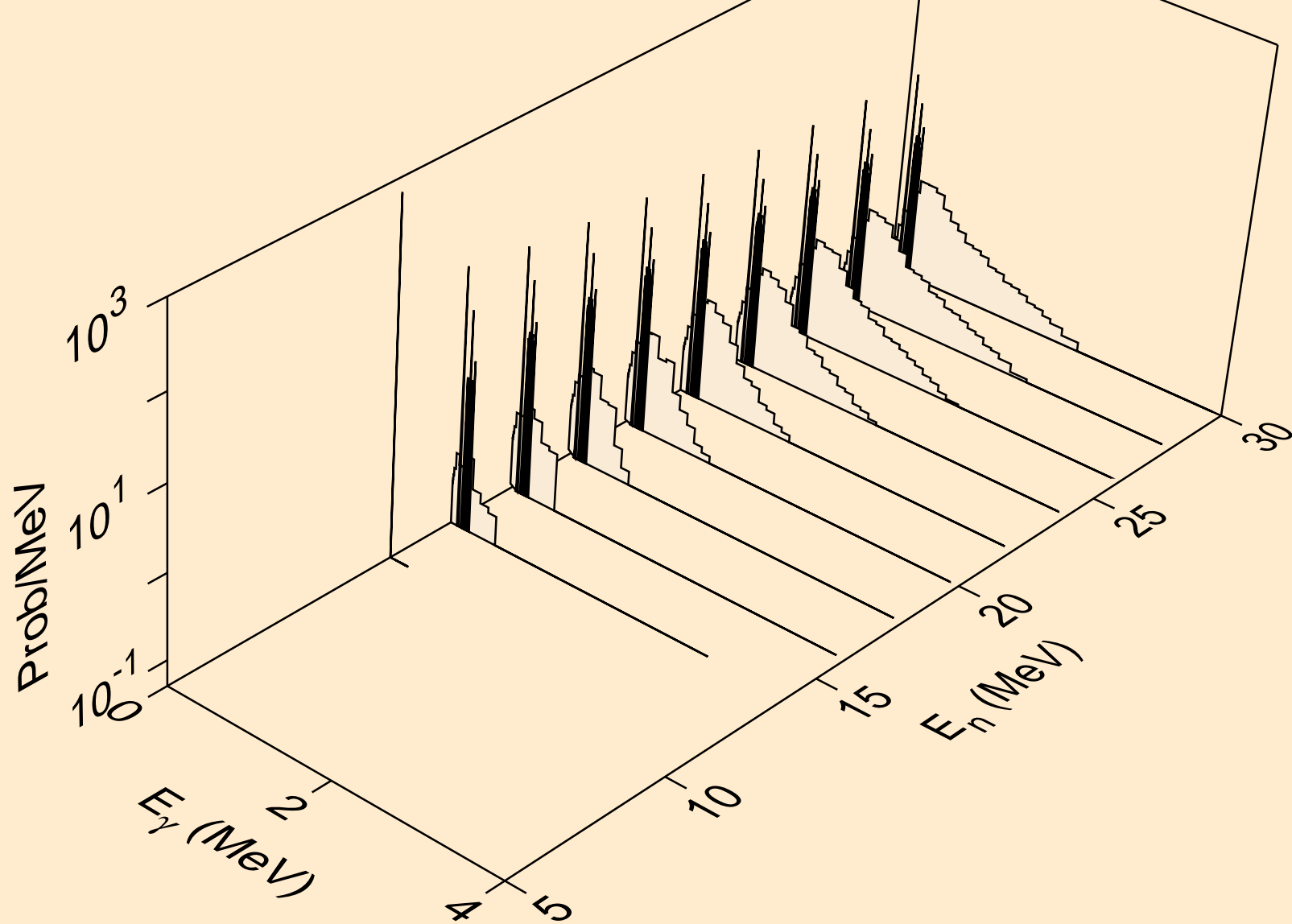



RA226 PROTON ACER TENDL-2021 LIBRARY; T=0.K  
Photon emission for (n,n\*)t

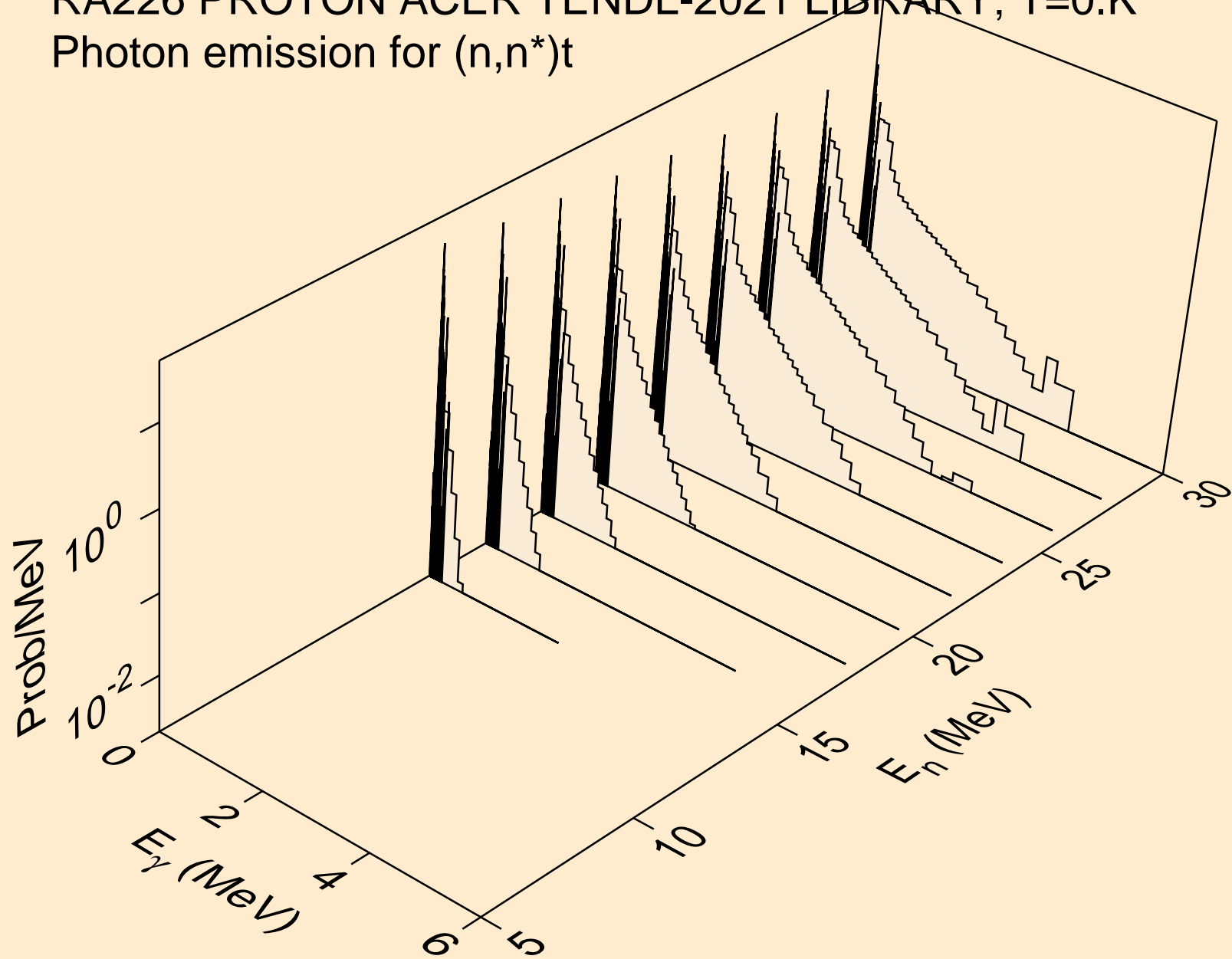

RA226 PROTON ACER TENDL-2021 LIBRARY; T=0.K  
Photon emission for (n,n\*)he3

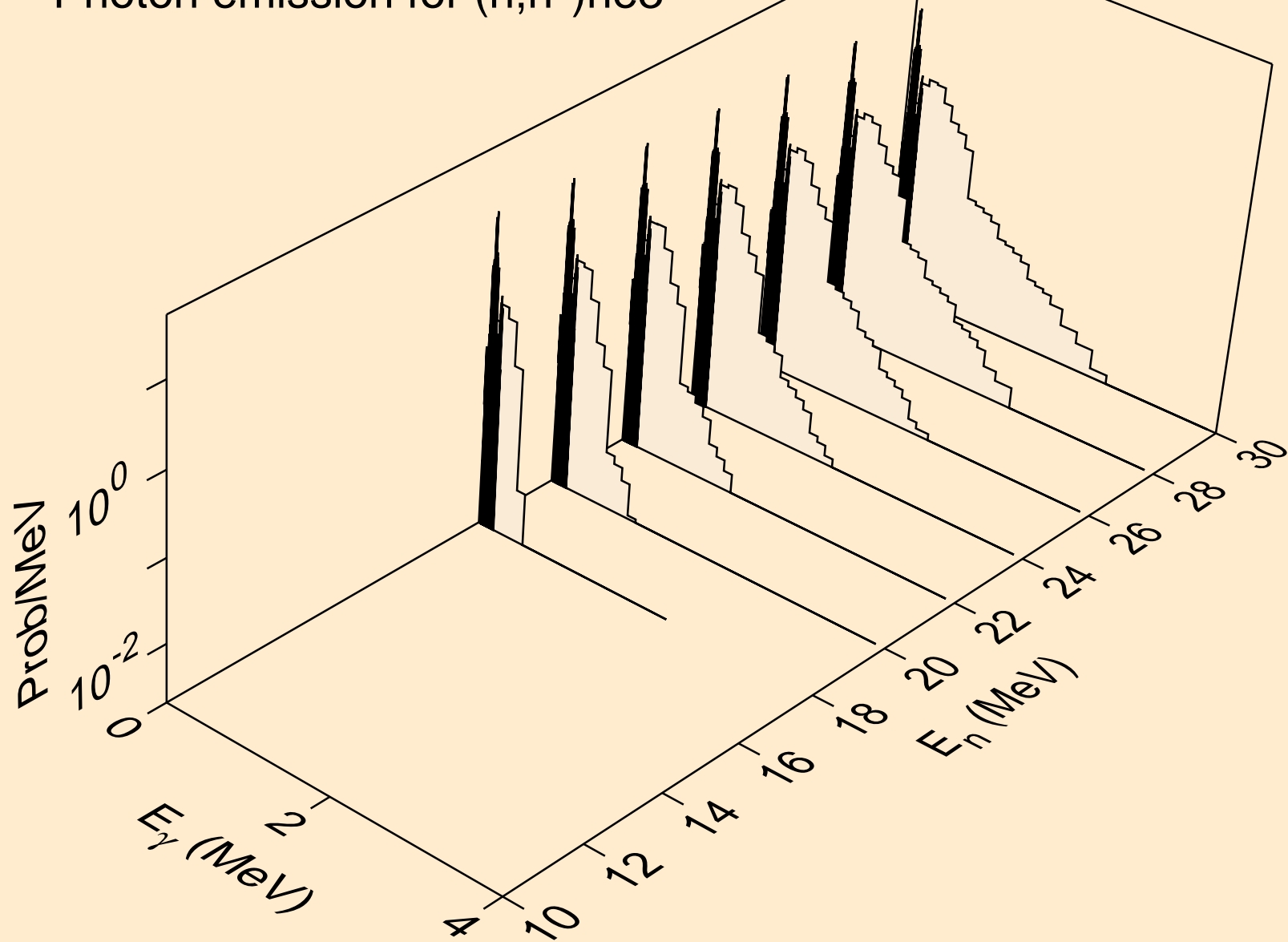

RA226 PROTON ACER TENDL-2021 LIBRARY; T=0.K  
Photon emission for (n,4n)

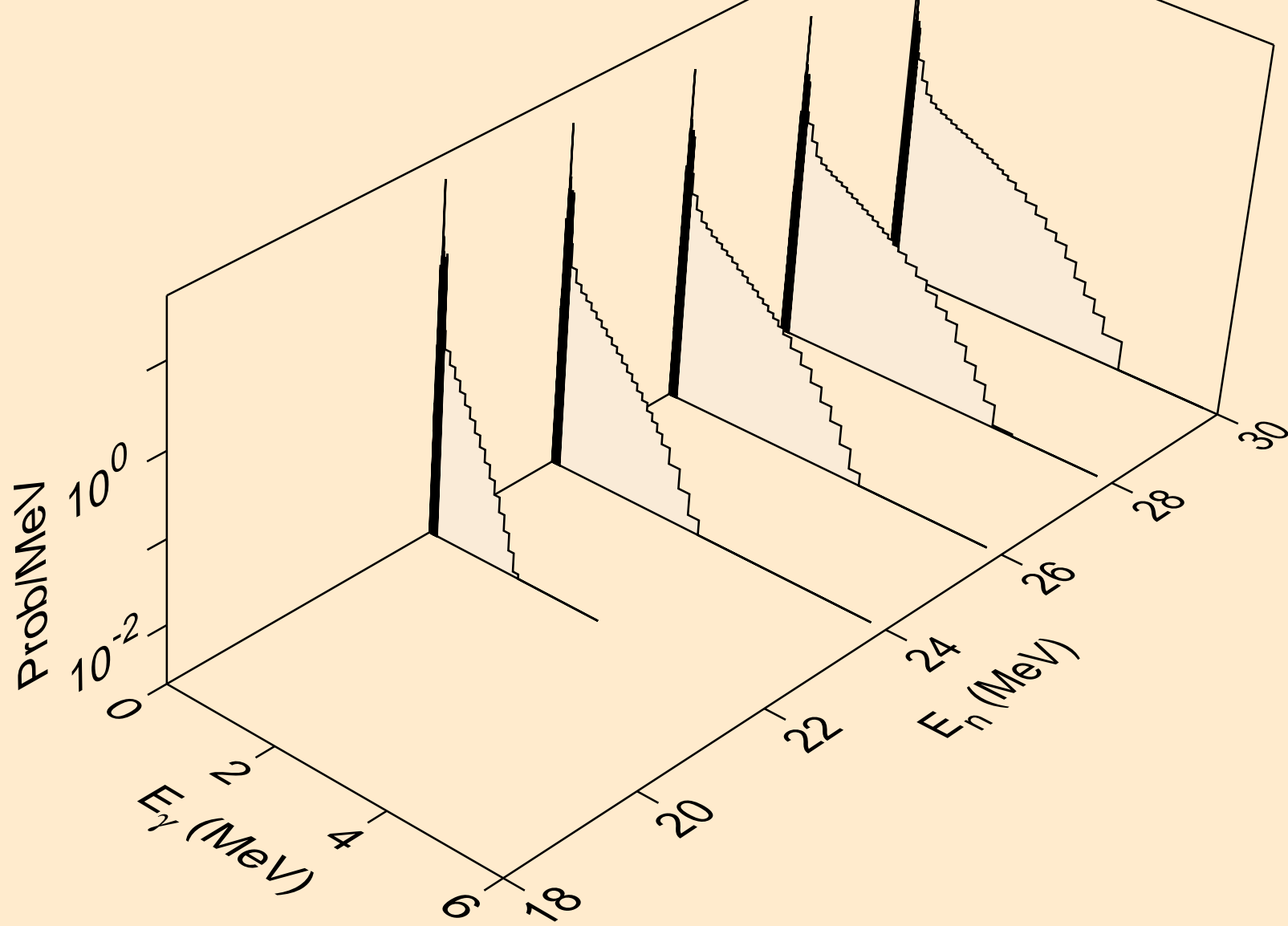

RA226 PROTON ACER TENDL-2021 LIBRARY; T=0.K  
Photon emission for (n,2np)

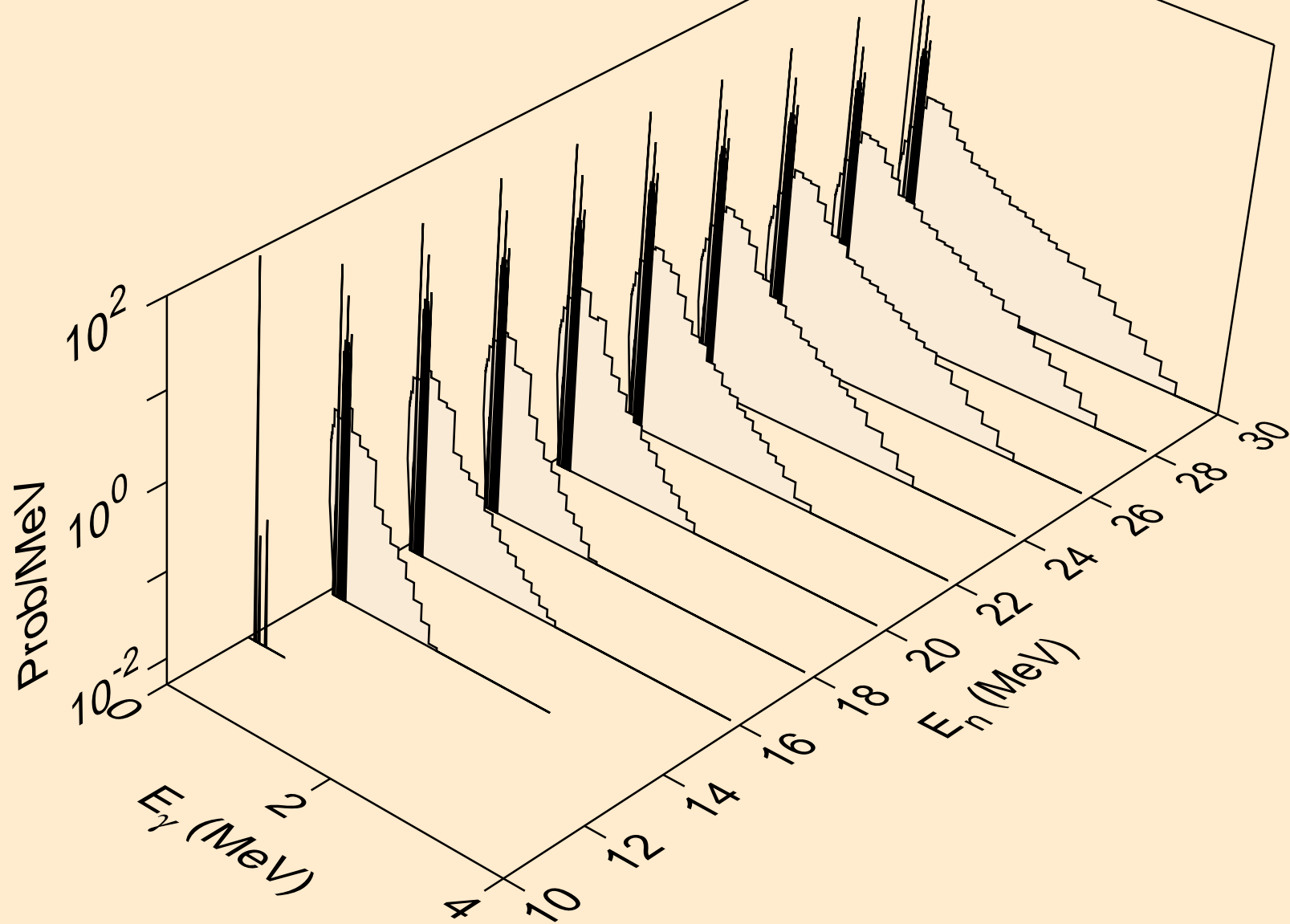

RA226 PROTON ACER TENDL-2021 LIBRARY; T=0.K  
Photon emission for (n,3np)

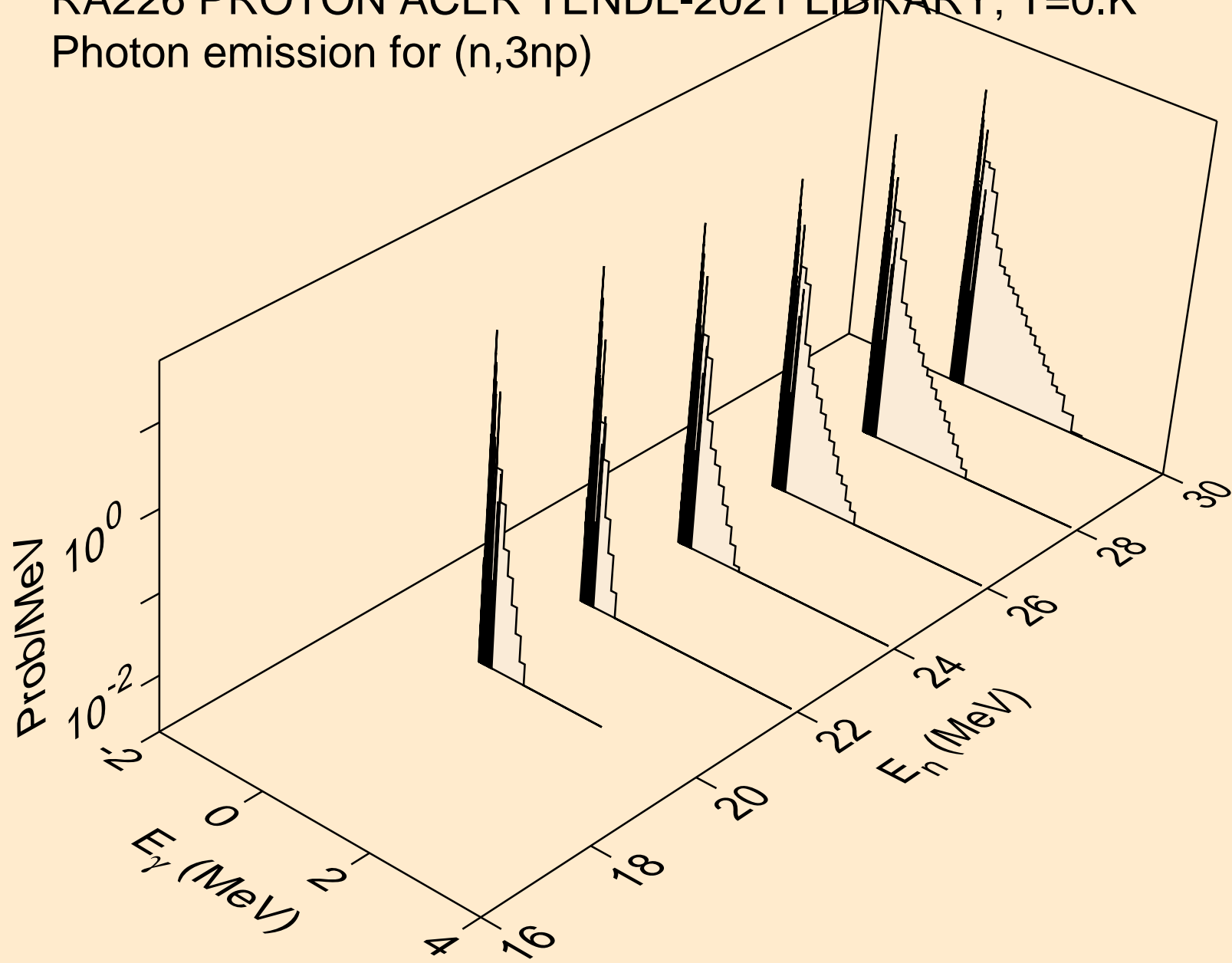

RA226 PROTON ACER TENDL-2021 LIBRARY; T=0.K  
Photon emission for (n,2np)

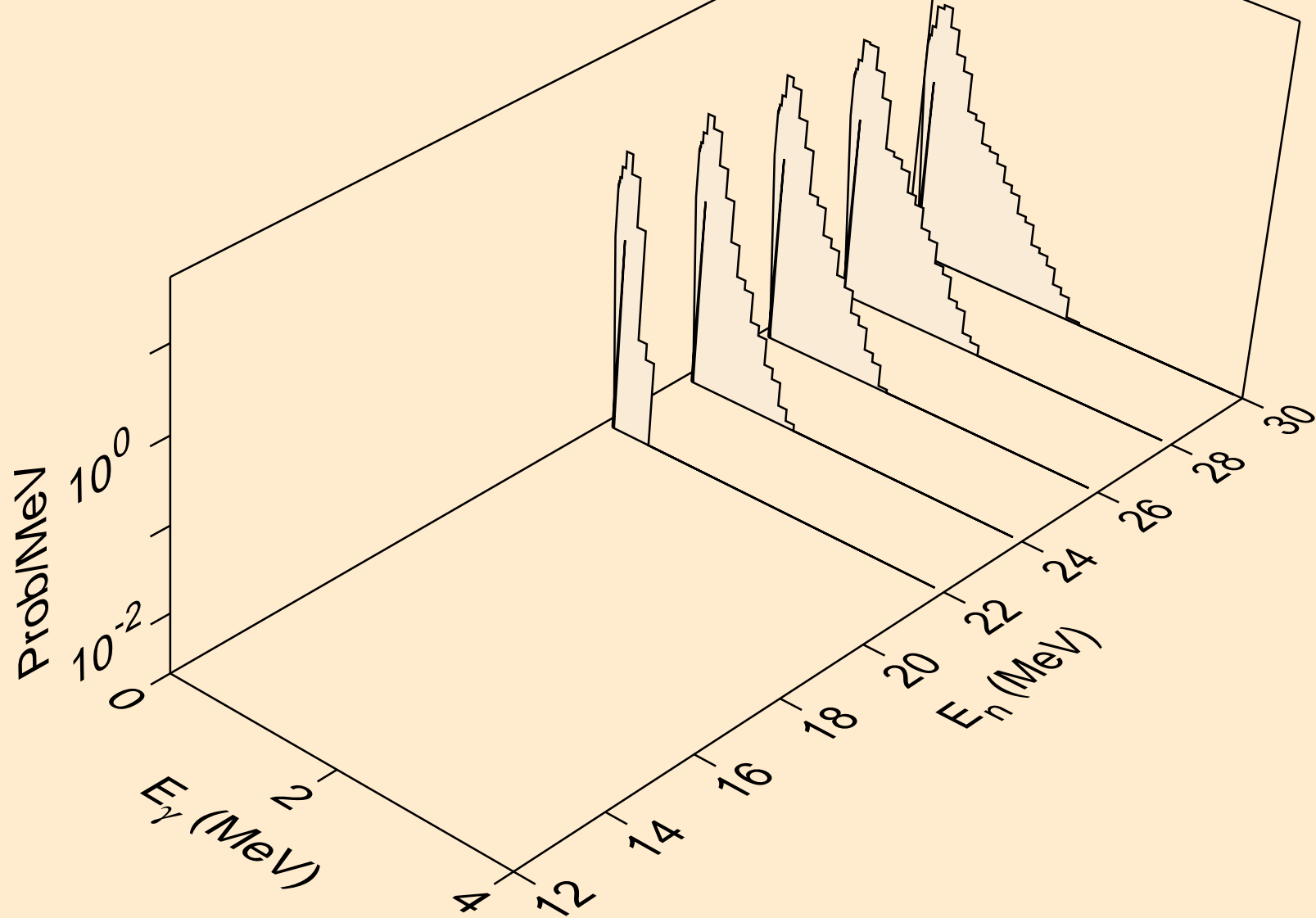

RA226 PROTON ACER TENDL-2021 LIBRARY; T=0.K  
Photon emission for (n,npa)

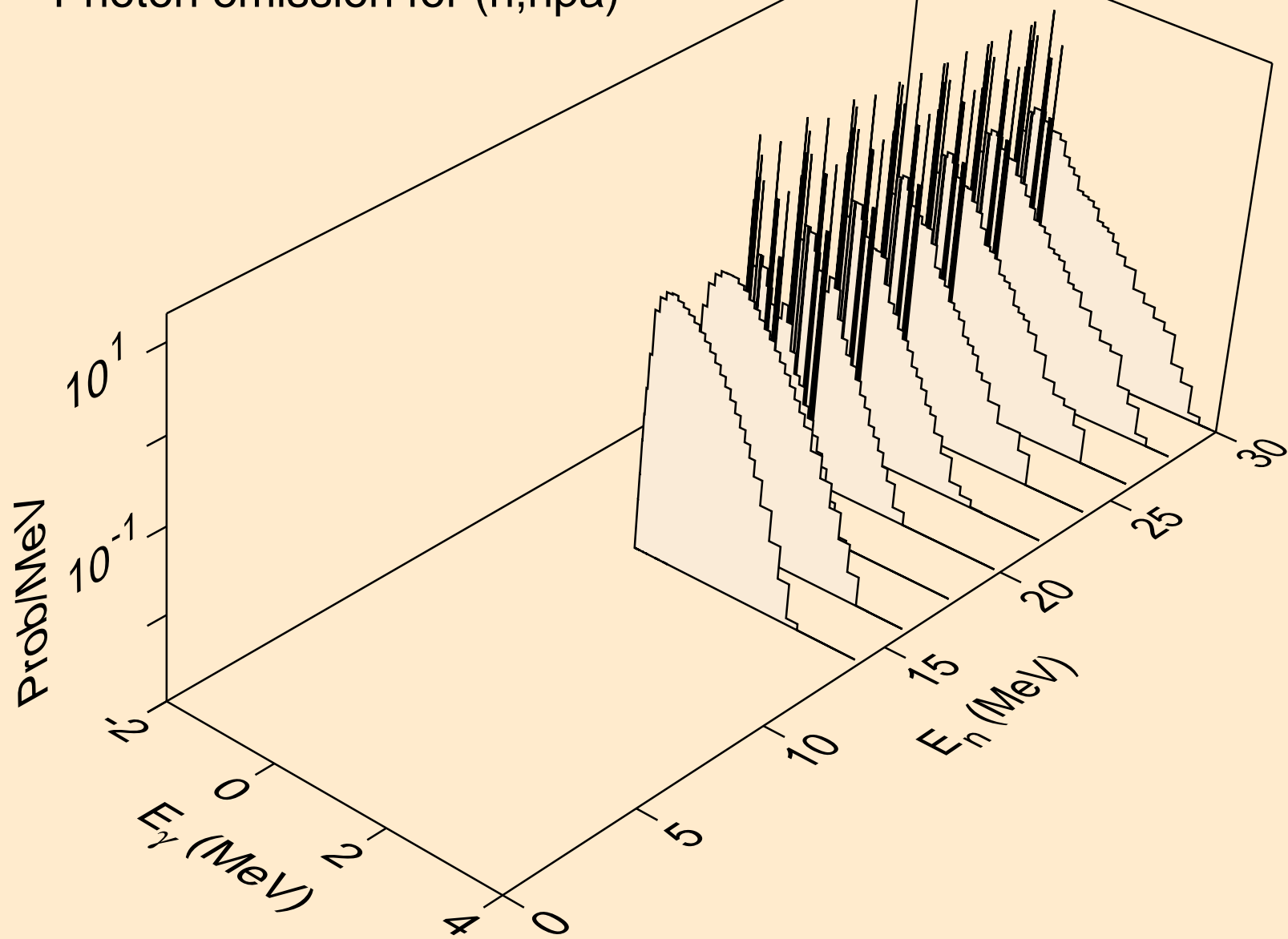

RA226 PROTON ACER TENDL-2021 LIBRARY; T=0.K  
Photon emission for (n,gma)

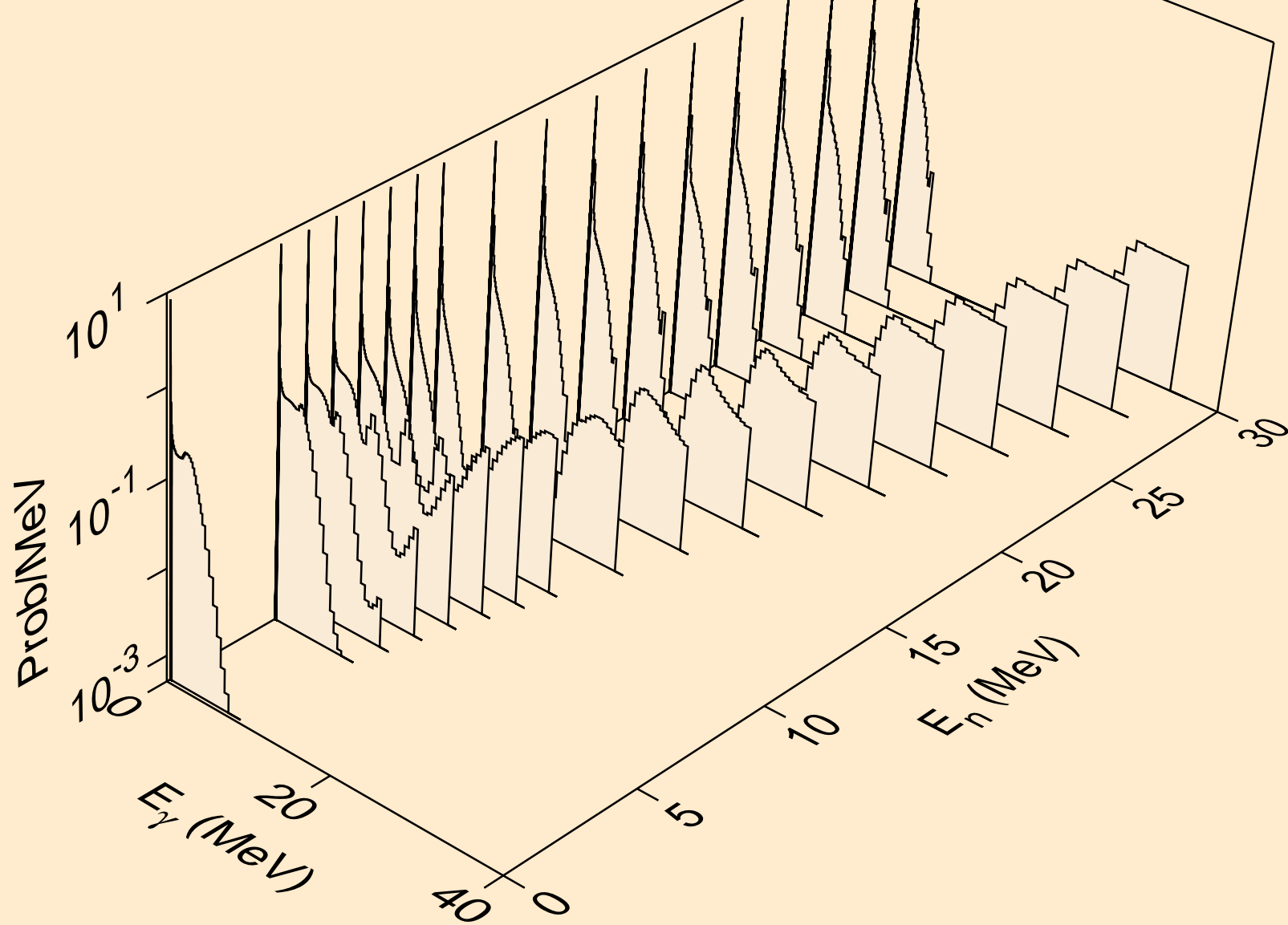



RA226 PROTON ACER TENDL-2021 LIBRARY; T=0.K  
Photon emission for inelastic

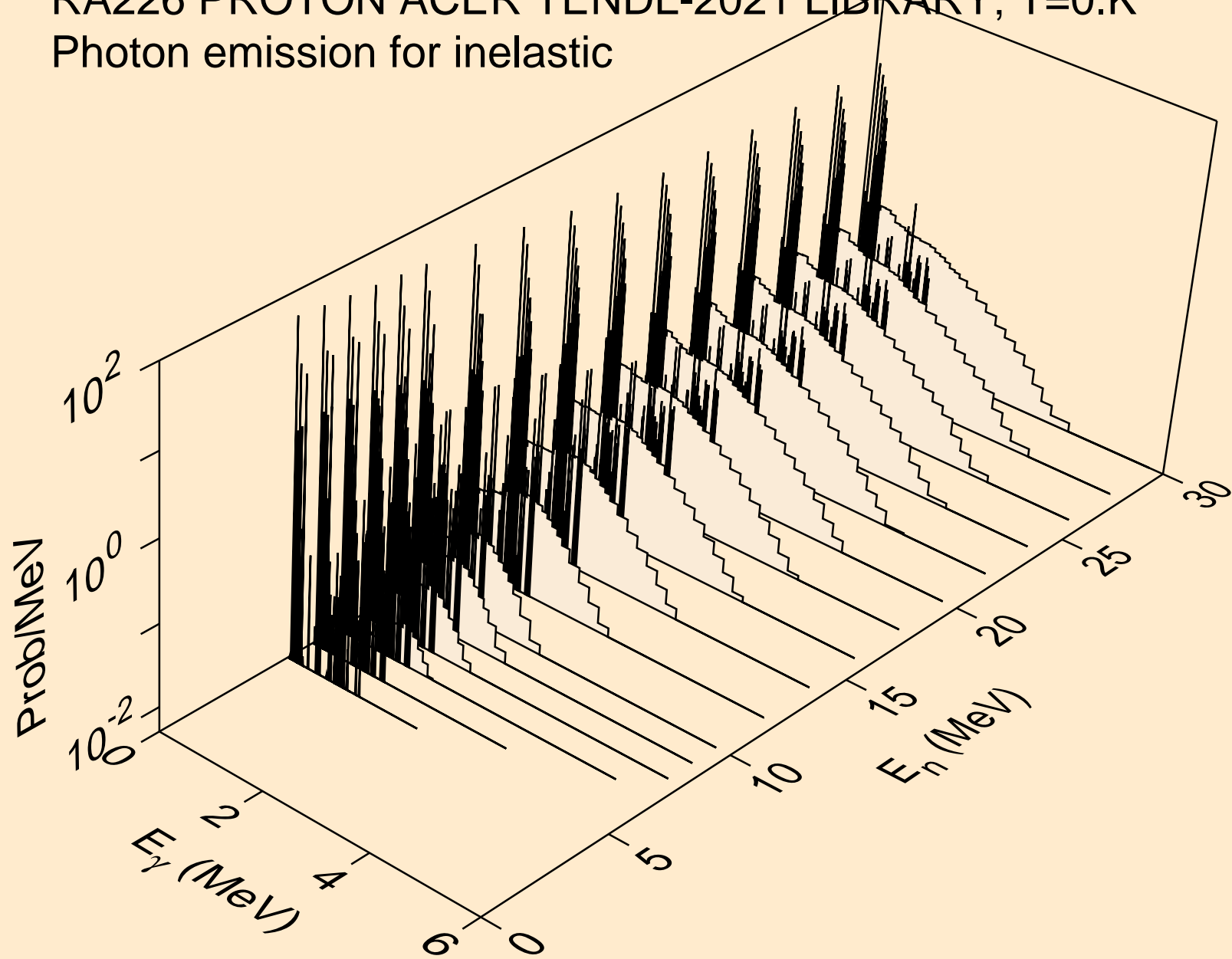

RA226 PROTON ACER TENDL-2021 LIBRARY; T=0.K  
Photon emission for (n,d)

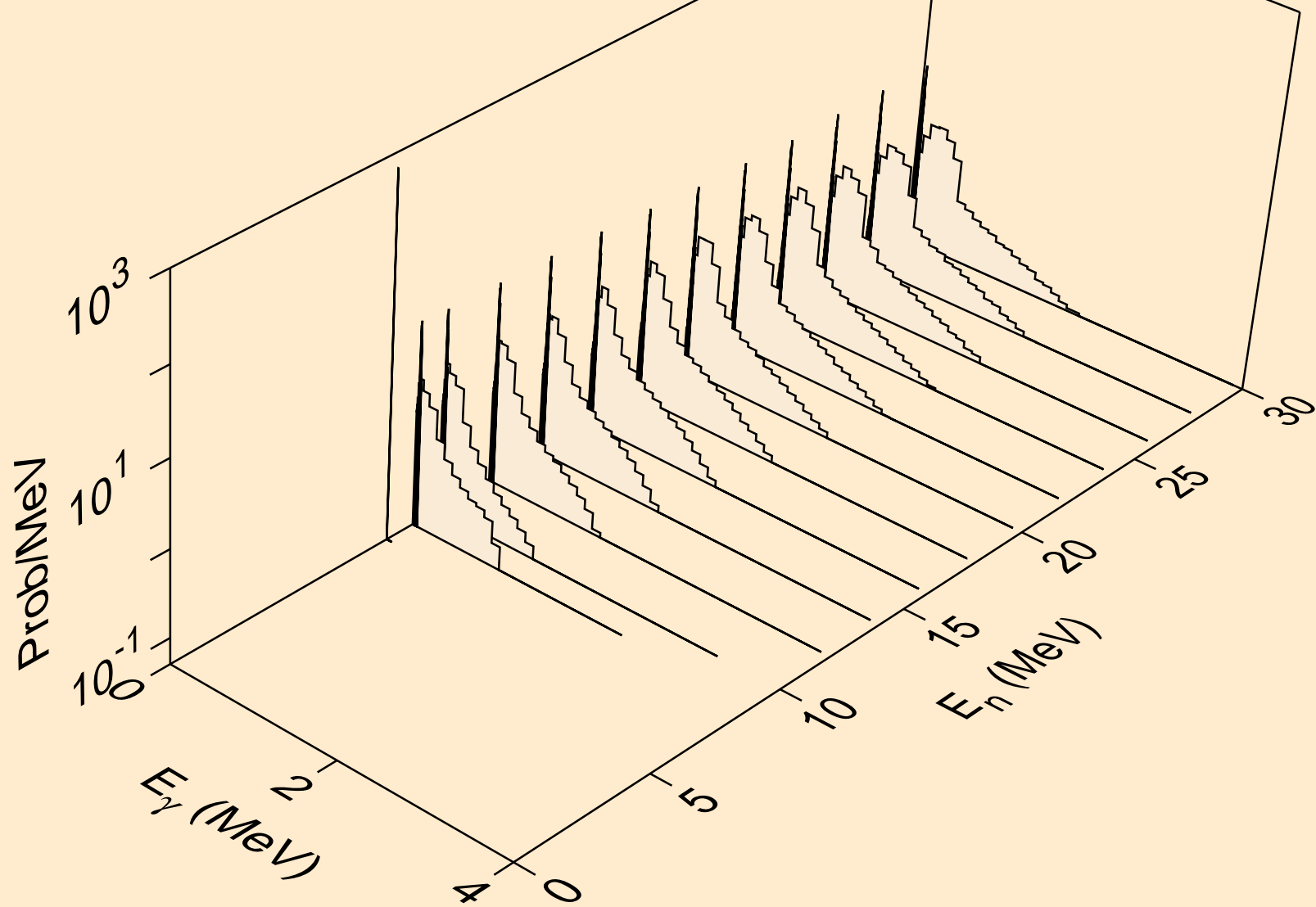

RA226 PROTON ACER TENDL-2021 LIBRARY; T=0.K  
Photon emission for (n,t)

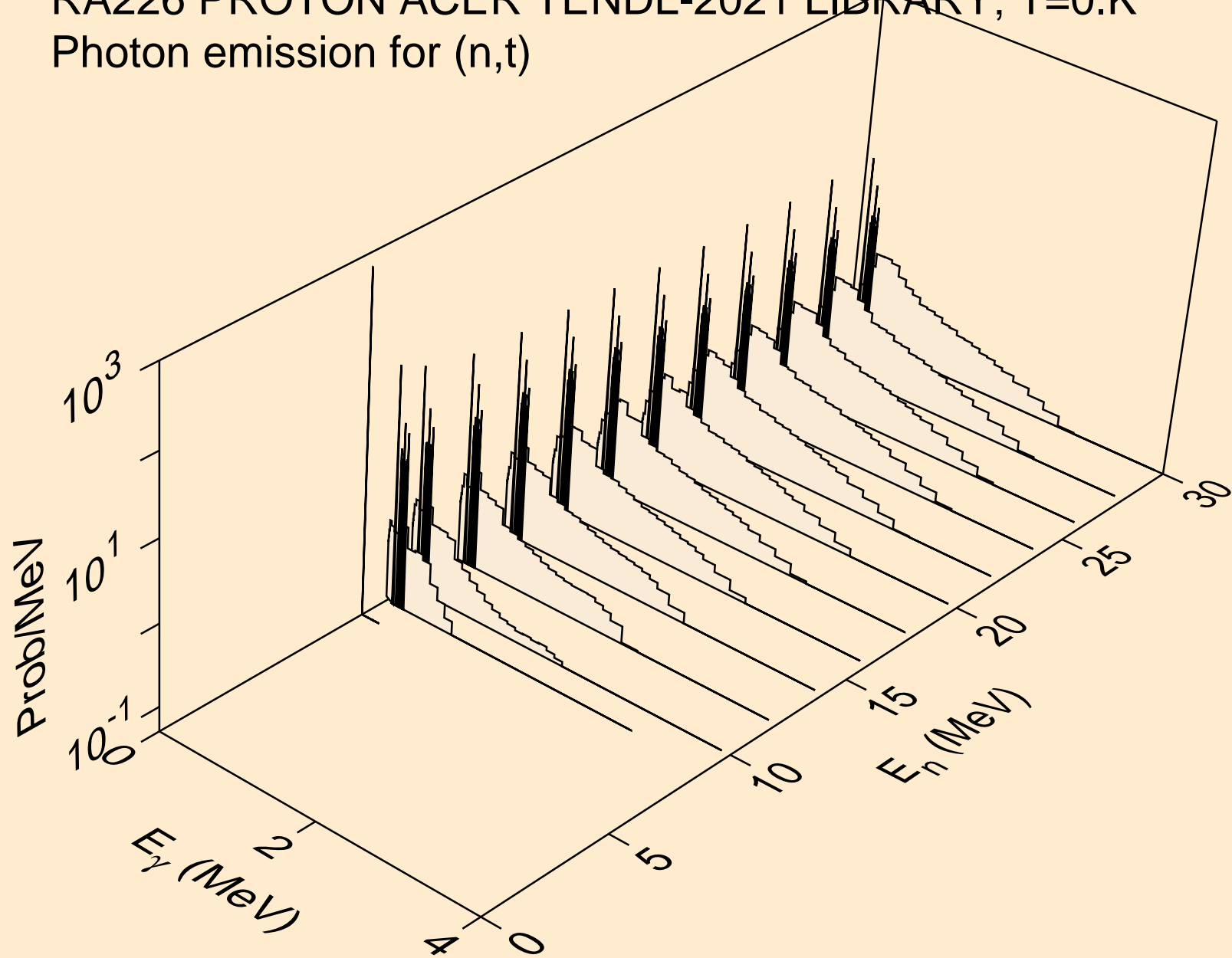

RA226 PROTON ACER TENDL-2021 LIBRARY; T=0.K  
Photon emission for (n,he3)

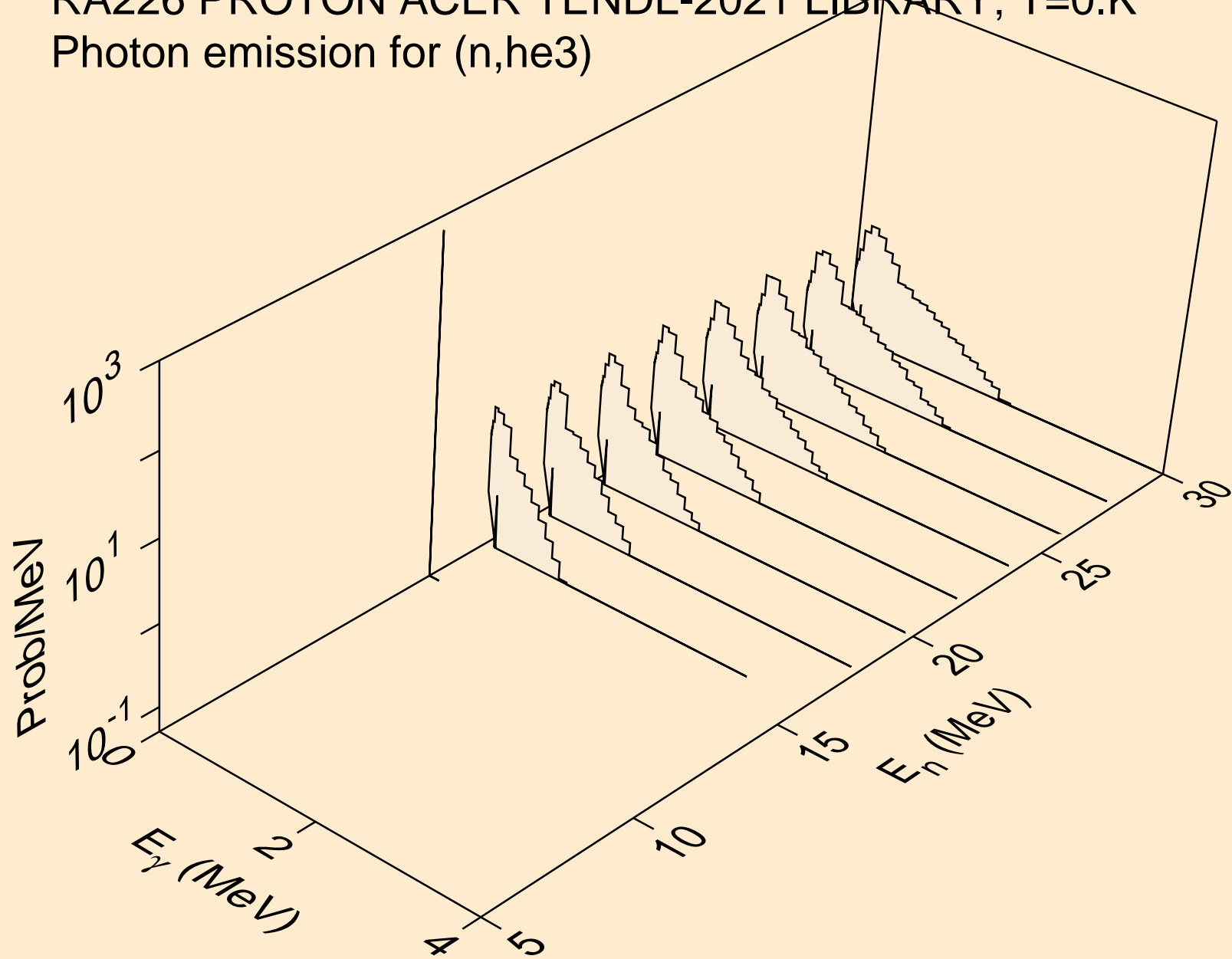

RA226 PROTON ACER TENDL-2021 LIBRARY; T=0.K  
Photon emission for (n,a)

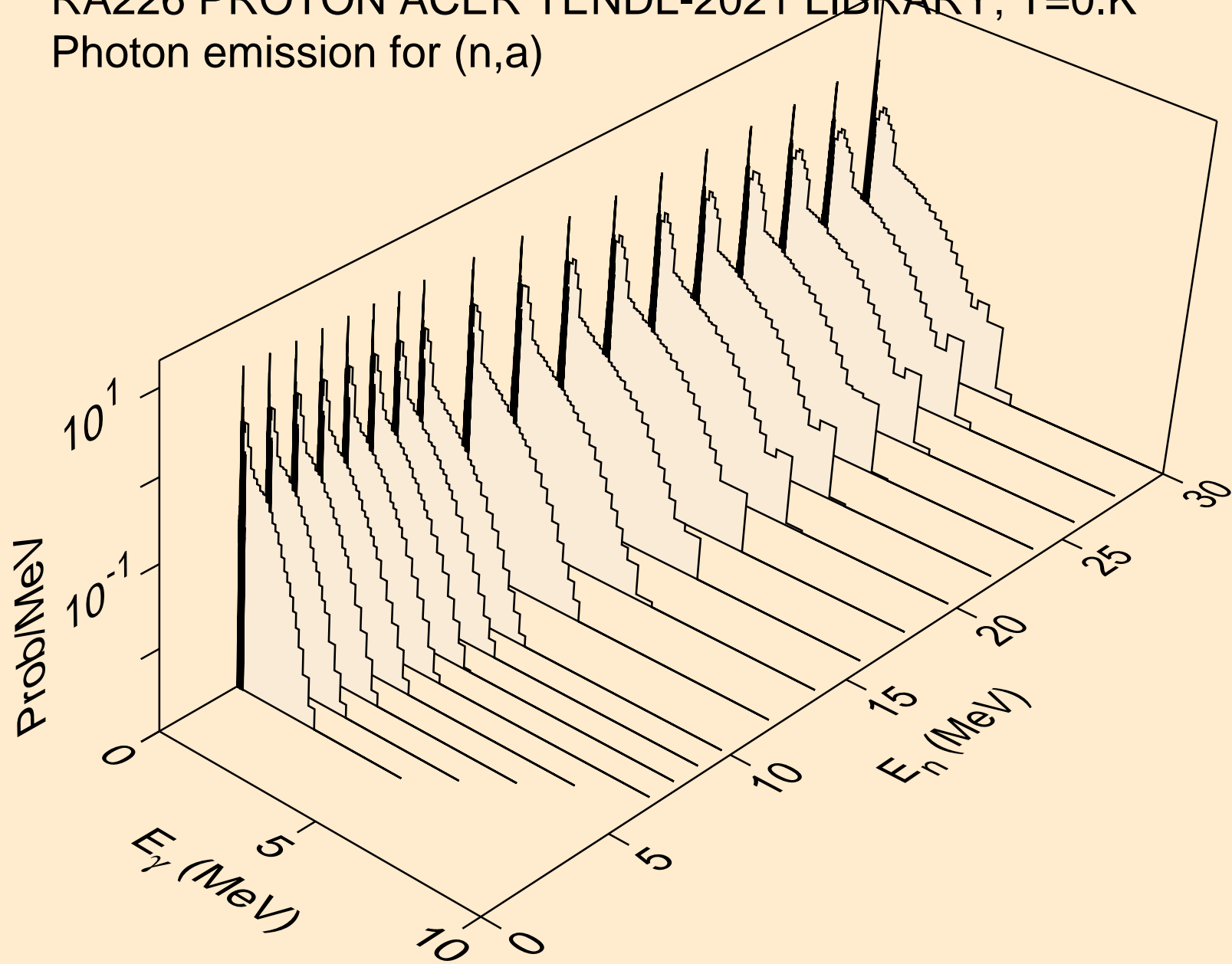

RA226 PROTON ACER TENDL-2021 LIBRARY; T=0.K  
Photon emission for (n,2a)

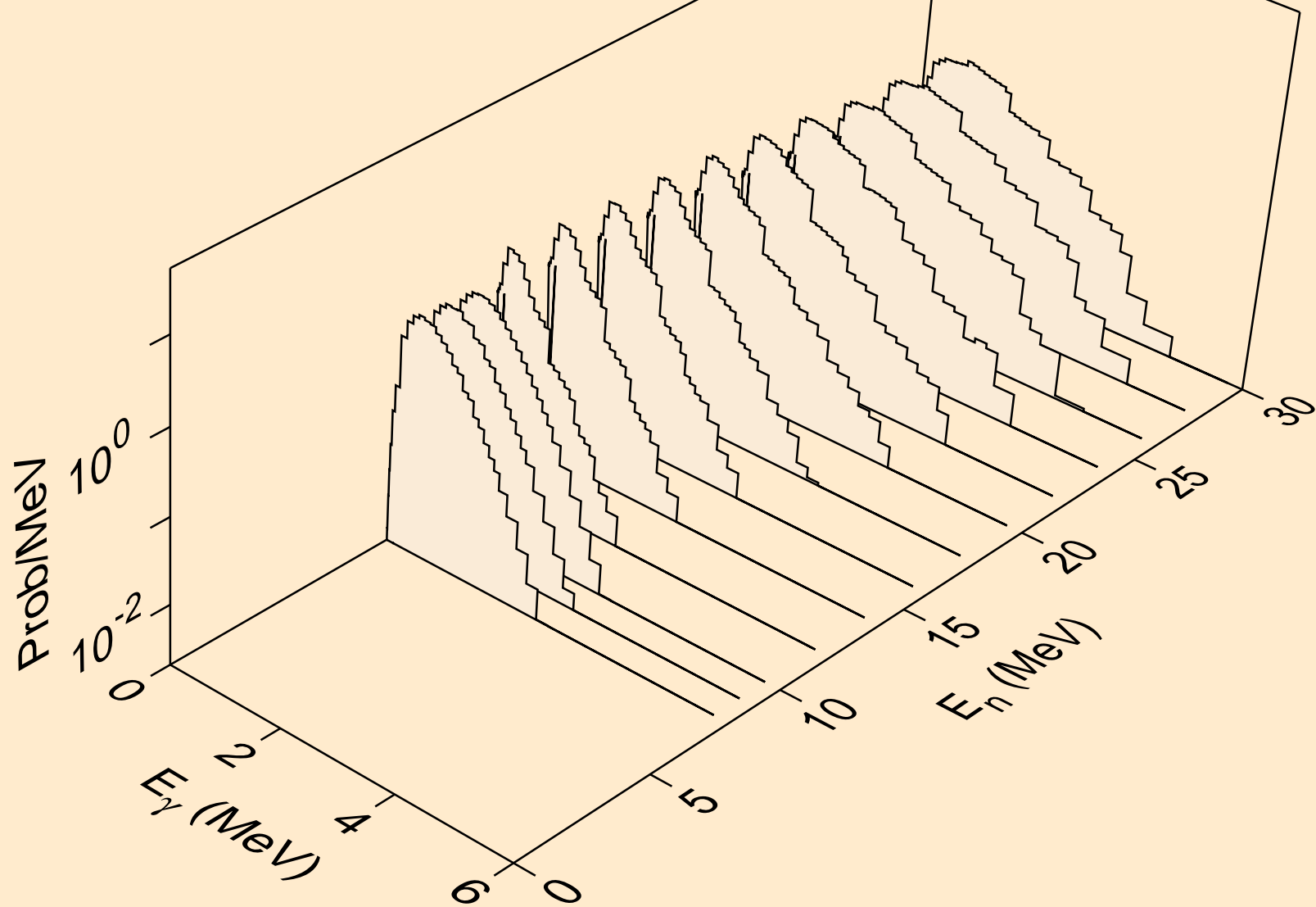

RA226 PROTON ACER TENDL-2021 LIBRARY; T=0.K  
Photon emission for (n,2p)

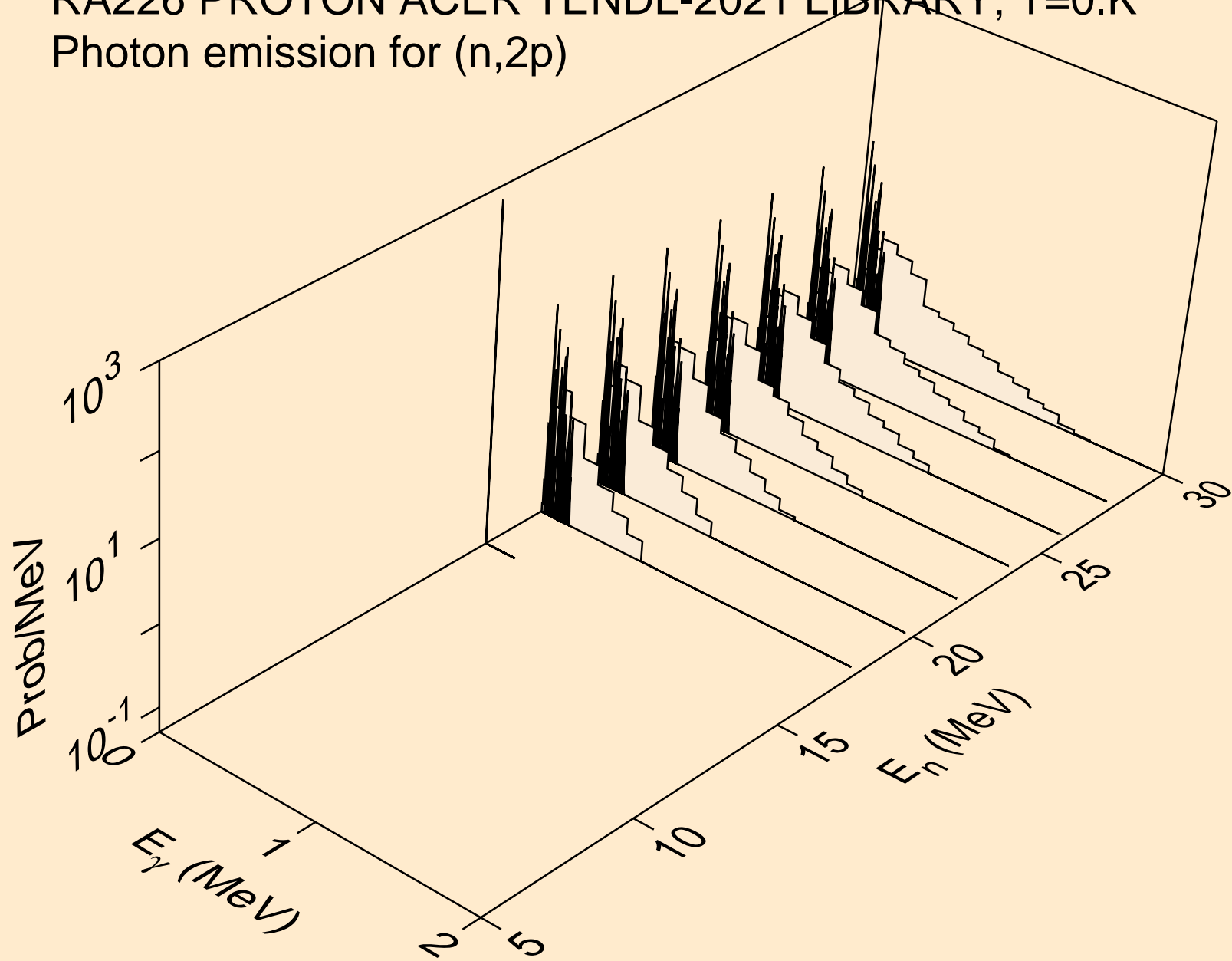

RA226 PROTON ACER TENDL-2021 LIBRARY; T=0.K  
Photon emission for (n,pa)

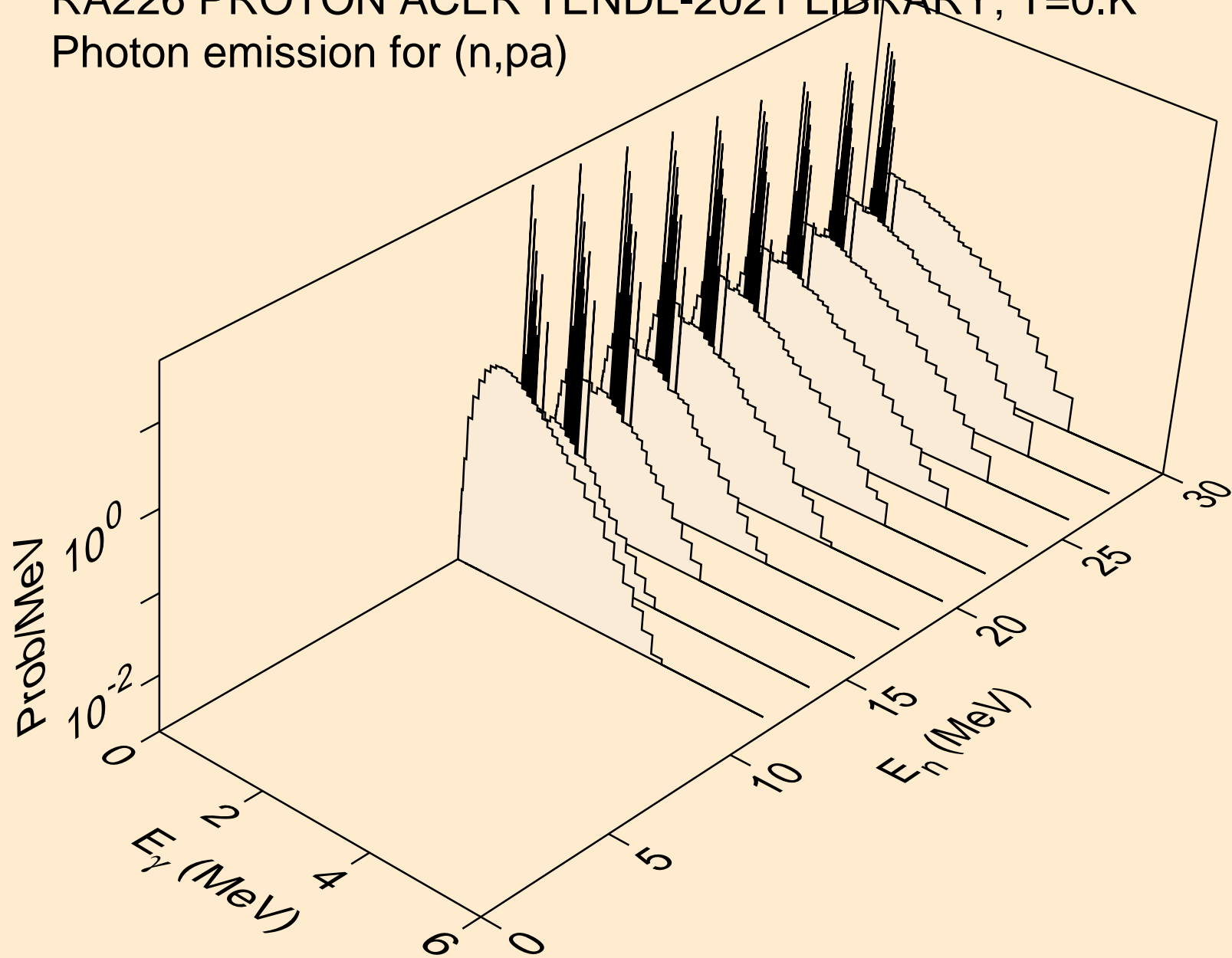



RA226 PROTON ACER TENDL-2021 LIBRARY; T=0.K  
Particle heating contributions

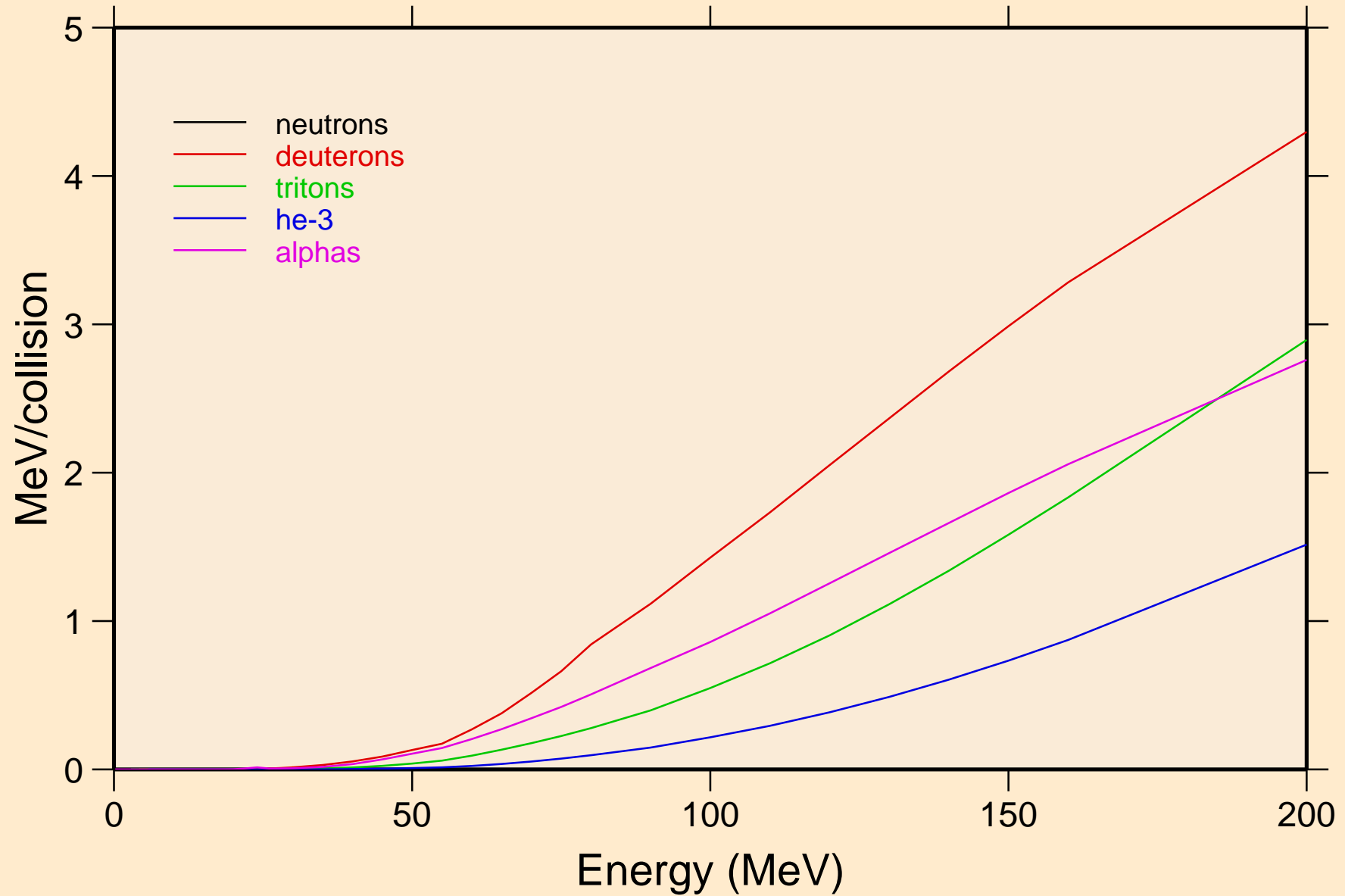

RA226 PROTON ACER TENDL-2021 LIBRARY; T=0.K  
Recoil Heating

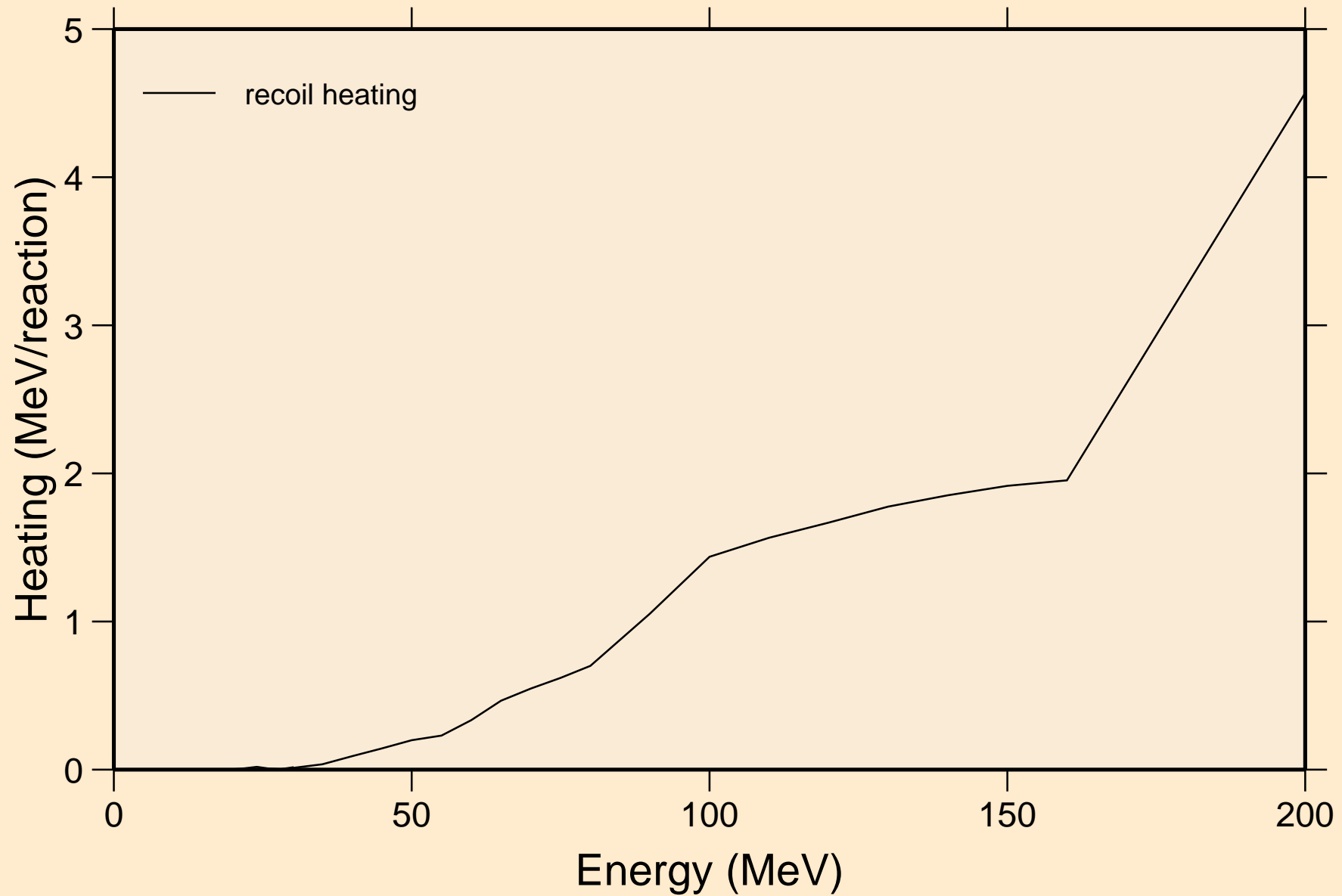

RA226 PROTON ACER TENDL-2021 LIBRARY; T=0.K  
Particle production cross sections

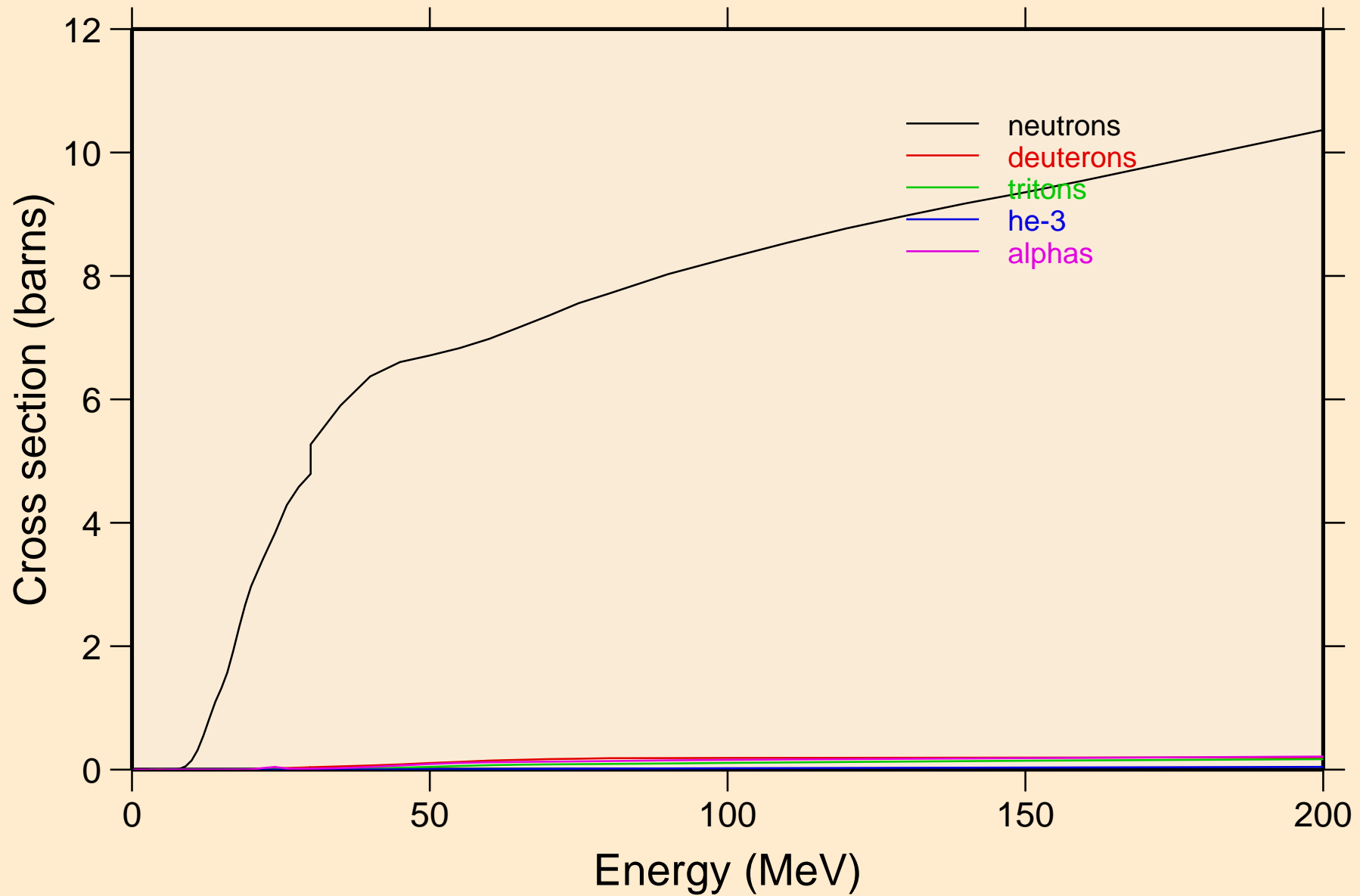

RA226 PROTON ACER TENDL-2021 LIBRARY; T=0.K  
neutrons from (p,n)

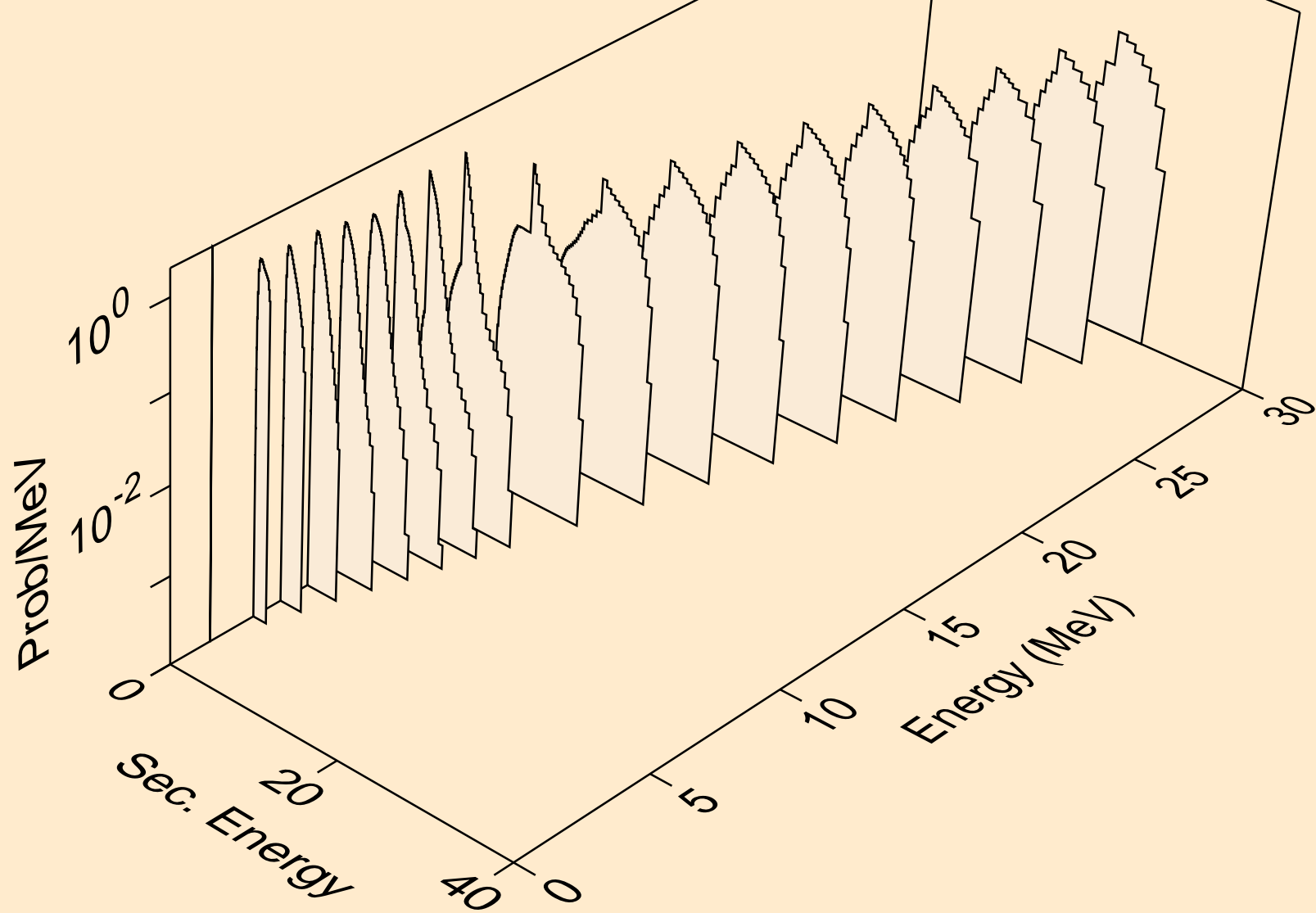

RA226 PROTON ACER TENDL-2021 LIBRARY; T=0.K  
neutrons from (p,x)

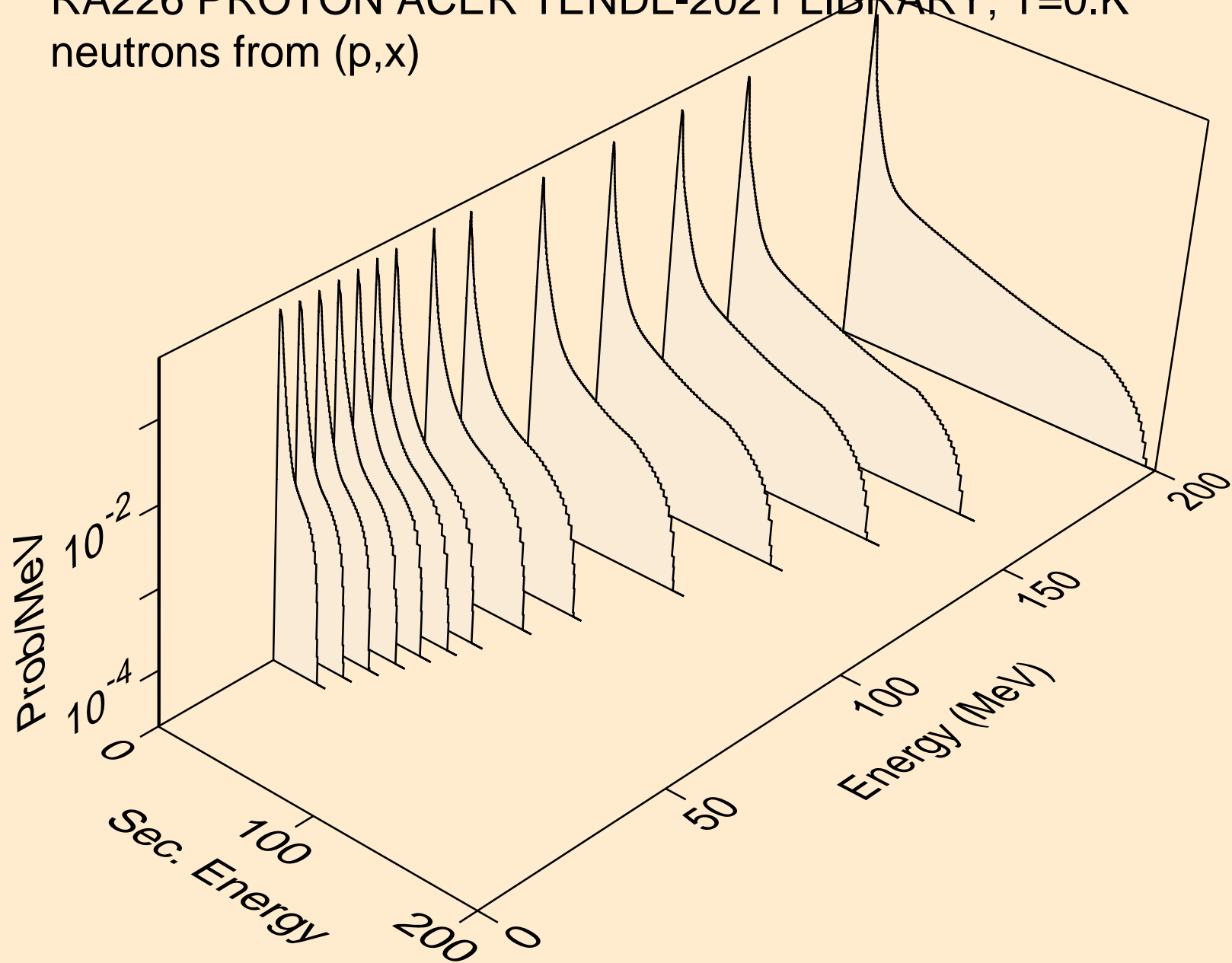

RA226 PROTON ACER TENDL-2021 LIBRARY; T=0.K  
neutrons from (p,2nd)

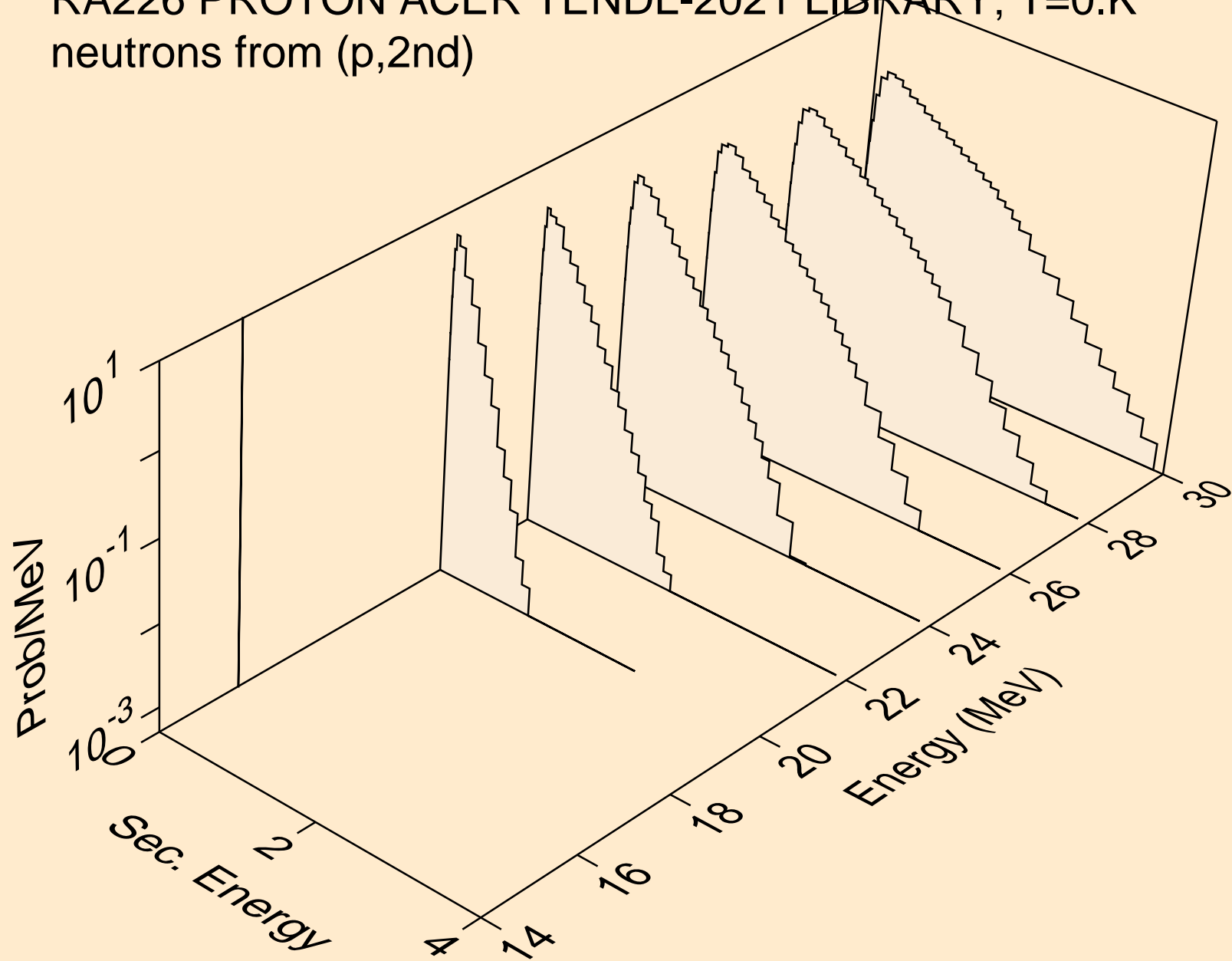

RA226 PROTON ACER TENDL-2021 LIBRARY; T=0.K  
neutrons from (p,2n)

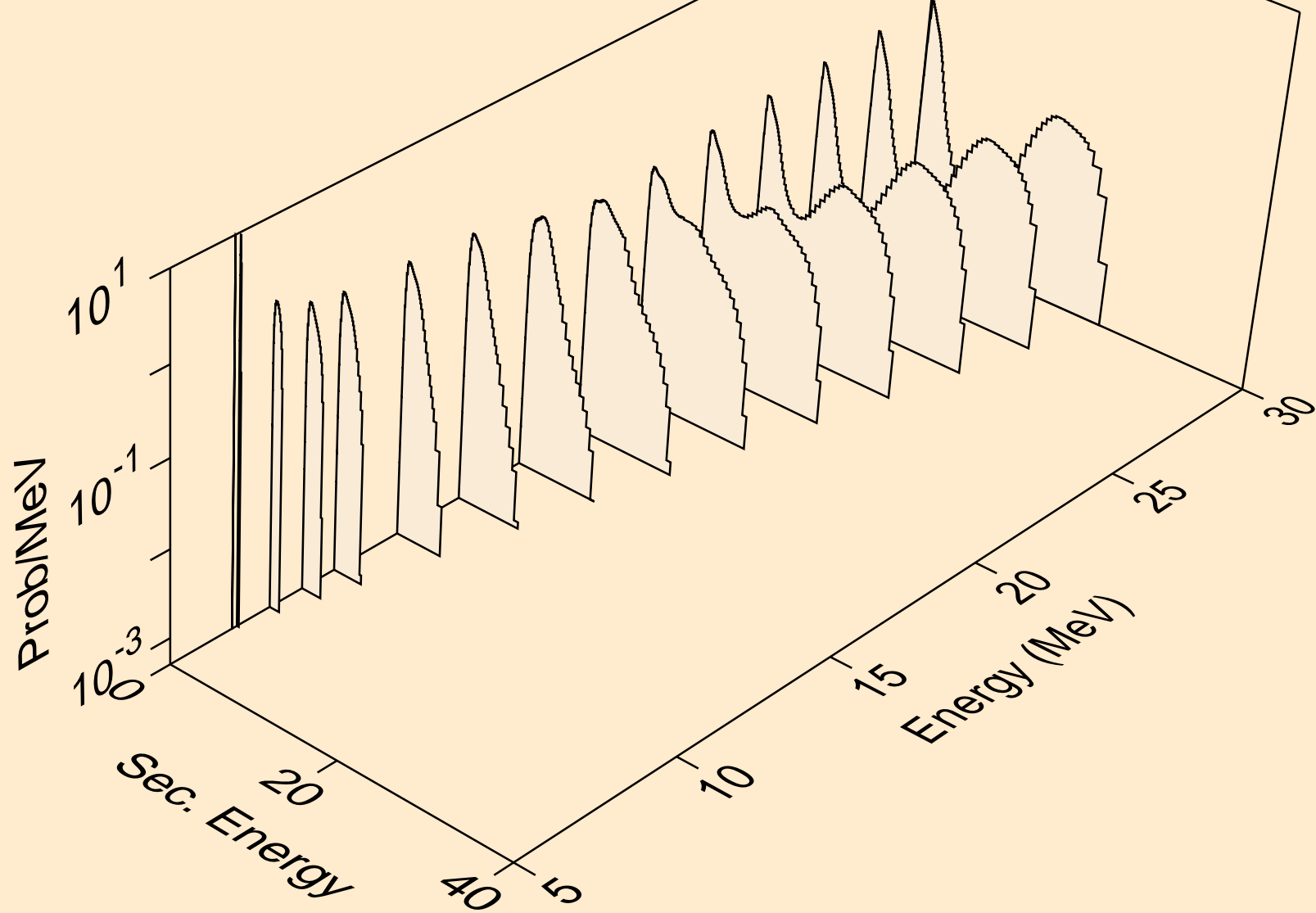

RA226 PROTON ACER TENDL-2021 LIBRARY; T=0.K  
neutrons from (p,3n)

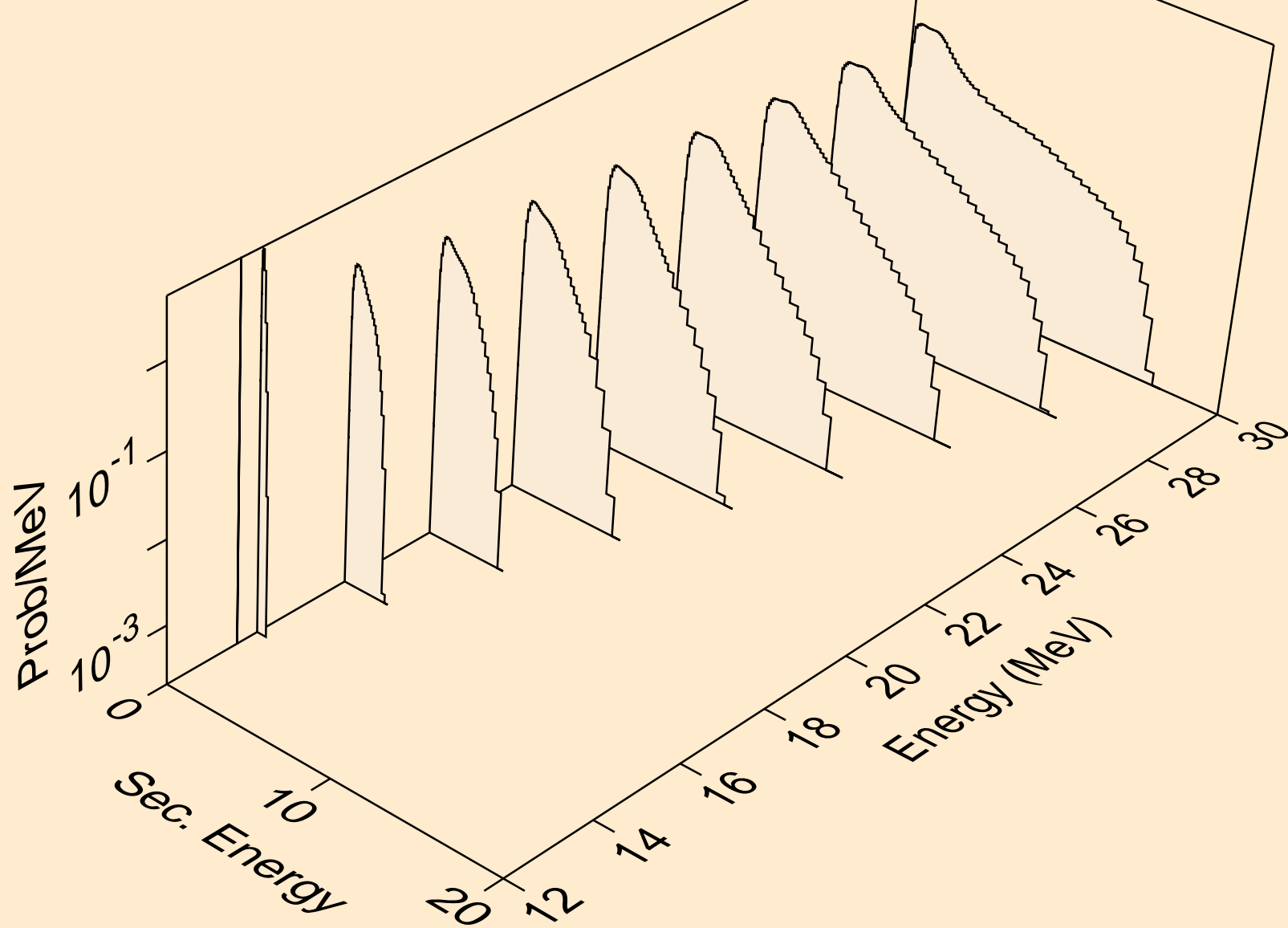



RA226 PROTON ACER TENDL-2021 LIBRARY; T=0.K  
neutrons from (p,n\*)a

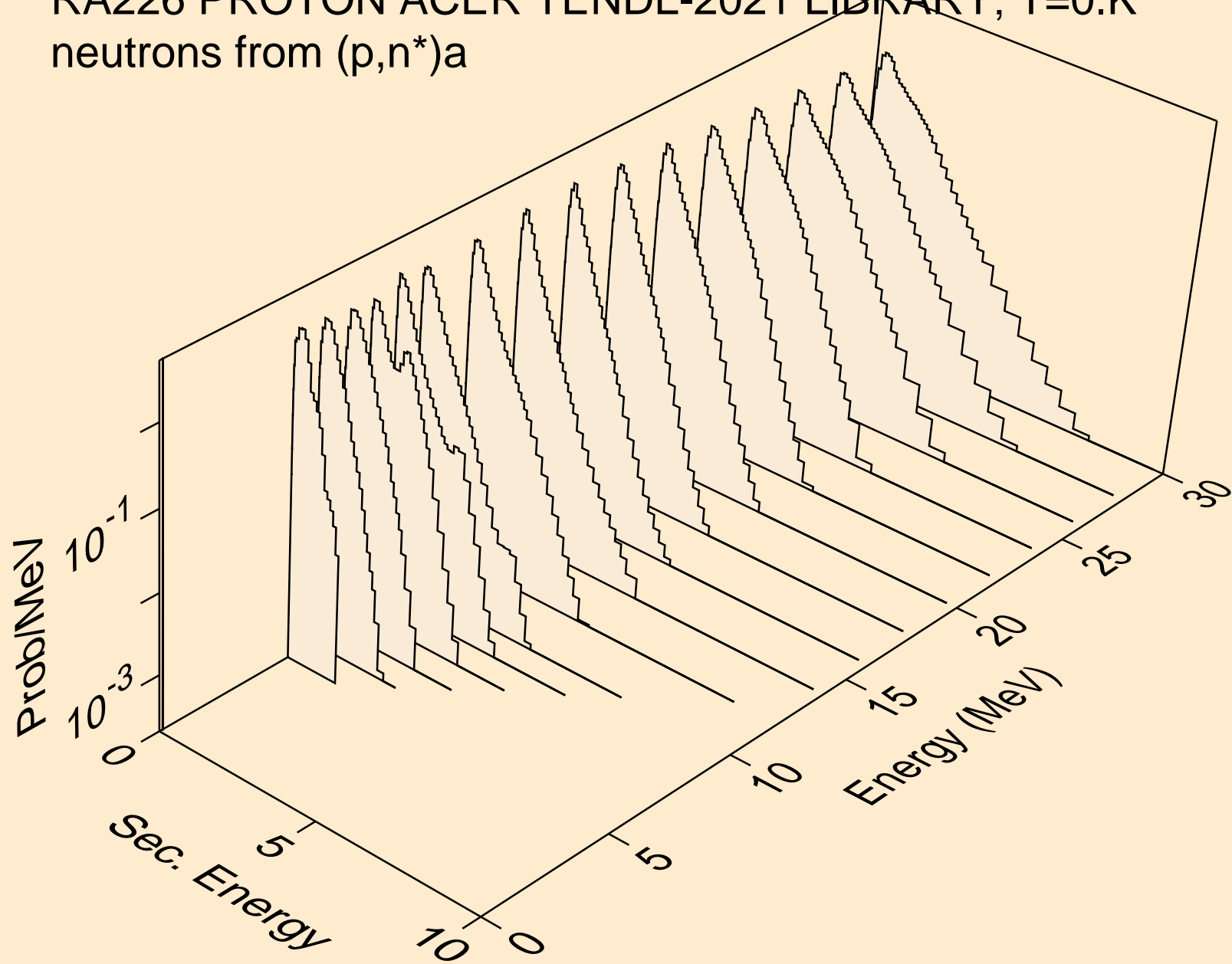

RA226 PROTON ACER TENDL-2021 LIBRARY; T=0.K  
neutrons from (p,2n)a

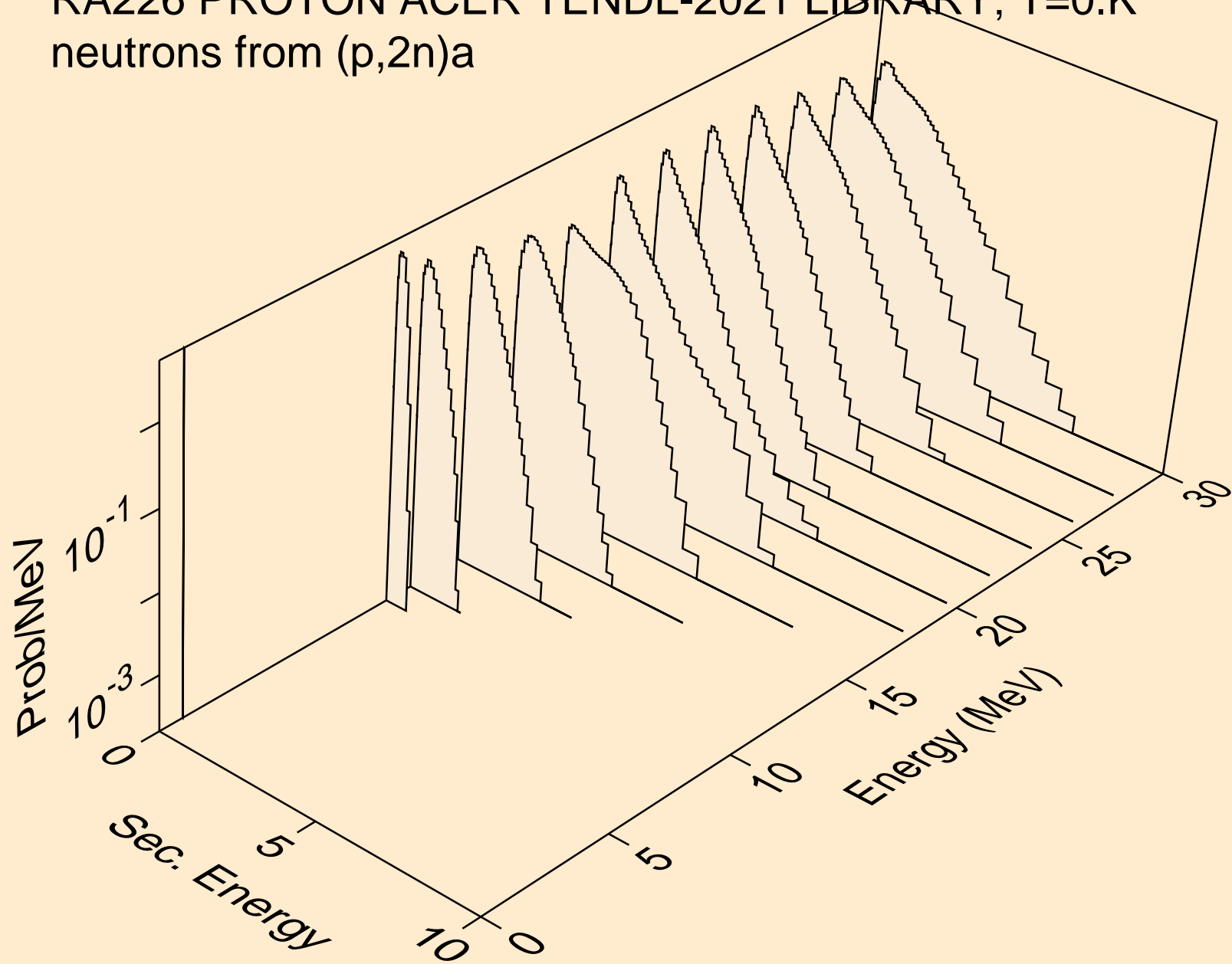

RA226 PROTON ACER TENDL-2021 LIBRARY; T=0.K  
neutrons from (p,3n)a

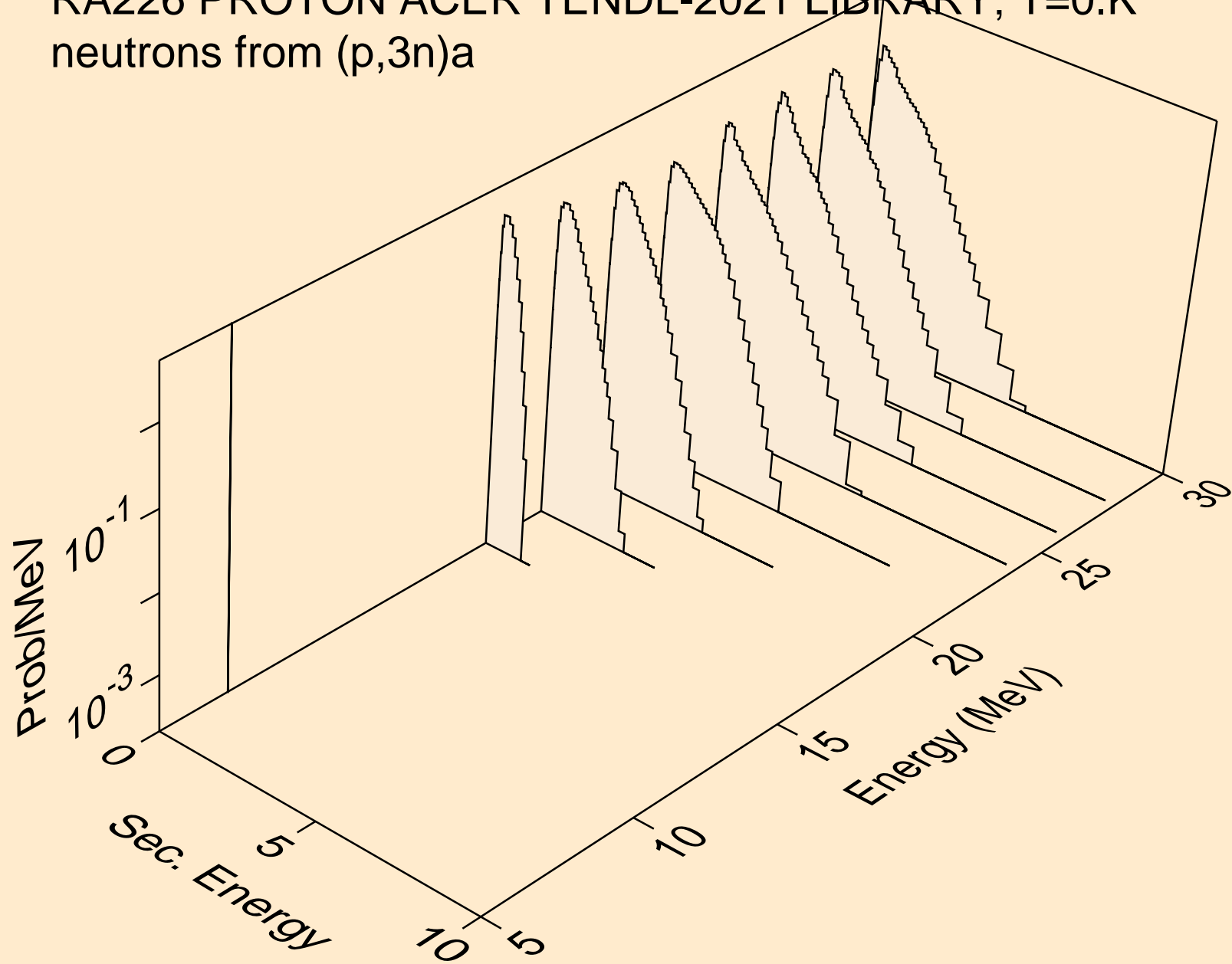

RA226 PROTON ACER TENDL-2021 LIBRARY; T=0.K  
neutrons from (p,n\*)p

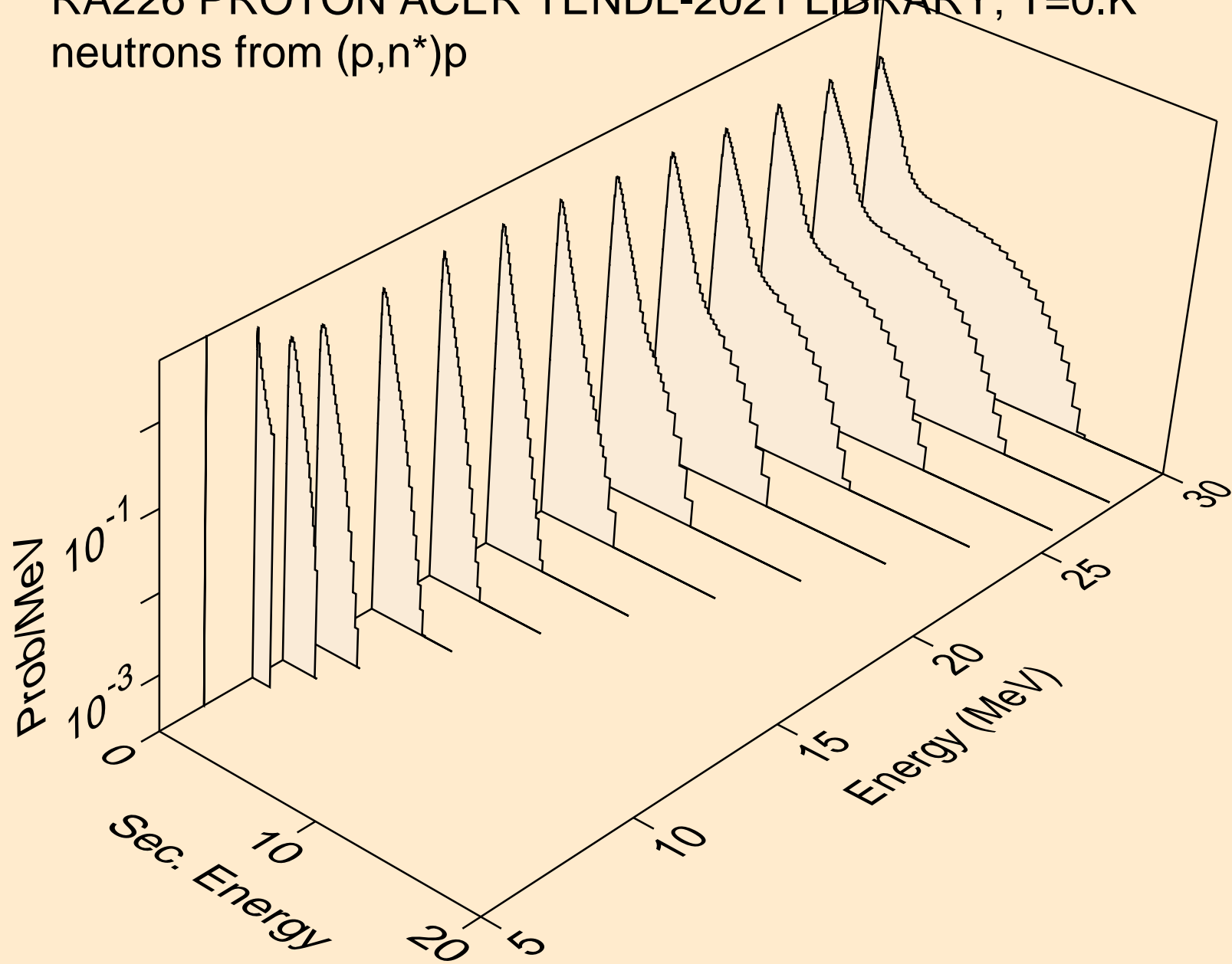

RA226 PROTON ACER TENDL-2021 LIBRARY; T=0.K  
neutrons from (p,n\*)2a

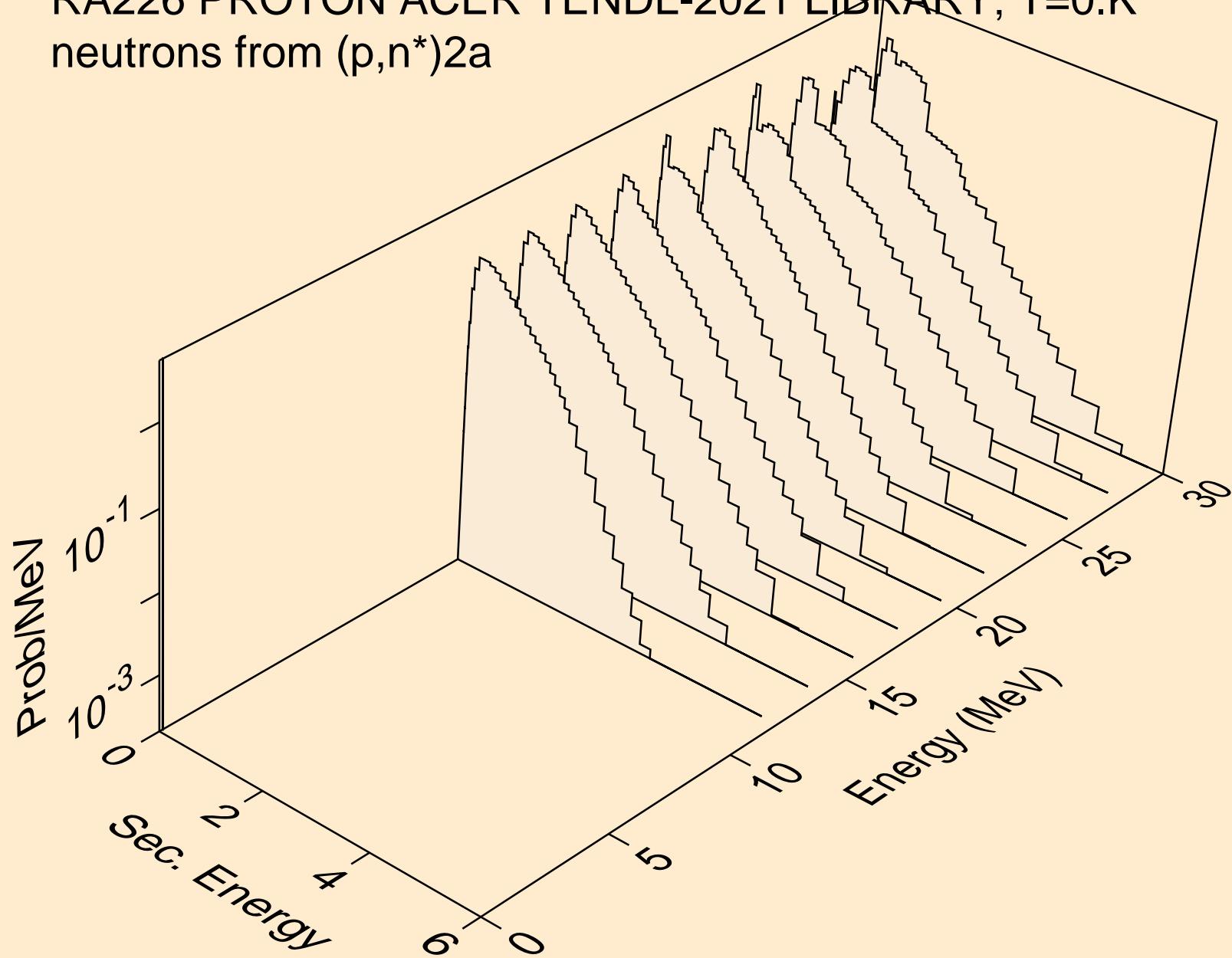

RA226 PROTON ACER TENDL-2021 LIBRARY; T=0.K  
neutrons from (p,2n)2a

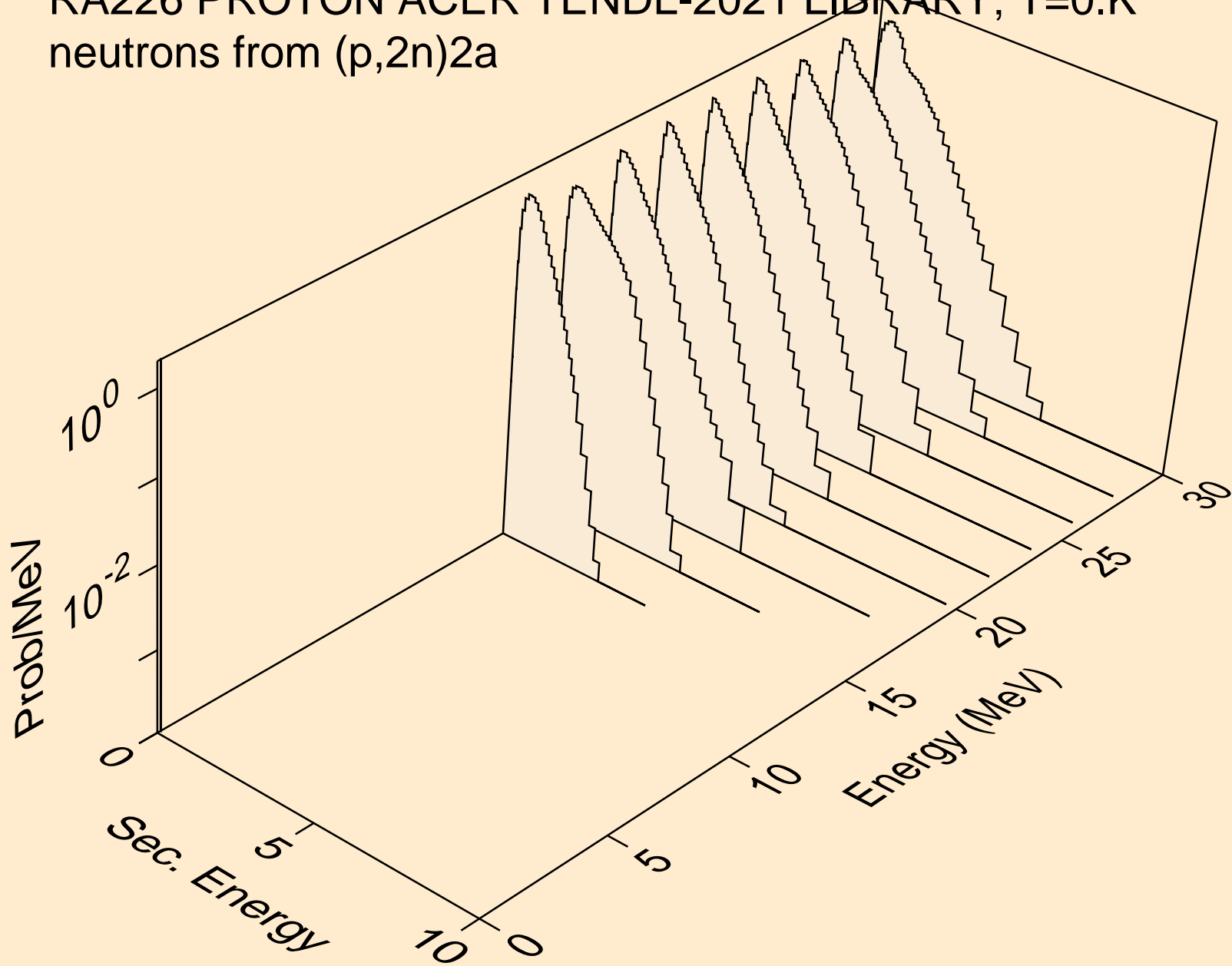

RA226 PROTON ACER TENDL-2021 LIBRARY; T=0.K  
neutrons from (p,n\*)d

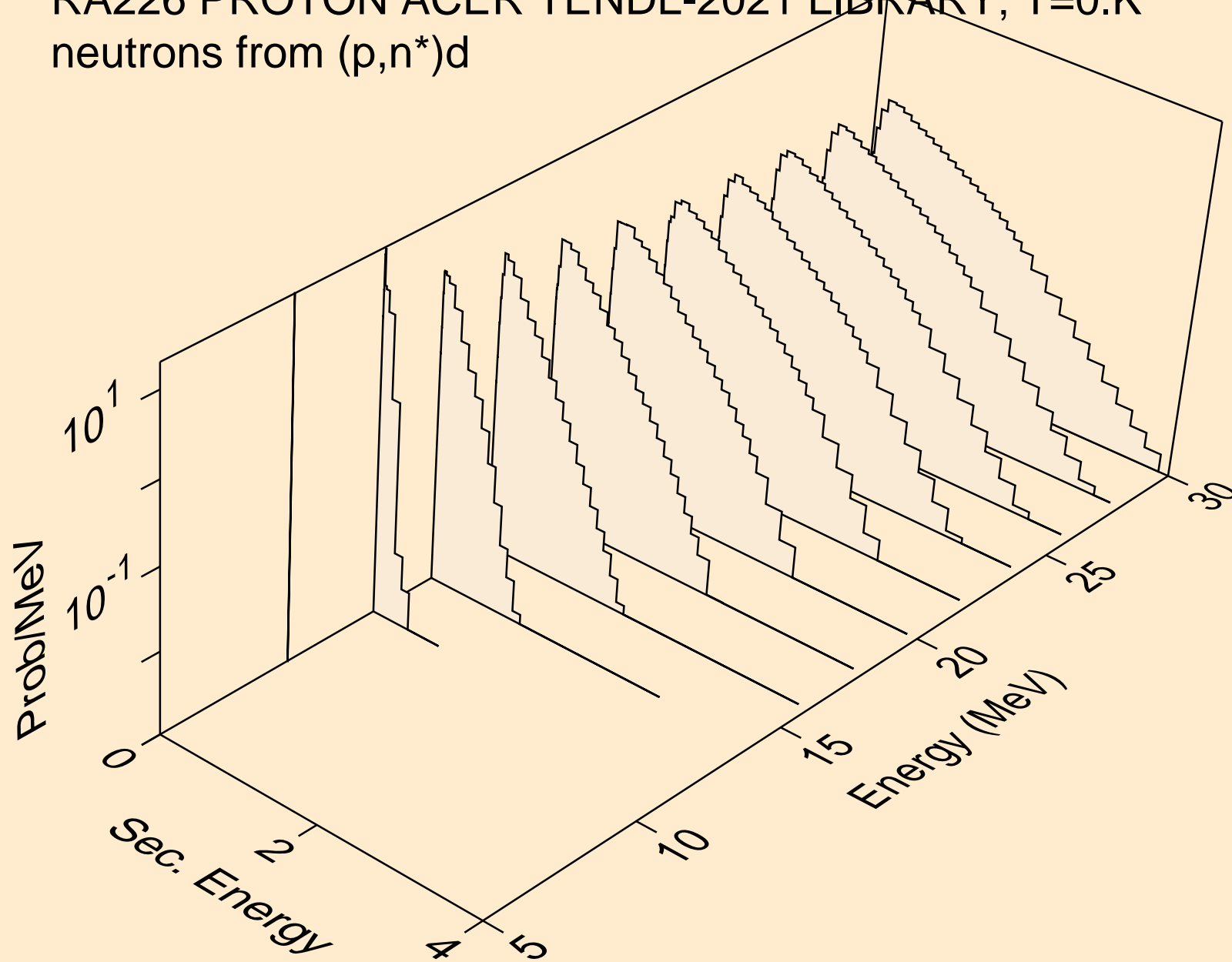

RA226 PROTON ACER TENDL-2021 LIBRARY; T=0.K  
neutrons from (p,n\*)t

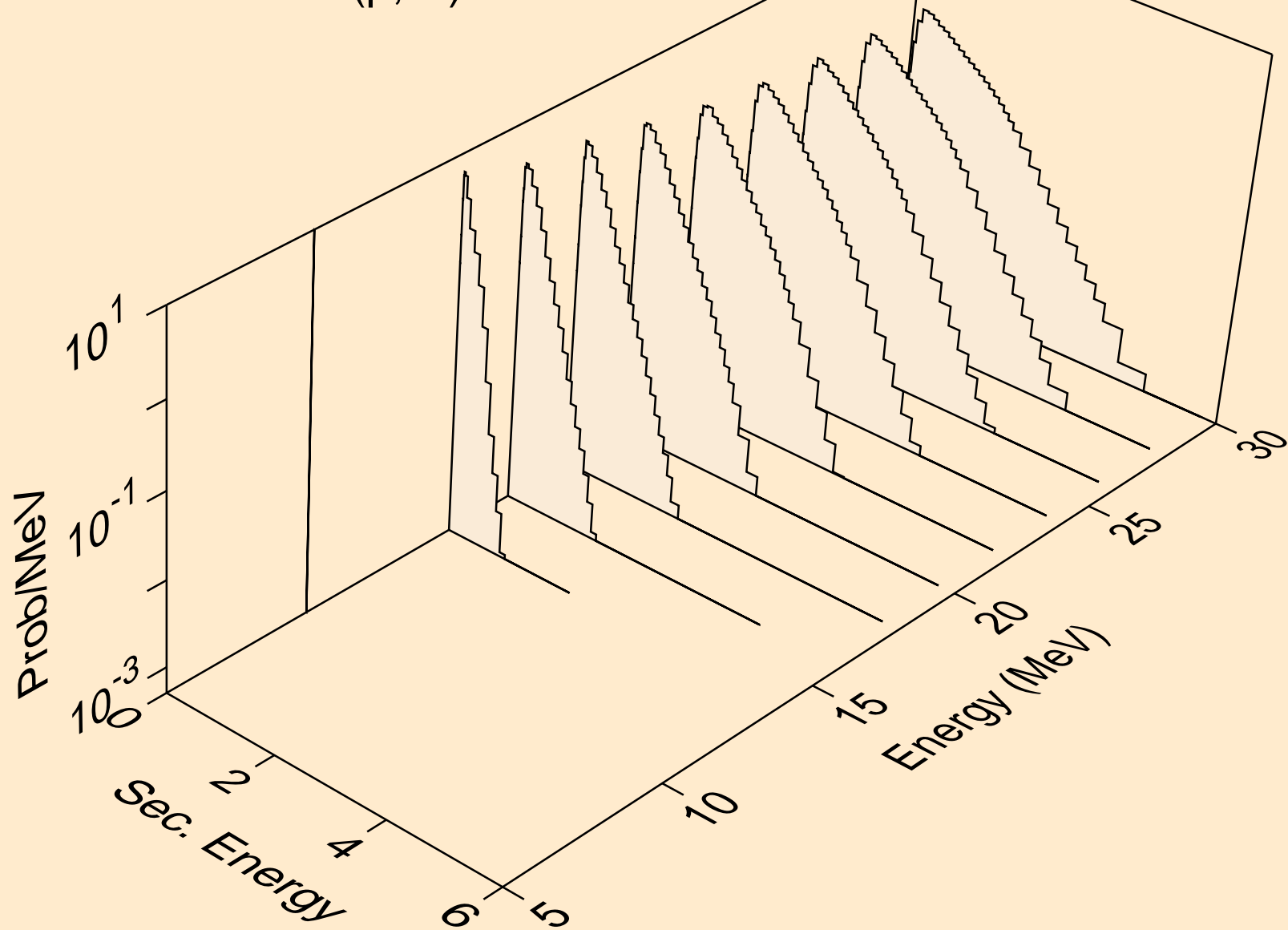



RA226 PROTON ACER TENDL-2021 LIBRARY; T=0.K  
neutrons from (p,n\*)he3

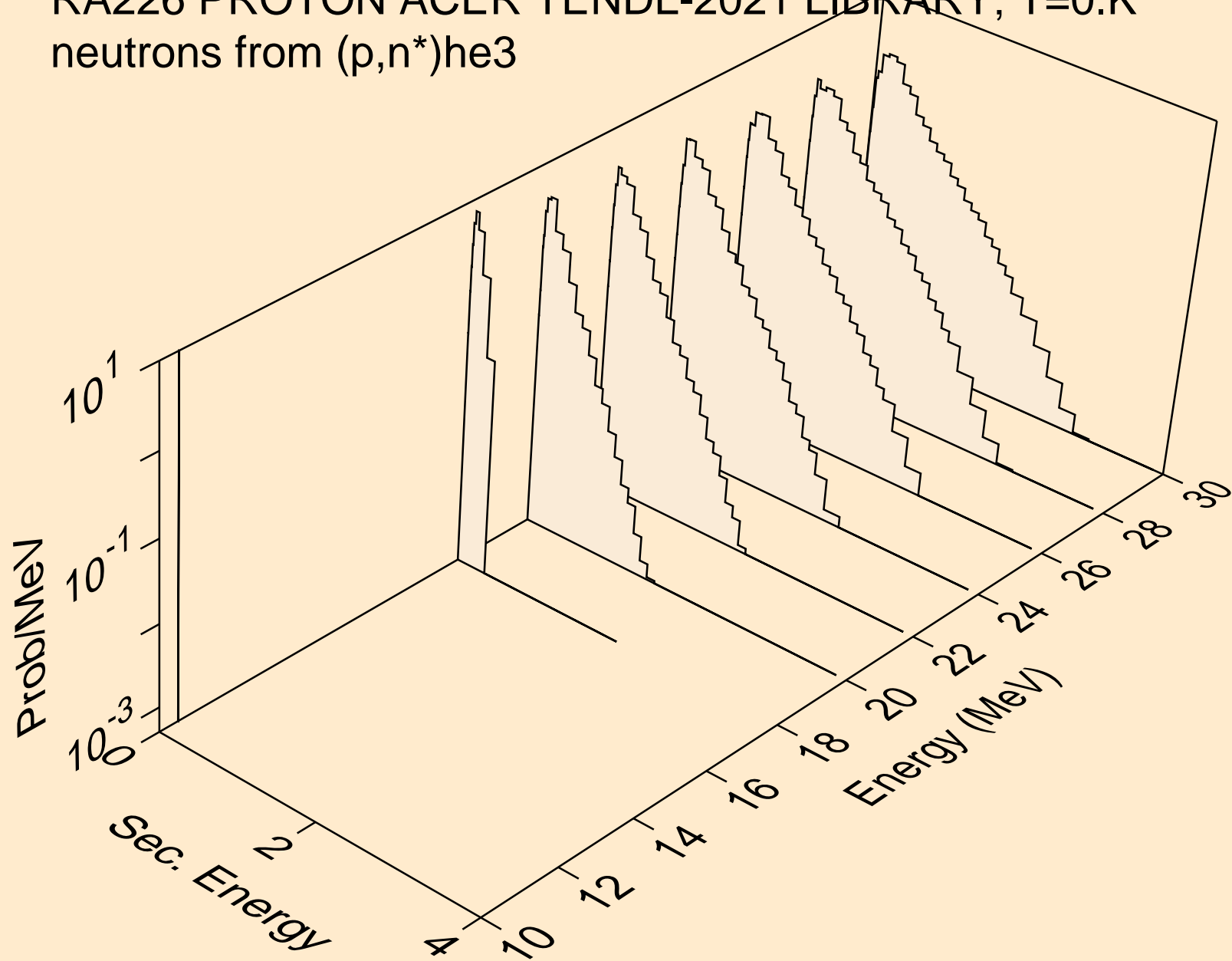

RA226 PROTON ACER TENDL-2021 LIBRARY; T=0.K  
neutrons from (p,4n)

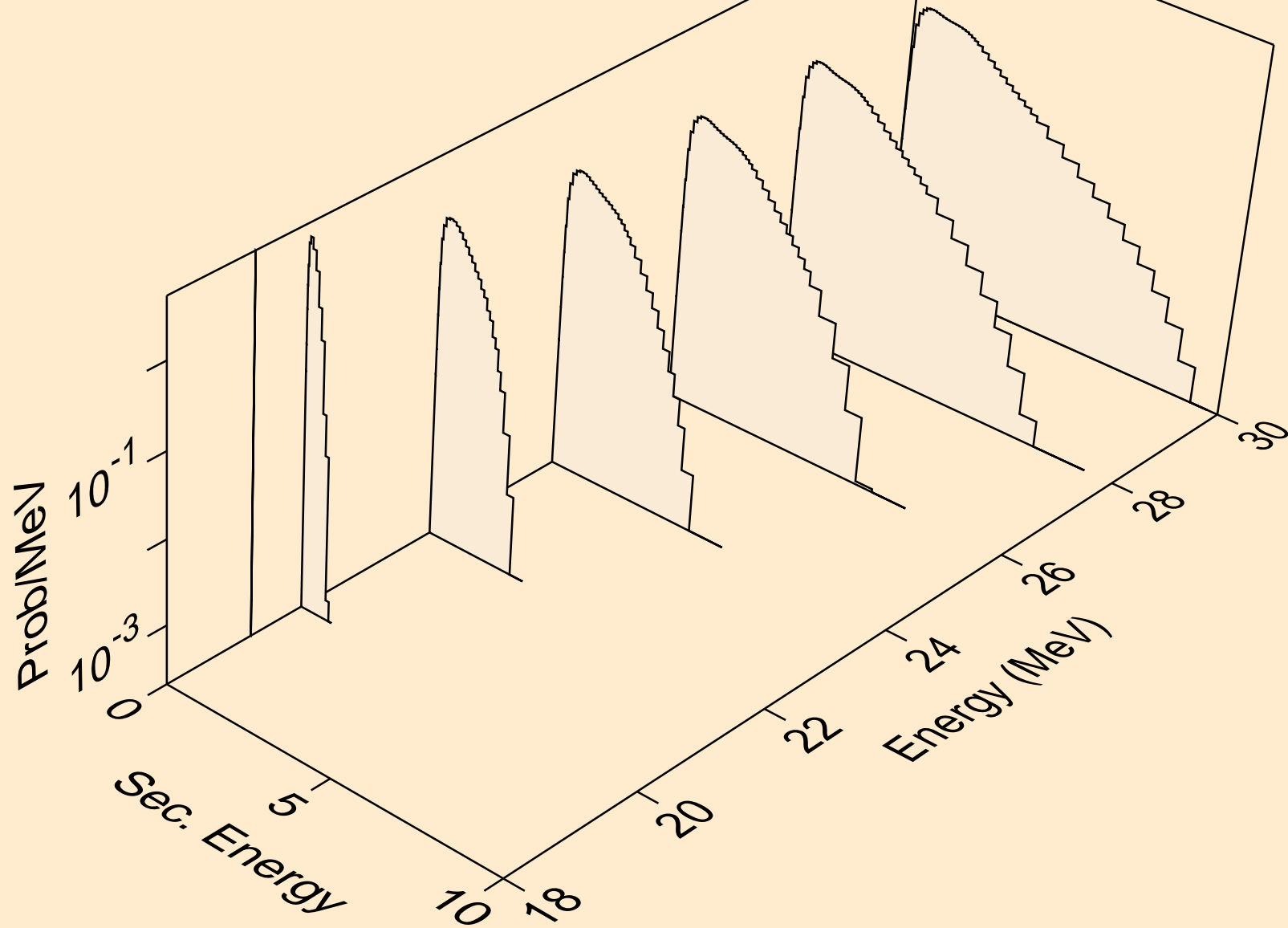

RA226 PROTON ACER TENDL-2021 LIBRARY; T=0.K  
neutrons from (p,2np)

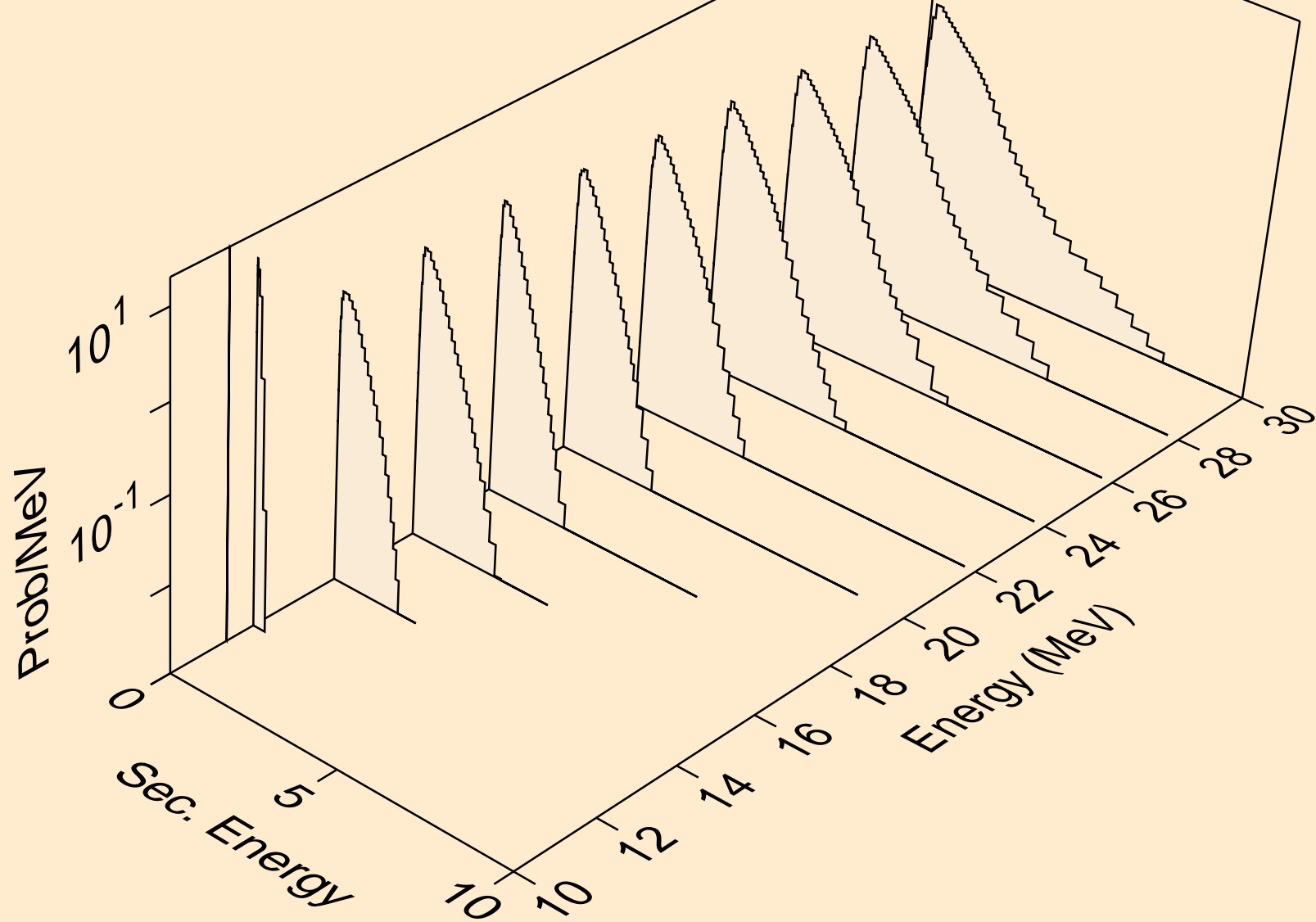

RA226 PROTON ACER TENDL-2021 LIBRARY; T=0.K  
neutrons from (p,3np)

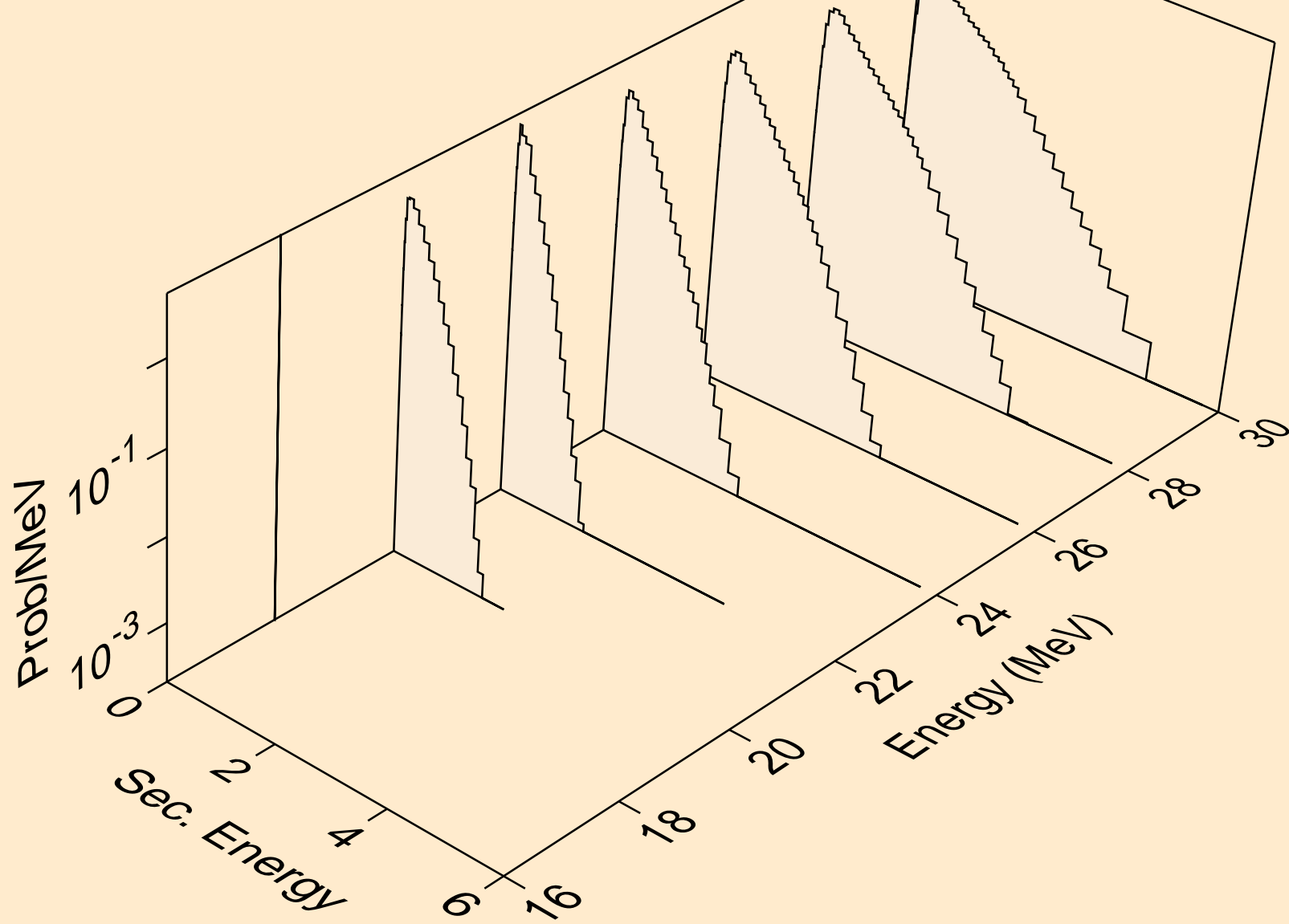

RA226 PROTON ACER TENDL-2021 LIBRARY; T=0.K  
neutrons from (p,2np)

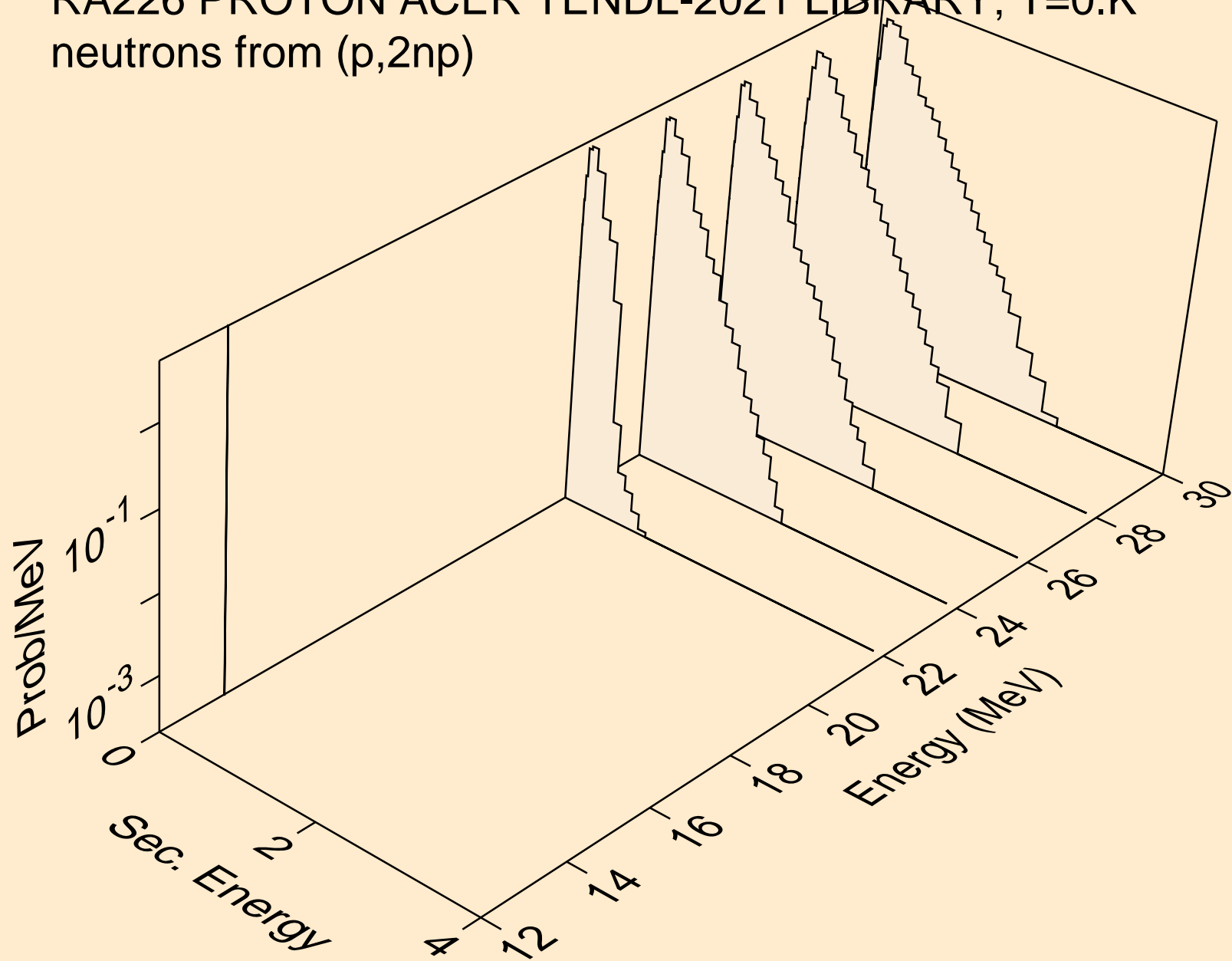

RA226 PROTON ACER TENDL-2021 LIBRARY; T=0.K  
neutrons from (p,npa)

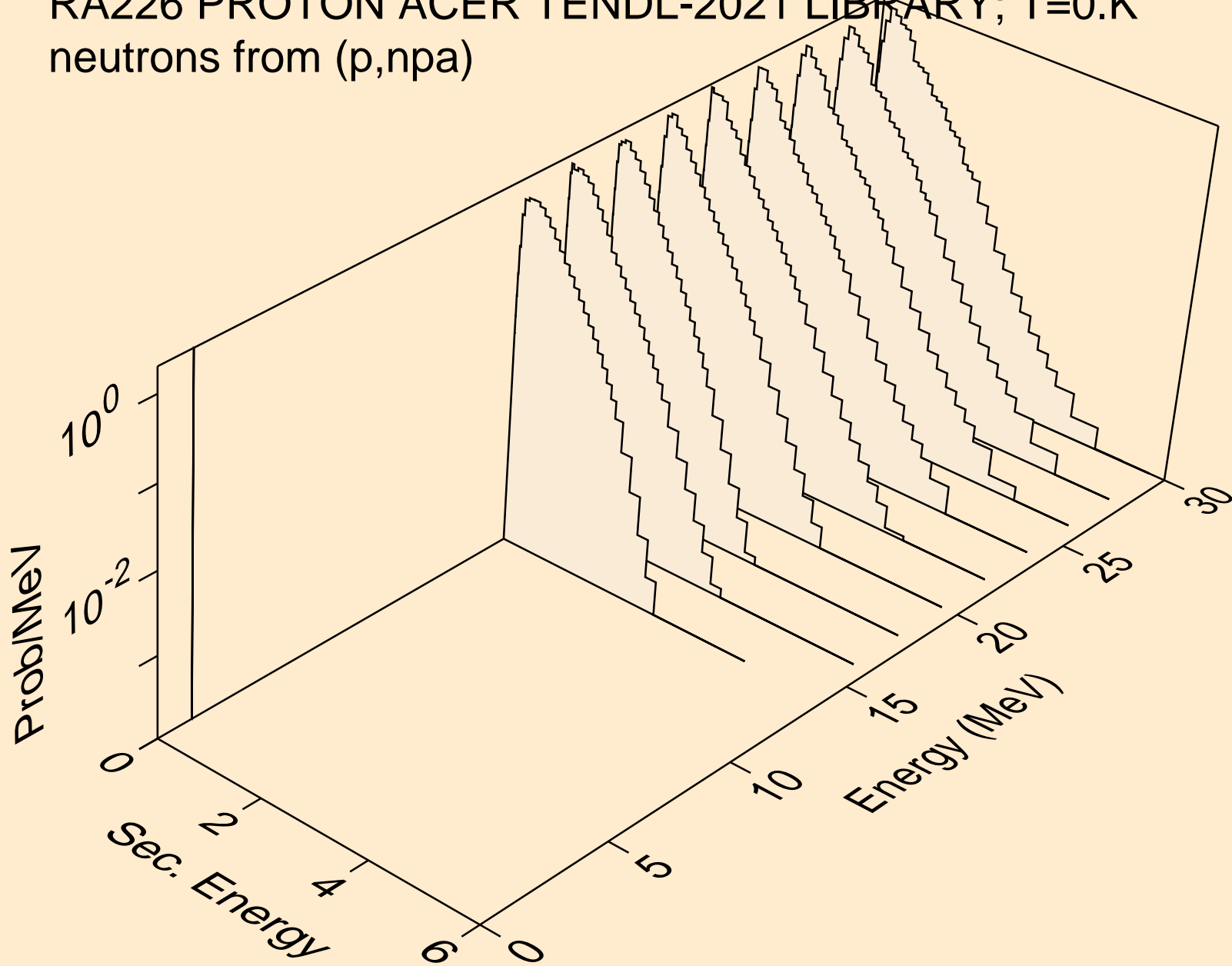

RA226 PROTON ACER TENDL-2021 LIBRARY; T=0.K  
deuterons from (p,x)

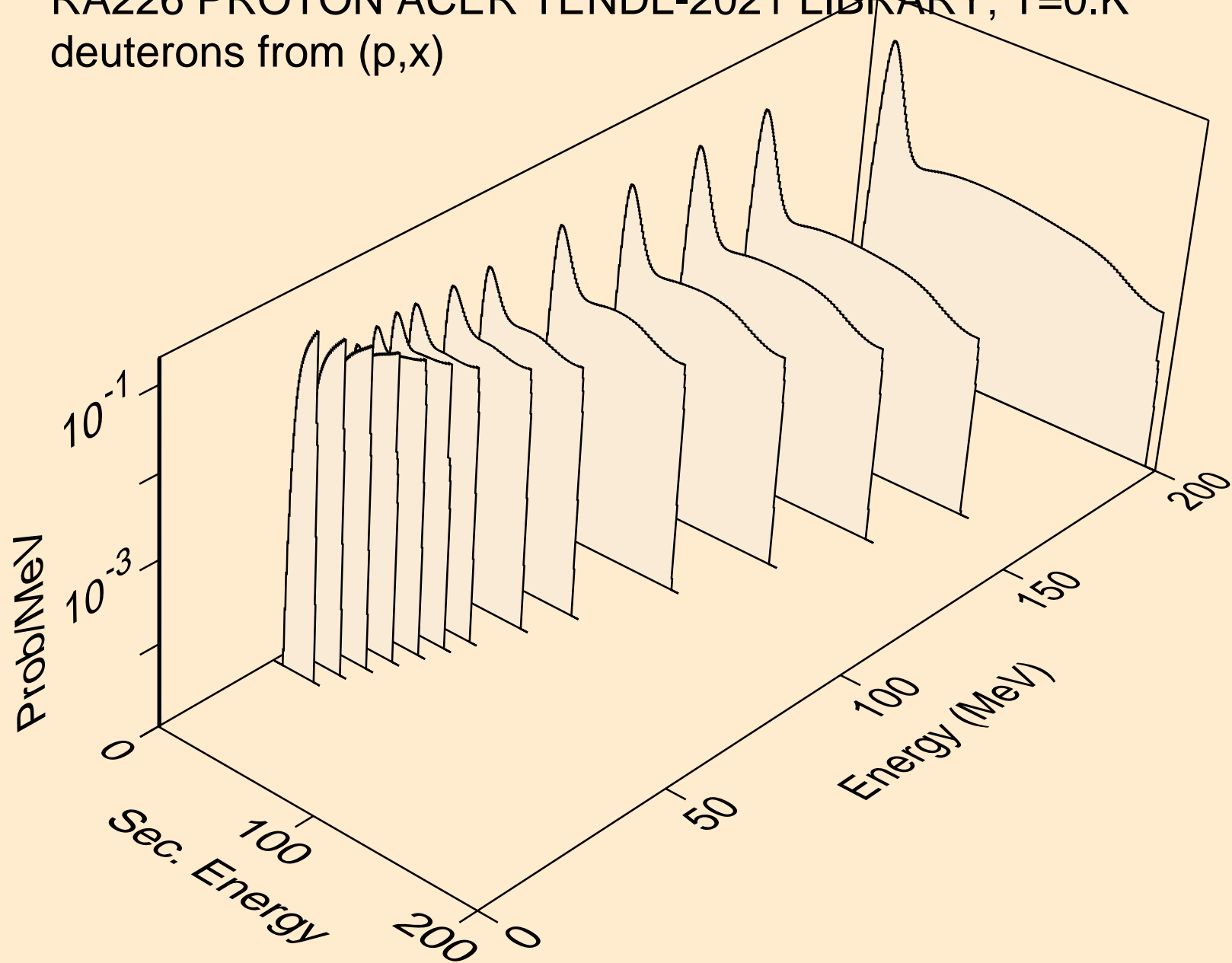

RA226 PROTON ACER TENDL-2021 LIBRARY; T=0.K  
deuterons from (p,2nd)

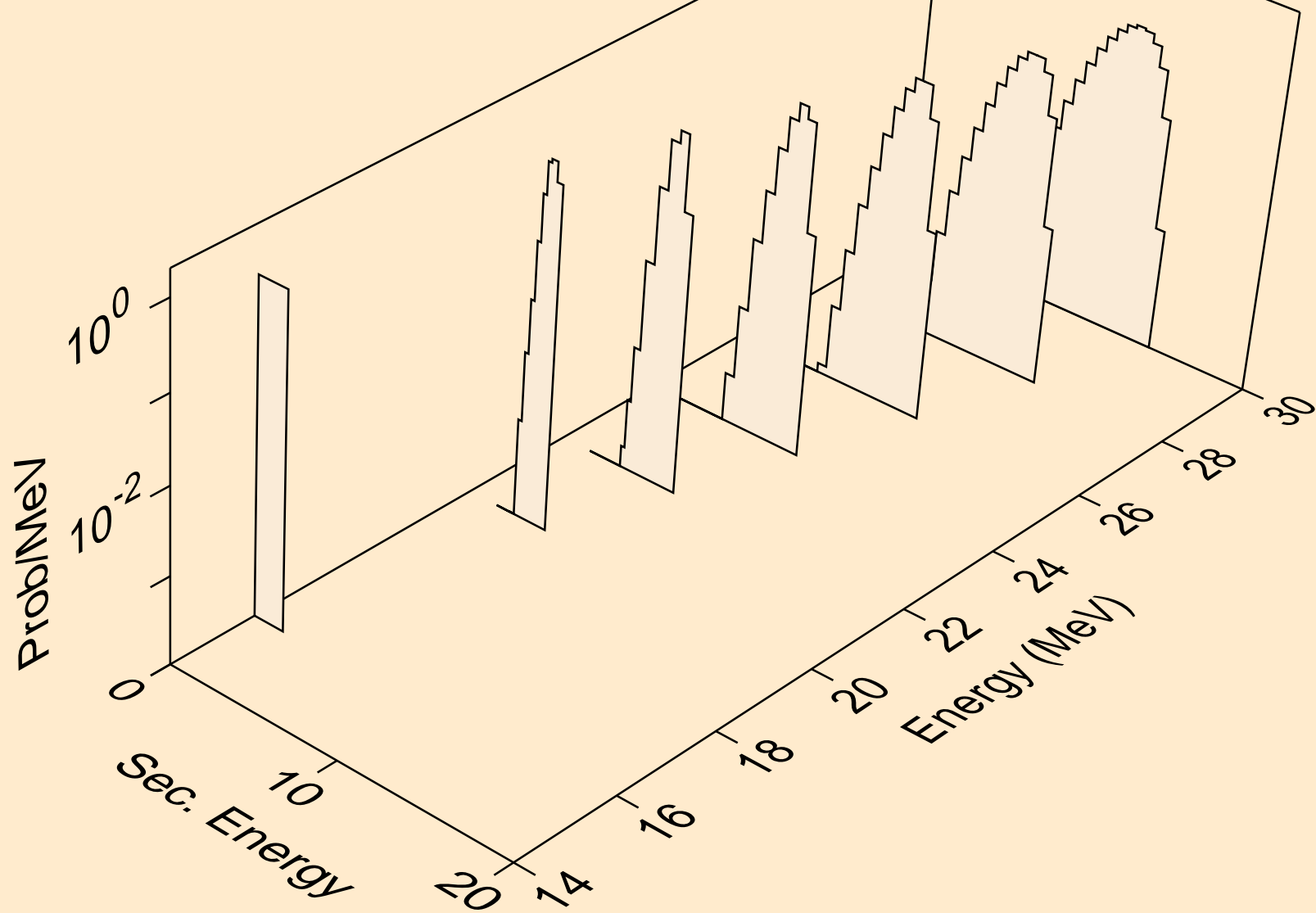



RA226 PROTON ACER TENDL-2021 LIBRARY; T=0.K  
deuterons from (p,n\*)d

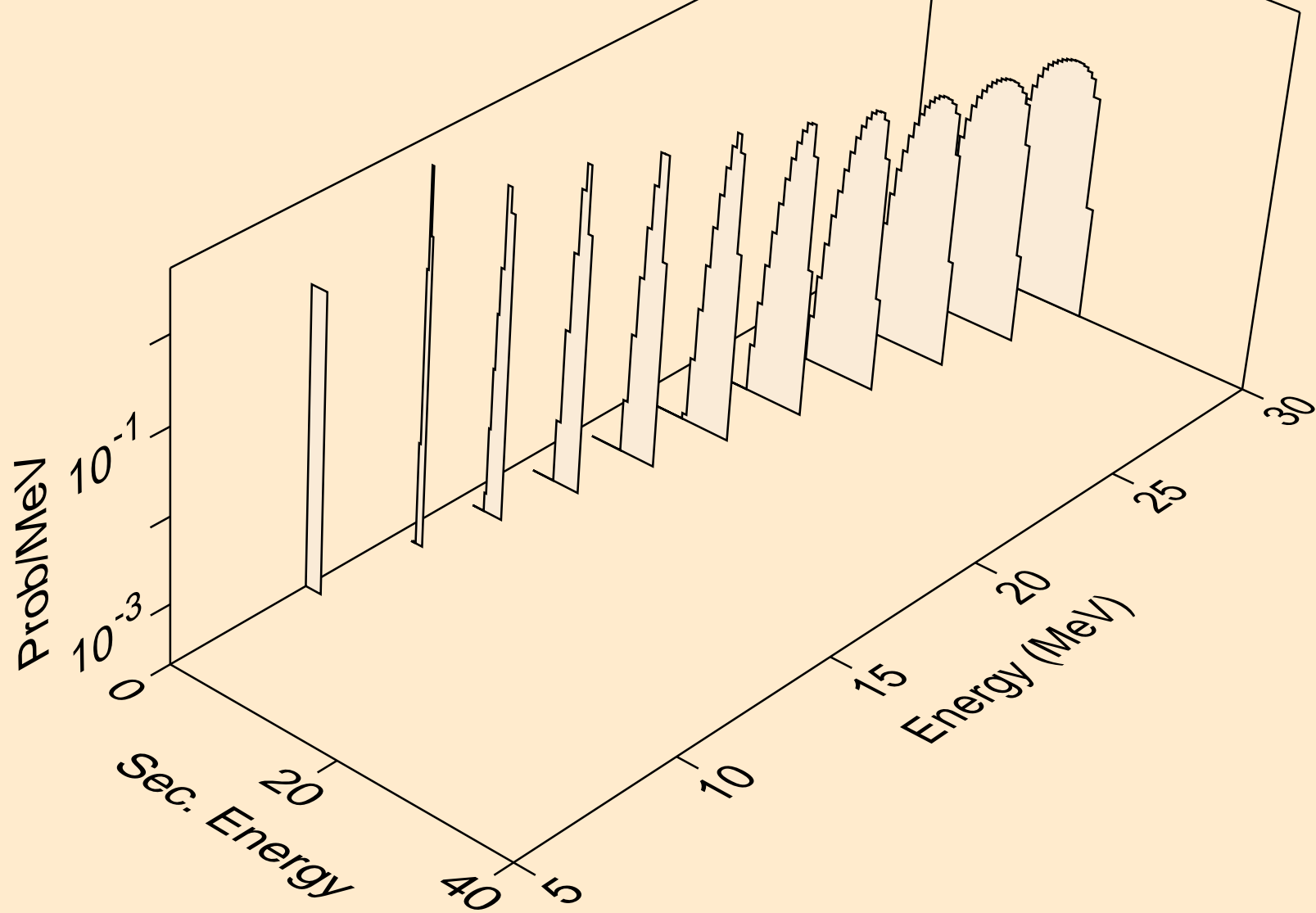

RA226 PROTON ACER TENDL-2021 LIBRARY; T=0.K  
deuterons from (p,d)

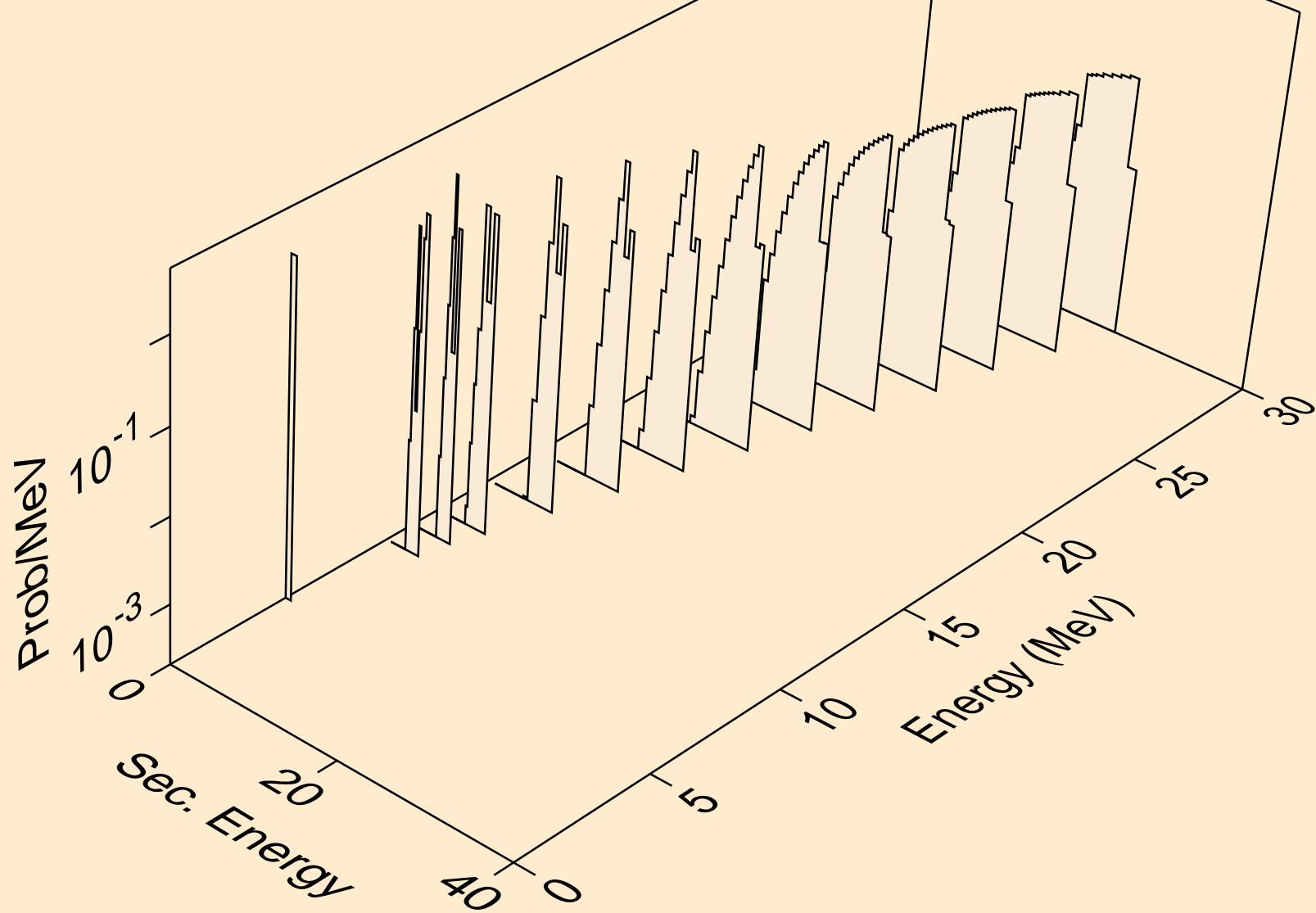

RA226 PROTON ACER TENDL-2021 LIBRARY; T=0.K  
tritons from (p,x)

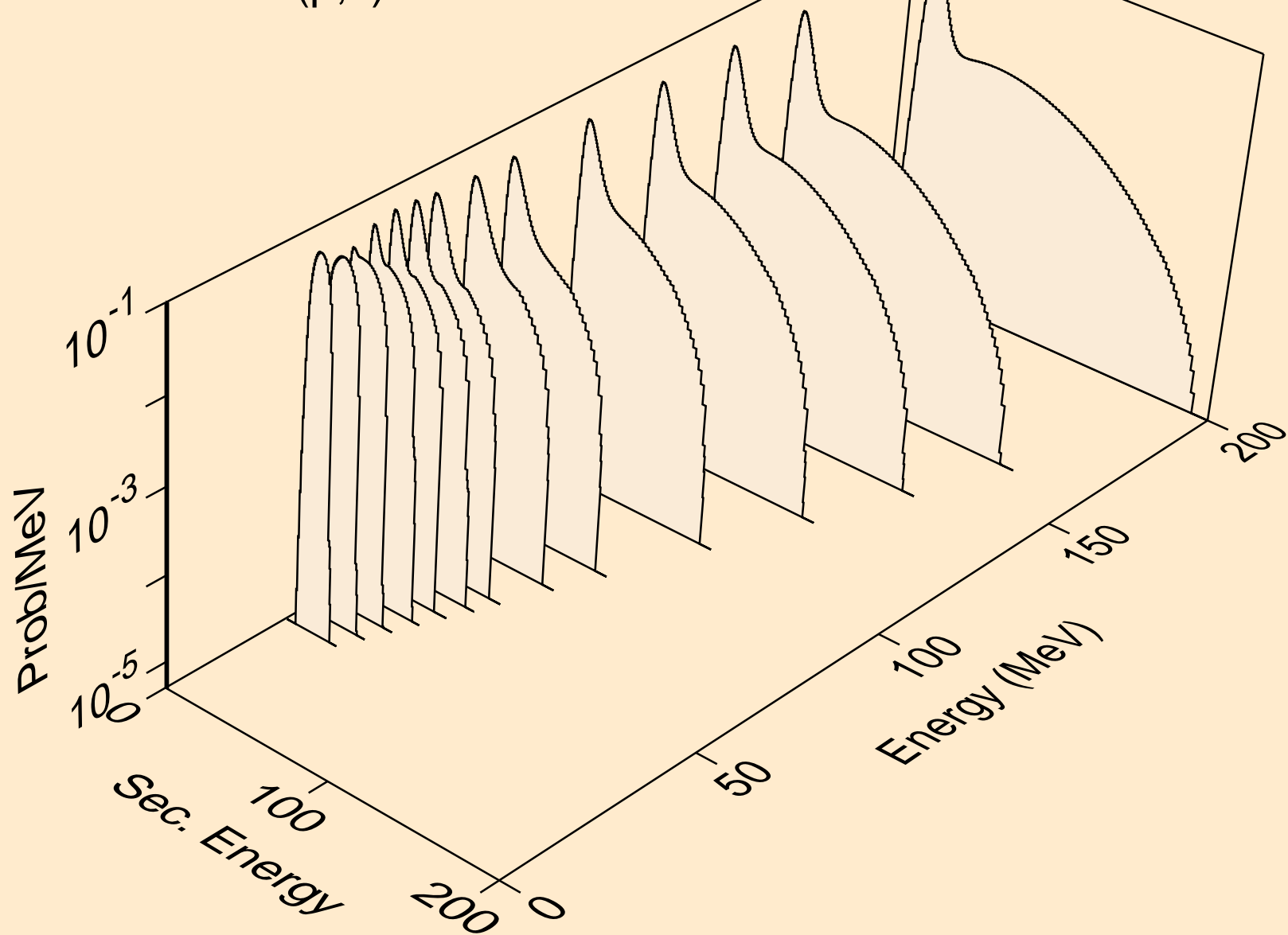

RA226 PROTON ACER TENDL-2021 LIBRARY; T=0.K  
tritons from (p,n\*)t

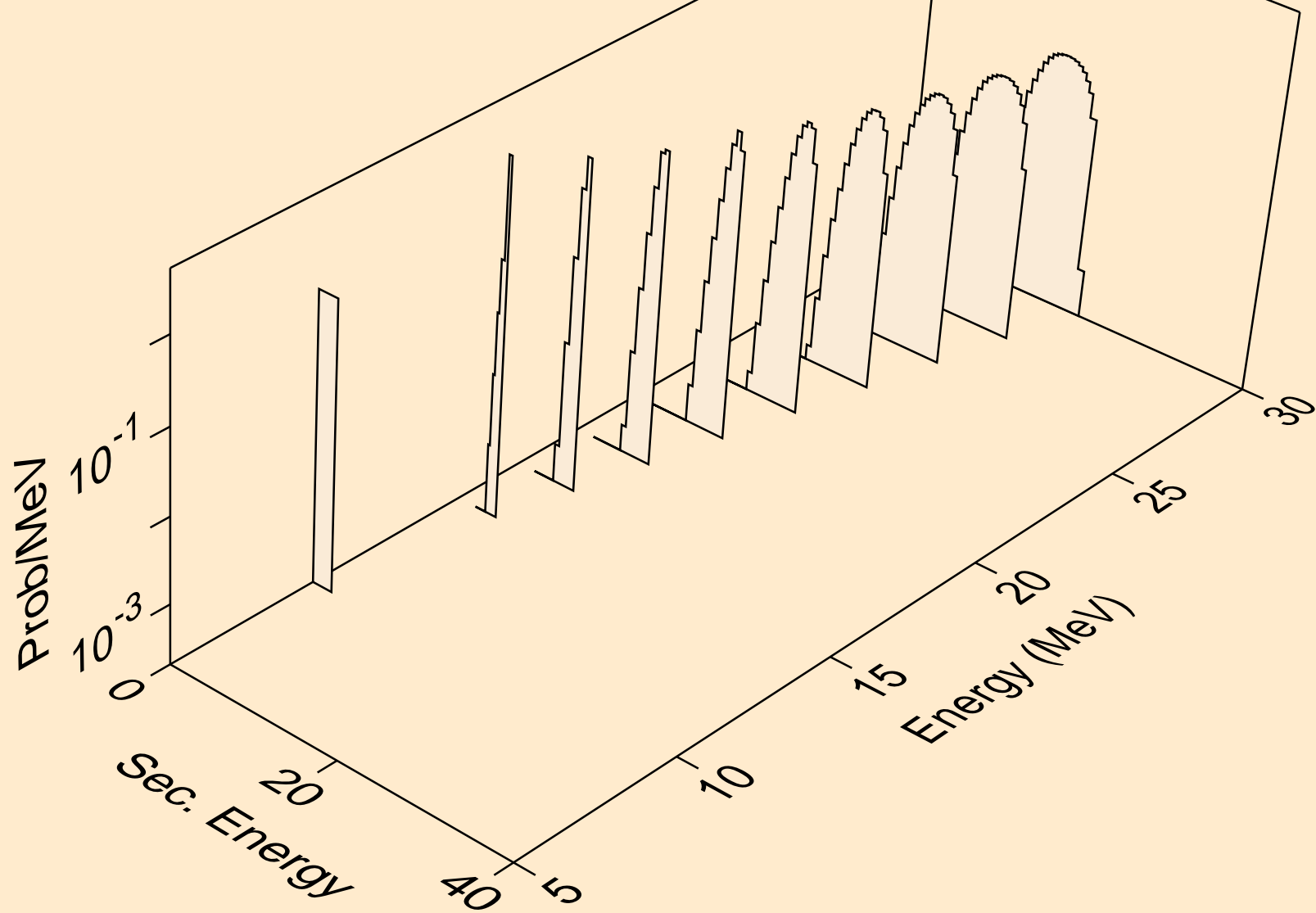

RA226 PROTON ACER TENDL-2021 LIBRARY; T=0.K  
tritons from (p,t)

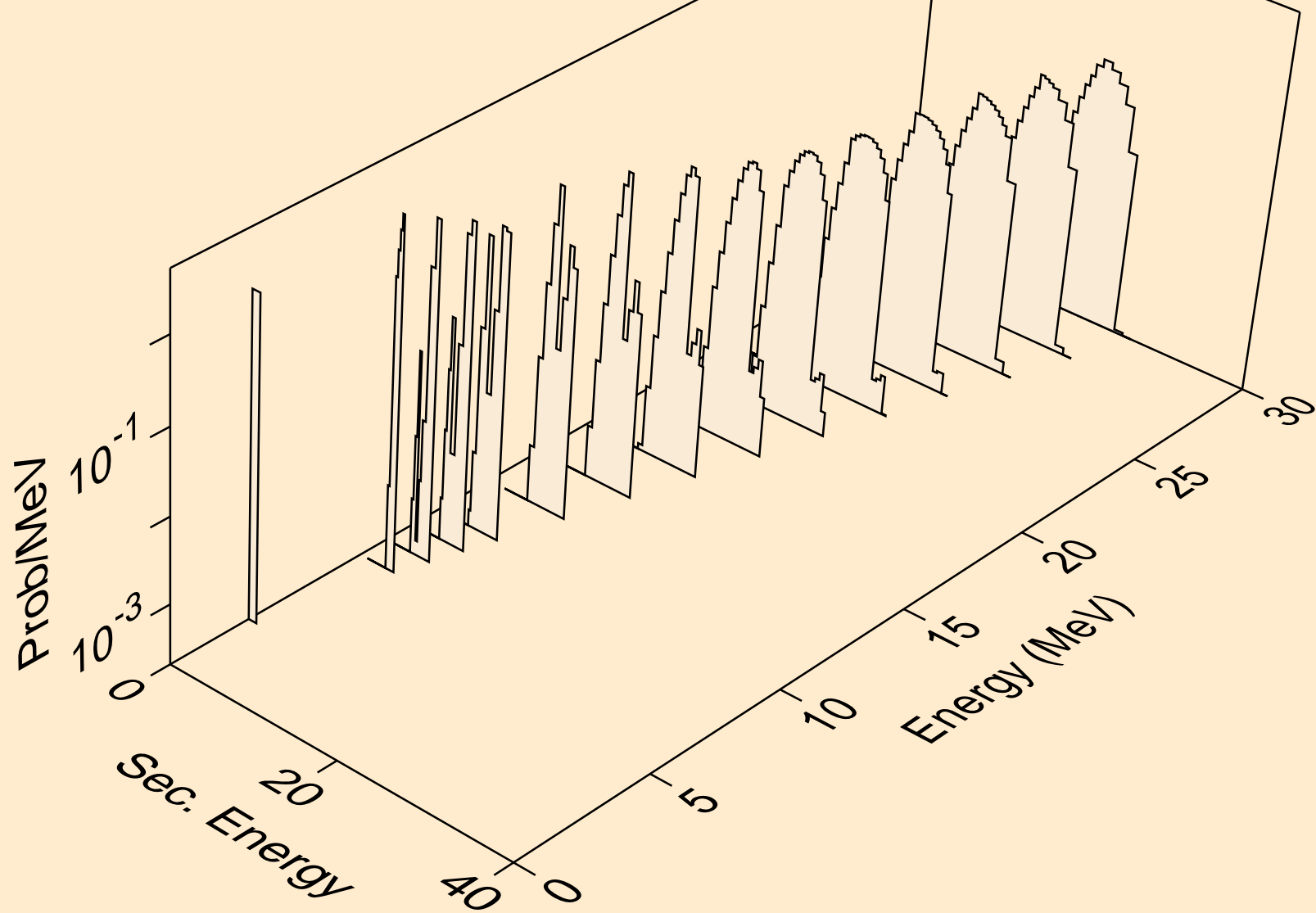

RA226 PROTON ACER TENDL-2021 LIBRARY; T=0.K  
he3s from (p,x)

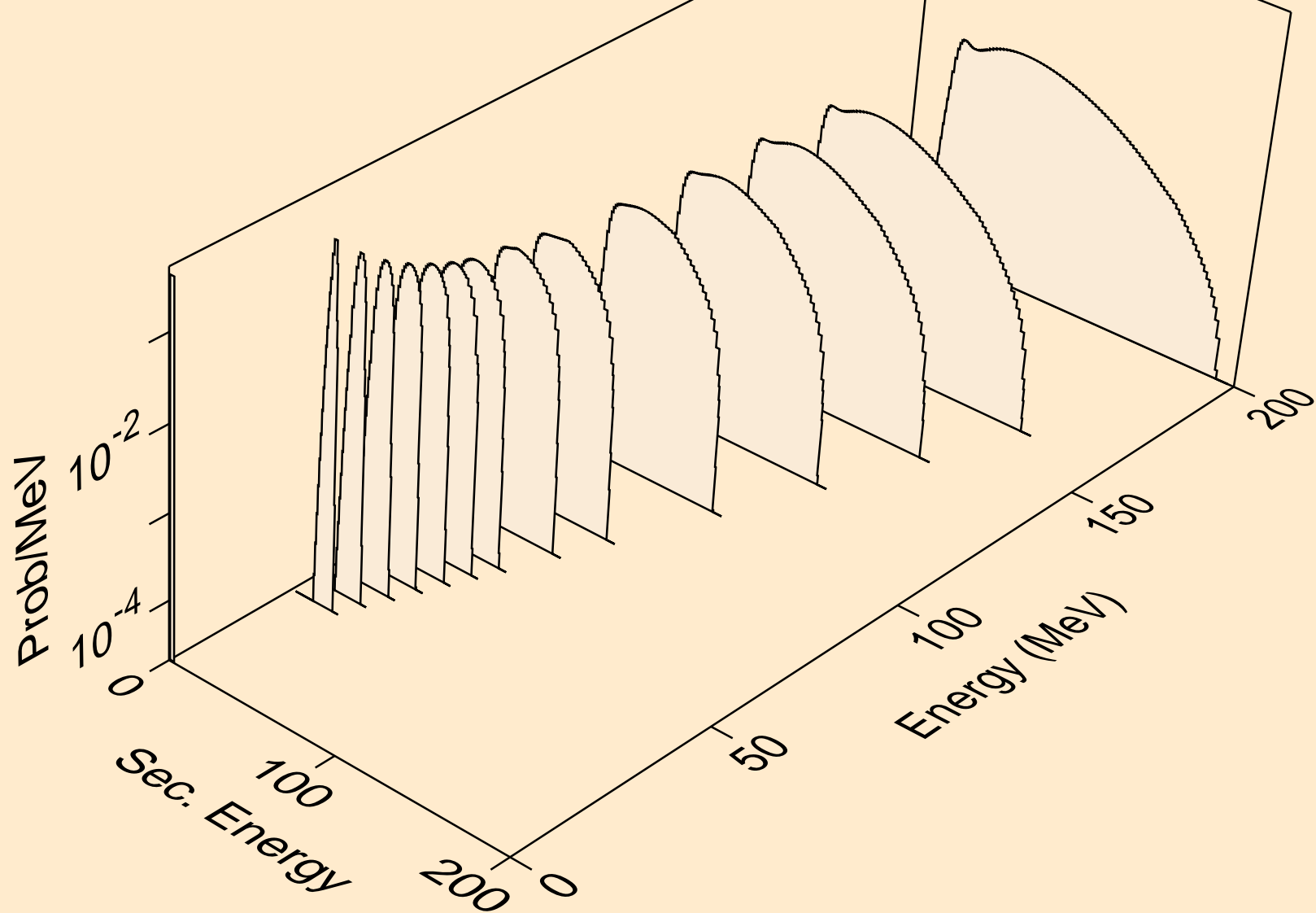

RA226 PROTON ACER TENDL-2021 LIBRARY; T=0.K  
he3s from (p,n\*)he3

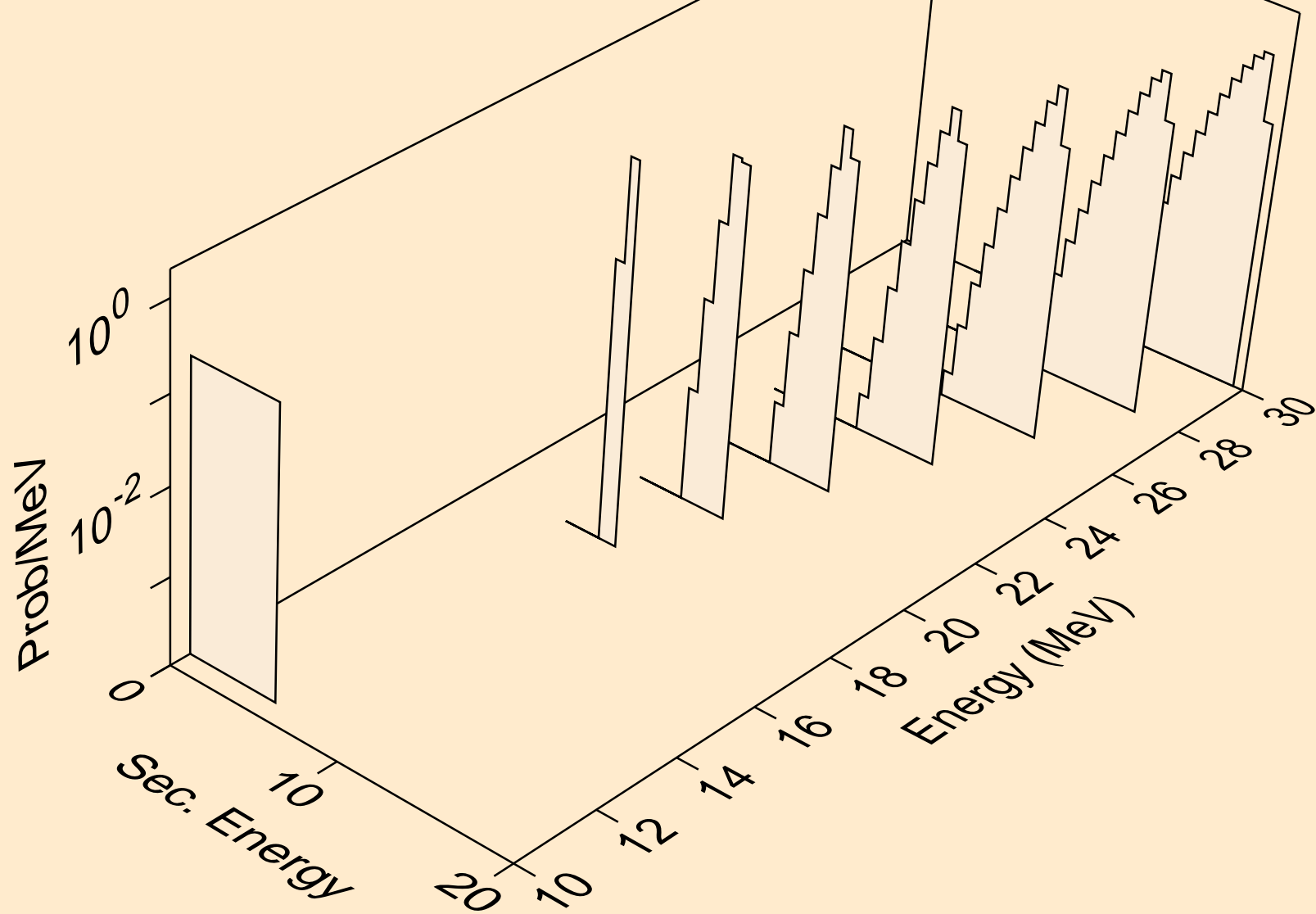

RA226 PROTON ACER TENDL-2021 LIBRARY; T=0.K  
he3s from (p,he3)

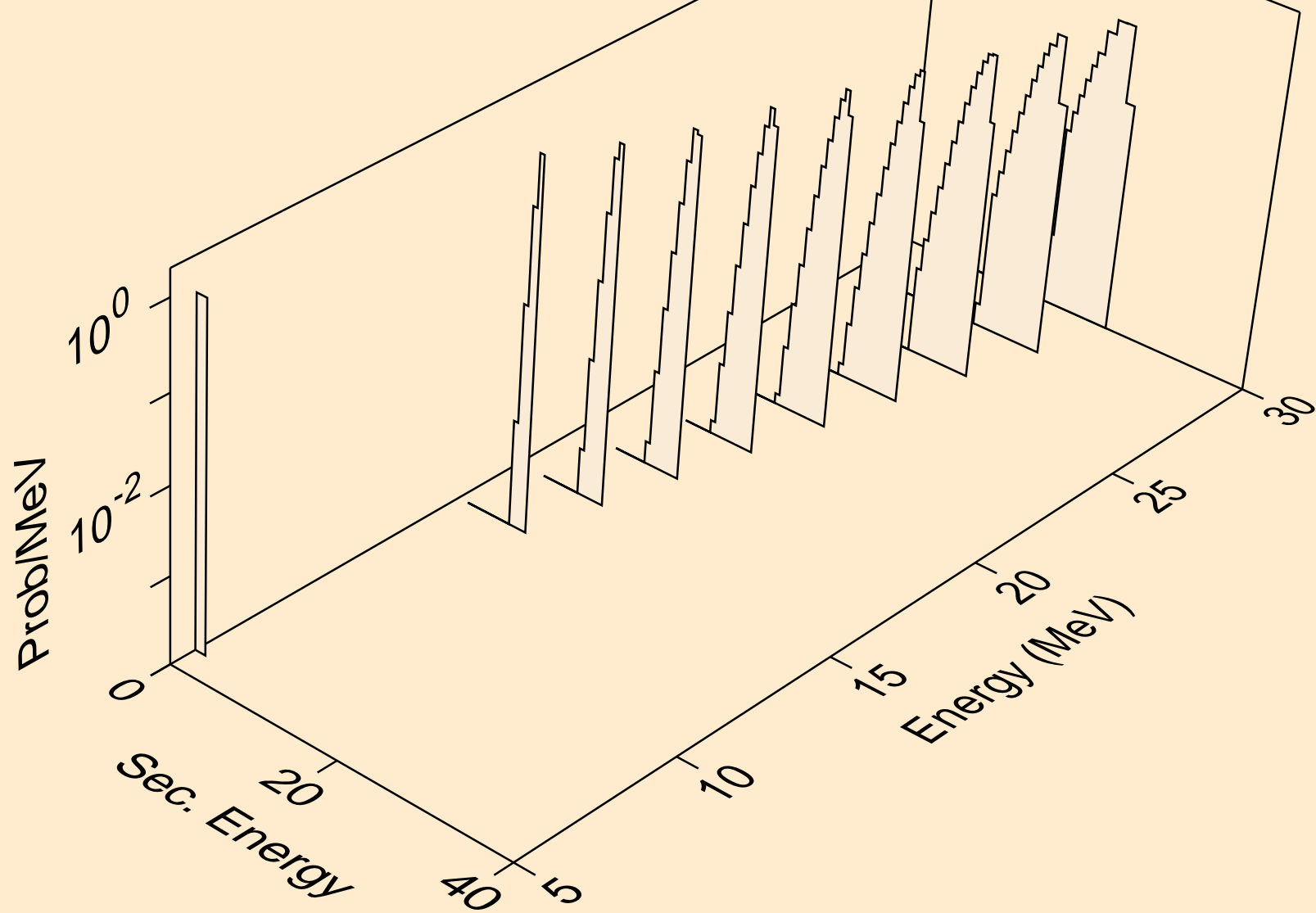



RA226 PROTON ACER TENDL-2021 LIBRARY; T=0.K  
alphas from (p,x)

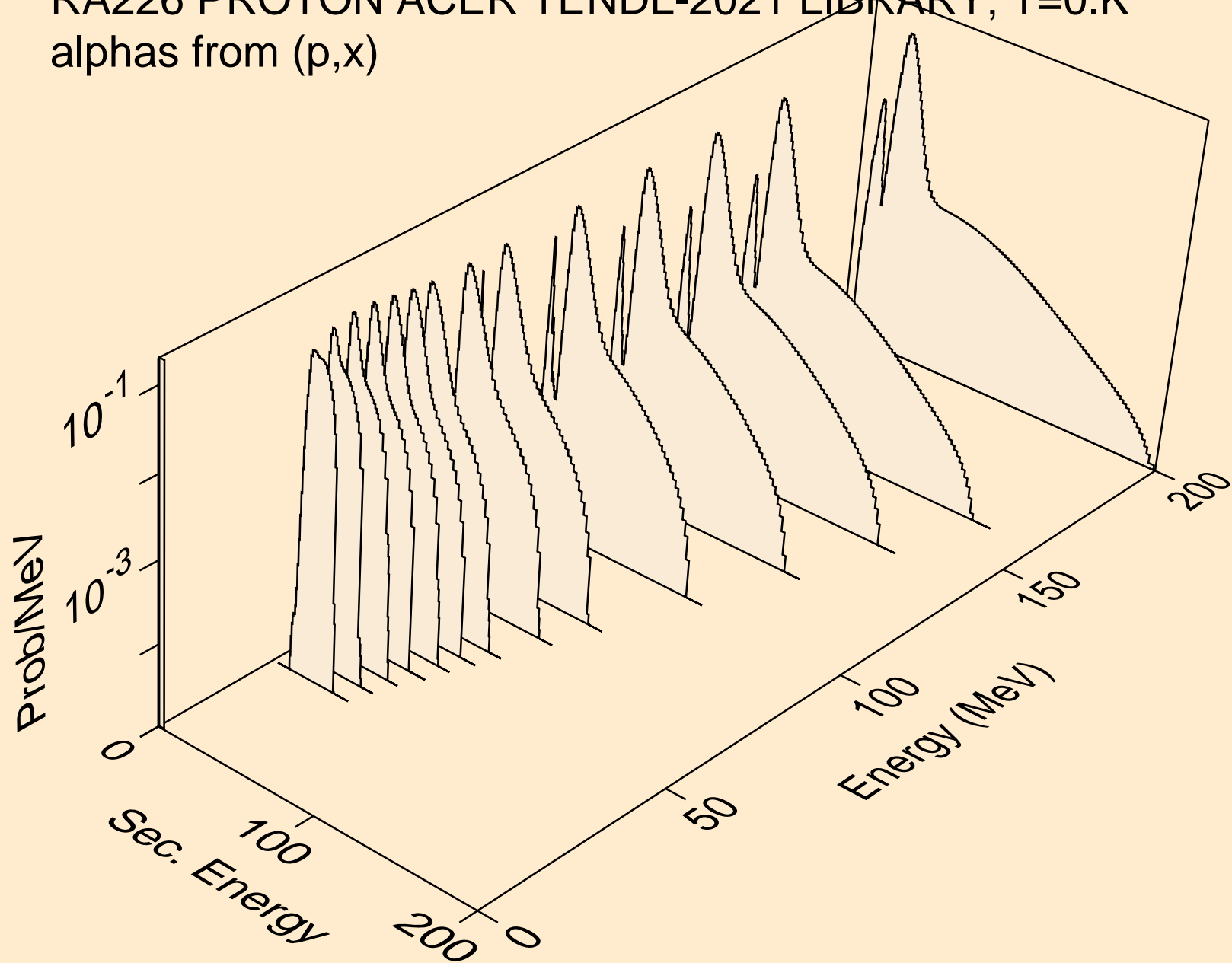

RA226 PROTON ACER TENDL-2021 LIBRARY; T=0.K  
alphas from (p,n\*)a

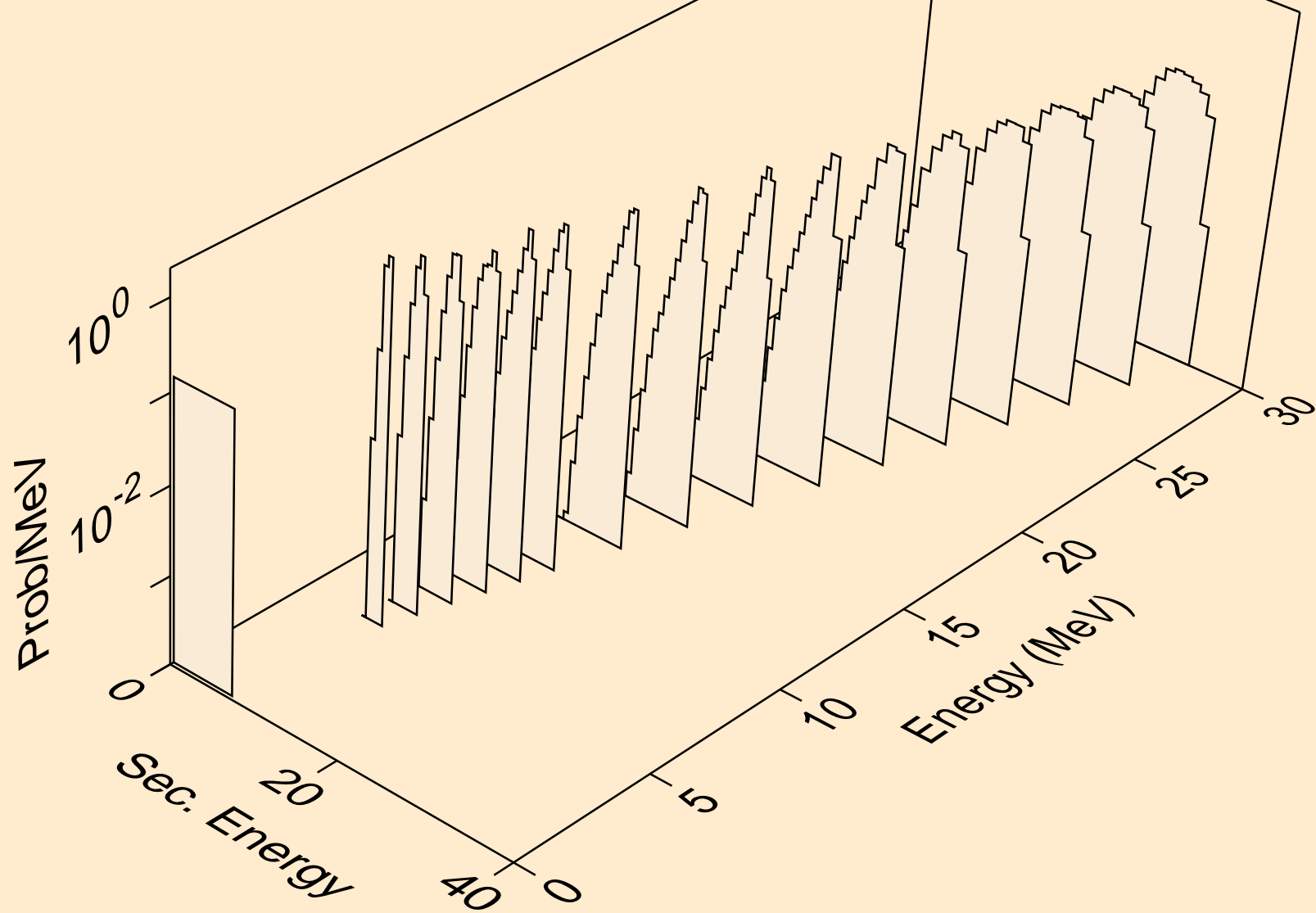

RA226 PROTON ACER TENDL-2021 LIBRARY; T=0.K  
alphas from (p,2n)a

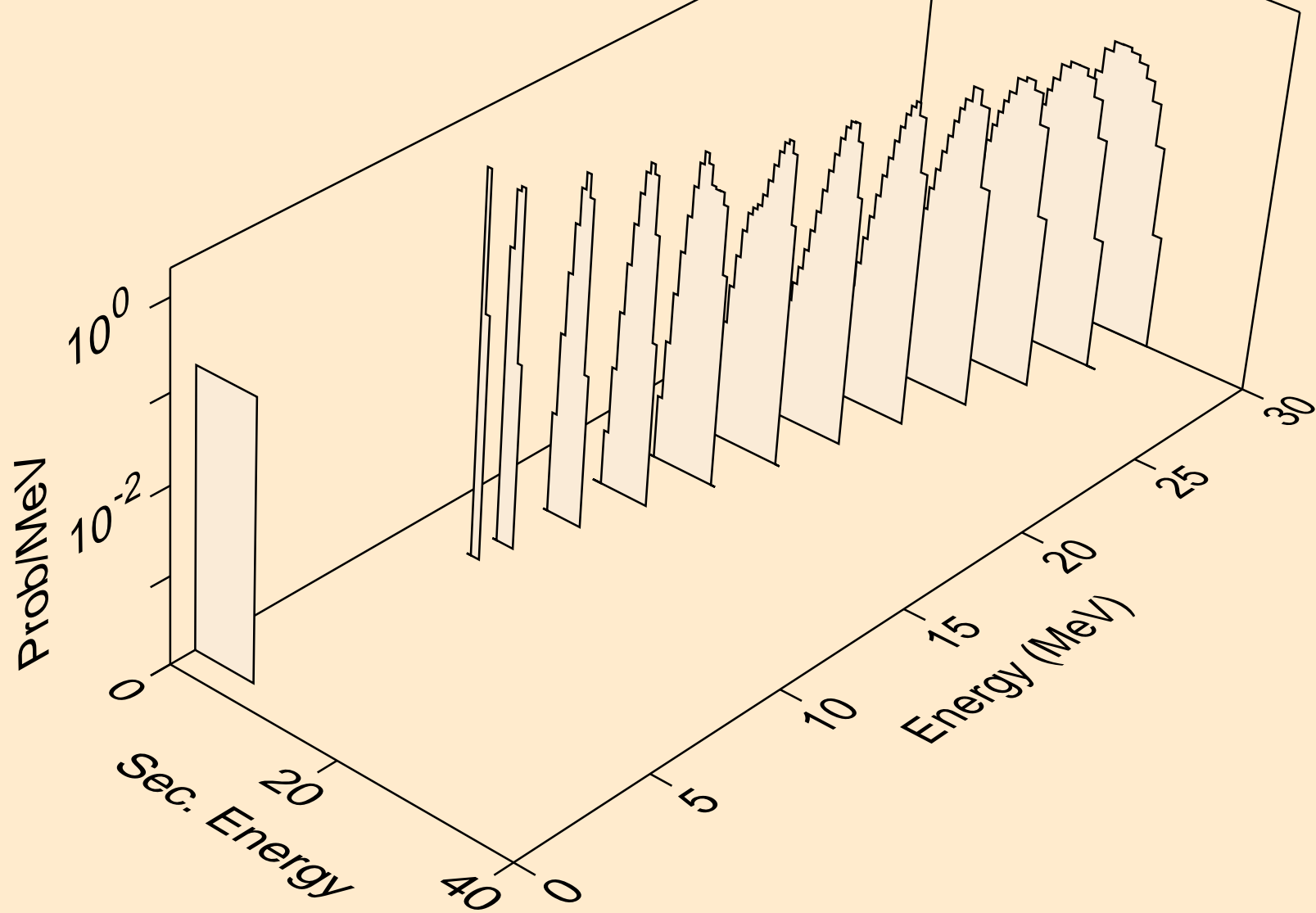

RA226 PROTON ACER TENDL-2021 LIBRARY; T=0.K  
alphas from (p,3n)a

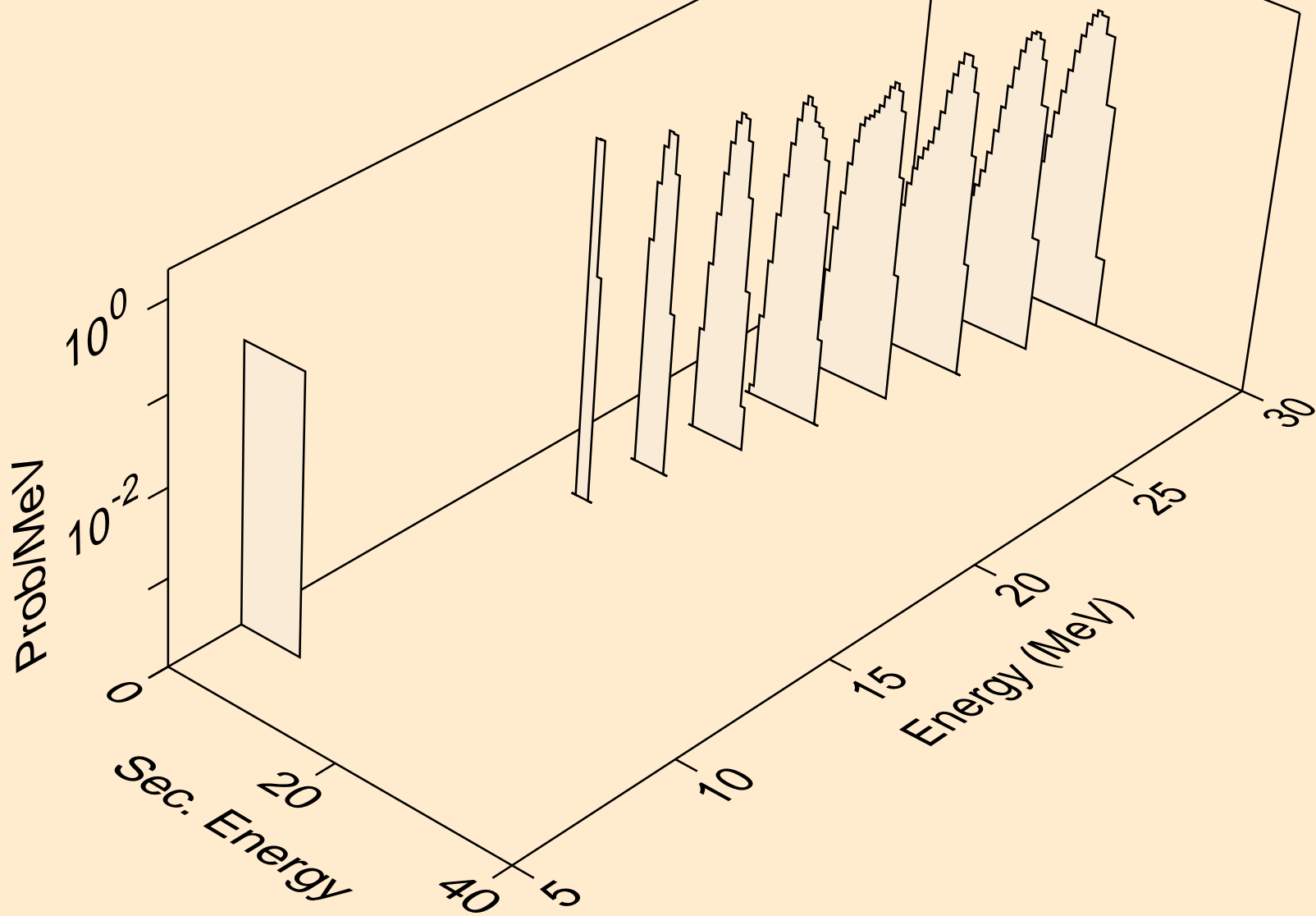

RA226 PROTON ACER TENDL-2021 LIBRARY; T=0.K  
alphas from (p,n\*)2a

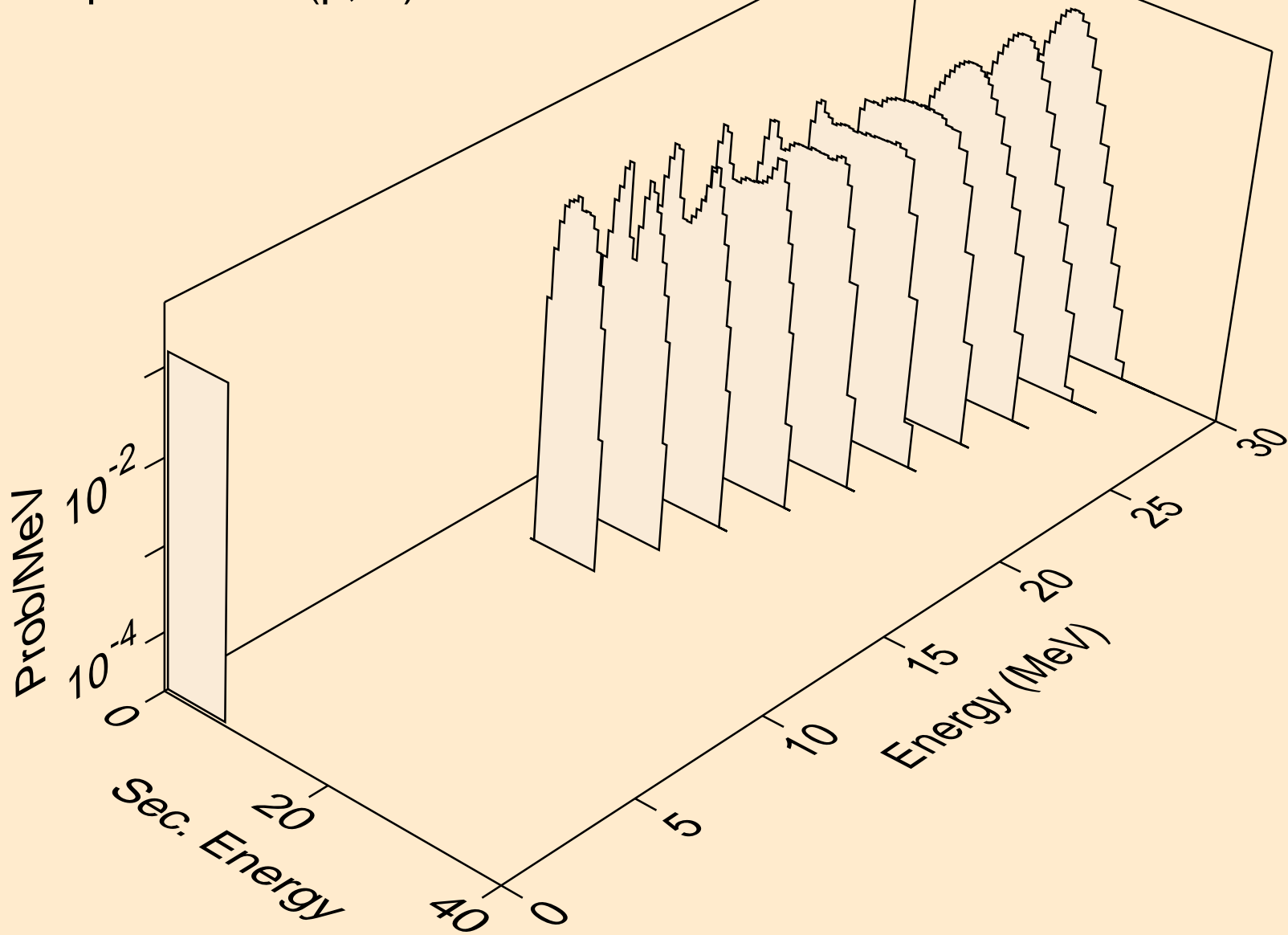

RA226 PROTON ACER TENDL-2021 LIBRARY; T=0.K  
alphas from (p,2n)2a

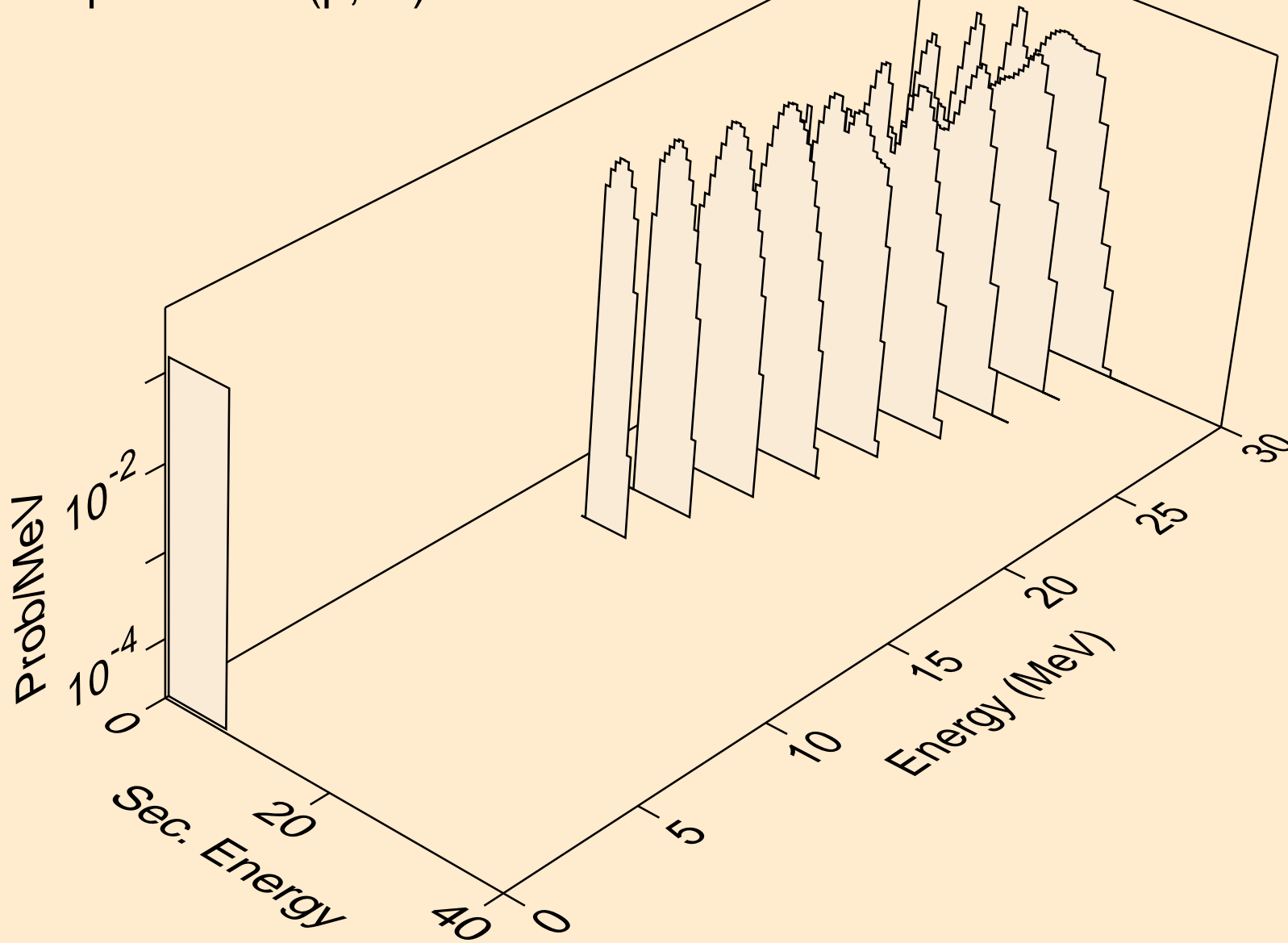

RA226 PROTON ACER TENDL-2021 LIBRARY; T=0.K  
alphas from (p,npa)

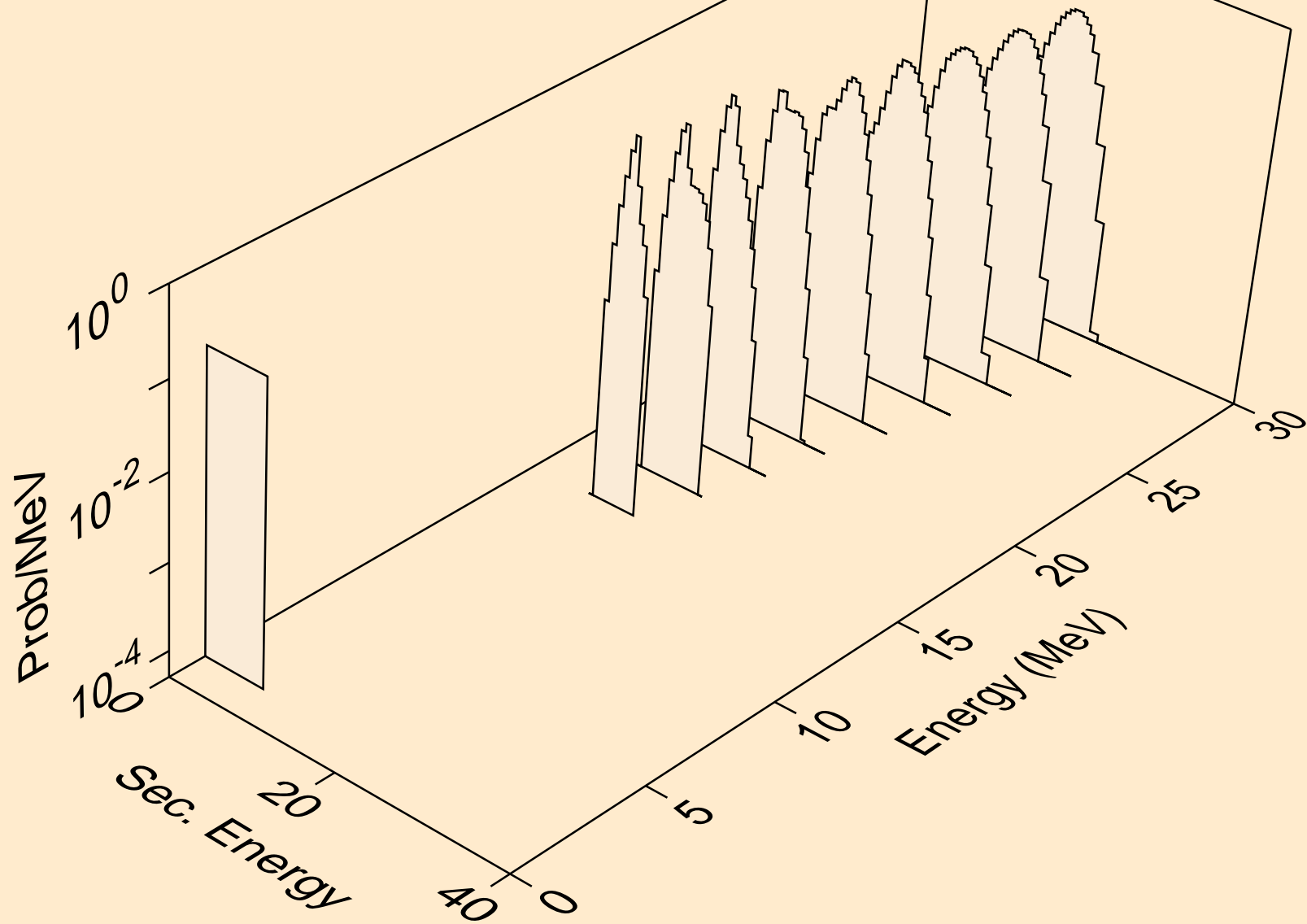

RA226 PROTON ACER TENDL-2021 LIBRARY; T=0.K  
alphas from (p,a)

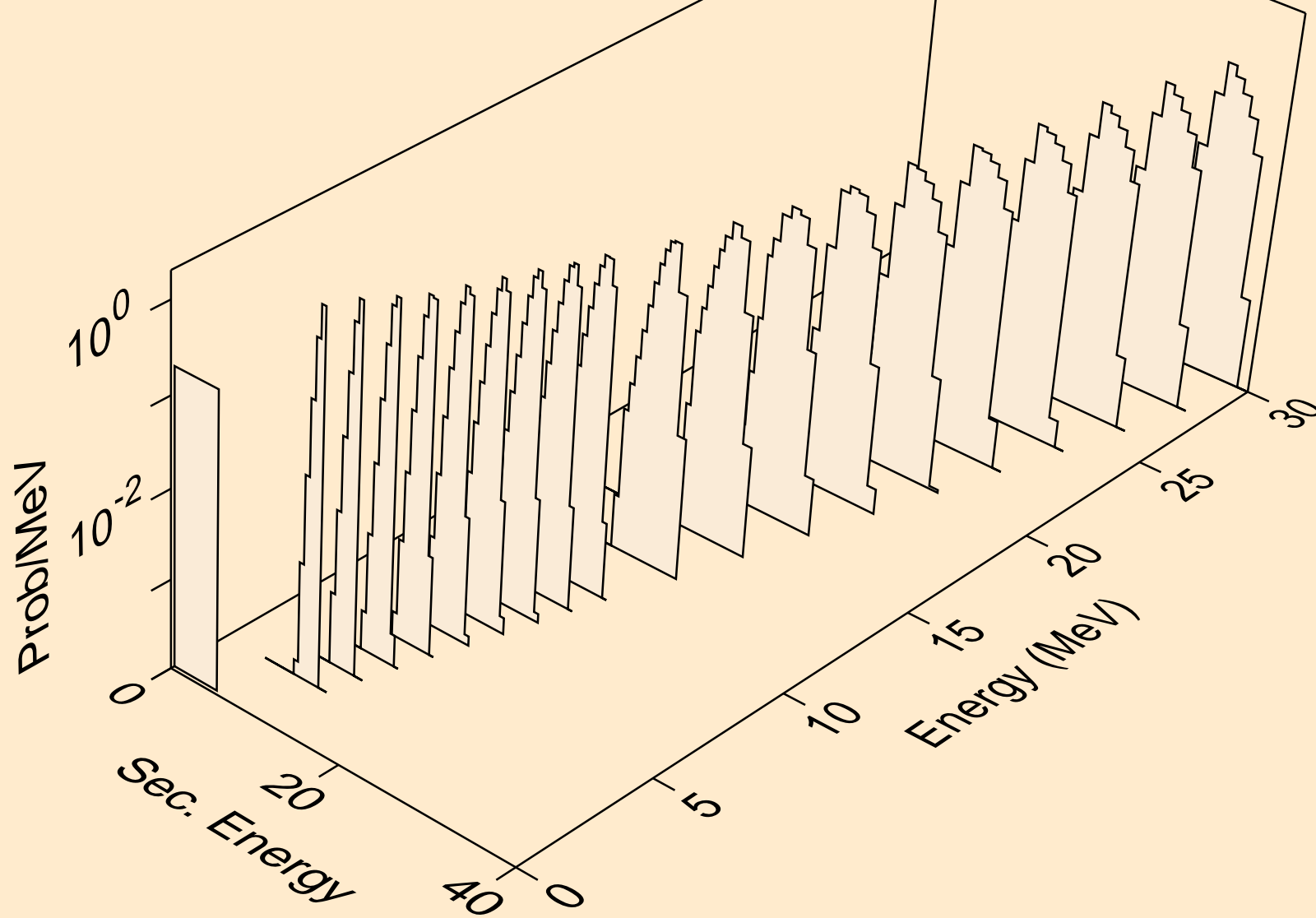



RA226 PROTON ACER TENDL-2021 LIBRARY; T=0.K  
alphas from (p,2a)

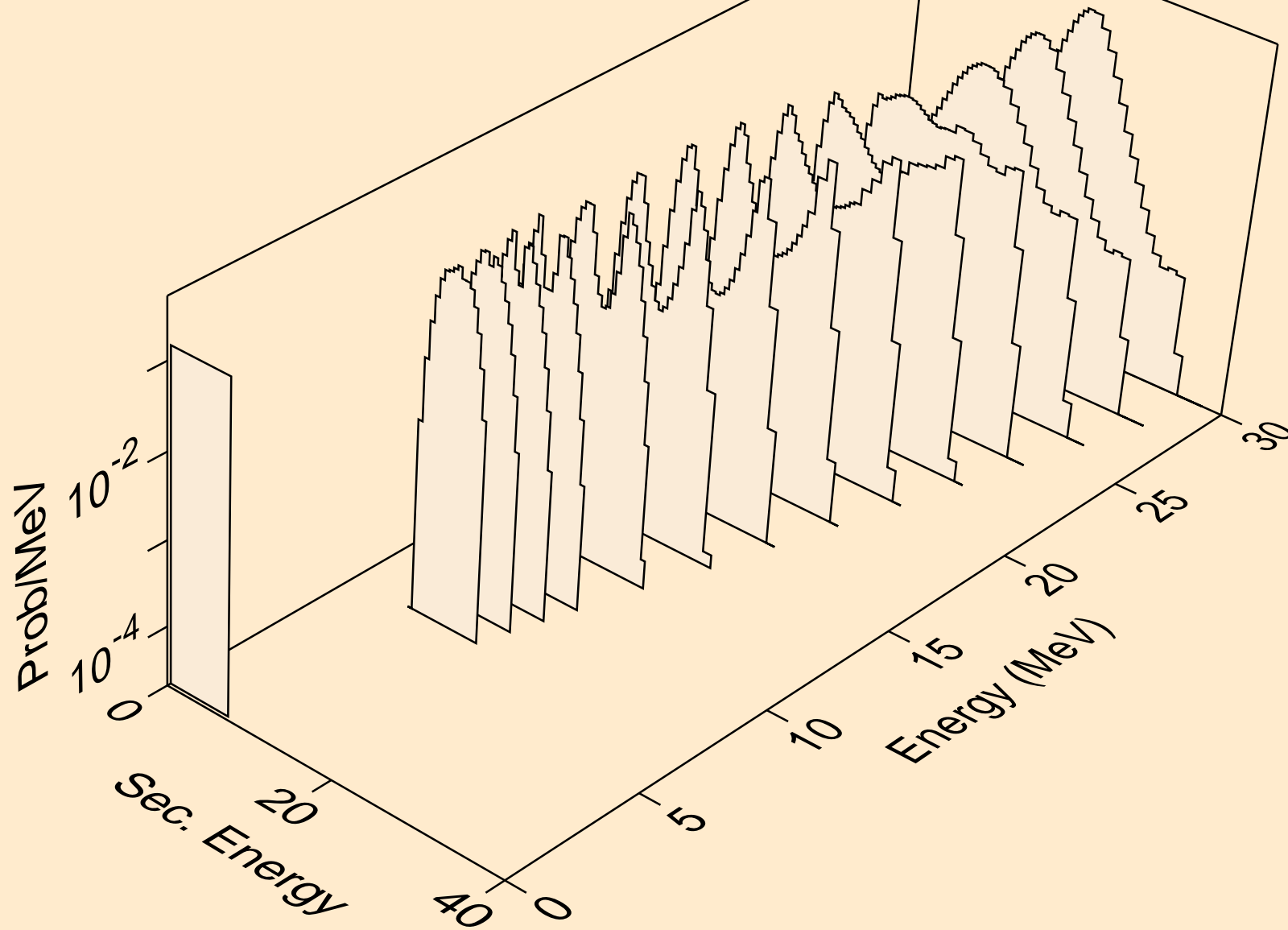

RA226 PROTON ACER TENDL-2021 LIBRARY; T=0.K  
alphas from (p,pa)

