

# RA234 PROTON ACER TENDL-2021 LIBRARY; T=0.K

## Principal cross sections

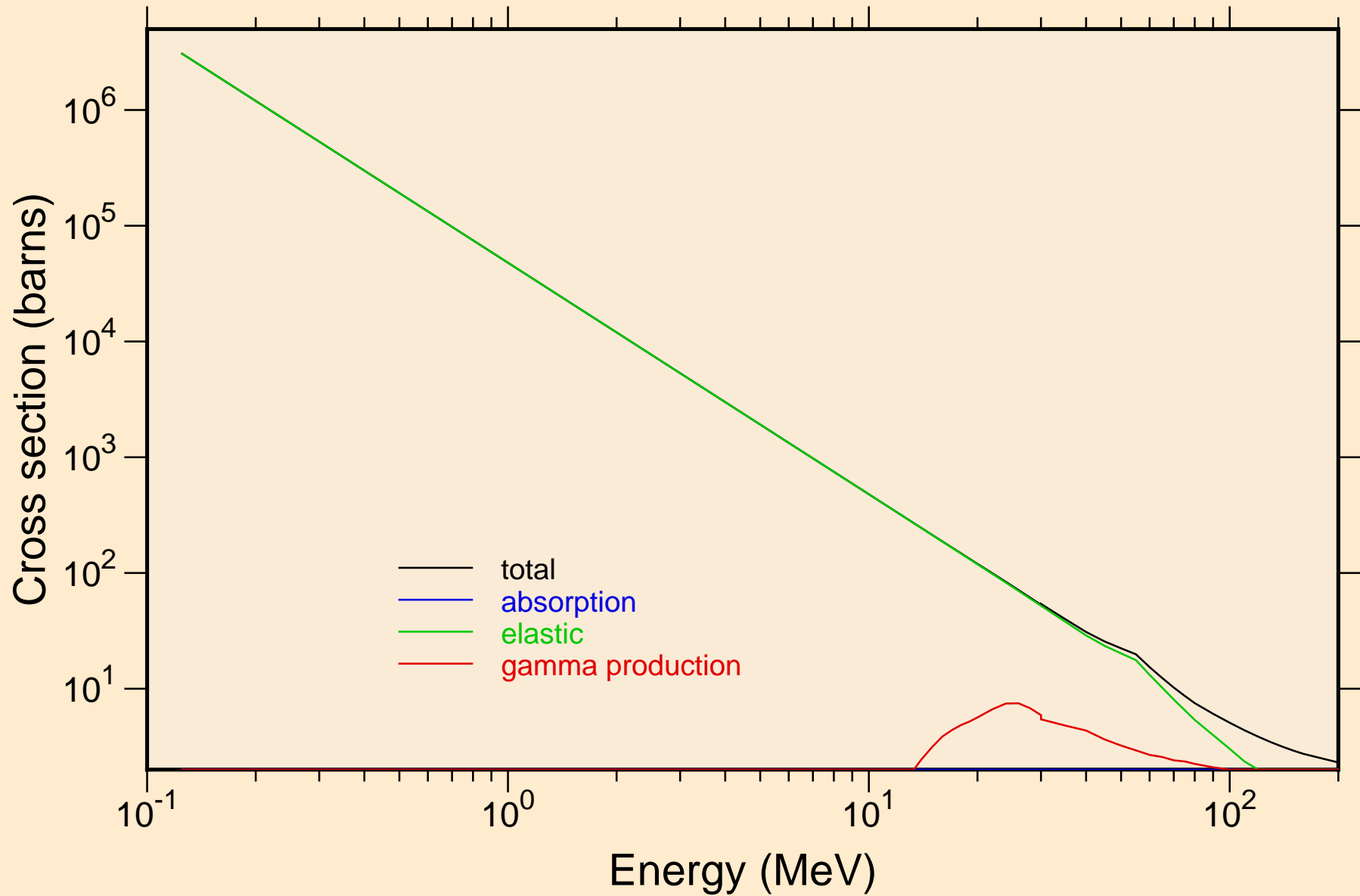

# RA234 PROTON ACER TENDL-2021 LIBRARY; T=0.K

## Heating

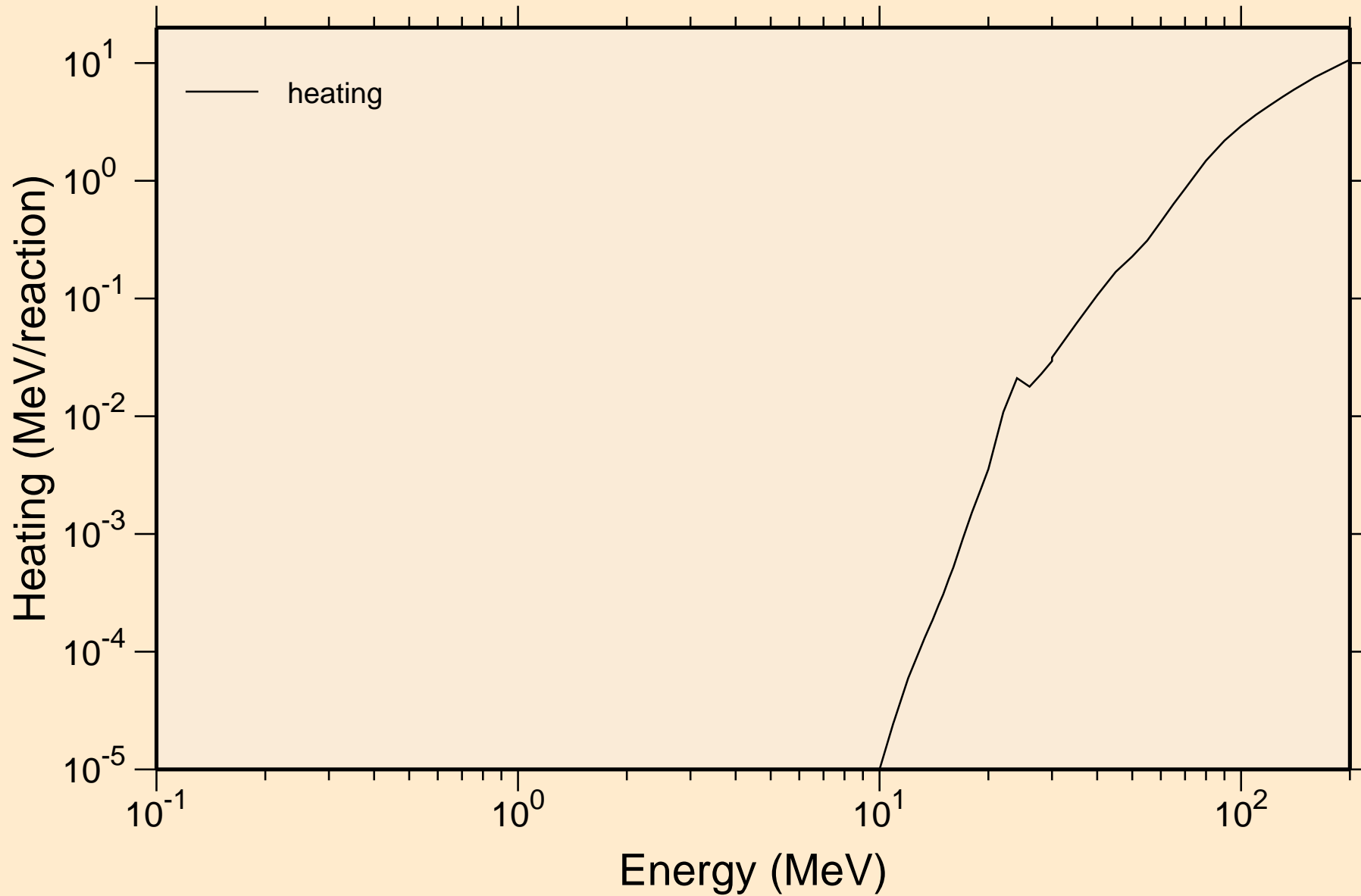

# RA234 PROTON ACER TENDL-2021 LIBRARY; T=0.K

## Principal cross sections

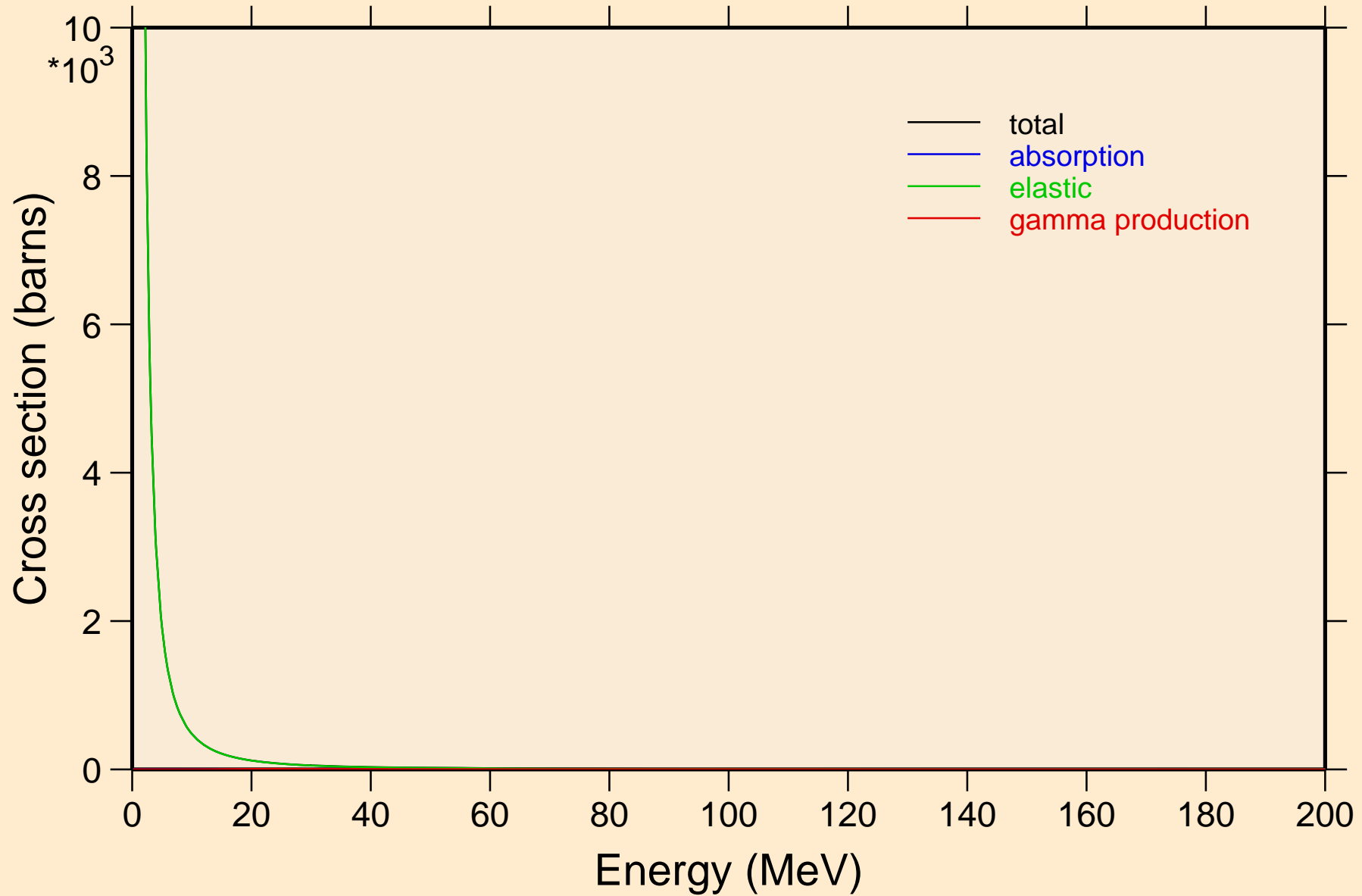

RA234 PROTON ACER TENDL-2021 LIBRARY; T=0.K

Heating

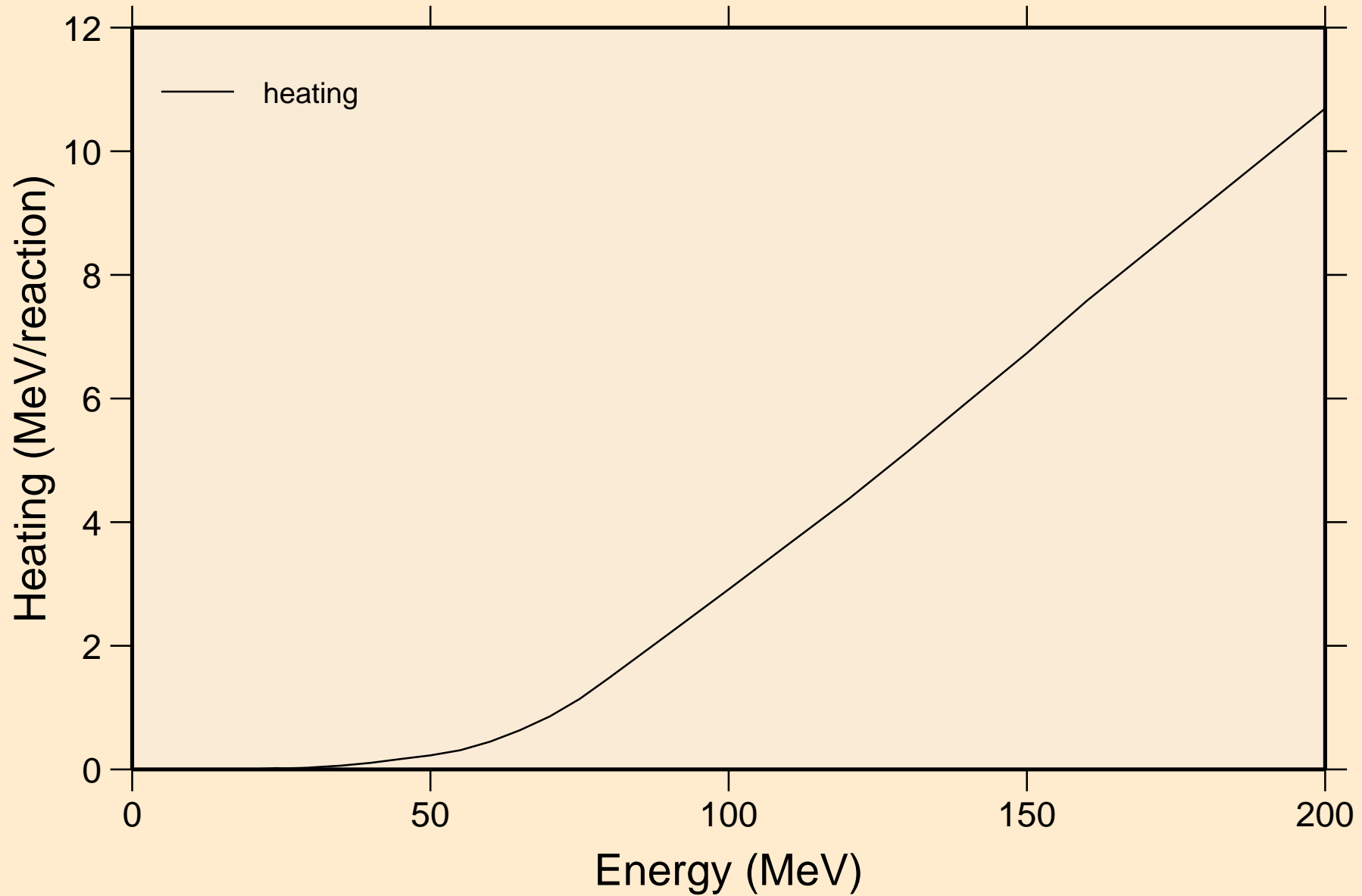

RA234 PROTON ACER TENDL-2021 LIBRARY; T=0.K  
Threshold reactions

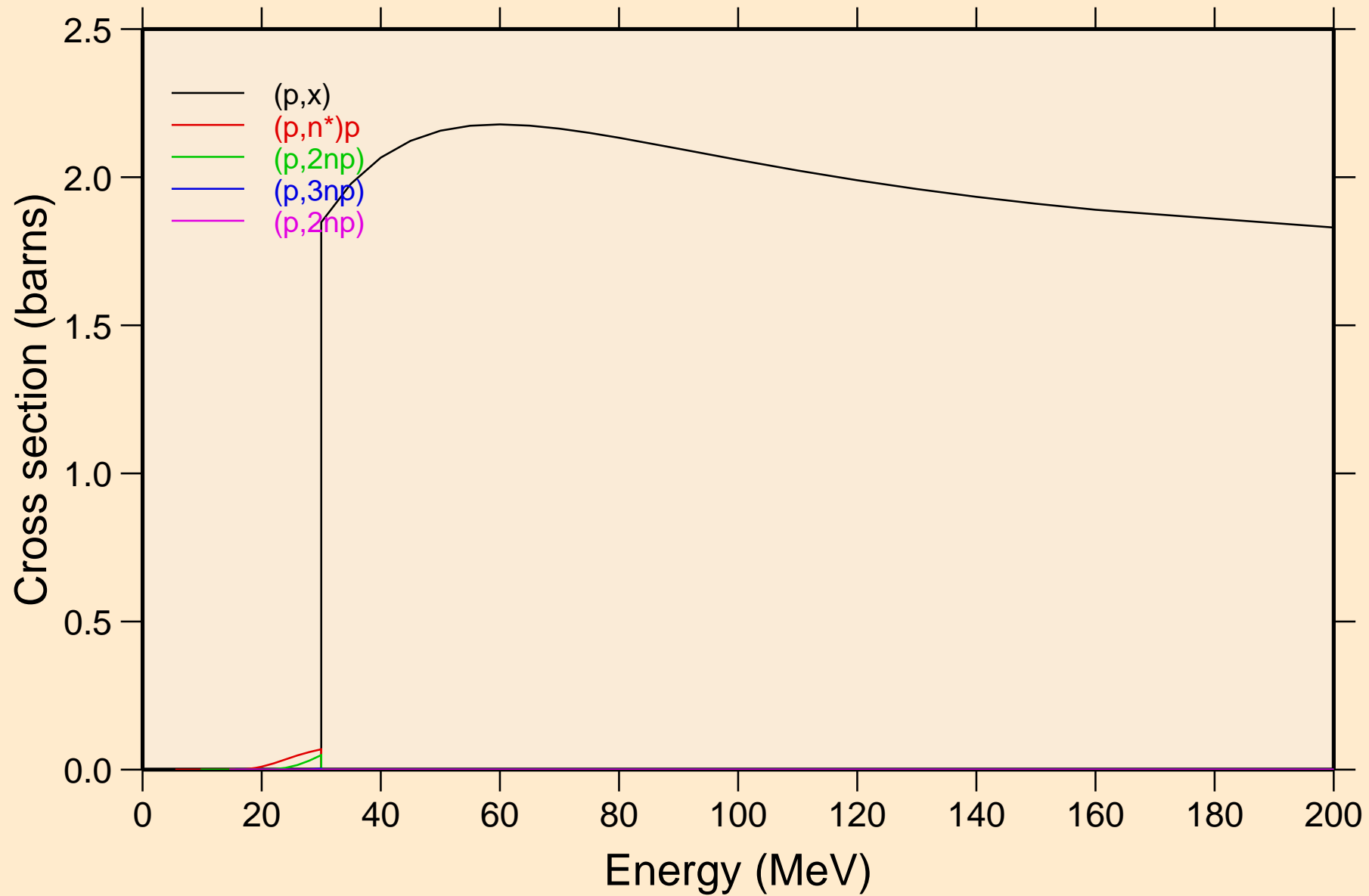

RA234 PROTON ACER TENDL-2021 LIBRARY; T=0.K  
Threshold reactions

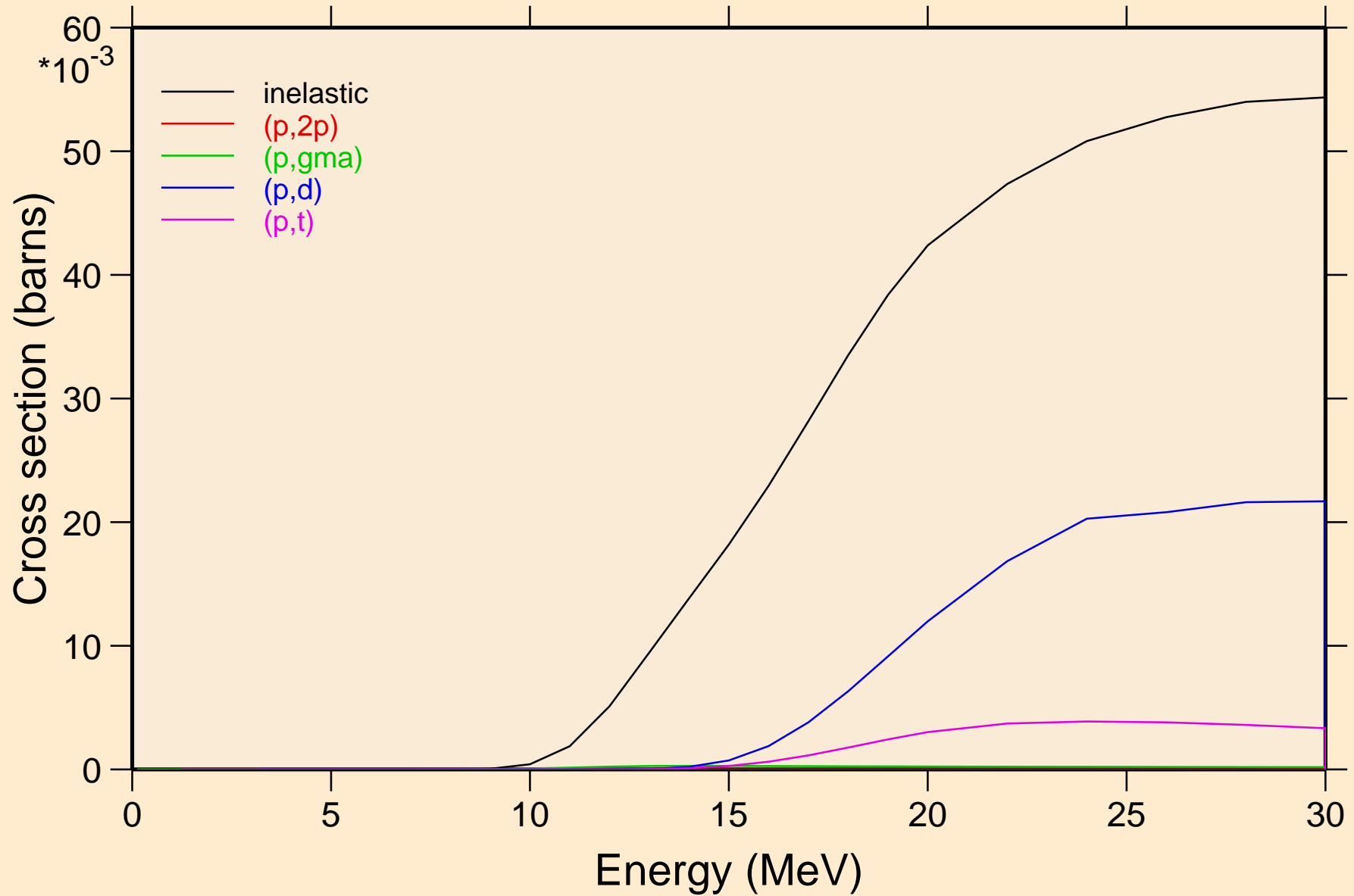

RA234 PROTON ACER TENDL-2021 LIBRARY; T=0.K  
Threshold reactions

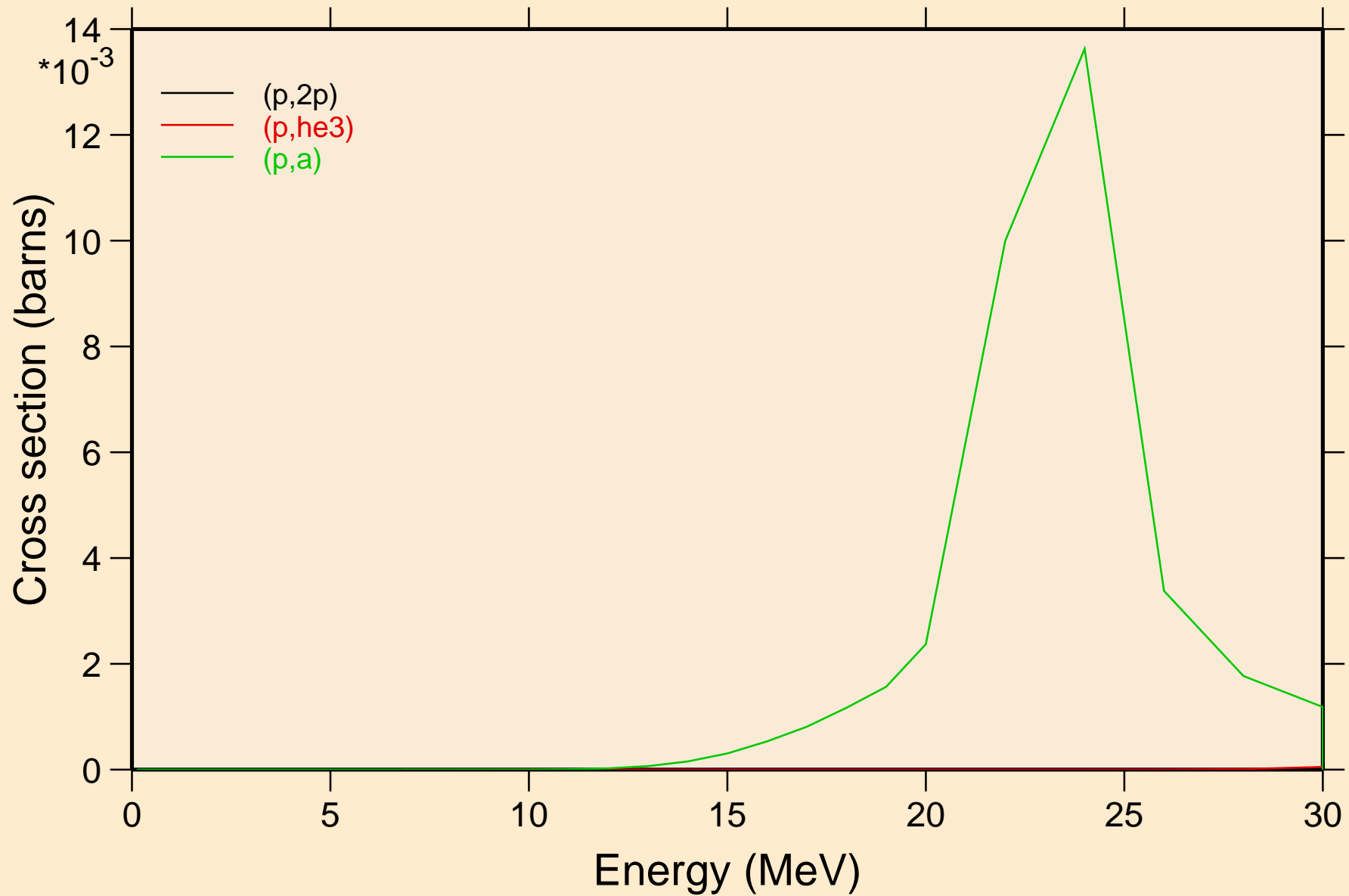

RA234 PROTON ACER TENDL-2021 LIBRARY; T=0.K  
Threshold reactions

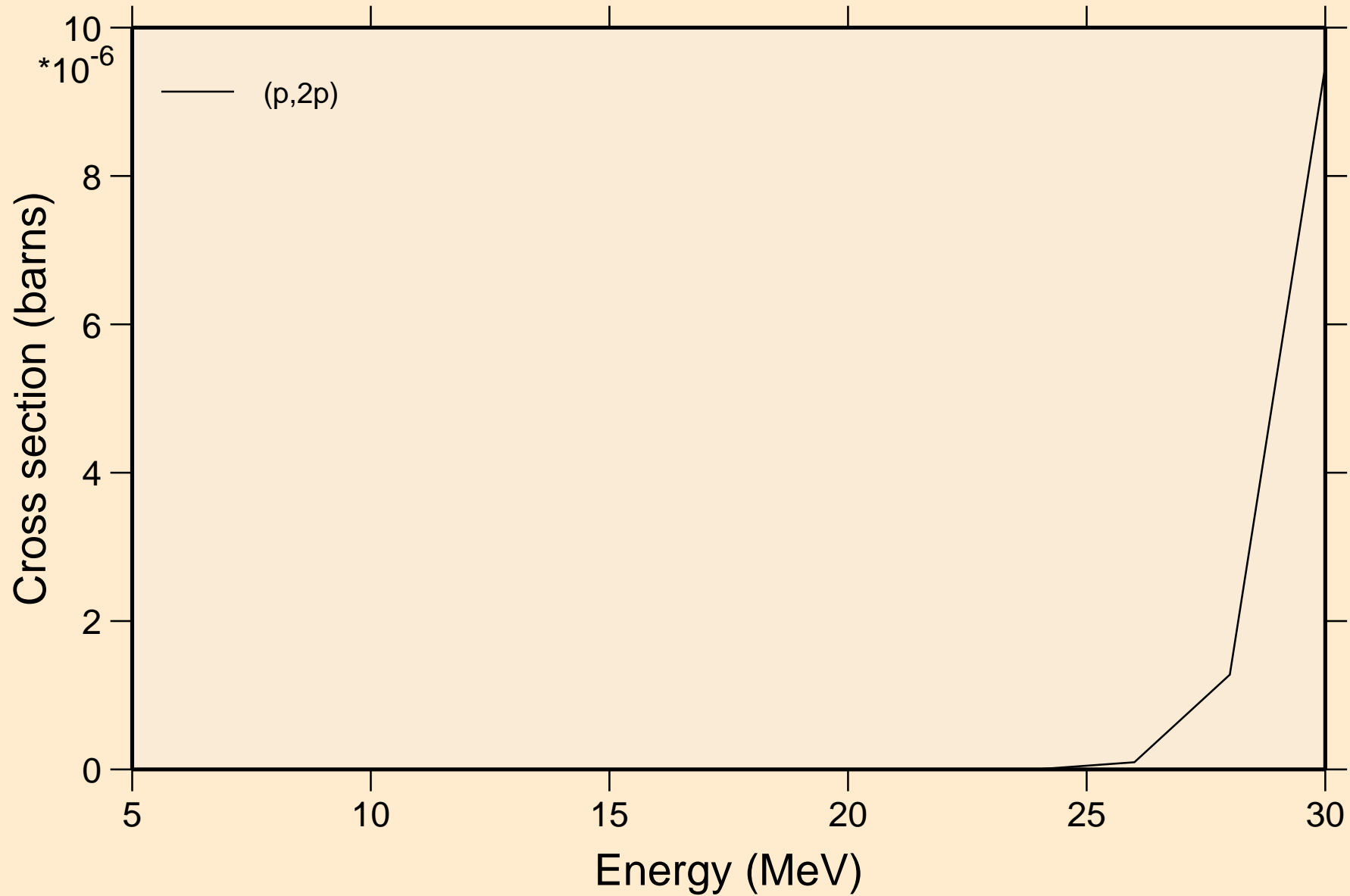



RA234 PROTON ACER TENDL-2021 LIBRARY; T=0.K  
angular distribution for elastic

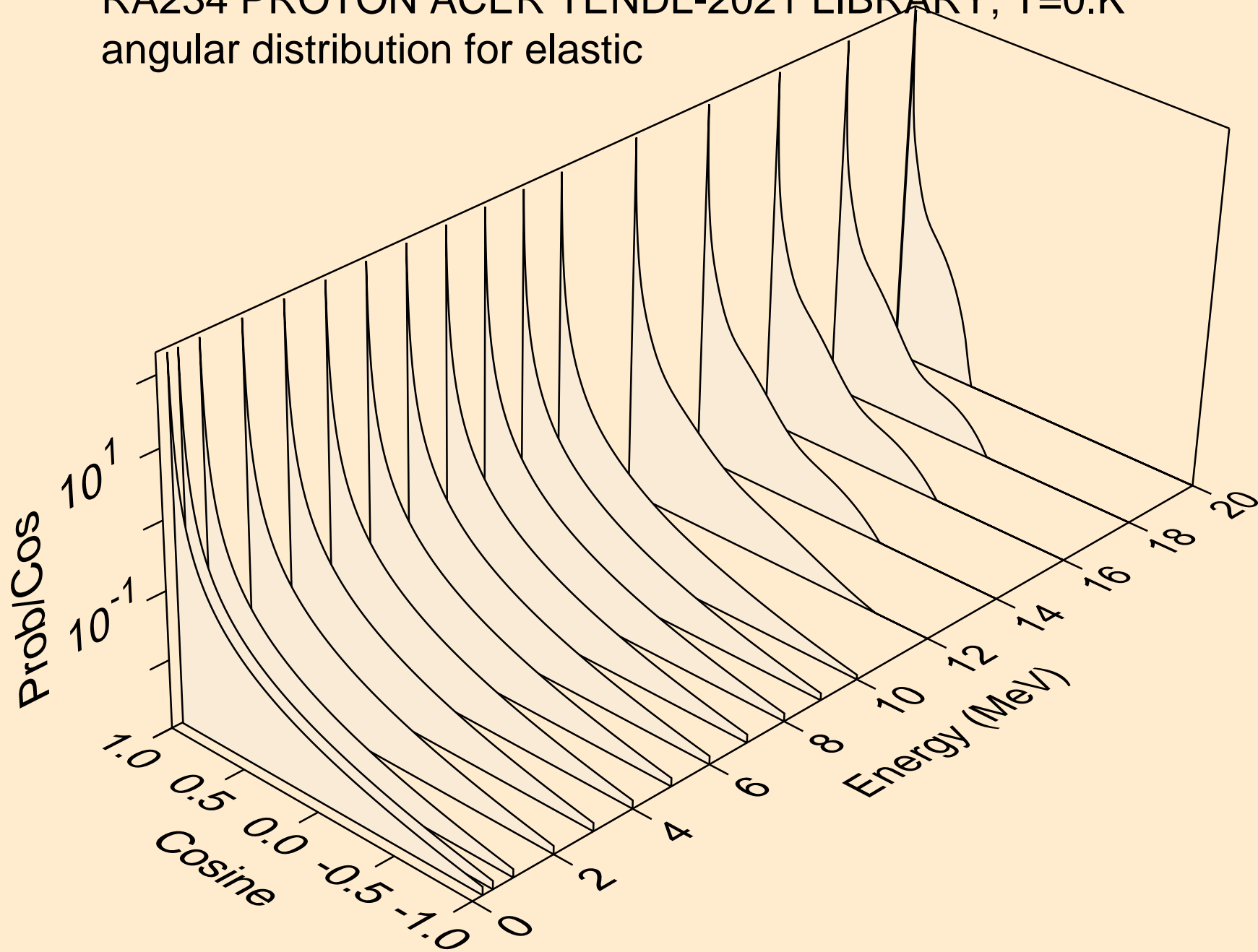

RA234 PROTON ACER TENDL-2021 LIBRARY; T=0.K  
angular distribution for elastic

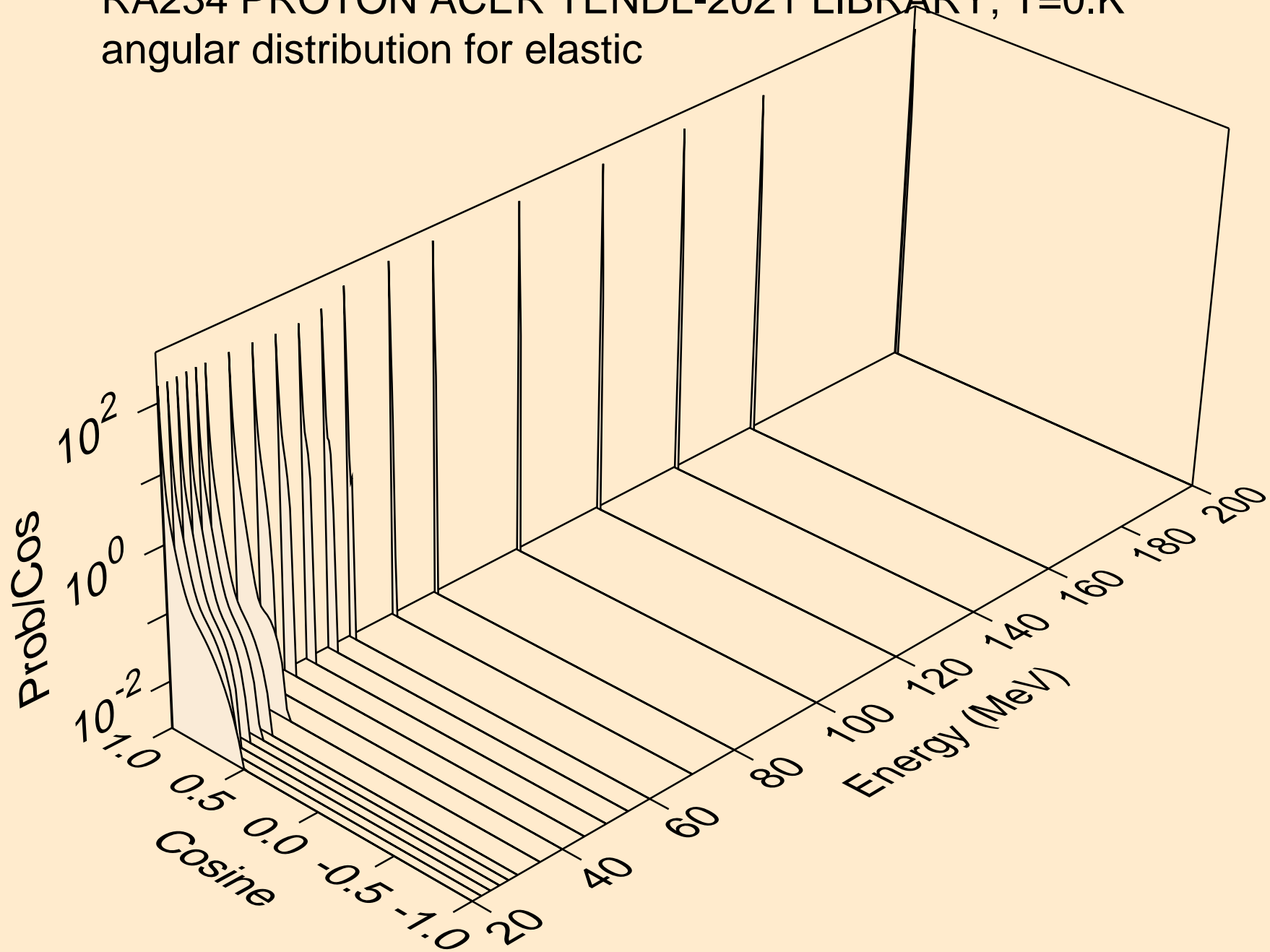

RA234 PROTON ACER TENDL-2021 LIBRARY; T=0.K  
Proton emission for (p,x)

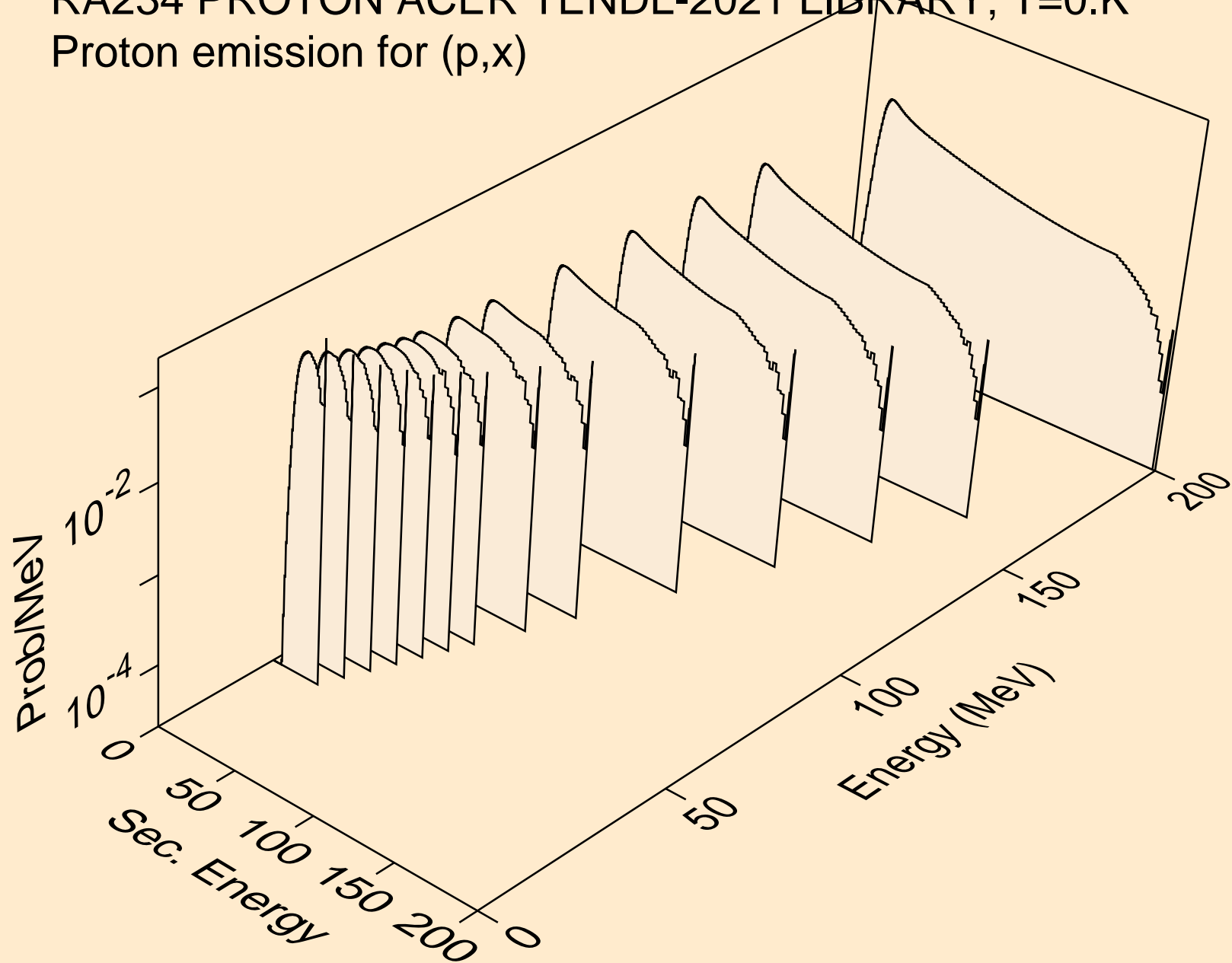

RA234 PROTON ACER TENDL-2021 LIBRARY; T=0.K  
Proton emission for (p,n\*)p

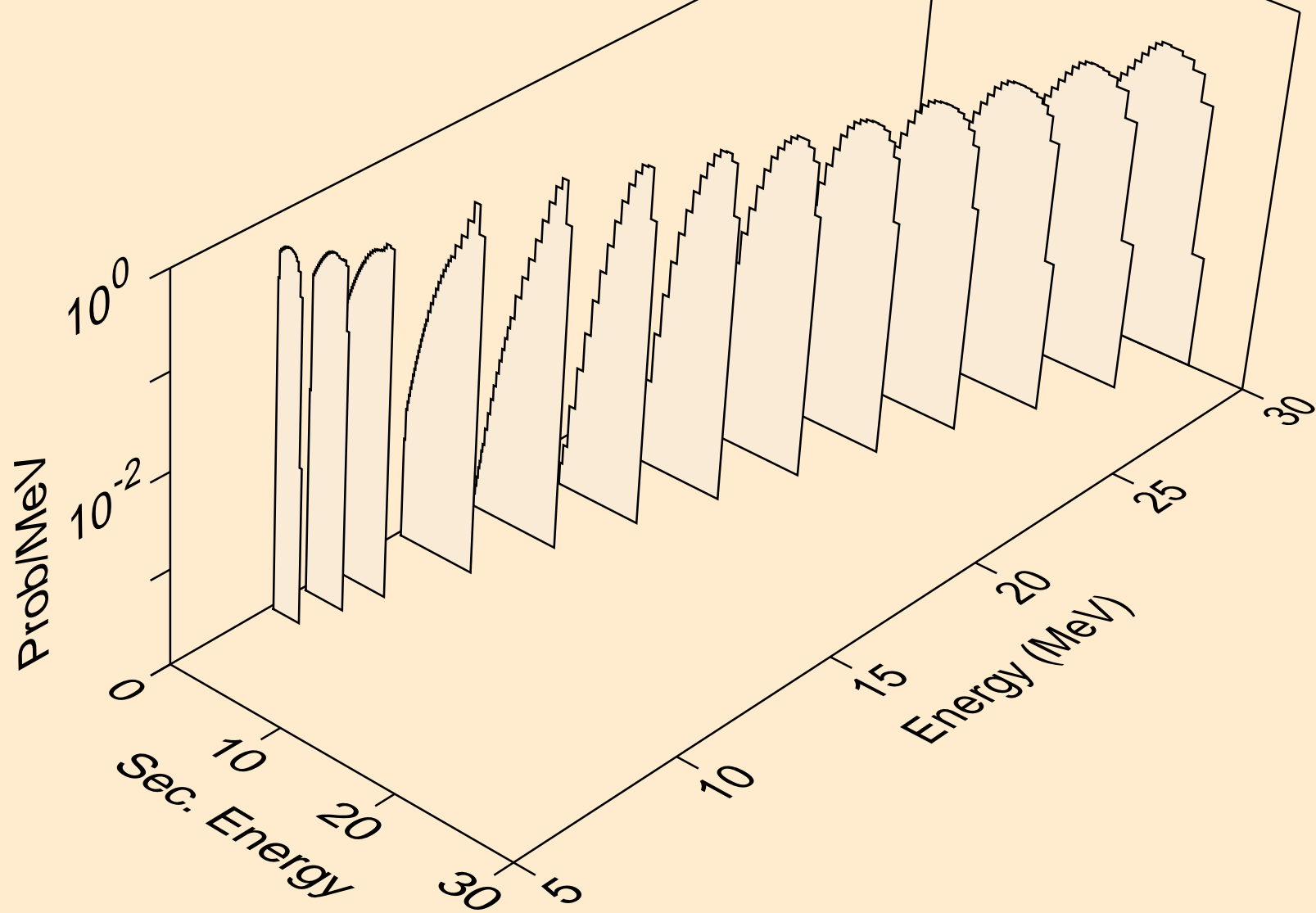

RA234 PROTON ACER TENDL-2021 LIBRARY; T=0.K  
Proton emission for (p,2np)

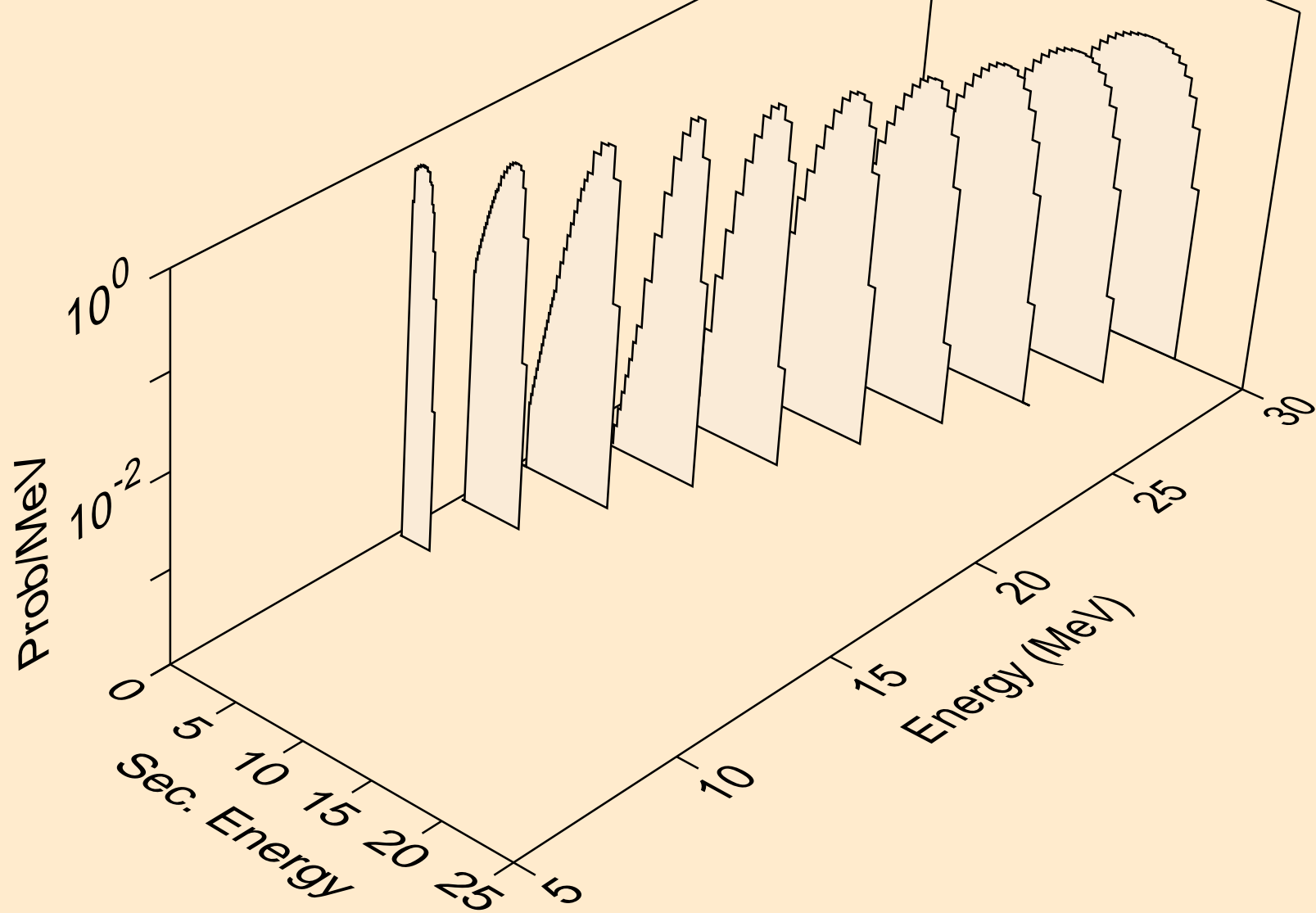

RA234 PROTON ACER TENDL-2021 LIBRARY; T=0.K  
Proton emission for (p,3np)

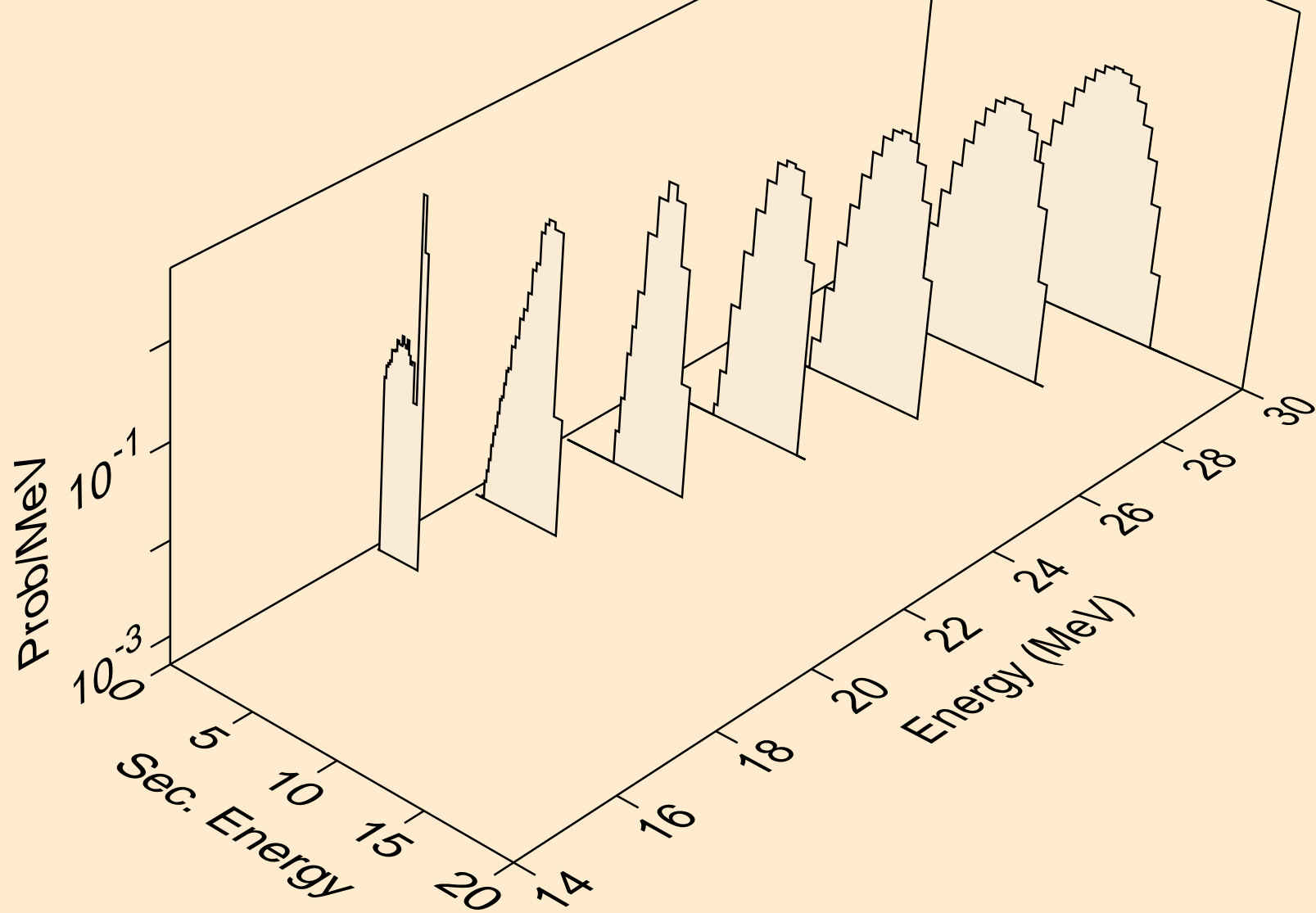

RA234 PROTON ACER TENDL-2021 LIBRARY; T=0.K  
Proton emission for (p,2np)

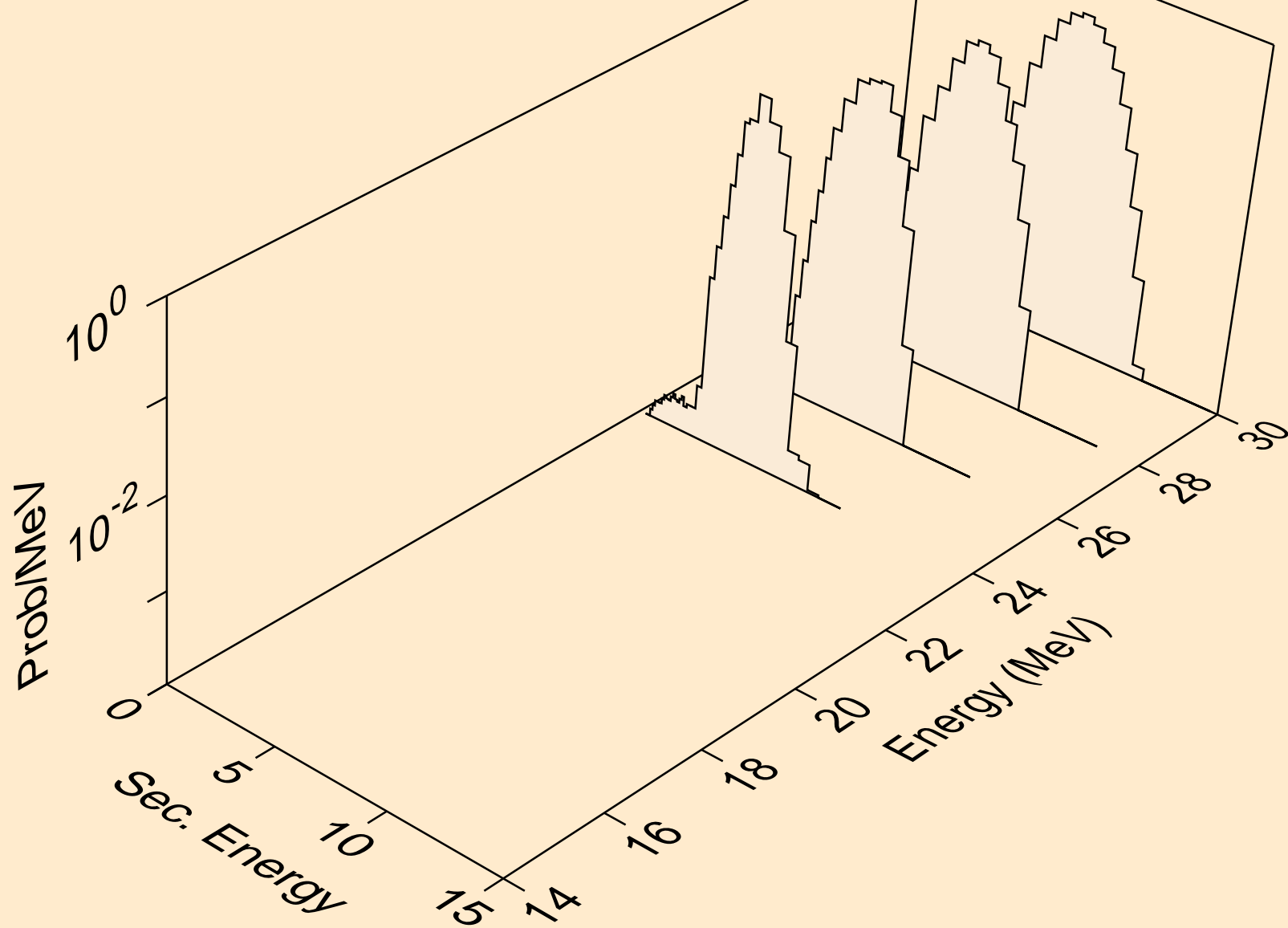

RA234 PROTON ACER TENDL-2021 LIBRARY; T=0.K  
Proton emission for inelastic

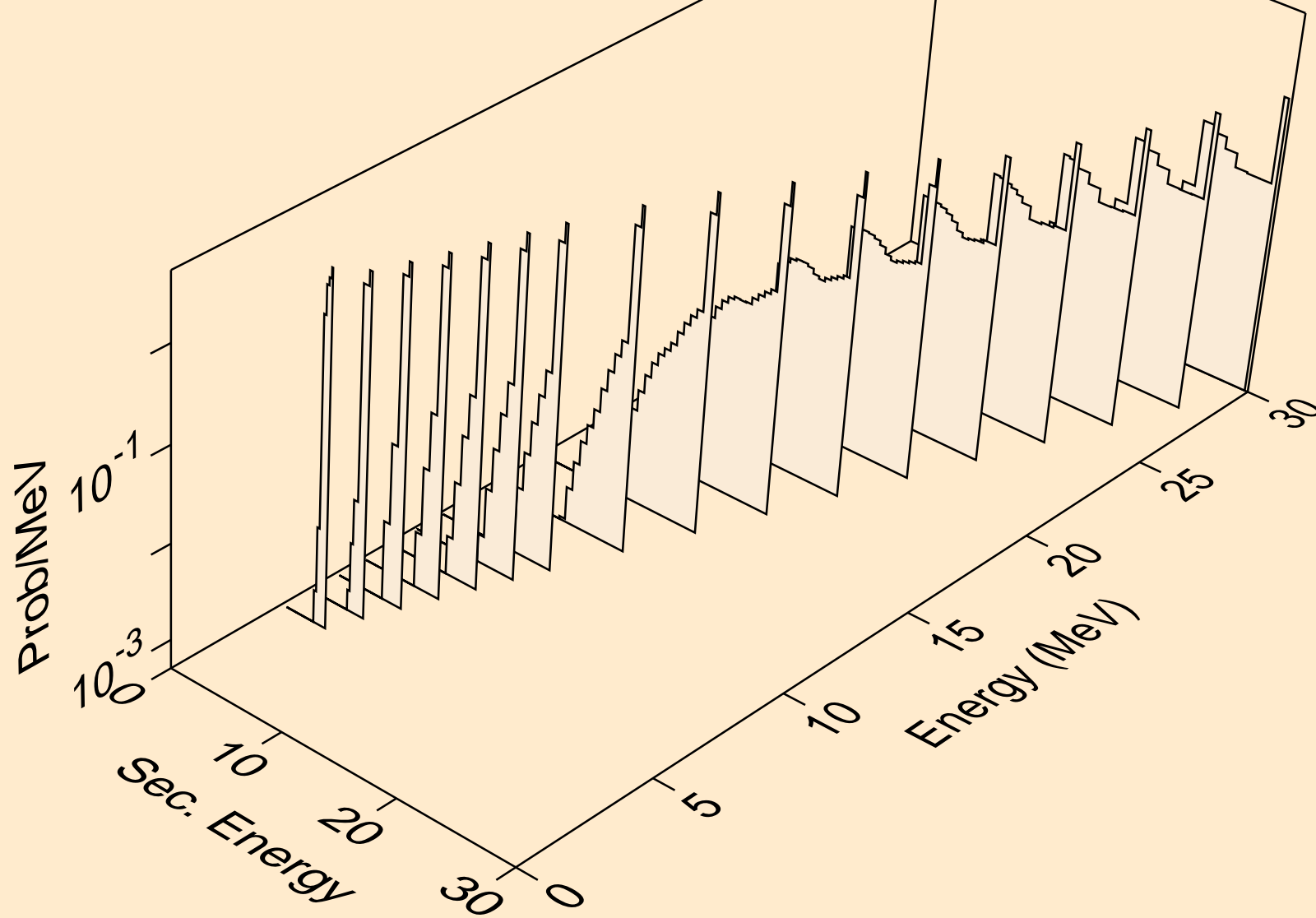



RA234 PROTON ACER TENDL-2021 LIBRARY; T=0.K  
Proton emission for (p,2p)

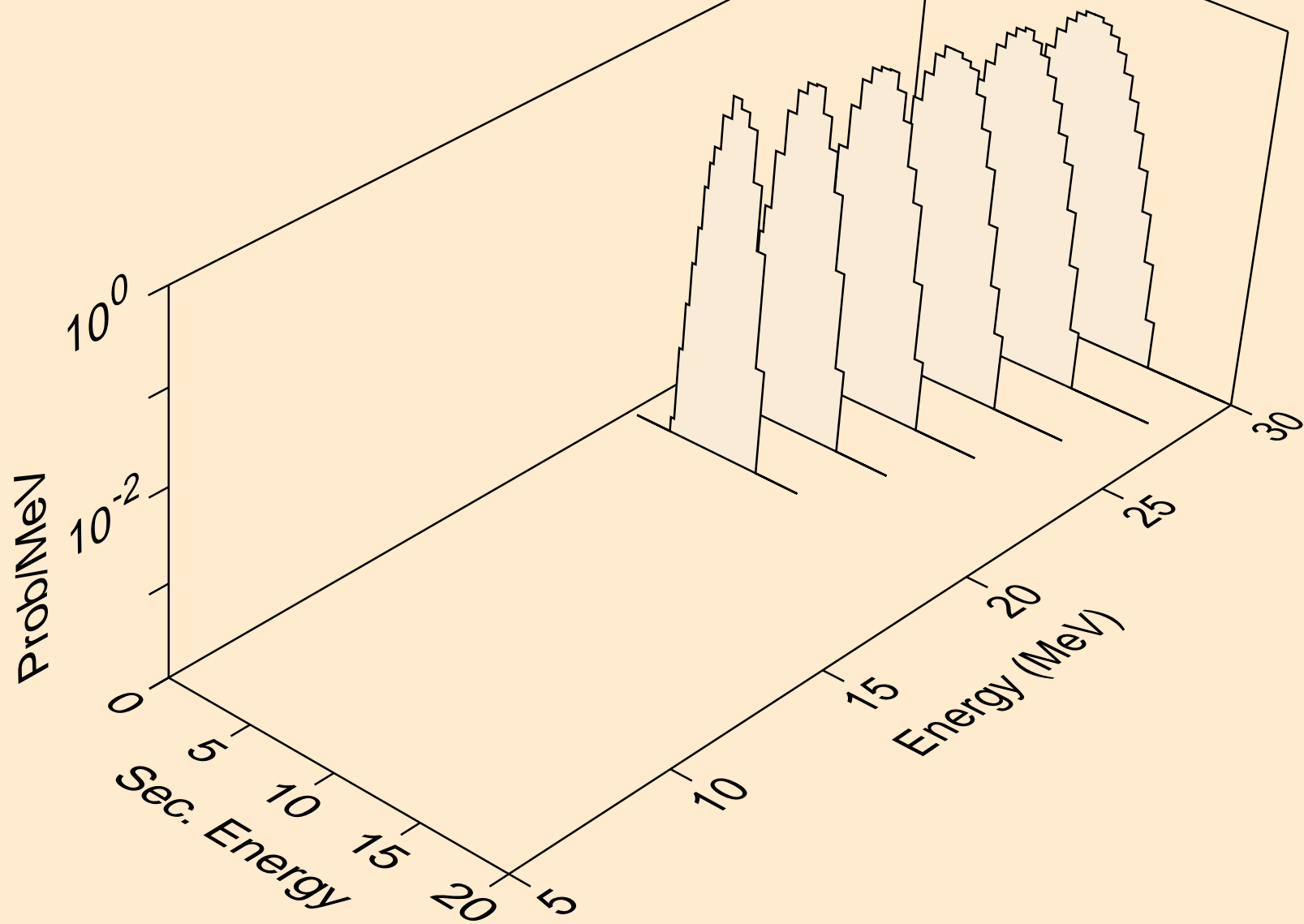

RA234 PROTON ACER TENDL-2021 LIBRARY; T=0.K  
Photon emission for (z,n)

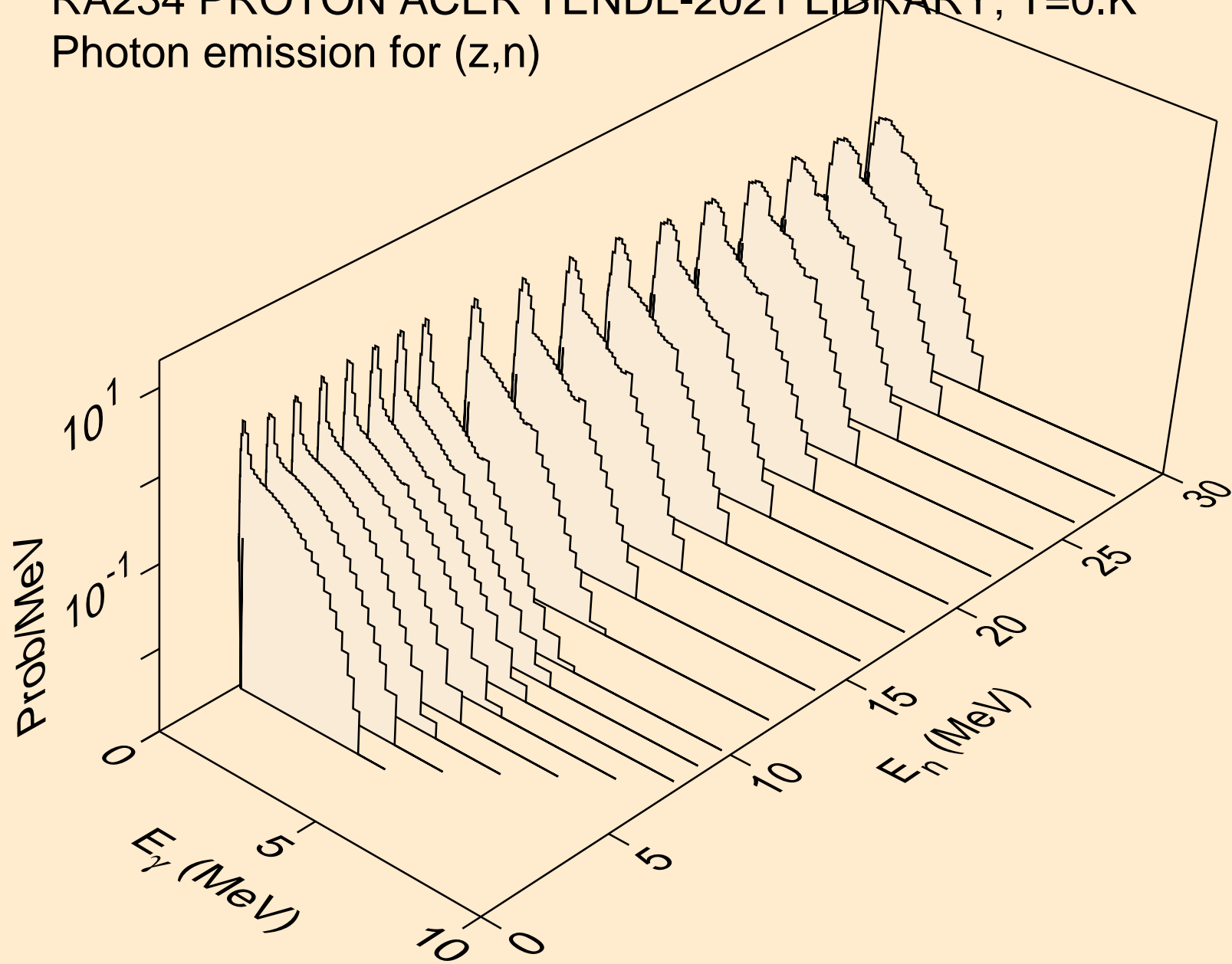

RA234 PROTON ACER TENDL-2021 LIBRARY; T=0.K  
Photon emission for (n,x)

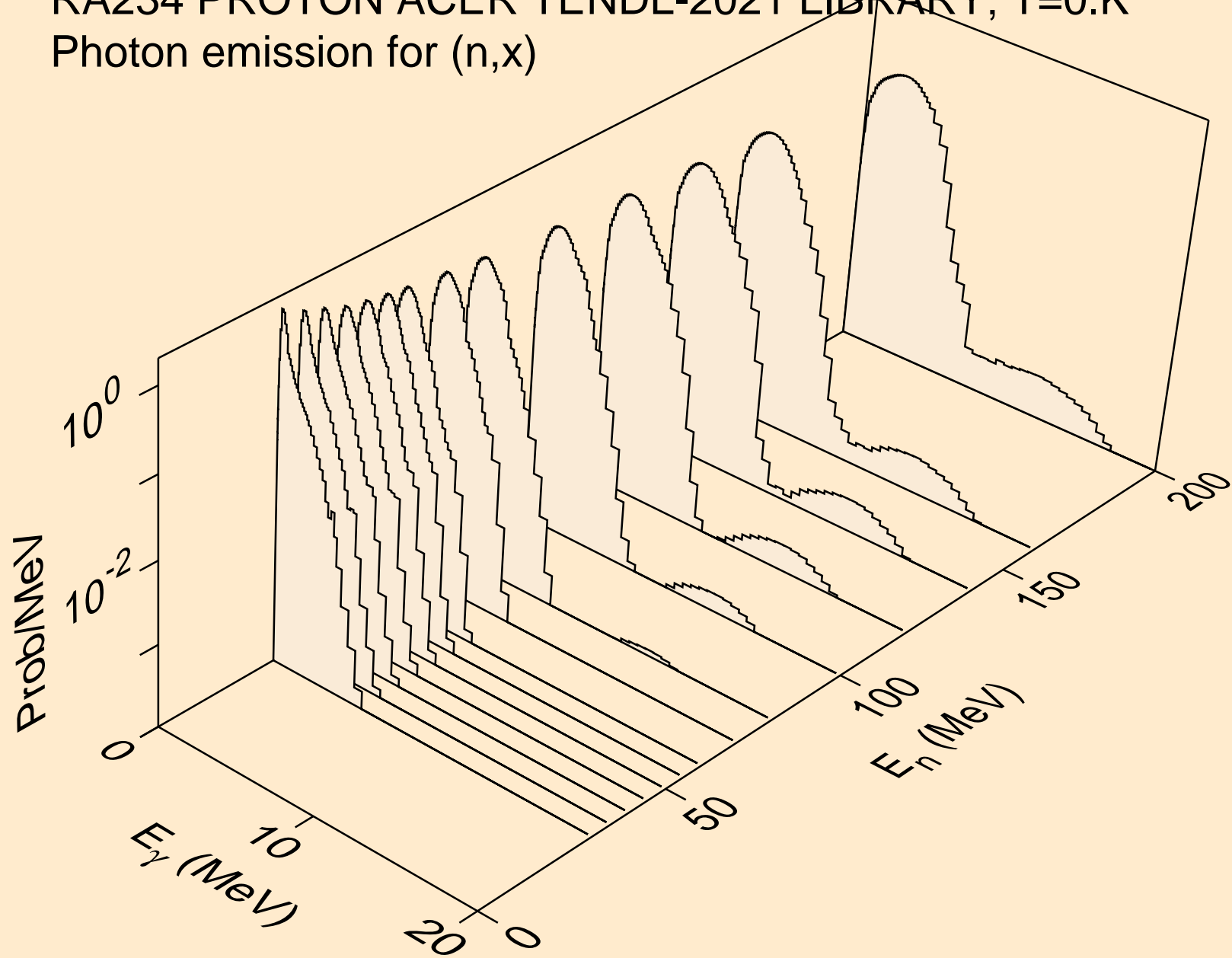

RA234 PROTON ACER TENDL-2021 LIBRARY; T=0.K  
Photon emission for (n,2nd)

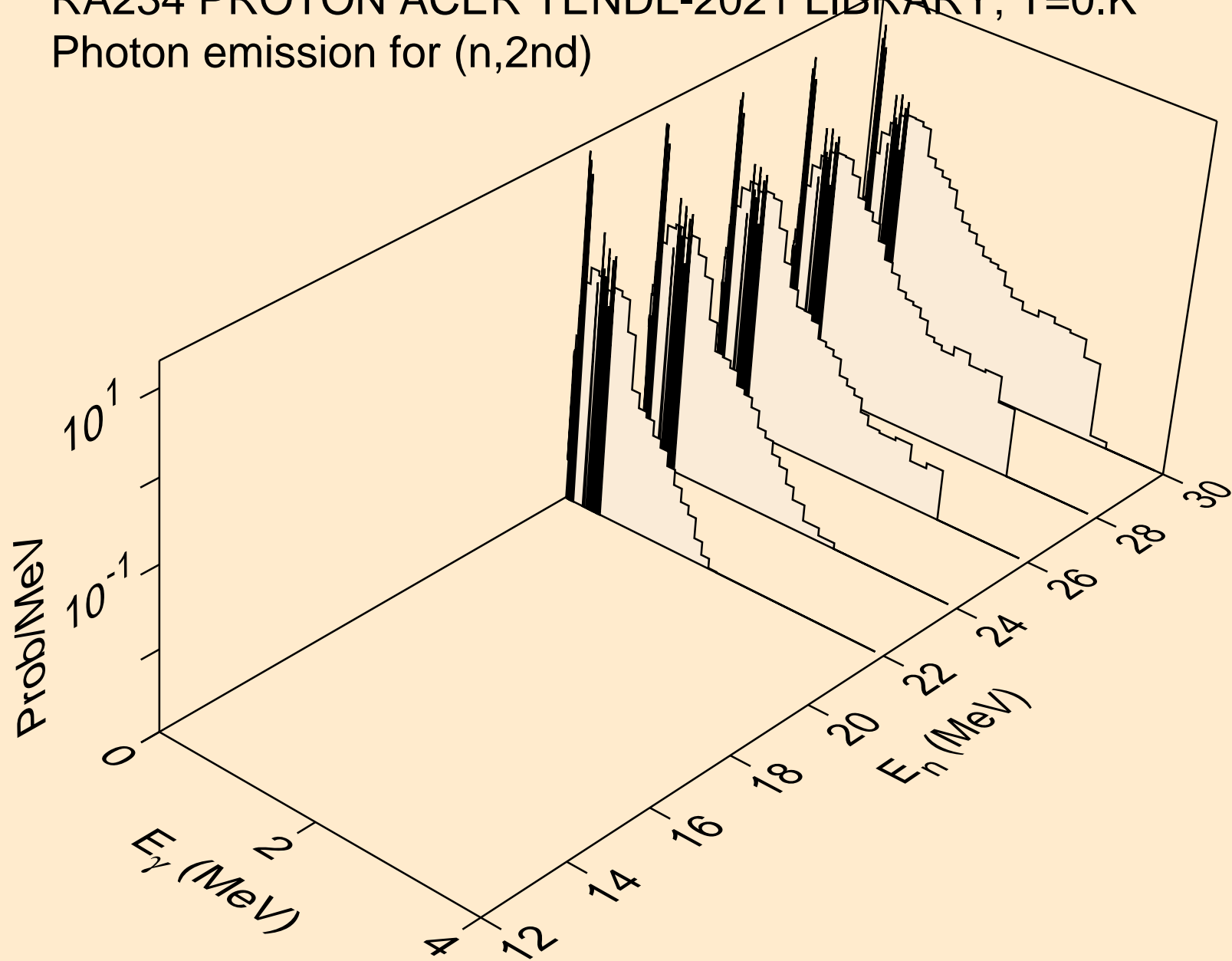

RA234 PROTON ACER TENDL-2021 LIBRARY; T=0.K  
Photon emission for (n,2n)

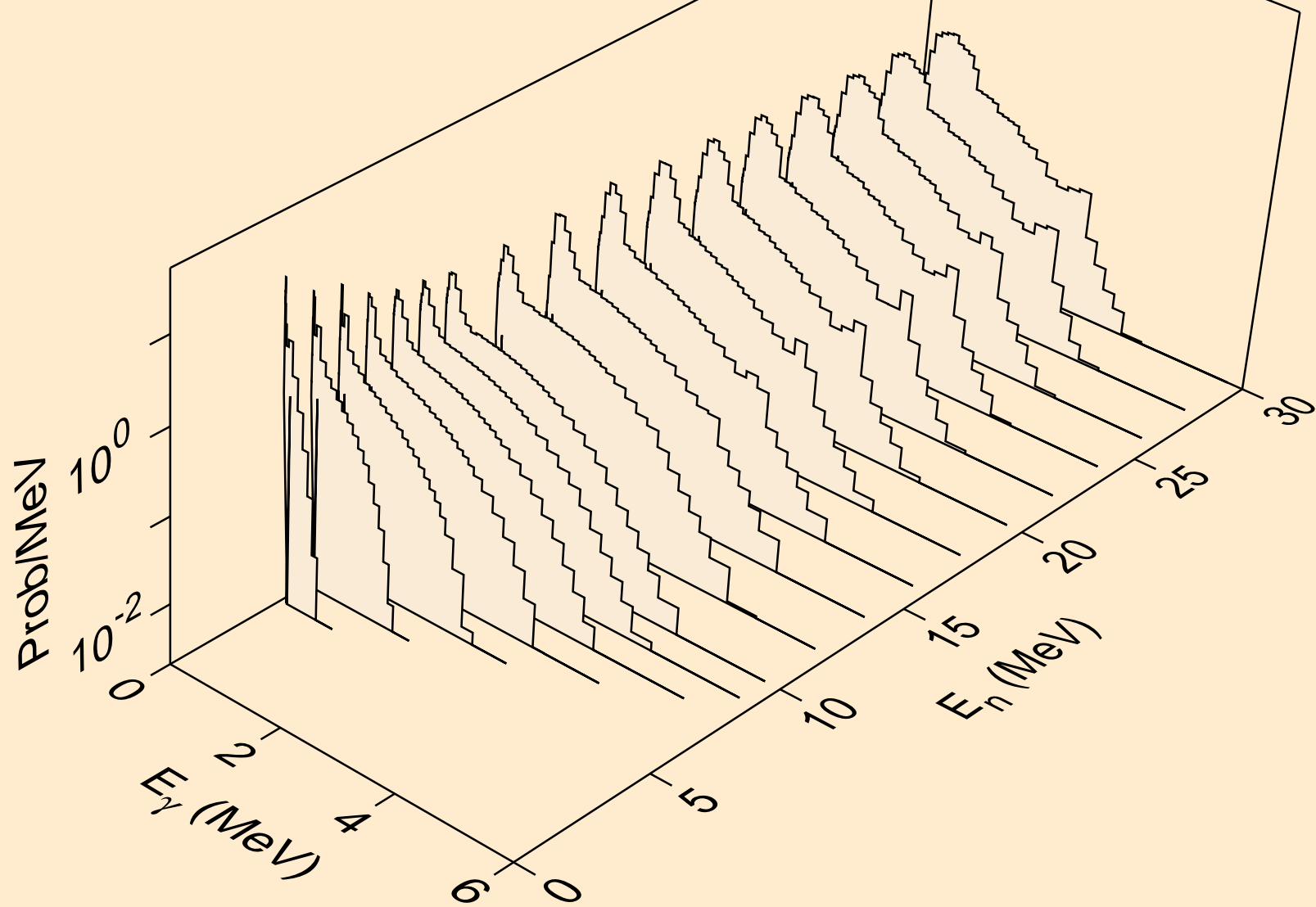

RA234 PROTON ACER TENDL-2021 LIBRARY; T=0.K  
Photon emission for (n,3n)

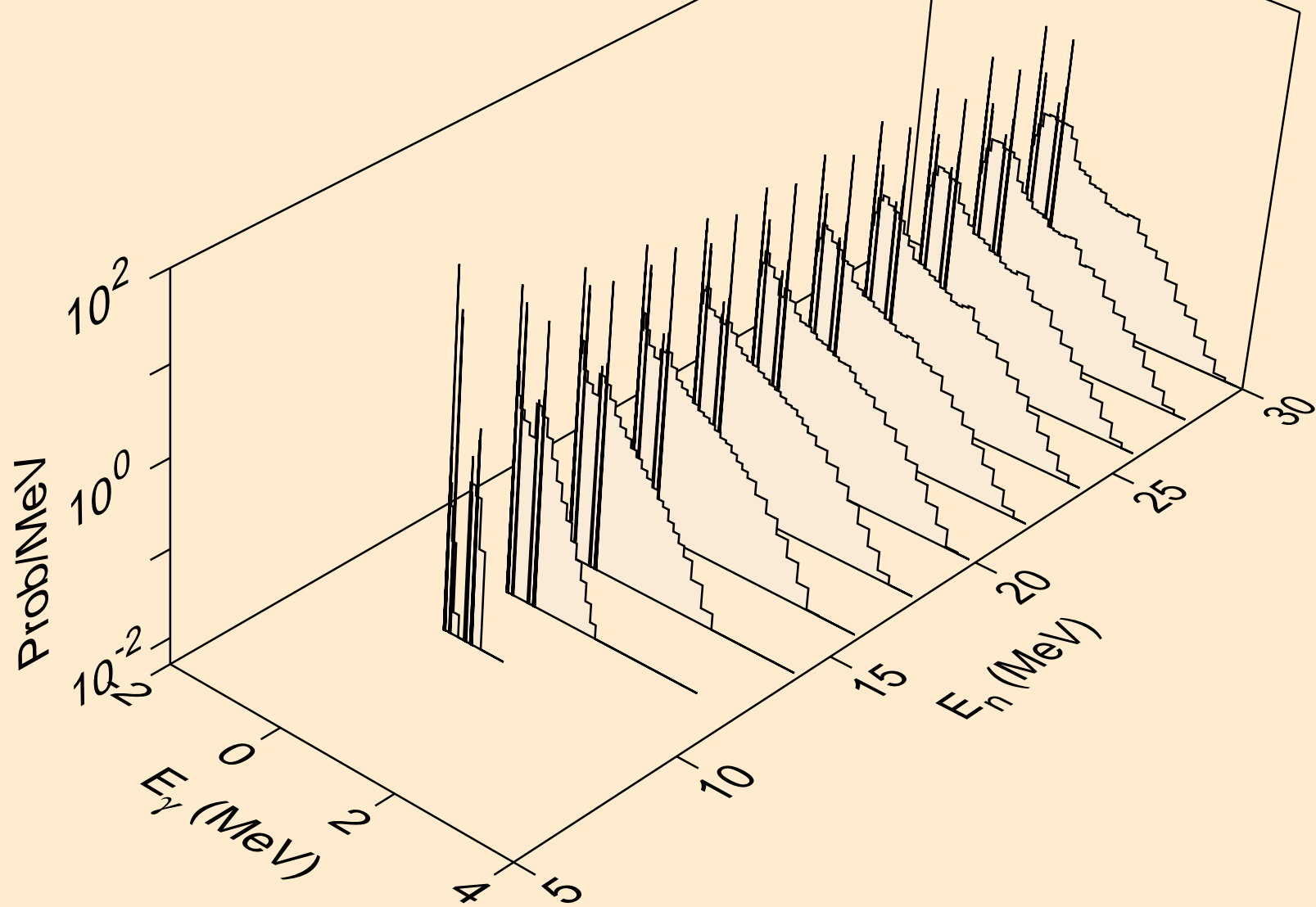

RA234 PROTON ACER TENDL-2021 LIBRARY; T=0.K  
Photon emission for (n,n\*)a

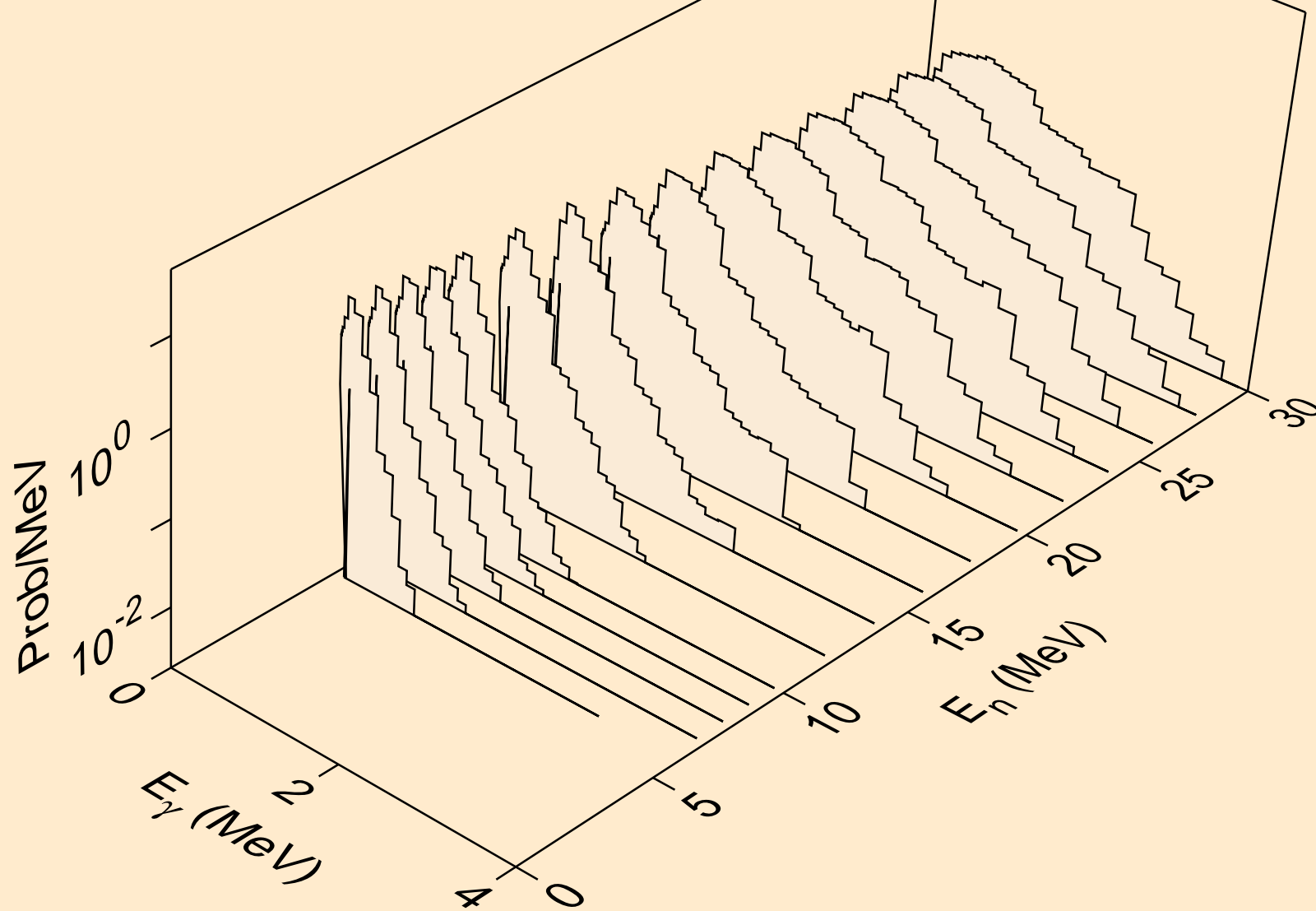

RA234 PROTON ACER TENDL-2021 LIBRARY; T=0.K  
Photon emission for (n,2n)a

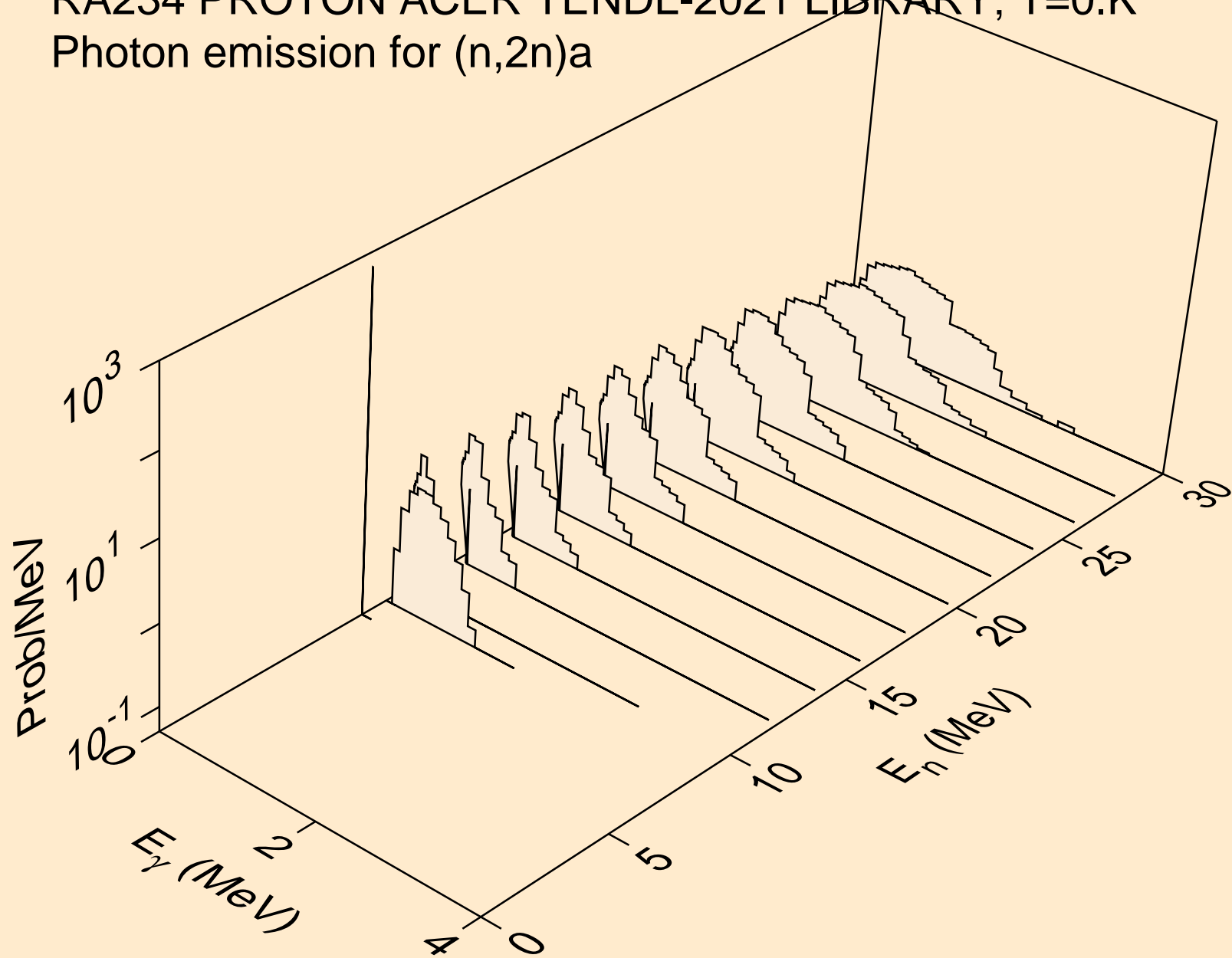



RA234 PROTON ACER TENDL-2021 LIBRARY; T=0.K  
Photon emission for (n,3n)a

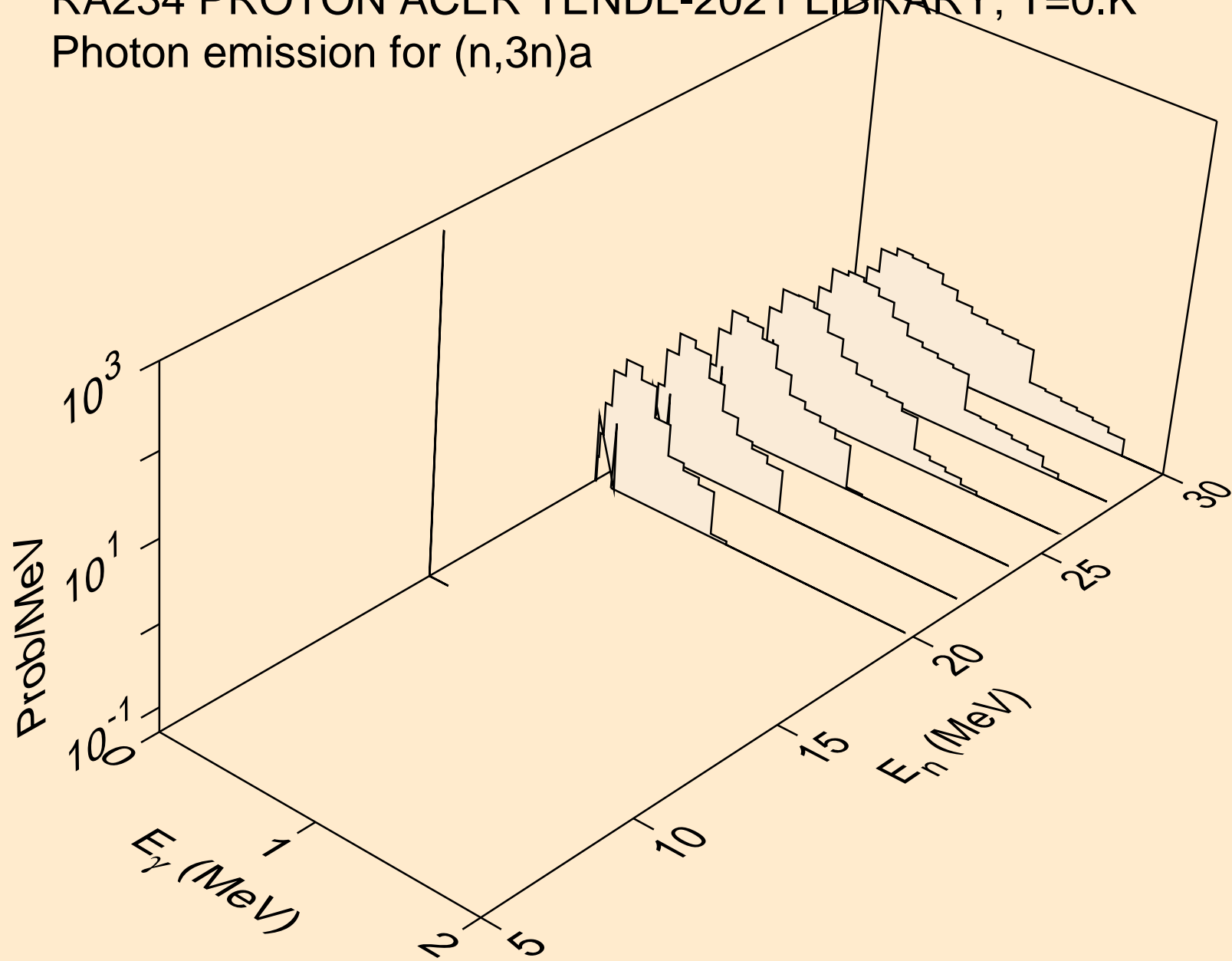

RA234 PROTON ACER TENDL-2021 LIBRARY; T=0.K  
Photon emission for (n,n\*)p

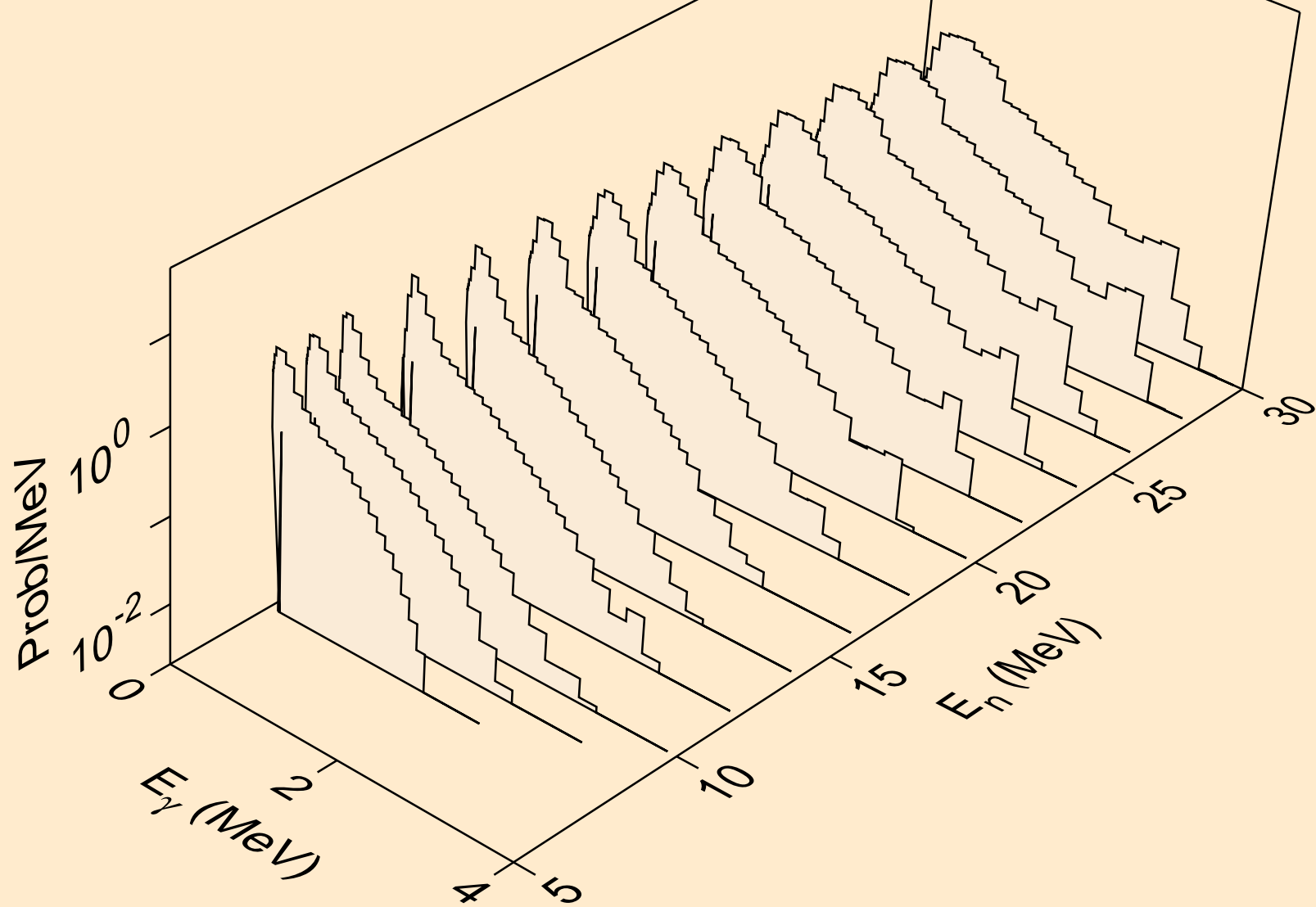

RA234 PROTON ACER TENDL-2021 LIBRARY; T=0.K  
Photon emission for (n,n\*)d

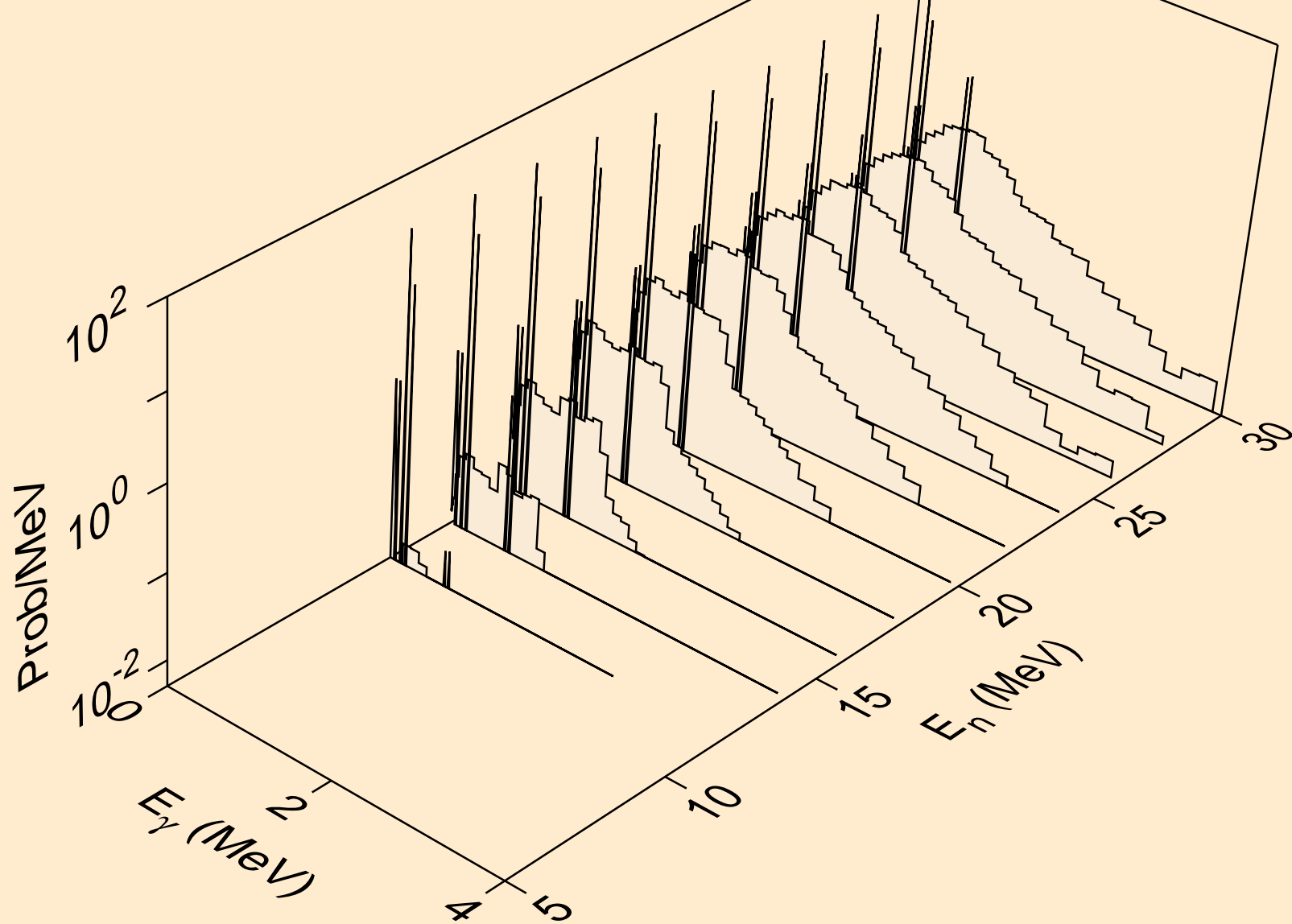

RA234 PROTON ACER TENDL-2021 LIBRARY; T=0.K  
Photon emission for (n,n\*)t

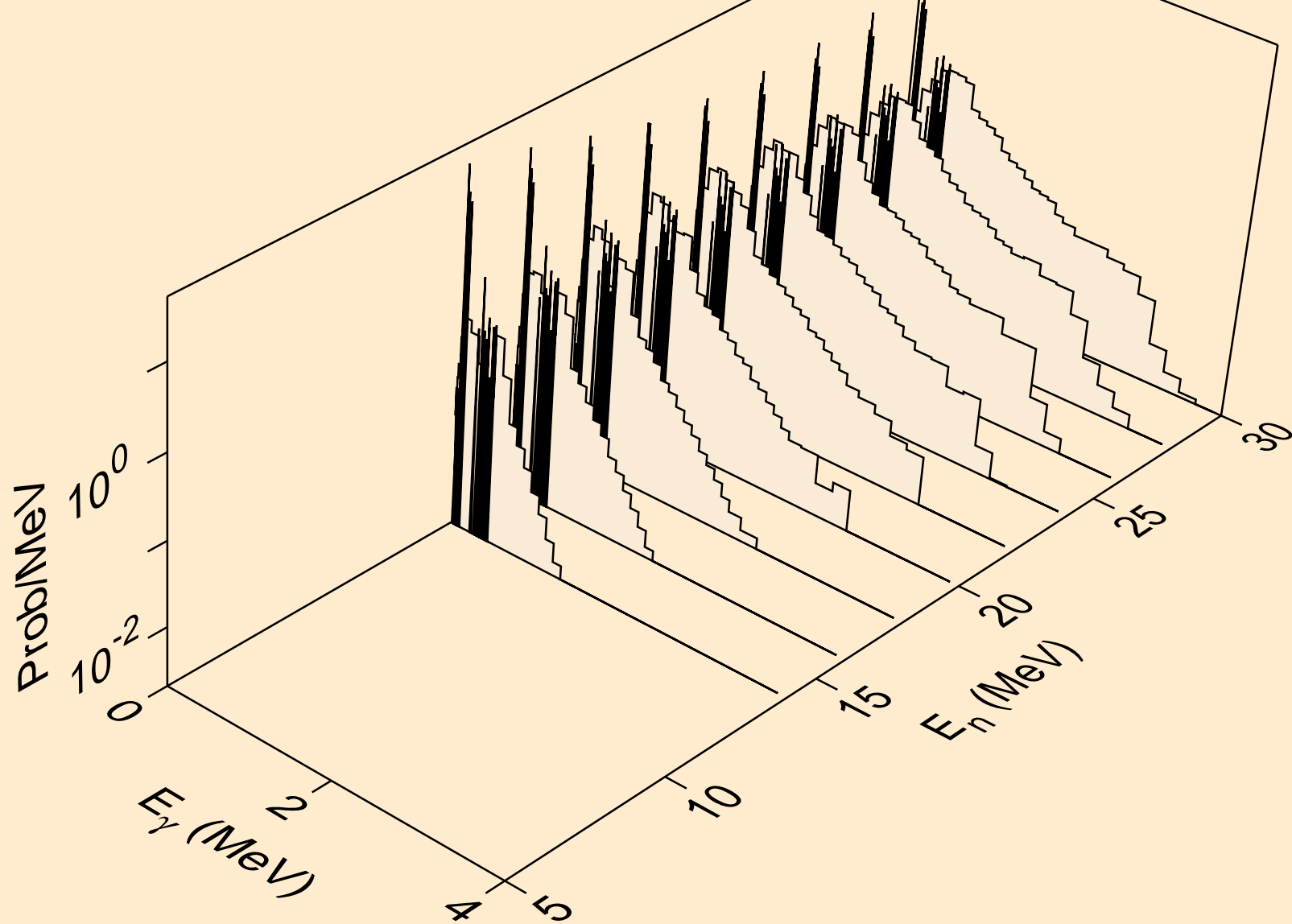

RA234 PROTON ACER TENDL-2021 LIBRARY; T=0.K  
Photon emission for (n,n\*)he3

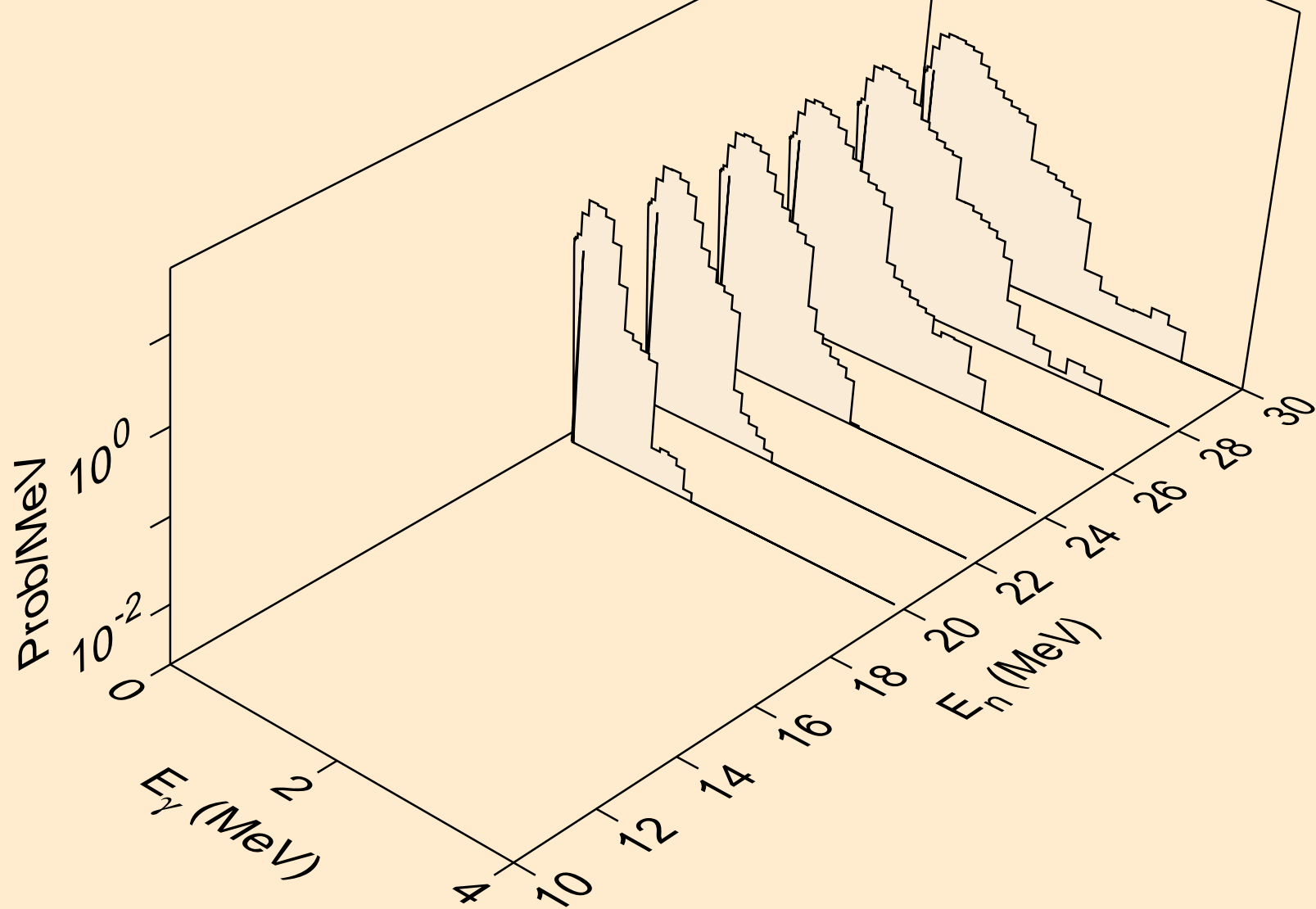

RA234 PROTON ACER TENDL-2021 LIBRARY; T=0.K  
Photon emission for (n,4n)

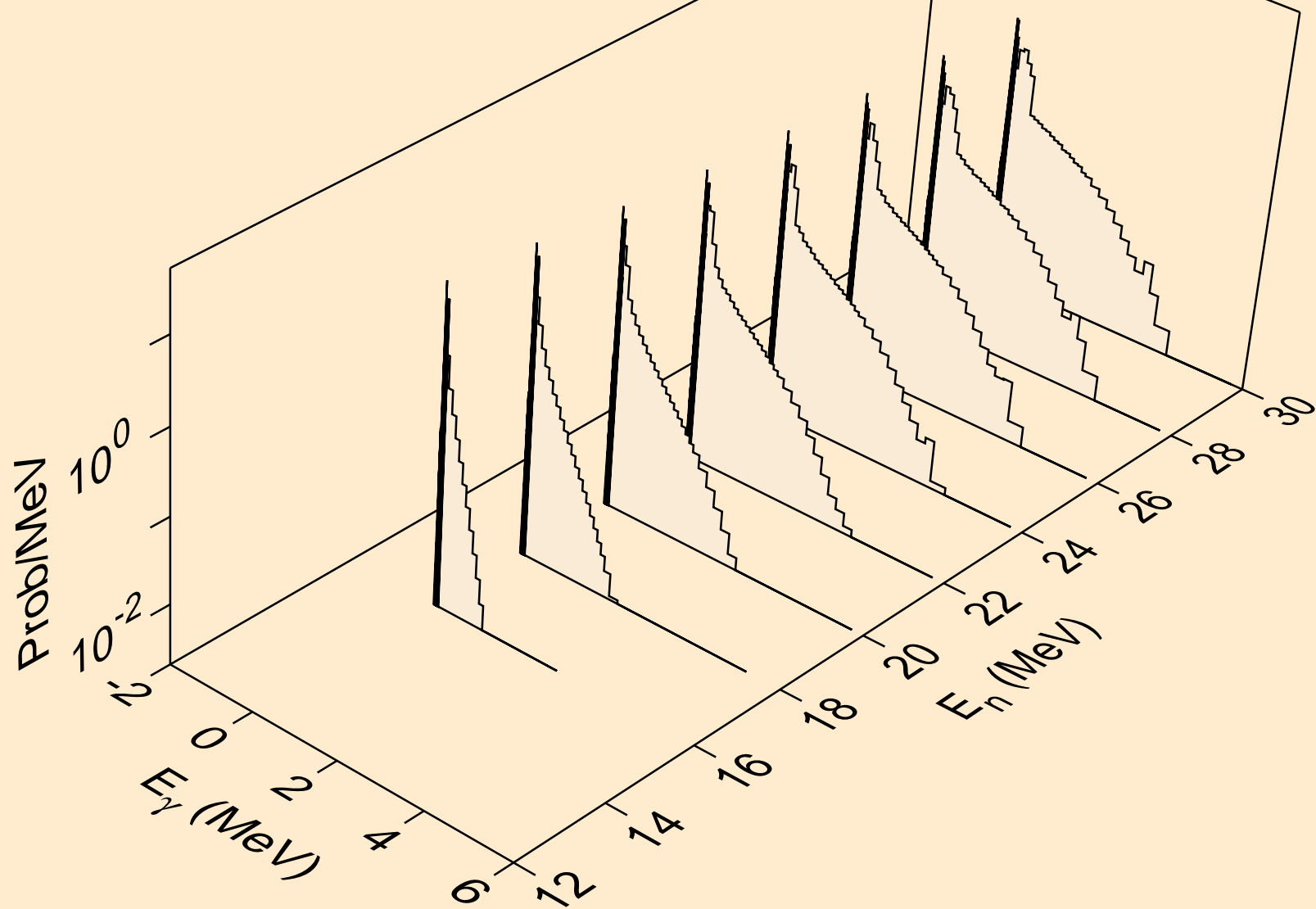

RA234 PROTON ACER TENDL-2021 LIBRARY; T=0.K  
Photon emission for (n,2np)

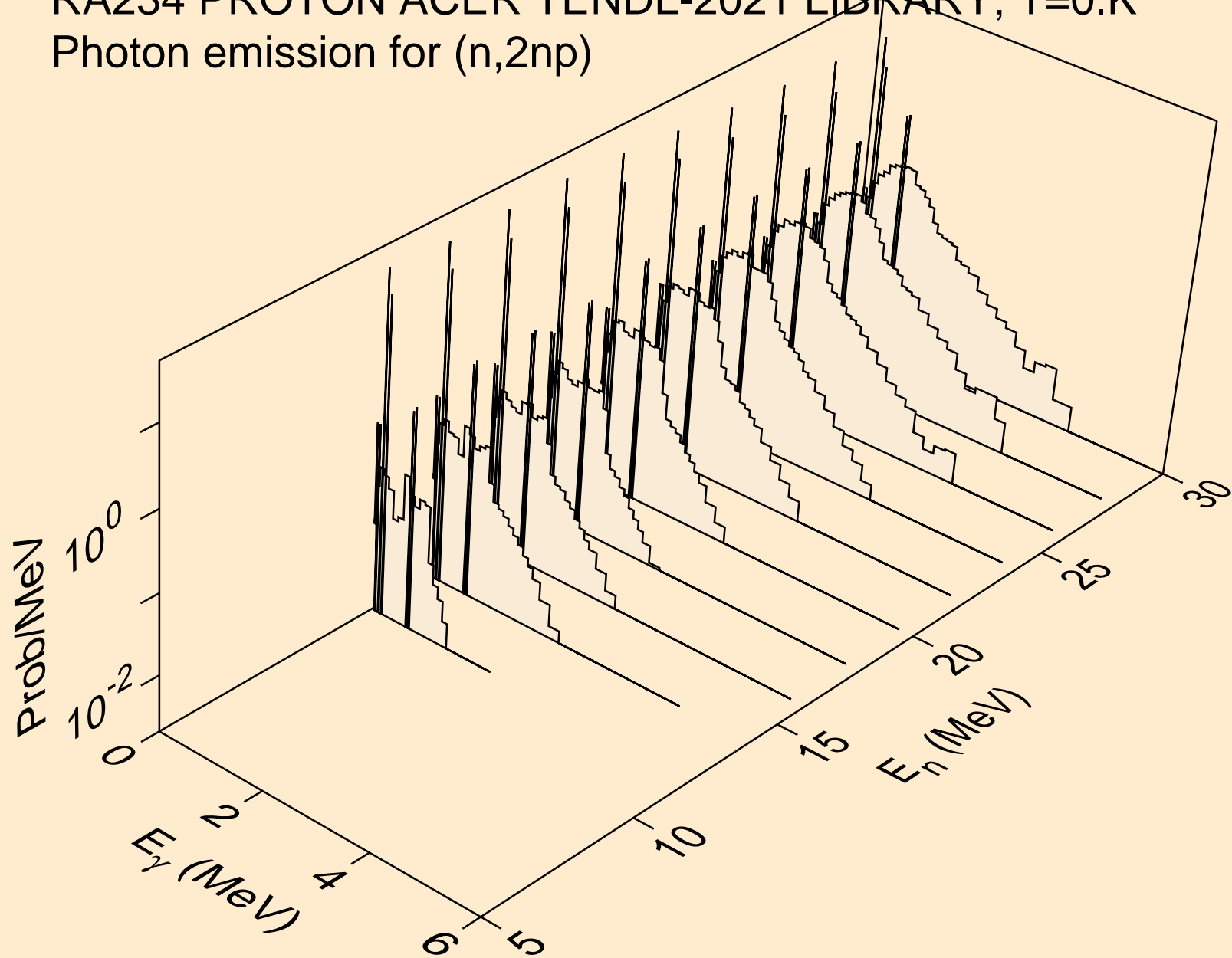

RA234 PROTON ACER TENDL-2021 LIBRARY; T=0.K  
Photon emission for (n,3np)

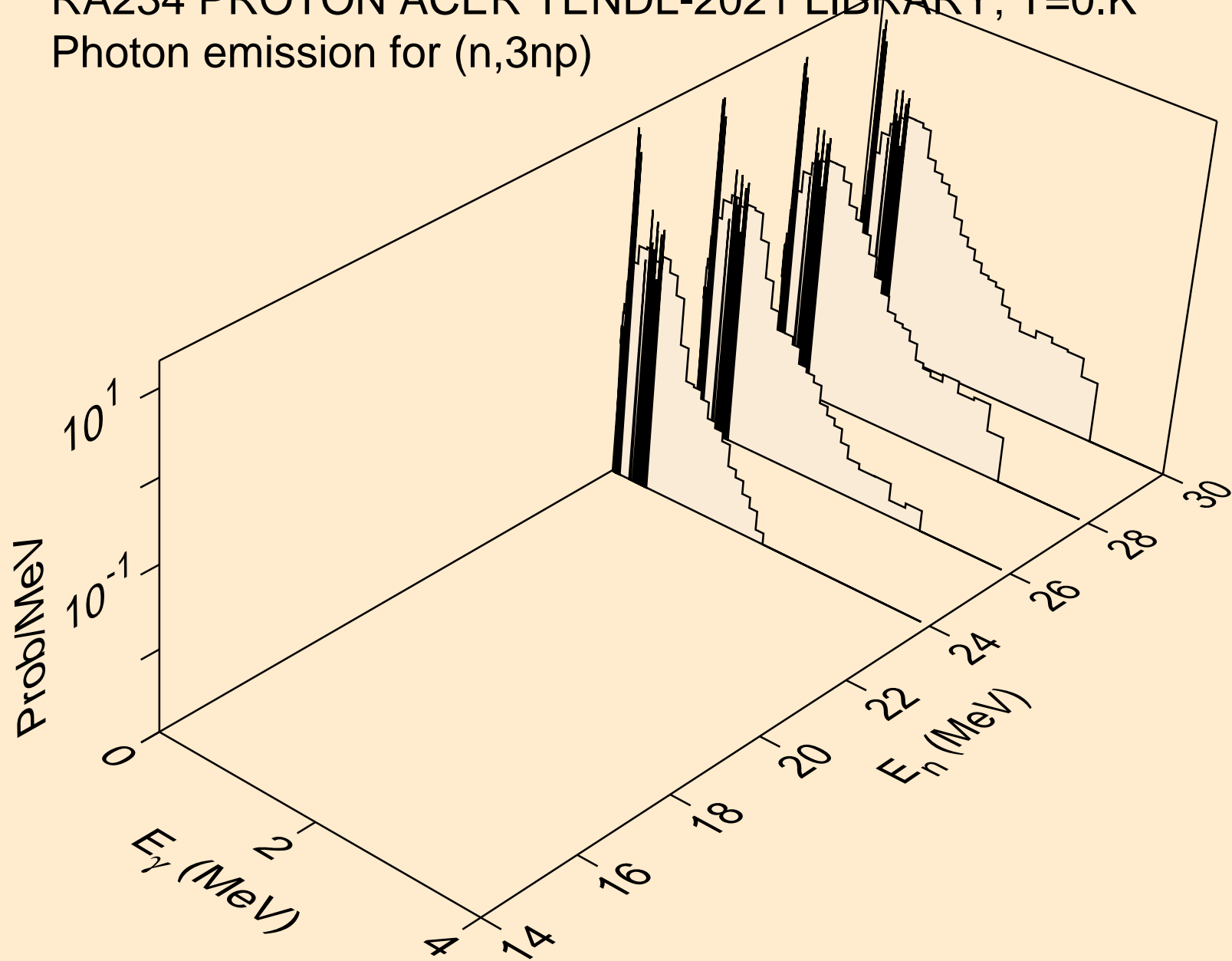



RA234 PROTON ACER TENDL-2021 LIBRARY; T=0.K  
Photon emission for (n,2np)

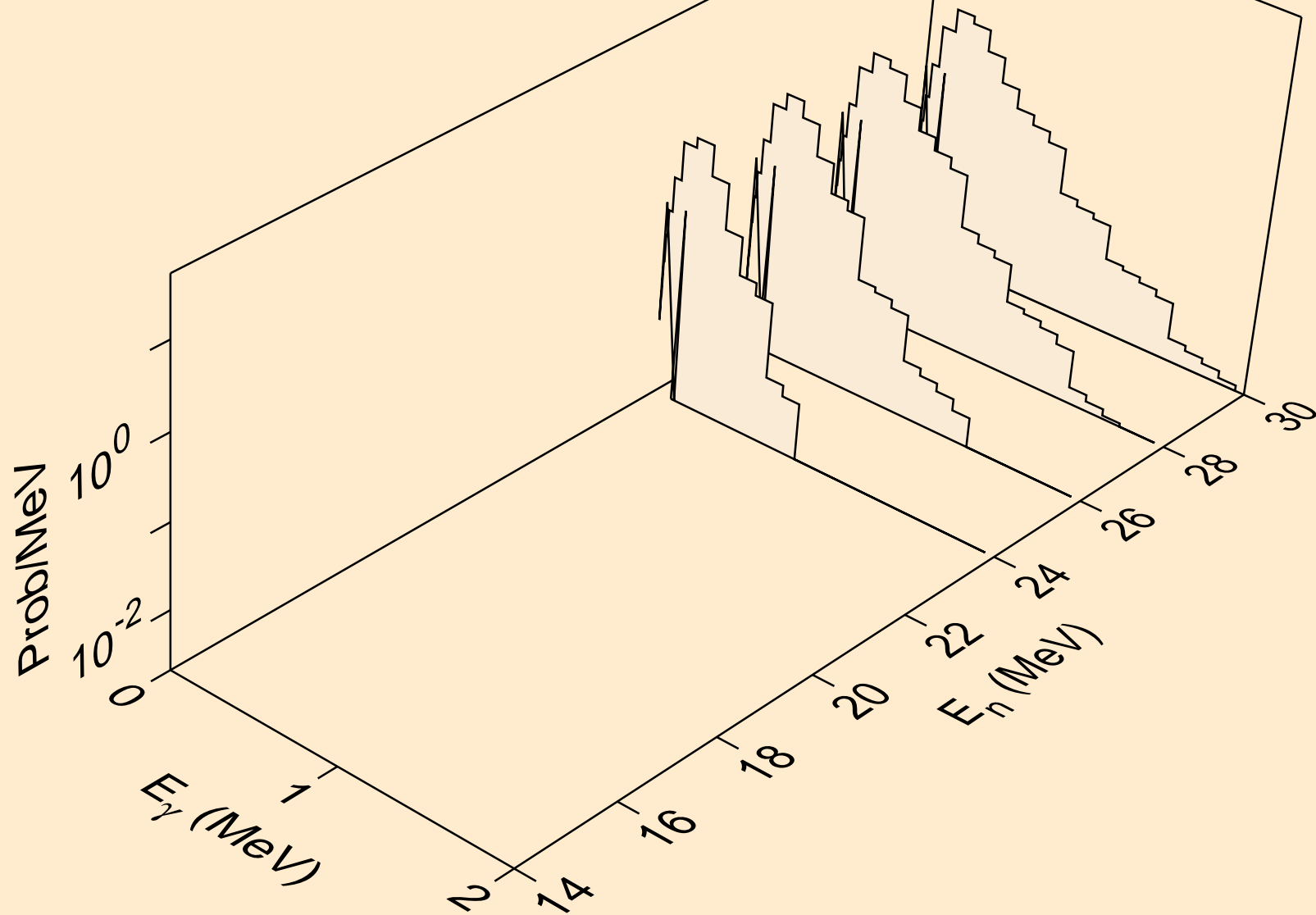

RA234 PROTON ACER TENDL-2021 LIBRARY; T=0.K  
Photon emission for (n,gma)

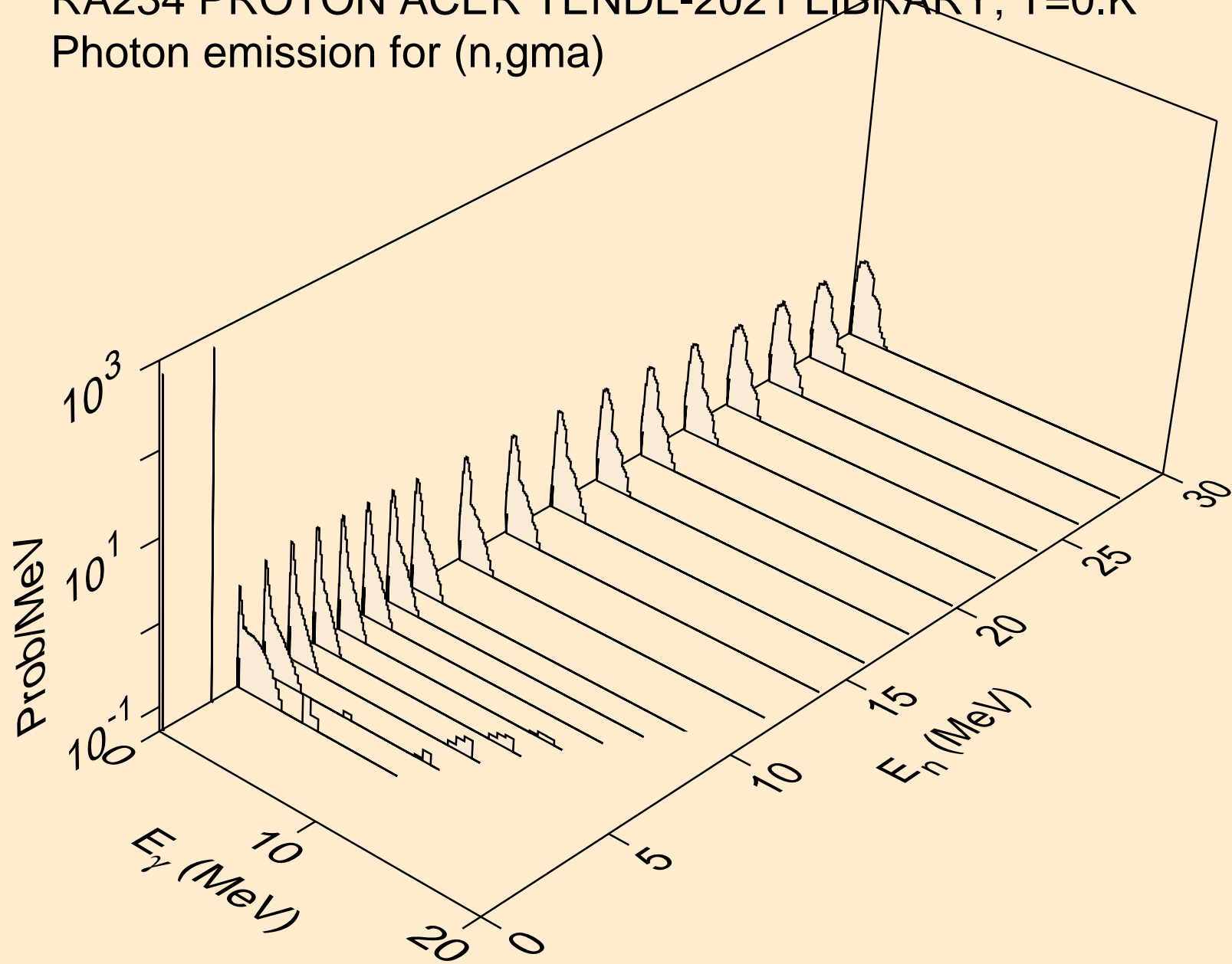

RA234 PROTON ACER TENDL-2021 LIBRARY; T=0.K  
Photon emission for inelastic

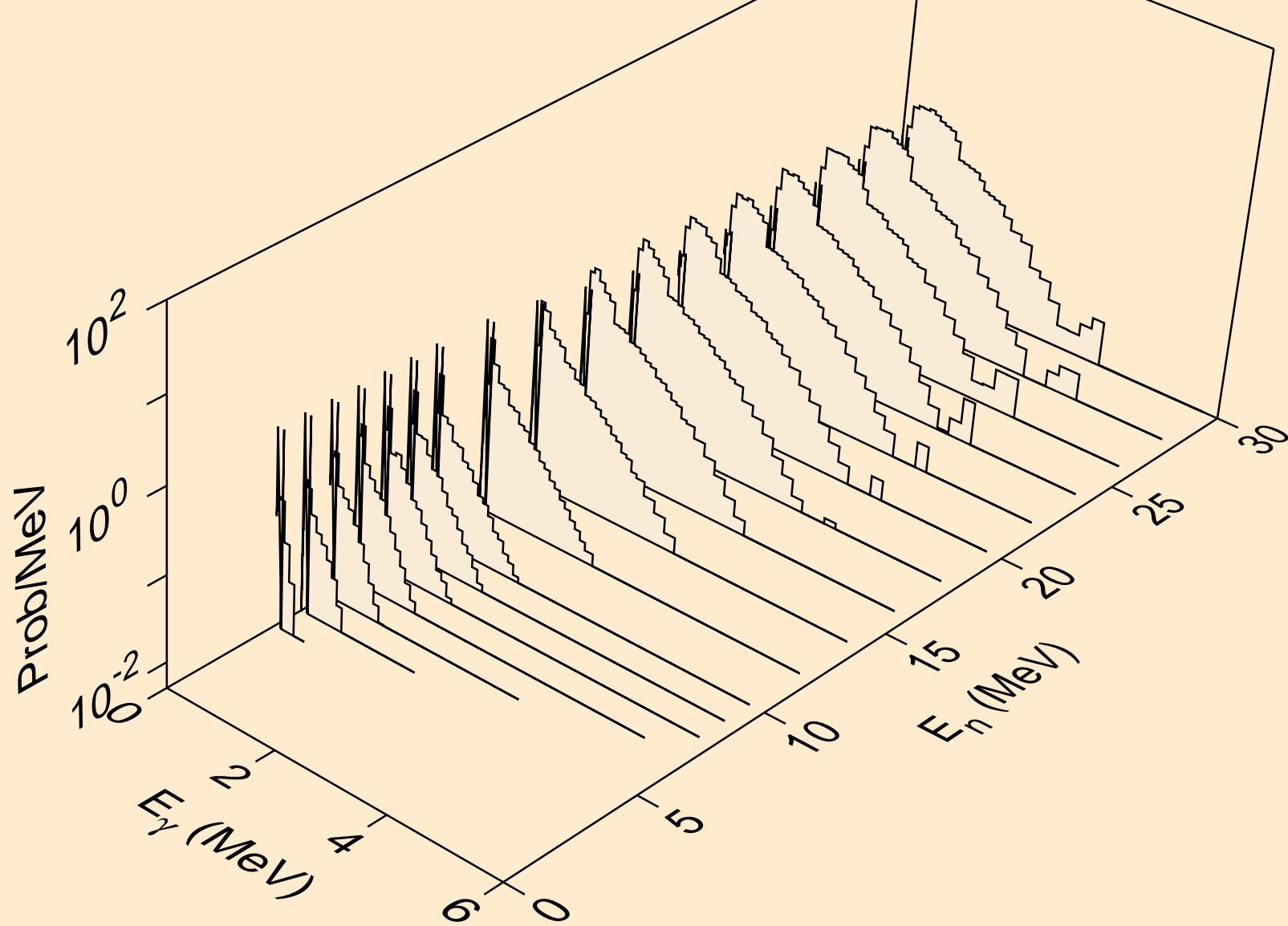

RA234 PROTON ACER TENDL-2021 LIBRARY; T=0.K  
Photon emission for (n,d)

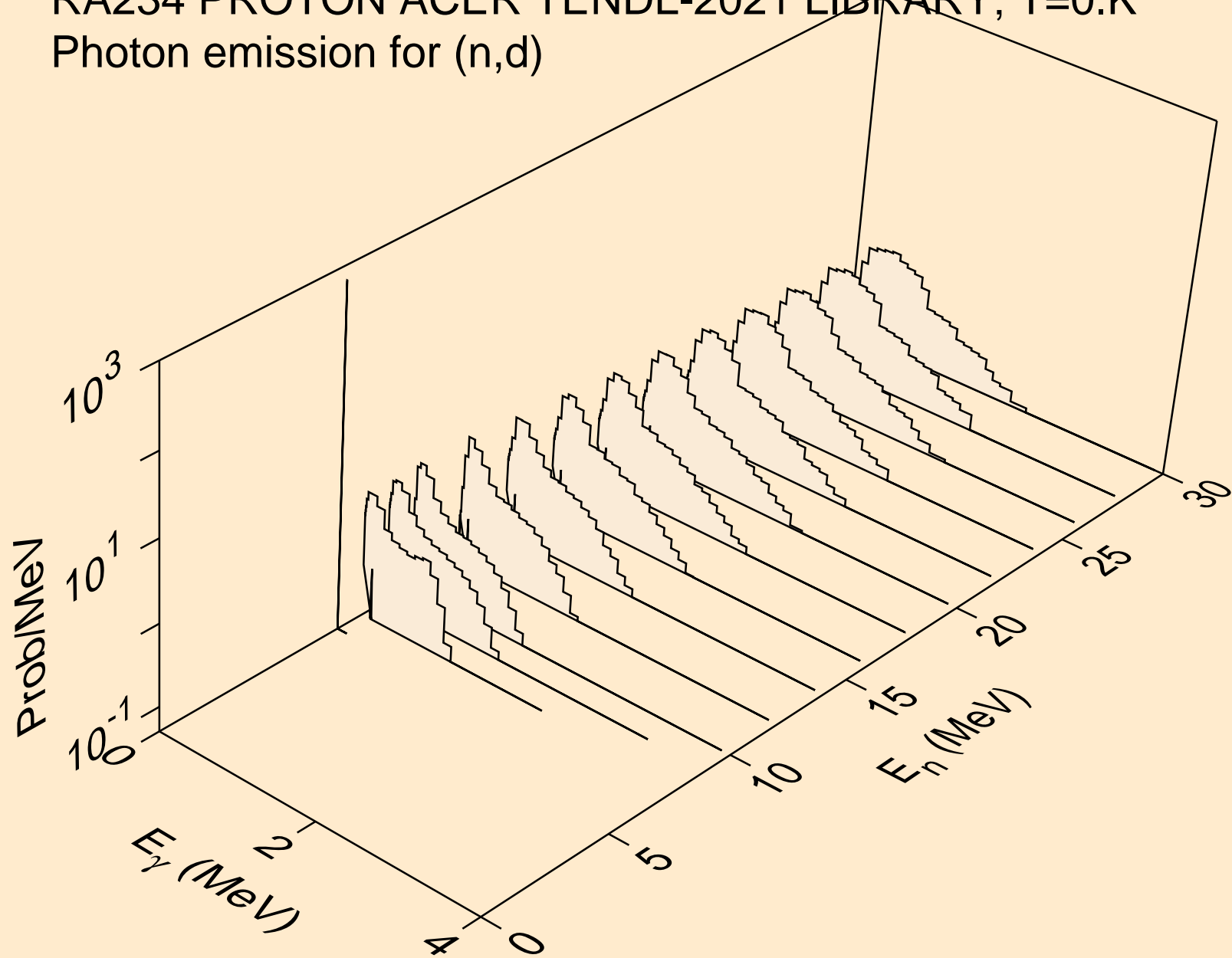

RA234 PROTON ACER TENDL-2021 LIBRARY; T=0.K  
Photon emission for (n,t)

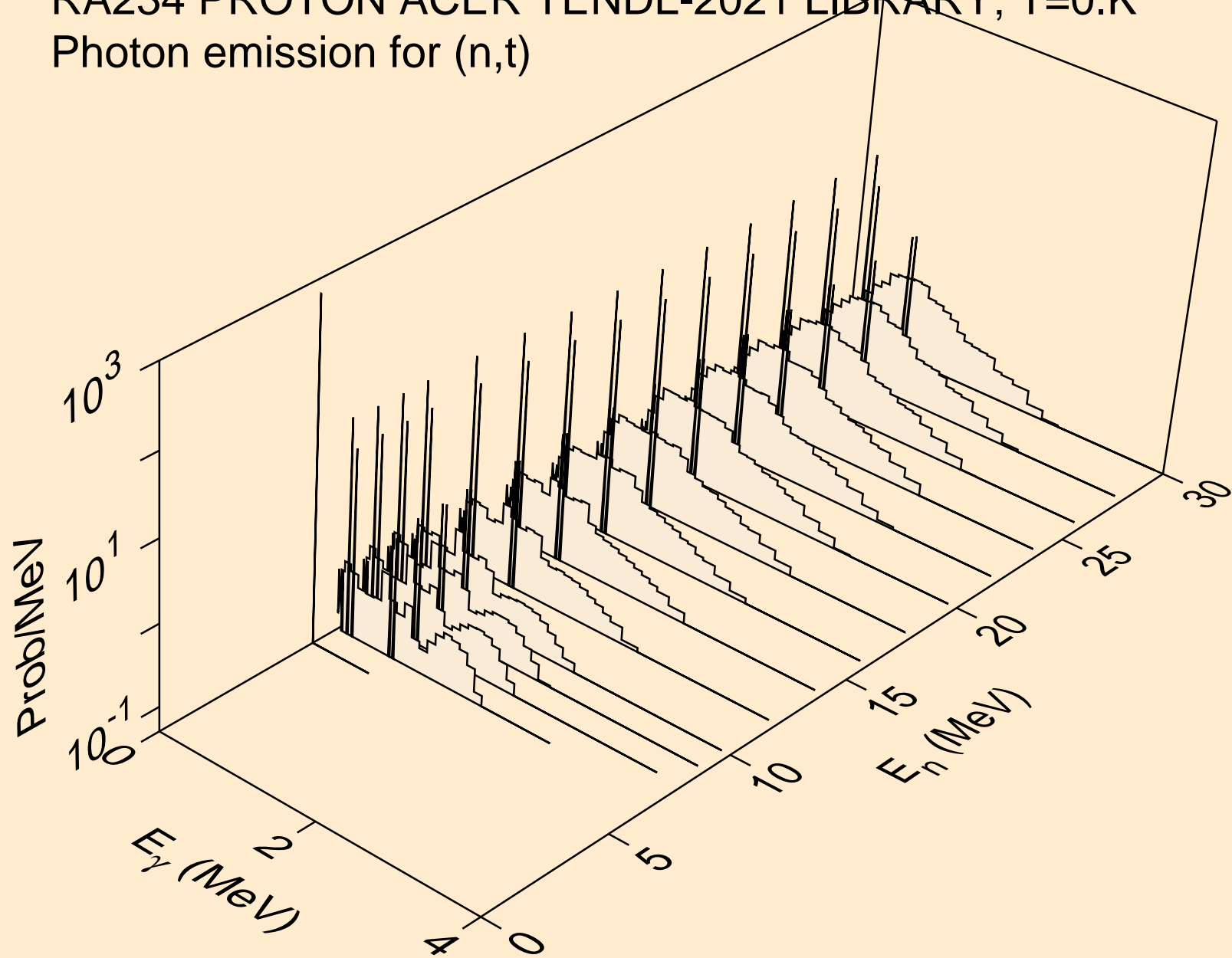

RA234 PROTON ACER TENDL-2021 LIBRARY; T=0.K  
Photon emission for (n,he3)

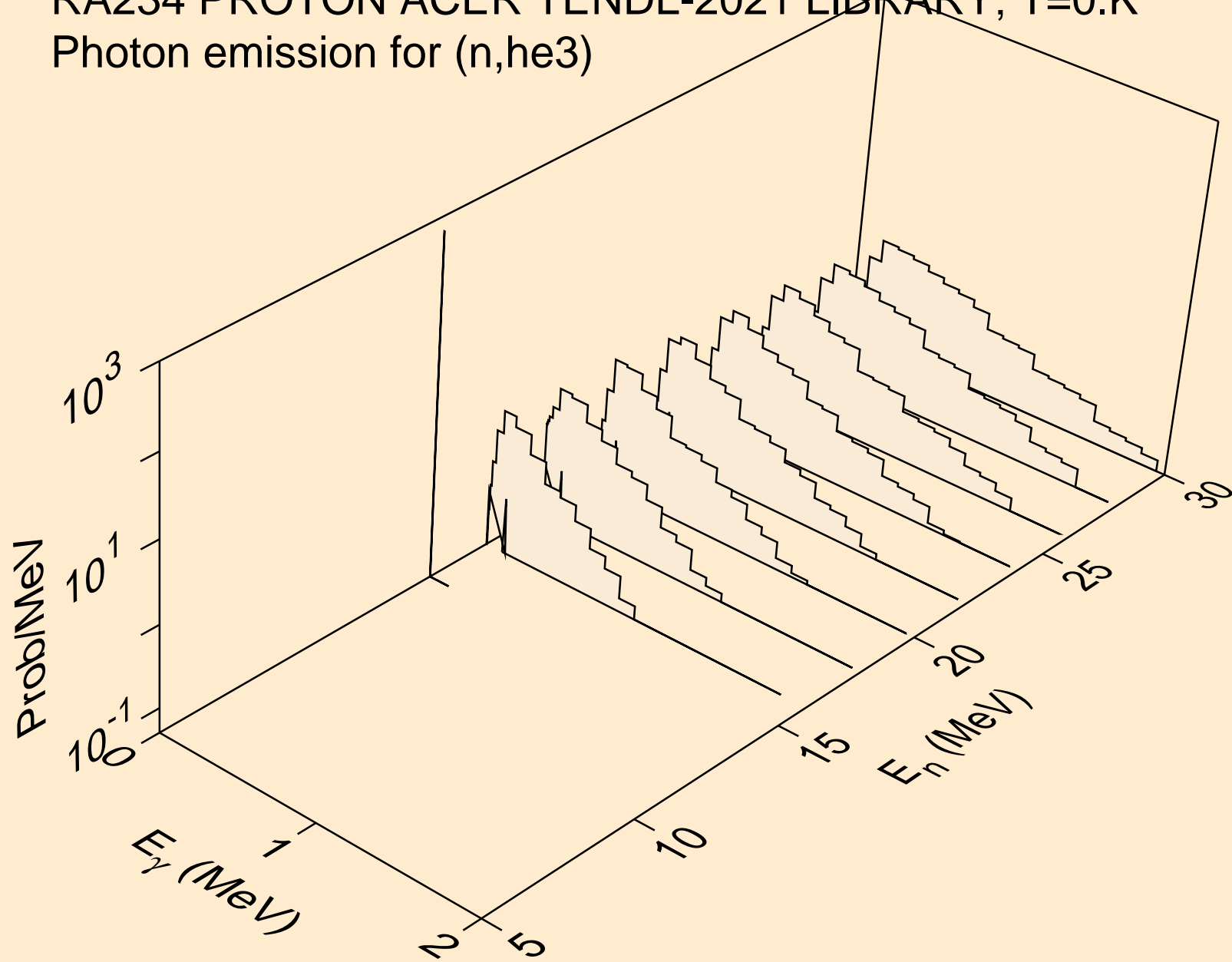

RA234 PROTON ACER TENDL-2021 LIBRARY; T=0.K  
Photon emission for (n,a)

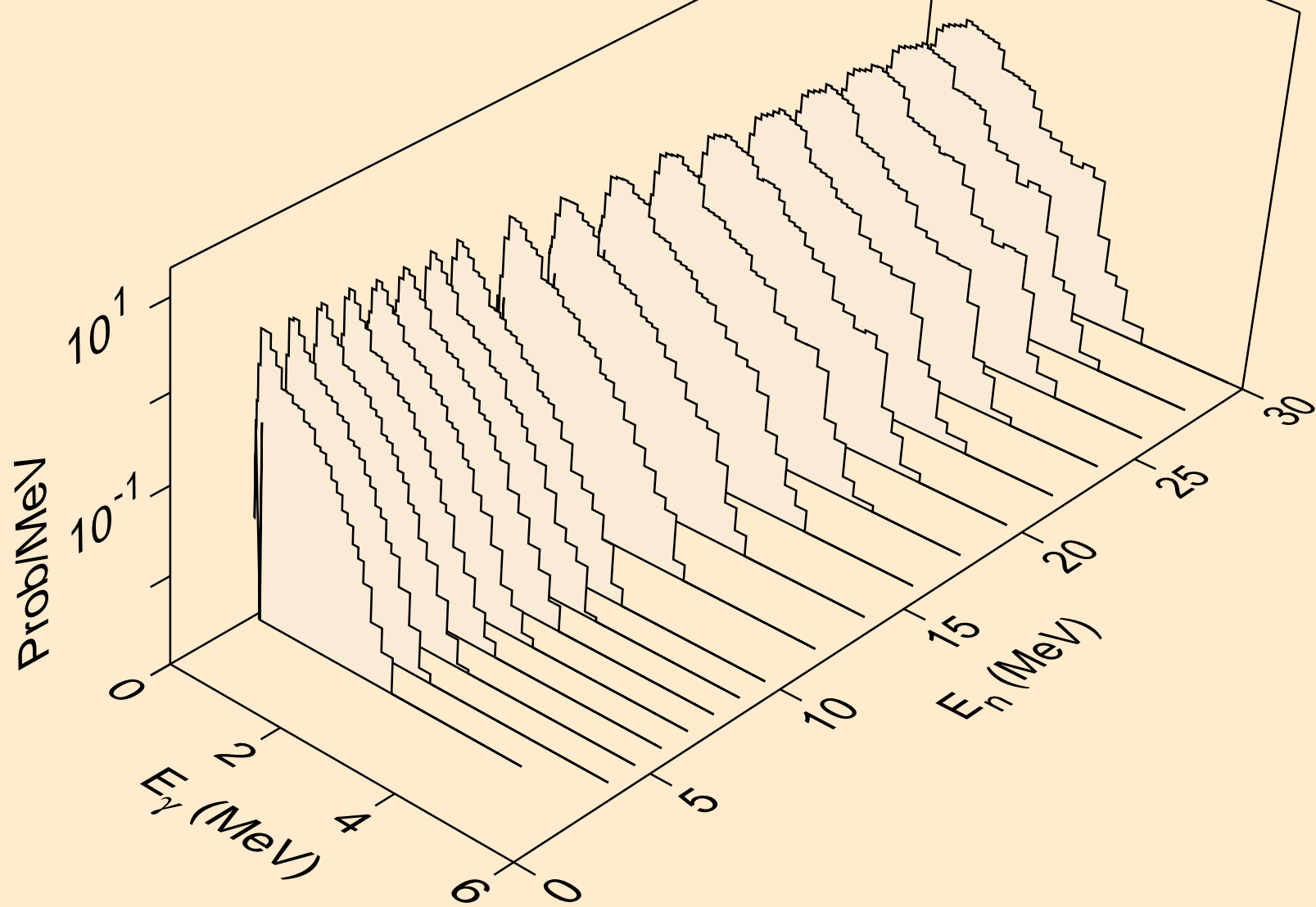

RA234 PROTON ACER TENDL-2021 LIBRARY; T=0.K  
Photon emission for (n,2p)

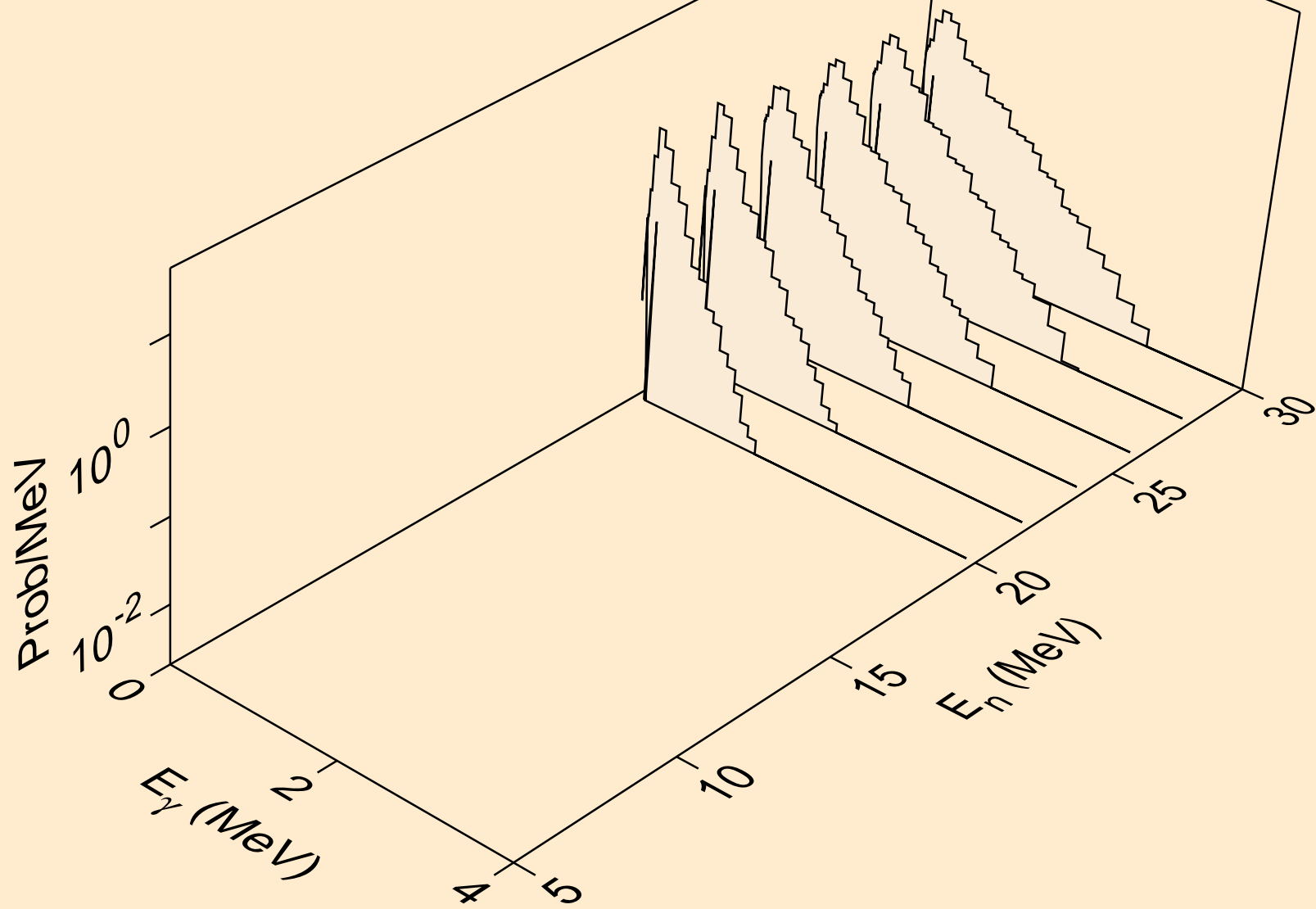



RA234 PROTON ACER TENDL-2021 LIBRARY; T=0.K  
Particle heating contributions

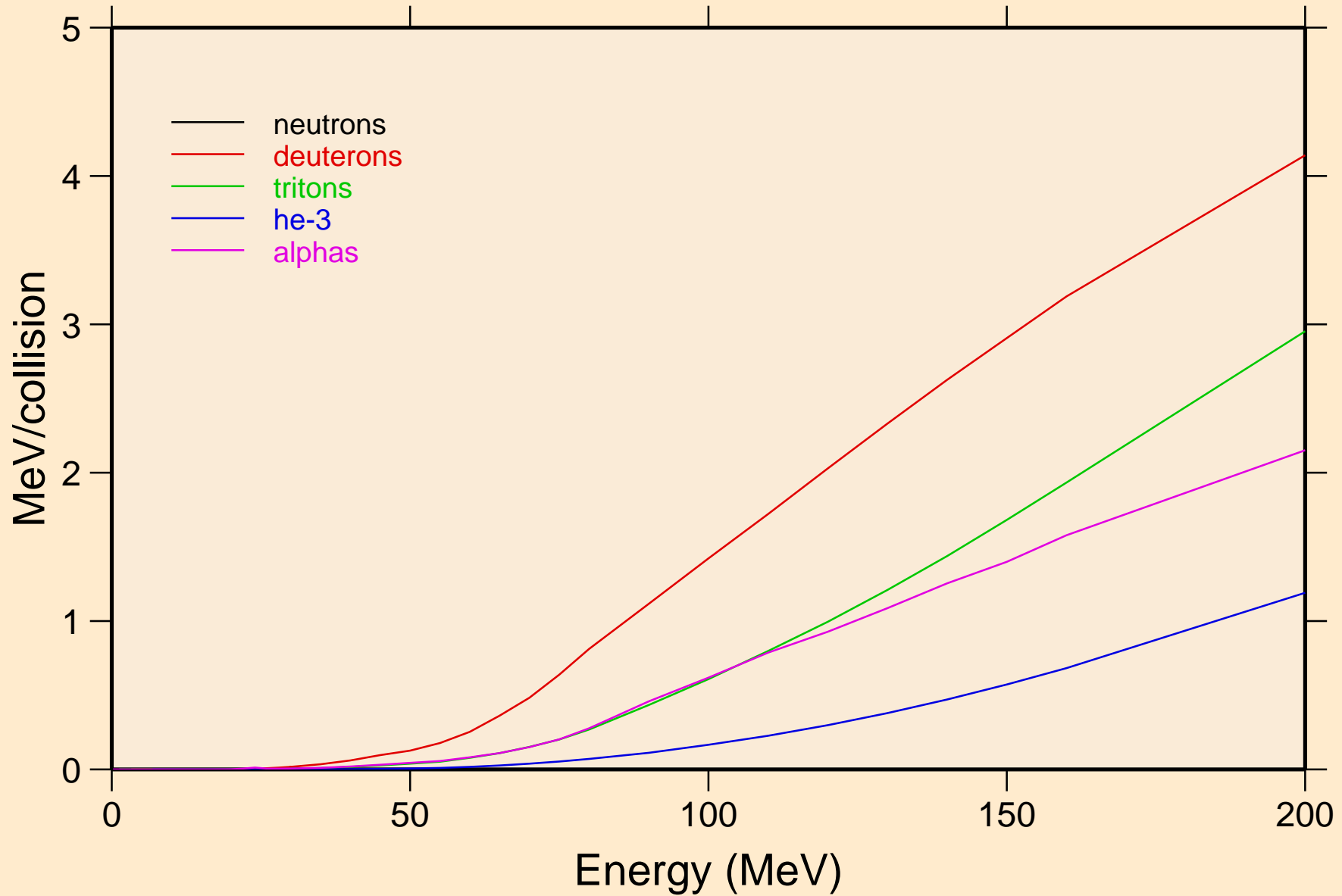

RA234 PROTON ACER TENDL-2021 LIBRARY; T=0.K

Recoil Heating

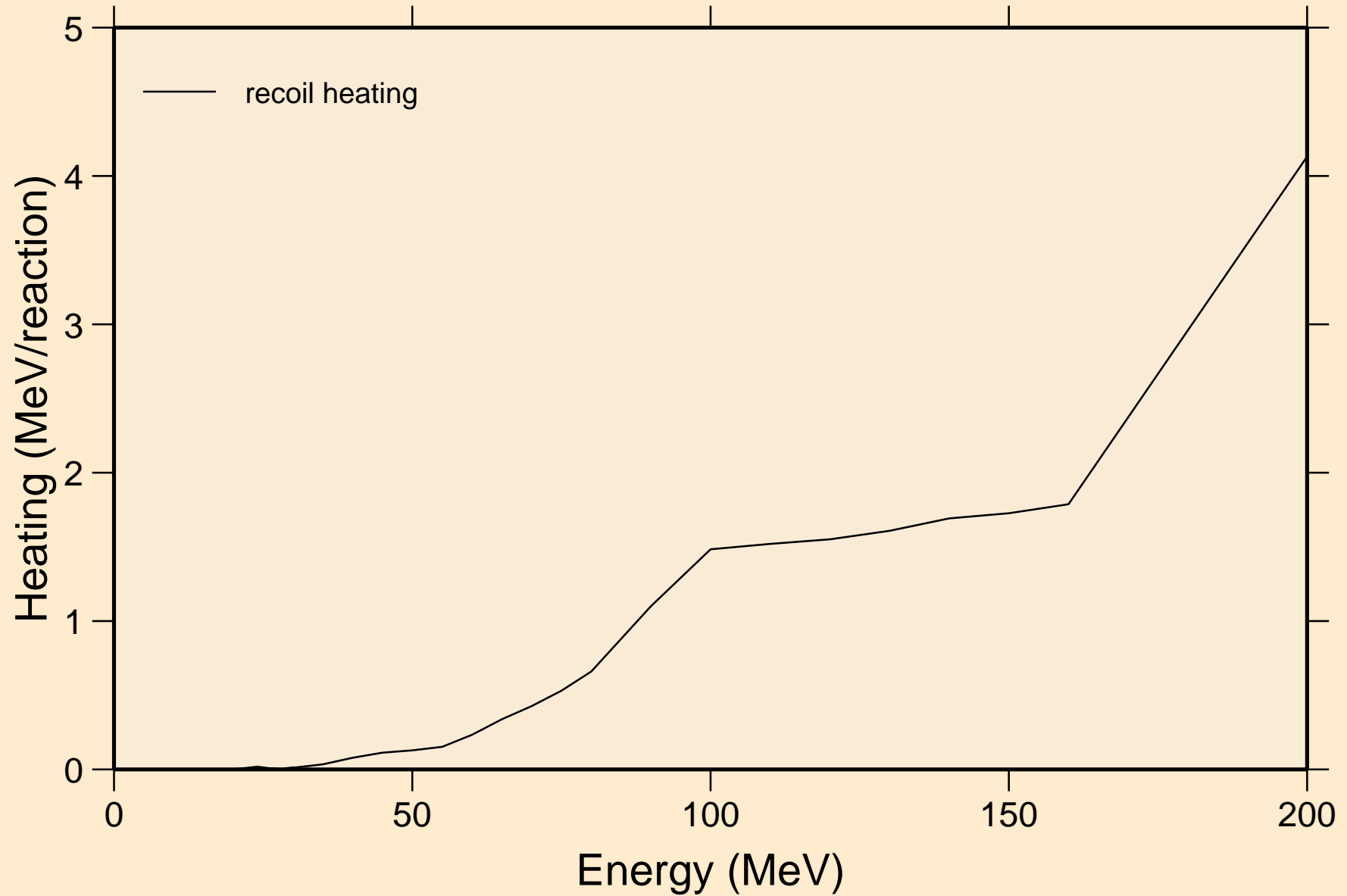

RA234 PROTON ACER TENDL-2021 LIBRARY; T=0.K  
Particle production cross sections

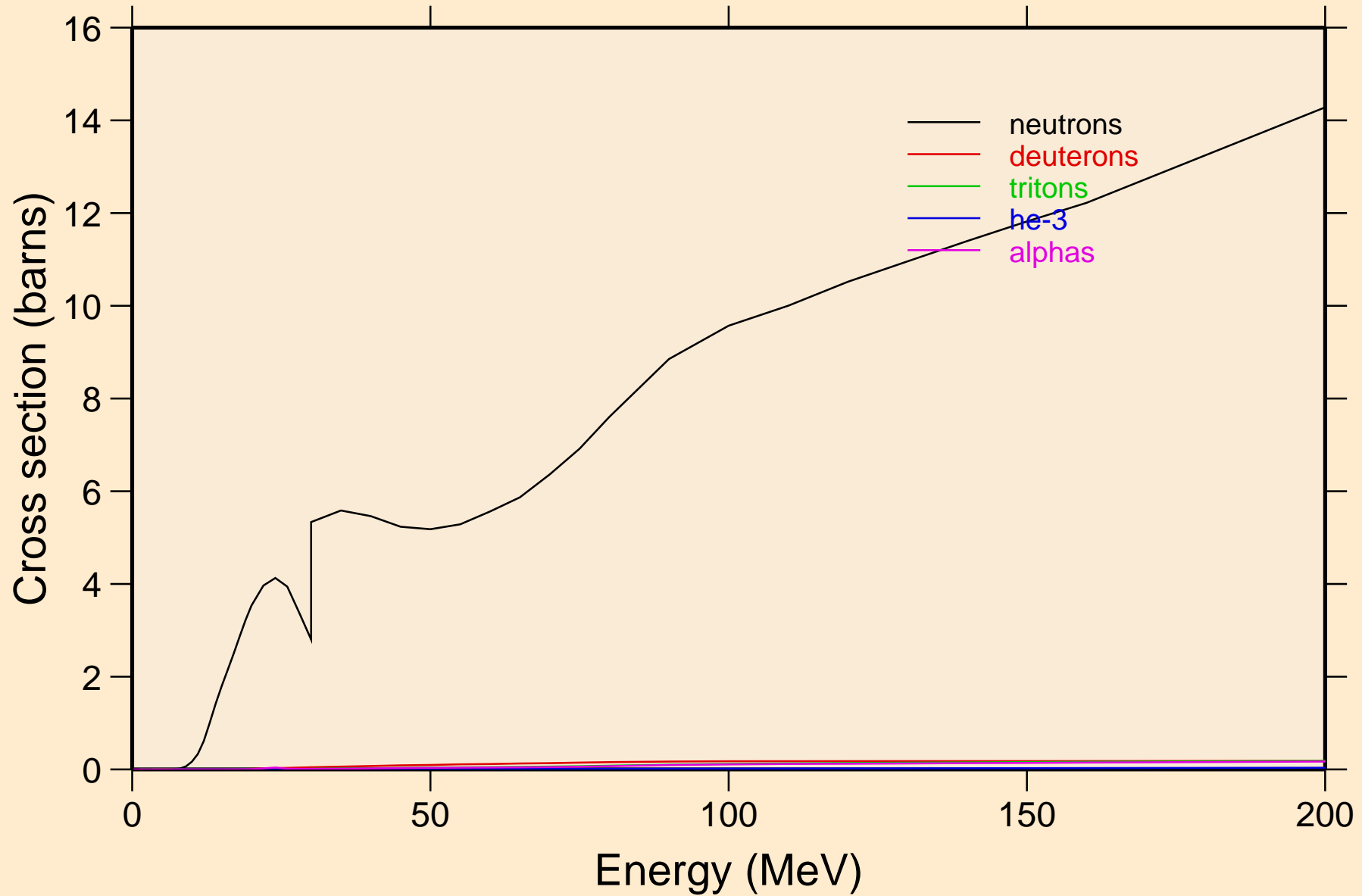

RA234 PROTON ACER TENDL-2021 LIBRARY; T=0.K  
neutrons from (p,n)

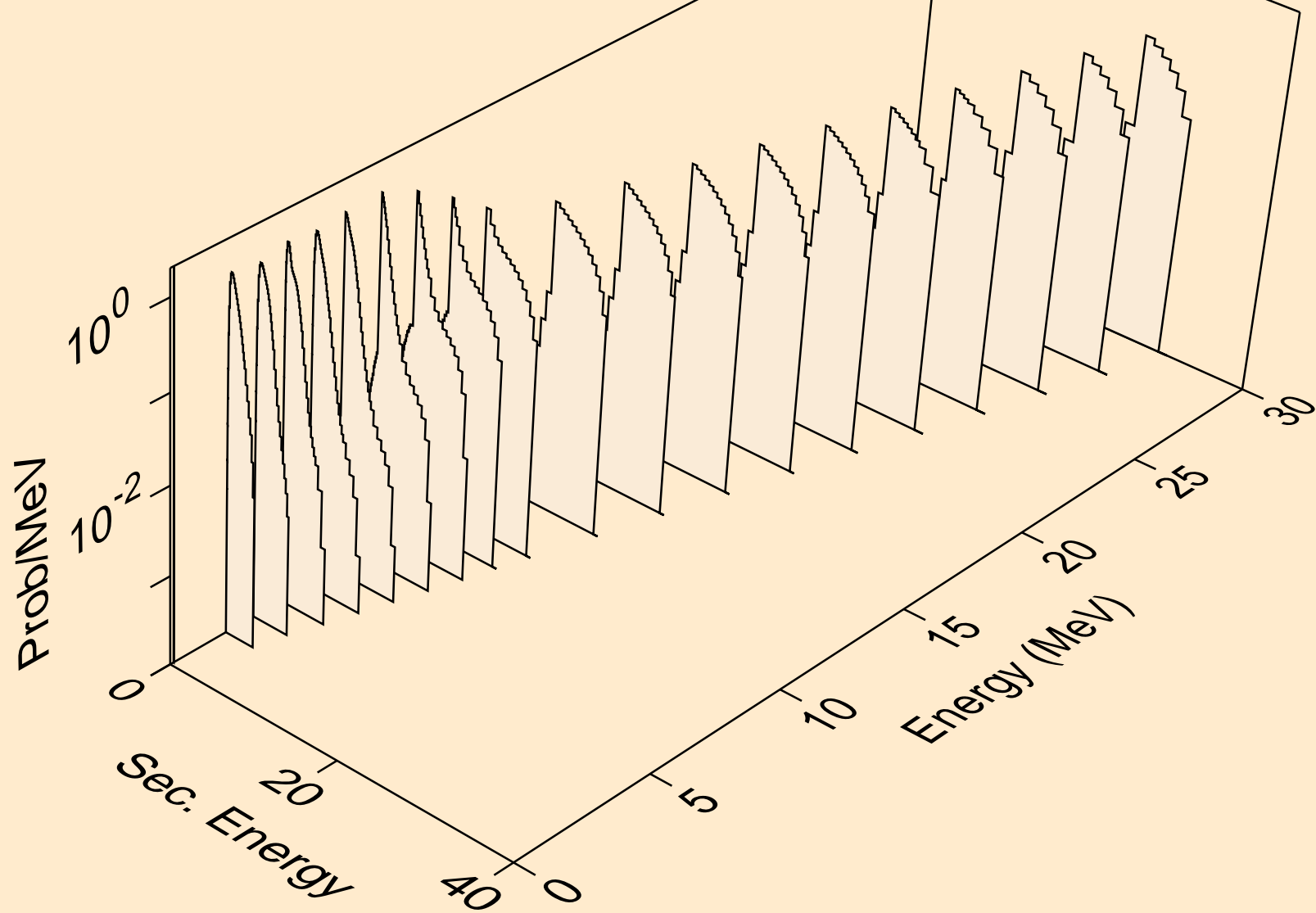

RA234 PROTON ACER TENDL-2021 LIBRARY; T=0.K  
neutrons from (p,x)

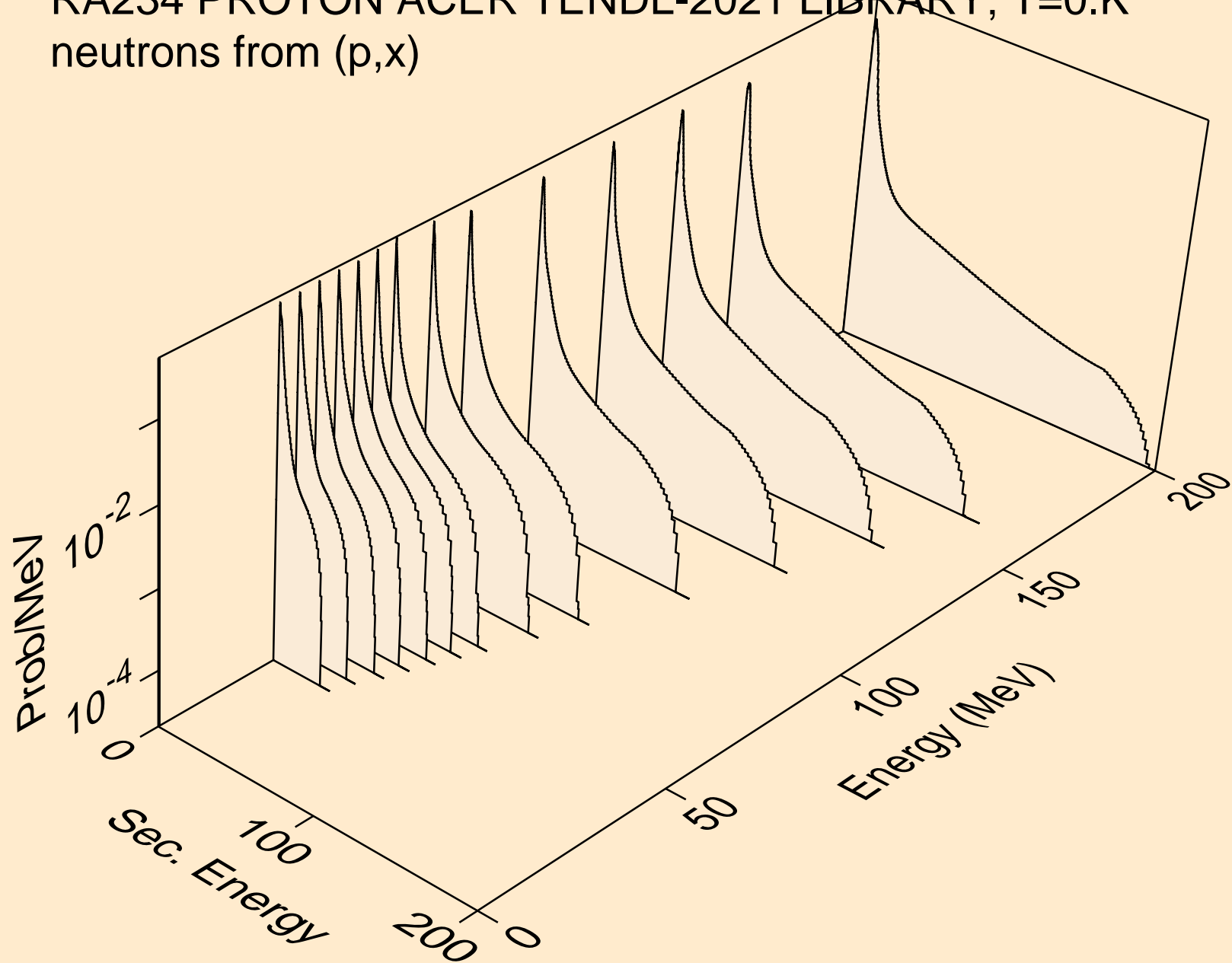

RA234 PROTON ACER TENDL-2021 LIBRARY; T=0.K  
neutrons from (p,2nd)

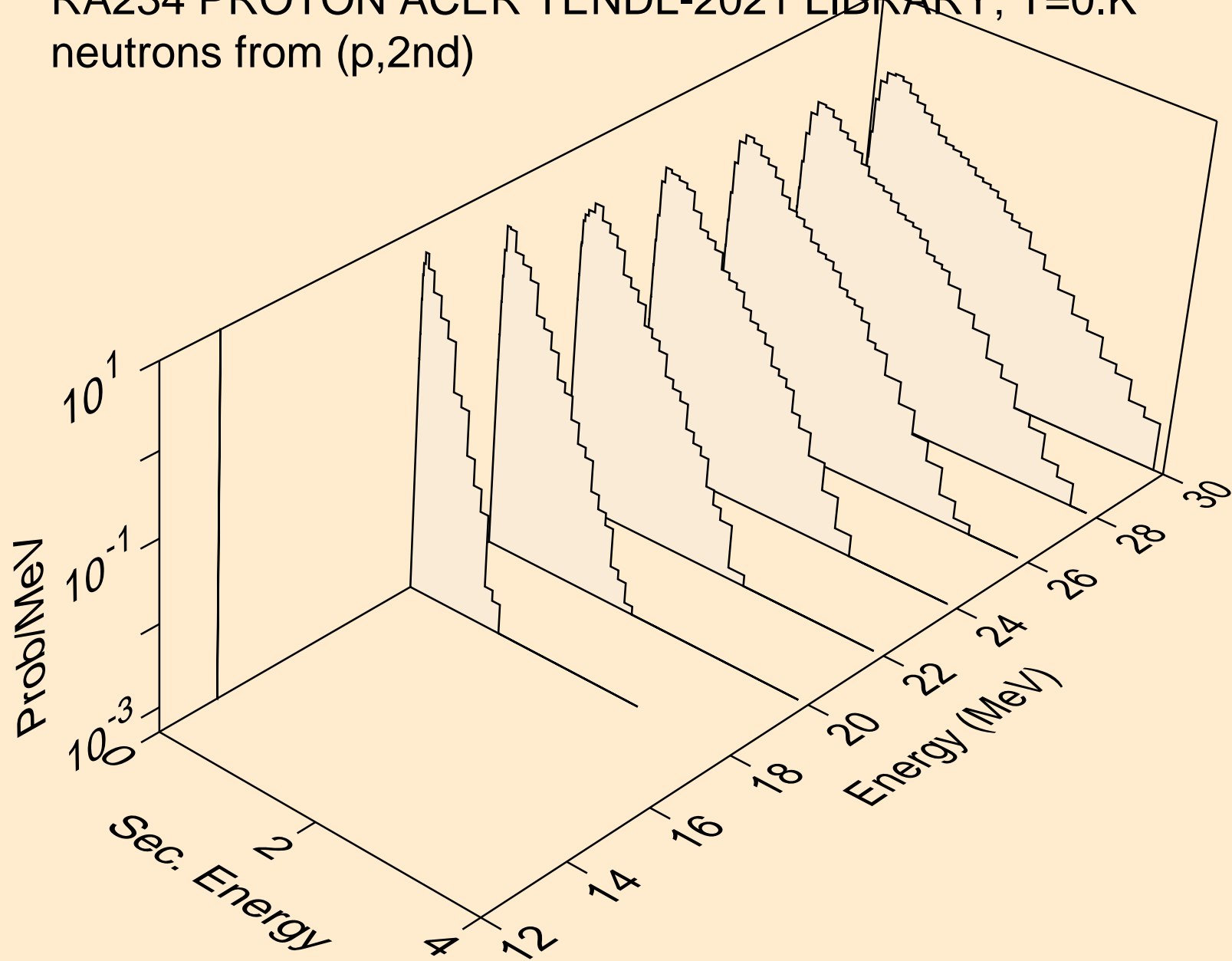

RA234 PROTON ACER TENDL-2021 LIBRARY; T=0.K  
neutrons from (p,2n)

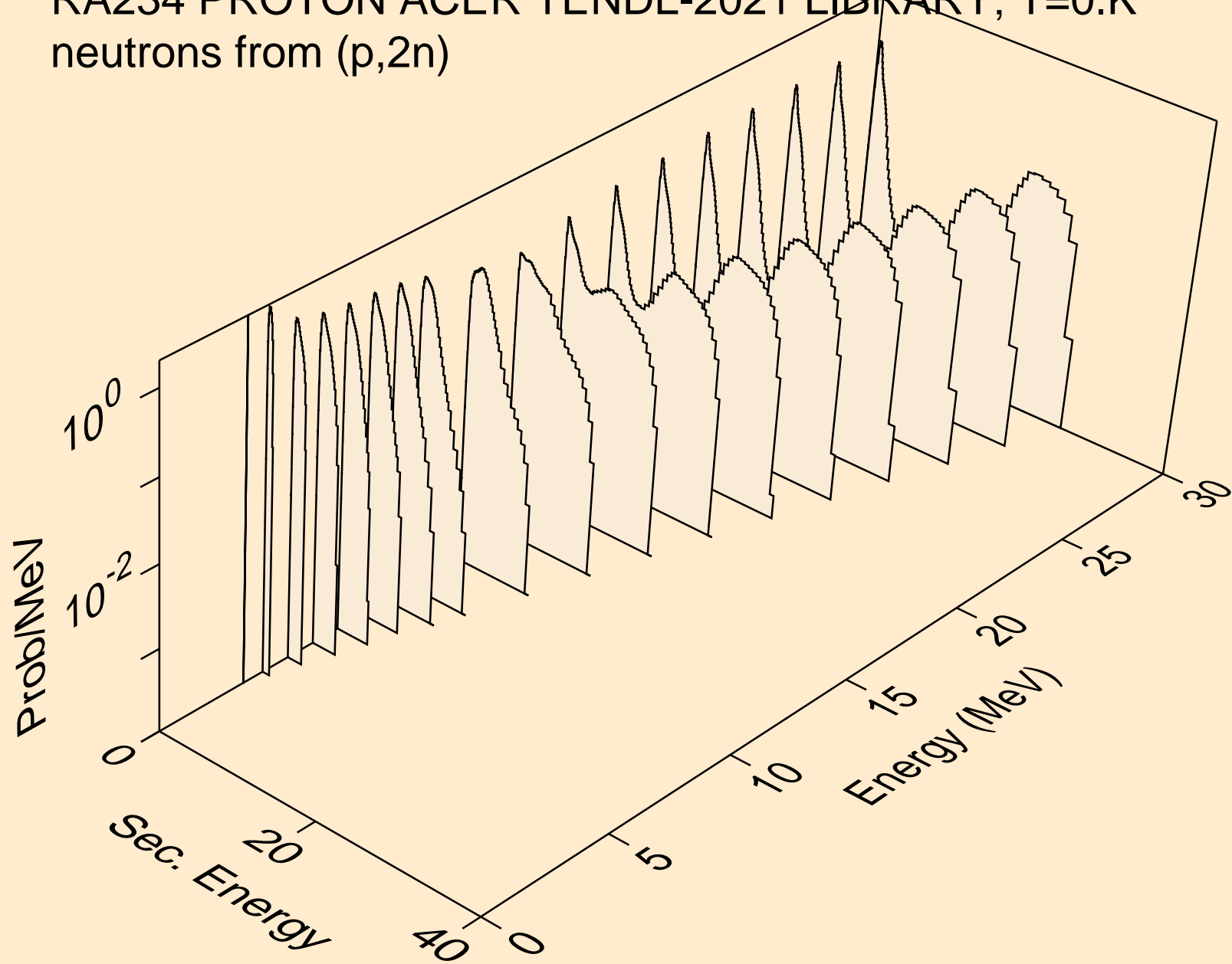

RA234 PROTON ACER TENDL-2021 LIBRARY; T=0.K  
neutrons from (p,3n)

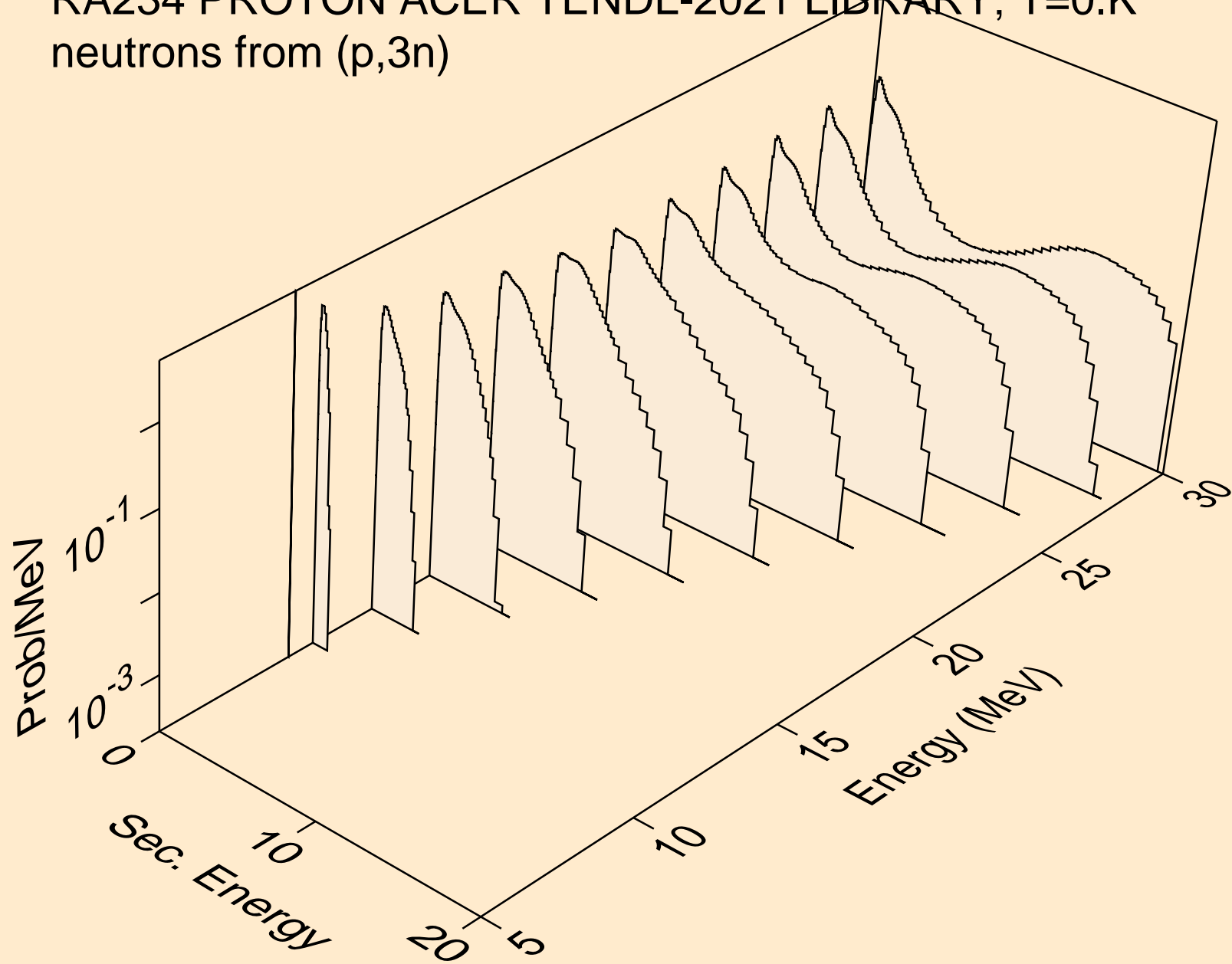



RA234 PROTON ACER TENDL-2021 LIBRARY; T=0.K  
neutrons from (p,n\*)a

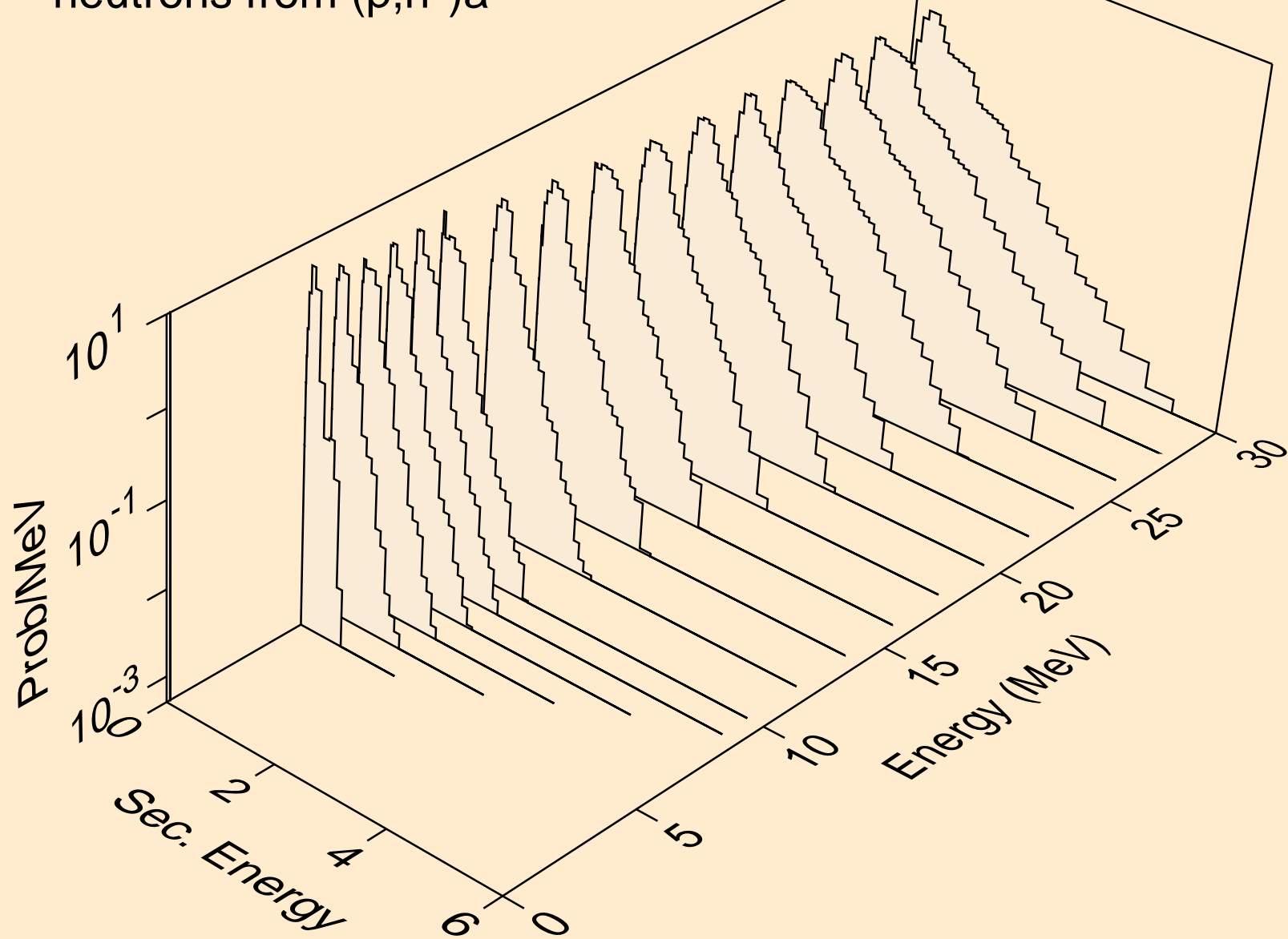

RA234 PROTON ACER TENDL-2021 LIBRARY; T=0.K  
neutrons from (p,2n)a

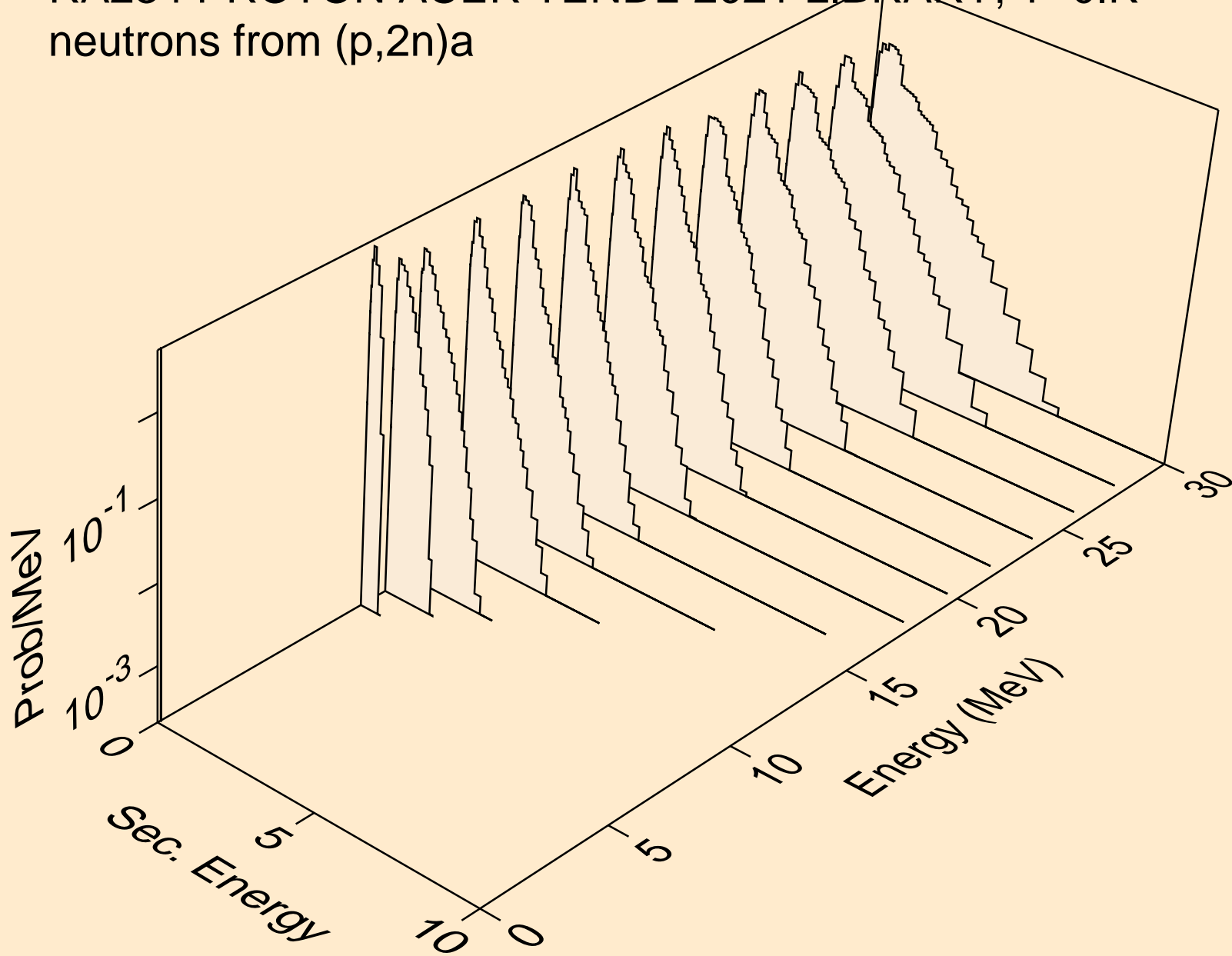

RA234 PROTON ACER TENDL-2021 LIBRARY; T=0.K  
neutrons from (p,3n)a

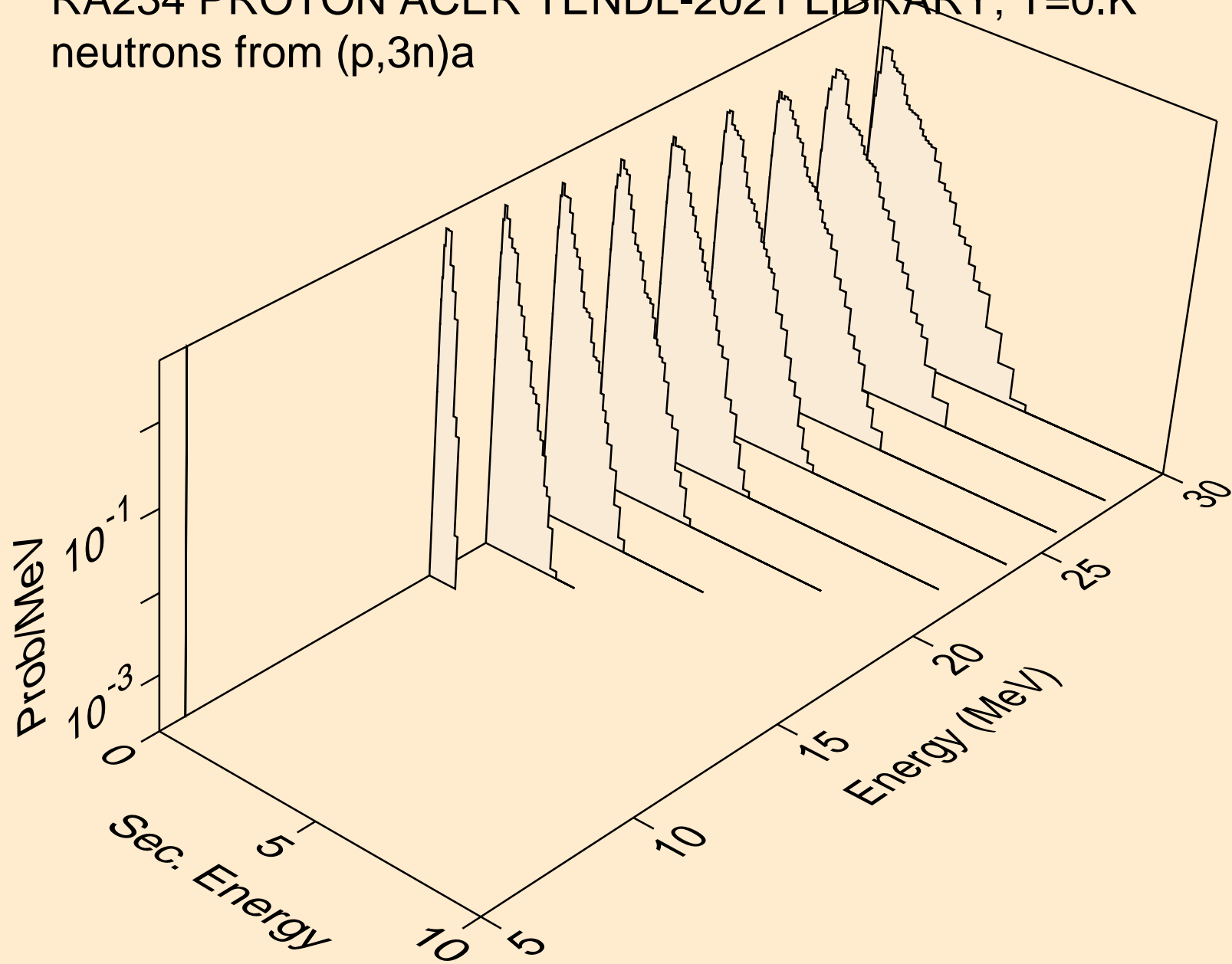

RA234 PROTON ACER TENDL-2021 LIBRARY; T=0.K  
neutrons from (p,n\*)p

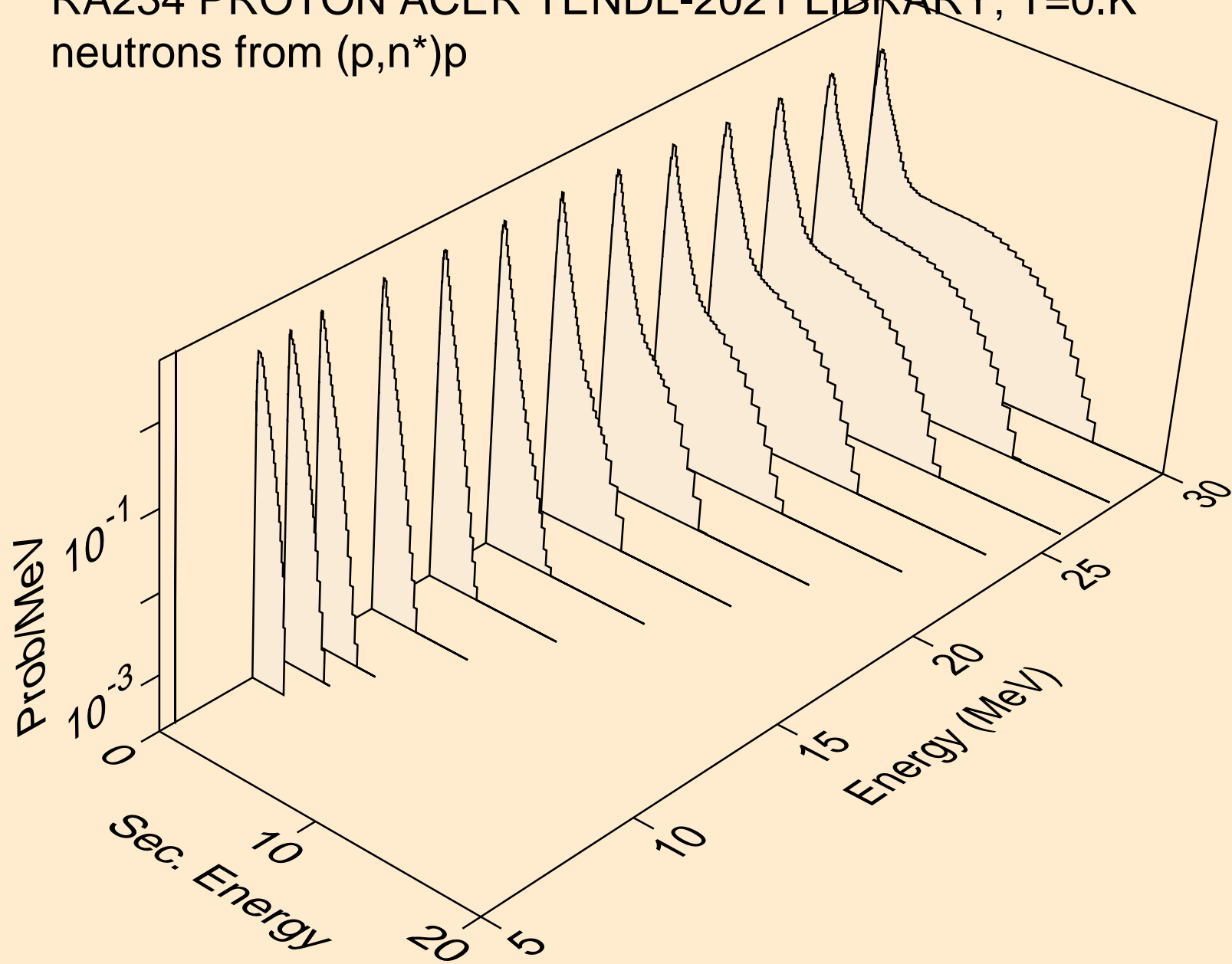

RA234 PROTON ACER TENDL-2021 LIBRARY; T=0.K  
neutrons from (p,n\*)d

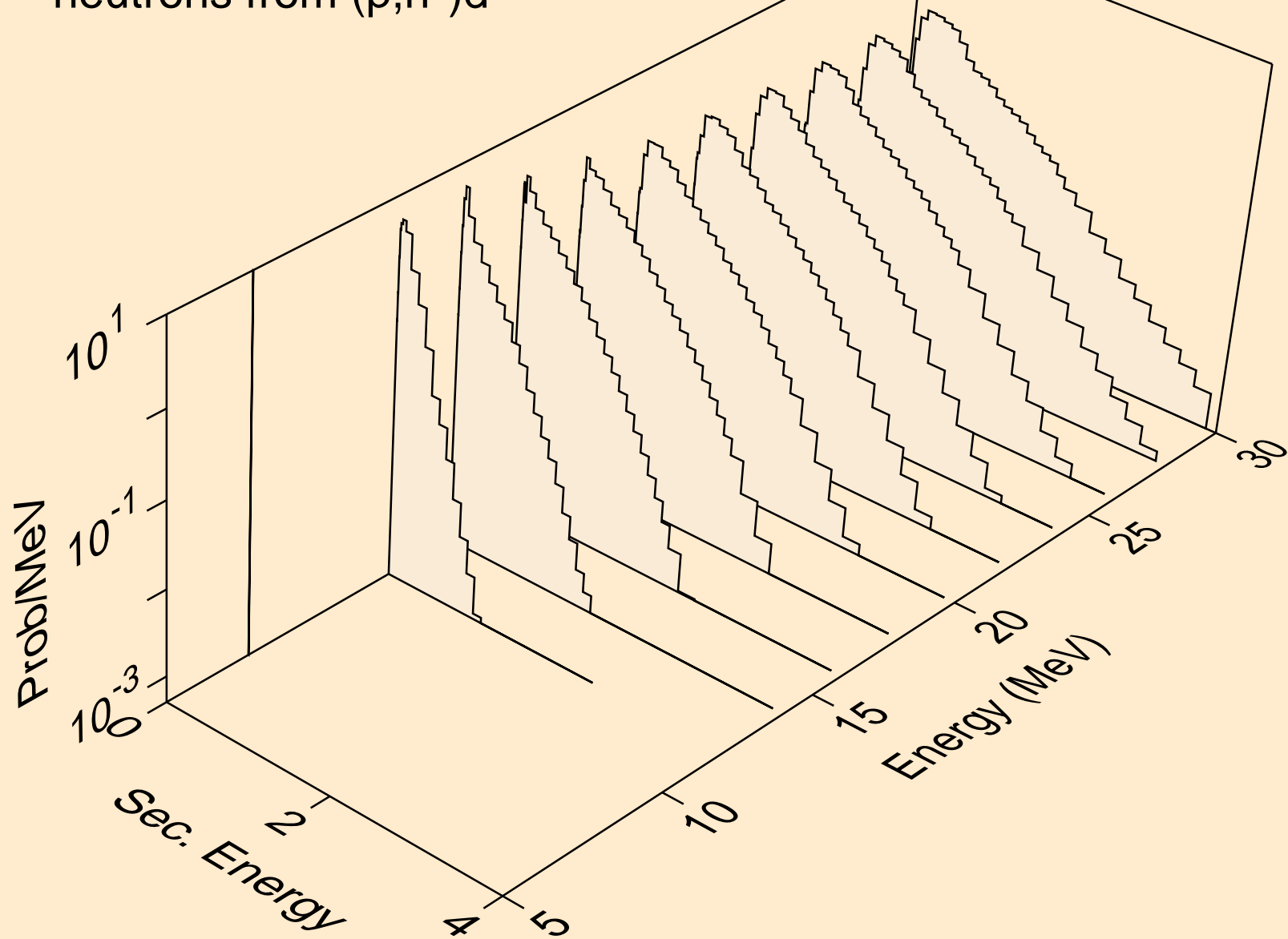

RA234 PROTON ACER TENDL-2021 LIBRARY; T=0.K  
neutrons from (p,n\*)t

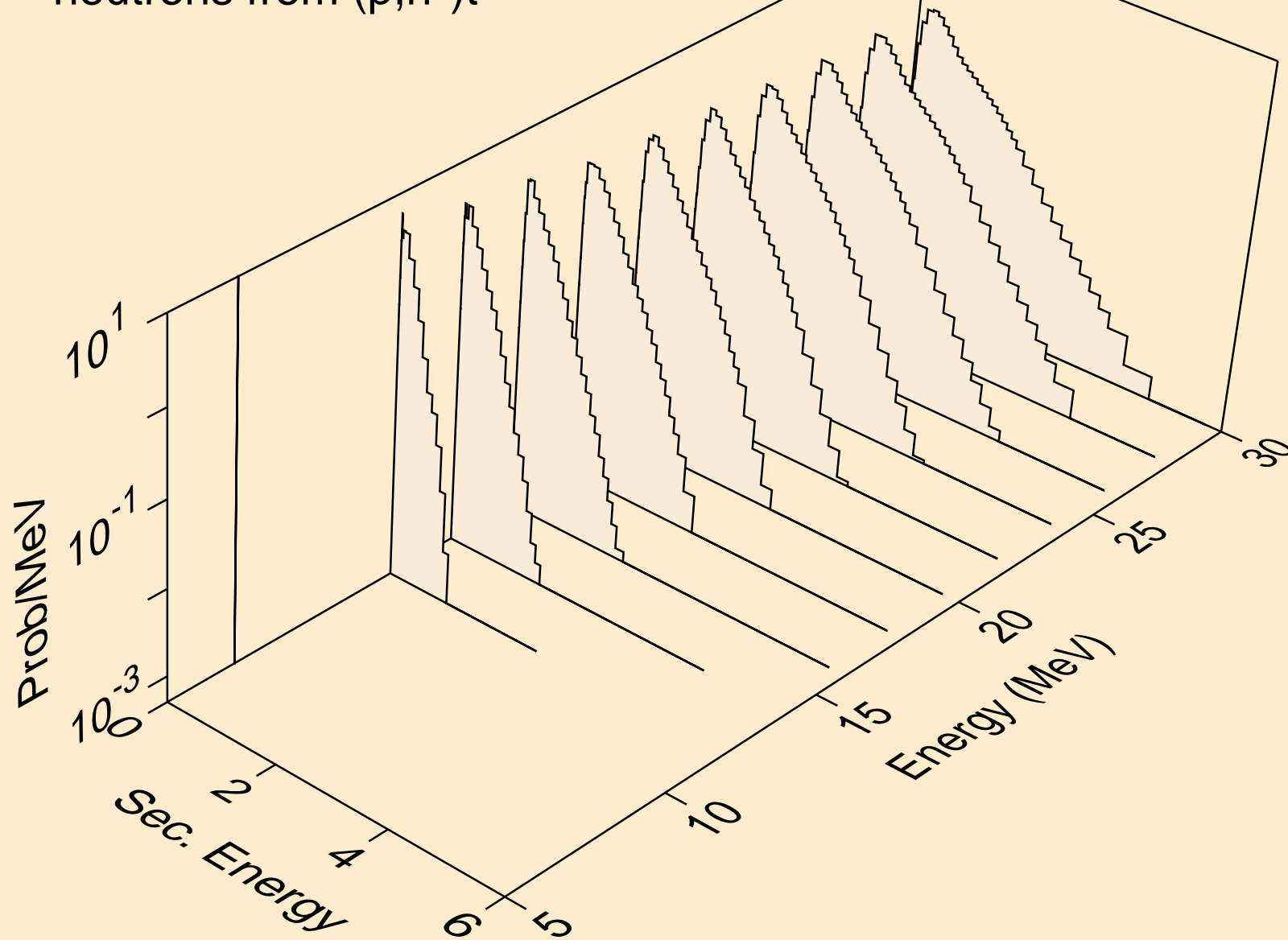

RA234 PROTON ACER TENDL-2021 LIBRARY; T=0.K  
neutrons from (p,n\*)he3

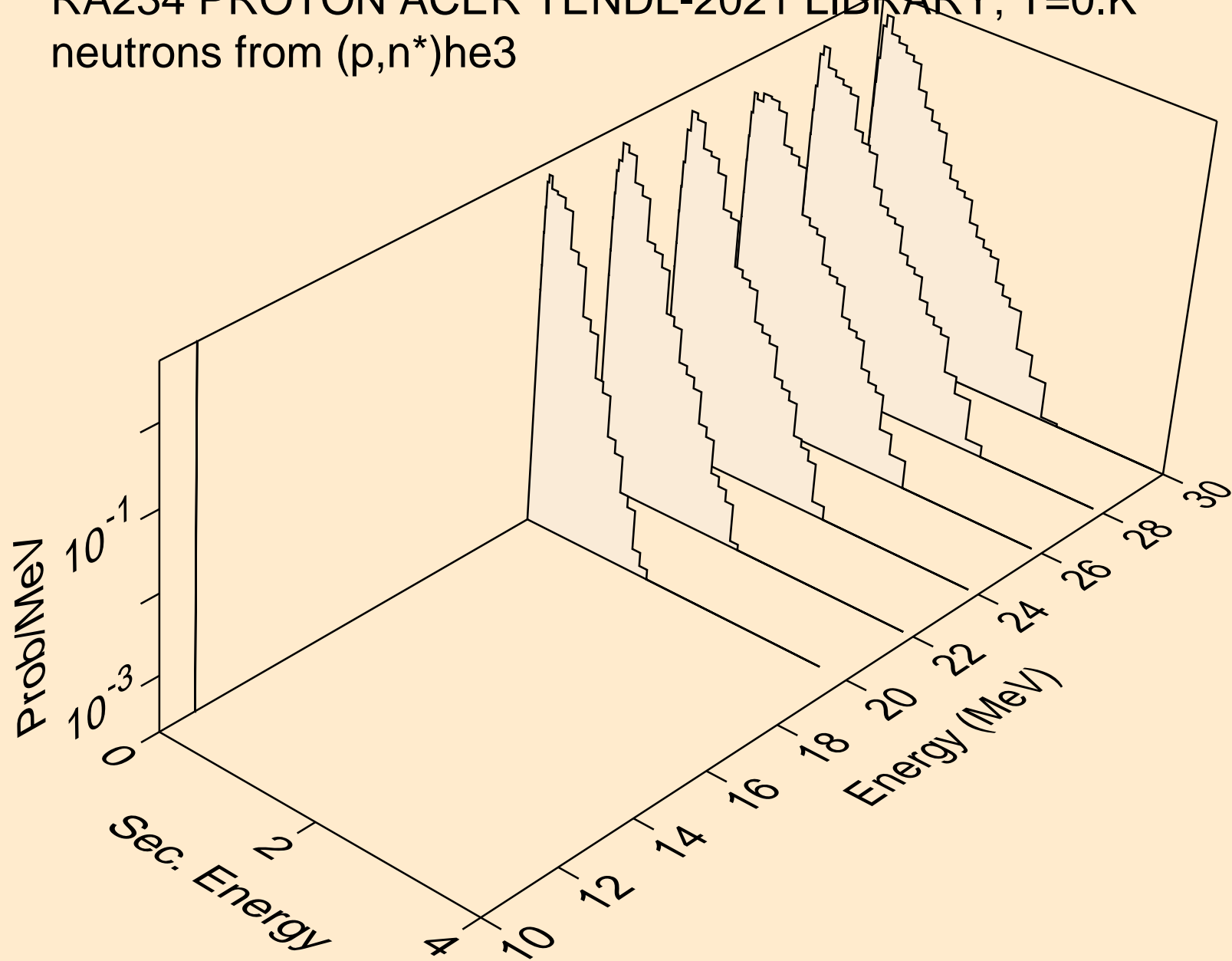

RA234 PROTON ACER TENDL-2021 LIBRARY; T=0.K  
neutrons from (p,4n)

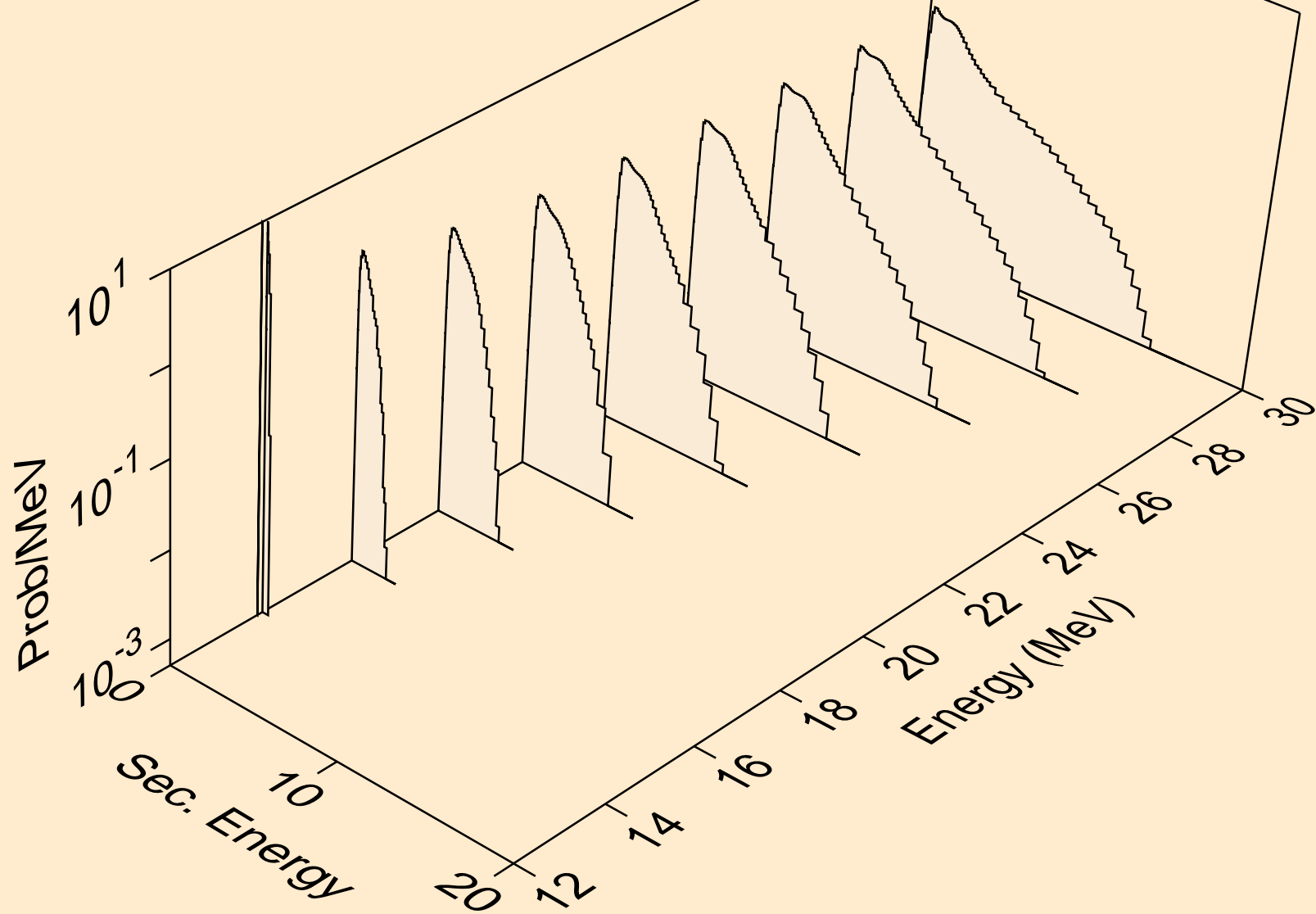



RA234 PROTON ACER TENDL-2021 LIBRARY; T=0.K  
neutrons from (p,2np)

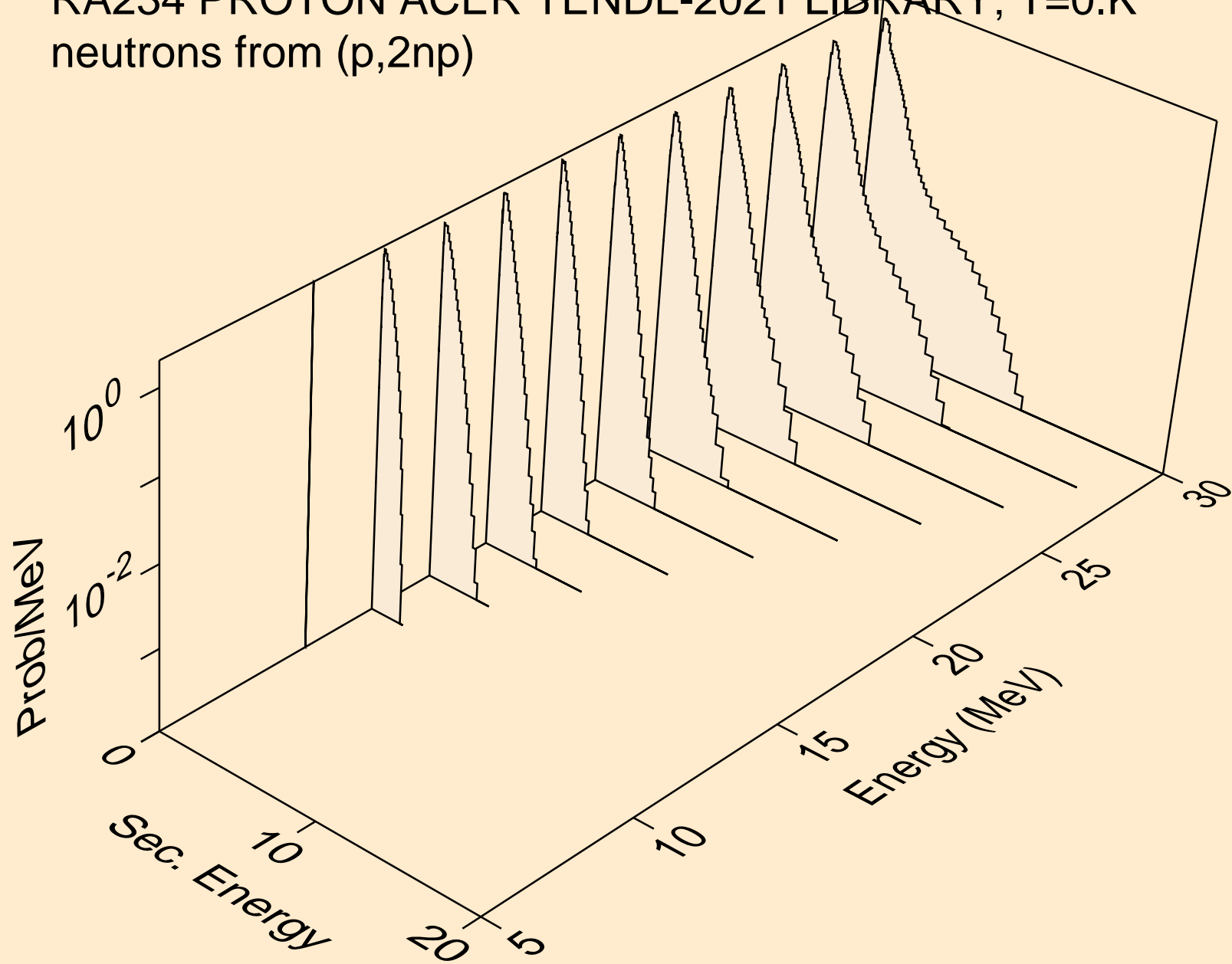

RA234 PROTON ACER TENDL-2021 LIBRARY; T=0.K  
neutrons from (p,3np)

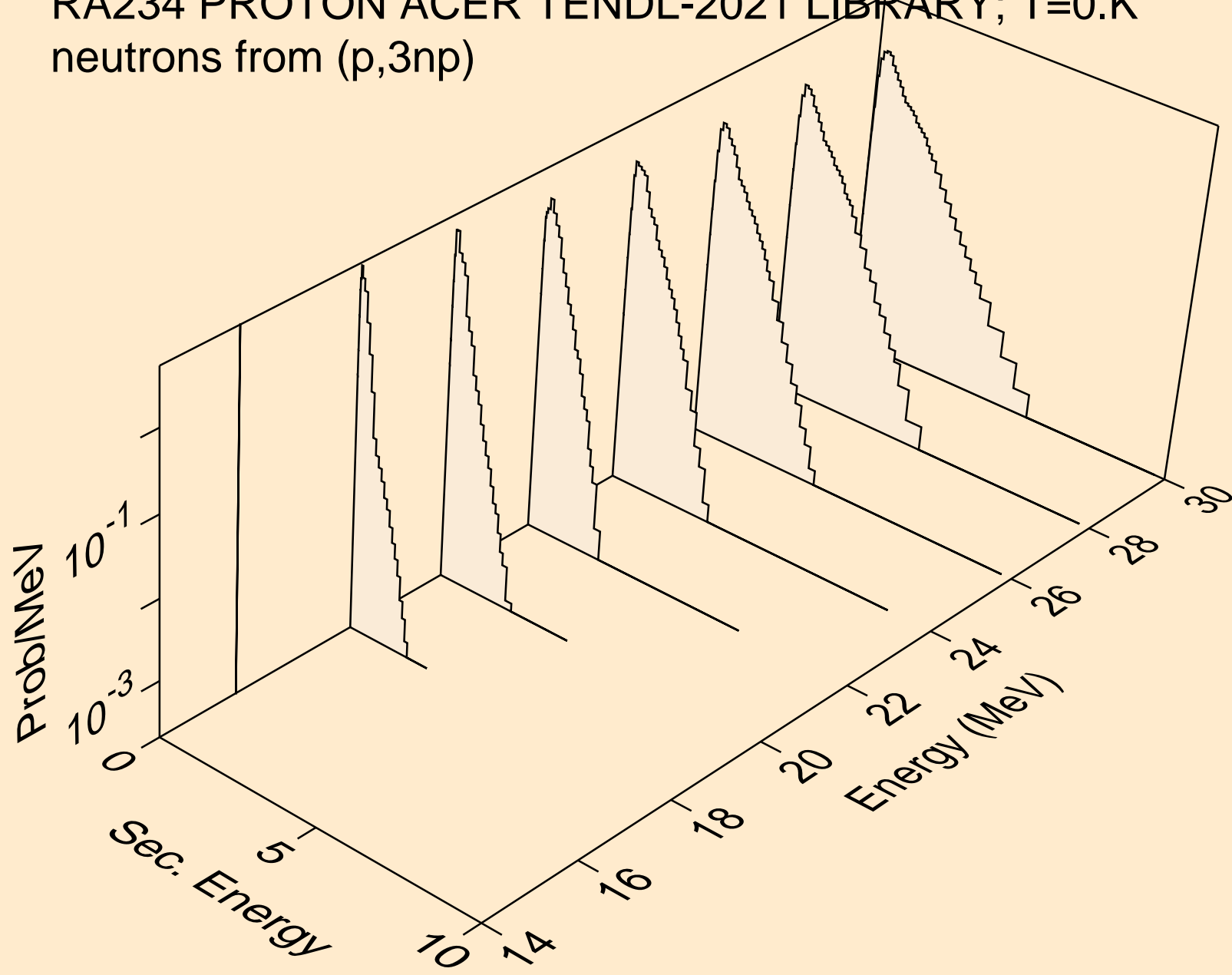

RA234 PROTON ACER TENDL-2021 LIBRARY; T=0.K  
neutrons from (p,2np)

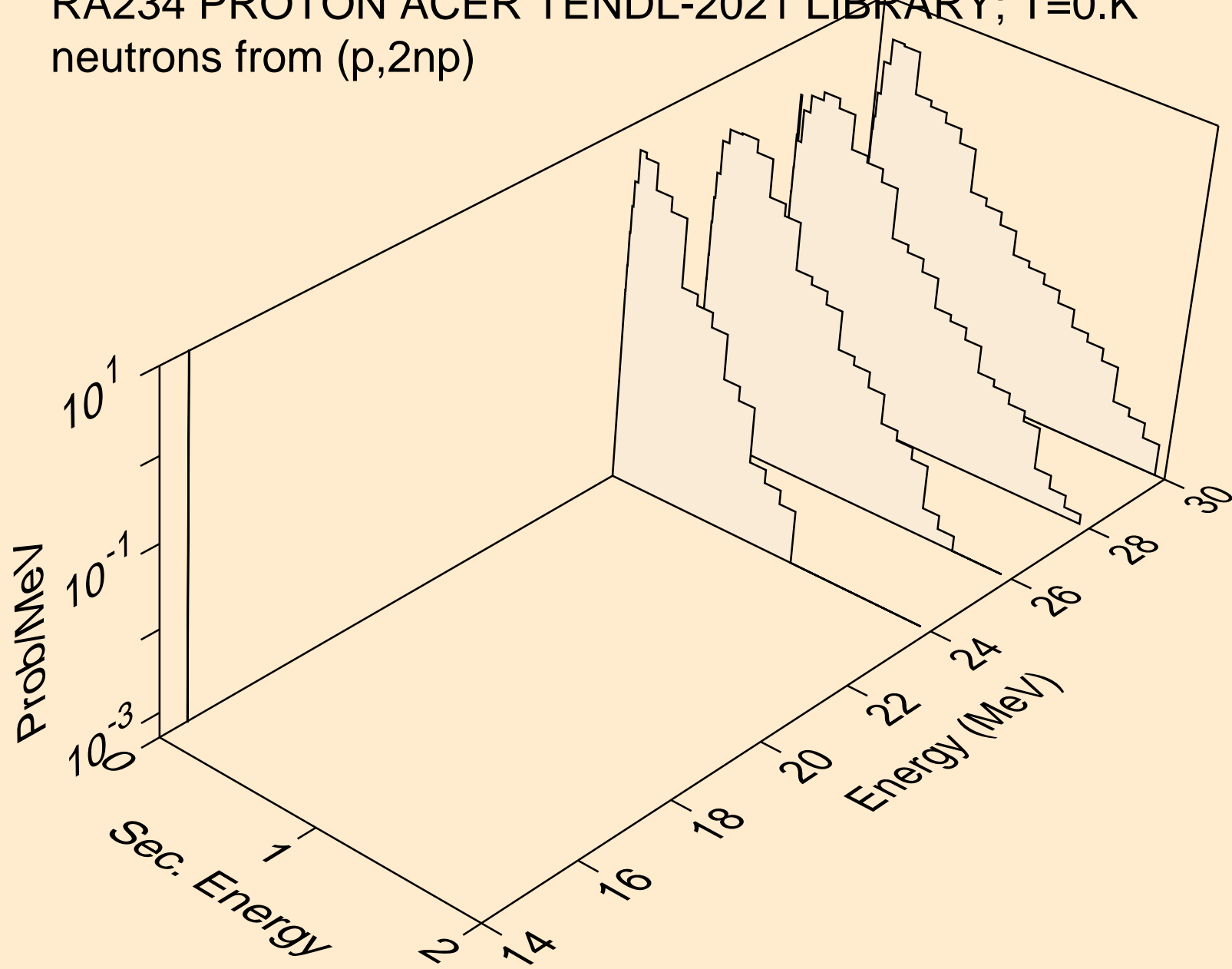

RA234 PROTON ACER TENDL-2021 LIBRARY; T=0.K  
deuterons from (p,x)

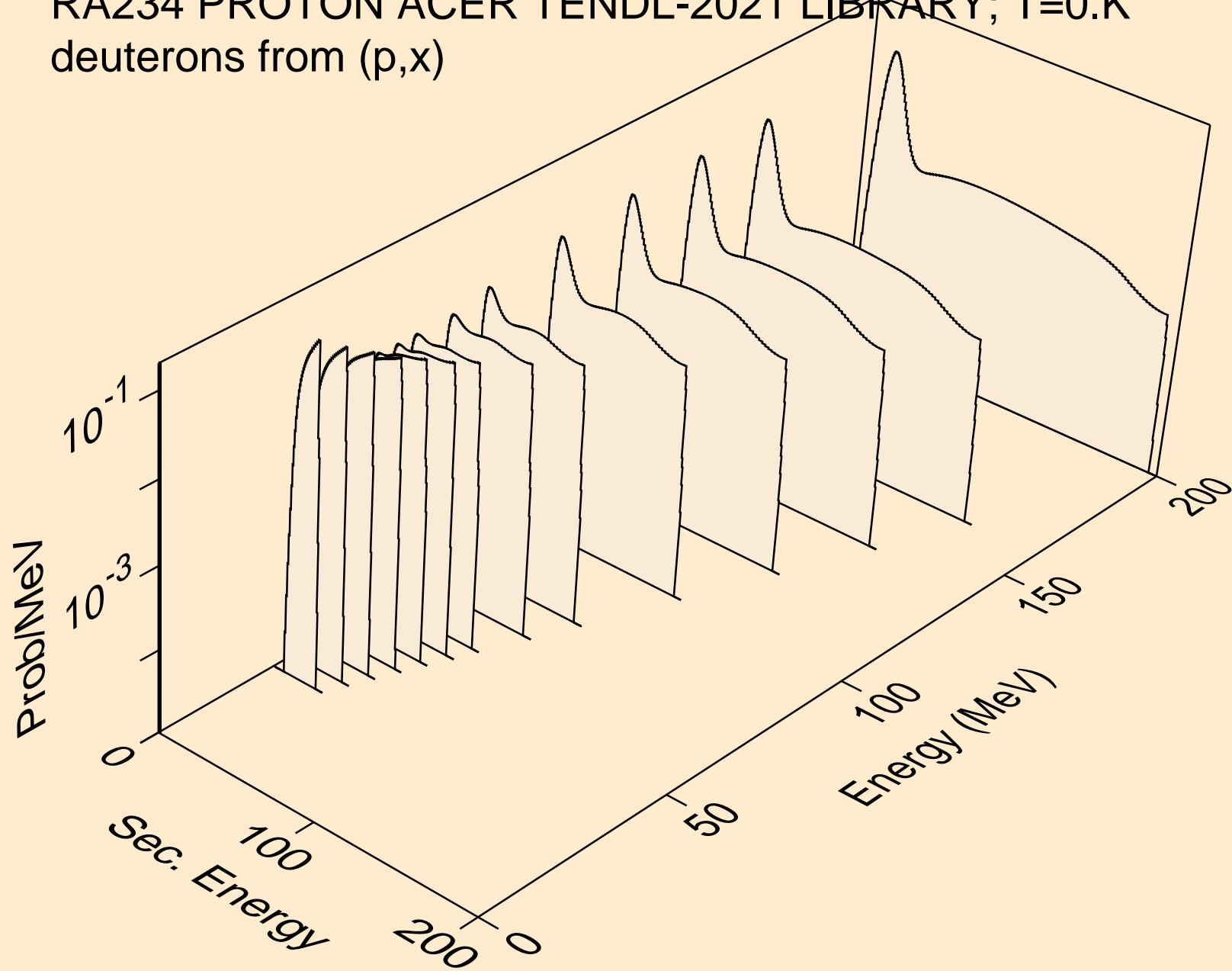

RA234 PROTON ACER TENDL-2021 LIBRARY; T=0.K  
deuterons from (p,2nd)

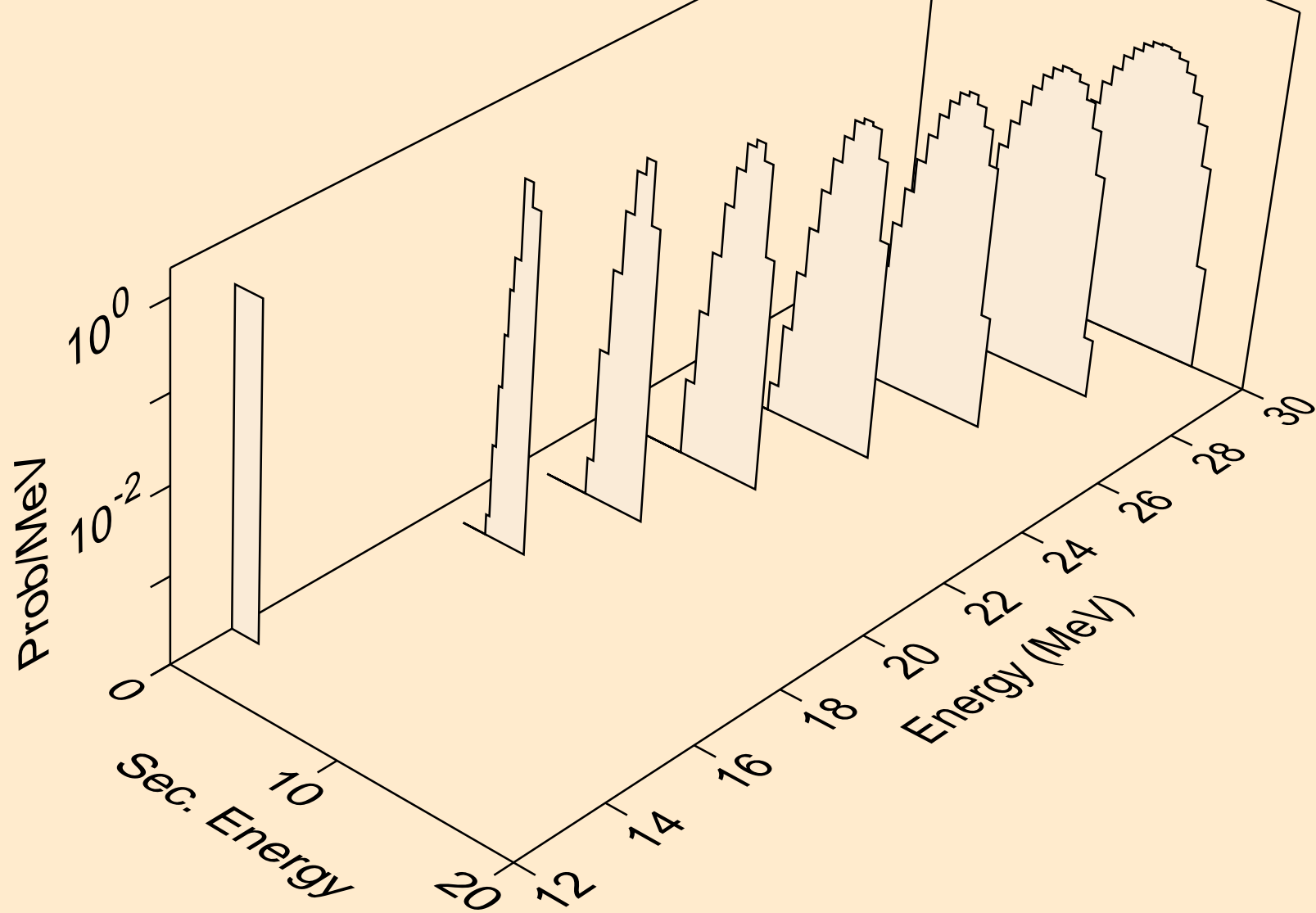

RA234 PROTON ACER TENDL-2021 LIBRARY; T=0.K  
deuterons from (p,n\*)d

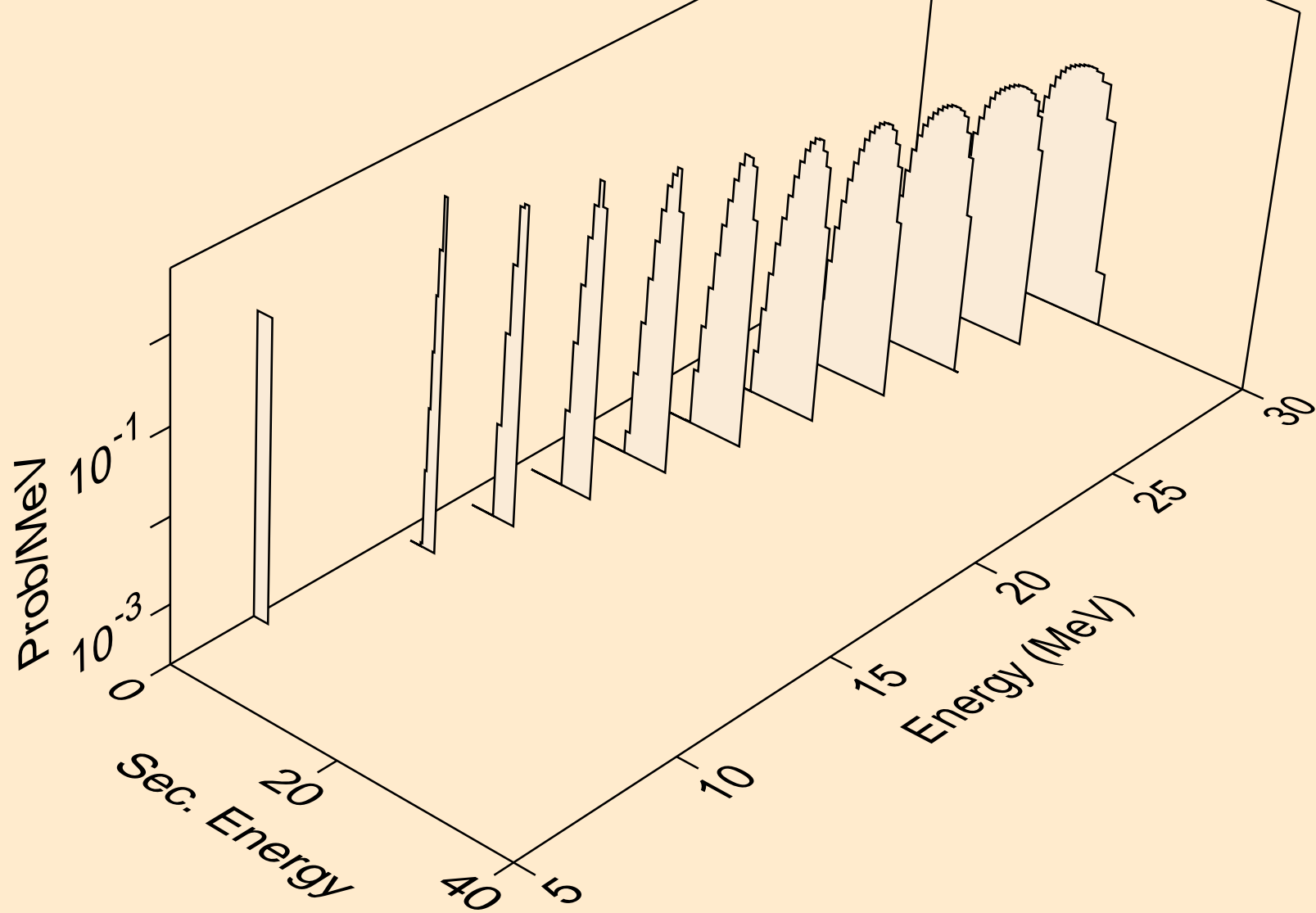

RA234 PROTON ACER TENDL-2021 LIBRARY; T=0.K  
deuterons from (p,d)

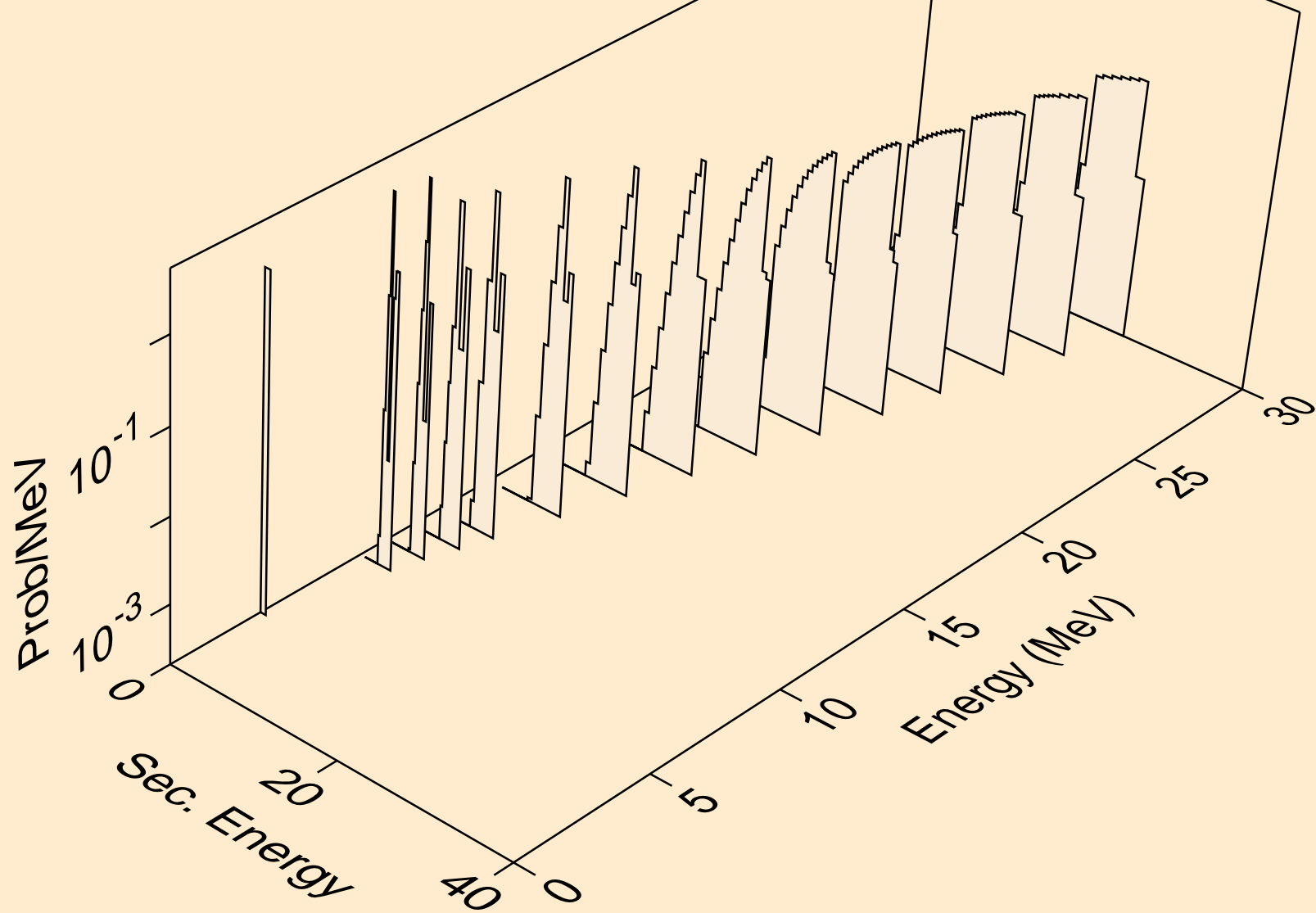

RA234 PROTON ACER TENDL-2021 LIBRARY; T=0.K  
tritons from (p,x)

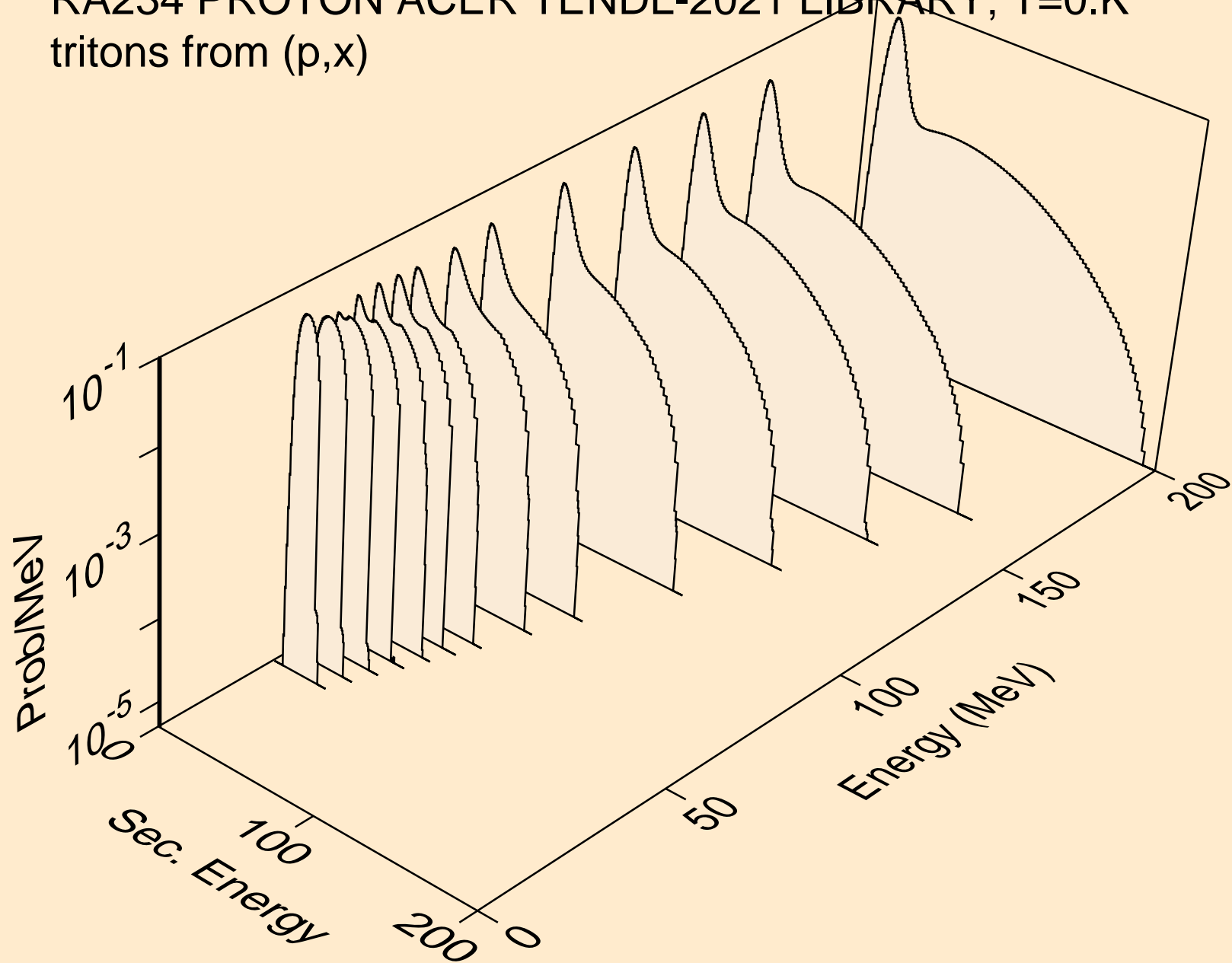



RA234 PROTON ACER TENDL-2021 LIBRARY; T=0.K  
tritons from (p,n\*)t

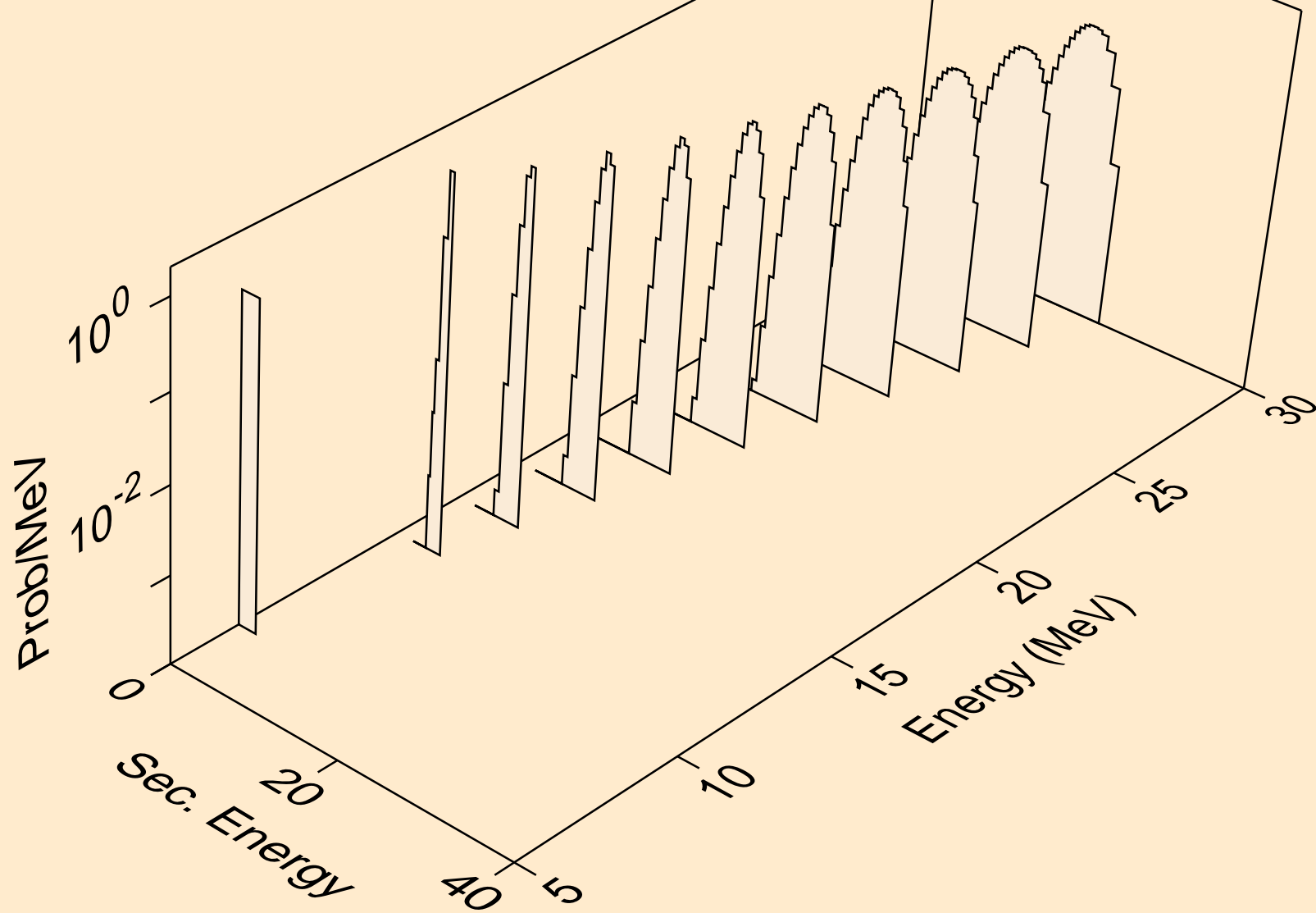

RA234 PROTON ACER TENDL-2021 LIBRARY; T=0.K  
tritons from (p,t)

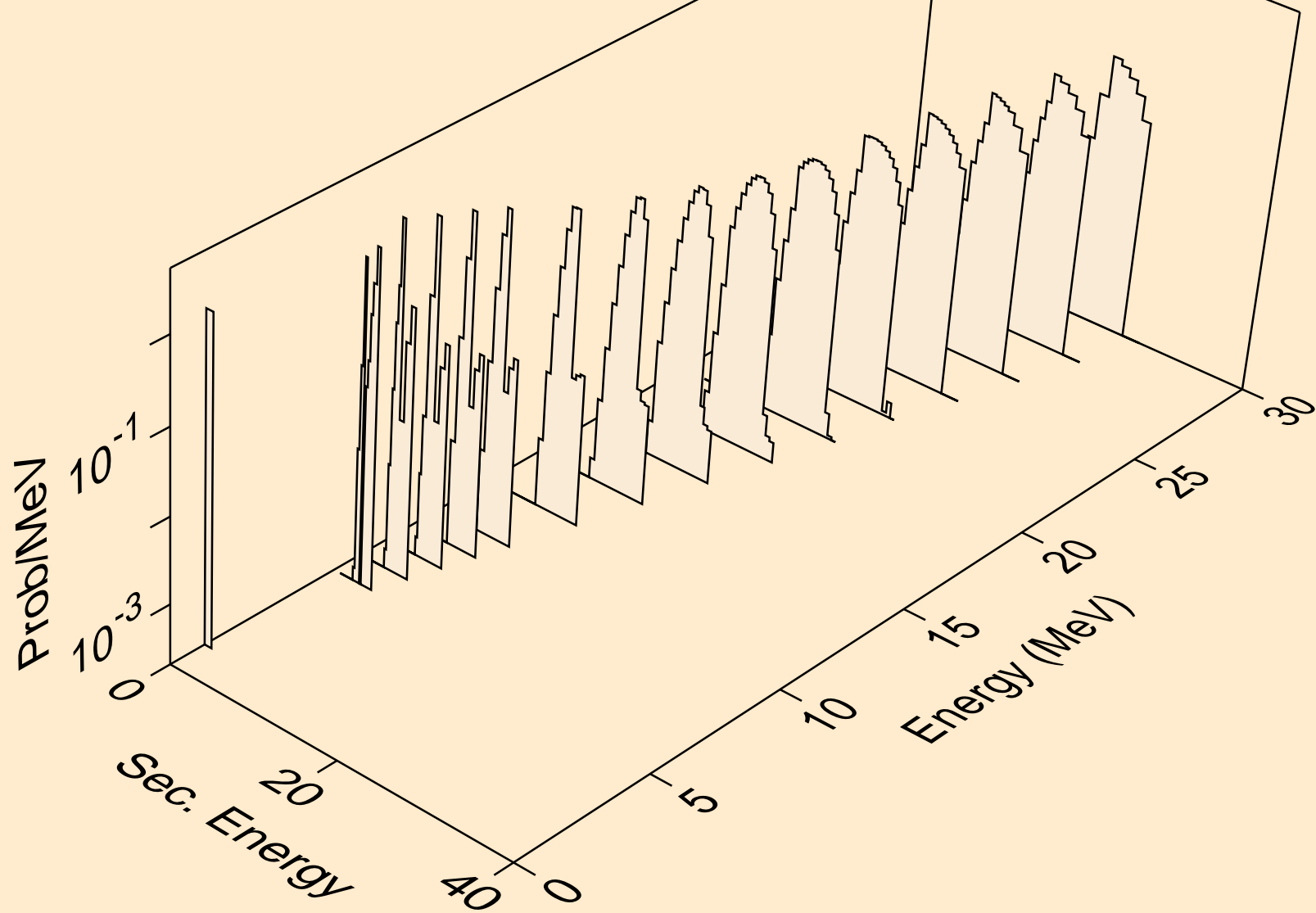

RA234 PROTON ACER TENDL-2021 LIBRARY; T=0.K  
he3s from (p,x)

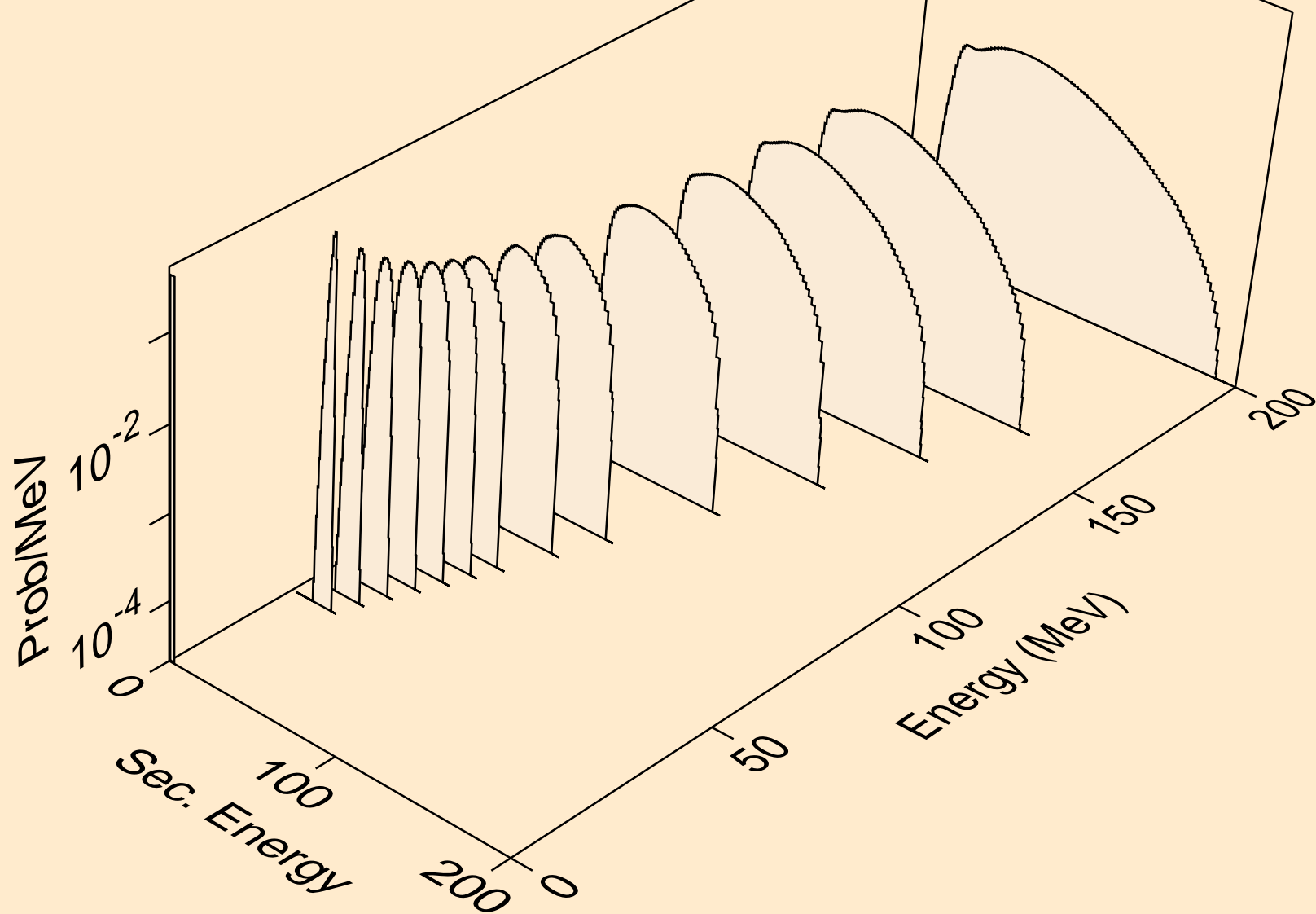

RA234 PROTON ACER TENDL-2021 LIBRARY; T=0.K  
he3s from (p,n\*)he3

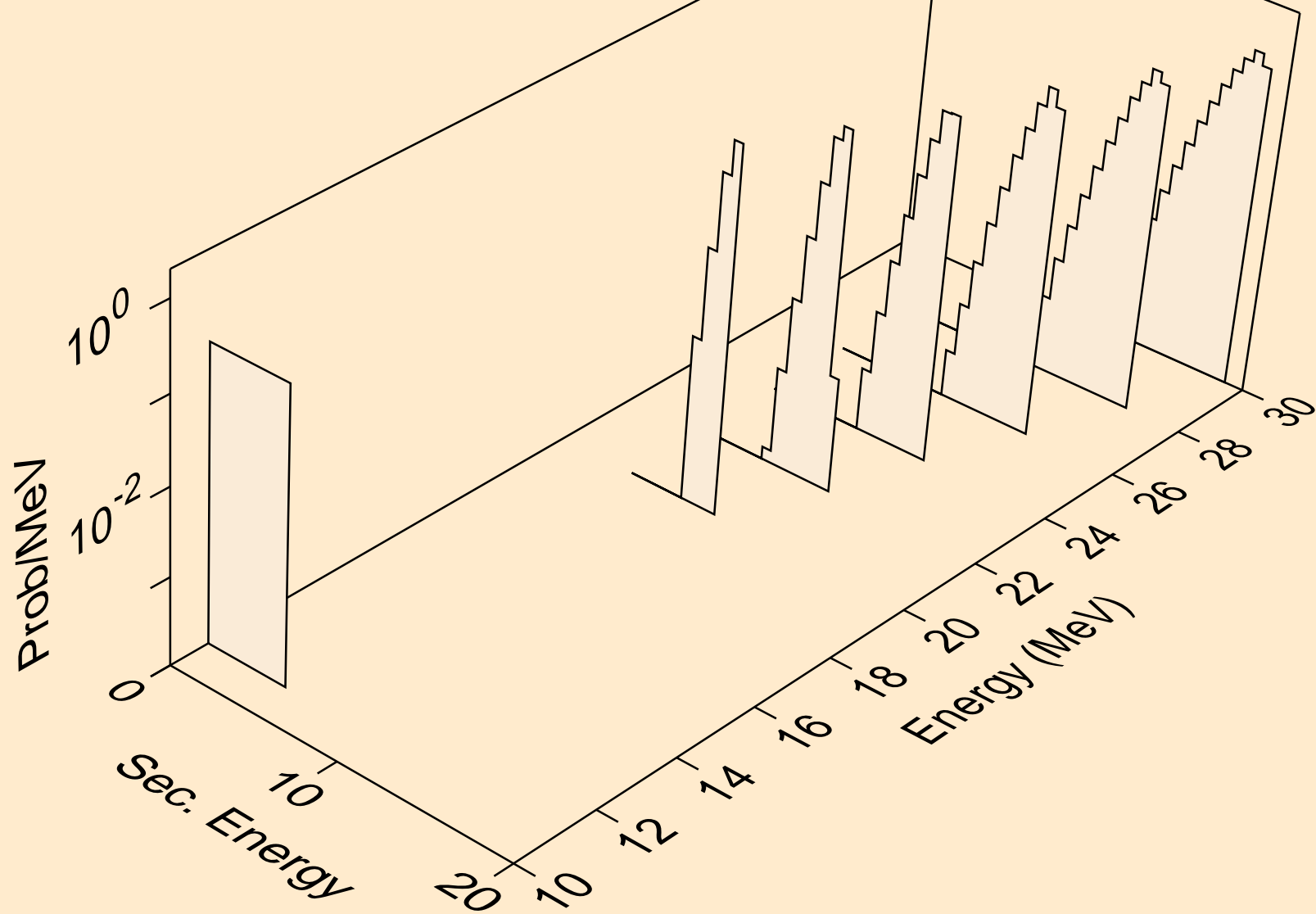

RA234 PROTON ACER TENDL-2021 LIBRARY; T=0.K  
he3s from (p,he3)

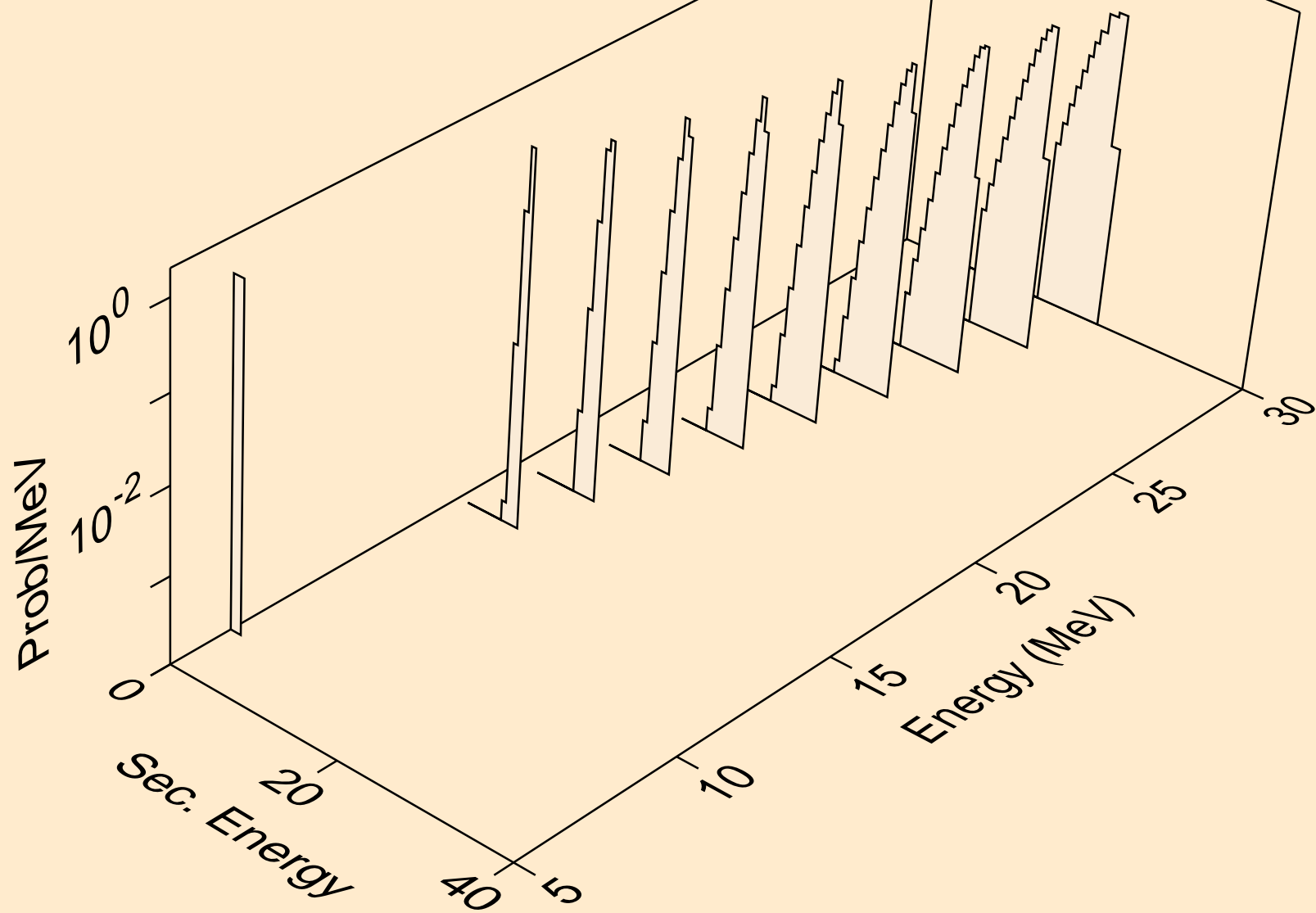

RA234 PROTON ACER TENDL-2021 LIBRARY; T=0.K  
alphas from (p,x)

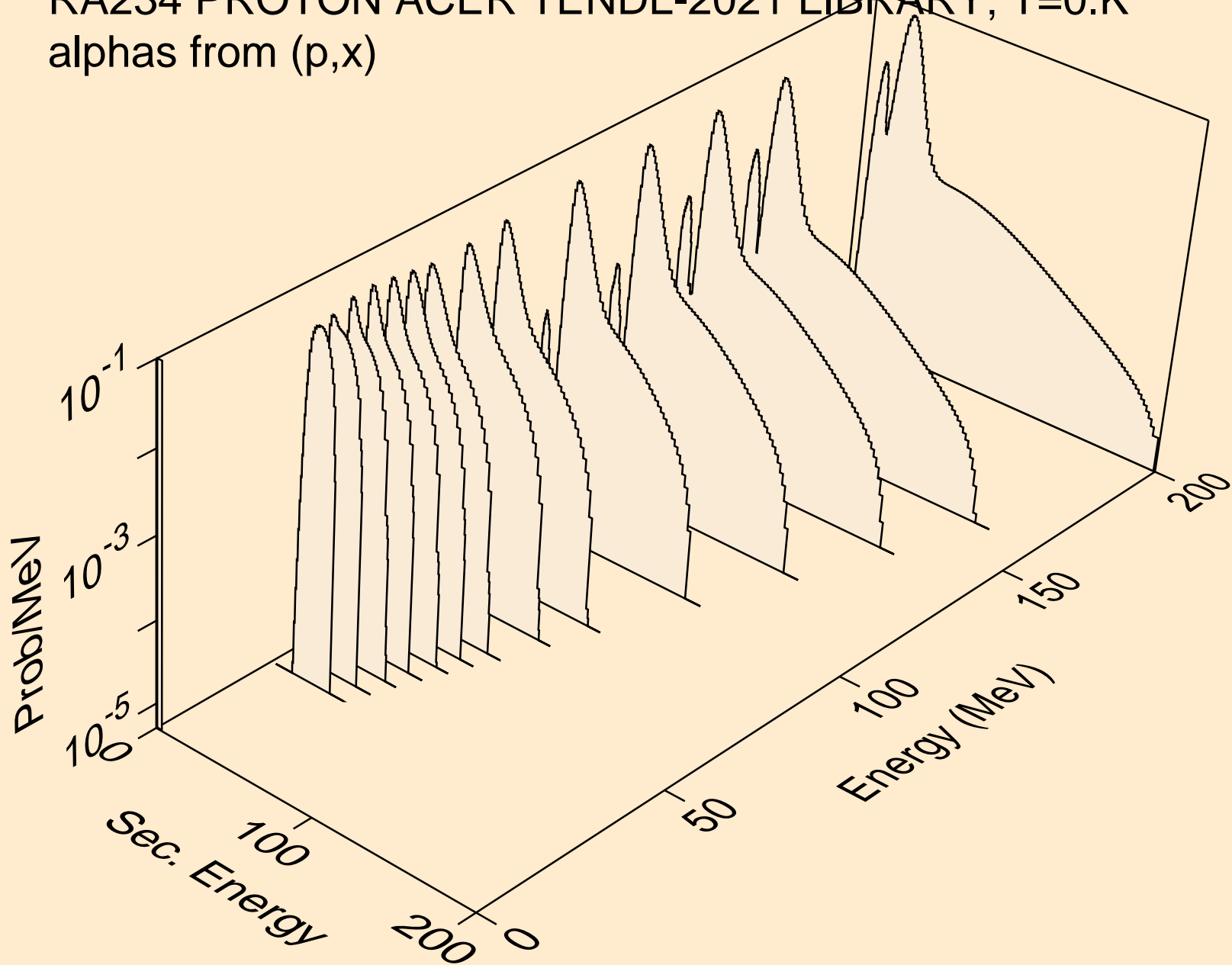

RA234 PROTON ACER TENDL-2021 LIBRARY; T=0.K  
alphas from (p,n\*)a

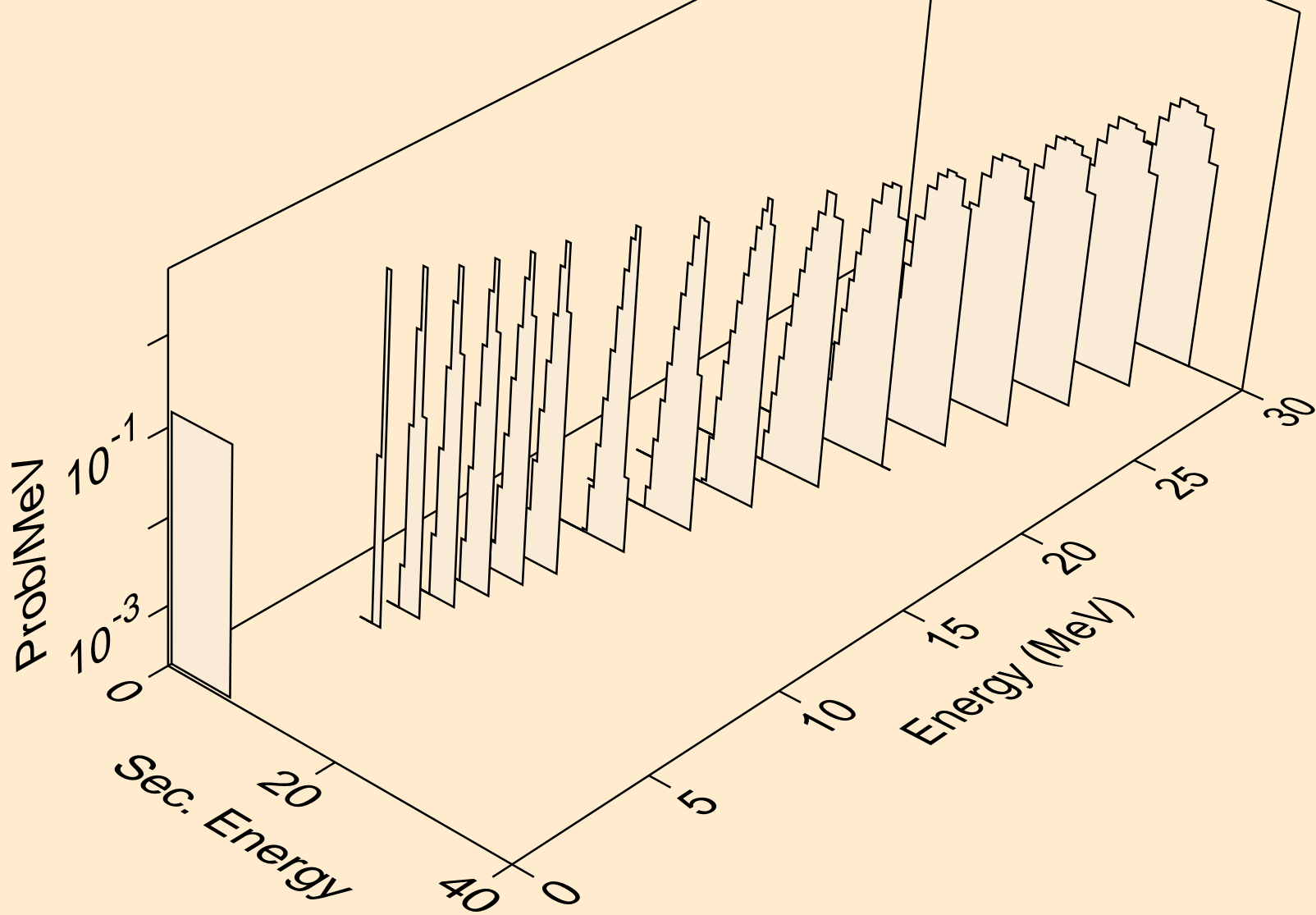

RA234 PROTON ACER TENDL-2021 LIBRARY; T=0.K  
alphas from (p,2n)a

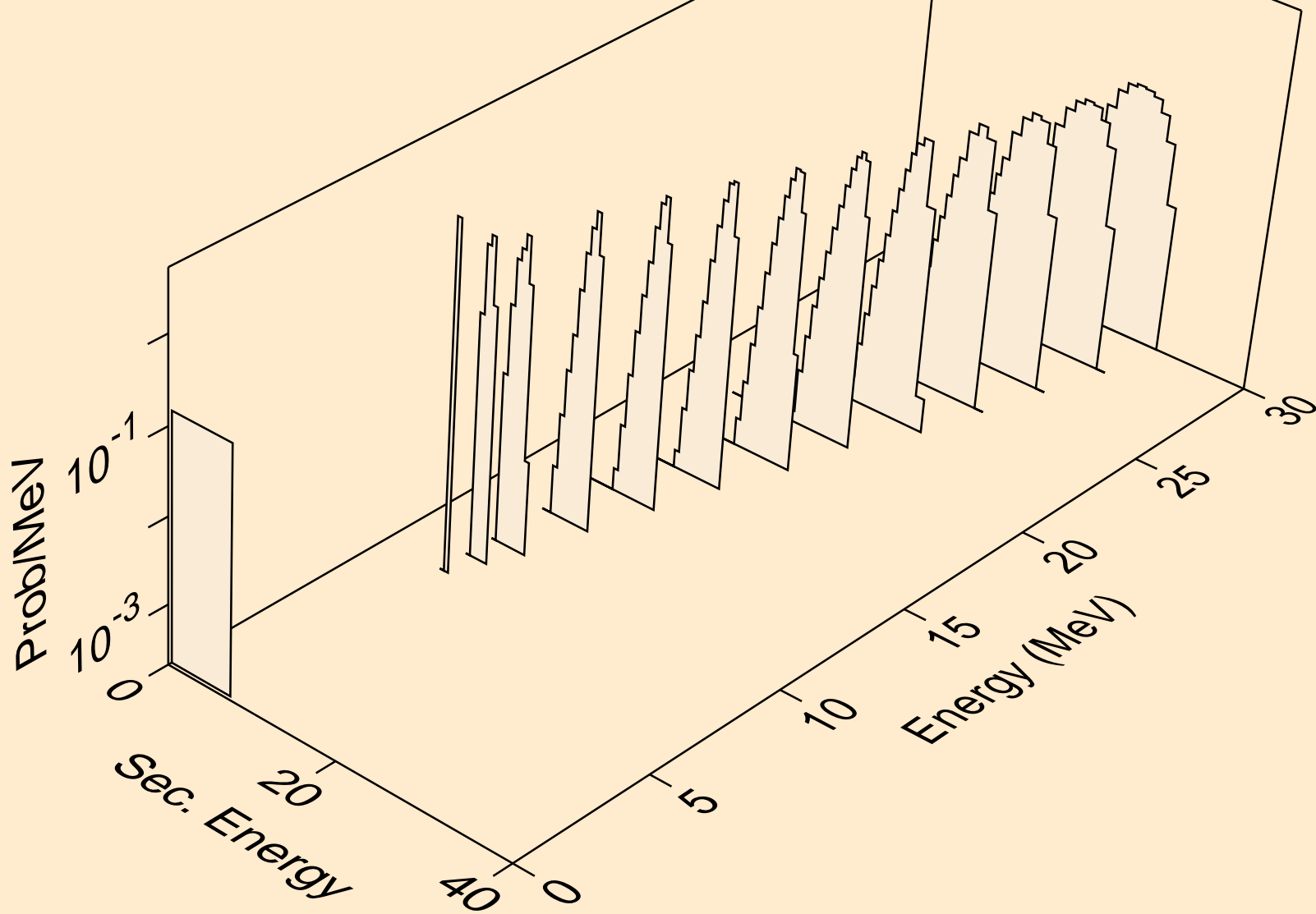



RA234 PROTON ACER TENDL-2021 LIBRARY; T=0.K  
alphas from (p,3n)a

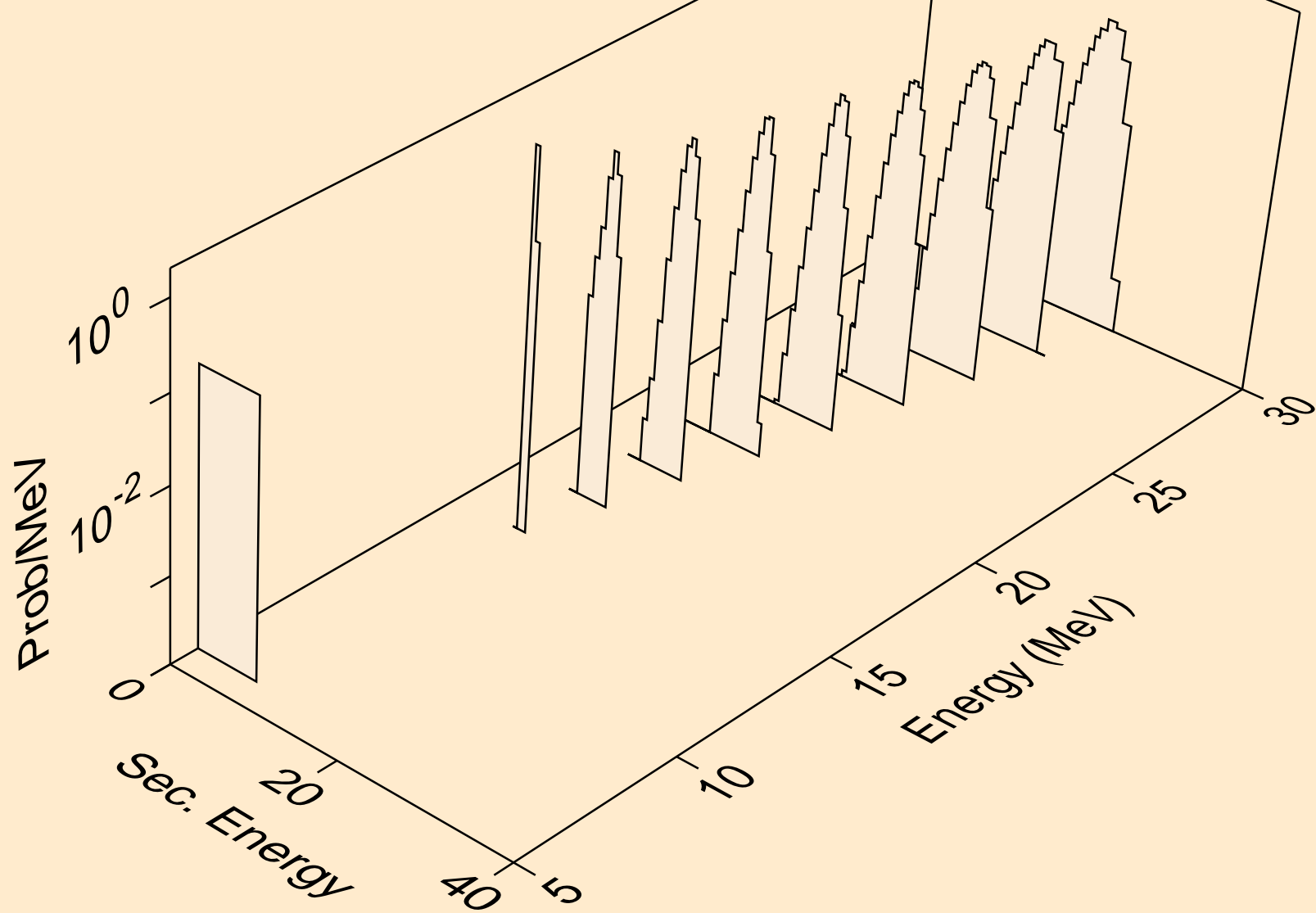

RA234 PROTON ACER TENDL-2021 LIBRARY; T=0.K  
alphas from (p,a)

