

RE171 PROTON ACER TENDL-2021 LIBRARY; T=0.K  
Principal cross sections

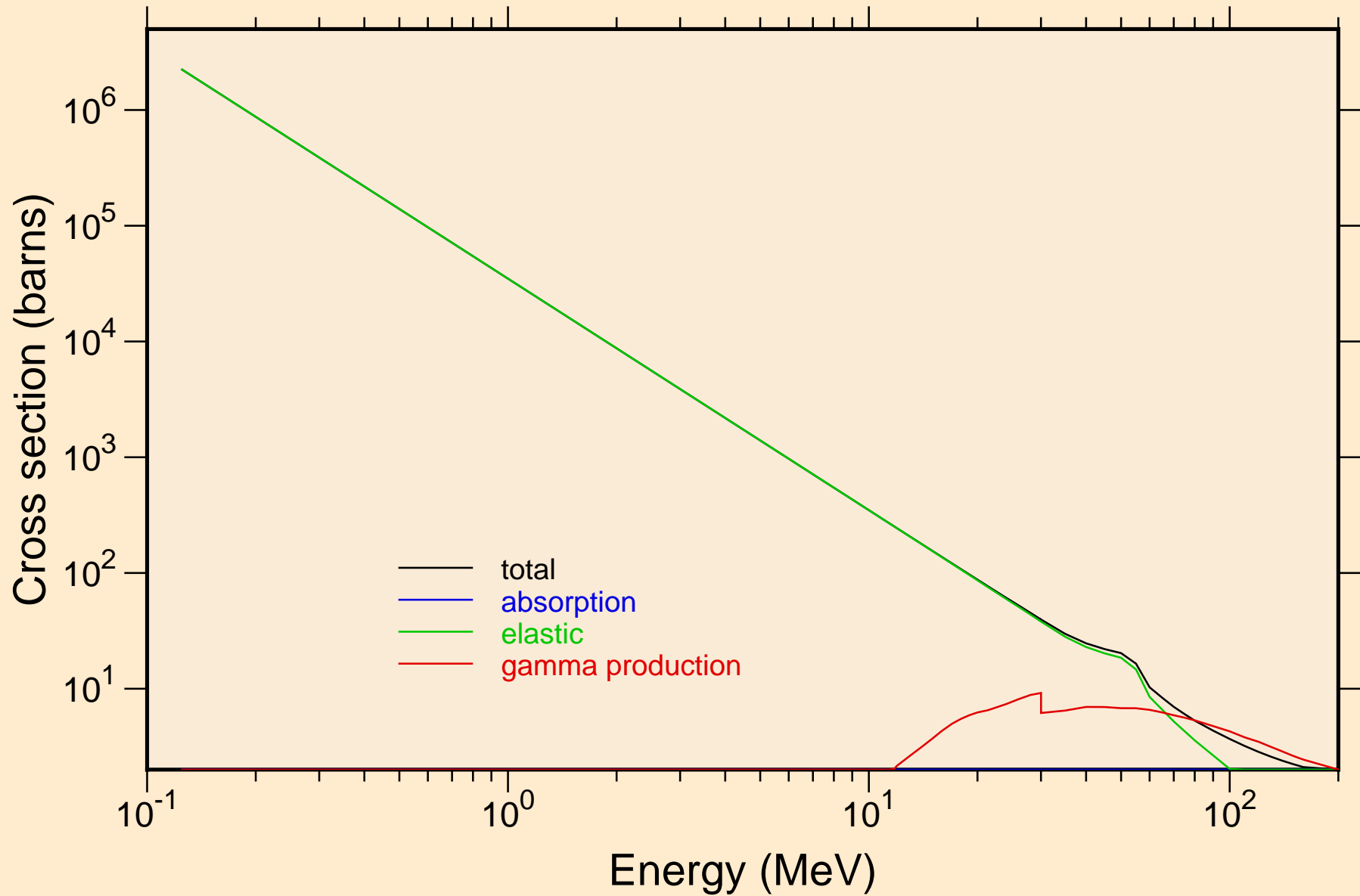

RE171 PROTON ACER TENDL-2021 LIBRARY; T=0.K

Heating

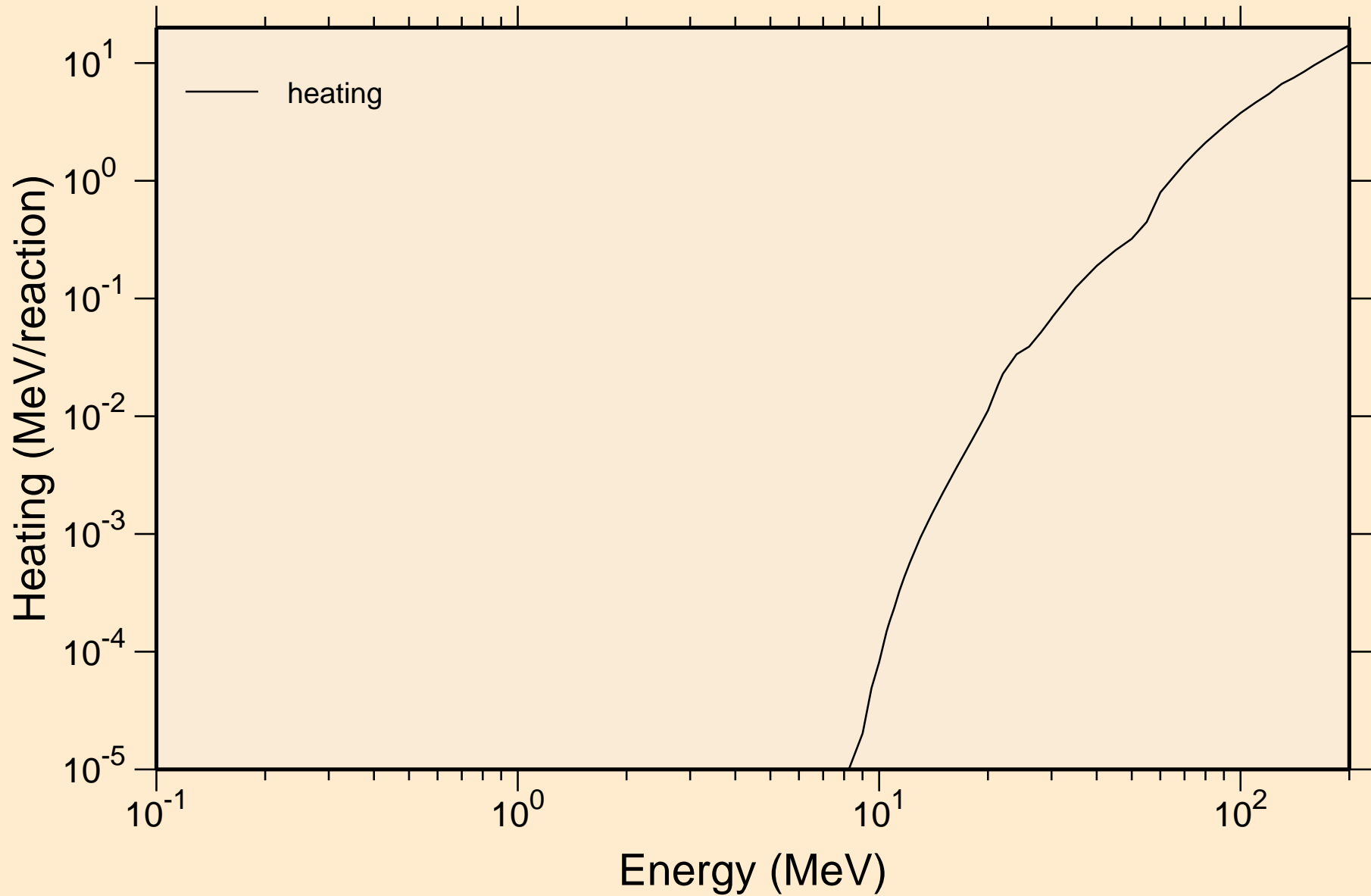

# RE171 PROTON ACER TENDL-2021 LIBRARY; T=0.K

## Principal cross sections

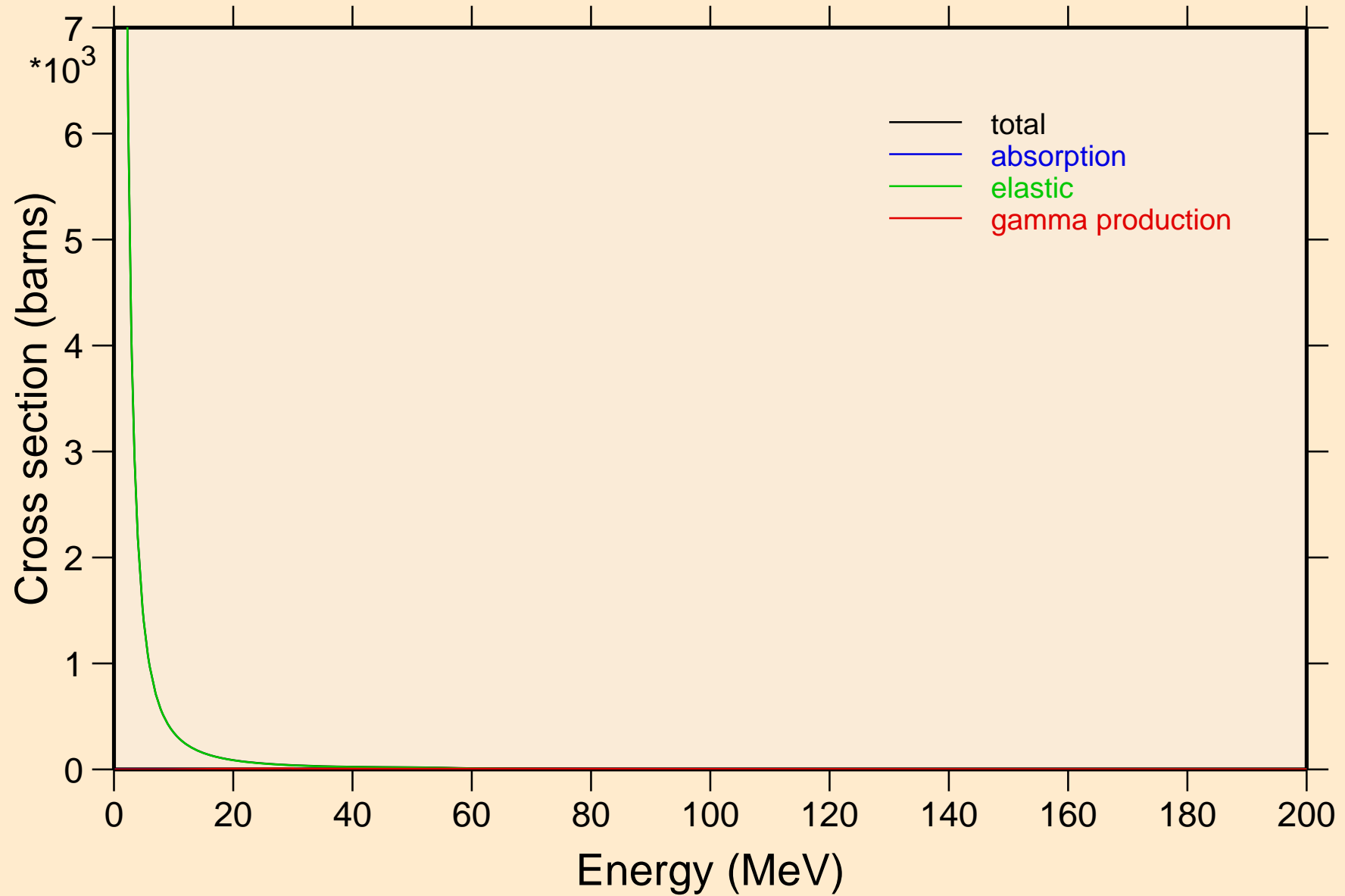

RE171 PROTON ACER TENDL-2021 LIBRARY; T=0.K

Heating

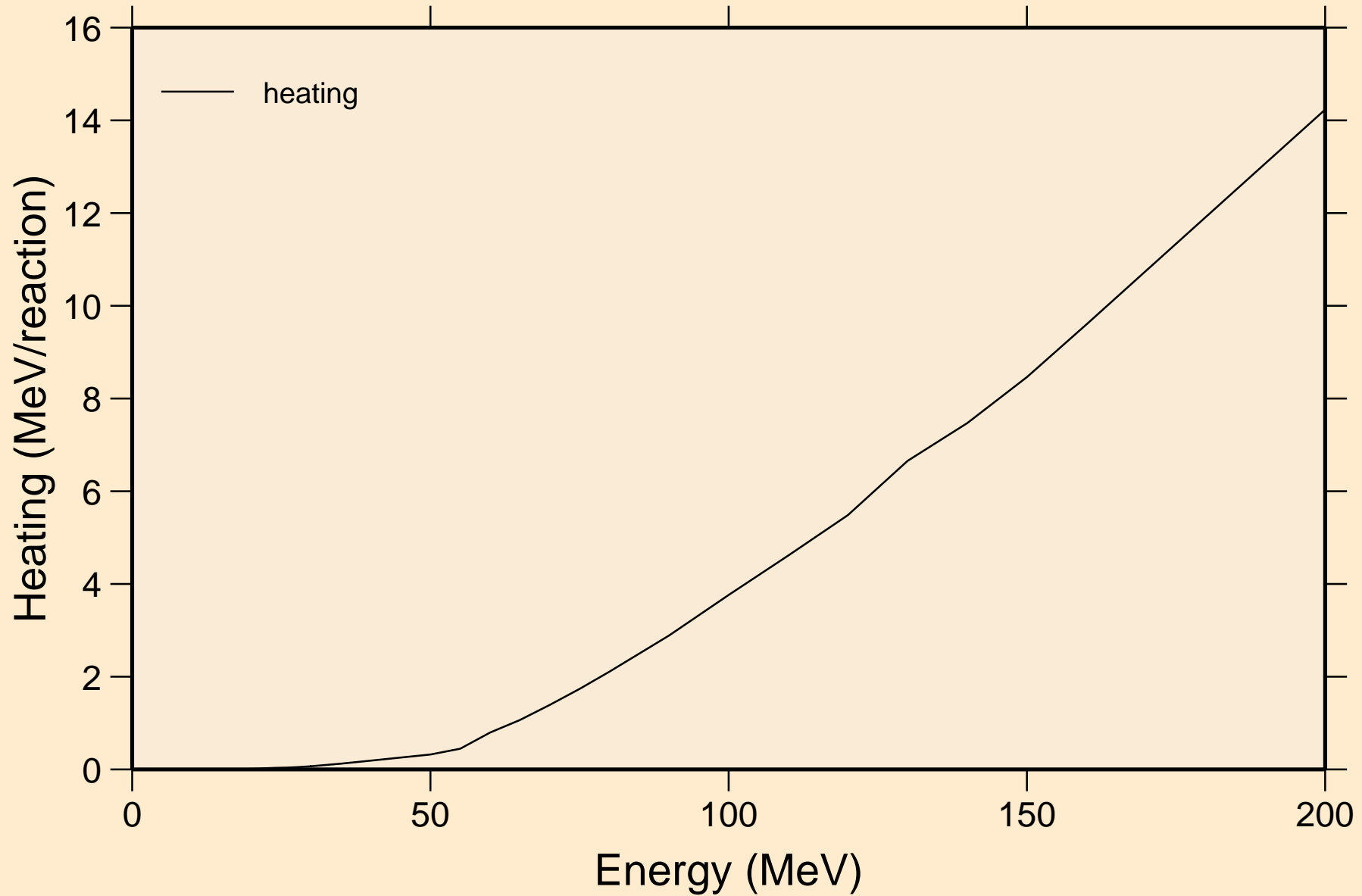

# RE171 PROTON ACER TENDL-2021 LIBRARY; T=0.K

## Threshold reactions

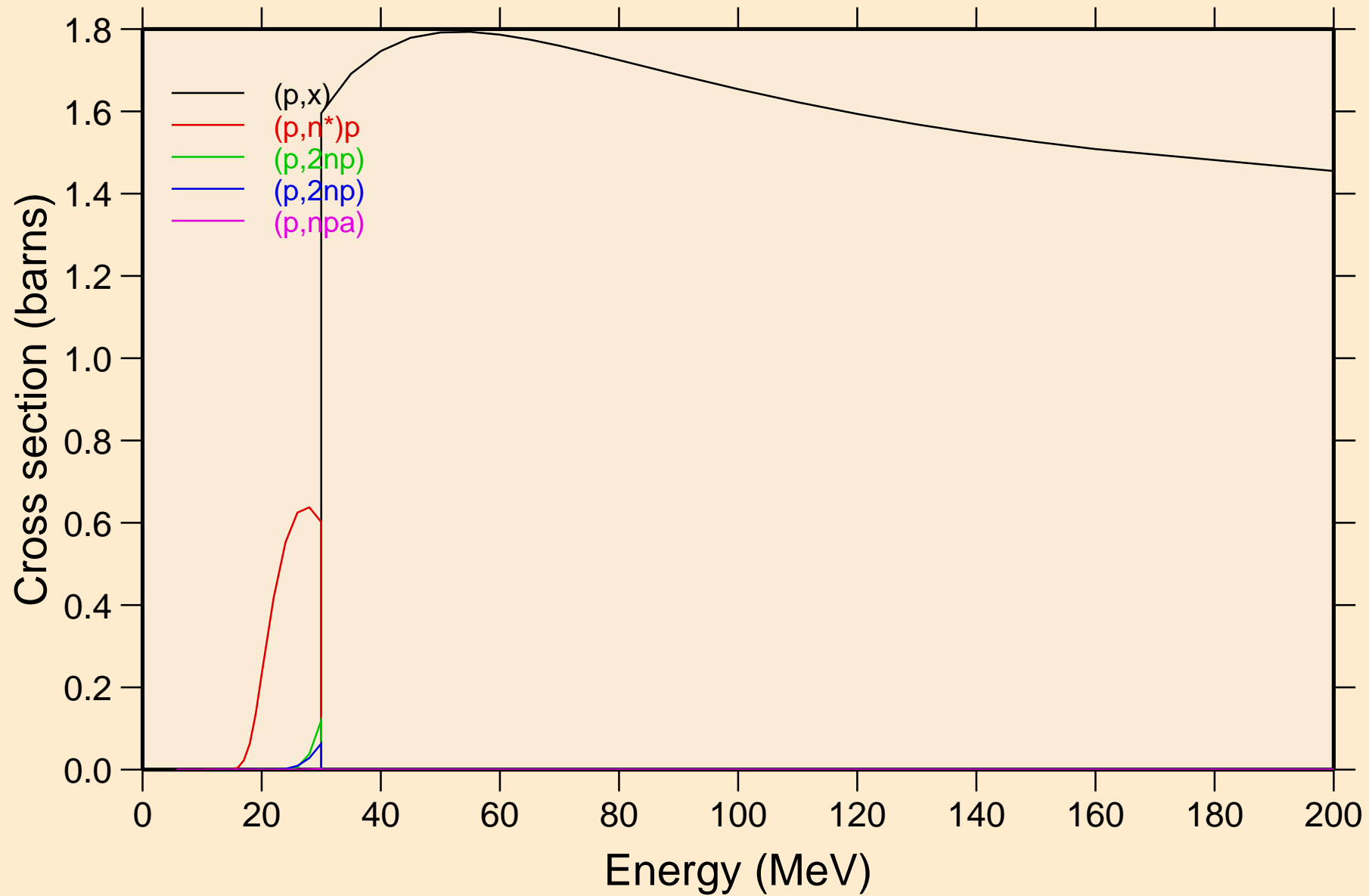

# RE171 PROTON ACER TENDL-2021 LIBRARY; T=0.K

## Threshold reactions

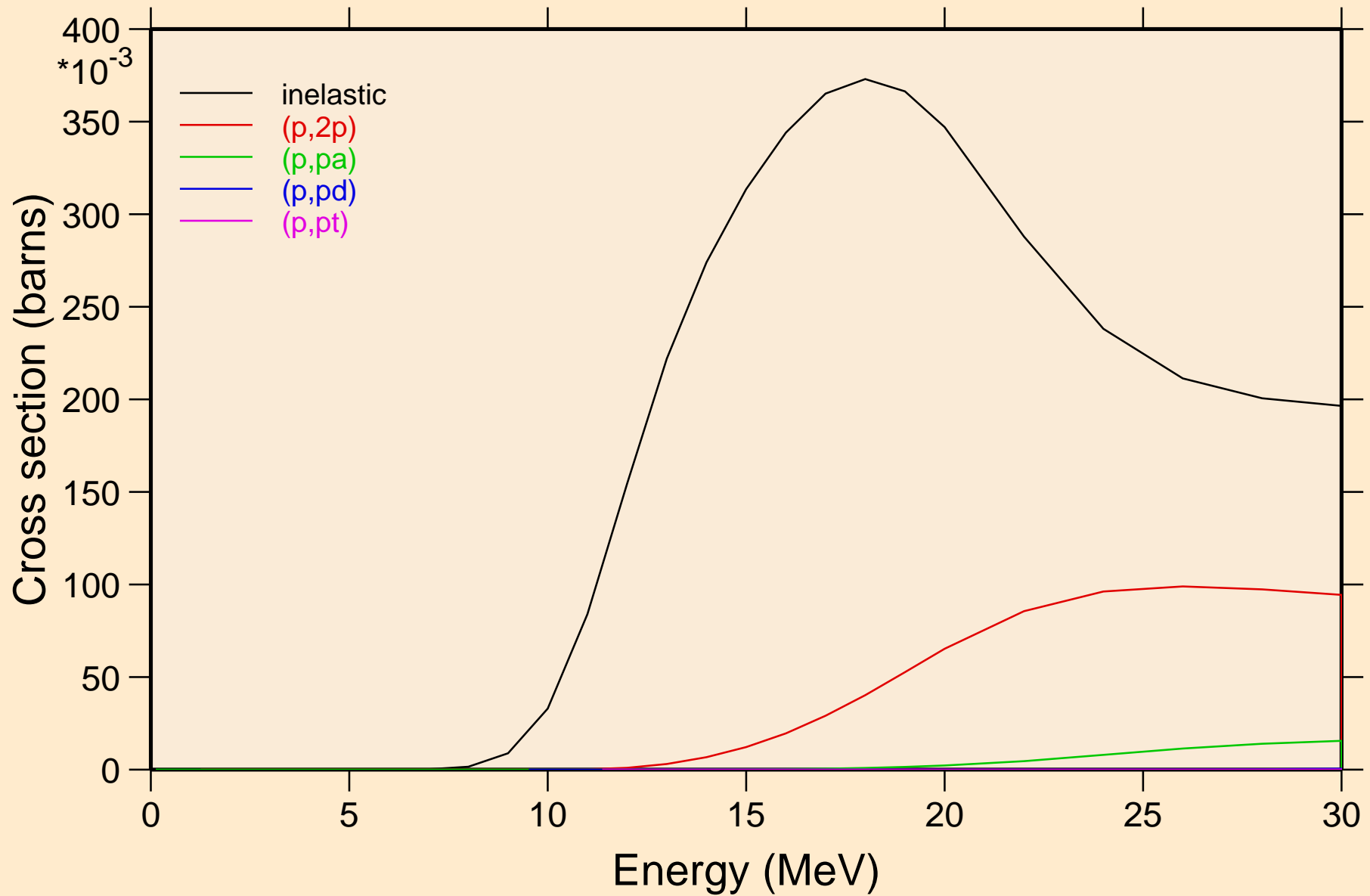

RE171 PROTON ACER TENDL-2021 LIBRARY; T=0.K  
Threshold reactions

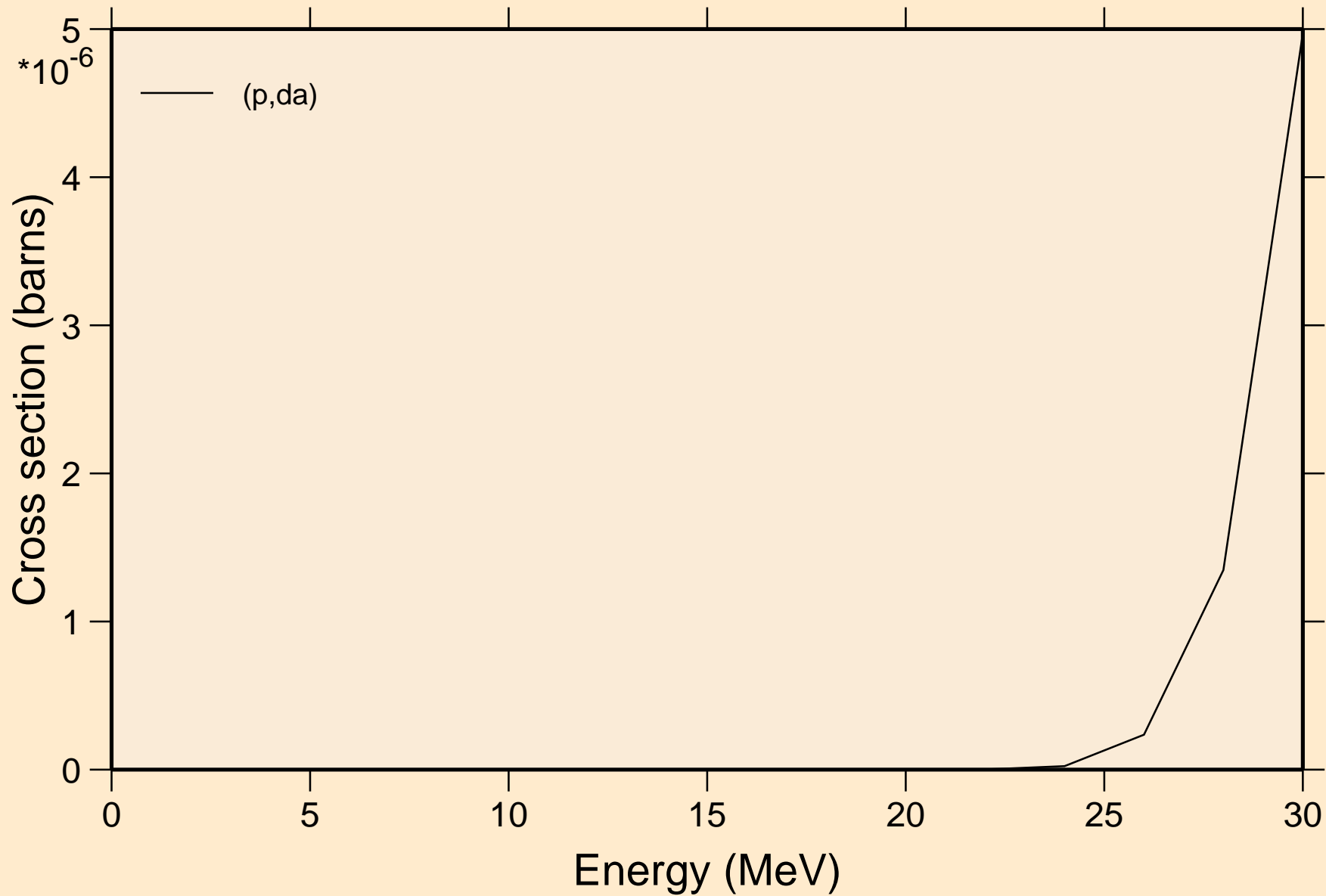

RE171 PROTON ACER TENDL-2021 LIBRARY; T=0.K  
angular distribution for elastic

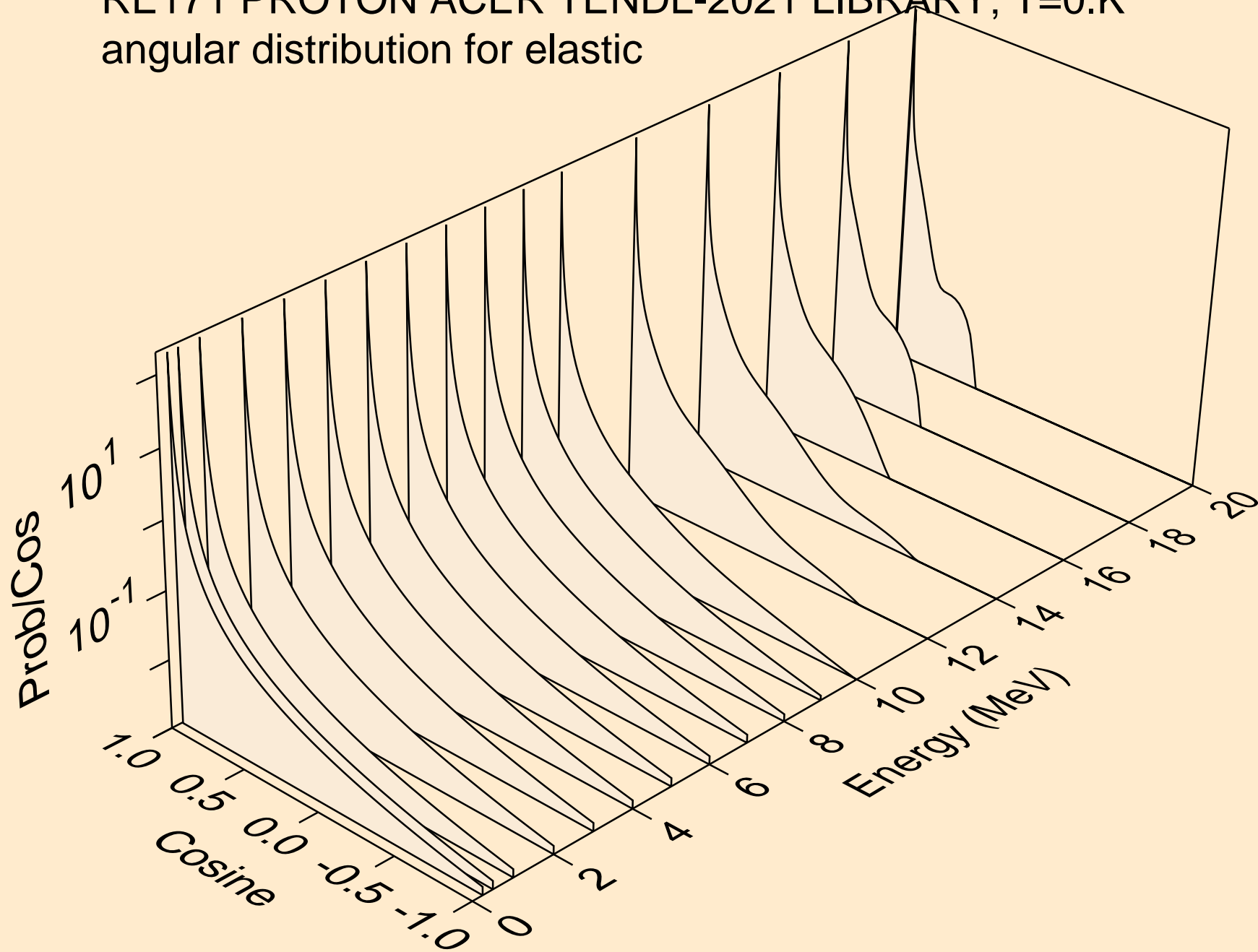



RE171 PROTON ACER TENDL-2021 LIBRARY; T=0.K  
angular distribution for elastic

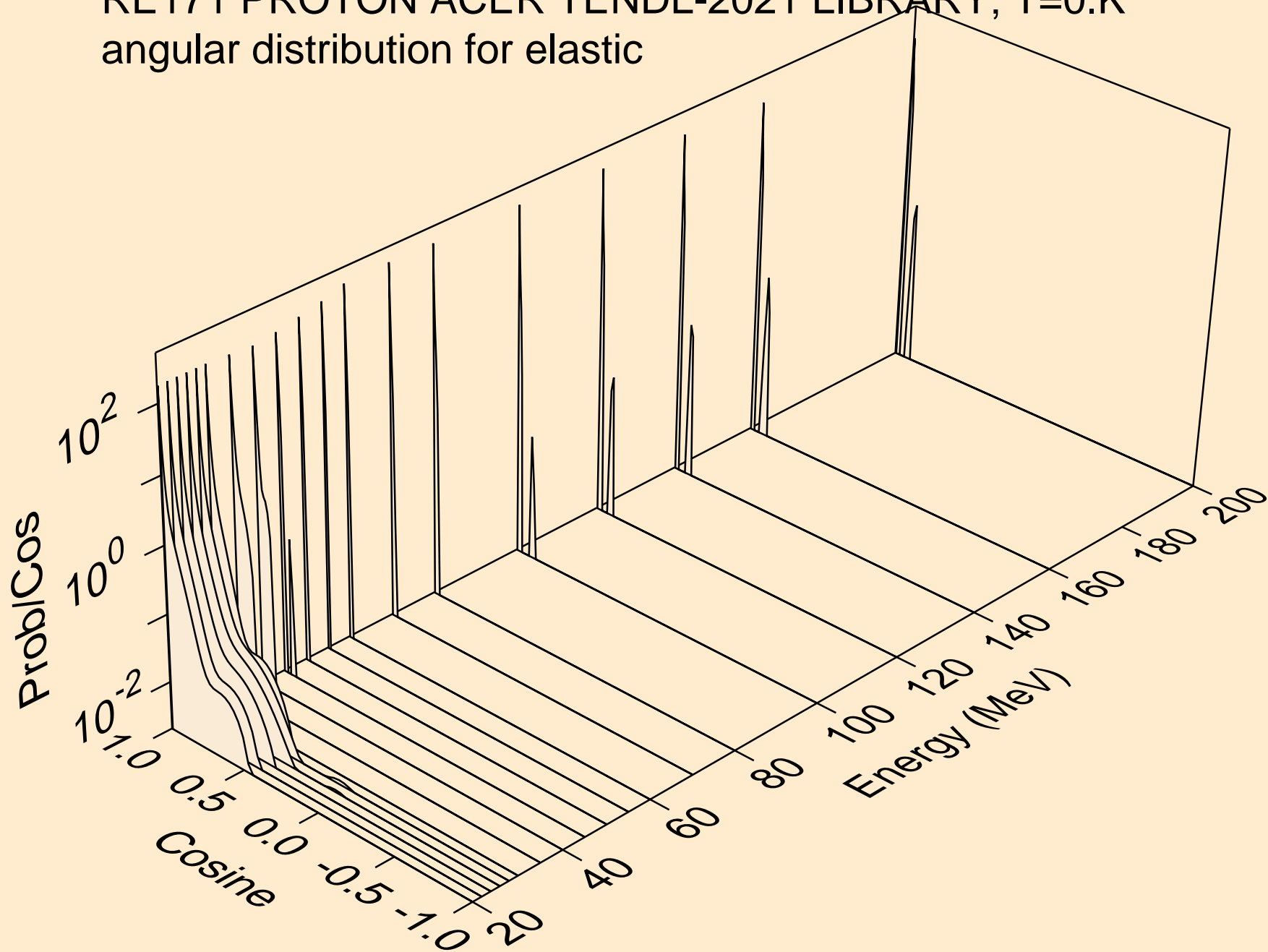

RE171 PROTON ACER TENDL-2021 LIBRARY; T=0.K  
Proton emission for (p,x)

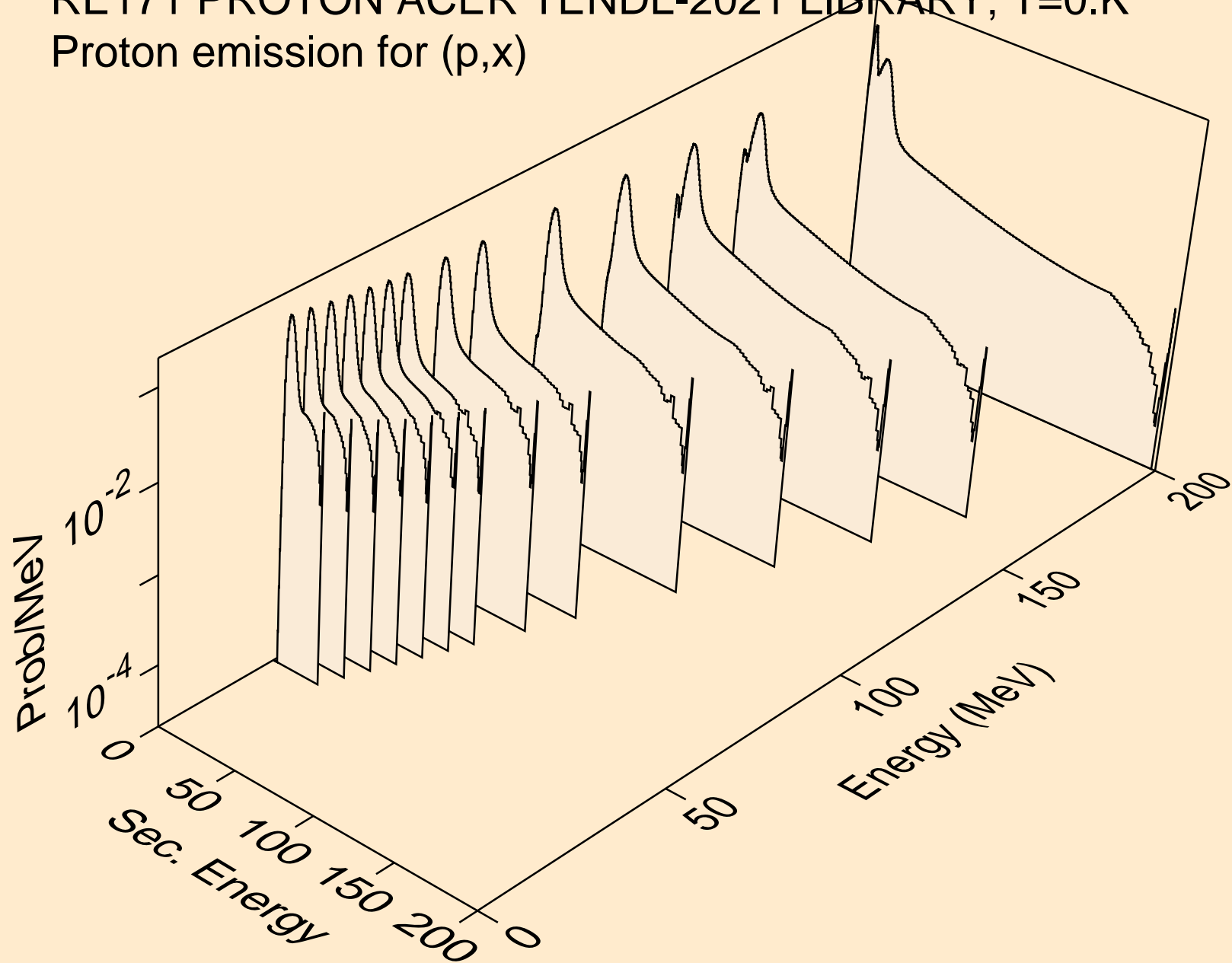

RE171 PROTON ACER TENDL-2021 LIBRARY; T=0.K  
Proton emission for (p,n\*)p

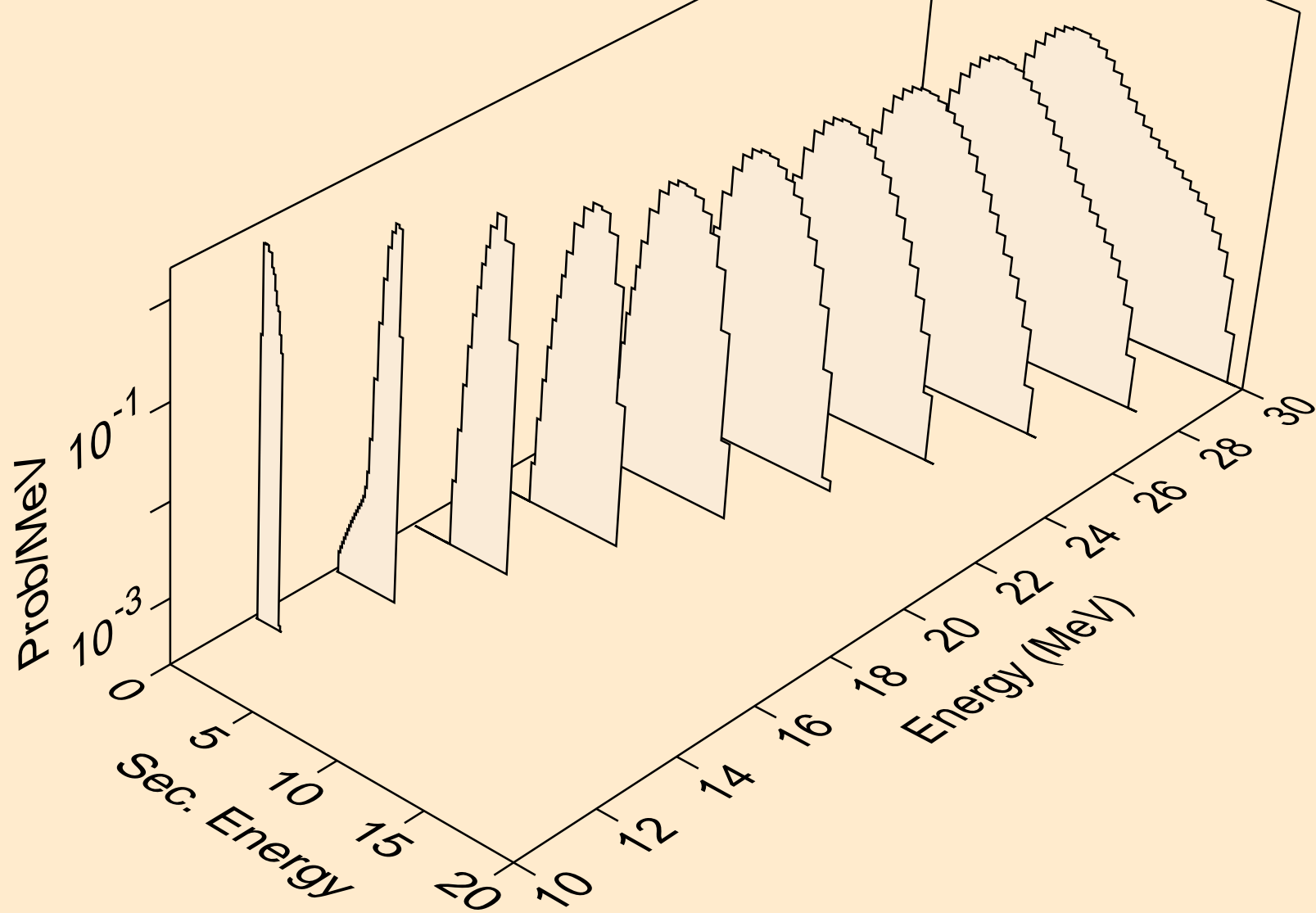

RE171 PROTON ACER TENDL-2021 LIBRARY; T=0.K  
Proton emission for (p,2np)

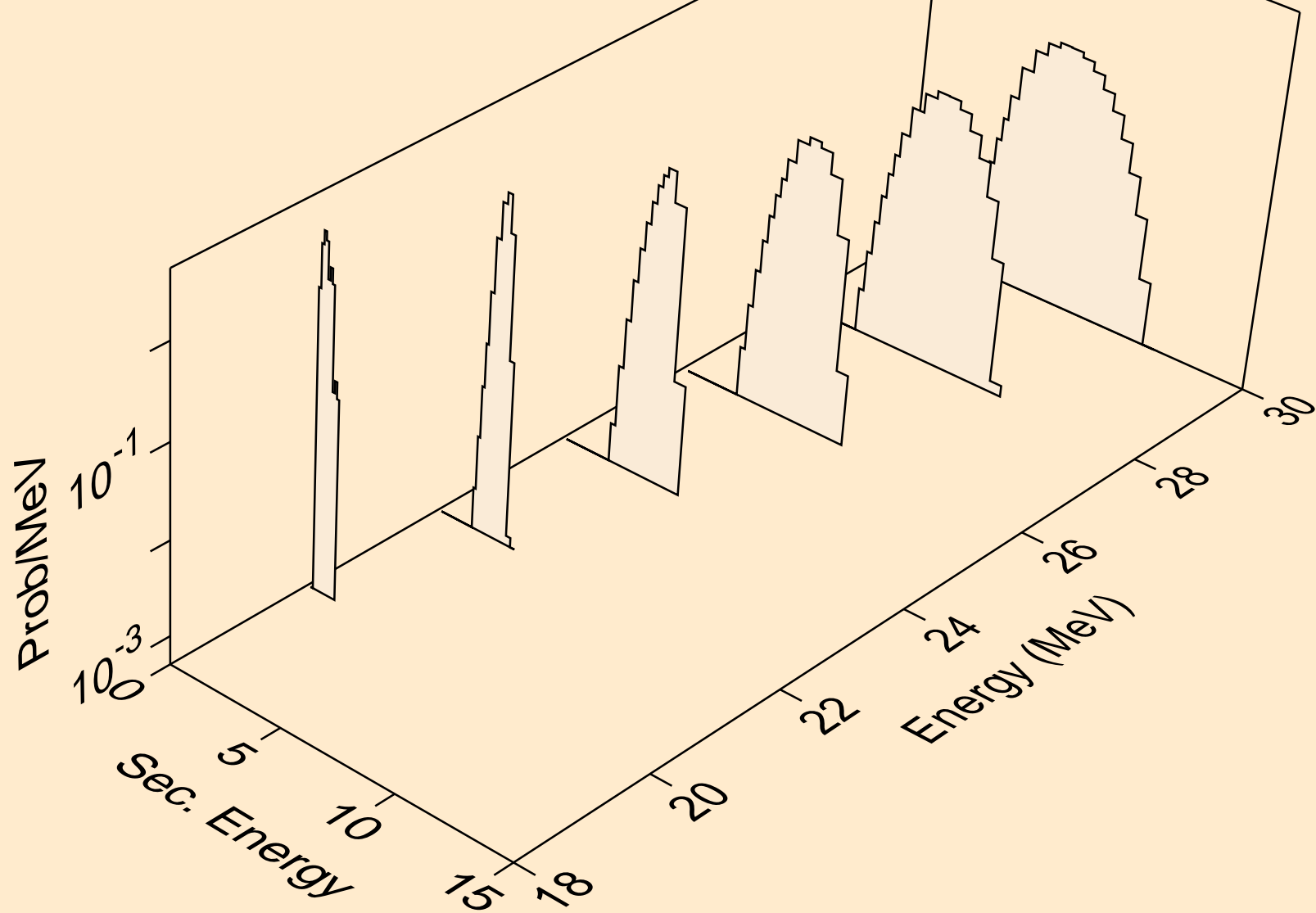

RE171 PROTON ACER TENDL-2021 LIBRARY; T=0.K  
Proton emission for (p,2np)

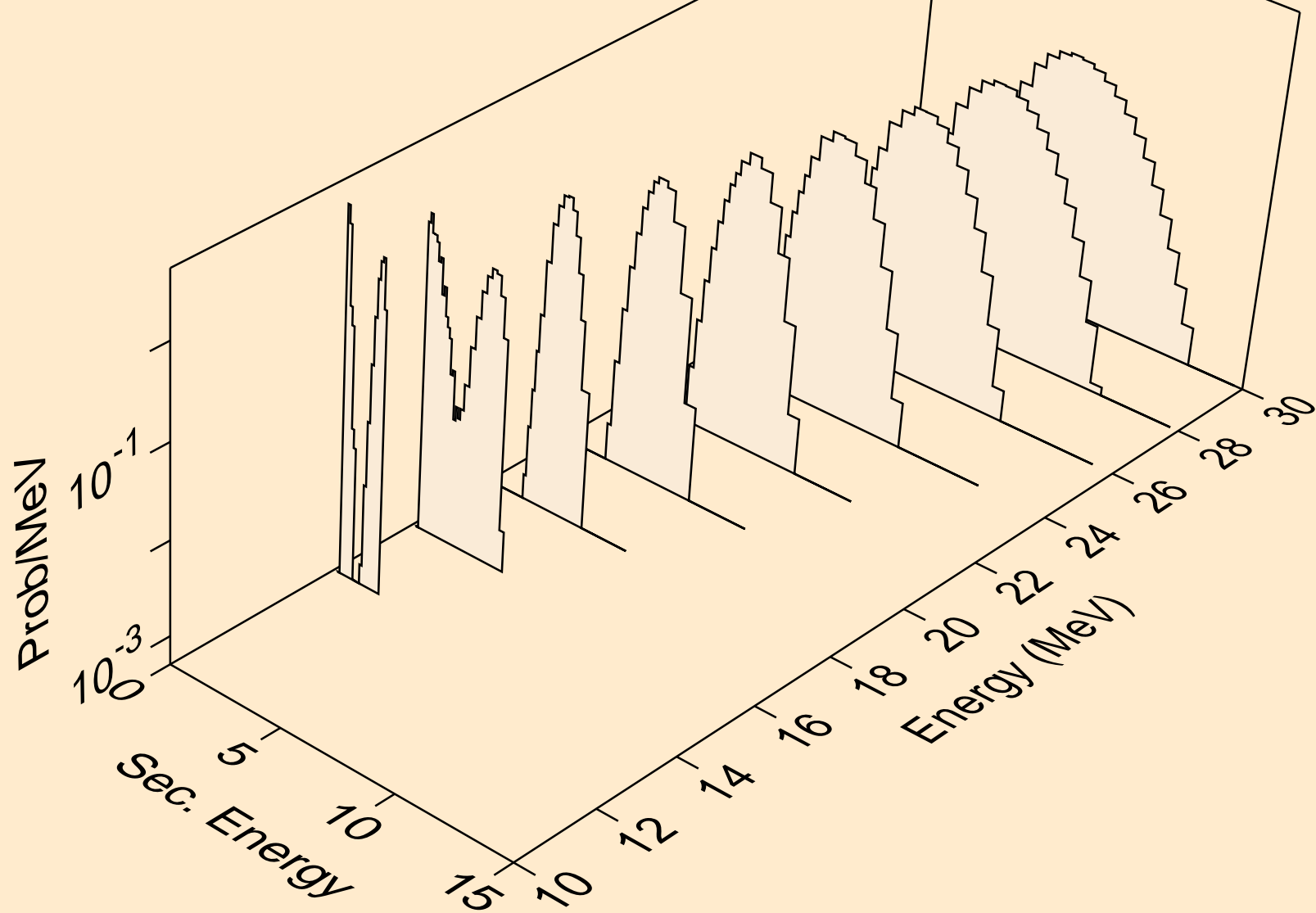

RE171 PROTON ACER TENDL-2021 LIBRARY; T=0.K  
Proton emission for (p,npa)

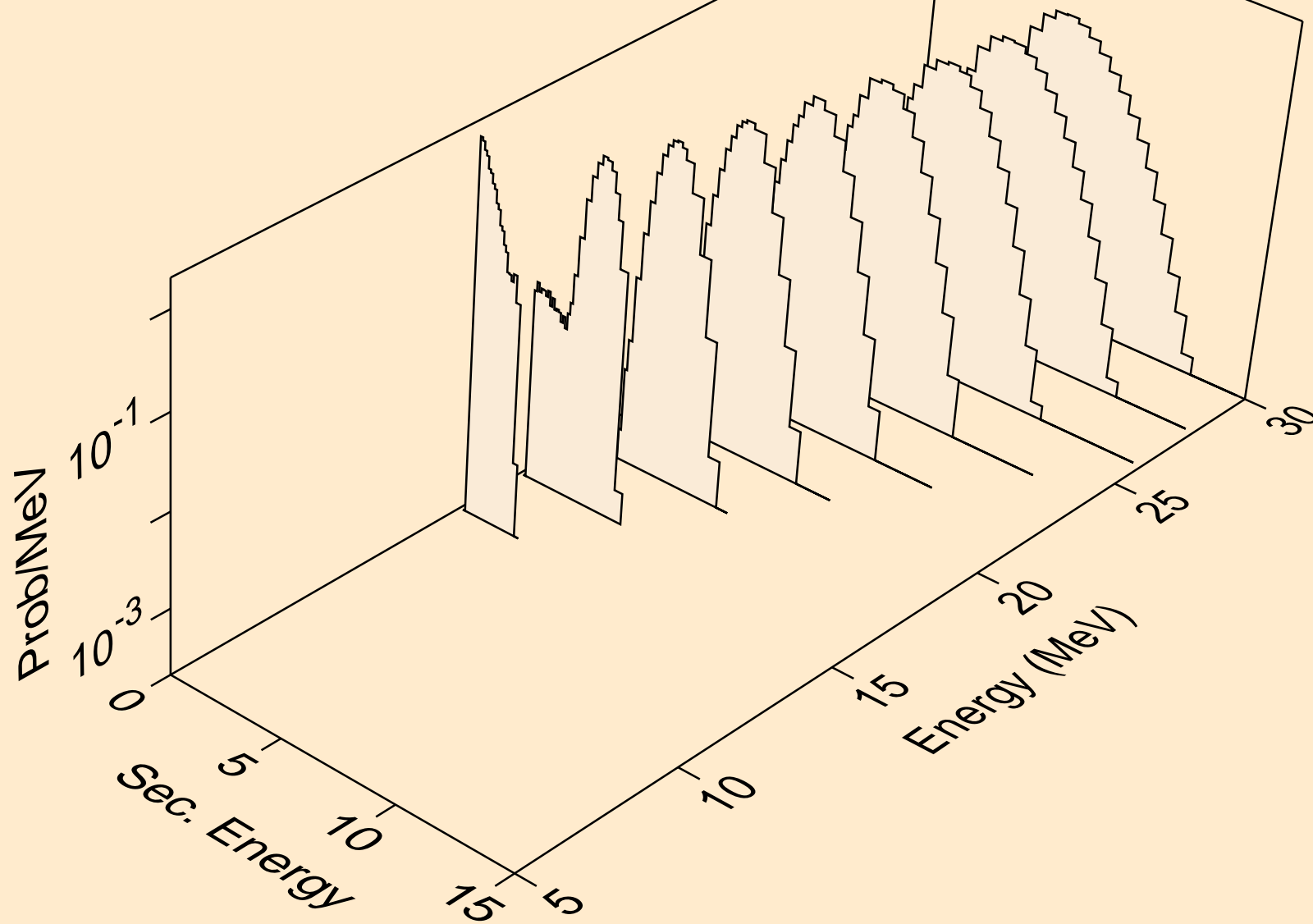

RE171 PROTON ACER TENDL-2021 LIBRARY; T=0.K  
Proton emission for inelastic

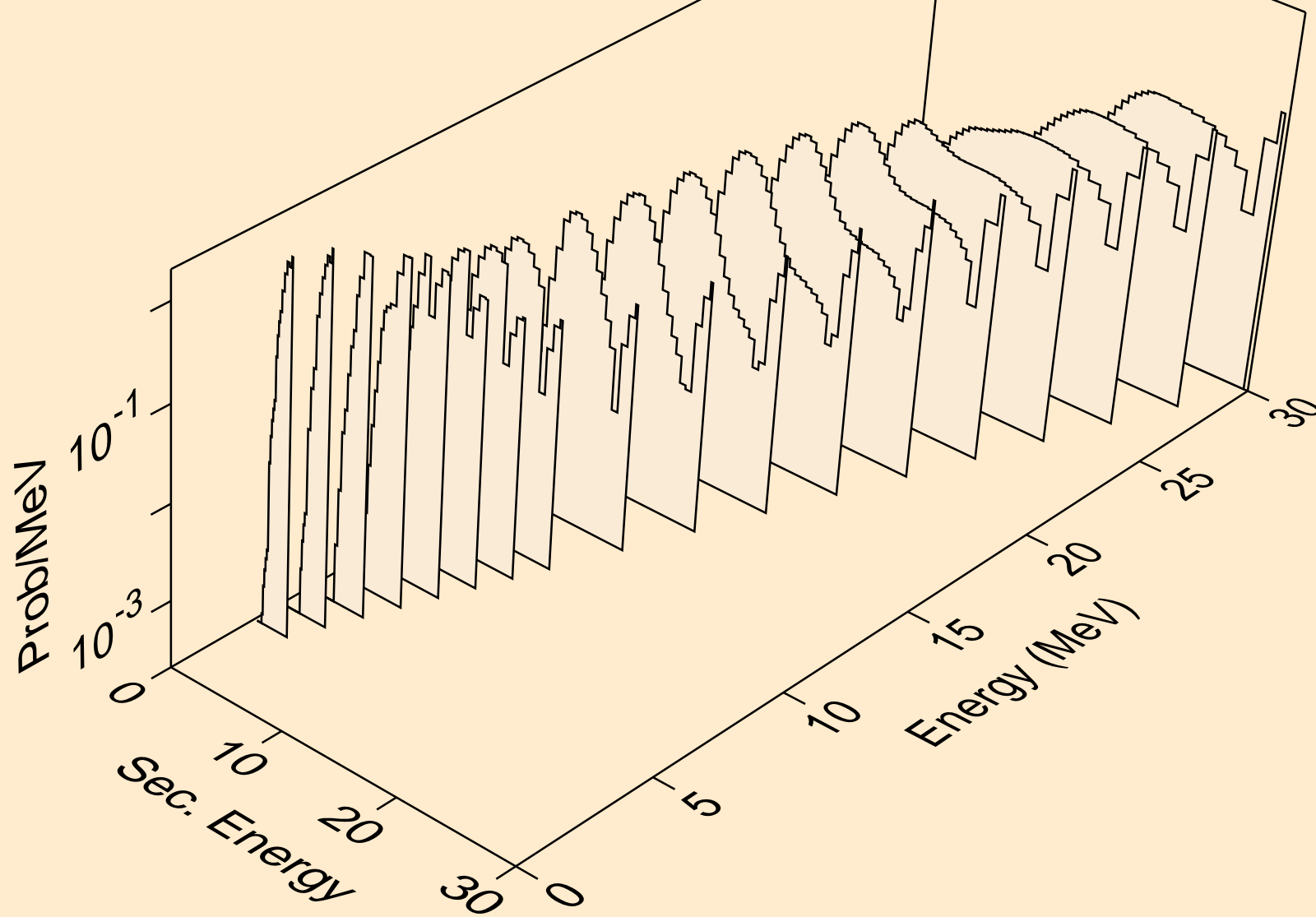

RE171 PROTON ACER TENDL-2021 LIBRARY; T=0.K  
Proton emission for (p,2p)

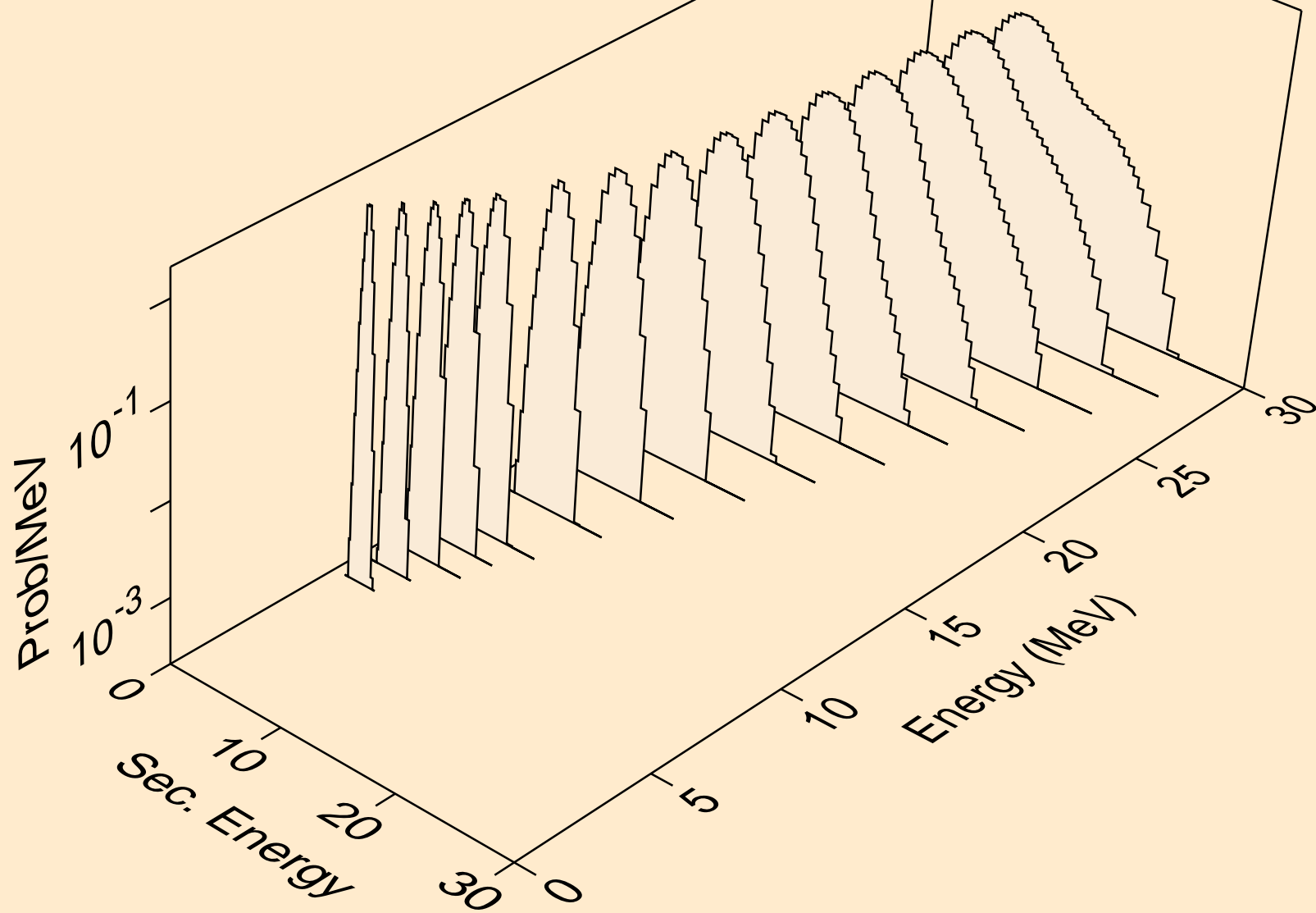



RE171 PROTON ACER TENDL-2021 LIBRARY; T=0.K  
Proton emission for (p,pa)

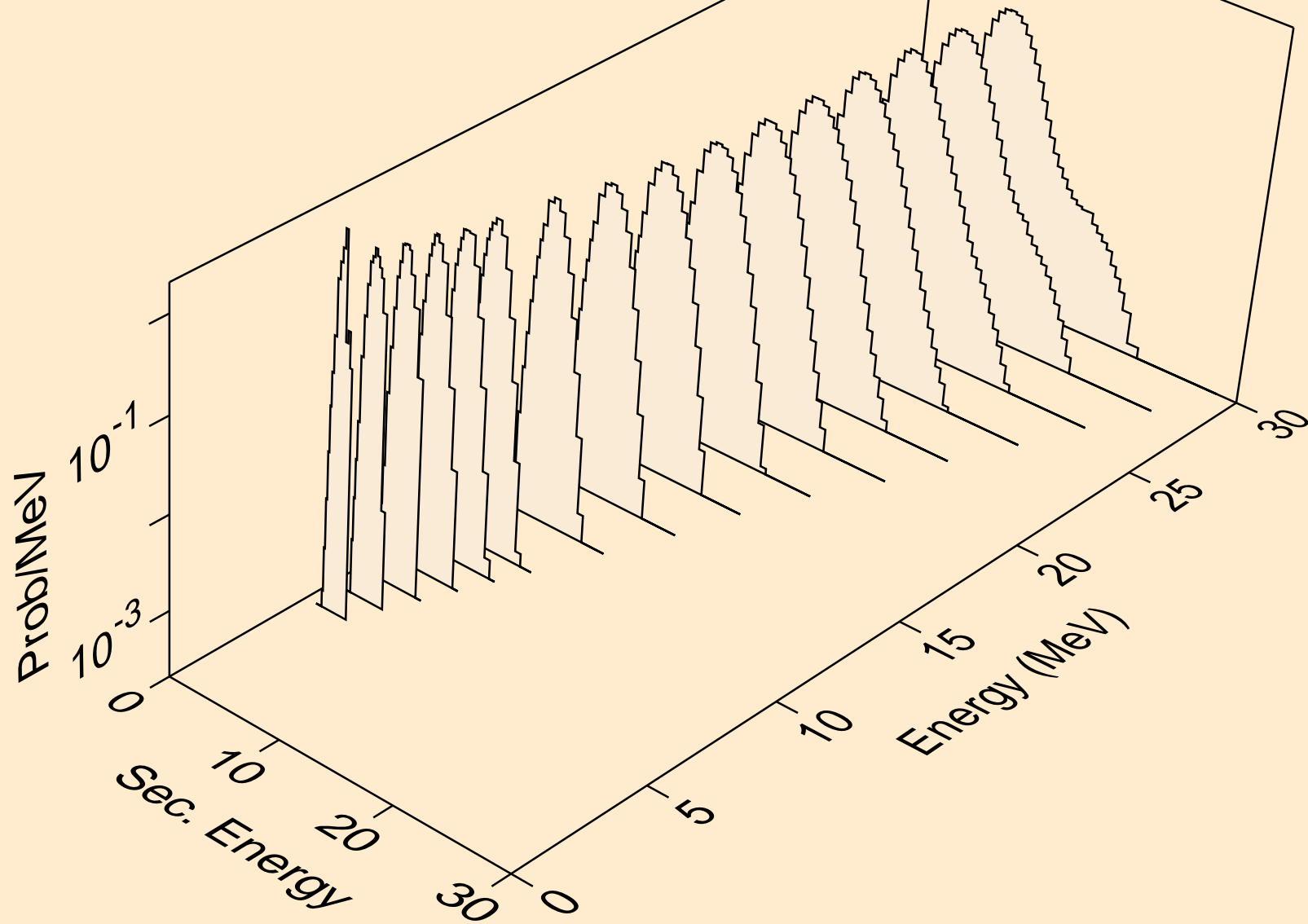

RE171 PROTON ACER TENDL-2021 LIBRARY; T=0.K  
Proton emission for (p,pd)

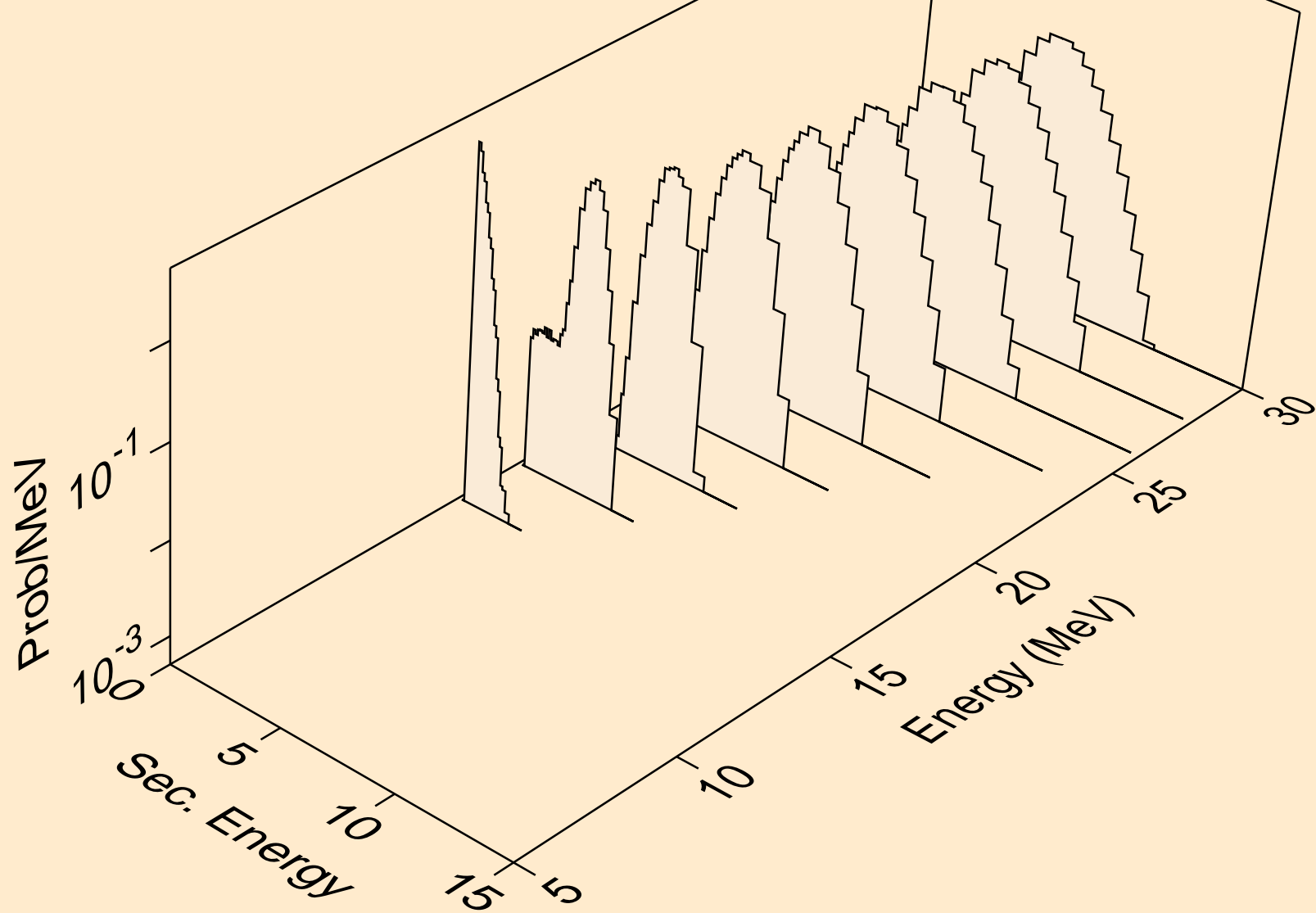

RE171 PROTON ACER TENDL-2021 LIBRARY; T=0.K  
Proton emission for (p,pt)

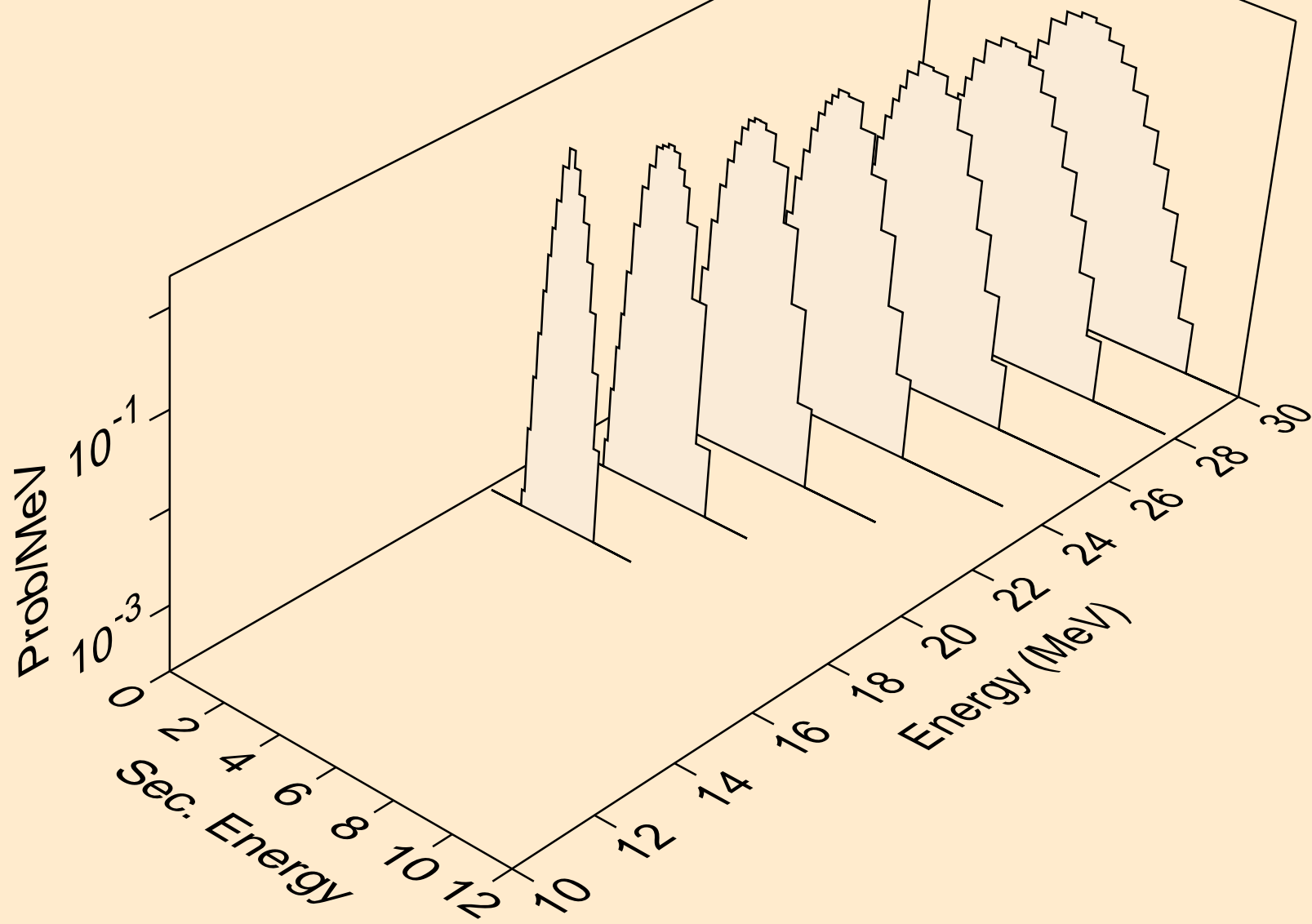

RE171 PROTON ACER TENDL-2021 LIBRARY; T=0.K  
Photon emission for (z,n)

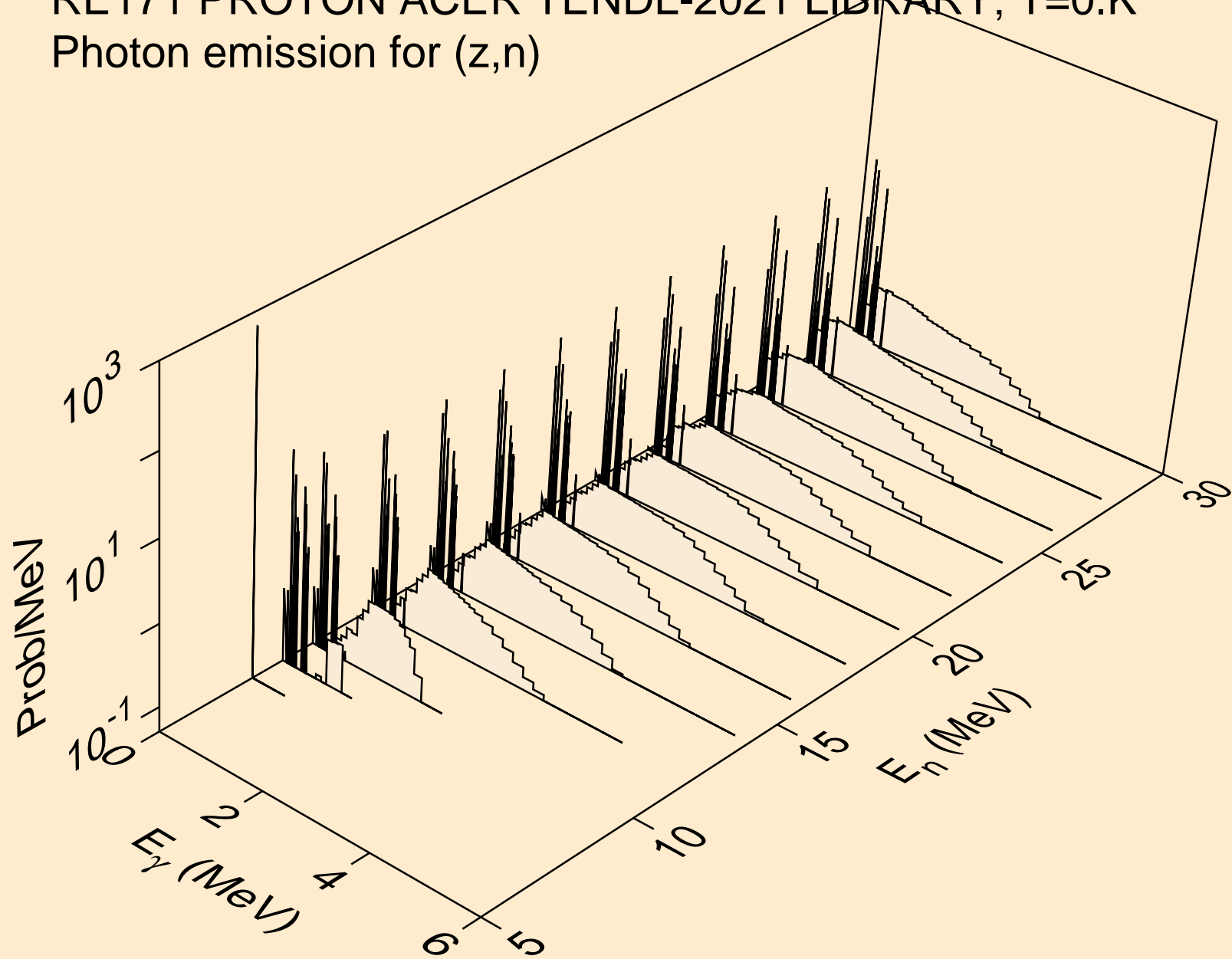

RE171 PROTON ACER TENDL-2021 LIBRARY; T=0.K  
Photon emission for (n,x)

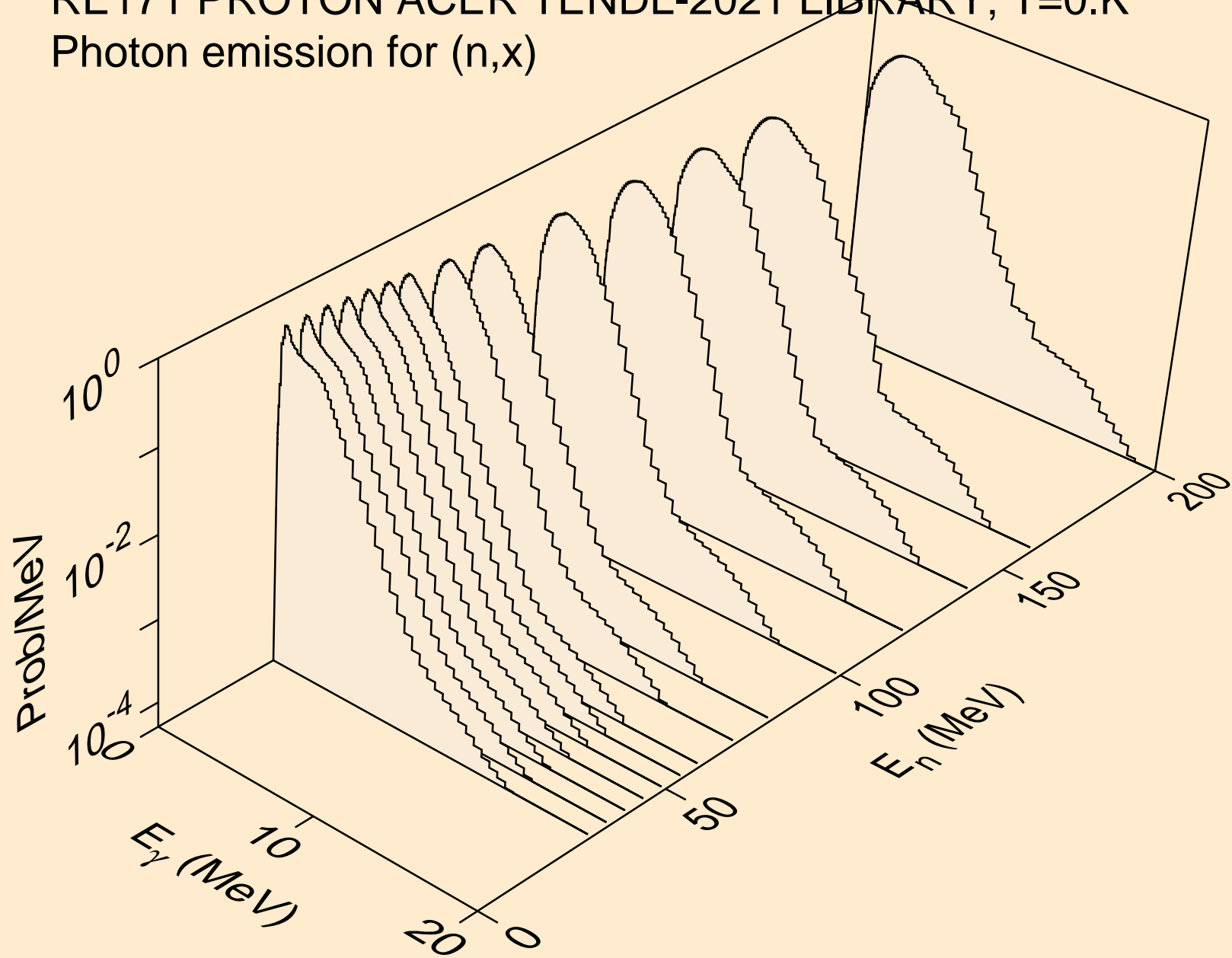

RE171 PROTON ACER TENDL-2021 LIBRARY; T=0.K  
Photon emission for (n,2n)

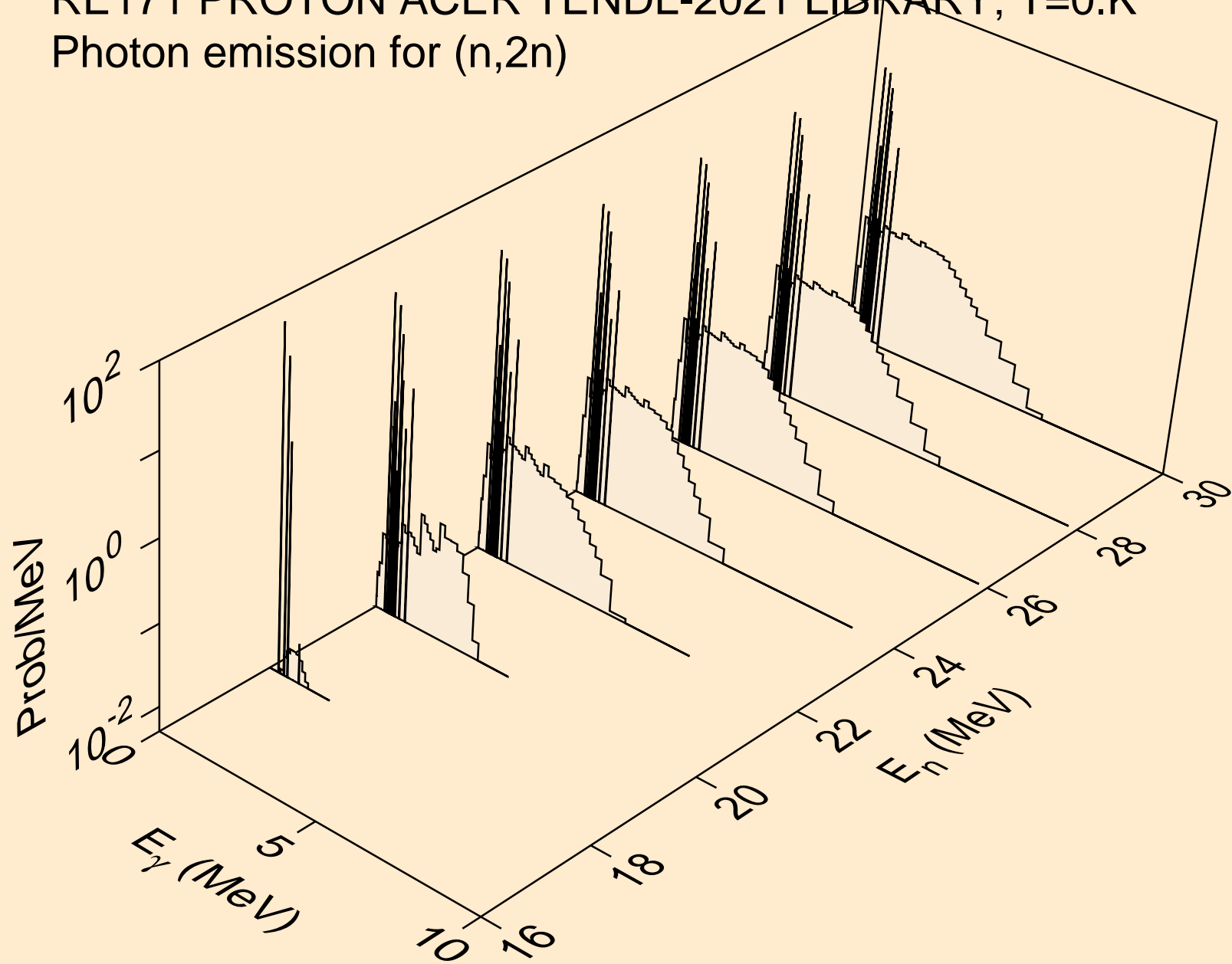

RE171 PROTON ACER TENDL-2021 LIBRARY; T=0.K  
Photon emission for (n,3n)

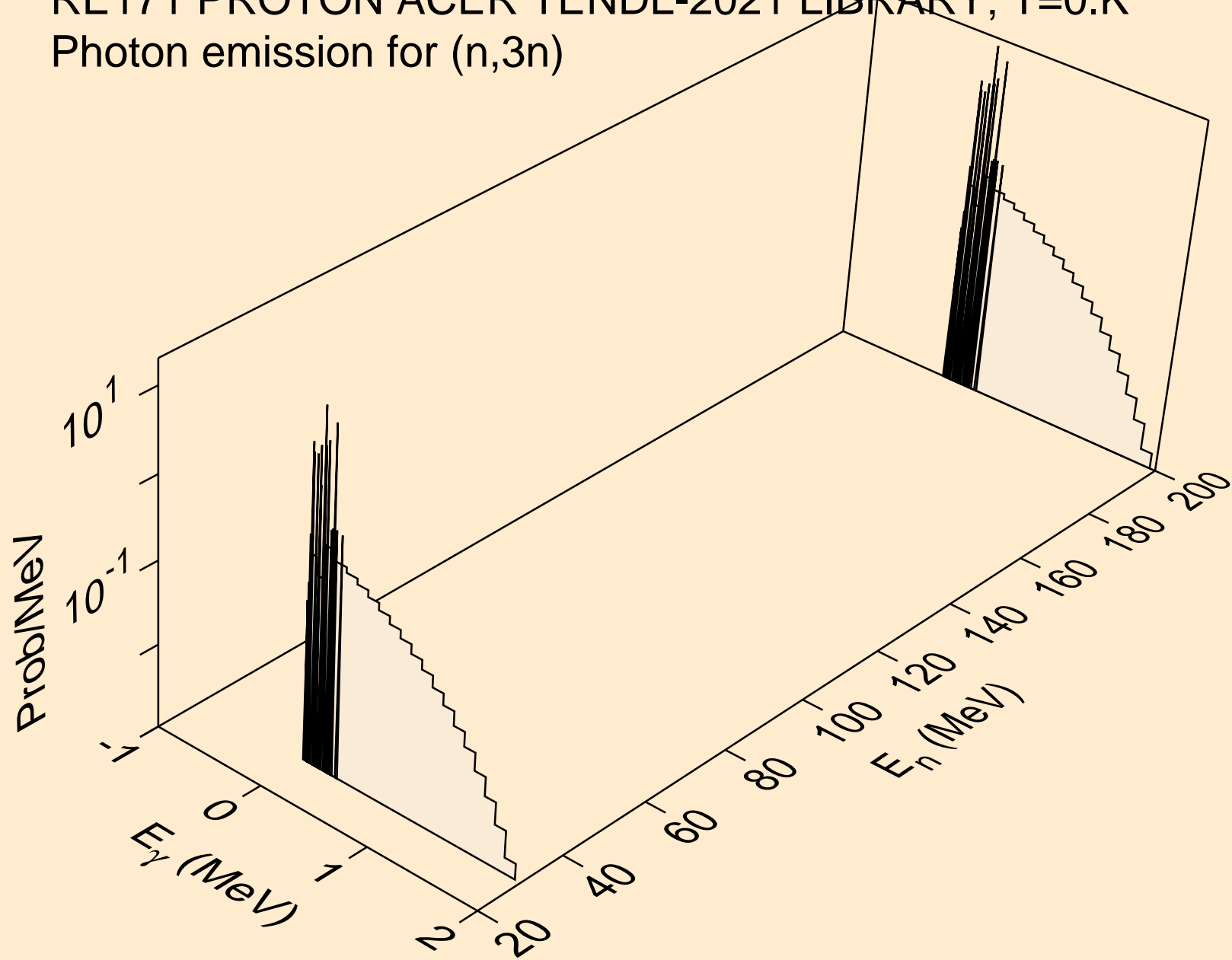

RE171 PROTON ACER TENDL-2021 LIBRARY; T=0.K  
Photon emission for (n,n\*)a

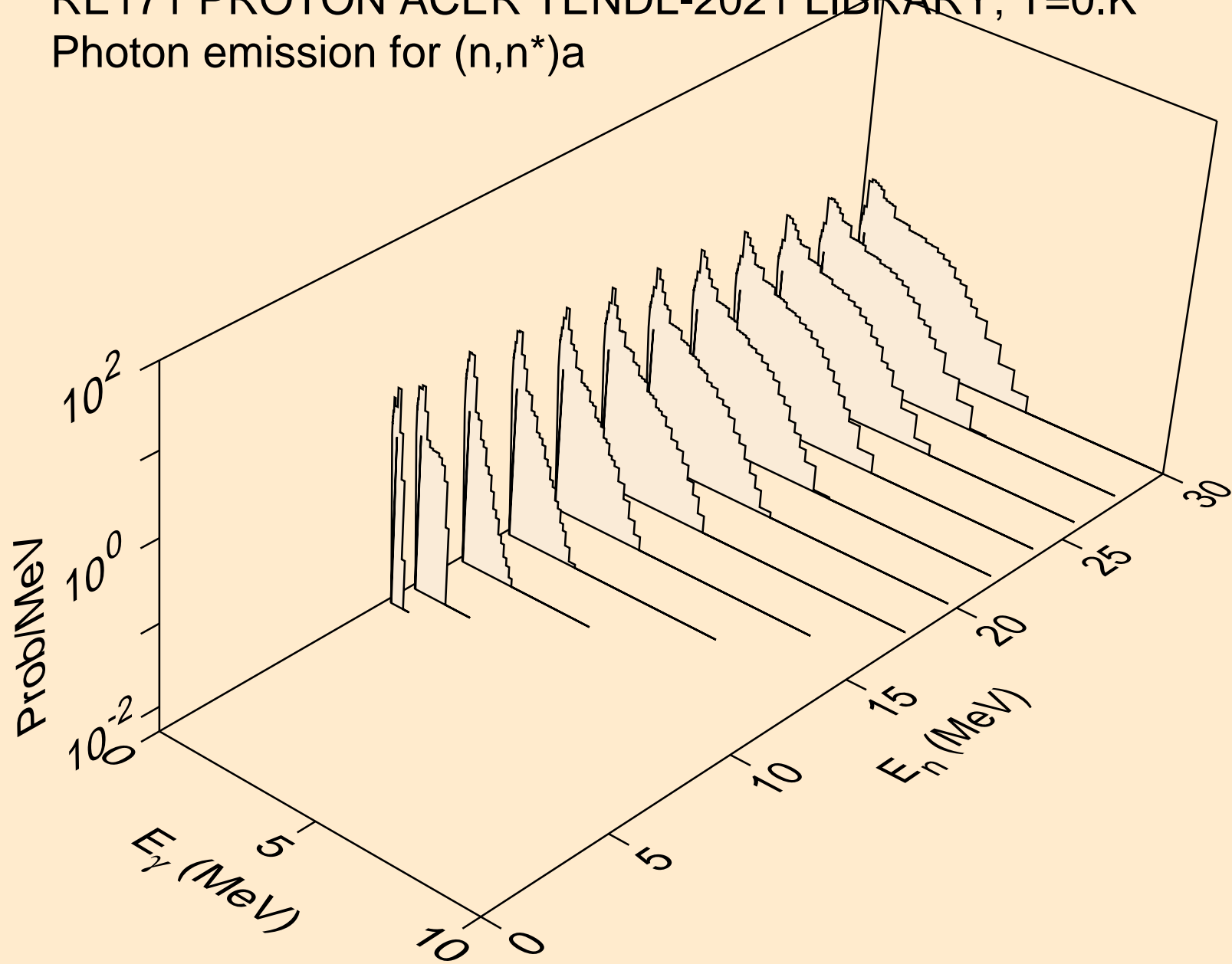



RE171 PROTON ACER TENDL-2021 LIBRARY; T=0.K  
Photon emission for (n,2n)a

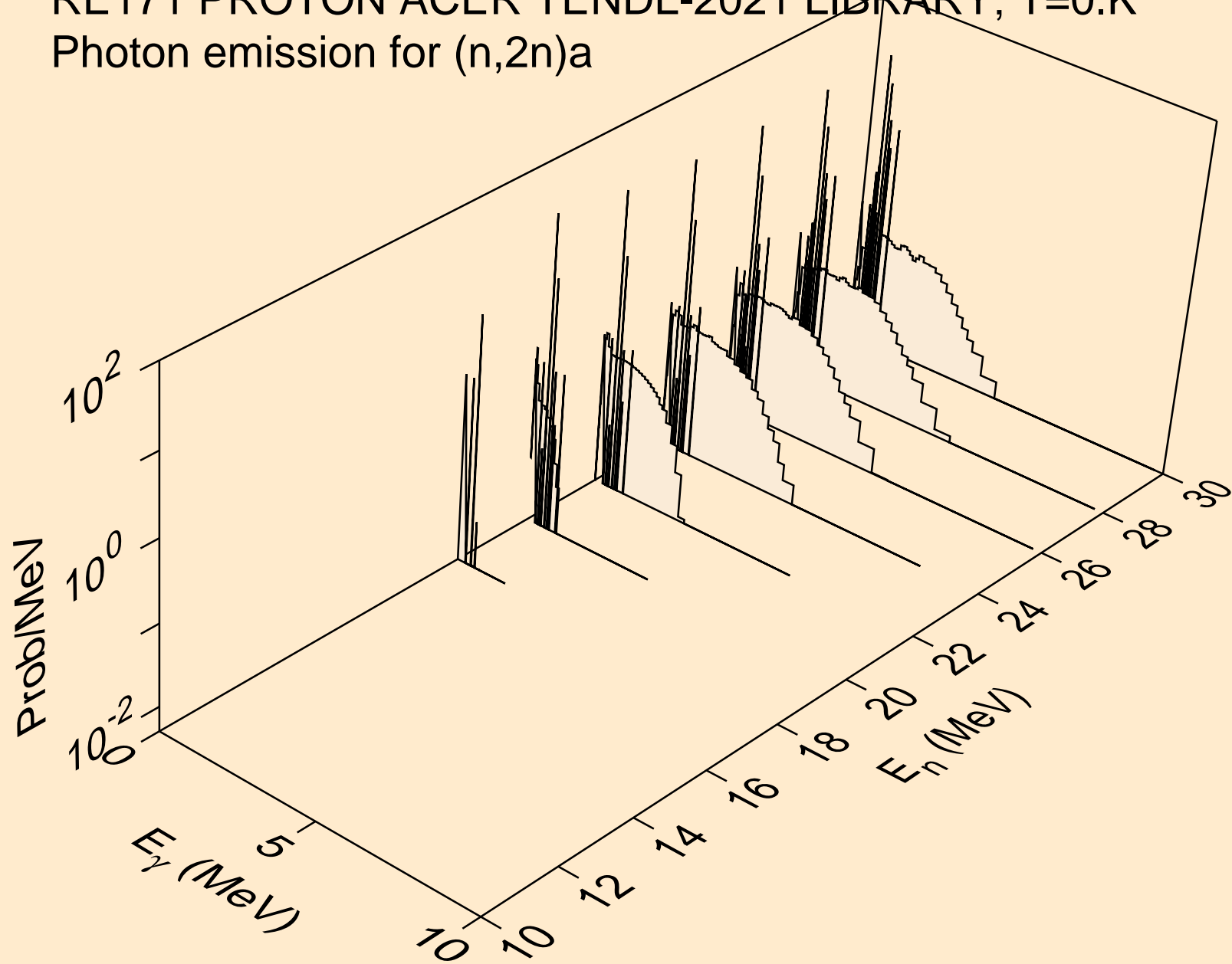

RE171 PROTON ACER TENDL-2021 LIBRARY; T=0.K  
Photon emission for (n,3n)a

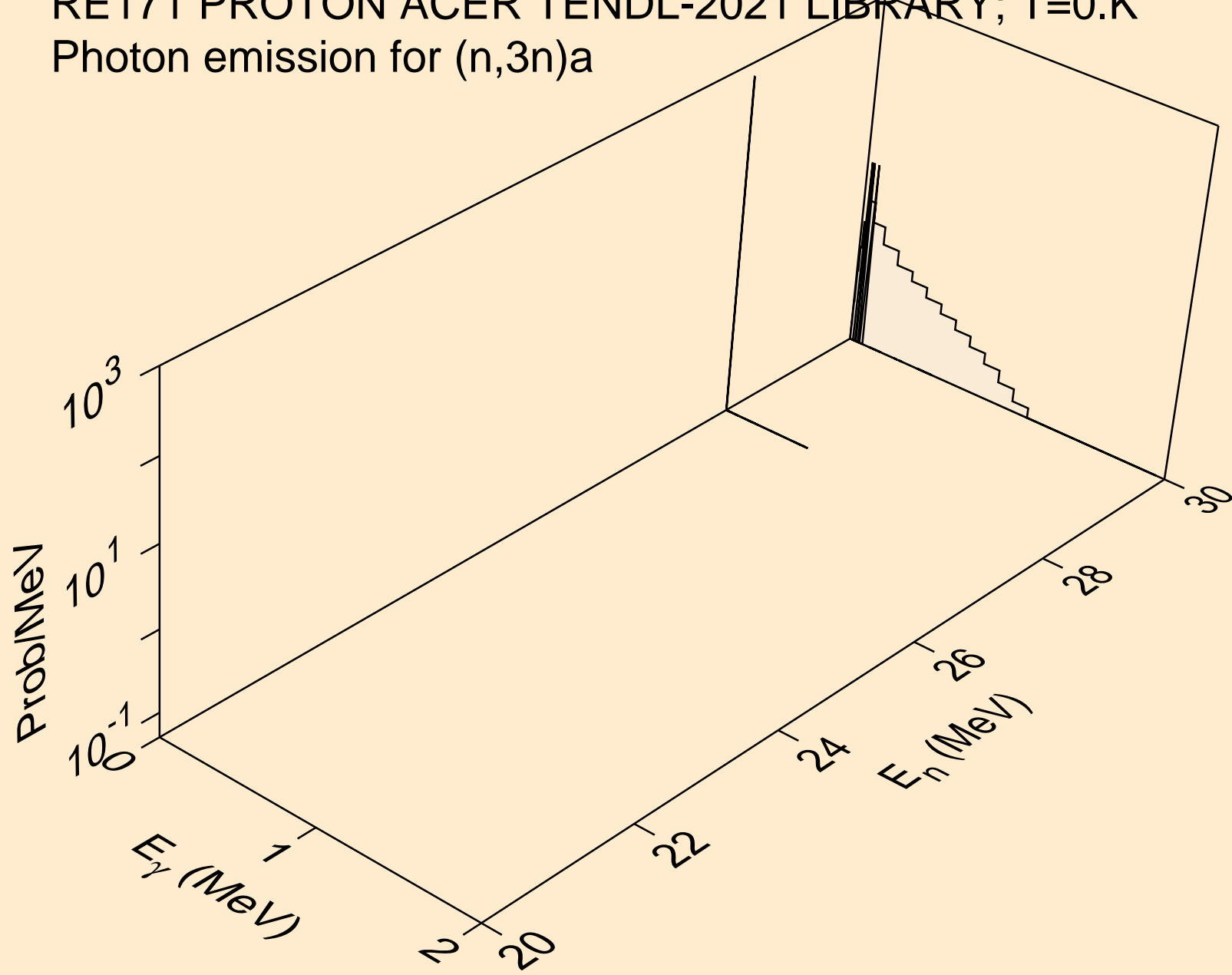

RE171 PROTON ACER TENDL-2021 LIBRARY; T=0.K  
Photon emission for (n,n\*)p

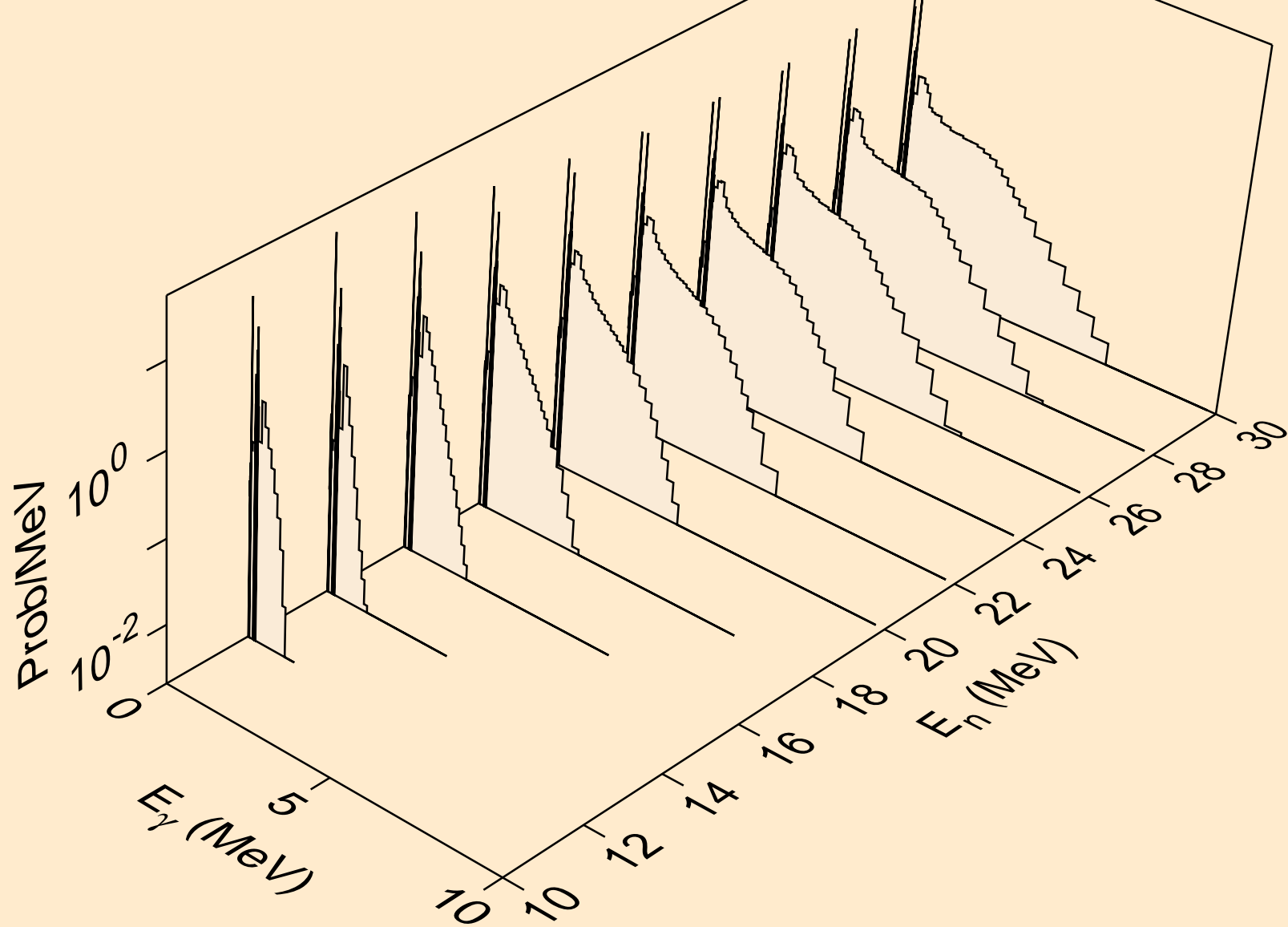

RE171 PROTON ACER TENDL-2021 LIBRARY; T=0.K  
Photon emission for (n,n\*)2a

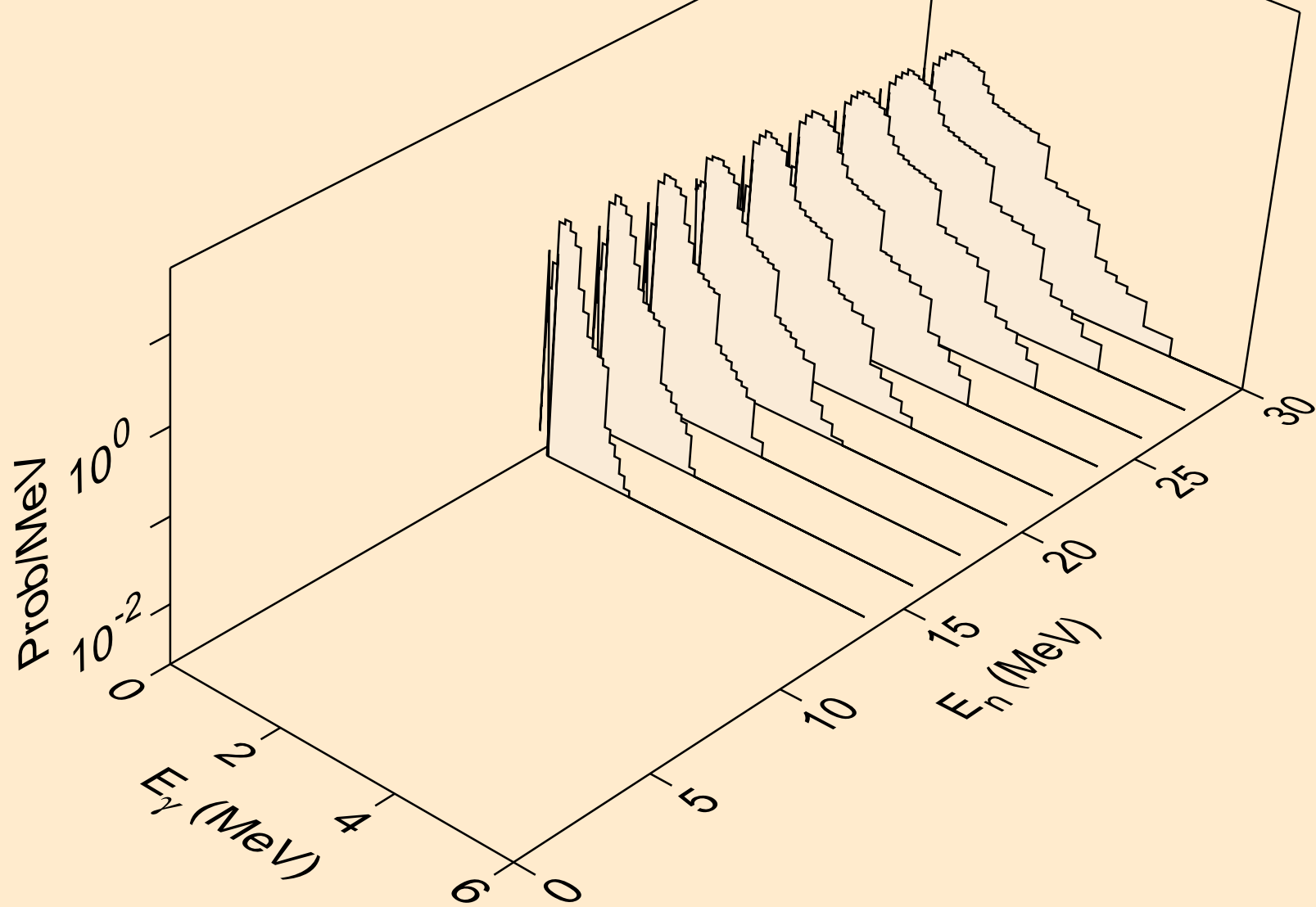

RE171 PROTON ACER TENDL-2021 LIBRARY; T=0.K  
Photon emission for (n,2n)2a

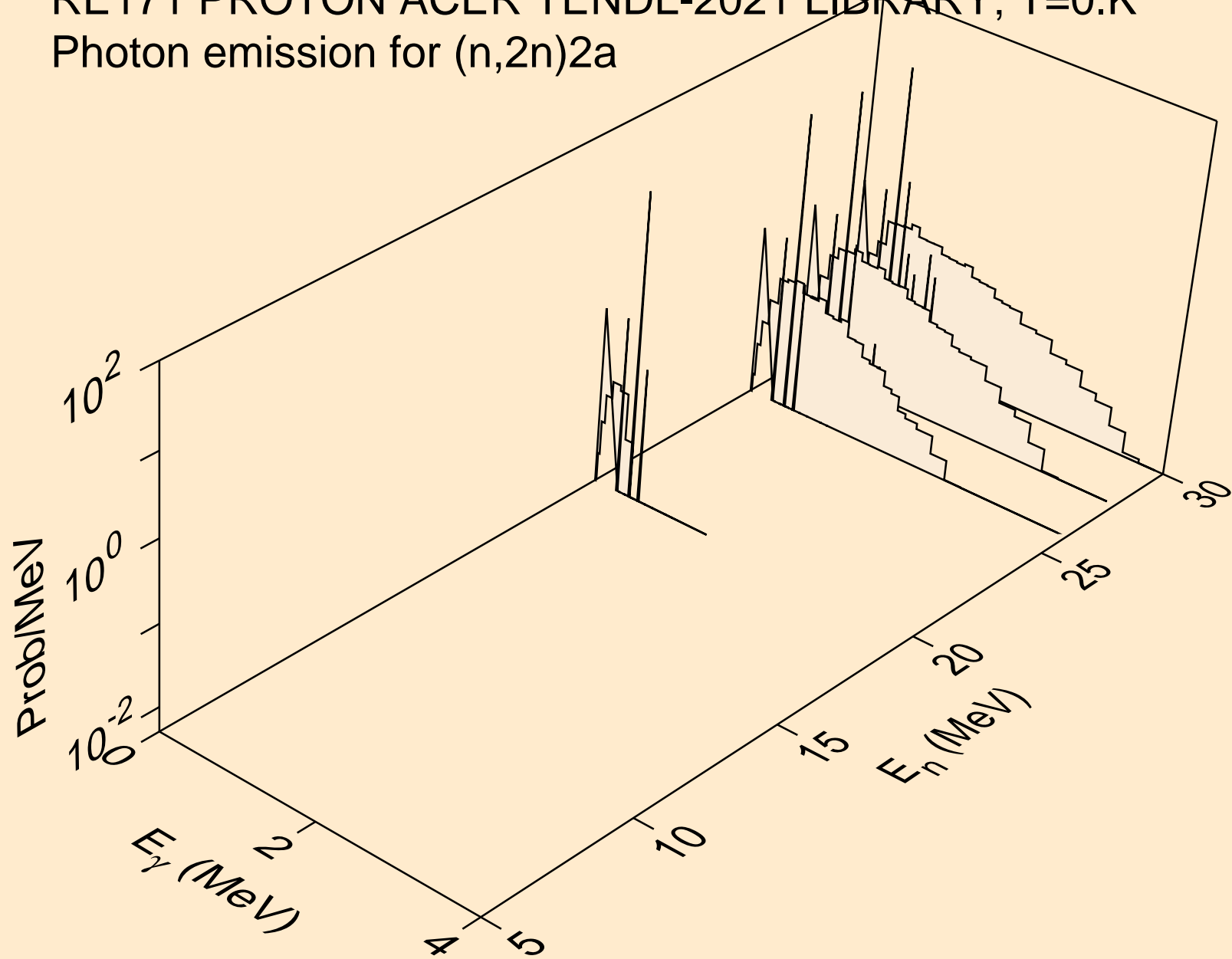

RE171 PROTON ACER TENDL-2021 LIBRARY; T=0.K  
Photon emission for (n,n\*)d

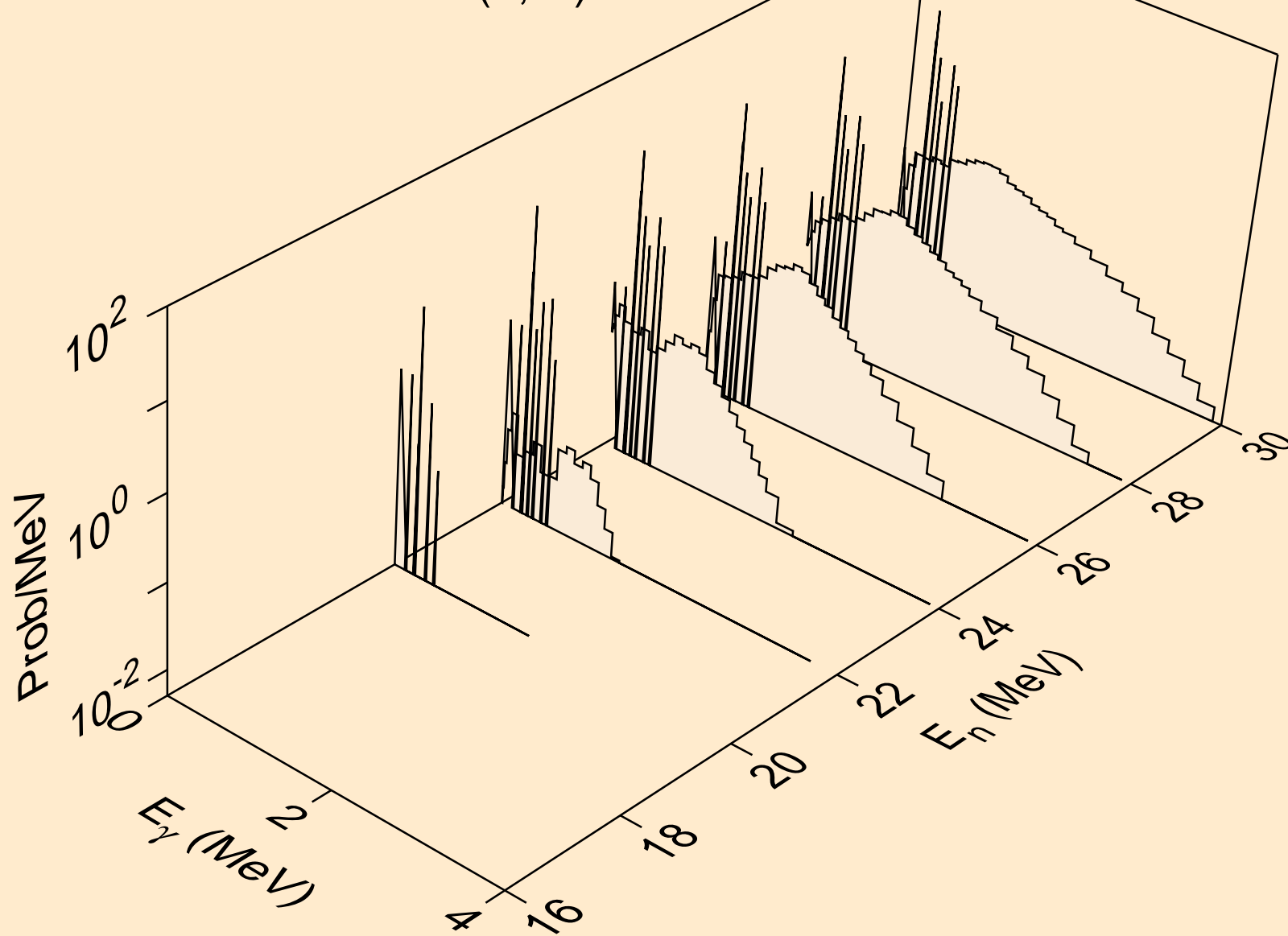

RE171 PROTON ACER TENDL-2021 LIBRARY; T=0.K  
Photon emission for (n,n\*)t

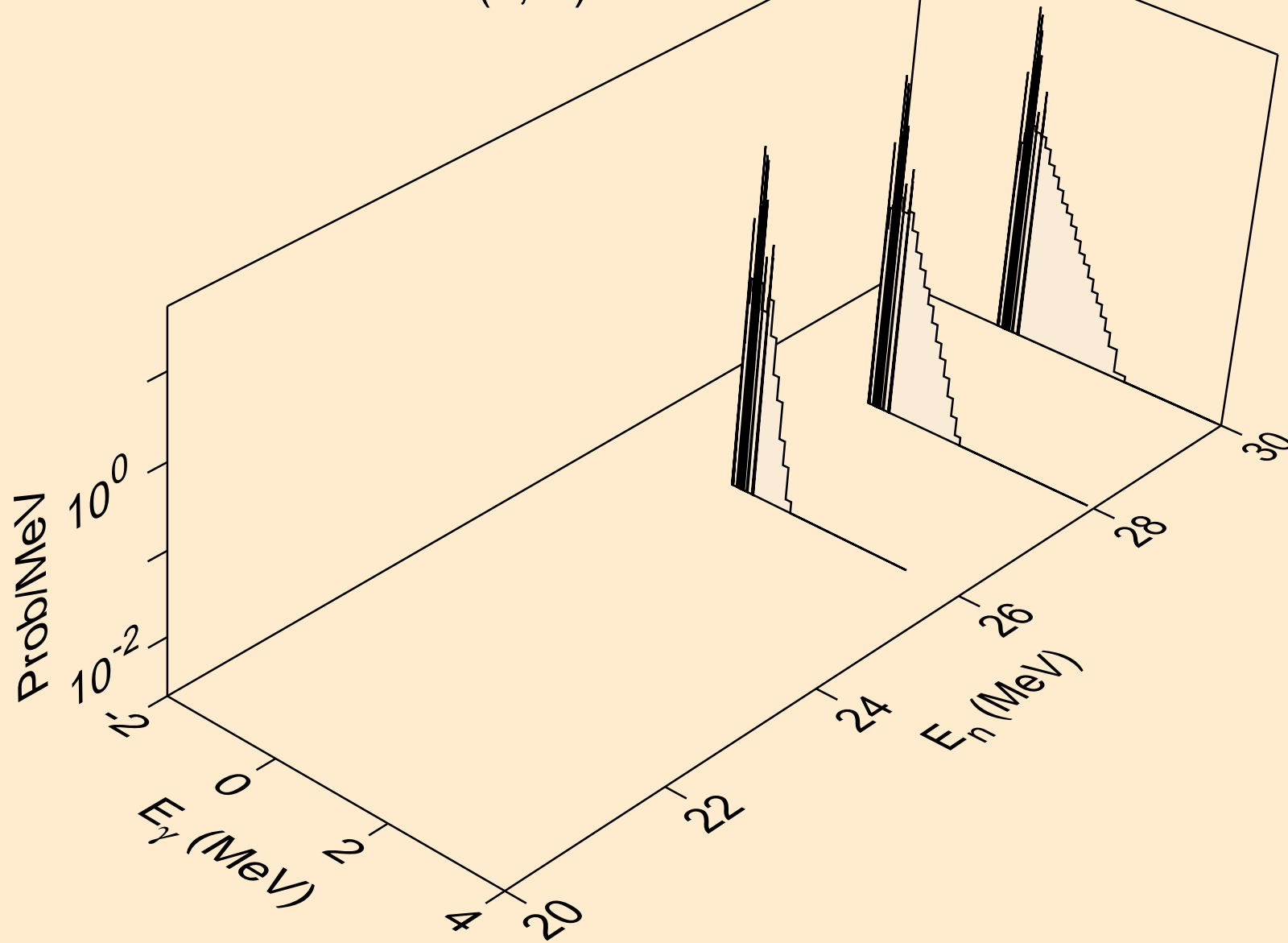

RE171 PROTON ACER TENDL-2021 LIBRARY; T=0.K  
Photon emission for (n,n\*)he3

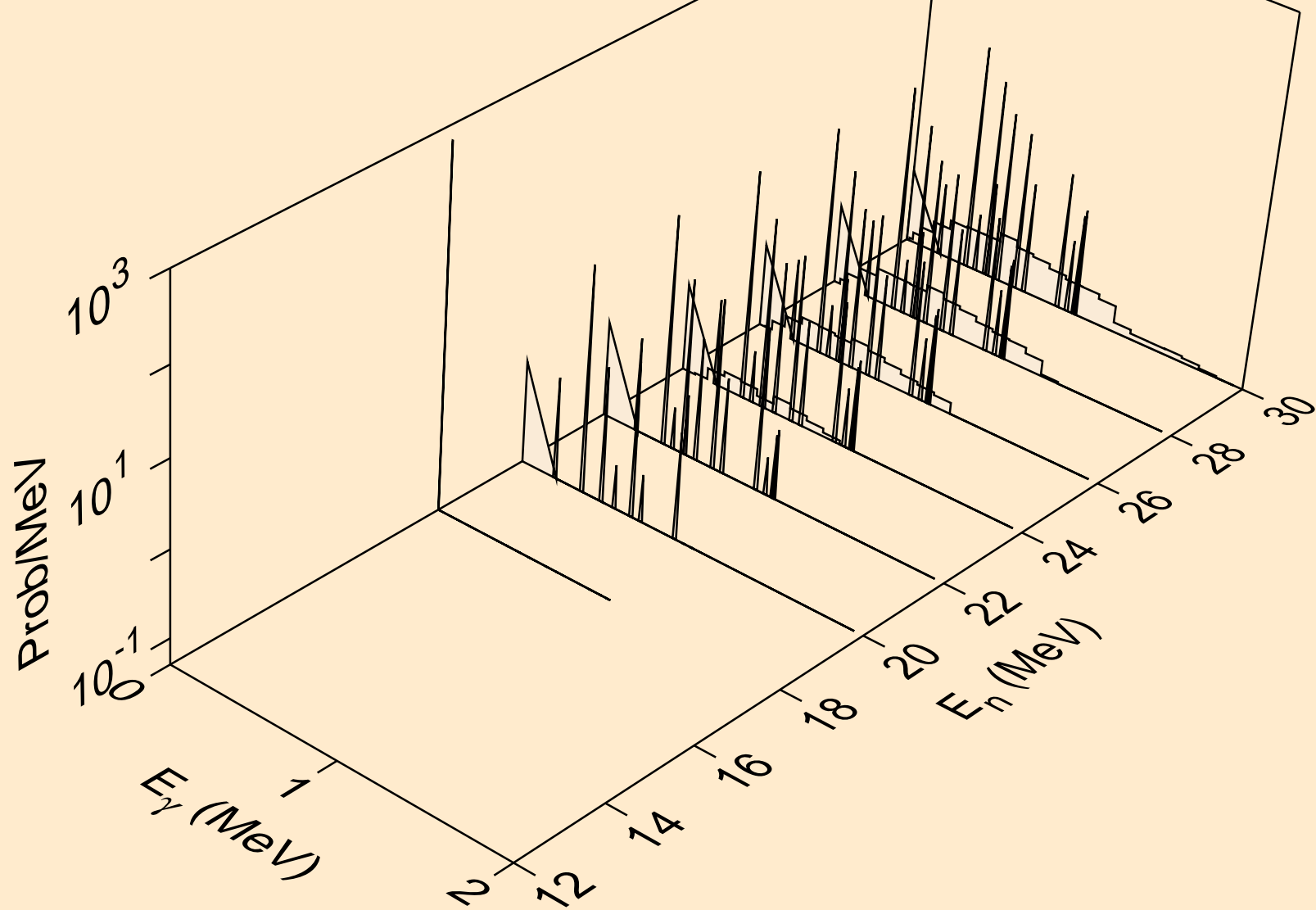



RE171 PROTON ACER TENDL-2021 LIBRARY; T=0.K  
Photon emission for (n,2np)

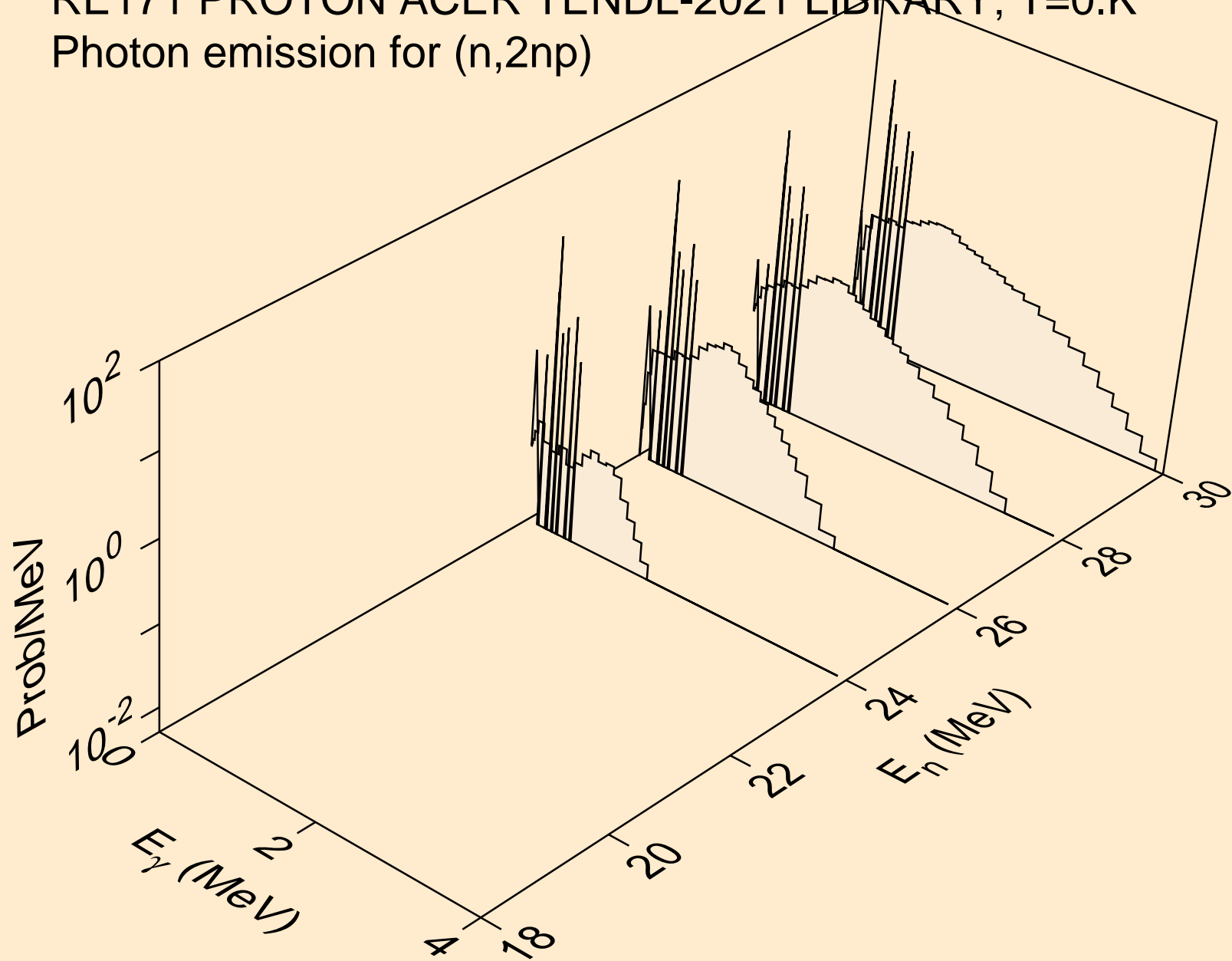

RE171 PROTON ACER TENDL-2021 LIBRARY; T=0.K  
Photon emission for (n,2np)

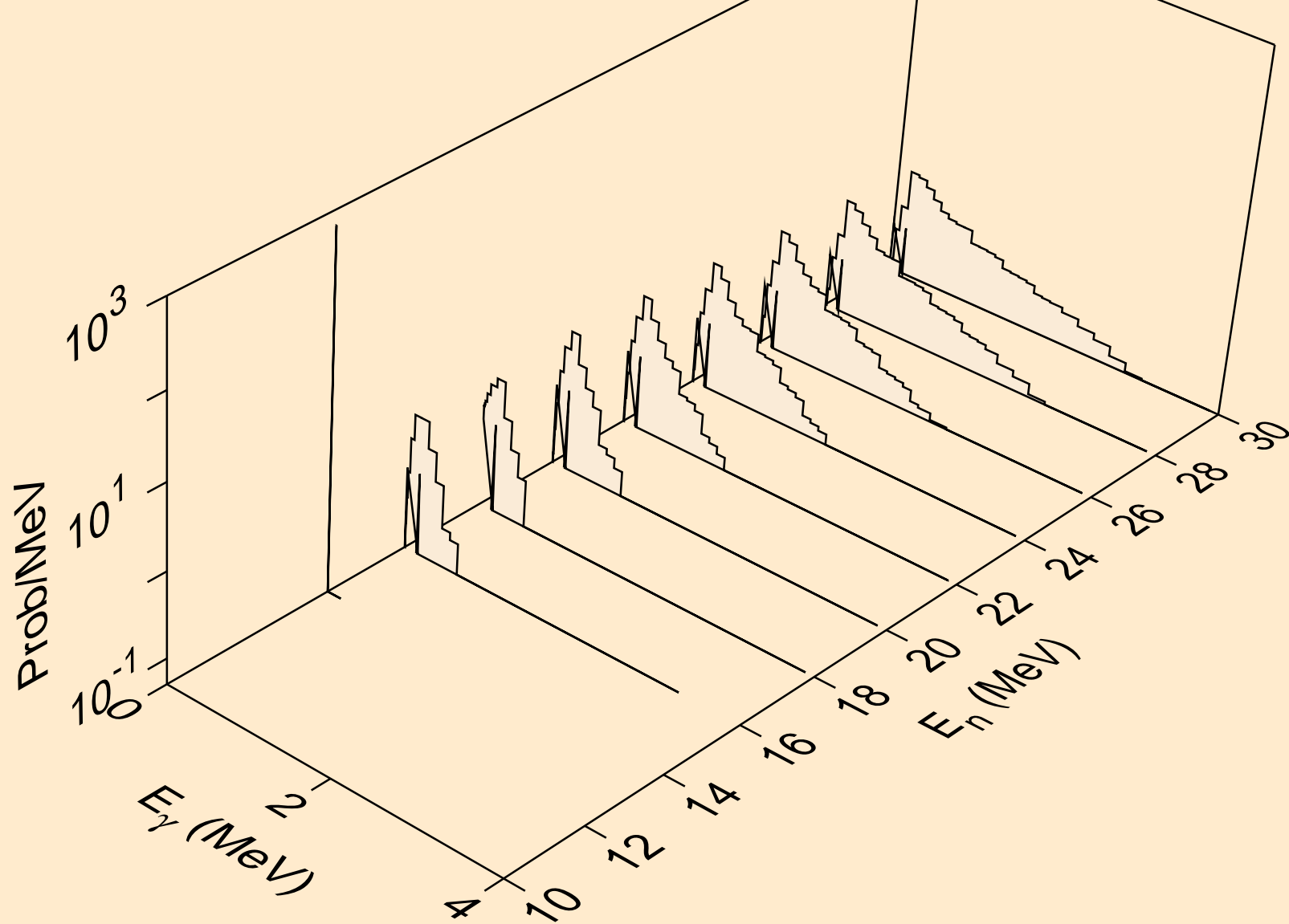

RE171 PROTON ACER TENDL-2021 LIBRARY; T=0.K  
Photon emission for (n,npa)

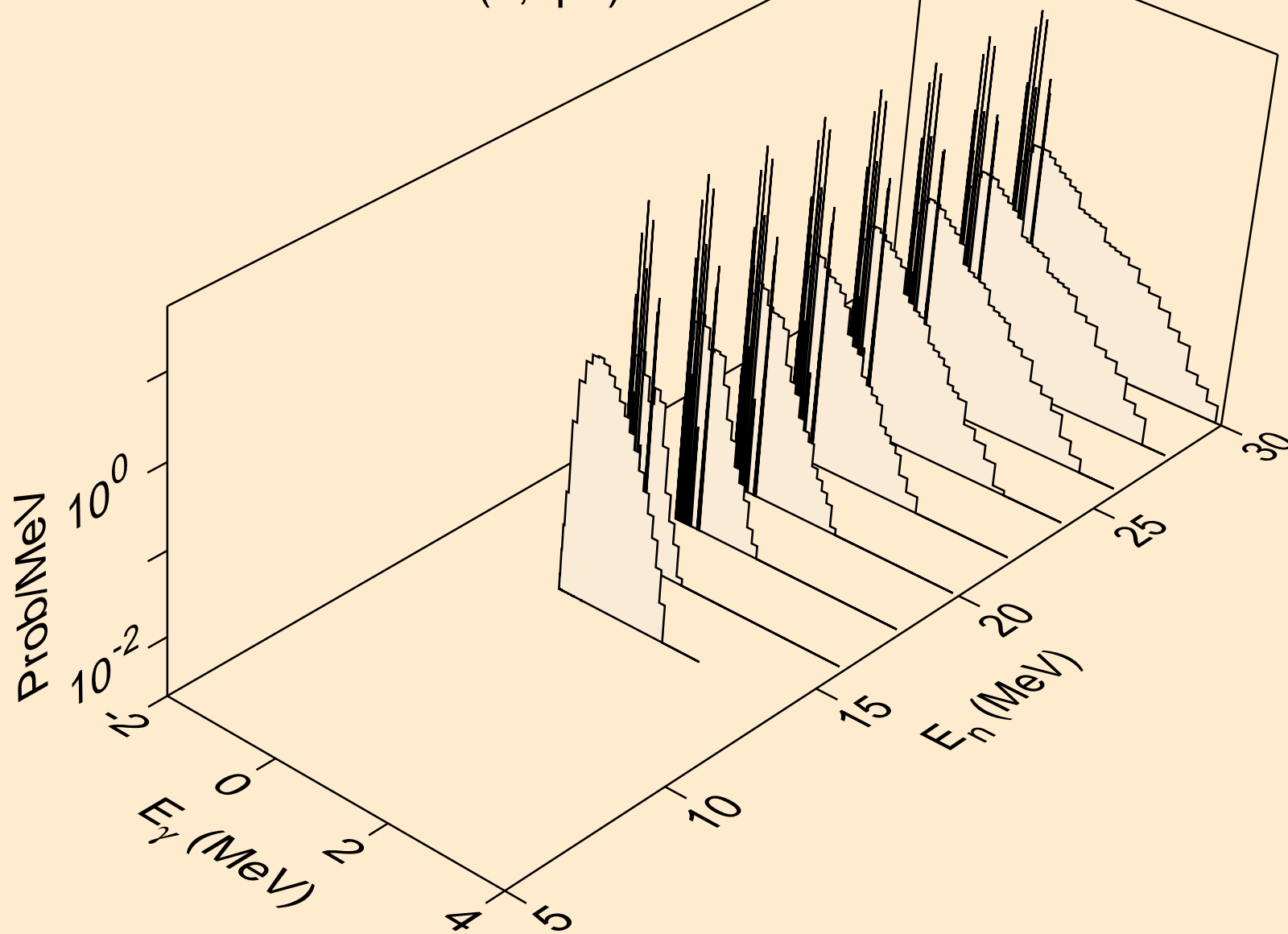

RE171 PROTON ACER TENDL-2021 LIBRARY; T=0.K  
Photon emission for (n,gma)

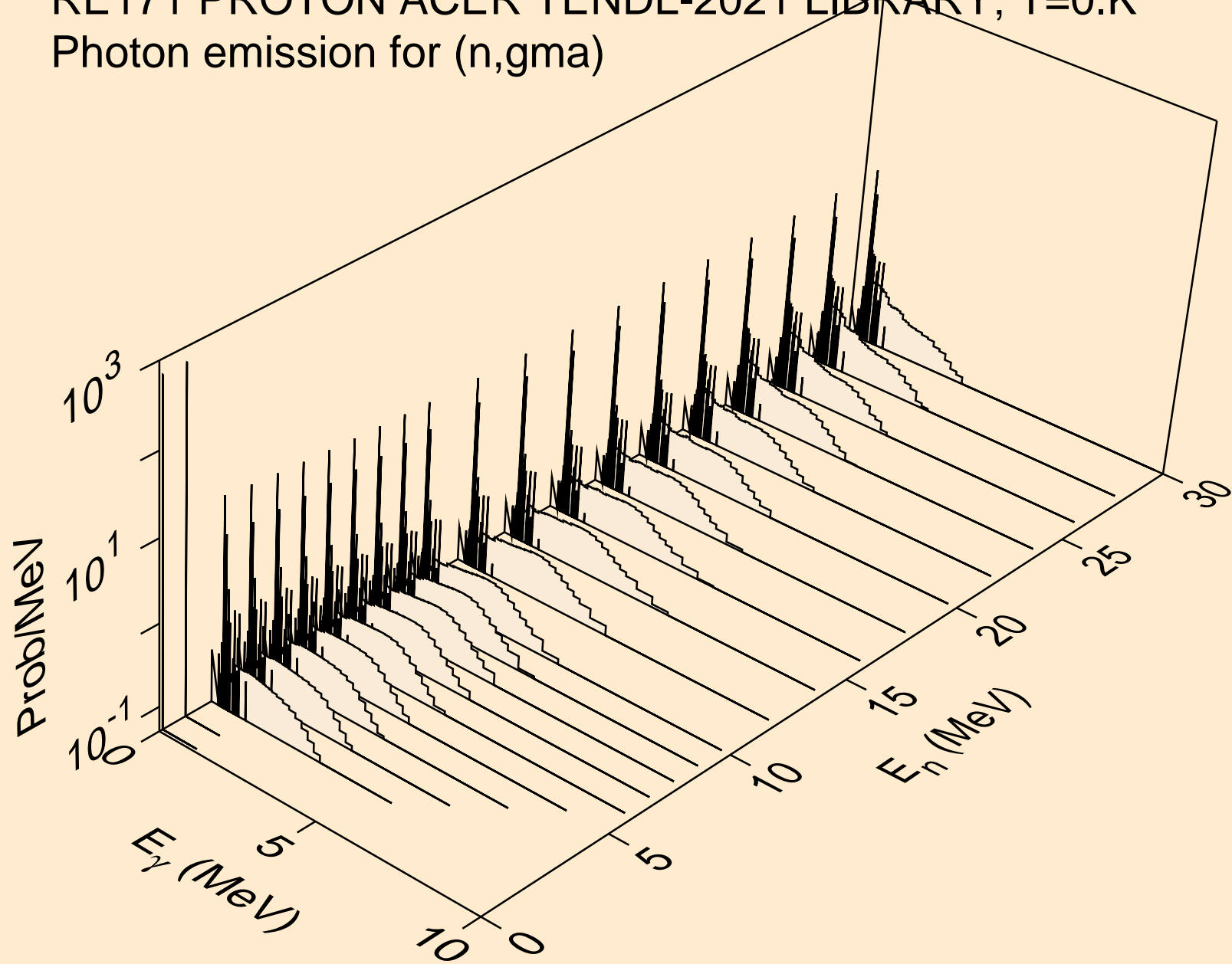

RE171 PROTON ACER TENDL-2021 LIBRARY; T=0.K  
Photon emission for inelastic

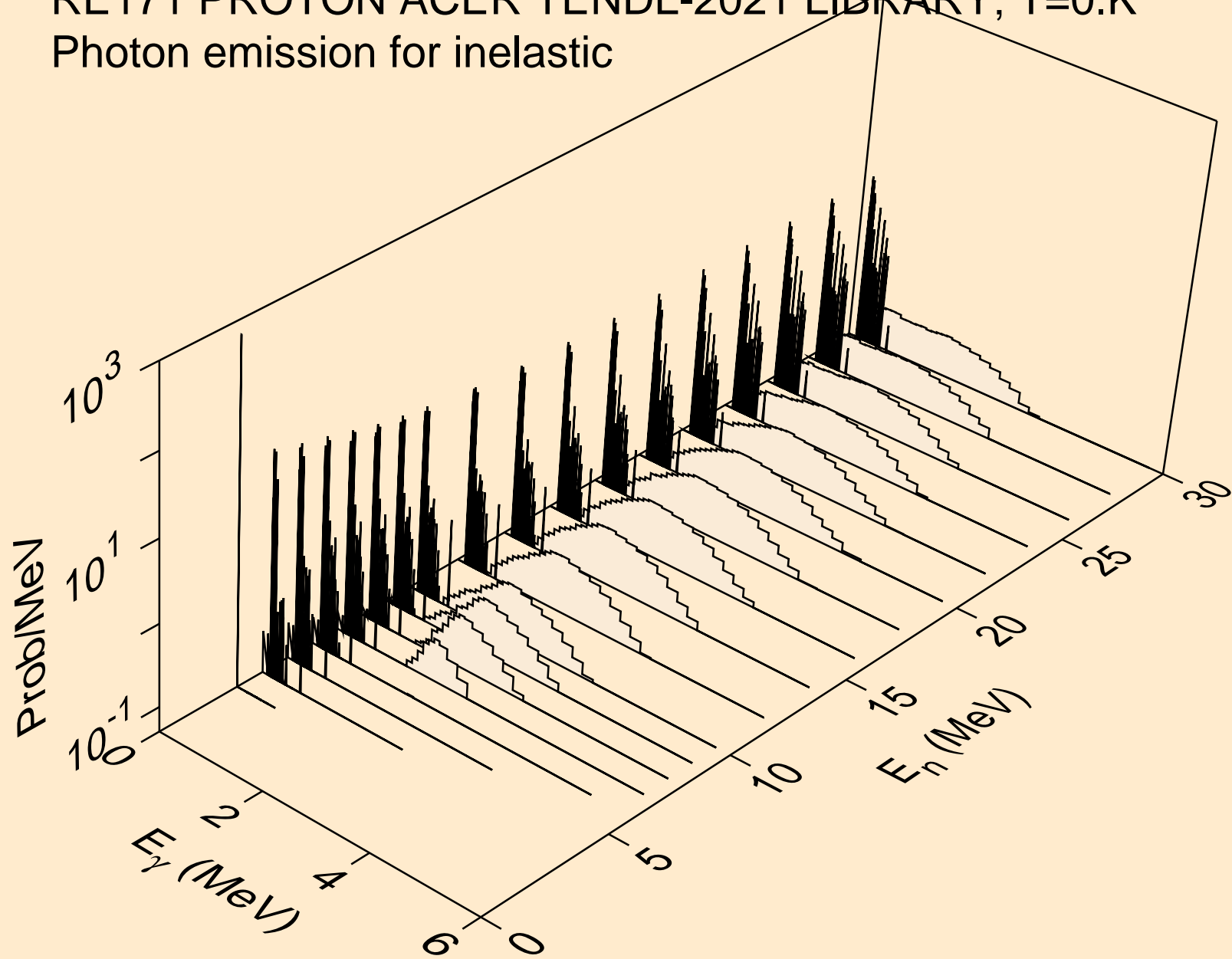

RE171 PROTON ACER TENDL-2021 LIBRARY; T=0.K  
Photon emission for (n,d)

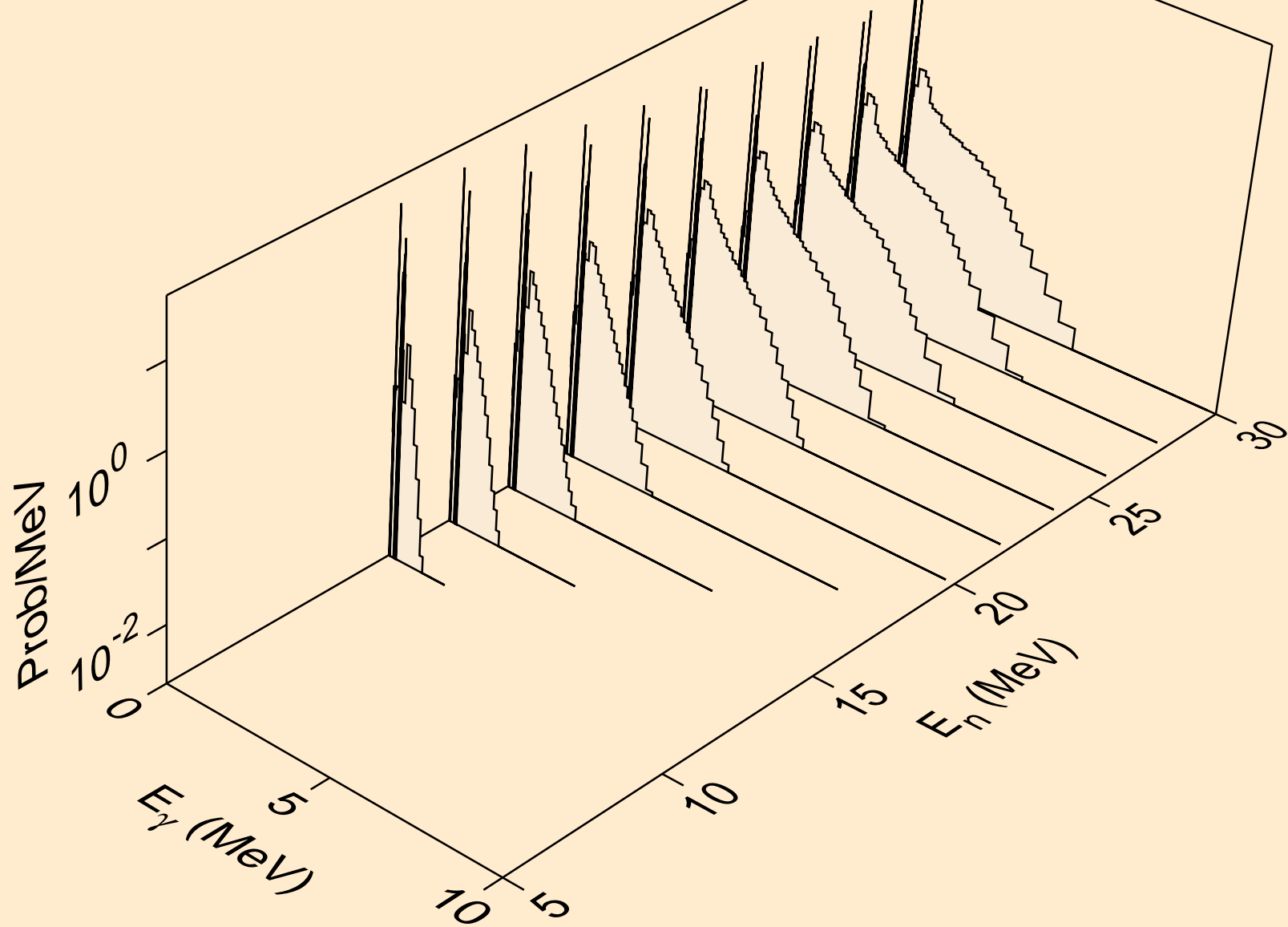

RE171 PROTON ACER TENDL-2021 LIBRARY; T=0.K  
Photon emission for (n,t)

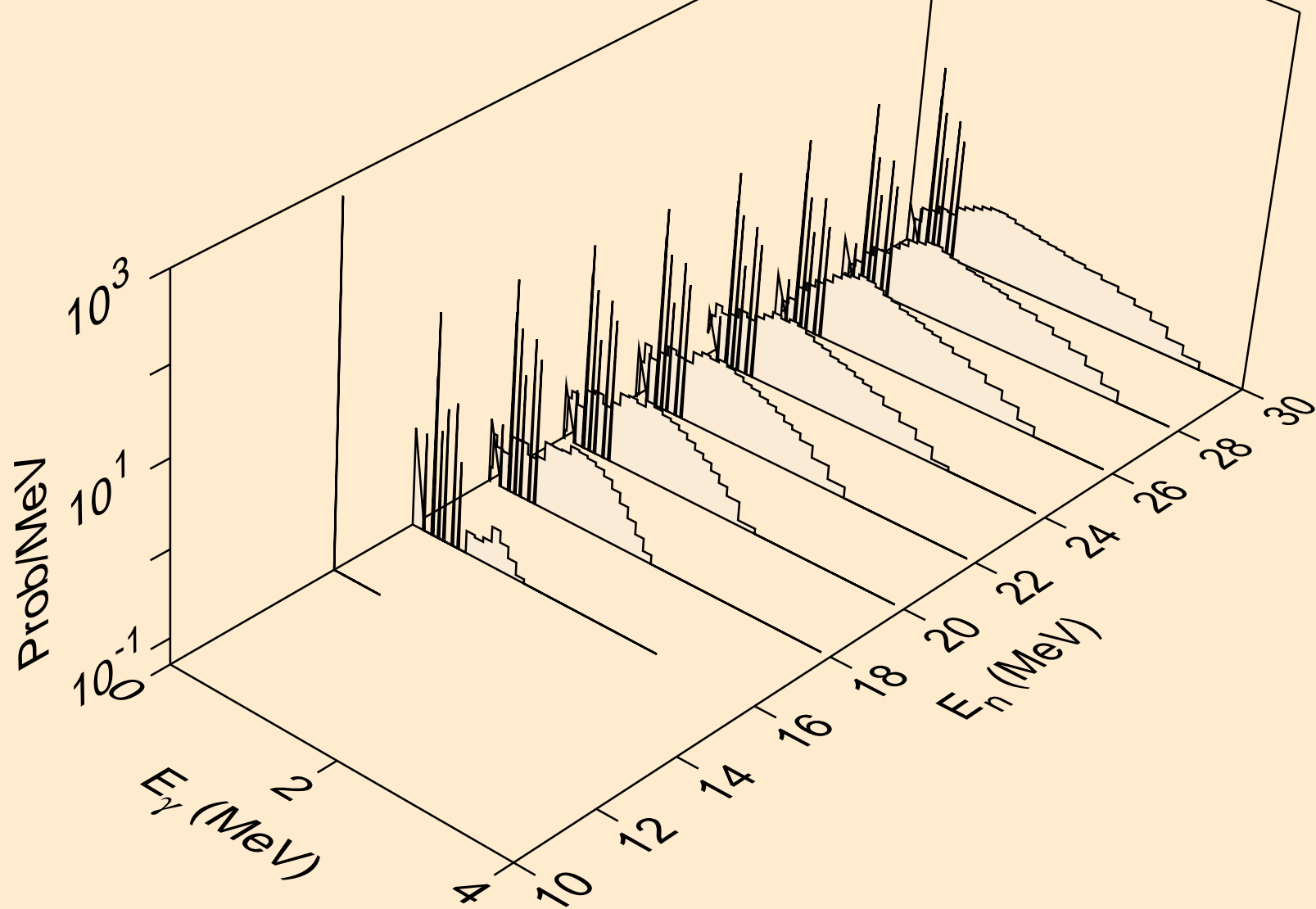

RE171 PROTON ACER TENDL-2021 LIBRARY; T=0.K  
Photon emission for (n,he3)

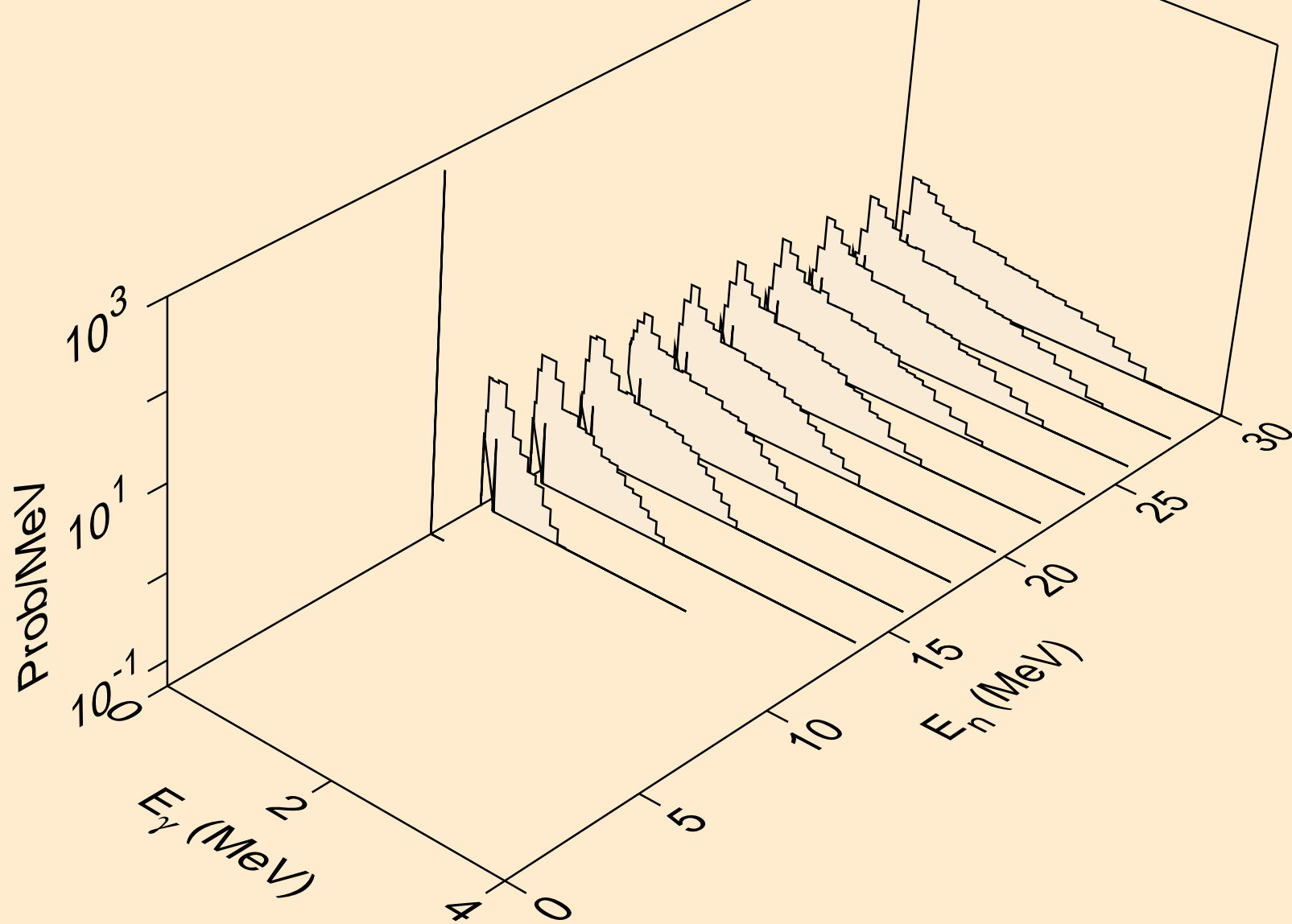



RE171 PROTON ACER TENDL-2021 LIBRARY; T=0.K  
Photon emission for (n,a)

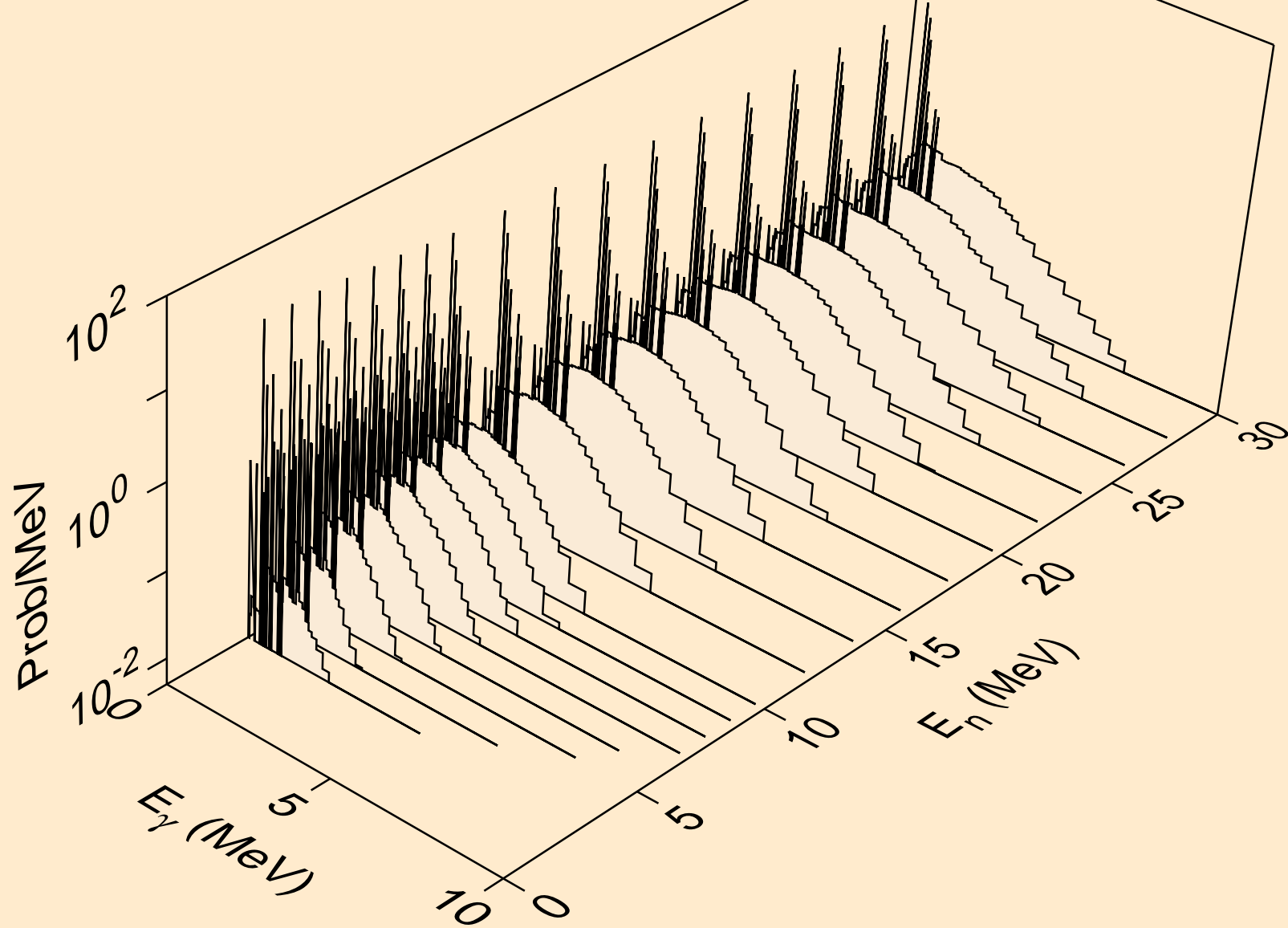

RE171 PROTON ACER TENDL-2021 LIBRARY; T=0.K  
Photon emission for (n,2a)

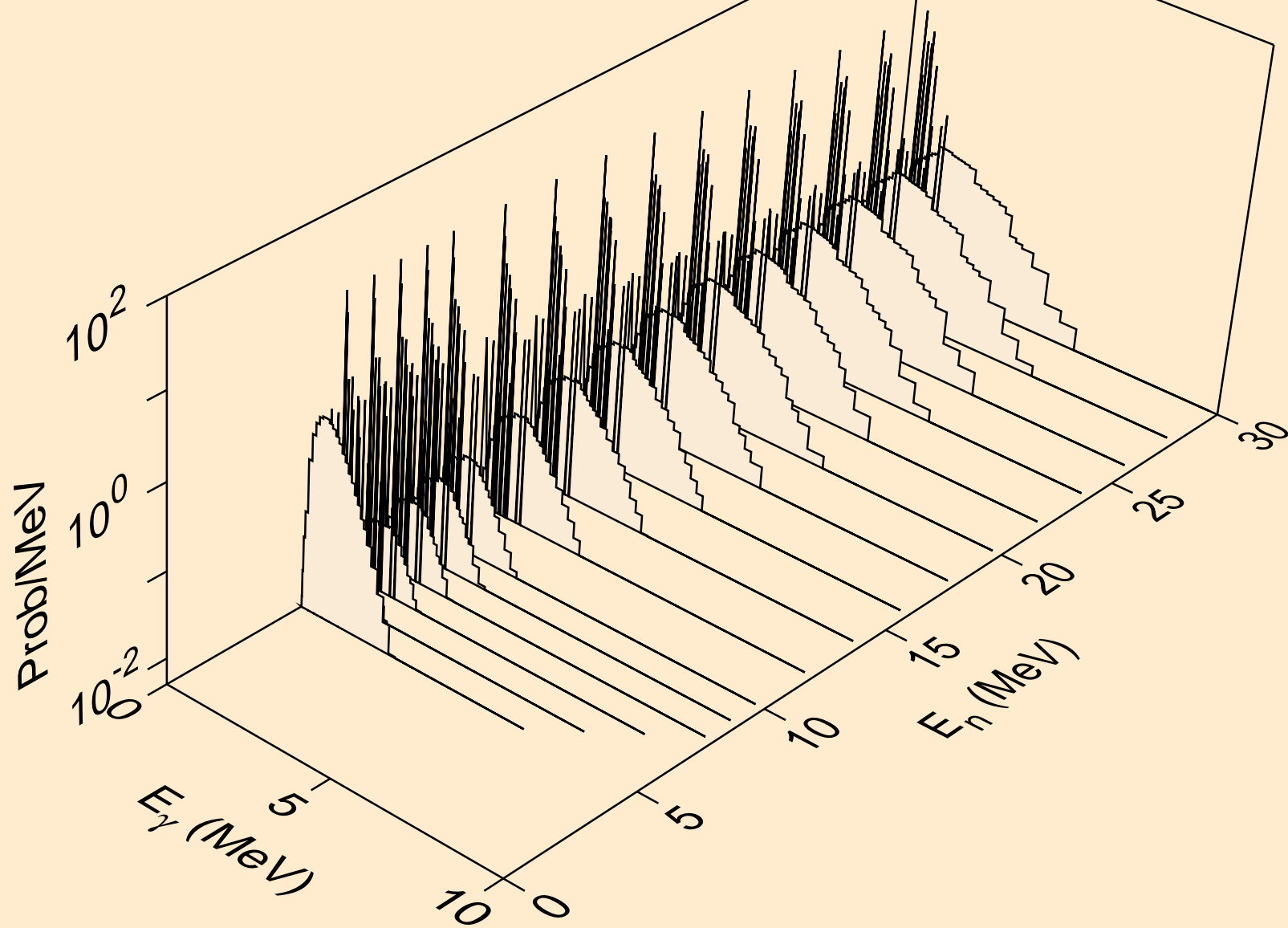

RE171 PROTON ACER TENDL-2021 LIBRARY; T=0.K  
Photon emission for (n,3a)

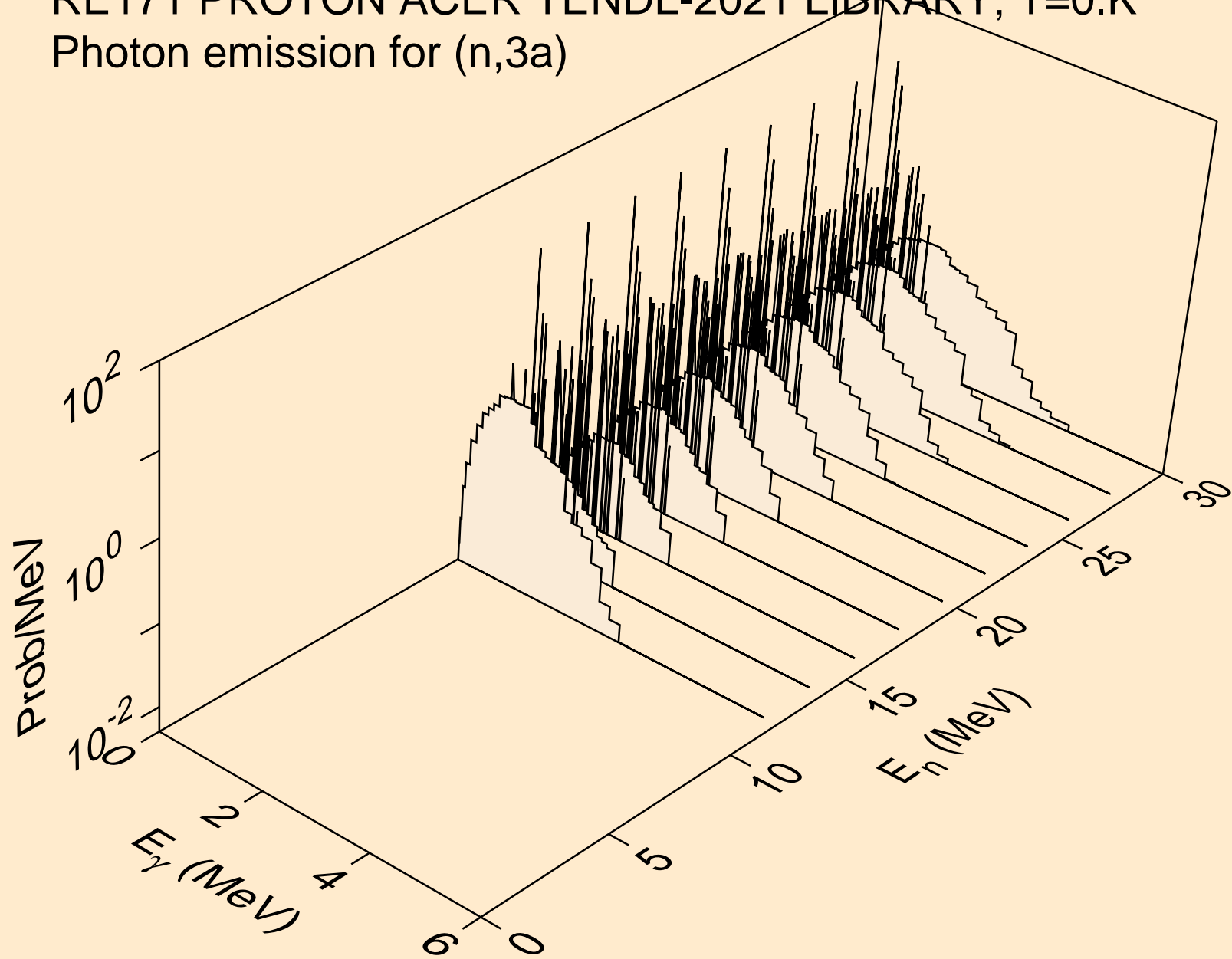

RE171 PROTON ACER TENDL-2021 LIBRARY; T=0.K  
Photon emission for (n,2p)

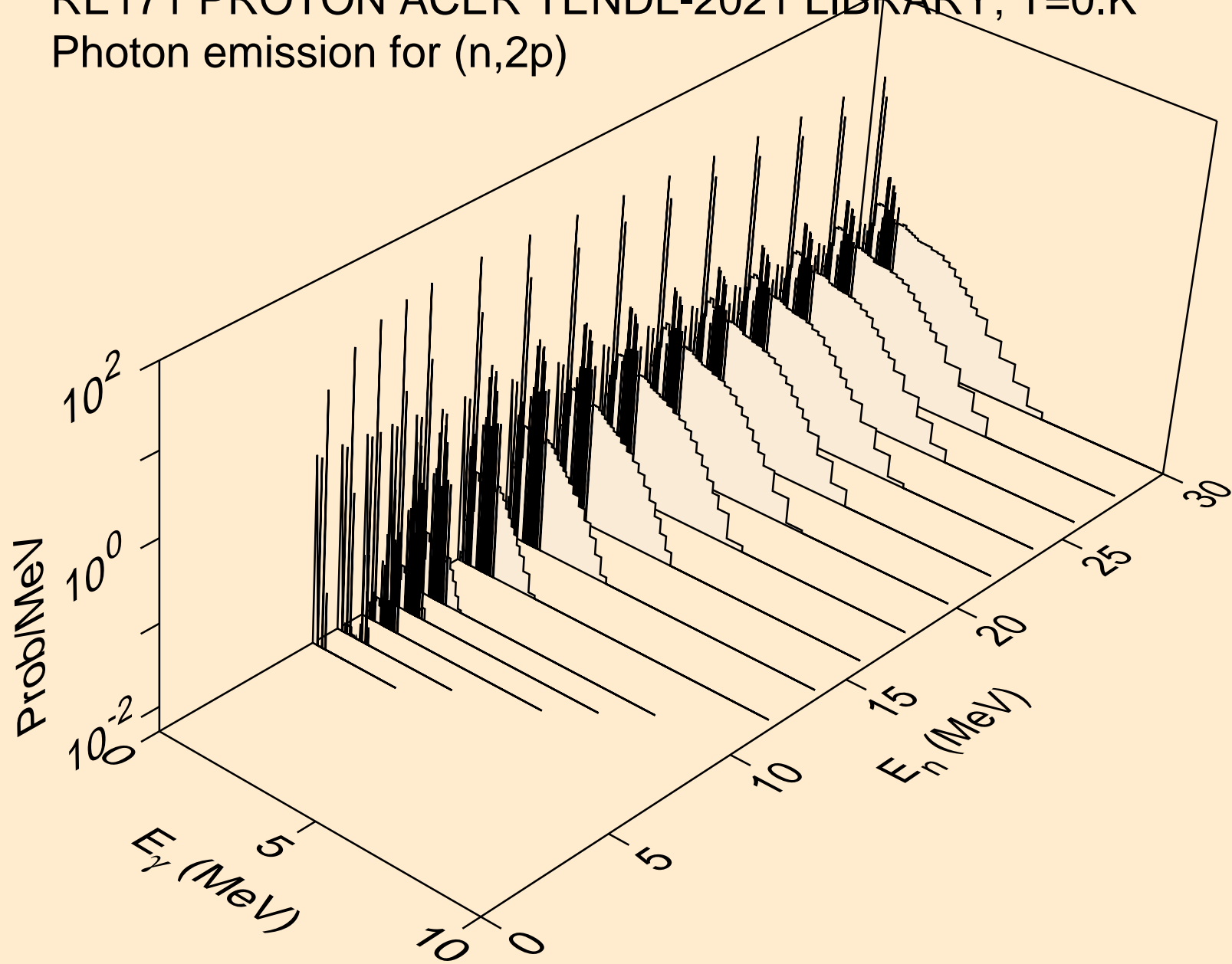

RE171 PROTON ACER TENDL-2021 LIBRARY; T=0.K  
Photon emission for (n,pa)

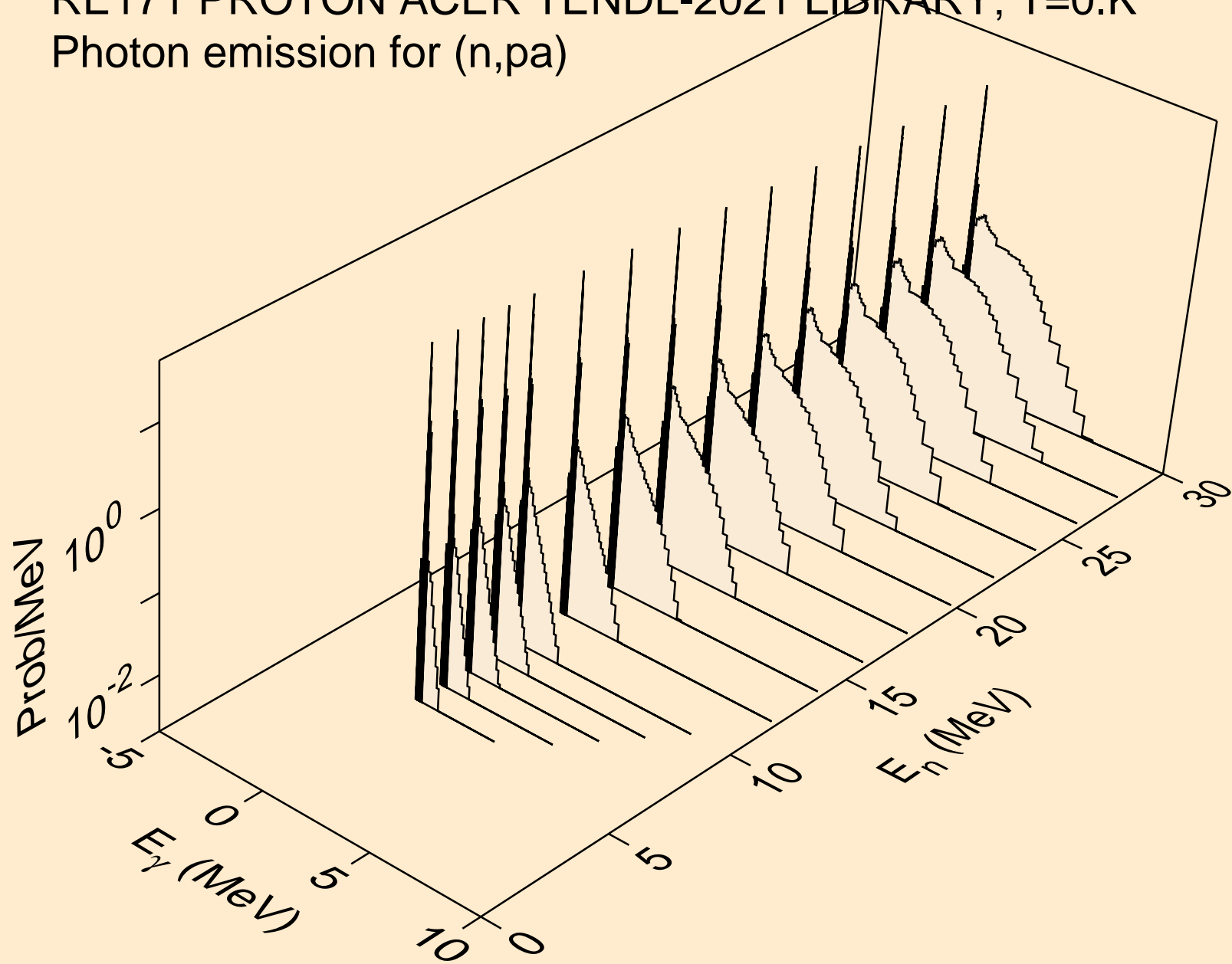

RE171 PROTON ACER TENDL-2021 LIBRARY; T=0.K  
Photon emission for (n,pd)

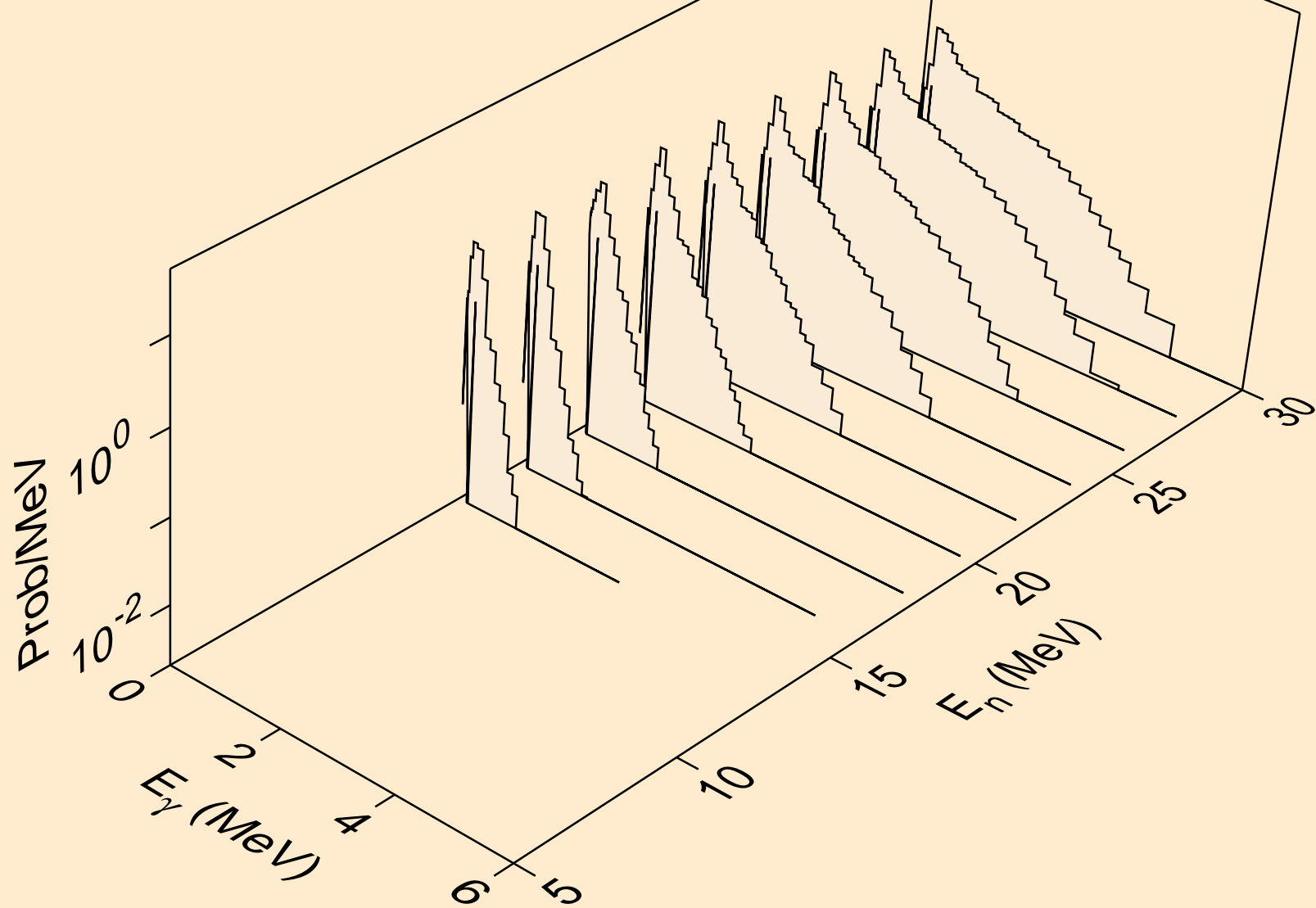

RE171 PROTON ACER TENDL-2021 LIBRARY; T=0.K  
Photon emission for (n,pt)

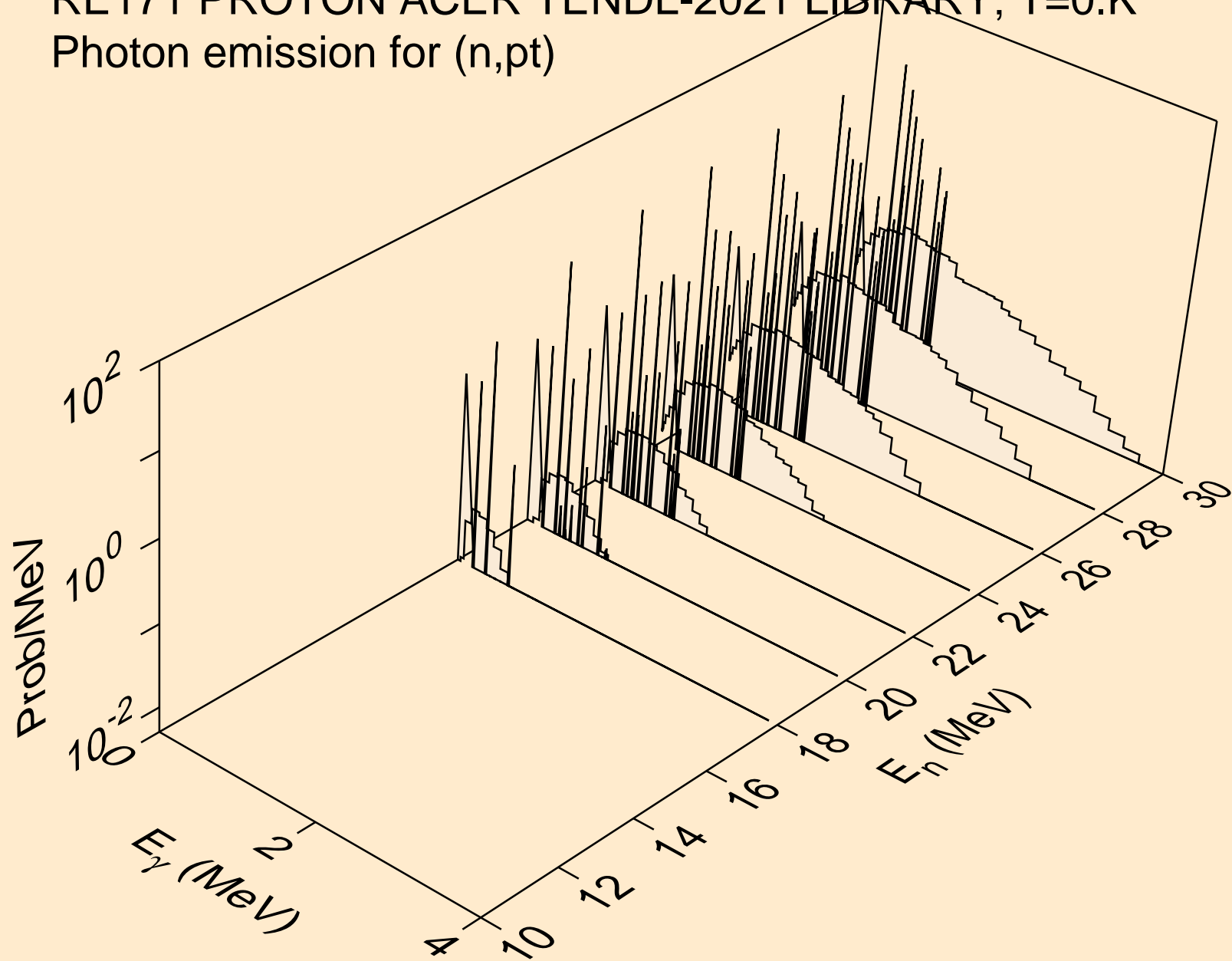

RE171 PROTON ACER TENDL-2021 LIBRARY; T=0.K  
Photon emission for (n,da)

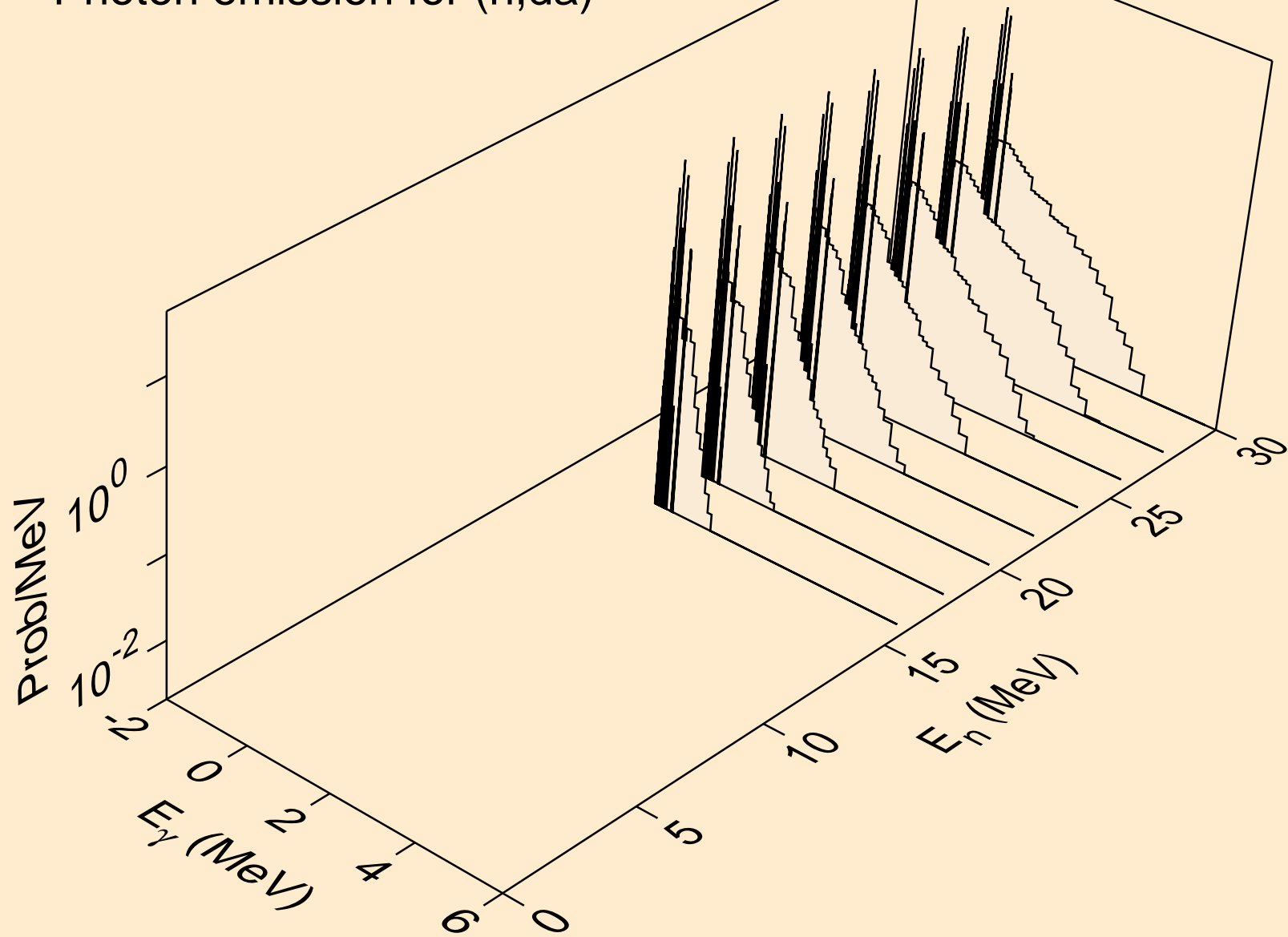



RE171 PROTON ACER TENDL-2021 LIBRARY; T=0.K  
Particle heating contributions

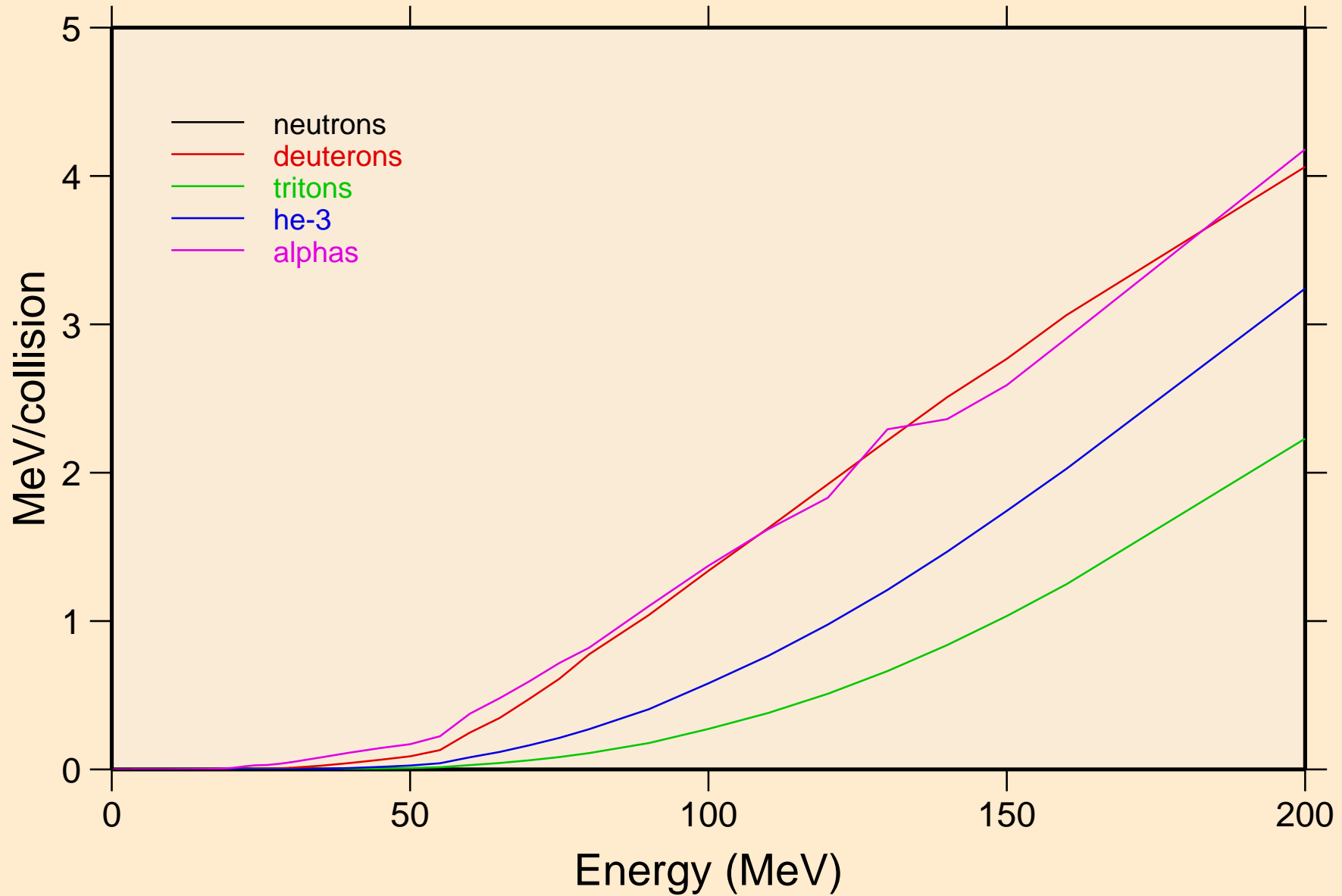

RE171 PROTON ACER TENDL-2021 LIBRARY; T=0.K  
Recoil Heating

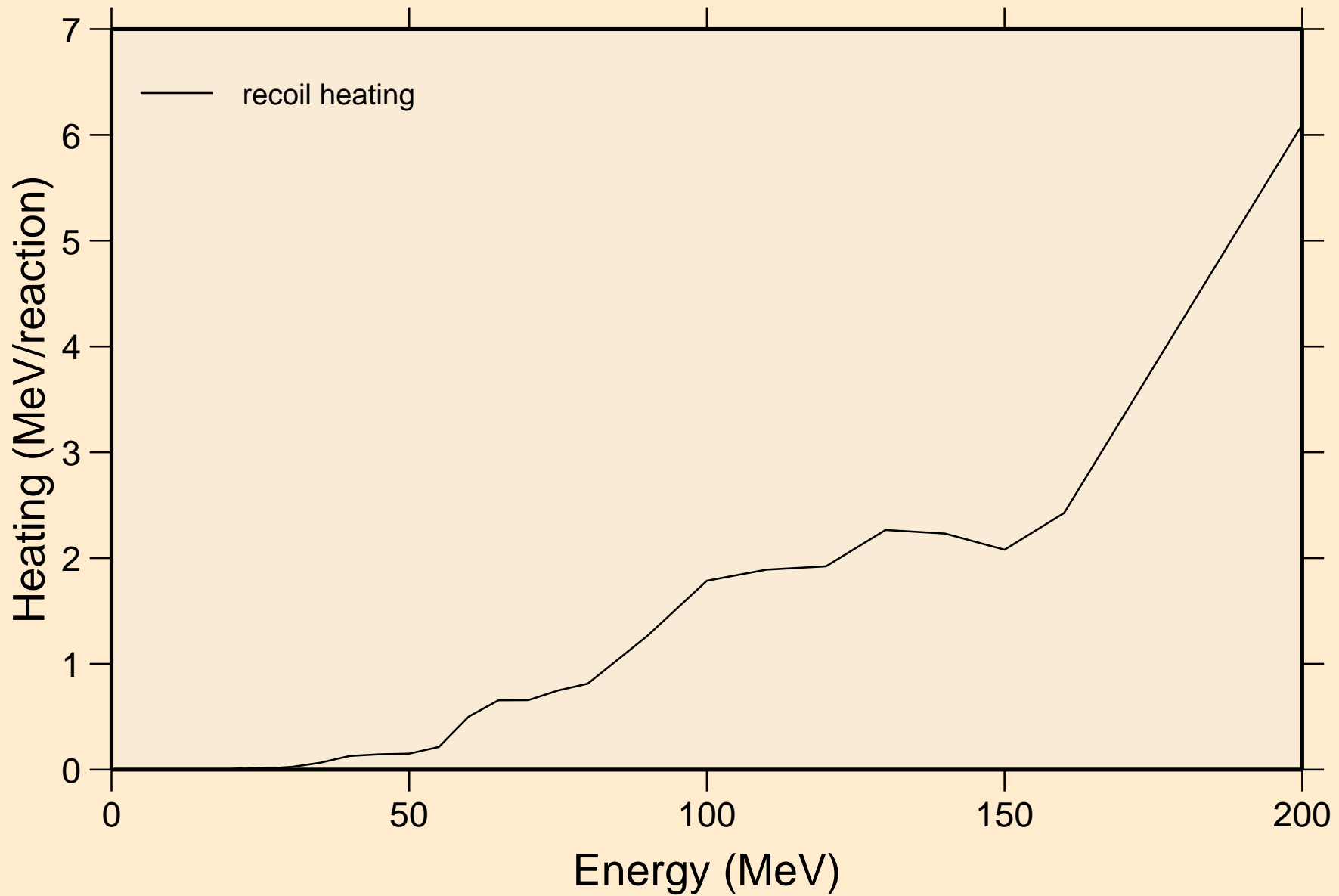

RE171 PROTON ACER TENDL-2021 LIBRARY; T=0.K  
Particle production cross sections

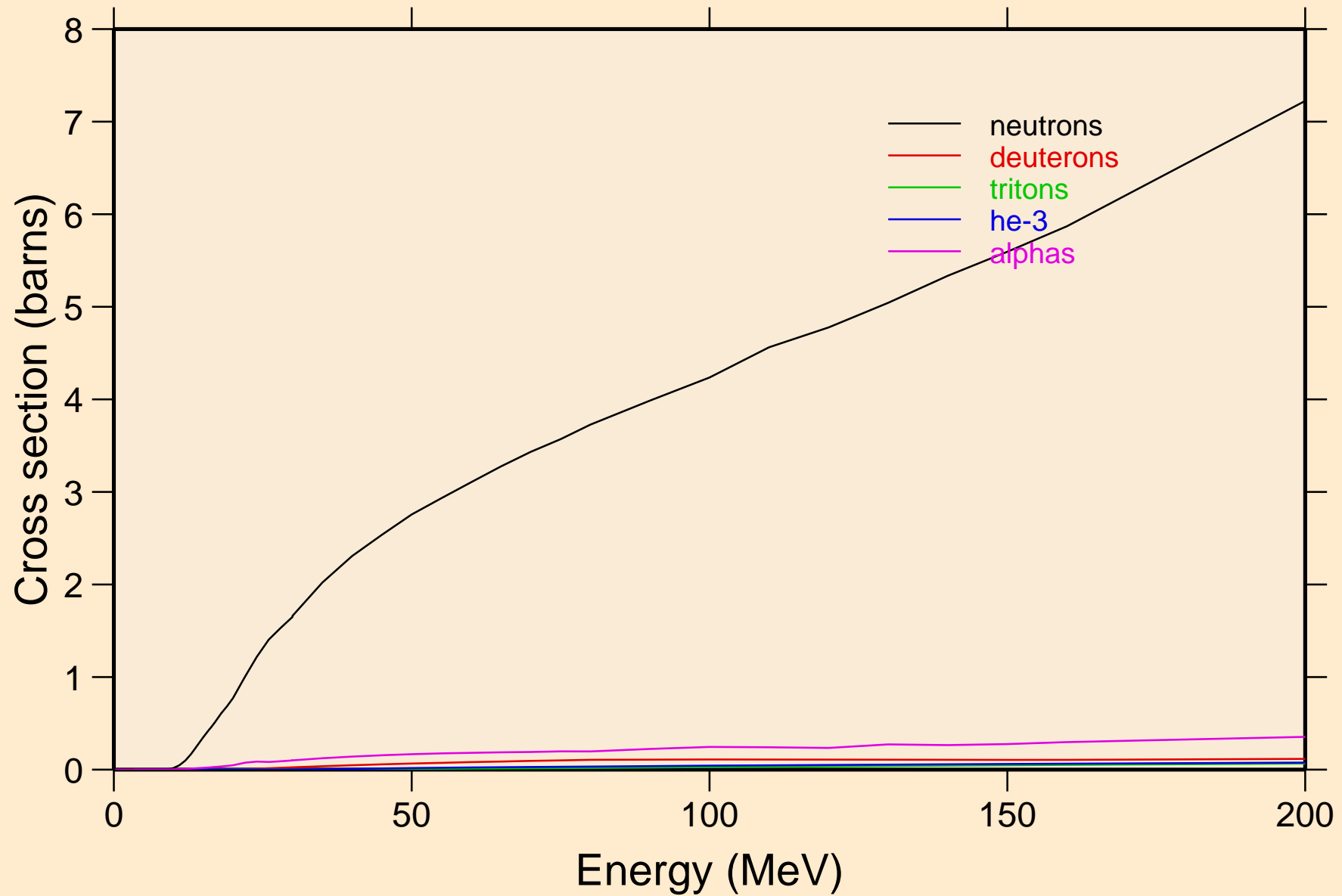

RE171 PROTON ACER TENDL-2021 LIBRARY; T=0.K  
neutrons from (p,n)

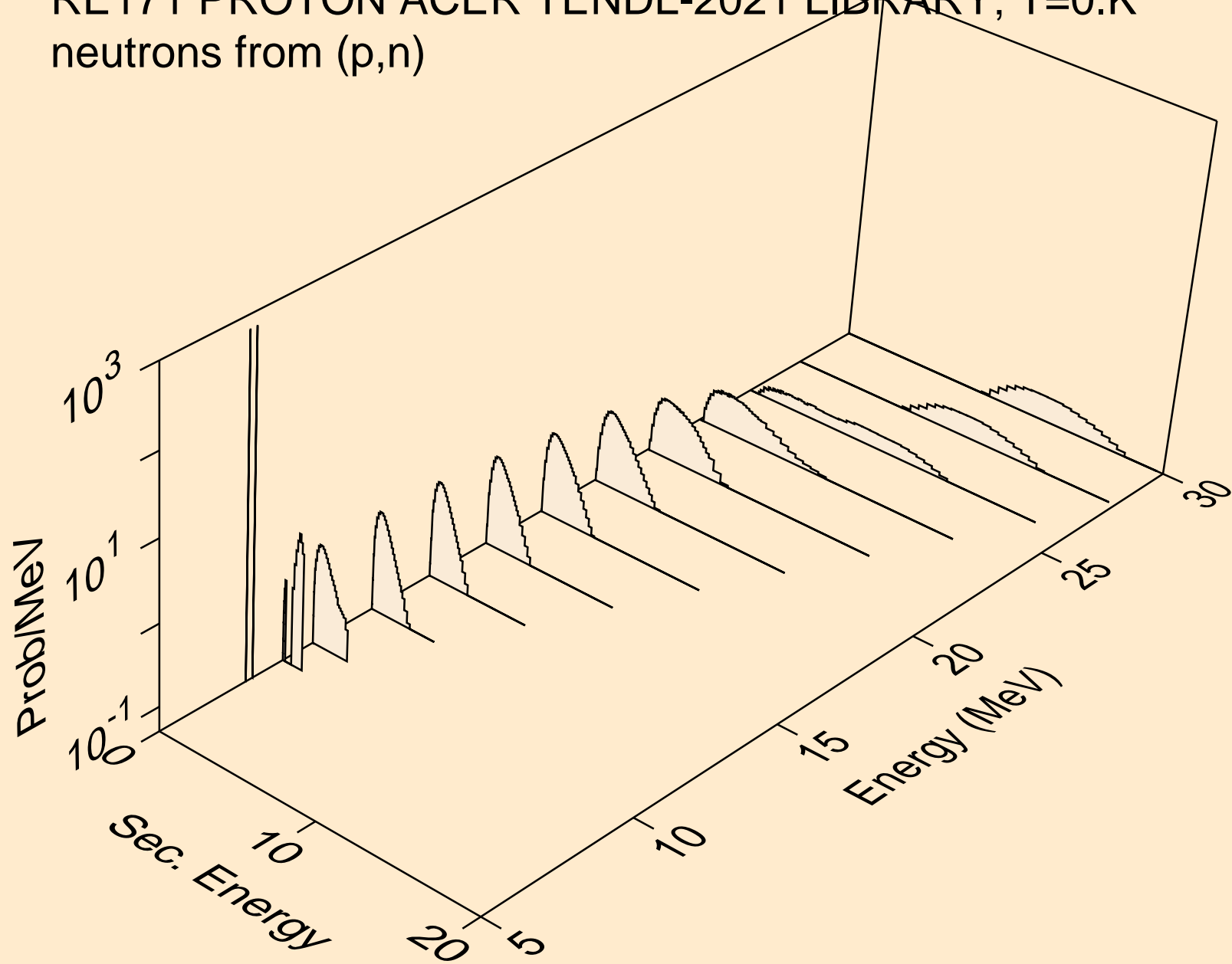

RE171 PROTON ACER TENDL-2021 LIBRARY; T=0.K  
neutrons from (p,x)

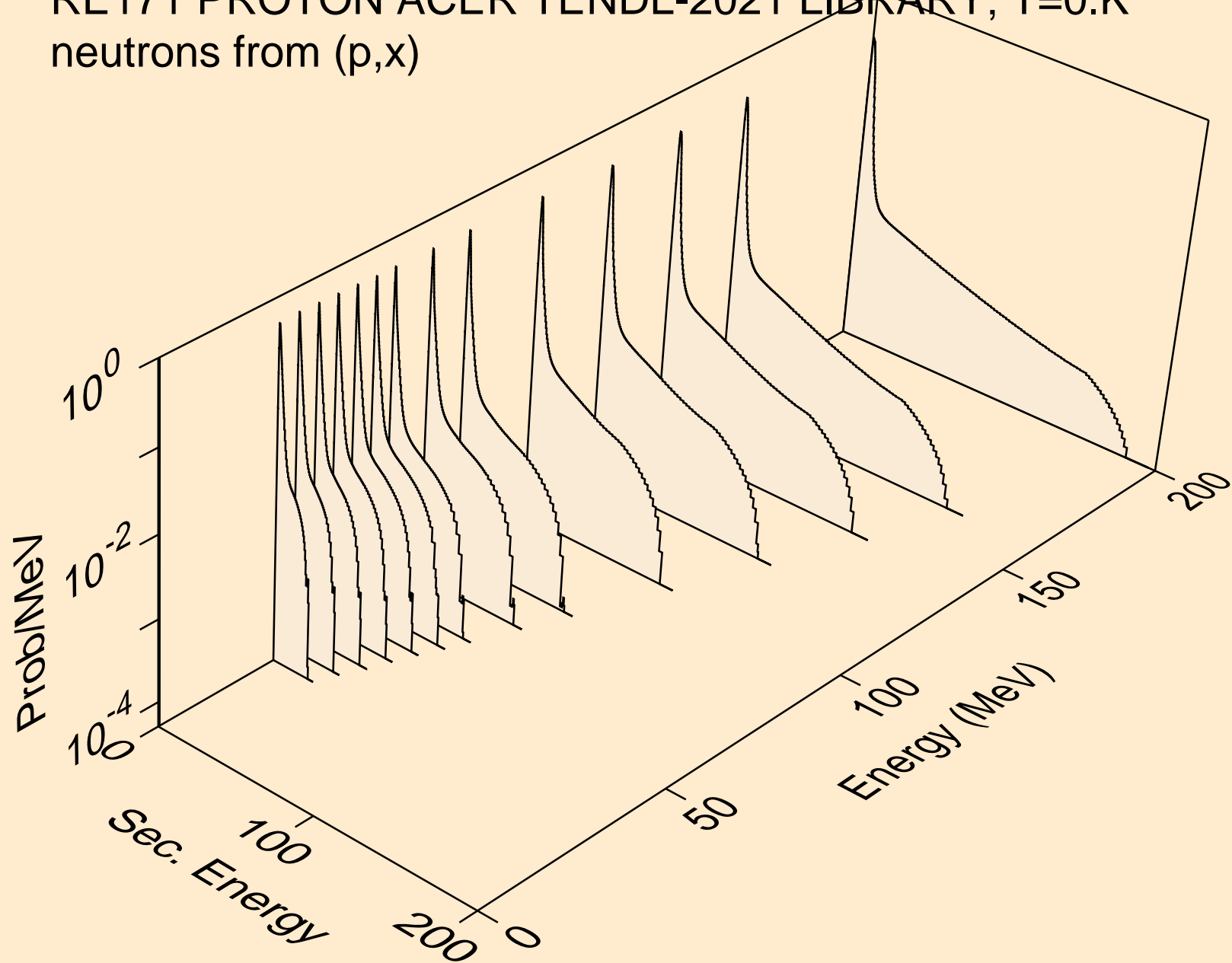

RE171 PROTON ACER TENDL-2021 LIBRARY; T=0.K  
neutrons from (p,2n)

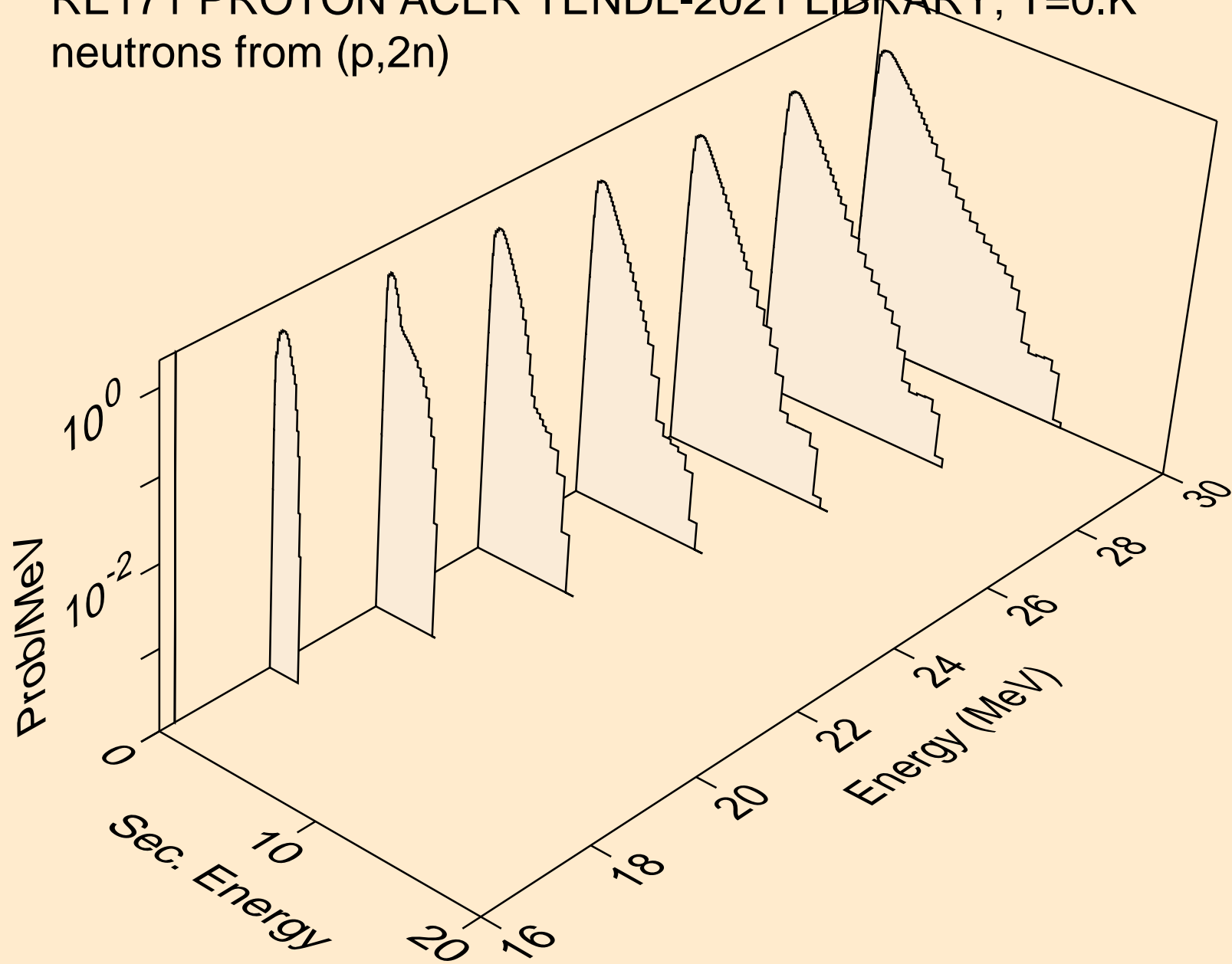

RE171 PROTON ACER TENDL-2021 LIBRARY; T=0.K  
neutrons from (p,3n)

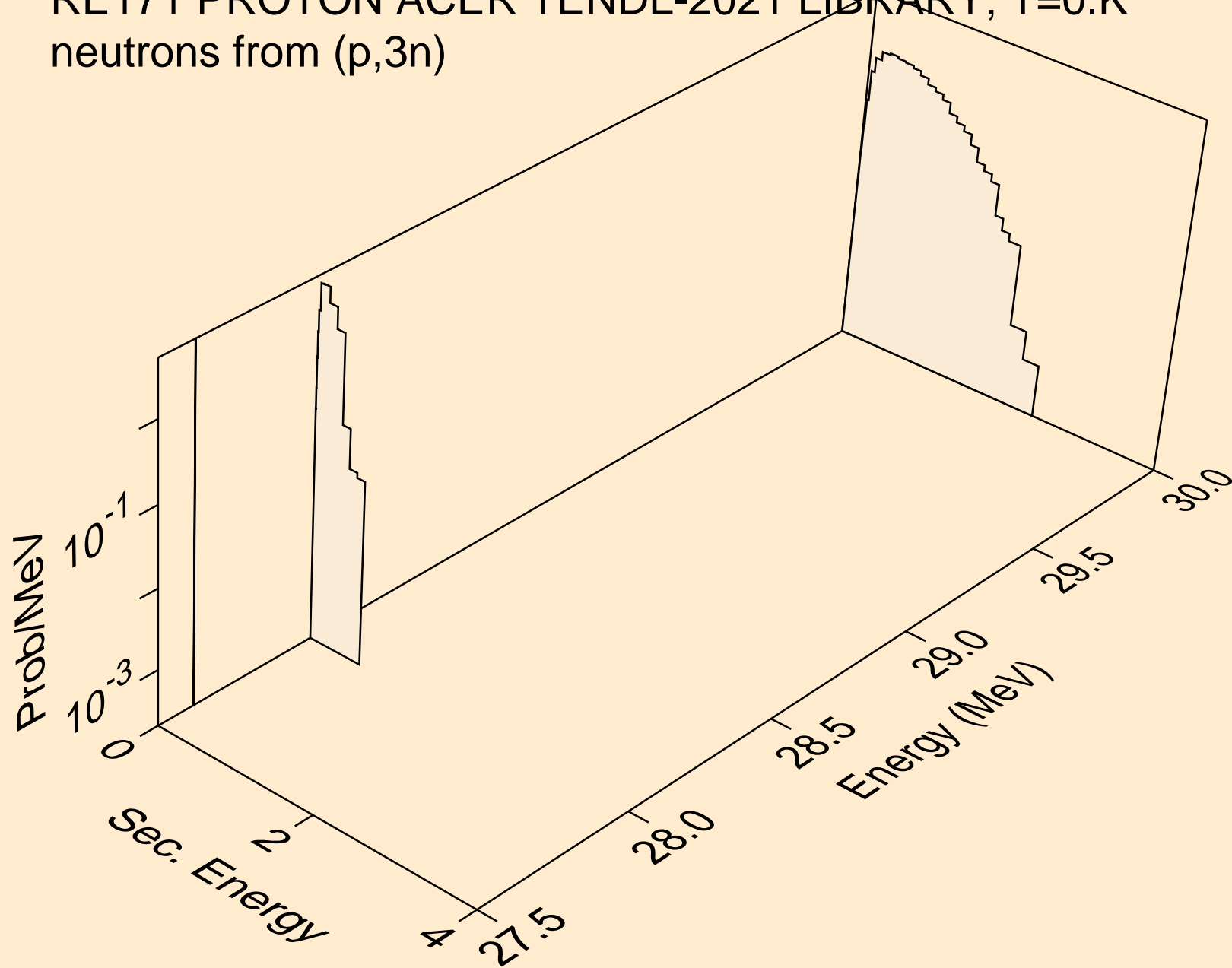

RE171 PROTON ACER TENDL-2021 LIBRARY; T=0.K  
neutrons from (p,n\*)a

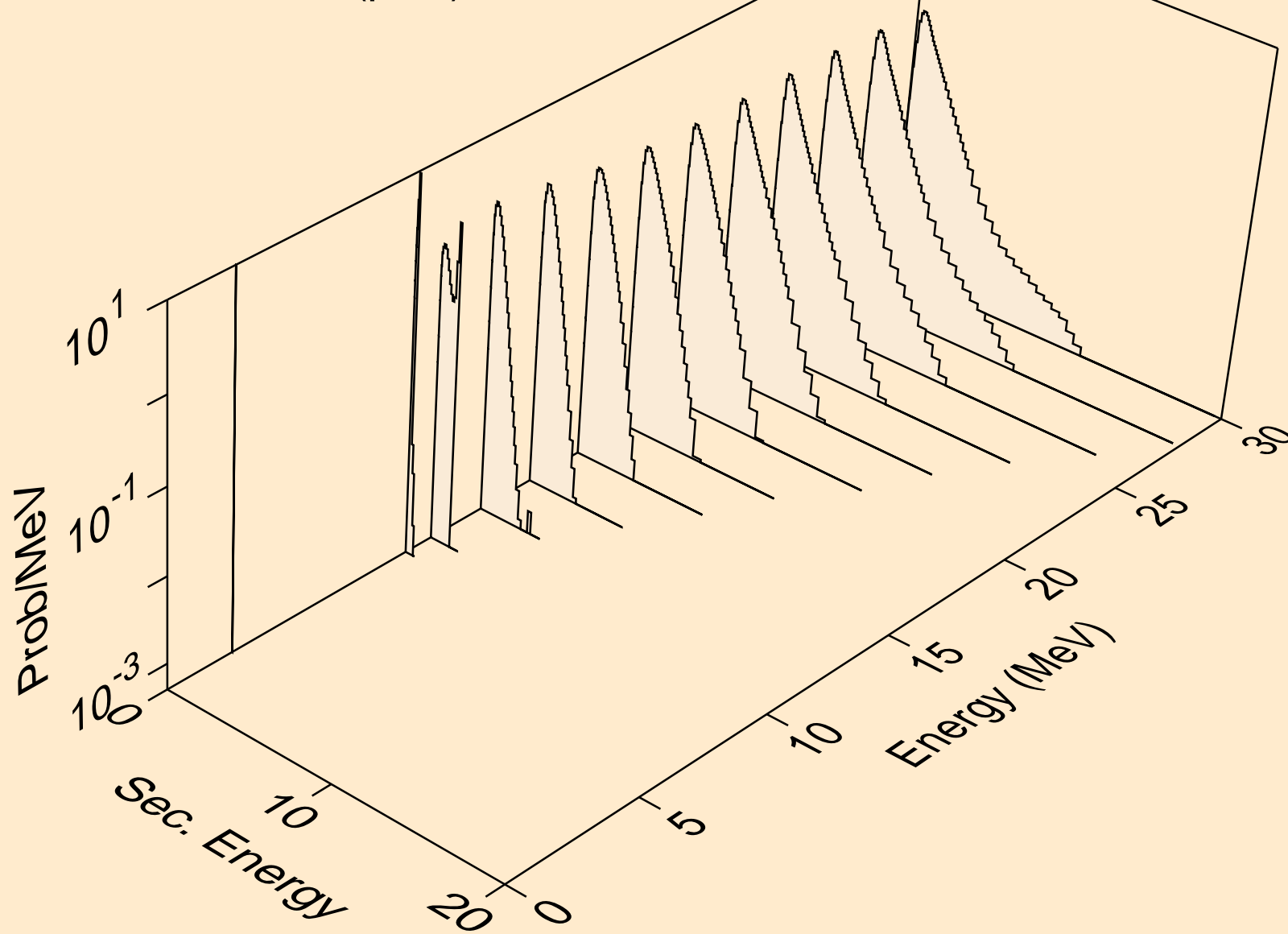



RE171 PROTON ACER TENDL-2021 LIBRARY; T=0.K  
neutrons from (p,2n)a

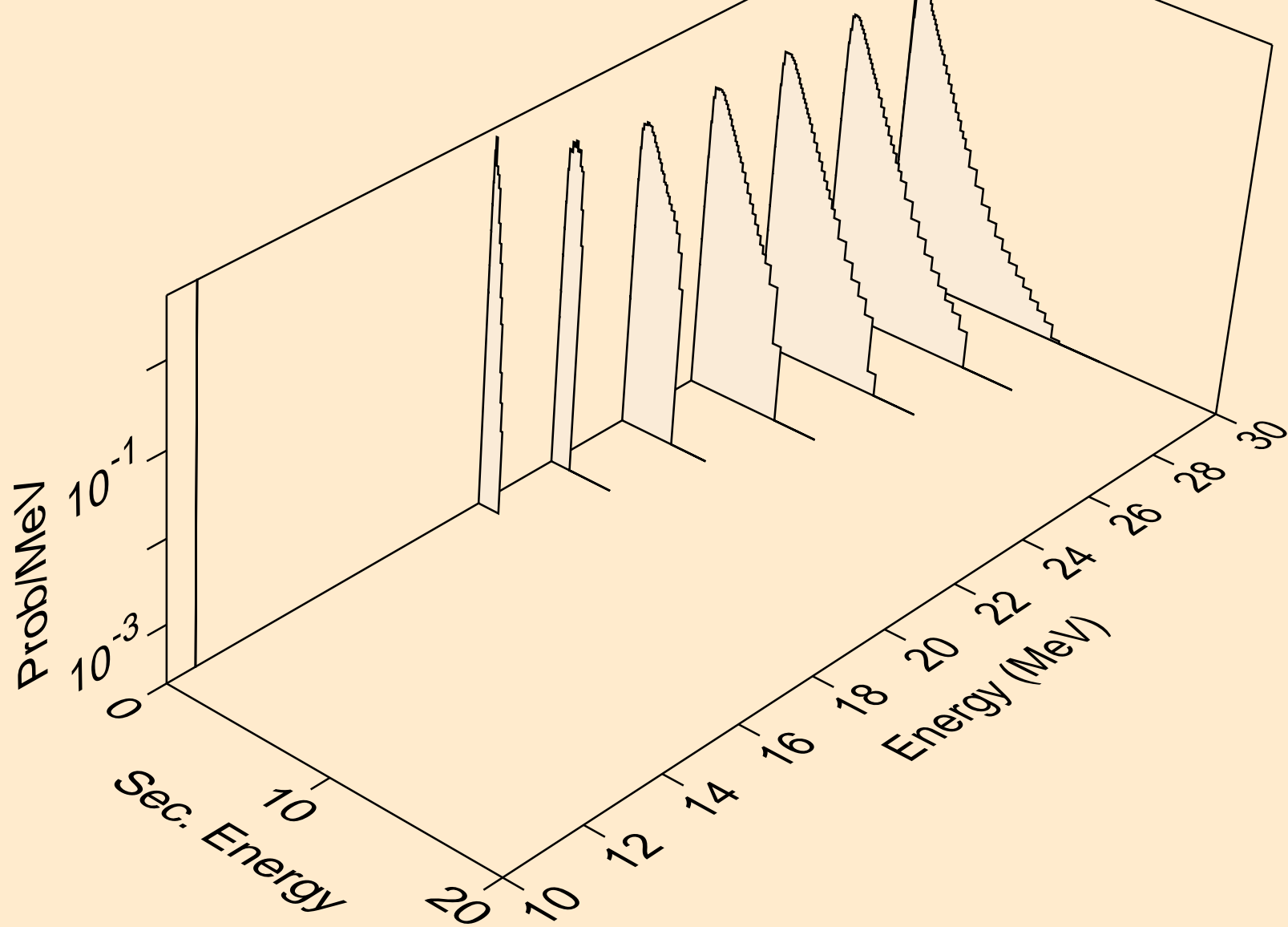

RE171 PROTON ACER TENDL-2021 LIBRARY; T=0.K  
neutrons from (p,3n)a

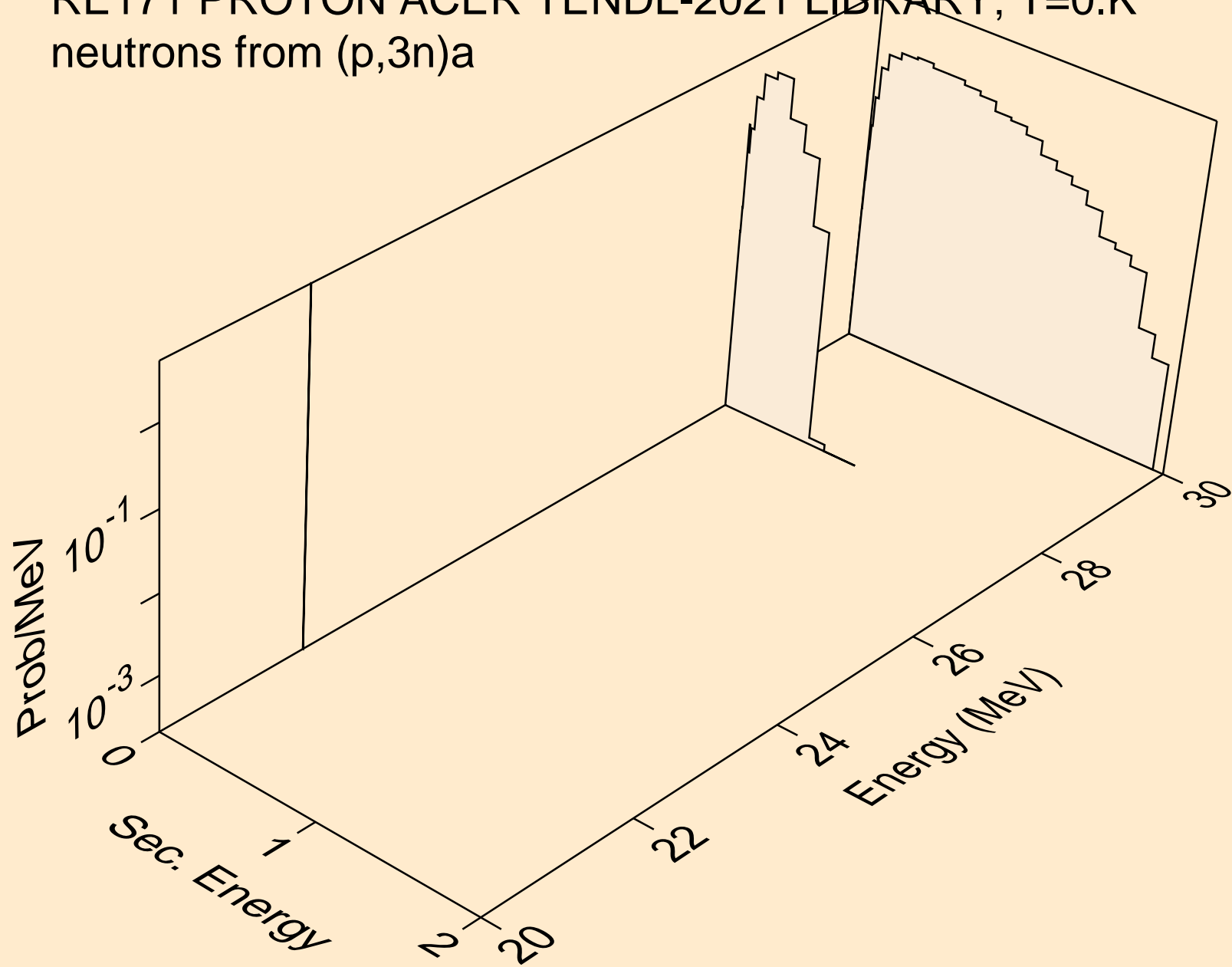

RE171 PROTON ACER TENDL-2021 LIBRARY; T=0.K  
neutrons from (p,n\*)p

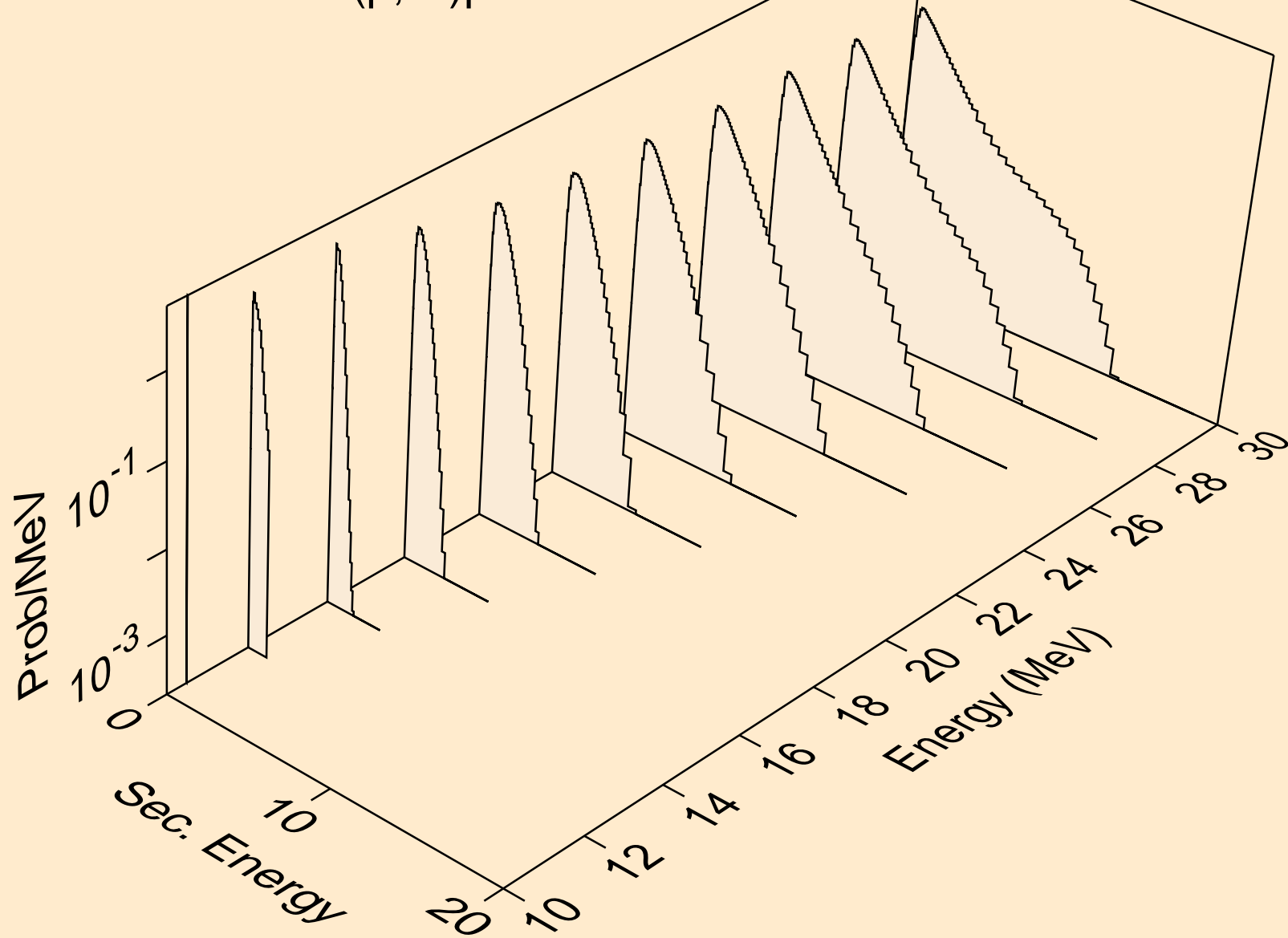

RE171 PROTON ACER TENDL-2021 LIBRARY; T=0.K  
neutrons from (p,n\*)2a

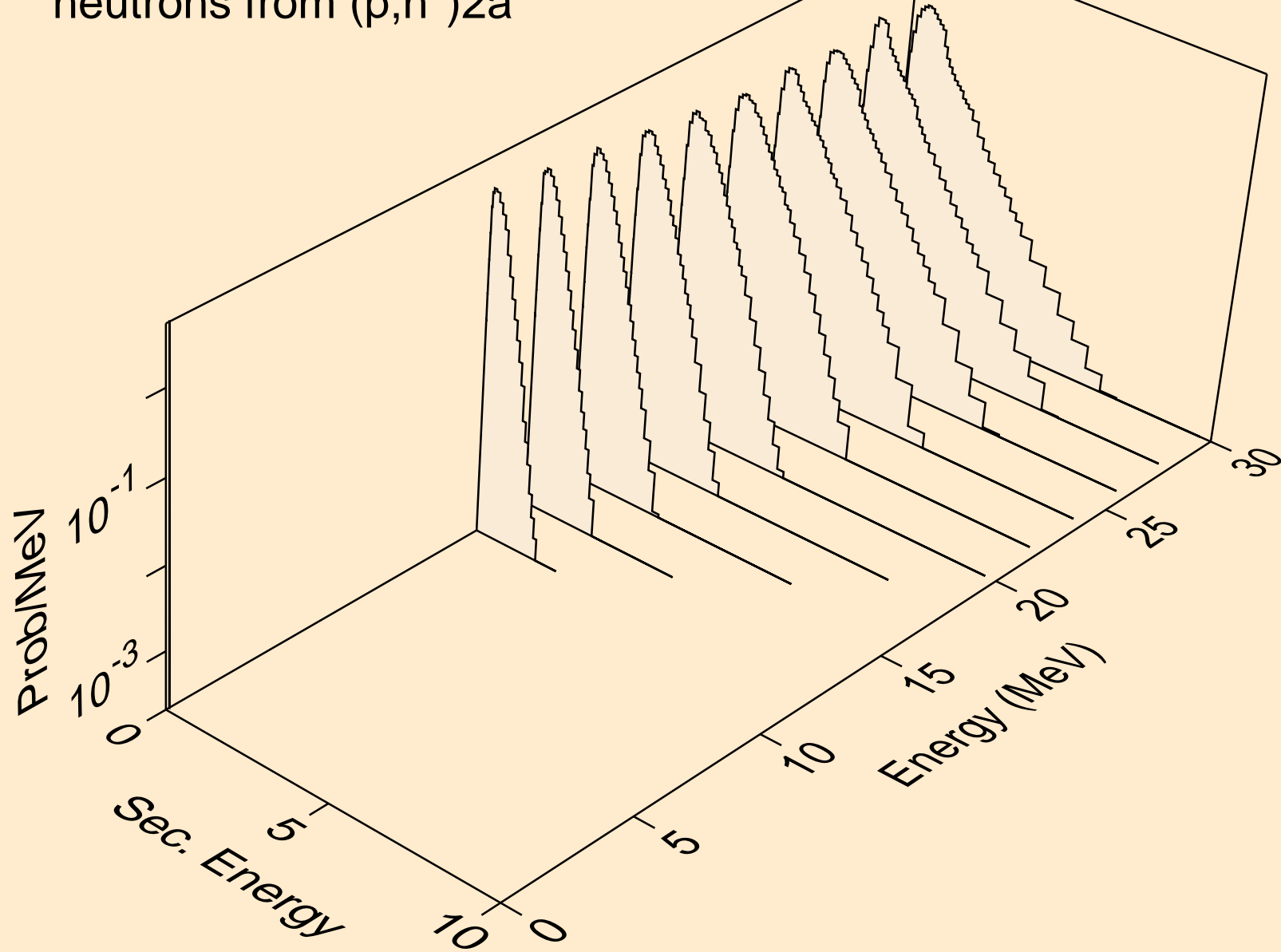

RE171 PROTON ACER TENDL-2021 LIBRARY; T=0.K  
neutrons from (p,2n)2a

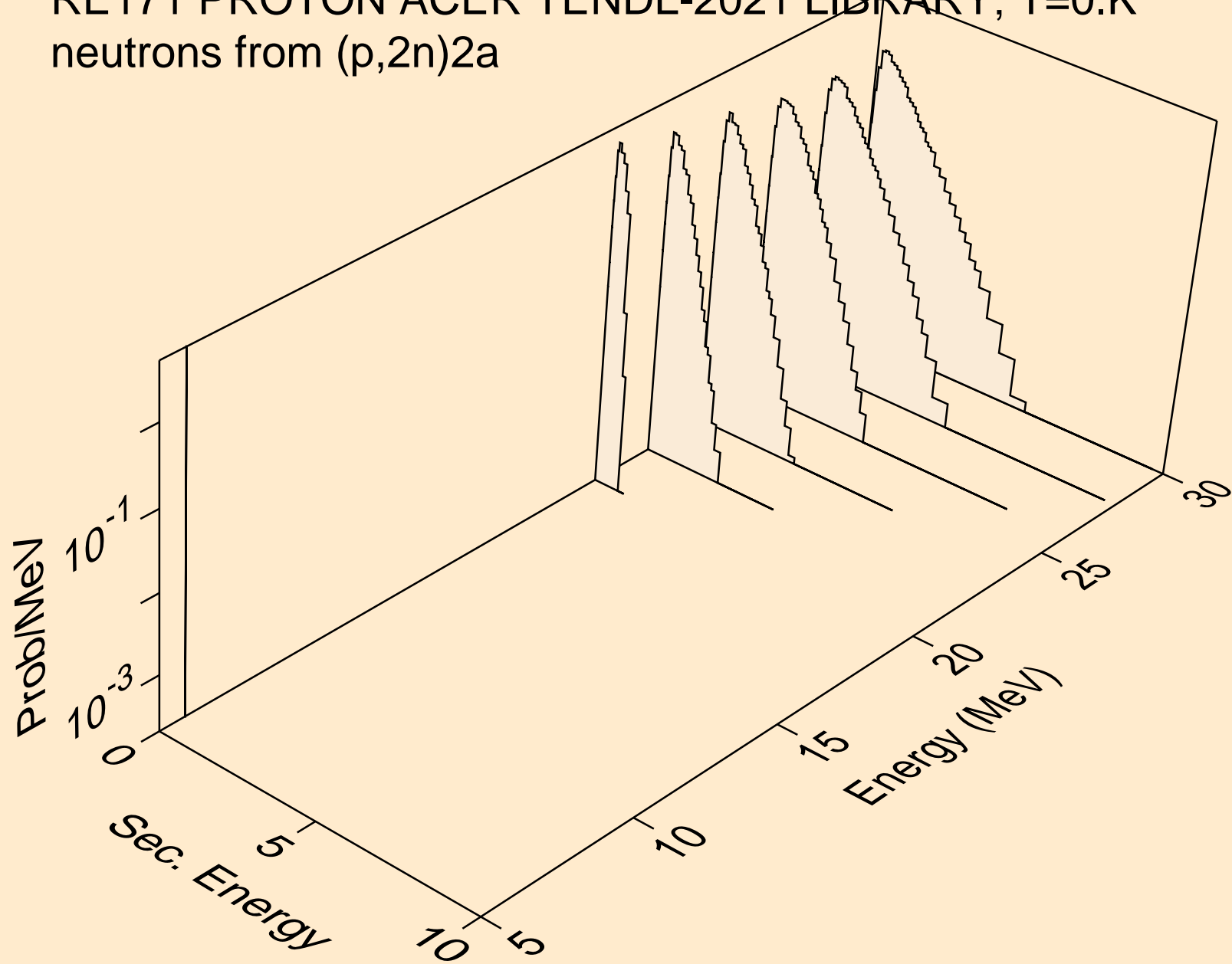

RE171 PROTON ACER TENDL-2021 LIBRARY; T=0.K  
neutrons from (p,n\*)d

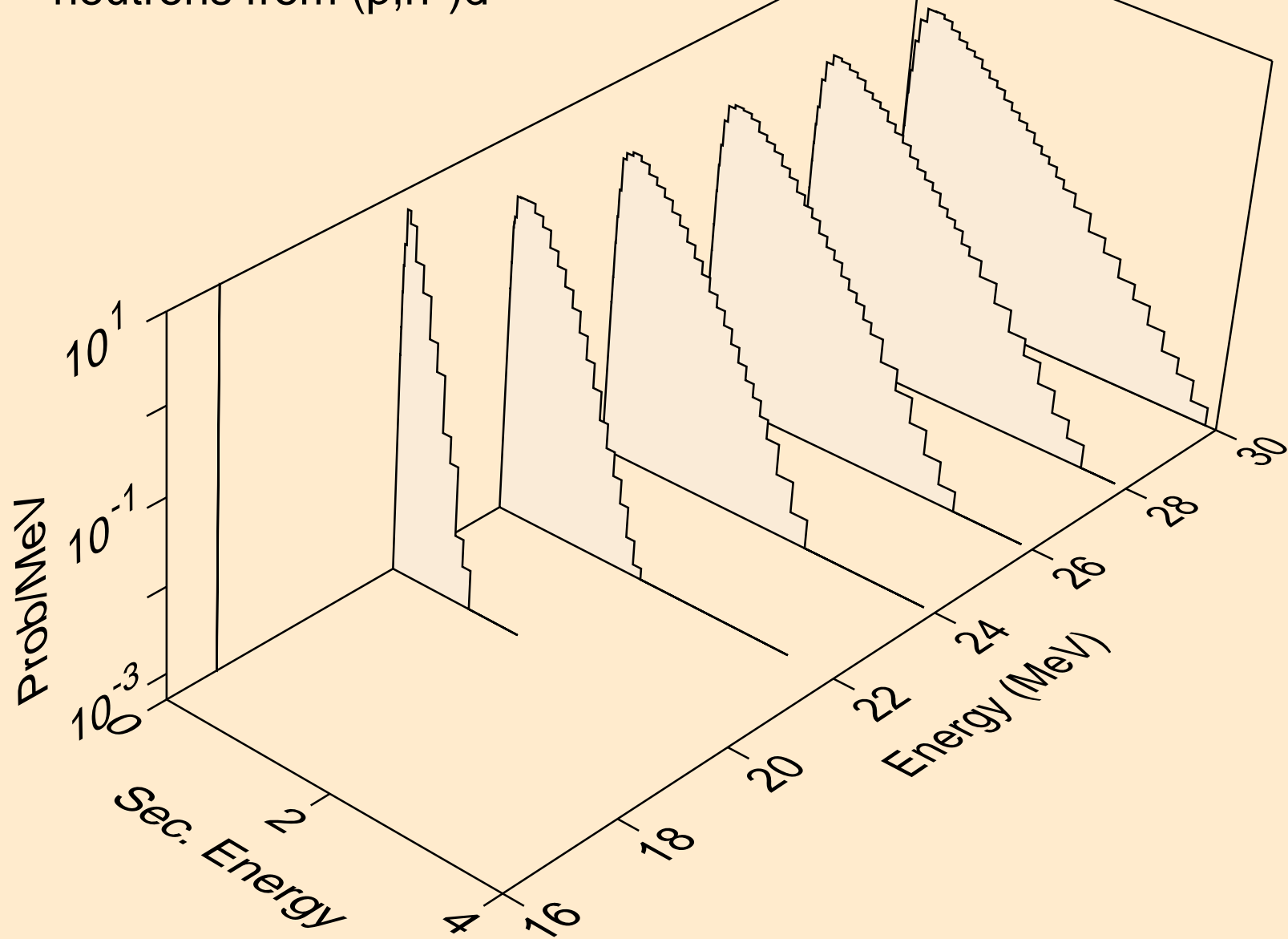

RE171 PROTON ACER TENDL-2021 LIBRARY; T=0.K  
neutrons from (p,n\*)t

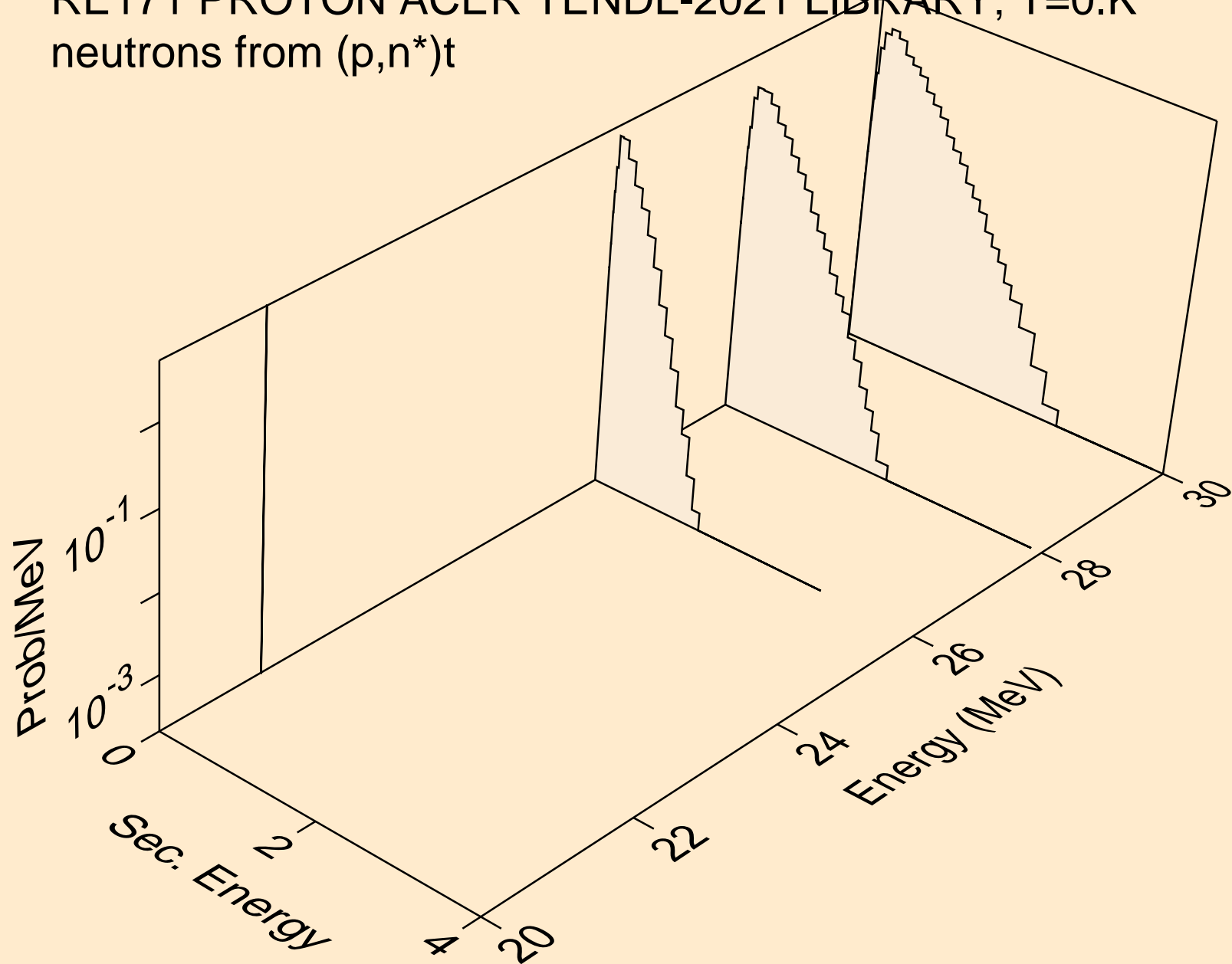

RE171 PROTON ACER TENDL-2021 LIBRARY; T=0.K  
neutrons from (p,n\*)he3

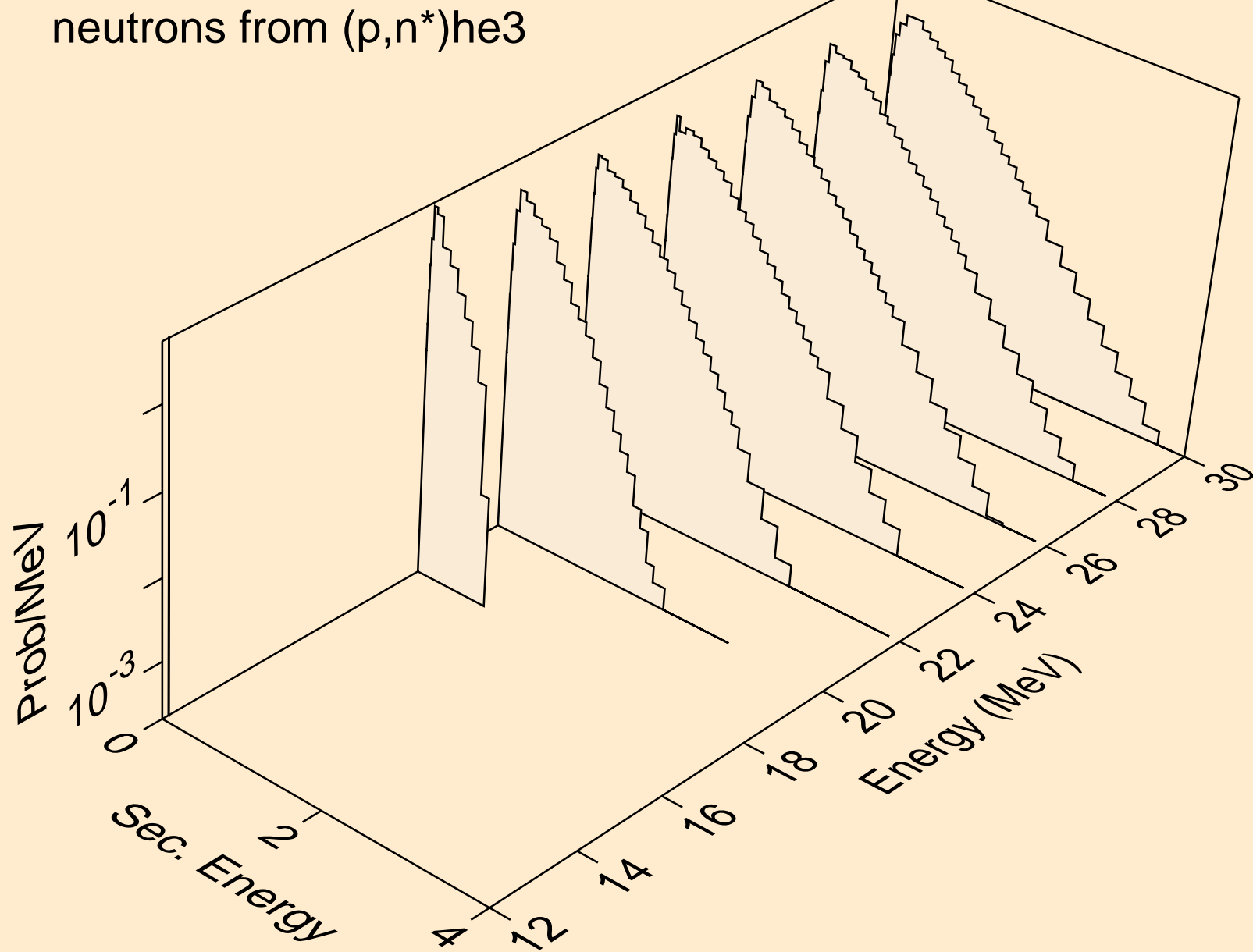



RE171 PROTON ACER TENDL-2021 LIBRARY; T=0.K  
neutrons from (p,2np)

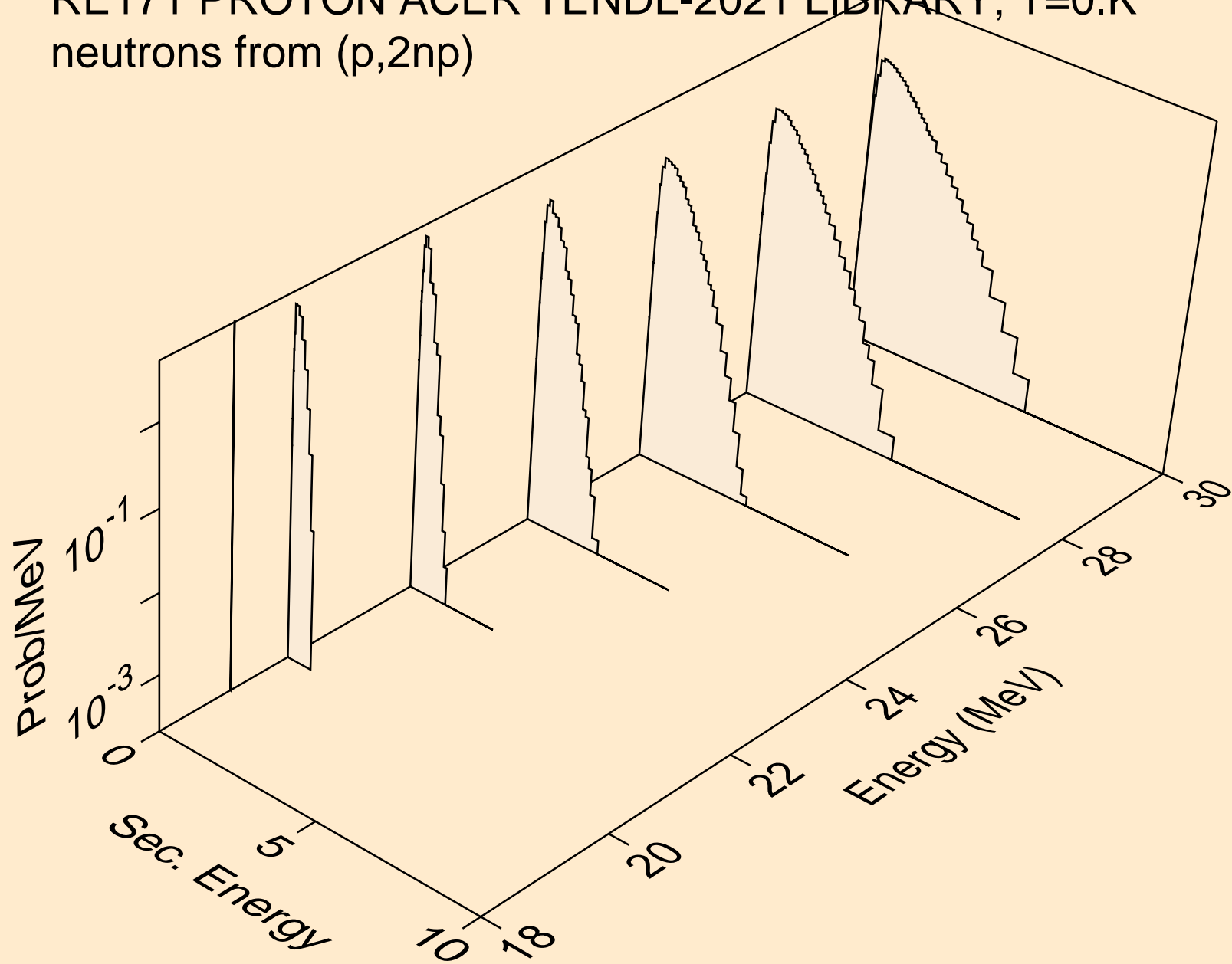

RE171 PROTON ACER TENDL-2021 LIBRARY; T=0.K  
neutrons from (p,2np)

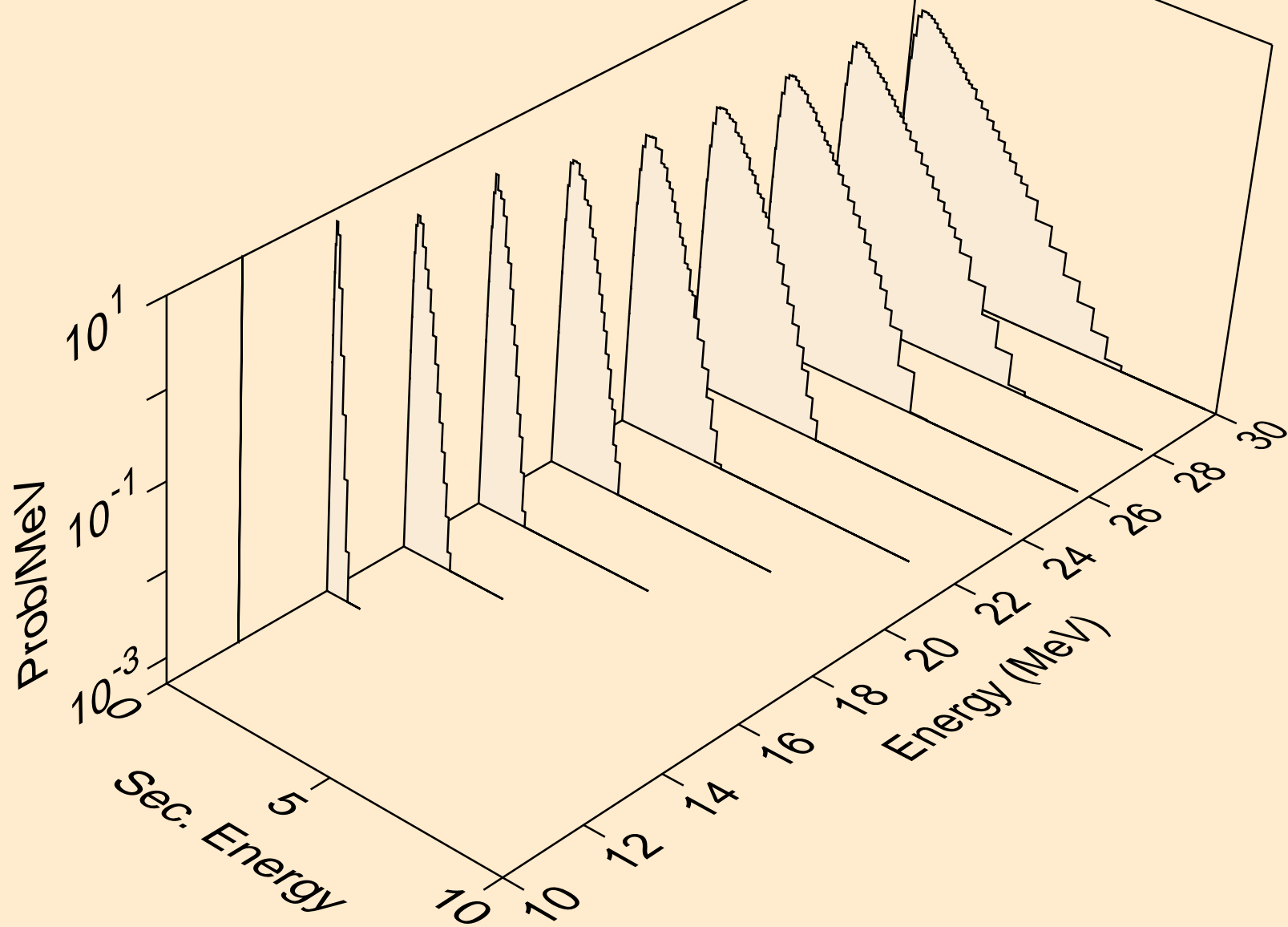

RE171 PROTON ACER TENDL-2021 LIBRARY; T=0.K  
neutrons from (p,npa)

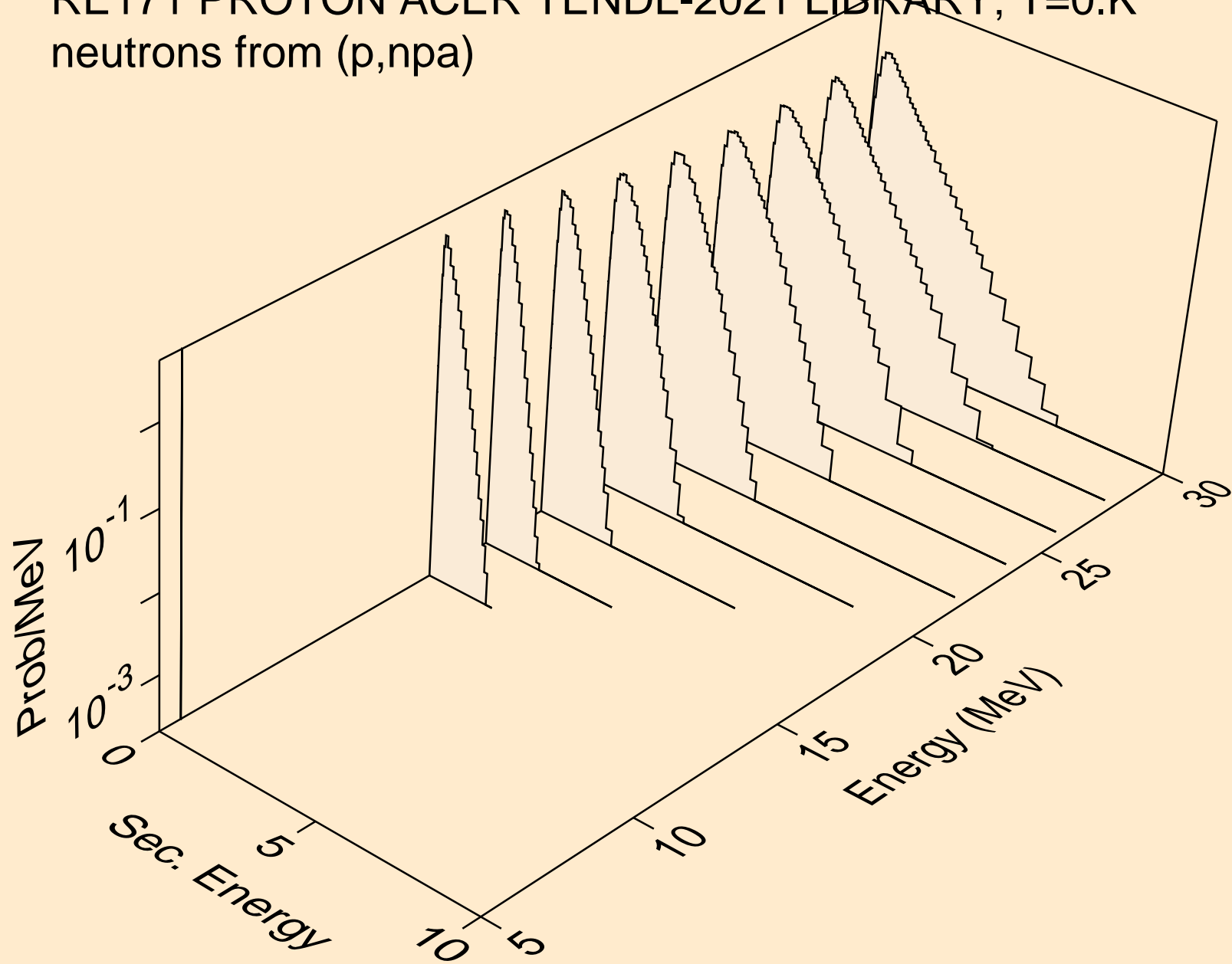

RE171 PROTON ACER TENDL-2021 LIBRARY; T=0.K  
deuterons from (p,x)

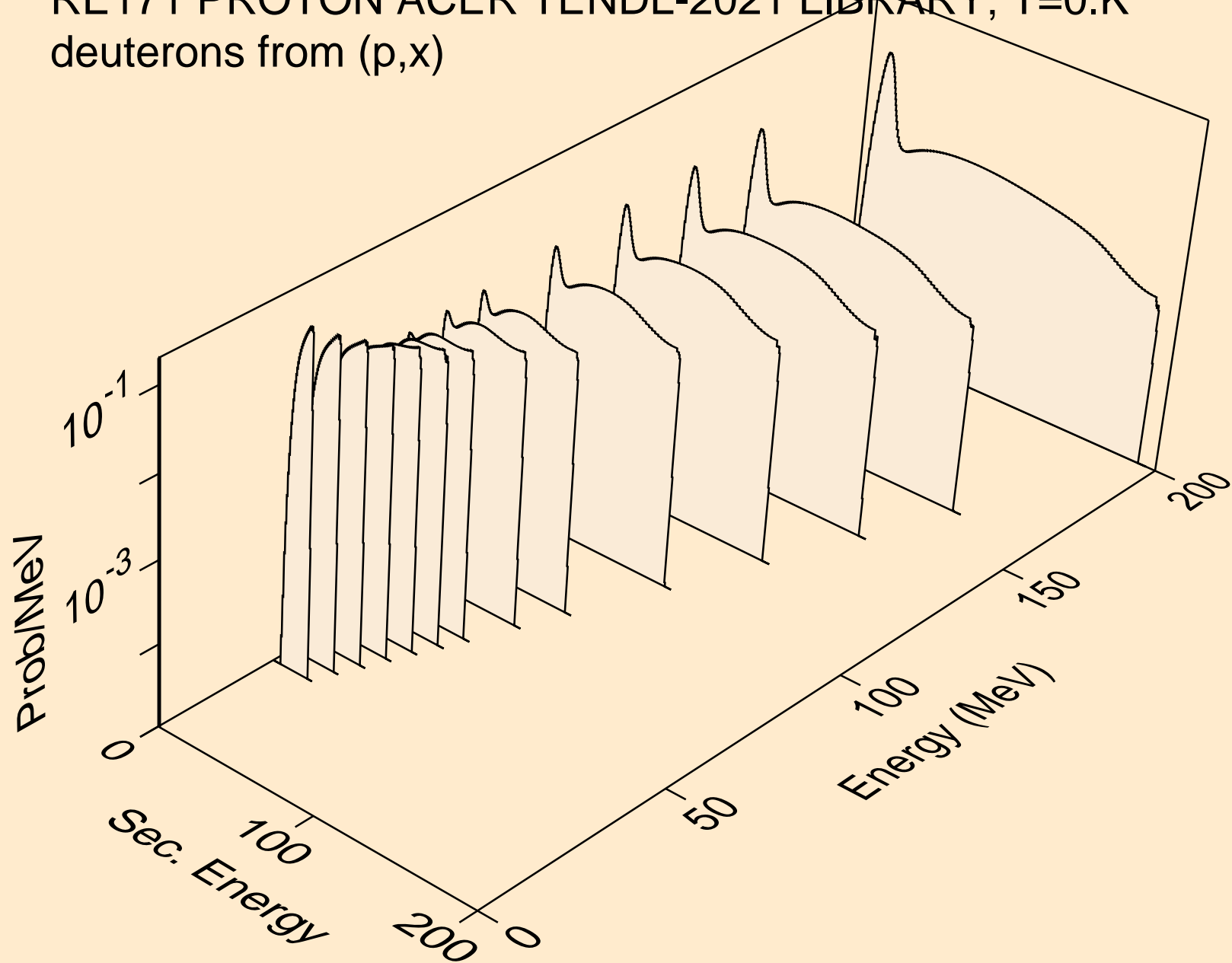

RE171 PROTON ACER TENDL-2021 LIBRARY; T=0.K  
deuterons from (p,n\*)d

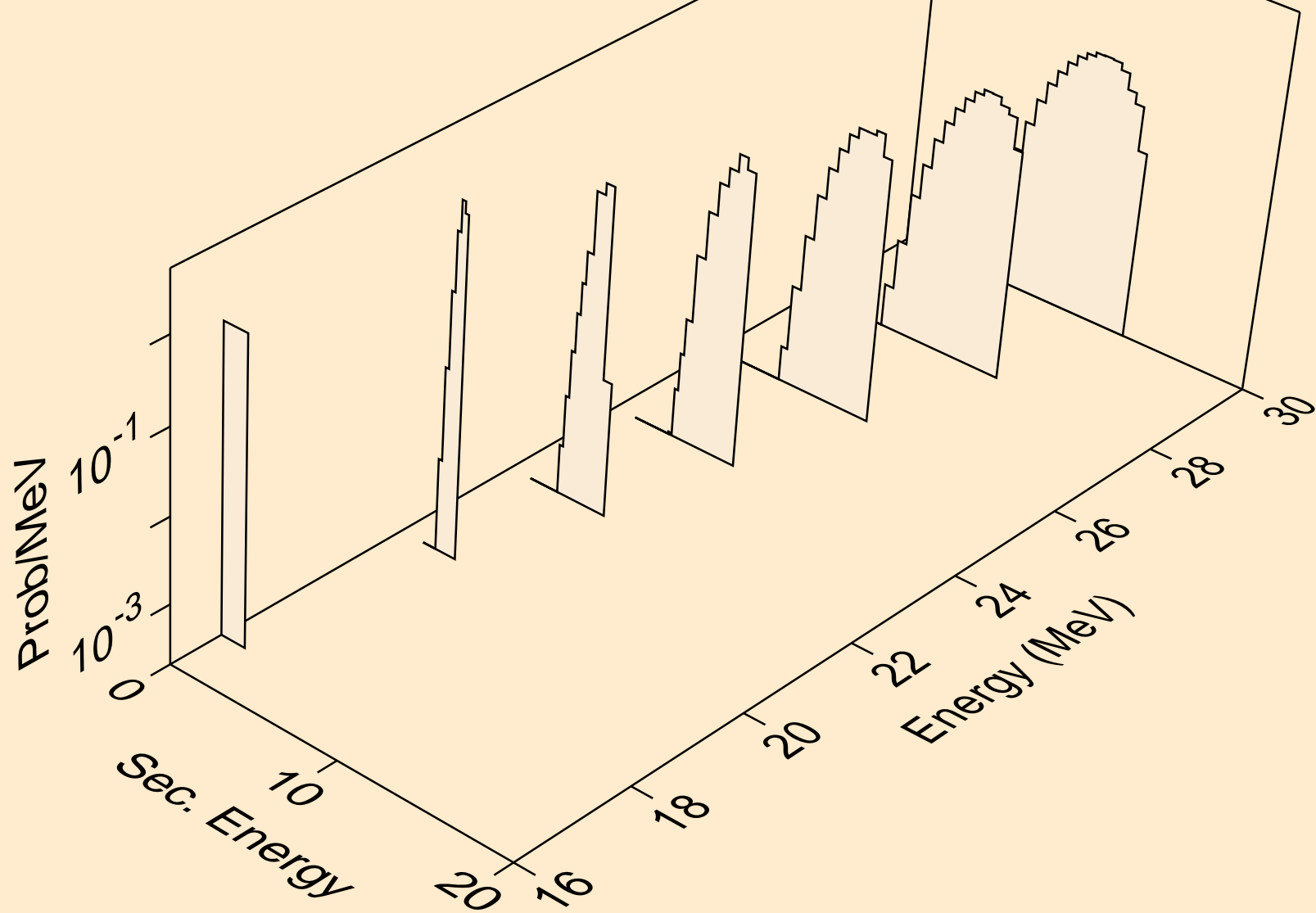

RE171 PROTON ACER TENDL-2021 LIBRARY; T=0.K  
deuterons from (p,d)

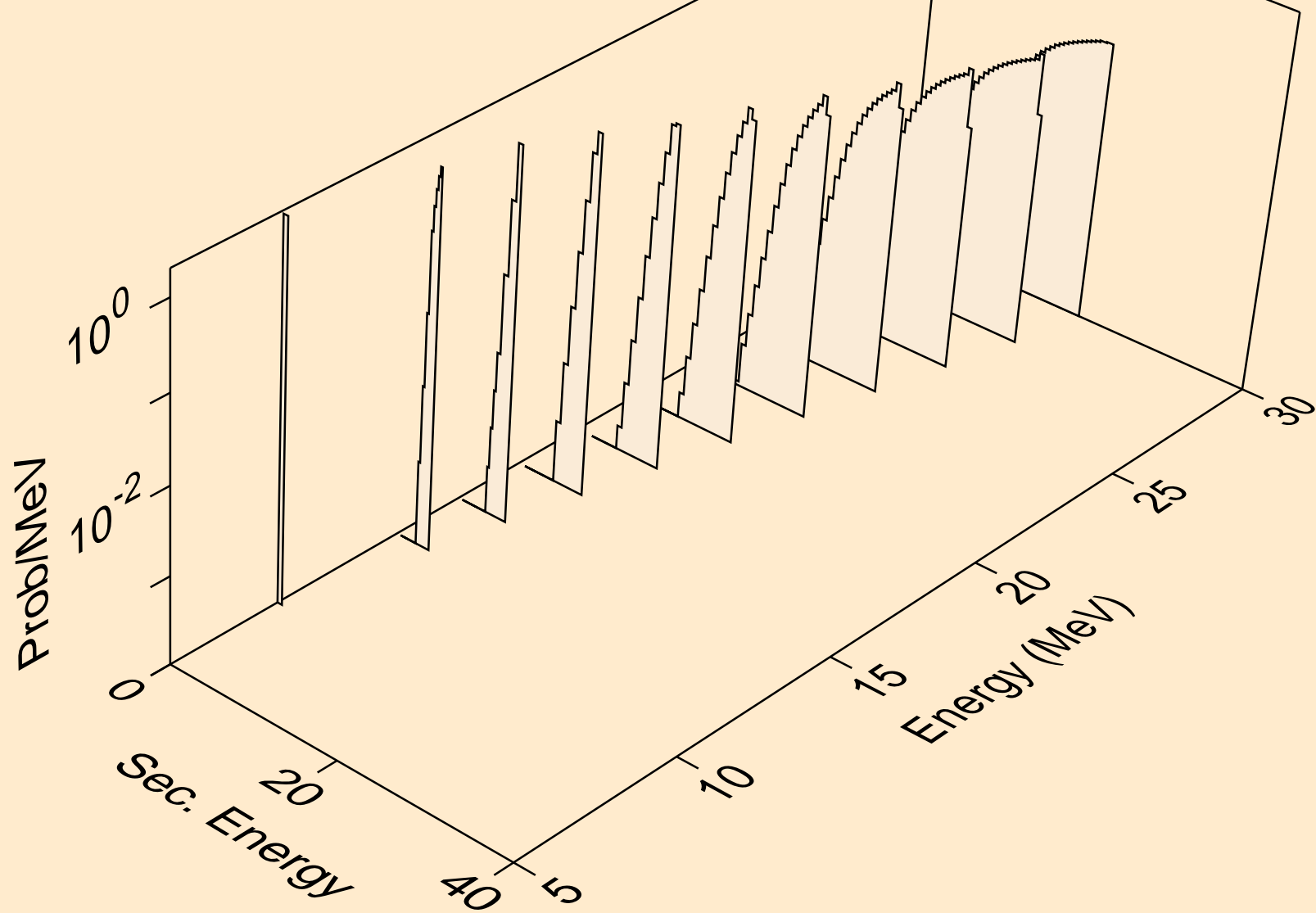

RE171 PROTON ACER TENDL-2021 LIBRARY; T=0.K  
deuterons from (p,pd)

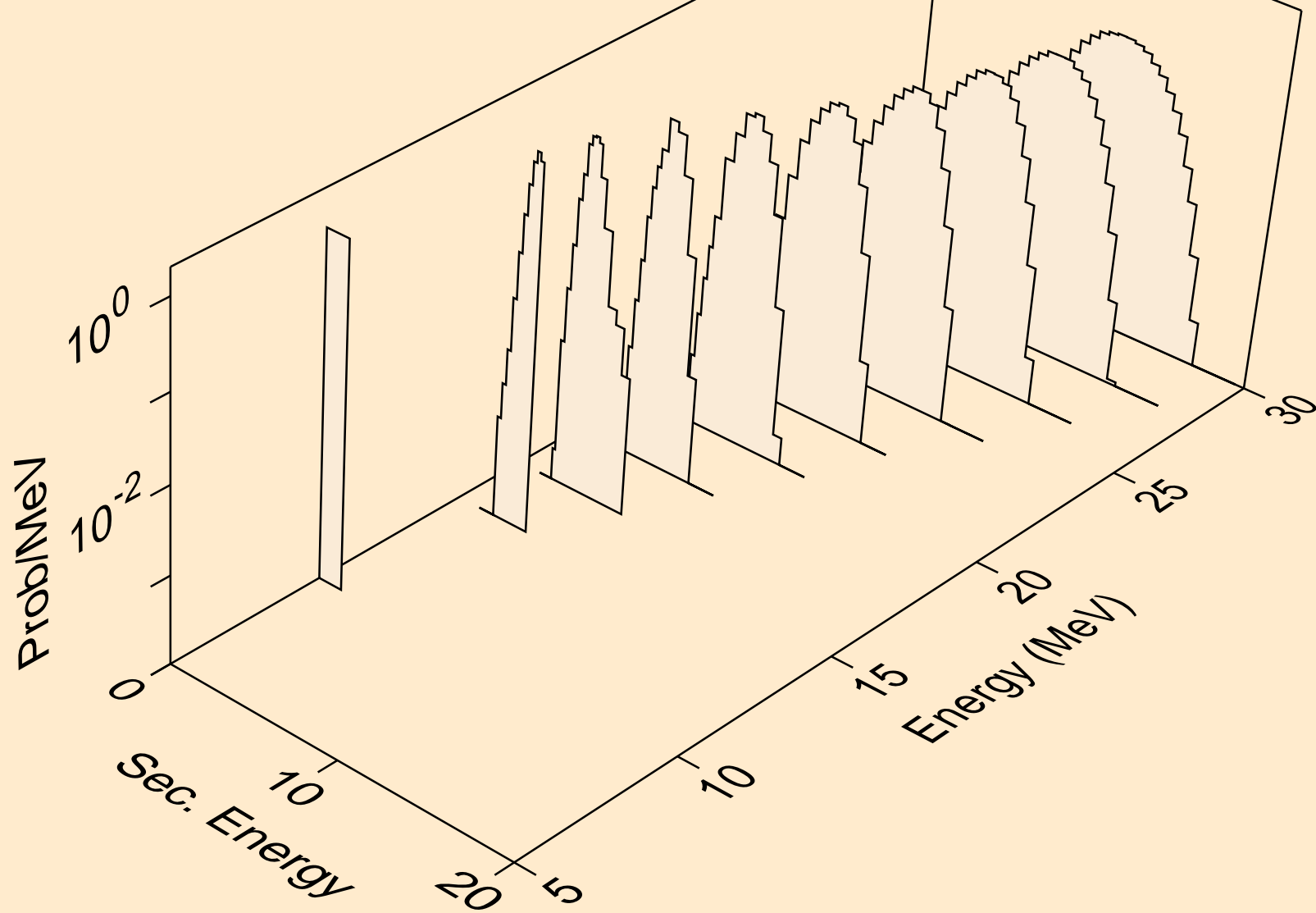

RE171 PROTON ACER TENDL-2021 LIBRARY; T=0.K  
deuterons from (p,da)

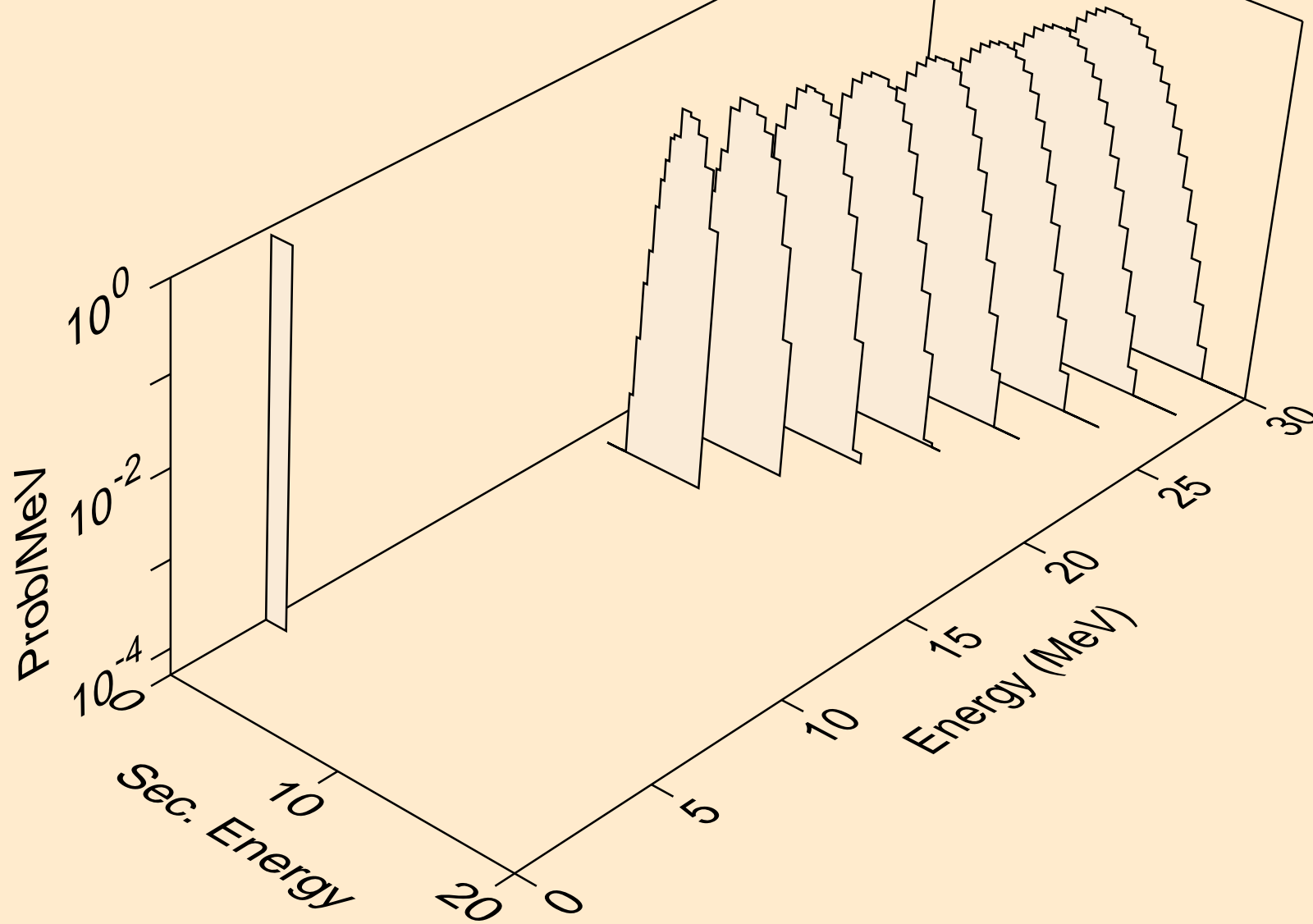



RE171 PROTON ACER TENDL-2021 LIBRARY; T=0.K  
tritons from (p,x)

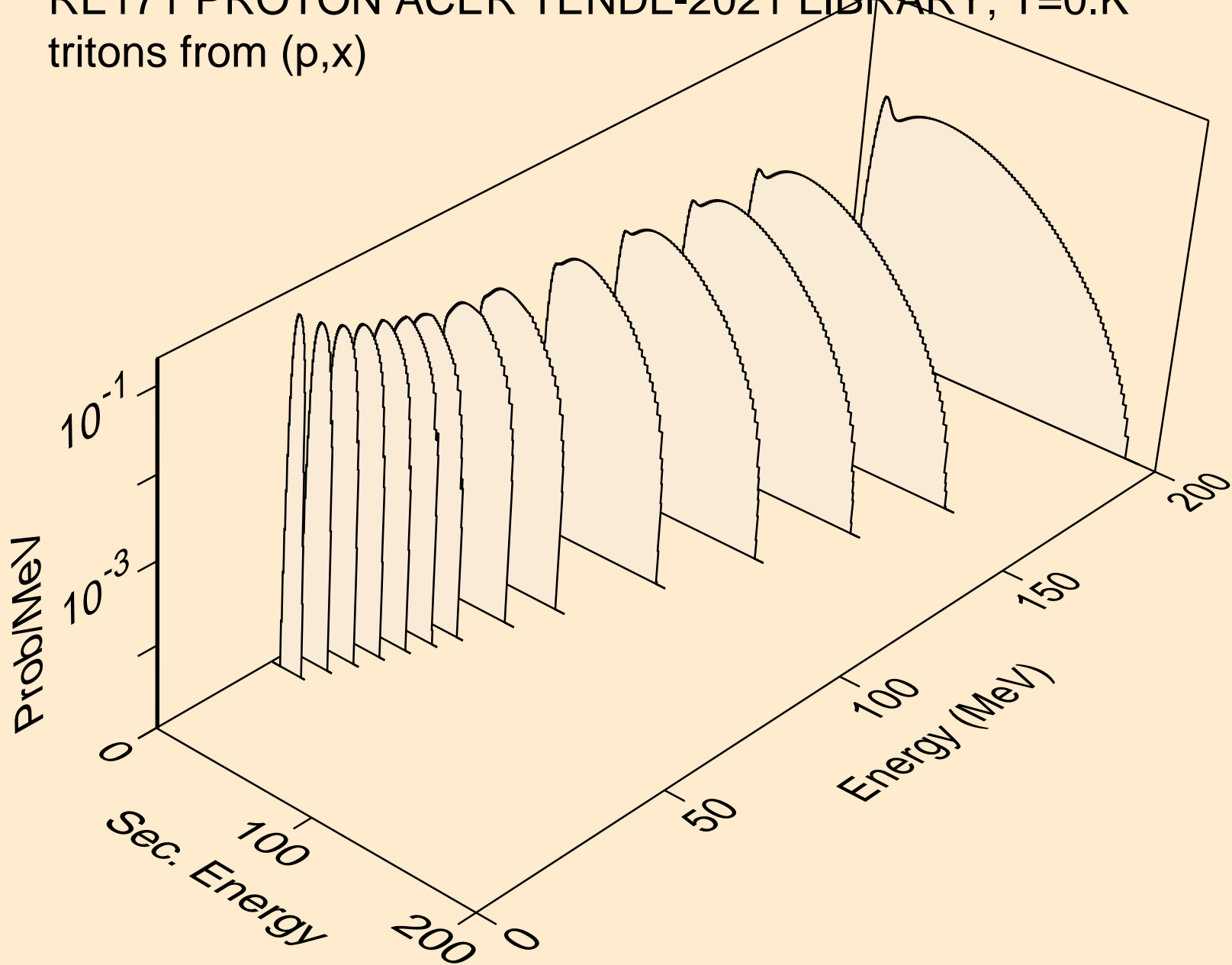

# RE171 PROTON ACER TENDL-2021 LIBRARY; T=0.K

tritons from (p,n\*)t

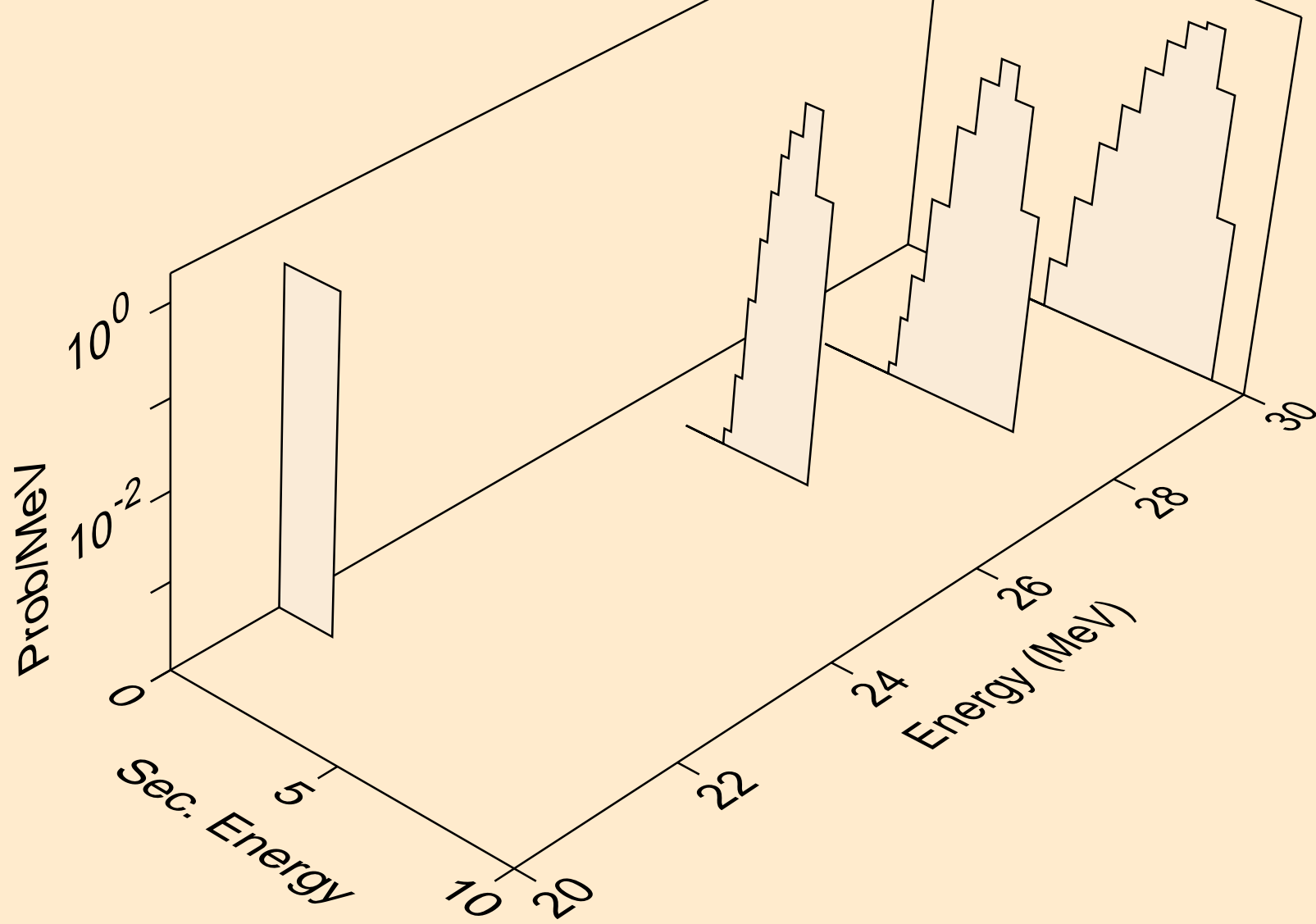

RE171 PROTON ACER TENDL-2021 LIBRARY; T=0.K  
tritons from (p,t)

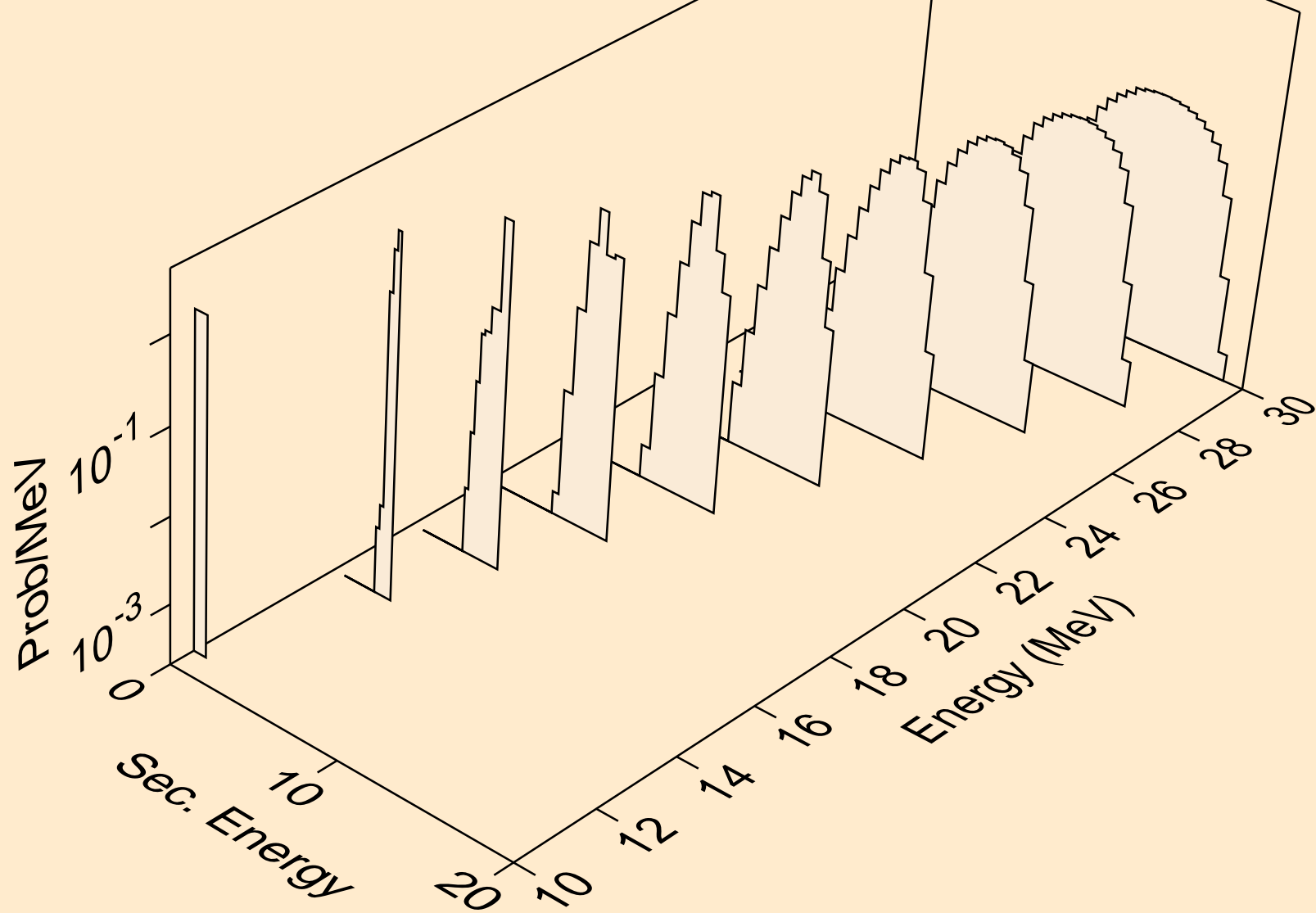

RE171 PROTON ACER TENDL-2021 LIBRARY; T=0.K  
tritons from (p,pt)

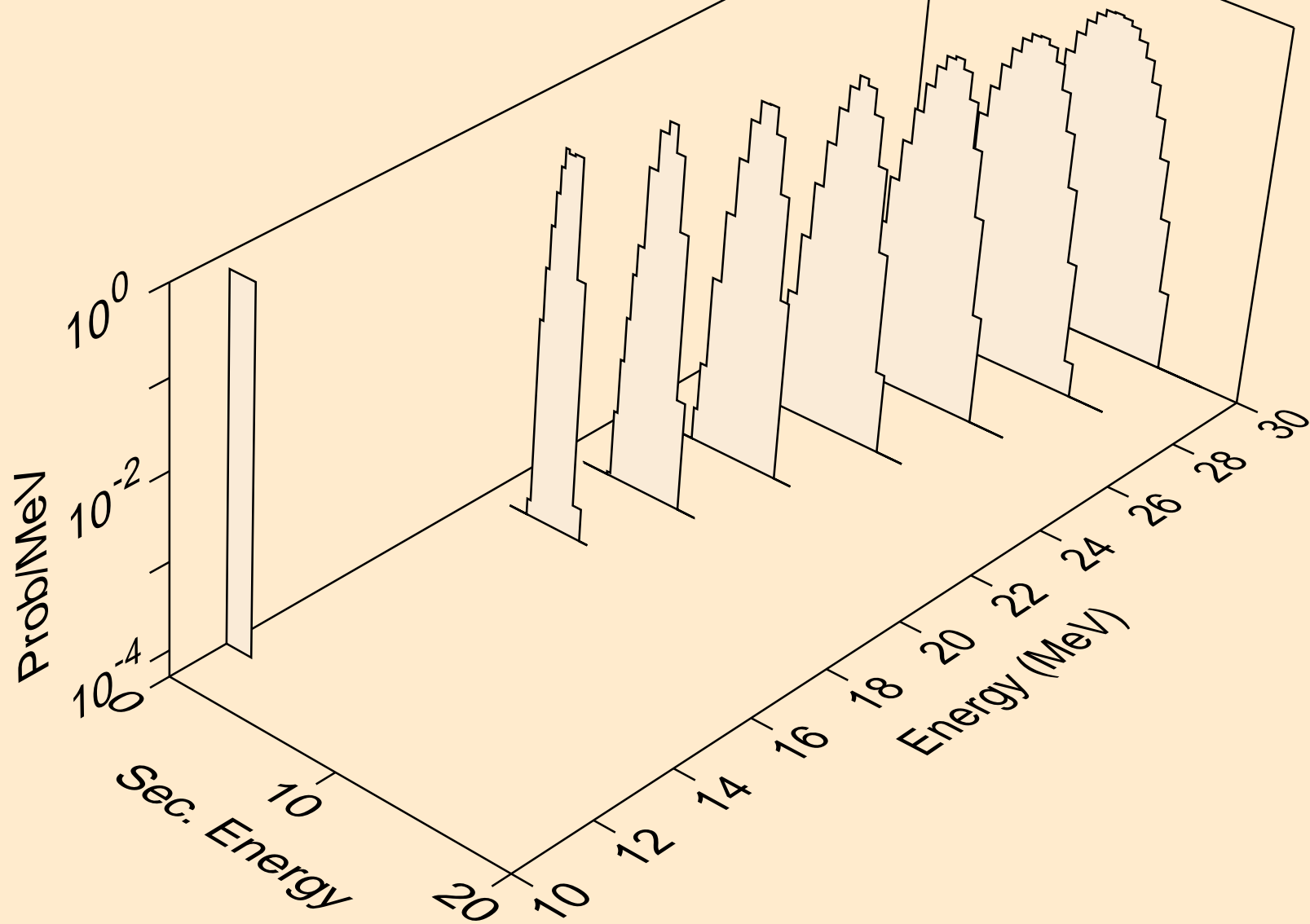

RE171 PROTON ACER TENDL-2021 LIBRARY; T=0.K  
he3s from (p,x)

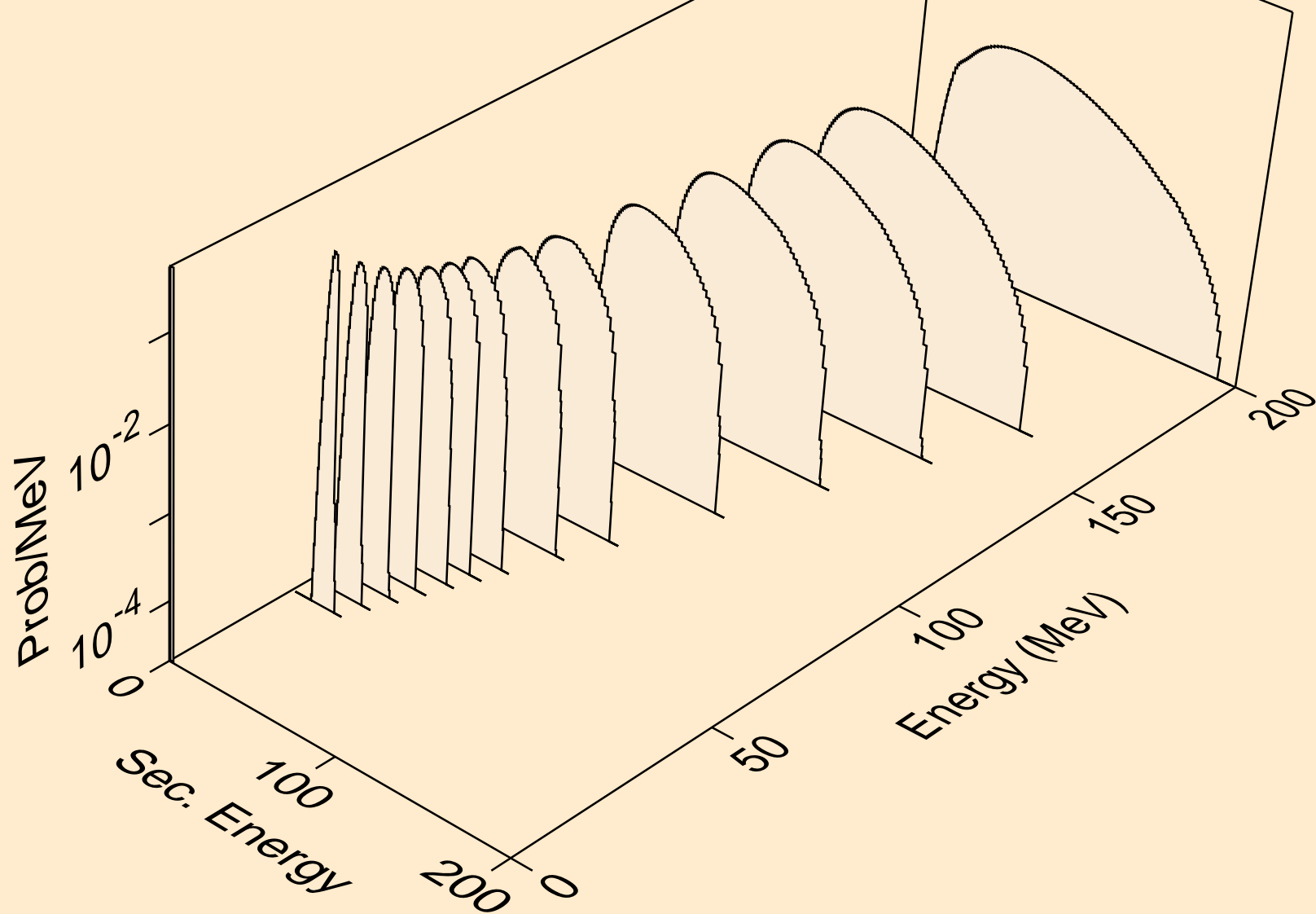

RE171 PROTON ACER TENDL-2021 LIBRARY; T=0.K  
he3s from (p,n\*)he3

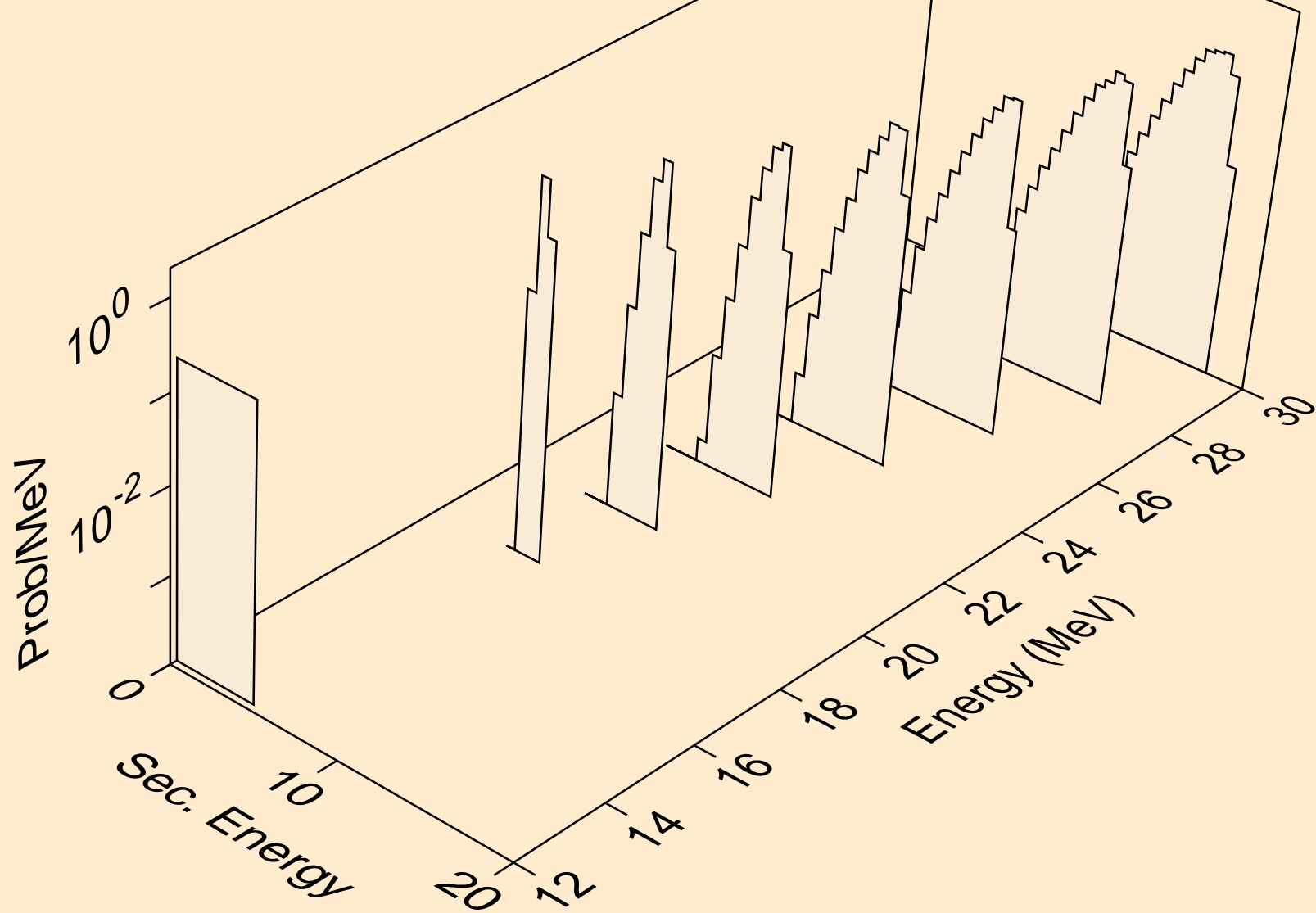

RE171 PROTON ACER TENDL-2021 LIBRARY; T=0.K  
he3s from (p,he3)

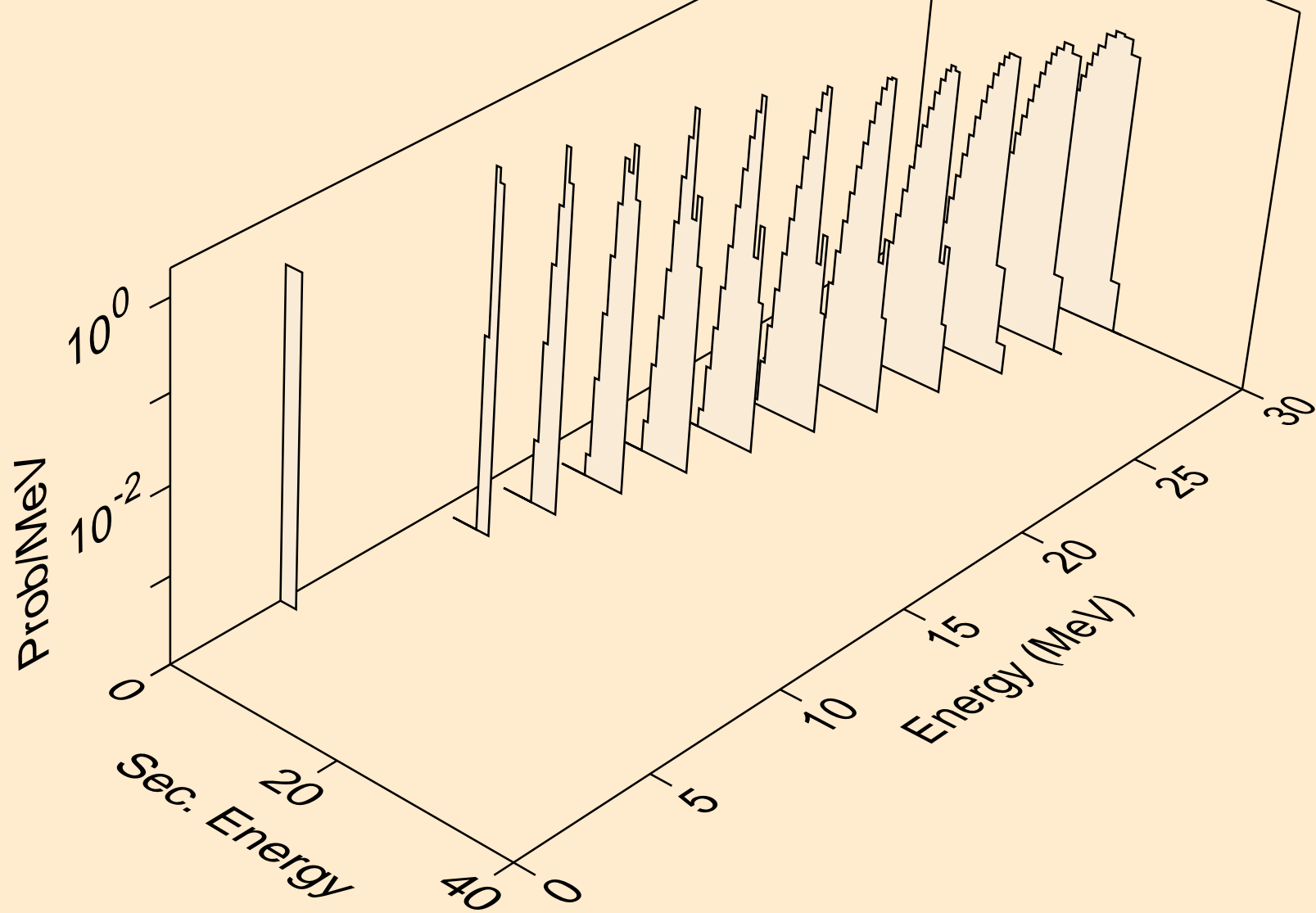

RE171 PROTON ACER TENDL-2021 LIBRARY; T=0.K  
alphas from (p,x)

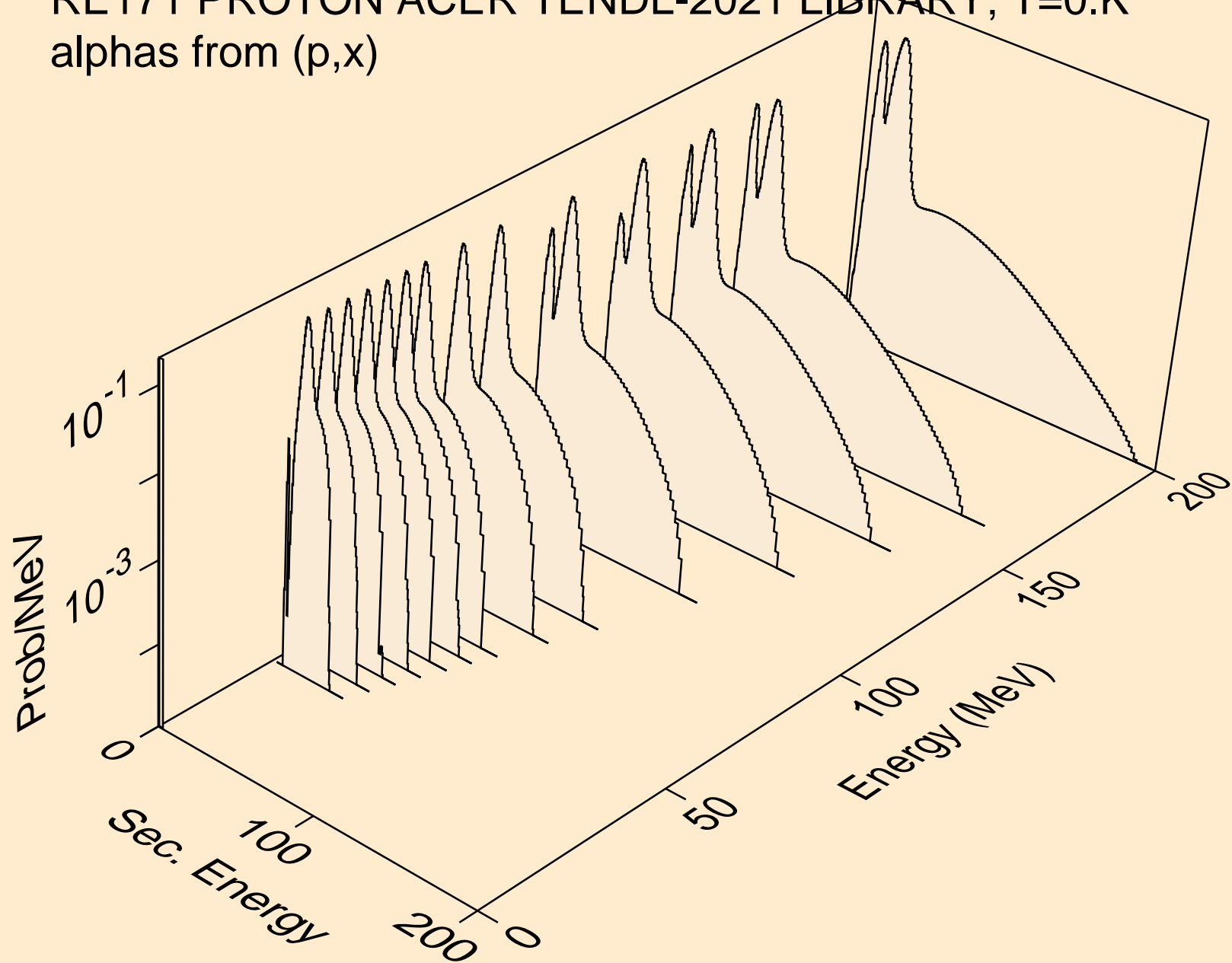



RE171 PROTON ACER TENDL-2021 LIBRARY; T=0.K  
alphas from (p,n\*)a

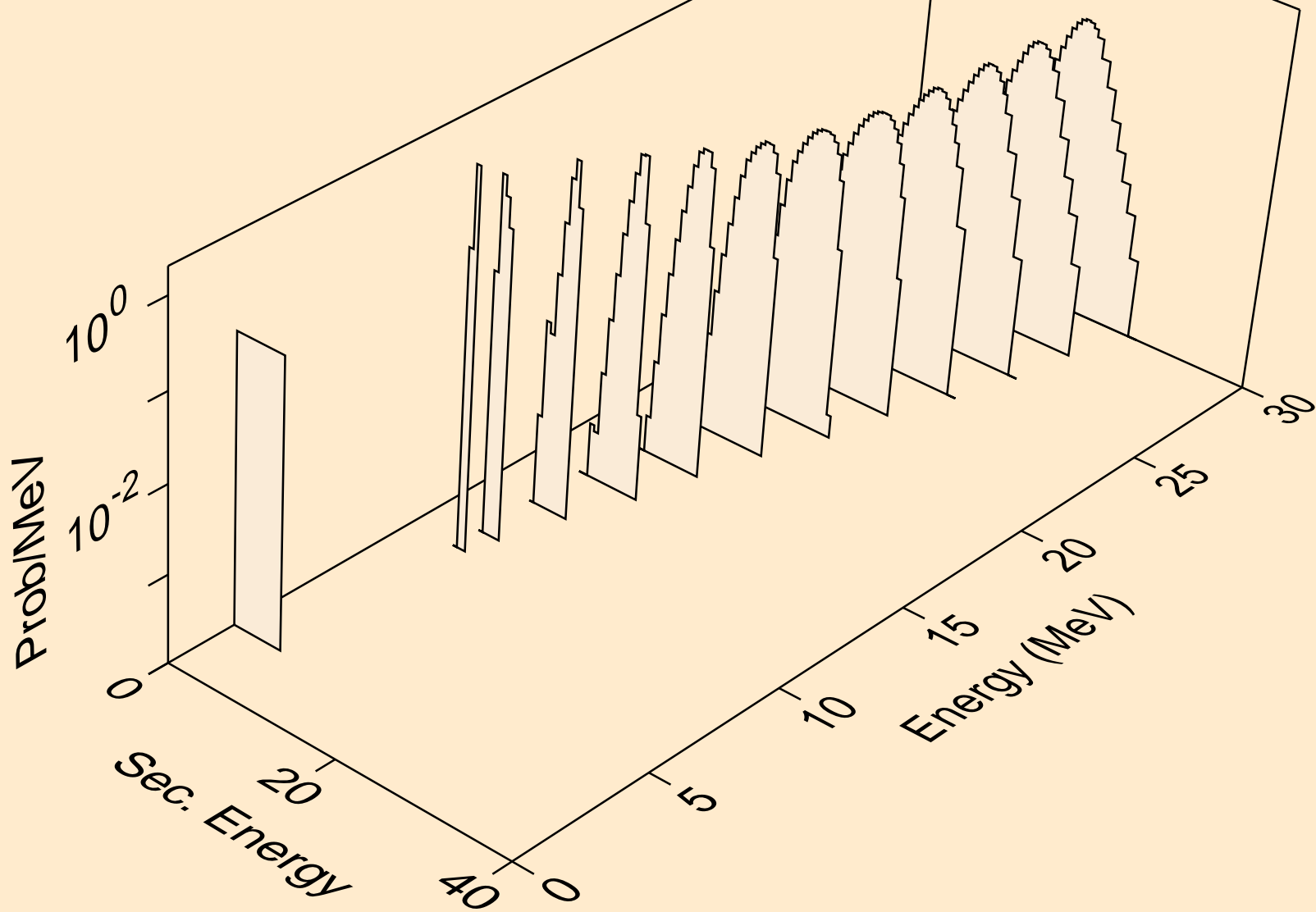

RE171 PROTON ACER TENDL-2021 LIBRARY; T=0.K  
alphas from (p,2n)a

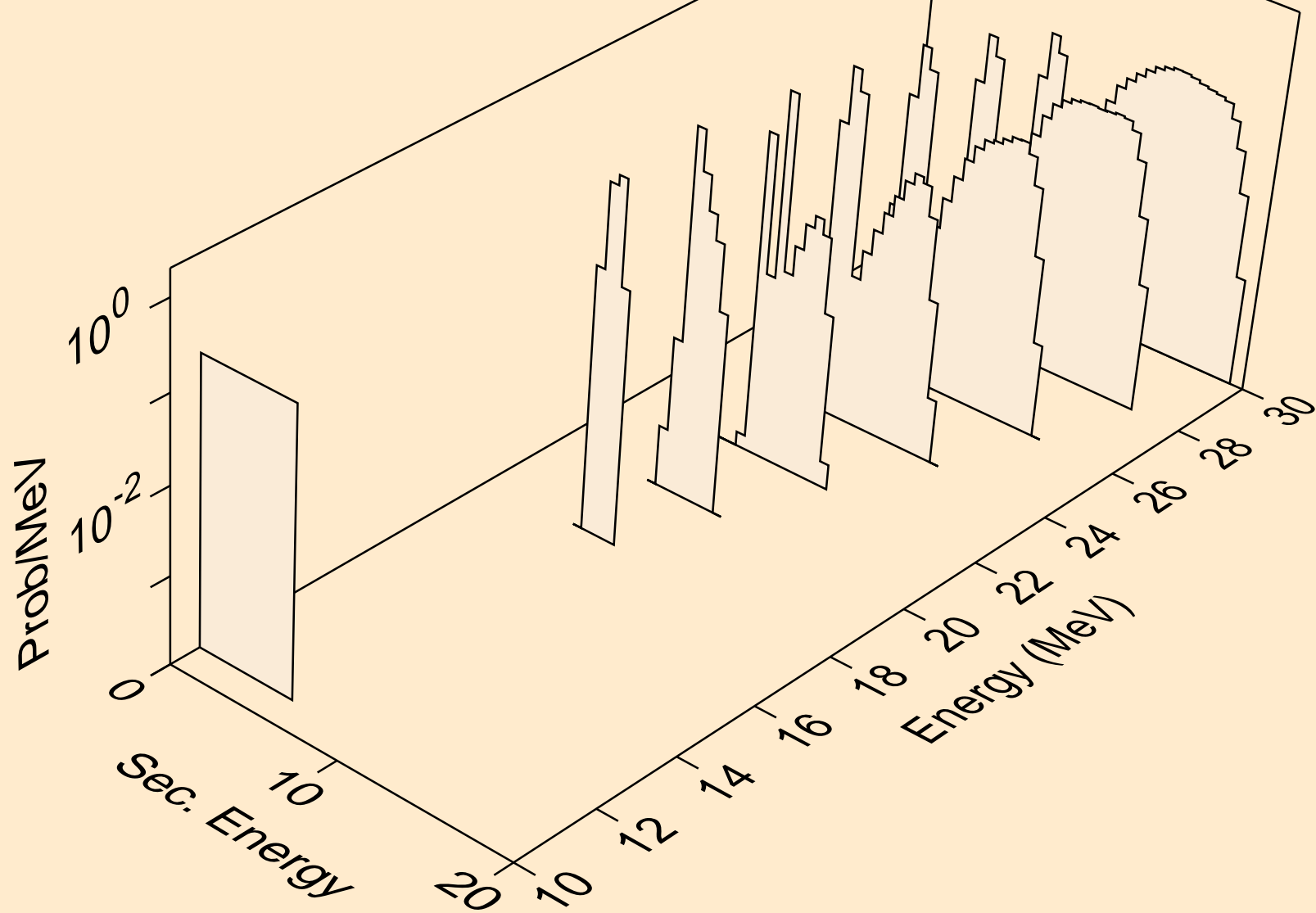

RE171 PROTON ACER TENDL-2021 LIBRARY; T=0.K  
alphas from (p,3n)a

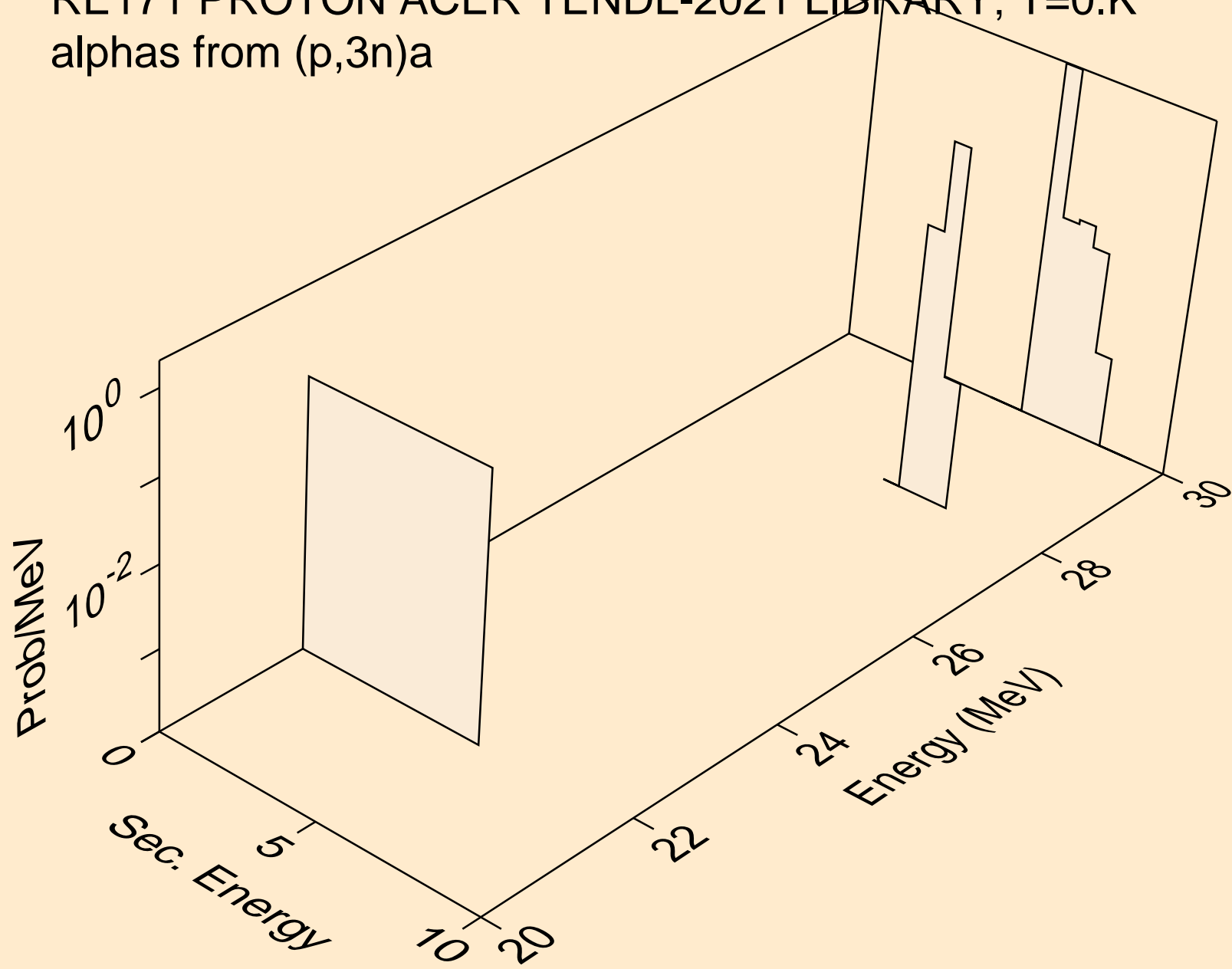

RE171 PROTON ACER TENDL-2021 LIBRARY; T=0.K  
alphas from (p,n\*)2a

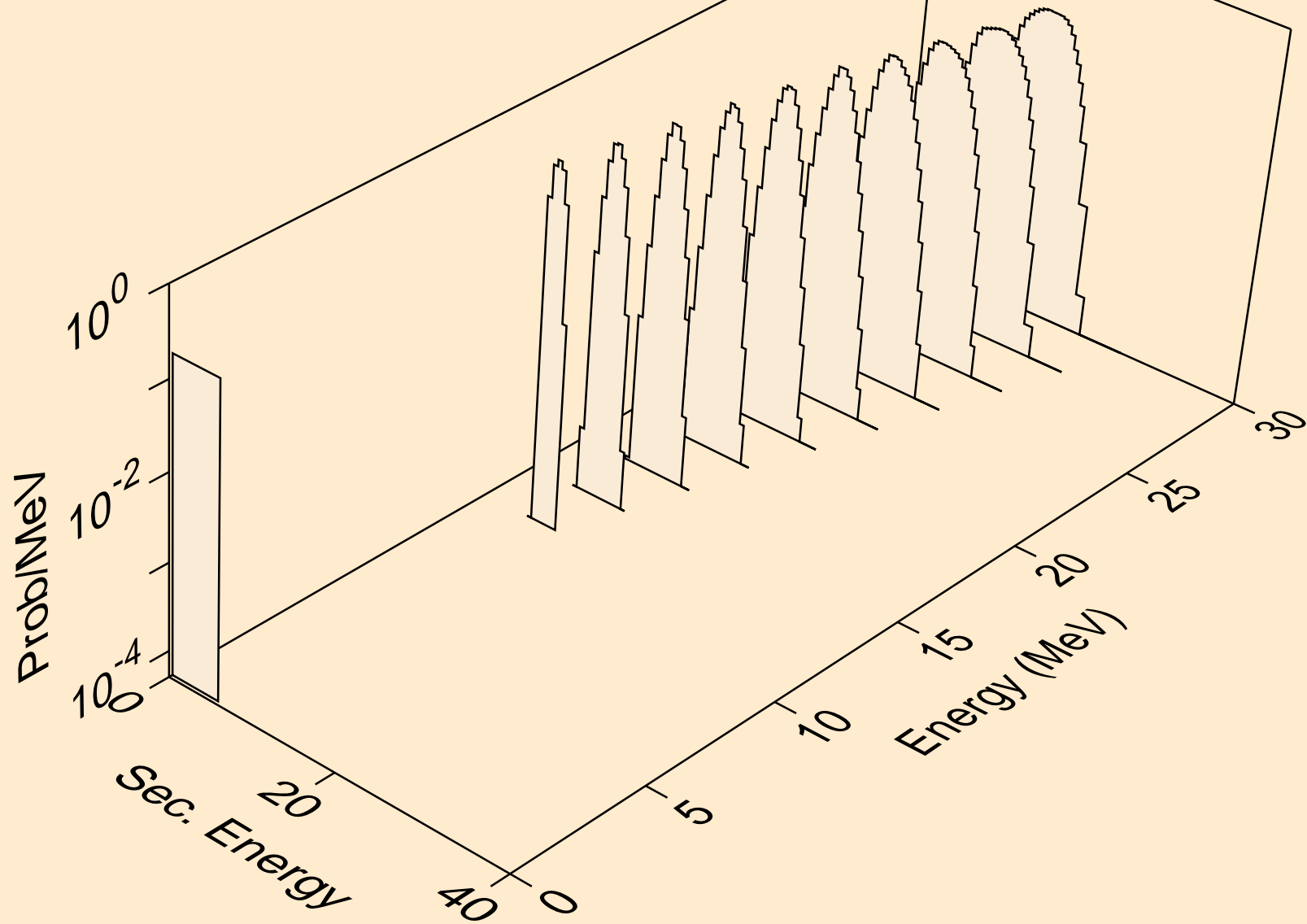

RE171 PROTON ACER TENDL-2021 LIBRARY; T=0.K  
alphas from (p,2n)2a

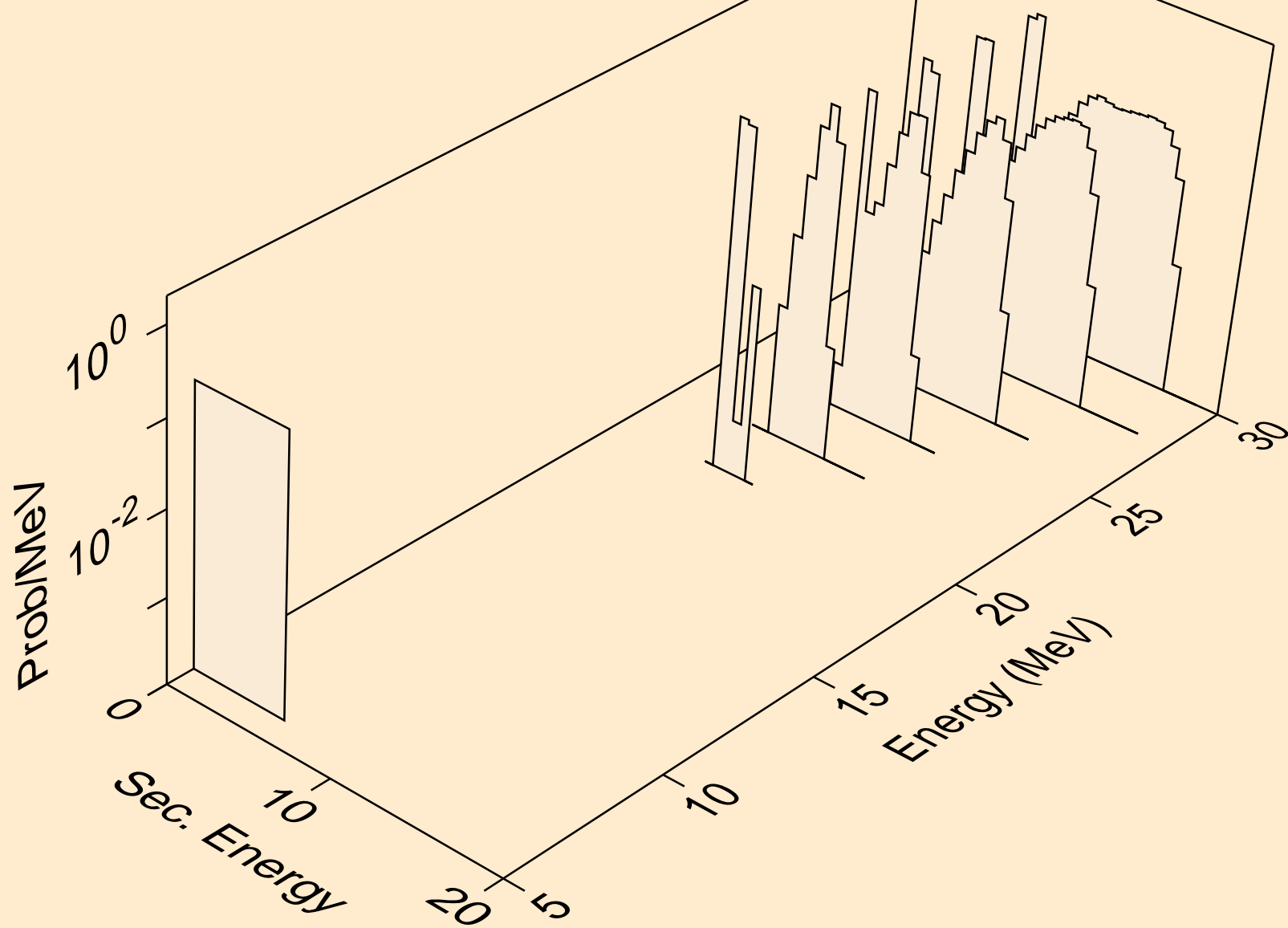

RE171 PROTON ACER TENDL-2021 LIBRARY; T=0.K  
alphas from (p,npa)

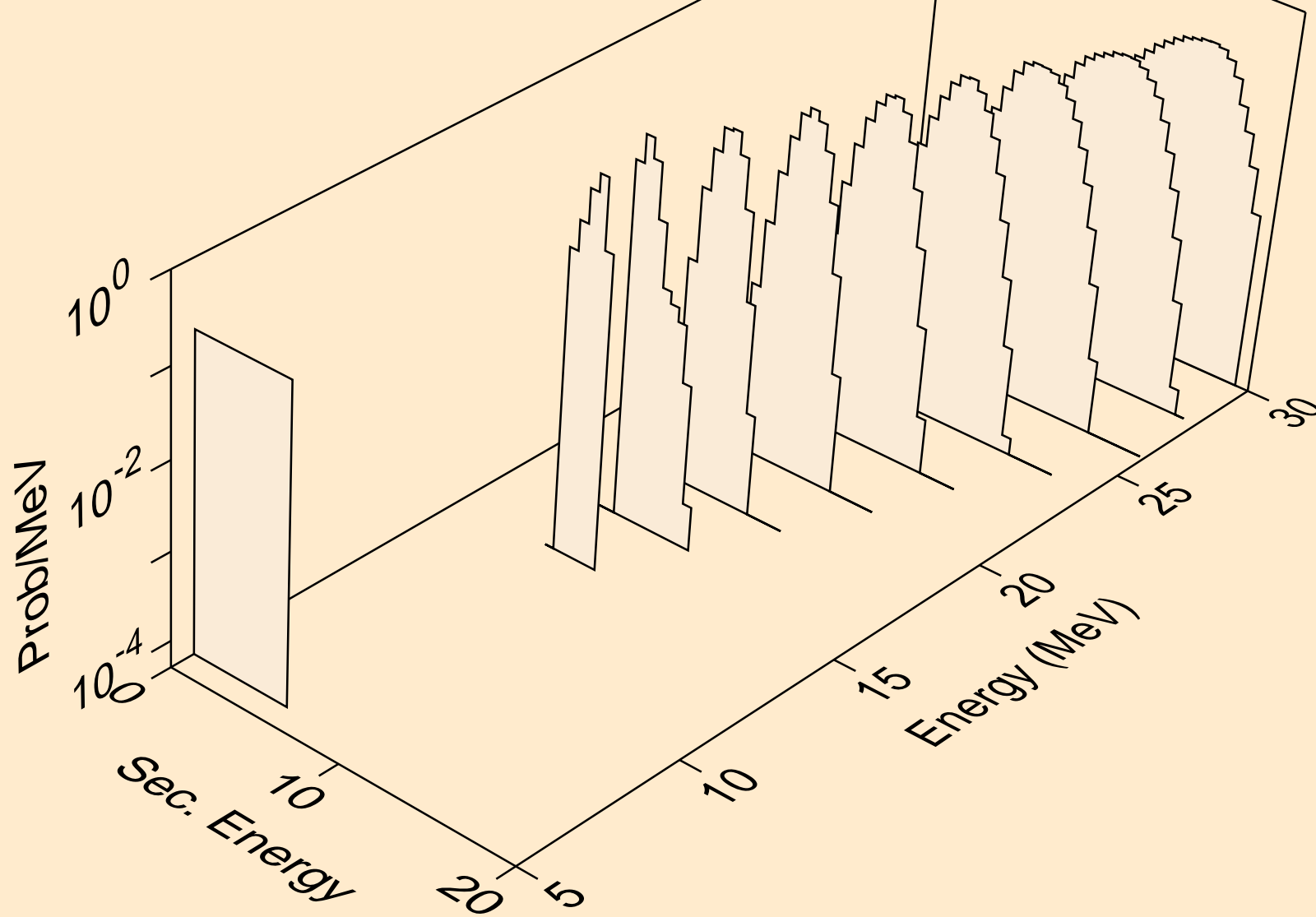

RE171 PROTON ACER TENDL-2021 LIBRARY; T=0.K  
alphas from (p,a)

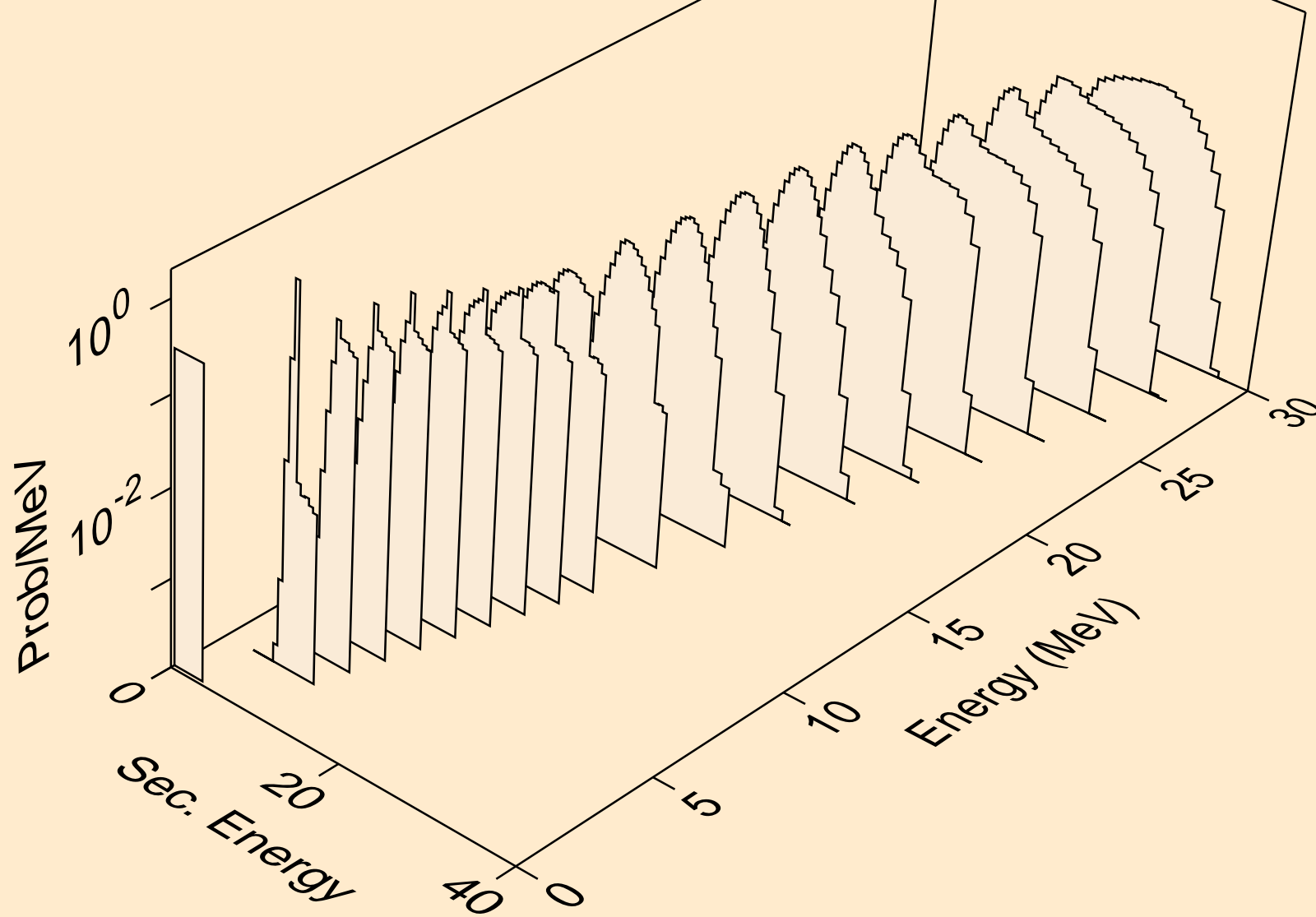

RE171 PROTON ACER TENDL-2021 LIBRARY; T=0.K  
alphas from (p,2a)

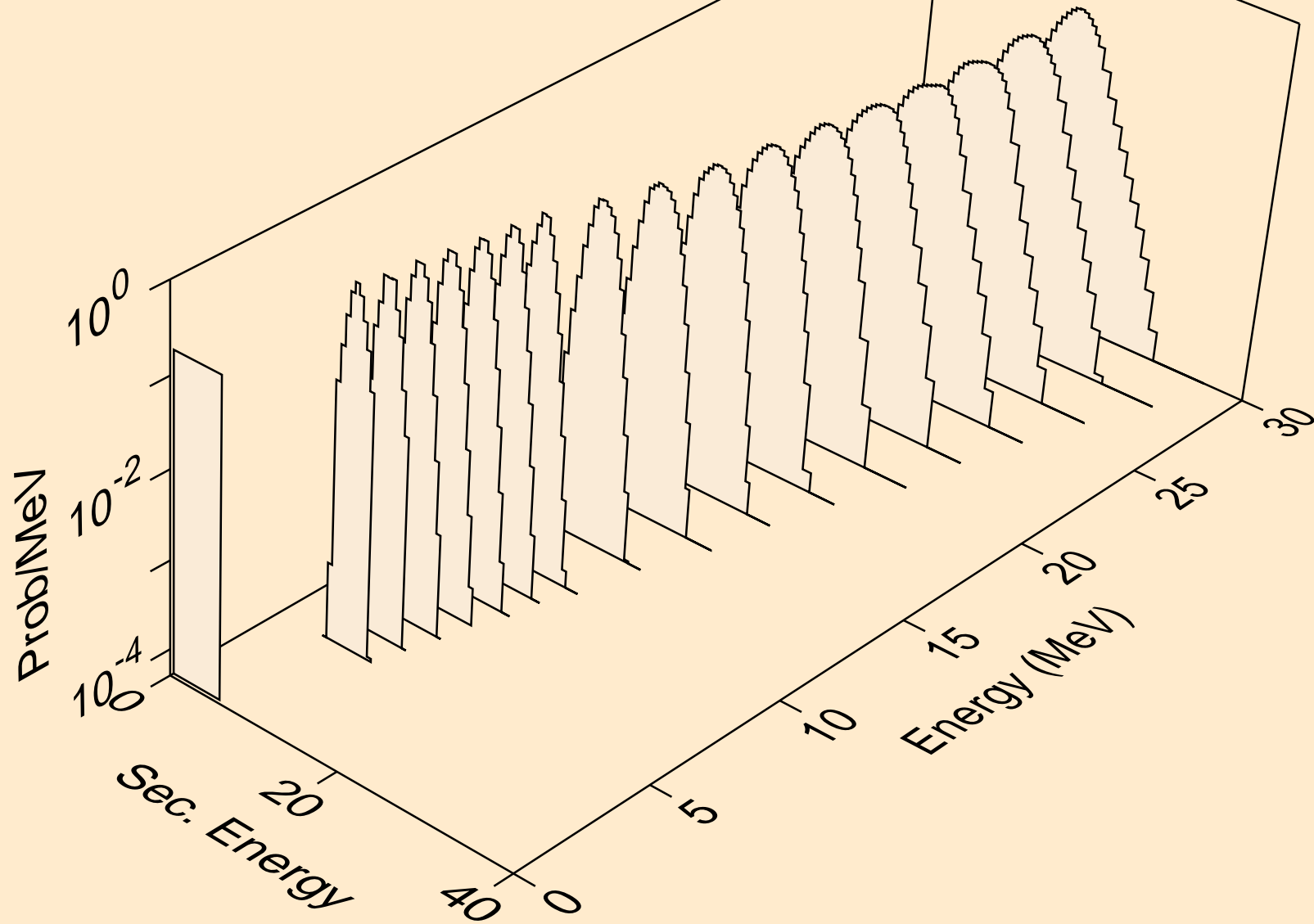



RE171 PROTON ACER TENDL-2021 LIBRARY; T=0.K  
alphas from (p,3a)

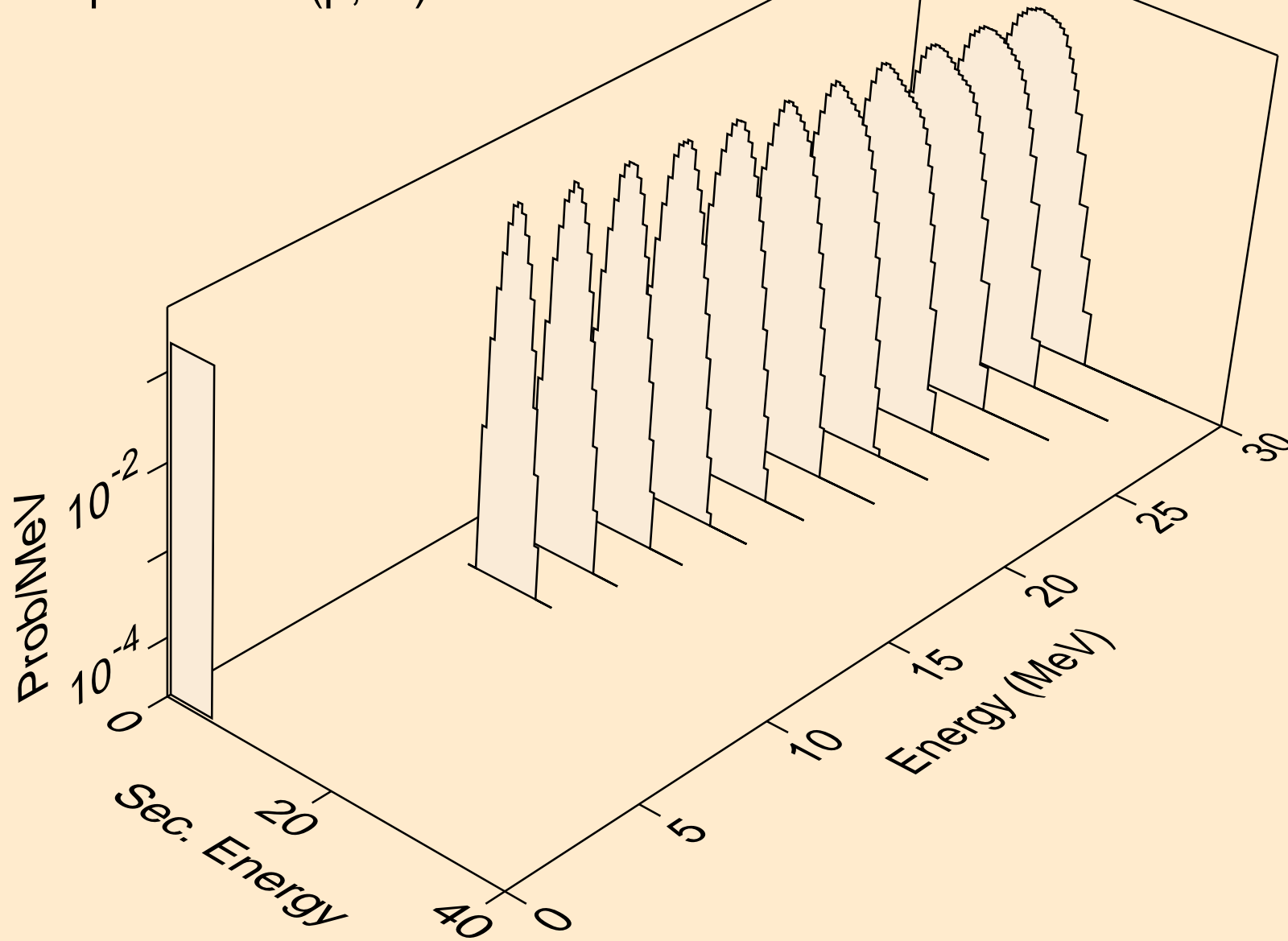

RE171 PROTON ACER TENDL-2021 LIBRARY; T=0.K  
alphas from (p,pa)

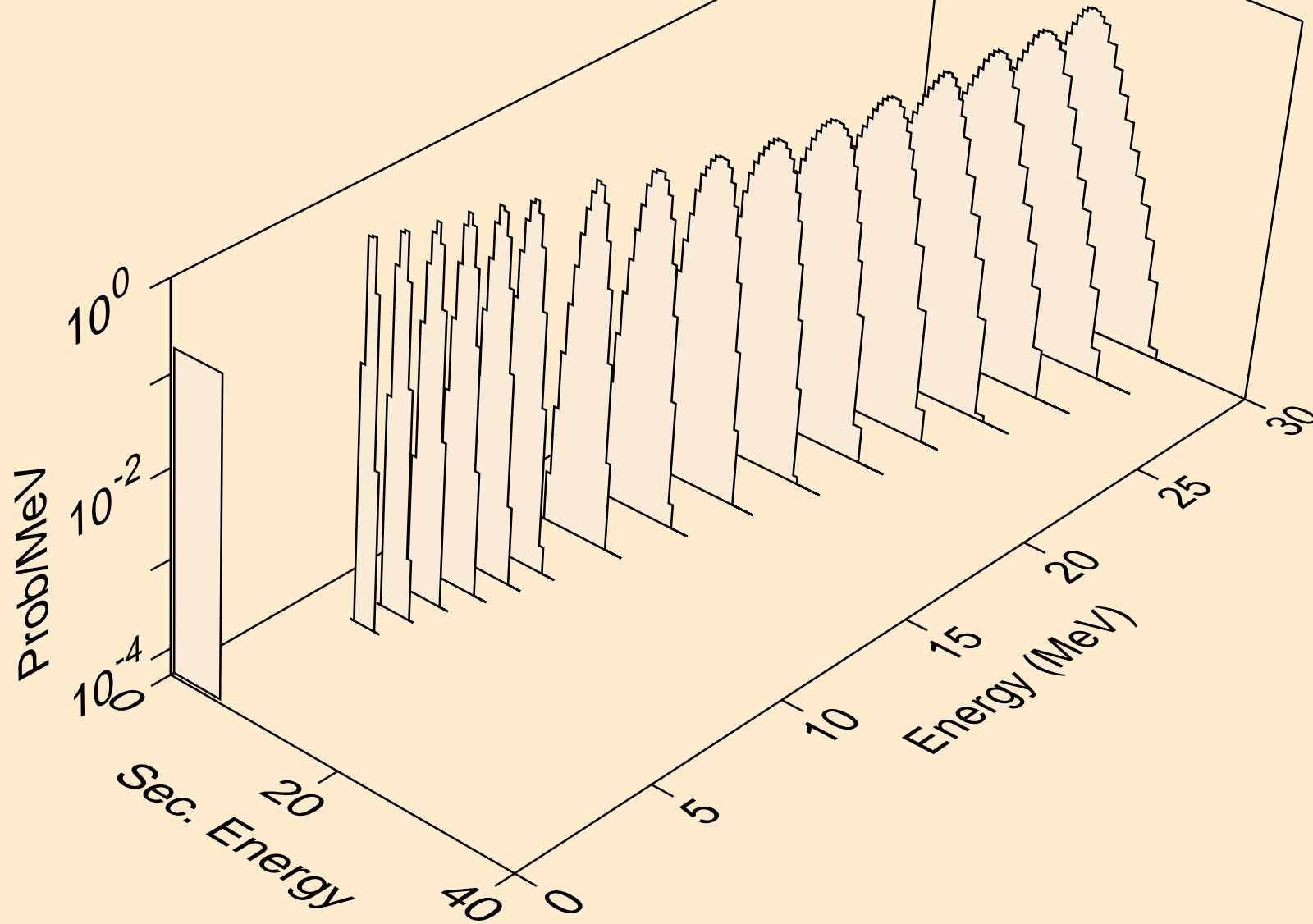

RE171 PROTON ACER TENDL-2021 LIBRARY; T=0.K  
alphas from (p,da)

