

RF259 PROTON ACER TENDL-2021 LIBRARY; T=0.K  
Principal cross sections

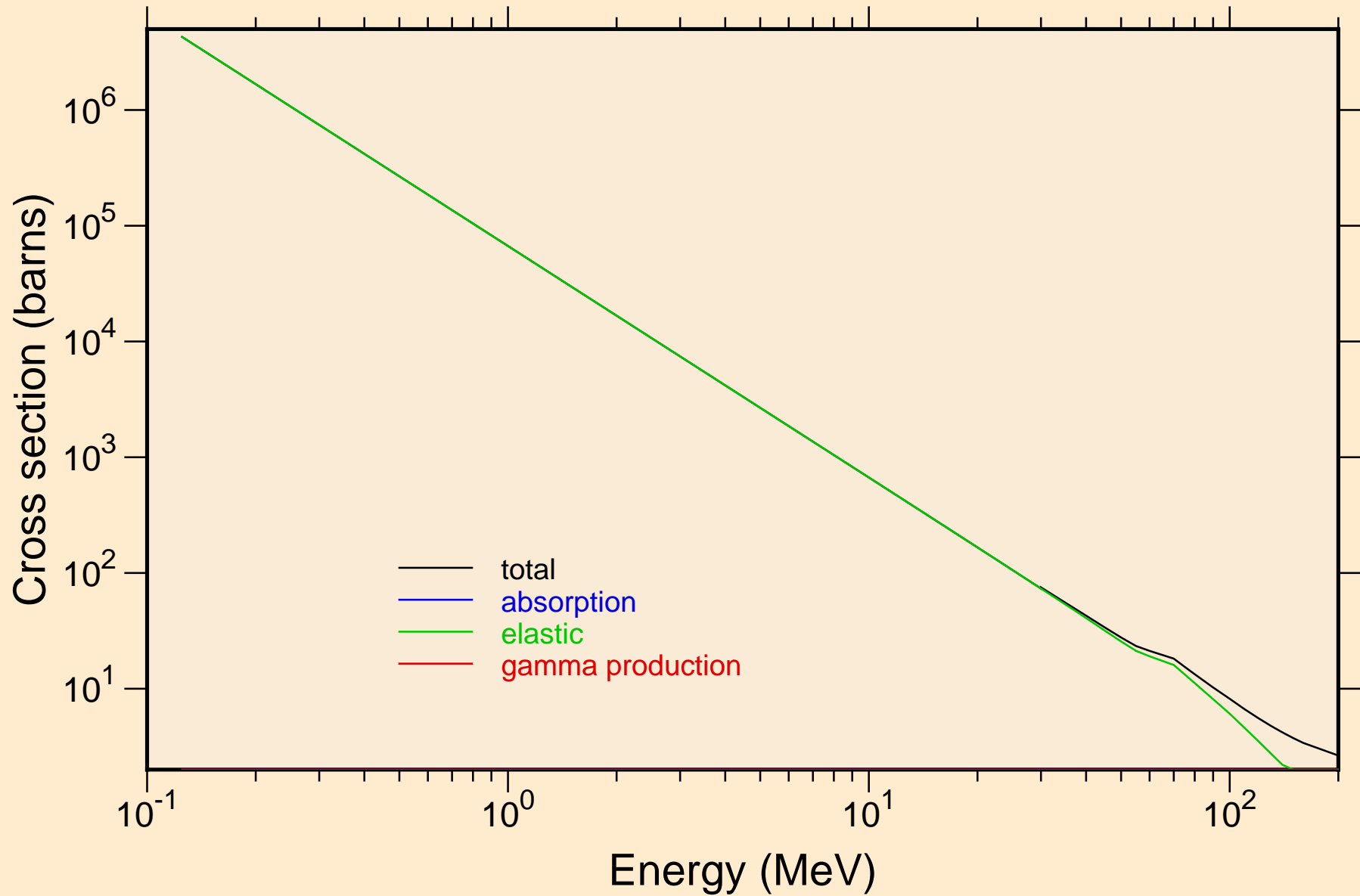

# RF259 PROTON ACER TENDL-2021 LIBRARY; T=0.K

## Heating

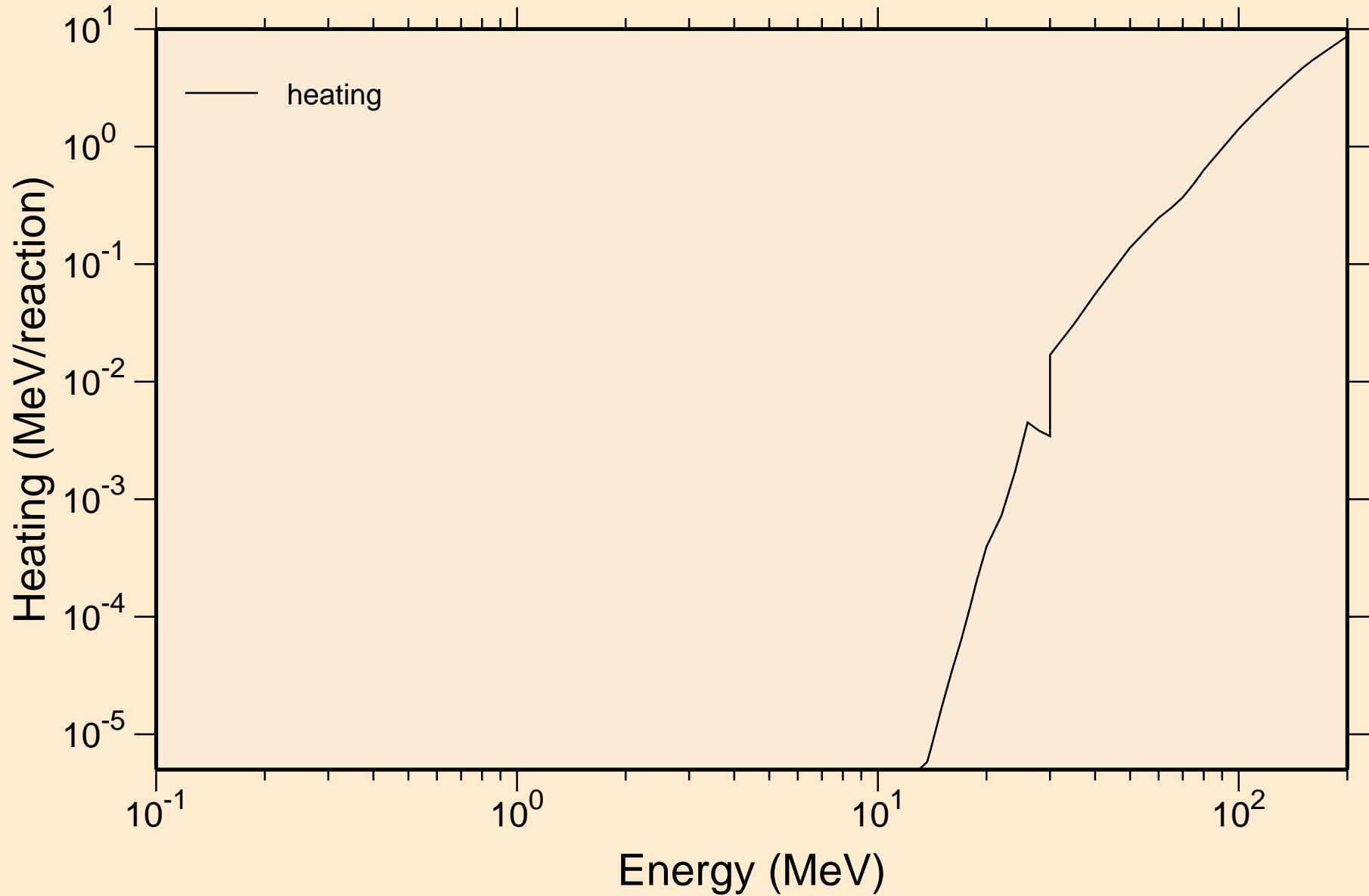

# RF259 PROTON ACER TENDL-2021 LIBRARY; T=0.K

## Principal cross sections

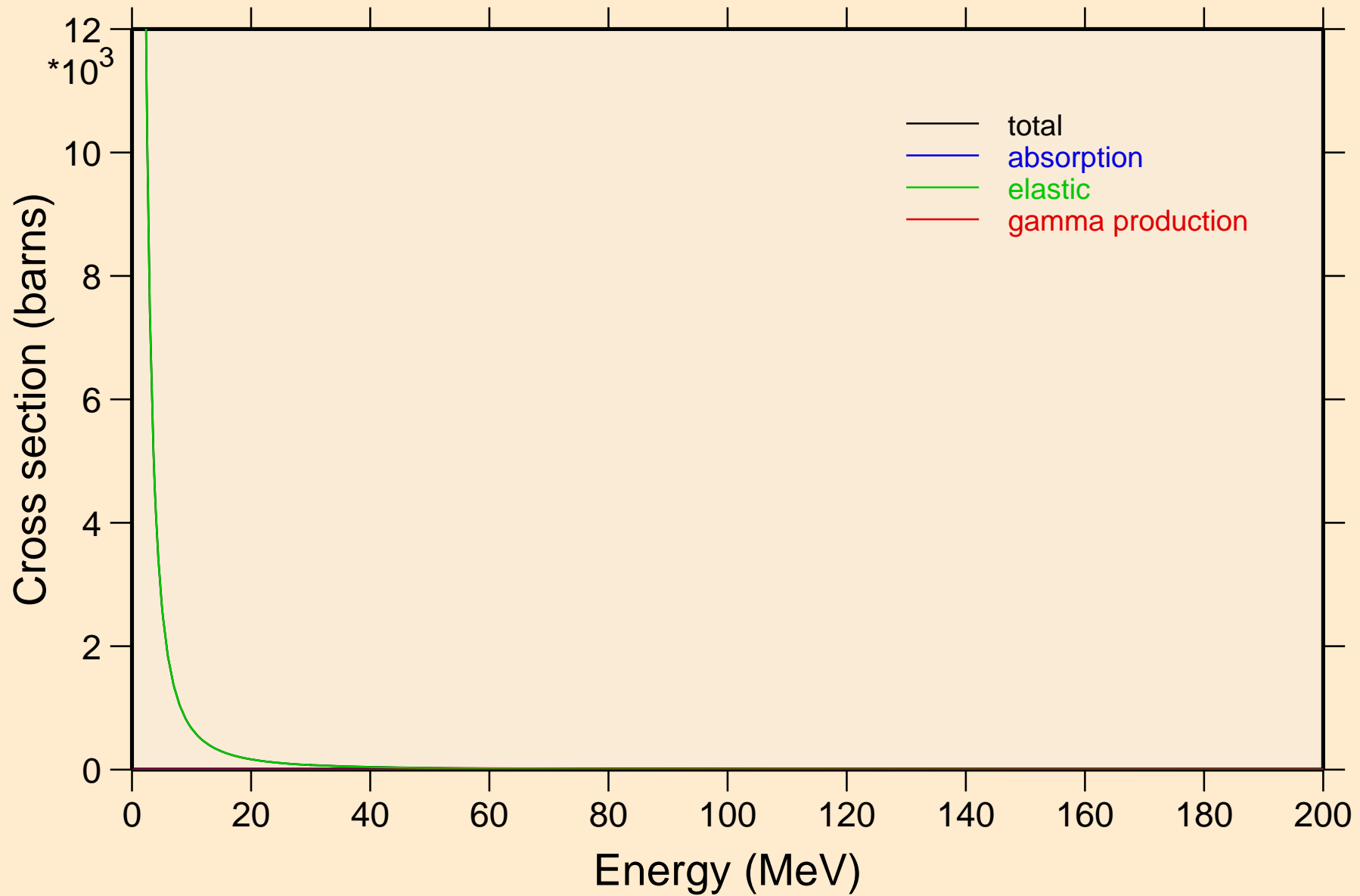

RF259 PROTON ACER TENDL-2021 LIBRARY; T=0.K

Heating

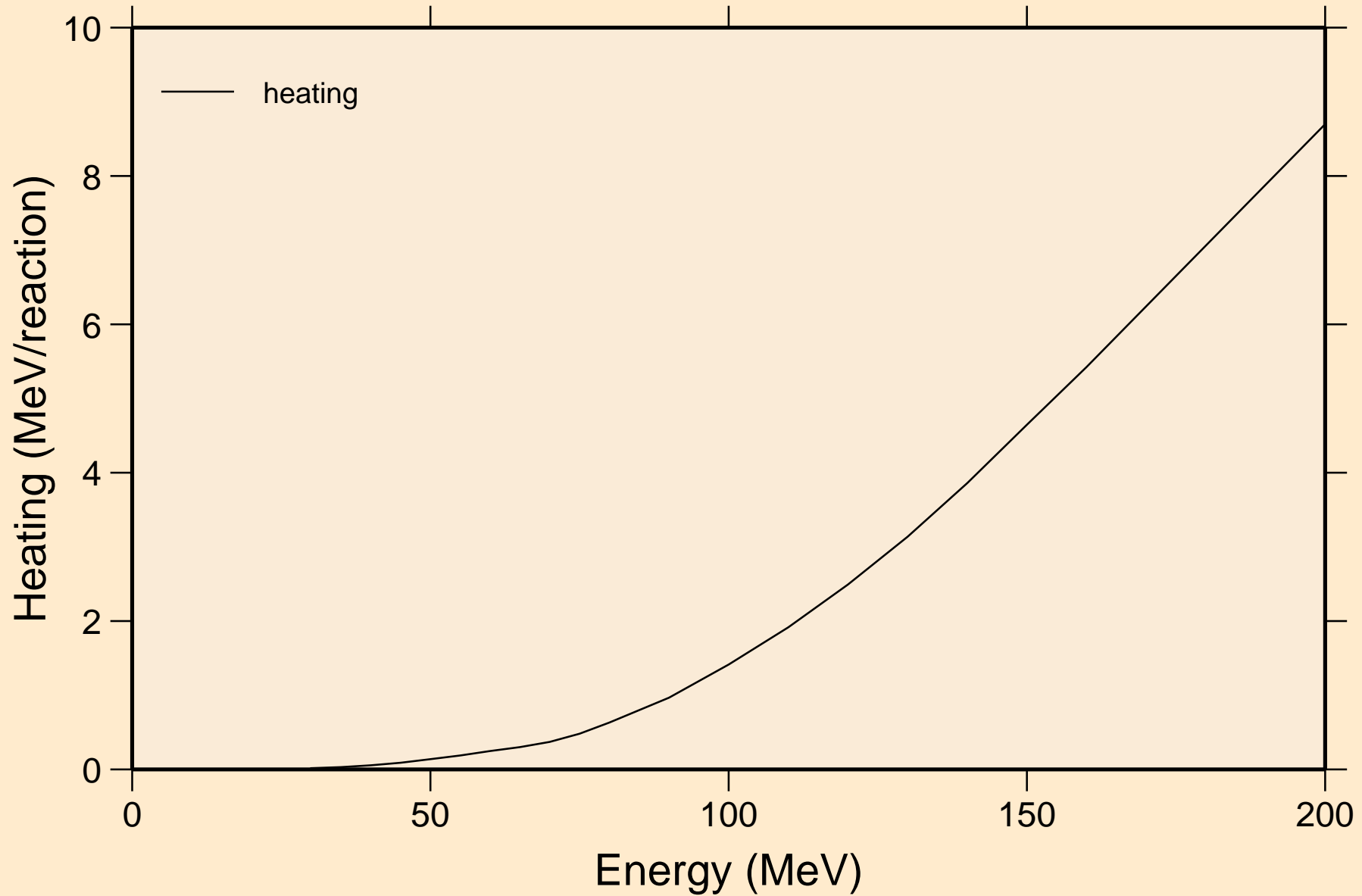

RF259 PROTON ACER TENDL-2021 LIBRARY; T=0.K  
Threshold reactions

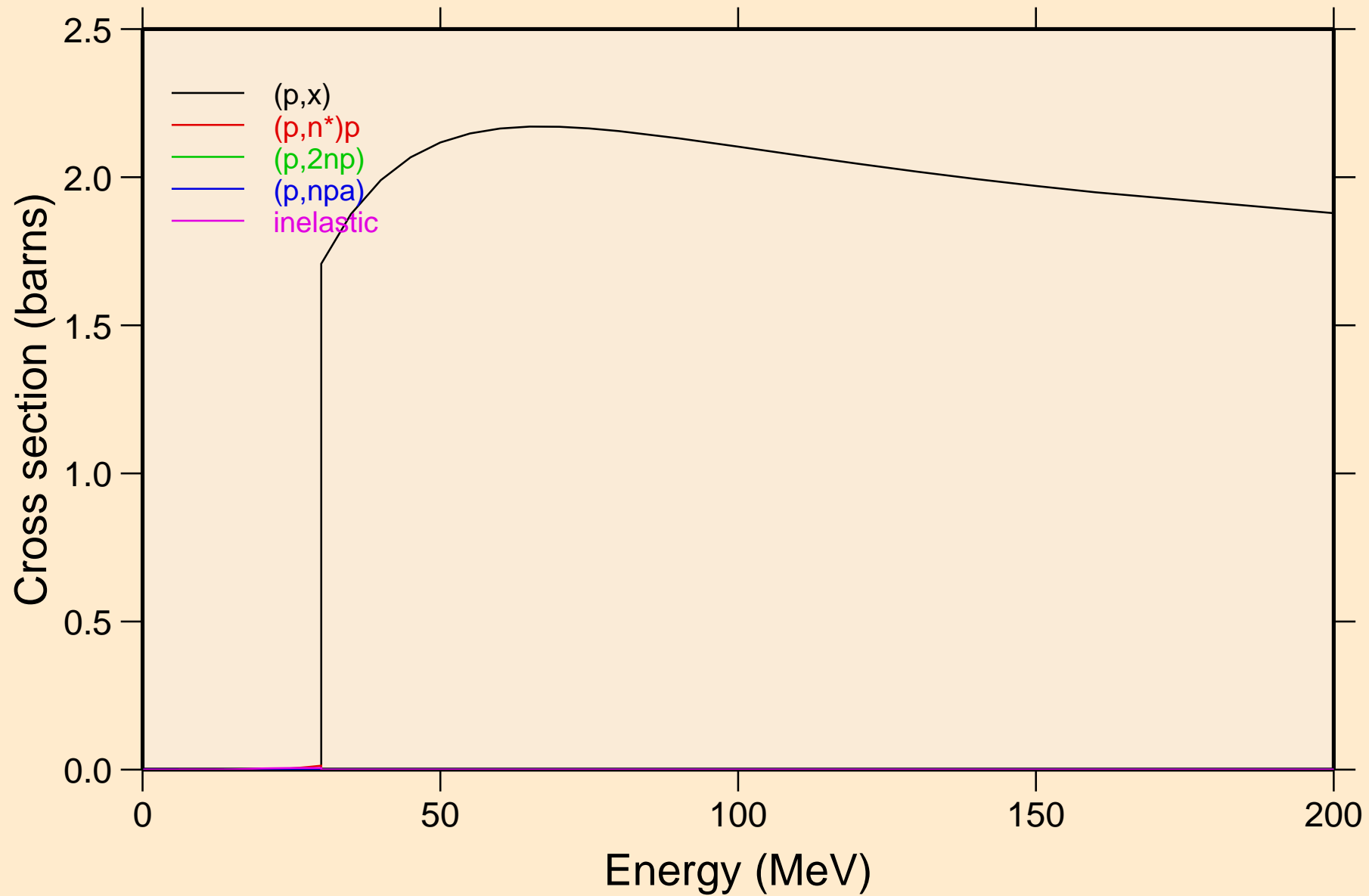

RF259 PROTON ACER TENDL-2021 LIBRARY; T=0.K  
Threshold reactions

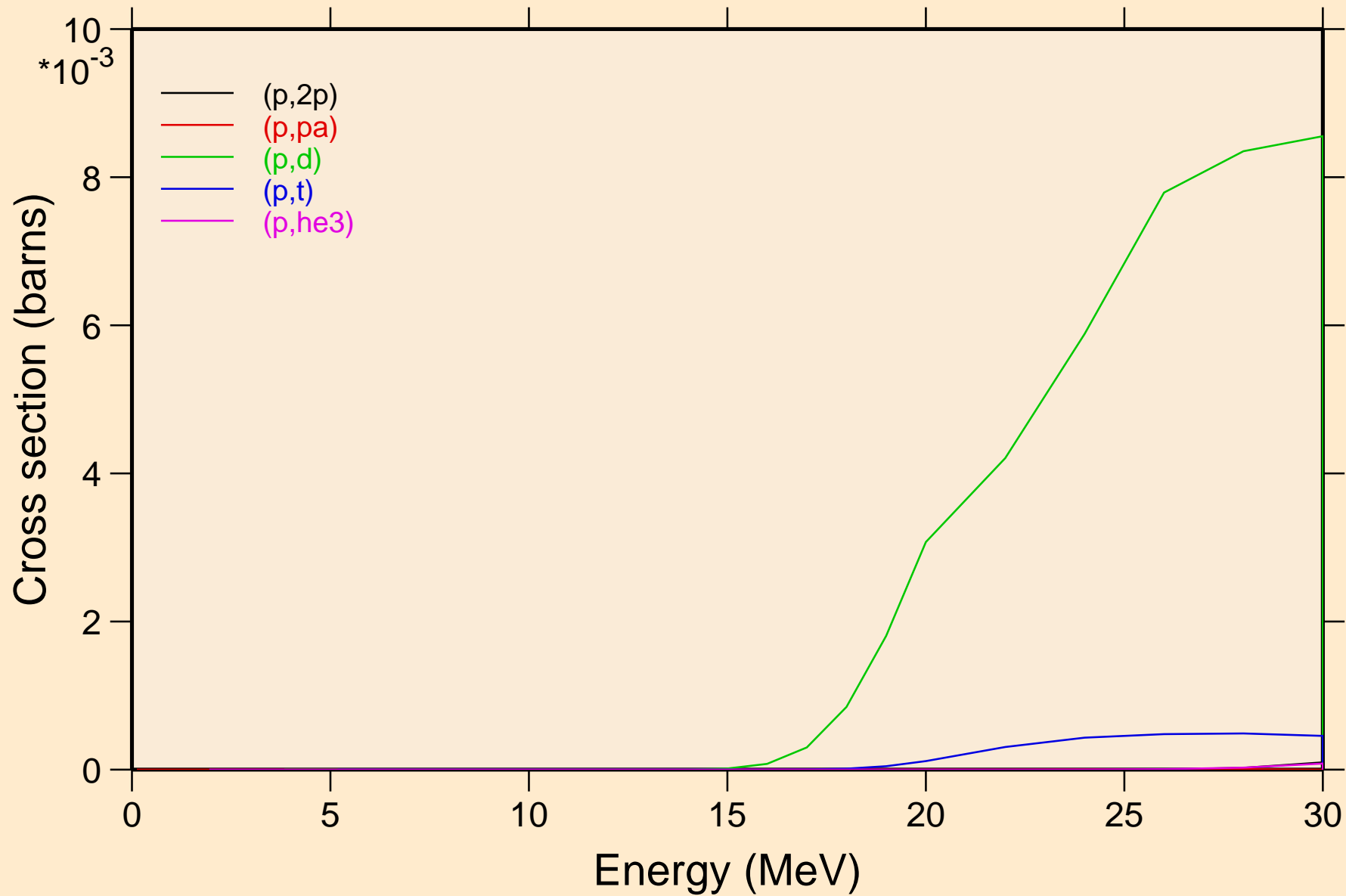

RF259 PROTON ACER TENDL-2021 LIBRARY; T=0.K  
Threshold reactions

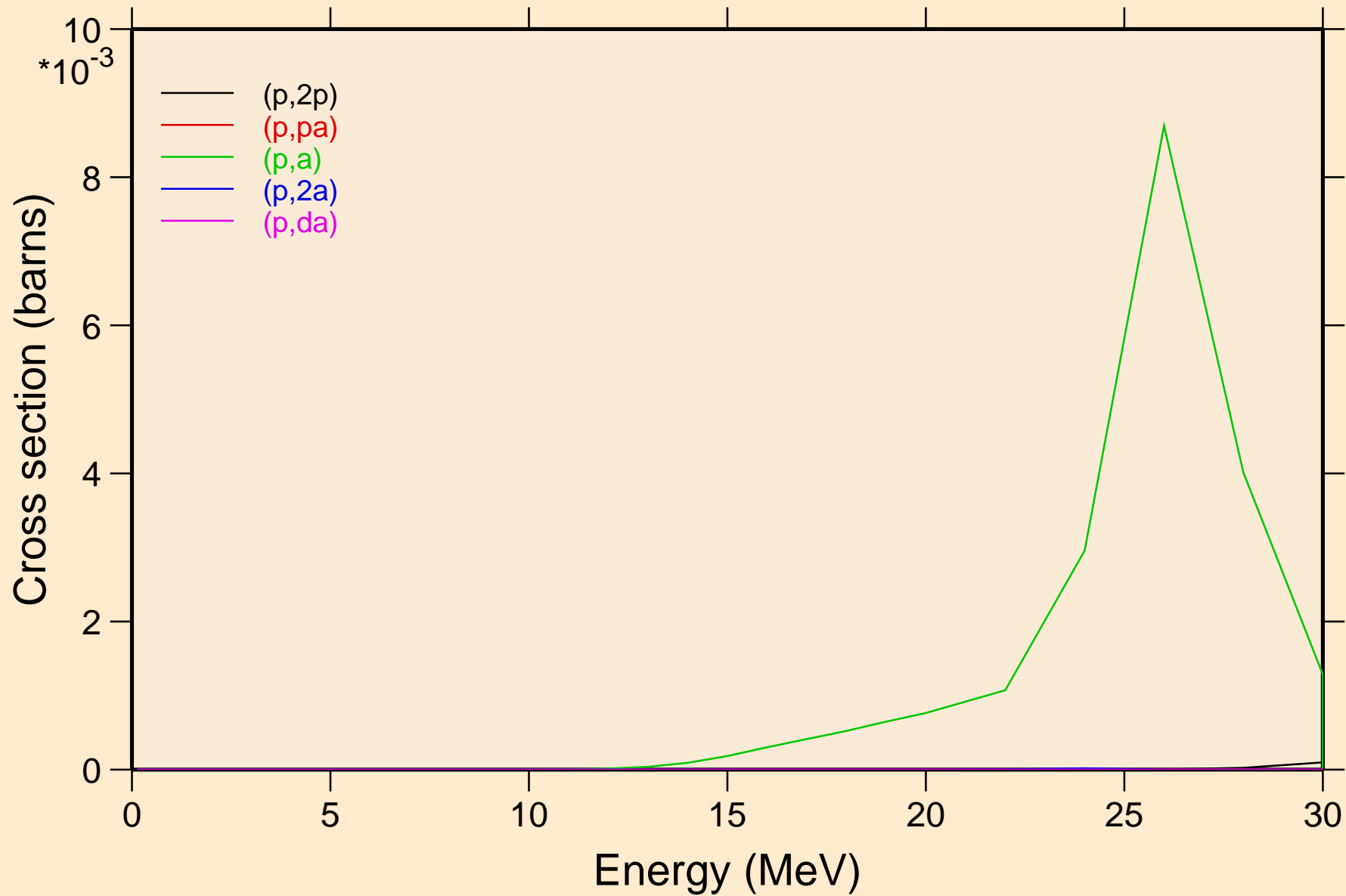

RF259 PROTON ACER TENDL-2021 LIBRARY; T=0.K  
angular distribution for elastic

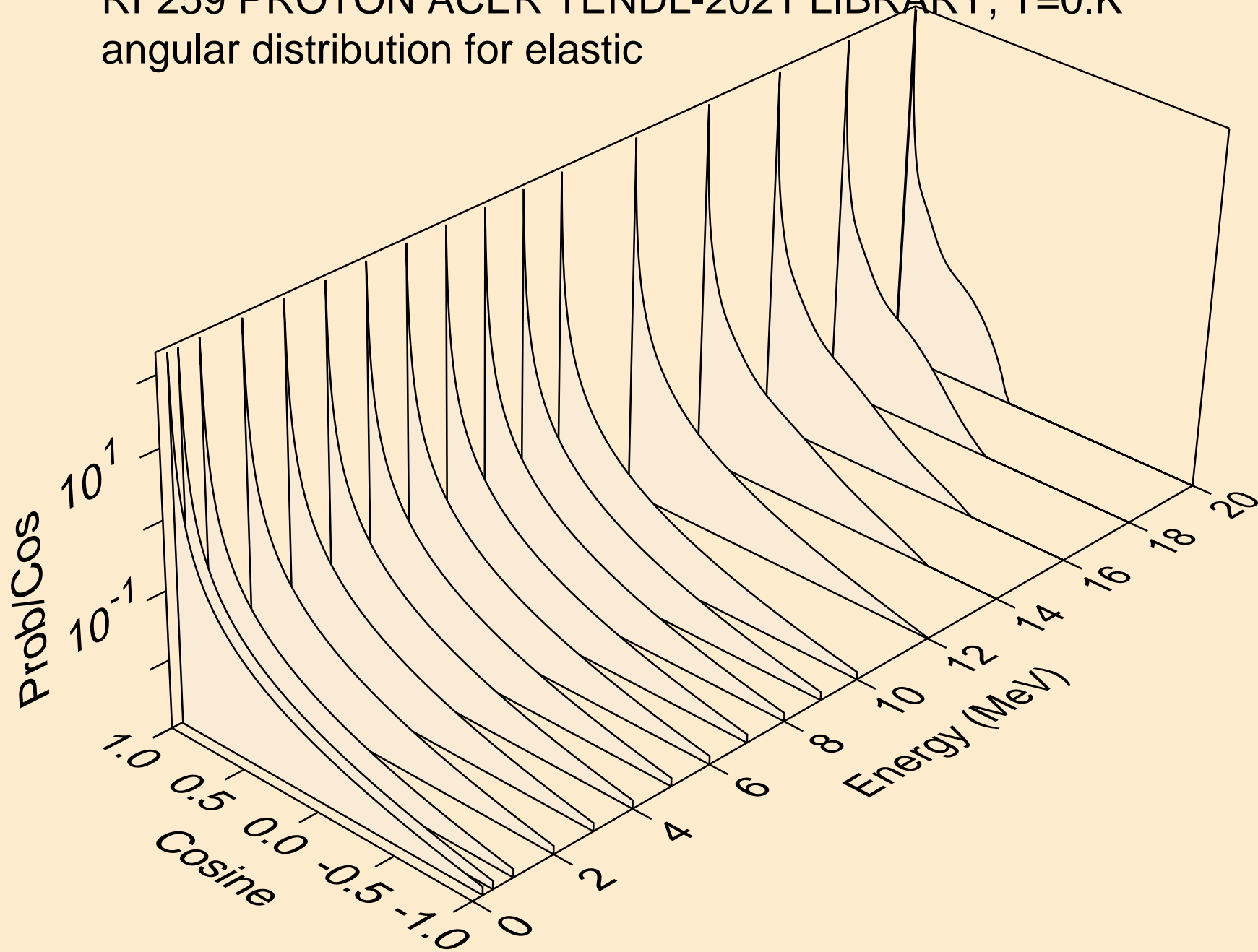



RF259 PROTON ACER TENDL-2021 LIBRARY; T=0.K  
angular distribution for elastic

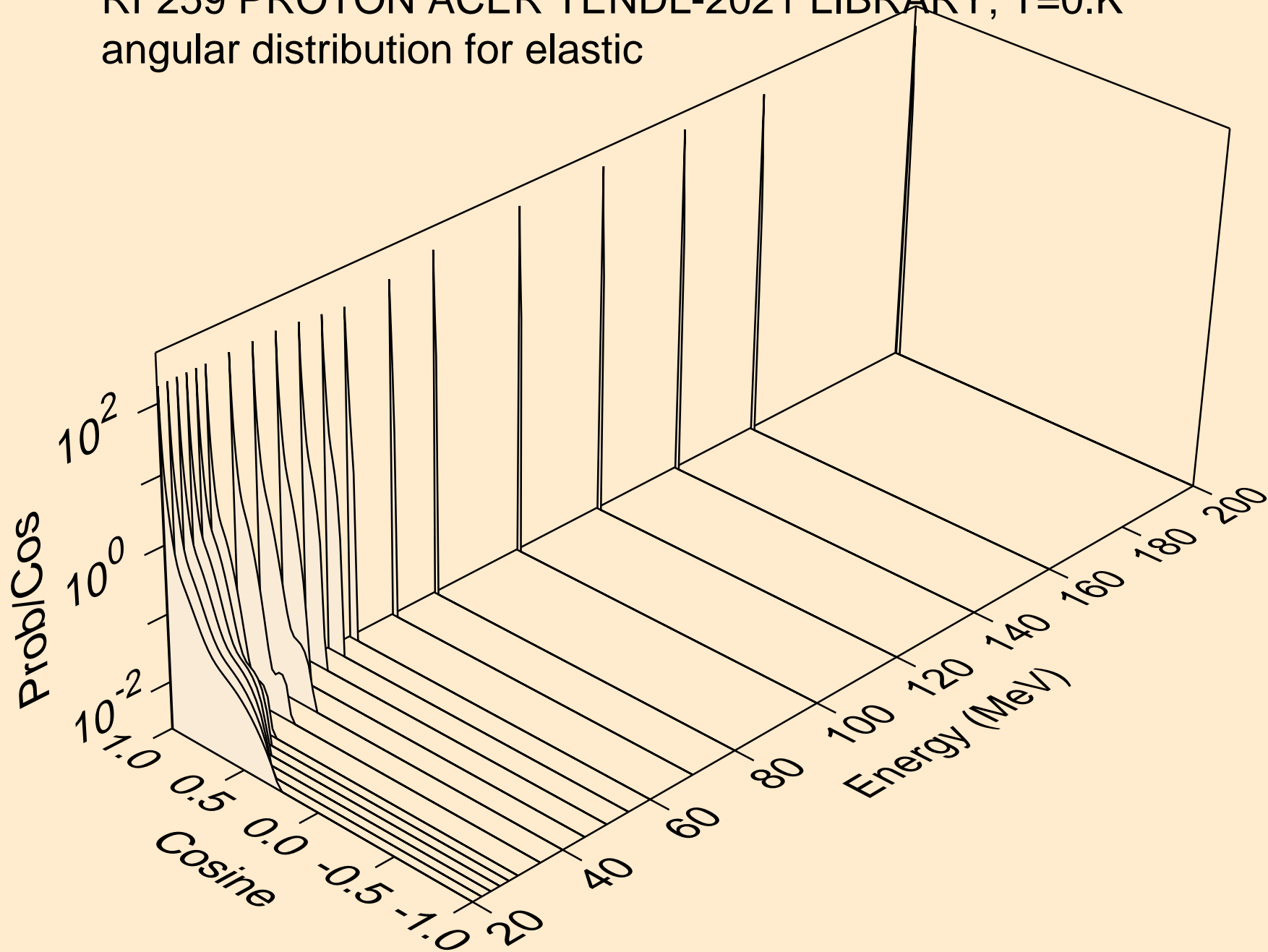

RF259 PROTON ACER TENDL-2021 LIBRARY; T=0.K  
Proton emission for (p,x)

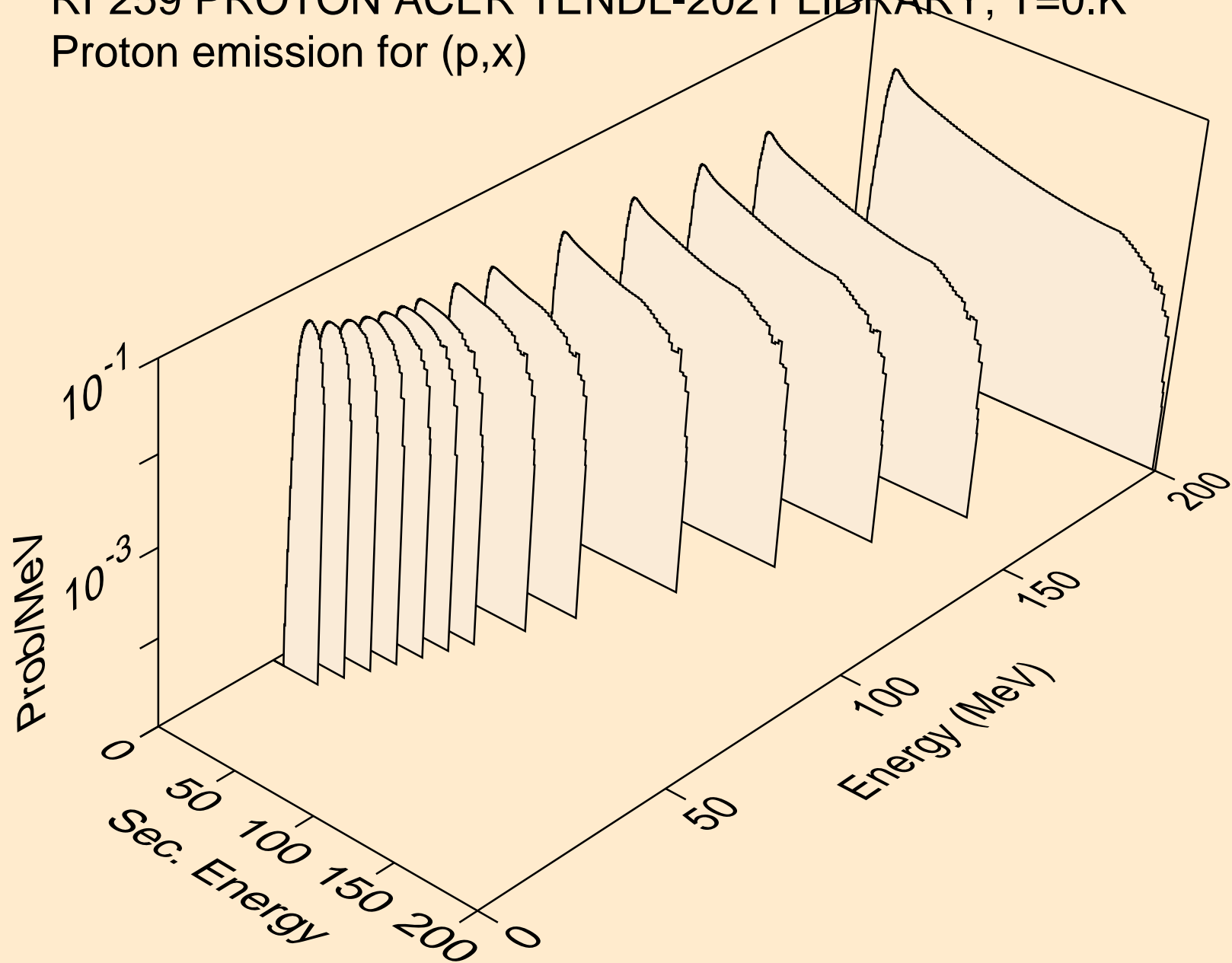

RF259 PROTON ACER TENDL-2021 LIBRARY; T=0.K  
Proton emission for (p,n\*)p

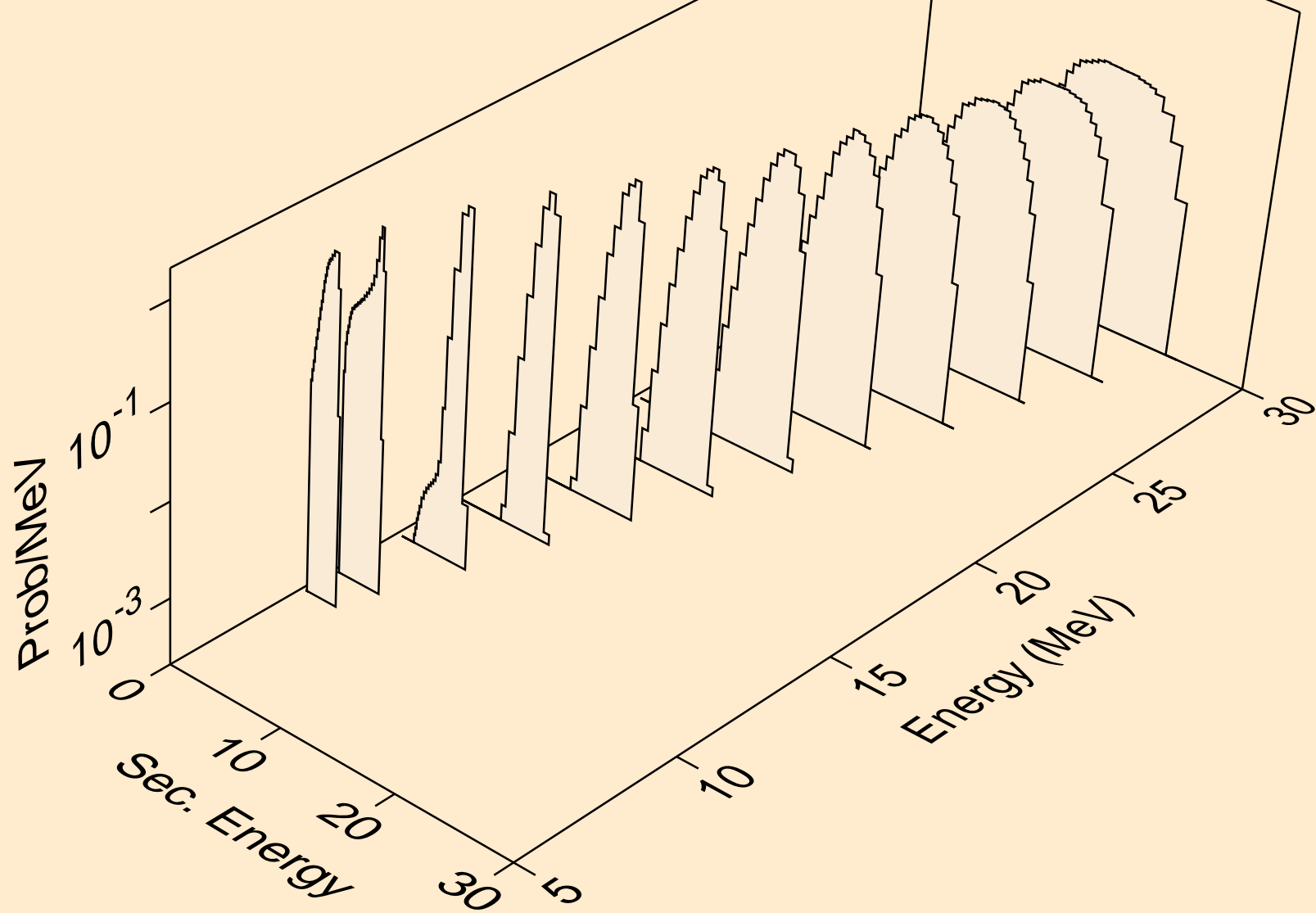

RF259 PROTON ACER TENDL-2021 LIBRARY; T=0.K  
Proton emission for (p,2np)

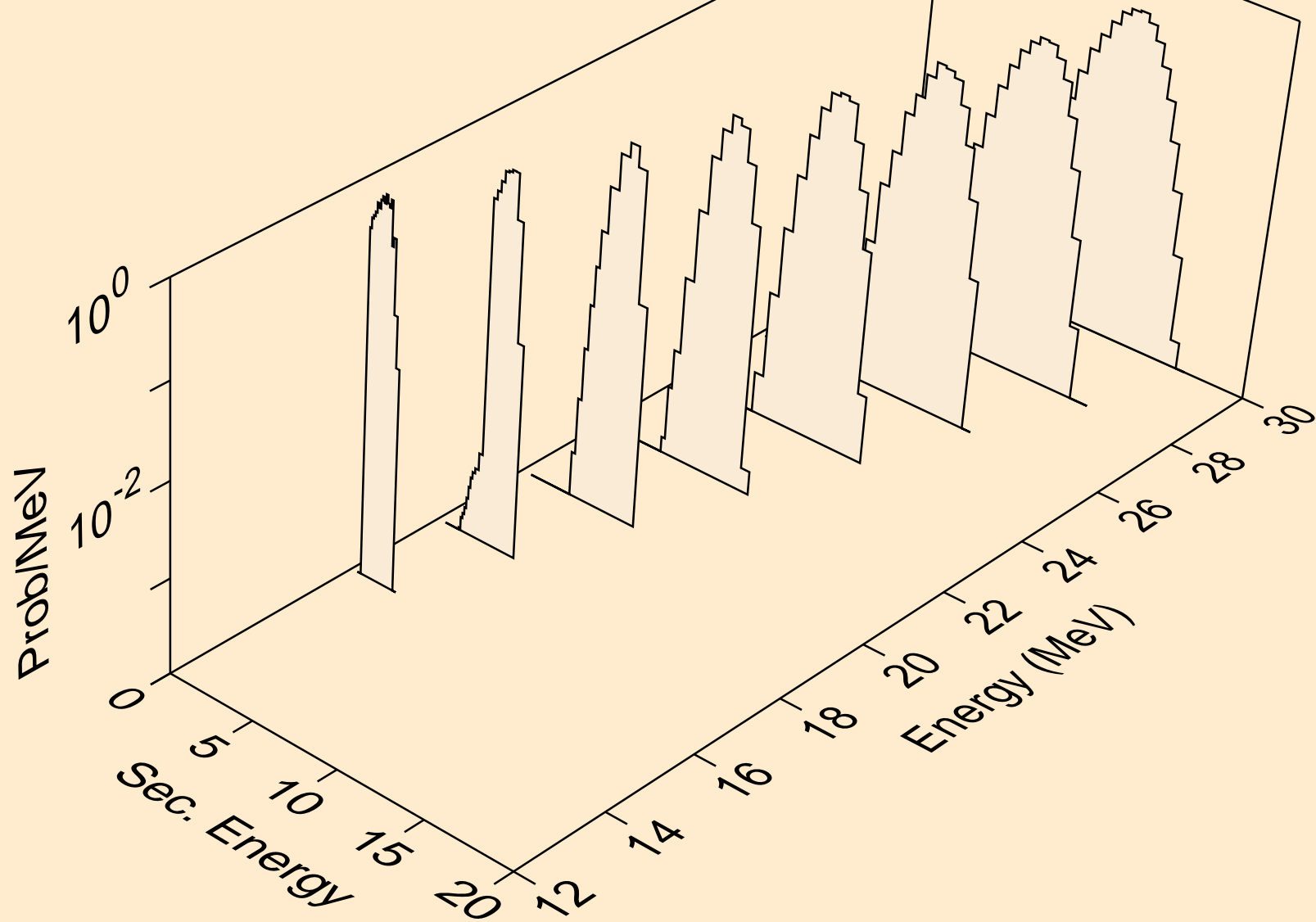

RF259 PROTON ACER TENDL-2021 LIBRARY; T=0.K  
Proton emission for (p,npa)

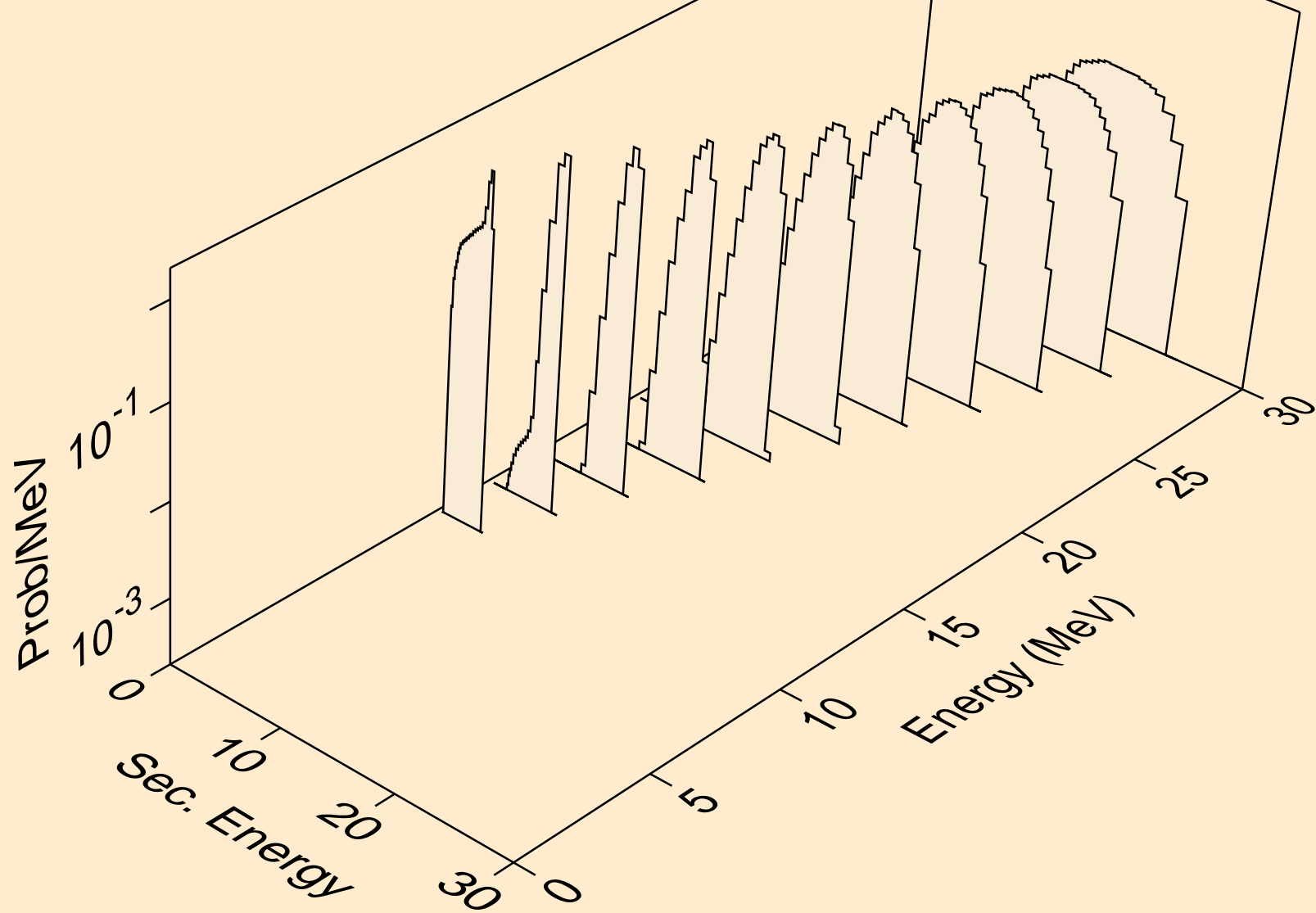

RF259 PROTON ACER TENDL-2021 LIBRARY; T=0.K  
Proton emission for inelastic

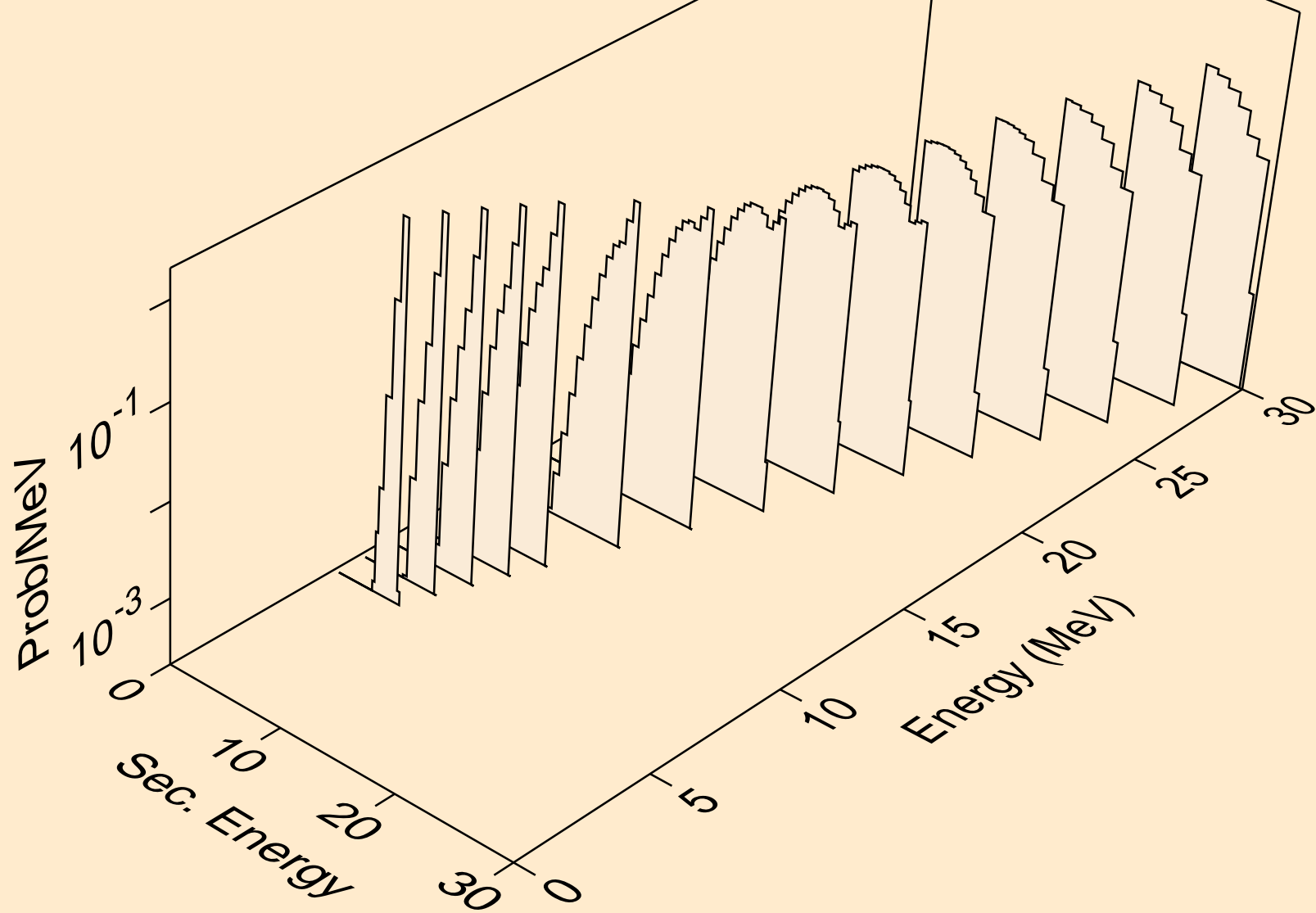

RF259 PROTON ACER TENDL-2021 LIBRARY; T=0.K  
Proton emission for (p,2p)

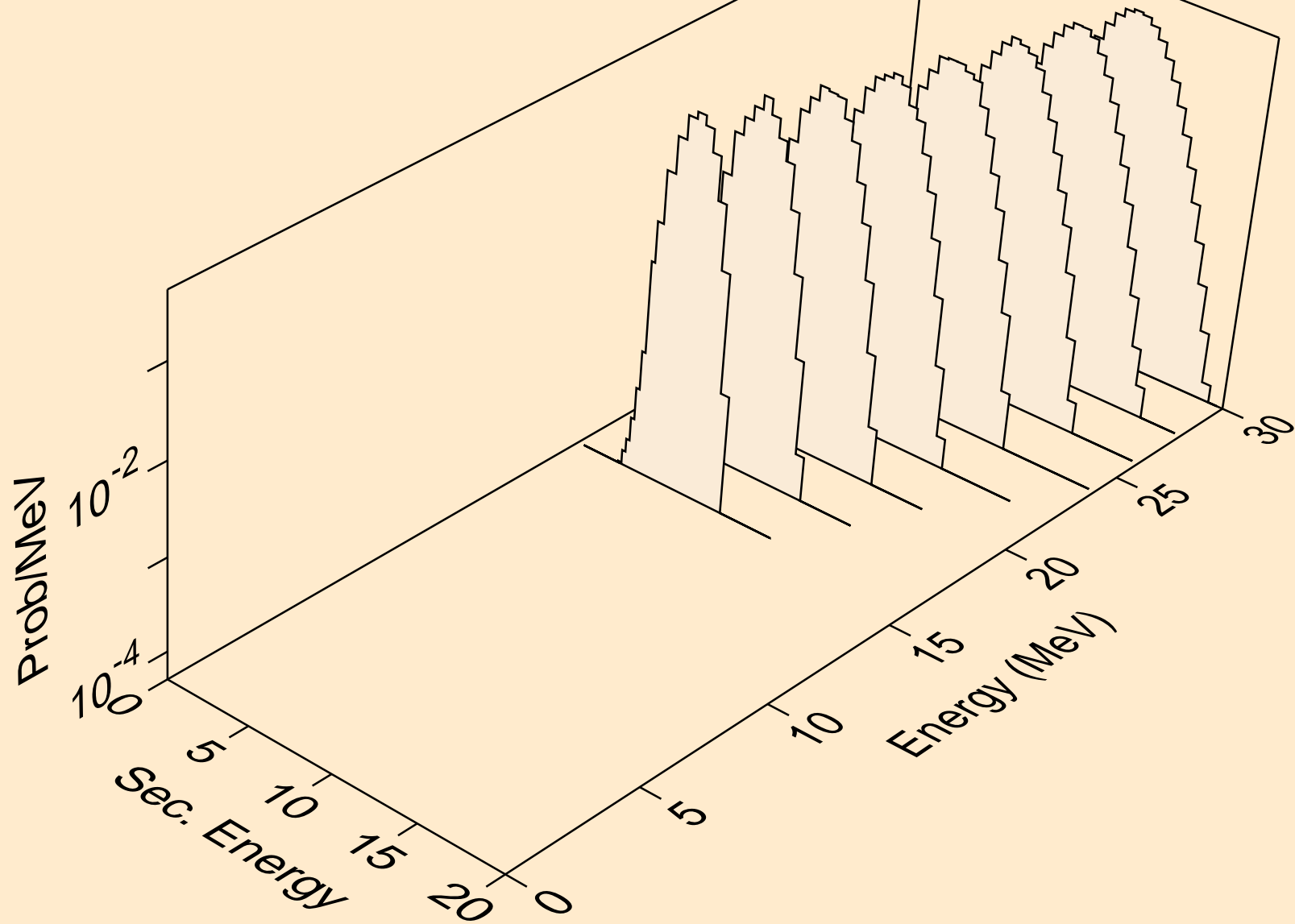

RF259 PROTON ACER TENDL-2021 LIBRARY; T=0.K  
Proton emission for (p,pa)

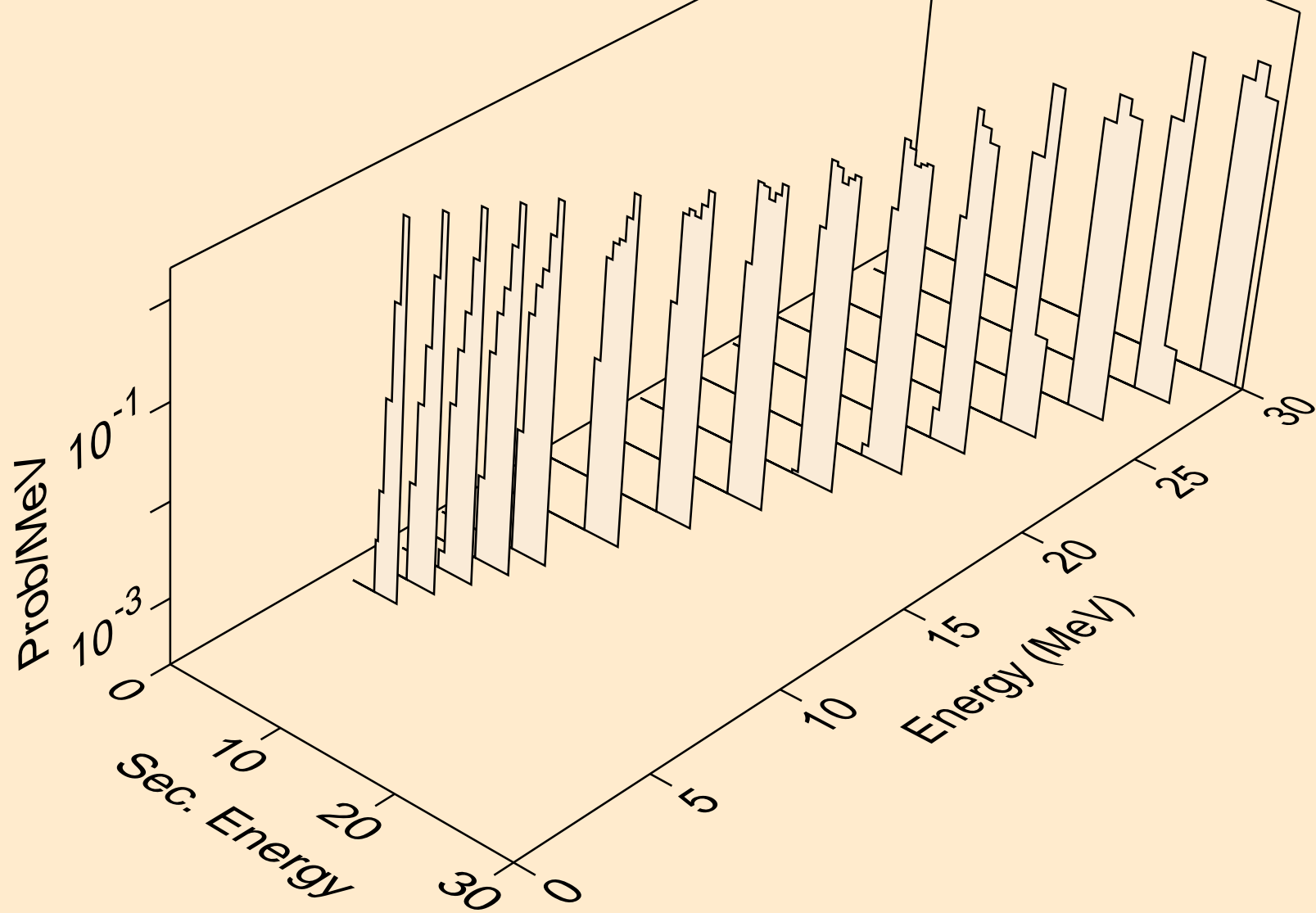



RF259 PROTON ACER TENDL-2021 LIBRARY; T=0.K  
Photon emission for (z,n)

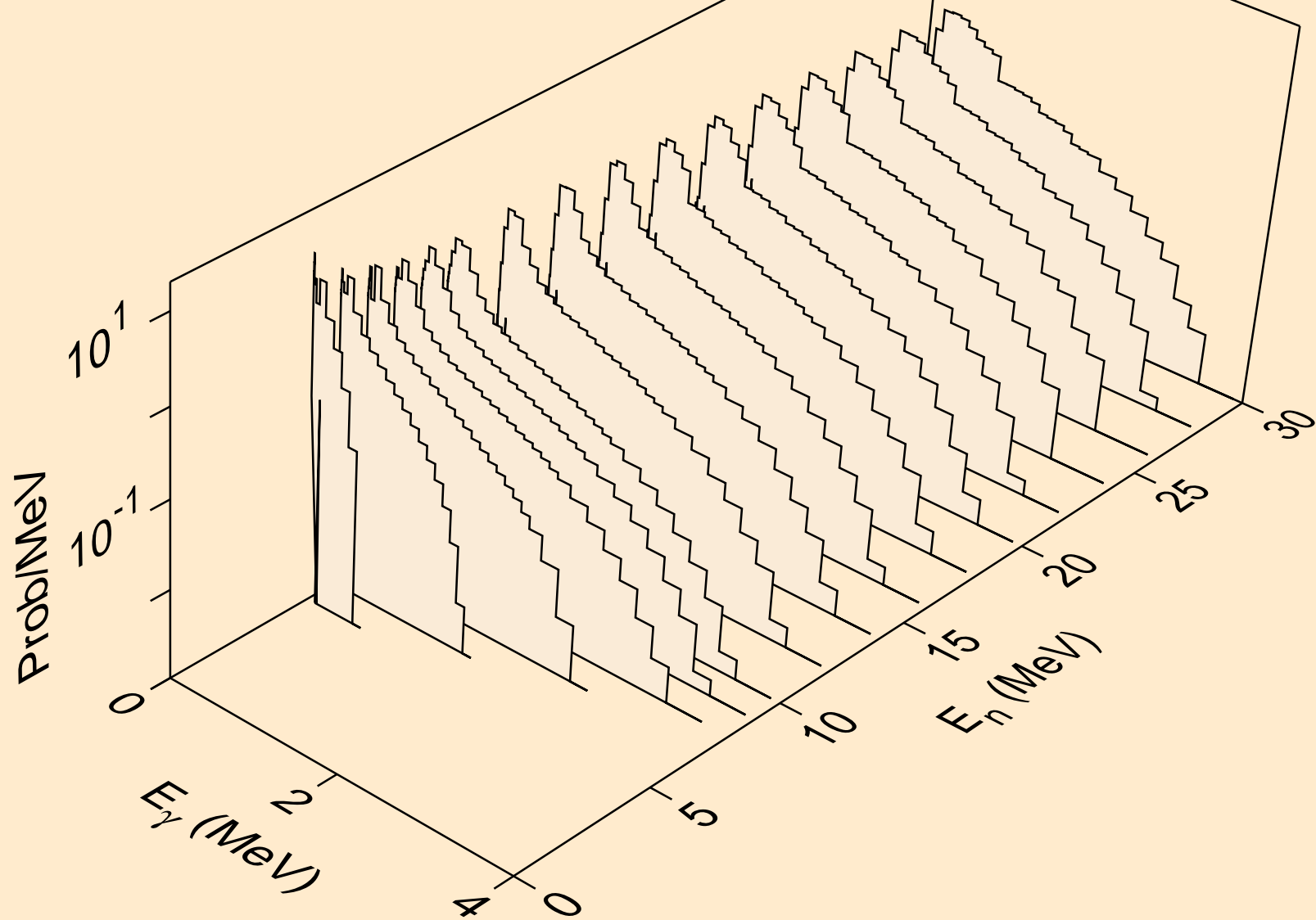

RF259 PROTON ACER TENDL-2021 LIBRARY; T=0.K  
Photon emission for (n,x)

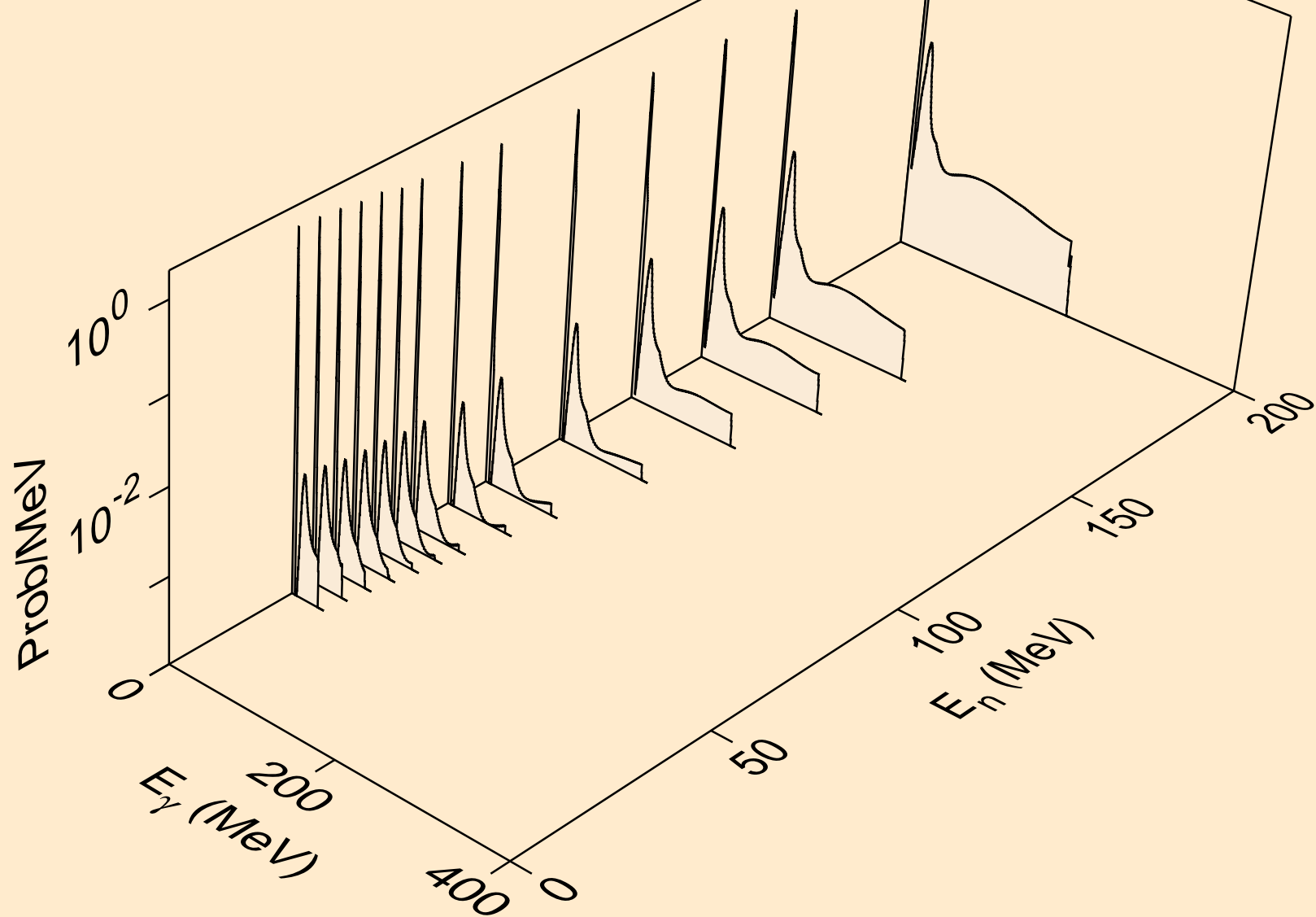

RF259 PROTON ACER TENDL-2021 LIBRARY; T=0.K  
Photon emission for (n,2n)

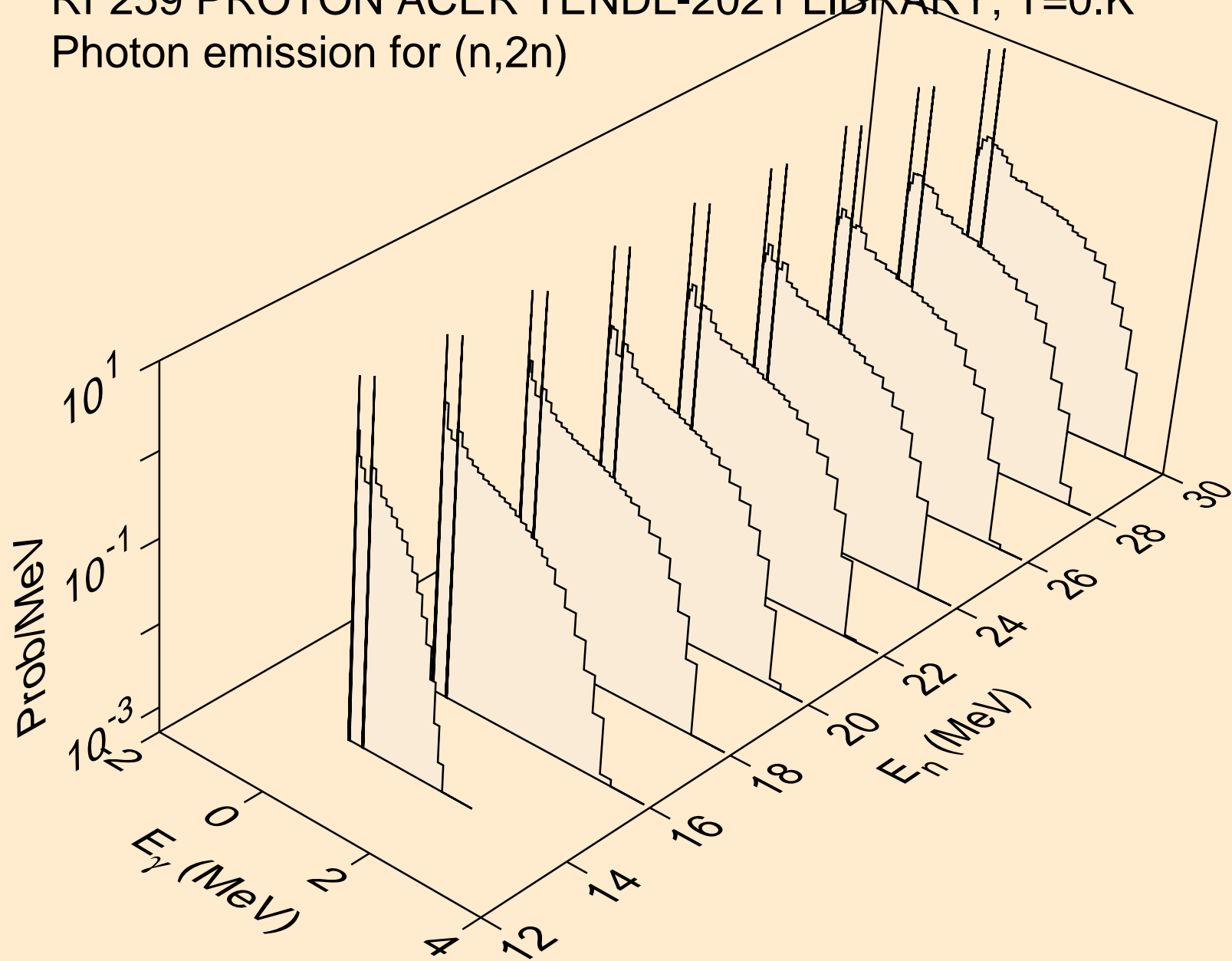

RF259 PROTON ACER TENDL-2021 LIBRARY; T=0.K  
Photon emission for (n,3n)

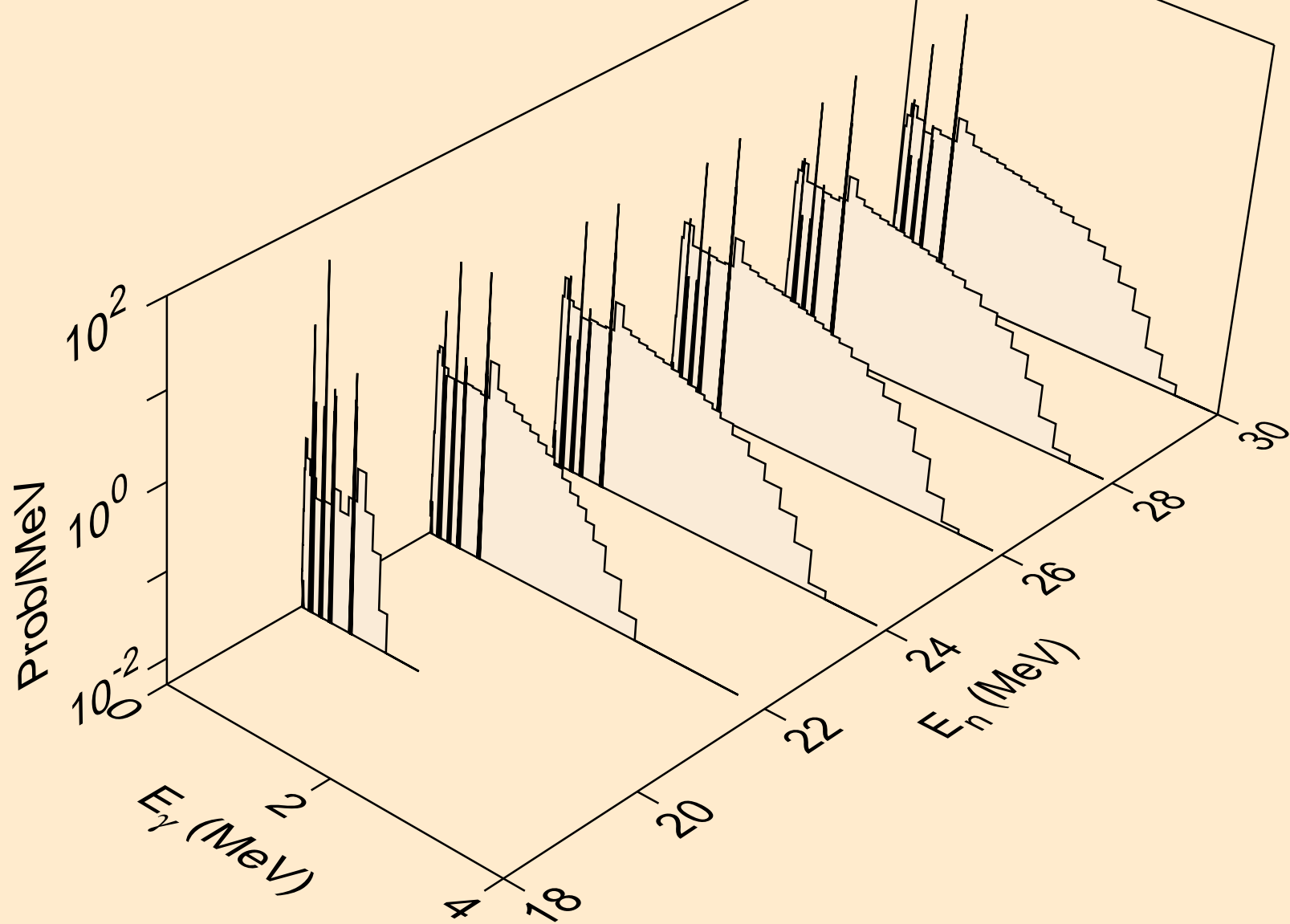

RF259 PROTON ACER TENDL-2021 LIBRARY; T=0.K  
Photon emission for (n,n\*)a

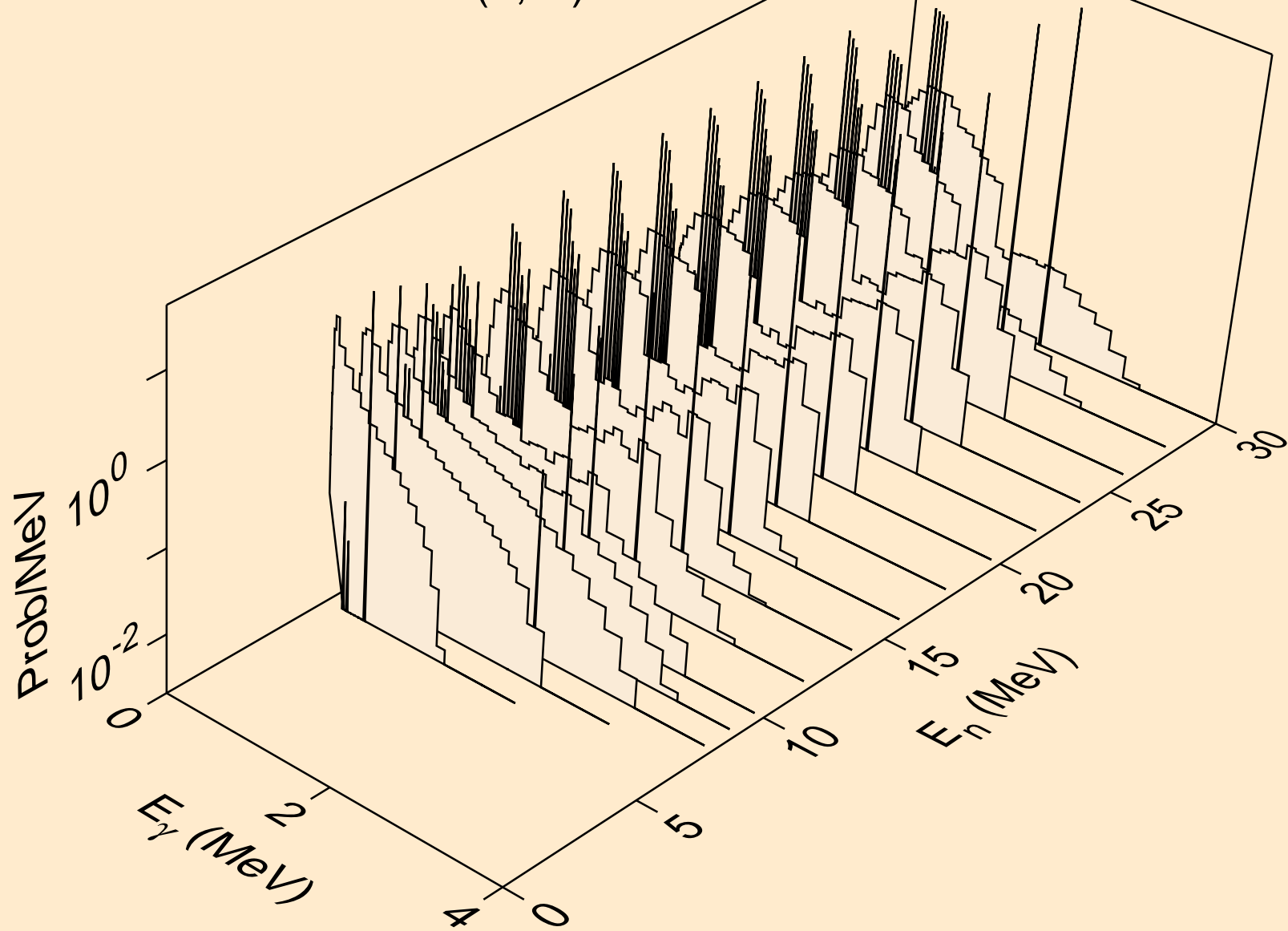

RF259 PROTON ACER TENDL-2021 LIBRARY; T=0.K  
Photon emission for (n,2n)a

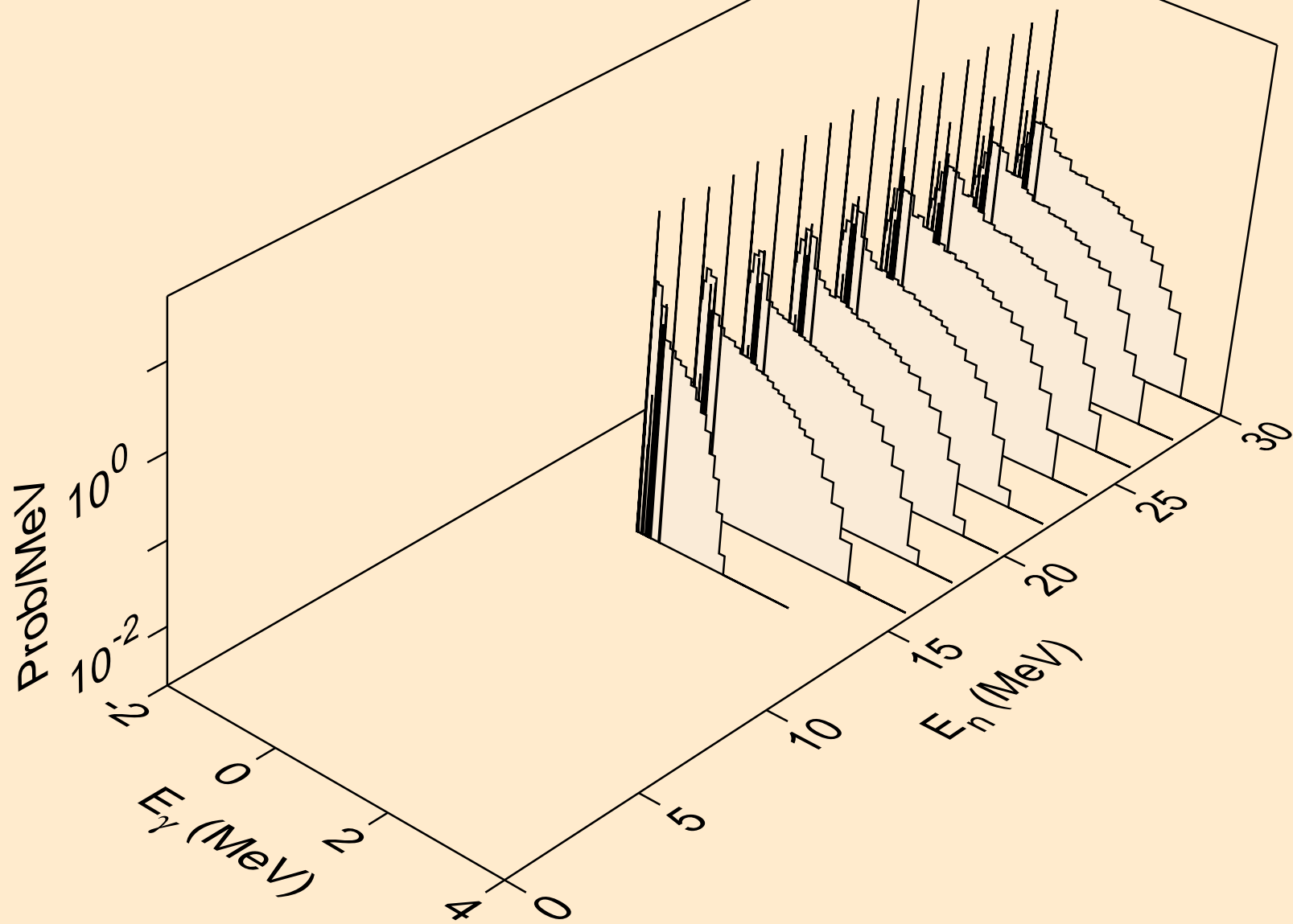

RF259 PROTON ACER TENDL-2021 LIBRARY; T=0.K  
Photon emission for (n,3n)a

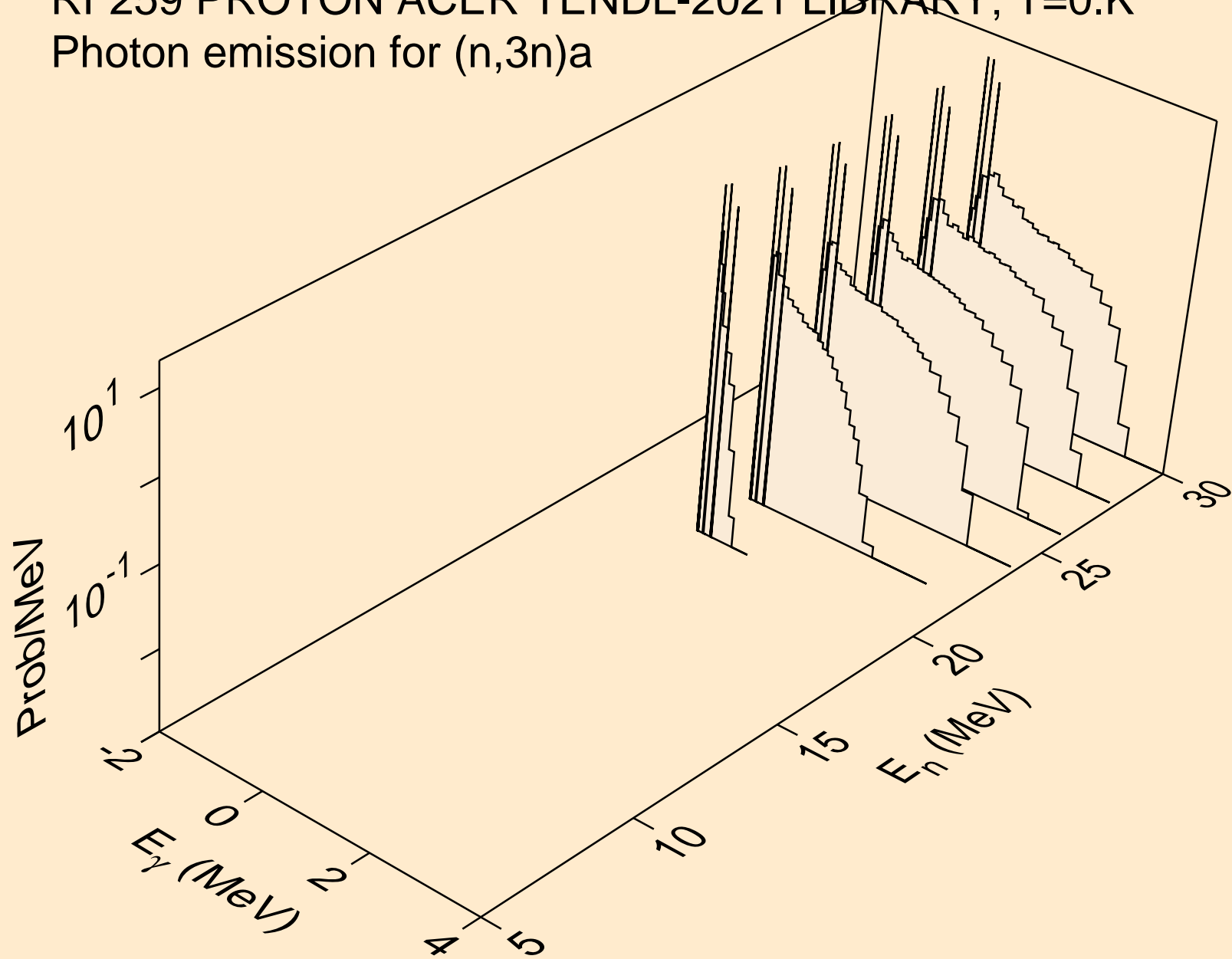

RF259 PROTON ACER TENDL-2021 LIBRARY; T=0.K  
Photon emission for (n,n\*)p

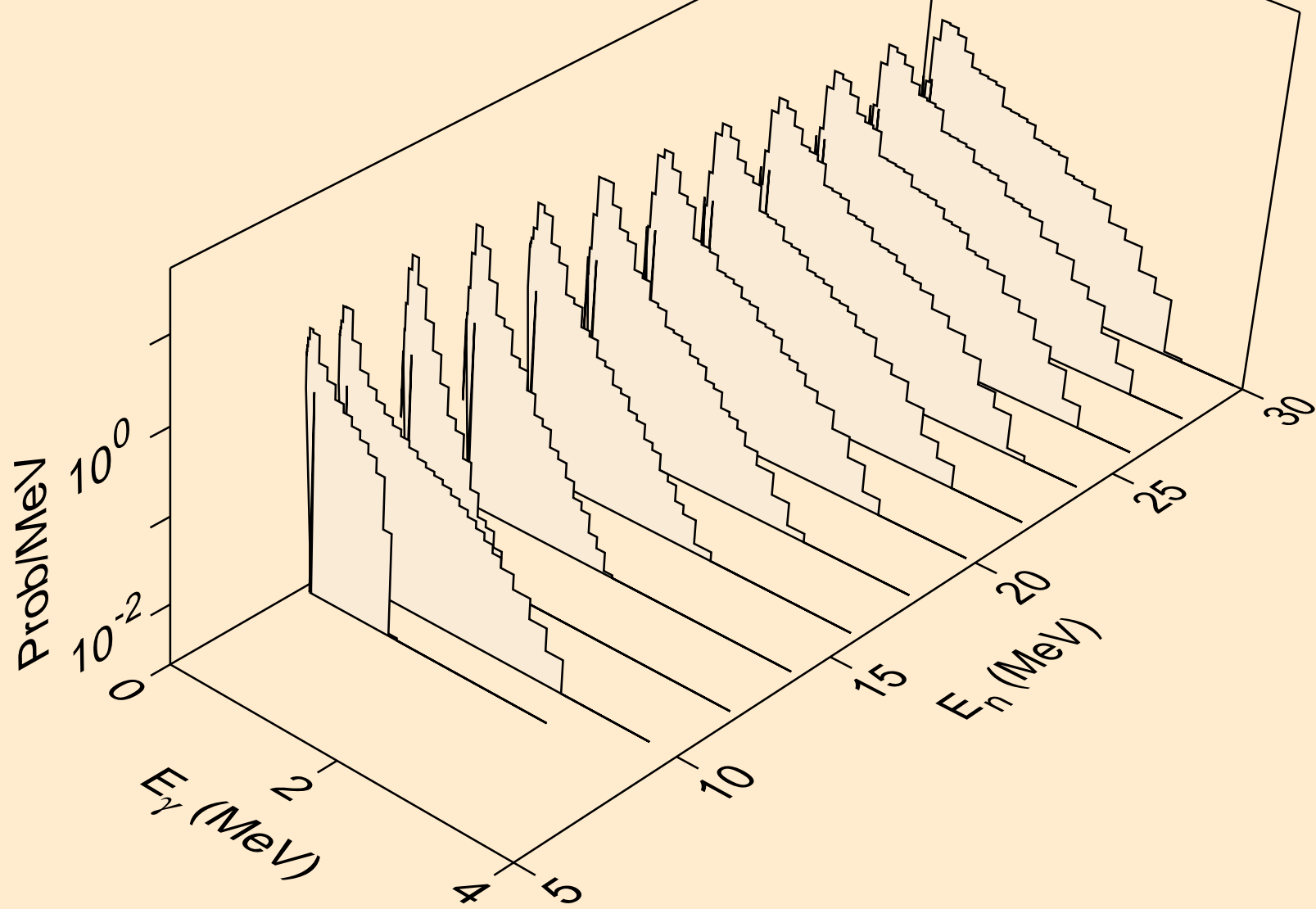



RF259 PROTON ACER TENDL-2021 LIBRARY; T=0.K  
Photon emission for (n,n\*)2a

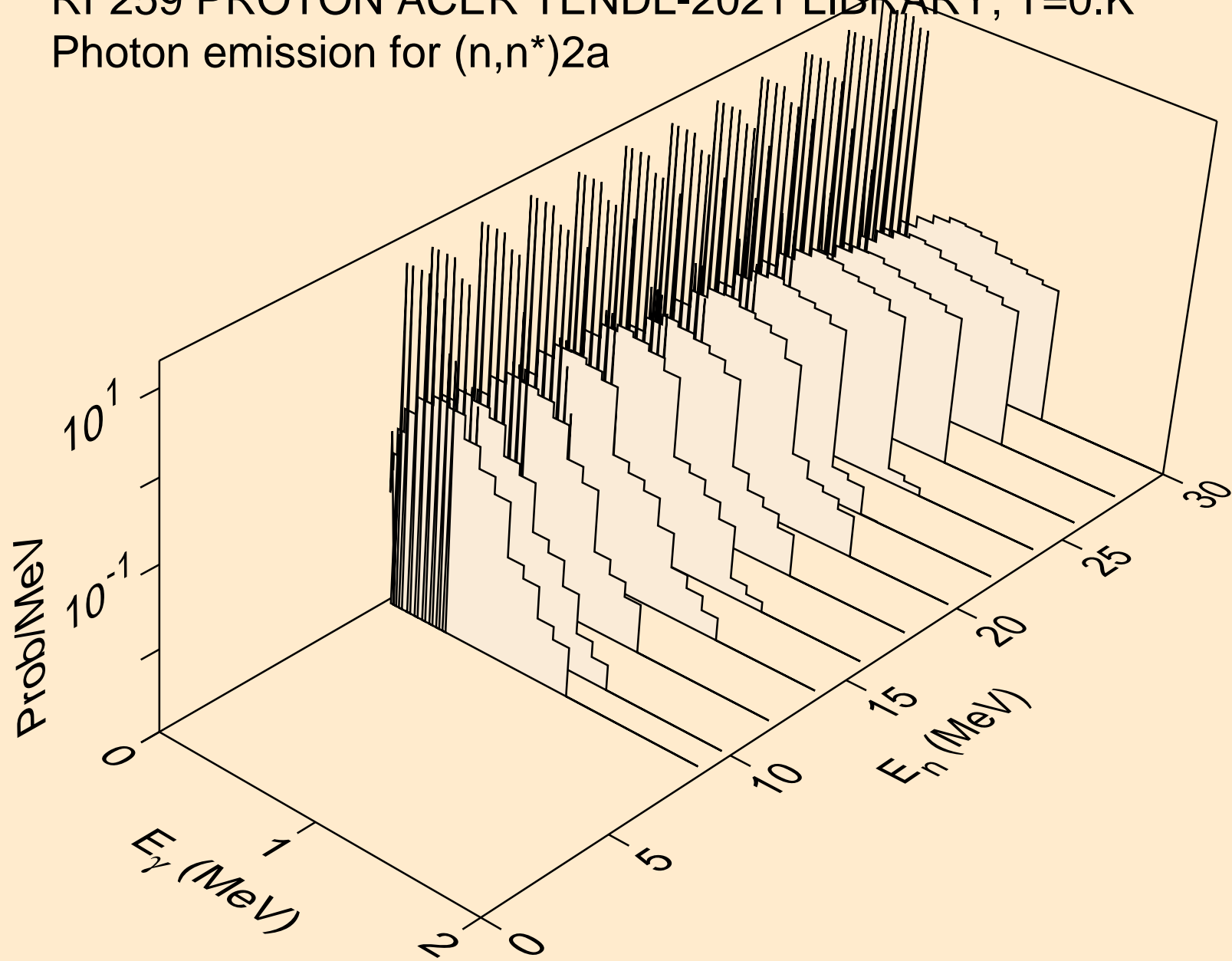

RF259 PROTON ACER TENDL-2021 LIBRARY; T=0.K  
Photon emission for (n,n\*)d

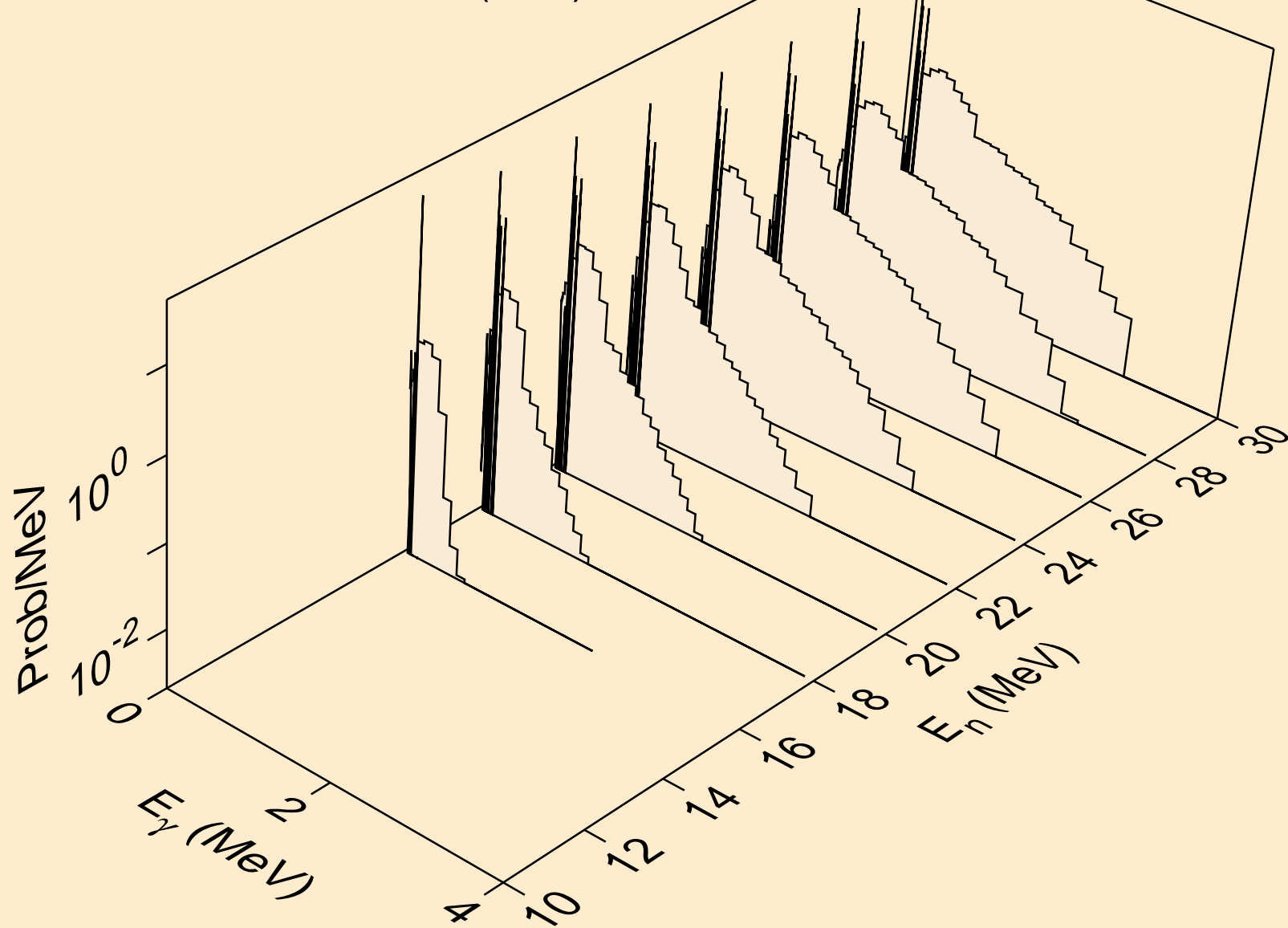

RF259 PROTON ACER TENDL-2021 LIBRARY; T=0.K  
Photon emission for (n,n\*)t

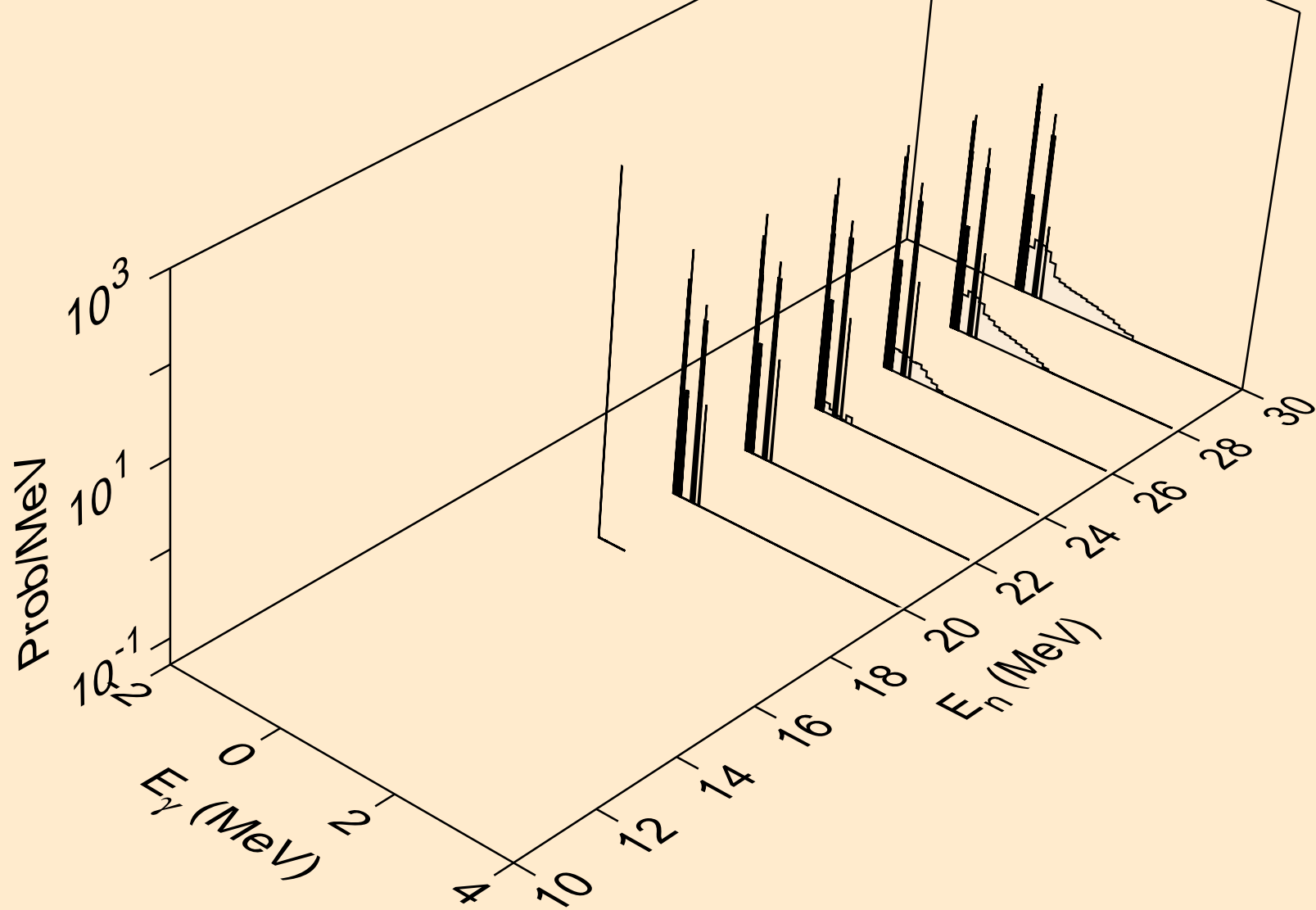

RF259 PROTON ACER TENDL-2021 LIBRARY; T=0.K  
Photon emission for (n,2np)

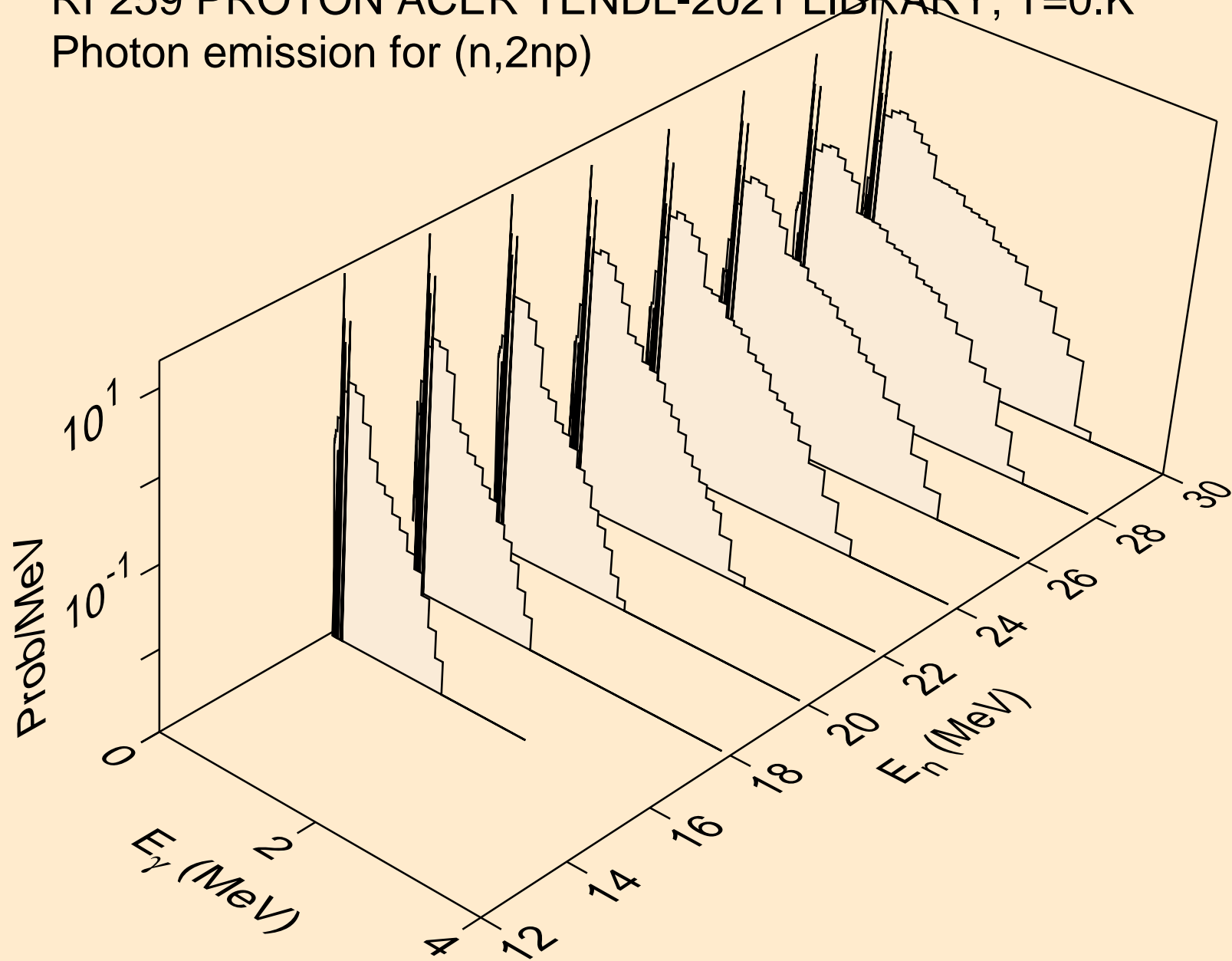

RF259 PROTON ACER TENDL-2021 LIBRARY; T=0.K  
Photon emission for (n,npa)

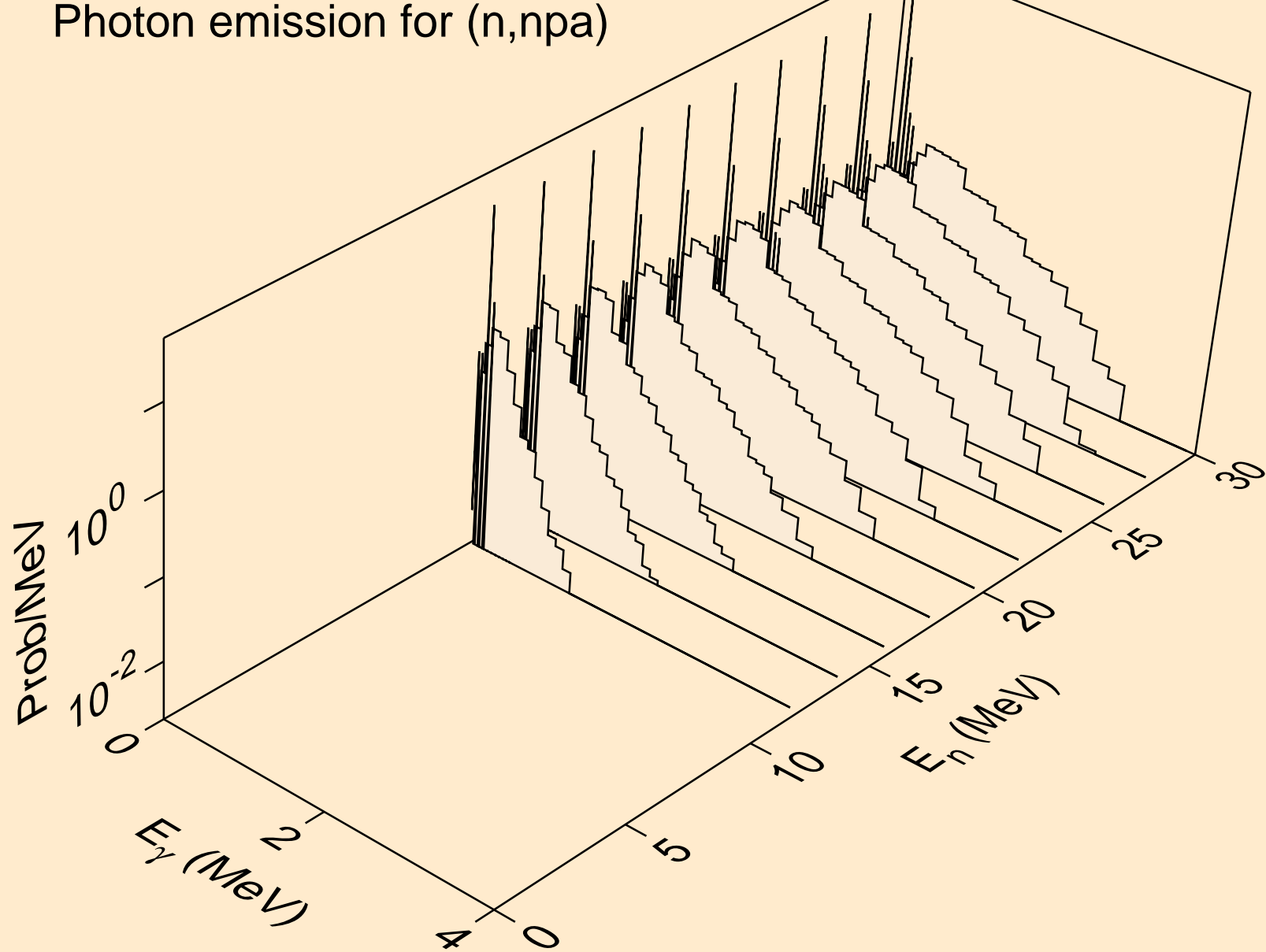

RF259 PROTON ACER TENDL-2021 LIBRARY; T=0.K  
Photon emission for (n,gma)

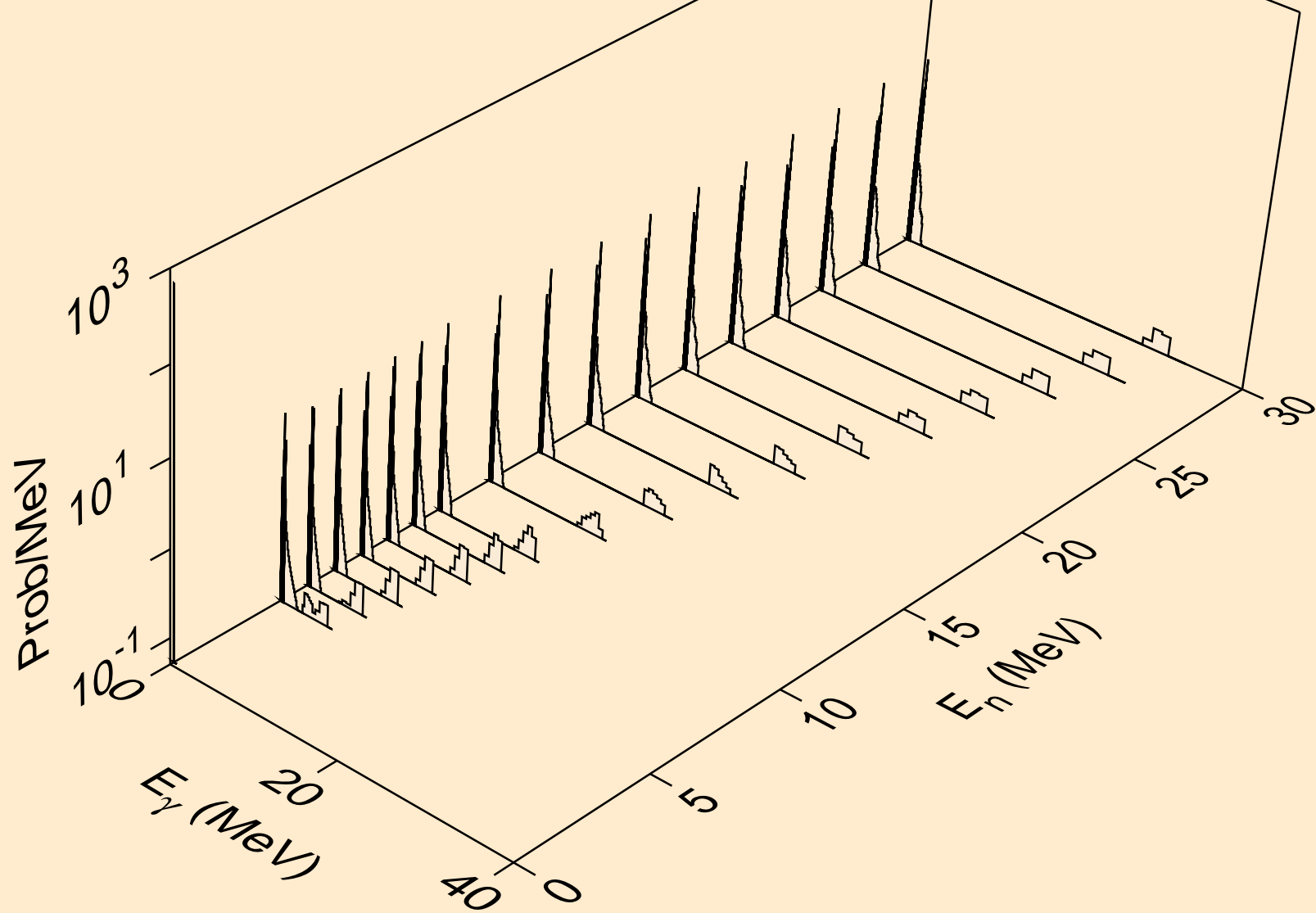

RF259 PROTON ACER TENDL-2021 LIBRARY; T=0.K  
Photon emission for inelastic

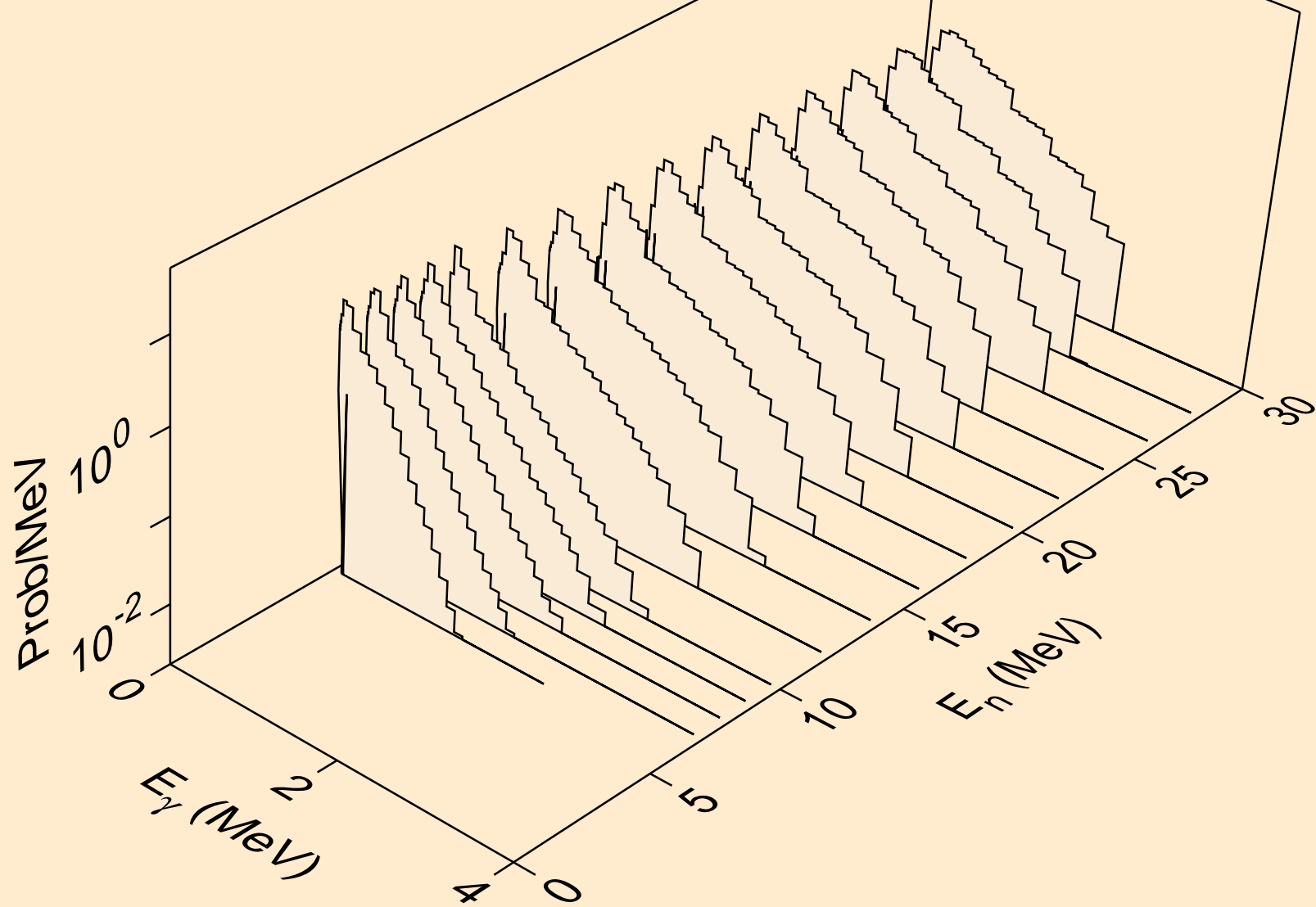

RF259 PROTON ACER TENDL-2021 LIBRARY; T=0.K  
Photon emission for (n,d)

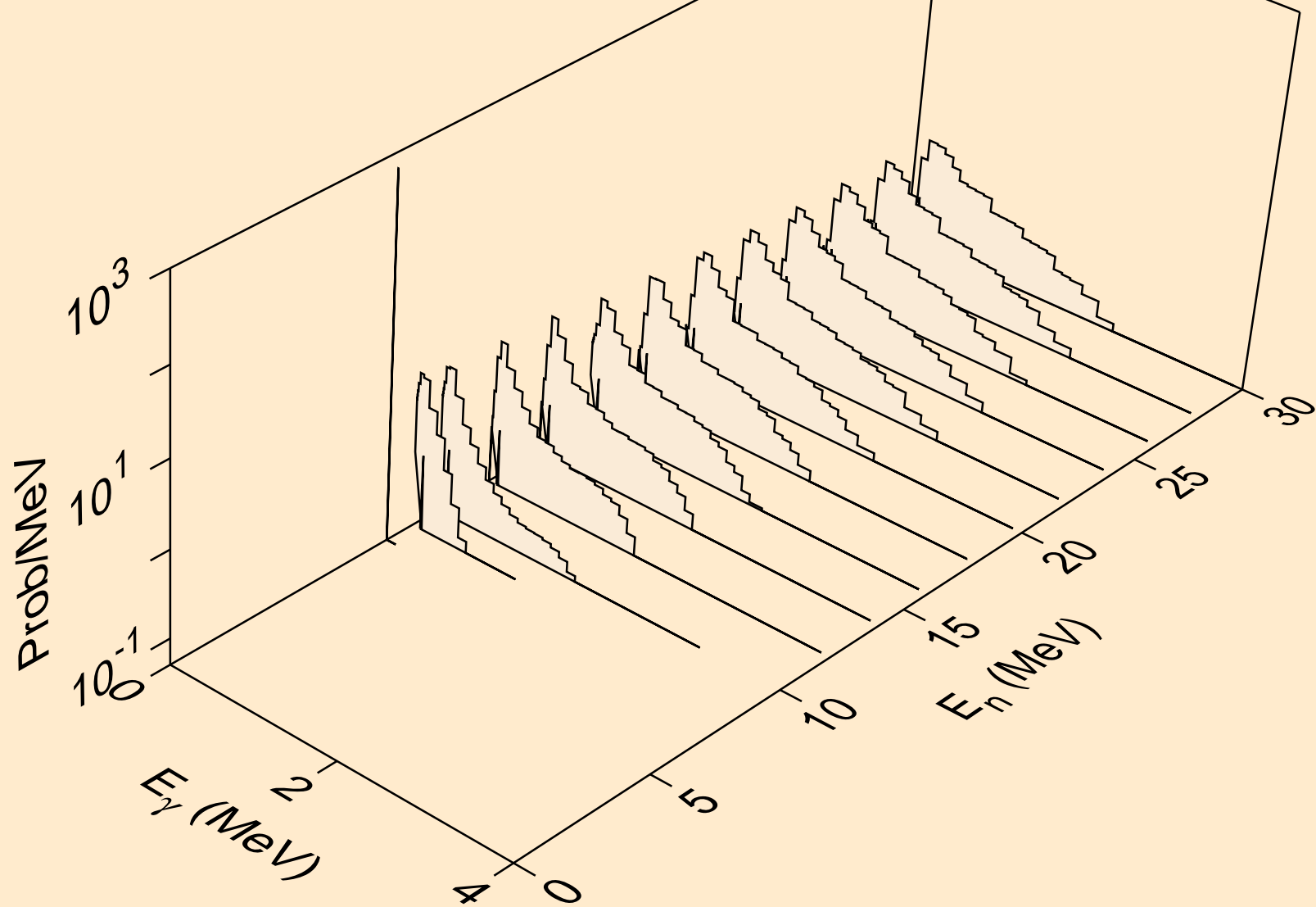



RF259 PROTON ACER TENDL-2021 LIBRARY; T=0.K  
Photon emission for (n,t)

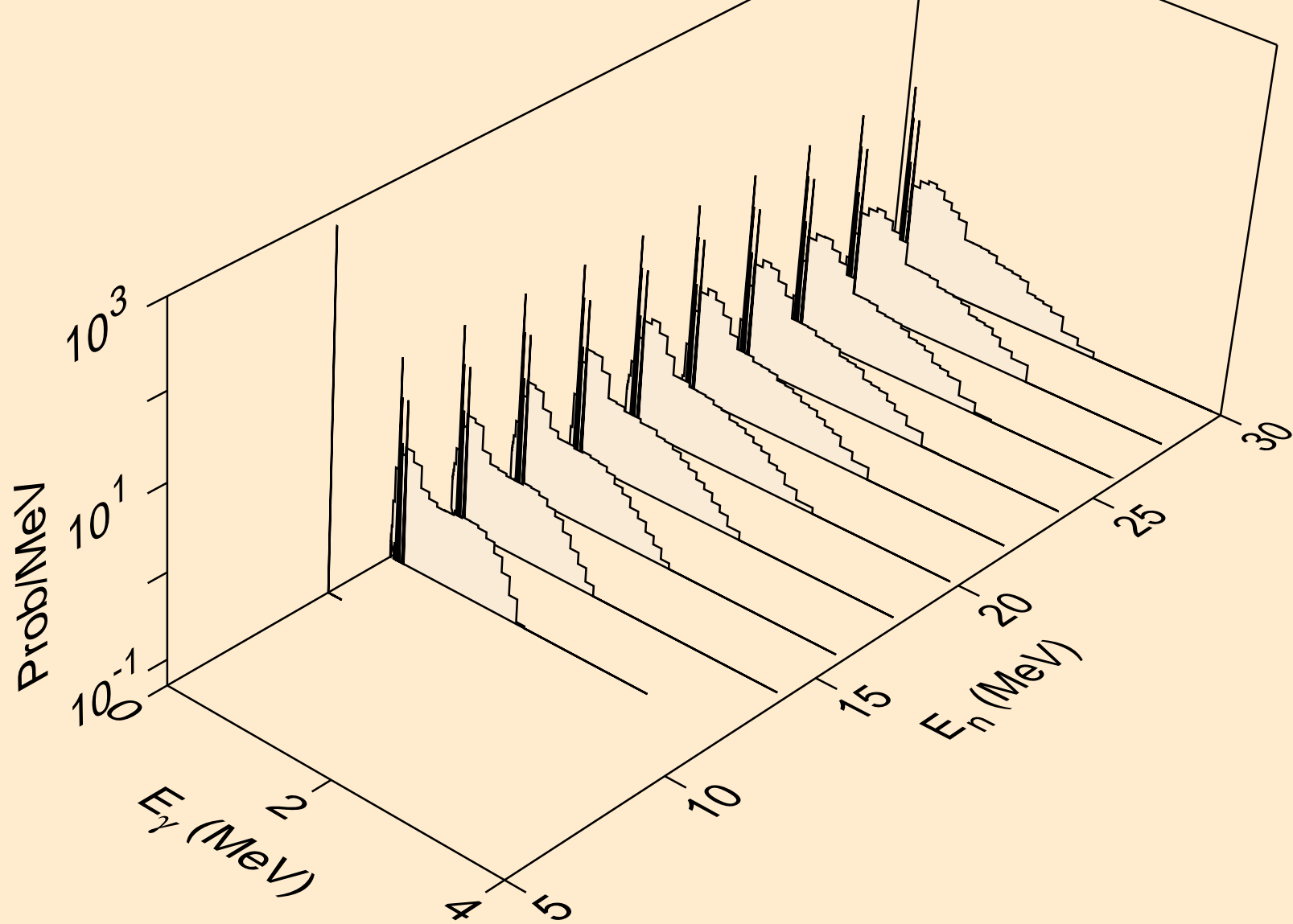

RF259 PROTON ACER TENDL-2021 LIBRARY; T=0.K  
Photon emission for (n,he3)

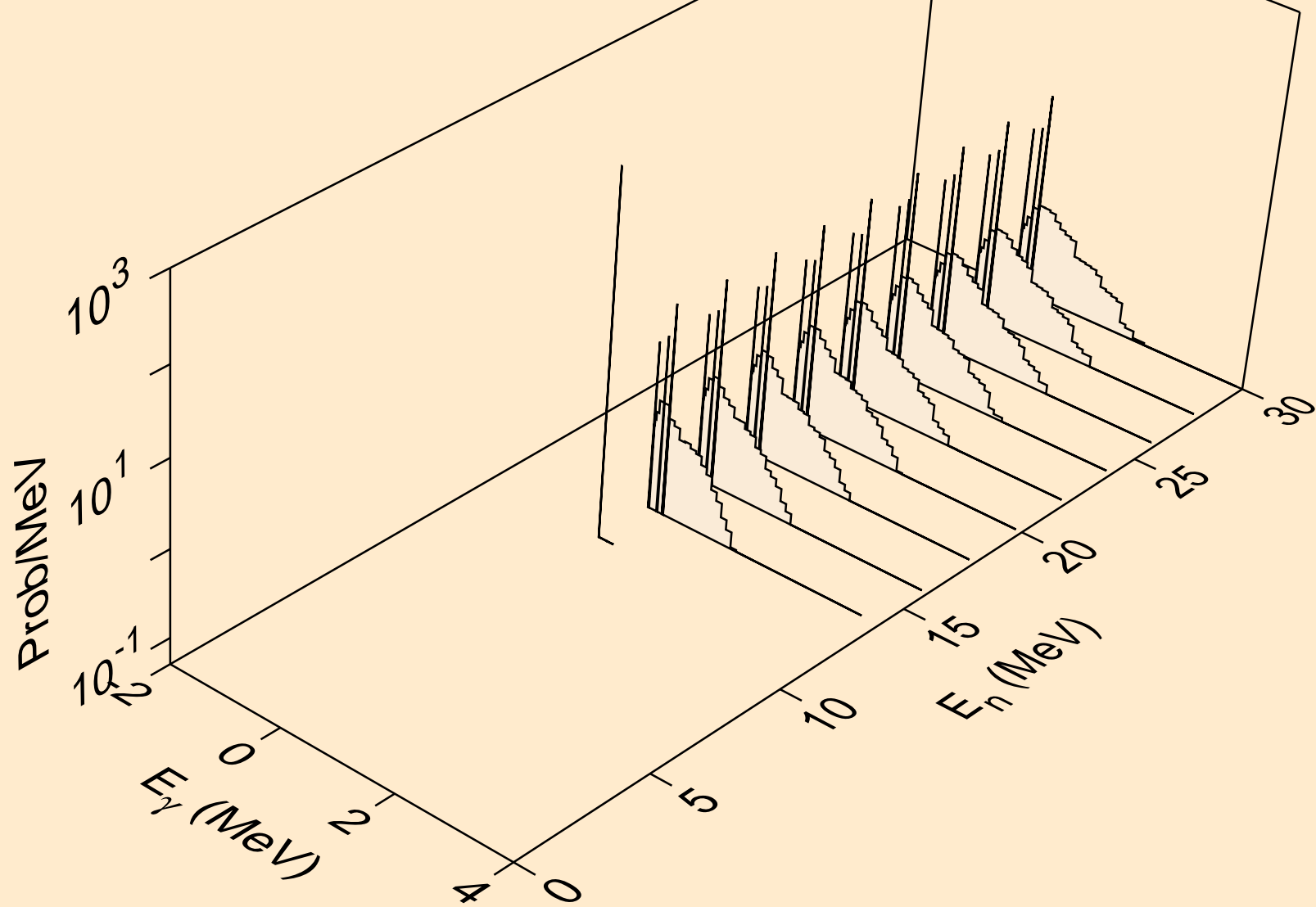

RF259 PROTON ACER TENDL-2021 LIBRARY; T=0.K  
Photon emission for (n,a)

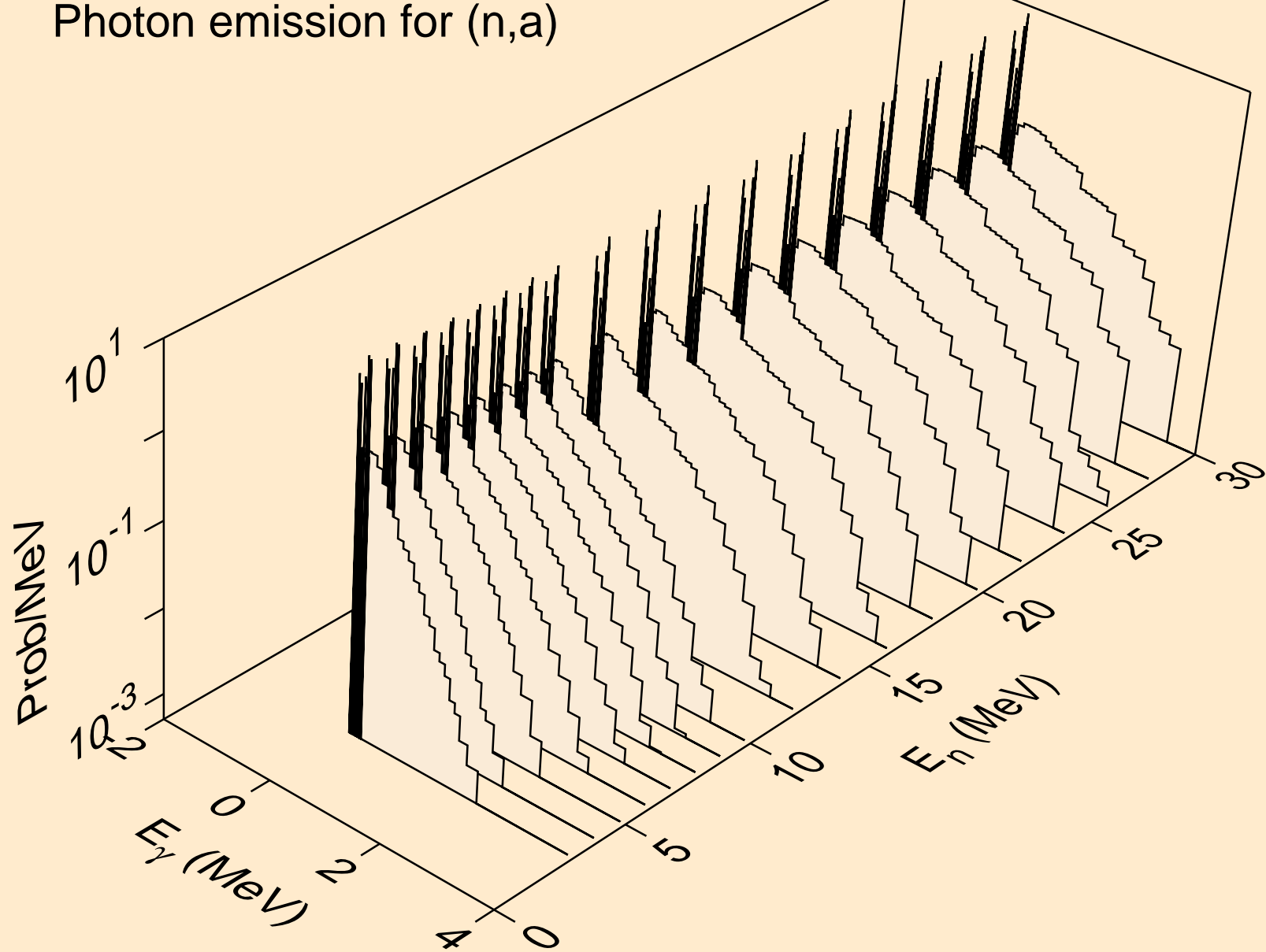

RF259 PROTON ACER TENDL-2021 LIBRARY; T=0.K  
Photon emission for (n,2a)

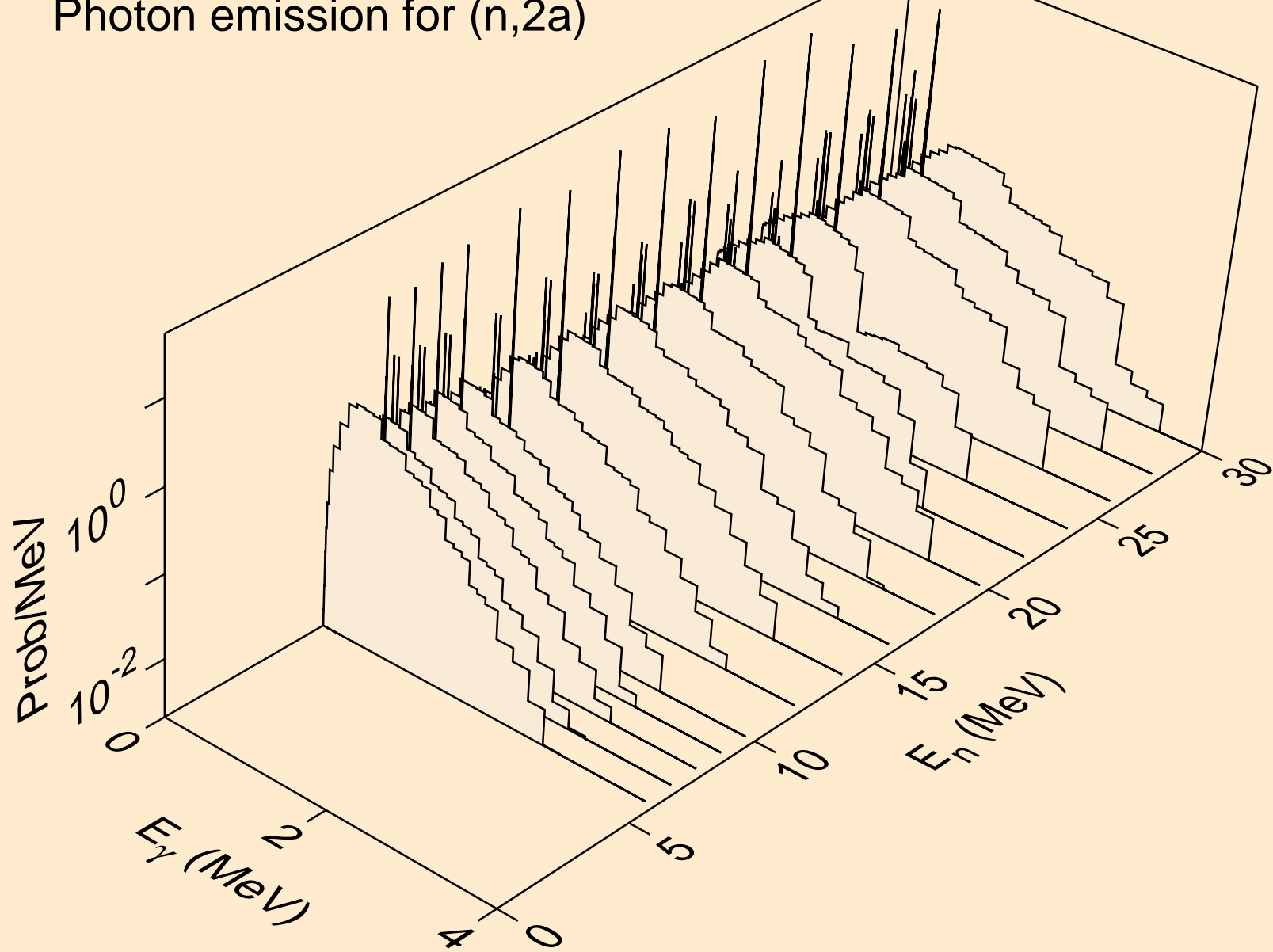

RF259 PROTON ACER TENDL-2021 LIBRARY; T=0.K  
Photon emission for (n,2p)

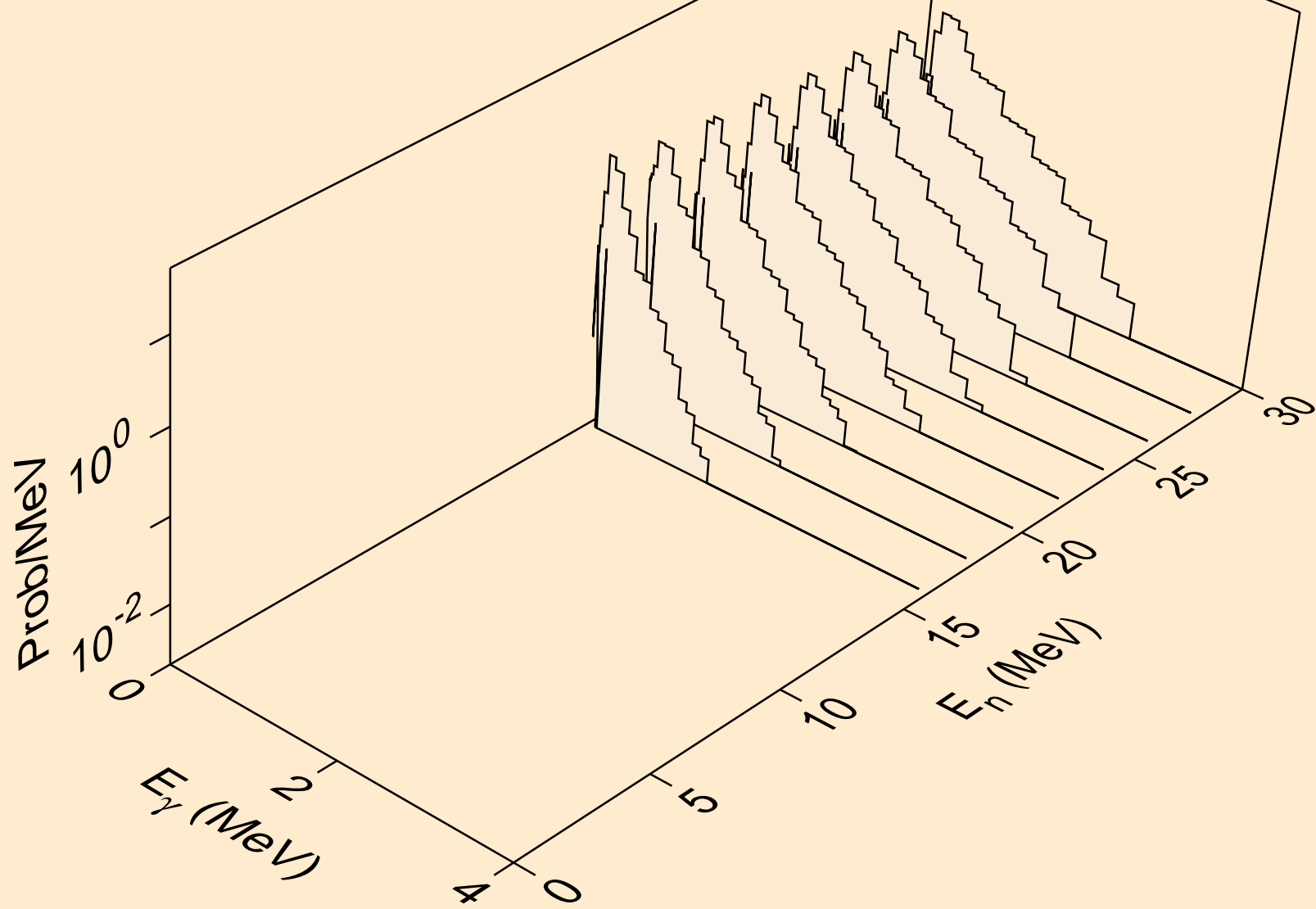

RF259 PROTON ACER TENDL-2021 LIBRARY; T=0.K  
Photon emission for (n,pa)

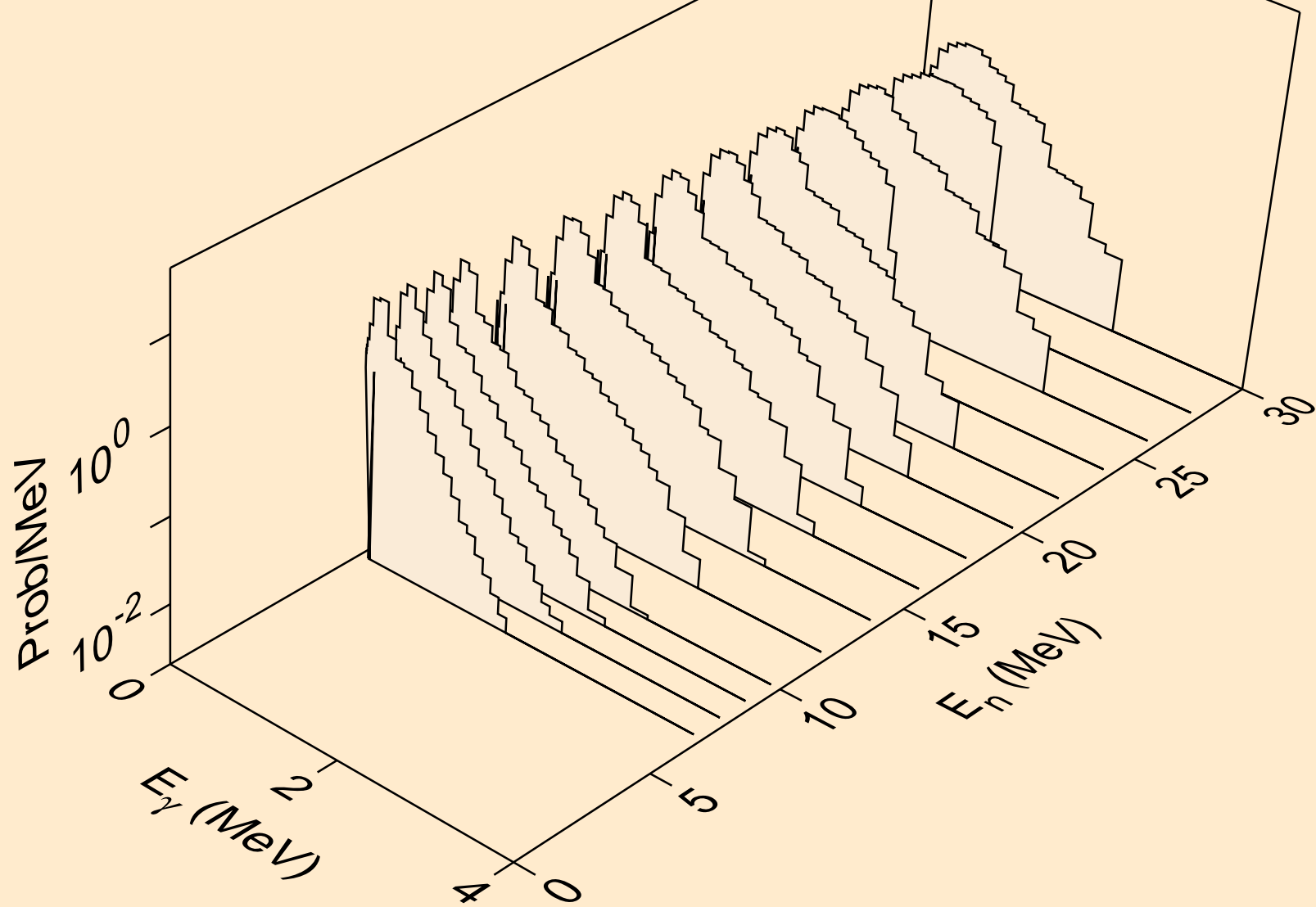

RF259 PROTON ACER TENDL-2021 LIBRARY; T=0.K  
Photon emission for (n,da)

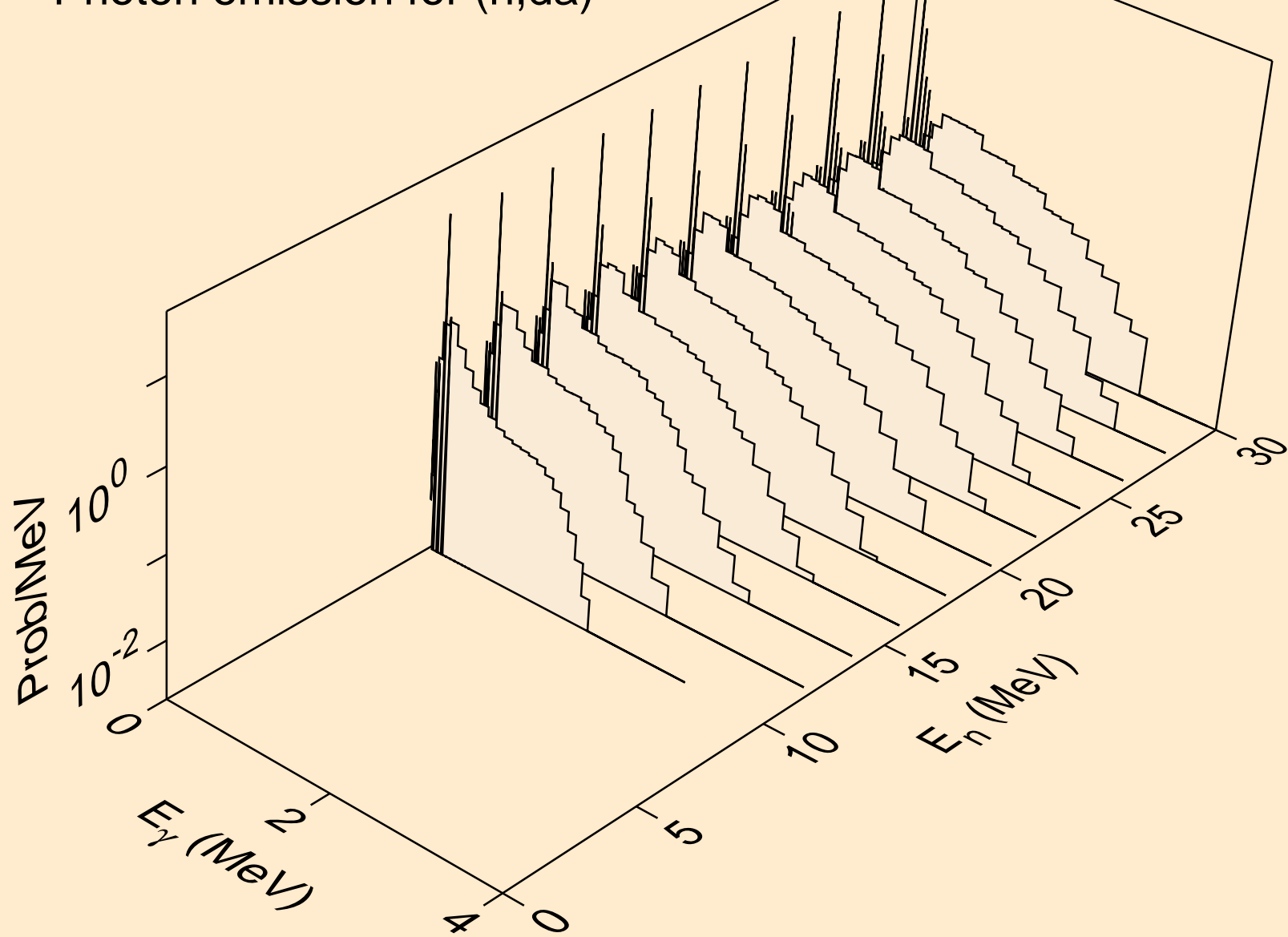

RF259 PROTON ACER TENDL-2021 LIBRARY; T=0.K  
Particle heating contributions

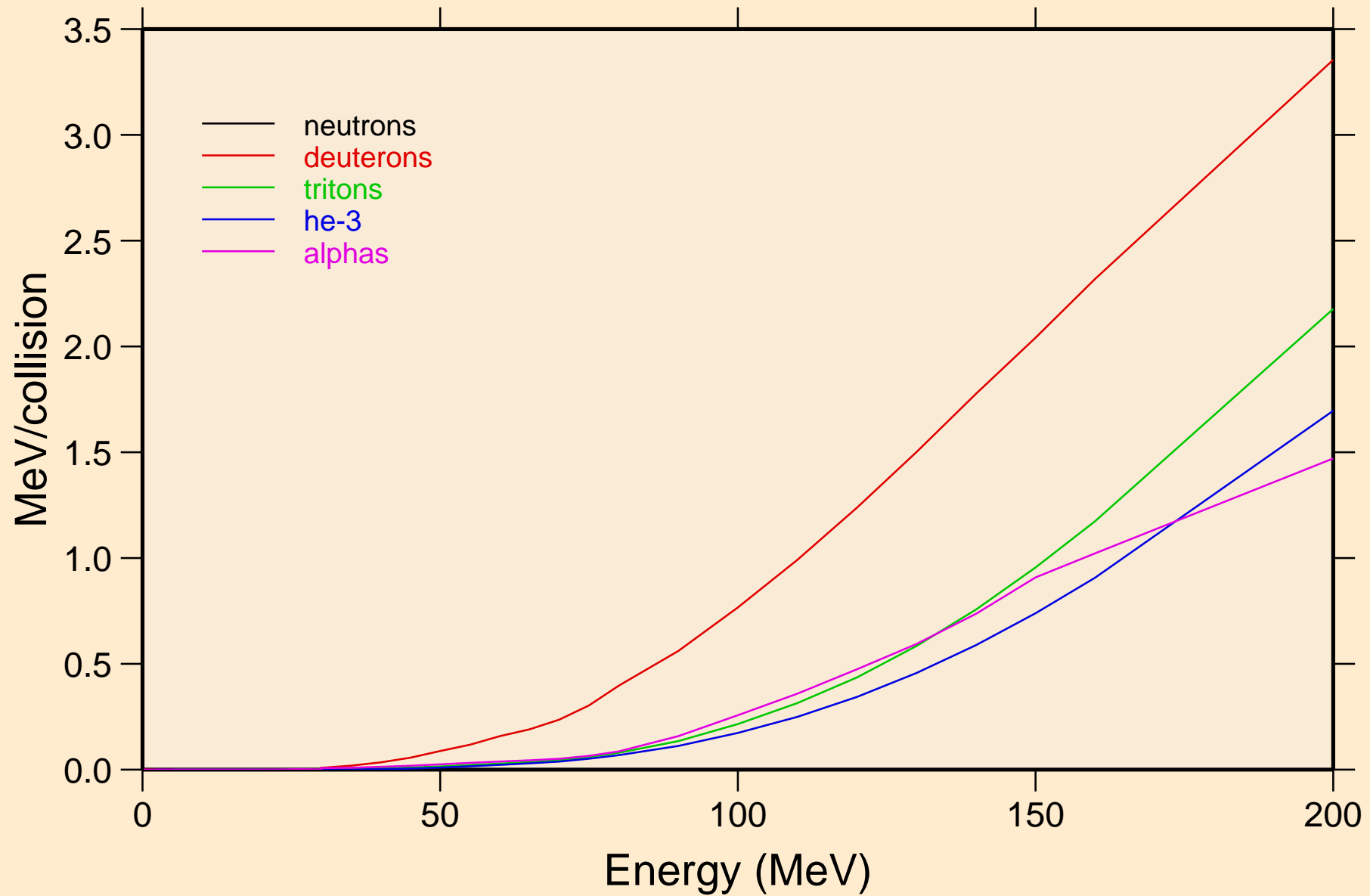



RF259 PROTON ACER TENDL-2021 LIBRARY; T=0.K

Recoil Heating

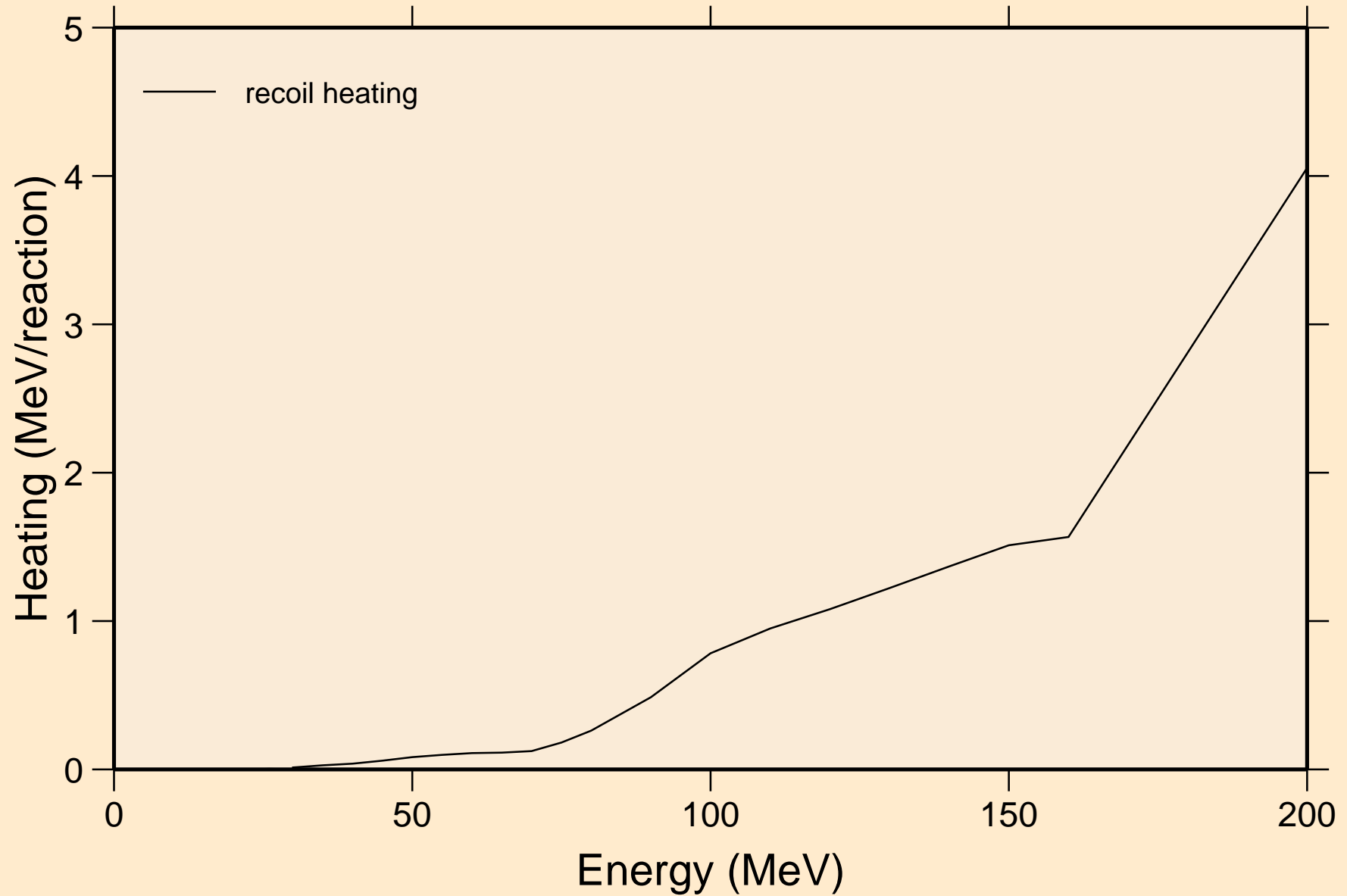

RF259 PROTON ACER TENDL-2021 LIBRARY; T=0.K  
Particle production cross sections

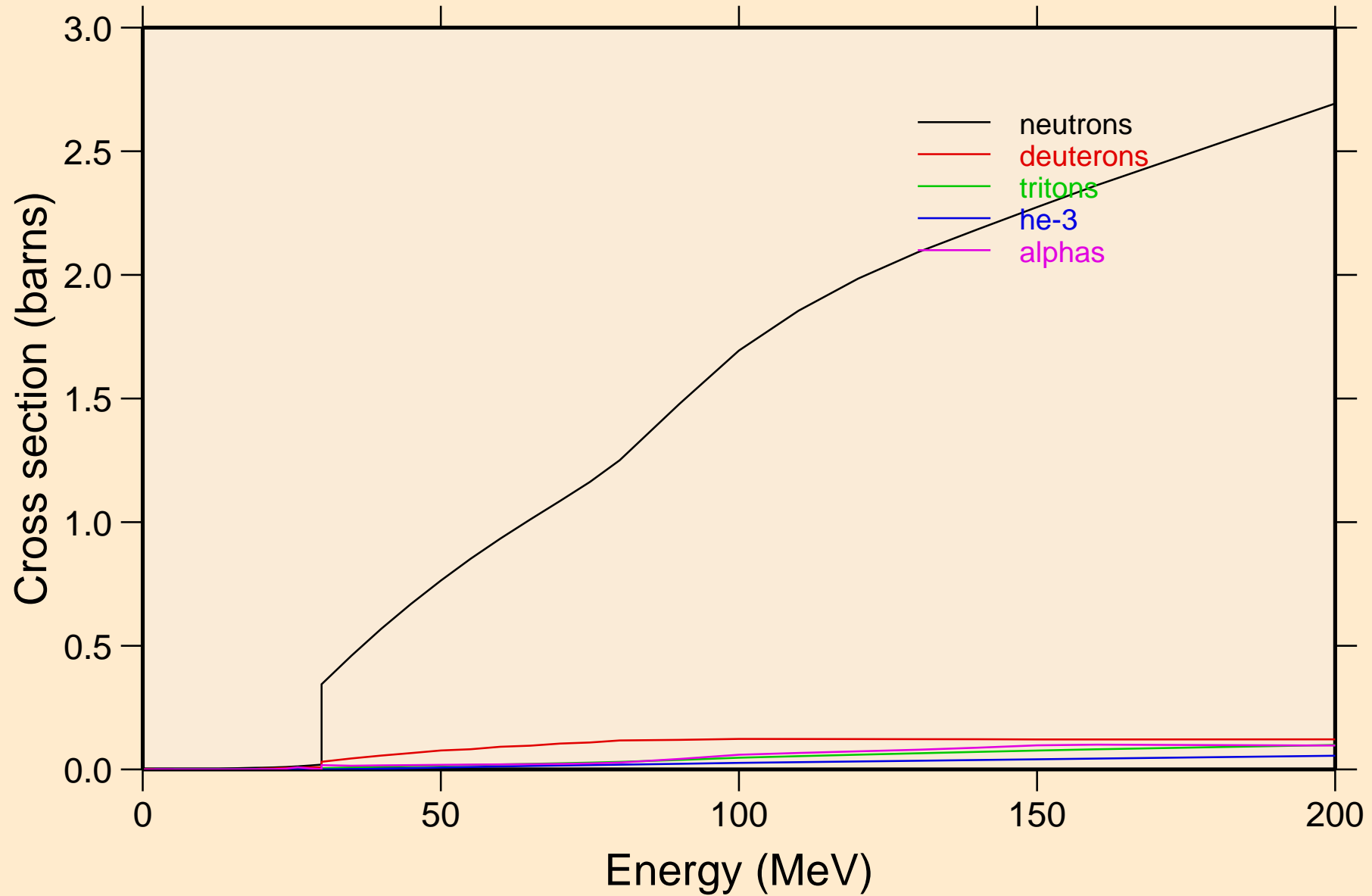

RF259 PROTON ACER TENDL-2021 LIBRARY; T=0.K  
neutrons from (p,n)

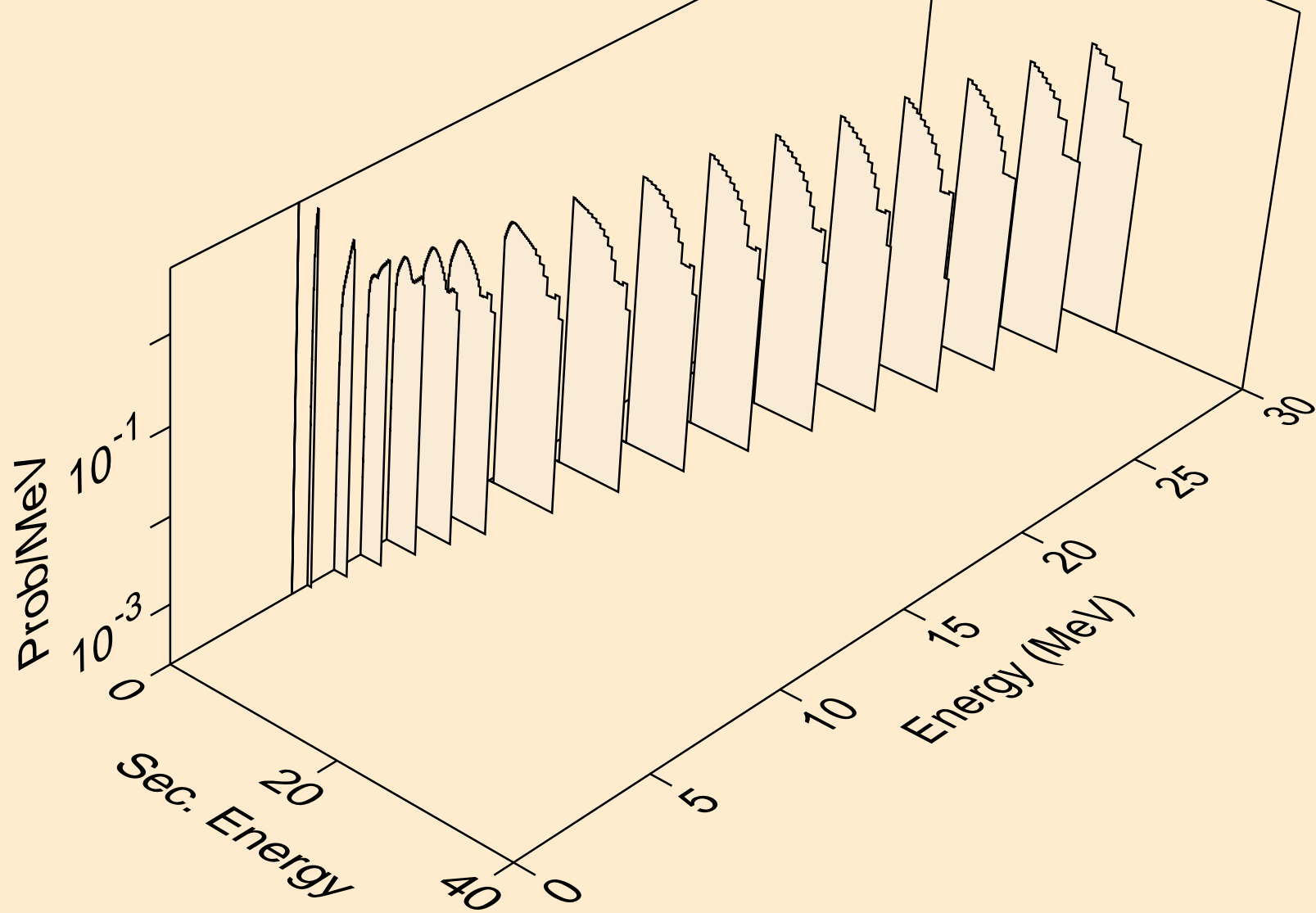

RF259 PROTON ACER TENDL-2021 LIBRARY; T=0.K  
neutrons from (p,x)

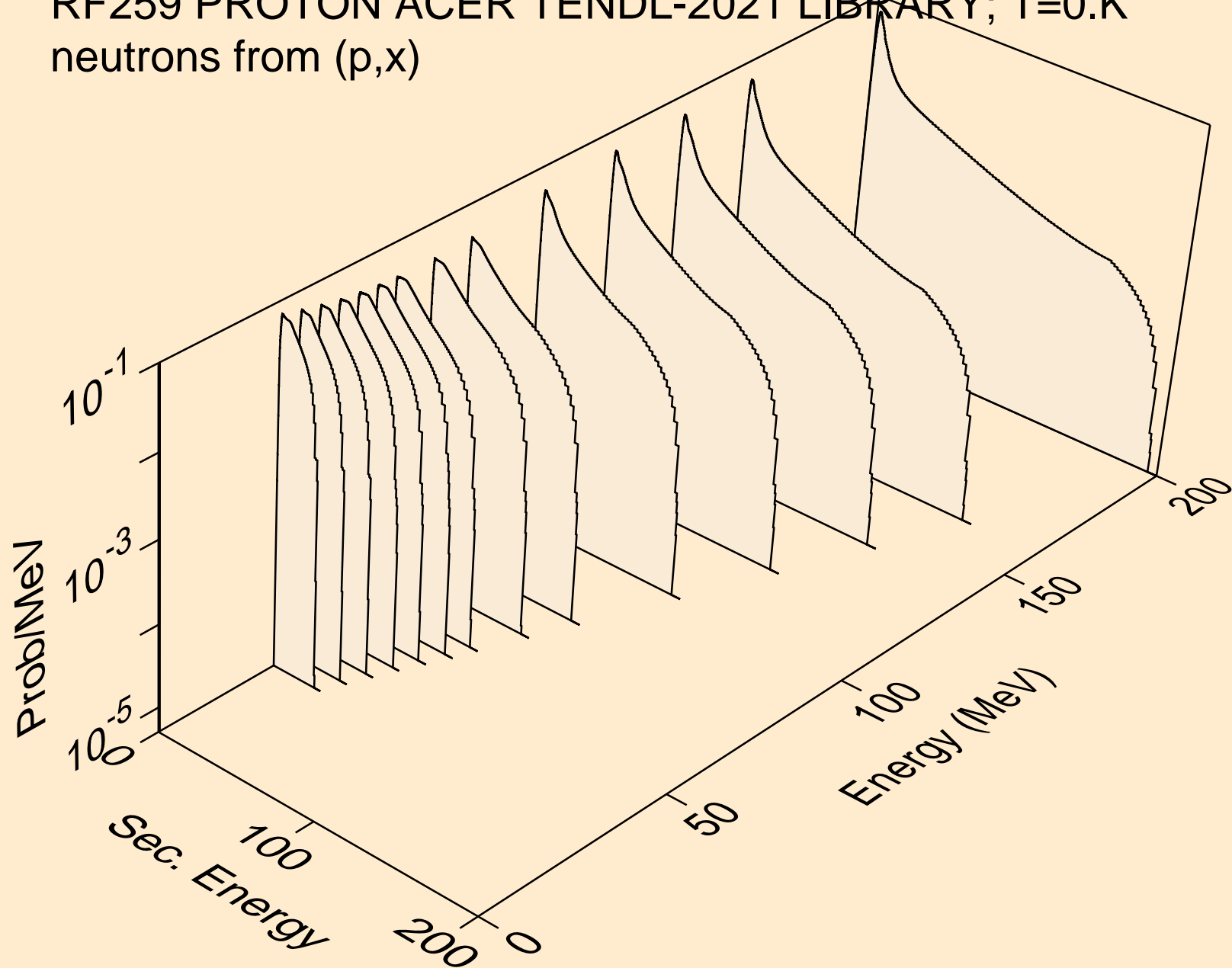

RF259 PROTON ACER TENDL-2021 LIBRARY; T=0.K  
neutrons from (p,2n)

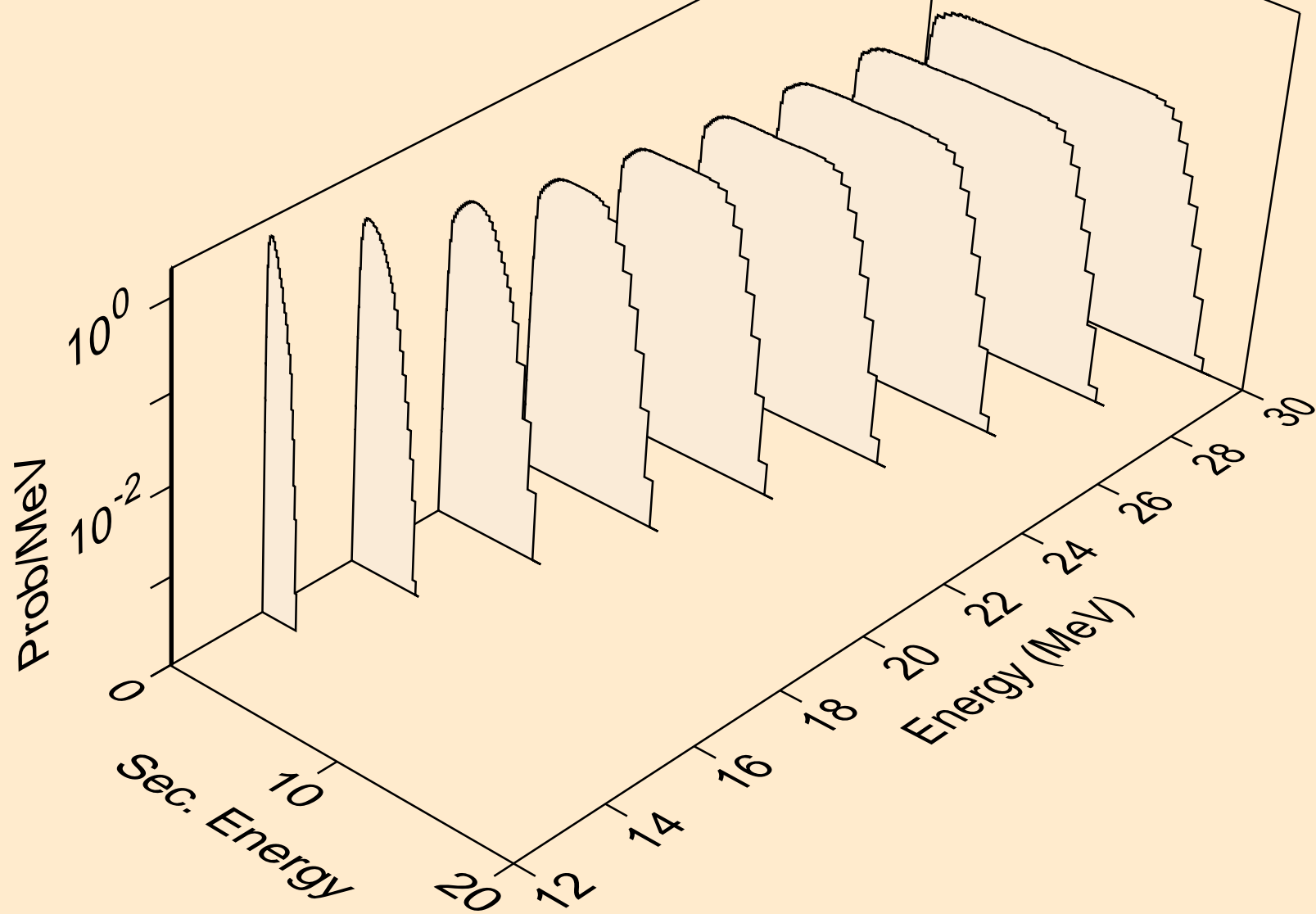

RF259 PROTON ACER TENDL-2021 LIBRARY; T=0.K  
neutrons from (p,3n)

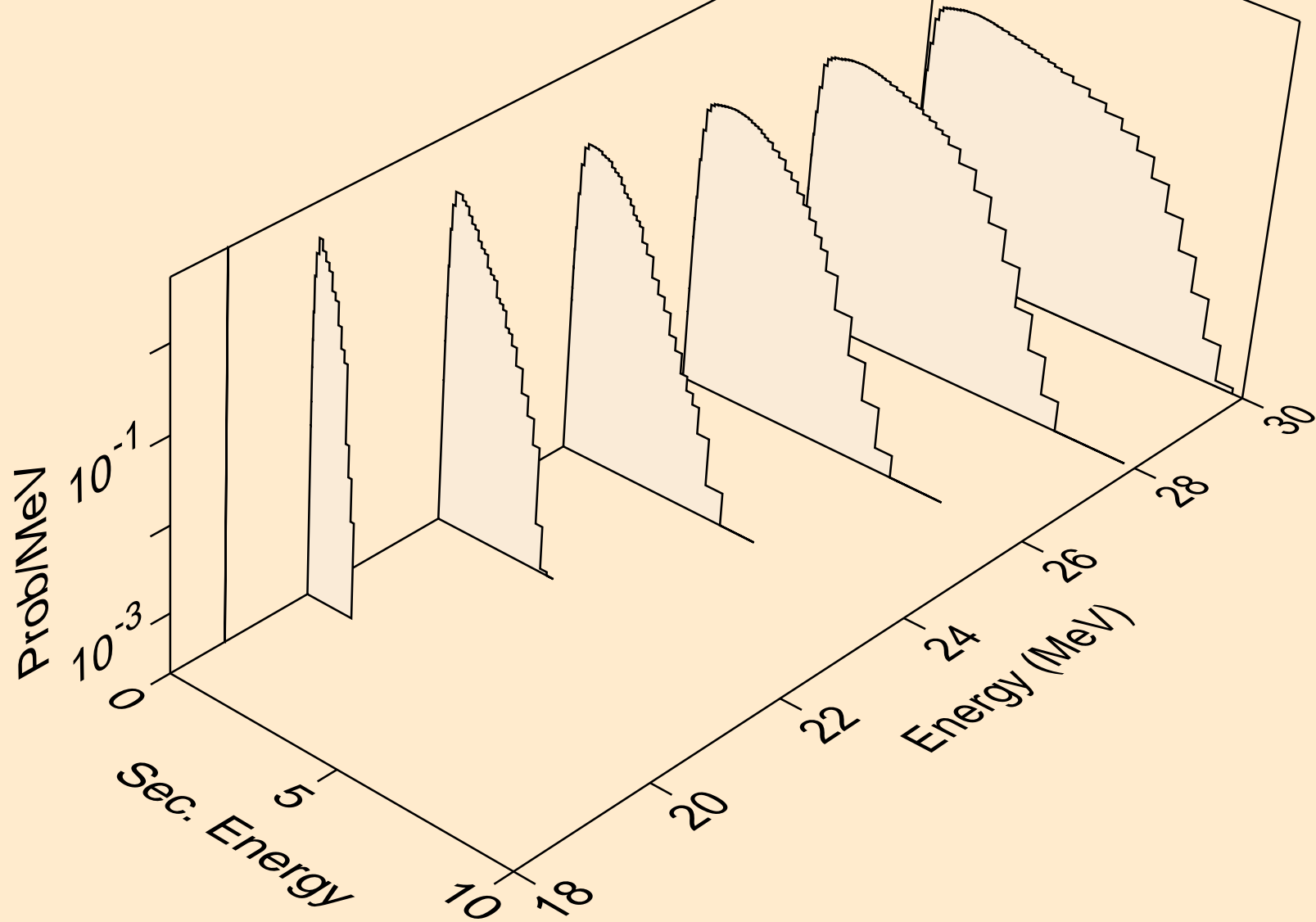

RF259 PROTON ACER TENDL-2021 LIBRARY; T=0.K  
neutrons from (p,n\*)a

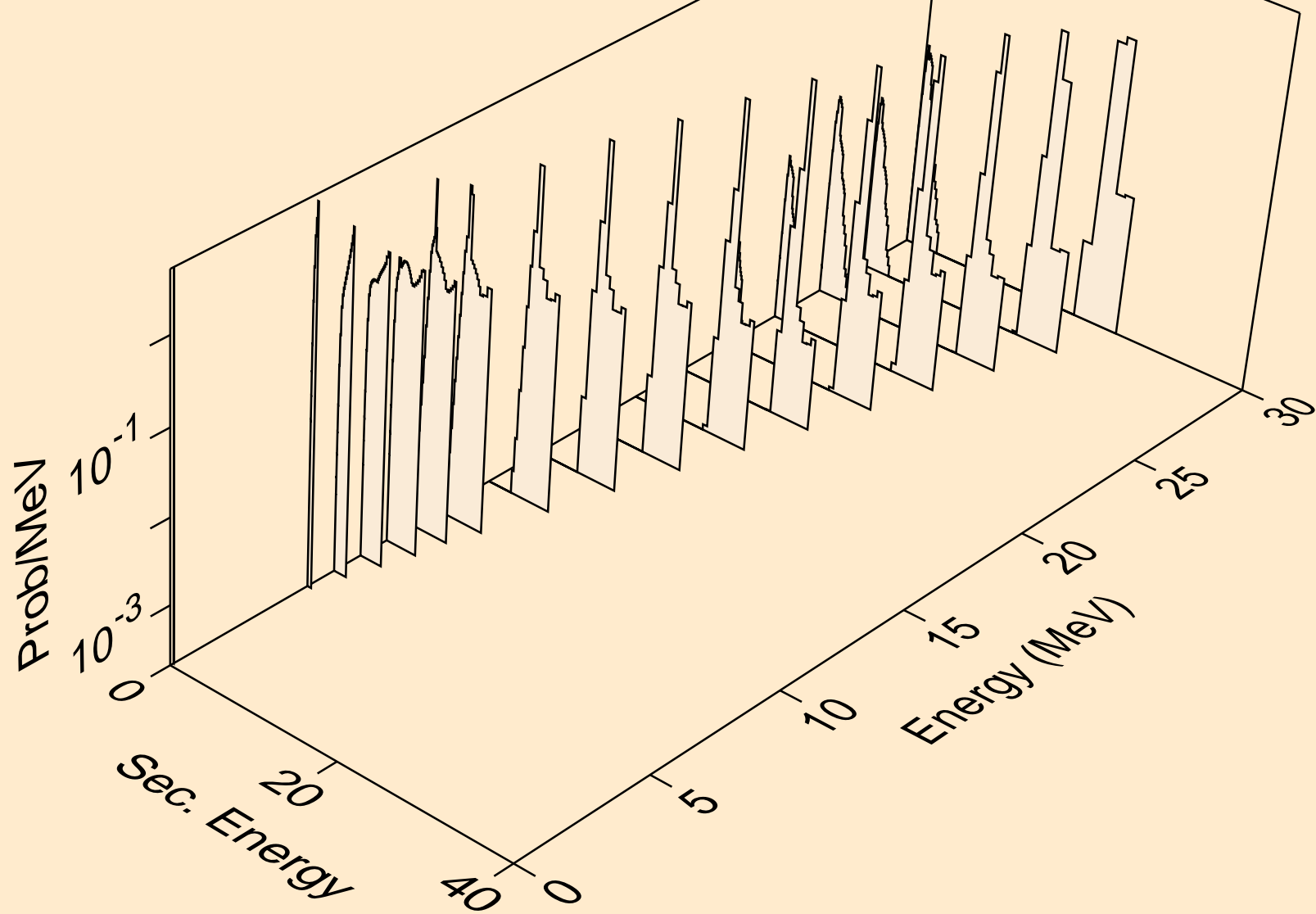

RF259 PROTON ACER TENDL-2021 LIBRARY; T=0.K  
neutrons from (p,2n)a

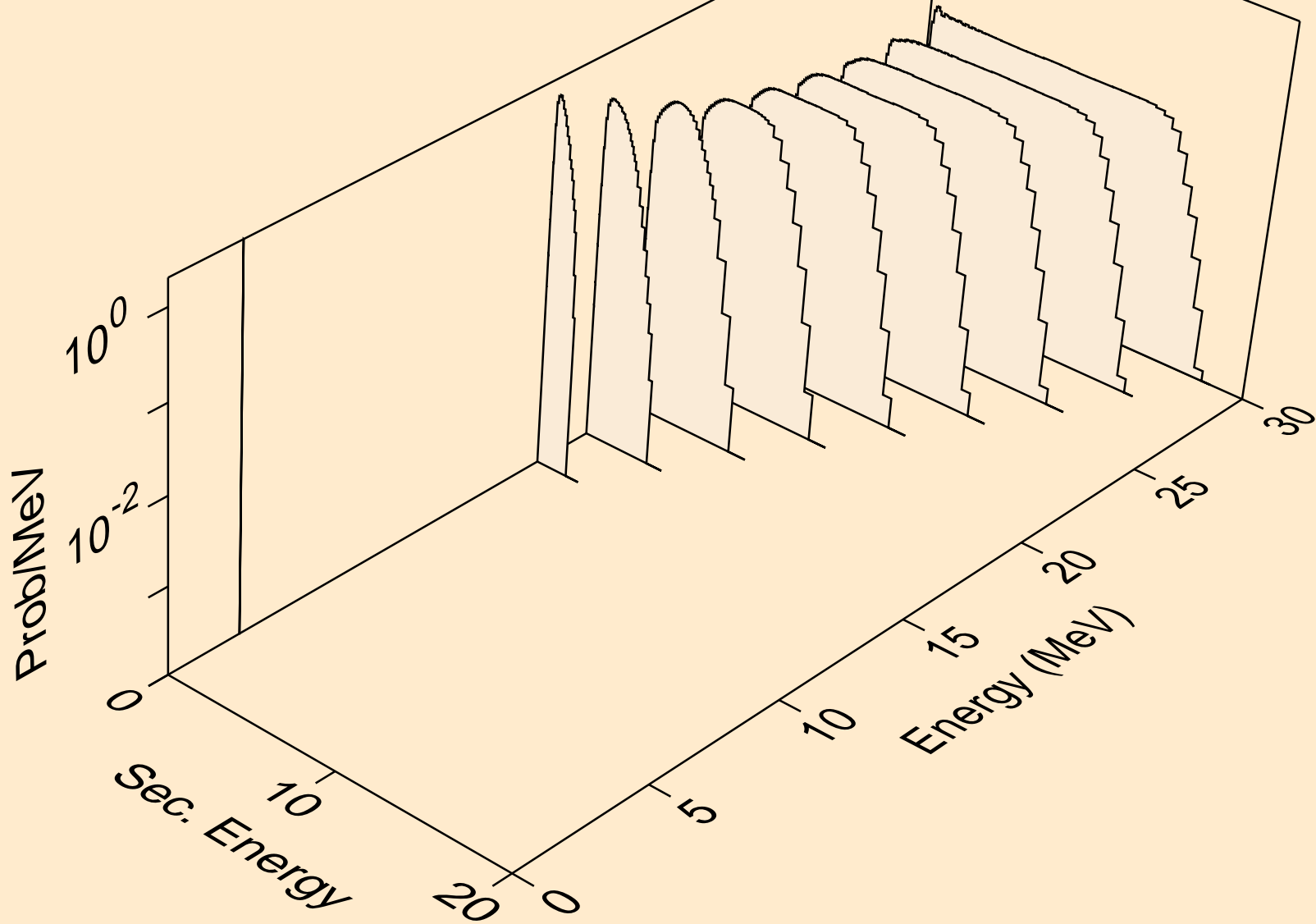



RF259 PROTON ACER TENDL-2021 LIBRARY; T=0.K  
neutrons from (p,3n)a

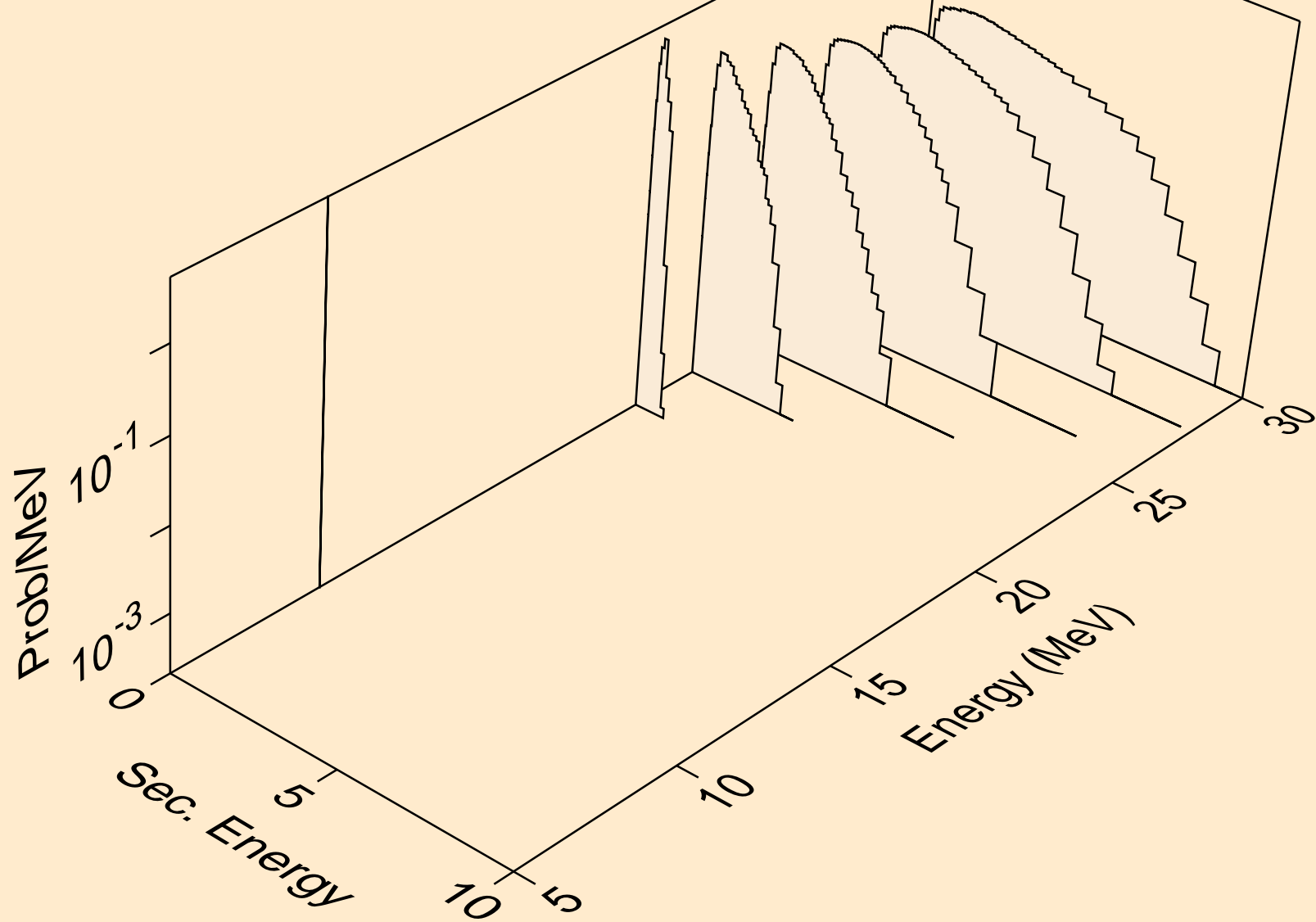

RF259 PROTON ACER TENDL-2021 LIBRARY; T=0.K  
neutrons from (p,n\*)p

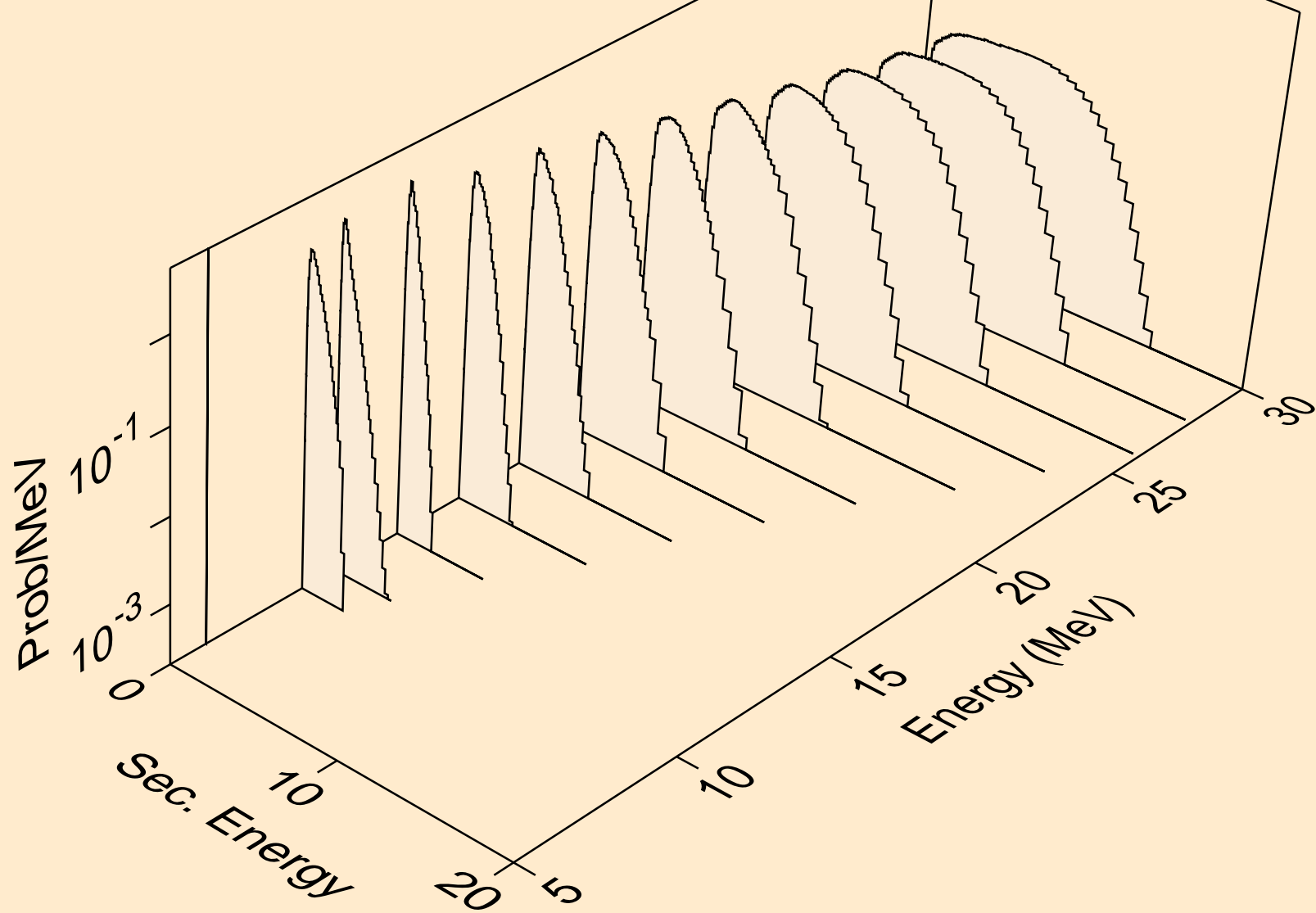

RF259 PROTON ACER TENDL-2021 LIBRARY; T=0.K  
neutrons from (p,n\*)2a

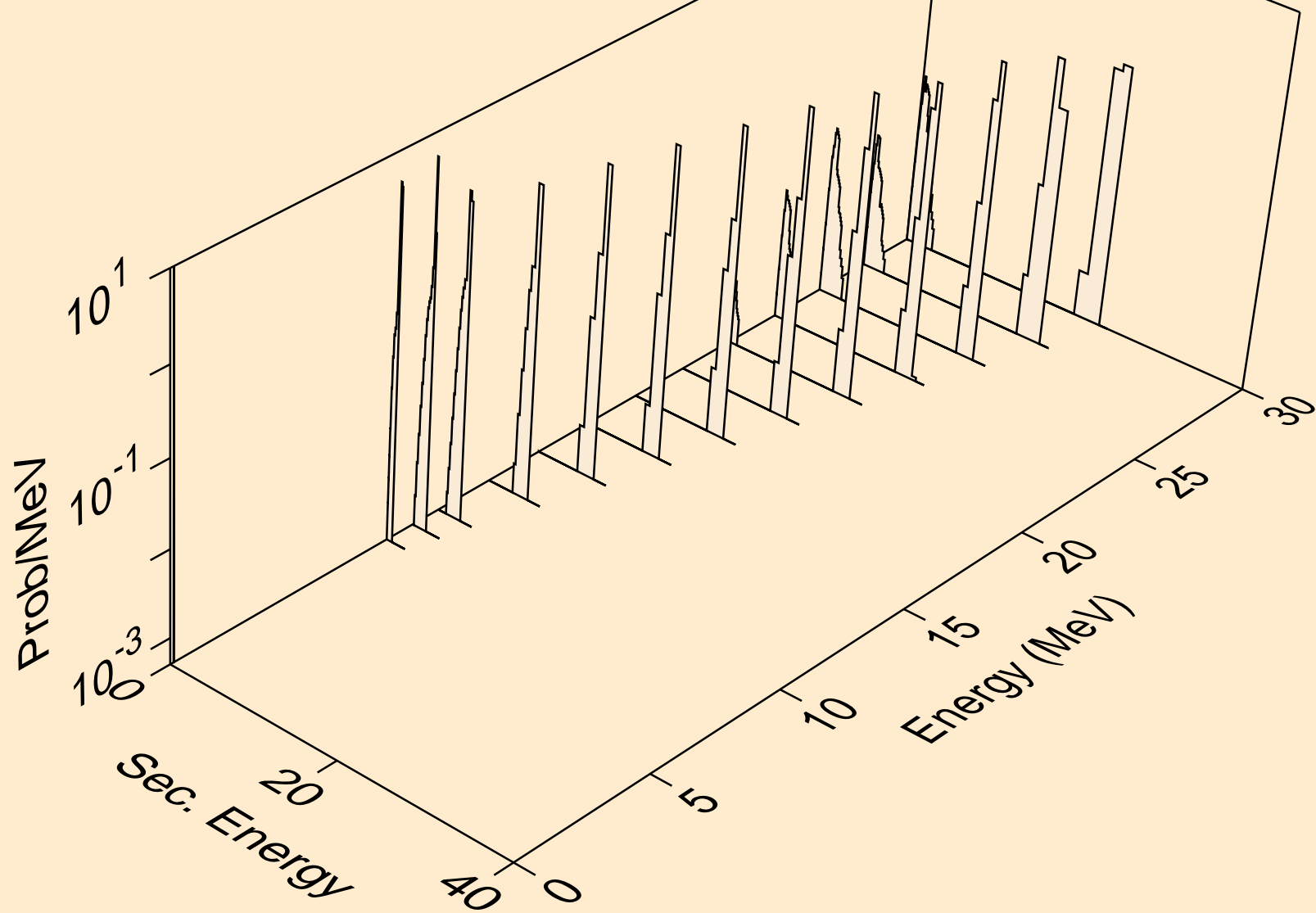

RF259 PROTON ACER TENDL-2021 LIBRARY; T=0.K  
neutrons from (p,n\*)d

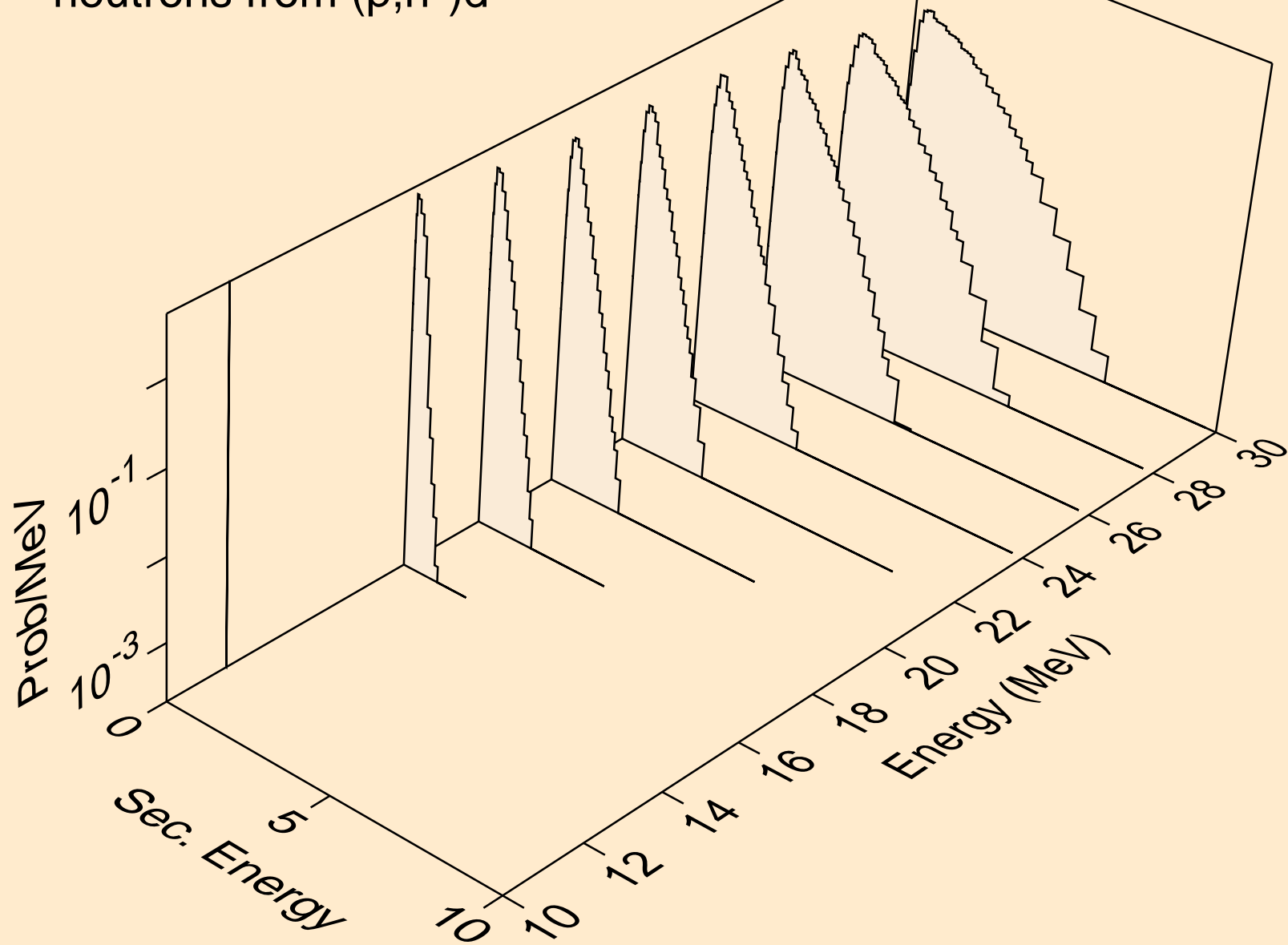

RF259 PROTON ACER TENDL-2021 LIBRARY; T=0.K  
neutrons from (p,n\*)t

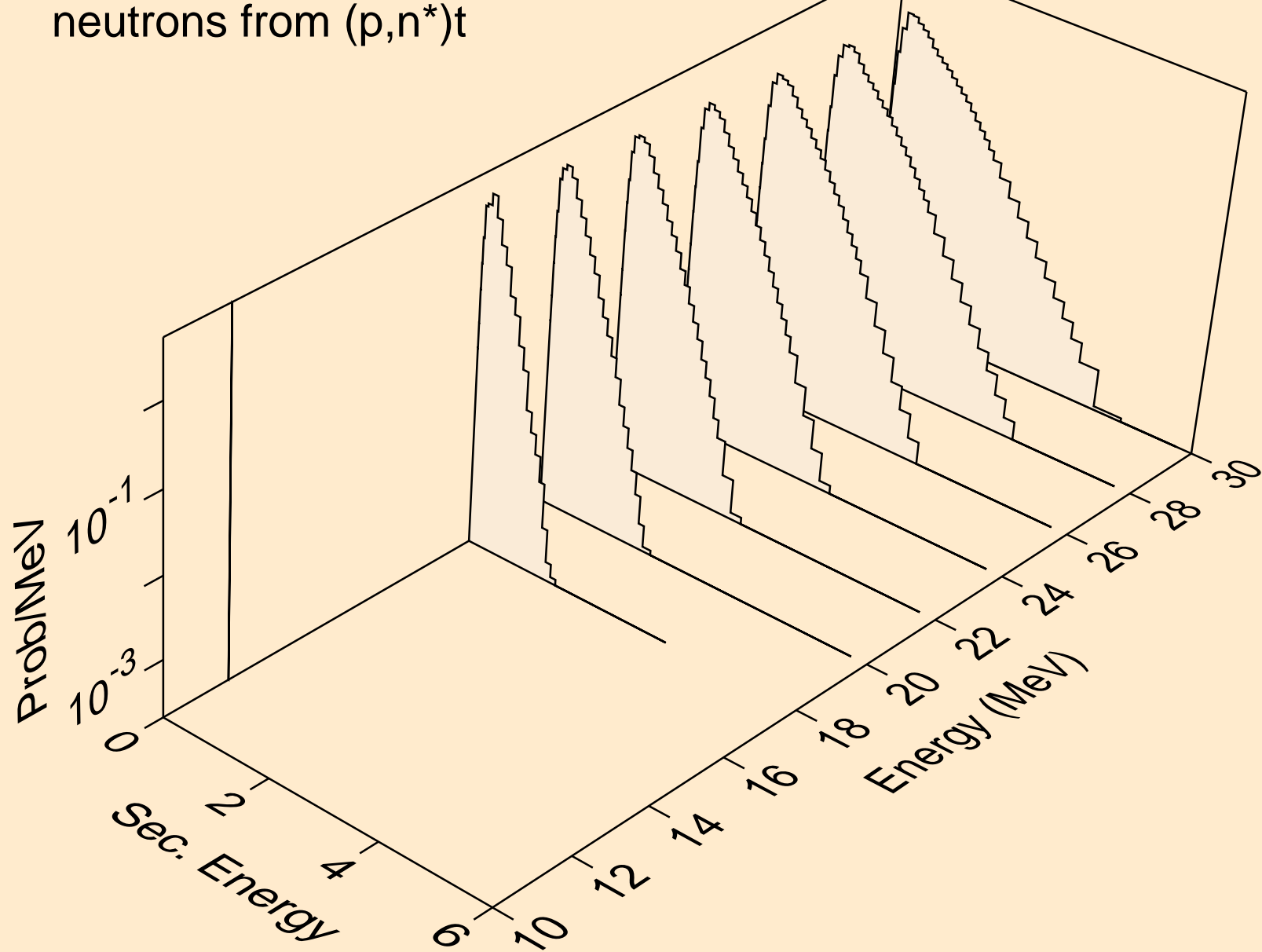

RF259 PROTON ACER TENDL-2021 LIBRARY; T=0.K  
neutrons from (p,2np)

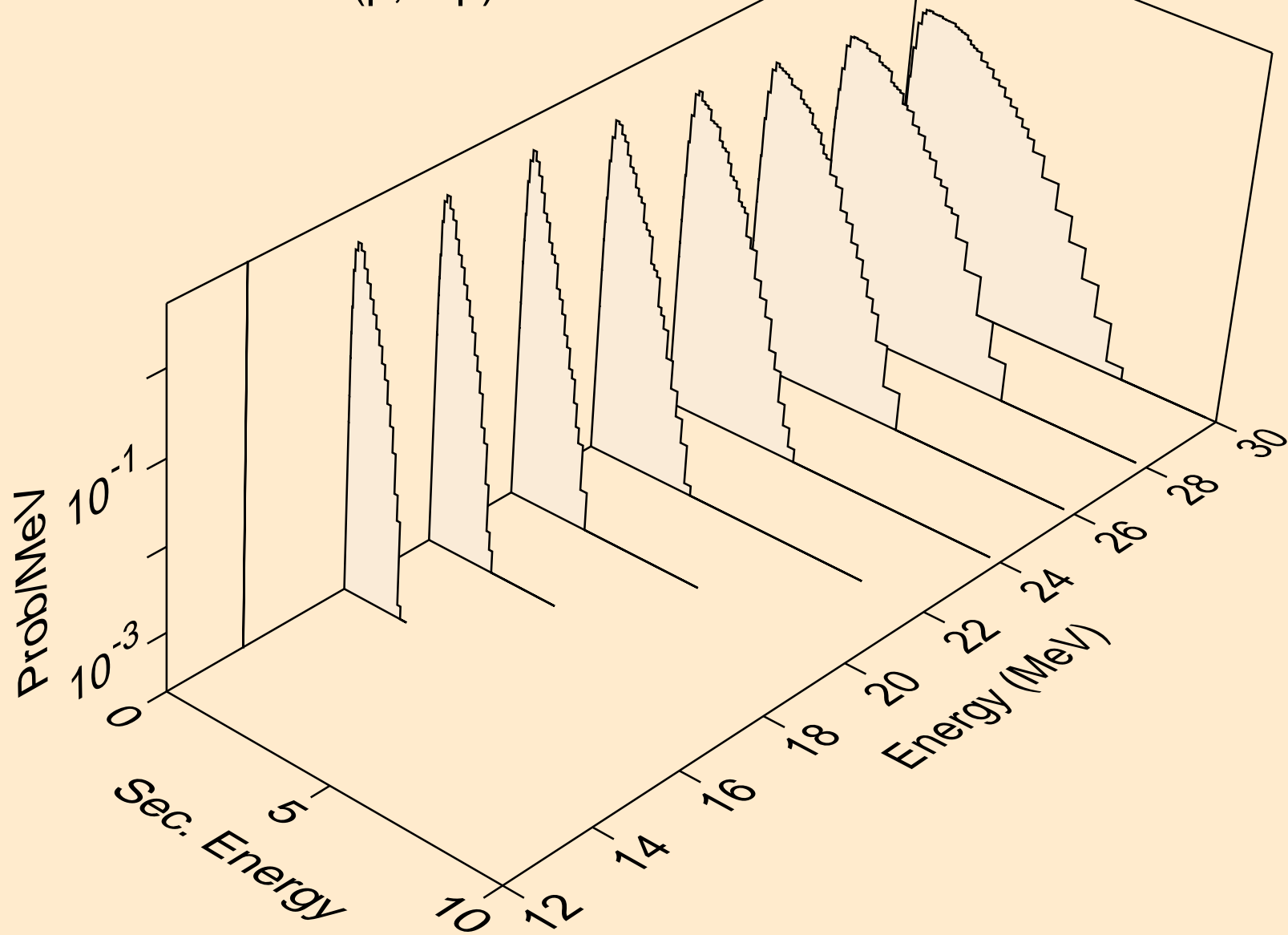

RF259 PROTON ACER TENDL-2021 LIBRARY; T=0.K  
neutrons from (p,npa)

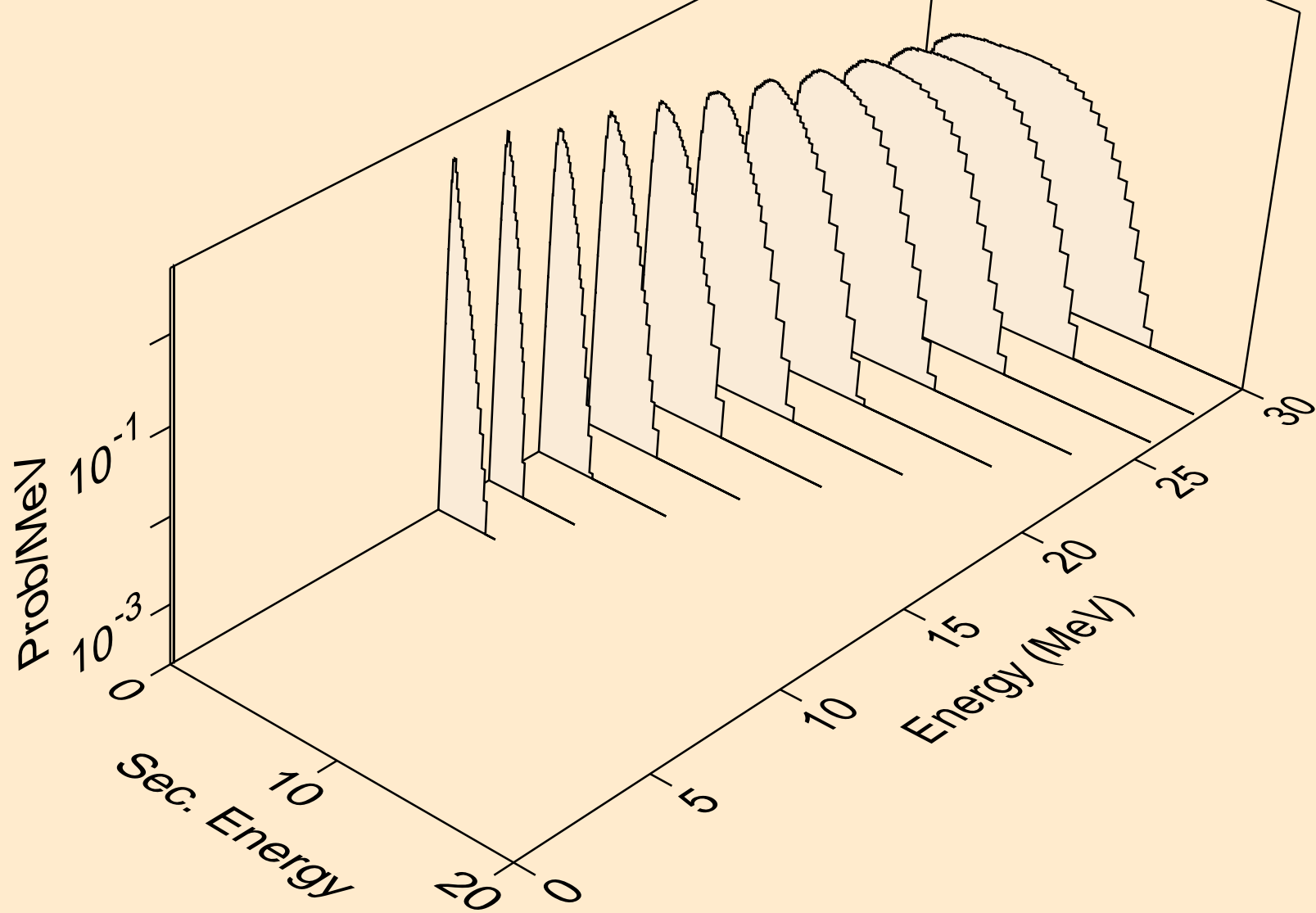

RF259 PROTON ACER TENDL-2021 LIBRARY; T=0.K  
deuterons from (p,x)

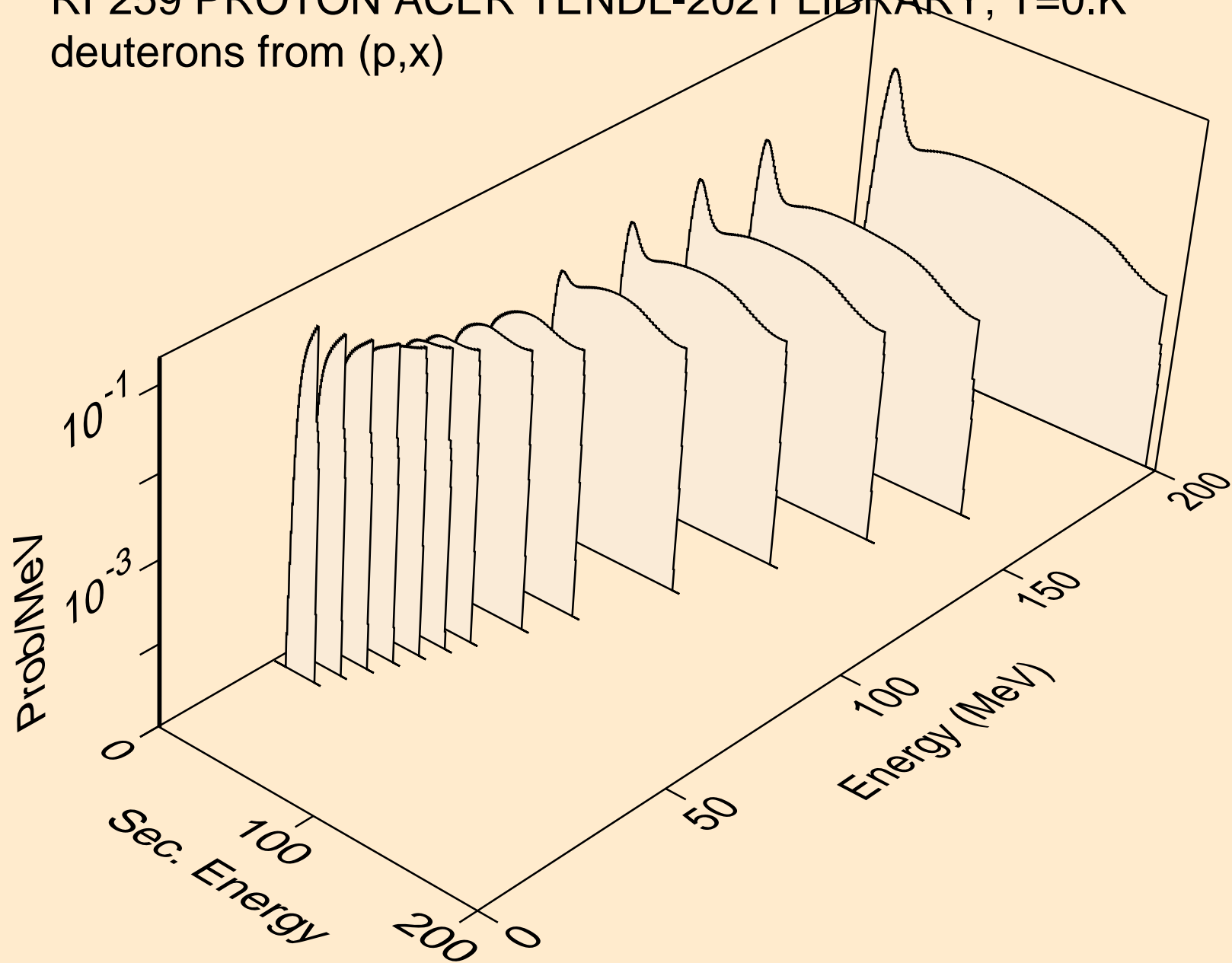



RF259 PROTON ACER TENDL-2021 LIBRARY; T=0.K  
deuterons from (p,n\*)d

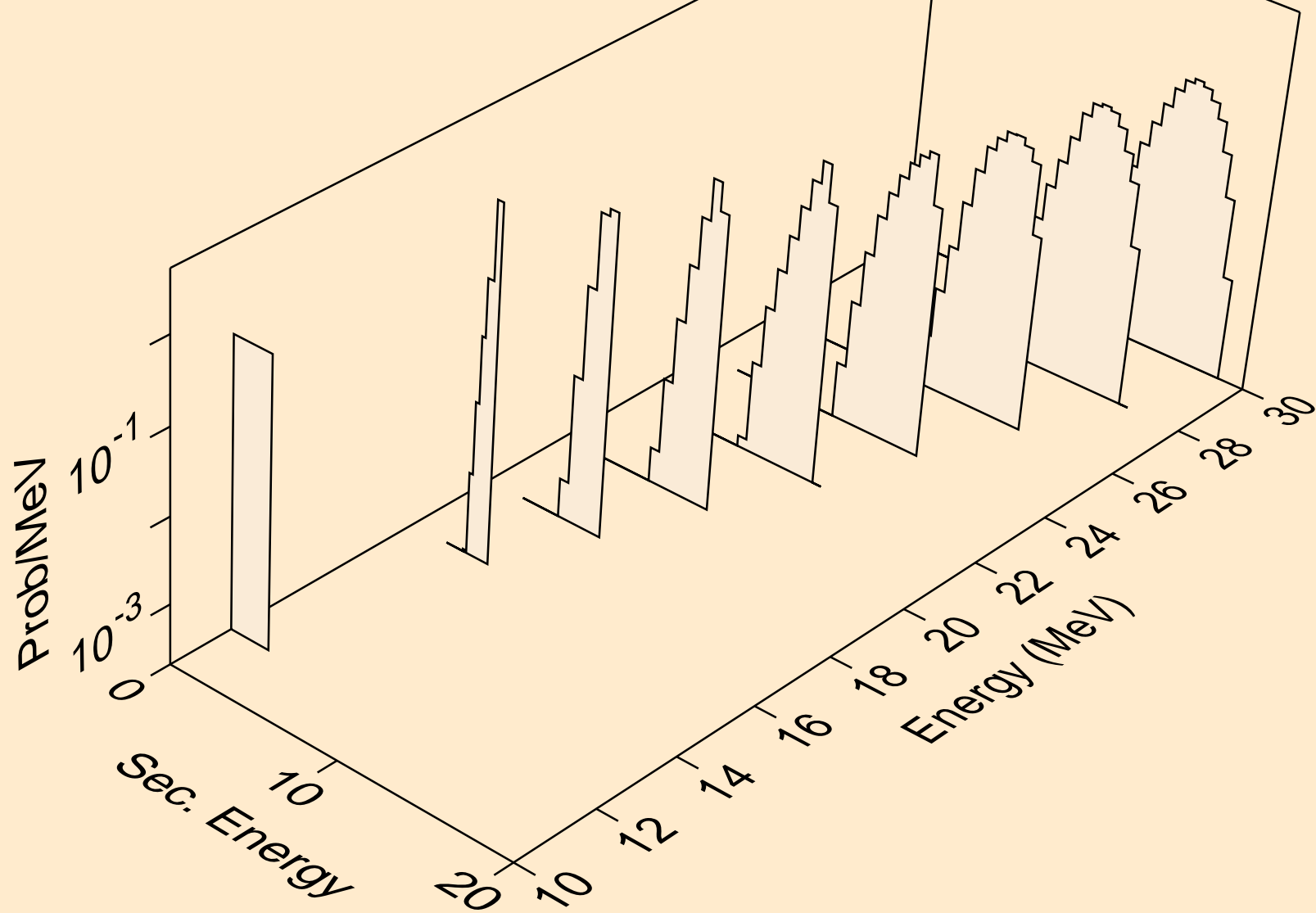

RF259 PROTON ACER TENDL-2021 LIBRARY; T=0.K  
deuterons from (p,d)

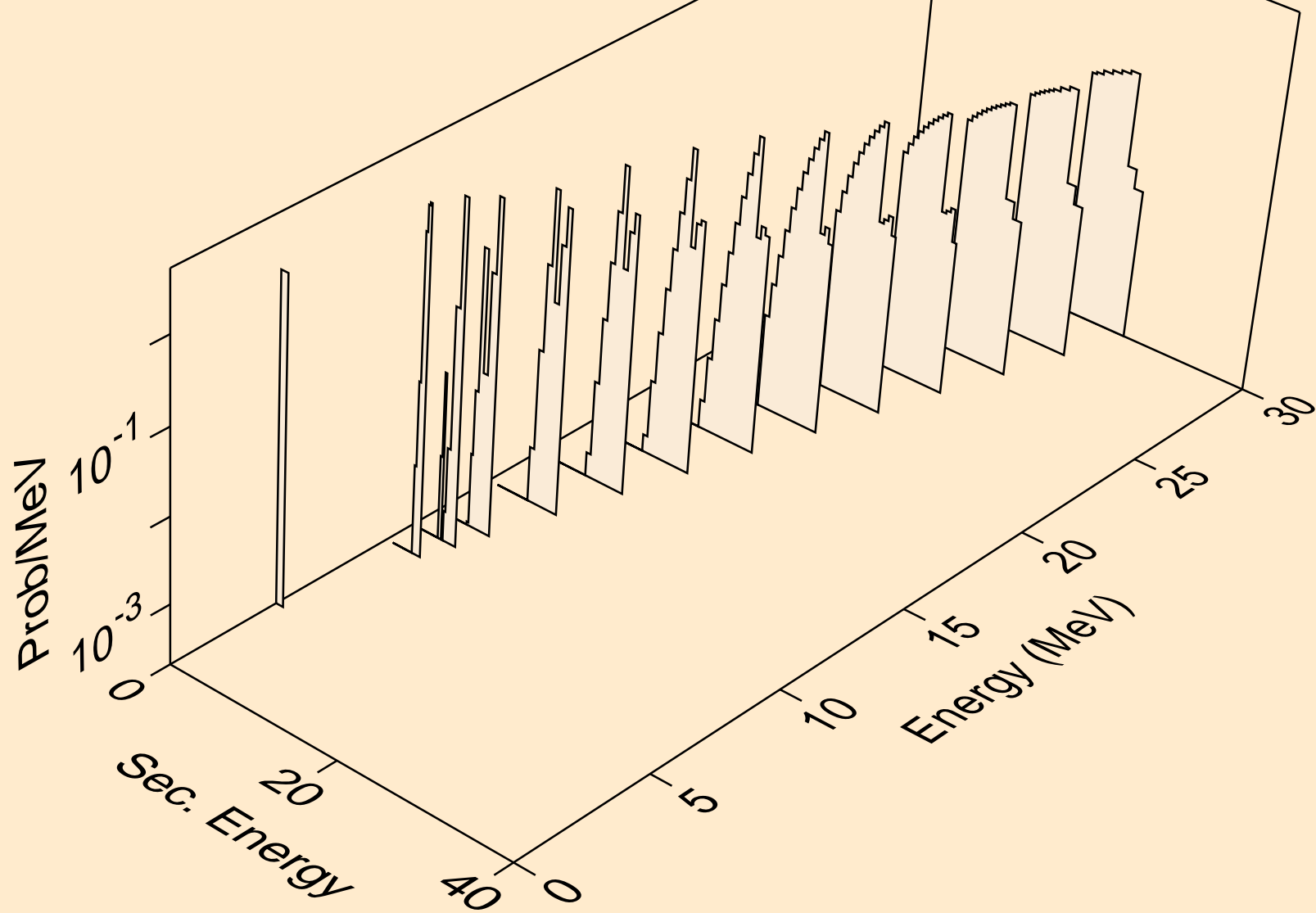

RF259 PROTON ACER TENDL-2021 LIBRARY; T=0.K  
deuterons from (p,da)

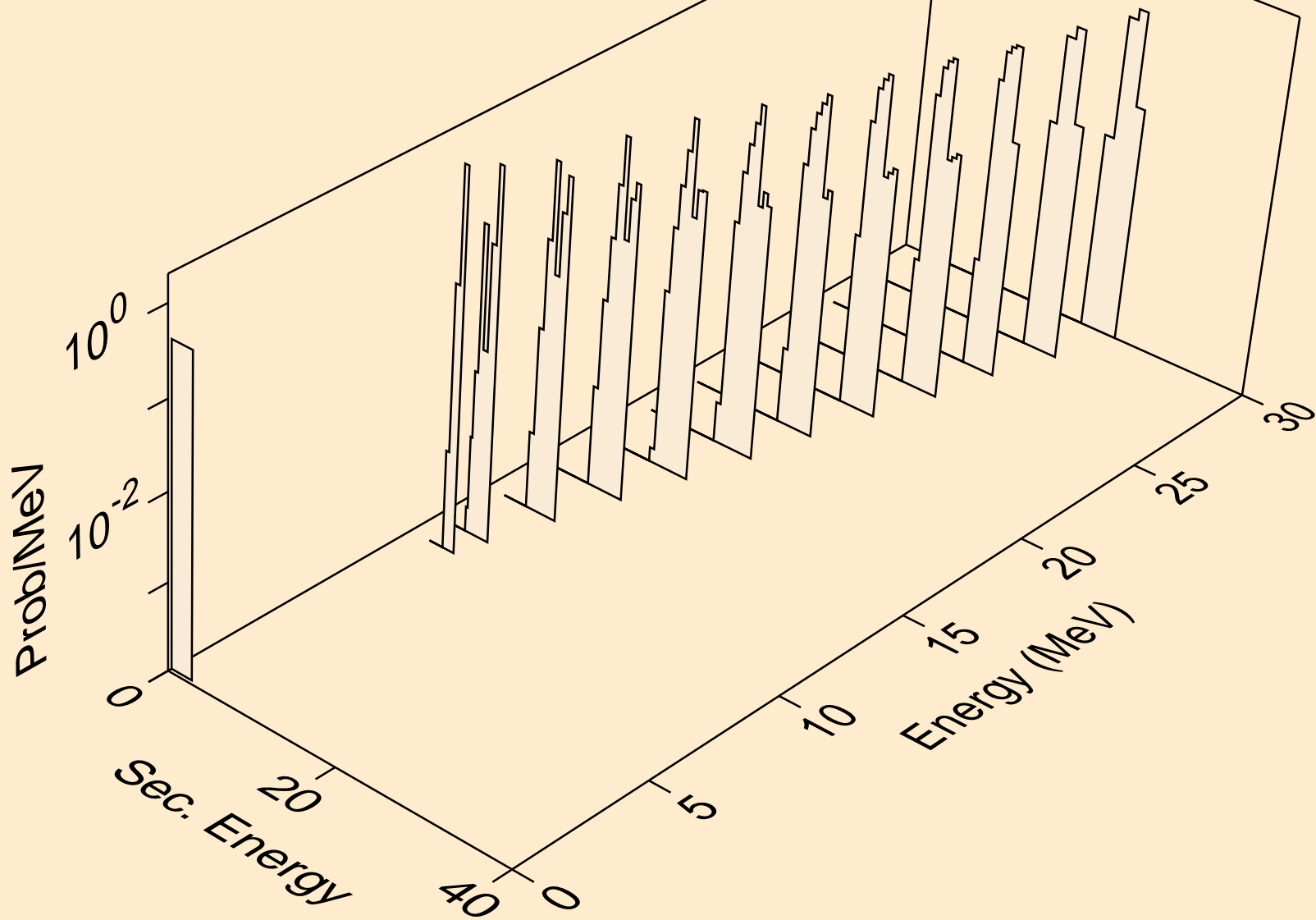

RF259 PROTON ACER TENDL-2021 LIBRARY; T=0.K  
tritons from (p,x)

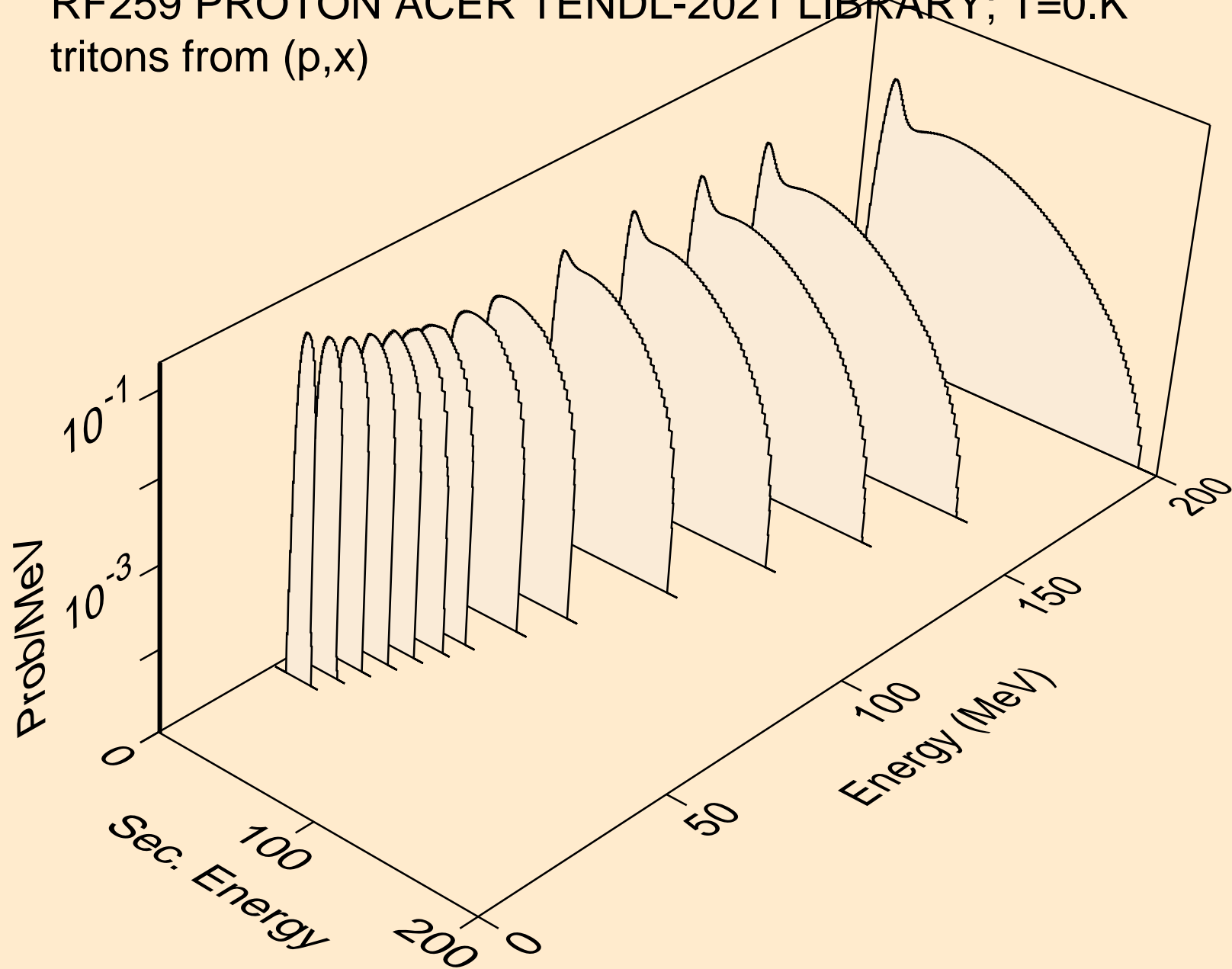

RF259 PROTON ACER TENDL-2021 LIBRARY; T=0.K  
tritons from (p,n\*)t

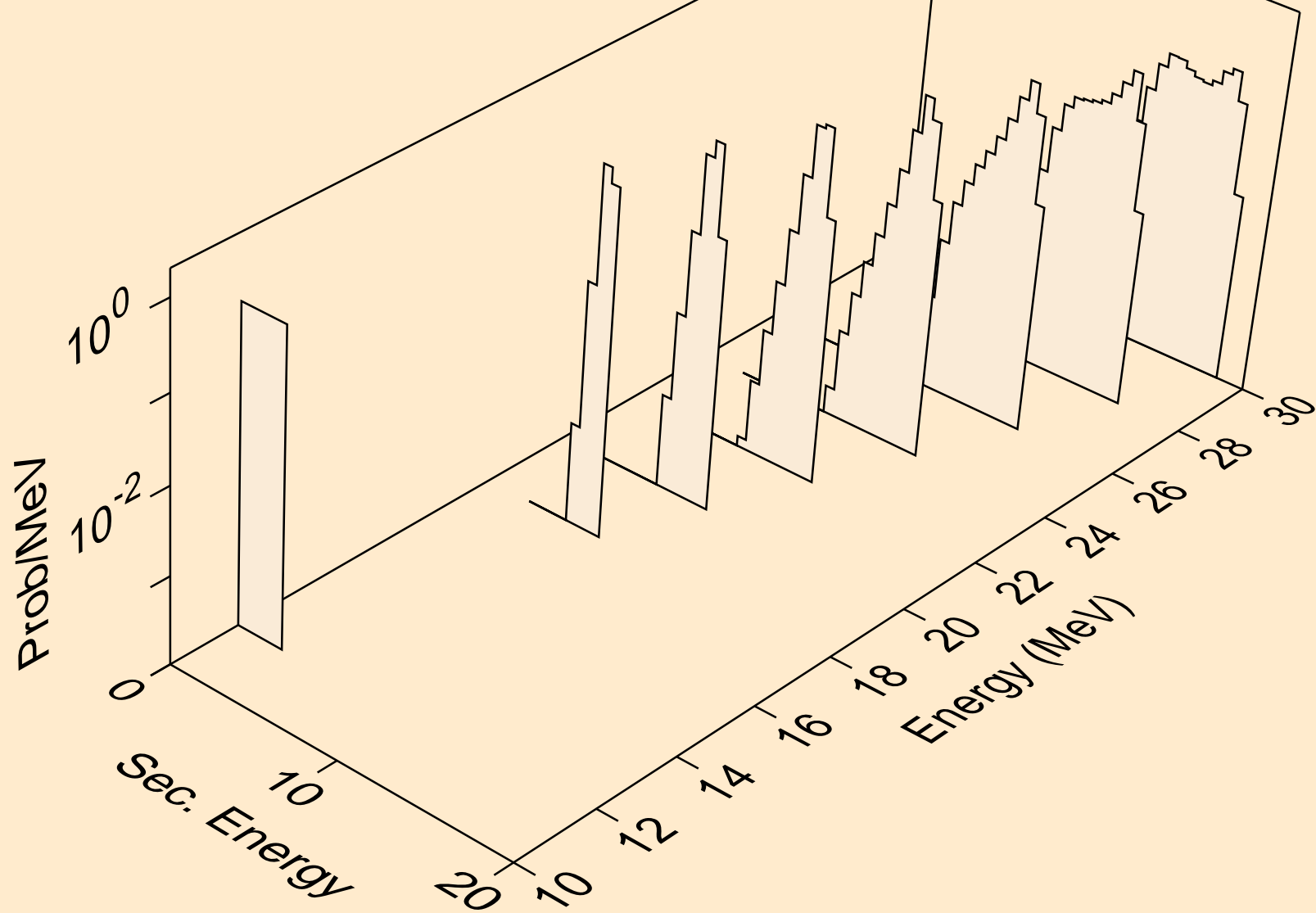

RF259 PROTON ACER TENDL-2021 LIBRARY; T=0.K  
tritons from (p,t)

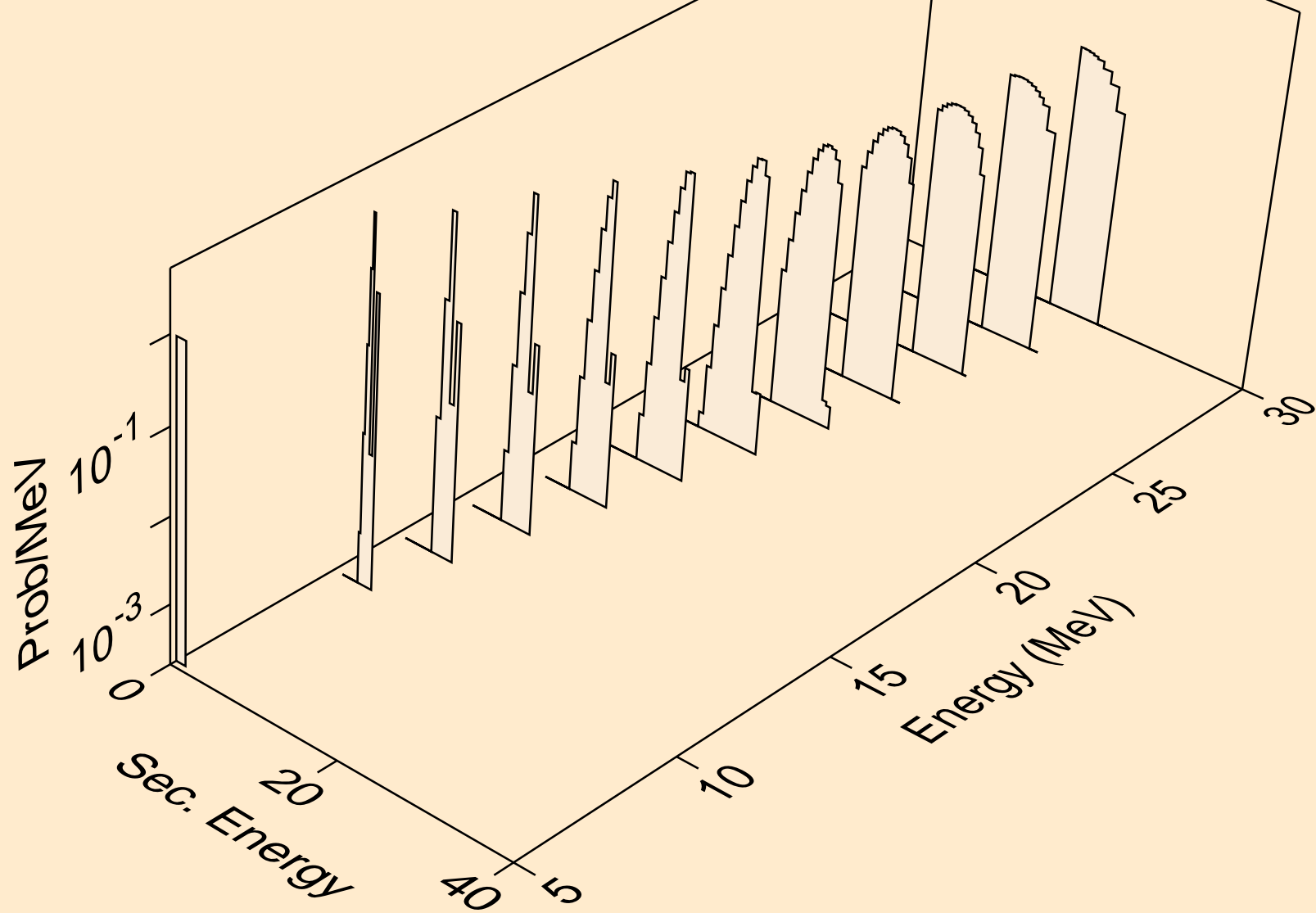

RF259 PROTON ACER TENDL-2021 LIBRARY; T=0.K  
he3s from (p,x)

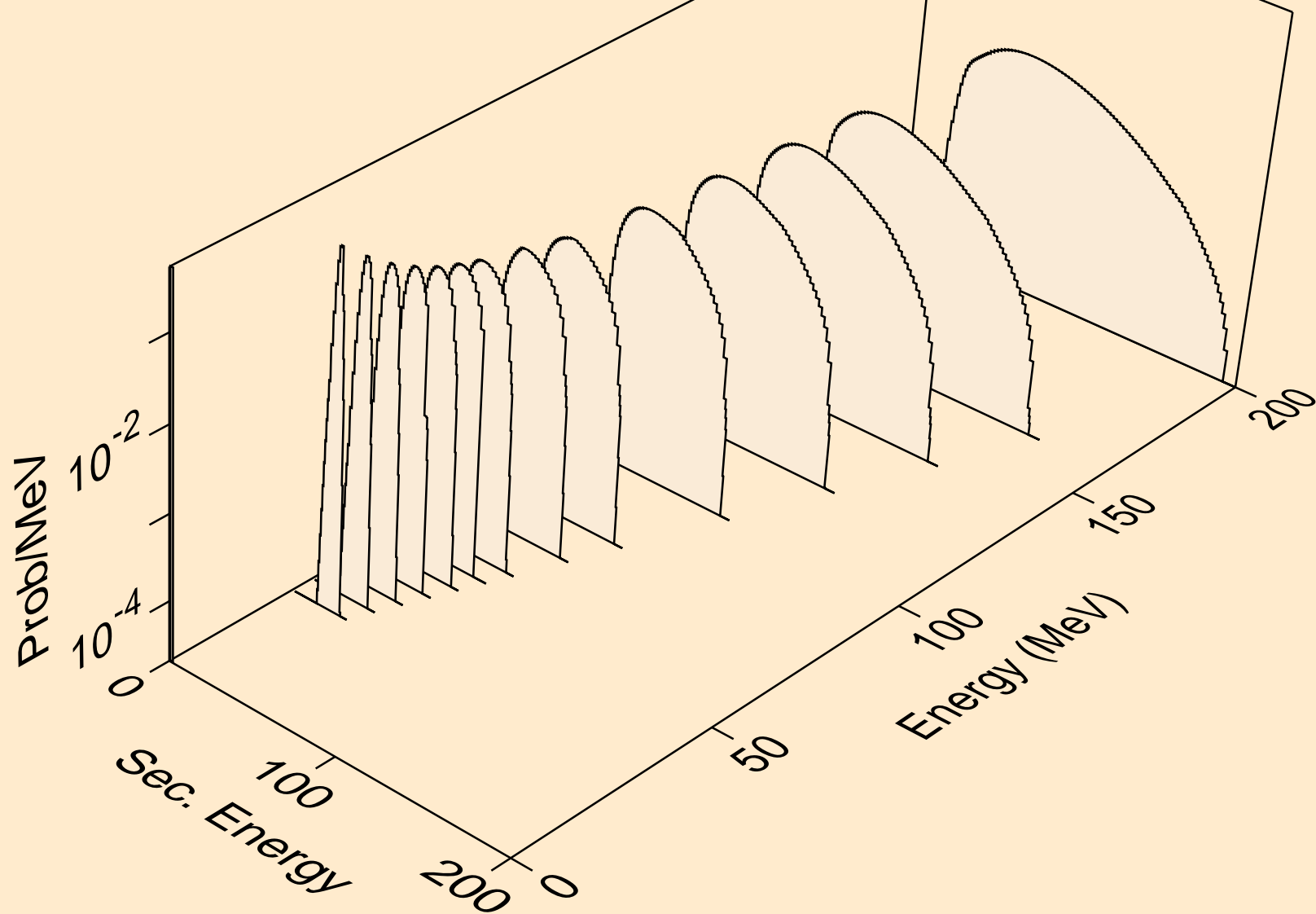

RF259 PROTON ACER TENDL-2021 LIBRARY; T=0.K  
he3s from (p,he3)

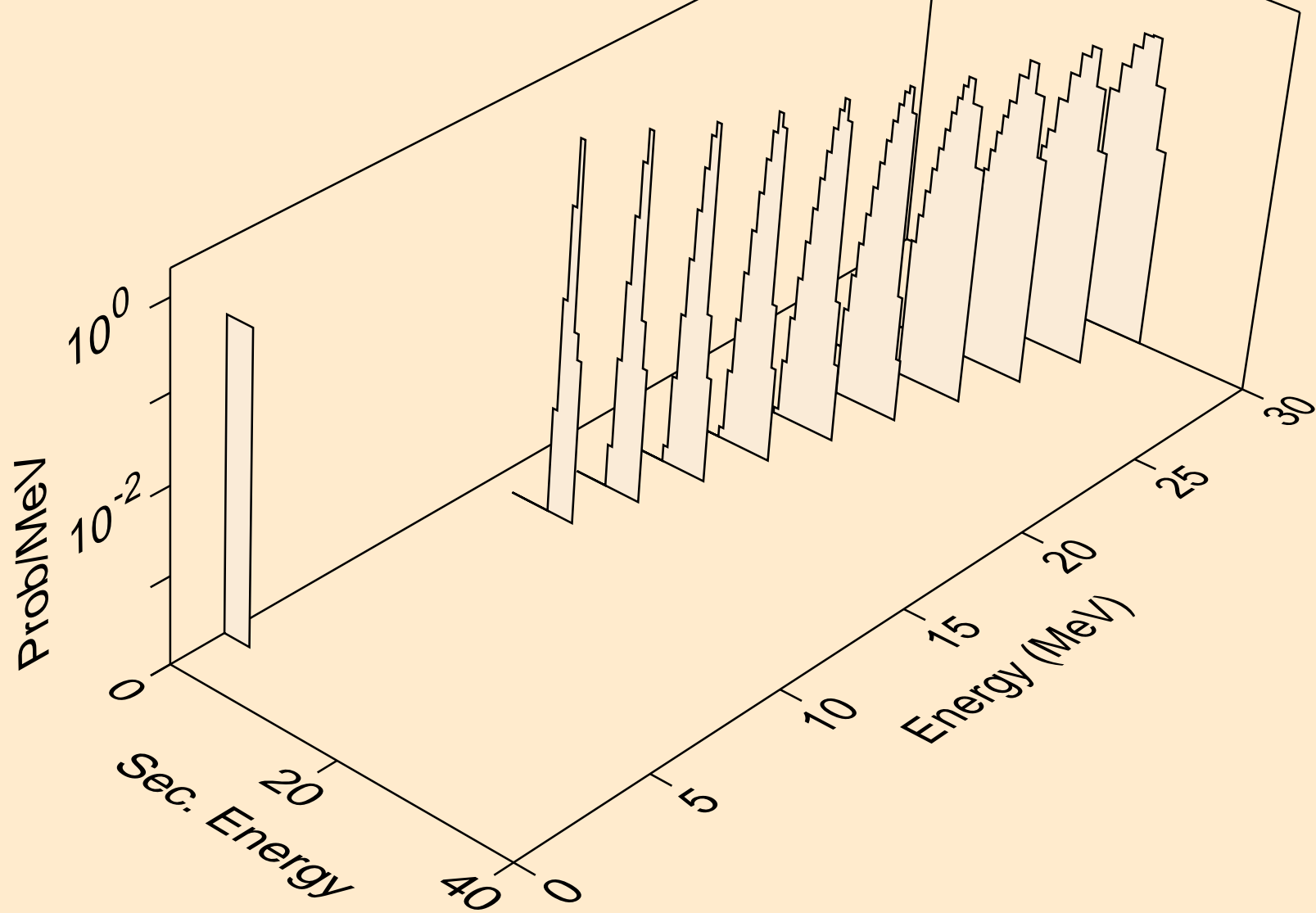



RF259 PROTON ACER TENDL-2021 LIBRARY; T=0.K  
alphas from (p,x)

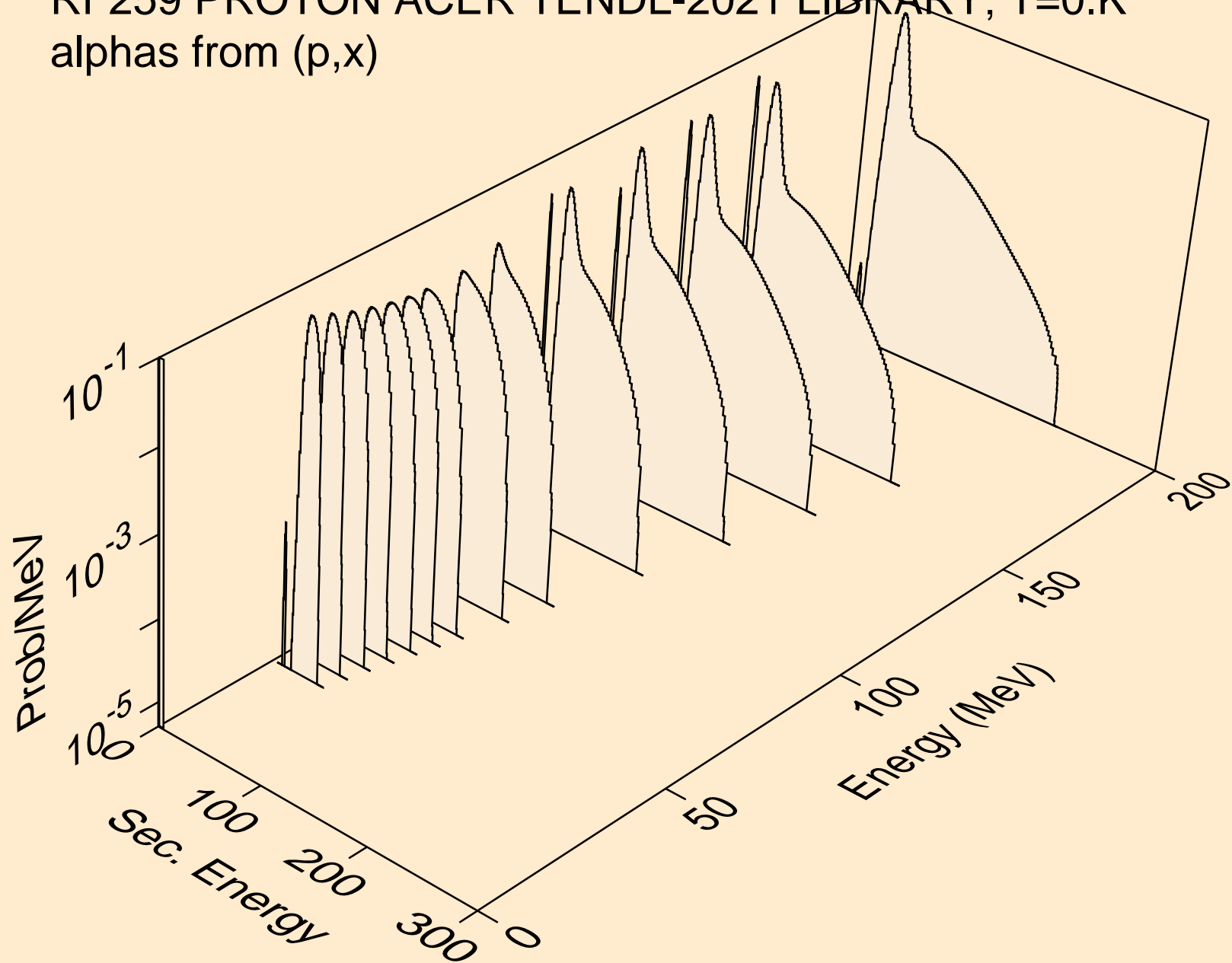

RF259 PROTON ACER TENDL-2021 LIBRARY; T=0.K  
alphas from (p,n\*)a

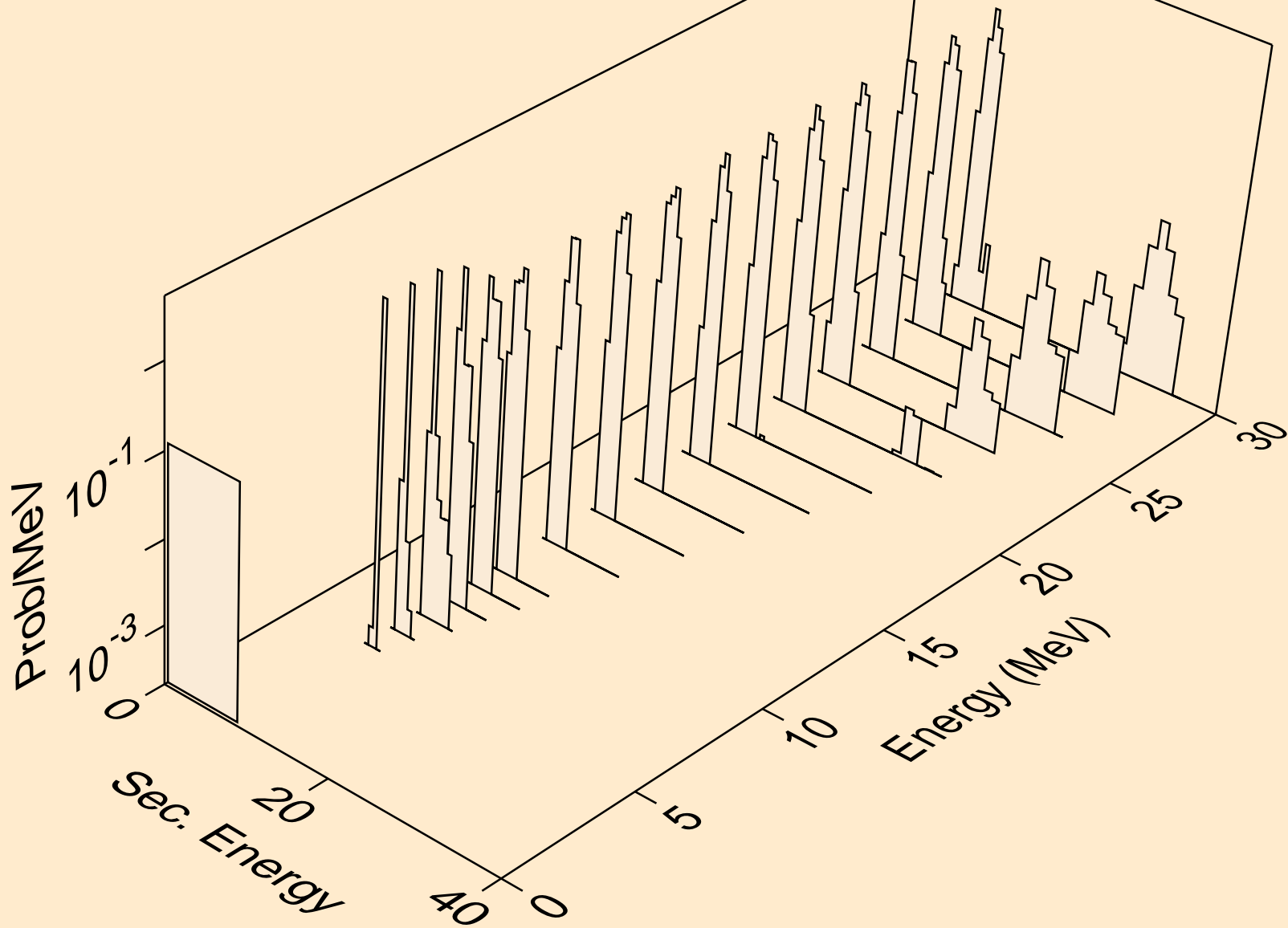

RF259 PROTON ACER TENDL-2021 LIBRARY; T=0.K  
alphas from (p,2n)a

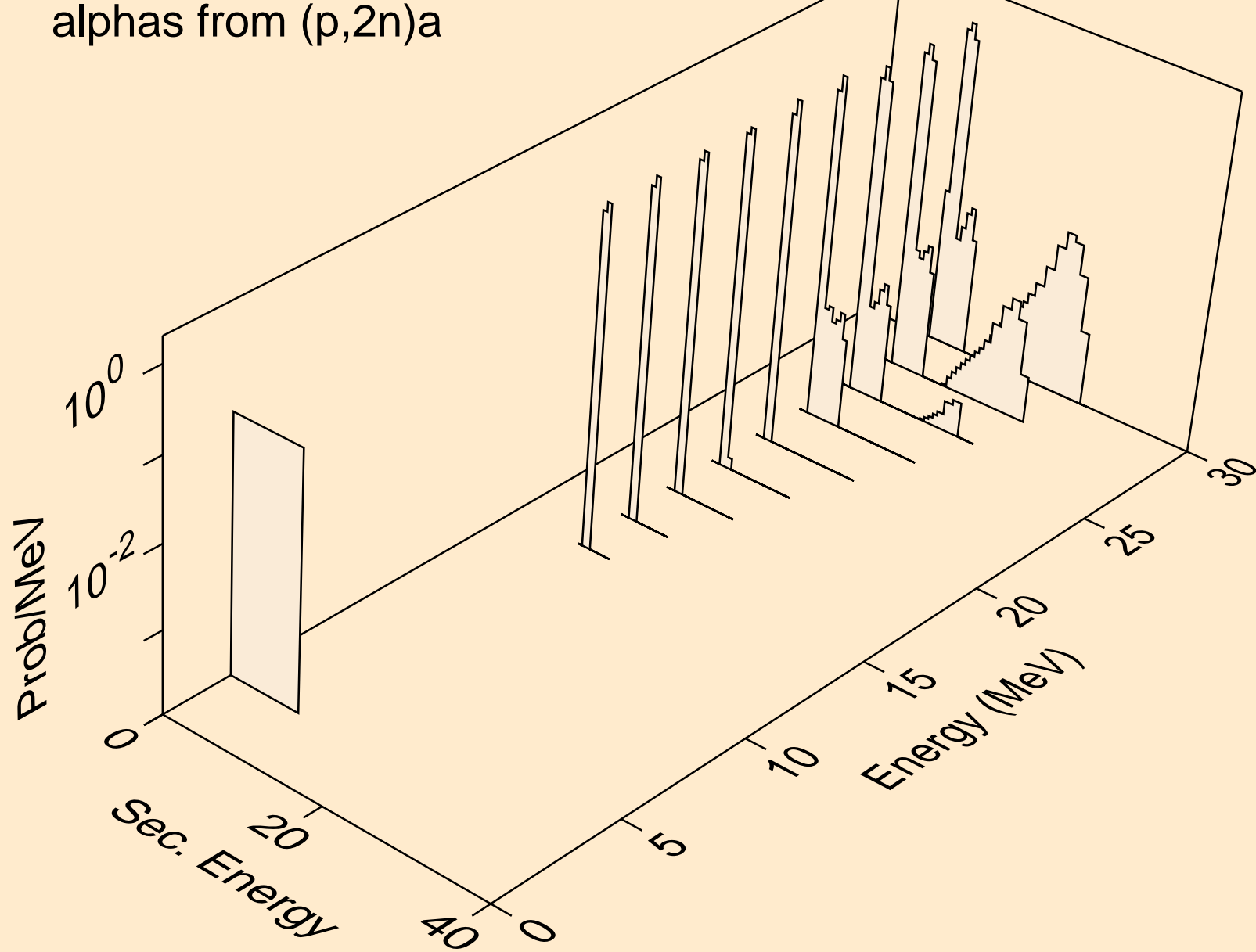

RF259 PROTON ACER TENDL-2021 LIBRARY; T=0.K  
alphas from (p,3n)a

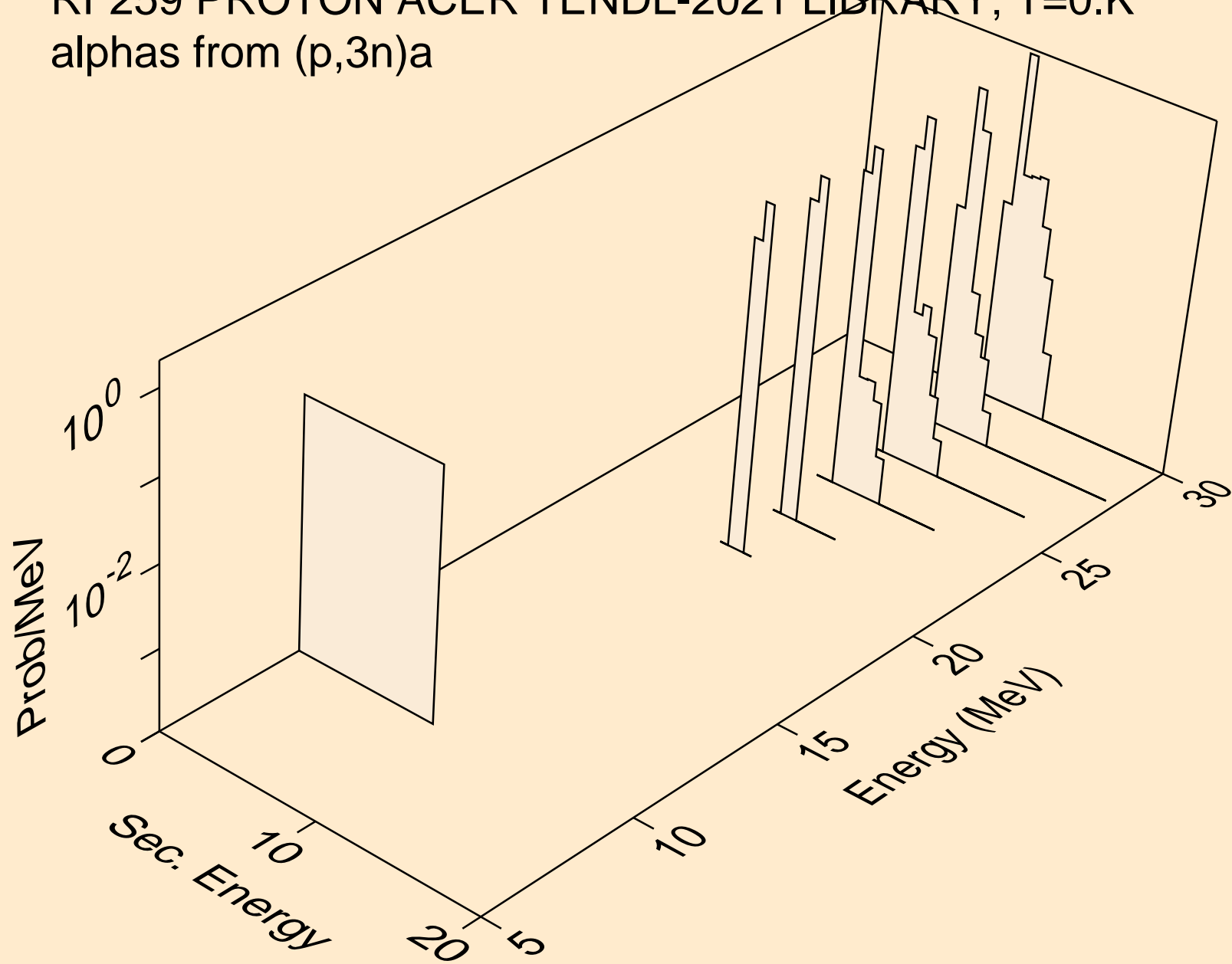

RF259 PROTON ACER TENDL-2021 LIBRARY; T=0.K  
alphas from (p,n\*)2a

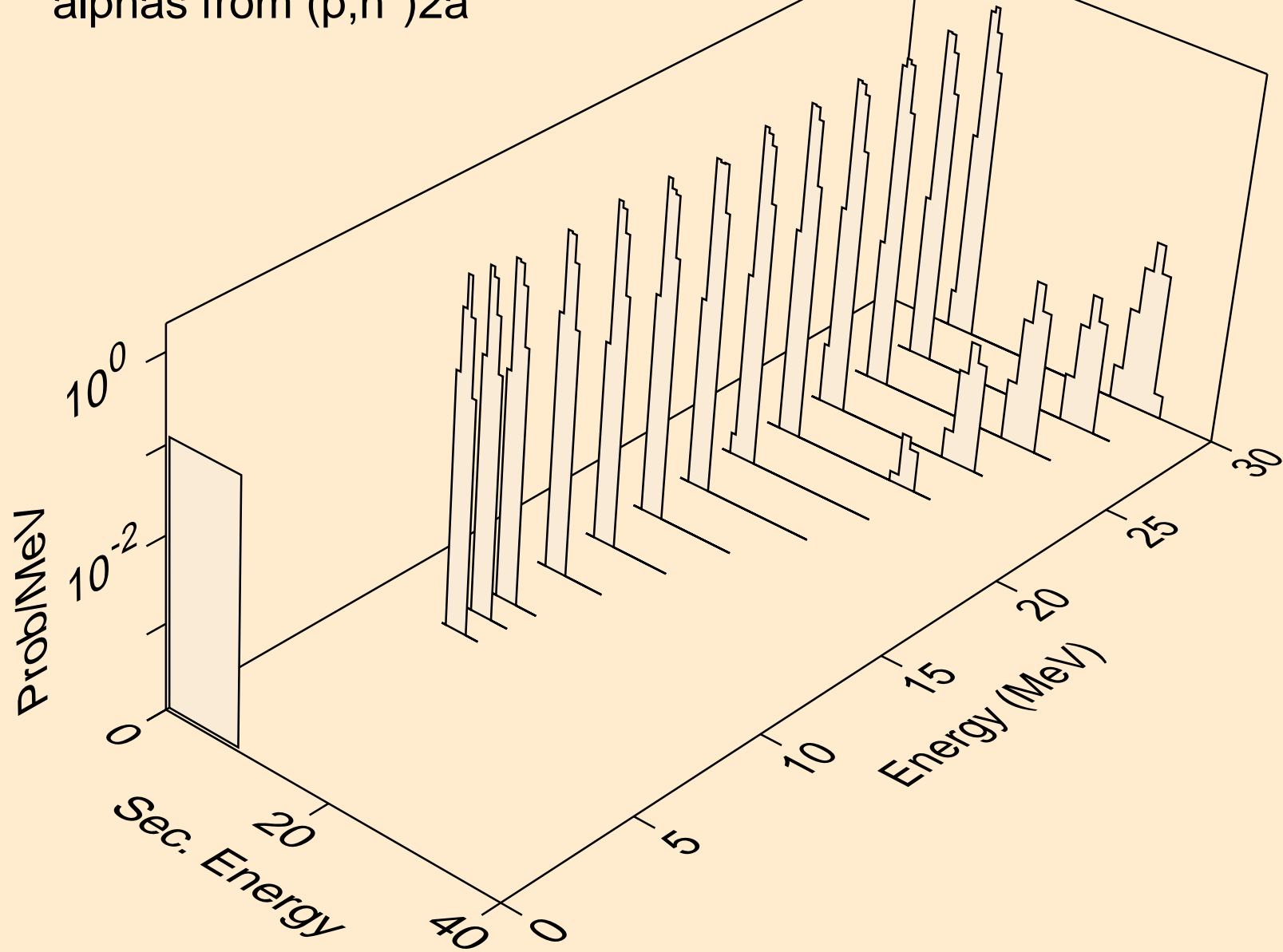

RF259 PROTON ACER TENDL-2021 LIBRARY; T=0.K  
alphas from (p,npa)

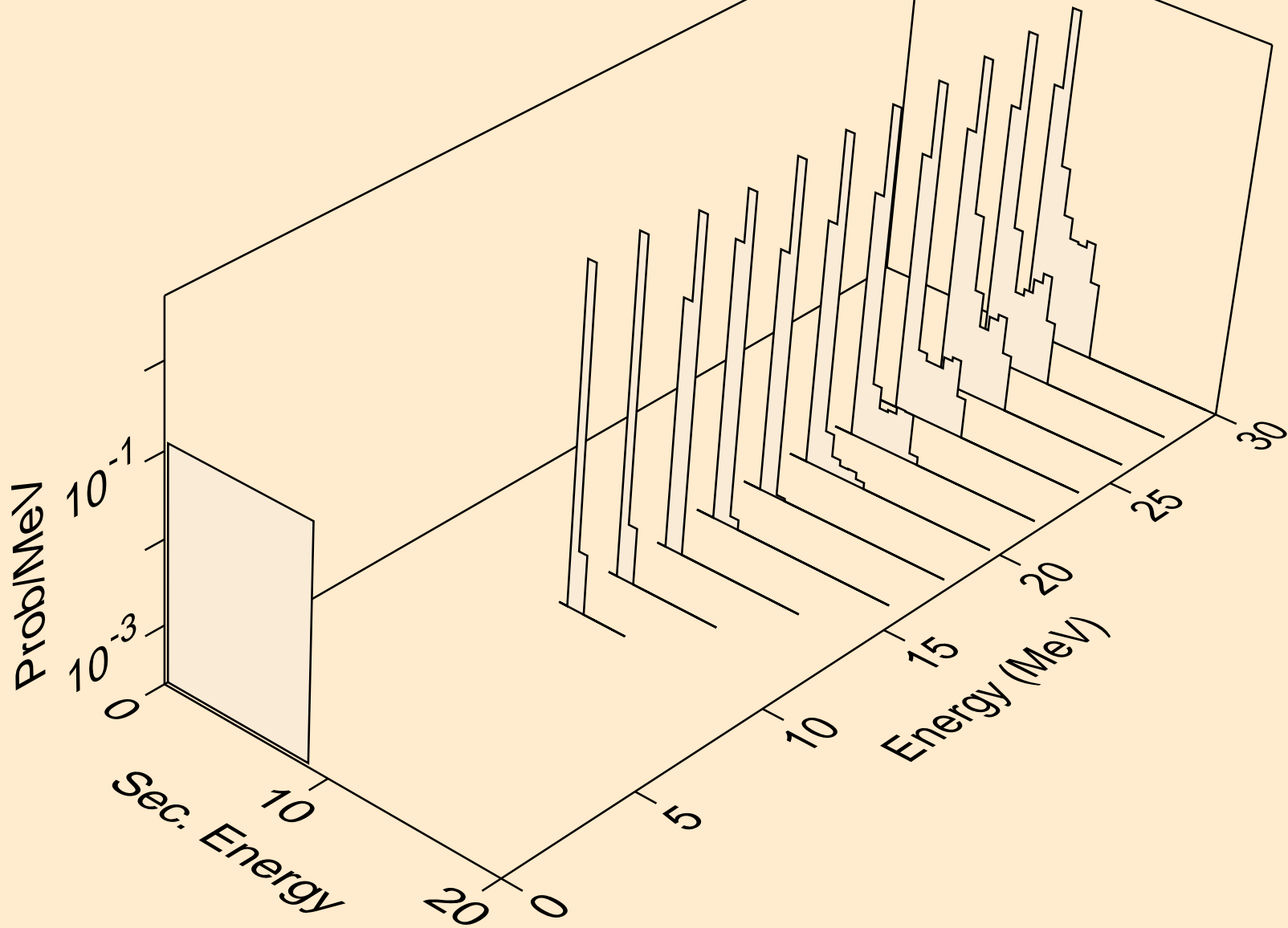

RF259 PROTON ACER TENDL-2021 LIBRARY; T=0.K  
alphas from (p,a)

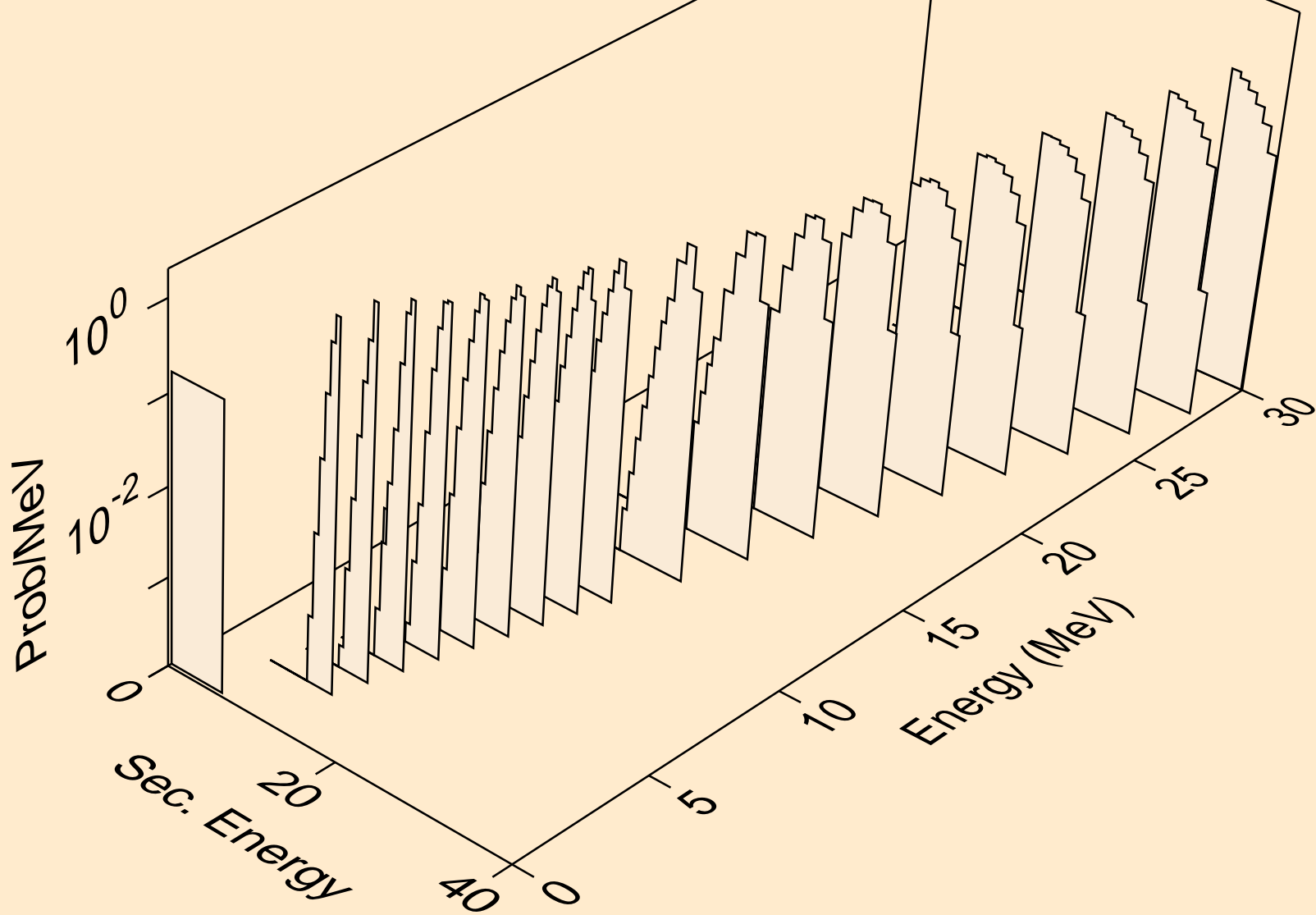

RF259 PROTON ACER TENDL-2021 LIBRARY; T=0.K  
alphas from (p,2a)

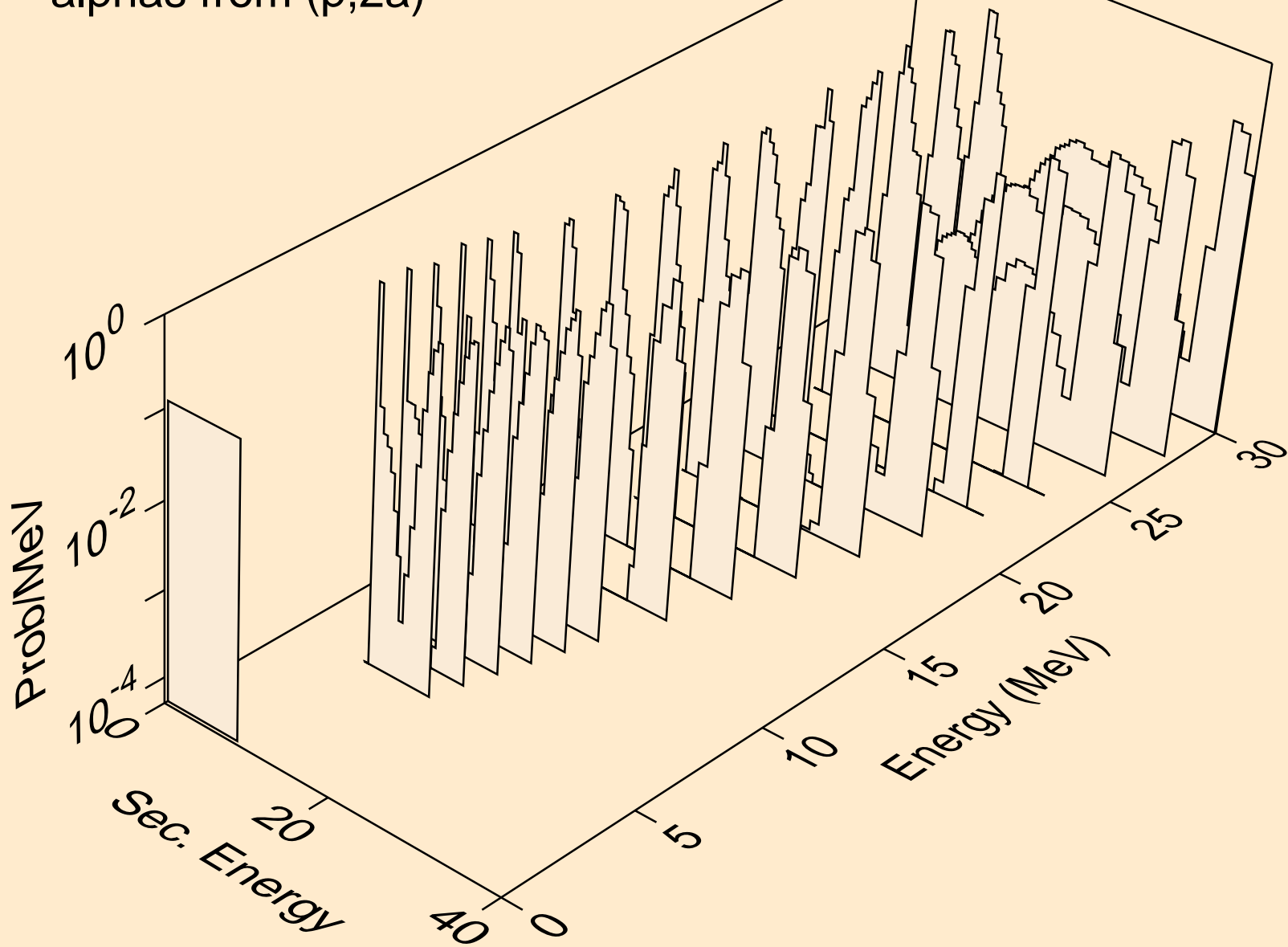



RF259 PROTON ACER TENDL-2021 LIBRARY; T=0.K  
alphas from (p,pa)

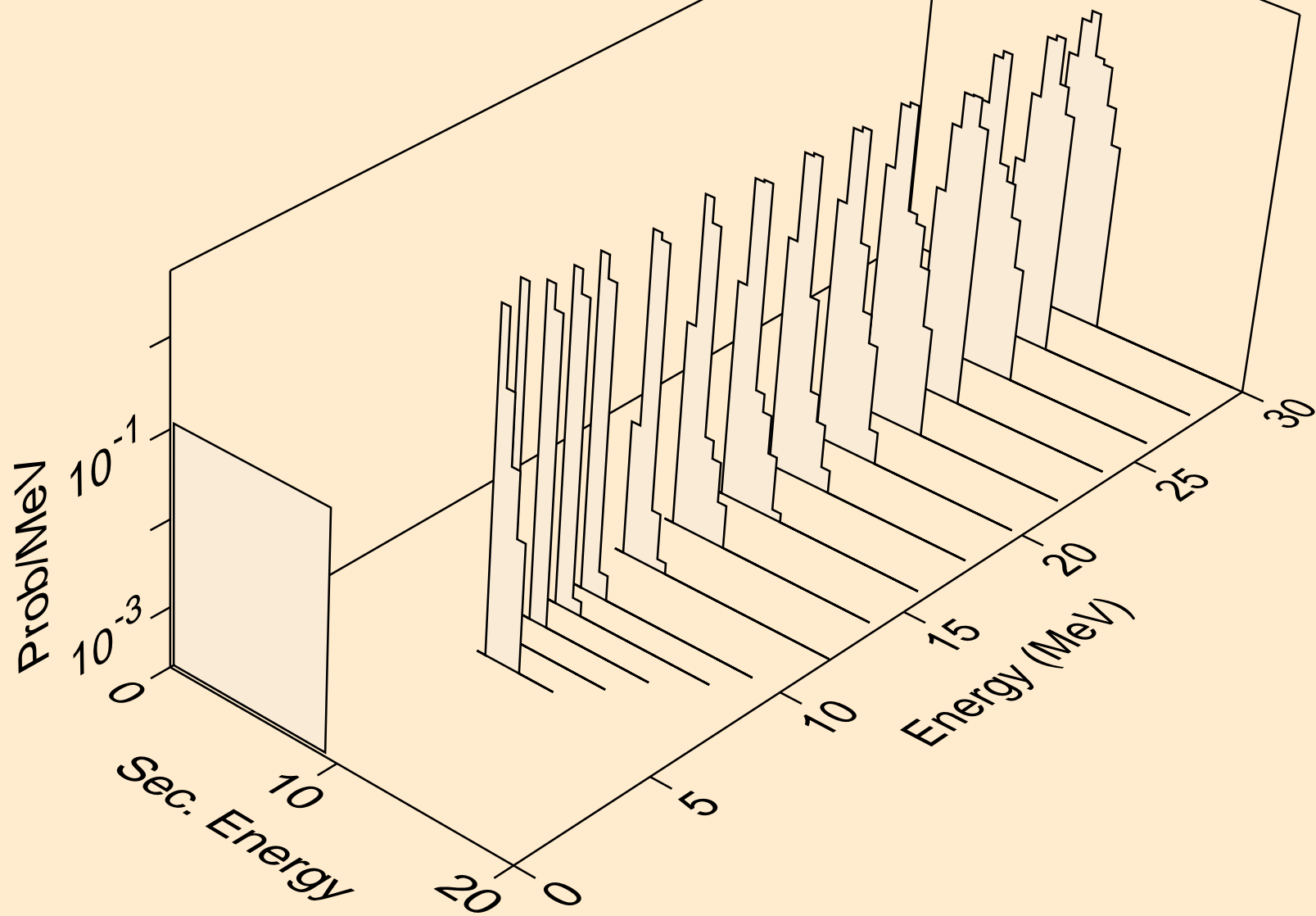

RF259 PROTON ACER TENDL-2021 LIBRARY; T=0.K  
alphas from (p,da)

