

RF266 PROTON ACER TENDL-2021 LIBRARY; T=0.K
Principal cross sections

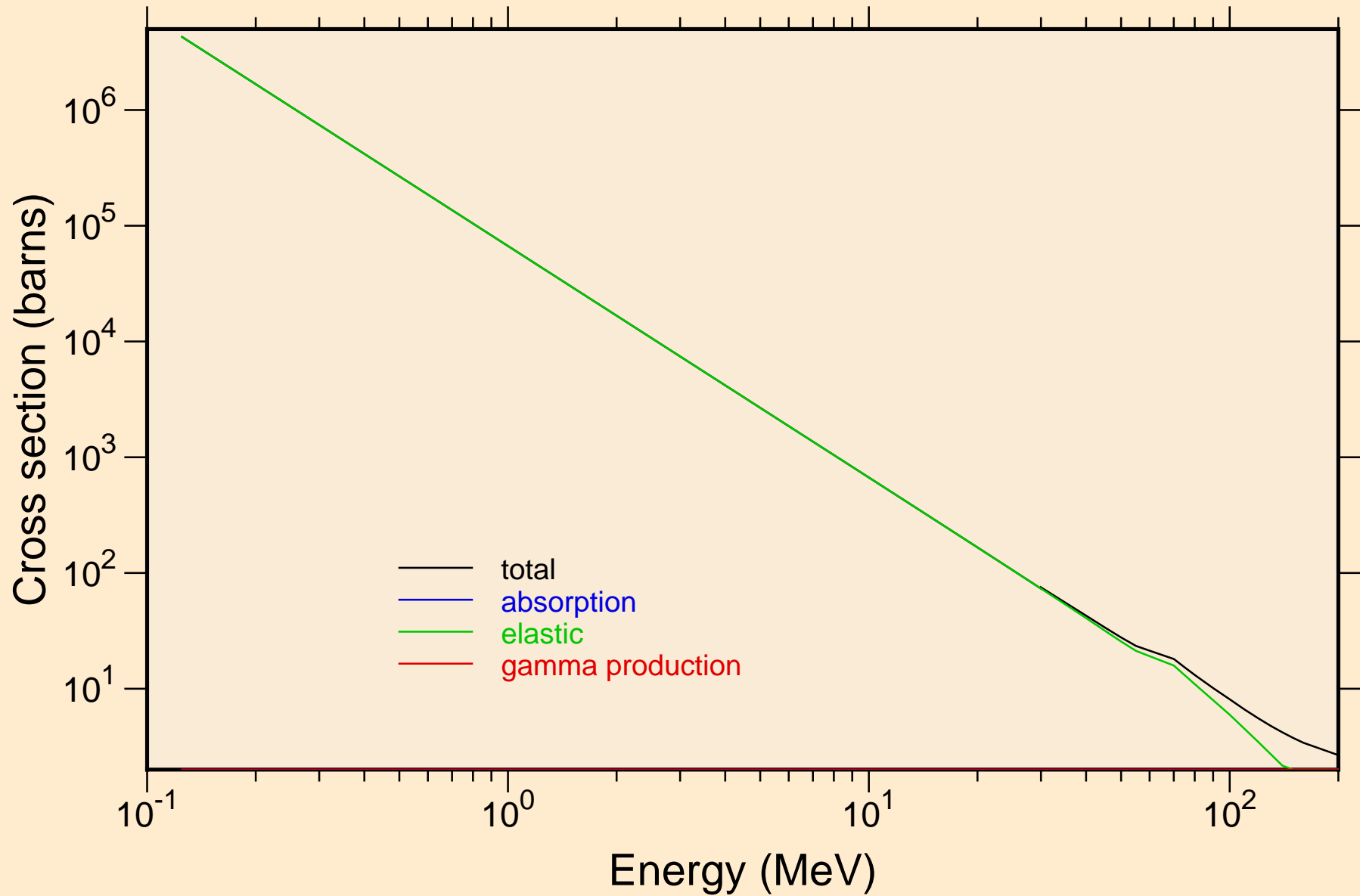

RF266 PROTON ACER TENDL-2021 LIBRARY; T=0.K

Heating

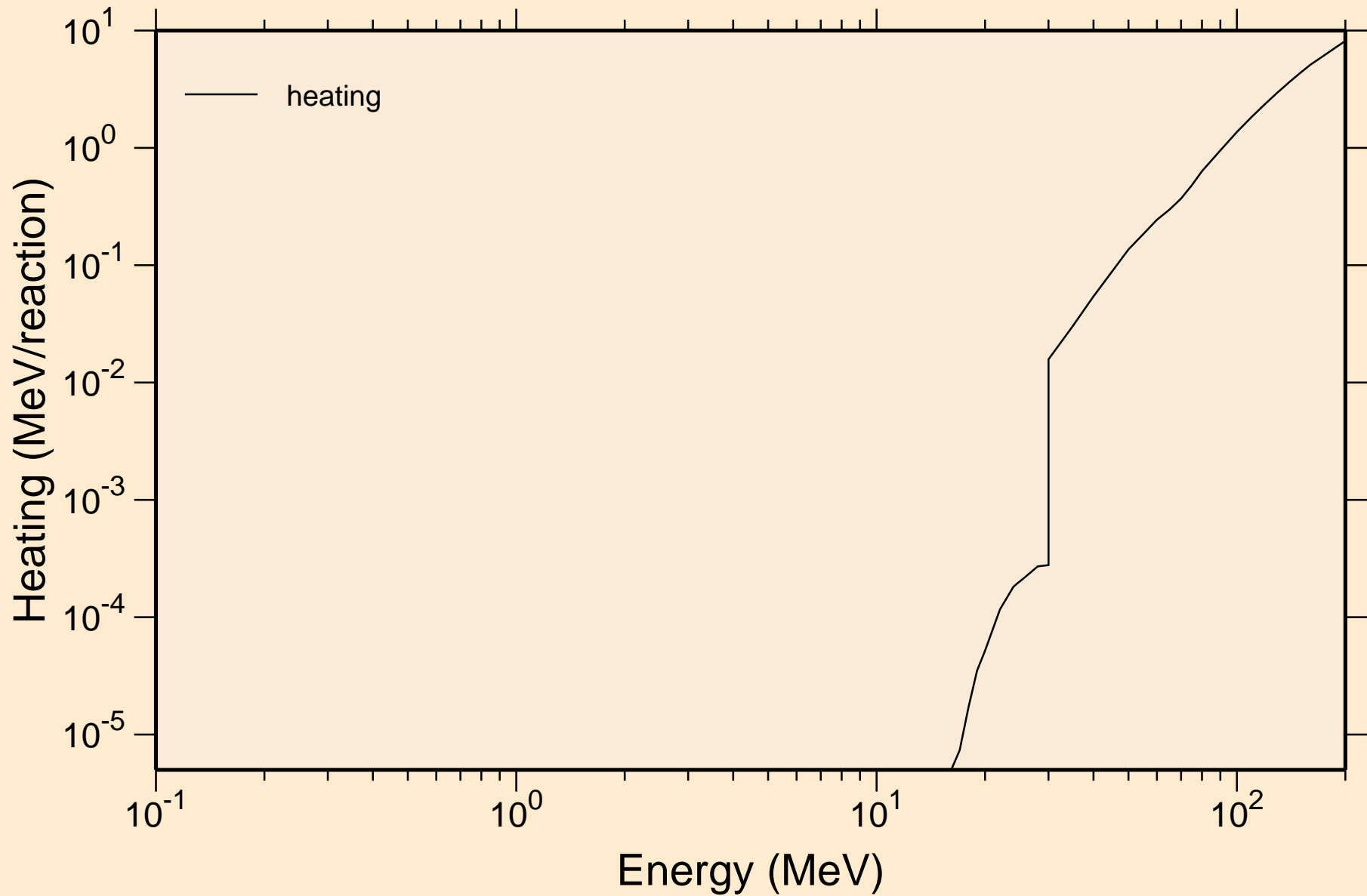

RF266 PROTON ACER TENDL-2021 LIBRARY; T=0.K

Principal cross sections

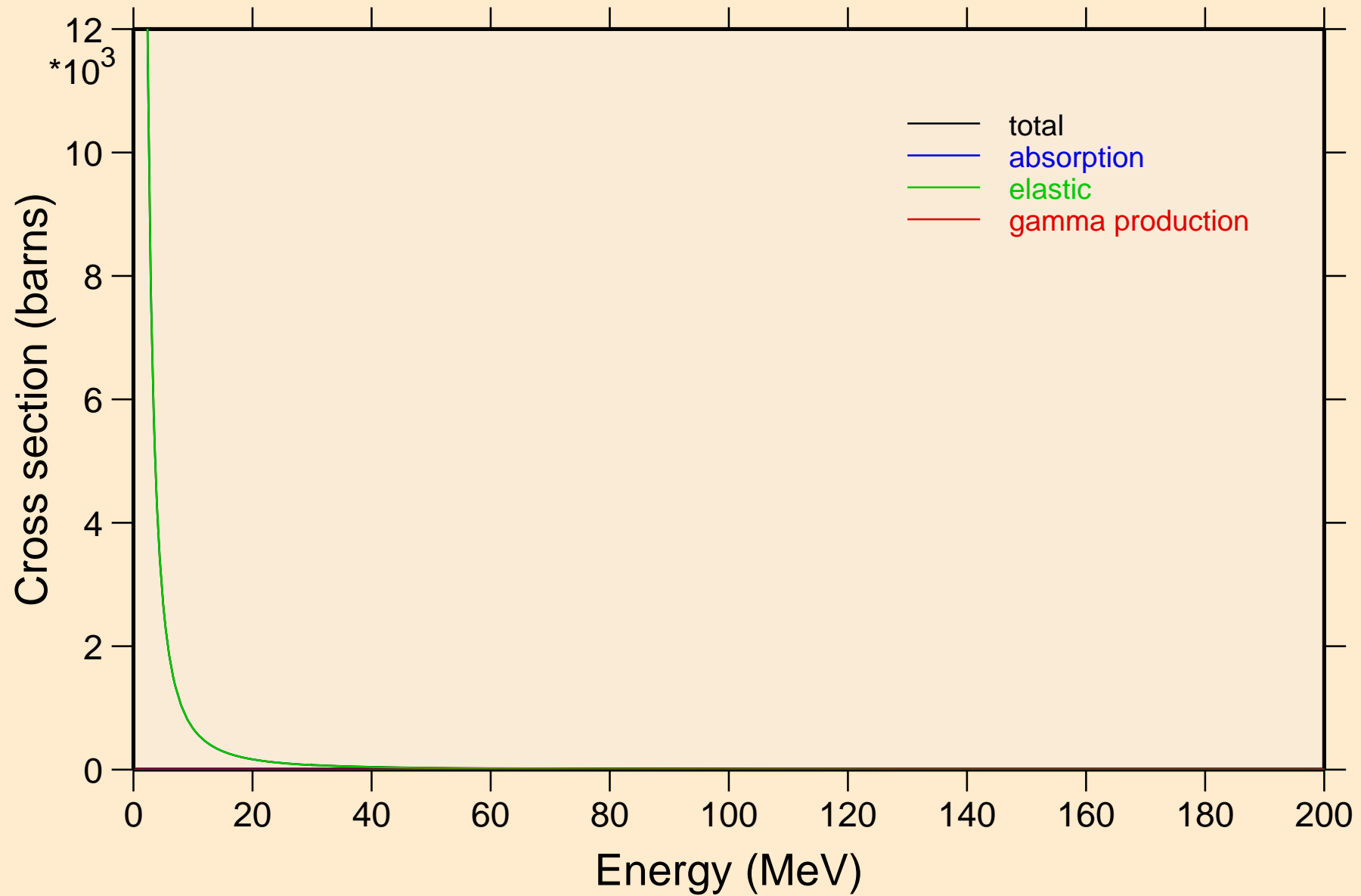

RF266 PROTON ACER TENDL-2021 LIBRARY; T=0.K

Heating

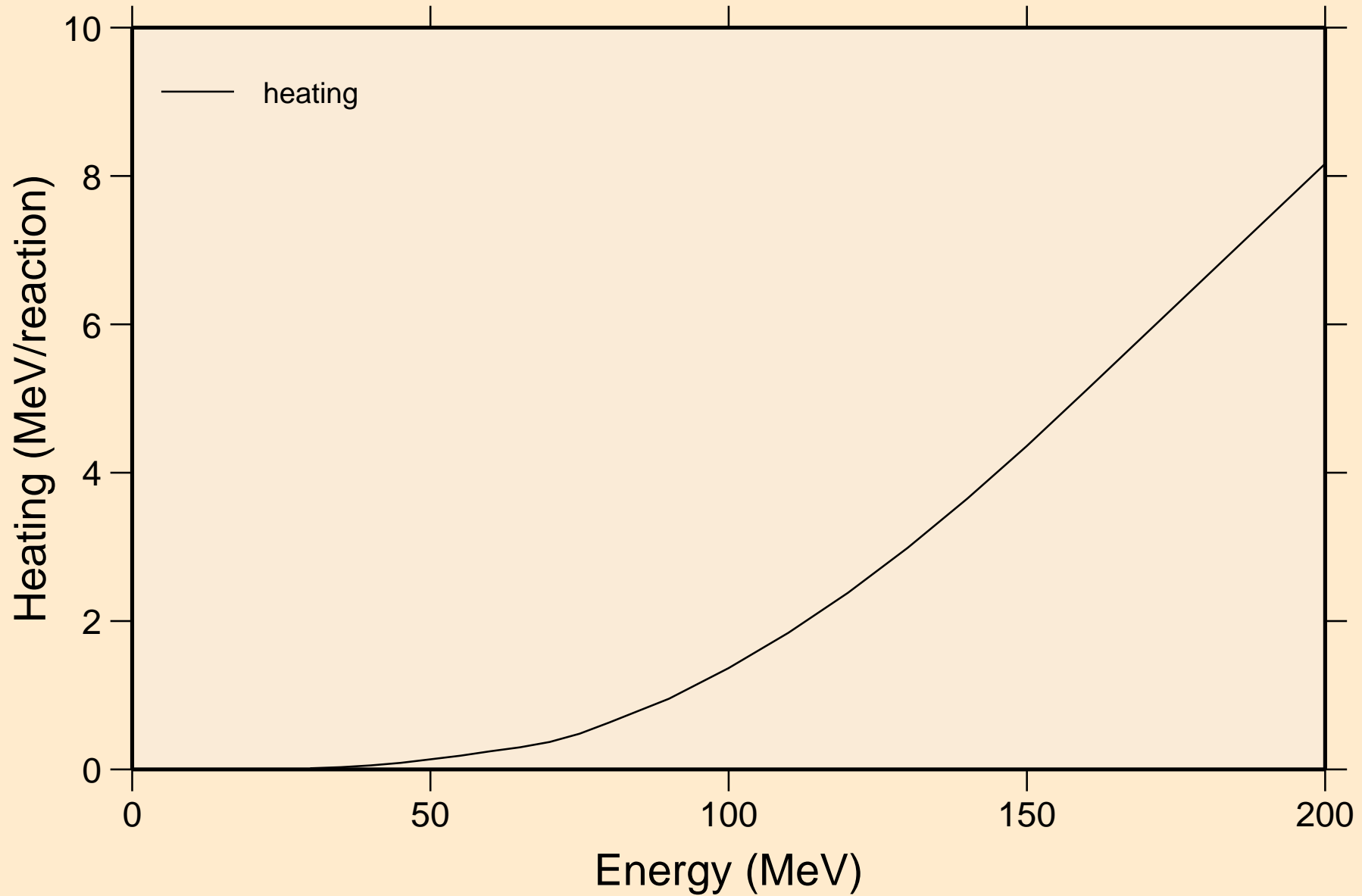

RF266 PROTON ACER TENDL-2021 LIBRARY; T=0.K
Threshold reactions

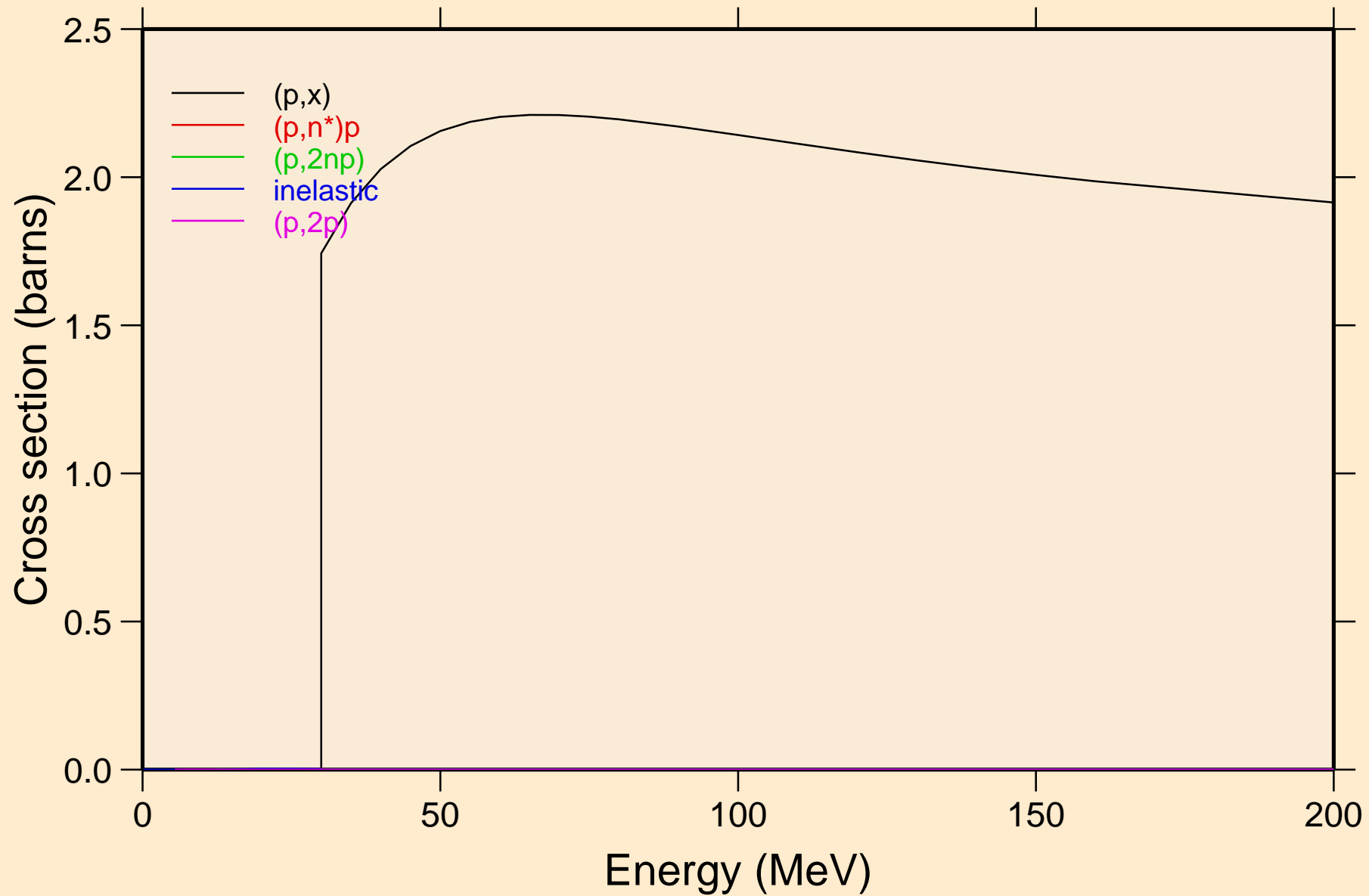

RF266 PROTON ACER TENDL-2021 LIBRARY; T=0.K
angular distribution for elastic

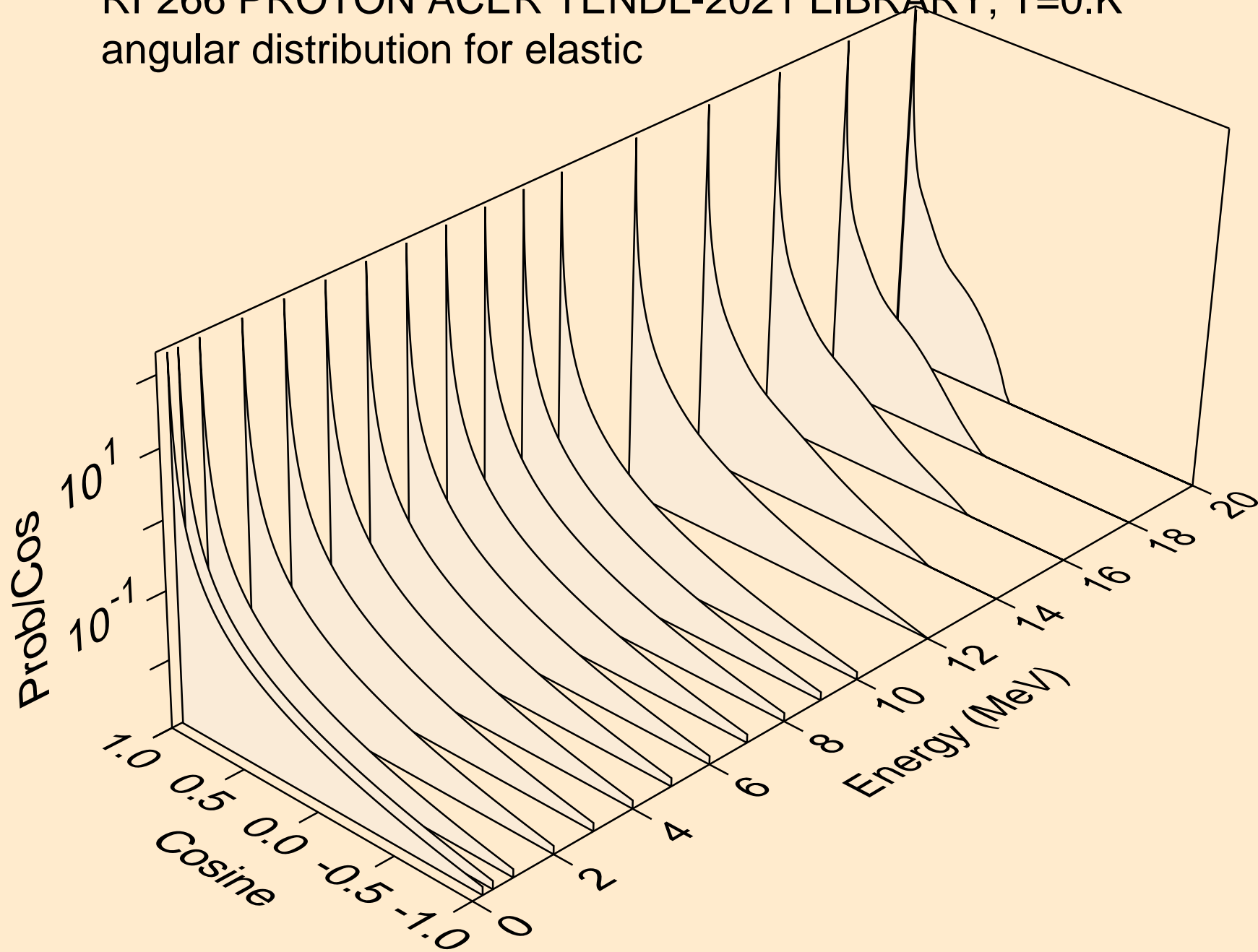

RF266 PROTON ACER TENDL-2021 LIBRARY; T=0.K
angular distribution for elastic

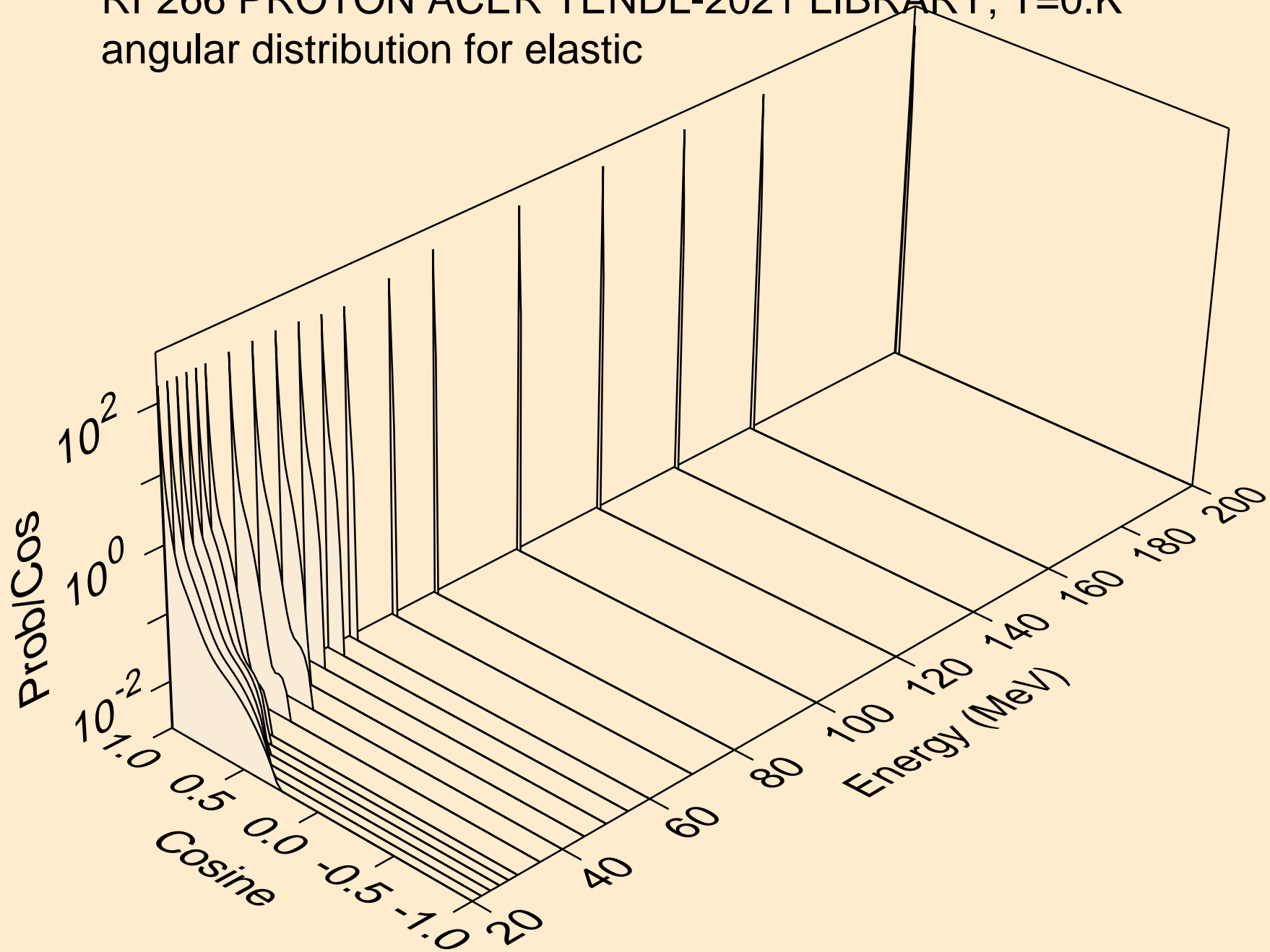

RF266 PROTON ACER TENDL-2021 LIBRARY; T=0.K
Proton emission for (p,x)

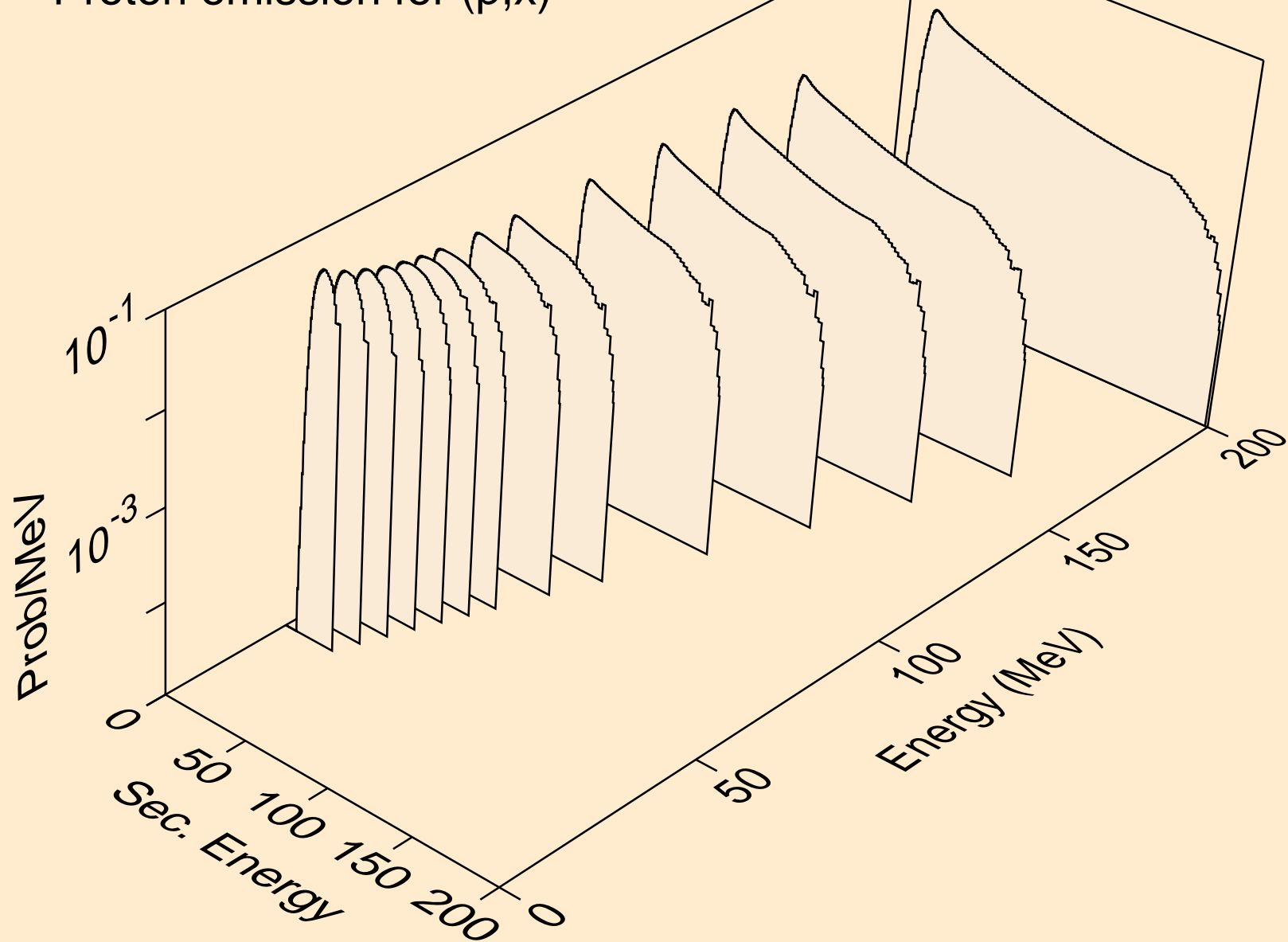

RF266 PROTON ACER TENDL-2021 LIBRARY; T=0.K
Proton emission for (p,n*)p

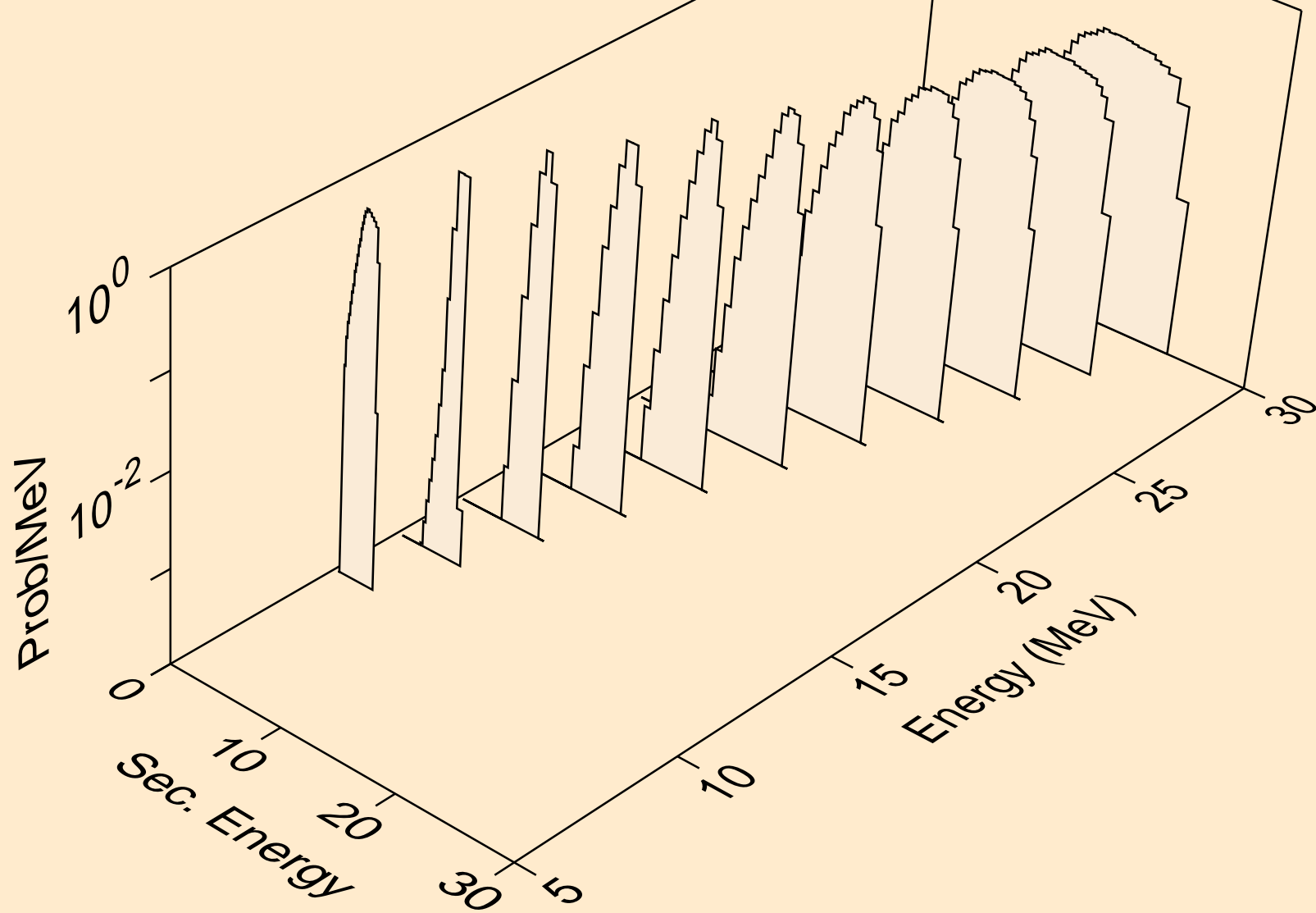

RF266 PROTON ACER TENDL-2021 LIBRARY; T=0.K
Proton emission for (p,2np)

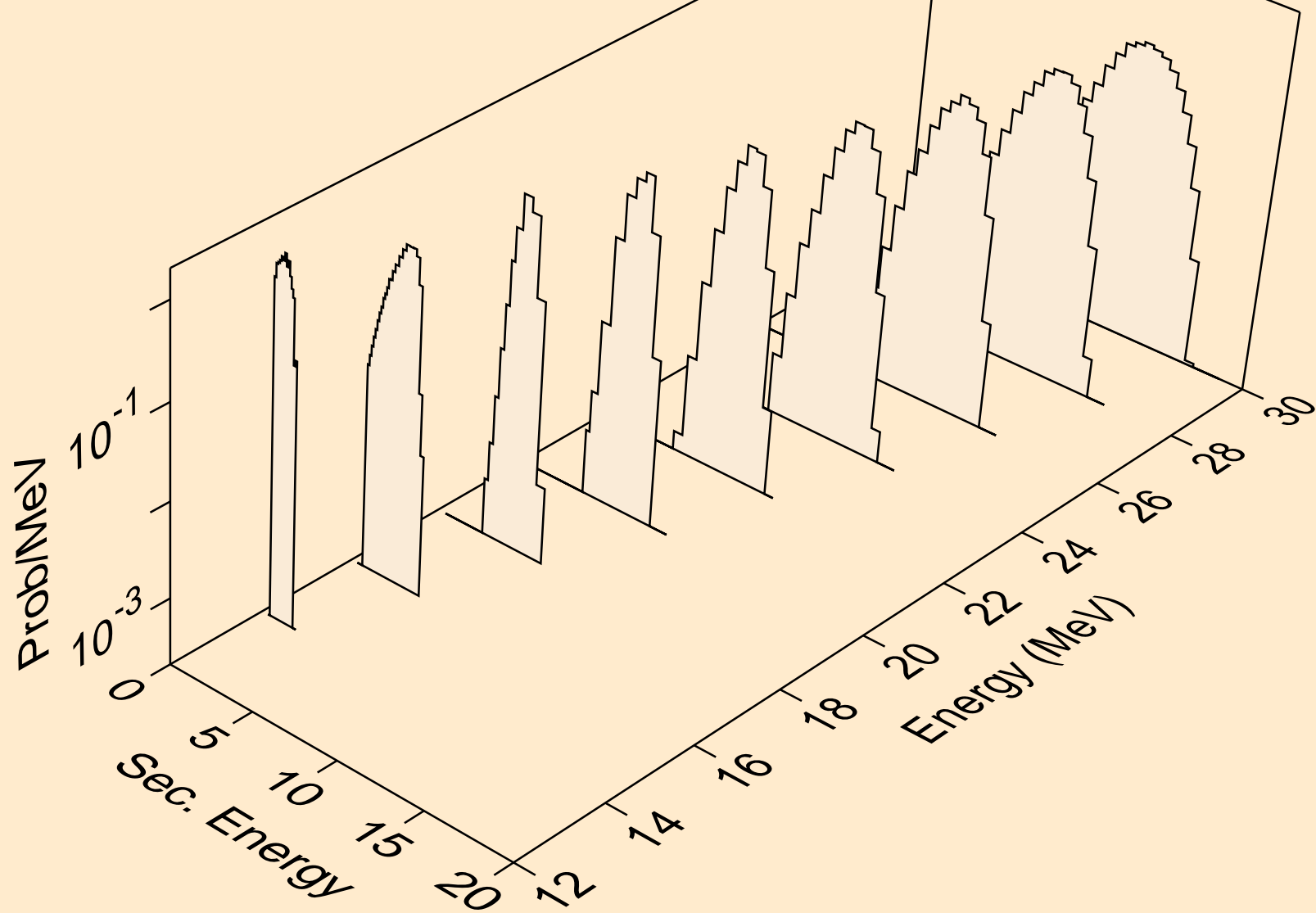

RF266 PROTON ACER TENDL-2021 LIBRARY; T=0.K
Proton emission for inelastic

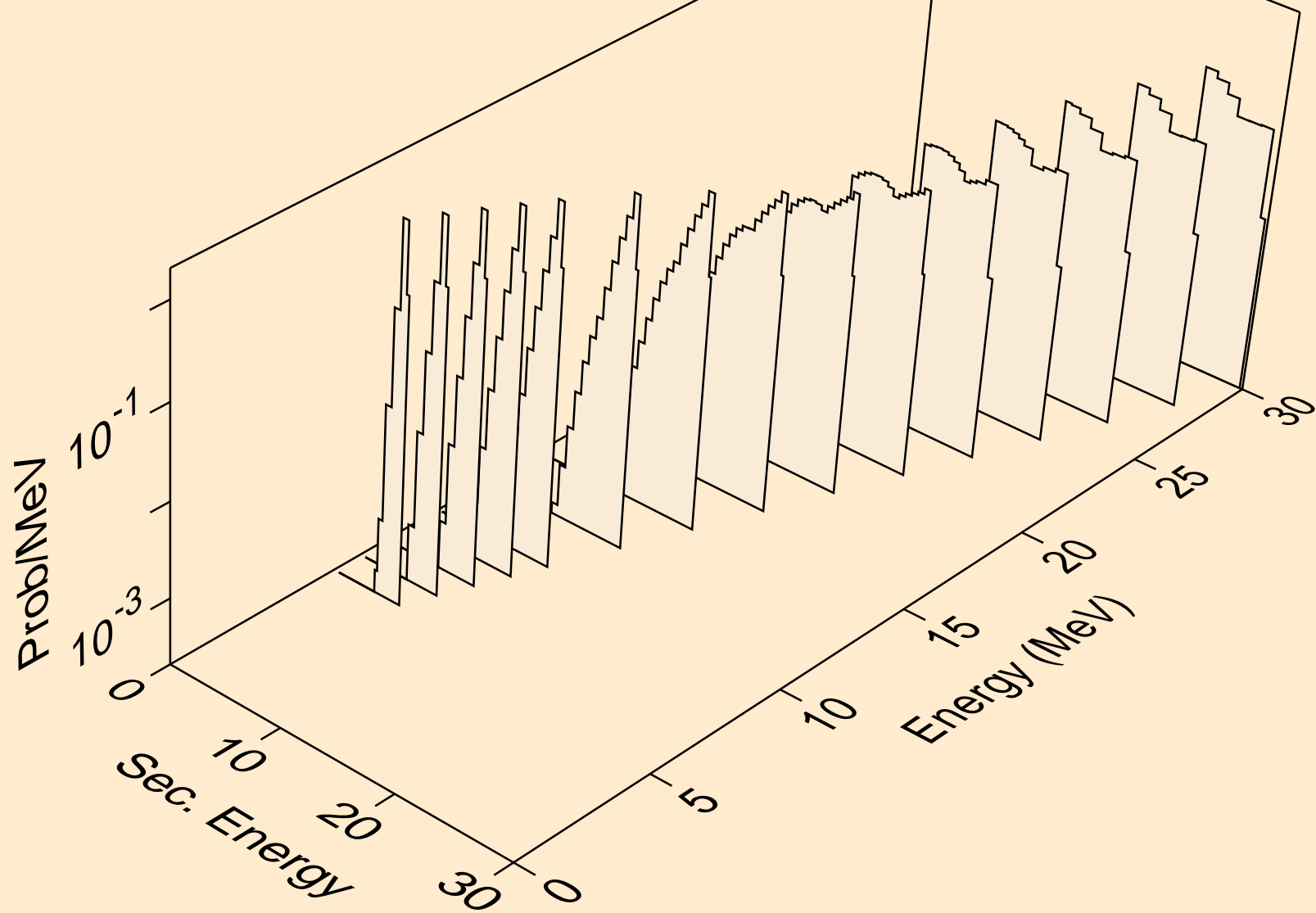

RF266 PROTON ACER TENDL-2021 LIBRARY; T=0.K
Proton emission for (p,2p)

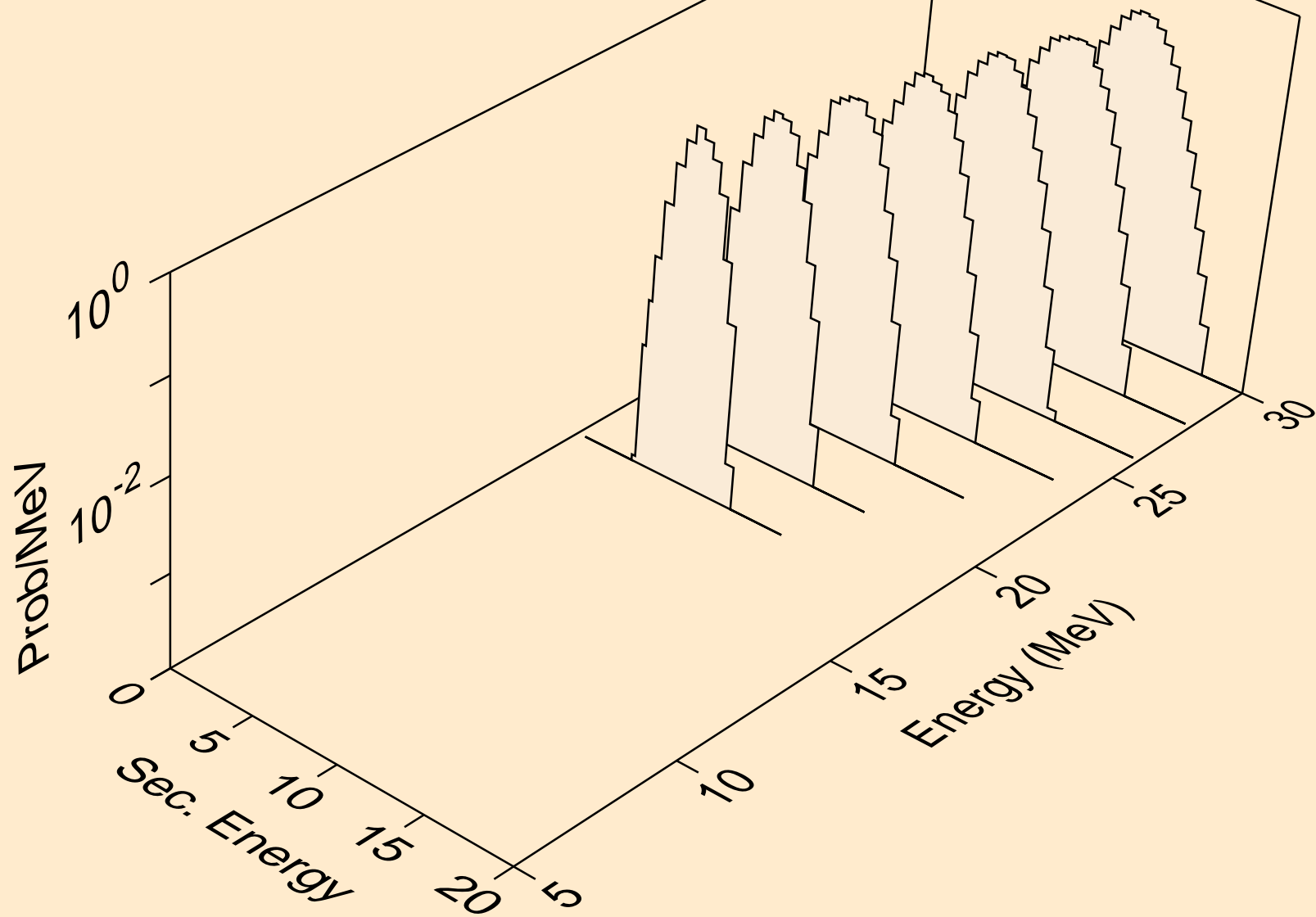

RF266 PROTON ACER TENDL-2021 LIBRARY; T=0.K
Photon emission for (z,n)

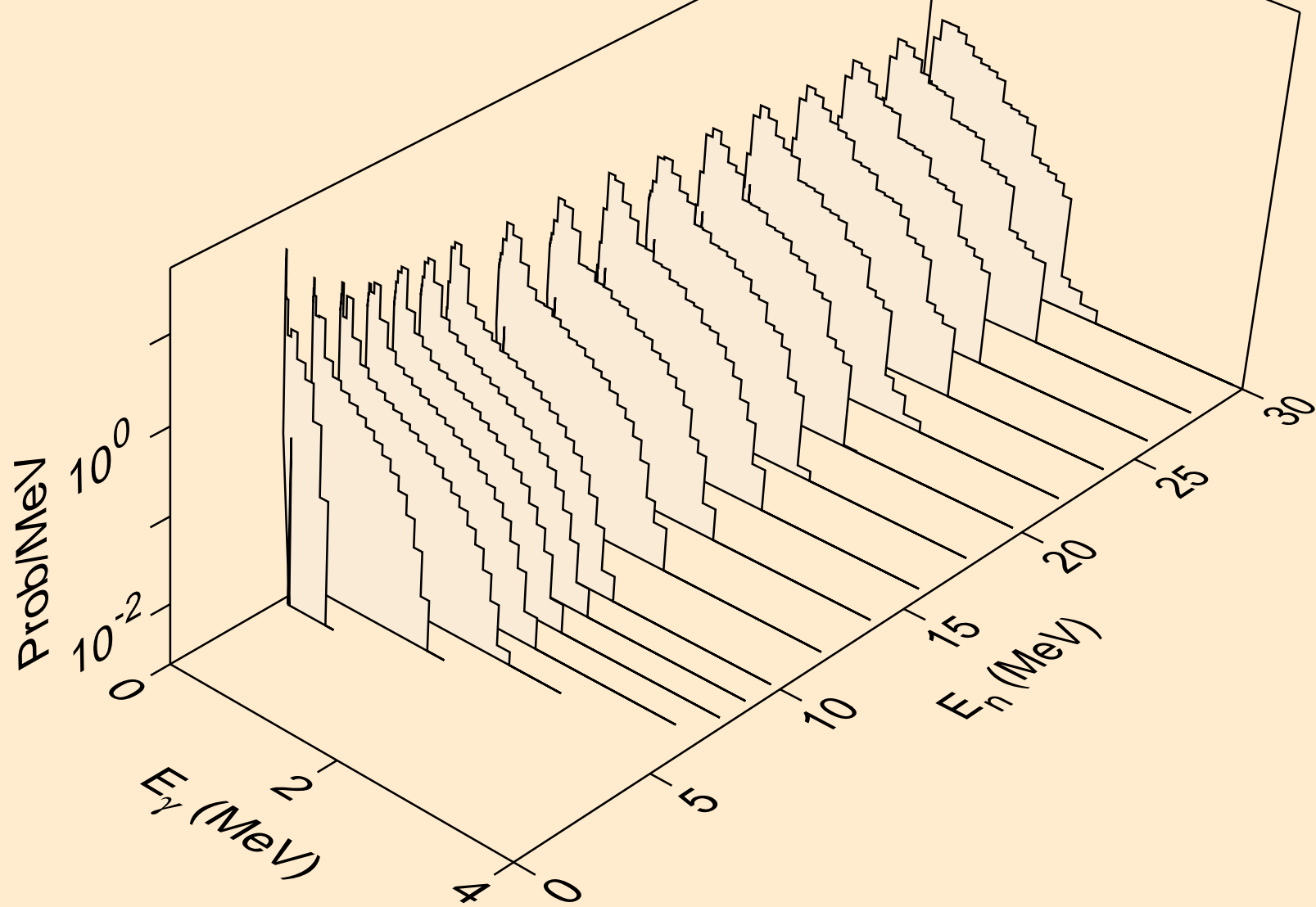

RF266 PROTON ACER TENDL-2021 LIBRARY; T=0.K
Photon emission for (n,x)

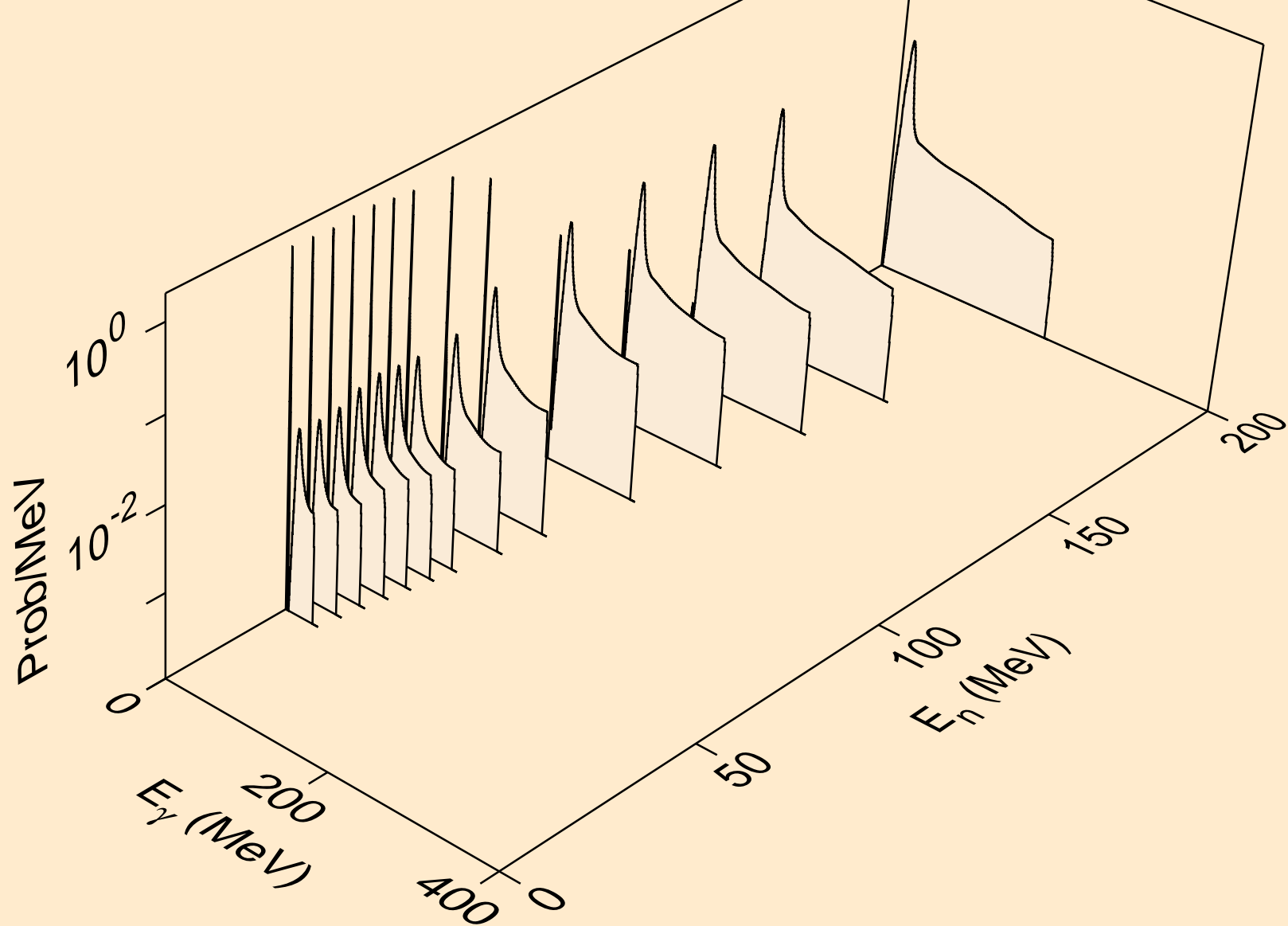

RF266 PROTON ACER TENDL-2021 LIBRARY; T=0.K
Photon emission for (n,2n)

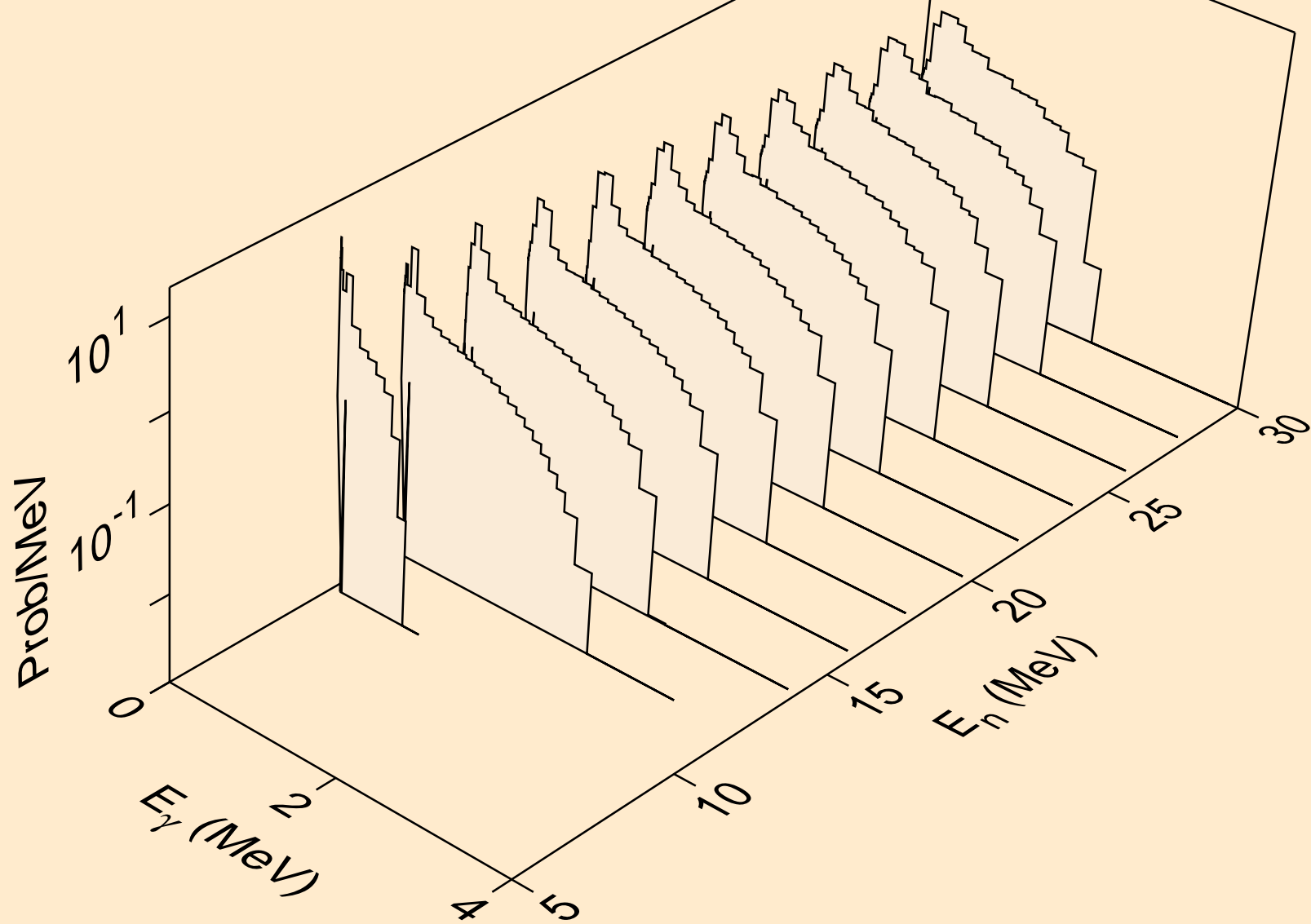

RF266 PROTON ACER TENDL-2021 LIBRARY; T=0.K
Photon emission for (n,3n)

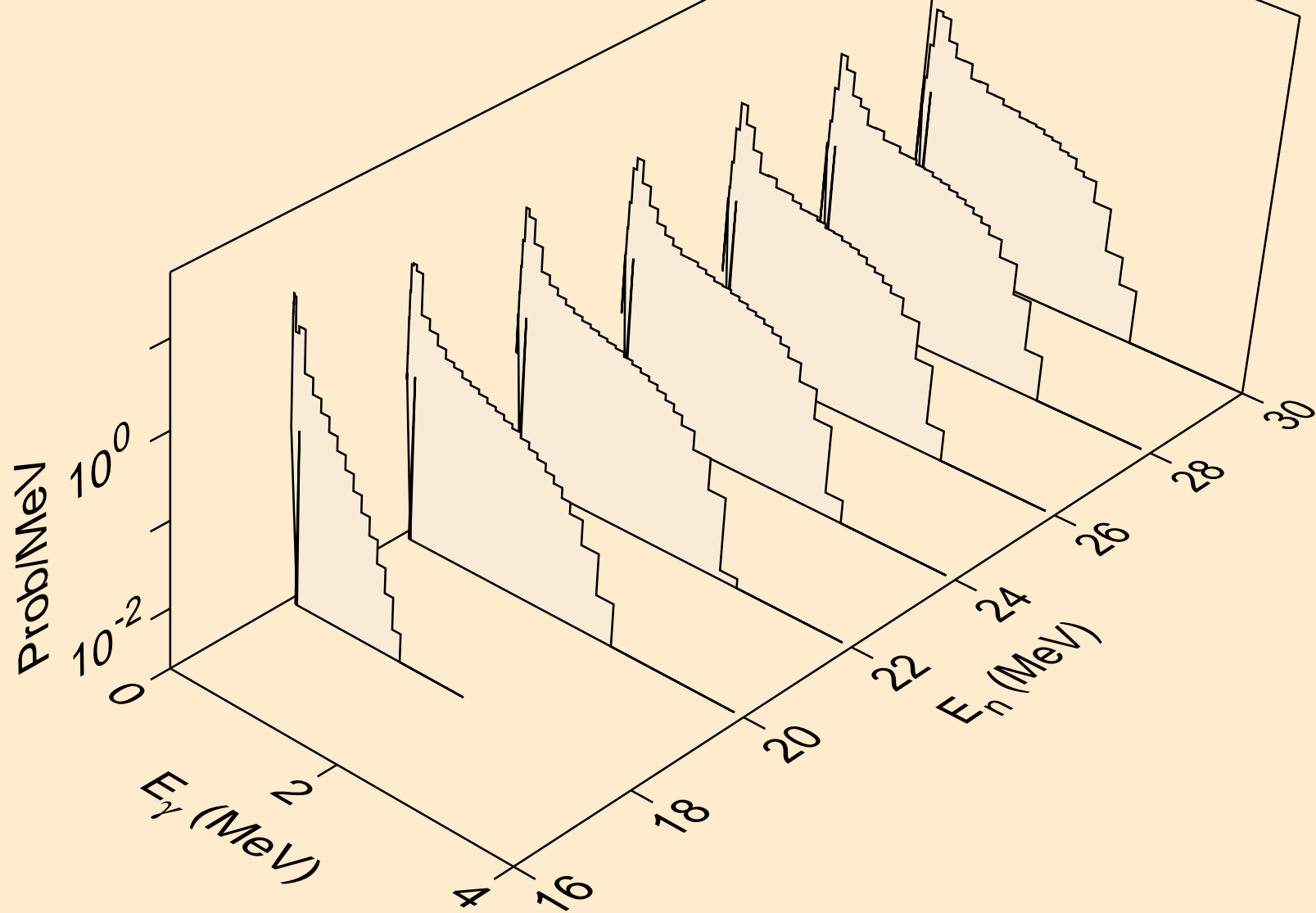

RF266 PROTON ACER TENDL-2021 LIBRARY; T=0.K
Photon emission for (n,n*)a

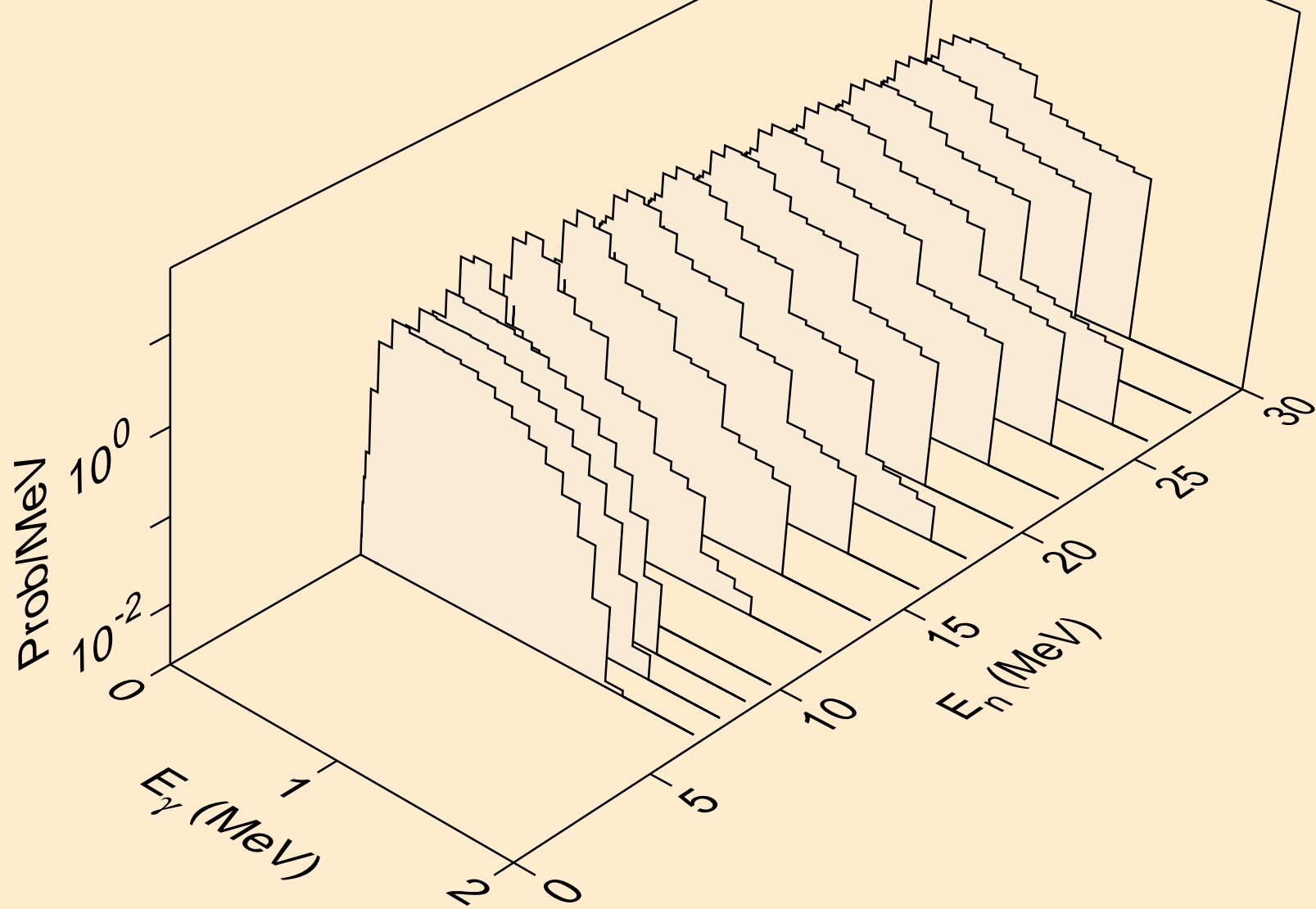

RF266 PROTON ACER TENDL-2021 LIBRARY; T=0.K
Photon emission for (n,n*)p

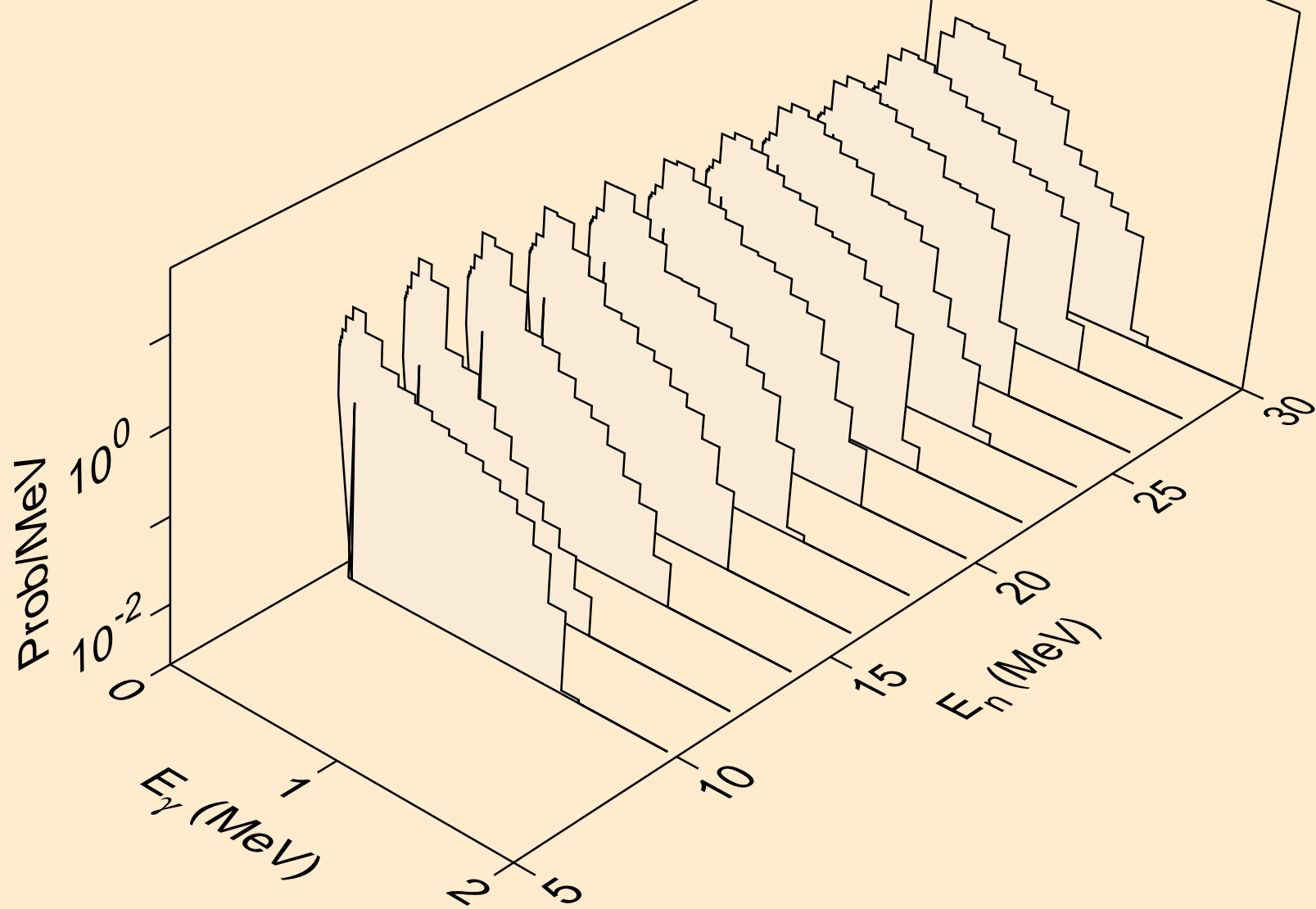

RF266 PROTON ACER TENDL-2021 LIBRARY; T=0.K
Photon emission for (n,n*)d

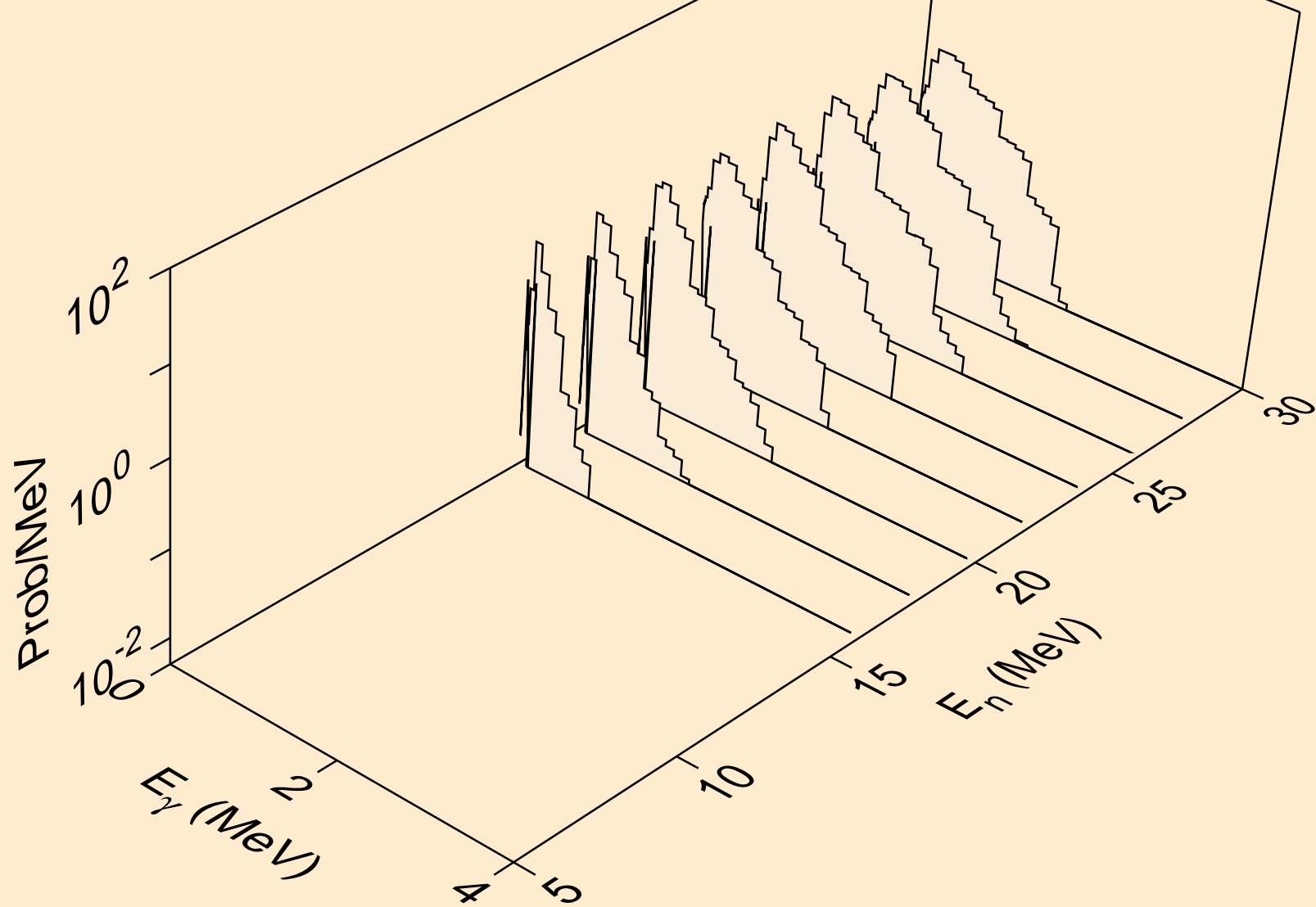

RF266 PROTON ACER TENDL-2021 LIBRARY; T=0.K
Photon emission for (n,n*)t

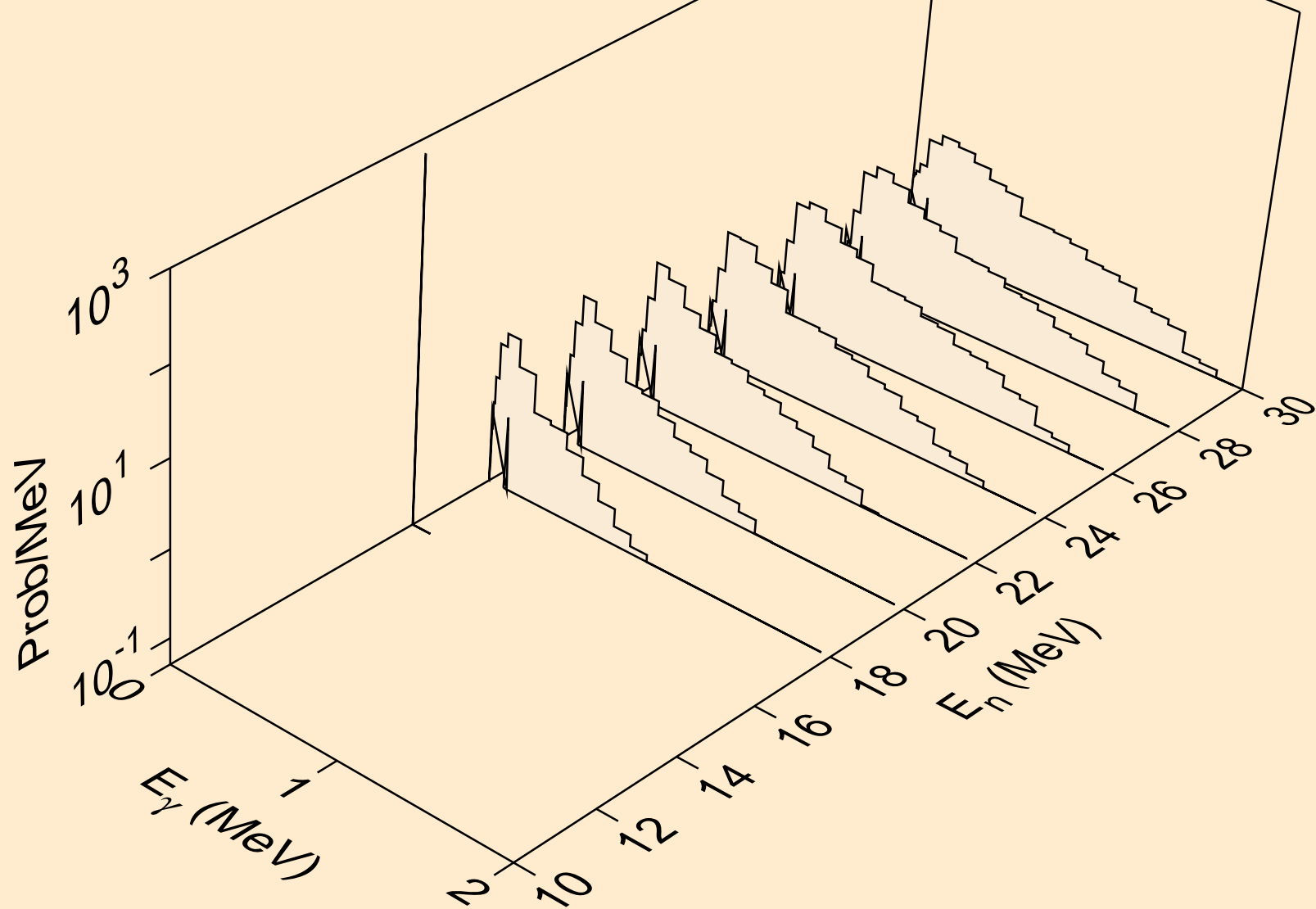

RF266 PROTON ACER TENDL-2021 LIBRARY; T=0.K
Photon emission for (n,2np)

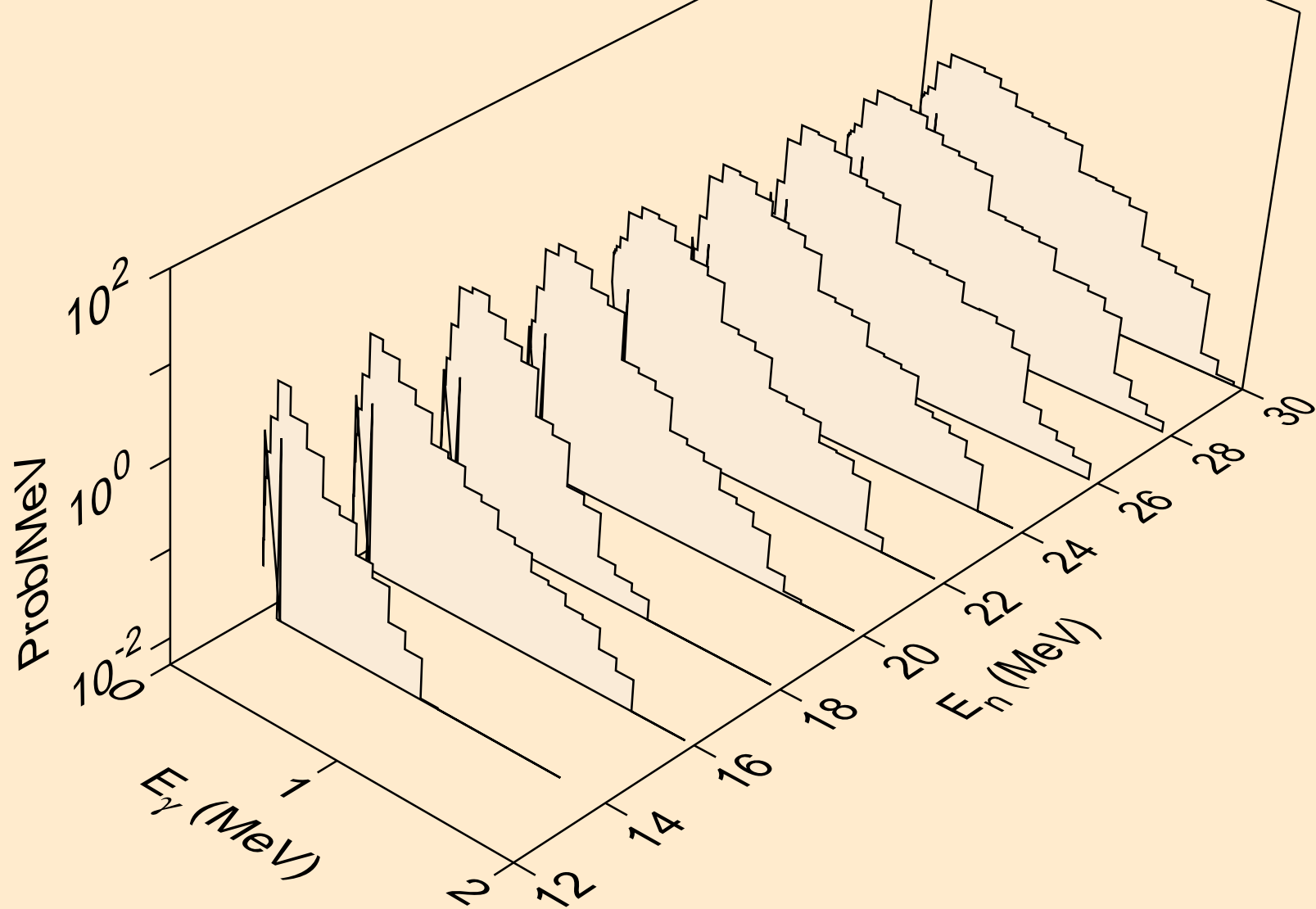

RF266 PROTON ACER TENDL-2021 LIBRARY; T=0.K
Photon emission for (n,gma)

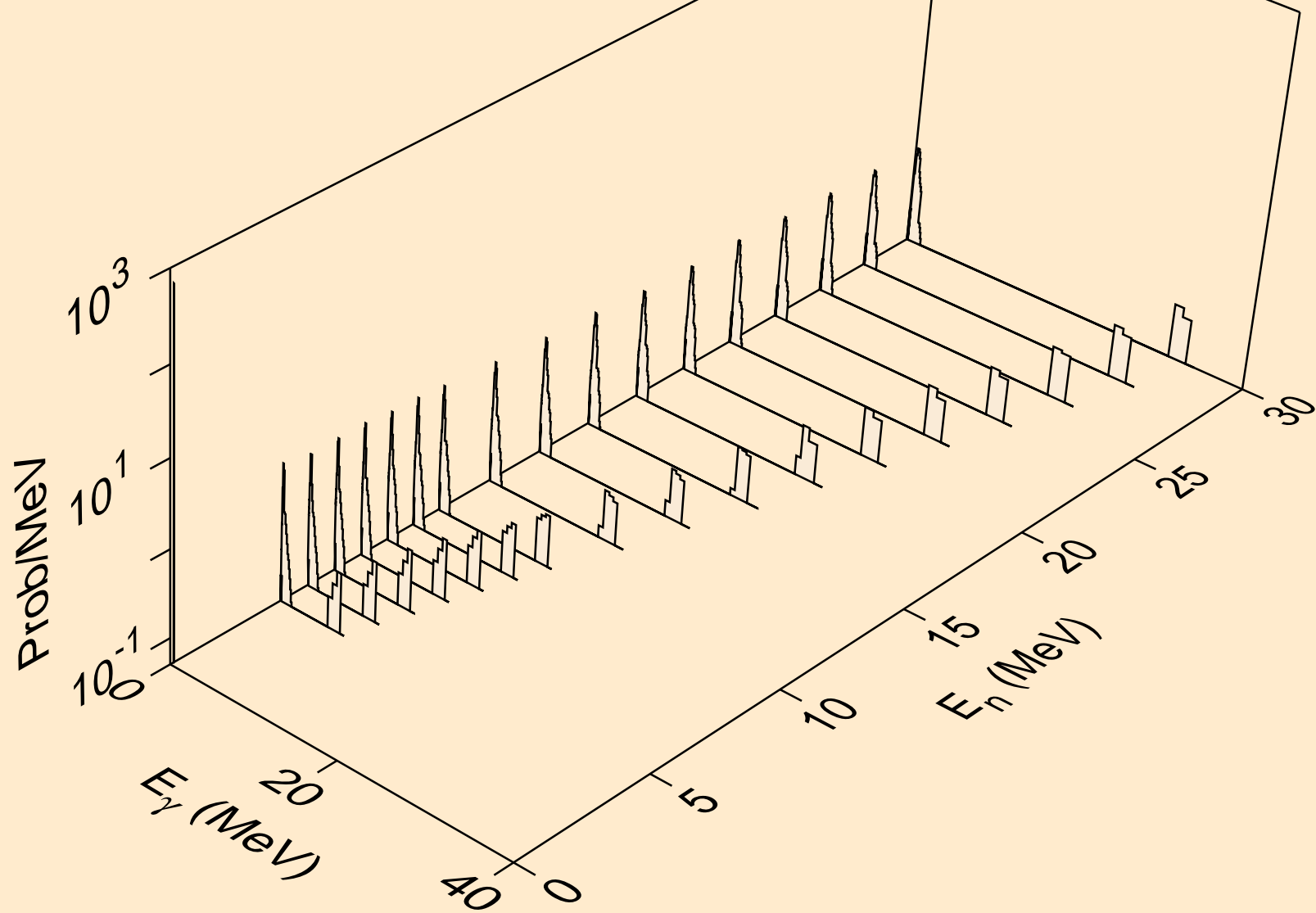

RF266 PROTON ACER TENDL-2021 LIBRARY; T=0.K
Photon emission for inelastic

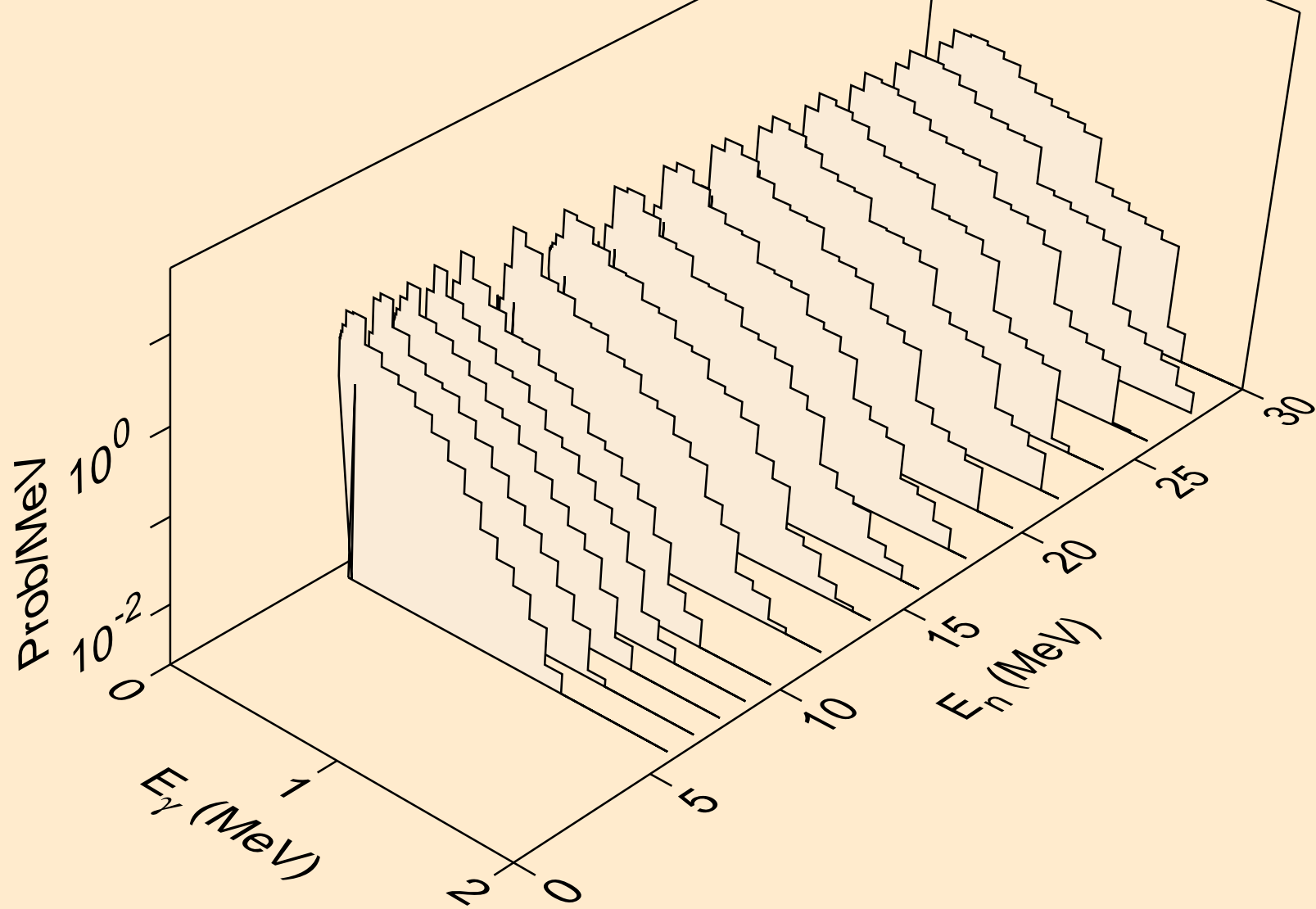

RF266 PROTON ACER TENDL-2021 LIBRARY; T=0.K
Photon emission for (n,d)

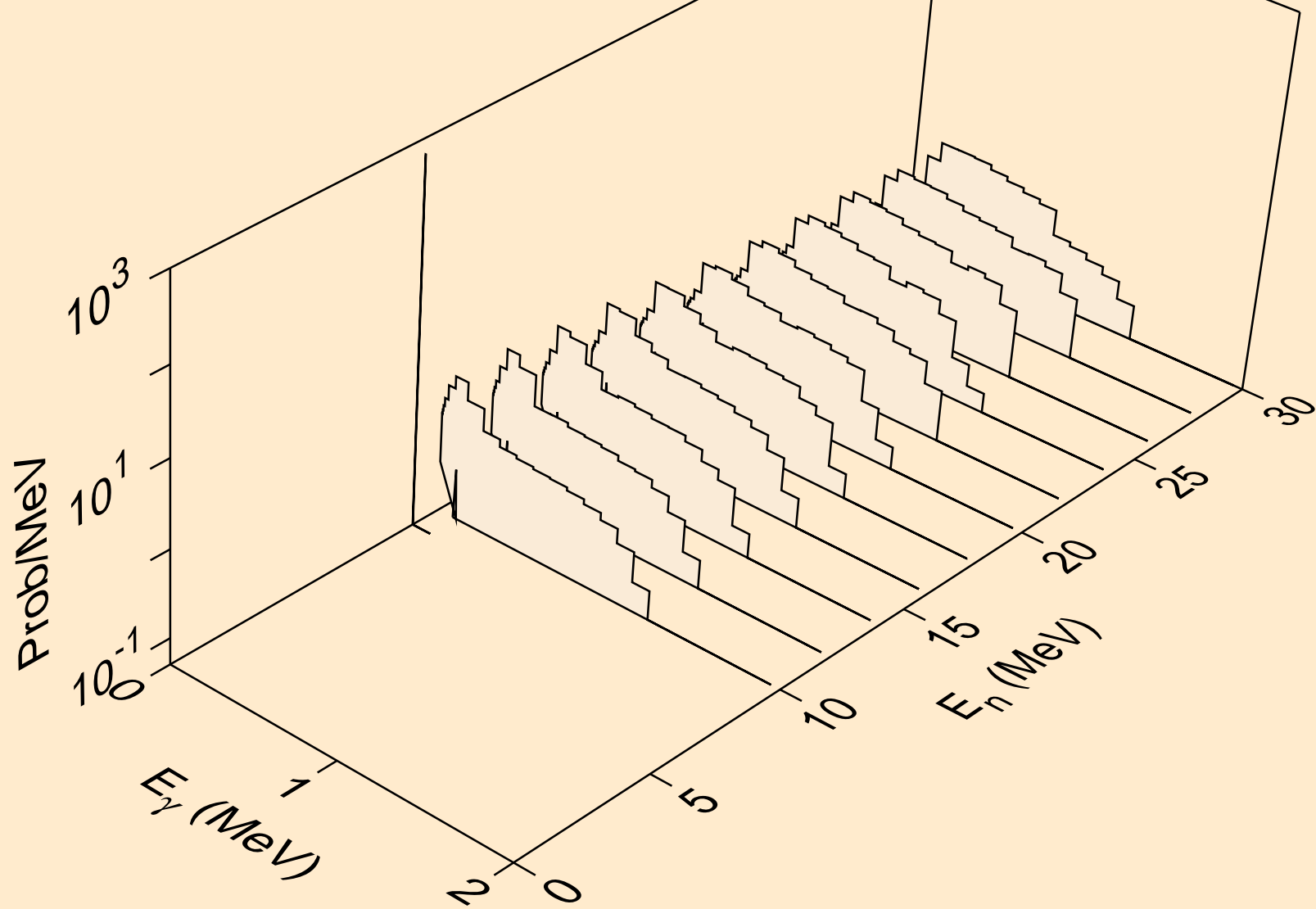

RF266 PROTON ACER TENDL-2021 LIBRARY; T=0.K
Photon emission for (n,t)

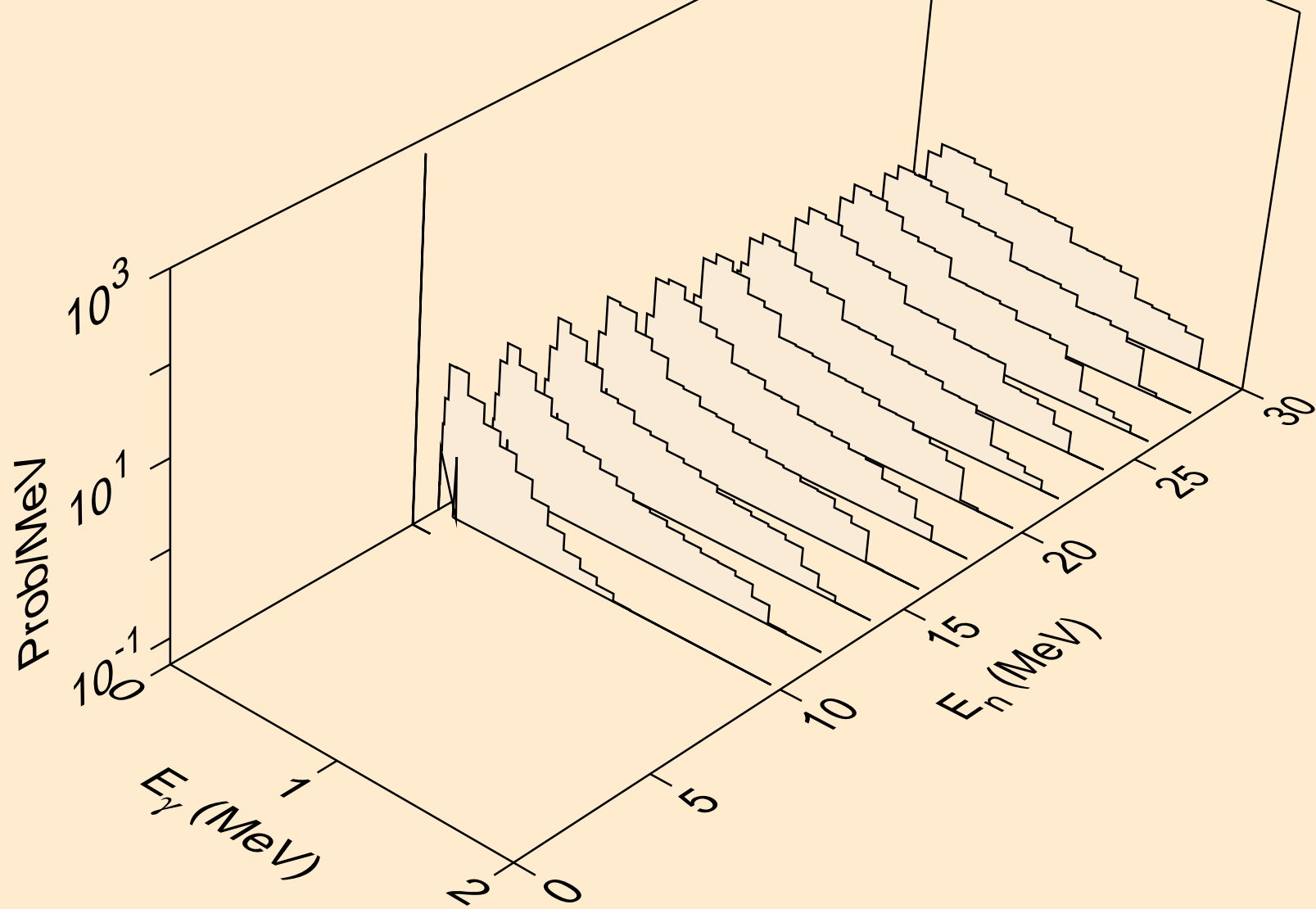

RF266 PROTON ACER TENDL-2021 LIBRARY; T=0.K
Photon emission for (n,he3)

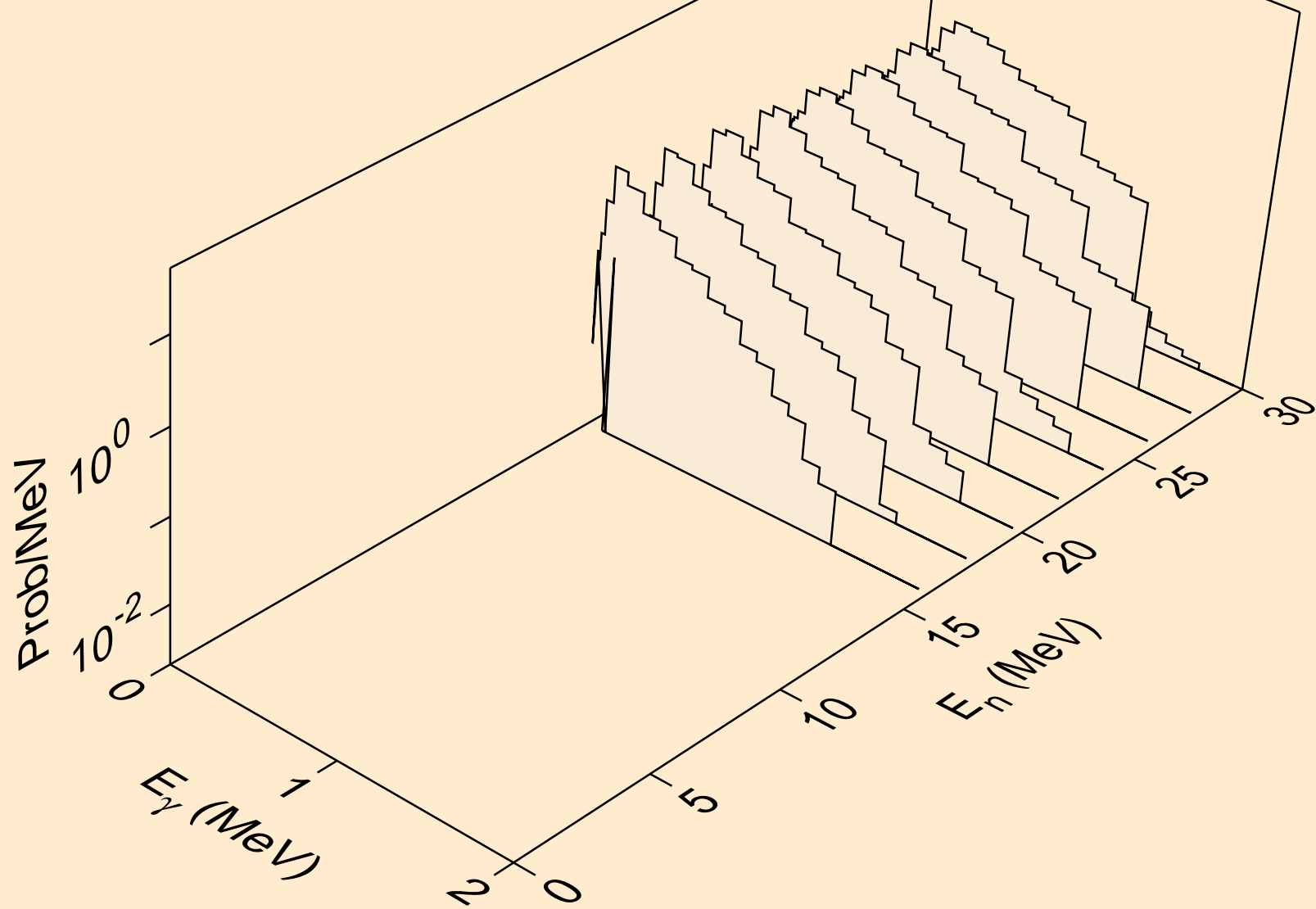

RF266 PROTON ACER TENDL-2021 LIBRARY; T=0.K
Photon emission for (n,a)

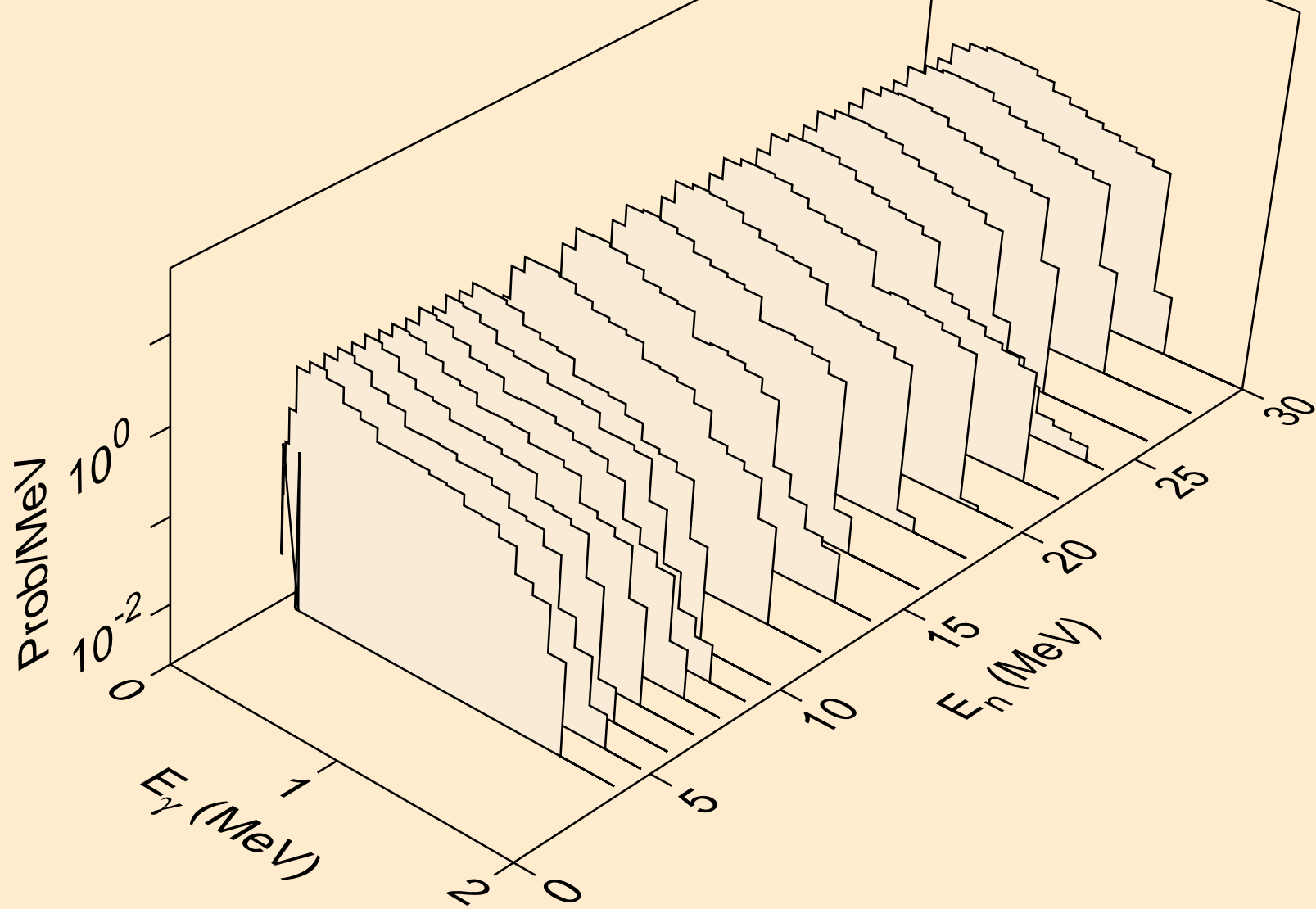

RF266 PROTON ACER TENDL-2021 LIBRARY; T=0.K
Photon emission for (n,2p)

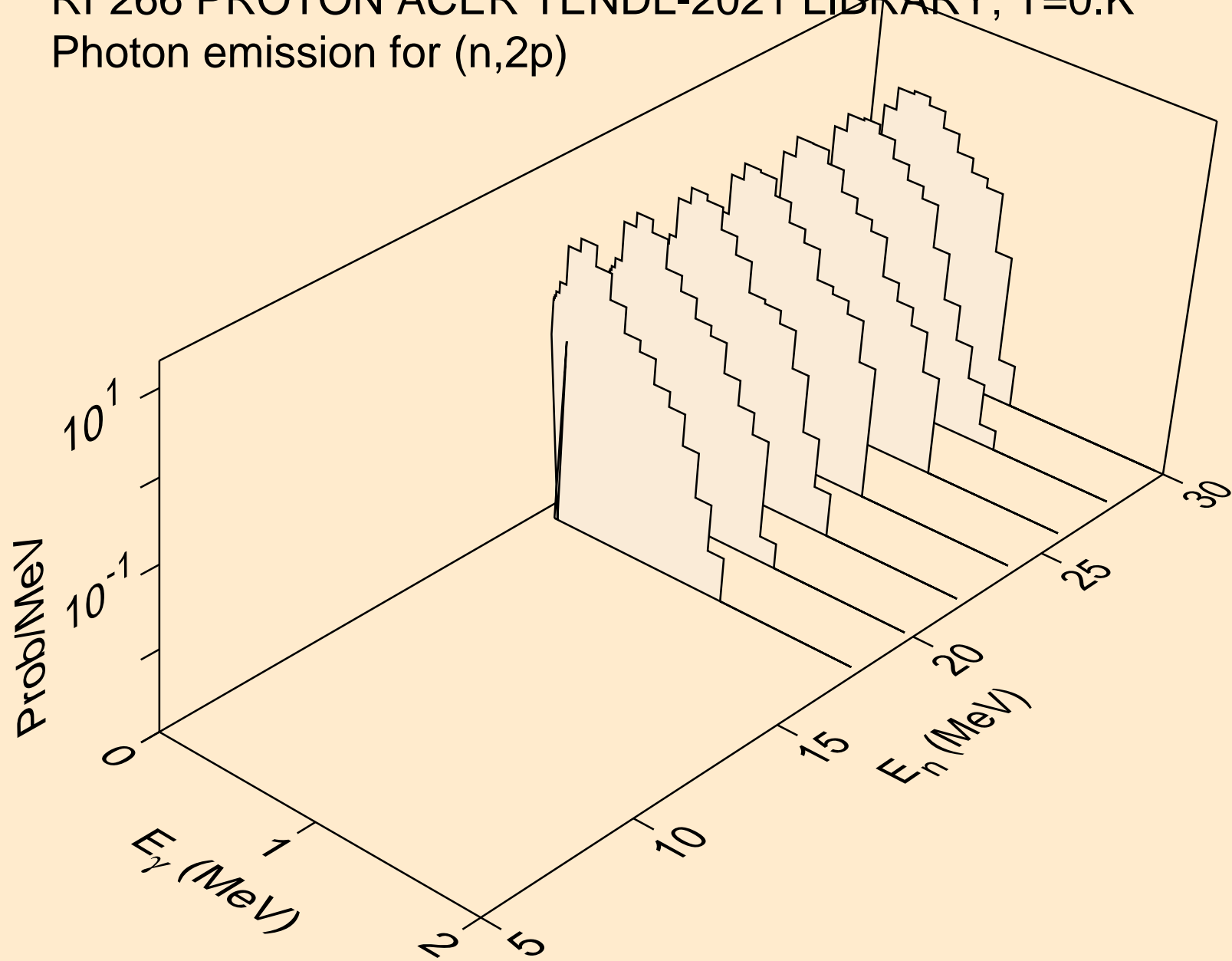

RF266 PROTON ACER TENDL-2021 LIBRARY; T=0.K
Particle heating contributions

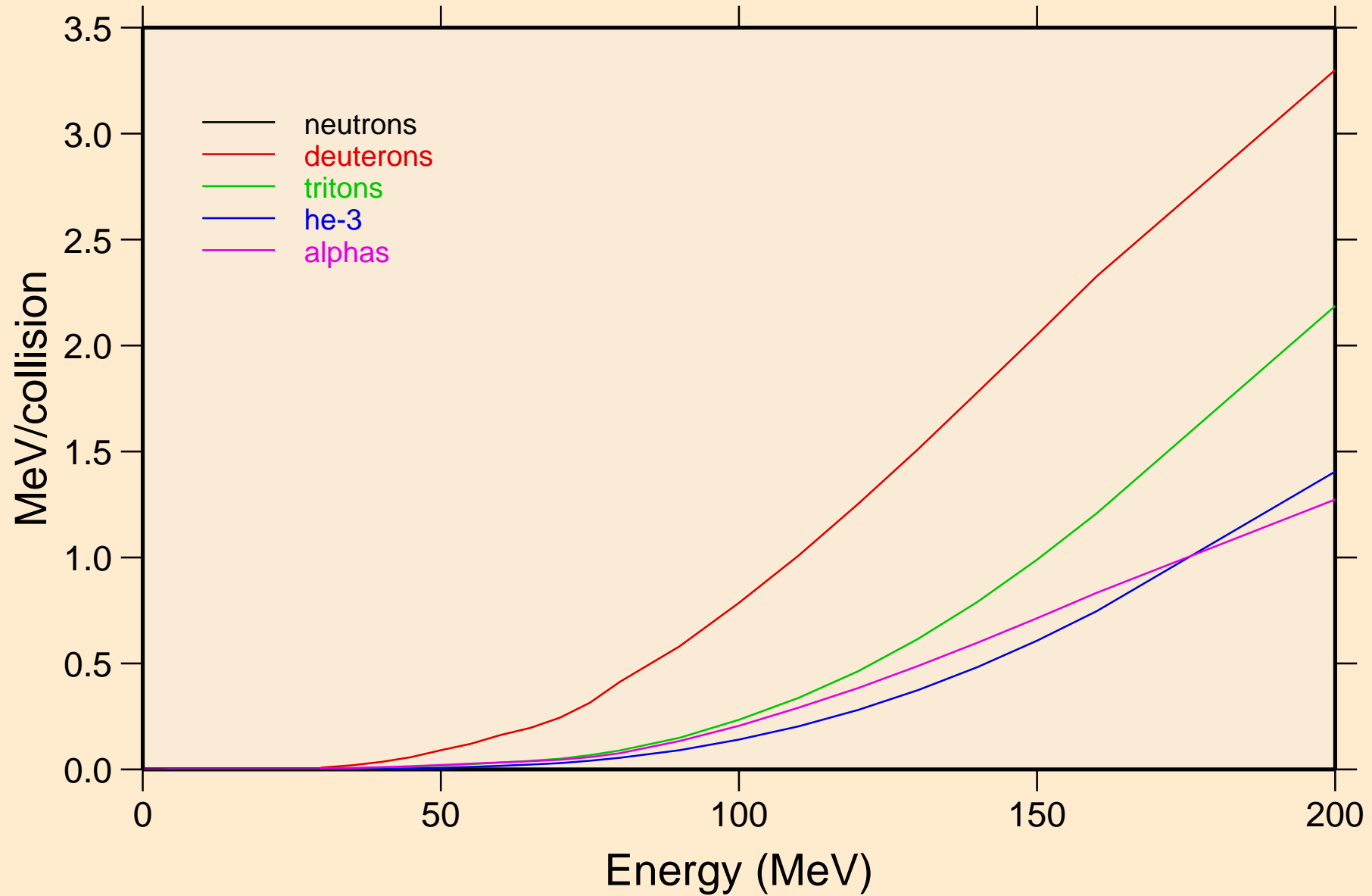

RF266 PROTON ACER TENDL-2021 LIBRARY; T=0.K
Recoil Heating

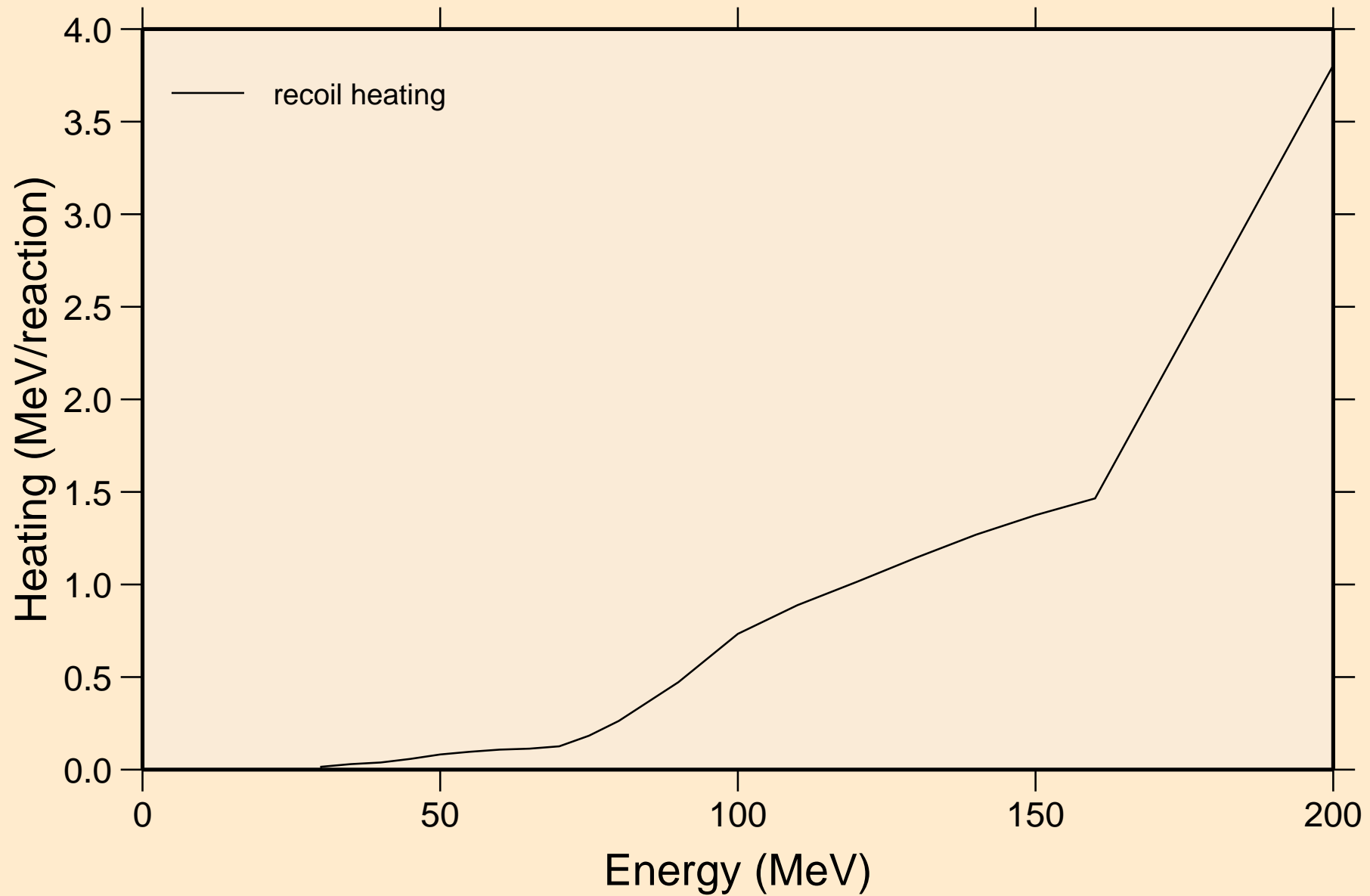

RF266 PROTON ACER TENDL-2021 LIBRARY; T=0.K
Particle production cross sections

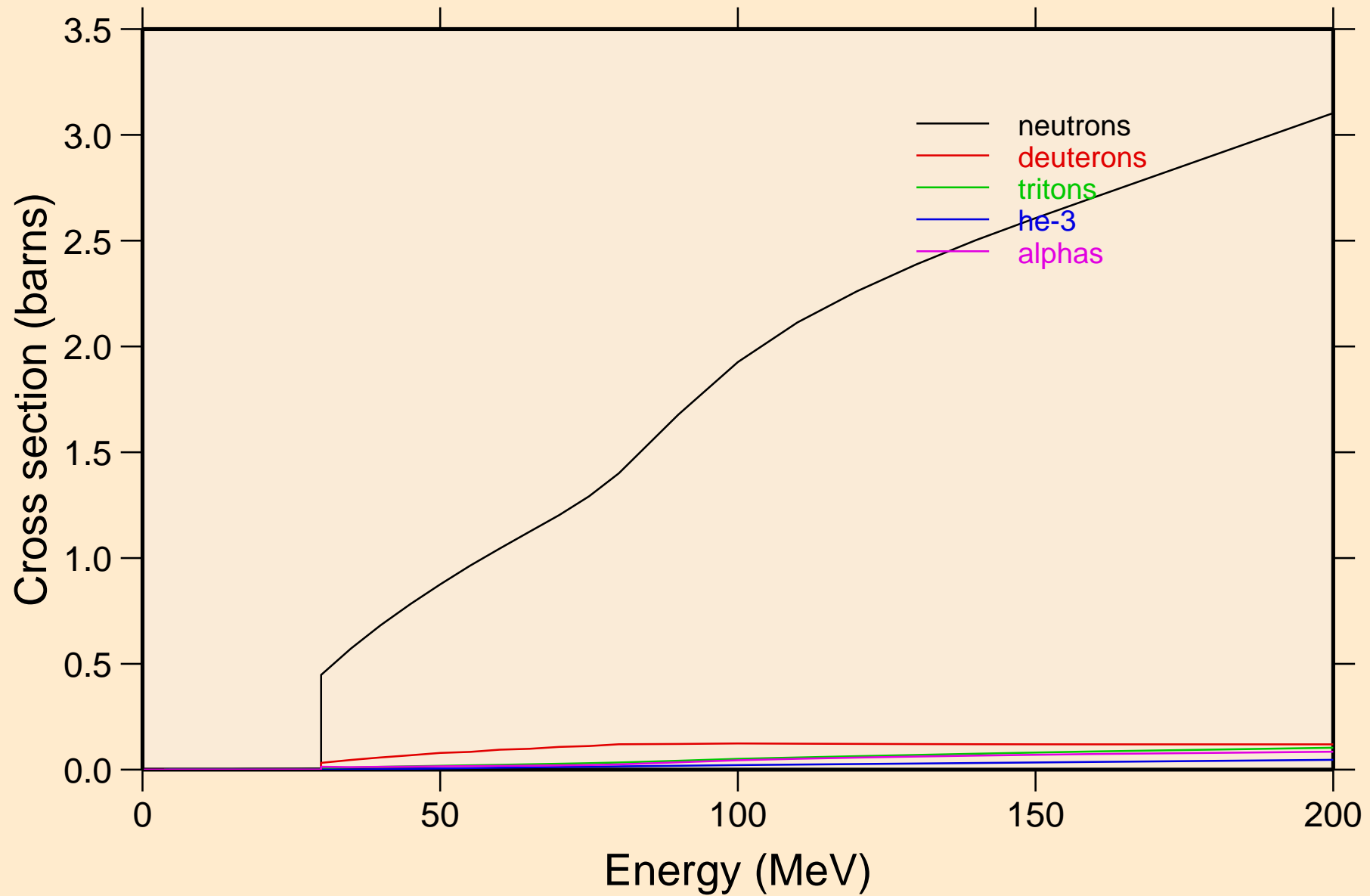

RF266 PROTON ACER TENDL-2021 LIBRARY; T=0.K
neutrons from (p,n)

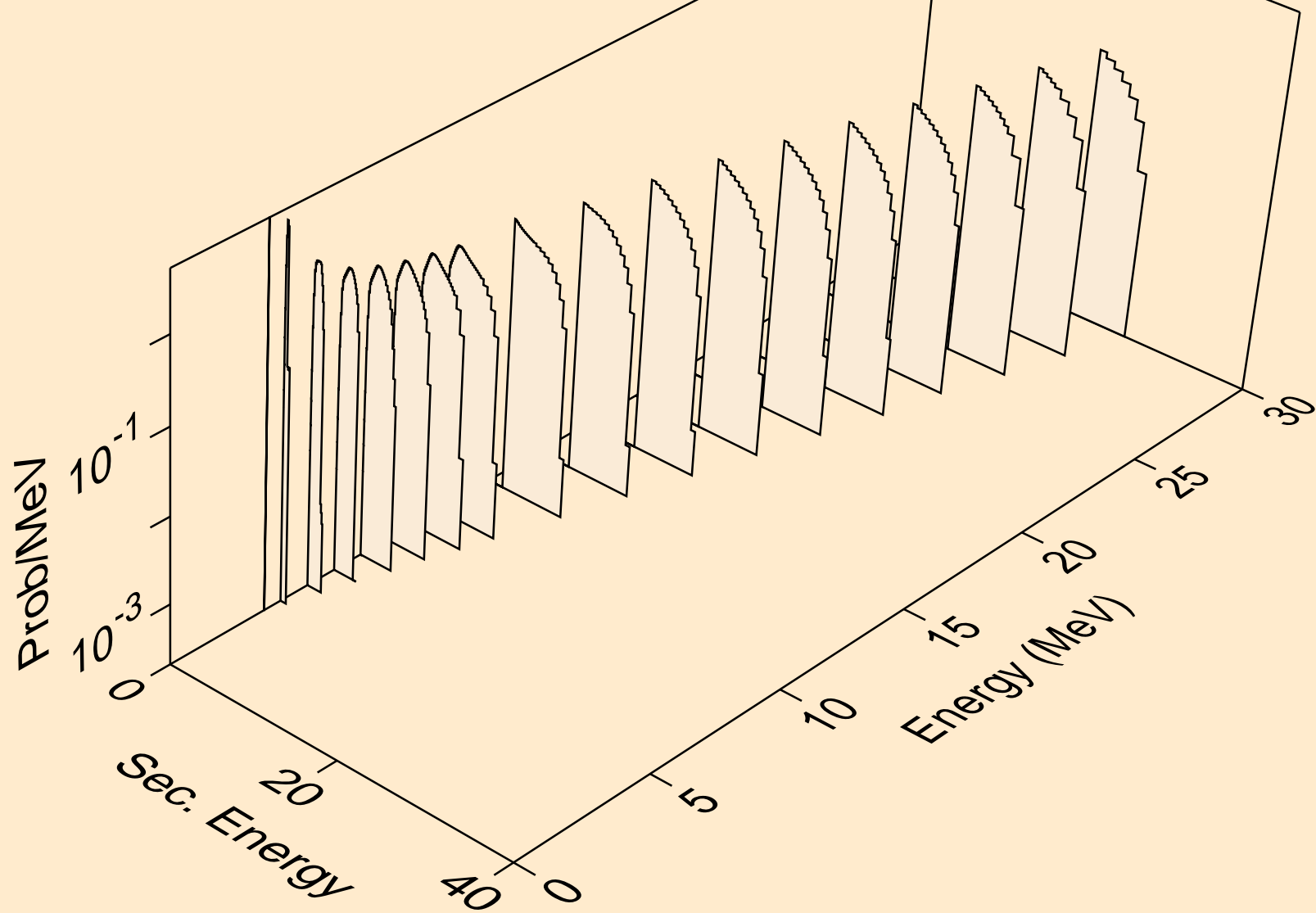

RF266 PROTON ACER TENDL-2021 LIBRARY; T=0.K
neutrons from (p,x)

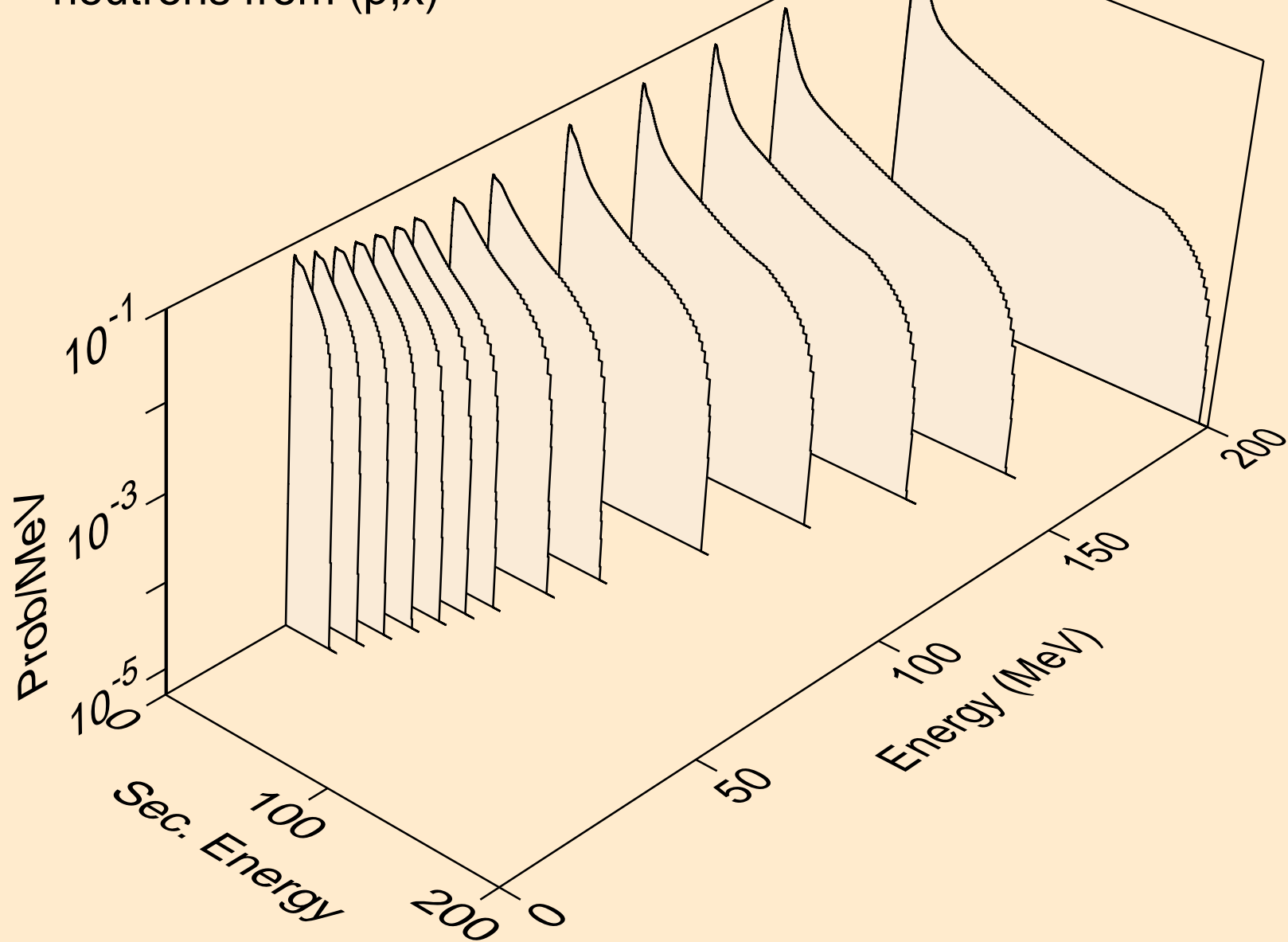

RF266 PROTON ACER TENDL-2021 LIBRARY; T=0.K
neutrons from (p,2n)

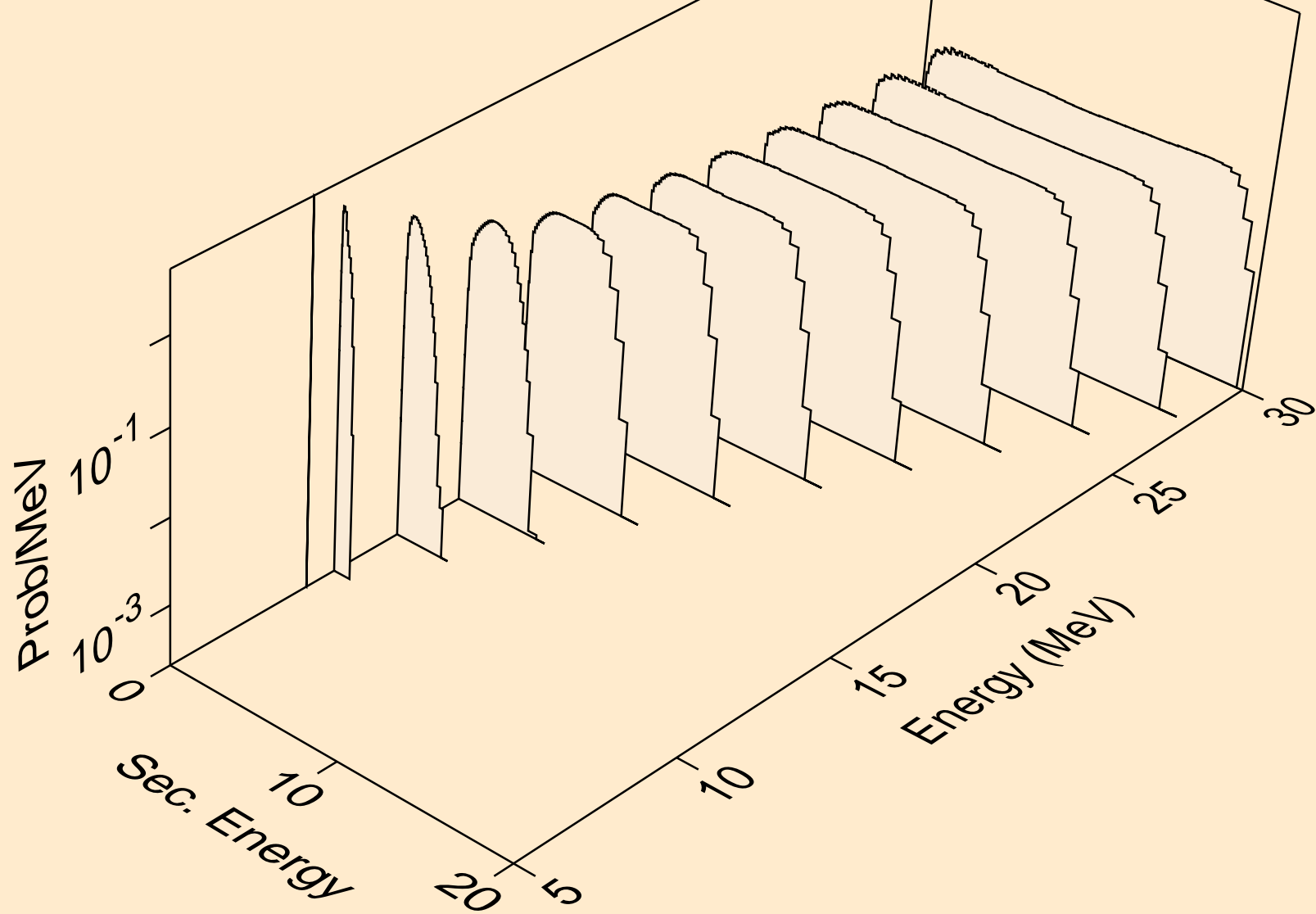

RF266 PROTON ACER TENDL-2021 LIBRARY; T=0.K
neutrons from (p,3n)

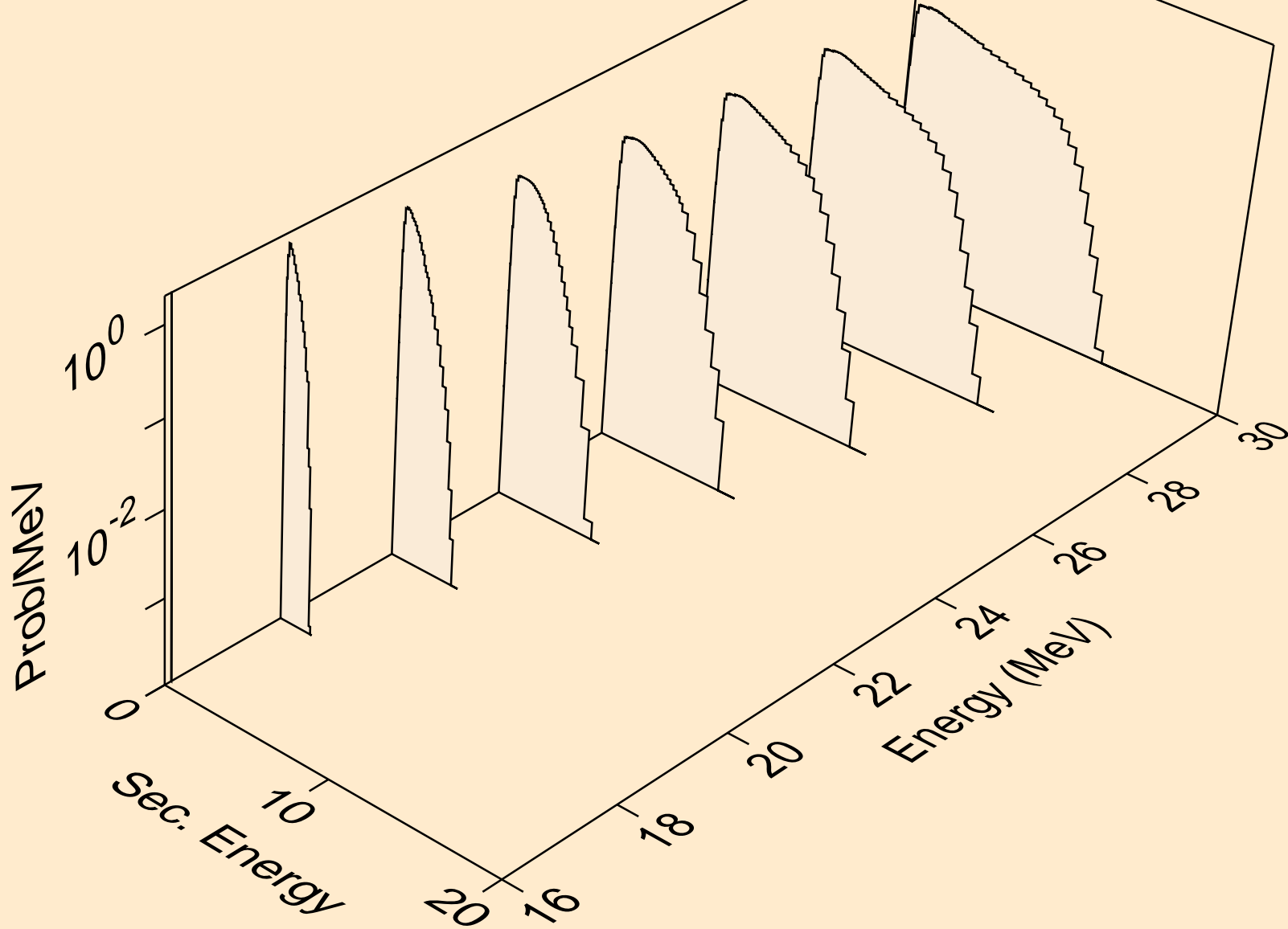

RF266 PROTON ACER TENDL-2021 LIBRARY; T=0.K
neutrons from (p,n*)a

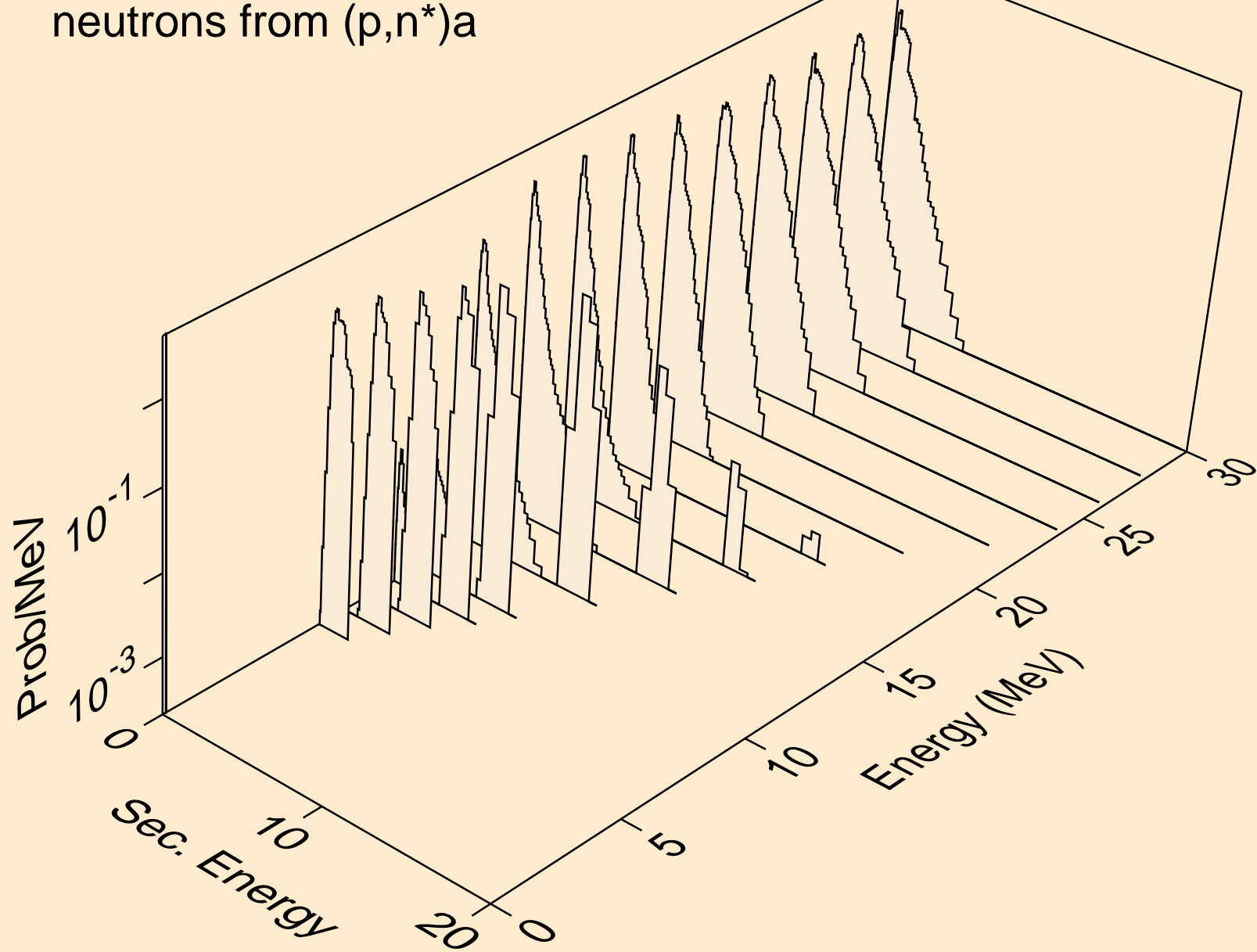

RF266 PROTON ACER TENDL-2021 LIBRARY; T=0.K
neutrons from (p,n*)p

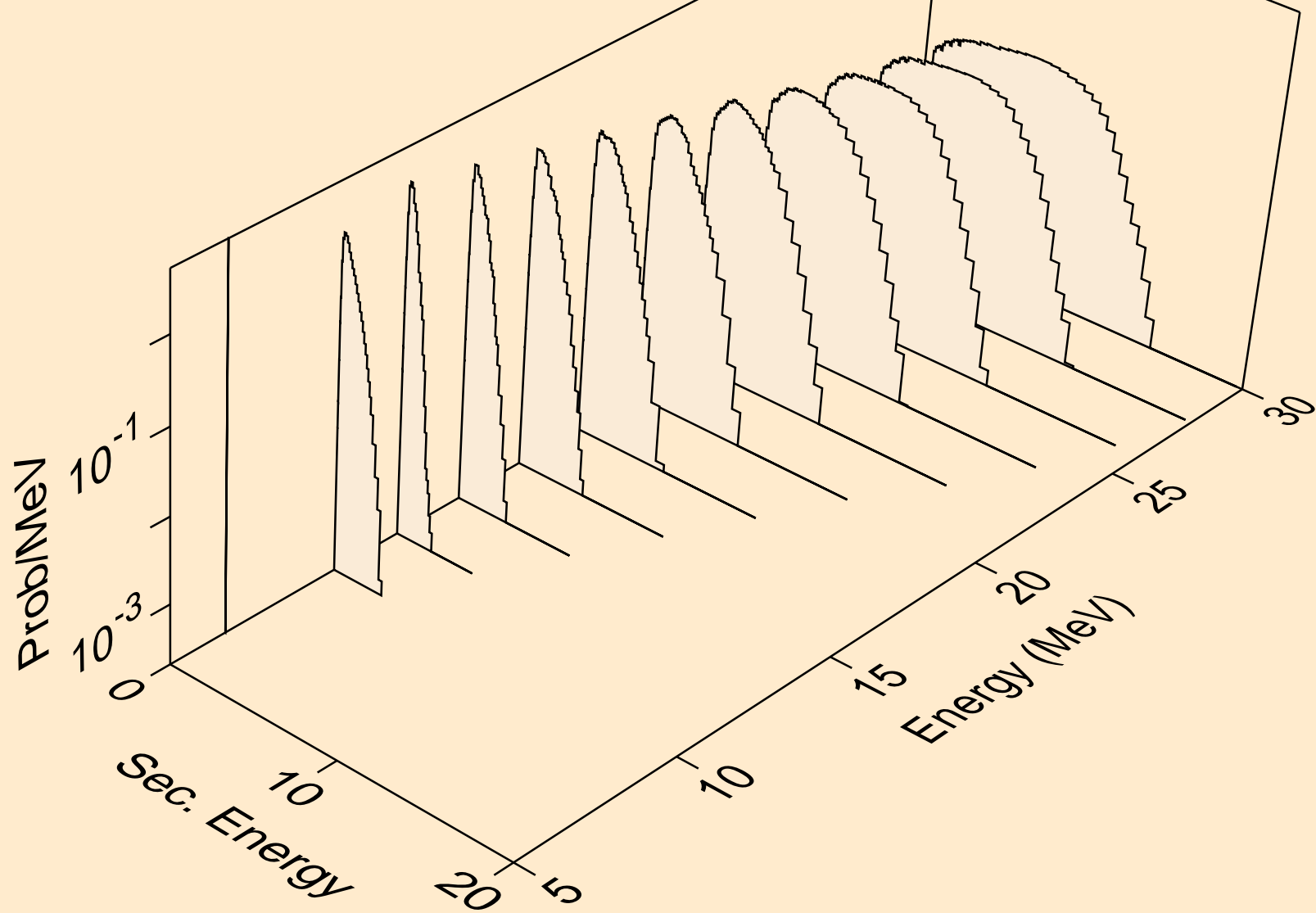

RF266 PROTON ACER TENDL-2021 LIBRARY; T=0.K
neutrons from (p,n*)d

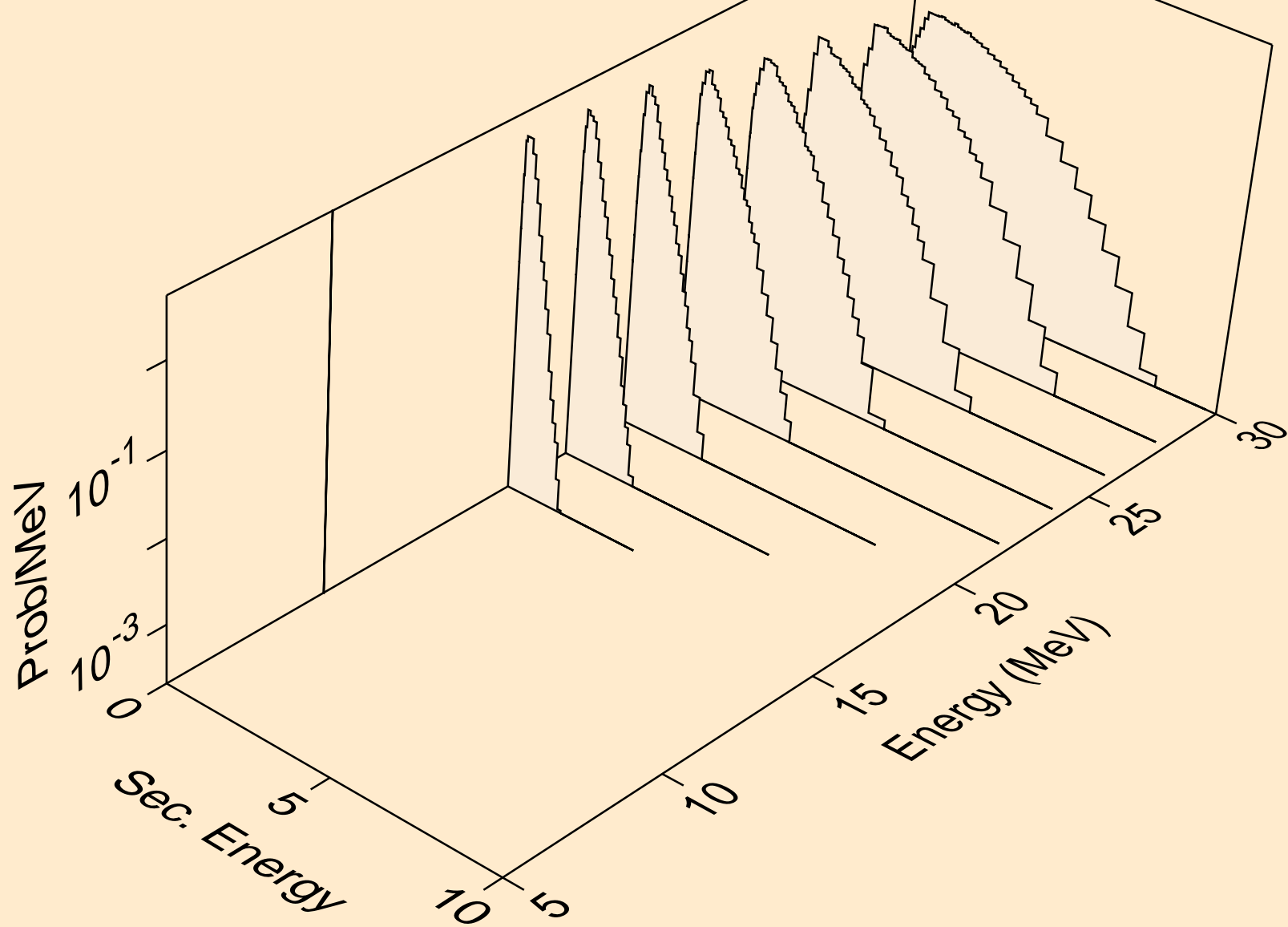

RF266 PROTON ACER TENDL-2021 LIBRARY; T=0.K
neutrons from (p,n*)t

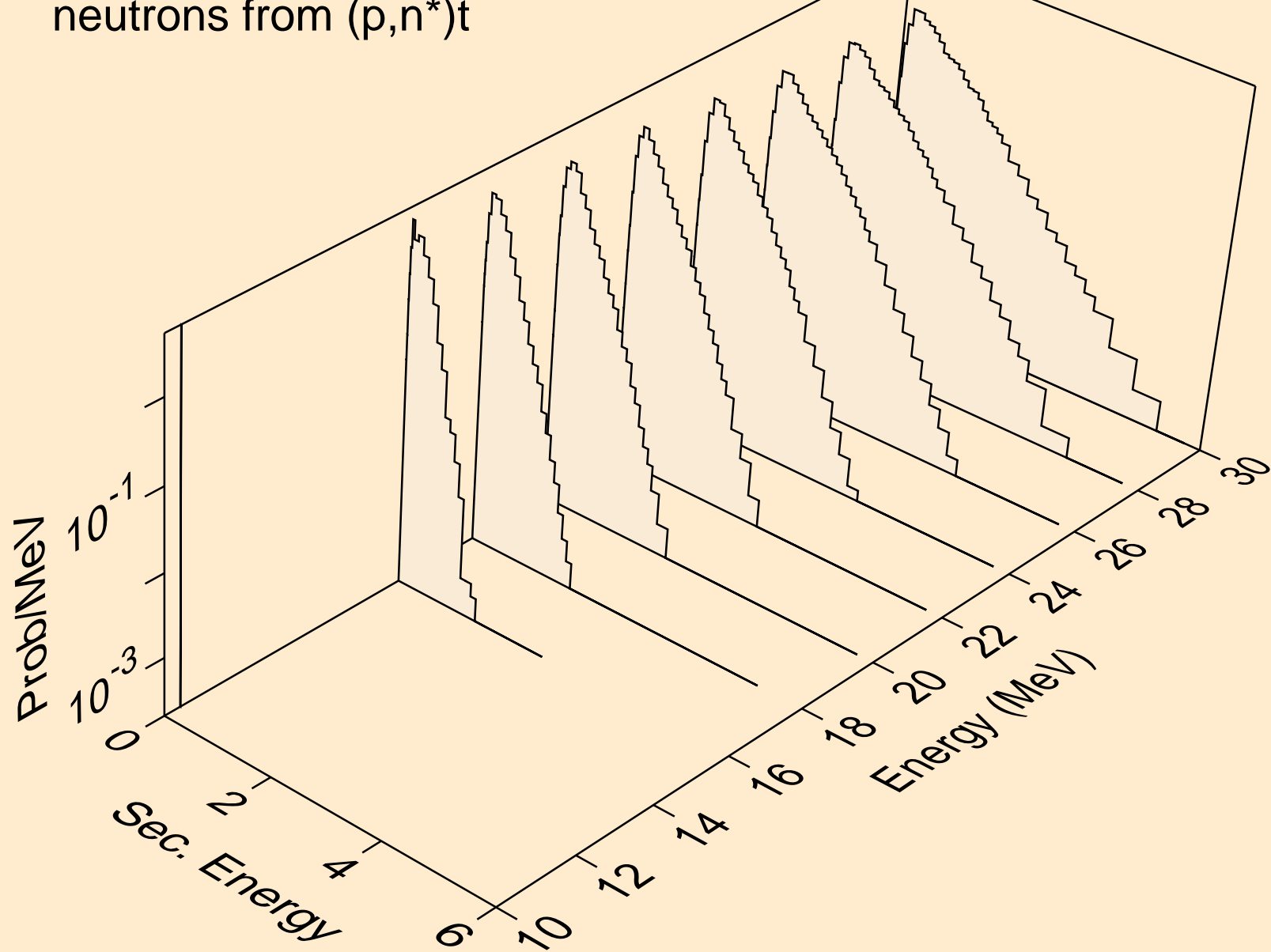

RF266 PROTON ACER TENDL-2021 LIBRARY; T=0.K
neutrons from (p,2np)

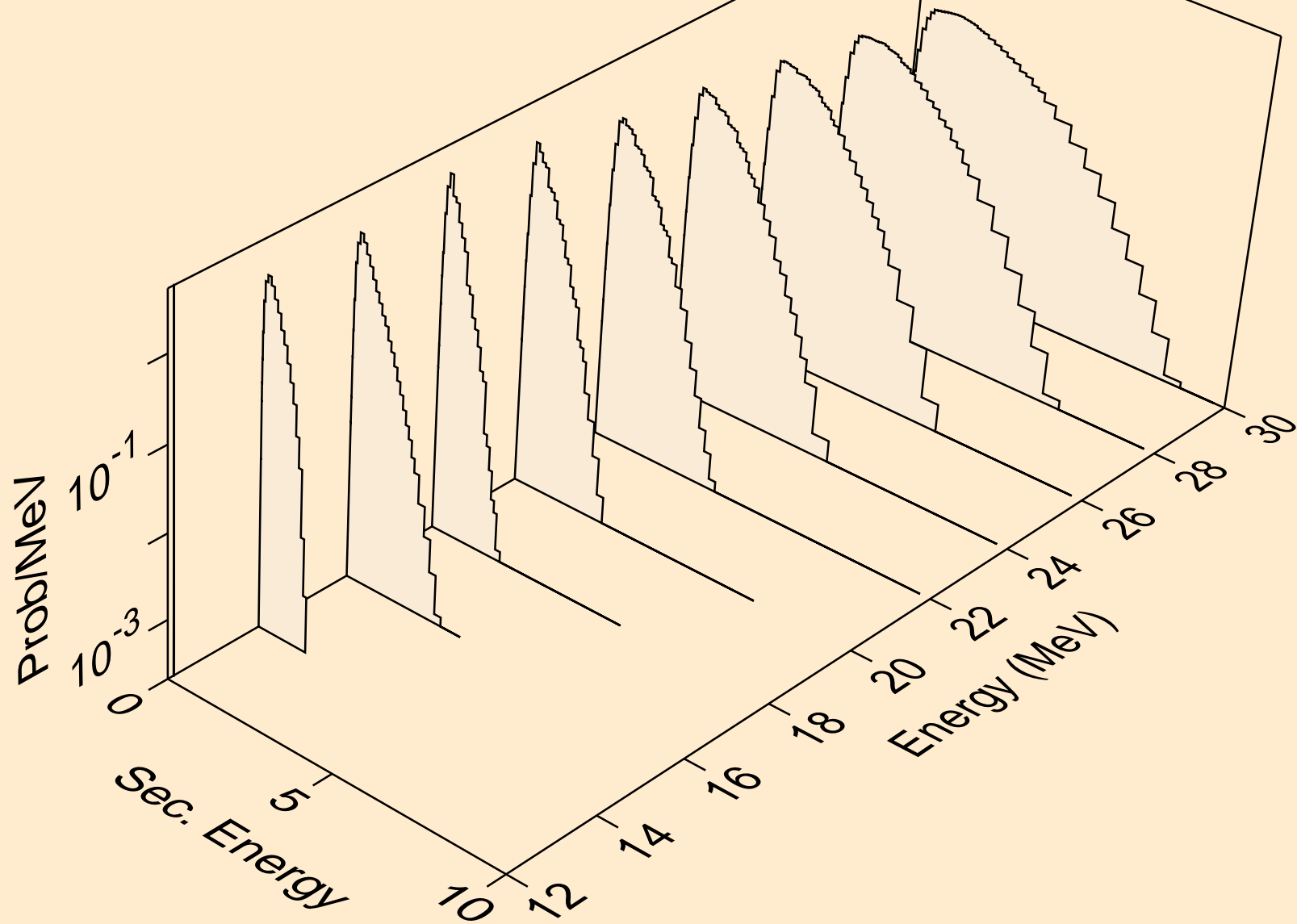

RF266 PROTON ACER TENDL-2021 LIBRARY; T=0.K
deuterons from (p,x)

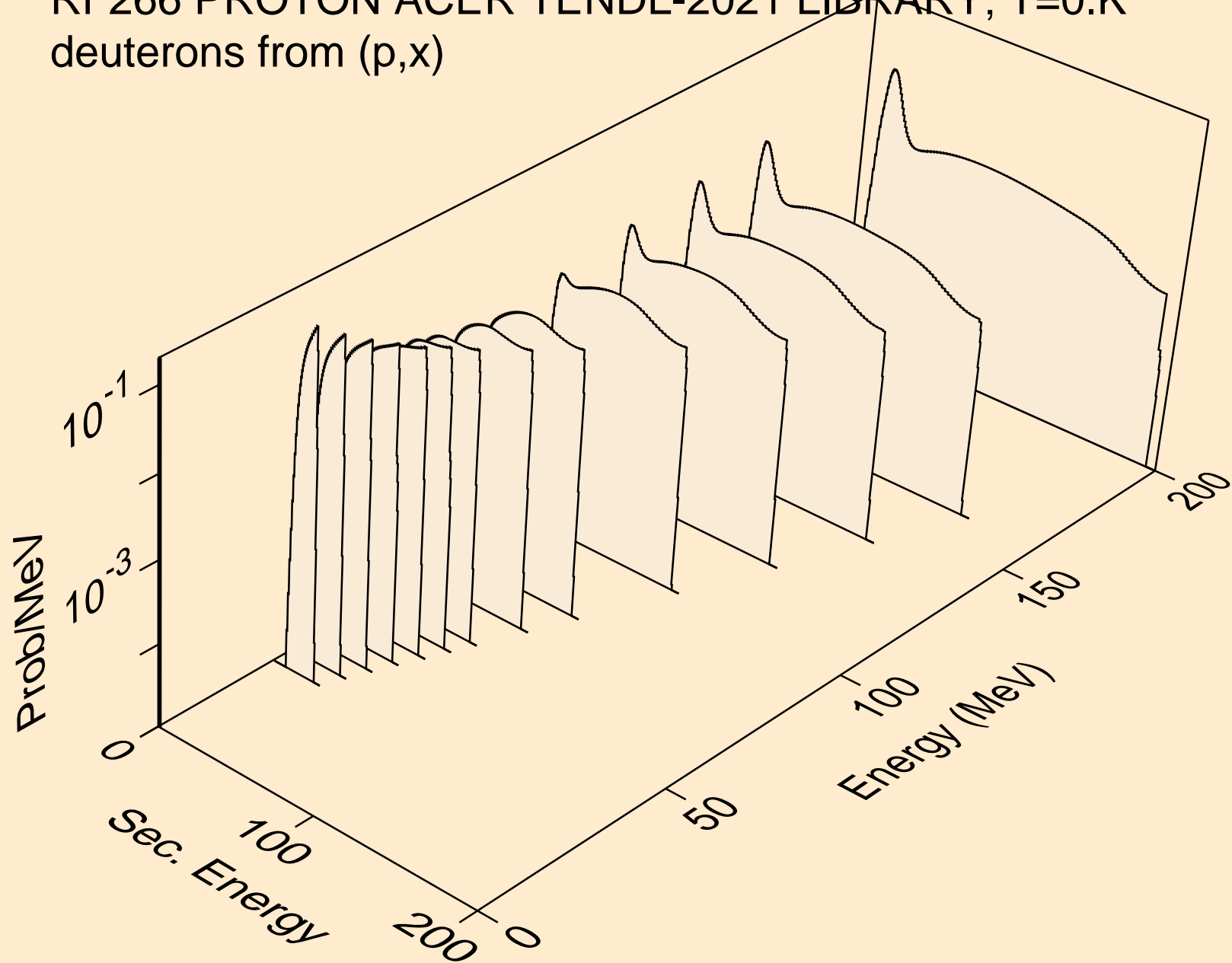

RF266 PROTON ACER TENDL-2021 LIBRARY; T=0.K
deuterons from (p,n*)d

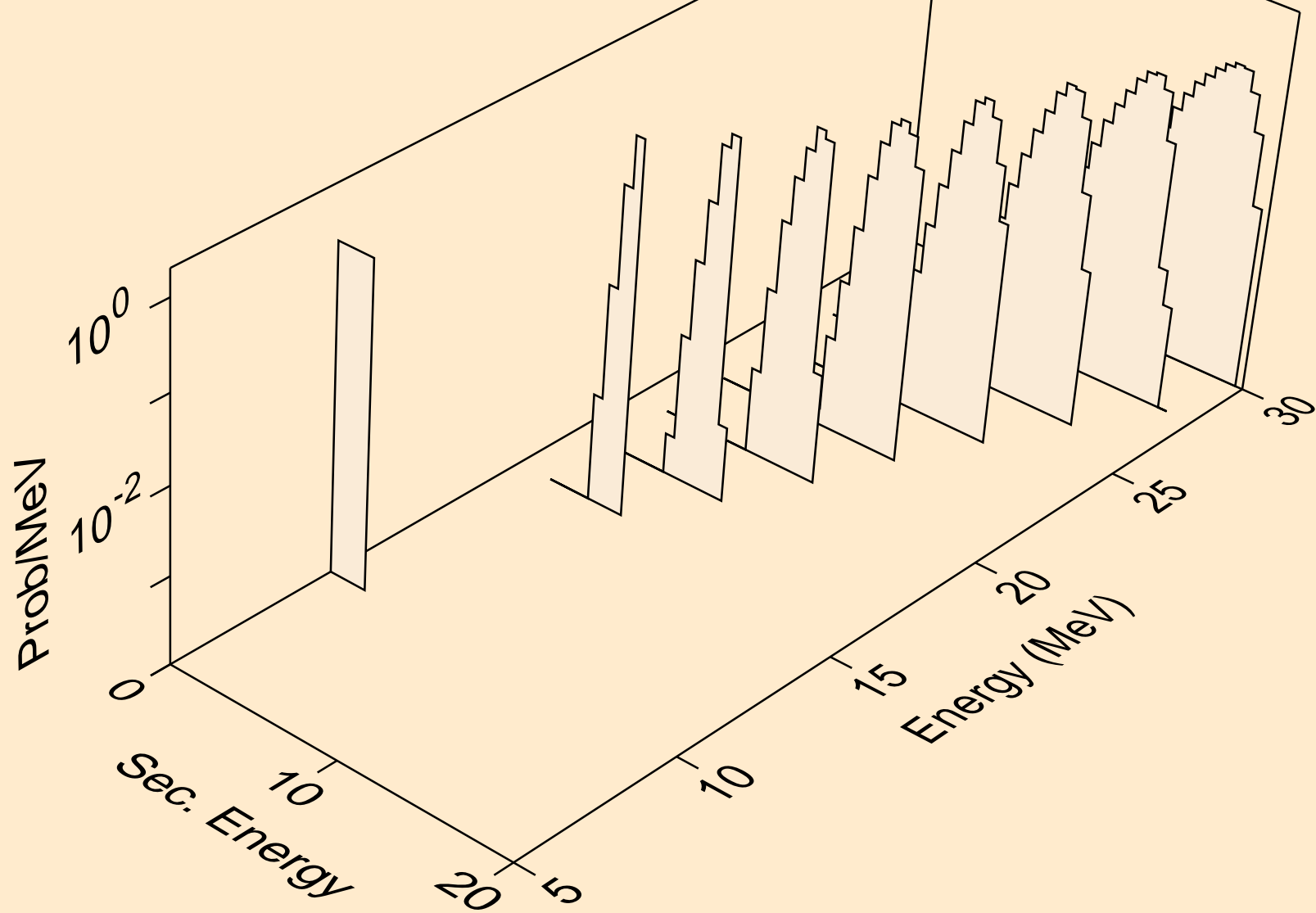

RF266 PROTON ACER TENDL-2021 LIBRARY; T=0.K
deuterons from (p,d)

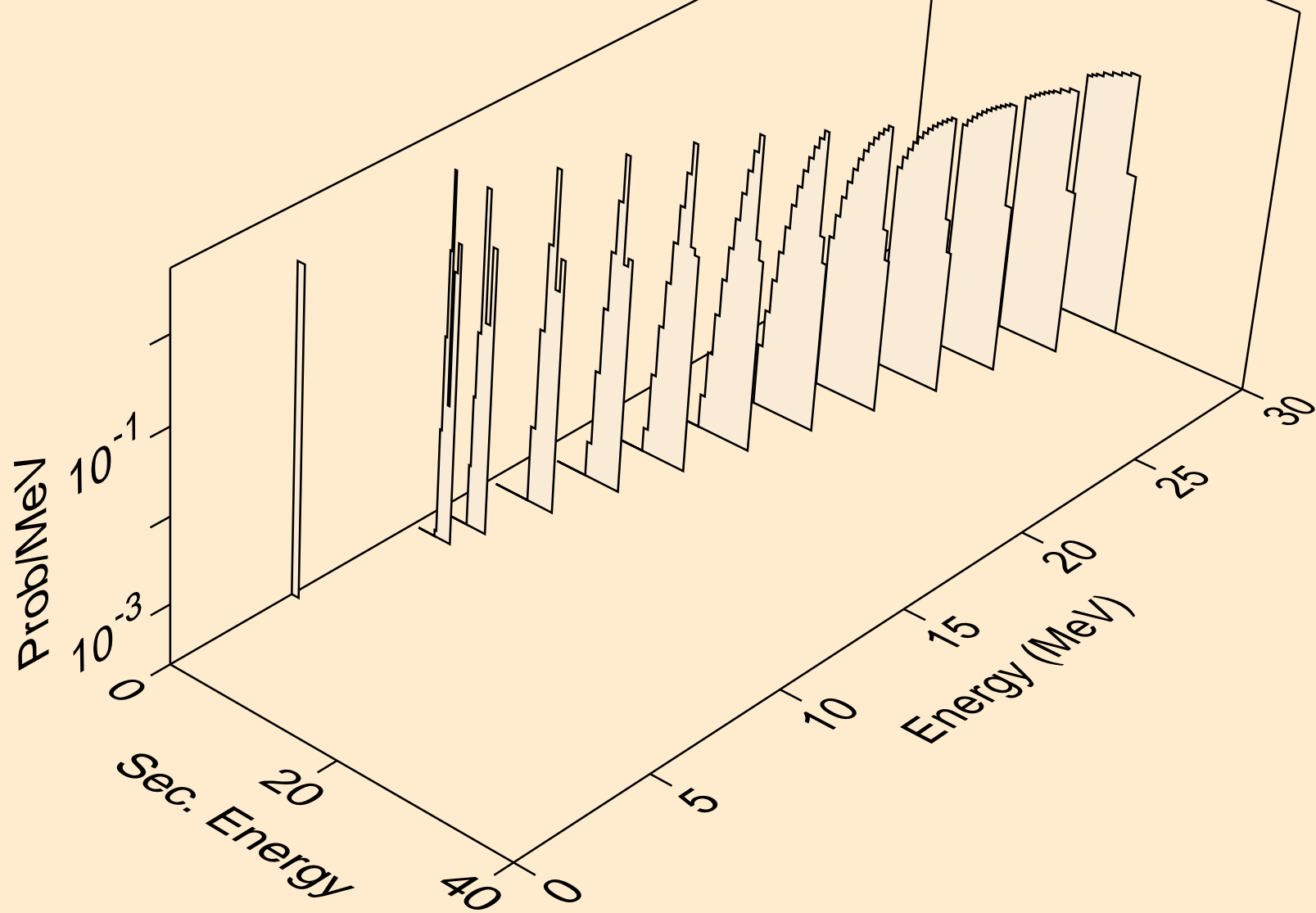

RF266 PROTON ACER TENDL-2021 LIBRARY; T=0.K
tritons from (p,x)

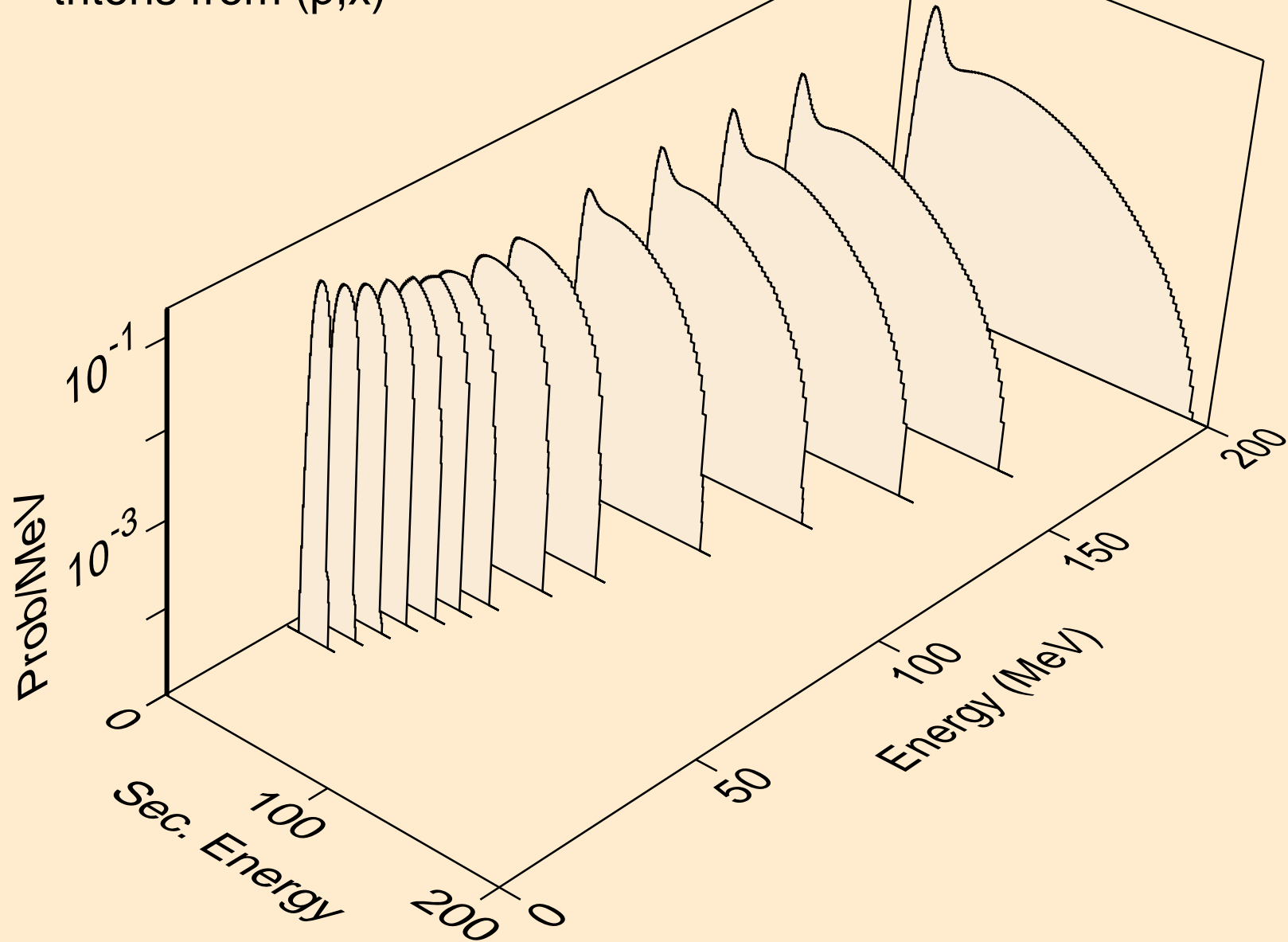

RF266 PROTON ACER TENDL-2021 LIBRARY; T=0.K
tritons from (p,n*)t

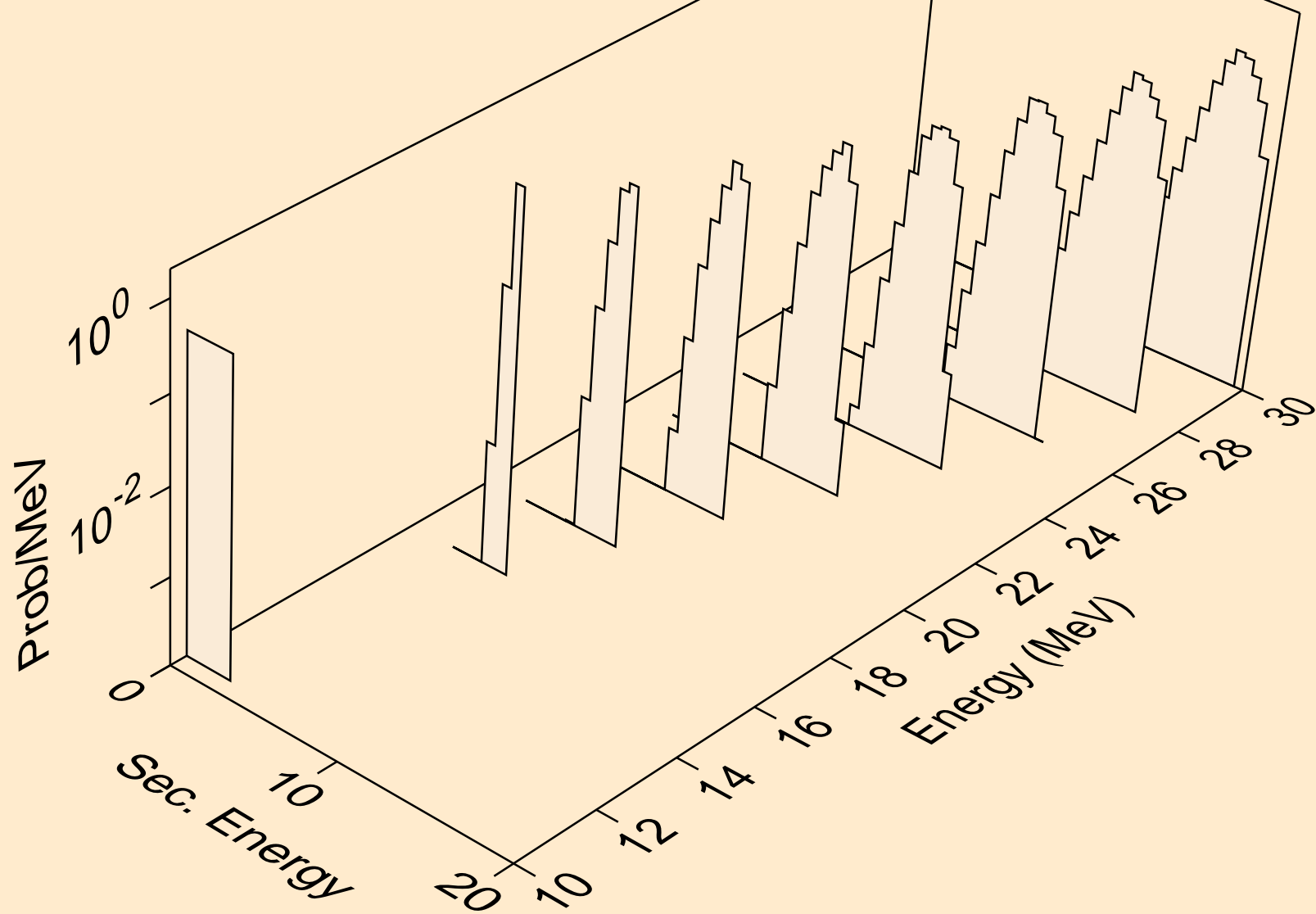

RF266 PROTON ACER TENDL-2021 LIBRARY; T=0.K
tritons from (p,t)

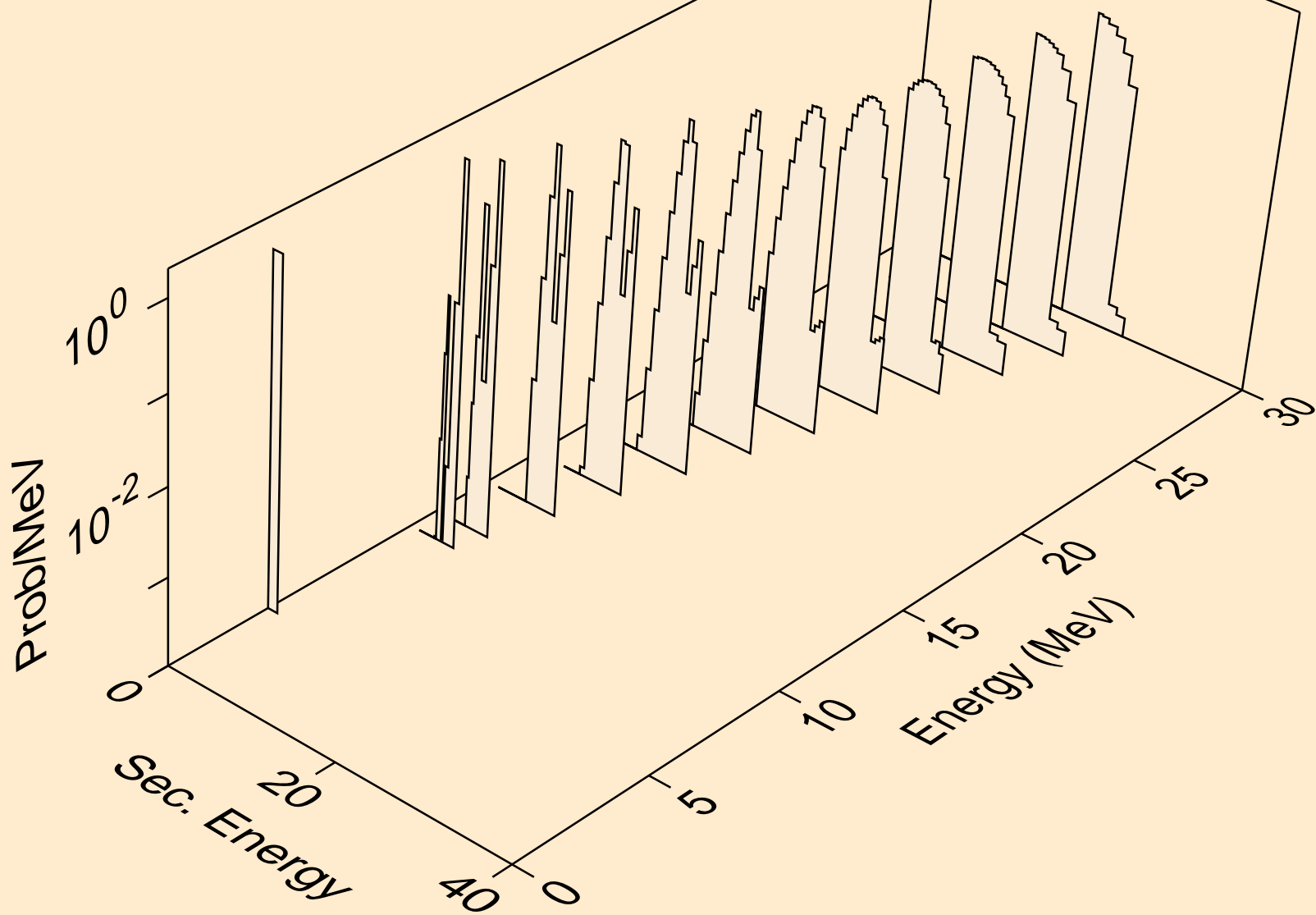

RF266 PROTON ACER TENDL-2021 LIBRARY; T=0.K
he3s from (p,x)

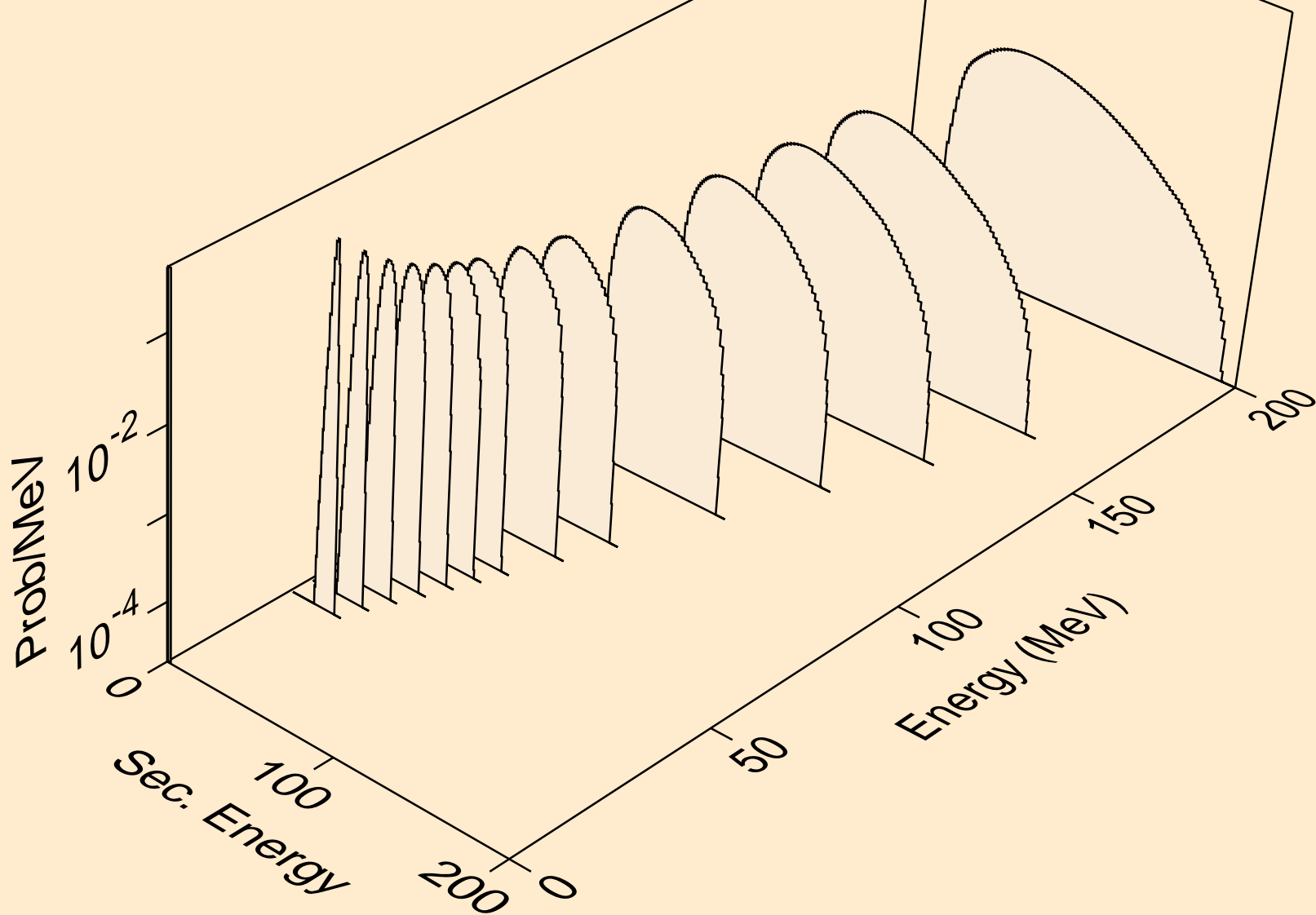

RF266 PROTON ACER TENDL-2021 LIBRARY; T=0.K
he3s from (p,he3)

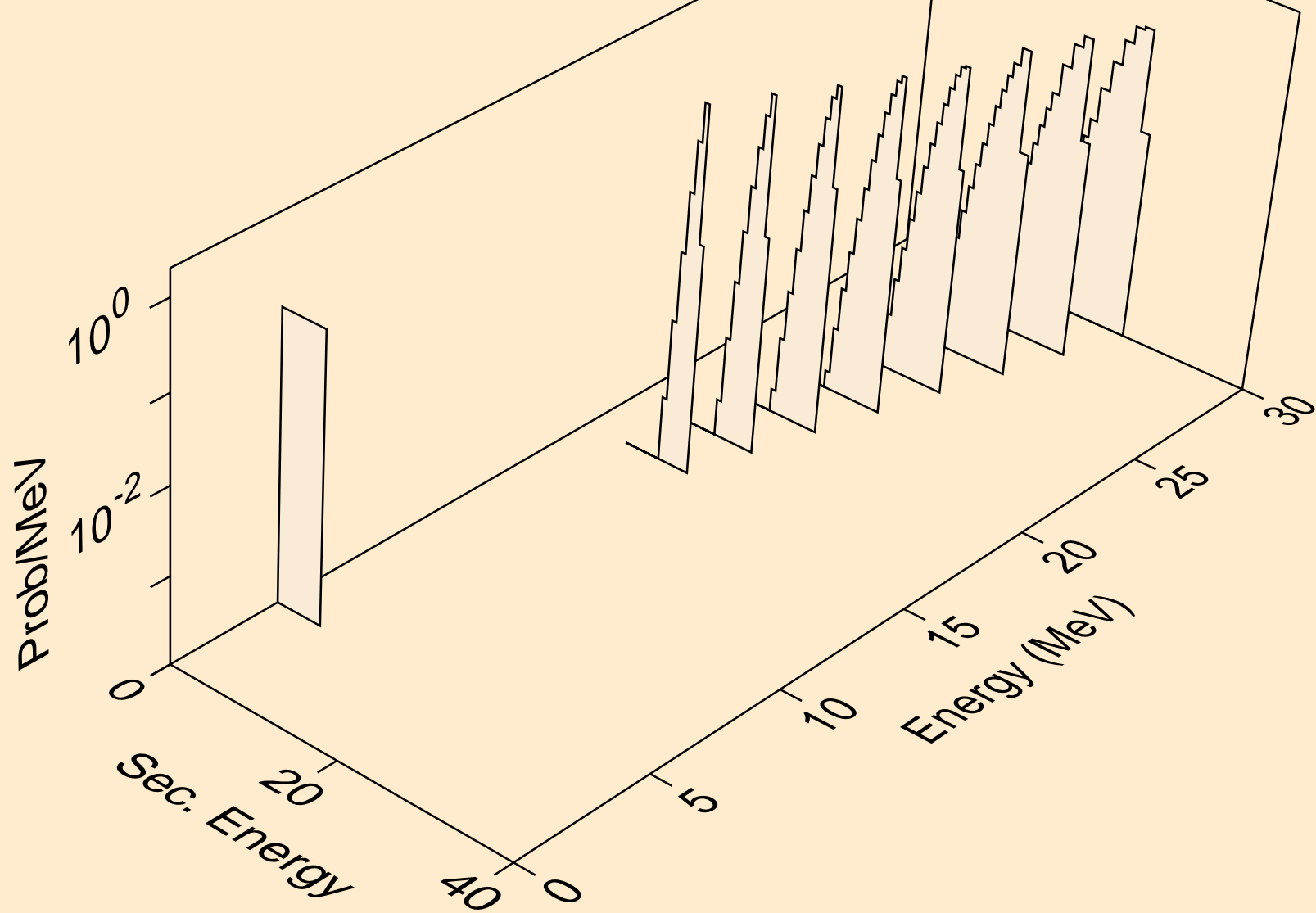

RF266 PROTON ACER TENDL-2021 LIBRARY; T=0.K
alphas from (p,x)

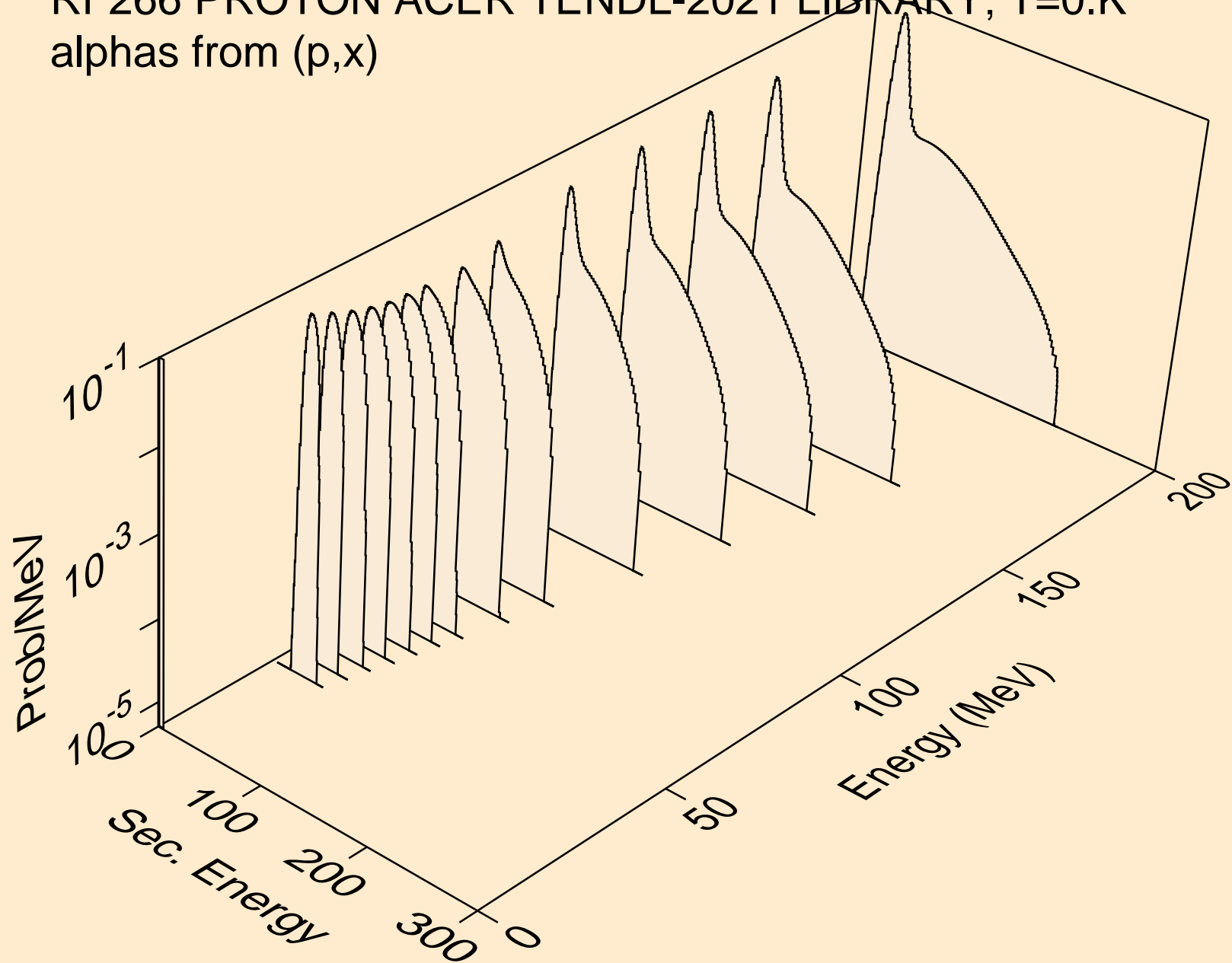

RF266 PROTON ACER TENDL-2021 LIBRARY; T=0.K
alphas from (p,n*)a

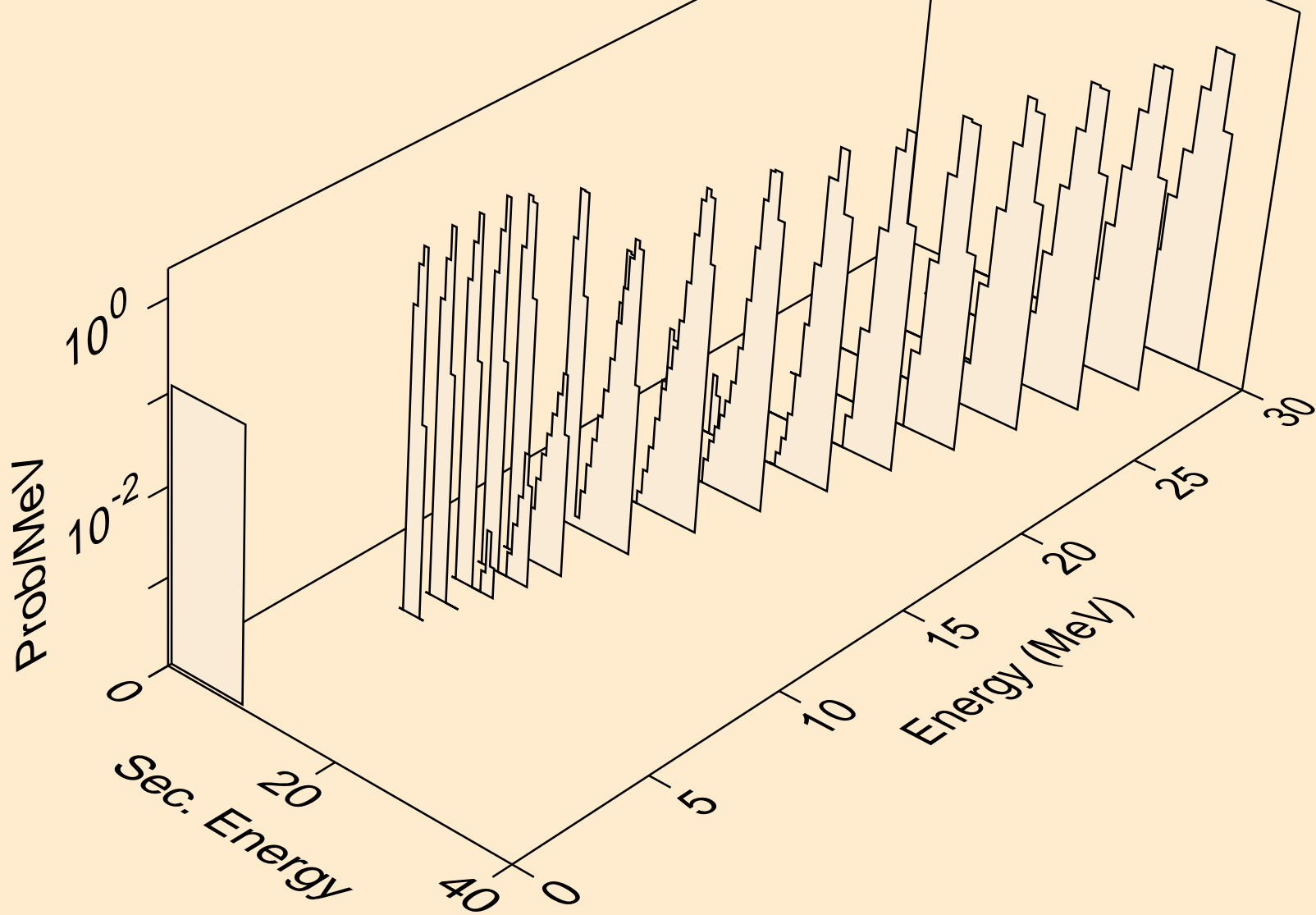

RF266 PROTON ACER TENDL-2021 LIBRARY; T=0.K
alphas from (p,a)

