

# RN224 PROTON ACER TENDL-2021 LIBRARY; T=0.K

## Principal cross sections

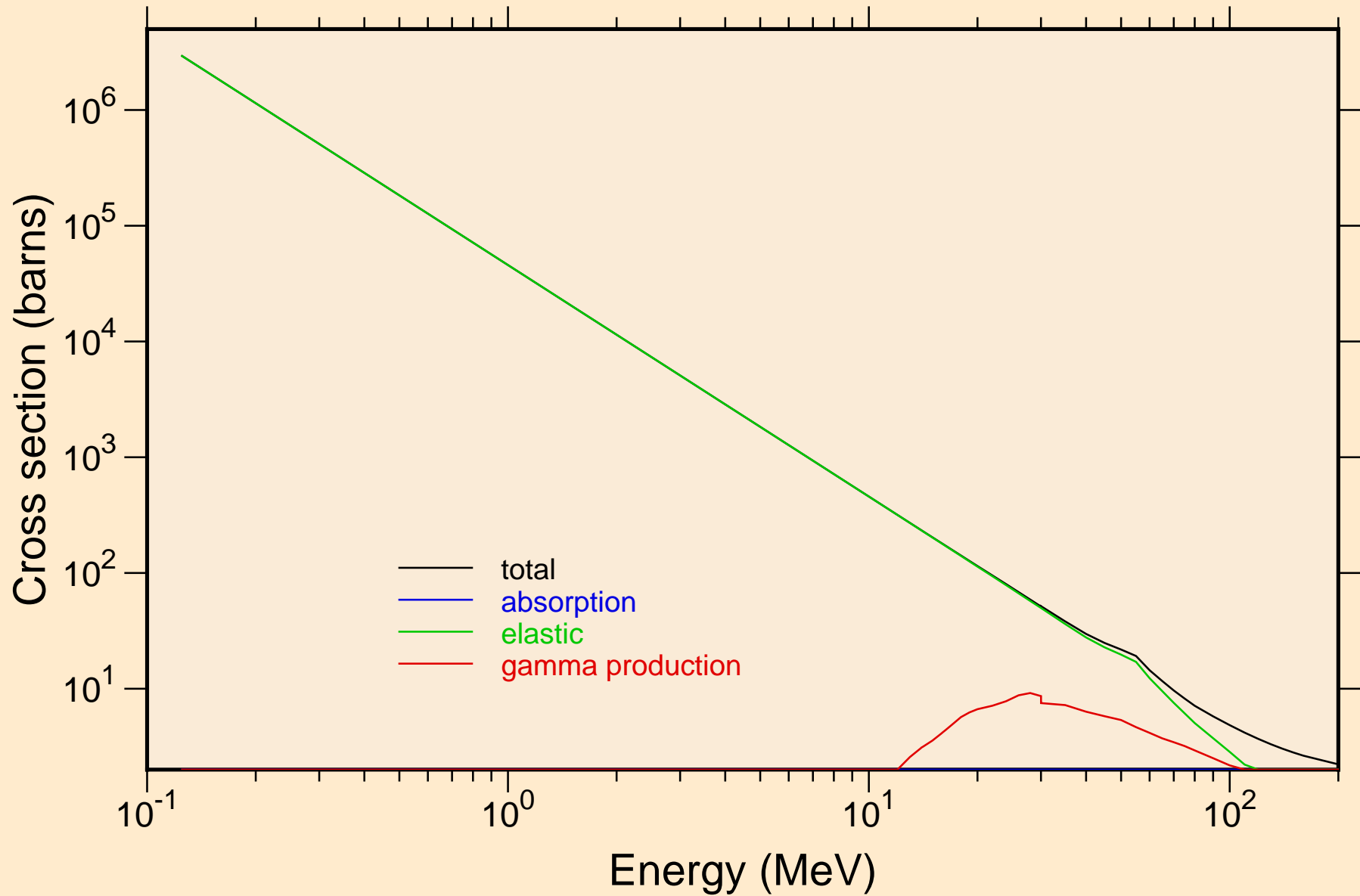

RN224 PROTON ACER TENDL-2021 LIBRARY; T=0.K  
Heating

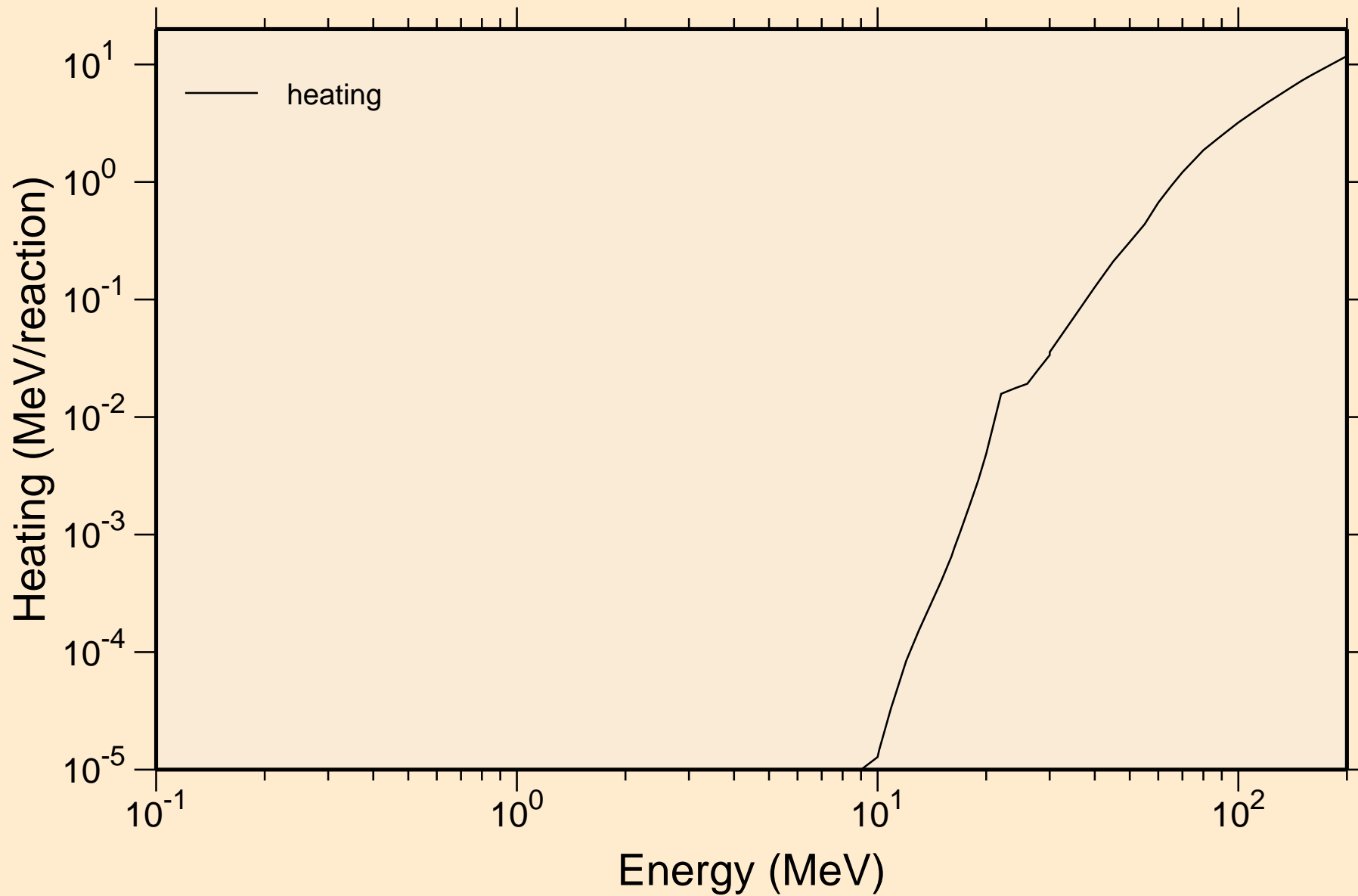

RN224 PROTON ACER TENDL-2021 LIBRARY; T=0.K  
Principal cross sections

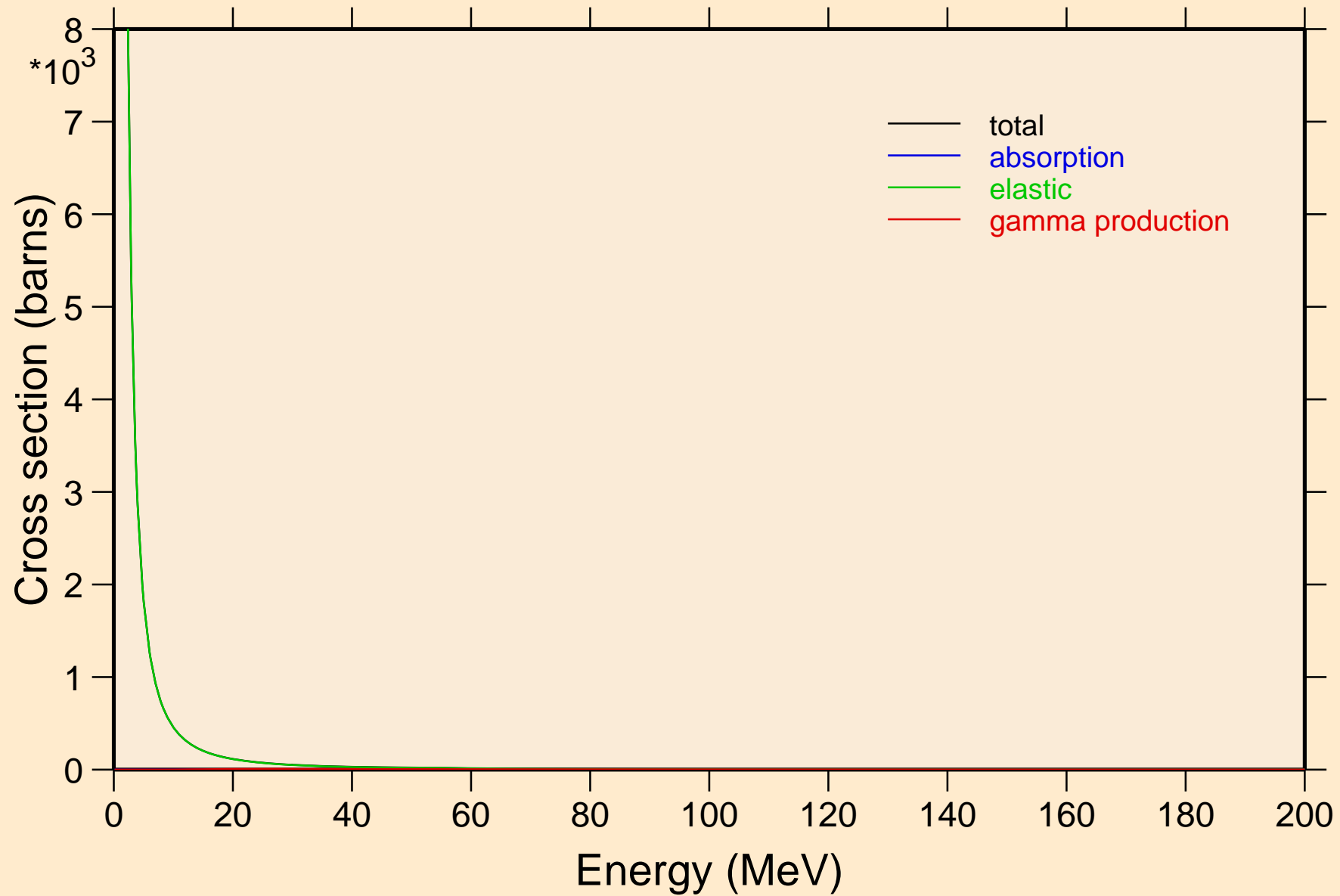

RN224 PROTON ACER TENDL-2021 LIBRARY; T=0.K

Heating

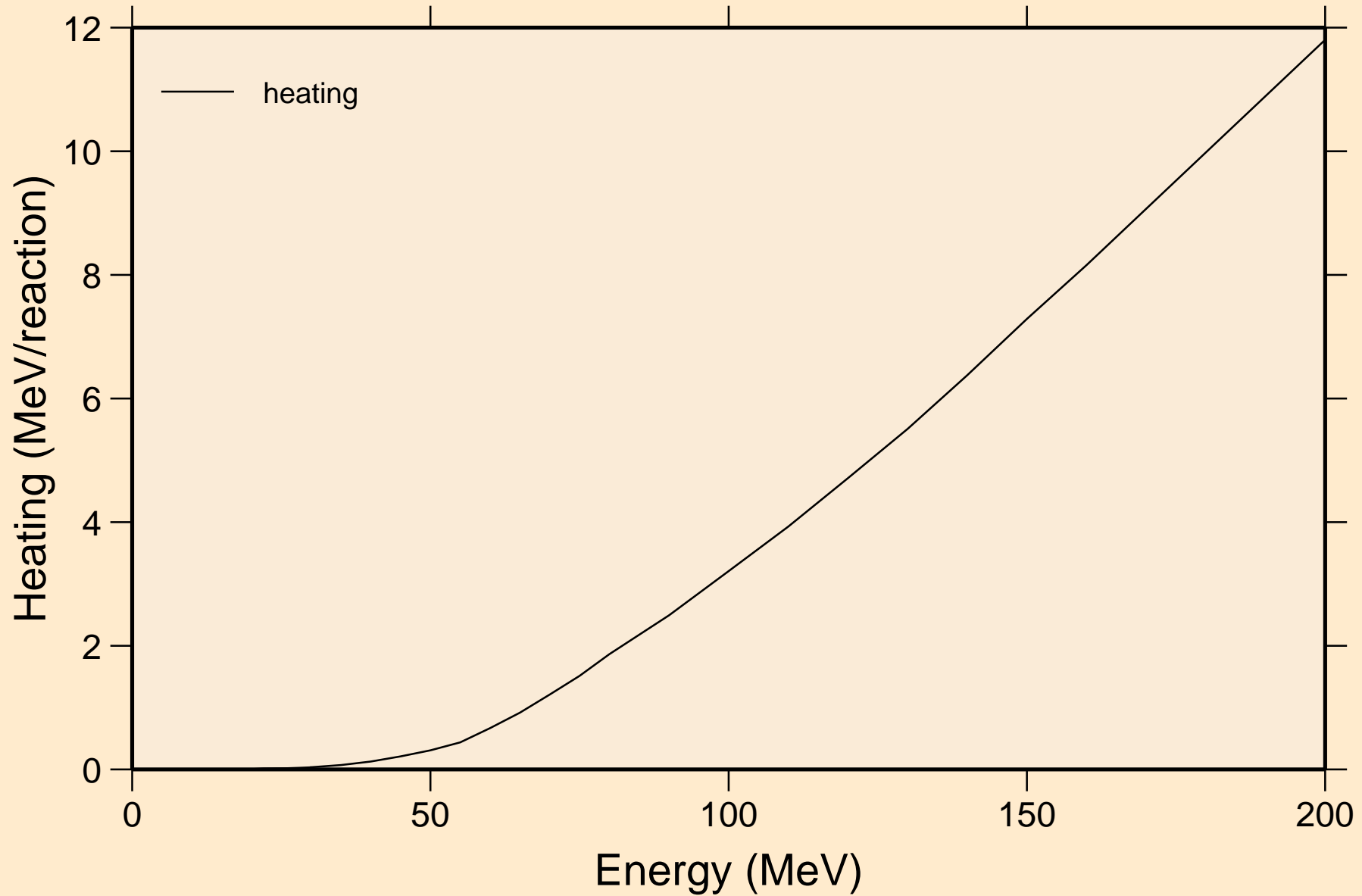

RN224 PROTON ACER TENDL-2021 LIBRARY; T=0.K  
Threshold reactions

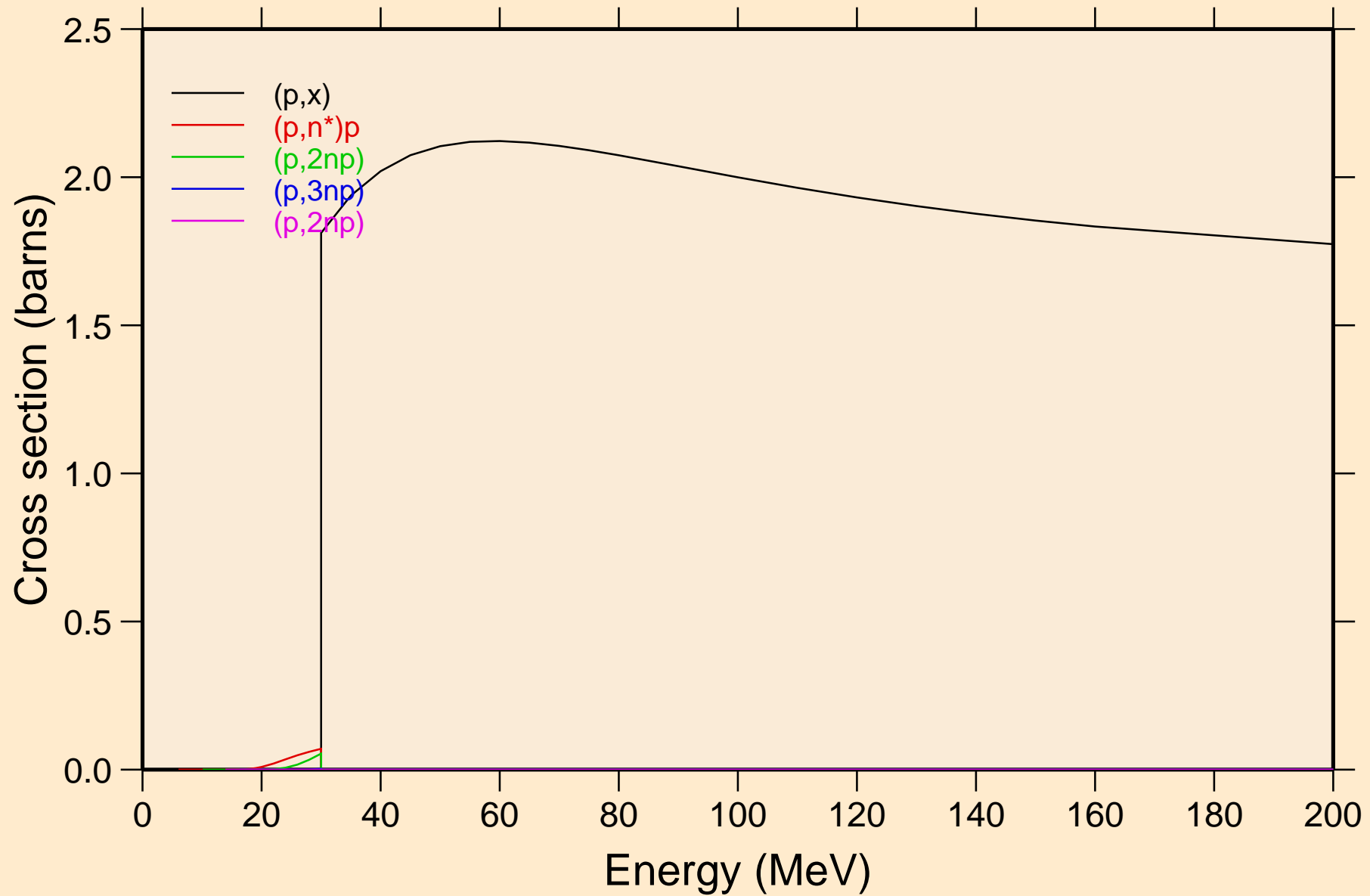

# RN224 PROTON ACER TENDL-2021 LIBRARY; T=0.K

## Threshold reactions

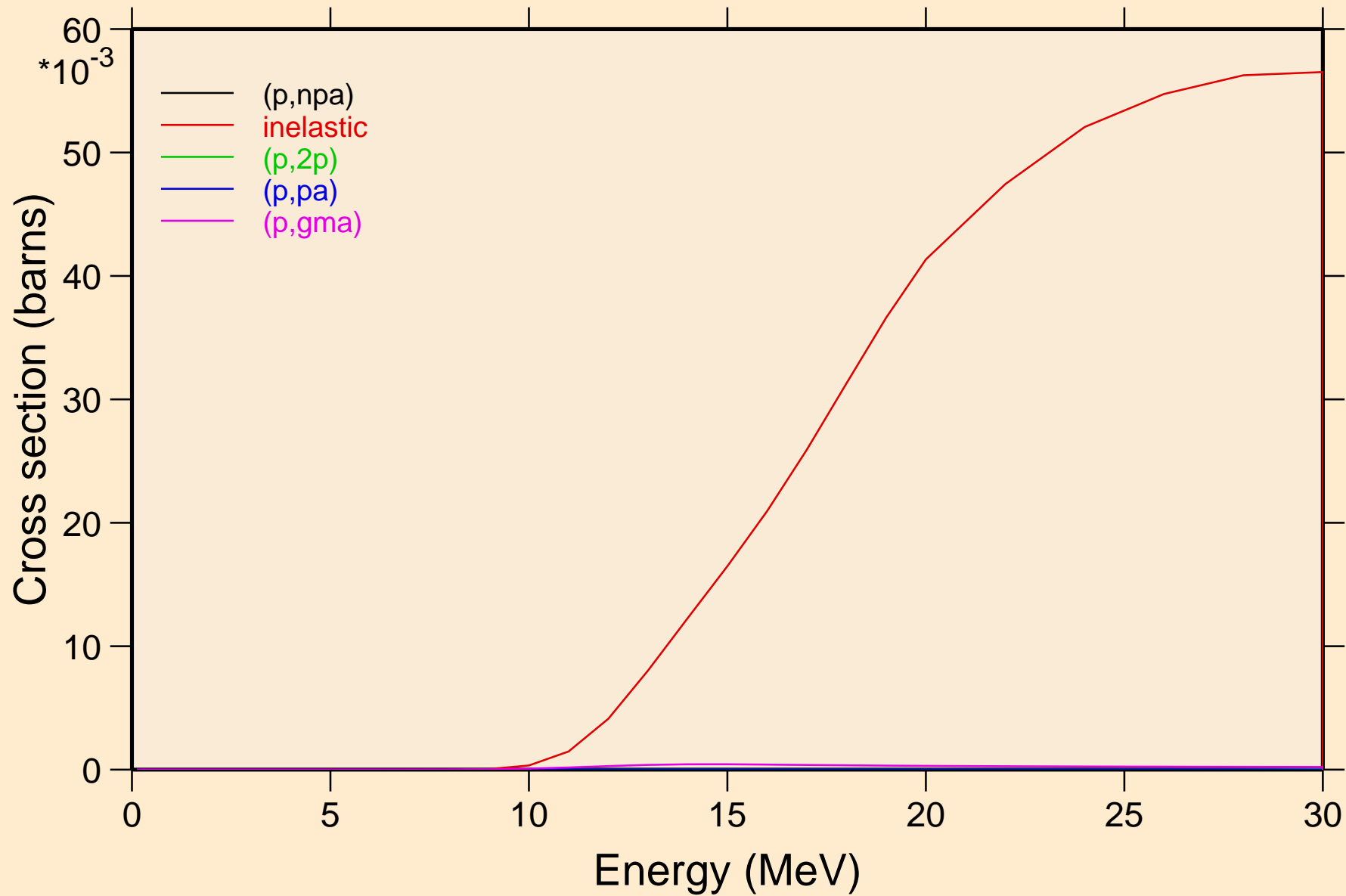

# RN224 PROTON ACER TENDL-2021 LIBRARY; T=0.K

## Threshold reactions

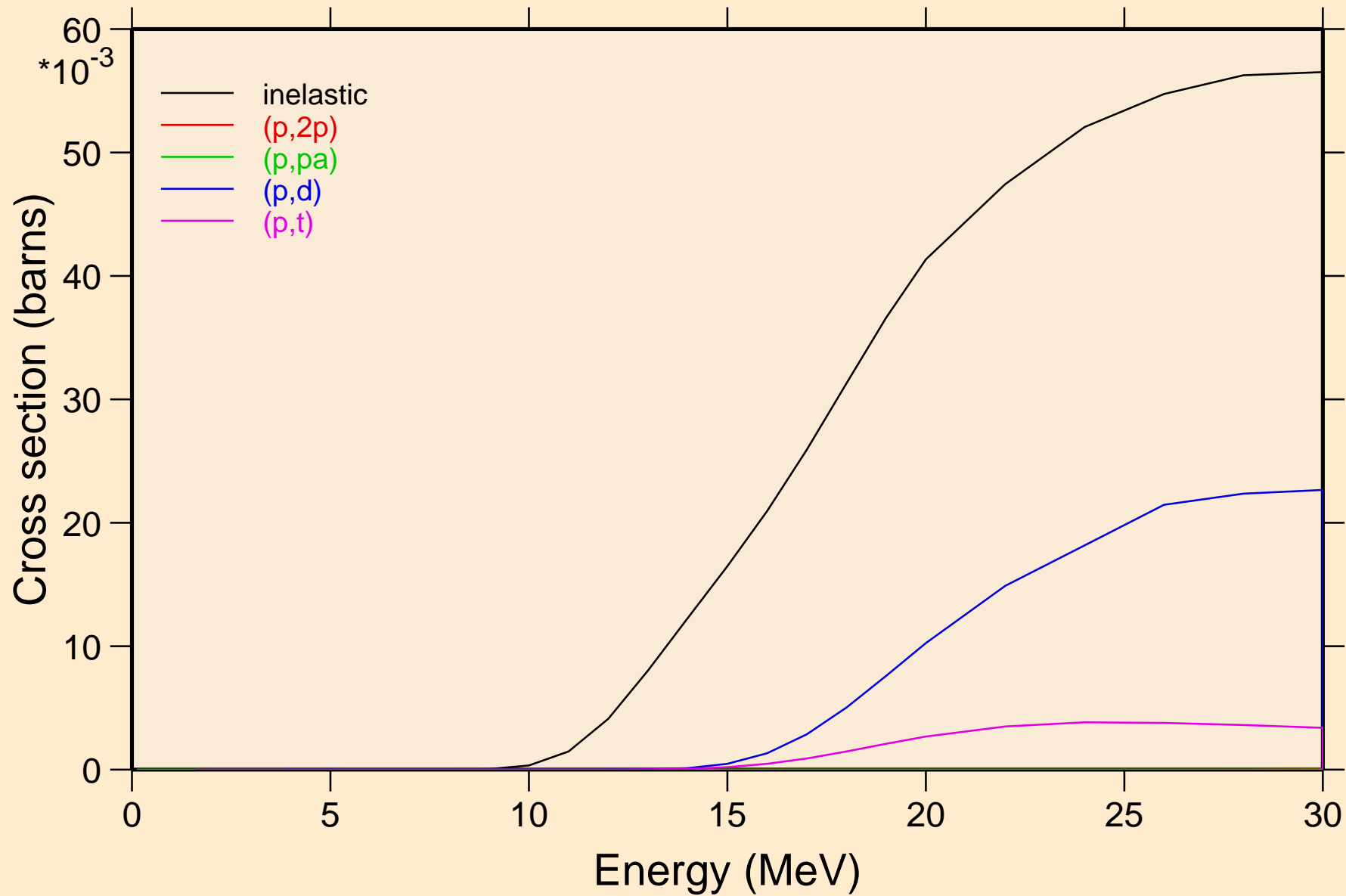

RN224 PROTON ACER TENDL-2021 LIBRARY; T=0.K  
Threshold reactions

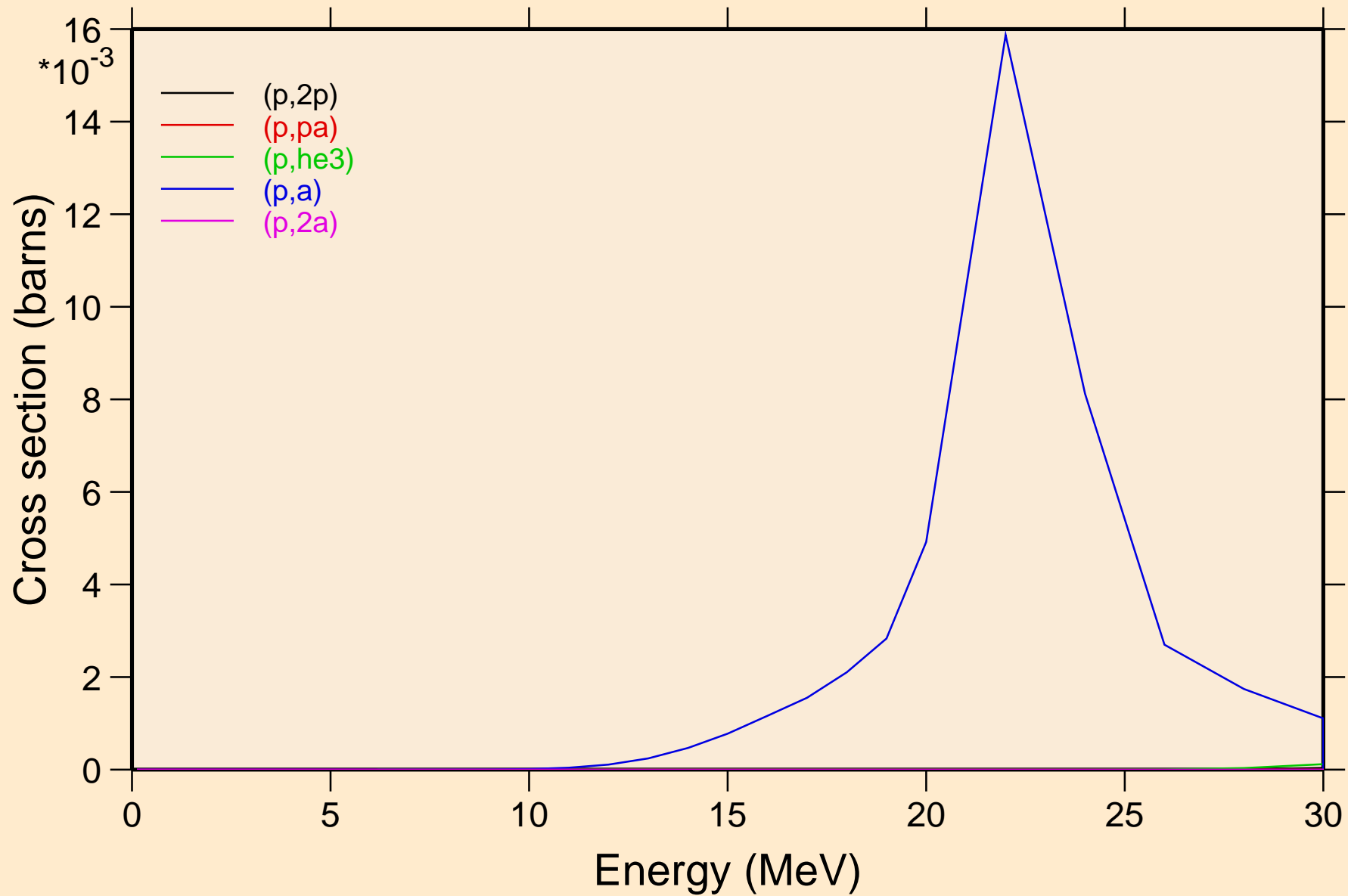



# RN224 PROTON ACER TENDL-2021 LIBRARY; T=0.K

## Threshold reactions

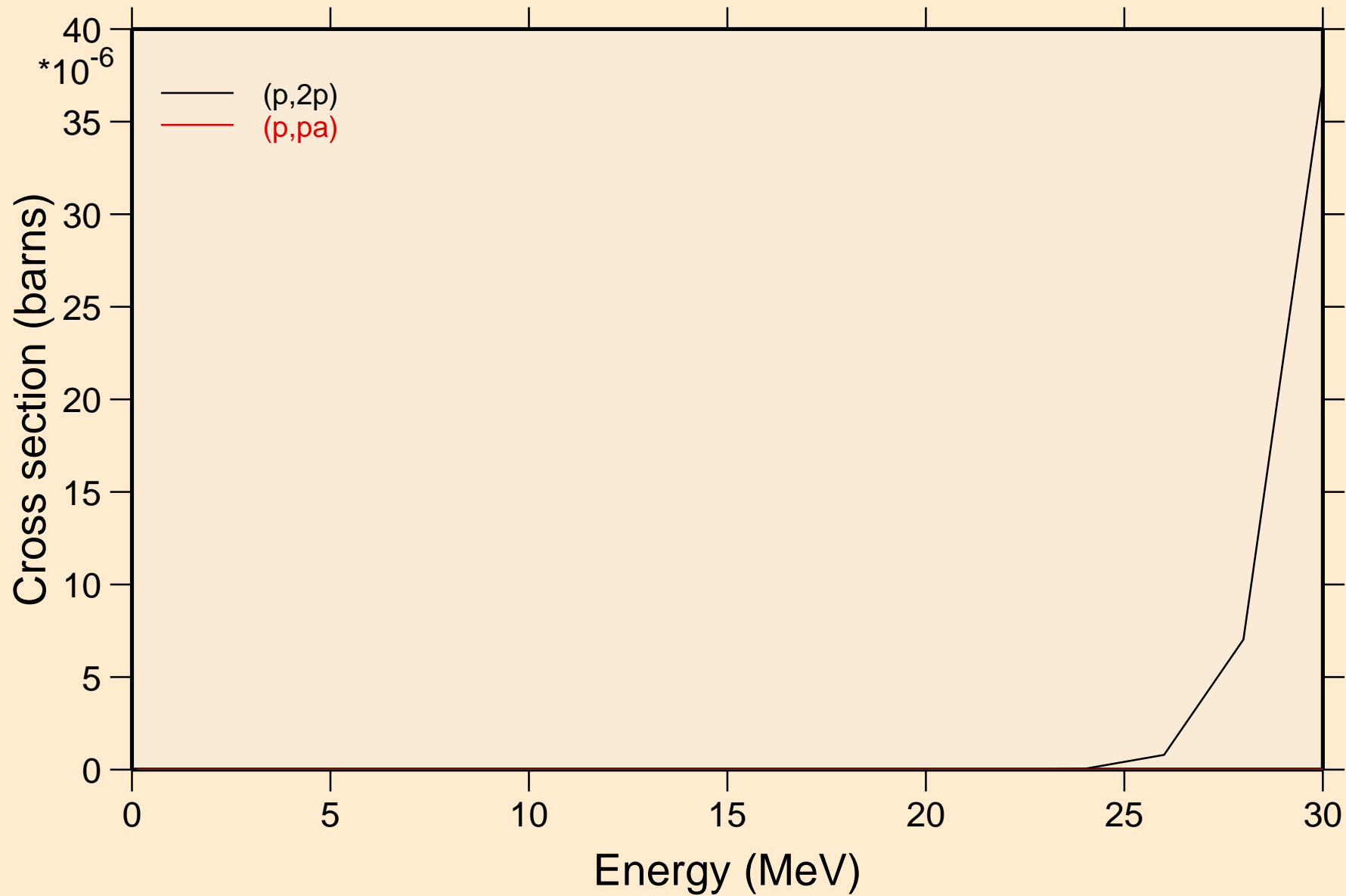

RN224 PROTON ACER TENDL-2021 LIBRARY; T=0.K  
angular distribution for elastic

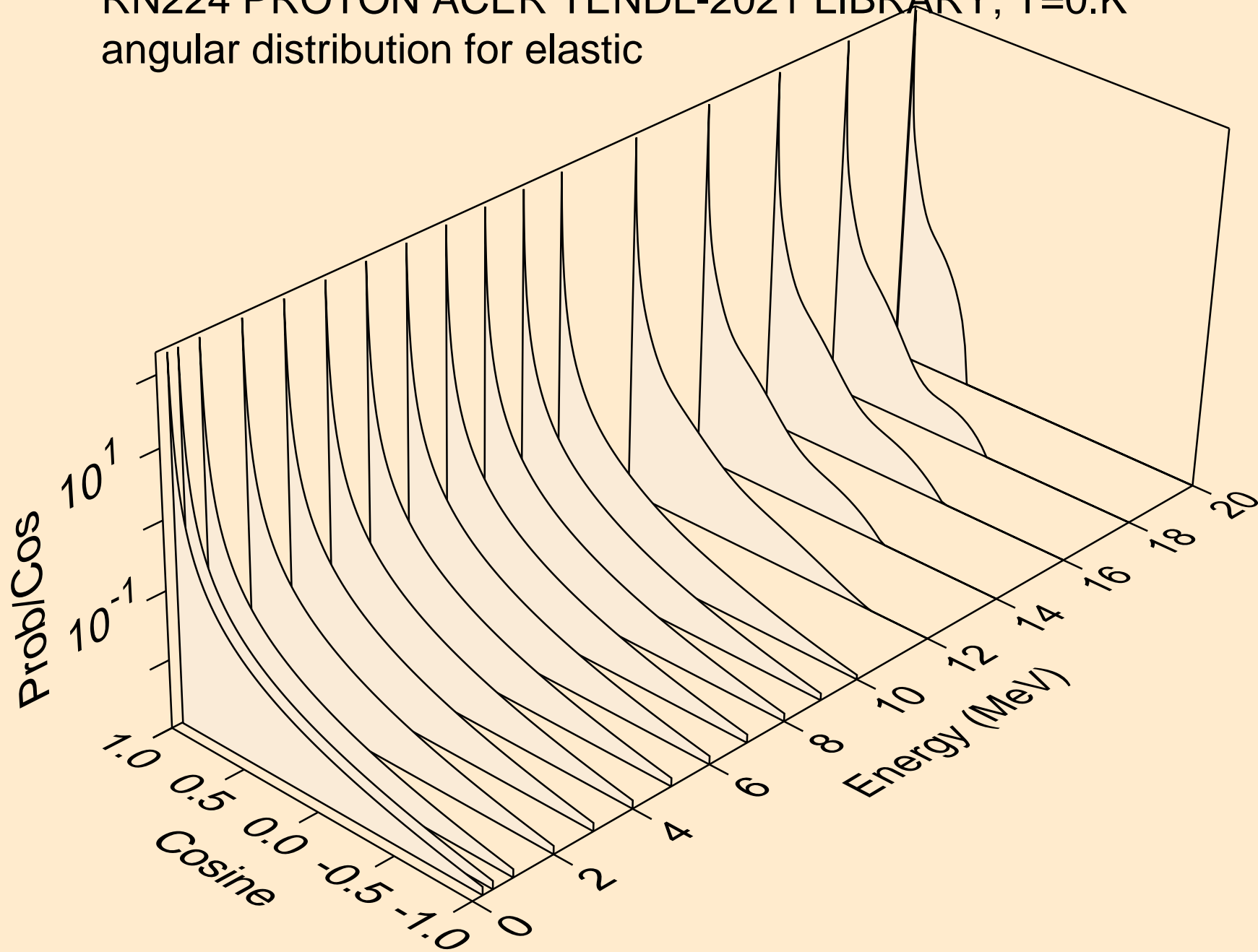

RN224 PROTON ACER TENDL-2021 LIBRARY; T=0.K  
angular distribution for elastic

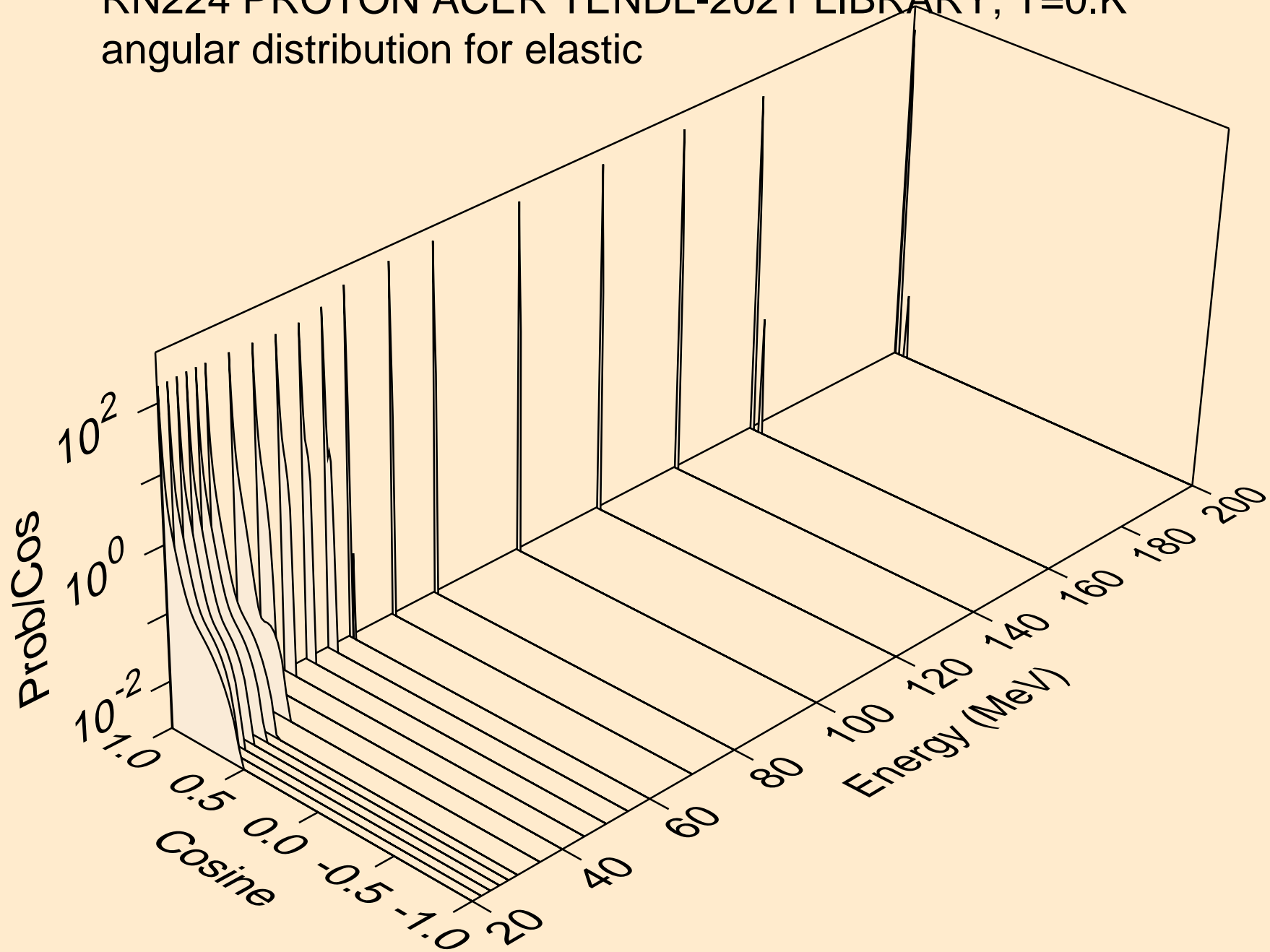

RN224 PROTON ACER TENDL-2021 LIBRARY; T=0.K  
Proton emission for (p,x)

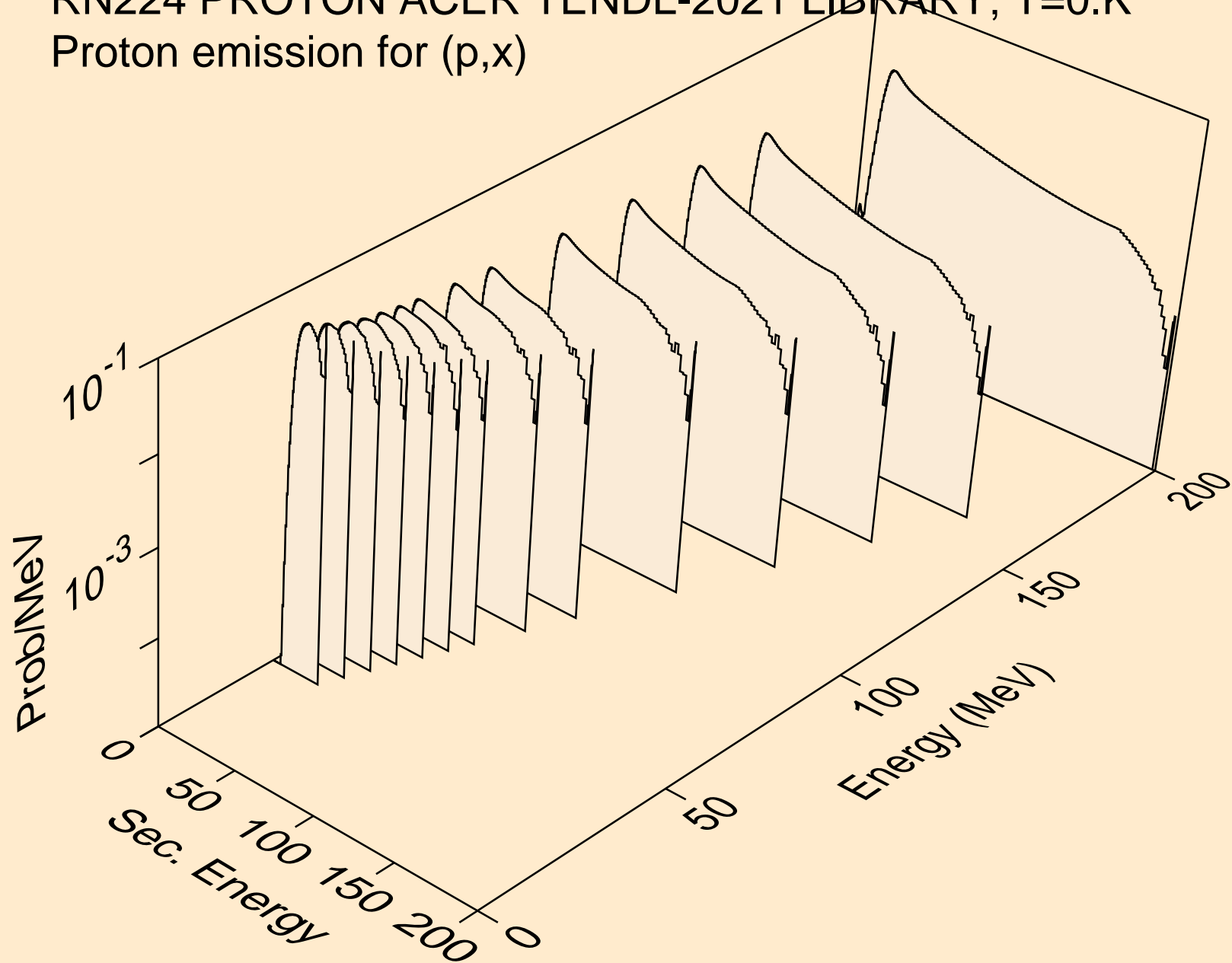

RN224 PROTON ACER TENDL-2021 LIBRARY; T=0.K  
Proton emission for (p,n\*)p

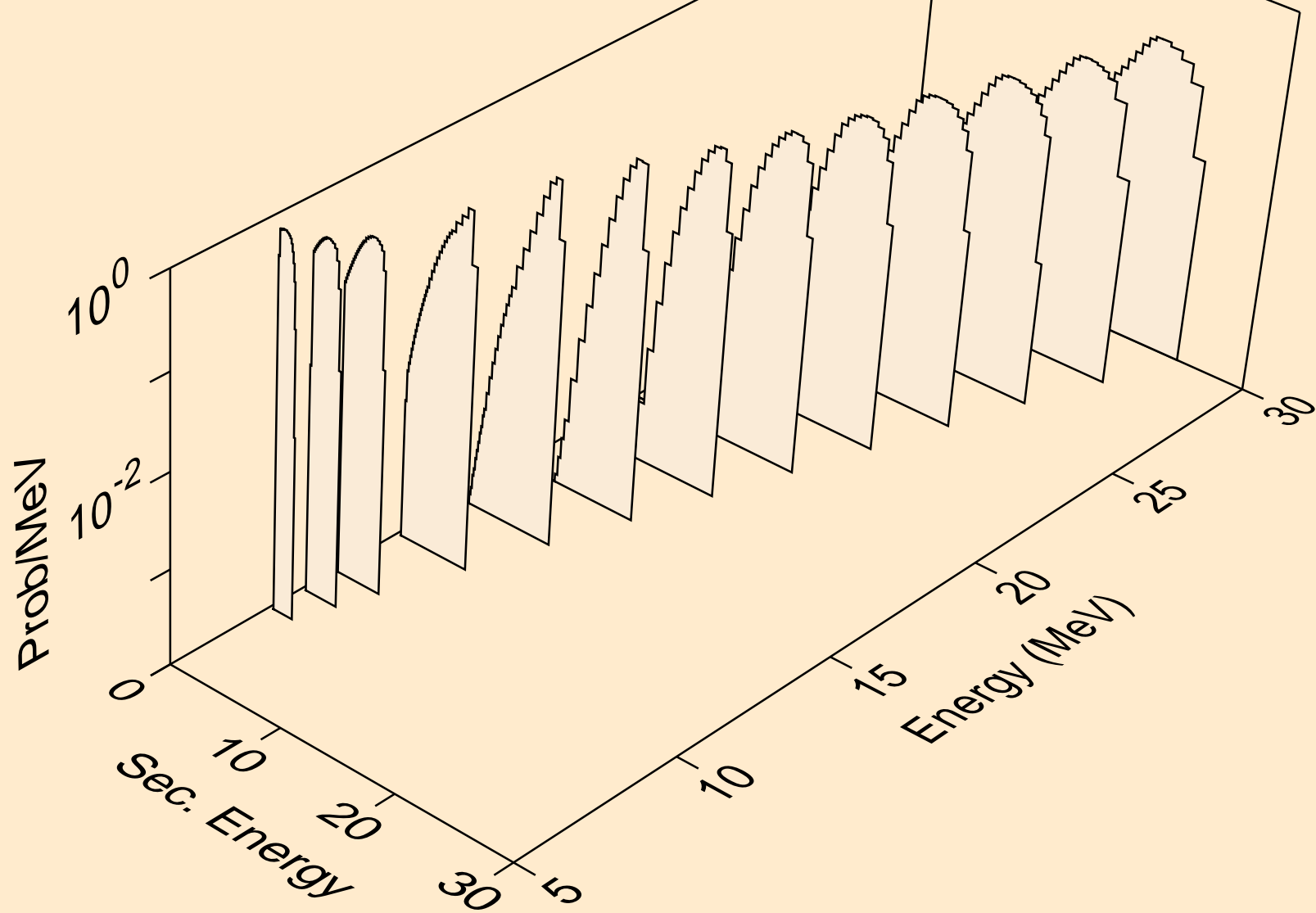

RN224 PROTON ACER TENDL-2021 LIBRARY; T=0.K  
Proton emission for (p,2np)

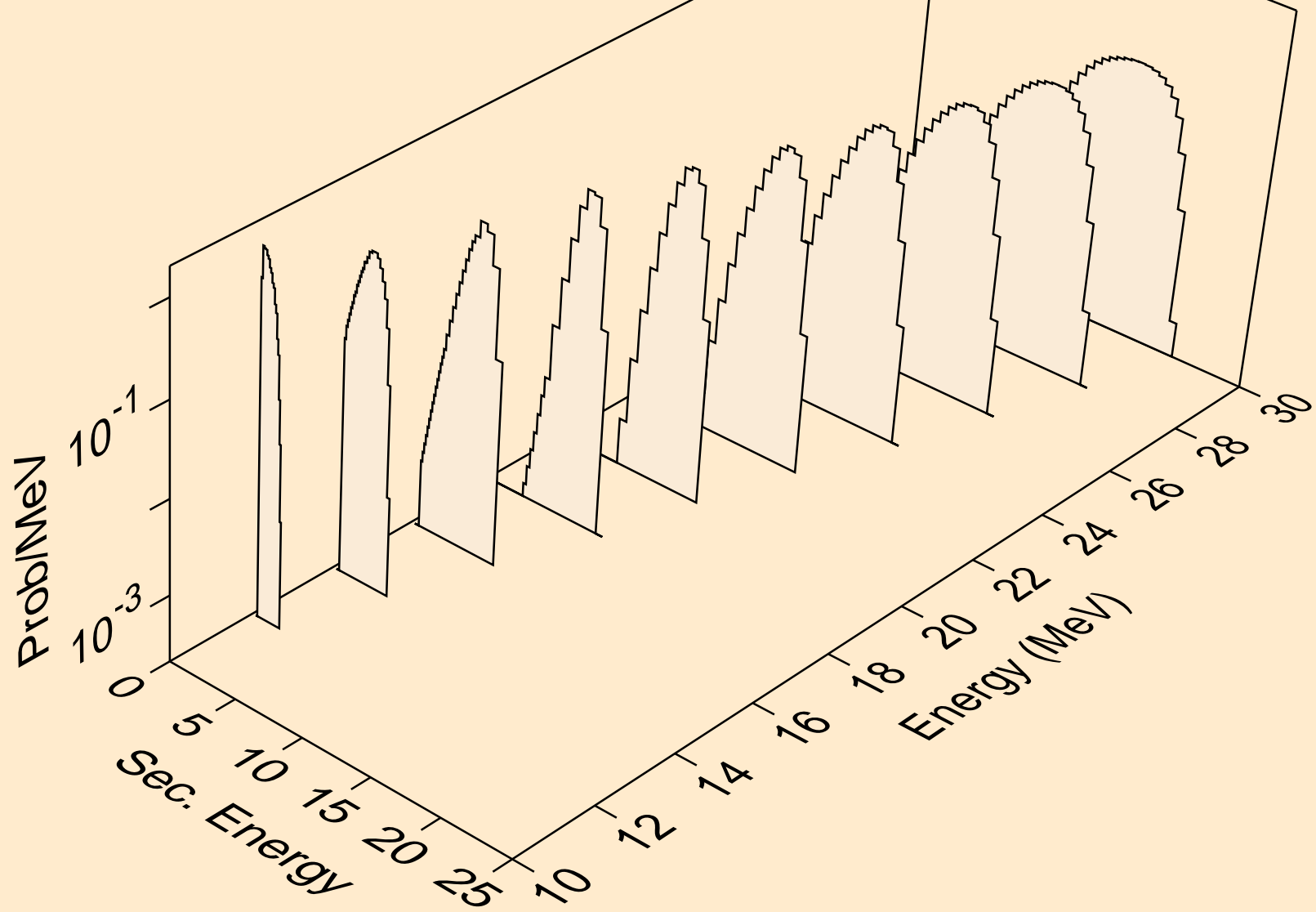

RN224 PROTON ACER TENDL-2021 LIBRARY; T=0.K  
Proton emission for (p,3np)

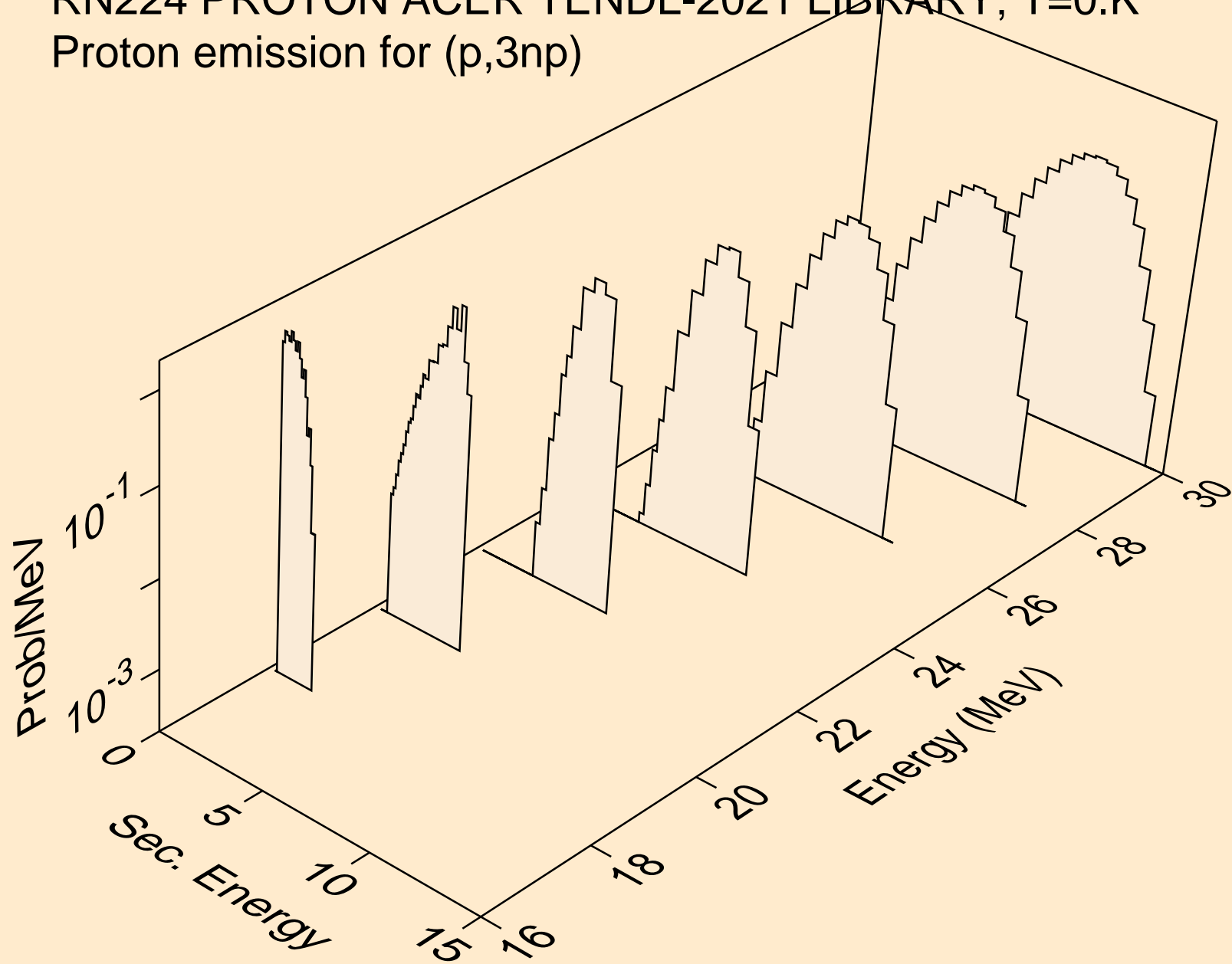

RN224 PROTON ACER TENDL-2021 LIBRARY; T=0.K  
Proton emission for (p,2np)

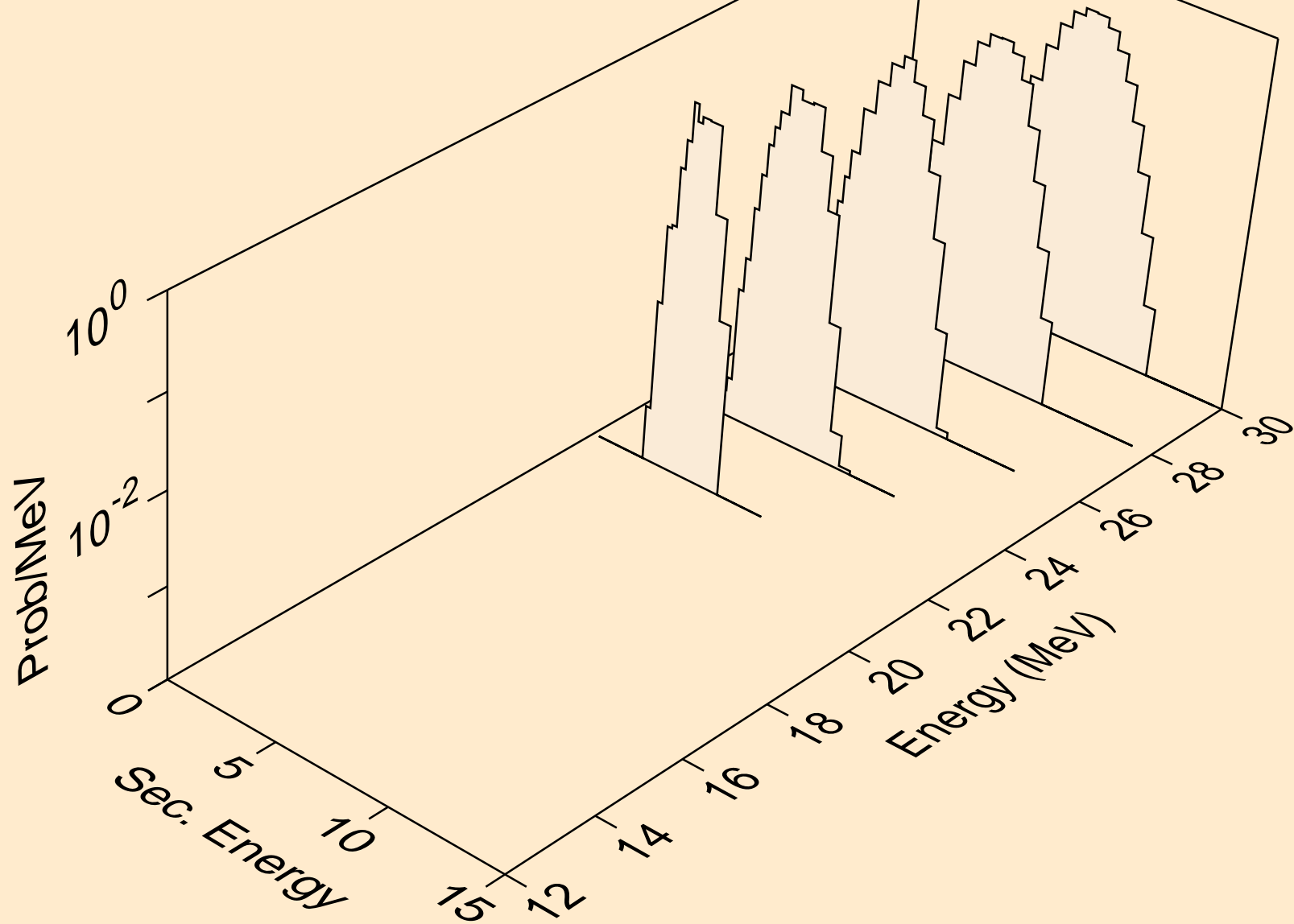



RN224 PROTON ACER TENDL-2021 LIBRARY; T=0.K  
Proton emission for (p,npa)

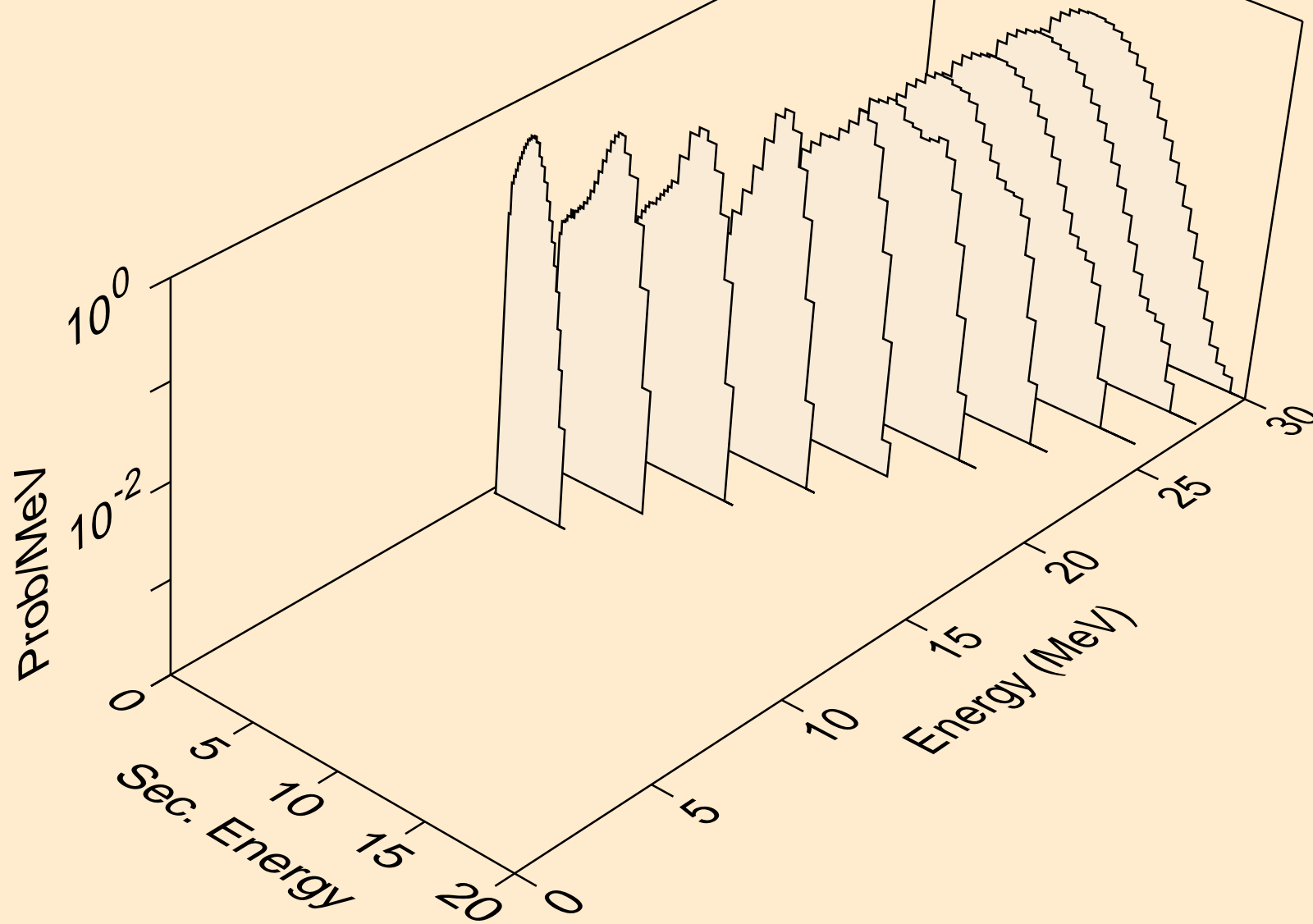

RN224 PROTON ACER TENDL-2021 LIBRARY; T=0.K  
Proton emission for inelastic

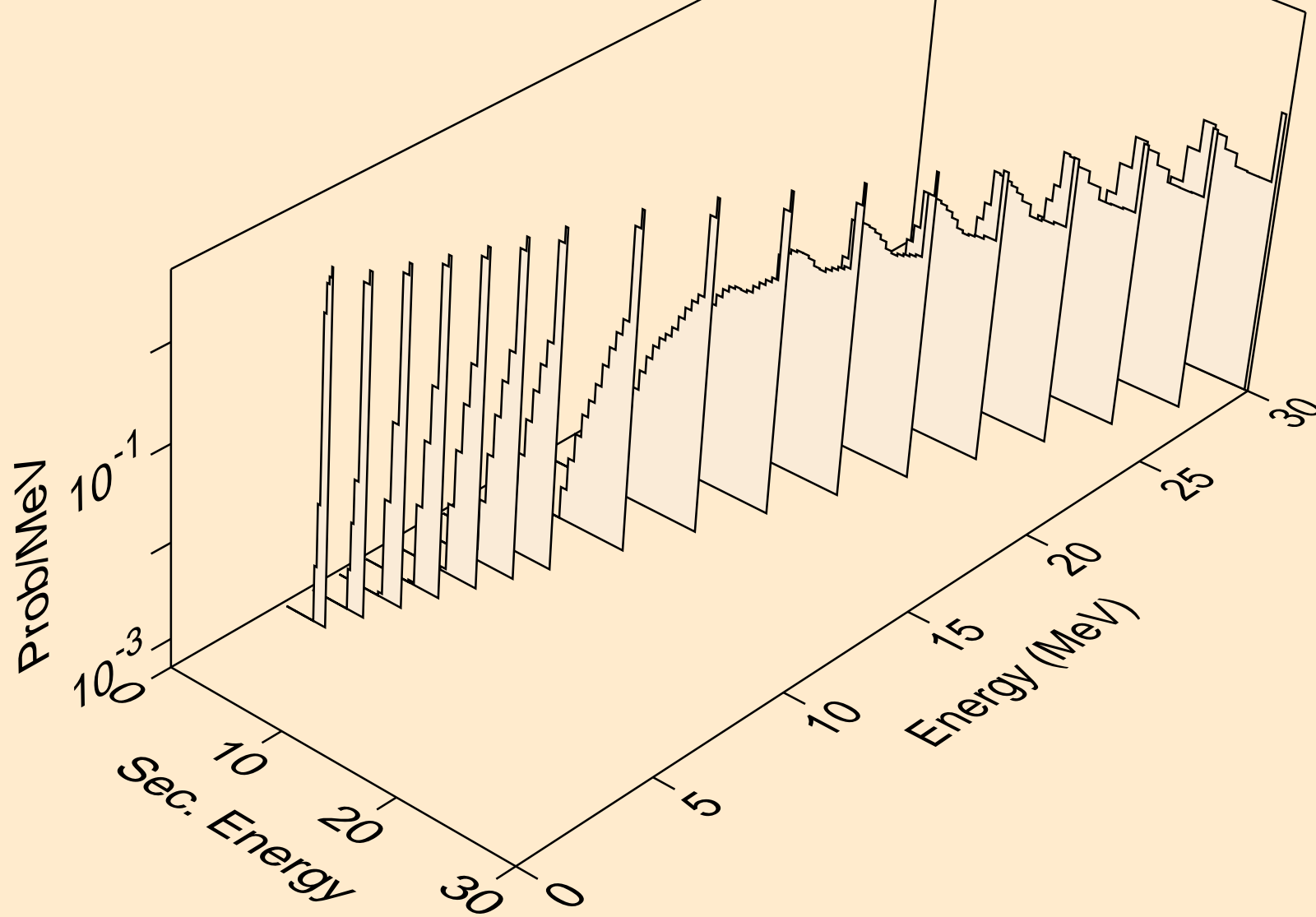

RN224 PROTON ACER TENDL-2021 LIBRARY; T=0.K  
Proton emission for (p,2p)

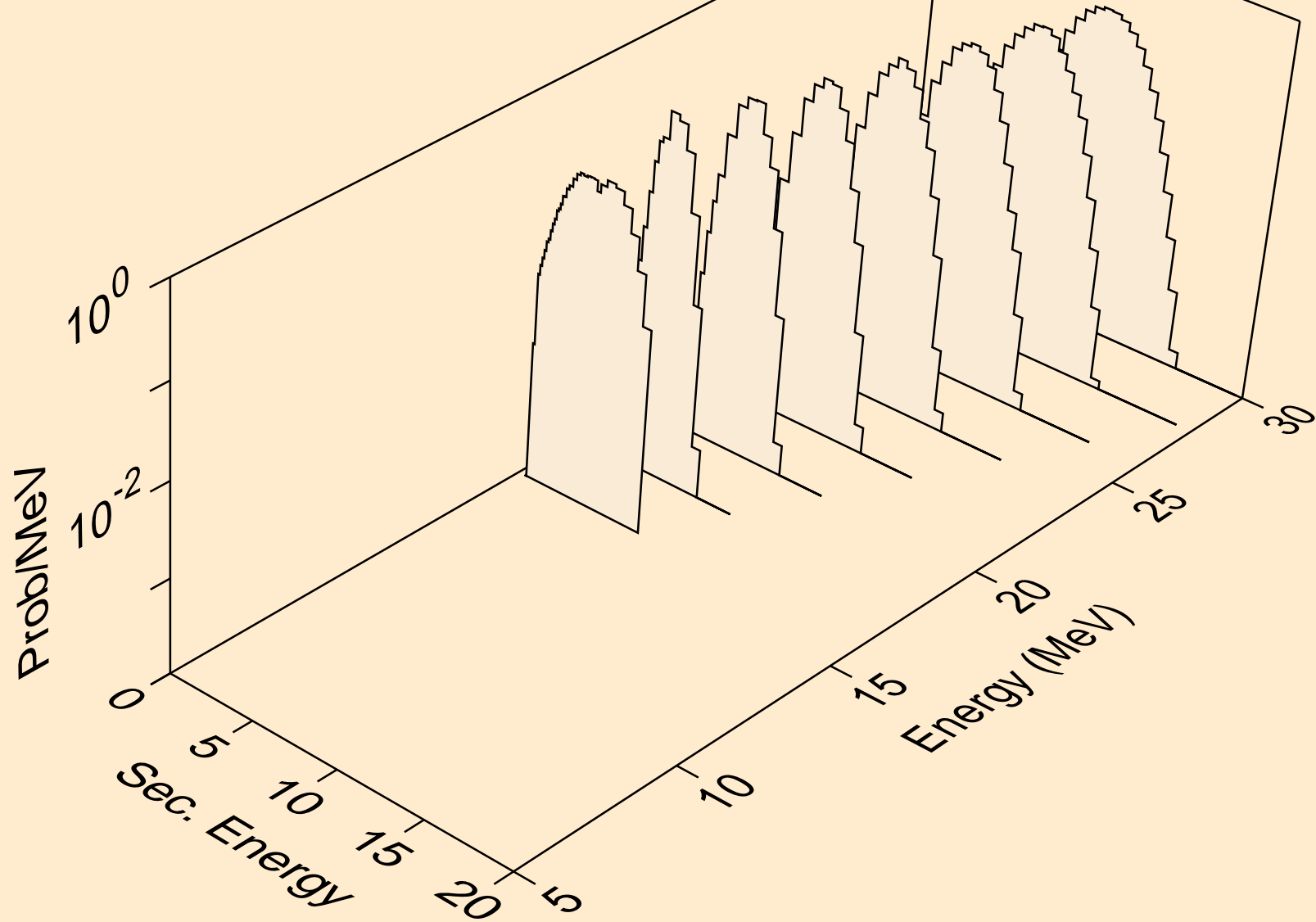

RN224 PROTON ACER TENDL-2021 LIBRARY; T=0.K  
Proton emission for (p,pa)

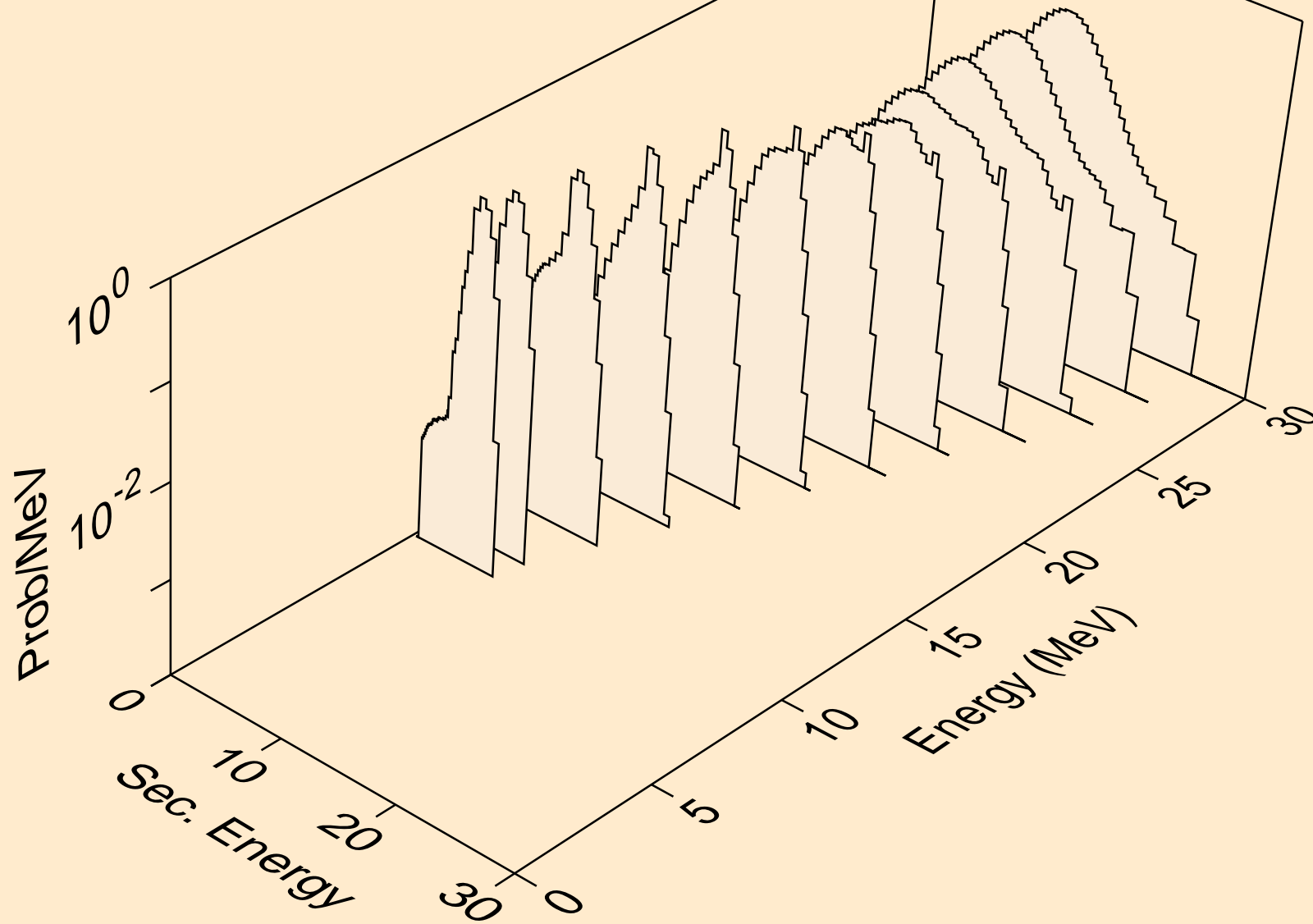

RN224 PROTON ACER TENDL-2021 LIBRARY; T=0.K  
Photon emission for (z,n)

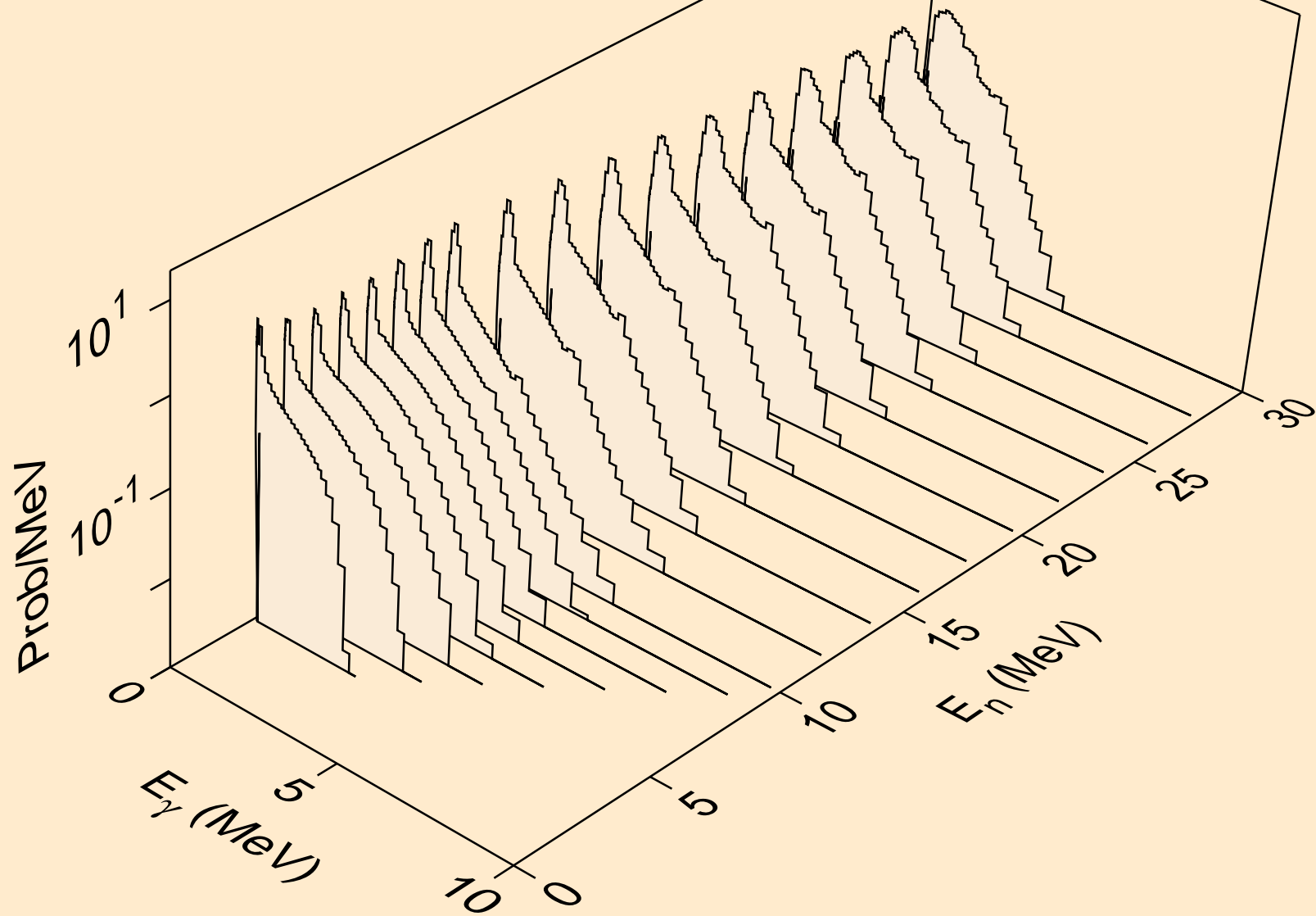

RN224 PROTON ACER TENDL-2021 LIBRARY; T=0.K  
Photon emission for (n,x)

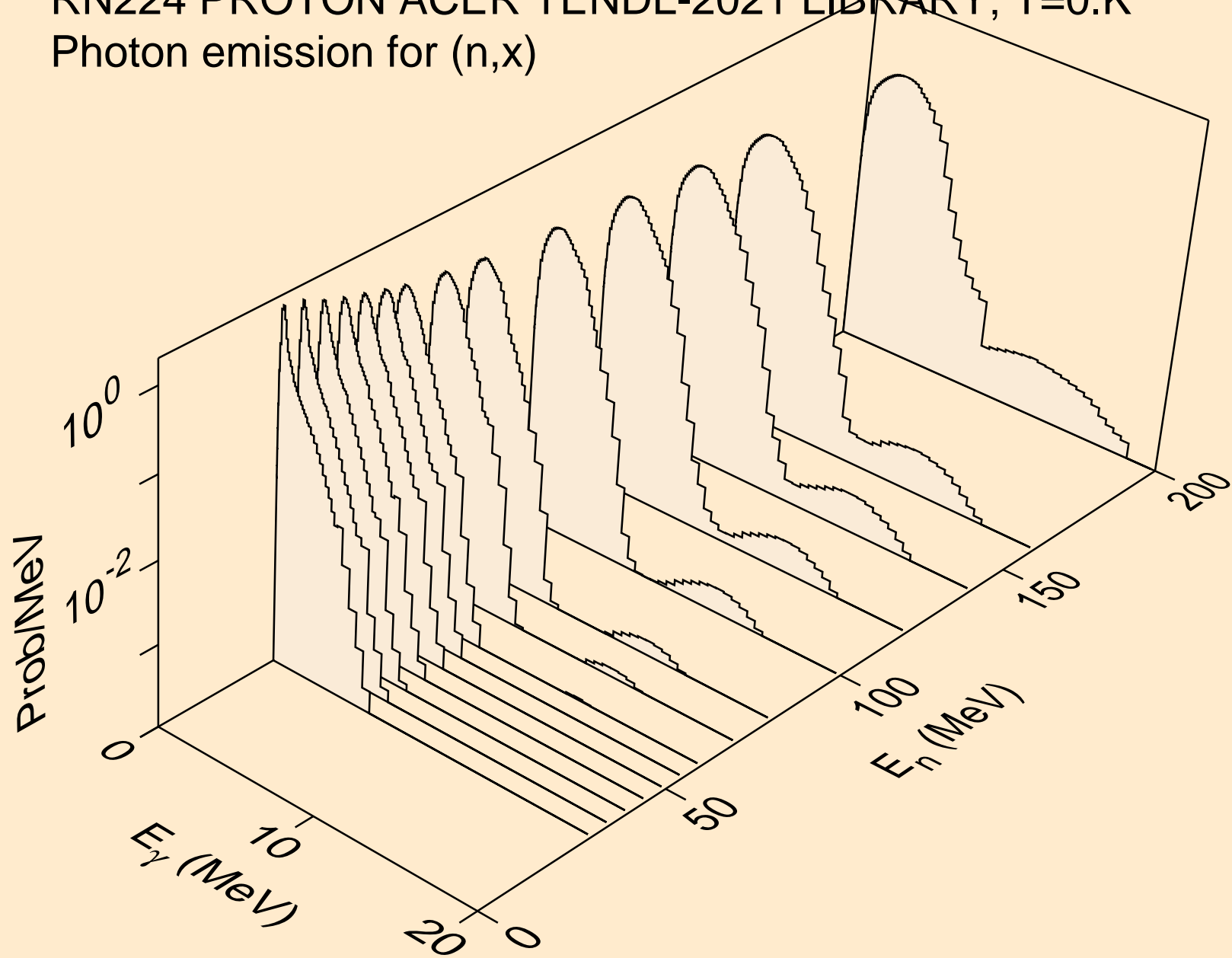

RN224 PROTON ACER TENDL-2021 LIBRARY; T=0.K  
Photon emission for (n,2nd)

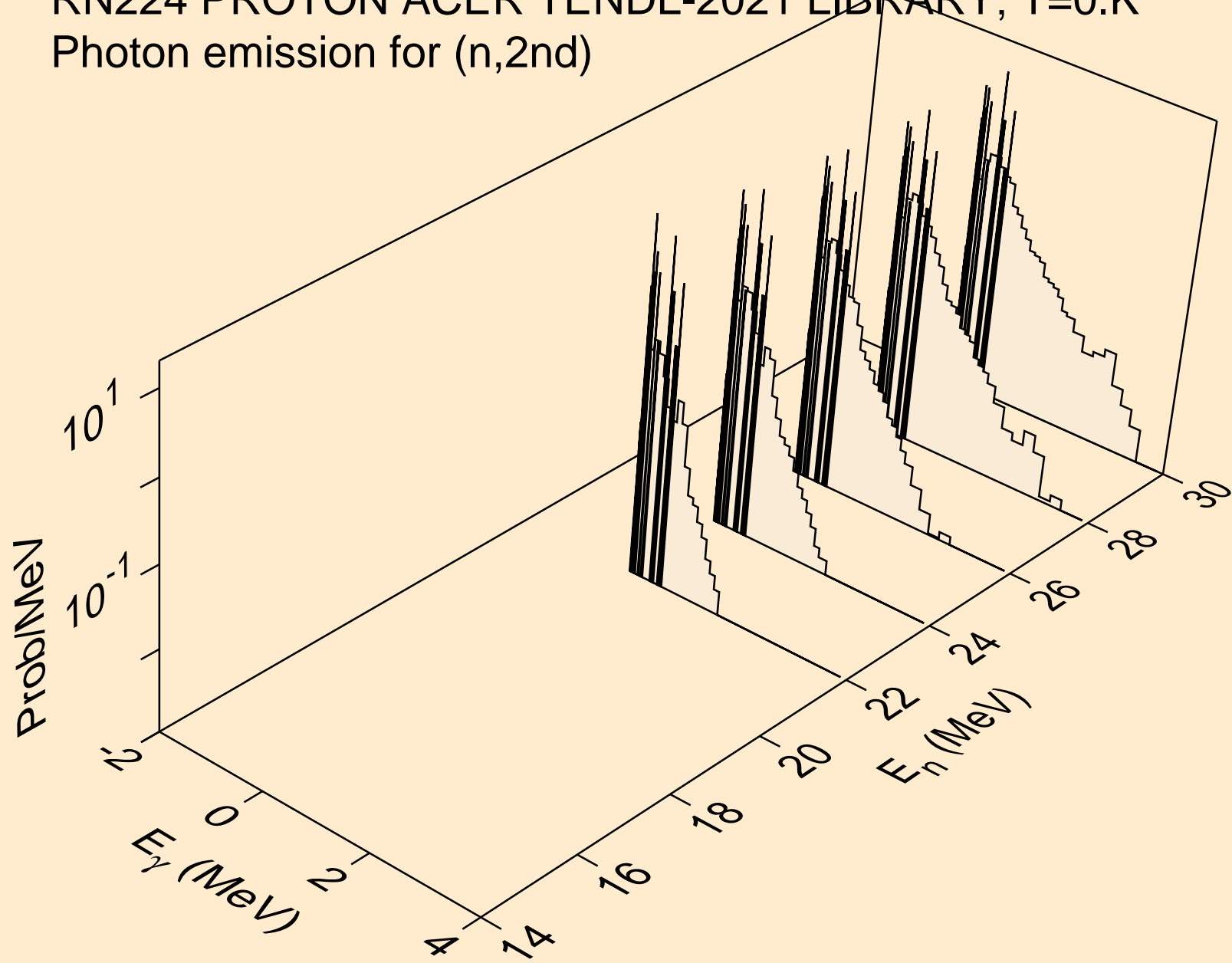

RN224 PROTON ACER TENDL-2021 LIBRARY; T=0.K  
Photon emission for (n,2n)

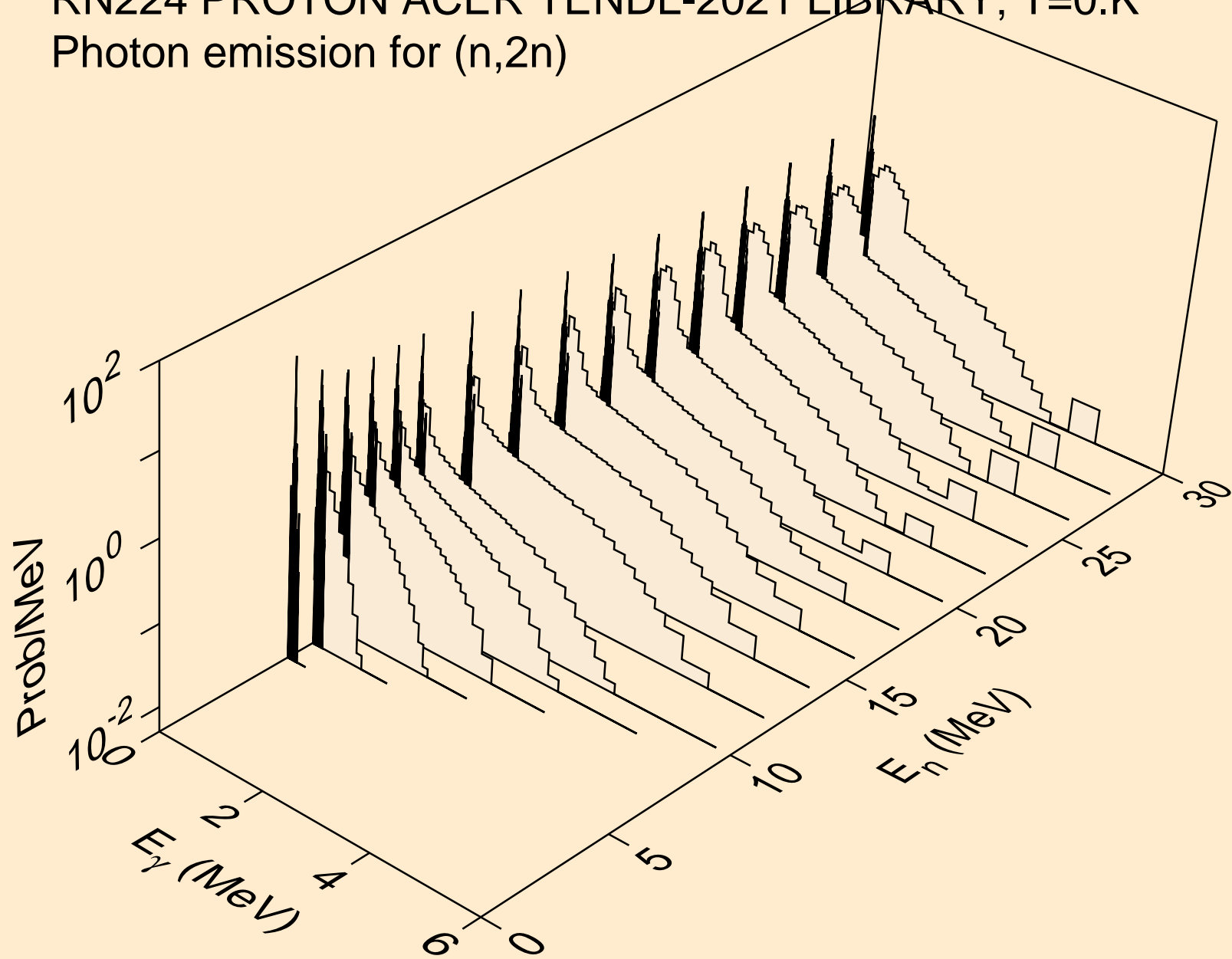



RN224 PROTON ACER TENDL-2021 LIBRARY; T=0.K  
Photon emission for (n,3n)

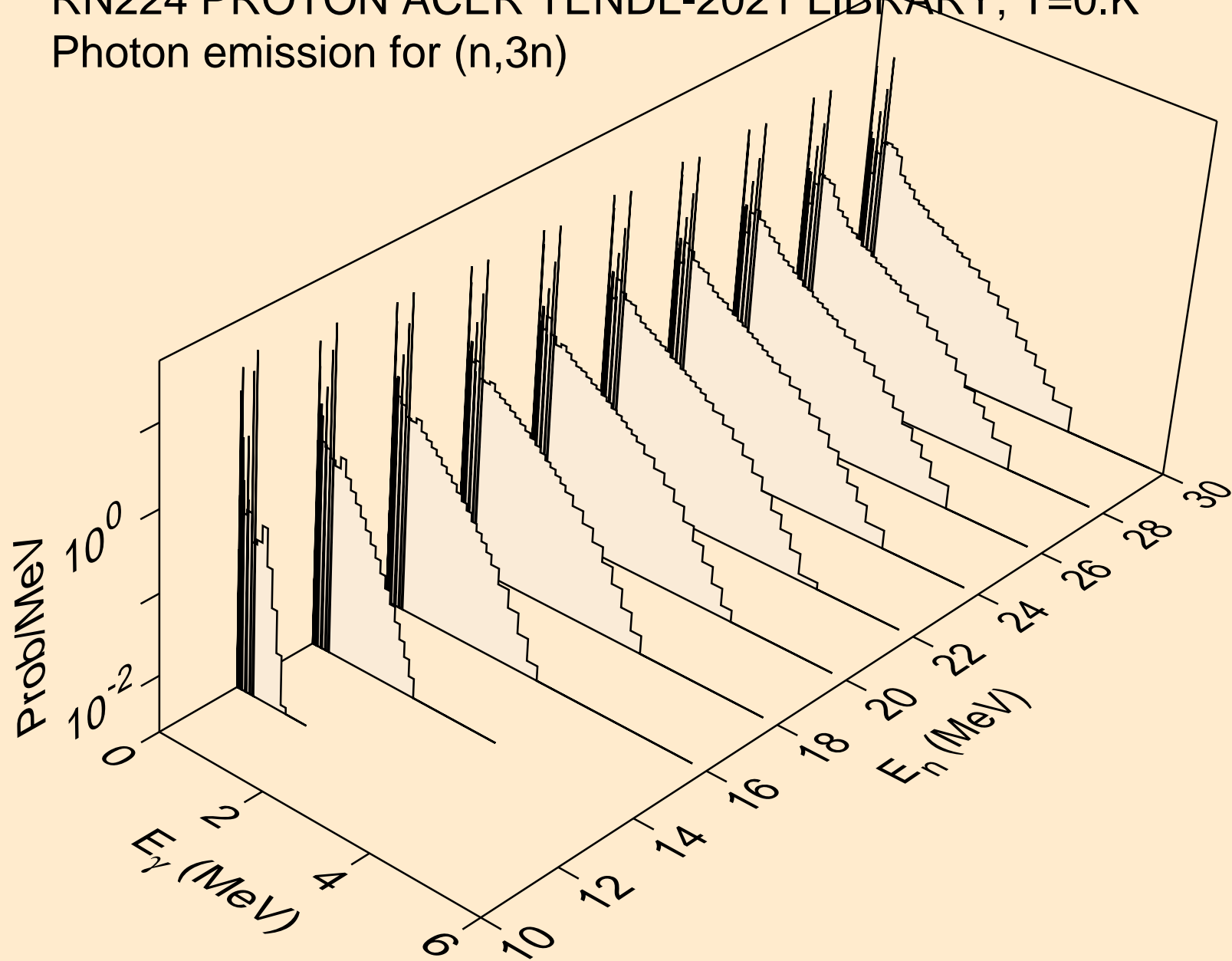

RN224 PROTON ACER TENDL-2021 LIBRARY; T=0.K  
Photon emission for (n,n\*)a

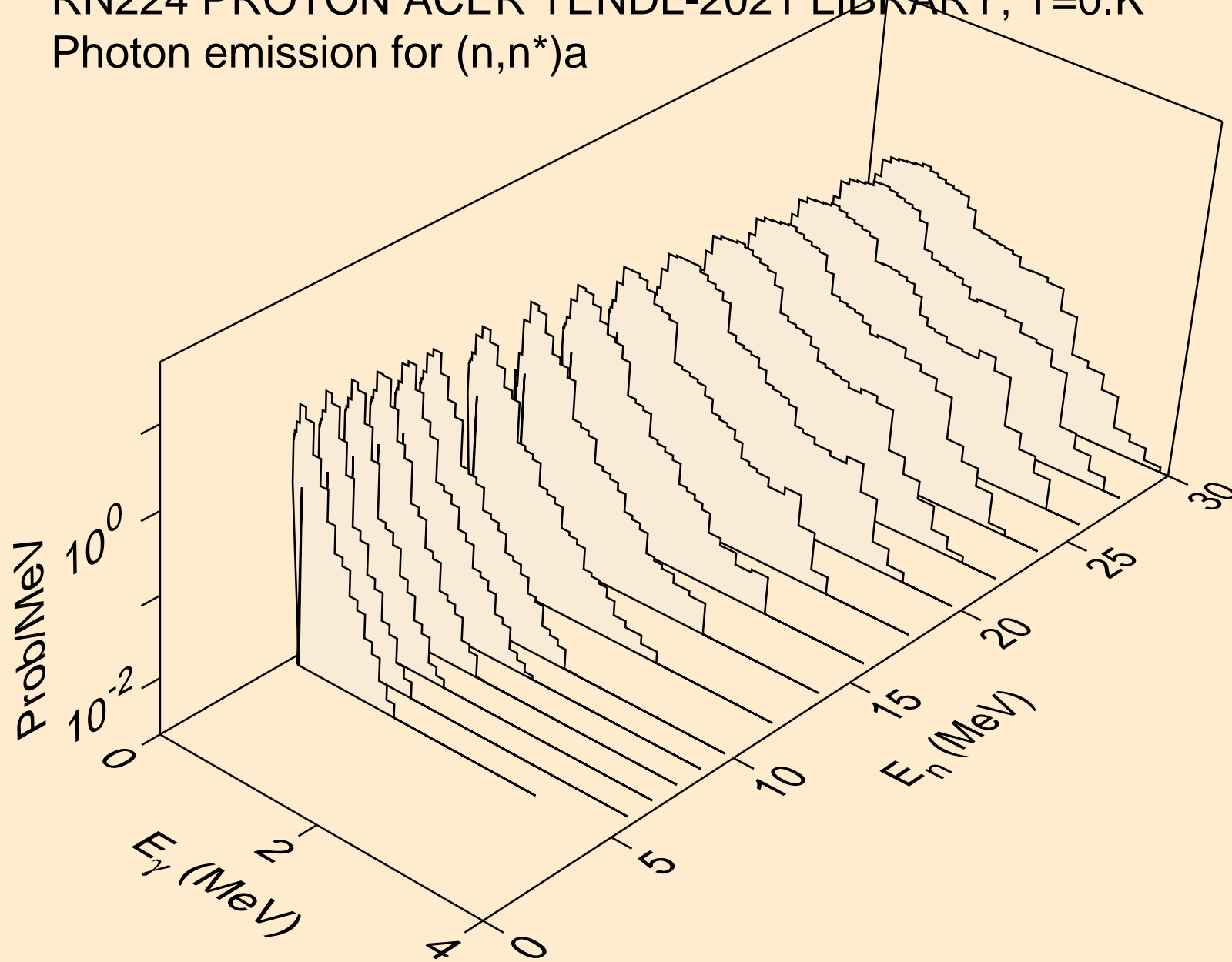

RN224 PROTON ACER TENDL-2021 LIBRARY; T=0.K  
Photon emission for (n,2n)a

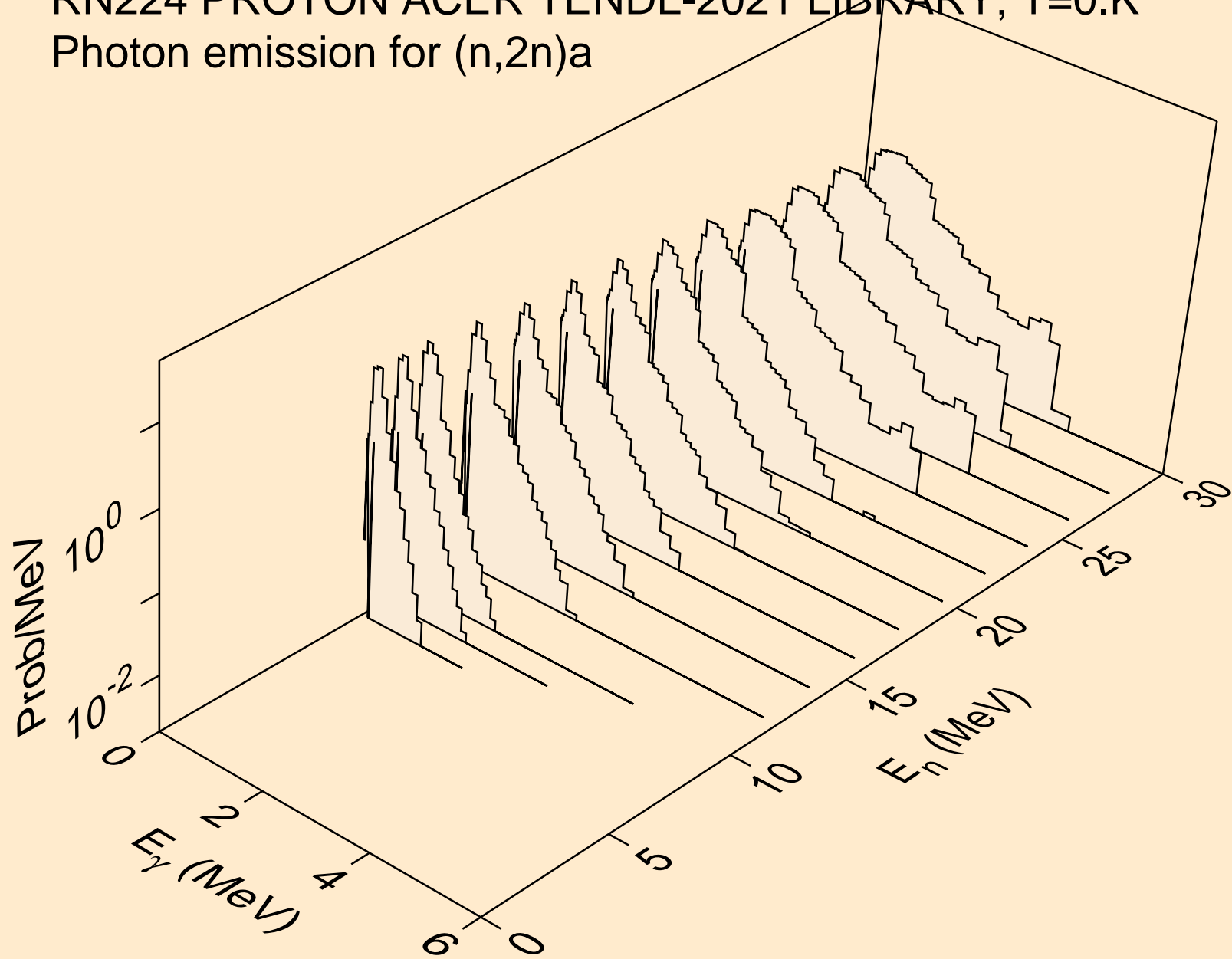

RN224 PROTON ACER TENDL-2021 LIBRARY; T=0.K  
Photon emission for (n,3n)a

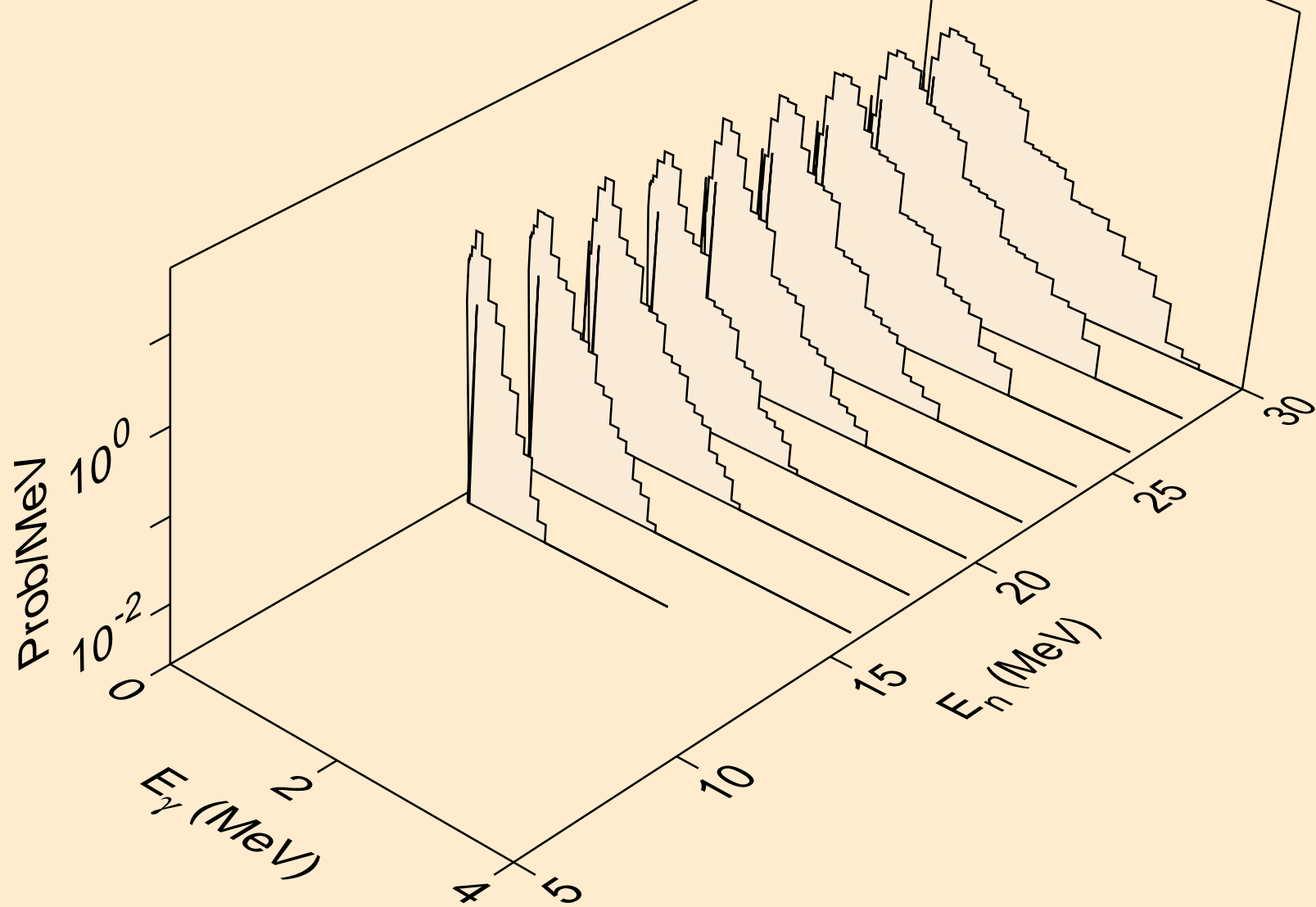

RN224 PROTON ACER TENDL-2021 LIBRARY; T=0.K  
Photon emission for (n,n\*)p

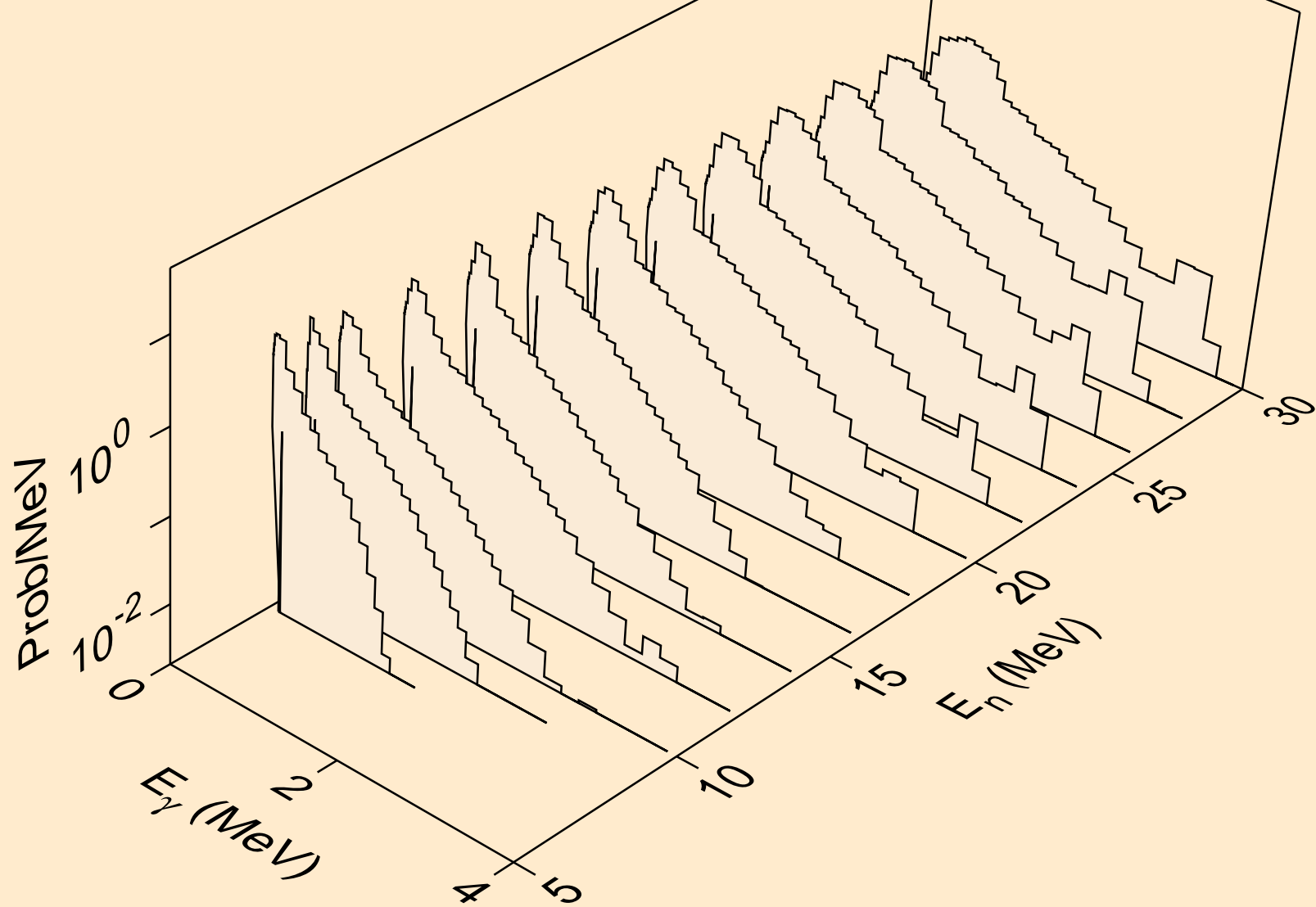

RN224 PROTON ACER TENDL-2021 LIBRARY; T=0.K  
Photon emission for (n,n\*)2a

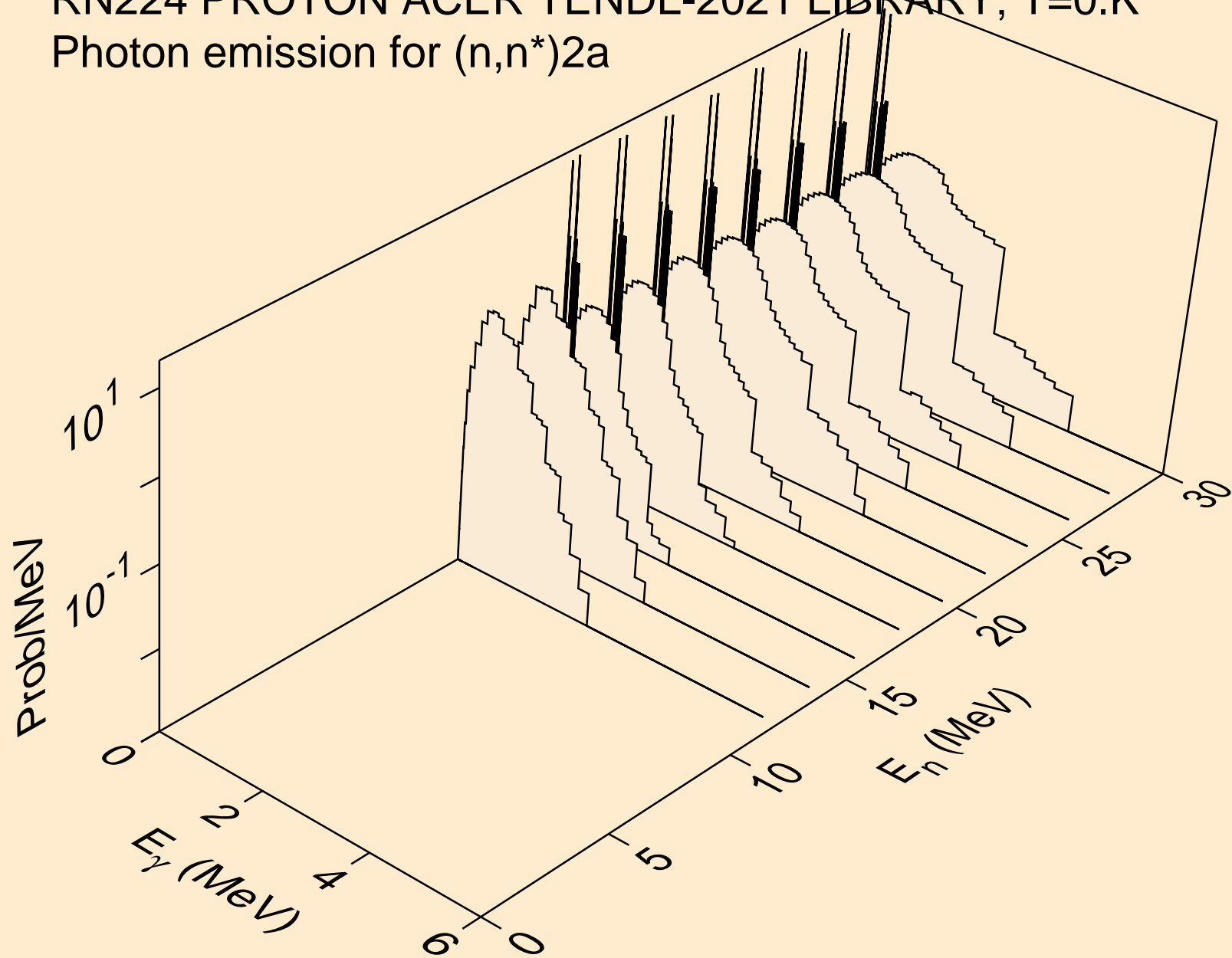

RN224 PROTON ACER TENDL-2021 LIBRARY; T=0.K  
Photon emission for (n,2n)2a

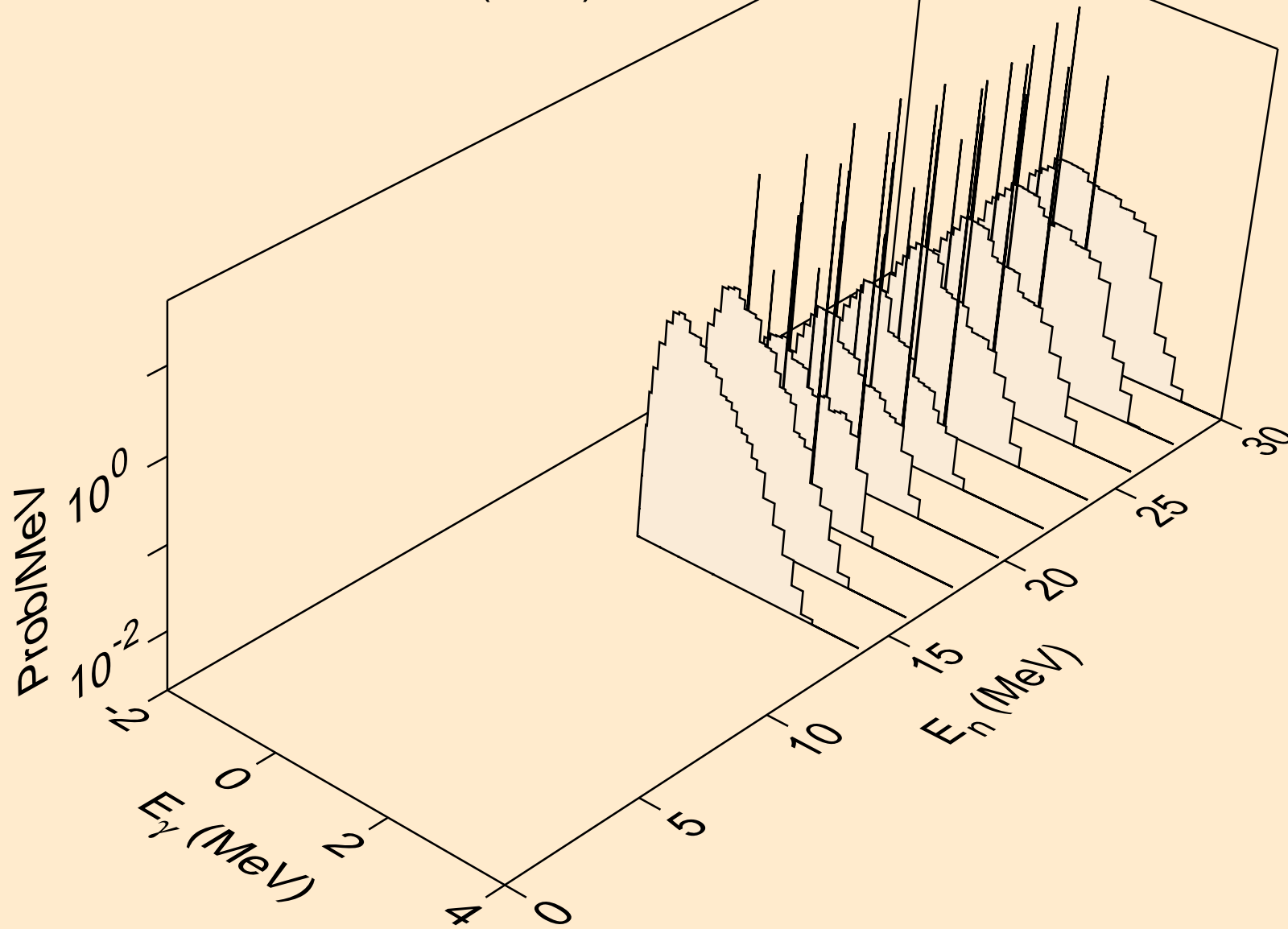

RN224 PROTON ACER TENDL-2021 LIBRARY; T=0.K  
Photon emission for (n,n\*)d

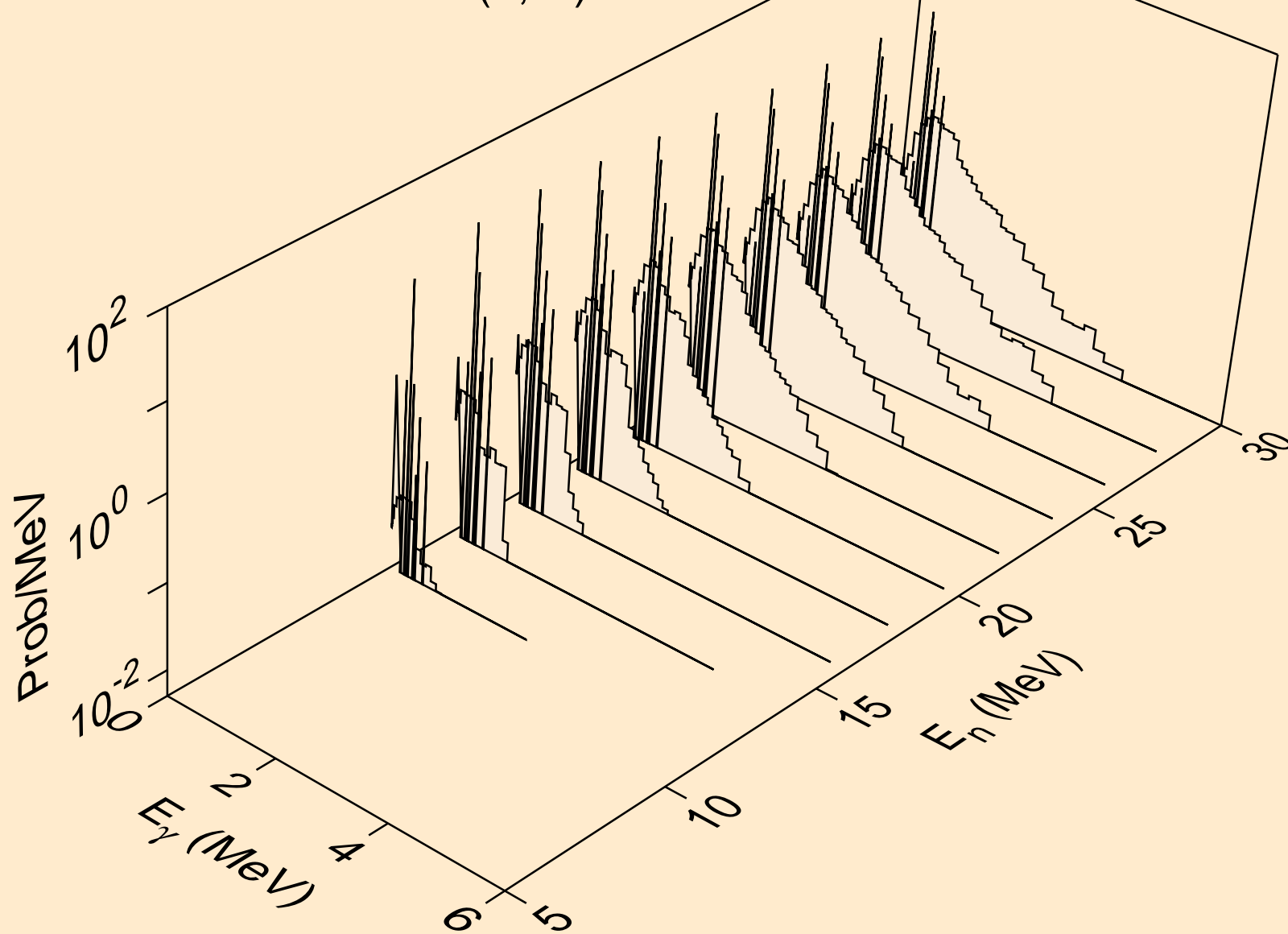



RN224 PROTON ACER TENDL-2021 LIBRARY; T=0.K  
Photon emission for (n,n\*)t

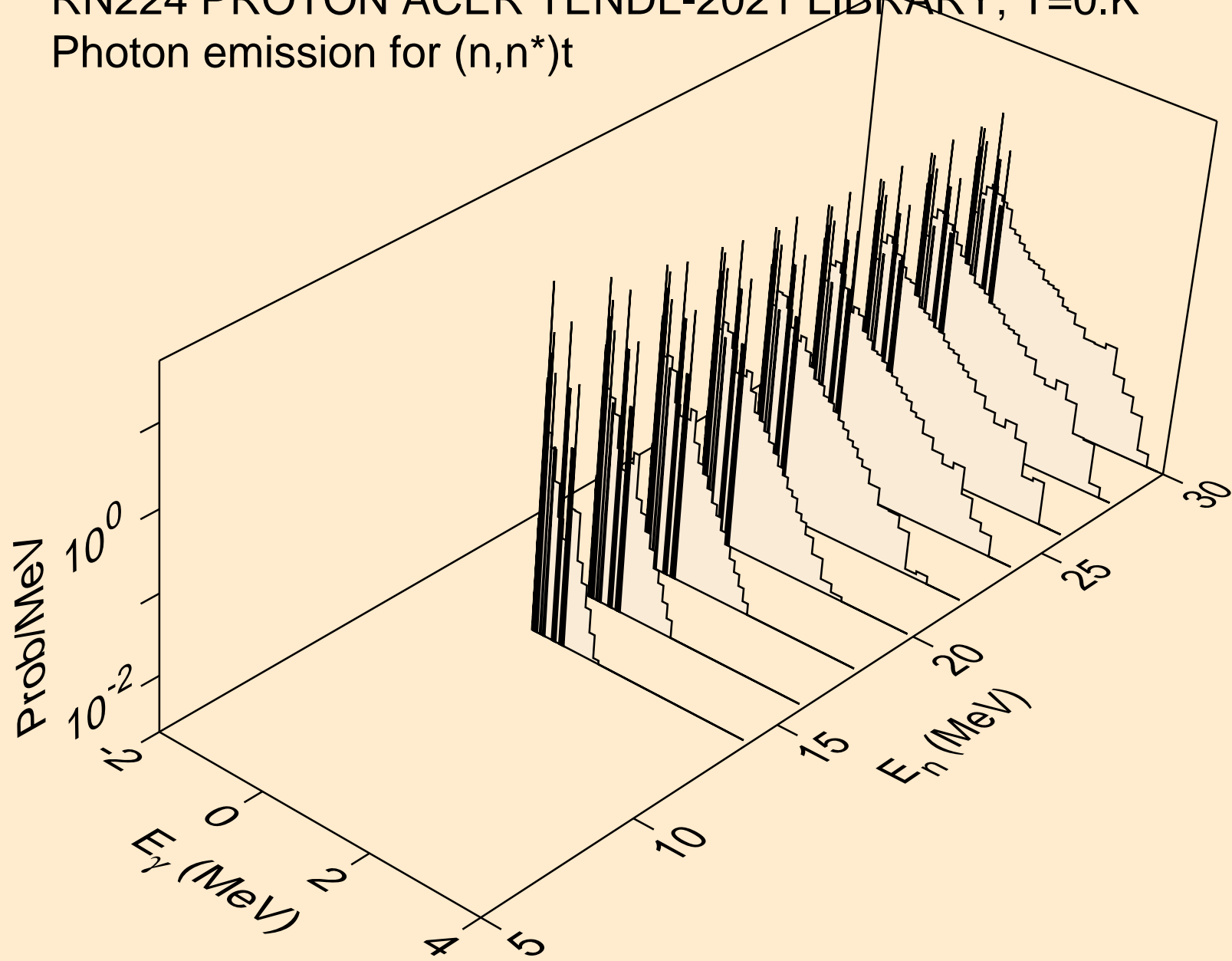

RN224 PROTON ACER TENDL-2021 LIBRARY; T=0.K  
Photon emission for (n,n\*)he3

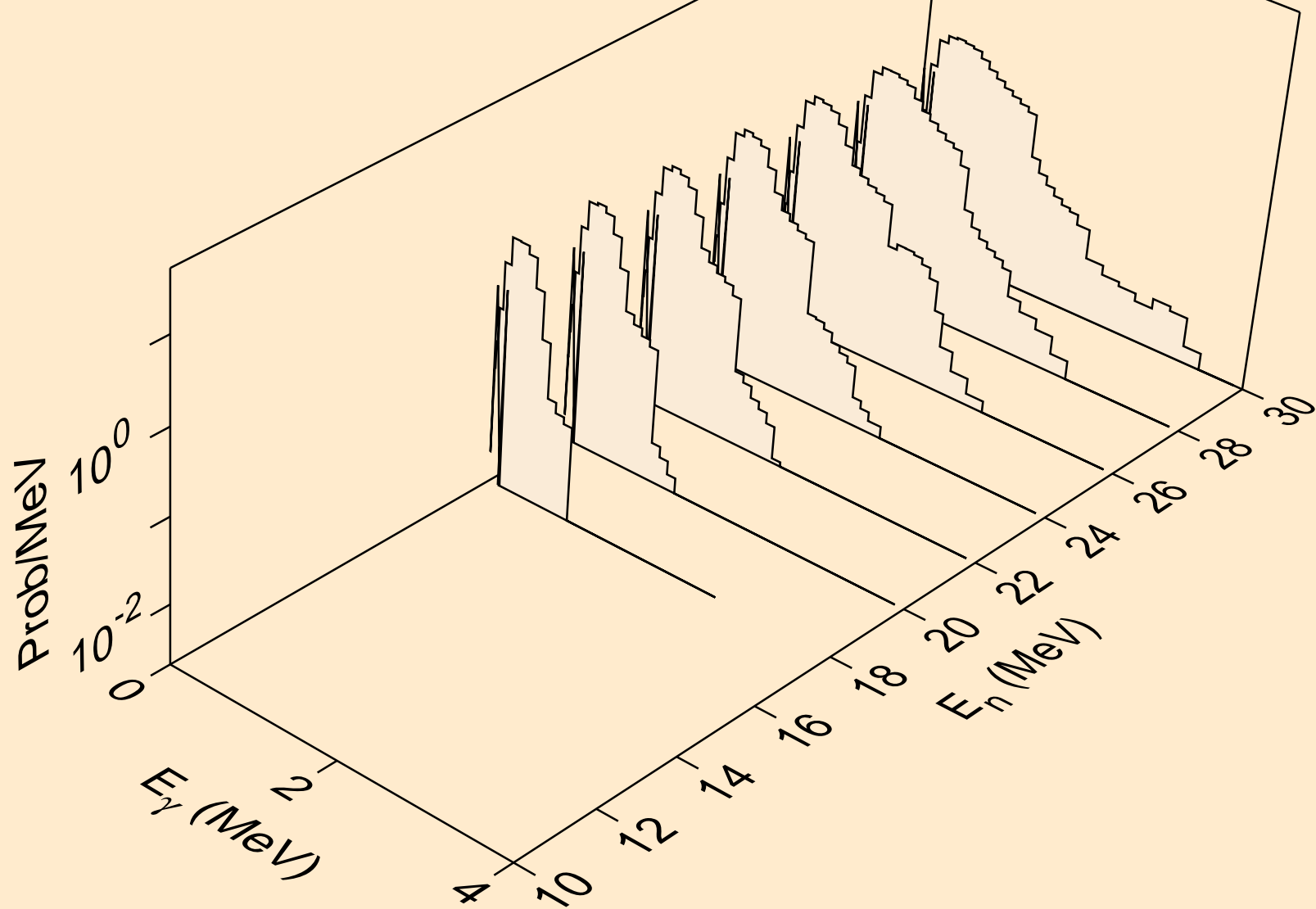

RN224 PROTON ACER TENDL-2021 LIBRARY; T=0.K  
Photon emission for (n,4n)

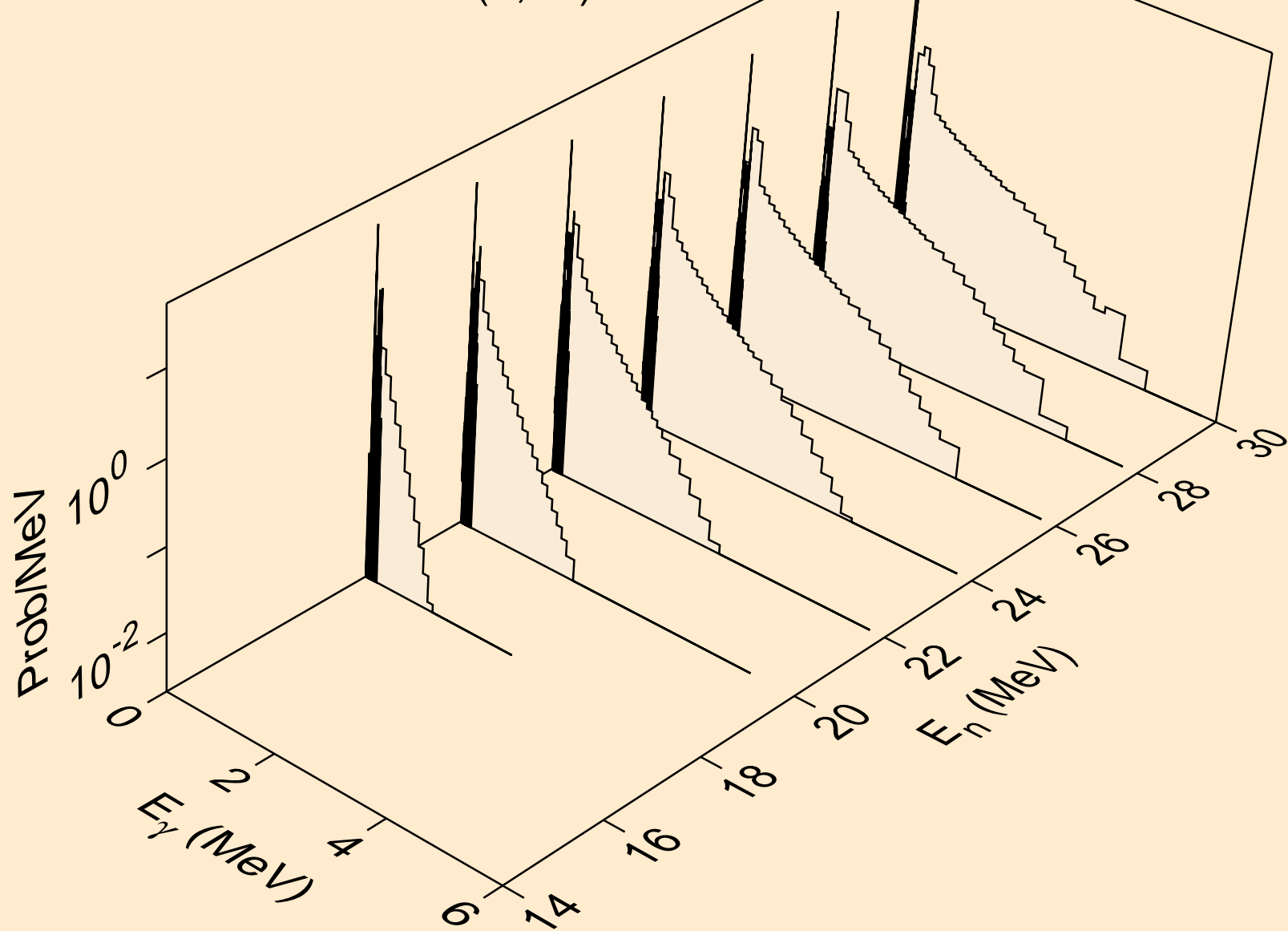

RN224 PROTON ACER TENDL-2021 LIBRARY; T=0.K  
Photon emission for (n,2np)

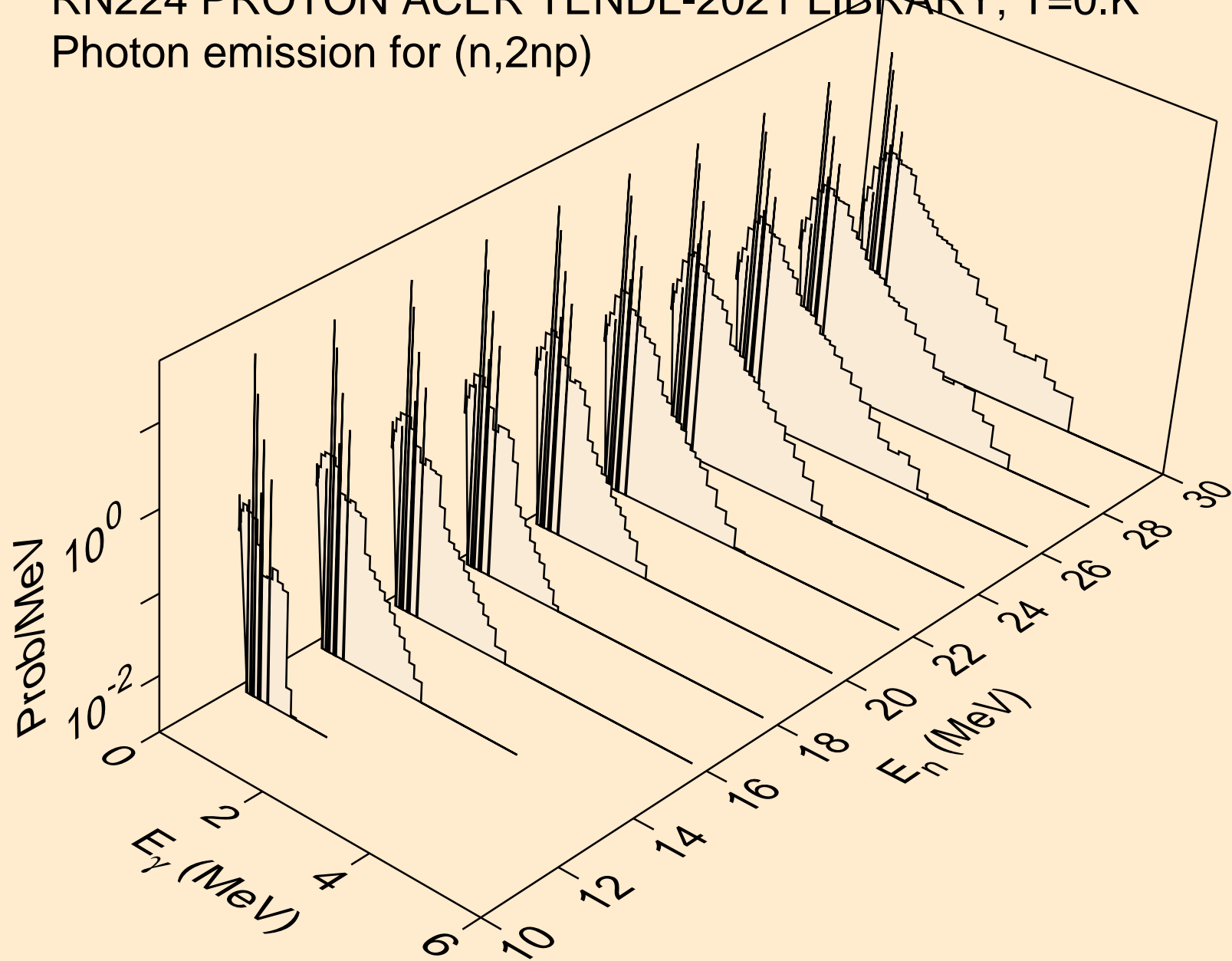

RN224 PROTON ACER TENDL-2021 LIBRARY; T=0.K  
Photon emission for (n,3np)

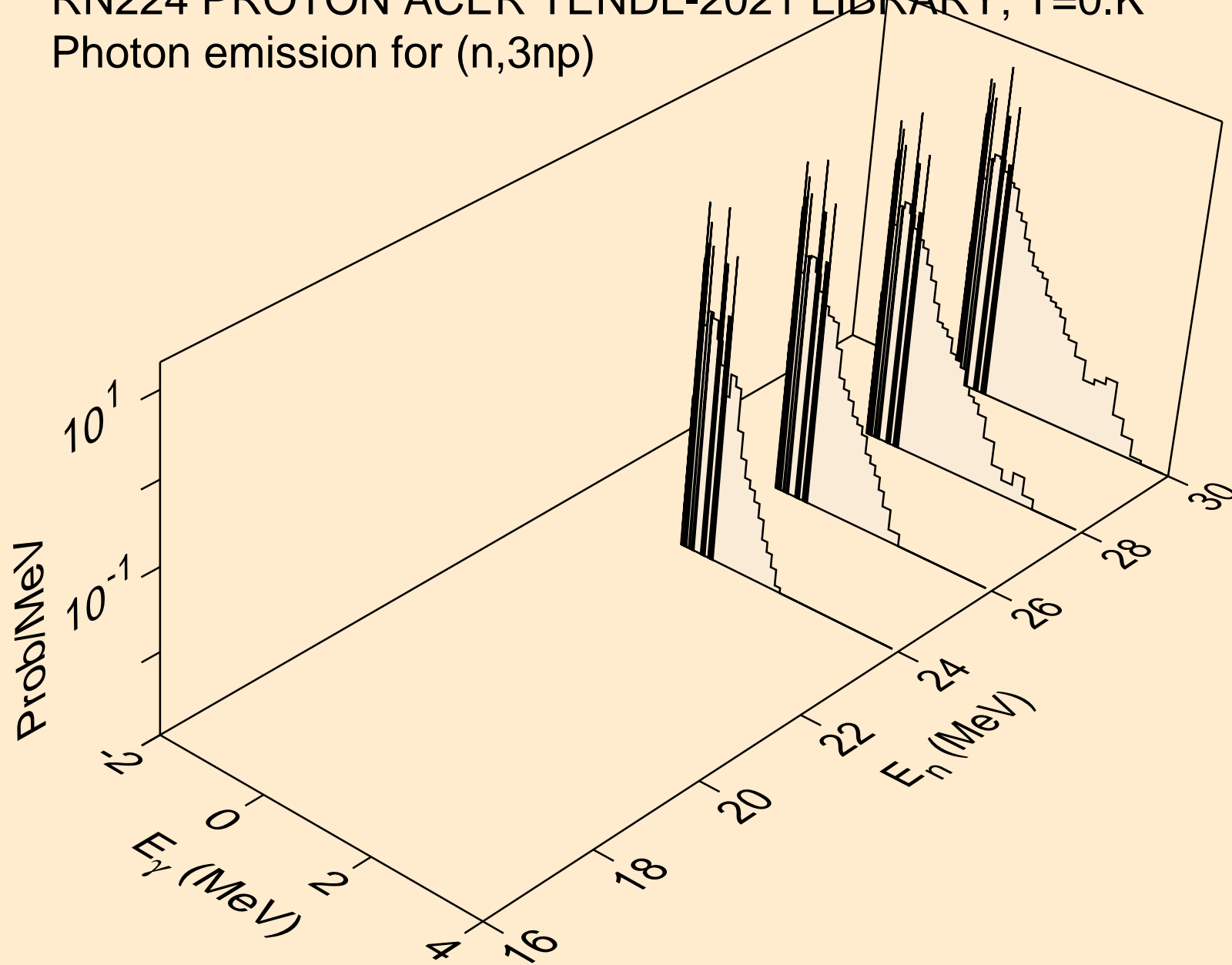

RN224 PROTON ACER TENDL-2021 LIBRARY; T=0.K  
Photon emission for (n,2np)

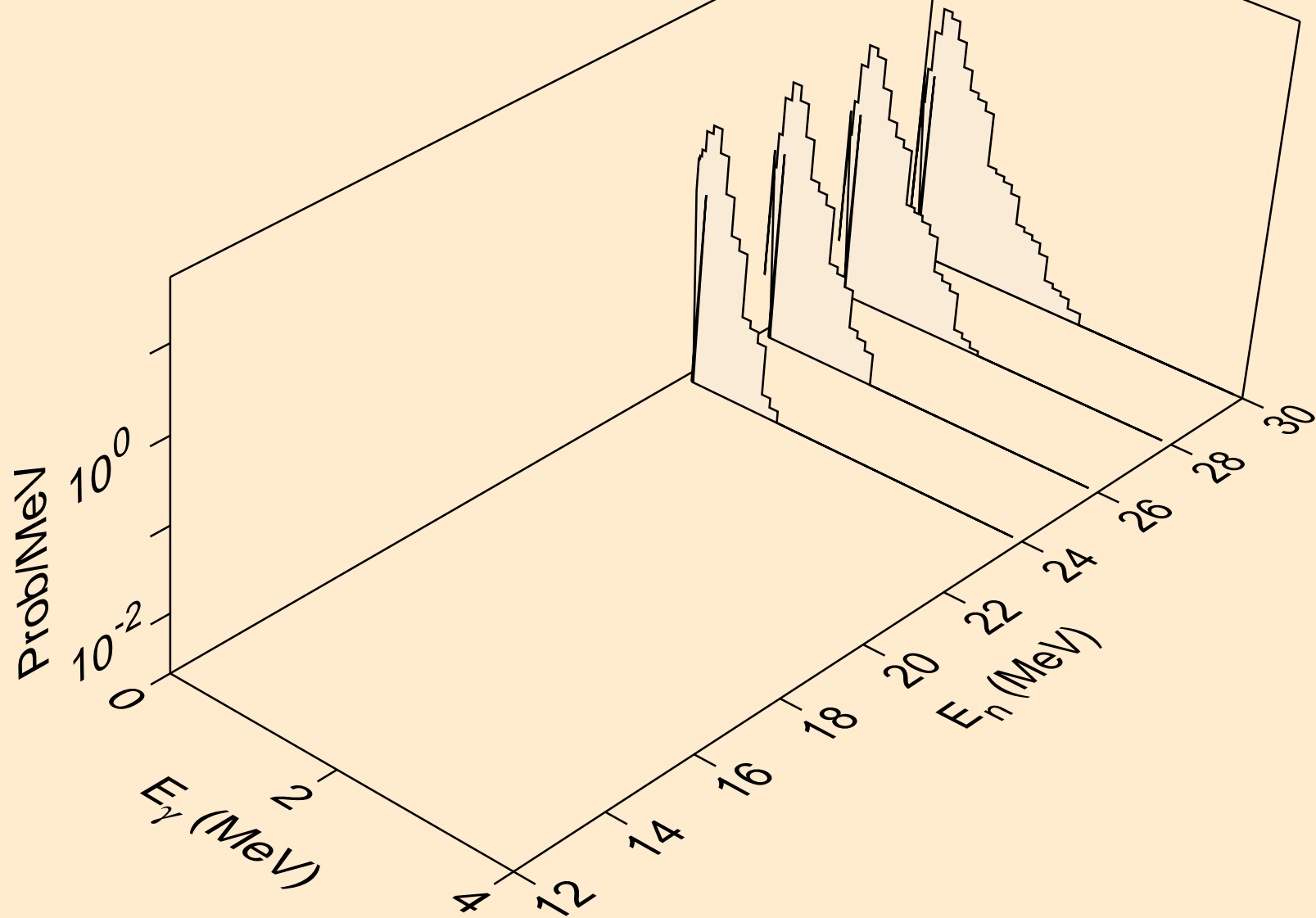

RN224 PROTON ACER TENDL-2021 LIBRARY; T=0.K  
Photon emission for (n,npa)

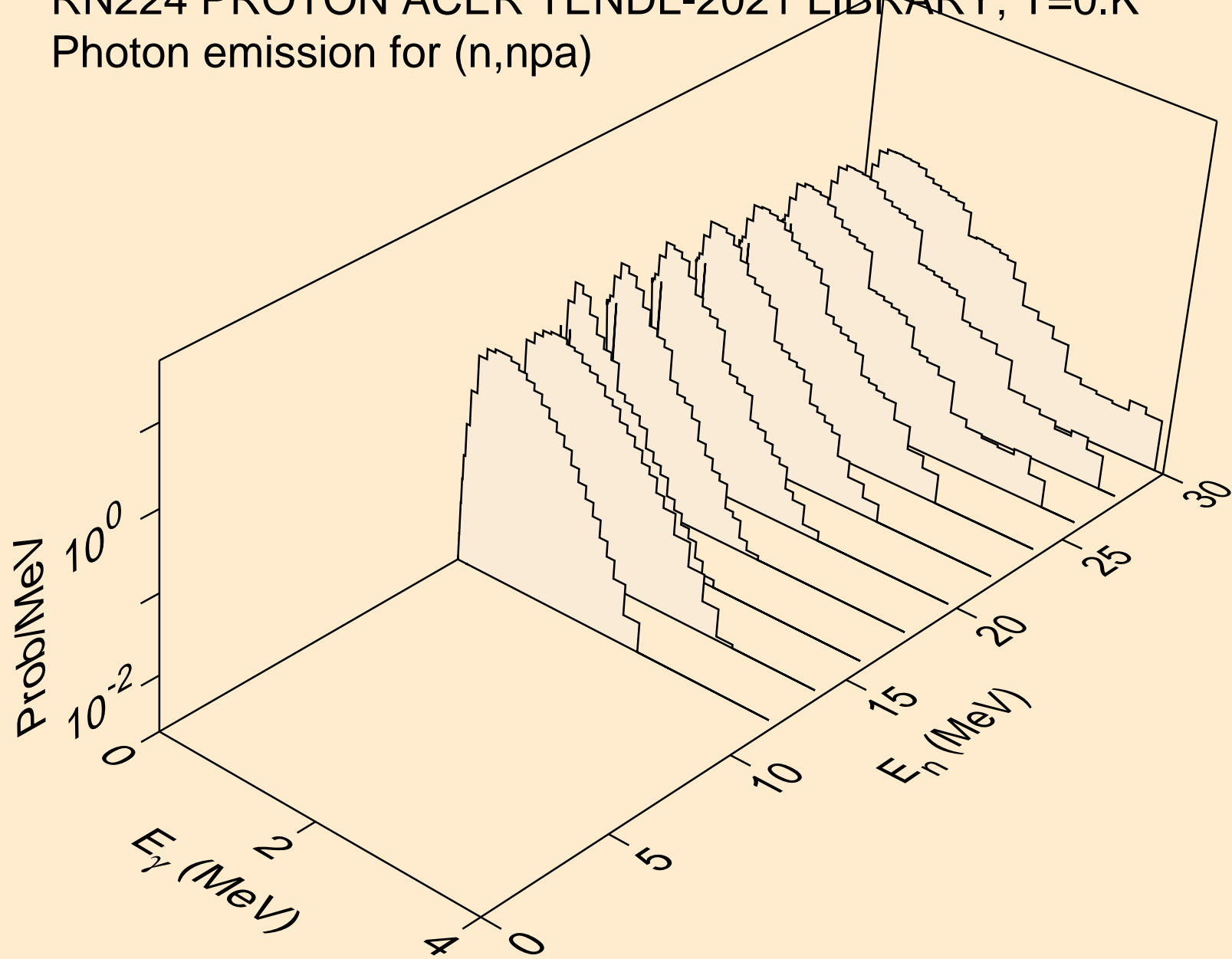

RN224 PROTON ACER TENDL-2021 LIBRARY; T=0.K  
Photon emission for (n,gma)

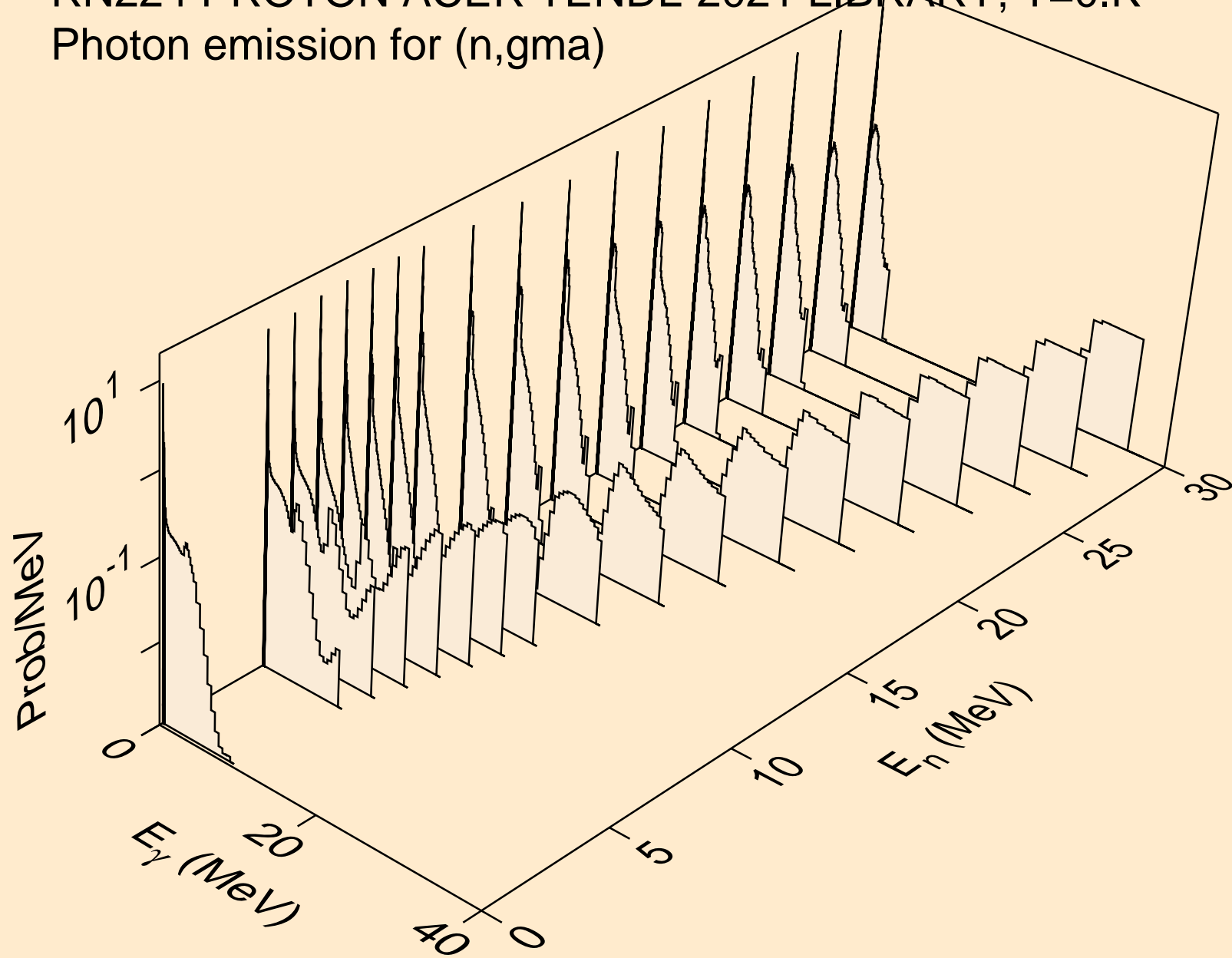



RN224 PROTON ACER TENDL-2021 LIBRARY; T=0.K  
Photon emission for inelastic

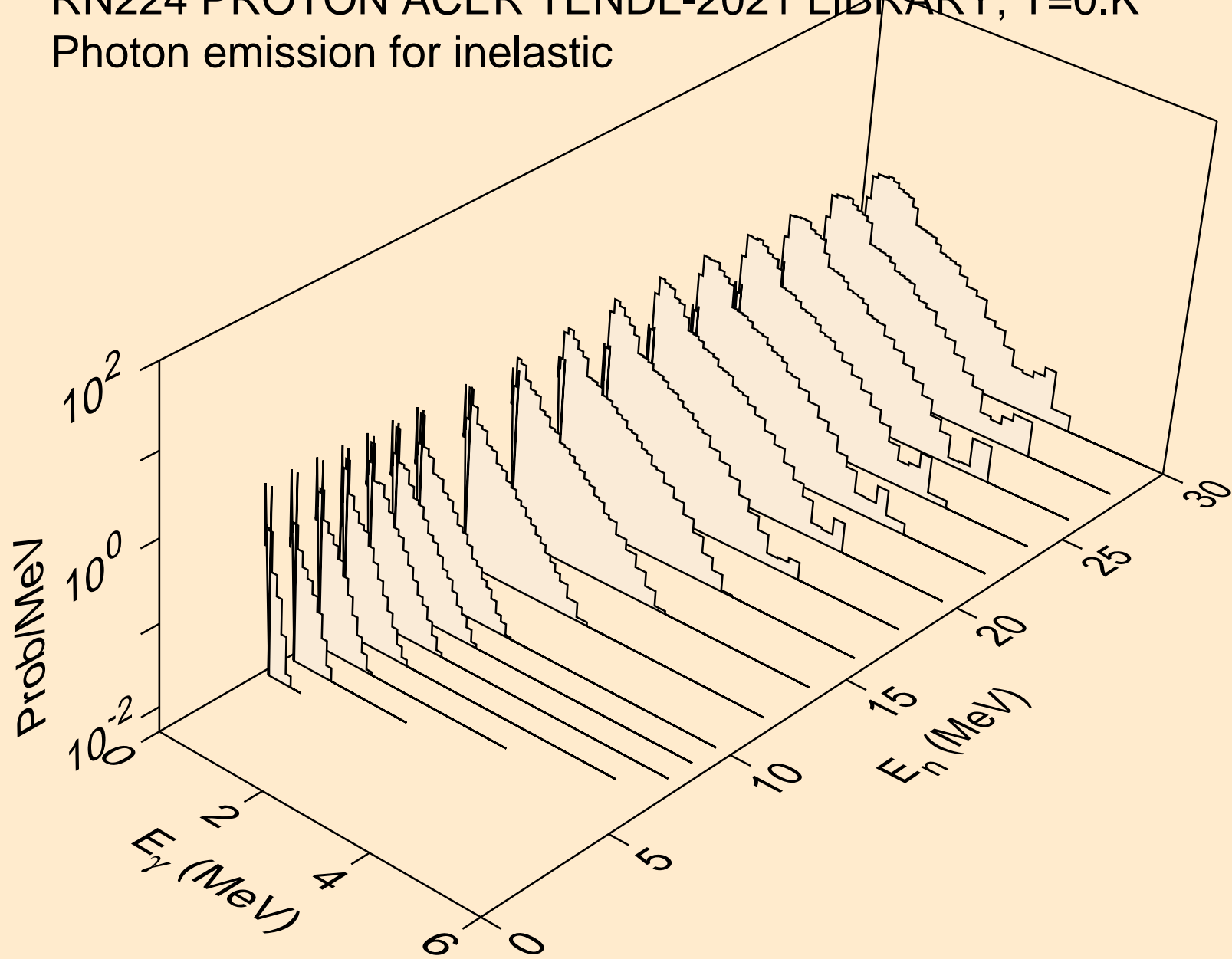

RN224 PROTON ACER TENDL-2021 LIBRARY; T=0.K  
Photon emission for (n,d)

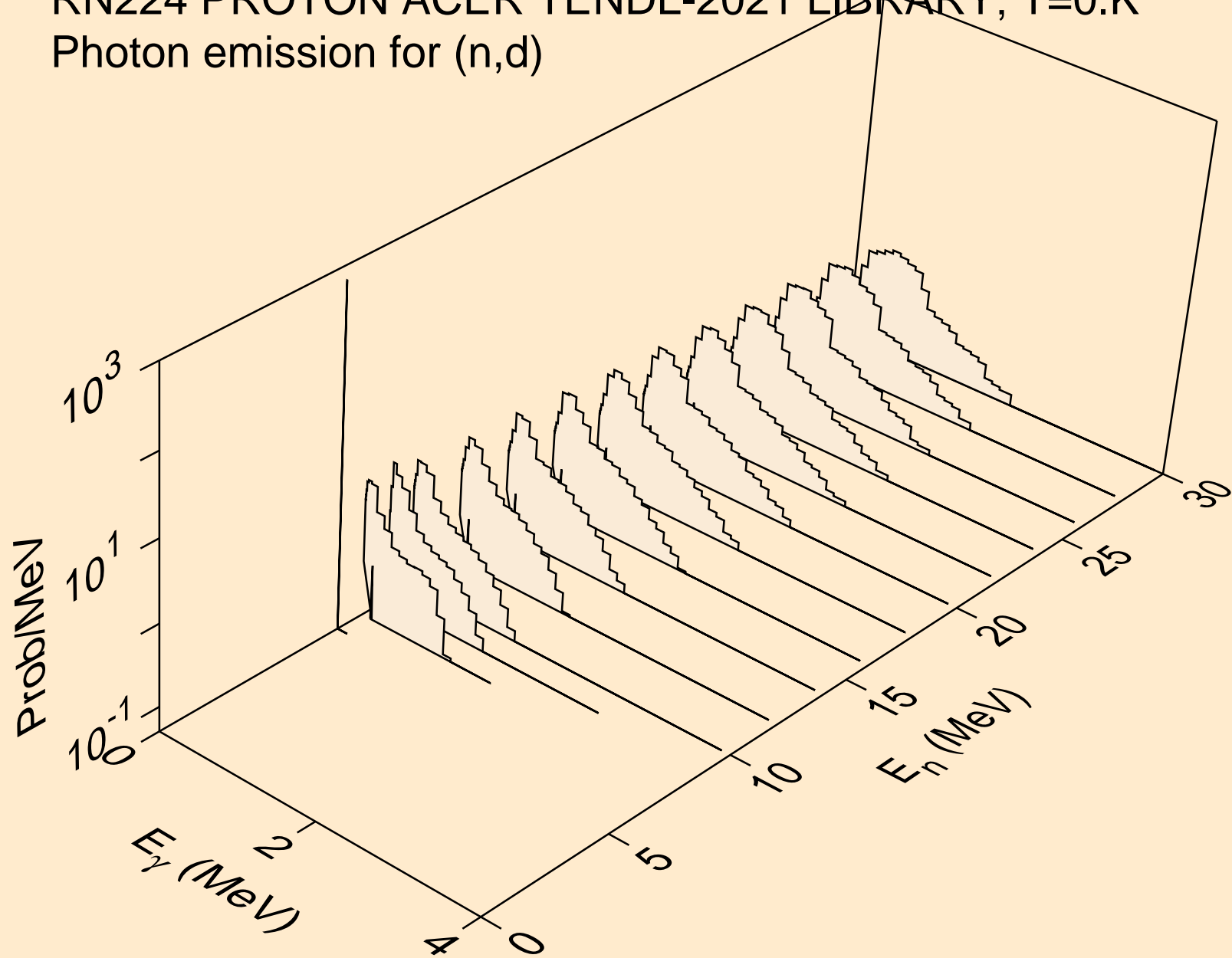

RN224 PROTON ACER TENDL-2021 LIBRARY; T=0.K  
Photon emission for (n,t)

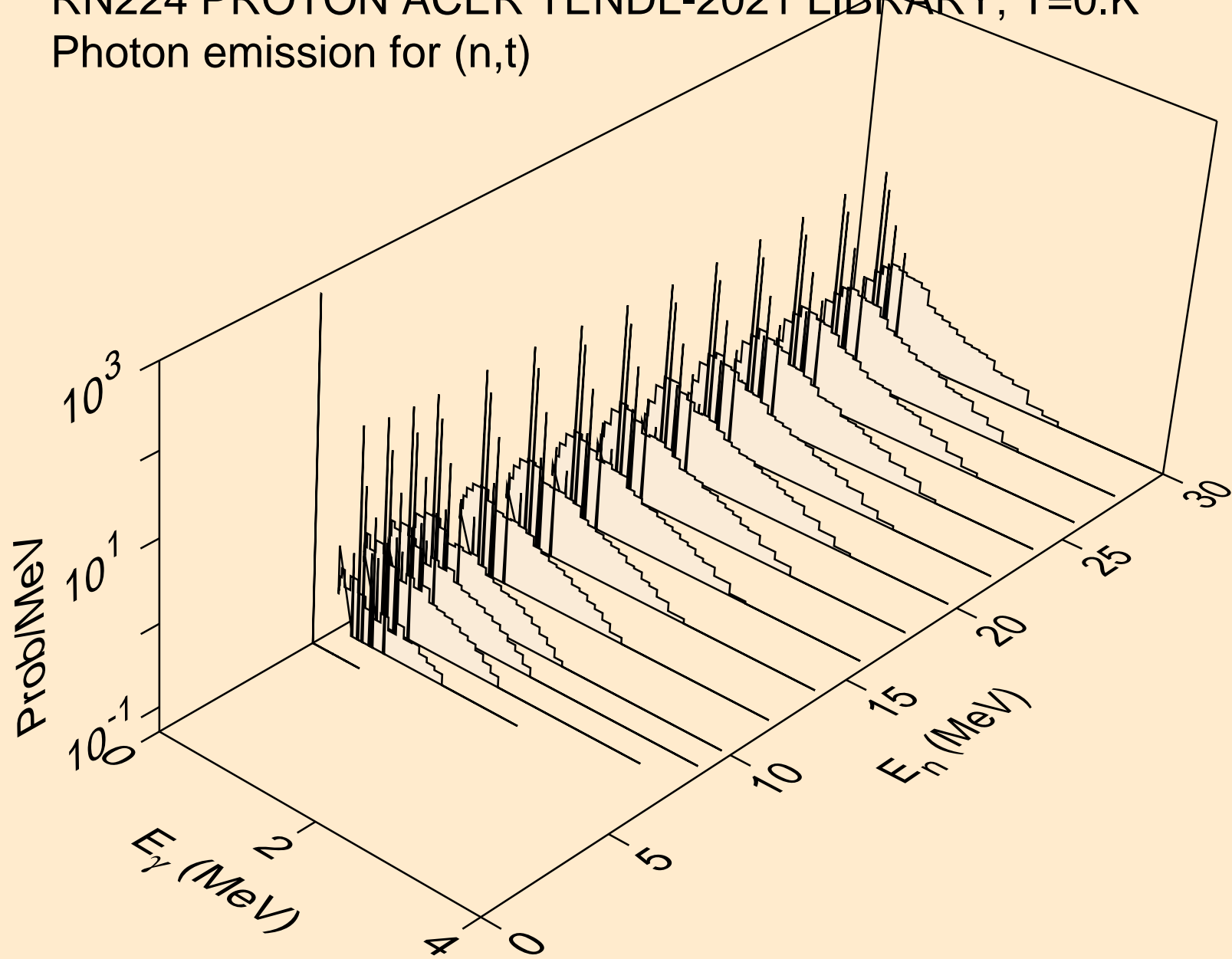

RN224 PROTON ACER TENDL-2021 LIBRARY; T=0.K  
Photon emission for (n,he3)

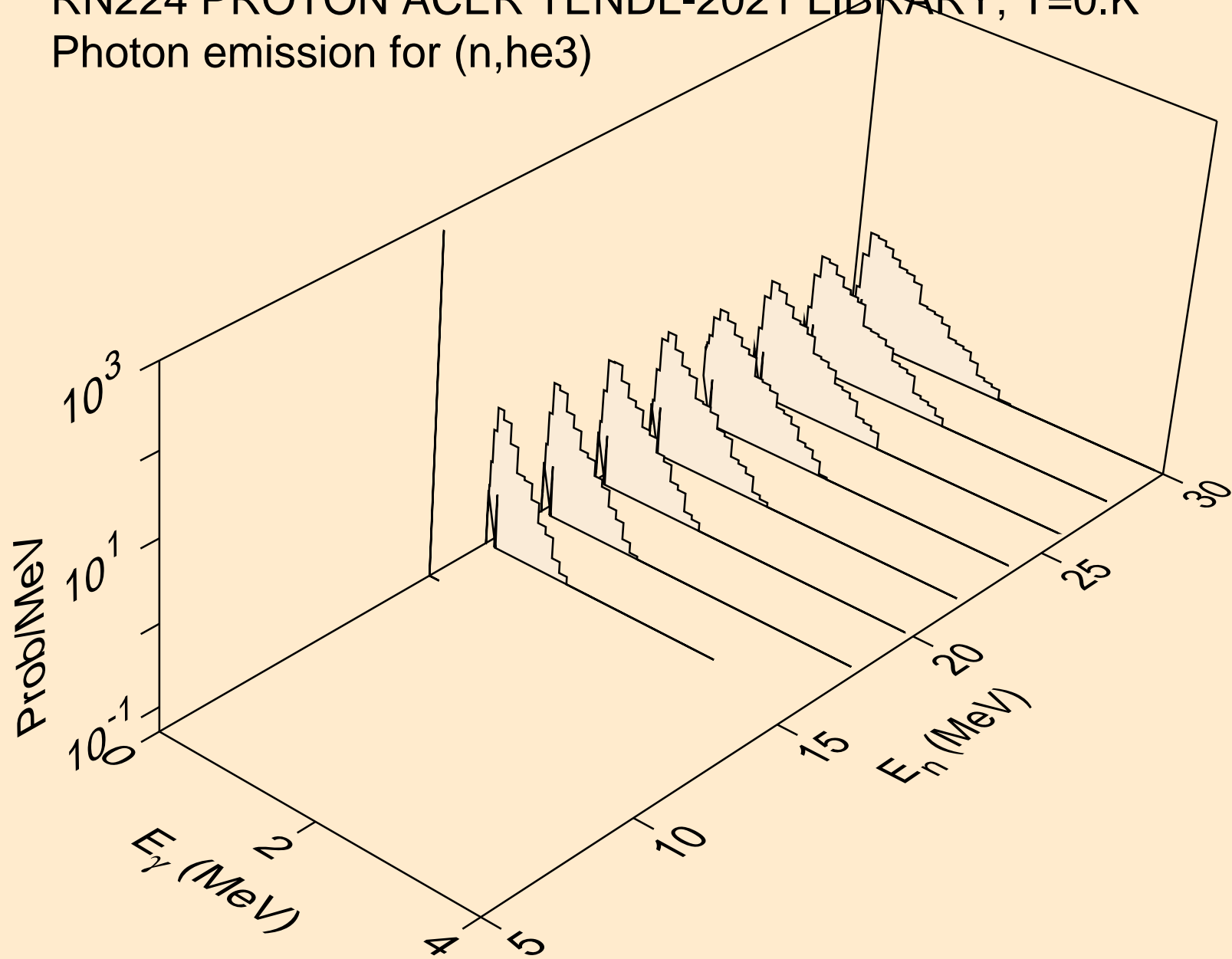

RN224 PROTON ACER TENDL-2021 LIBRARY; T=0.K  
Photon emission for (n,a)

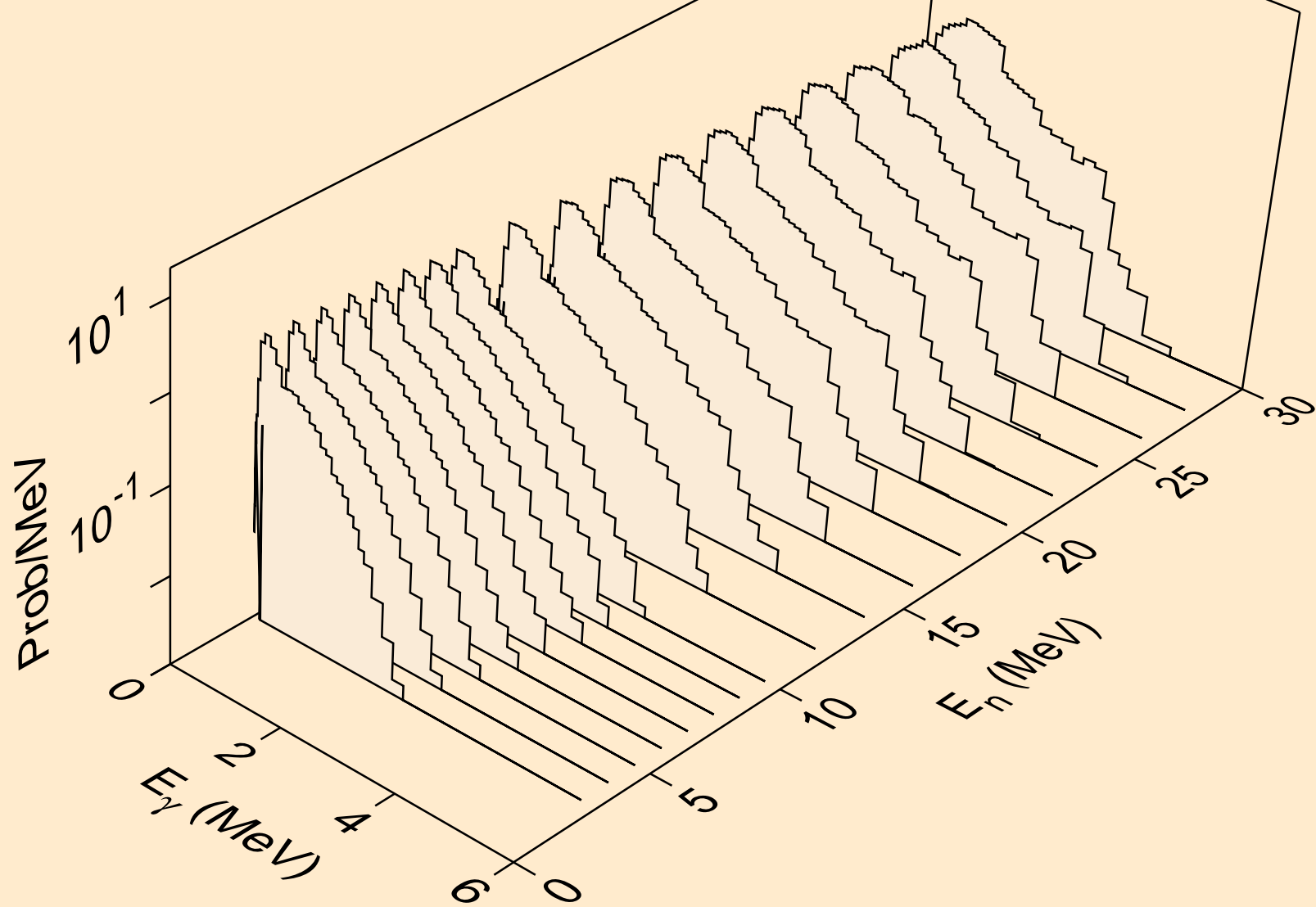

RN224 PROTON ACER TENDL-2021 LIBRARY; T=0.K  
Photon emission for (n,2a)

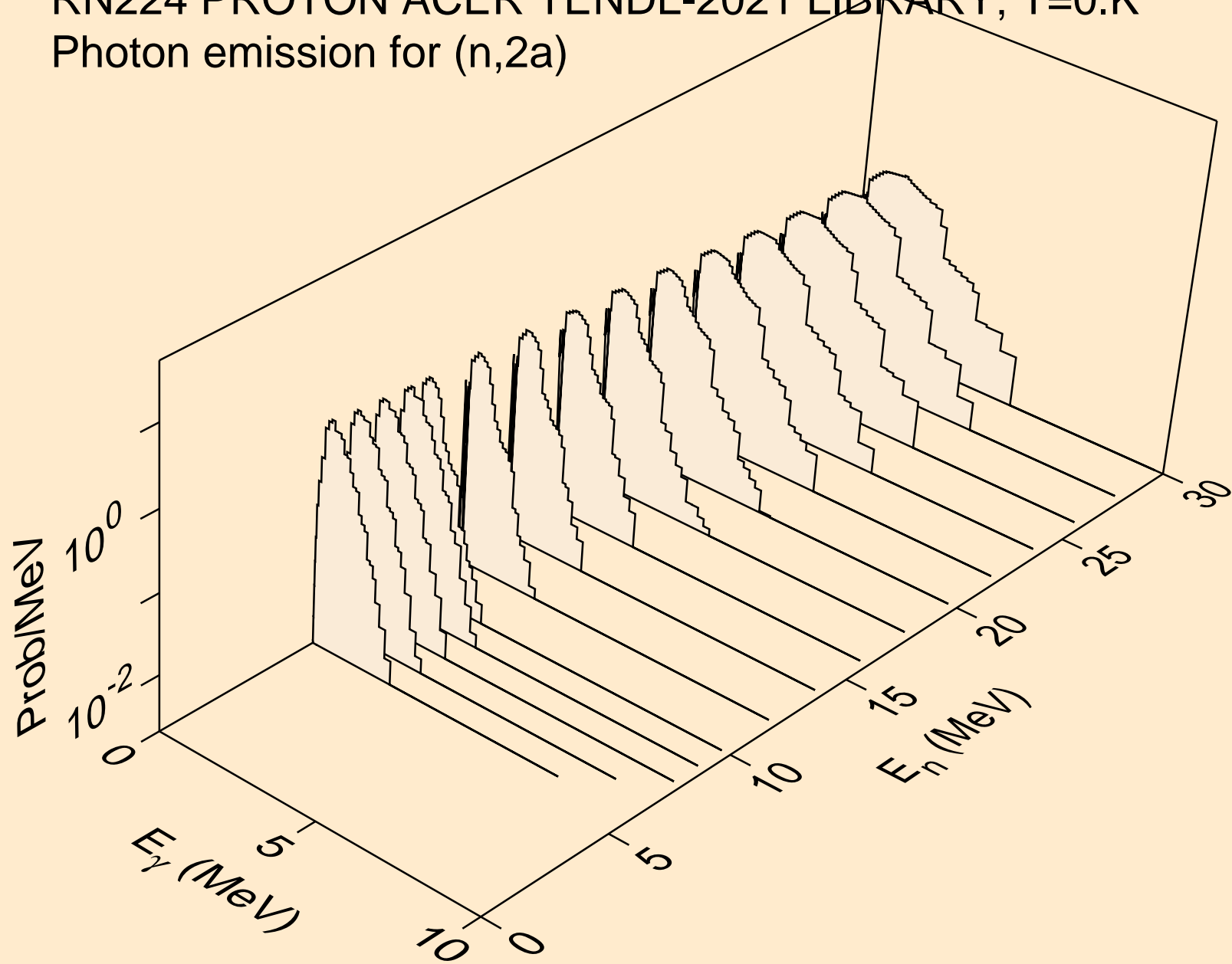

RN224 PROTON ACER TENDL-2021 LIBRARY; T=0.K  
Photon emission for (n,2p)

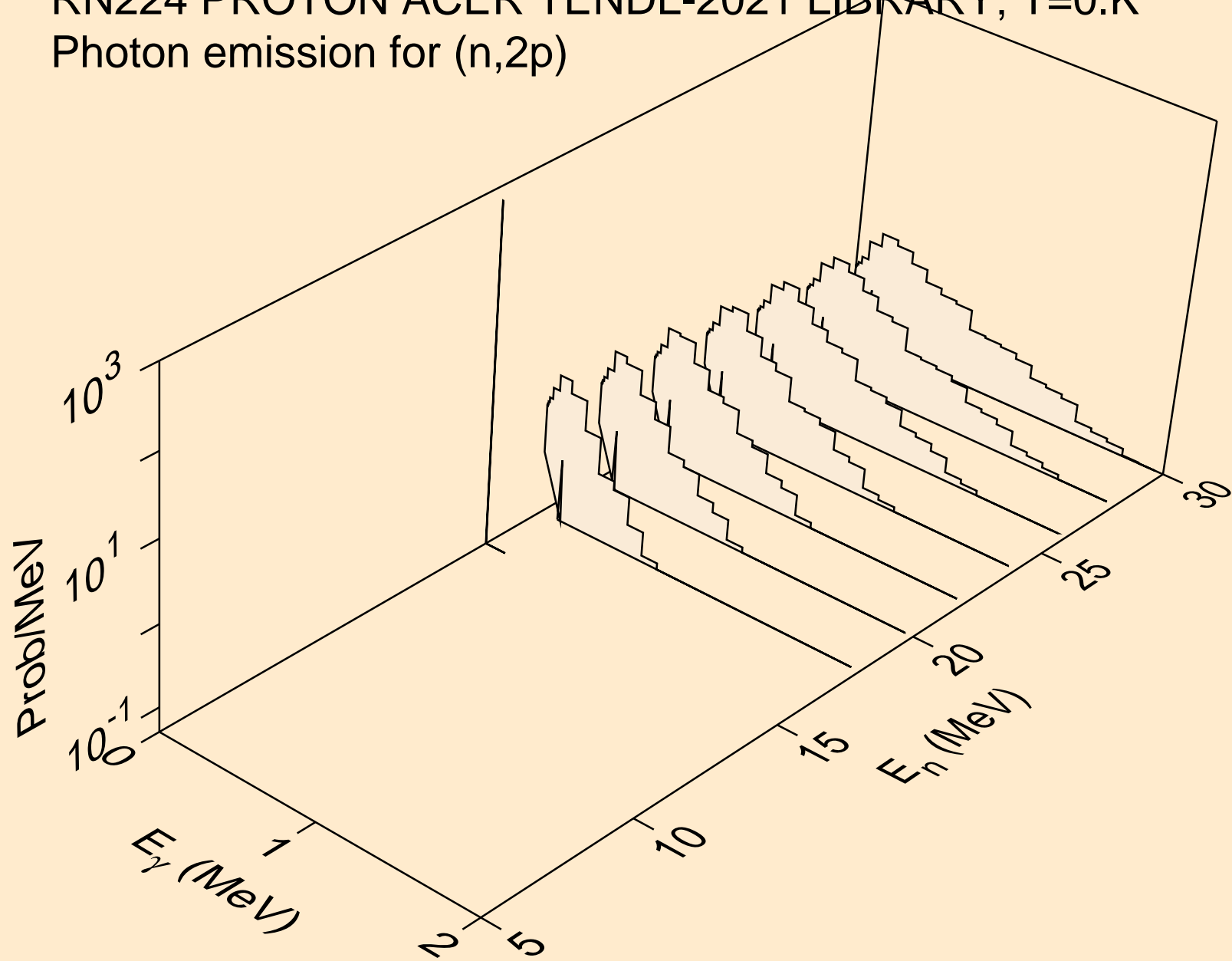

RN224 PROTON ACER TENDL-2021 LIBRARY; T=0.K  
Photon emission for (n,pa)

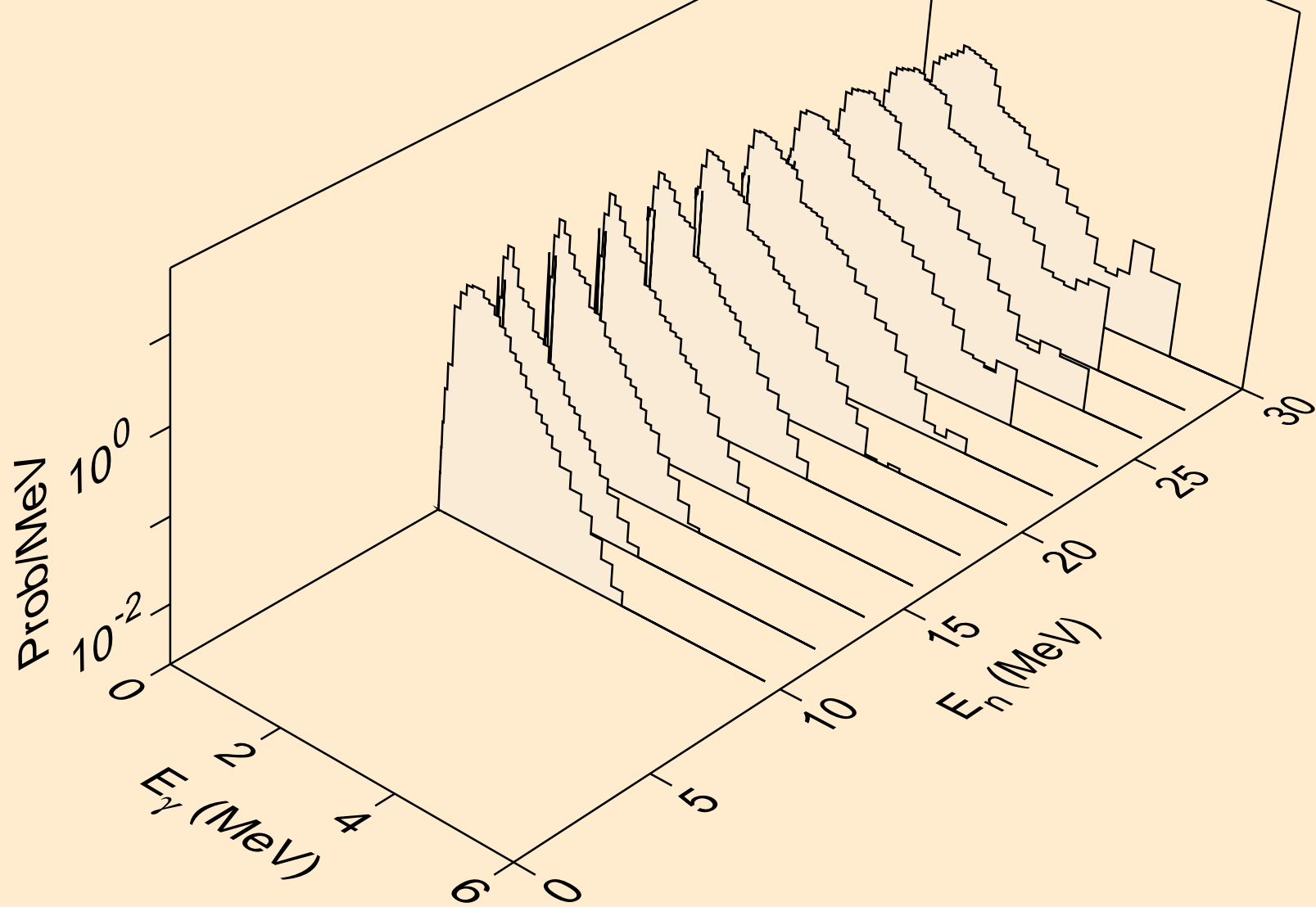



RN224 PROTON ACER TENDL-2021 LIBRARY; T=0.K  
Particle heating contributions

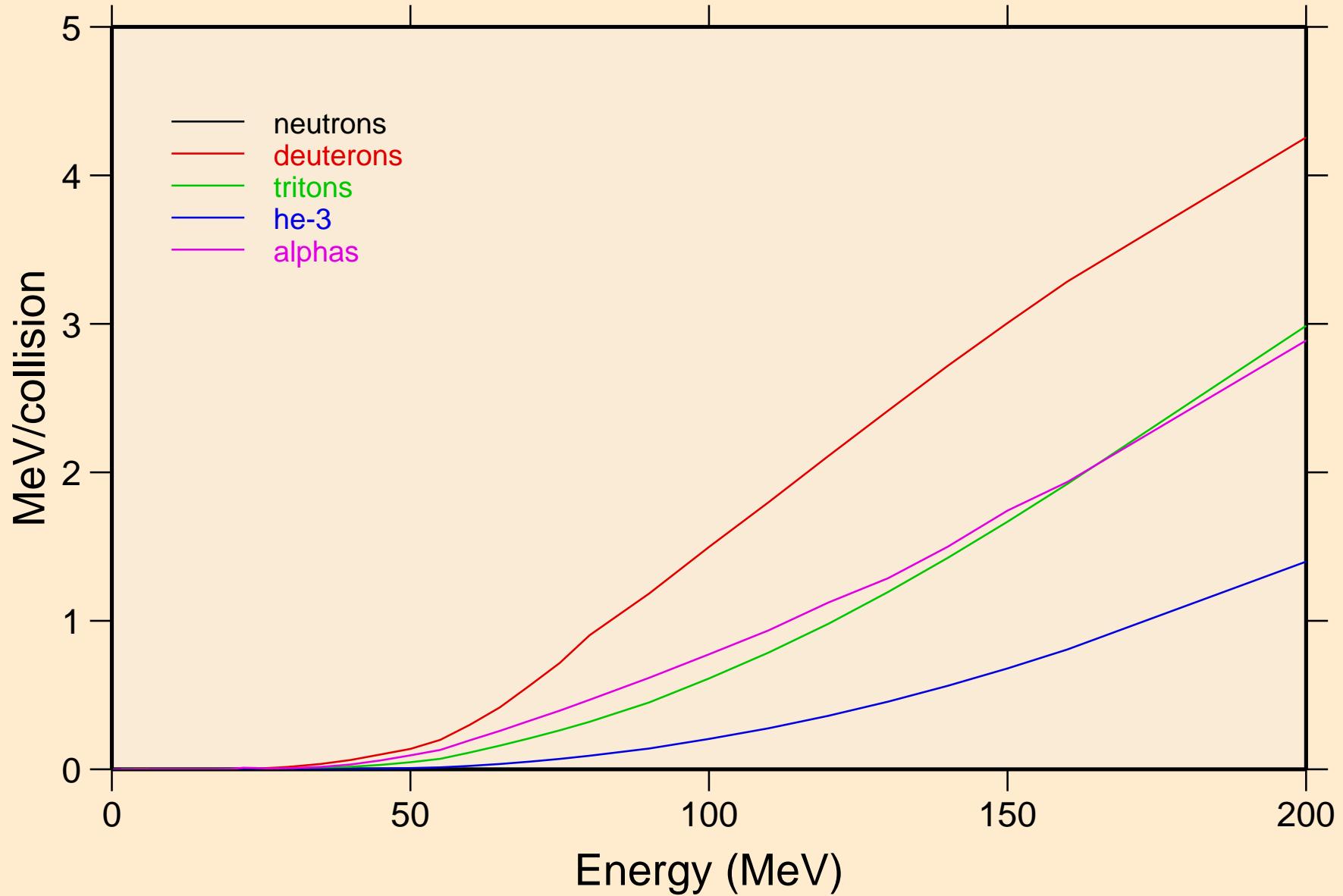

RN224 PROTON ACER TENDL-2021 LIBRARY; T=0.K  
Recoil Heating

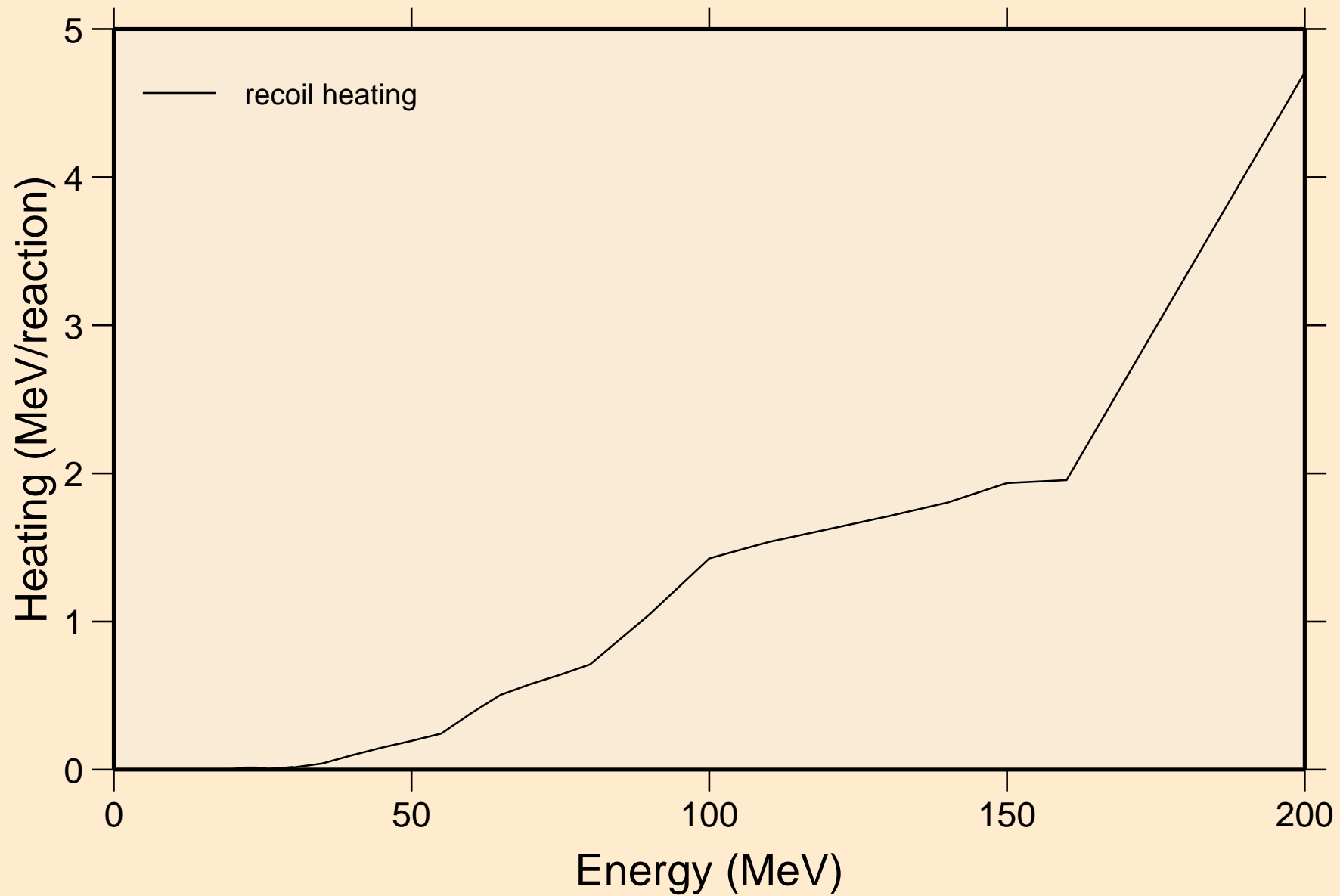

RN224 PROTON ACER TENDL-2021 LIBRARY; T=0.K  
Particle production cross sections

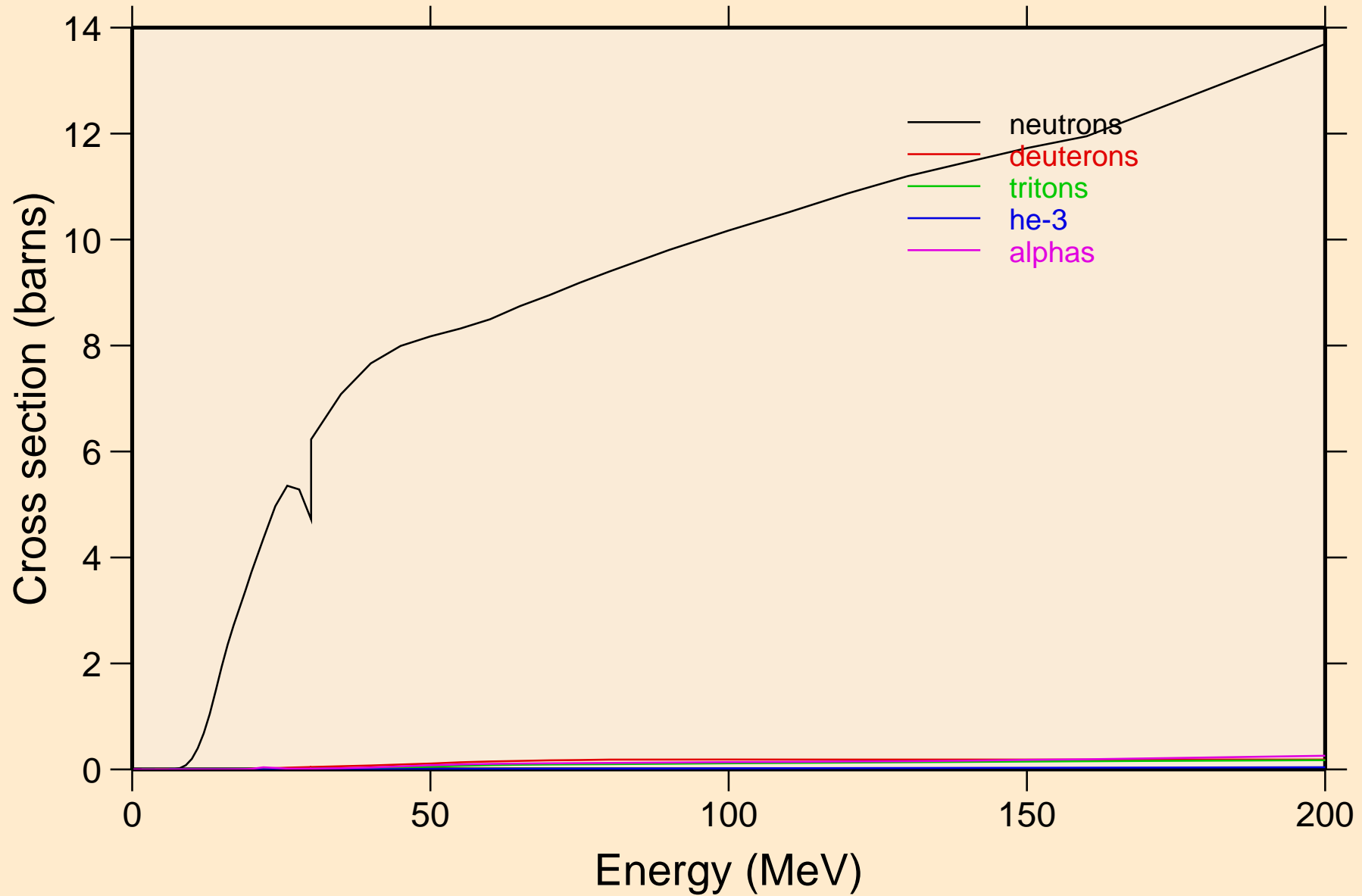

RN224 PROTON ACER TENDL-2021 LIBRARY; T=0.K  
neutrons from (p,n)

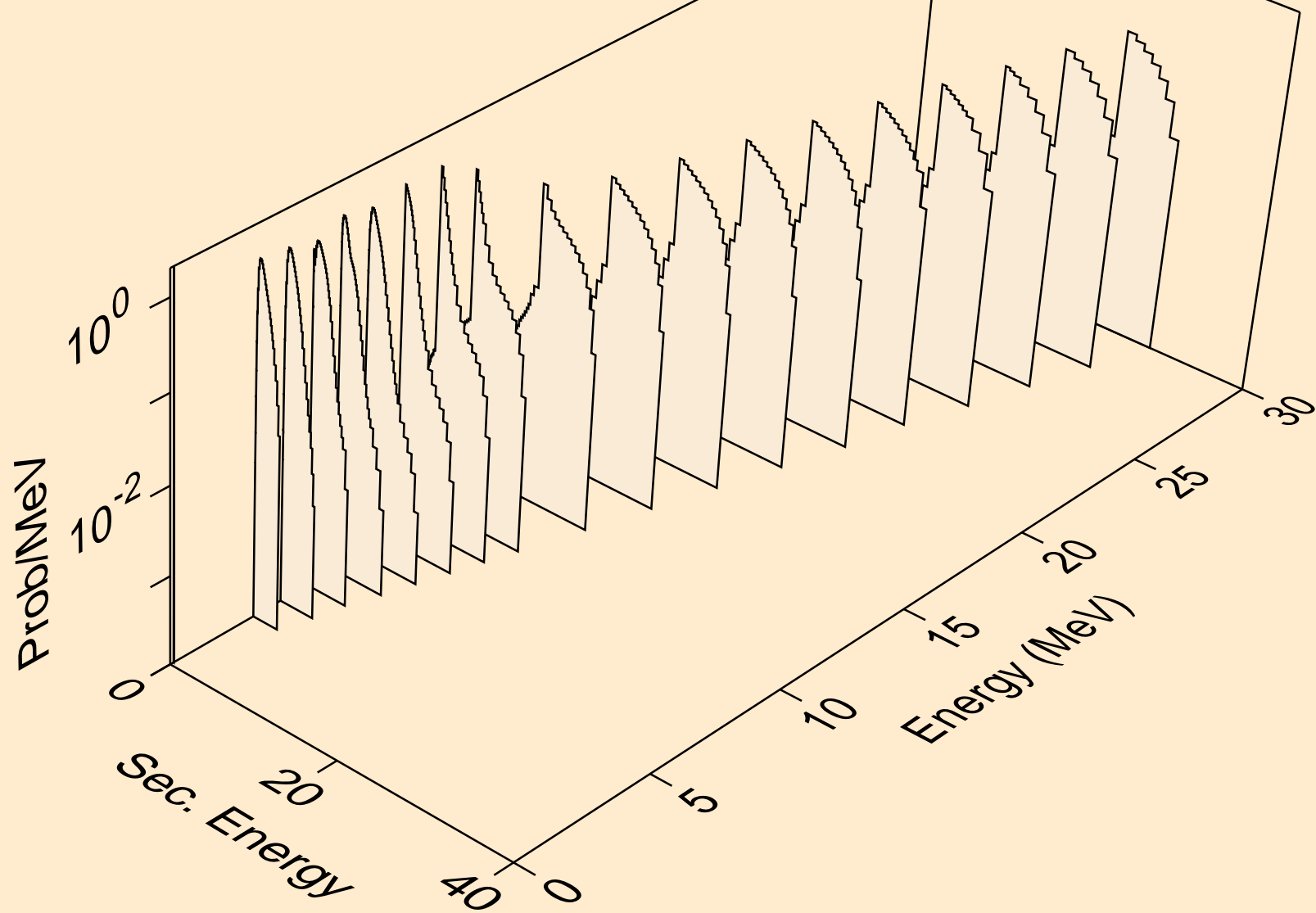

RN224 PROTON ACER TENDL-2021 LIBRARY; T=0.K  
neutrons from (p,x)

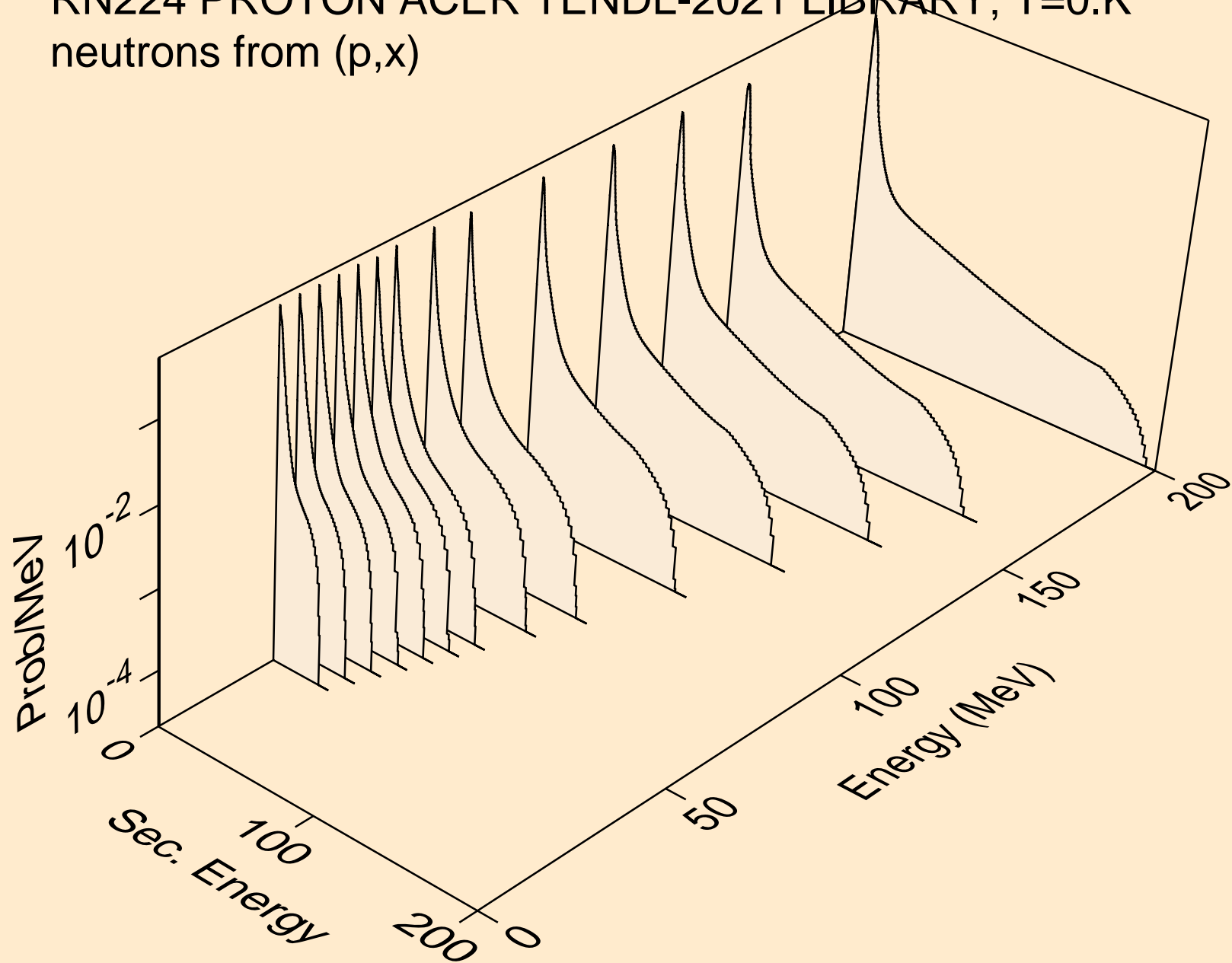

RN224 PROTON ACER TENDL-2021 LIBRARY; T=0.K  
neutrons from (p,2nd)

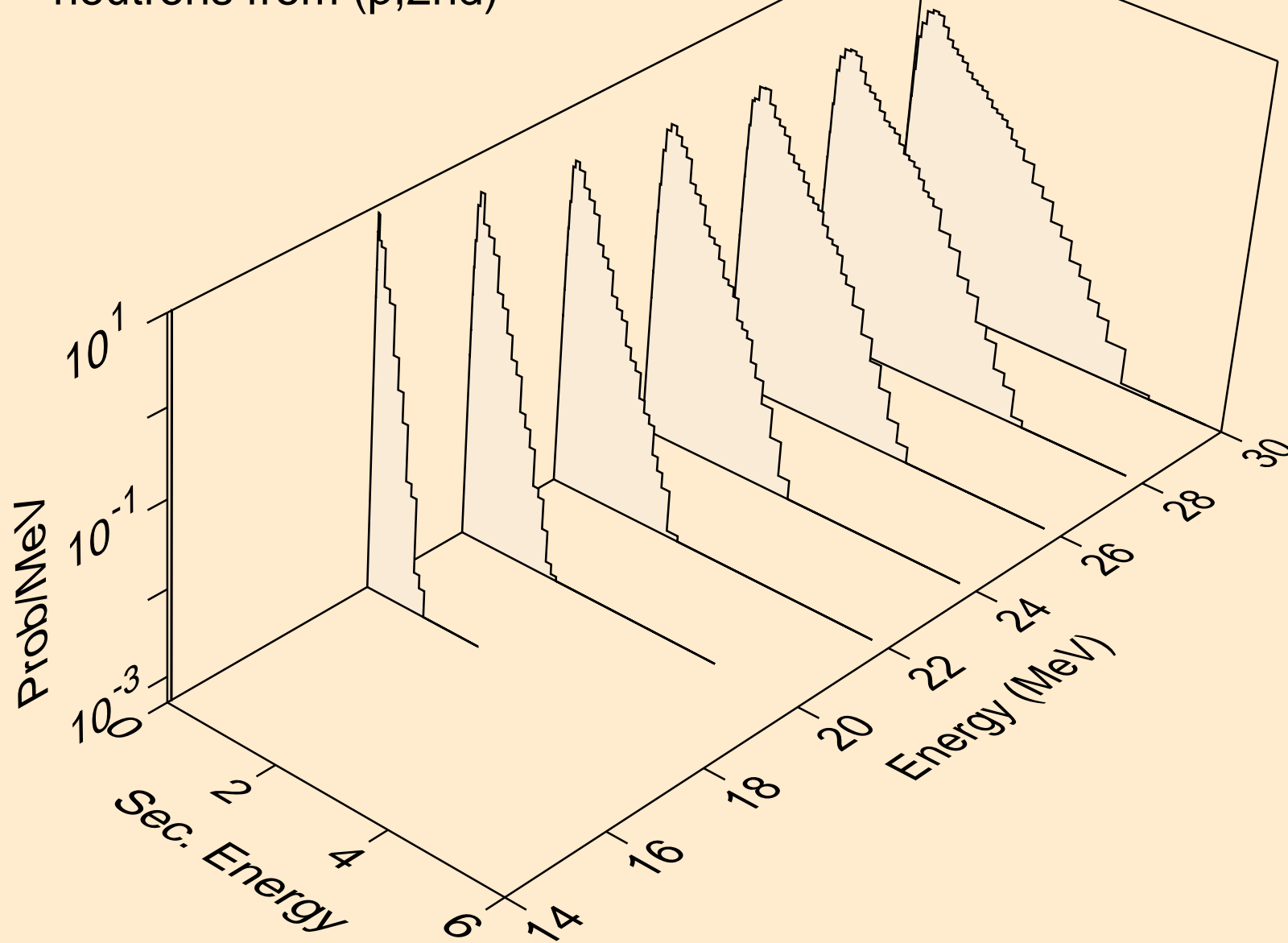

RN224 PROTON ACER TENDL-2021 LIBRARY; T=0.K  
neutrons from (p,2n)

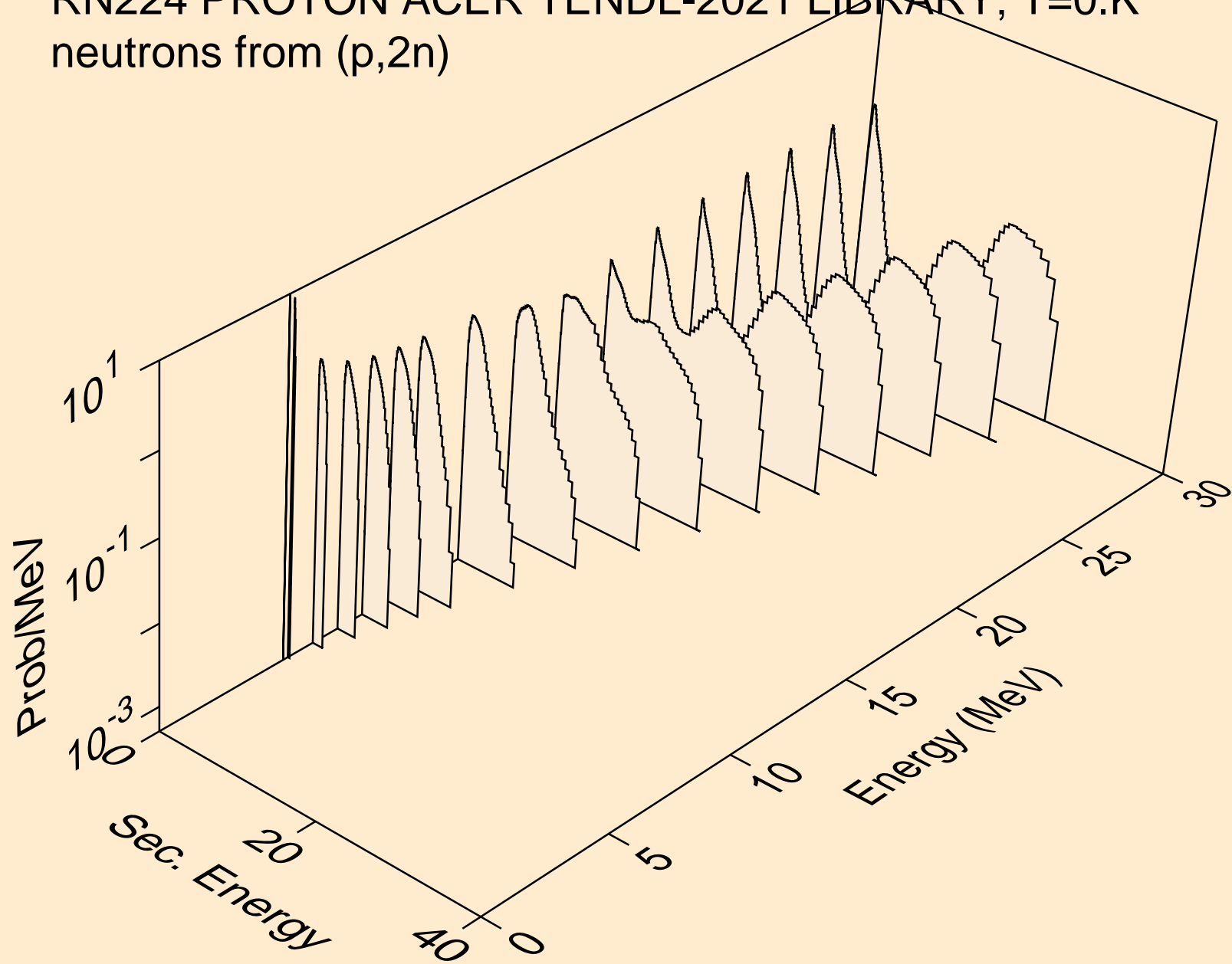

RN224 PROTON ACER TENDL-2021 LIBRARY; T=0.K  
neutrons from (p,3n)

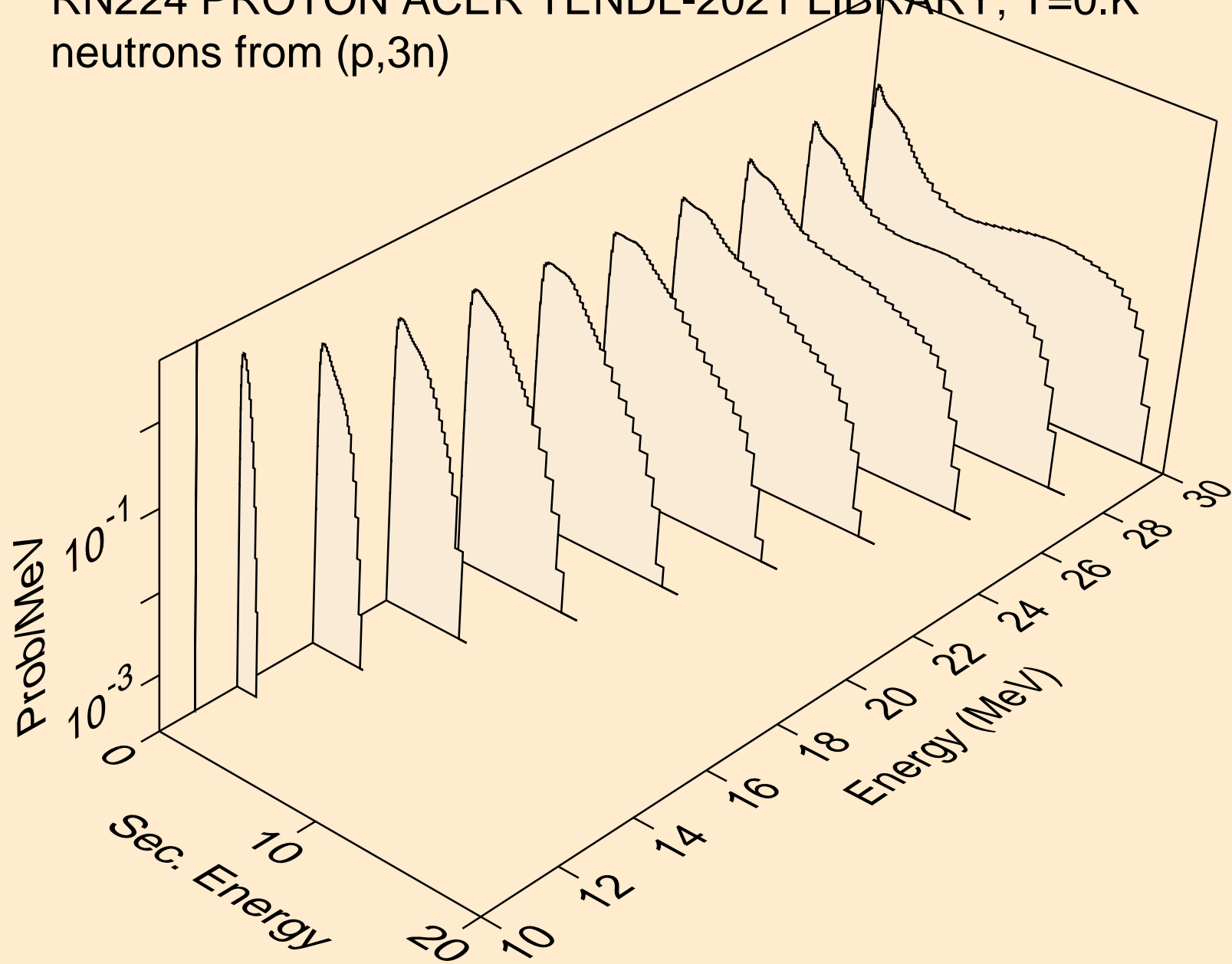



RN224 PROTON ACER TENDL-2021 LIBRARY; T=0.K  
neutrons from (p,n\*)a

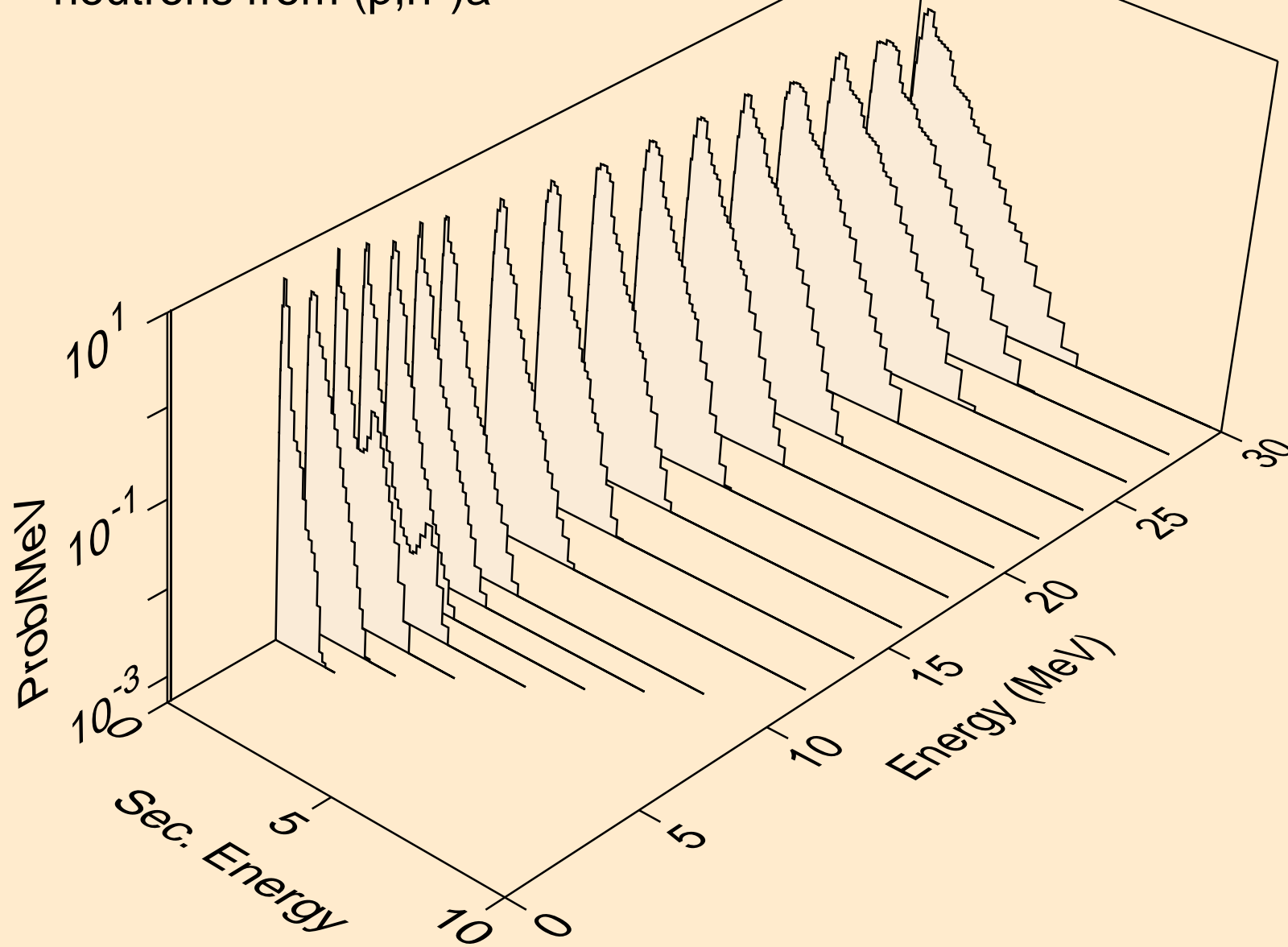

RN224 PROTON ACER TENDL-2021 LIBRARY; T=0.K  
neutrons from (p,2n)a

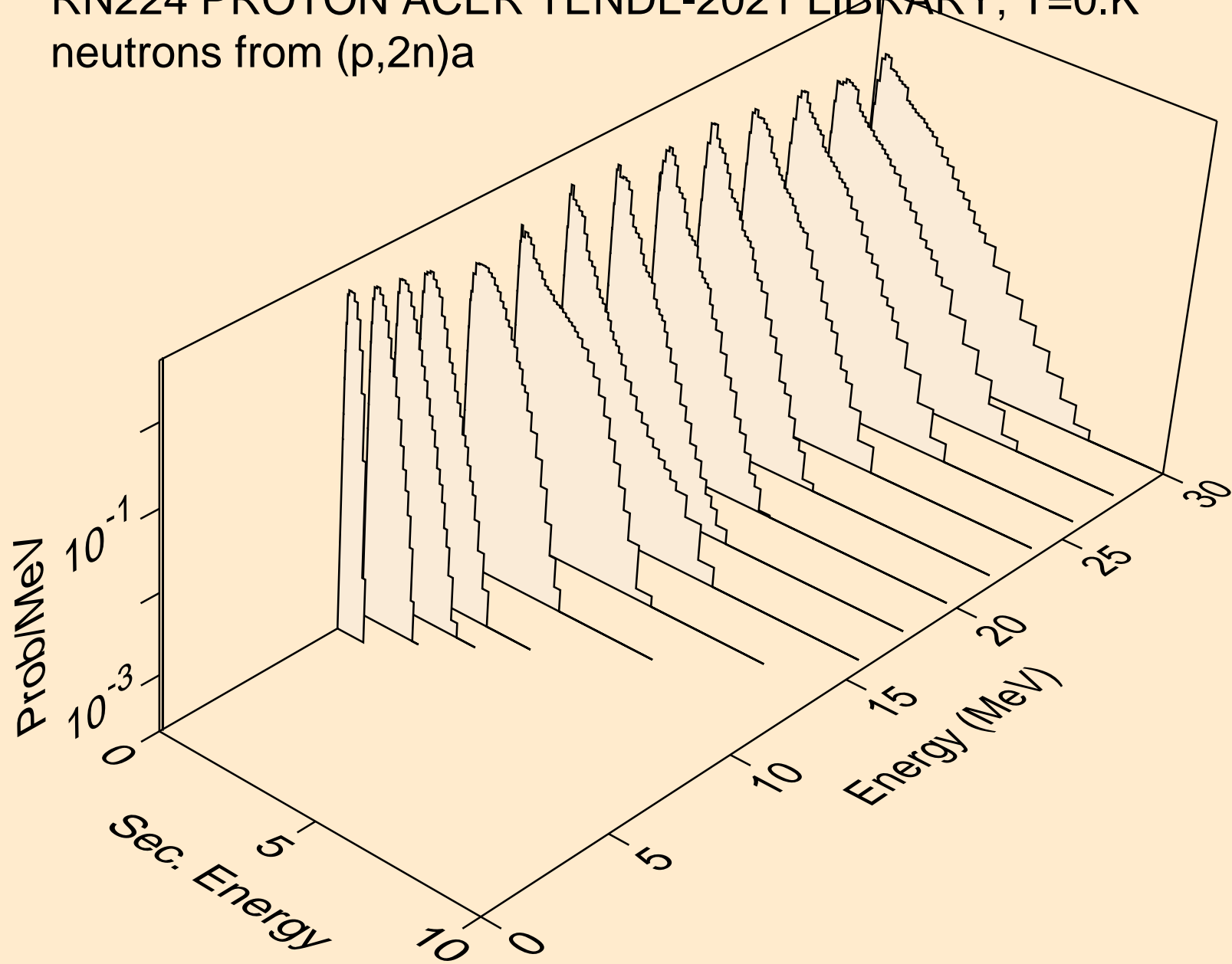

RN224 PROTON ACER TENDL-2021 LIBRARY; T=0.K  
neutrons from (p,3n)a

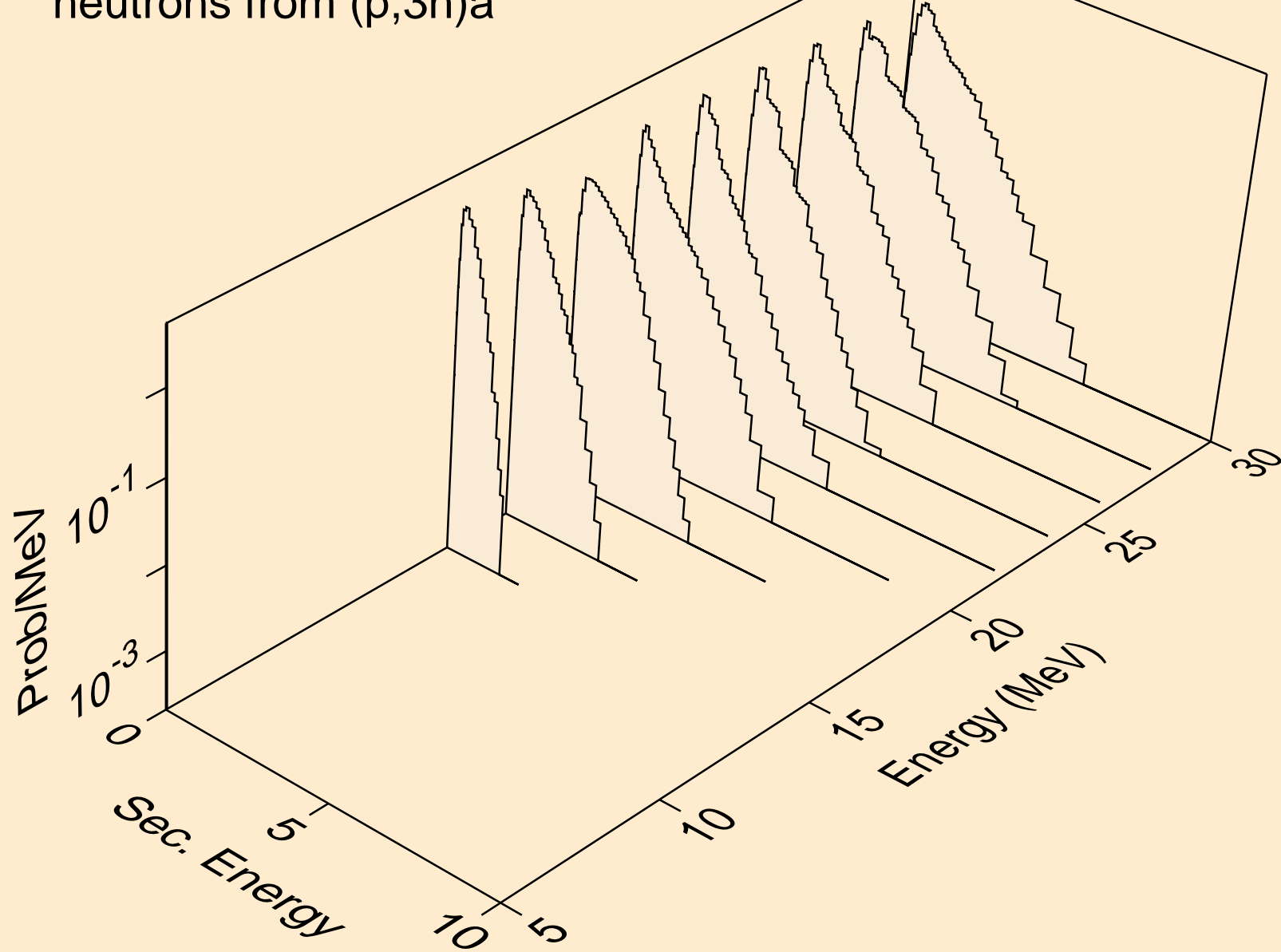

RN224 PROTON ACER TENDL-2021 LIBRARY; T=0.K  
neutrons from (p,n\*)p

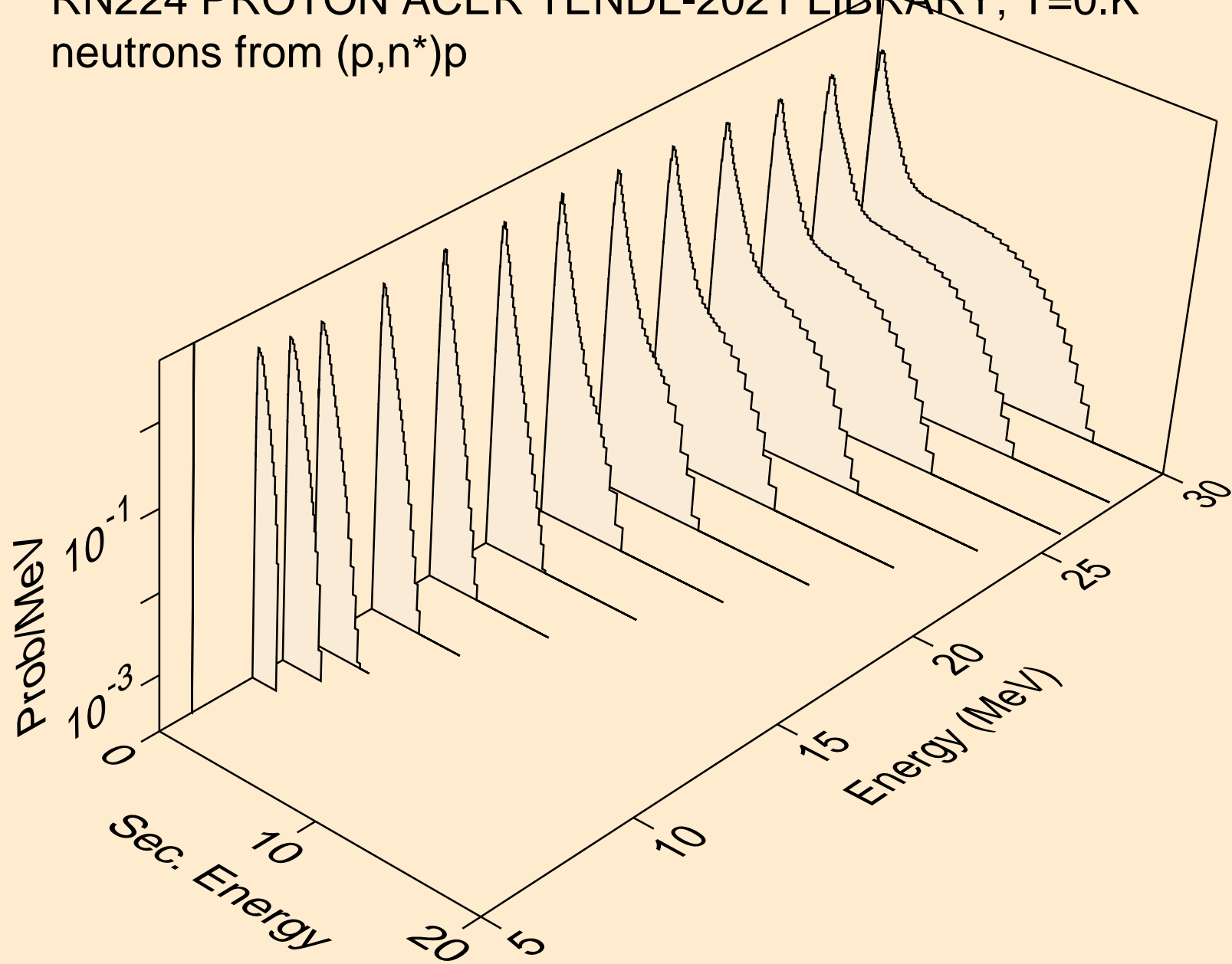

RN224 PROTON ACER TENDL-2021 LIBRARY; T=0.K  
neutrons from (p,n\*)2a

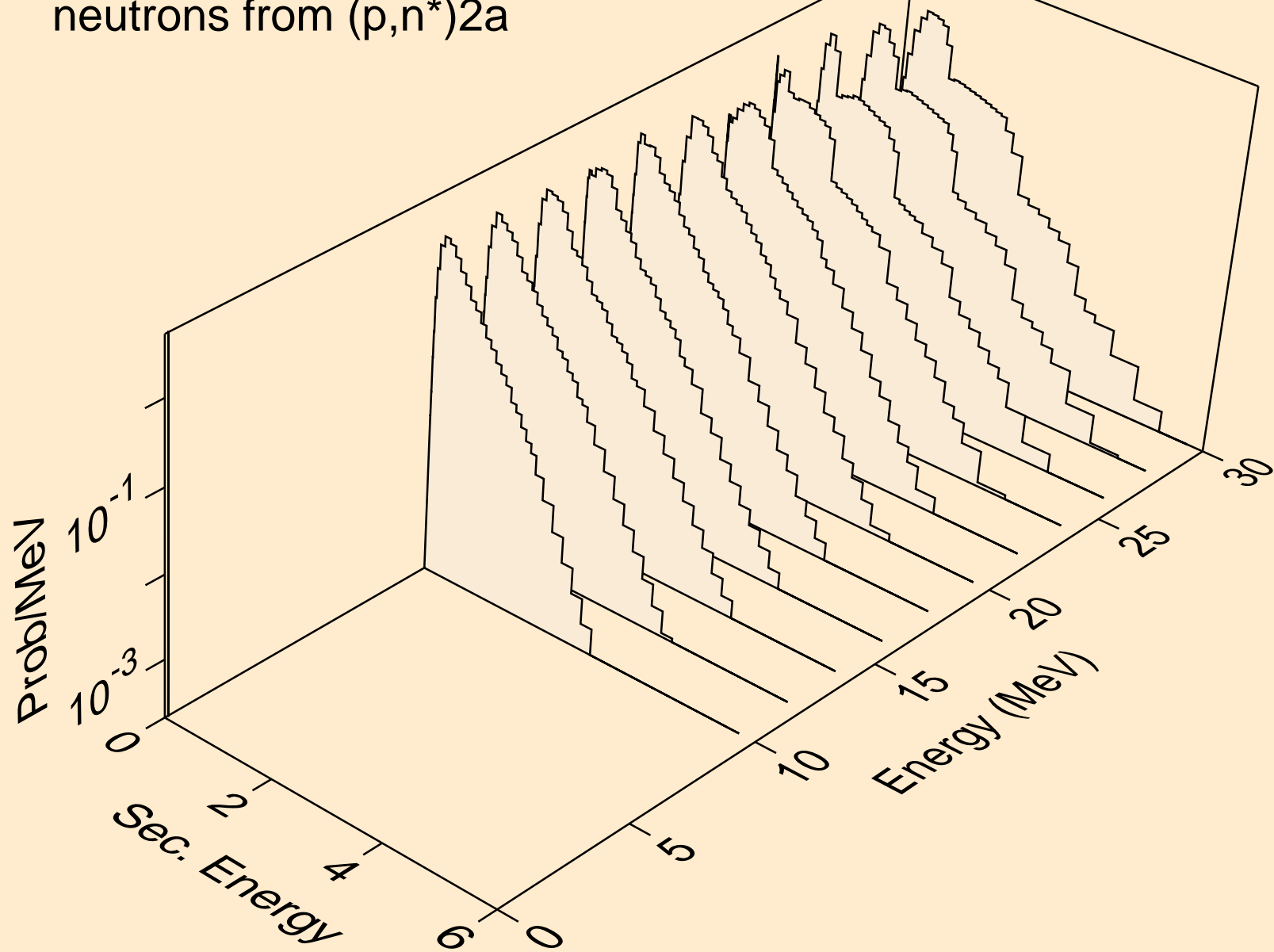

RN224 PROTON ACER TENDL-2021 LIBRARY; T=0.K  
neutrons from (p,2n)2a

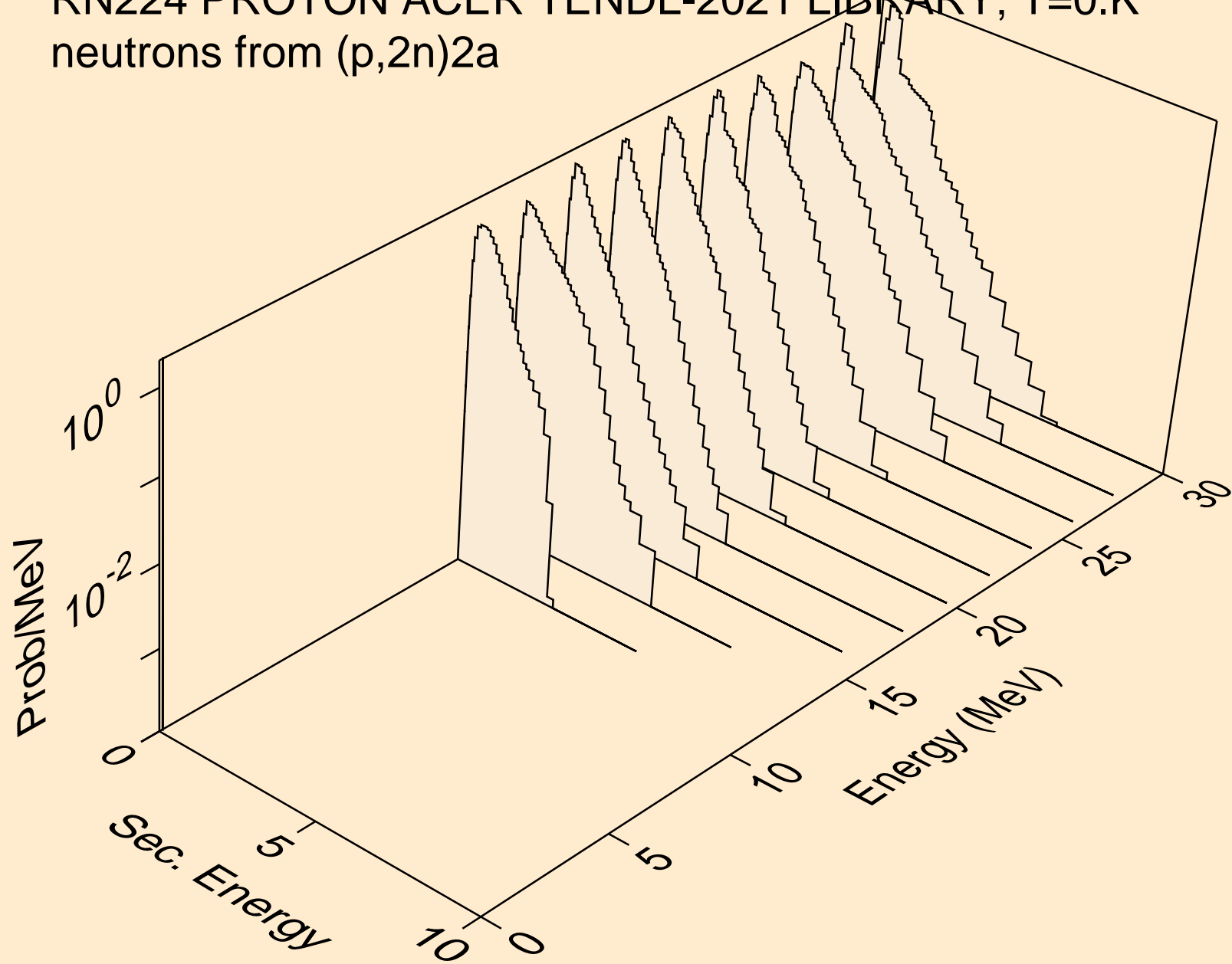

RN224 PROTON ACER TENDL-2021 LIBRARY; T=0.K  
neutrons from (p,n\*)d

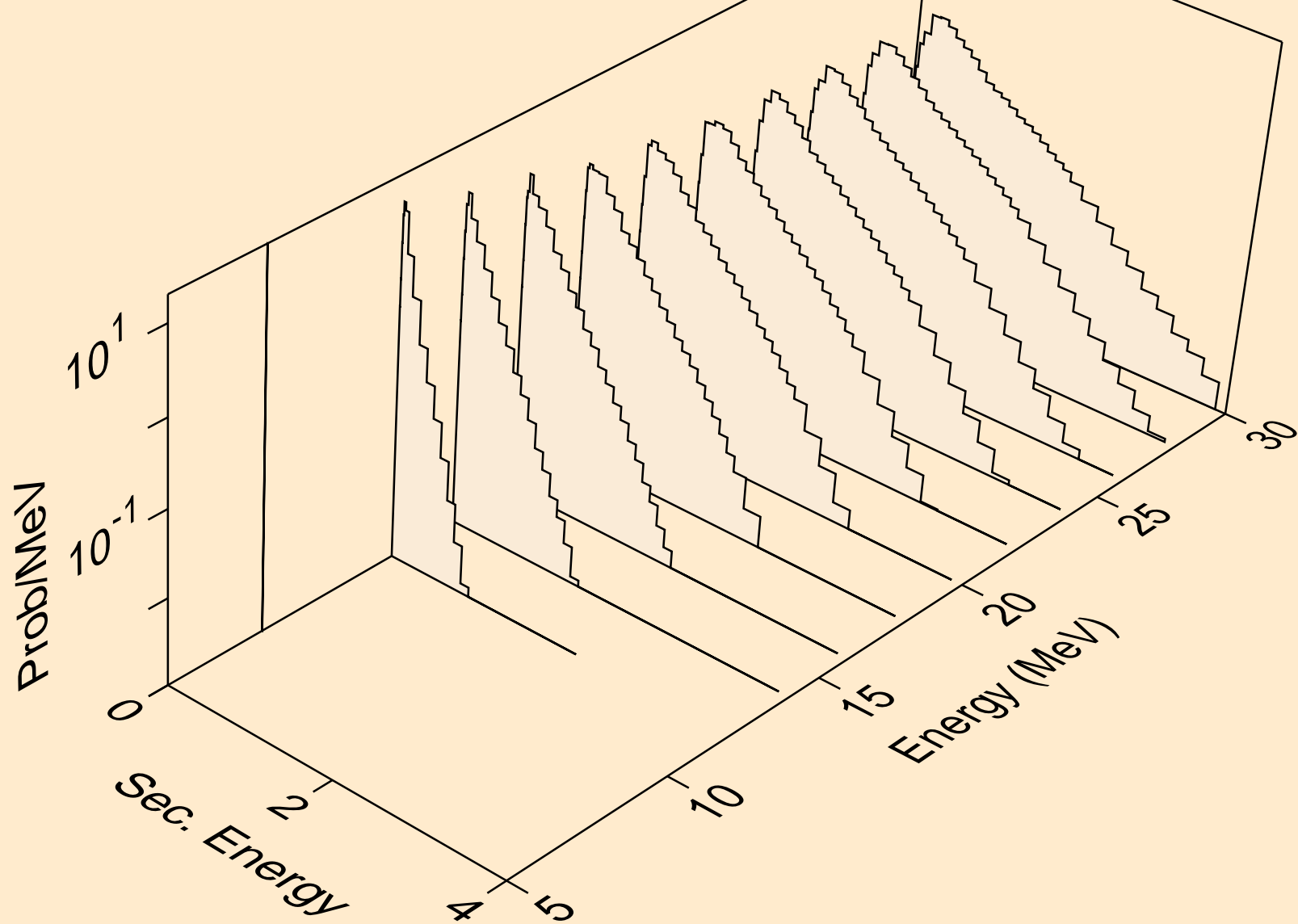

RN224 PROTON ACER TENDL-2021 LIBRARY; T=0.K  
neutrons from (p,n\*)t

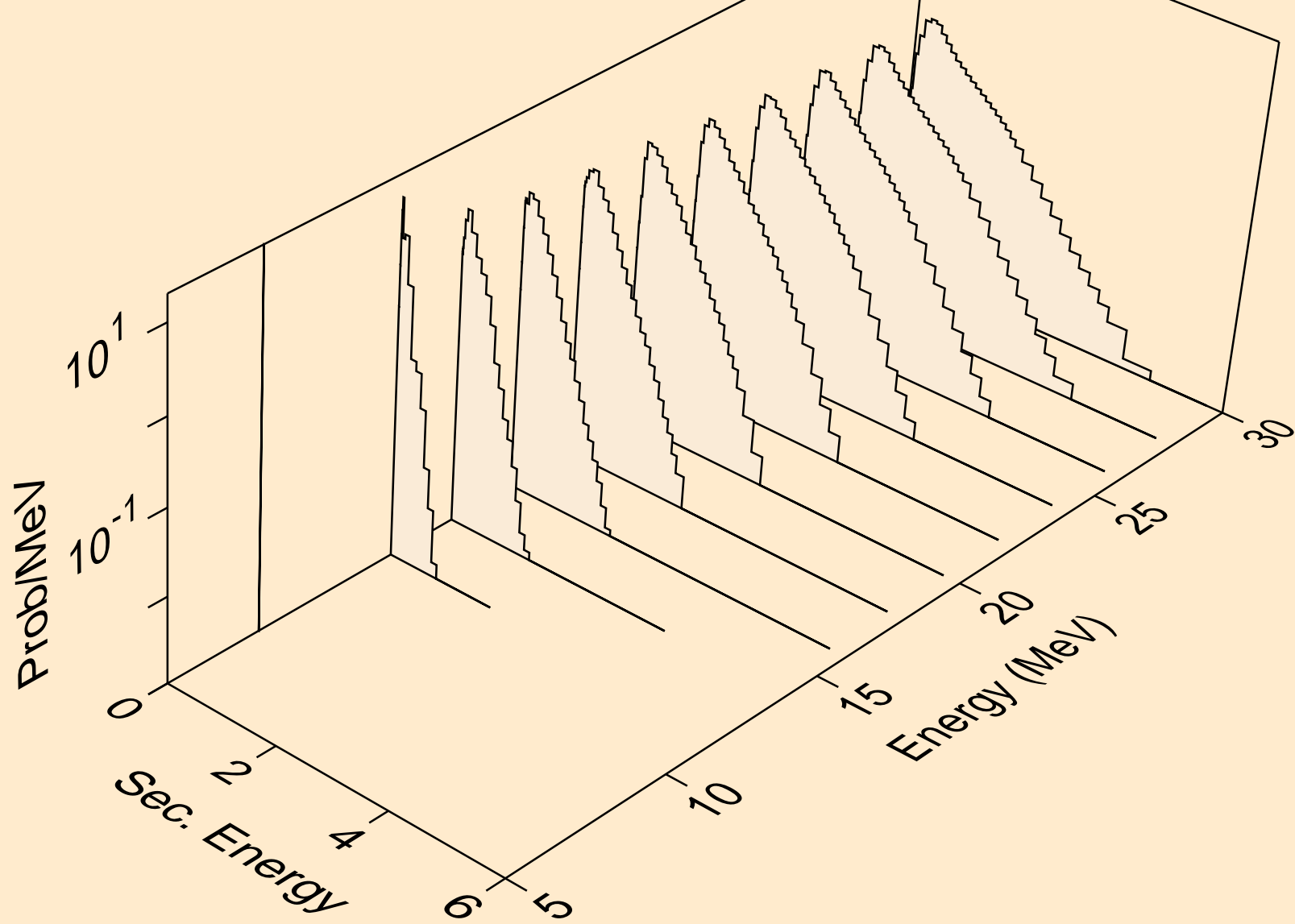



RN224 PROTON ACER TENDL-2021 LIBRARY; T=0.K  
neutrons from (p,n\*)he3

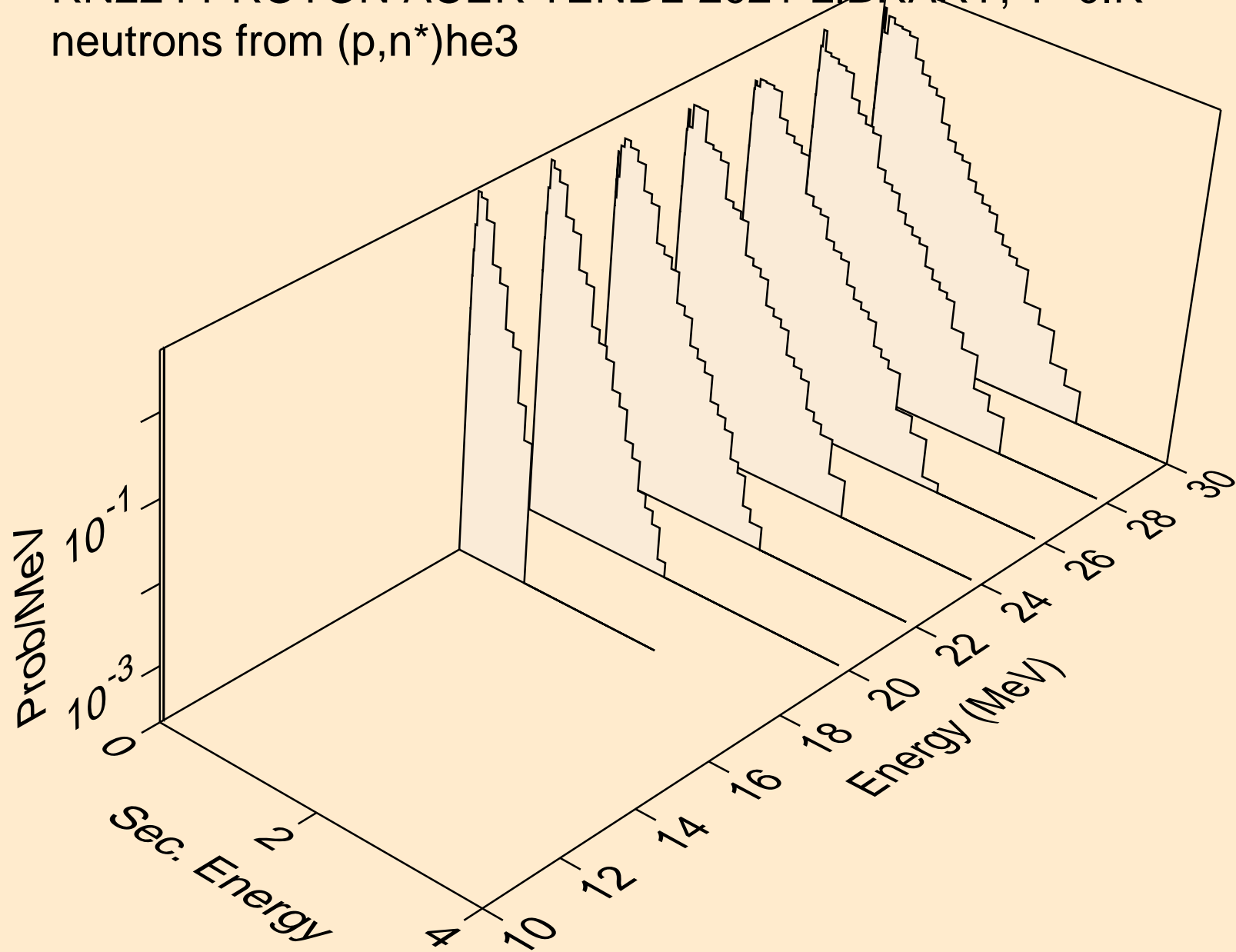

RN224 PROTON ACER TENDL-2021 LIBRARY; T=0.K  
neutrons from (p,4n)

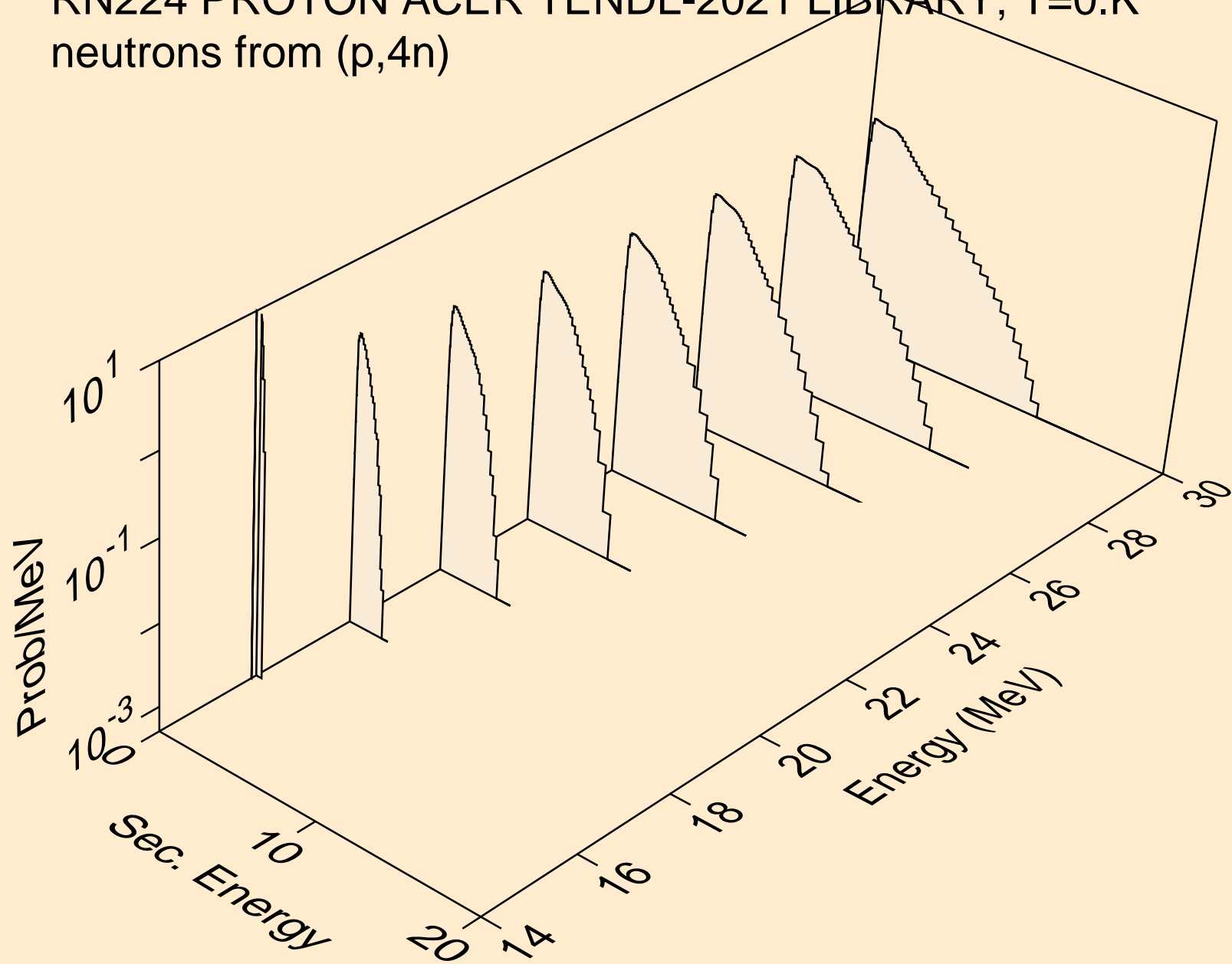

RN224 PROTON ACER TENDL-2021 LIBRARY; T=0.K  
neutrons from (p,2np)

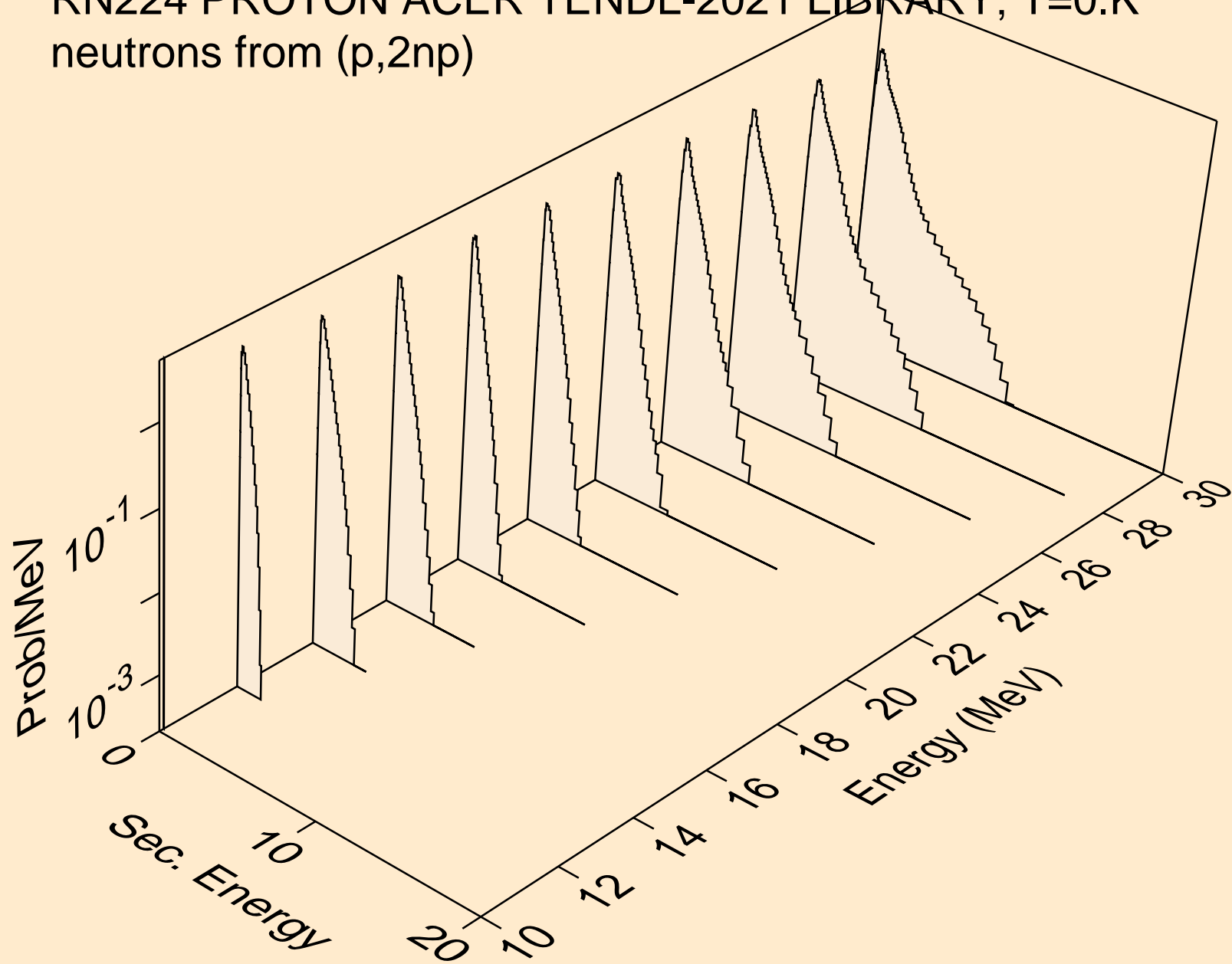

RN224 PROTON ACER TENDL-2021 LIBRARY; T=0.K  
neutrons from (p,3np)

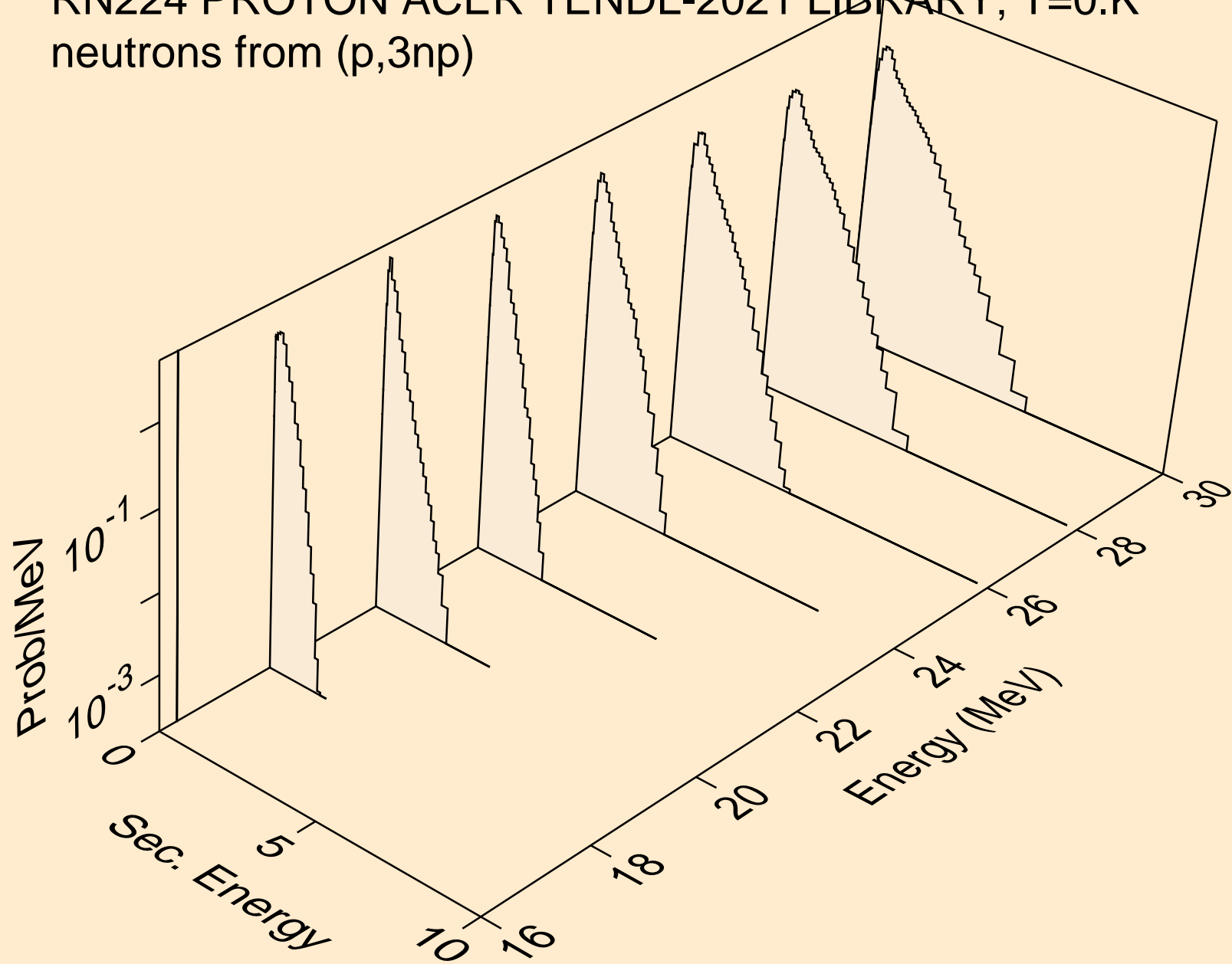

RN224 PROTON ACER TENDL-2021 LIBRARY; T=0.K  
neutrons from (p,2np)

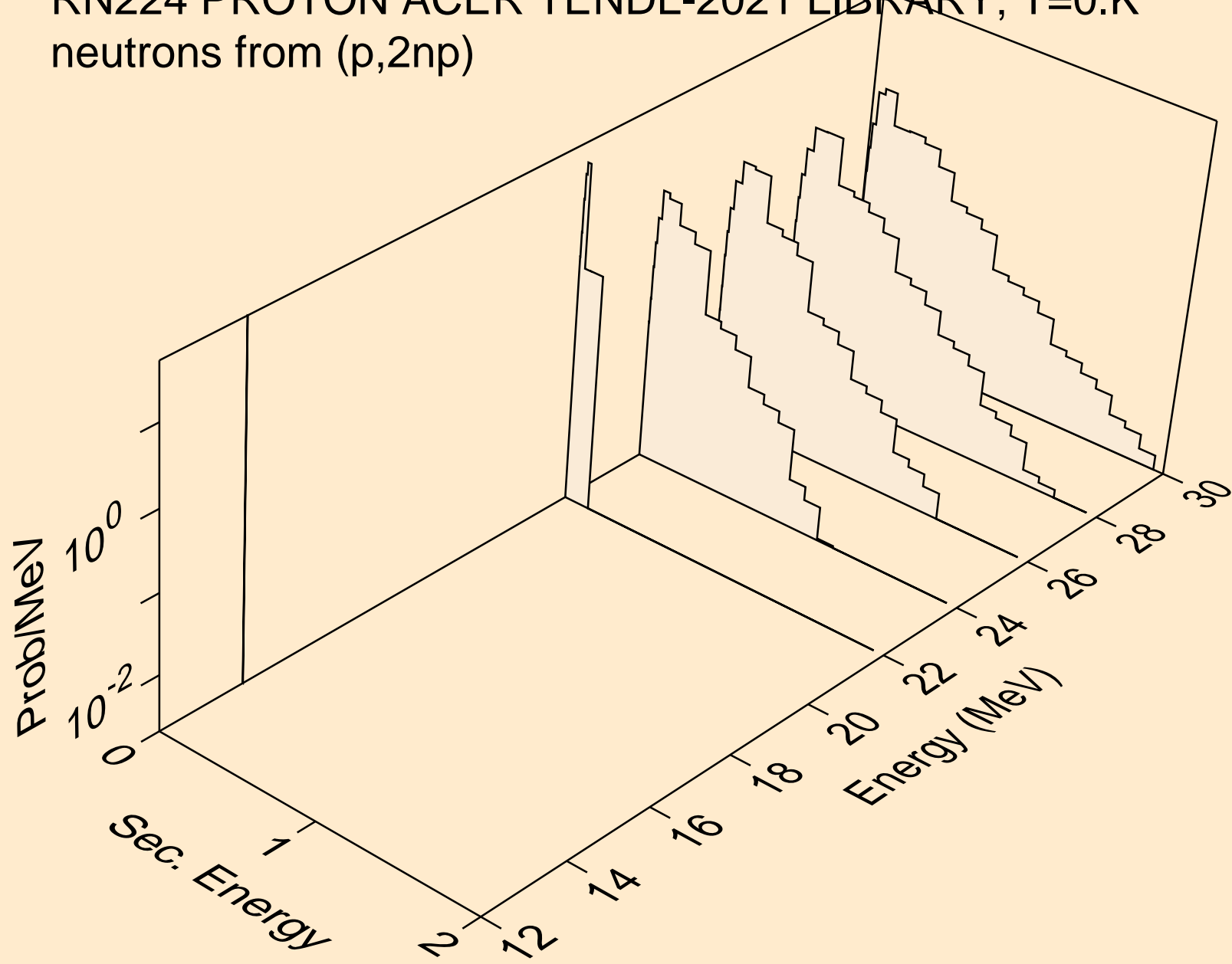

RN224 PROTON ACER TENDL-2021 LIBRARY; T=0.K  
neutrons from (p,npa)

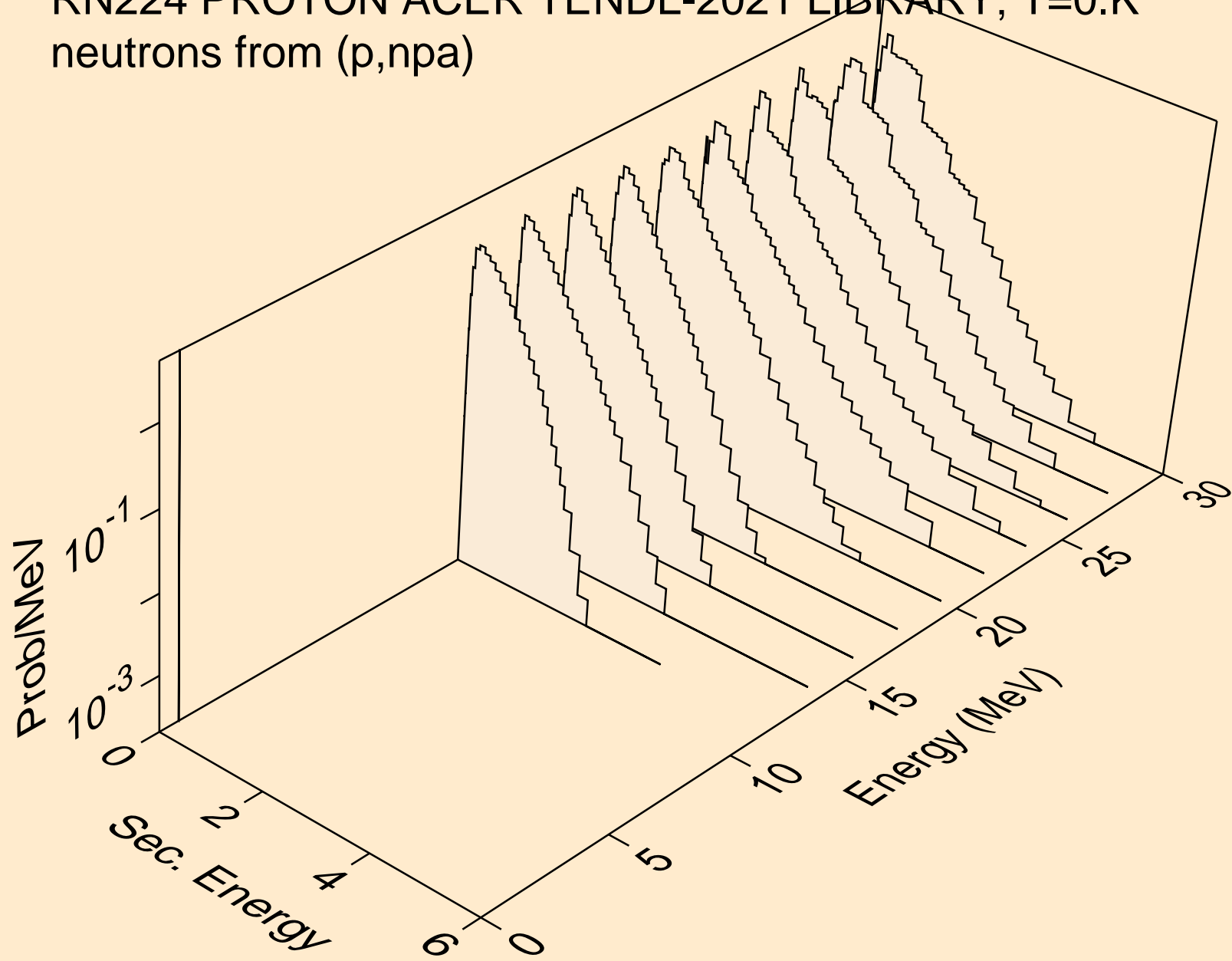

RN224 PROTON ACER TENDL-2021 LIBRARY; T=0.K  
deuterons from (p,x)

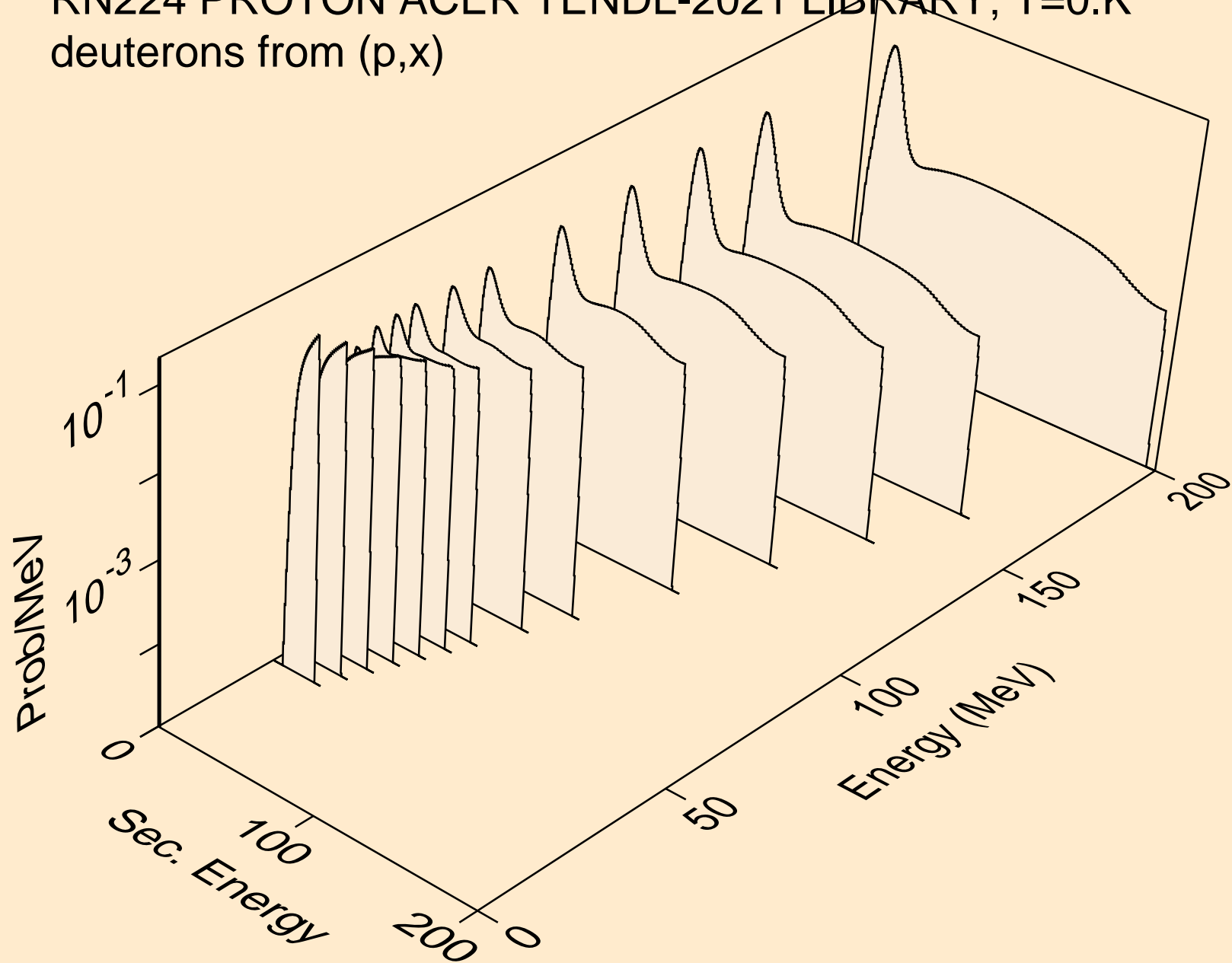

RN224 PROTON ACER TENDL-2021 LIBRARY; T=0.K  
deuterons from (p,2nd)

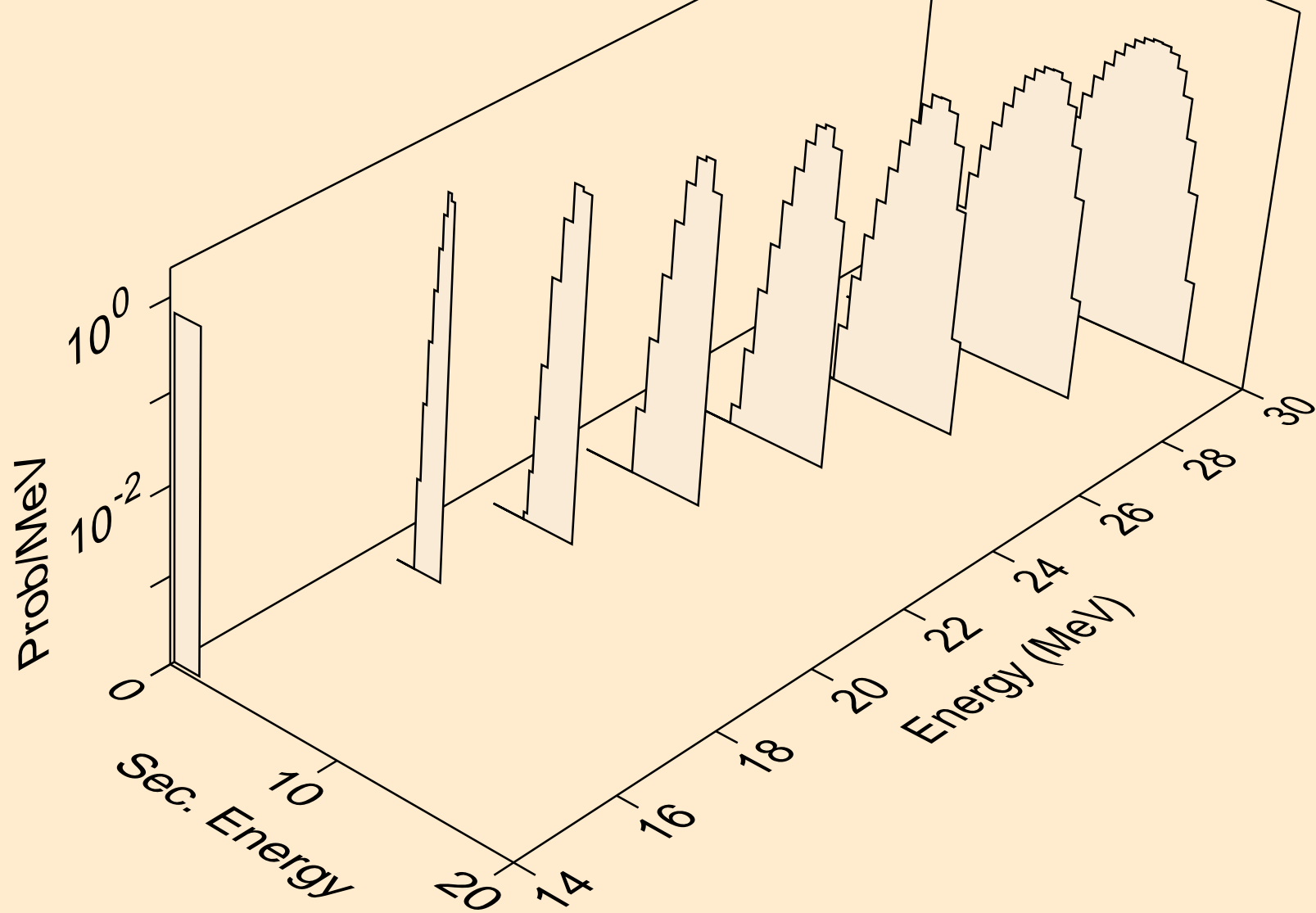



RN224 PROTON ACER TENDL-2021 LIBRARY; T=0.K  
deuterons from (p,n\*)d

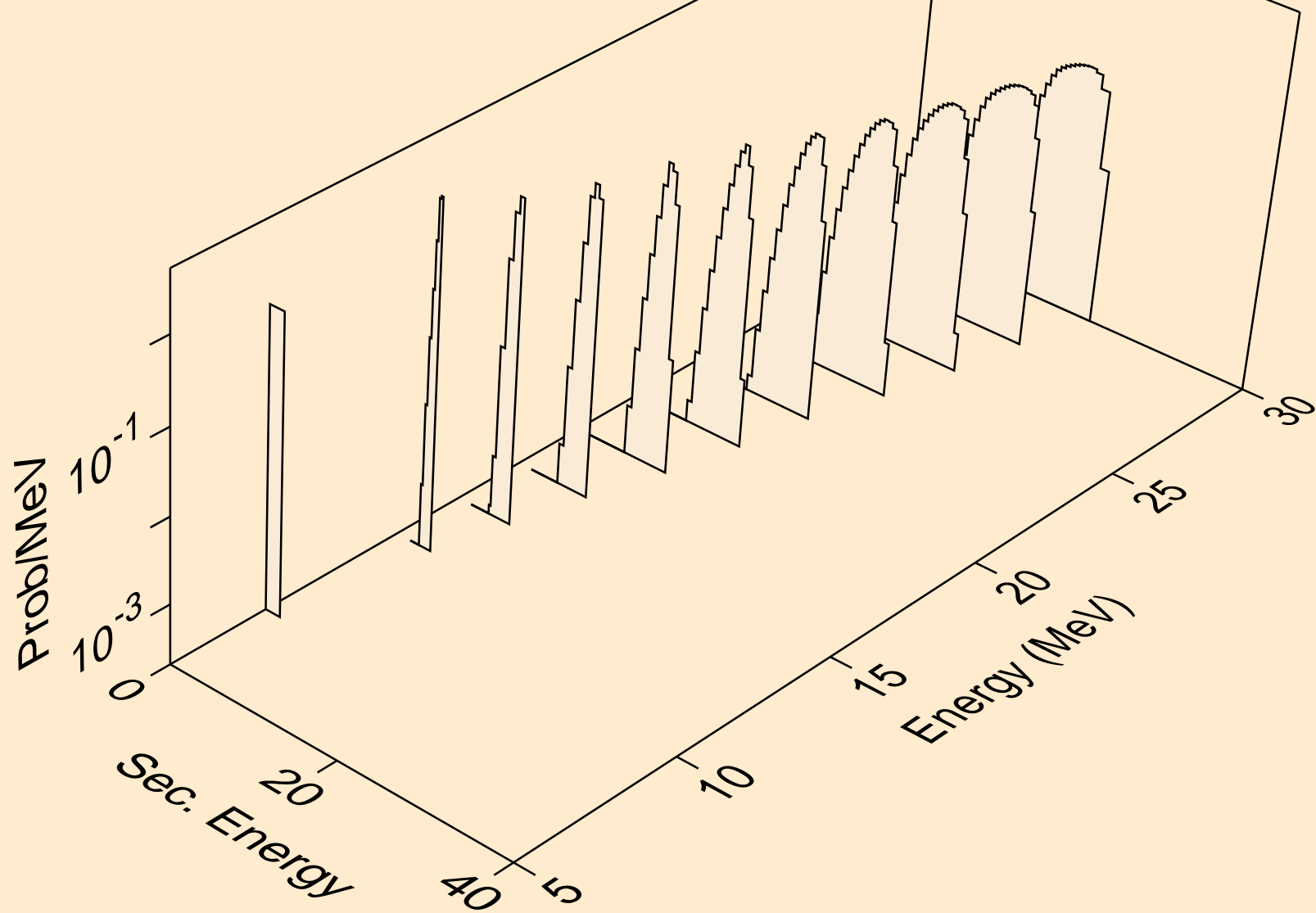

RN224 PROTON ACER TENDL-2021 LIBRARY; T=0.K  
deuterons from (p,d)

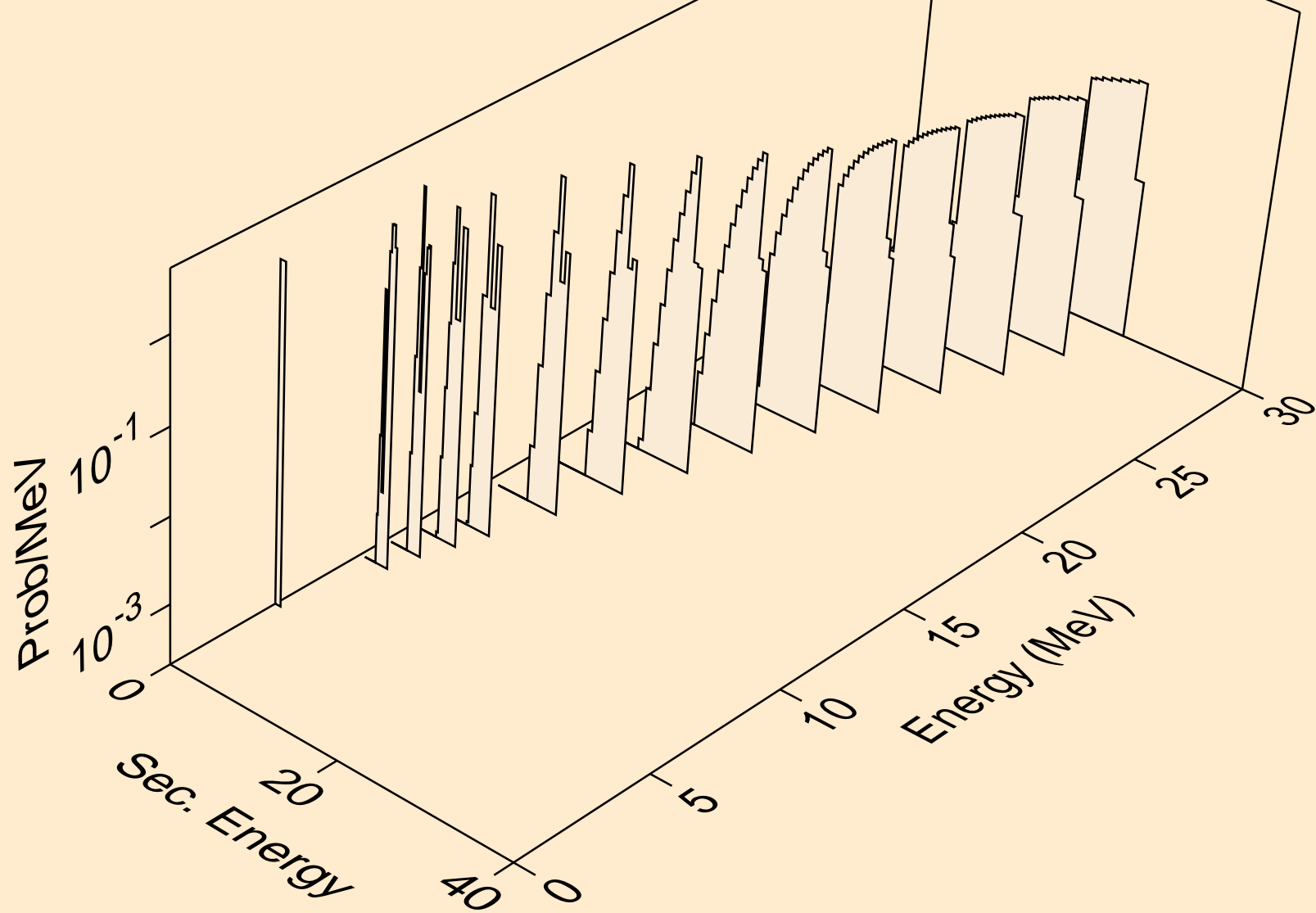

RN224 PROTON ACER TENDL-2021 LIBRARY; T=0.K  
tritons from (p,x)

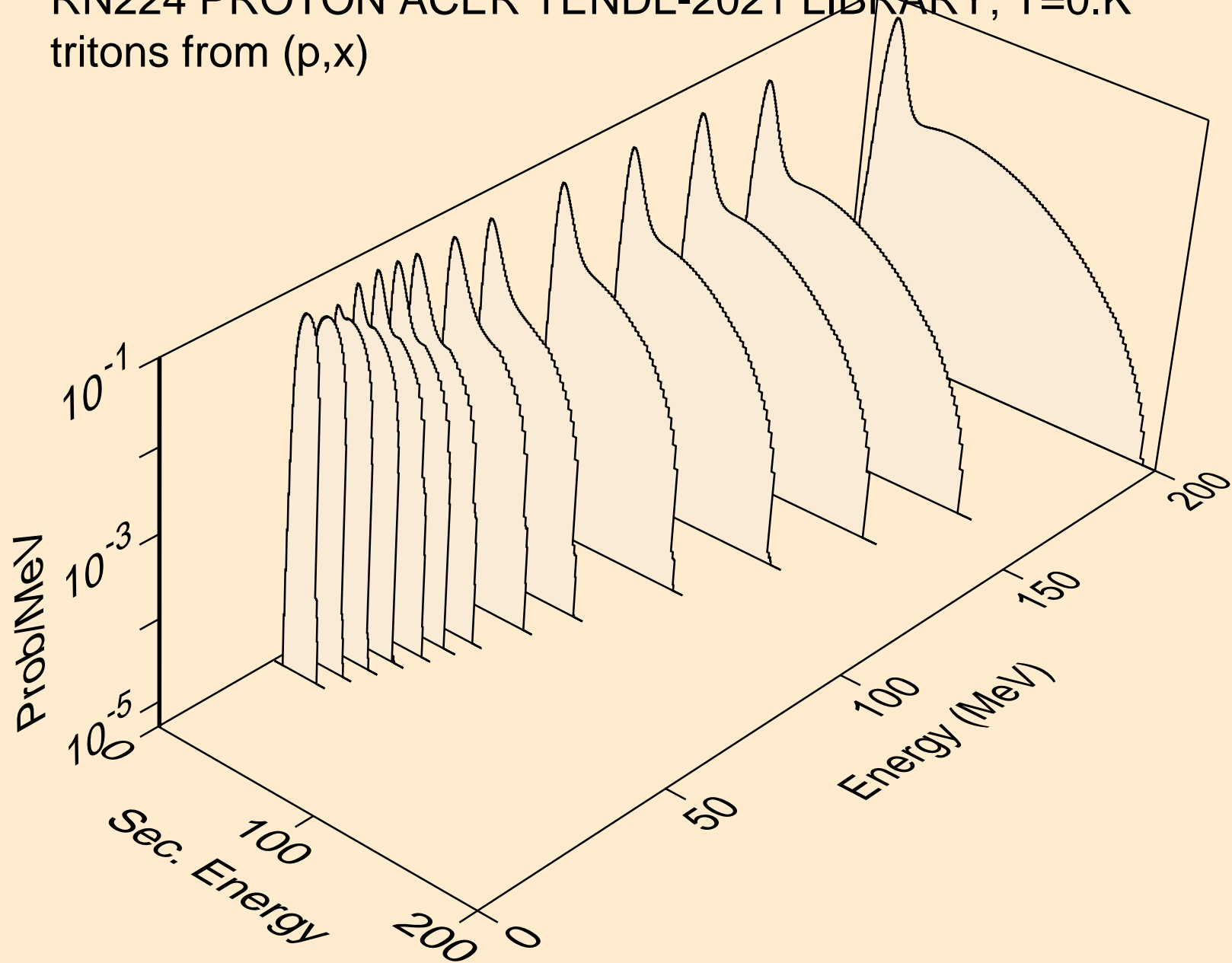

RN224 PROTON ACER TENDL-2021 LIBRARY; T=0.K  
tritons from (p,n\*)t

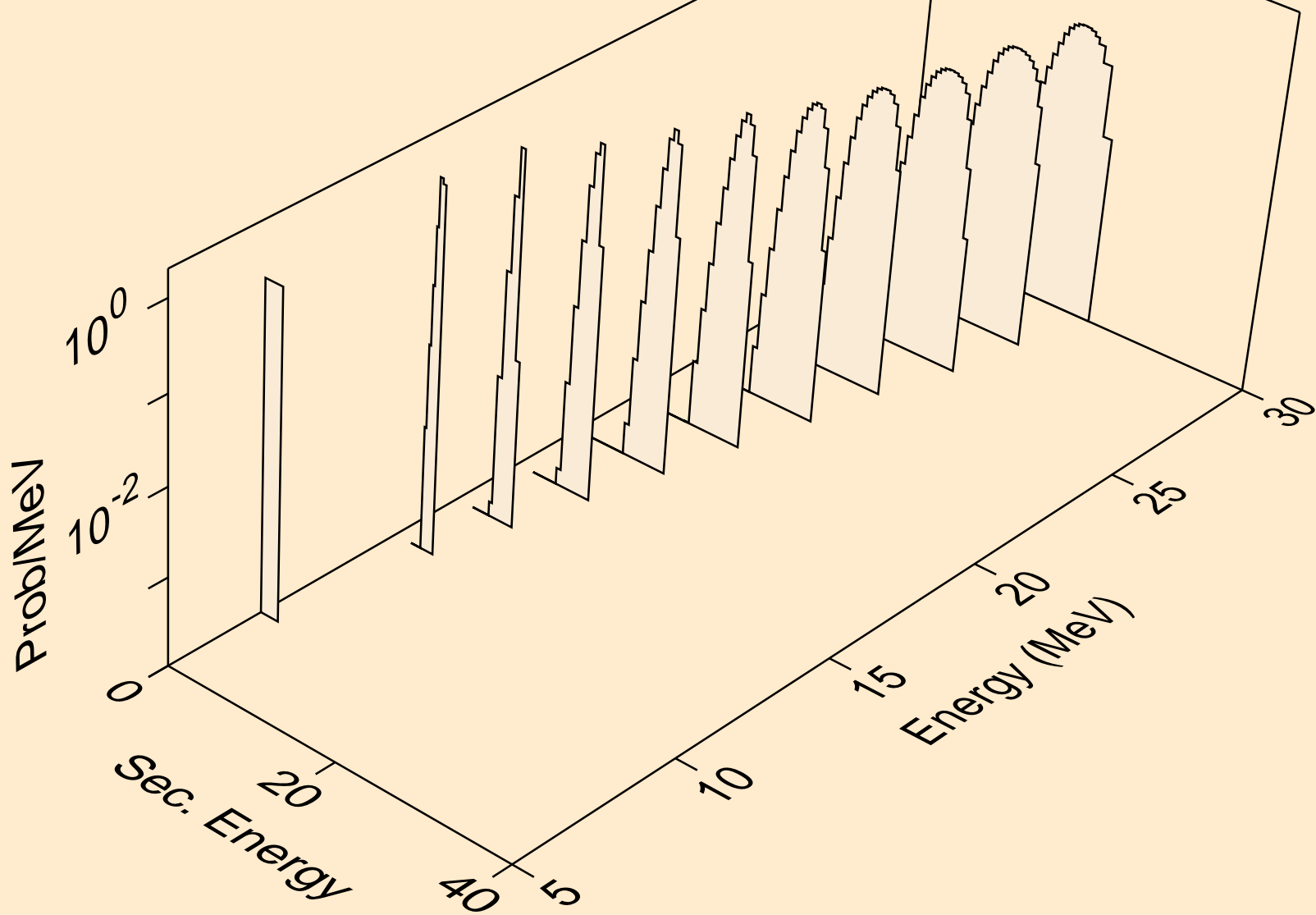

RN224 PROTON ACER TENDL-2021 LIBRARY; T=0.K  
tritons from (p,t)

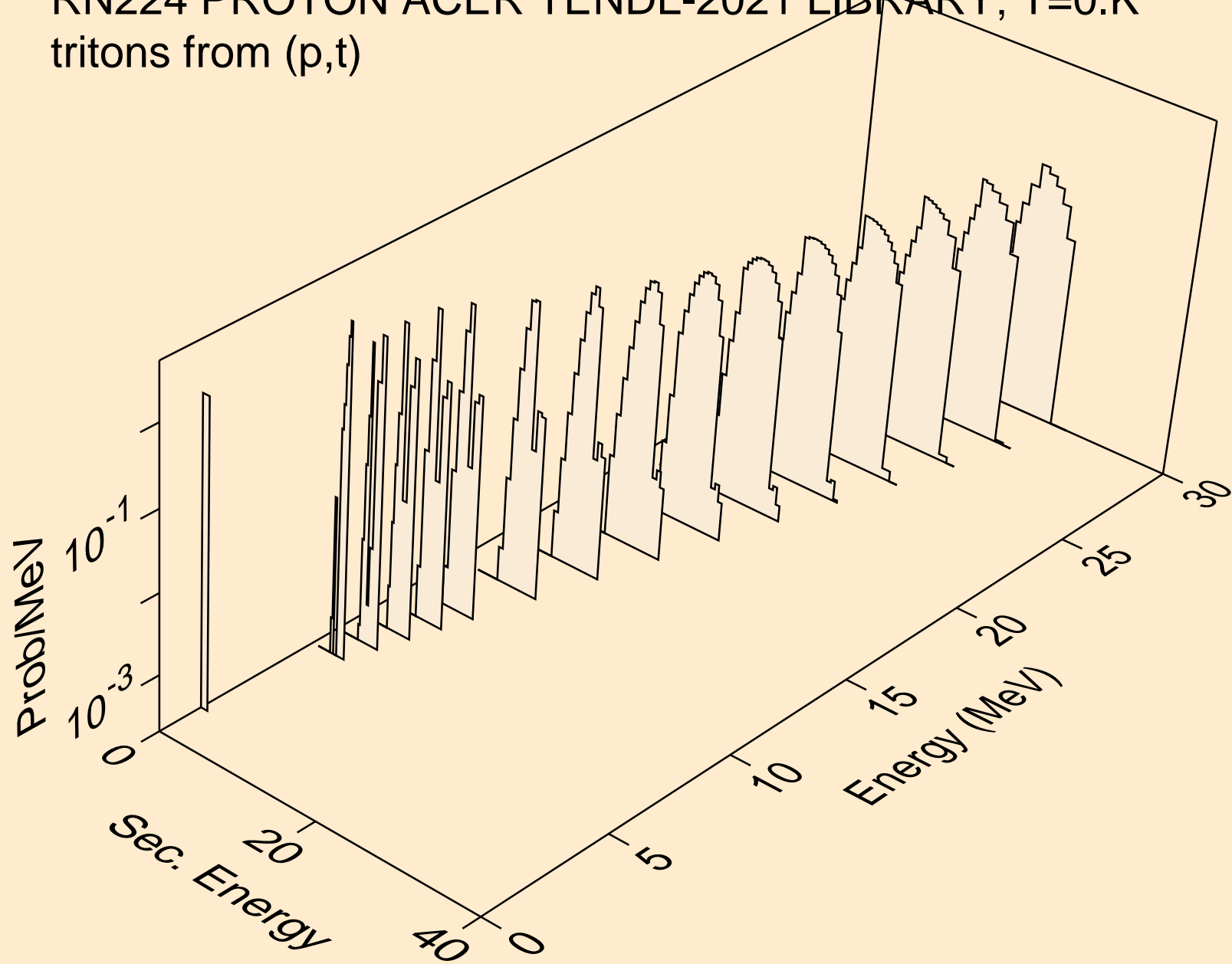

RN224 PROTON ACER TENDL-2021 LIBRARY; T=0.K  
he3s from (p,x)

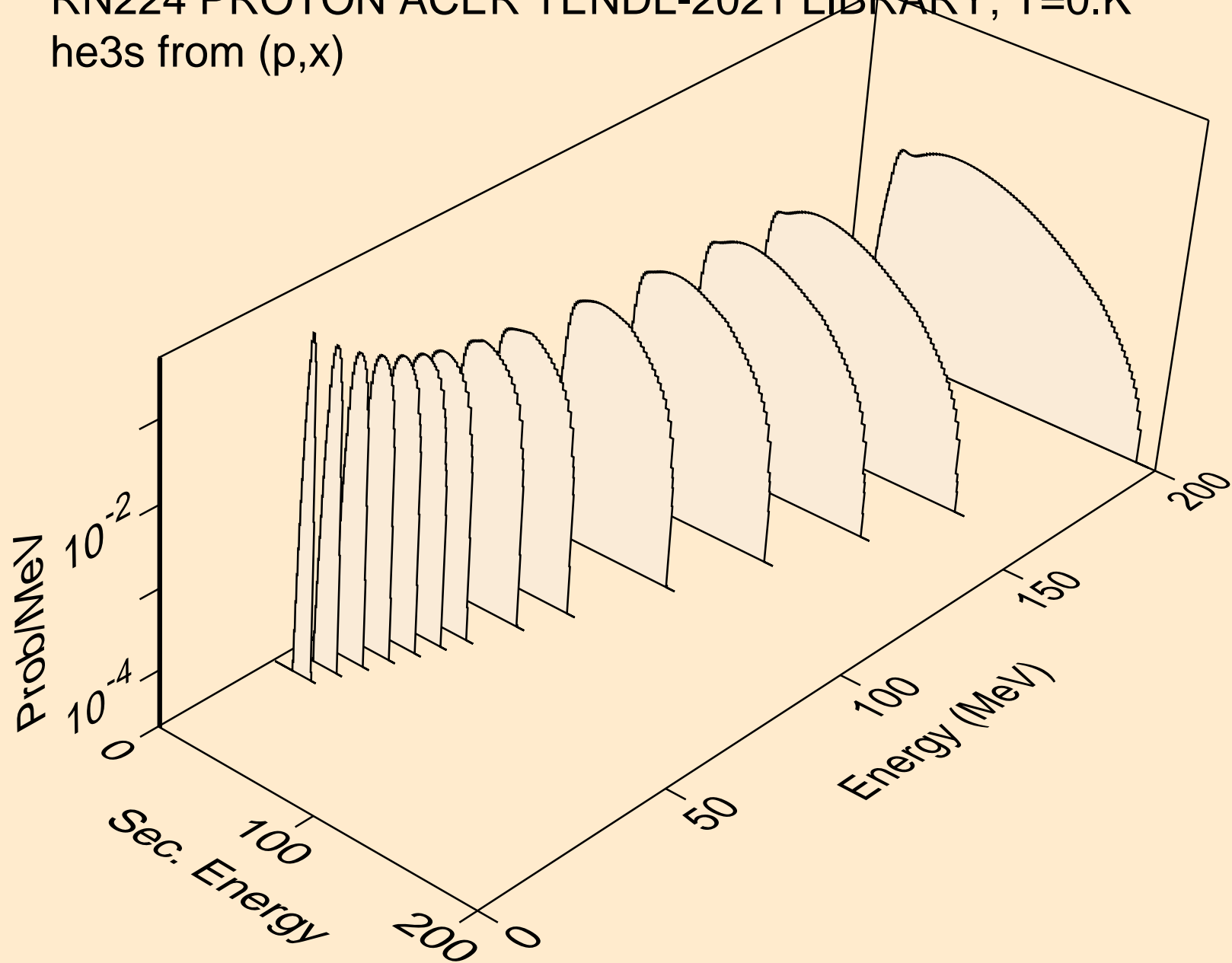

RN224 PROTON ACER TENDL-2021 LIBRARY; T=0.K  
he3s from (p,n\*)he3

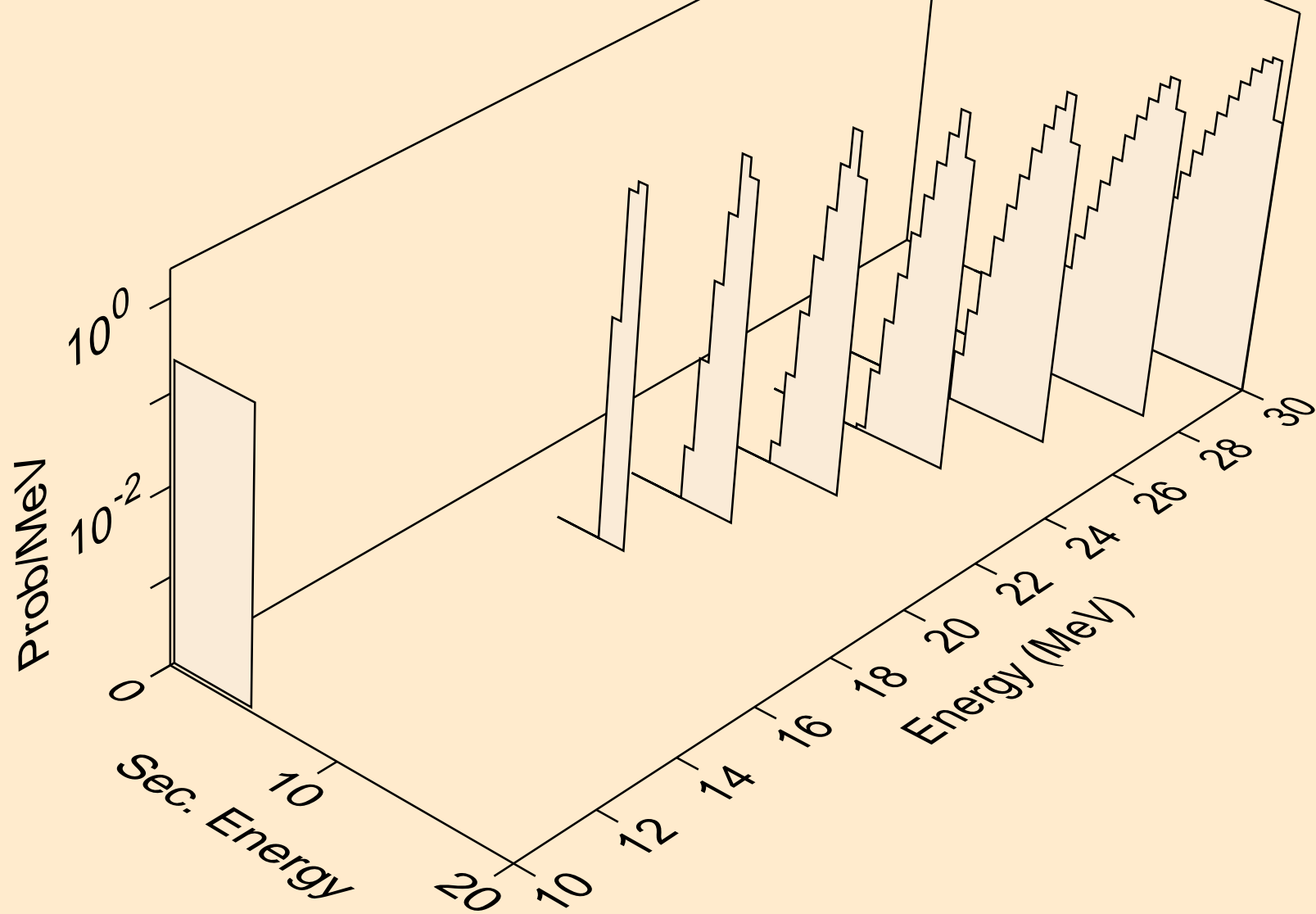

RN224 PROTON ACER TENDL-2021 LIBRARY; T=0.K  
he3s from (p,he3)

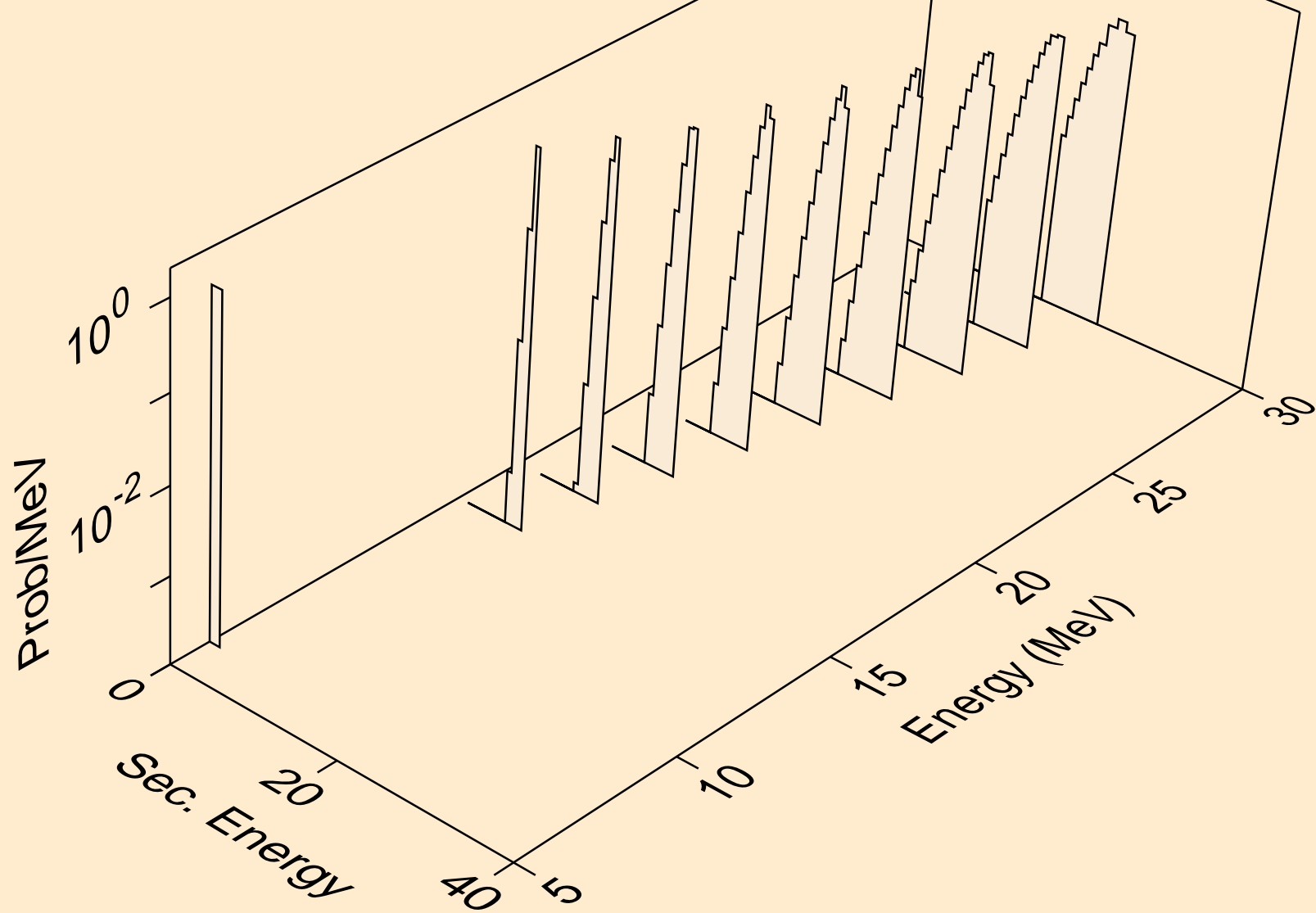



RN224 PROTON ACER TENDL-2021 LIBRARY; T=0.K  
alphas from (p,x)

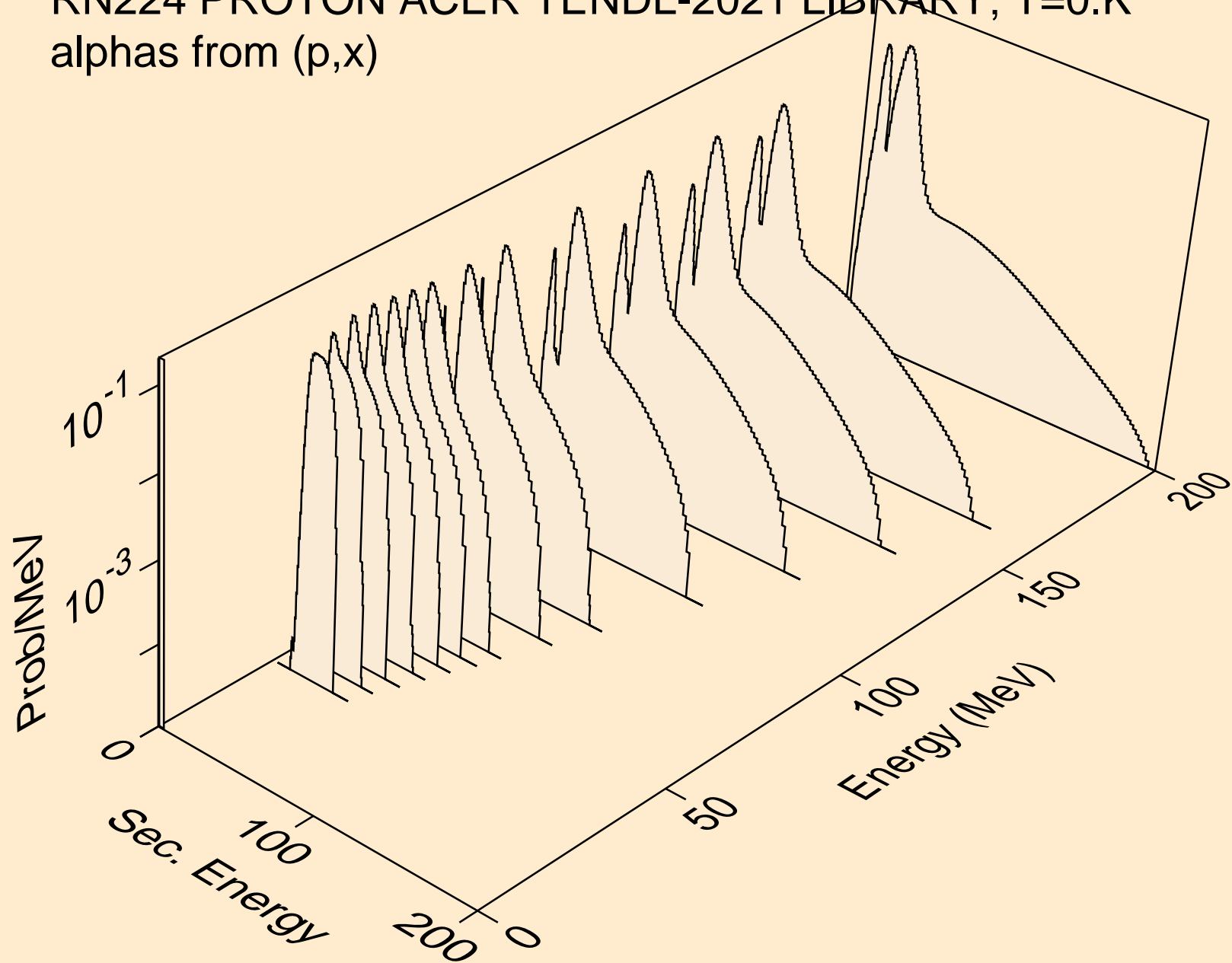

RN224 PROTON ACER TENDL-2021 LIBRARY; T=0.K  
alphas from (p,n\*)a

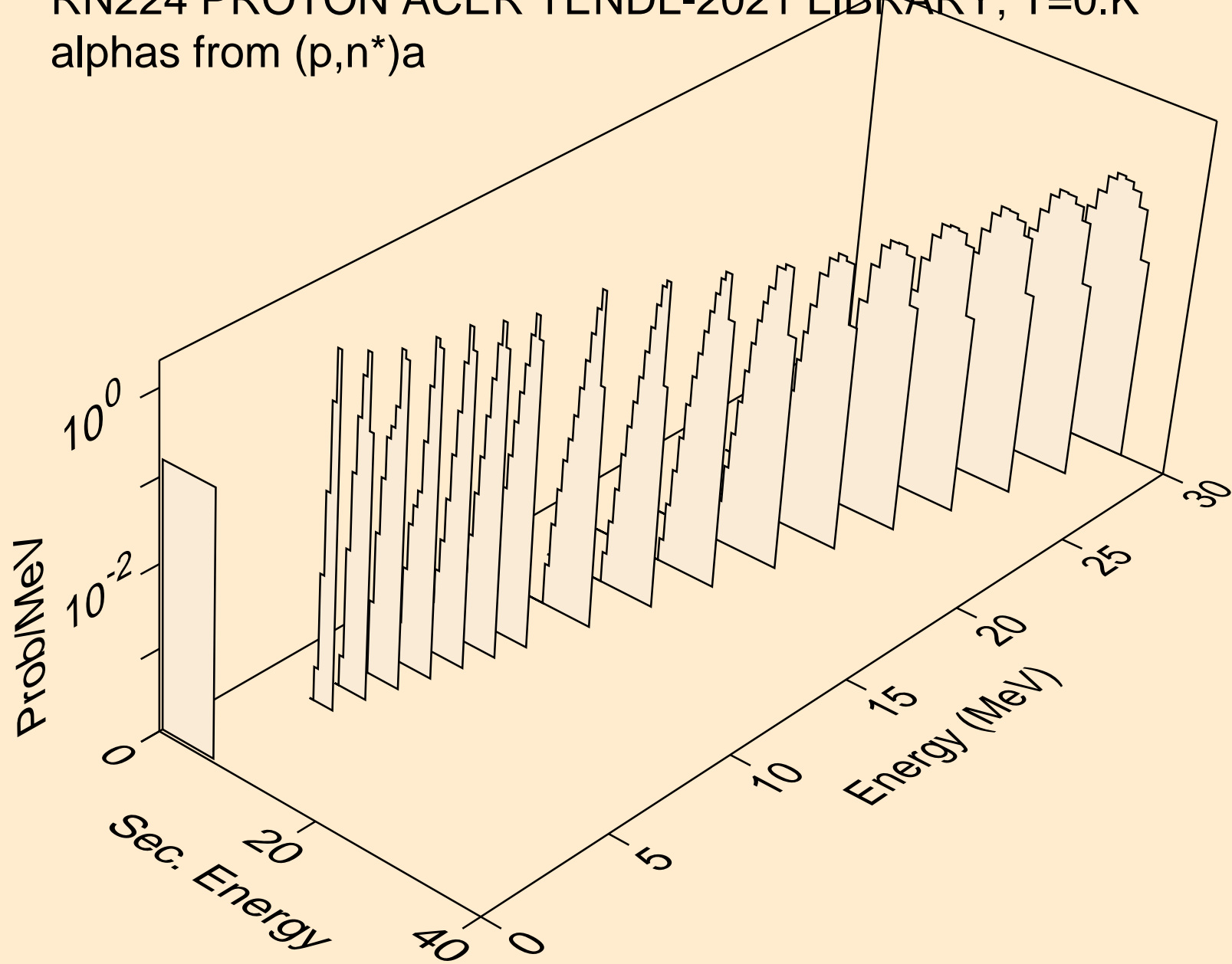

RN224 PROTON ACER TENDL-2021 LIBRARY; T=0.K  
alphas from (p,2n)a

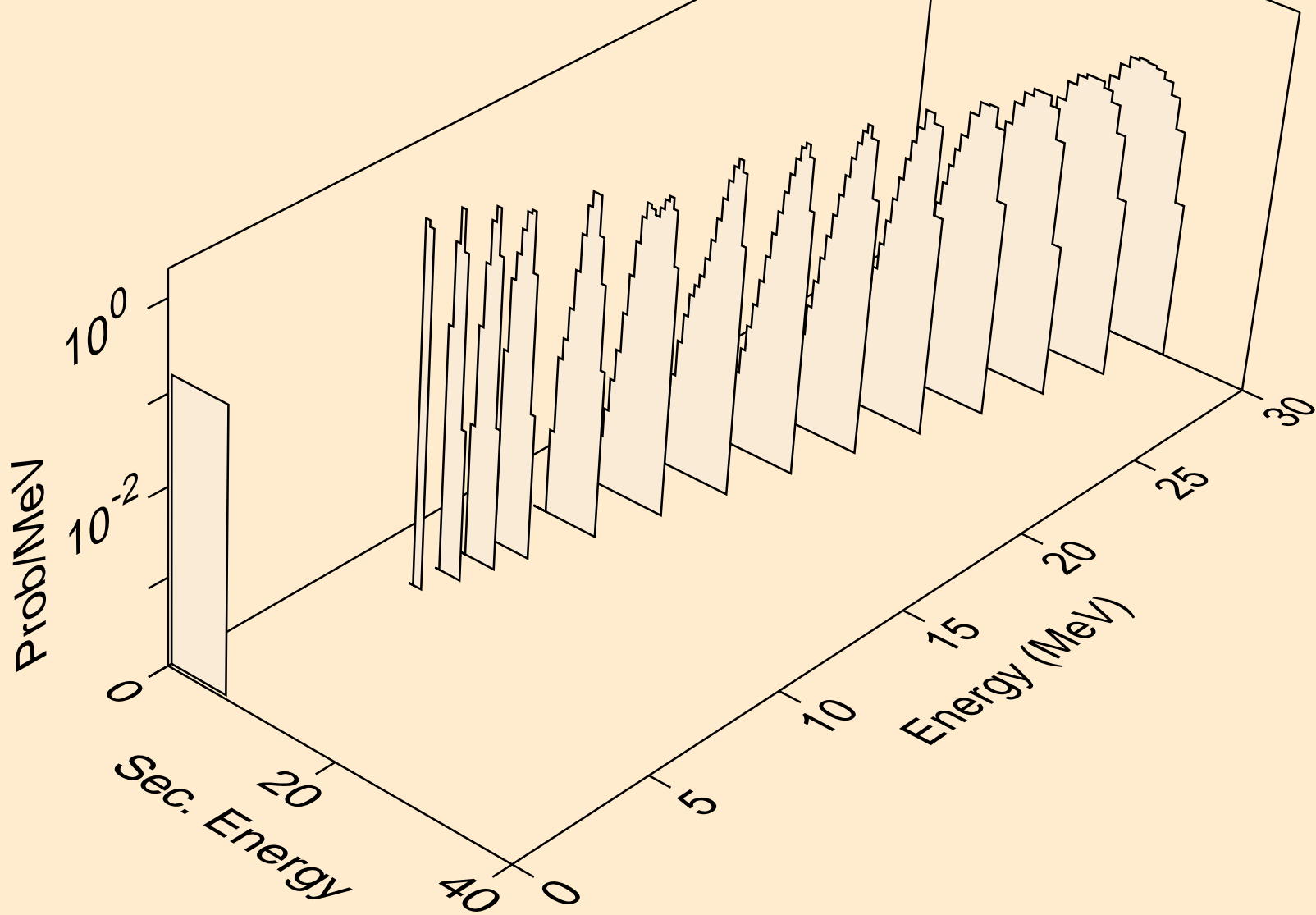

RN224 PROTON ACER TENDL-2021 LIBRARY; T=0.K  
alphas from (p,3n)a

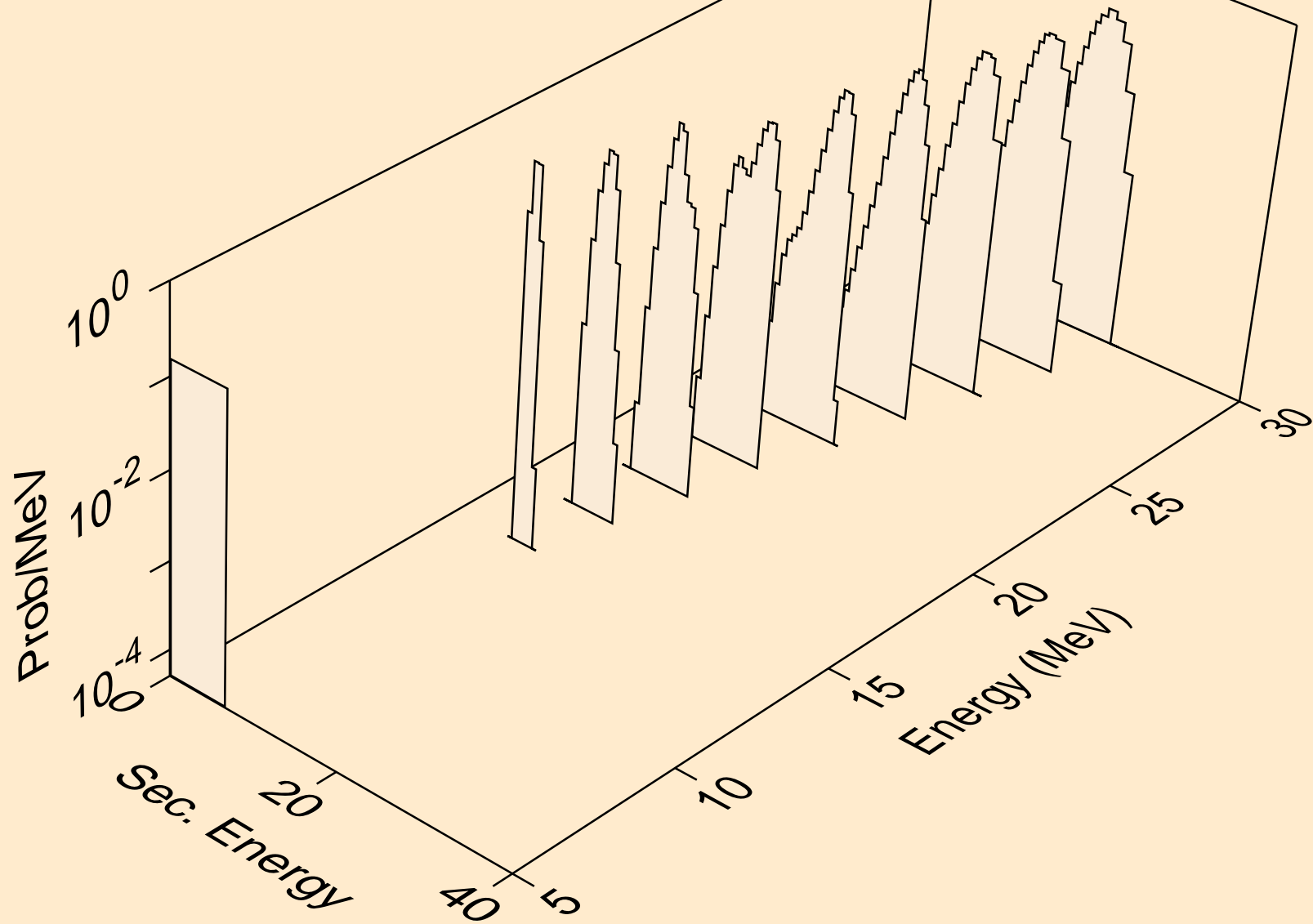

RN224 PROTON ACER TENDL-2021 LIBRARY; T=0.K  
alphas from (p,n\*)2a

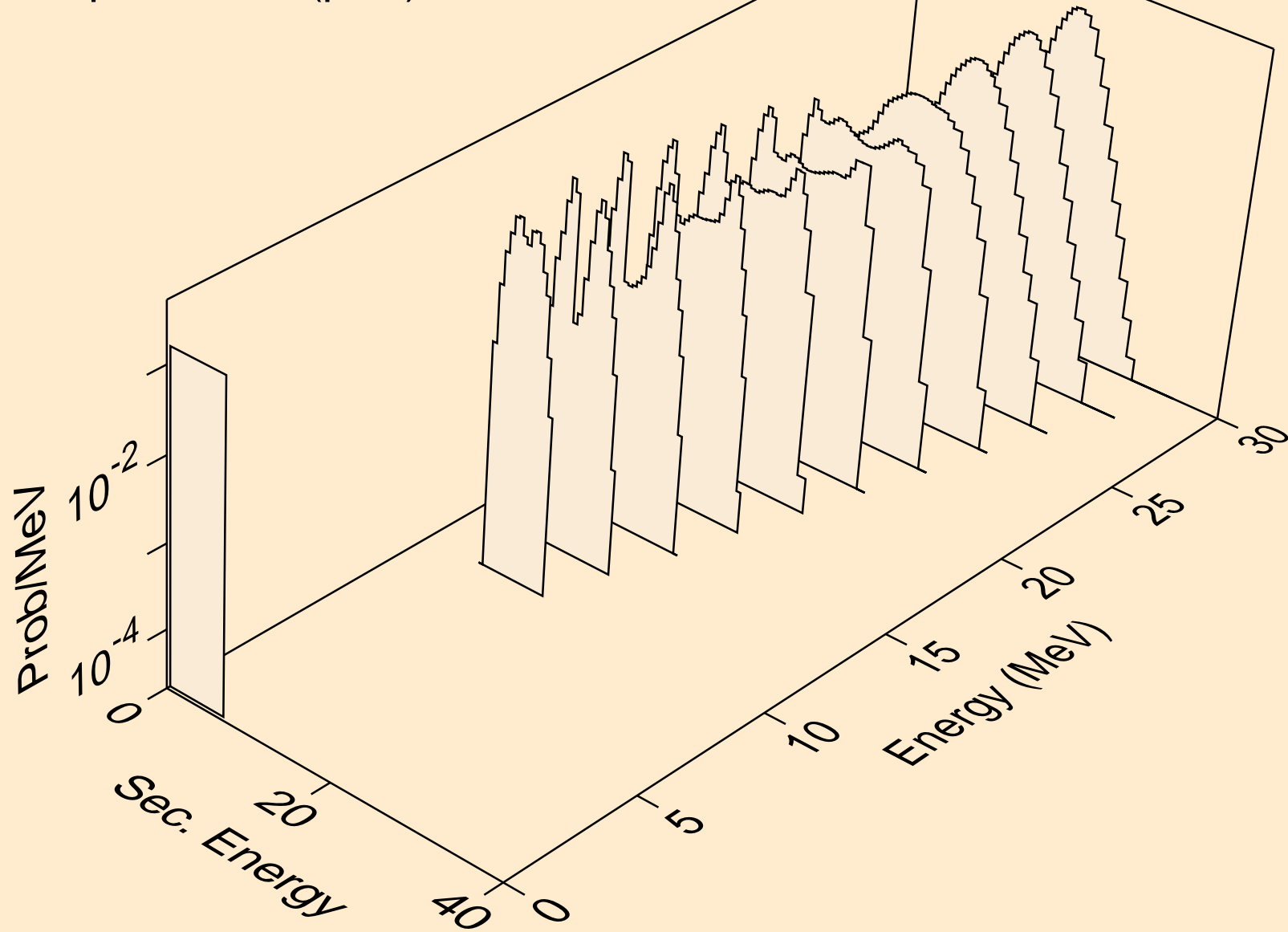

RN224 PROTON ACER TENDL-2021 LIBRARY; T=0.K  
alphas from (p,2n)2a

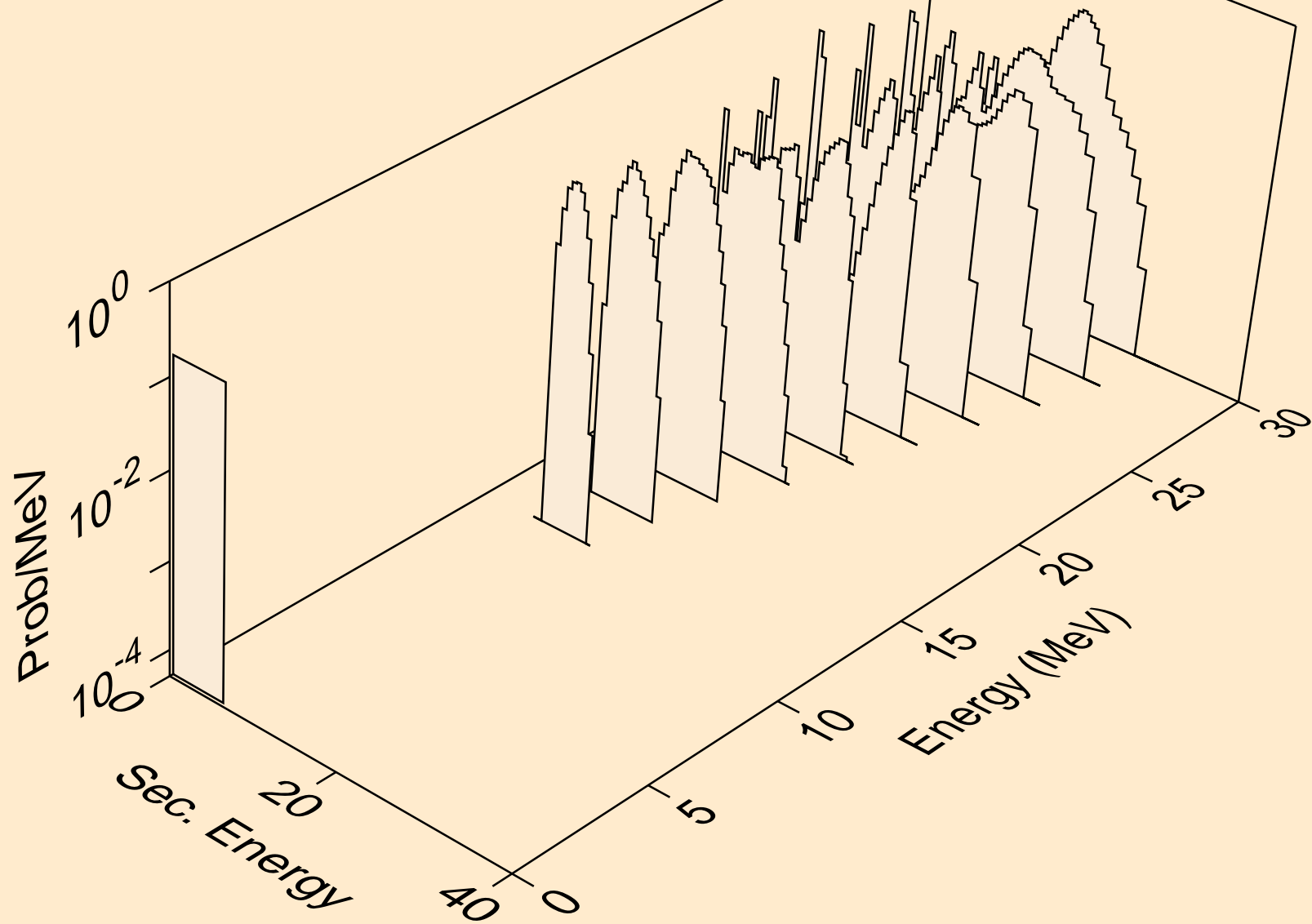

RN224 PROTON ACER TENDL-2021 LIBRARY; T=0.K  
alphas from (p,npa)

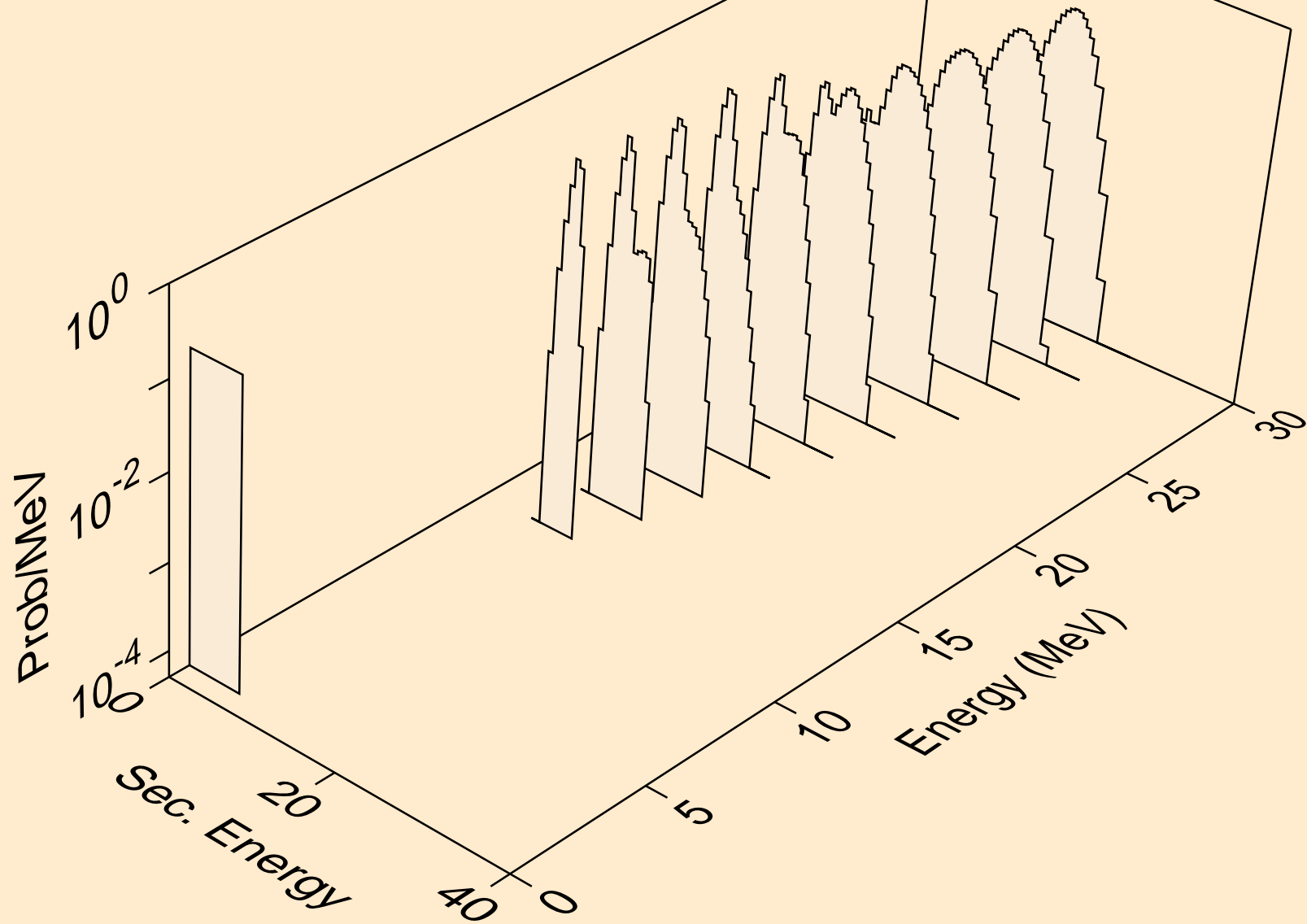

RN224 PROTON ACER TENDL-2021 LIBRARY; T=0.K  
alphas from (p,a)

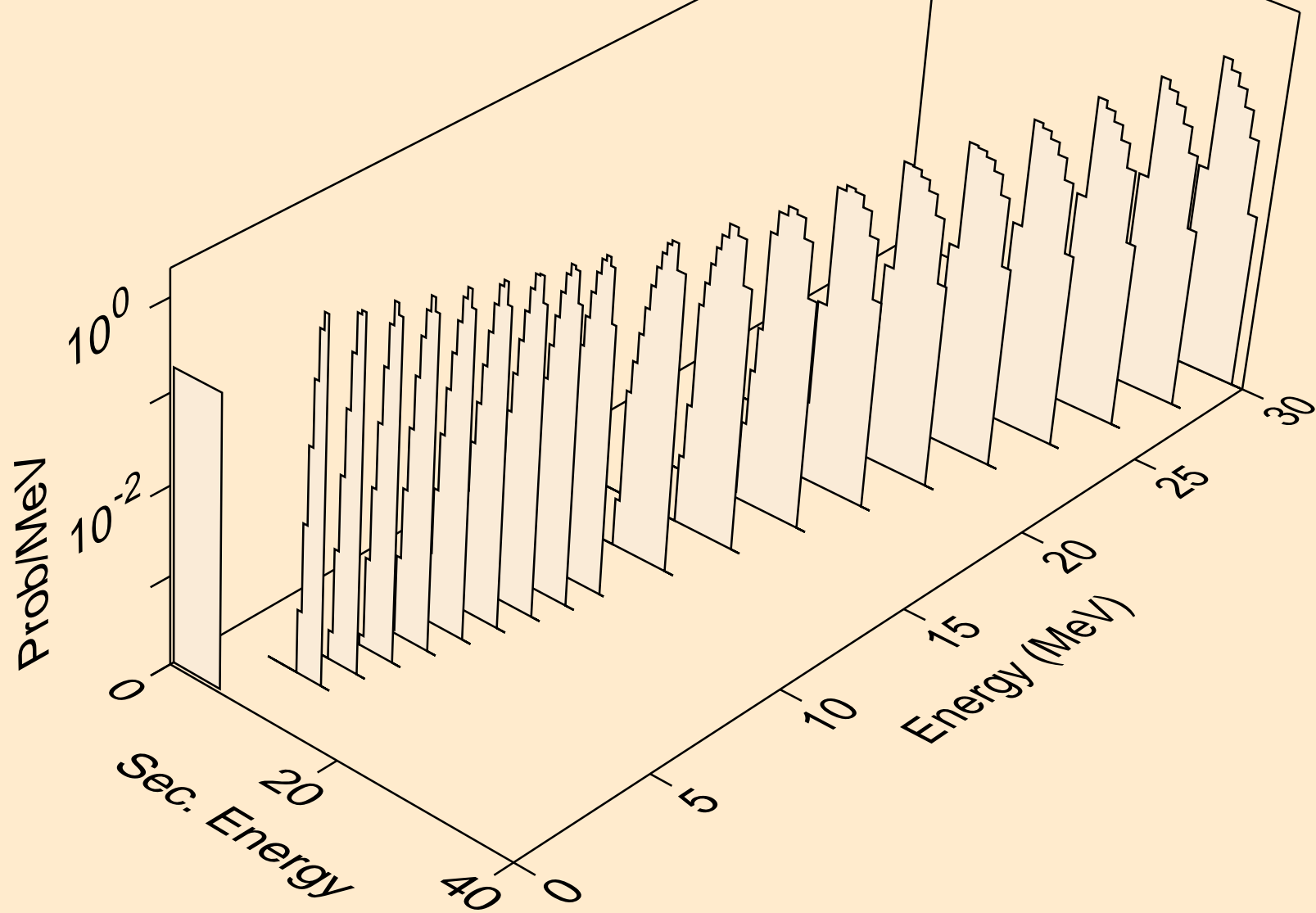



RN224 PROTON ACER TENDL-2021 LIBRARY; T=0.K  
alphas from (p,2a)

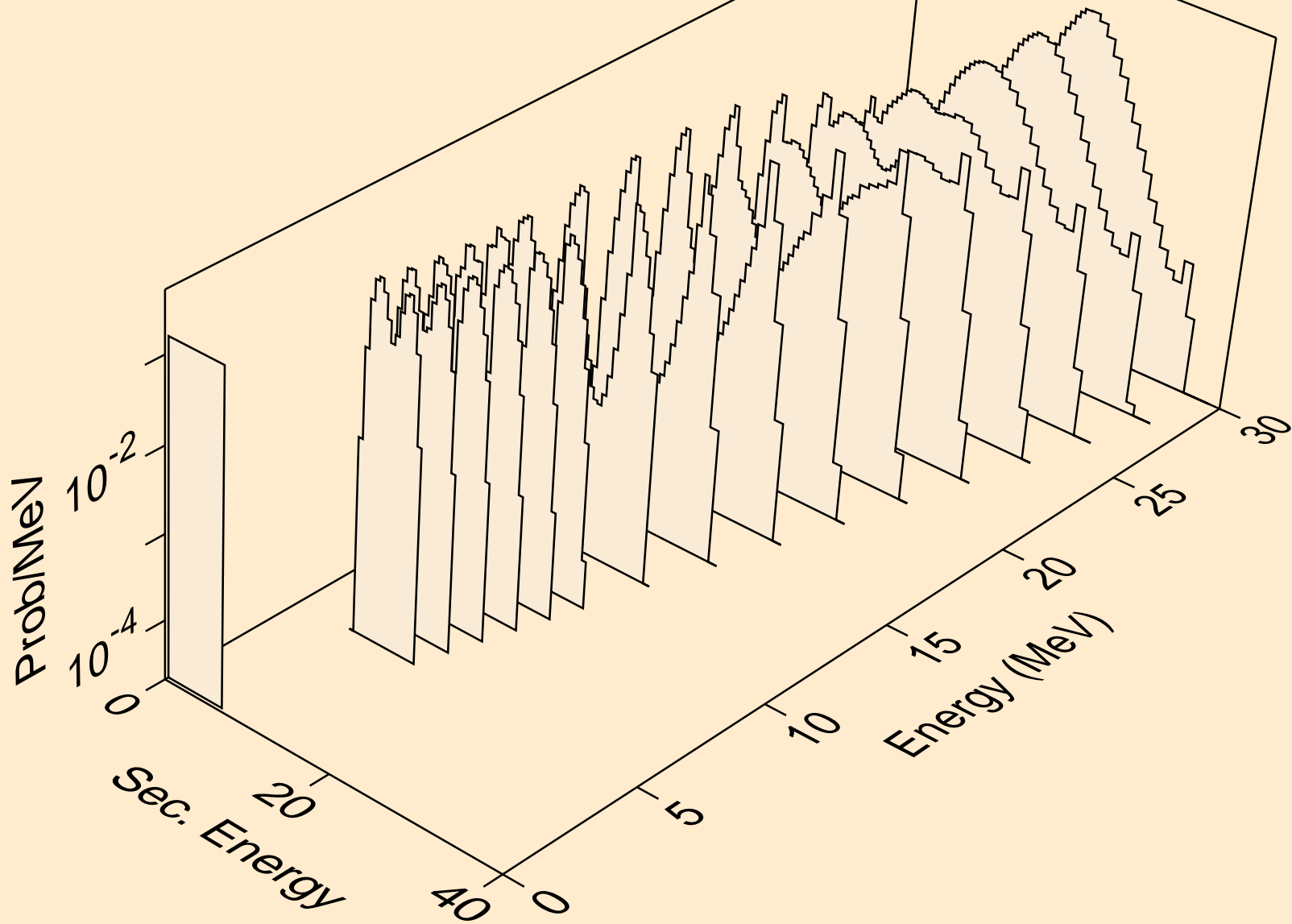

RN224 PROTON ACER TENDL-2021 LIBRARY; T=0.K  
alphas from (p,pa)

