

RN227 PROTON ACER TENDL-2021 LIBRARY; T=0.K

Principal cross sections

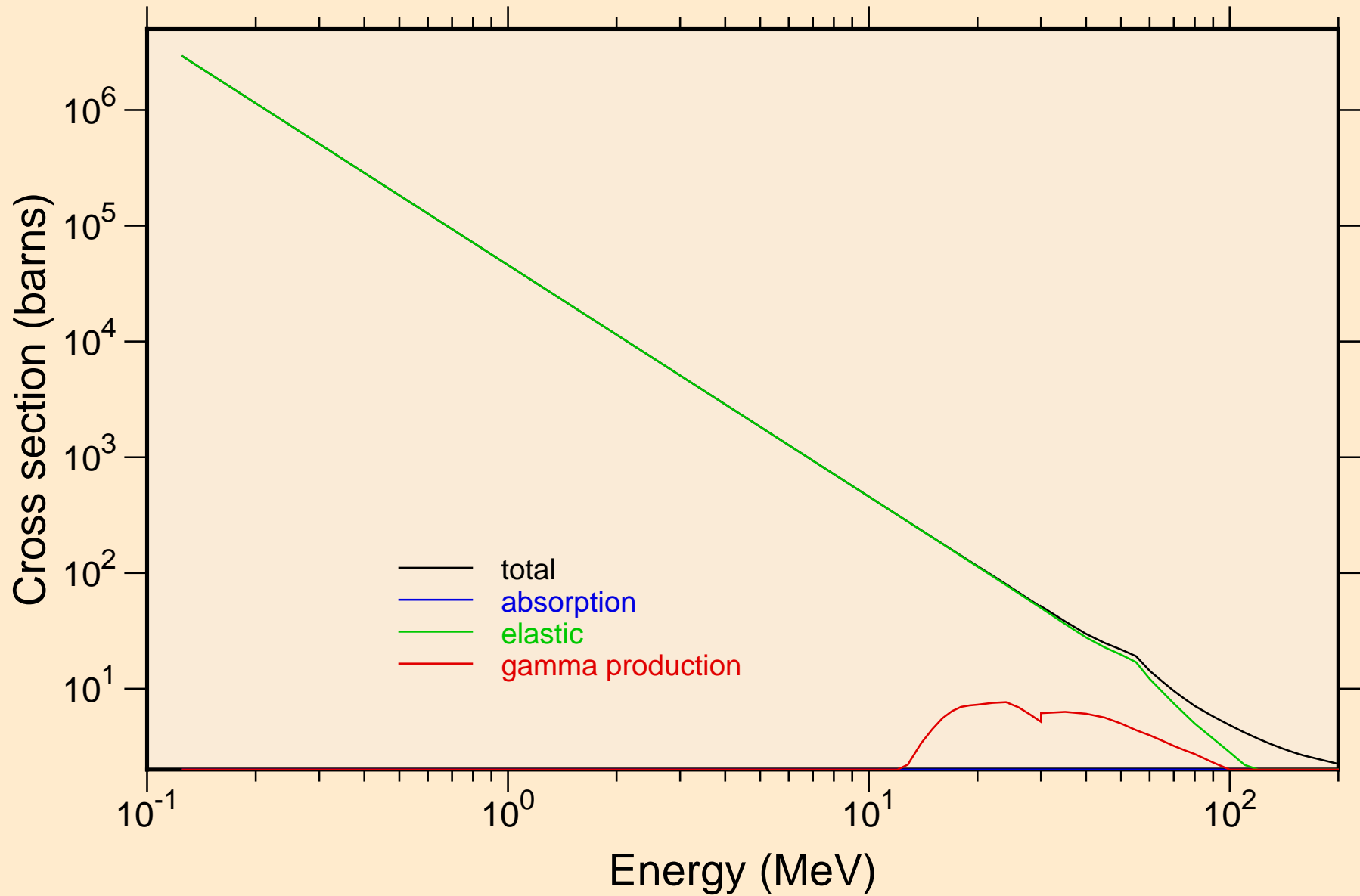

RN227 PROTON ACER TENDL-2021 LIBRARY; T=0.K
Heating

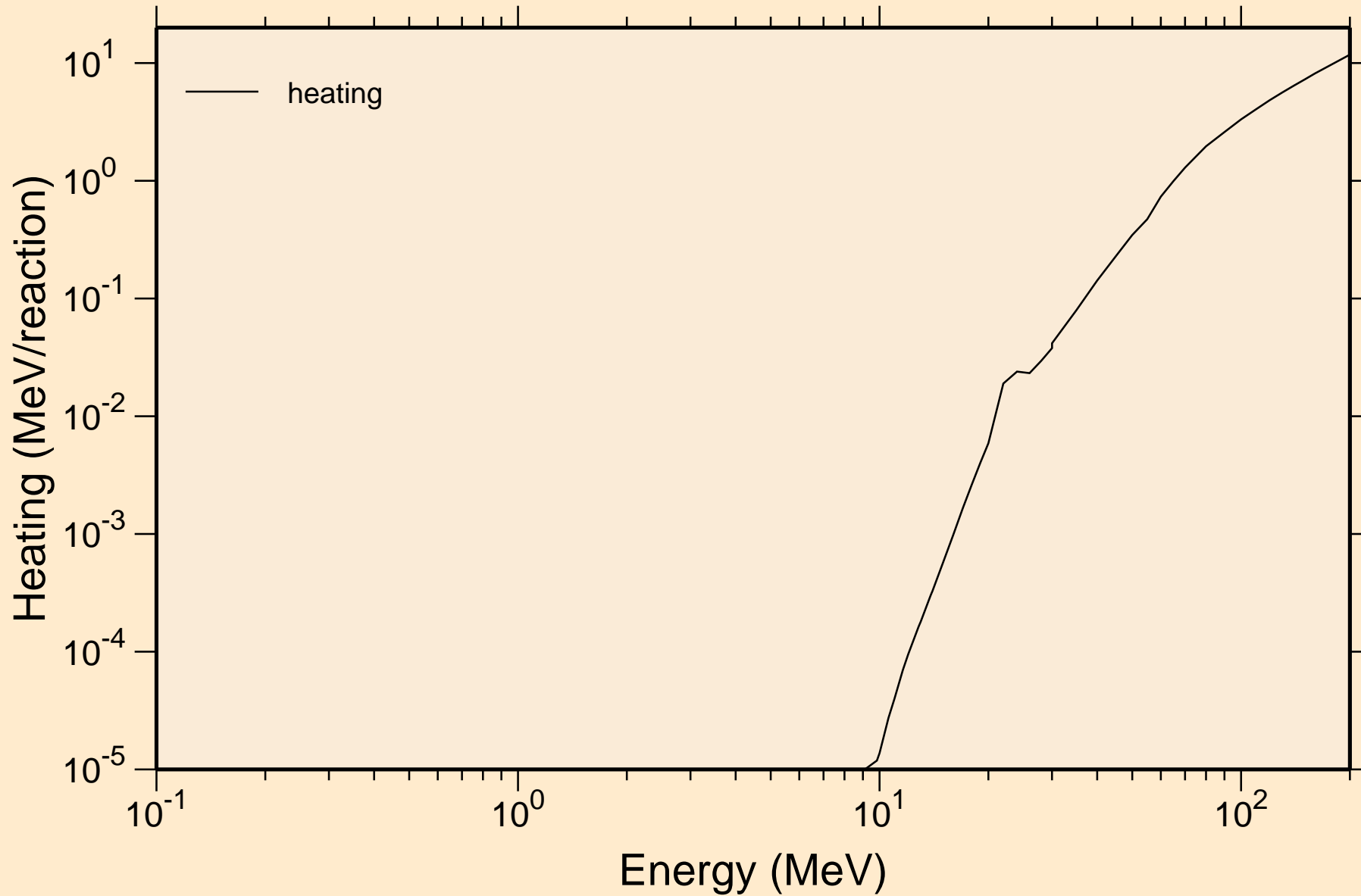

RN227 PROTON ACER TENDL-2021 LIBRARY; T=0.K
Principal cross sections

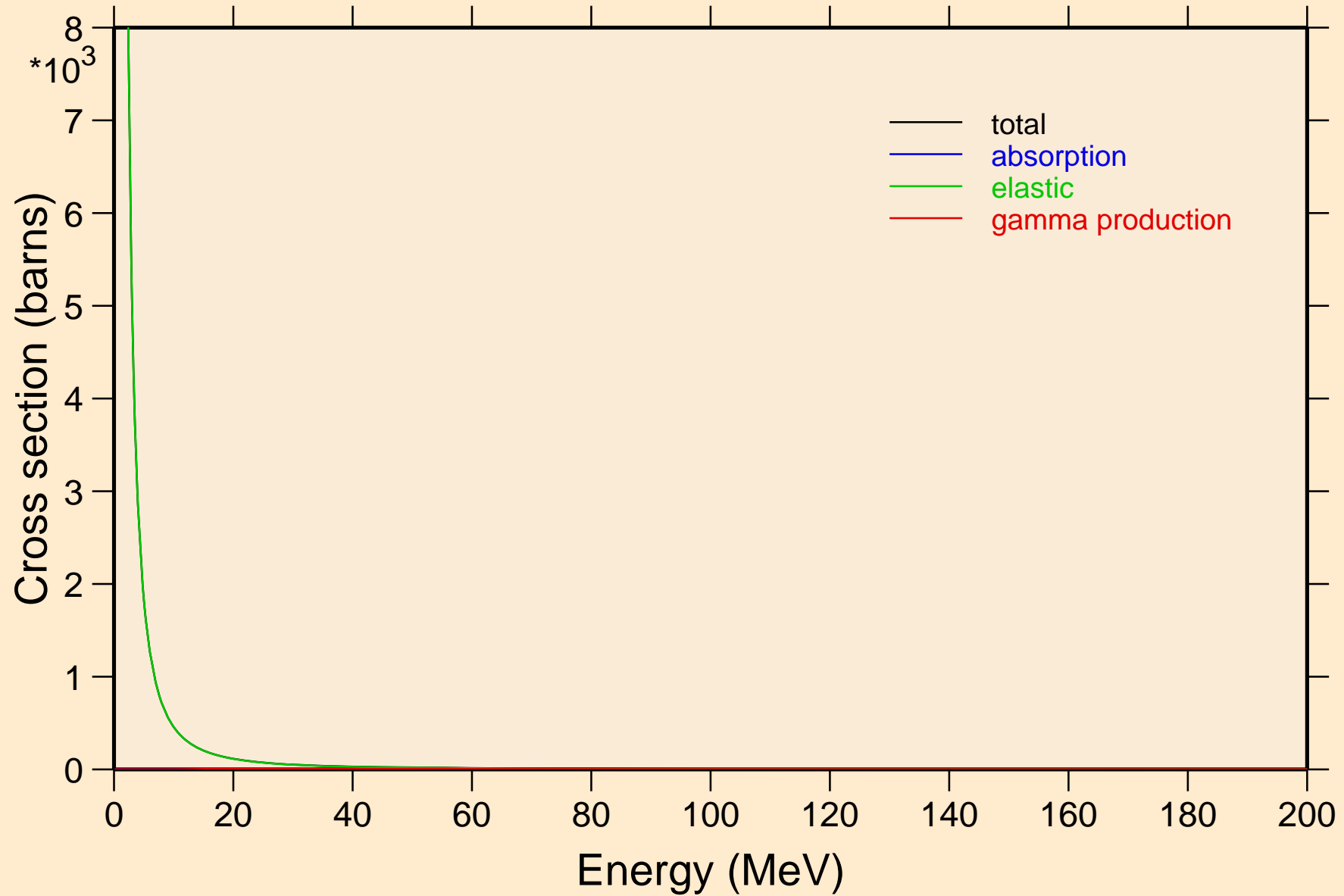

RN227 PROTON ACER TENDL-2021 LIBRARY; T=0.K

Heating

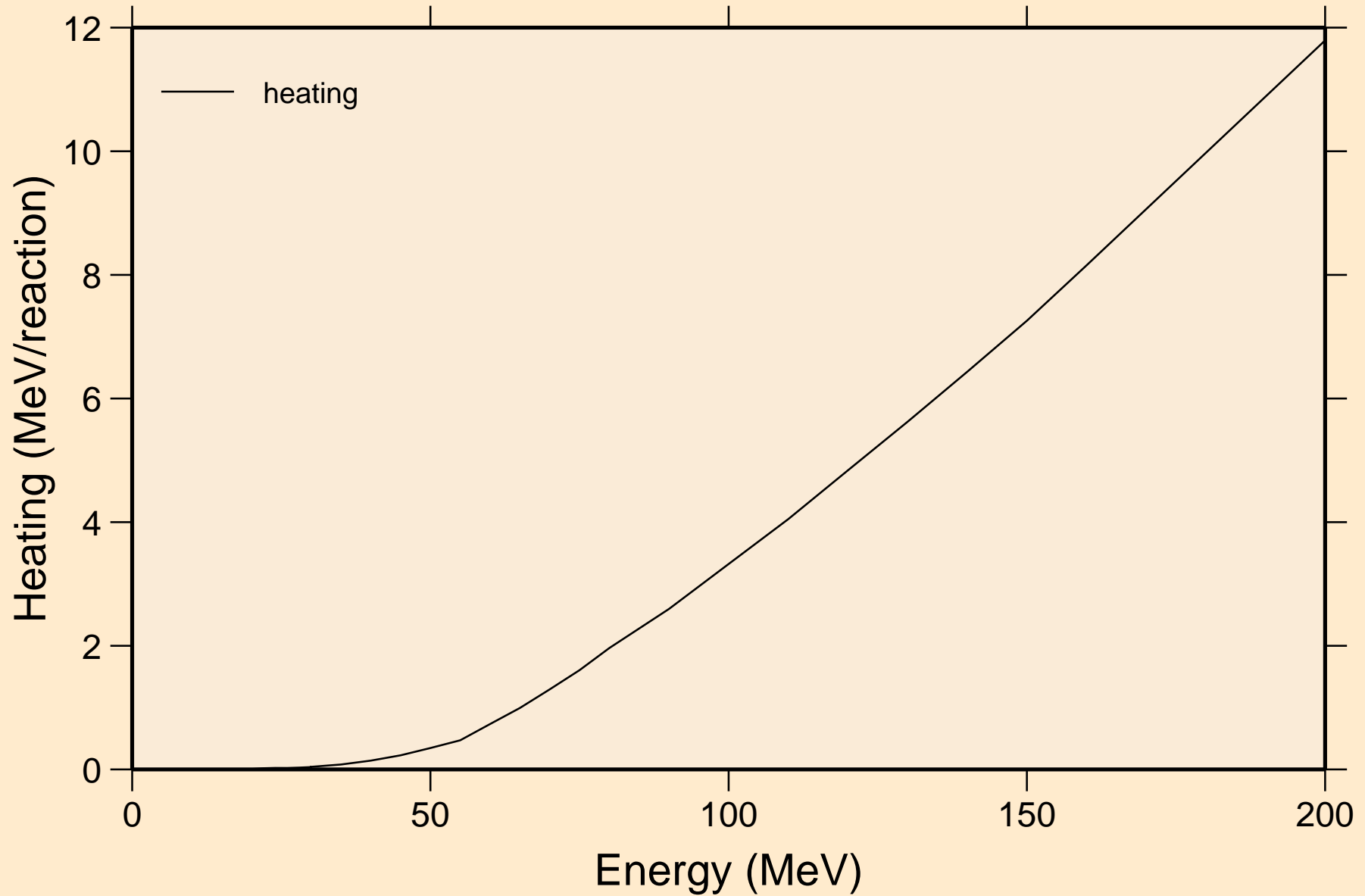

RN227 PROTON ACER TENDL-2021 LIBRARY; T=0.K
Threshold reactions

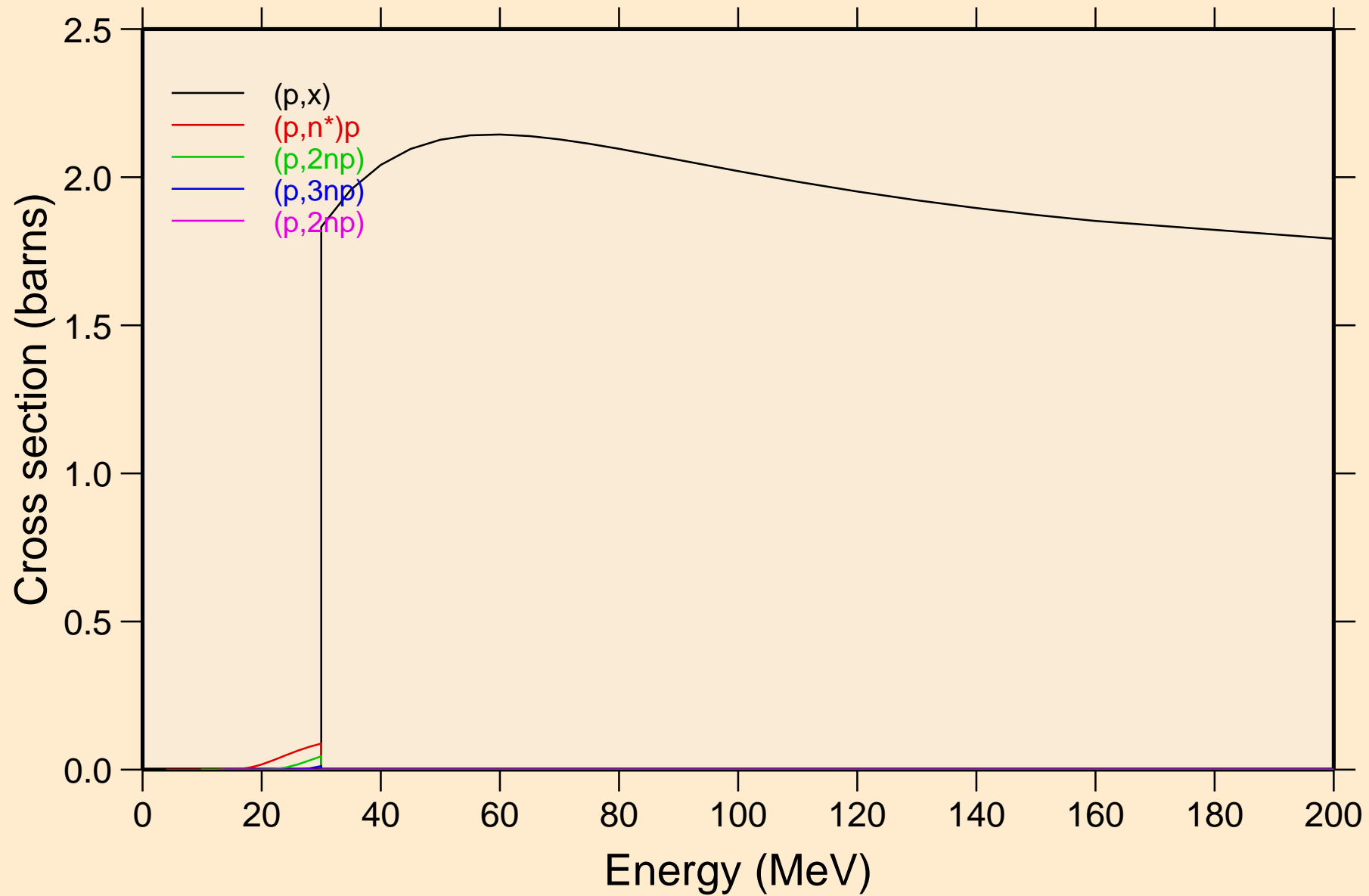

RN227 PROTON ACER TENDL-2021 LIBRARY; T=0.K

Threshold reactions

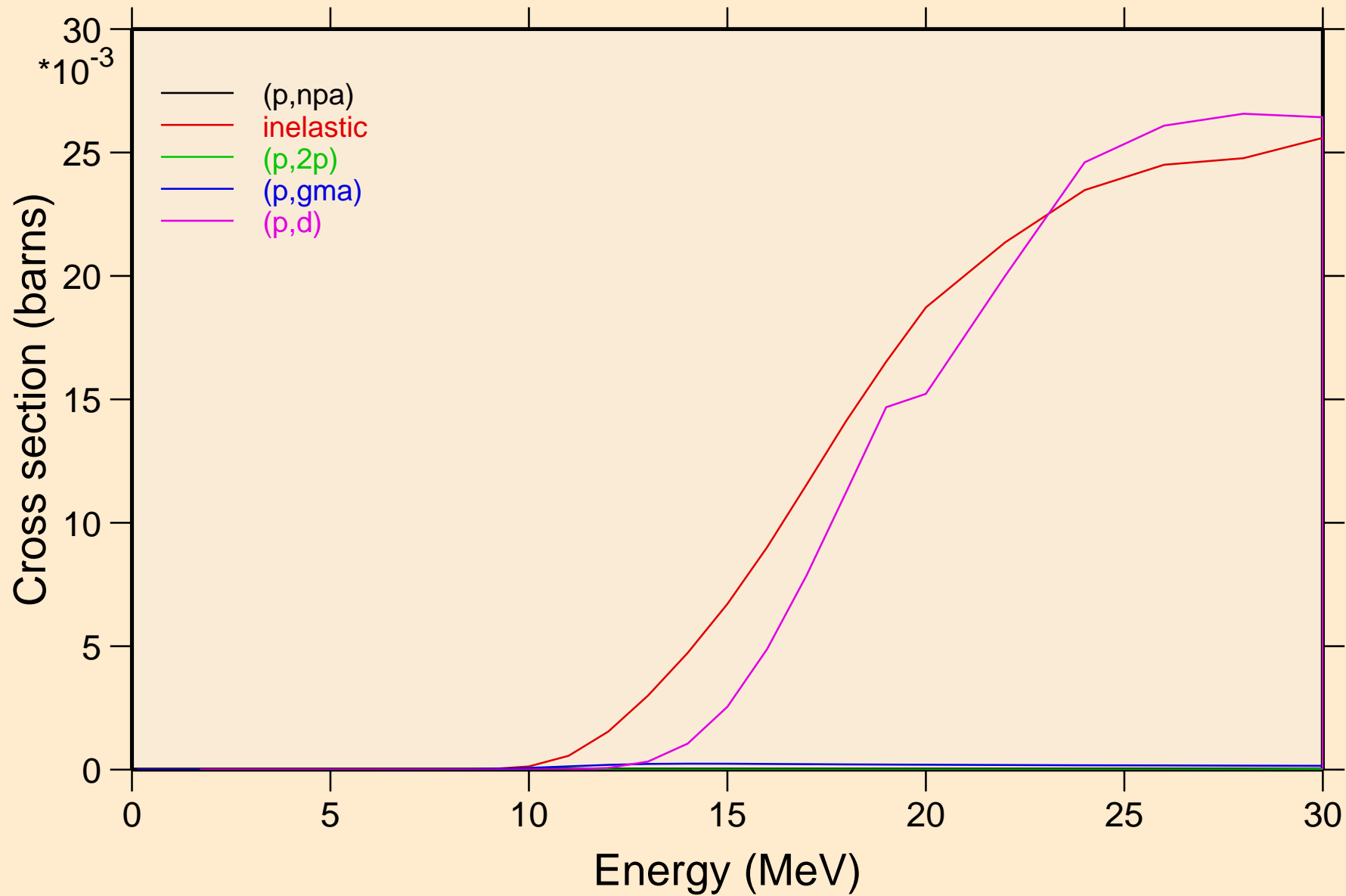

RN227 PROTON ACER TENDL-2021 LIBRARY; T=0.K
Threshold reactions

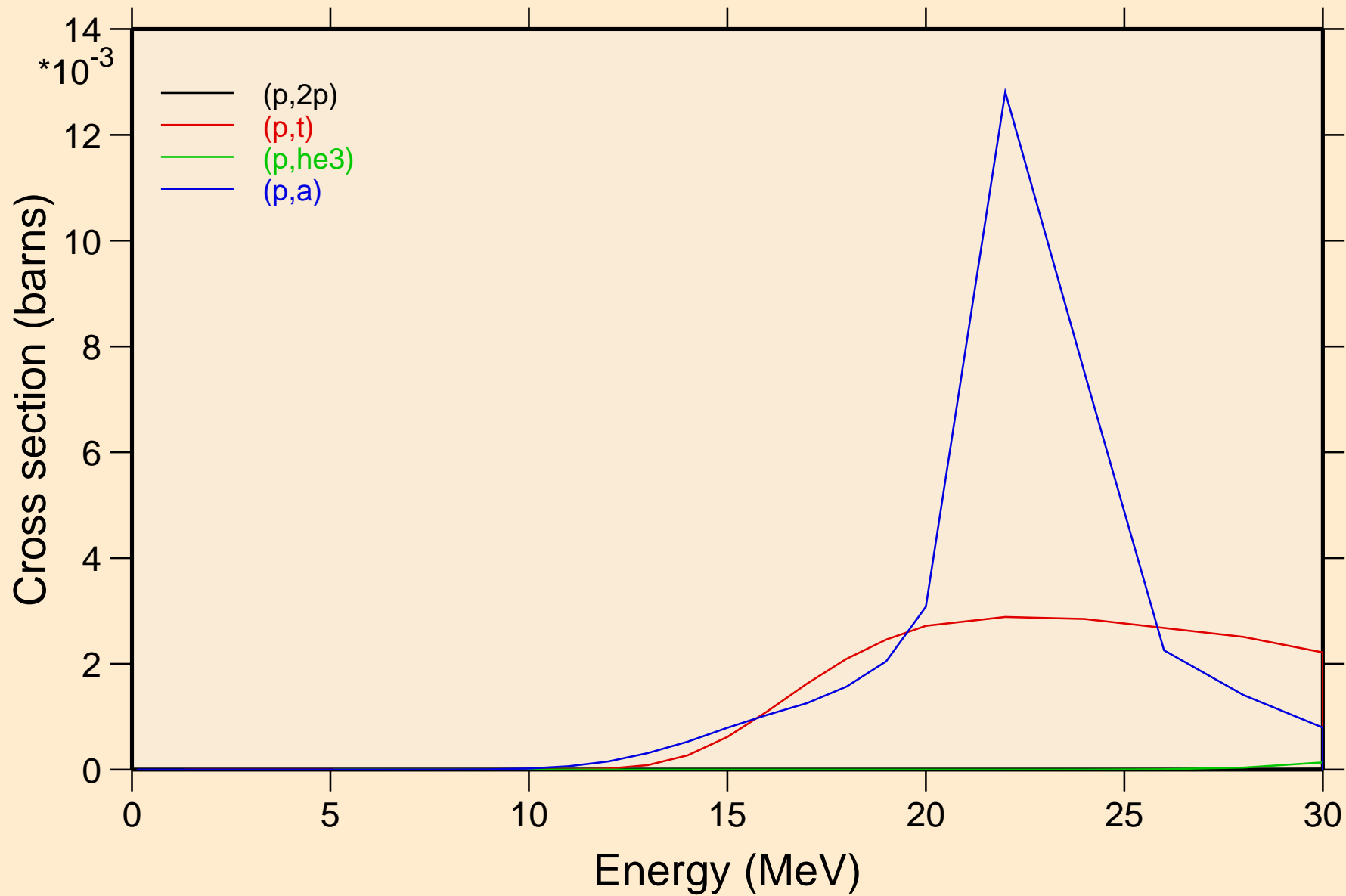

RN227 PROTON ACER TENDL-2021 LIBRARY; T=0.K
Threshold reactions

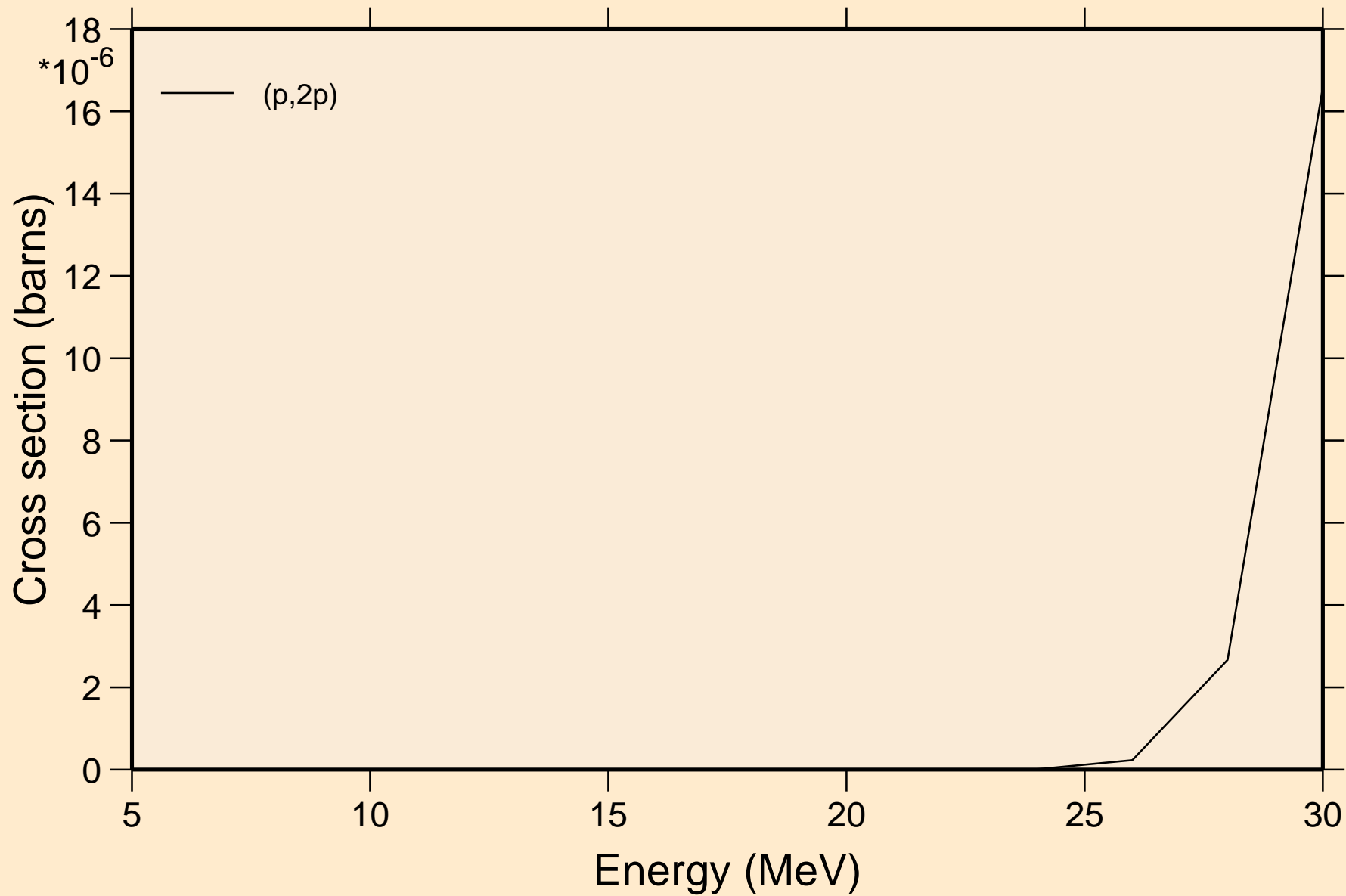

RN227 PROTON ACER TENDL-2021 LIBRARY; T=0.K
angular distribution for elastic

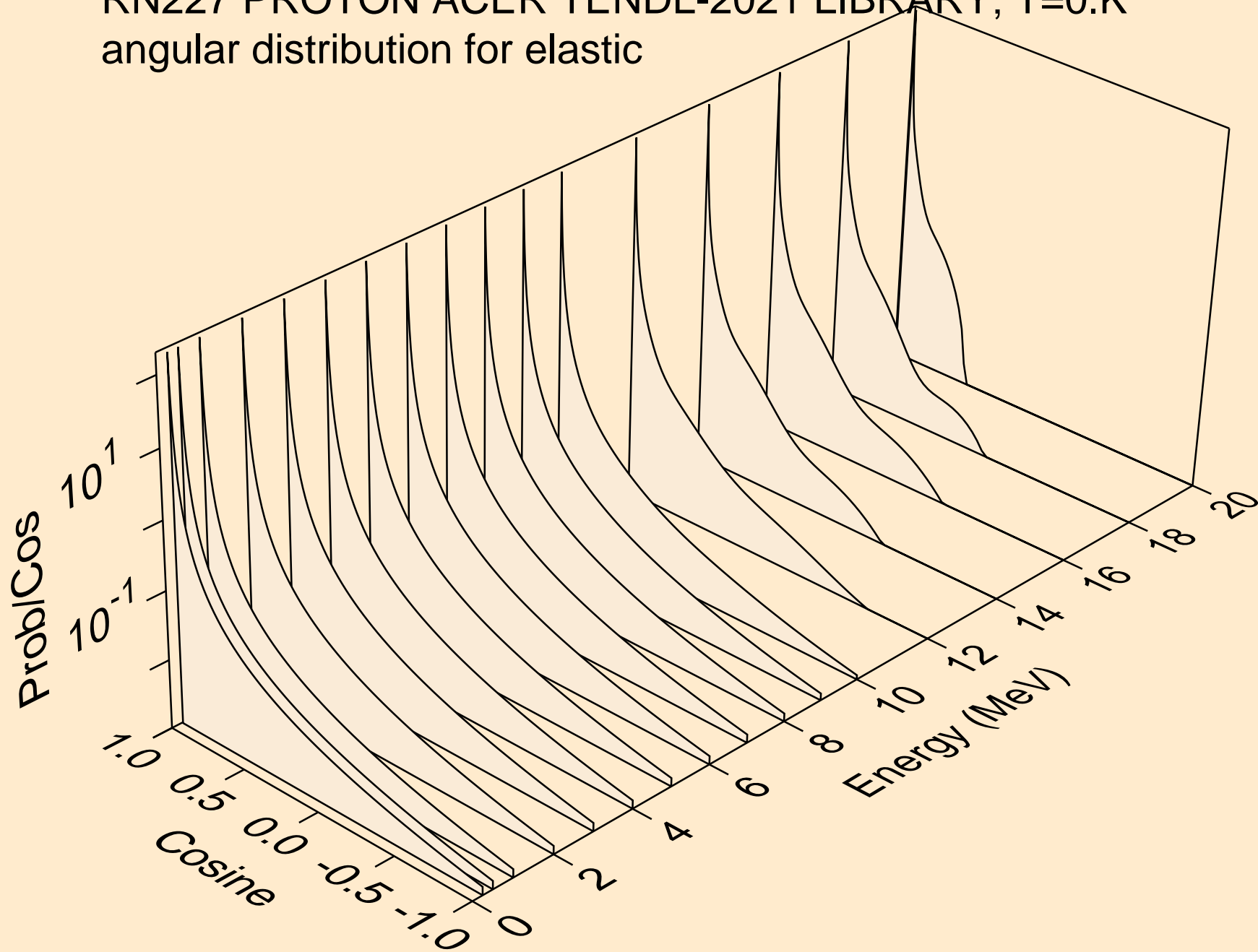

RN227 PROTON ACER TENDL-2021 LIBRARY; T=0.K
angular distribution for elastic

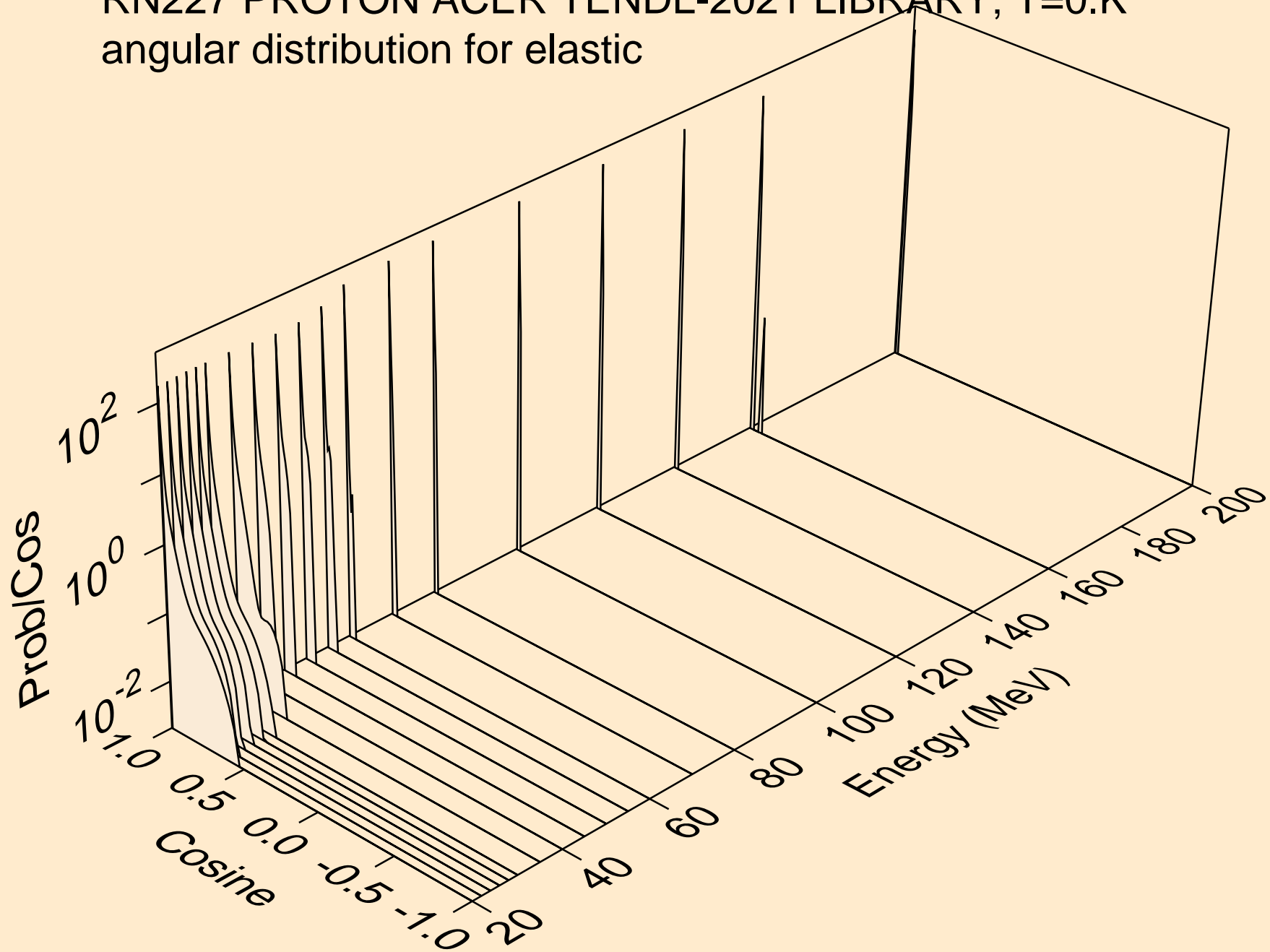

RN227 PROTON ACER TENDL-2021 LIBRARY; T=0.K
Proton emission for (p,x)

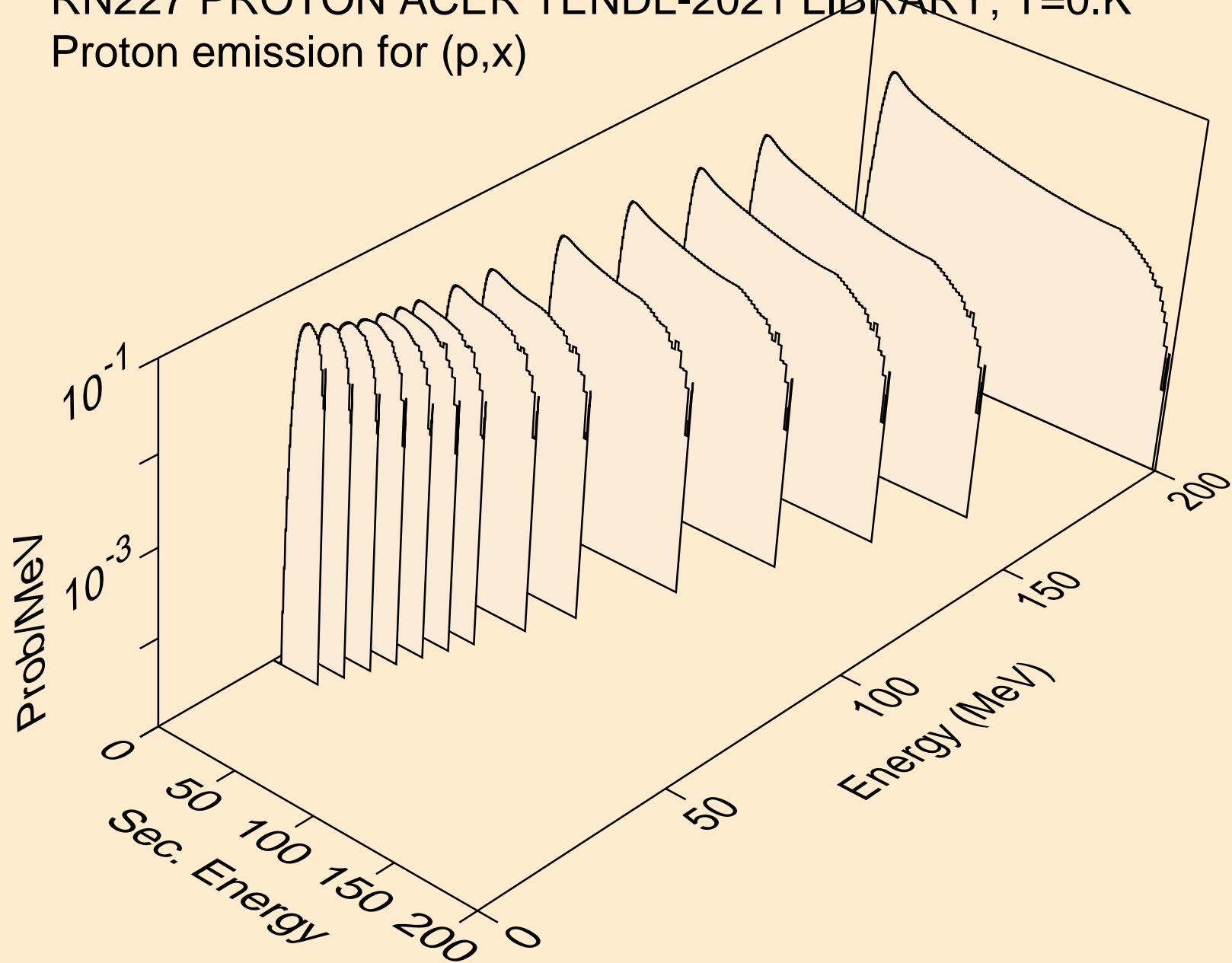

RN227 PROTON ACER TENDL-2021 LIBRARY; T=0.K
Proton emission for (p,n*)p

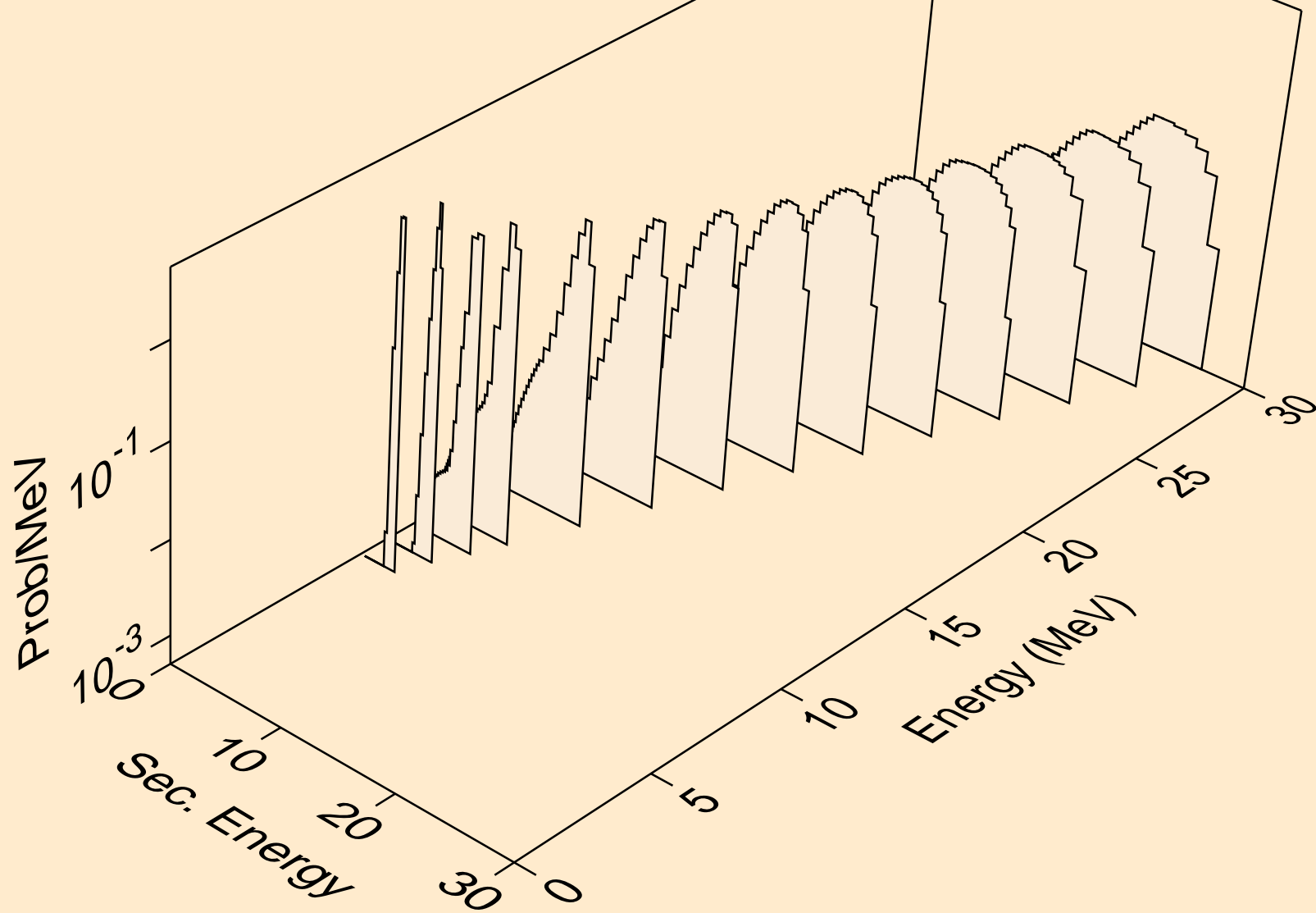

RN227 PROTON ACER TENDL-2021 LIBRARY; T=0.K
Proton emission for (p,2np)

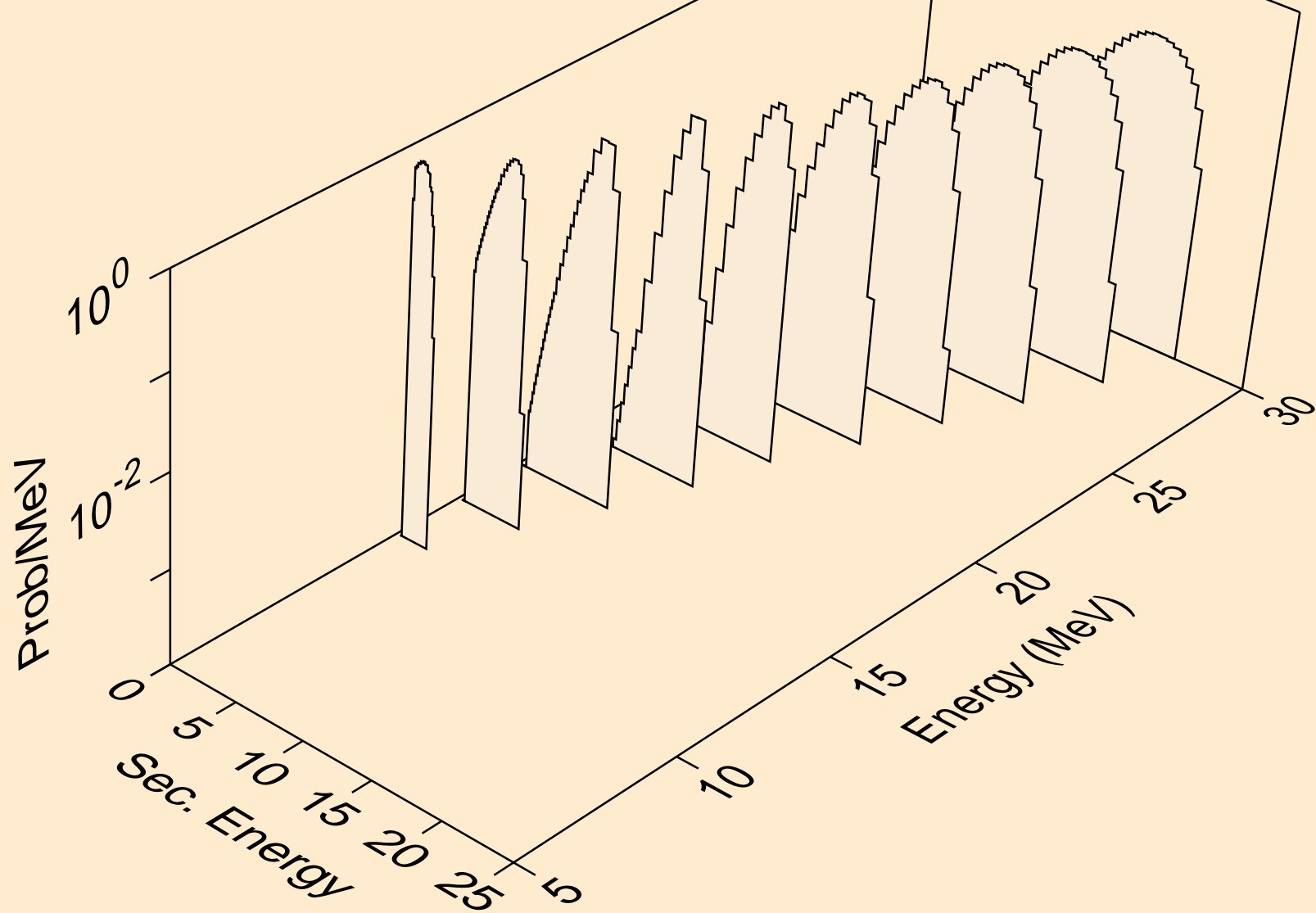

RN227 PROTON ACER TENDL-2021 LIBRARY; T=0.K
Proton emission for (p,3np)

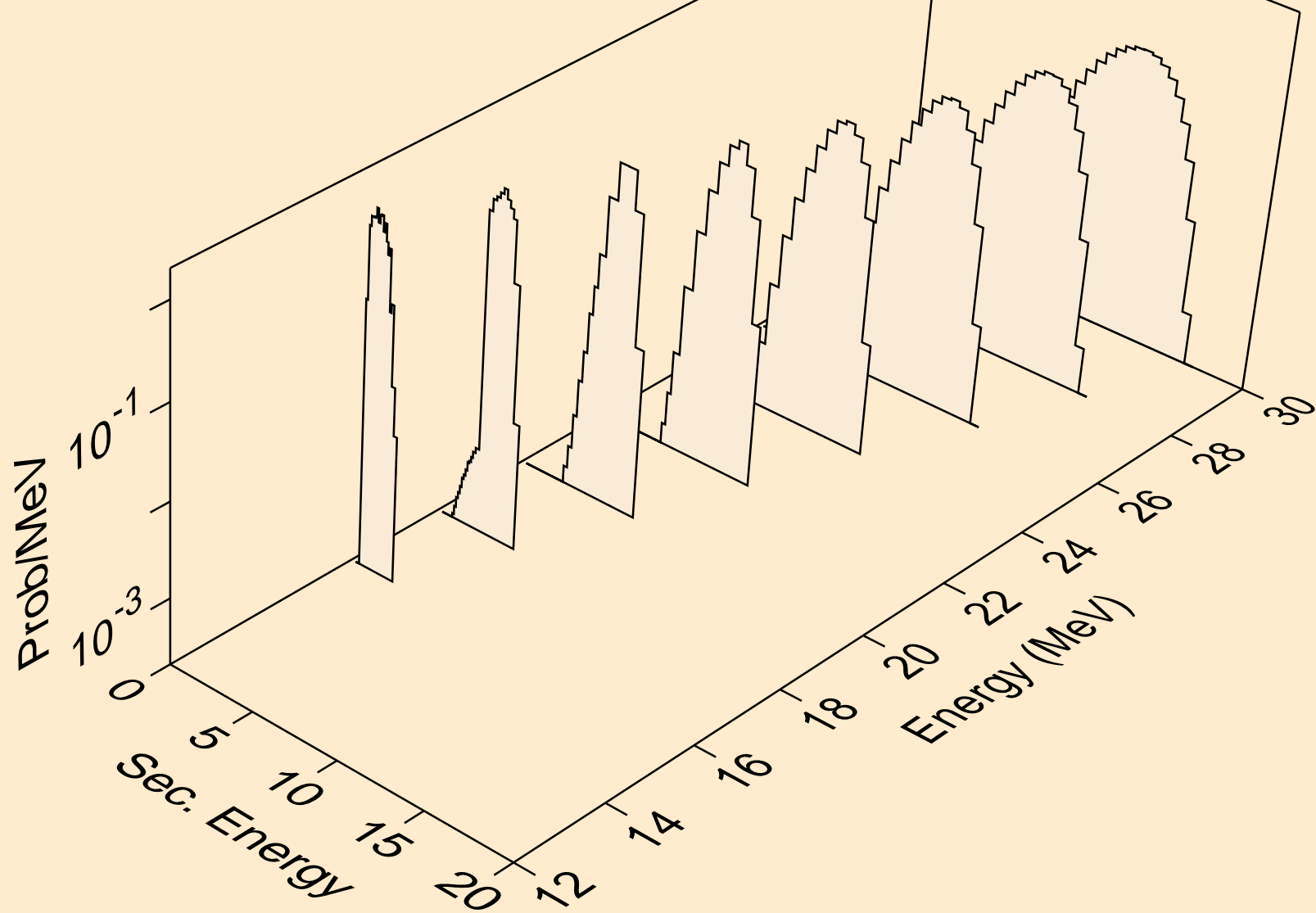

RN227 PROTON ACER TENDL-2021 LIBRARY; T=0.K
Proton emission for (p,2np)

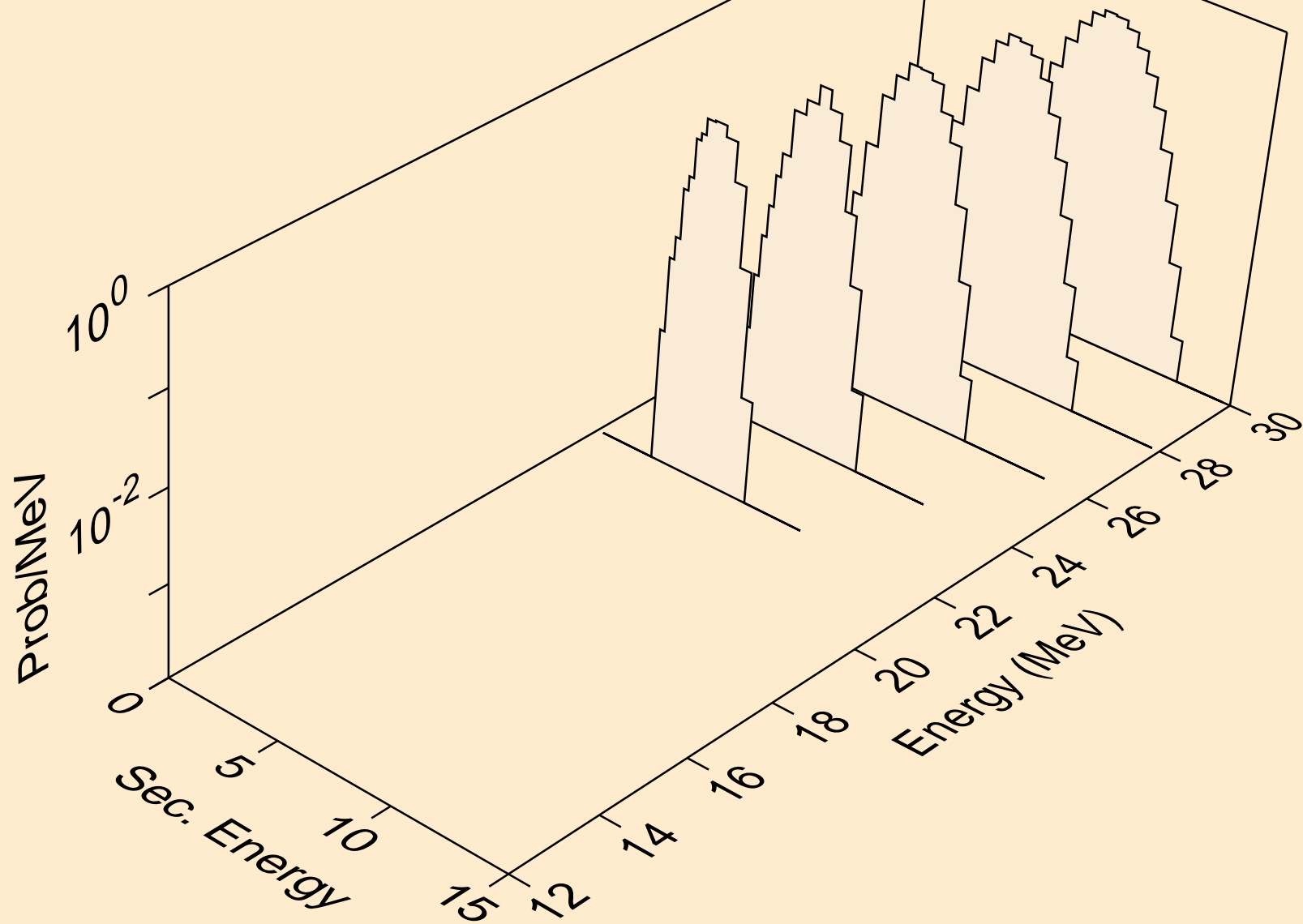

RN227 PROTON ACER TENDL-2021 LIBRARY; T=0.K
Proton emission for (p,npa)

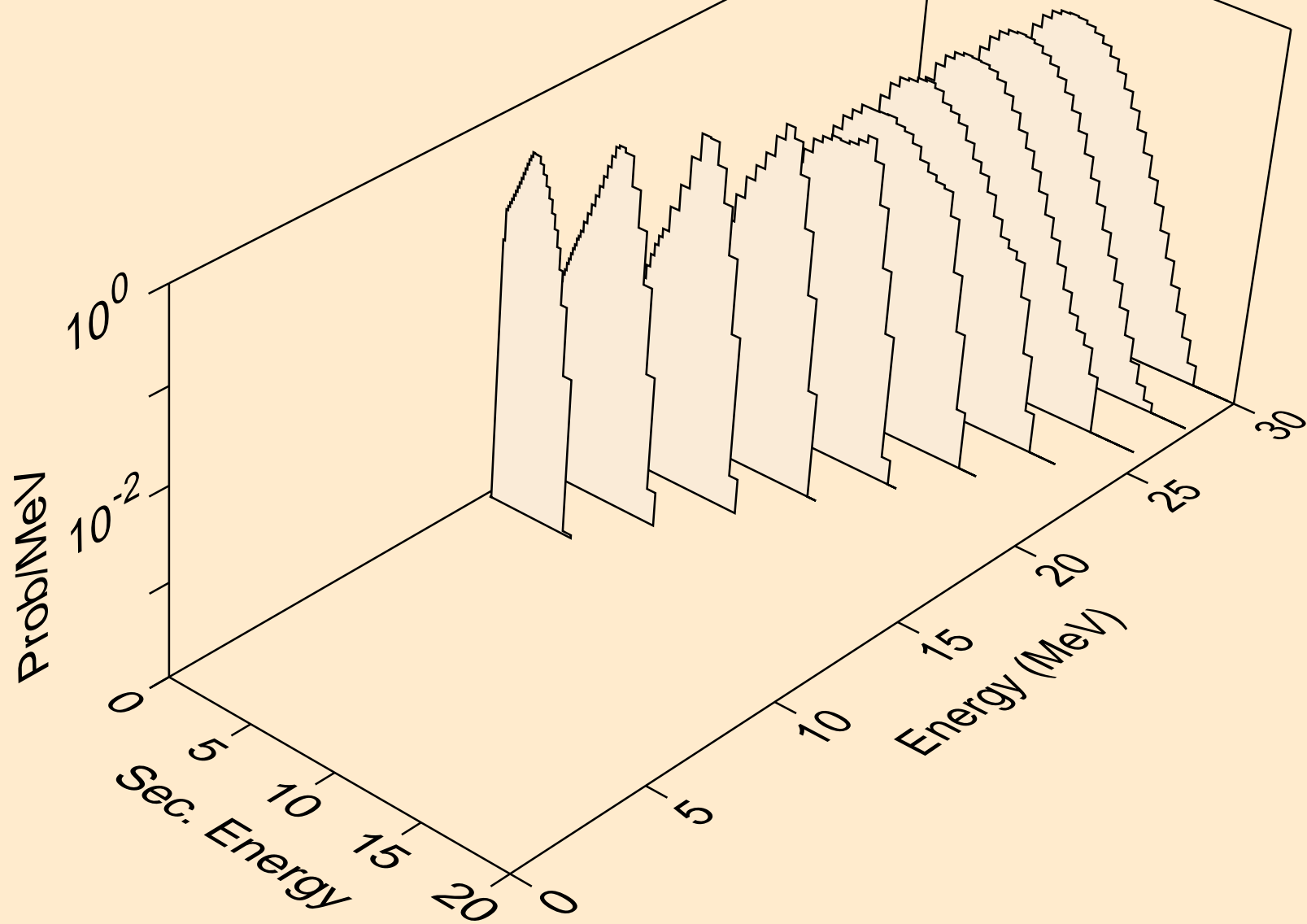

RN227 PROTON ACER TENDL-2021 LIBRARY; T=0.K
Proton emission for inelastic

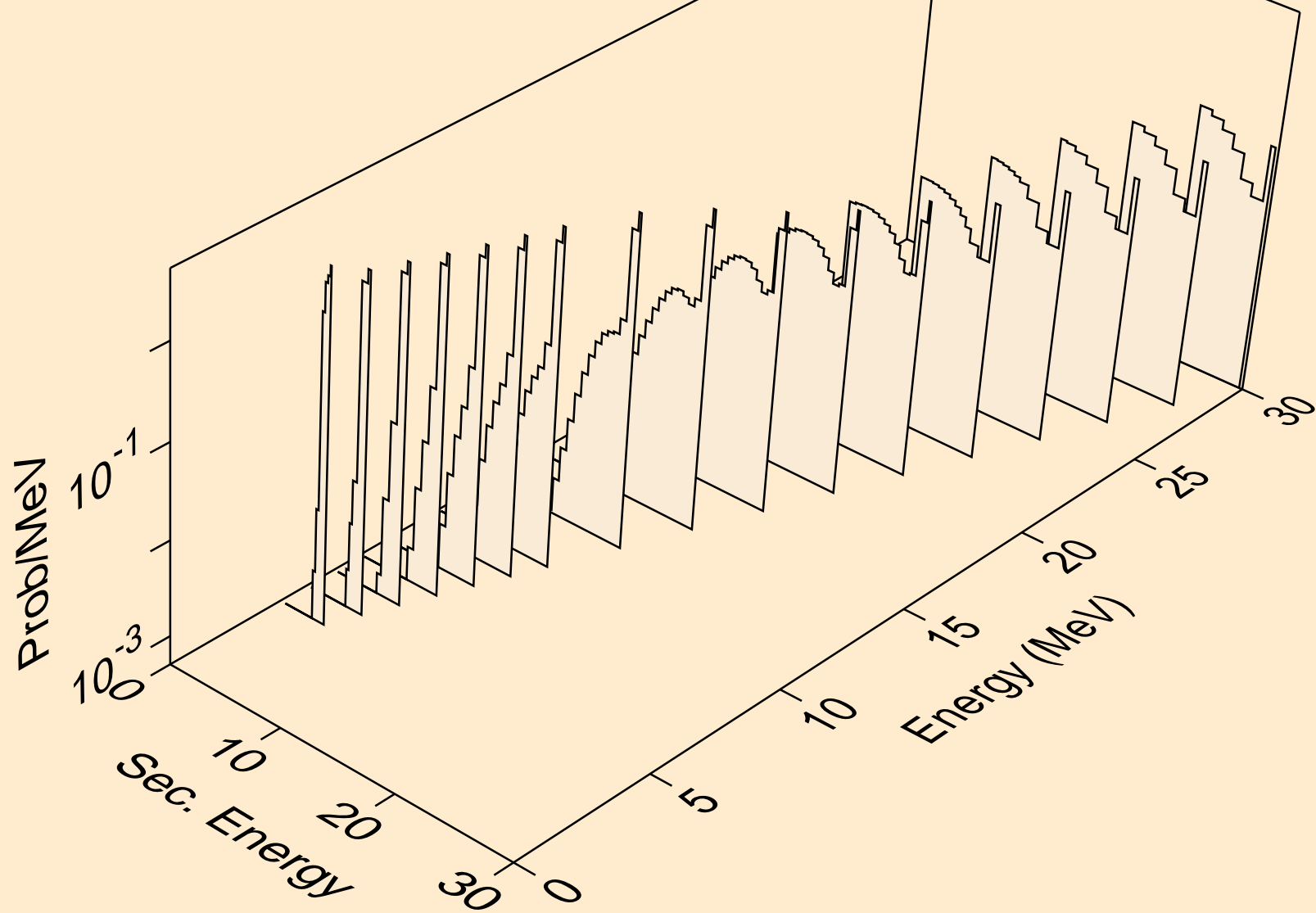

RN227 PROTON ACER TENDL-2021 LIBRARY; T=0.K
Proton emission for (p,2p)

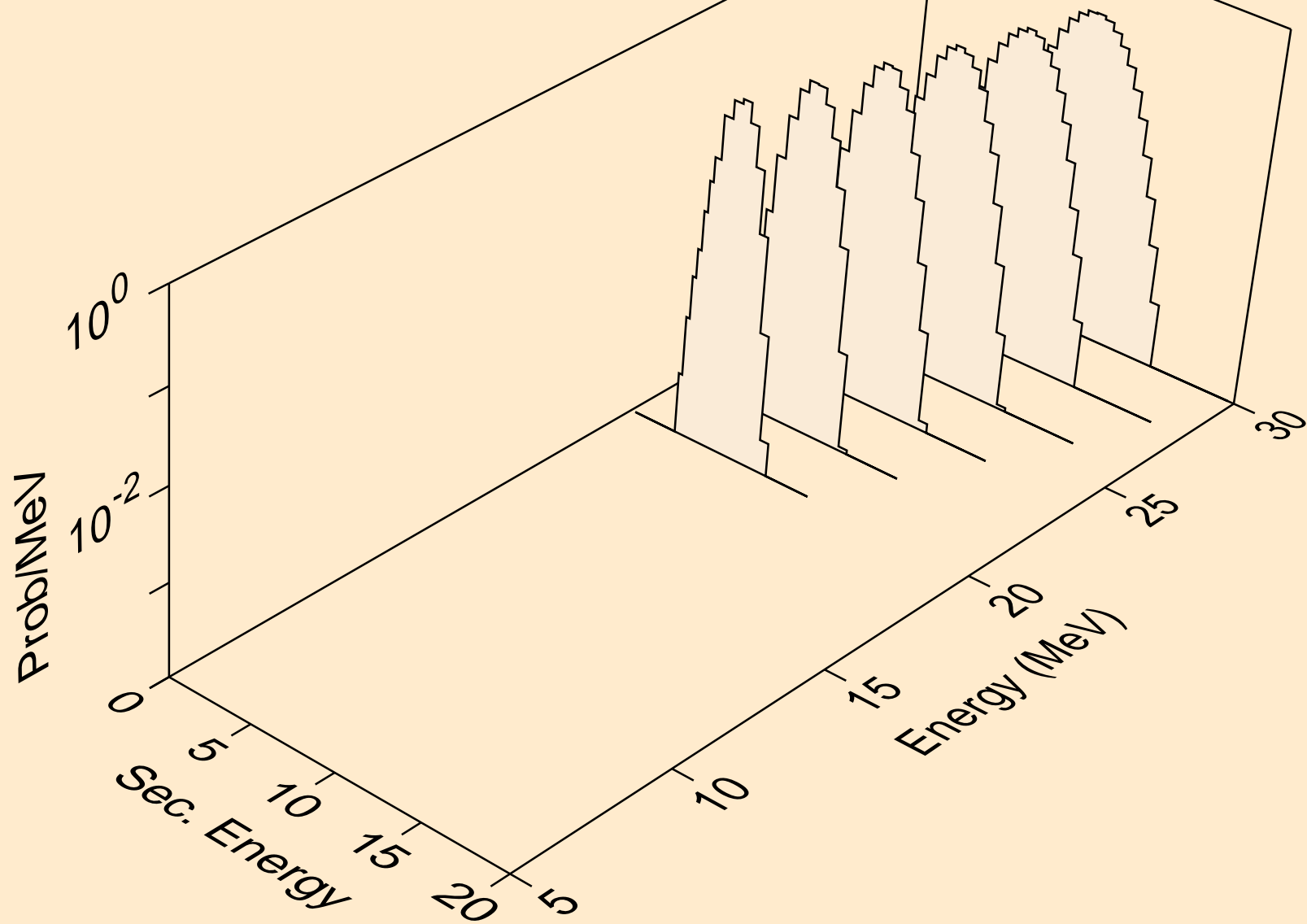

RN227 PROTON ACER TENDL-2021 LIBRARY; T=0.K
Photon emission for (z,n)

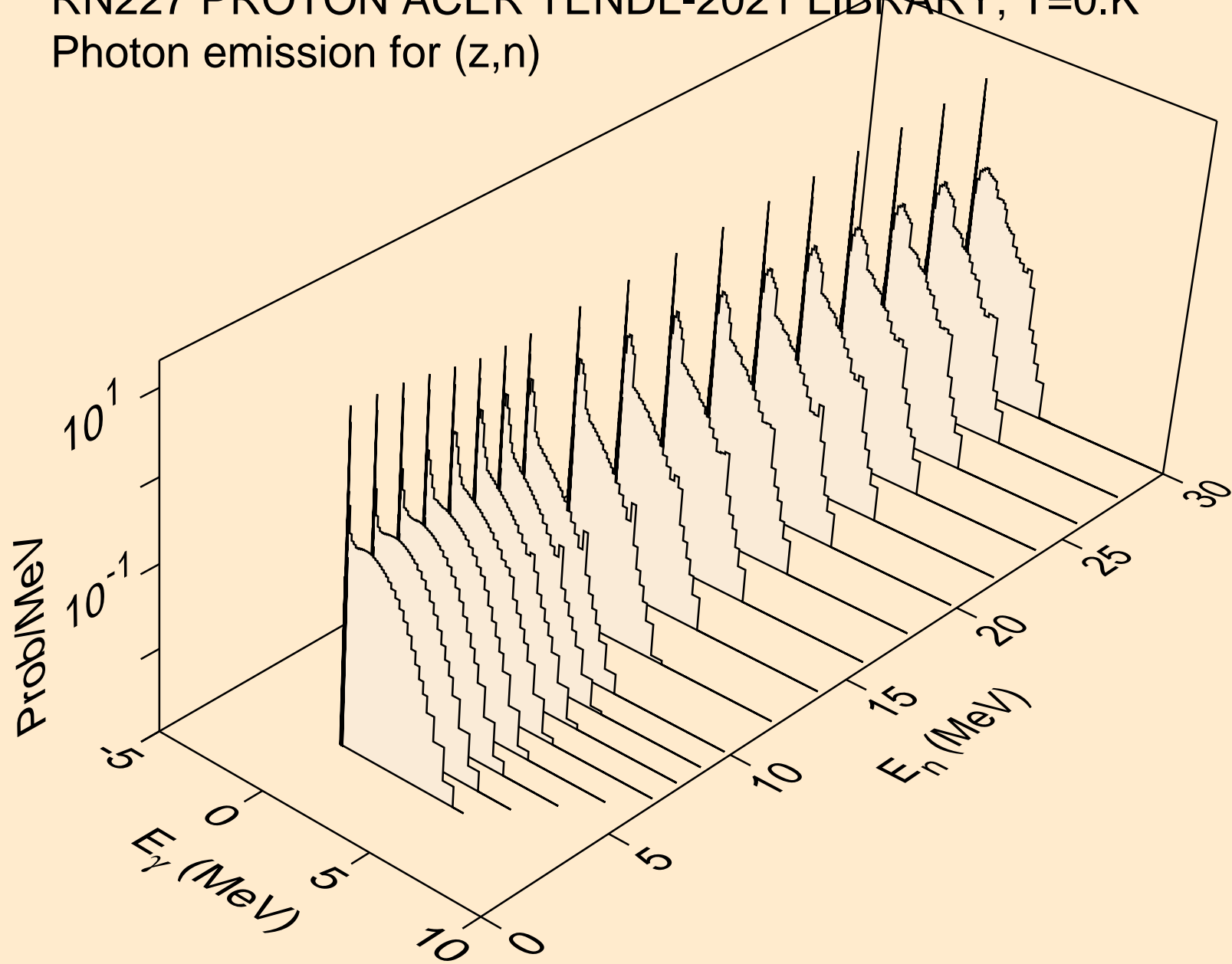

RN227 PROTON ACER TENDL-2021 LIBRARY; T=0.K
Photon emission for (n,x)

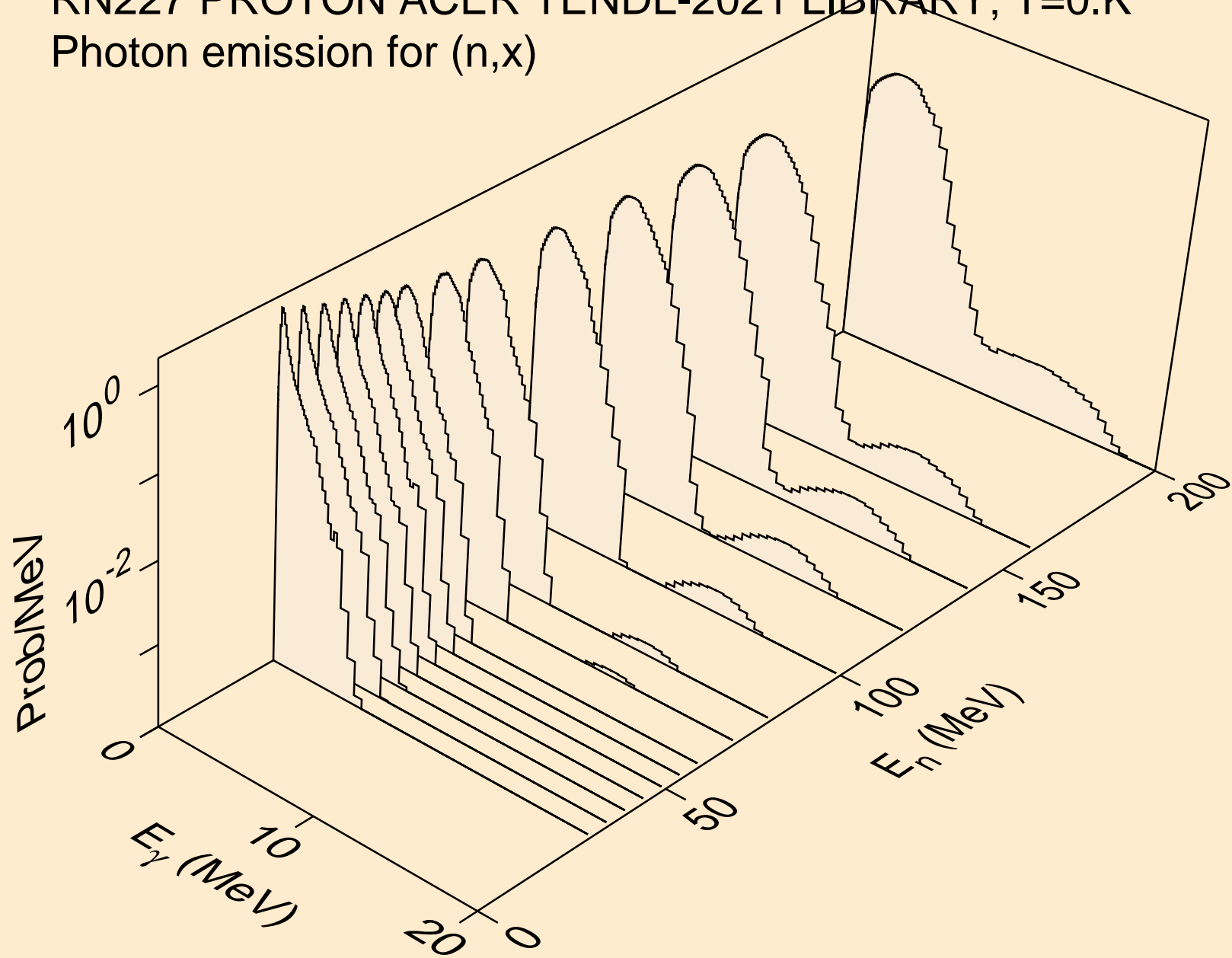

RN227 PROTON ACER TENDL-2021 LIBRARY; T=0.K
Photon emission for (n,2nd)

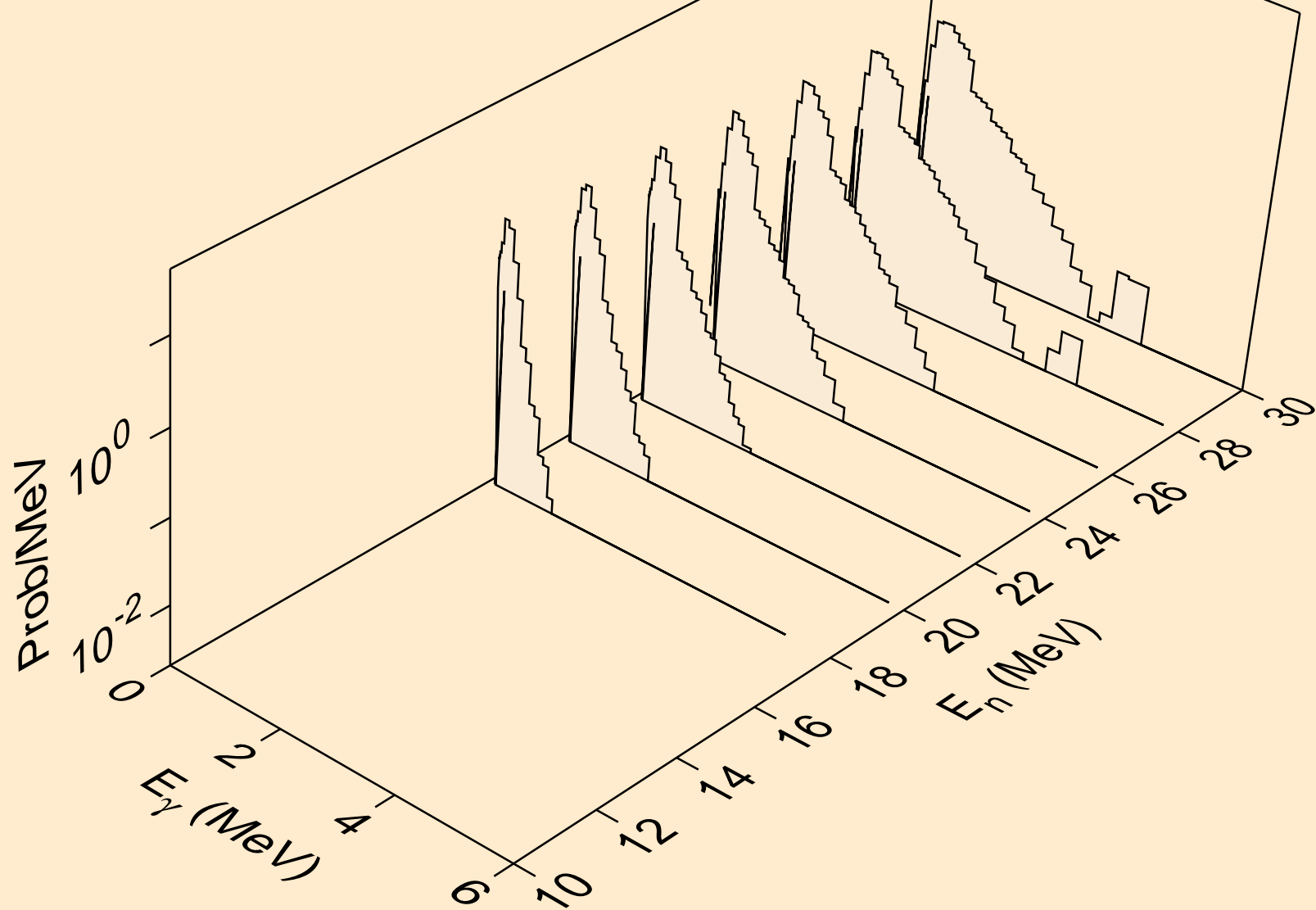

RN227 PROTON ACER TENDL-2021 LIBRARY; T=0.K
Photon emission for (n,2n)

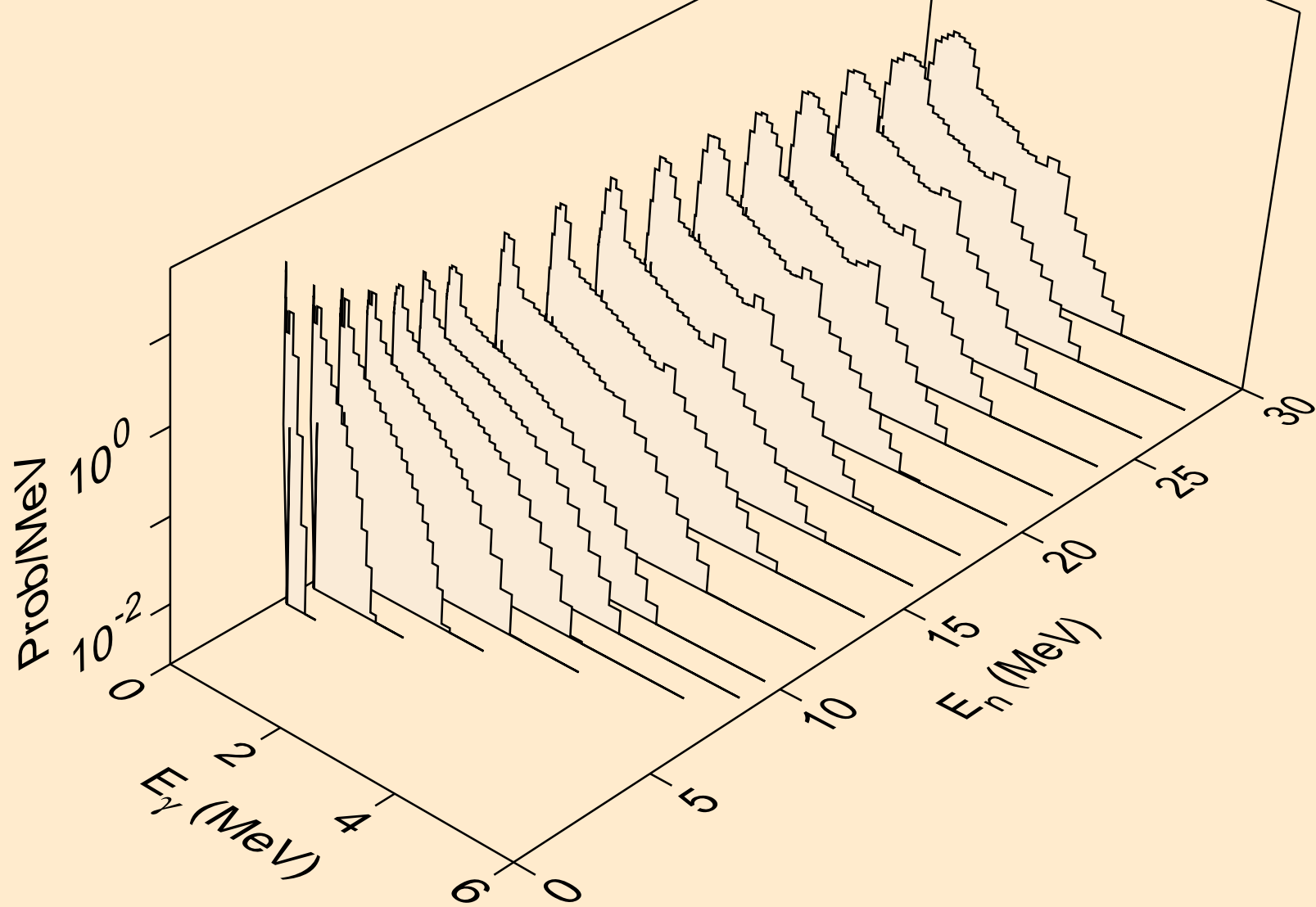

RN227 PROTON ACER TENDL-2021 LIBRARY; T=0.K
Photon emission for (n,3n)

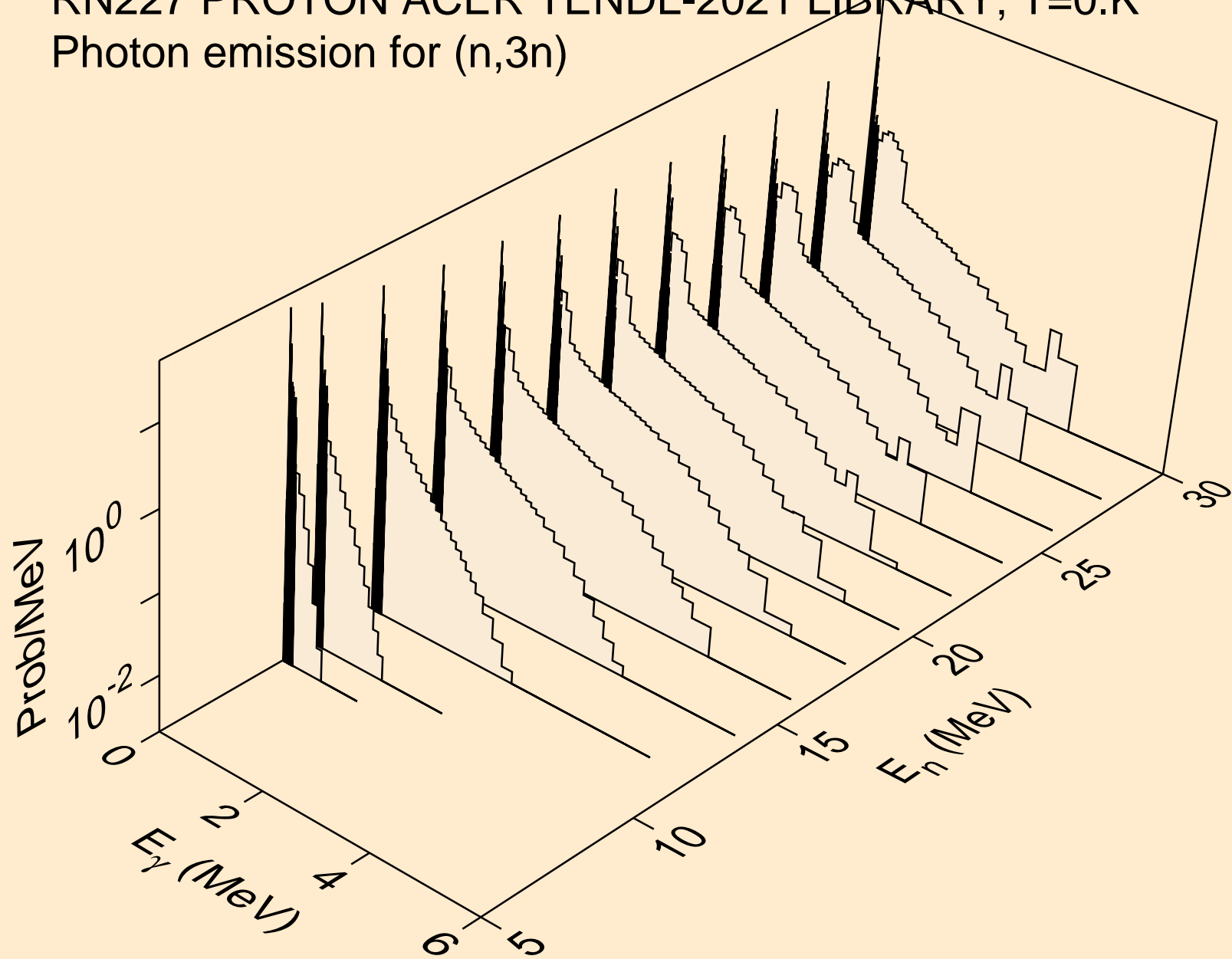

RN227 PROTON ACER TENDL-2021 LIBRARY; T=0.K
Photon emission for (n,n*)a

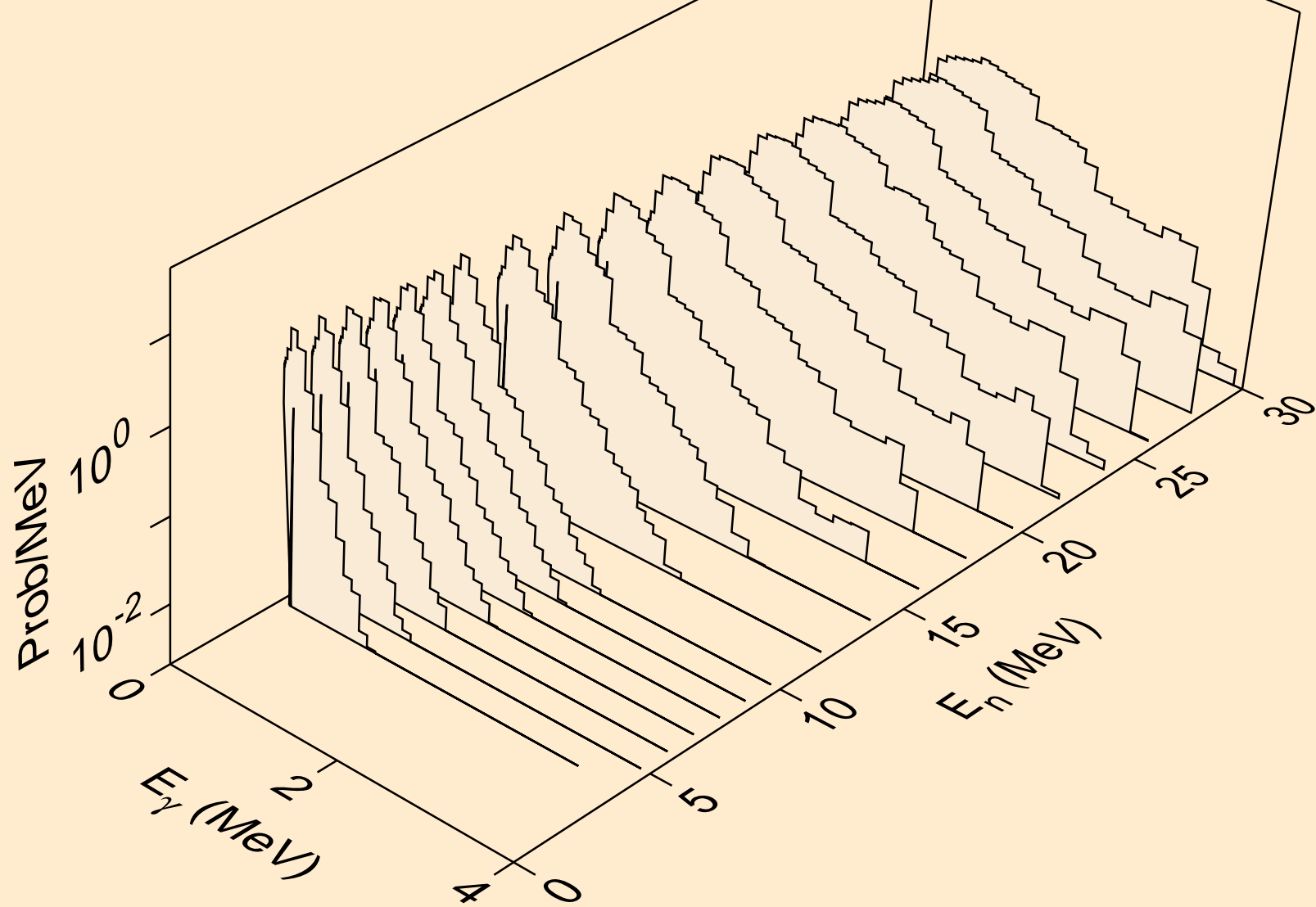

RN227 PROTON ACER TENDL-2021 LIBRARY; T=0.K
Photon emission for (n,2n)a

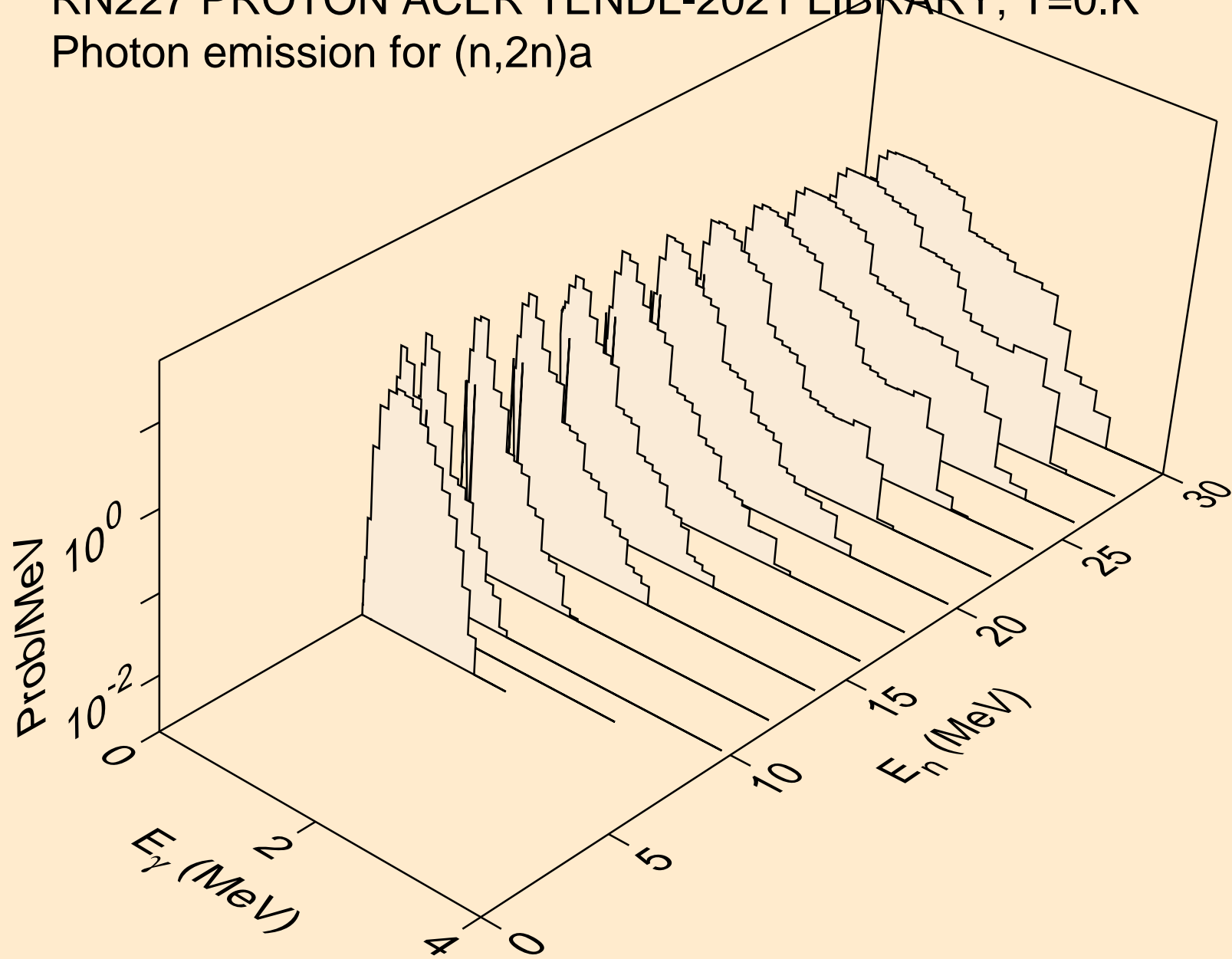

RN227 PROTON ACER TENDL-2021 LIBRARY; T=0.K
Photon emission for (n,3n)a

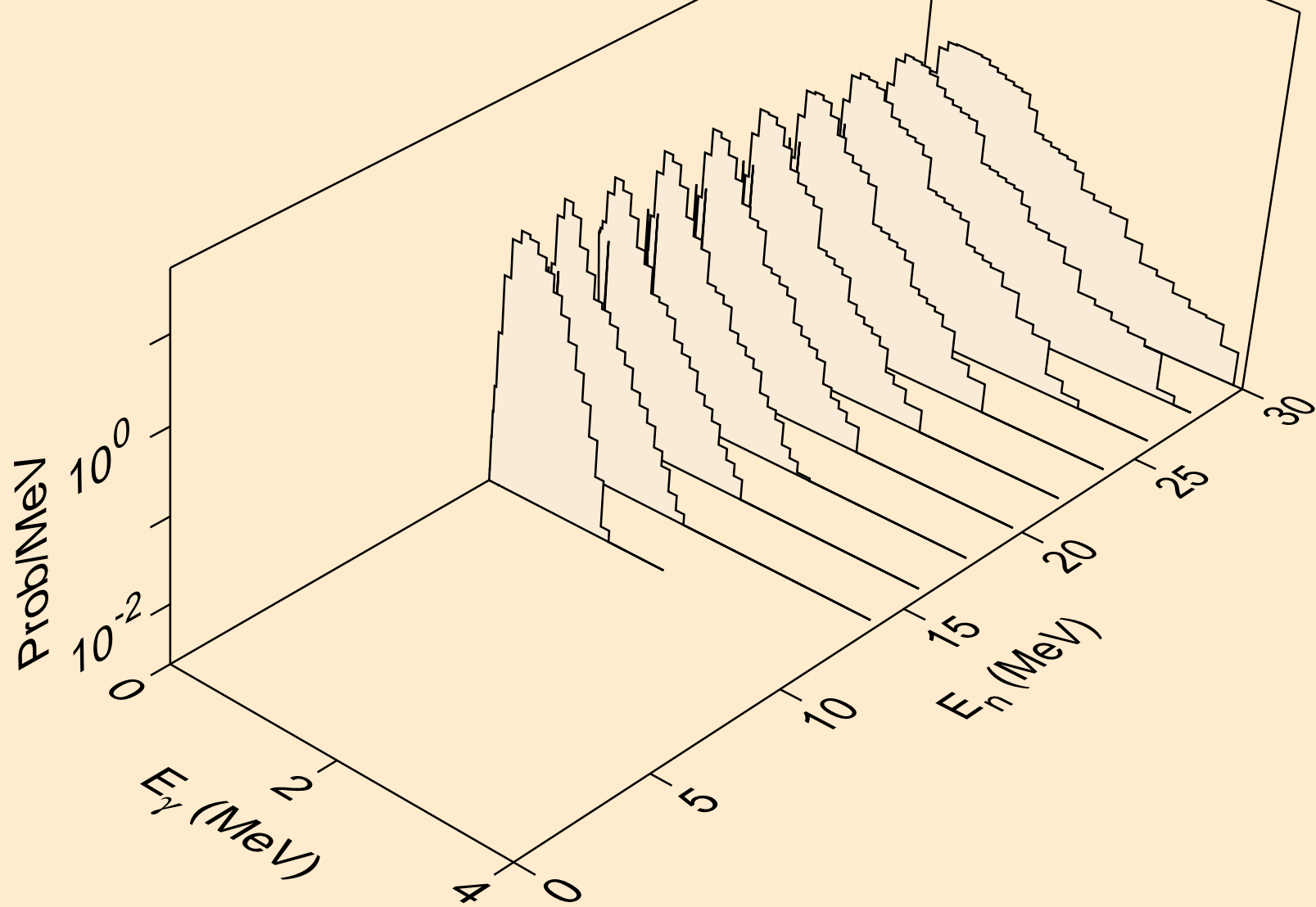

RN227 PROTON ACER TENDL-2021 LIBRARY; T=0.K
Photon emission for (n,n*)p

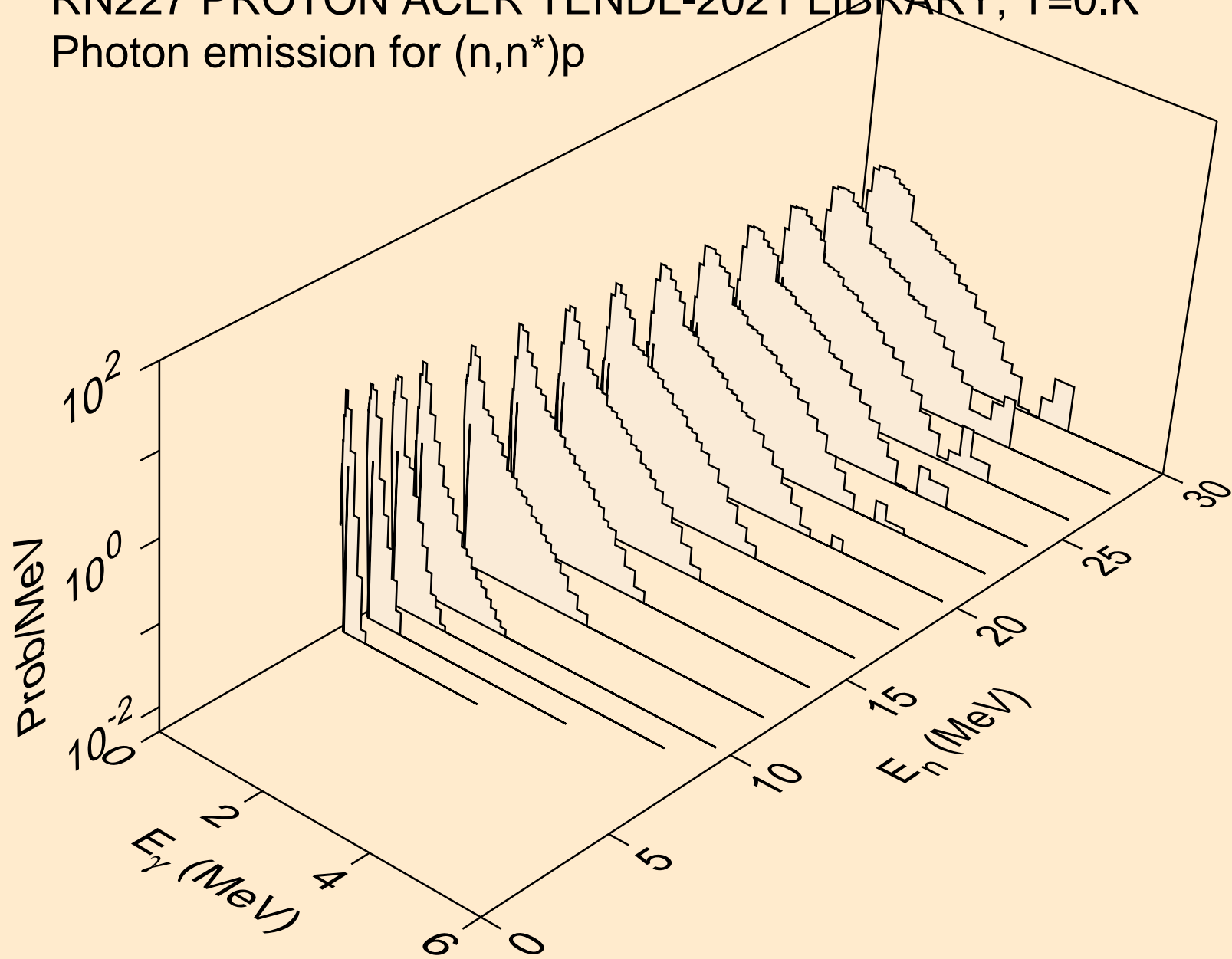

RN227 PROTON ACER TENDL-2021 LIBRARY; T=0.K
Photon emission for (n,n*)2a

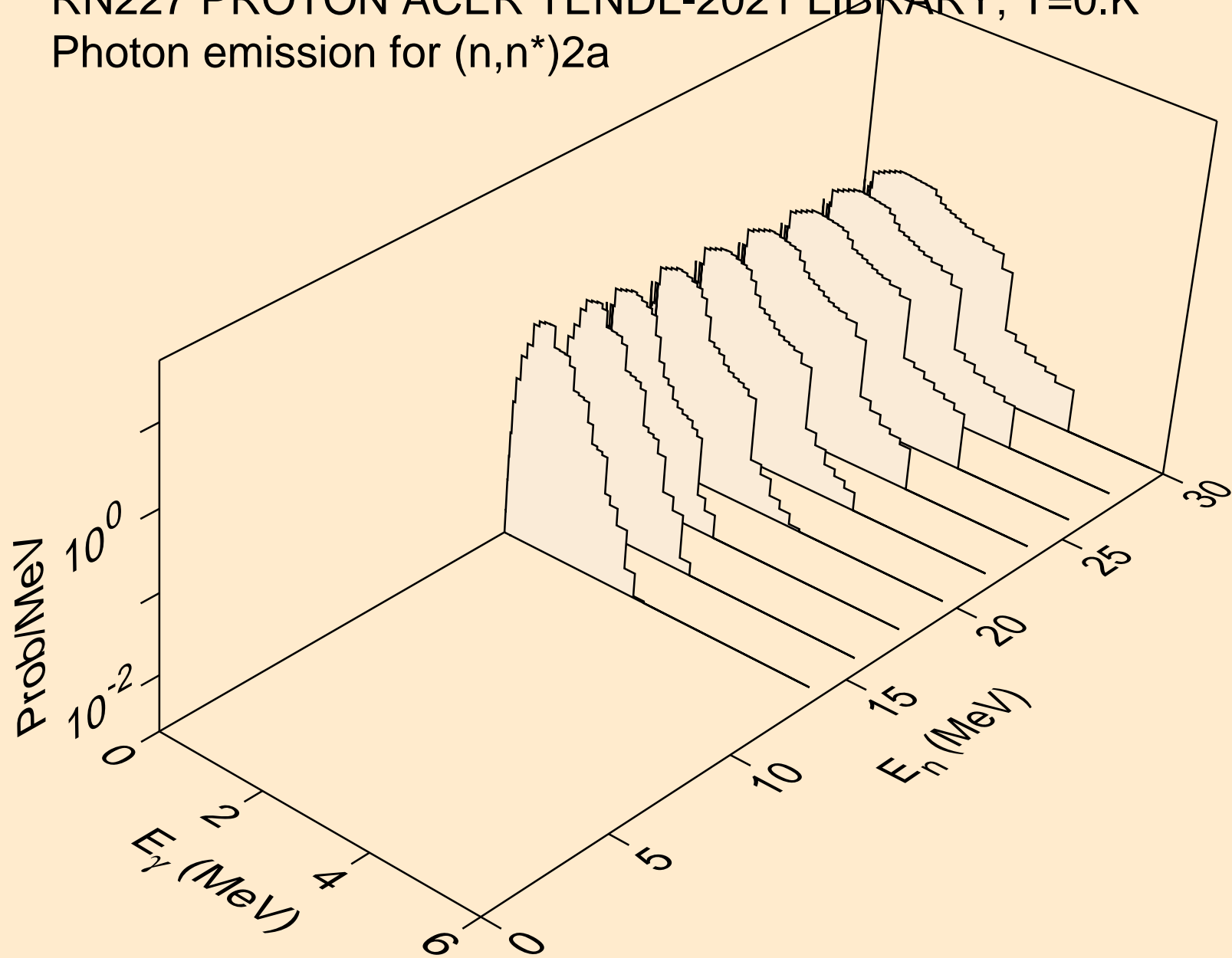

RN227 PROTON ACER TENDL-2021 LIBRARY; T=0.K
Photon emission for (n,n*)d

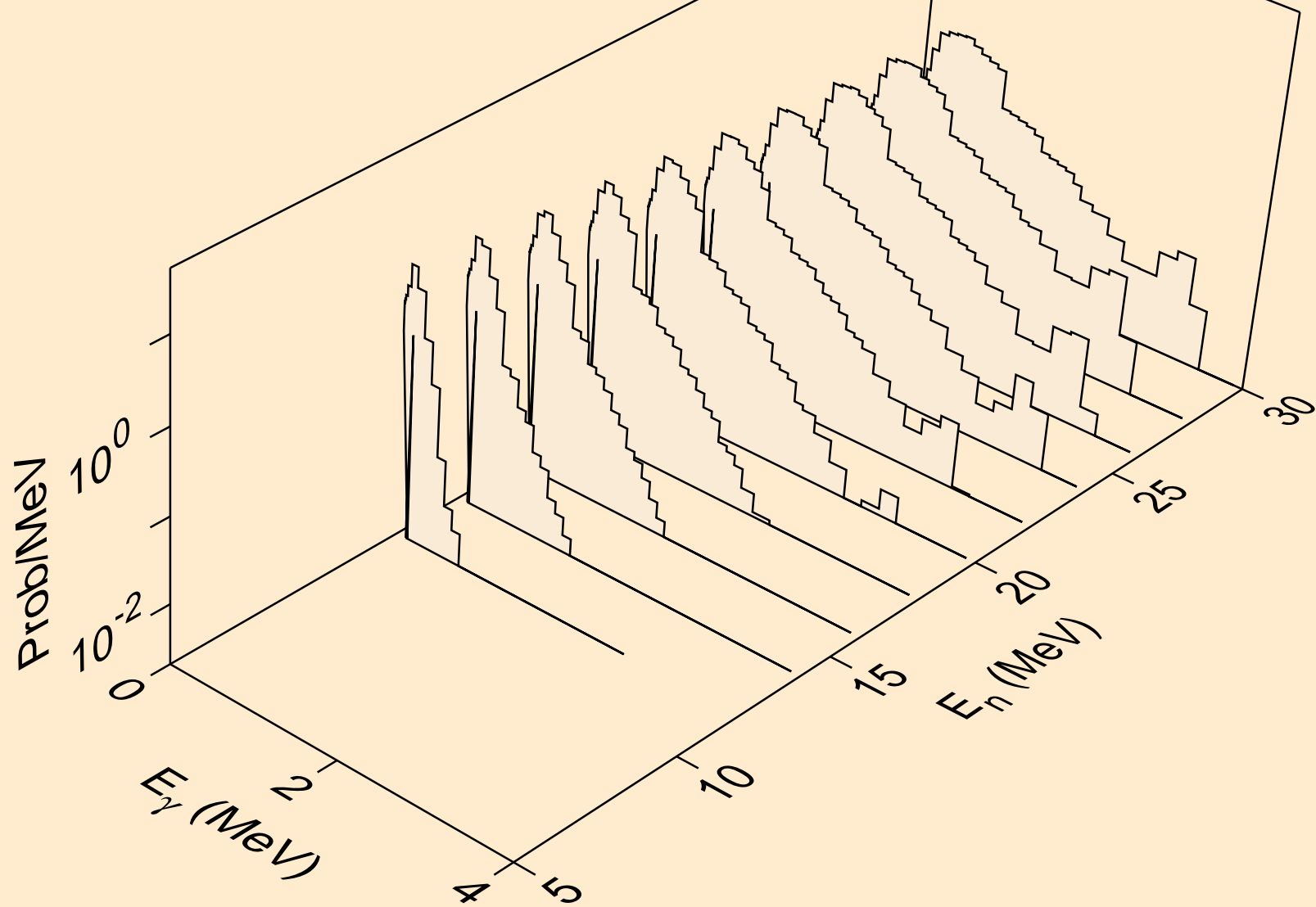

RN227 PROTON ACER TENDL-2021 LIBRARY; T=0.K
Photon emission for (n,n*)t

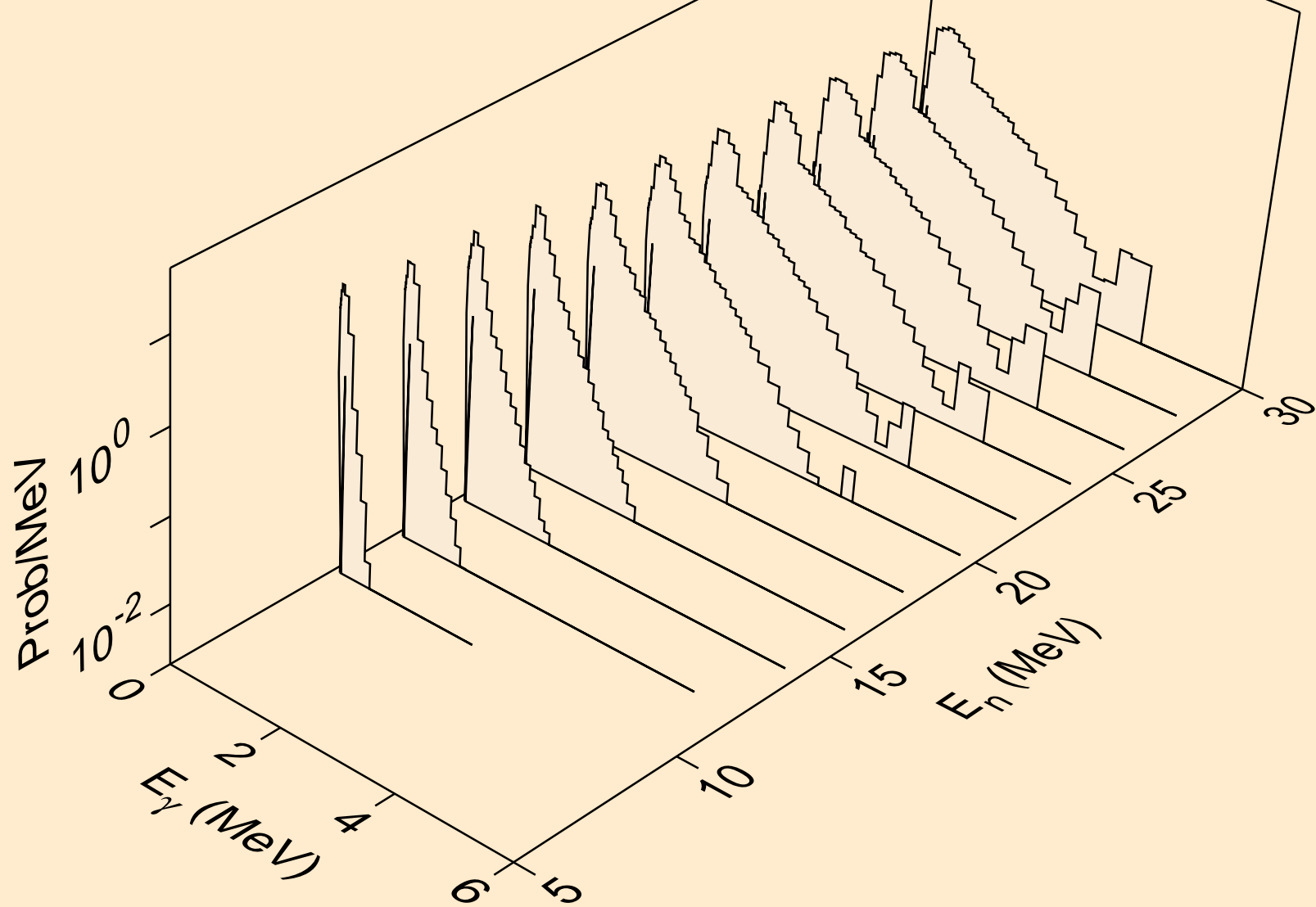

RN227 PROTON ACER TENDL-2021 LIBRARY; T=0.K
Photon emission for (n,n*)he3

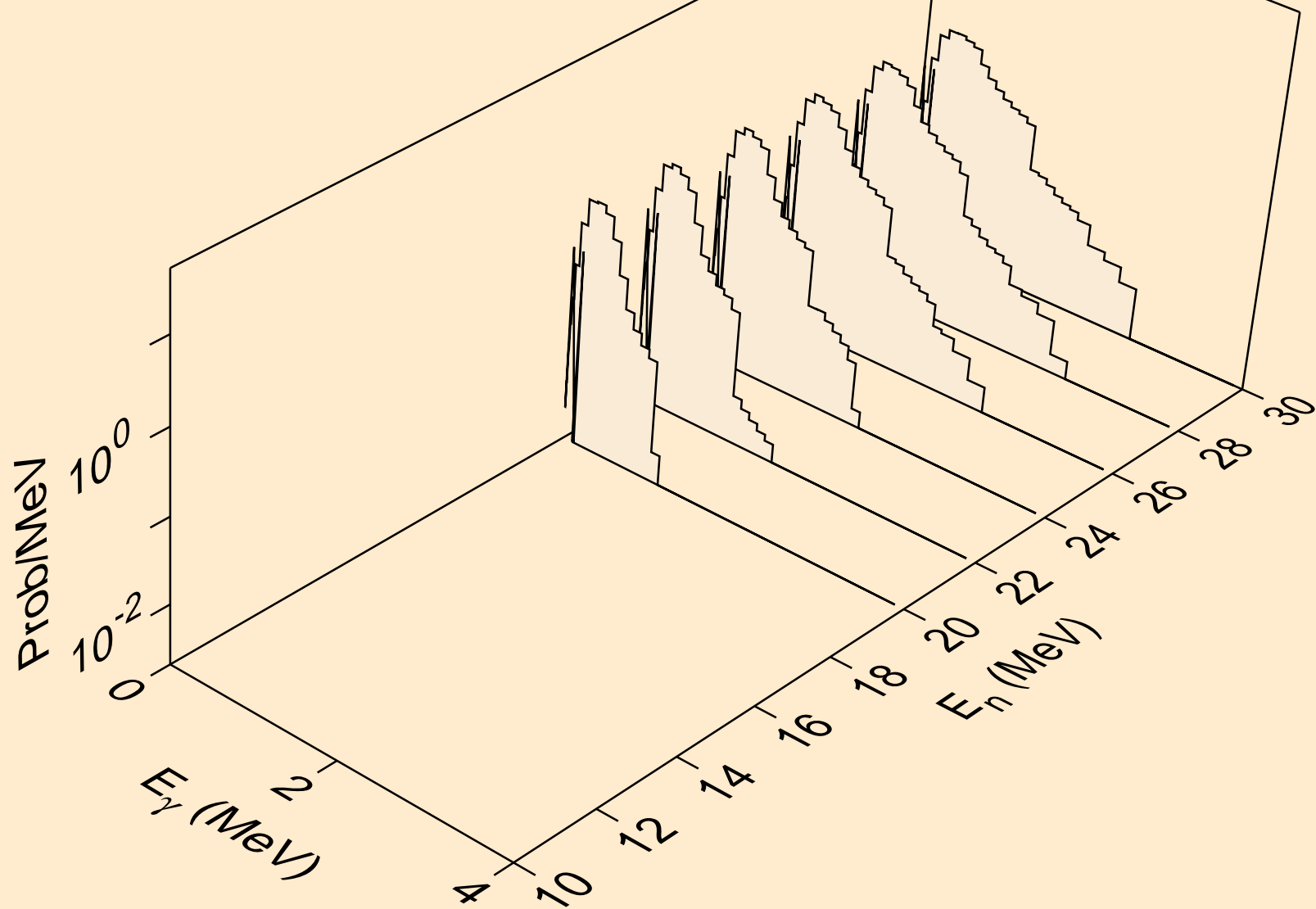

RN227 PROTON ACER TENDL-2021 LIBRARY; T=0.K
Photon emission for (n,4n)

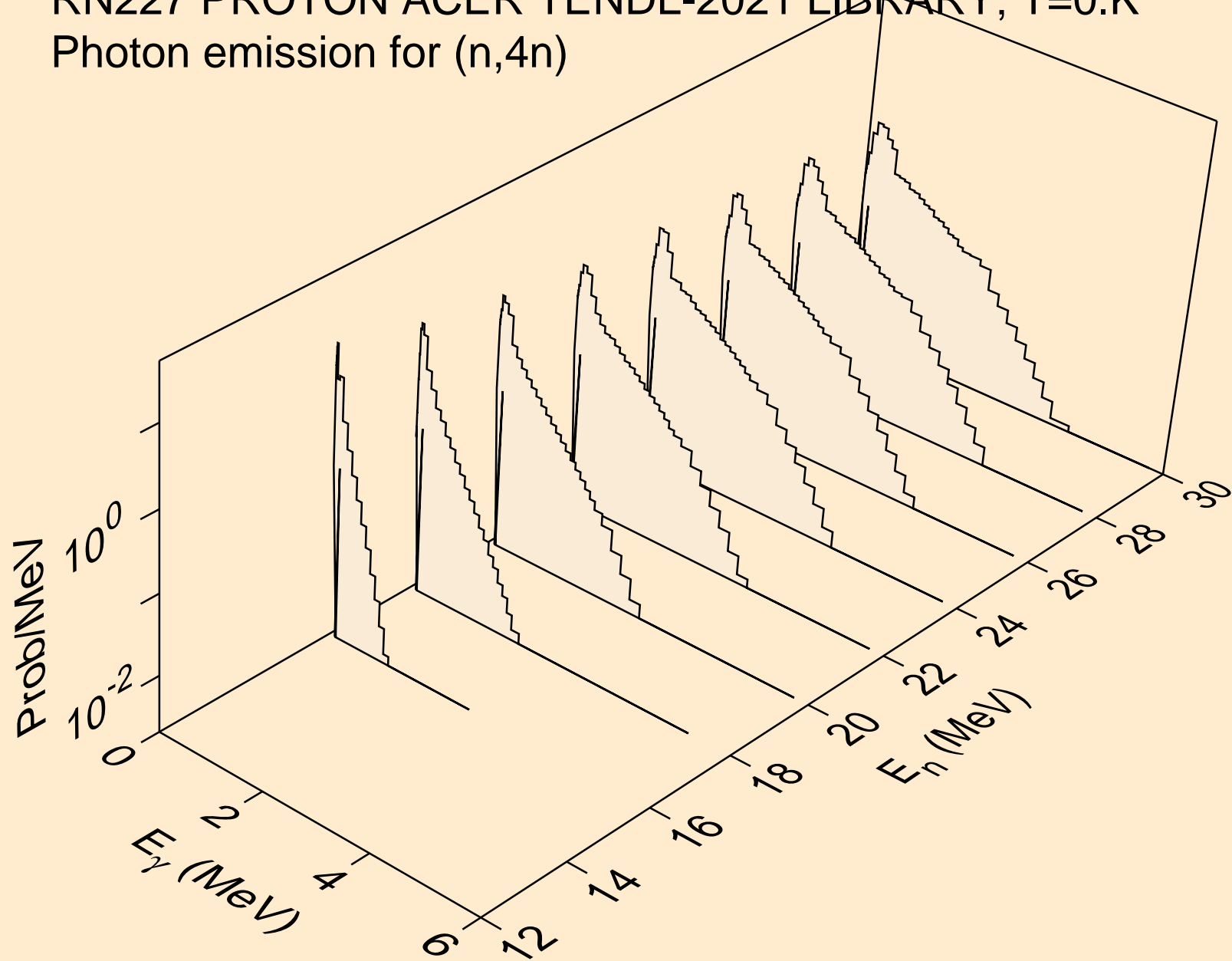

RN227 PROTON ACER TENDL-2021 LIBRARY; T=0.K
Photon emission for (n,2np)

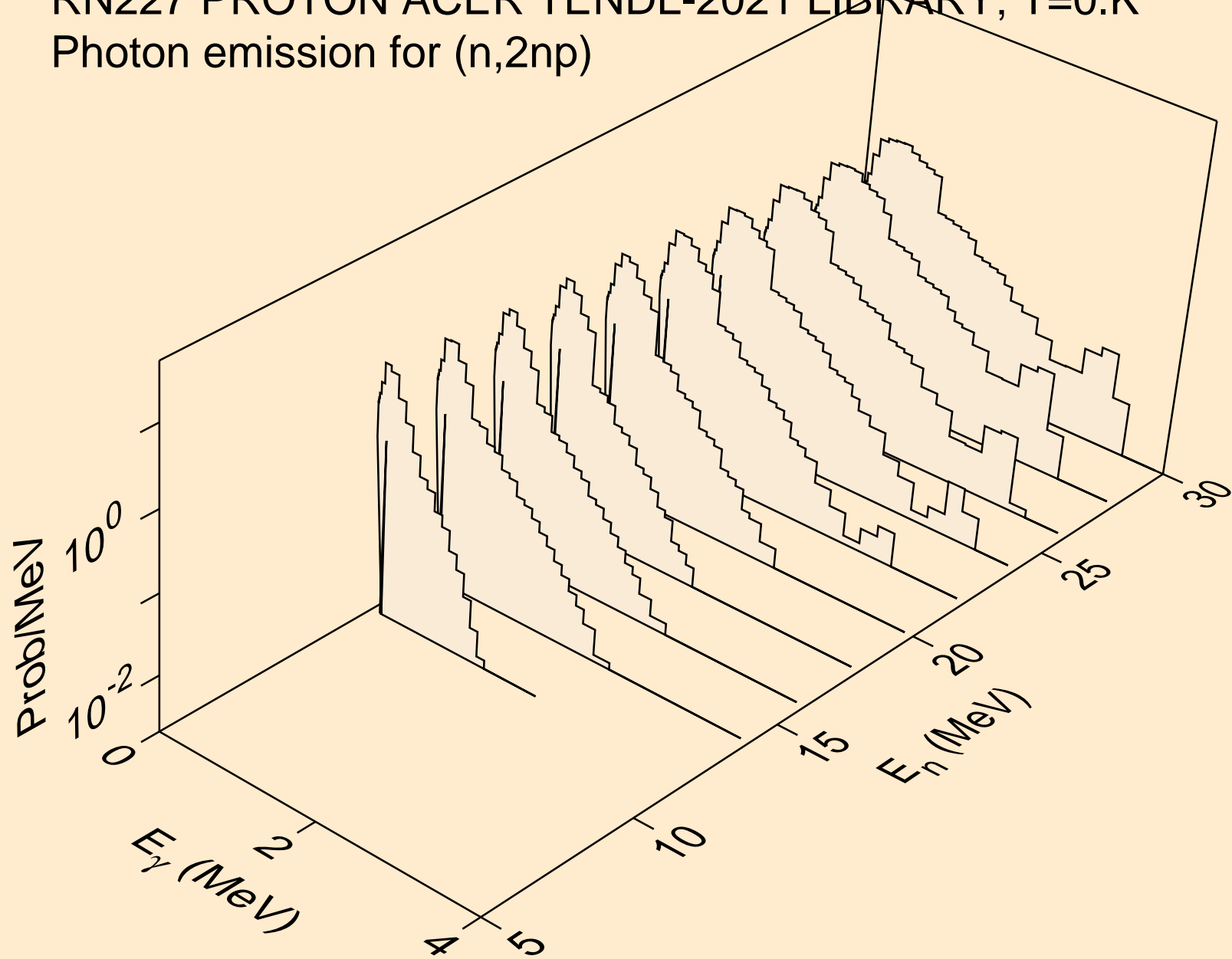

RN227 PROTON ACER TENDL-2021 LIBRARY; T=0.K
Photon emission for (n,3np)

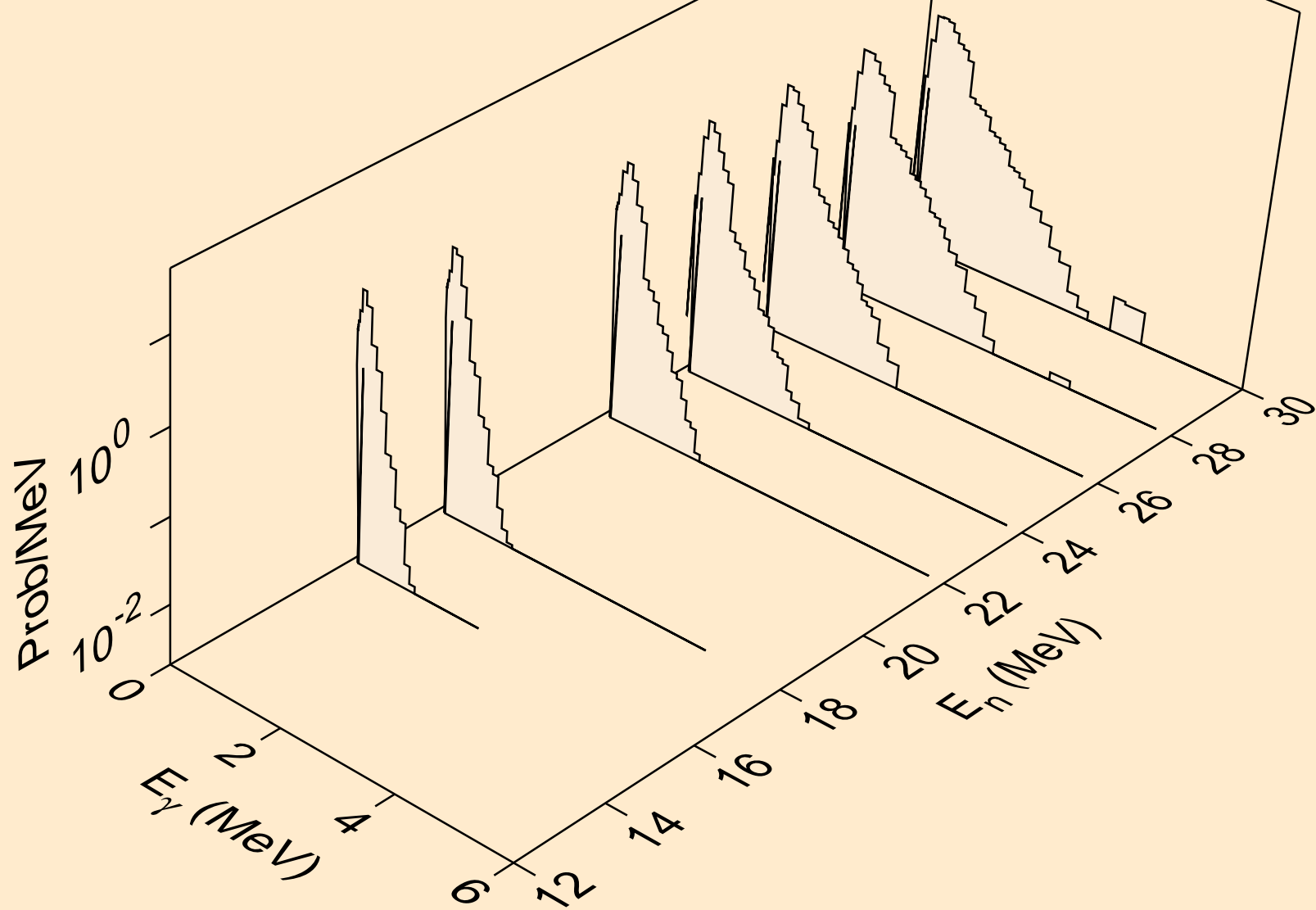

RN227 PROTON ACER TENDL-2021 LIBRARY; T=0.K
Photon emission for (n,2np)

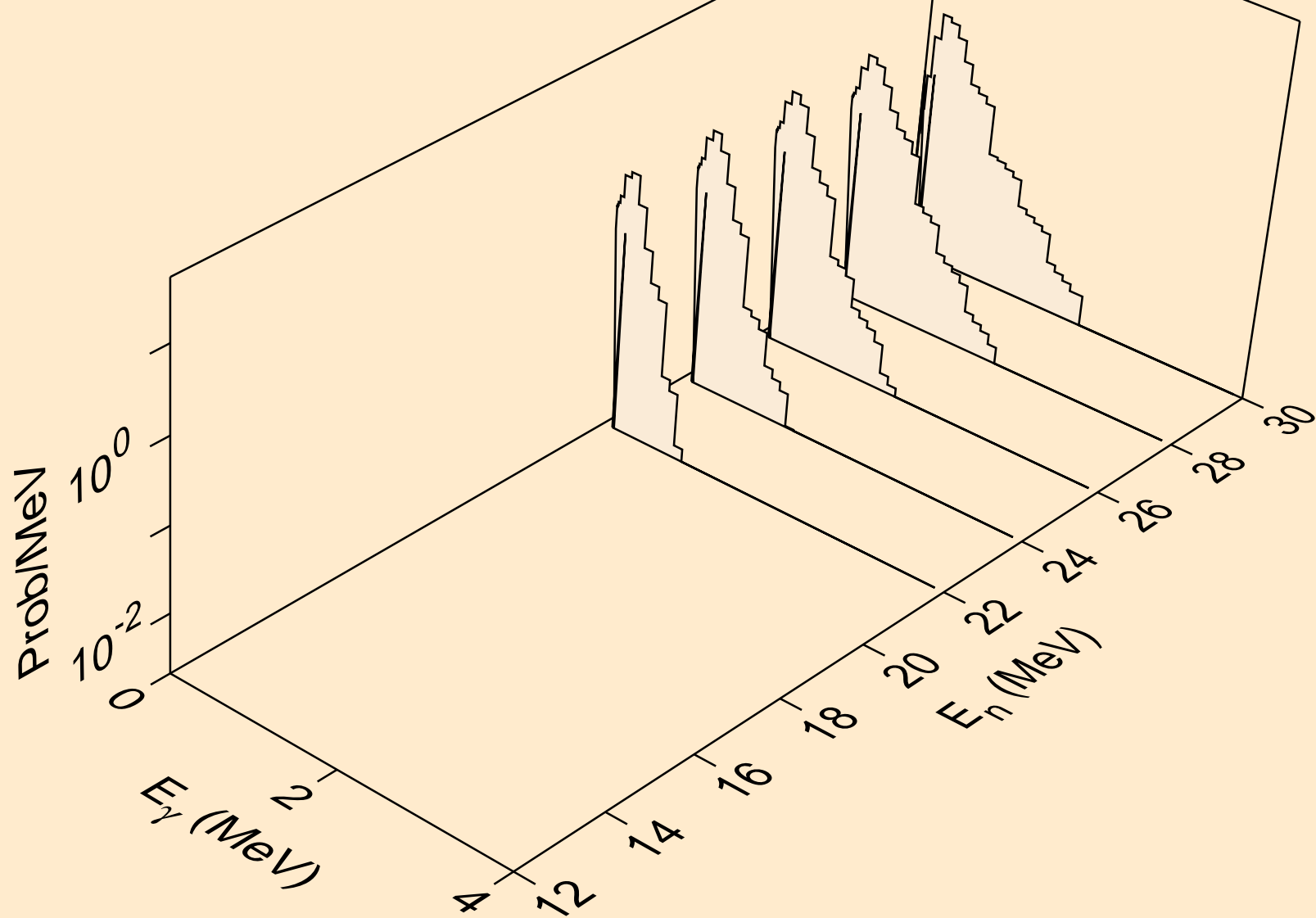

RN227 PROTON ACER TENDL-2021 LIBRARY; T=0.K
Photon emission for (n,npa)

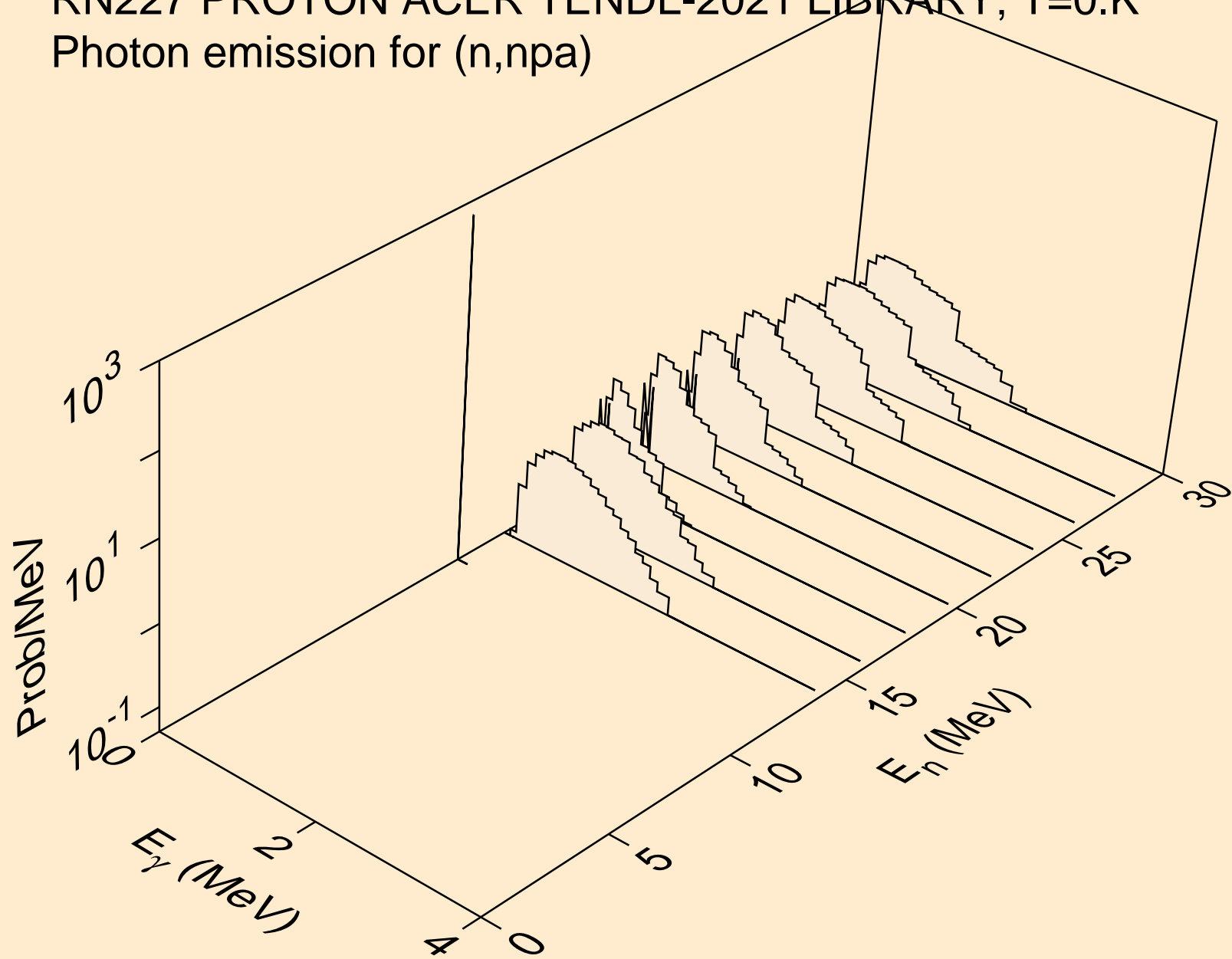

RN227 PROTON ACER TENDL-2021 LIBRARY; T=0.K
Photon emission for (n,gma)

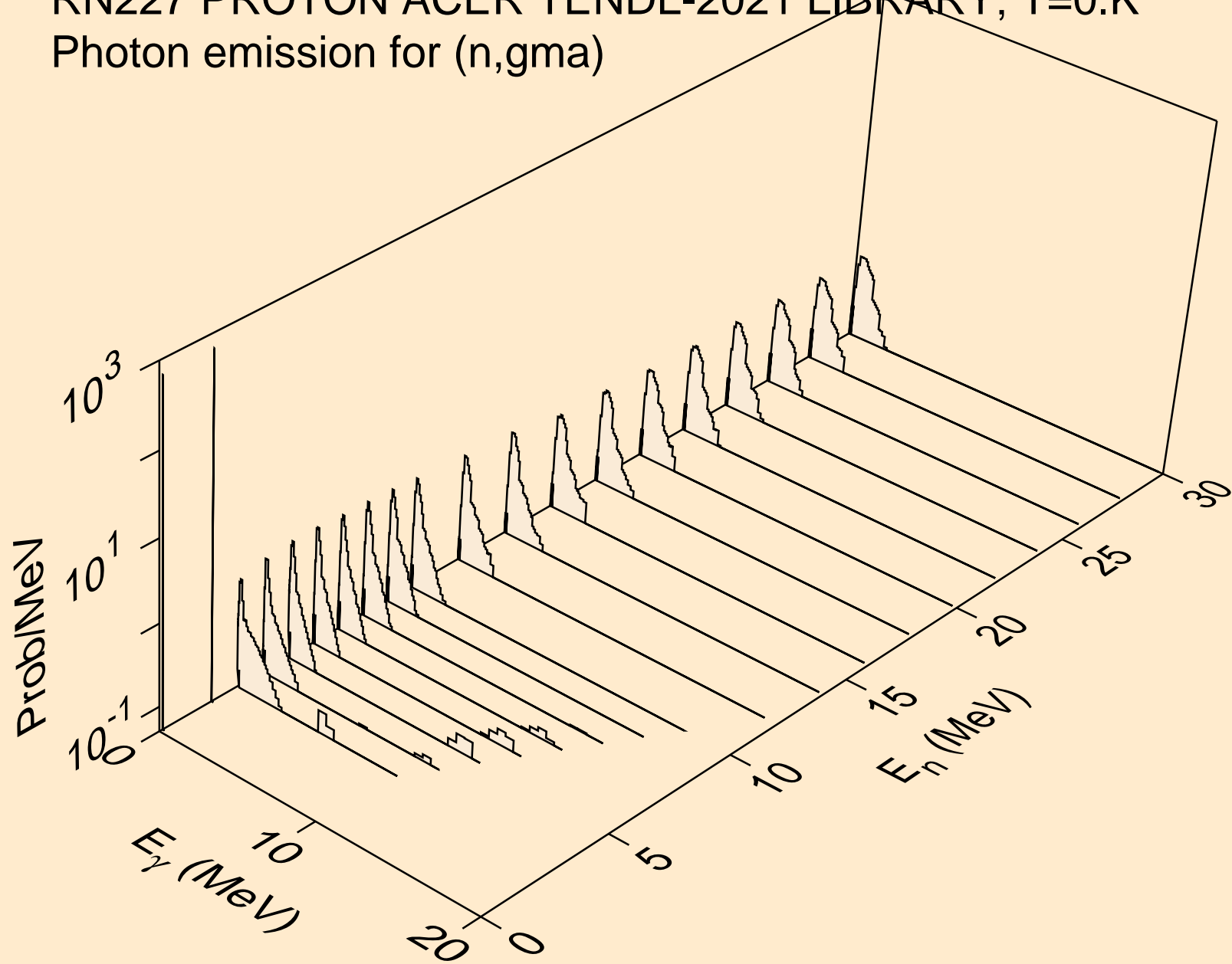

RN227 PROTON ACER TENDL-2021 LIBRARY; T=0.K
Photon emission for inelastic

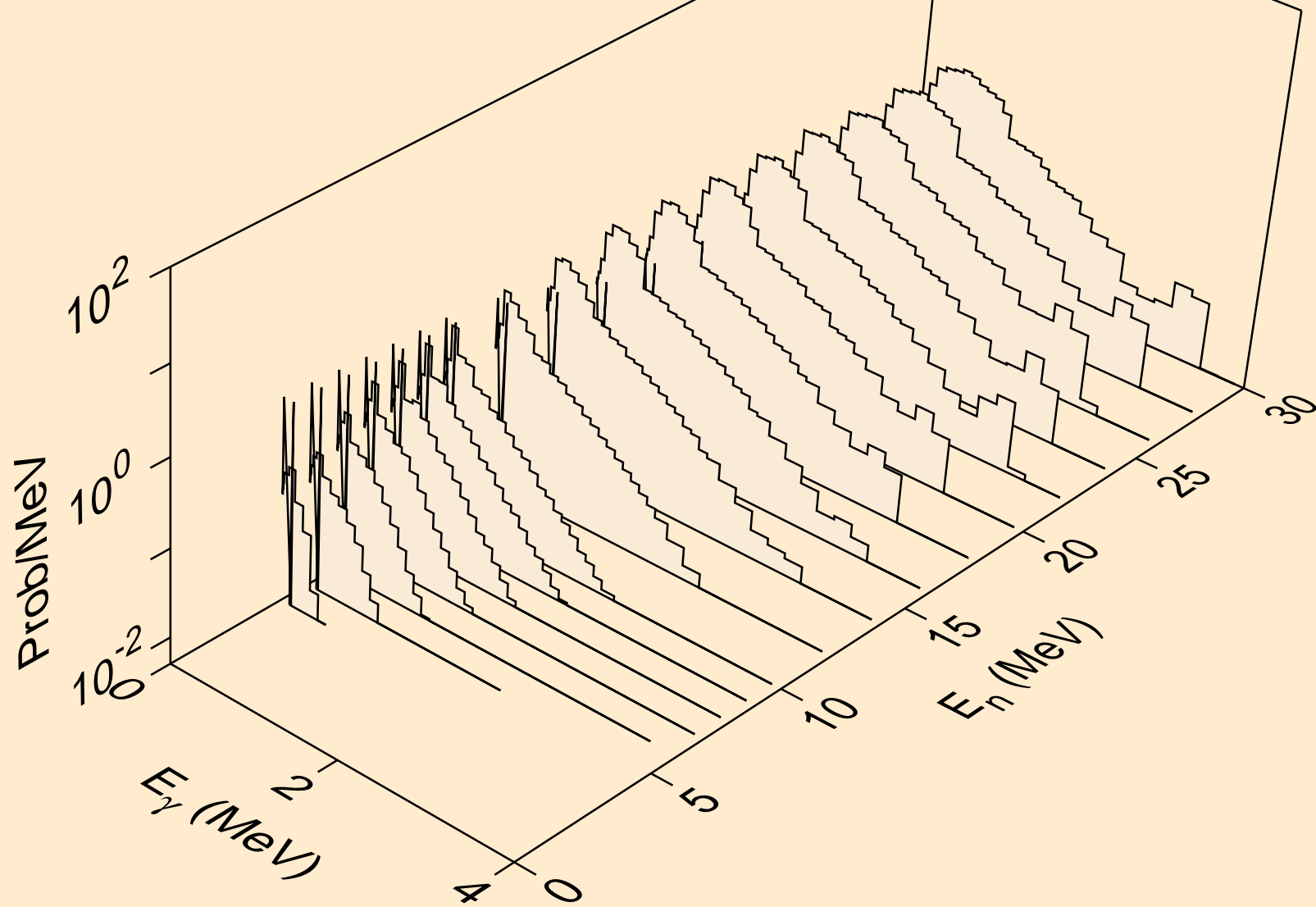

RN227 PROTON ACER TENDL-2021 LIBRARY; T=0.K
Photon emission for (n,d)

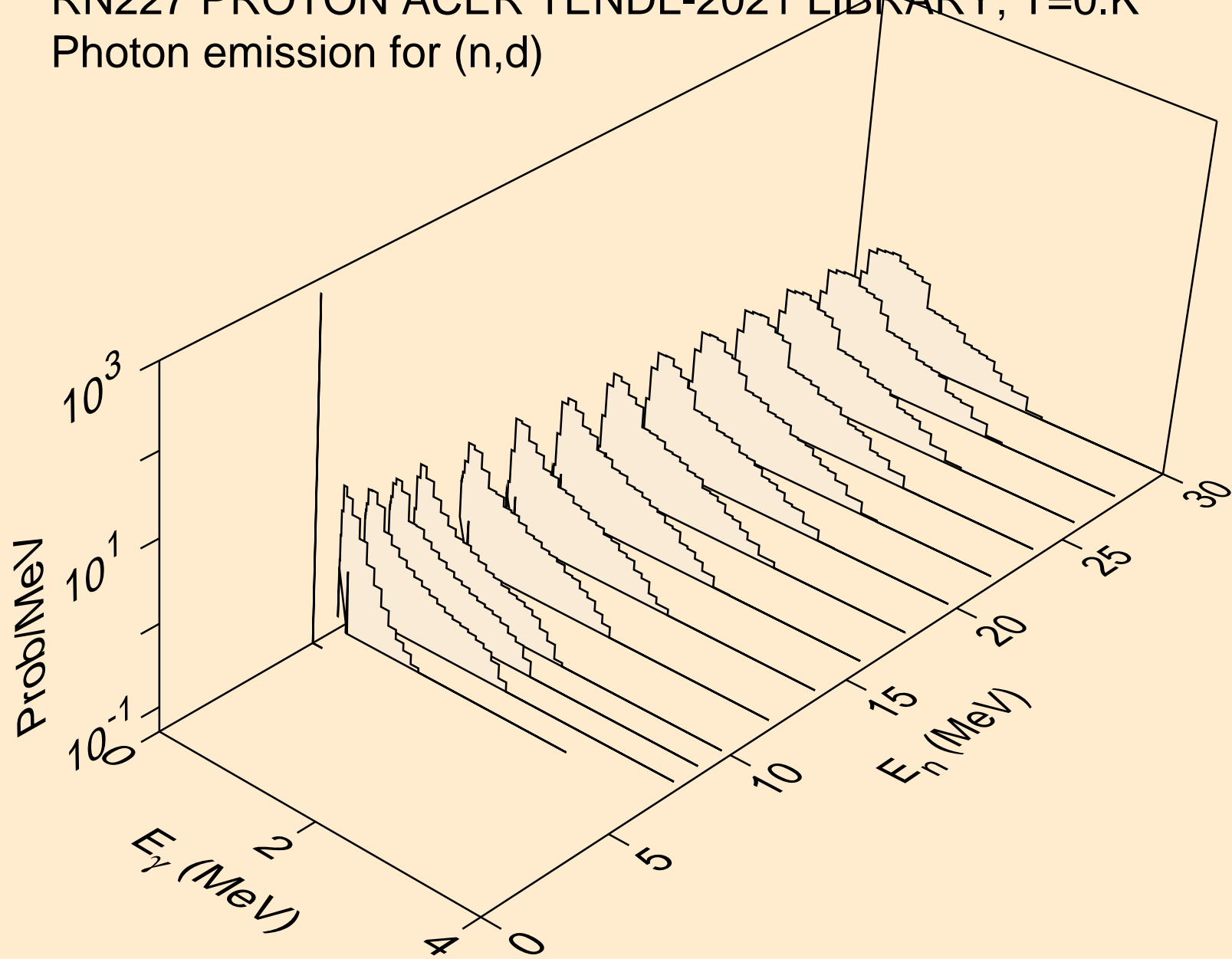

RN227 PROTON ACER TENDL-2021 LIBRARY; T=0.K
Photon emission for (n,t)

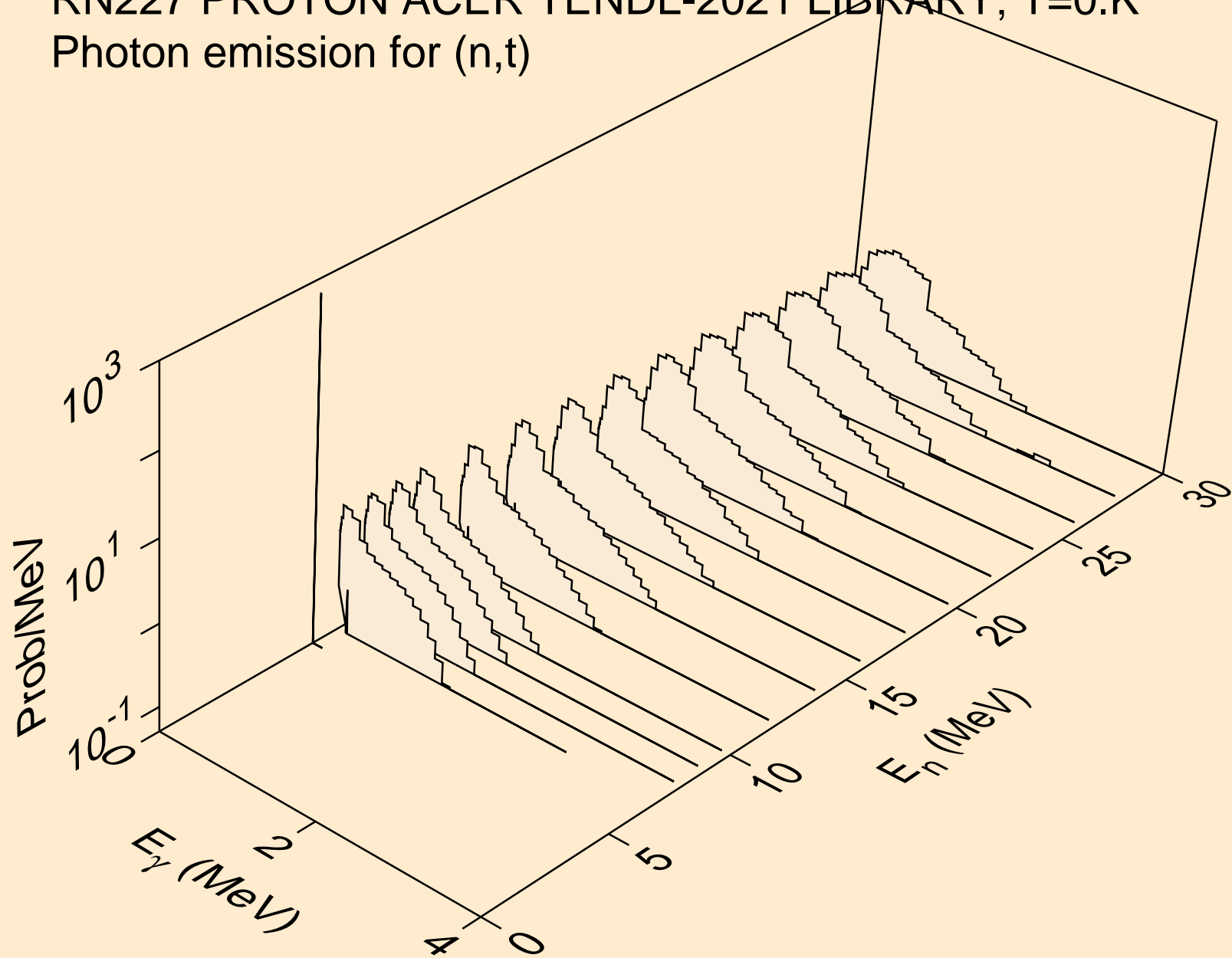

RN227 PROTON ACER TENDL-2021 LIBRARY; T=0.K
Photon emission for (n,he3)

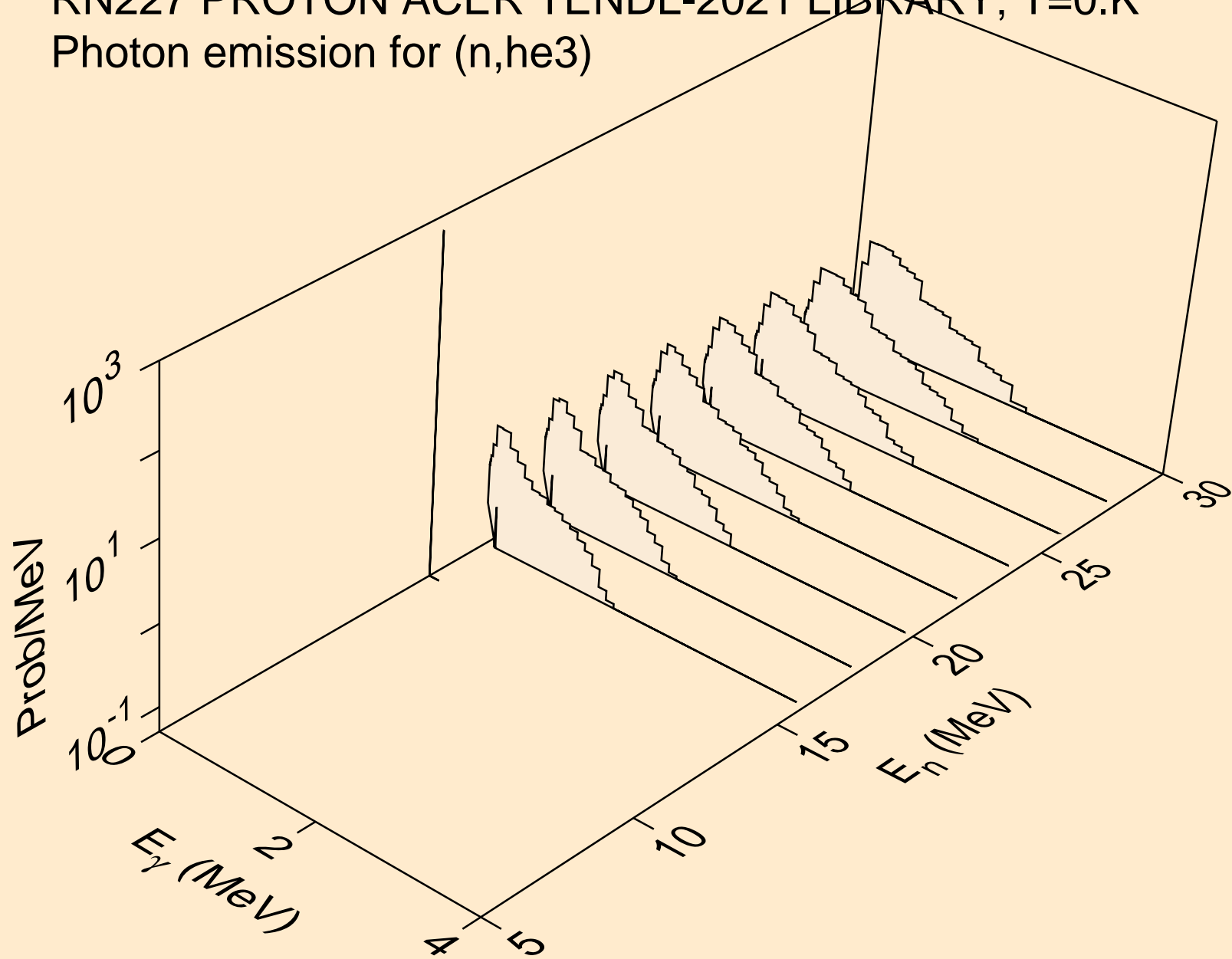

RN227 PROTON ACER TENDL-2021 LIBRARY; T=0.K
Photon emission for (n,a)

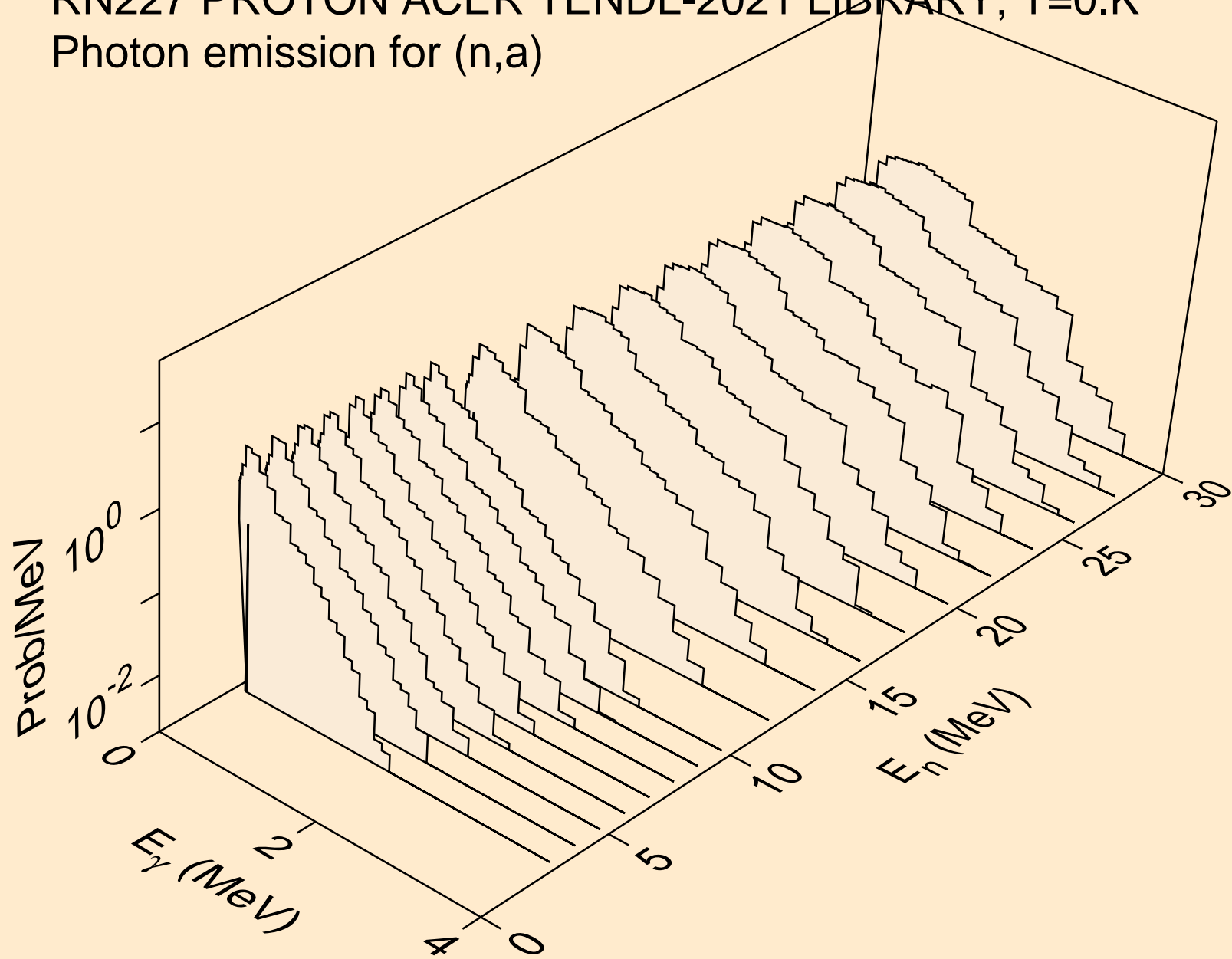

RN227 PROTON ACER TENDL-2021 LIBRARY; T=0.K
Photon emission for (n,2p)

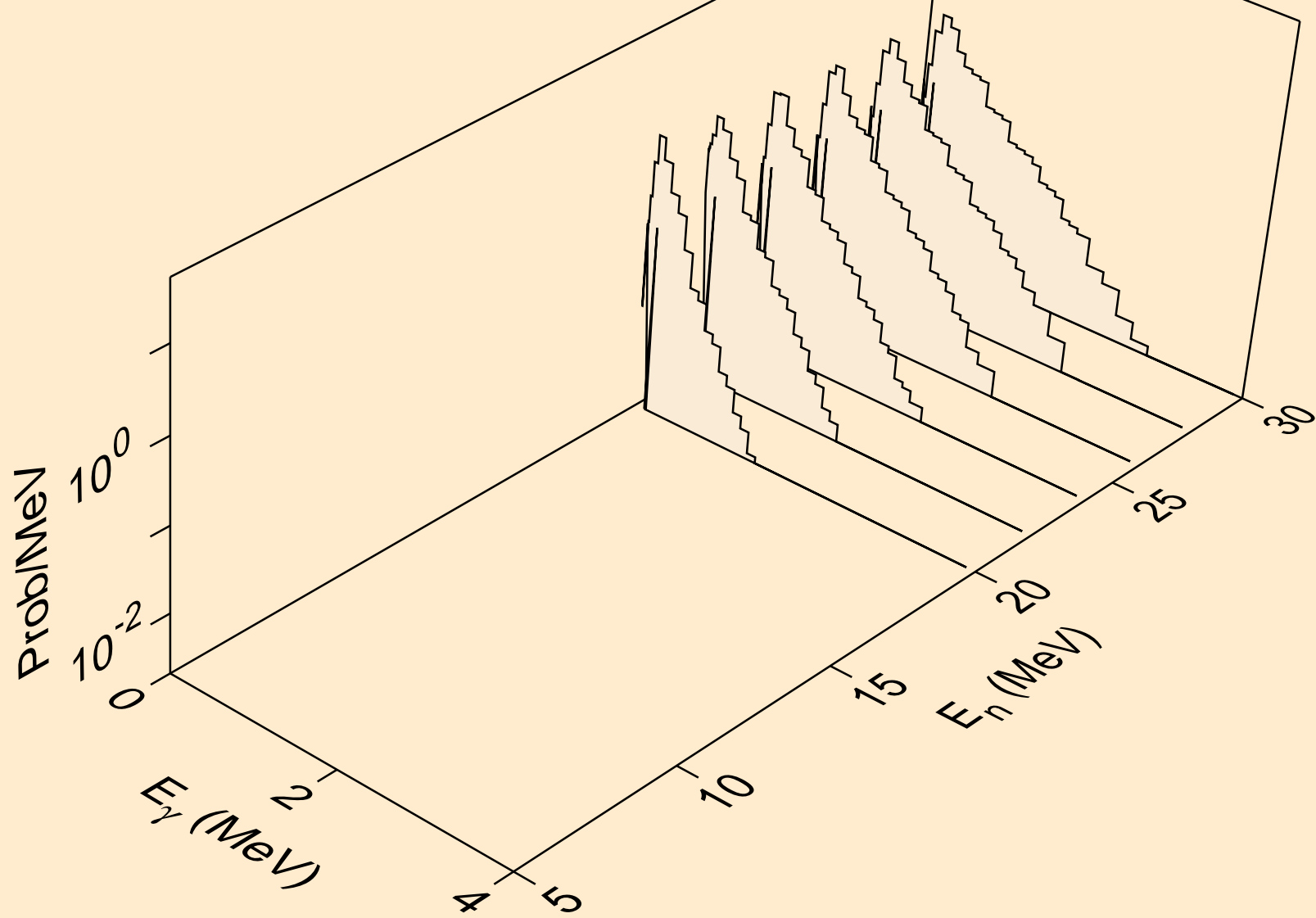

RN227 PROTON ACER TENDL-2021 LIBRARY; T=0.K
Particle heating contributions

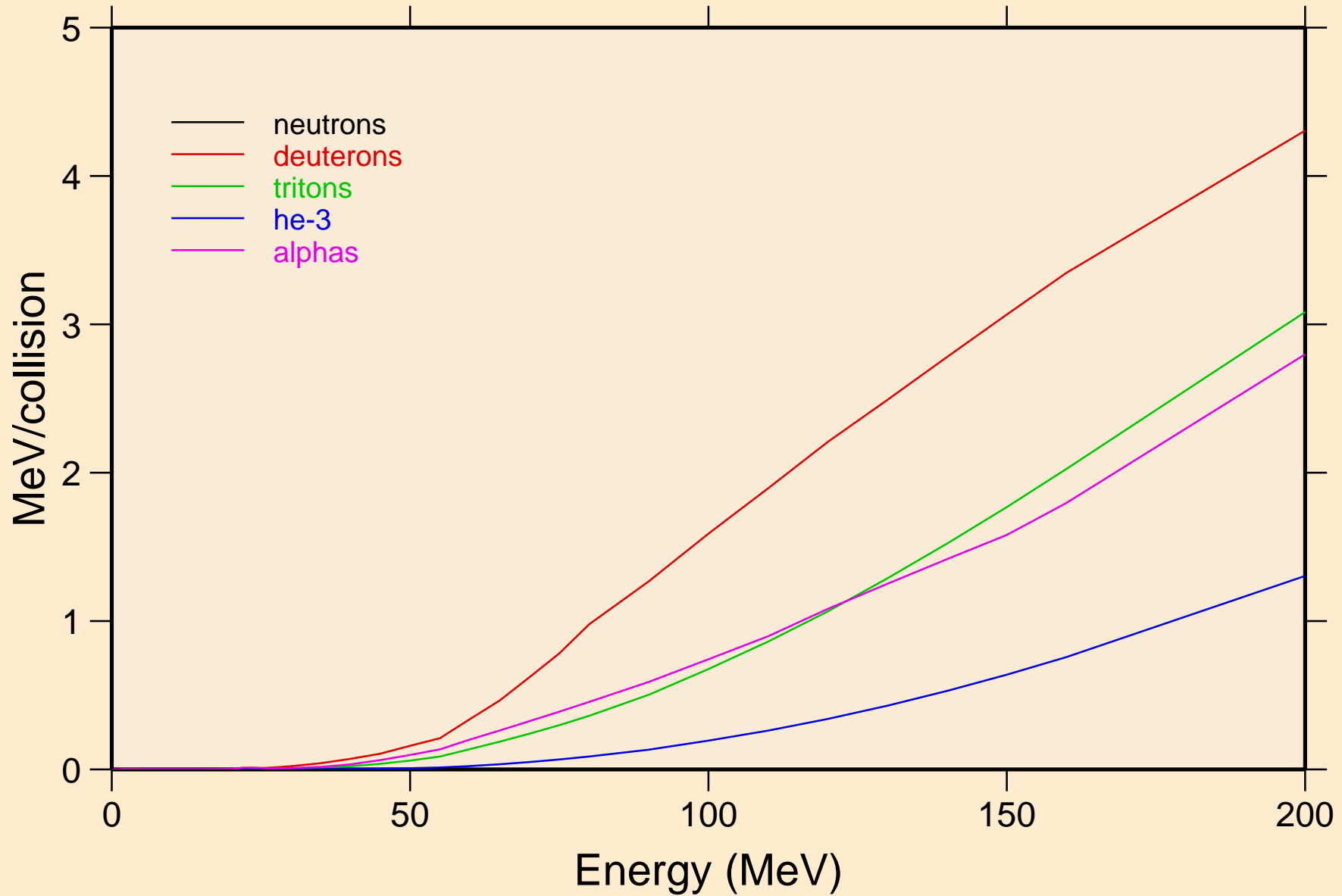

RN227 PROTON ACER TENDL-2021 LIBRARY; T=0.K
Recoil Heating

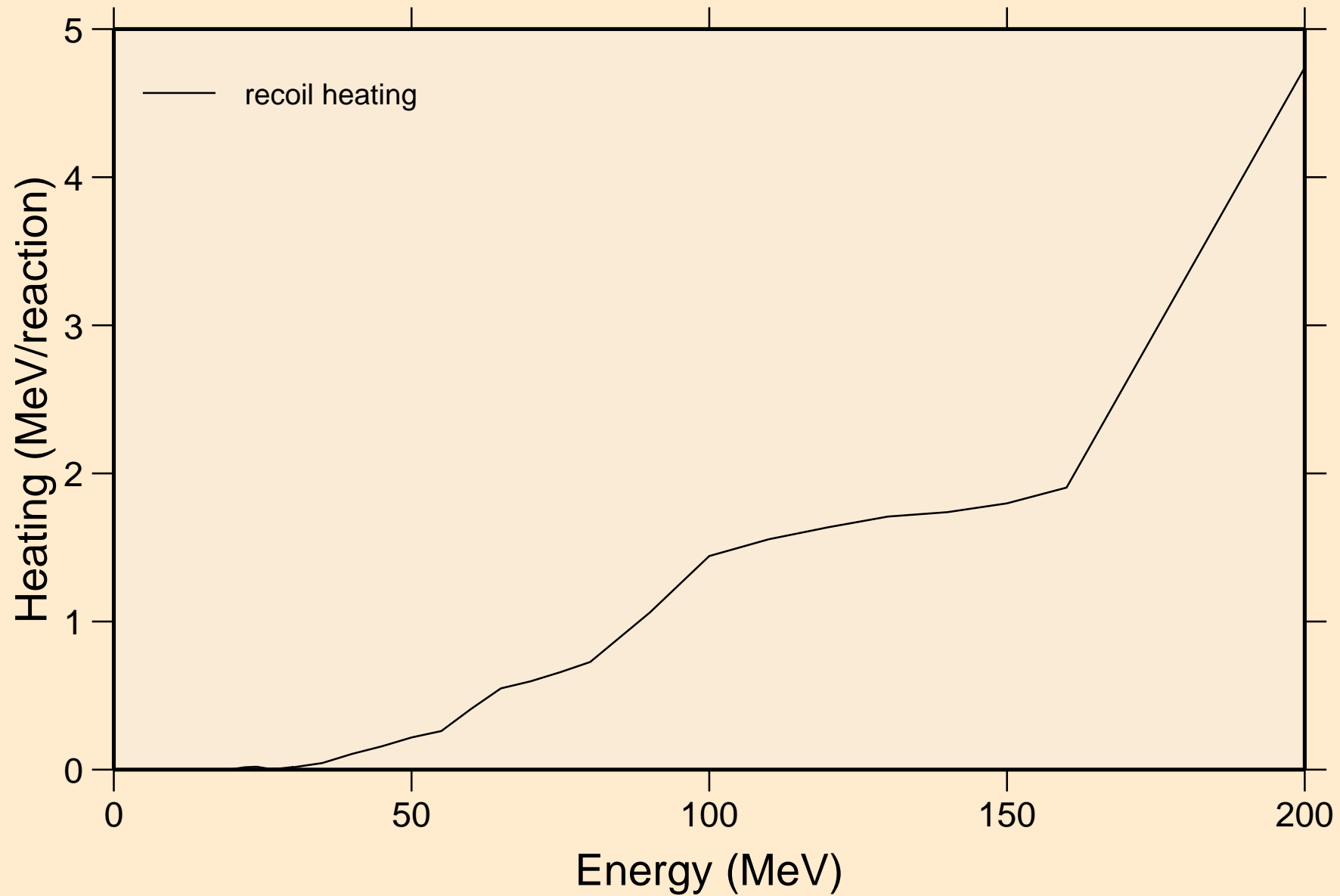

RN227 PROTON ACER TENDL-2021 LIBRARY; T=0.K
Particle production cross sections

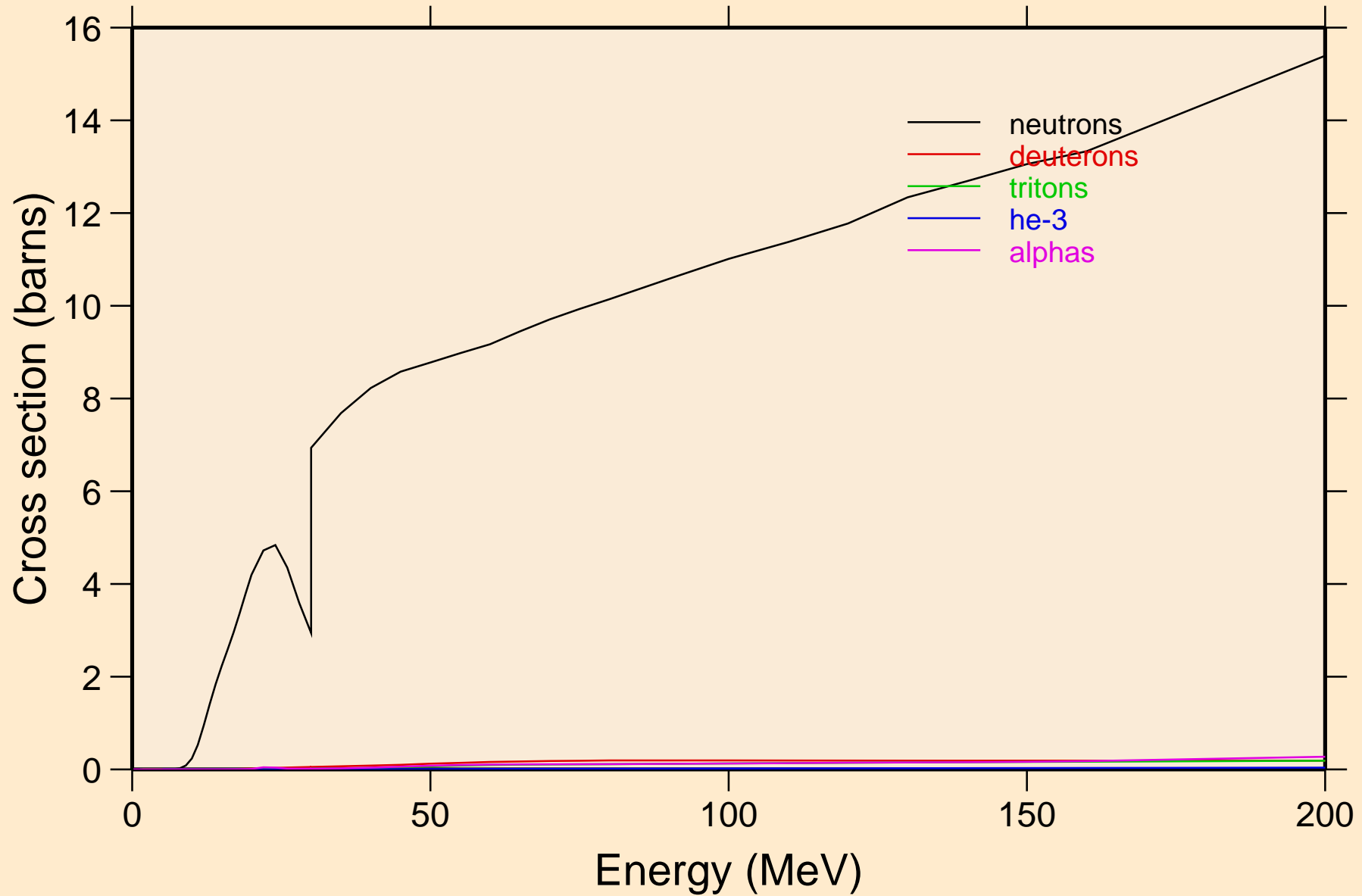

RN227 PROTON ACER TENDL-2021 LIBRARY; T=0.K
neutrons from (p,n)

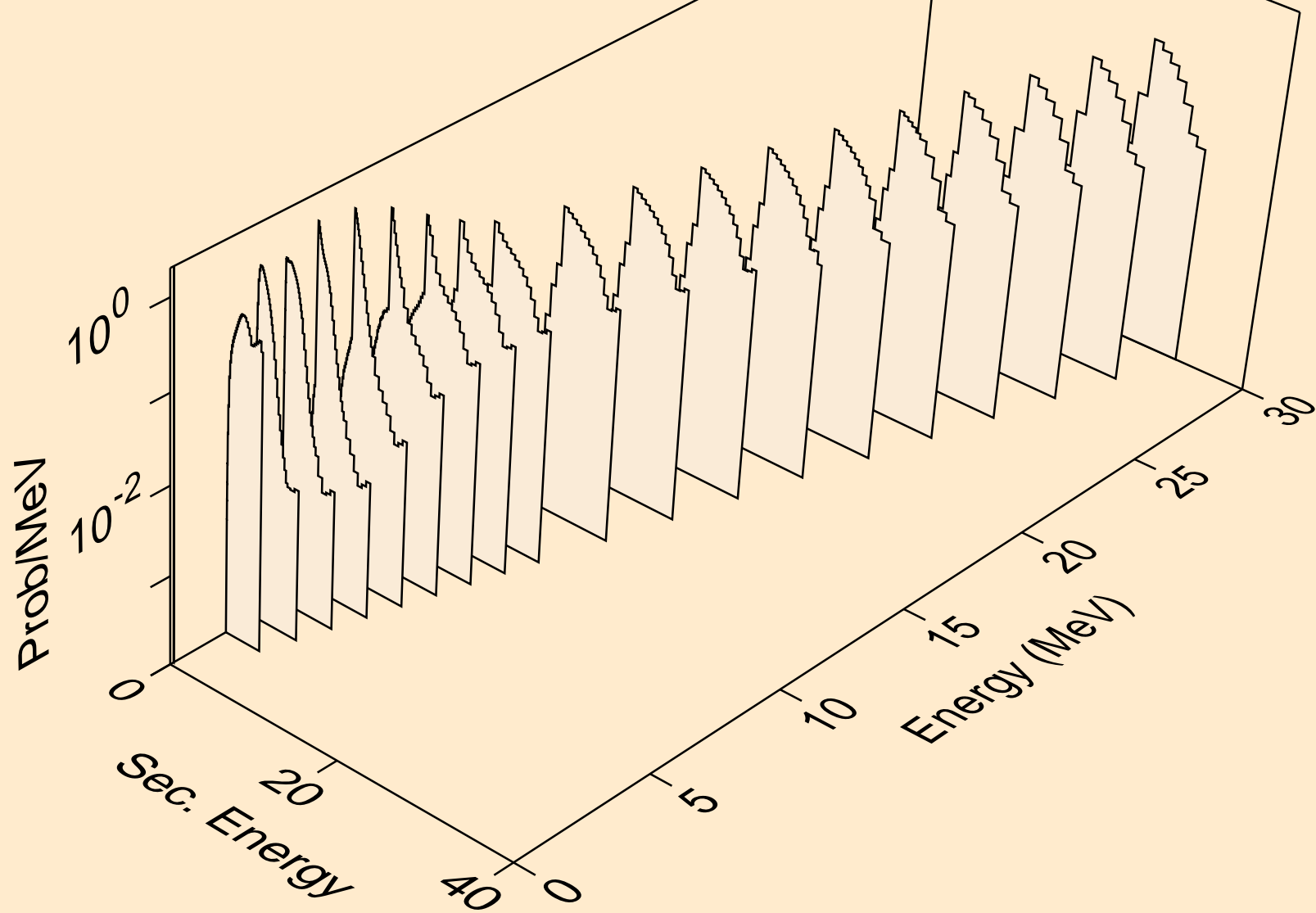

RN227 PROTON ACER TENDL-2021 LIBRARY; T=0.K
neutrons from (p,x)

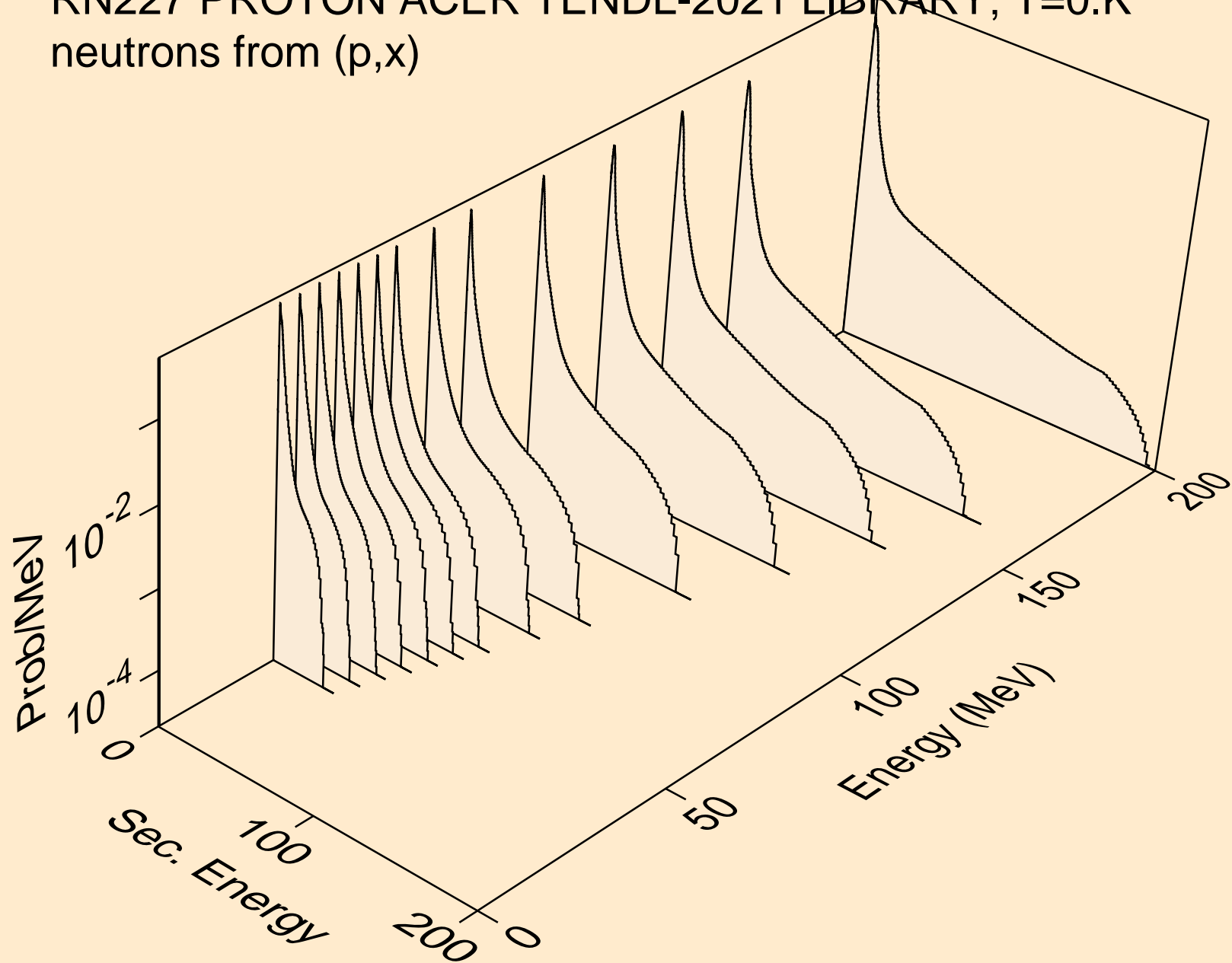

RN227 PROTON ACER TENDL-2021 LIBRARY; T=0.K
neutrons from (p,2nd)

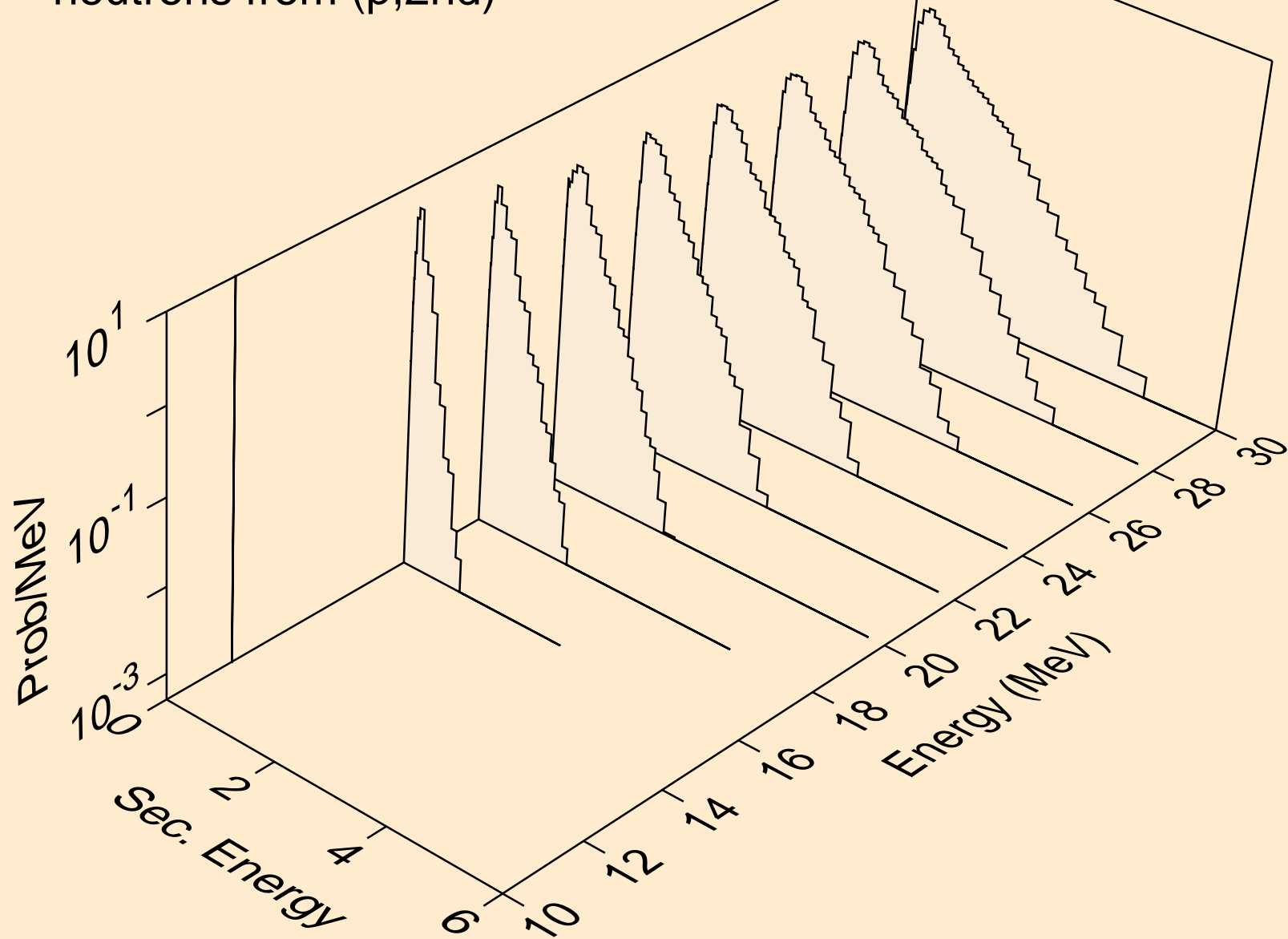

RN227 PROTON ACER TENDL-2021 LIBRARY; T=0.K
neutrons from (p,2n)

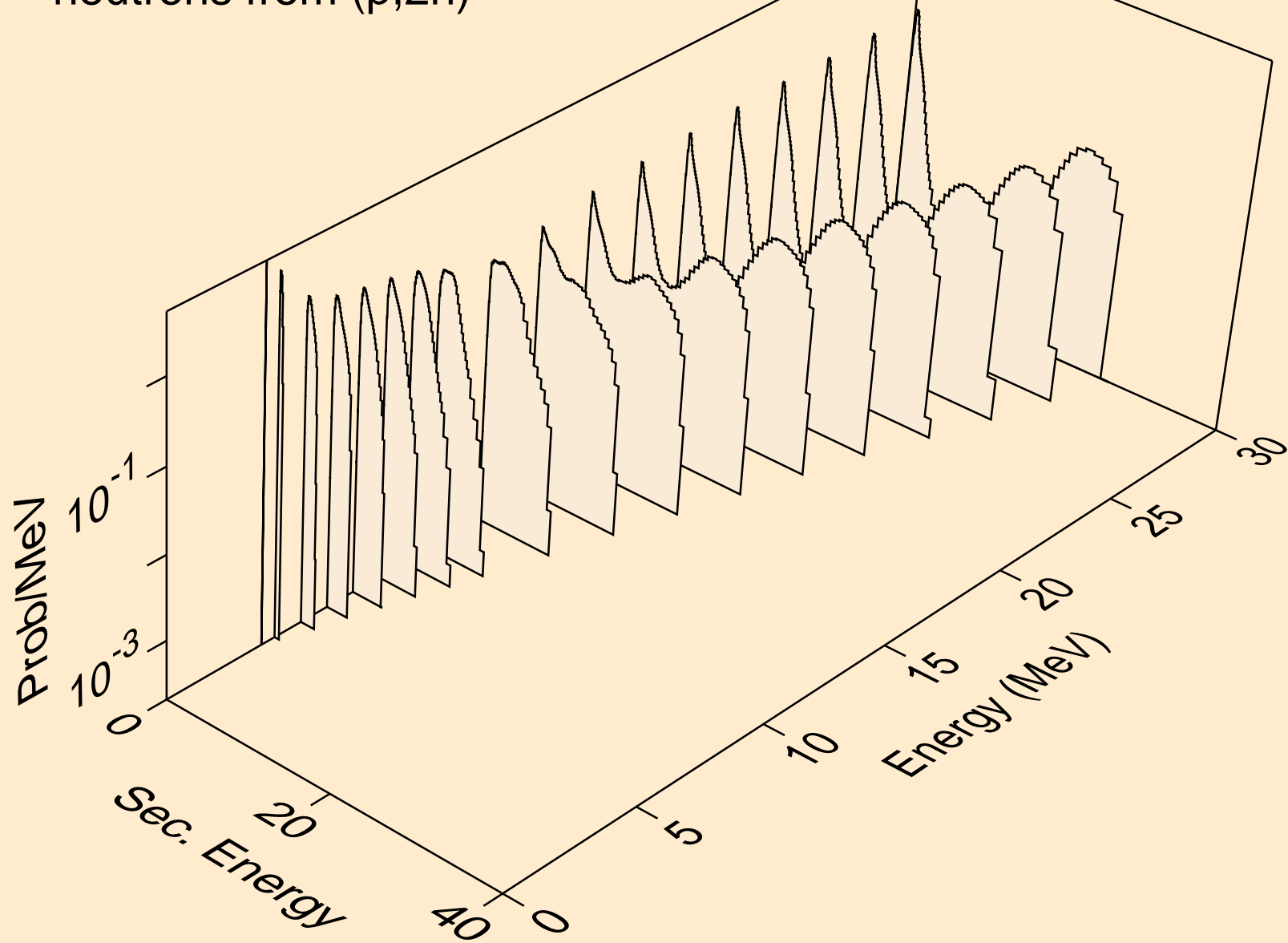

RN227 PROTON ACER TENDL-2021 LIBRARY; T=0.K
neutrons from (p,3n)

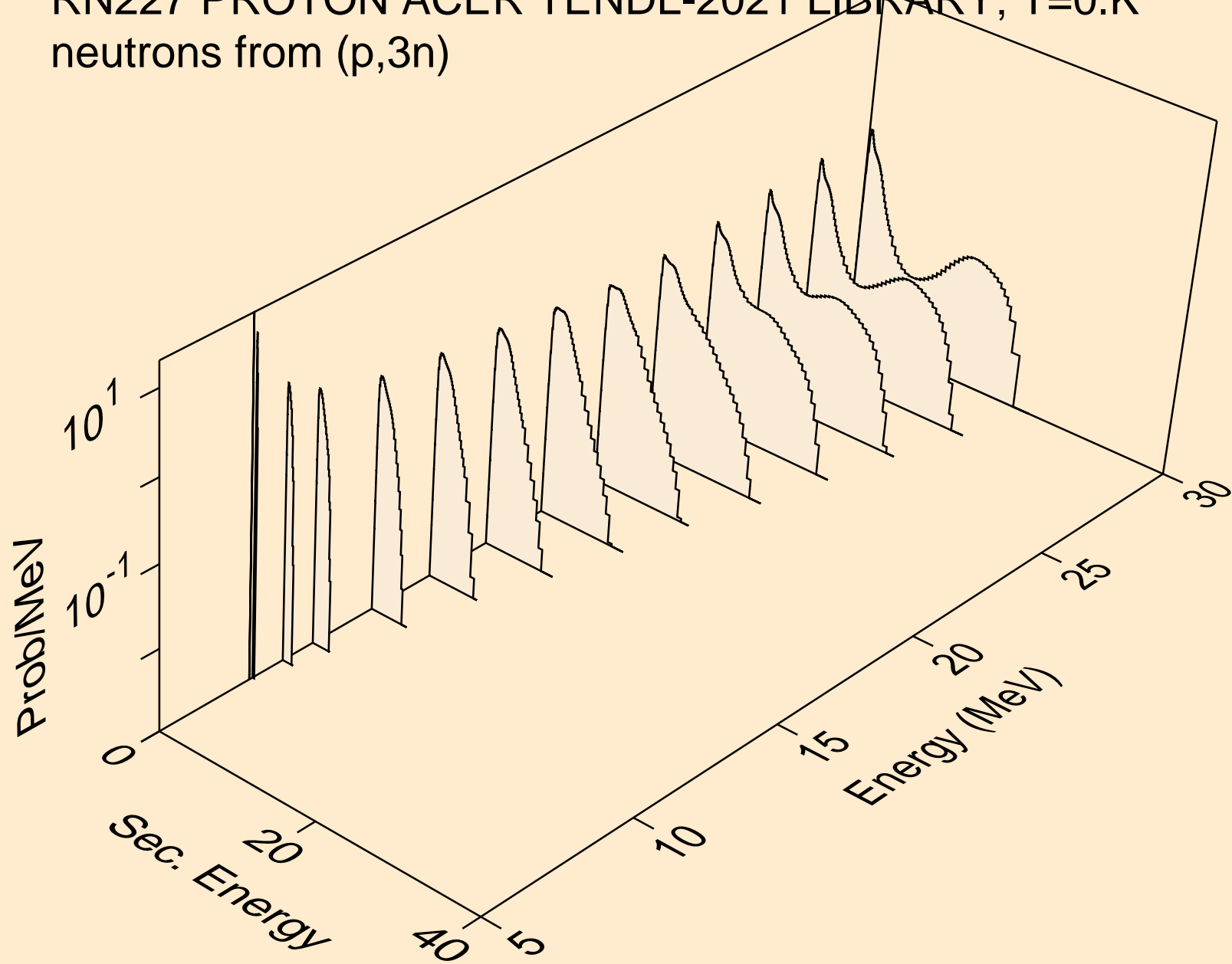

RN227 PROTON ACER TENDL-2021 LIBRARY; T=0.K
neutrons from (p,n*)a

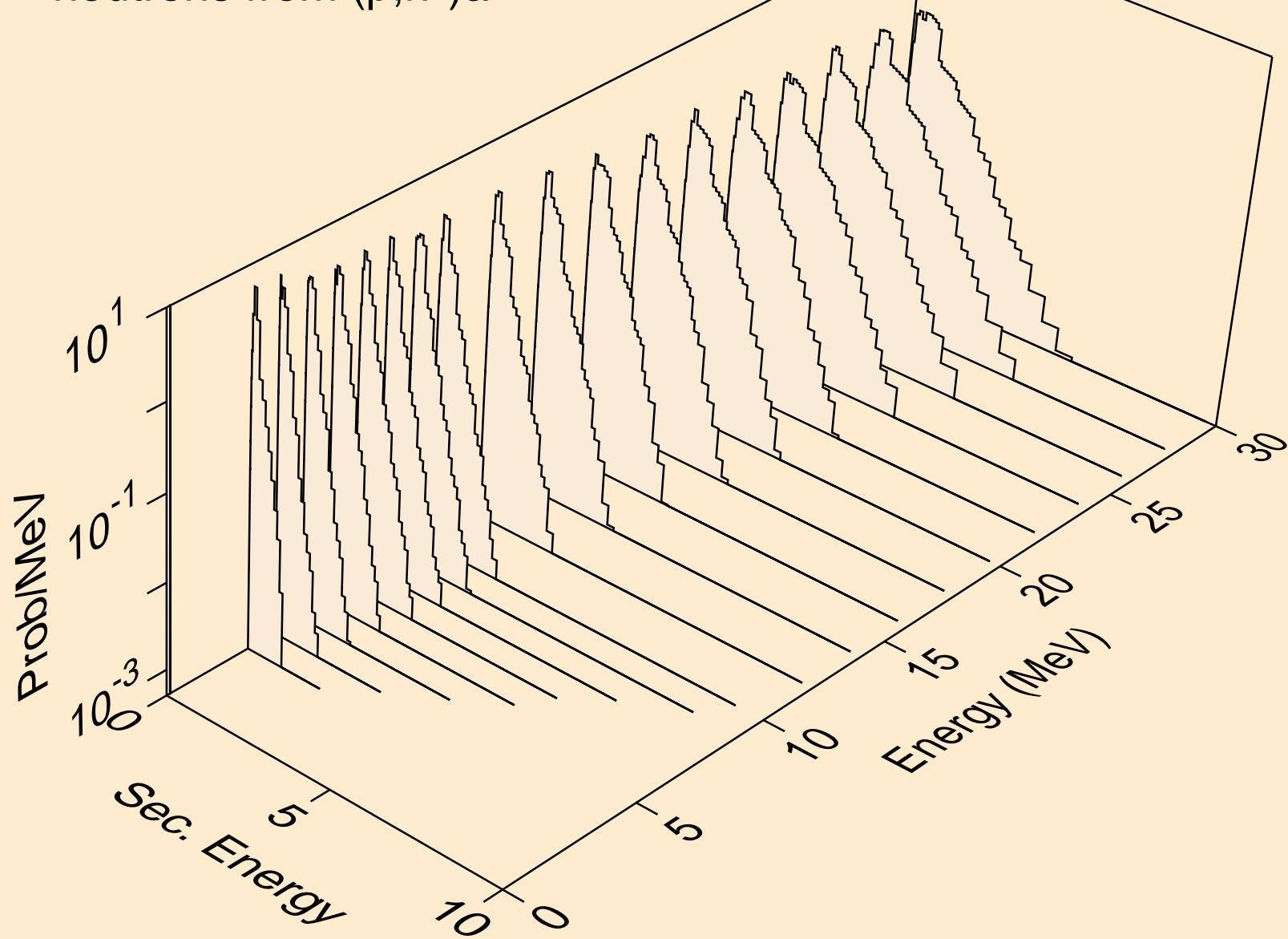

RN227 PROTON ACER TENDL-2021 LIBRARY; T=0.K
neutrons from (p,2n)a

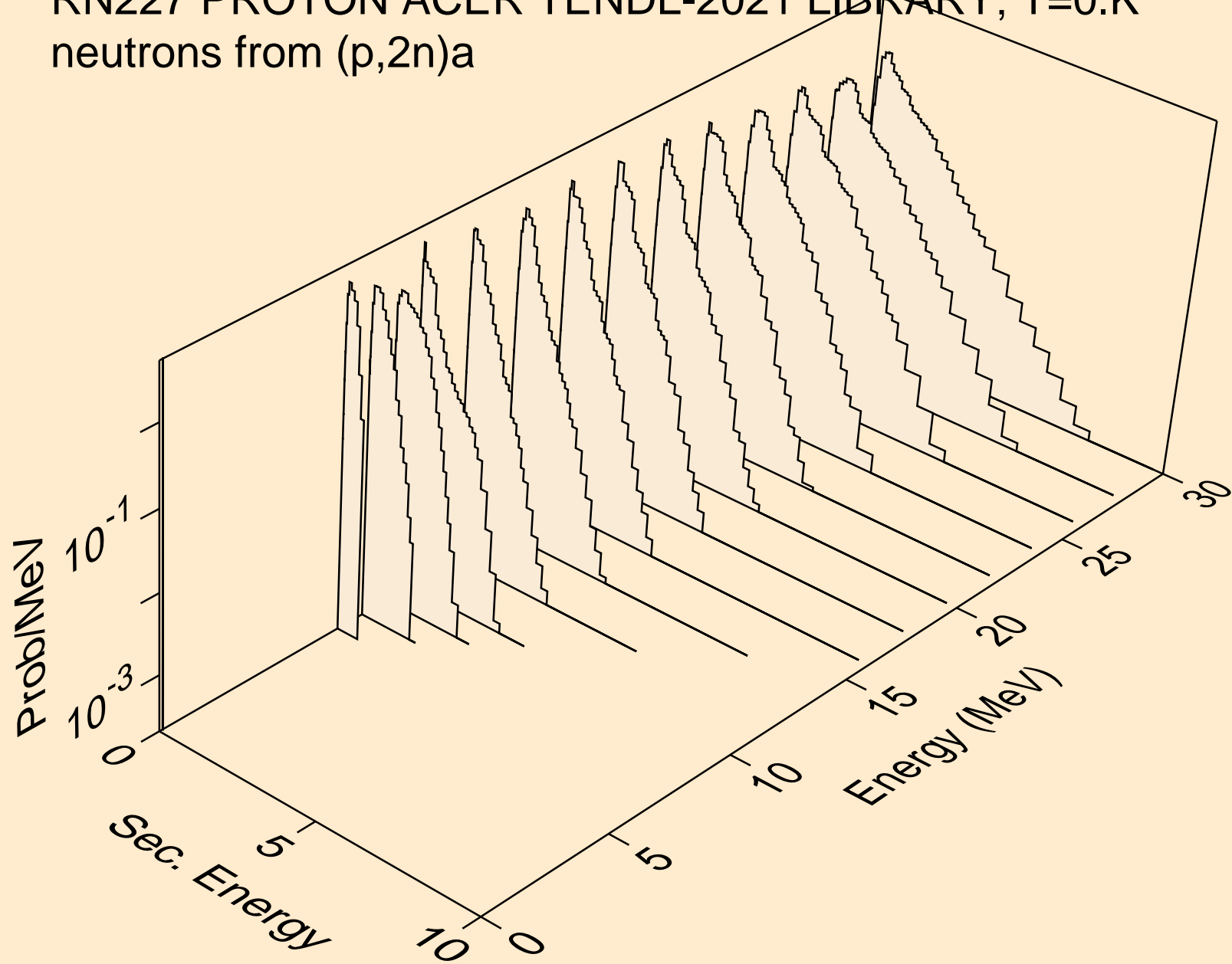

RN227 PROTON ACER TENDL-2021 LIBRARY; T=0.K
neutrons from (p,3n)a

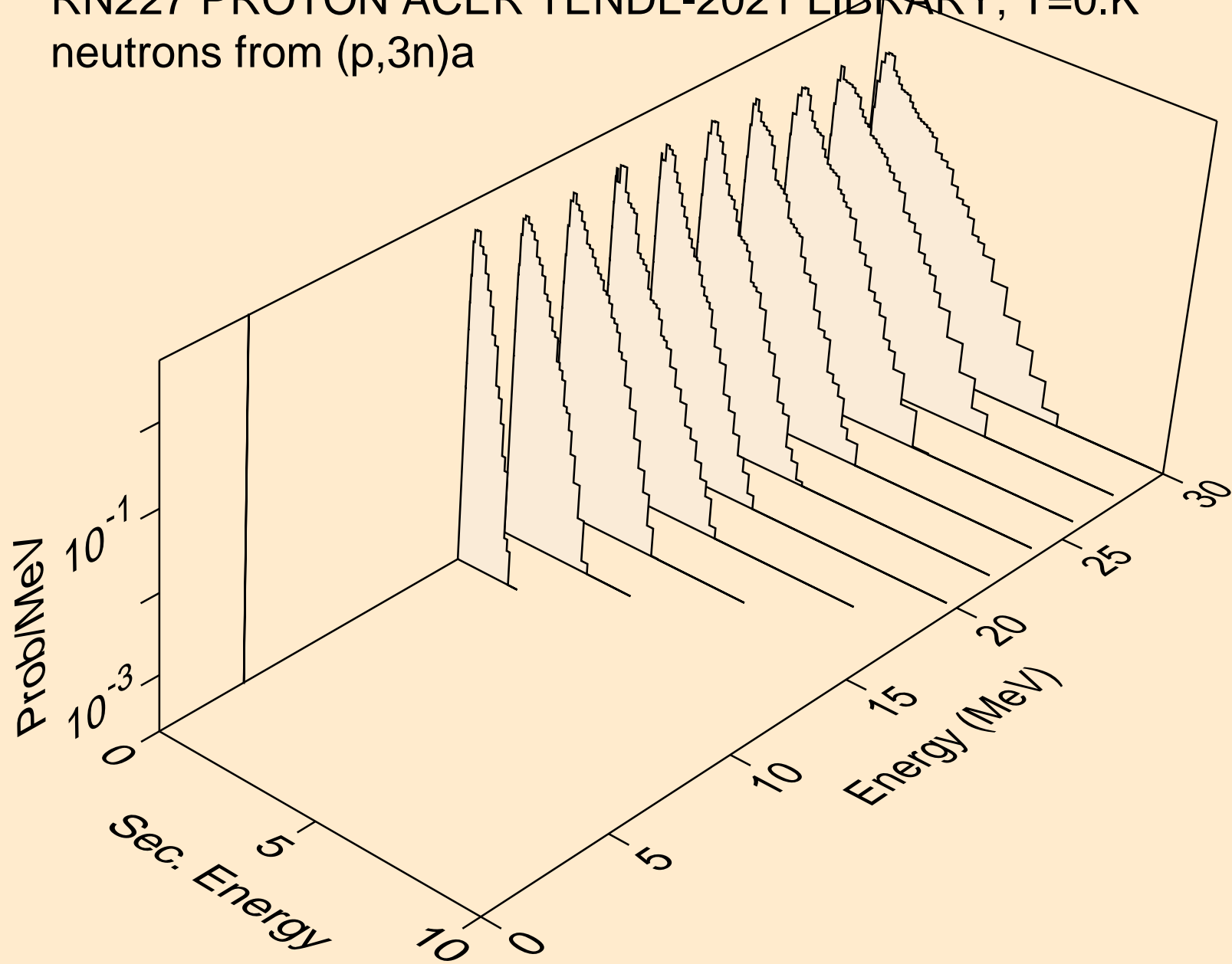

RN227 PROTON ACER TENDL-2021 LIBRARY; T=0.K
neutrons from (p,n*)p

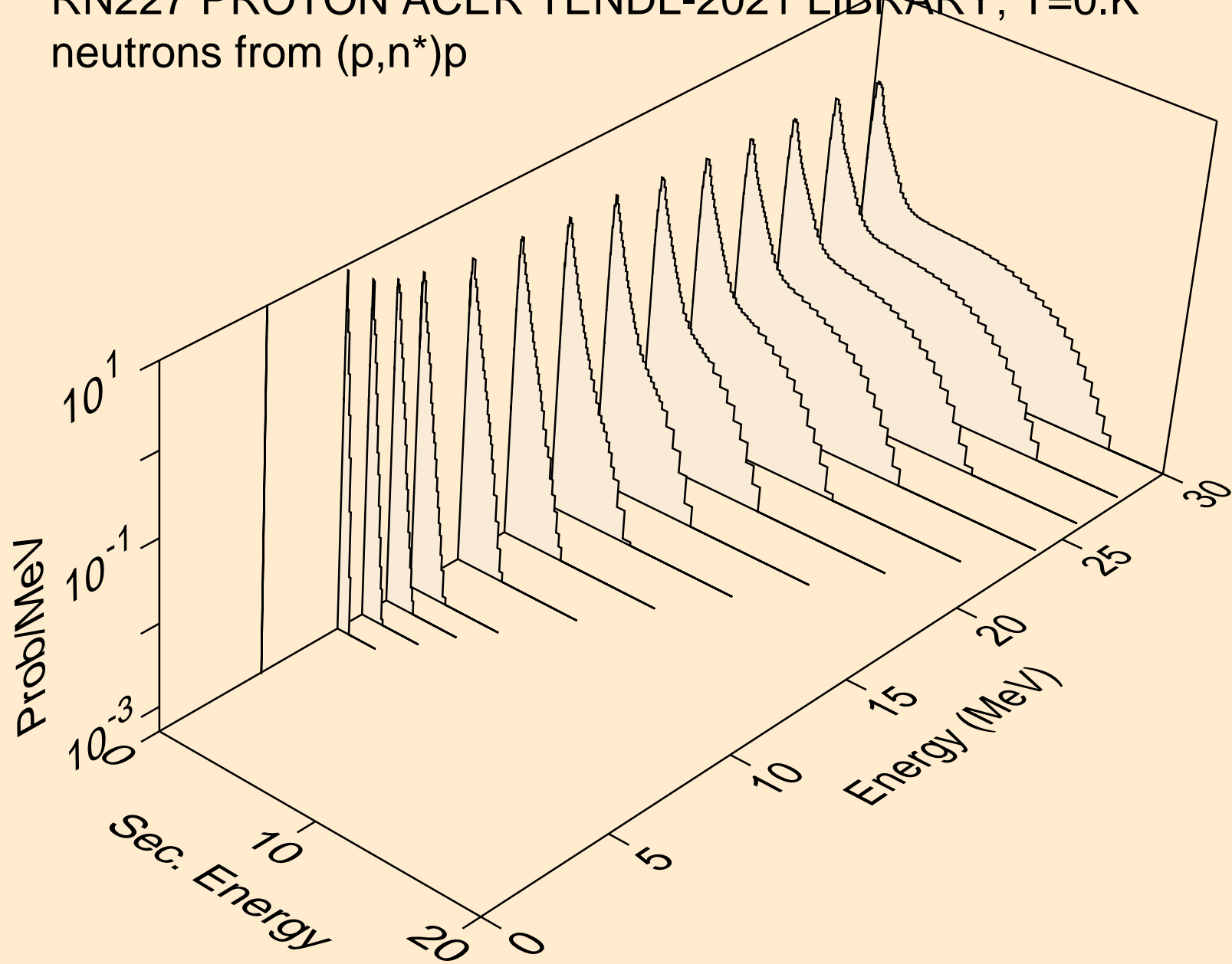

RN227 PROTON ACER TENDL-2021 LIBRARY; T=0.K
neutrons from (p,n*)2a

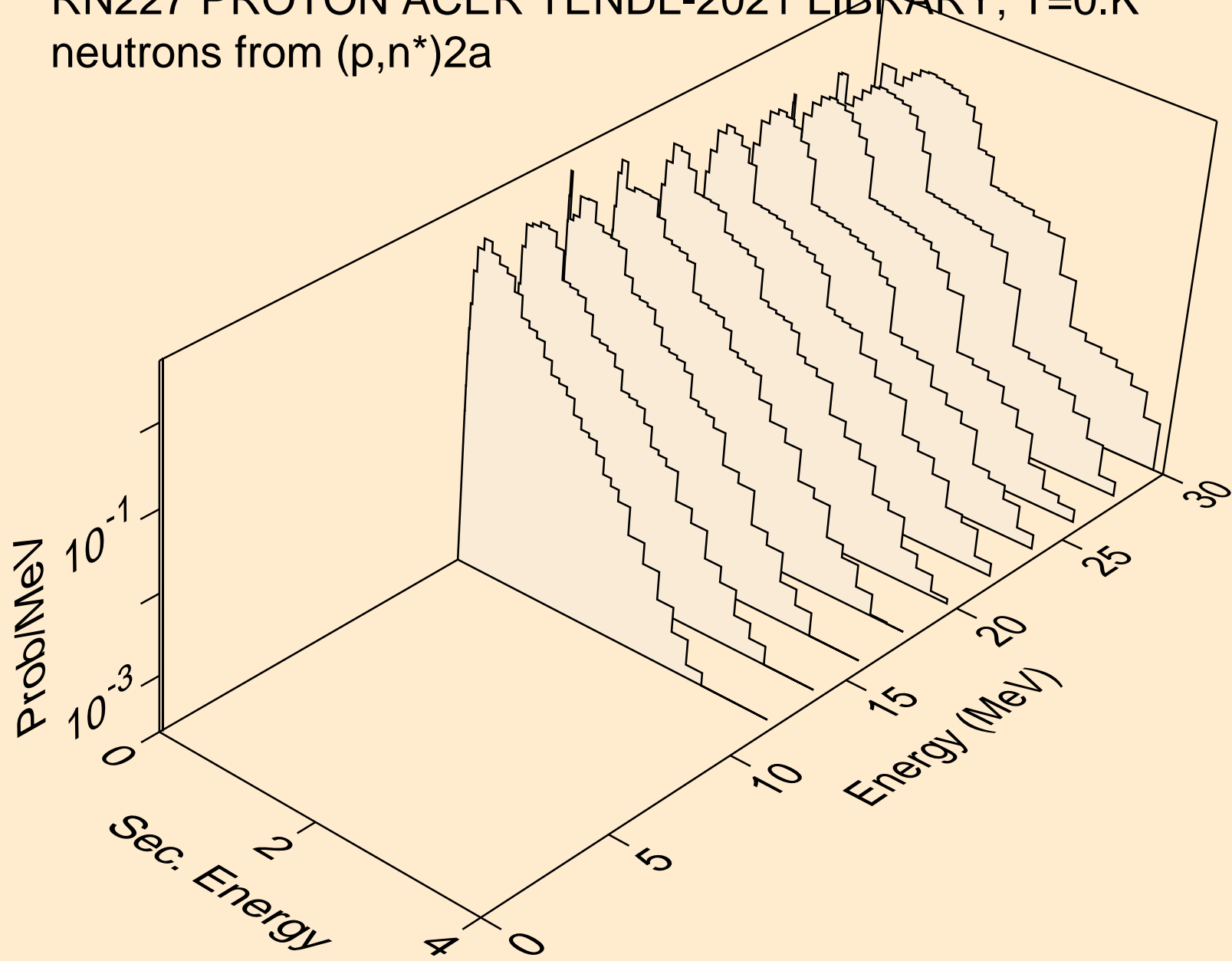

RN227 PROTON ACER TENDL-2021 LIBRARY; T=0.K
neutrons from (p,n*)d

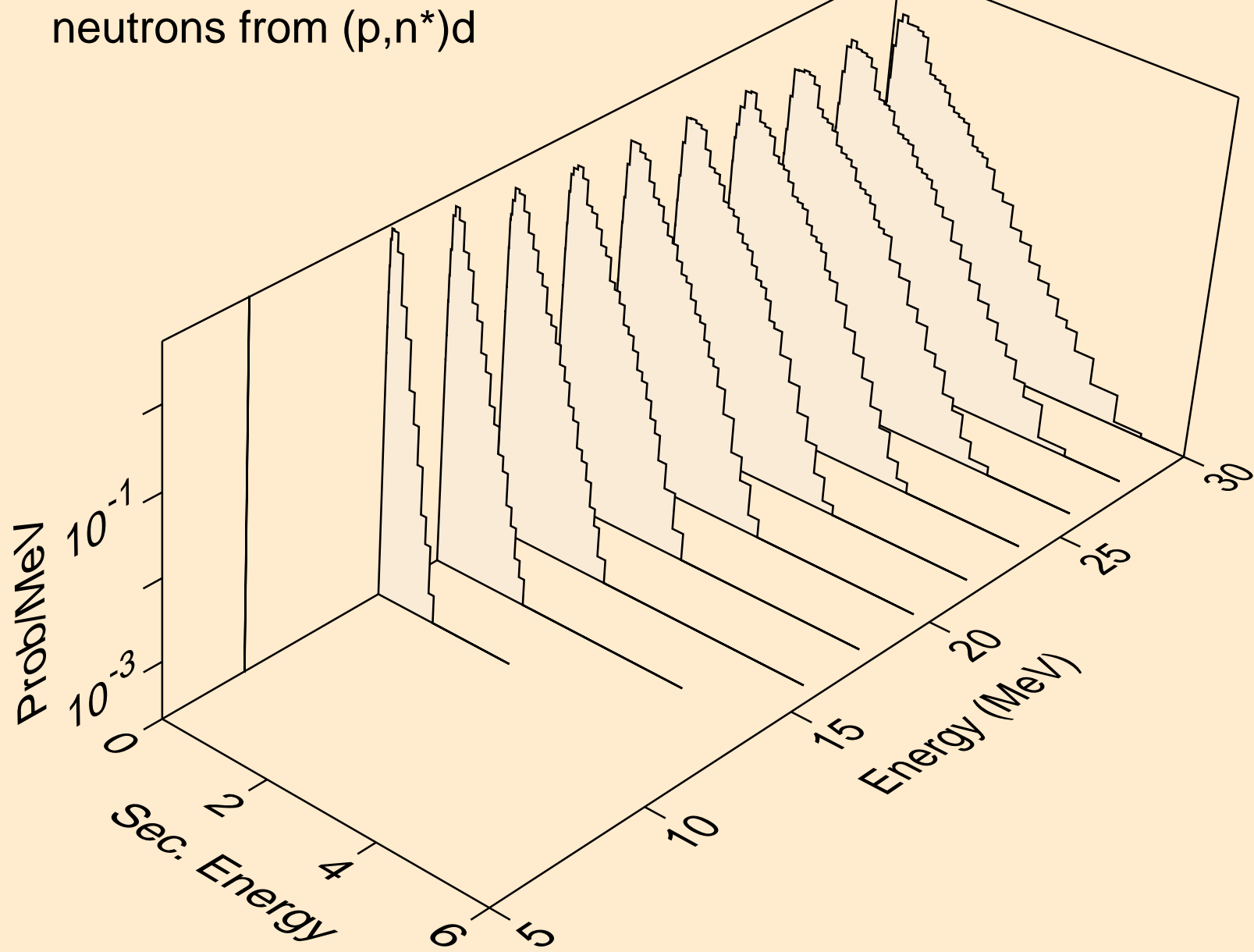

RN227 PROTON ACER TENDL-2021 LIBRARY; T=0.K
neutrons from (p,n*)t

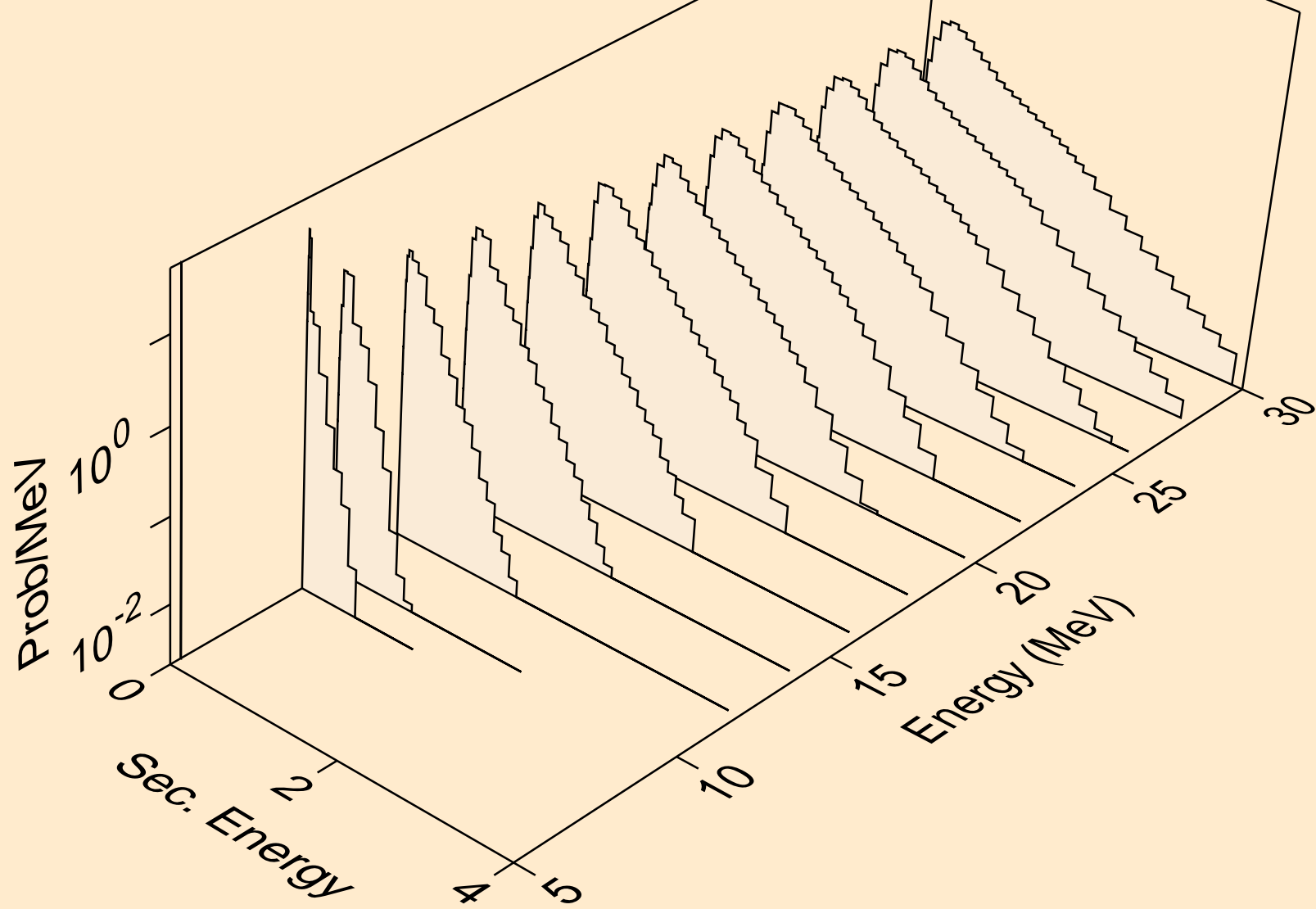

RN227 PROTON ACER TENDL-2021 LIBRARY; T=0.K
neutrons from (p,n*)he3

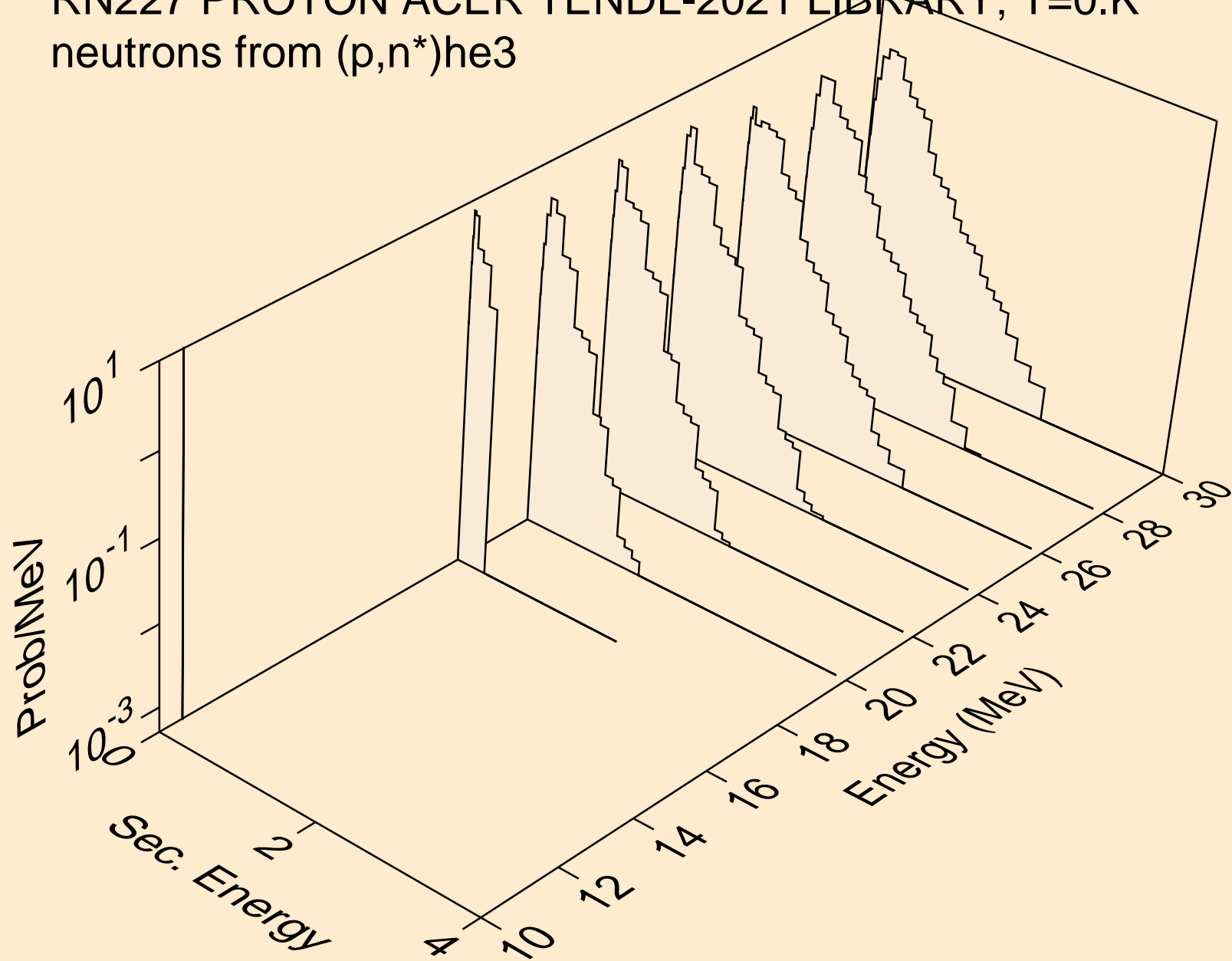

RN227 PROTON ACER TENDL-2021 LIBRARY; T=0.K
neutrons from (p,4n)

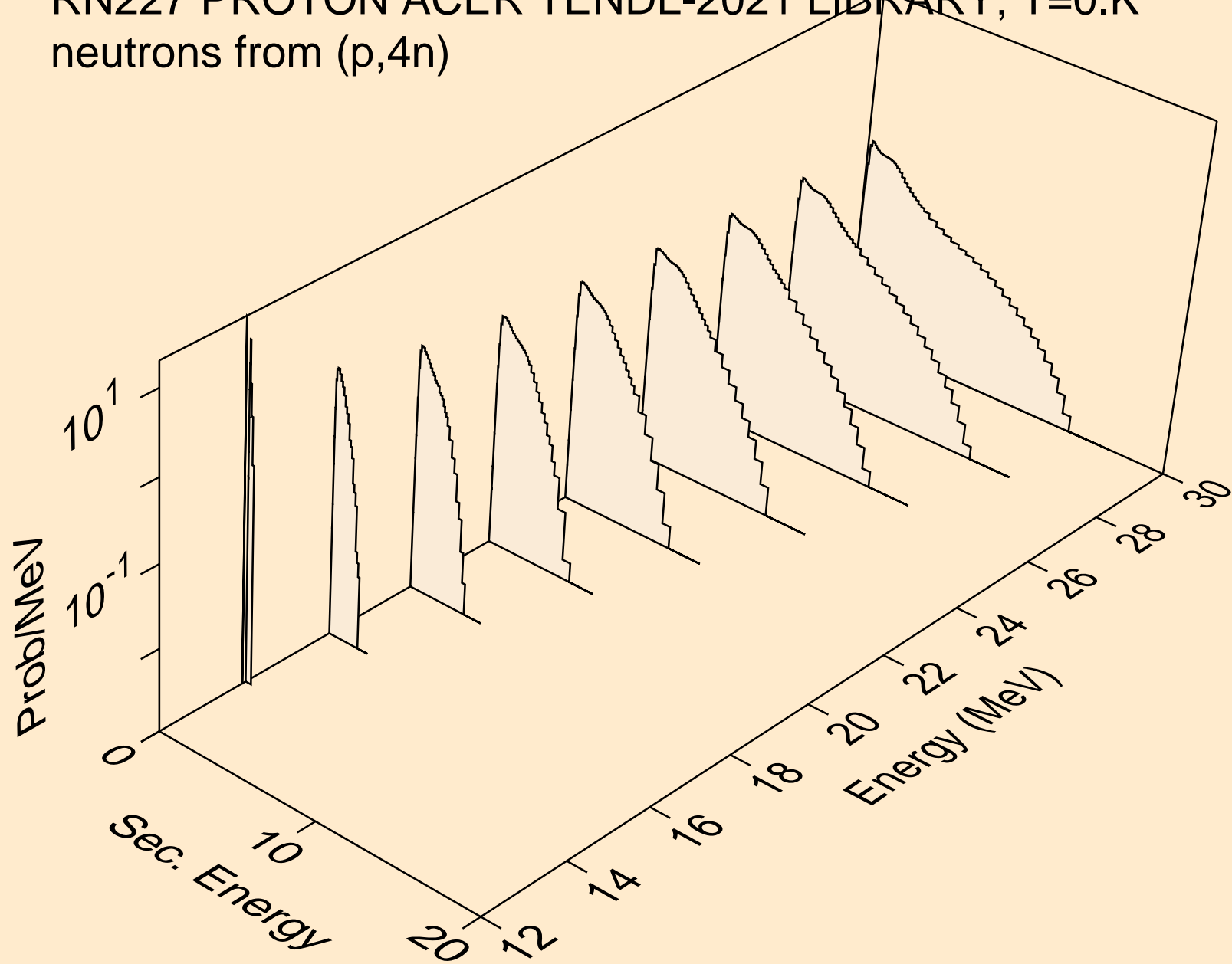

RN227 PROTON ACER TENDL-2021 LIBRARY; T=0.K
neutrons from (p,2np)

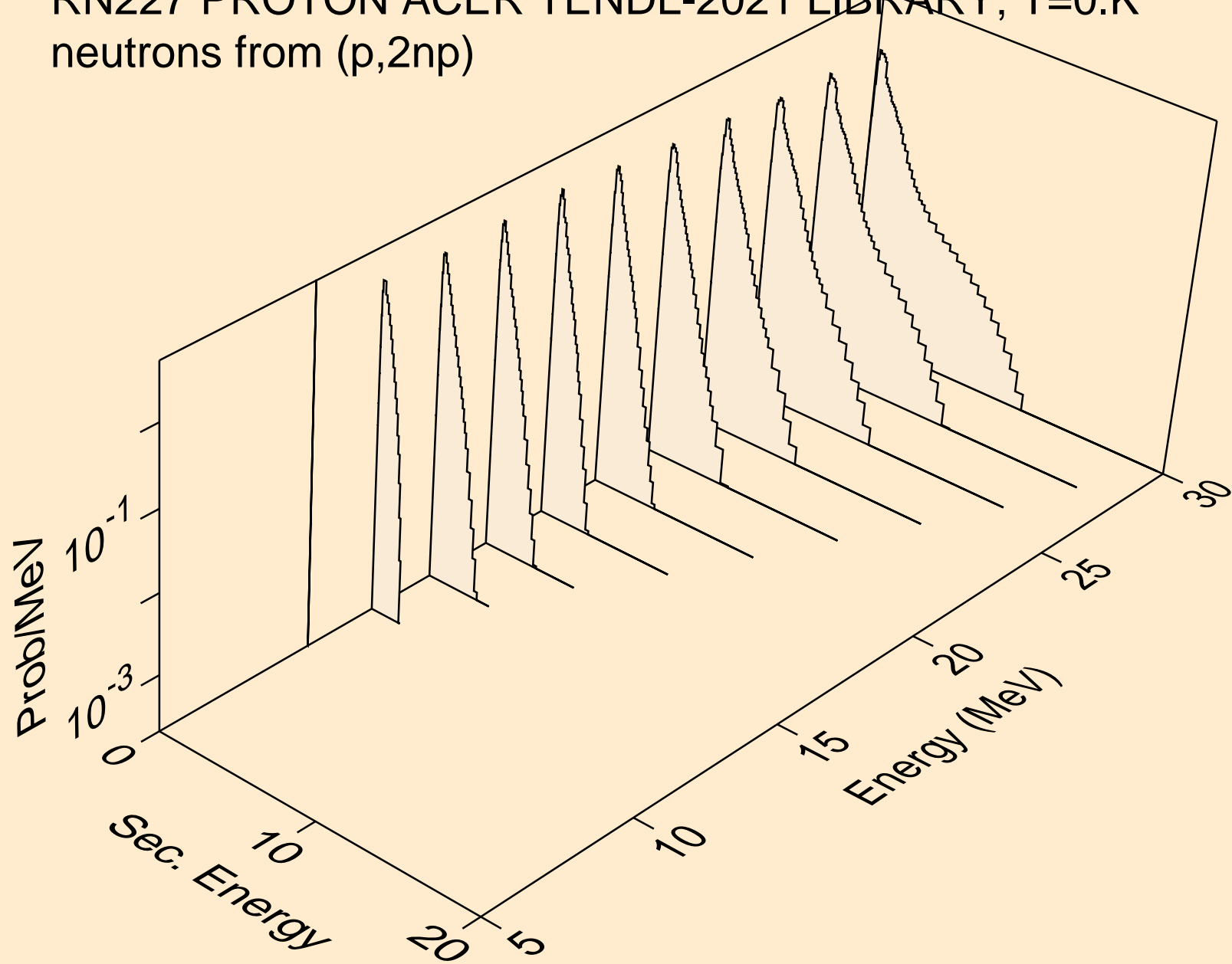

RN227 PROTON ACER TENDL-2021 LIBRARY; T=0.K
neutrons from (p,3np)

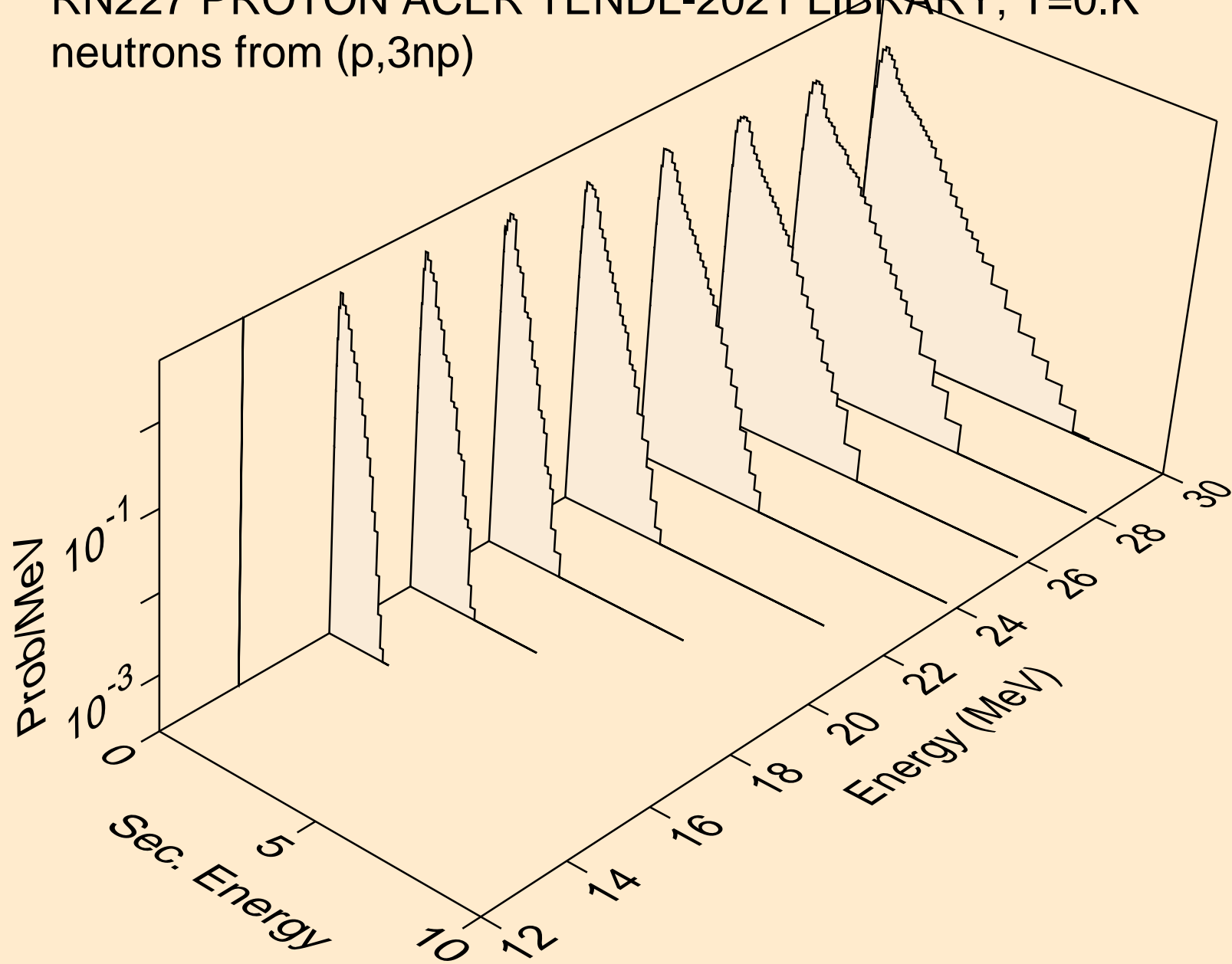

RN227 PROTON ACER TENDL-2021 LIBRARY; T=0.K
neutrons from (p,2np)

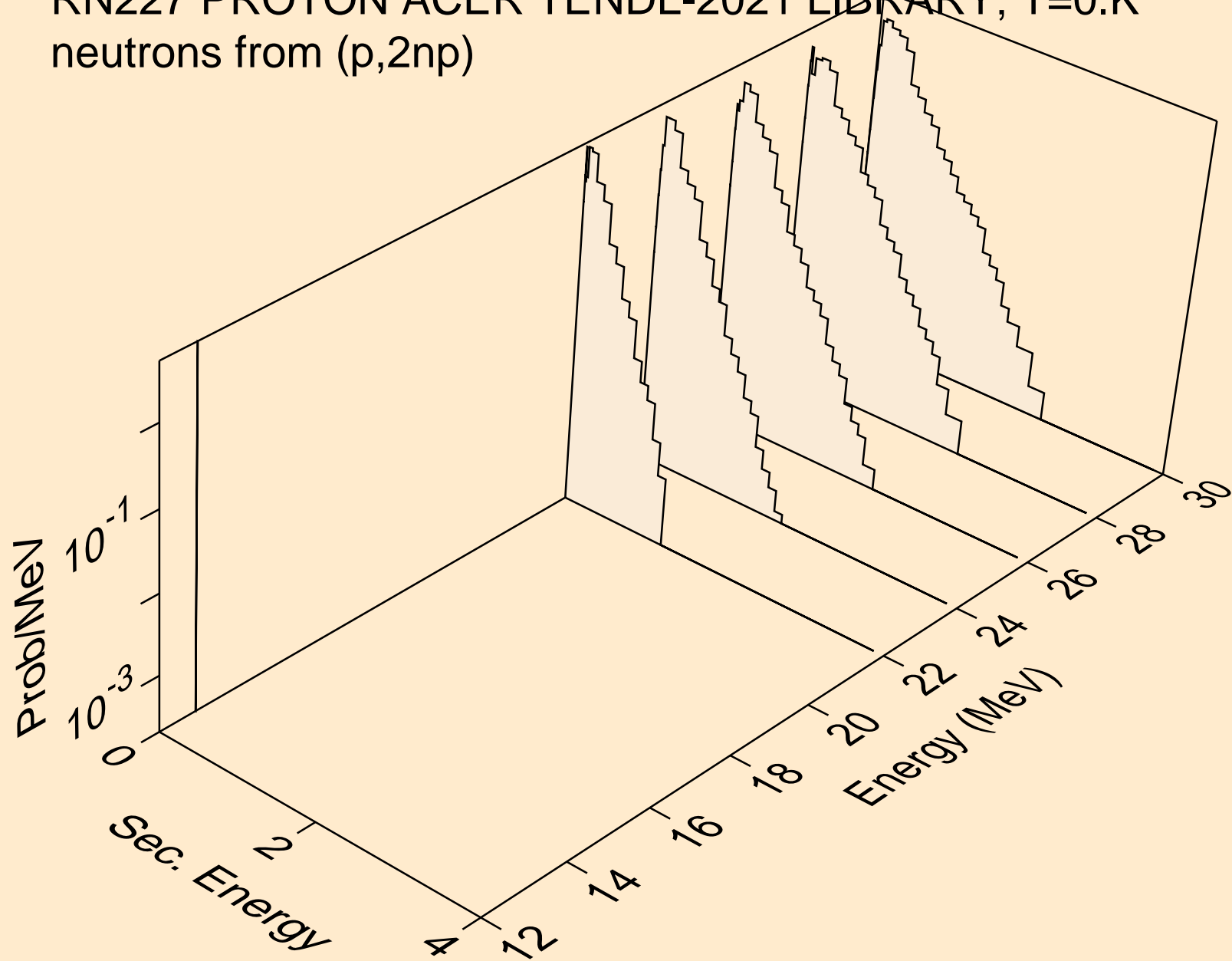

RN227 PROTON ACER TENDL-2021 LIBRARY; T=0.K
neutrons from (p,npa)

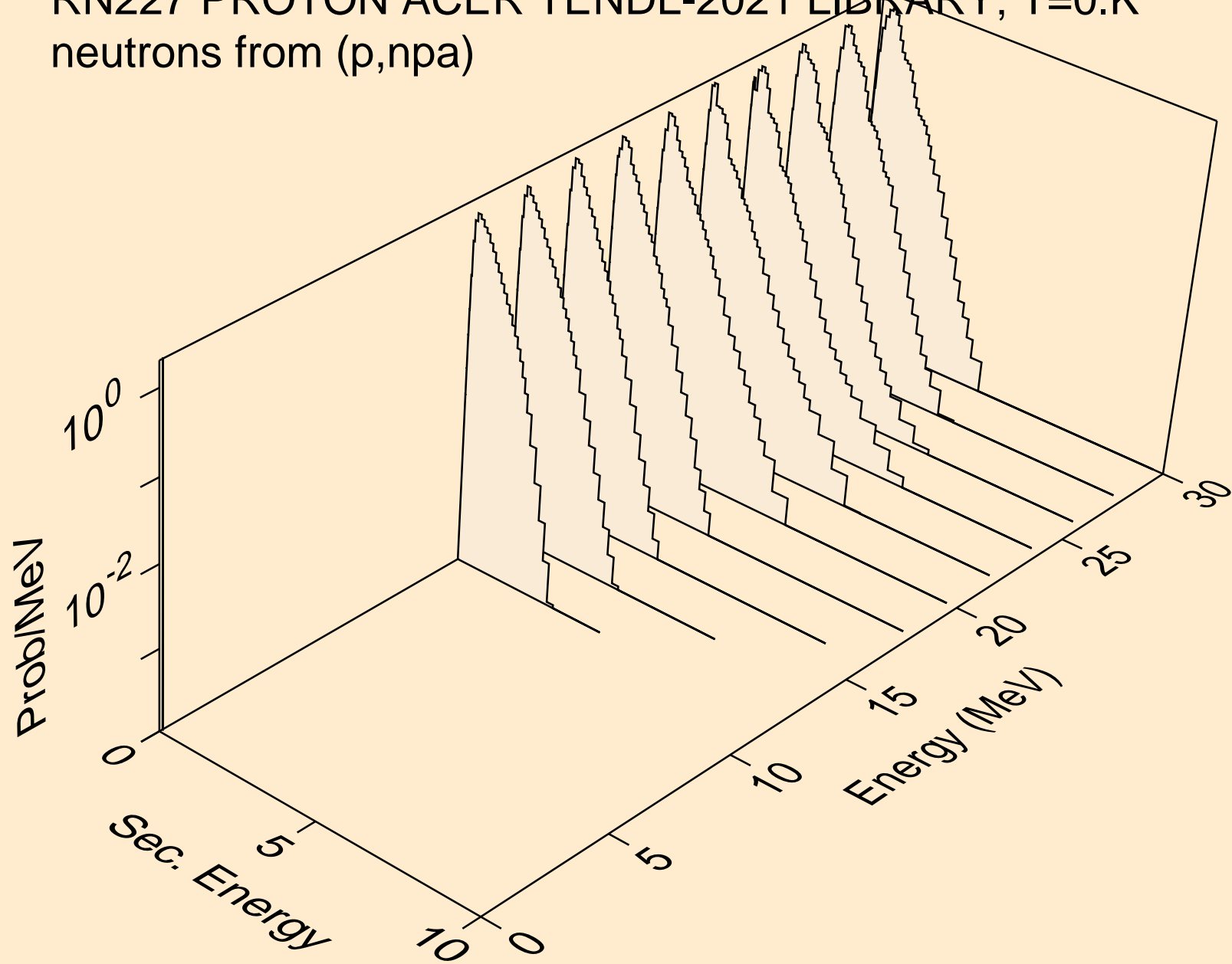

RN227 PROTON ACER TENDL-2021 LIBRARY; T=0.K
deuterons from (p,x)

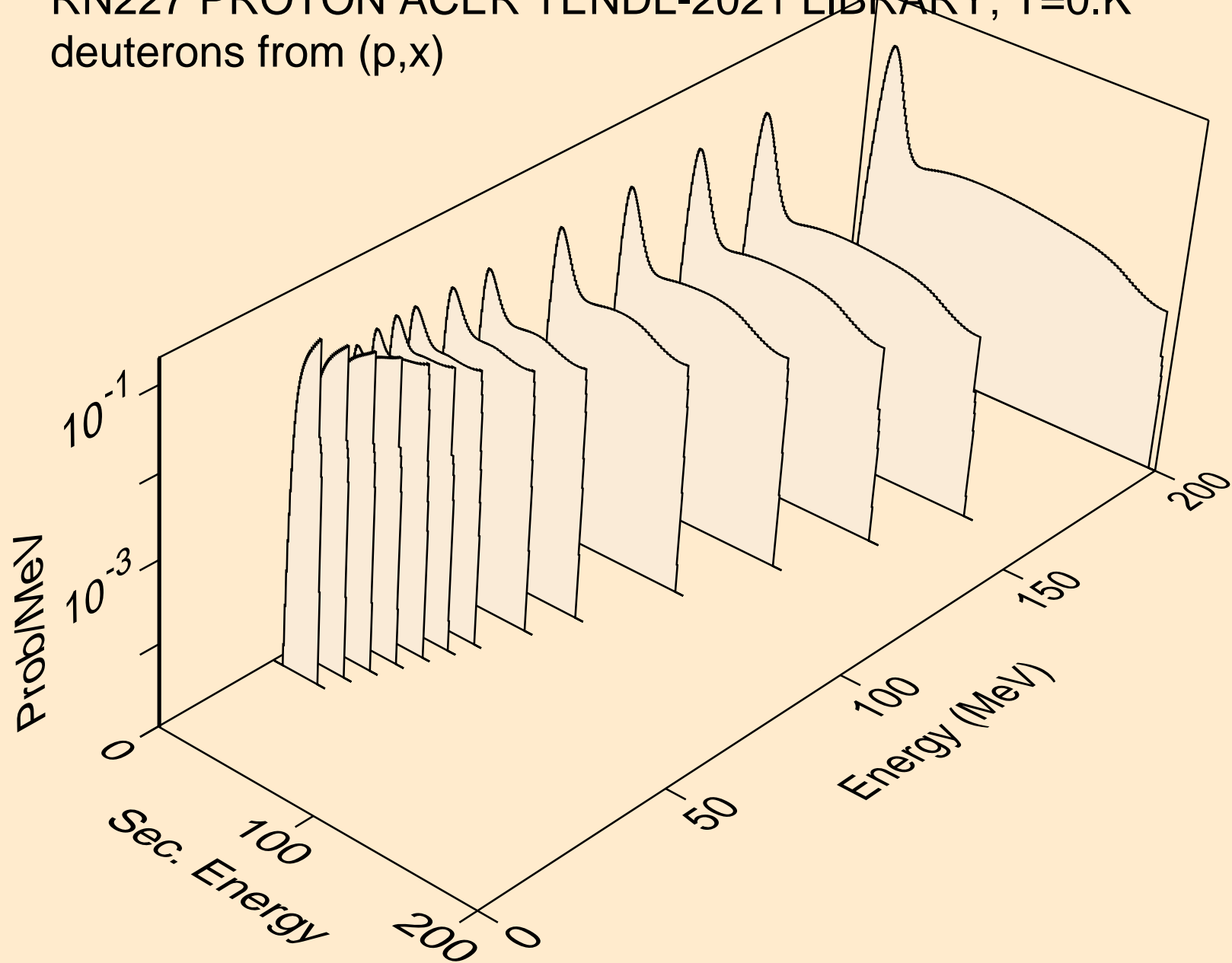

RN227 PROTON ACER TENDL-2021 LIBRARY; T=0.K
deuterons from (p,2nd)

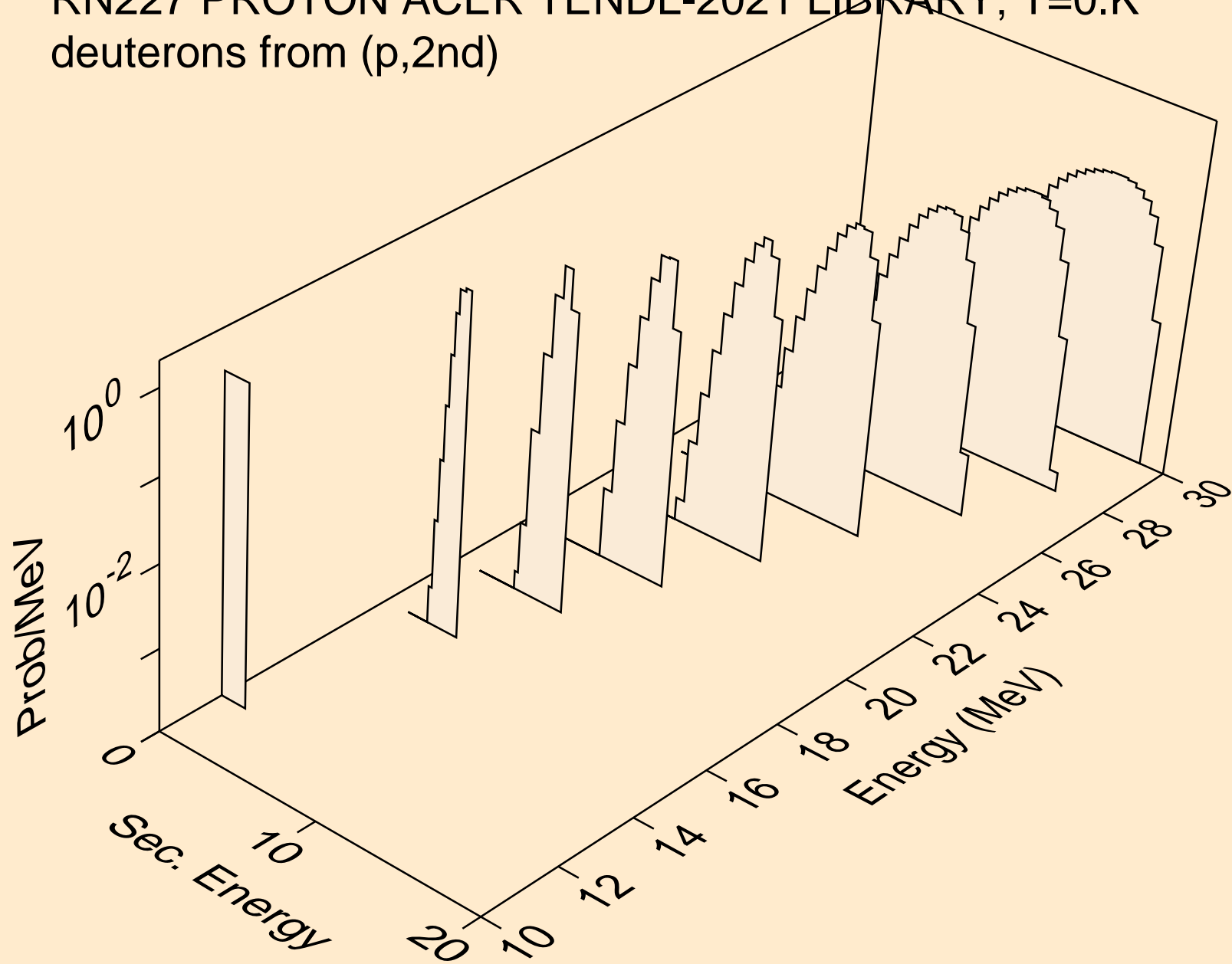

RN227 PROTON ACER TENDL-2021 LIBRARY; T=0.K
deuterons from (p,n*)d

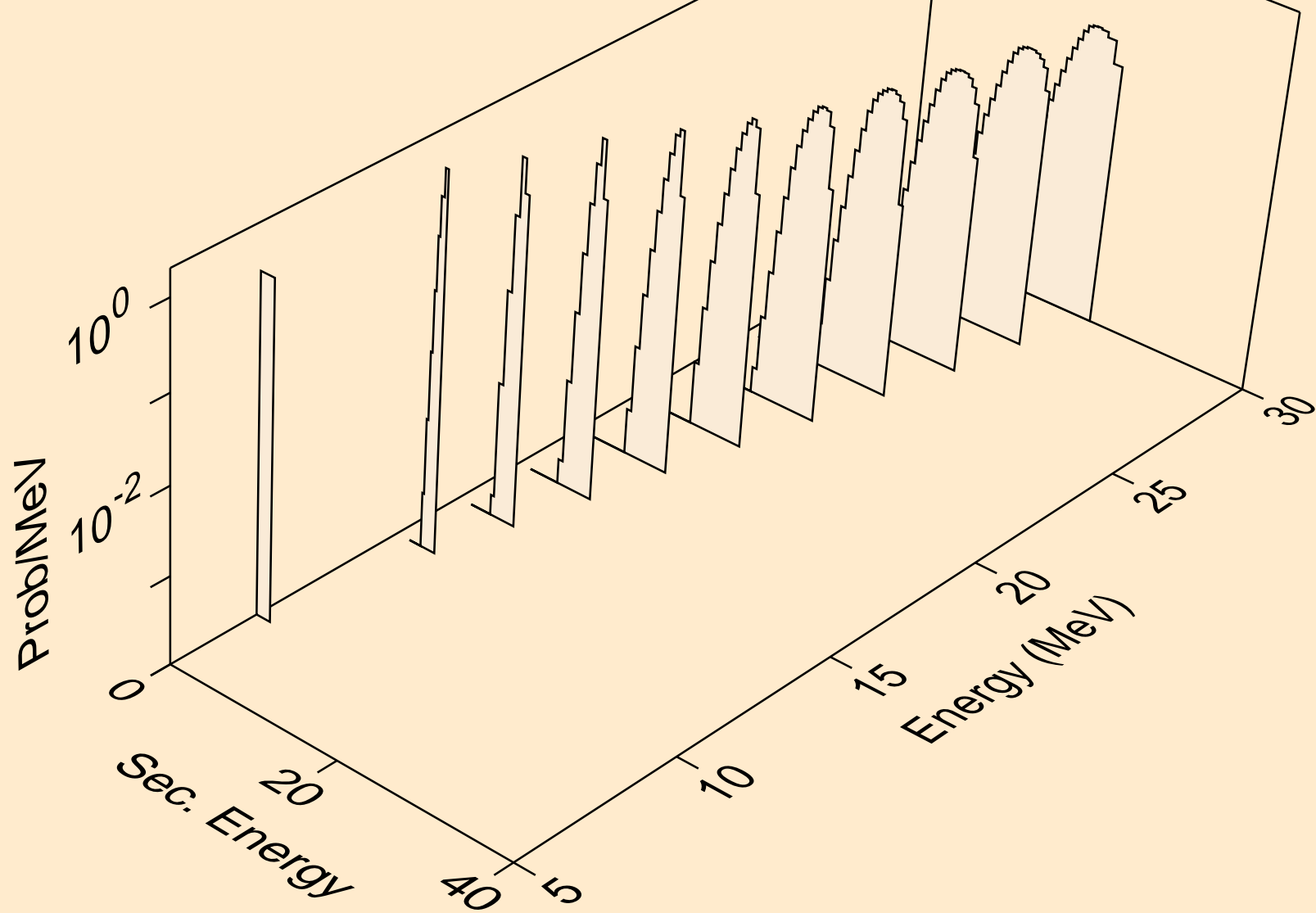

RN227 PROTON ACER TENDL-2021 LIBRARY; T=0.K
deuterons from (p,d)

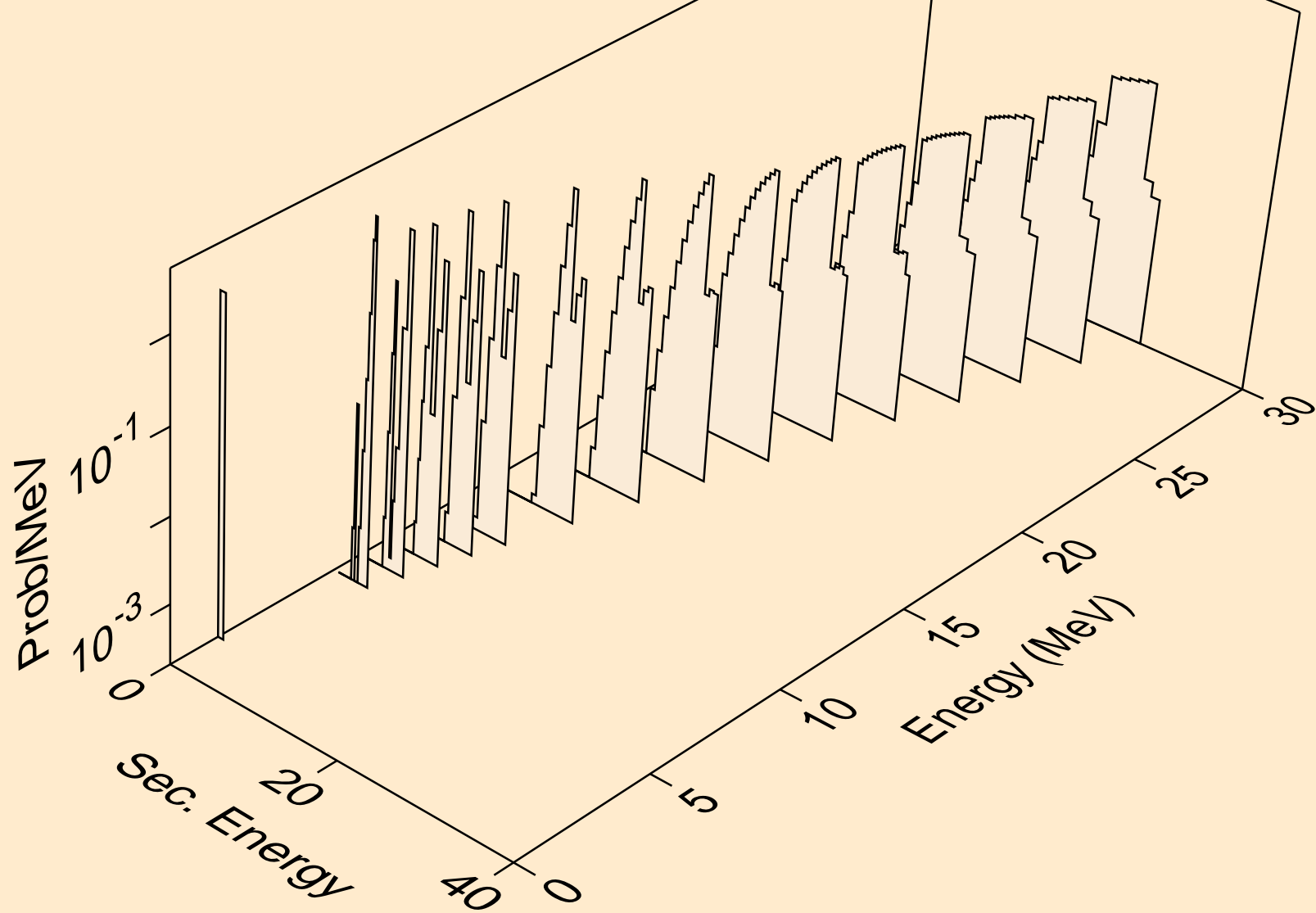

RN227 PROTON ACER TENDL-2021 LIBRARY; T=0.K
tritons from (p,x)

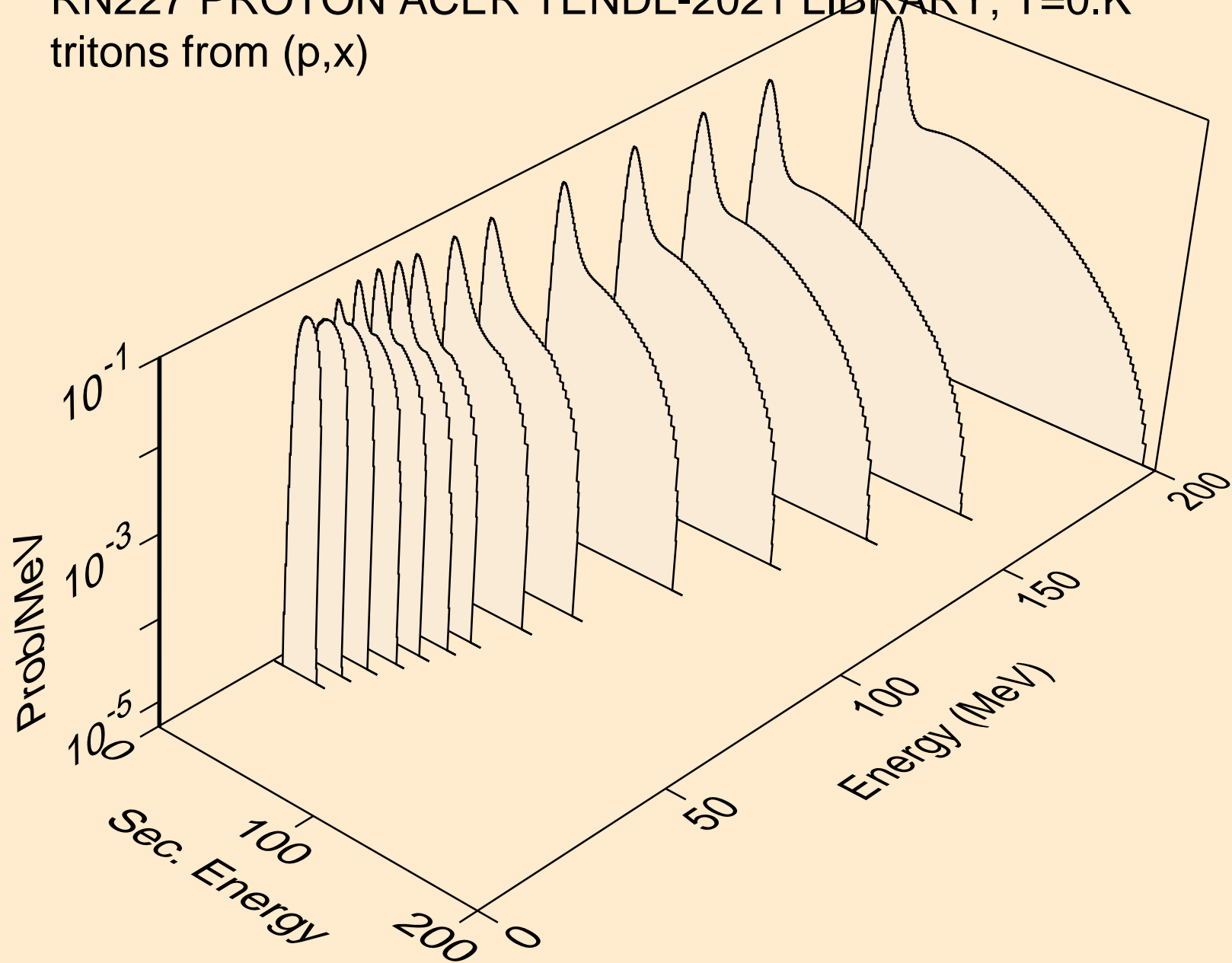

RN227 PROTON ACER TENDL-2021 LIBRARY; T=0.K
tritons from (p,n*)t

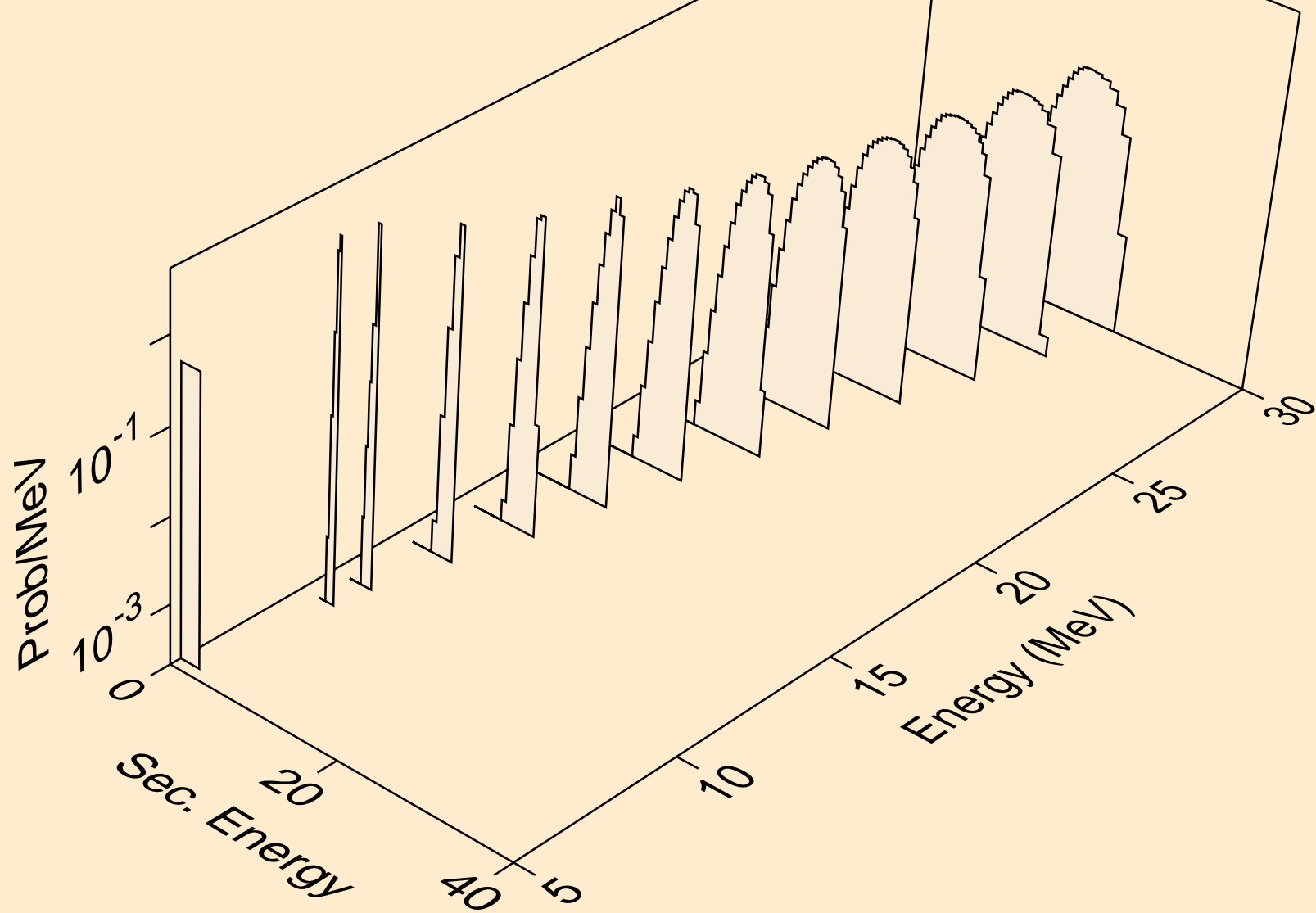

RN227 PROTON ACER TENDL-2021 LIBRARY; T=0.K
tritons from (p,t)

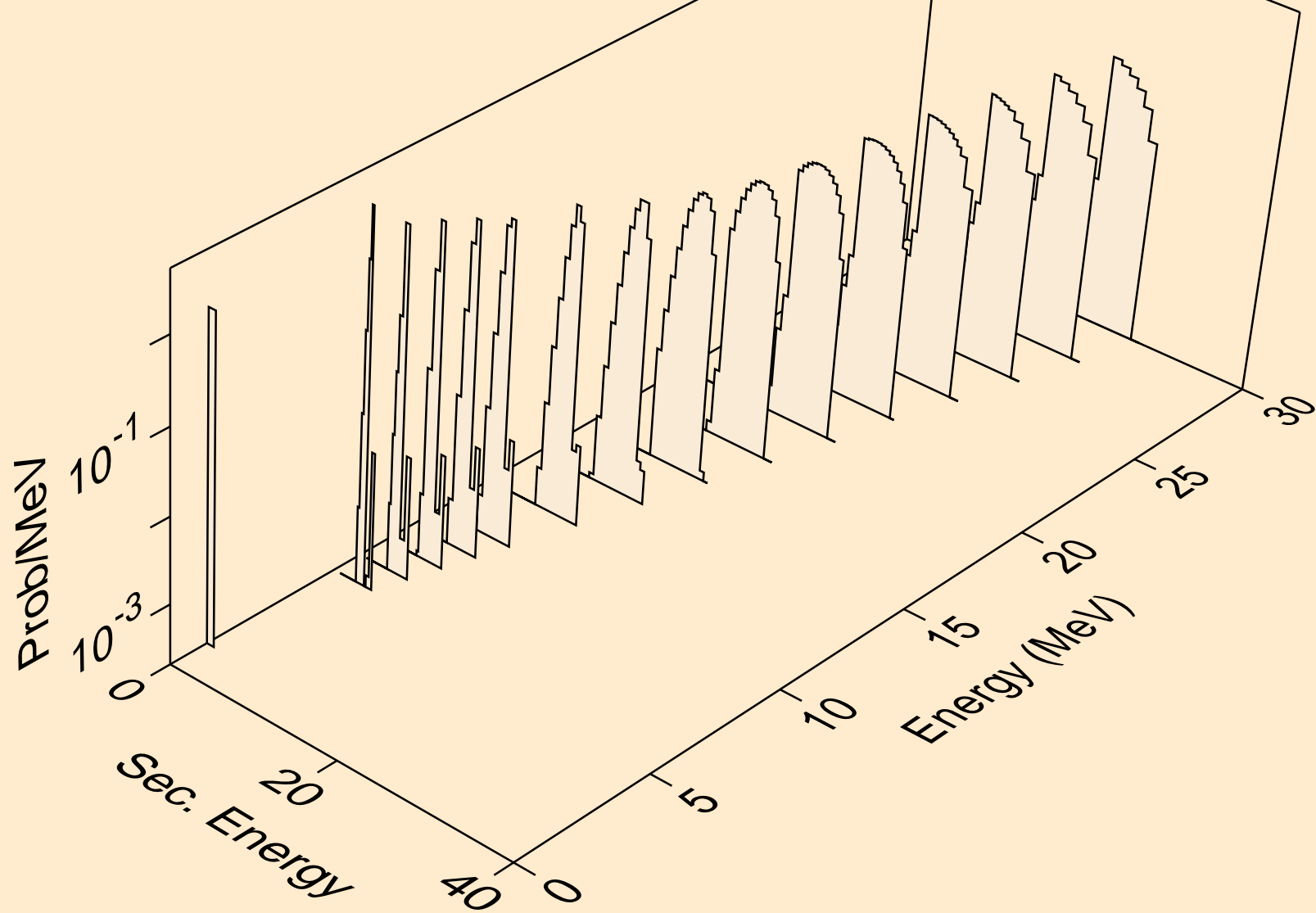

RN227 PROTON ACER TENDL-2021 LIBRARY; T=0.K
he3s from (p,x)

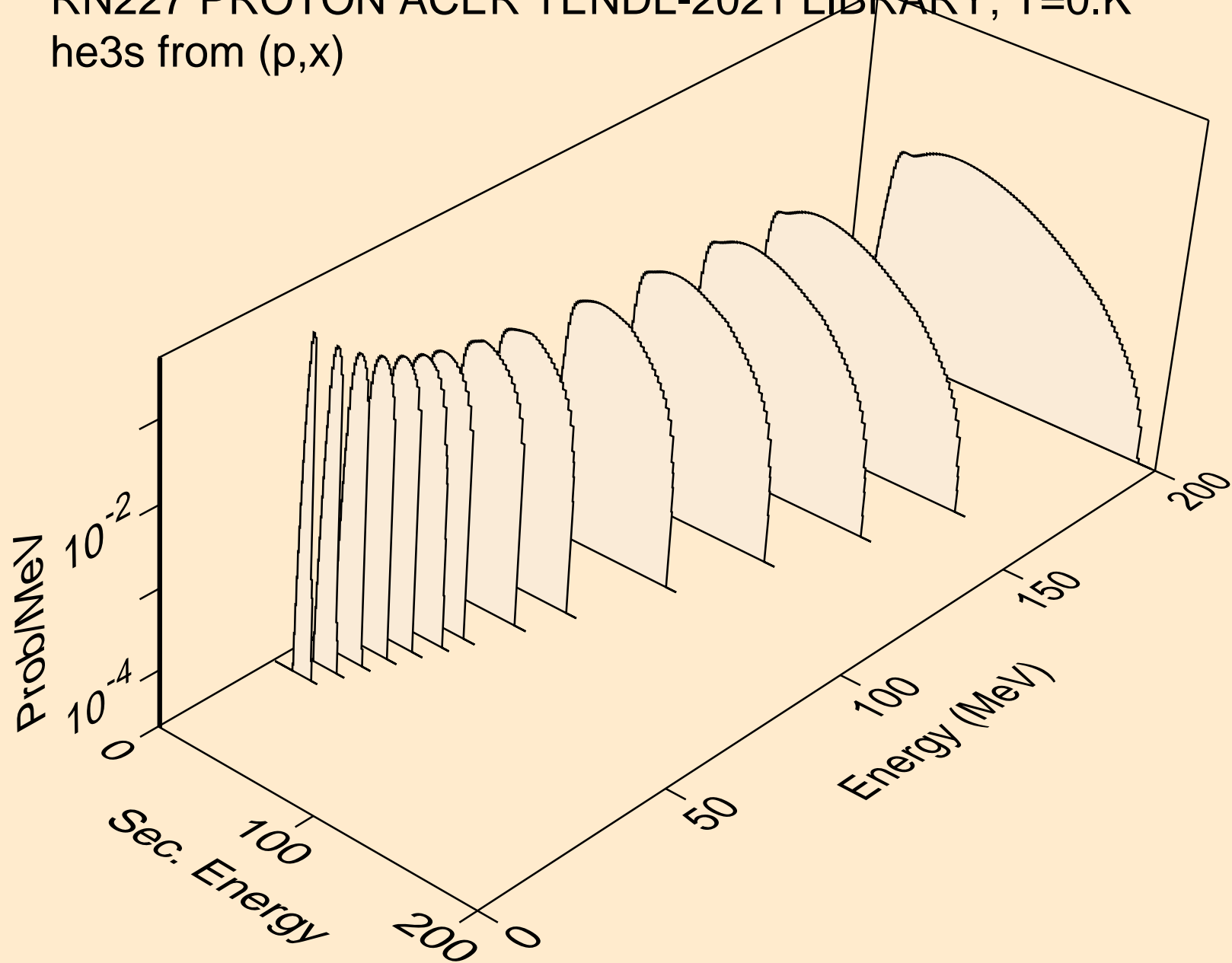

RN227 PROTON ACER TENDL-2021 LIBRARY; T=0.K
he3s from (p,n*)he3

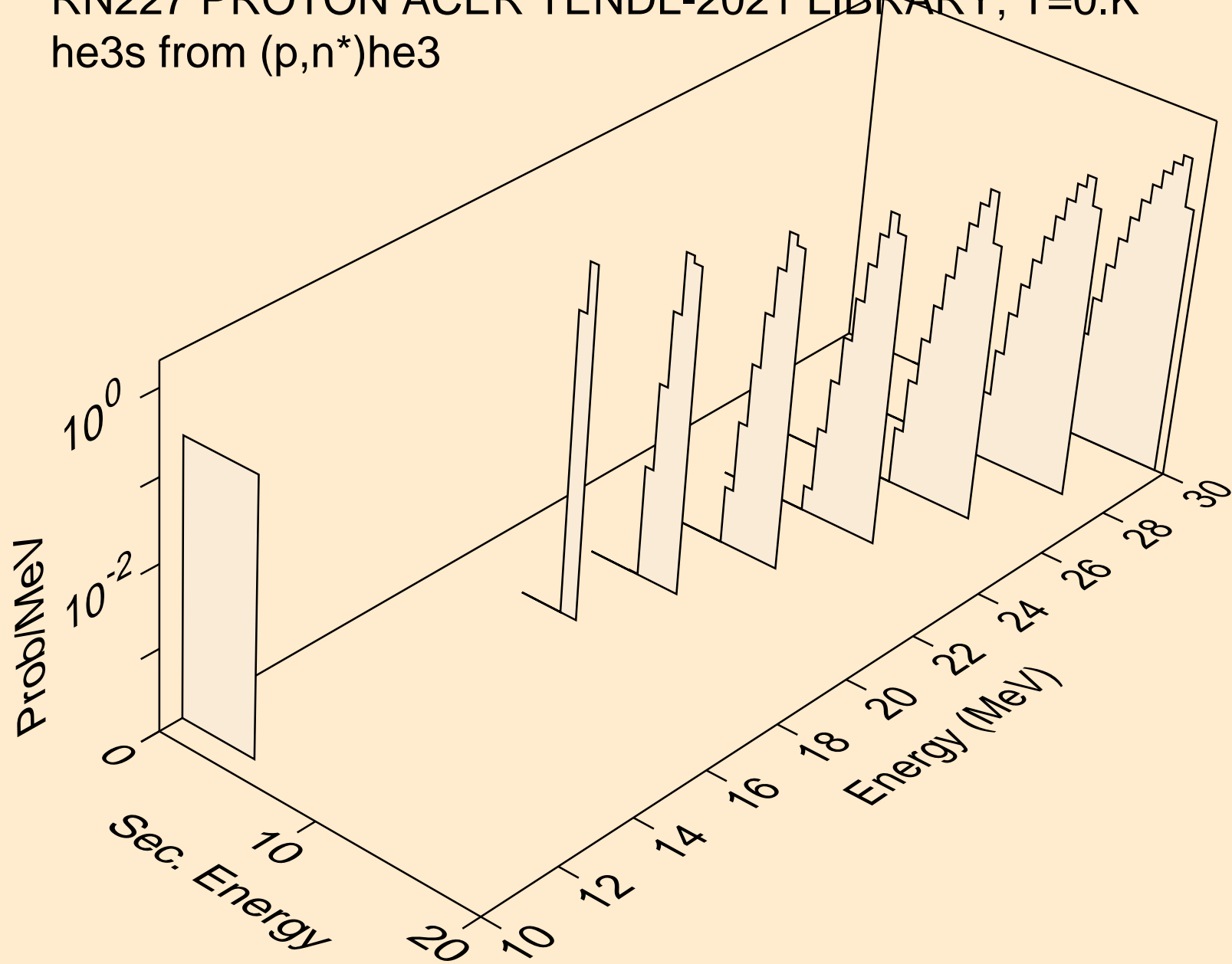

RN227 PROTON ACER TENDL-2021 LIBRARY; T=0.K
he3s from (p,he3)

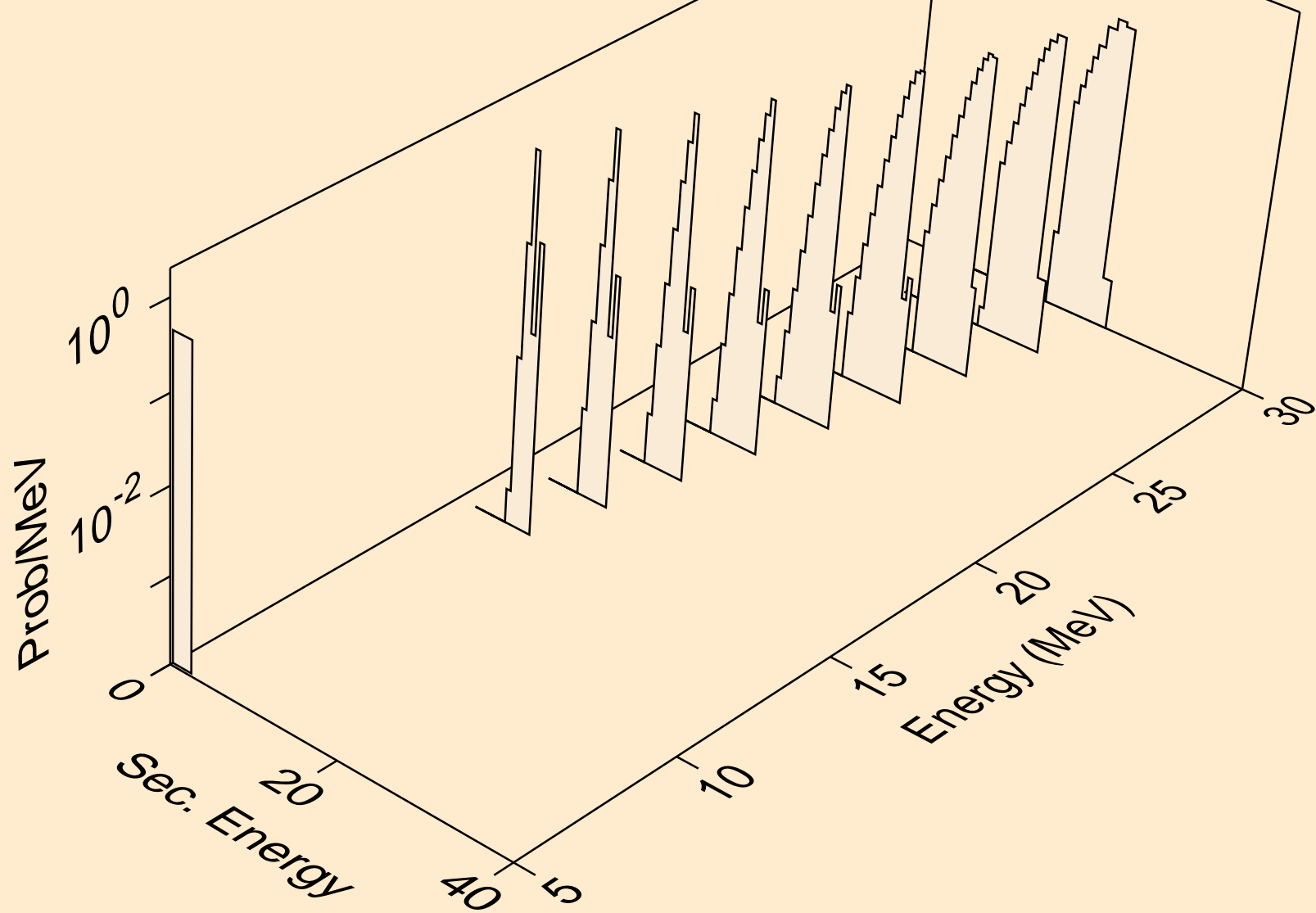

RN227 PROTON ACER TENDL-2021 LIBRARY; T=0.K
alphas from (p,x)

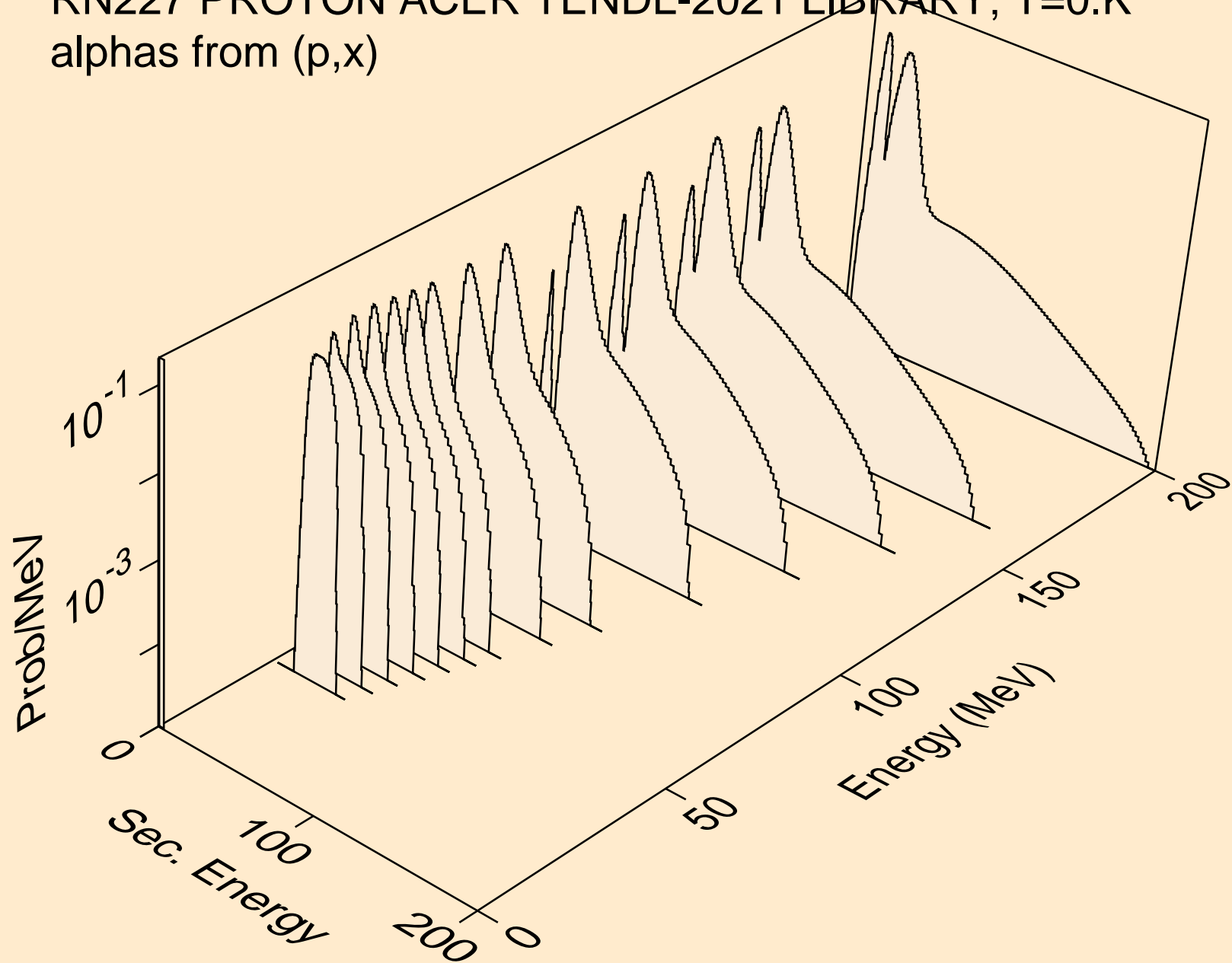

RN227 PROTON ACER TENDL-2021 LIBRARY; T=0.K
alphas from (p,n*)a

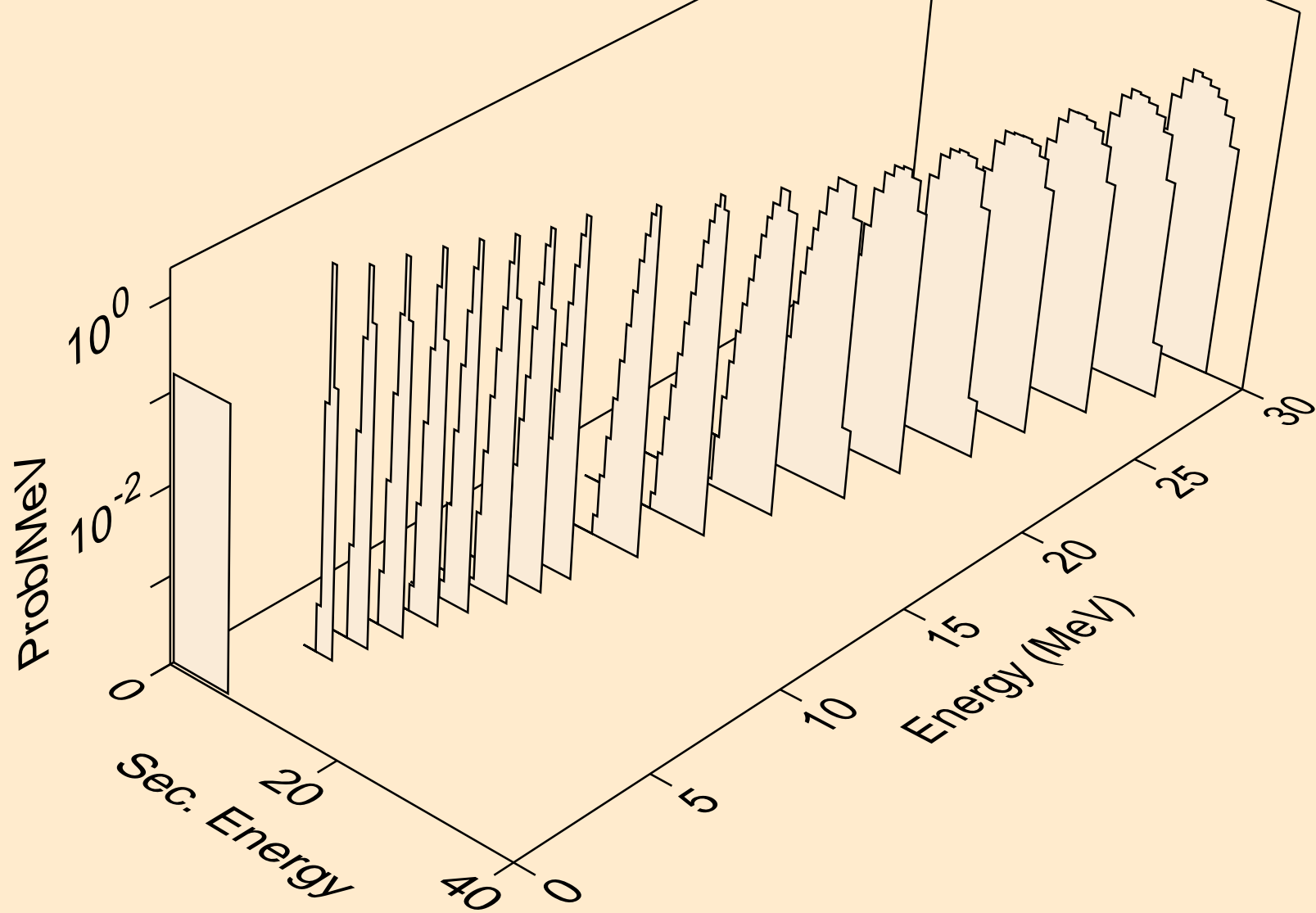

RN227 PROTON ACER TENDL-2021 LIBRARY; T=0.K
alphas from (p,2n)a

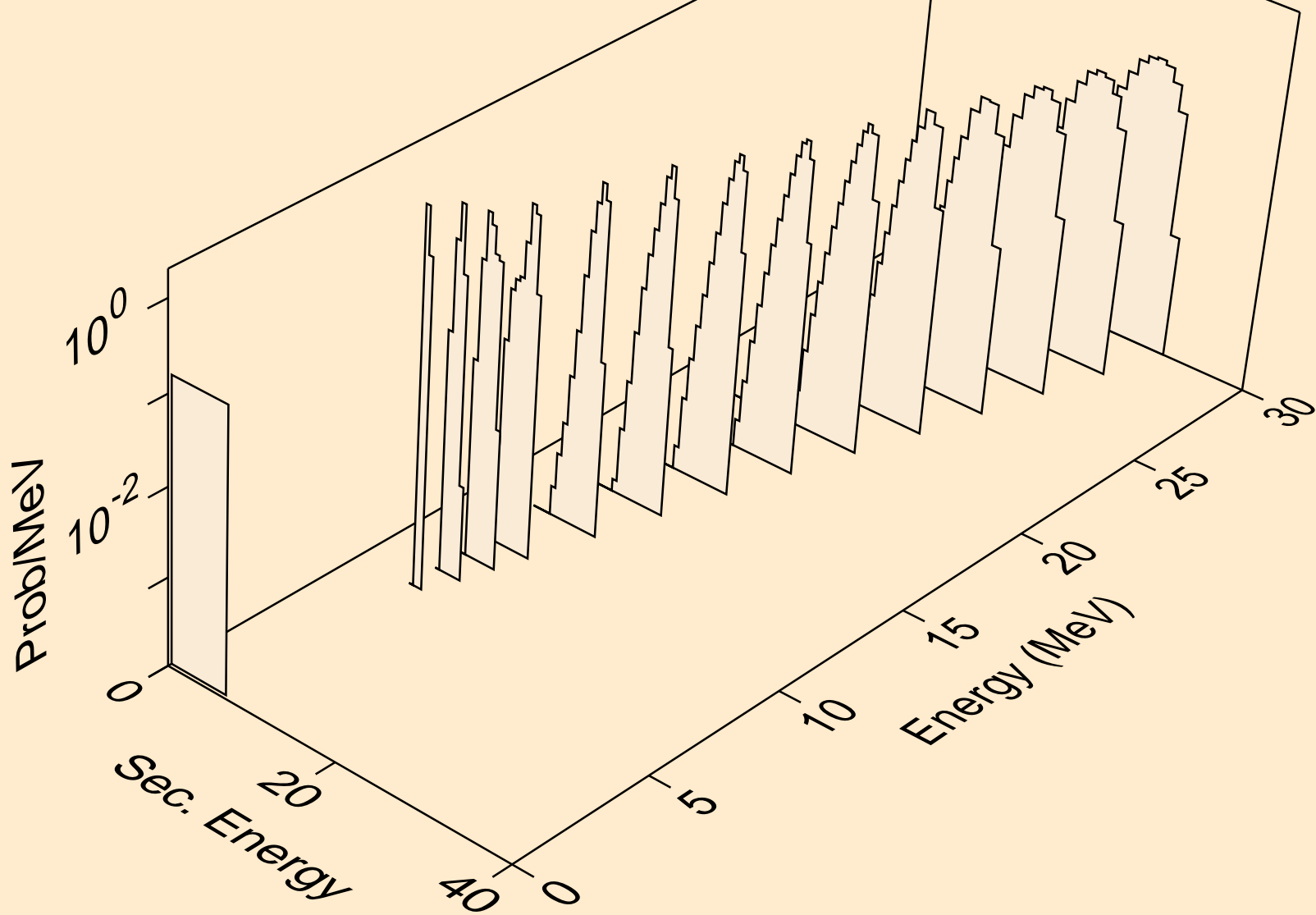

RN227 PROTON ACER TENDL-2021 LIBRARY; T=0.K
alphas from (p,3n)a

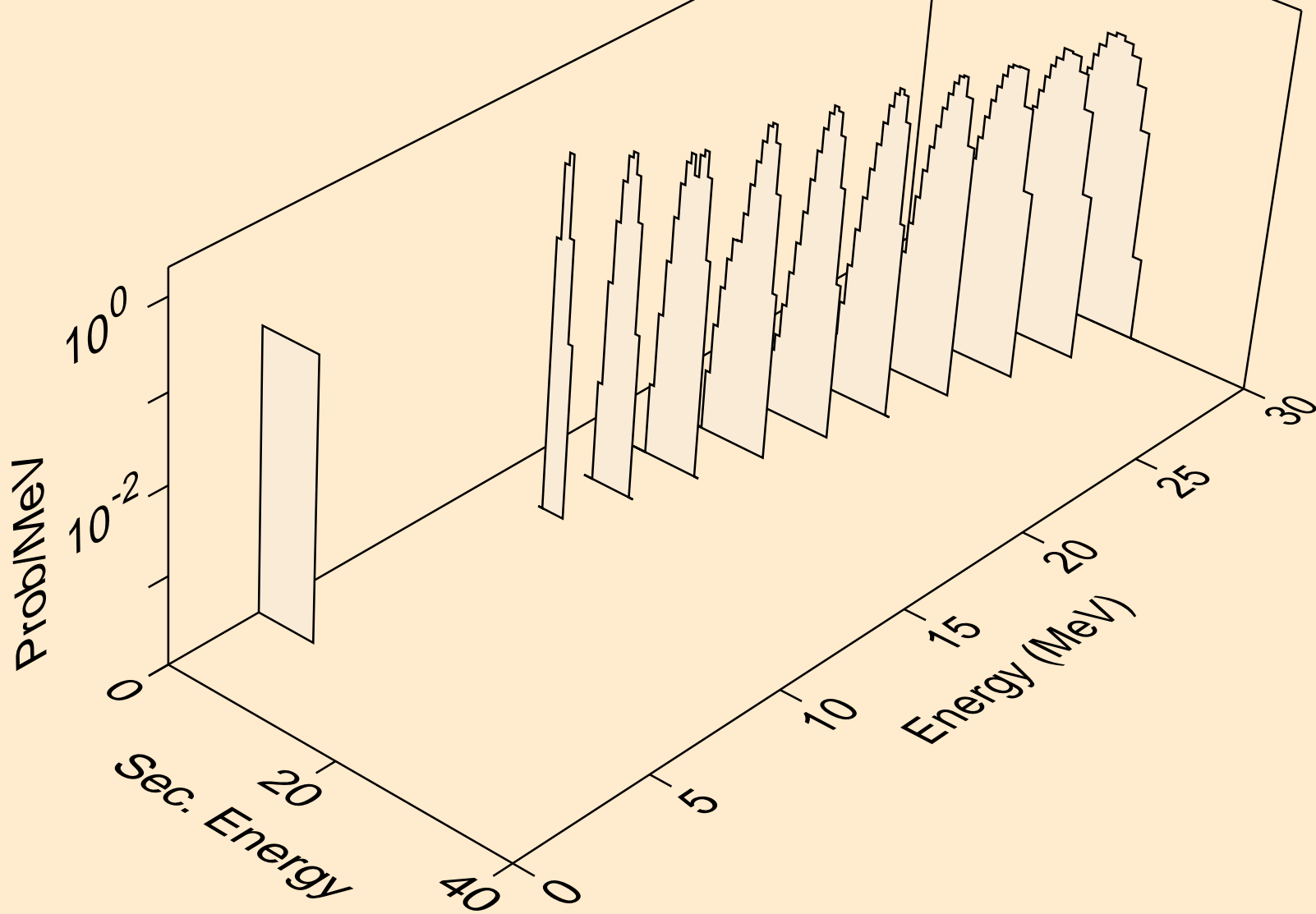

RN227 PROTON ACER TENDL-2021 LIBRARY; T=0.K
alphas from (p,n*)2a

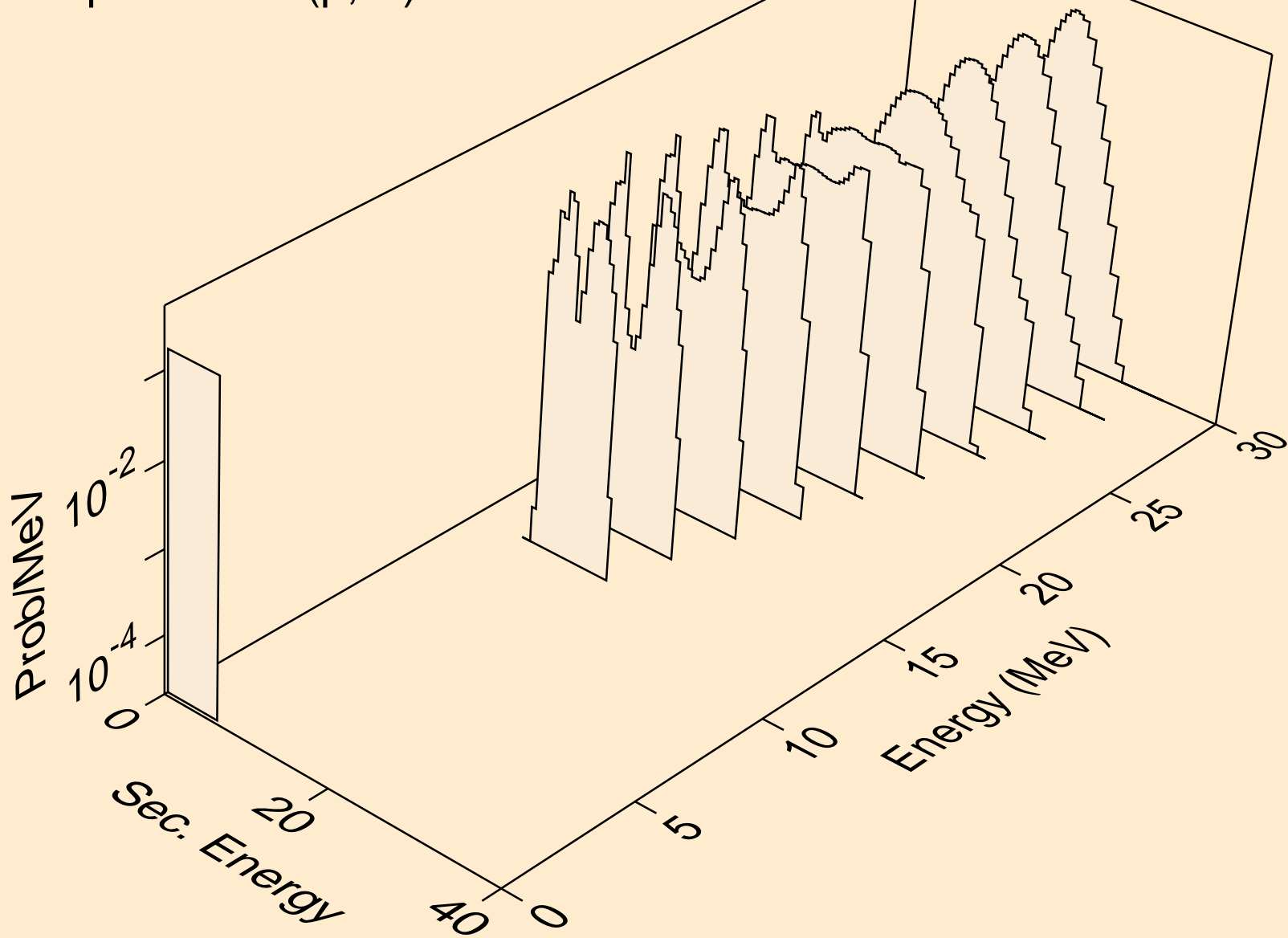

RN227 PROTON ACER TENDL-2021 LIBRARY; T=0.K
alphas from (p,npa)

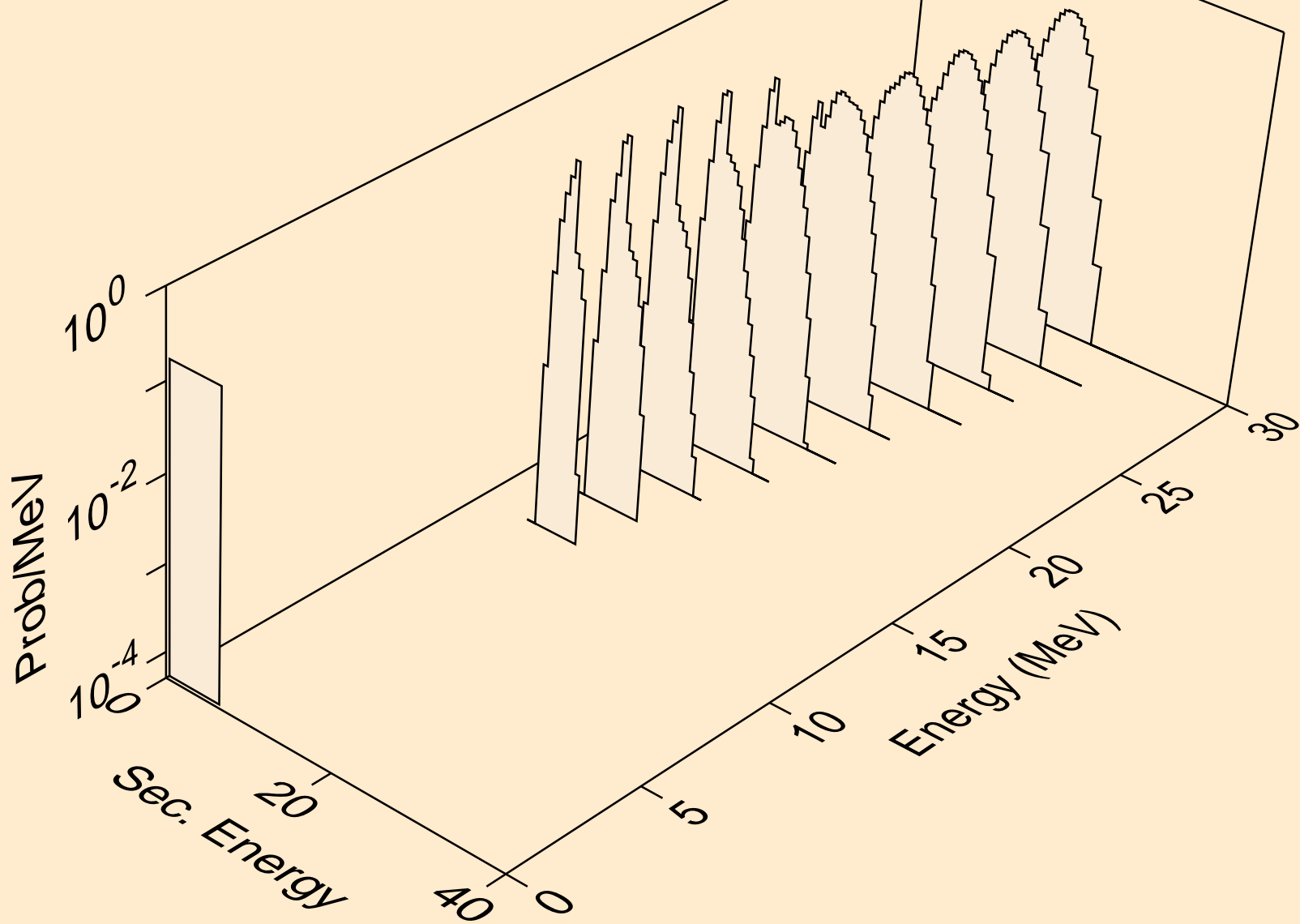

RN227 PROTON ACER TENDL-2021 LIBRARY; T=0.K
alphas from (p,a)

