

SE078 PROTON ACER TENDL-2021 LIBRARY; T=0.K  
Principal cross sections

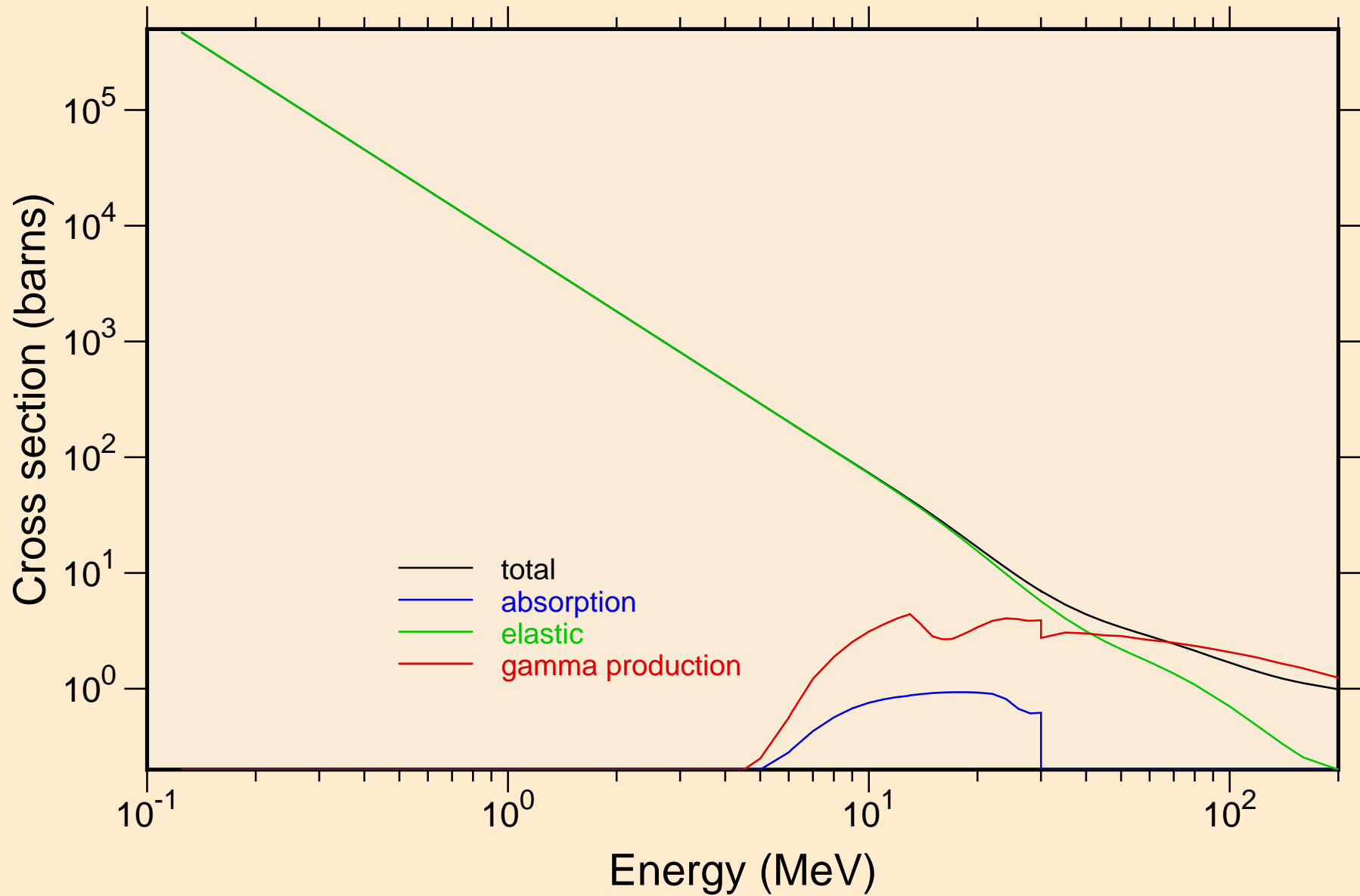

# SE078 PROTON ACER TENDL-2021 LIBRARY; T=0.K

## Heating

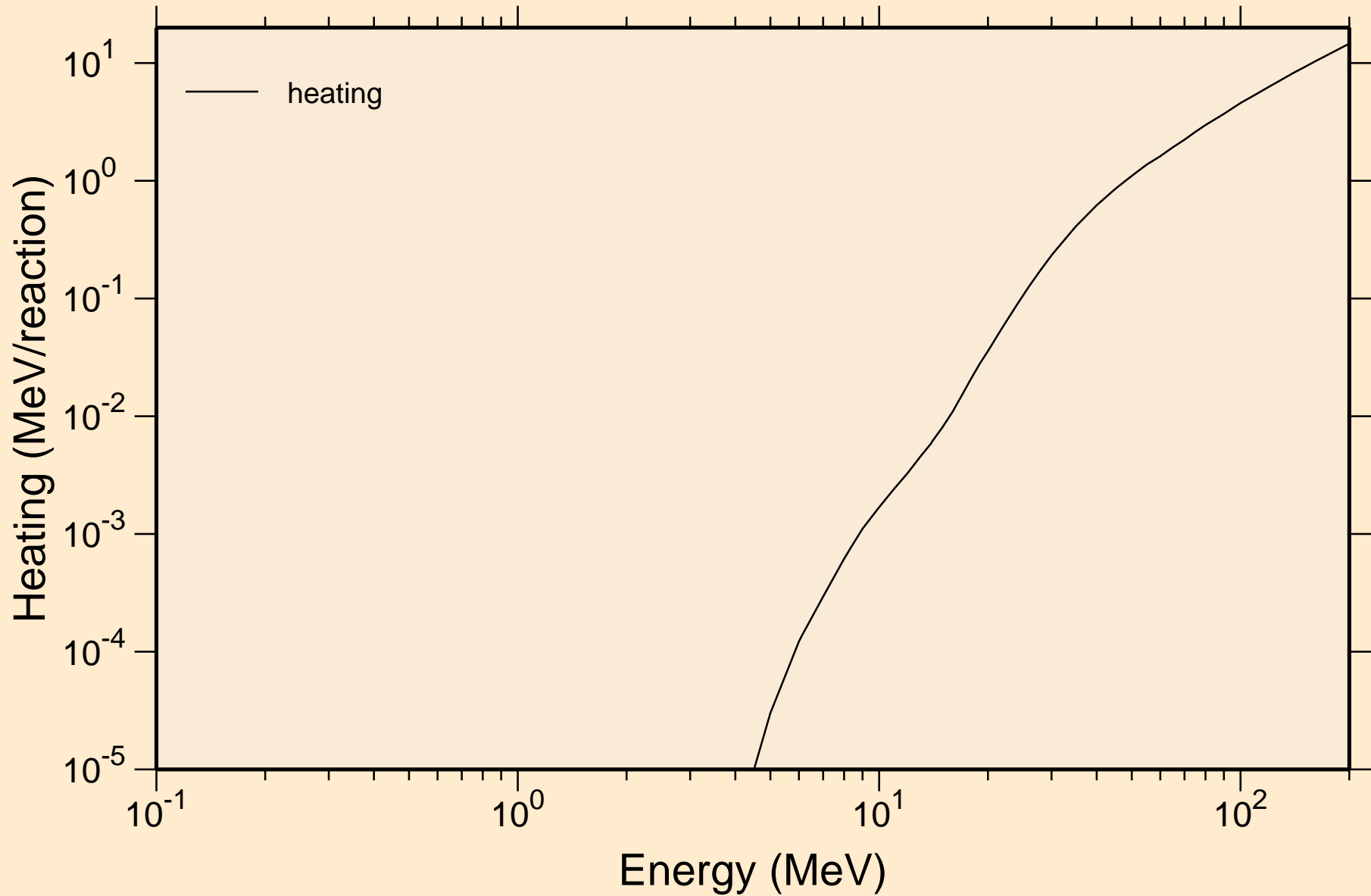

# SE078 PROTON ACER TENDL-2021 LIBRARY; T=0.K

## Principal cross sections

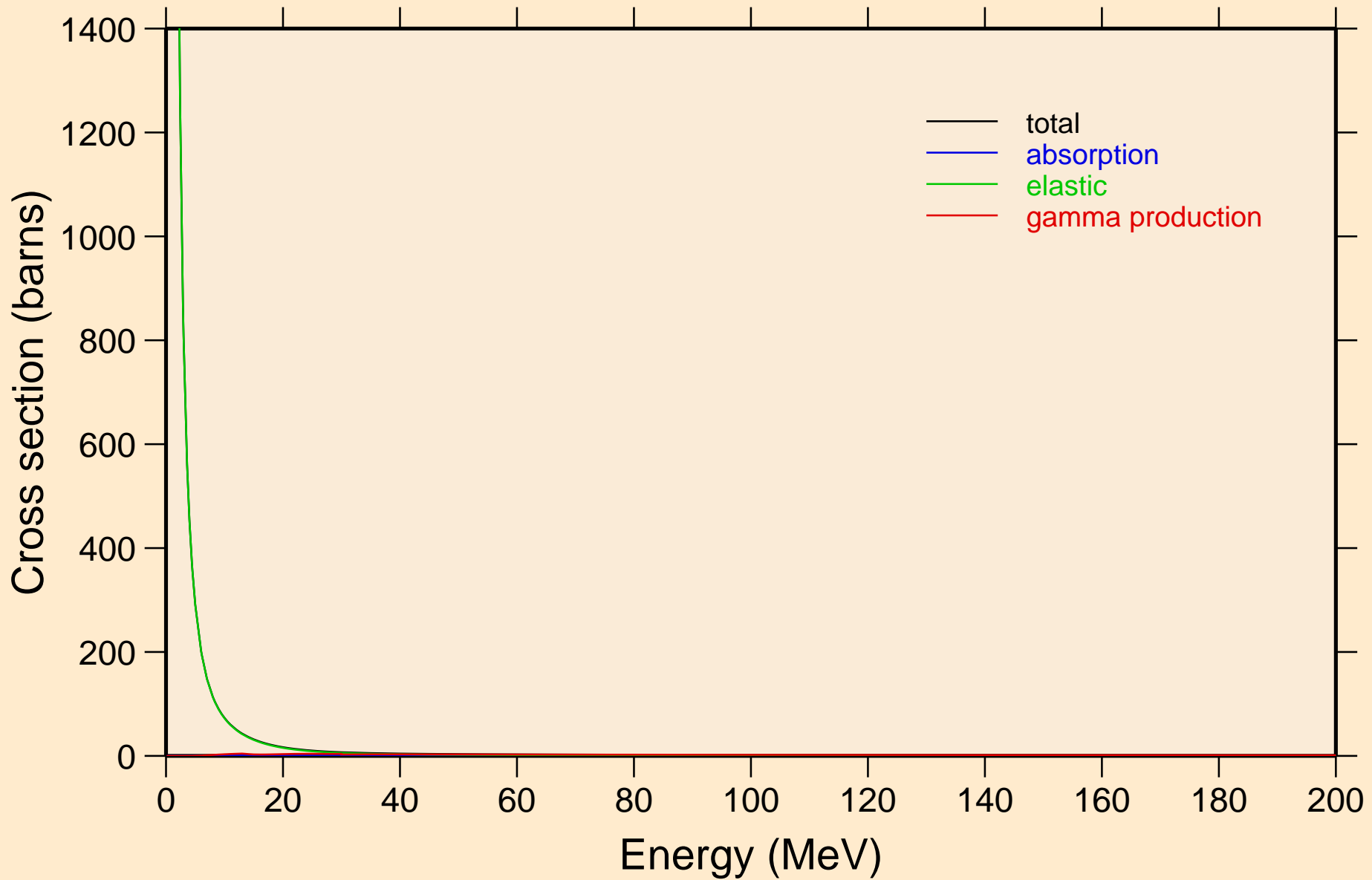

SE078 PROTON ACER TENDL-2021 LIBRARY; T=0.K

Heating

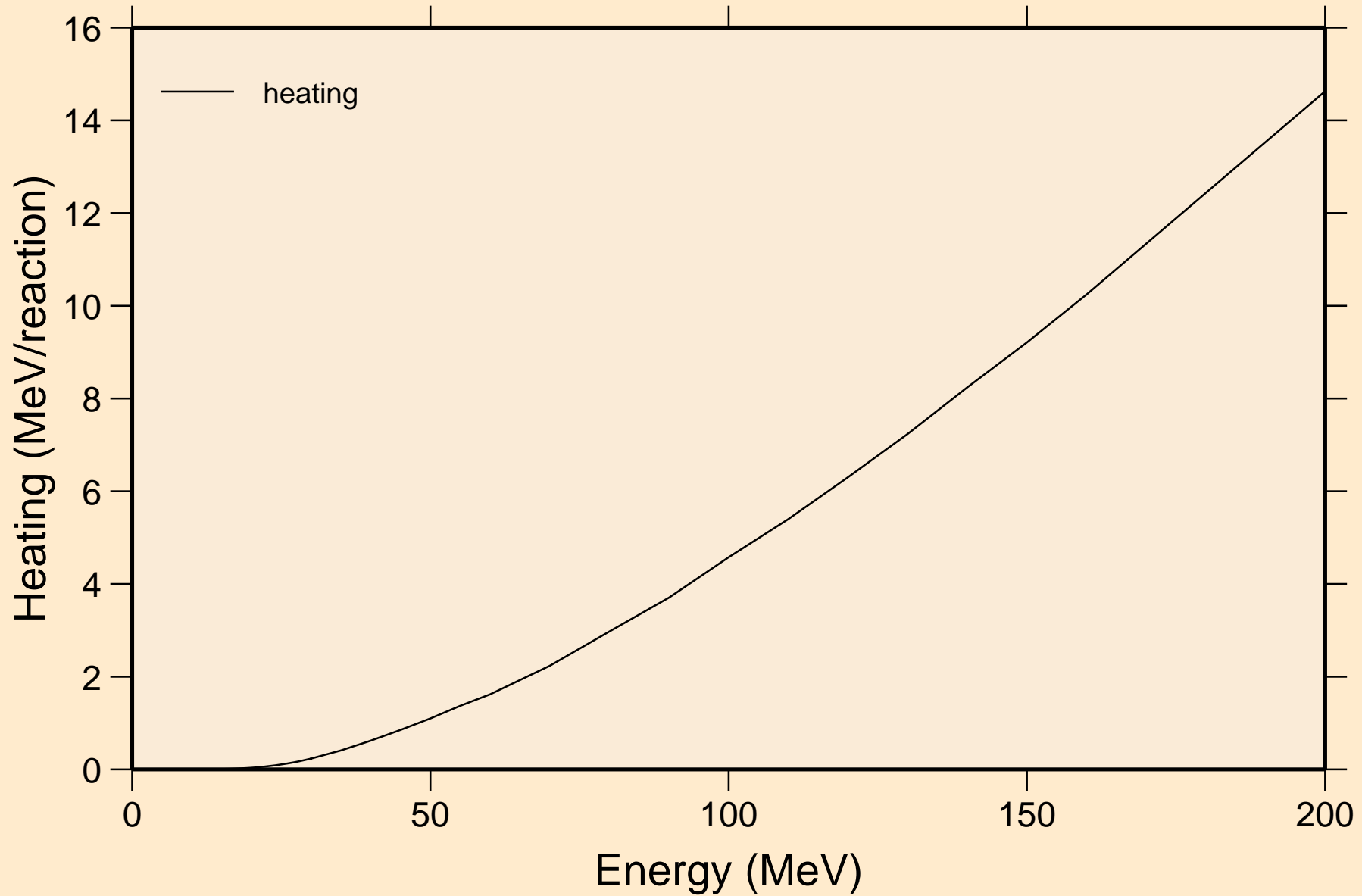

# SE078 PROTON ACER TENDL-2021 LIBRARY; T=0.K

## Threshold reactions

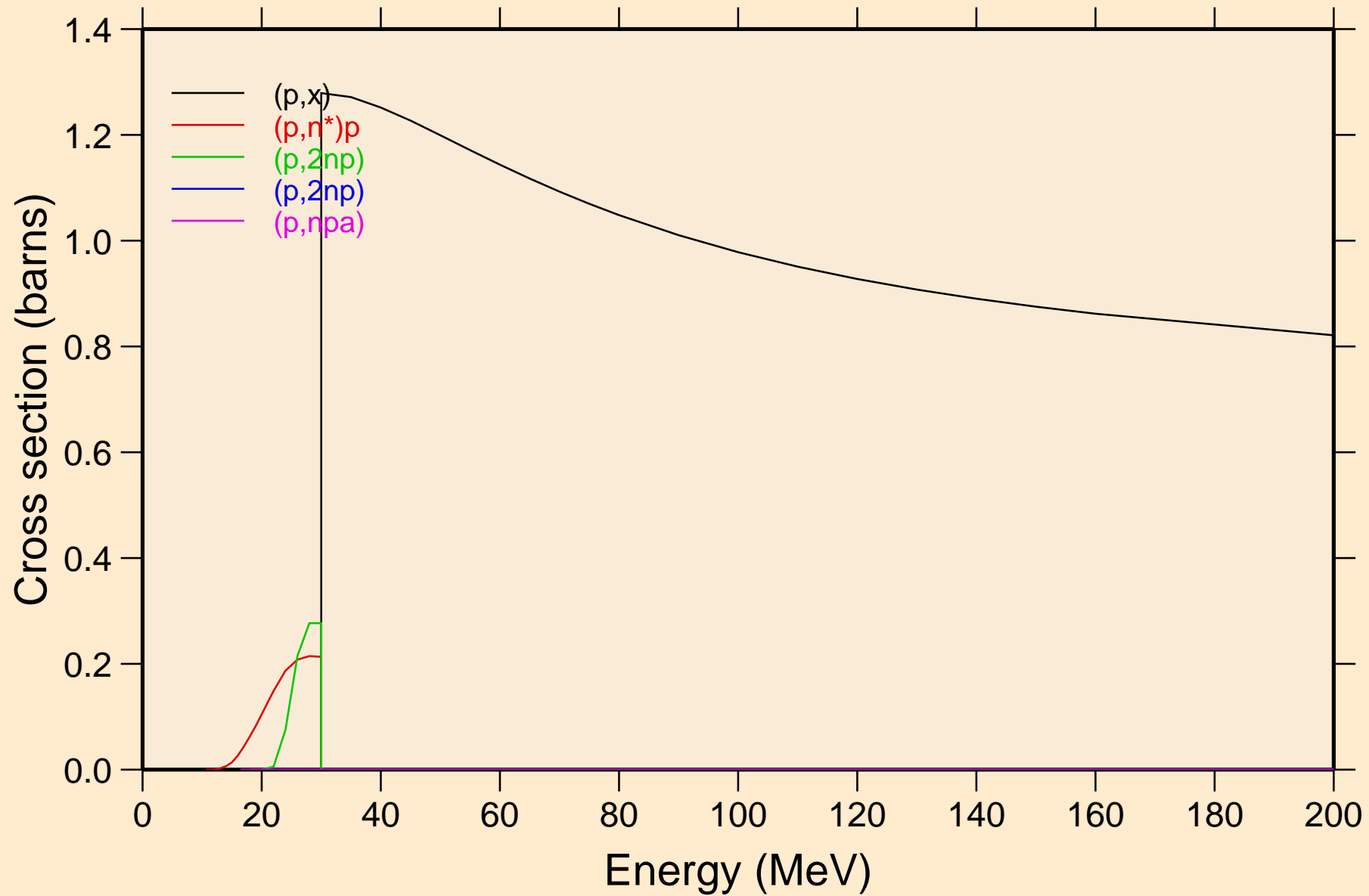

SE078 PROTON ACER TENDL-2021 LIBRARY; T=0.K  
Threshold reactions

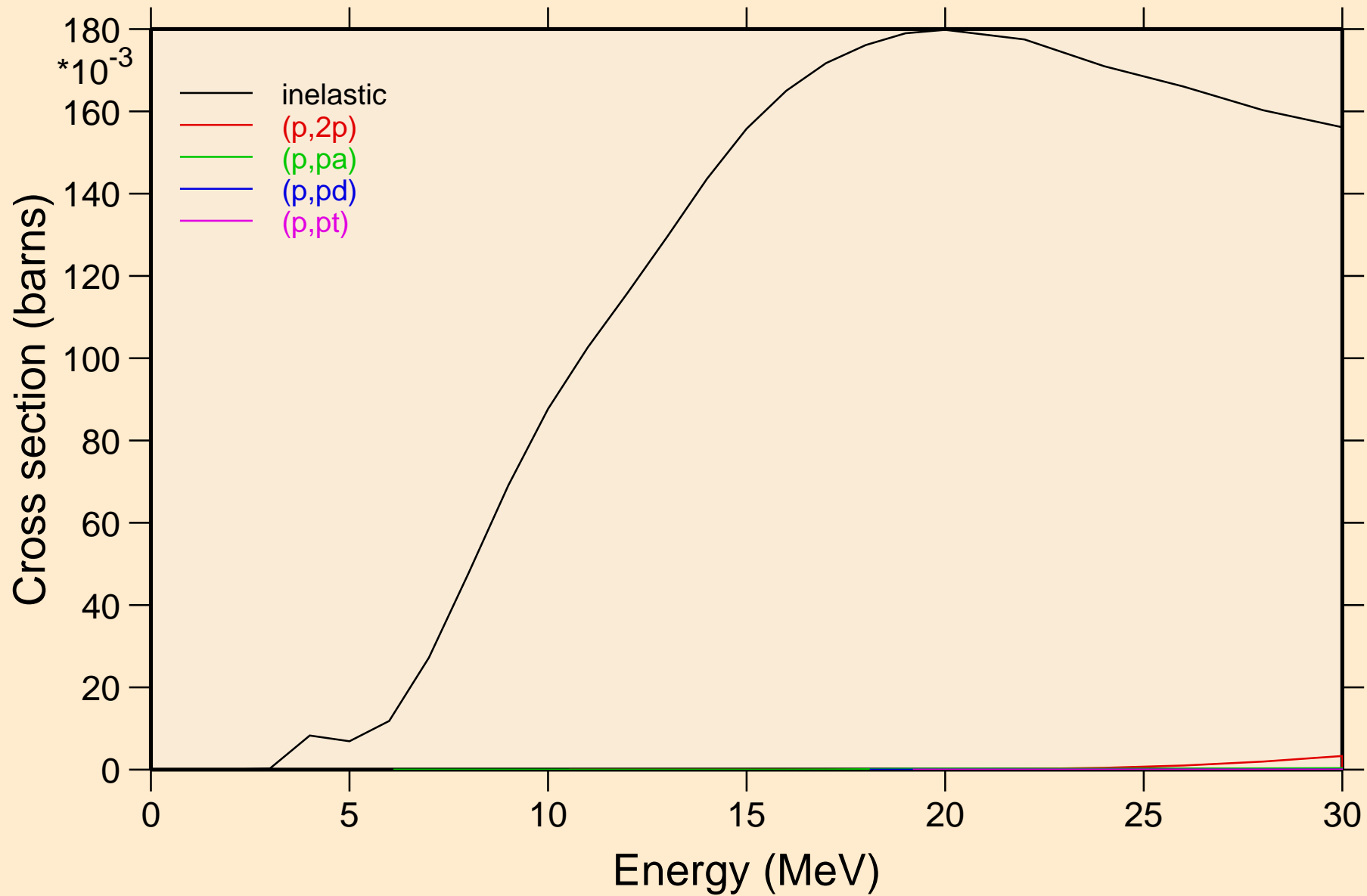

SE078 PROTON ACER TENDL-2021 LIBRARY; T=0.K  
Threshold reactions

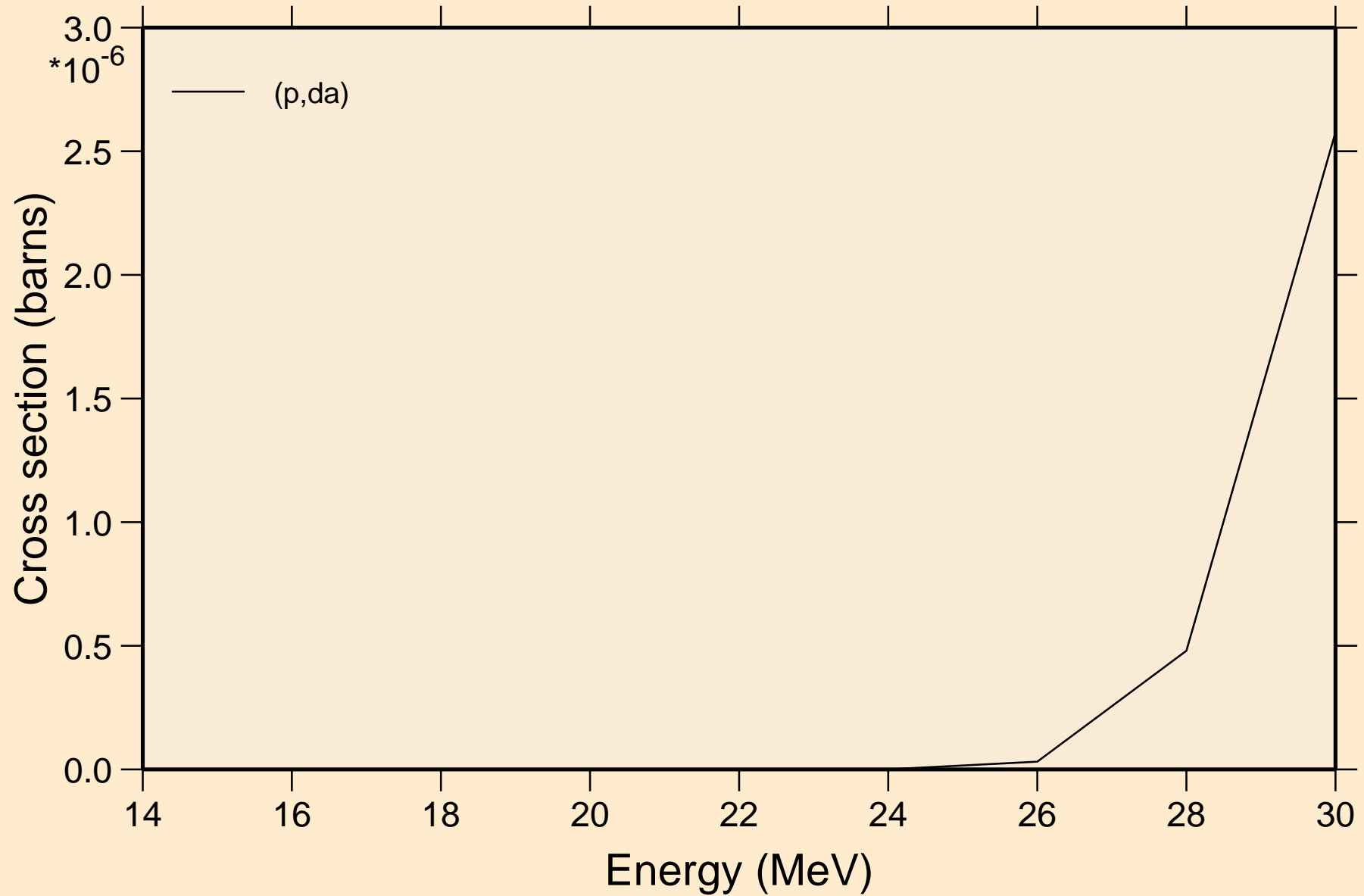

SE078 PROTON ACER TENDL-2021 LIBRARY; T=0.K  
angular distribution for elastic

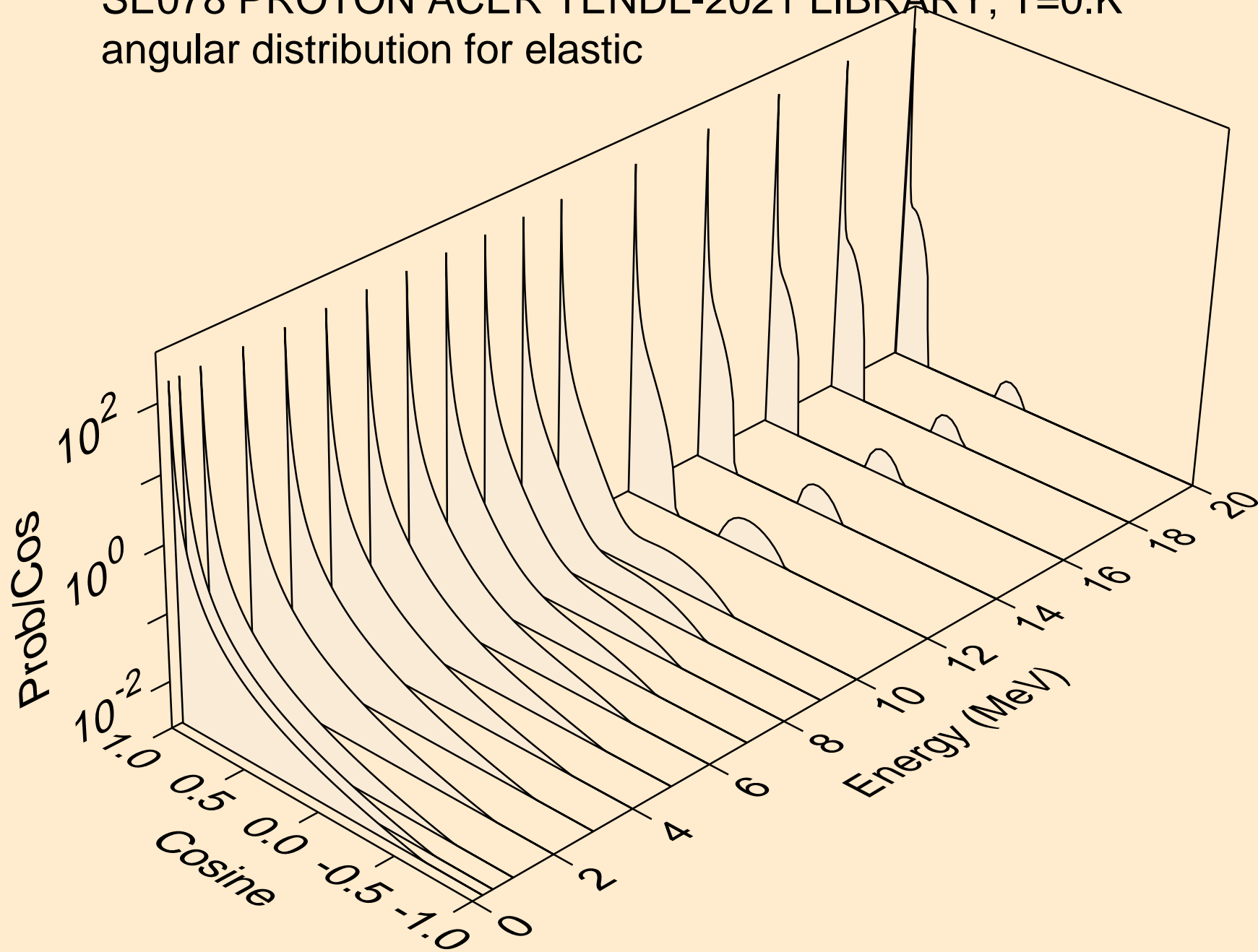



SE078 PROTON ACER TENDL-2021 LIBRARY; T=0.K  
angular distribution for elastic

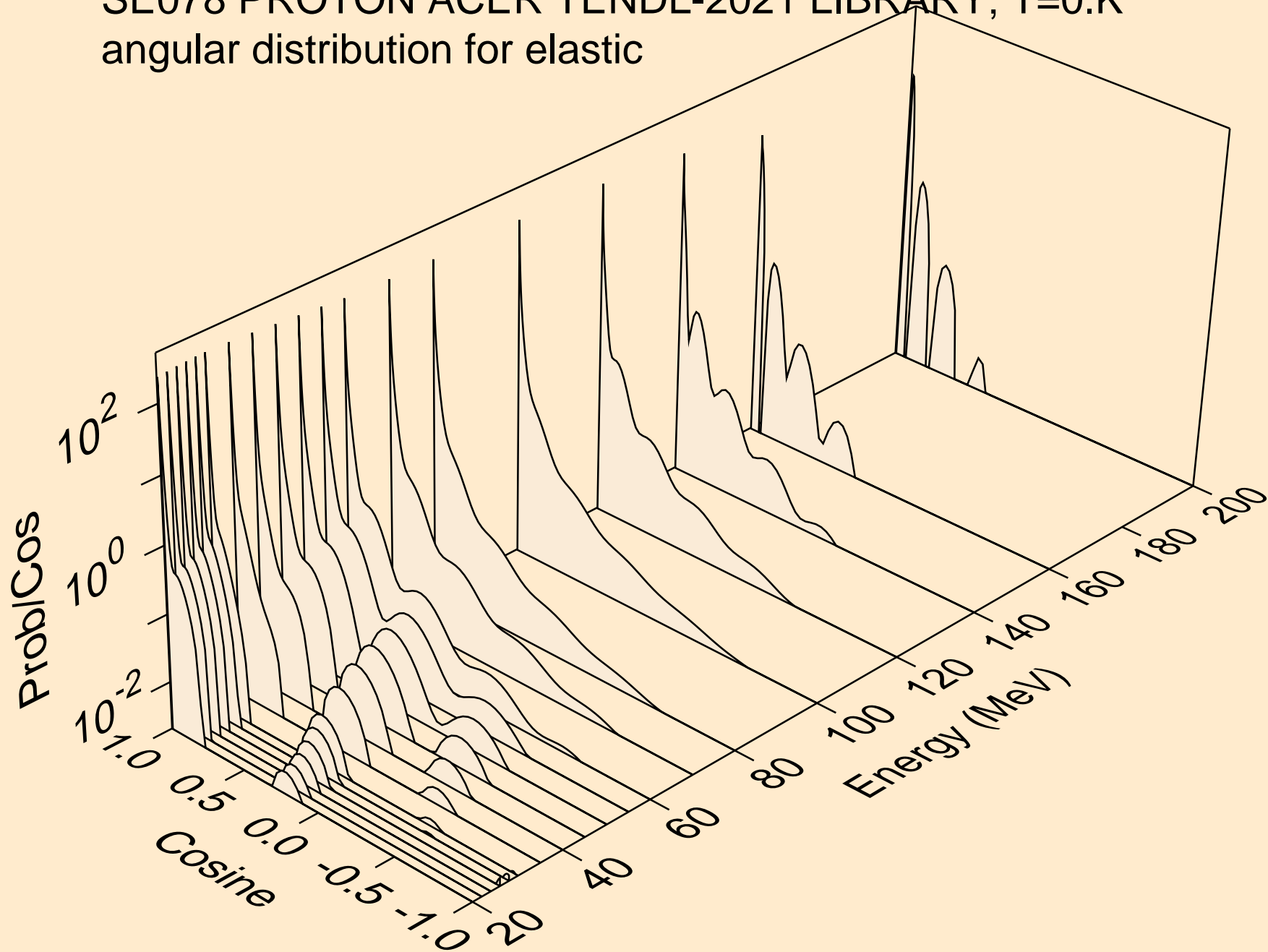

SE078 PROTON ACER TENDL-2021 LIBRARY; T=0.K  
Proton emission for (p,x)

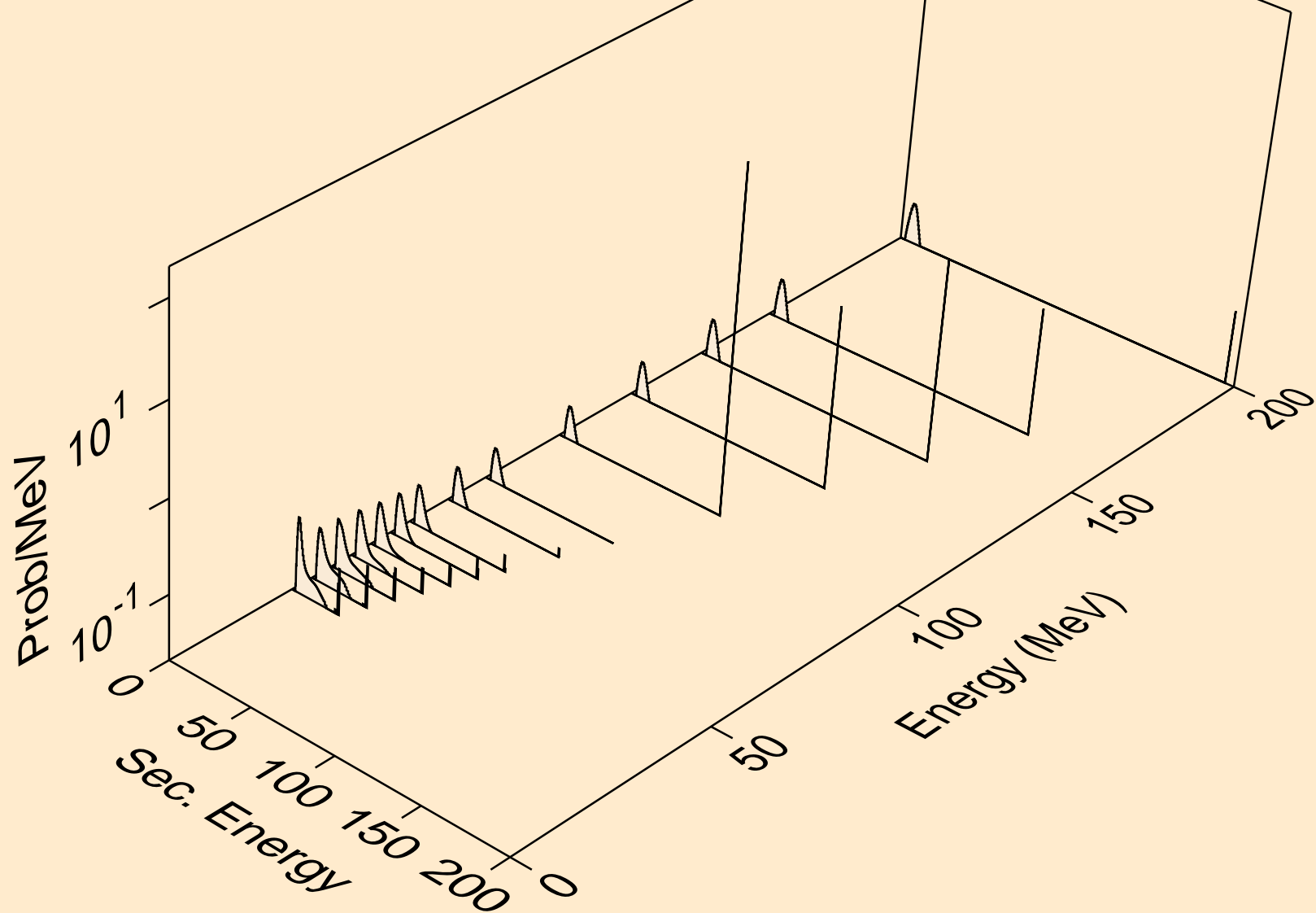

SE078 PROTON ACER TENDL-2021 LIBRARY; T=0.K  
Proton emission for (p,n\*)p

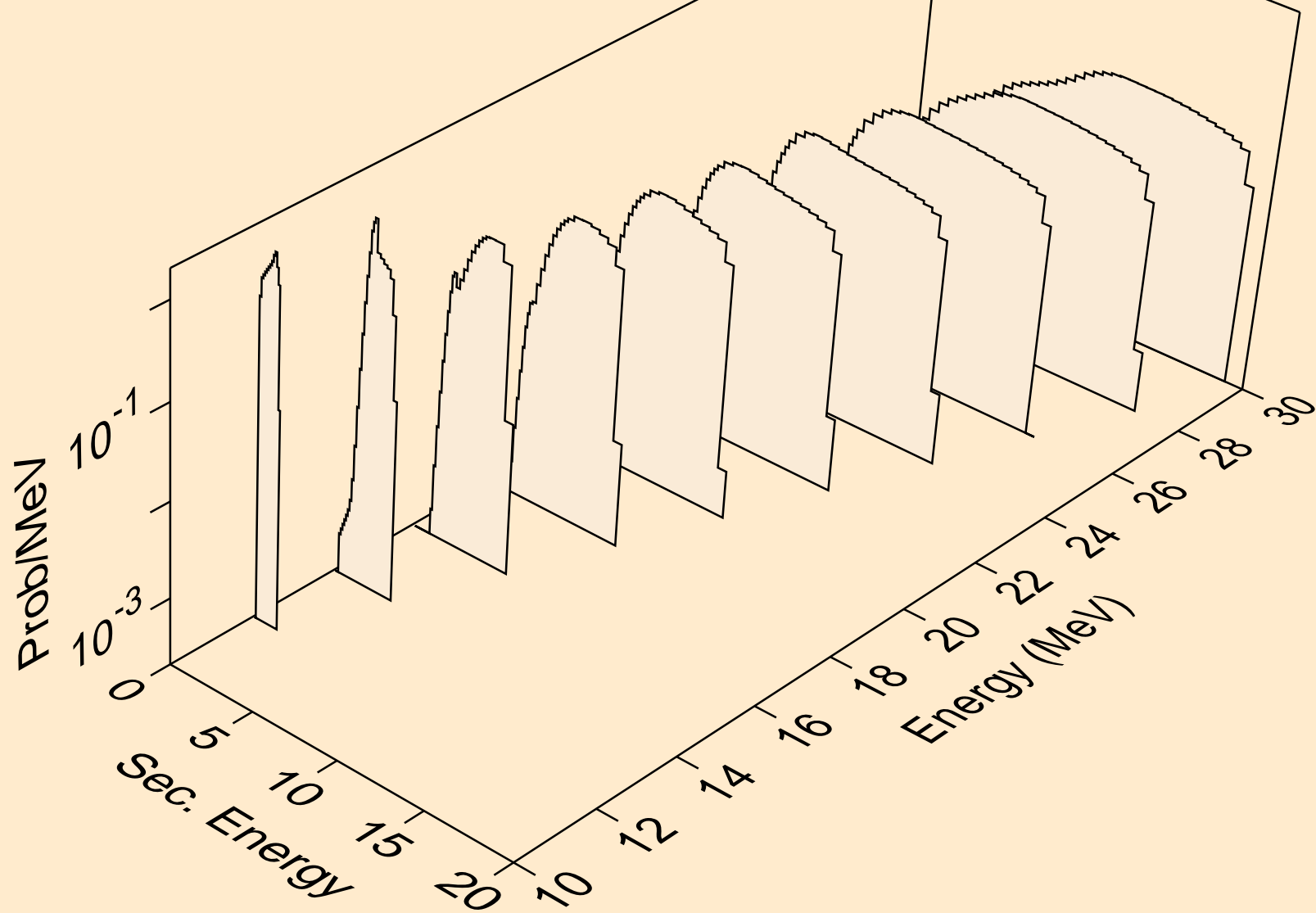

SE078 PROTON ACER TENDL-2021 LIBRARY; T=0.K  
Proton emission for (p,2np)

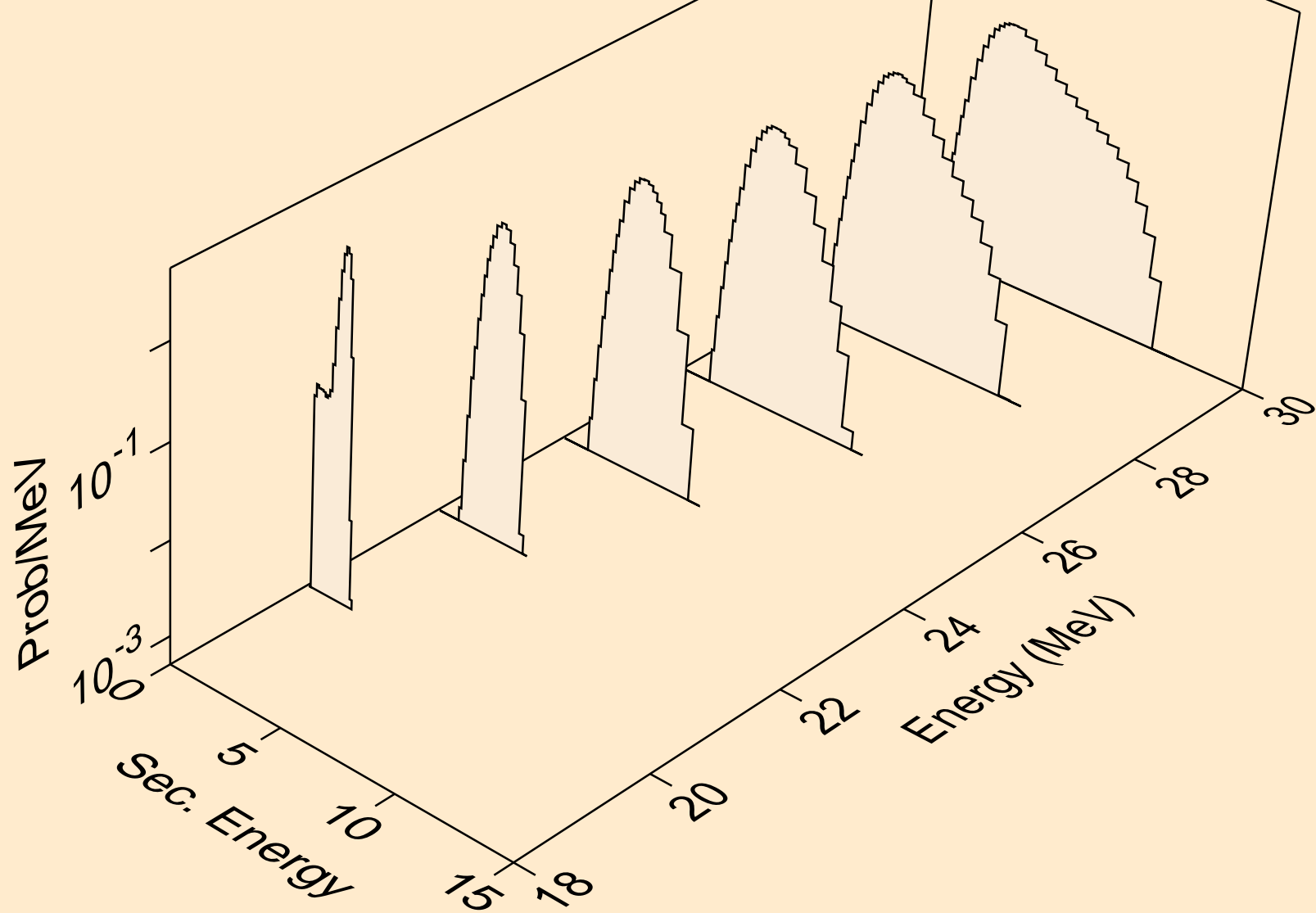

SE078 PROTON ACER TENDL-2021 LIBRARY; T=0.K  
Proton emission for (p,2np)

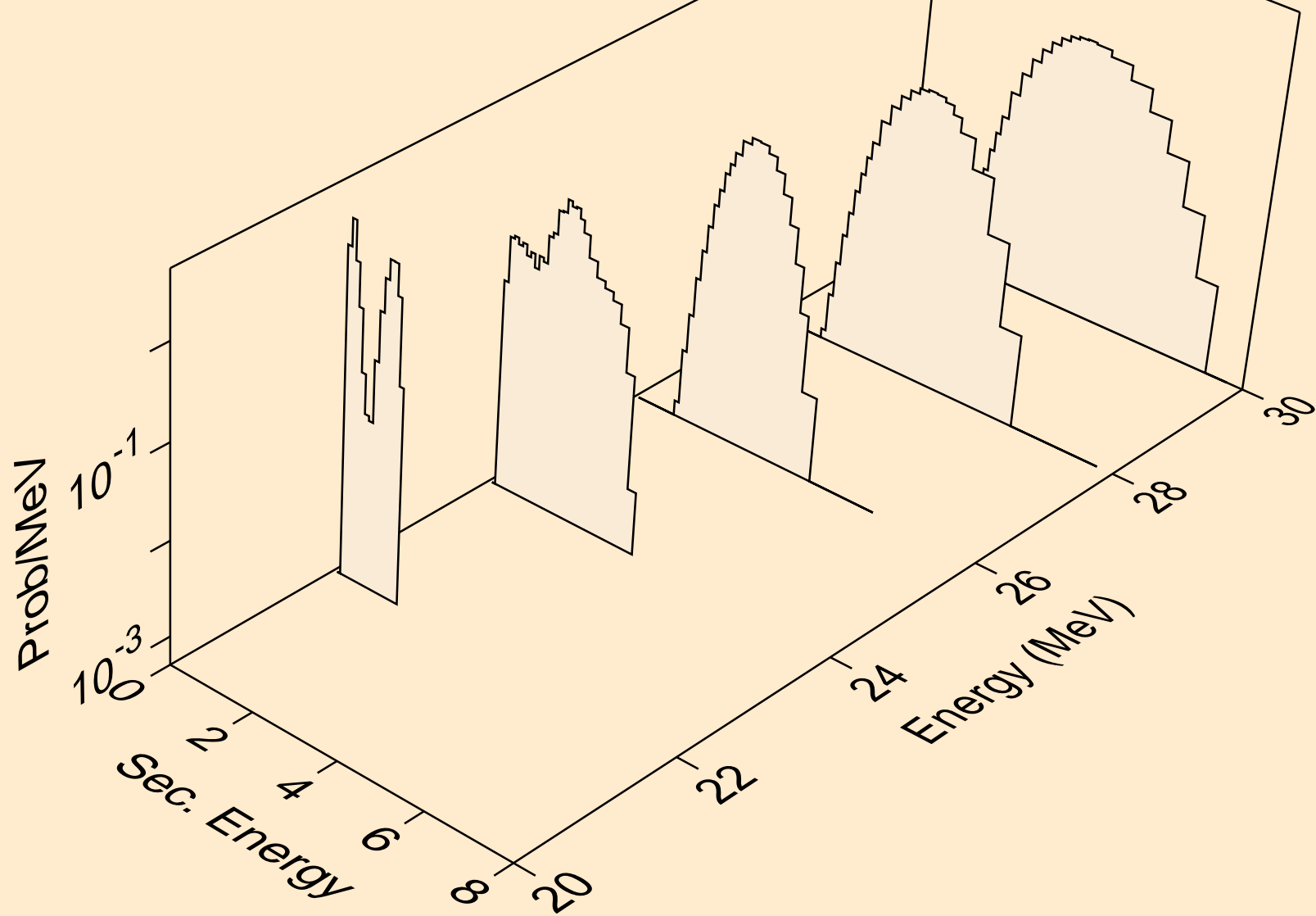

SE078 PROTON ACER TENDL-2021 LIBRARY; T=0.K  
Proton emission for (p,npa)

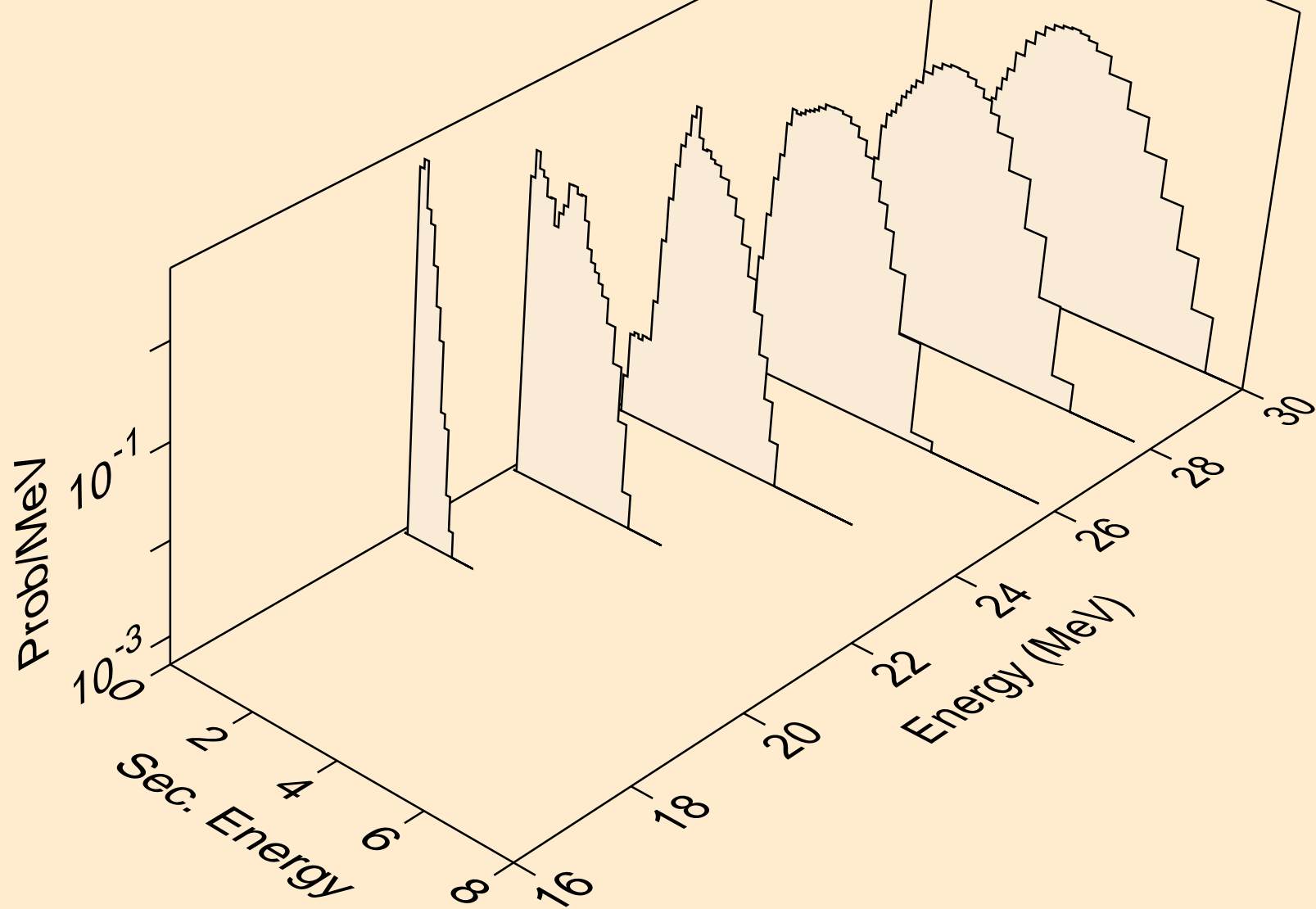

SE078 PROTON ACER TENDL-2021 LIBRARY; T=0.K  
Proton emission for inelastic

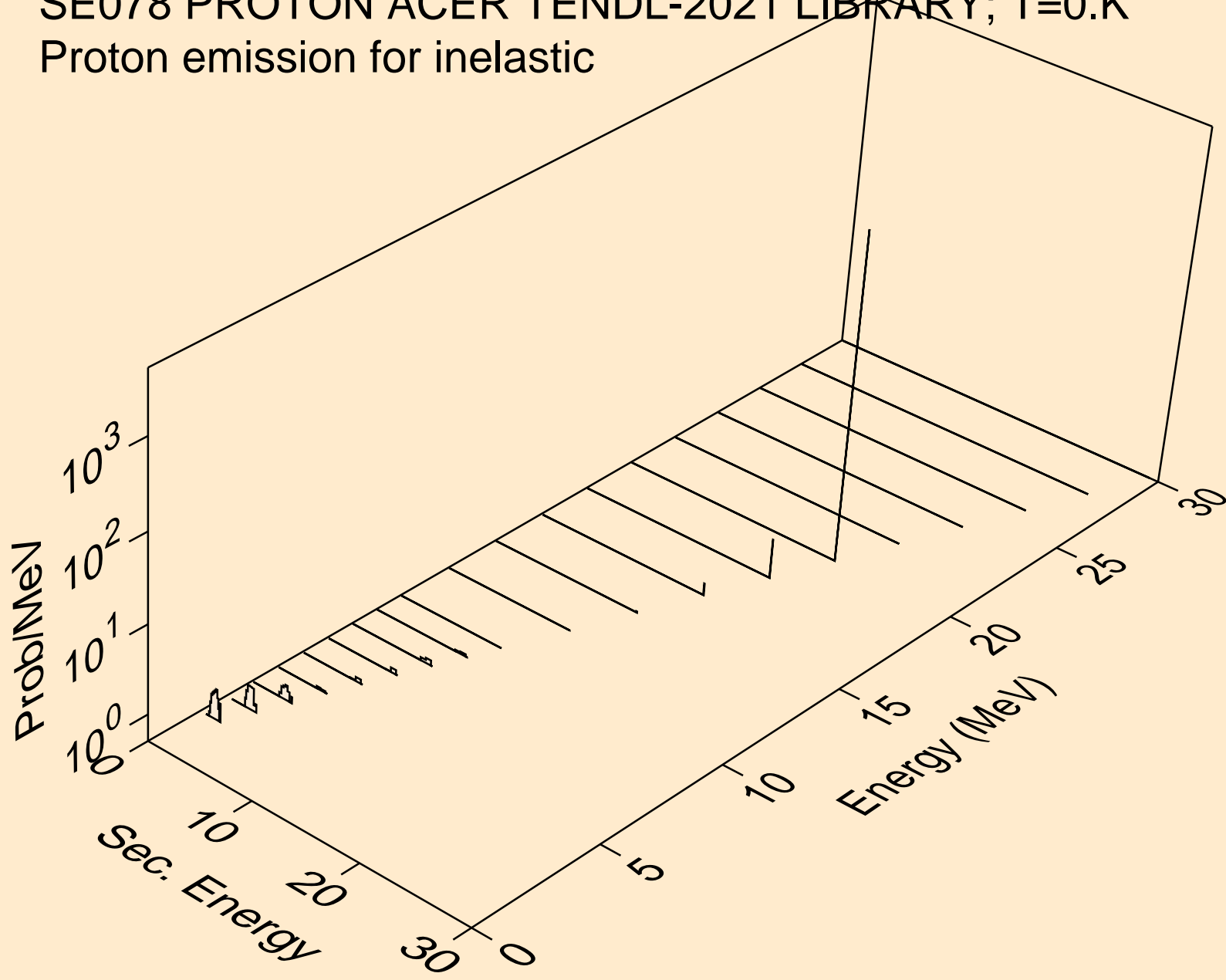

SE078 PROTON ACER TENDL-2021 LIBRARY; T=0.K  
Proton emission for (p,2p)

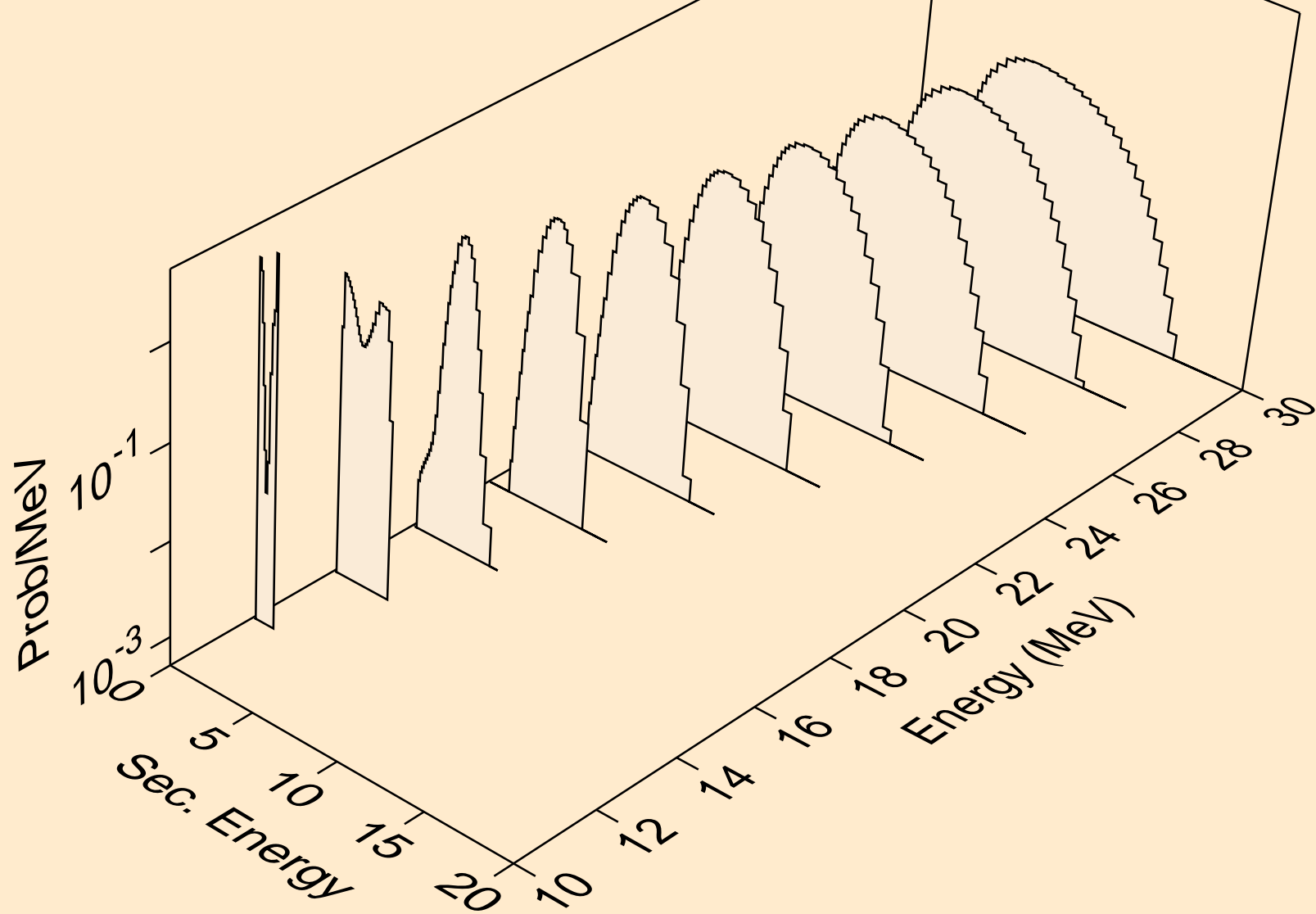



SE078 PROTON ACER TENDL-2021 LIBRARY; T=0.K  
Proton emission for (p,pa)

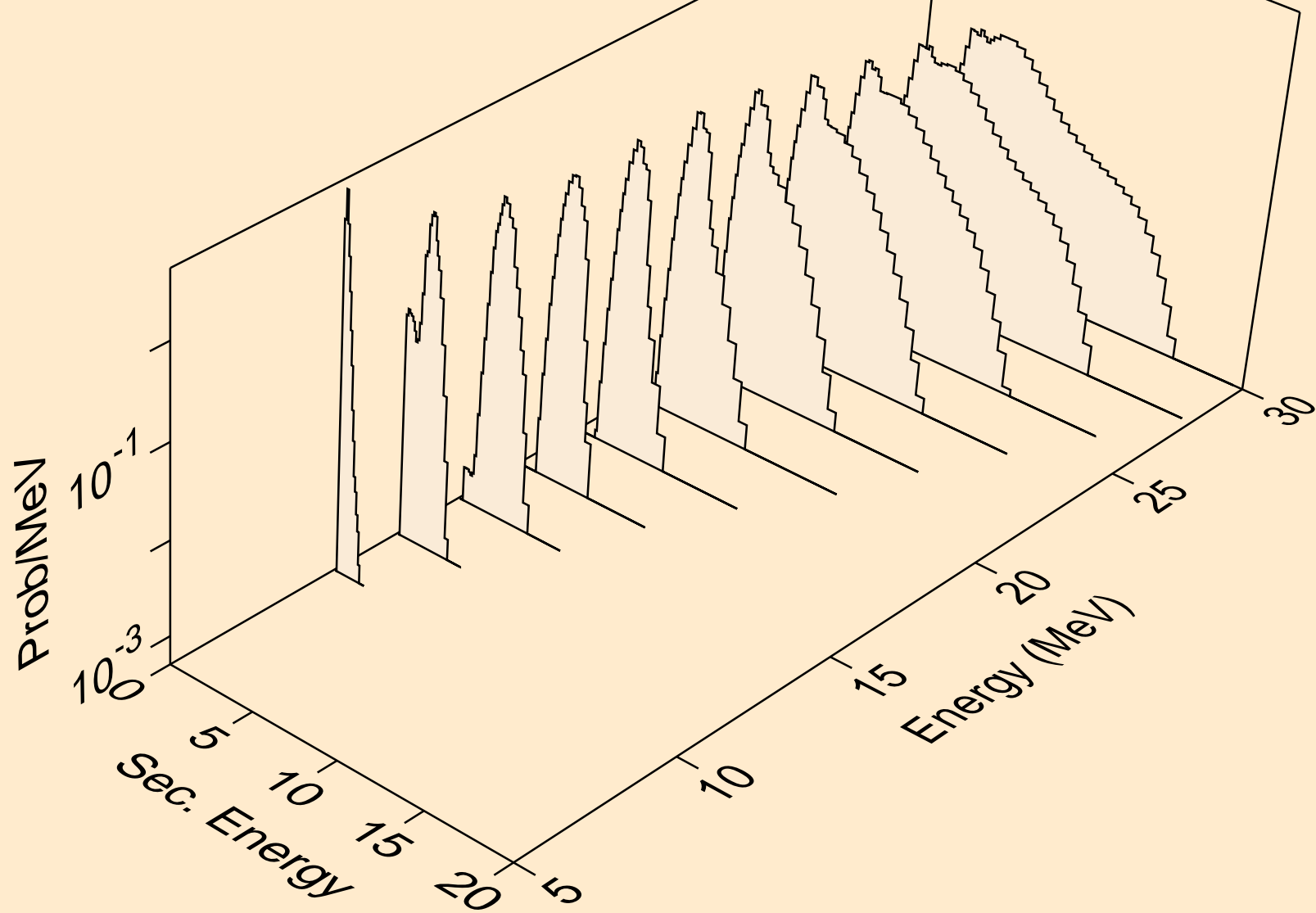

SE078 PROTON ACER TENDL-2021 LIBRARY; T=0.K  
Proton emission for (p,pd)

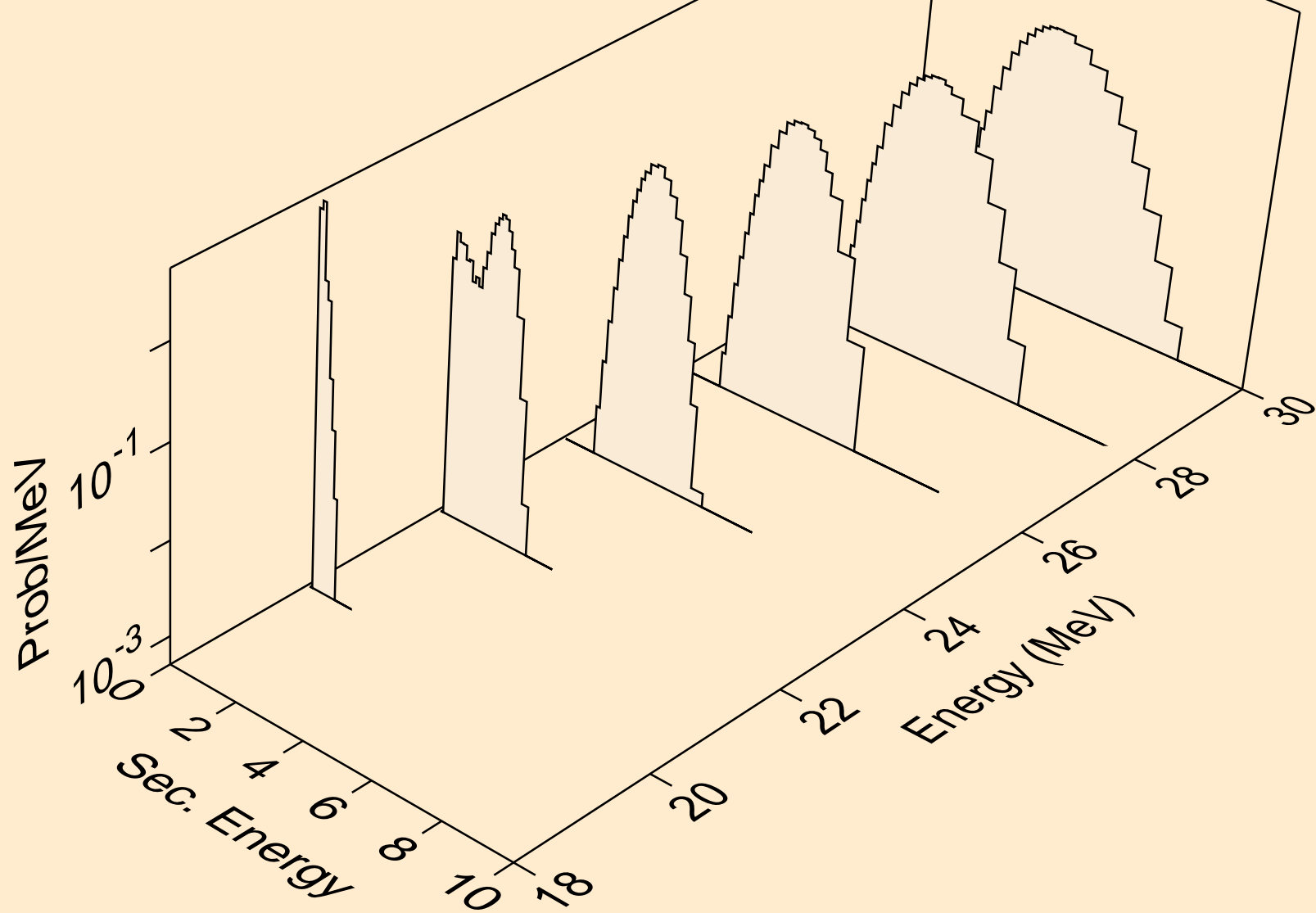

SE078 PROTON ACER TENDL-2021 LIBRARY; T=0.K  
Proton emission for (p,pt)

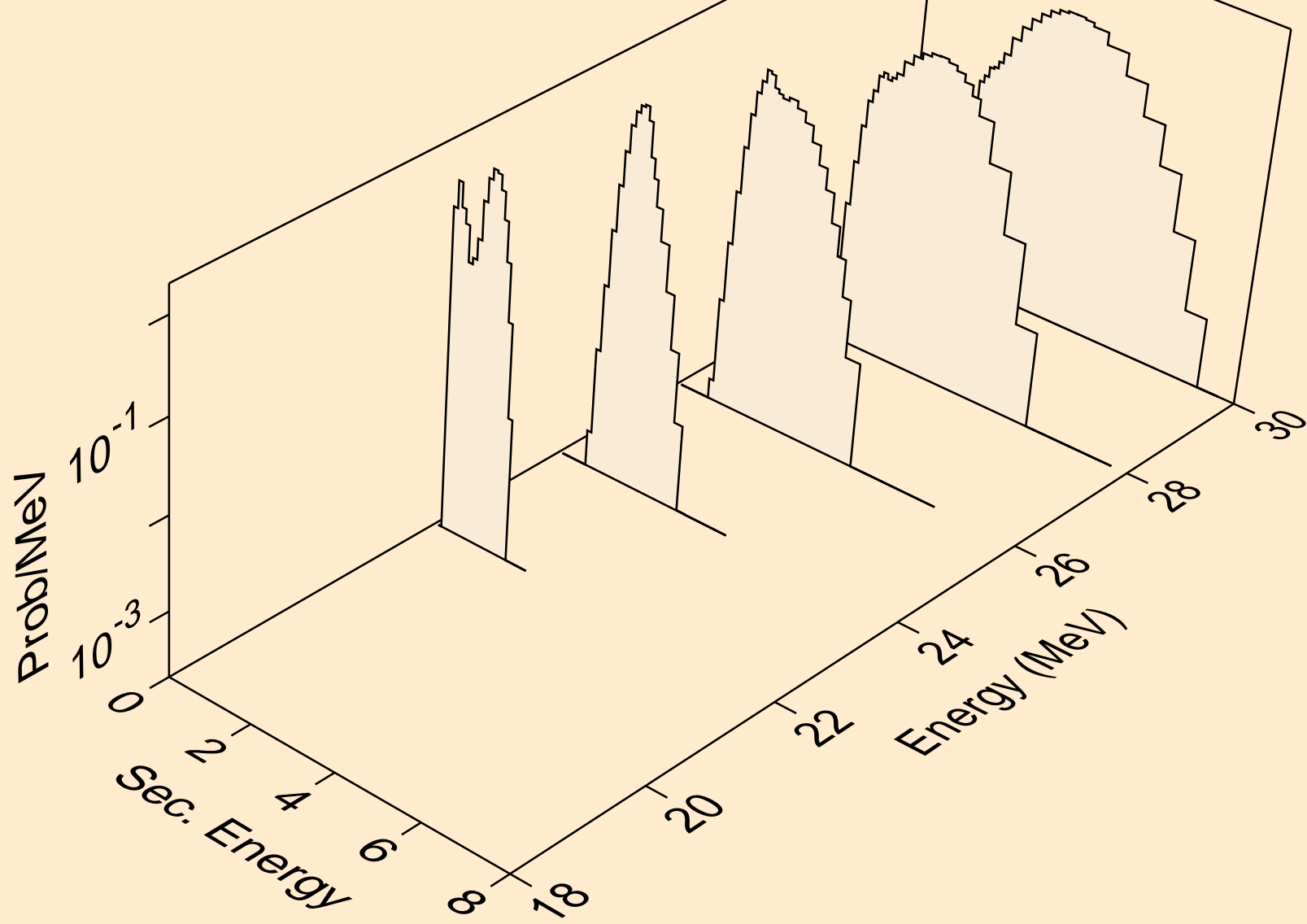

SE078 PROTON ACER TENDL-2021 LIBRARY; T=0.K  
Photon emission for (z,n)

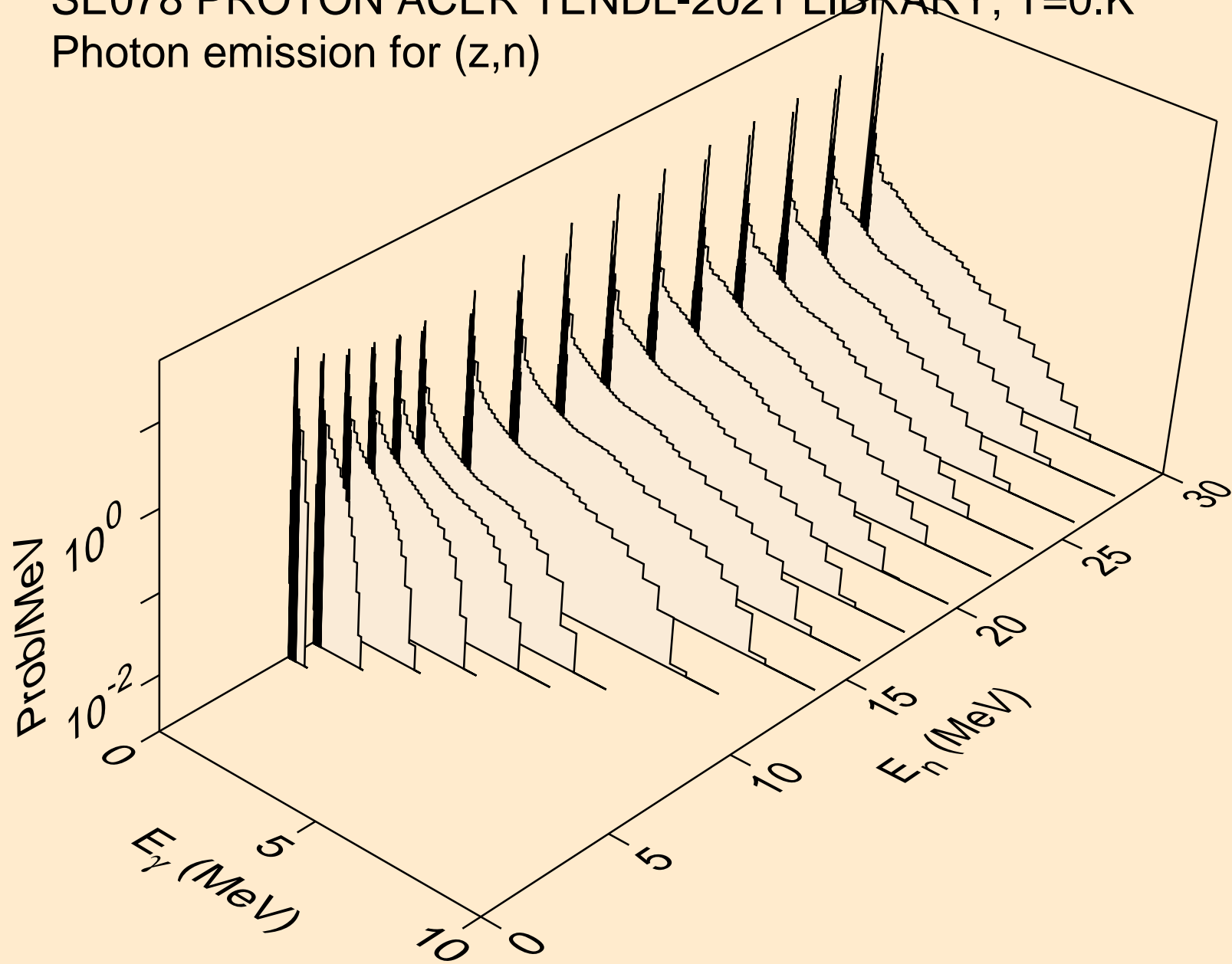

SE078 PROTON ACER TENDL-2021 LIBRARY; T=0.K  
Photon emission for (n,x)

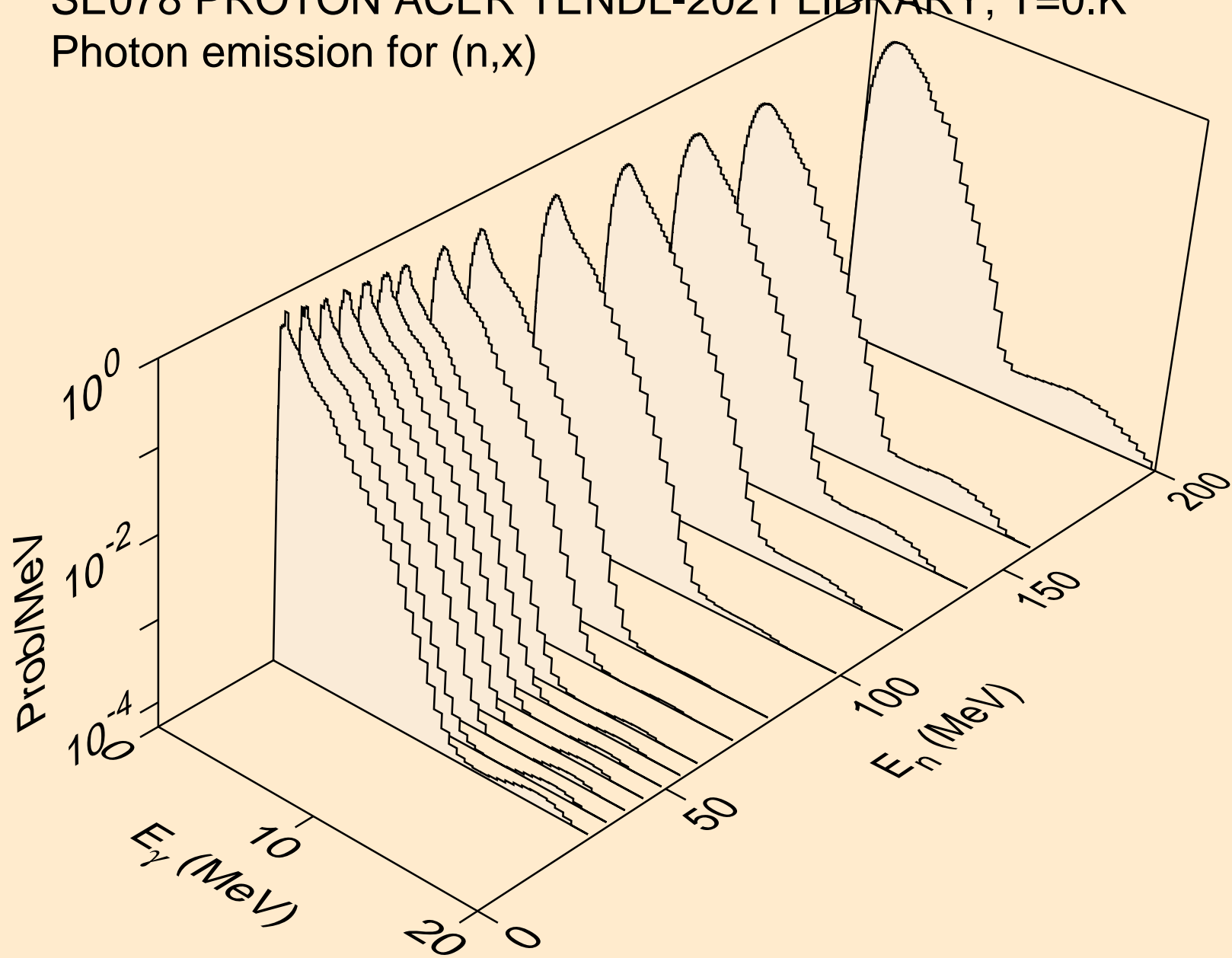

SE078 PROTON ACER TENDL-2021 LIBRARY; T=0.K  
Photon emission for (n,2nd)

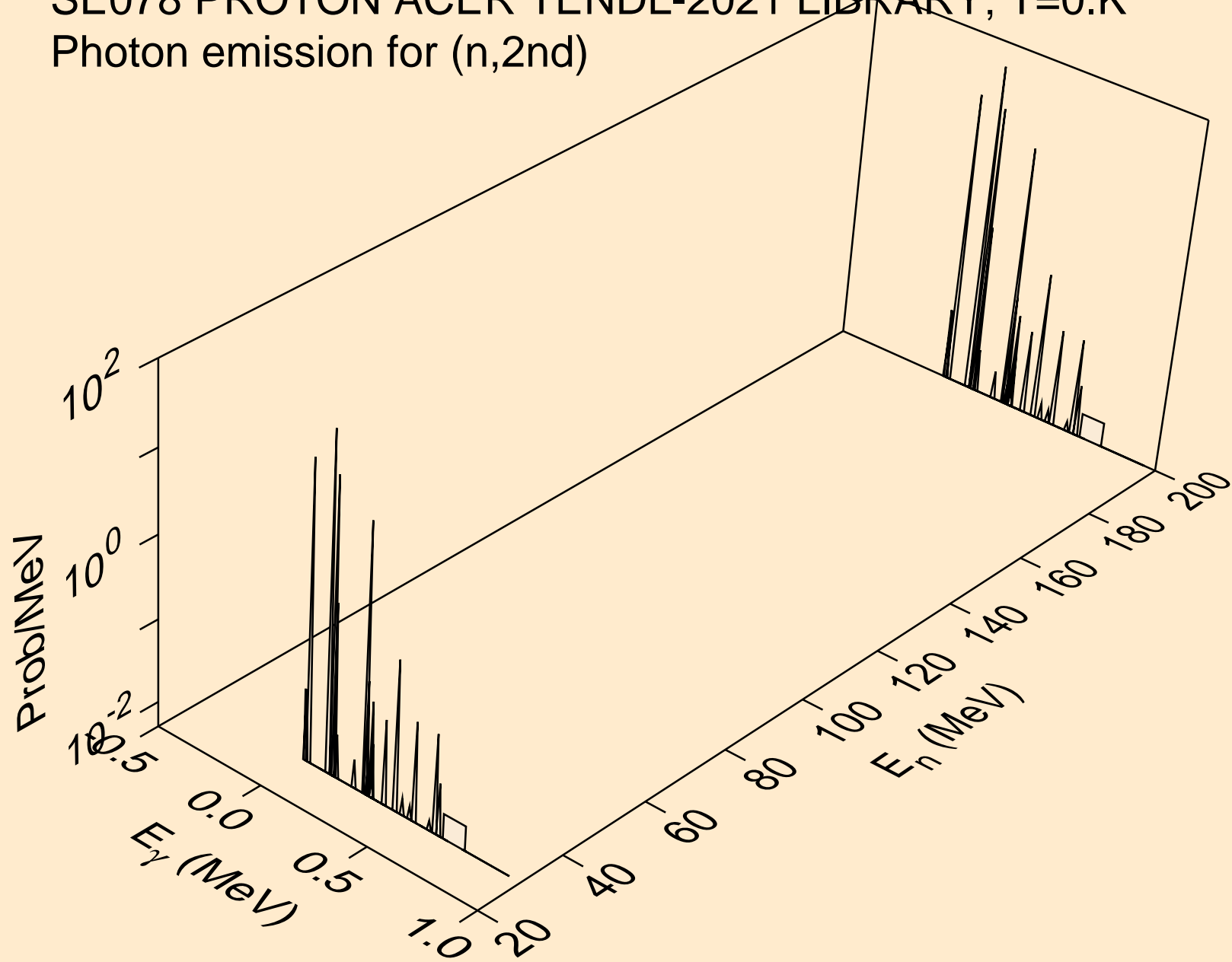

SE078 PROTON ACER TENDL-2021 LIBRARY; T=0.K  
Photon emission for (n,2n)

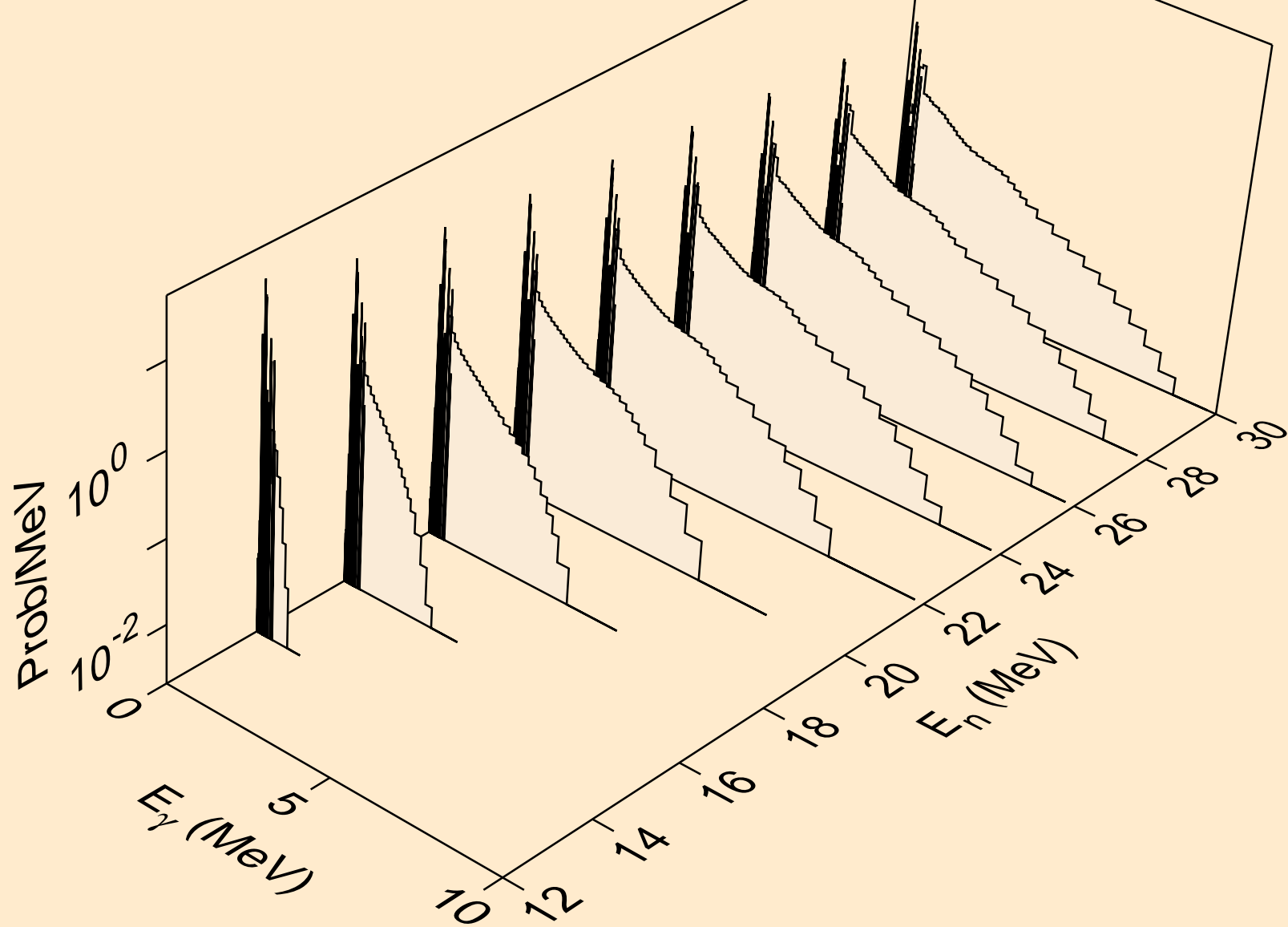

SE078 PROTON ACER TENDL-2021 LIBRARY; T=0.K  
Photon emission for (n,3n)

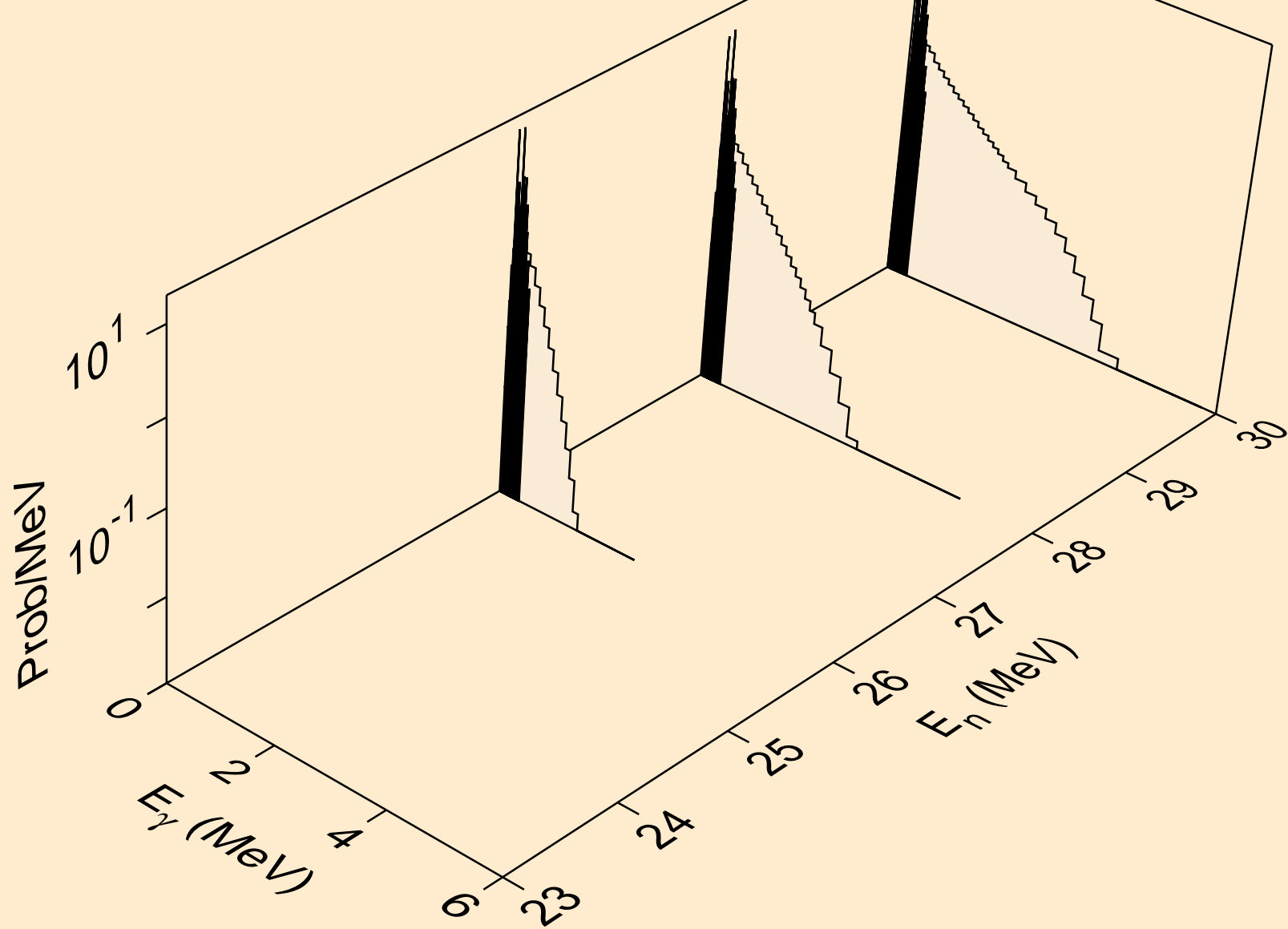



SE078 PROTON ACER TENDL-2021 LIBRARY; T=0.K  
Photon emission for (n,n\*)a

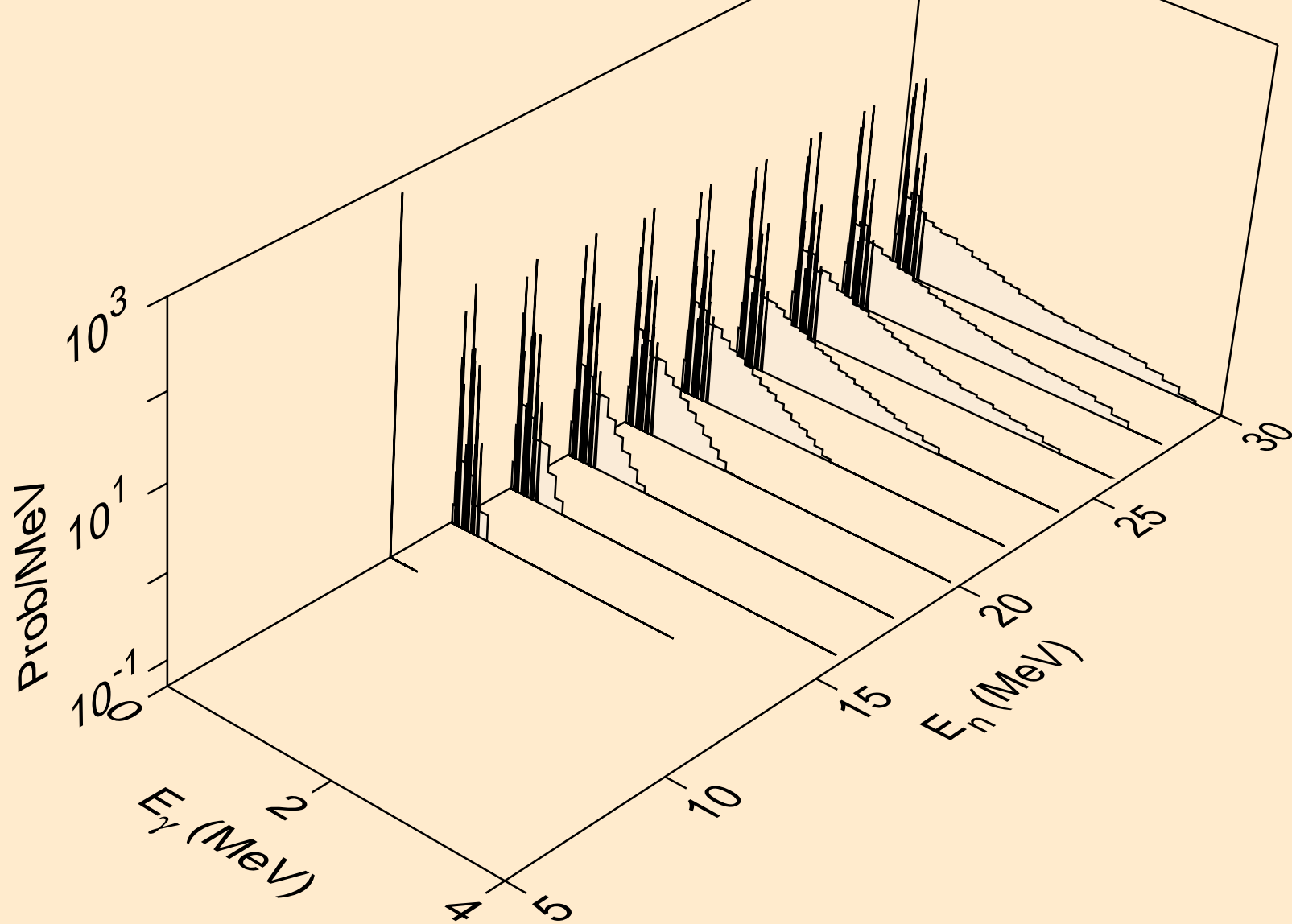

SE078 PROTON ACER TENDL-2021 LIBRARY; T=0.K  
Photon emission for (n,2n)a

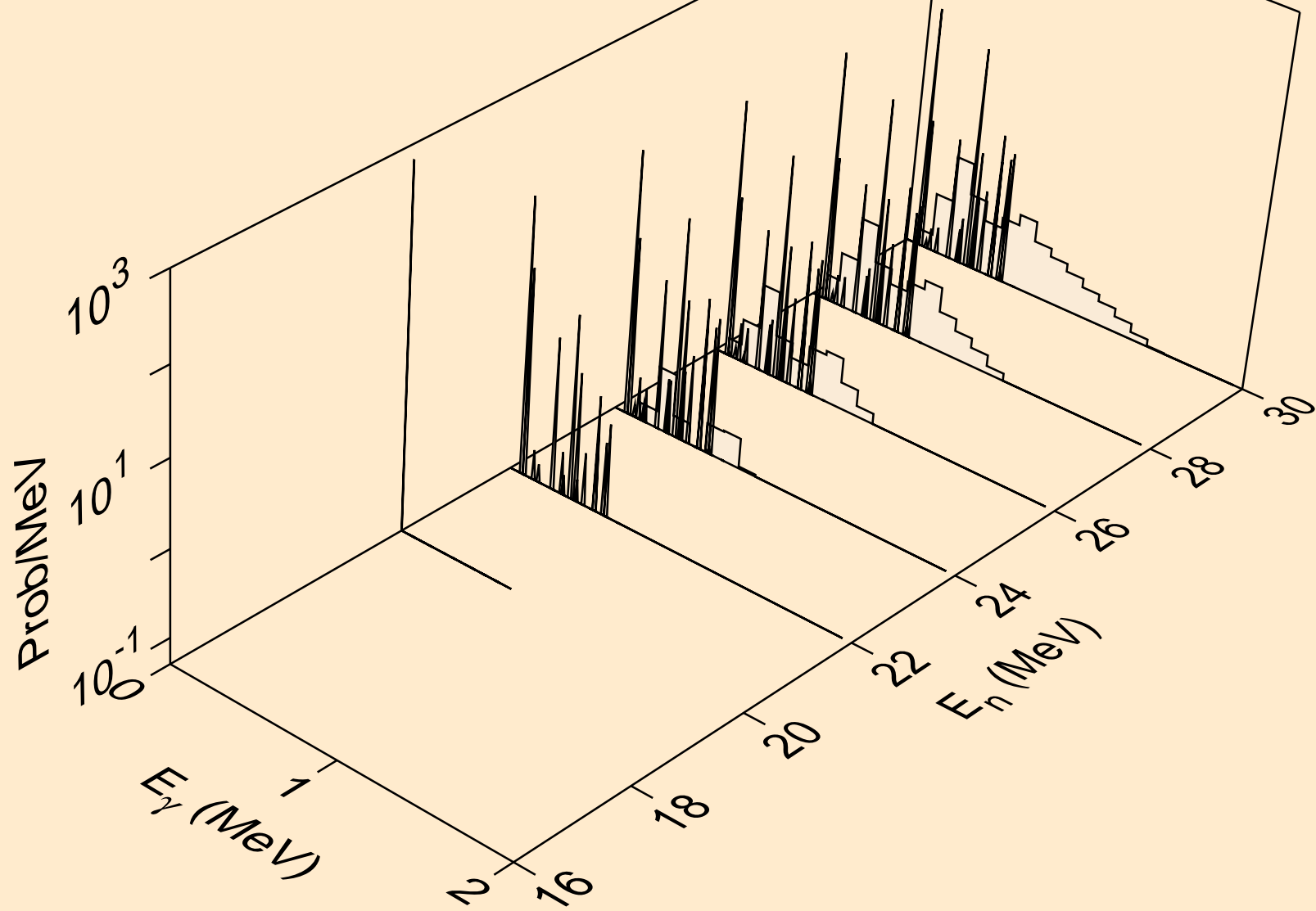

SE078 PROTON ACER TENDL-2021 LIBRARY; T=0.K  
Photon emission for (n,n\*)p

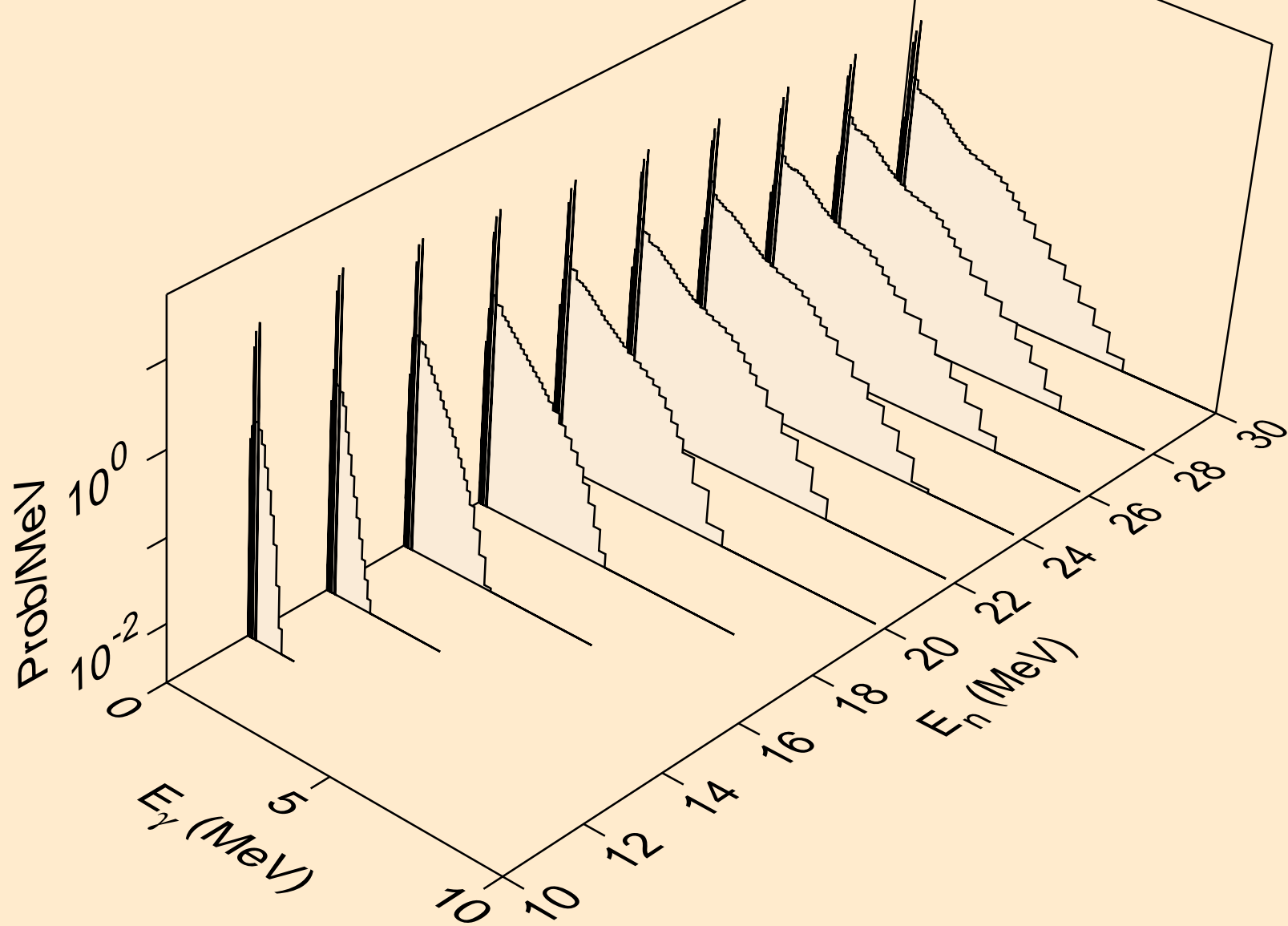

SE078 PROTON ACER TENDL-2021 LIBRARY; T=0.K  
Photon emission for (n,n\*)2a

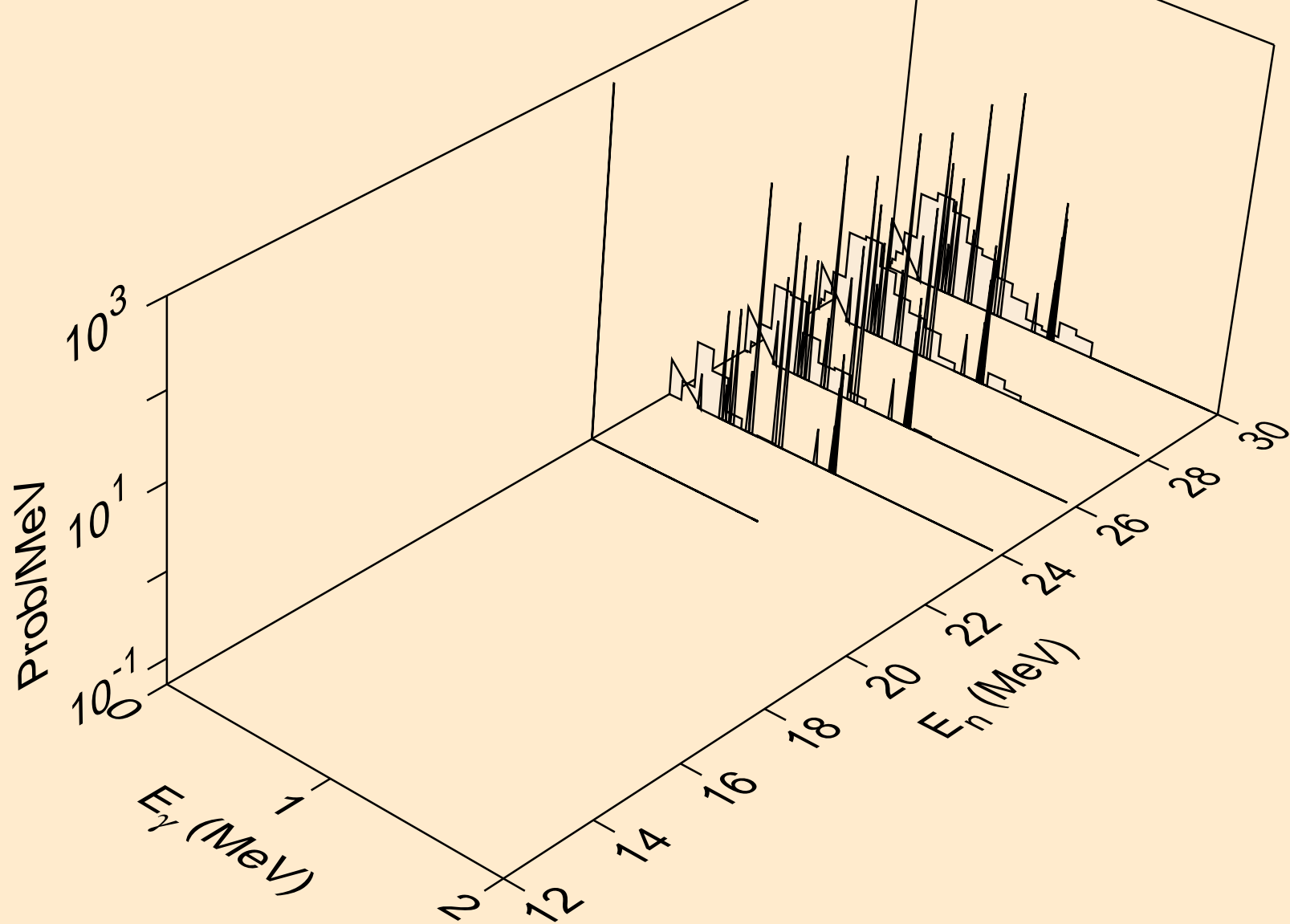

SE078 PROTON ACER TENDL-2021 LIBRARY; T=0.K  
Photon emission for (n,n\*)d

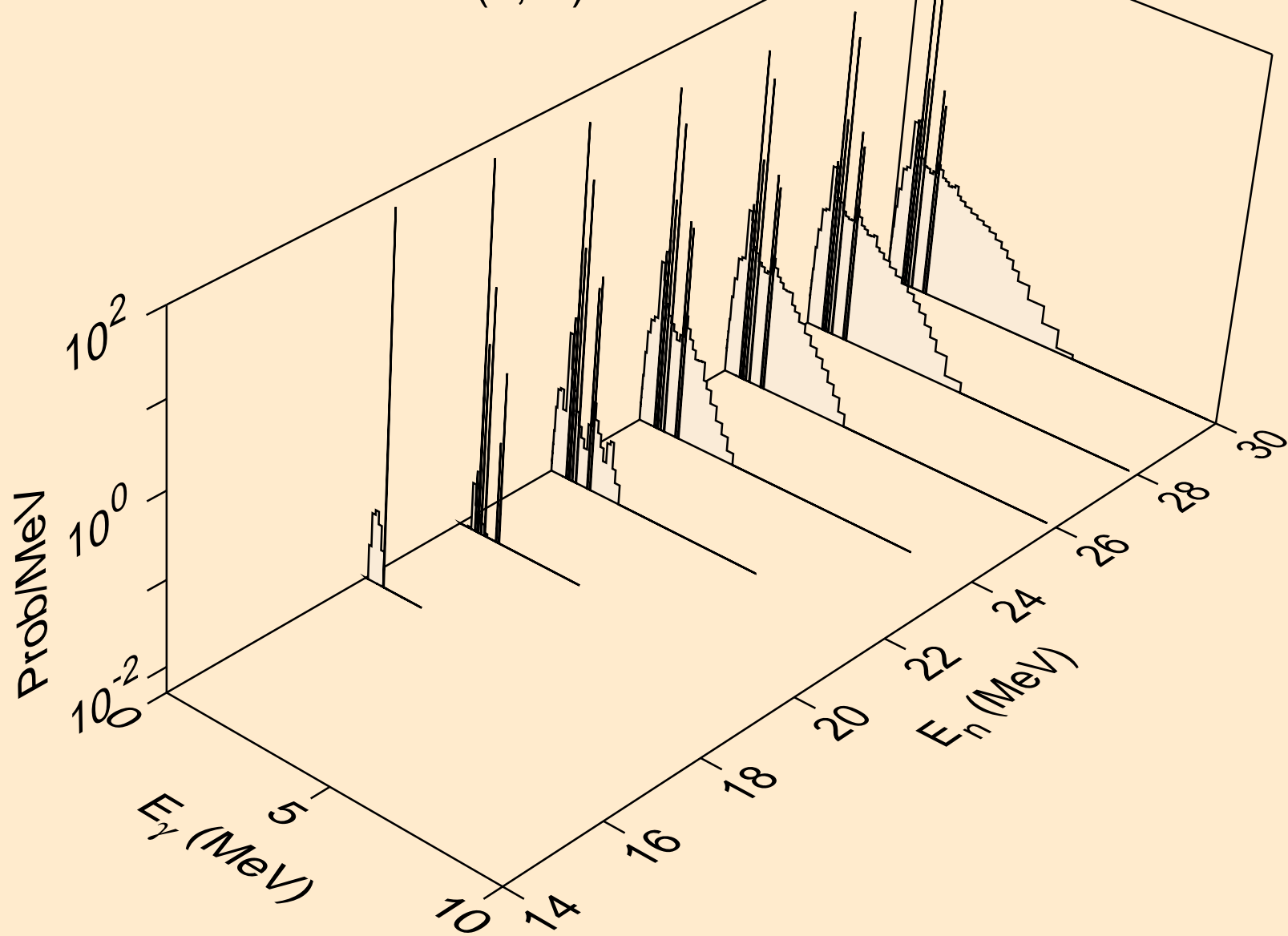

SE078 PROTON ACER TENDL-2021 LIBRARY; T=0.K  
Photon emission for (n,n\*)t

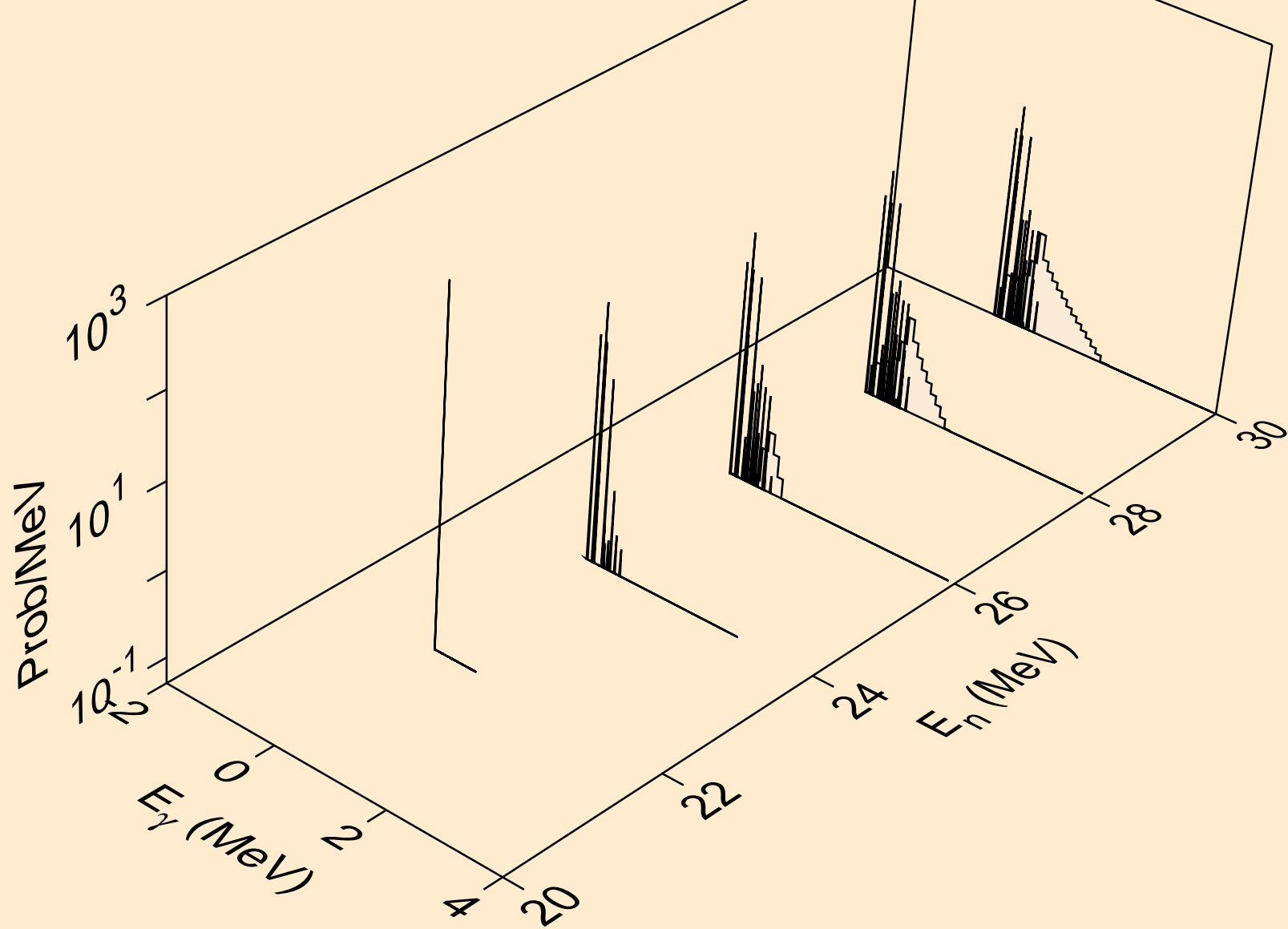

SE078 PROTON ACER TENDL-2021 LIBRARY; T=0.K  
Photon emission for (n,n\*)he3

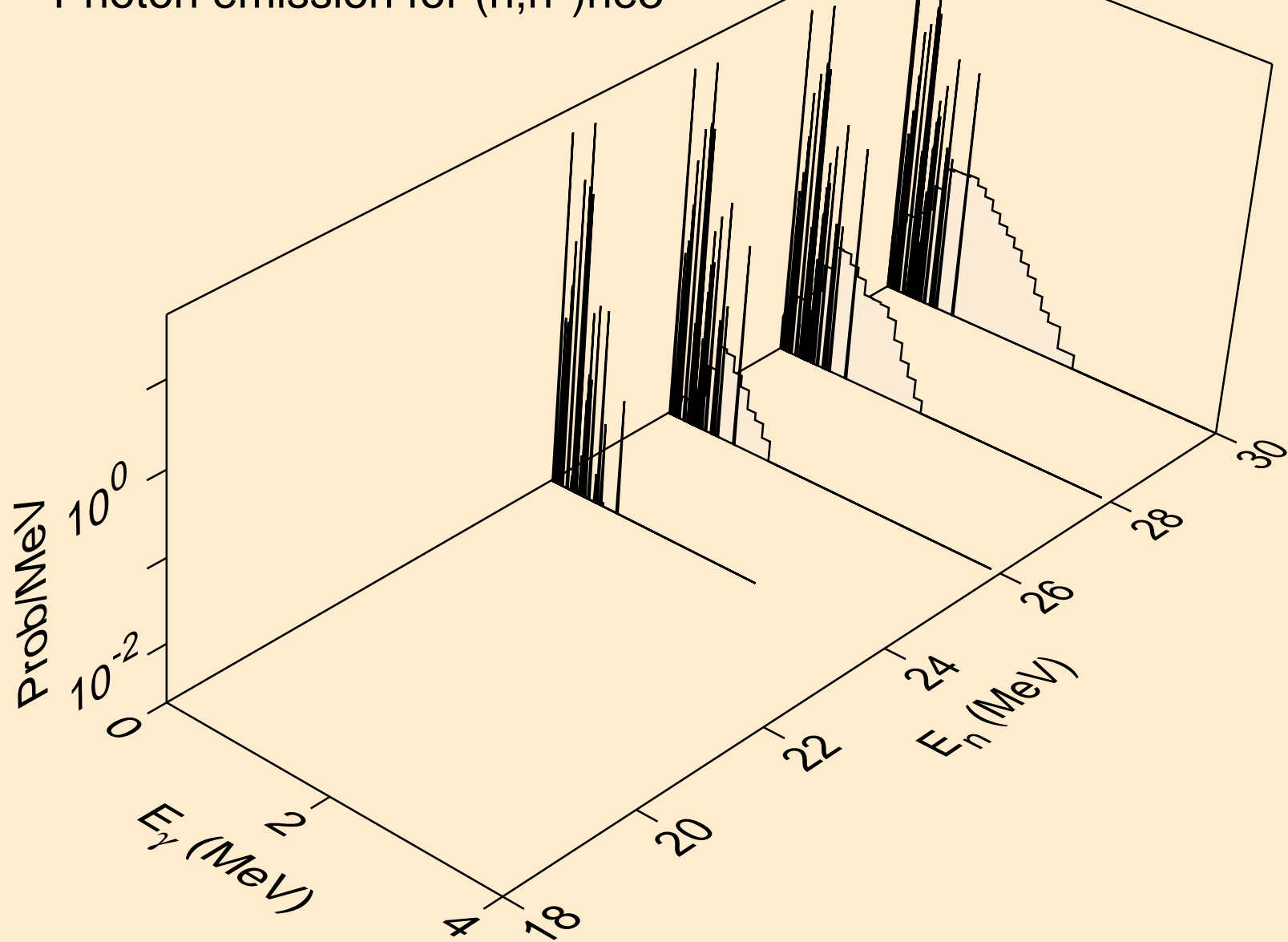

SE078 PROTON ACER TENDL-2021 LIBRARY; T=0.K  
Photon emission for (n,2np)

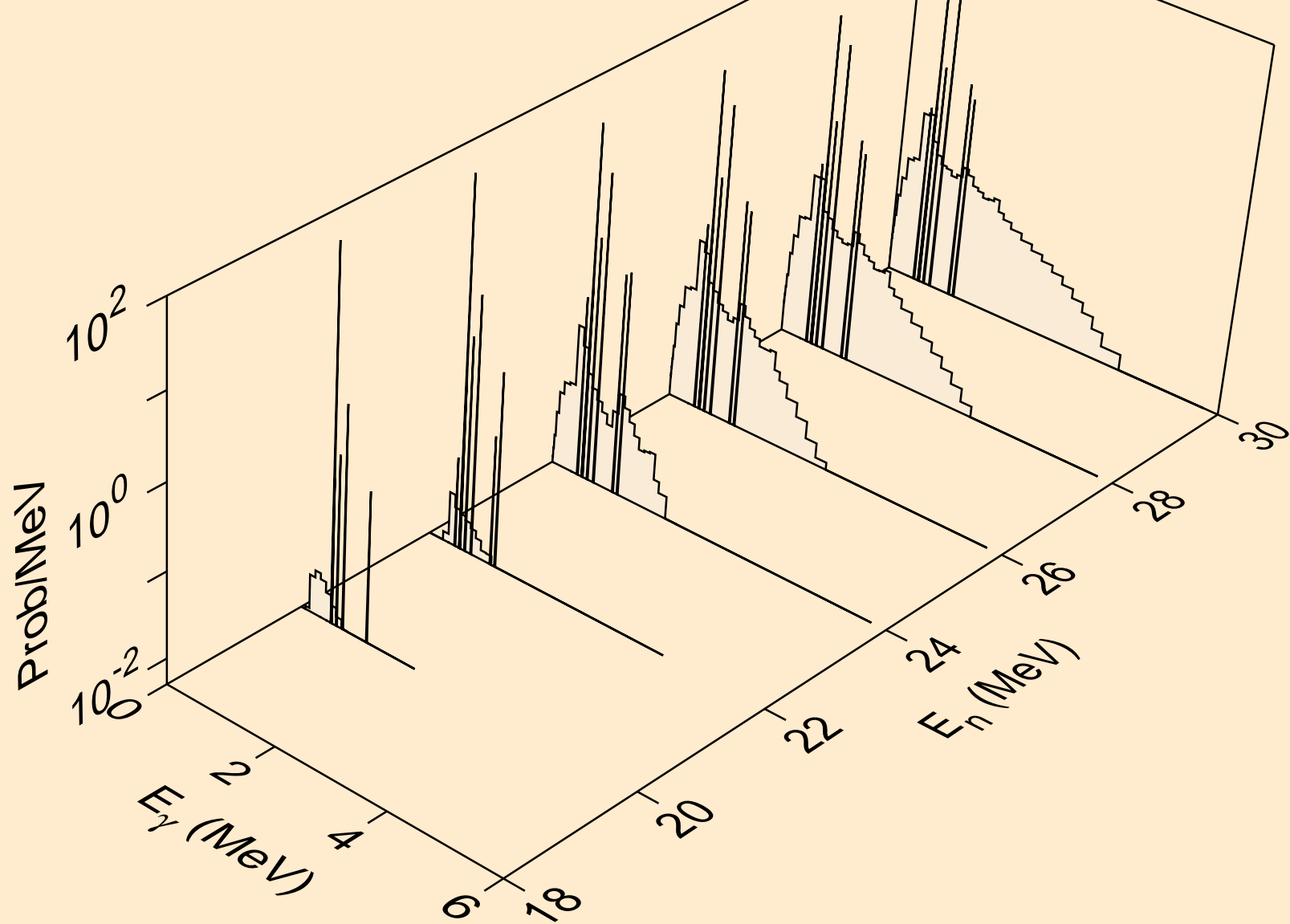



SE078 PROTON ACER TENDL-2021 LIBRARY; T=0.K  
Photon emission for (n,2np)

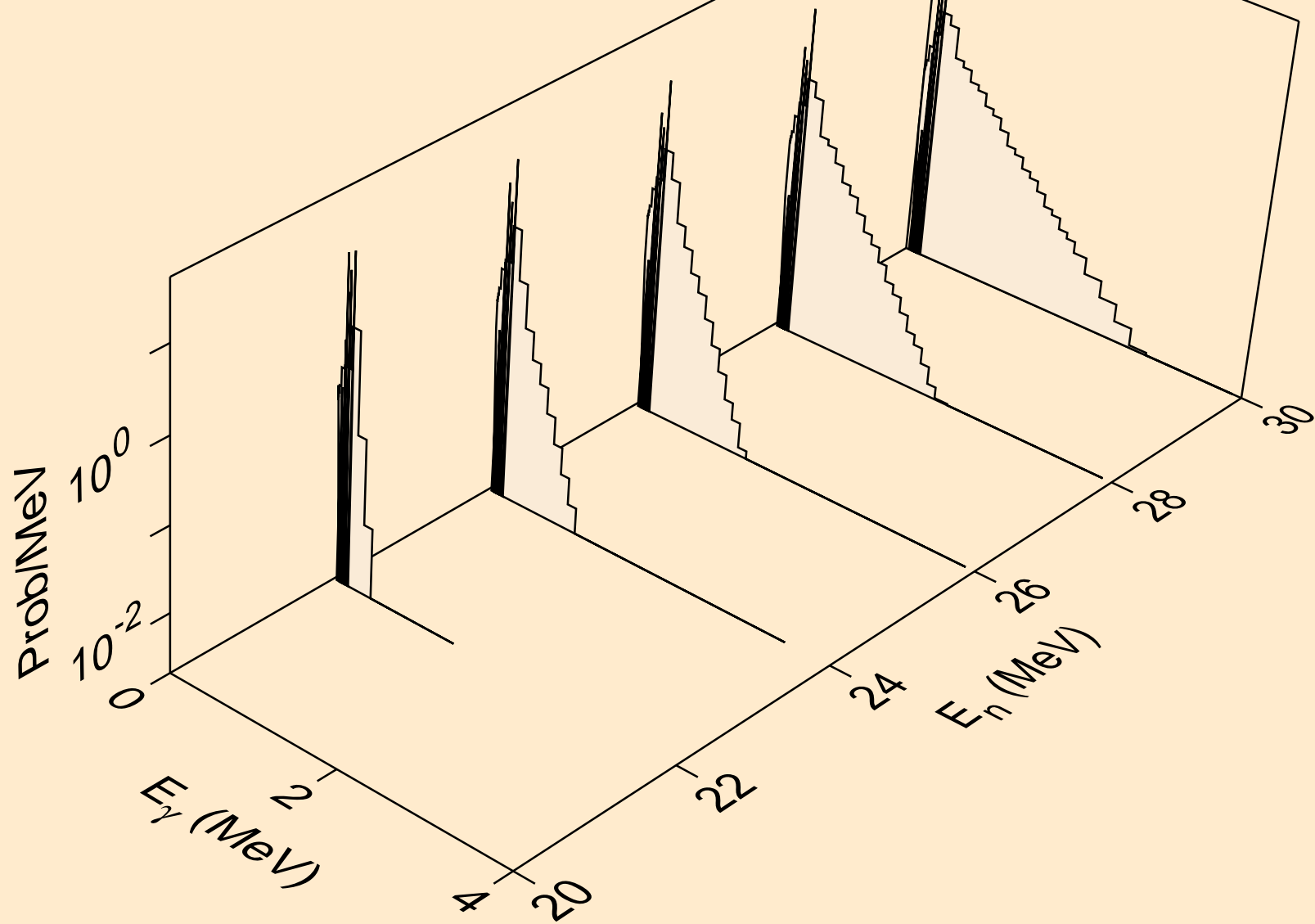

SE078 PROTON ACER TENDL-2021 LIBRARY; T=0.K  
Photon emission for (n,npa)

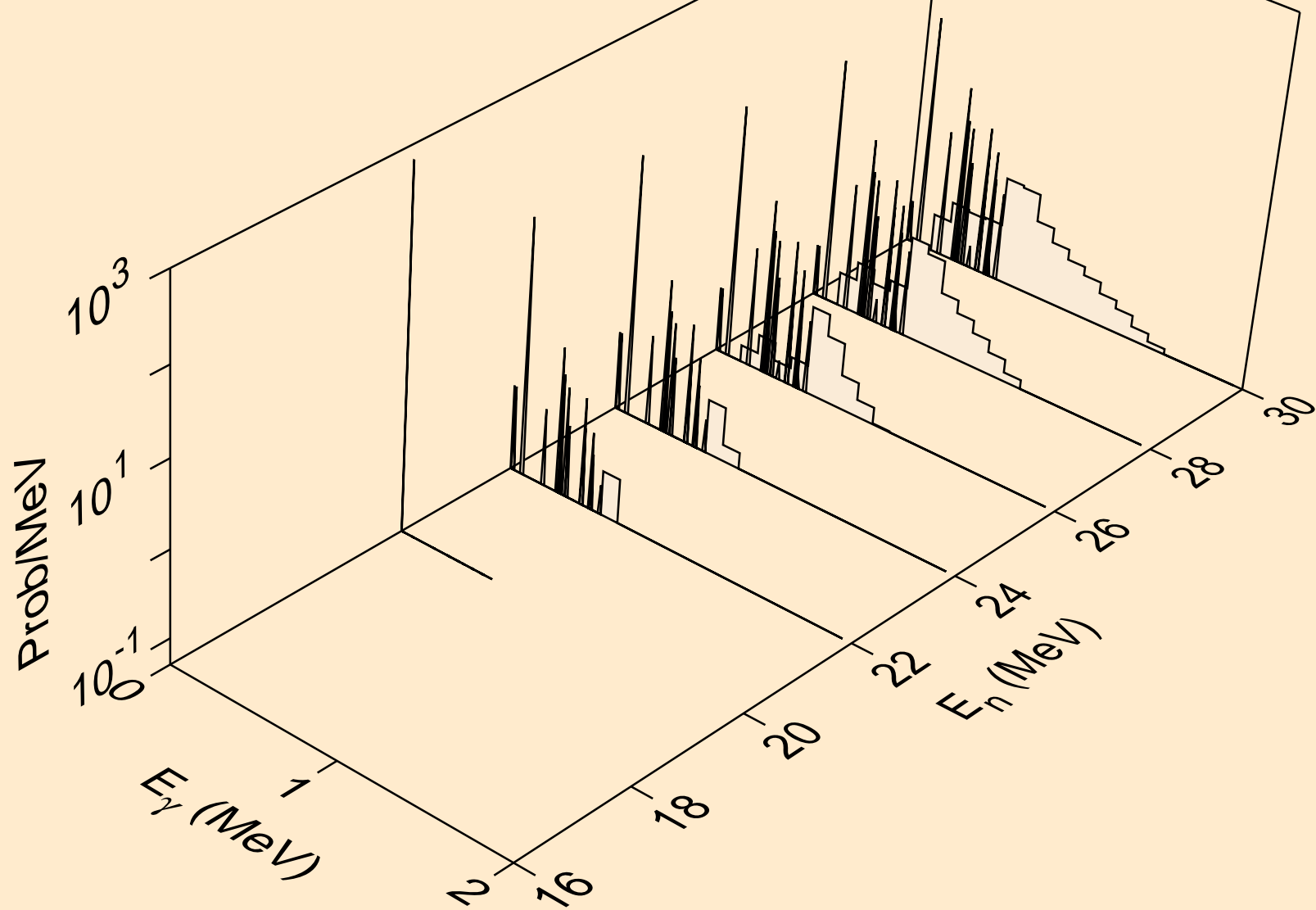

SE078 PROTON ACER TENDL-2021 LIBRARY; T=0.K  
Photon emission for (n,gma)

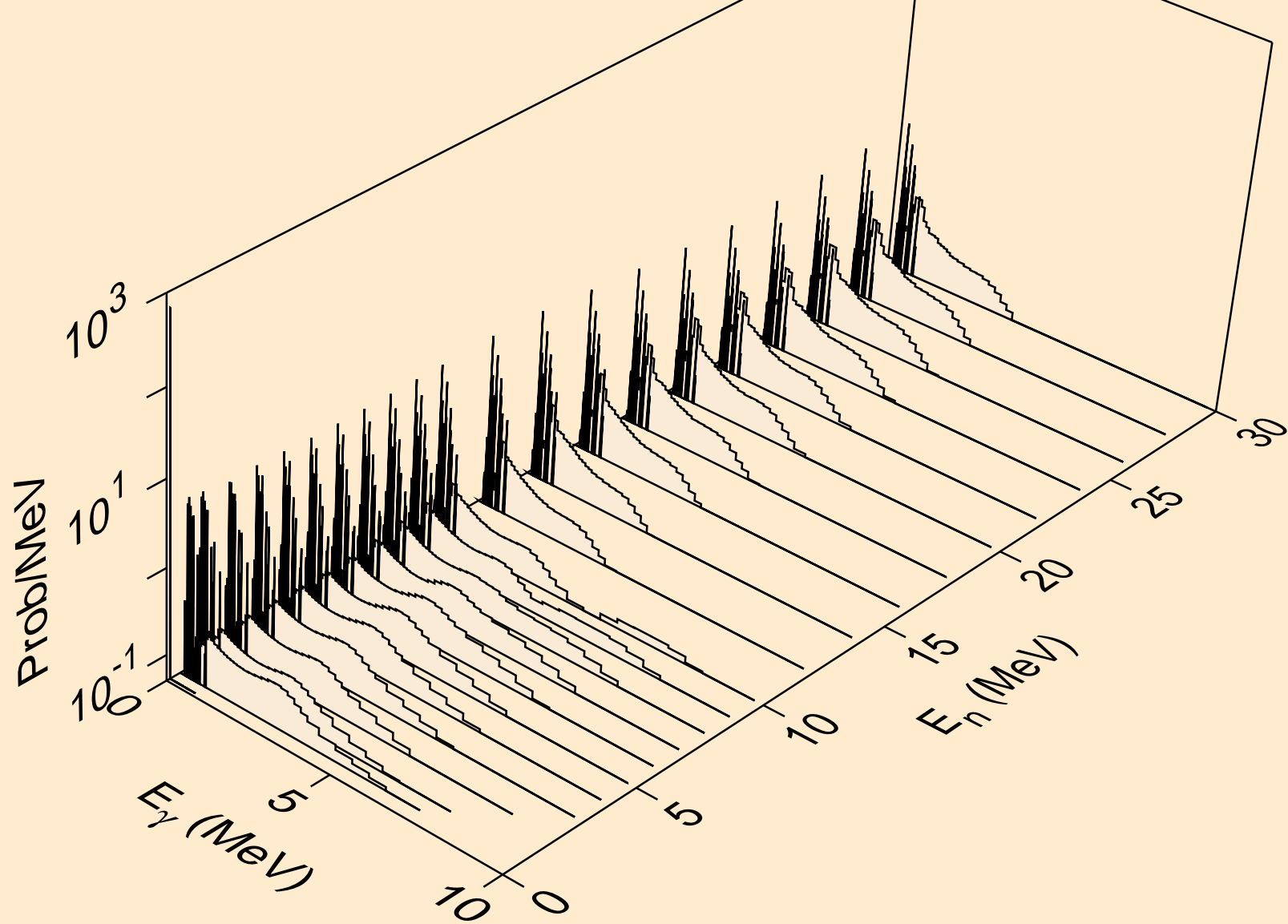

SE078 PROTON ACER TENDL-2021 LIBRARY; T=0.K  
Photon emission for inelastic

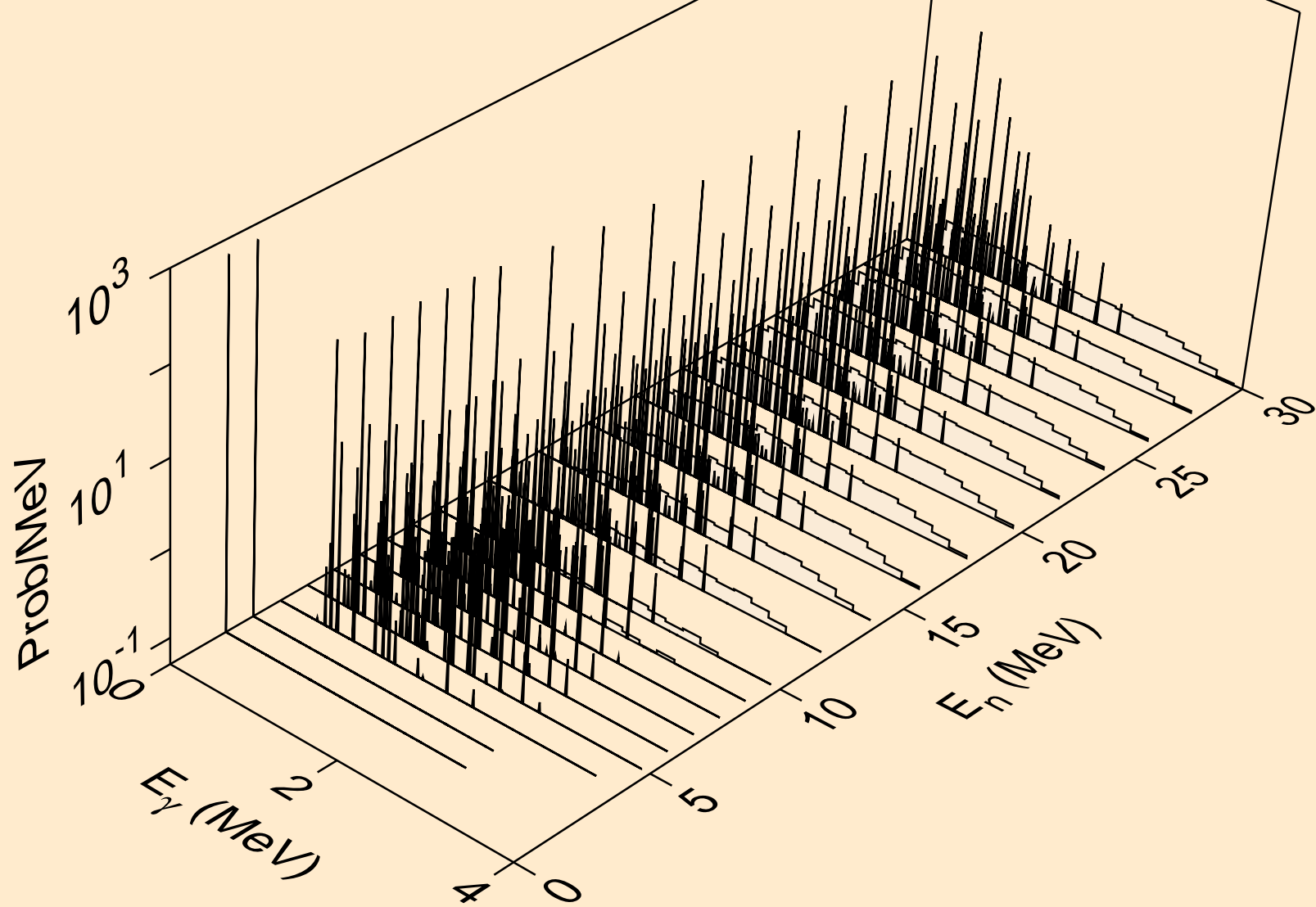

SE078 PROTON ACER TENDL-2021 LIBRARY; T=0.K  
Photon emission for (n,d)

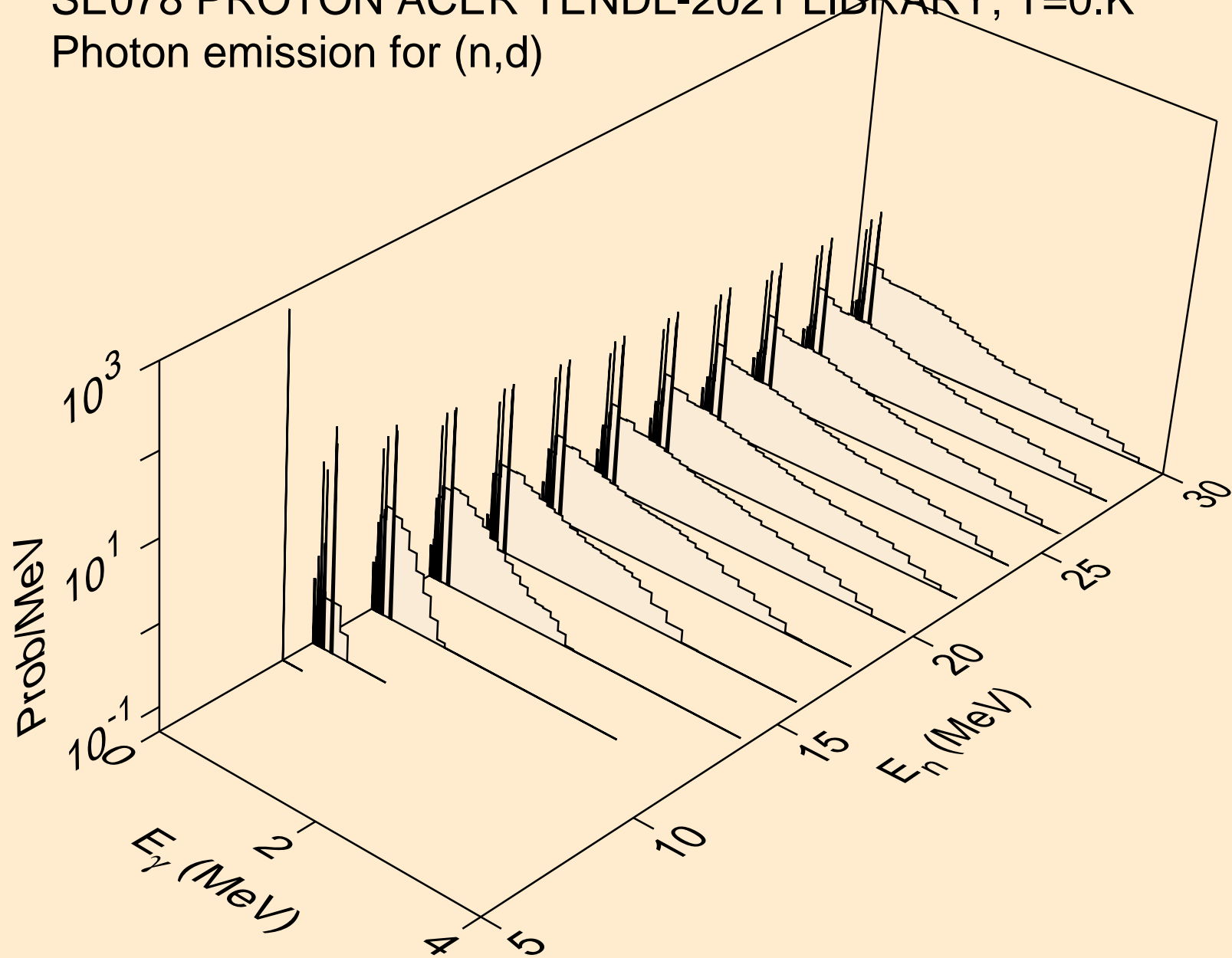

SE078 PROTON ACER TENDL-2021 LIBRARY; T=0.K  
Photon emission for (n,t)

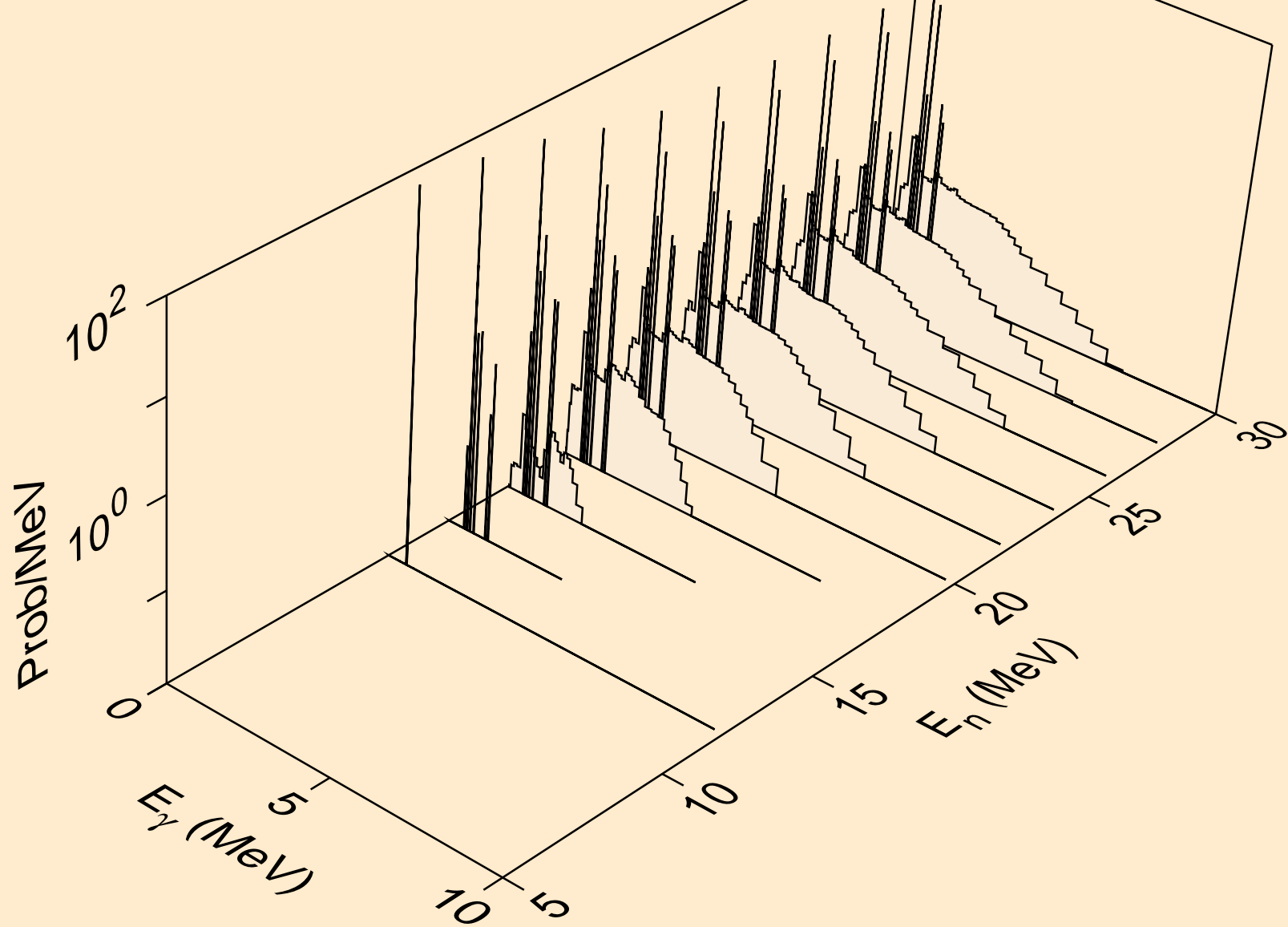

SE078 PROTON ACER TENDL-2021 LIBRARY; T=0.K  
Photon emission for (n,he3)

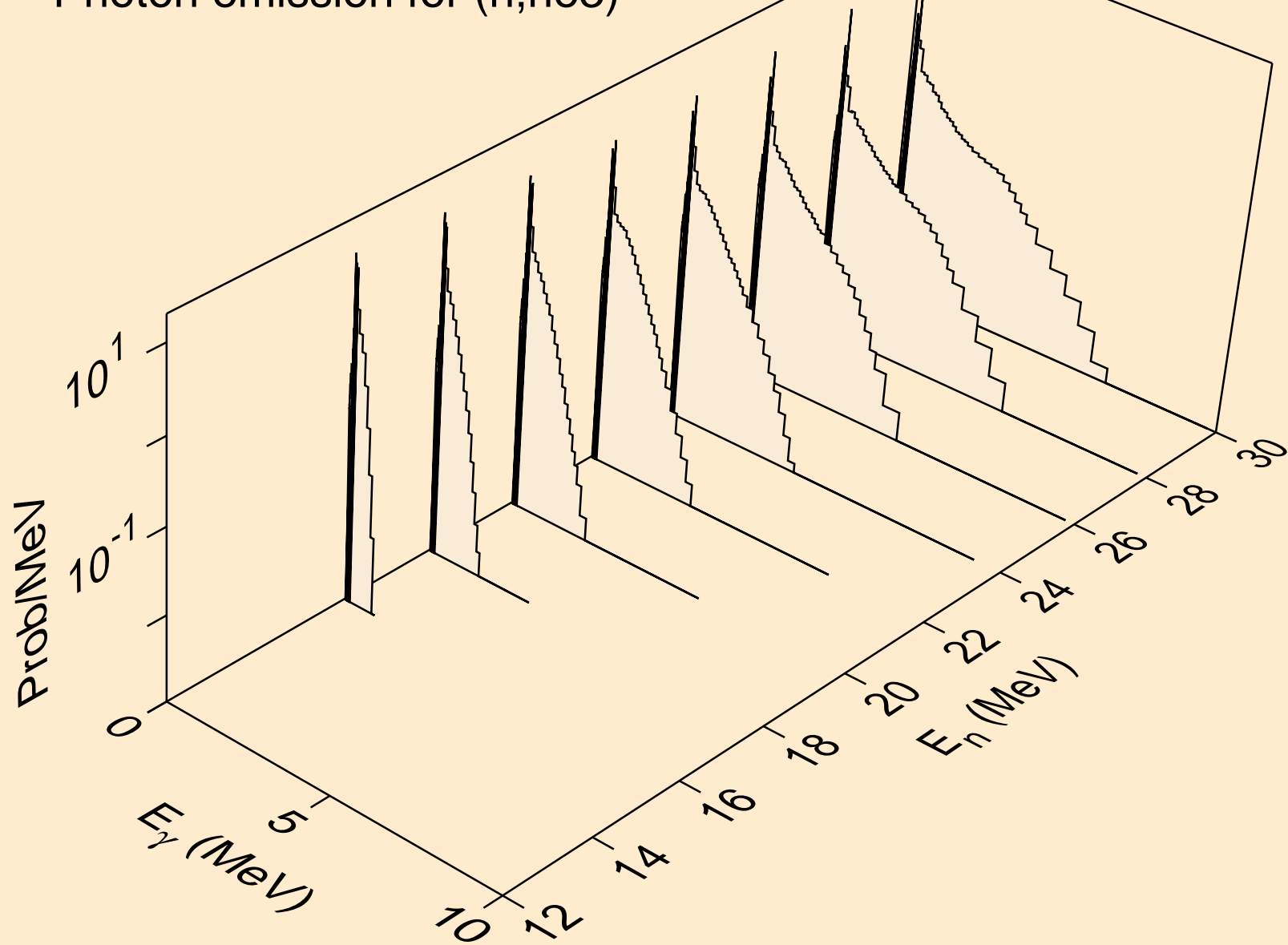

SE078 PROTON ACER TENDL-2021 LIBRARY; T=0.K  
Photon emission for (n,a)

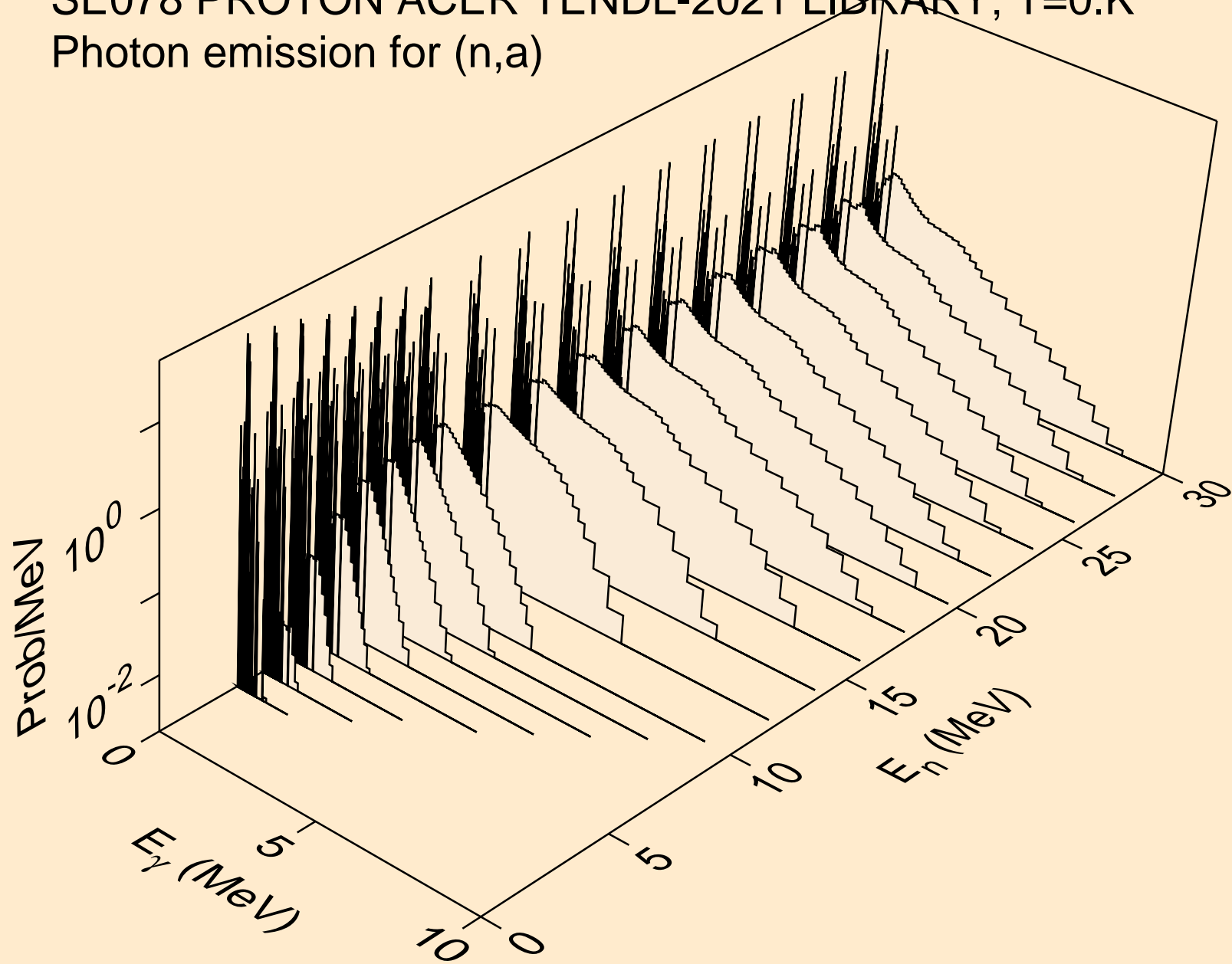



SE078 PROTON ACER TENDL-2021 LIBRARY; T=0.K  
Photon emission for (n,2a)

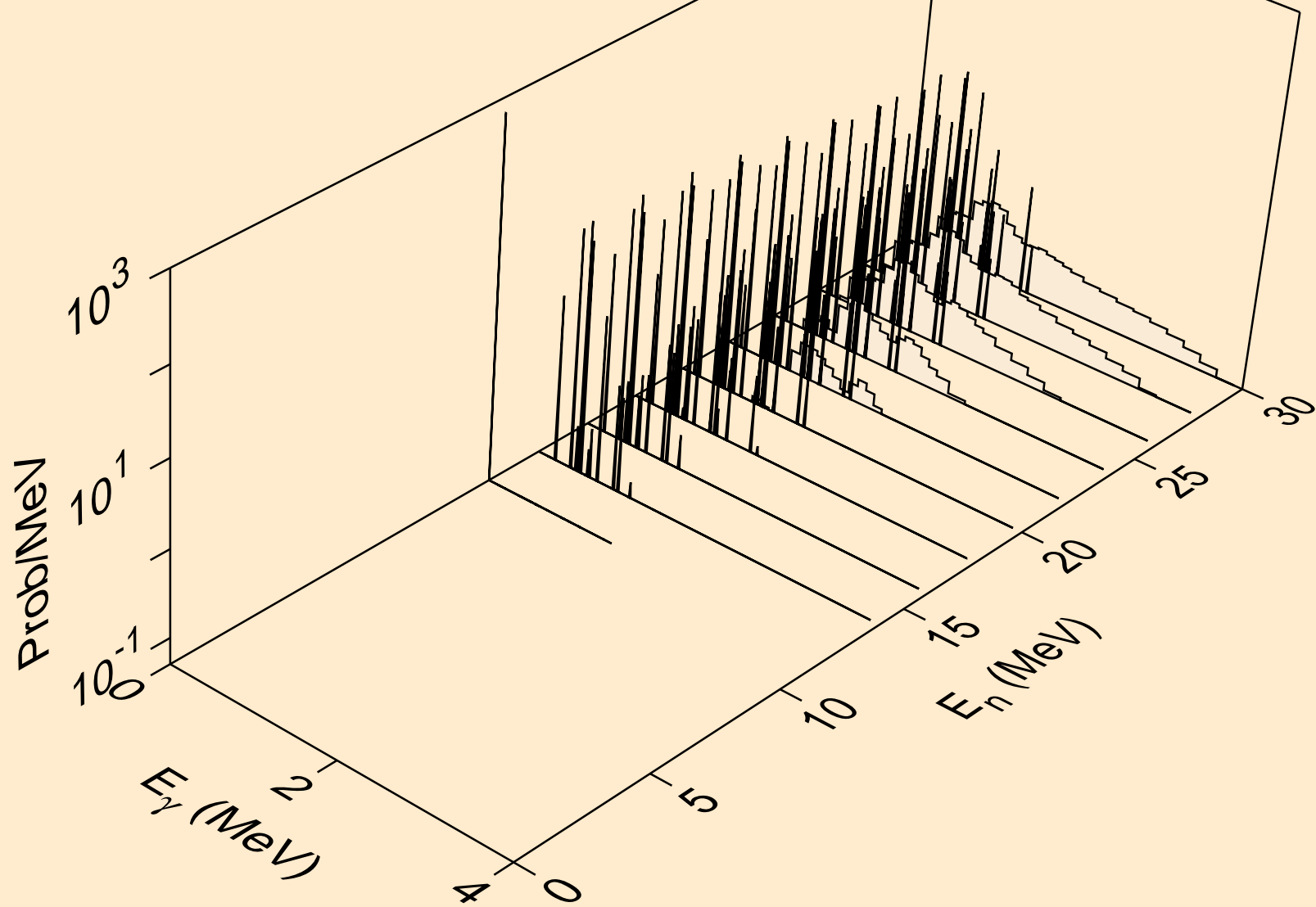

SE078 PROTON ACER TENDL-2021 LIBRARY; T=0.K  
Photon emission for (n,2p)

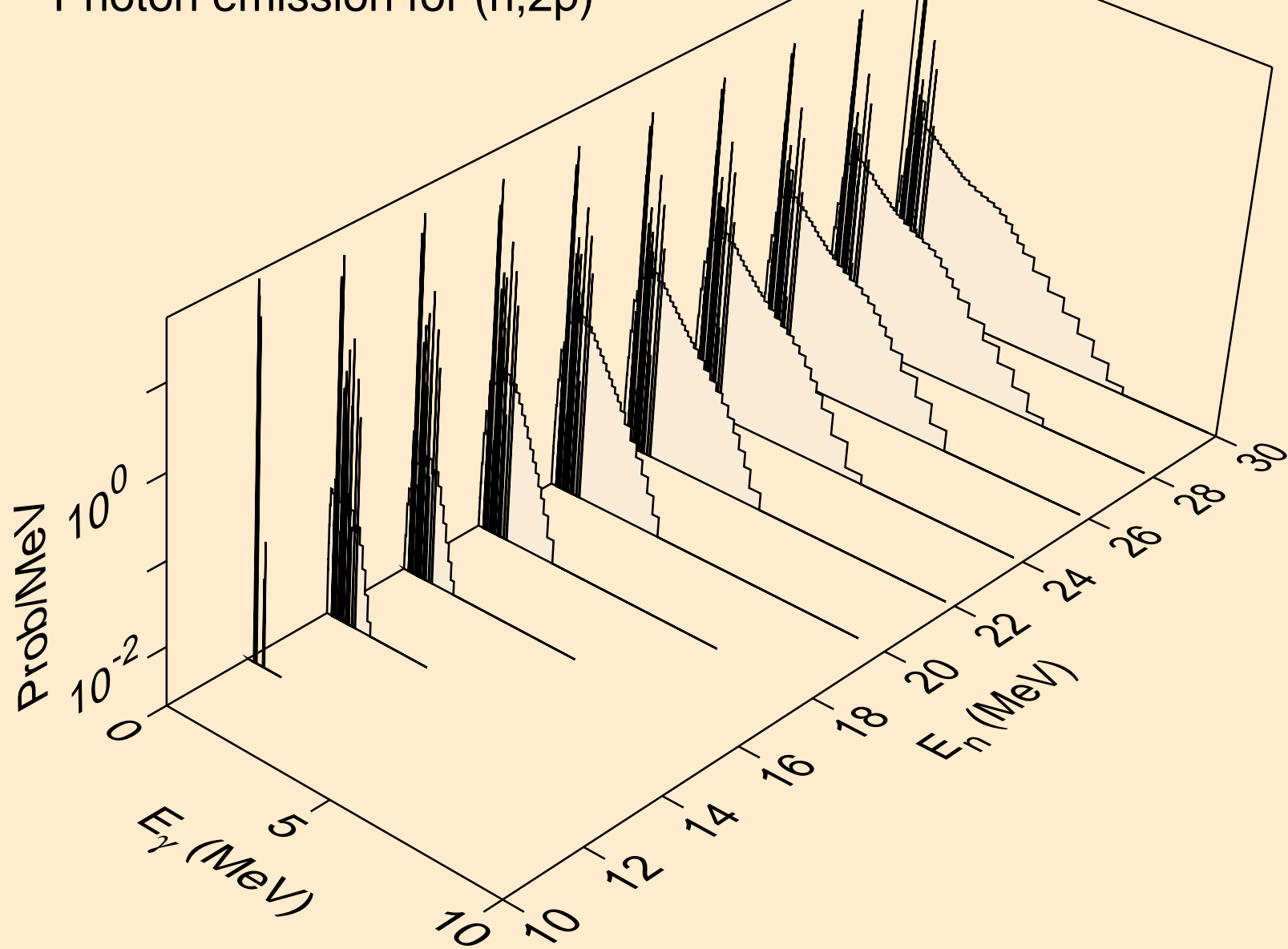

SE078 PROTON ACER TENDL-2021 LIBRARY; T=0.K  
Photon emission for (n,pa)

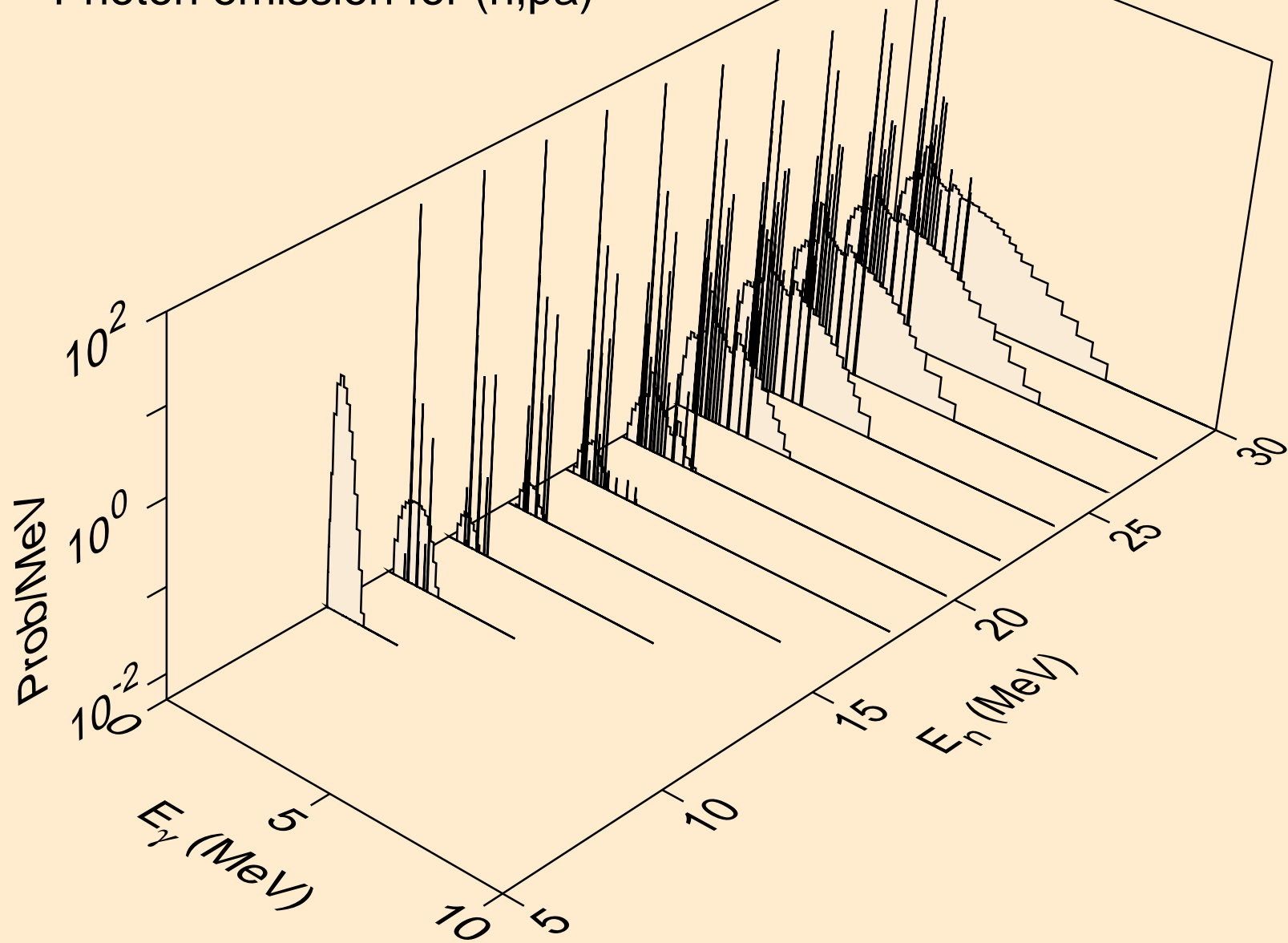

SE078 PROTON ACER TENDL-2021 LIBRARY; T=0.K  
Photon emission for (n,pd)

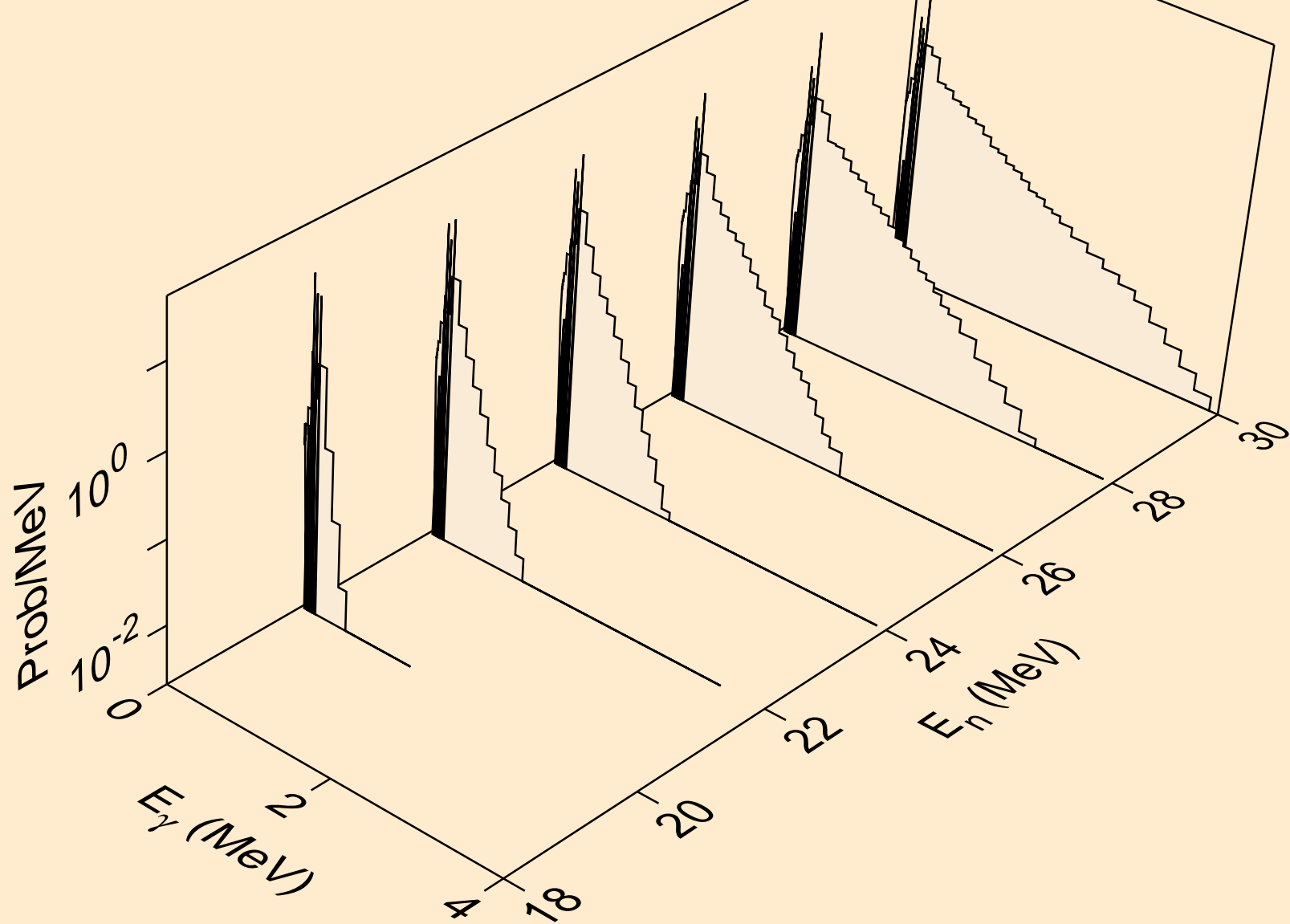

SE078 PROTON ACER TENDL-2021 LIBRARY; T=0.K  
Photon emission for (n,pt)

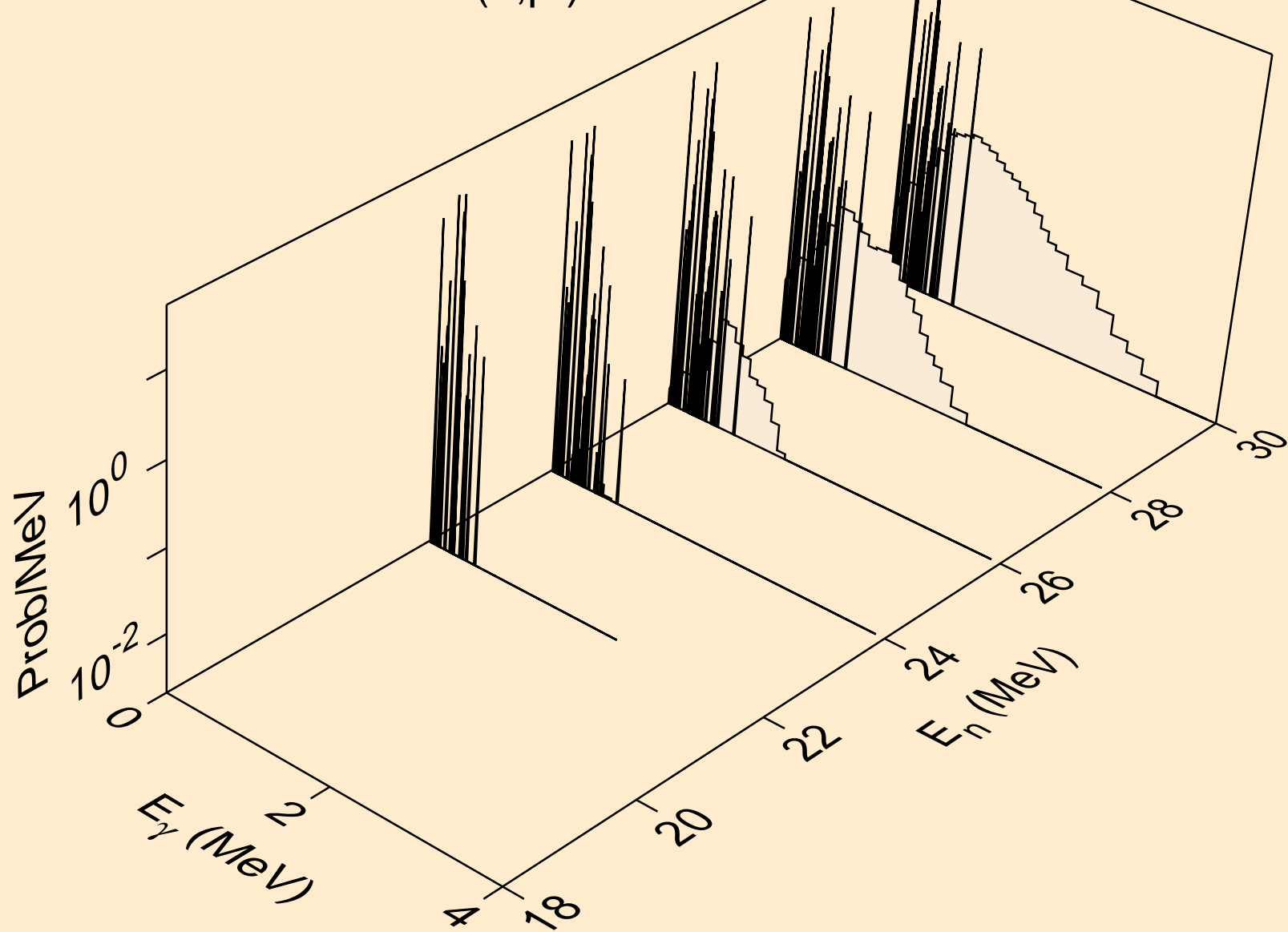

SE078 PROTON ACER TENDL-2021 LIBRARY; T=0.K  
Photon emission for (n,da)

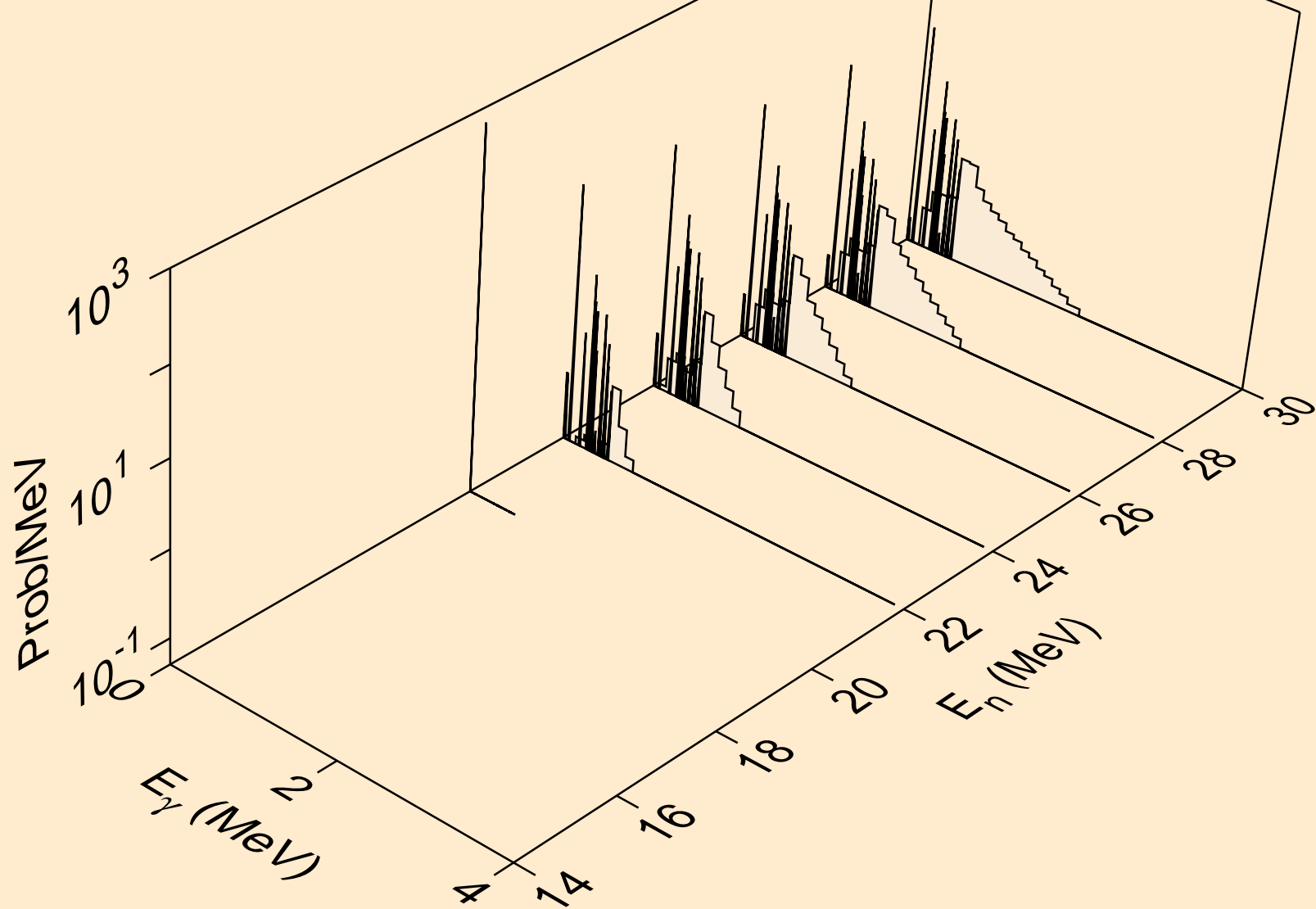

SE078 PROTON ACER TENDL-2021 LIBRARY; T=0.K  
Particle heating contributions

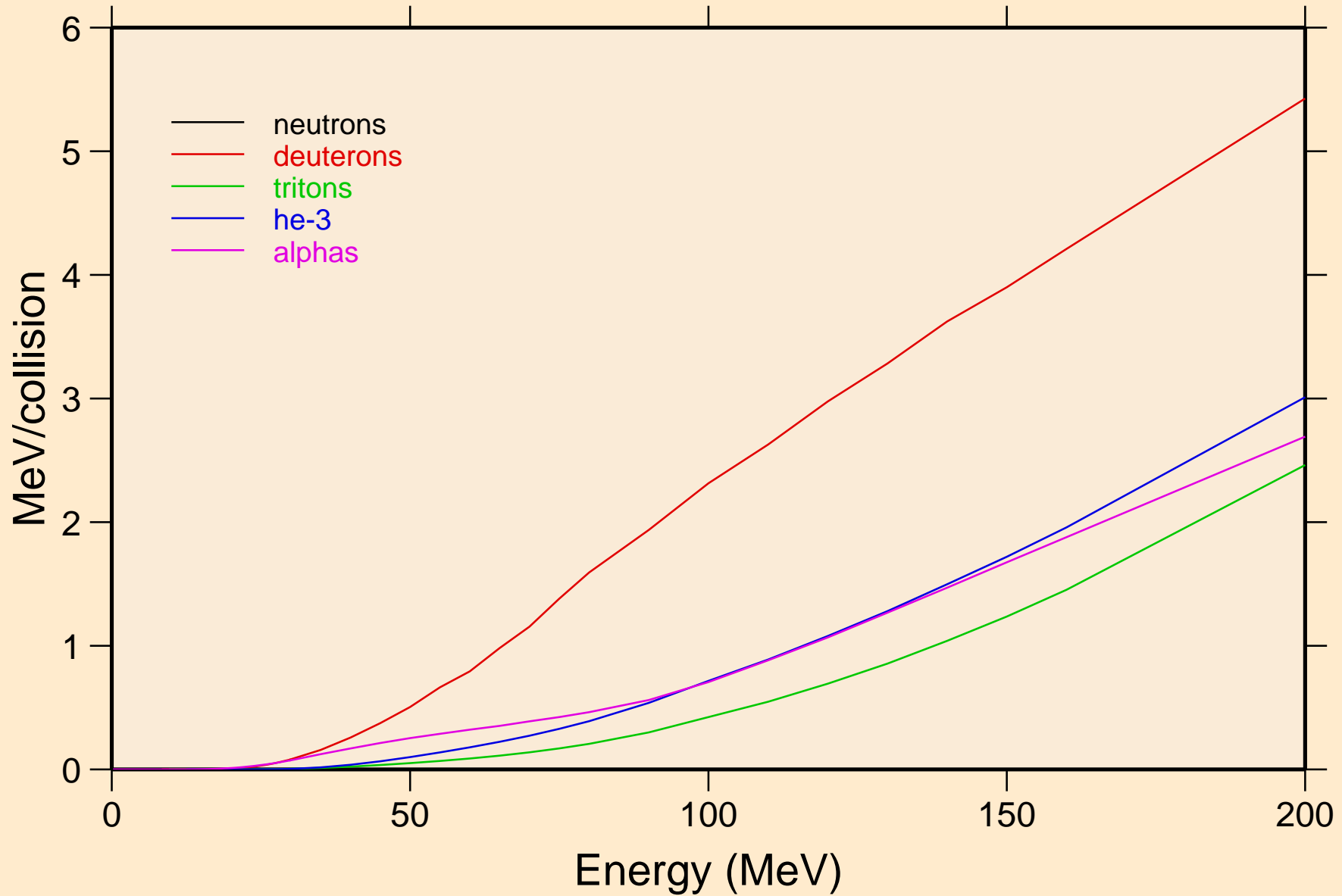

# SE078 PROTON ACER TENDL-2021 LIBRARY; T=0.K

## Recoil Heating

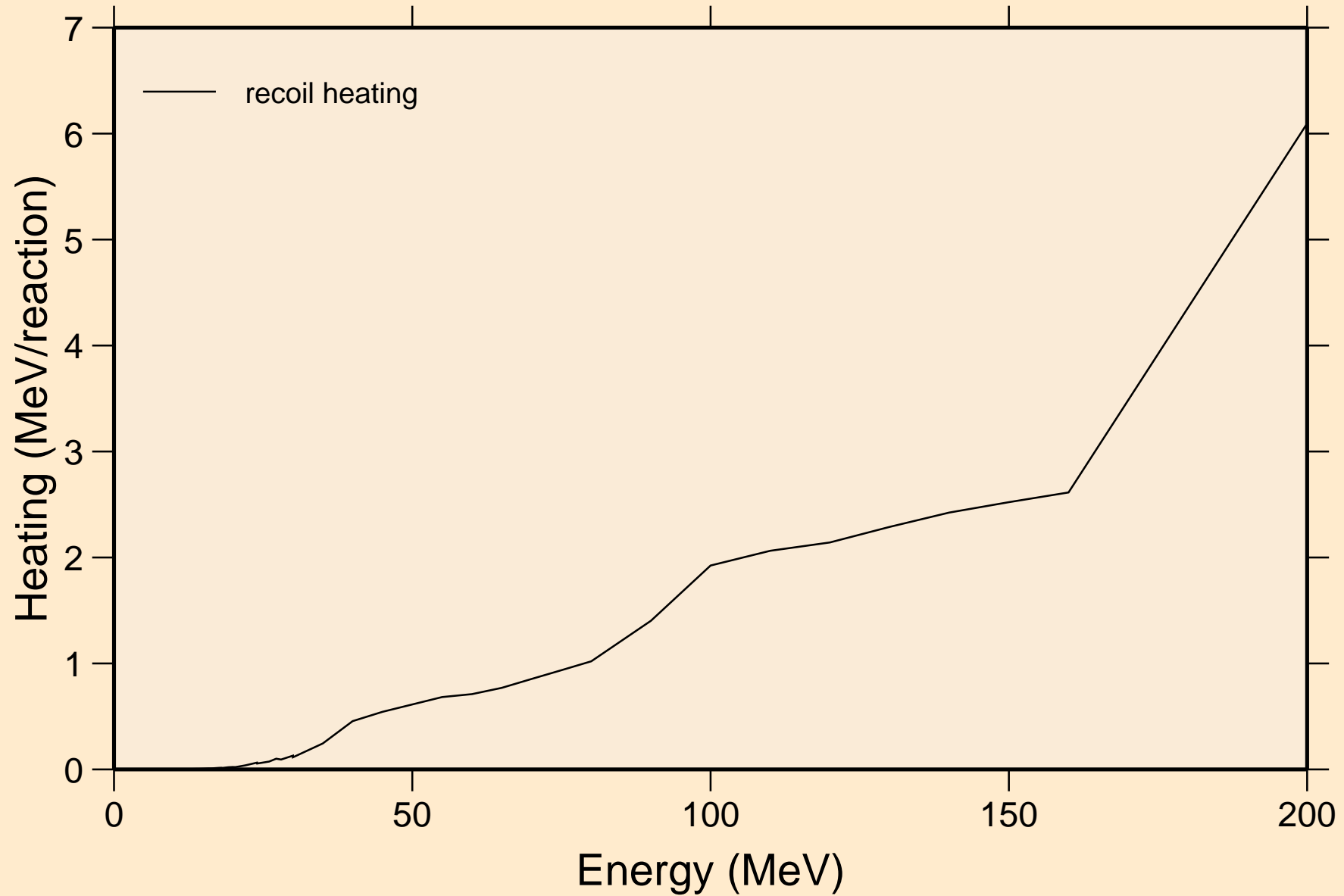



SE078 PROTON ACER TENDL-2021 LIBRARY; T=0.K  
Particle production cross sections

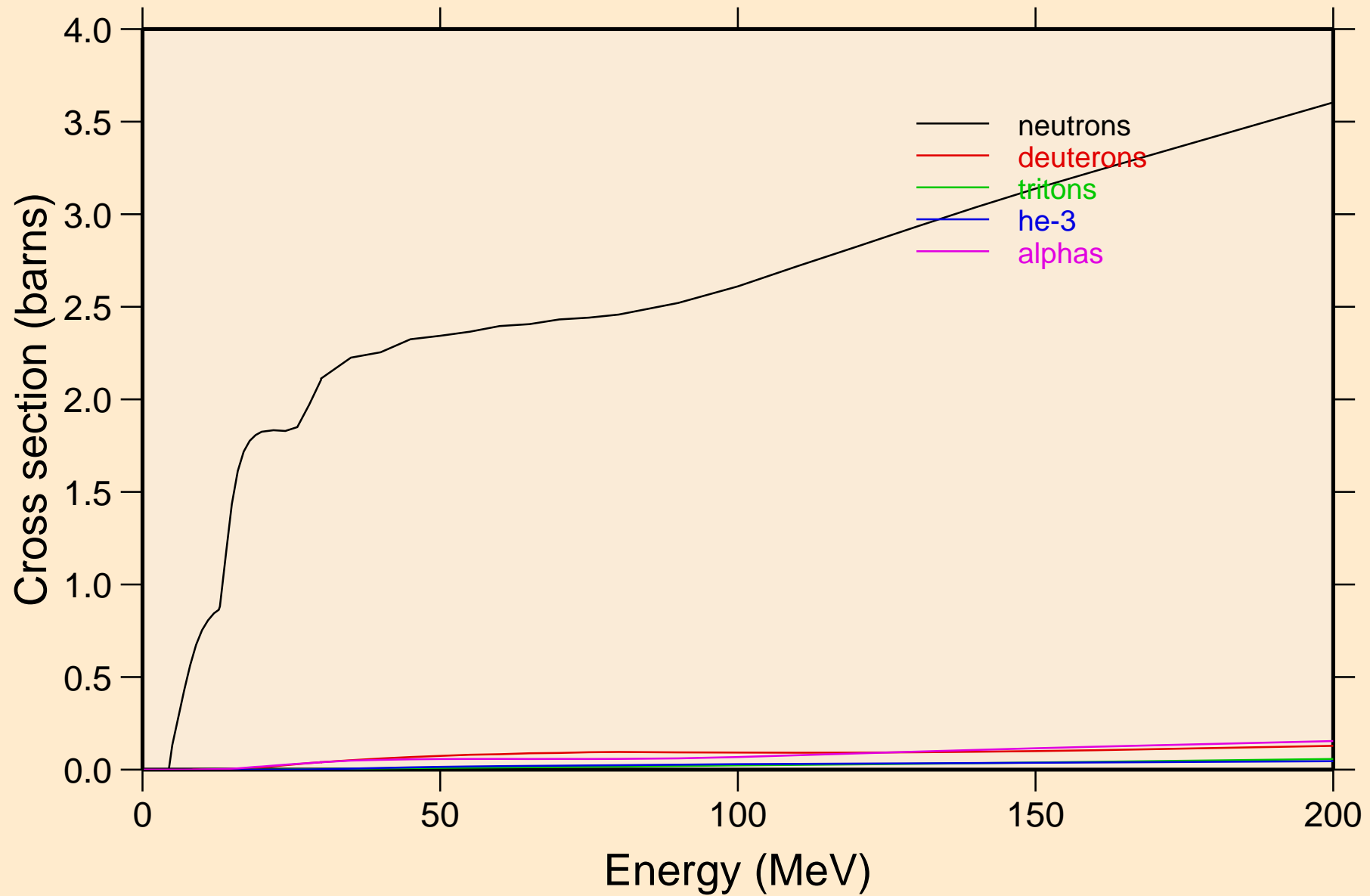

SE078 PROTON ACER TENDL-2021 LIBRARY; T=0.K  
neutrons from (p,n)

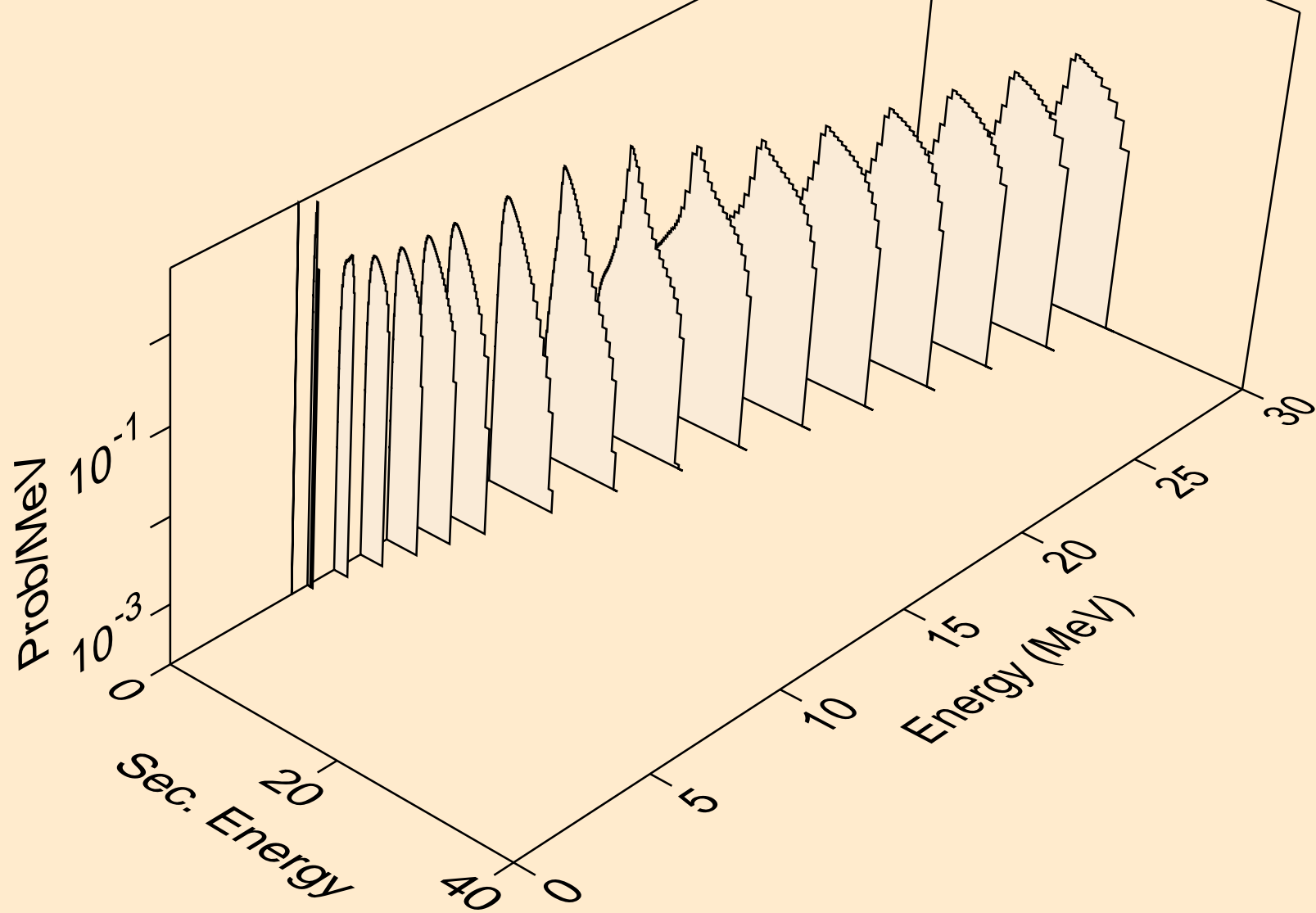

SE078 PROTON ACER TENDL-2021 LIBRARY; T=0.K  
neutrons from (p,x)

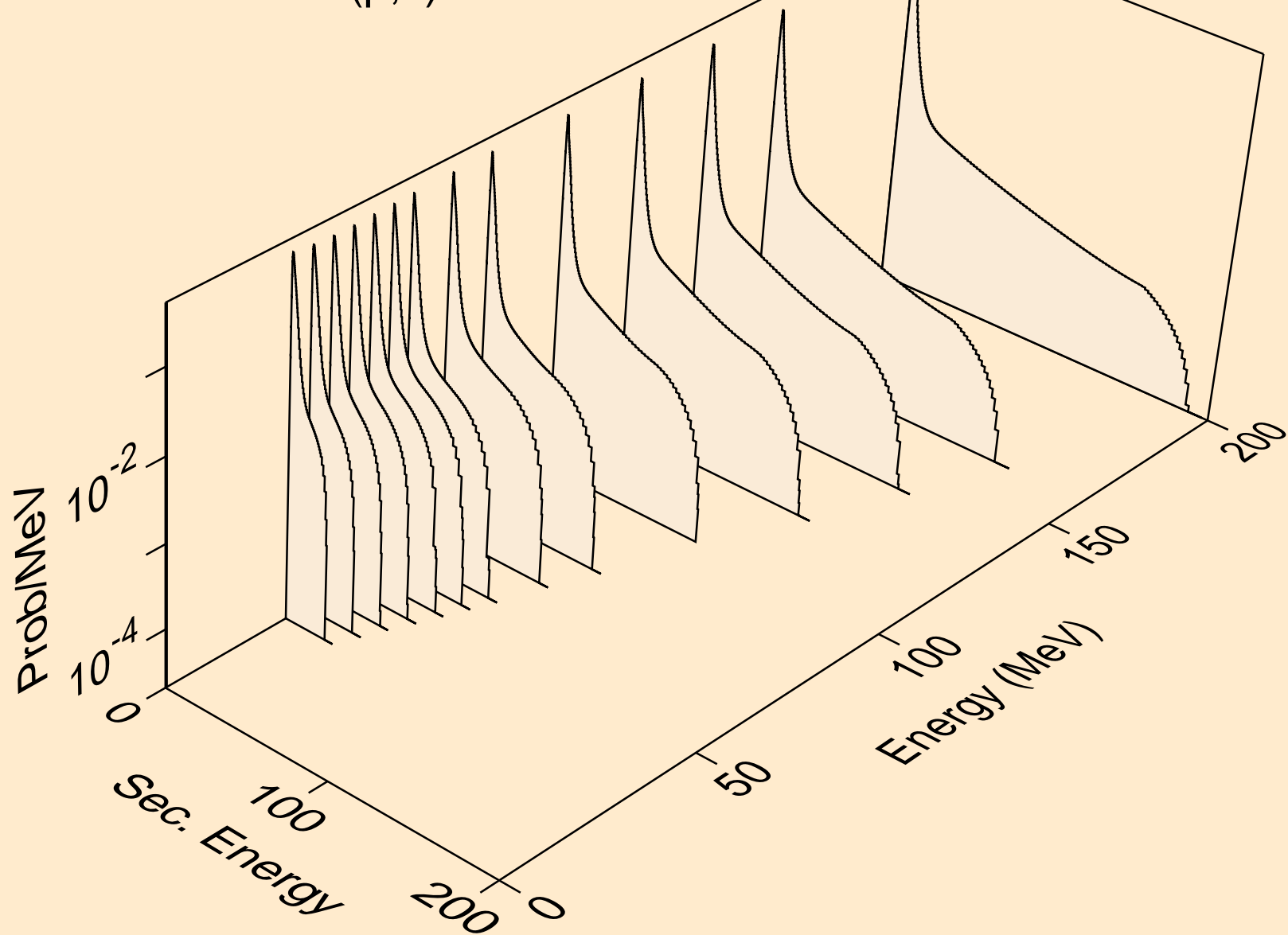

SE078 PROTON ACER TENDL-2021 LIBRARY; T=0.K  
neutrons from (p,2nd)

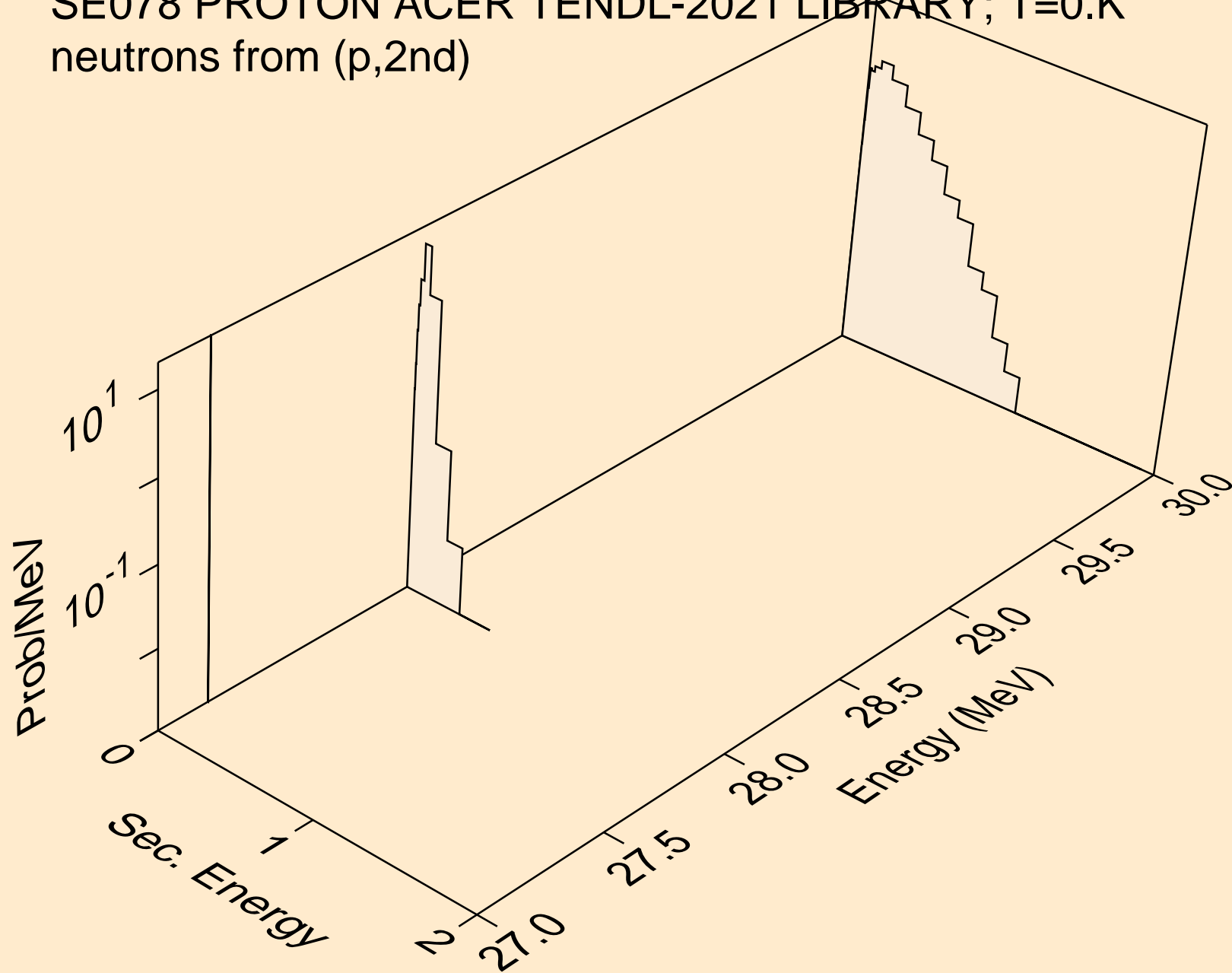

SE078 PROTON ACER TENDL-2021 LIBRARY; T=0.K  
neutrons from (p,2n)

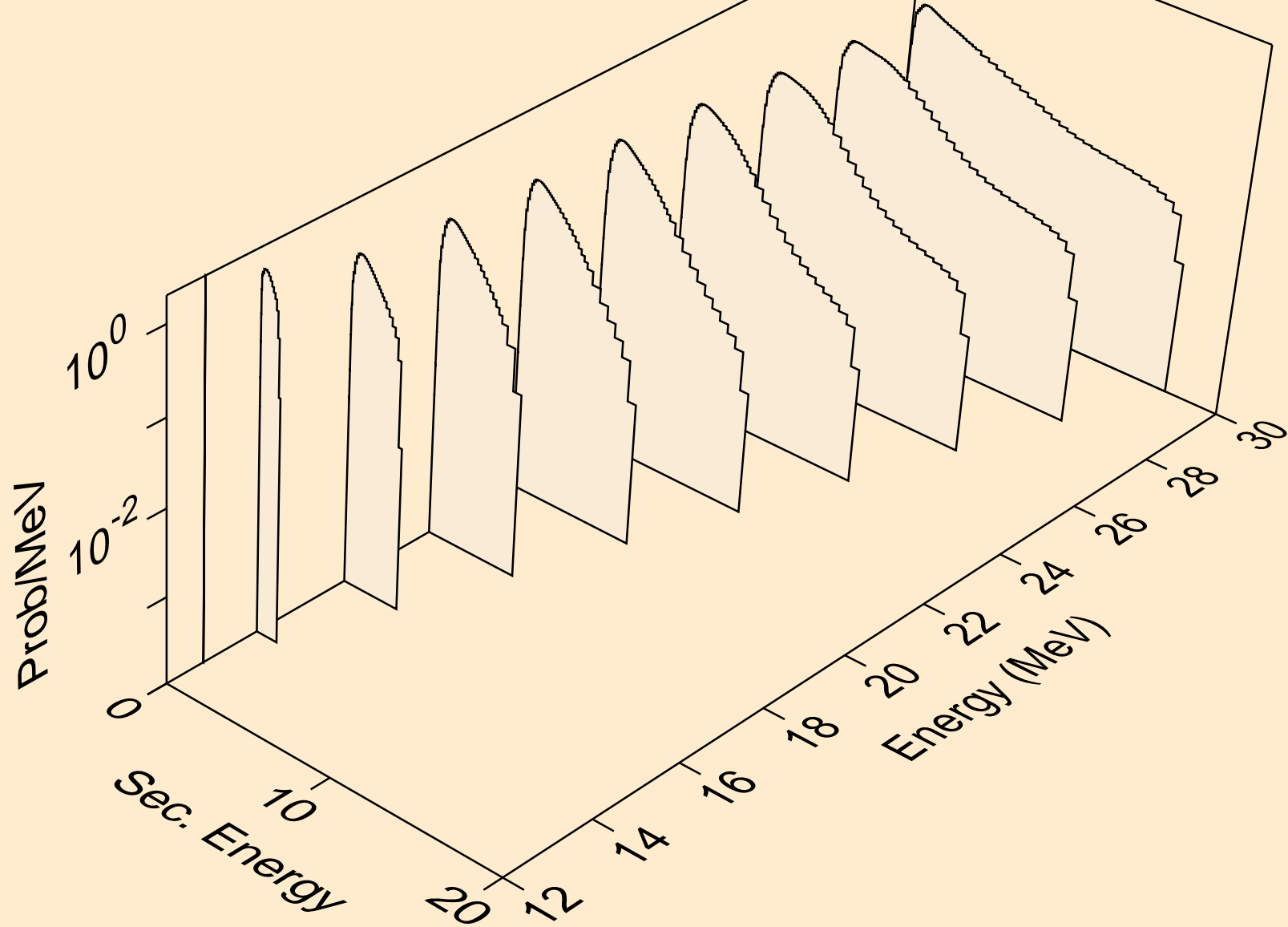

SE078 PROTON ACER TENDL-2021 LIBRARY; T=0.K  
neutrons from (p,3n)

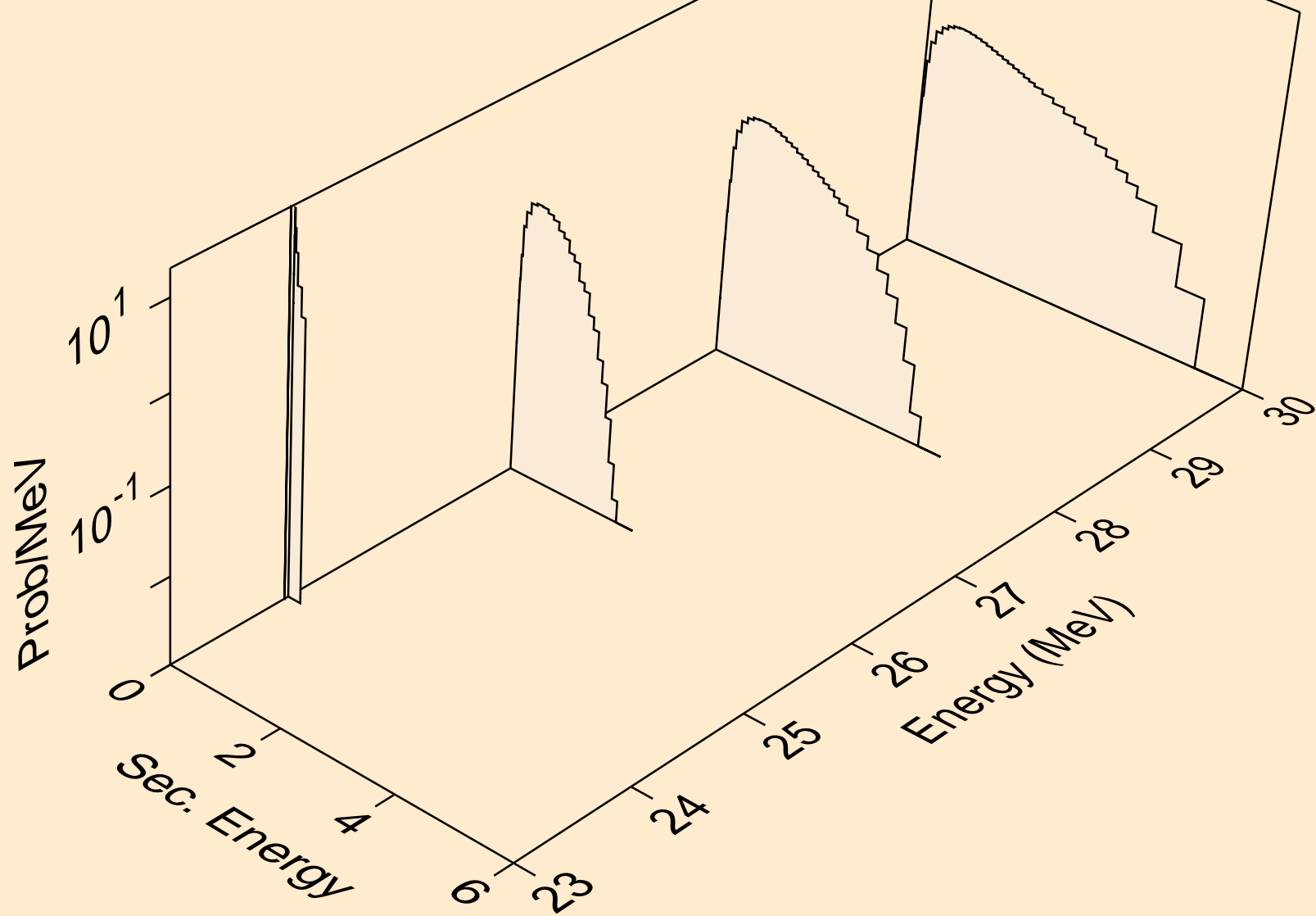

SE078 PROTON ACER TENDL-2021 LIBRARY; T=0.K  
neutrons from (p,n\*)a

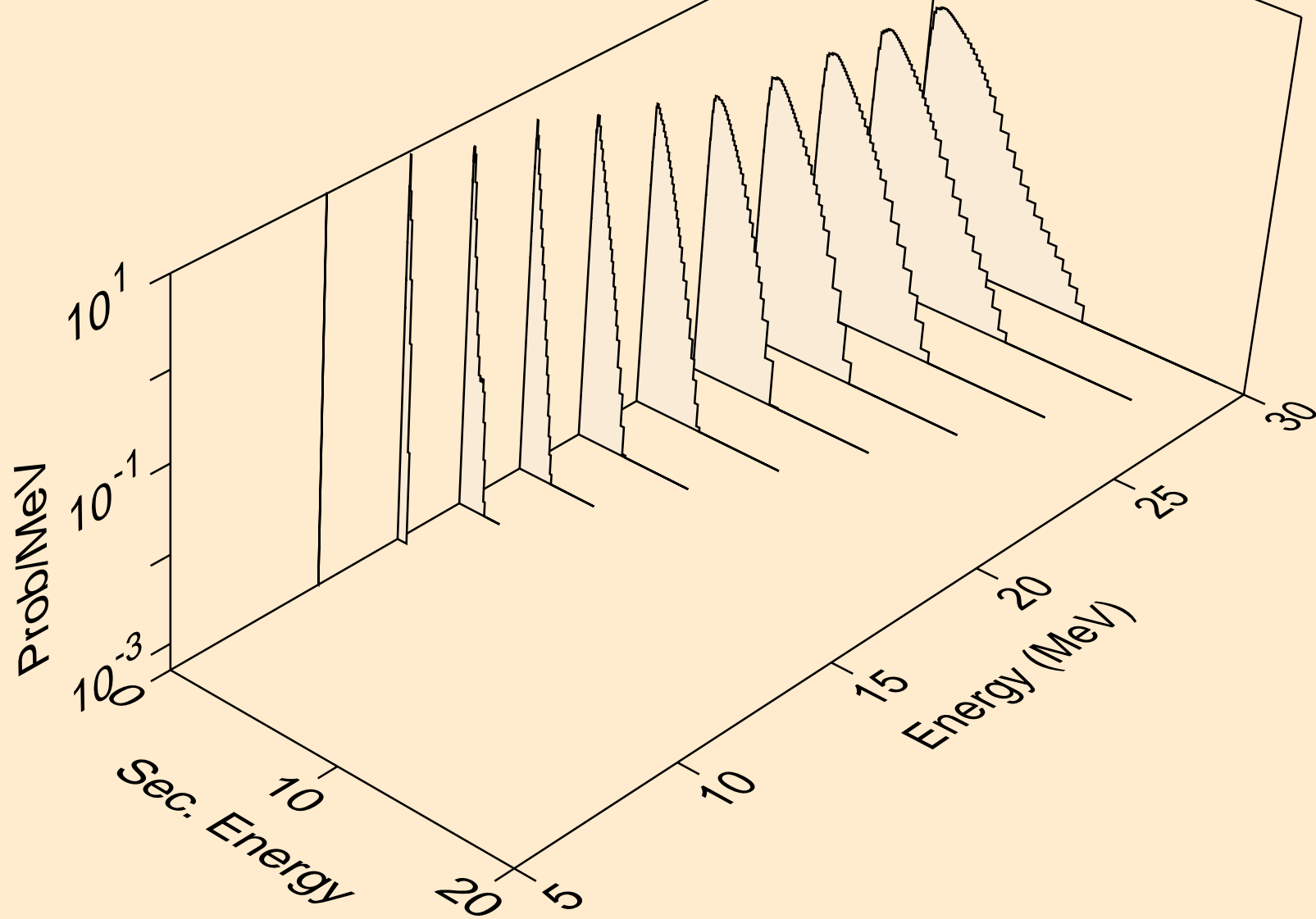

SE078 PROTON ACER TENDL-2021 LIBRARY; T=0.K  
neutrons from (p,2n)a

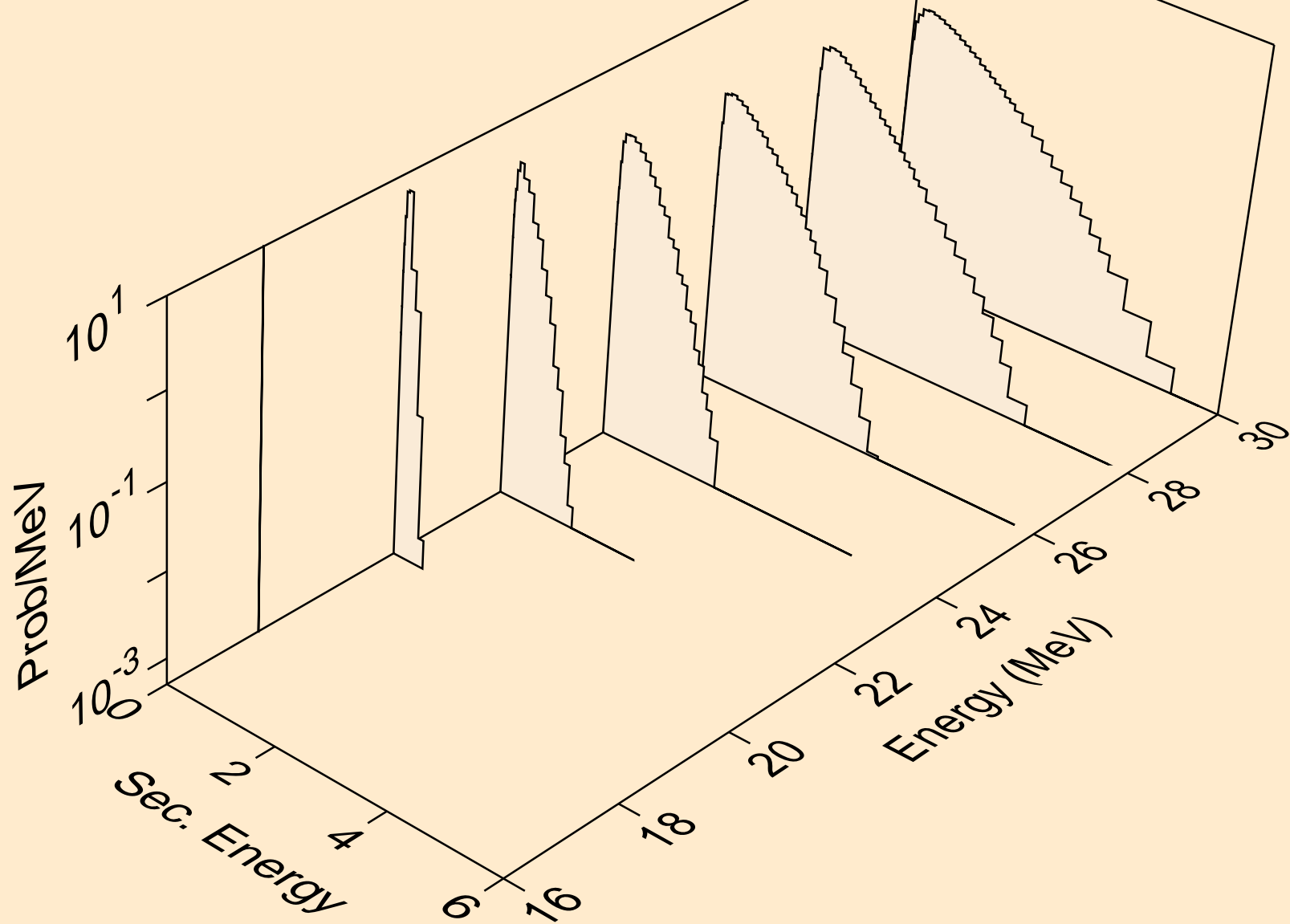



SE078 PROTON ACER TENDL-2021 LIBRARY; T=0.K  
neutrons from (p,n\*)p

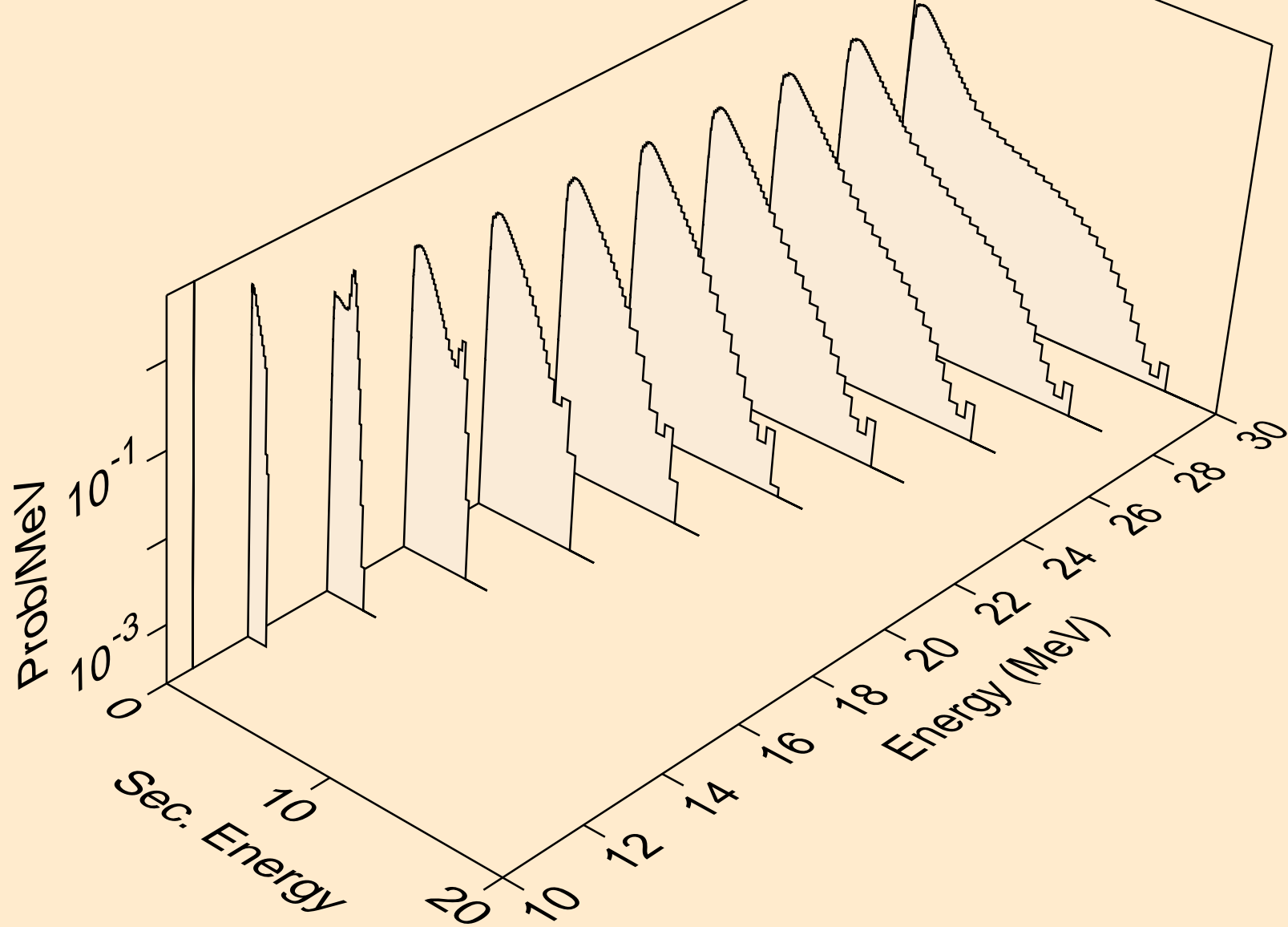

SE078 PROTON ACER TENDL-2021 LIBRARY; T=0.K  
neutrons from (p,n\*)2a

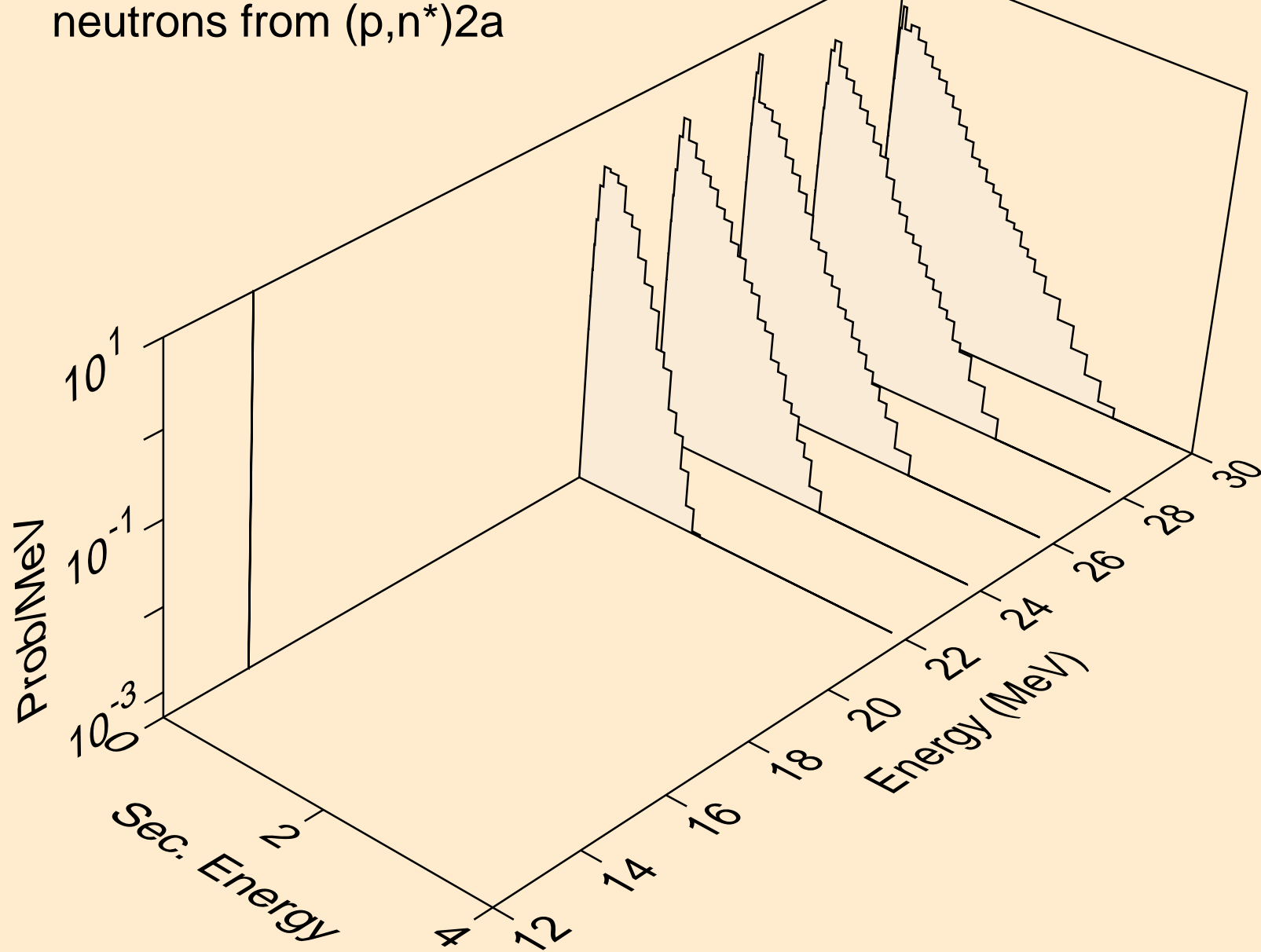

SE078 PROTON ACER TENDL-2021 LIBRARY; T=0.K  
neutrons from (p,n\*)d

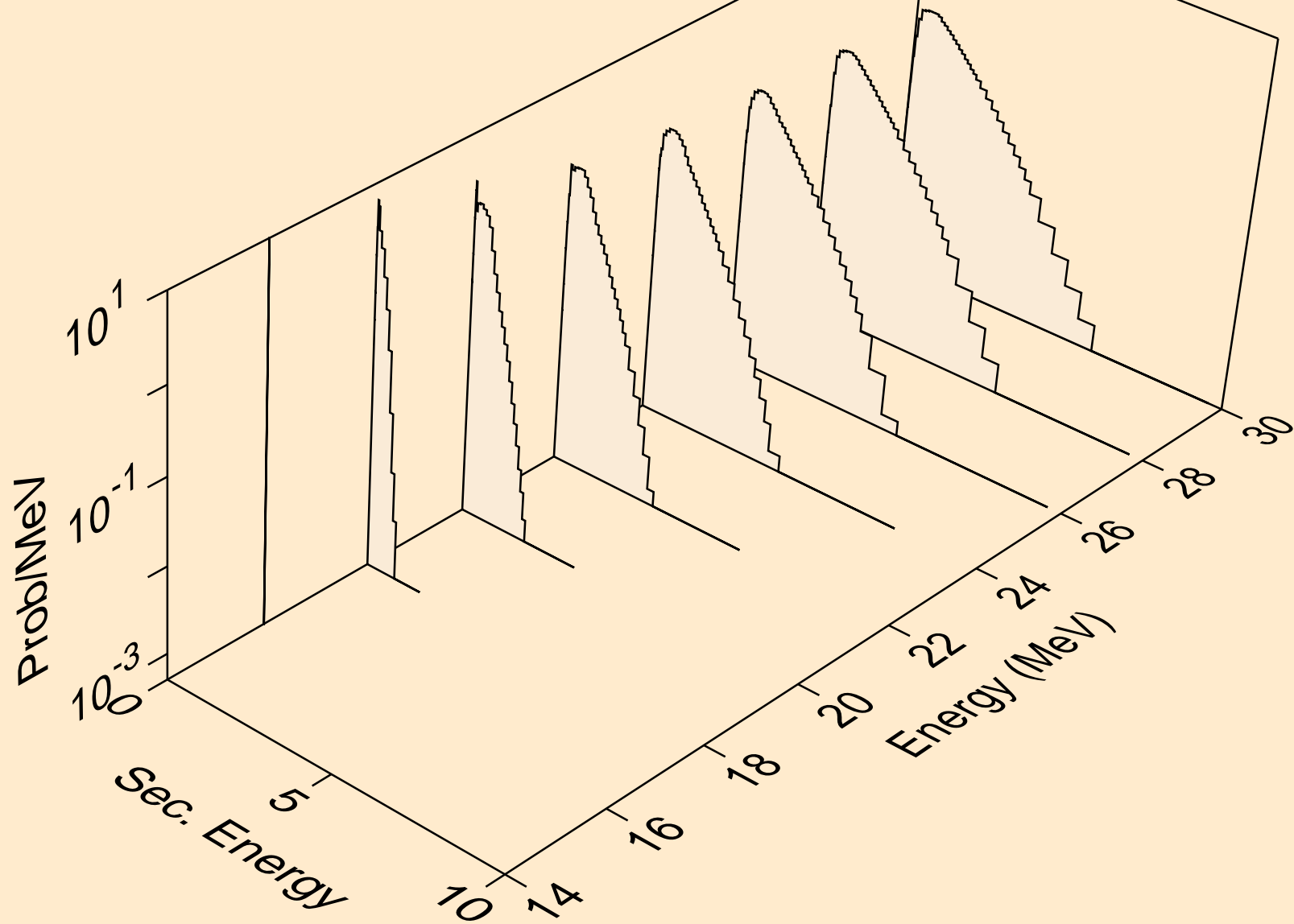

SE078 PROTON ACER TENDL-2021 LIBRARY; T=0.K  
neutrons from (p,n\*)t

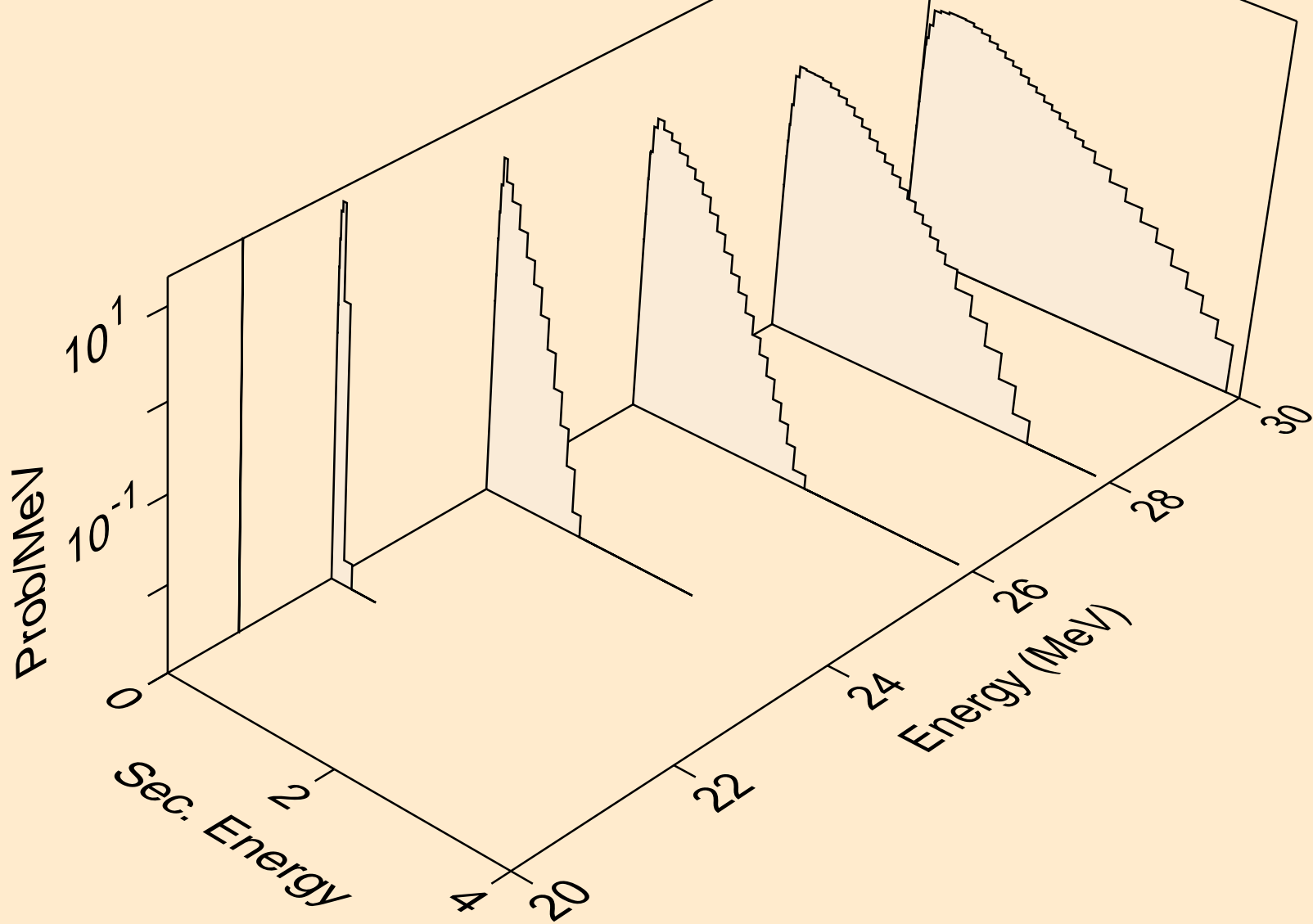

SE078 PROTON ACER TENDL-2021 LIBRARY; T=0.K  
neutrons from (p,n\*)he3

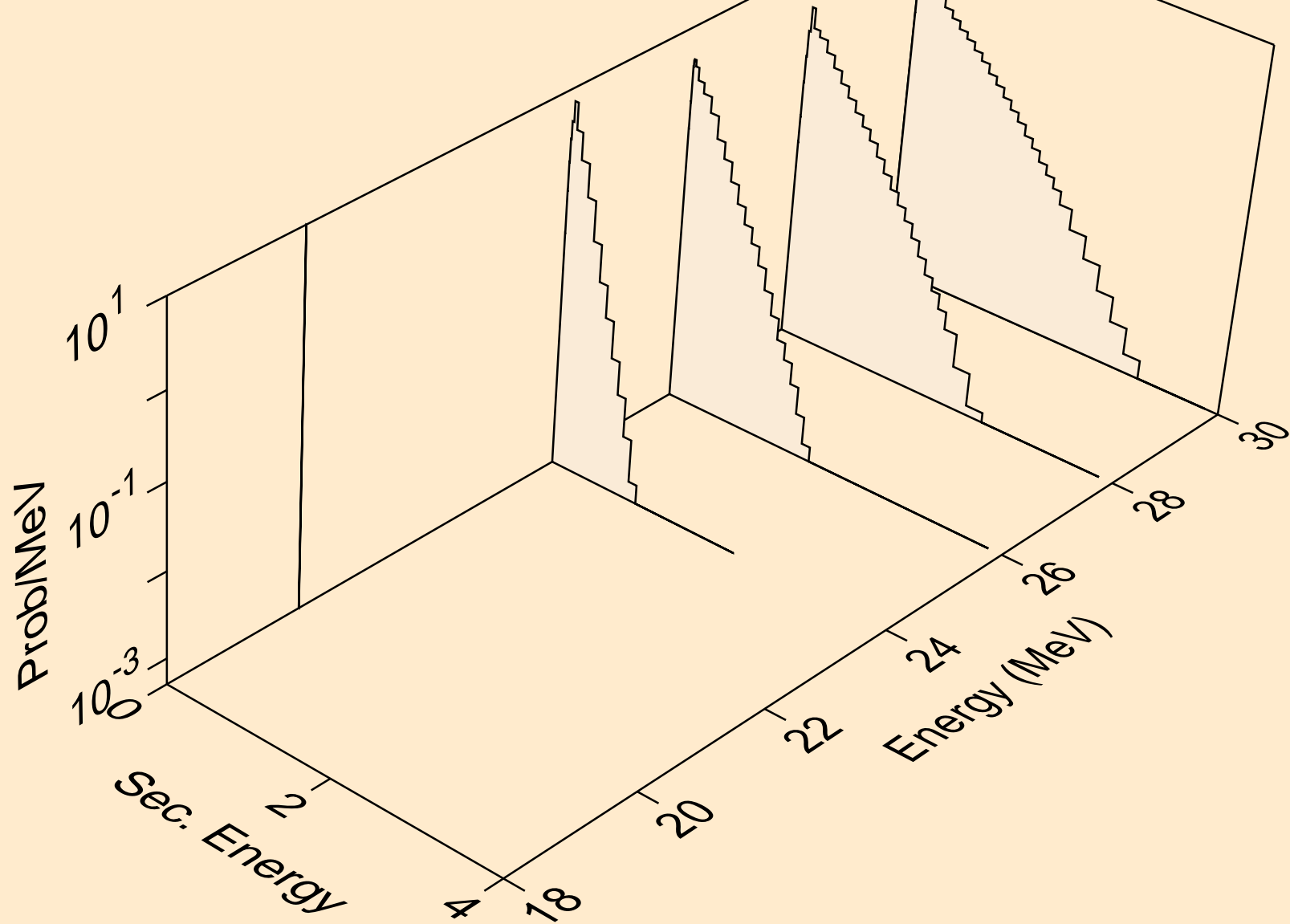

SE078 PROTON ACER TENDL-2021 LIBRARY; T=0.K  
neutrons from (p,2np)

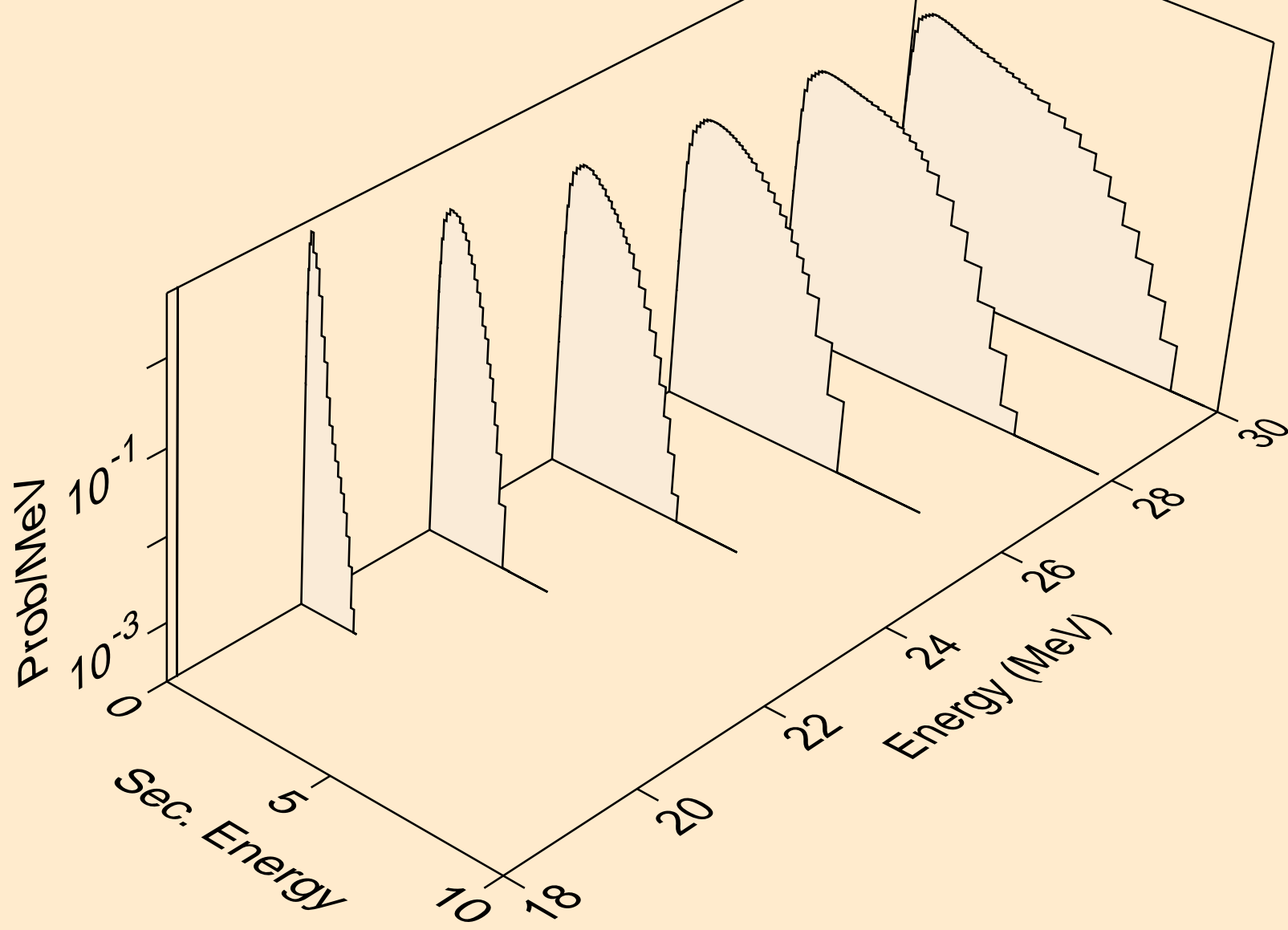

SE078 PROTON ACER TENDL-2021 LIBRARY; T=0.K  
neutrons from (p,2np)

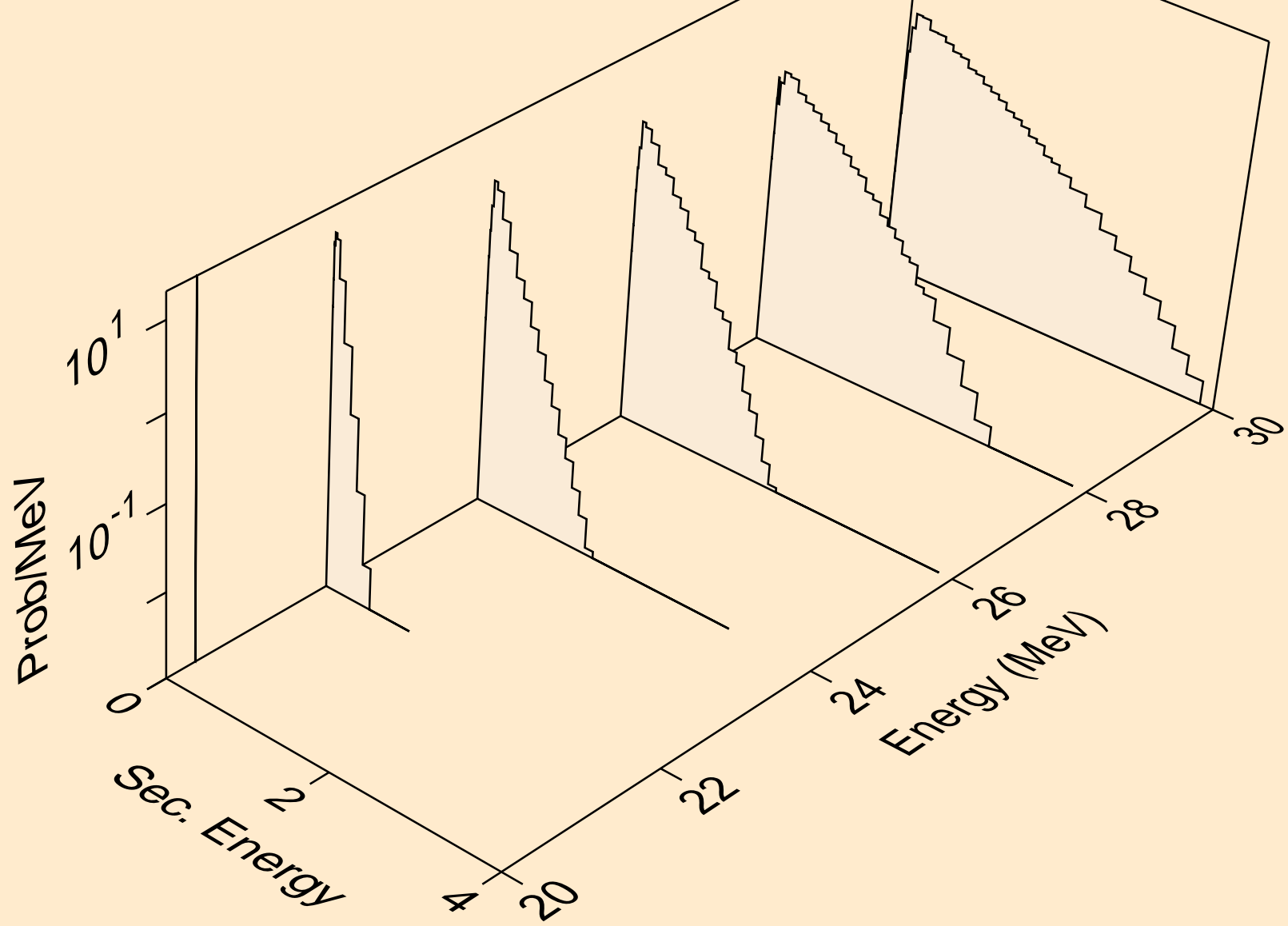

SE078 PROTON ACER TENDL-2021 LIBRARY; T=0.K  
neutrons from (p,npa)

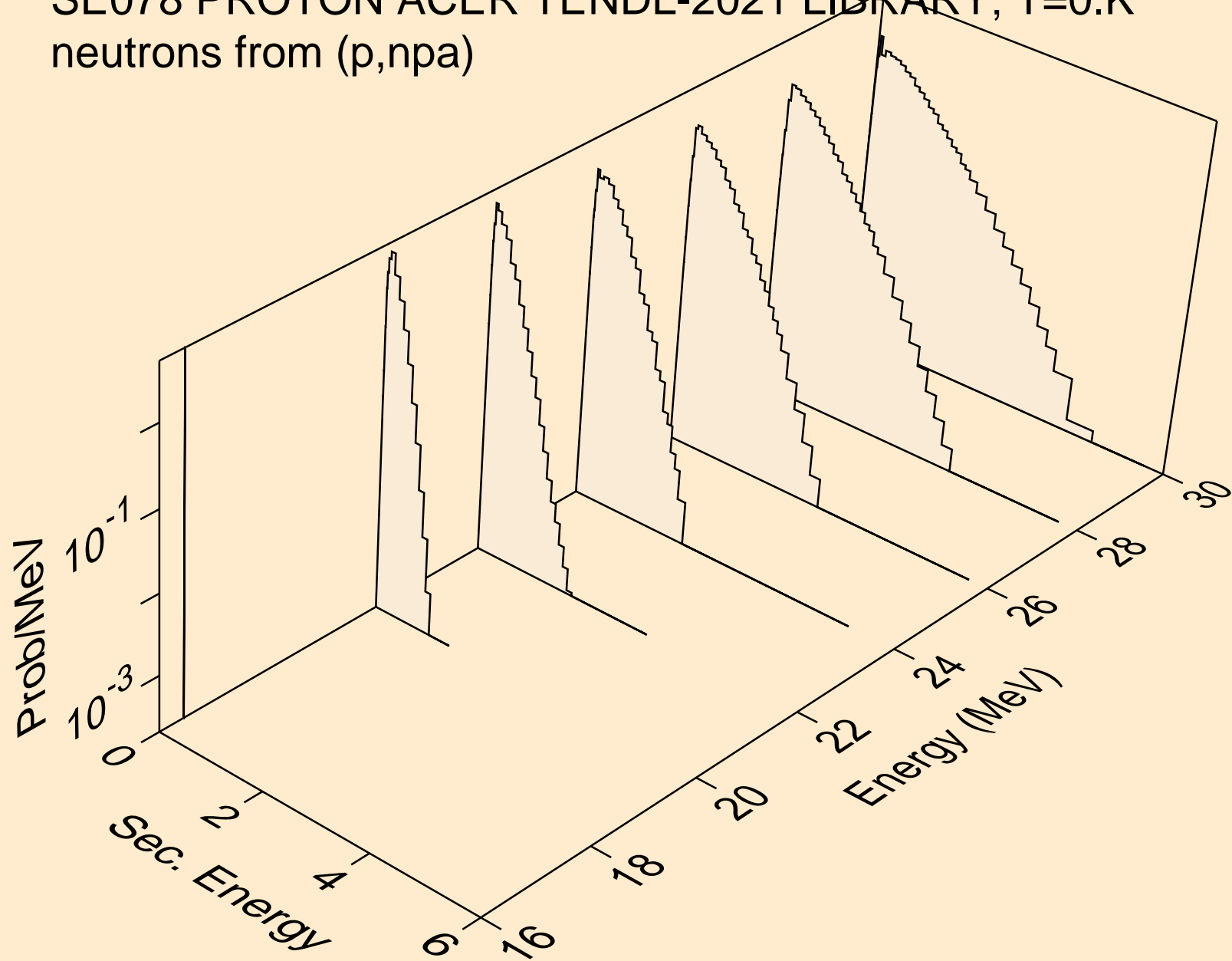



SE078 PROTON ACER TENDL-2021 LIBRARY; T=0.K  
deuterons from (p,x)

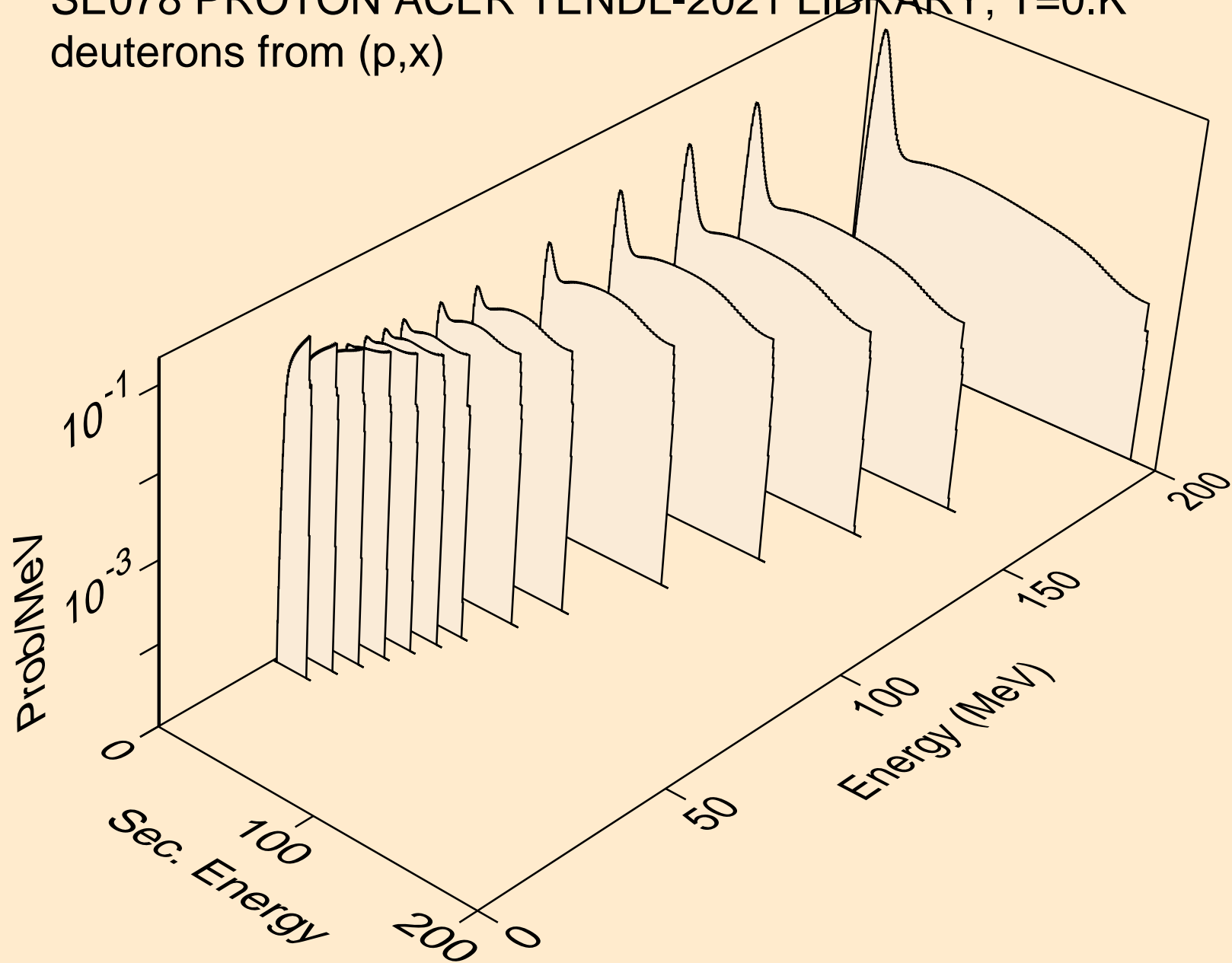

SE078 PROTON ACER TENDL-2021 LIBRARY; T=0.K  
deuterons from (p,2nd)

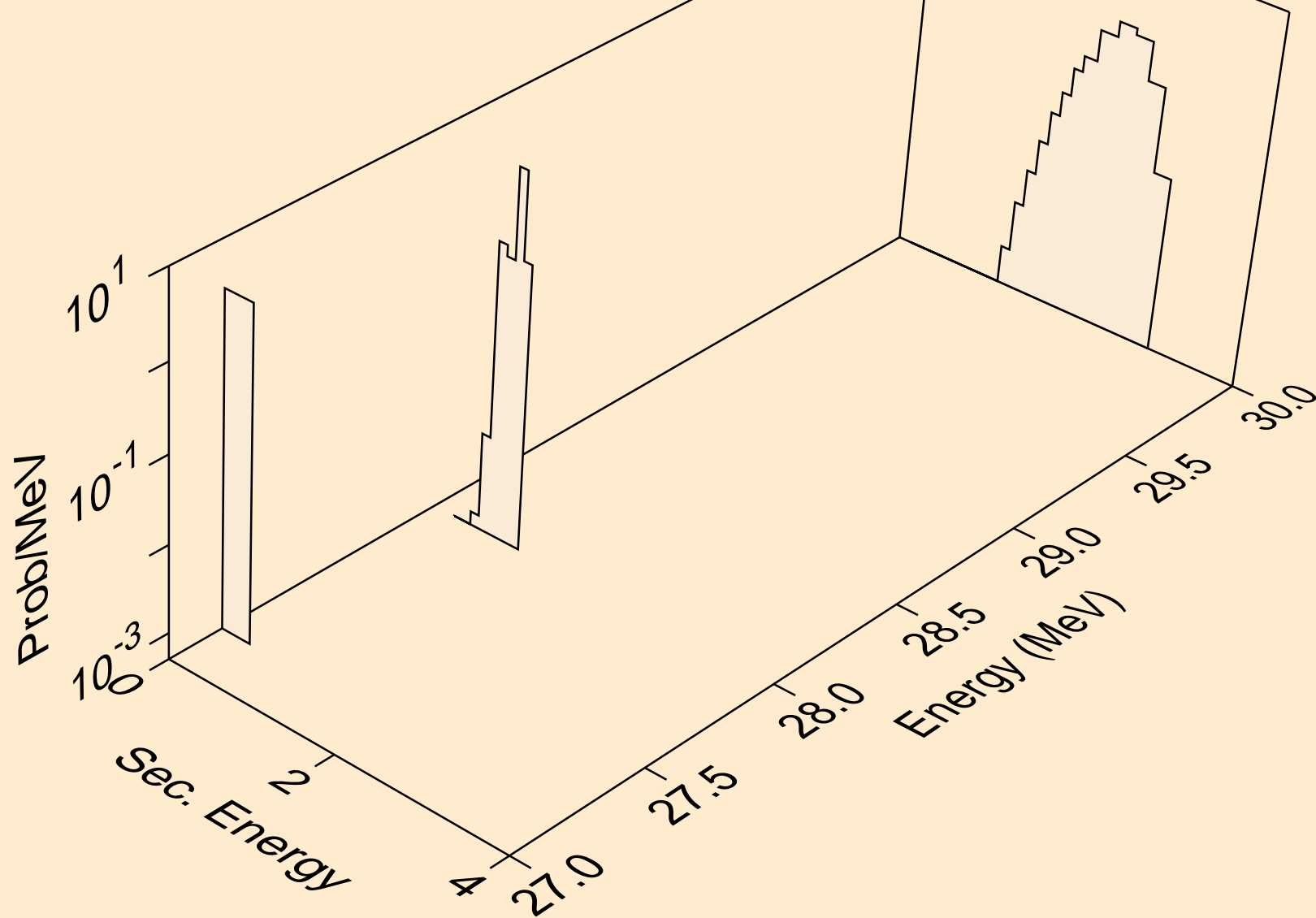

SE078 PROTON ACER TENDL-2021 LIBRARY; T=0.K  
deuterons from (p,n\*)d

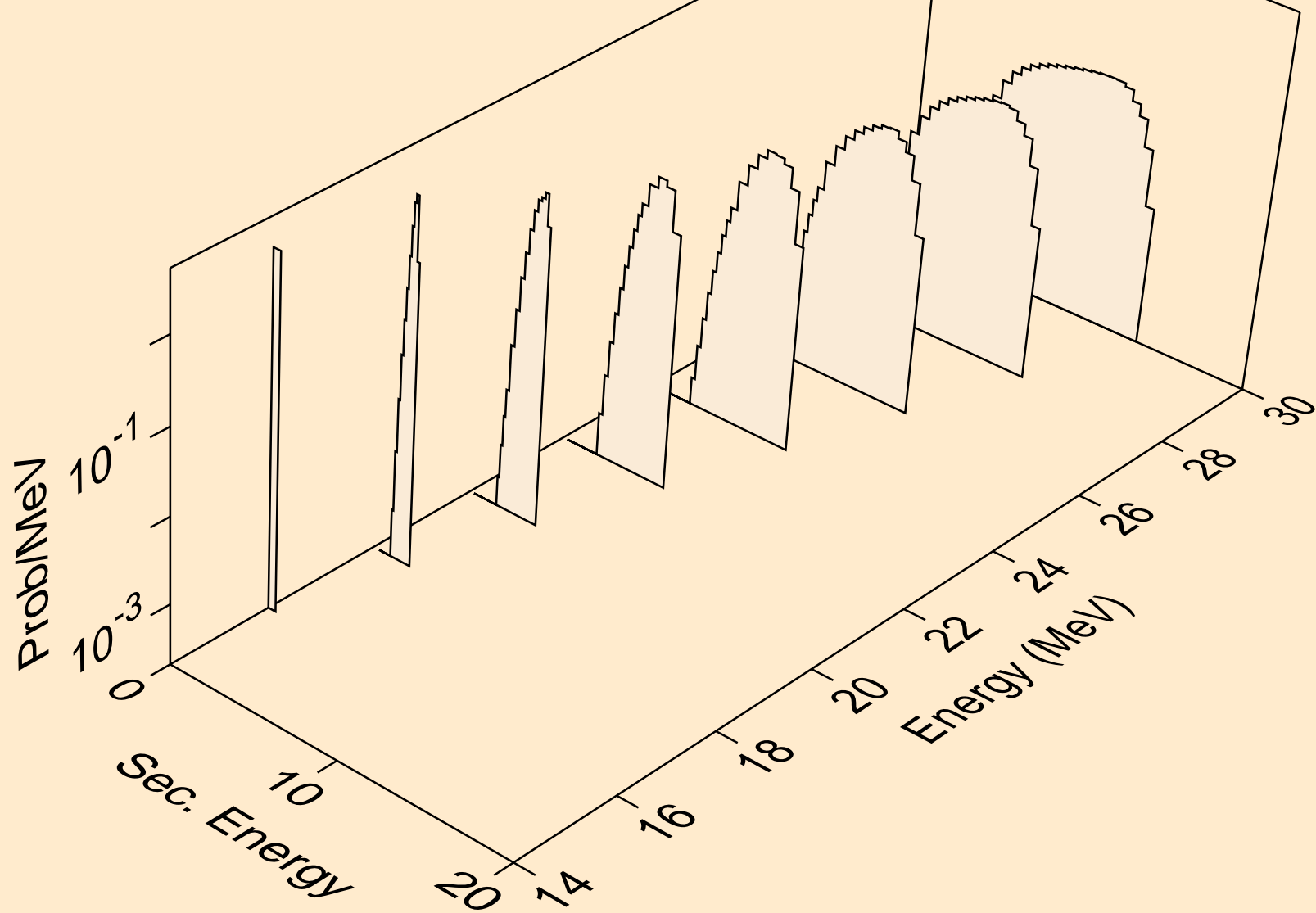

SE078 PROTON ACER TENDL-2021 LIBRARY; T=0.K  
deuterons from (p,d)

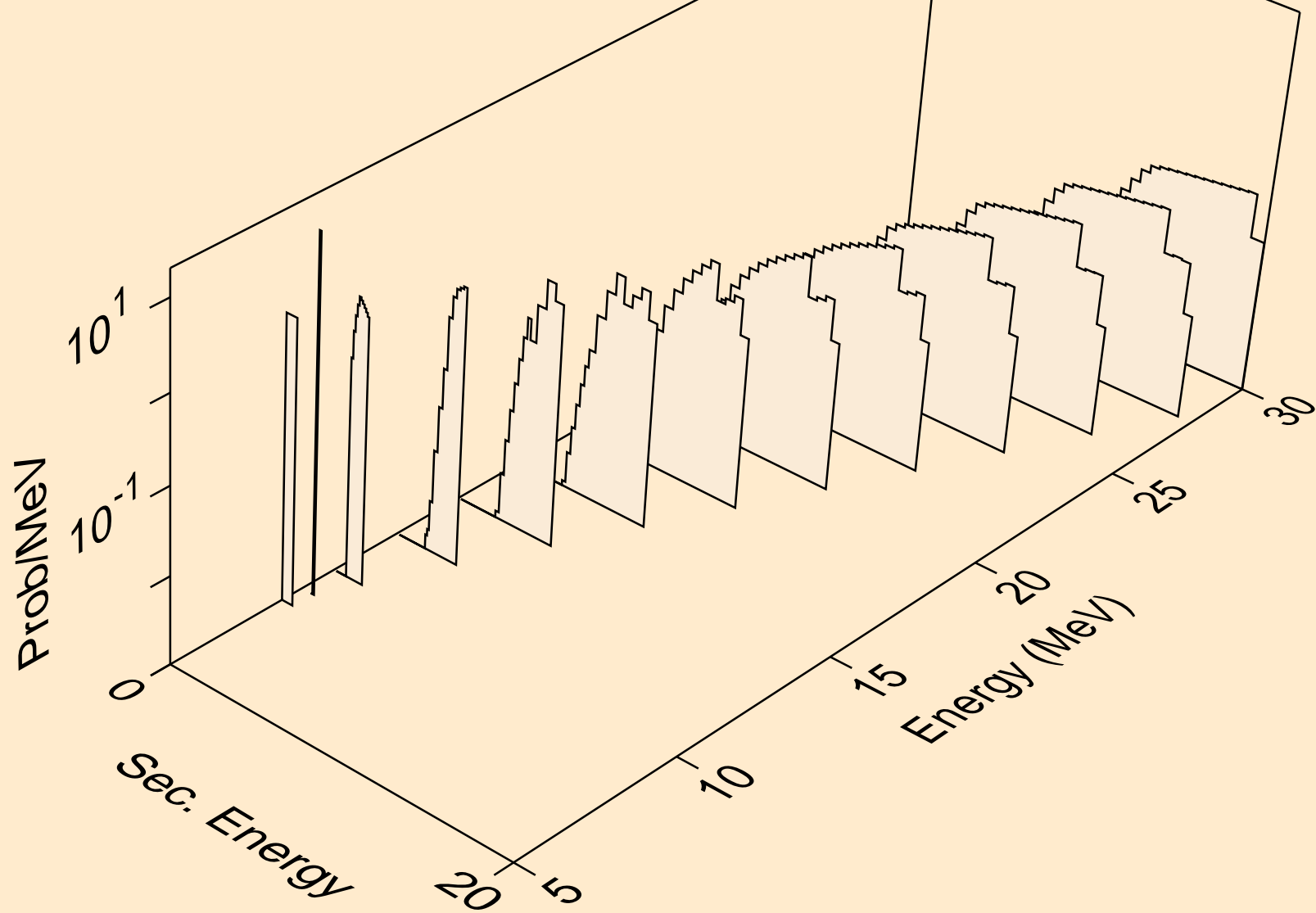

SE078 PROTON ACER TENDL-2021 LIBRARY; T=0.K  
deuterons from (p,pd)

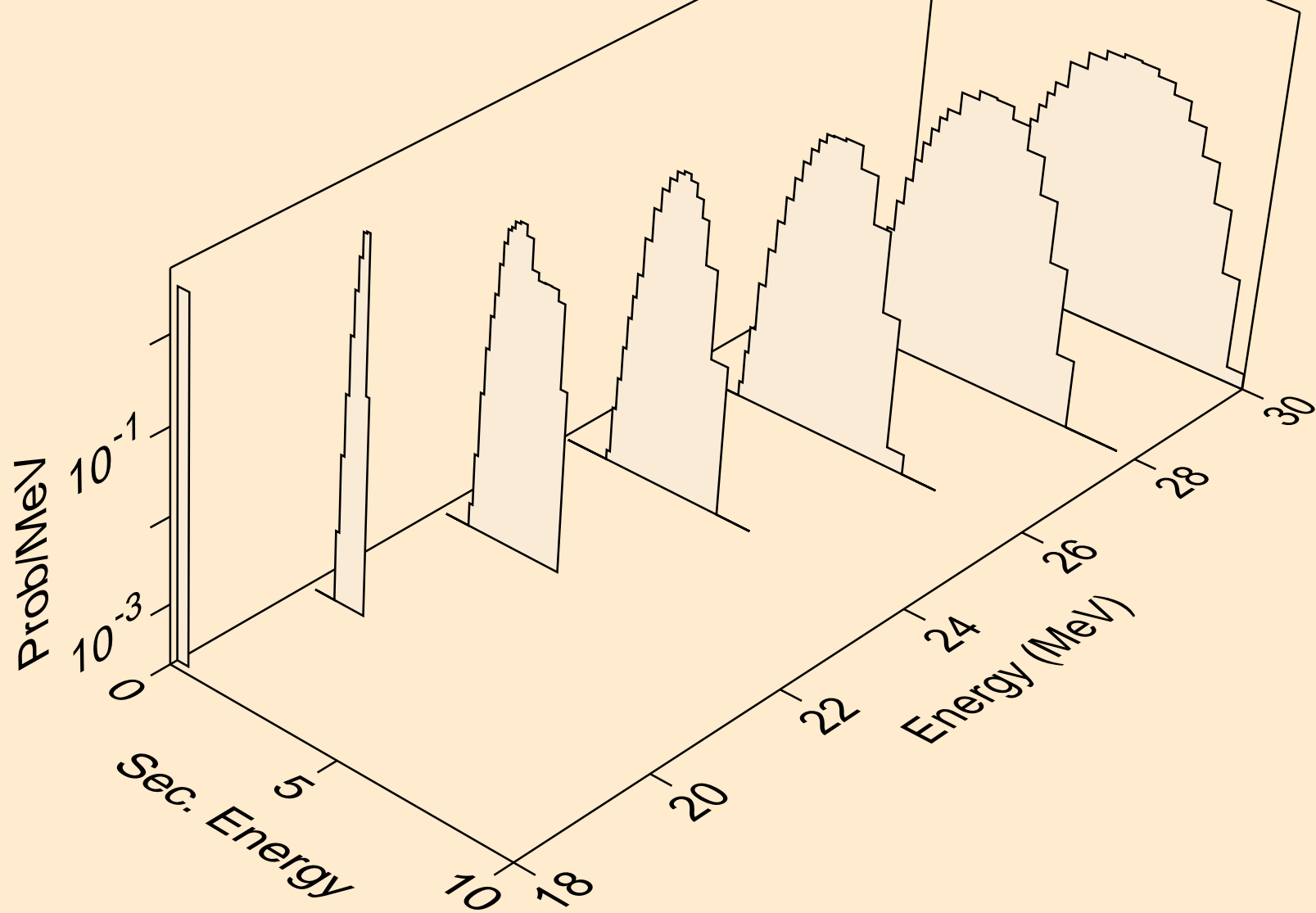

SE078 PROTON ACER TENDL-2021 LIBRARY; T=0.K  
deuterons from (p,da)

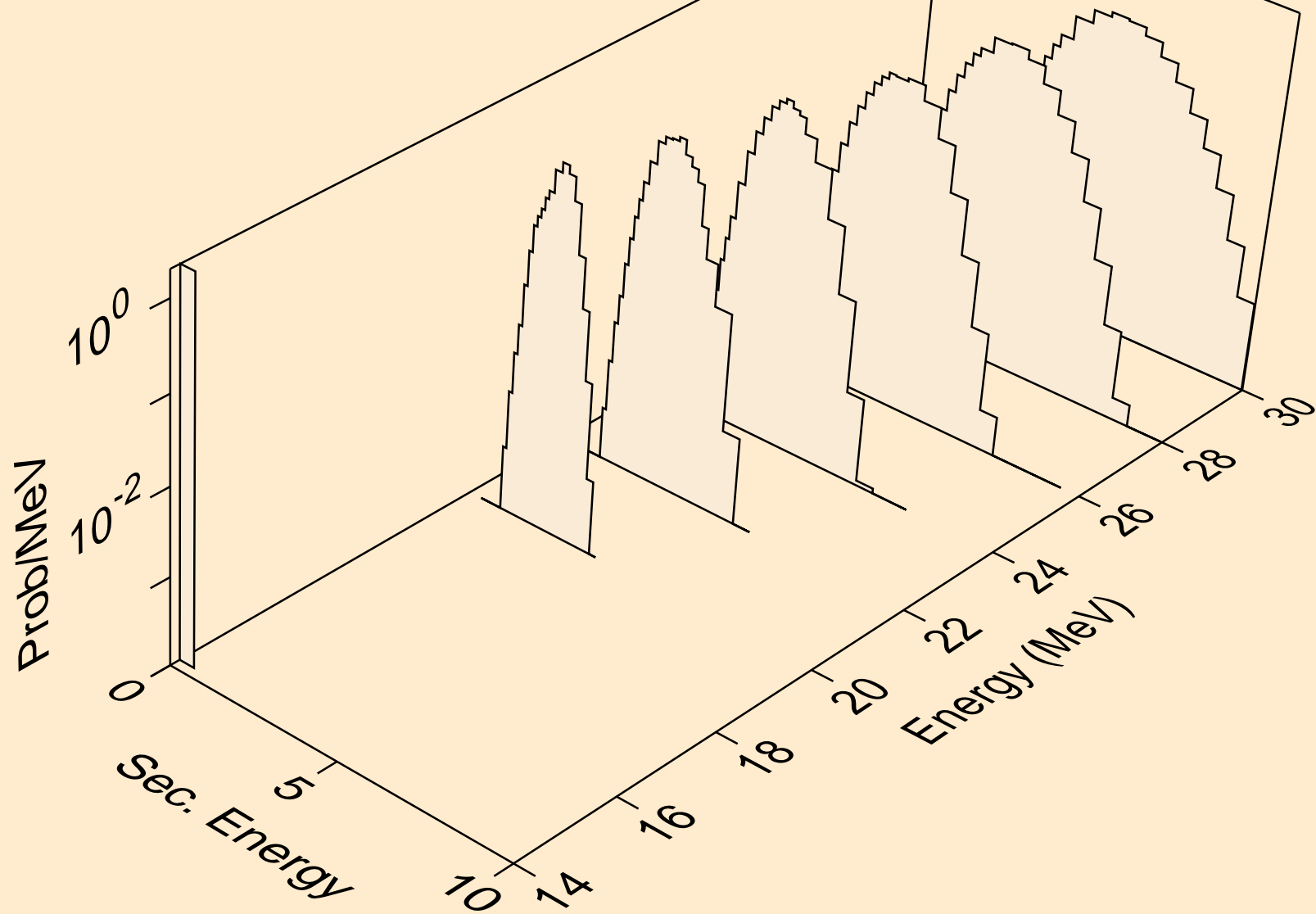

SE078 PROTON ACER TENDL-2021 LIBRARY; T=0.K  
tritons from (p,x)

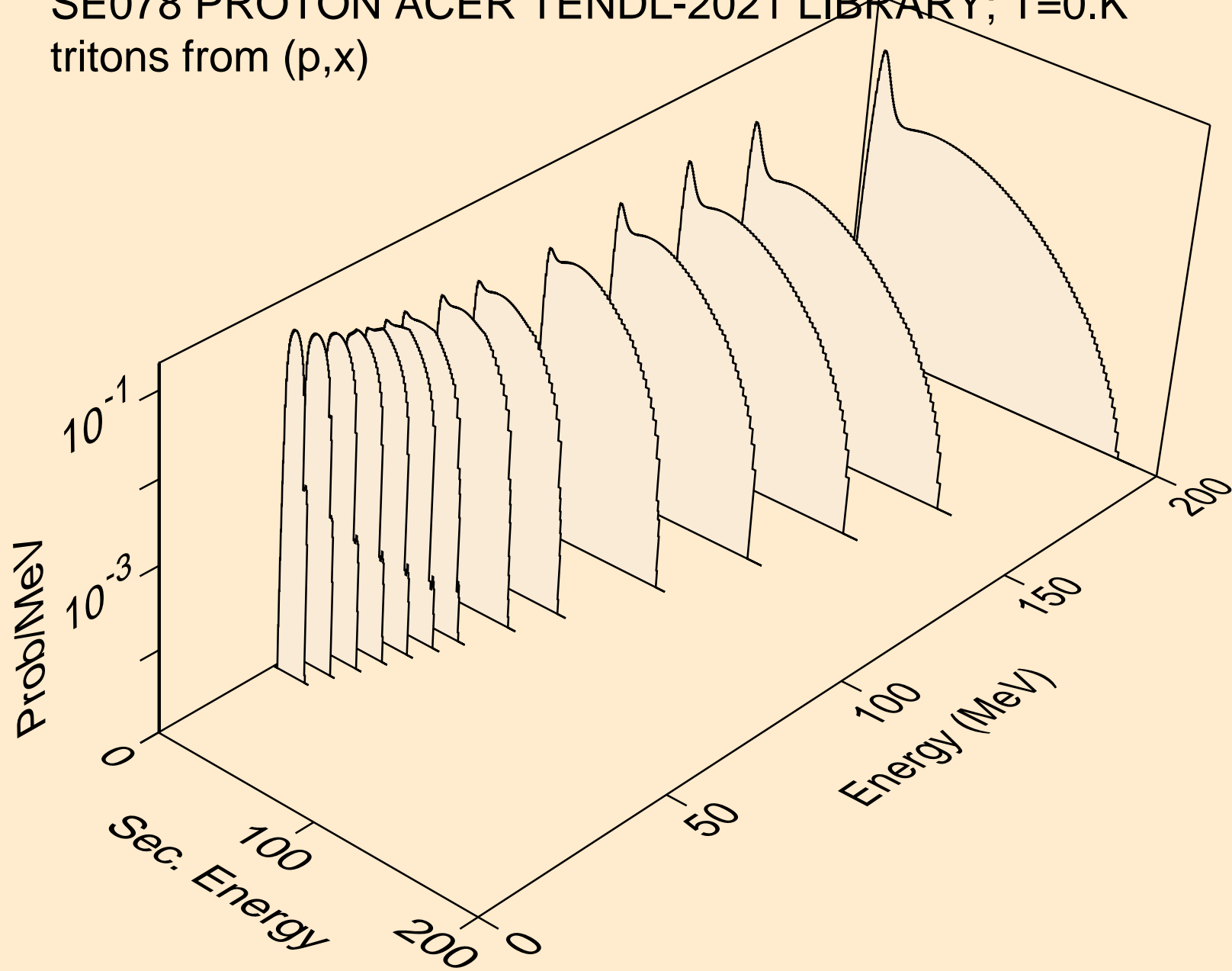

SE078 PROTON ACER TENDL-2021 LIBRARY; T=0.K  
tritons from (p,n\*)t

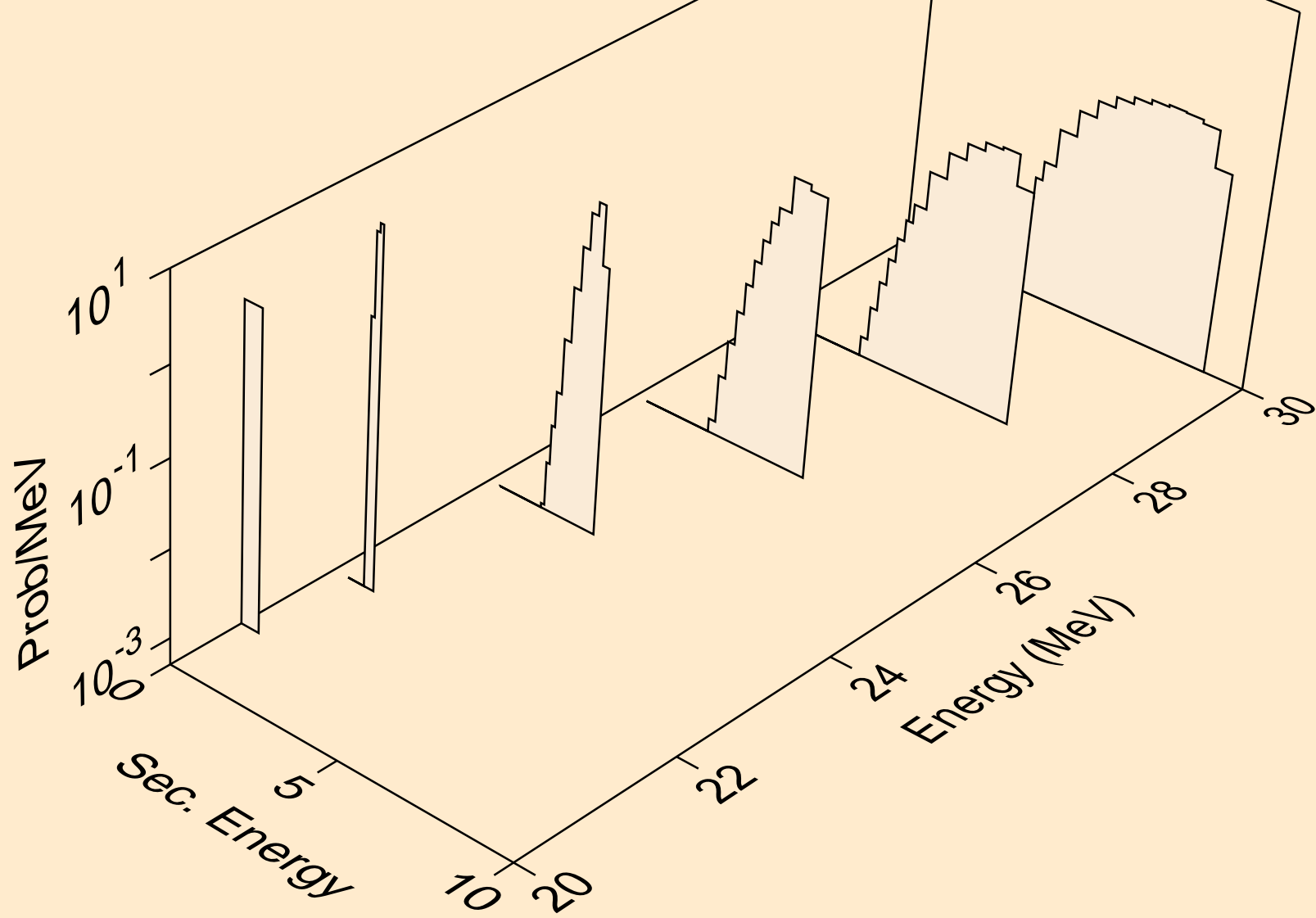



SE078 PROTON ACER TENDL-2021 LIBRARY; T=0.K  
tritons from (p,t)

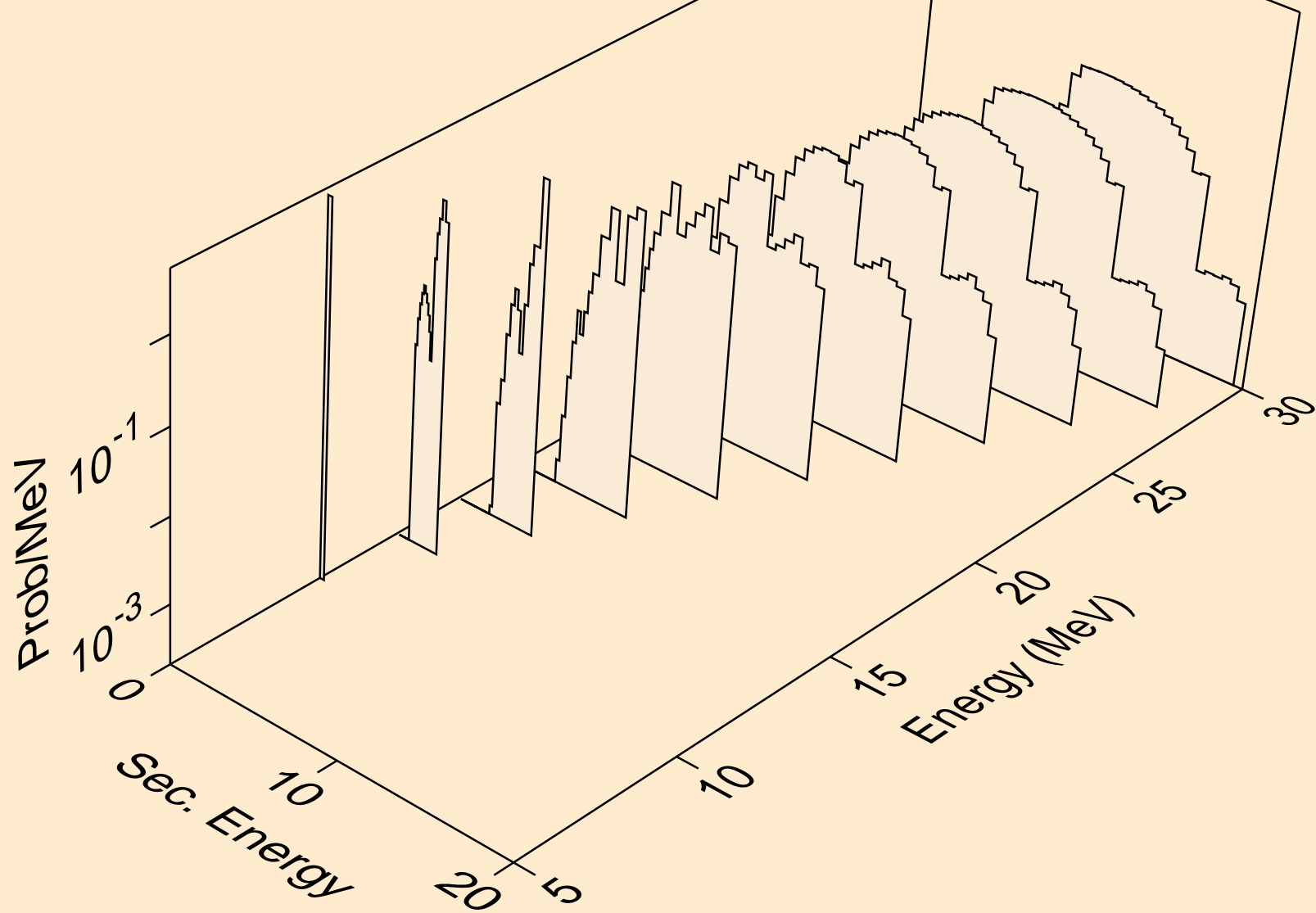

SE078 PROTON ACER TENDL-2021 LIBRARY; T=0.K  
tritons from (p,pt)

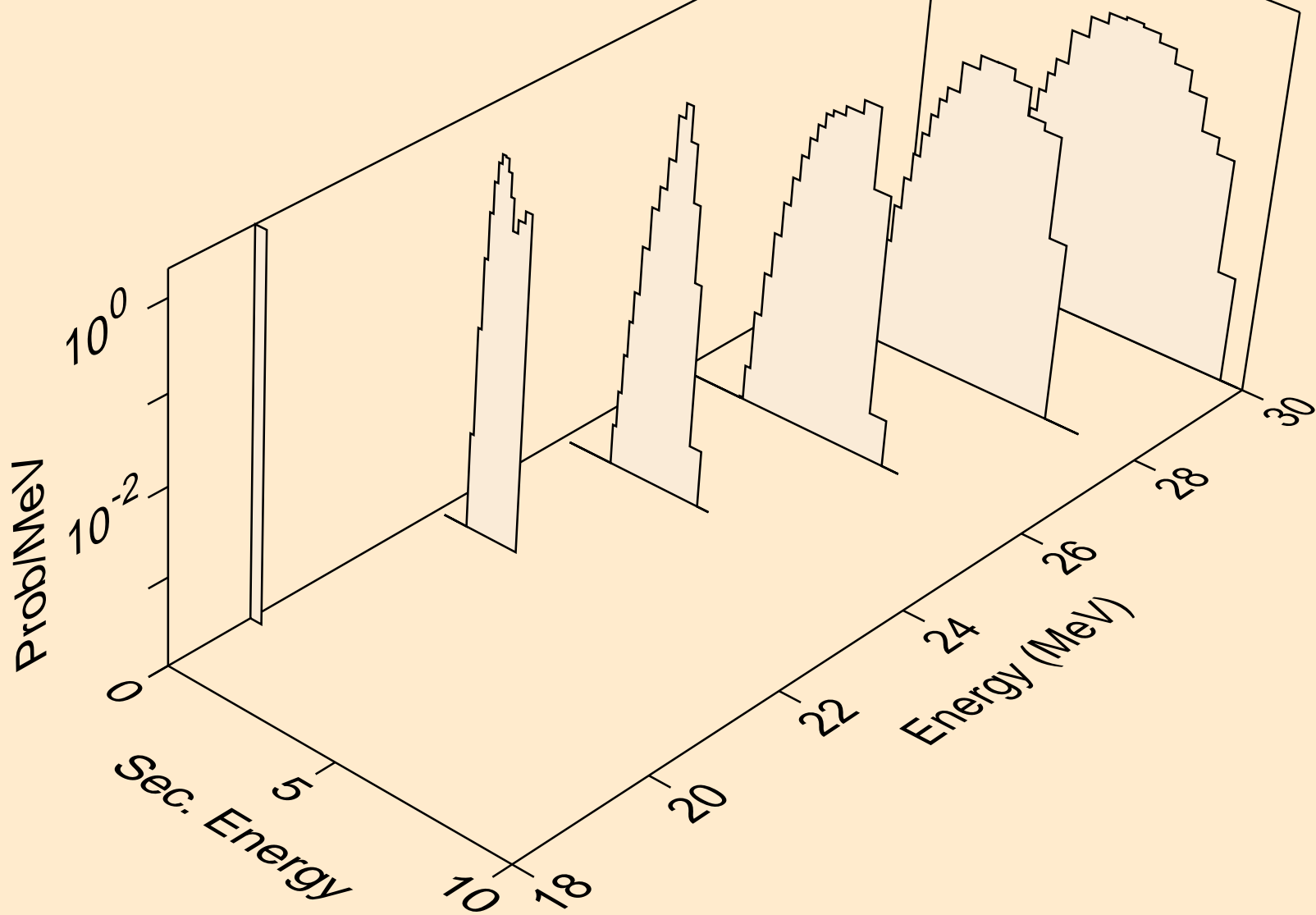

SE078 PROTON ACER TENDL-2021 LIBRARY; T=0.K  
he3s from (p,x)

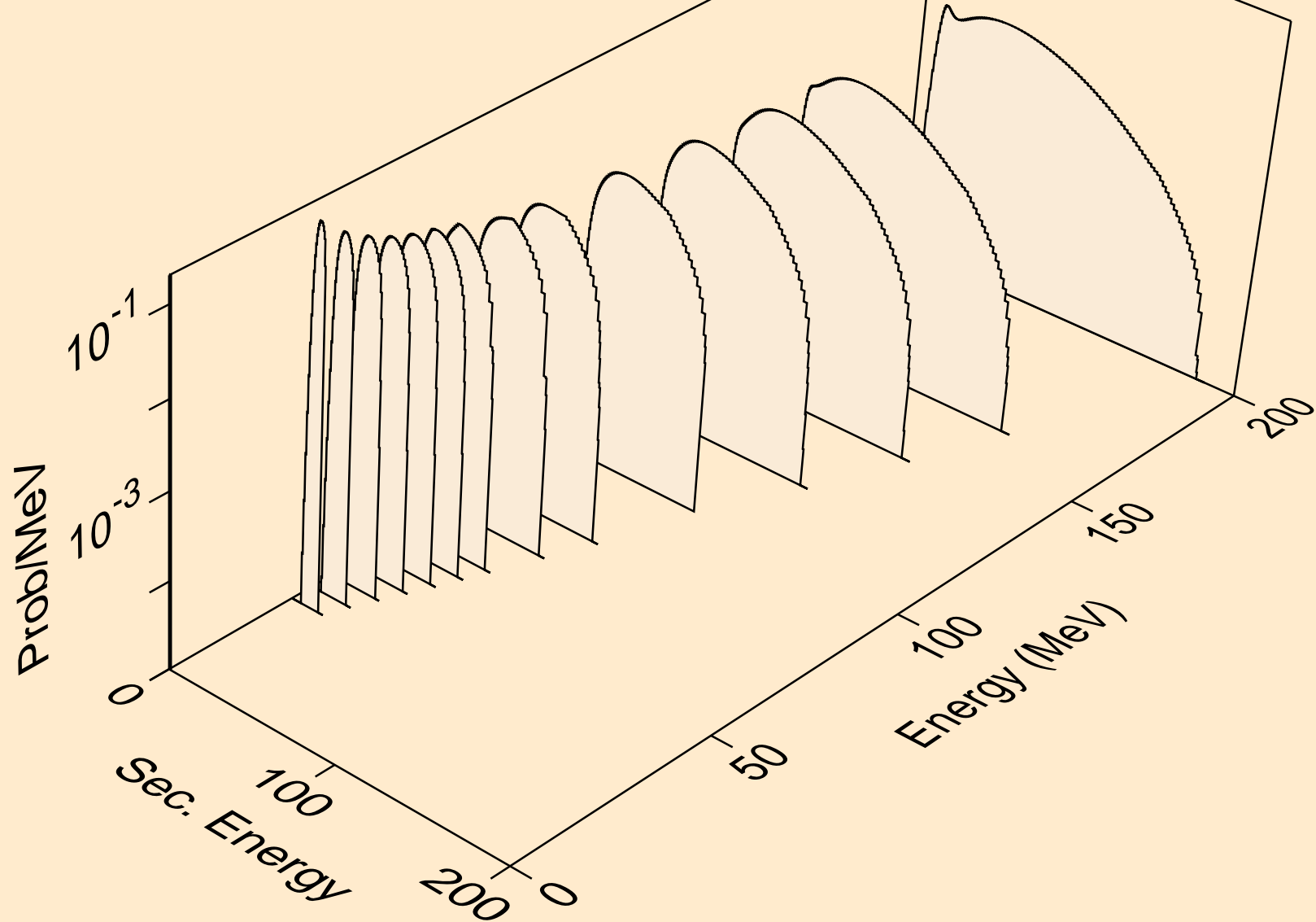

SE078 PROTON ACER TENDL-2021 LIBRARY; T=0.K  
he3s from (p,n\*)he3

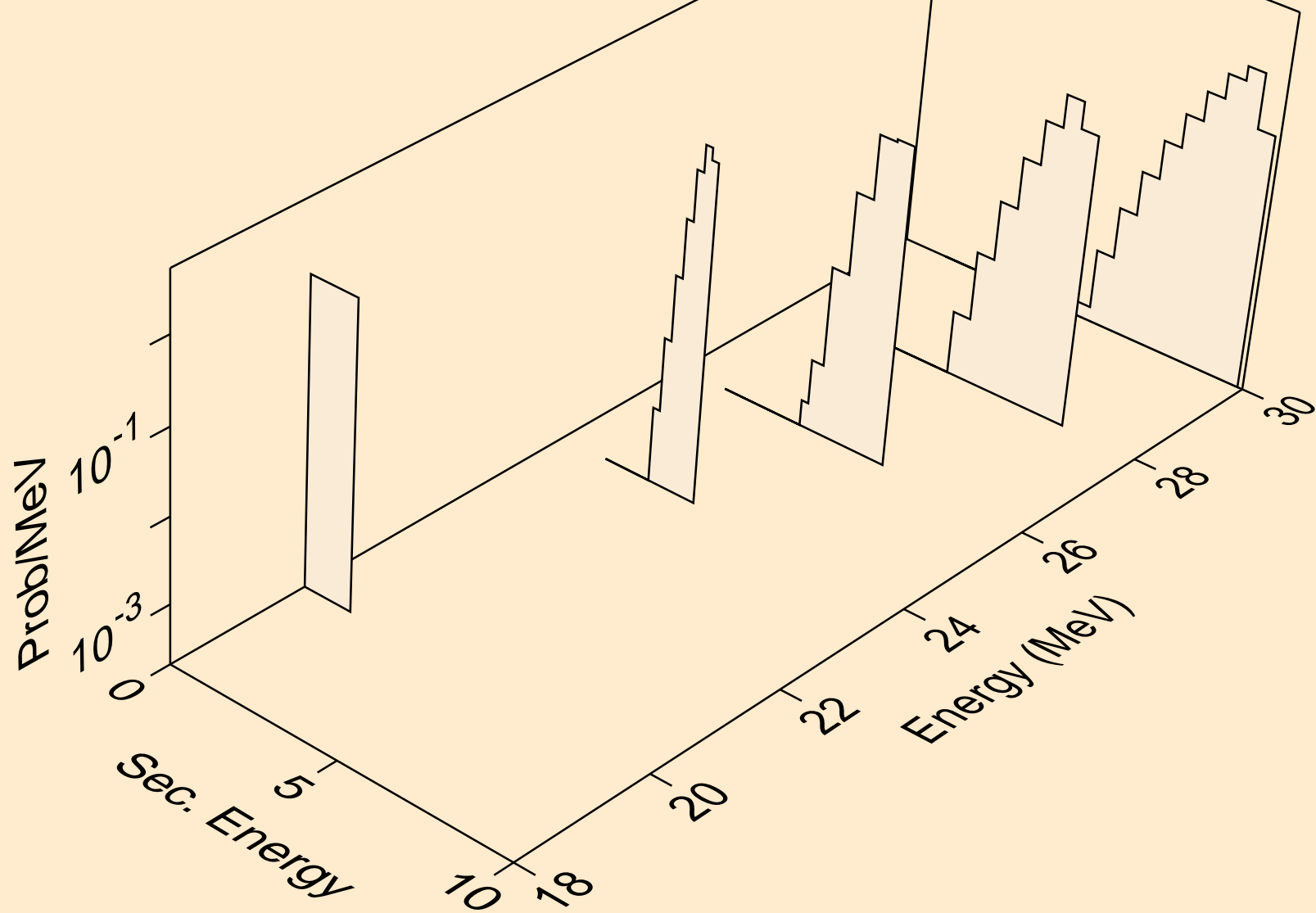

SE078 PROTON ACER TENDL-2021 LIBRARY; T=0.K  
he3s from (p,he3)

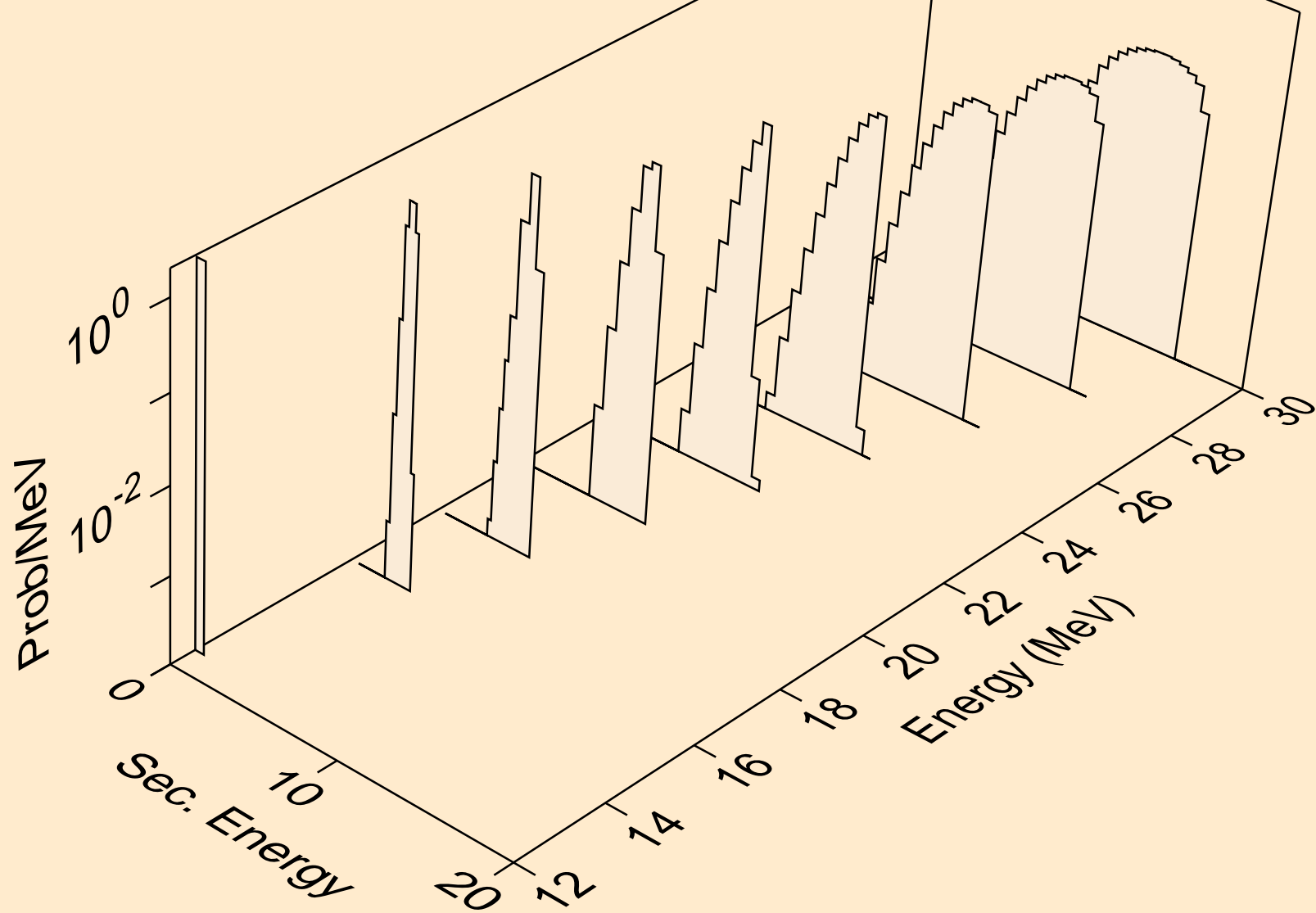

SE078 PROTON ACER TENDL-2021 LIBRARY; T=0.K  
alphas from (p,x)

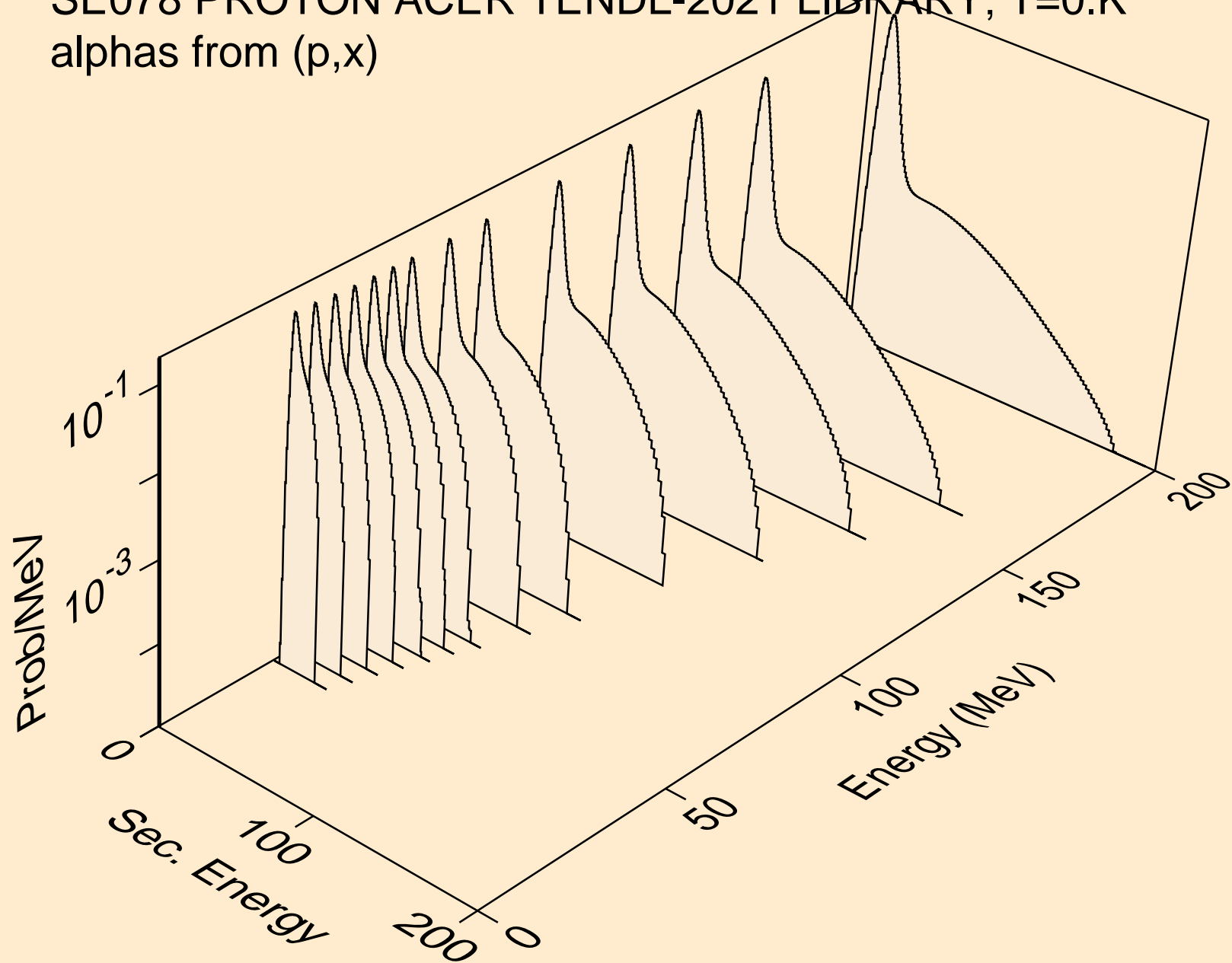

SE078 PROTON ACER TENDL-2021 LIBRARY; T=0.K  
alphas from (p,n\*)a

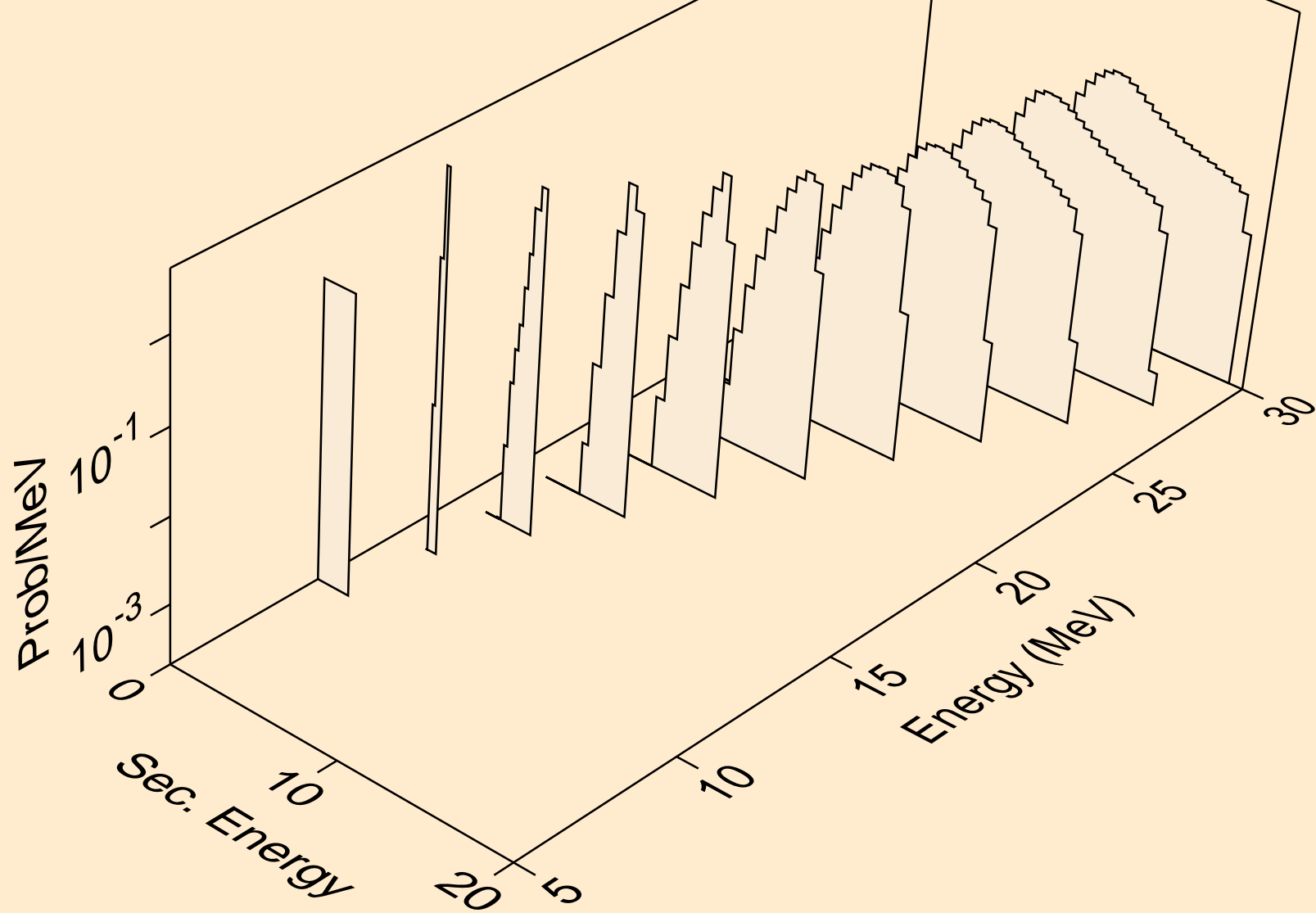

SE078 PROTON ACER TENDL-2021 LIBRARY; T=0.K  
alphas from (p,2n)a

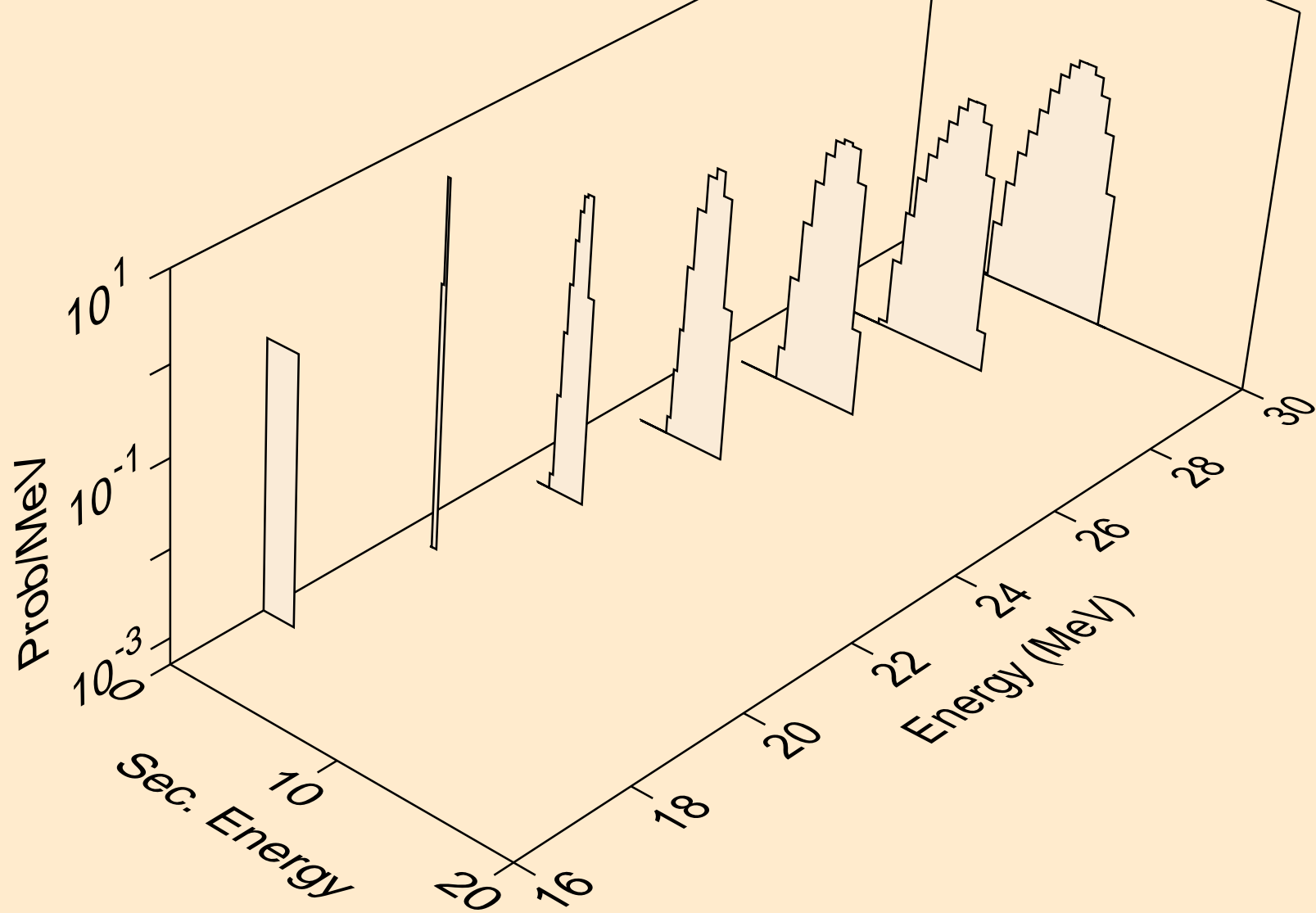



SE078 PROTON ACER TENDL-2021 LIBRARY; T=0.K  
alphas from (p,n\*)2a

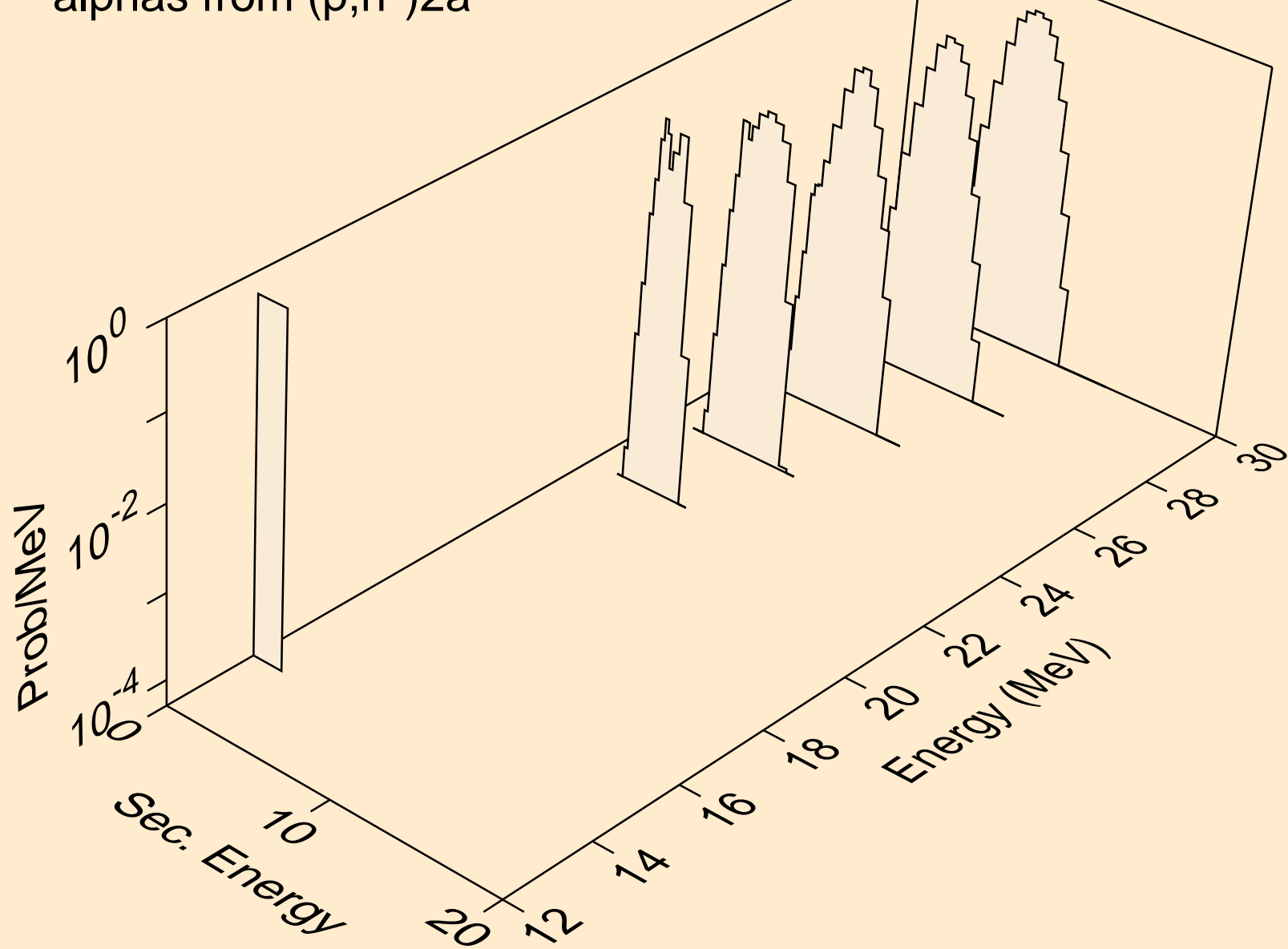

SE078 PROTON ACER TENDL-2021 LIBRARY; T=0.K  
alphas from (p,npa)

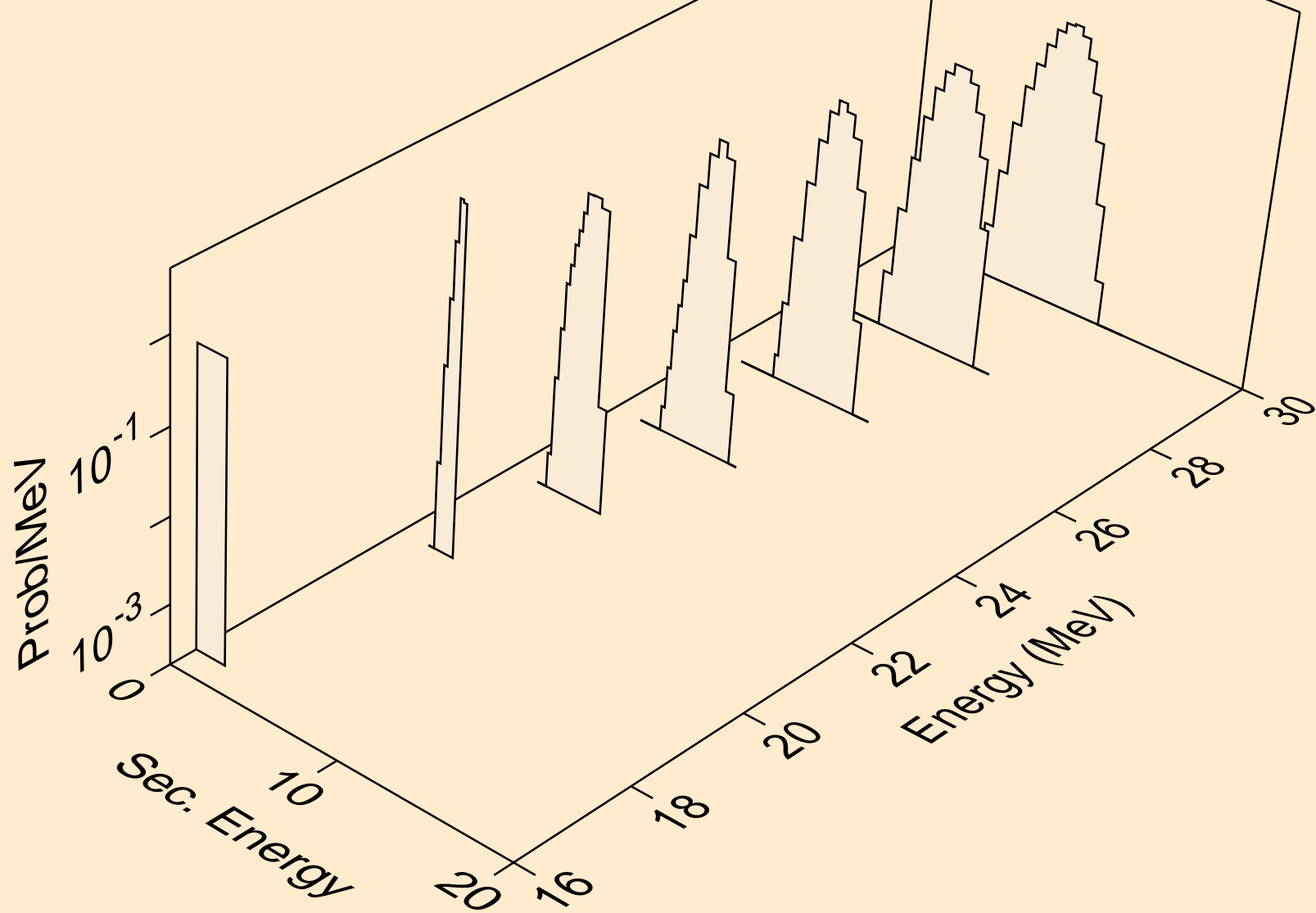

SE078 PROTON ACER TENDL-2021 LIBRARY; T=0.K  
alphas from (p,a)

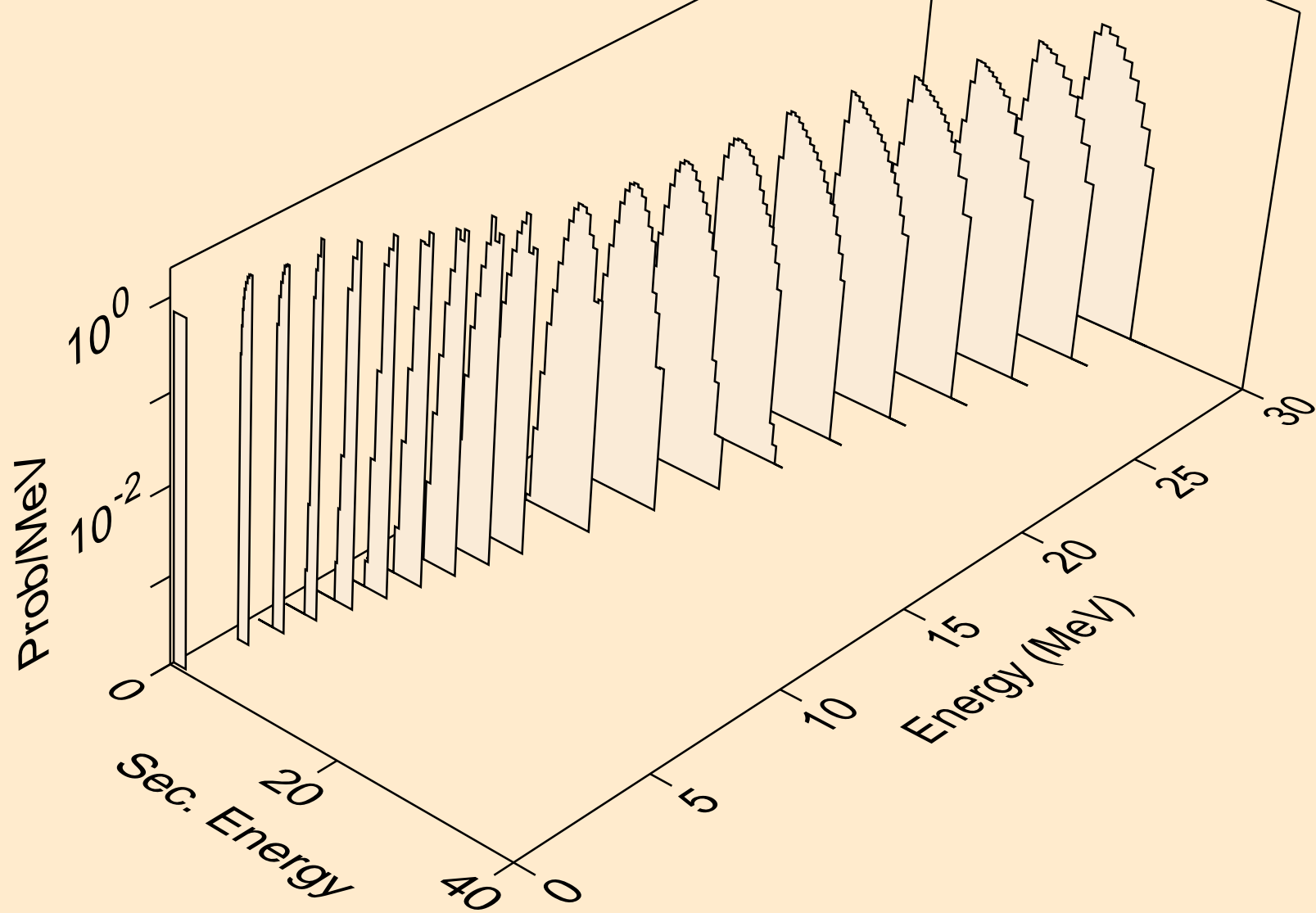

SE078 PROTON ACER TENDL-2021 LIBRARY; T=0.K  
alphas from (p,2a)

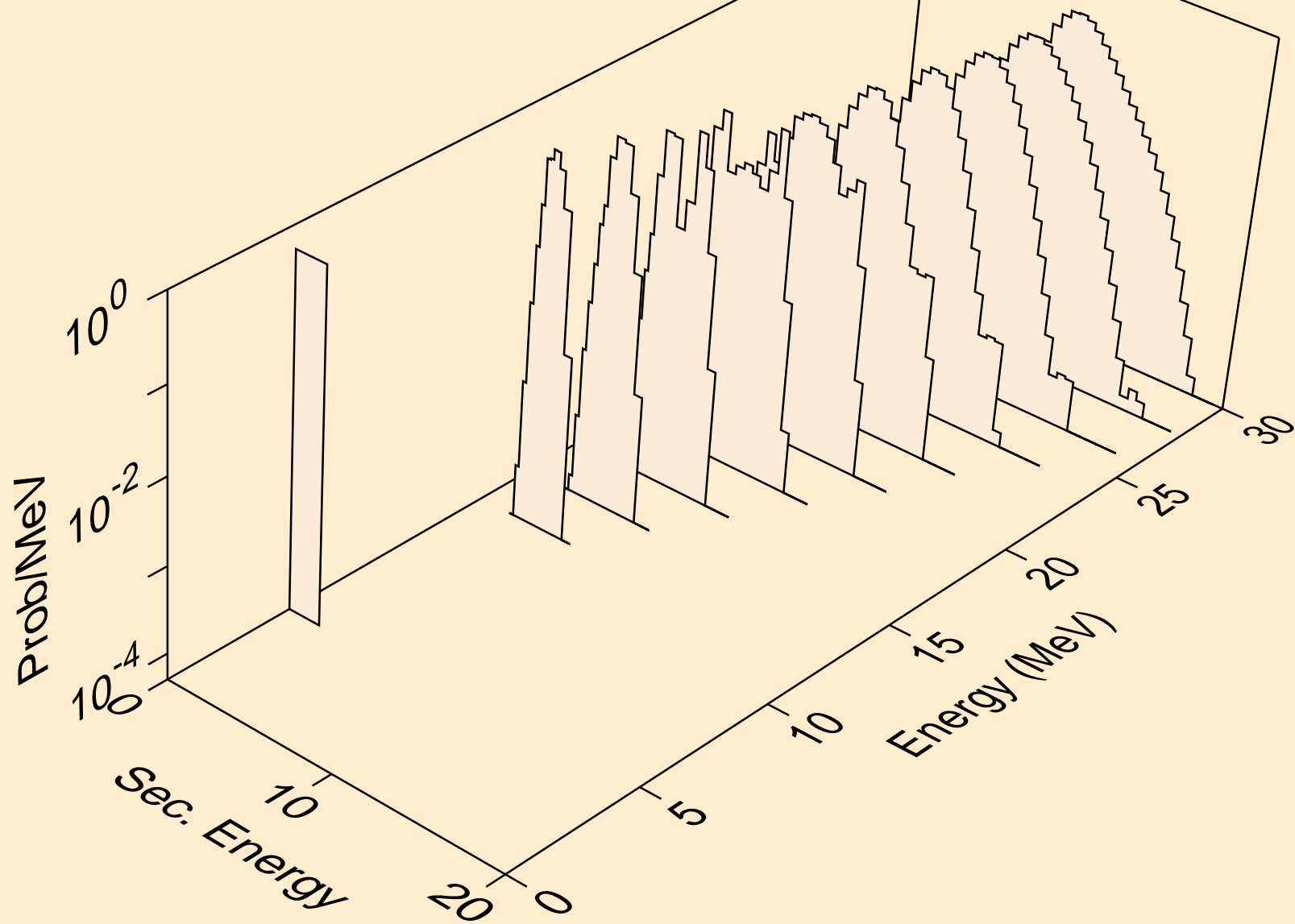

SE078 PROTON ACER TENDL-2021 LIBRARY; T=0.K  
alphas from (p,pa)

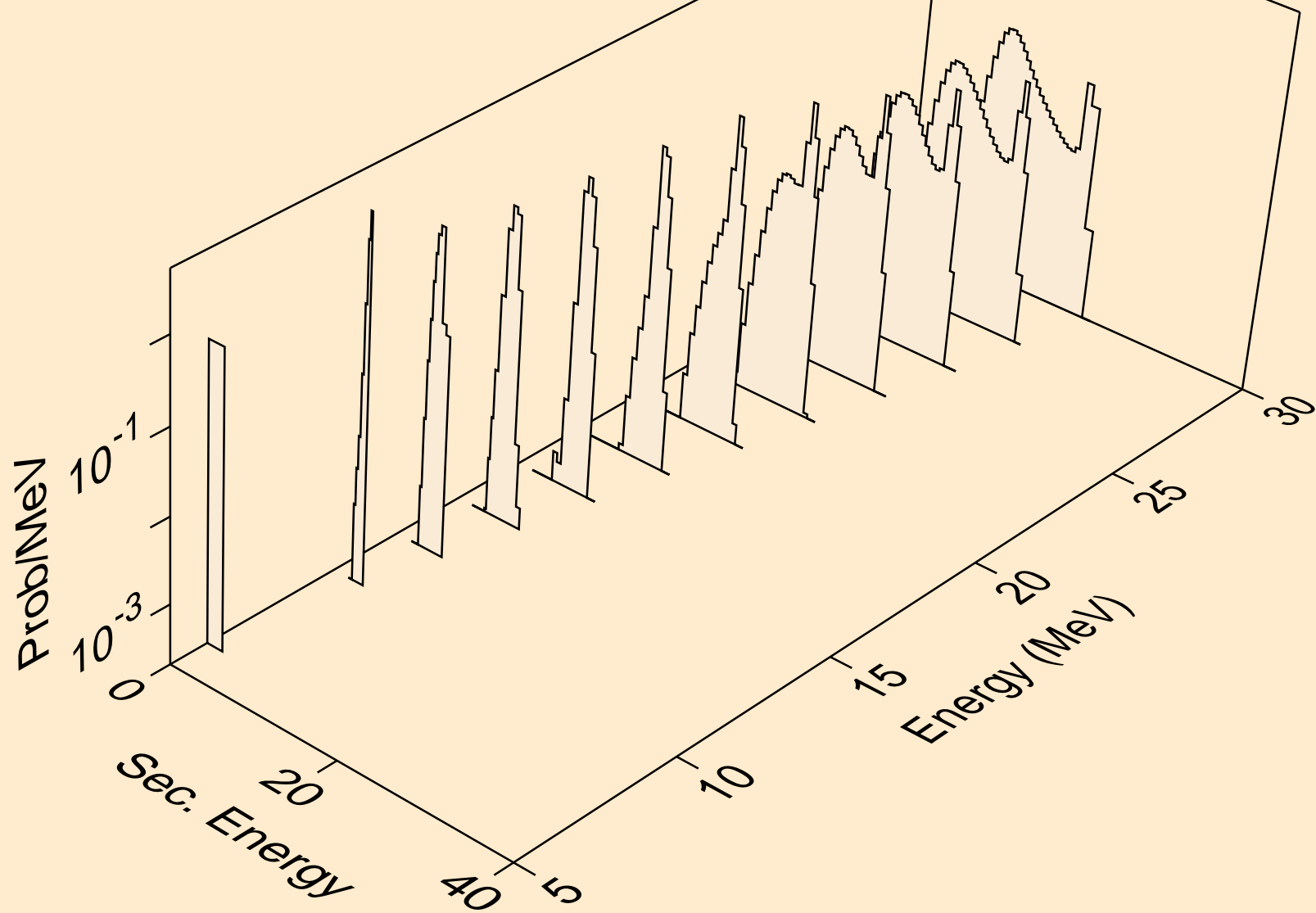

SE078 PROTON ACER TENDL-2021 LIBRARY; T=0.K  
alphas from (p,da)

