

SE079M PROTON ACER TENDL-2021 LIBRARY; T=0.K  
Principal cross sections

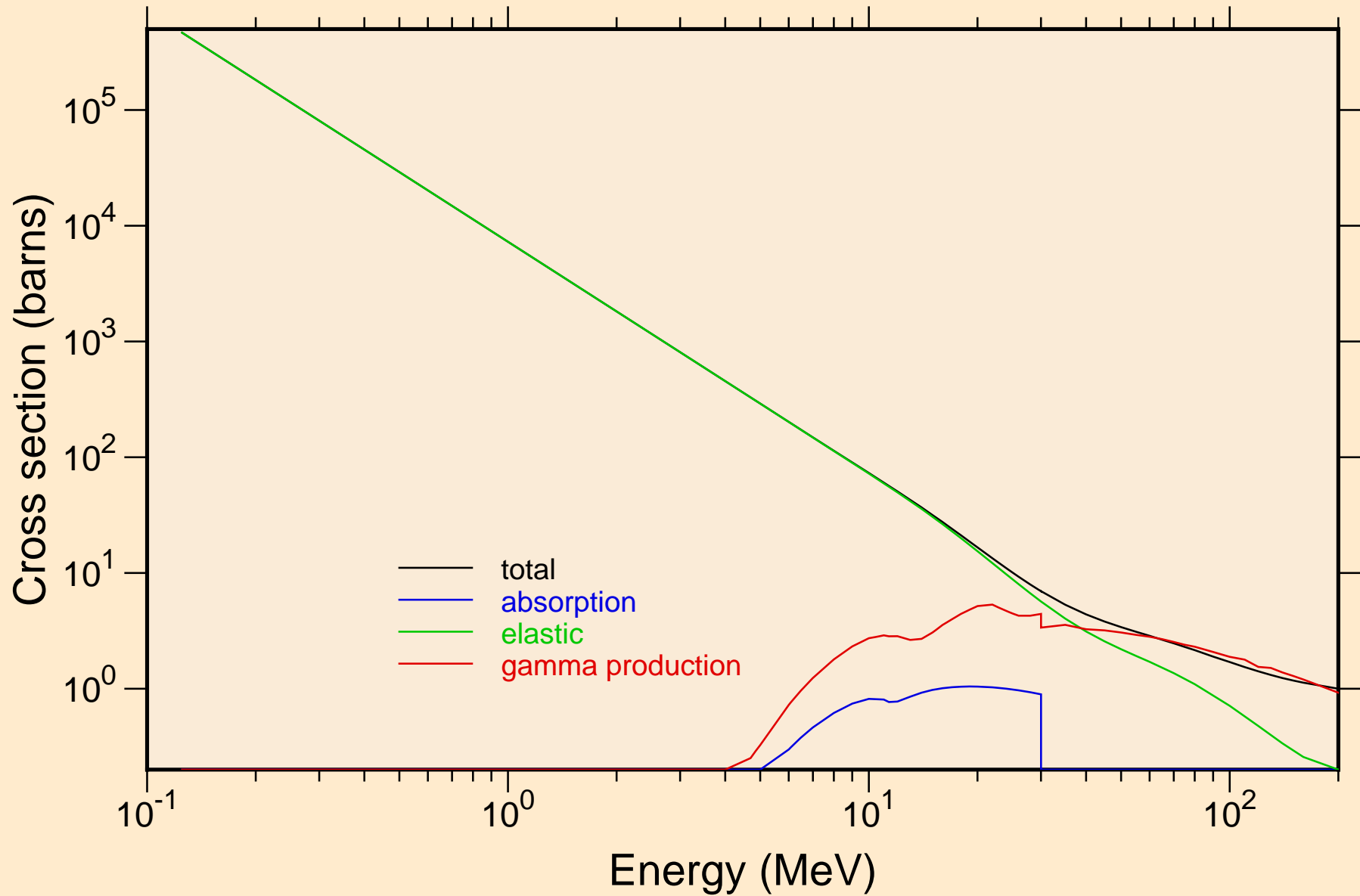

# SE079M PROTON ACER TENDL-2021 LIBRARY; T=0.K

## Heating

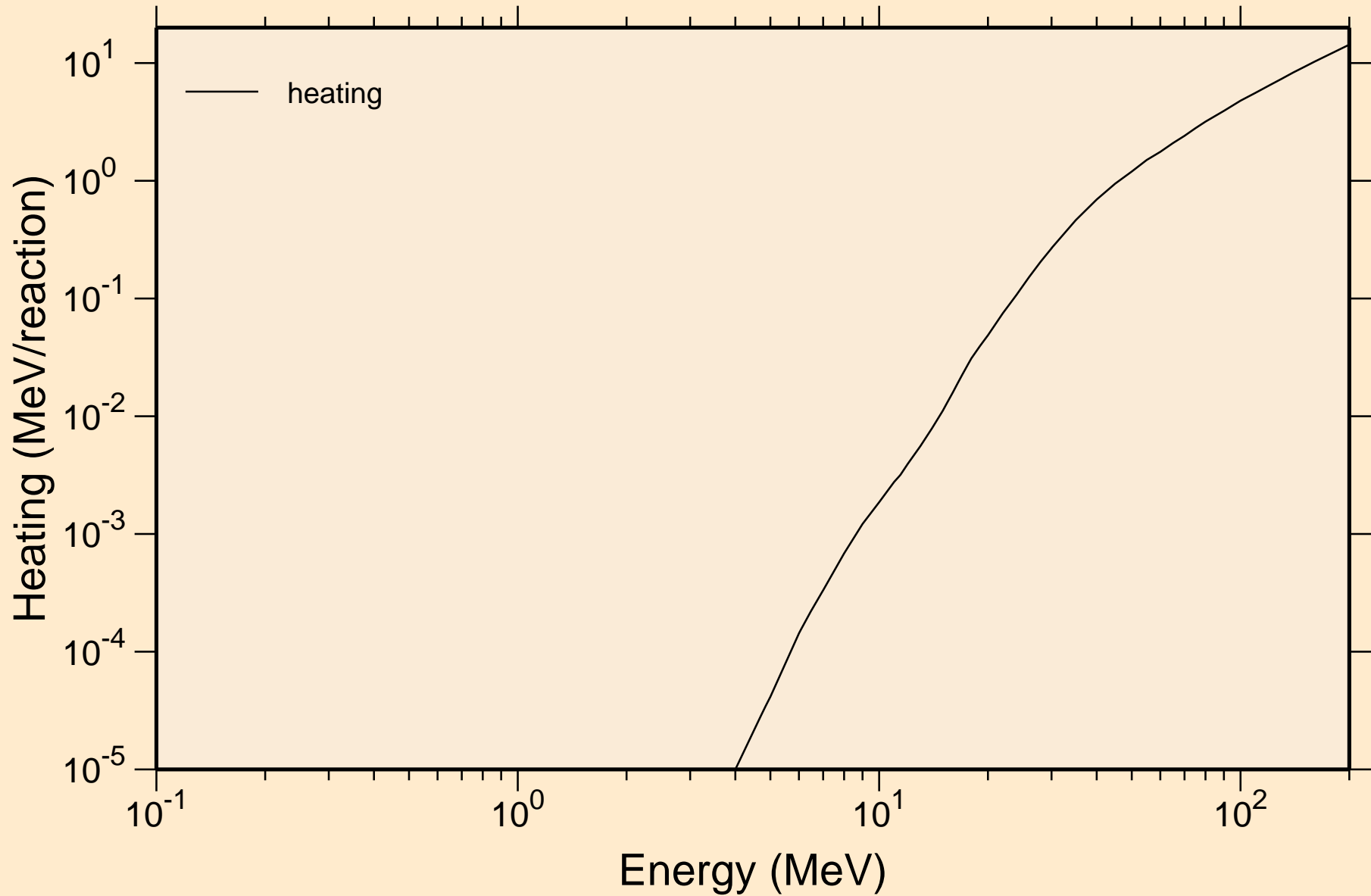

SE079M PROTON ACER TENDL-2021 LIBRARY; T=0.K  
Principal cross sections

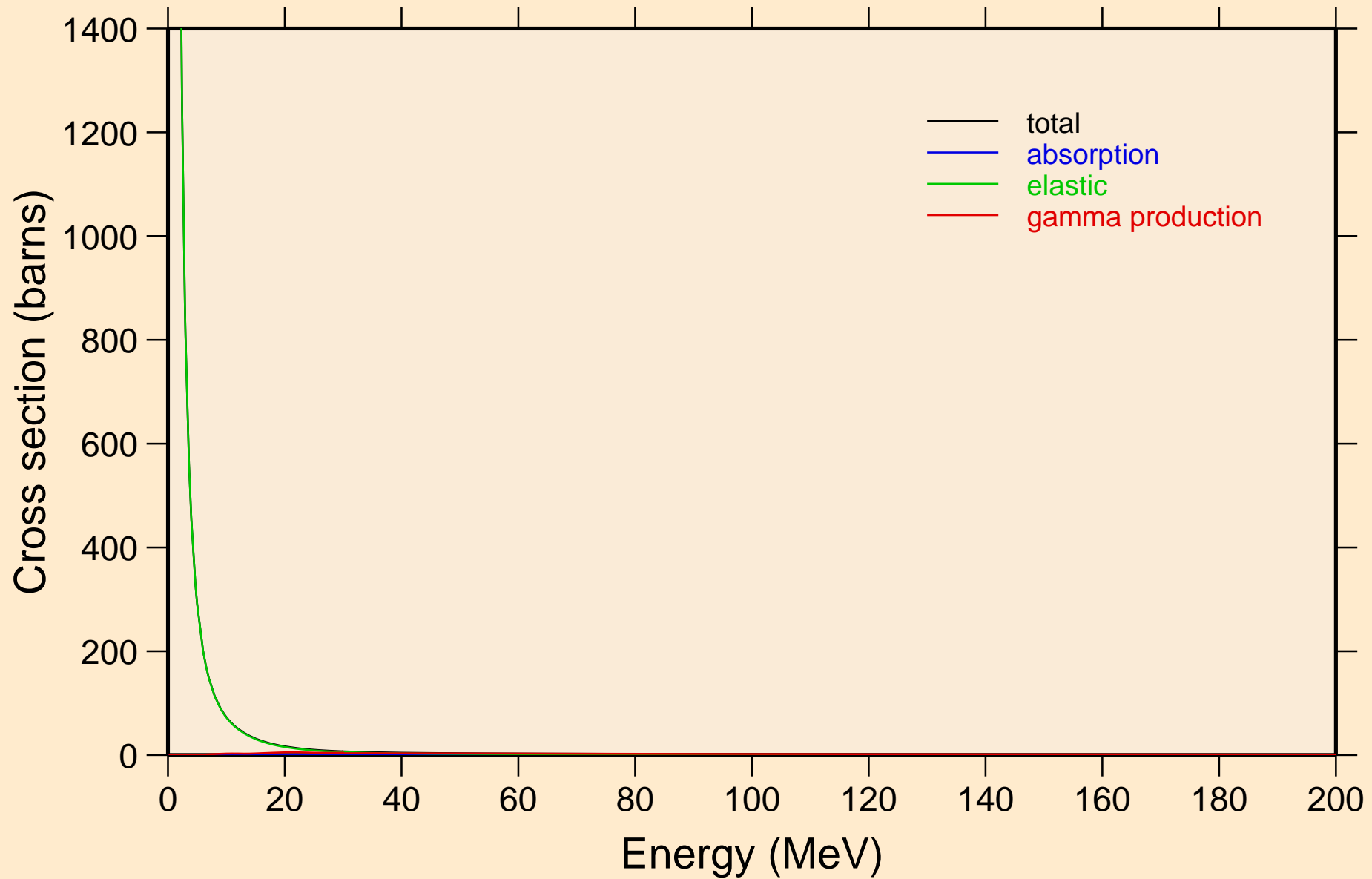

SE079M PROTON ACER TENDL-2021 LIBRARY; T=0.K

Heating

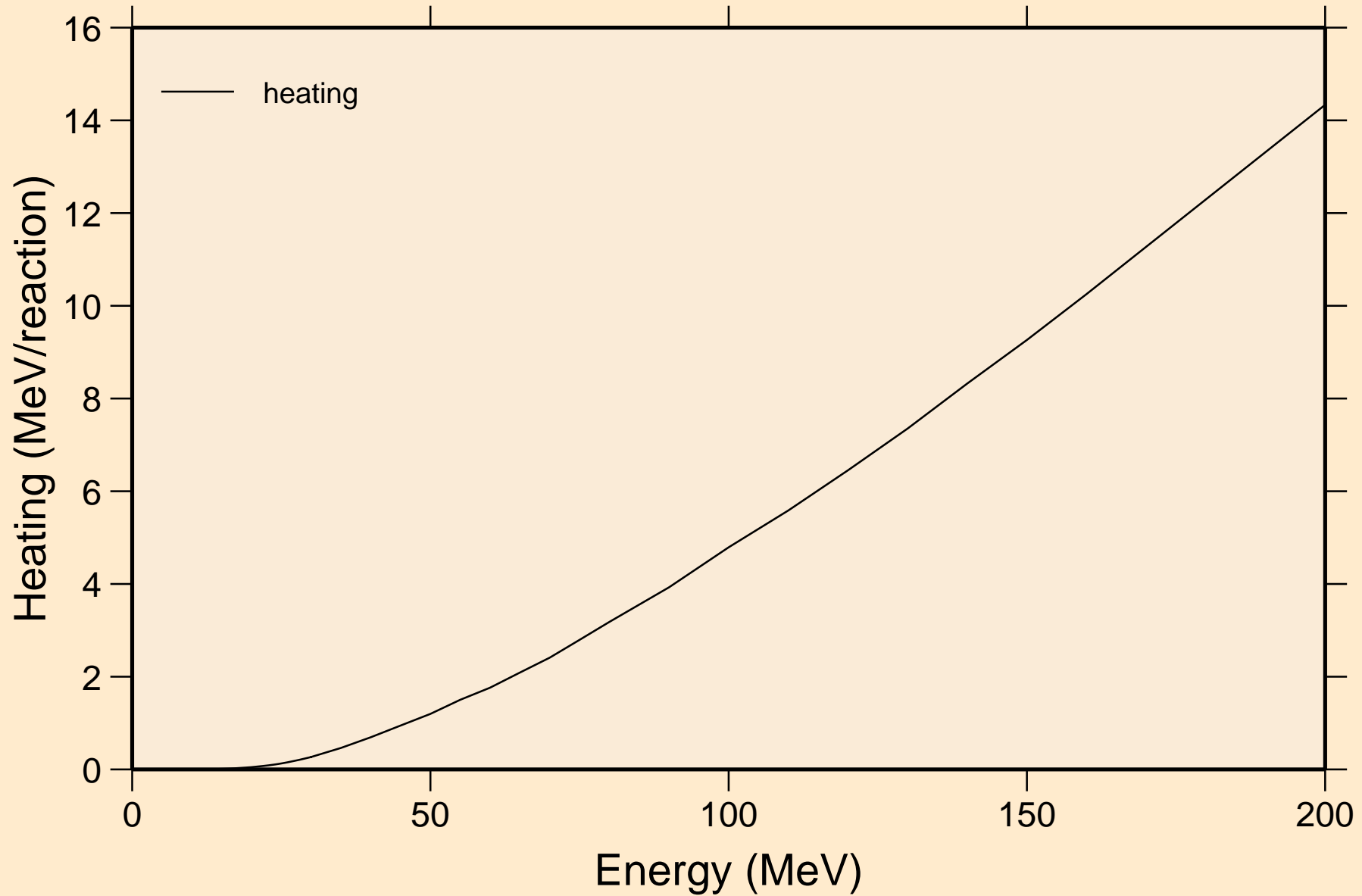

SE079M PROTON ACER TENDL-2021 LIBRARY; T=0.K  
Threshold reactions

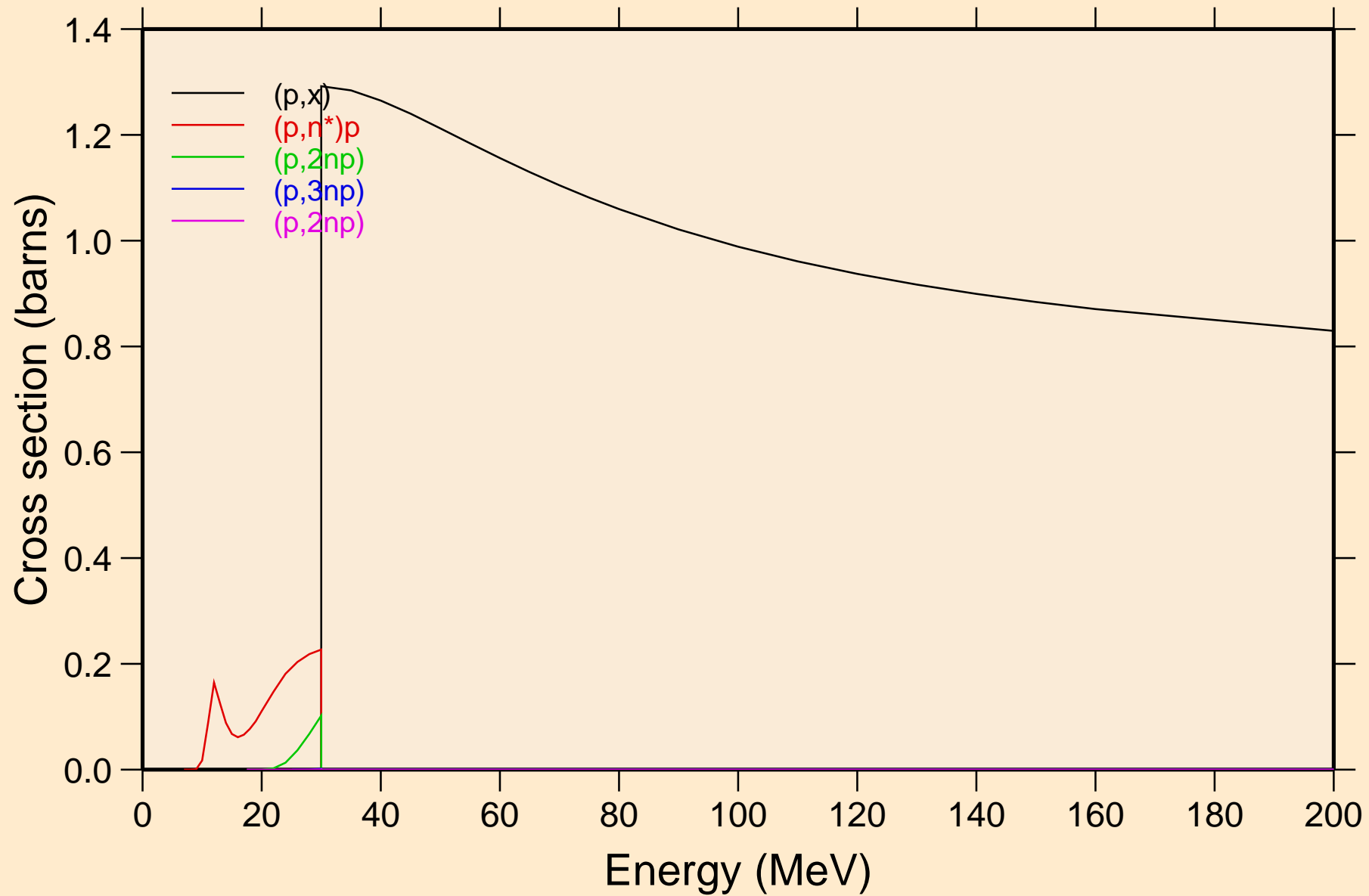

SE079M PROTON ACER TENDL-2021 LIBRARY; T=0.K  
Threshold reactions

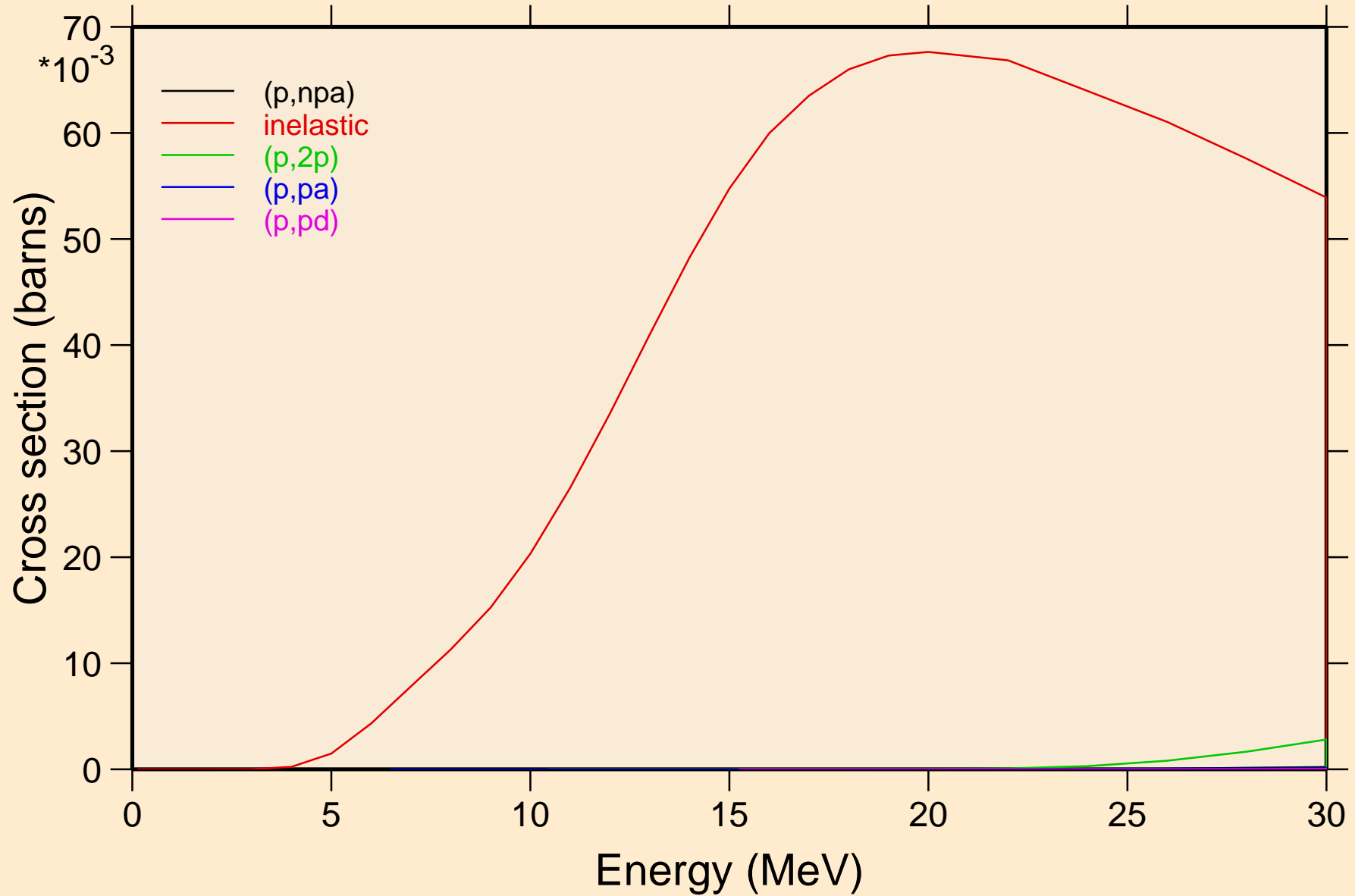

SE079M PROTON ACER TENDL-2021 LIBRARY; T=0.K  
Threshold reactions

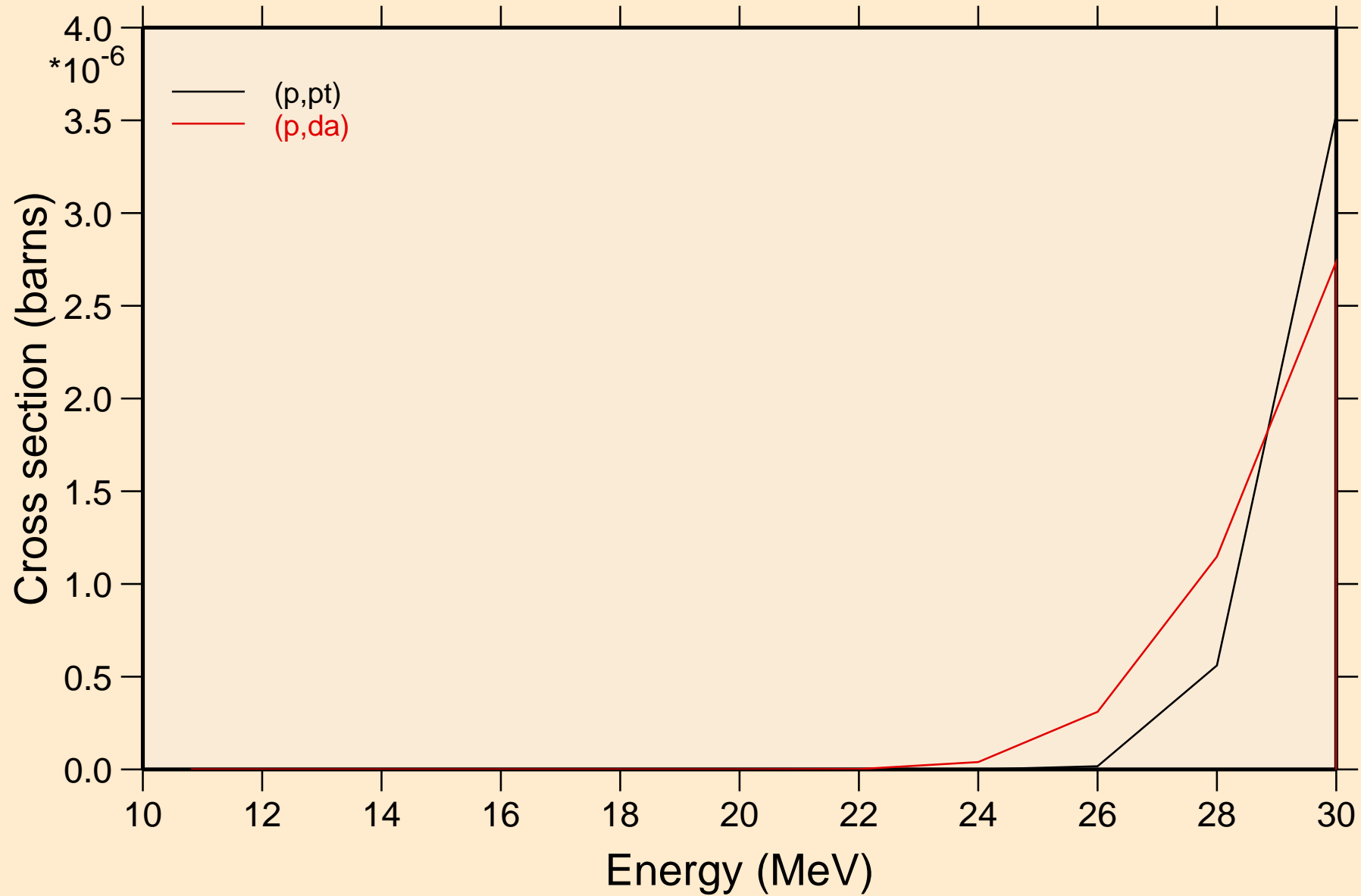

SE079M PROTON ACER TENDL-2021 LIBRARY; T=0.K  
angular distribution for elastic

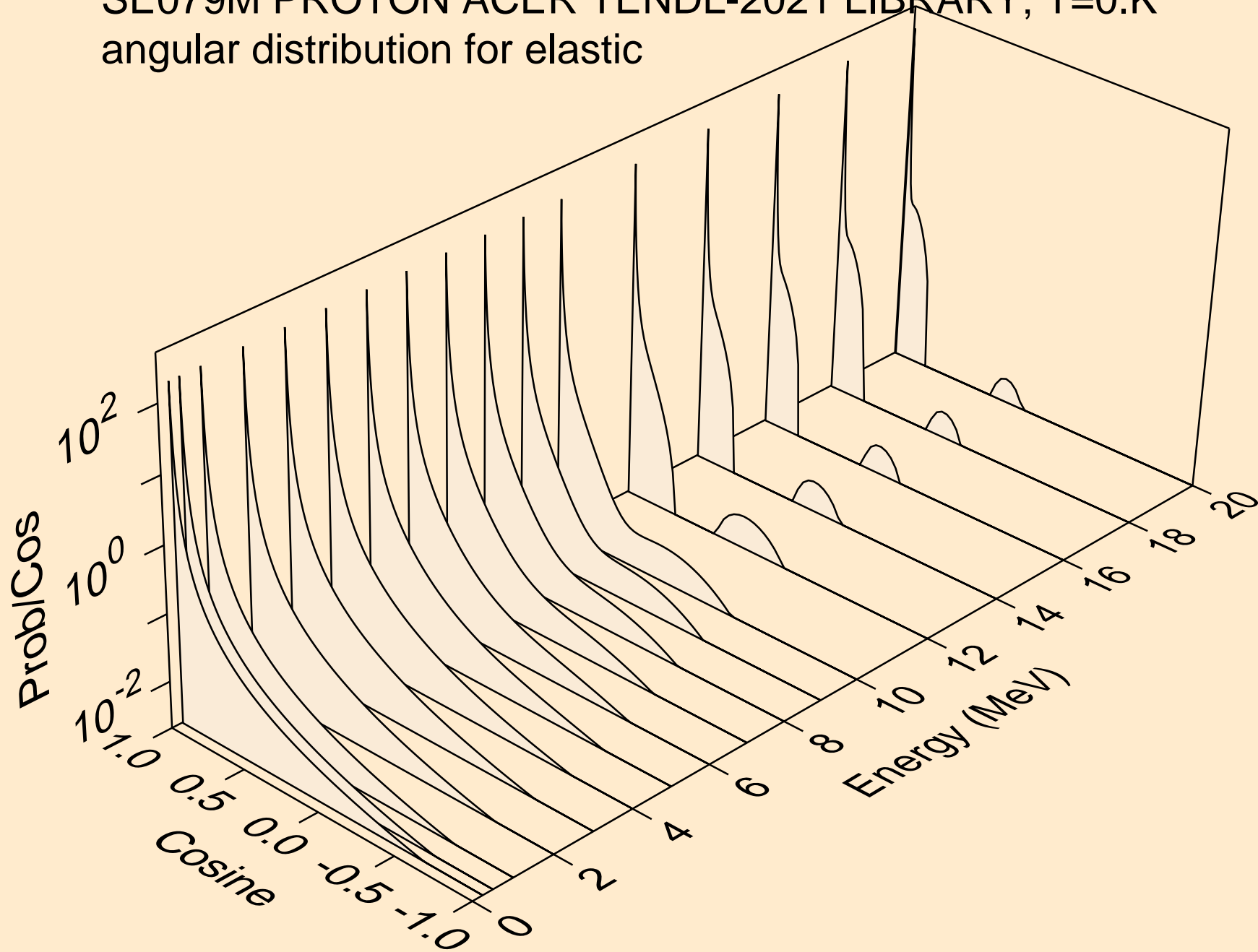



SE079M PROTON ACER TENDL-2021 LIBRARY; T=0.K  
angular distribution for elastic

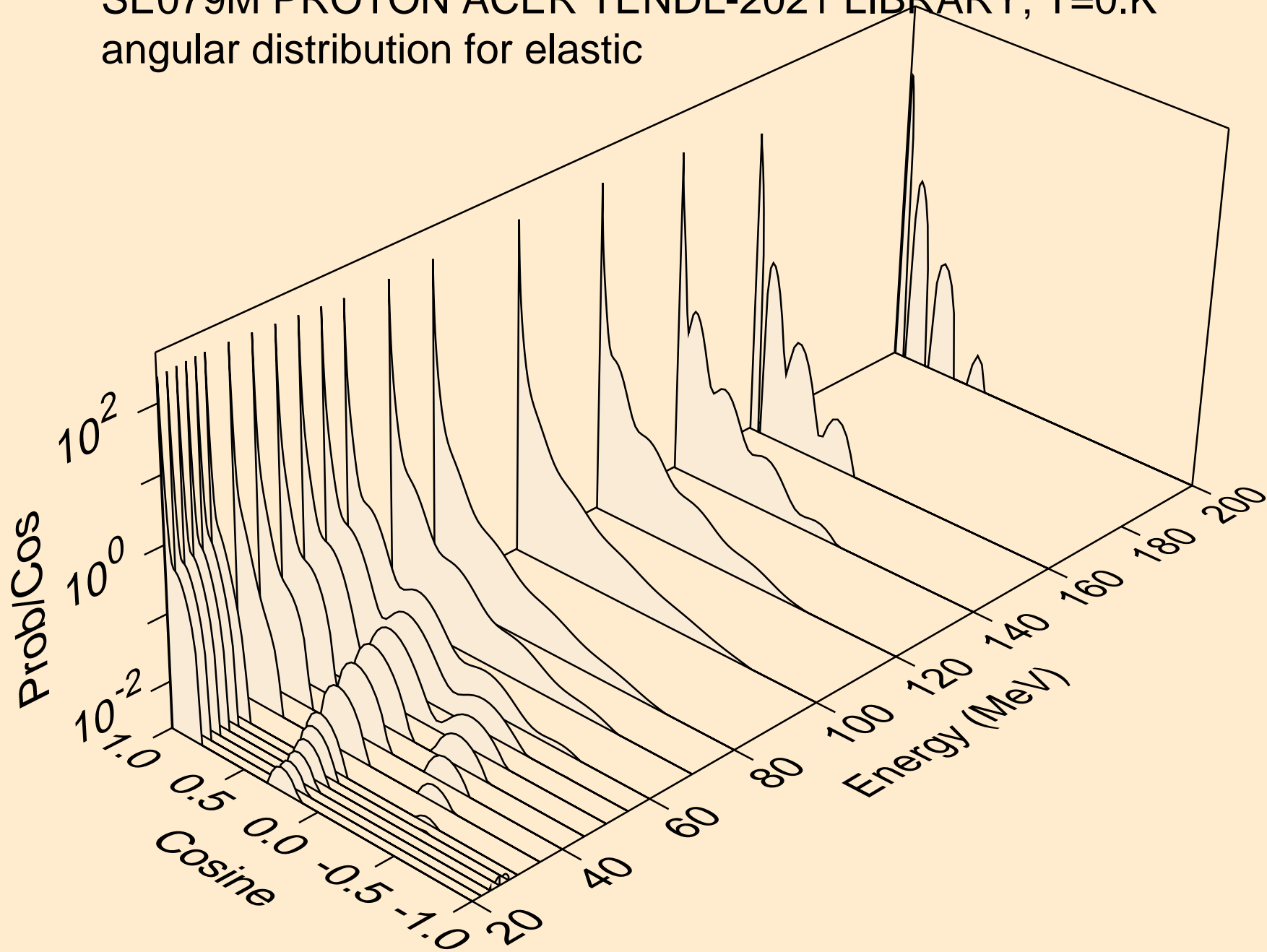

SE079M PROTON ACER TENDL-2021 LIBRARY; T=0.K  
Proton emission for (p,x)

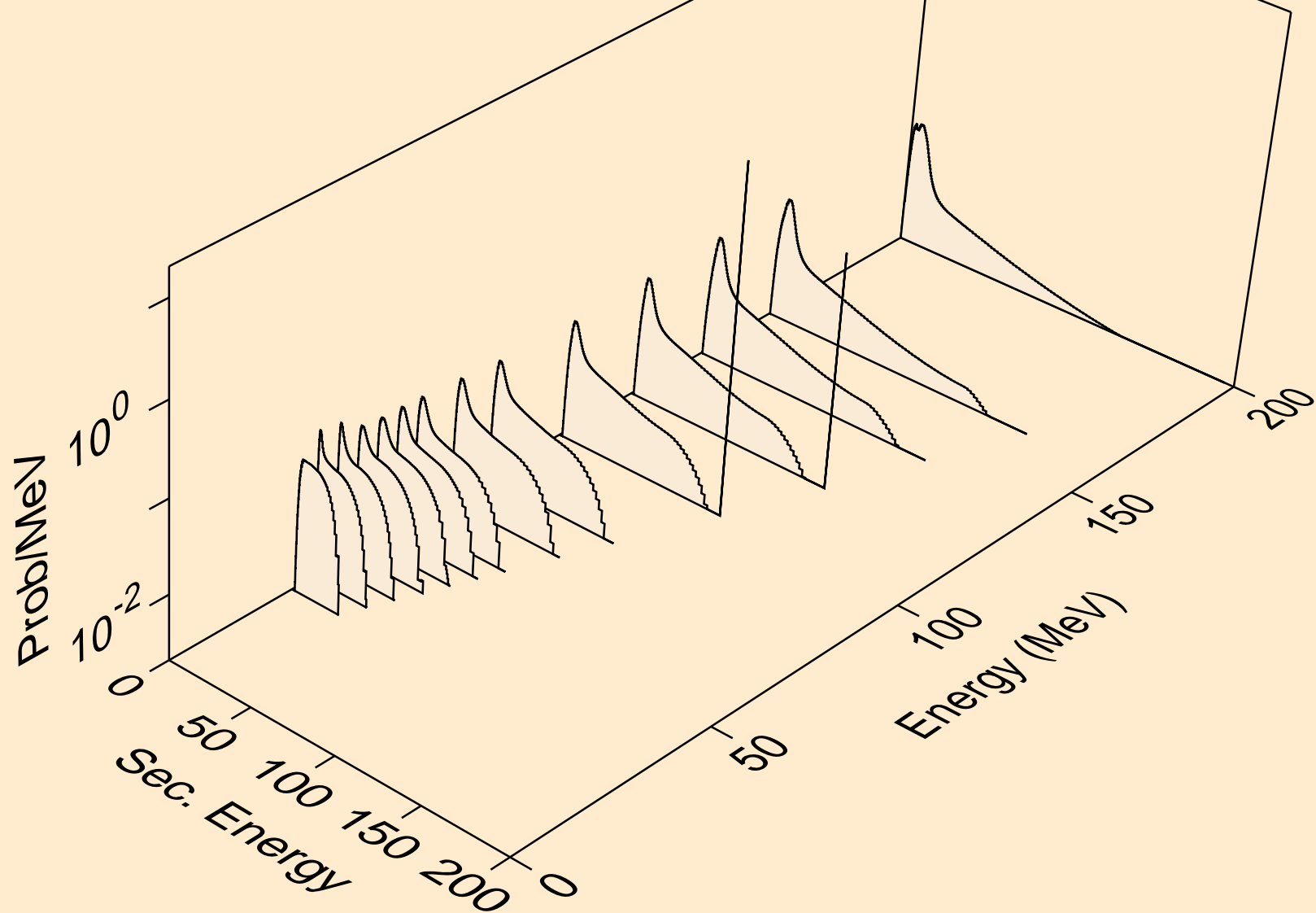

SE079M PROTON ACER TENDL-2021 LIBRARY; T=0.K  
Proton emission for (p,n\*)p

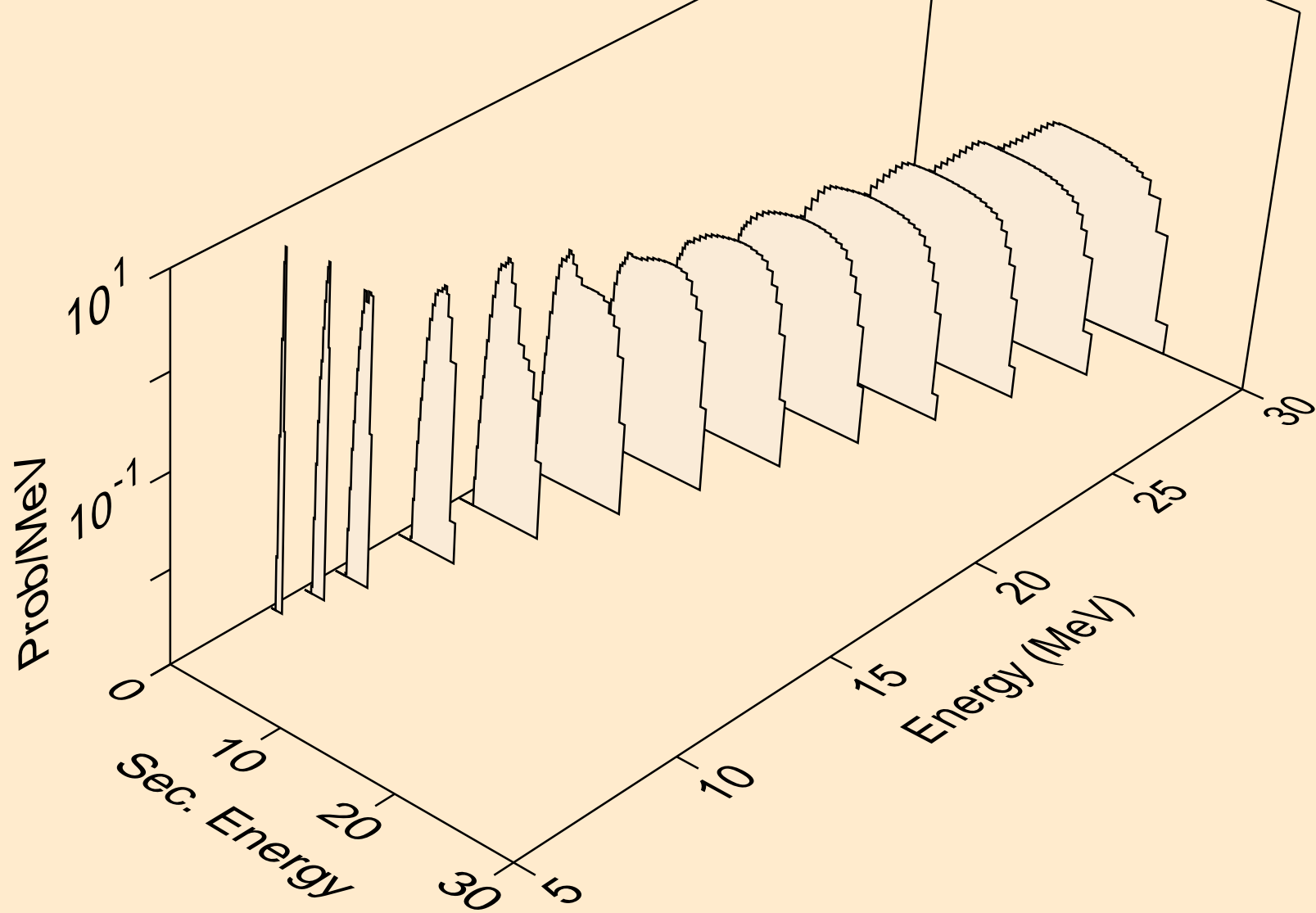

SE079M PROTON ACER TENDL-2021 LIBRARY; T=0.K  
Proton emission for (p,2np)

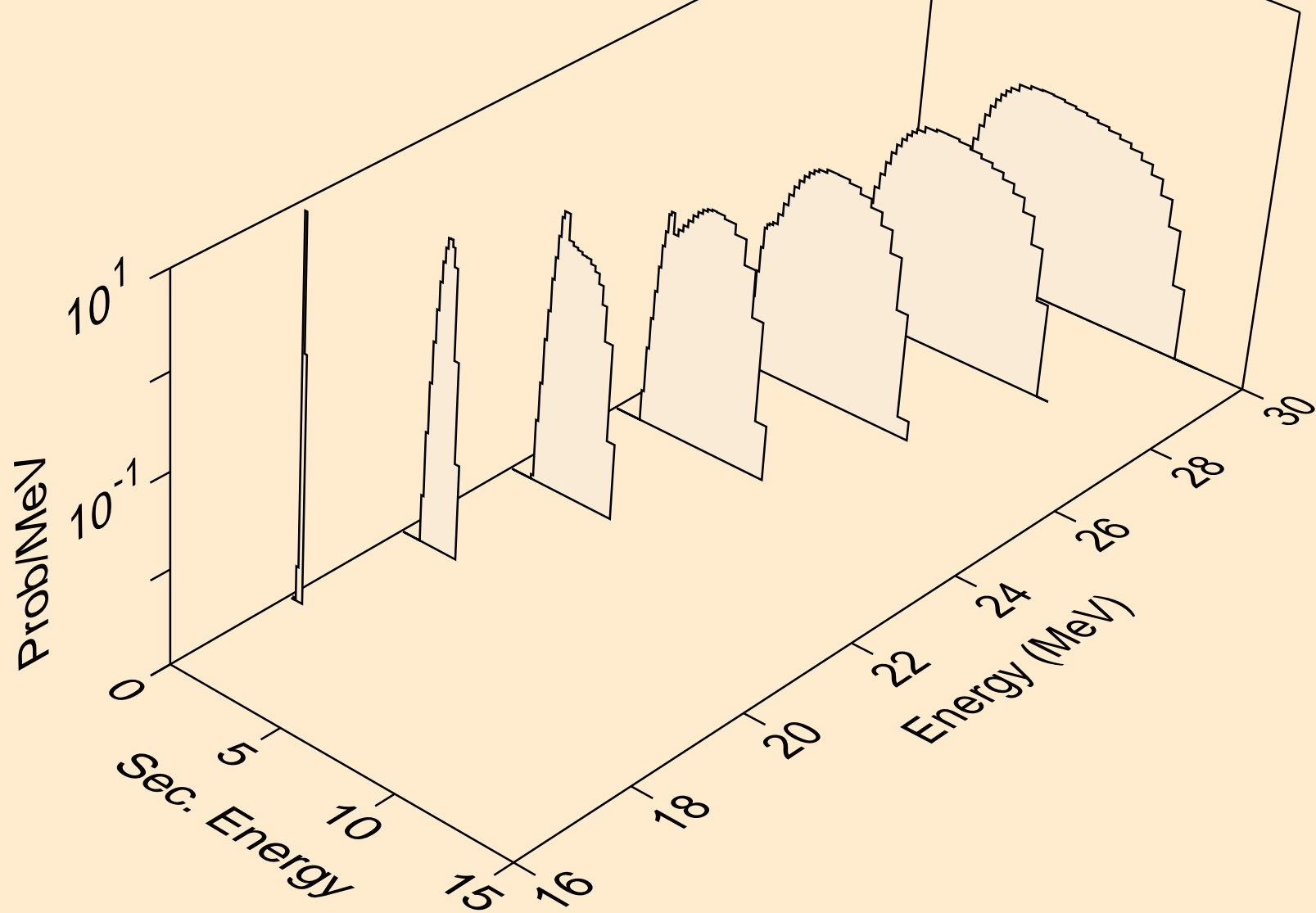

SE079M PROTON ACER TENDL-2021 LIBRARY; T=0.K  
Proton emission for (p,3np)

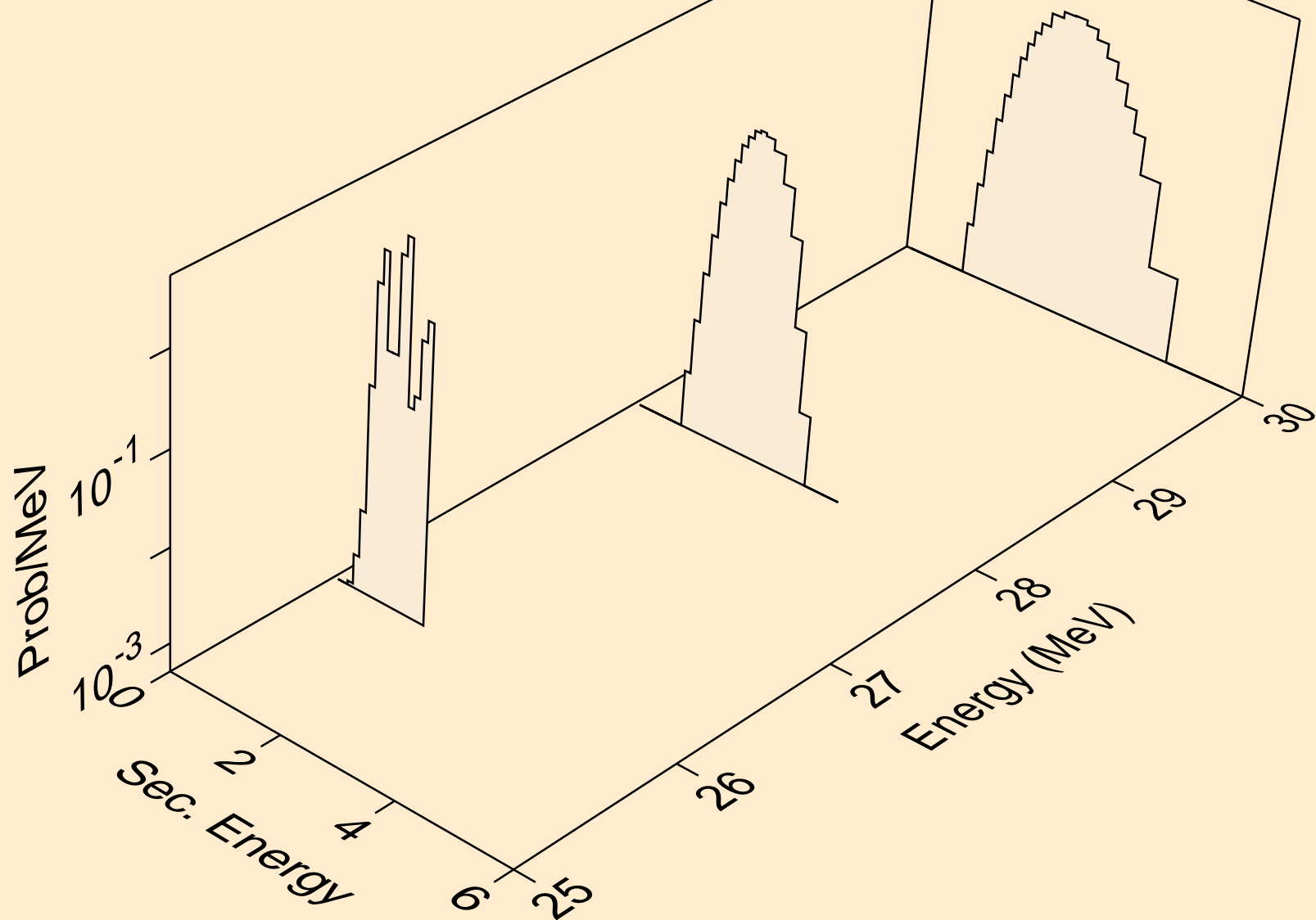

SE079M PROTON ACER TENDL-2021 LIBRARY; T=0.K  
Proton emission for (p,2np)

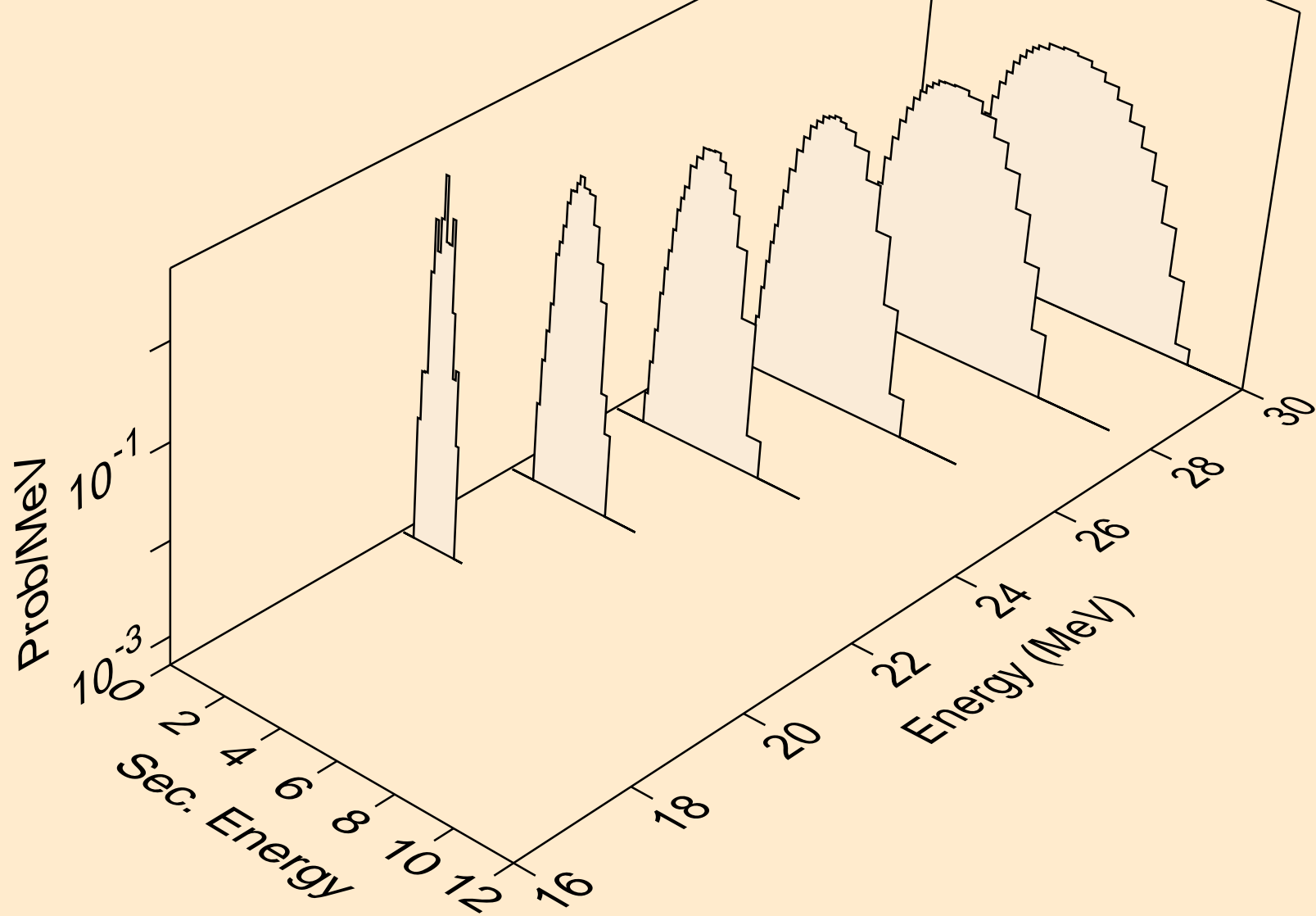

SE079M PROTON ACER TENDL-2021 LIBRARY; T=0.K  
Proton emission for (p,npa)

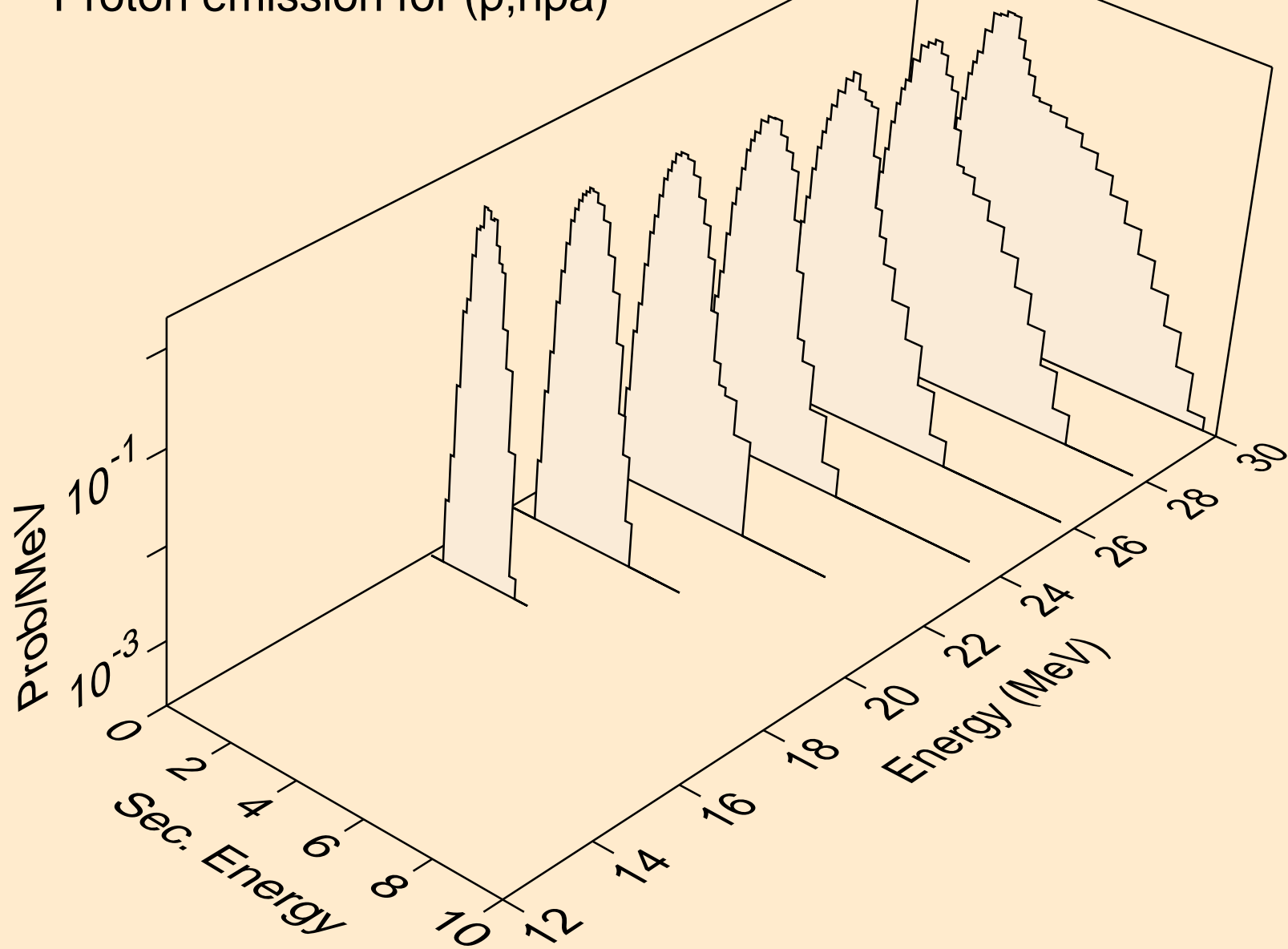

SE079M PROTON ACER TENDL-2021 LIBRARY; T=0.K  
Proton emission for inelastic

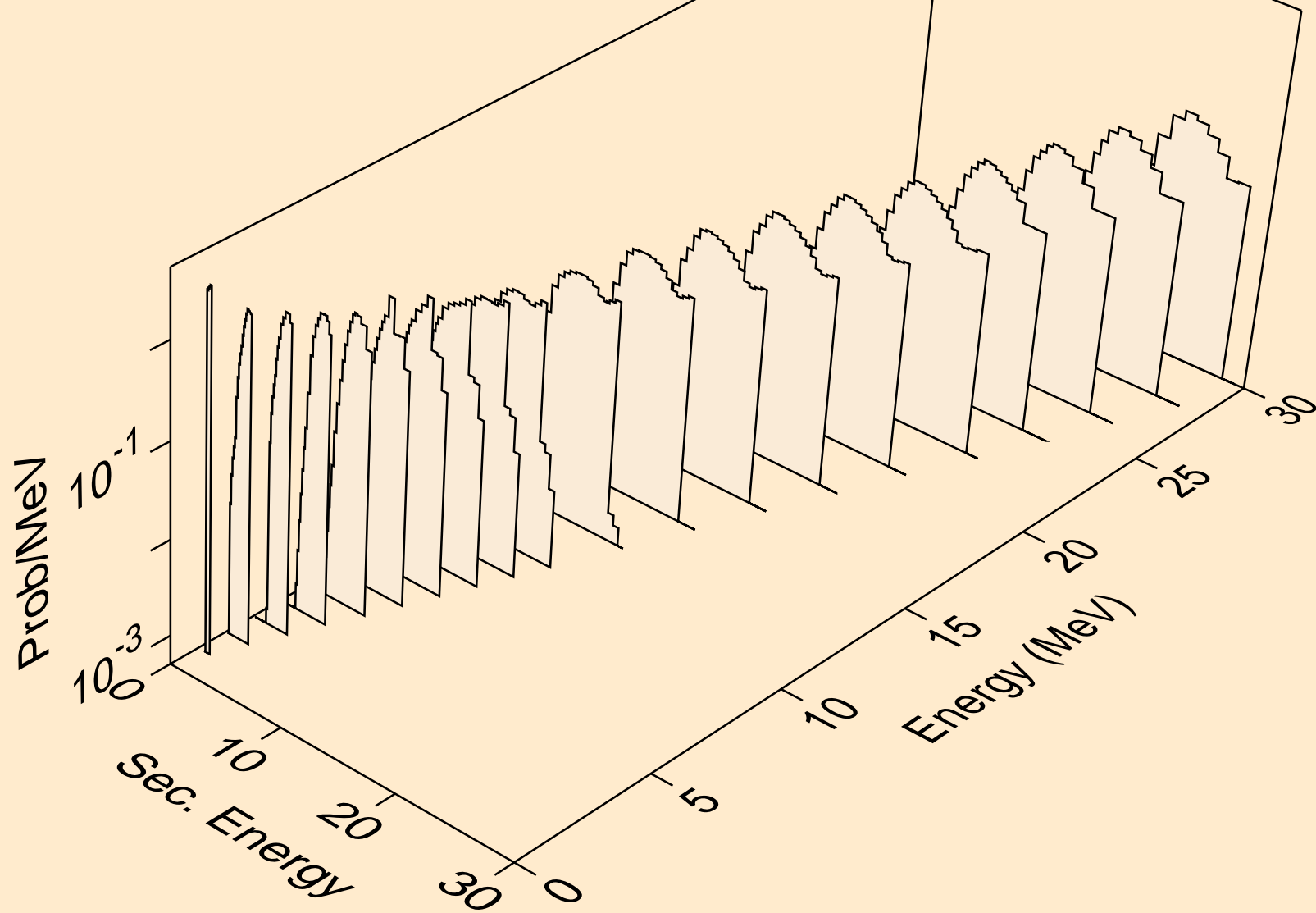



SE079M PROTON ACER TENDL-2021 LIBRARY; T=0.K  
Proton emission for (p,2p)

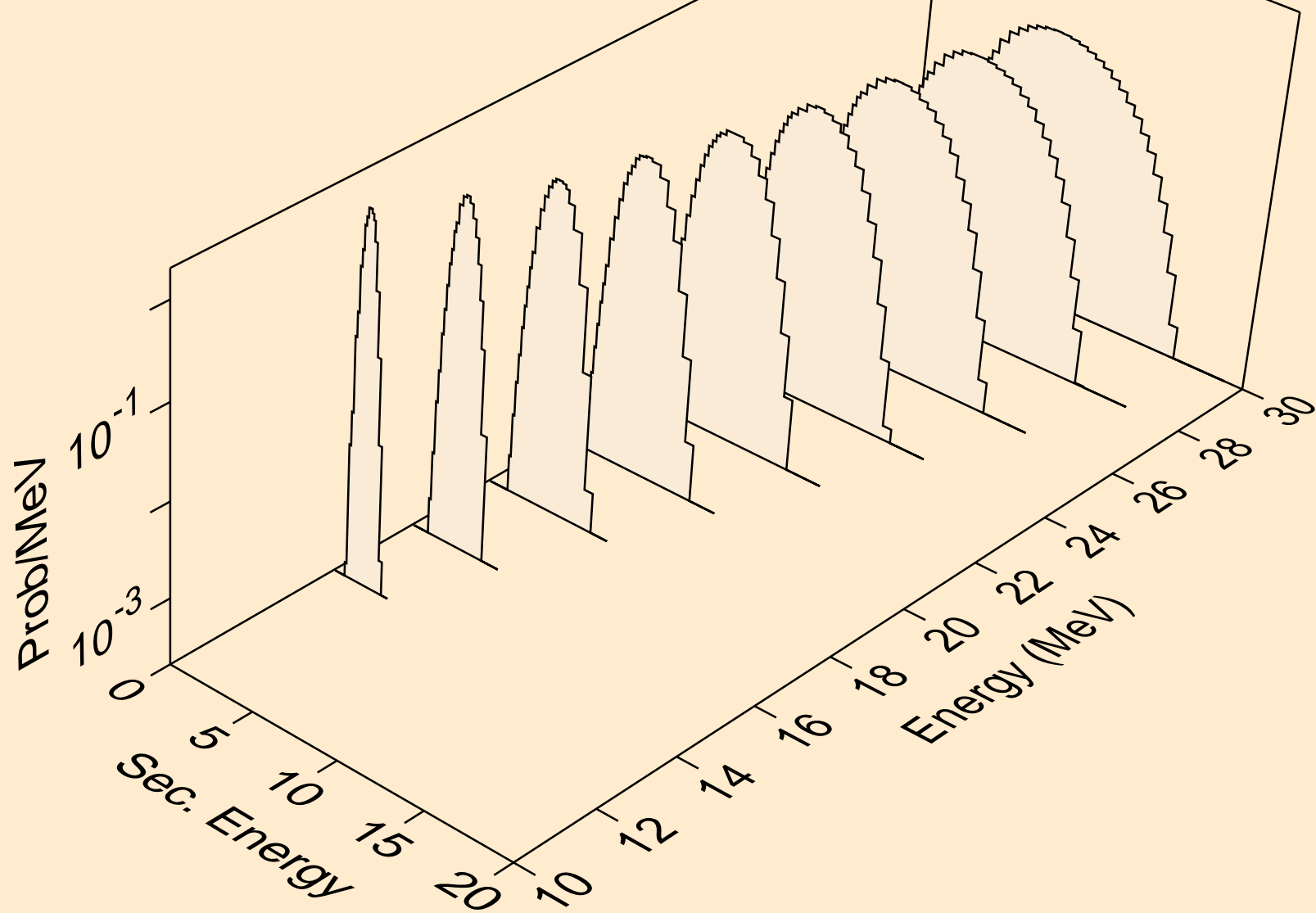

SE079M PROTON ACER TENDL-2021 LIBRARY; T=0.K  
Proton emission for (p,pa)

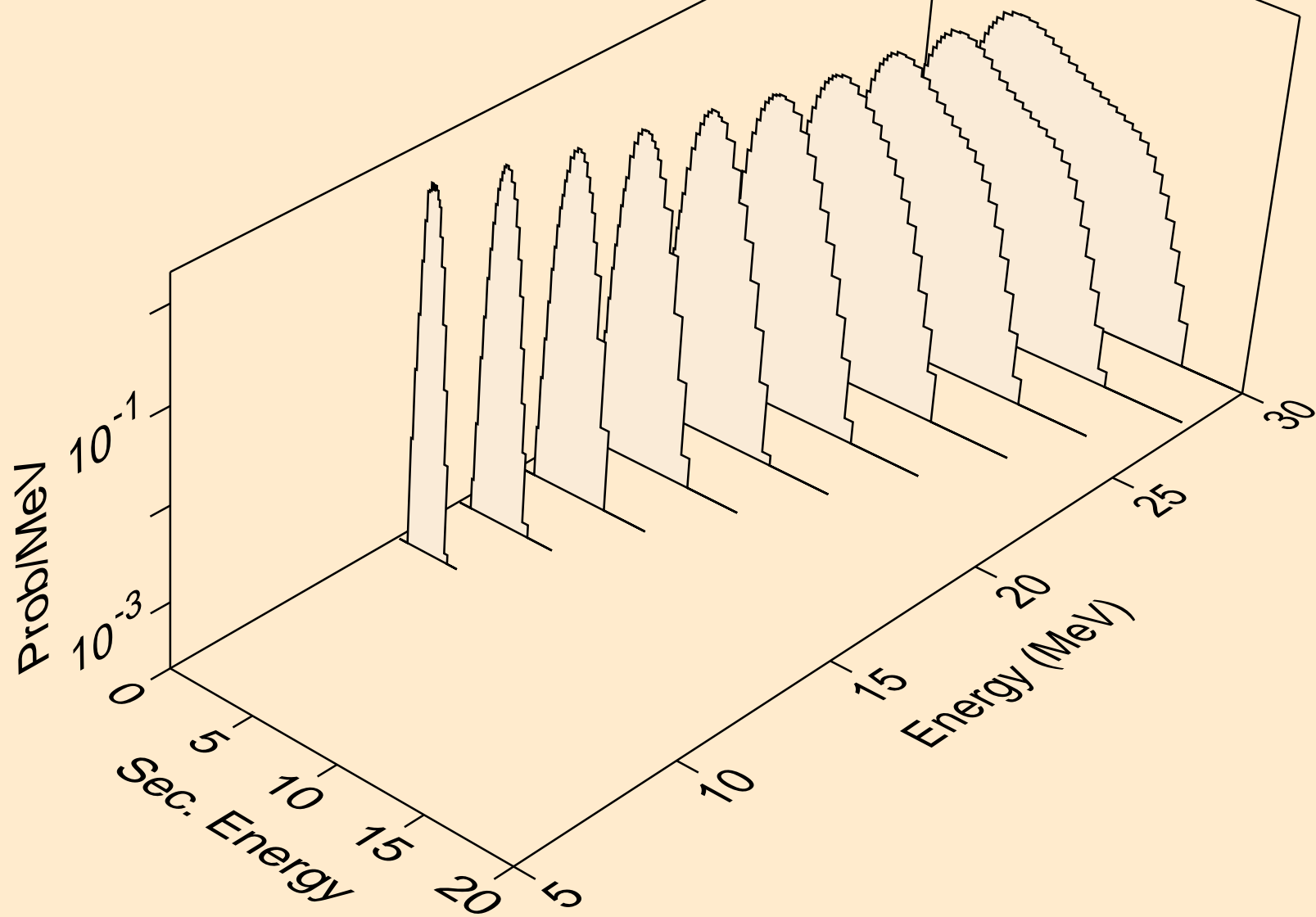

SE079M PROTON ACER TENDL-2021 LIBRARY; T=0.K  
Proton emission for (p,pd)

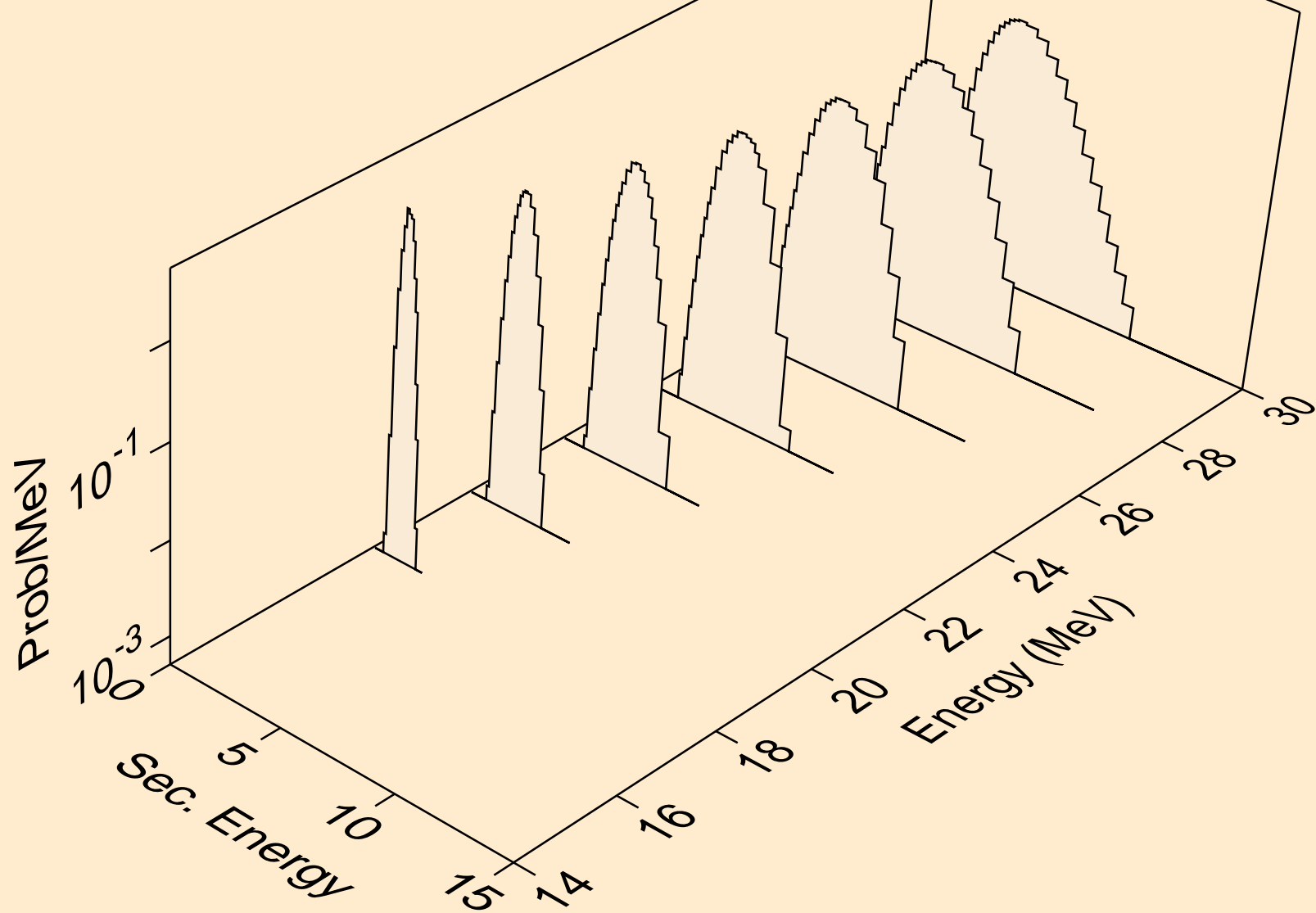

SE079M PROTON ACER TENDL-2021 LIBRARY; T=0.K  
Proton emission for (p,pt)

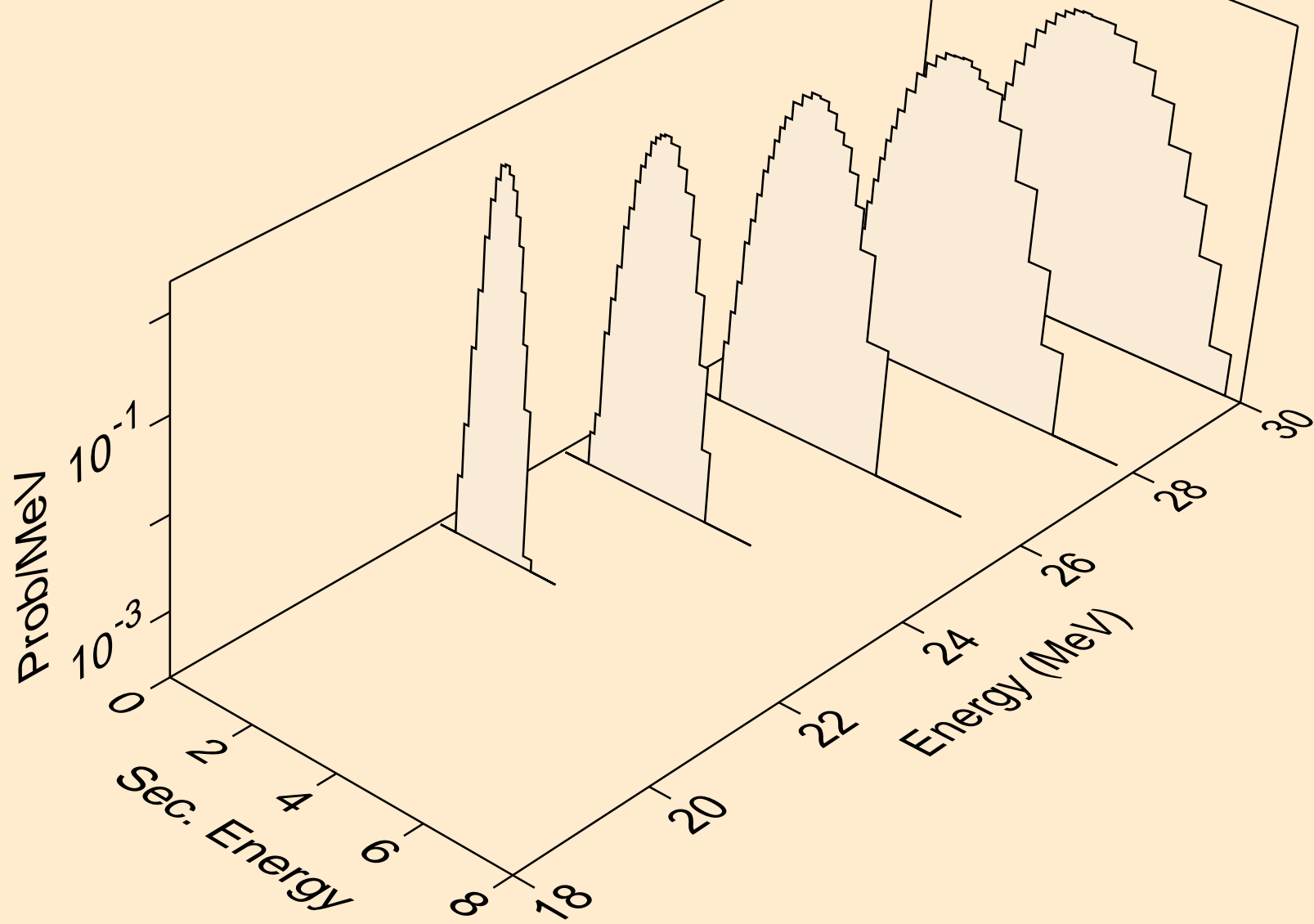

SE079M PROTON ACER TENDL-2021 LIBRARY; T=0.K  
Photon emission for (z,n)

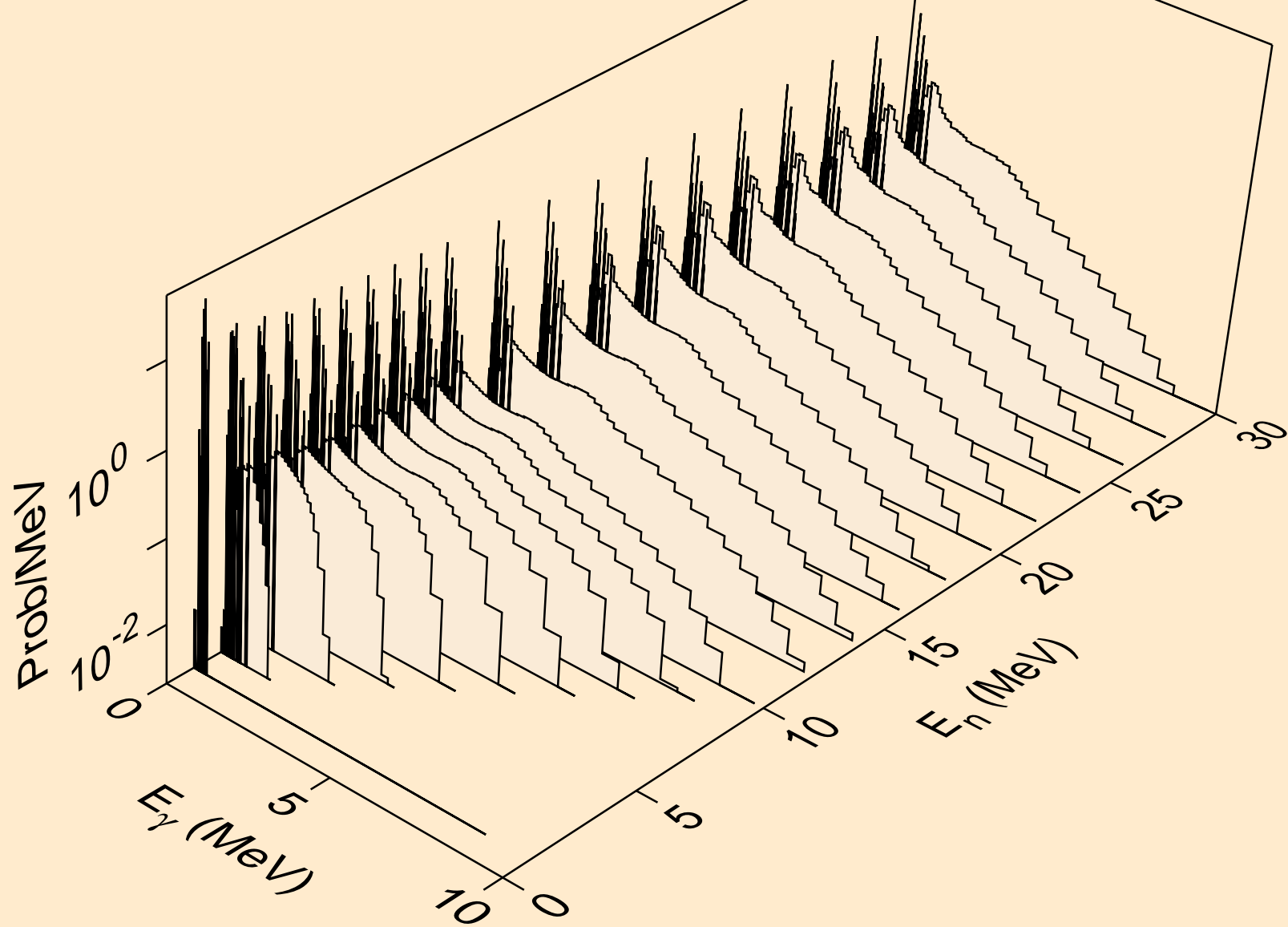

SE079M PROTON ACER TENDL-2021 LIBRARY; T=0.K  
Photon emission for (n,x)

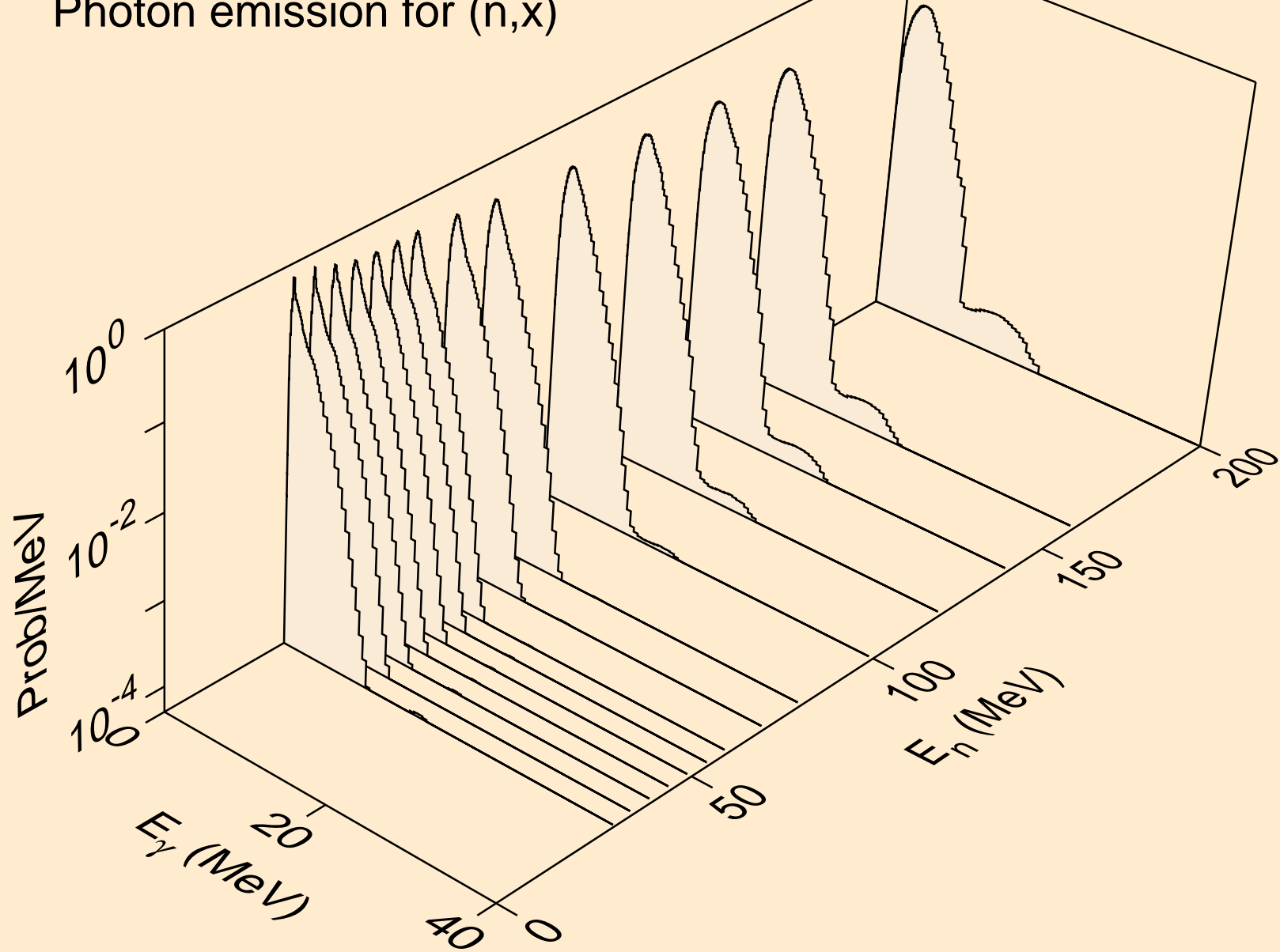

SE079M PROTON ACER TENDL-2021 LIBRARY; T=0.K  
Photon emission for (n,2nd)

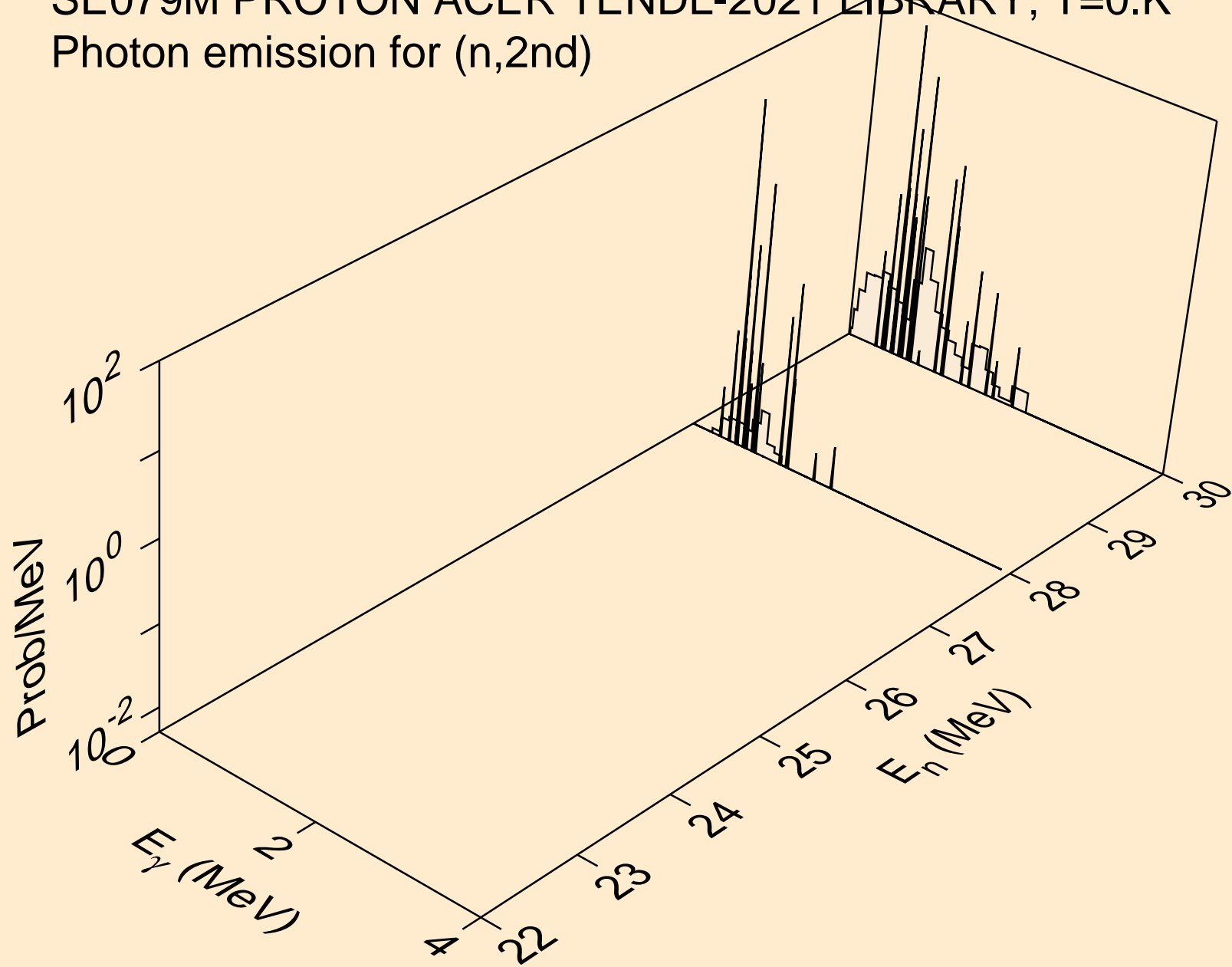

SE079M PROTON ACER TENDL-2021 LIBRARY; T=0.K  
Photon emission for (n,2n)

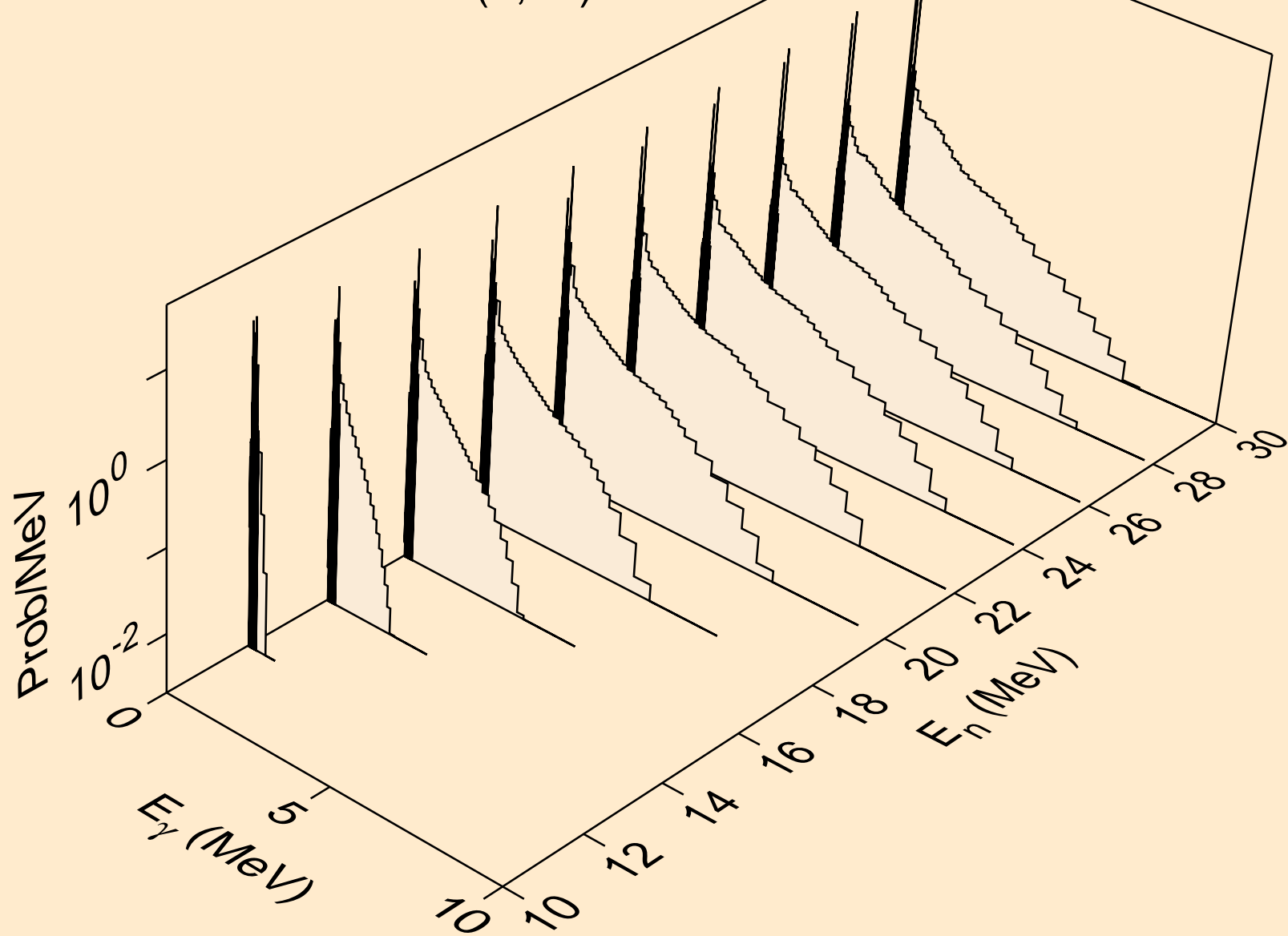



SE079M PROTON ACER TENDL-2021 LIBRARY; T=0.K  
Photon emission for (n,3n)

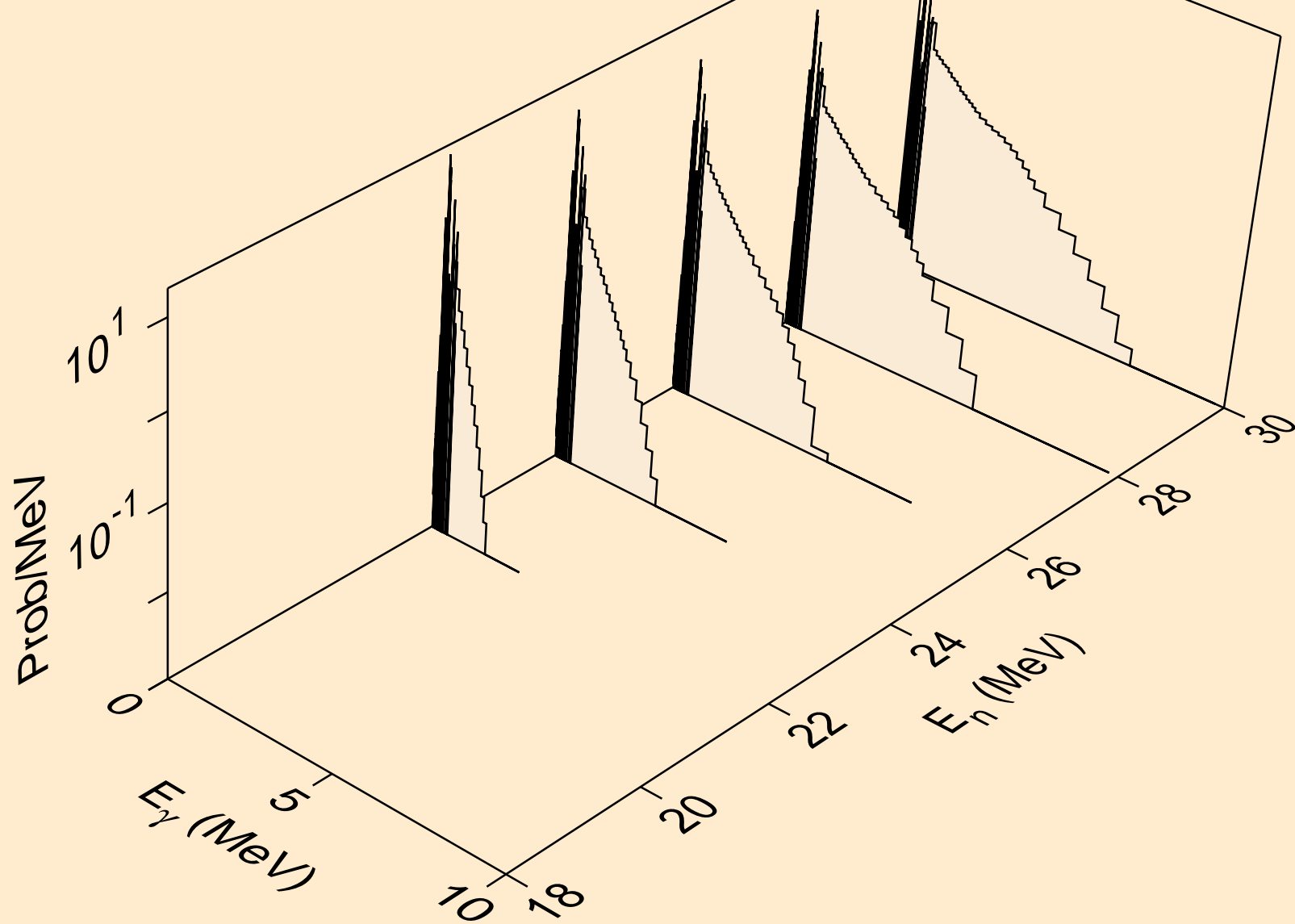

SE079M PROTON ACER TENDL-2021 LIBRARY; T=0.K  
Photon emission for (n,n\*)a

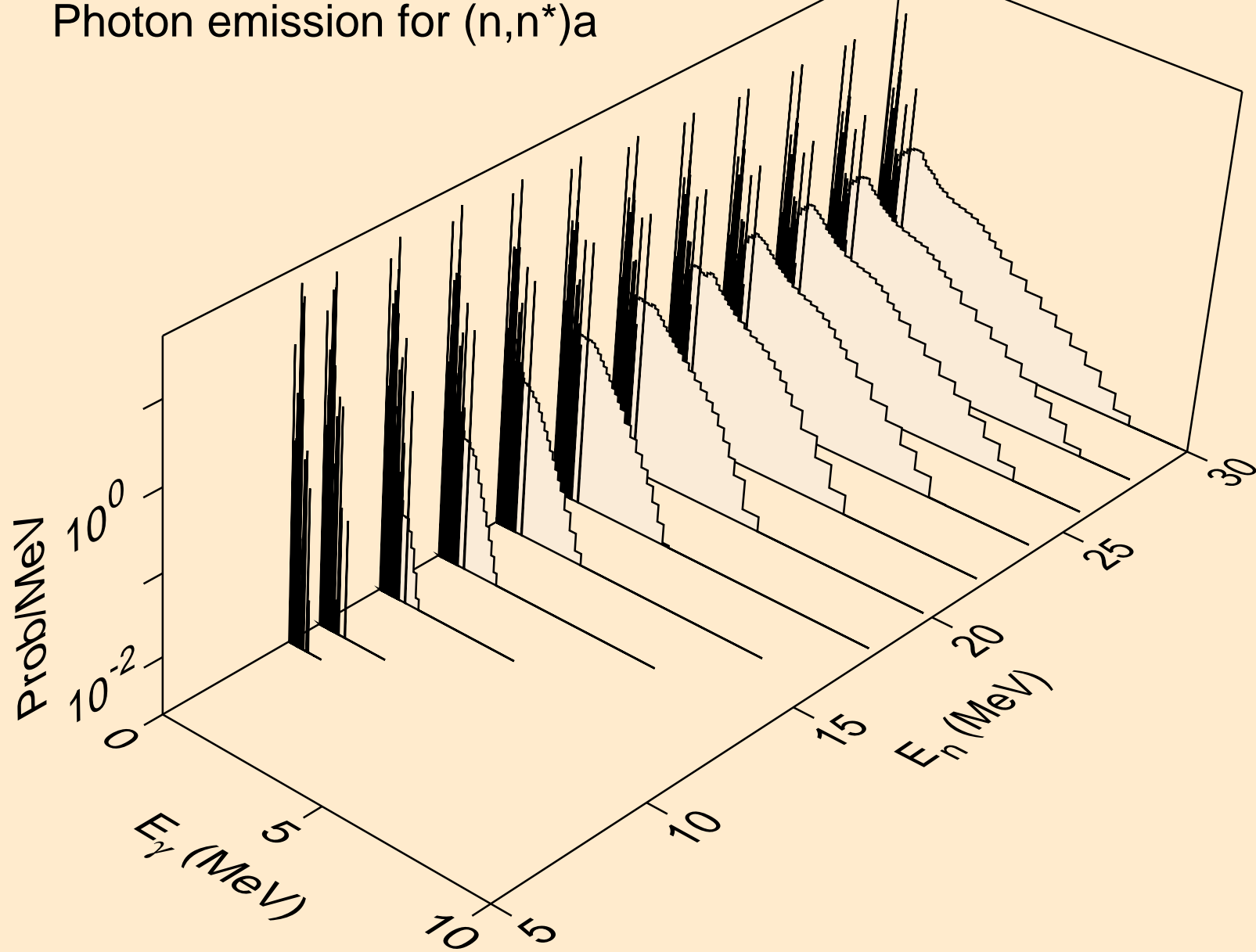

SE079M PROTON ACER TENDL-2021 LIBRARY; T=0.K  
Photon emission for (n,2n)a

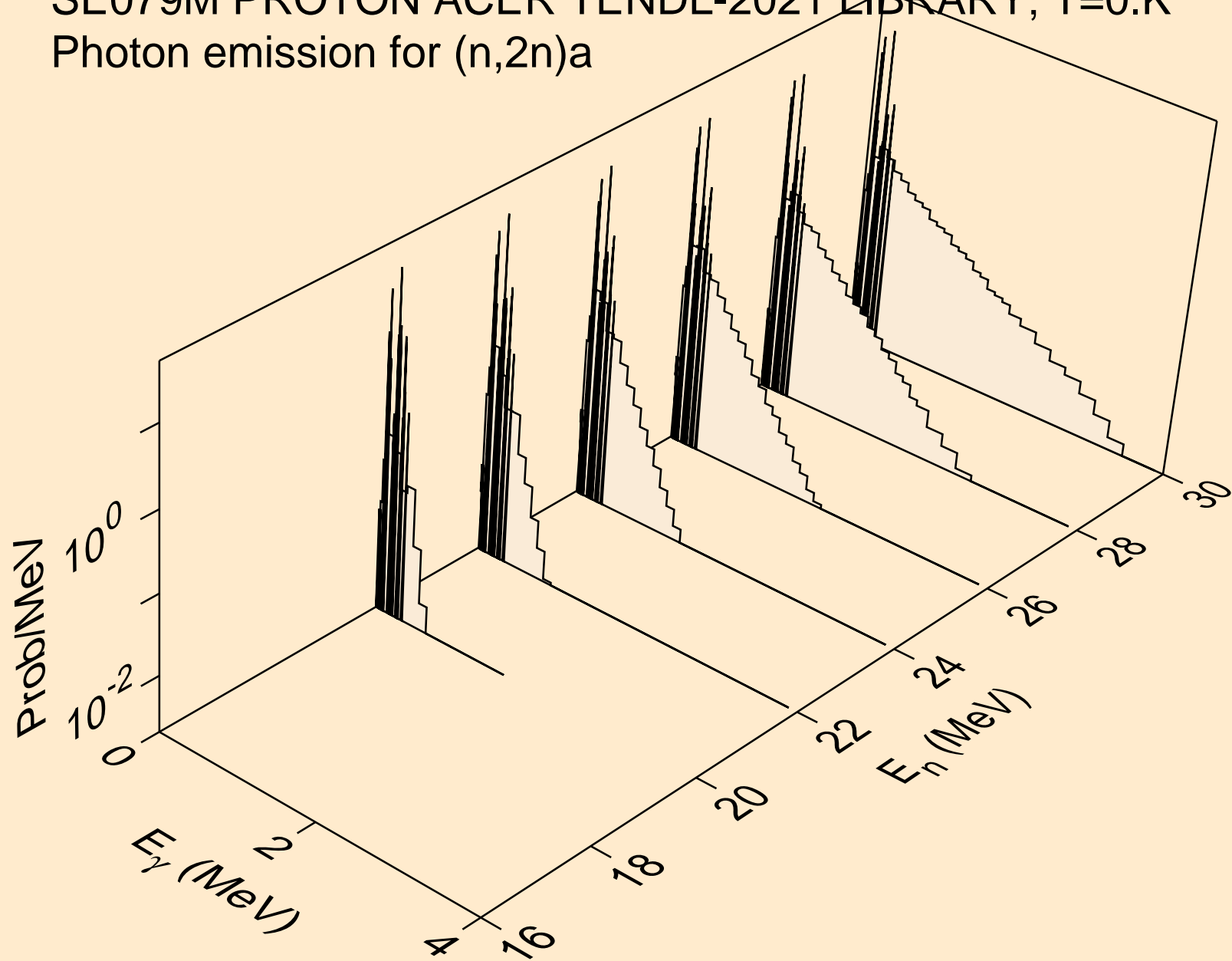

SE079M PROTON ACER TENDL-2021 LIBRARY; T=0.K  
Photon emission for (n,3n)a

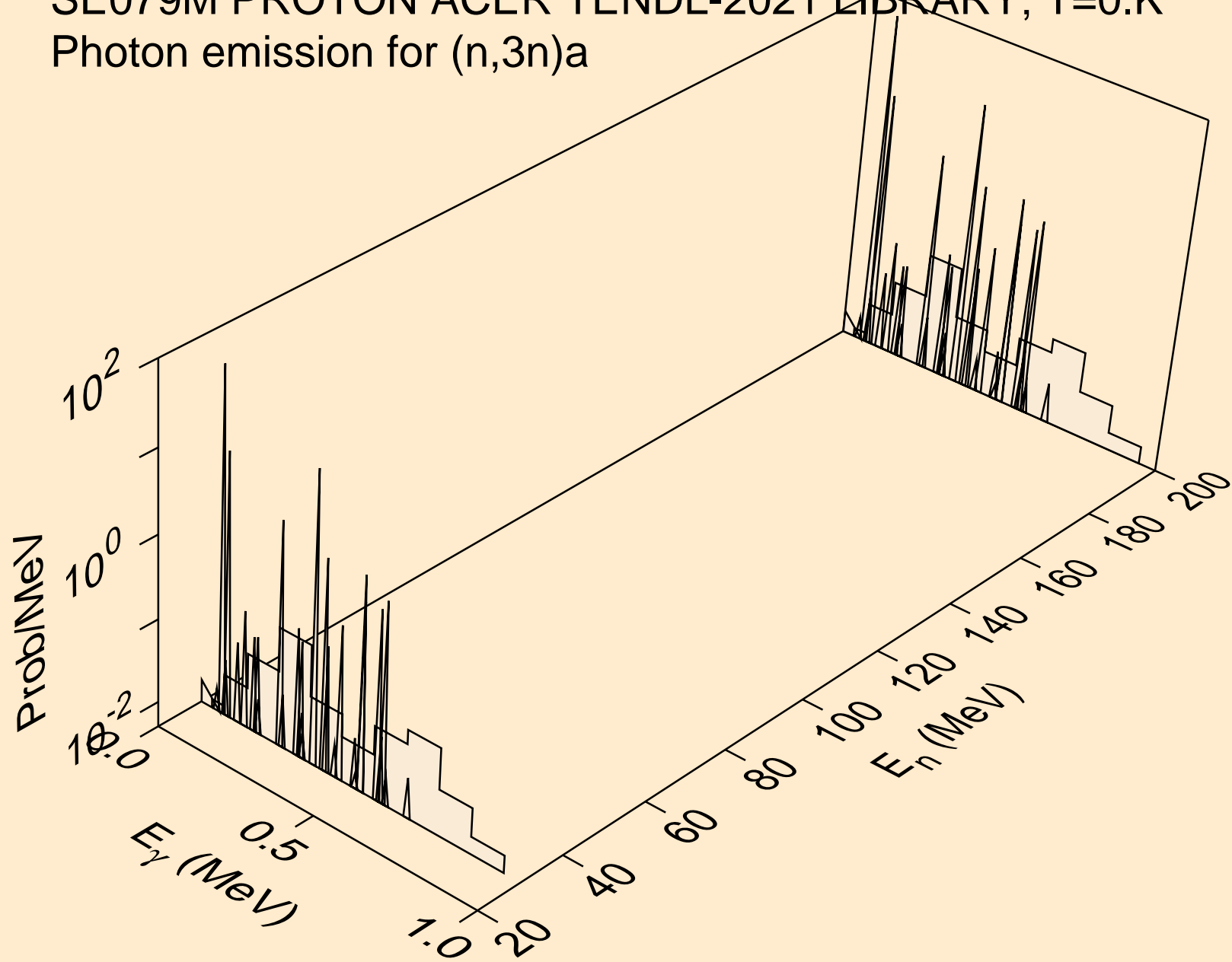

SE079M PROTON ACER TENDL-2021 LIBRARY; T=0.K  
Photon emission for (n,n\*)p

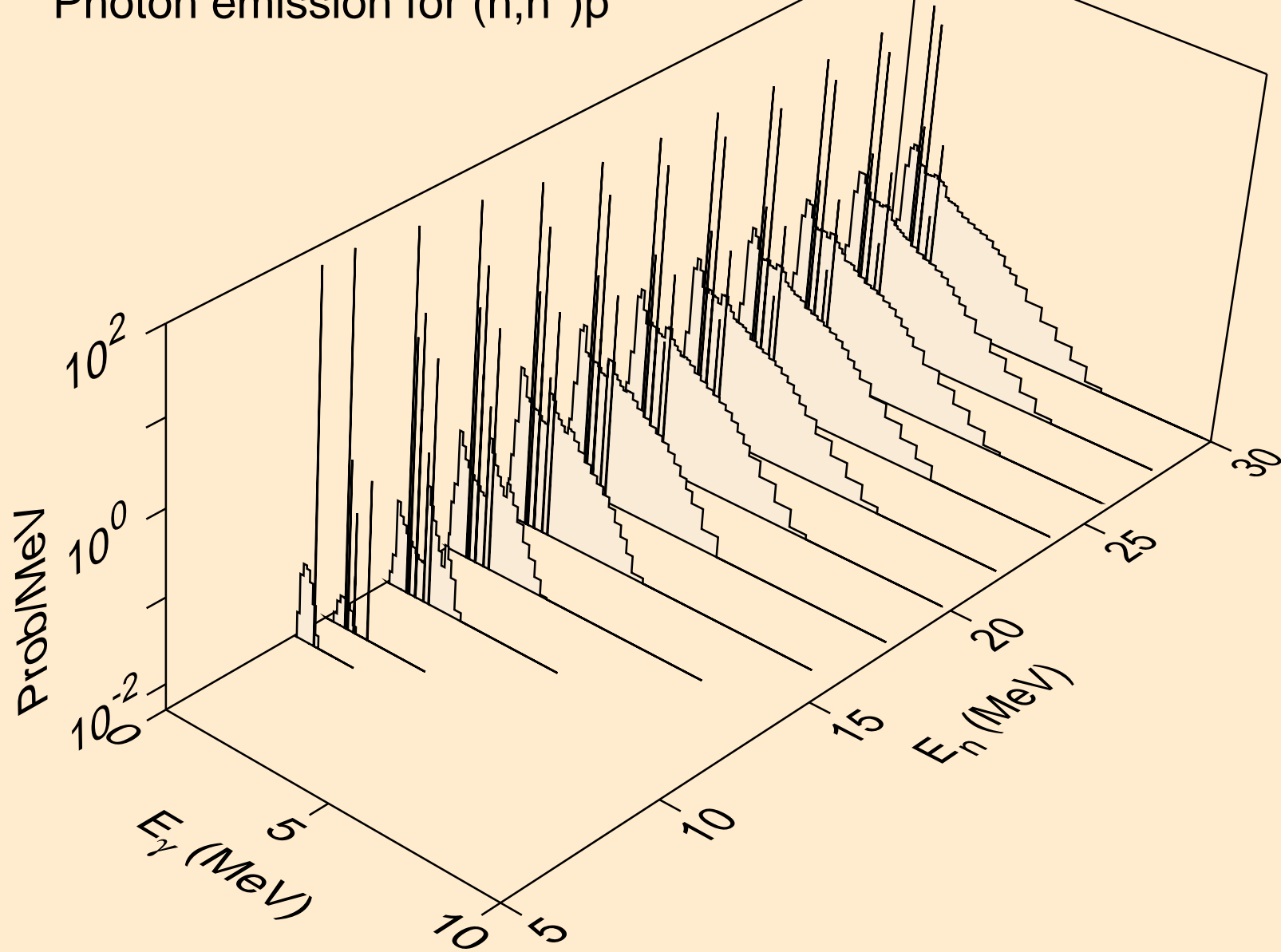

SE079M PROTON ACER TENDL-2021 LIBRARY; T=0.K  
Photon emission for (n,n\*)2a

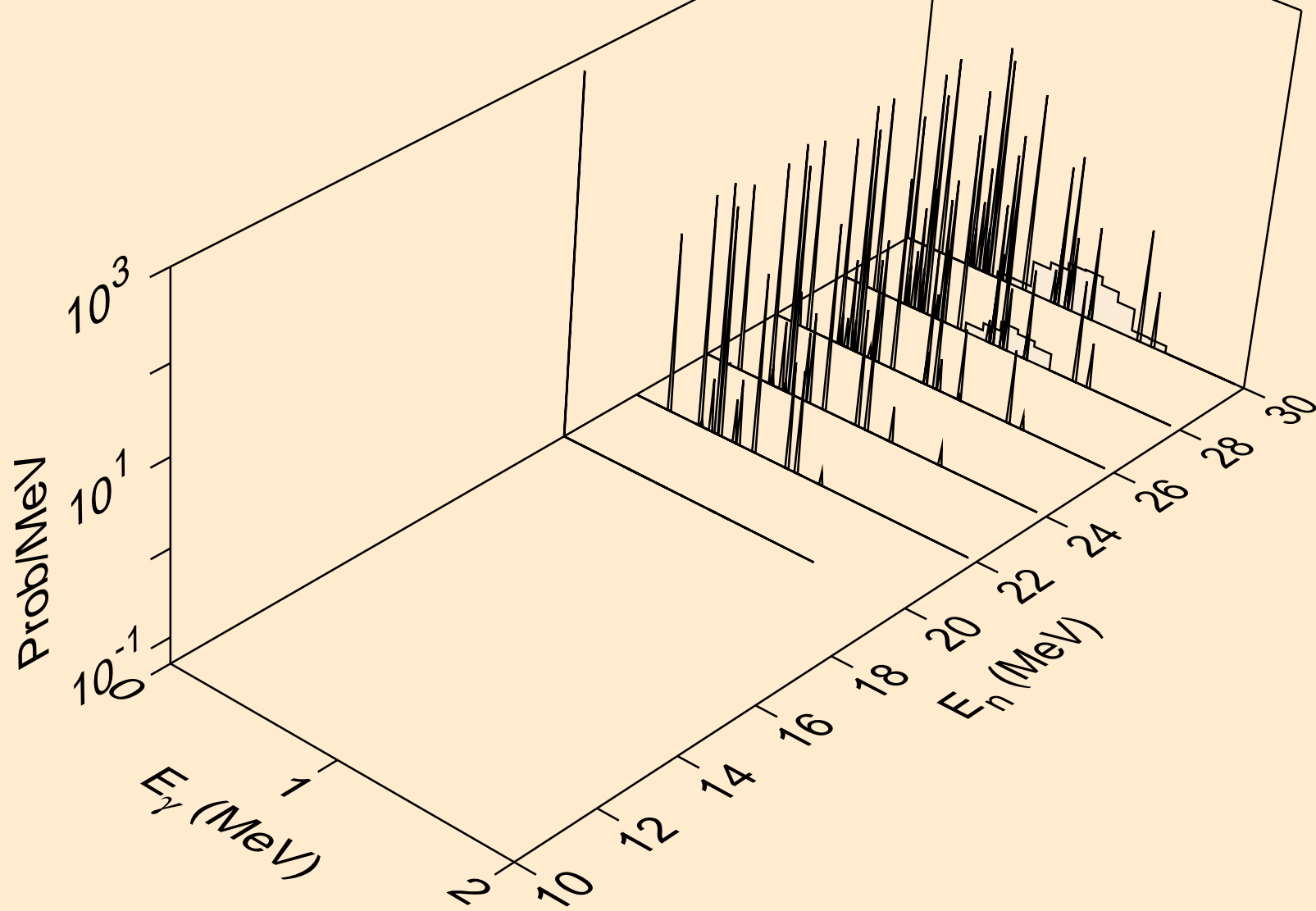

SE079M PROTON ACER TENDL-2021 LIBRARY; T=0.K  
Photon emission for (n,n\*)d

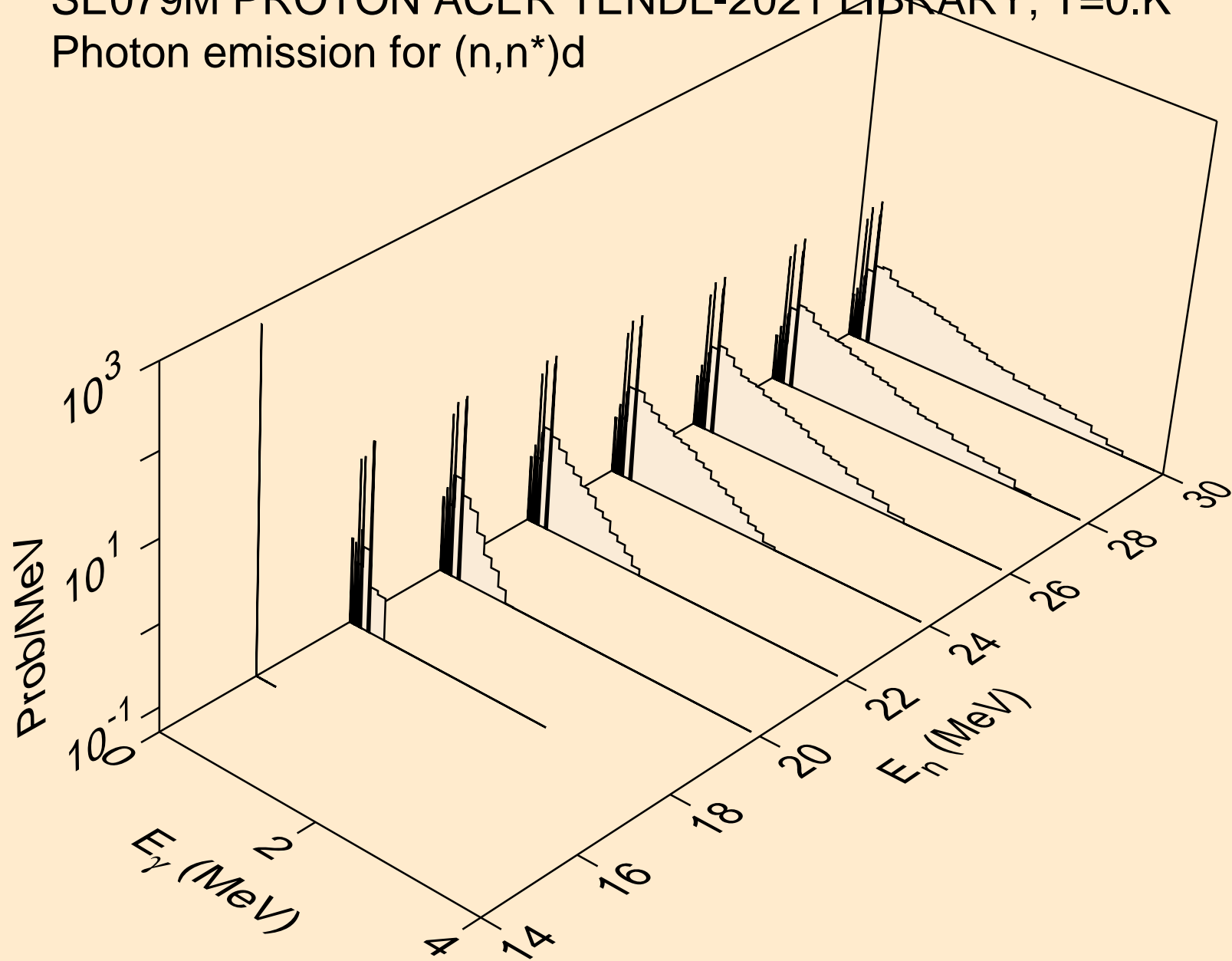

SE079M PROTON ACER TENDL-2021 LIBRARY; T=0.K  
Photon emission for (n,n\*)t

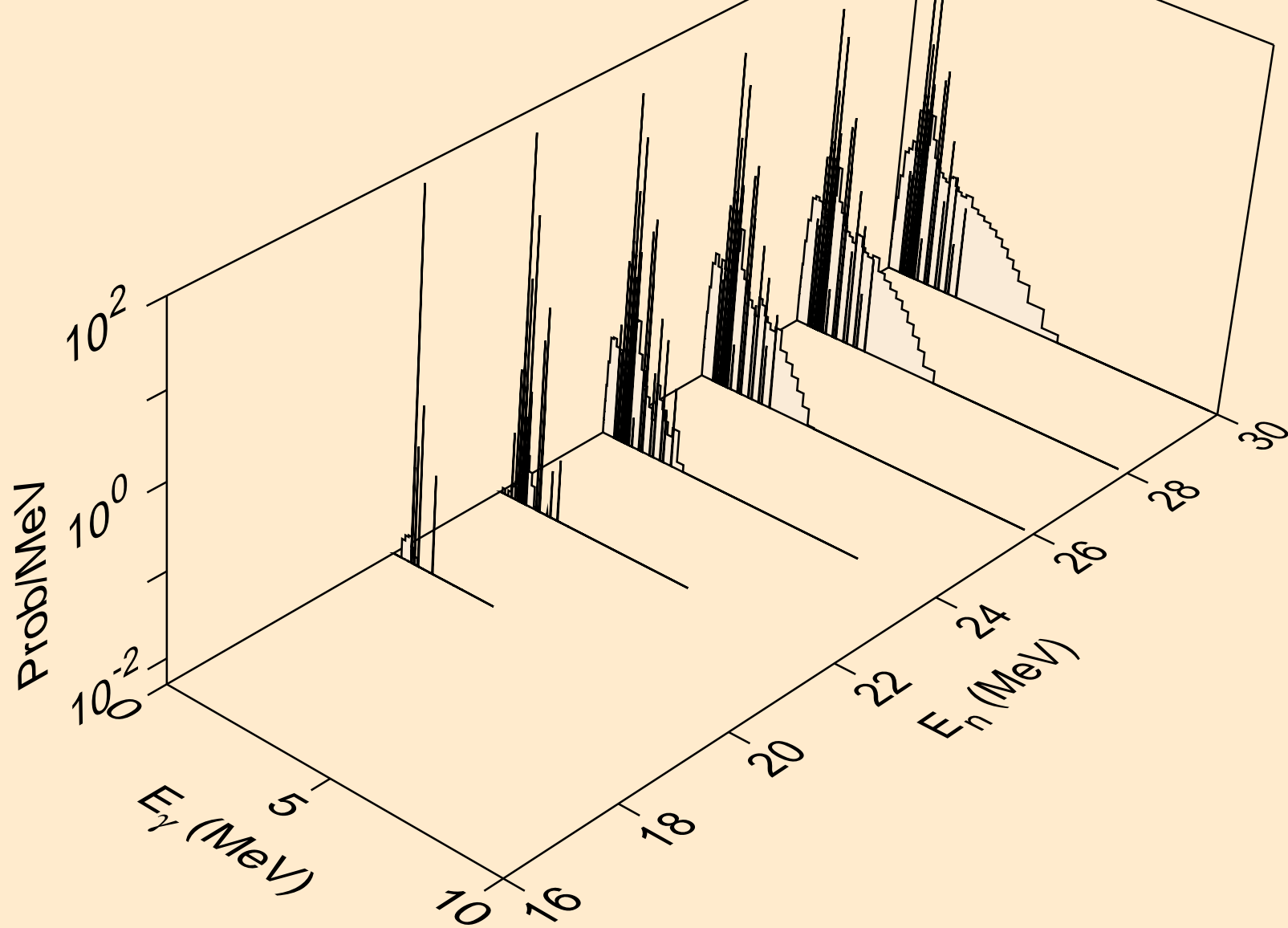



SE079M PROTON ACER TENDL-2021 LIBRARY; T=0.K  
Photon emission for (n,n\*)he3

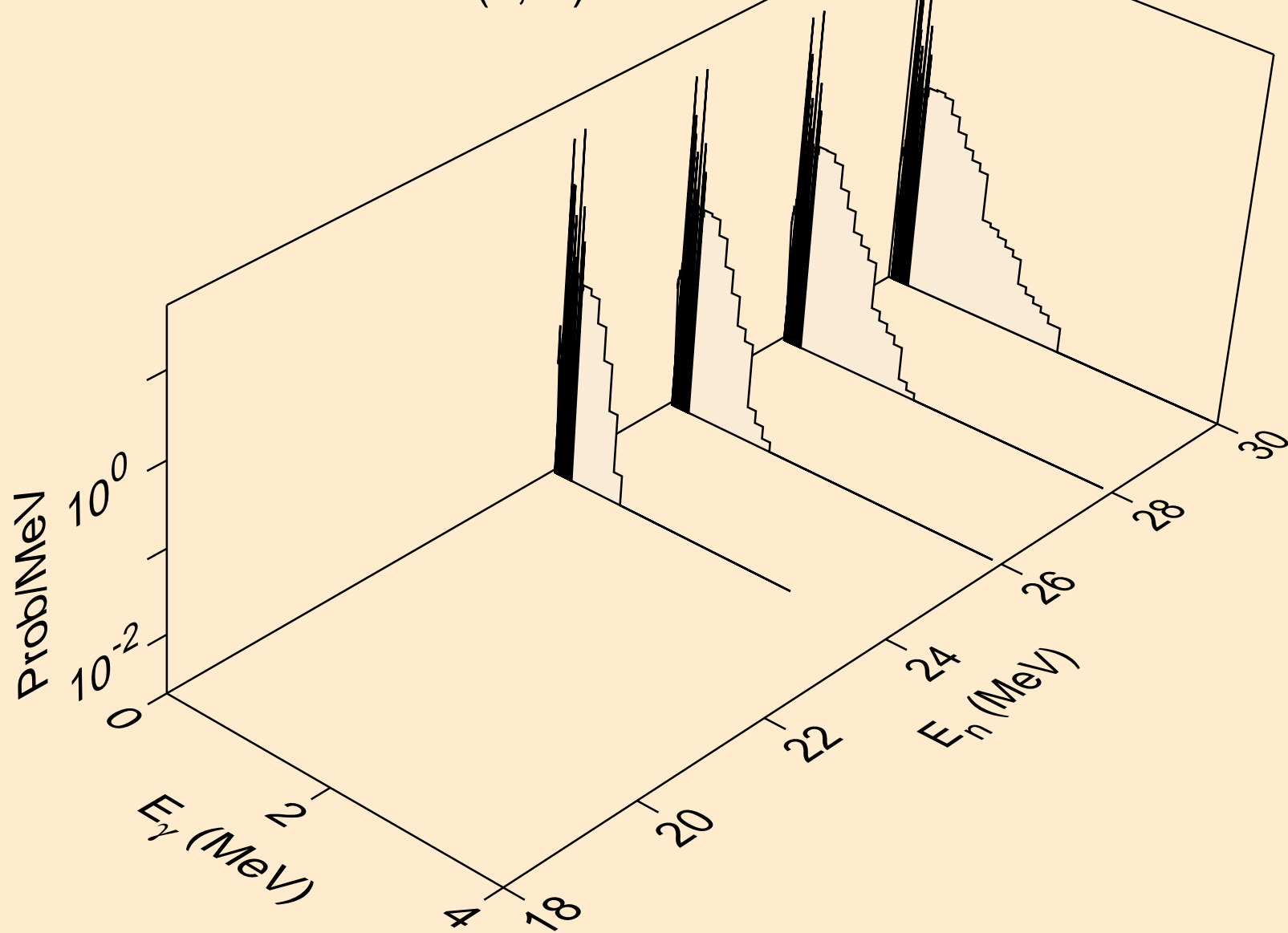

SE079M PROTON ACER TENDL-2021 LIBRARY; T=0.K  
Photon emission for (n,2np)

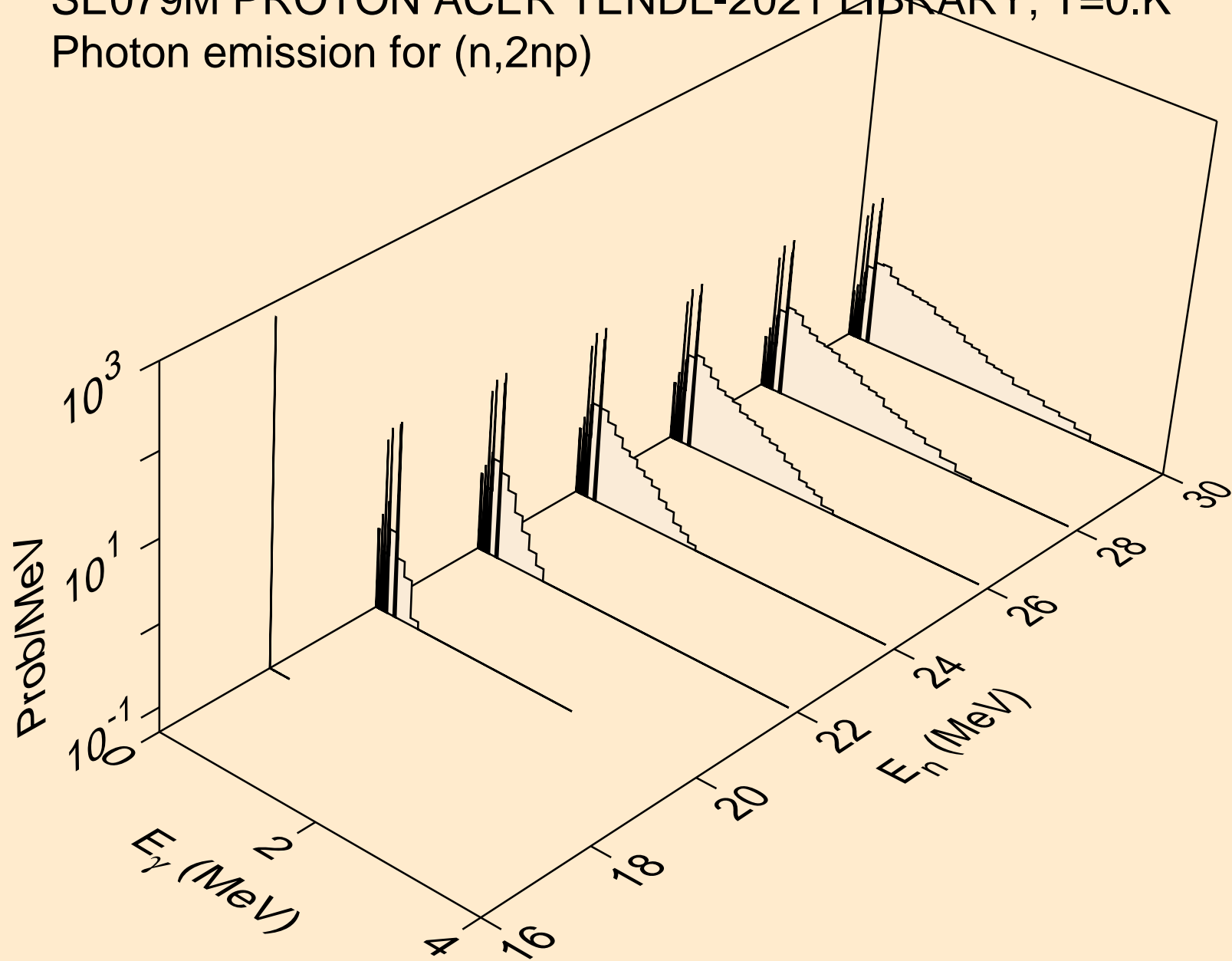

SE079M PROTON ACER TENDL-2021 LIBRARY; T=0.K  
Photon emission for (n,3np)

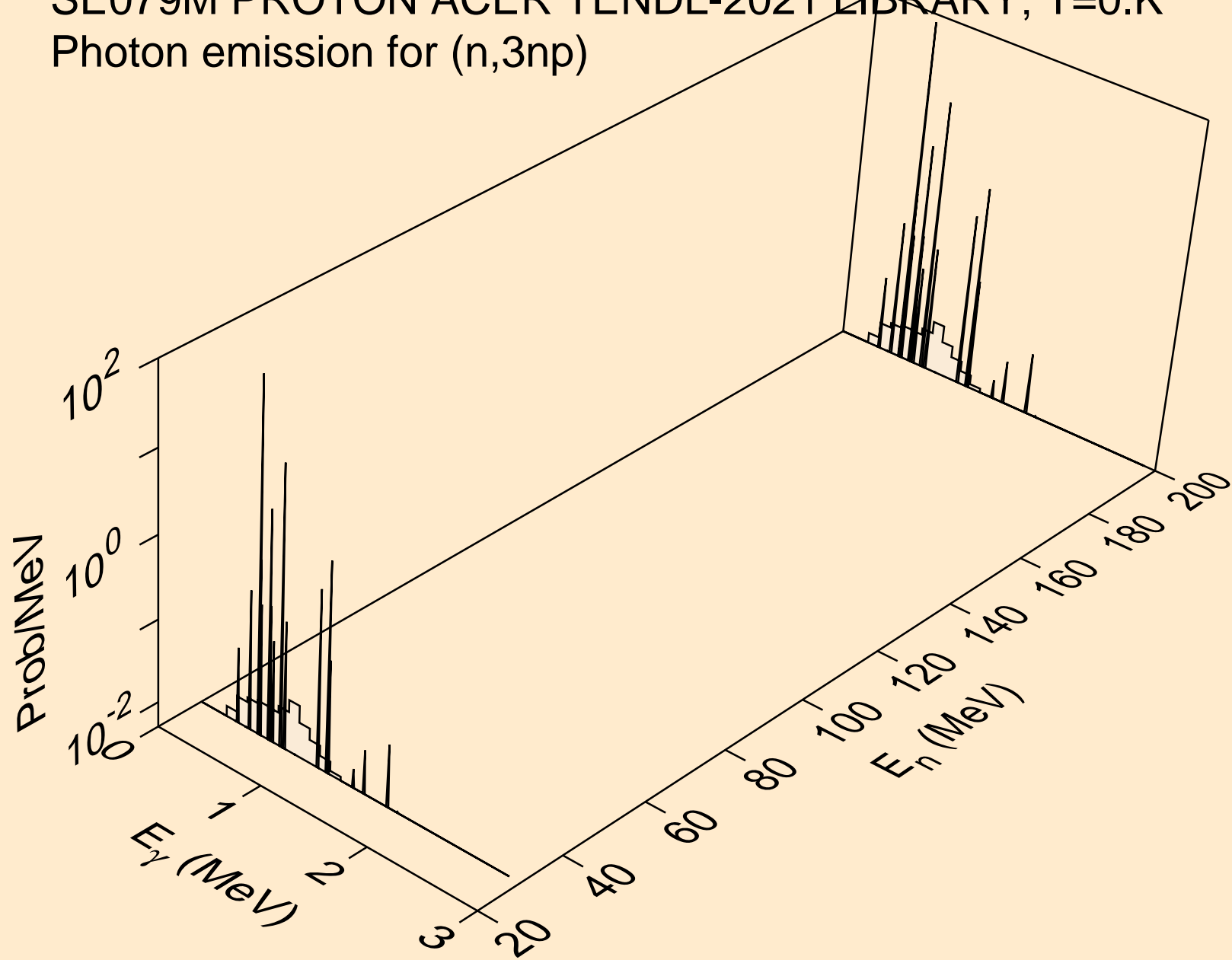

SE079M PROTON ACER TENDL-2021 LIBRARY; T=0.K  
Photon emission for (n,2np)

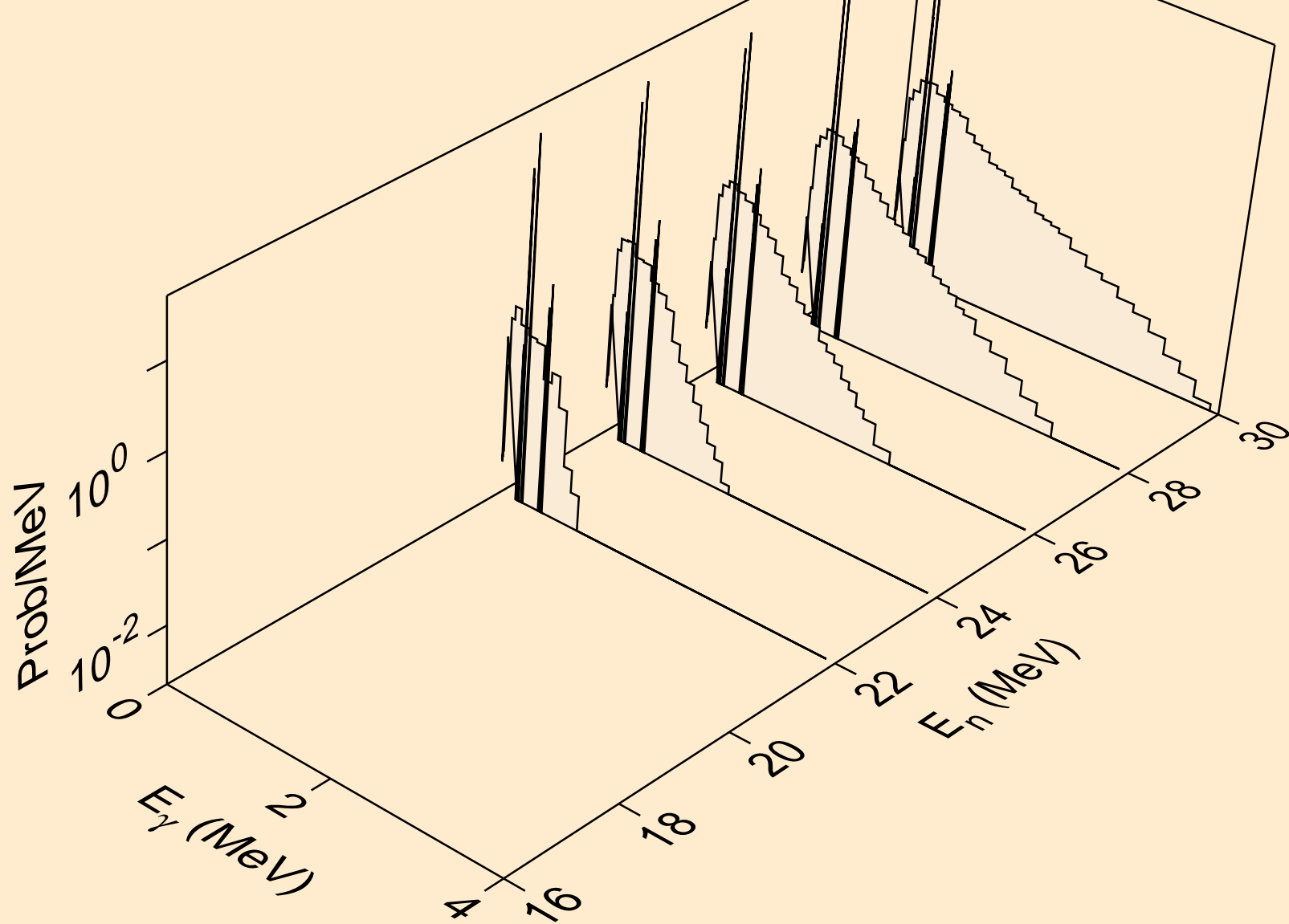

SE079M PROTON ACER TENDL-2021 LIBRARY; T=0.K  
Photon emission for (n,npa)

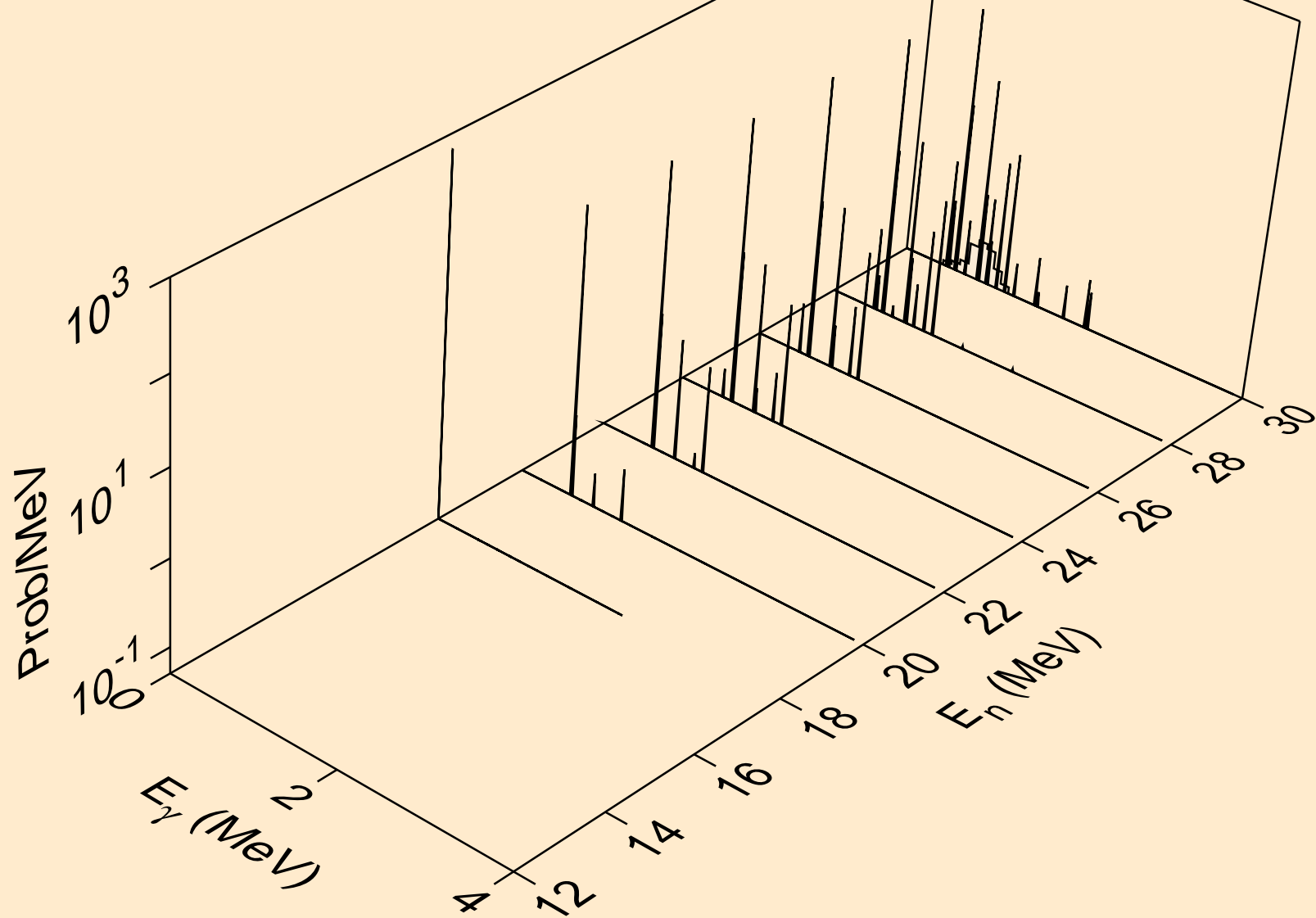

SE079M PROTON ACER TENDL-2021 LIBRARY; T=0.K  
Photon emission for (n,gma)

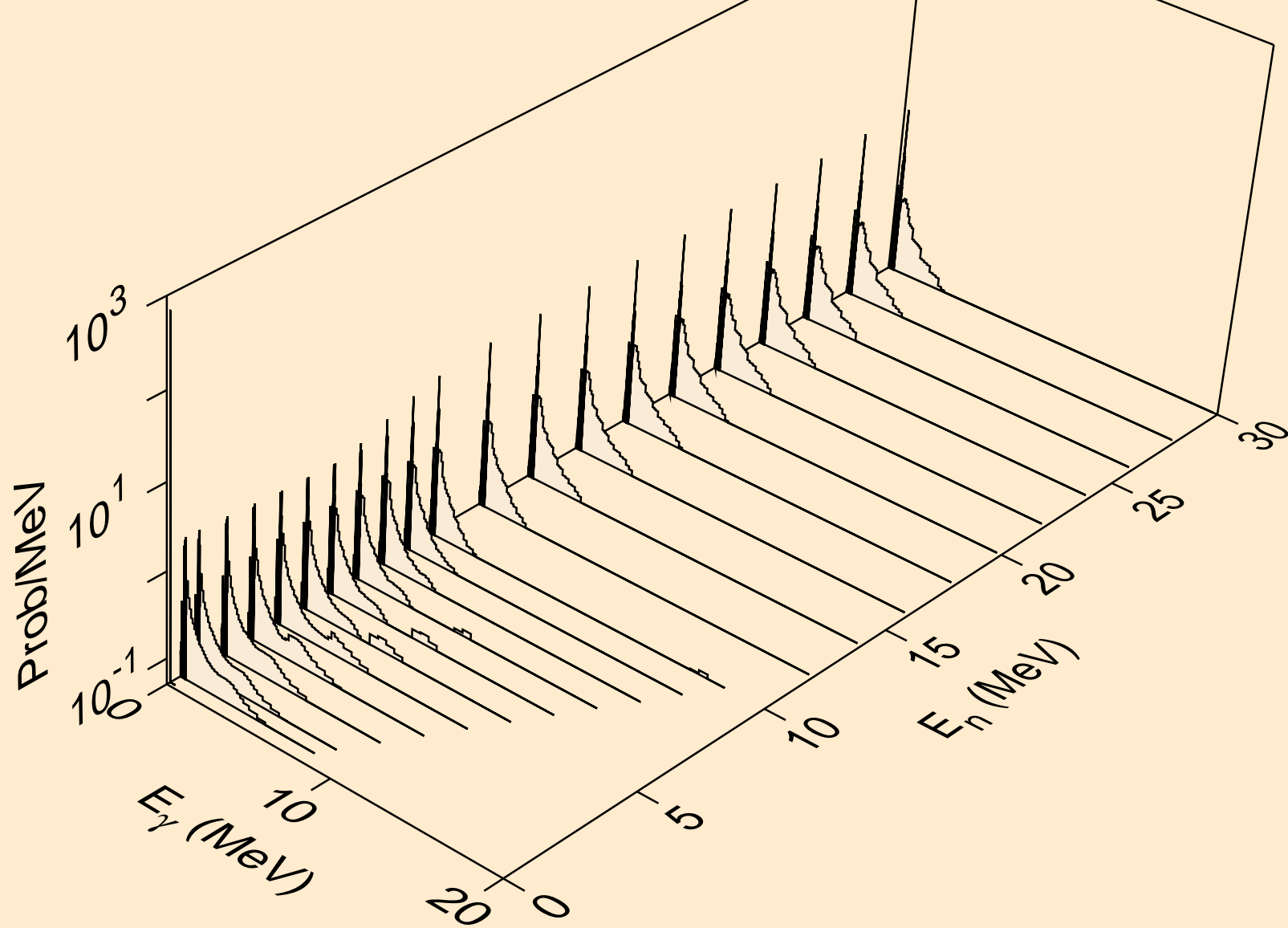

SE079M PROTON ACER TENDL-2021 LIBRARY; T=0.K  
Photon emission for inelastic

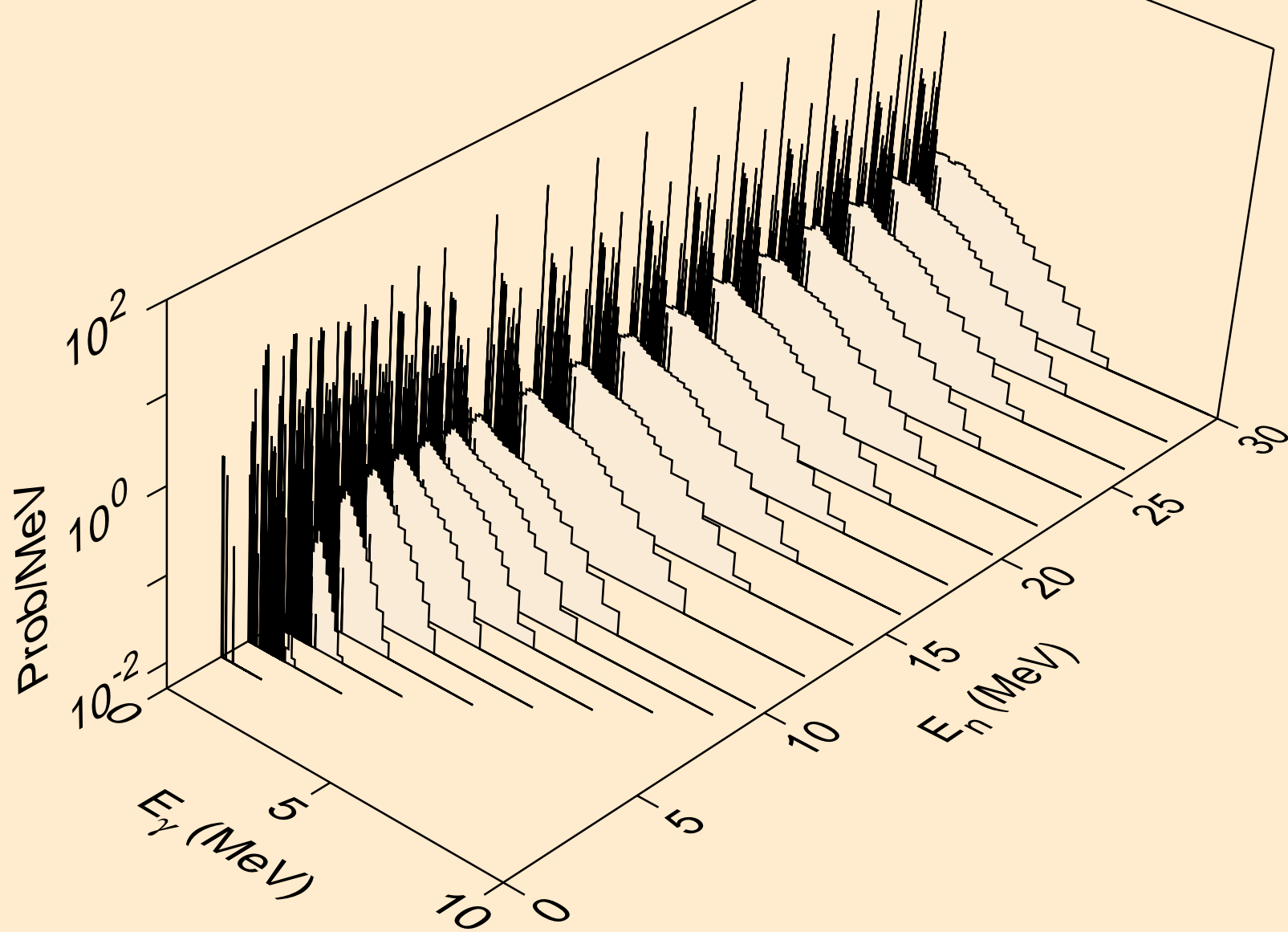

SE079M PROTON ACER TENDL-2021 LIBRARY; T=0.K  
Photon emission for (n,d)

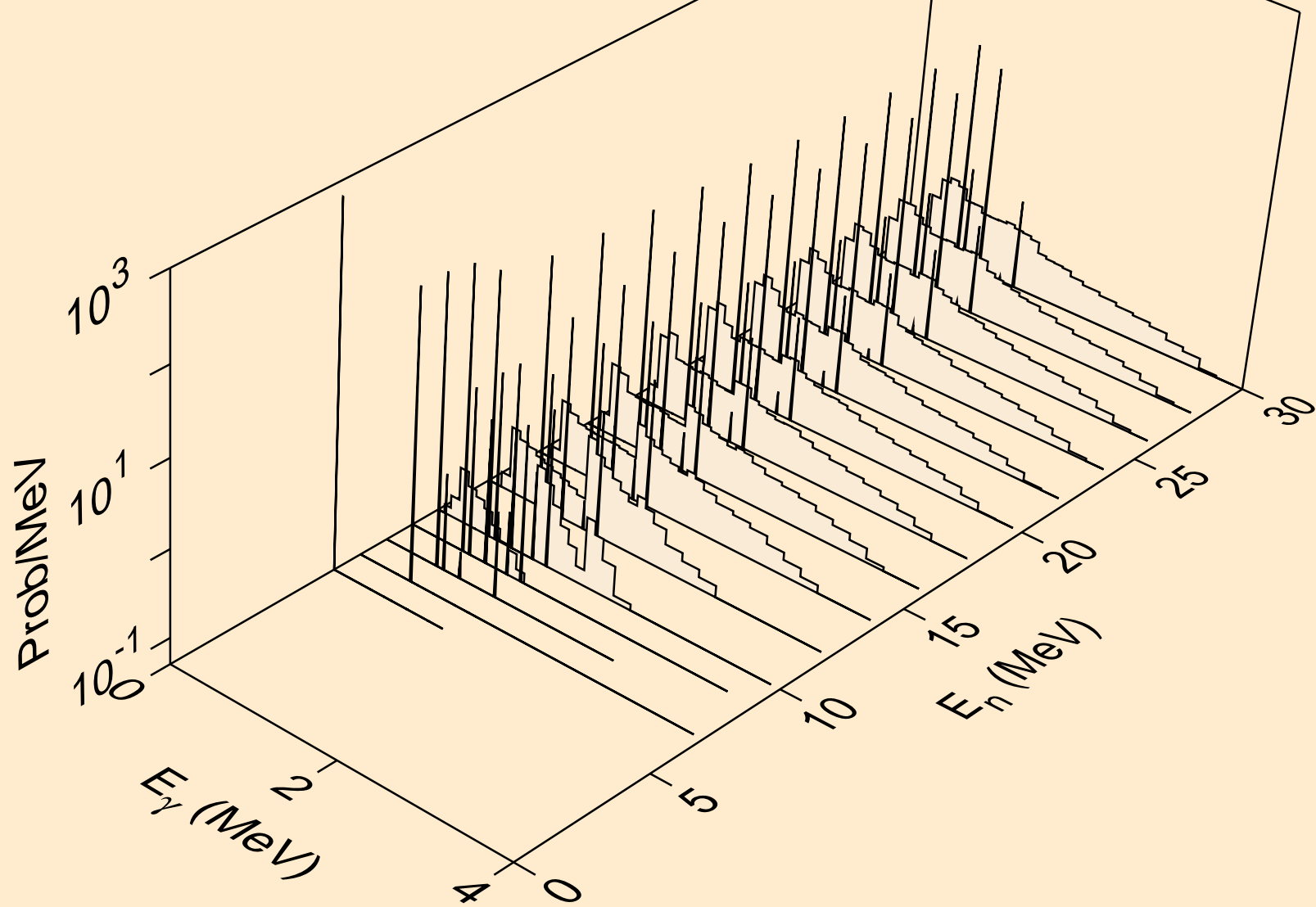



SE079M PROTON ACER TENDL-2021 LIBRARY; T=0.K  
Photon emission for (n,t)

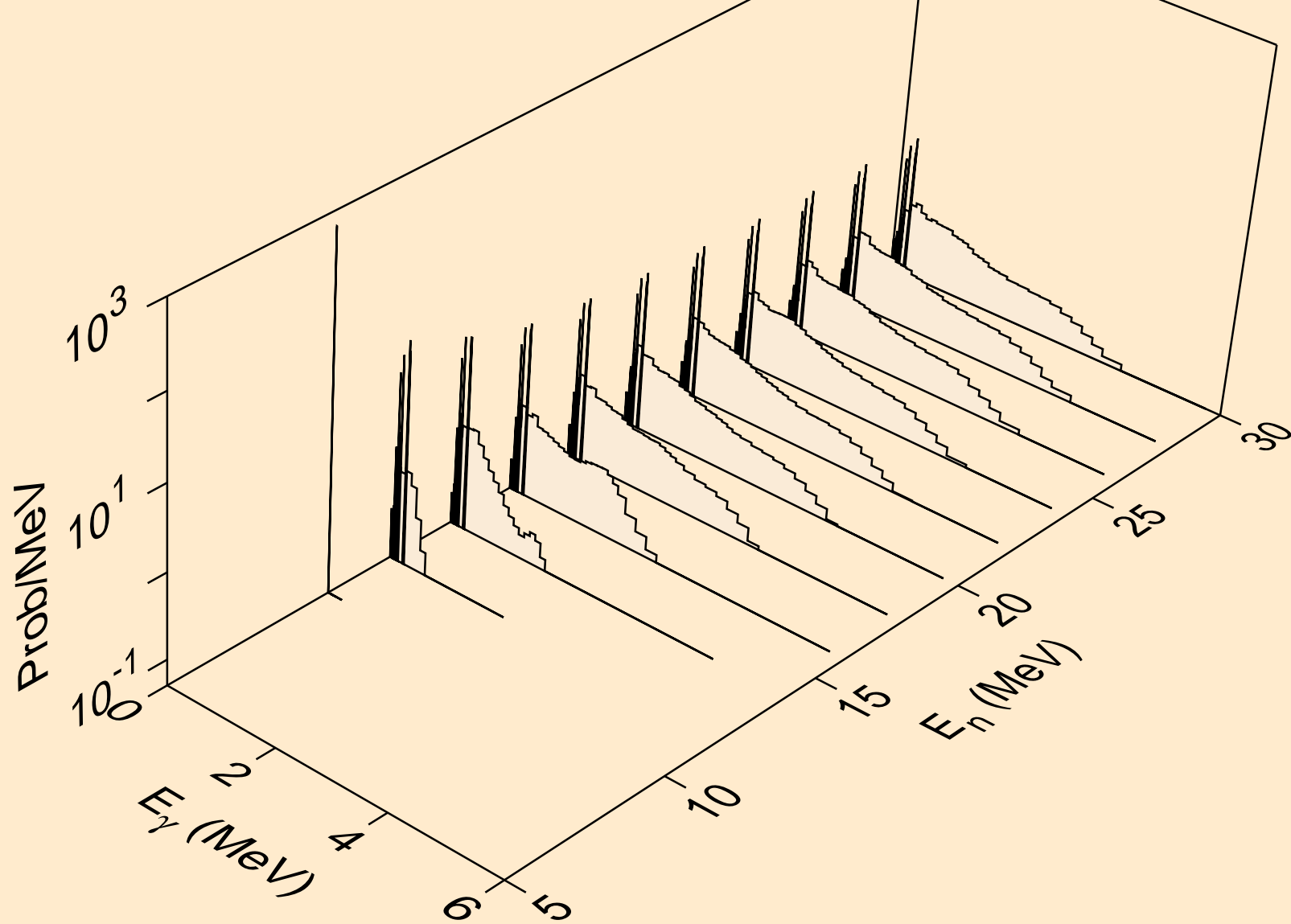

SE079M PROTON ACER TENDL-2021 LIBRARY; T=0.K  
Photon emission for (n,he3)

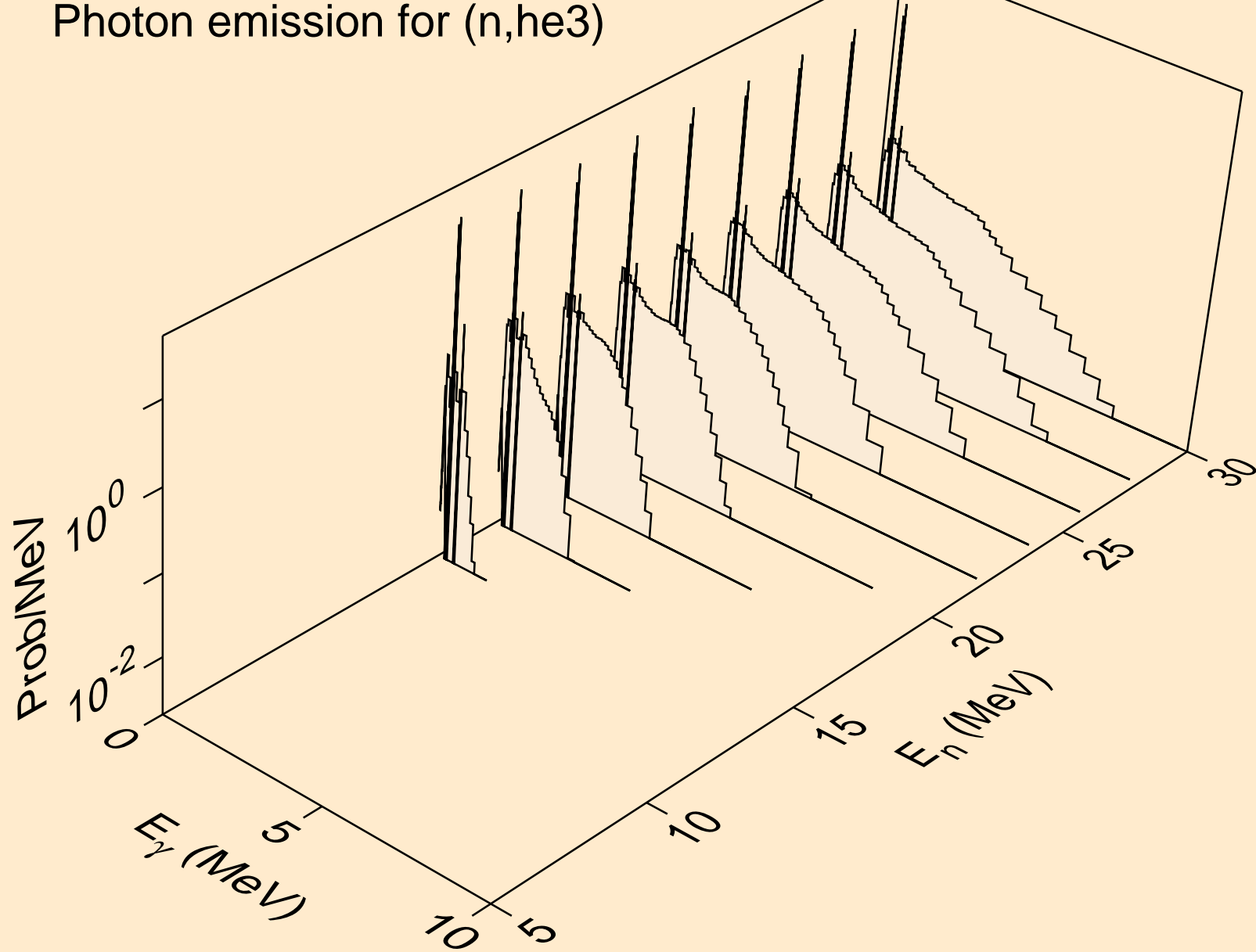

SE079M PROTON ACER TENDL-2021 LIBRARY; T=0.K  
Photon emission for (n,a)

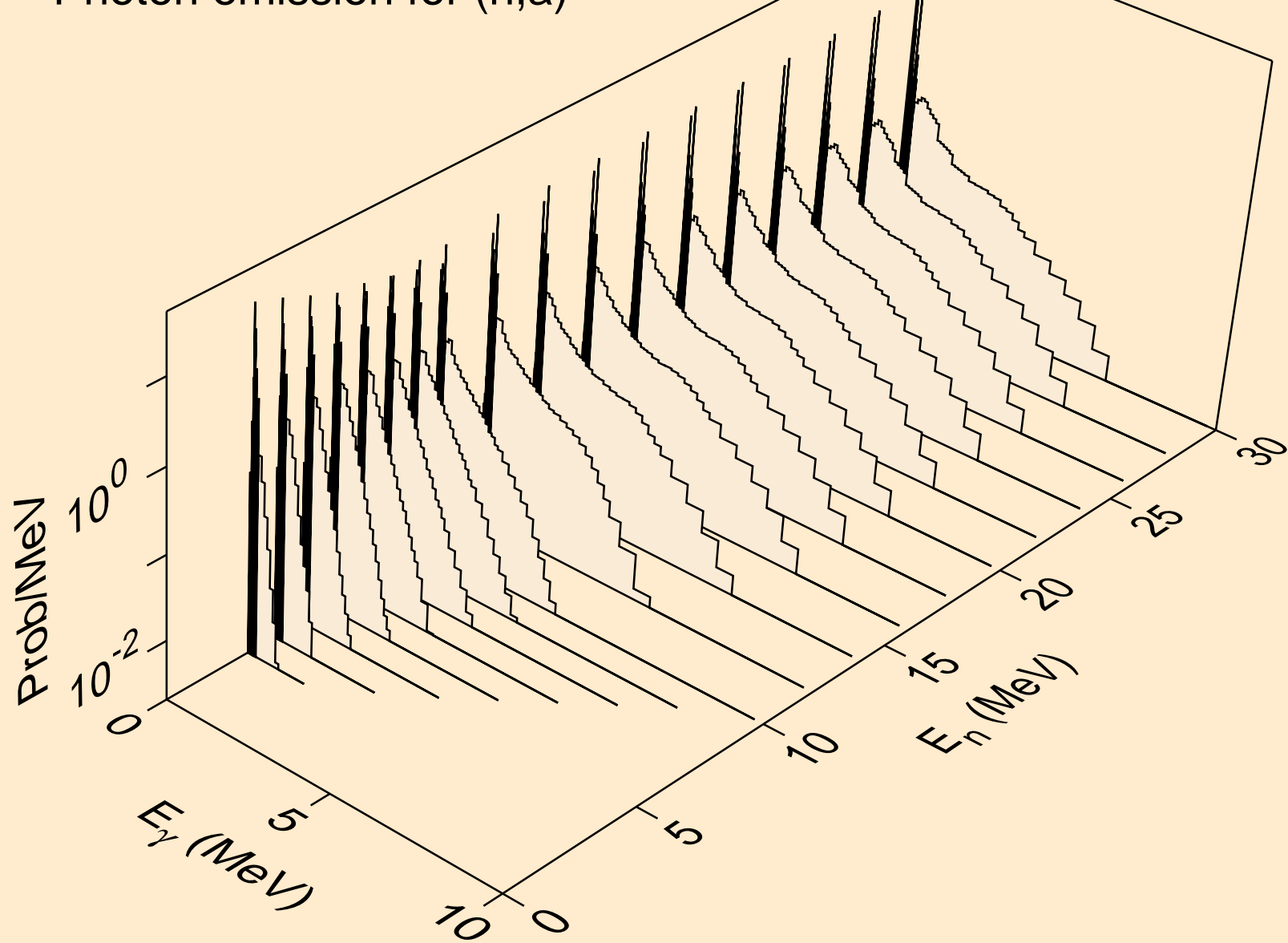

SE079M PROTON ACER TENDL-2021 LIBRARY; T=0.K  
Photon emission for (n,2a)

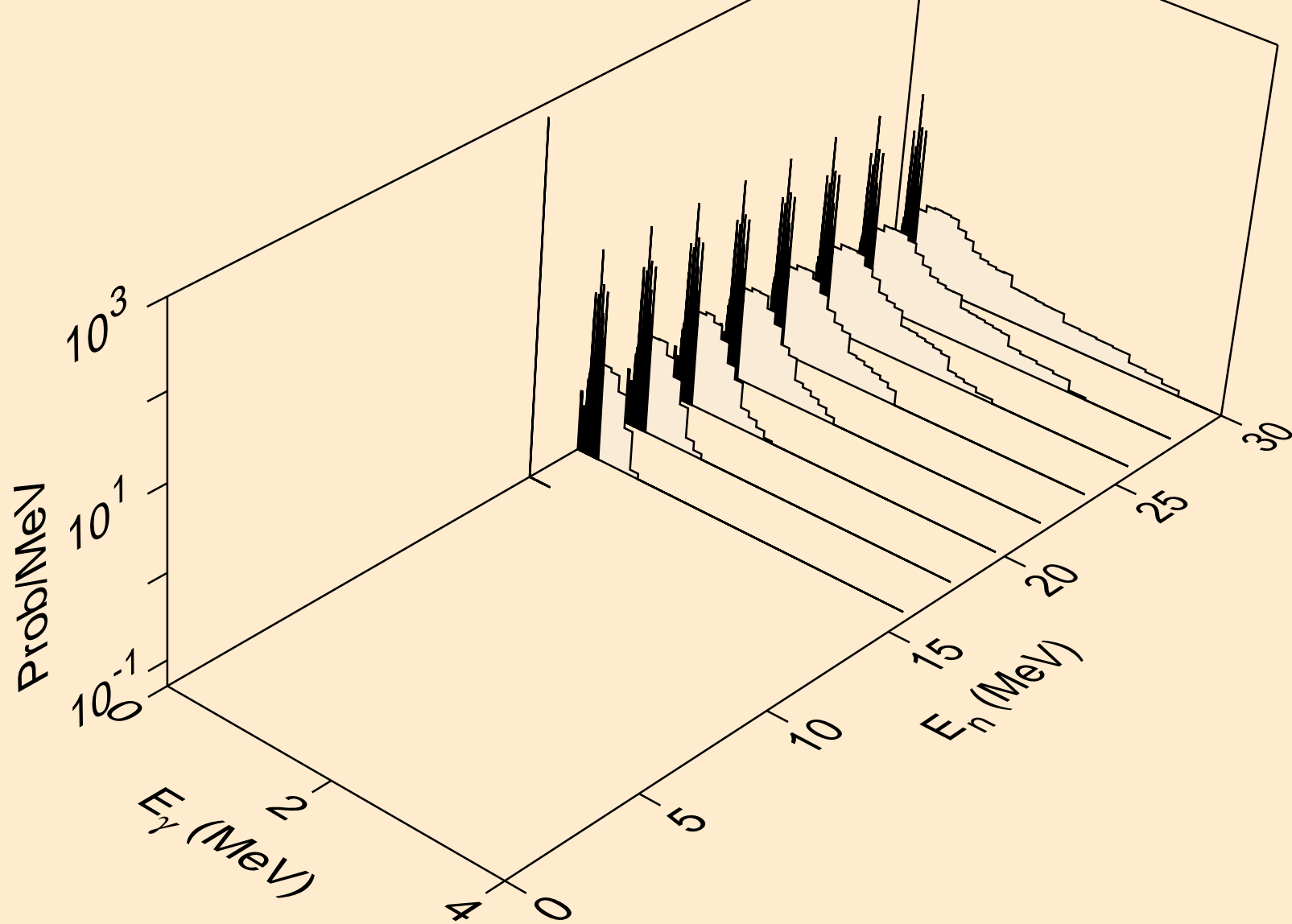

SE079M PROTON ACER TENDL-2021 LIBRARY; T=0.K  
Photon emission for (n,2p)

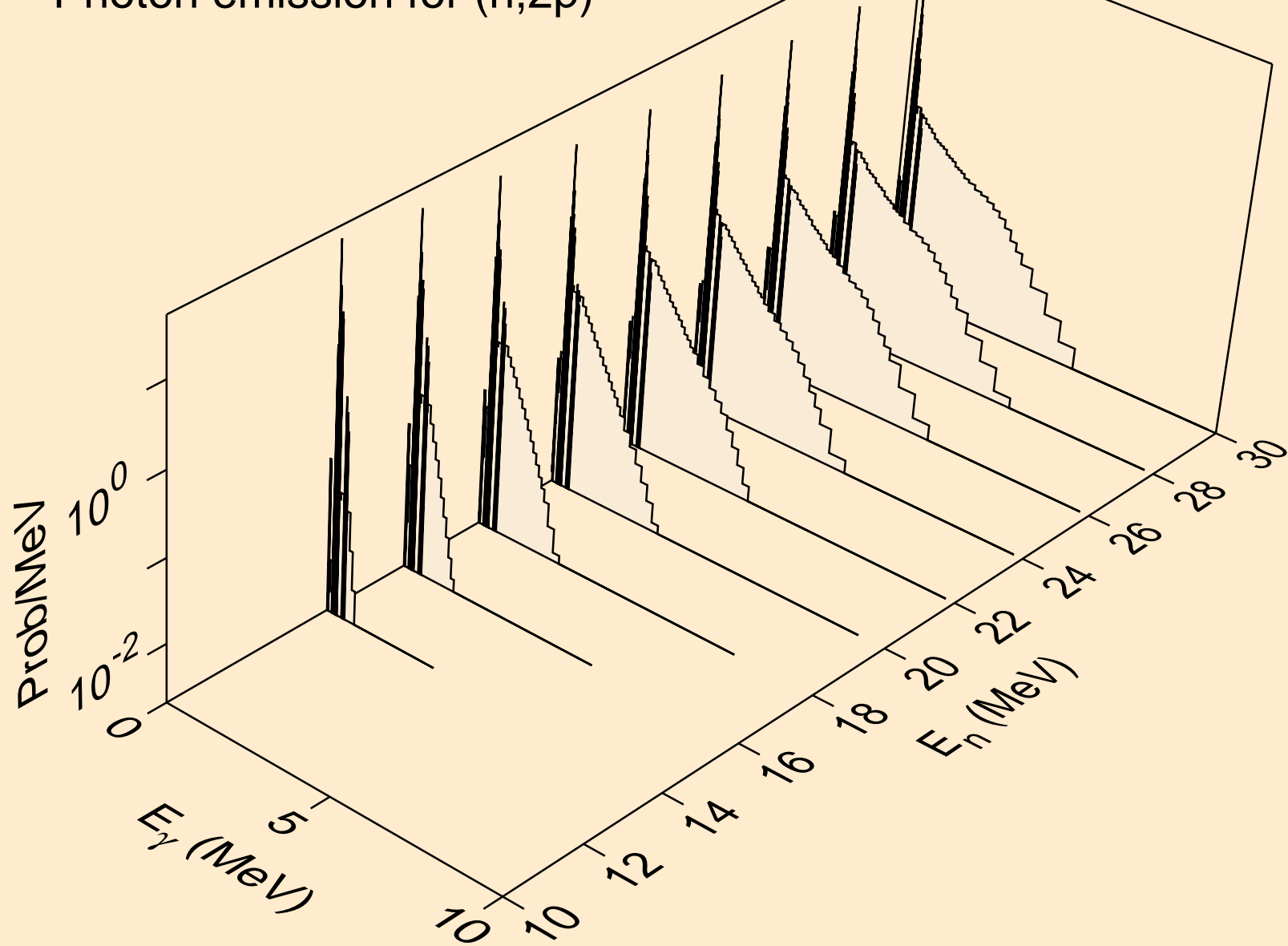

SE079M PROTON ACER TENDL-2021 LIBRARY; T=0.K  
Photon emission for (n,pa)

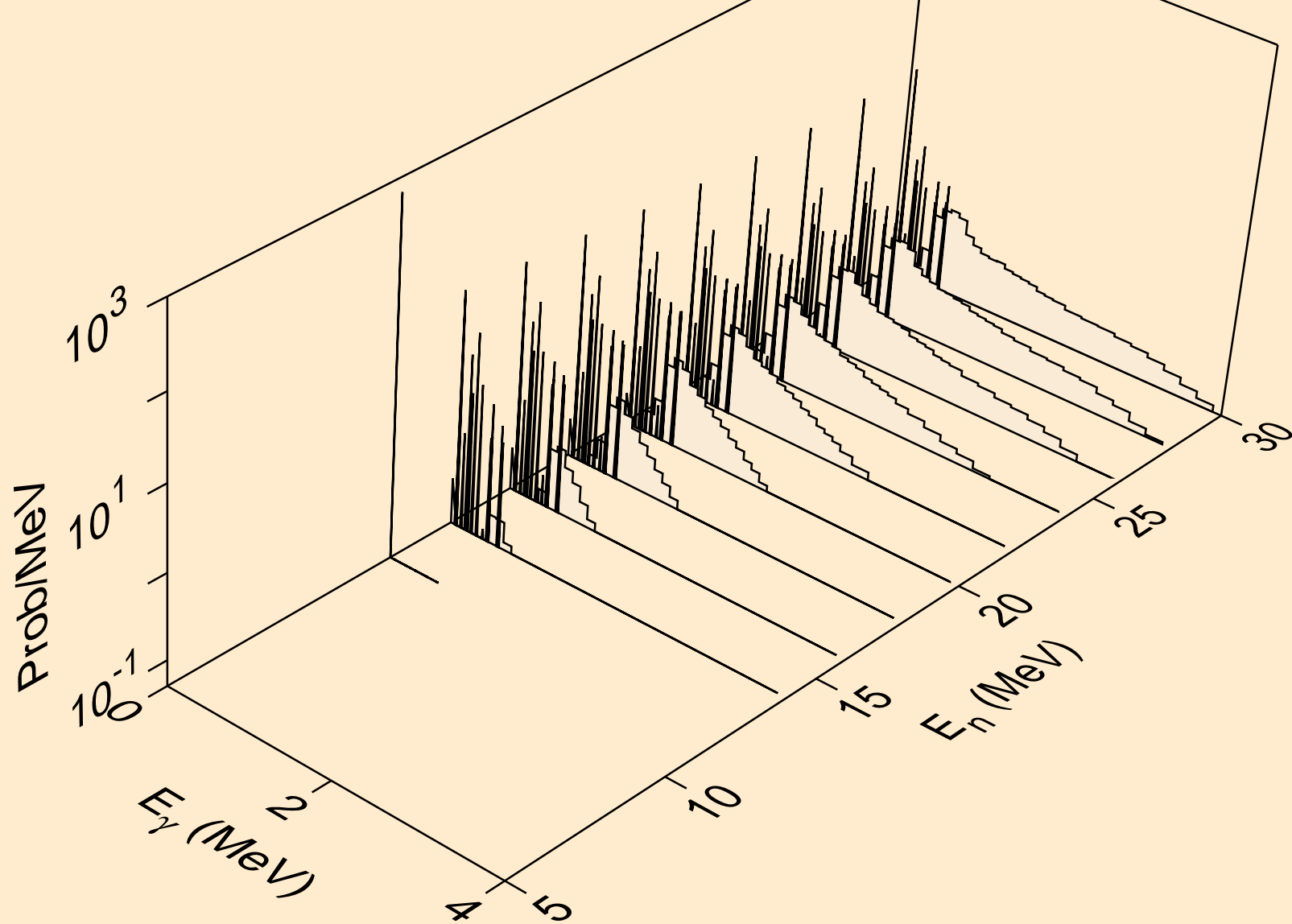

SE079M PROTON ACER TENDL-2021 LIBRARY; T=0.K  
Photon emission for (n,pd)

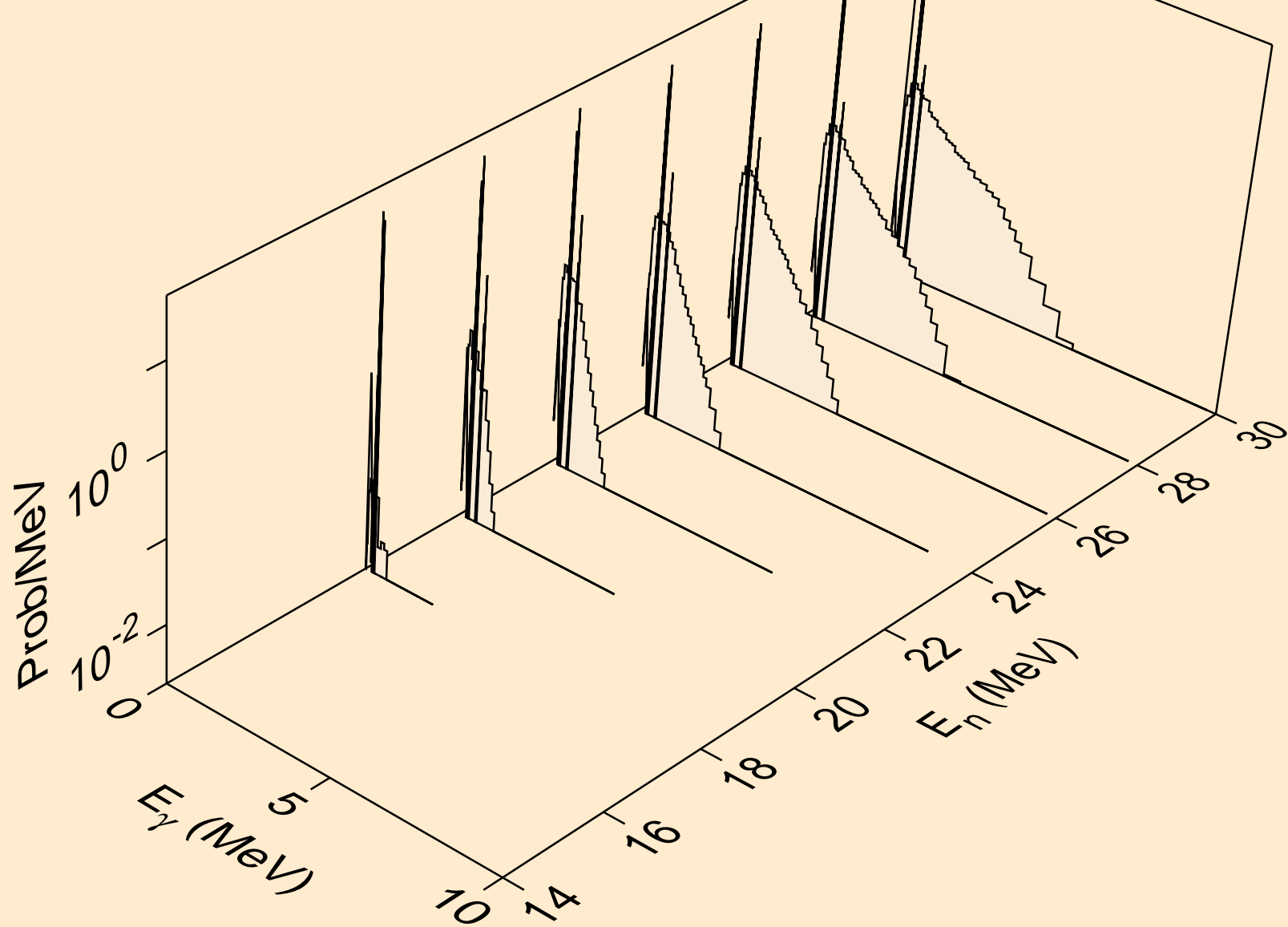

SE079M PROTON ACER TENDL-2021 LIBRARY; T=0.K  
Photon emission for (n,pt)

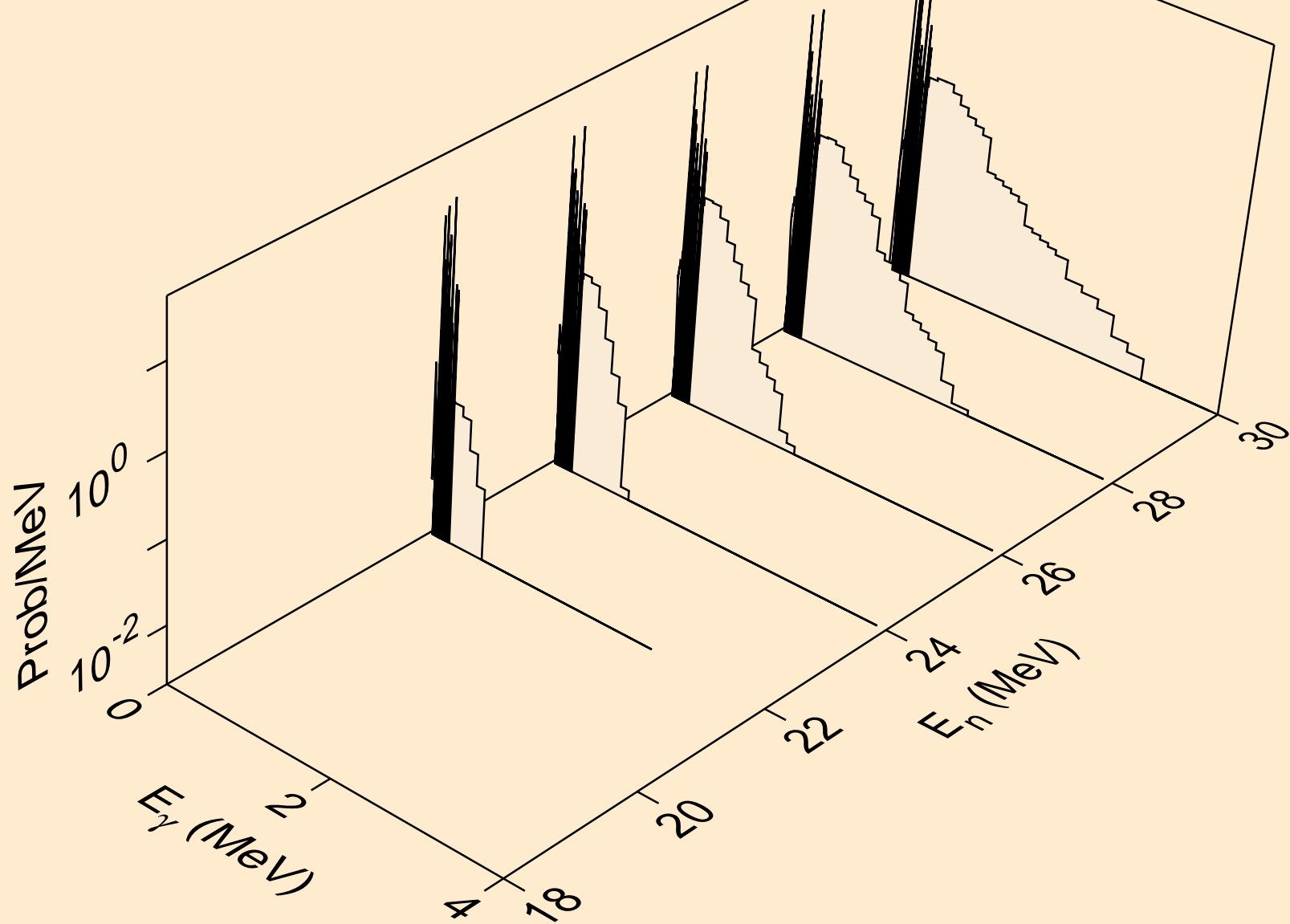



SE079M PROTON ACER TENDL-2021 LIBRARY; T=0.K  
Photon emission for (n,da)

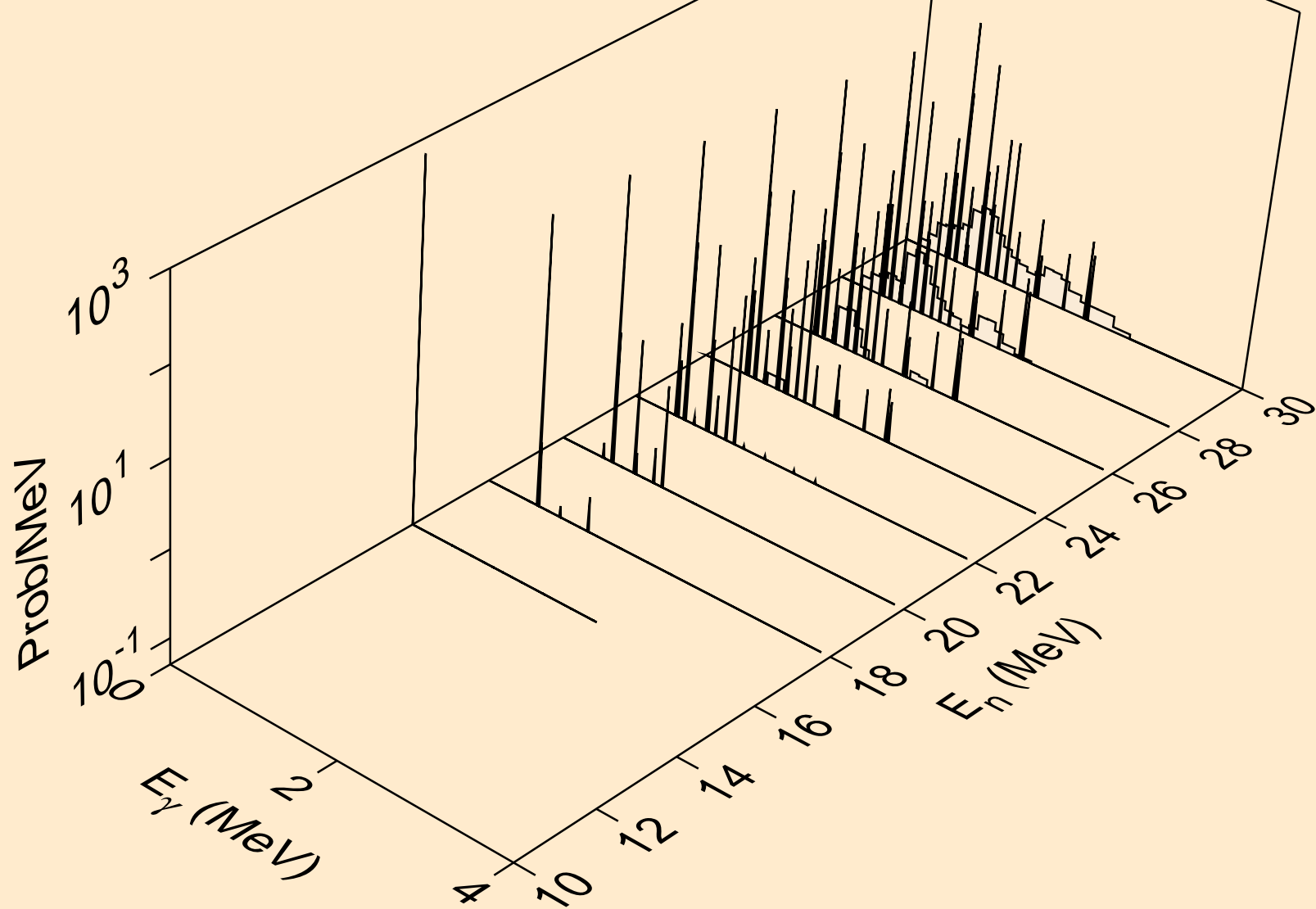

SE079M PROTON ACER TENDL-2021 LIBRARY; T=0.K  
Particle heating contributions

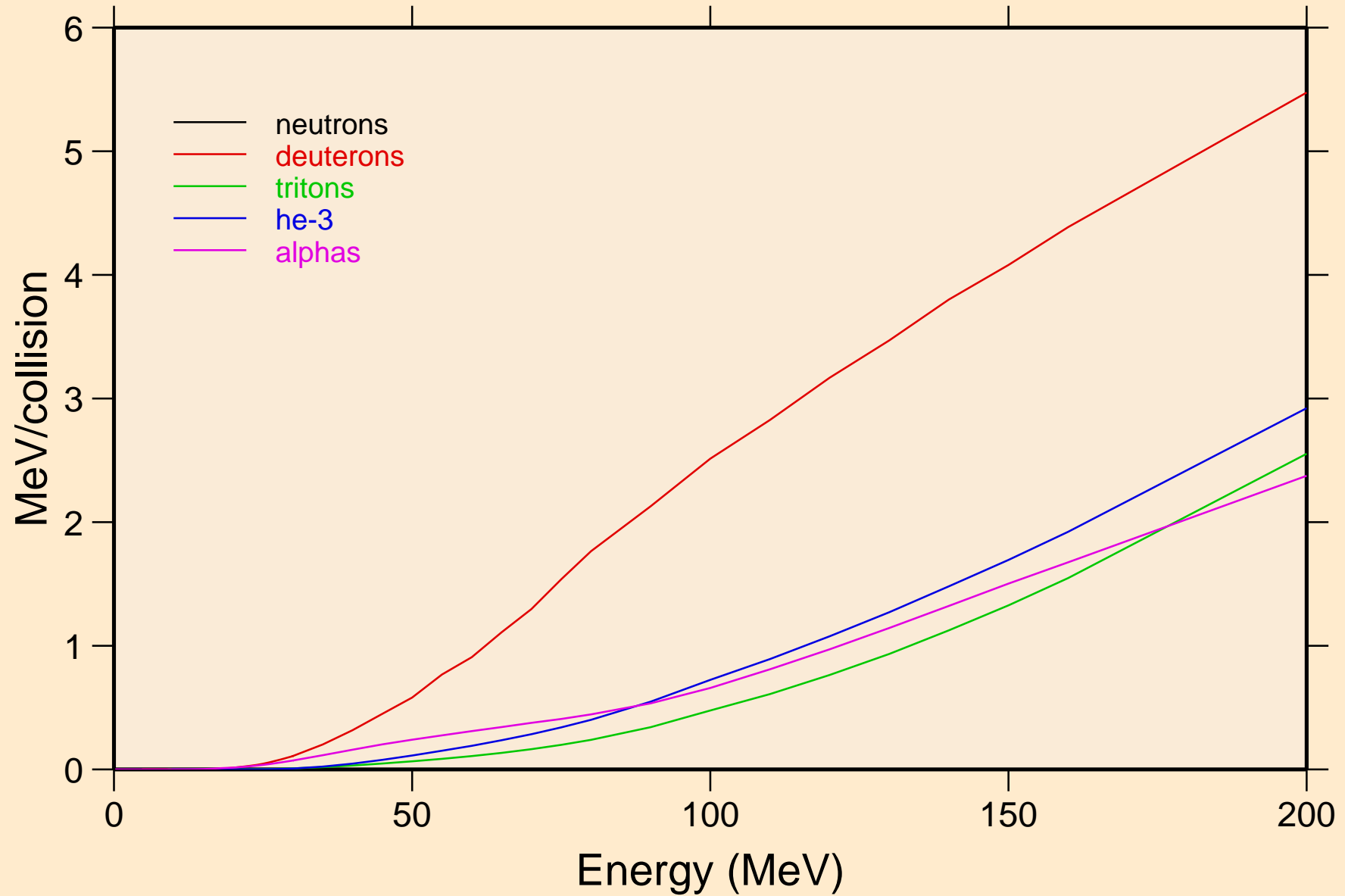

SE079M PROTON ACER TENDL-2021 LIBRARY; T=0.K  
Recoil Heating

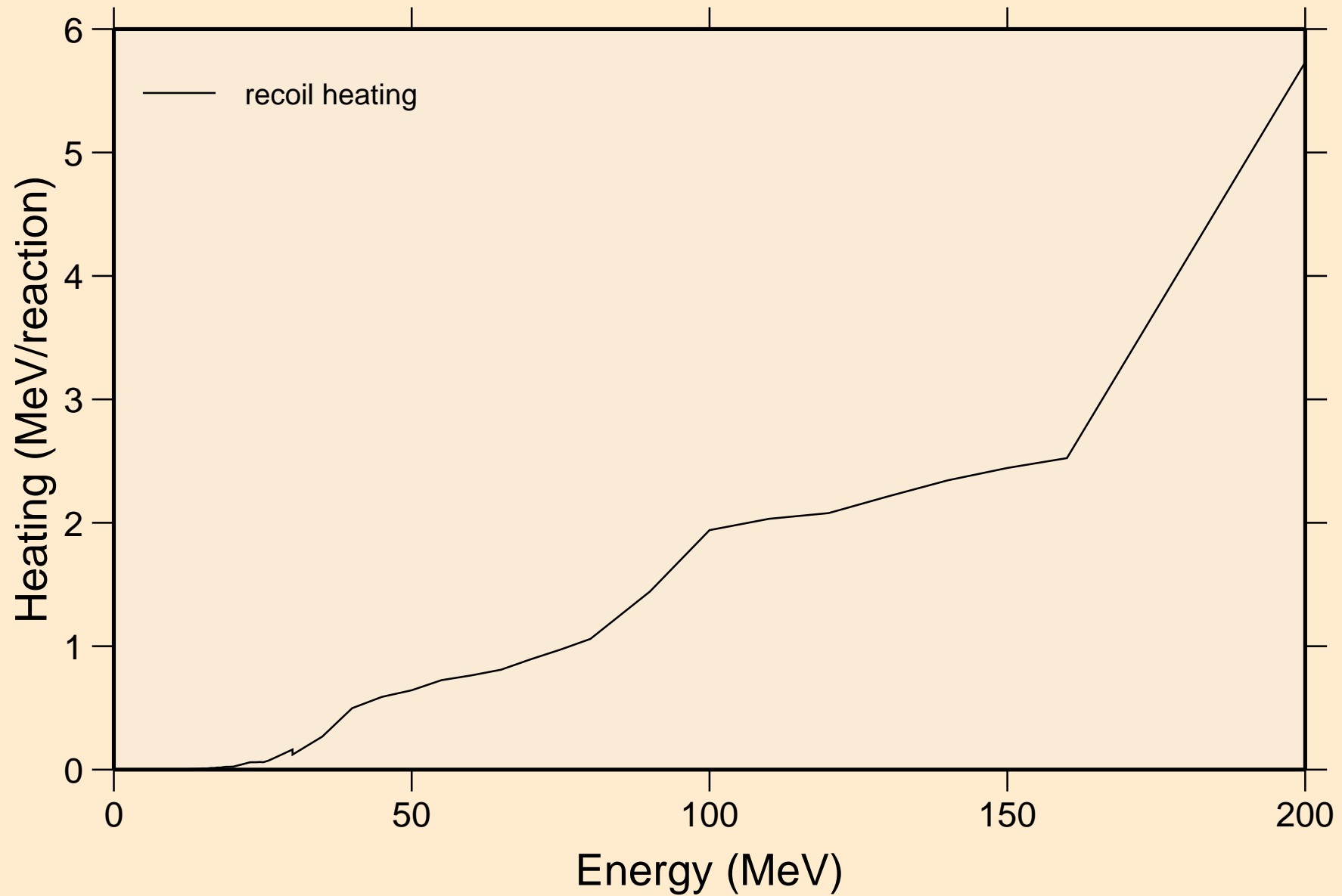

SE079M PROTON ACER TENDL-2021 LIBRARY; T=0.K  
Particle production cross sections

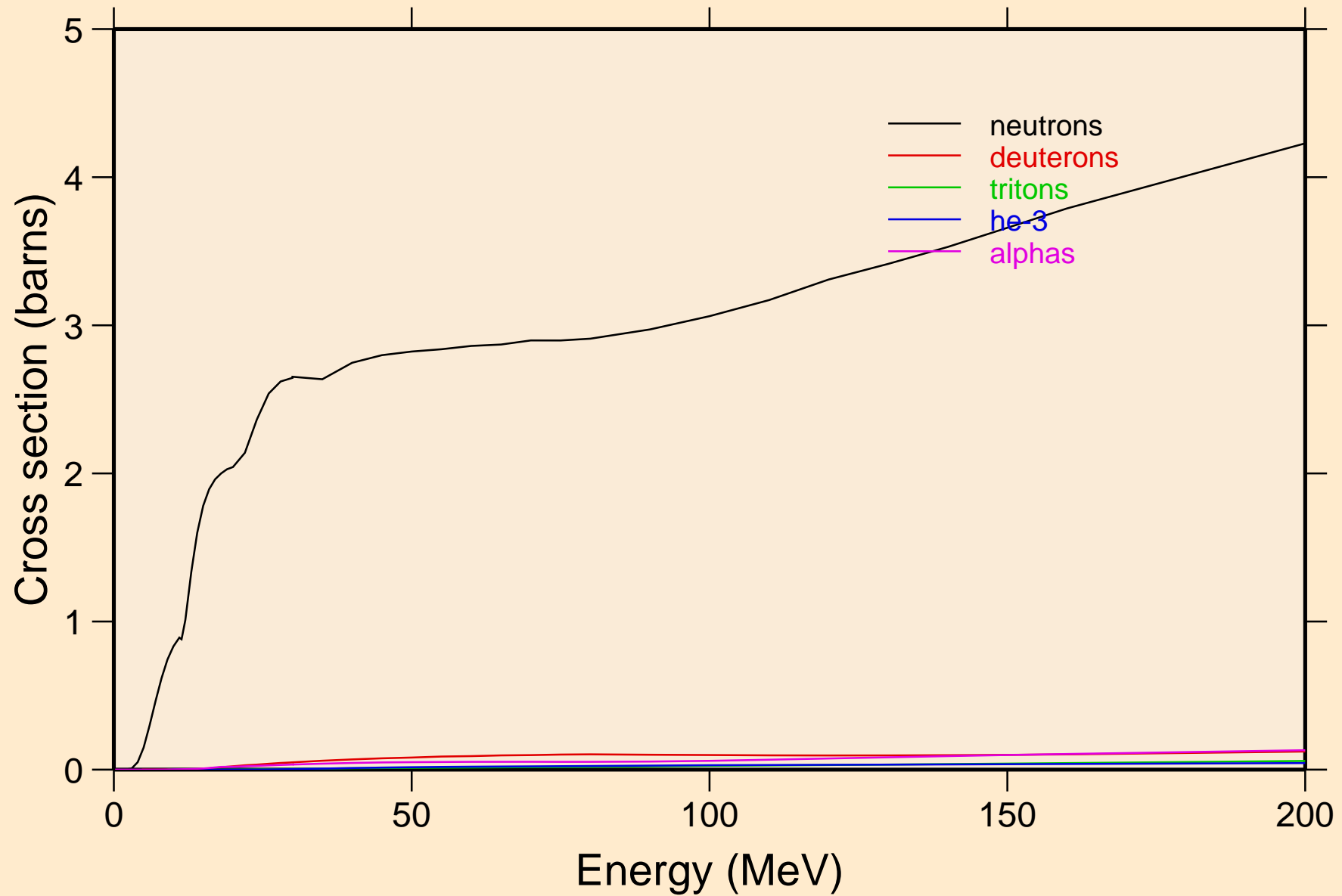

SE079M PROTON ACER TENDL-2021 LIBRARY; T=0.K  
neutrons from (p,n)

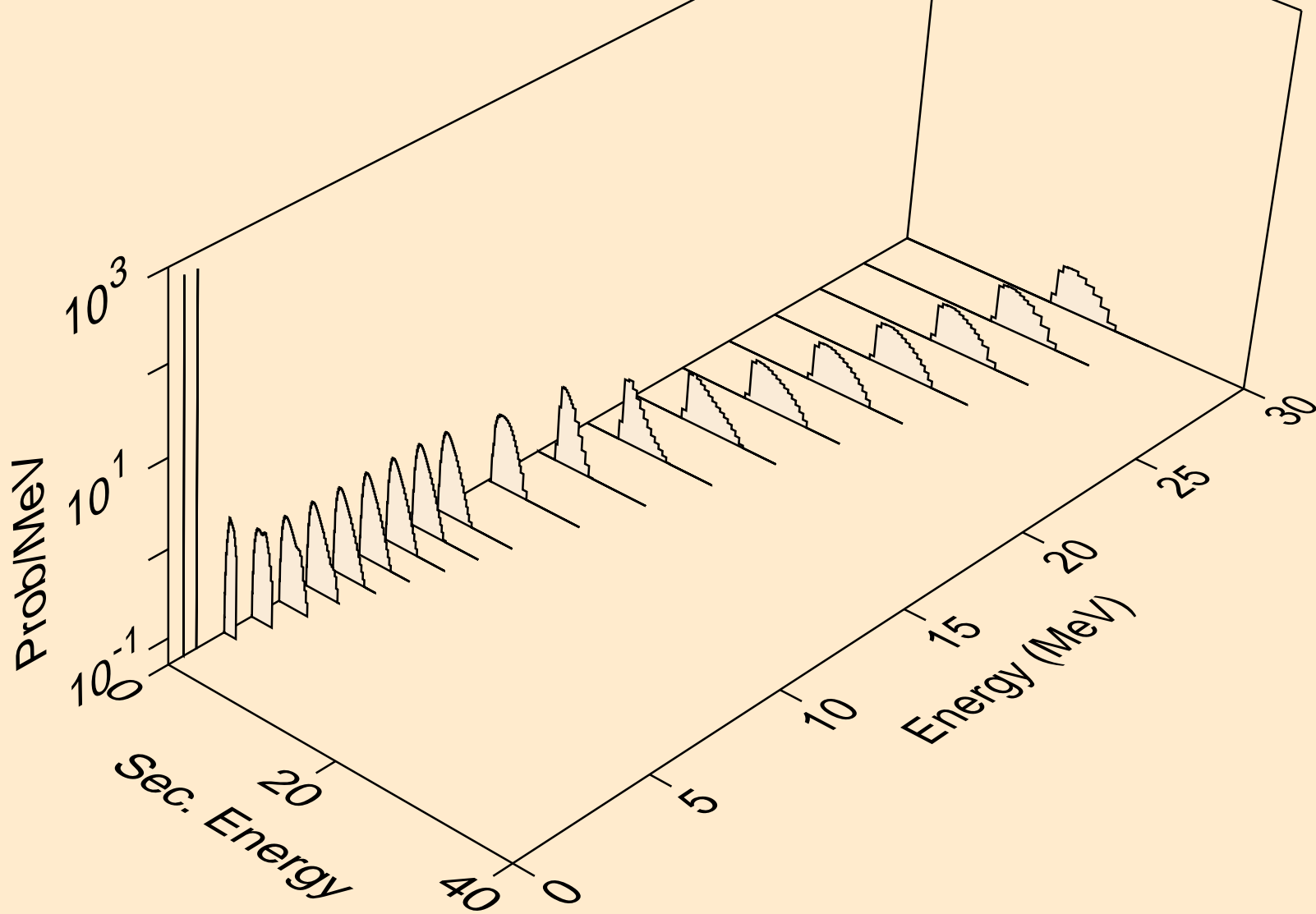

SE079M PROTON ACER TENDL-2021 LIBRARY; T=0.K  
neutrons from (p,x)

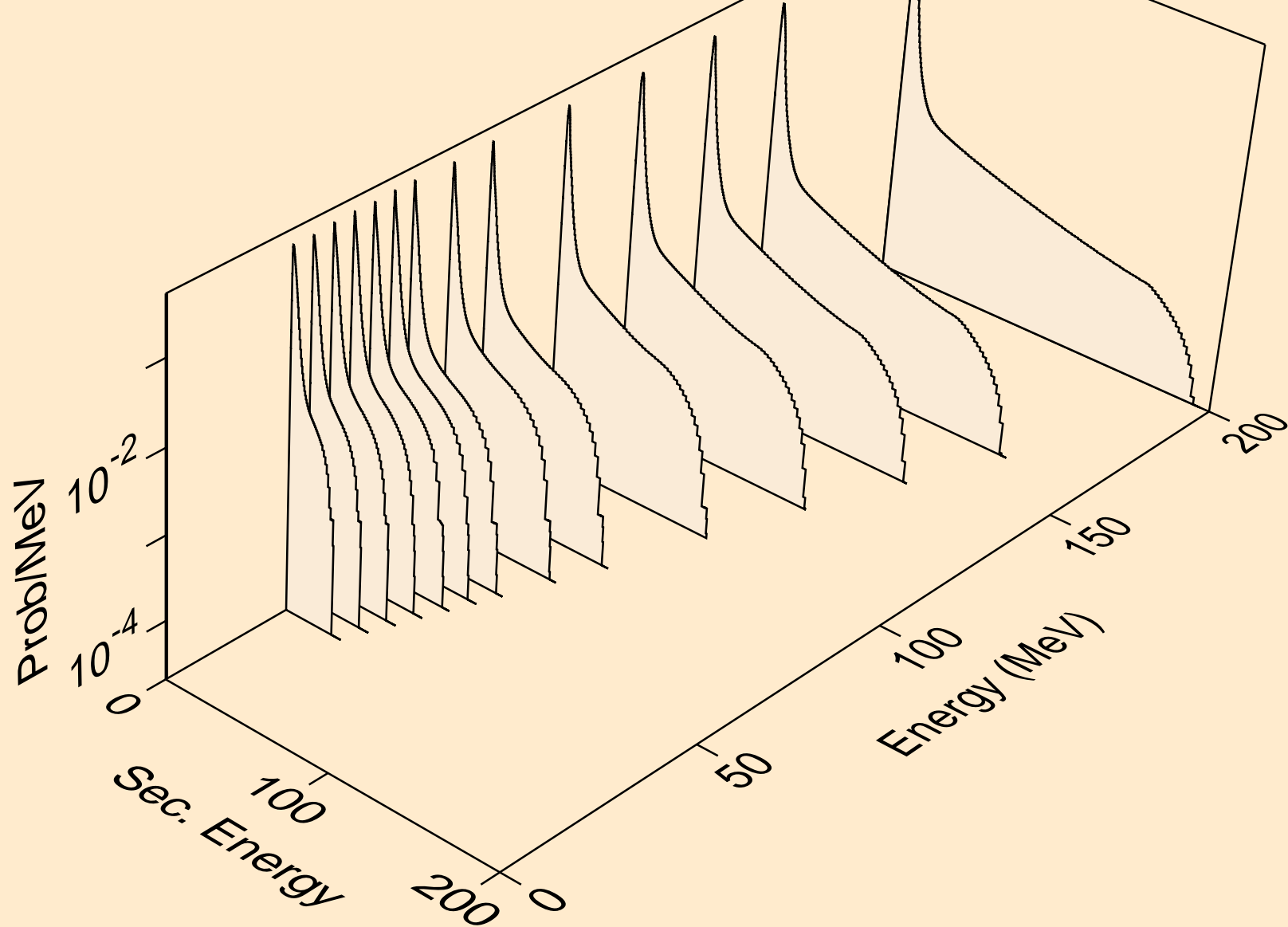

SE079M PROTON ACER TENDL-2021 LIBRARY; T=0.K  
neutrons from (p,2nd)

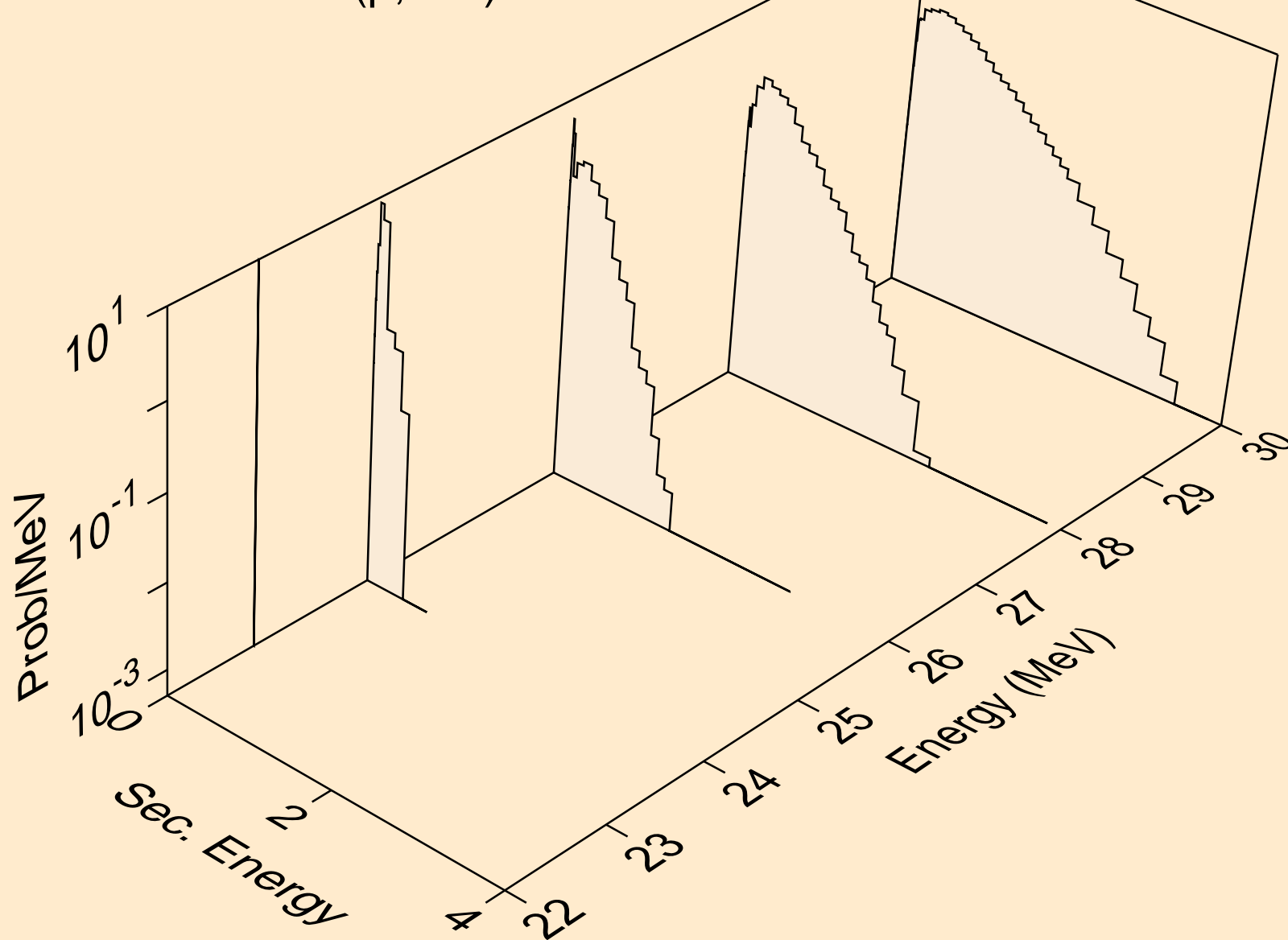

SE079M PROTON ACER TENDL-2021 LIBRARY; T=0.K  
neutrons from (p,2n)

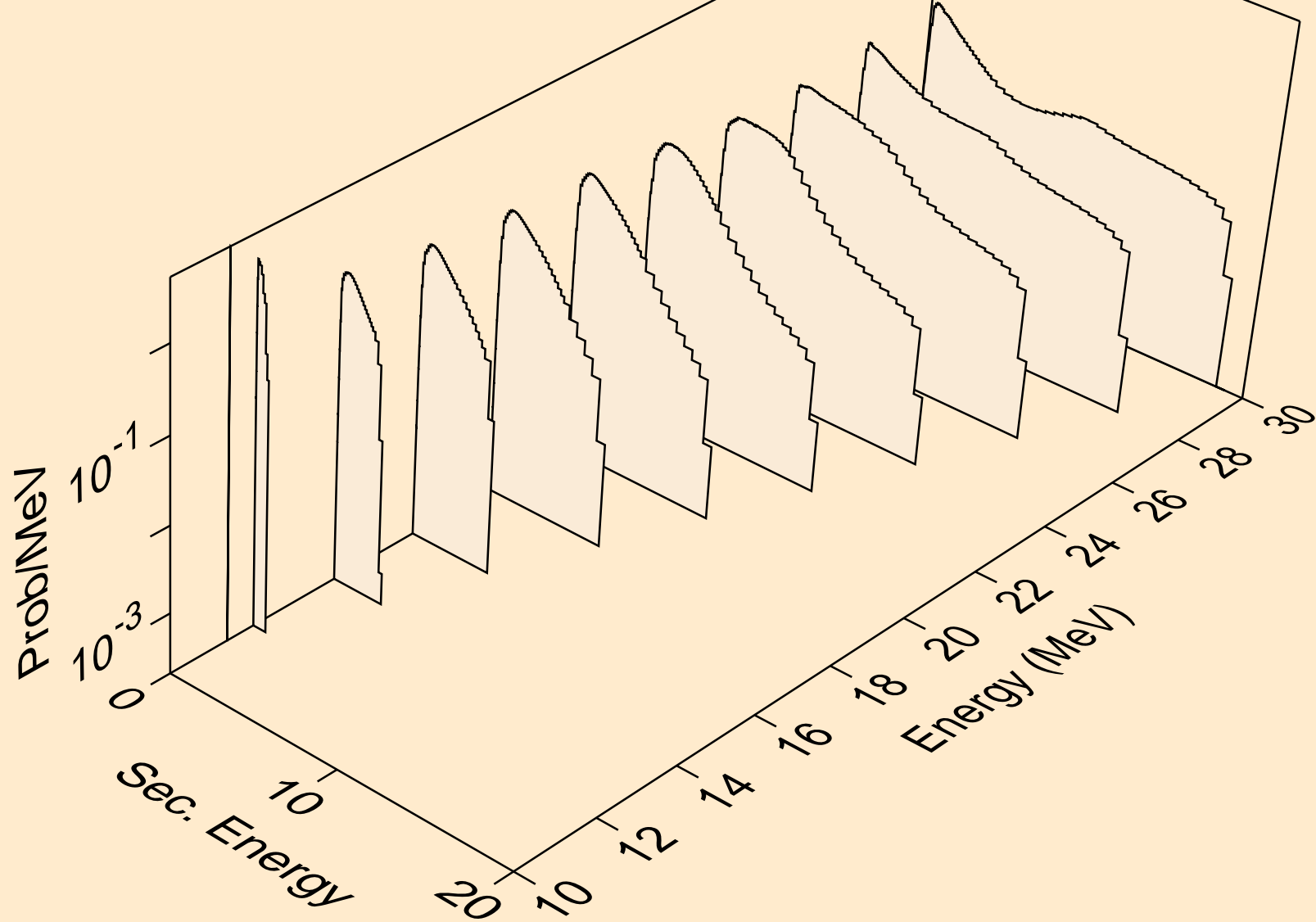



SE079M PROTON ACER TENDL-2021 LIBRARY; T=0.K  
neutrons from (p,3n)

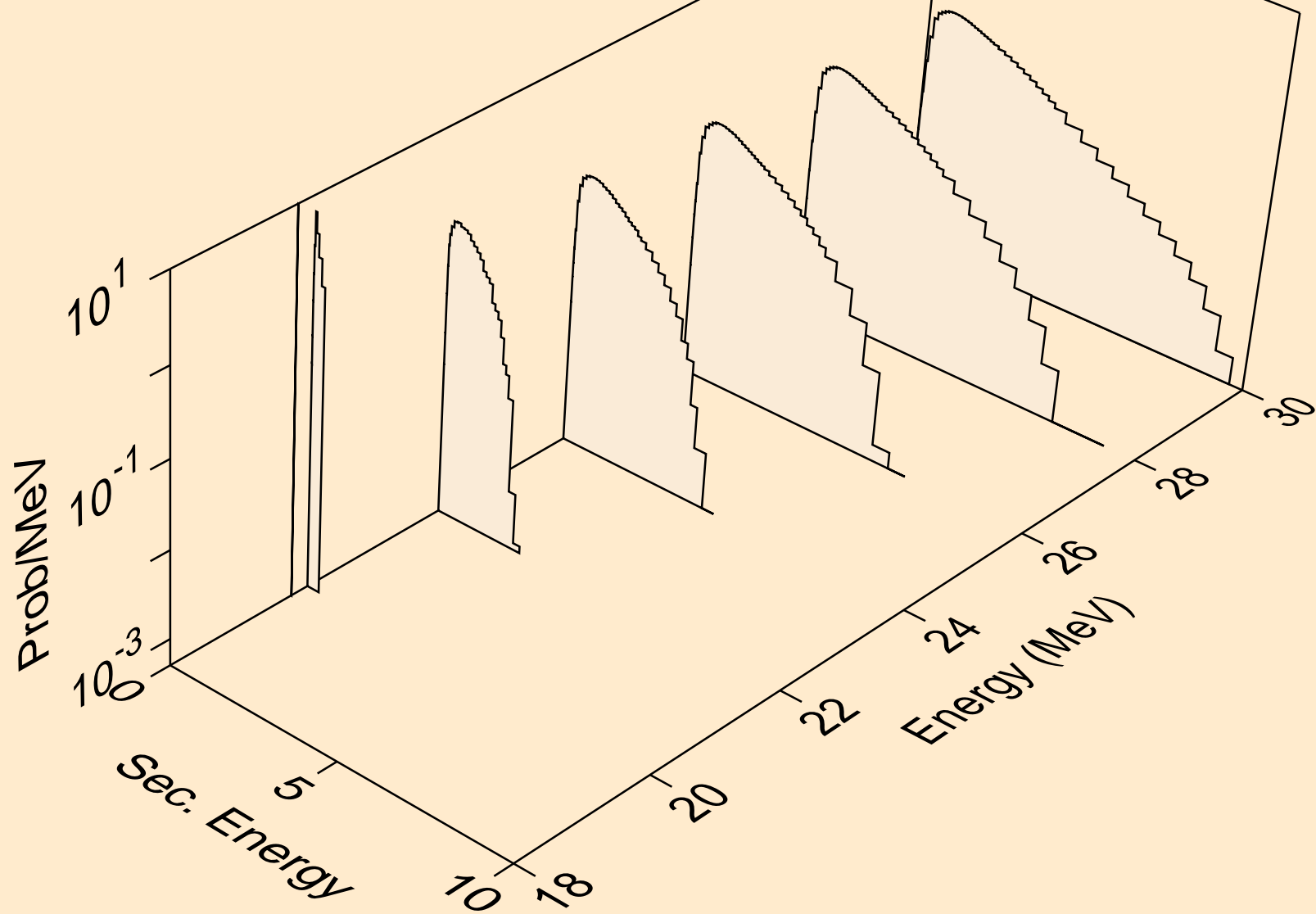

SE079M PROTON ACER TENDL-2021 LIBRARY; T=0.K  
neutrons from (p,n\*)a

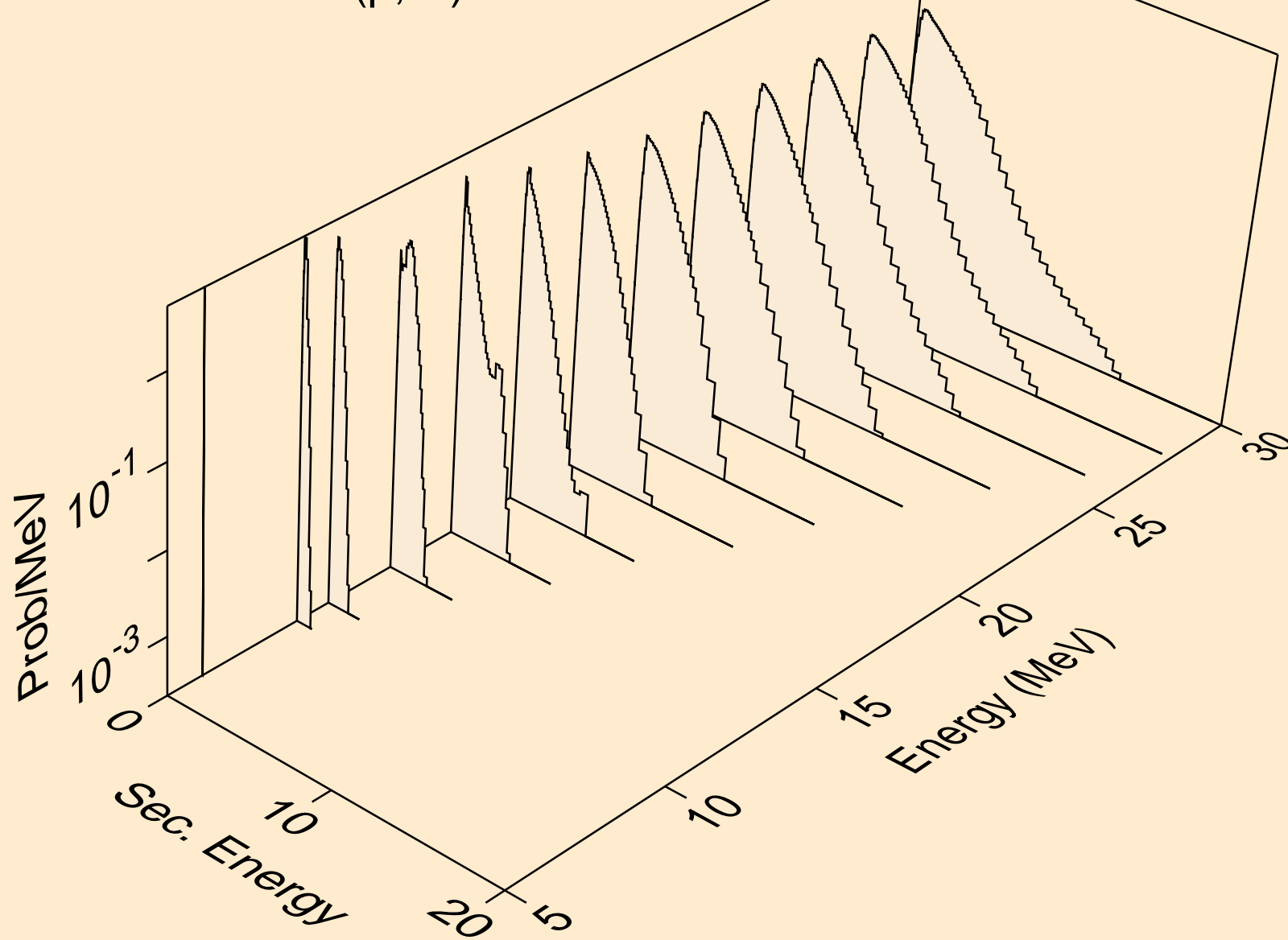

SE079M PROTON ACER TENDL-2021 LIBRARY; T=0.K  
neutrons from (p,2n)a

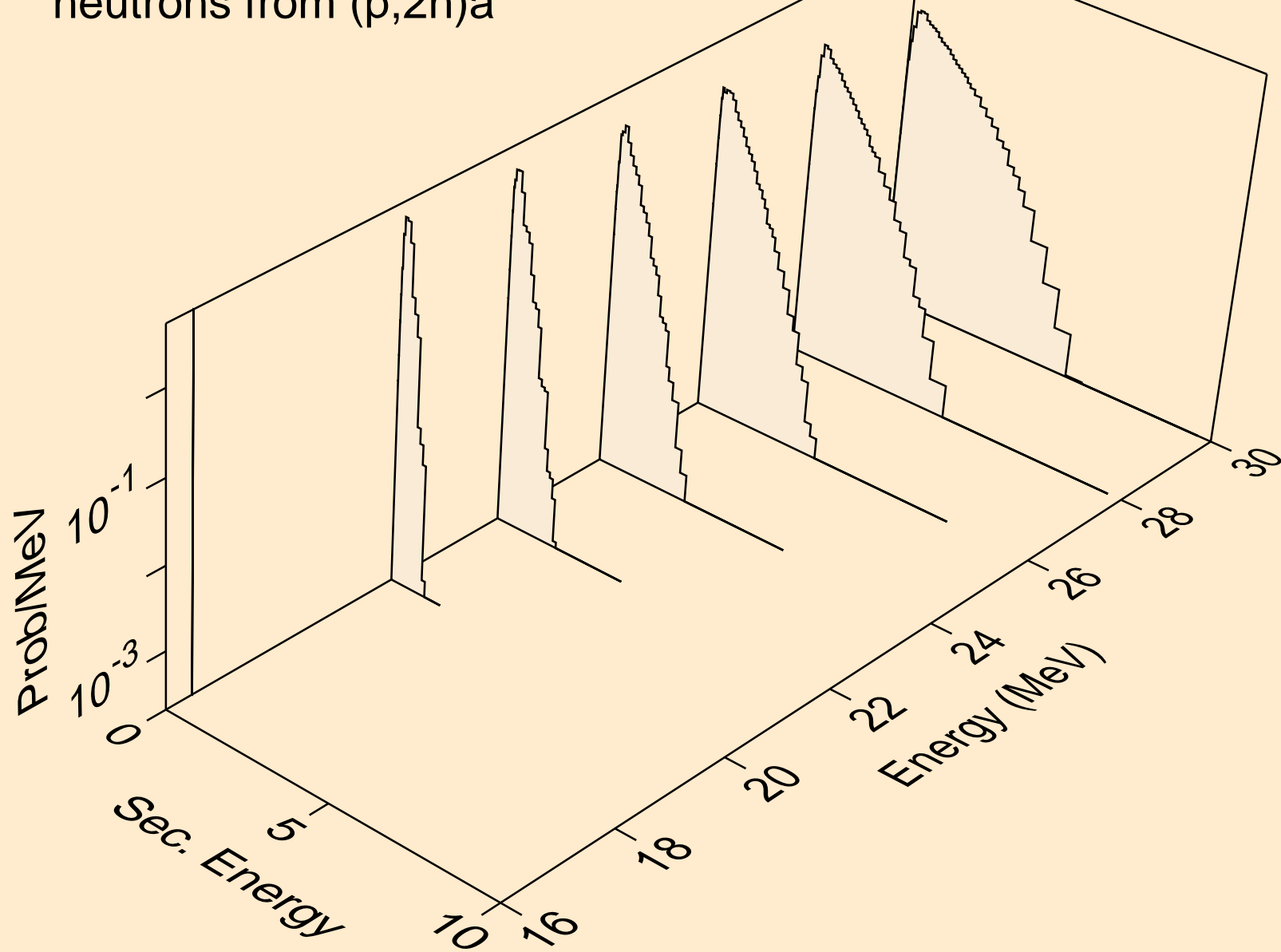

SE079M PROTON ACER TENDL-2021 LIBRARY; T=0.K  
neutrons from (p,3n)a

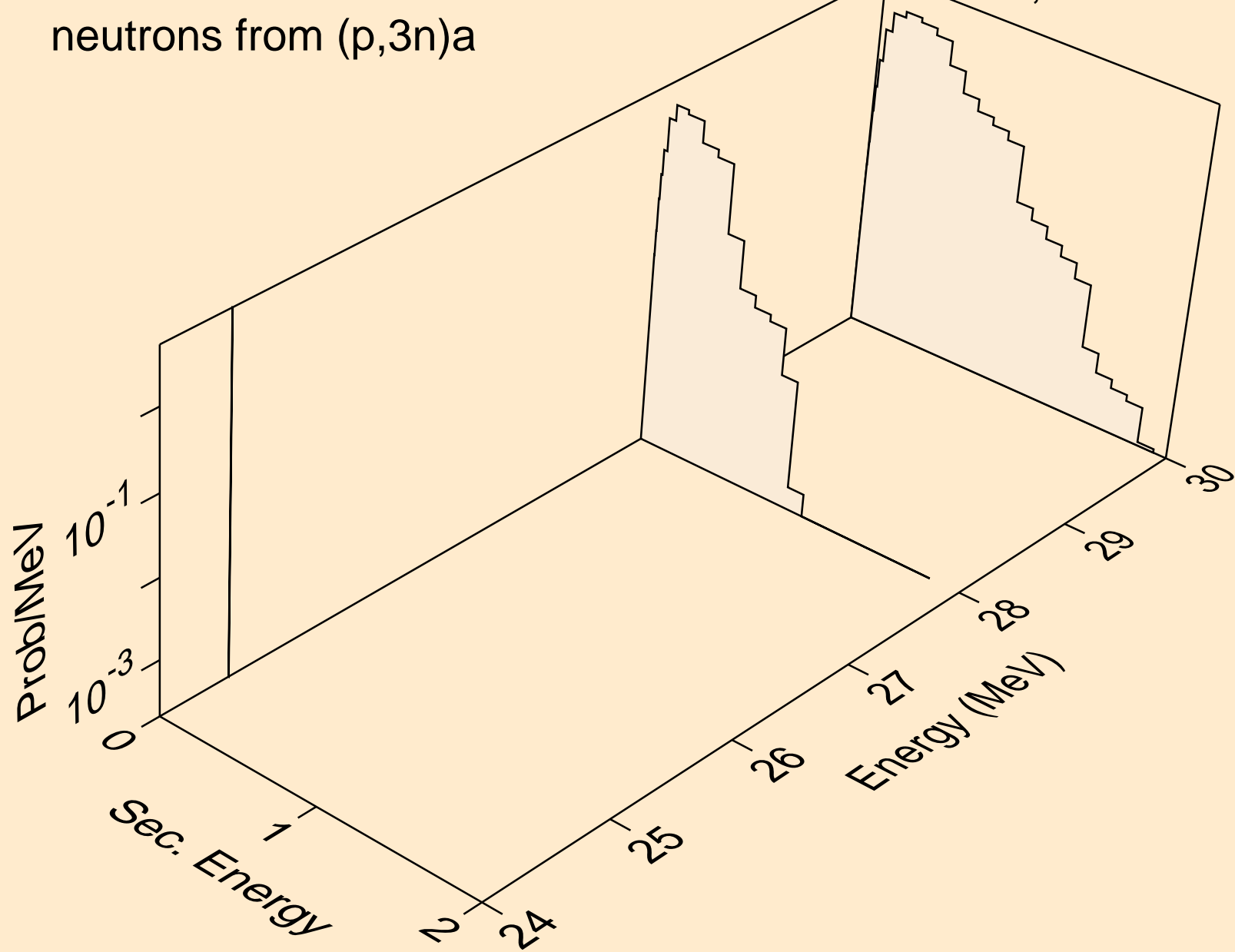

SE079M PROTON ACER TENDL-2021 LIBRARY; T=0.K  
neutrons from (p,n\*)p

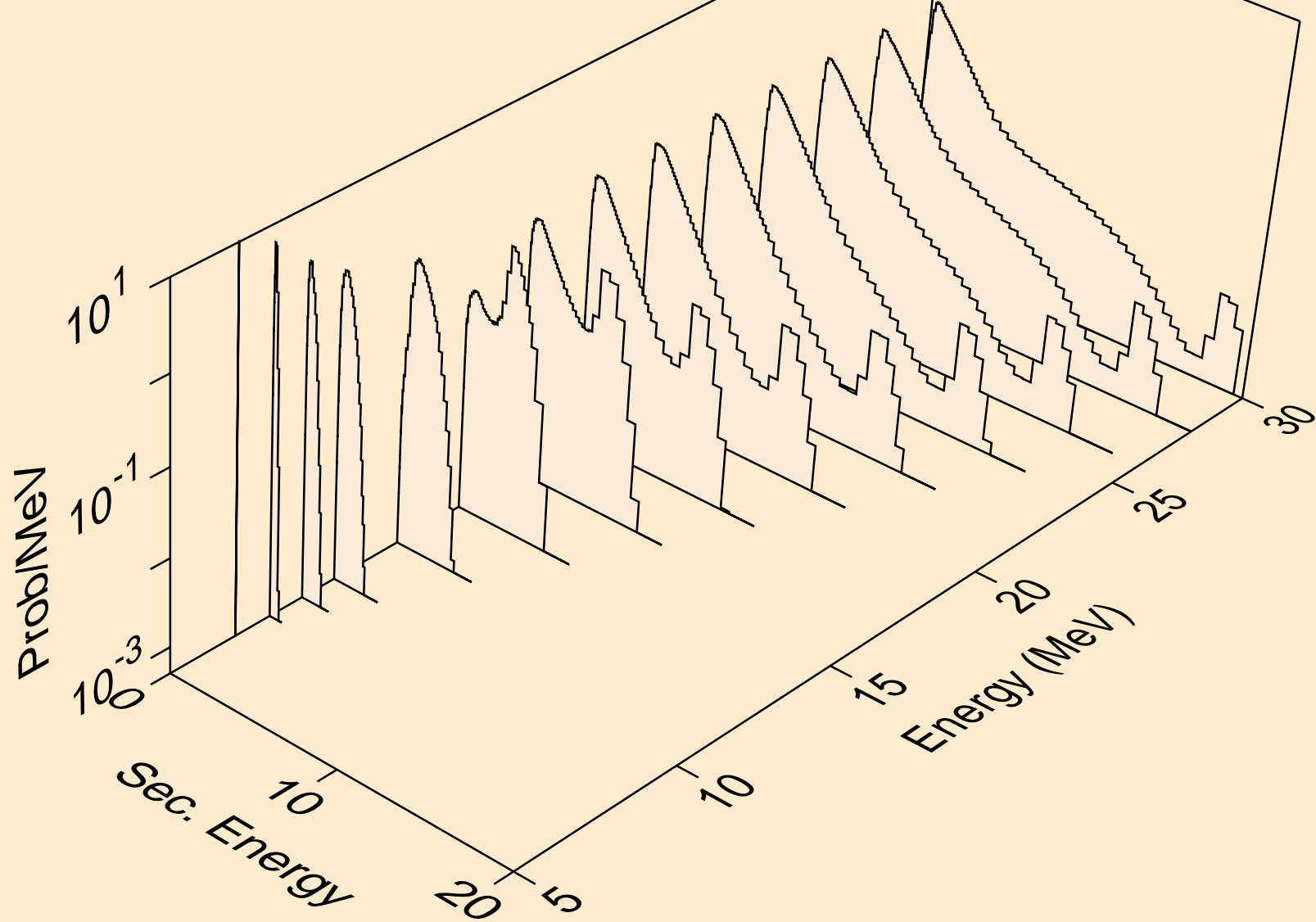

SE079M PROTON ACER TENDL-2021 LIBRARY; T=0.K  
neutrons from (p,n\*)2a

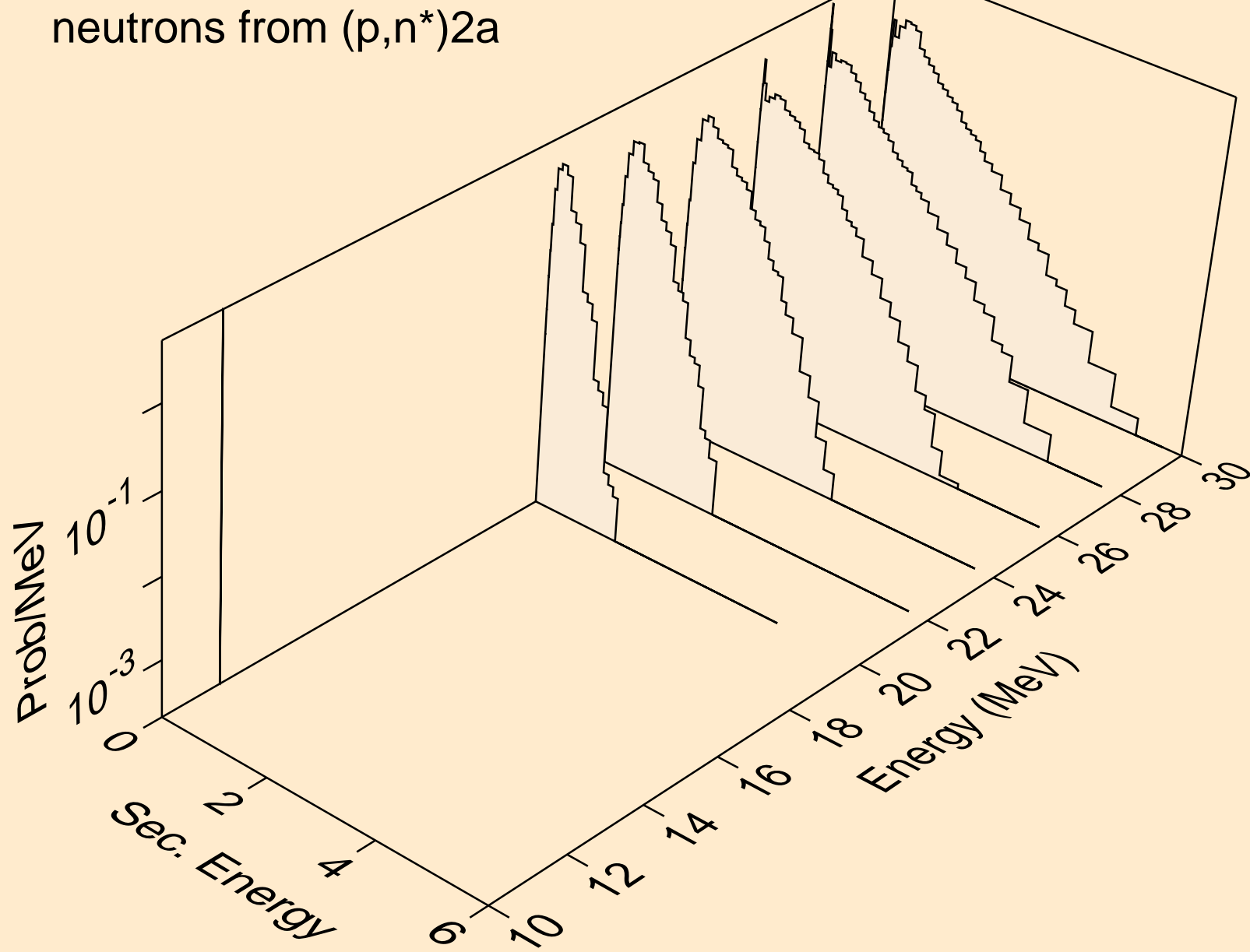

SE079M PROTON ACER TENDL-2021 LIBRARY; T=0.K  
neutrons from (p,n\*)d

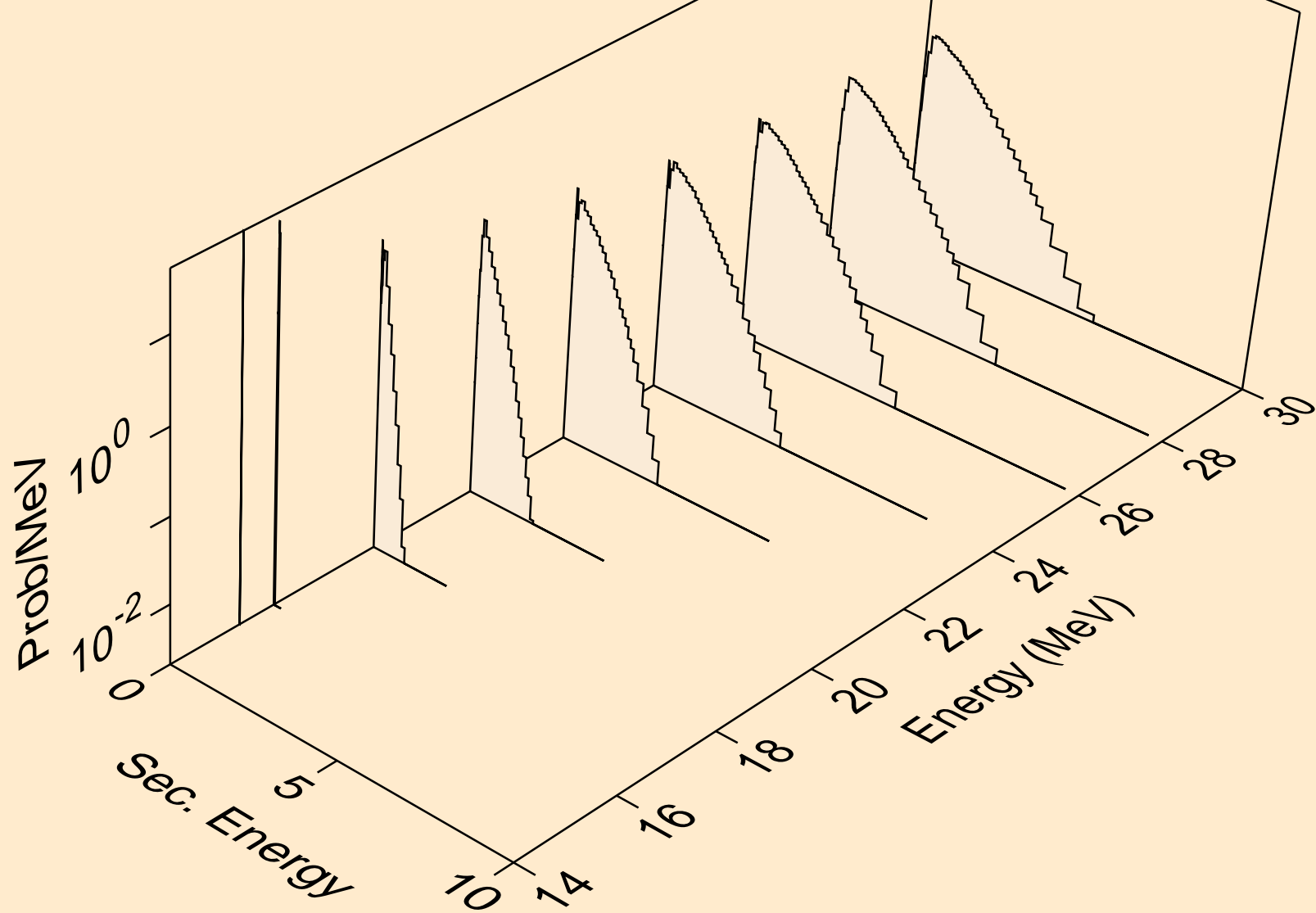

SE079M PROTON ACER TENDL-2021 LIBRARY; T=0.K  
neutrons from (p,n\*)t

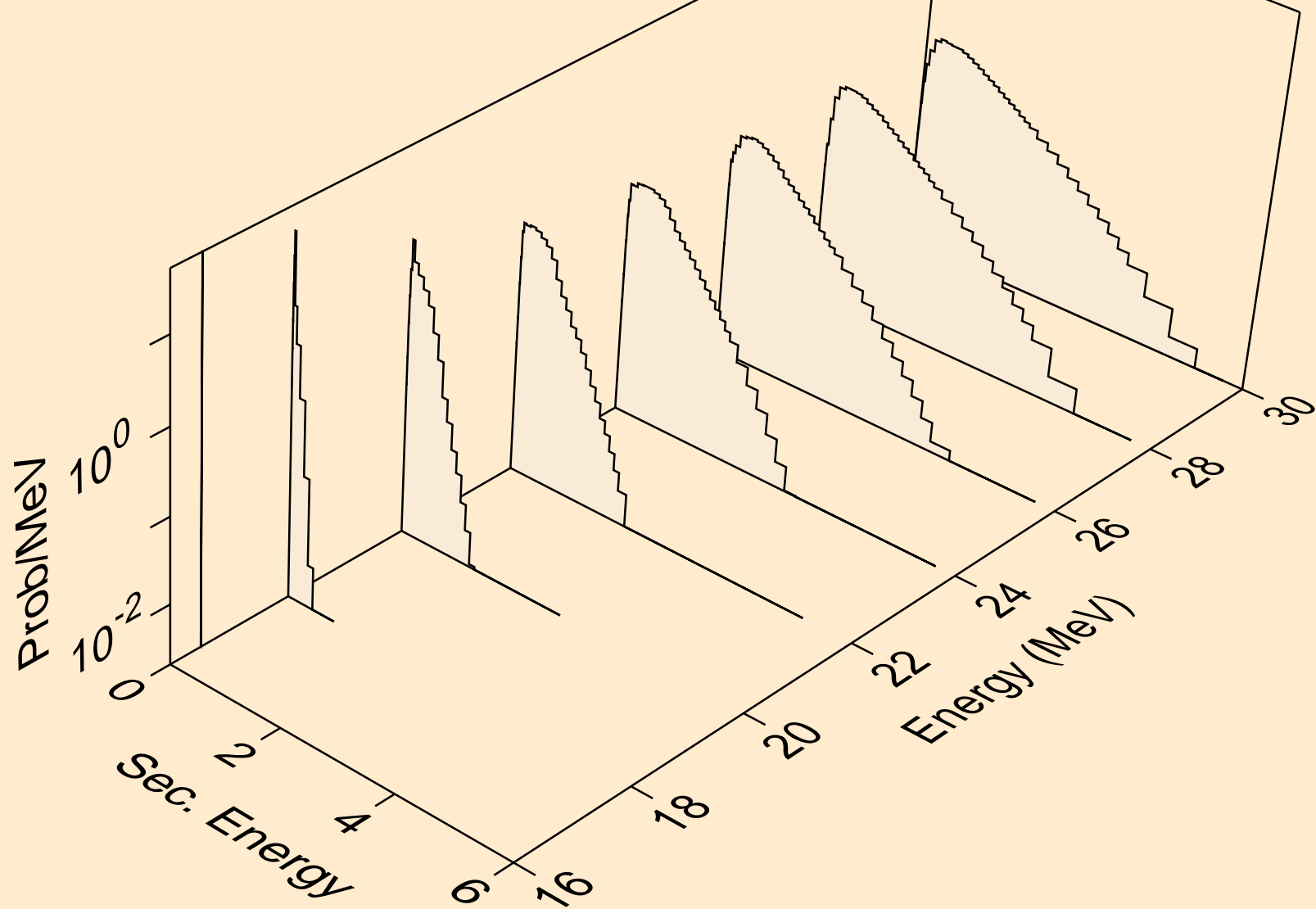



SE079M PROTON ACER TENDL-2021 LIBRARY; T=0.K  
neutrons from (p,n\*)he3

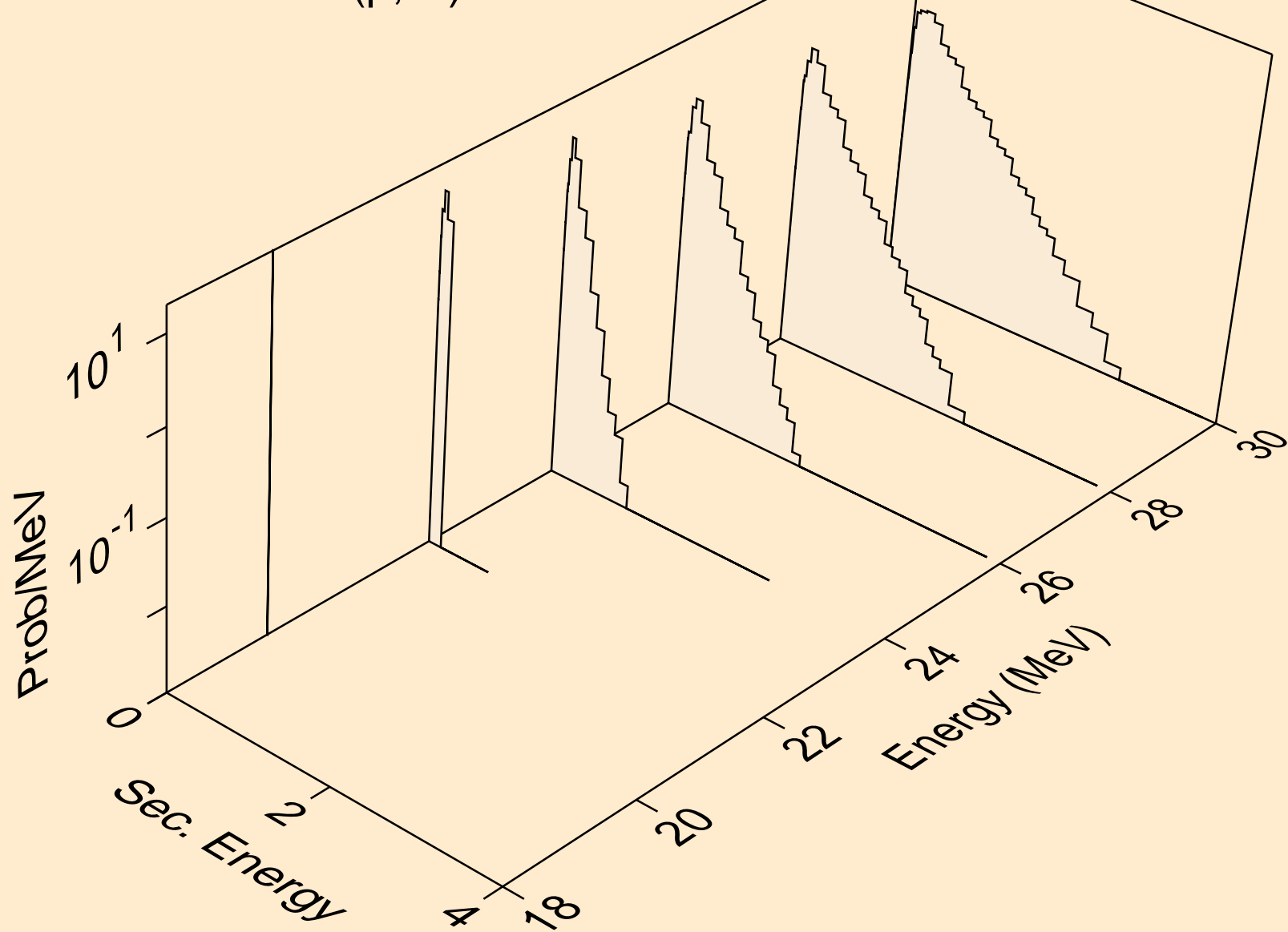

SE079M PROTON ACER TENDL-2021 LIBRARY; T=0.K  
neutrons from (p,2np)

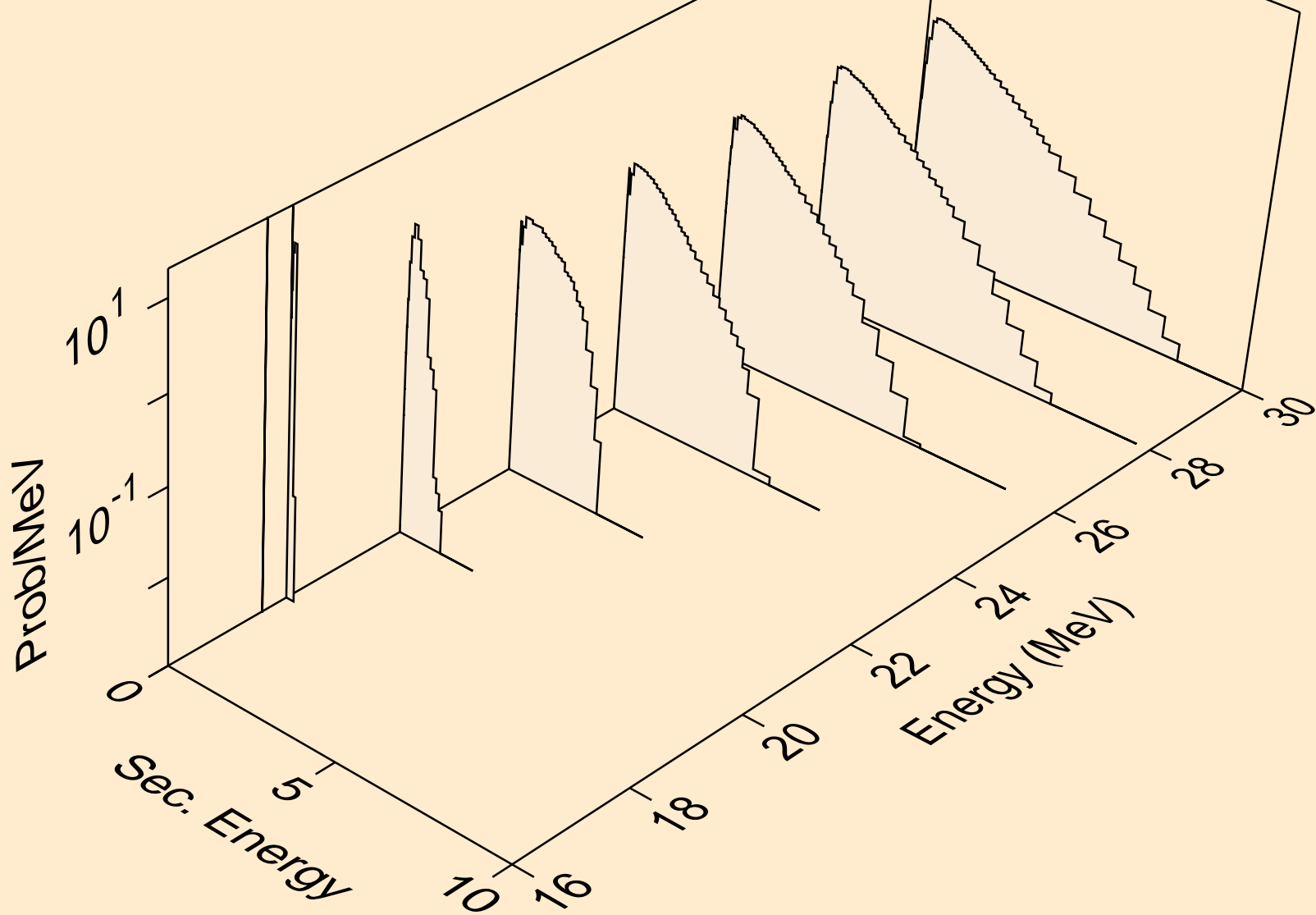

SE079M PROTON ACER TENDL-2021 LIBRARY; T=0.K  
neutrons from (p,3np)

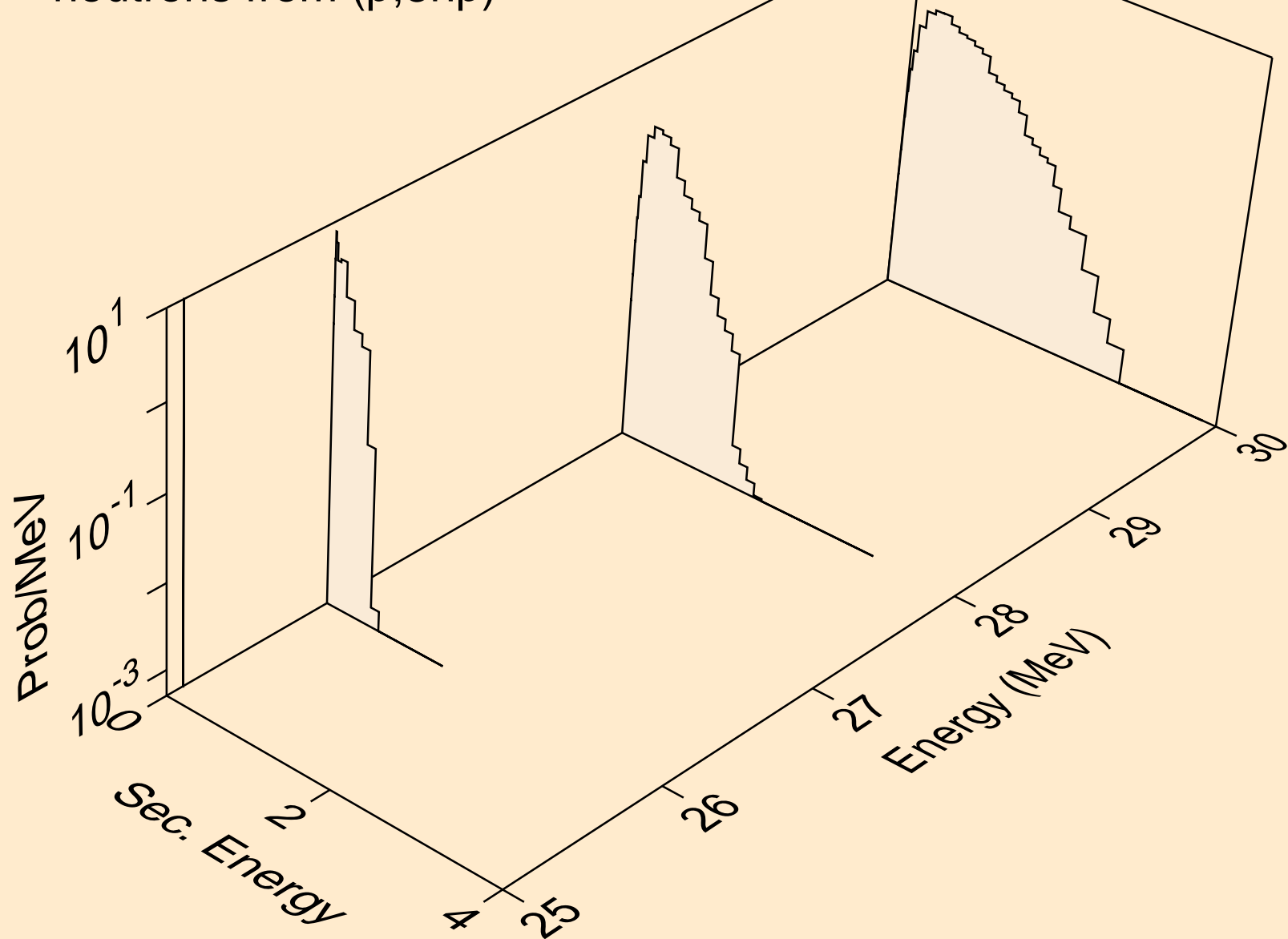

SE079M PROTON ACER TENDL-2021 LIBRARY; T=0.K  
neutrons from (p,2np)

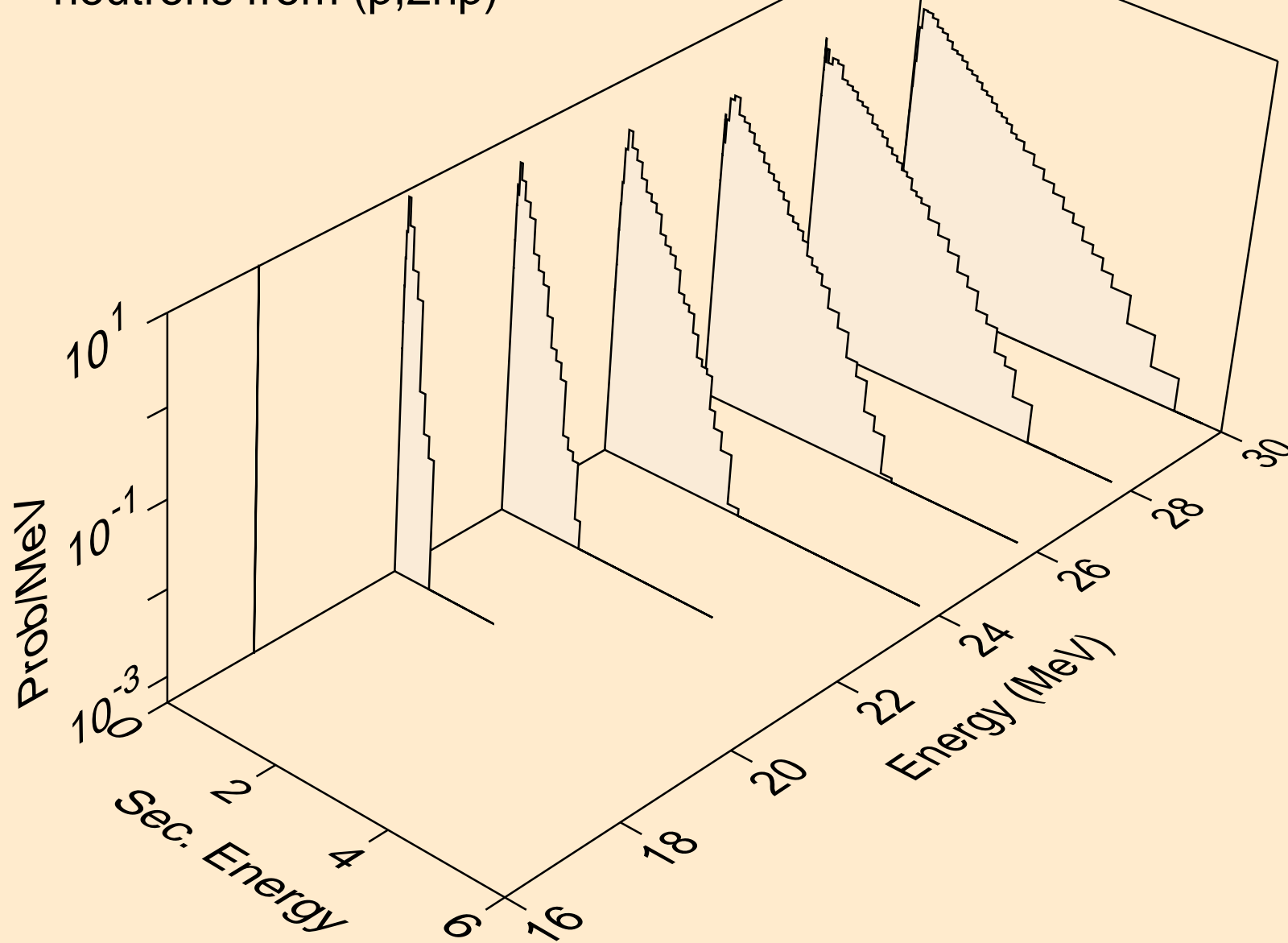

SE079M PROTON ACER TENDL-2021 LIBRARY; T=0.K  
neutrons from (p,npa)

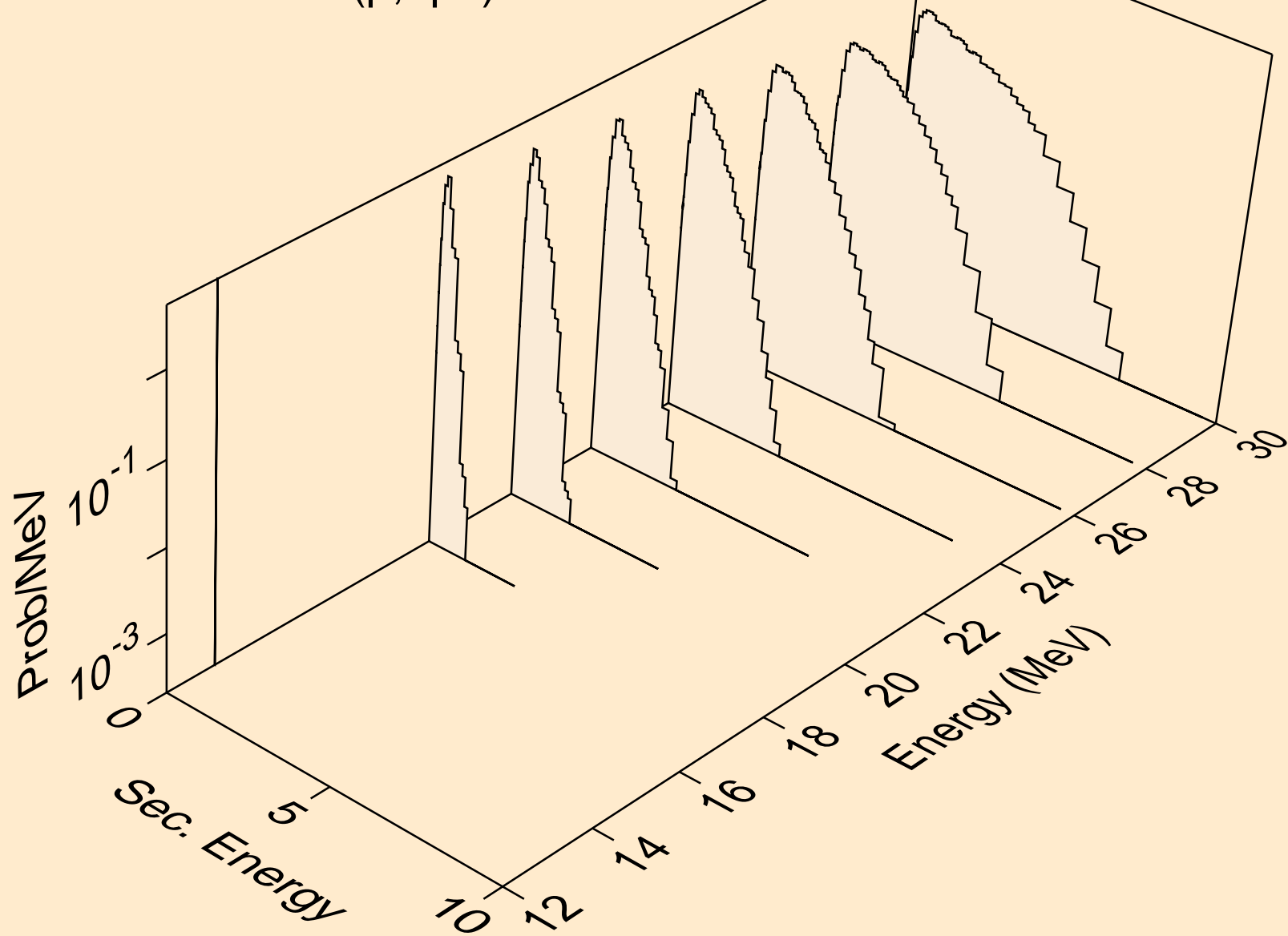

SE079M PROTON ACER TENDL-2021 LIBRARY; T=0.K  
deuterons from (p,x)

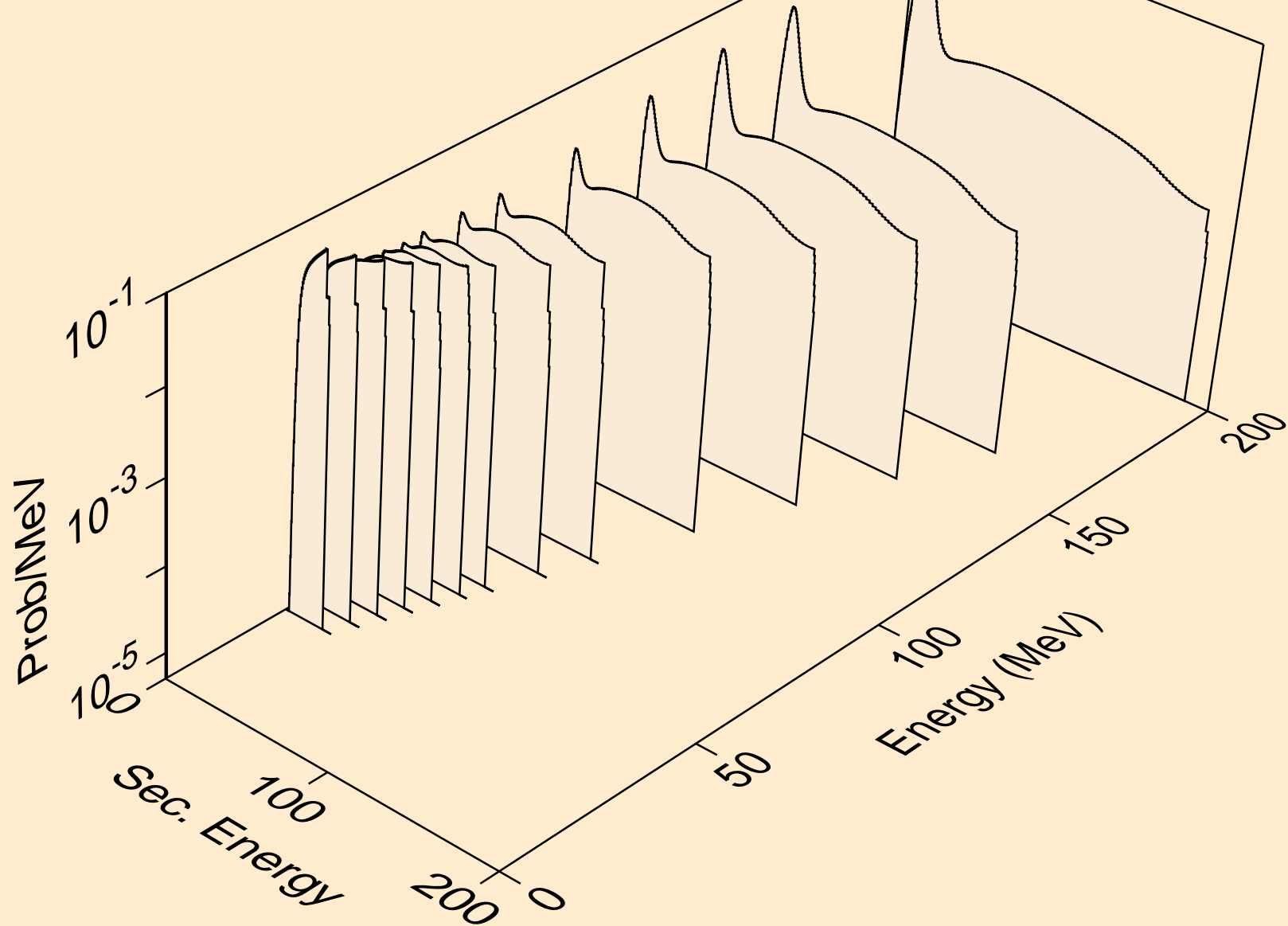

SE079M PROTON ACER TENDL-2021 LIBRARY; T=0.K  
deuterons from (p,2nd)

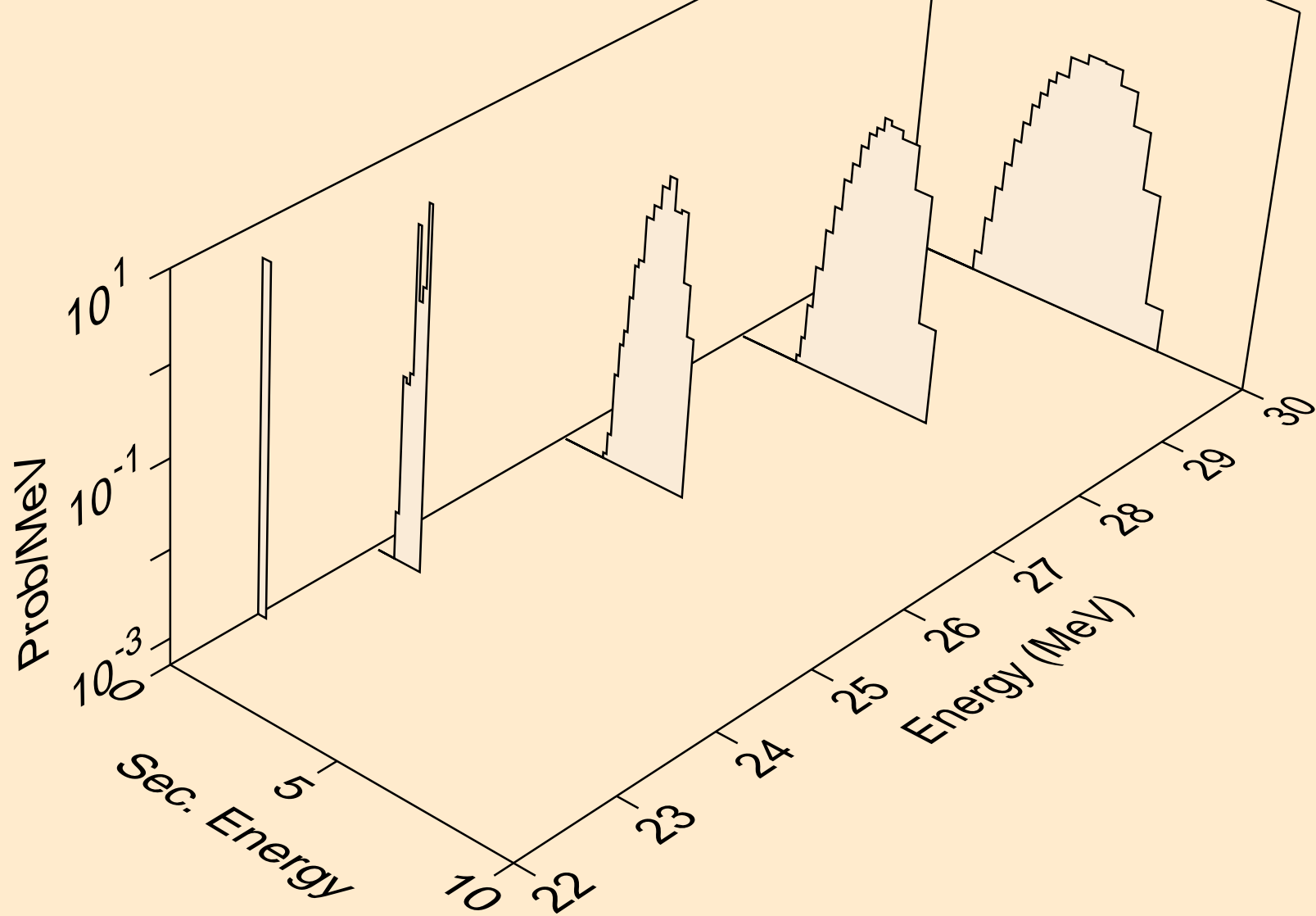

SE079M PROTON ACER TENDL-2021 LIBRARY; T=0.K  
deuterons from (p,n\*)d

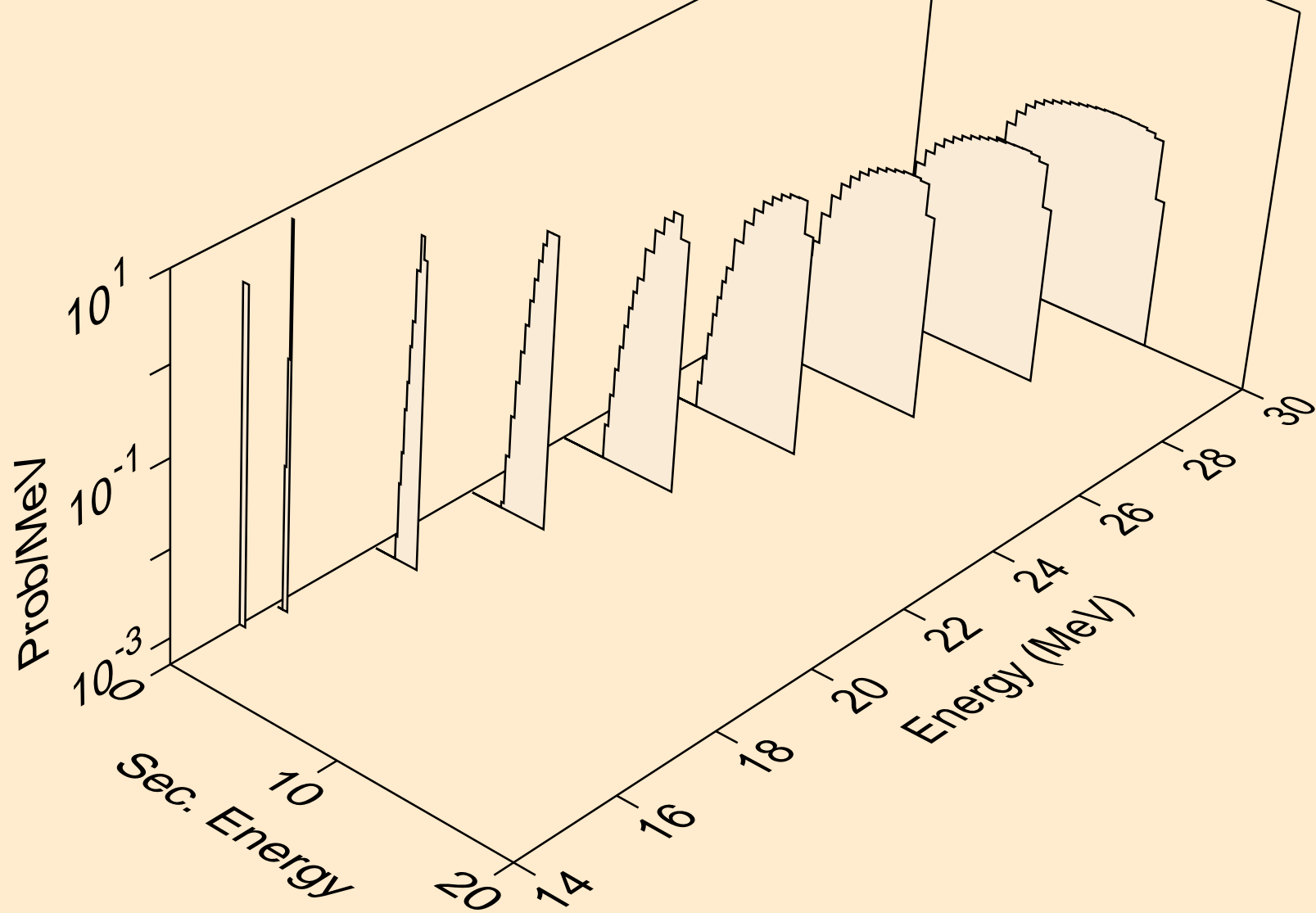



SE079M PROTON ACER TENDL-2021 LIBRARY; T=0.K  
deuterons from (p,d)

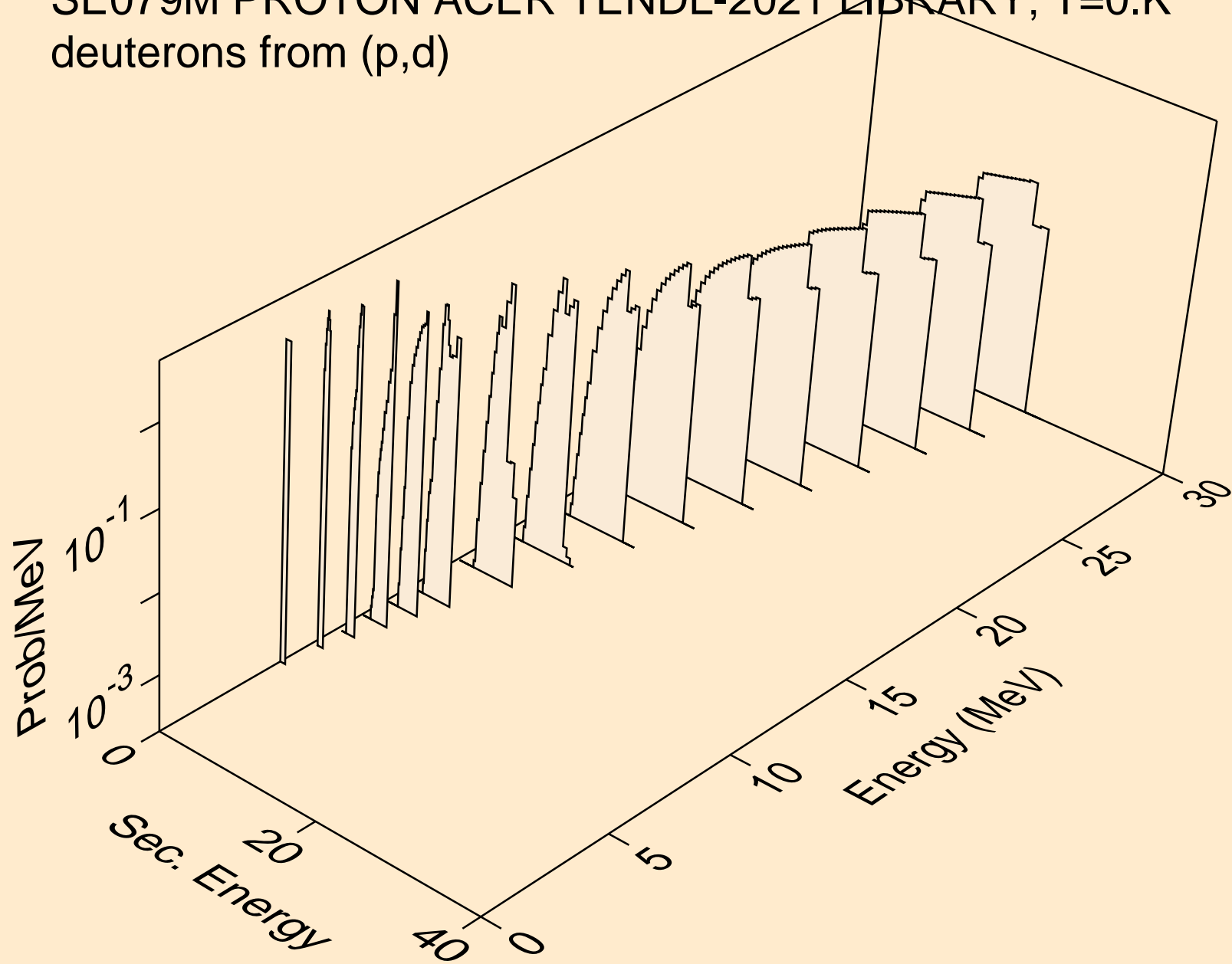

SE079M PROTON ACER TENDL-2021 LIBRARY; T=0.K  
deuterons from (p,pd)

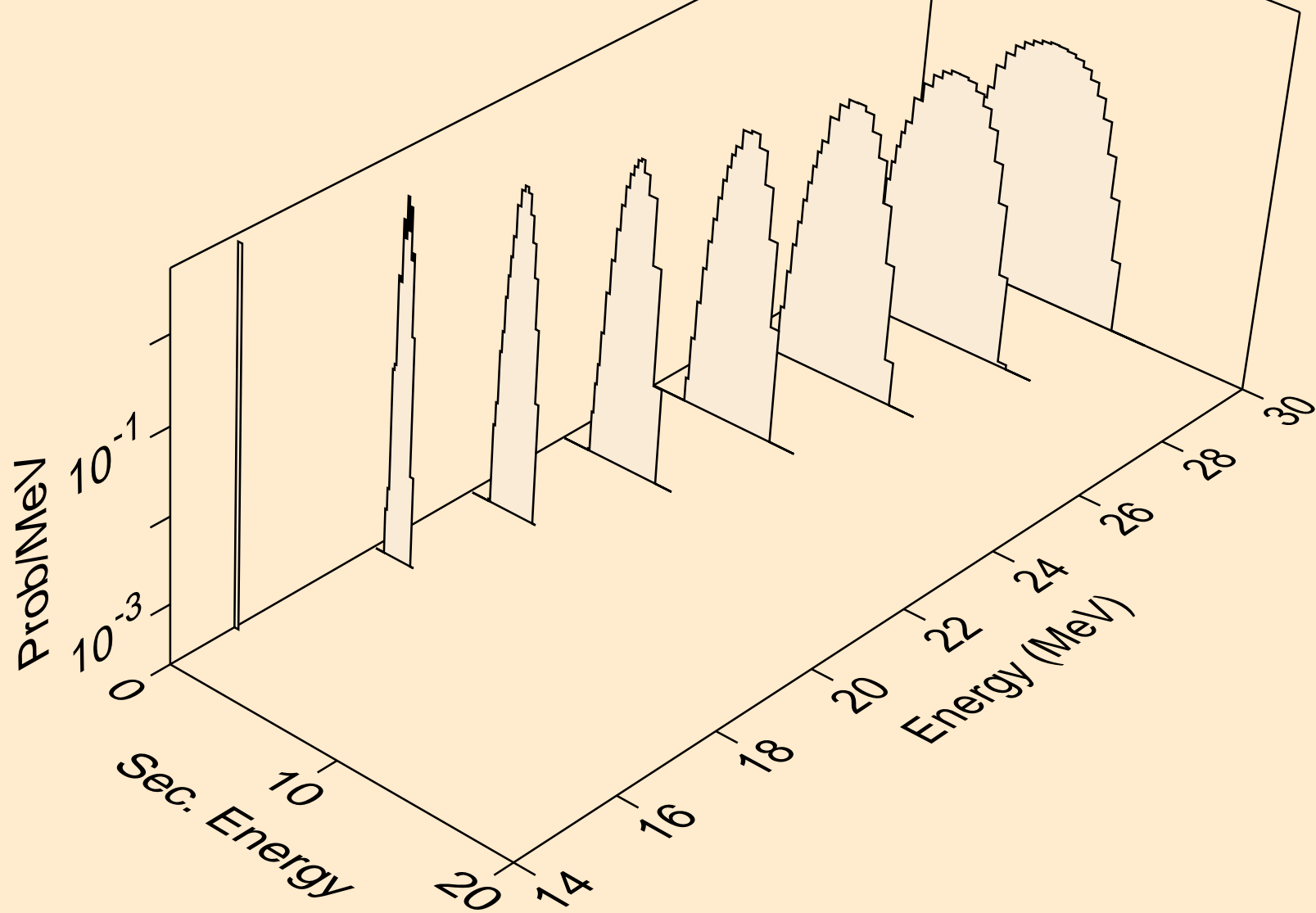

SE079M PROTON ACER TENDL-2021 LIBRARY; T=0.K  
deuterons from (p,da)

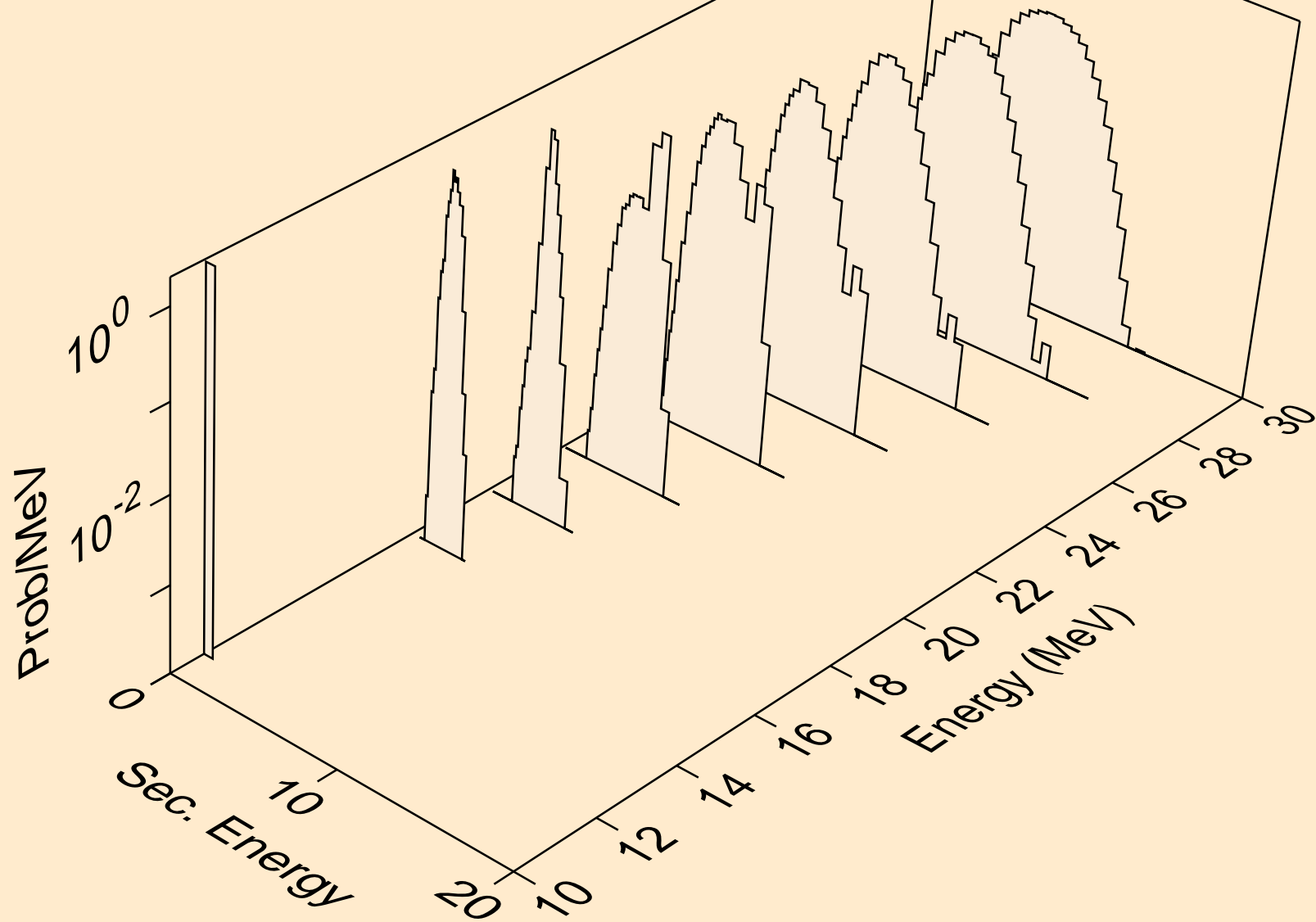

SE079M PROTON ACER TENDL-2021 LIBRARY; T=0.K  
tritons from (p,x)

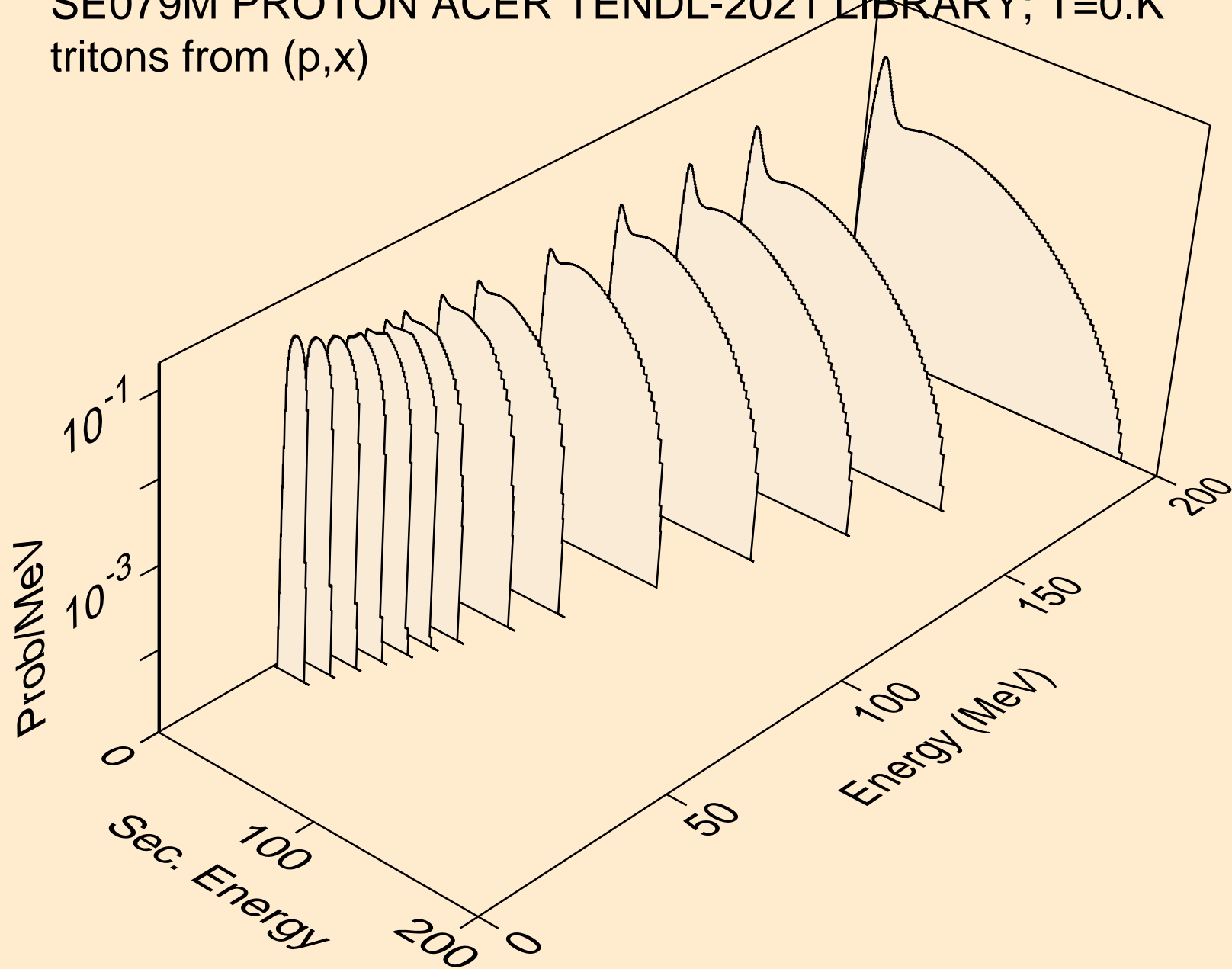

SE079M PROTON ACER TENDL-2021 LIBRARY; T=0.K  
tritons from (p,n\*)t

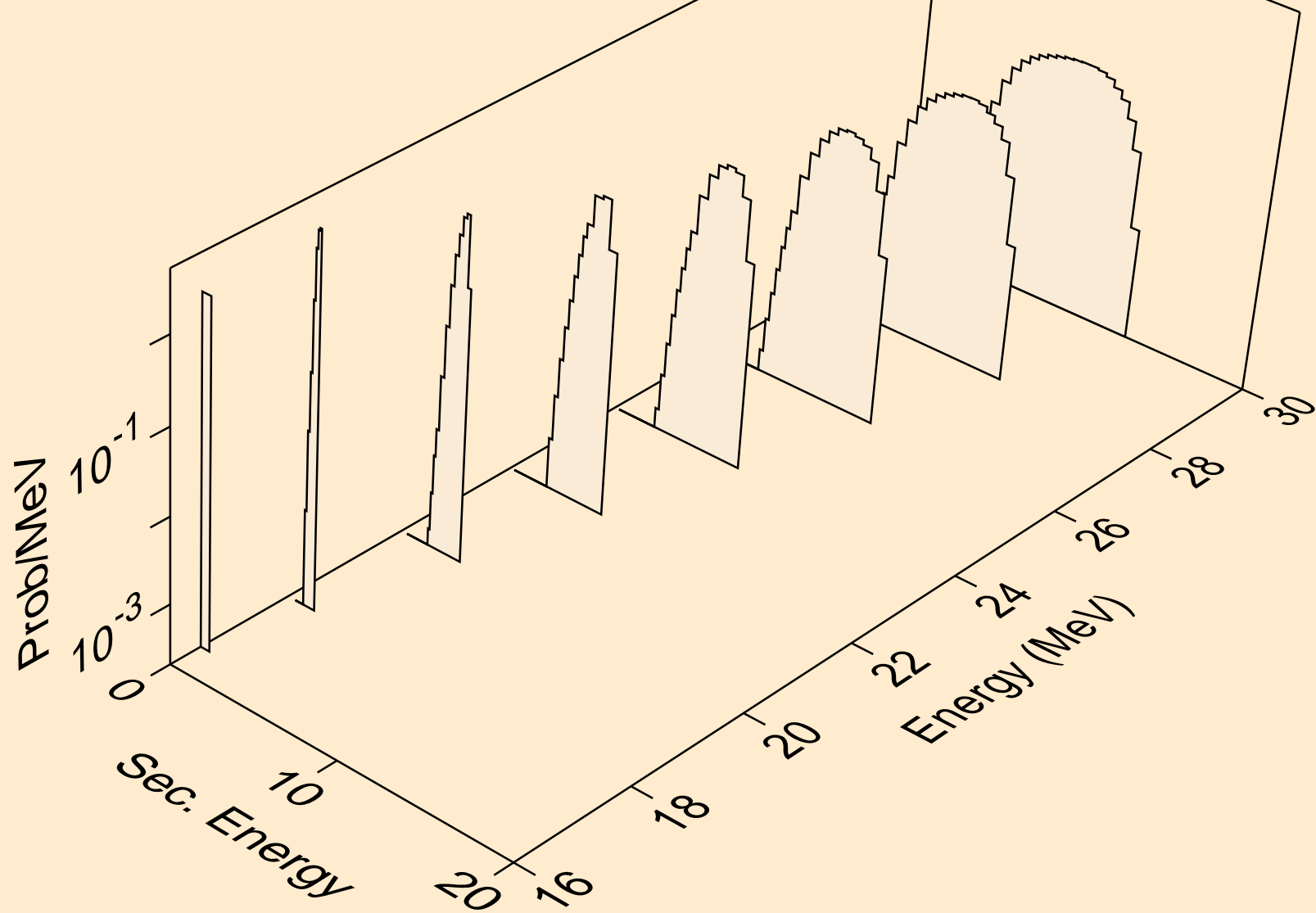

SE079M PROTON ACER TENDL-2021 LIBRARY; T=0.K  
tritons from (p,t)

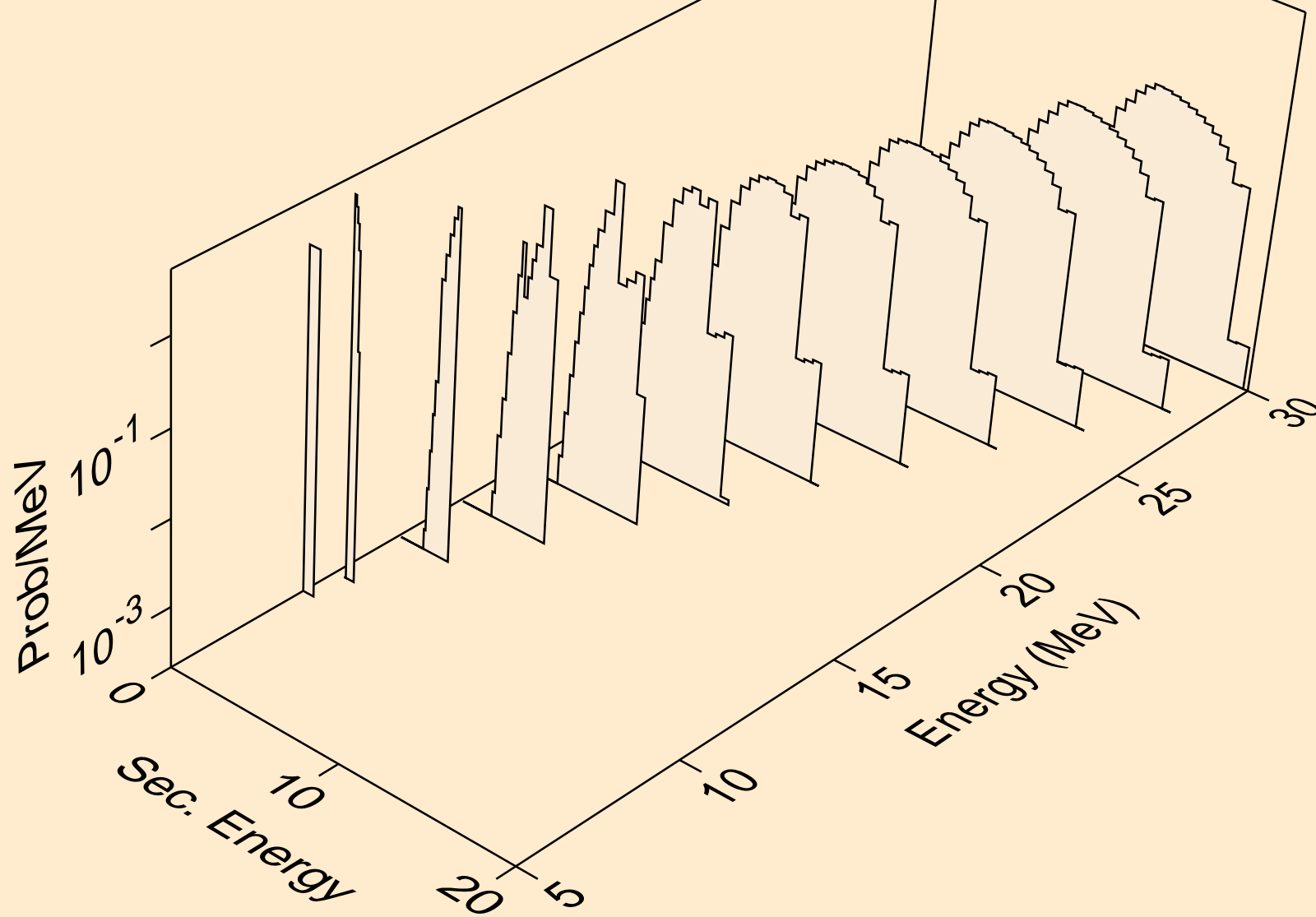

SE079M PROTON ACER TENDL-2021 LIBRARY; T=0.K  
tritons from (p,pt)

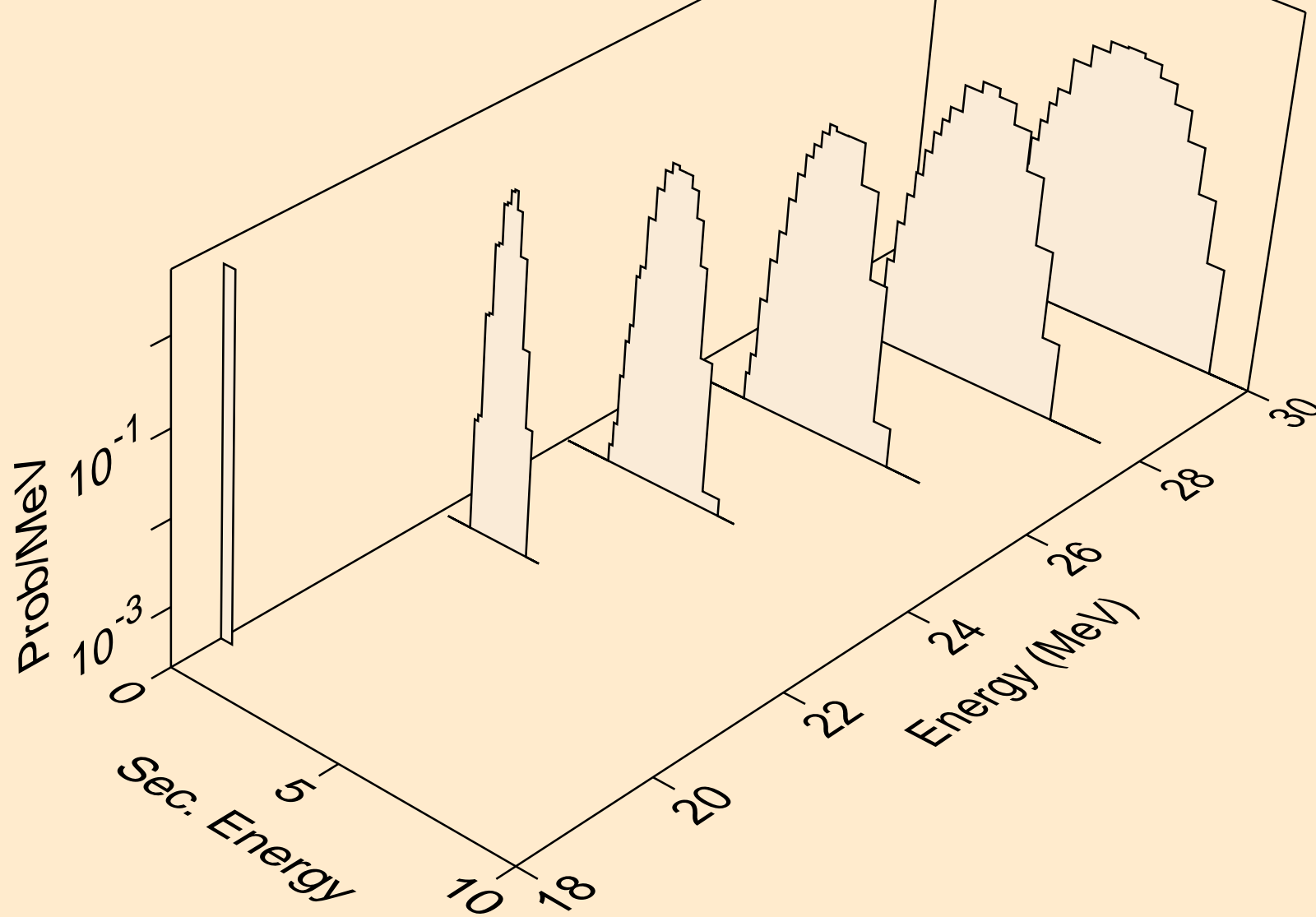

SE079M PROTON ACER TENDL-2021 LIBRARY; T=0.K  
he3s from (p,x)

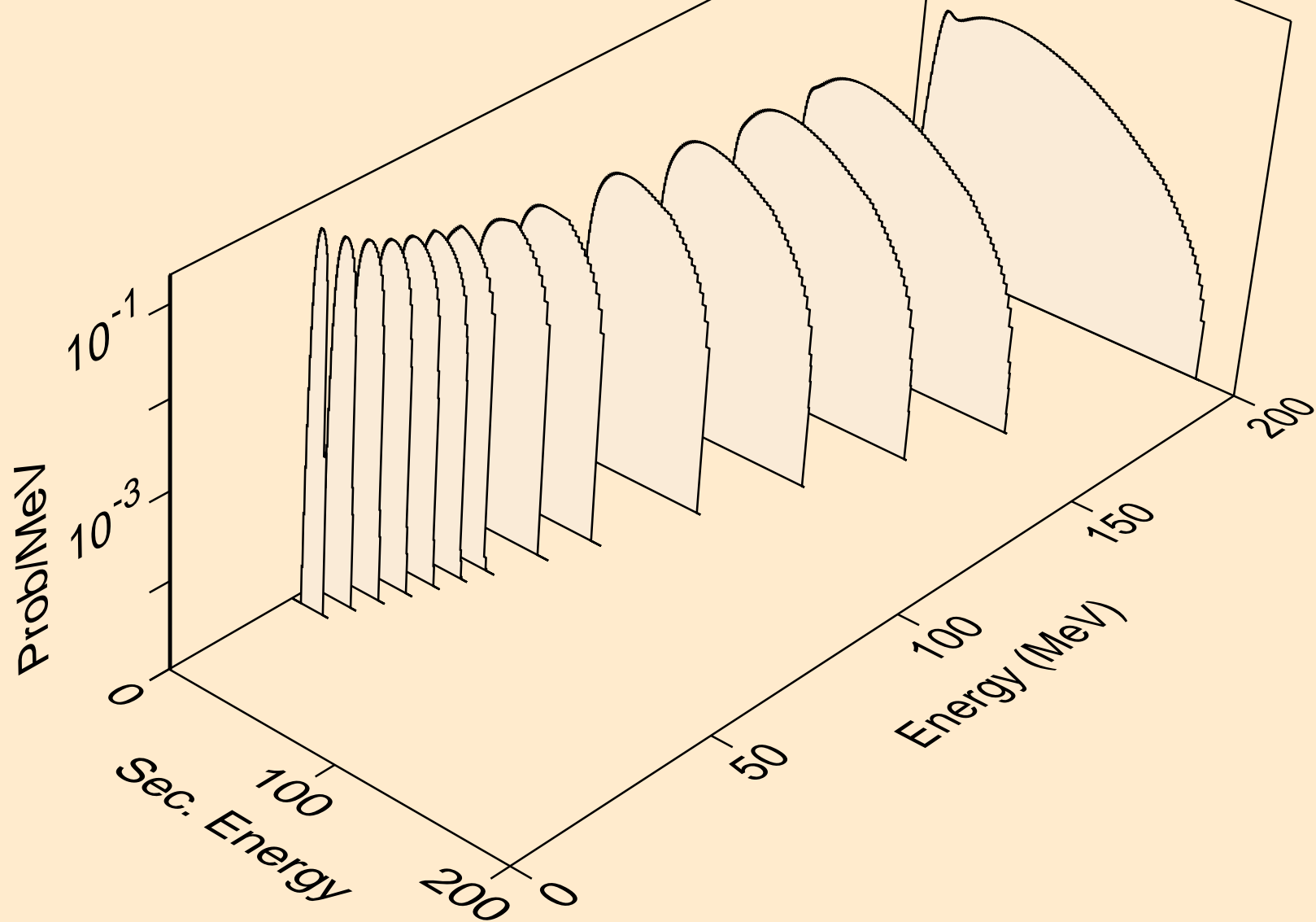



SE079M PROTON ACER TENDL-2021 LIBRARY; T=0.K  
he3s from (p,n\*)he3

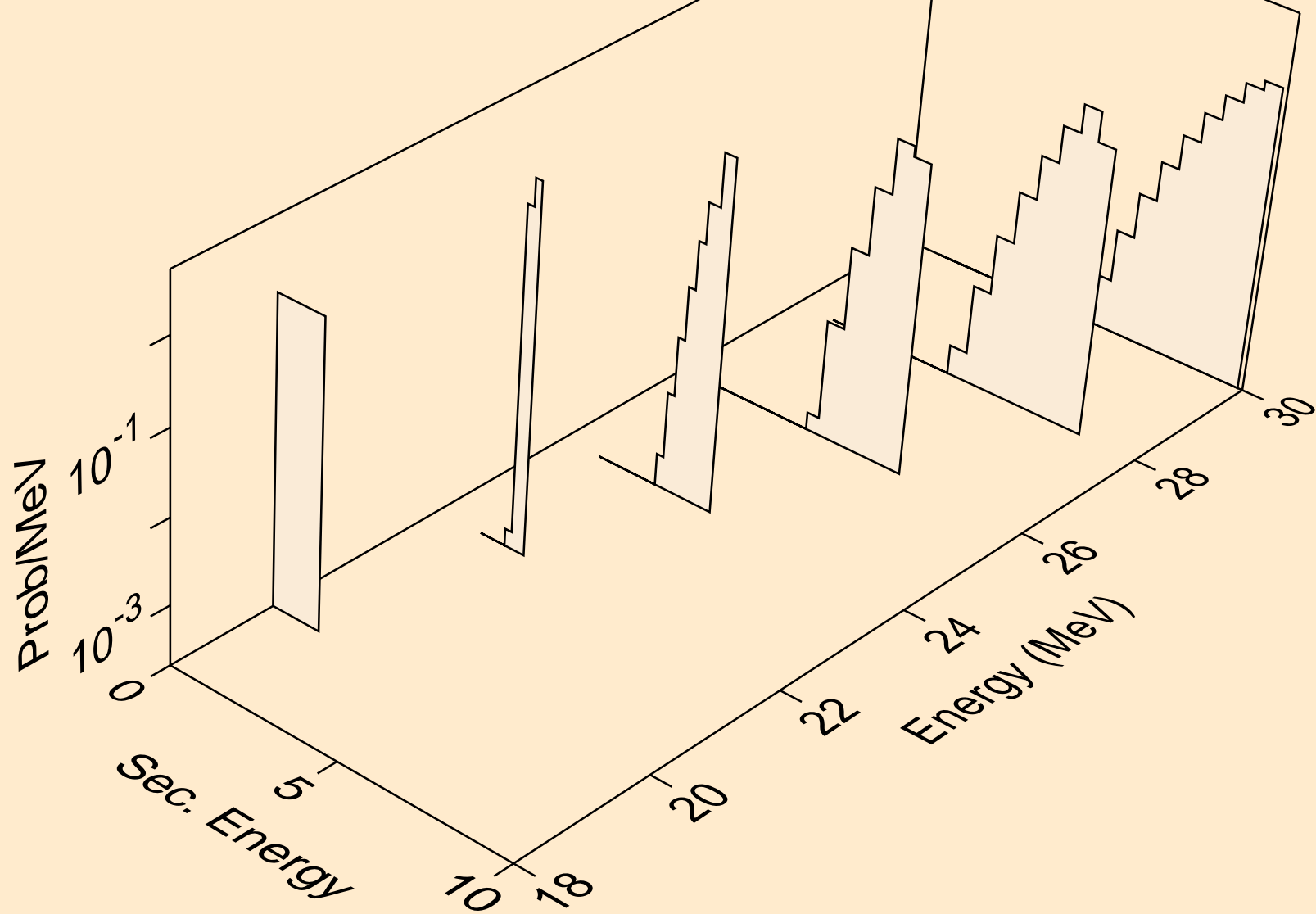

SE079M PROTON ACER TENDL-2021 LIBRARY; T=0.K  
he3s from (p,he3)

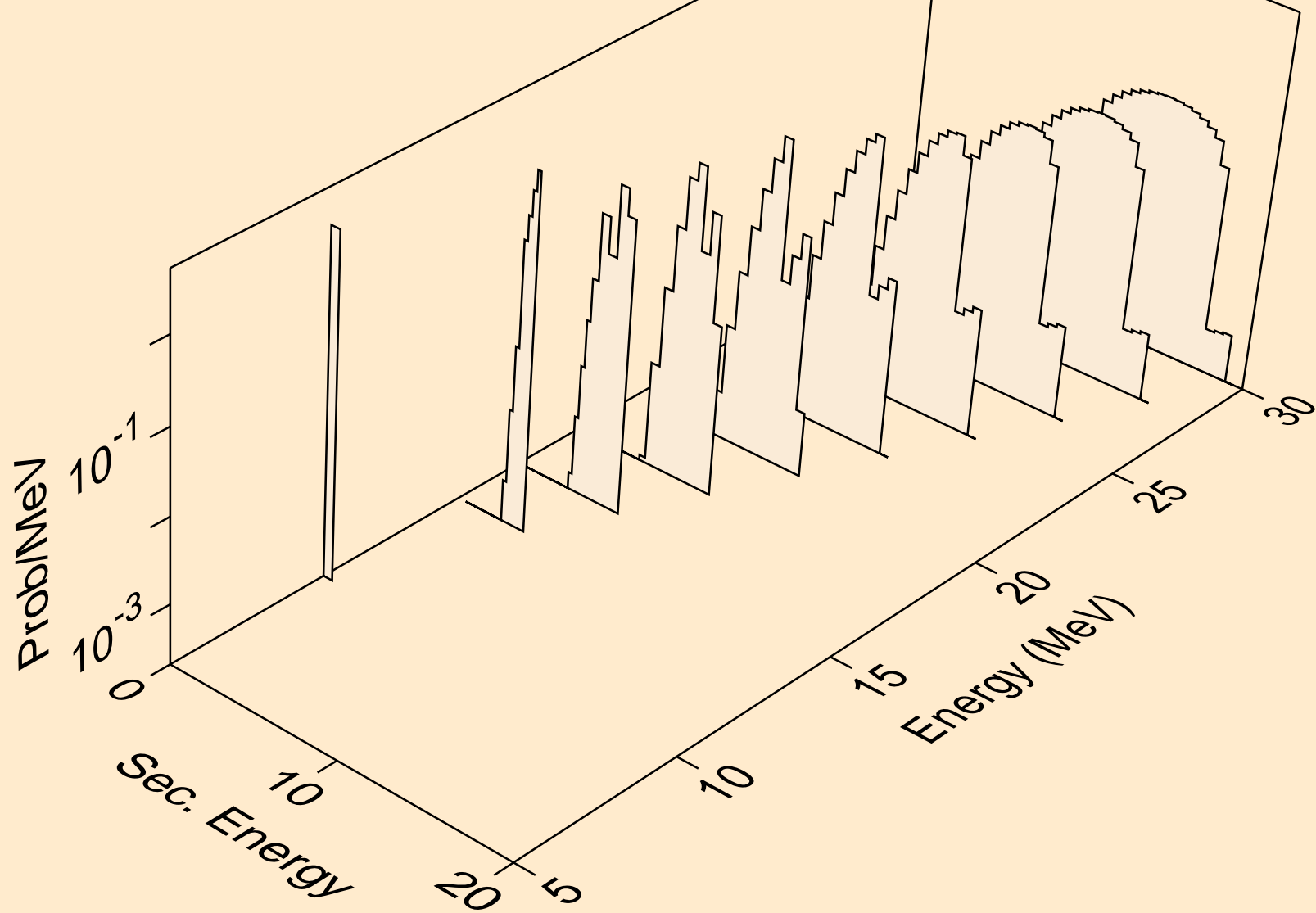

SE079M PROTON ACER TENDL-2021 LIBRARY; T=0.K  
alphas from (p,x)

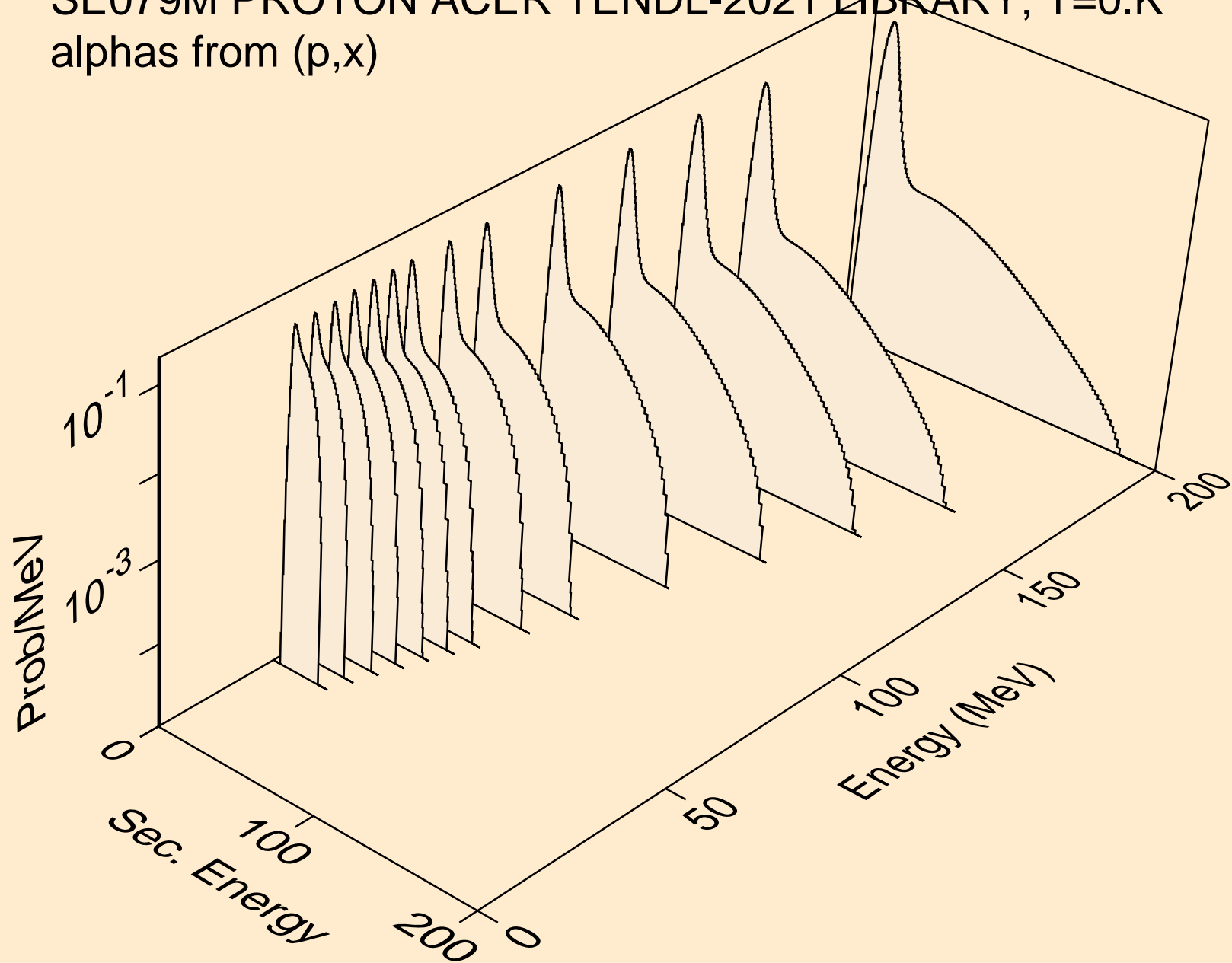

SE079M PROTON ACER TENDL-2021 LIBRARY; T=0.K  
alphas from (p,n\*)a

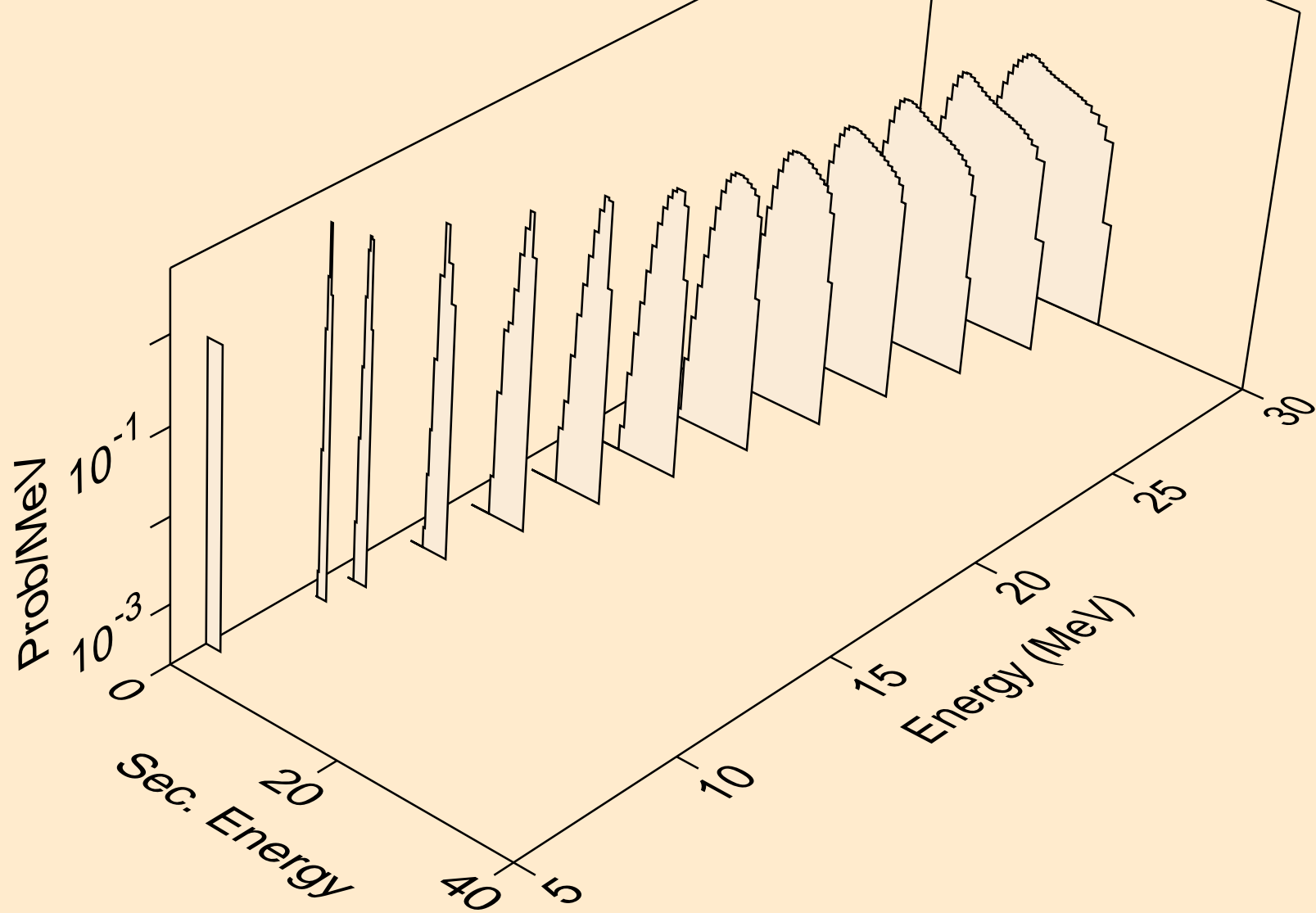

SE079M PROTON ACER TENDL-2021 LIBRARY; T=0.K  
alphas from (p,2n)a

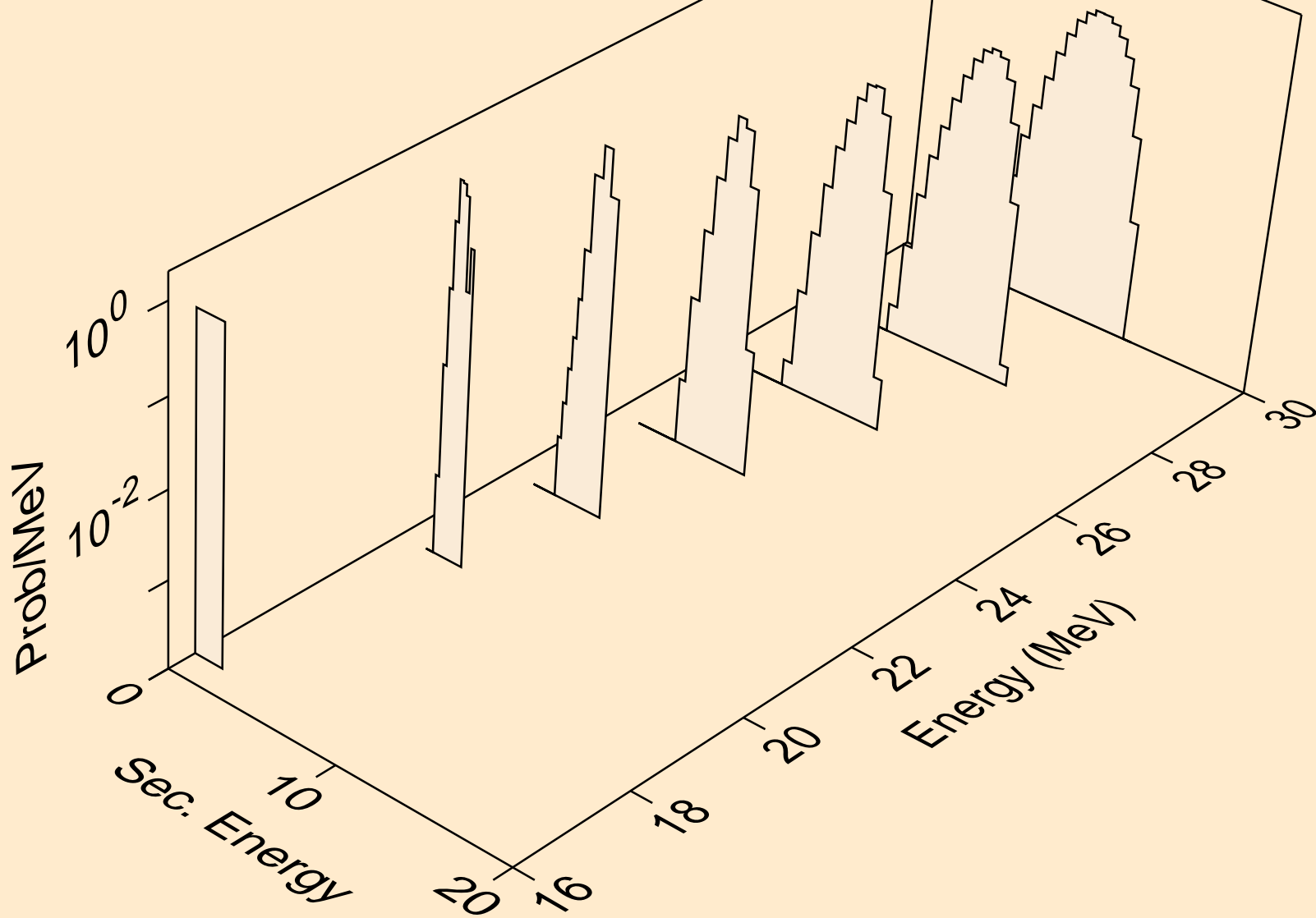

SE079M PROTON ACER TENDL-2021 LIBRARY; T=0.K  
alphas from (p,3n)a

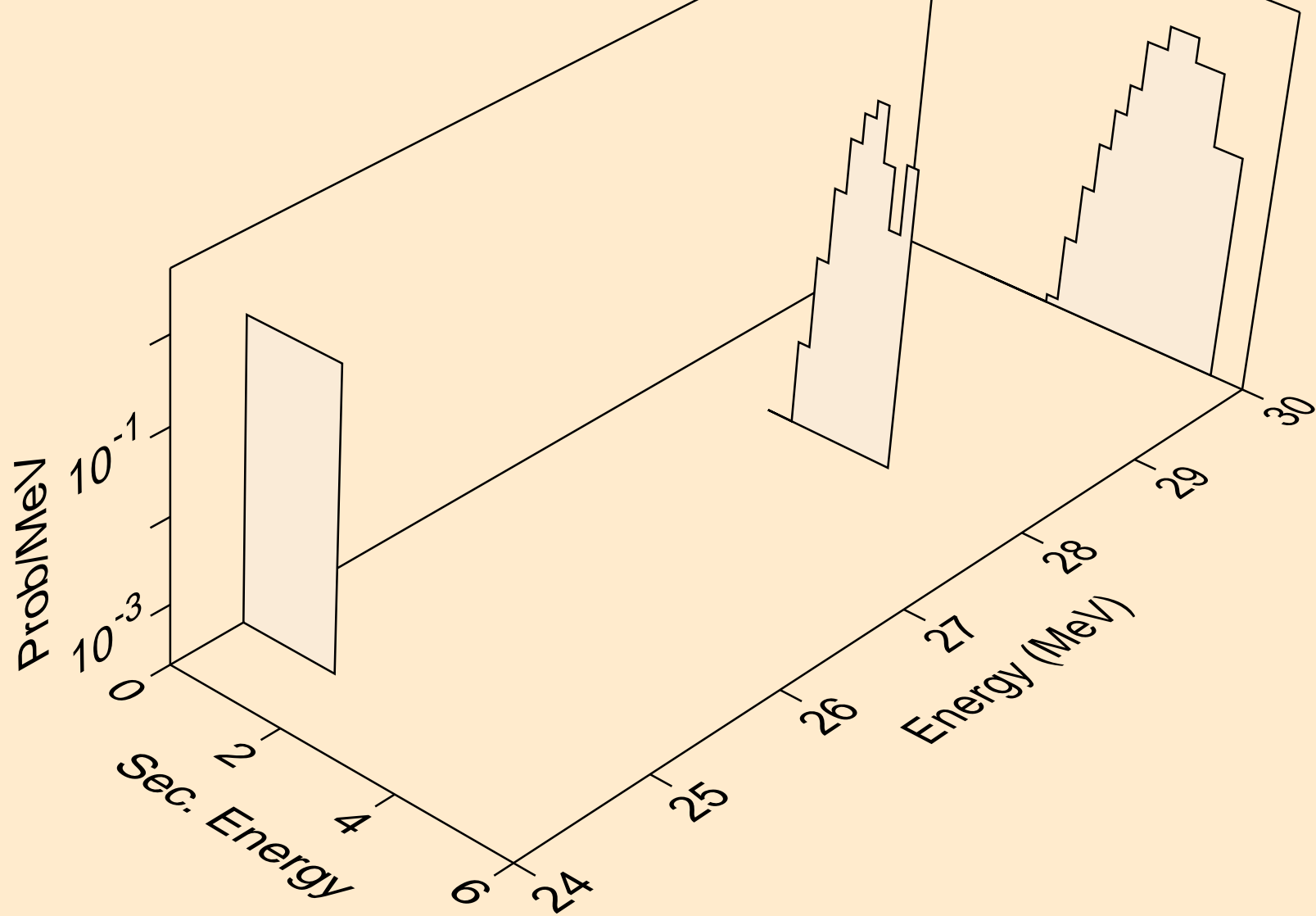

SE079M PROTON ACER TENDL-2021 LIBRARY; T=0.K  
alphas from (p,n\*)2a

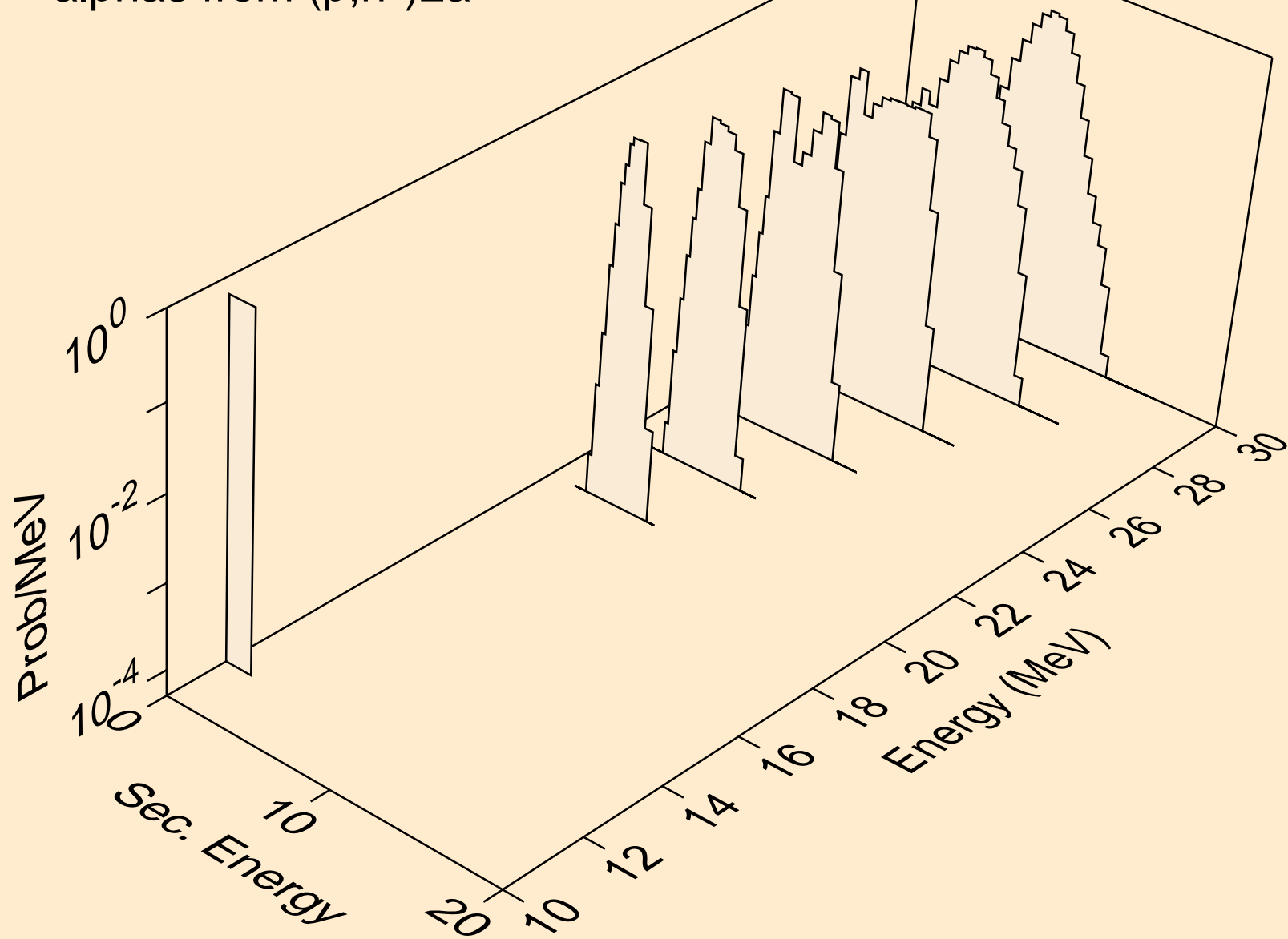

SE079M PROTON ACER TENDL-2021 LIBRARY; T=0.K  
alphas from (p,npa)

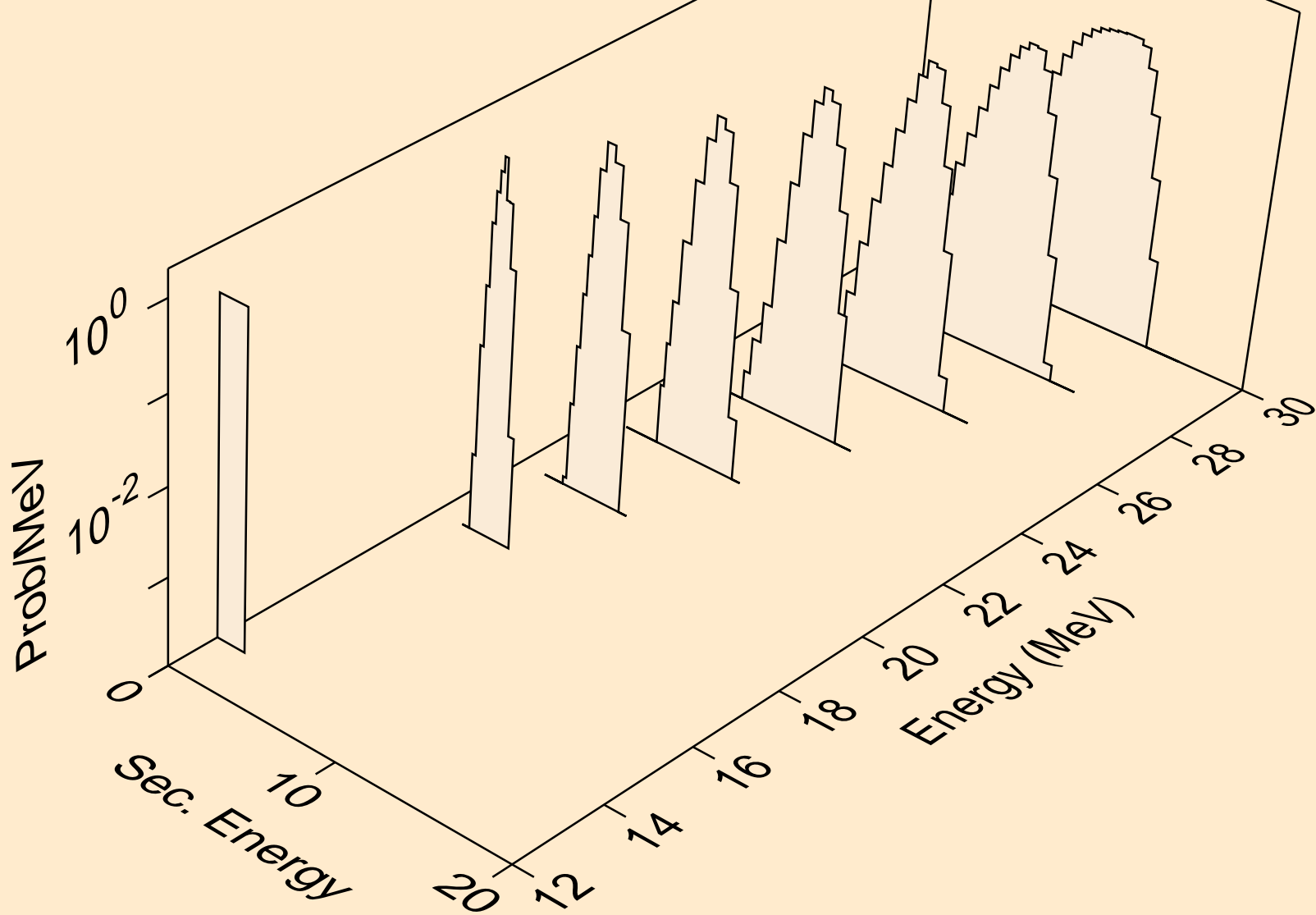



SE079M PROTON ACER TENDL-2021 LIBRARY; T=0.K  
alphas from (p,a)

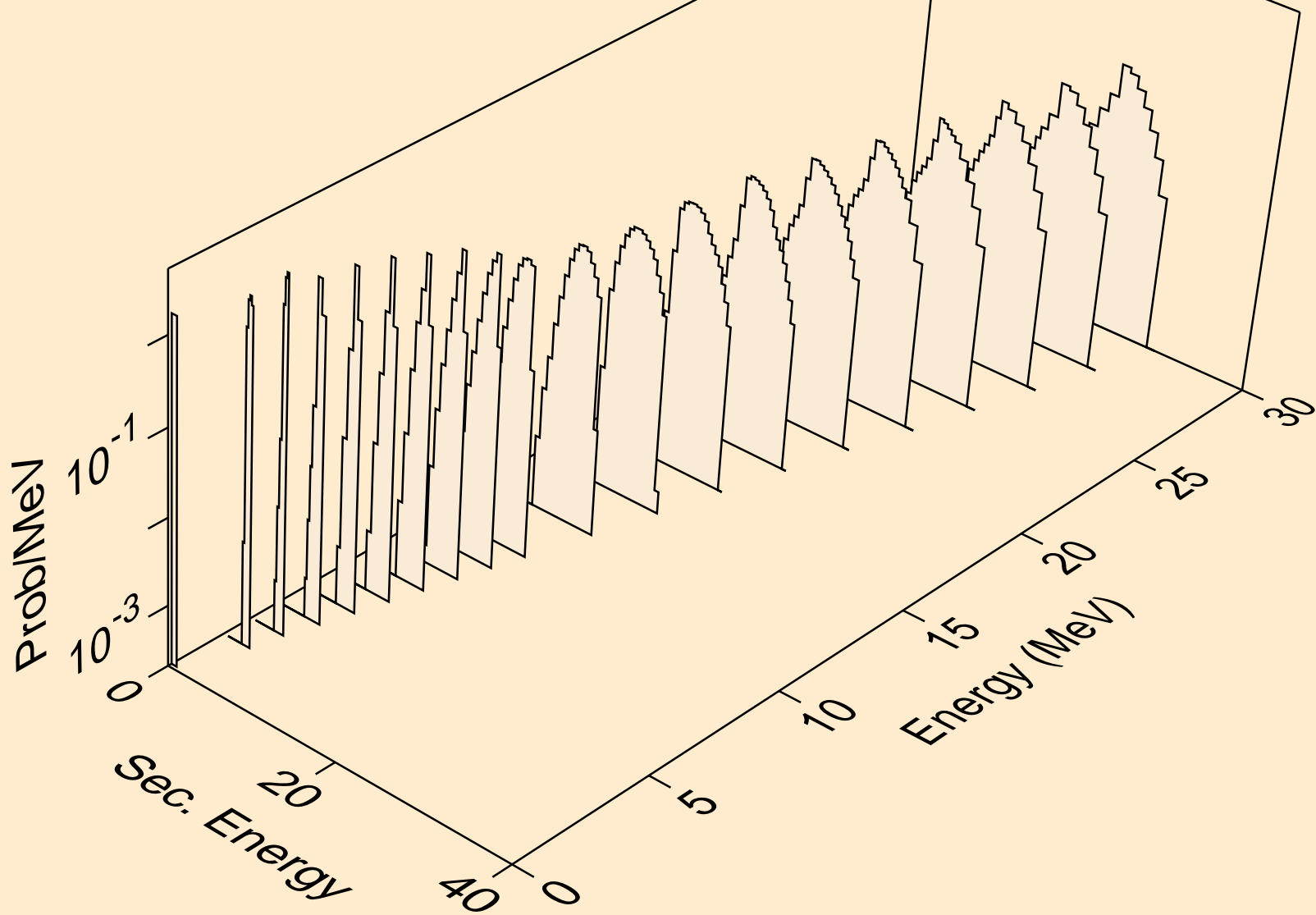

SE079M PROTON ACER TENDL-2021 LIBRARY; T=0.K  
alphas from (p,2a)

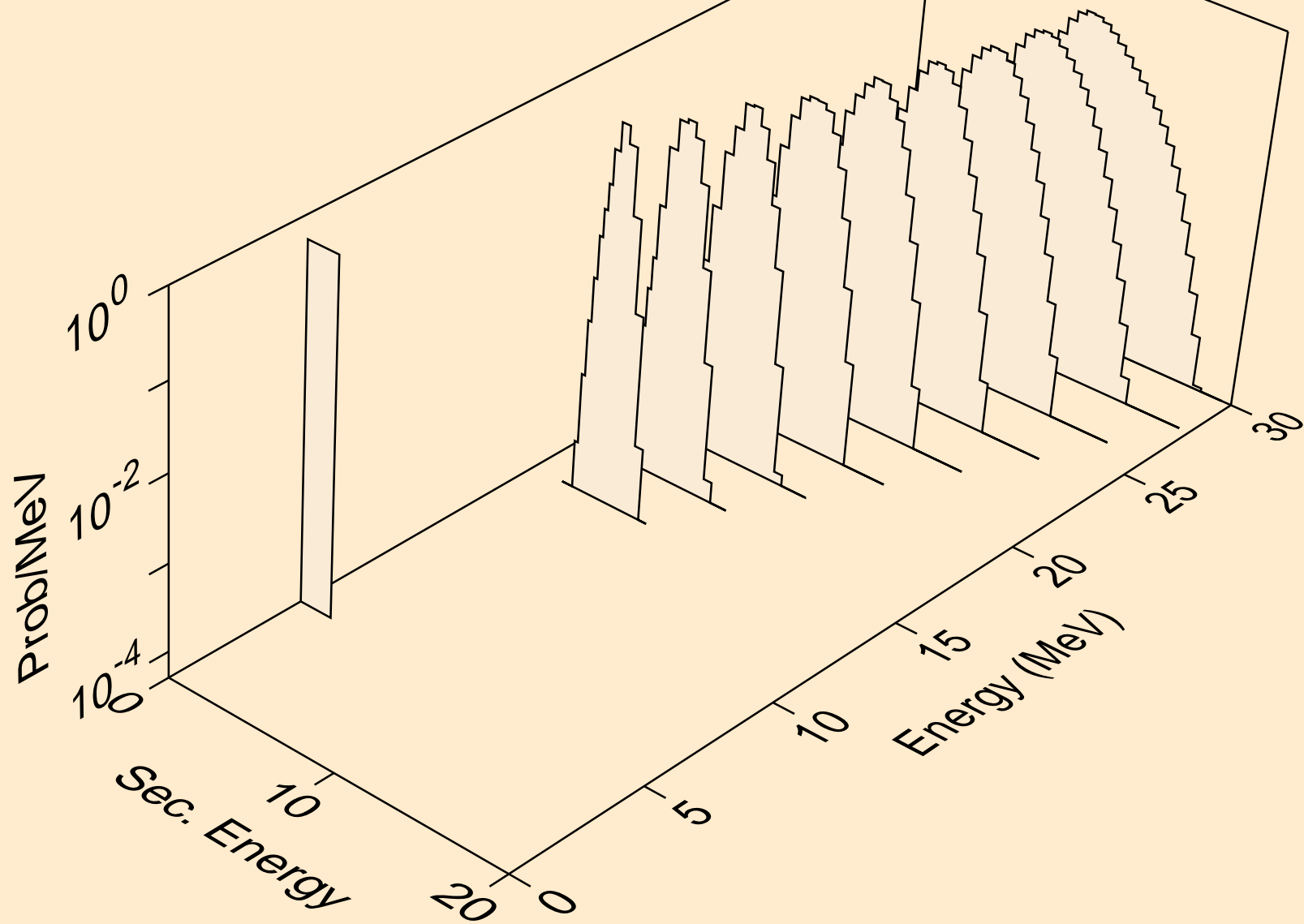

SE079M PROTON ACER TENDL-2021 LIBRARY; T=0.K  
alphas from (p,pa)

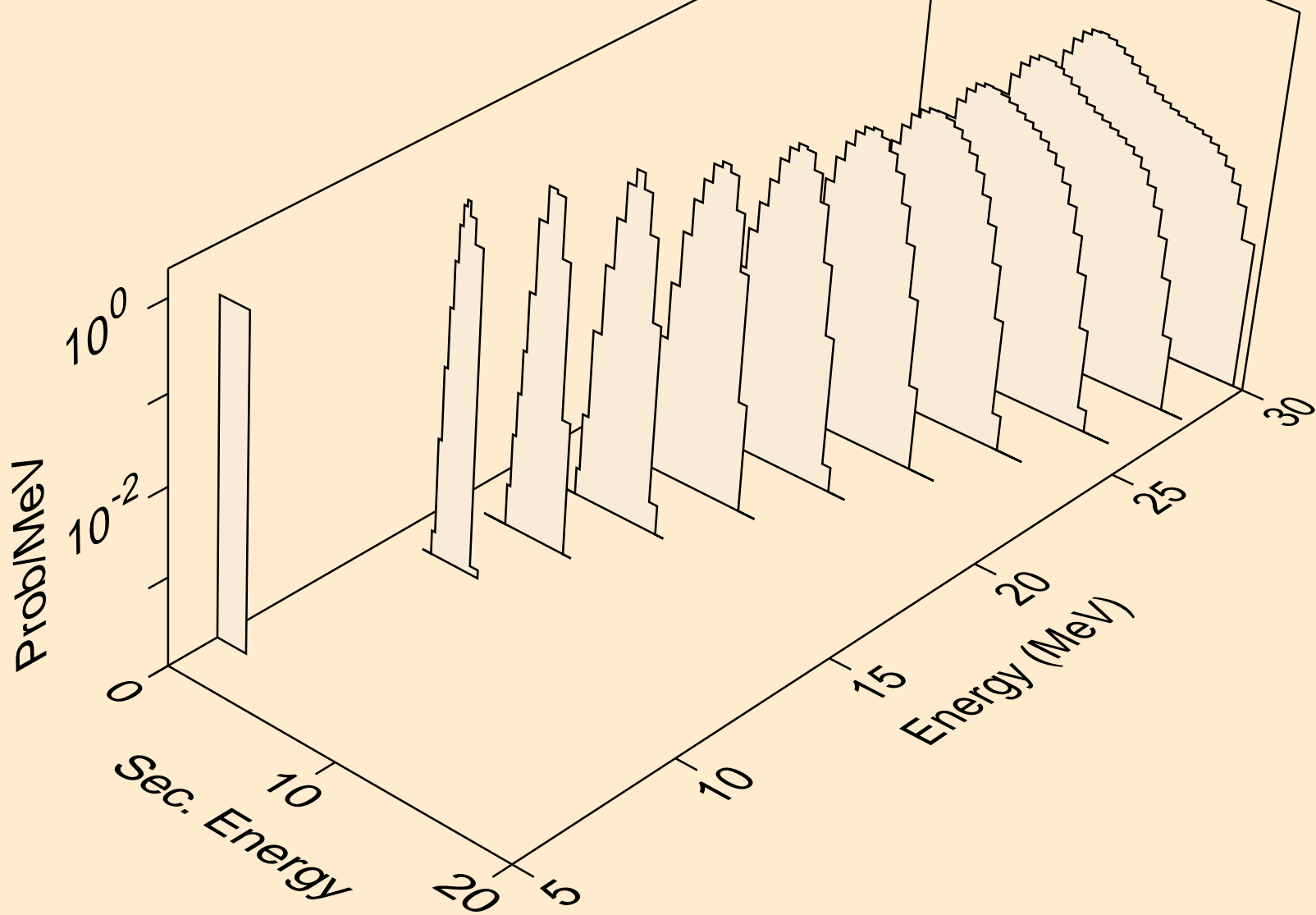

SE079M PROTON ACER TENDL-2021 LIBRARY; T=0.K  
alphas from (p,da)

