

SR078 PROTON ACER TENDL-2021 LIBRARY; T=0.K

Principal cross sections

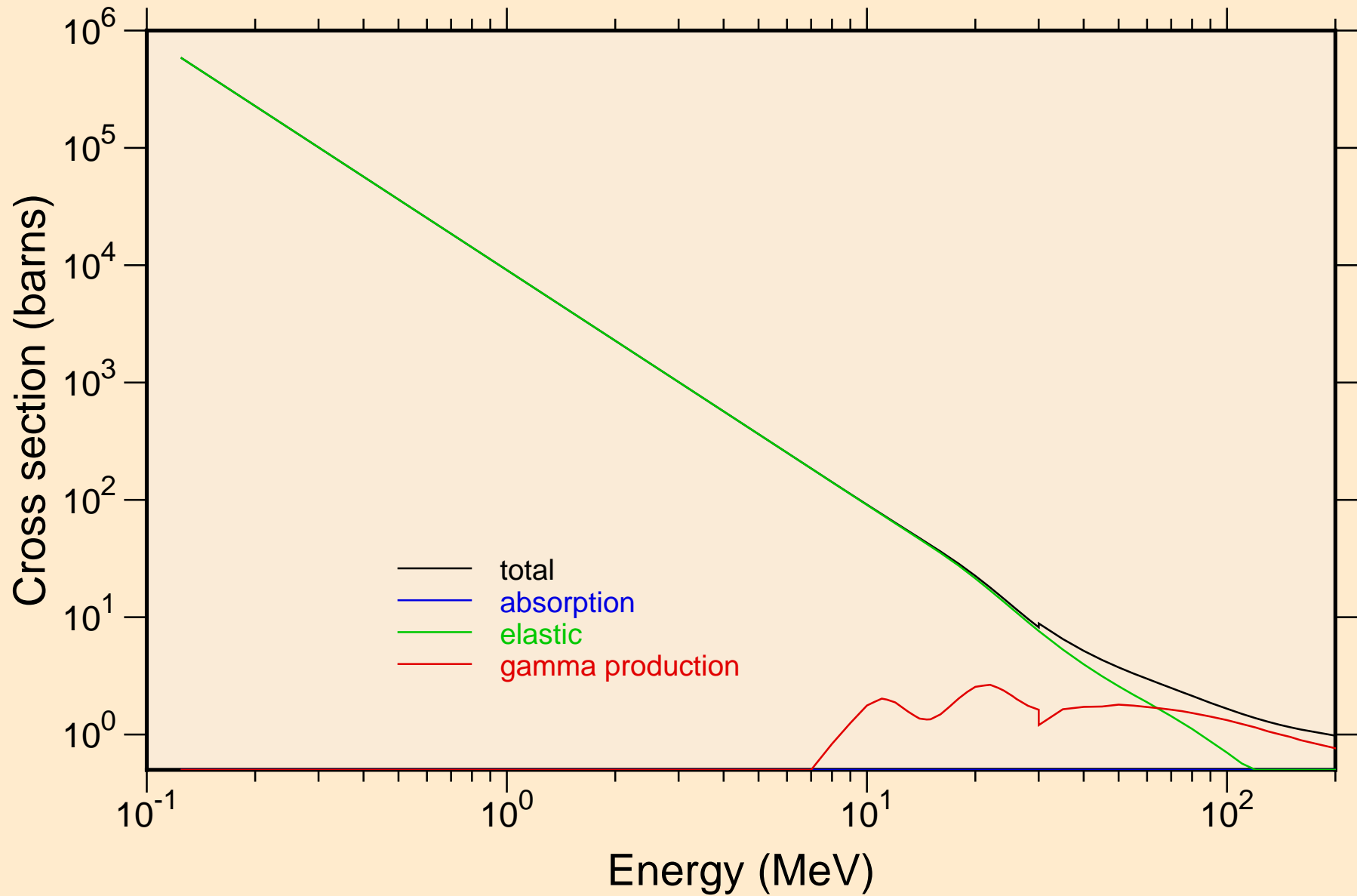

SR078 PROTON ACER TENDL-2021 LIBRARY; T=0.K

Heating

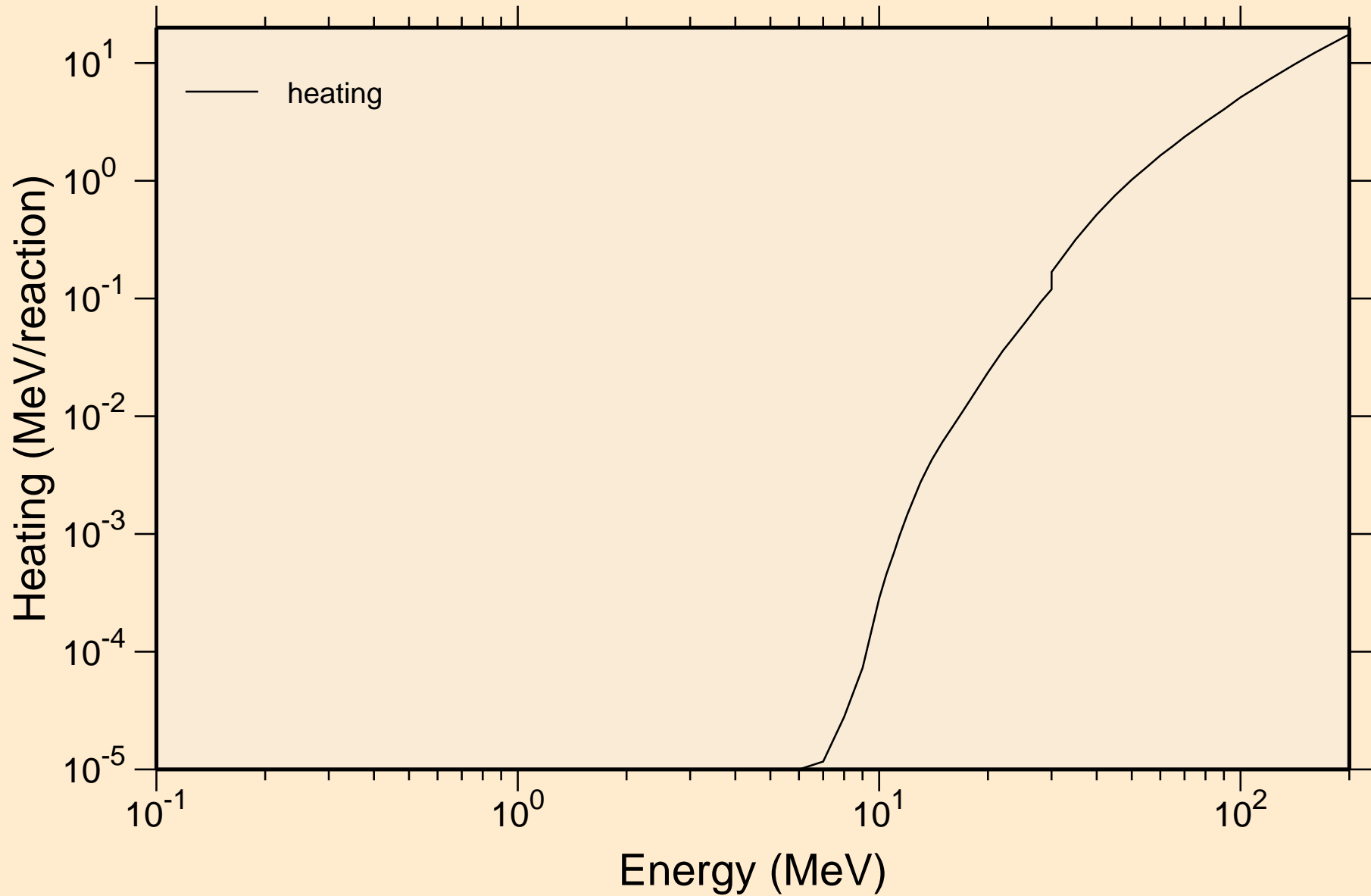

SR078 PROTON ACER TENDL-2021 LIBRARY; T=0.K
Principal cross sections

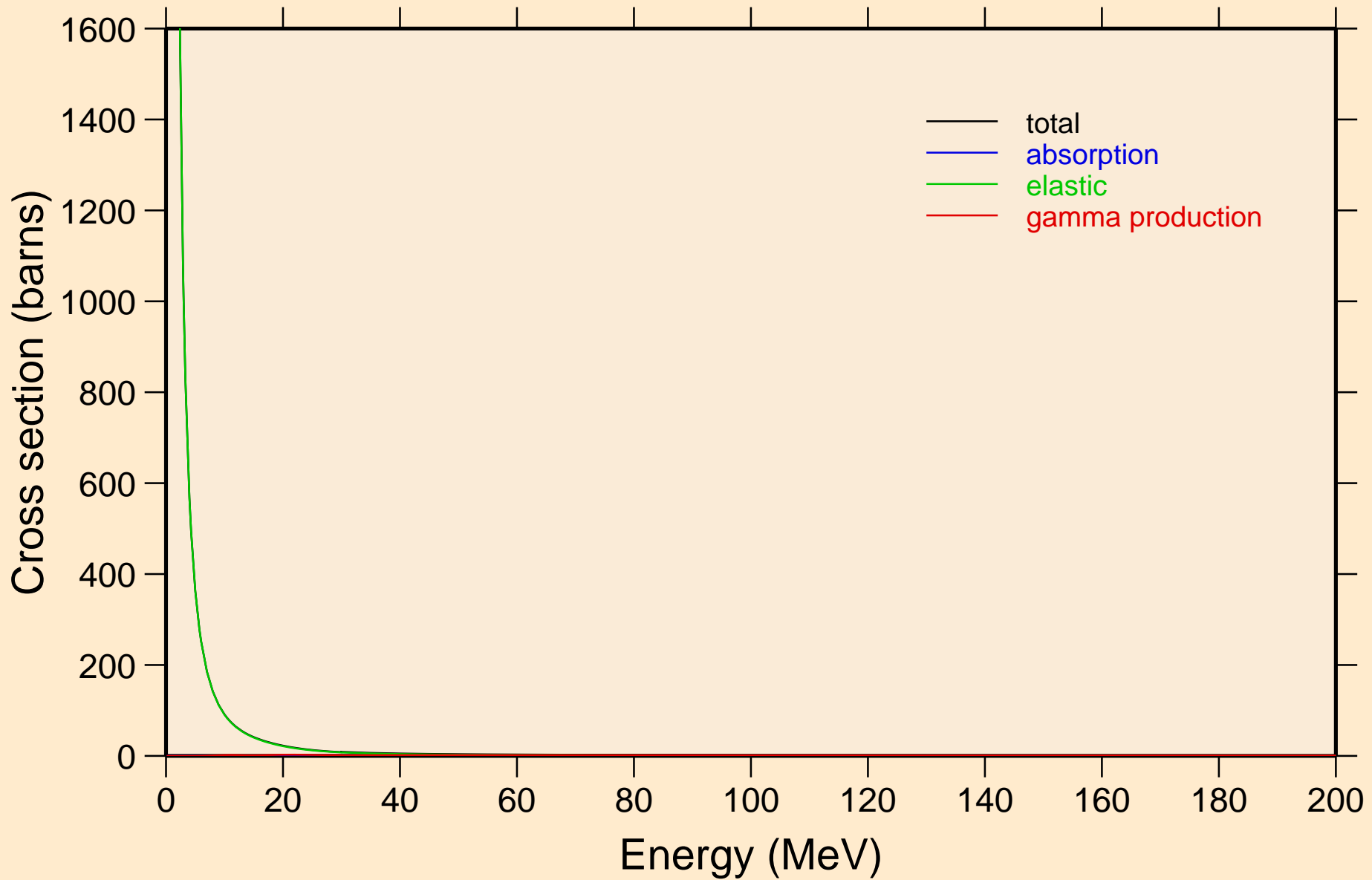

SR078 PROTON ACER TENDL-2021 LIBRARY; T=0.K

Heating

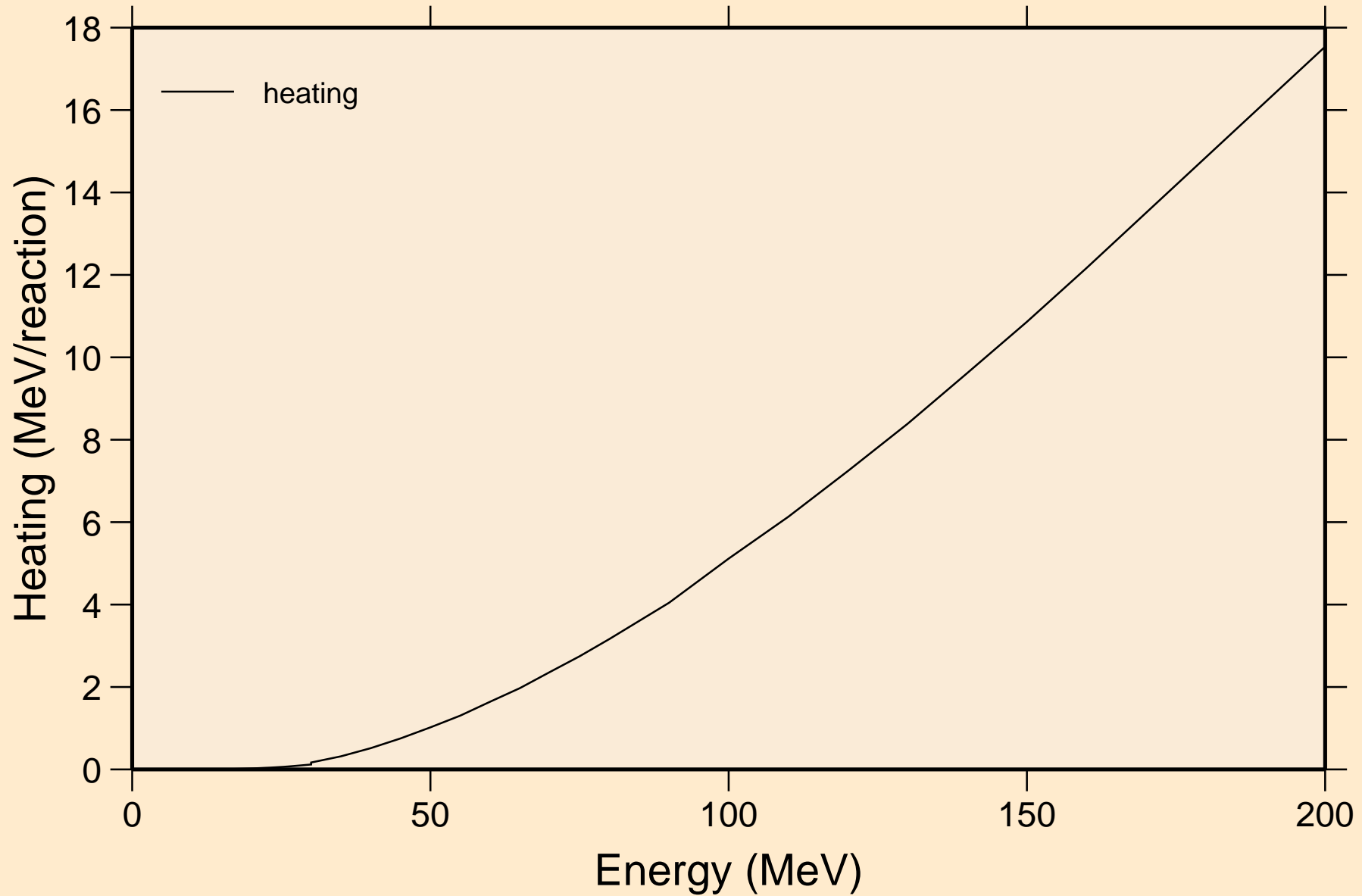

SR078 PROTON ACER TENDL-2021 LIBRARY; T=0.K

Threshold reactions

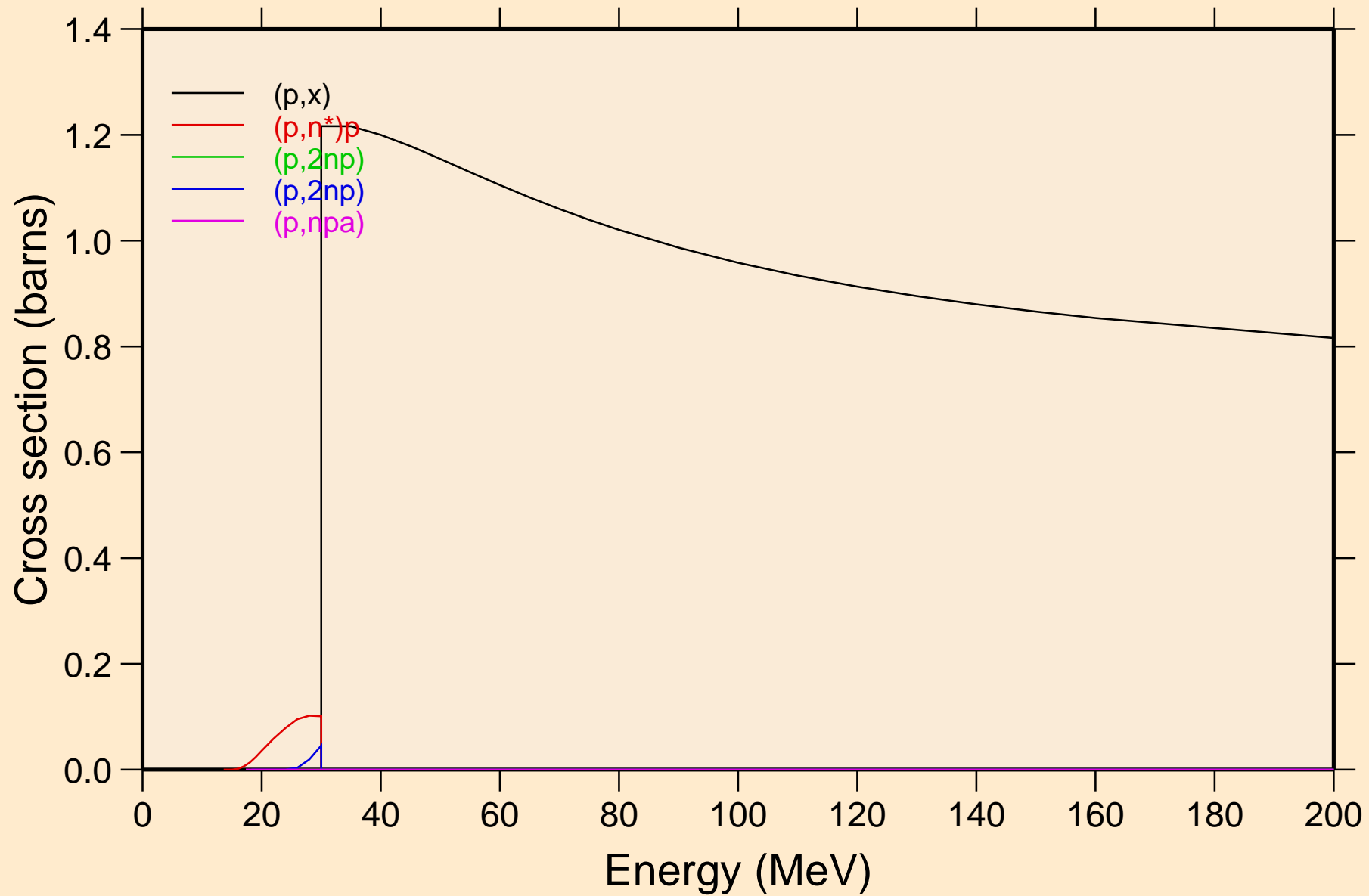

SR078 PROTON ACER TENDL-2021 LIBRARY; T=0.K

Threshold reactions

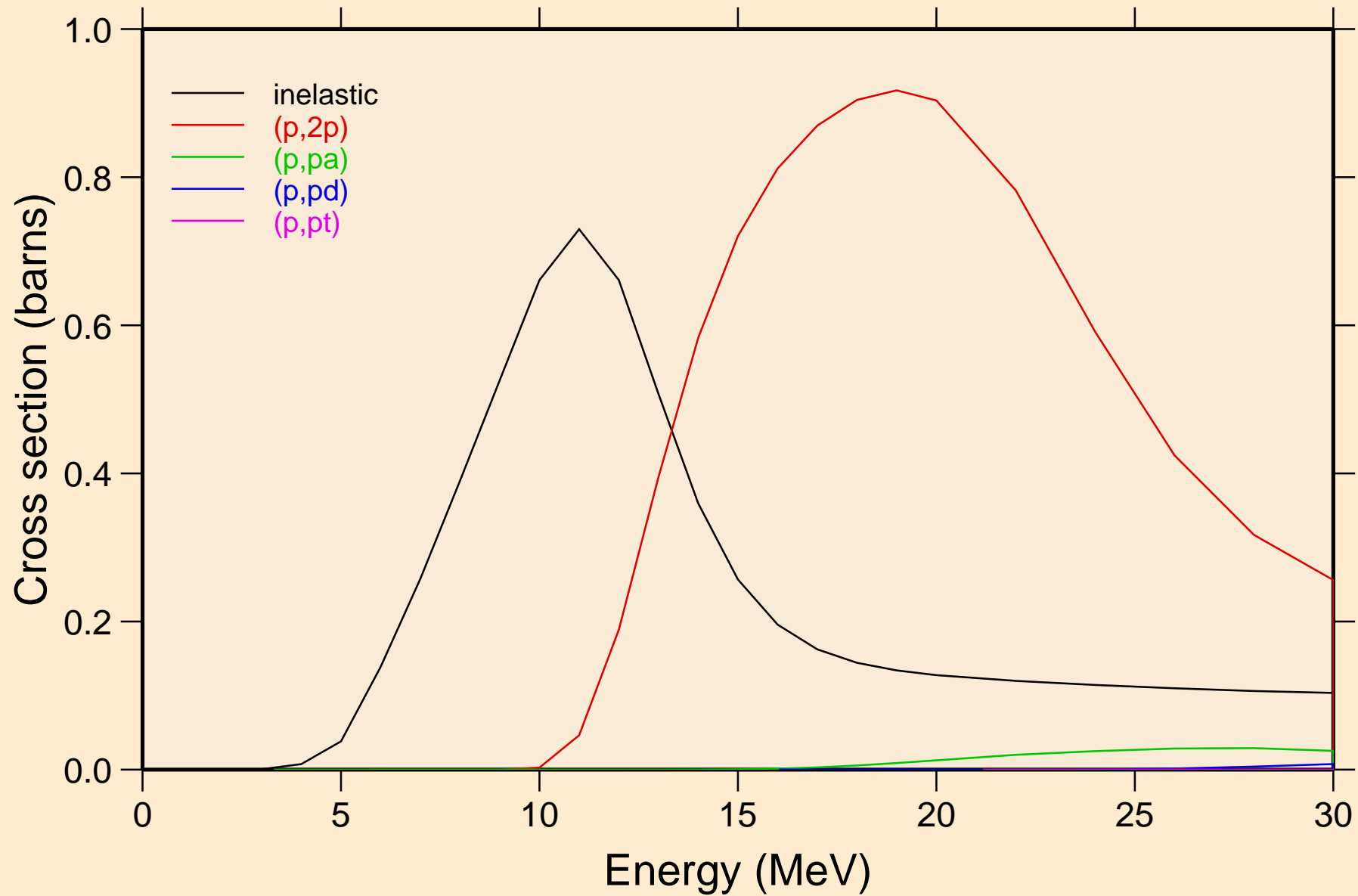

SR078 PROTON ACER TENDL-2021 LIBRARY; T=0.K
Threshold reactions

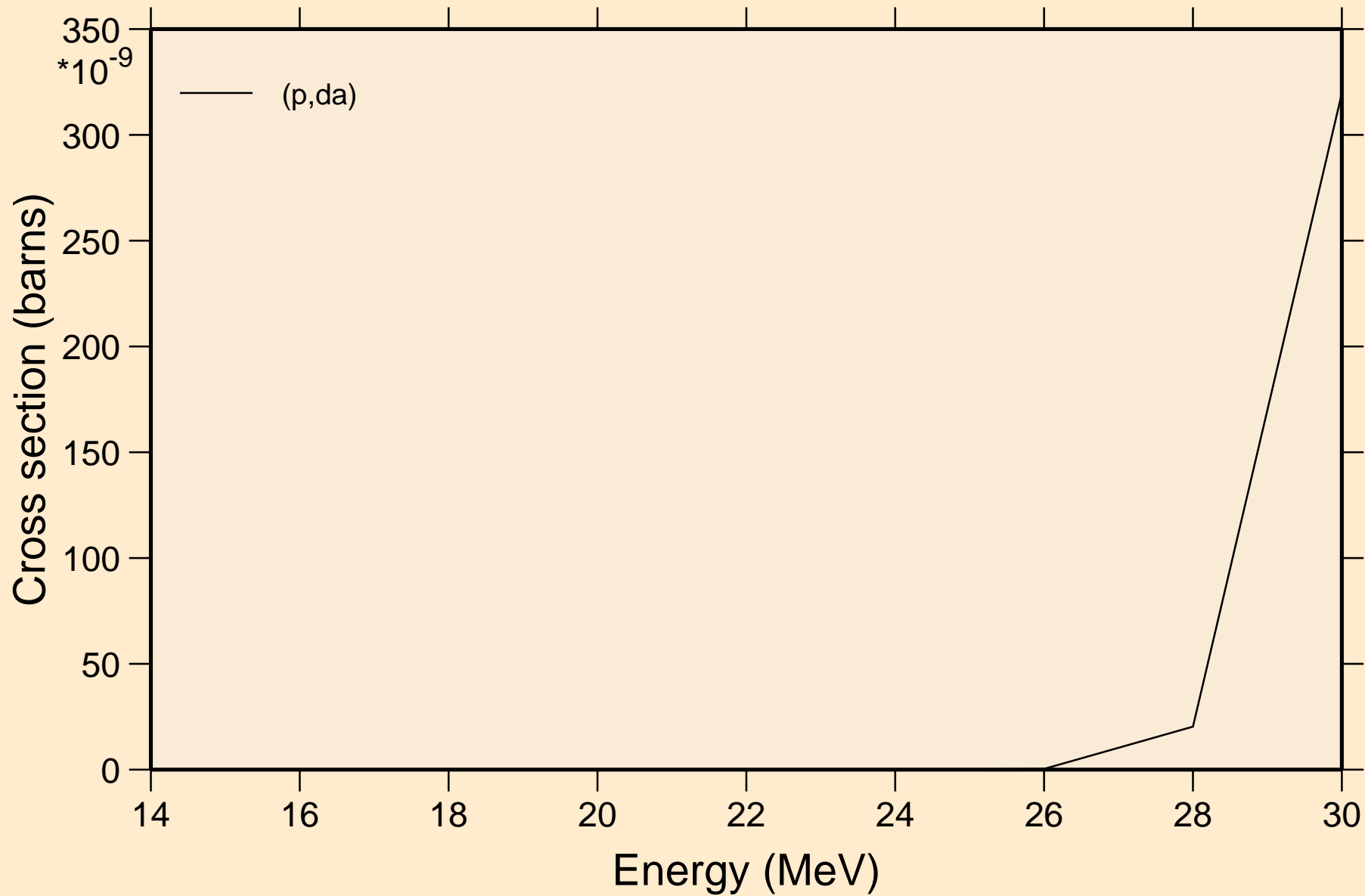

SR078 PROTON ACER TENDL-2021 LIBRARY; T=0.K
angular distribution for elastic

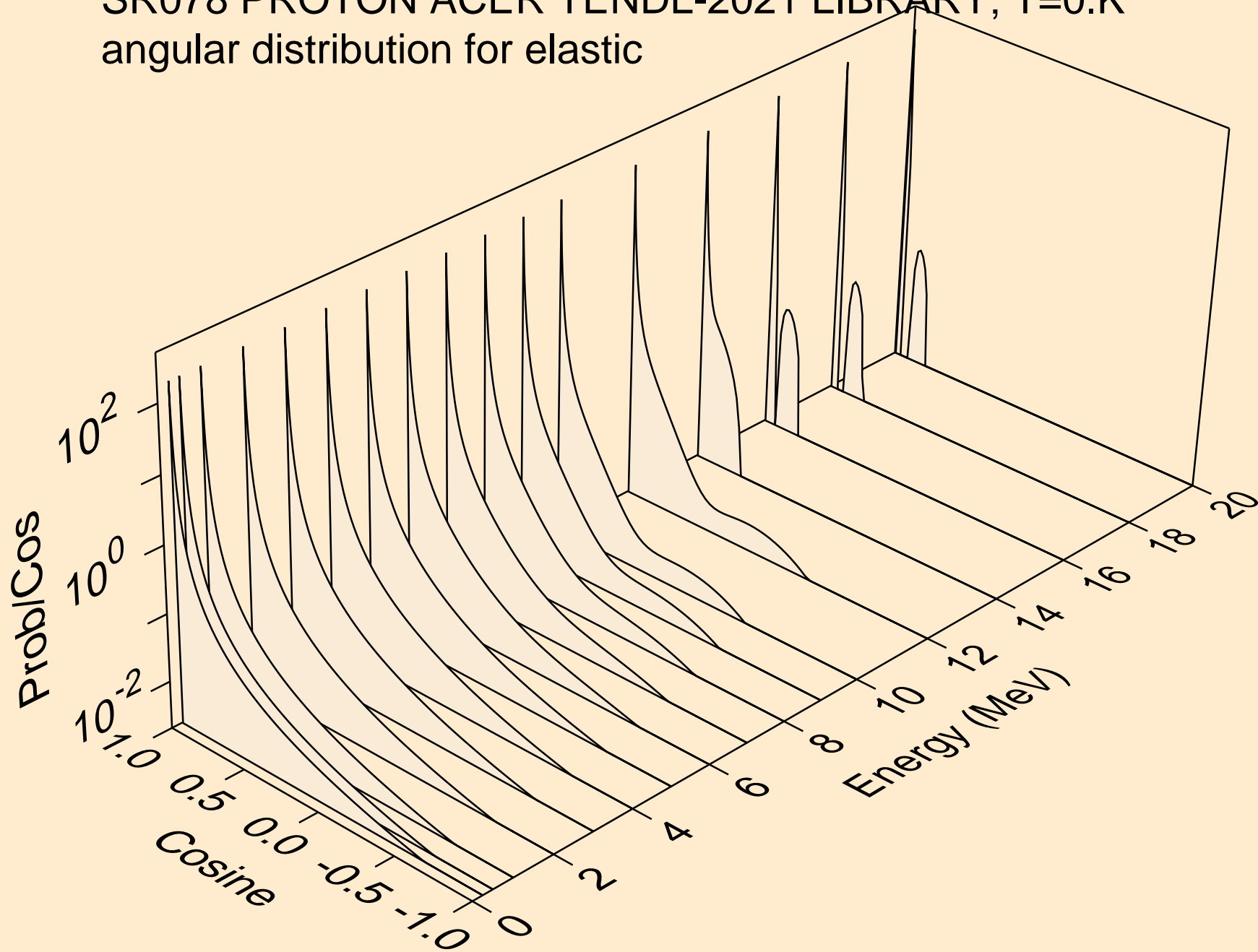

SR078 PROTON ACER TENDL-2021 LIBRARY; T=0.K
angular distribution for elastic

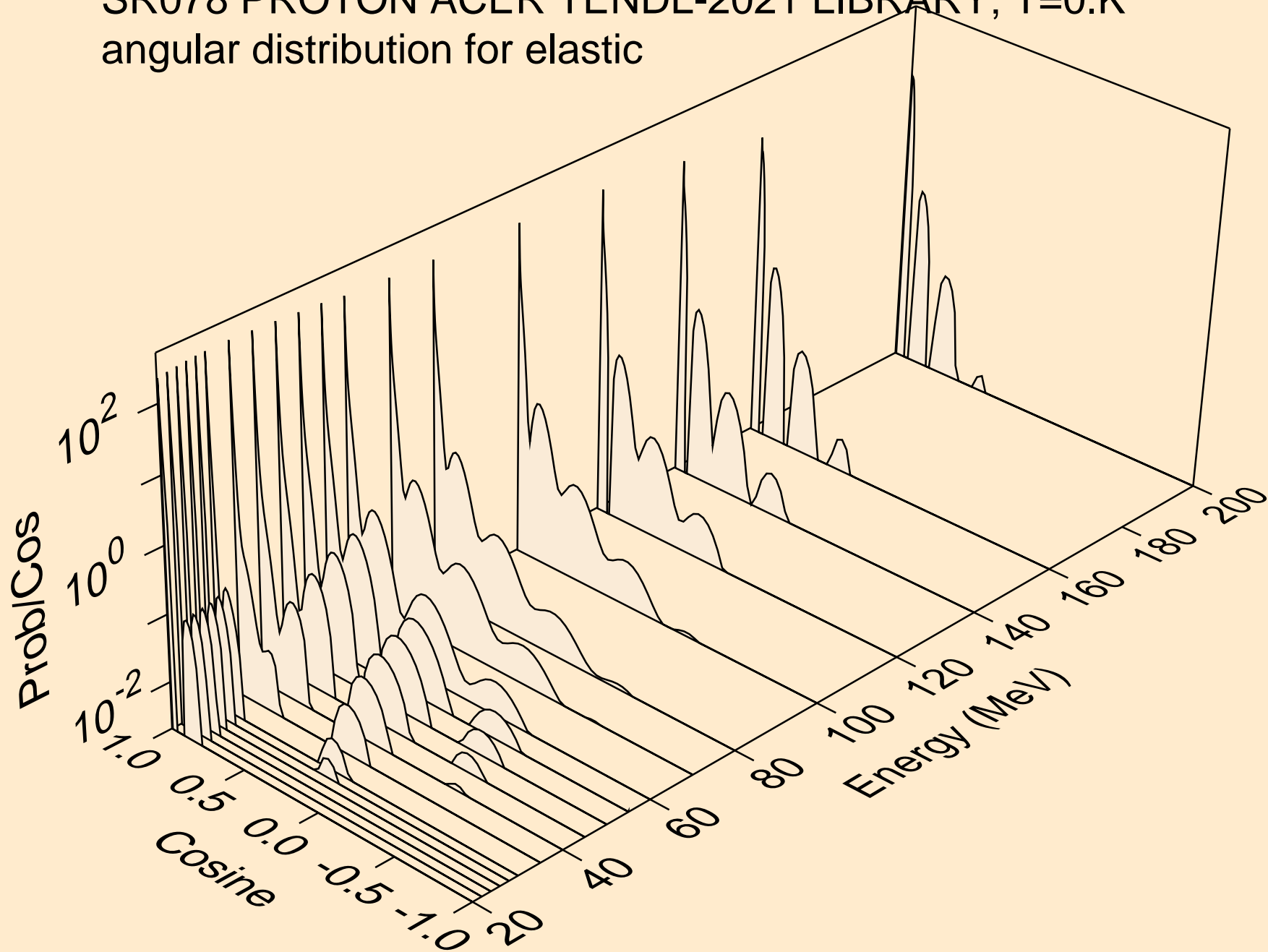

SR078 PROTON ACER TENDL-2021 LIBRARY; T=0.K
Proton emission for (p,x)

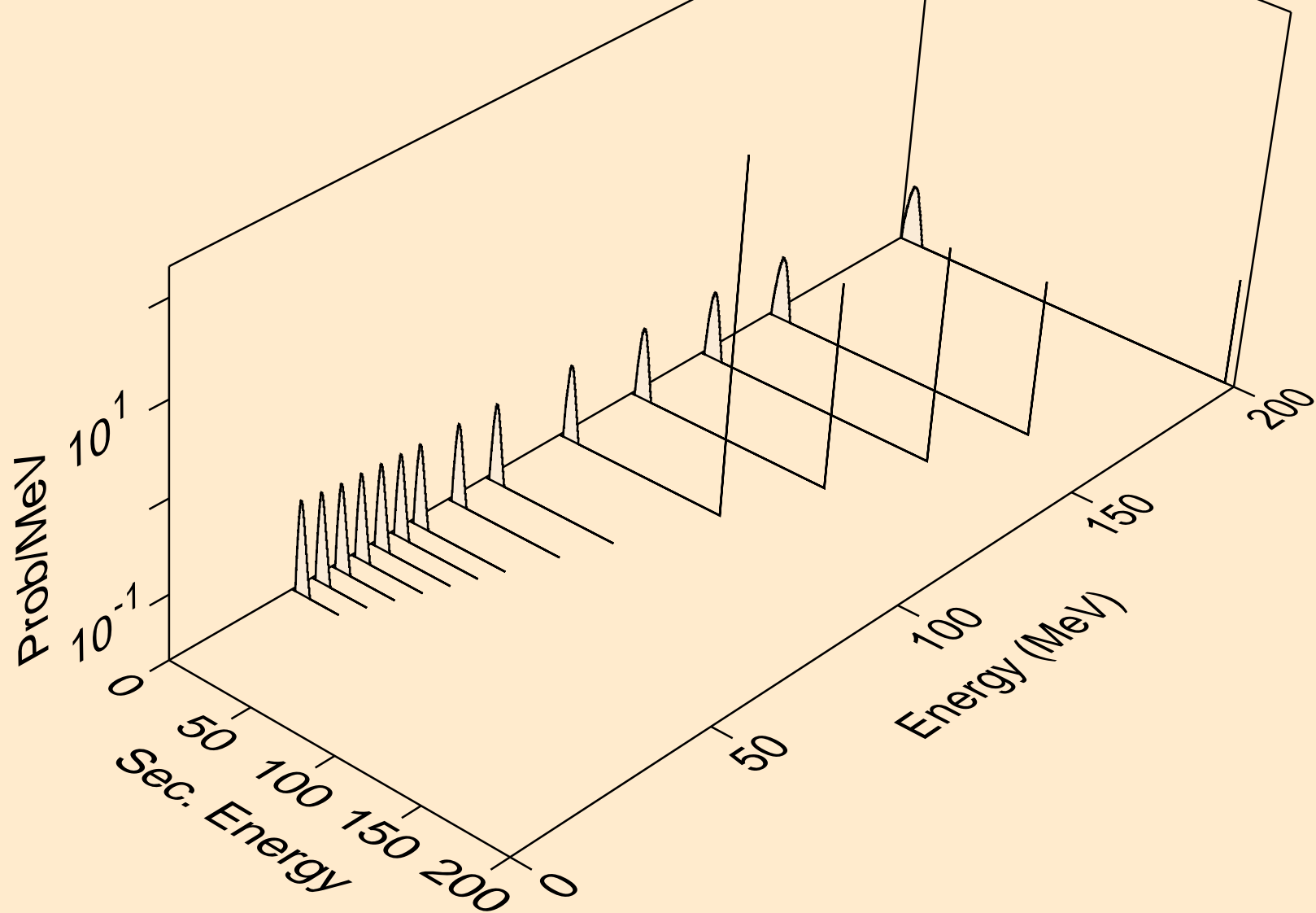

SR078 PROTON ACER TENDL-2021 LIBRARY; T=0.K
Proton emission for (p,n*)p

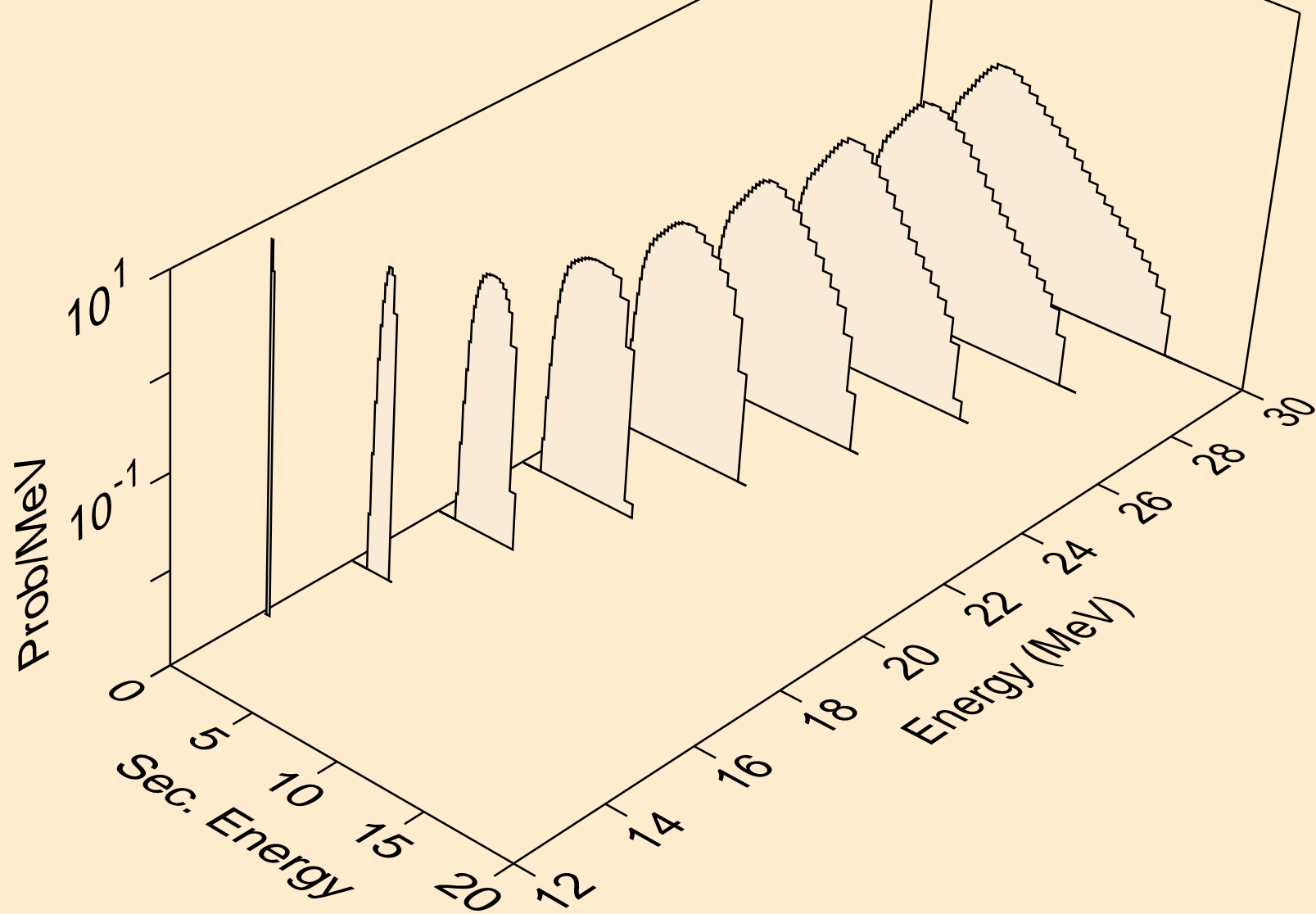

SR078 PROTON ACER TENDL-2021 LIBRARY; T=0.K
Proton emission for (p,2np)

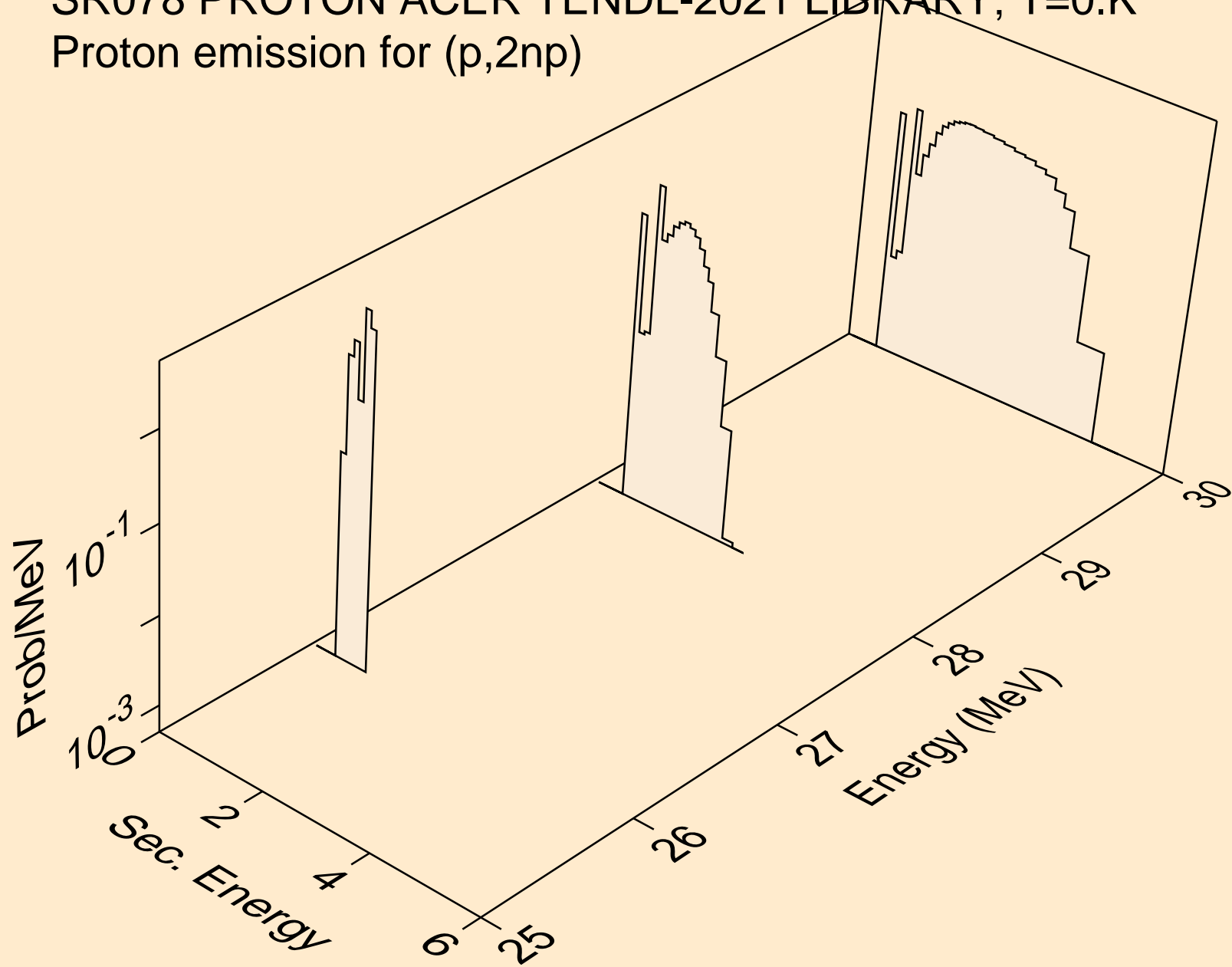

SR078 PROTON ACER TENDL-2021 LIBRARY; T=0.K
Proton emission for (p,2np)

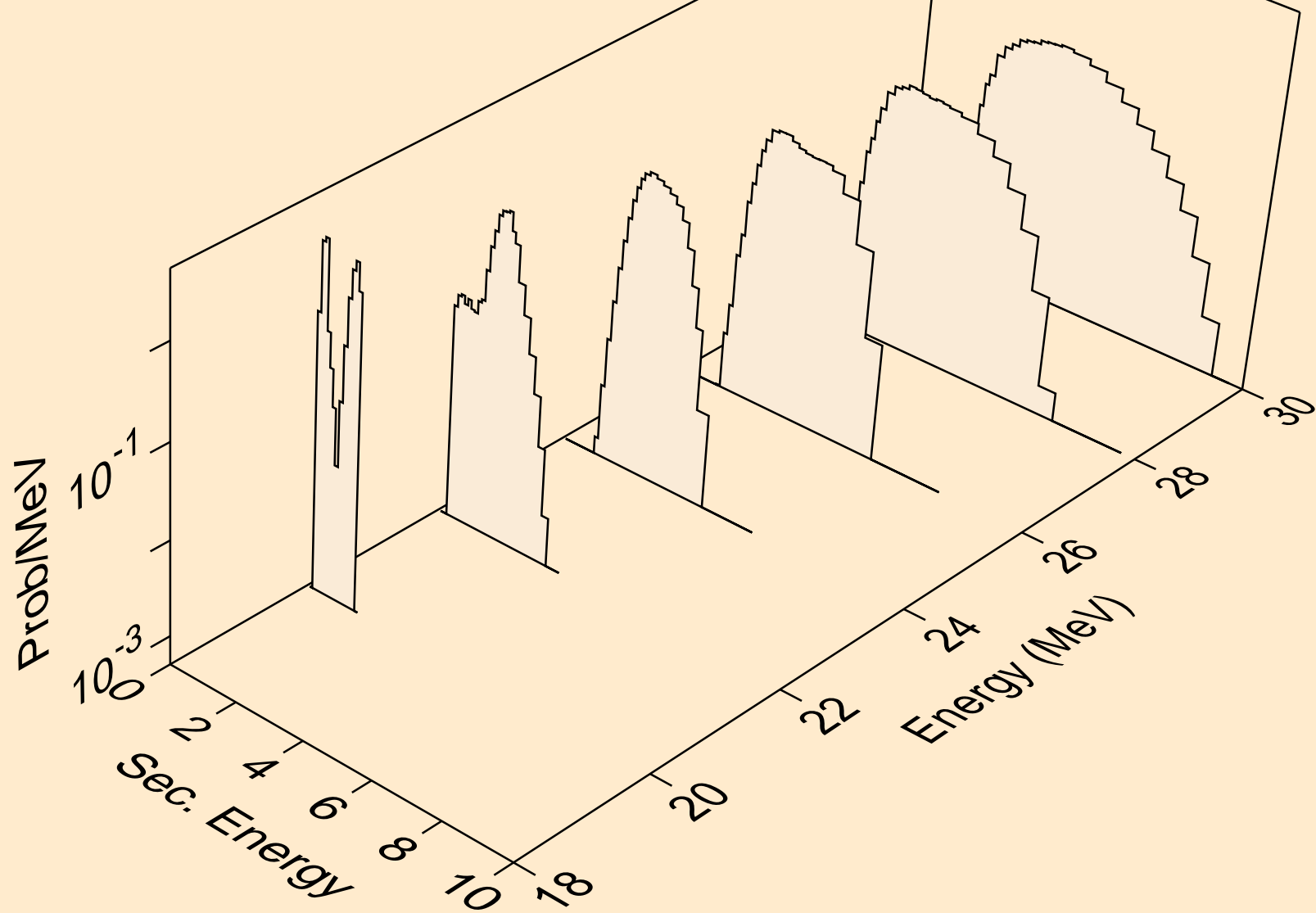

SR078 PROTON ACER TENDL-2021 LIBRARY; T=0.K
Proton emission for (p,npa)

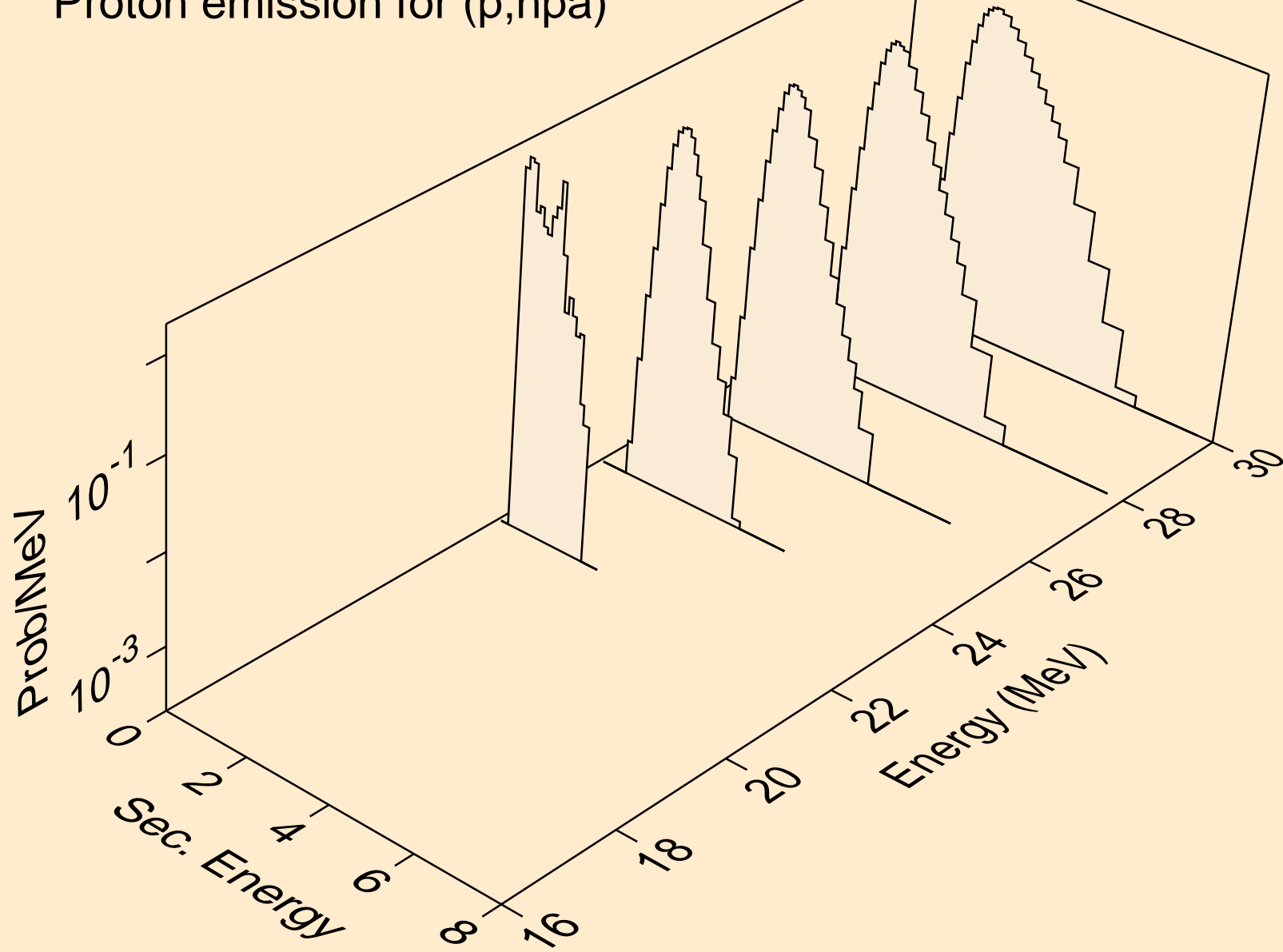

SR078 PROTON ACER TENDL-2021 LIBRARY; T=0.K
Proton emission for inelastic

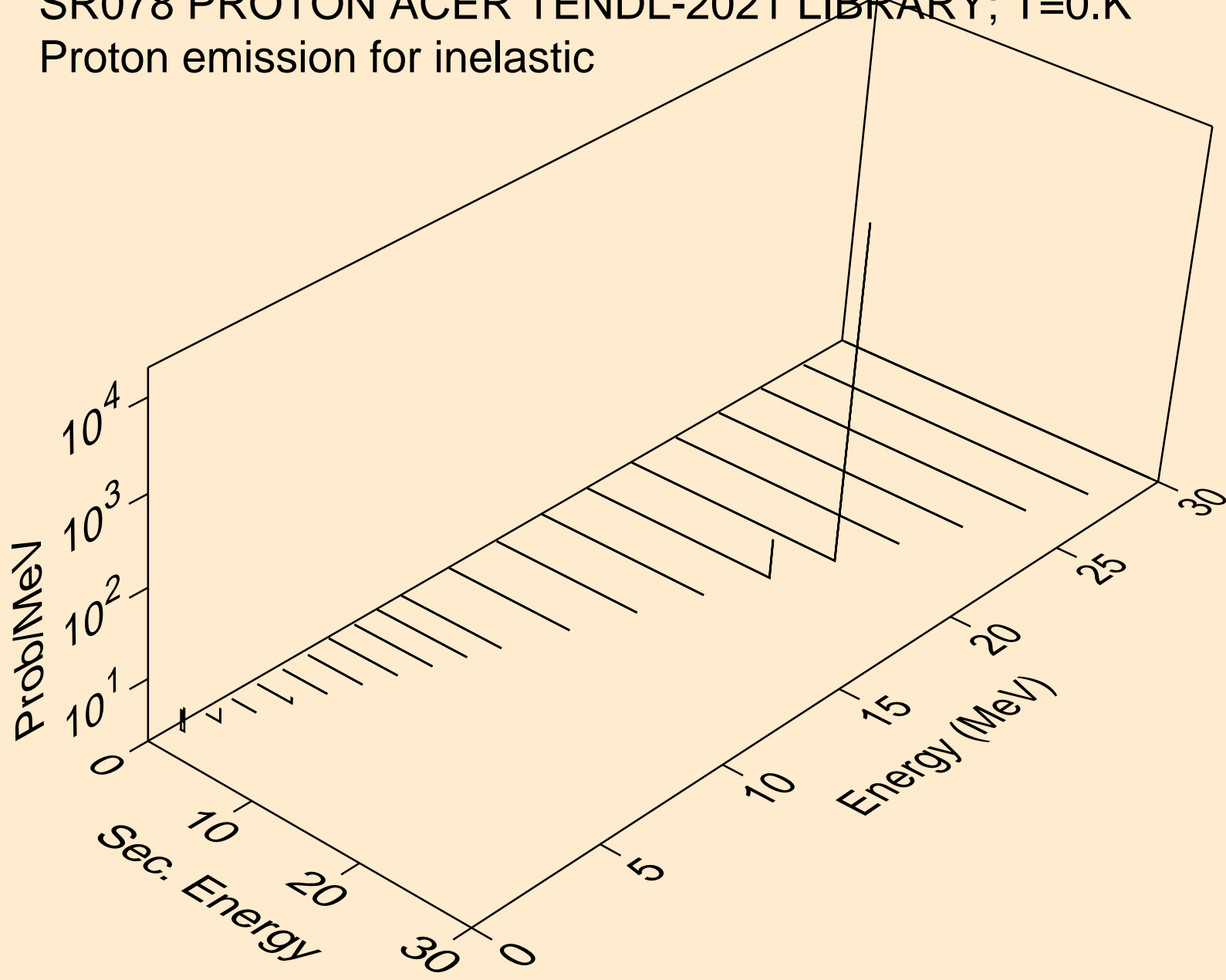

SR078 PROTON ACER TENDL-2021 LIBRARY; T=0.K
Proton emission for (p,2p)

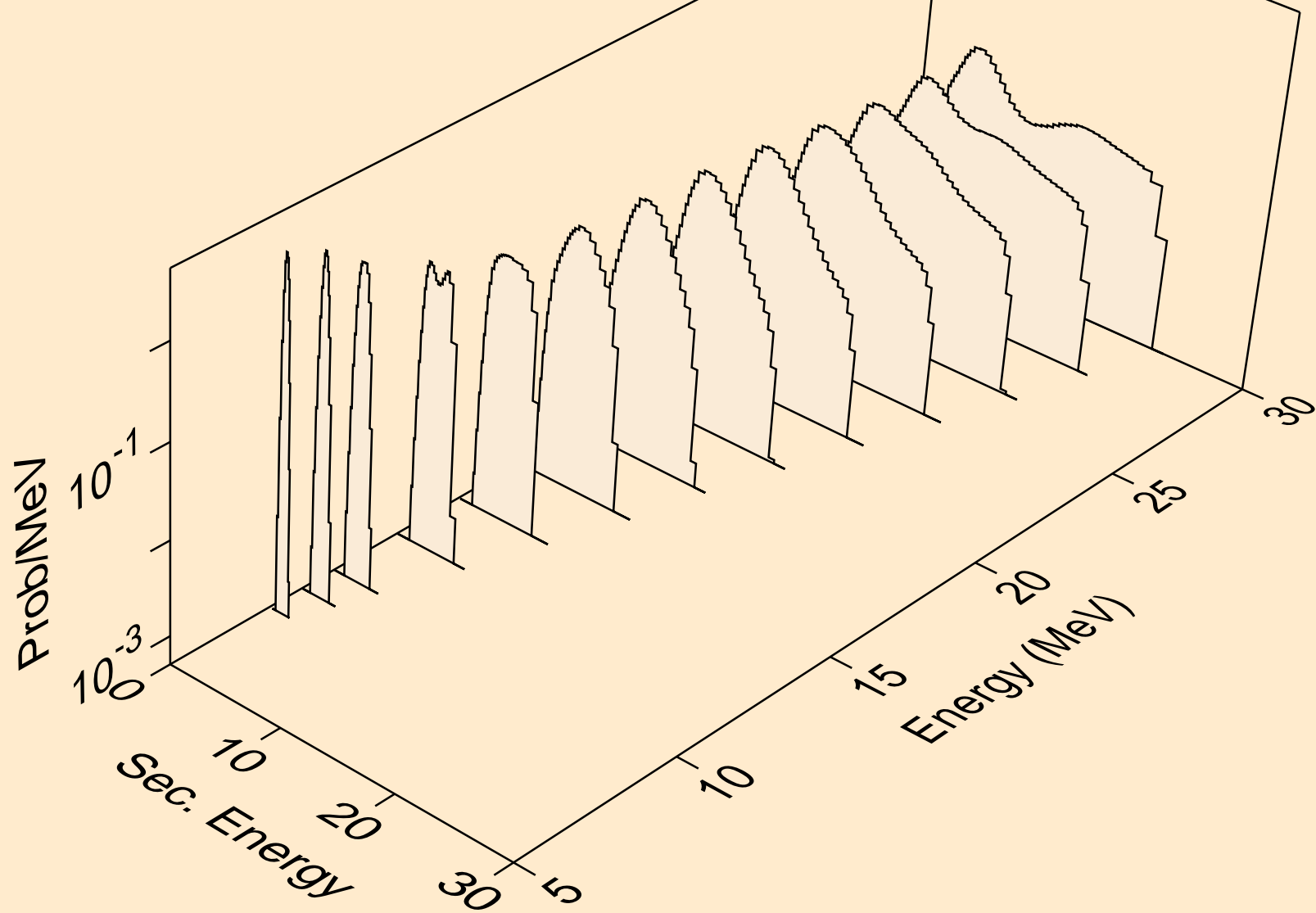

SR078 PROTON ACER TENDL-2021 LIBRARY; T=0.K
Proton emission for (p,pa)

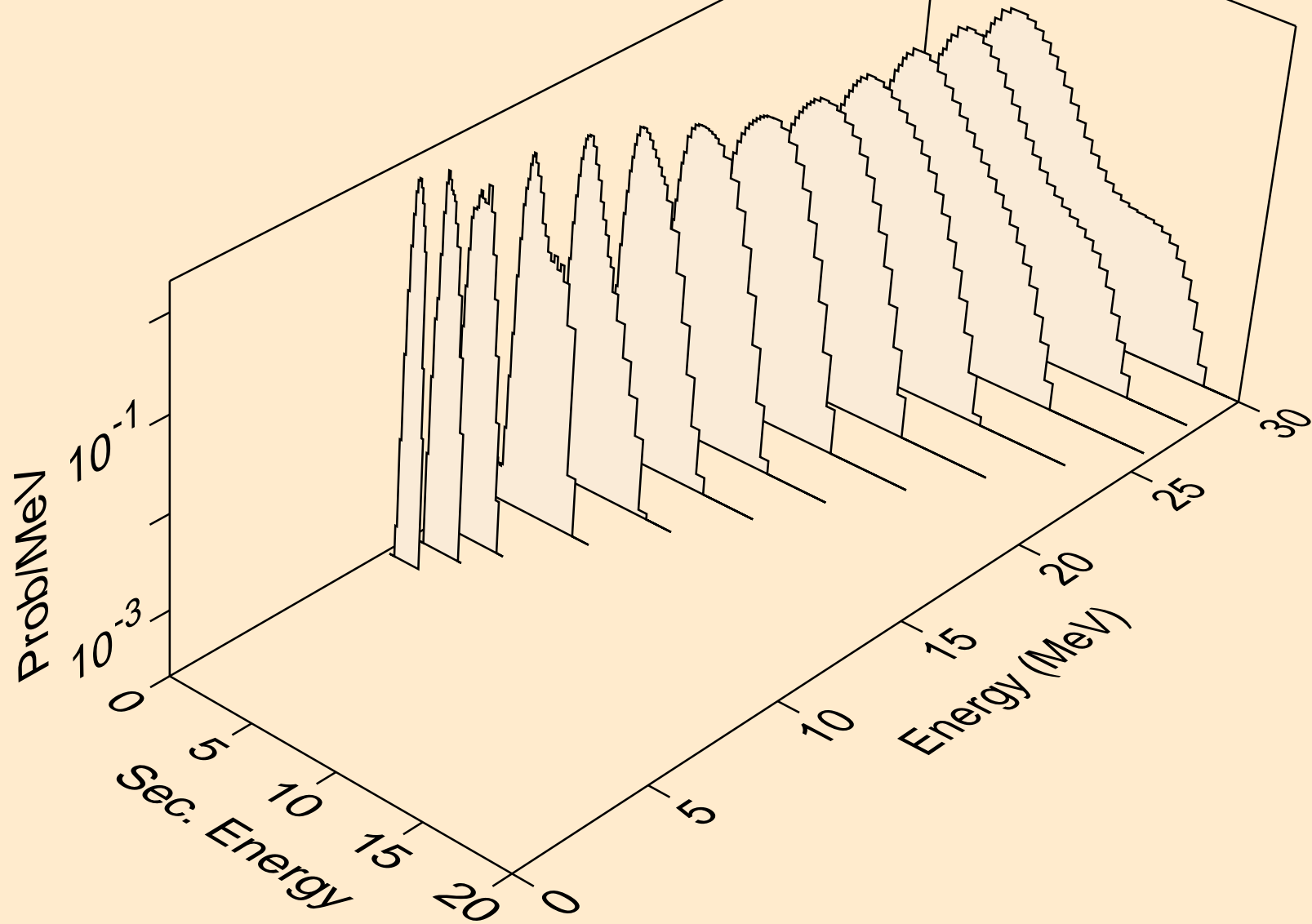

SR078 PROTON ACER TENDL-2021 LIBRARY; T=0.K
Proton emission for (p,pd)

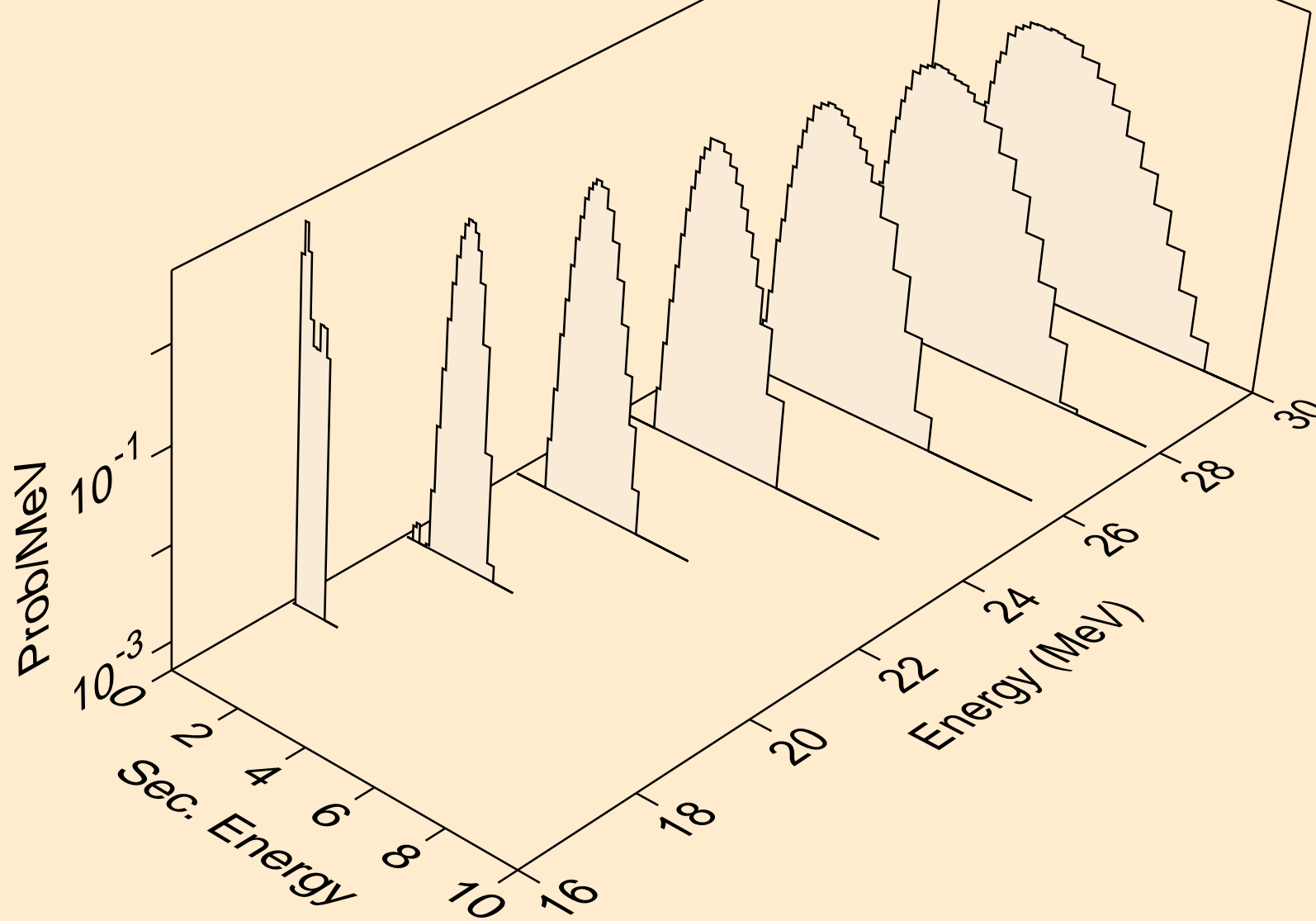

SR078 PROTON ACER TENDL-2021 LIBRARY; T=0.K
Proton emission for (p,pt)

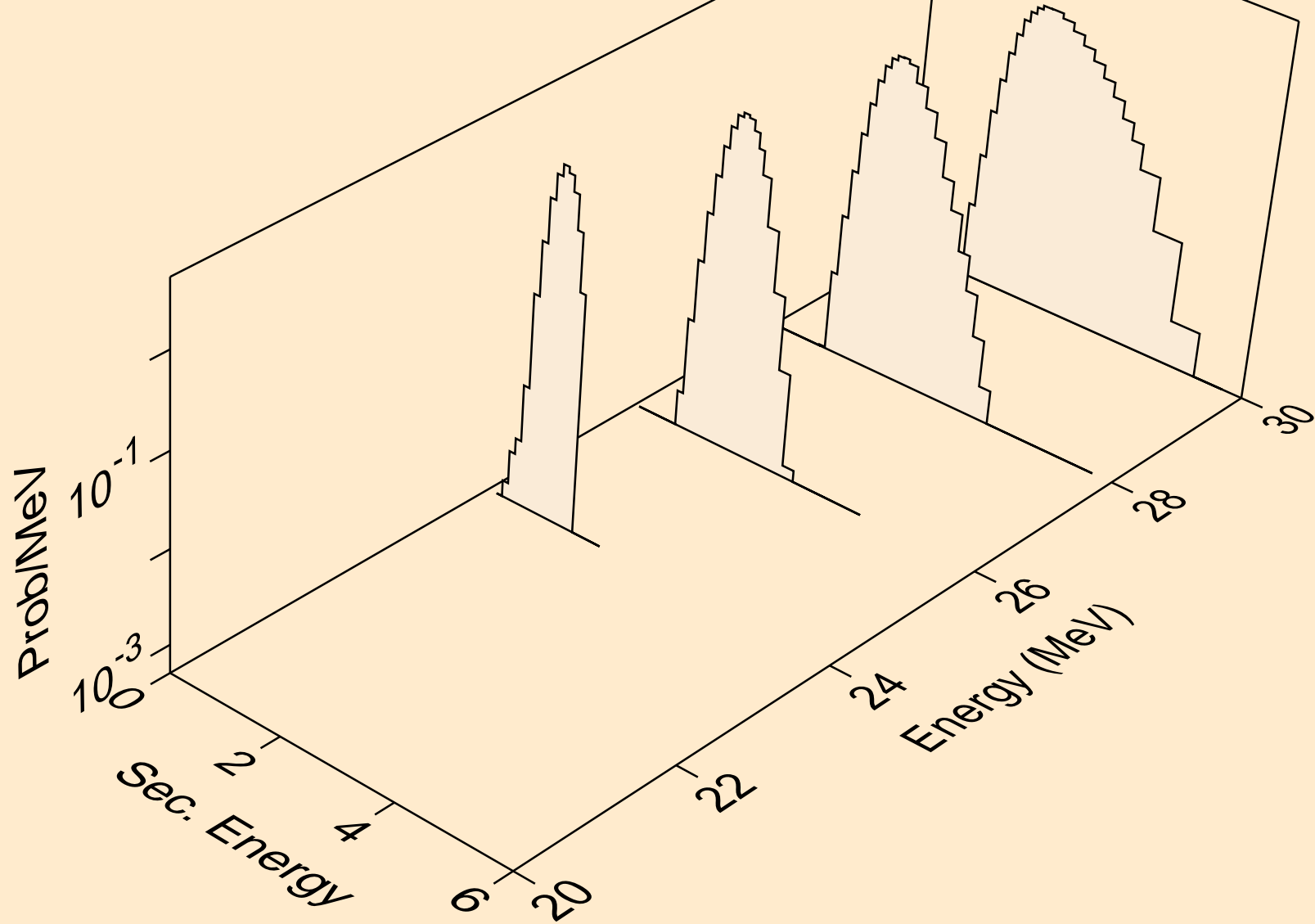

SR078 PROTON ACER TENDL-2021 LIBRARY; T=0.K
Photon emission for (z,n)

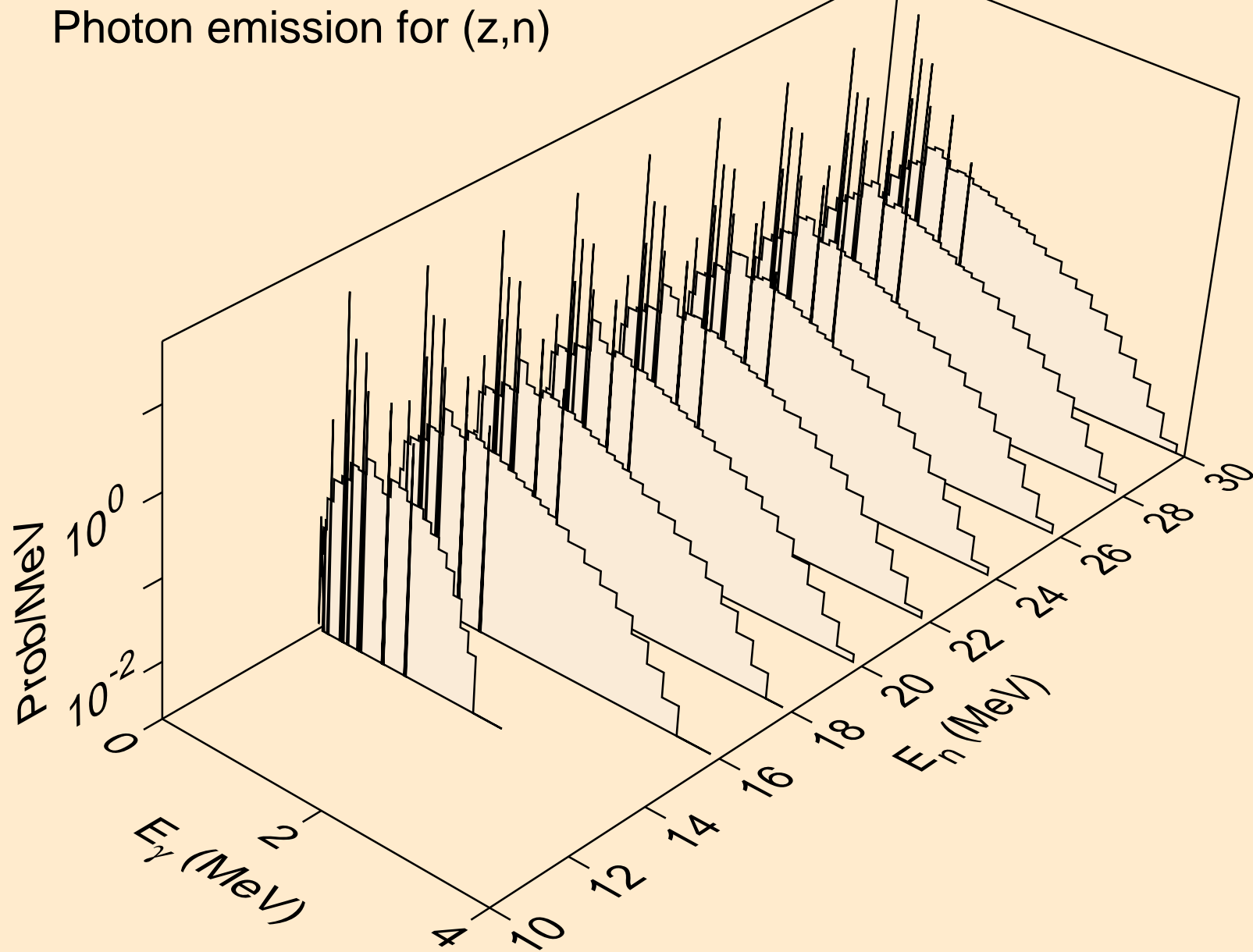

SR078 PROTON ACER TENDL-2021 LIBRARY; T=0.K
Photon emission for (n,x)

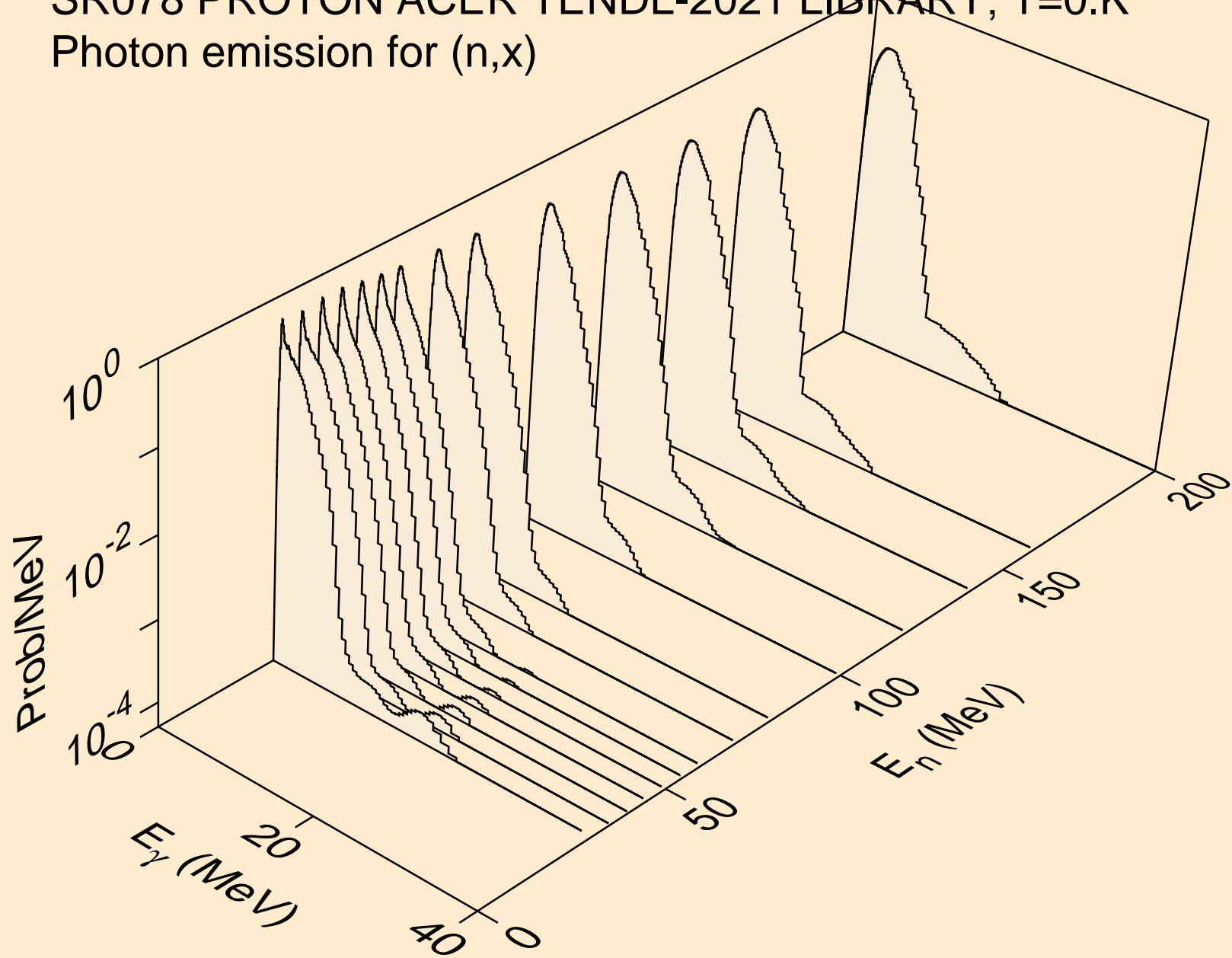

SR078 PROTON ACER TENDL-2021 LIBRARY; T=0.K
Photon emission for (n,2n)

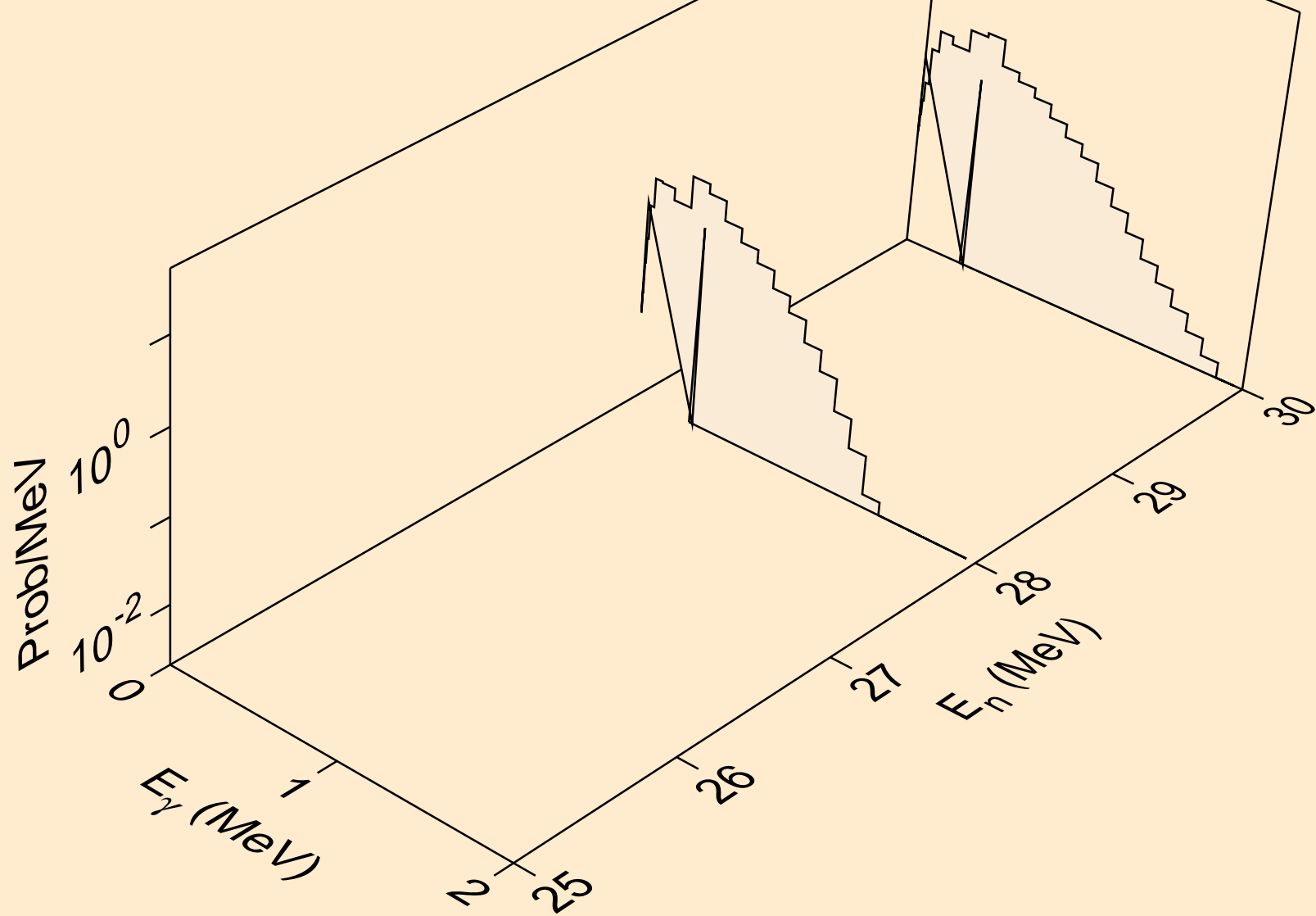

SR078 PROTON ACER TENDL-2021 LIBRARY; T=0.K
Photon emission for (n,n*)a

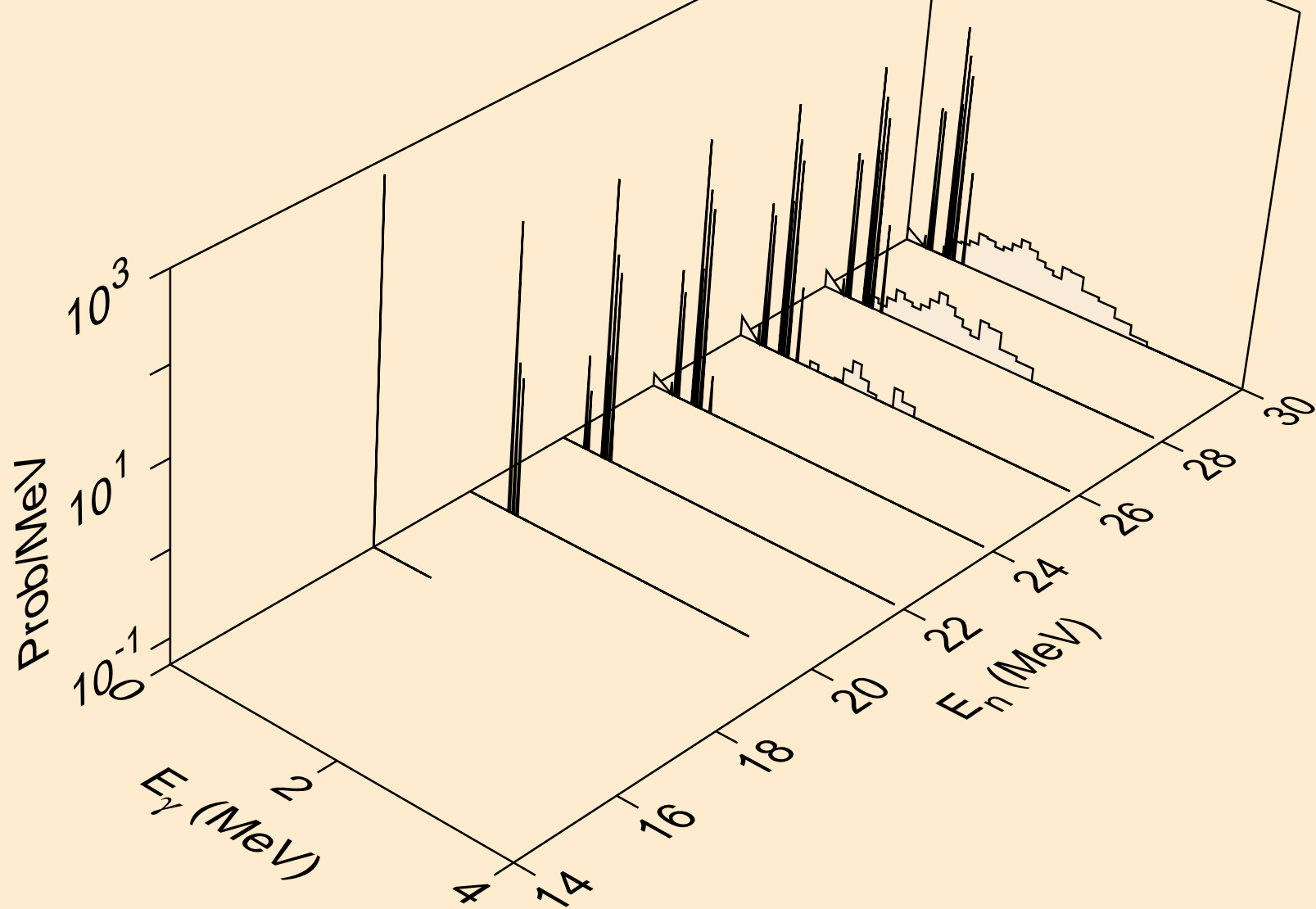

SR078 PROTON ACER TENDL-2021 LIBRARY; T=0.K
Photon emission for (n,n*)p

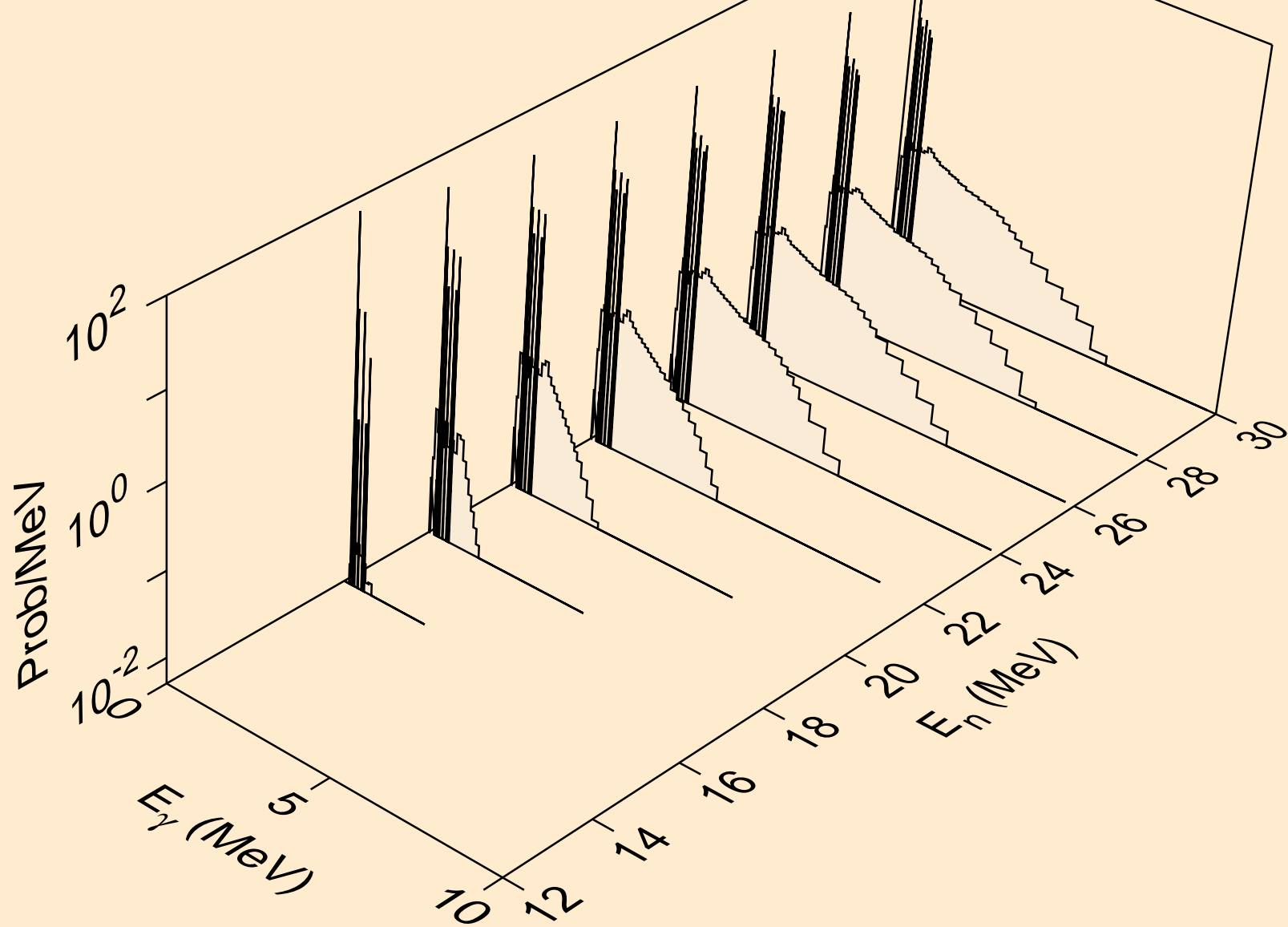

SR078 PROTON ACER TENDL-2021 LIBRARY; T=0.K
Photon emission for (n,n*)d

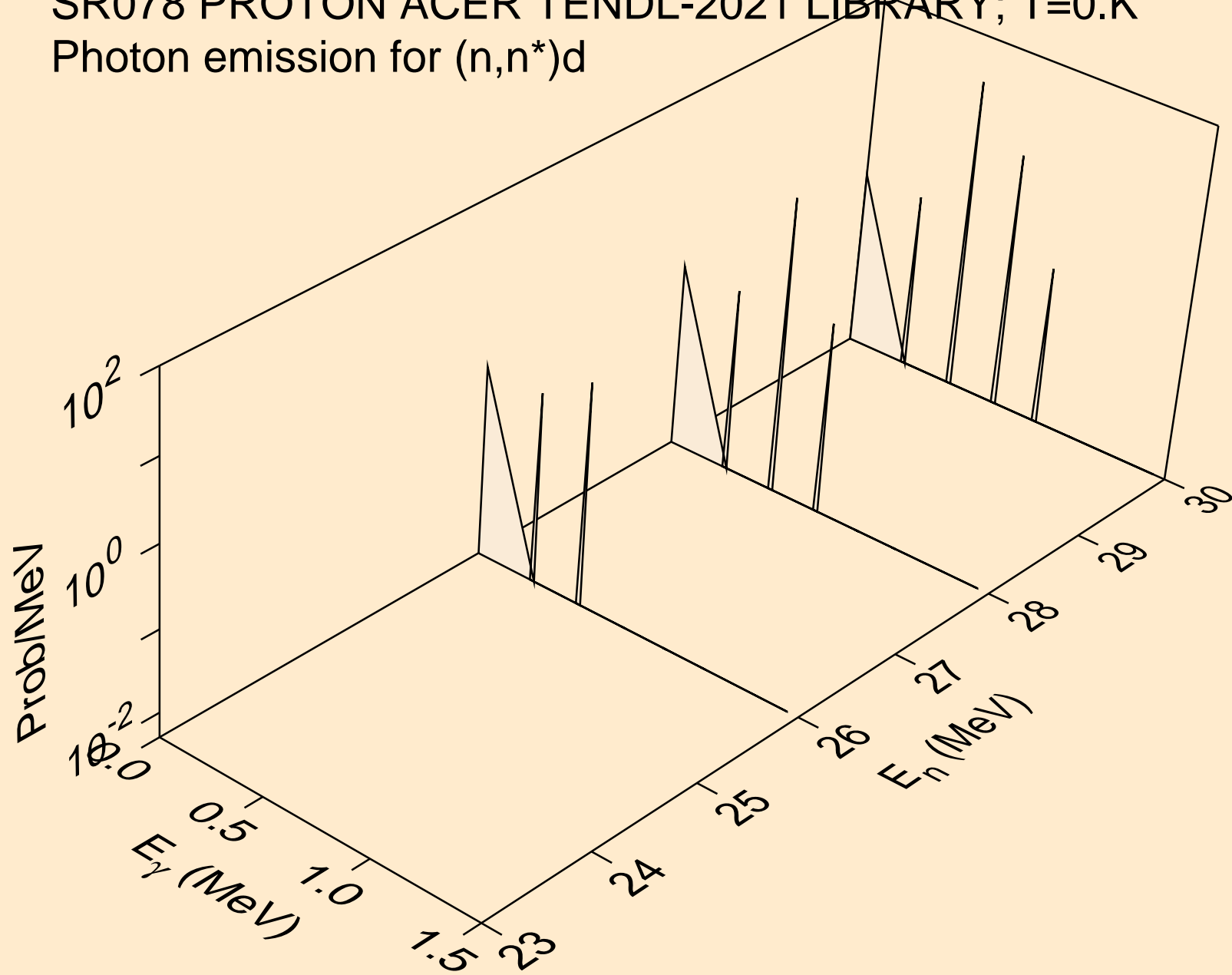

SR078 PROTON ACER TENDL-2021 LIBRARY; T=0.K
Photon emission for (n,n*)he3

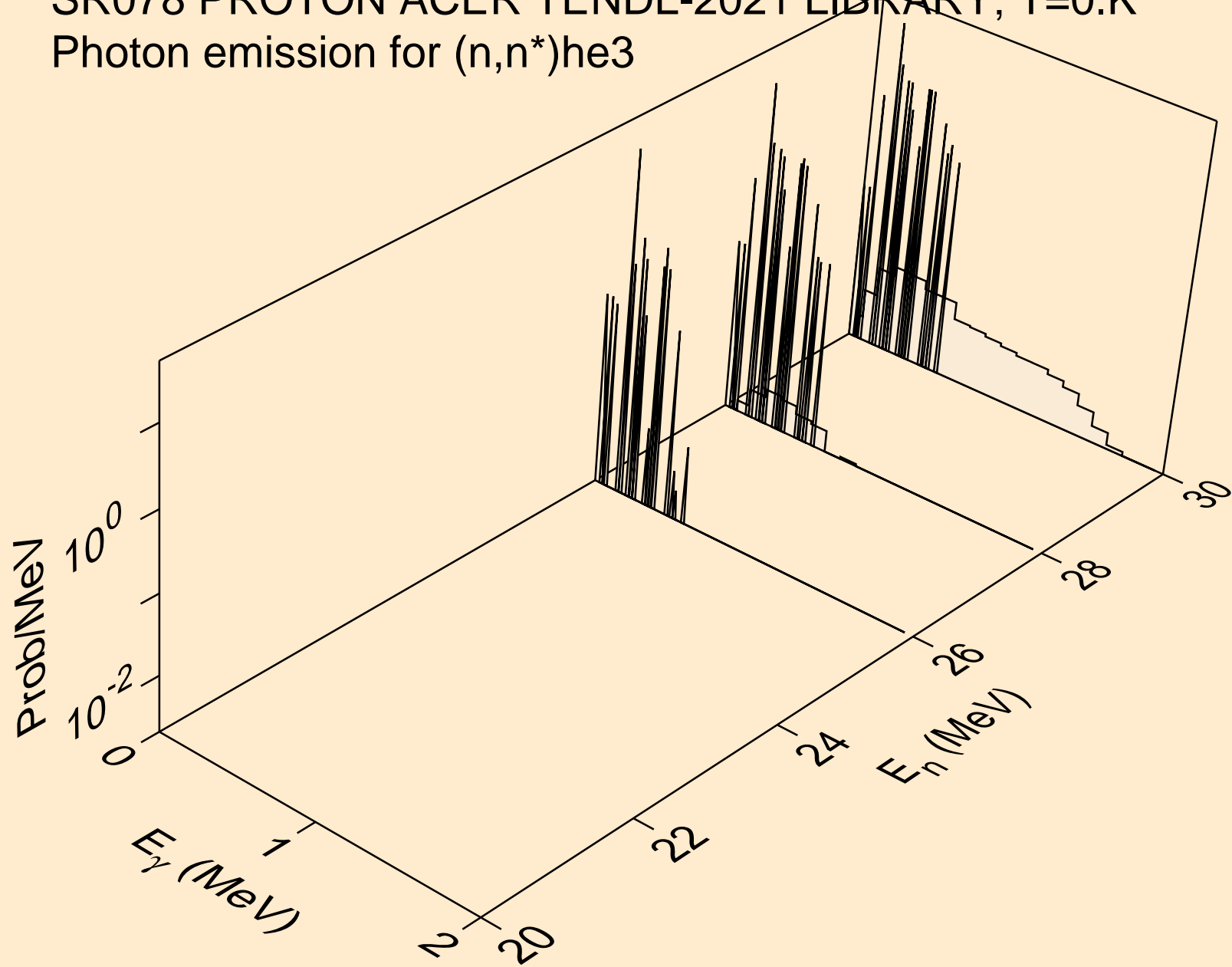

SR078 PROTON ACER TENDL-2021 LIBRARY; T=0.K
Photon emission for (n,2np)

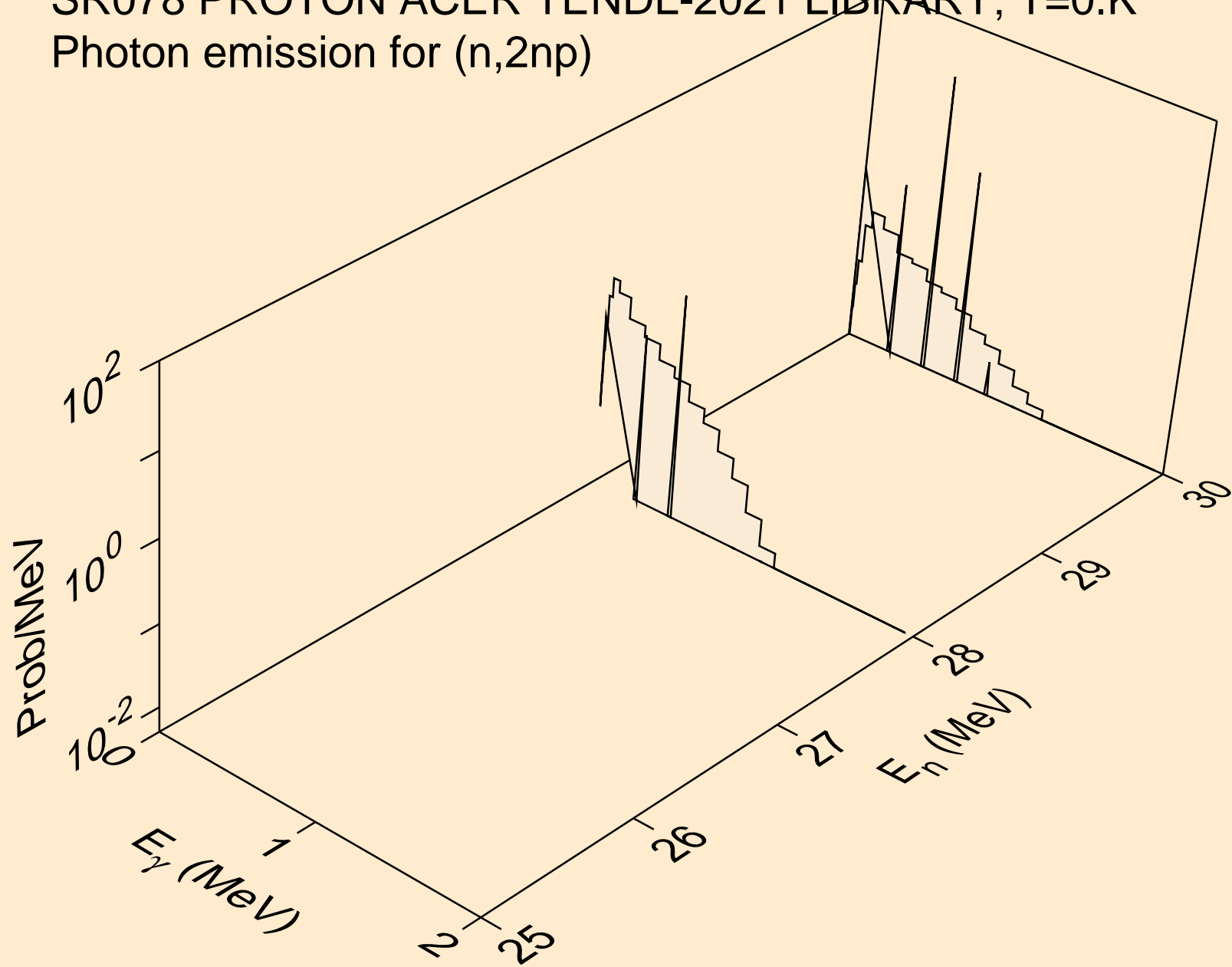

SR078 PROTON ACER TENDL-2021 LIBRARY; T=0.K
Photon emission for (n,2np)

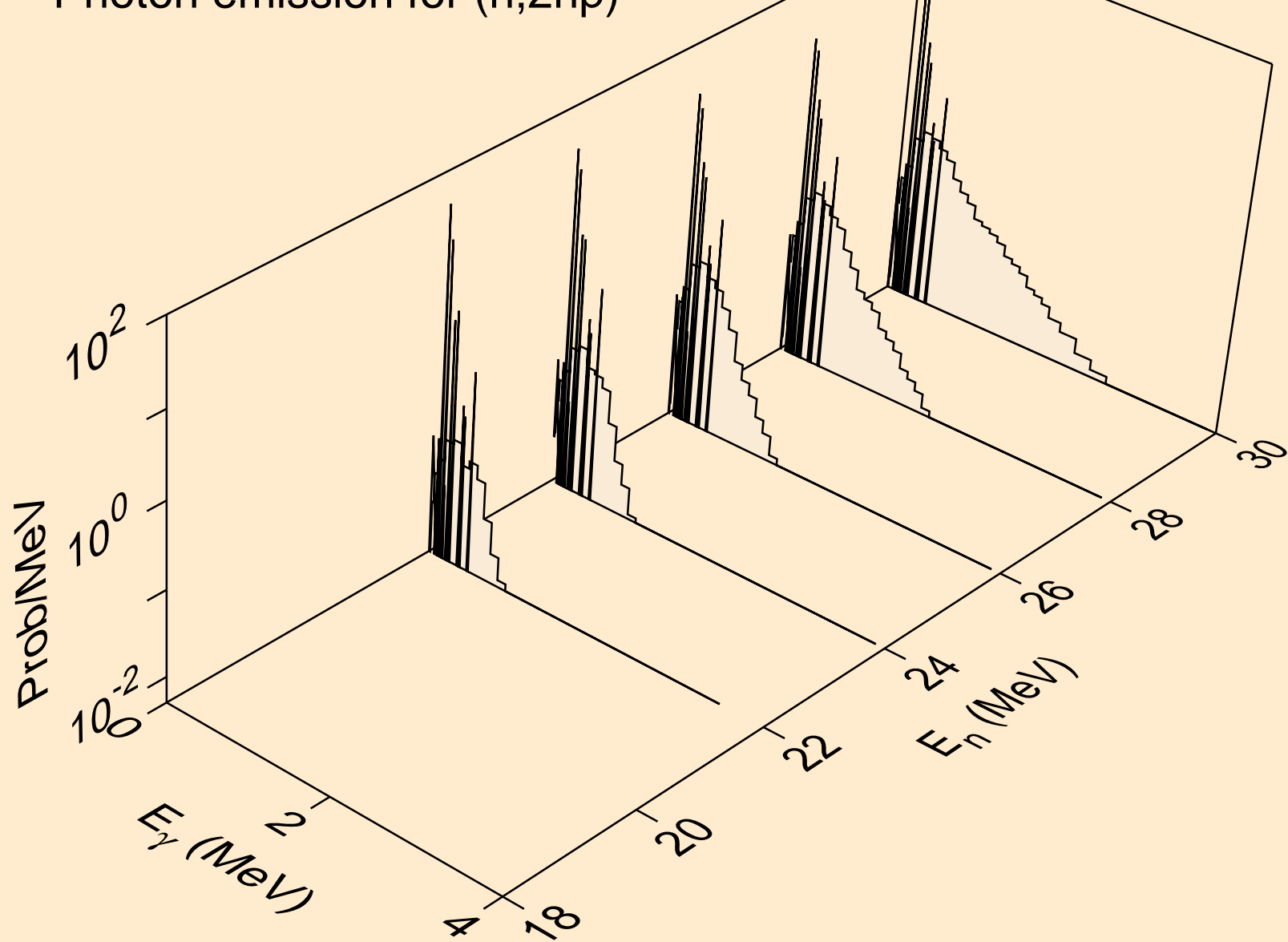

SR078 PROTON ACER TENDL-2021 LIBRARY; T=0.K
Photon emission for (n,npa)

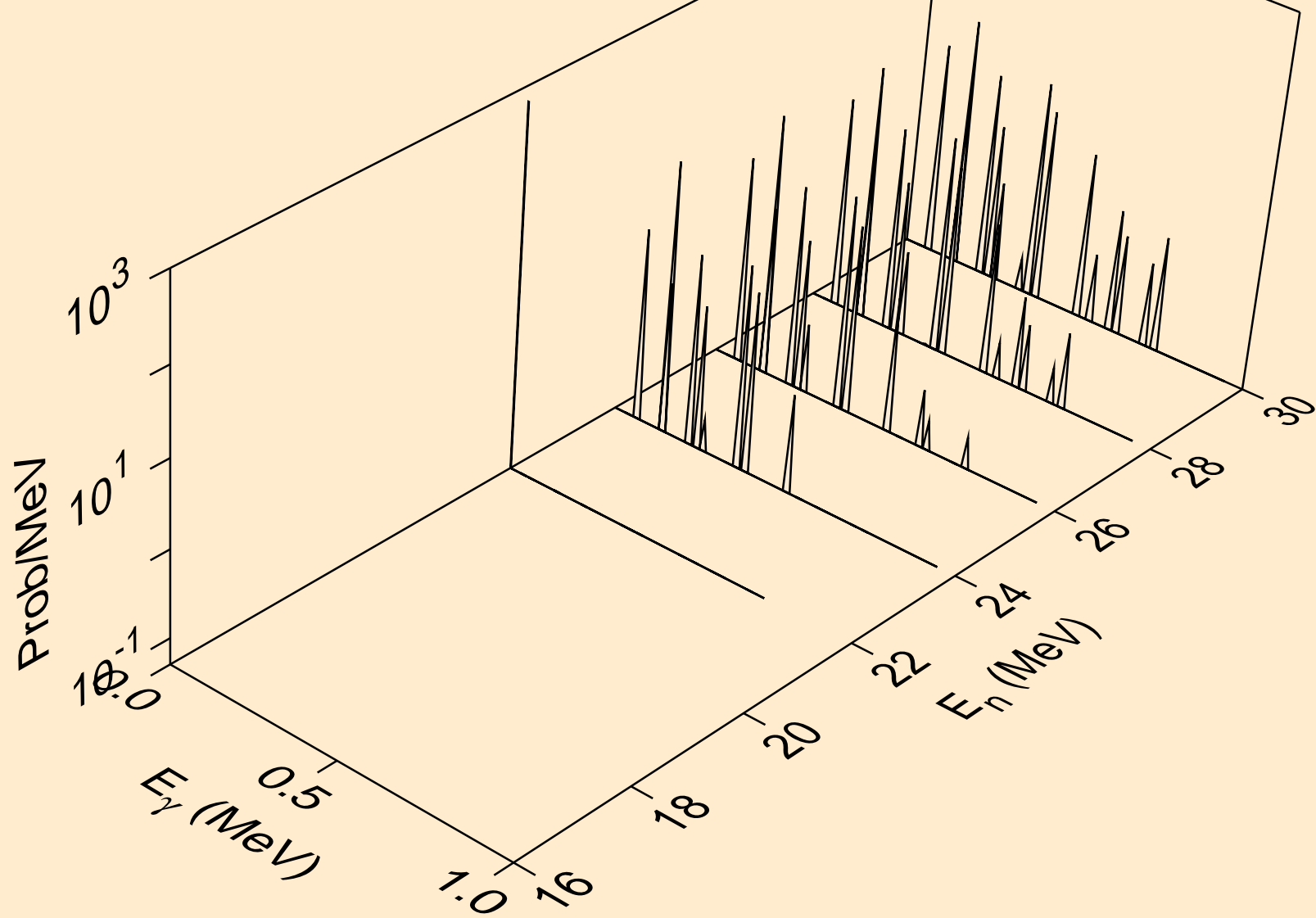

SR078 PROTON ACER TENDL-2021 LIBRARY; T=0.K
Photon emission for (n,gma)

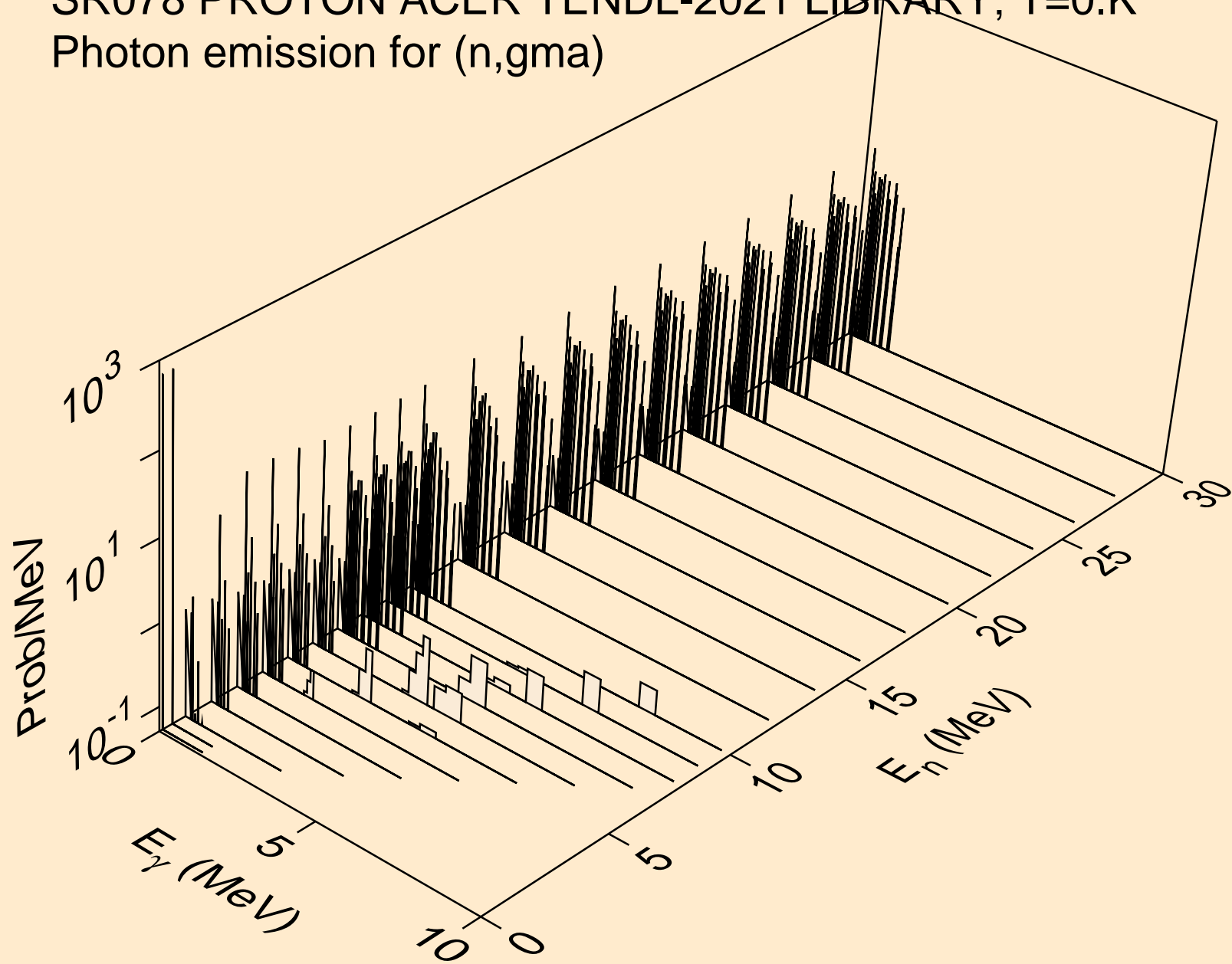

SR078 PROTON ACER TENDL-2021 LIBRARY; T=0.K
Photon emission for inelastic

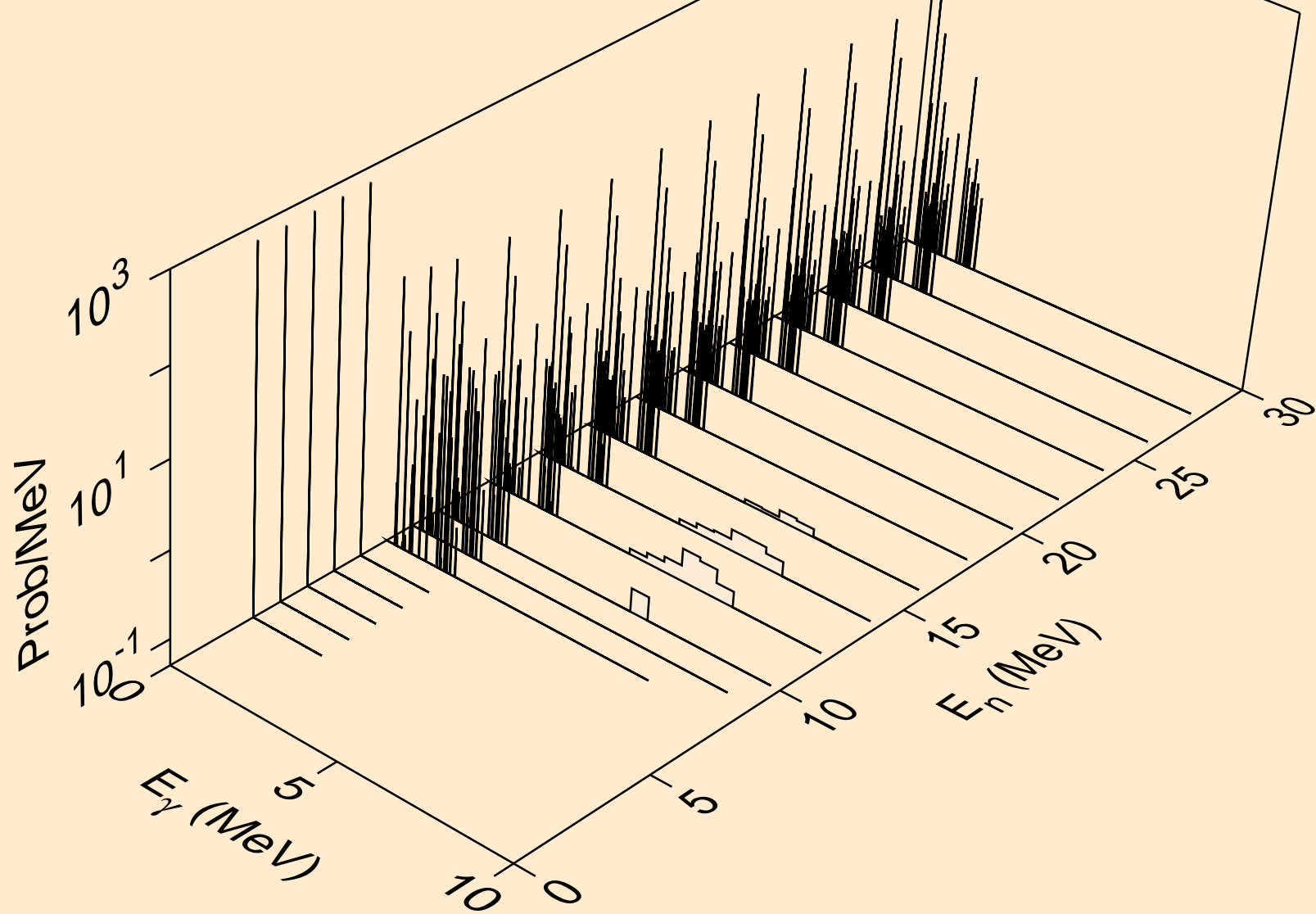

SR078 PROTON ACER TENDL-2021 LIBRARY; T=0.K
Photon emission for (n,d)

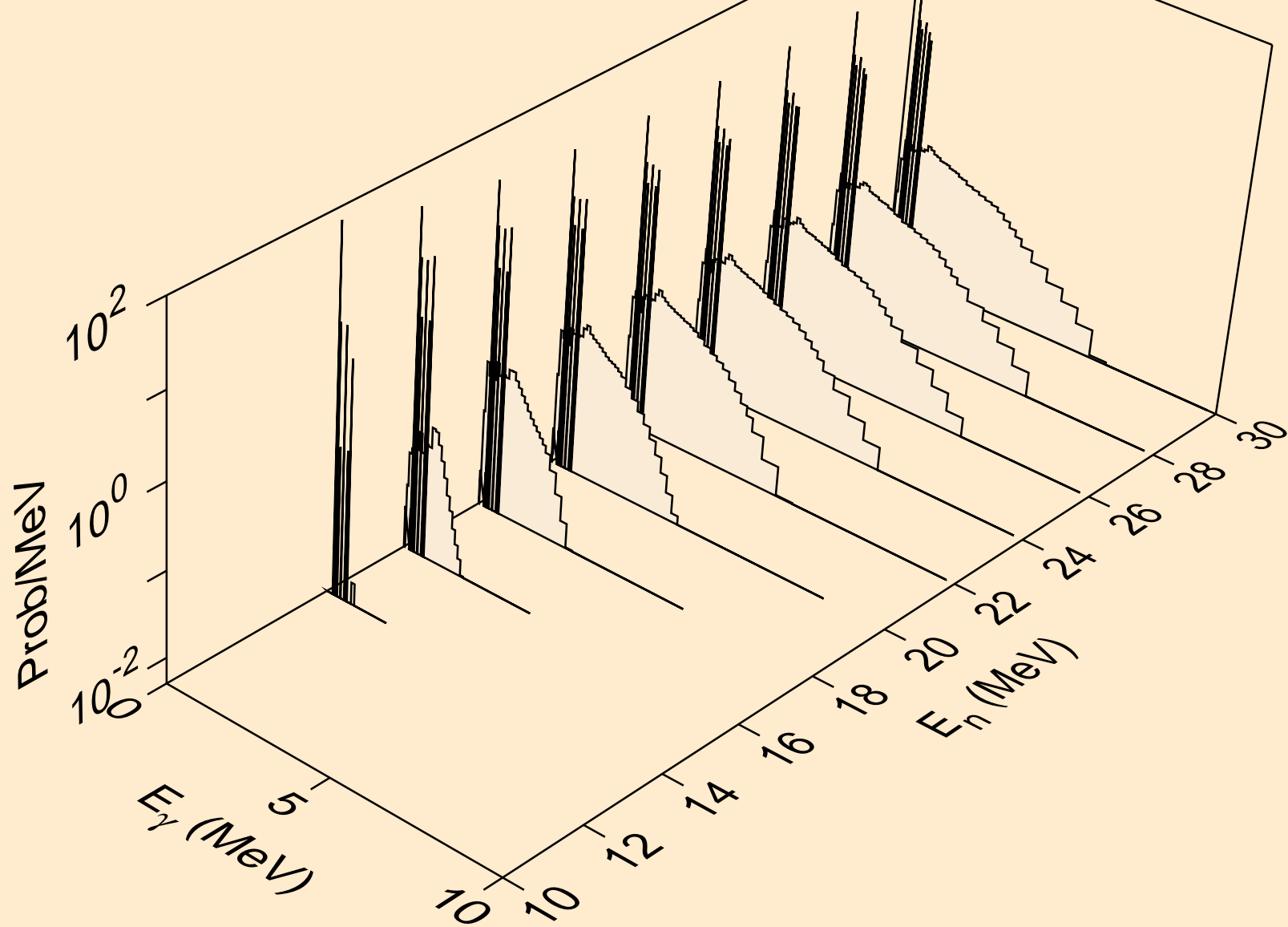

SR078 PROTON ACER TENDL-2021 LIBRARY; T=0.K
Photon emission for (n,t)

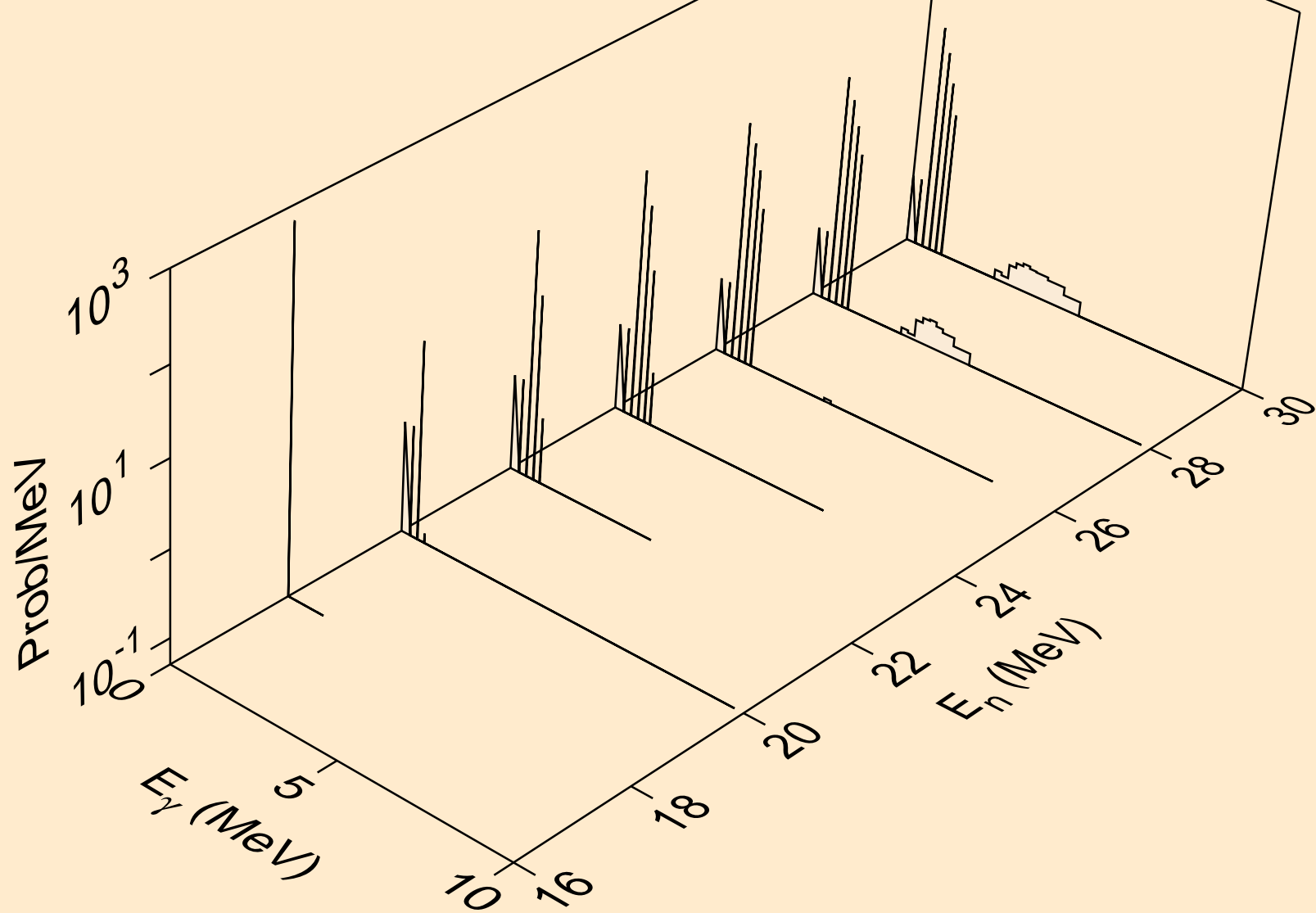

SR078 PROTON ACER TENDL-2021 LIBRARY; T=0.K
Photon emission for (n,he3)

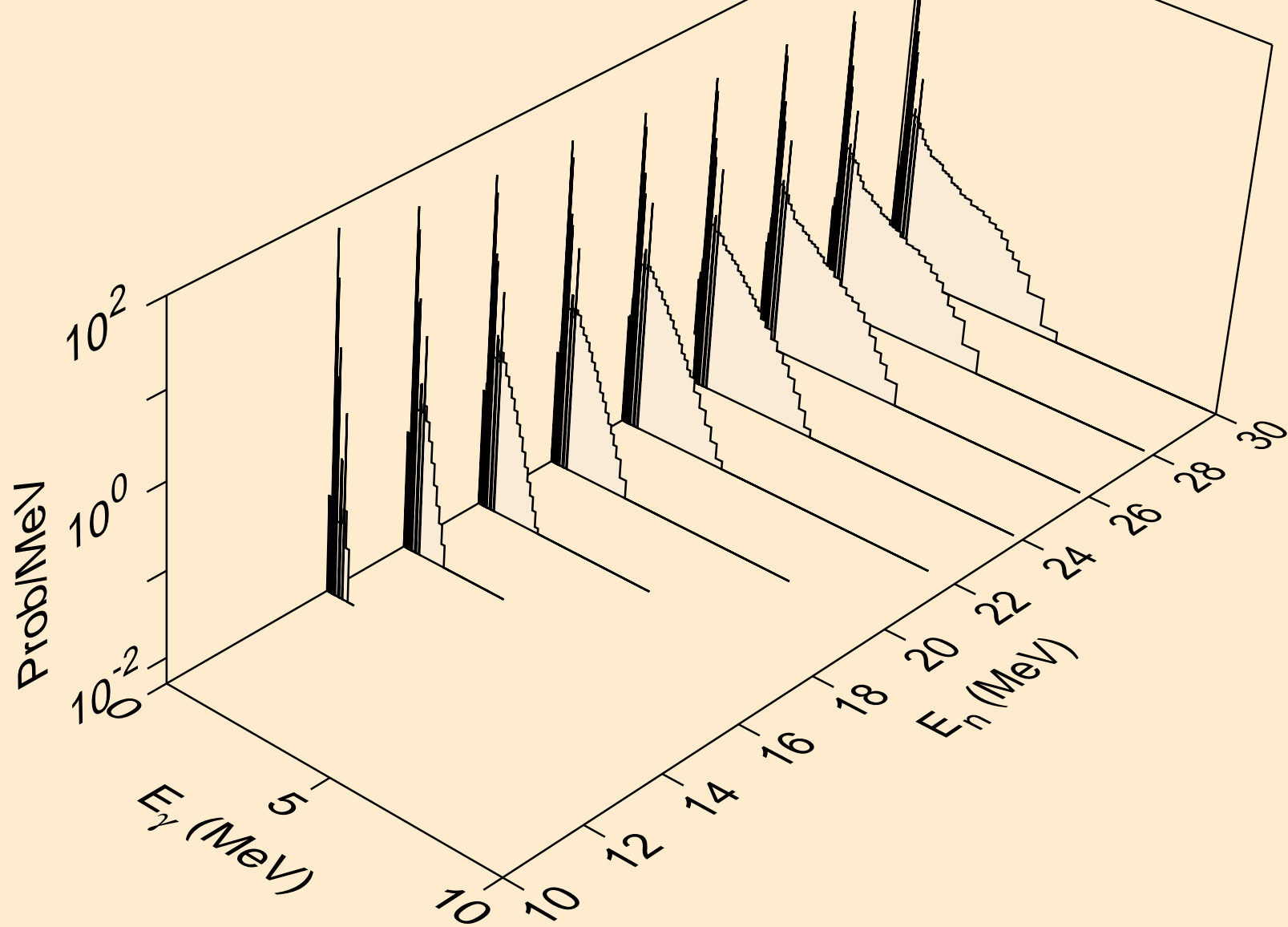

SR078 PROTON ACER TENDL-2021 LIBRARY; T=0.K
Photon emission for (n,a)

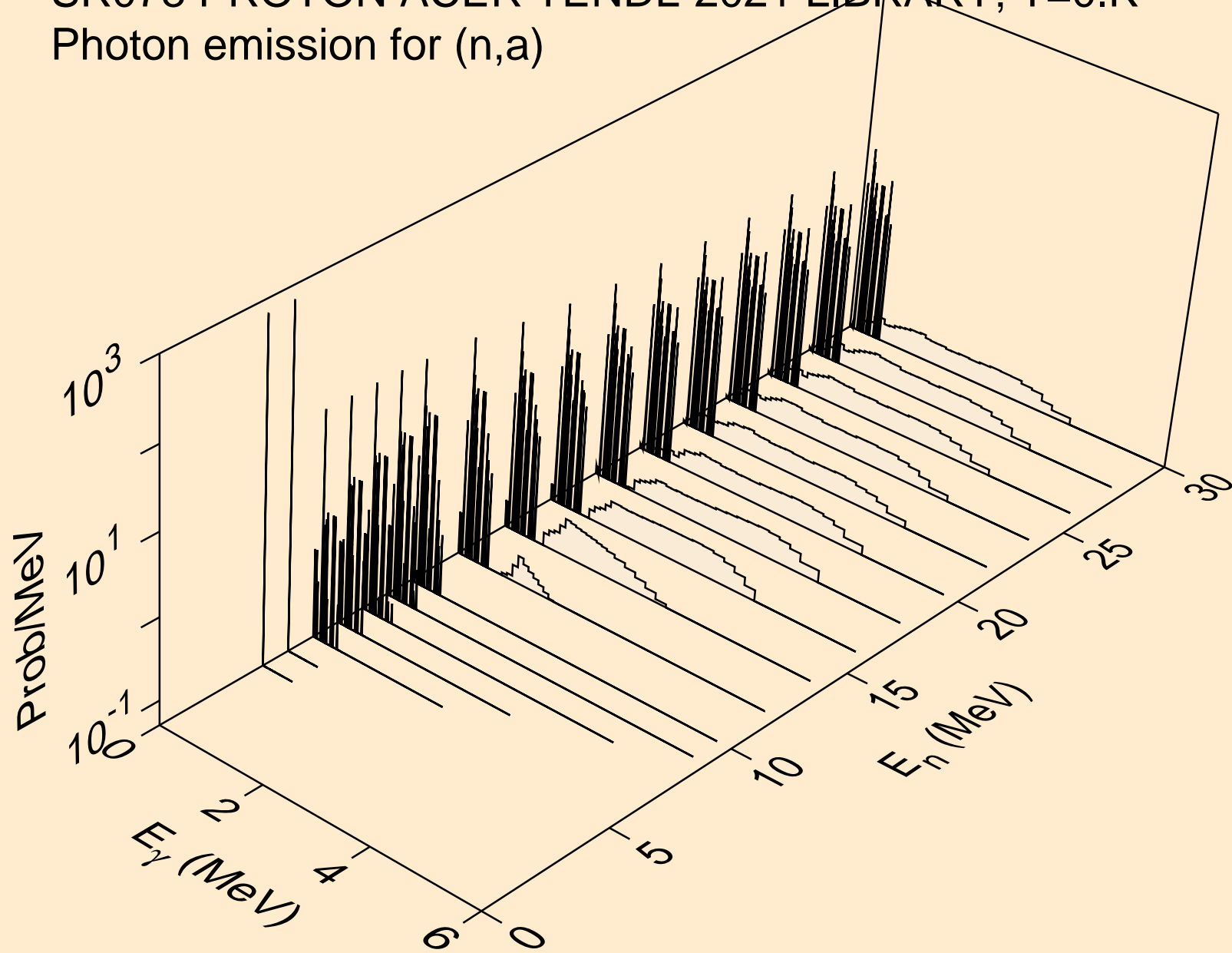

SR078 PROTON ACER TENDL-2021 LIBRARY; T=0.K
Photon emission for (n,2a)

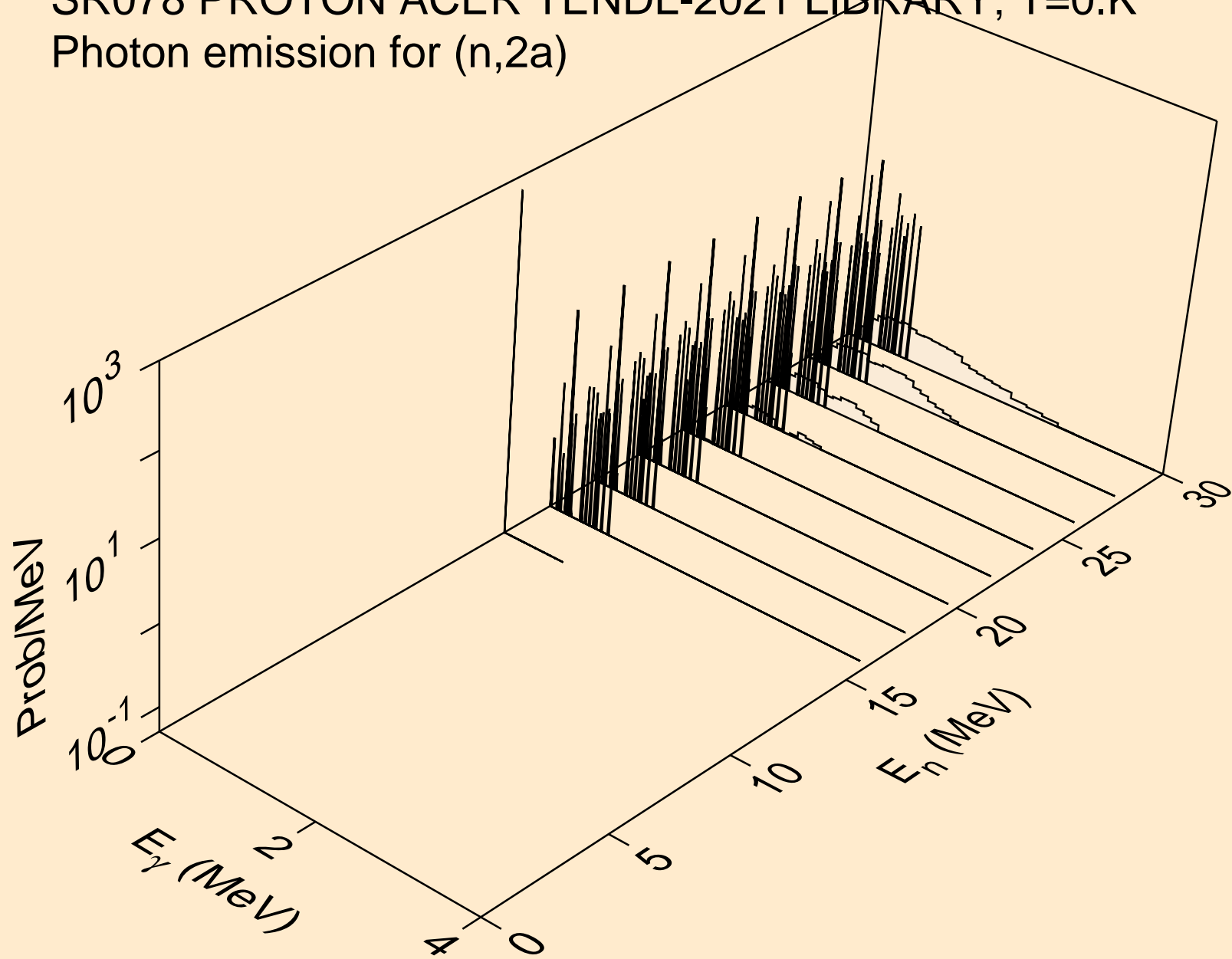

SR078 PROTON ACER TENDL-2021 LIBRARY; T=0.K
Photon emission for (n,2p)

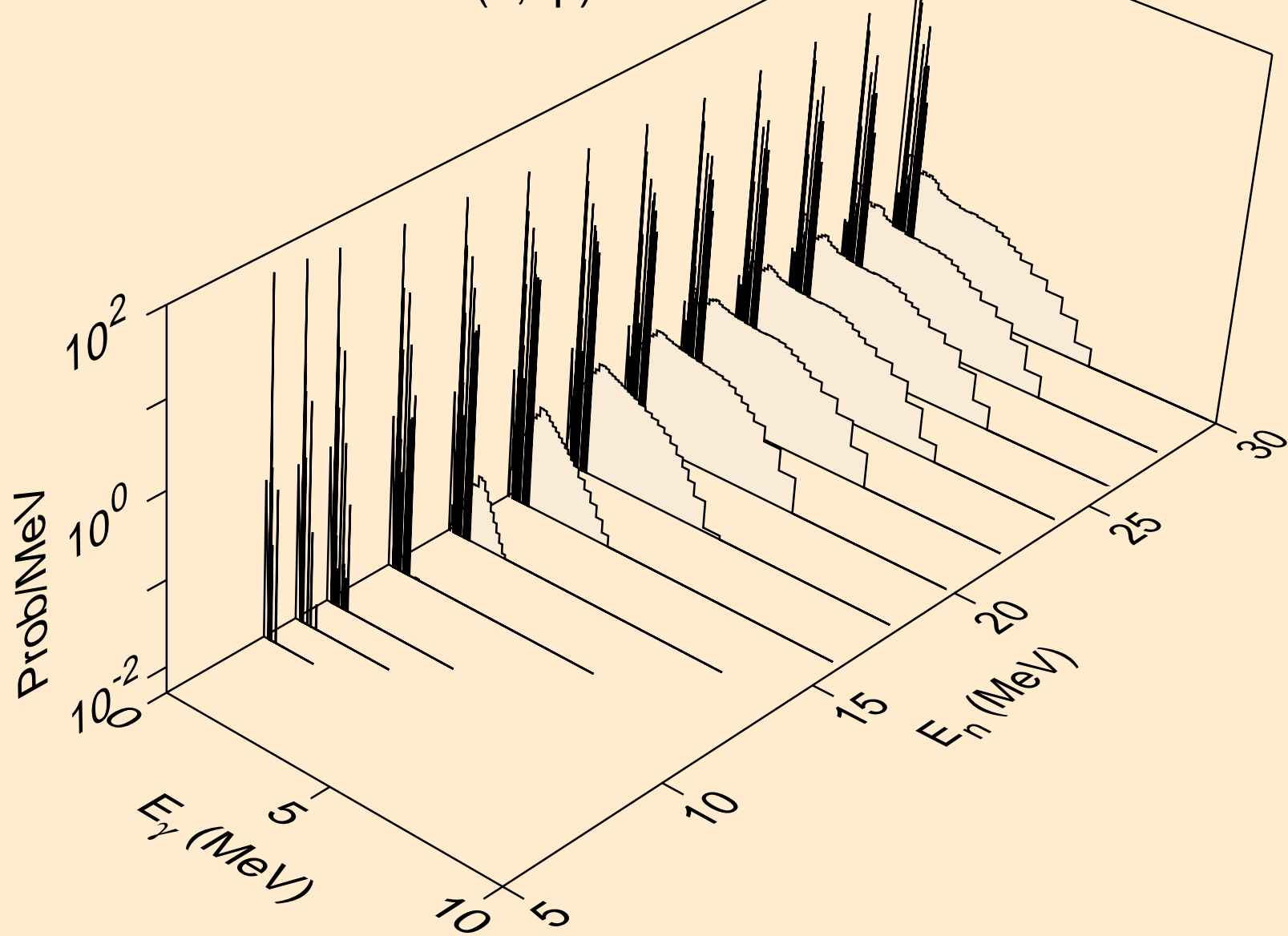

SR078 PROTON ACER TENDL-2021 LIBRARY; T=0.K
Photon emission for (n,pa)

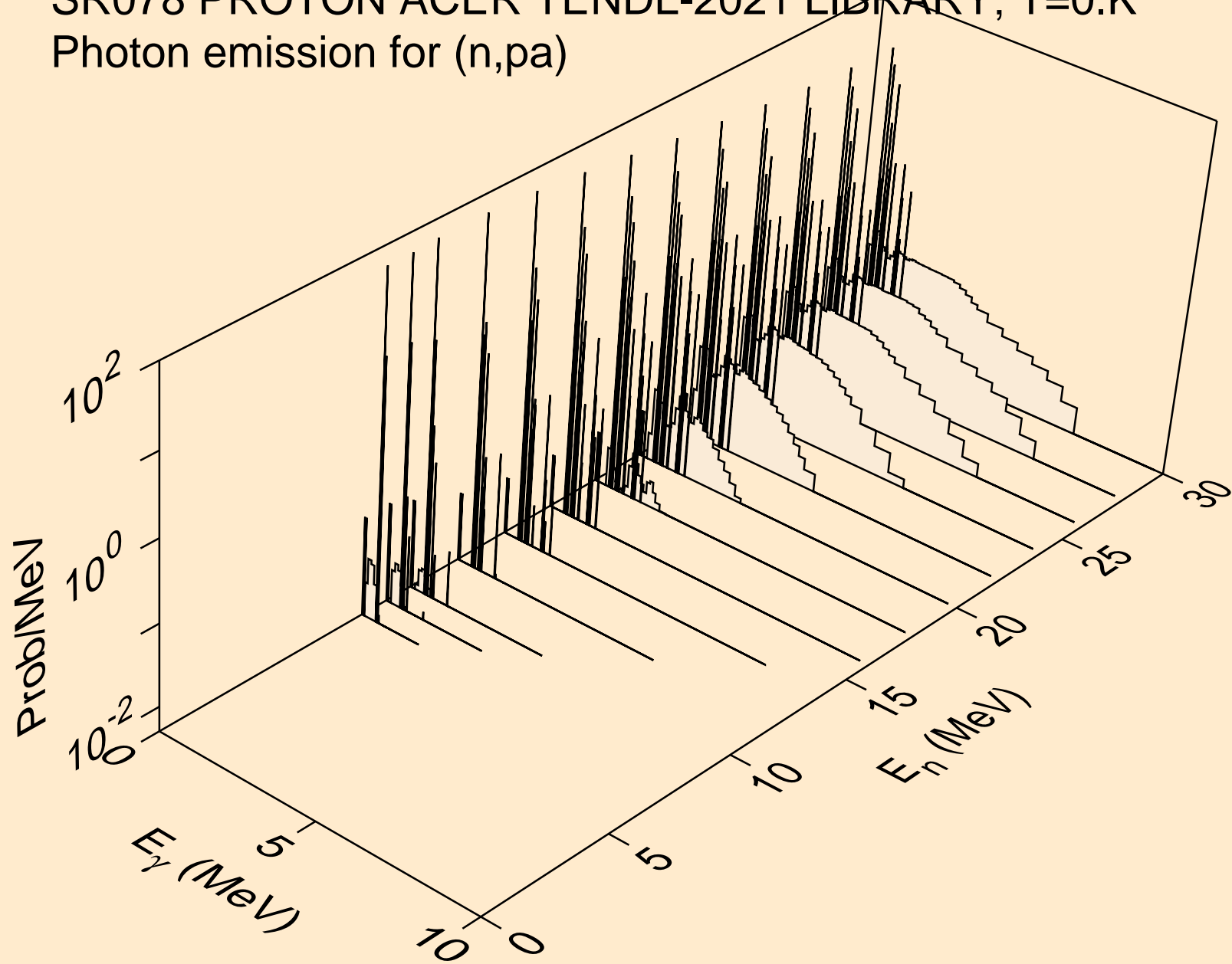

SR078 PROTON ACER TENDL-2021 LIBRARY; T=0.K
Photon emission for (n,pd)

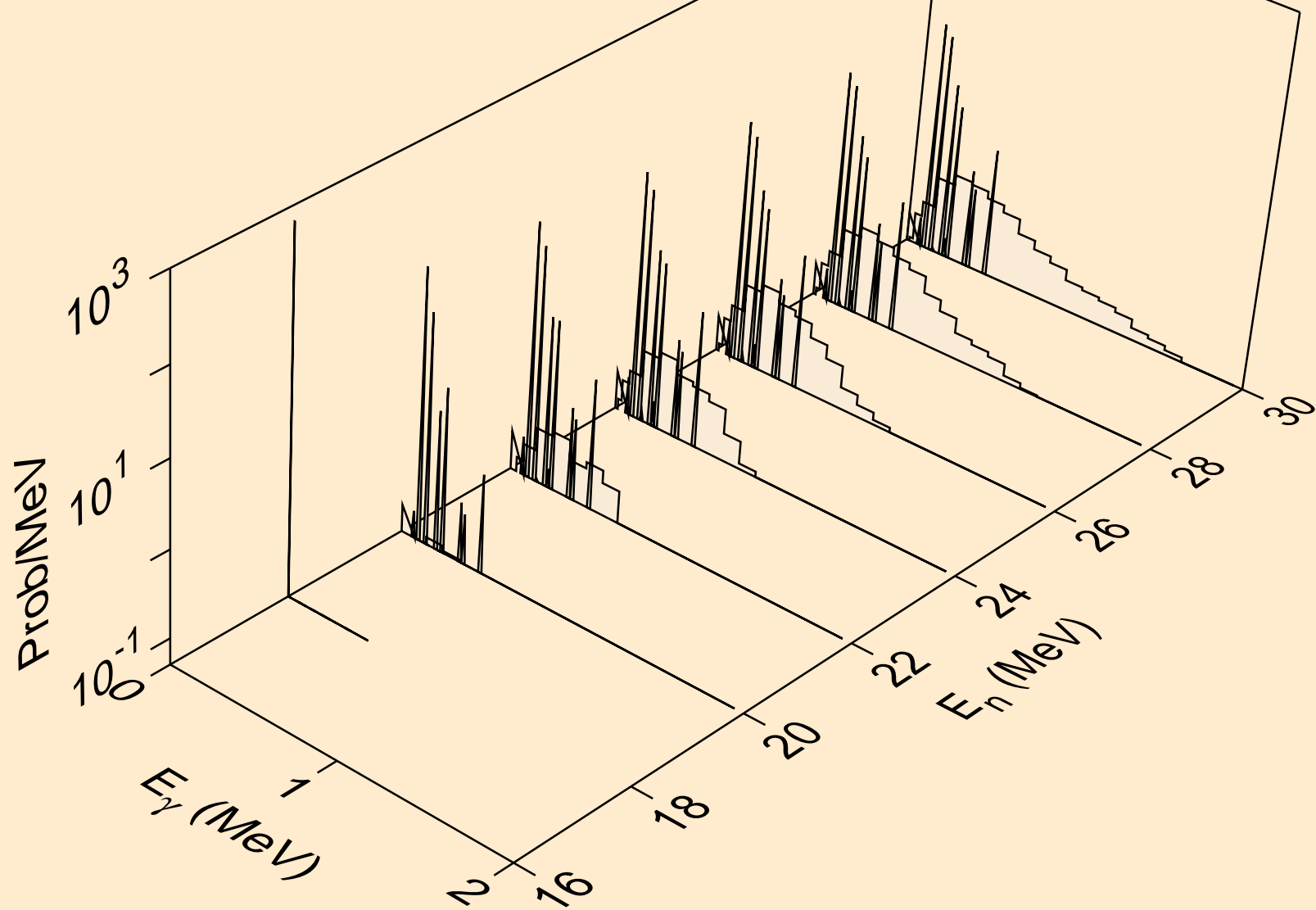

SR078 PROTON ACER TENDL-2021 LIBRARY; T=0.K
Photon emission for (n,pt)

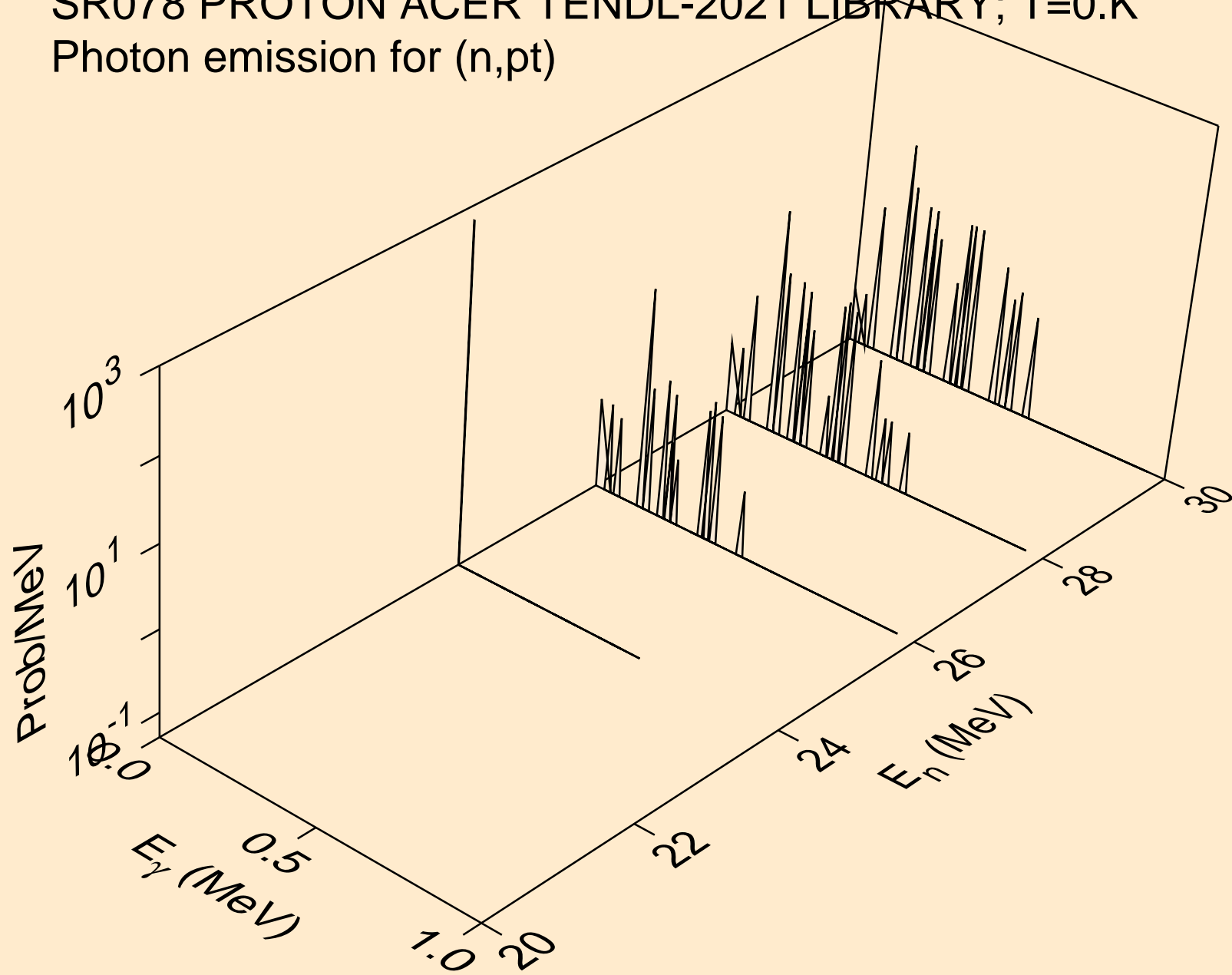

SR078 PROTON ACER TENDL-2021 LIBRARY; T=0.K
Photon emission for (n,da)

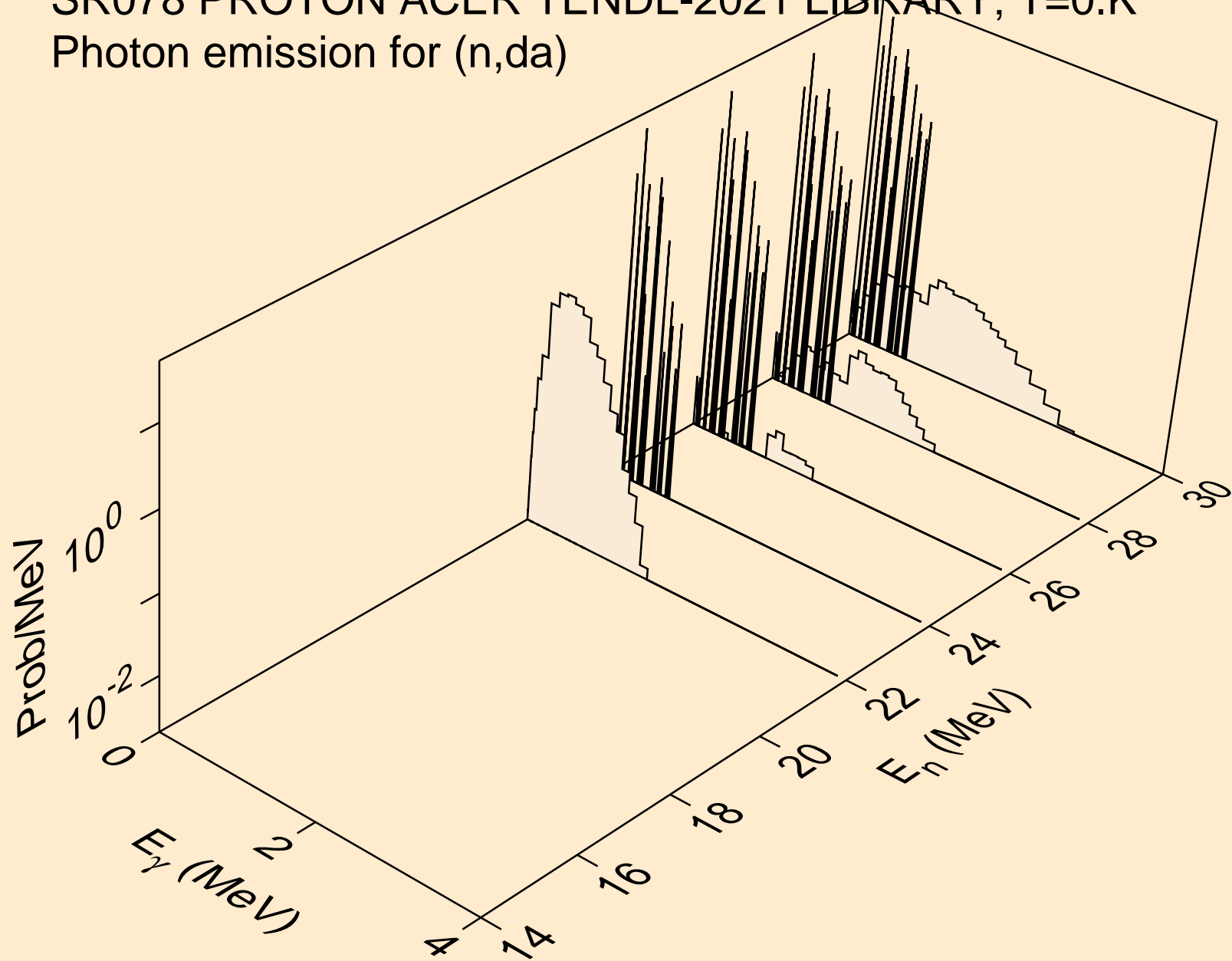

SR078 PROTON ACER TENDL-2021 LIBRARY; T=0.K
Particle heating contributions

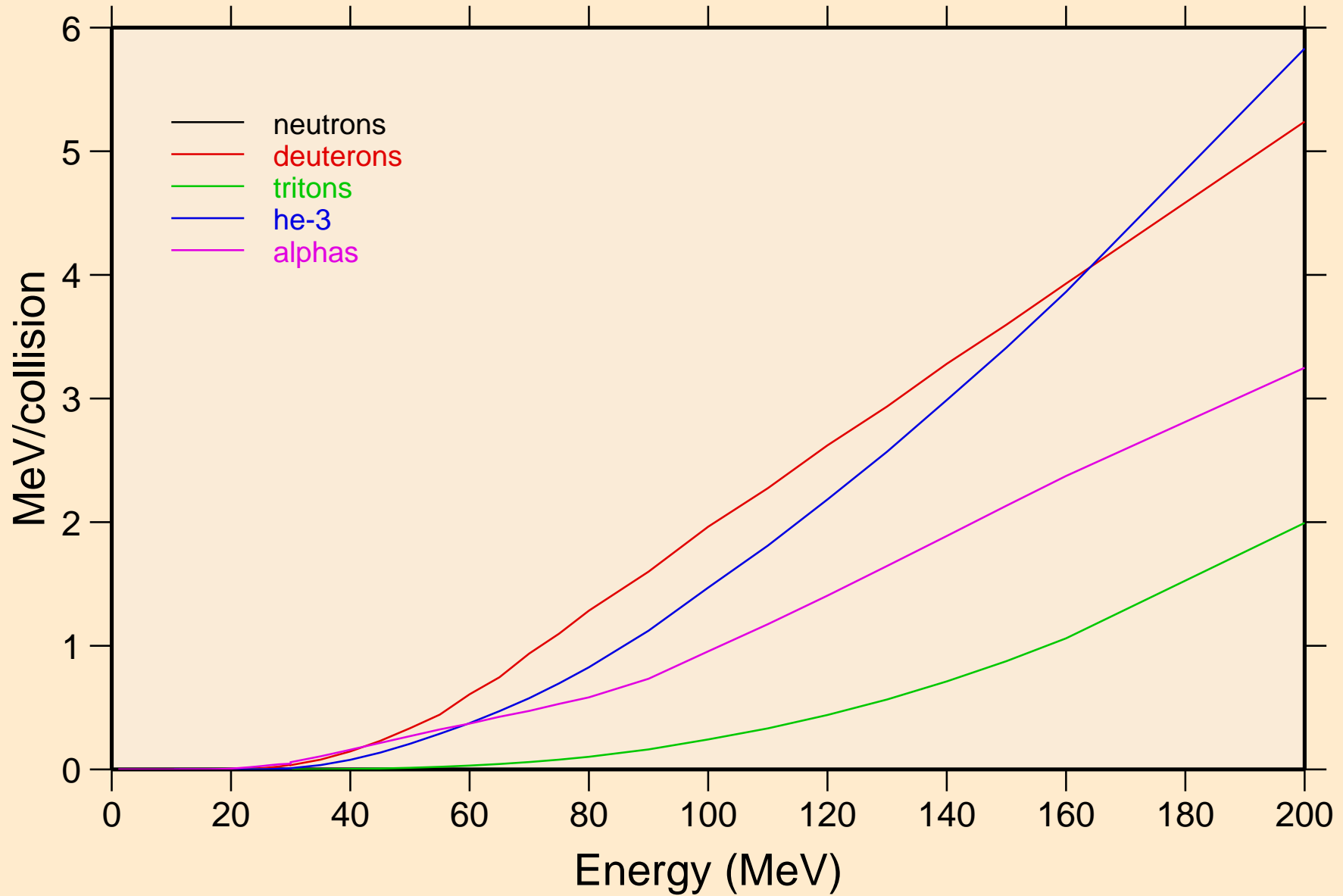

SR078 PROTON ACER TENDL-2021 LIBRARY; T=0.K

Recoil Heating

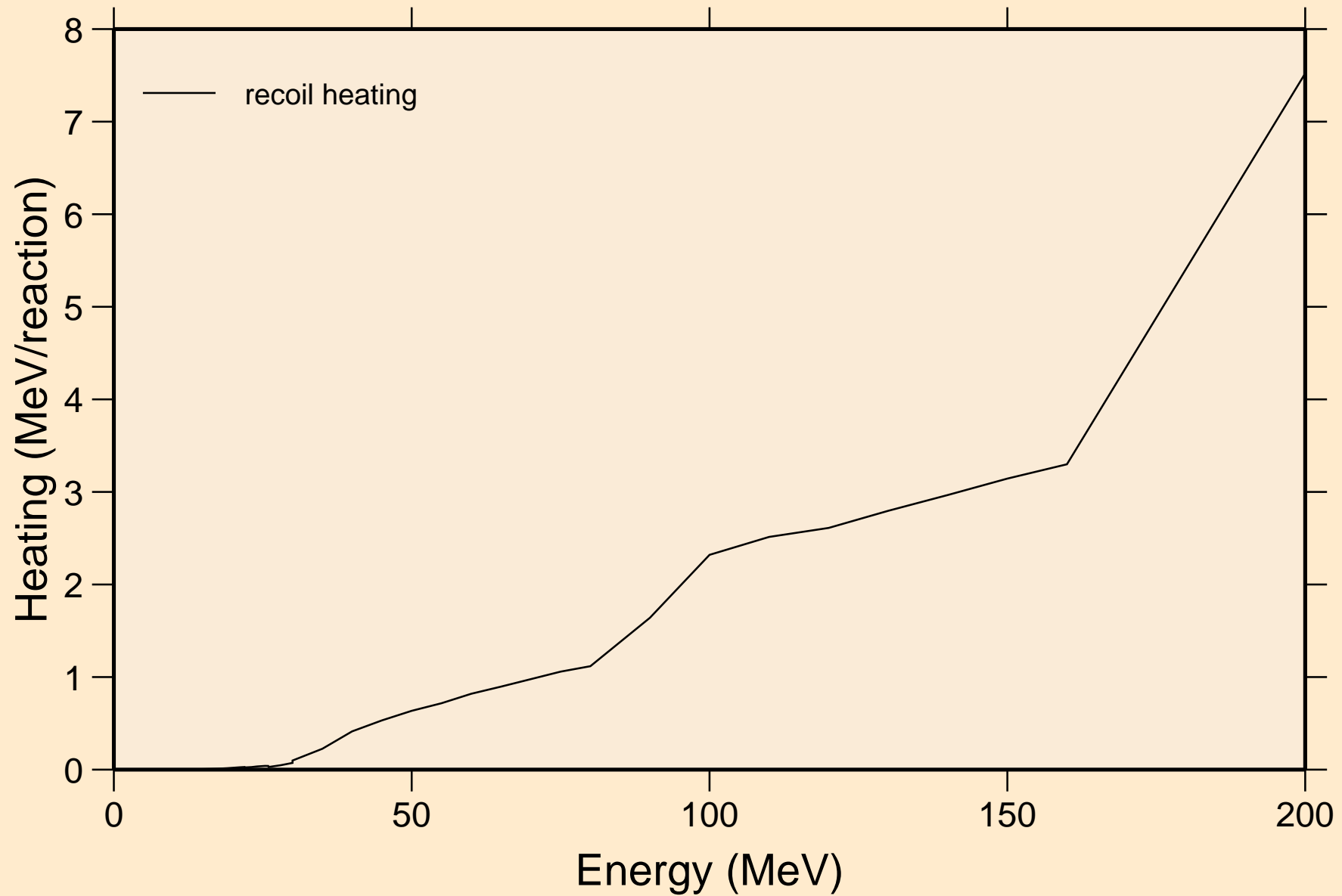

SR078 PROTON ACER TENDL-2021 LIBRARY; T=0.K

Particle production cross sections

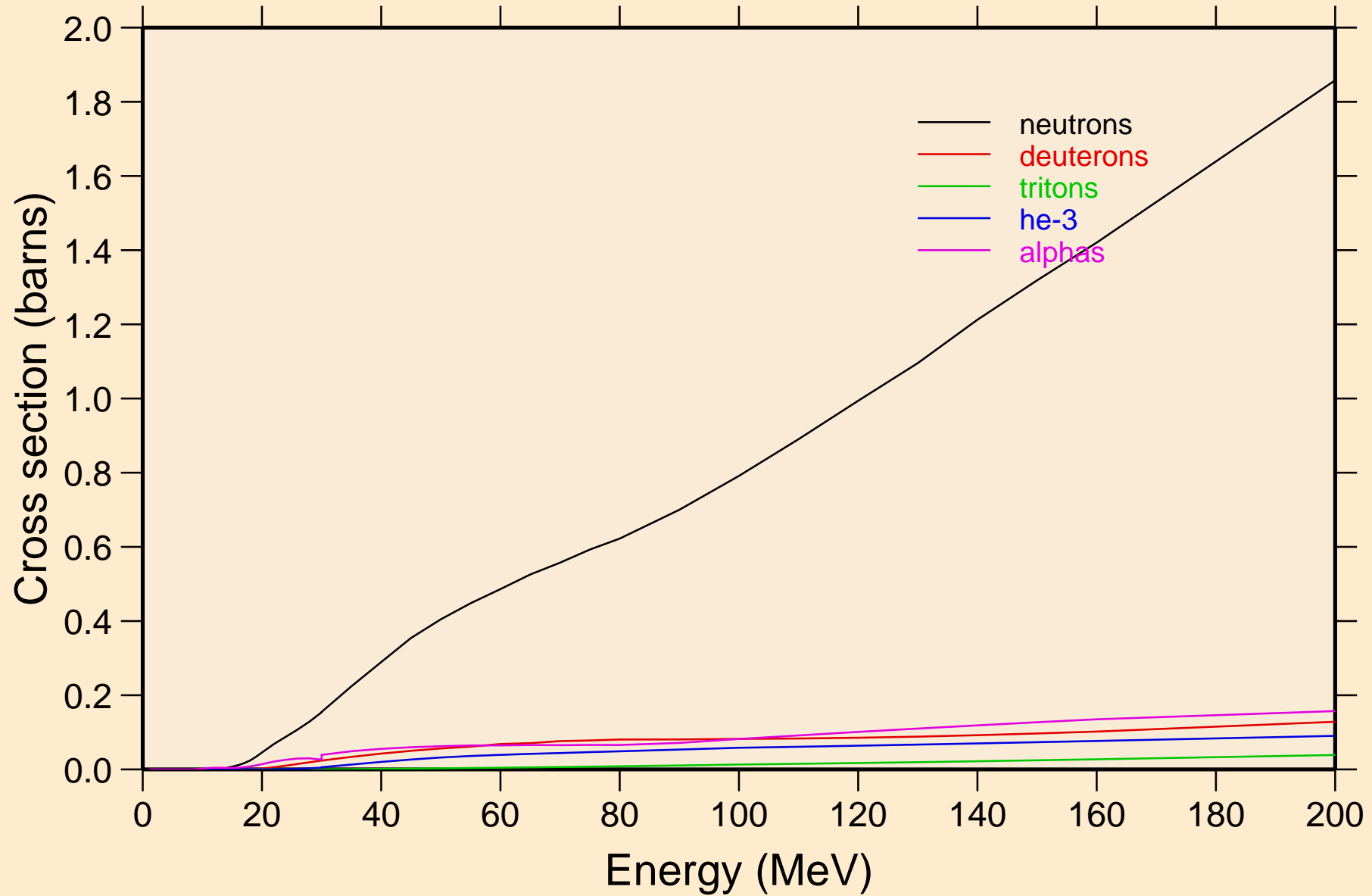

SR078 PROTON ACER TENDL-2021 LIBRARY; T=0.K
neutrons from (p,n)

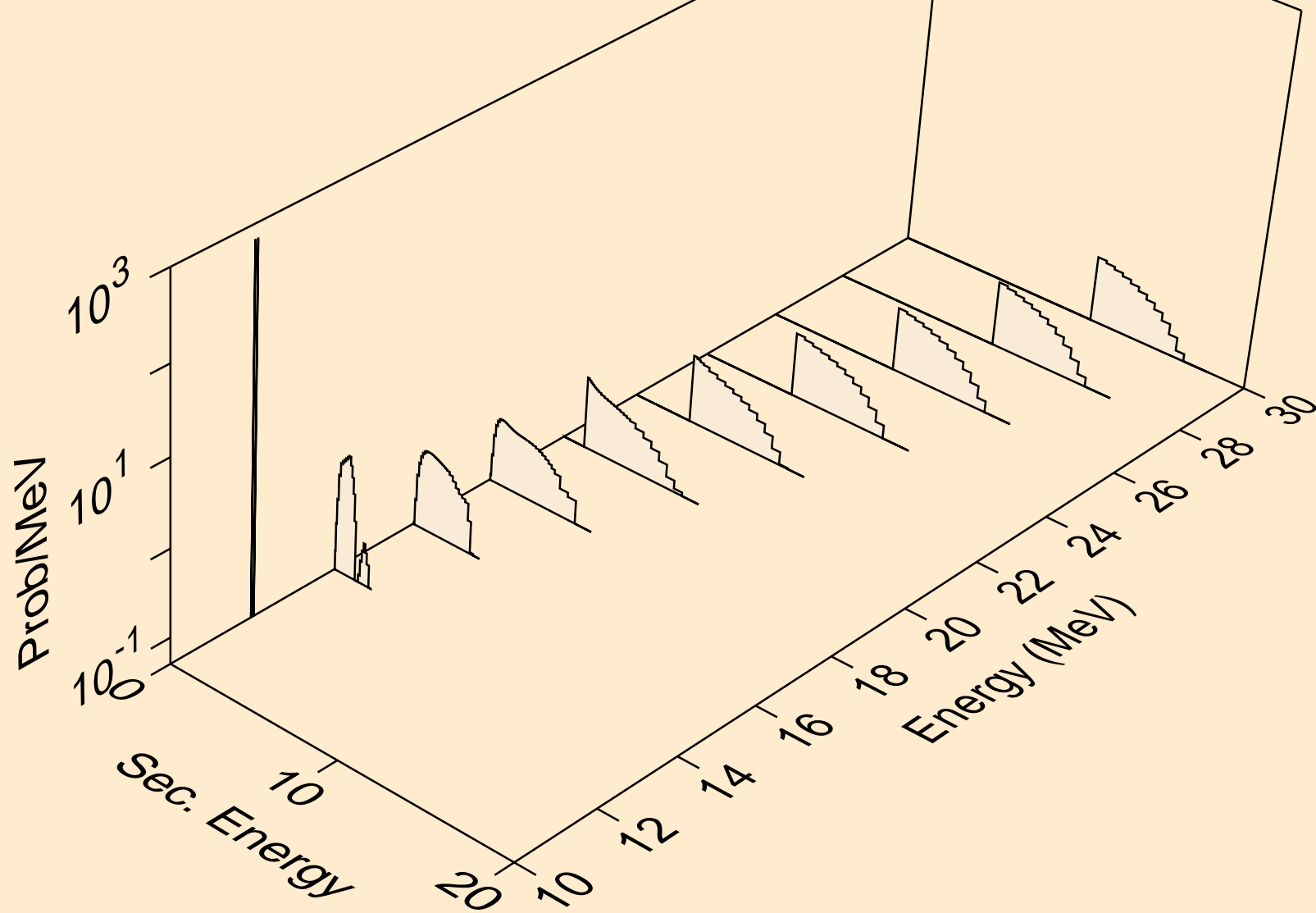

SR078 PROTON ACER TENDL-2021 LIBRARY; T=0.K
neutrons from (p,x)

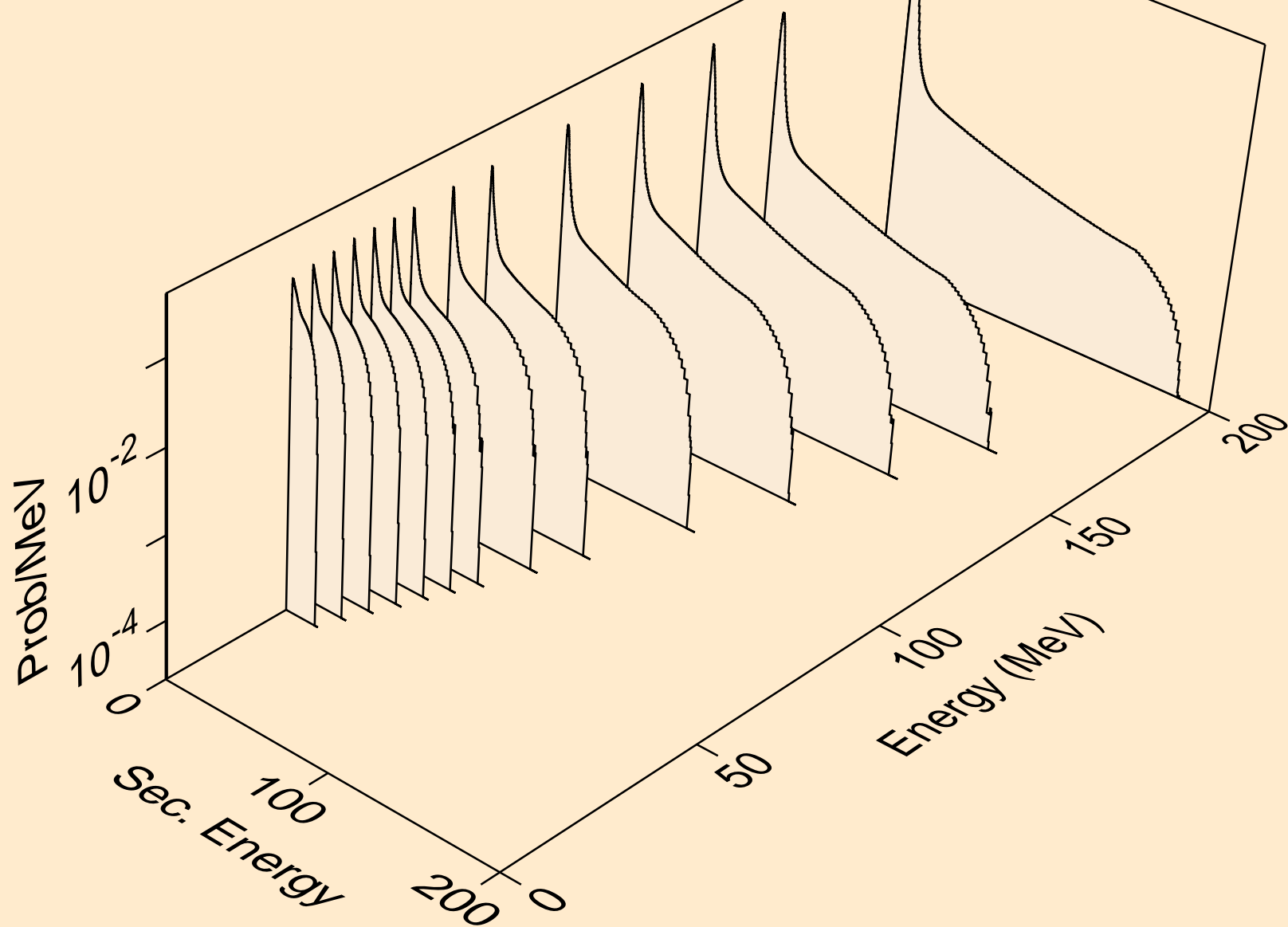

SR078 PROTON ACER TENDL-2021 LIBRARY; T=0.K
neutrons from (p,2n)

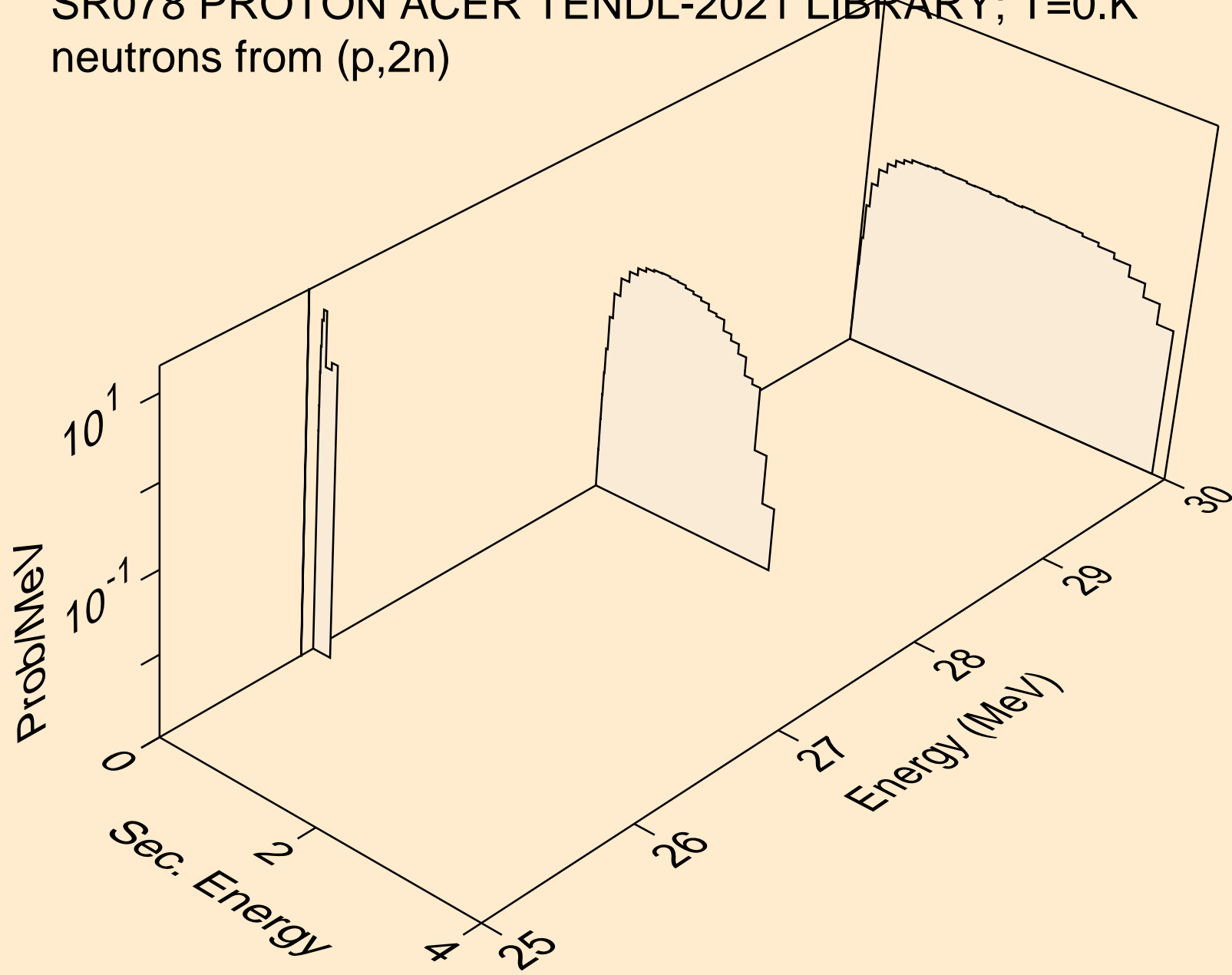

SR078 PROTON ACER TENDL-2021 LIBRARY; T=0.K
neutrons from (p,n*)a

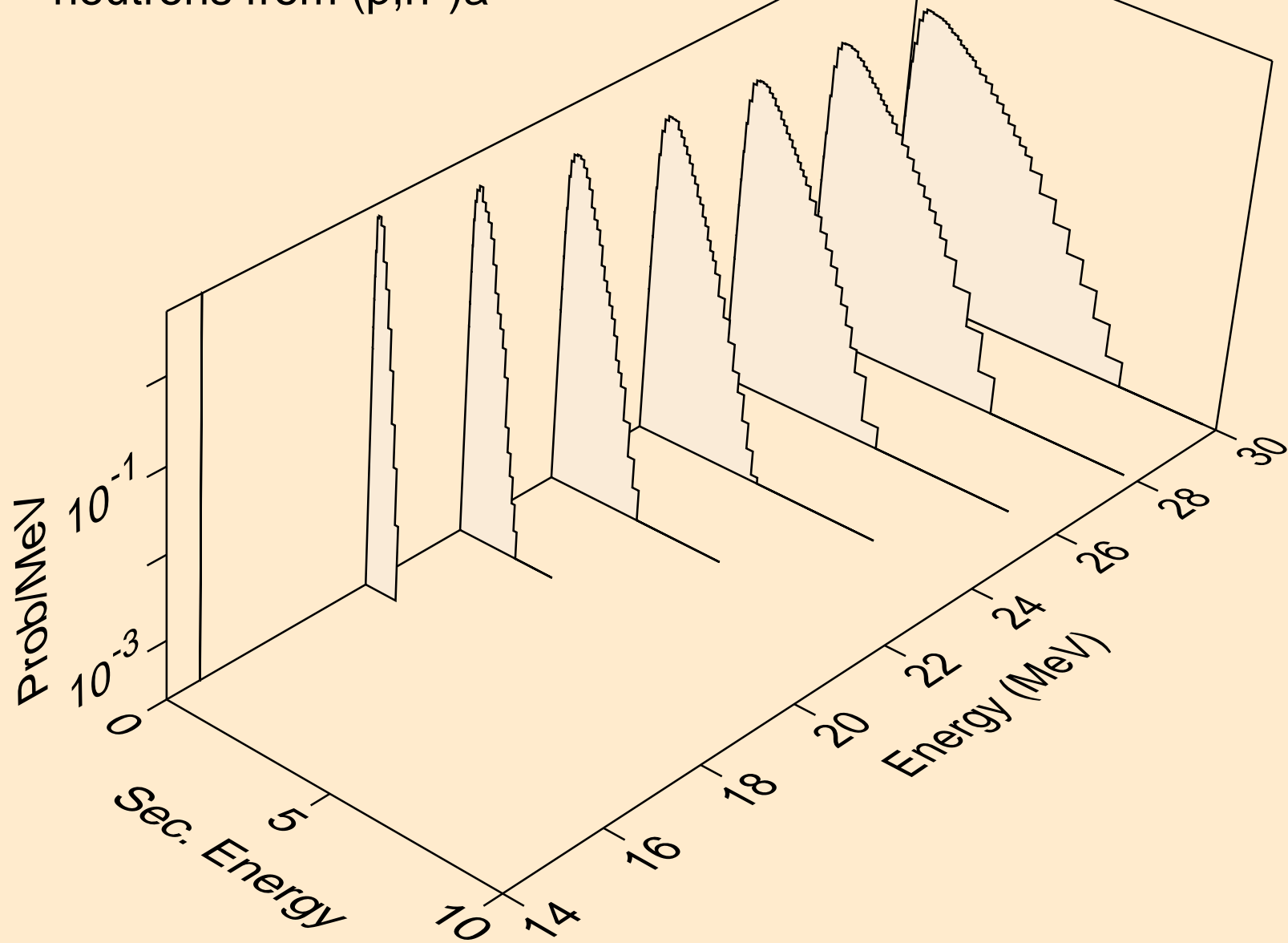

SR078 PROTON ACER TENDL-2021 LIBRARY; T=0.K
neutrons from (p,n*)p

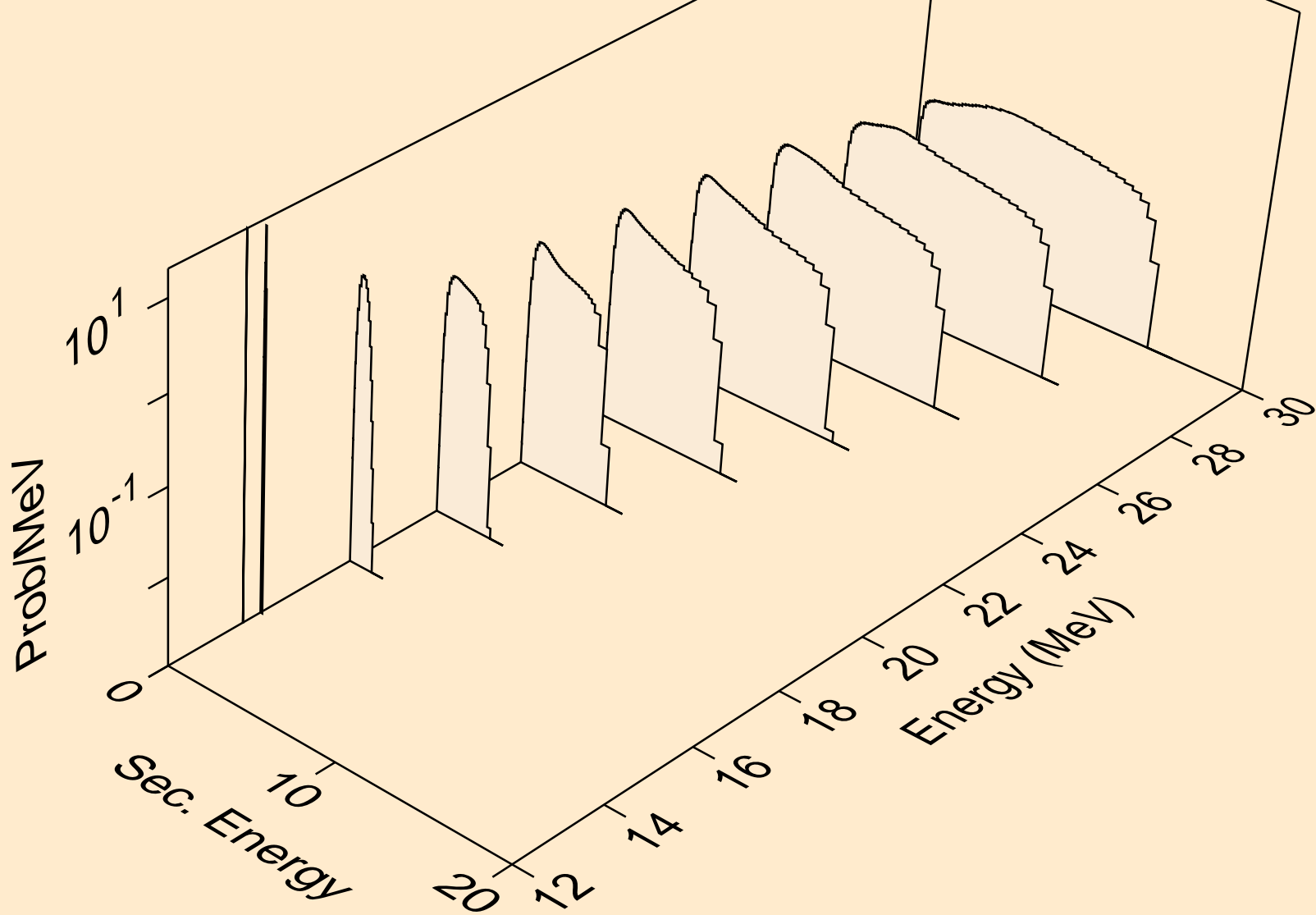

SR078 PROTON ACER TENDL-2021 LIBRARY; T=0.K
neutrons from (p,n*)d

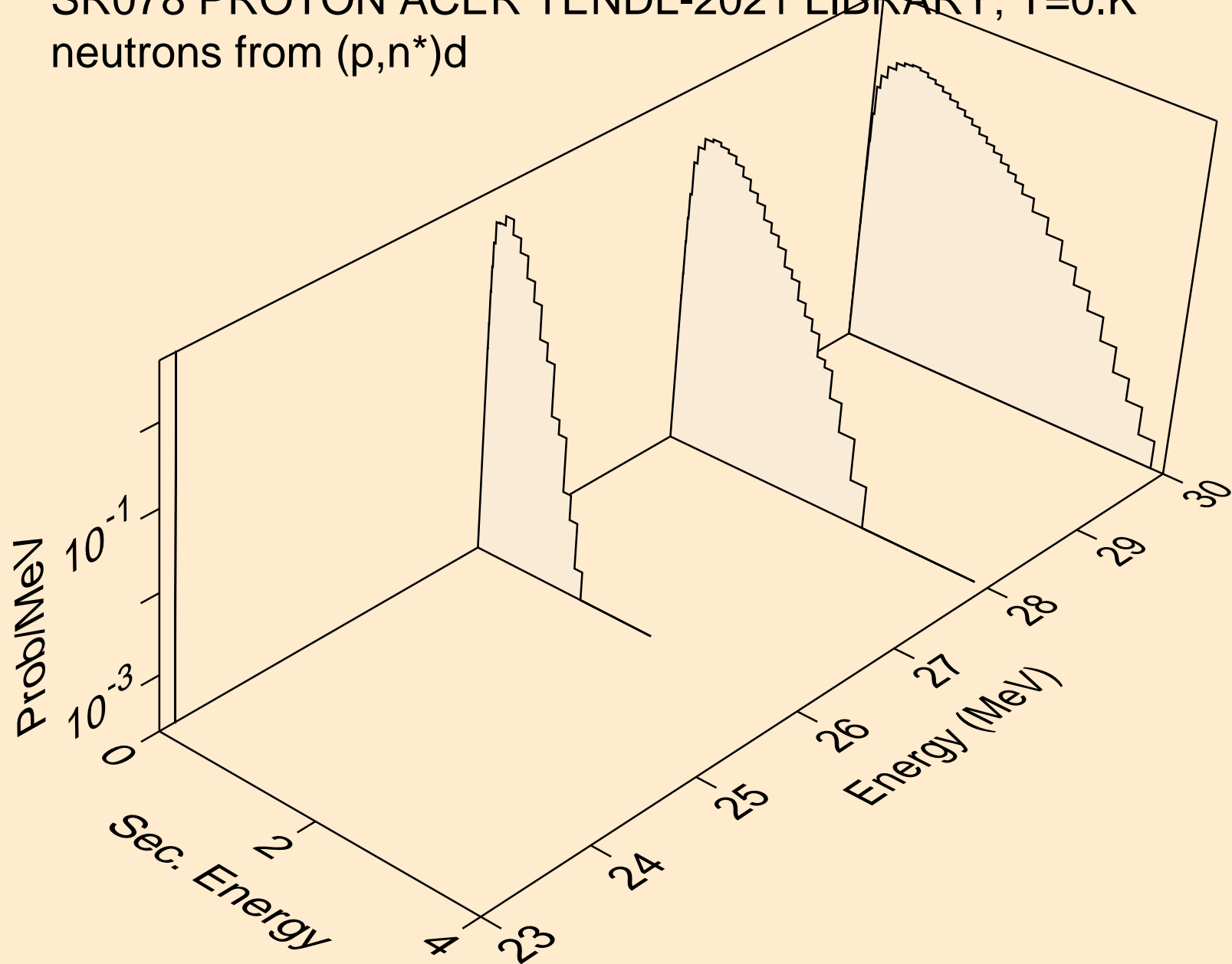

SR078 PROTON ACER TENDL-2021 LIBRARY; T=0.K
neutrons from (p,n*)he3

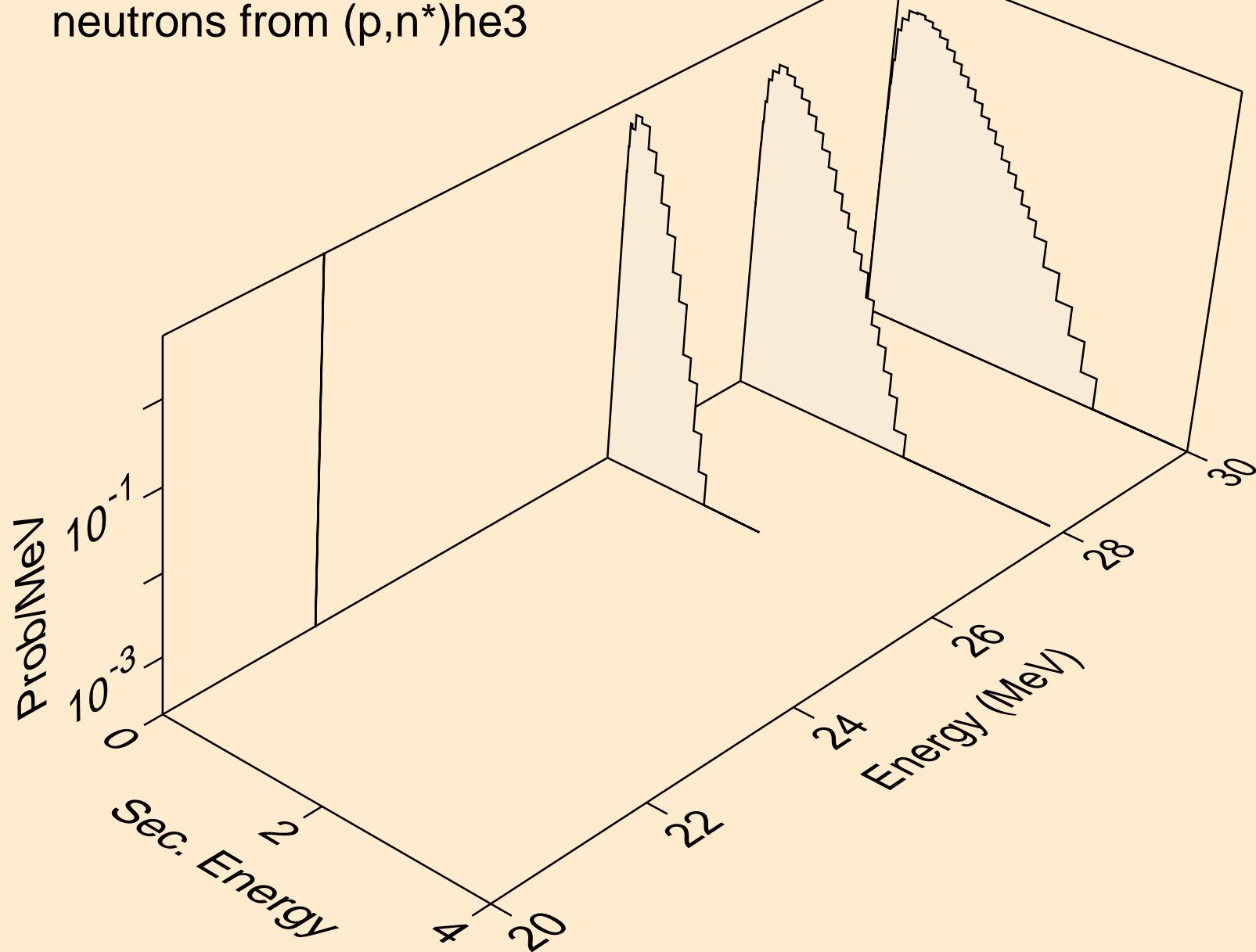

SR078 PROTON ACER TENDL-2021 LIBRARY; T=0.K
neutrons from (p,2np)

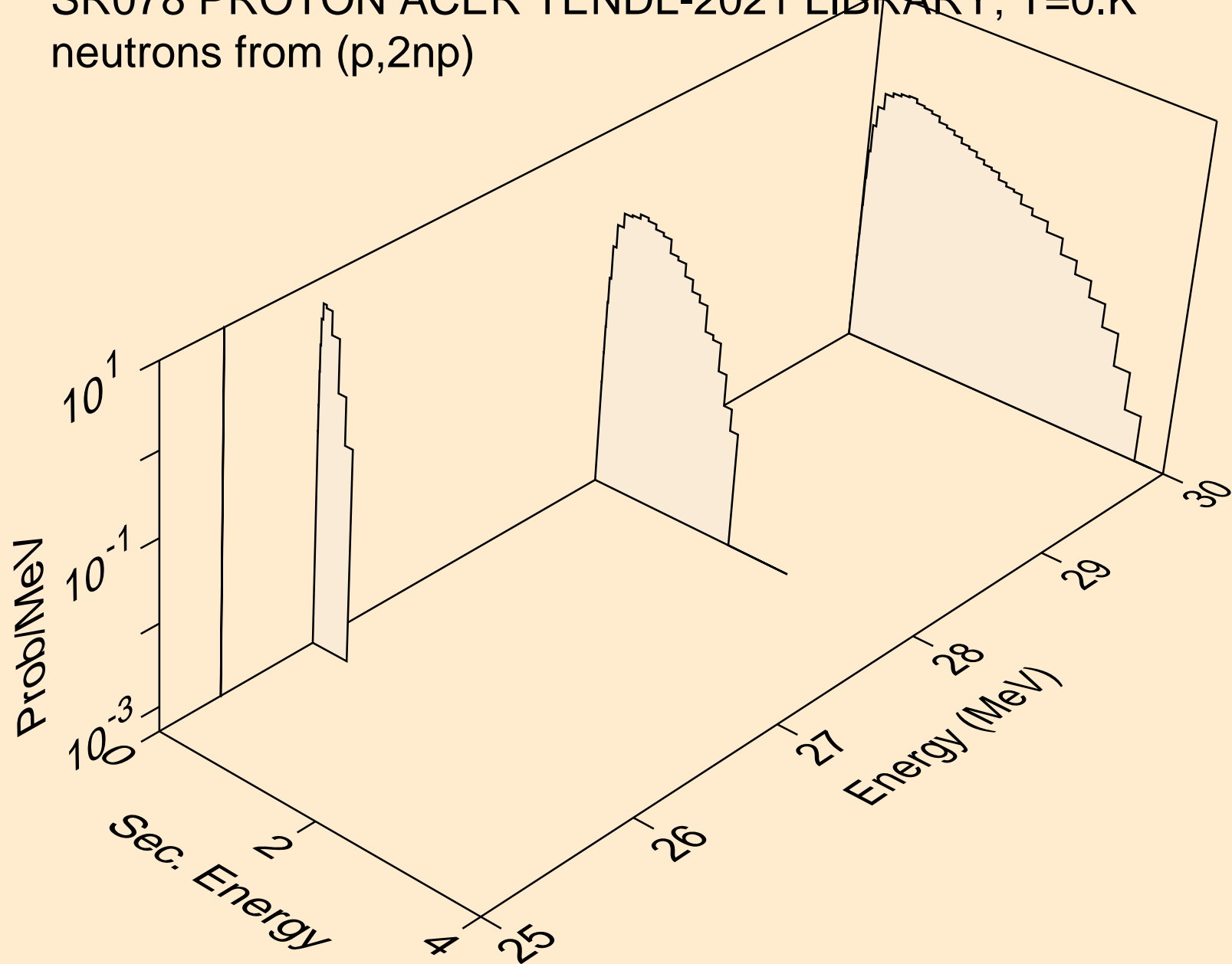

SR078 PROTON ACER TENDL-2021 LIBRARY; T=0.K
neutrons from (p,2np)

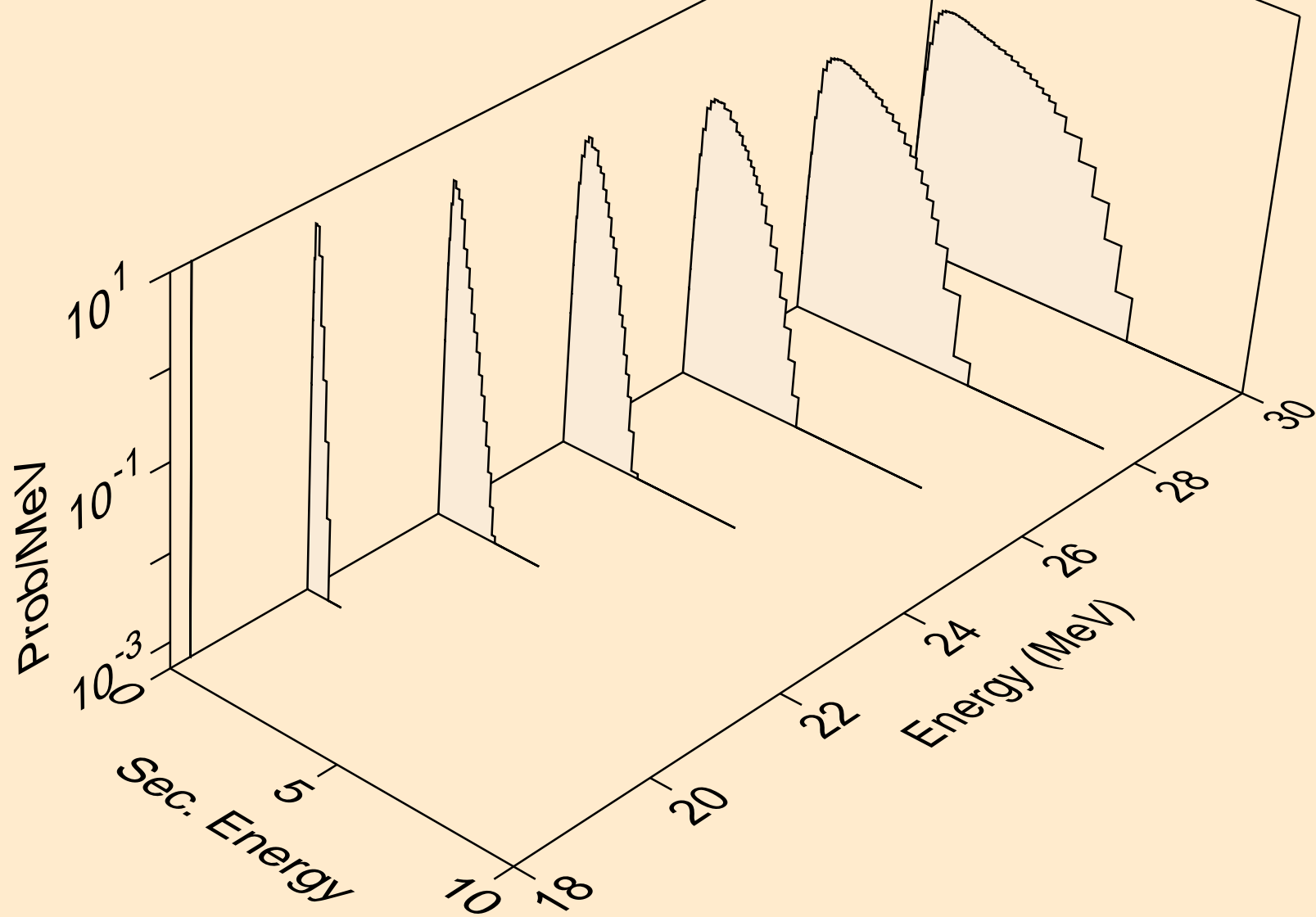

SR078 PROTON ACER TENDL-2021 LIBRARY; T=0.K
neutrons from (p,npa)

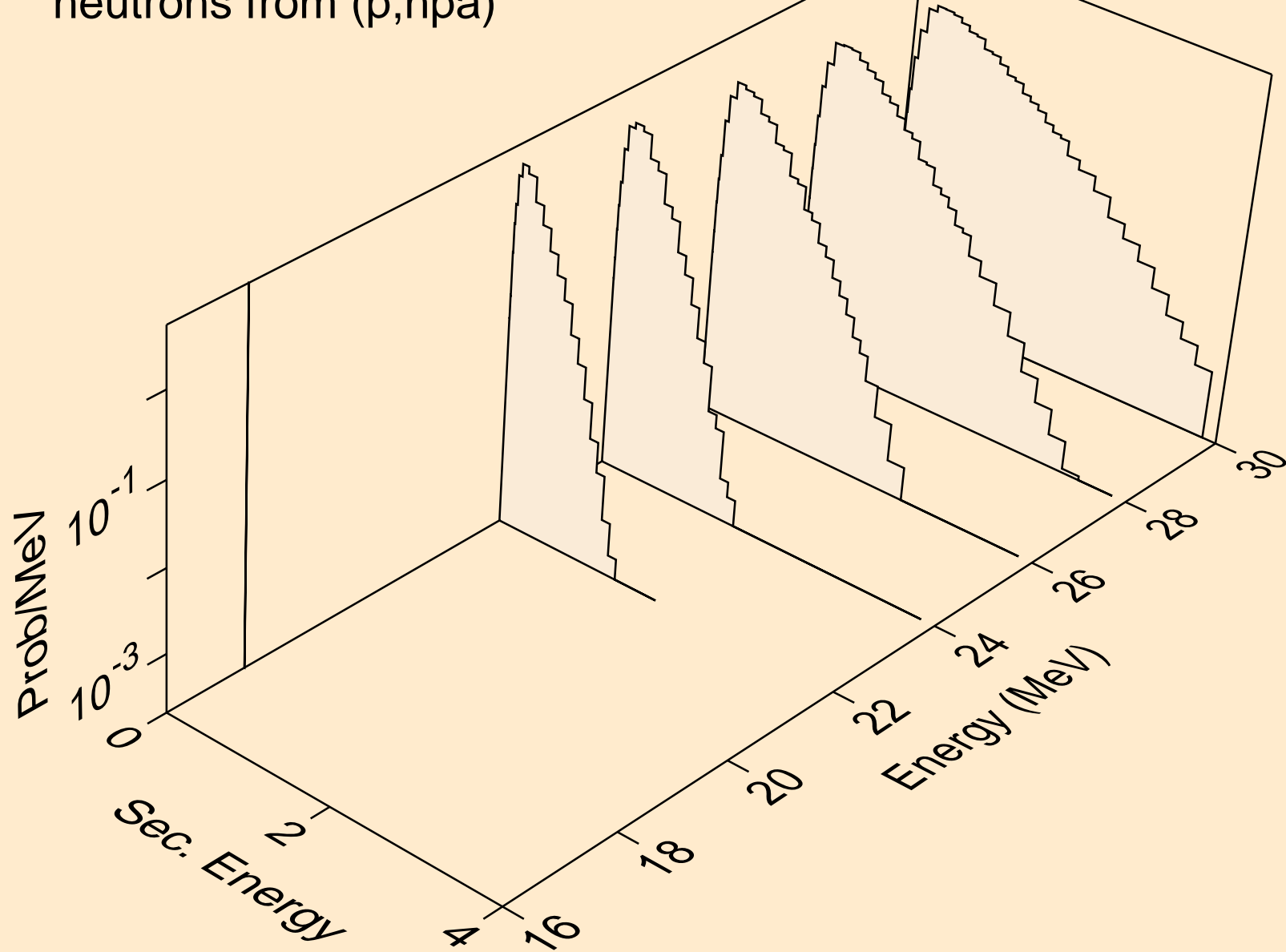

SR078 PROTON ACER TENDL-2021 LIBRARY; T=0.K
deuterons from (p,x)

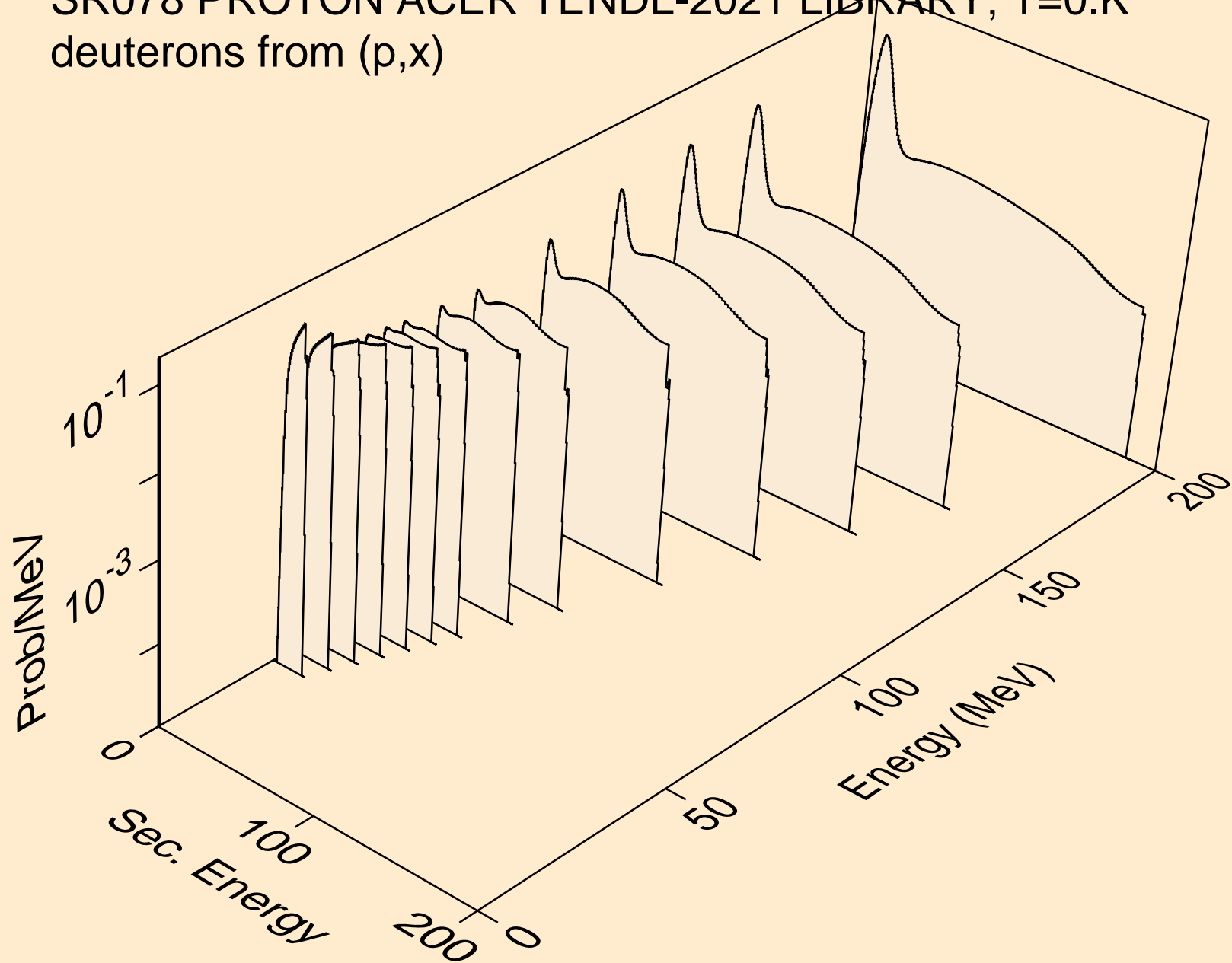

SR078 PROTON ACER TENDL-2021 LIBRARY; T=0.K
deuterons from (p,n*)d

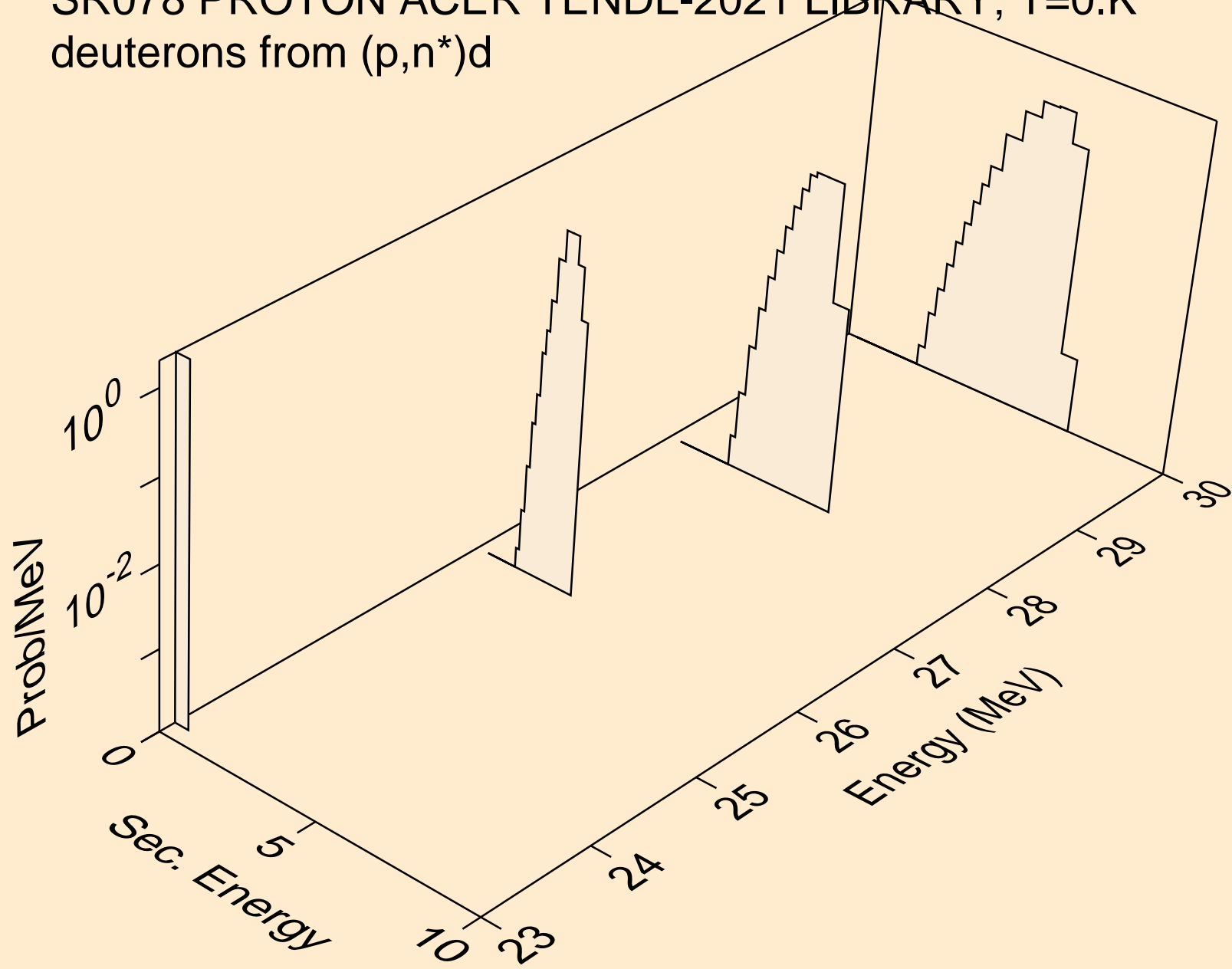

SR078 PROTON ACER TENDL-2021 LIBRARY; T=0.K
deuterons from (p,d)

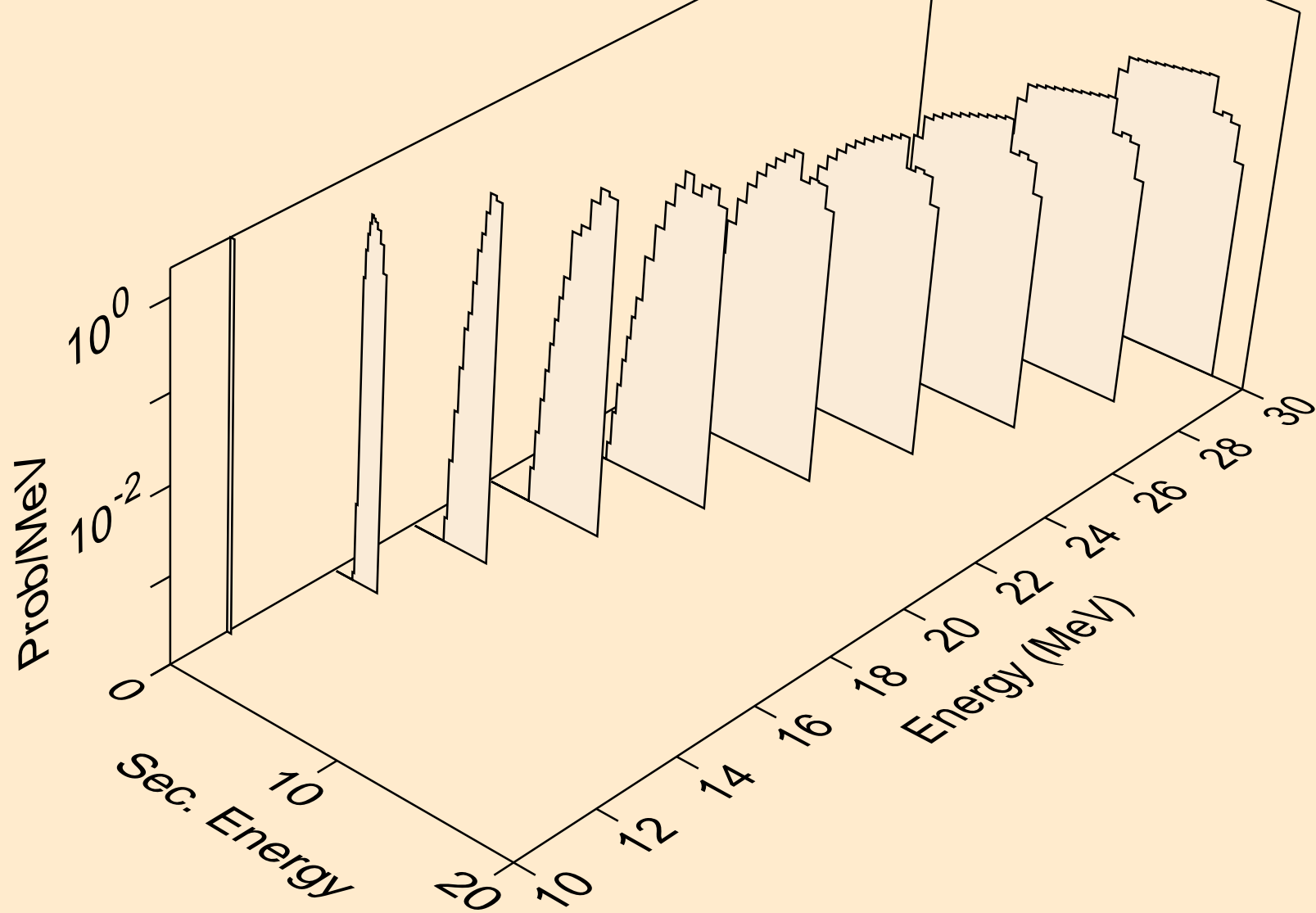

SR078 PROTON ACER TENDL-2021 LIBRARY; T=0.K
deuterons from (p,pd)

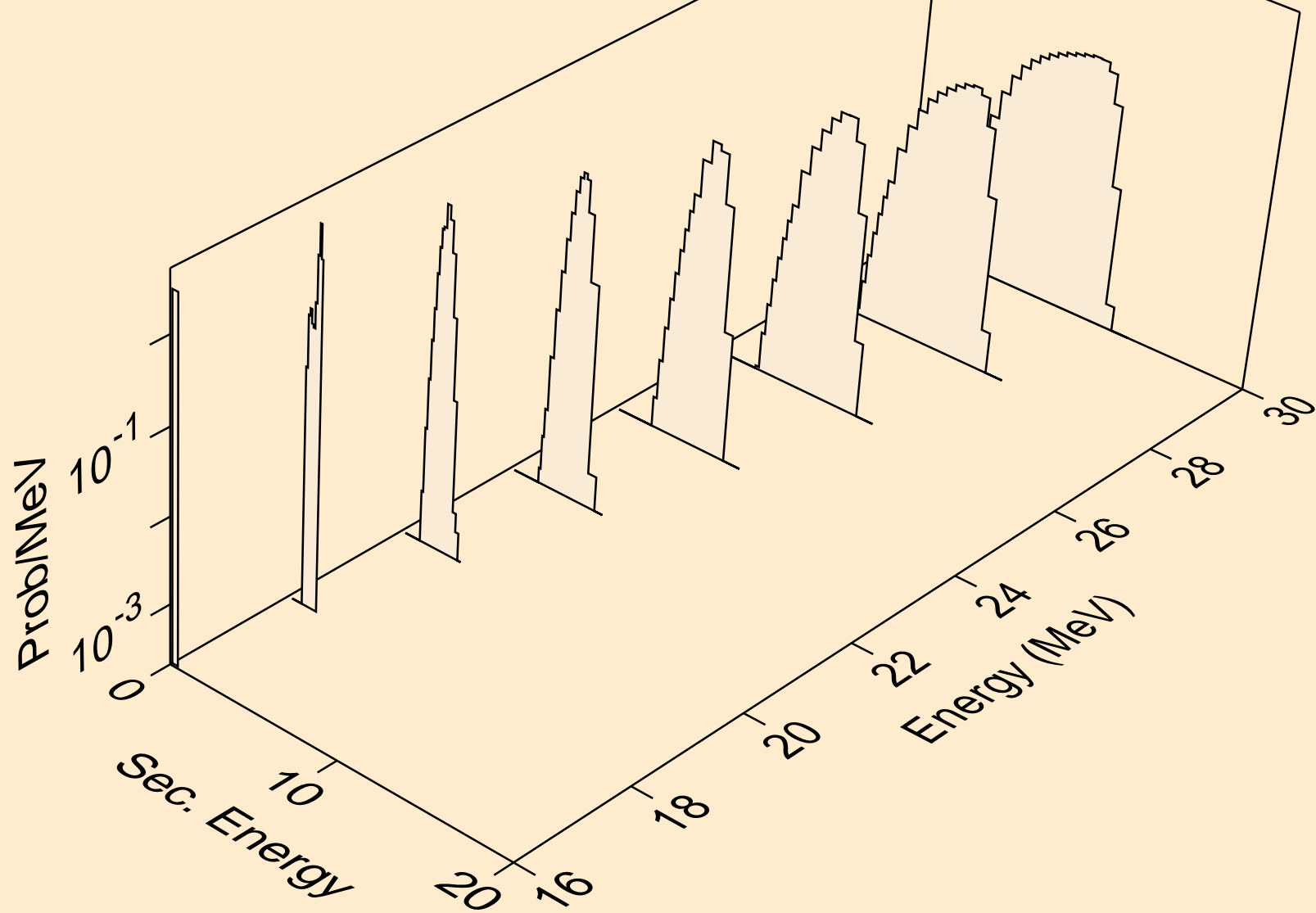

SR078 PROTON ACER TENDL-2021 LIBRARY; T=0.K
deuterons from (p,da)

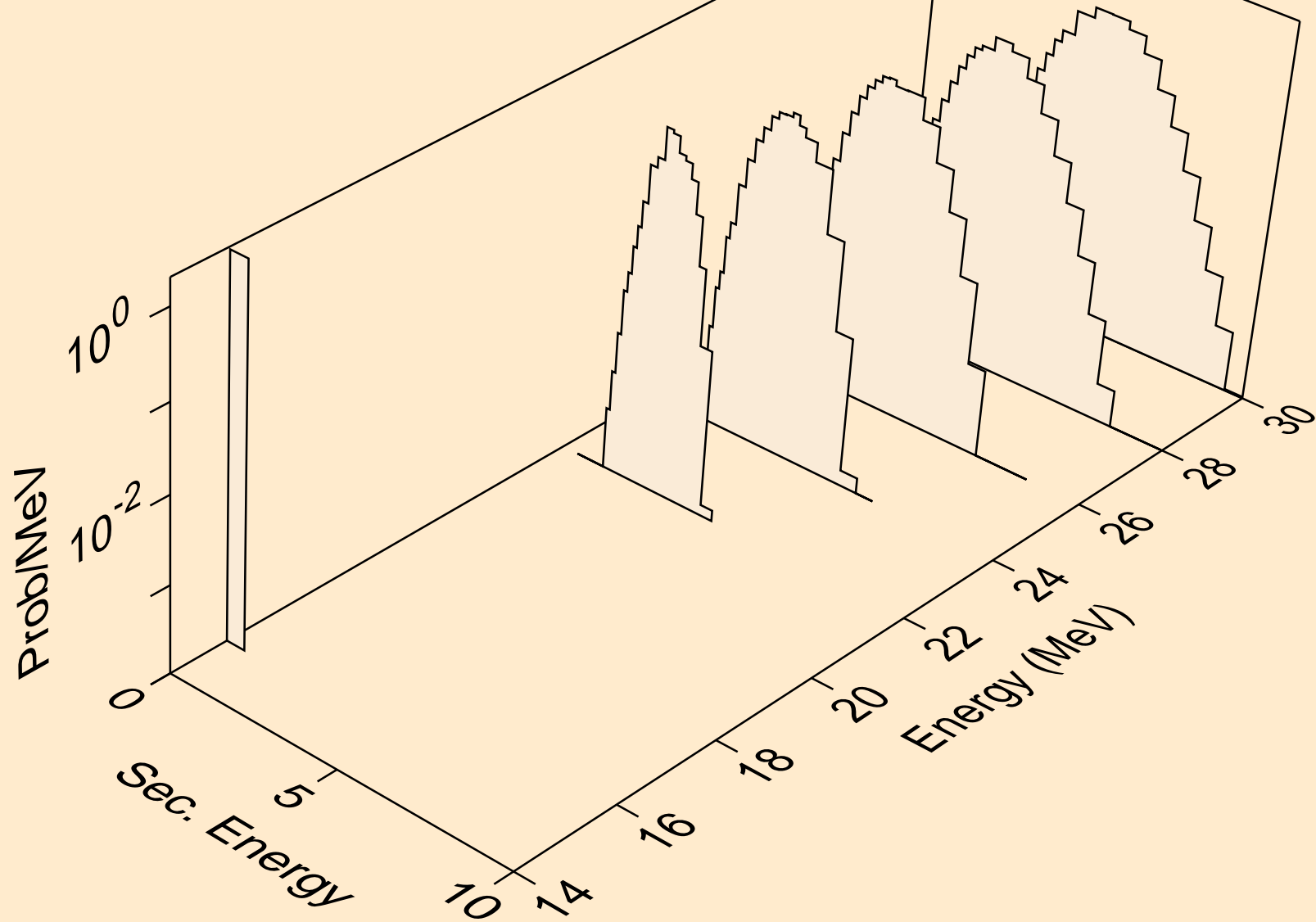

SR078 PROTON ACER TENDL-2021 LIBRARY; T=0.K
tritons from (p,x)

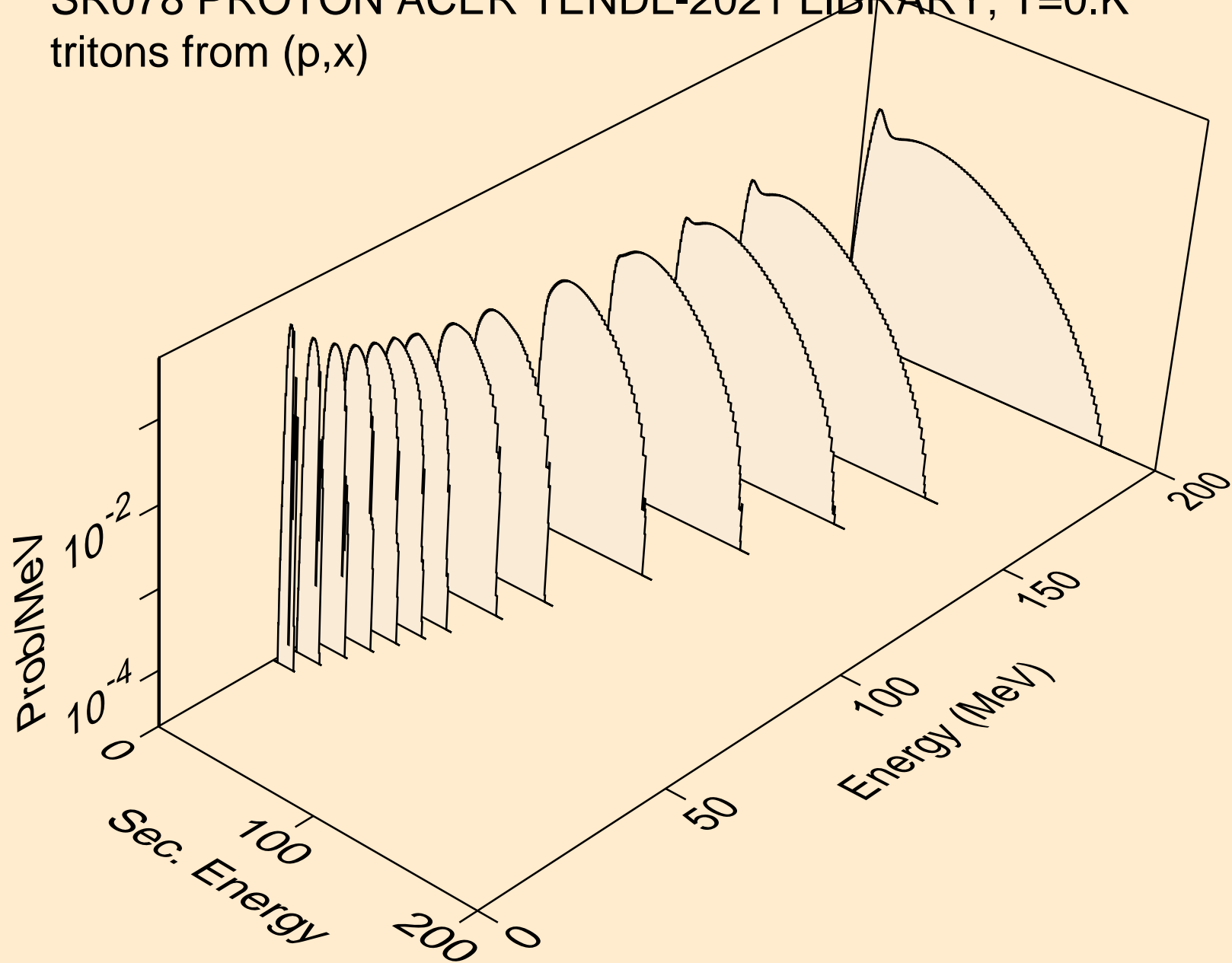

SR078 PROTON ACER TENDL-2021 LIBRARY; T=0.K
tritons from (p,t)

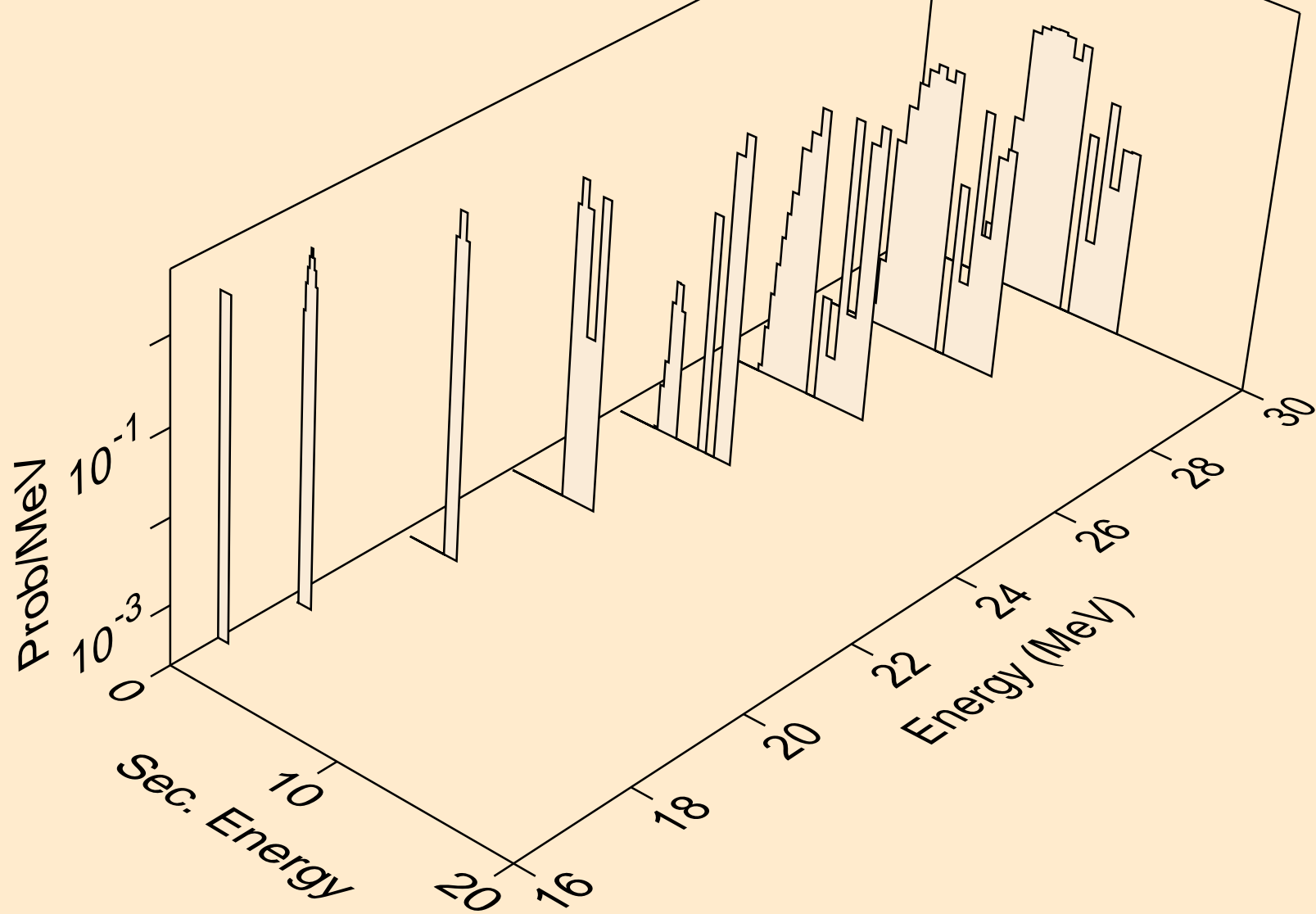

SR078 PROTON ACER TENDL-2021 LIBRARY; T=0.K
tritons from (p,pt)

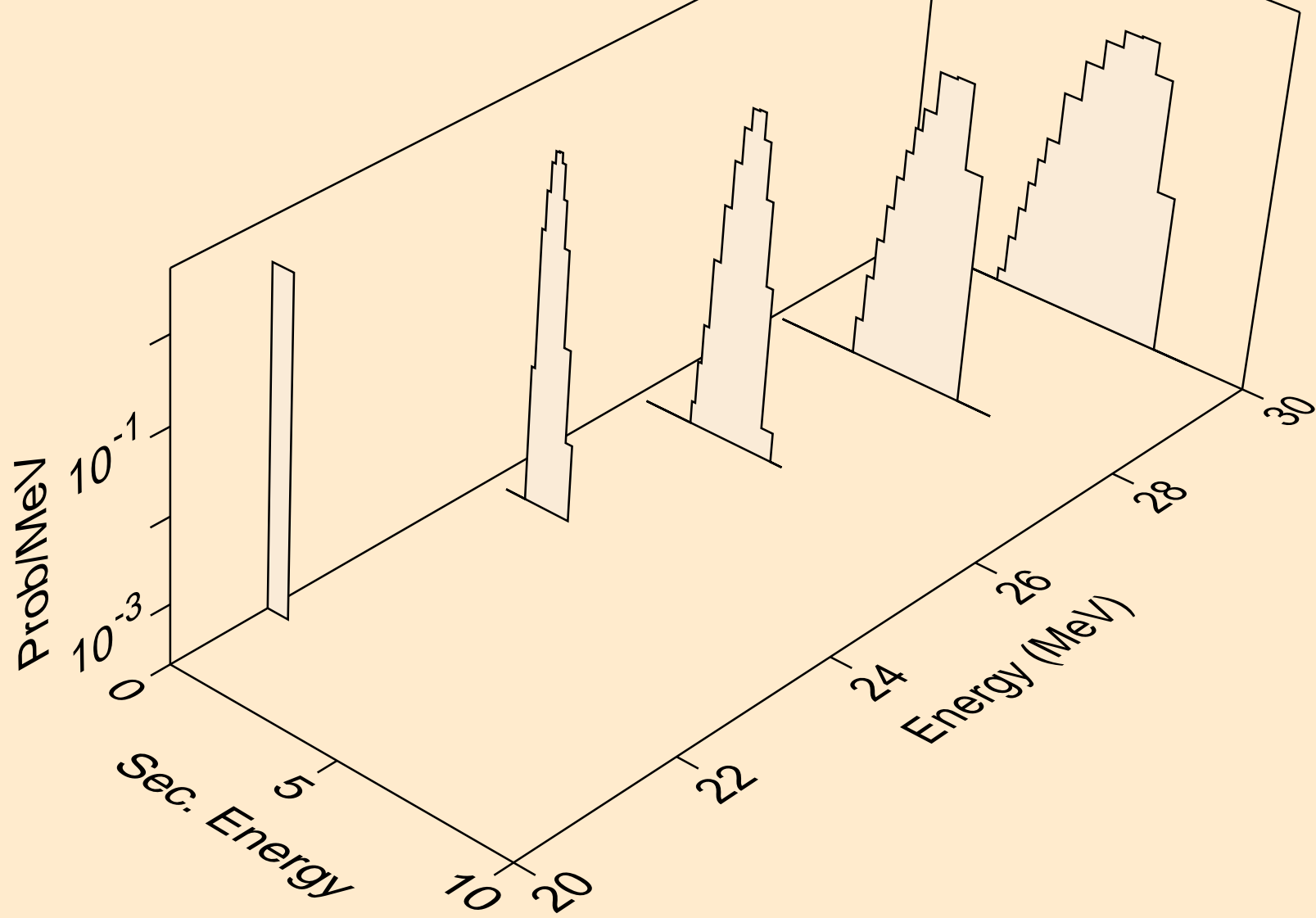

SR078 PROTON ACER TENDL-2021 LIBRARY; T=0.K
he3s from (p,x)

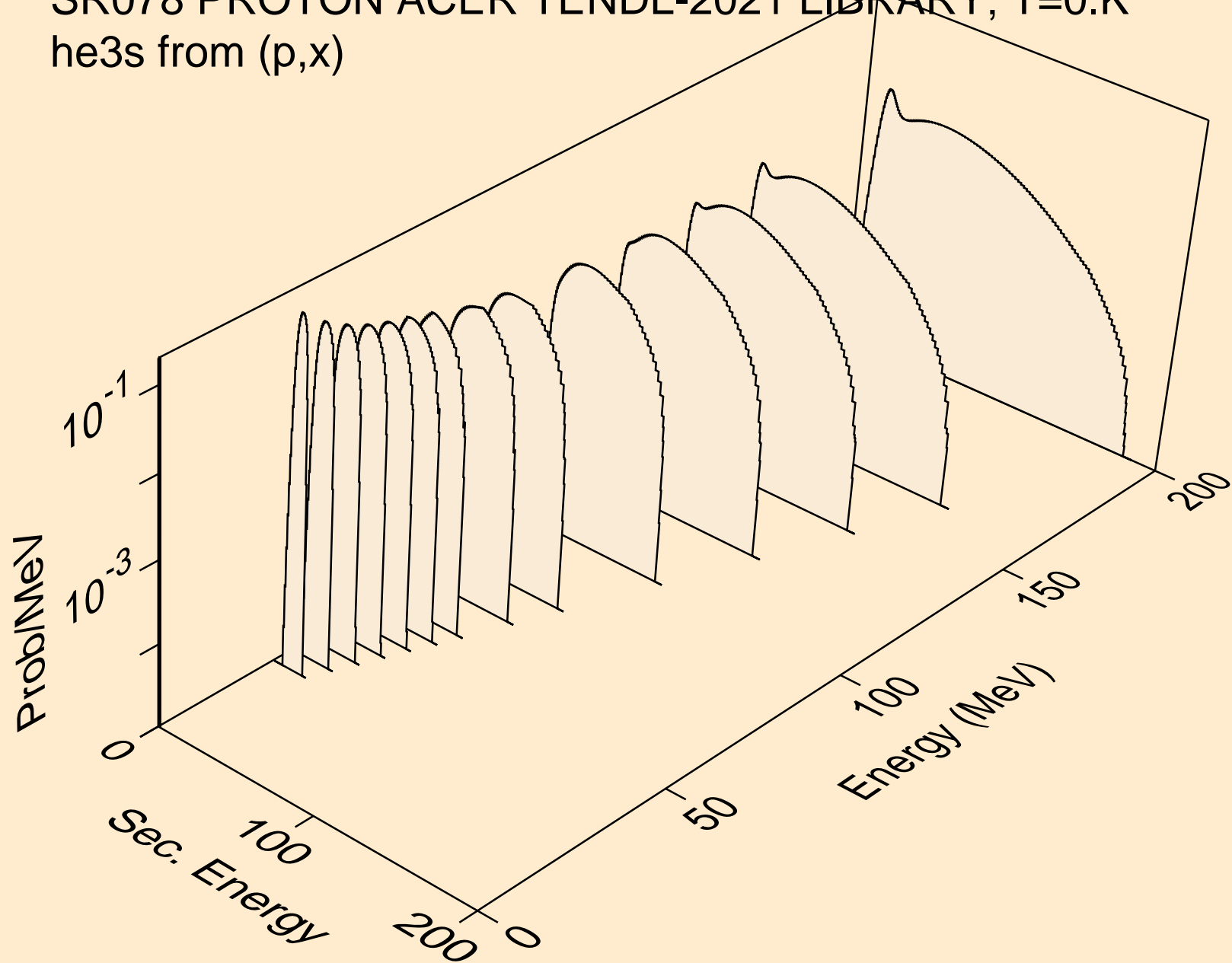

SR078 PROTON ACER TENDL-2021 LIBRARY; T=0.K
he3s from (p,n*)he3

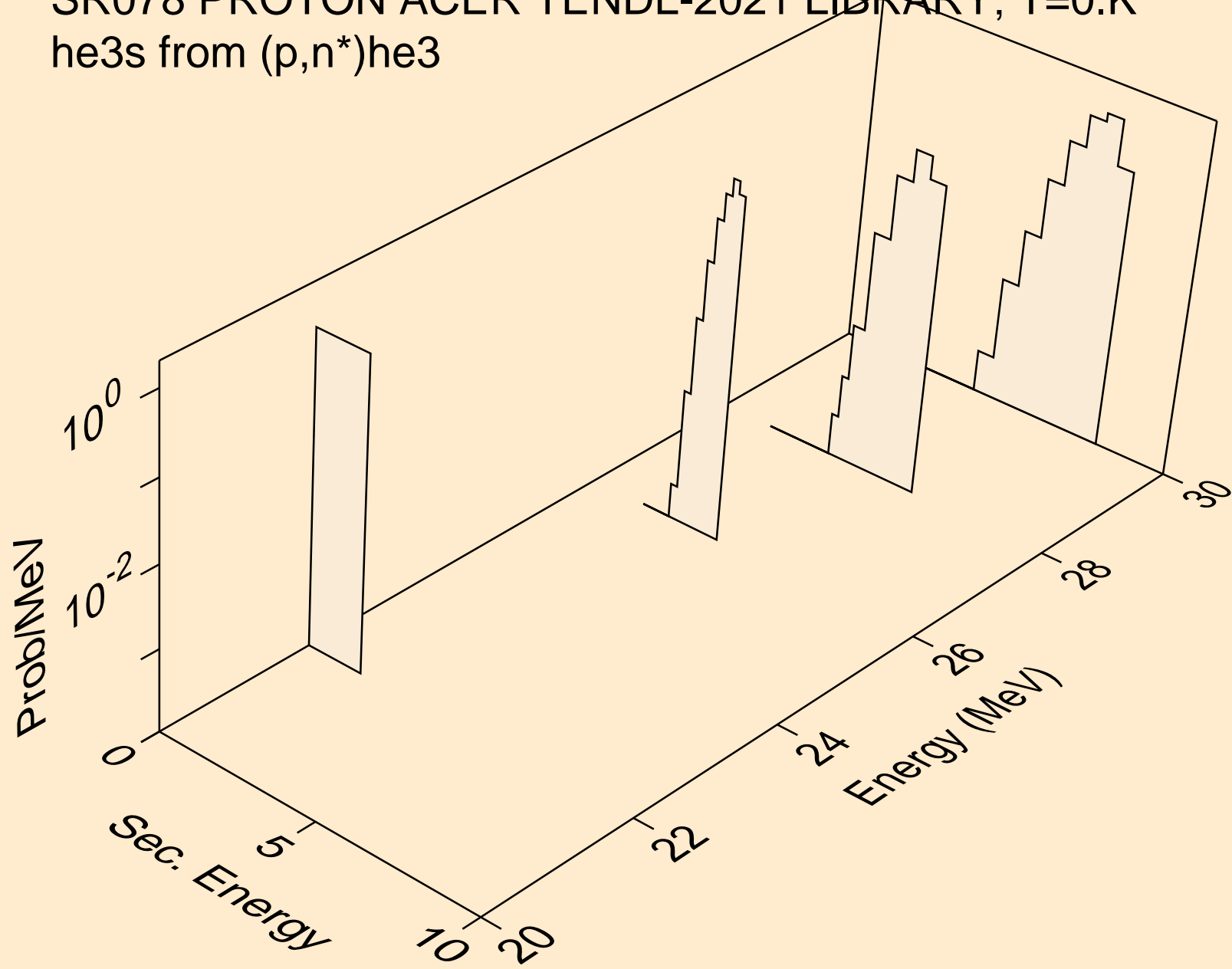

SR078 PROTON ACER TENDL-2021 LIBRARY; T=0.K
he3s from (p,he3)

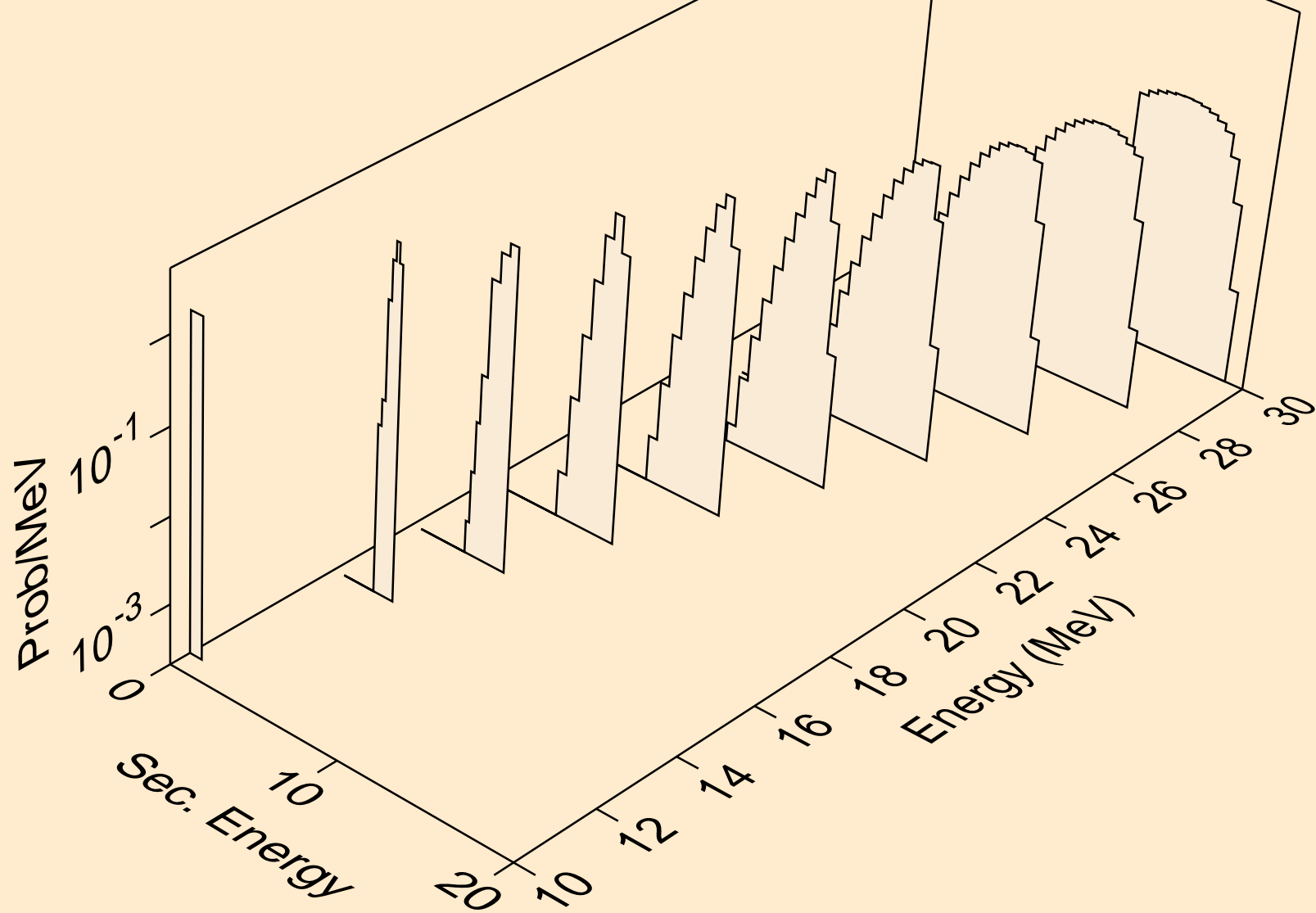

SR078 PROTON ACER TENDL-2021 LIBRARY; T=0.K
alphas from (p,x)

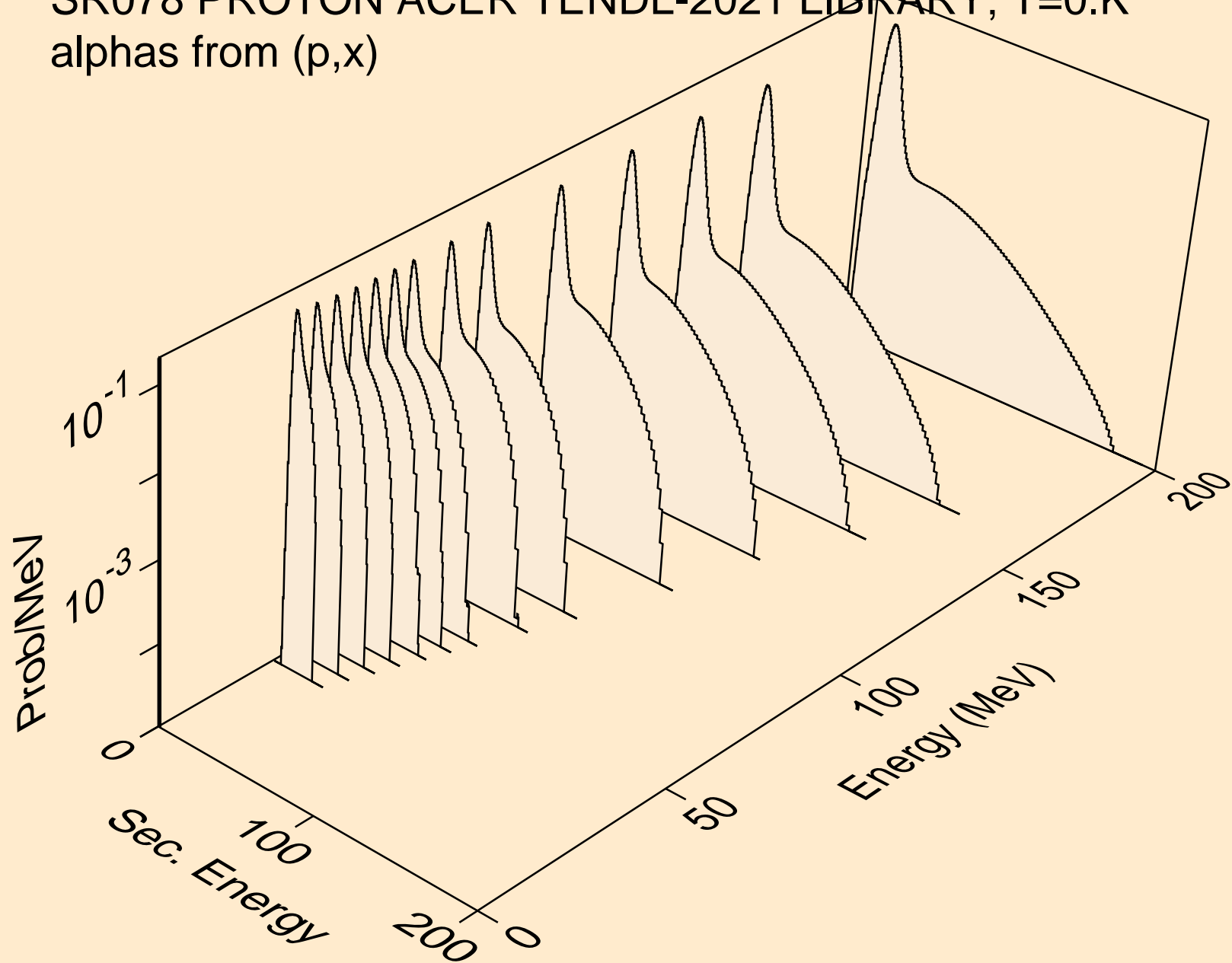

SR078 PROTON ACER TENDL-2021 LIBRARY; T=0.K
alphas from (p,n*)a

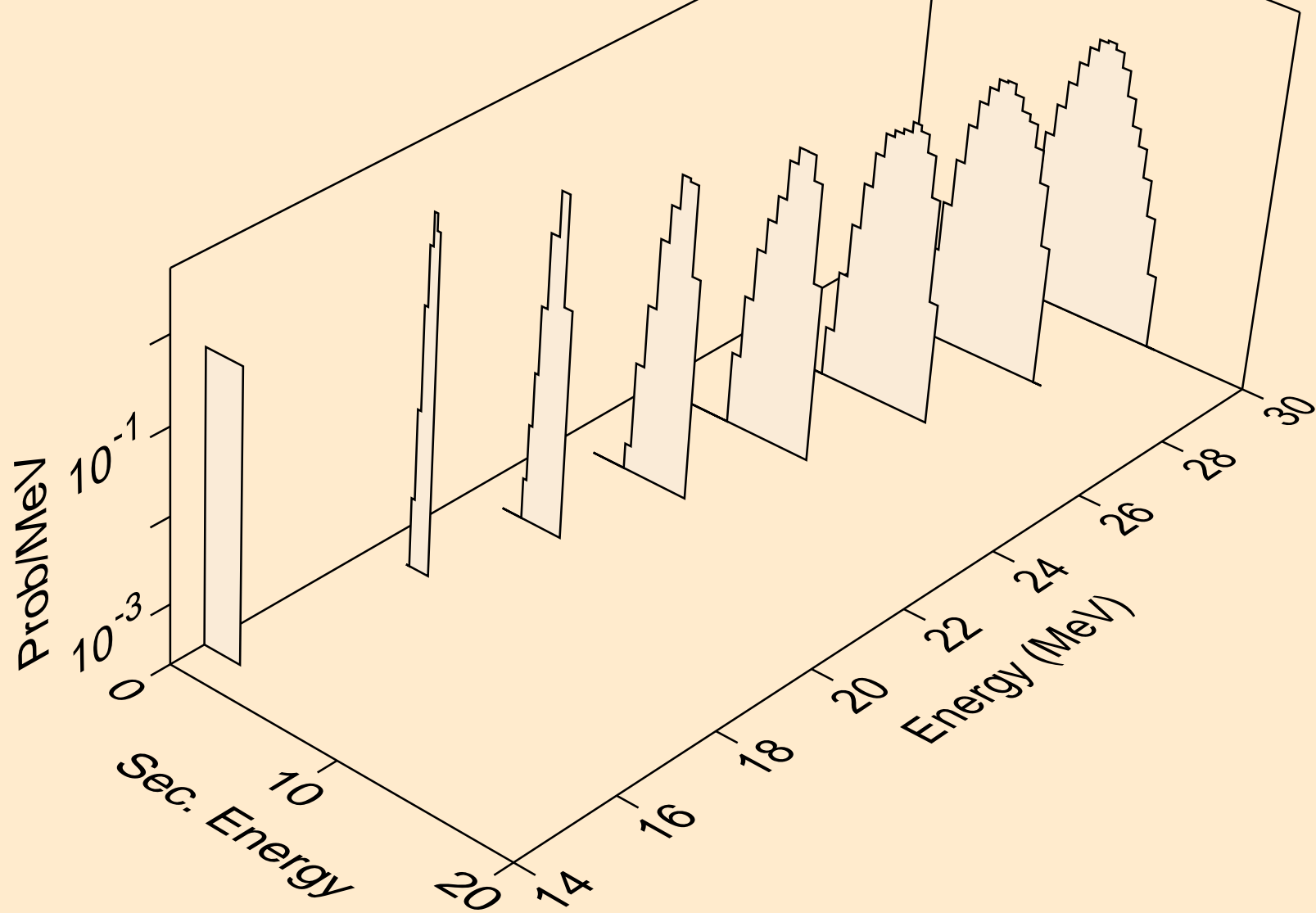

SR078 PROTON ACER TENDL-2021 LIBRARY; T=0.K
alphas from (p,npa)

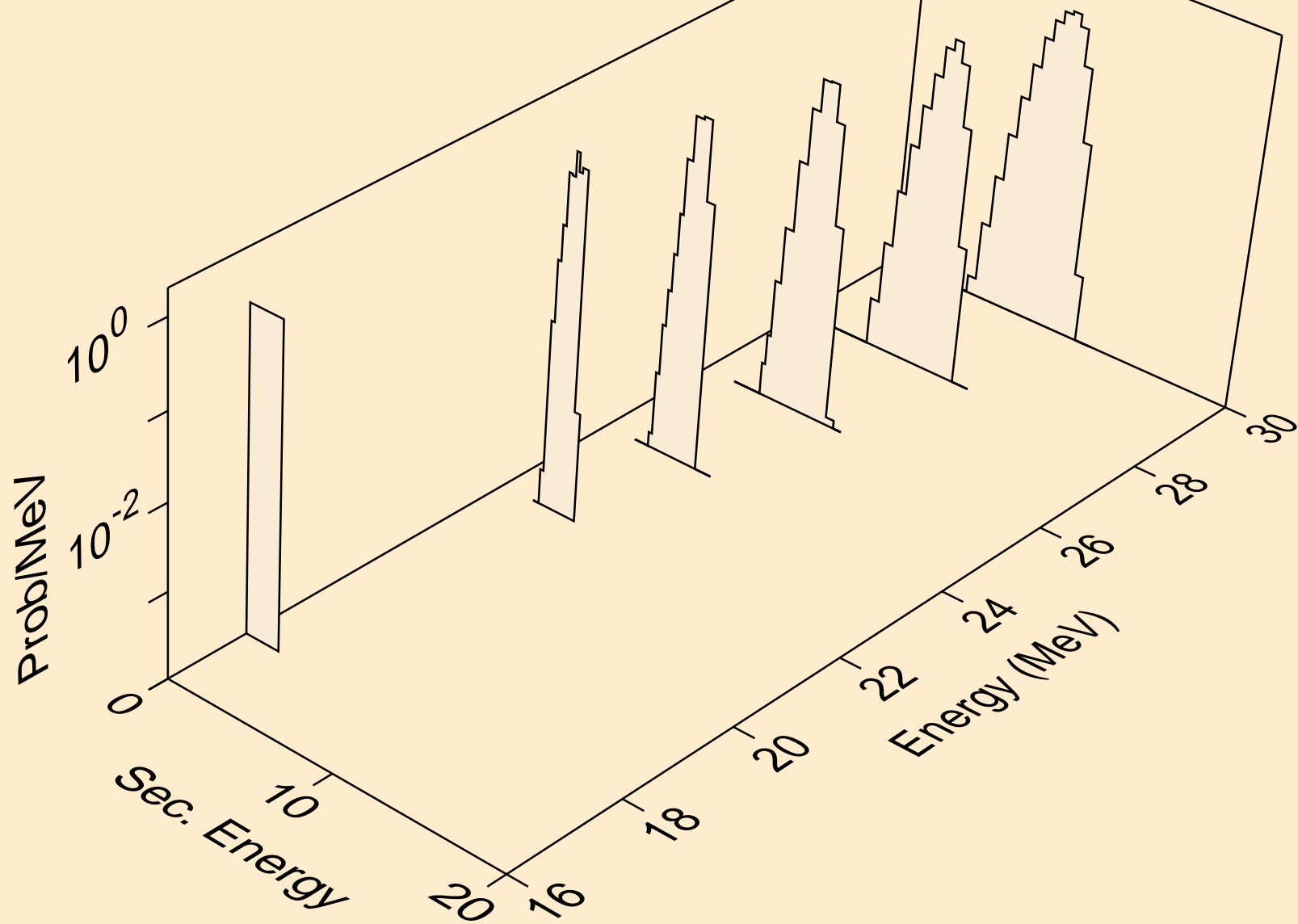

SR078 PROTON ACER TENDL-2021 LIBRARY; T=0.K
alphas from (p,a)

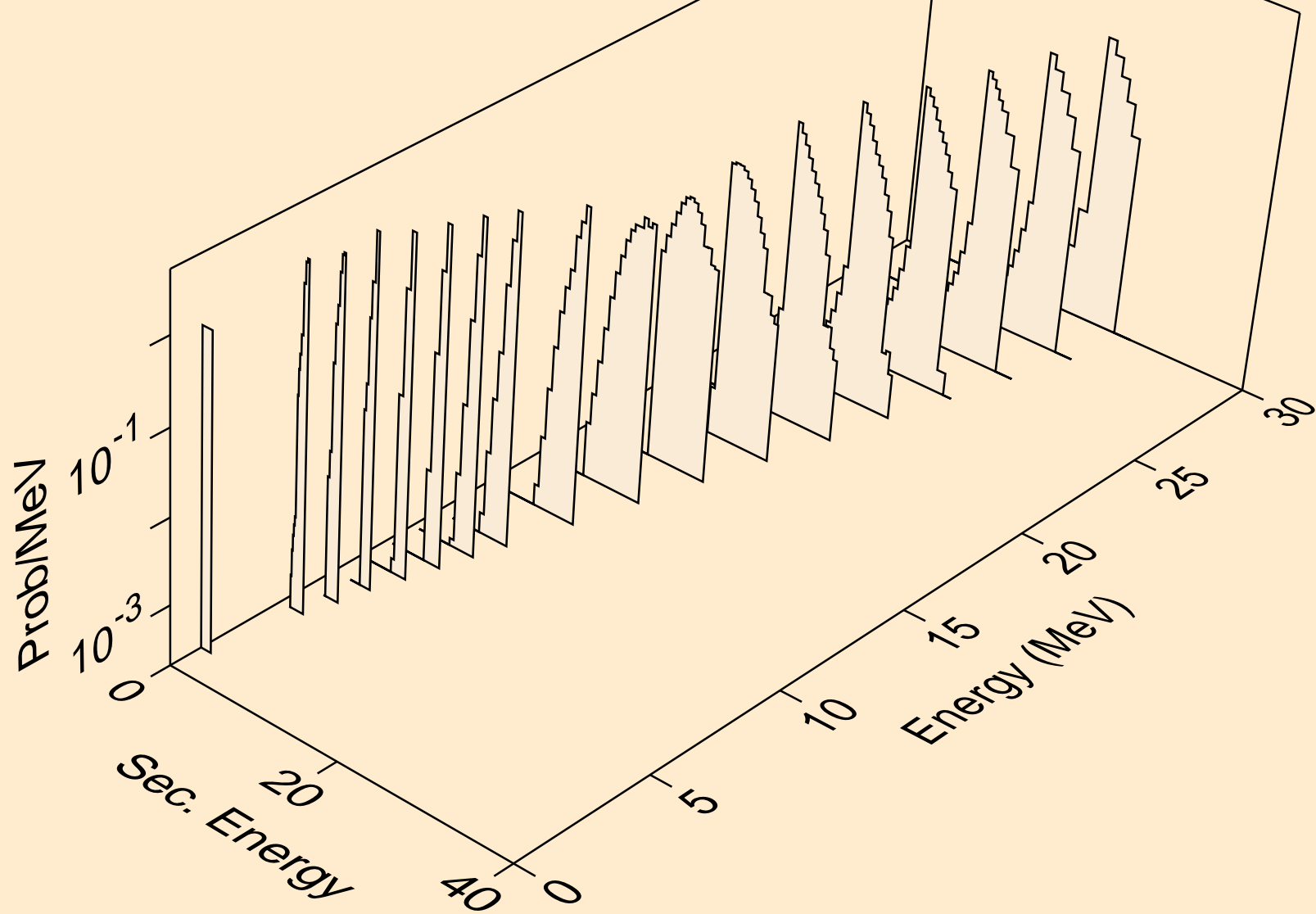

SR078 PROTON ACER TENDL-2021 LIBRARY; T=0.K
alphas from (p,2a)

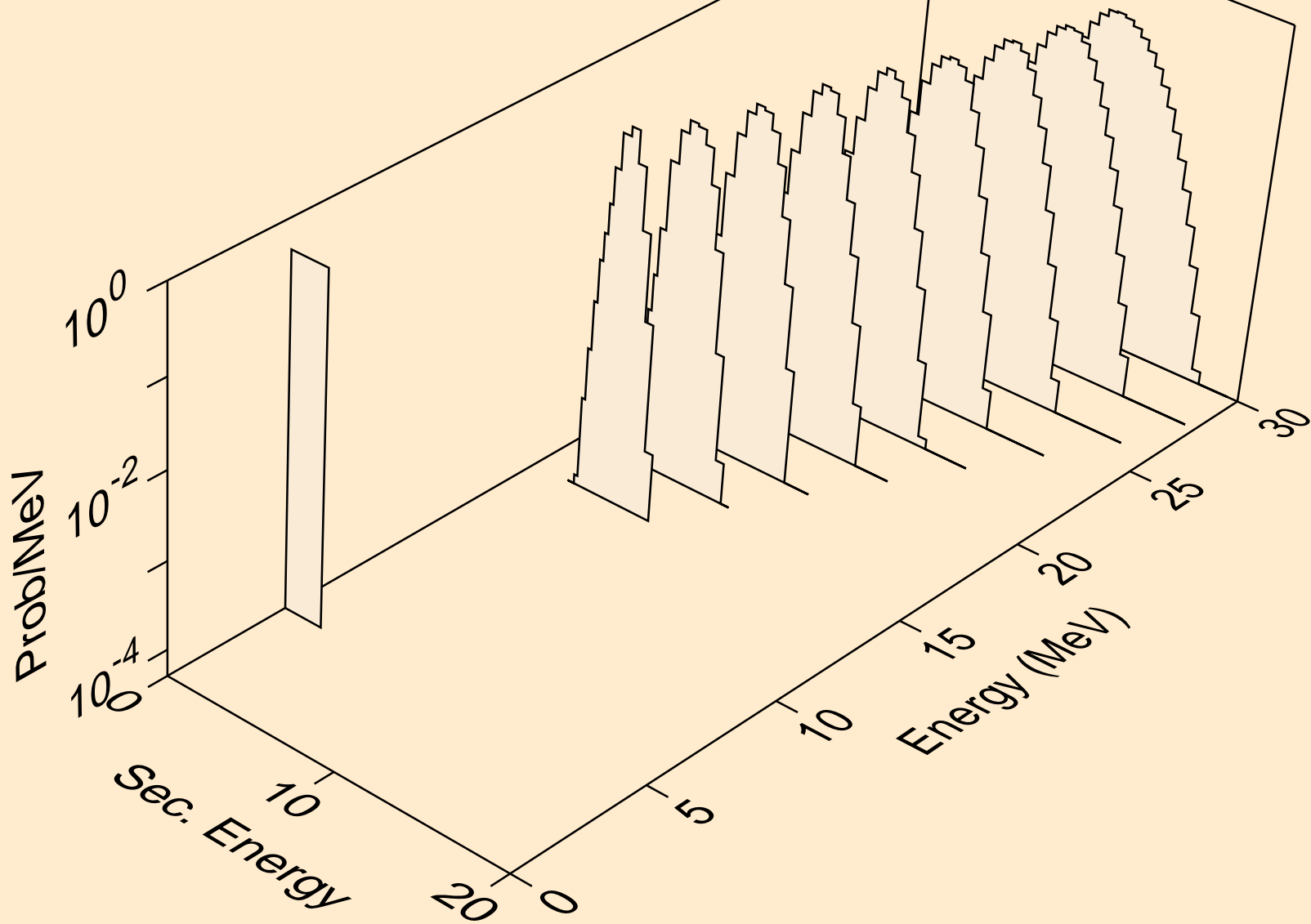

SR078 PROTON ACER TENDL-2021 LIBRARY; T=0.K
alphas from (p,pa)

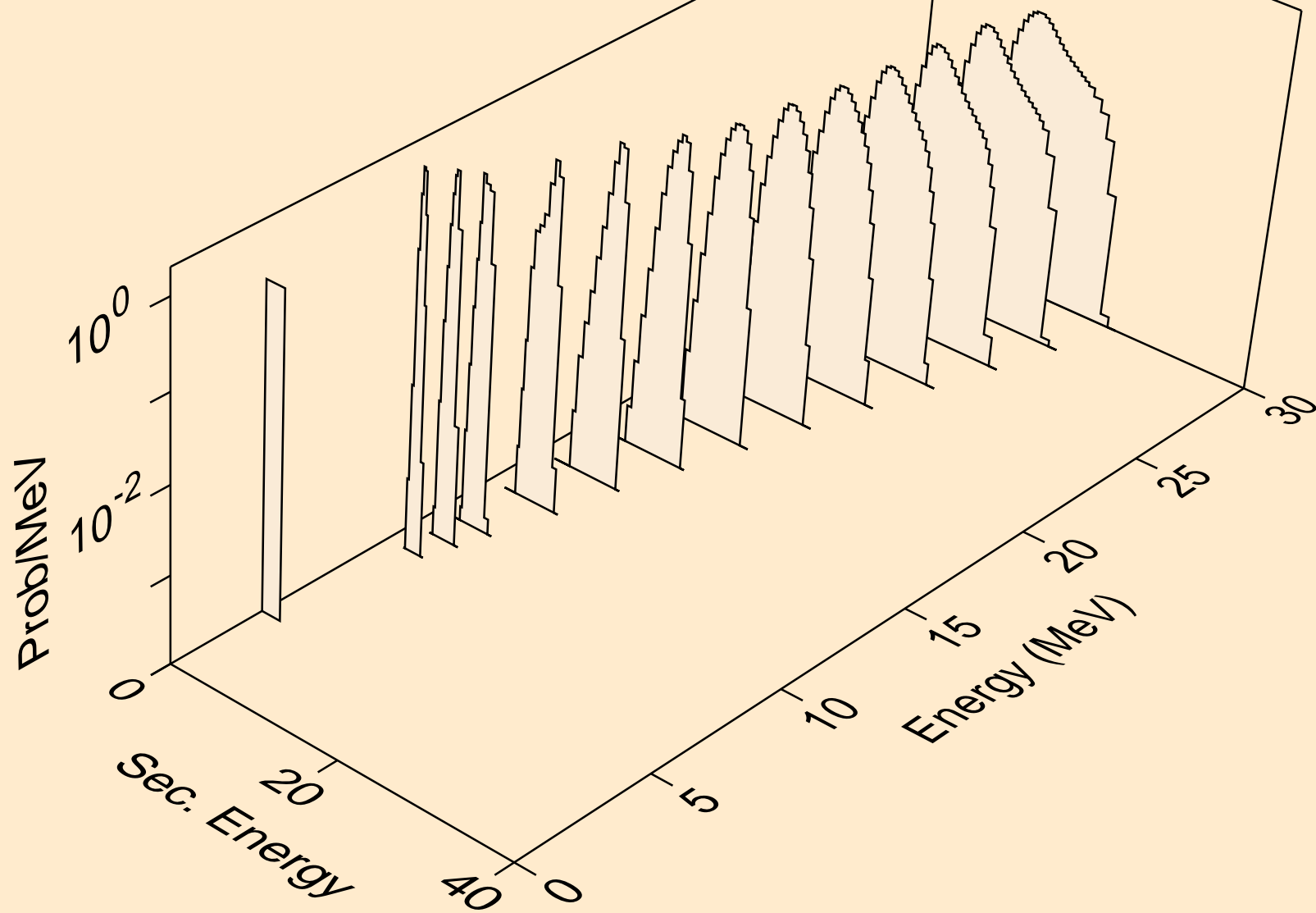

SR078 PROTON ACER TENDL-2021 LIBRARY; T=0.K
alphas from (p,da)

