

# SR096 PROTON ACER TENDL-2021 LIBRARY; T=0.K

## Principal cross sections

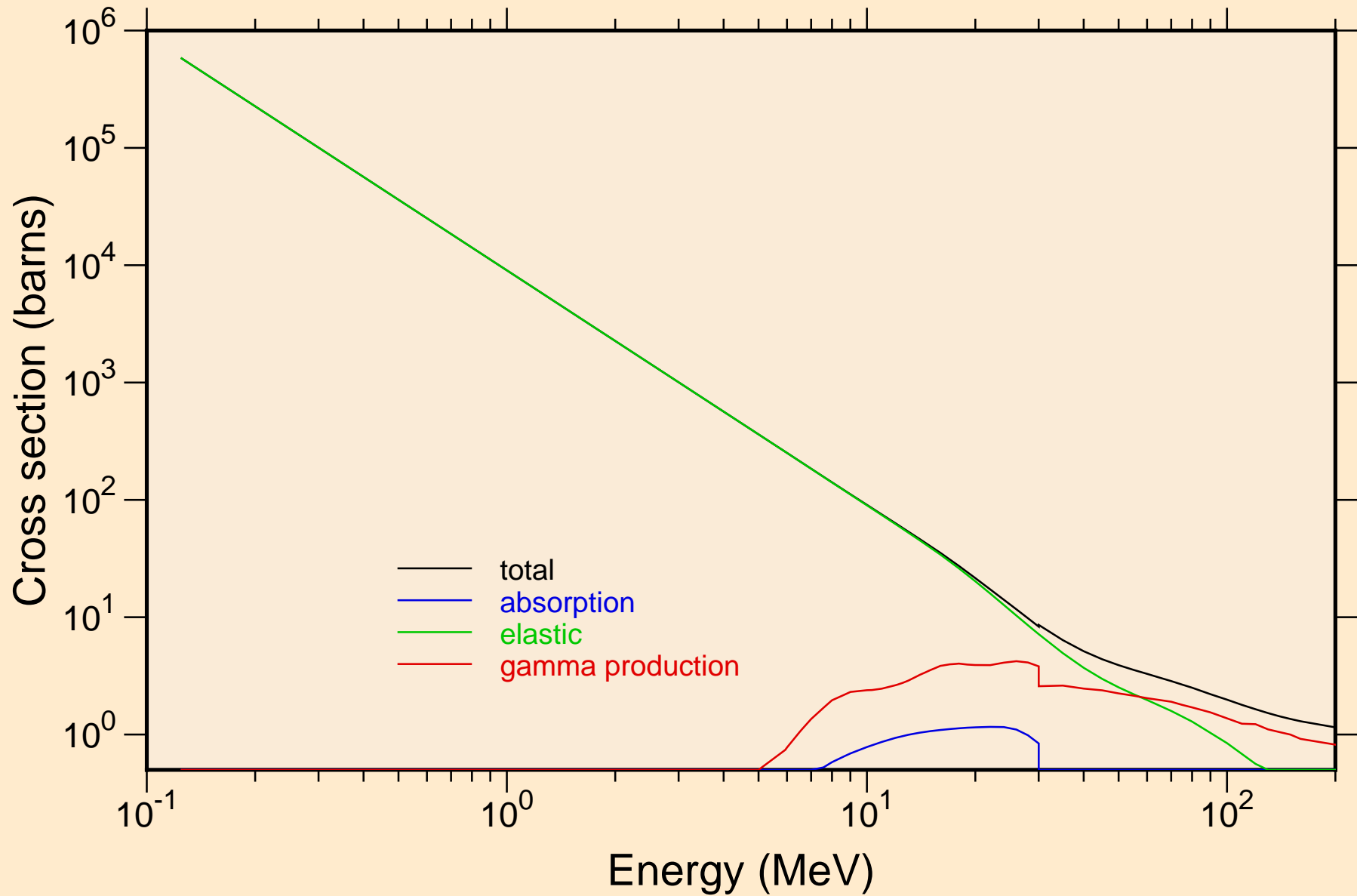

# SR096 PROTON ACER TENDL-2021 LIBRARY; T=0.K

## Heating

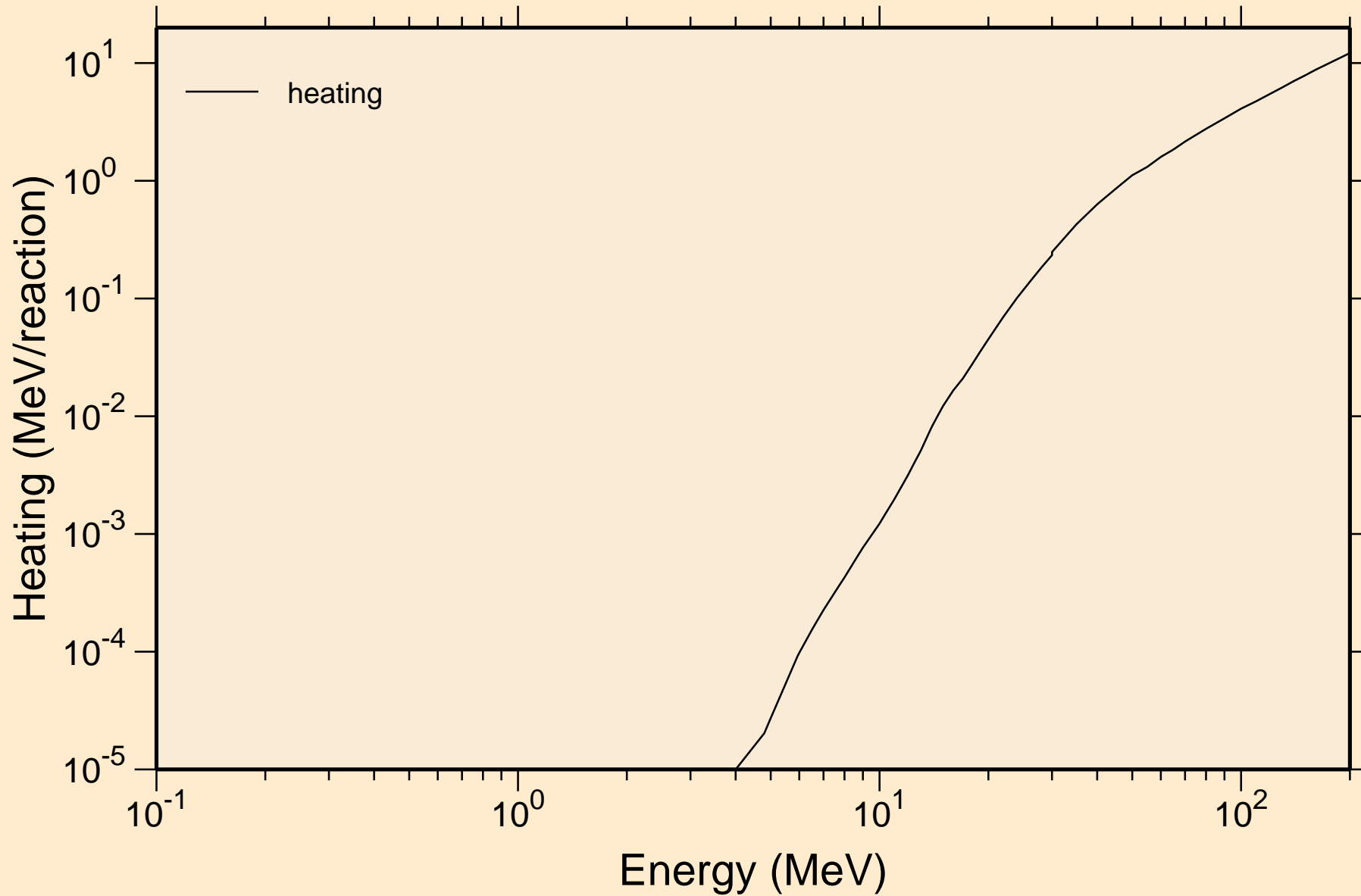

# SR096 PROTON ACER TENDL-2021 LIBRARY; T=0.K

## Principal cross sections

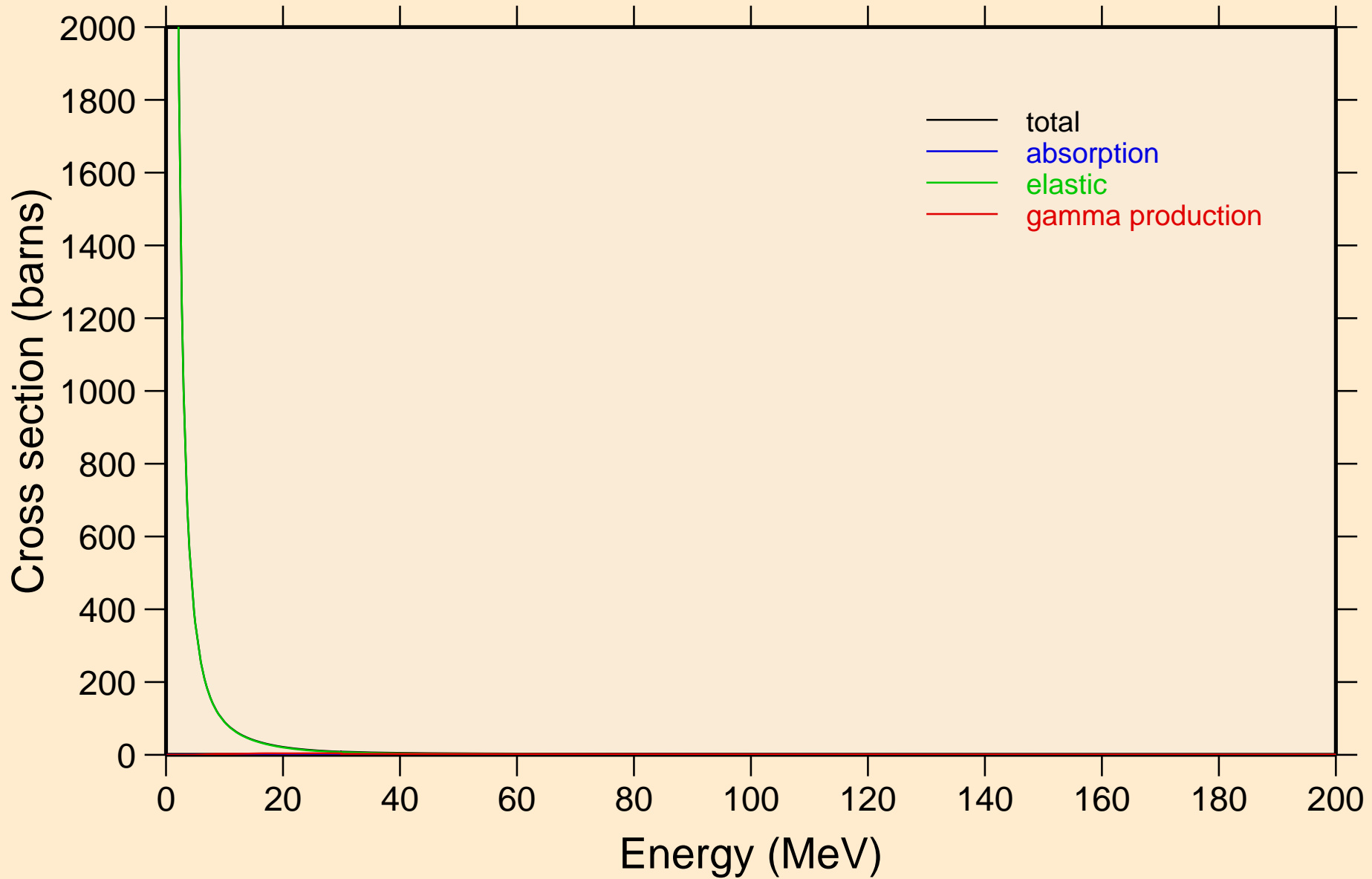

SR096 PROTON ACER TENDL-2021 LIBRARY; T=0.K

Heating

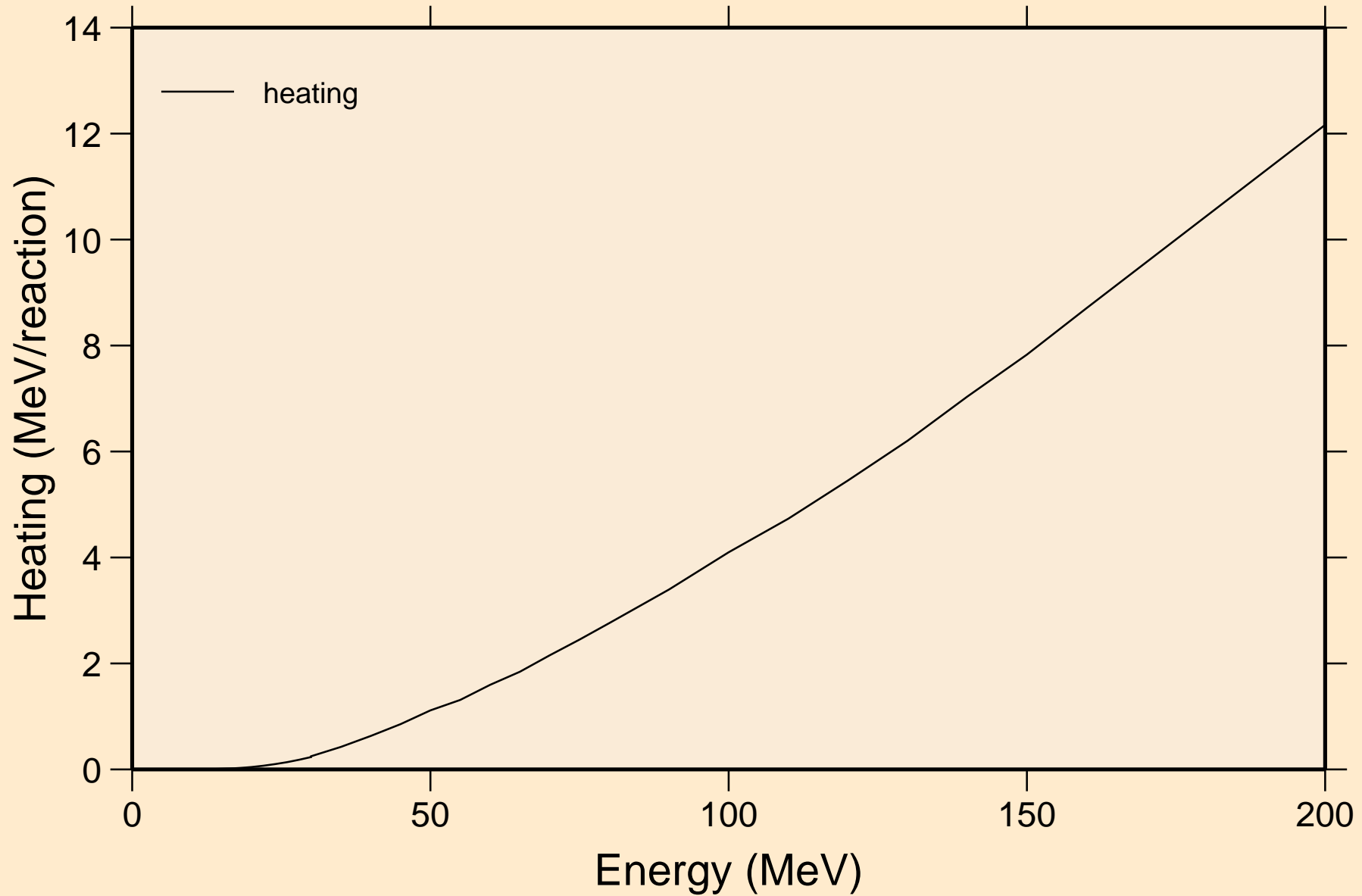

# SR096 PROTON ACER TENDL-2021 LIBRARY; T=0.K

## Threshold reactions

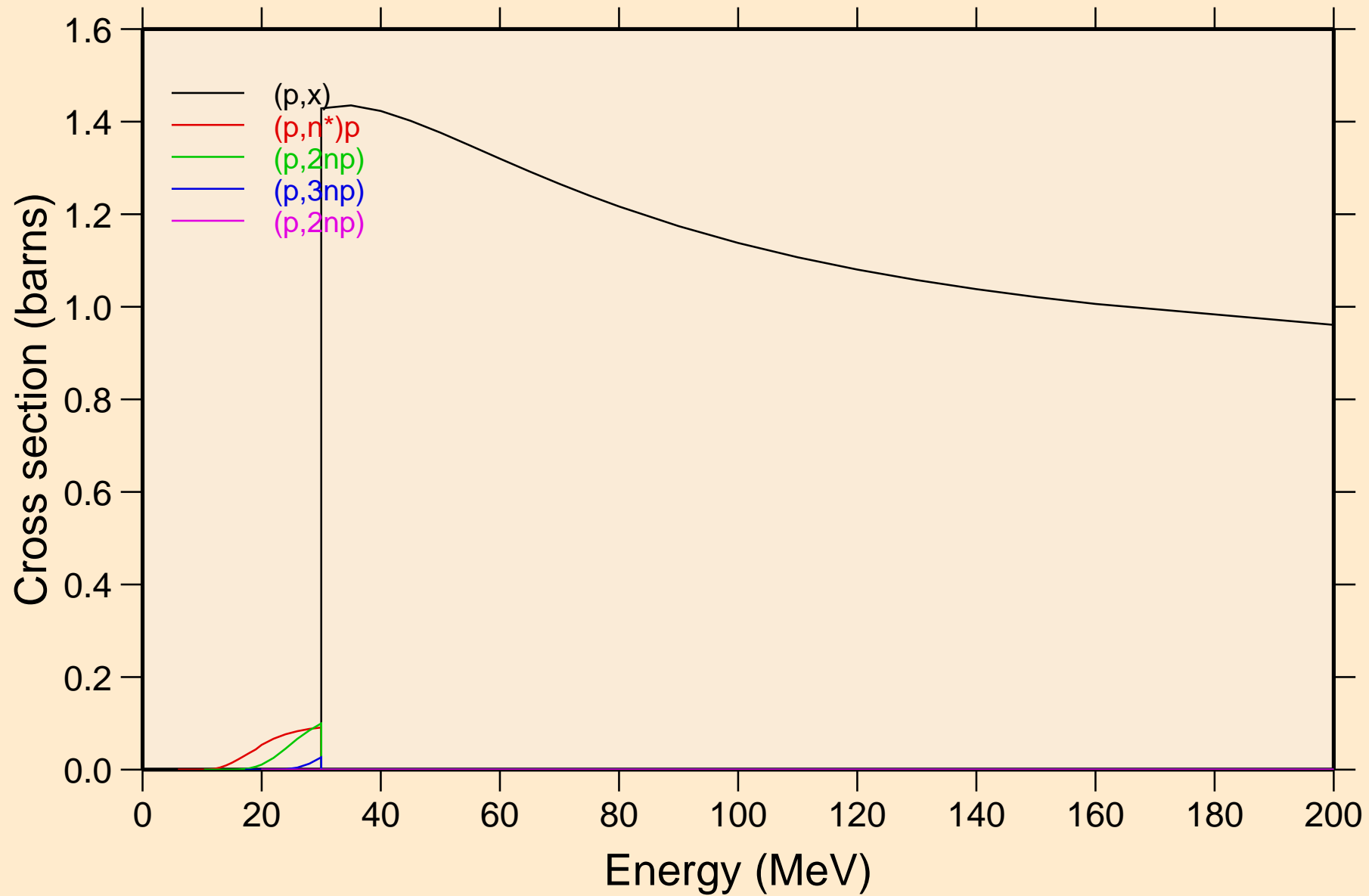

SR096 PROTON ACER TENDL-2021 LIBRARY; T=0.K  
Threshold reactions

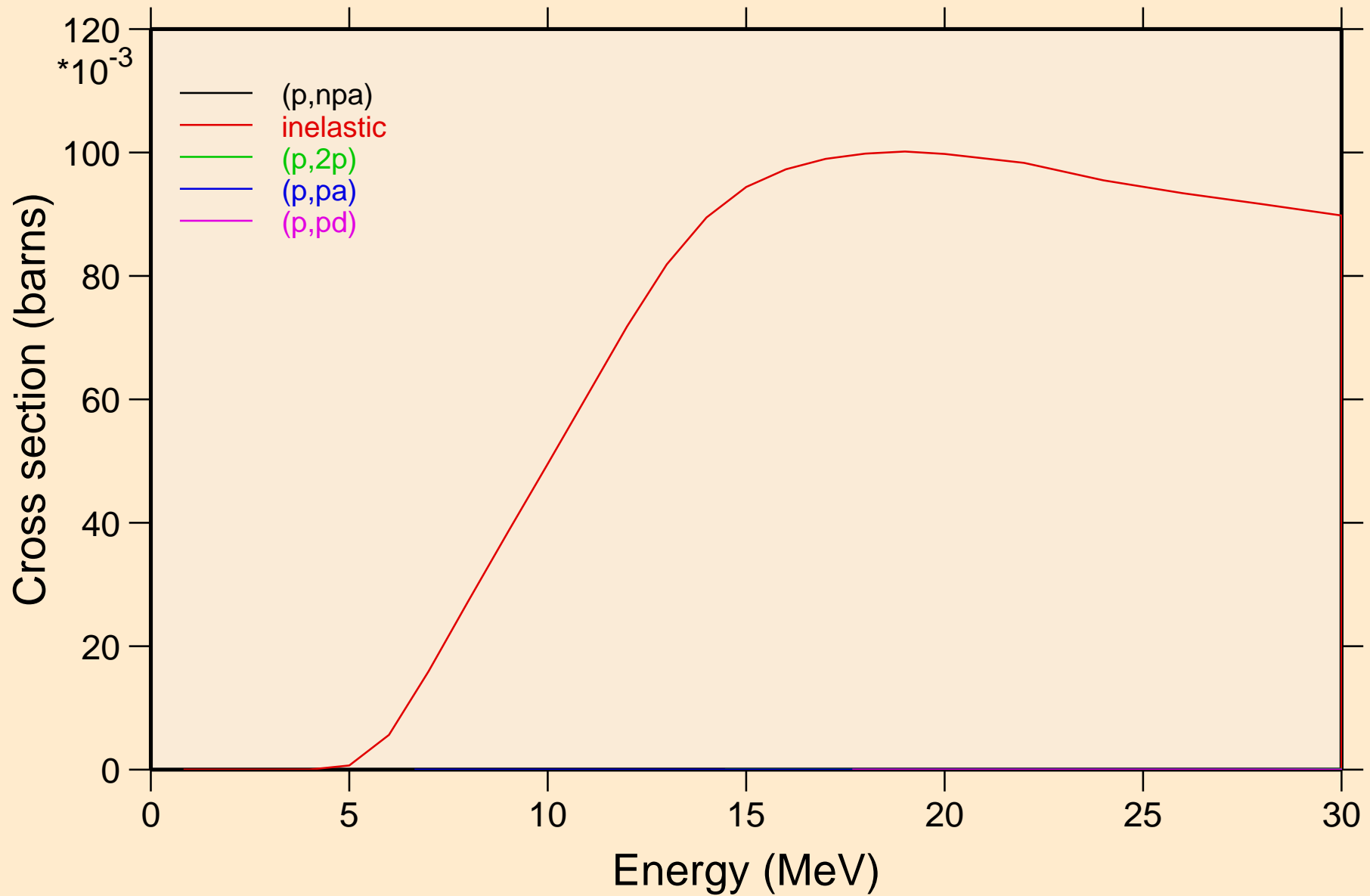

SR096 PROTON ACER TENDL-2021 LIBRARY; T=0.K  
Threshold reactions

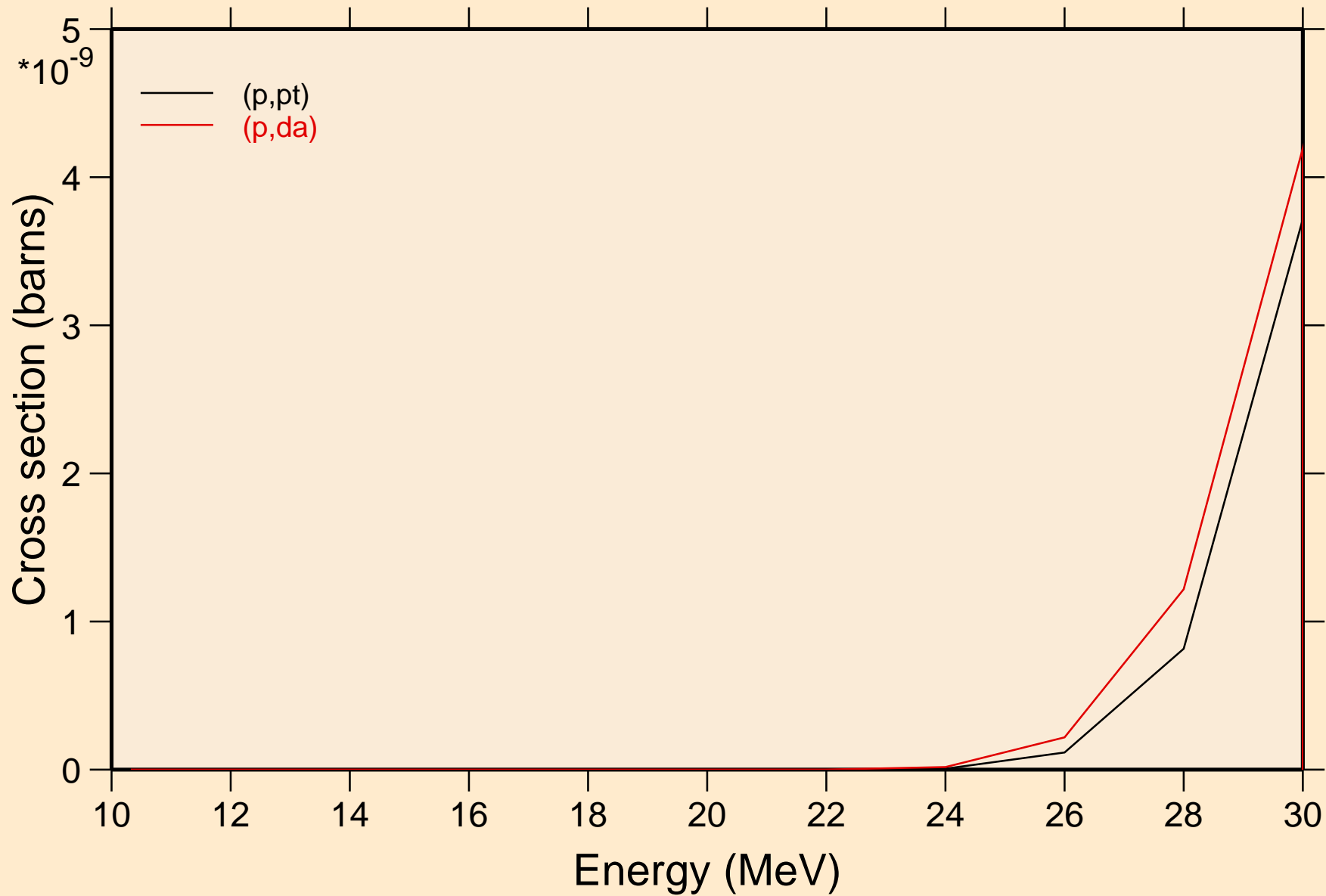

SR096 PROTON ACER TENDL-2021 LIBRARY; T=0.K  
angular distribution for elastic

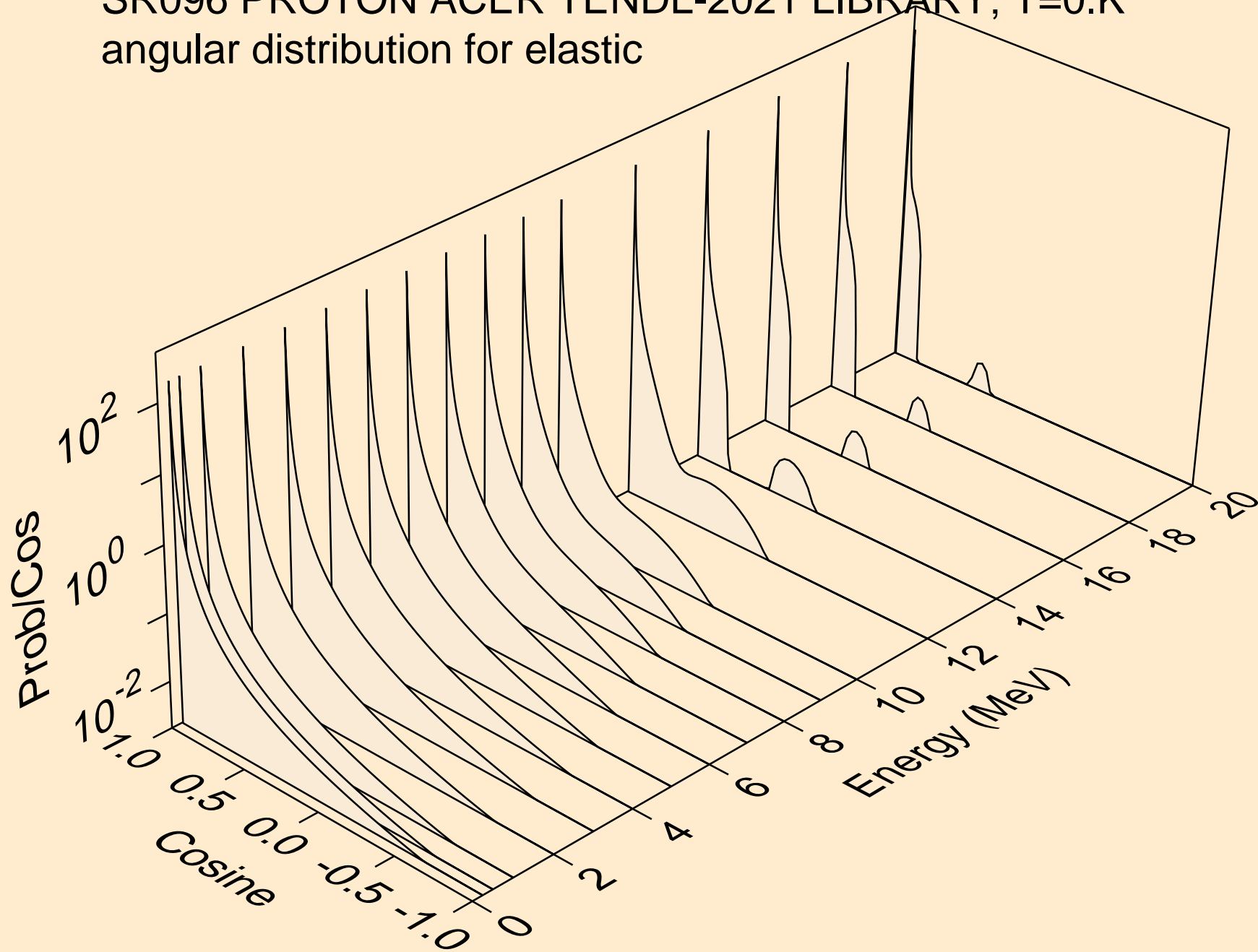



SR096 PROTON ACER TENDL-2021 LIBRARY; T=0.K  
angular distribution for elastic

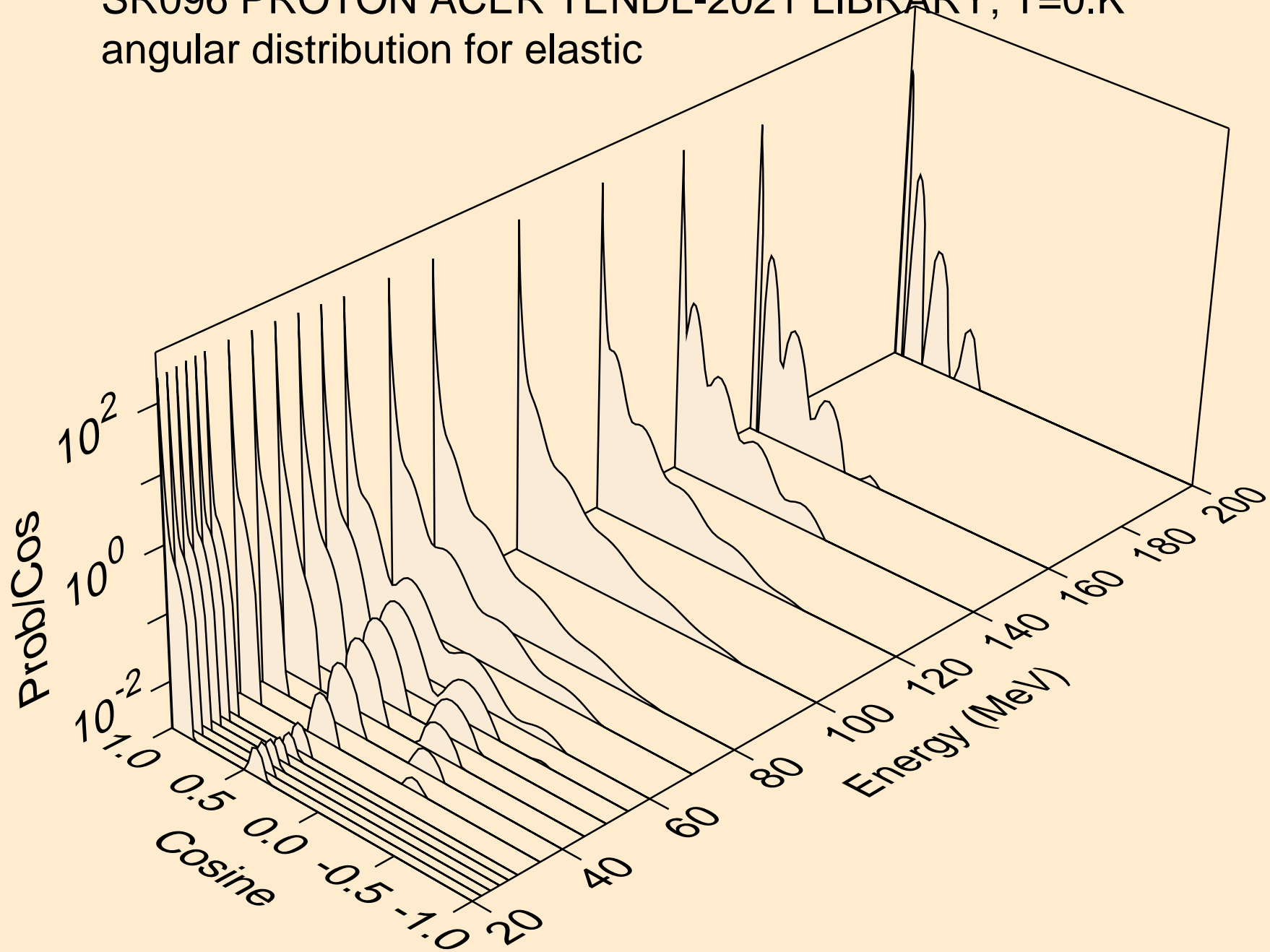

SR096 PROTON ACER TENDL-2021 LIBRARY; T=0.K  
Proton emission for (p,x)

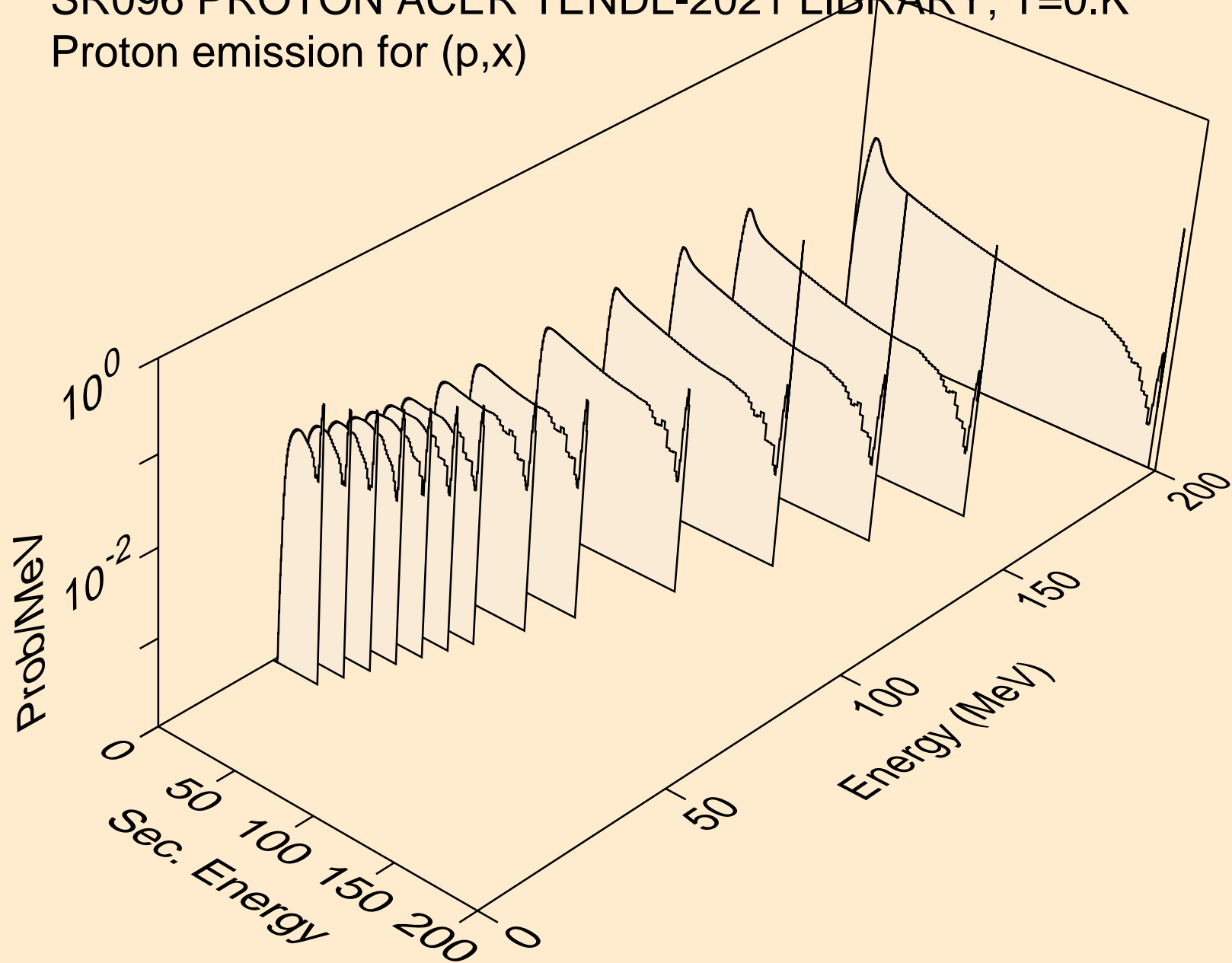

SR096 PROTON ACER TENDL-2021 LIBRARY; T=0.K  
Proton emission for (p,n\*)p

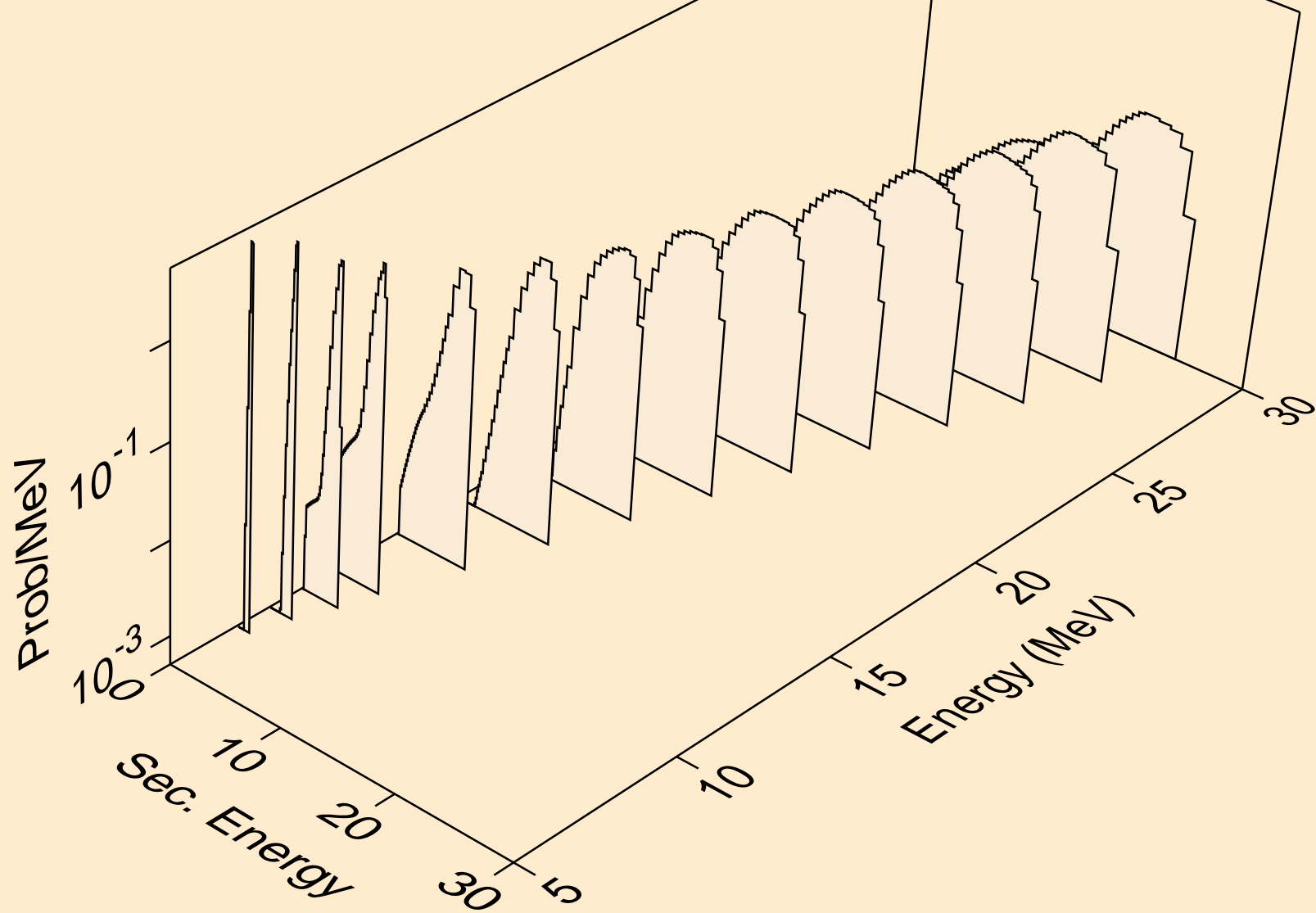

SR096 PROTON ACER TENDL-2021 LIBRARY; T=0.K  
Proton emission for (p,2np)

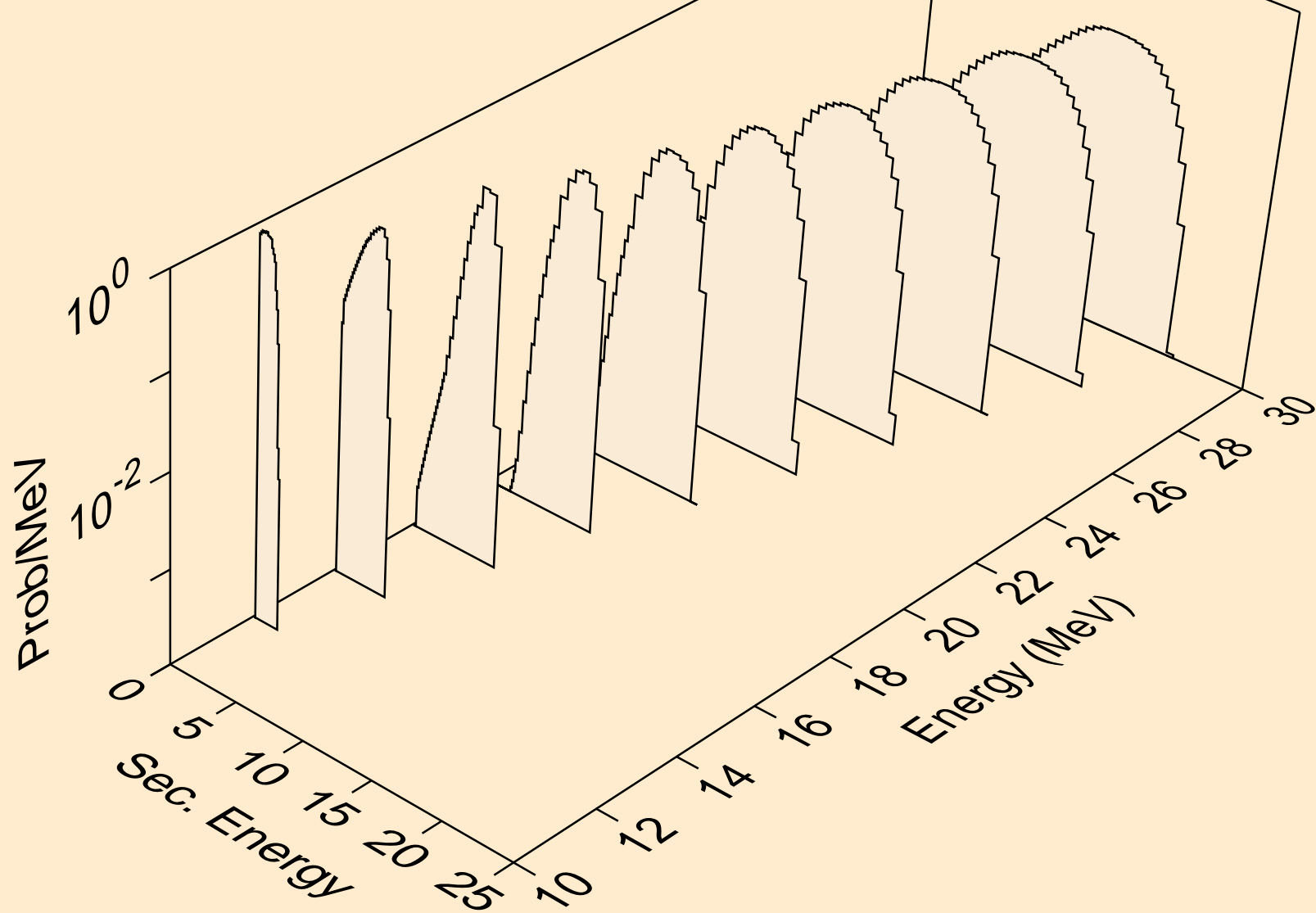

SR096 PROTON ACER TENDL-2021 LIBRARY; T=0.K  
Proton emission for (p,3np)

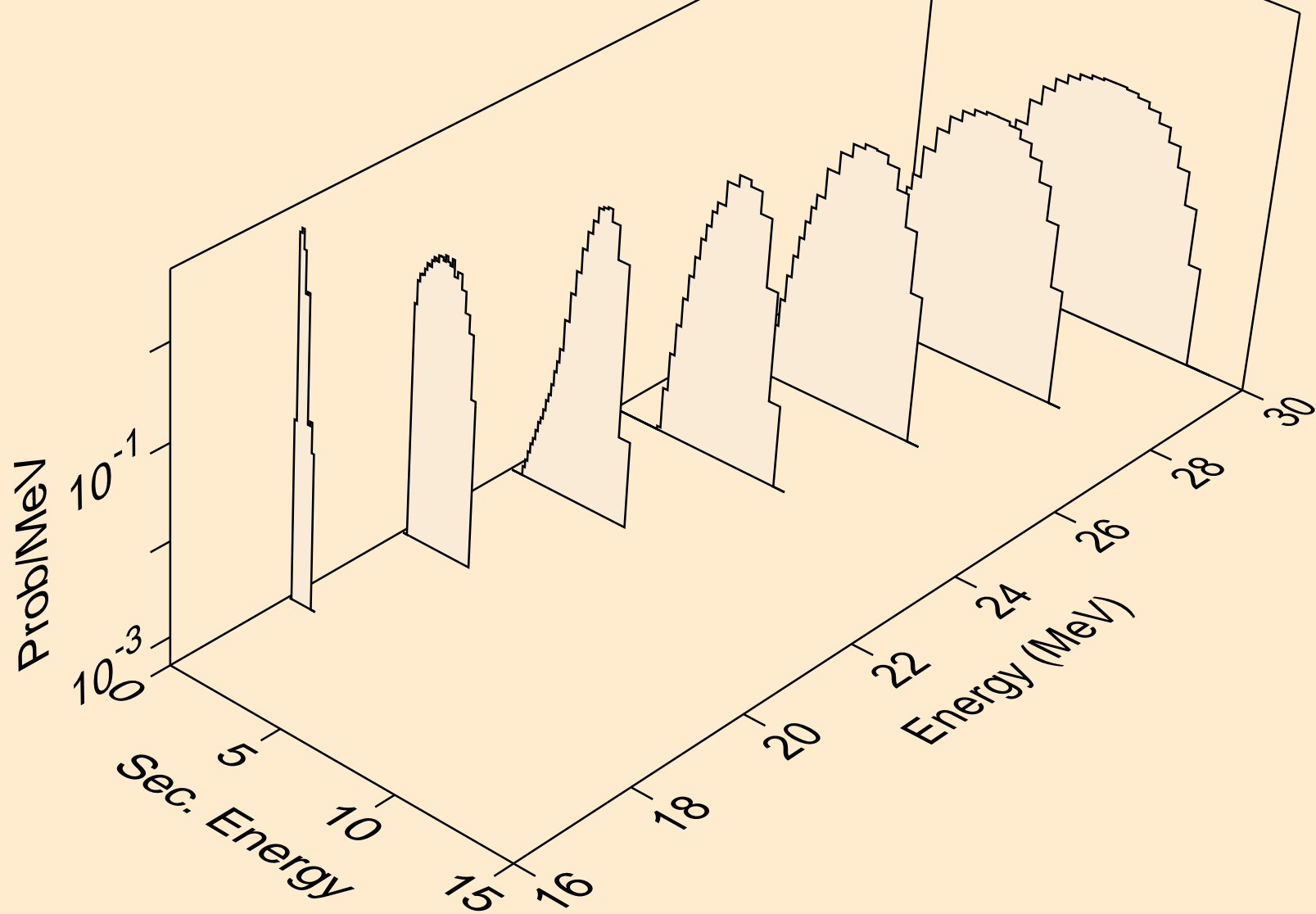

SR096 PROTON ACER TENDL-2021 LIBRARY; T=0.K  
Proton emission for (p,2np)

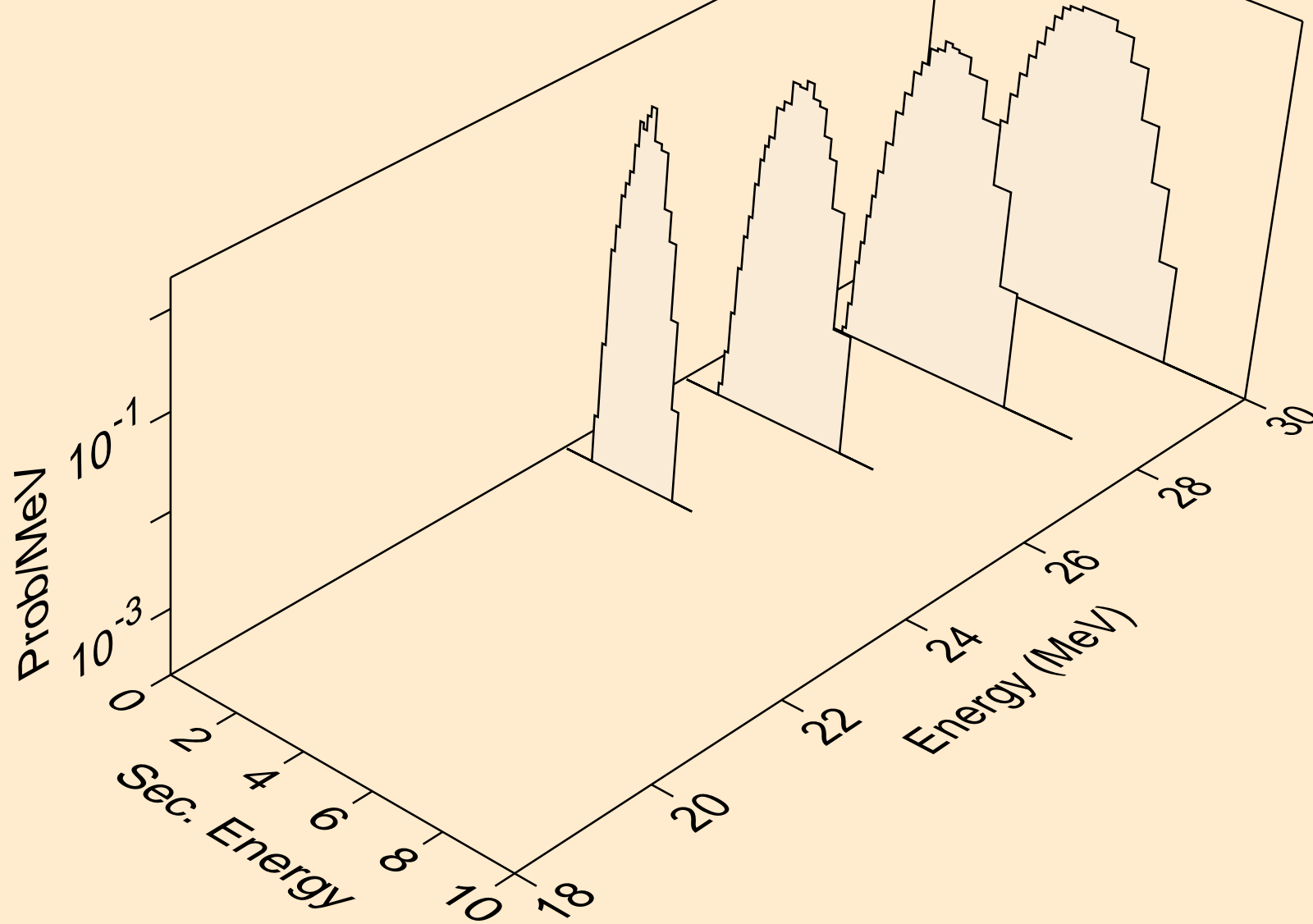

SR096 PROTON ACER TENDL-2021 LIBRARY; T=0.K  
Proton emission for (p,npa)

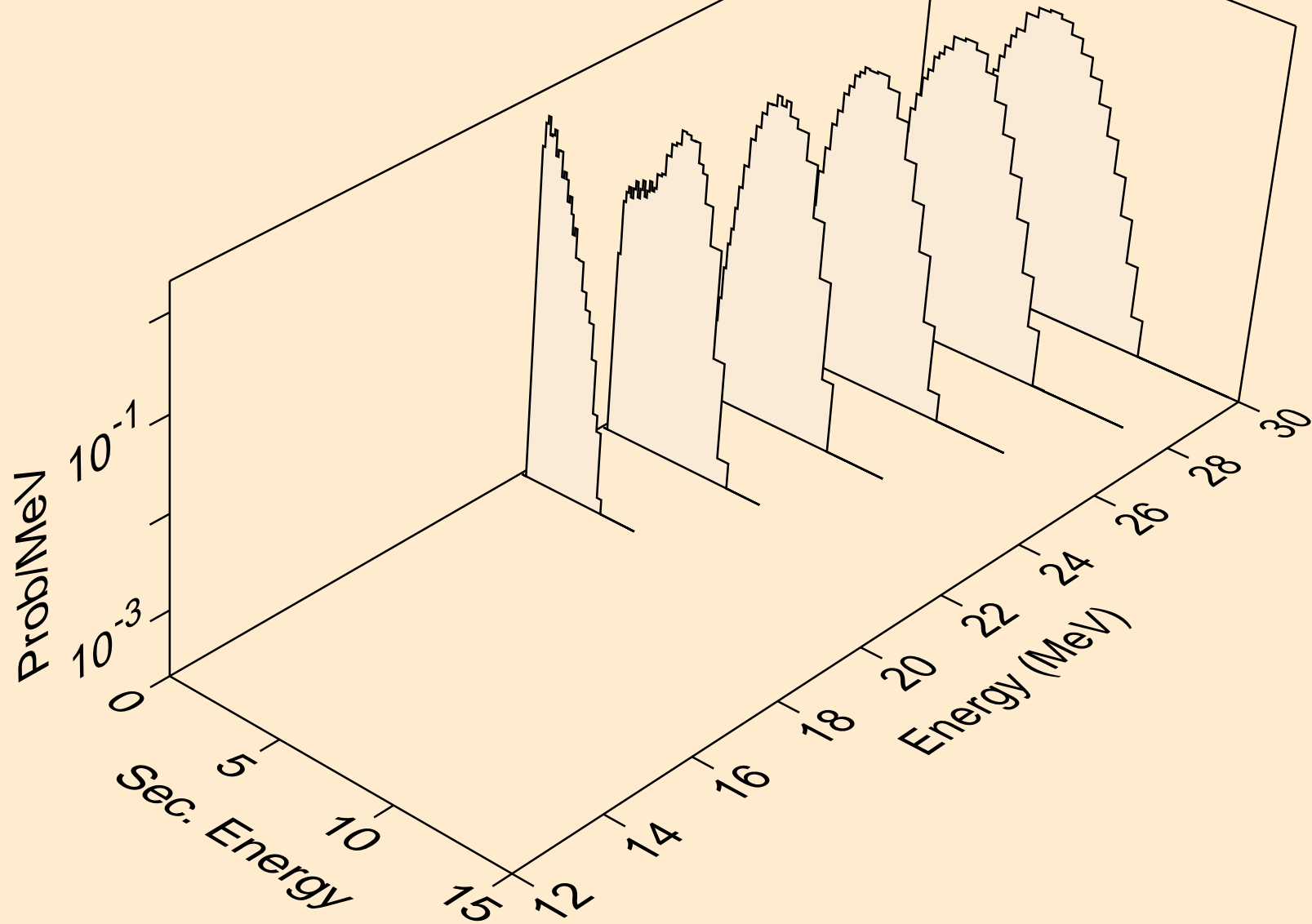

SR096 PROTON ACER TENDL-2021 LIBRARY; T=0.K  
Proton emission for inelastic

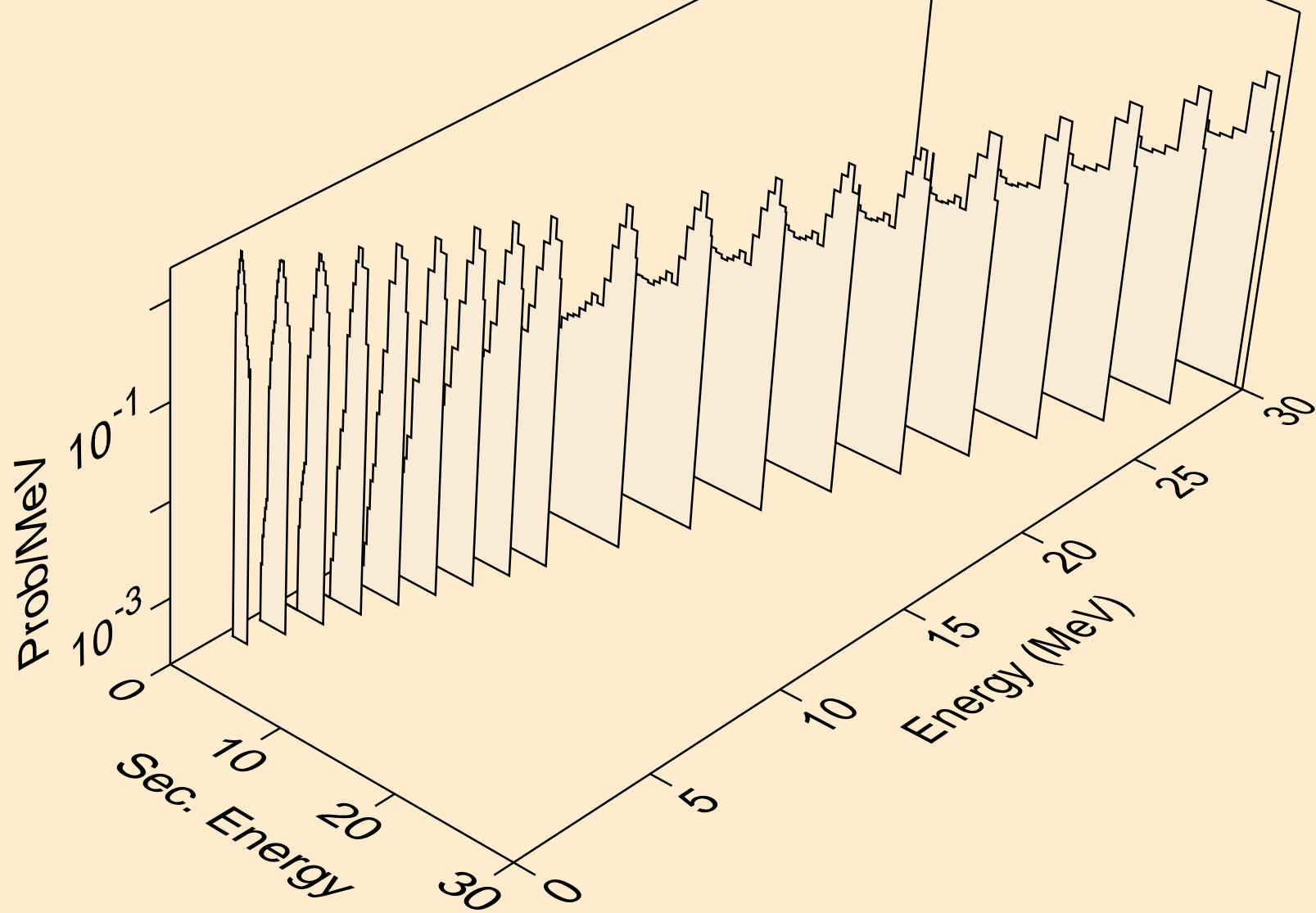



SR096 PROTON ACER TENDL-2021 LIBRARY; T=0.K  
Proton emission for (p,2p)

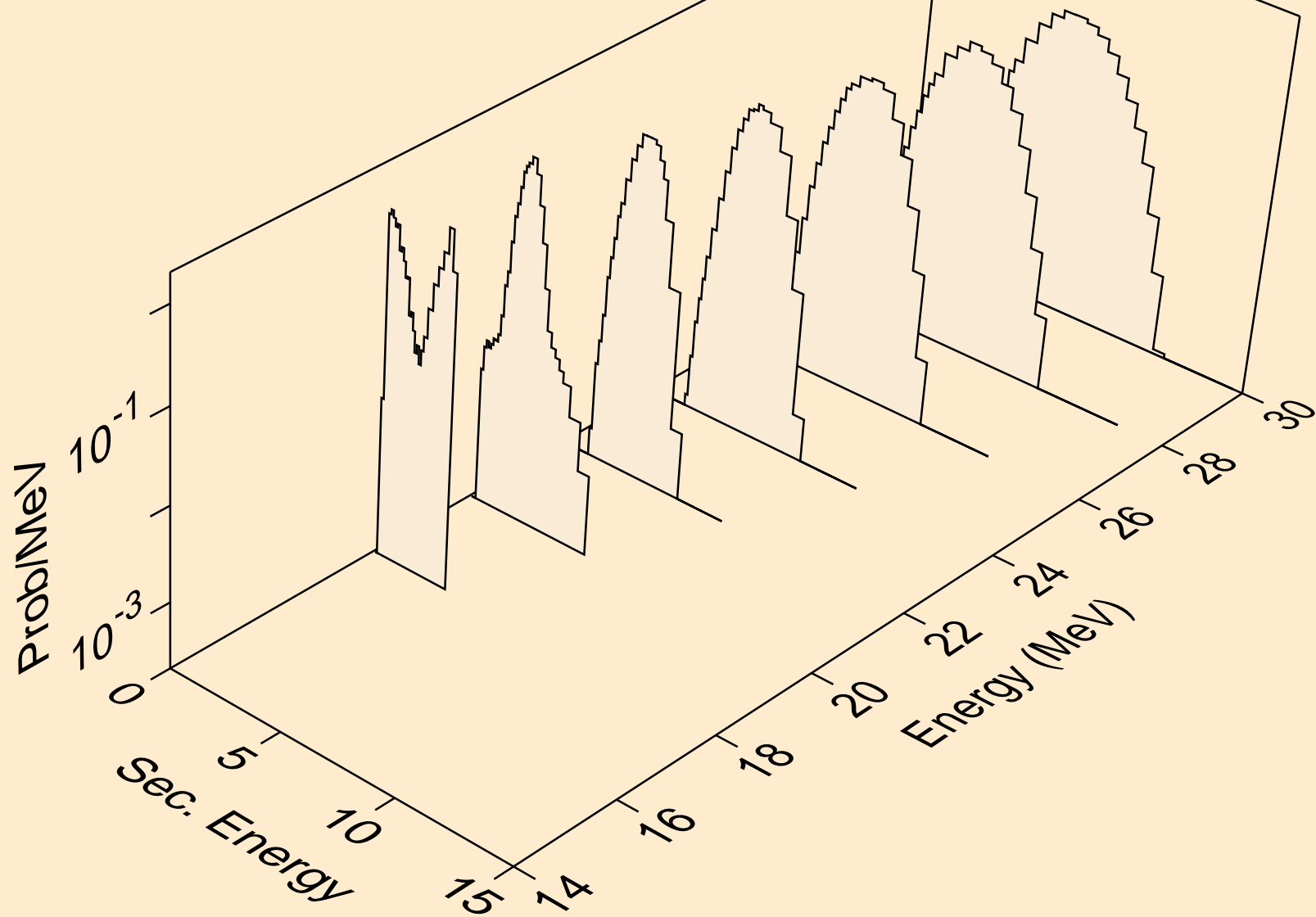

SR096 PROTON ACER TENDL-2021 LIBRARY; T=0.K  
Proton emission for (p,pa)

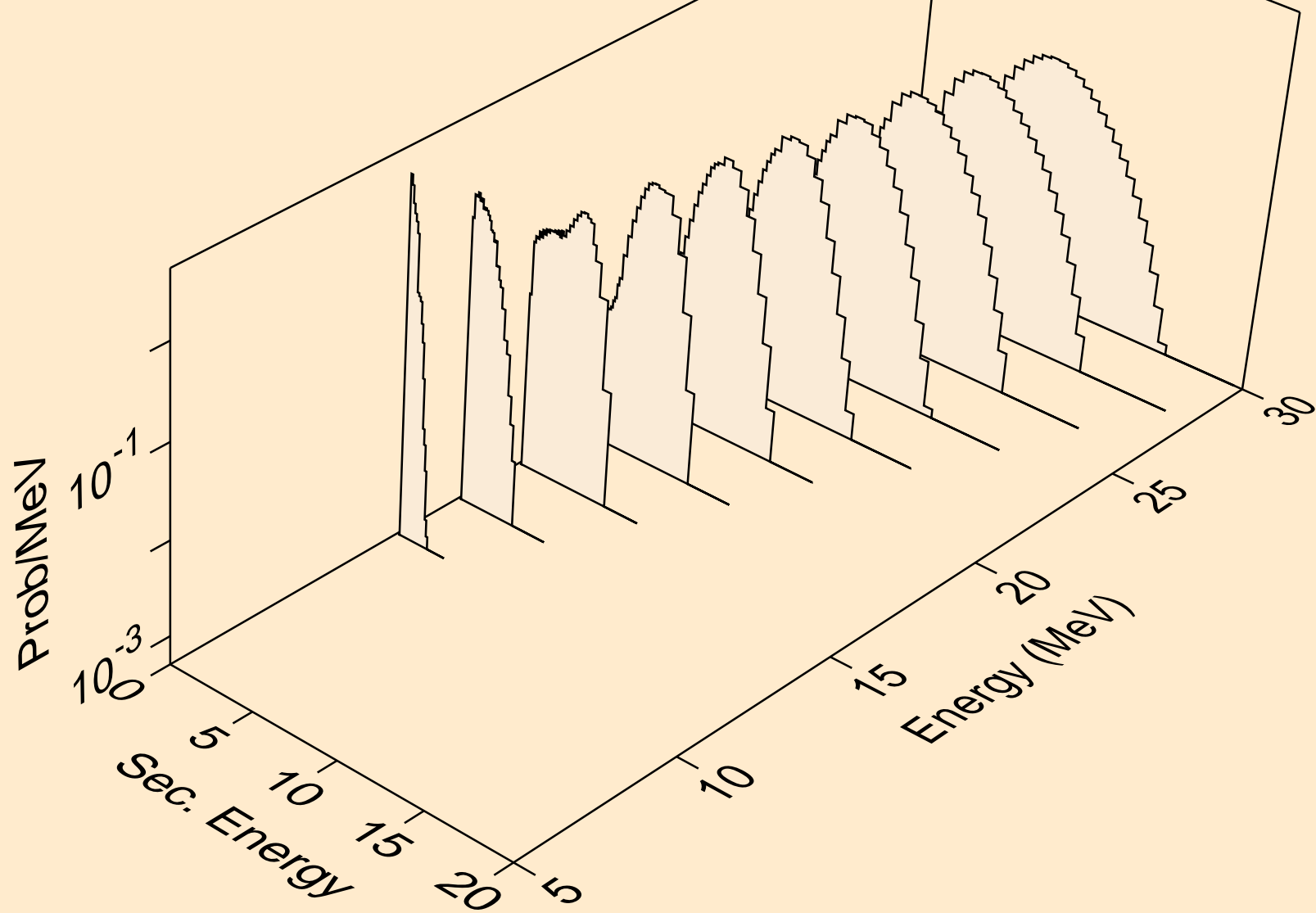

SR096 PROTON ACER TENDL-2021 LIBRARY; T=0.K  
Proton emission for (p,pd)

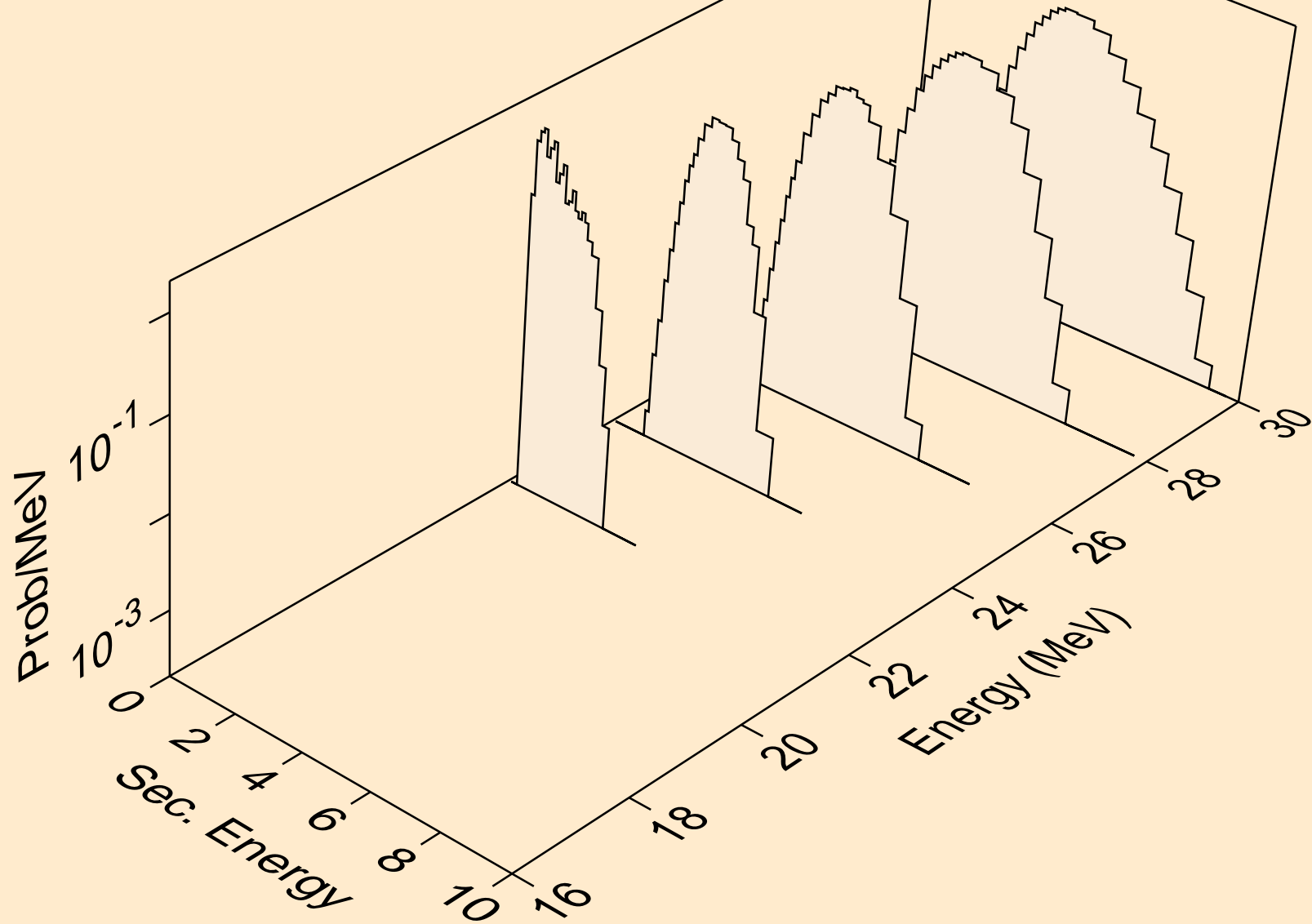

SR096 PROTON ACER TENDL-2021 LIBRARY; T=0.K  
Proton emission for (p,pt)

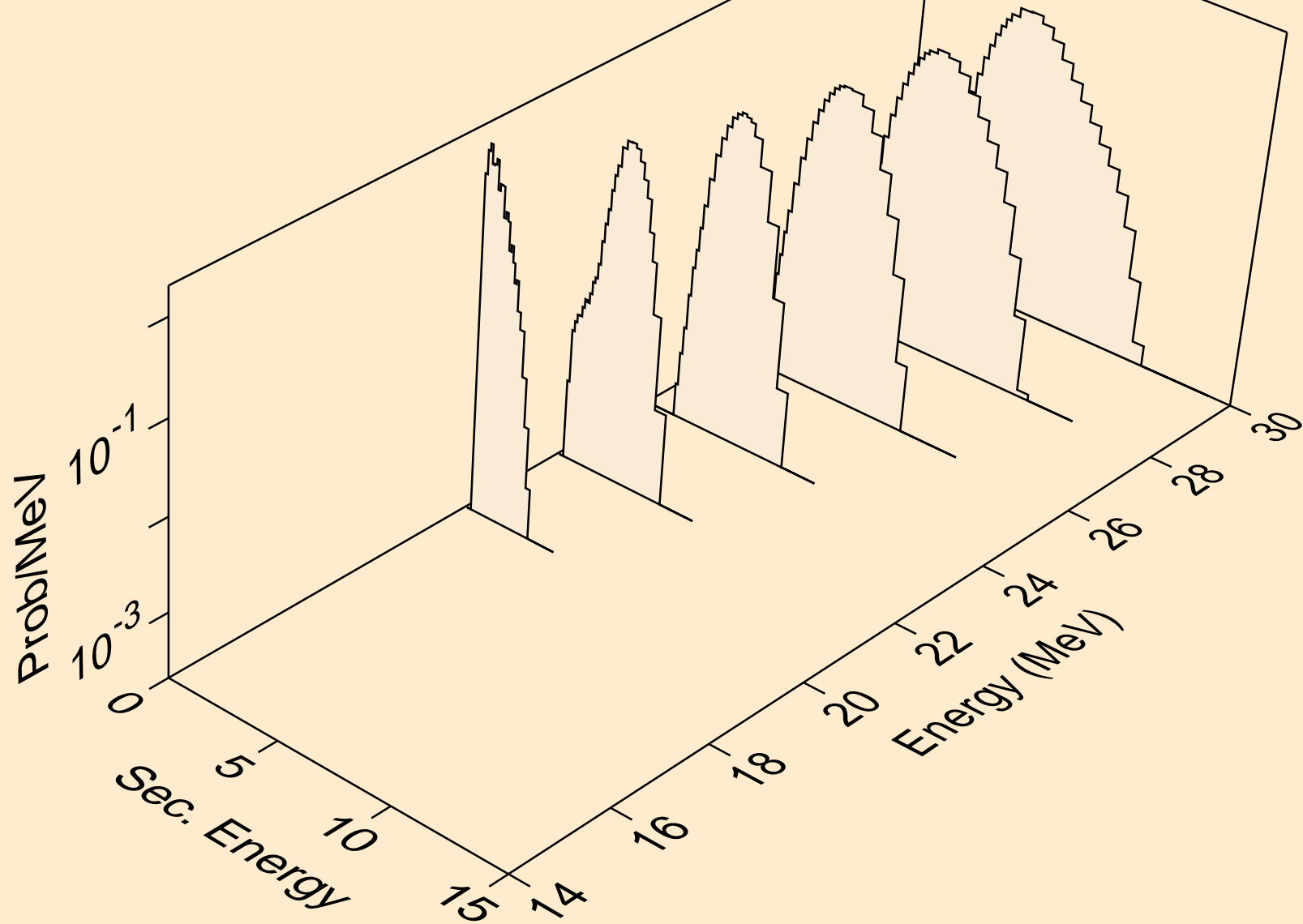

SR096 PROTON ACER TENDL-2021 LIBRARY; T=0.K  
Photon emission for (z,n)

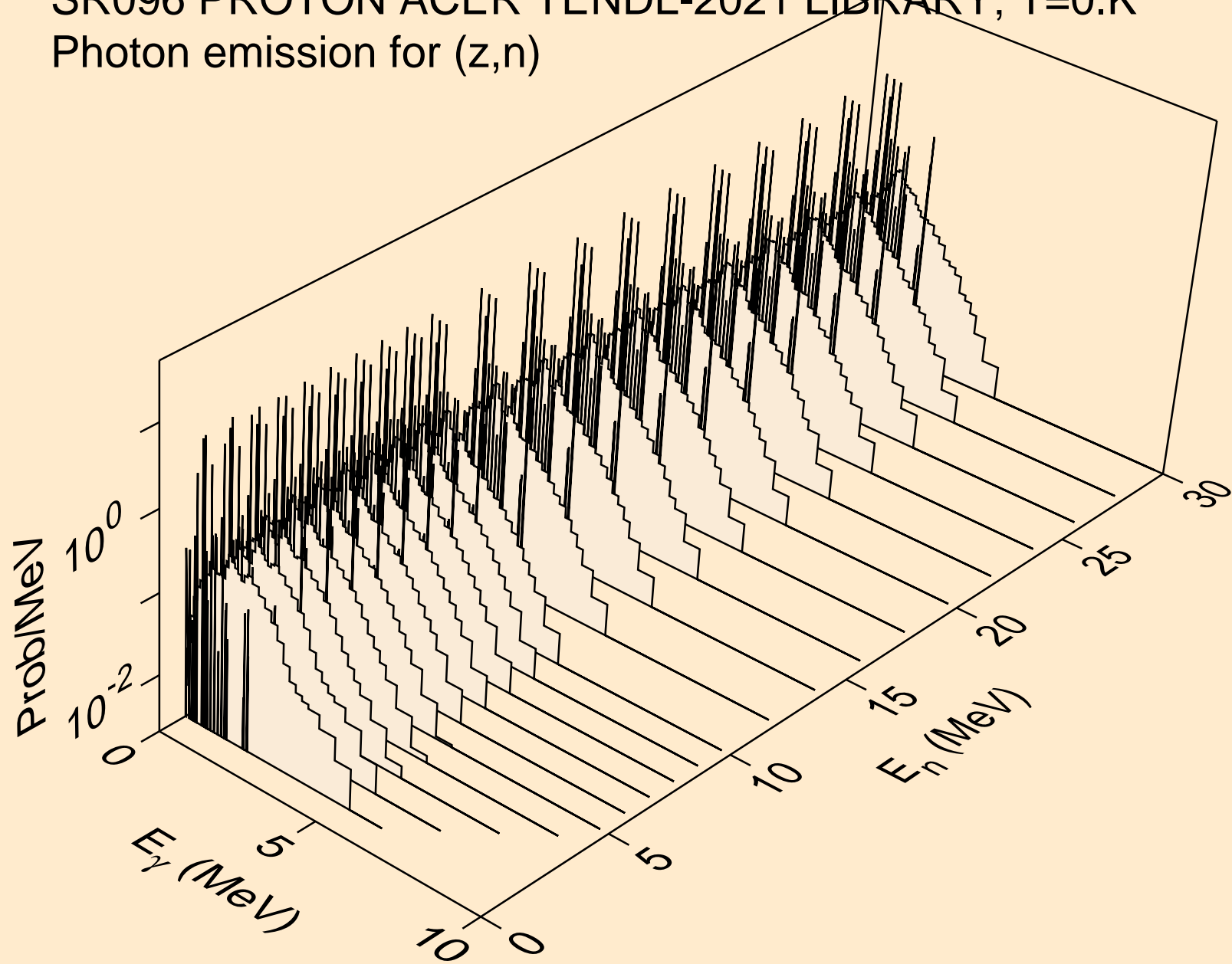

SR096 PROTON ACER TENDL-2021 LIBRARY; T=0.K  
Photon emission for (n,x)

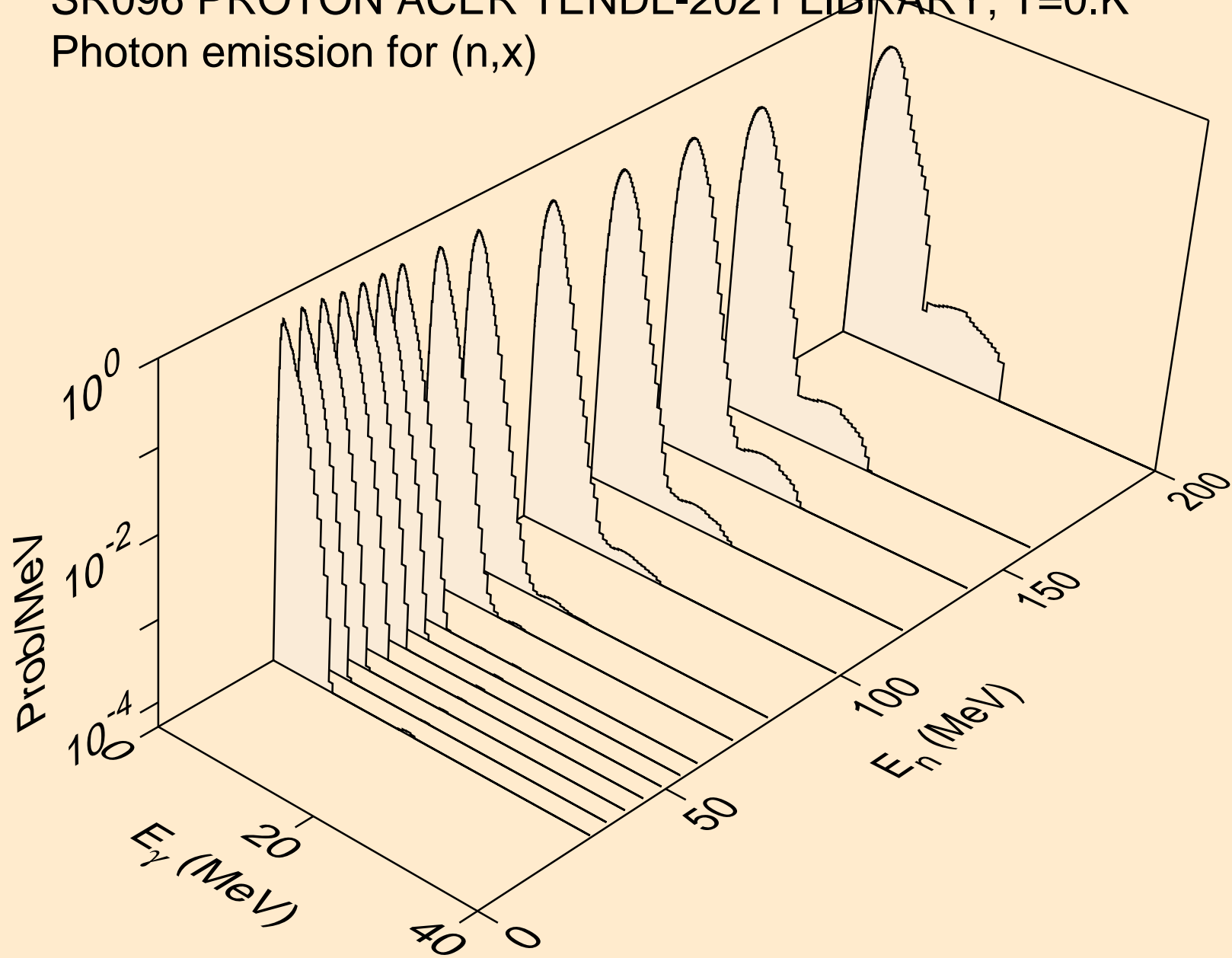

SR096 PROTON ACER TENDL-2021 LIBRARY; T=0.K  
Photon emission for (n,2nd)

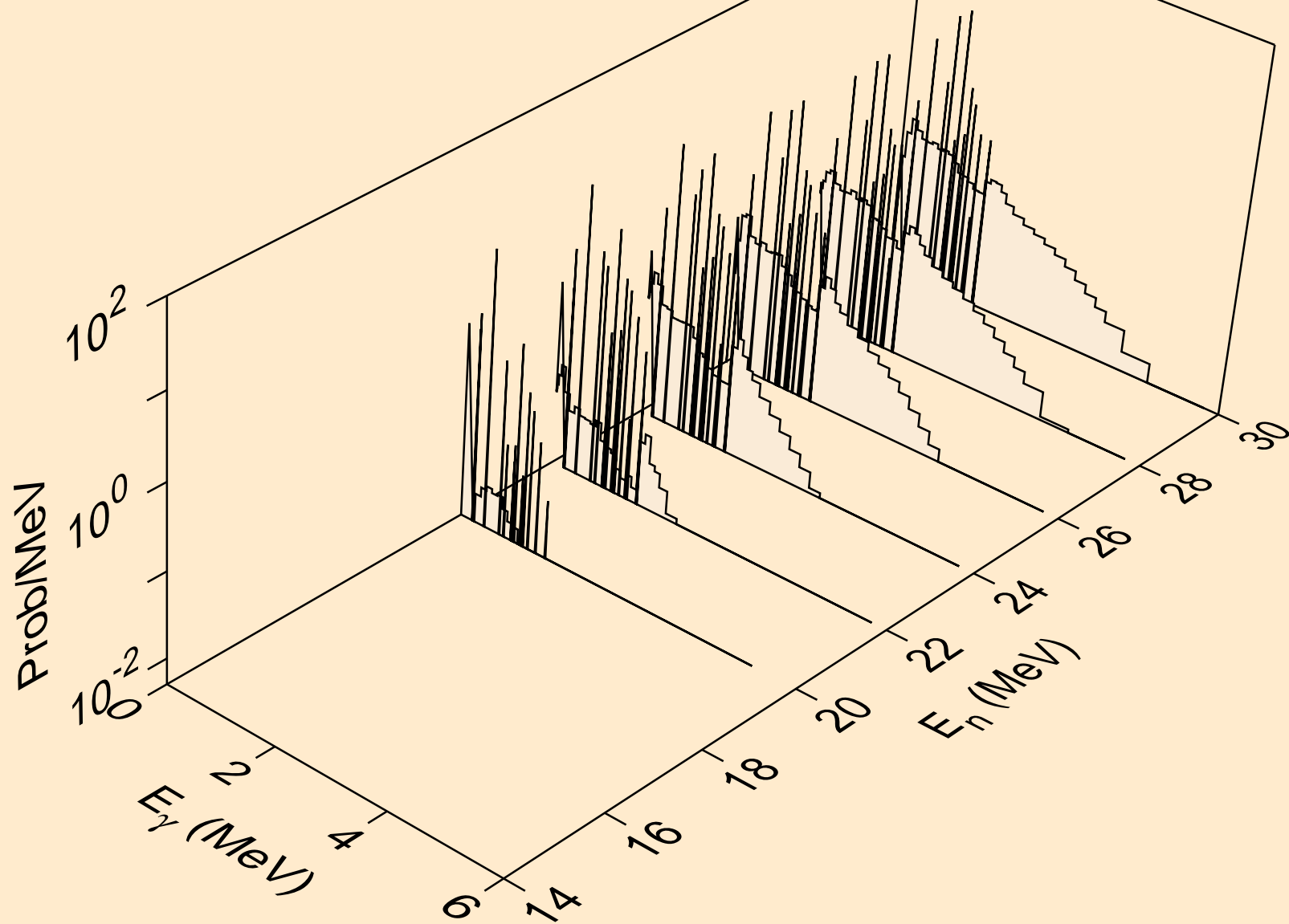

SR096 PROTON ACER TENDL-2021 LIBRARY; T=0.K  
Photon emission for (n,2n)

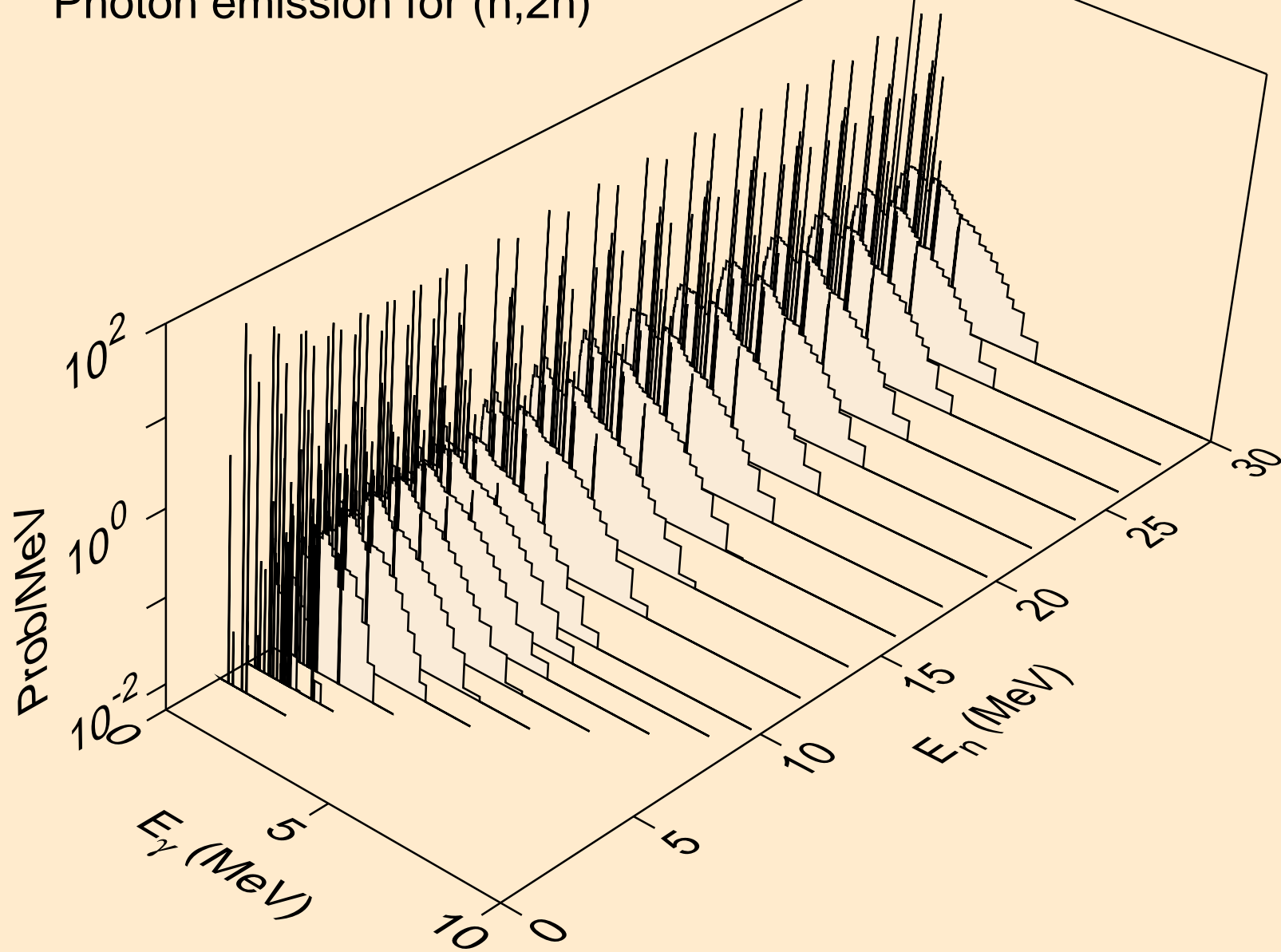



SR096 PROTON ACER TENDL-2021 LIBRARY; T=0.K  
Photon emission for (n,3n)

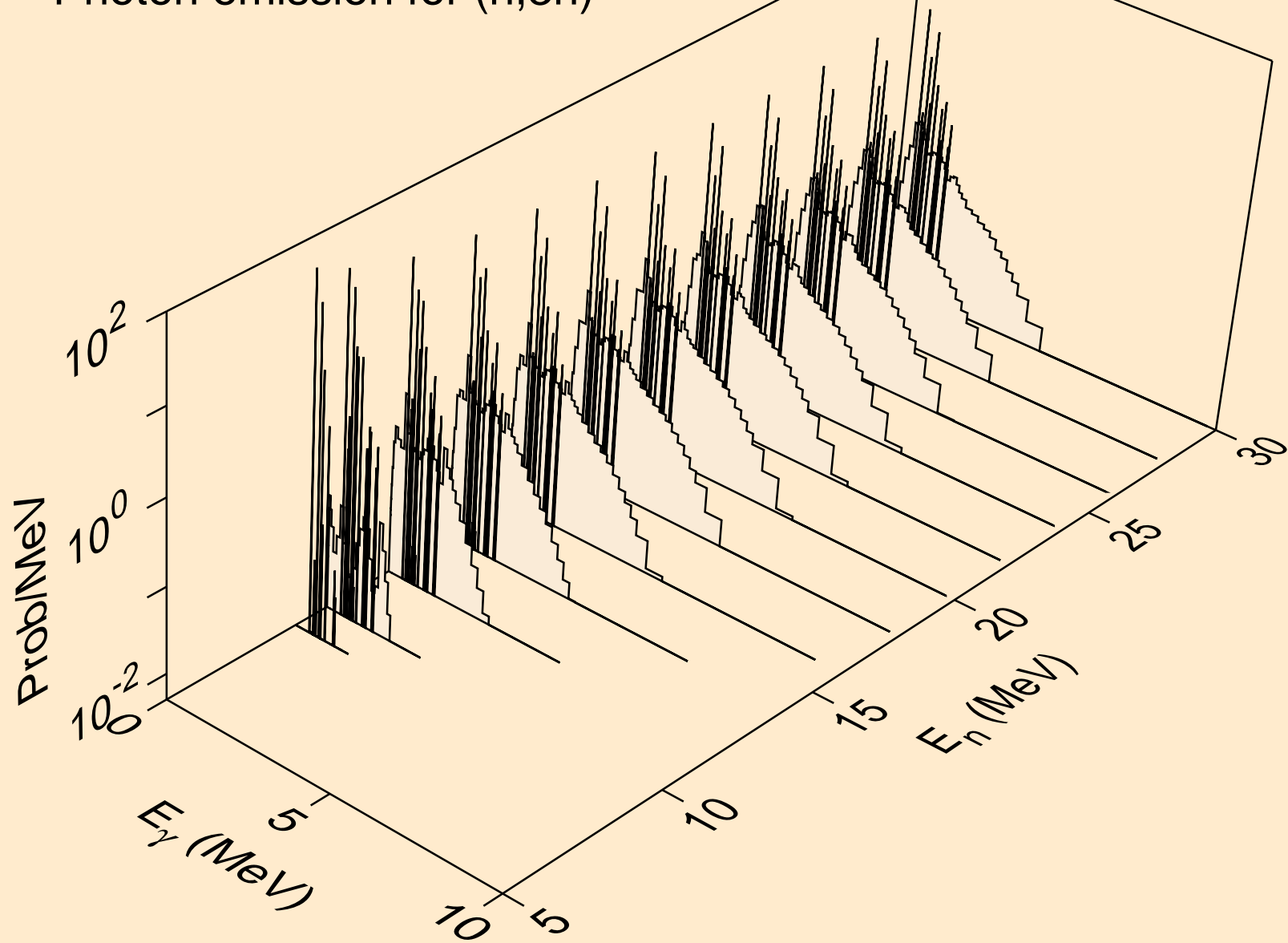

SR096 PROTON ACER TENDL-2021 LIBRARY; T=0.K  
Photon emission for (n,n\*)a

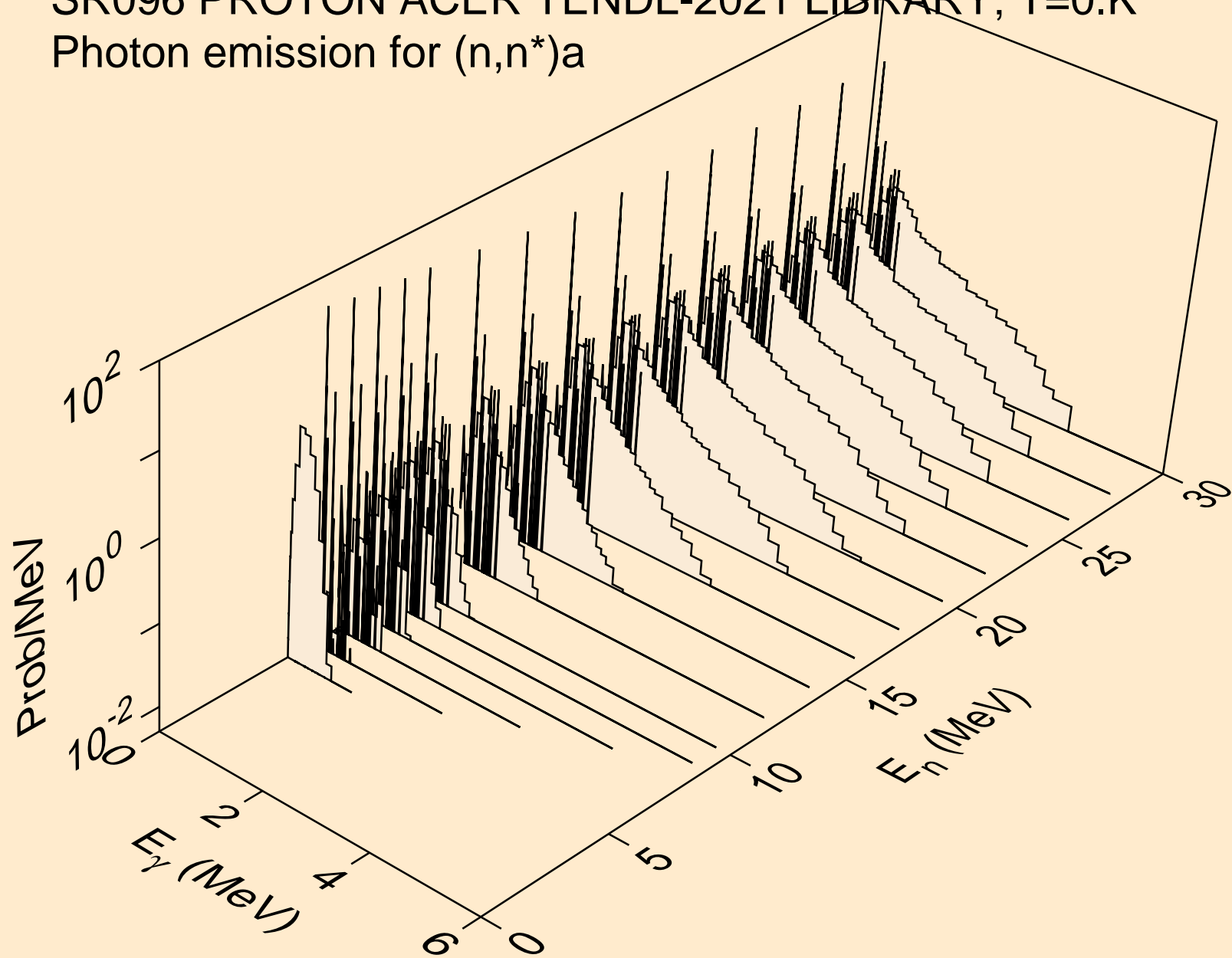

SR096 PROTON ACER TENDL-2021 LIBRARY; T=0.K  
Photon emission for (n,2n)a

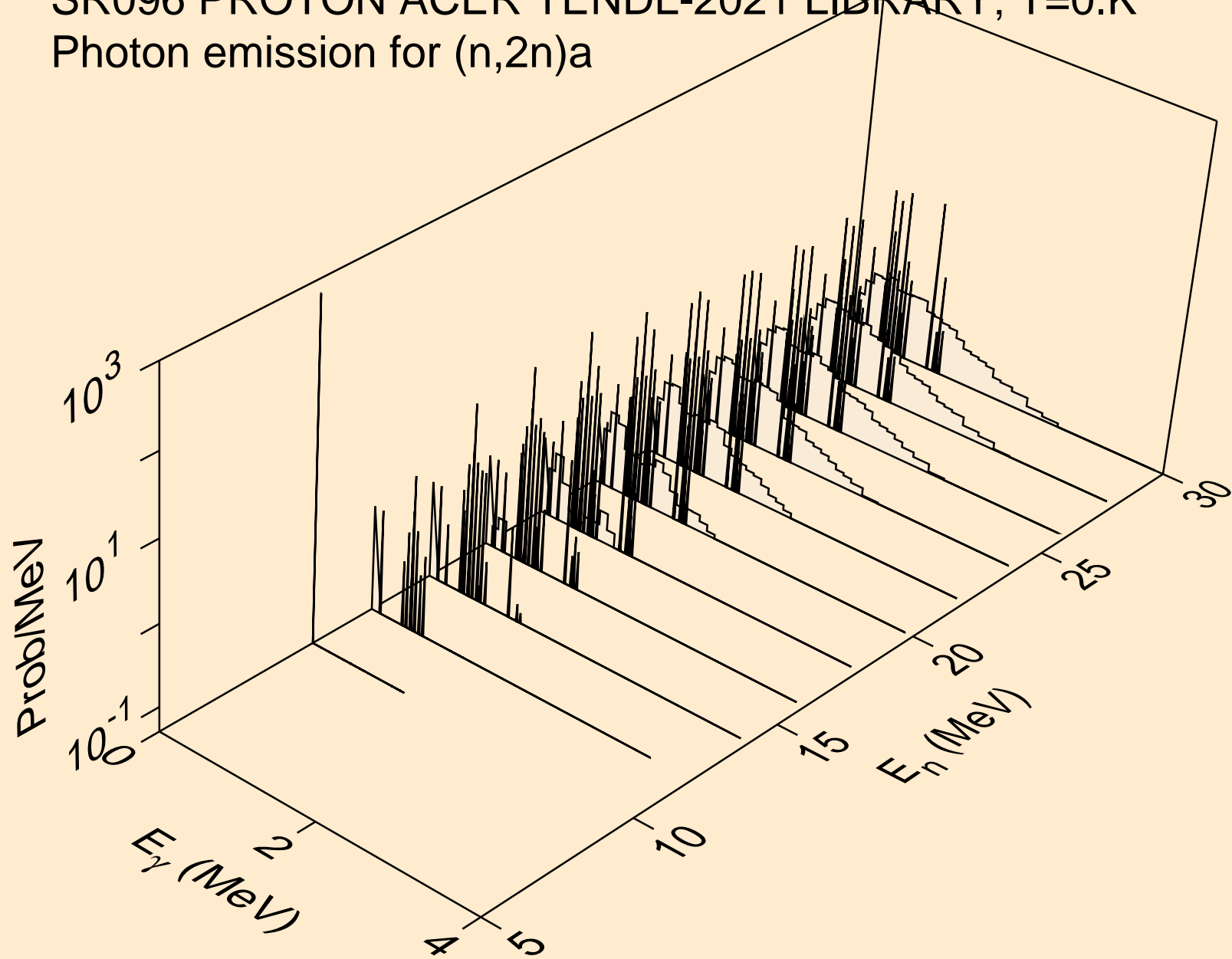

SR096 PROTON ACER TENDL-2021 LIBRARY; T=0.K  
Photon emission for (n,3n)a

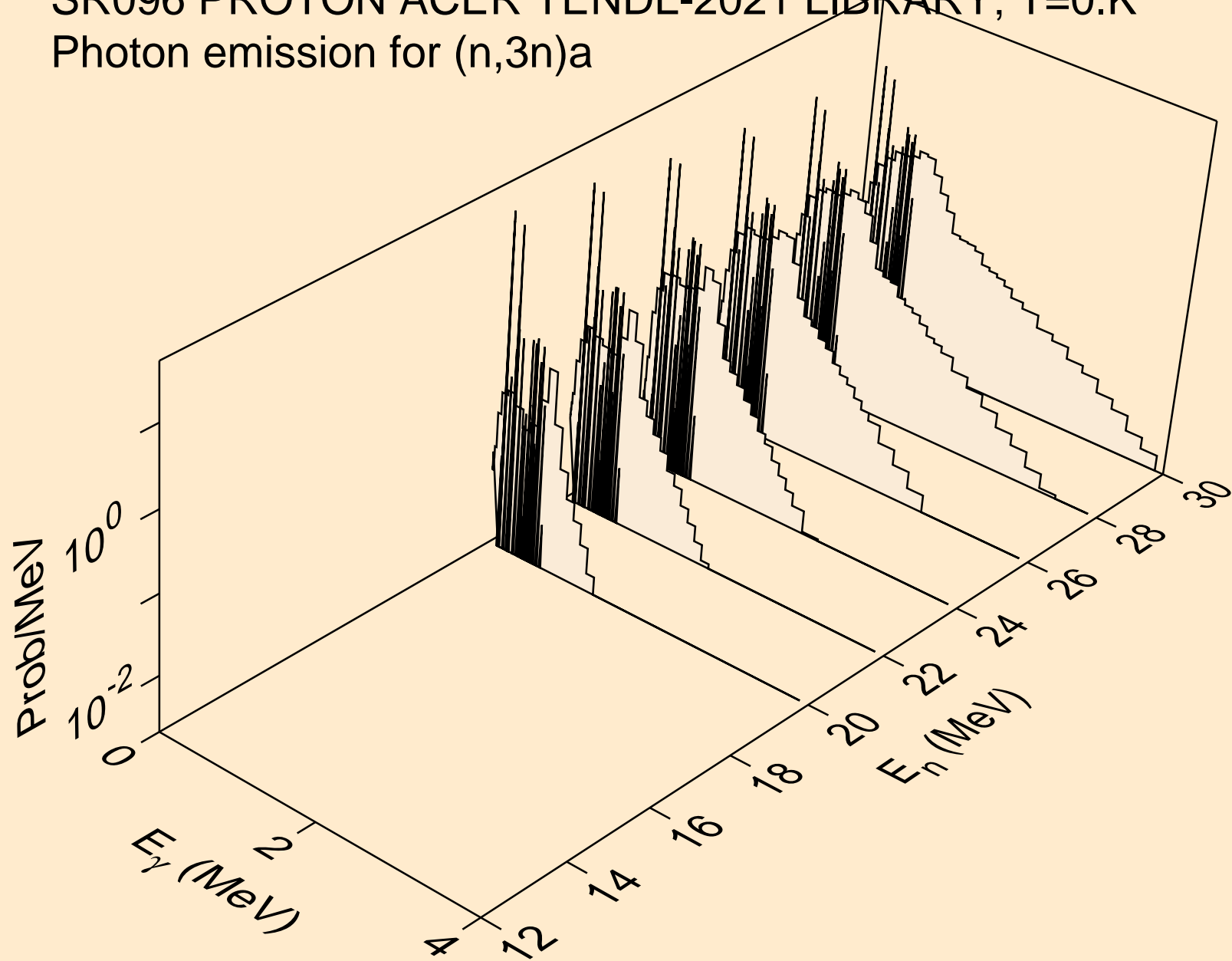

SR096 PROTON ACER TENDL-2021 LIBRARY; T=0.K  
Photon emission for (n,n\*)p

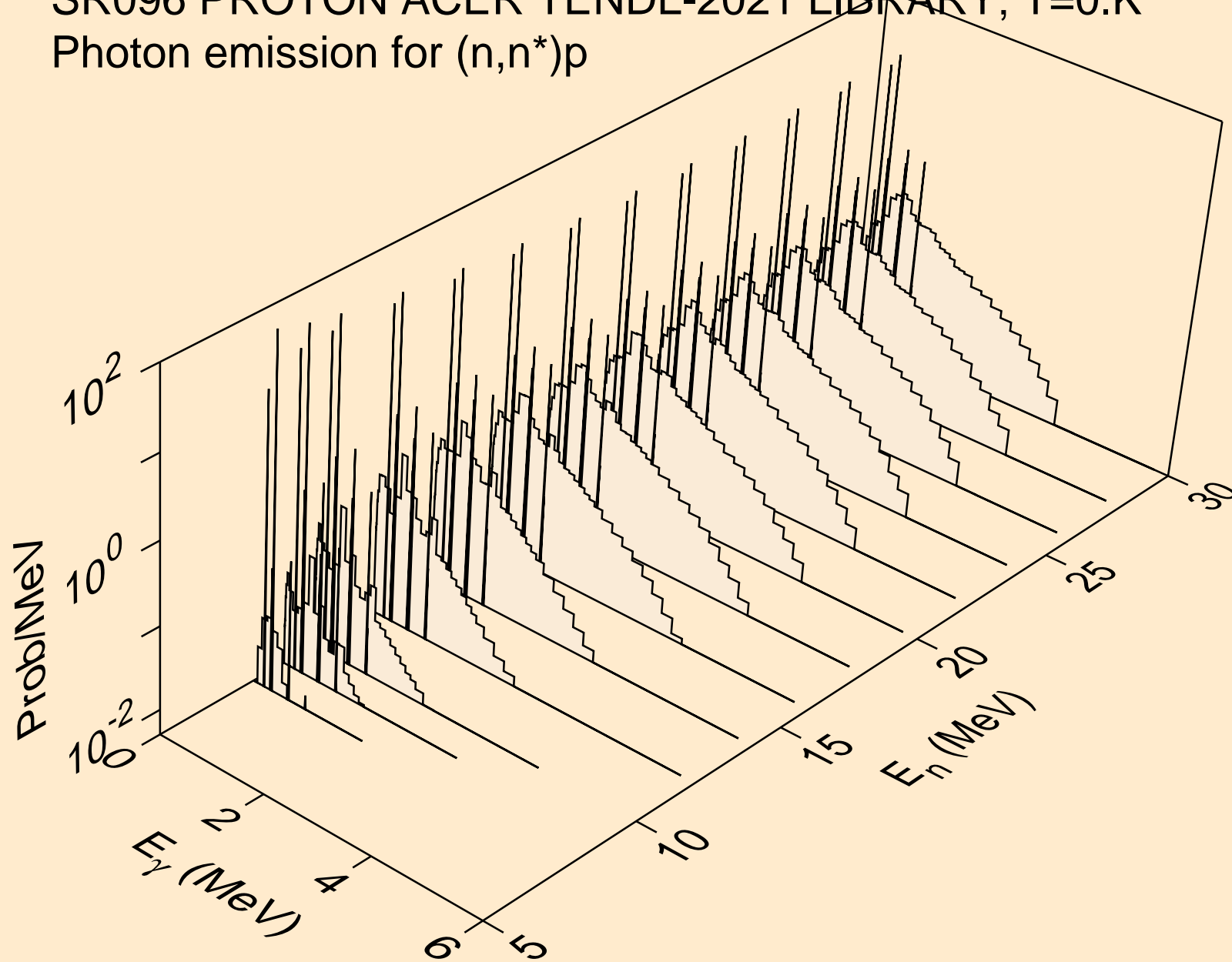

SR096 PROTON ACER TENDL-2021 LIBRARY; T=0.K  
Photon emission for (n,n\*)2a

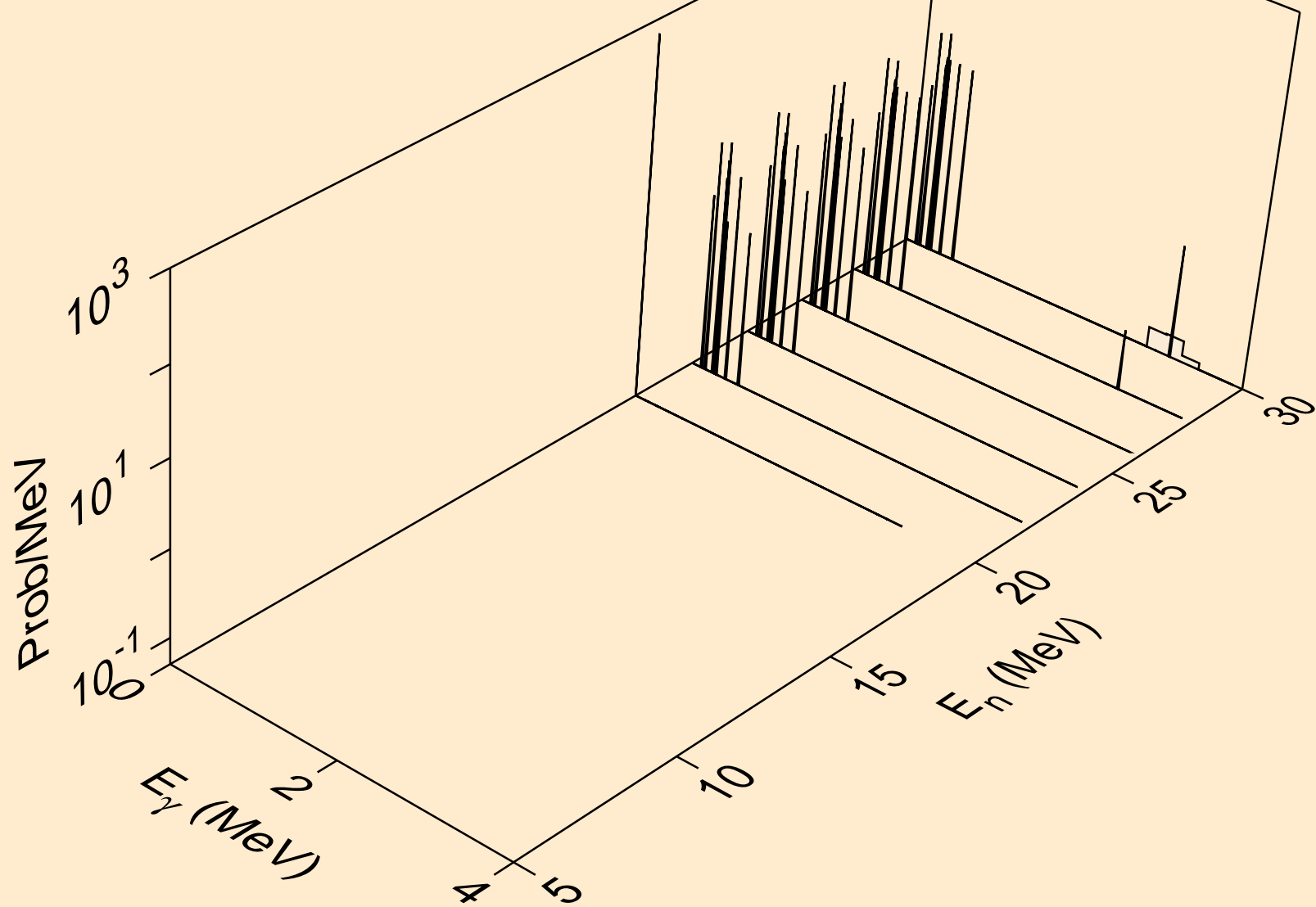

SR096 PROTON ACER TENDL-2021 LIBRARY; T=0.K  
Photon emission for (n,n\*)d

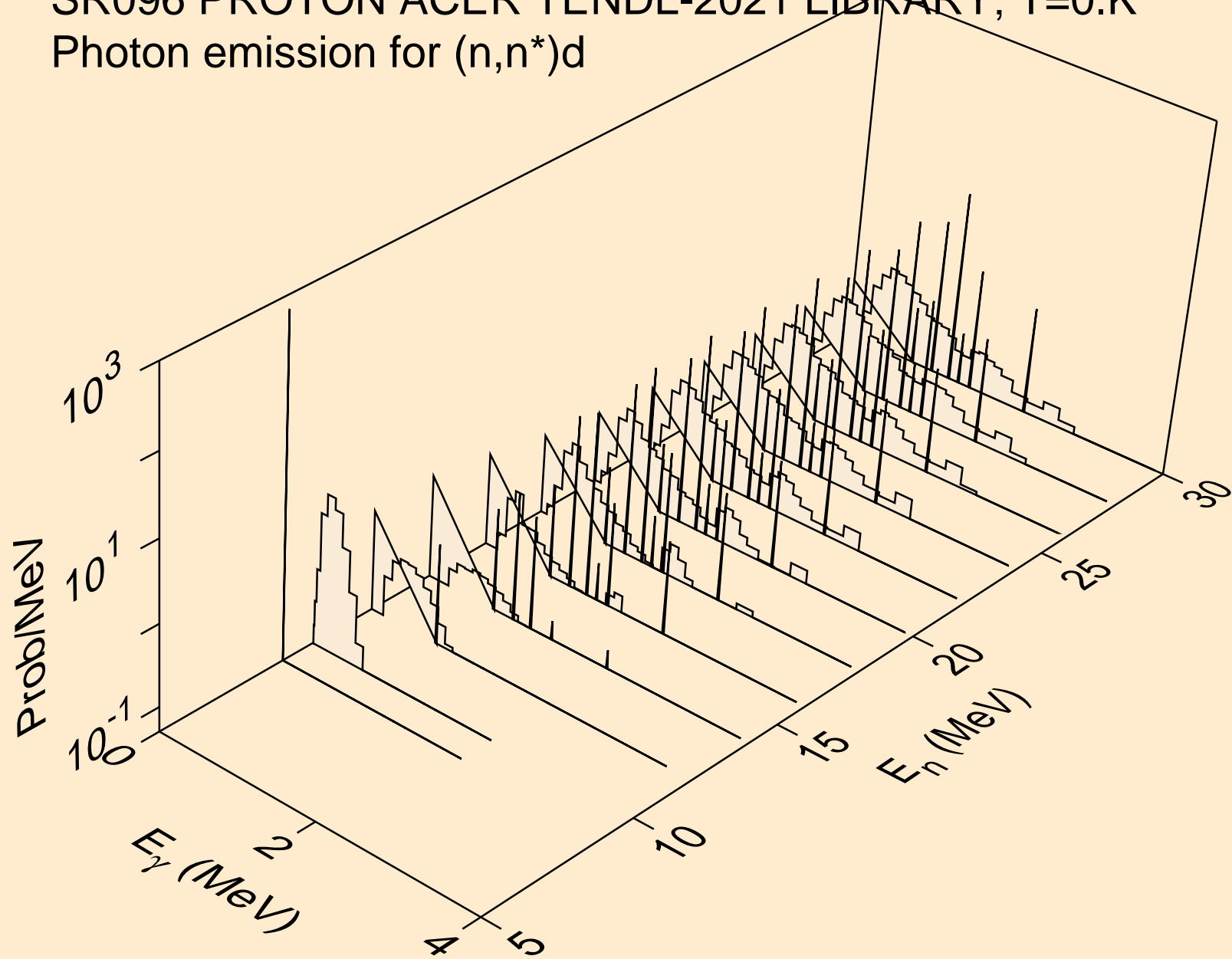

SR096 PROTON ACER TENDL-2021 LIBRARY; T=0.K  
Photon emission for (n,n\*)t

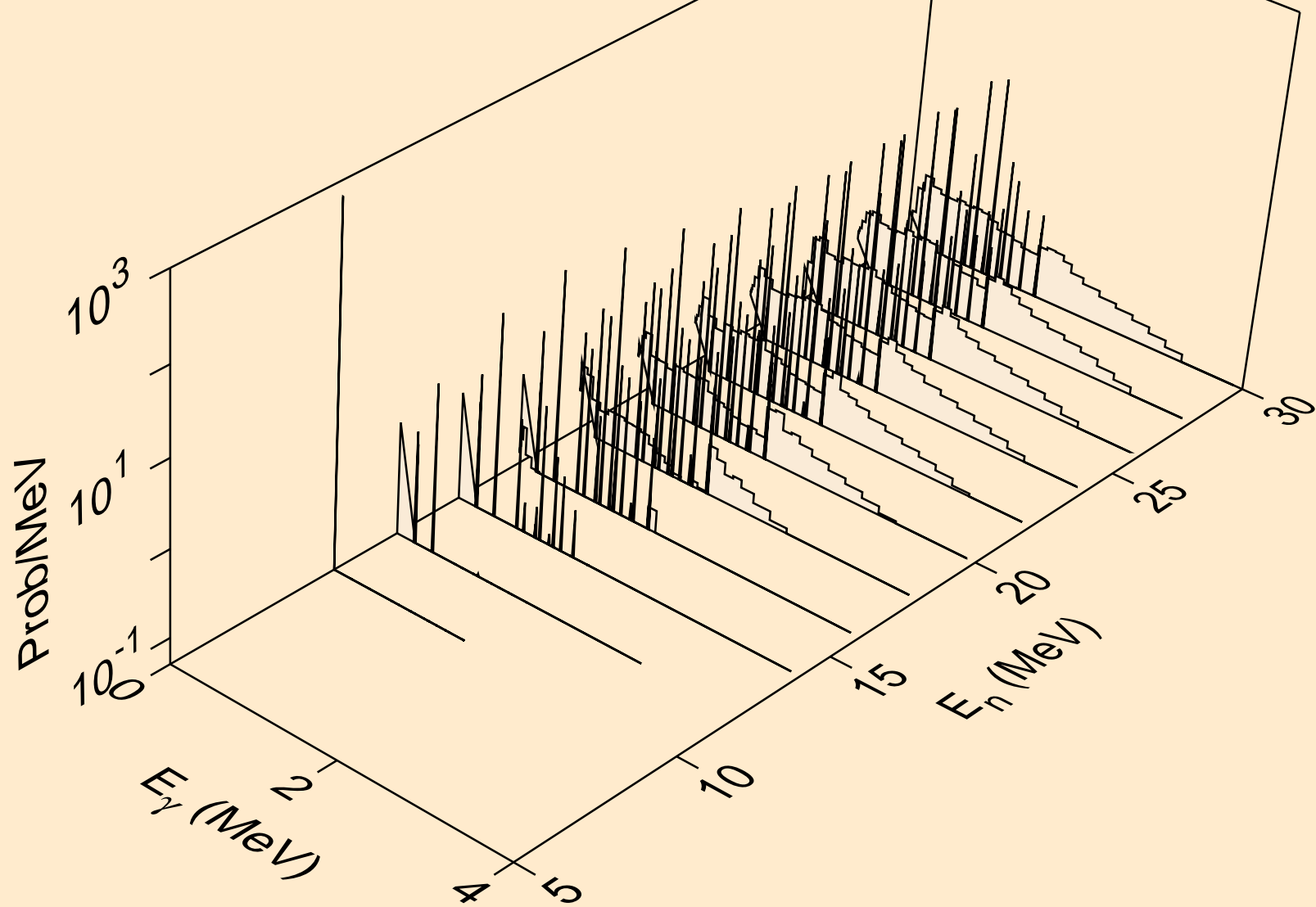



SR096 PROTON ACER TENDL-2021 LIBRARY; T=0.K  
Photon emission for (n,n\*)he3

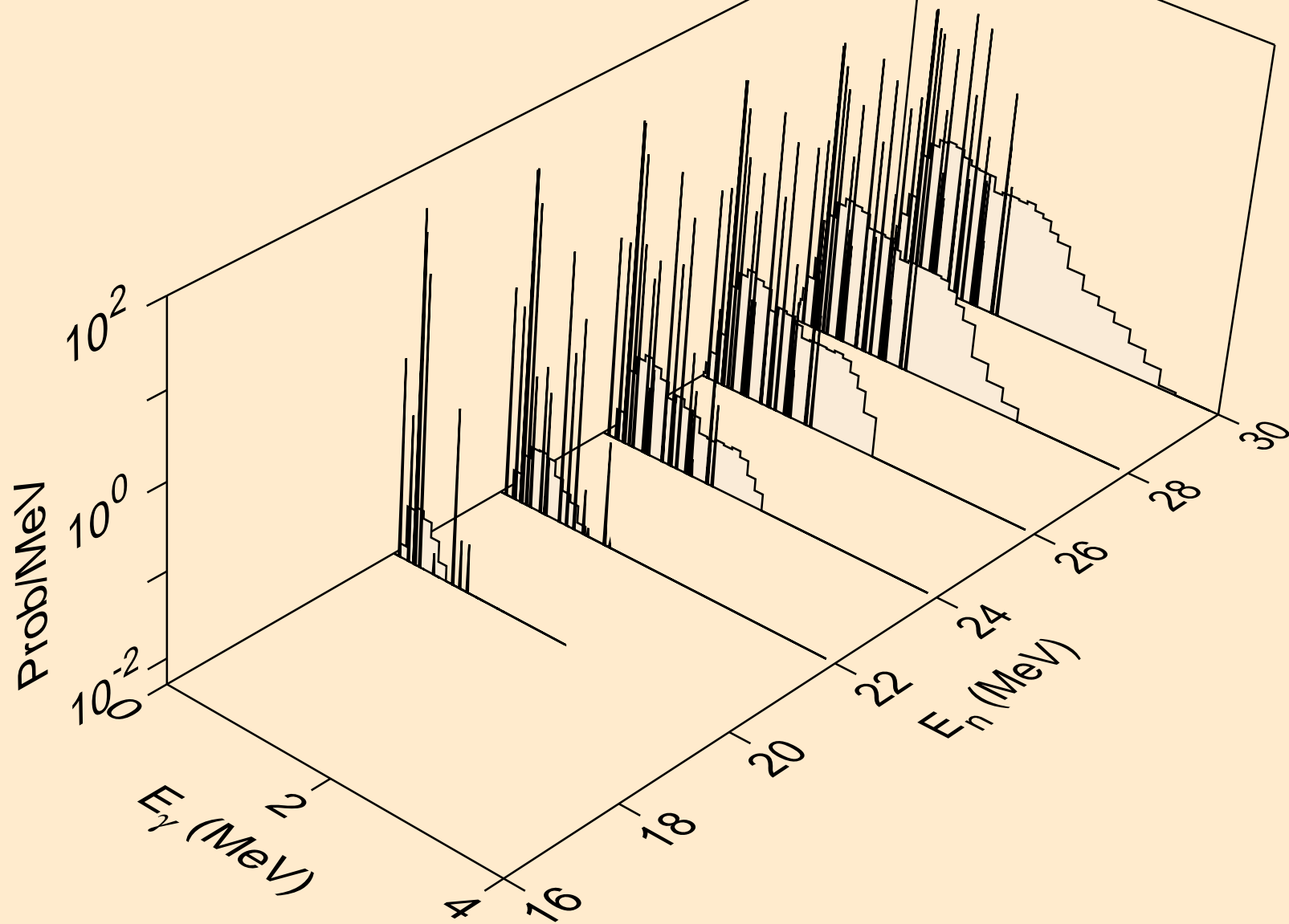

SR096 PROTON ACER TENDL-2021 LIBRARY; T=0.K  
Photon emission for (n,4n)

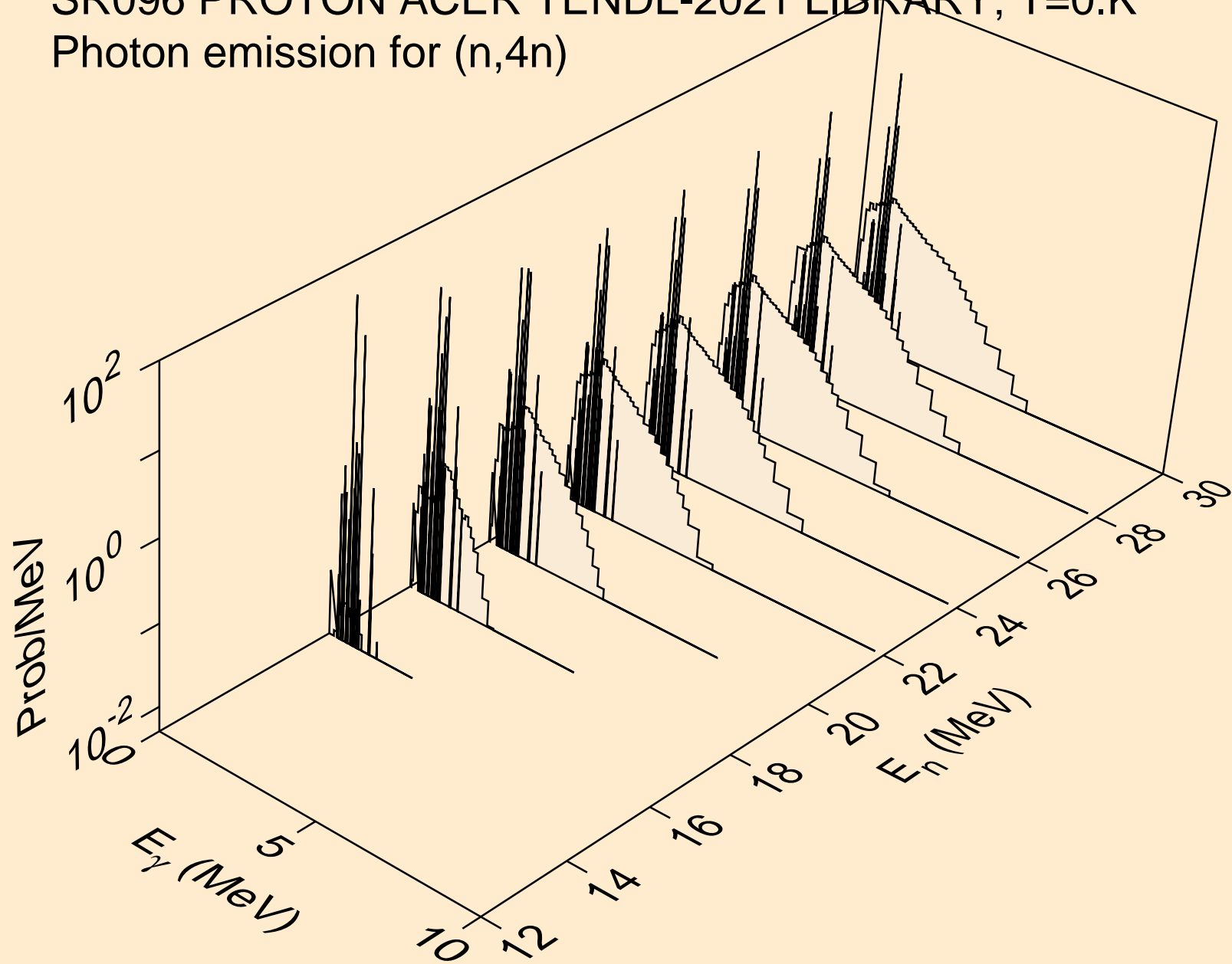

SR096 PROTON ACER TENDL-2021 LIBRARY; T=0.K  
Photon emission for (n,2np)

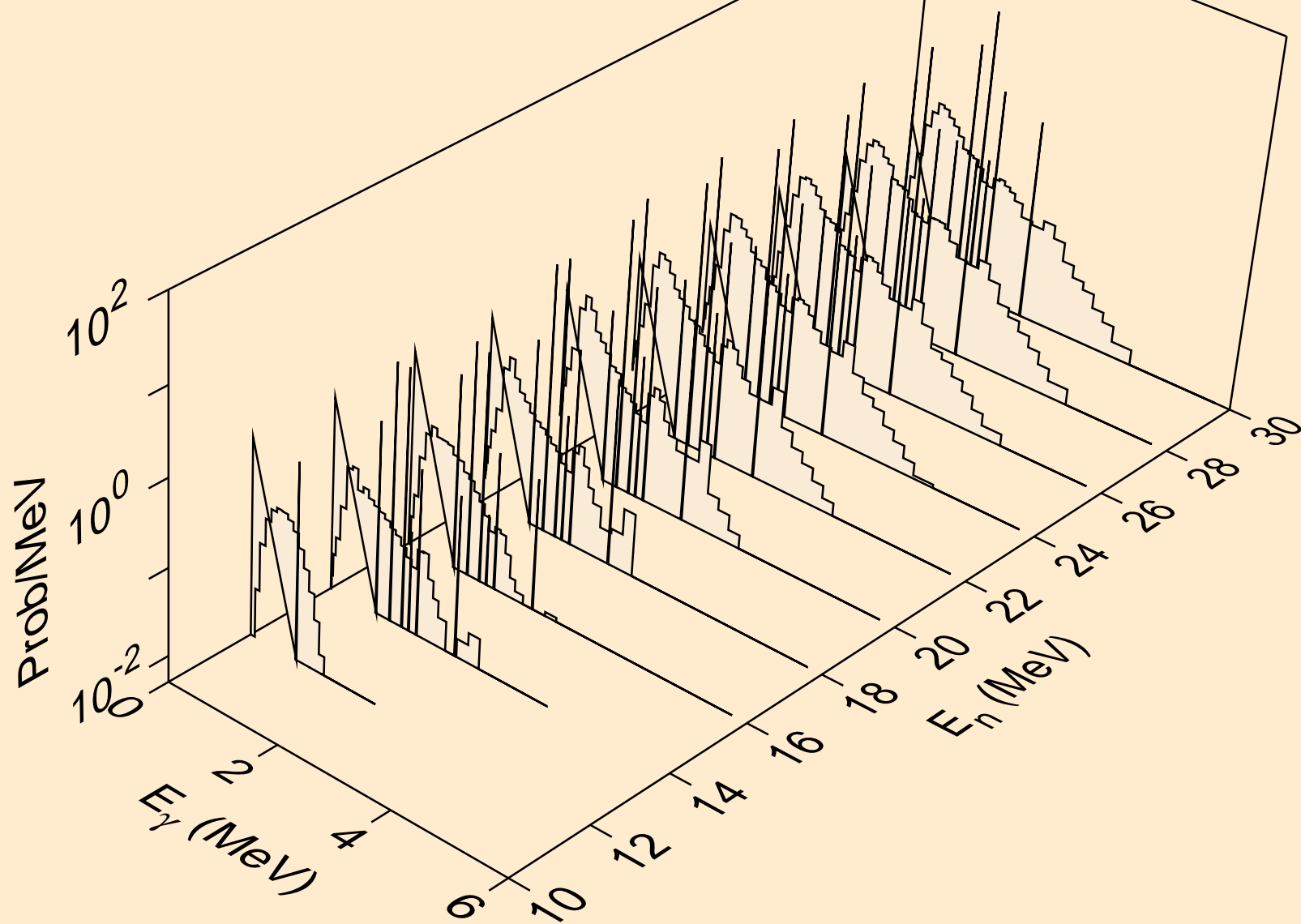

SR096 PROTON ACER TENDL-2021 LIBRARY; T=0.K  
Photon emission for (n,3np)

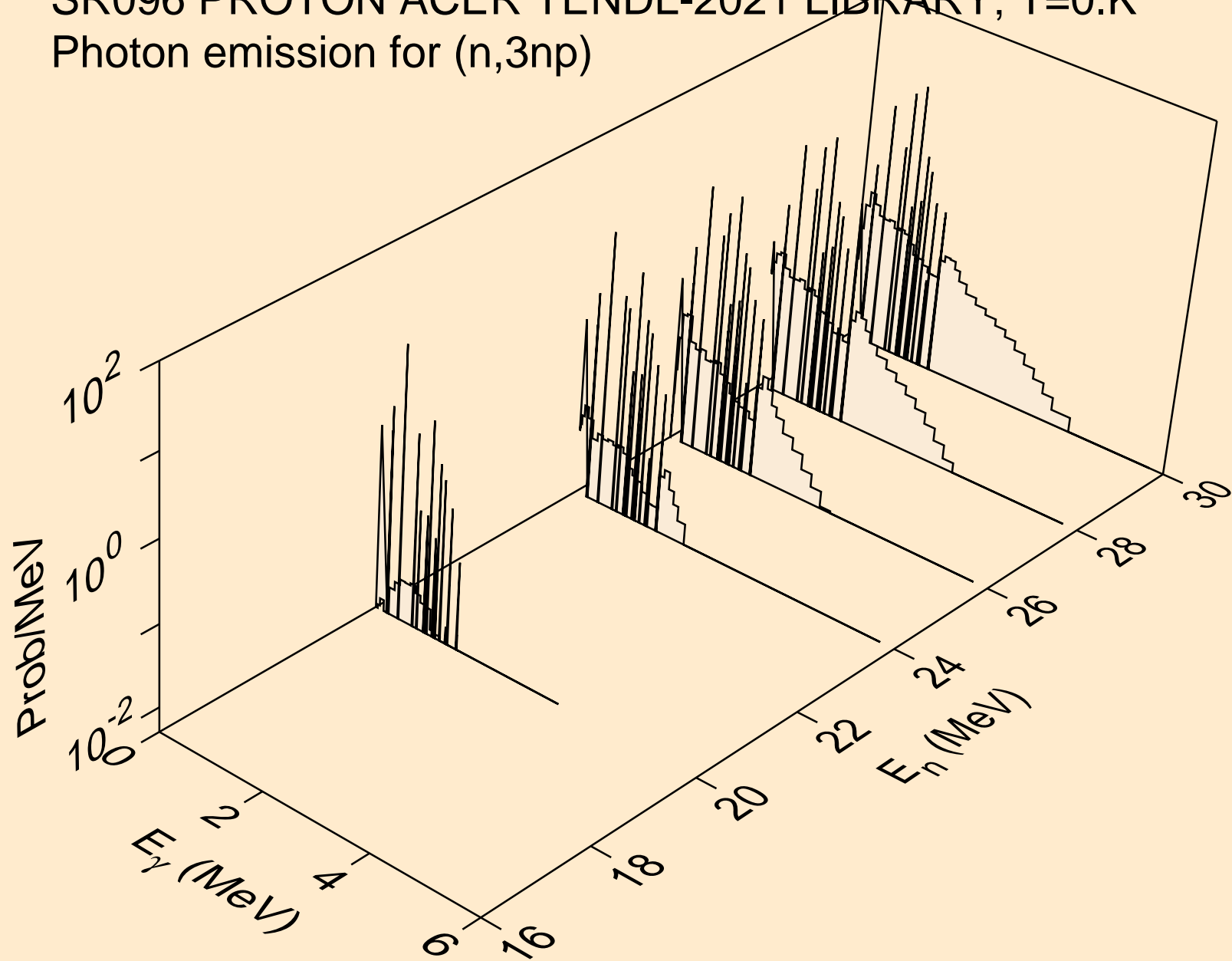

SR096 PROTON ACER TENDL-2021 LIBRARY; T=0.K  
Photon emission for (n,2np)

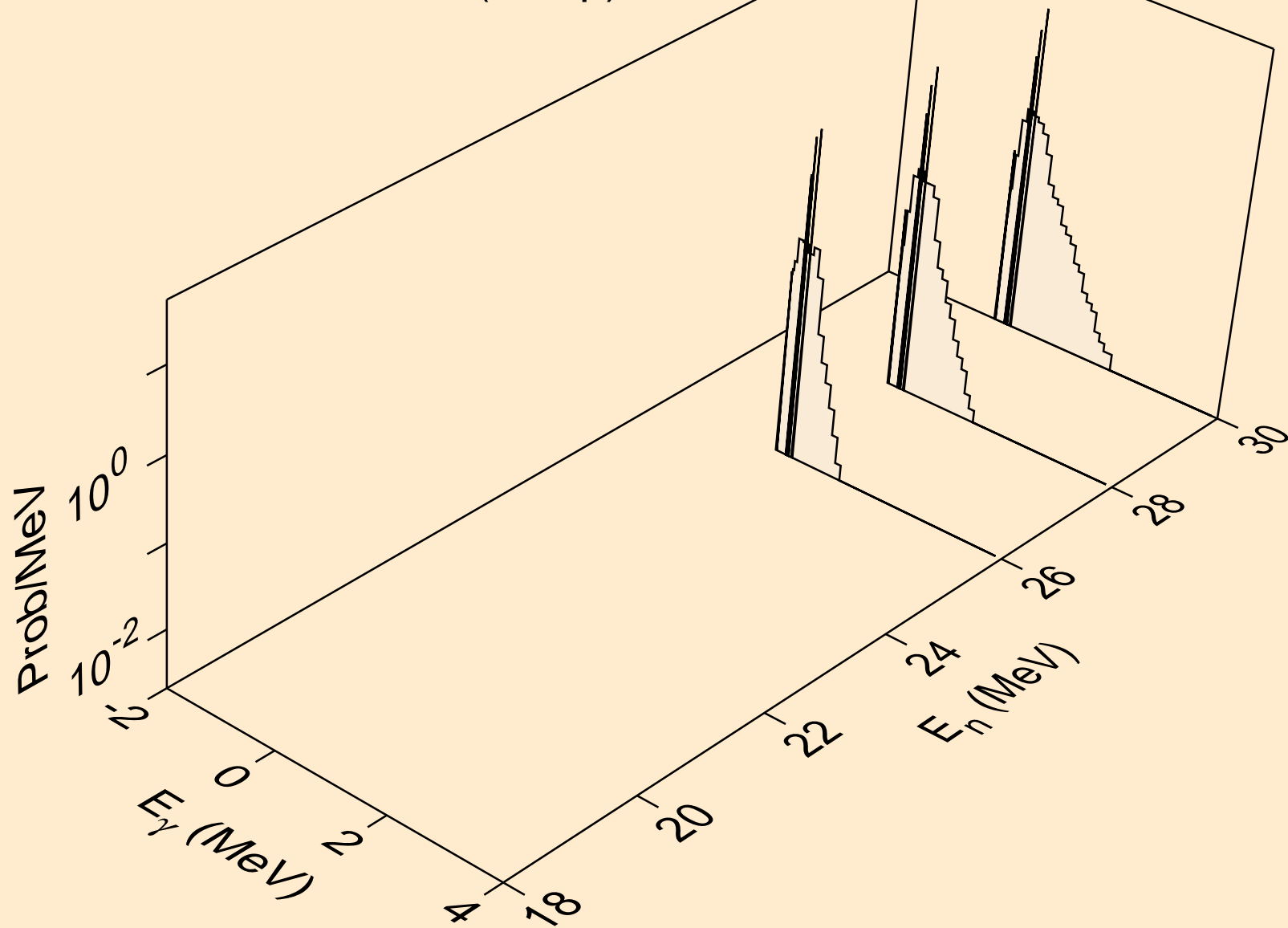

SR096 PROTON ACER TENDL-2021 LIBRARY; T=0.K  
Photon emission for (n,npa)

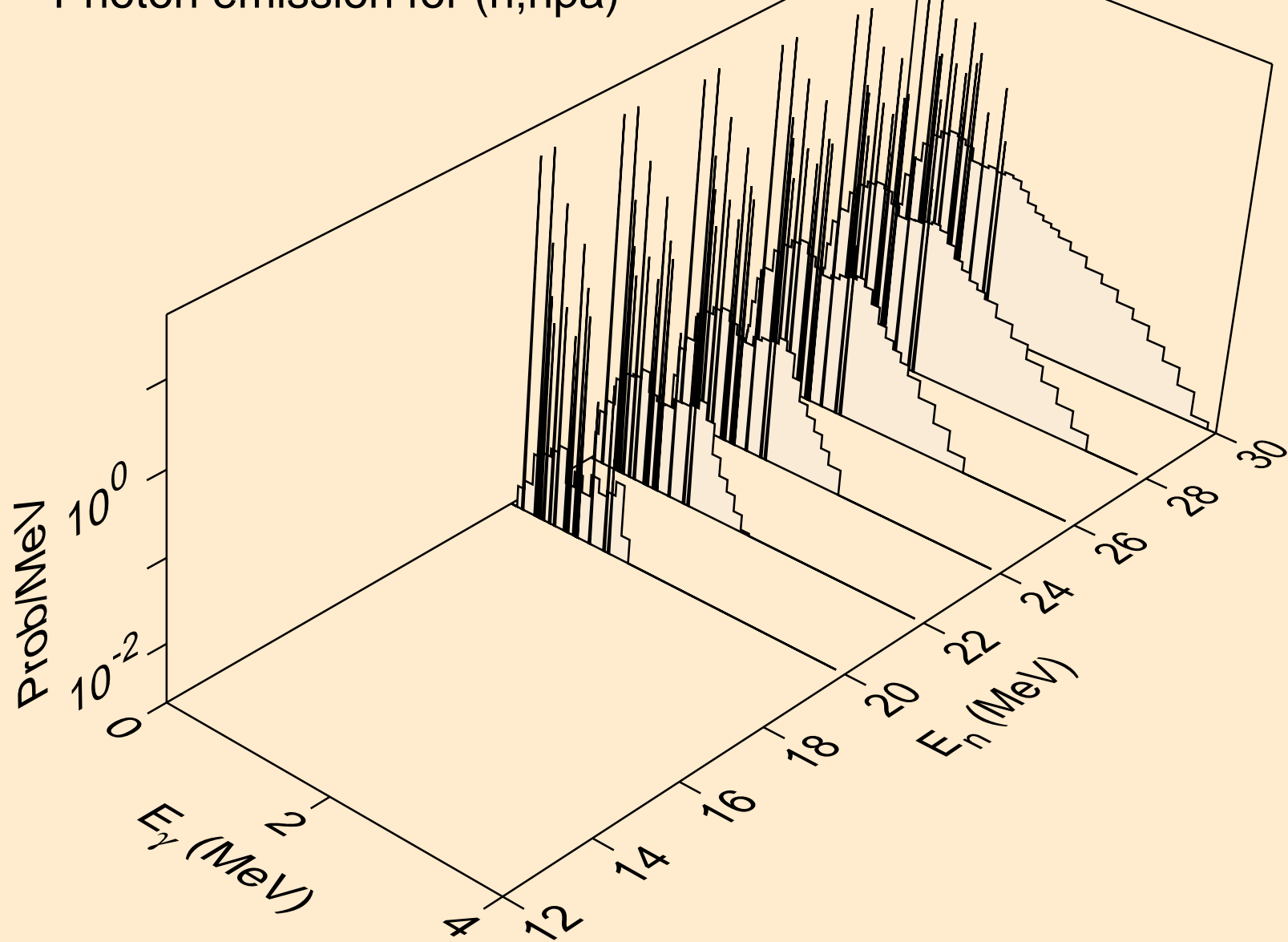

SR096 PROTON ACER TENDL-2021 LIBRARY; T=0.K  
Photon emission for (n,gma)

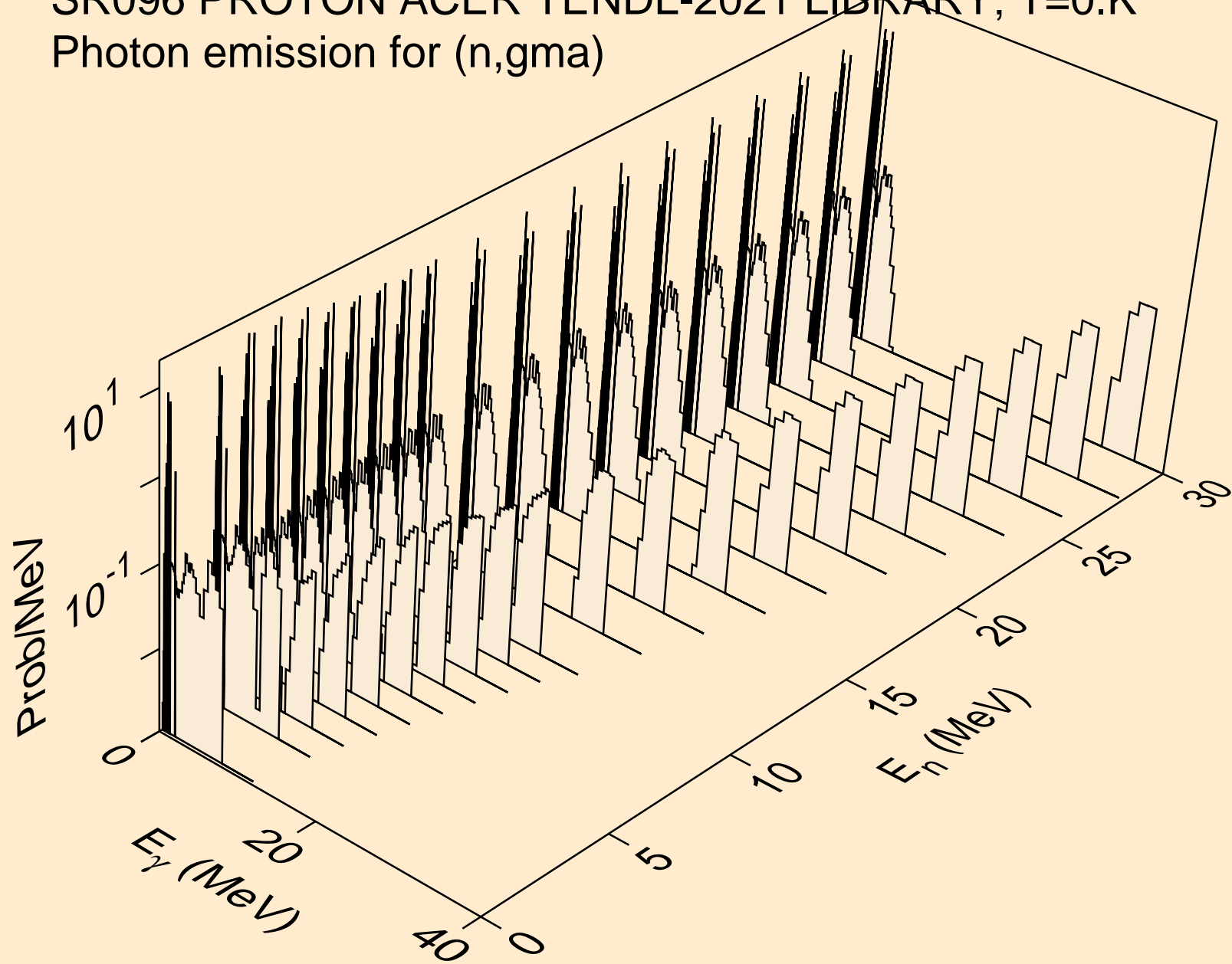

SR096 PROTON ACER TENDL-2021 LIBRARY; T=0.K  
Photon emission for inelastic

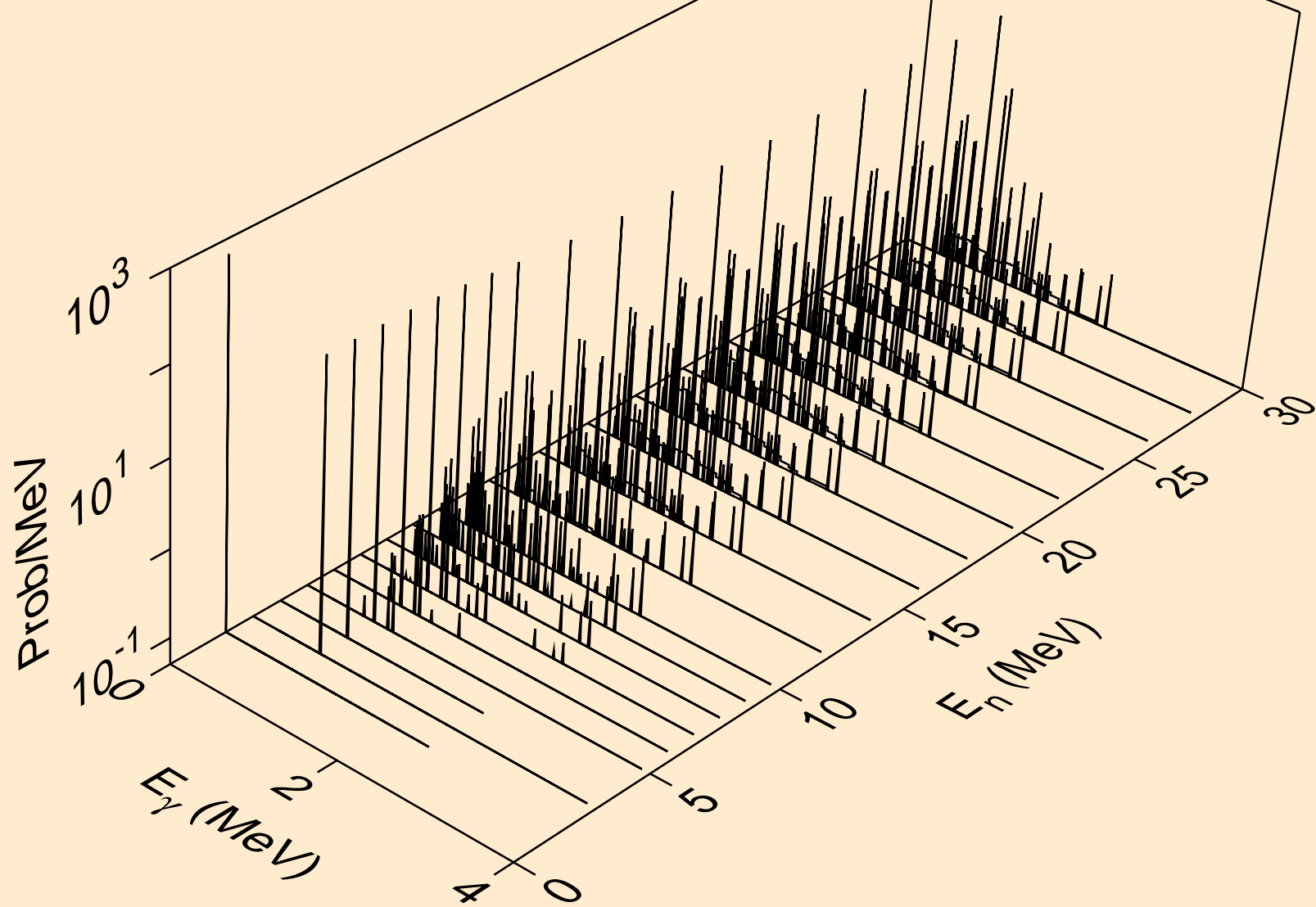



SR096 PROTON ACER TENDL-2021 LIBRARY; T=0.K  
Photon emission for (n,d)

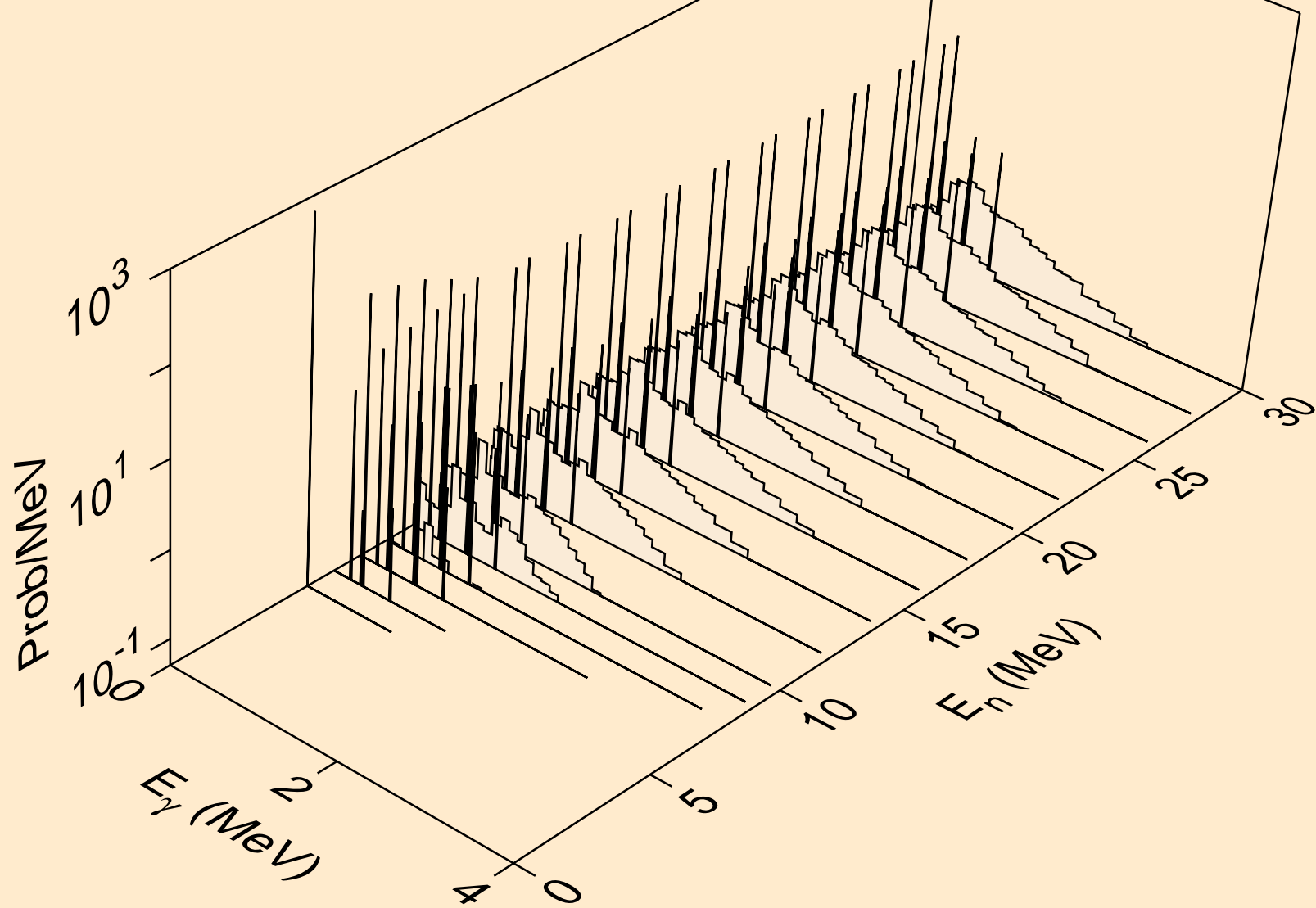

SR096 PROTON ACER TENDL-2021 LIBRARY; T=0.K  
Photon emission for (n,t)

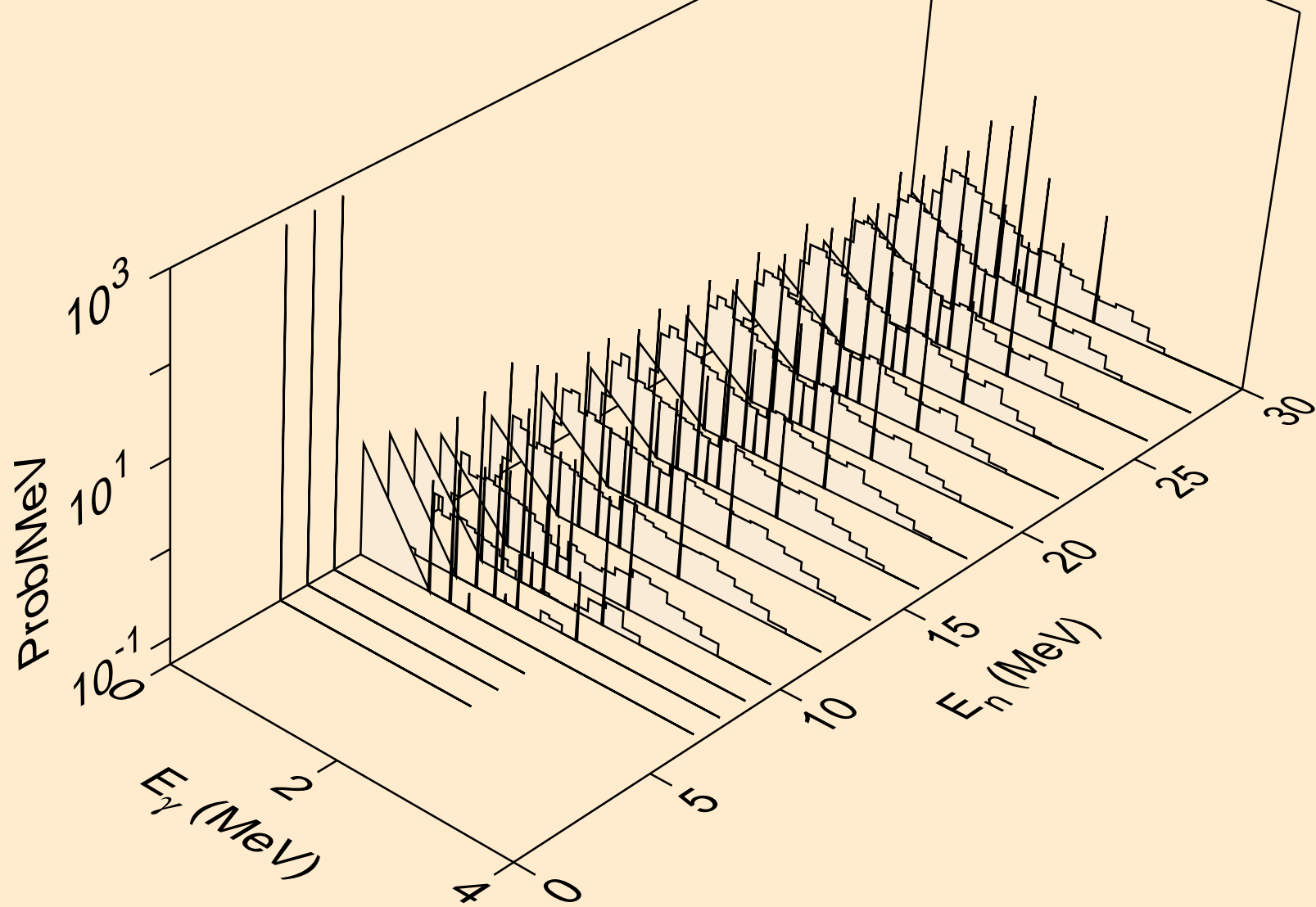

SR096 PROTON ACER TENDL-2021 LIBRARY; T=0.K  
Photon emission for (n,he3)

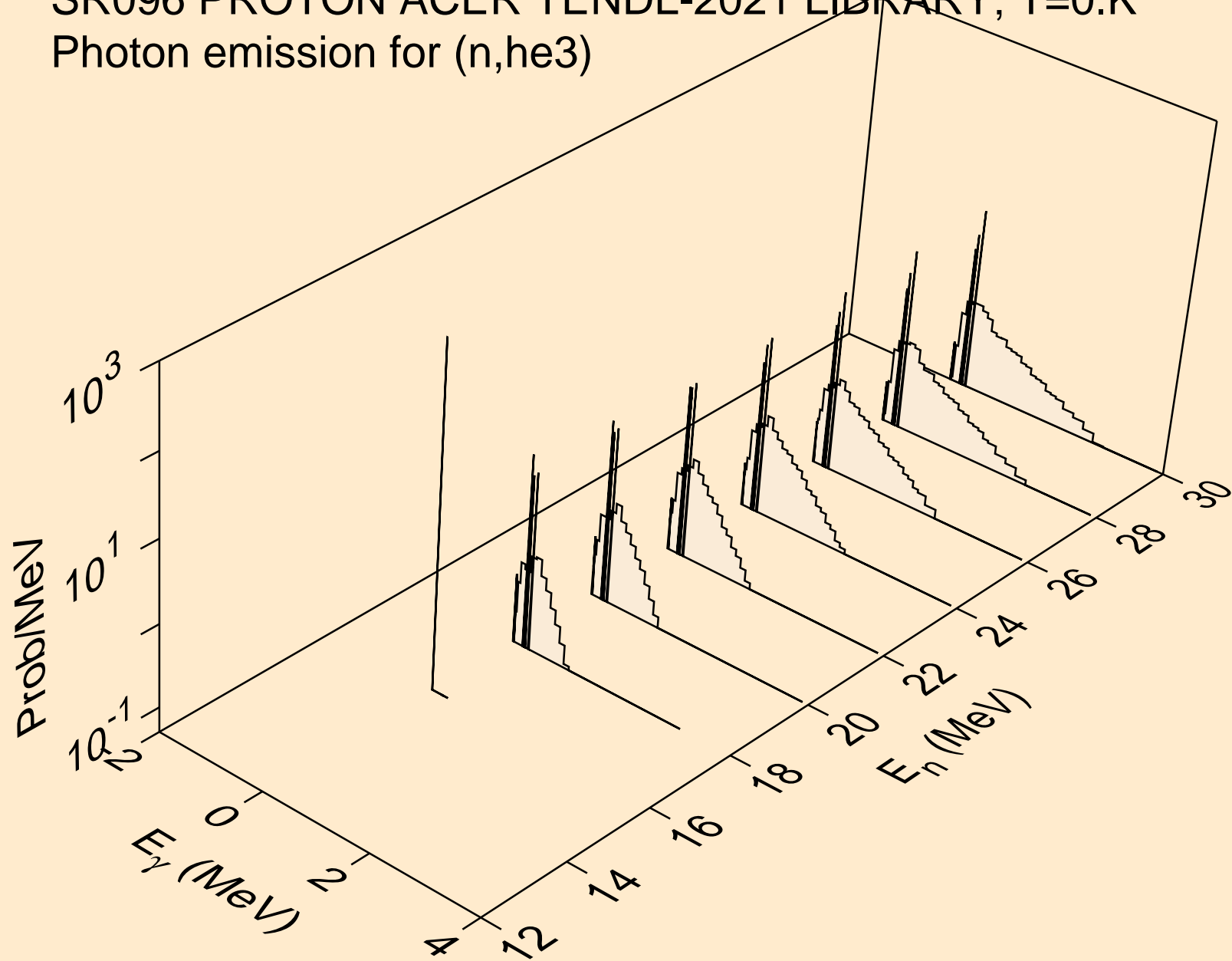

SR096 PROTON ACER TENDL-2021 LIBRARY; T=0.K  
Photon emission for (n,a)

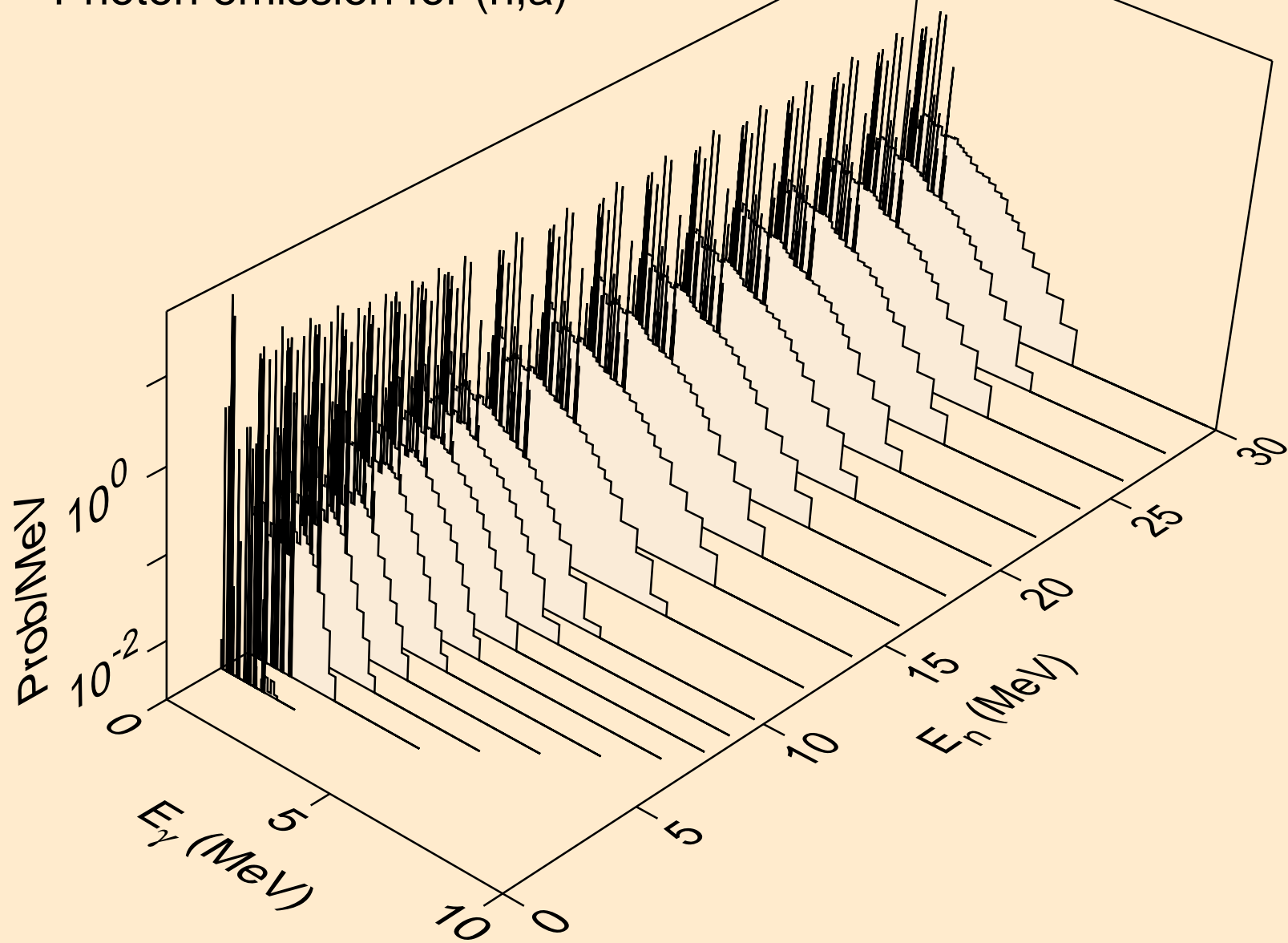

SR096 PROTON ACER TENDL-2021 LIBRARY; T=0.K  
Photon emission for (n,2a)

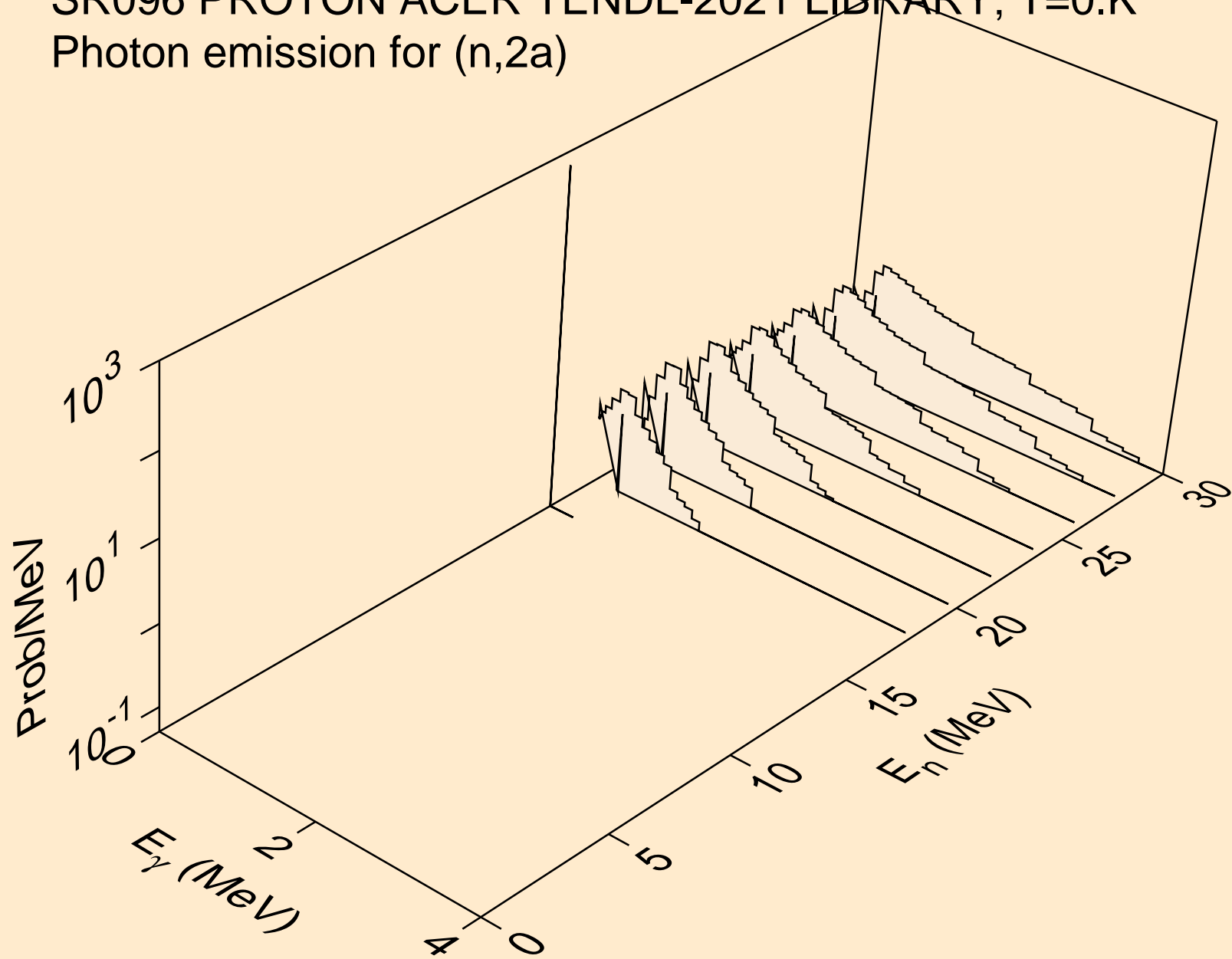

SR096 PROTON ACER TENDL-2021 LIBRARY; T=0.K  
Photon emission for (n,2p)

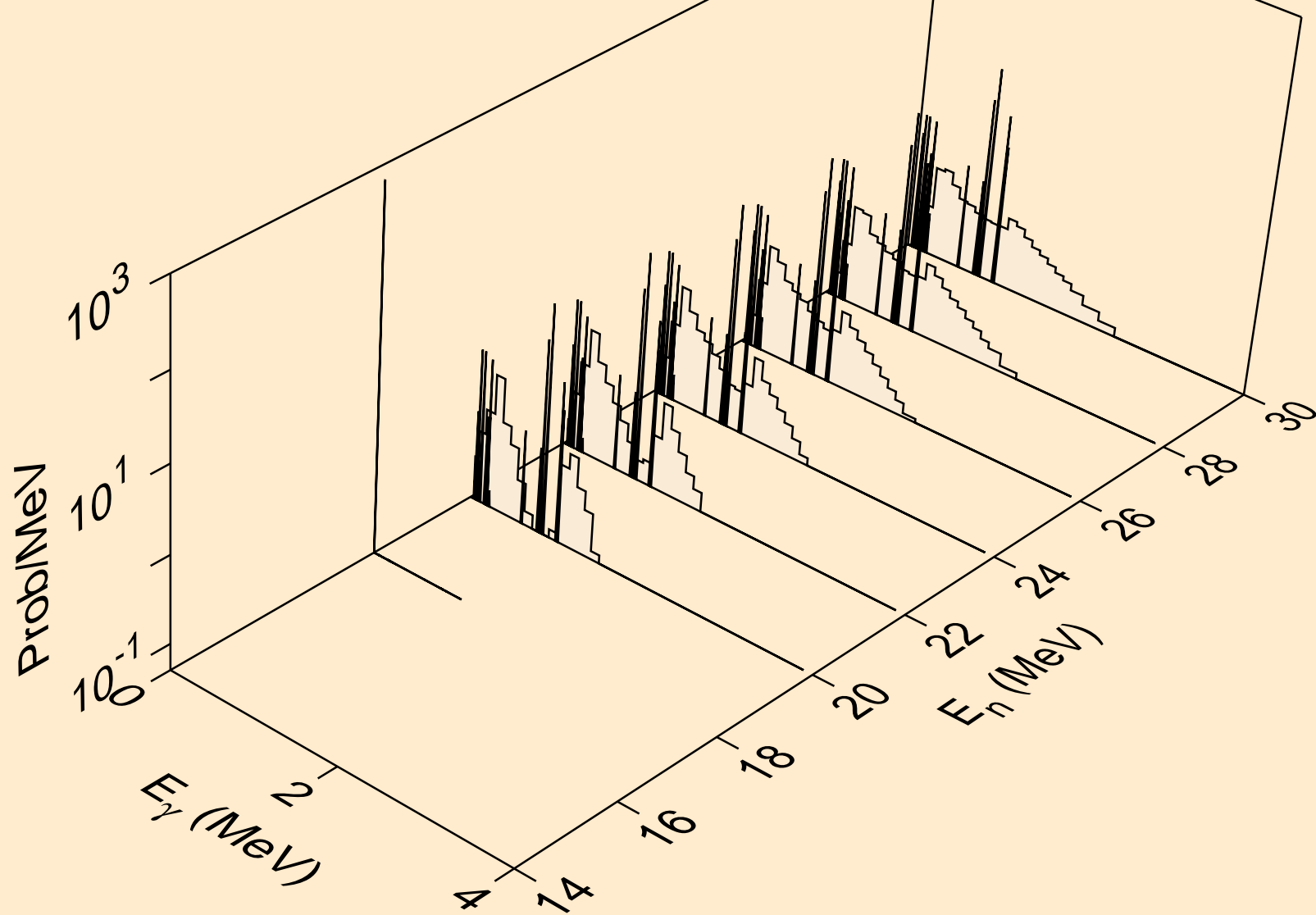

SR096 PROTON ACER TENDL-2021 LIBRARY; T=0.K  
Photon emission for (n,pa)

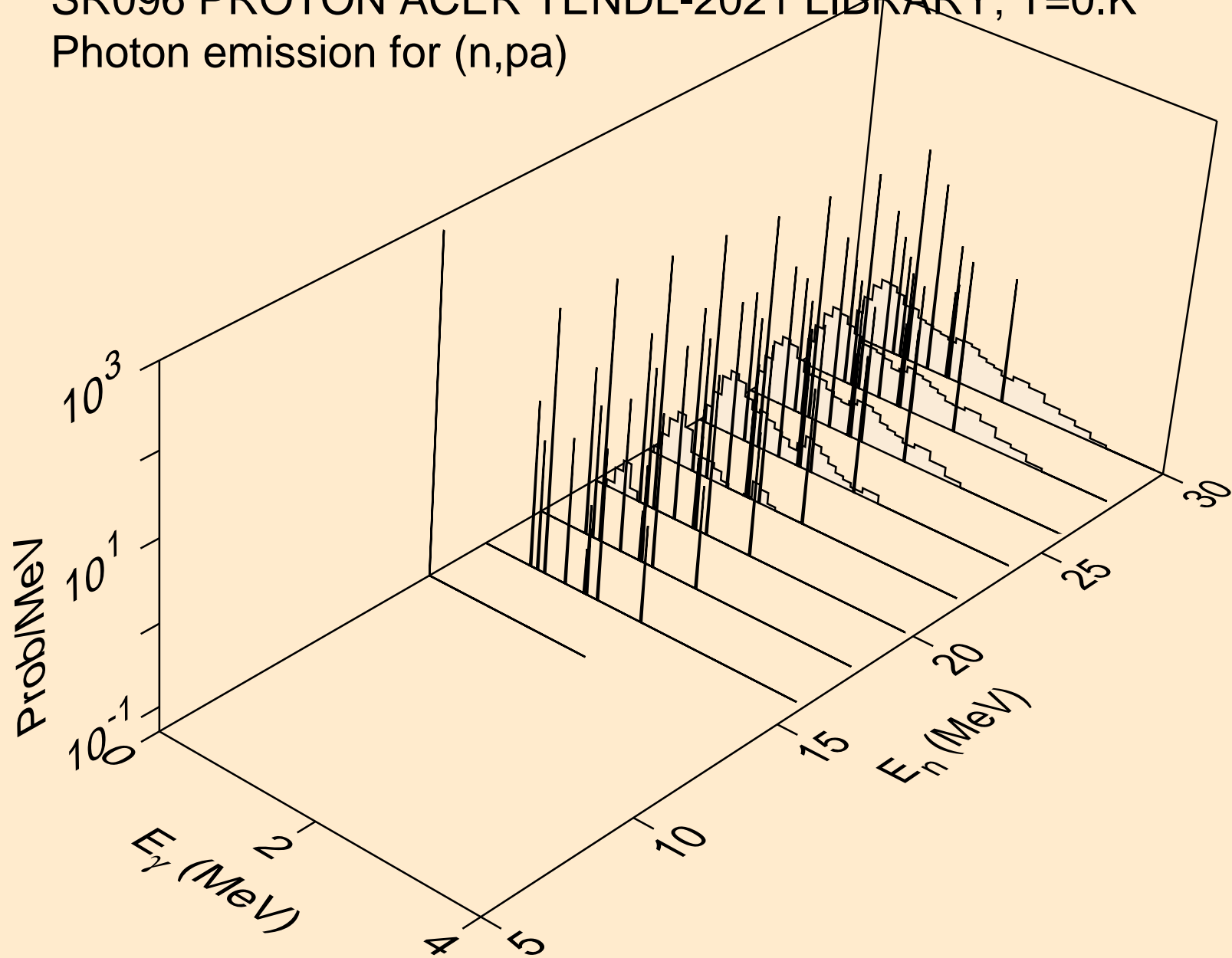

SR096 PROTON ACER TENDL-2021 LIBRARY; T=0.K  
Photon emission for (n,pd)

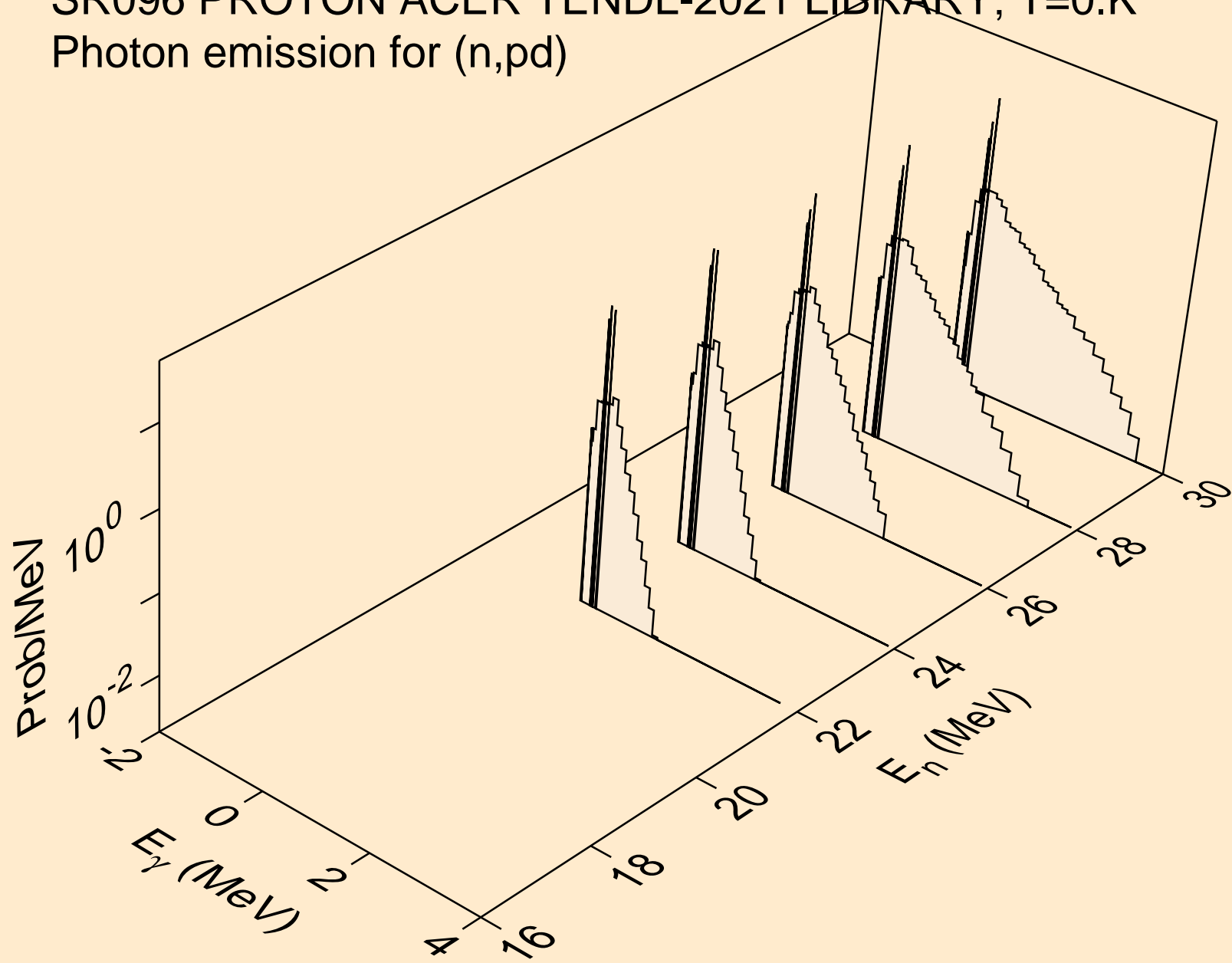



SR096 PROTON ACER TENDL-2021 LIBRARY; T=0.K  
Photon emission for (n,pt)

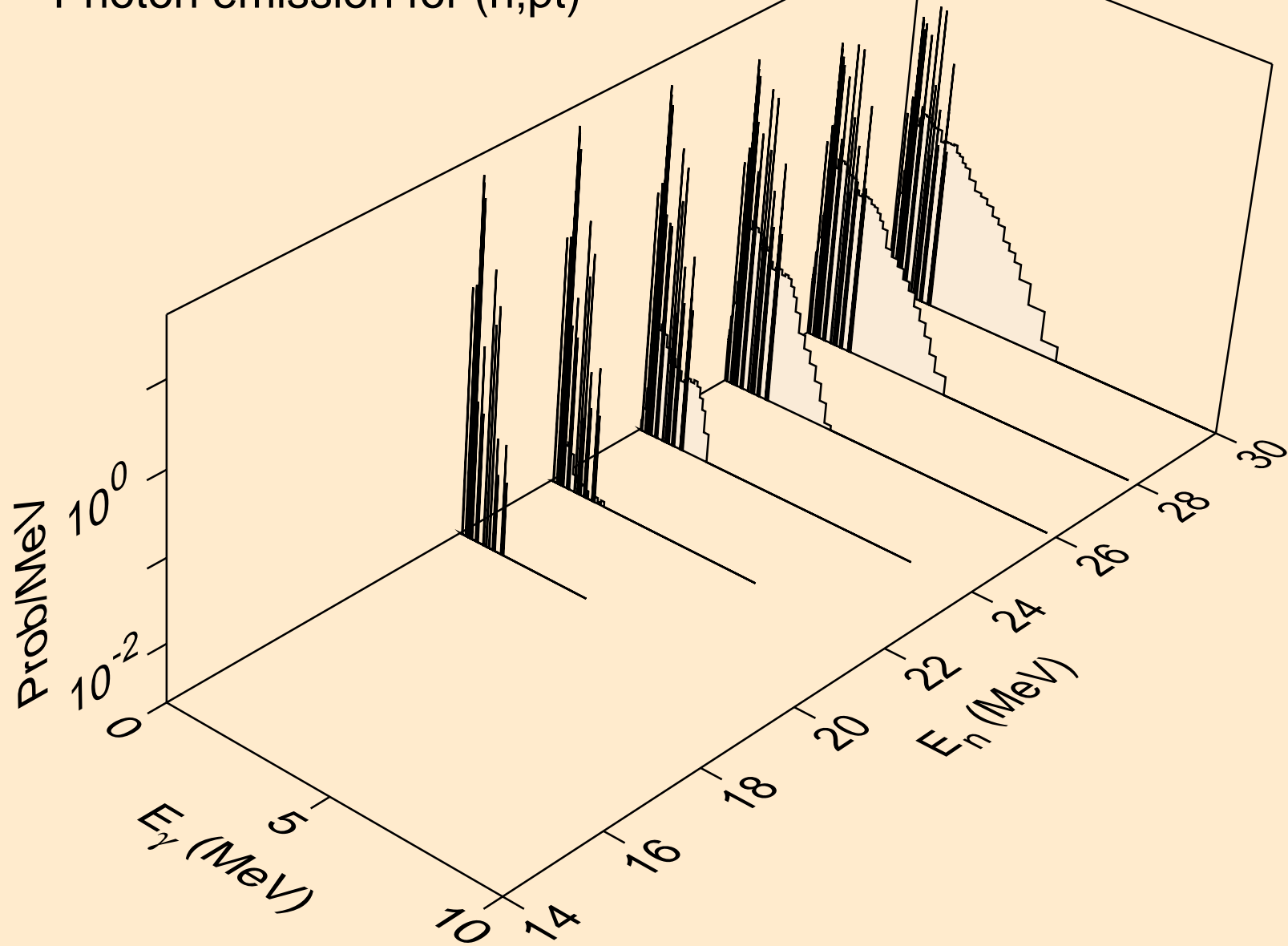

SR096 PROTON ACER TENDL-2021 LIBRARY; T=0.K  
Photon emission for (n,da)

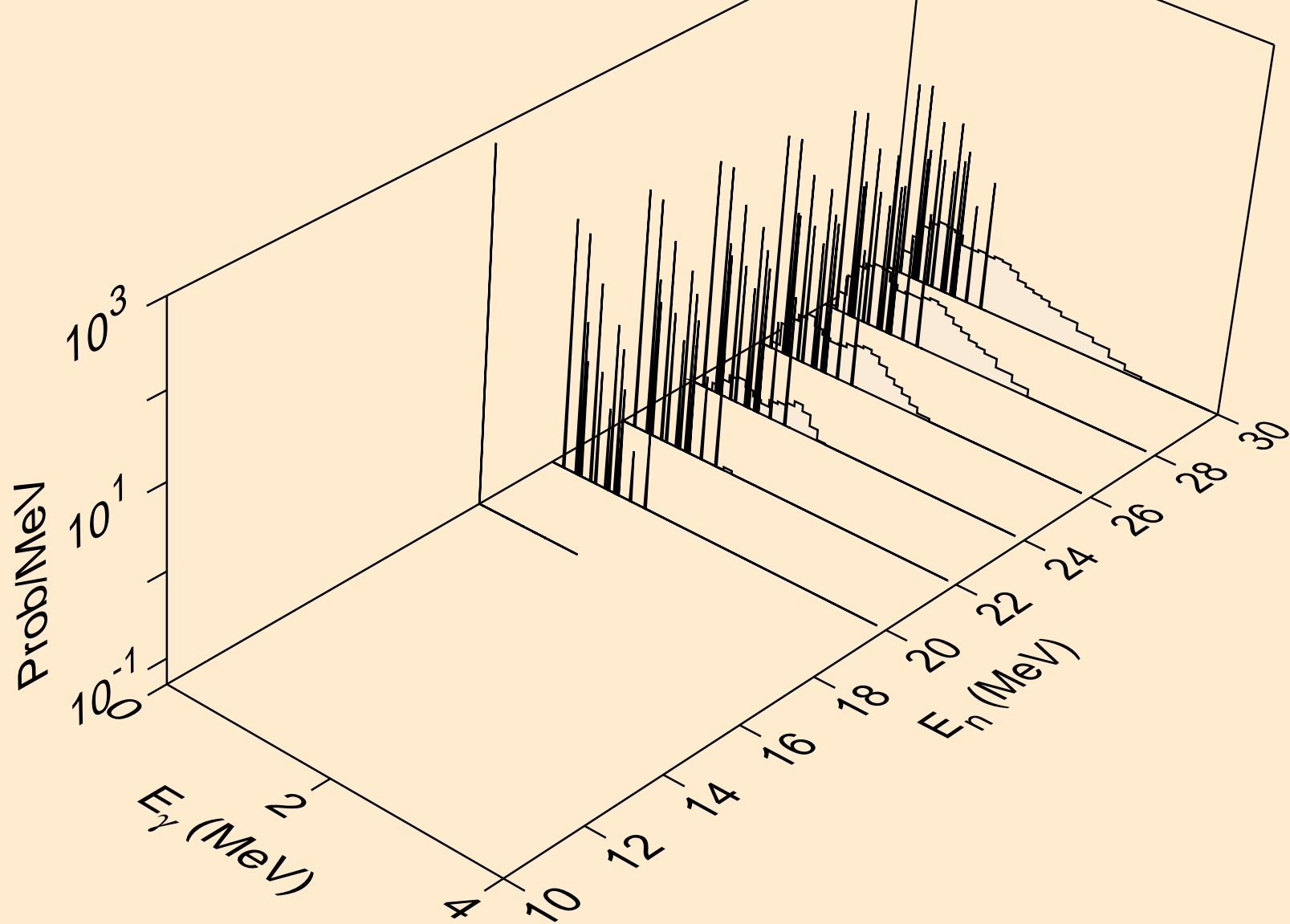

SR096 PROTON ACER TENDL-2021 LIBRARY; T=0.K  
Particle heating contributions

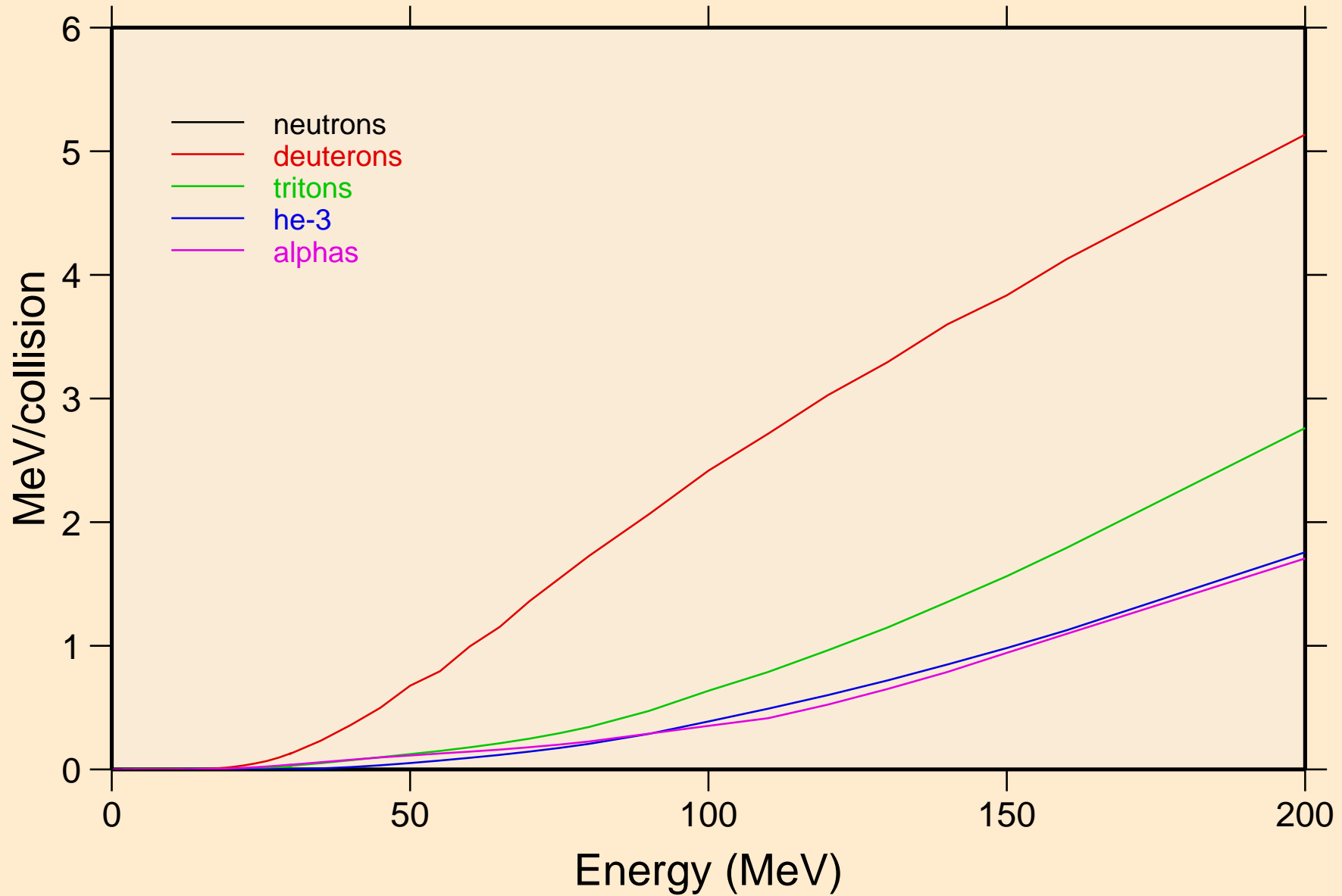

SR096 PROTON ACER TENDL-2021 LIBRARY; T=0.K  
Recoil Heating

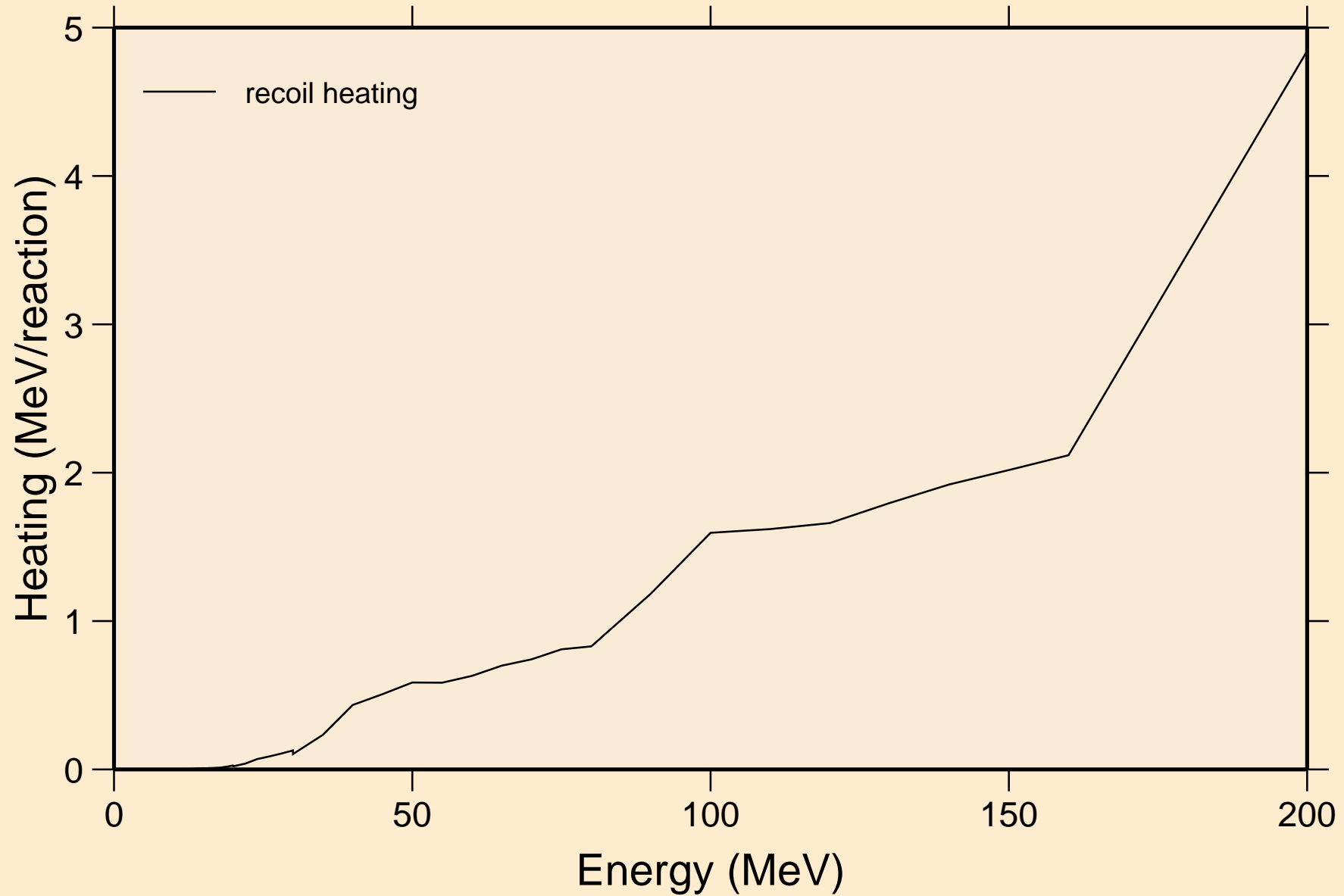

SR096 PROTON ACER TENDL-2021 LIBRARY; T=0.K  
Particle production cross sections

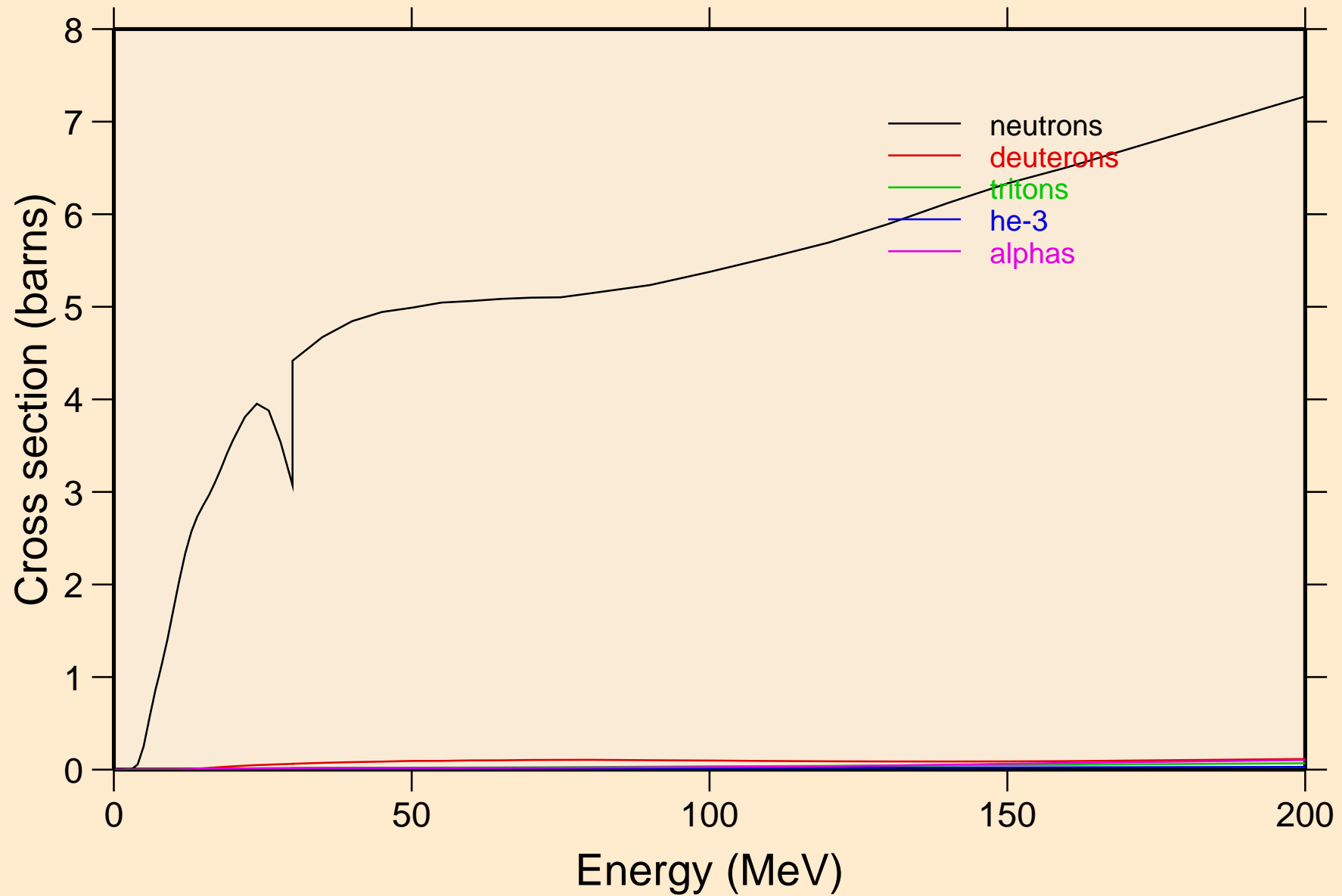

SR096 PROTON ACER TENDL-2021 LIBRARY; T=0.K  
neutrons from (p,n)

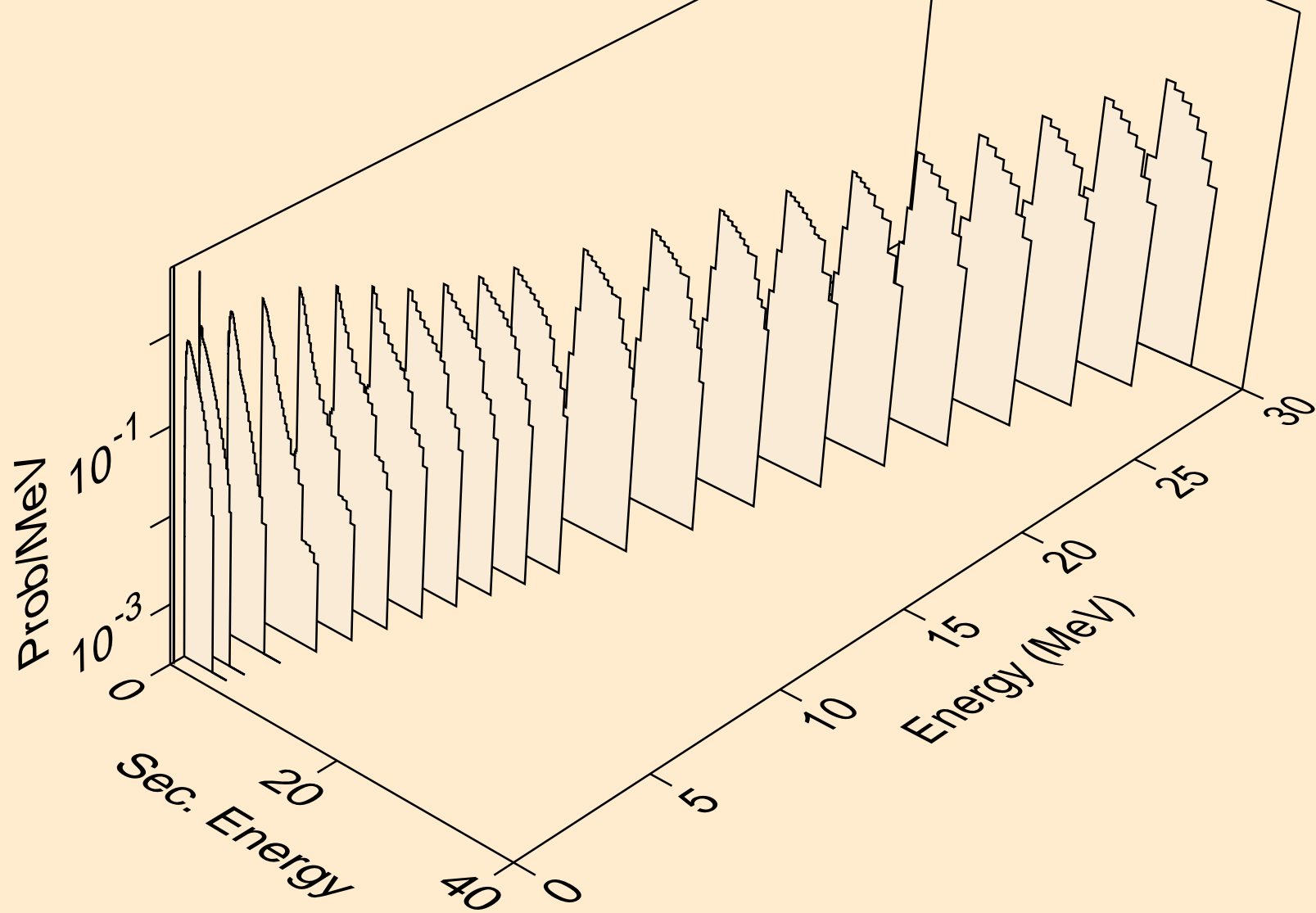

SR096 PROTON ACER TENDL-2021 LIBRARY; T=0.K  
neutrons from (p,x)

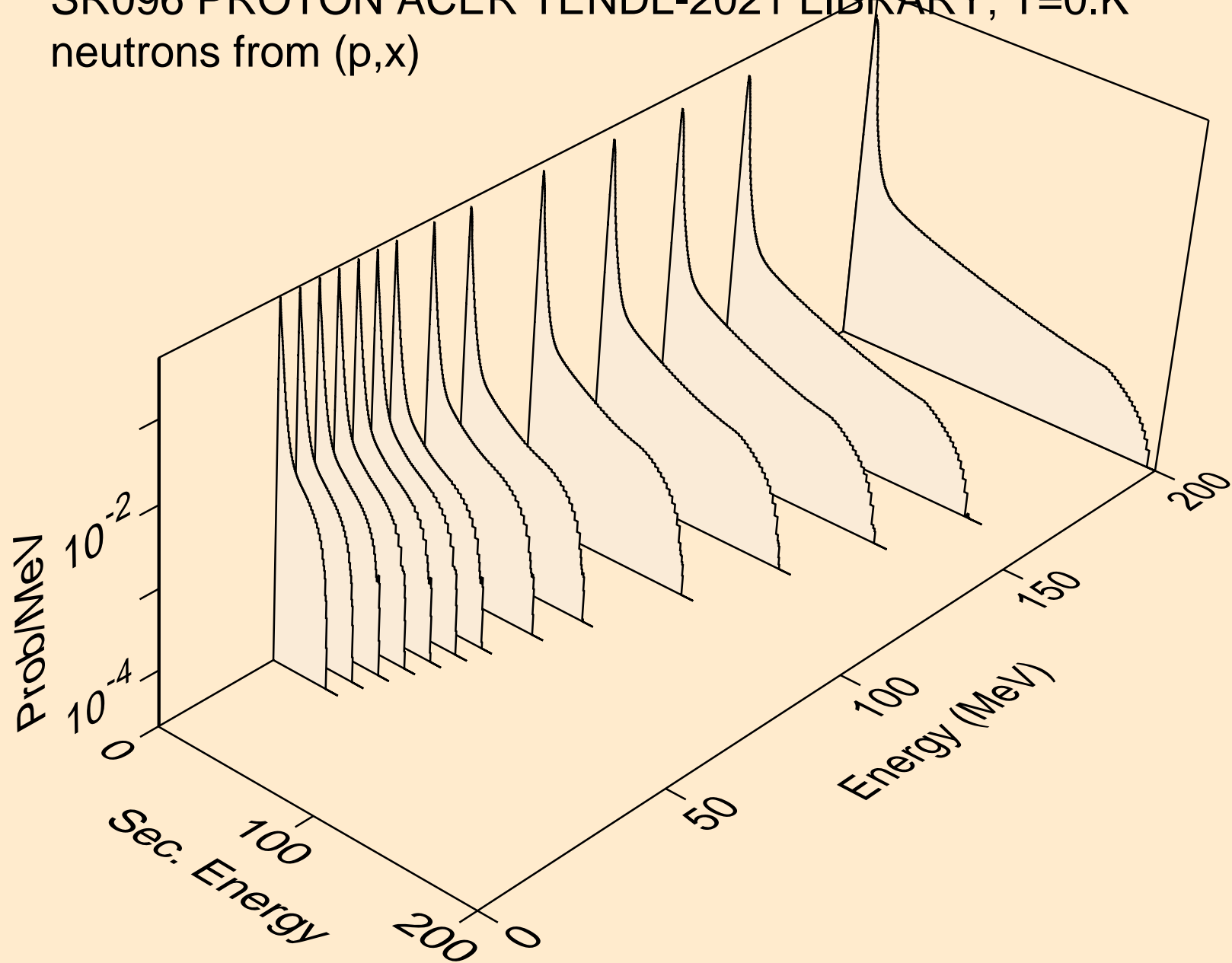

SR096 PROTON ACER TENDL-2021 LIBRARY; T=0.K  
neutrons from (p,2nd)

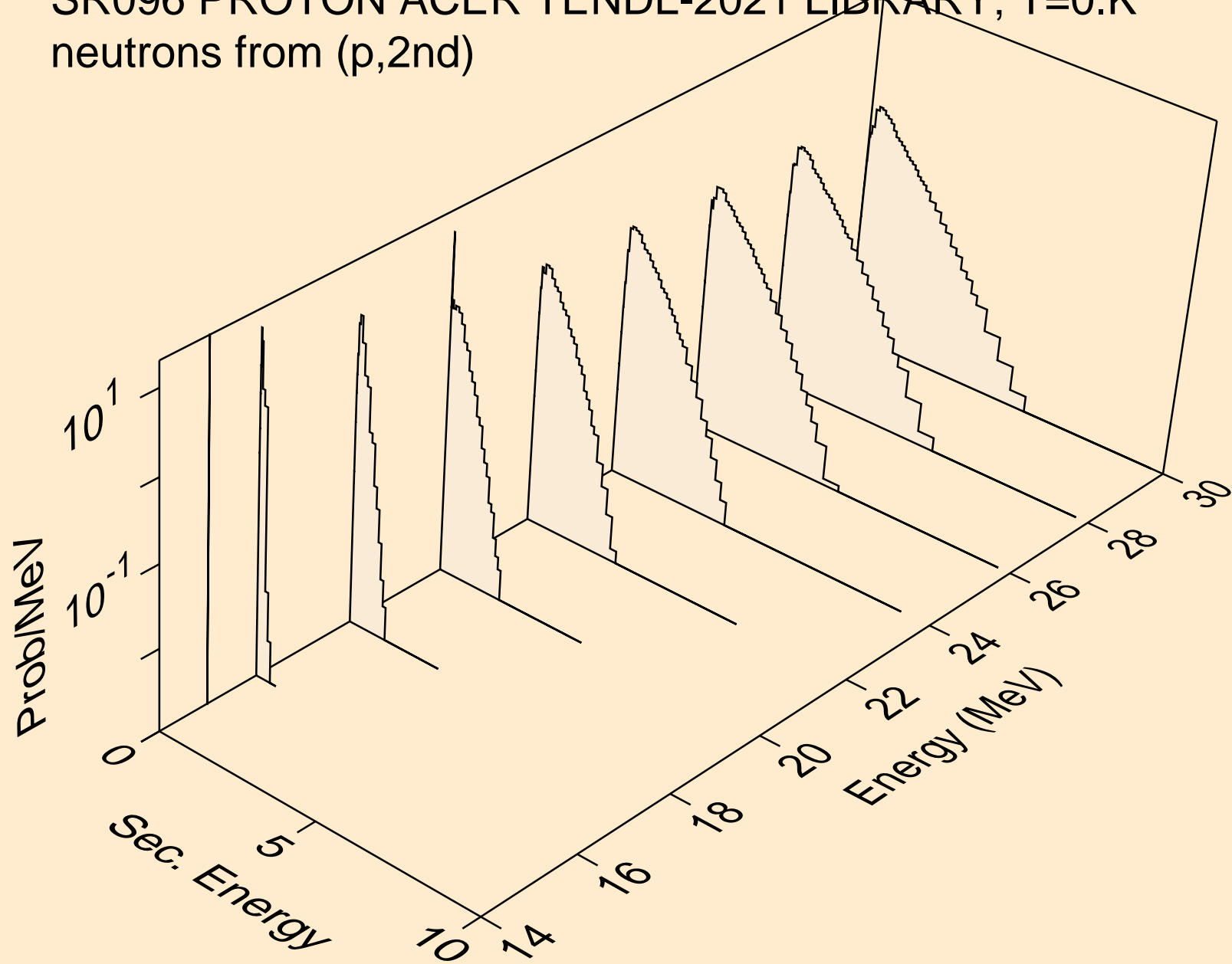



SR096 PROTON ACER TENDL-2021 LIBRARY; T=0.K  
neutrons from (p,2n)

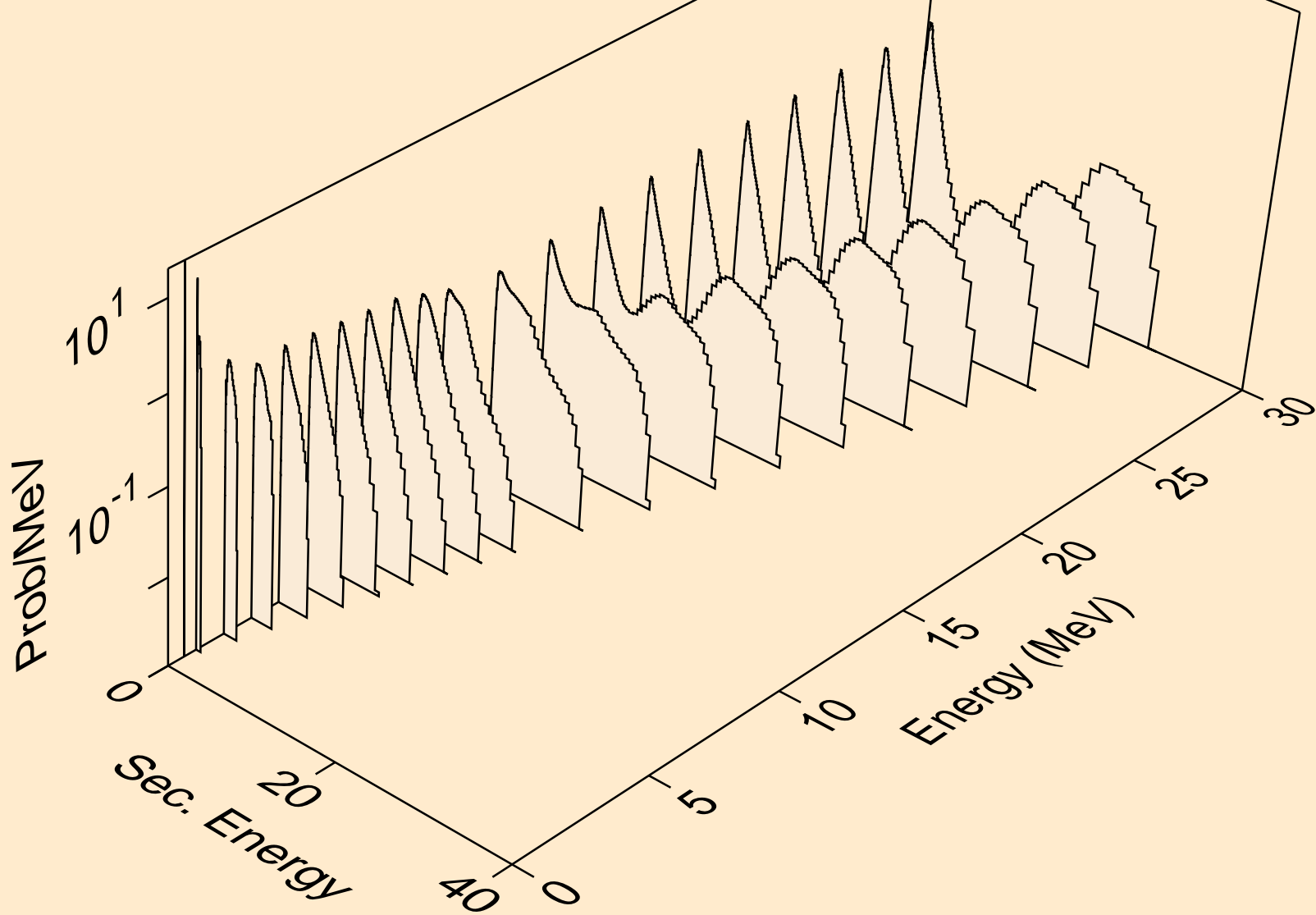

SR096 PROTON ACER TENDL-2021 LIBRARY; T=0.K  
neutrons from (p,3n)

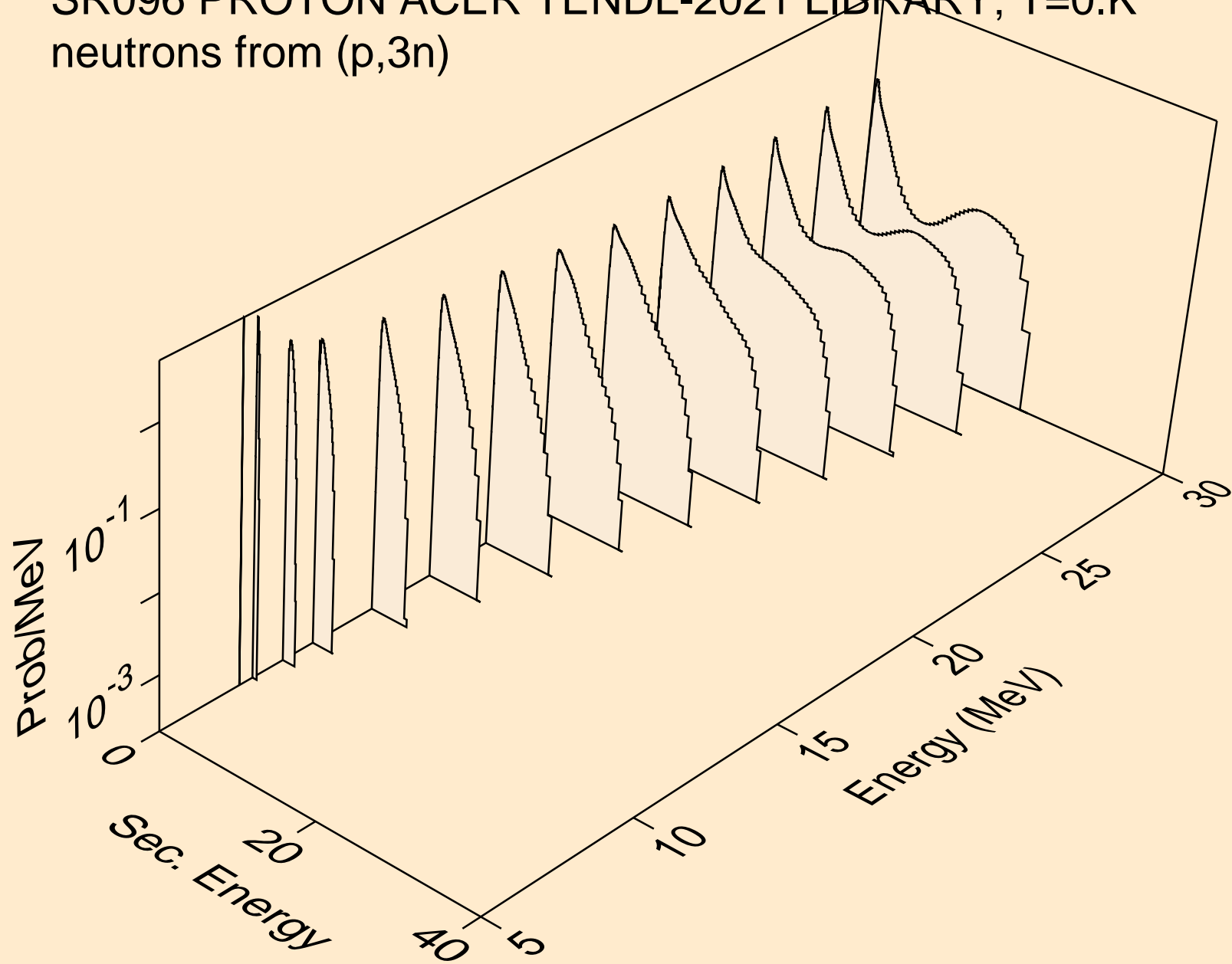

SR096 PROTON ACER TENDL-2021 LIBRARY; T=0.K  
neutrons from (p,n\*)a

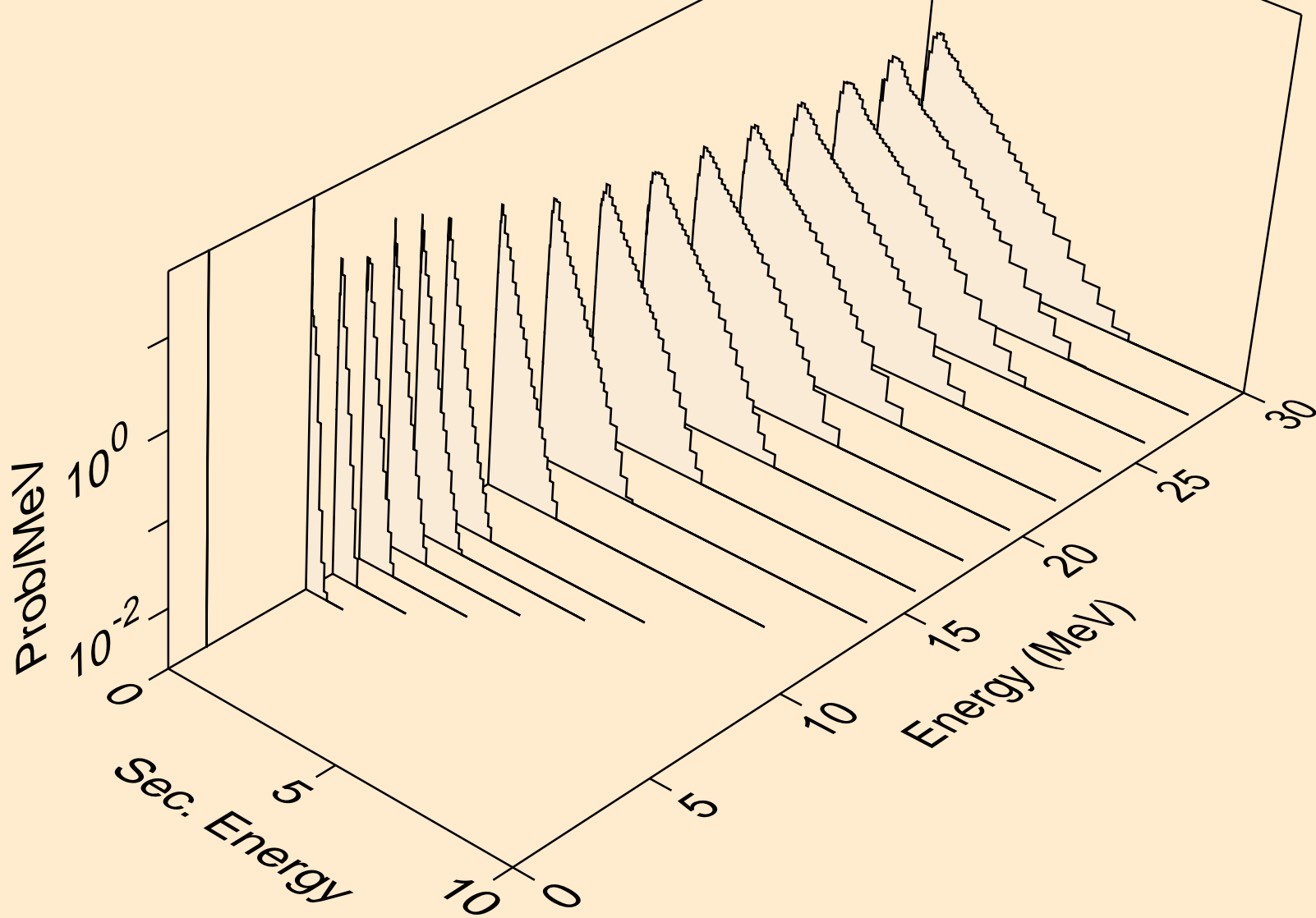

SR096 PROTON ACER TENDL-2021 LIBRARY; T=0.K  
neutrons from (p,2n)a

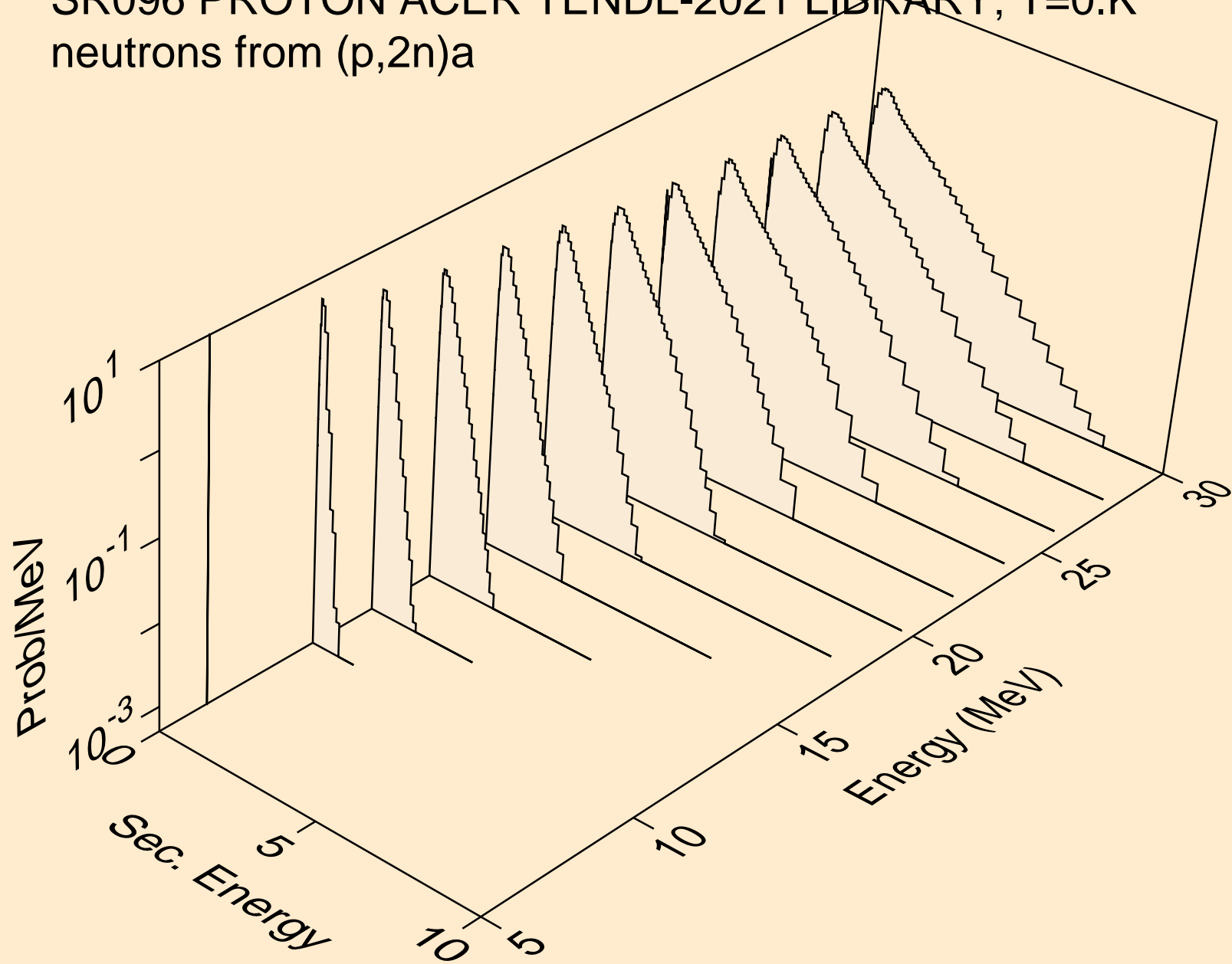

SR096 PROTON ACER TENDL-2021 LIBRARY; T=0.K  
neutrons from (p,3n)a

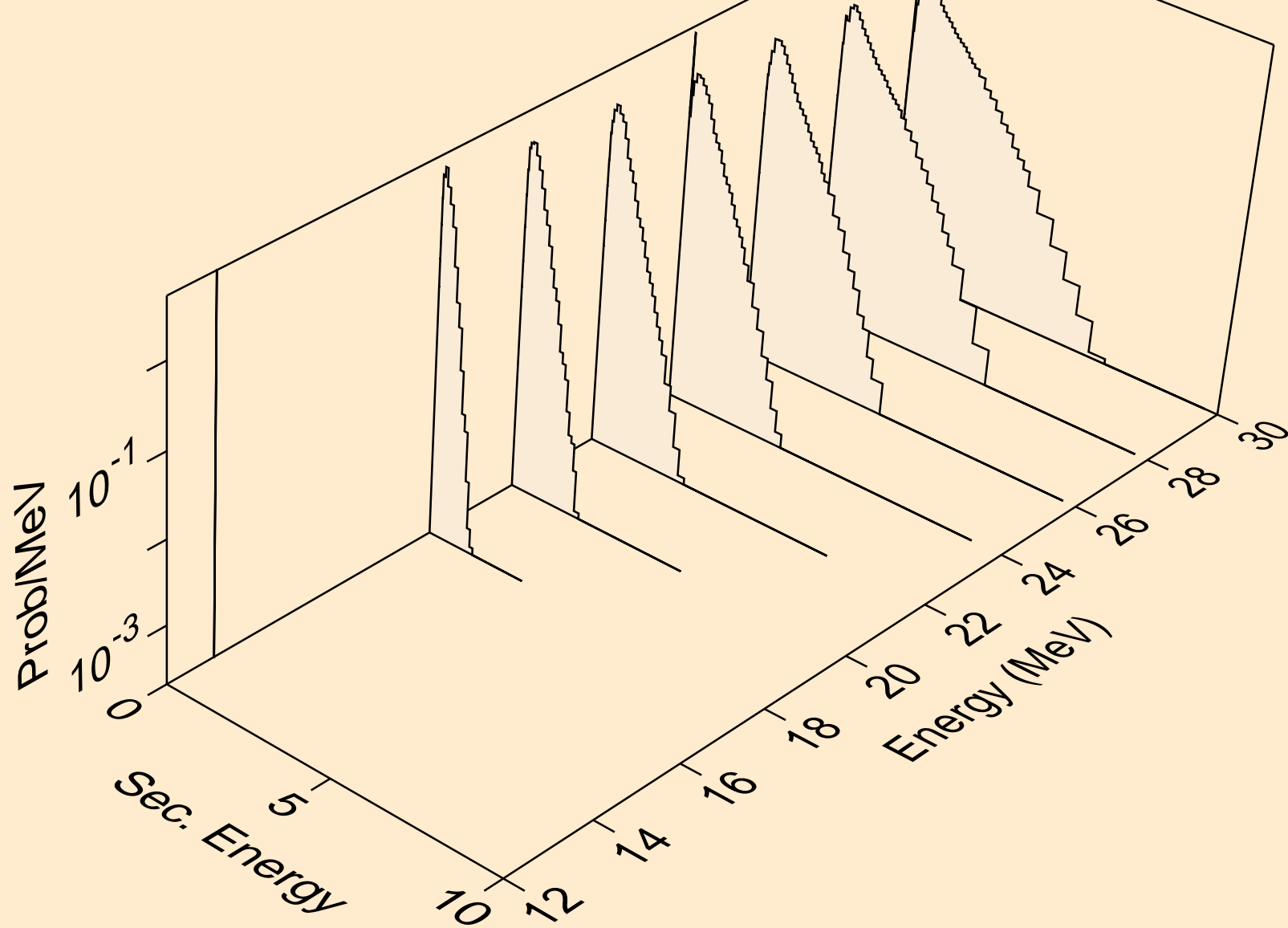

SR096 PROTON ACER TENDL-2021 LIBRARY; T=0.K  
neutrons from (p,n\*)p

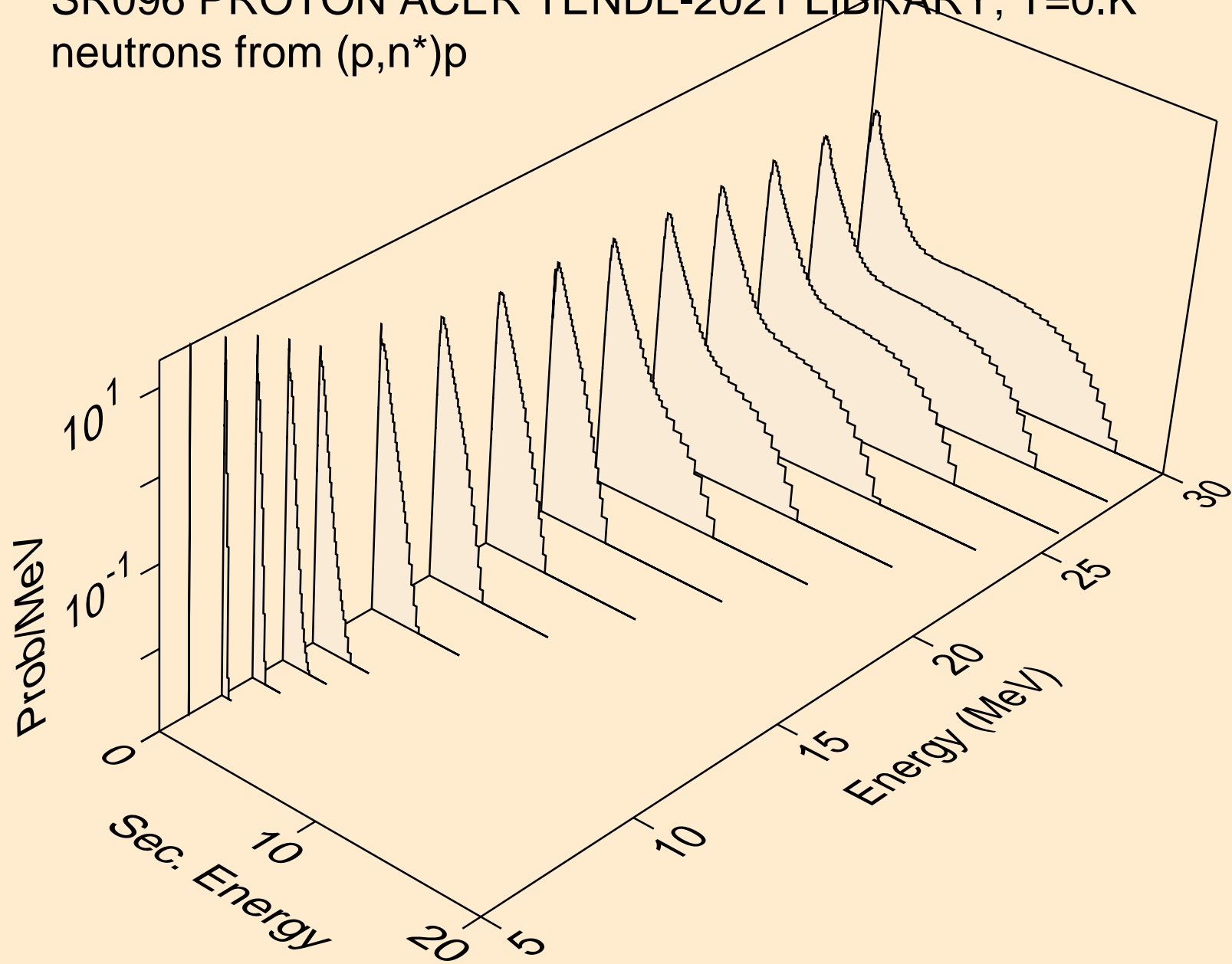

SR096 PROTON ACER TENDL-2021 LIBRARY; T=0.K  
neutrons from (p,n\*)2a

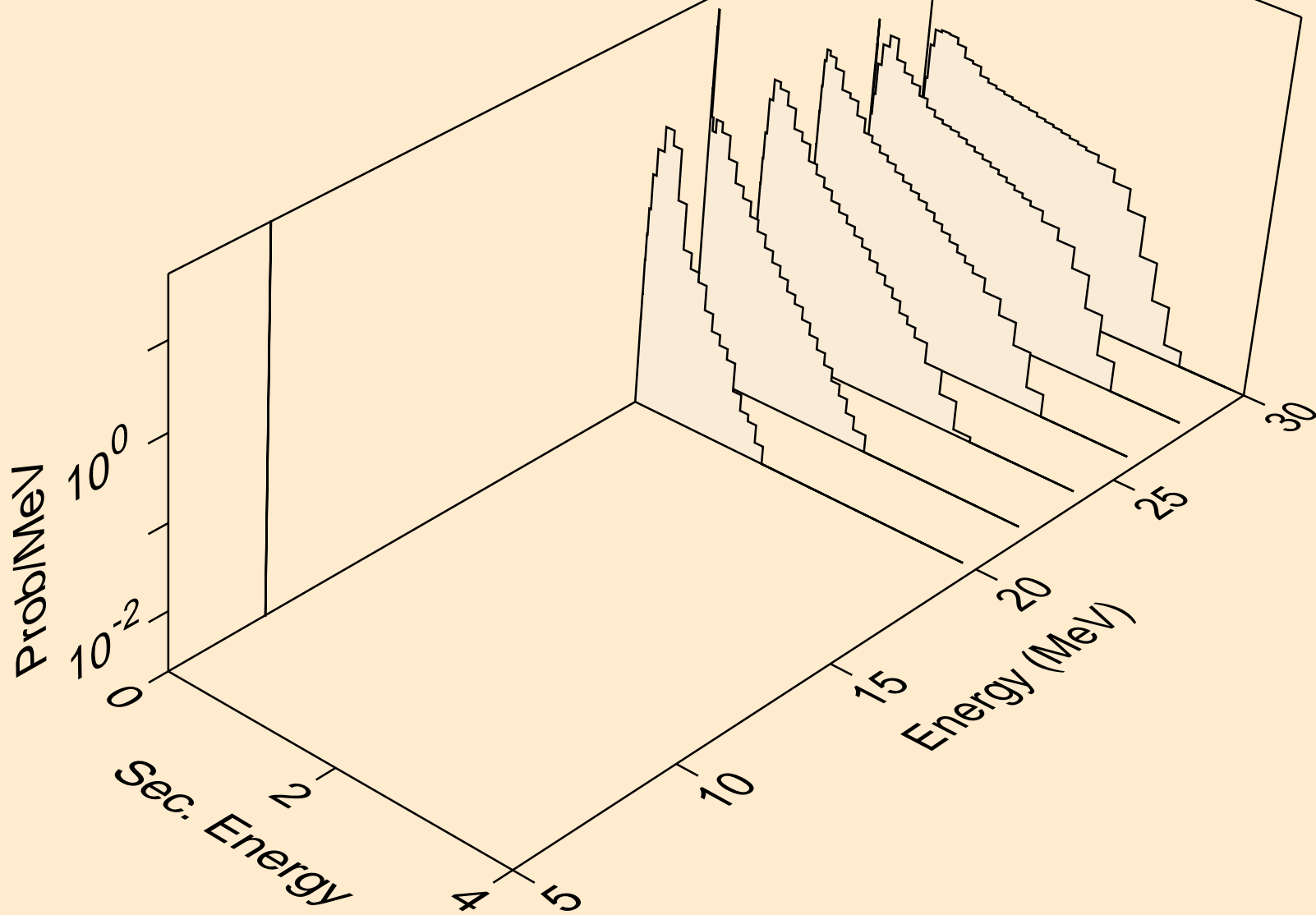

SR096 PROTON ACER TENDL-2021 LIBRARY; T=0.K  
neutrons from (p,n\*)d

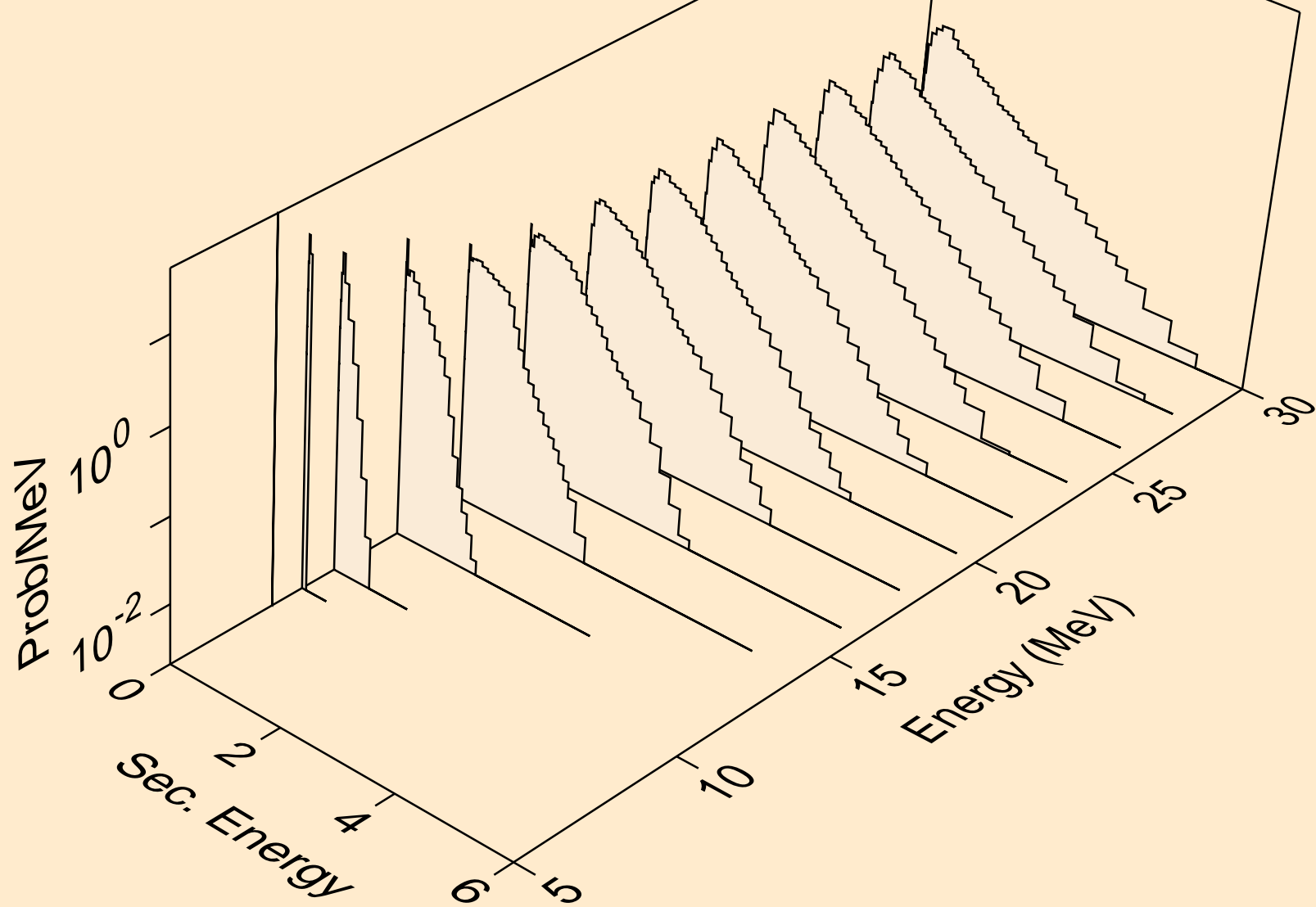



SR096 PROTON ACER TENDL-2021 LIBRARY; T=0.K  
neutrons from (p,n\*)t

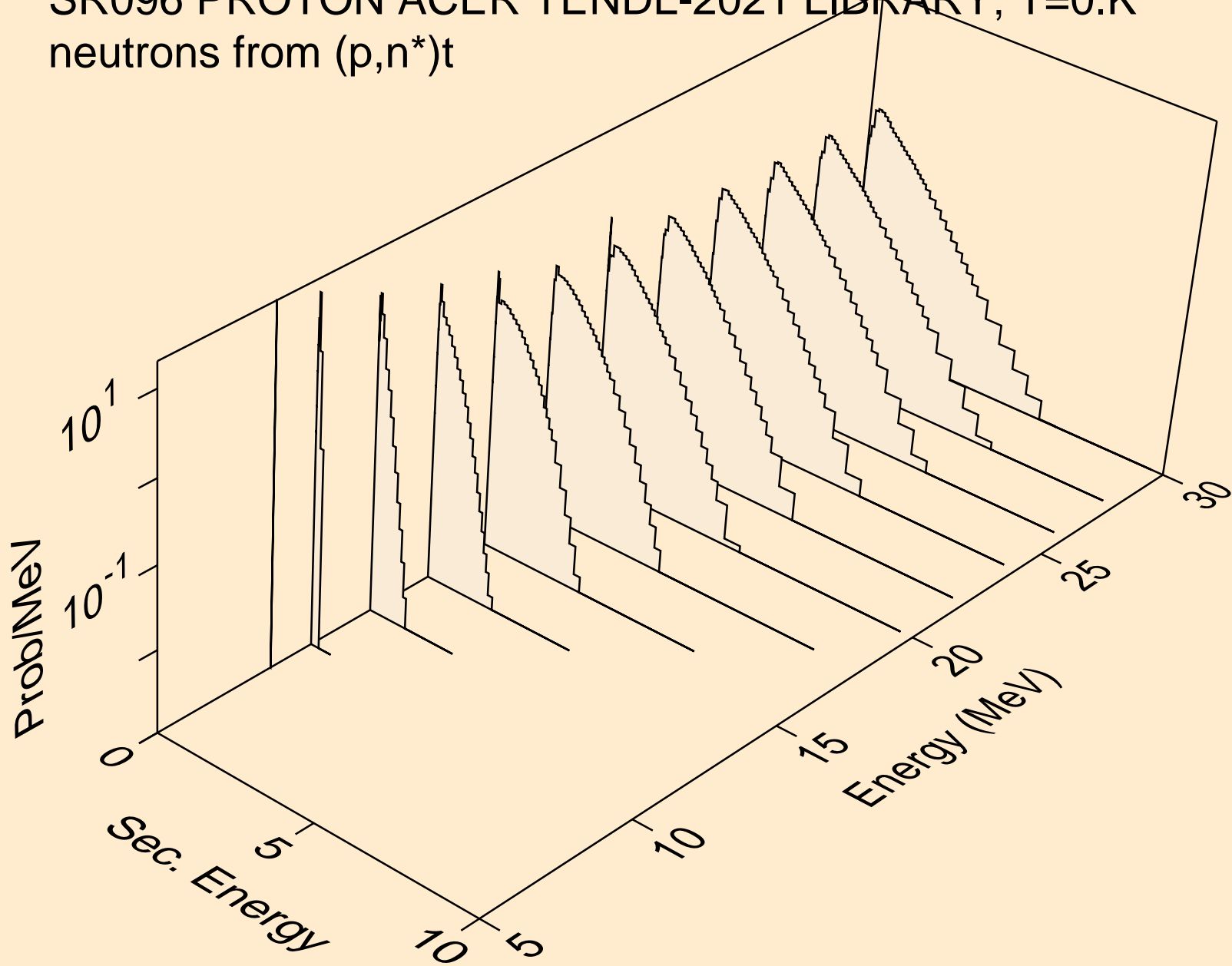

SR096 PROTON ACER TENDL-2021 LIBRARY; T=0.K  
neutrons from (p,n\*)he3

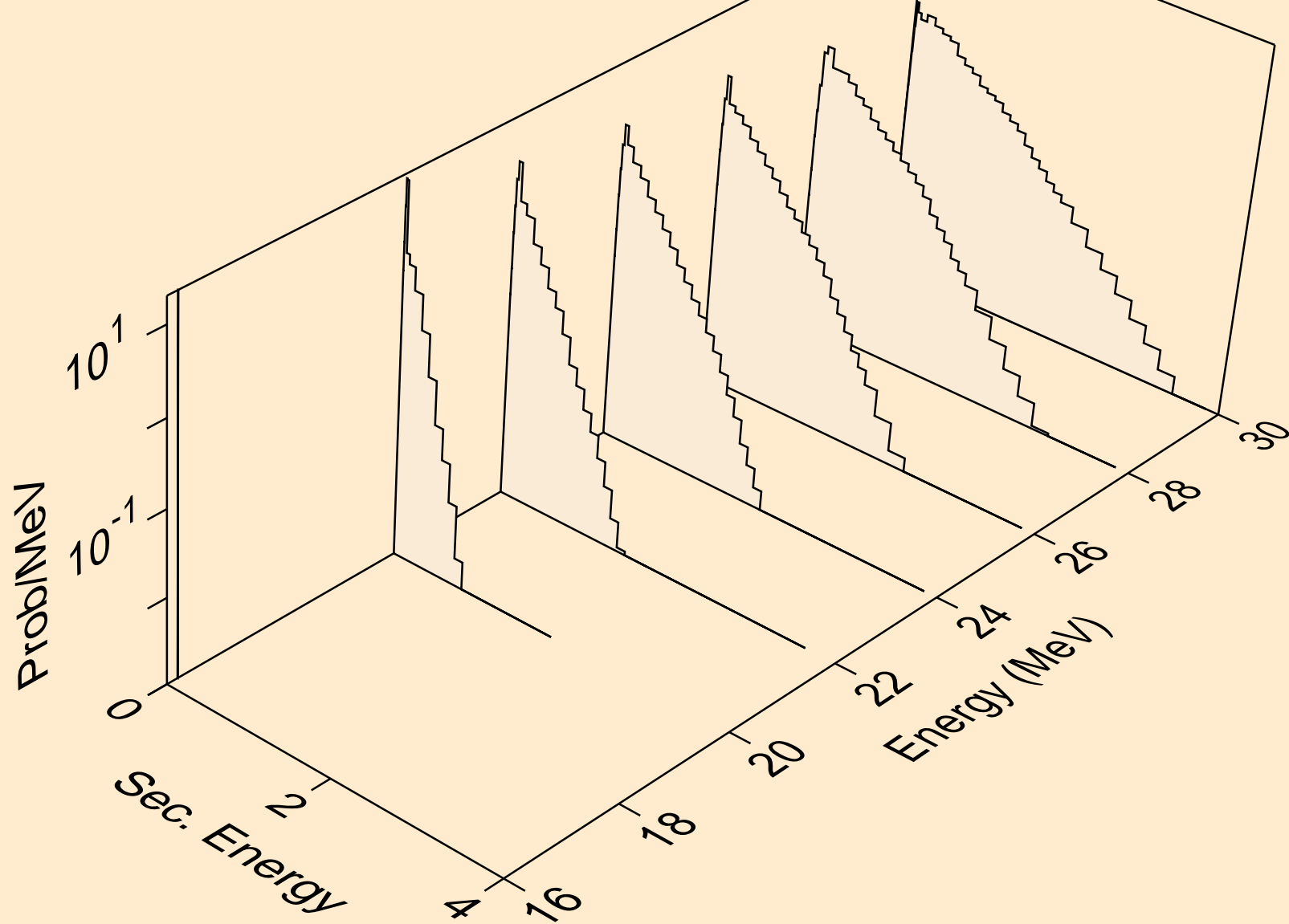

SR096 PROTON ACER TENDL-2021 LIBRARY; T=0.K  
neutrons from (p,4n)

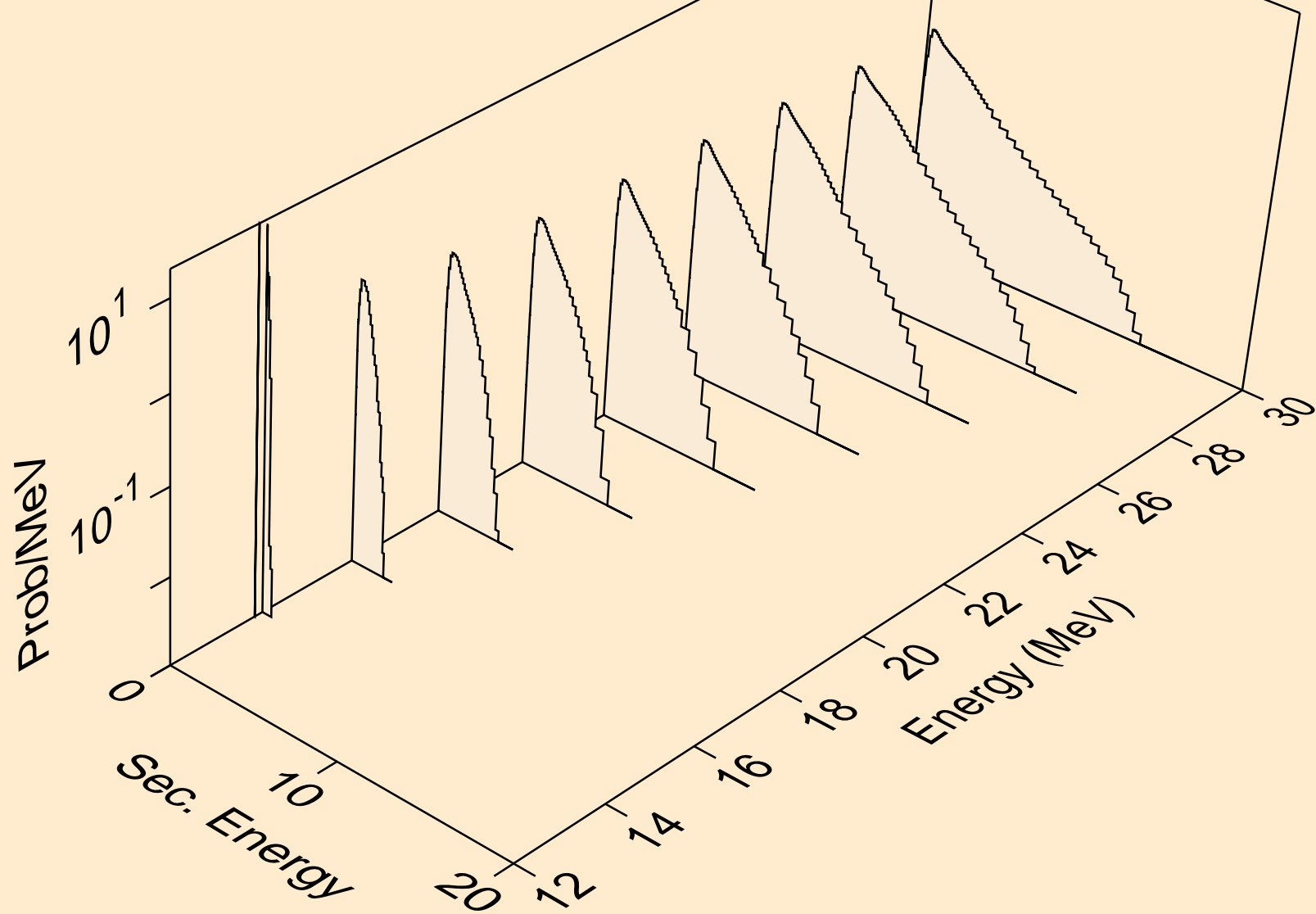

SR096 PROTON ACER TENDL-2021 LIBRARY; T=0.K  
neutrons from (p,2np)

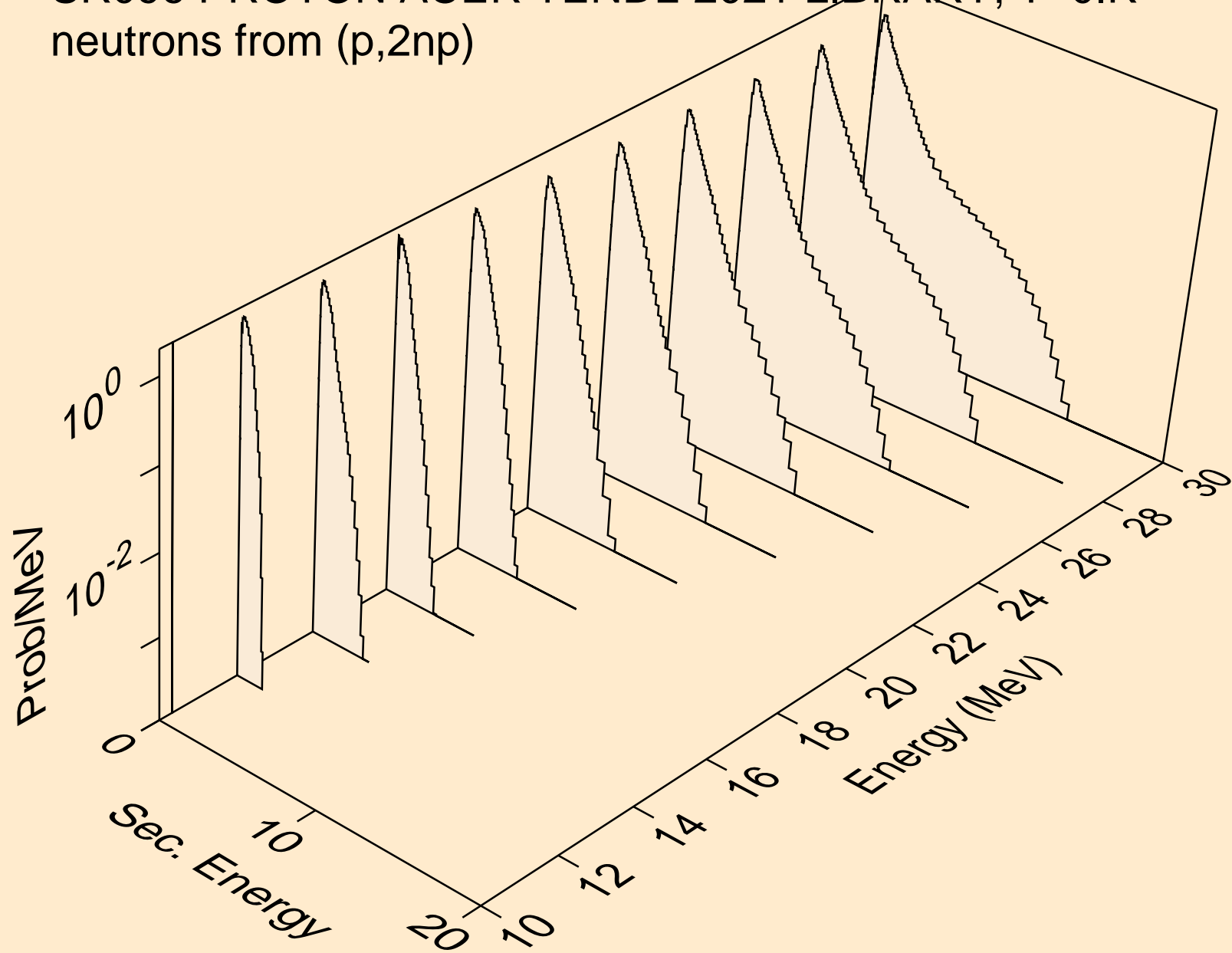

SR096 PROTON ACER TENDL-2021 LIBRARY; T=0.K  
neutrons from (p,3np)

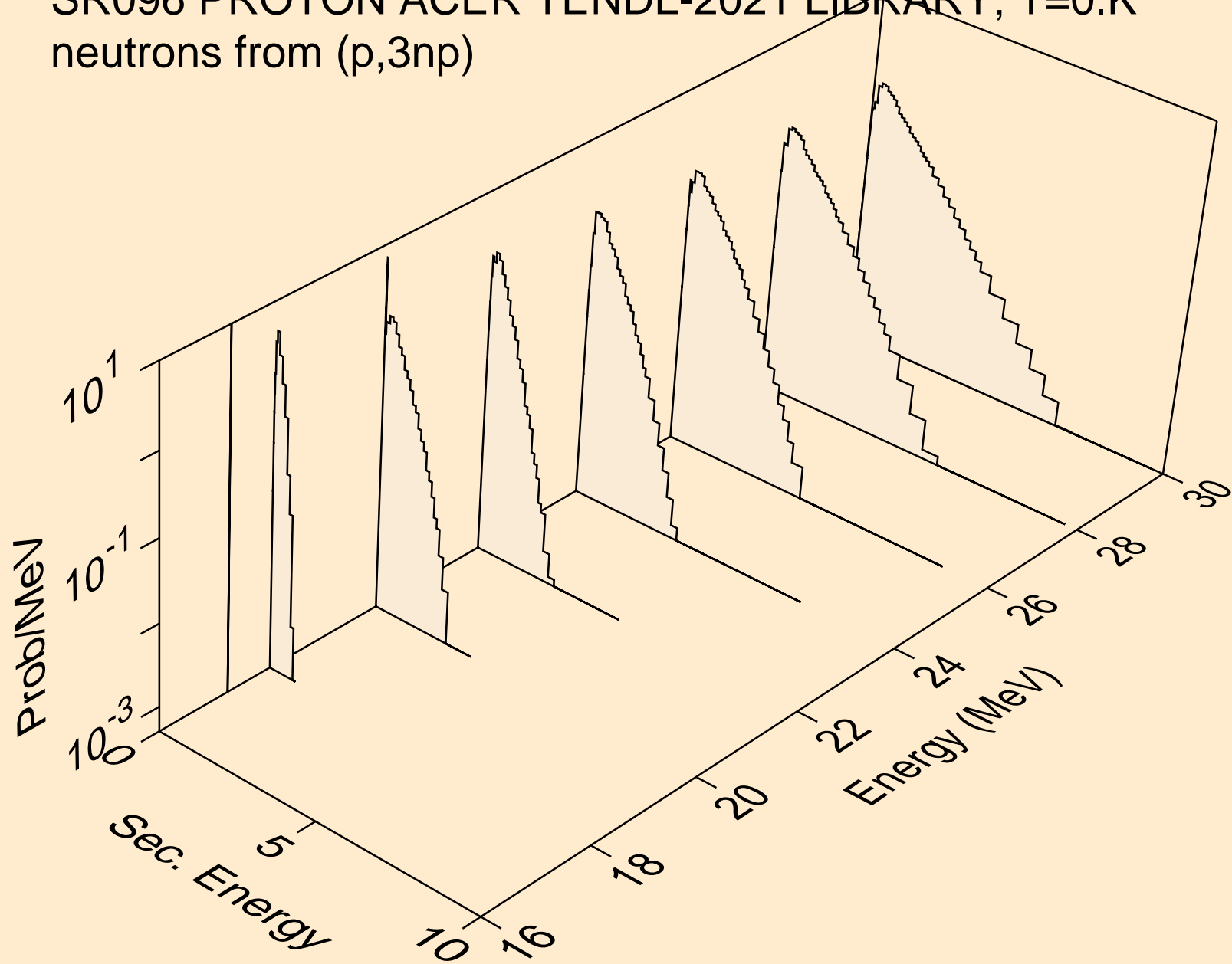

SR096 PROTON ACER TENDL-2021 LIBRARY; T=0.K  
neutrons from (p,2np)

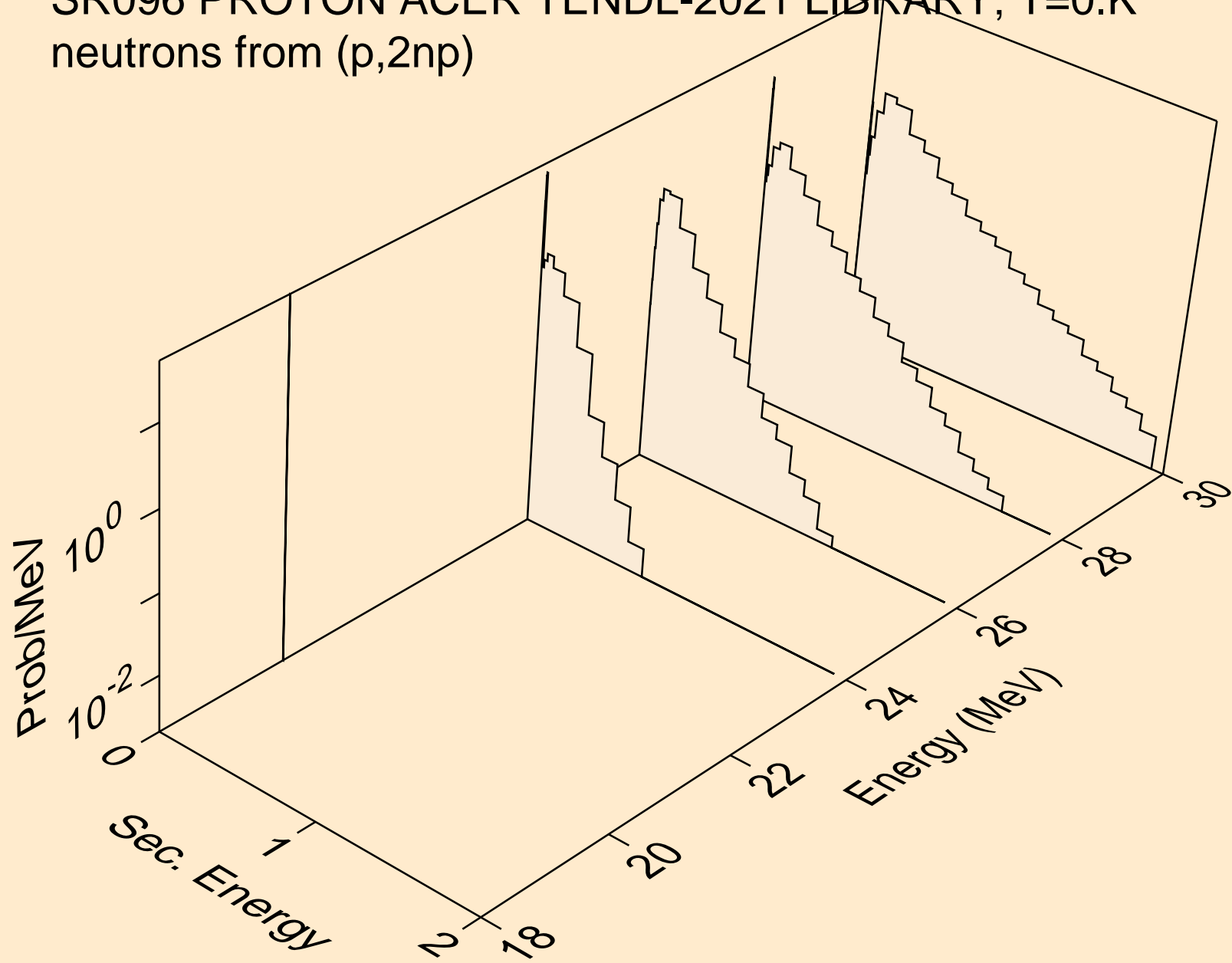

SR096 PROTON ACER TENDL-2021 LIBRARY; T=0.K  
neutrons from (p,npa)

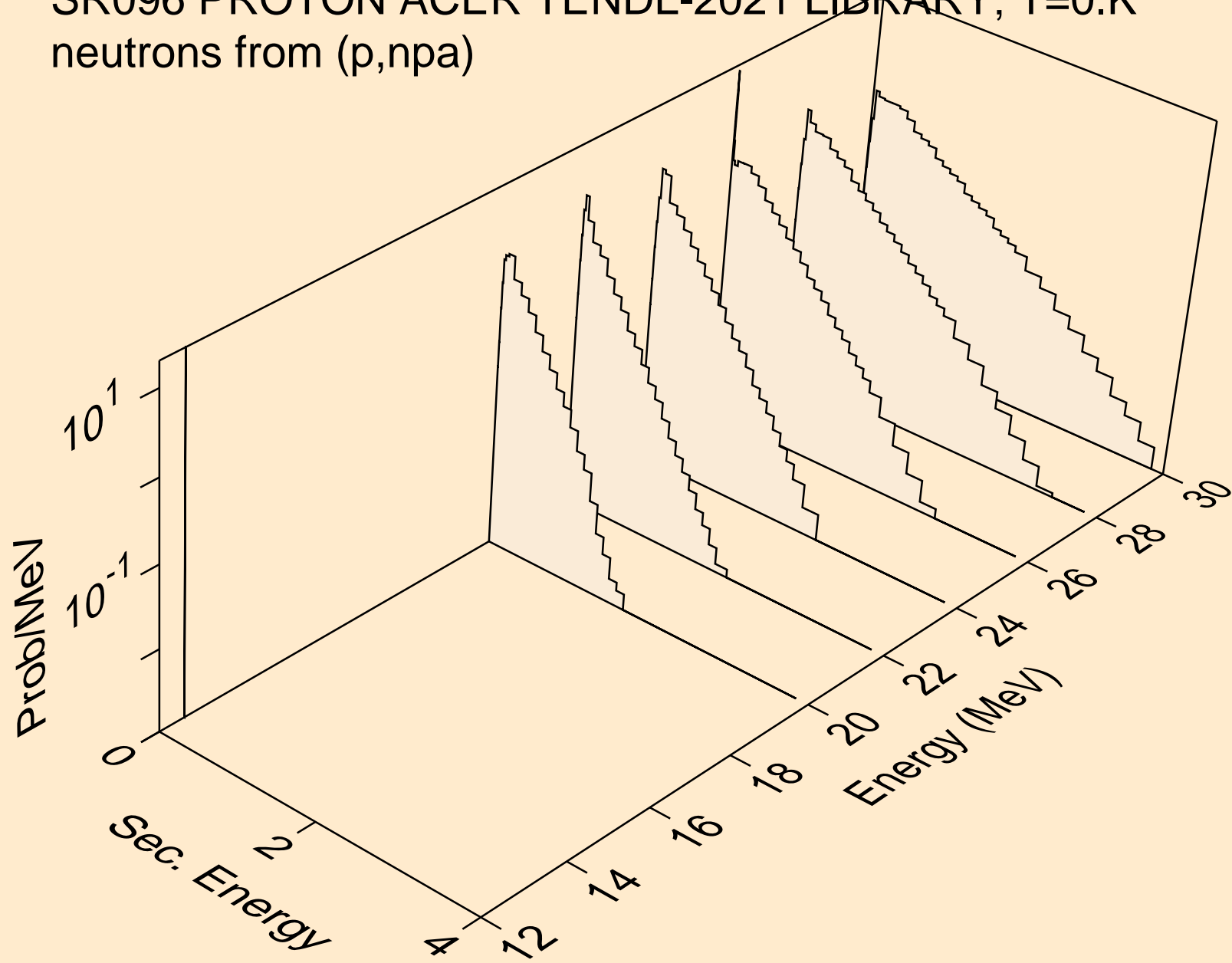

SR096 PROTON ACER TENDL-2021 LIBRARY; T=0.K  
deuterons from (p,x)

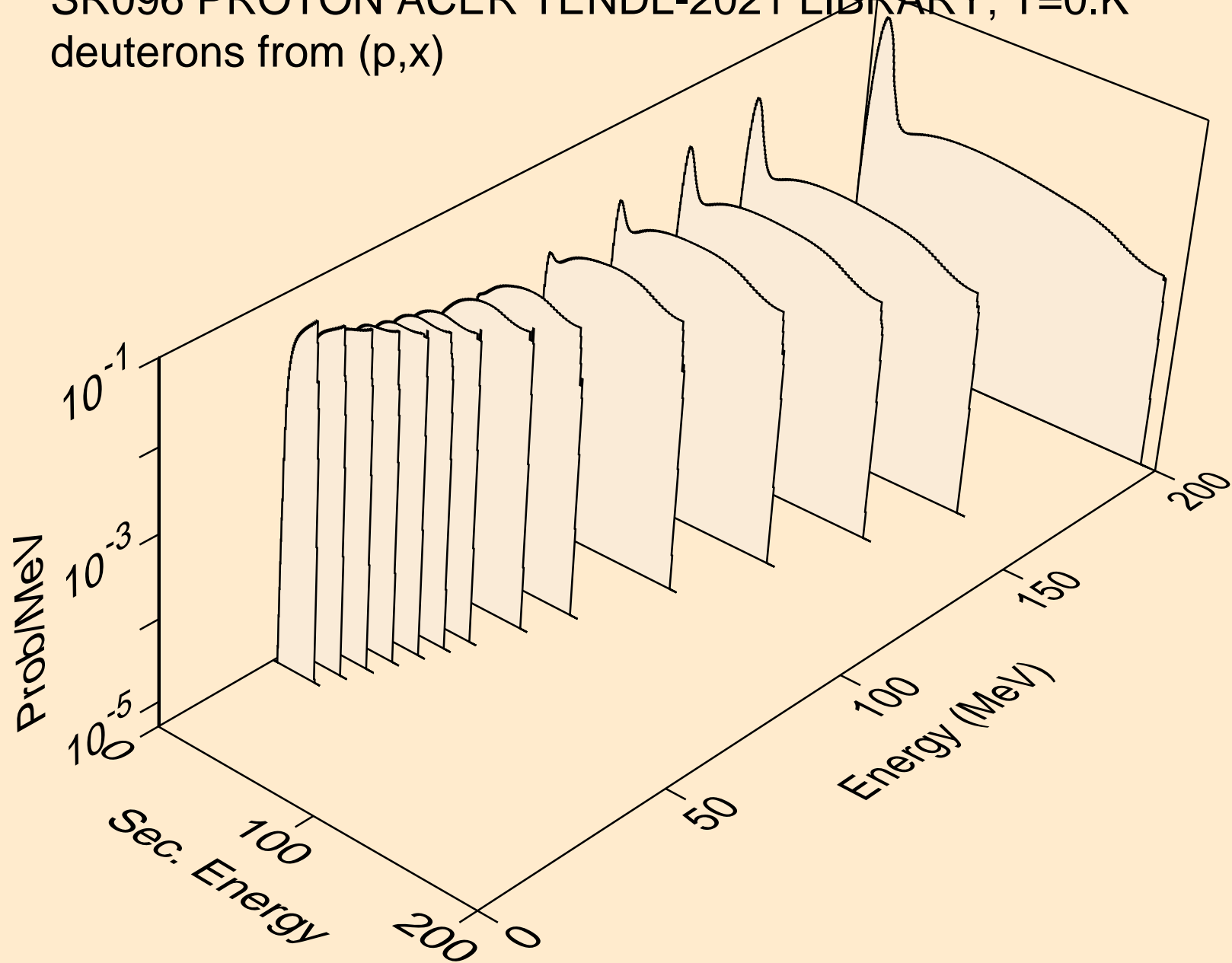



SR096 PROTON ACER TENDL-2021 LIBRARY; T=0.K  
deuterons from (p,2nd)

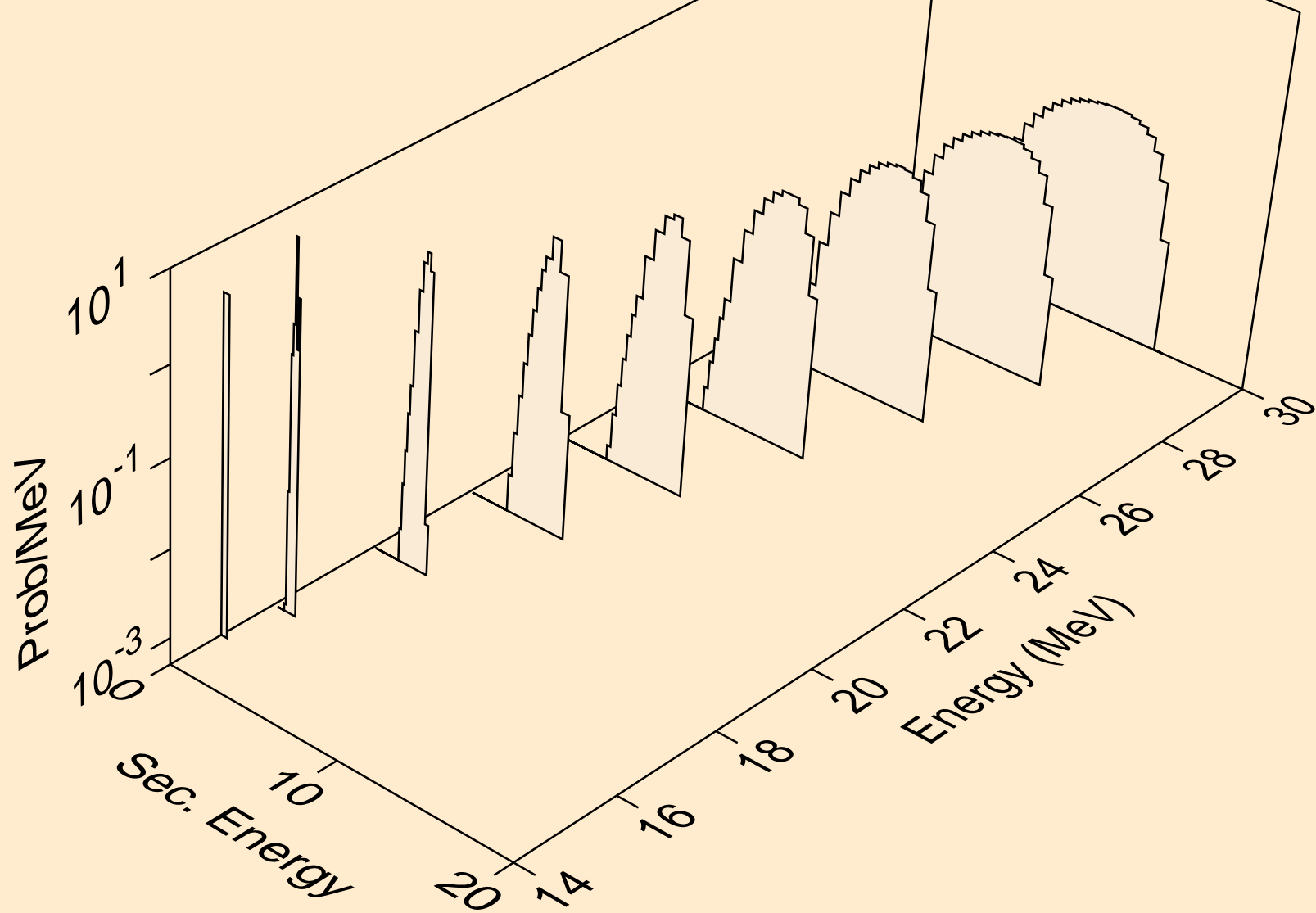

SR096 PROTON ACER TENDL-2021 LIBRARY; T=0.K  
deuterons from (p,n\*)d

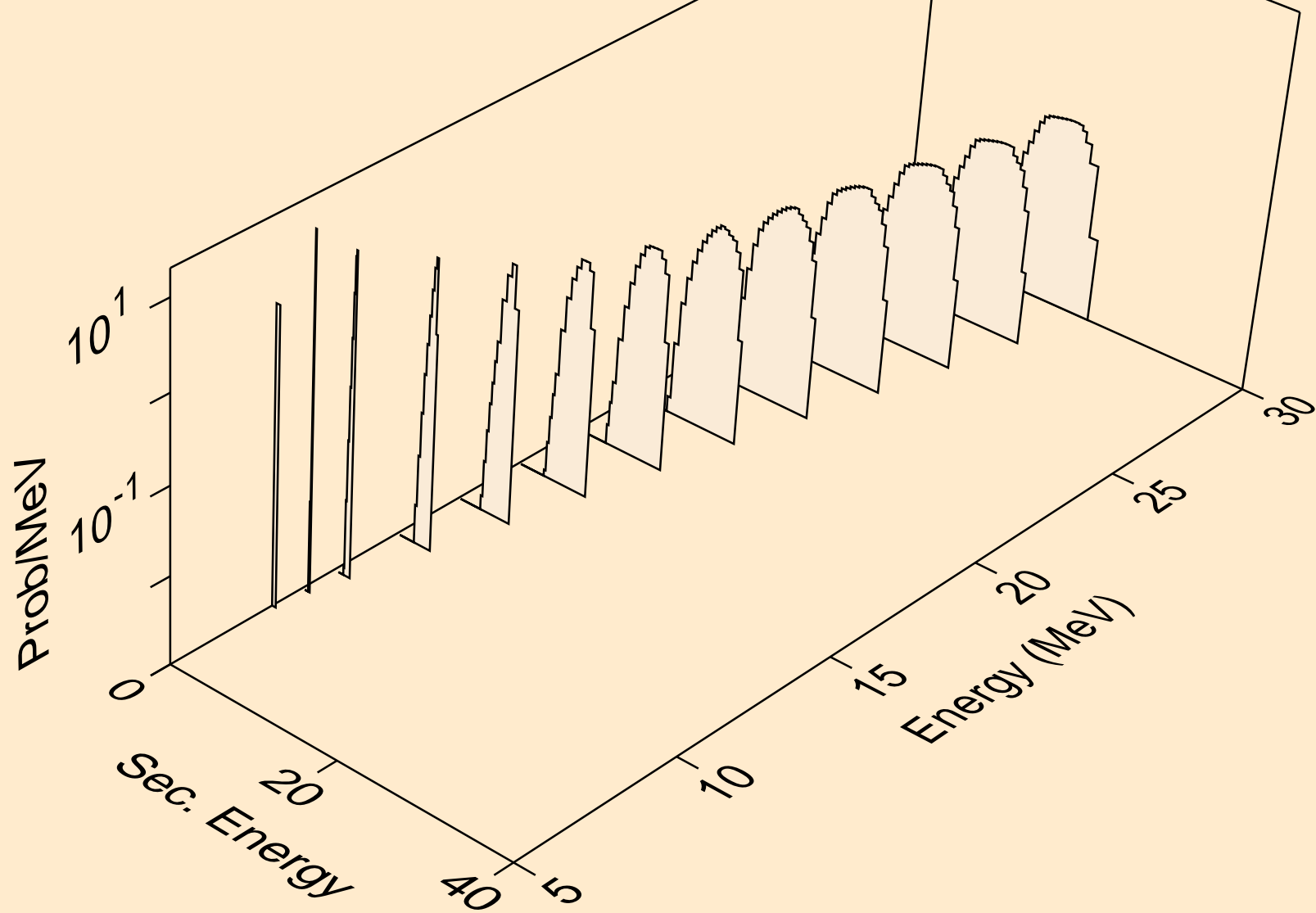

SR096 PROTON ACER TENDL-2021 LIBRARY; T=0.K  
deuterons from (p,d)

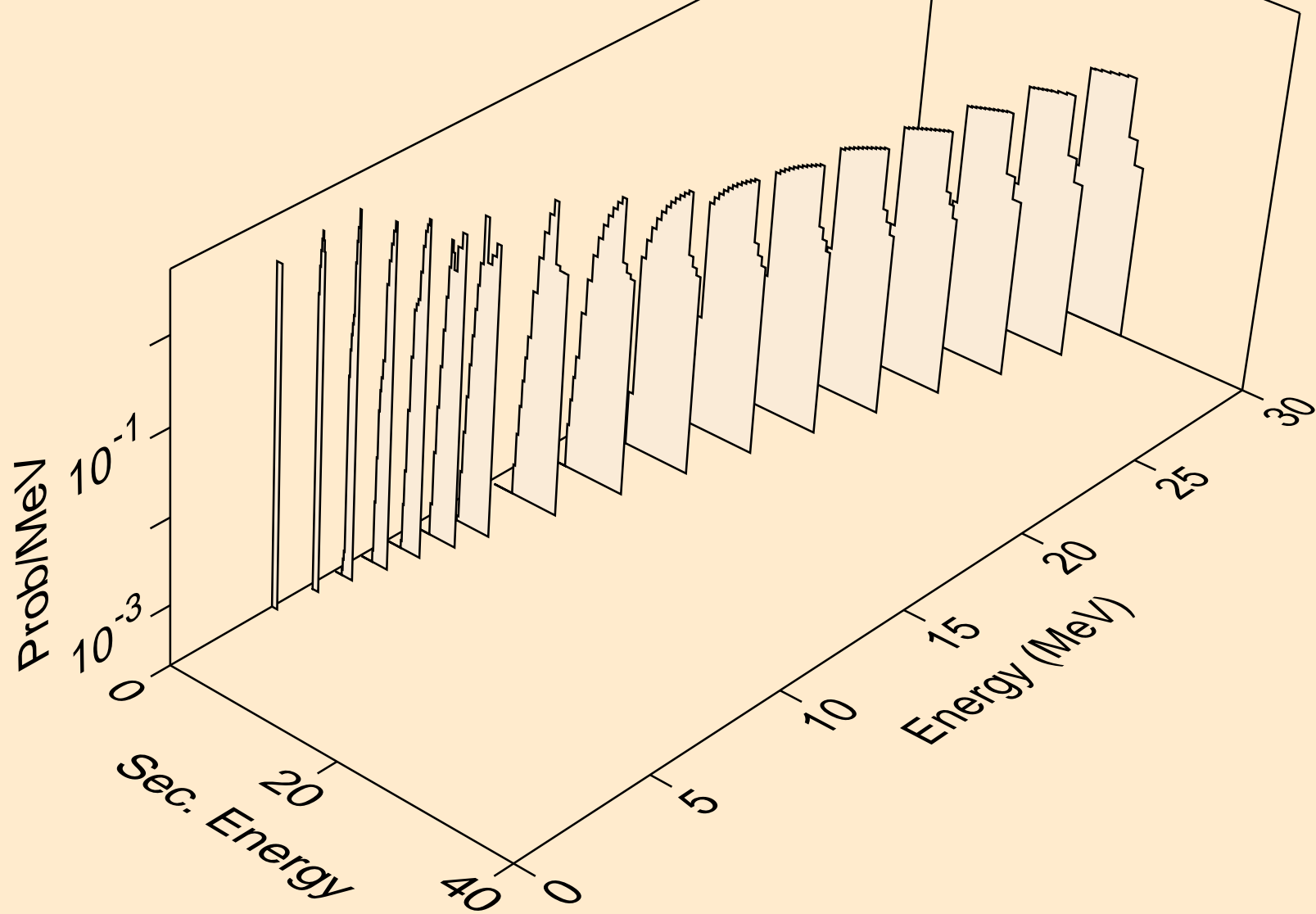

SR096 PROTON ACER TENDL-2021 LIBRARY; T=0.K  
deuterons from (p,pd)

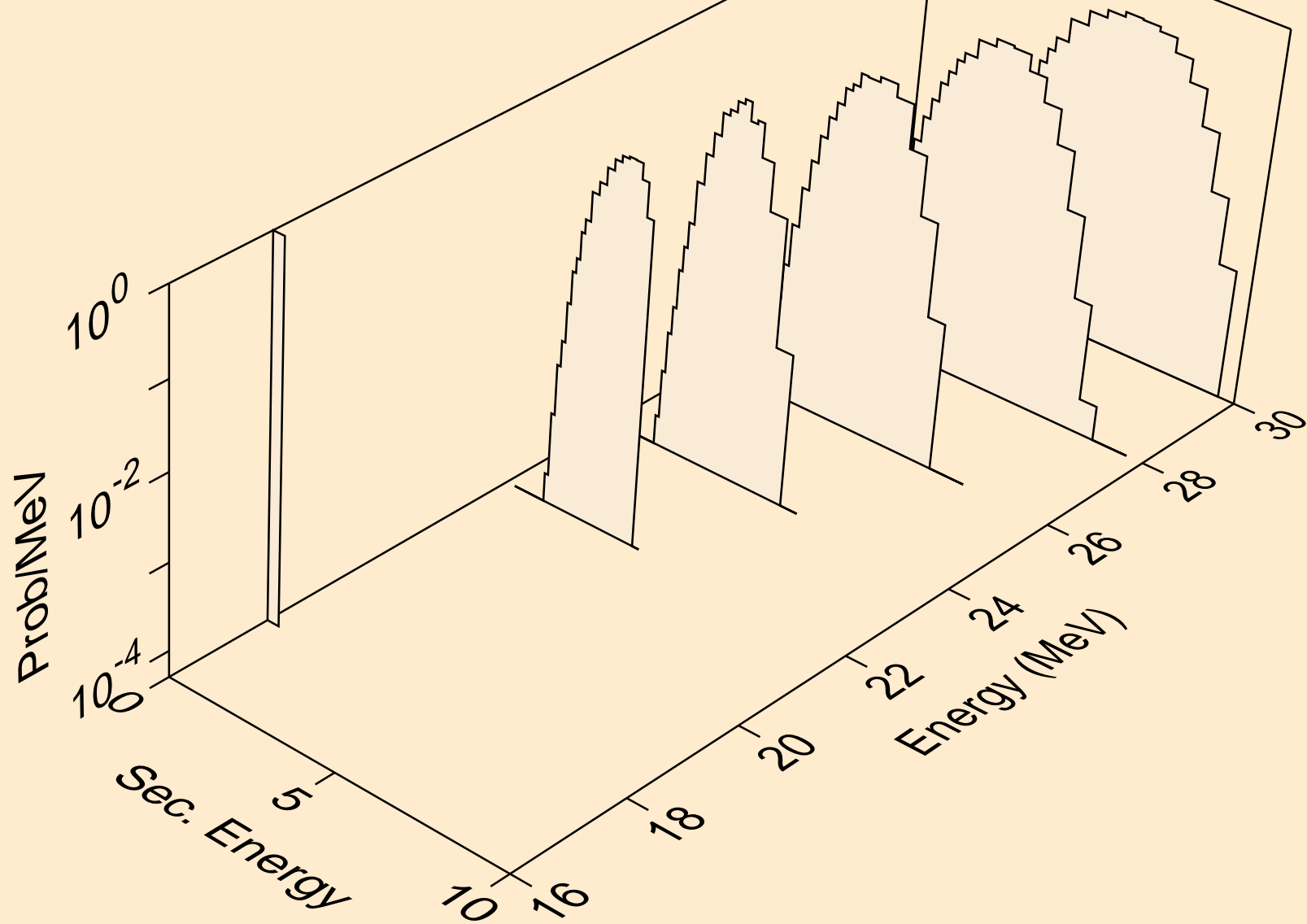

SR096 PROTON ACER TENDL-2021 LIBRARY; T=0.K  
deuterons from (p,da)

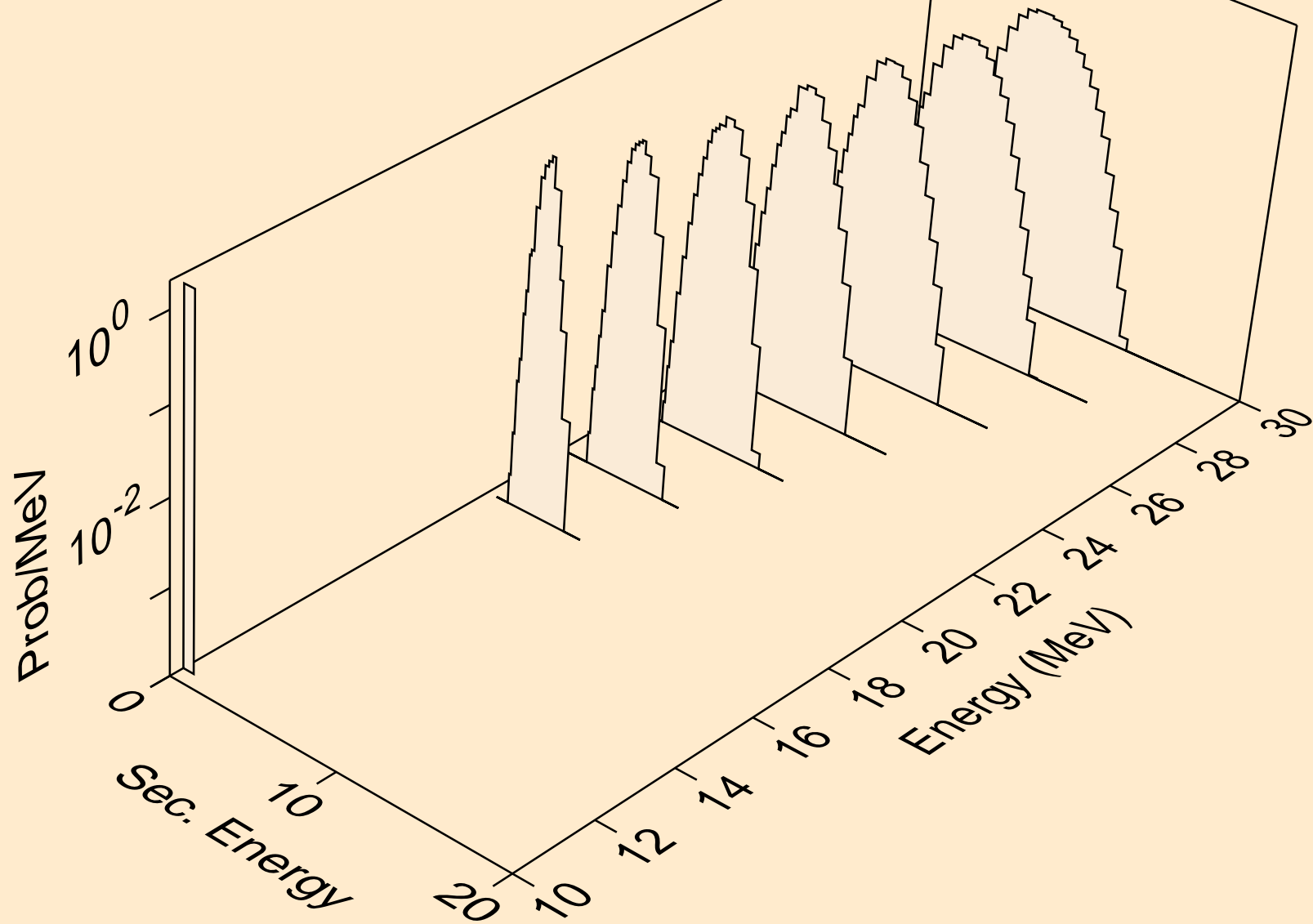

SR096 PROTON ACER TENDL-2021 LIBRARY; T=0.K  
tritons from (p,x)

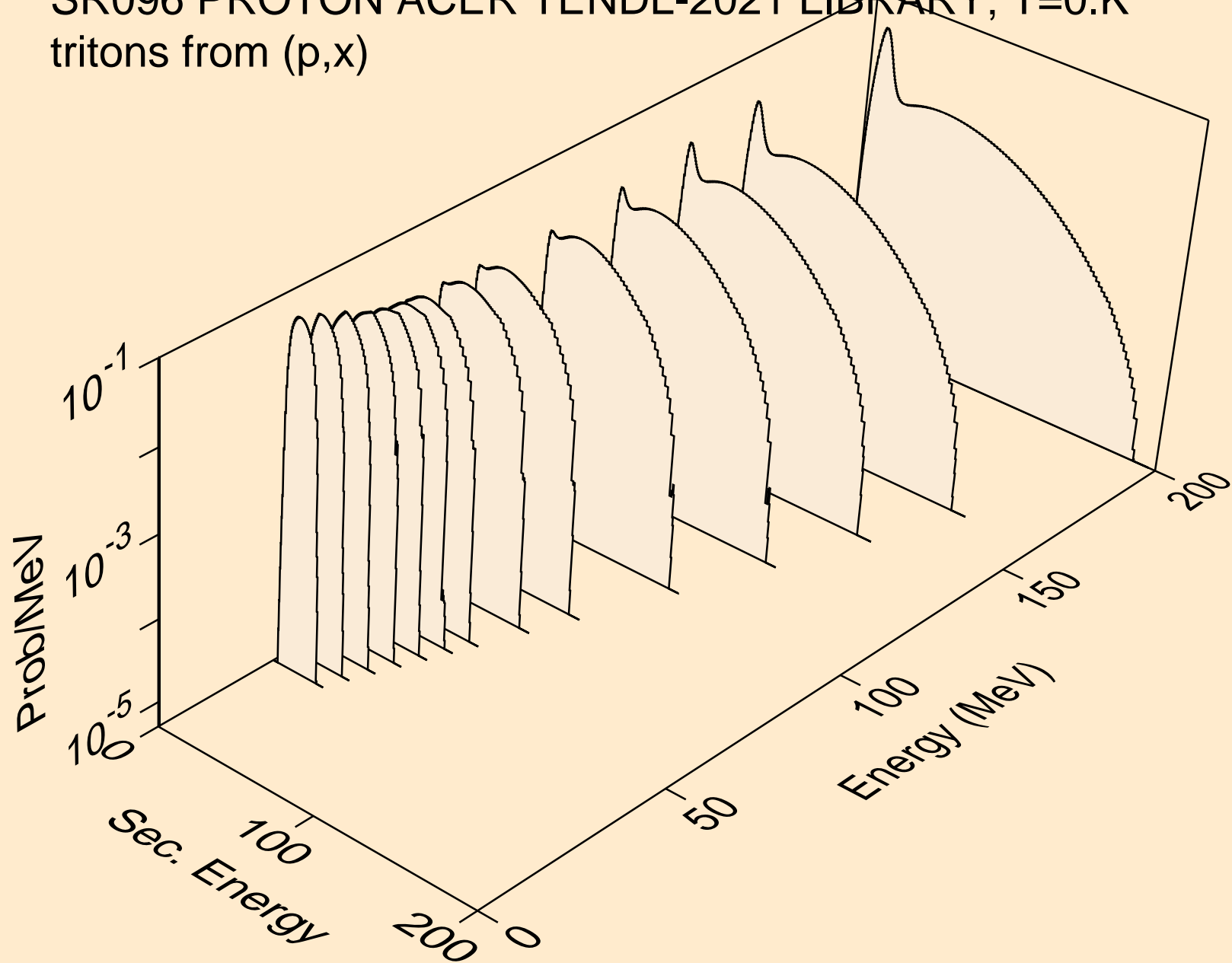

SR096 PROTON ACER TENDL-2021 LIBRARY; T=0.K  
tritons from (p,n\*)t

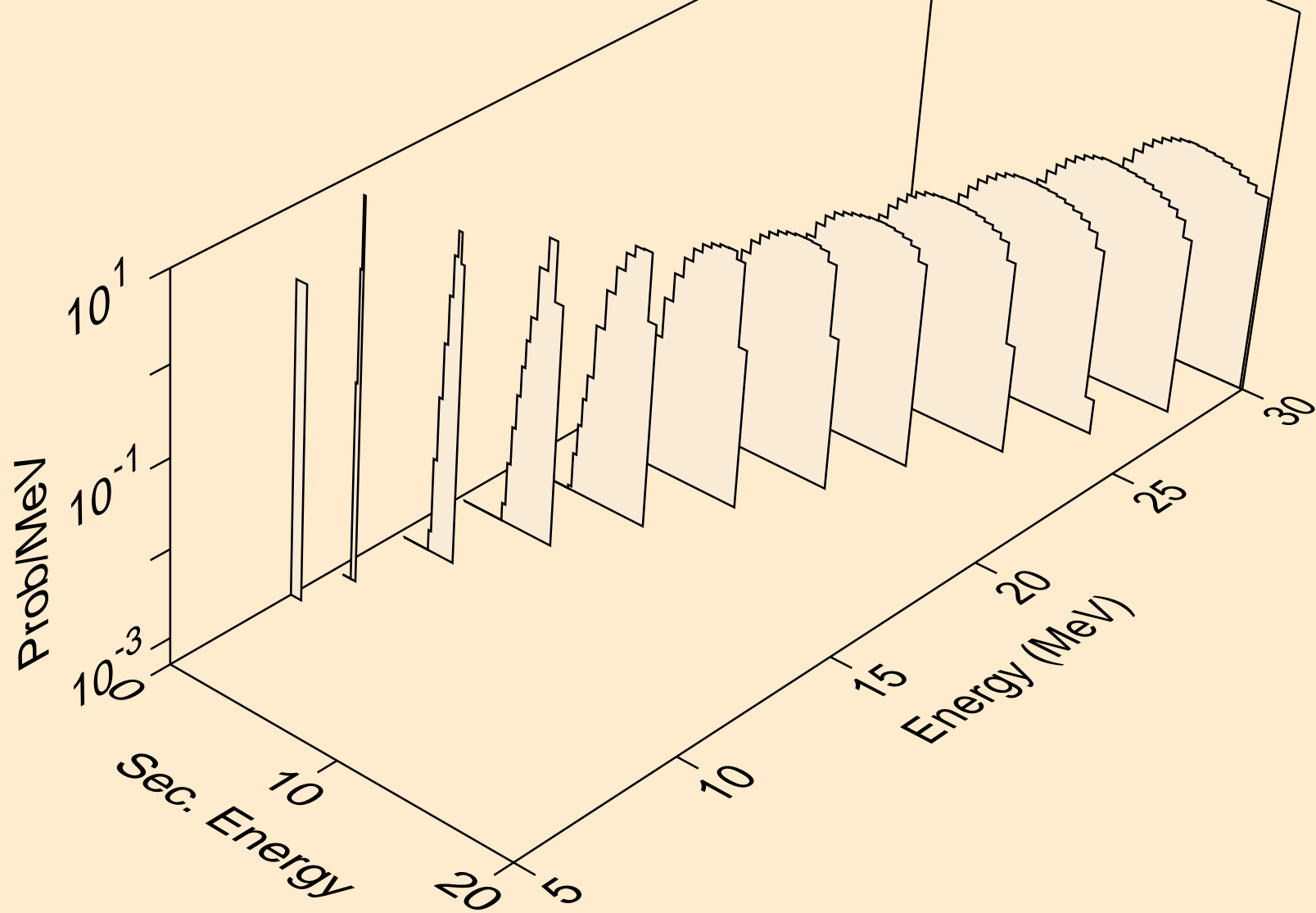

SR096 PROTON ACER TENDL-2021 LIBRARY; T=0.K  
tritons from (p,t)

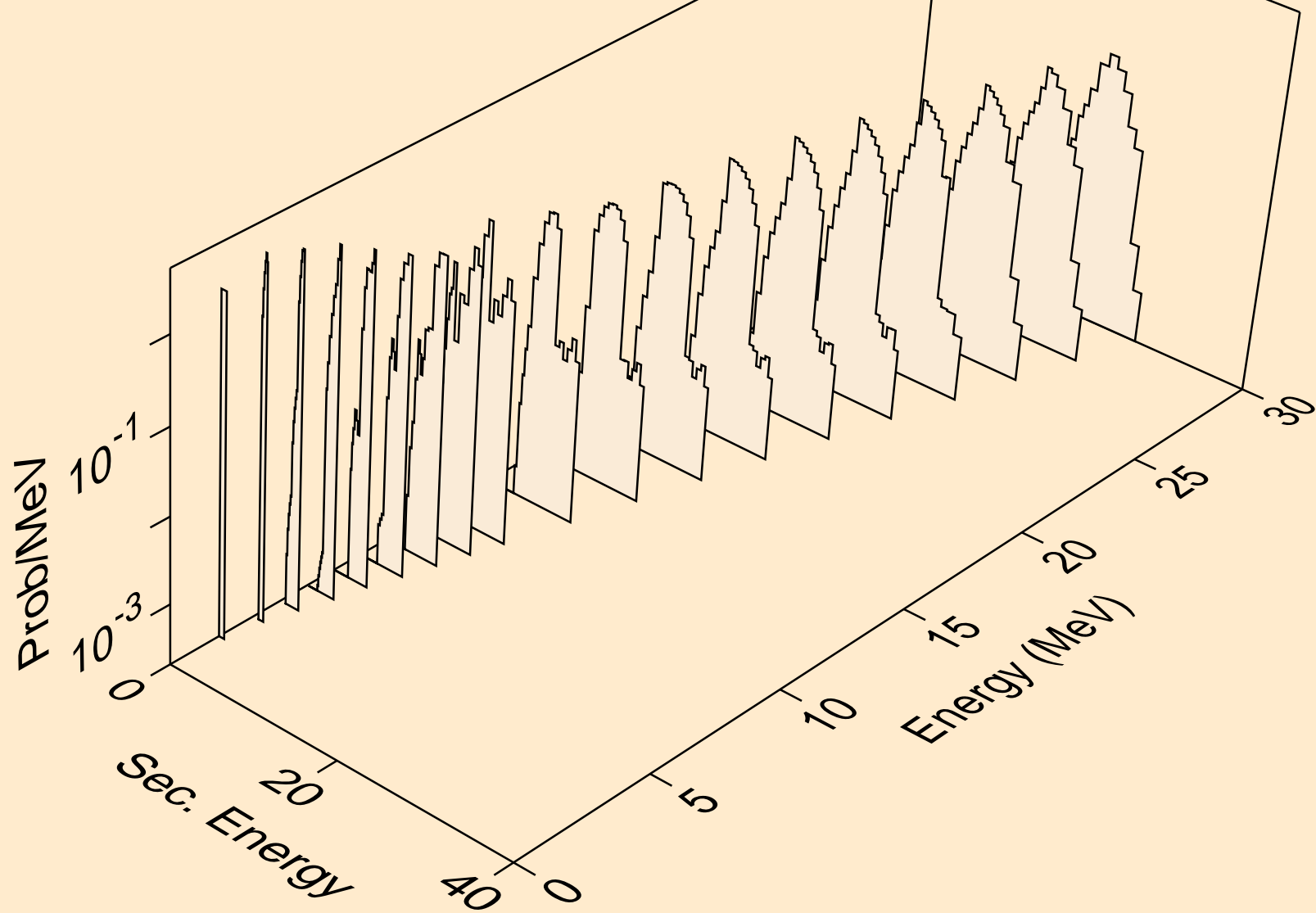



SR096 PROTON ACER TENDL-2021 LIBRARY; T=0.K  
tritons from (p,pt)

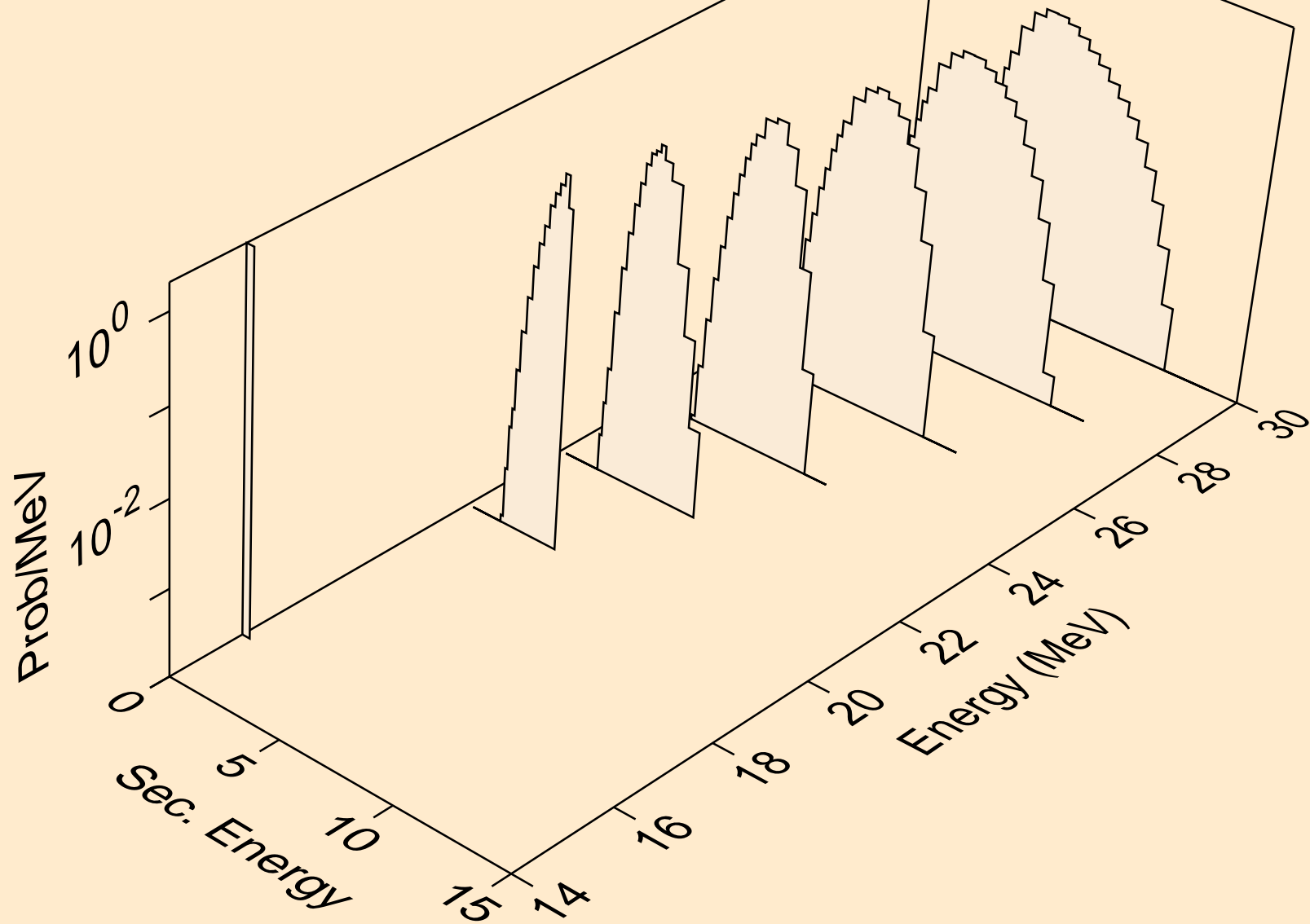

SR096 PROTON ACER TENDL-2021 LIBRARY; T=0.K  
he3s from (p,x)

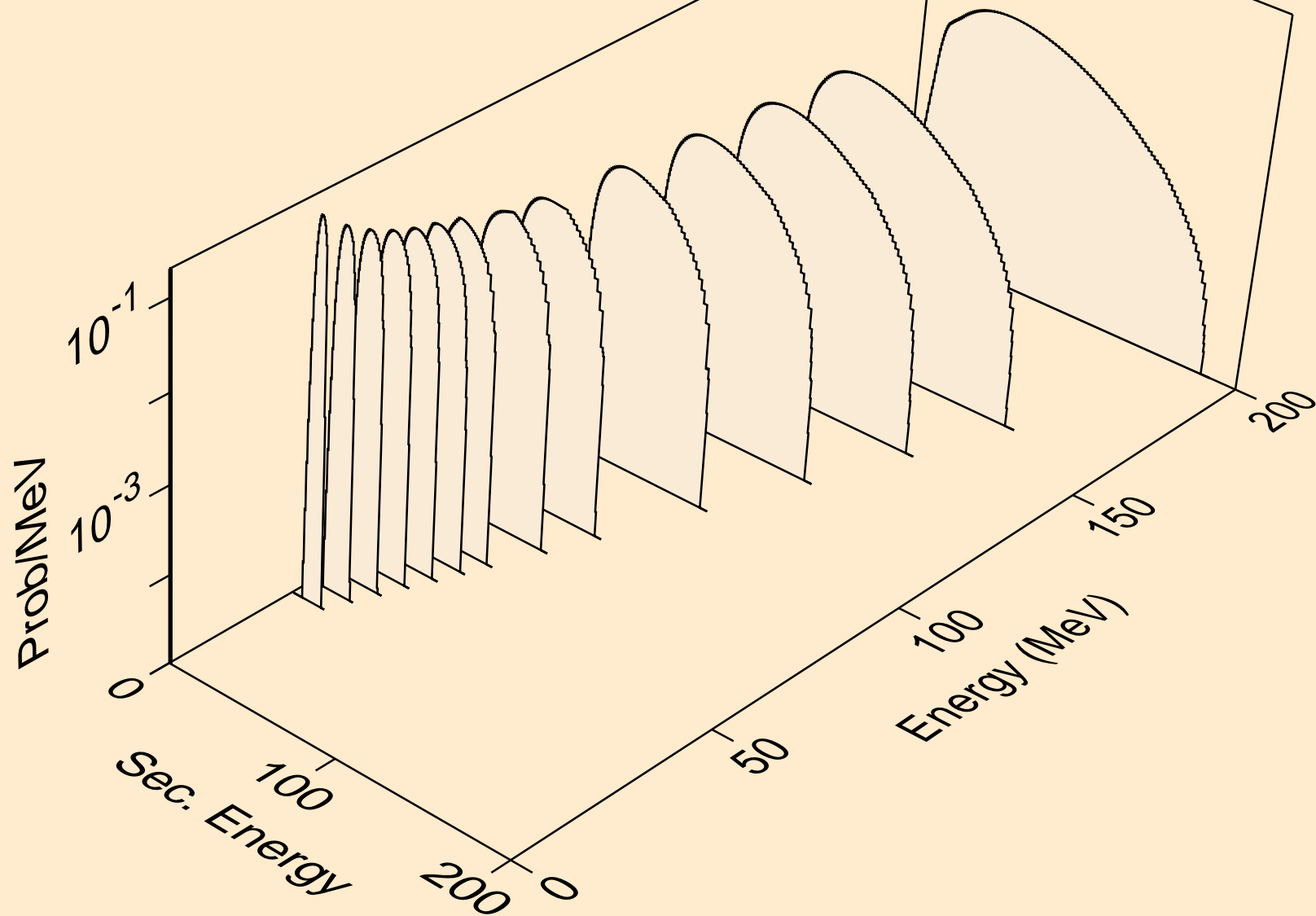

SR096 PROTON ACER TENDL-2021 LIBRARY; T=0.K  
he3s from (p,n\*)he3

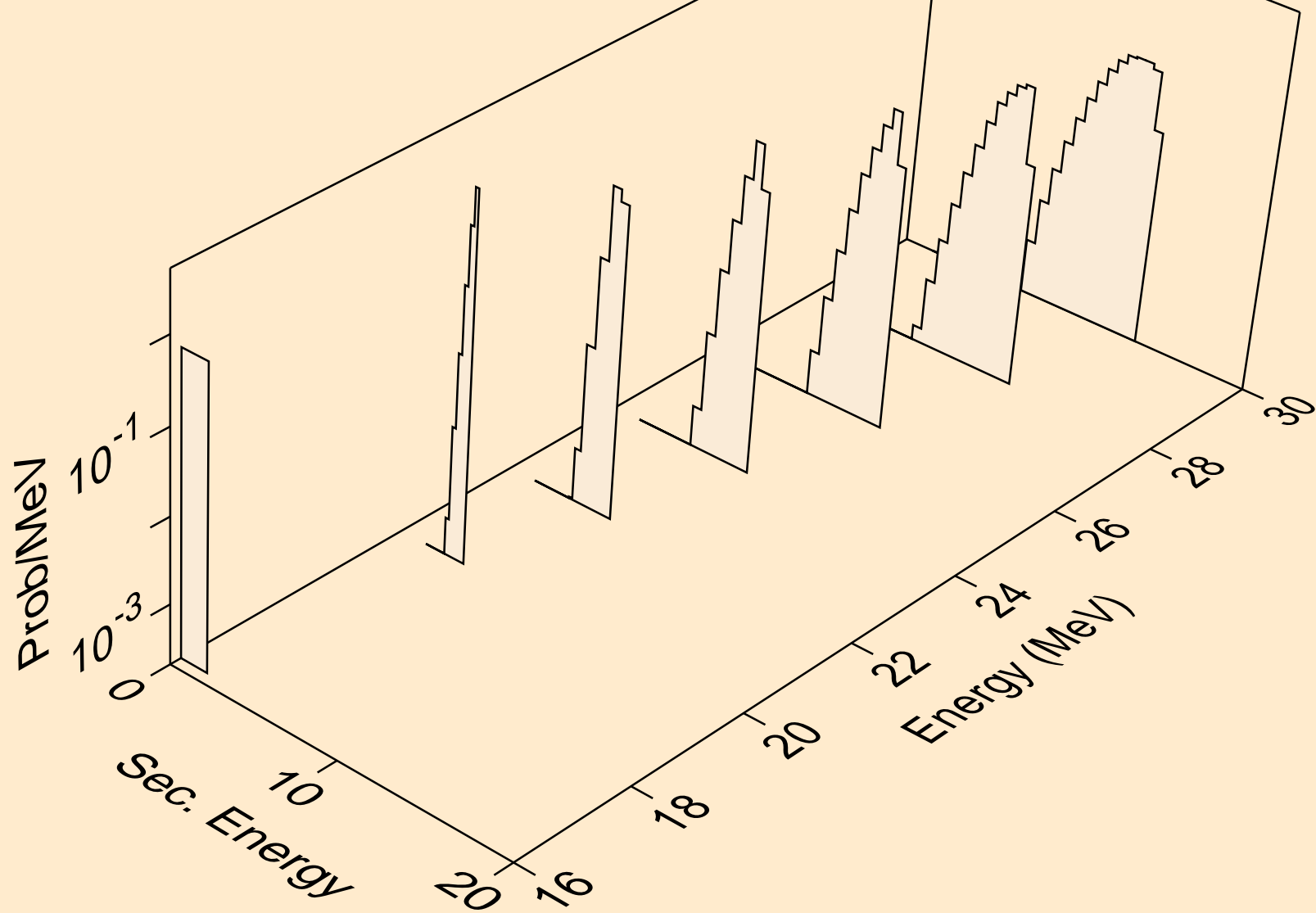

SR096 PROTON ACER TENDL-2021 LIBRARY; T=0.K  
he3s from (p,he3)

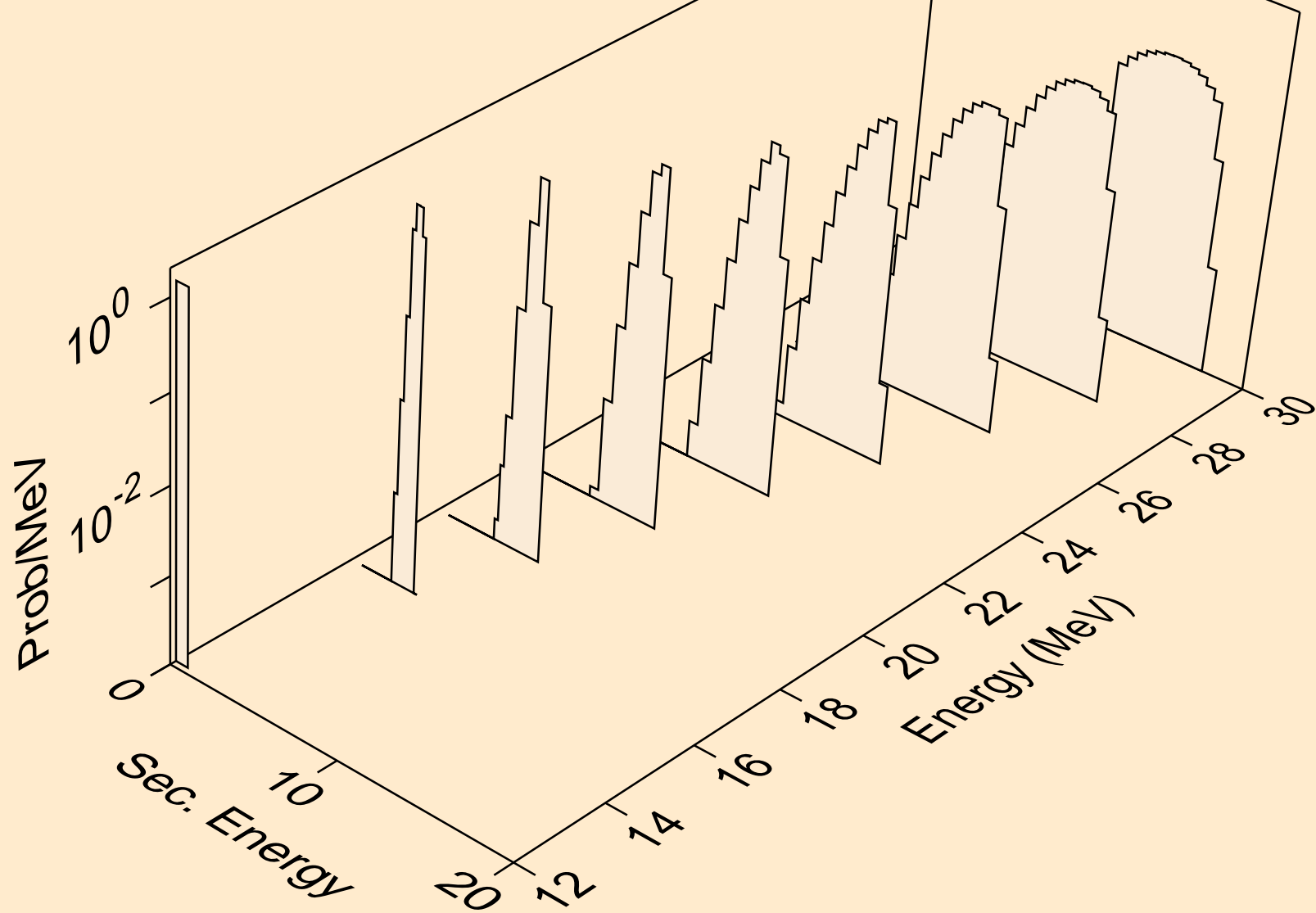

SR096 PROTON ACER TENDL-2021 LIBRARY; T=0.K  
alphas from (p,x)

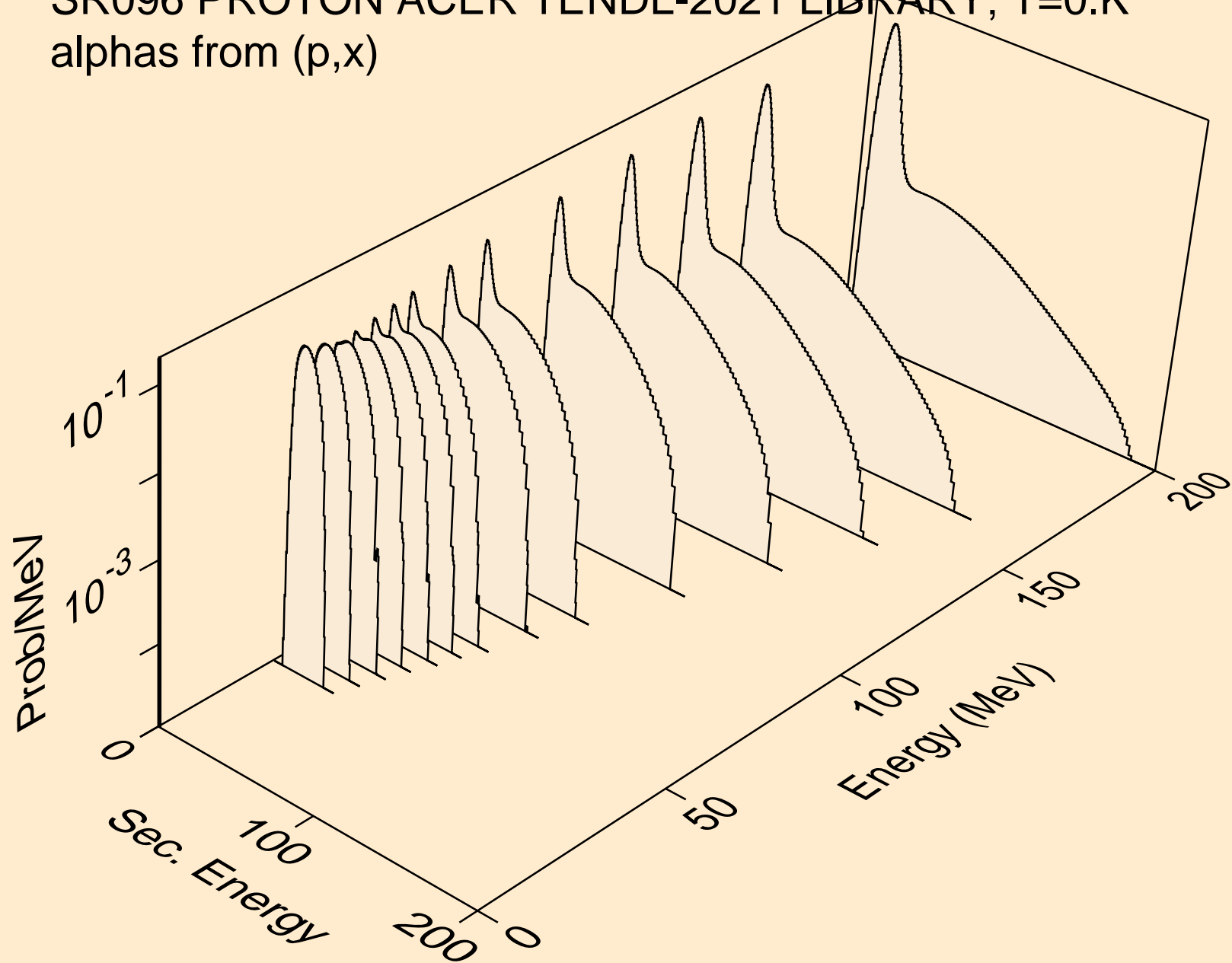

SR096 PROTON ACER TENDL-2021 LIBRARY; T=0.K  
alphas from (p,n\*)a

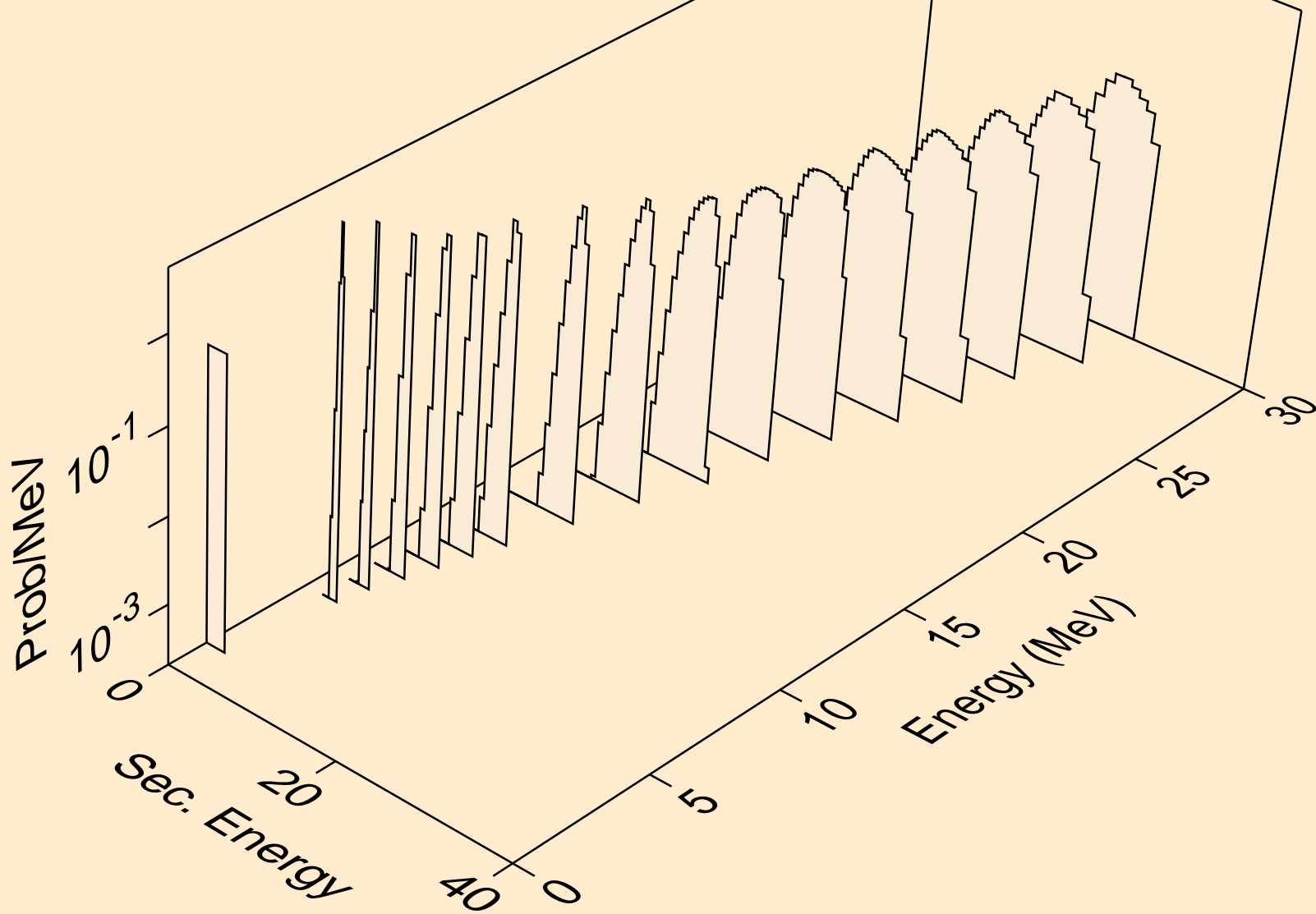

SR096 PROTON ACER TENDL-2021 LIBRARY; T=0.K  
alphas from (p,2n)a

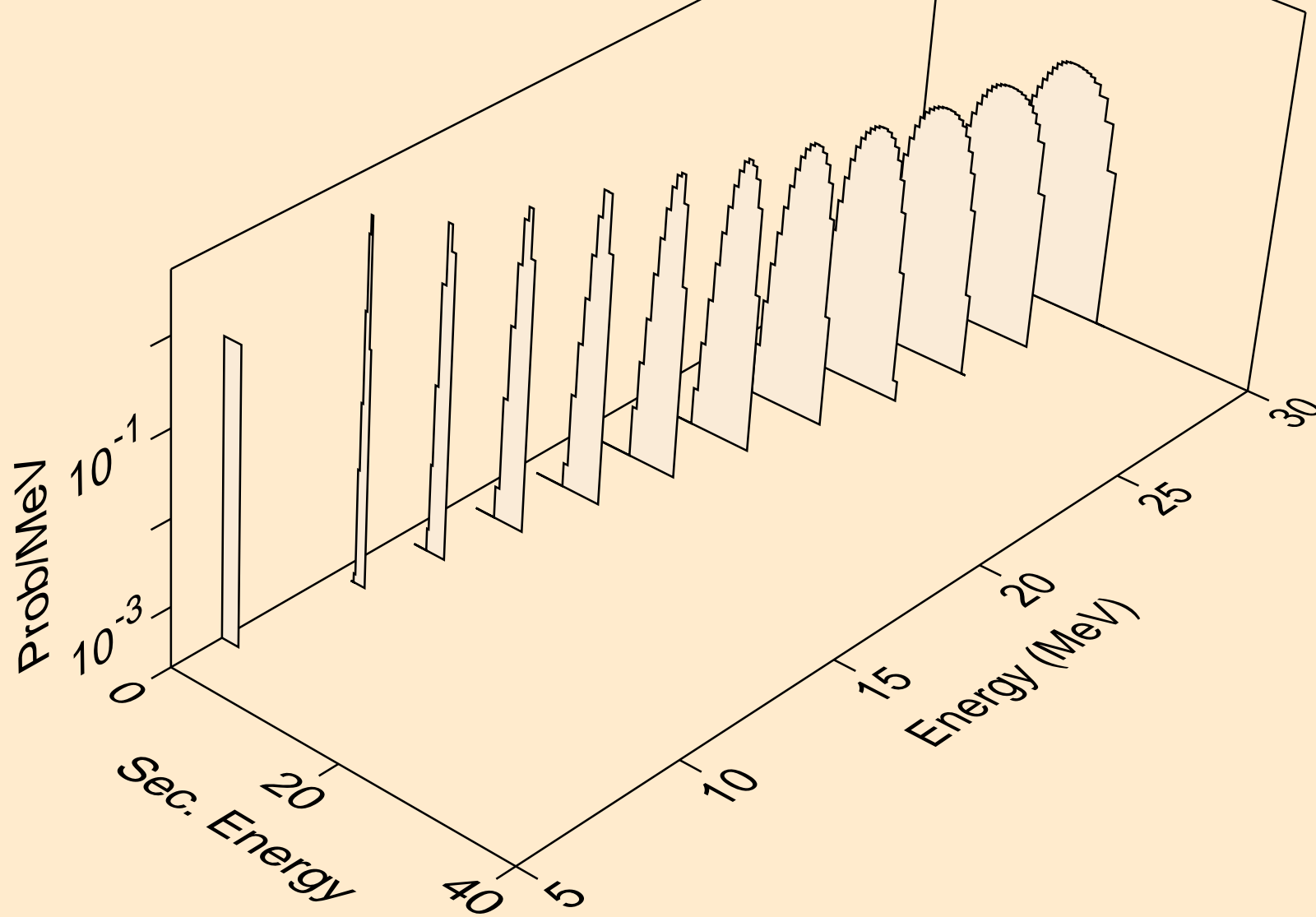

SR096 PROTON ACER TENDL-2021 LIBRARY; T=0.K  
alphas from (p,3n)a

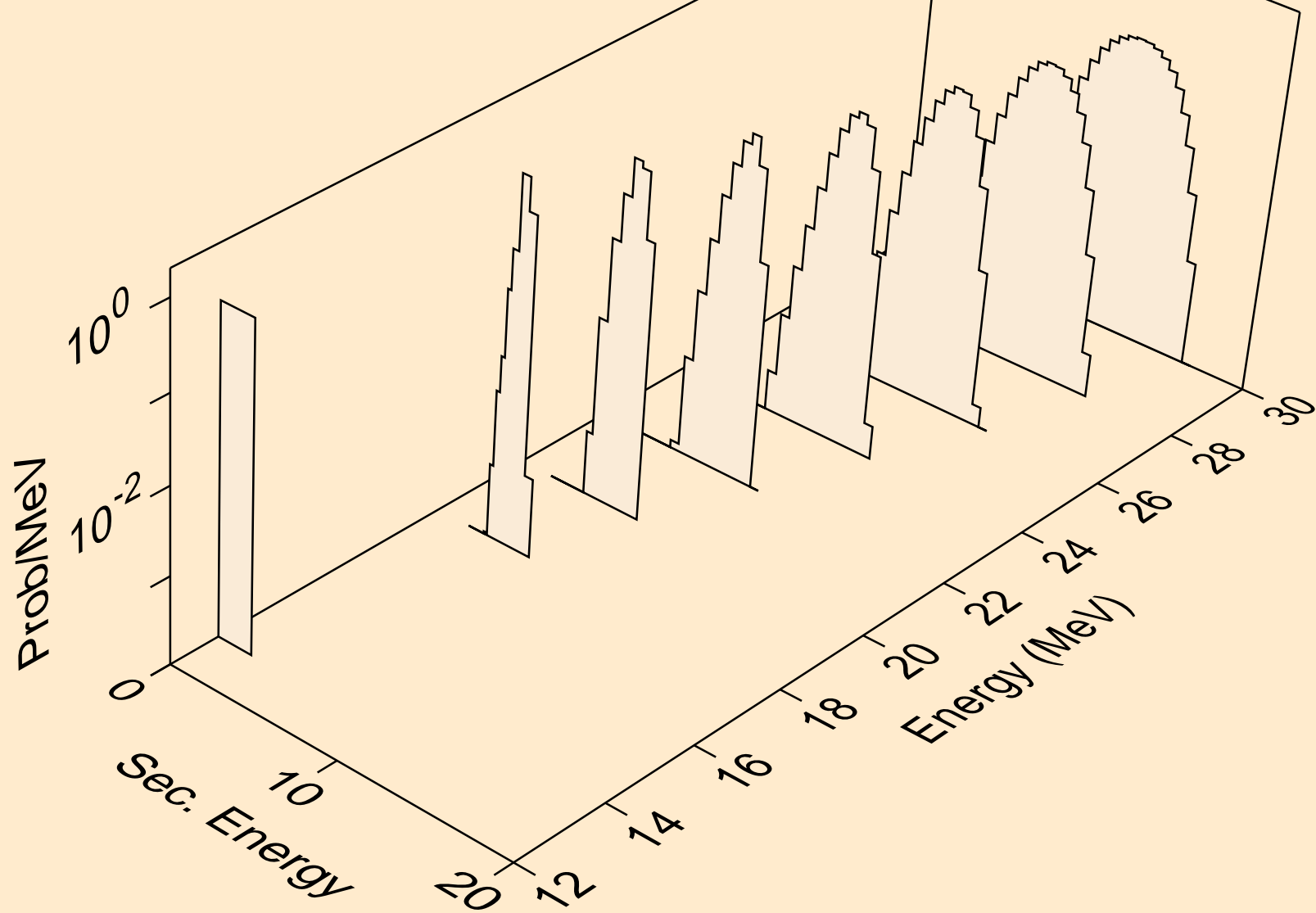



SR096 PROTON ACER TENDL-2021 LIBRARY; T=0.K  
alphas from (p,n\*)2a

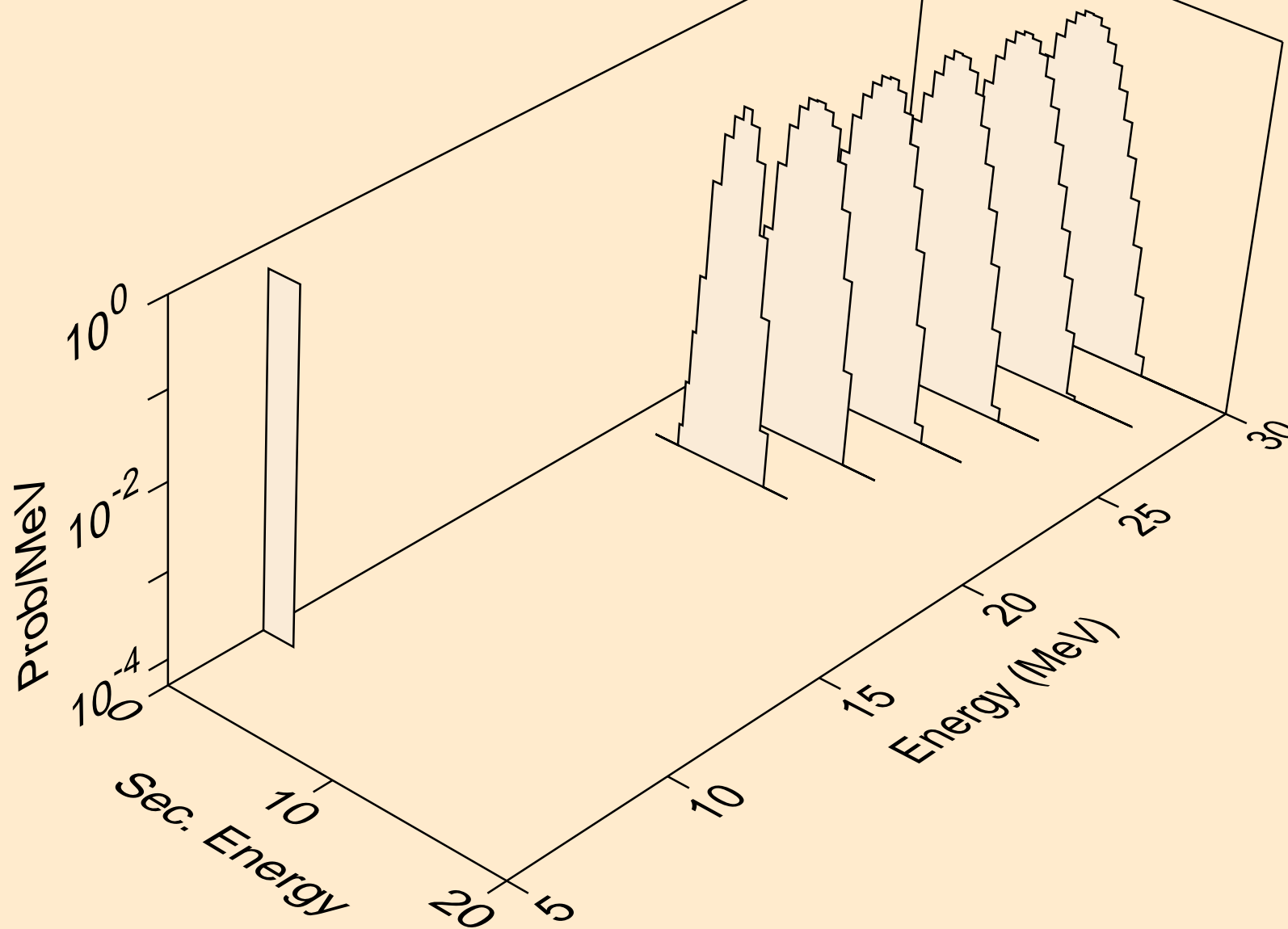

SR096 PROTON ACER TENDL-2021 LIBRARY; T=0.K  
alphas from (p,npa)

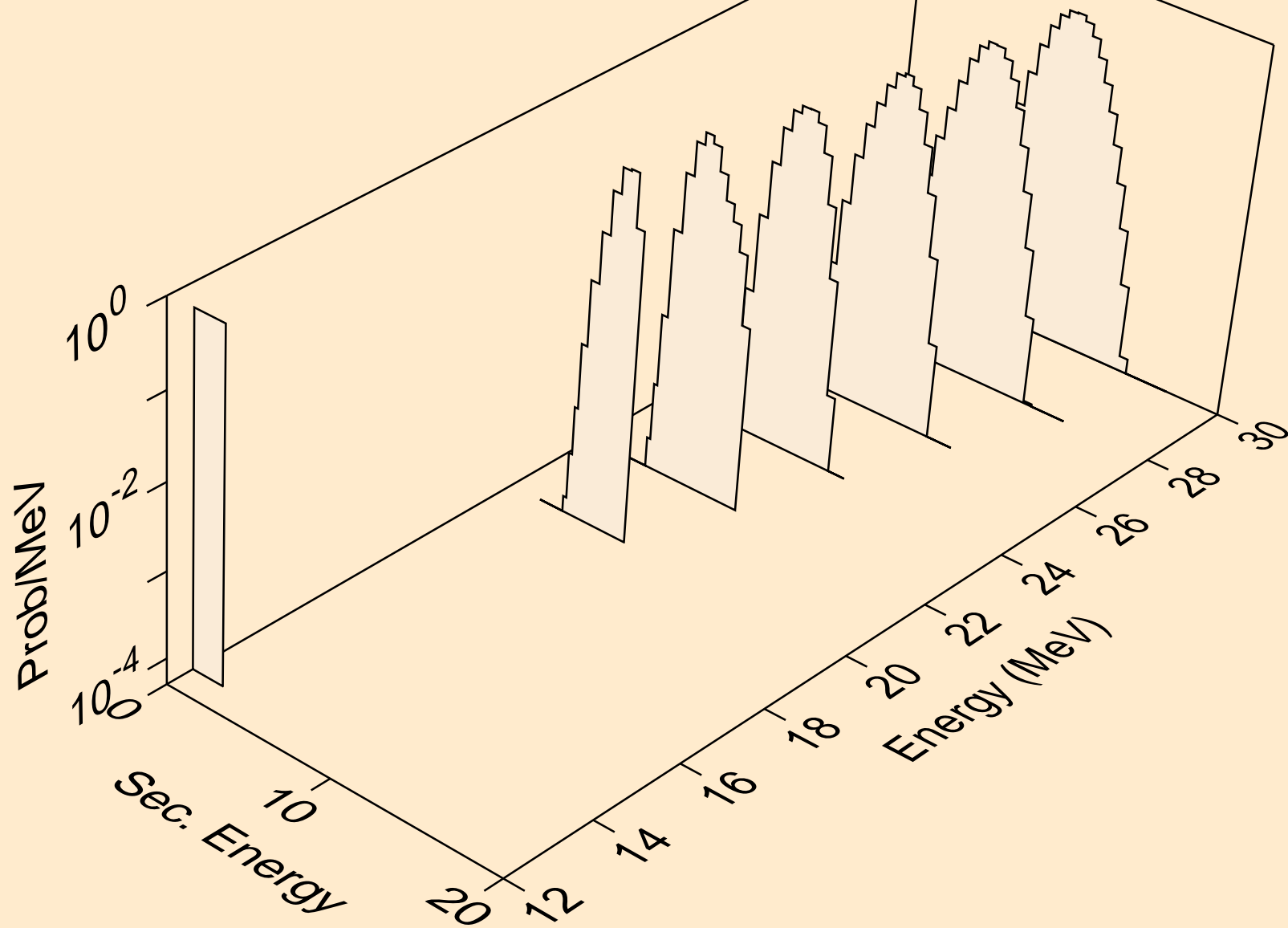

SR096 PROTON ACER TENDL-2021 LIBRARY; T=0.K  
alphas from (p,a)

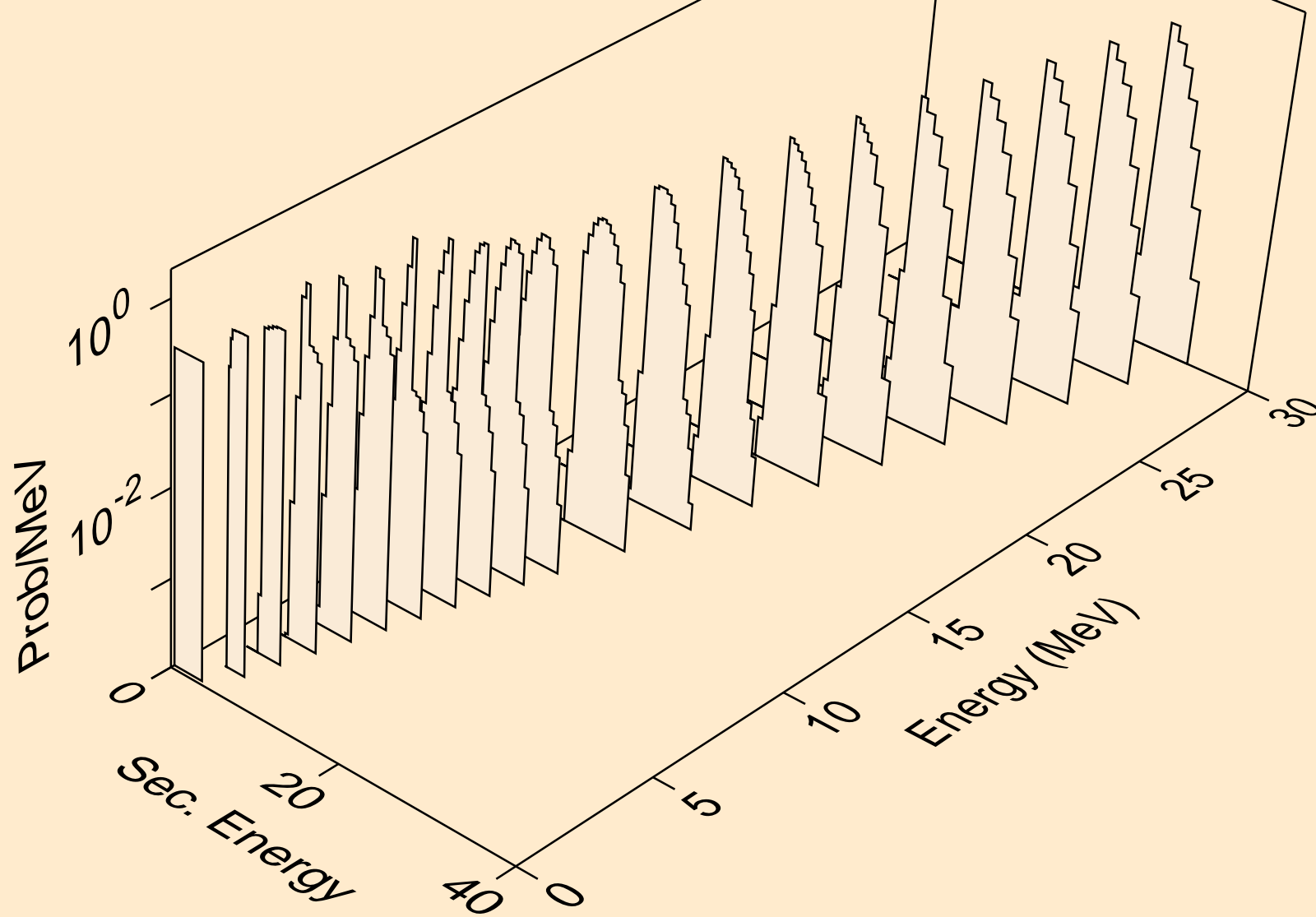

SR096 PROTON ACER TENDL-2021 LIBRARY; T=0.K  
alphas from (p,2a)

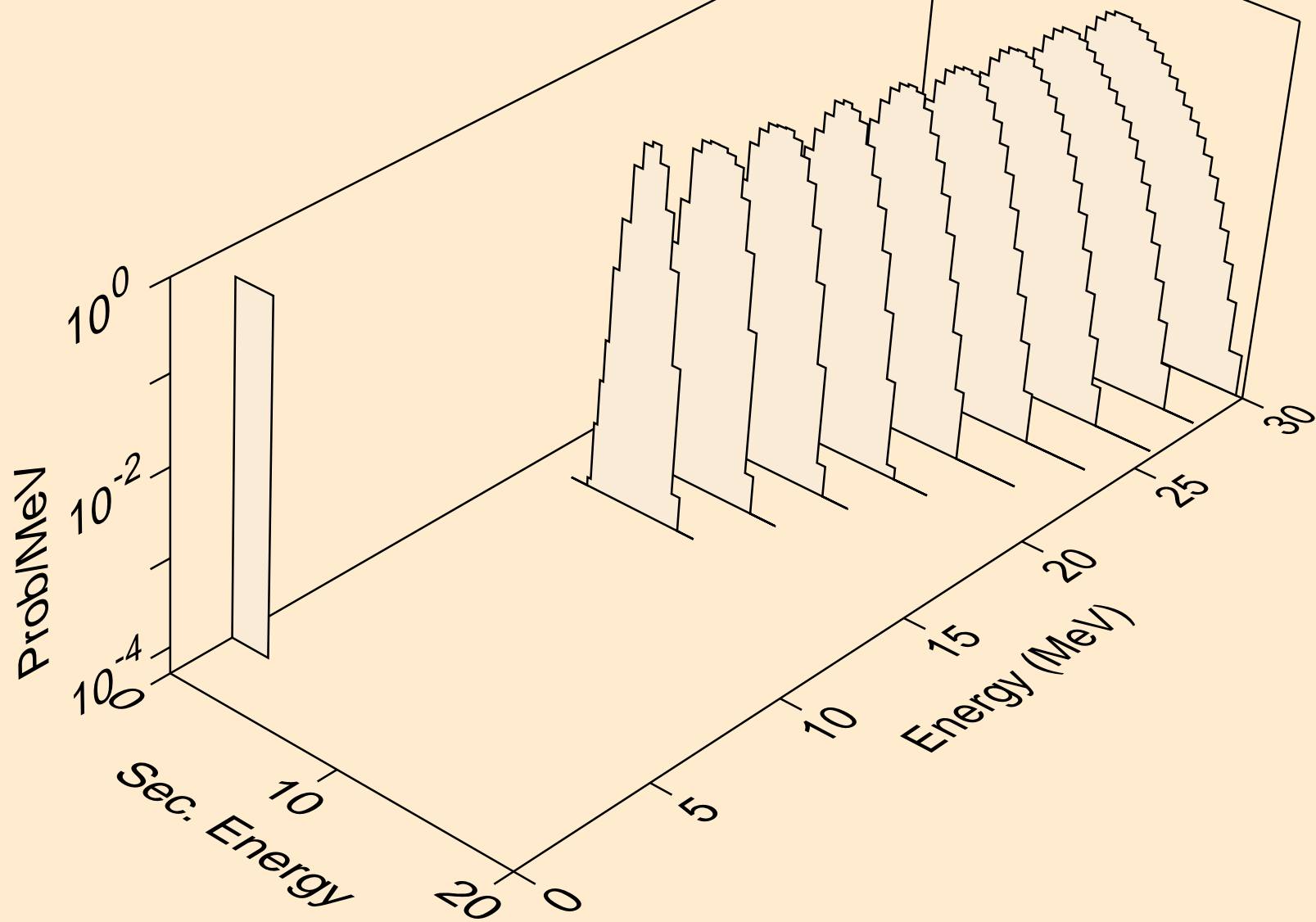

SR096 PROTON ACER TENDL-2021 LIBRARY; T=0.K  
alphas from (p,pa)

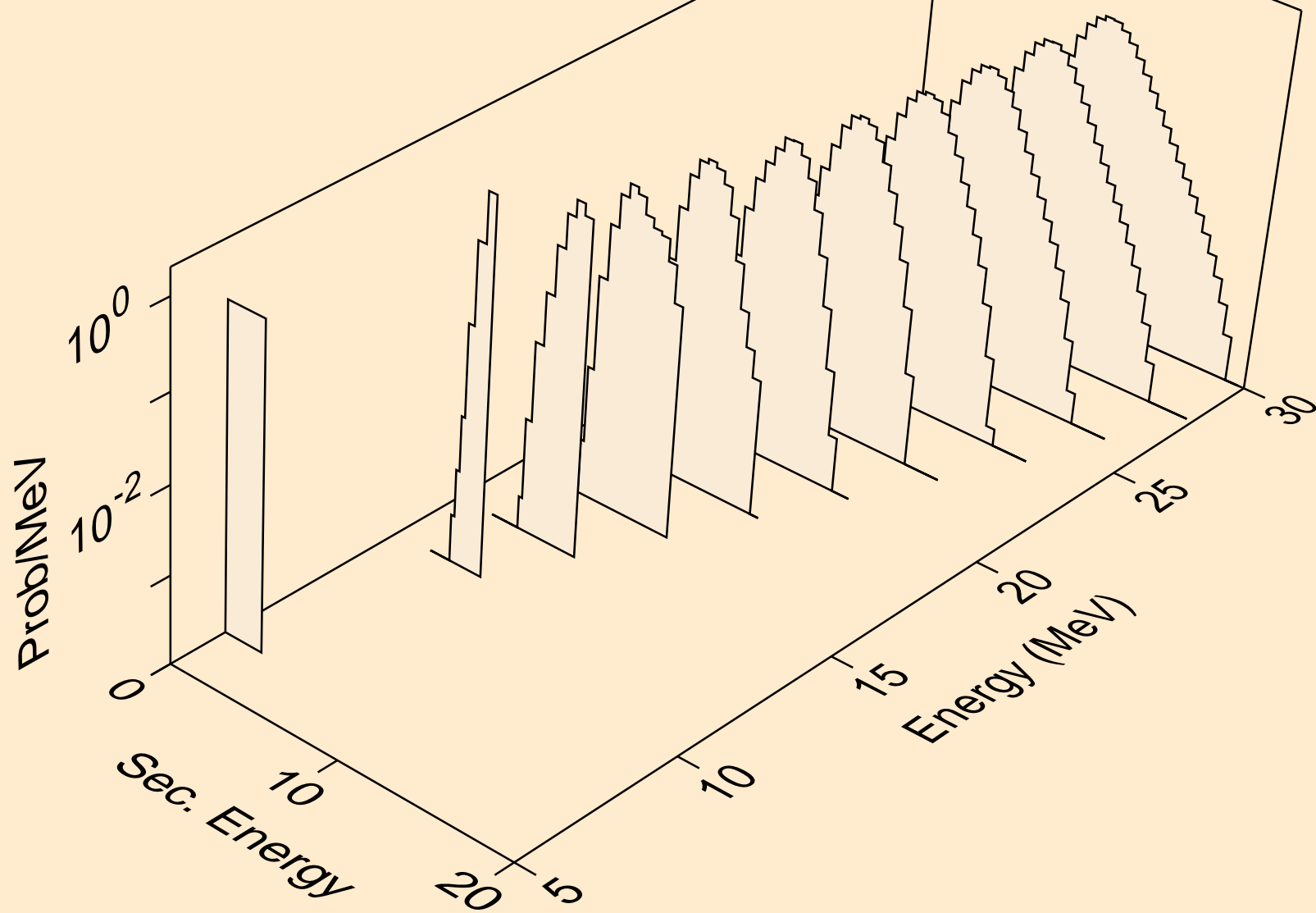

SR096 PROTON ACER TENDL-2021 LIBRARY; T=0.K  
alphas from (p,da)

