

TB167 PROTON ACER TENDL-2021 LIBRARY; T=0.K  
Principal cross sections

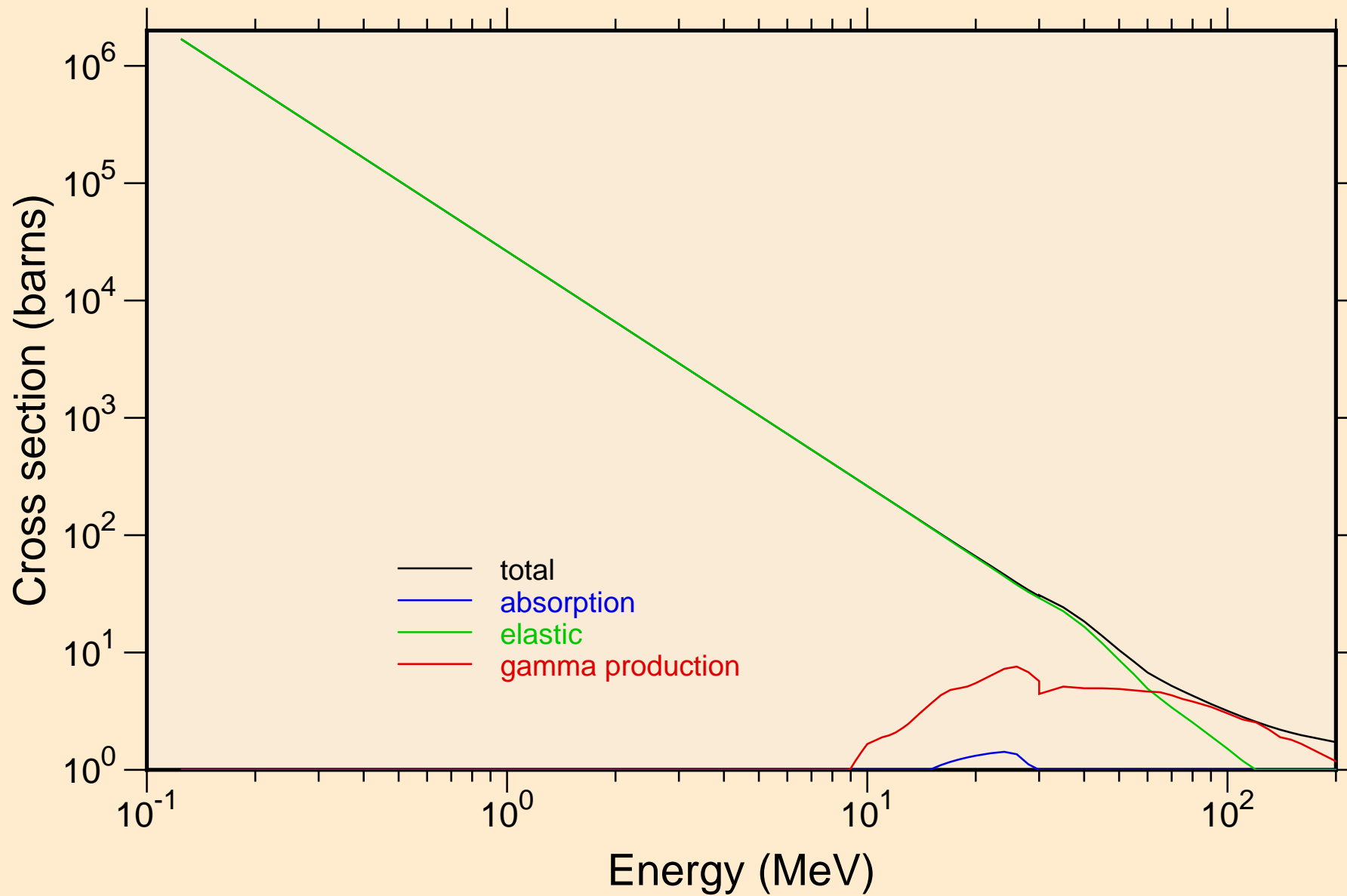

# TB167 PROTON ACER TENDL-2021 LIBRARY; T=0.K

## Heating

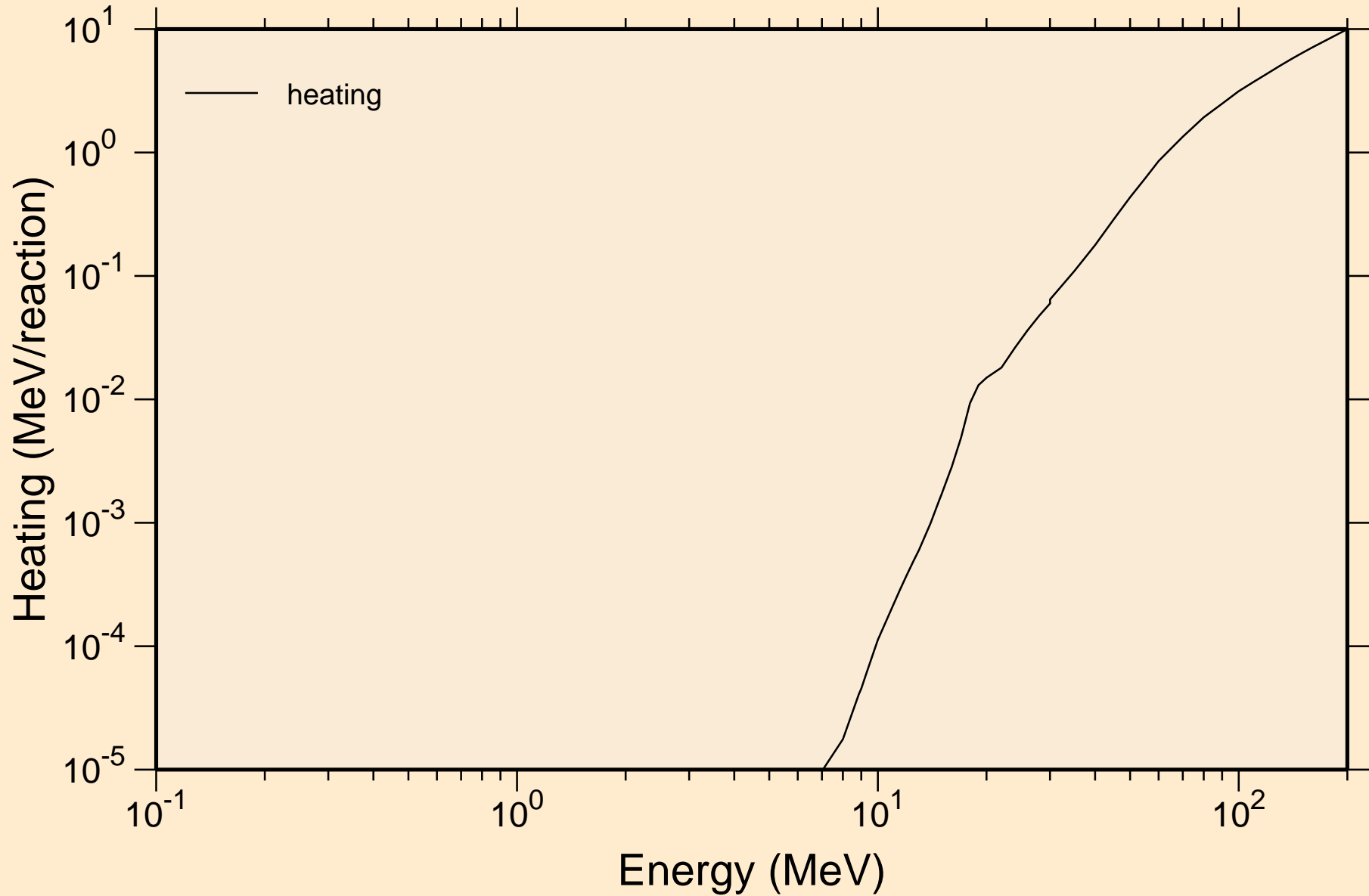

# TB167 PROTON ACER TENDL-2021 LIBRARY; T=0.K

## Principal cross sections

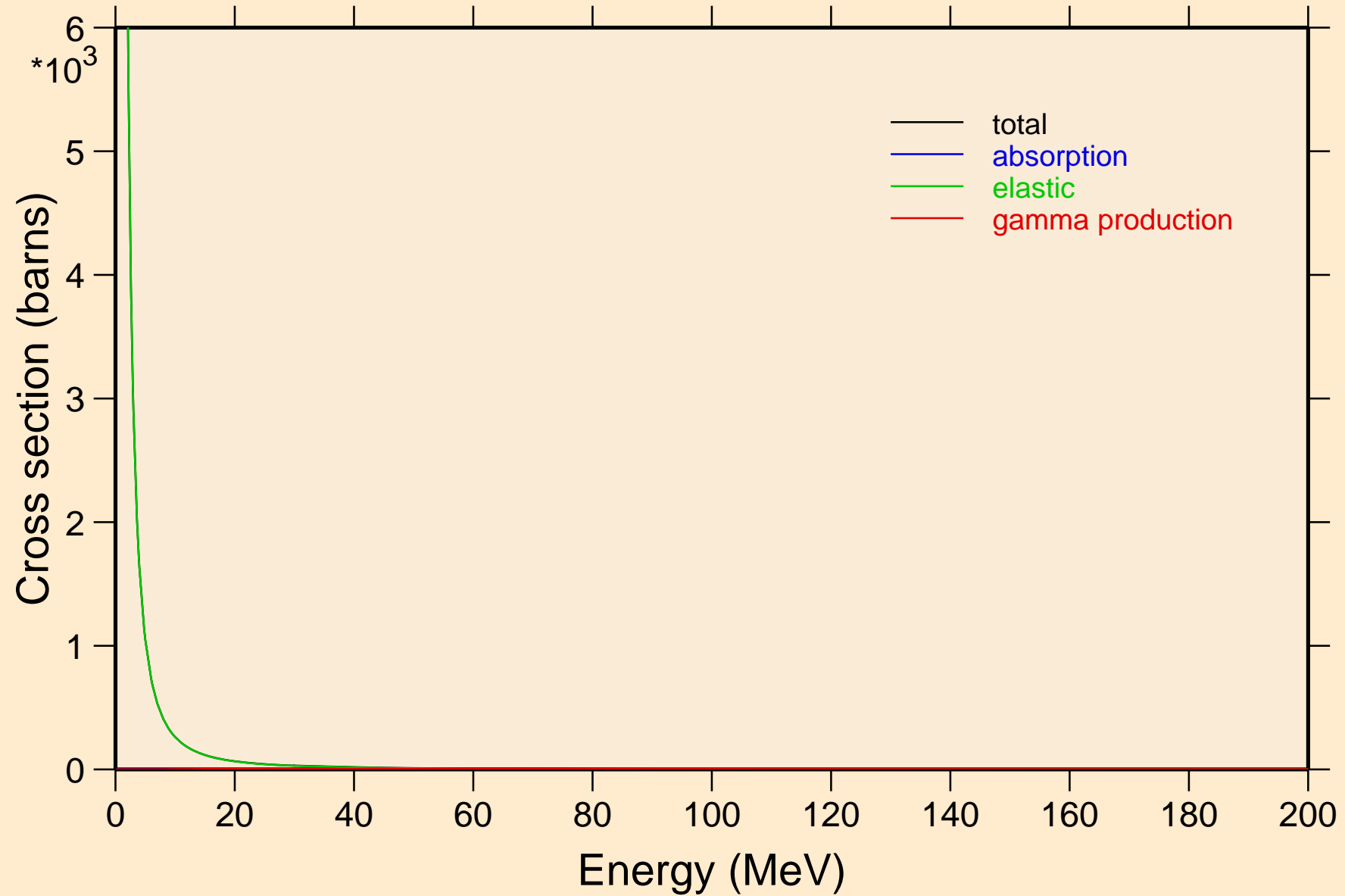

TB167 PROTON ACER TENDL-2021 LIBRARY; T=0.K

Heating

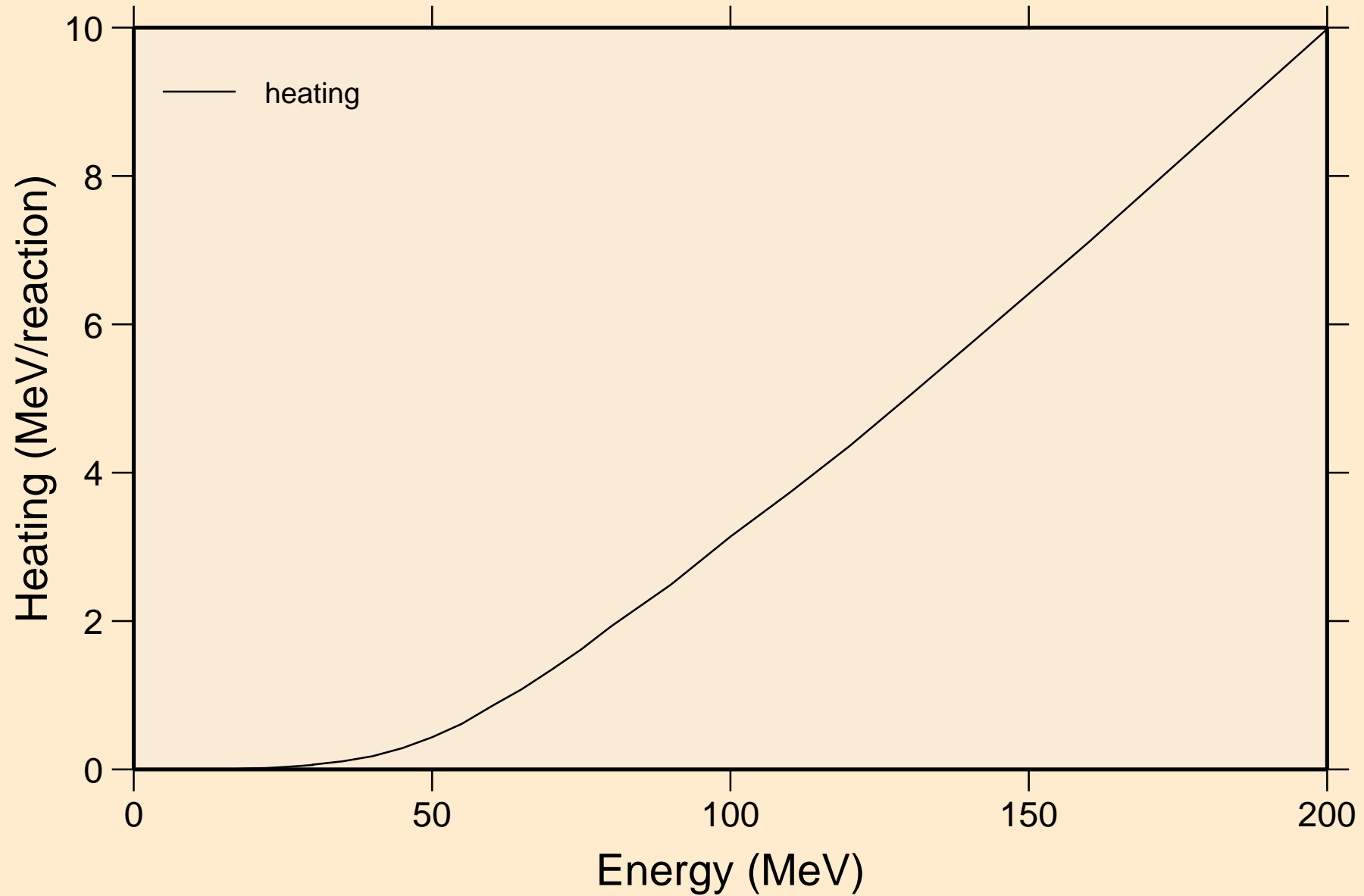

TB167 PROTON ACER TENDL-2021 LIBRARY; T=0.K  
Threshold reactions

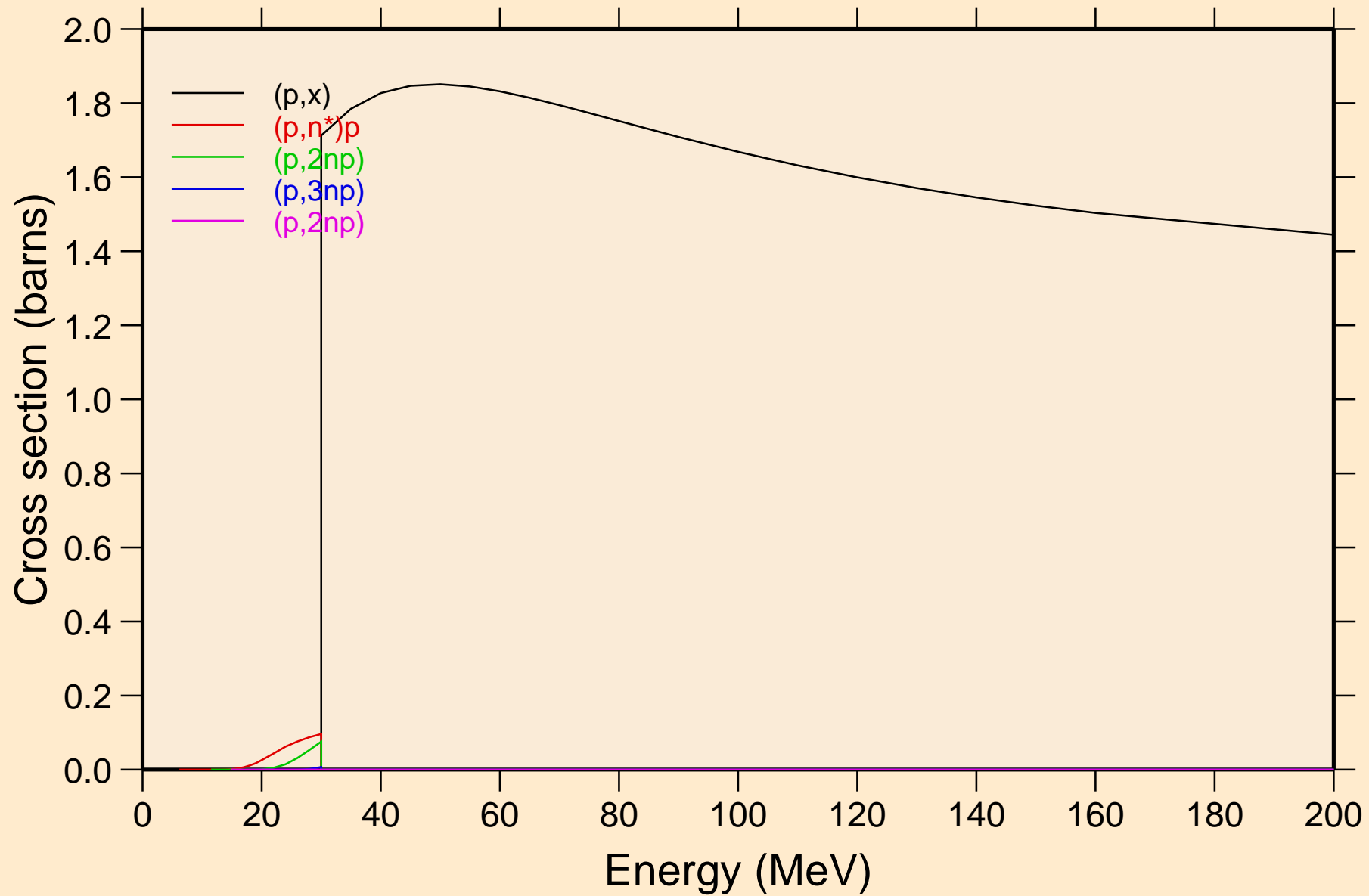

TB167 PROTON ACER TENDL-2021 LIBRARY; T=0.K  
Threshold reactions

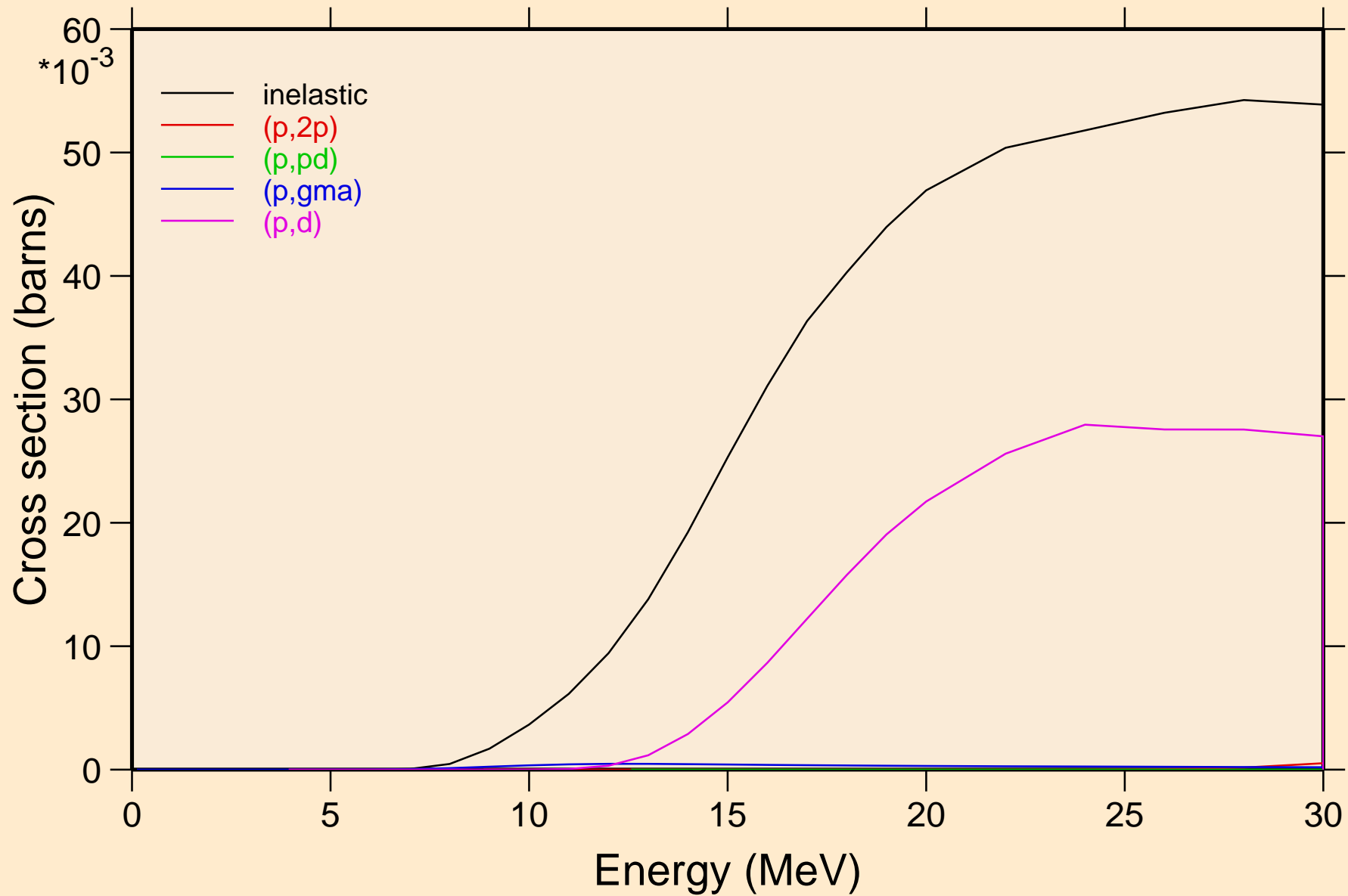

TB167 PROTON ACER TENDL-2021 LIBRARY; T=0.K  
Threshold reactions

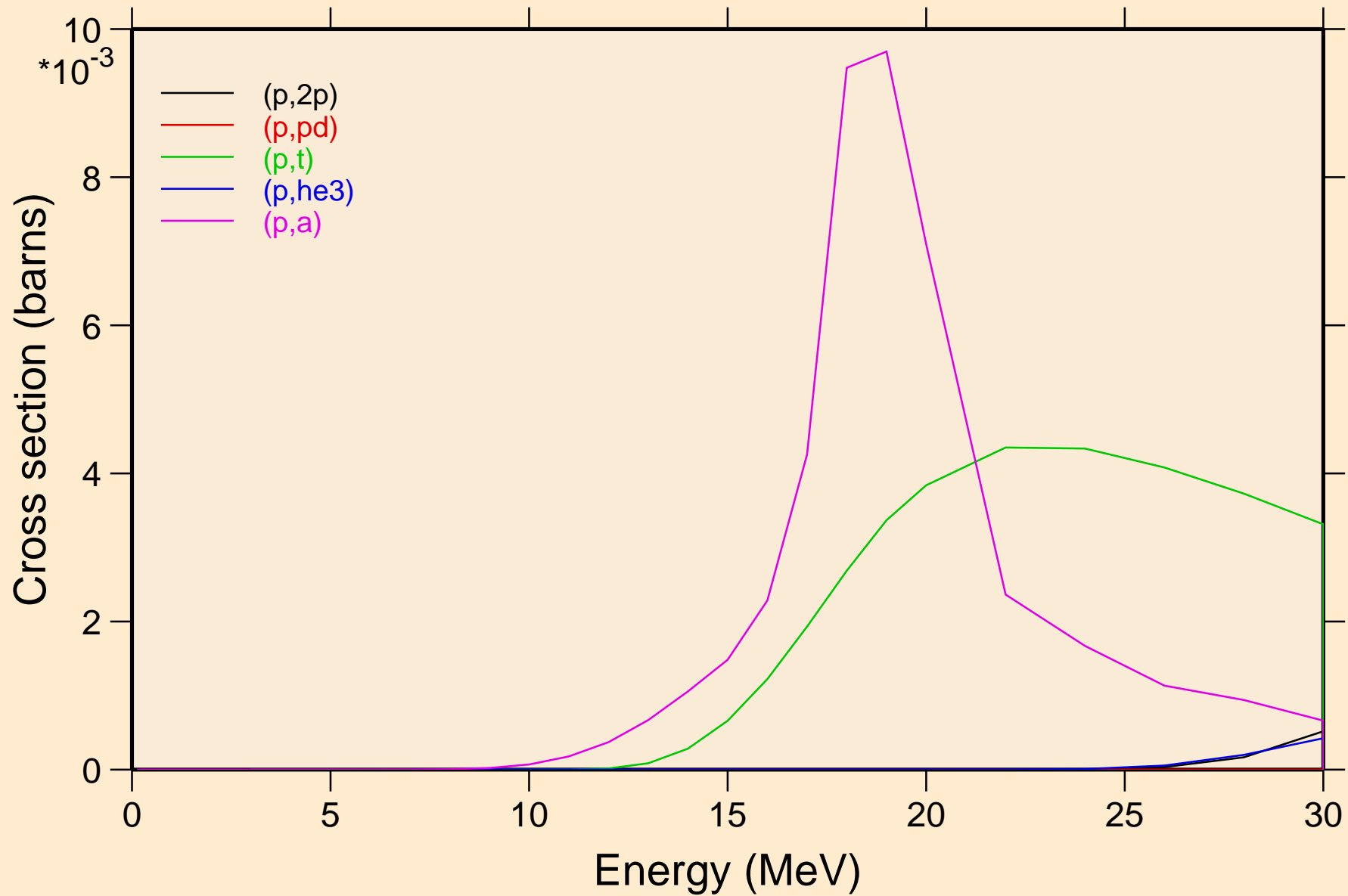

TB167 PROTON ACER TENDL-2021 LIBRARY; T=0.K  
Threshold reactions

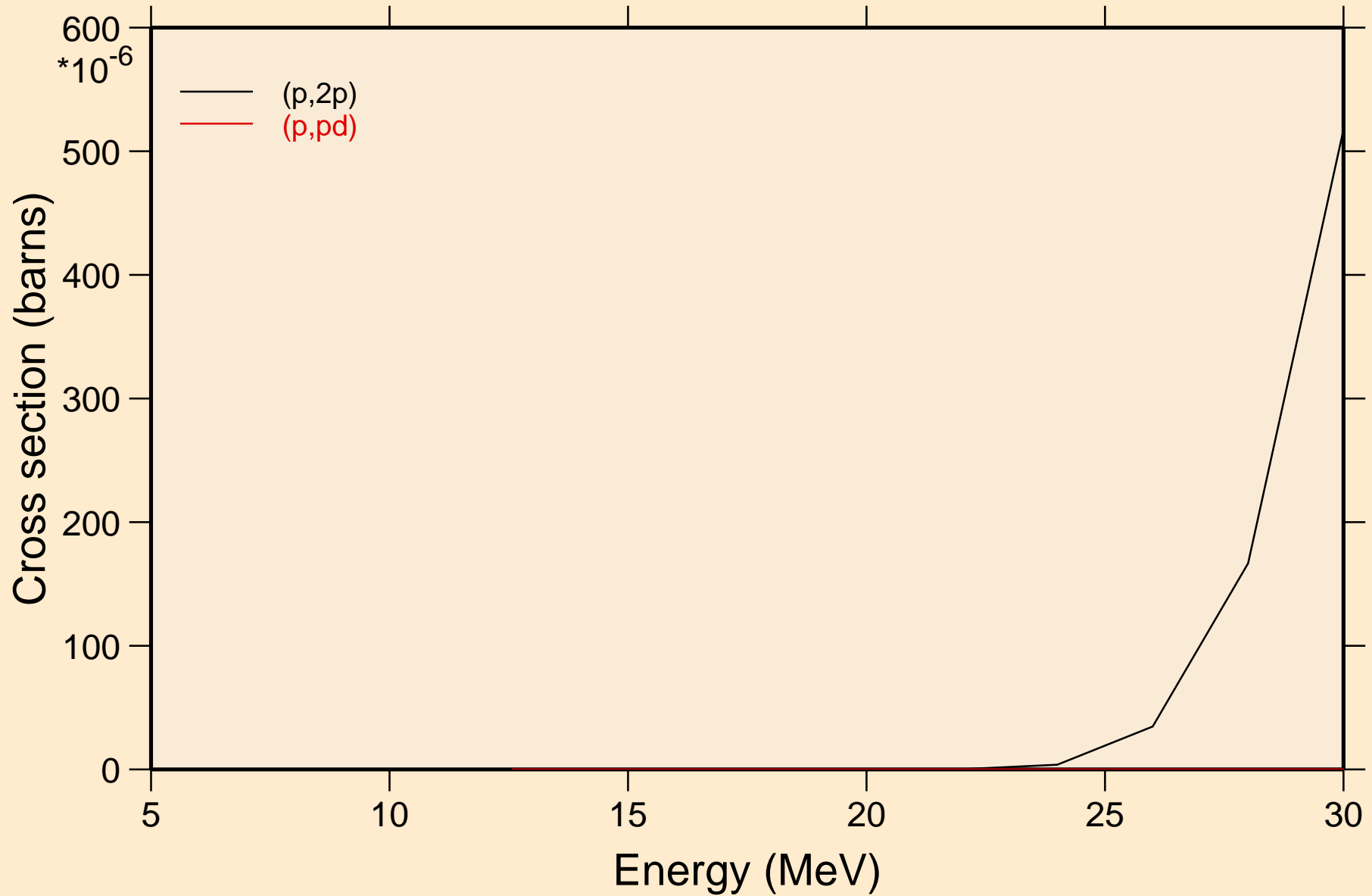



TB167 PROTON ACER TENDL-2021 LIBRARY; T=0.K  
angular distribution for elastic

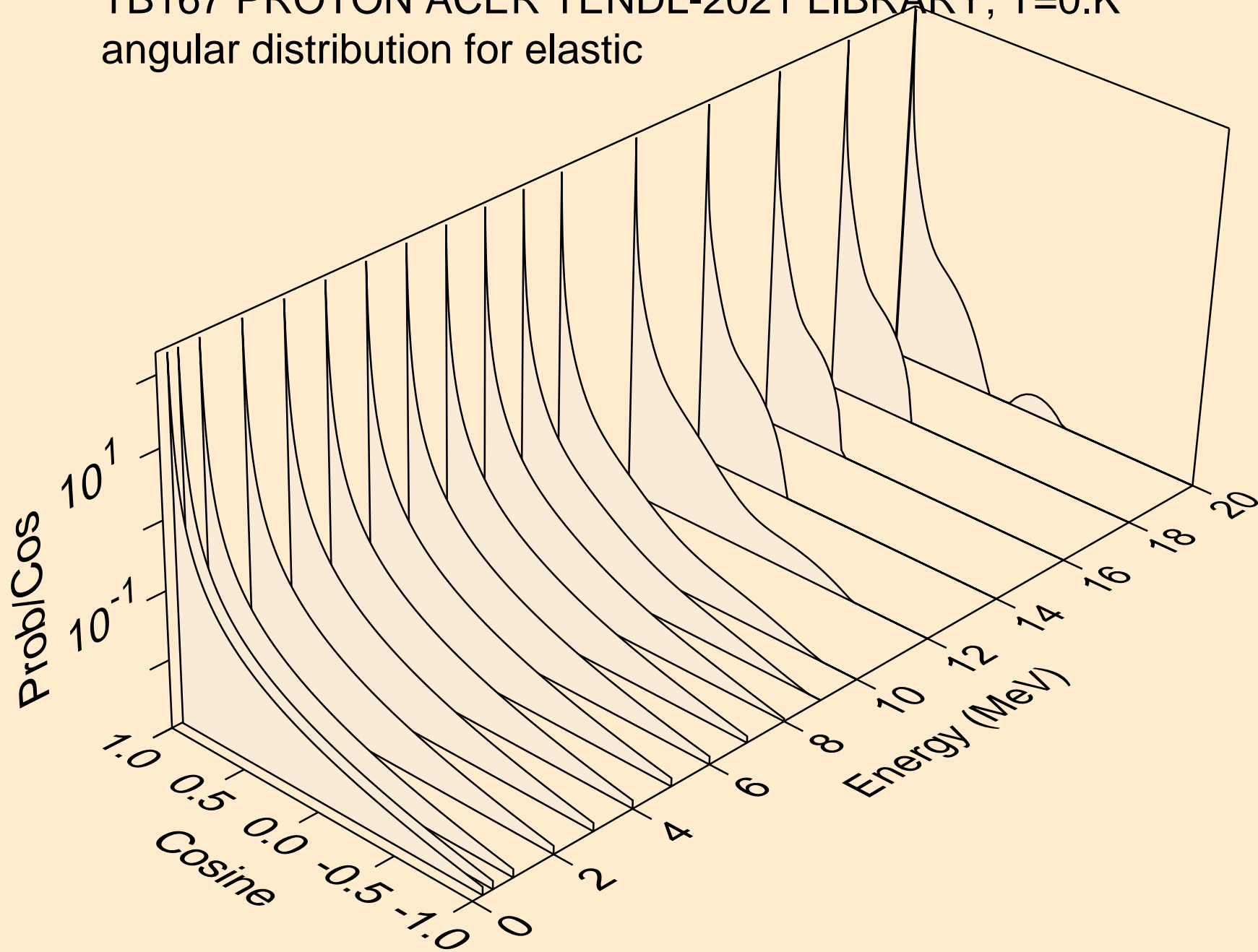

TB167 PROTON ACER TENDL-2021 LIBRARY; T=0.K  
angular distribution for elastic

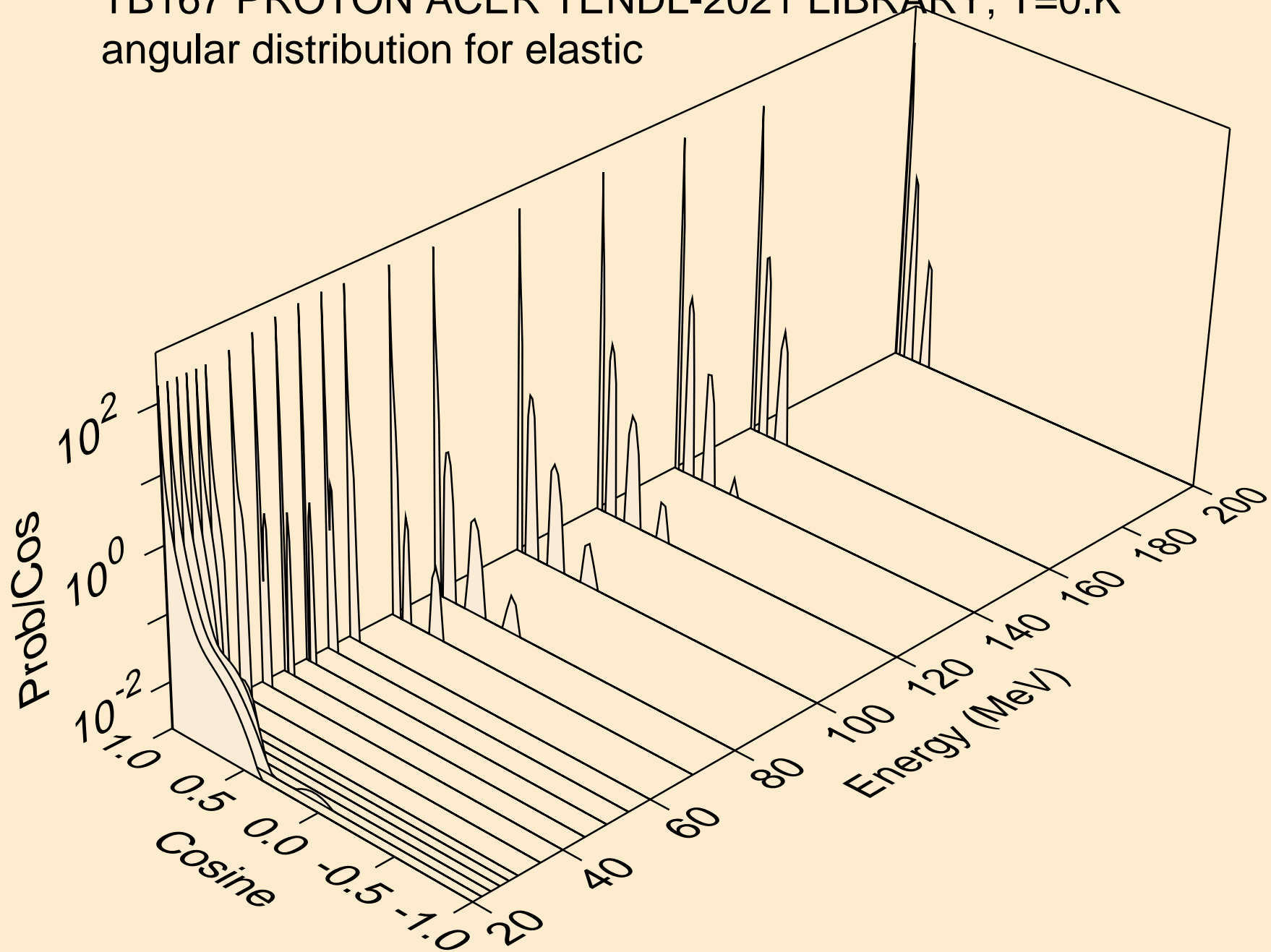

TB167 PROTON ACER TENDL-2021 LIBRARY; T=0.K  
Proton emission for (p,x)

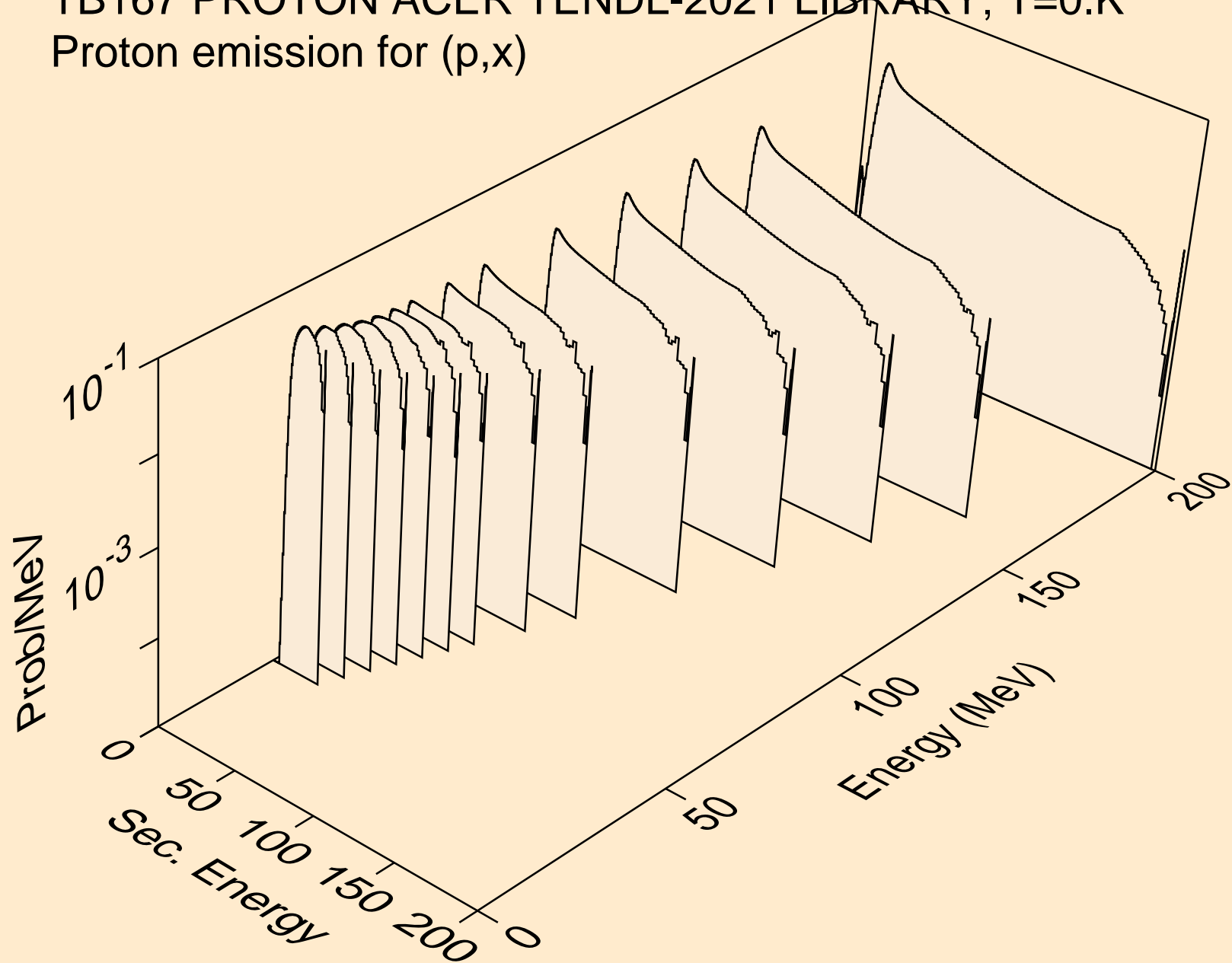

TB167 PROTON ACER TENDL-2021 LIBRARY; T=0.K  
Proton emission for (p,n\*)p

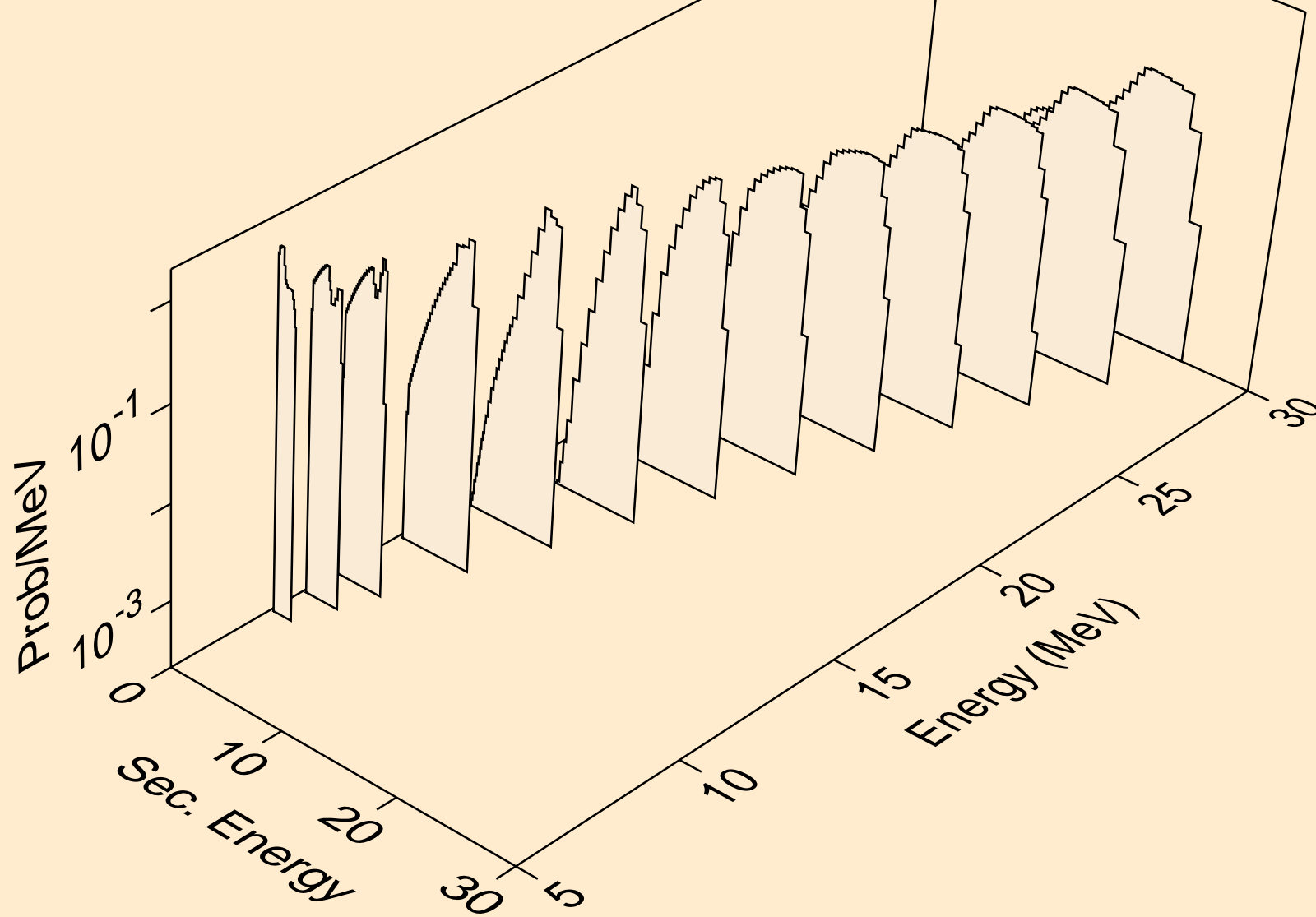

TB167 PROTON ACER TENDL-2021 LIBRARY; T=0.K  
Proton emission for (p,2np)

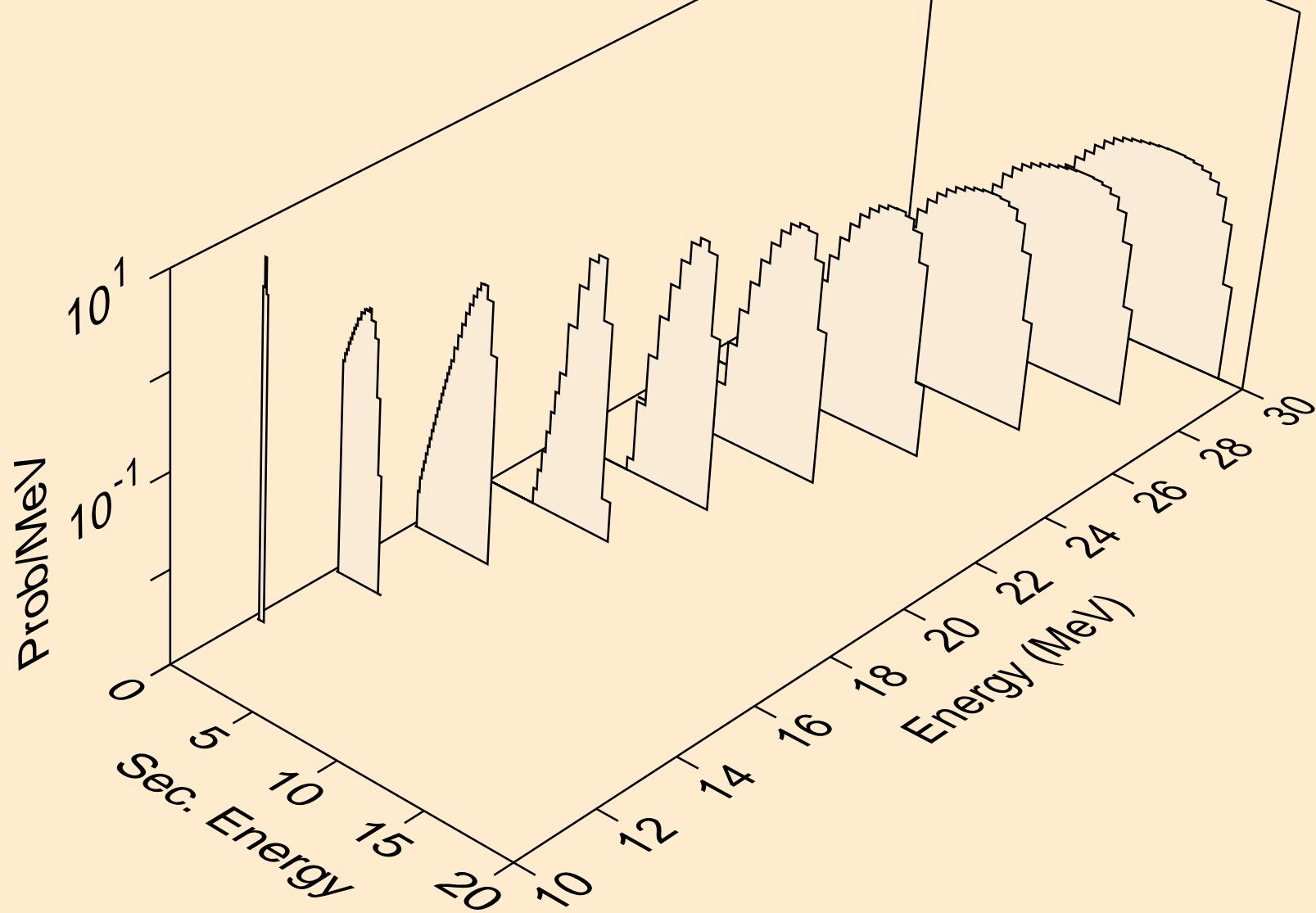

TB167 PROTON ACER TENDL-2021 LIBRARY; T=0.K  
Proton emission for (p,3np)

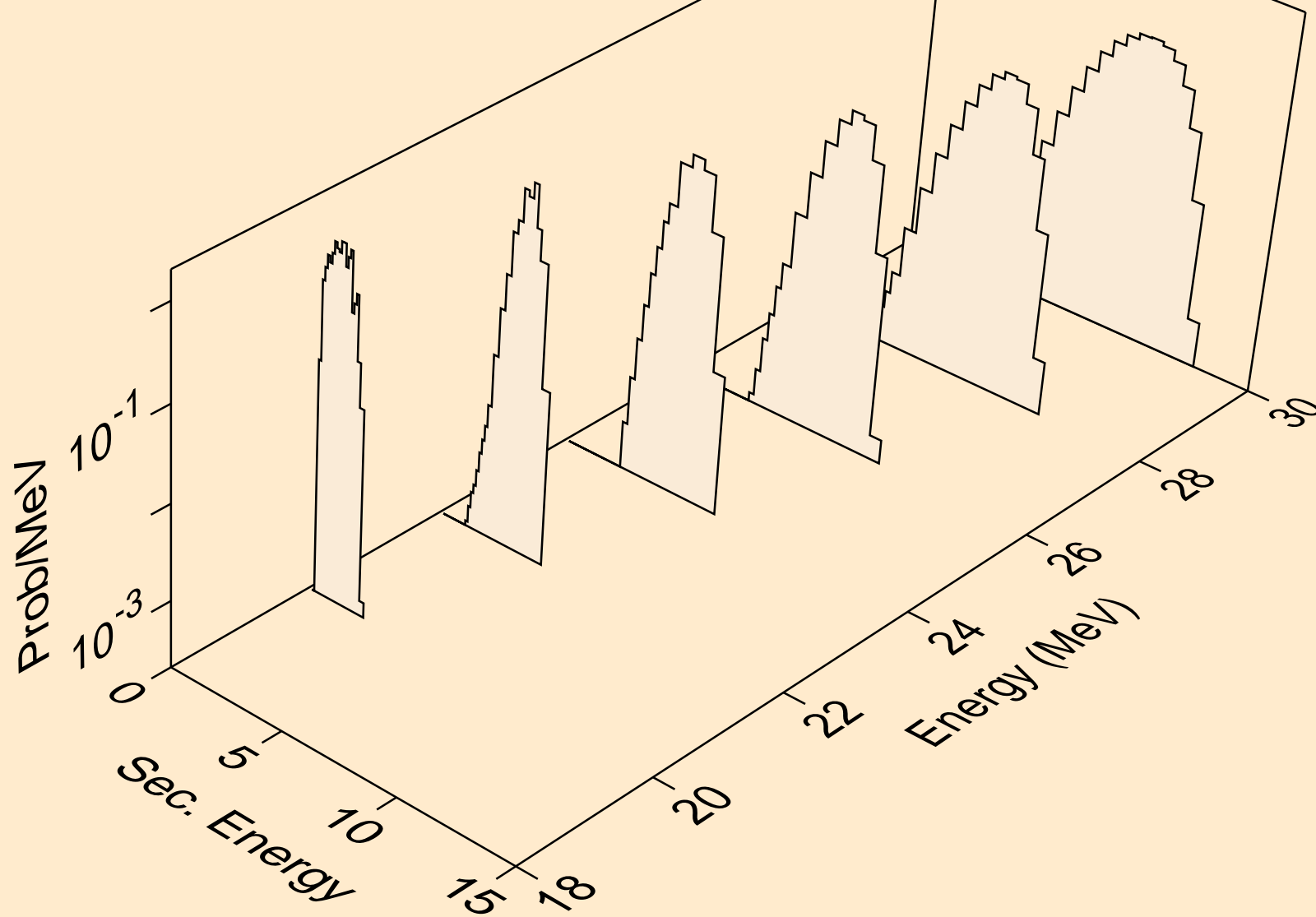

TB167 PROTON ACER TENDL-2021 LIBRARY; T=0.K  
Proton emission for (p,2np)

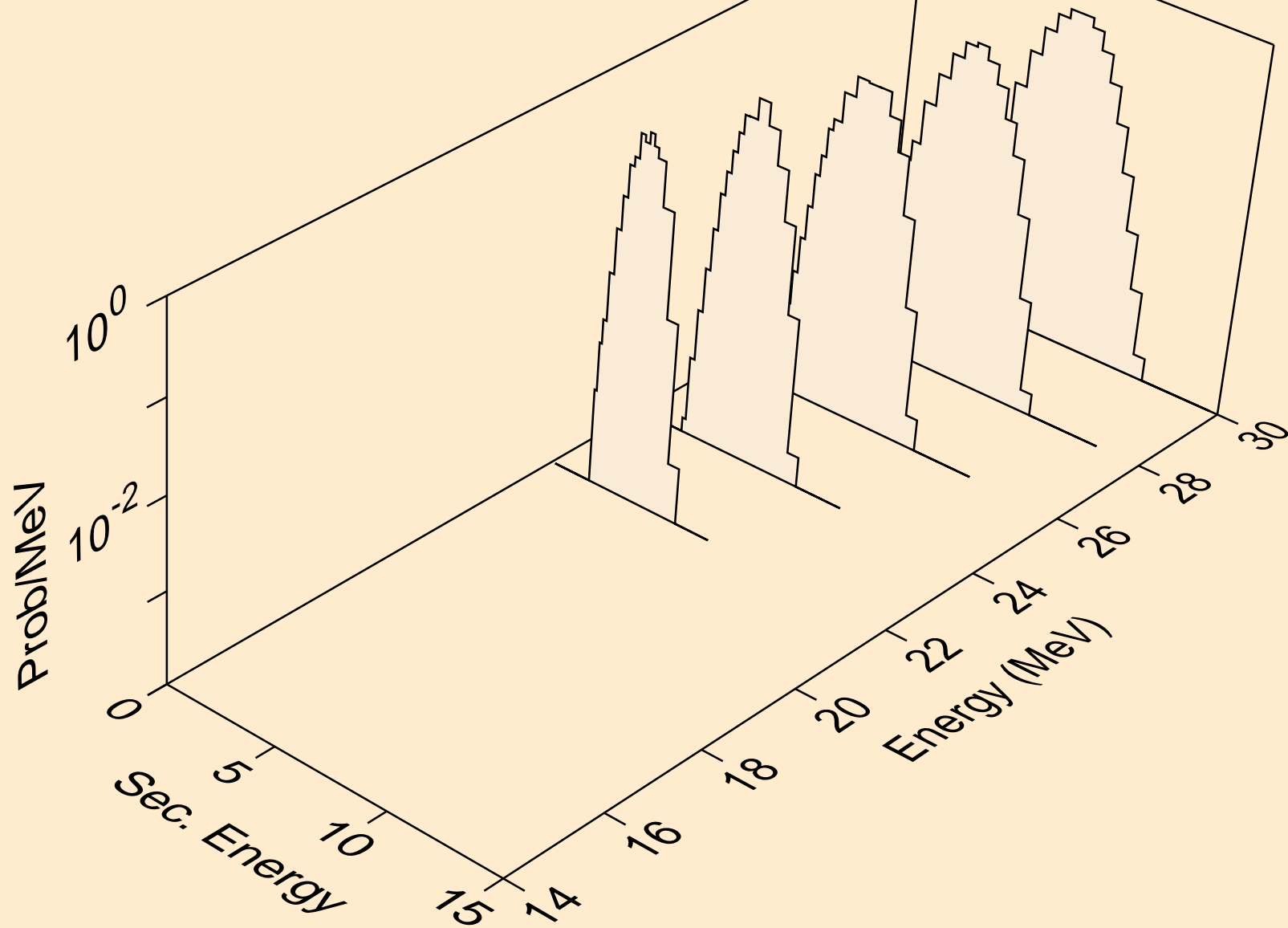

TB167 PROTON ACER TENDL-2021 LIBRARY; T=0.K  
Proton emission for inelastic

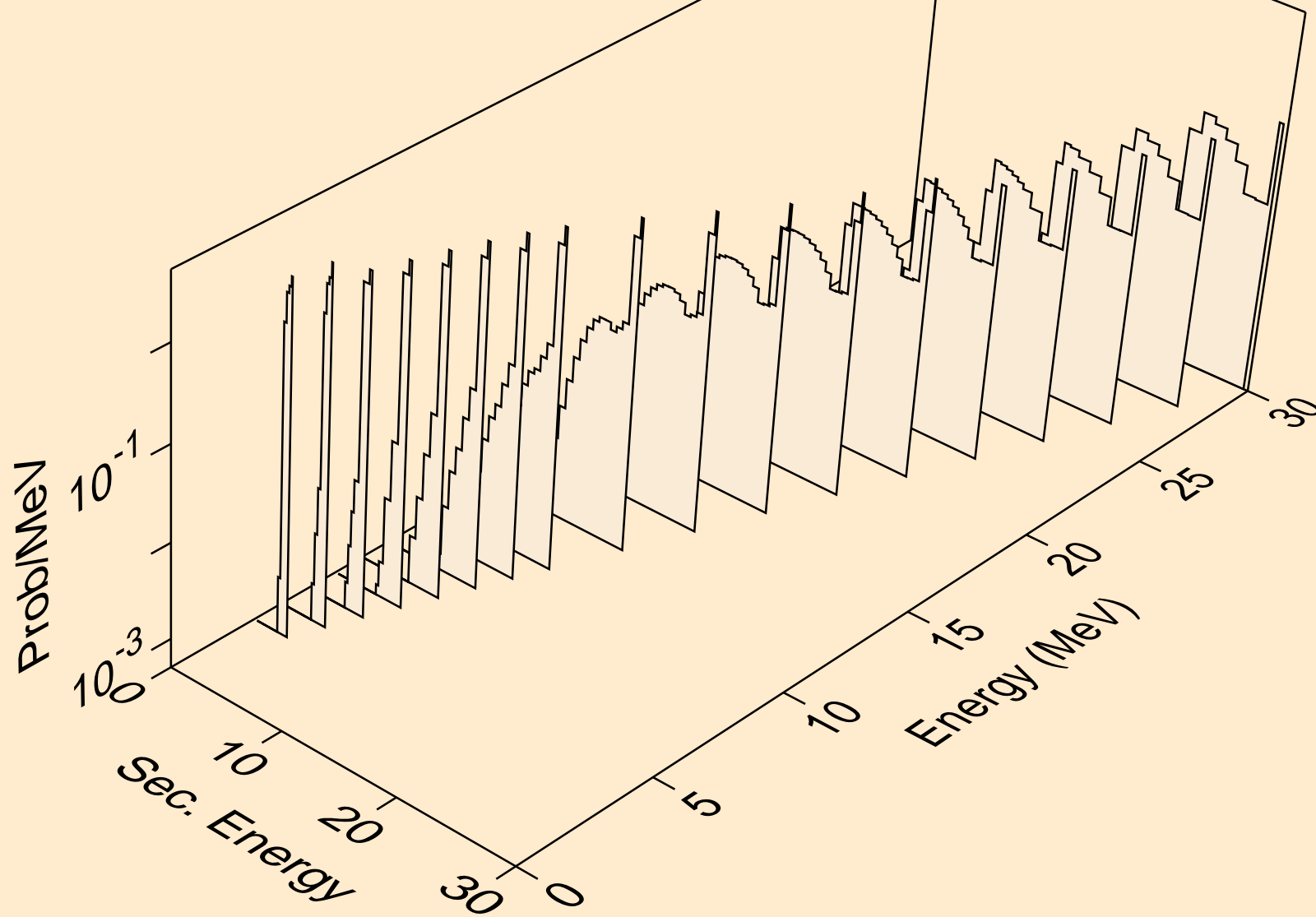



TB167 PROTON ACER TENDL-2021 LIBRARY; T=0.K  
Proton emission for (p,2p)

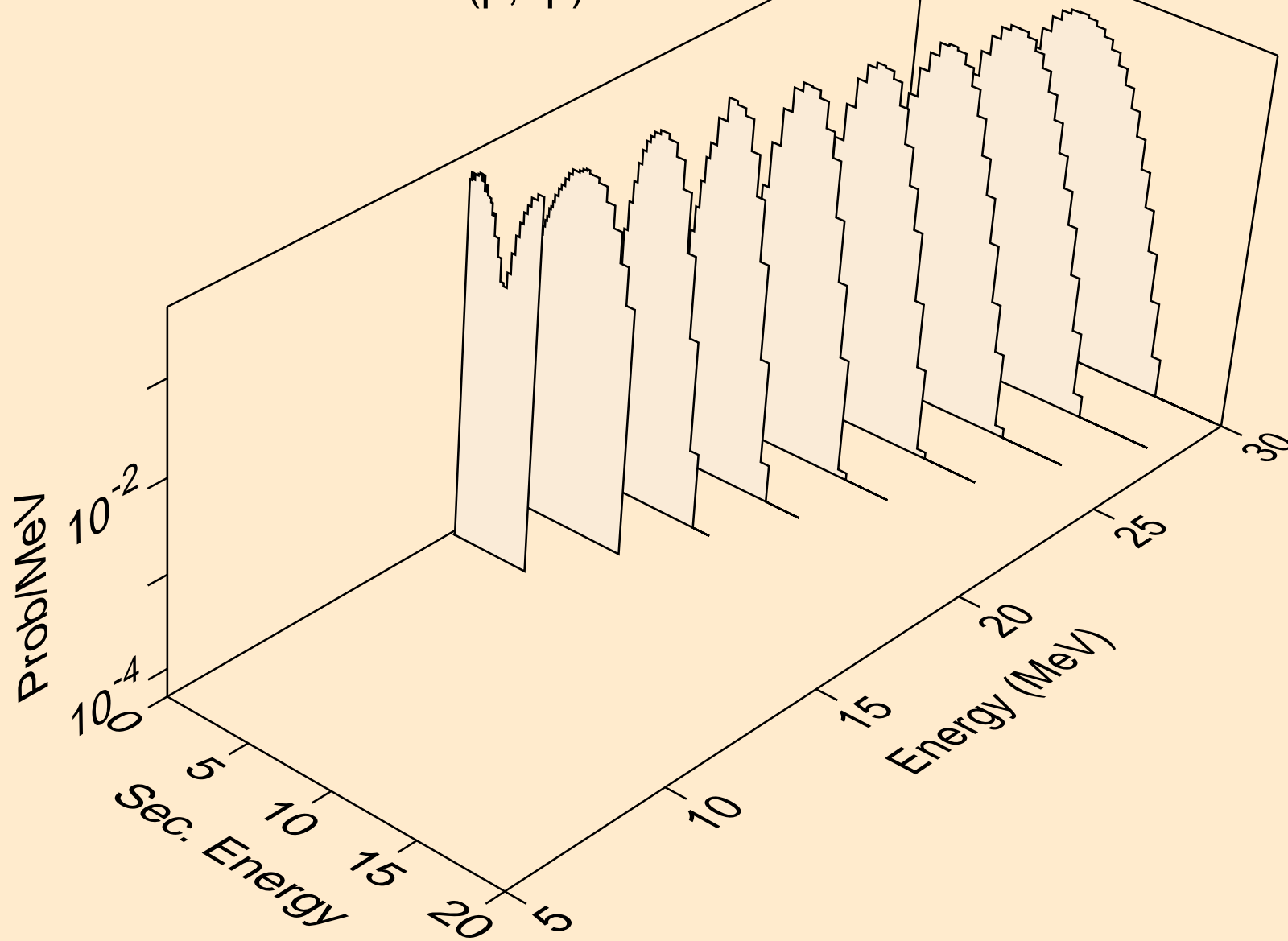

TB167 PROTON ACER TENDL-2021 LIBRARY; T=0.K  
Proton emission for (p,pd)

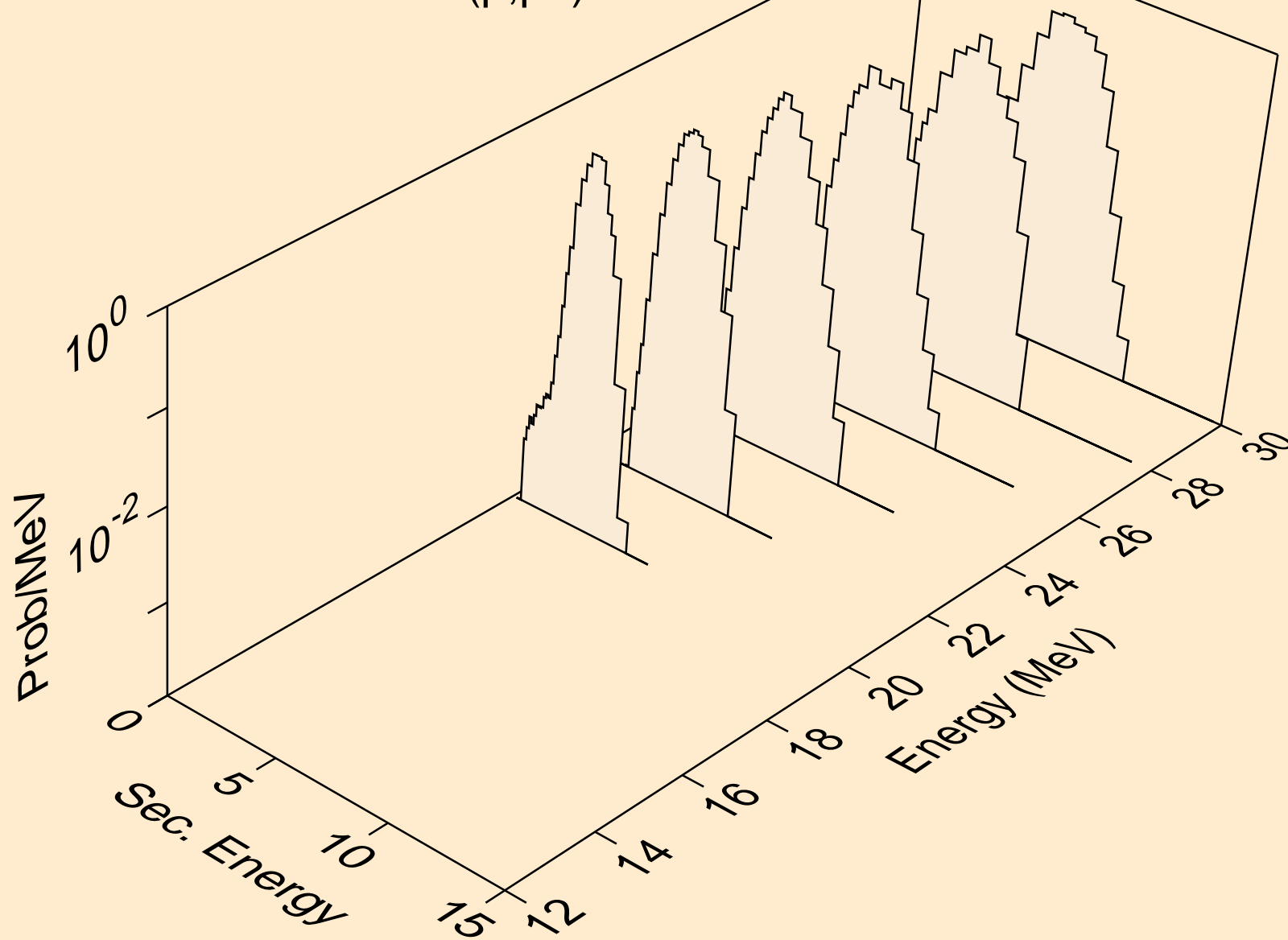

TB167 PROTON ACER TENDL-2021 LIBRARY; T=0.K  
Photon emission for (z,n)

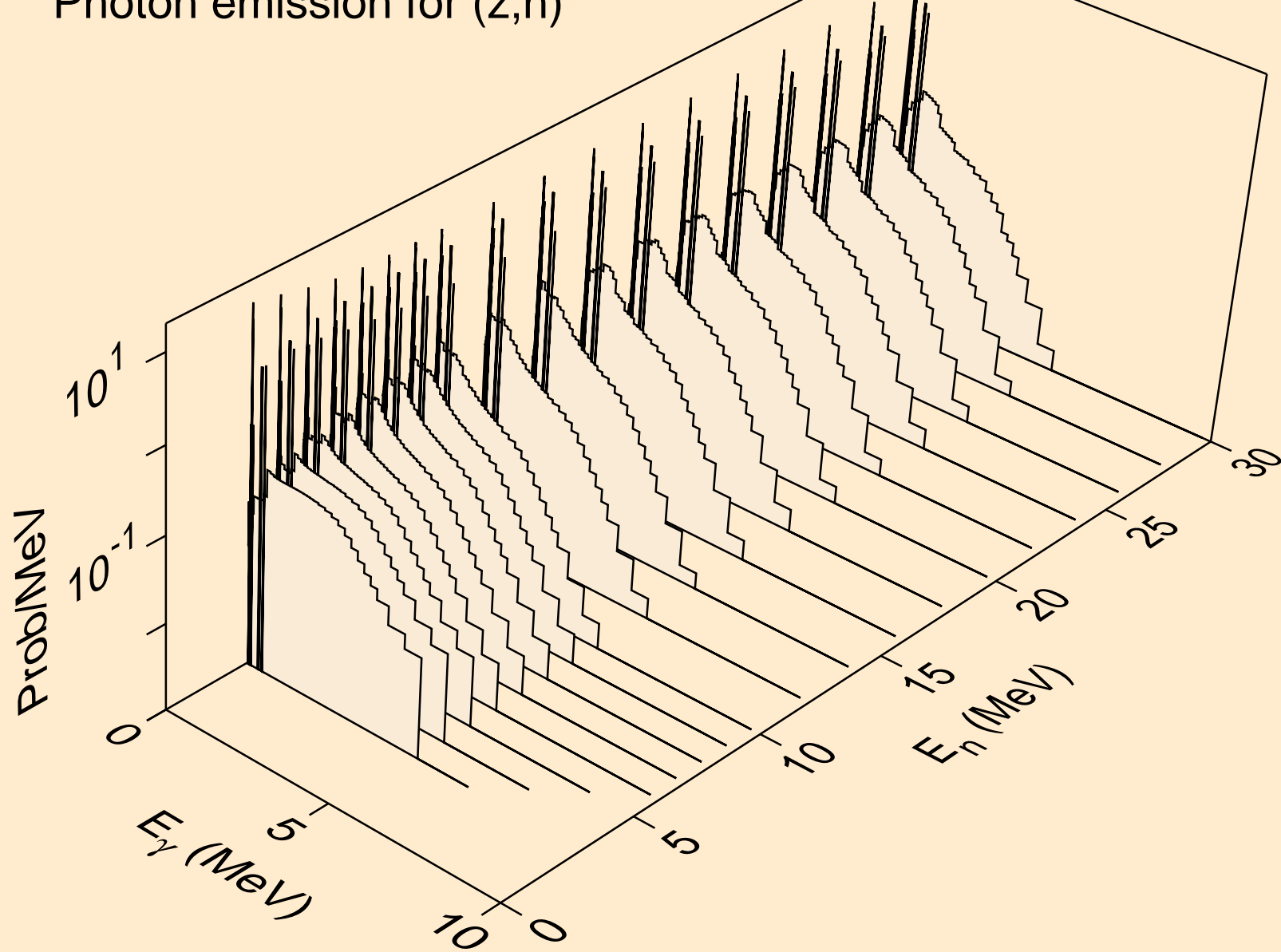

TB167 PROTON ACER TENDL-2021 LIBRARY; T=0.K  
Photon emission for (n,x)

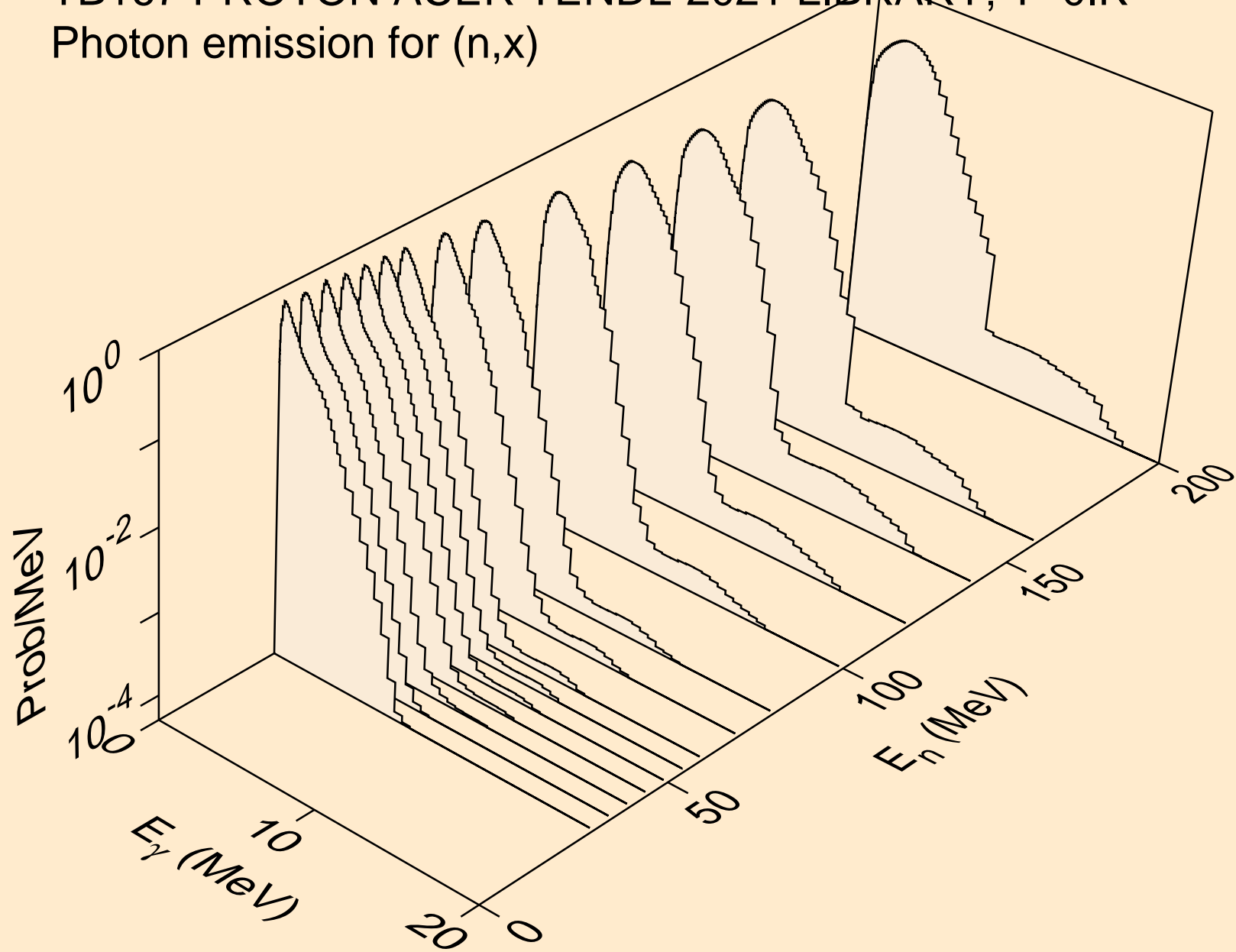

TB167 PROTON ACER TENDL-2021 LIBRARY; T=0.K  
Photon emission for (n,2nd)

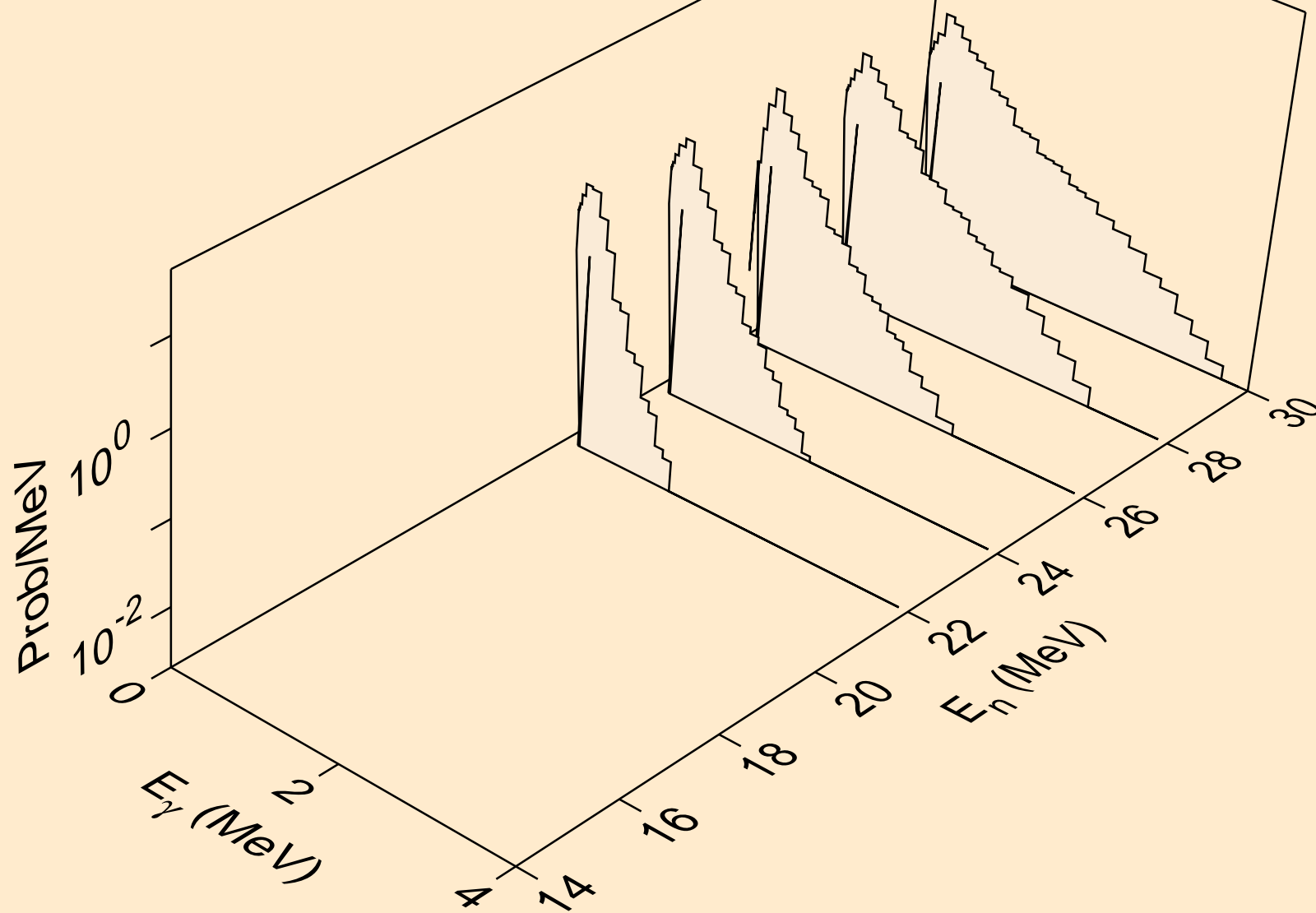

TB167 PROTON ACER TENDL-2021 LIBRARY; T=0.K  
Photon emission for (n,2n)

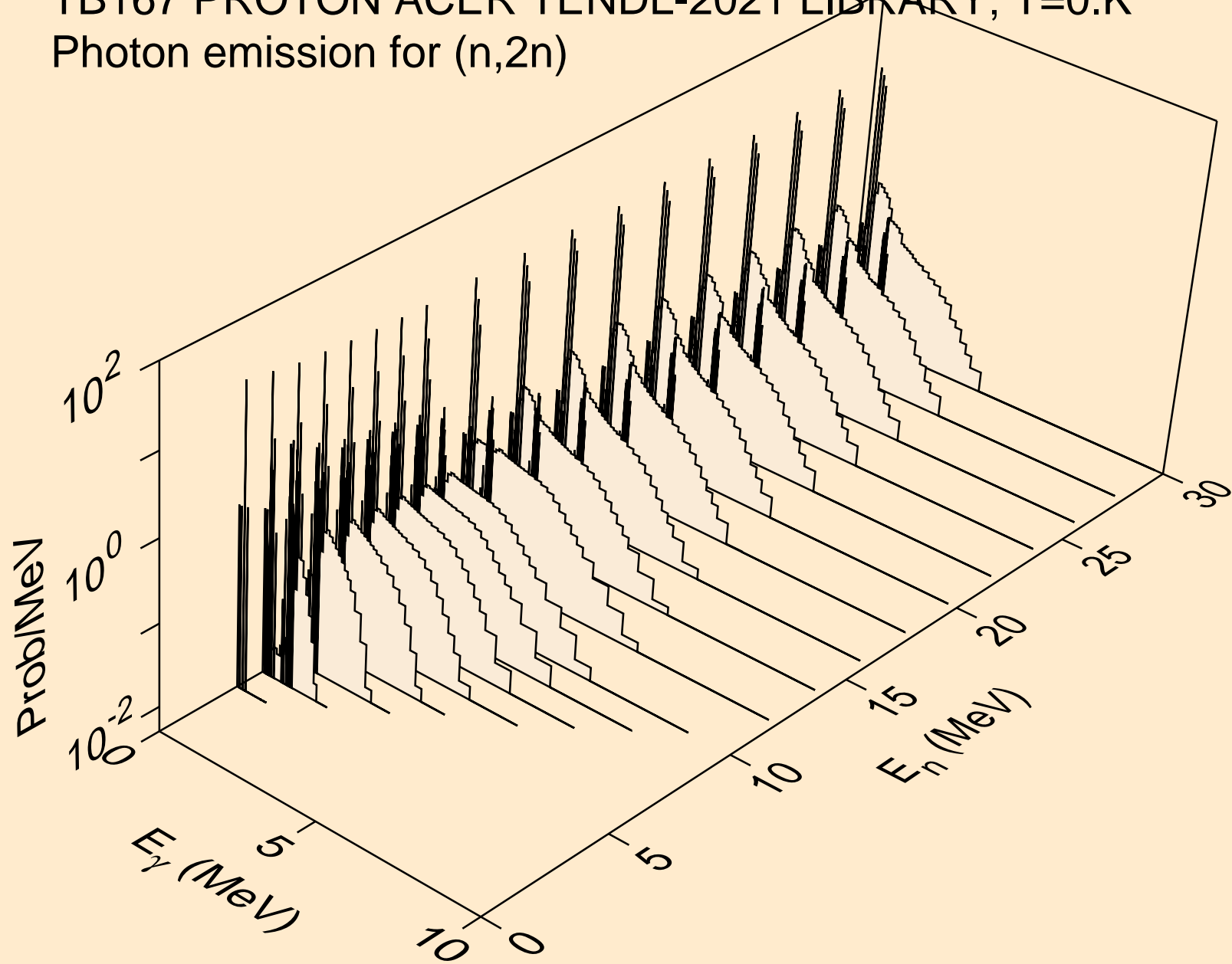

TB167 PROTON ACER TENDL-2021 LIBRARY; T=0.K  
Photon emission for (n,3n)

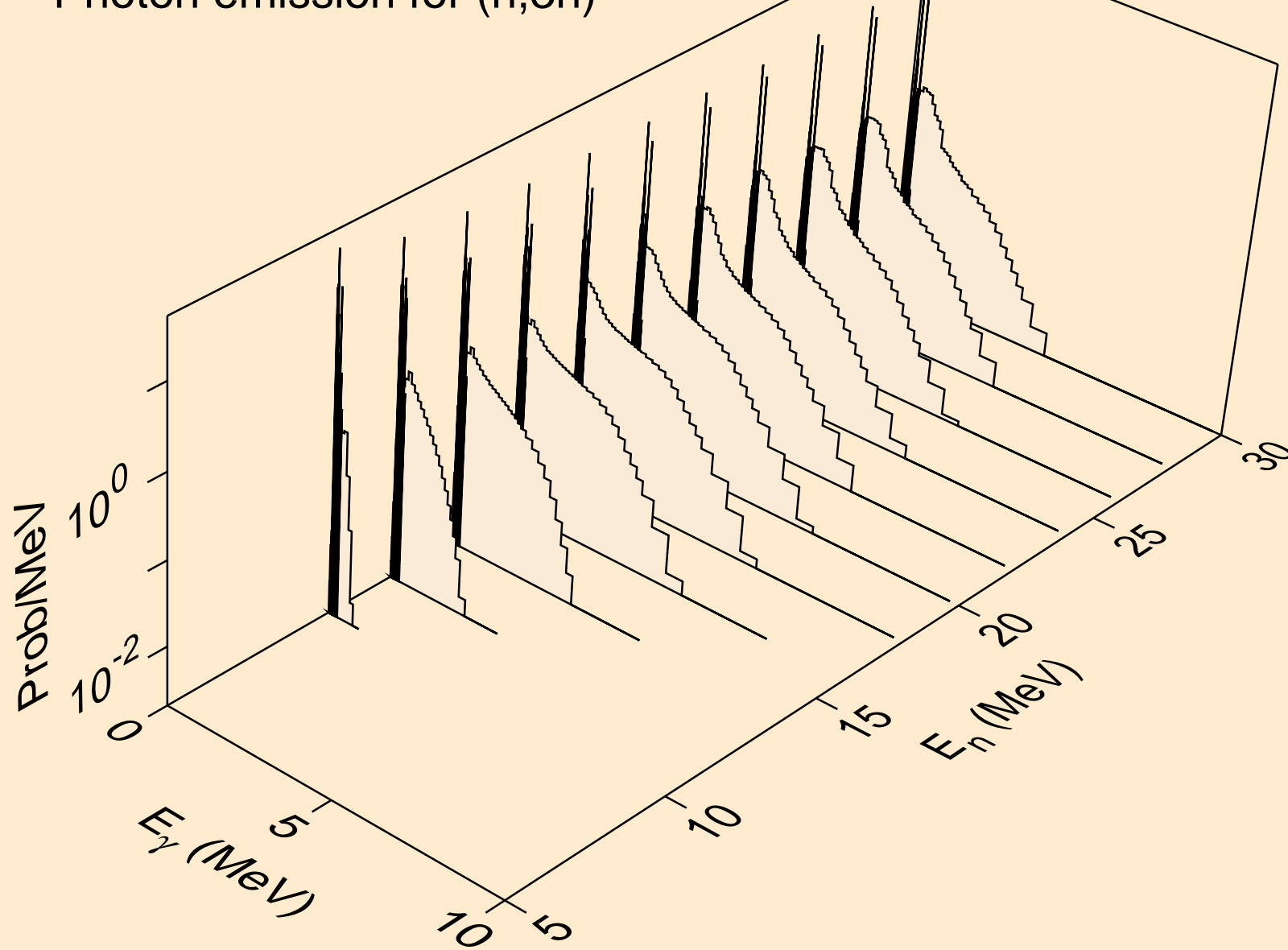

TB167 PROTON ACER TENDL-2021 LIBRARY; T=0.K  
Photon emission for (n,n\*)a

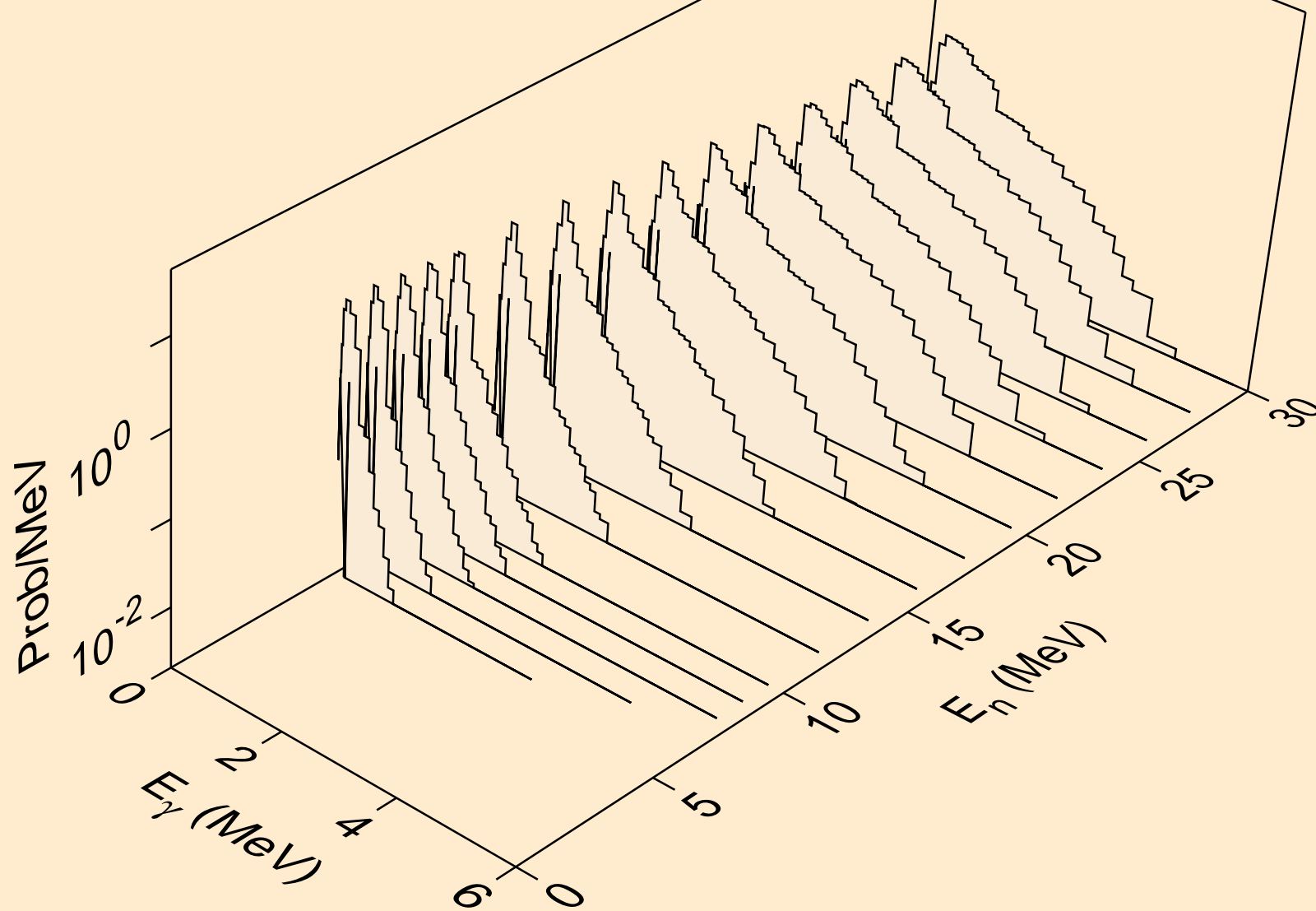



TB167 PROTON ACER TENDL-2021 LIBRARY; T=0.K  
Photon emission for (n,2n) $\alpha$

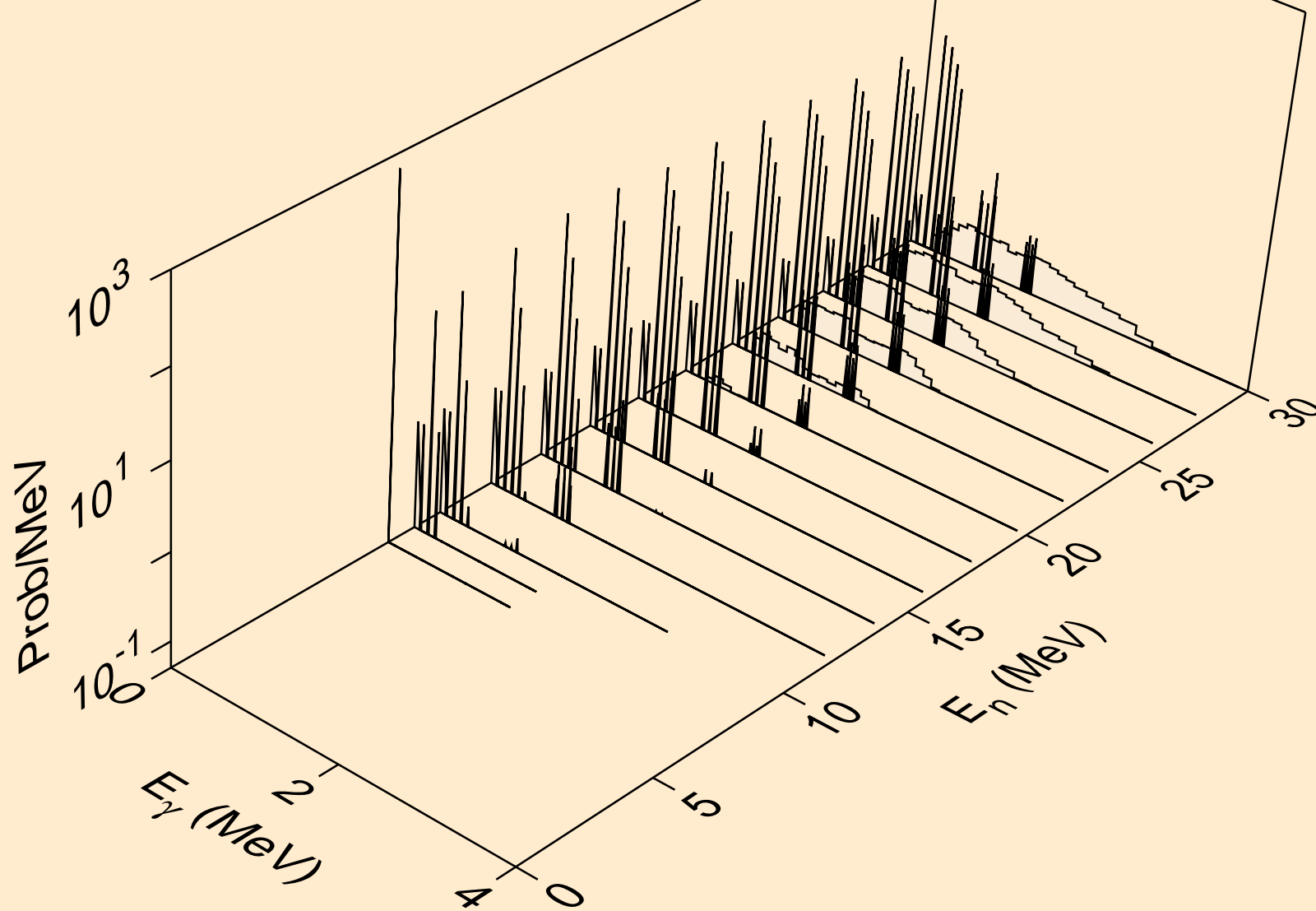

TB167 PROTON ACER TENDL-2021 LIBRARY; T=0.K  
Photon emission for (n,3n)a

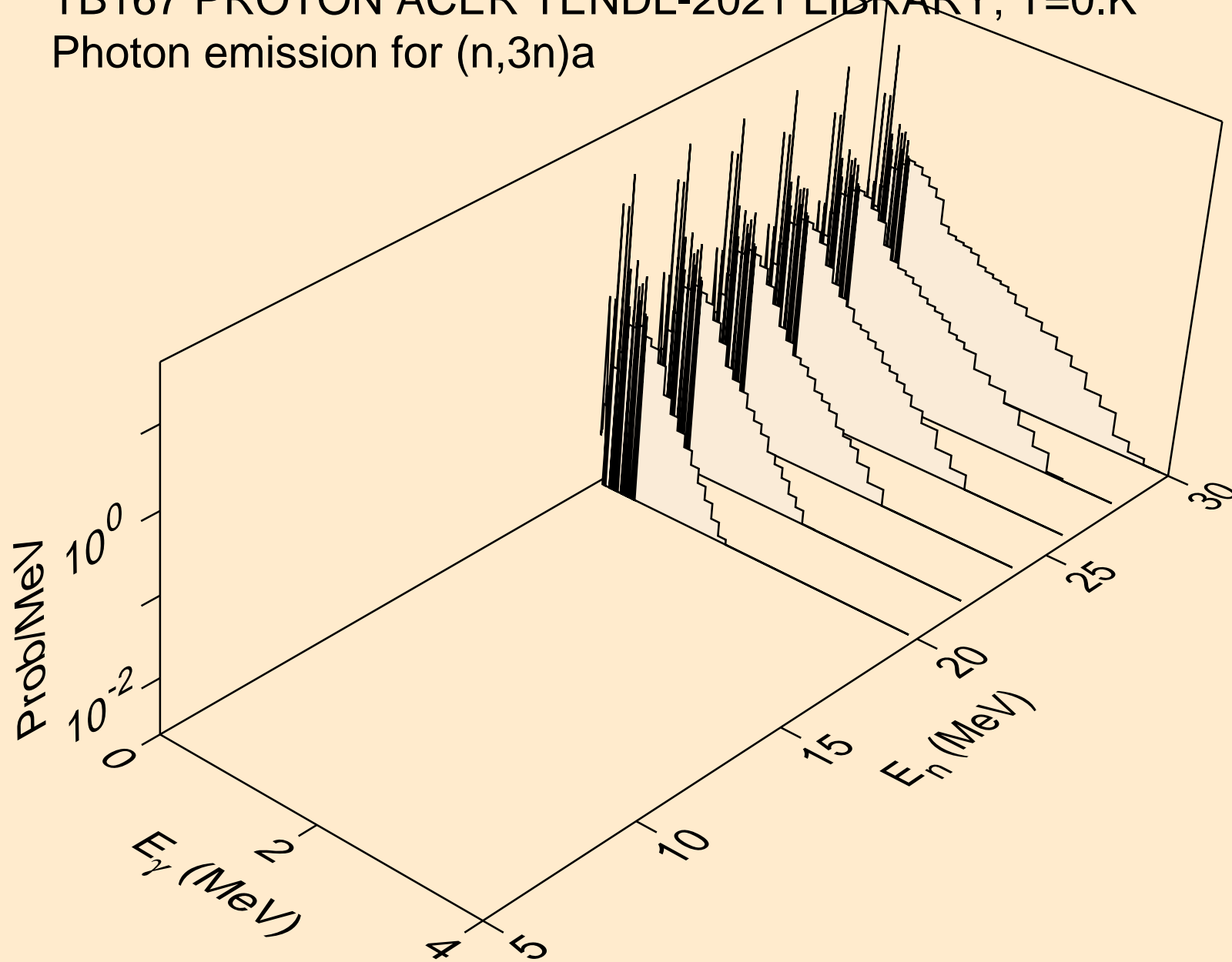

TB167 PROTON ACER TENDL-2021 LIBRARY; T=0.K  
Photon emission for (n,n\*)p

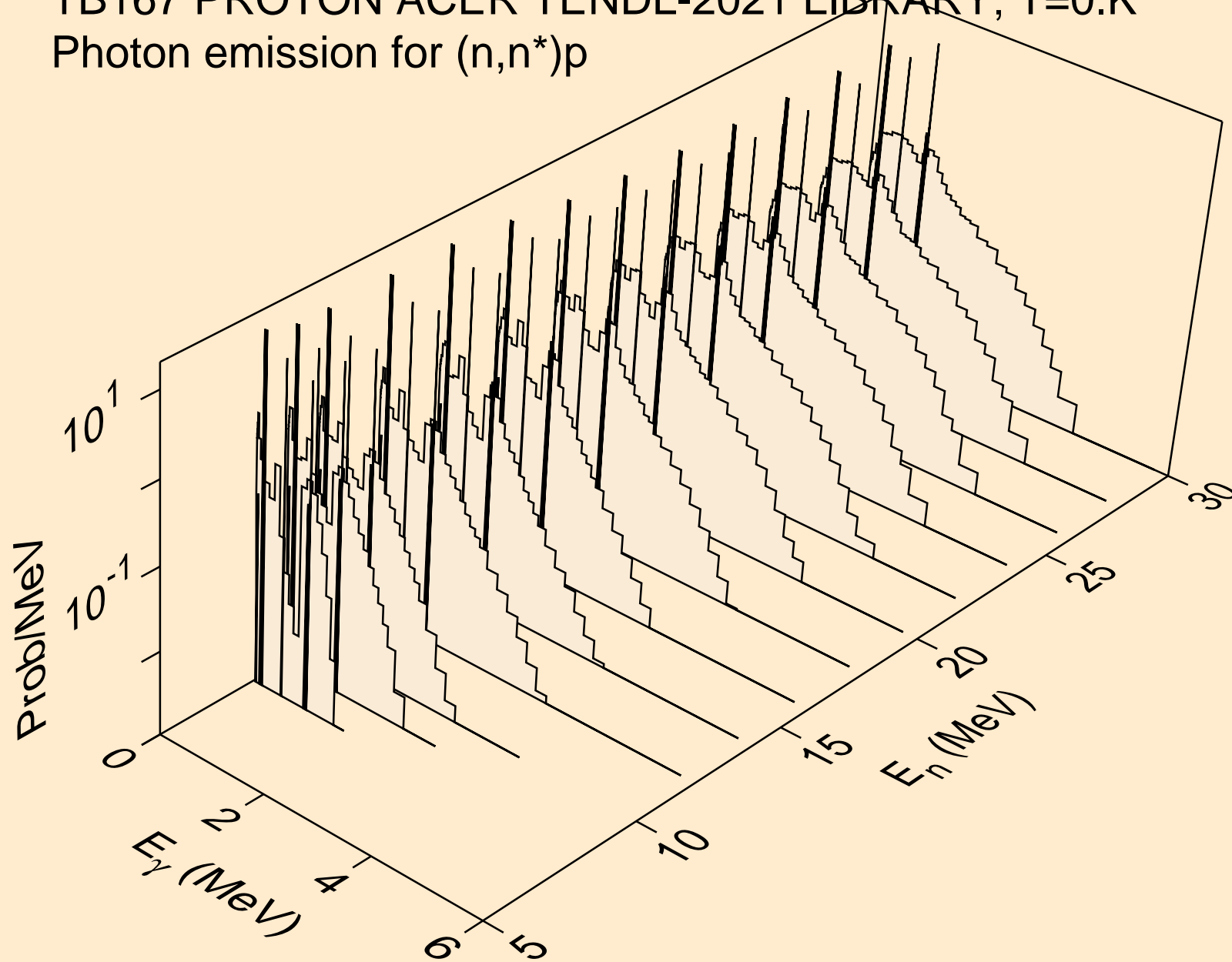

TB167 PROTON ACER TENDL-2021 LIBRARY; T=0.K  
Photon emission for (n,n\*)d

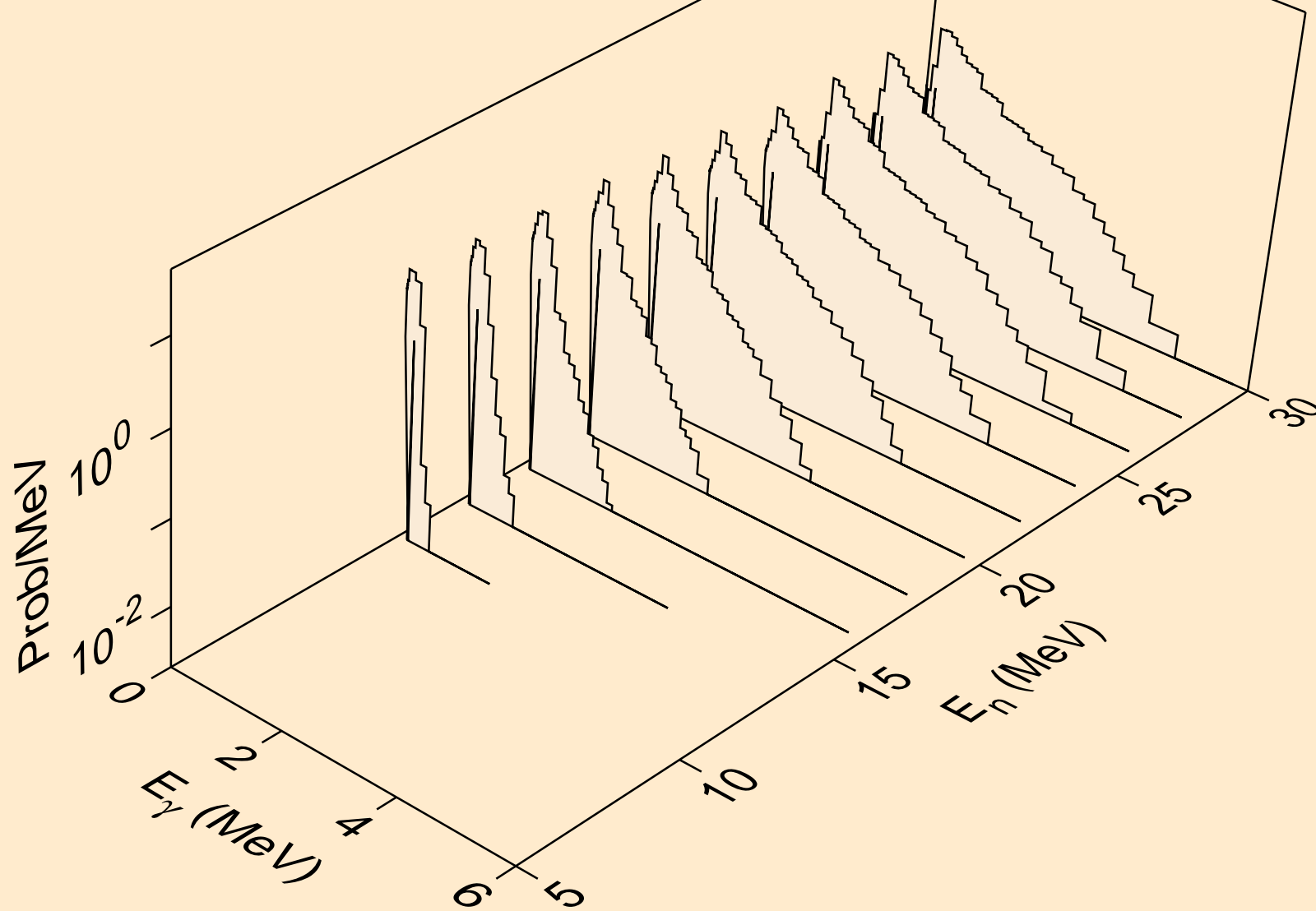

TB167 PROTON ACER TENDL-2021 LIBRARY; T=0.K  
Photon emission for (n,n\*)t

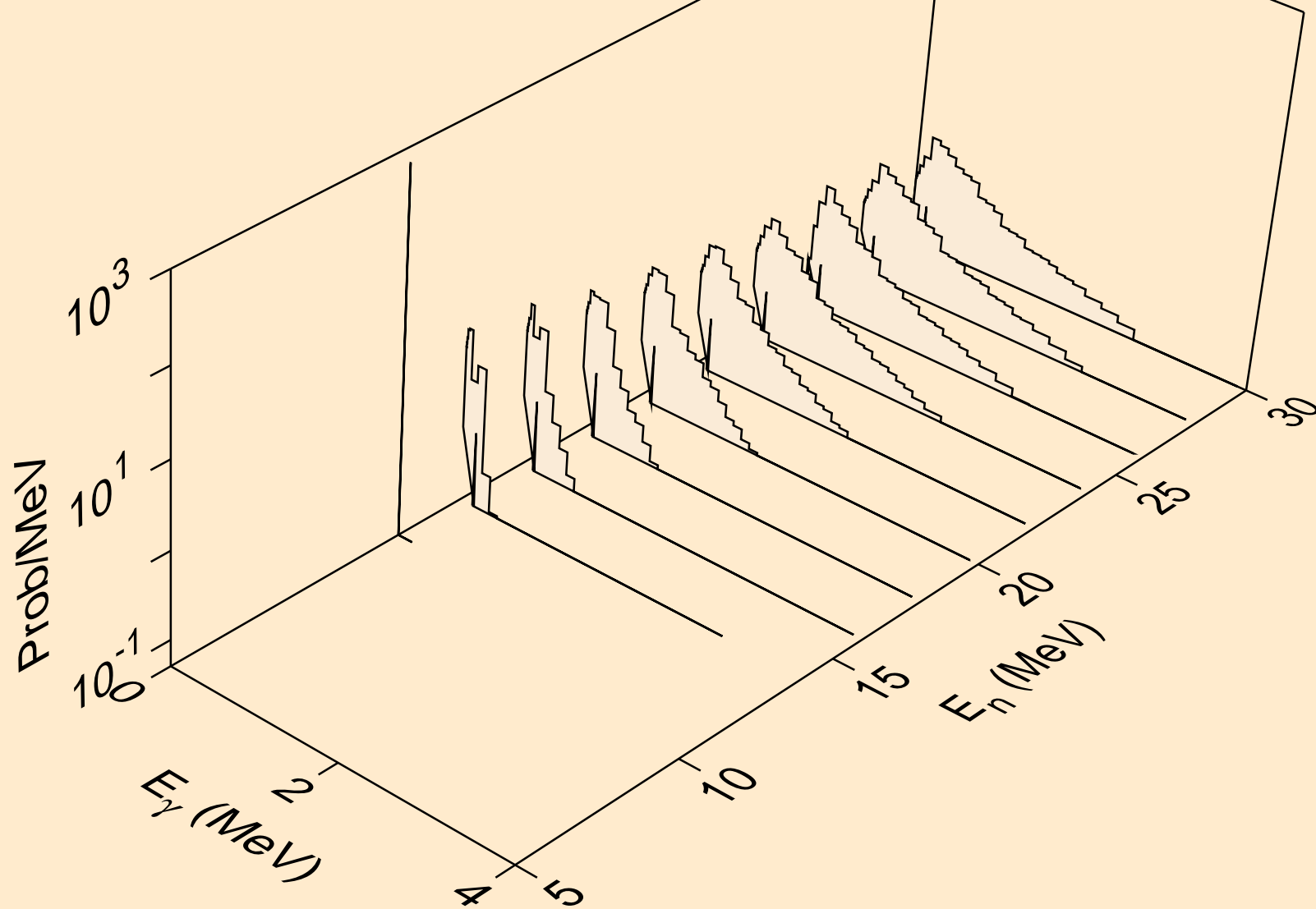

TB167 PROTON ACER TENDL-2021 LIBRARY; T=0.K  
Photon emission for (n,n\*)he3

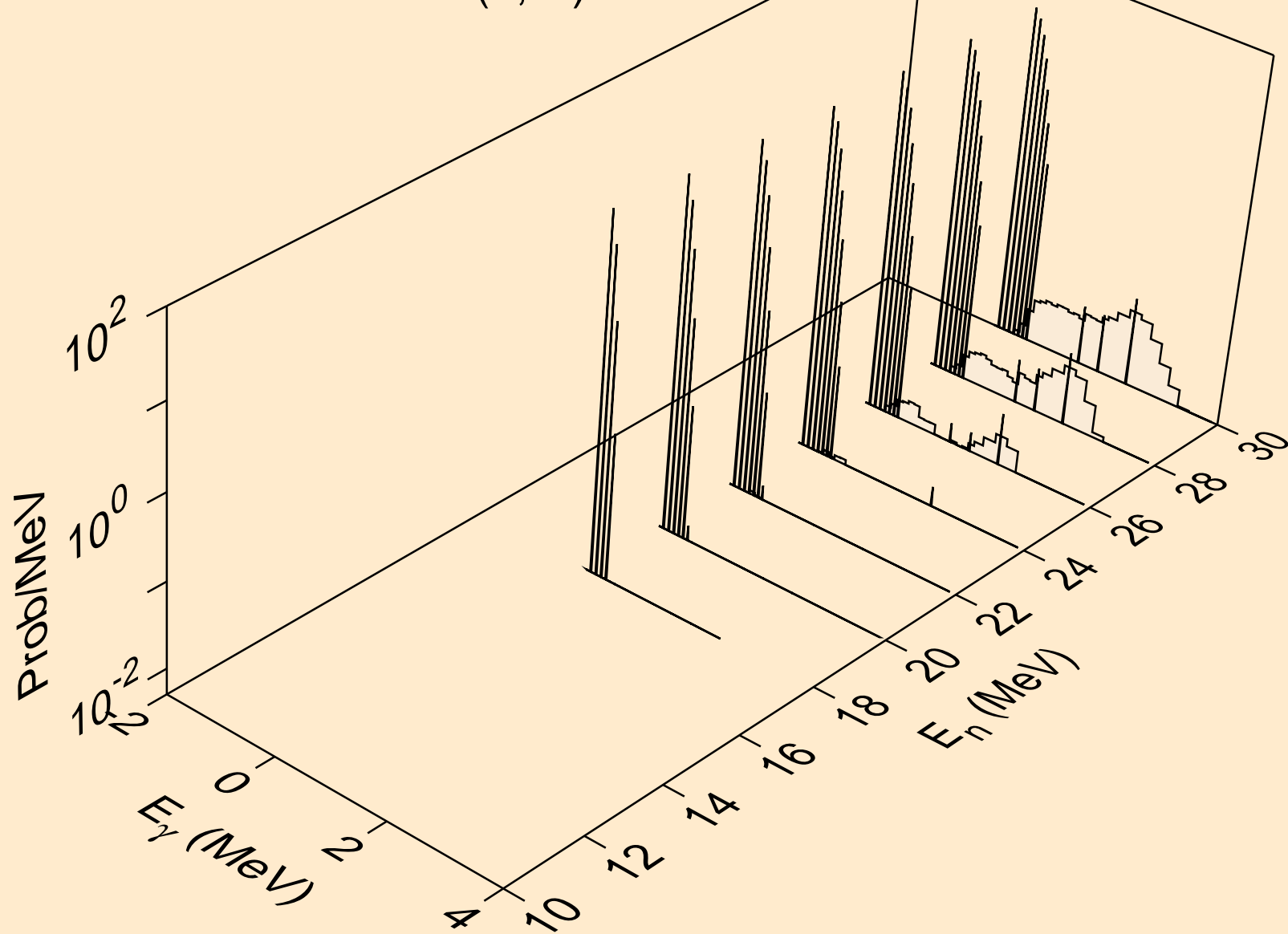

TB167 PROTON ACER TENDL-2021 LIBRARY; T=0.K  
Photon emission for (n,4n)

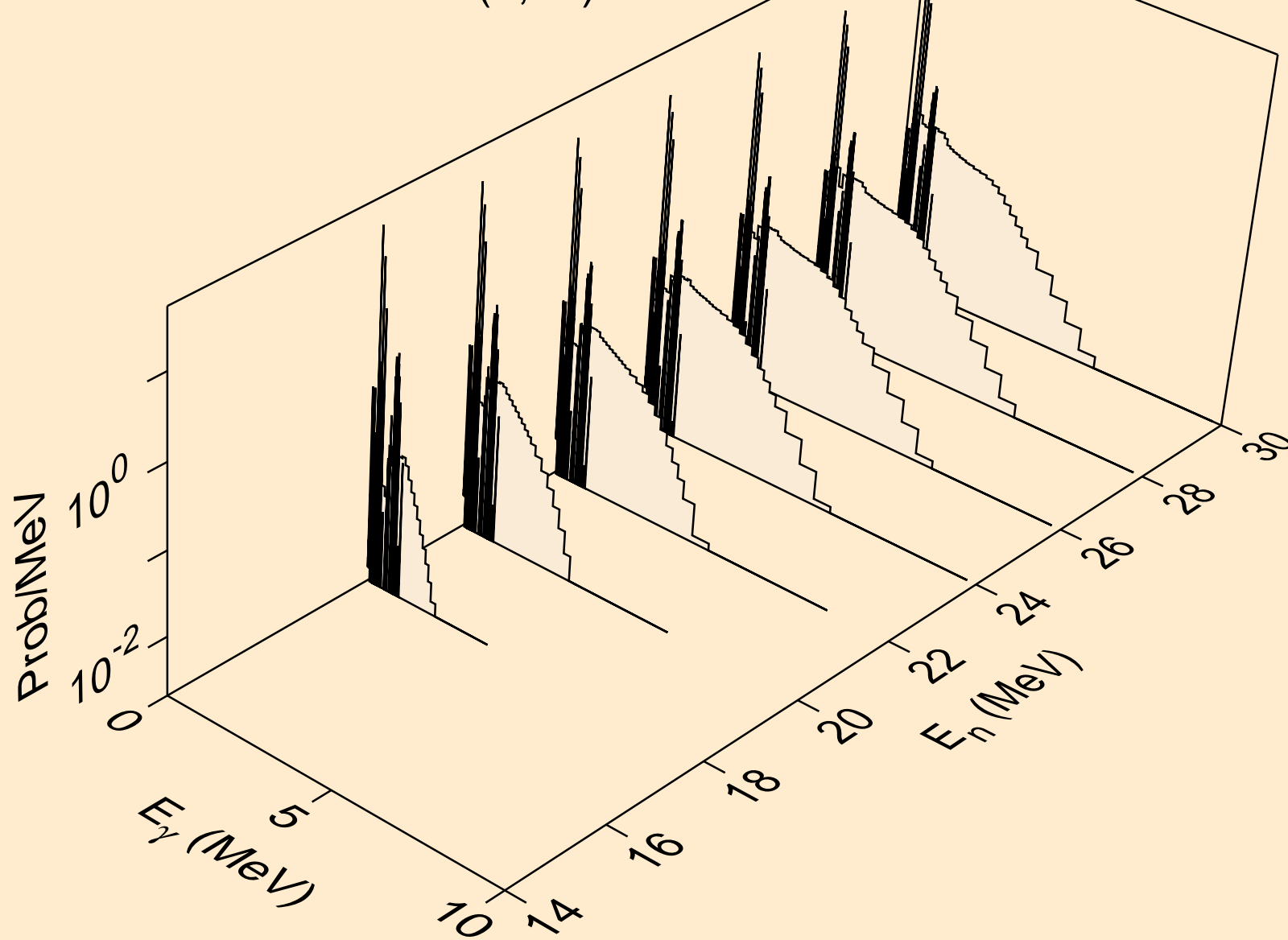

TB167 PROTON ACER TENDL-2021 LIBRARY; T=0.K  
Photon emission for (n,2np)

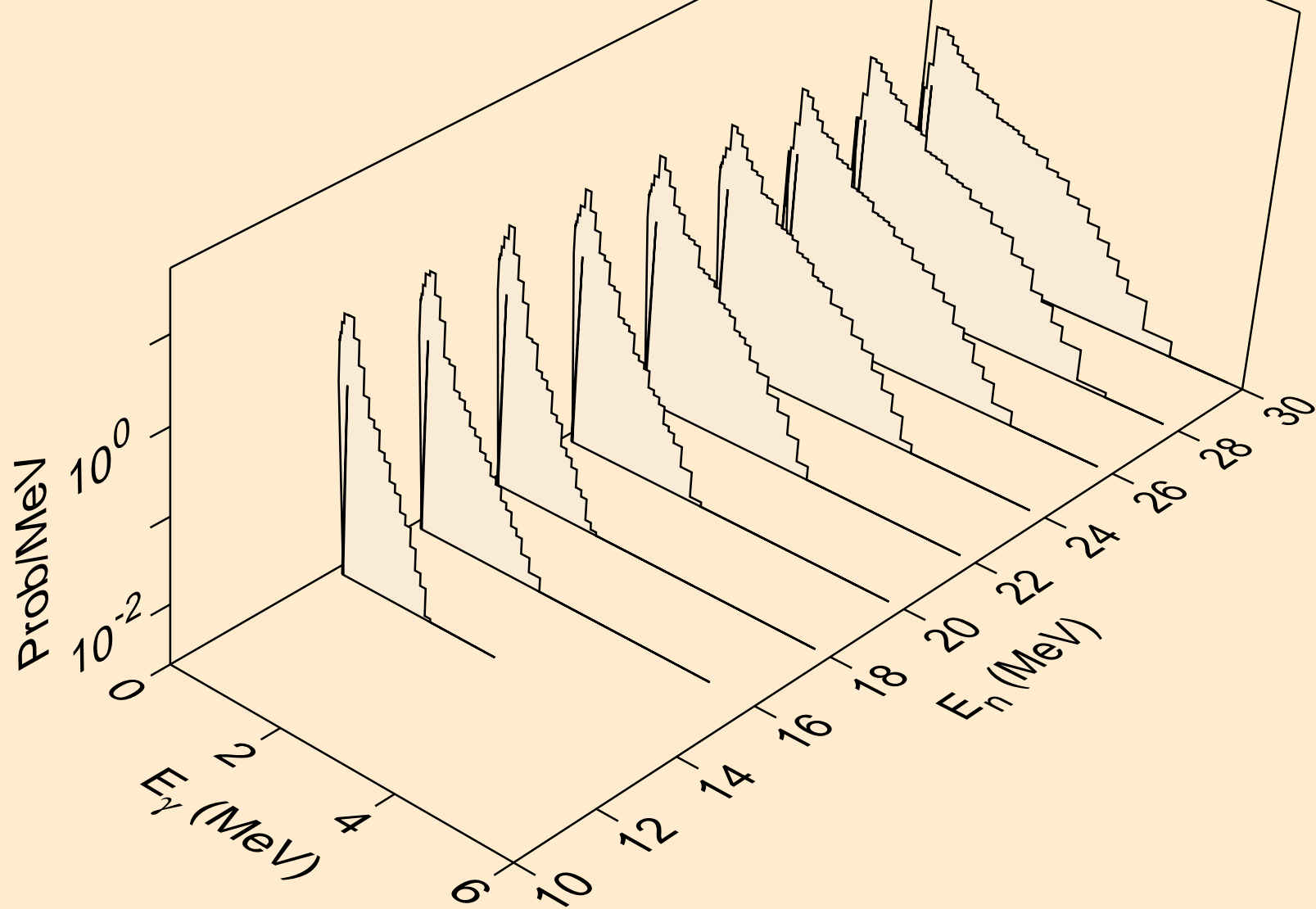



TB167 PROTON ACER TENDL-2021 LIBRARY; T=0.K  
Photon emission for (n,3np)

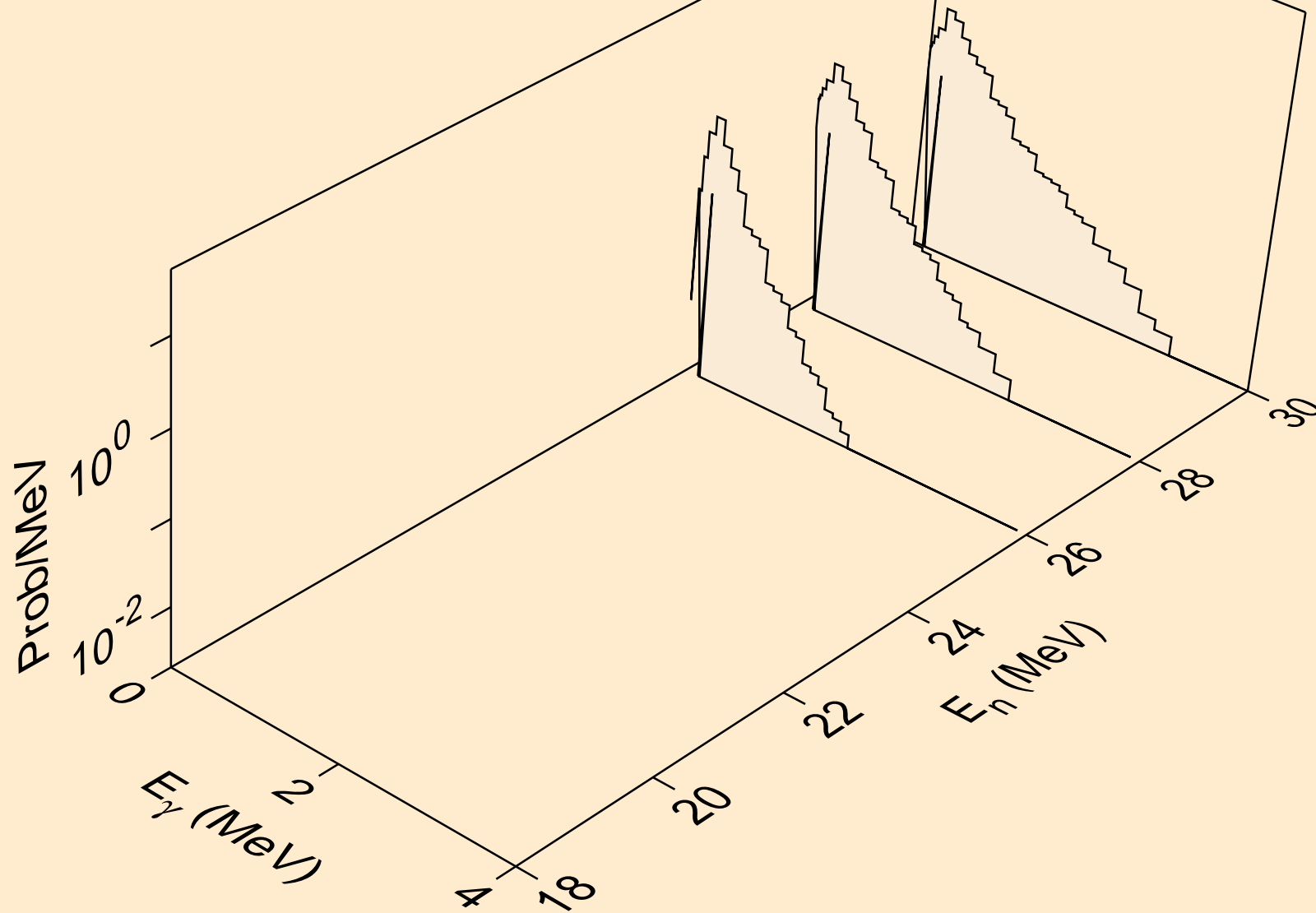

TB167 PROTON ACER TENDL-2021 LIBRARY; T=0.K  
Photon emission for (n,2np)

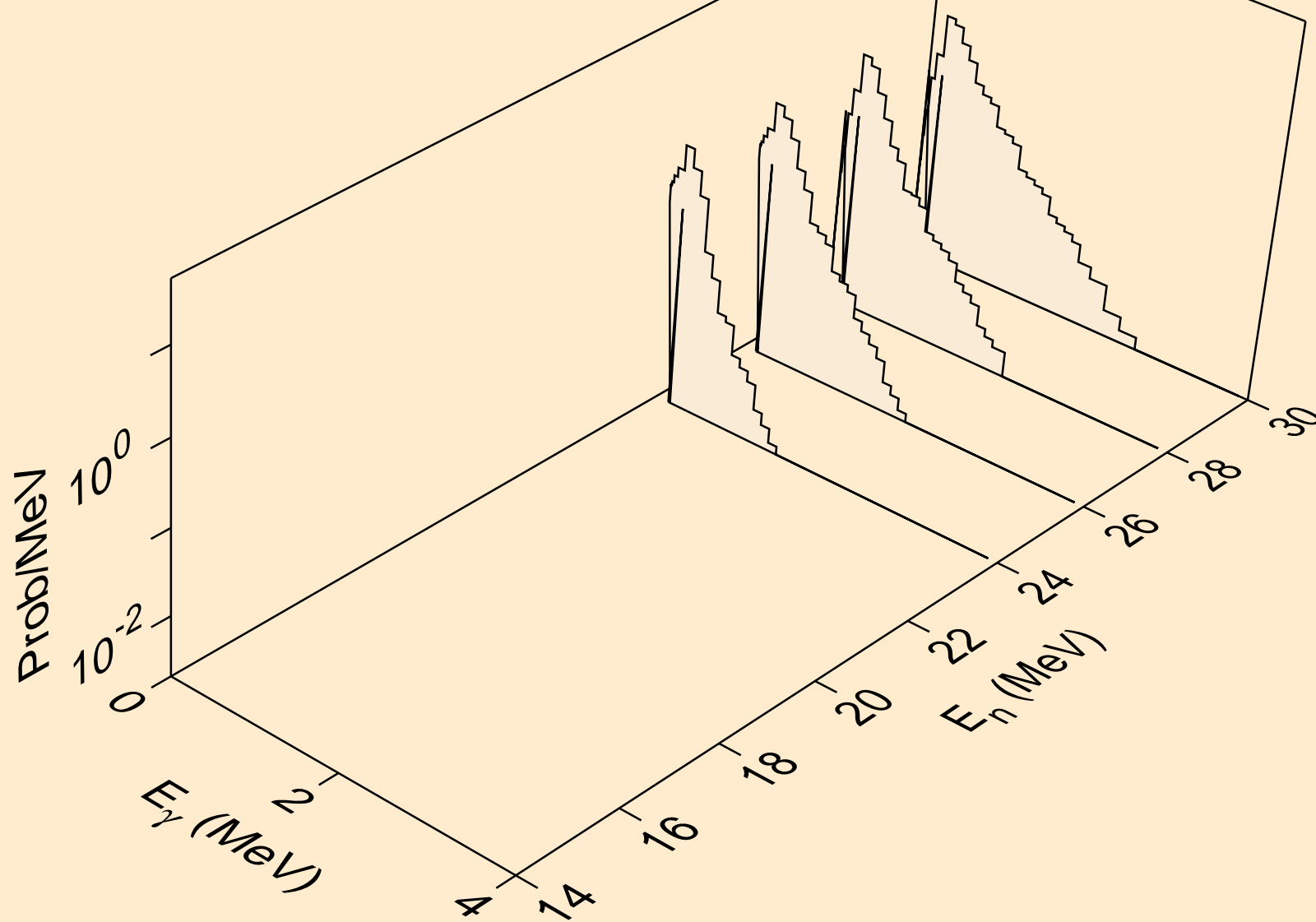

TB167 PROTON ACER TENDL-2021 LIBRARY; T=0.K  
Photon emission for (n,gma)

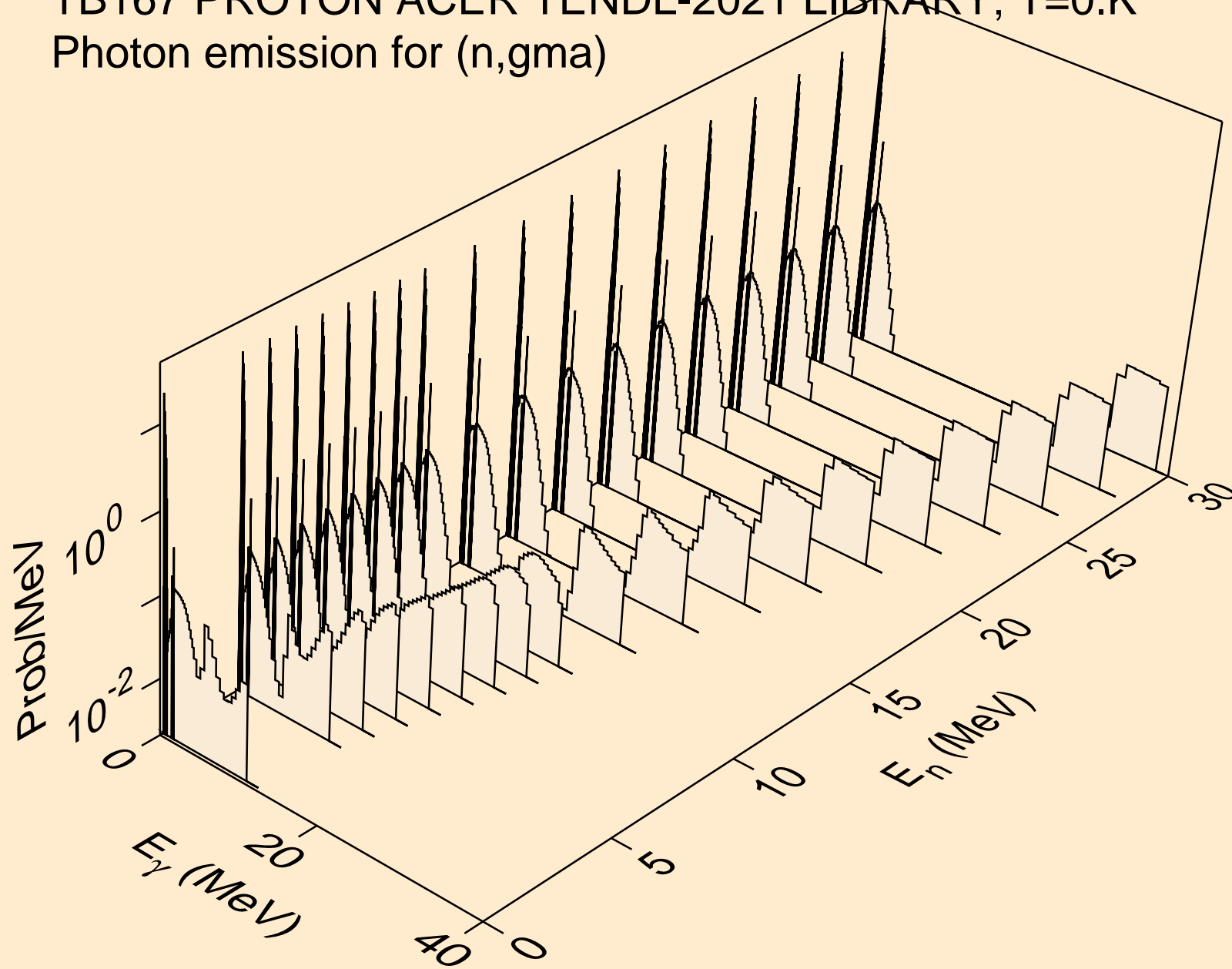

TB167 PROTON ACER TENDL-2021 LIBRARY; T=0.K  
Photon emission for inelastic

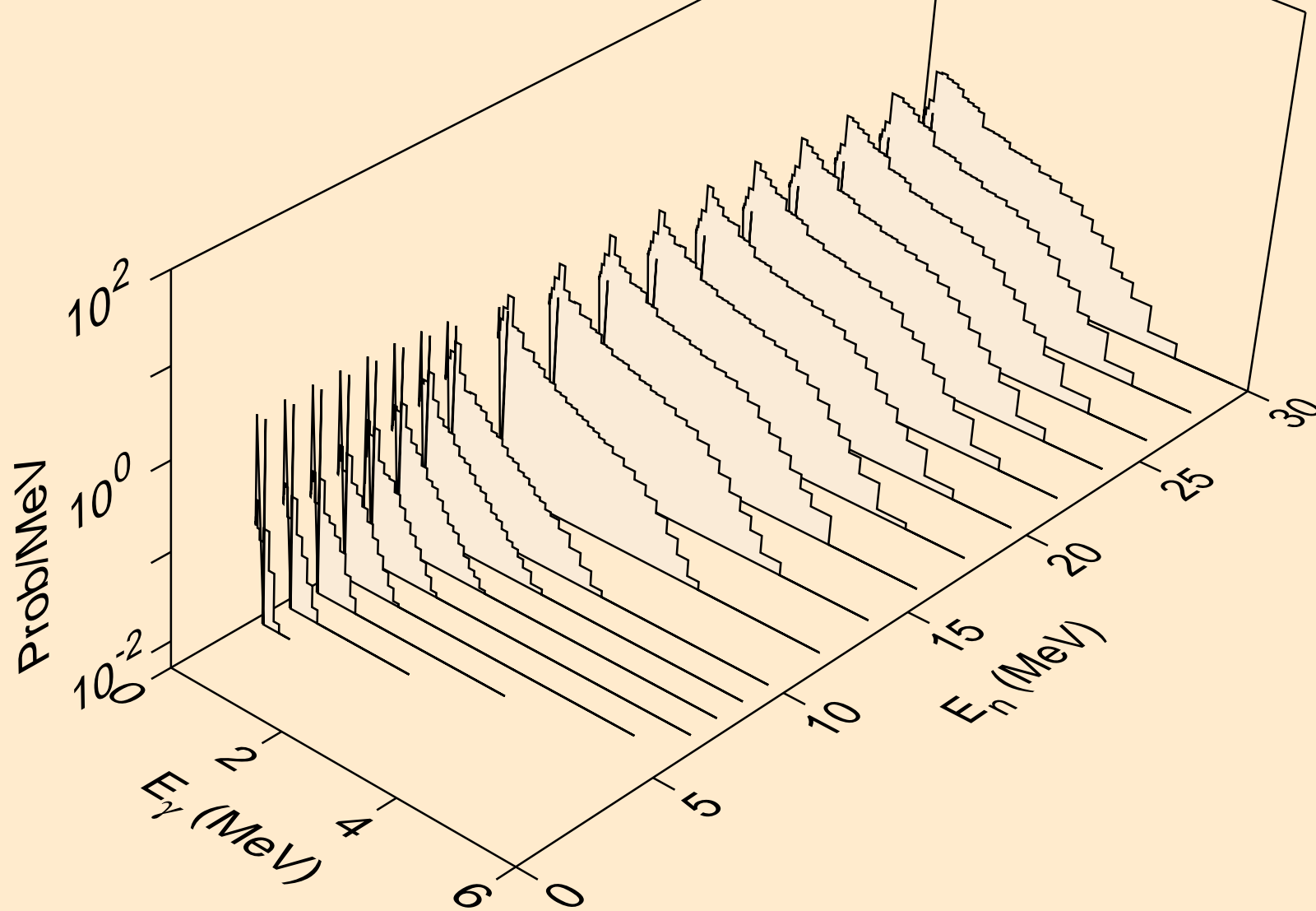

TB167 PROTON ACER TENDL-2021 LIBRARY; T=0.K  
Photon emission for (n,d)

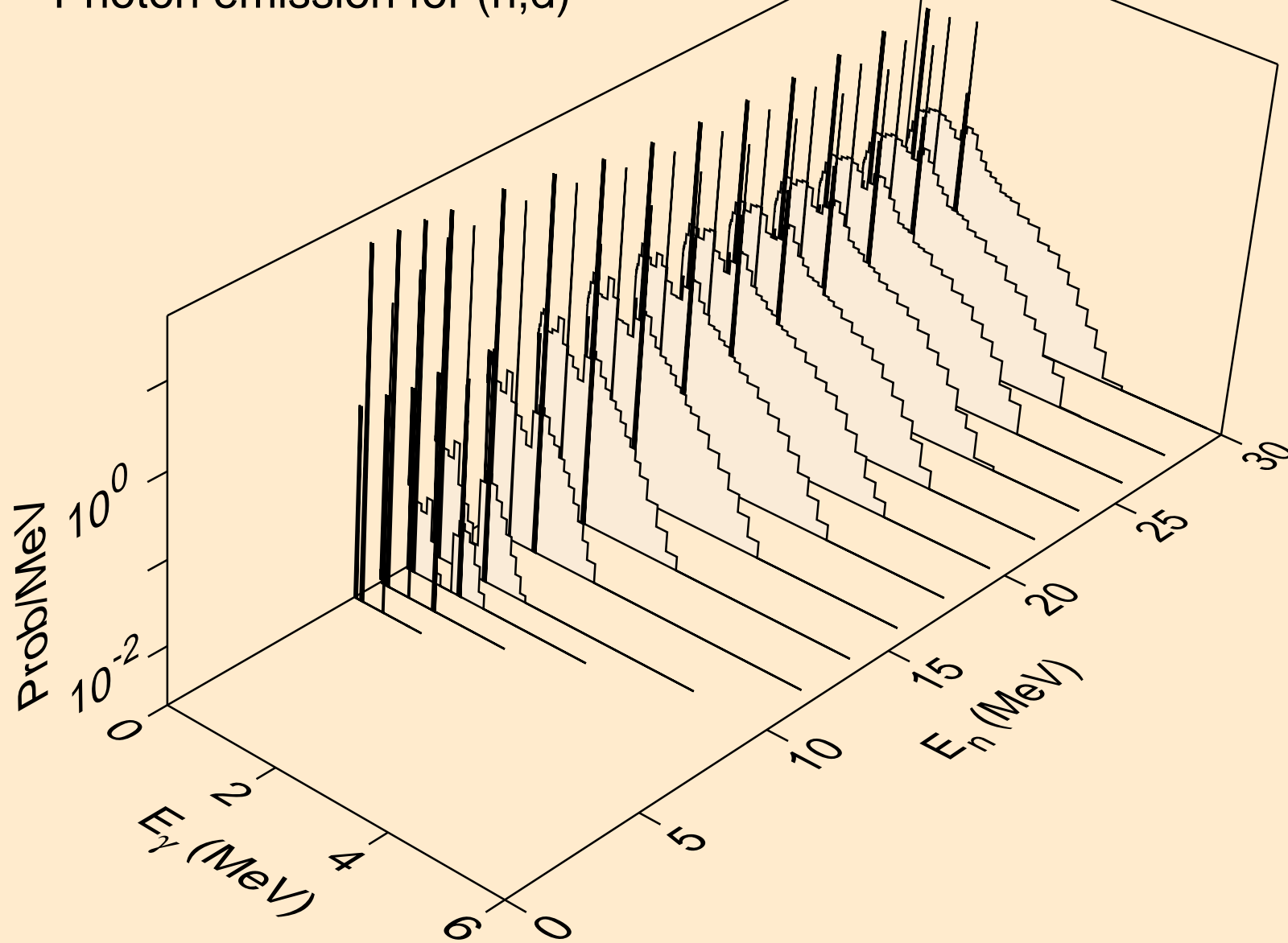

TB167 PROTON ACER TENDL-2021 LIBRARY; T=0.K  
Photon emission for (n,t)

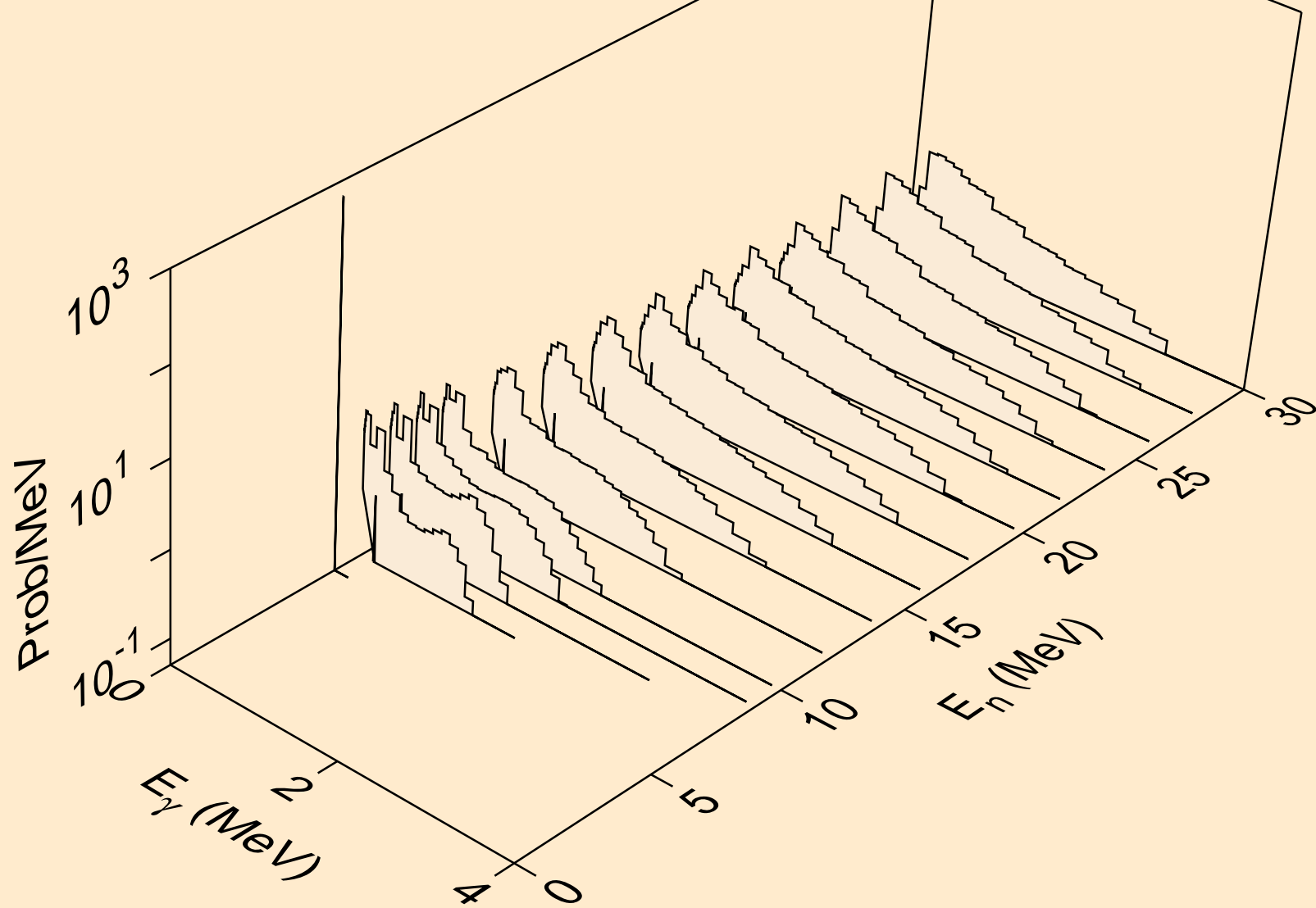

TB167 PROTON ACER TENDL-2021 LIBRARY; T=0.K  
Photon emission for (n,he3)

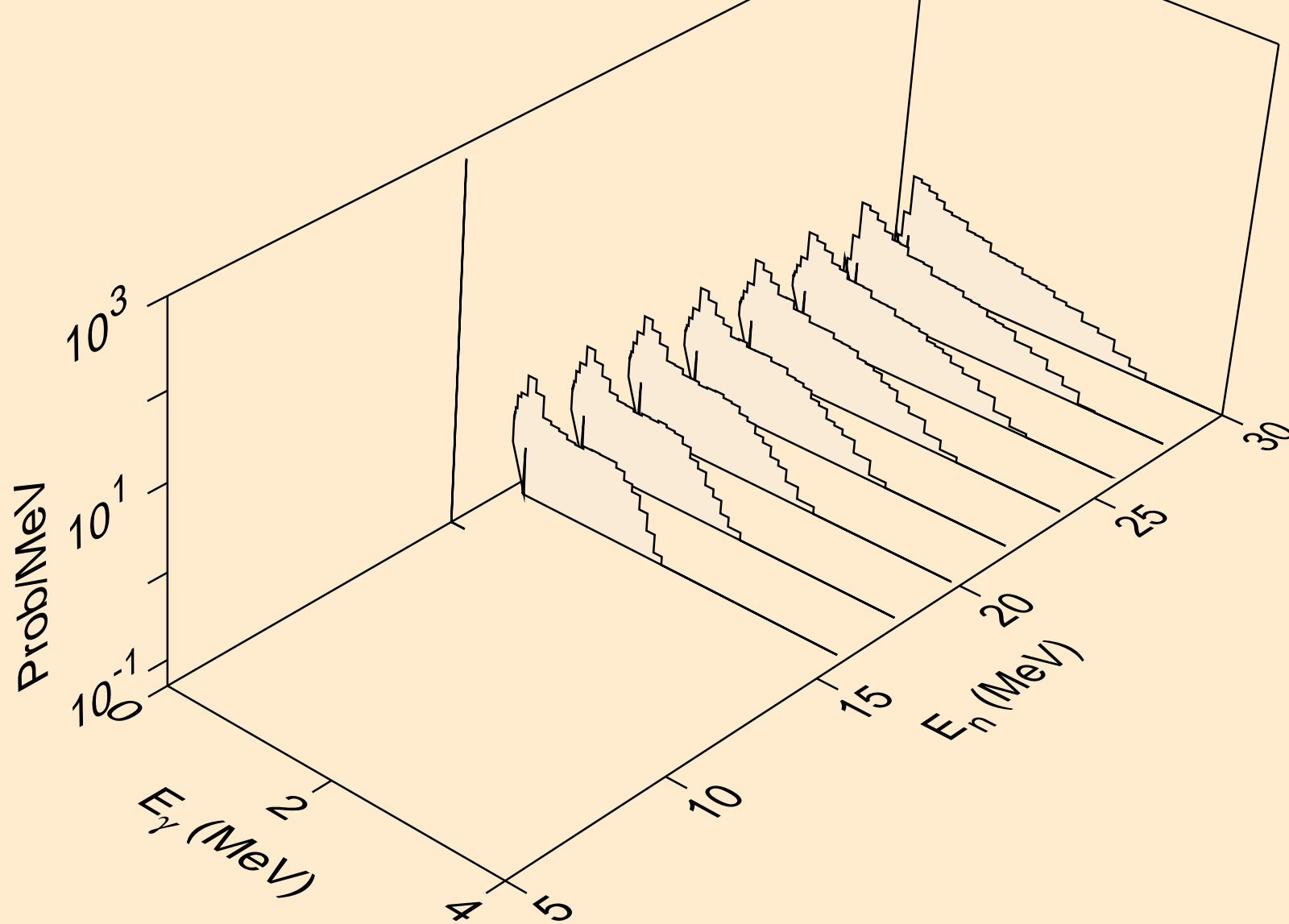

TB167 PROTON ACER TENDL-2021 LIBRARY; T=0.K  
Photon emission for (n,a)

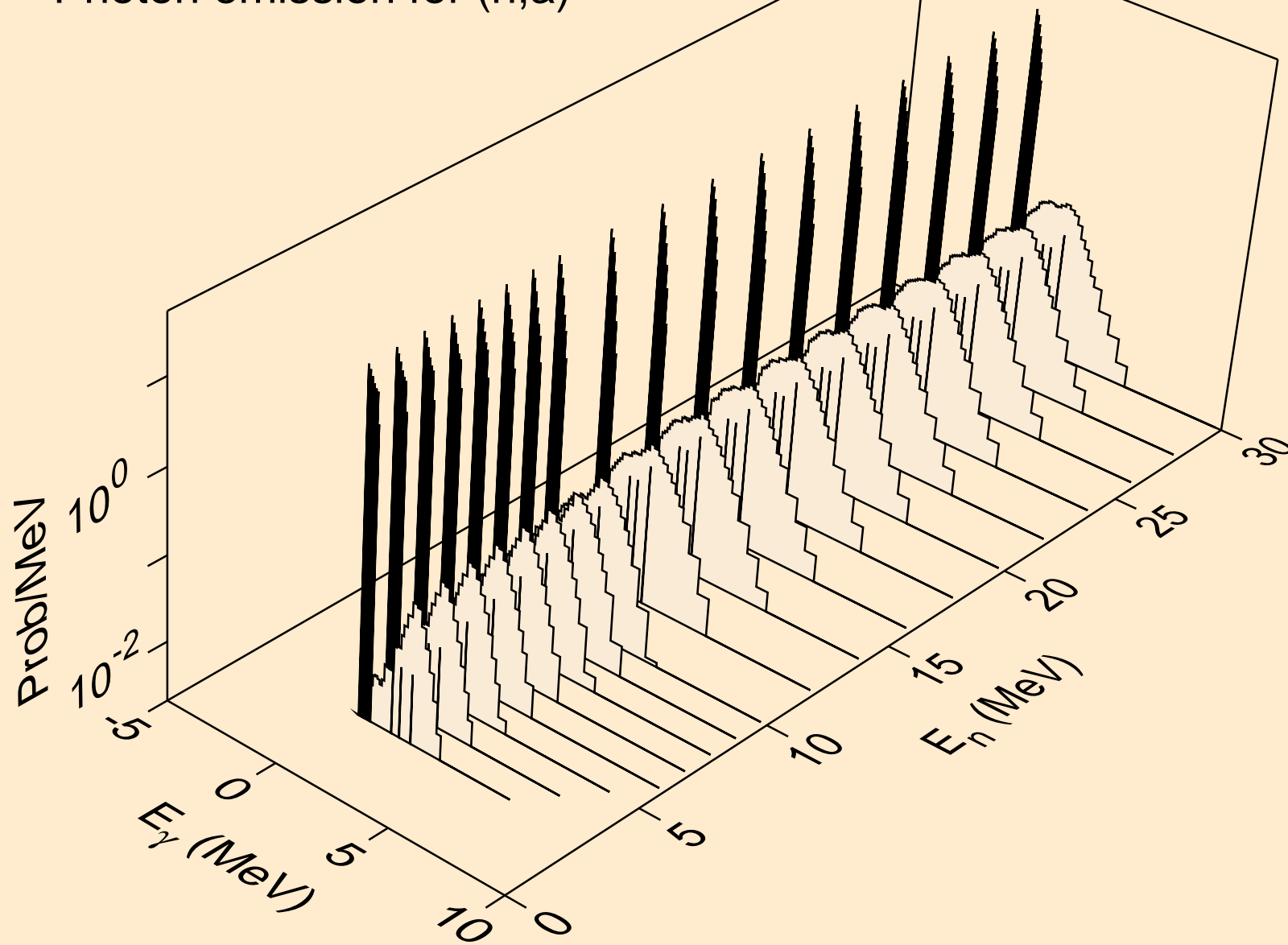



TB167 PROTON ACER TENDL-2021 LIBRARY; T=0.K  
Photon emission for (n,2p)

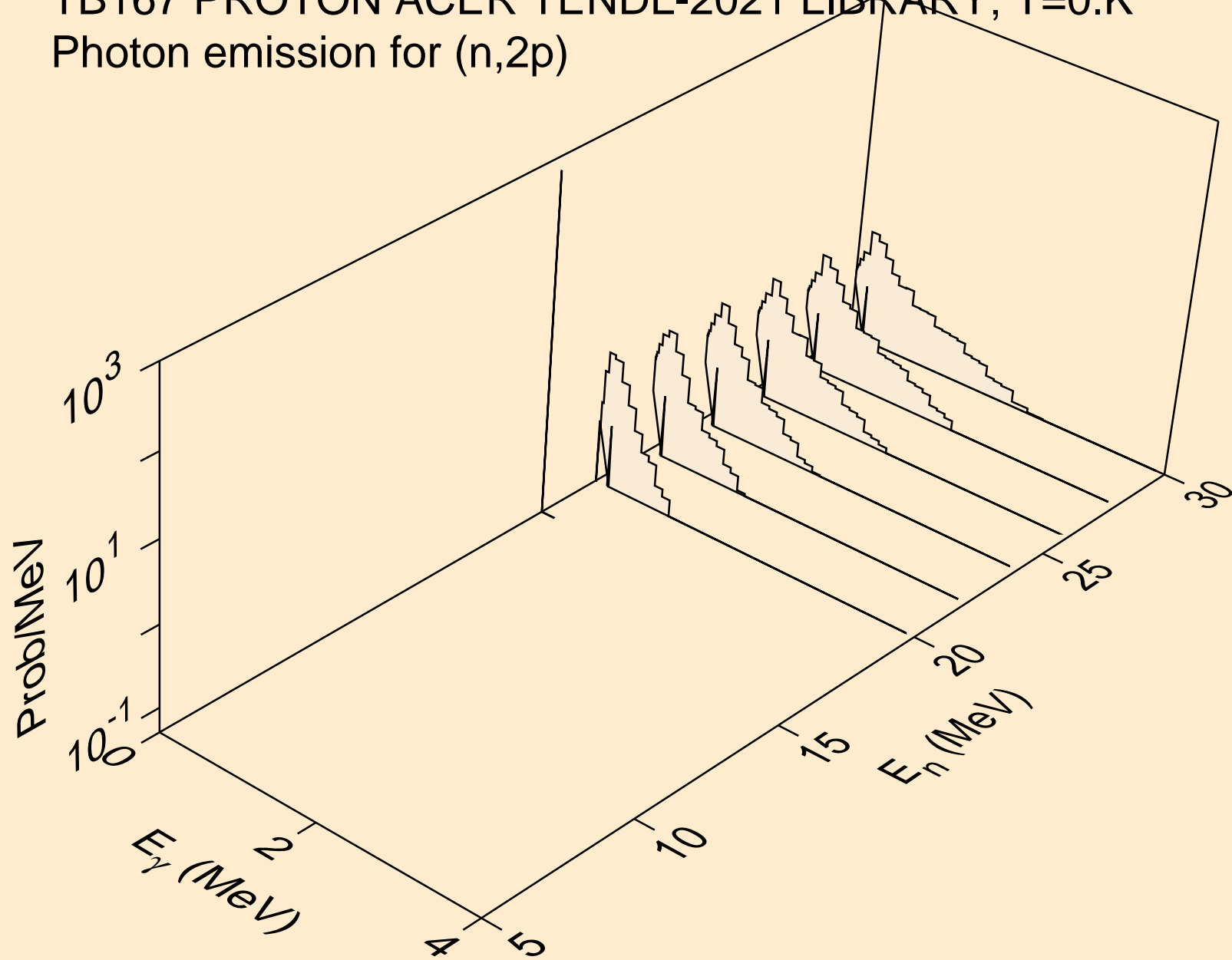

TB167 PROTON ACER TENDL-2021 LIBRARY; T=0.K  
Photon emission for (n,pd)

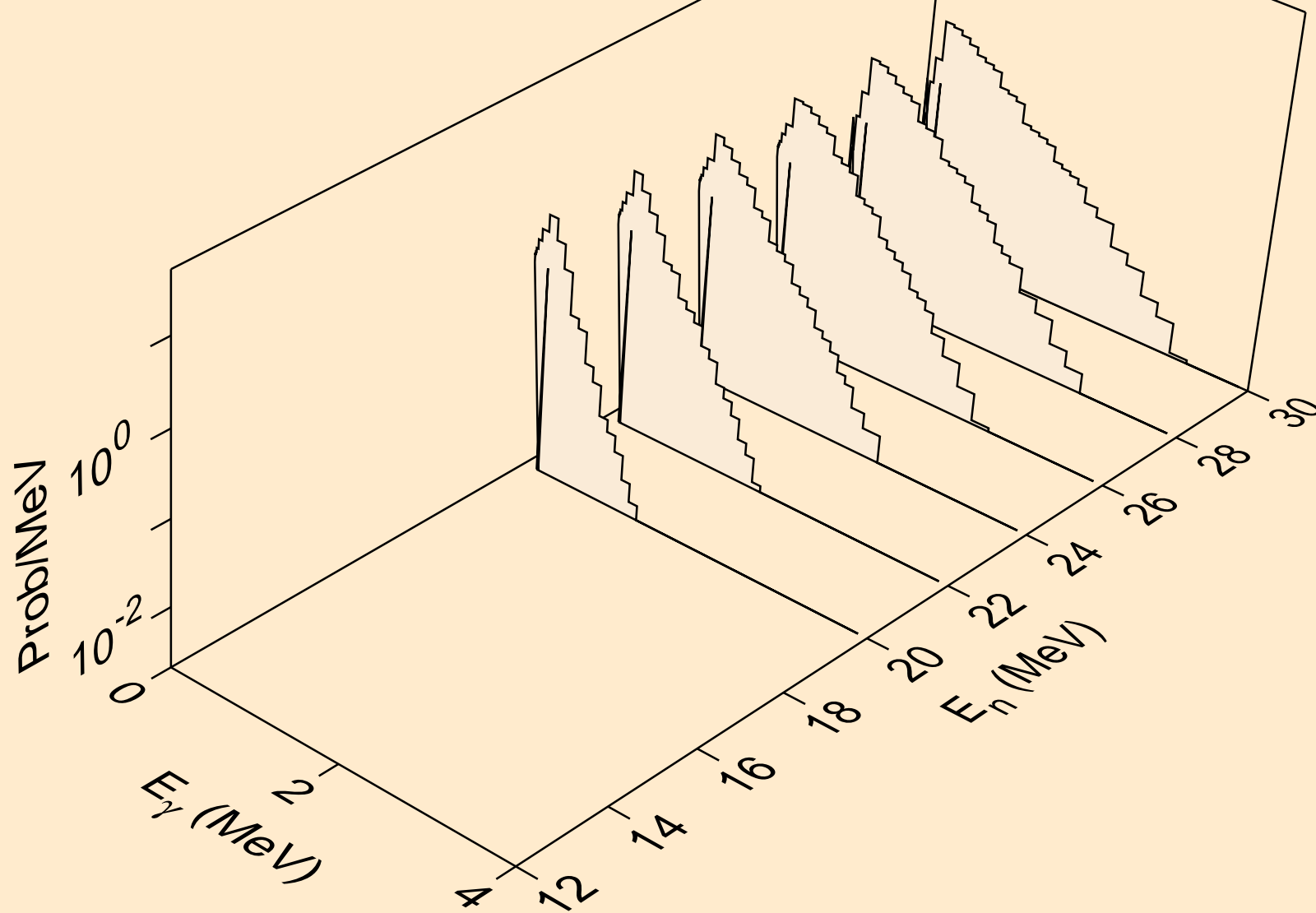

TB167 PROTON ACER TENDL-2021 LIBRARY; T=0.K  
Particle heating contributions

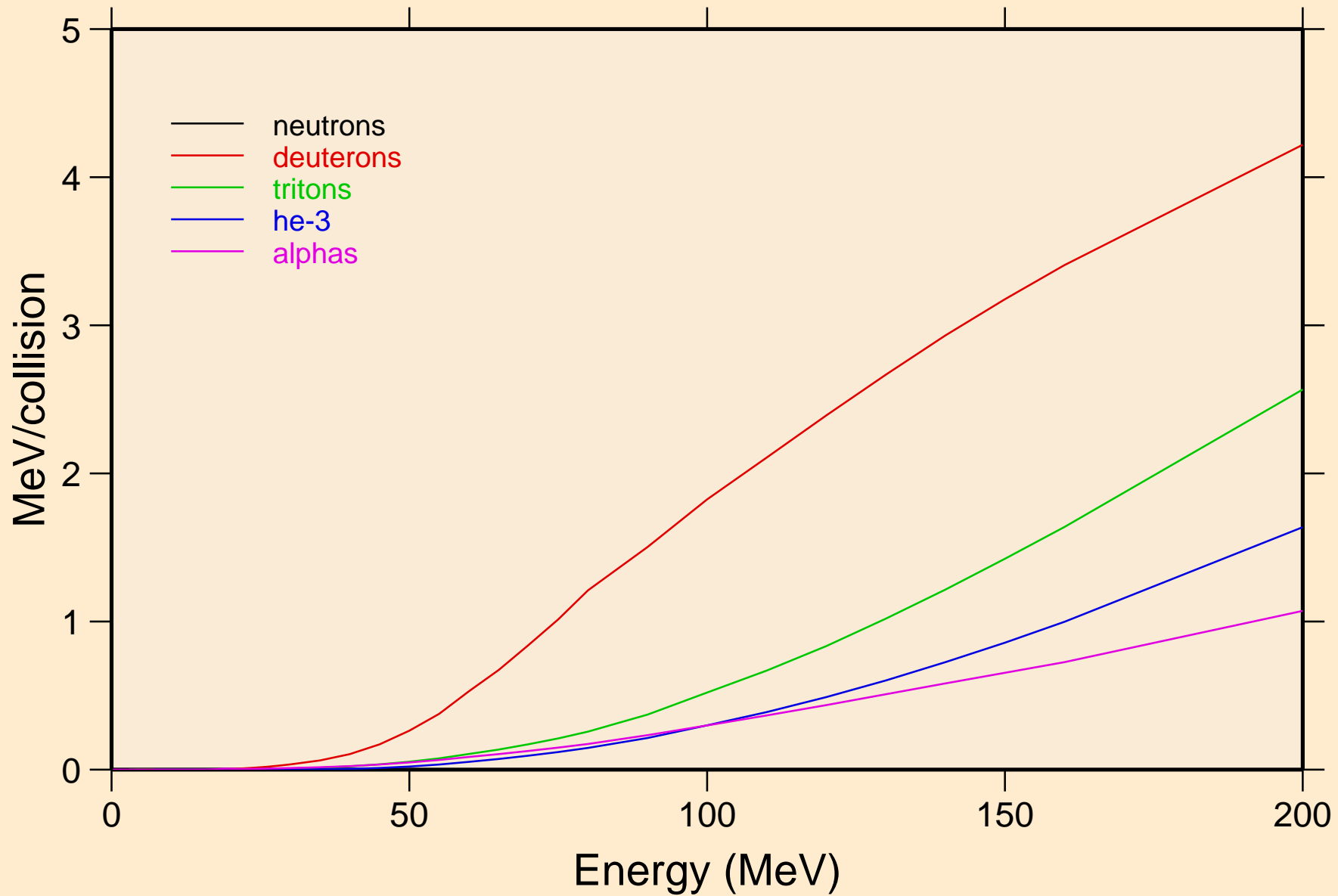

TB167 PROTON ACER TENDL-2021 LIBRARY; T=0.K  
Recoil Heating

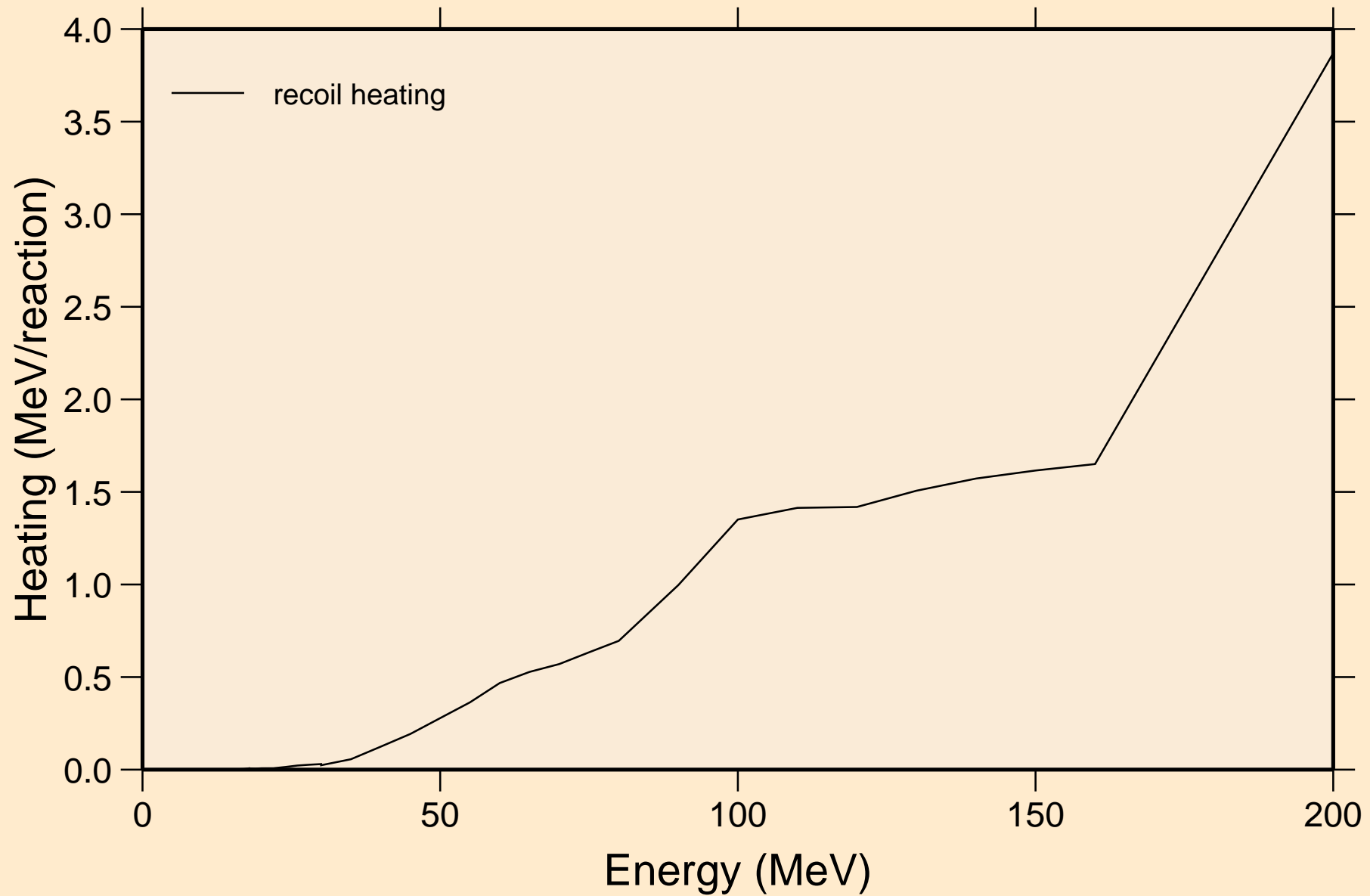

TB167 PROTON ACER TENDL-2021 LIBRARY; T=0.K  
Particle production cross sections

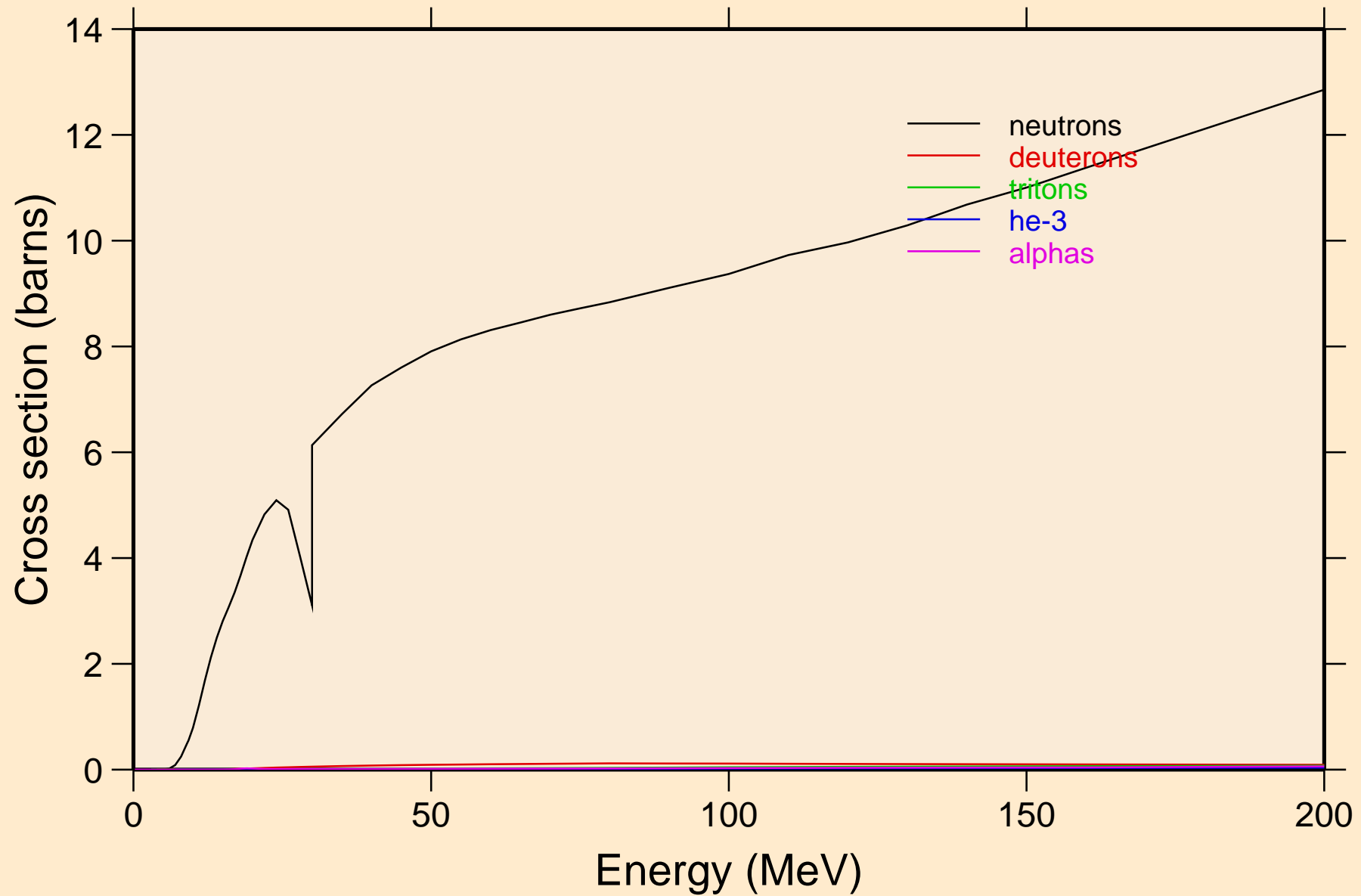

TB167 PROTON ACER TENDL-2021 LIBRARY; T=0.K  
neutrons from (p,n)

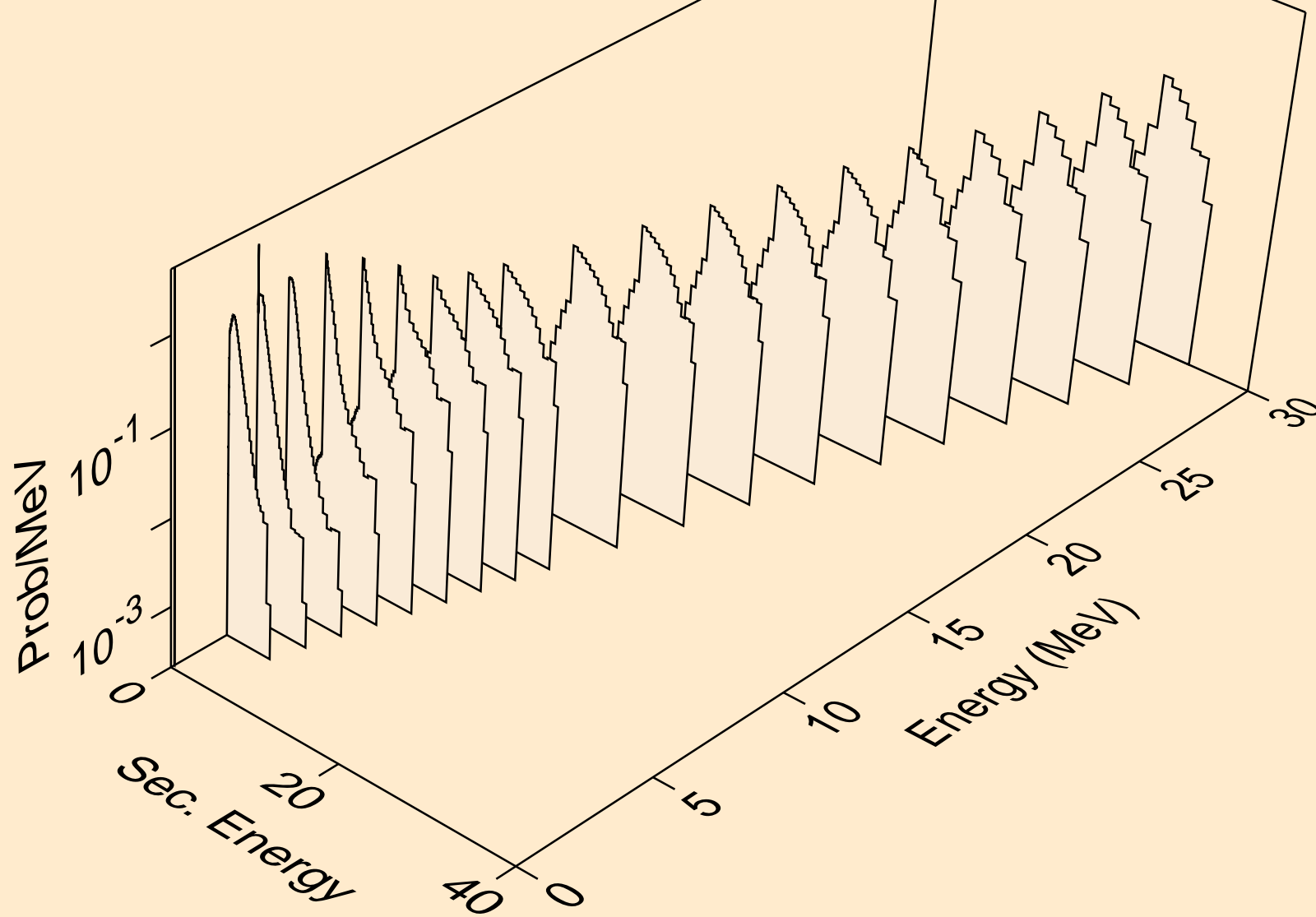

TB167 PROTON ACER TENDL-2021 LIBRARY; T=0.K  
neutrons from (p,x)

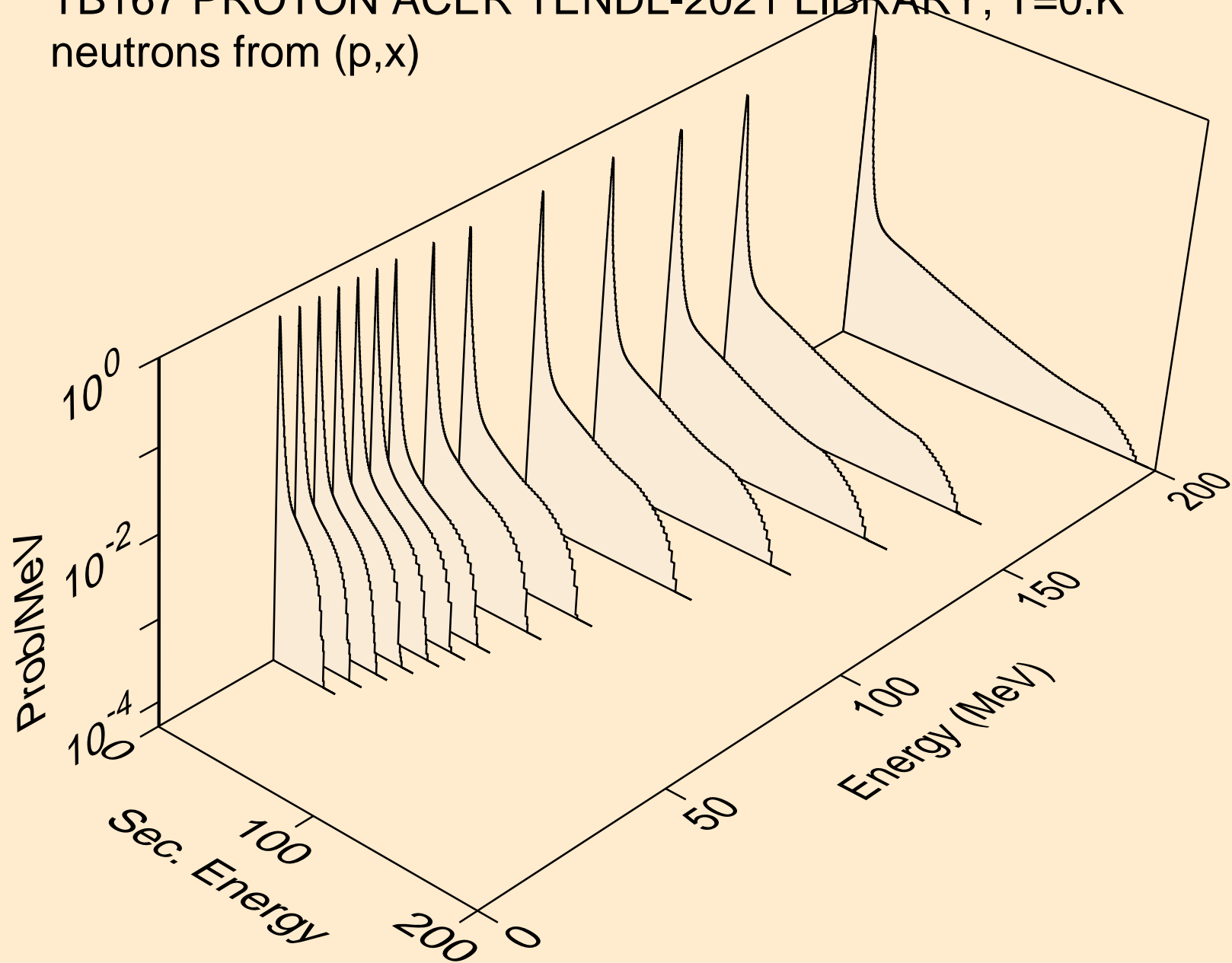

TB167 PROTON ACER TENDL-2021 LIBRARY; T=0.K  
neutrons from (p,2nd)

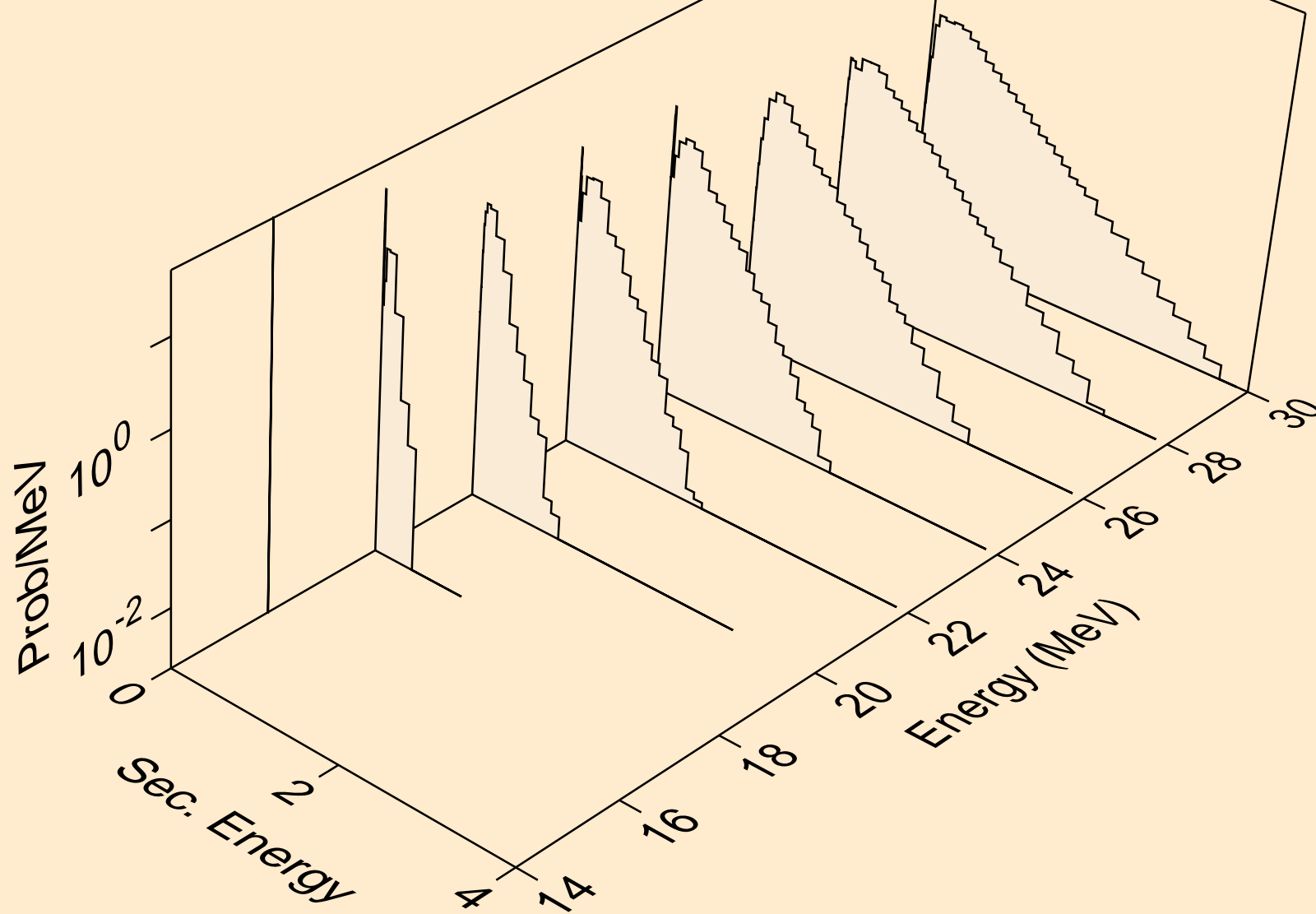



TB167 PROTON ACER TENDL-2021 LIBRARY; T=0.K  
neutrons from (p,2n)

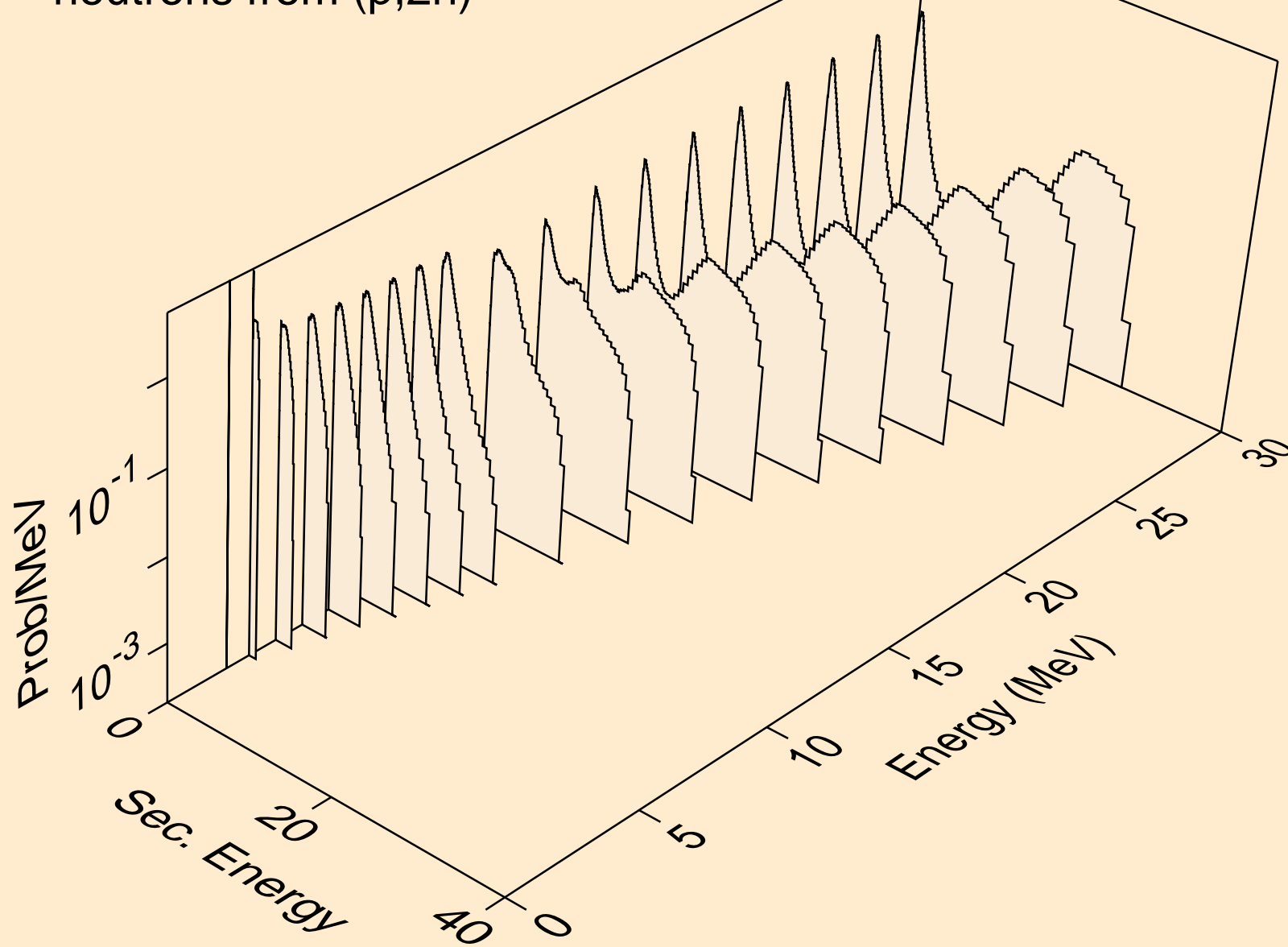

TB167 PROTON ACER TENDL-2021 LIBRARY; T=0.K  
neutrons from (p,3n)

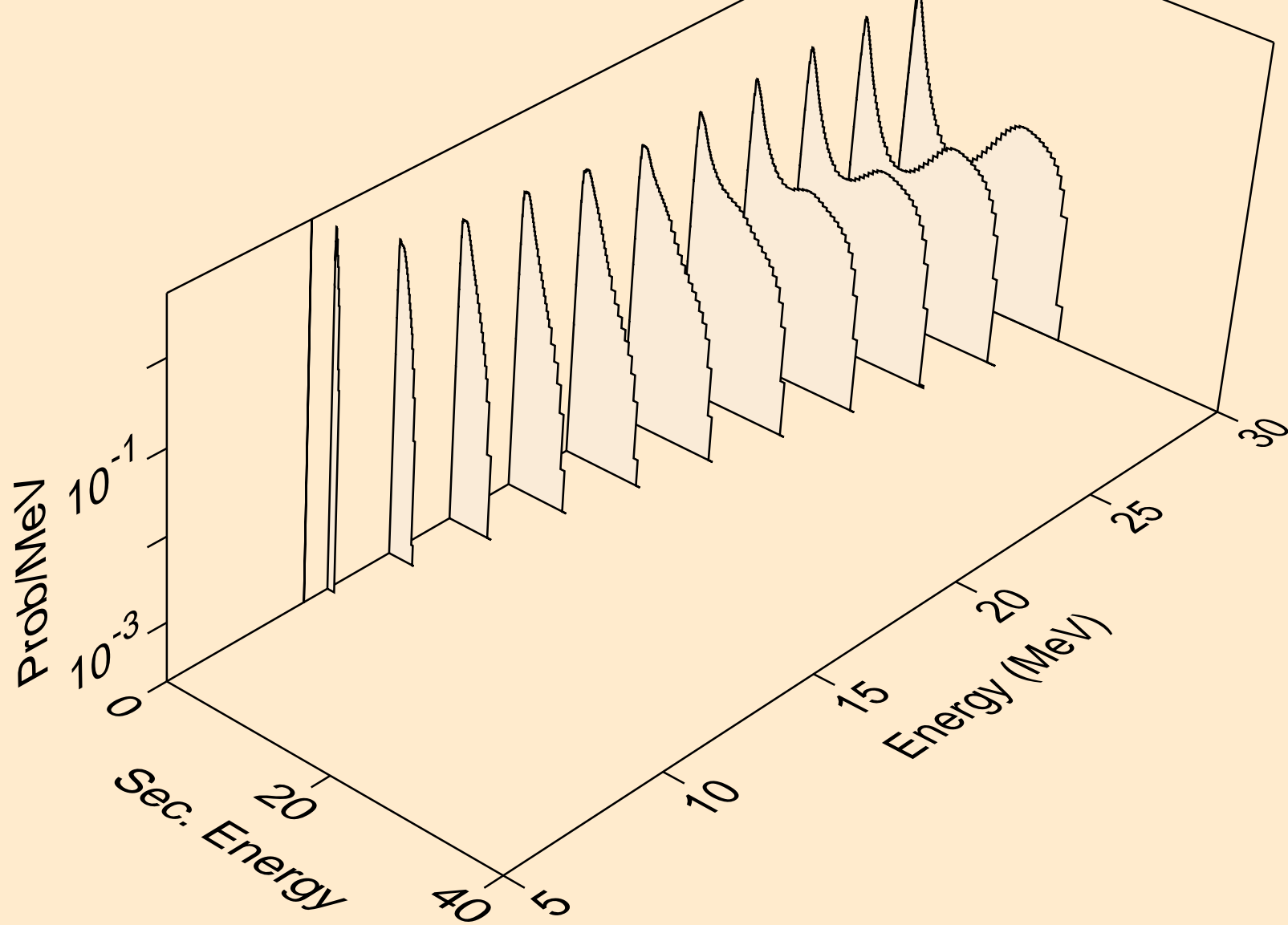

TB167 PROTON ACER TENDL-2021 LIBRARY; T=0.K  
neutrons from (p,n\*)a

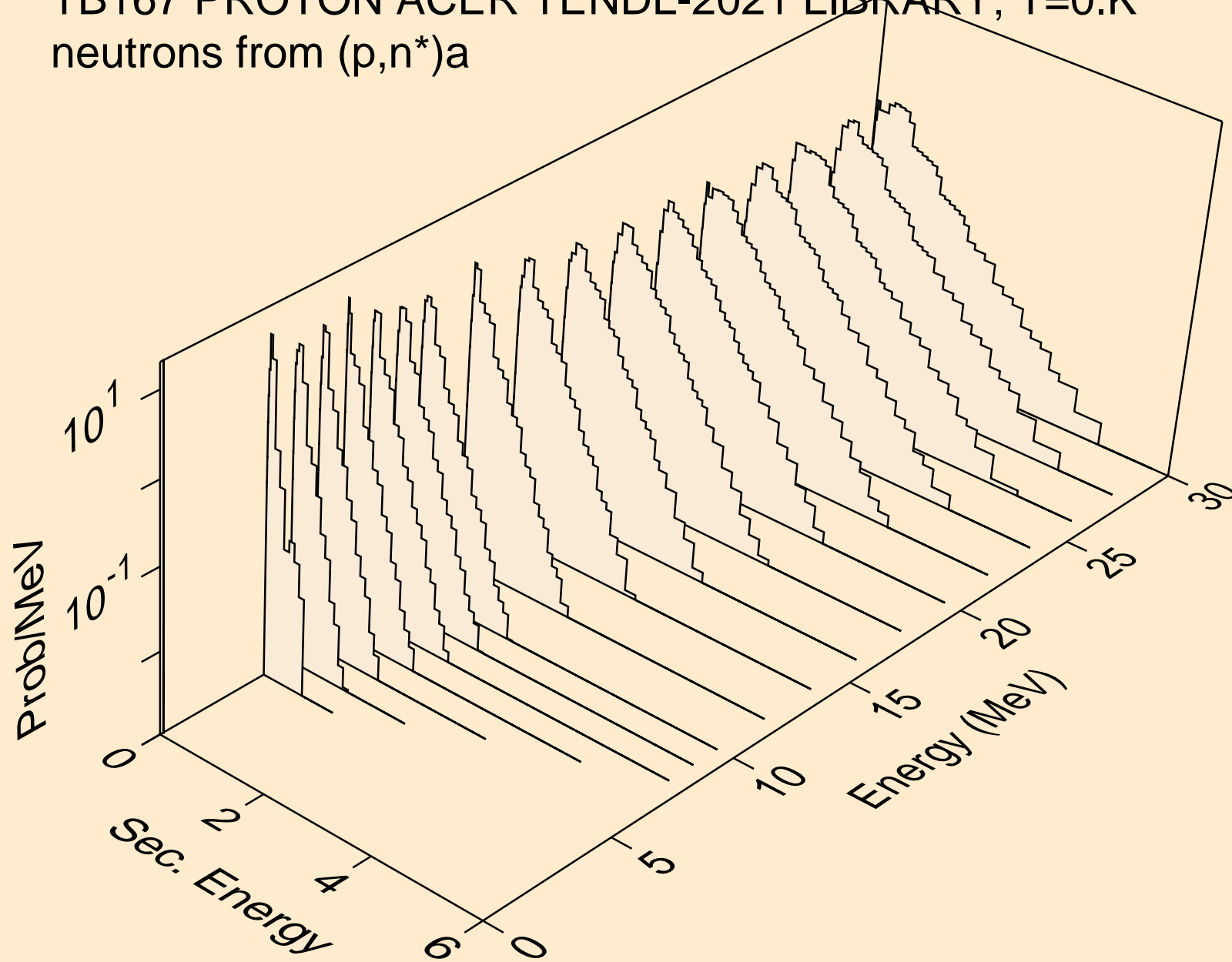

TB167 PROTON ACER TENDL-2021 LIBRARY; T=0.K  
neutrons from (p,2n)a

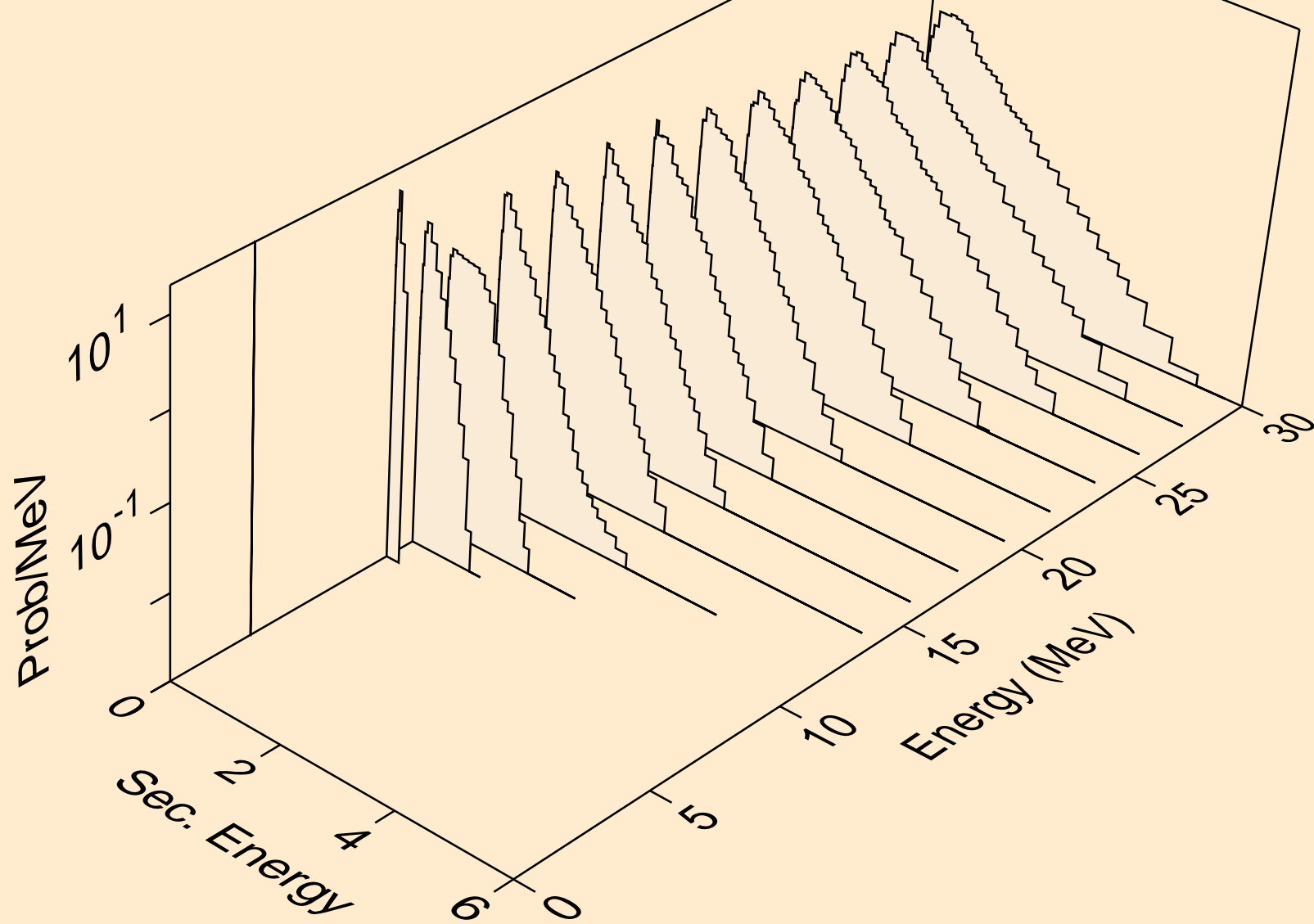

TB167 PROTON ACER TENDL-2021 LIBRARY; T=0.K  
neutrons from (p,3n)a

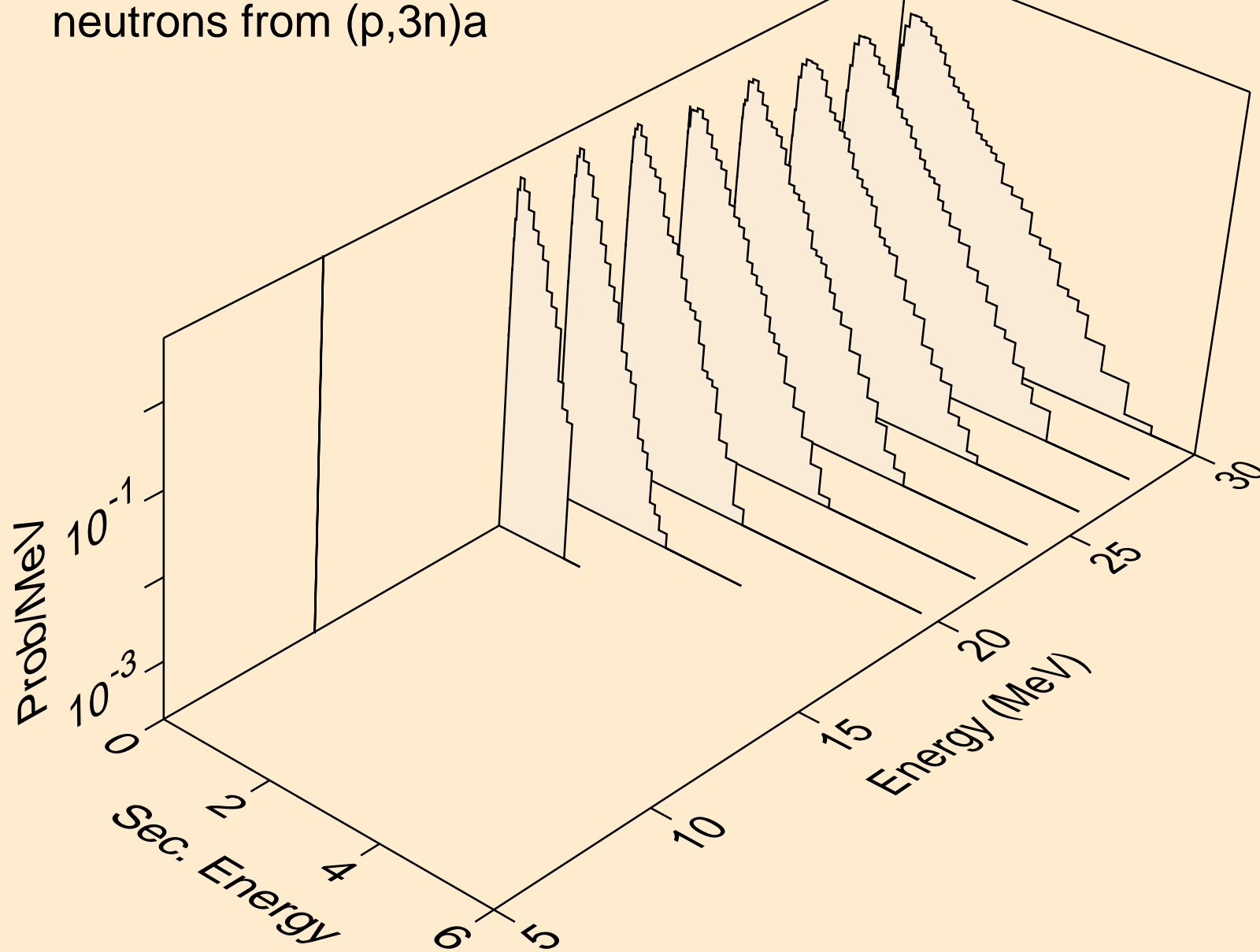

TB167 PROTON ACER TENDL-2021 LIBRARY; T=0.K  
neutrons from (p,n\*)p

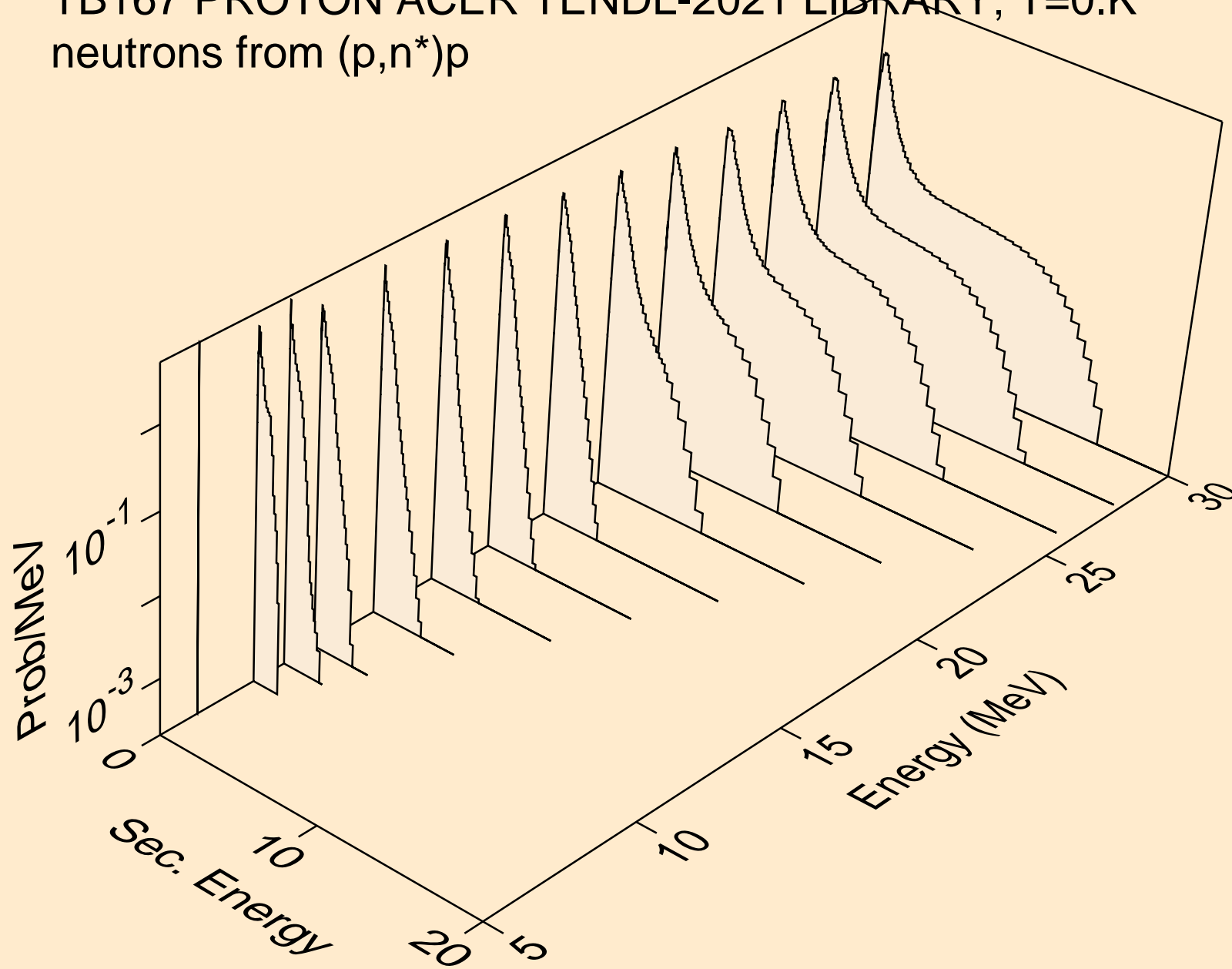

TB167 PROTON ACER TENDL-2021 LIBRARY; T=0.K  
neutrons from (p,n\*)d

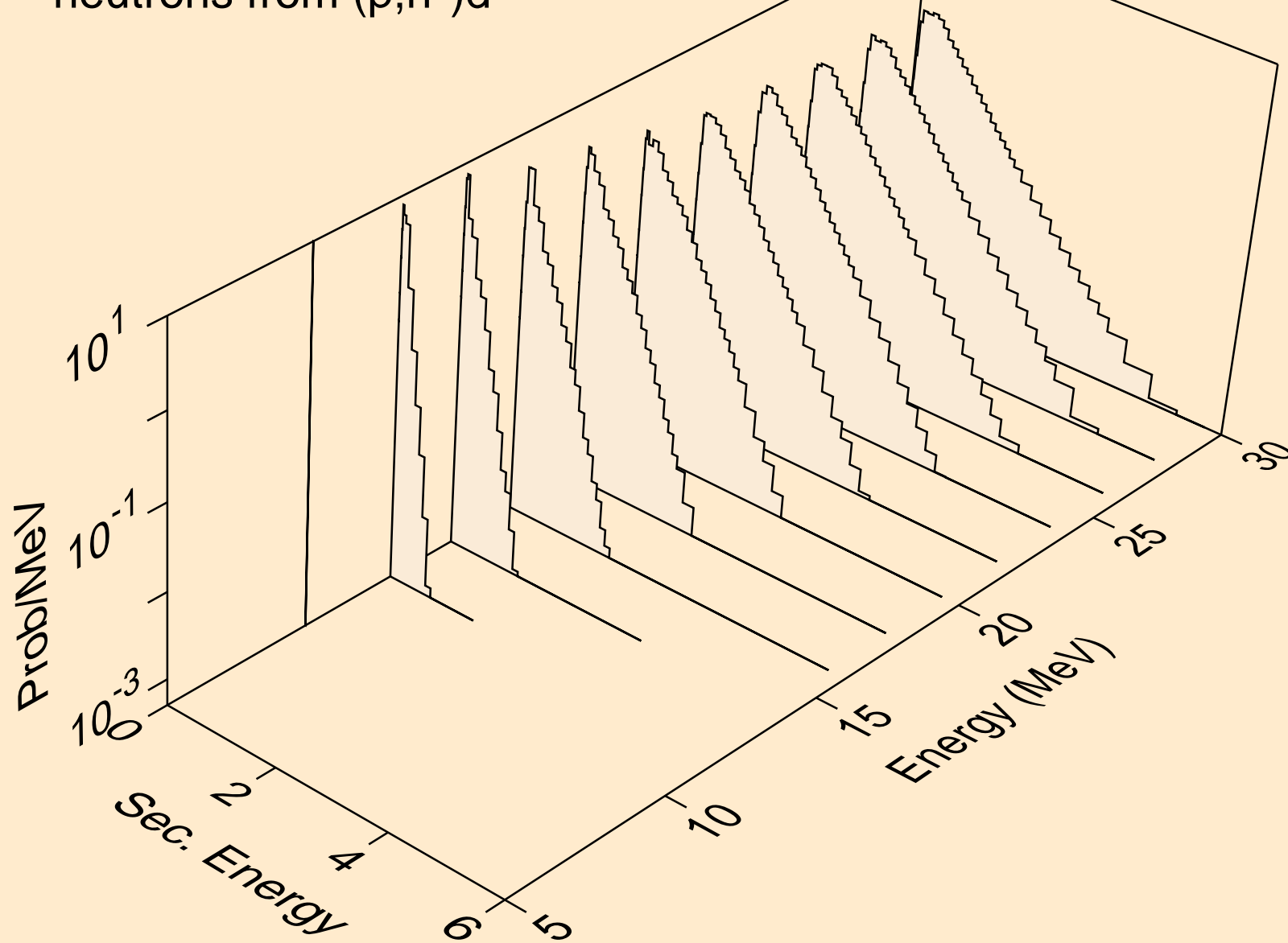

TB167 PROTON ACER TENDL-2021 LIBRARY; T=0.K  
neutrons from (p,n\*)t

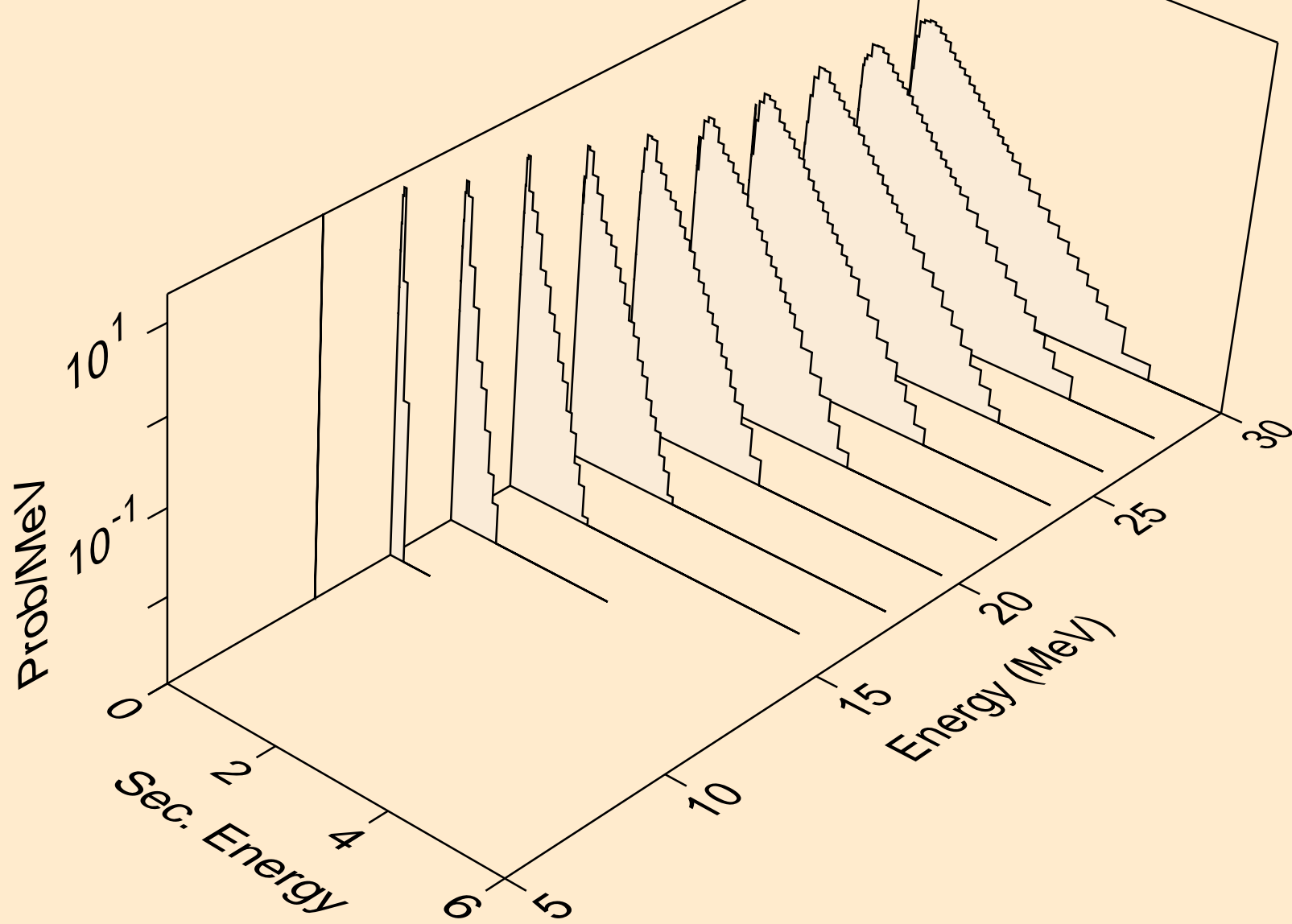



TB167 PROTON ACER TENDL-2021 LIBRARY; T=0.K  
neutrons from (p,n\*)he3

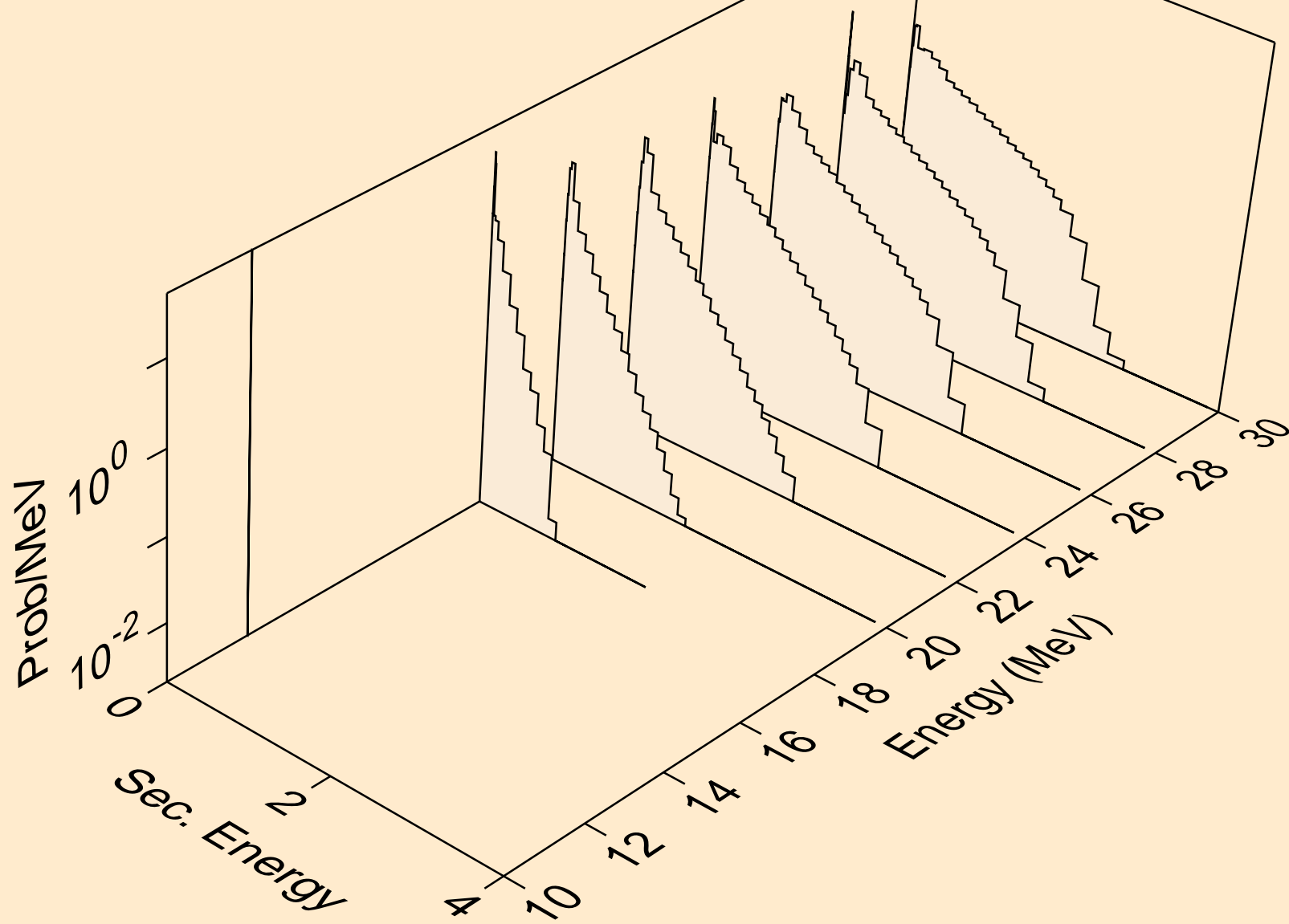

TB167 PROTON ACER TENDL-2021 LIBRARY; T=0.K  
neutrons from (p,4n)

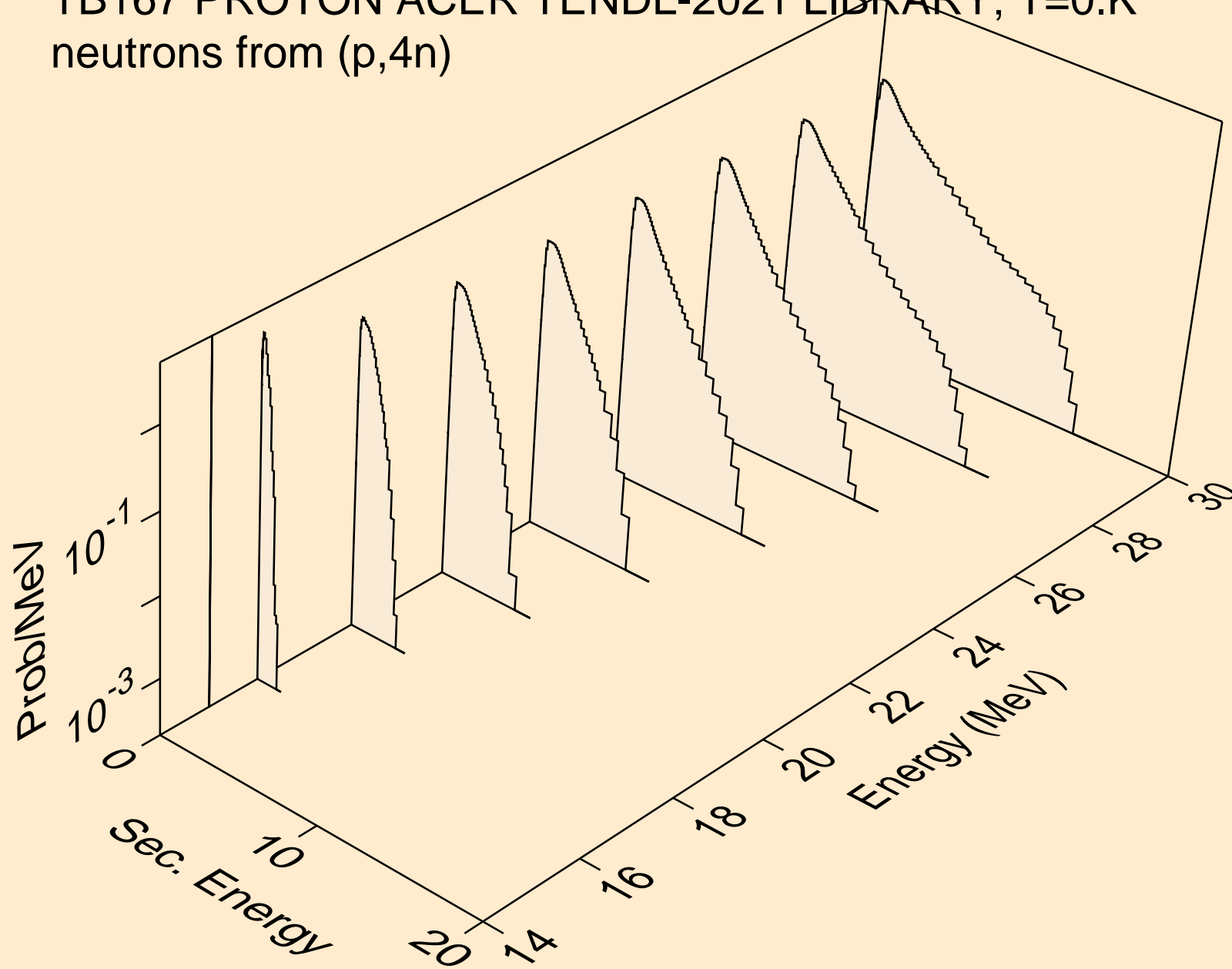

TB167 PROTON ACER TENDL-2021 LIBRARY; T=0.K  
neutrons from (p,2np)

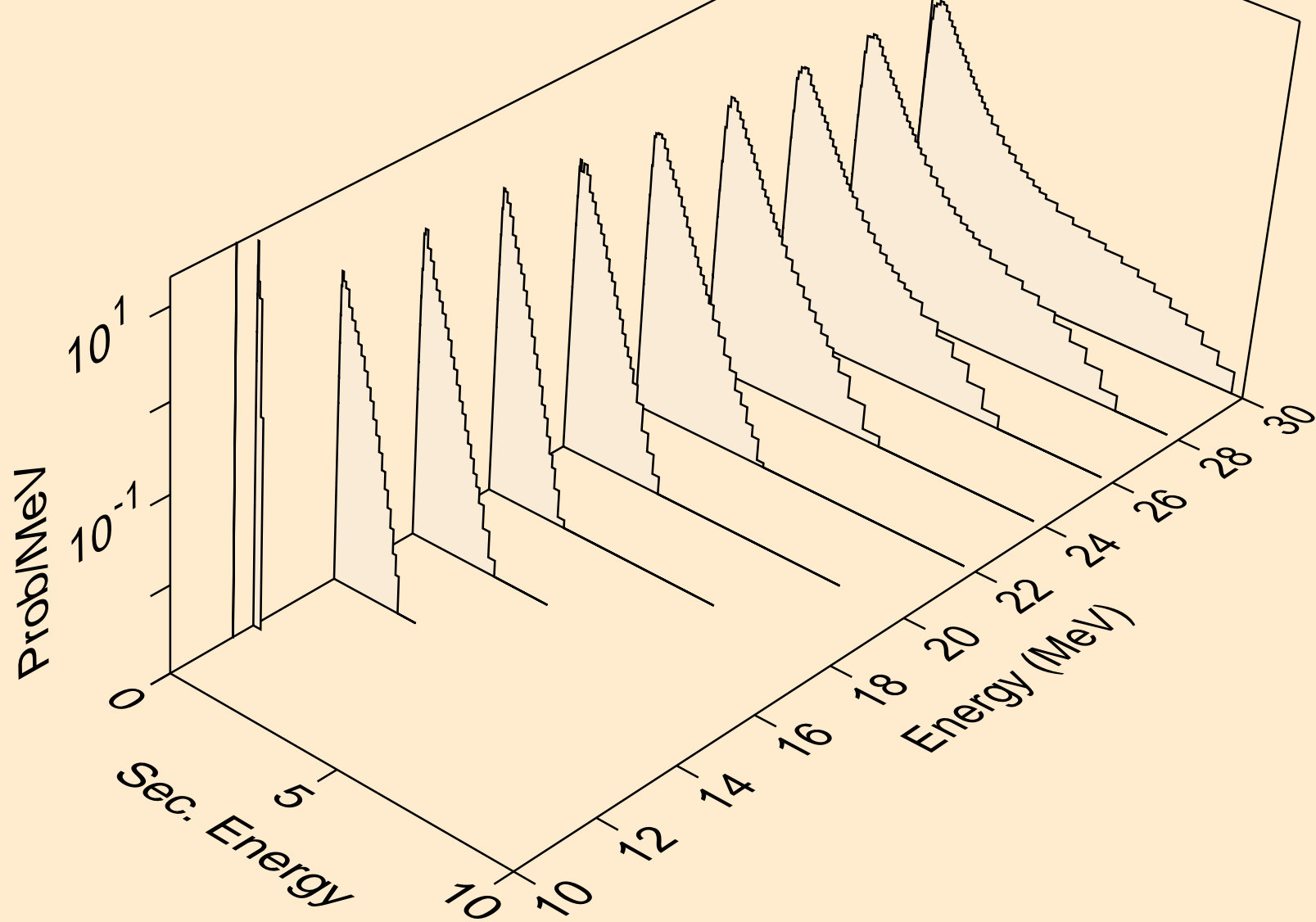

TB167 PROTON ACER TENDL-2021 LIBRARY; T=0.K  
neutrons from (p,3np)

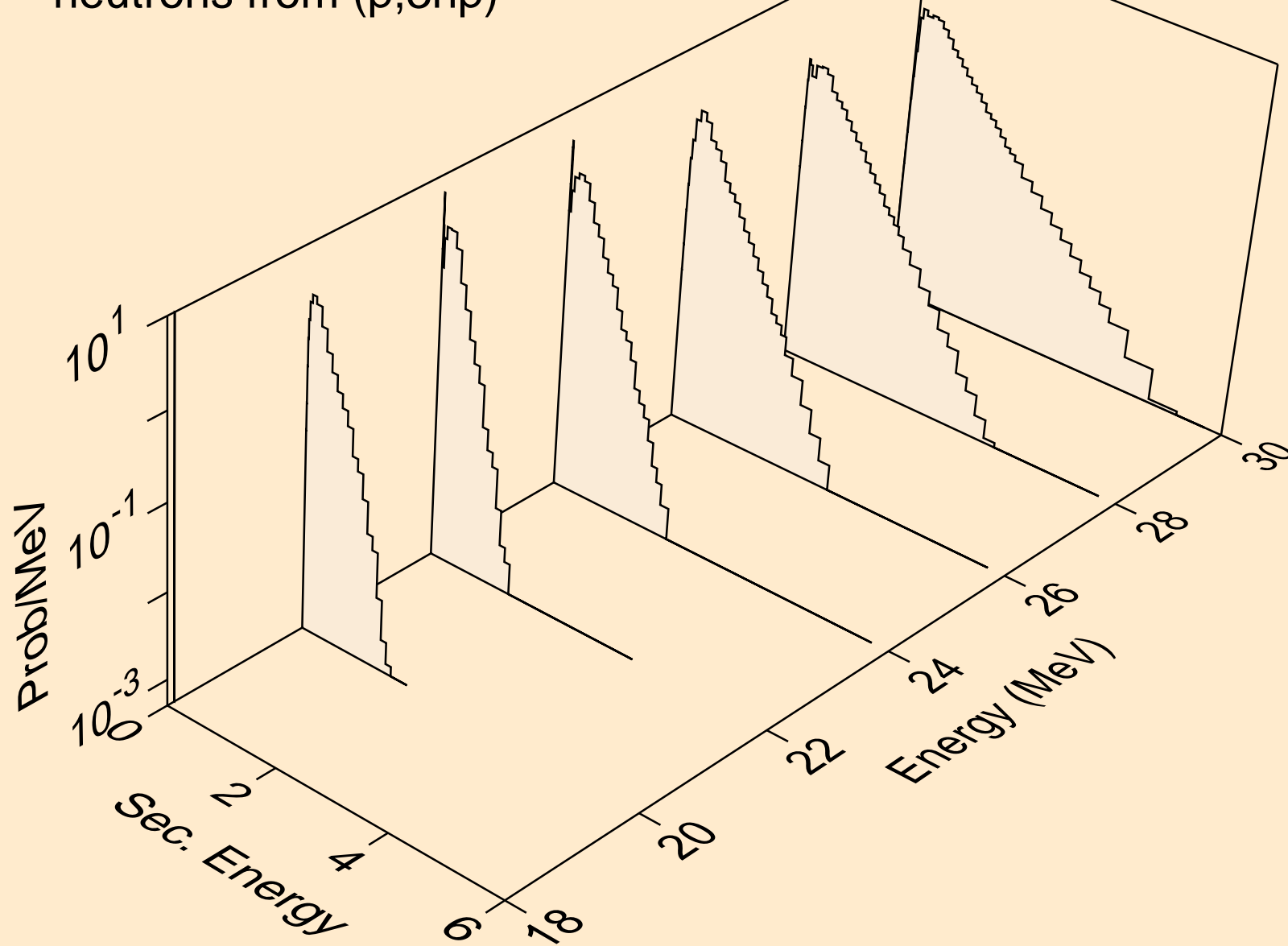

TB167 PROTON ACER TENDL-2021 LIBRARY; T=0.K  
neutrons from (p,2np)

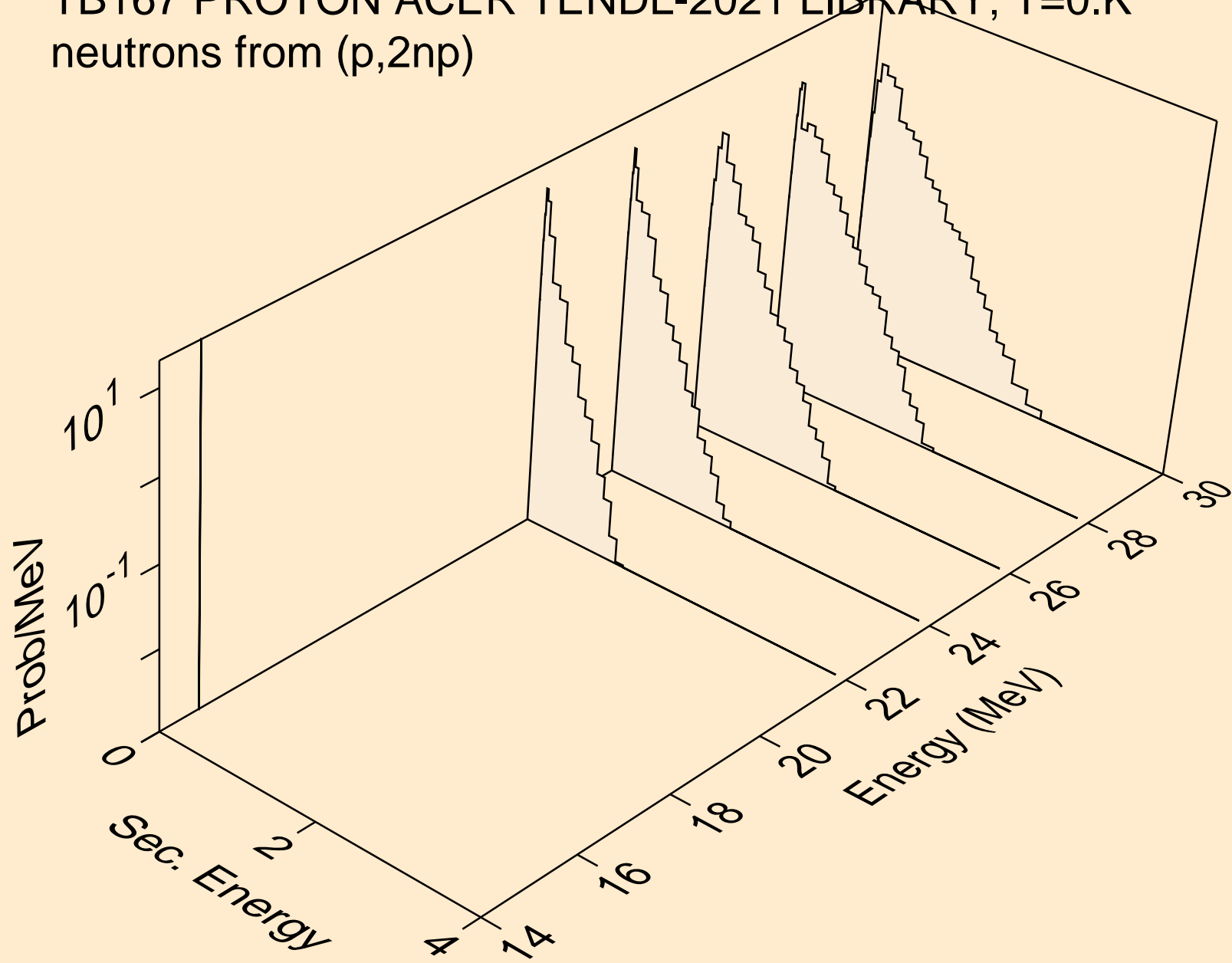

TB167 PROTON ACER TENDL-2021 LIBRARY; T=0.K  
deuterons from (p,x)

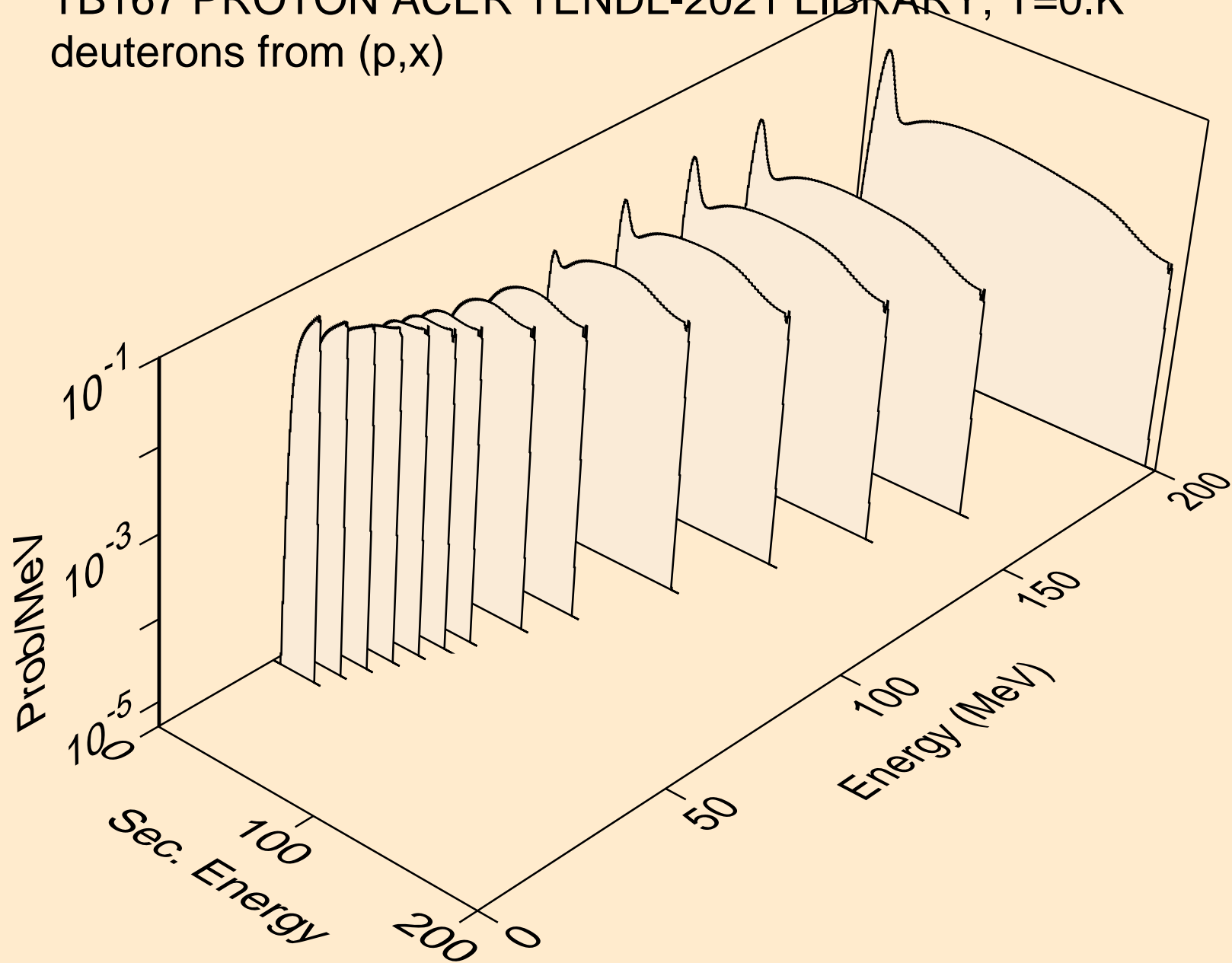

TB167 PROTON ACER TENDL-2021 LIBRARY; T=0.K  
deuterons from (p,2nd)

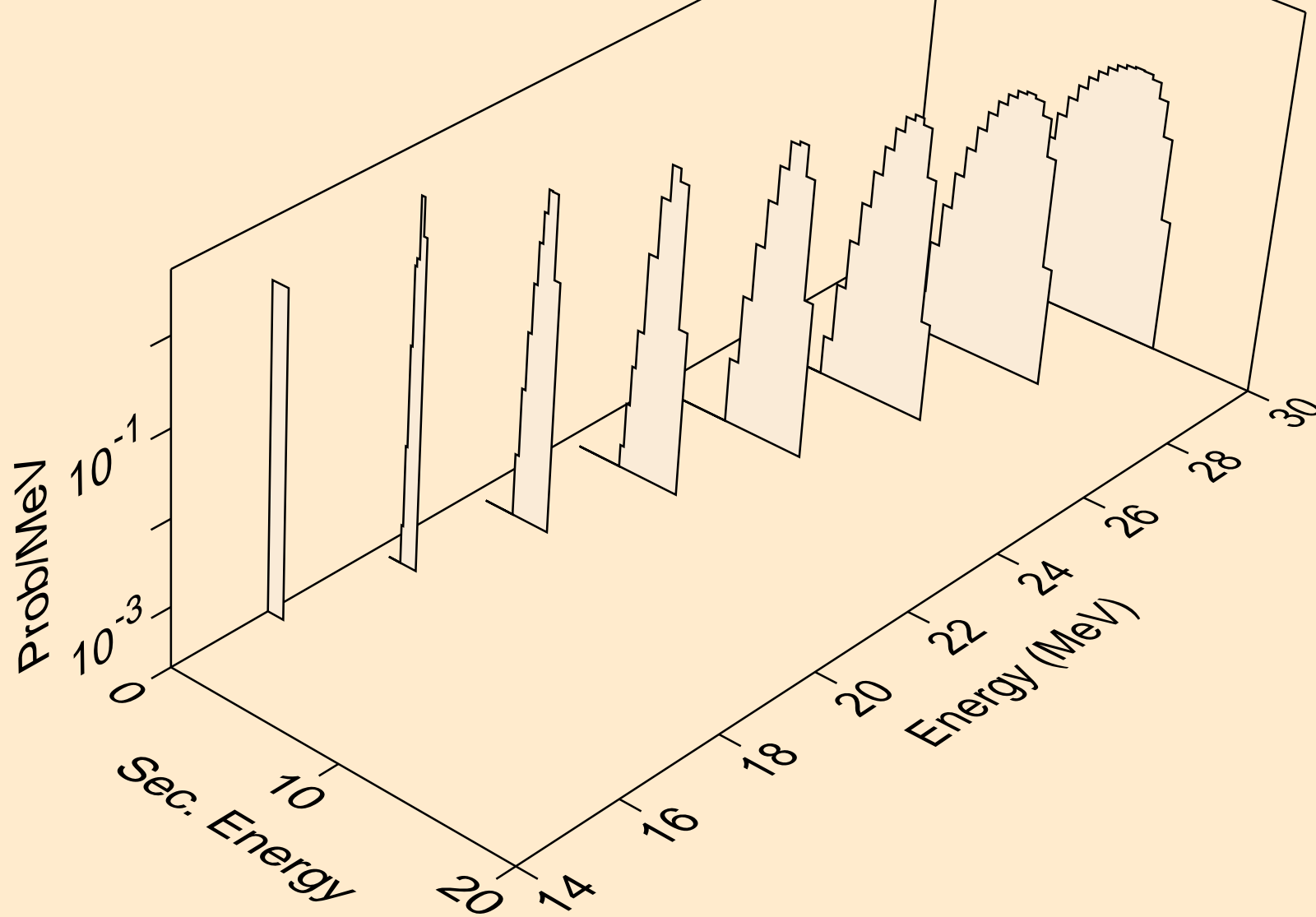

TB167 PROTON ACER TENDL-2021 LIBRARY; T=0.K  
deuterons from (p,n\*)d

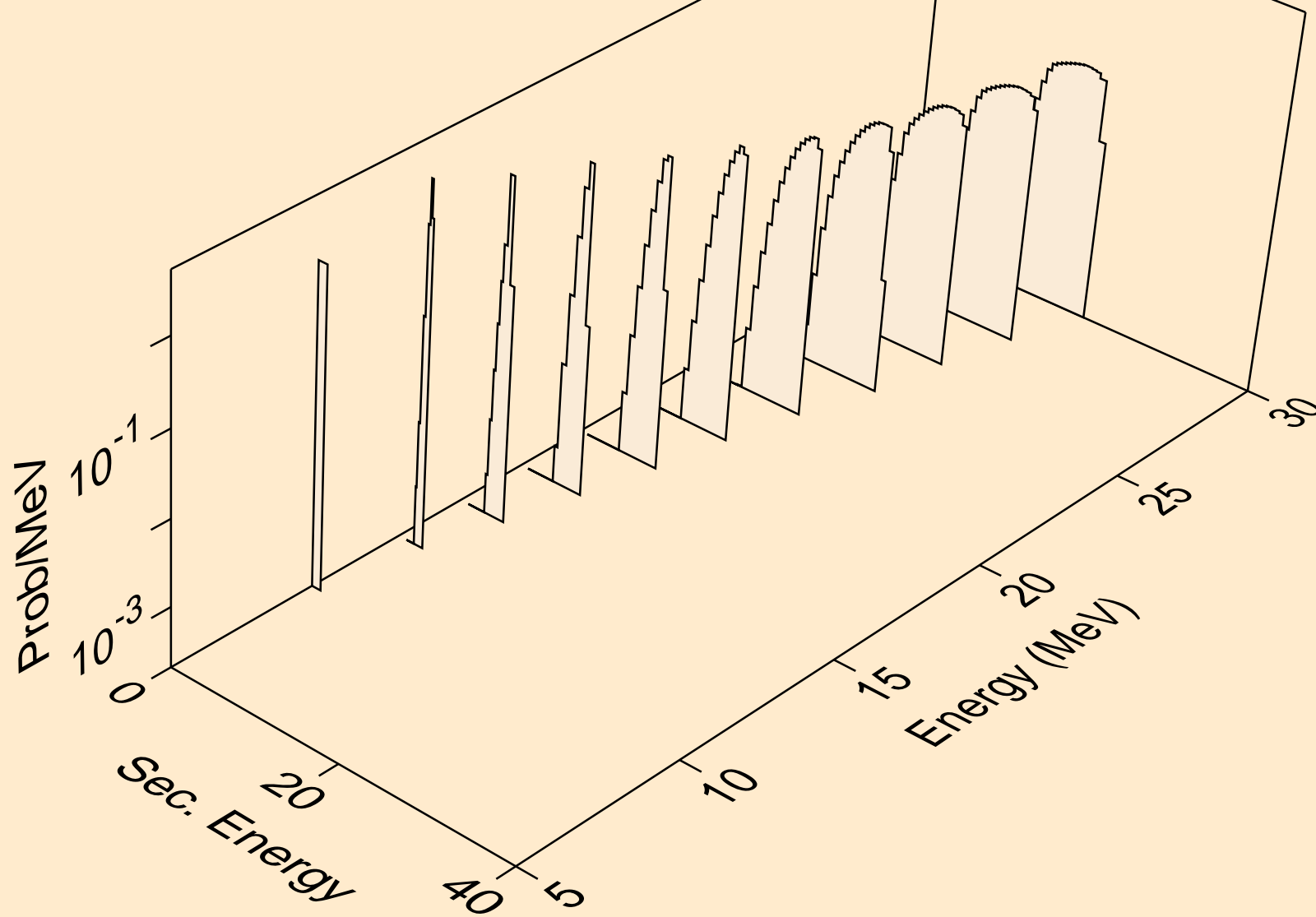



TB167 PROTON ACER TENDL-2021 LIBRARY; T=0.K  
deuterons from (p,d)

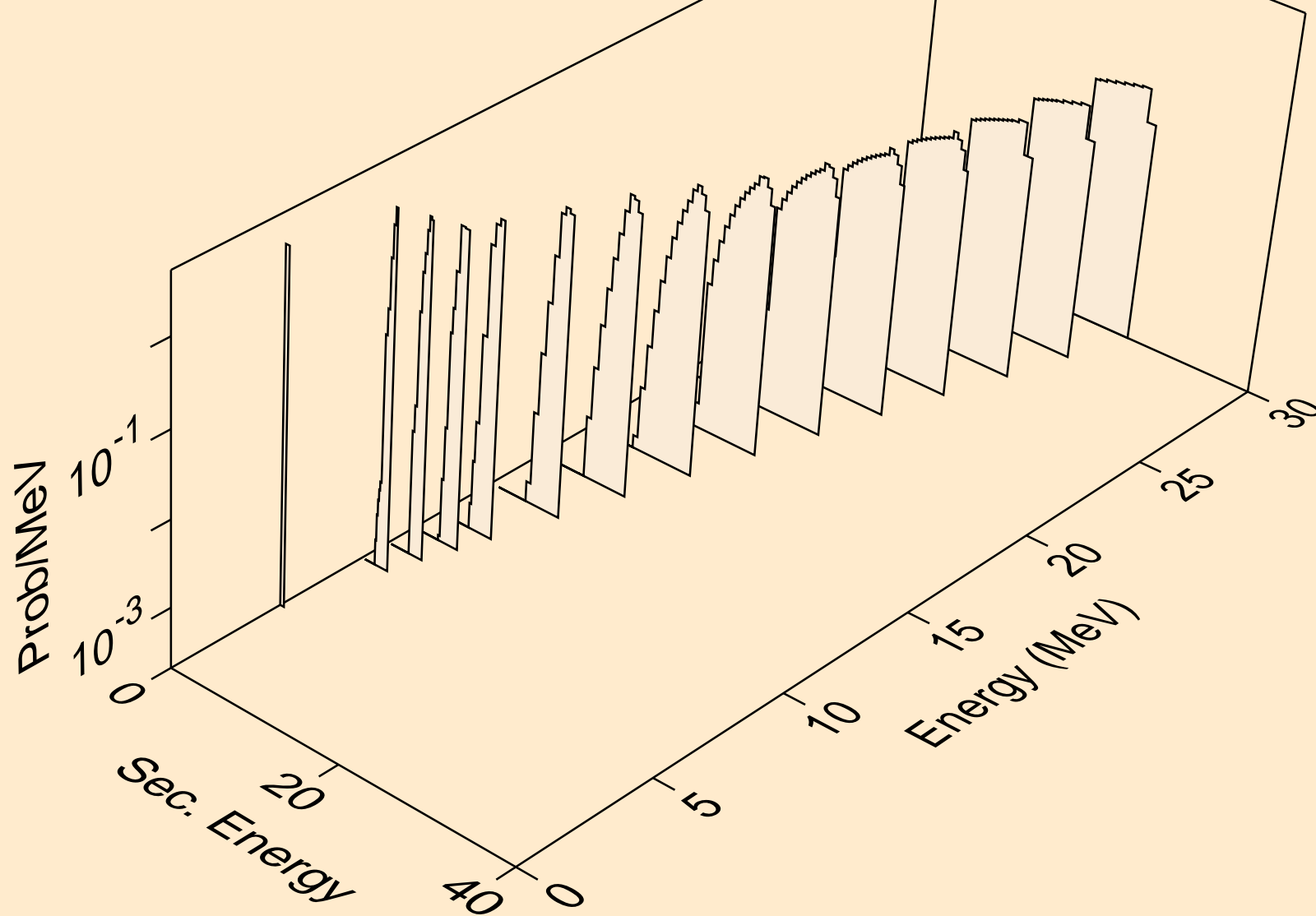

TB167 PROTON ACER TENDL-2021 LIBRARY; T=0.K  
deuterons from (p,pd)

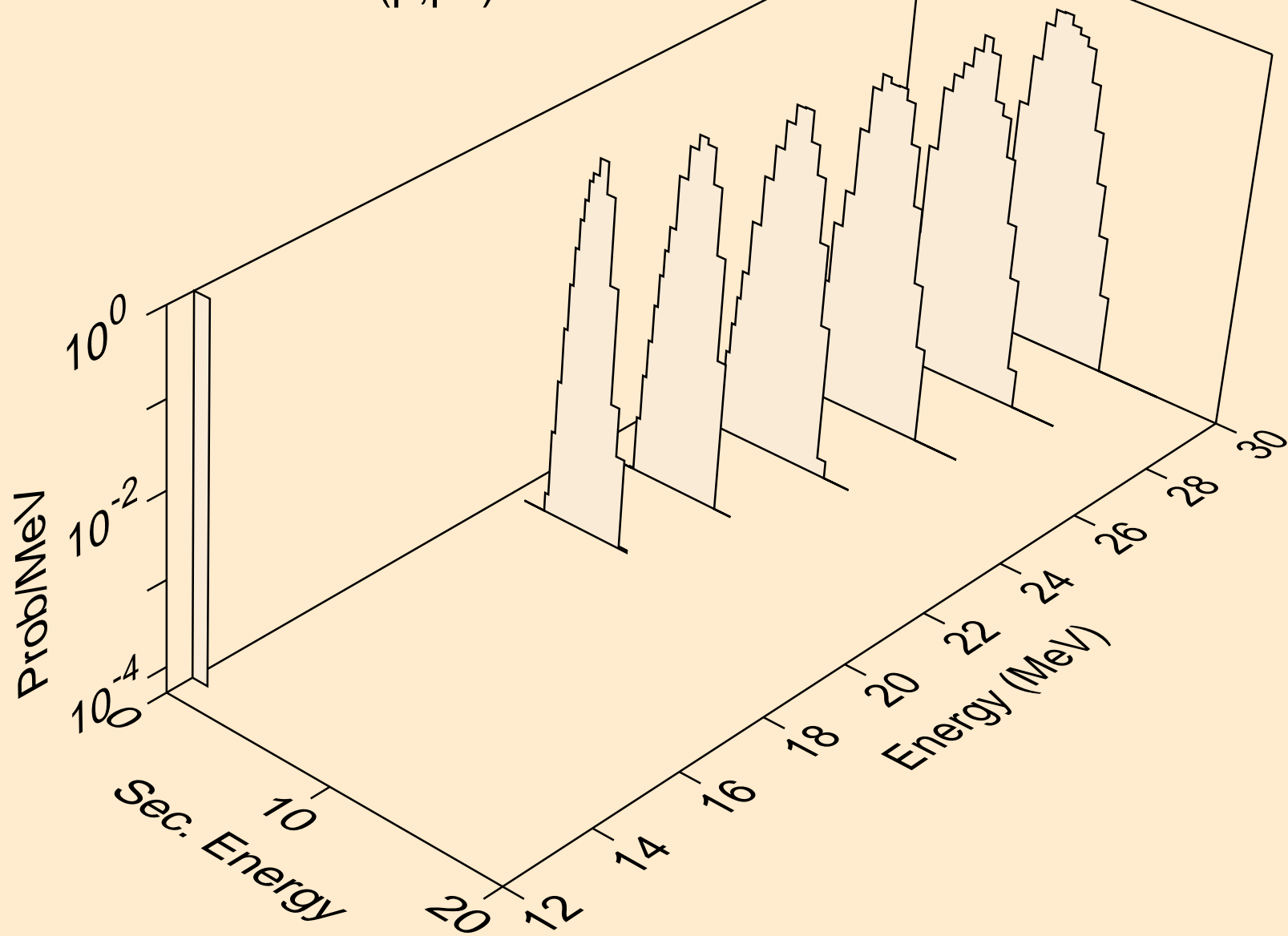

TB167 PROTON ACER TENDL-2021 LIBRARY; T=0.K  
tritons from (p,x)

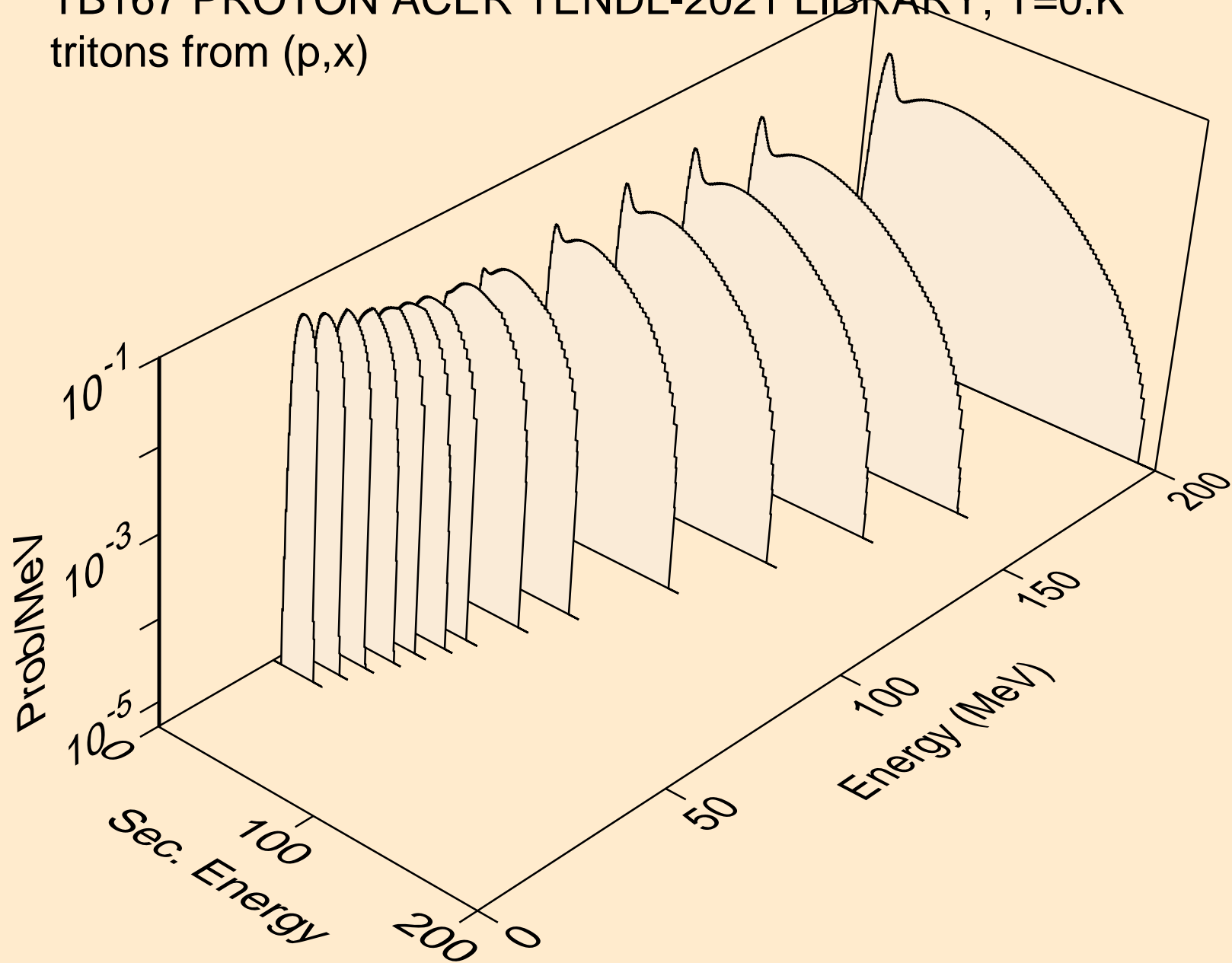

TB167 PROTON ACER TENDL-2021 LIBRARY; T=0.K  
tritons from (p,n\*)t

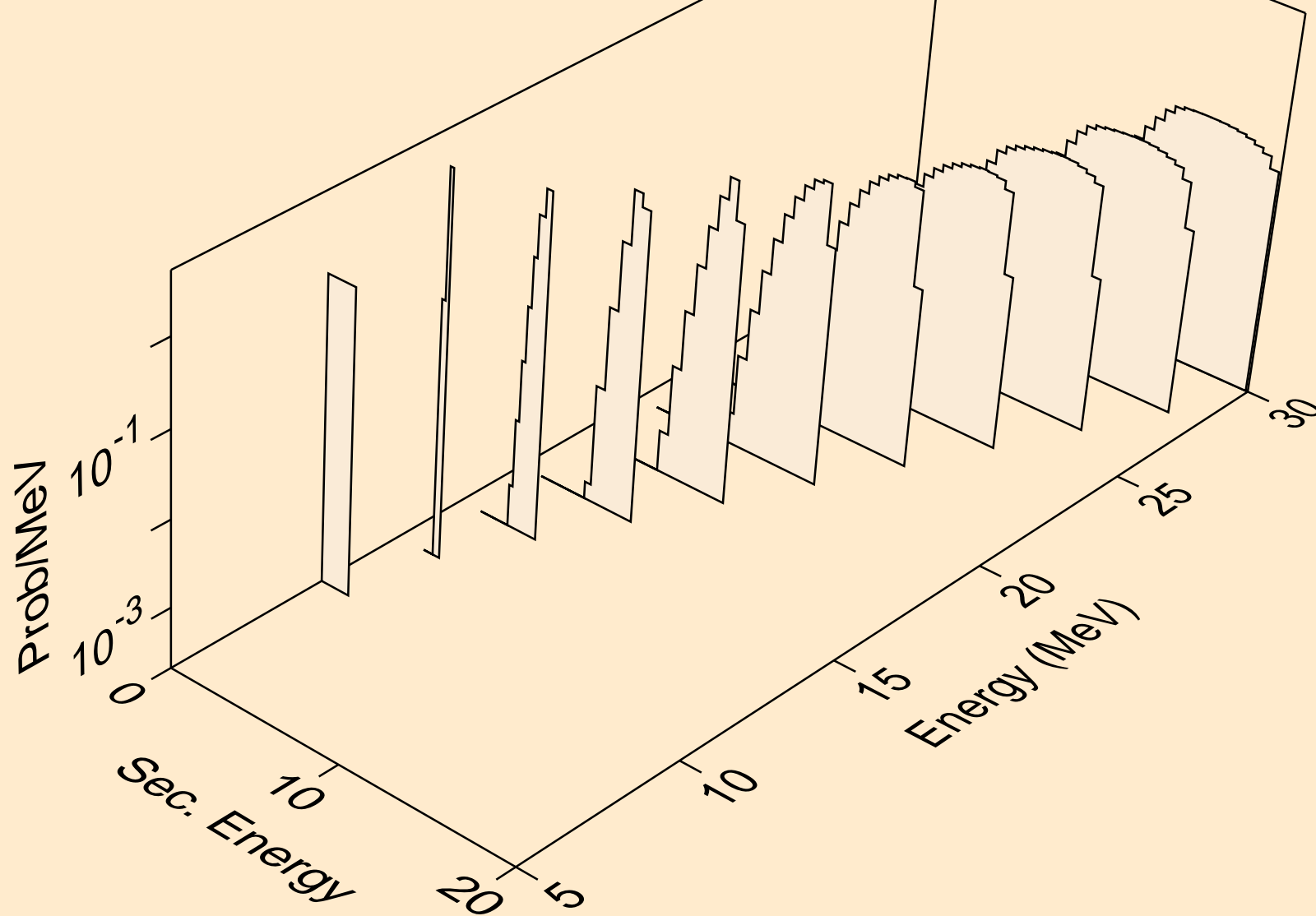

TB167 PROTON ACER TENDL-2021 LIBRARY; T=0.K  
tritons from (p,t)

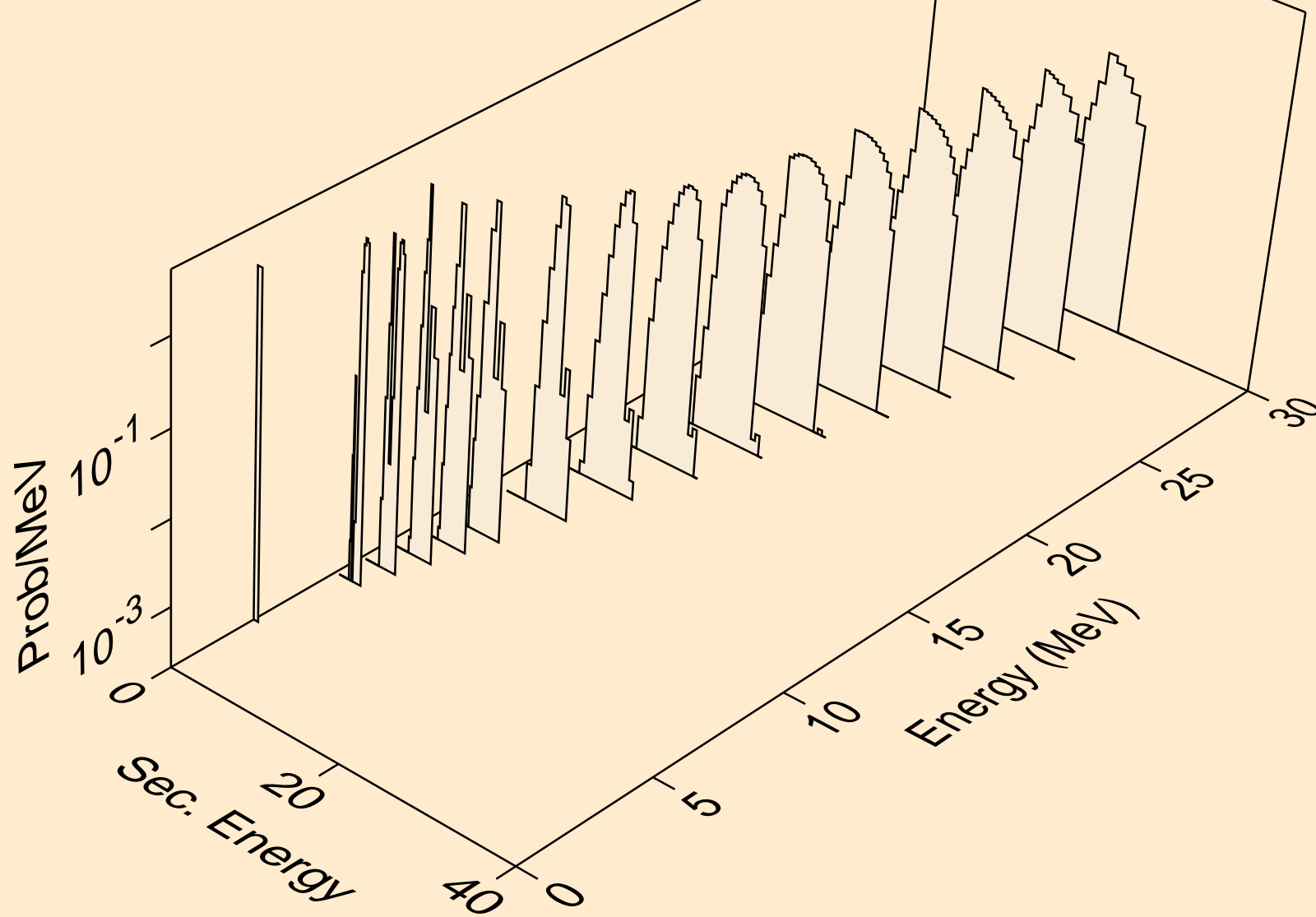

TB167 PROTON ACER TENDL-2021 LIBRARY; T=0.K  
he3s from (p,x)

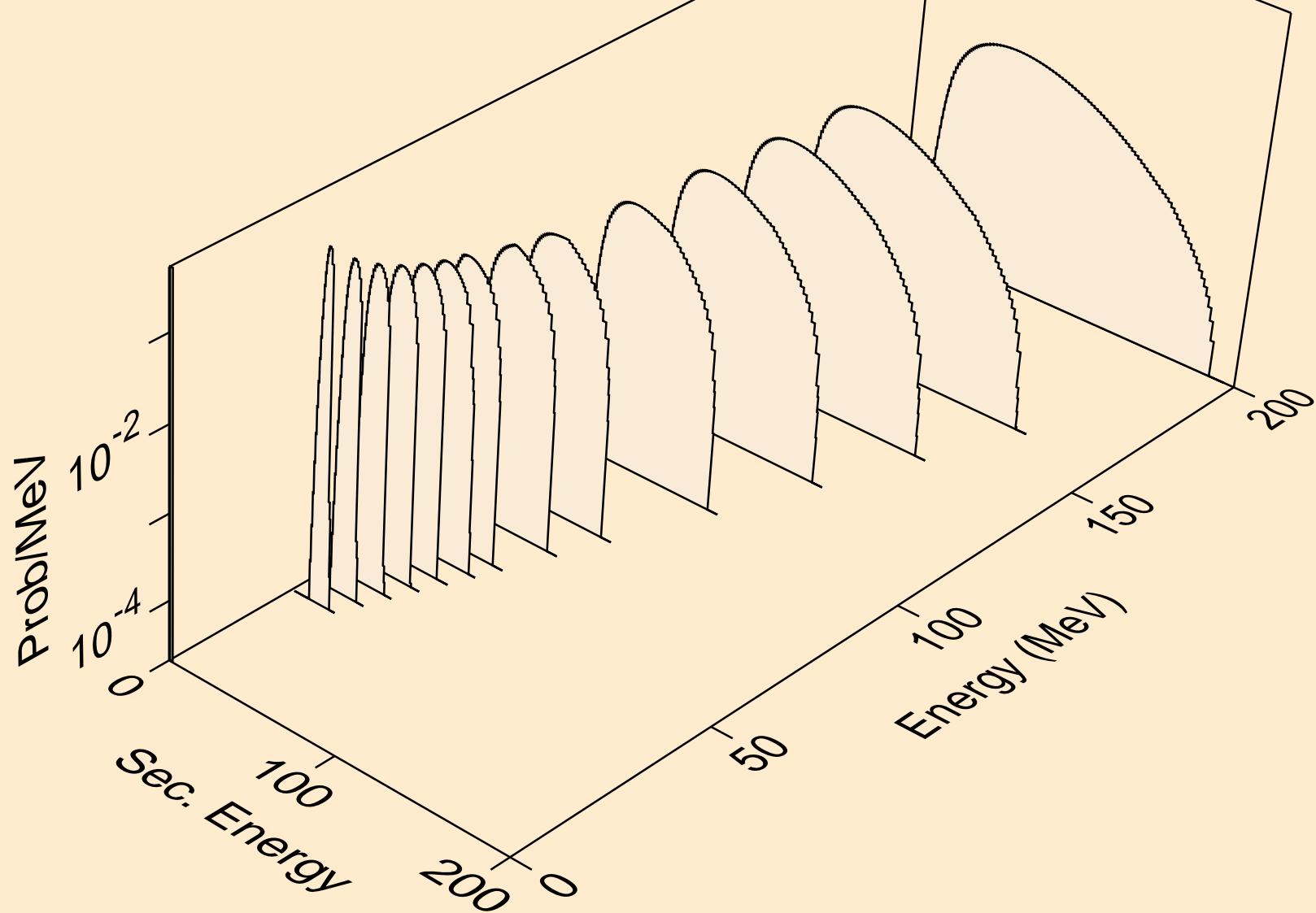

TB167 PROTON ACER TENDL-2021 LIBRARY; T=0.K  
he3s from (p,n\*)he3

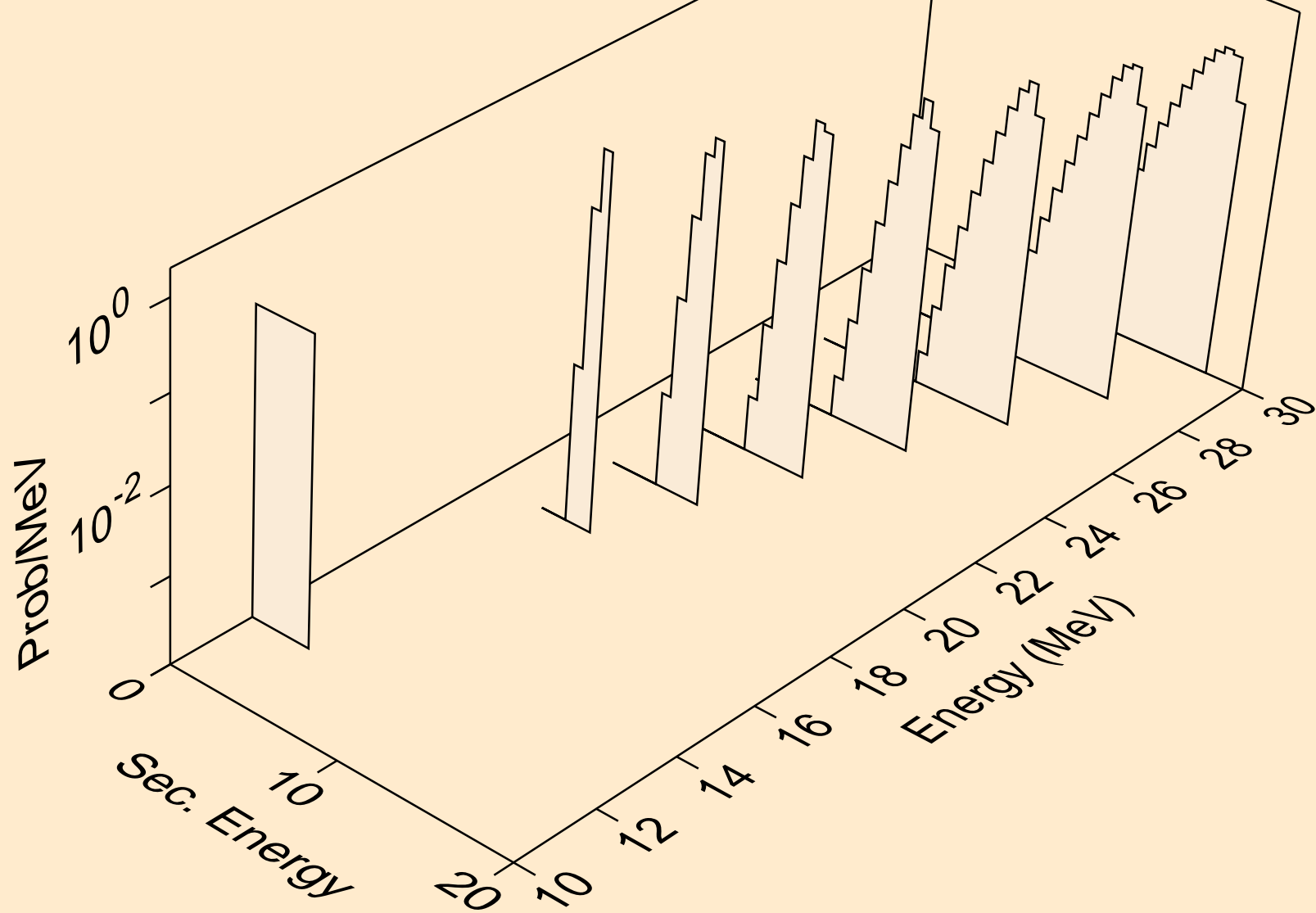

TB167 PROTON ACER TENDL-2021 LIBRARY; T=0.K  
he3s from (p,he3)

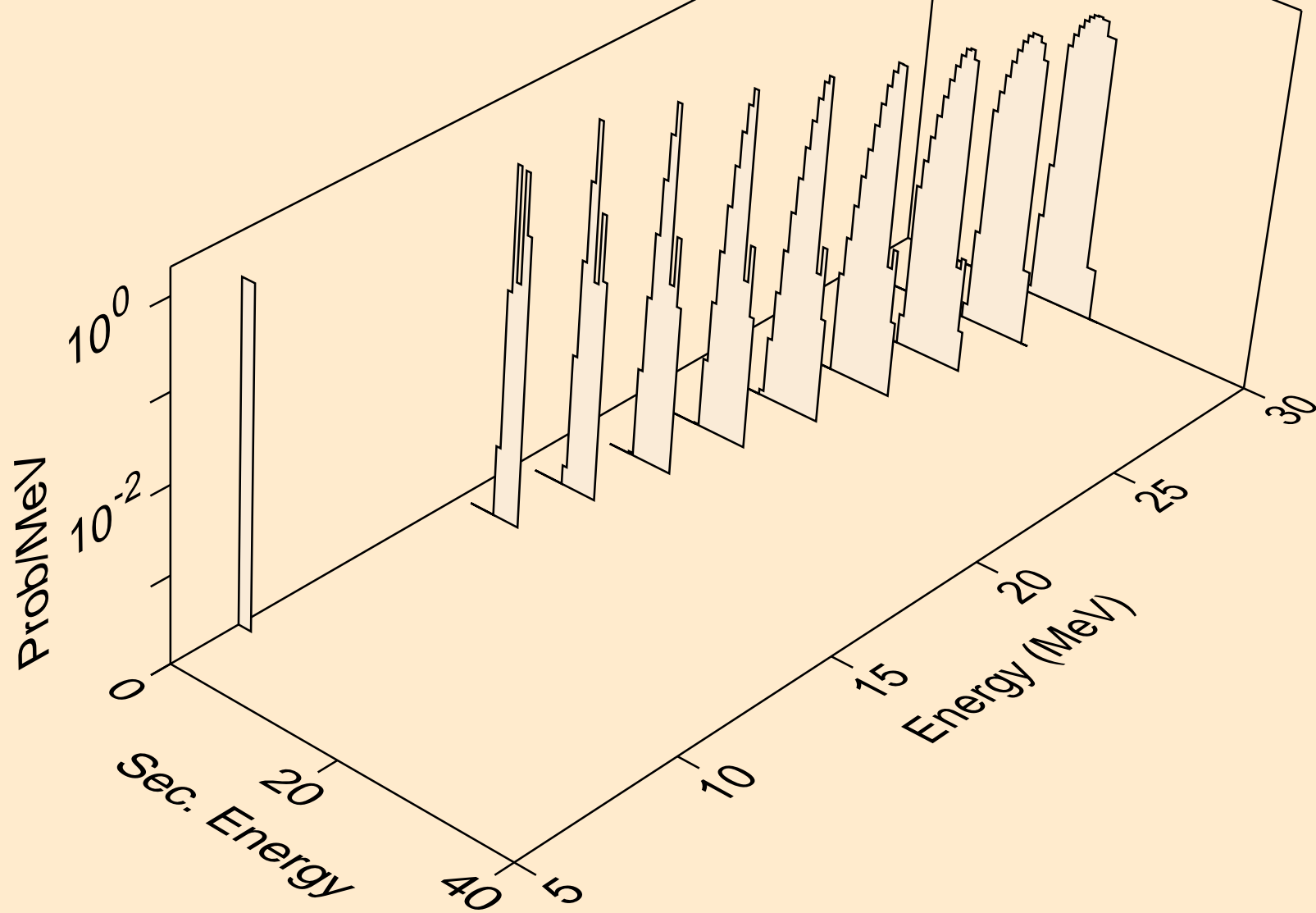



TB167 PROTON ACER TENDL-2021 LIBRARY; T=0.K  
alphas from (p,x)

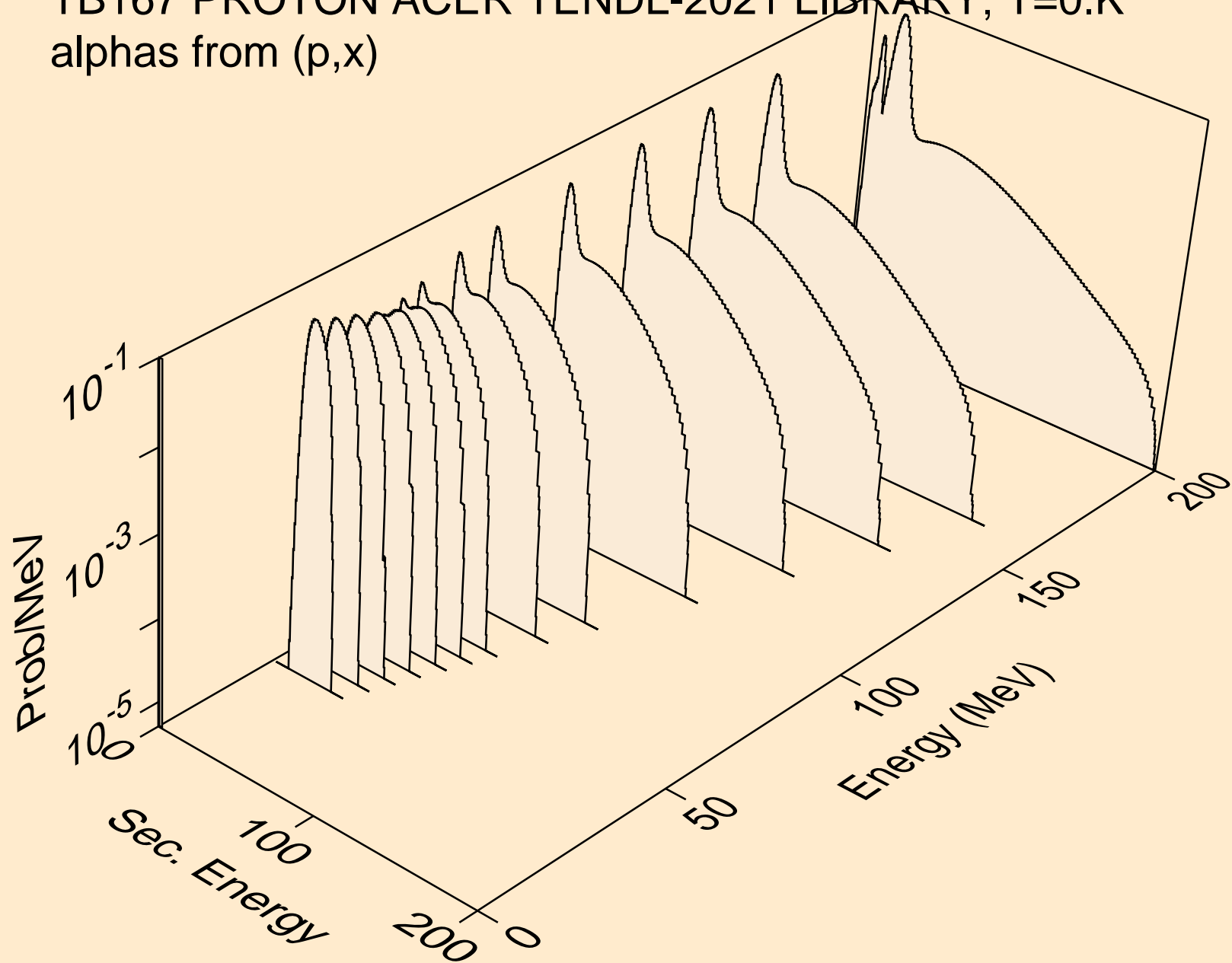

TB167 PROTON ACER TENDL-2021 LIBRARY; T=0.K  
alphas from (p,n\*)a

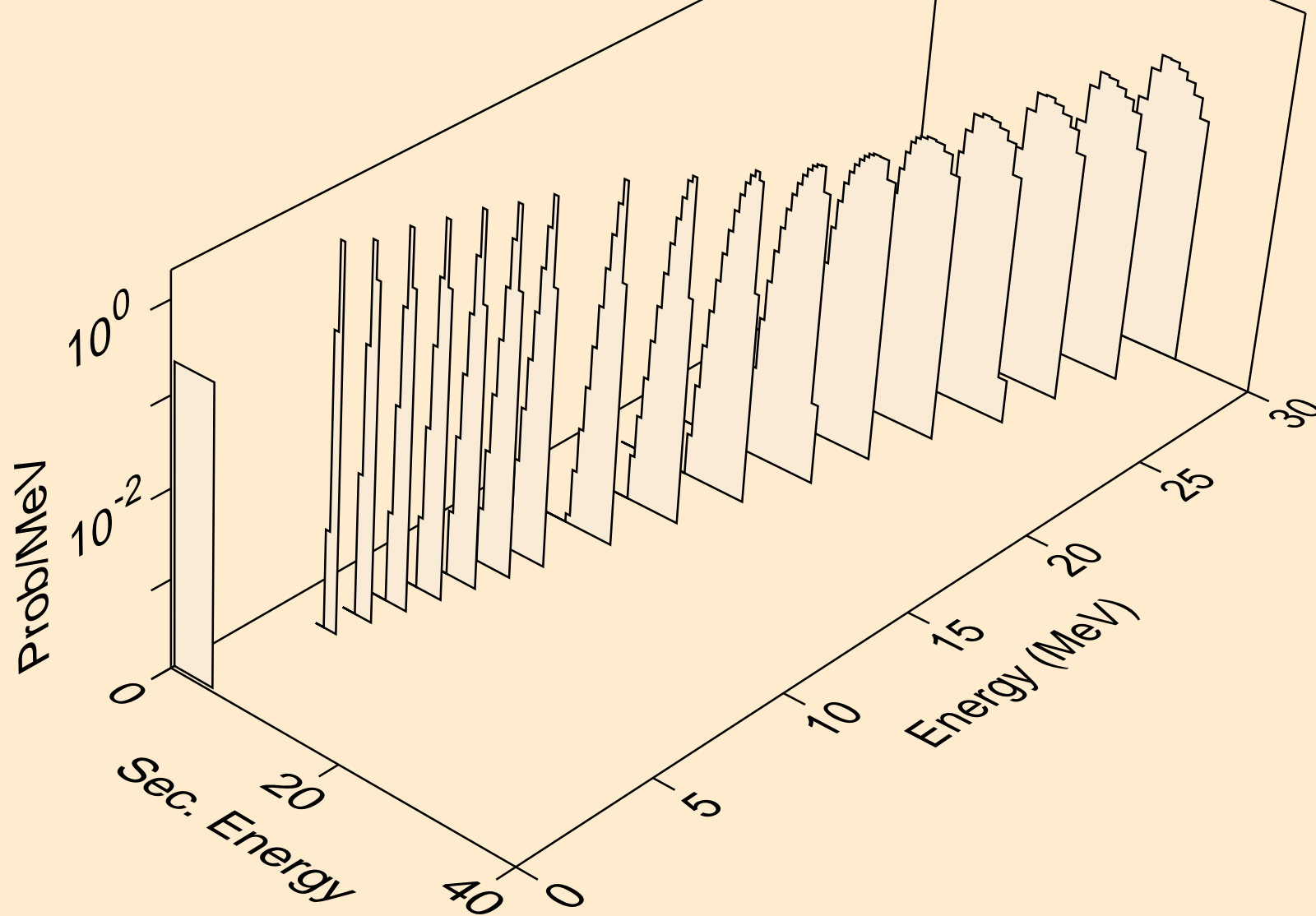

TB167 PROTON ACER TENDL-2021 LIBRARY; T=0.K  
alphas from (p,2n)a

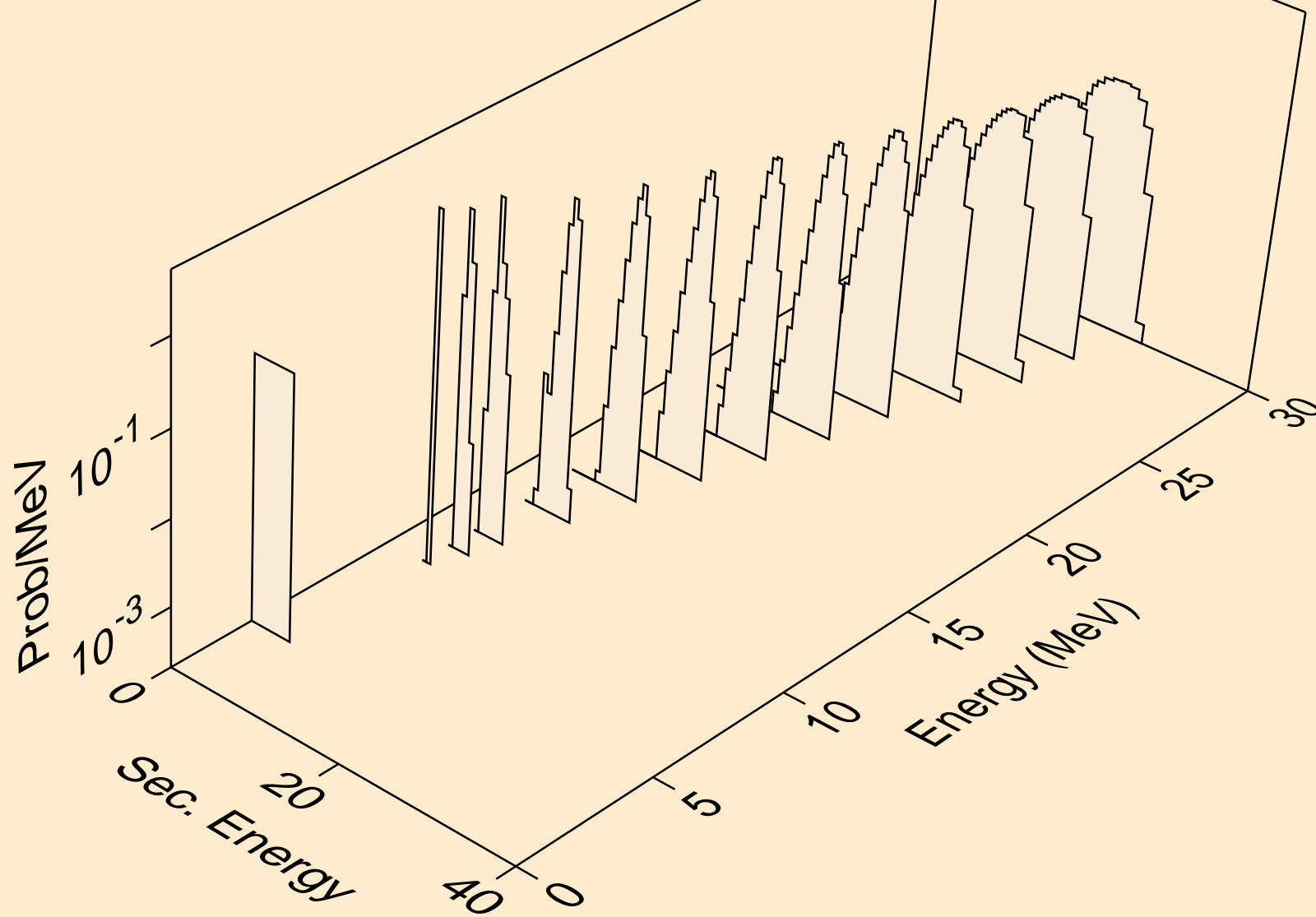

TB167 PROTON ACER TENDL-2021 LIBRARY; T=0.K  
alphas from (p,3n)a

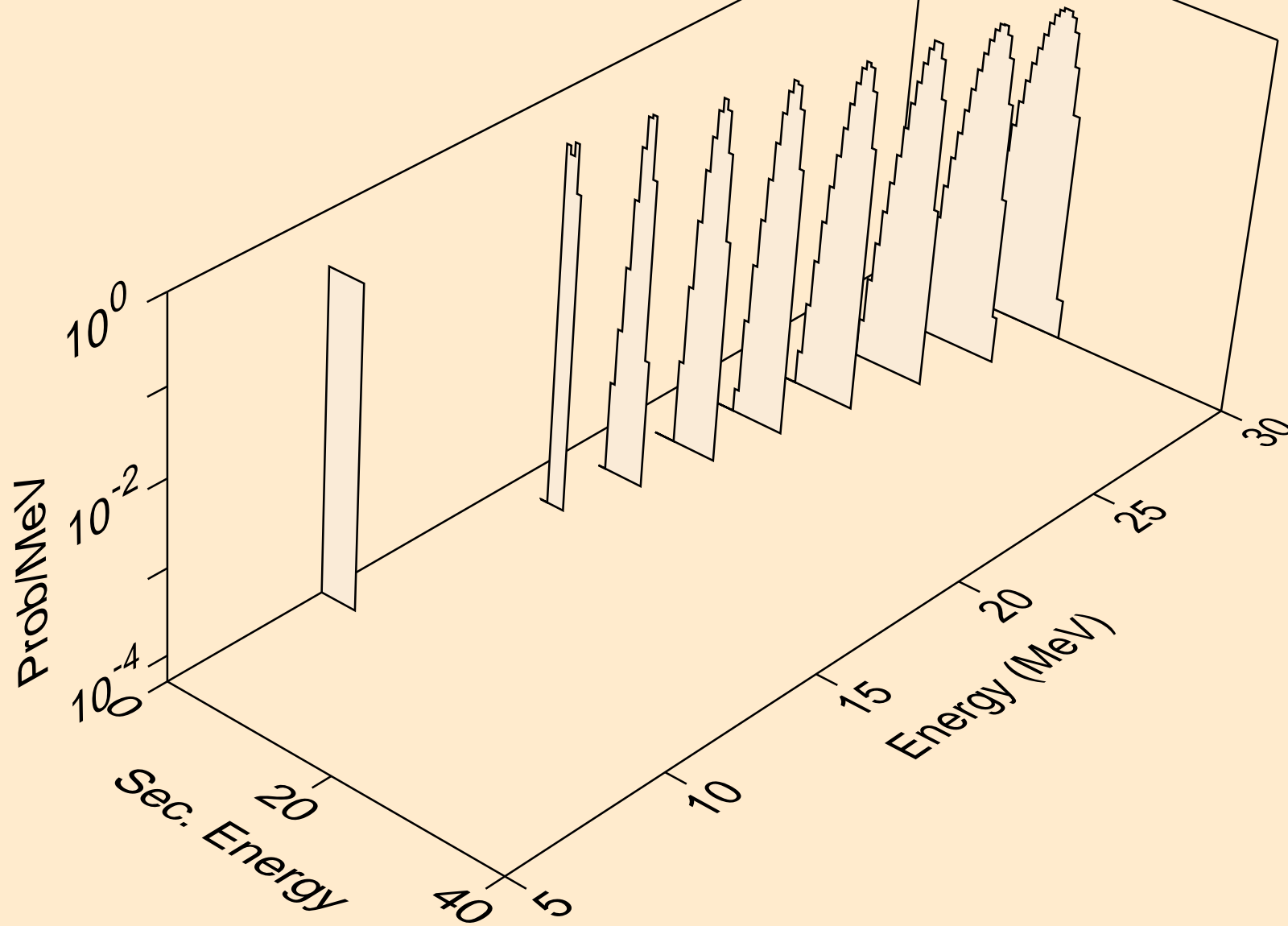

TB167 PROTON ACER TENDL-2021 LIBRARY; T=0.K  
alphas from (p,a)

