

TC099 PROTON ACER TENDL-2021 LIBRARY; T=0.K  
Principal cross sections

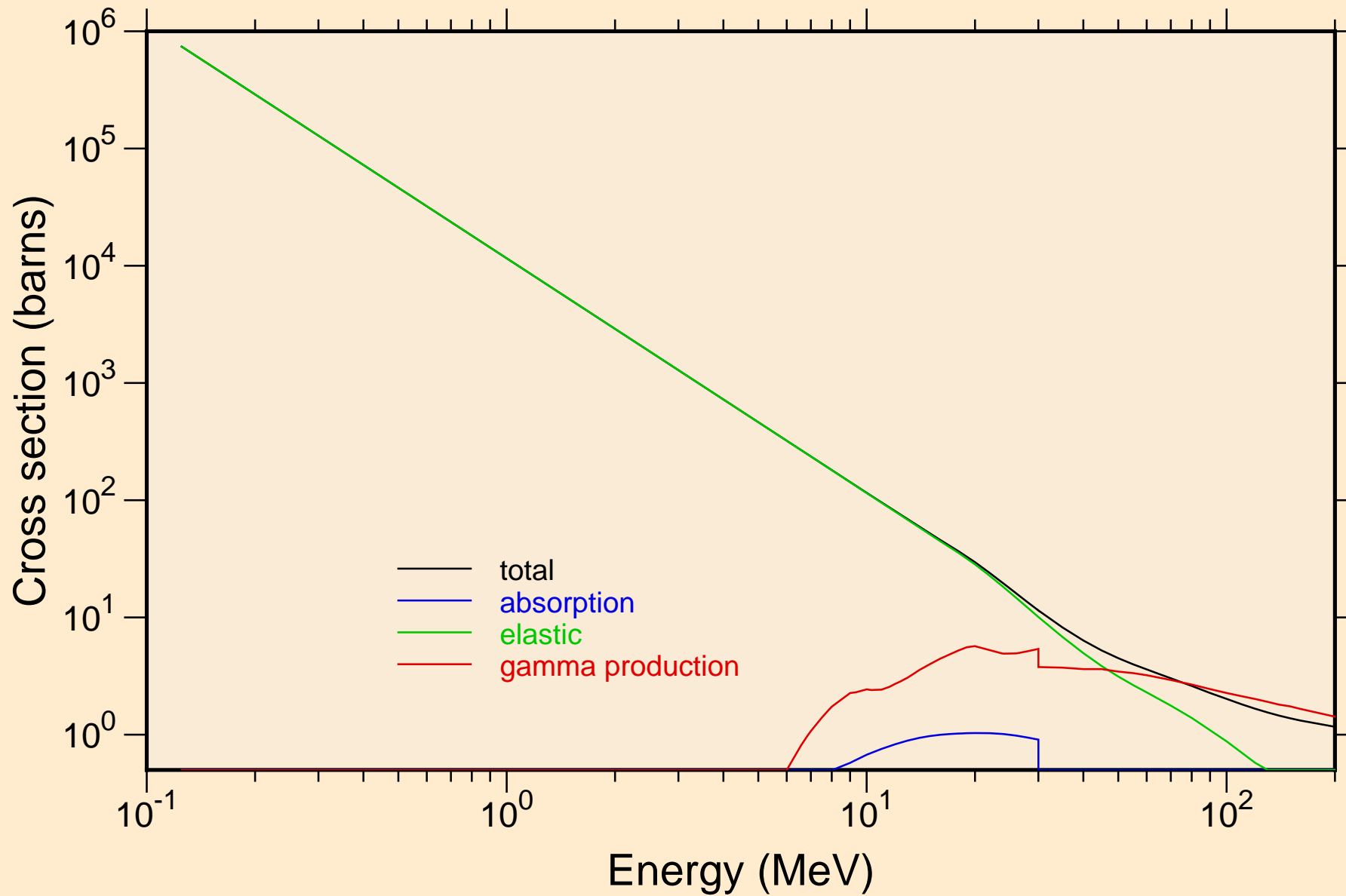

TC099 PROTON ACER TENDL-2021 LIBRARY; T=0.K

Heating

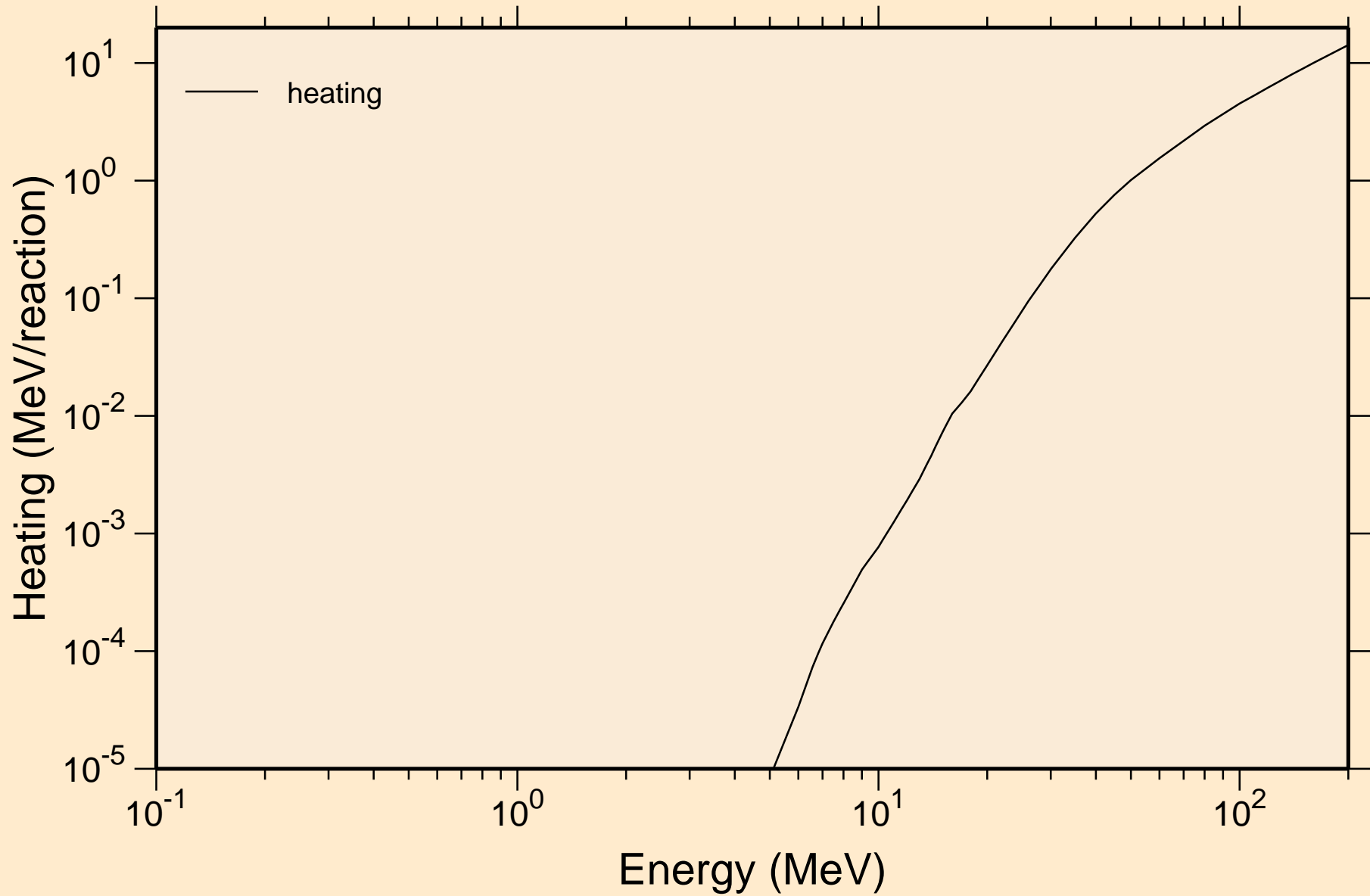

# TC099 PROTON ACER TENDL-2021 LIBRARY; T=0.K

## Principal cross sections

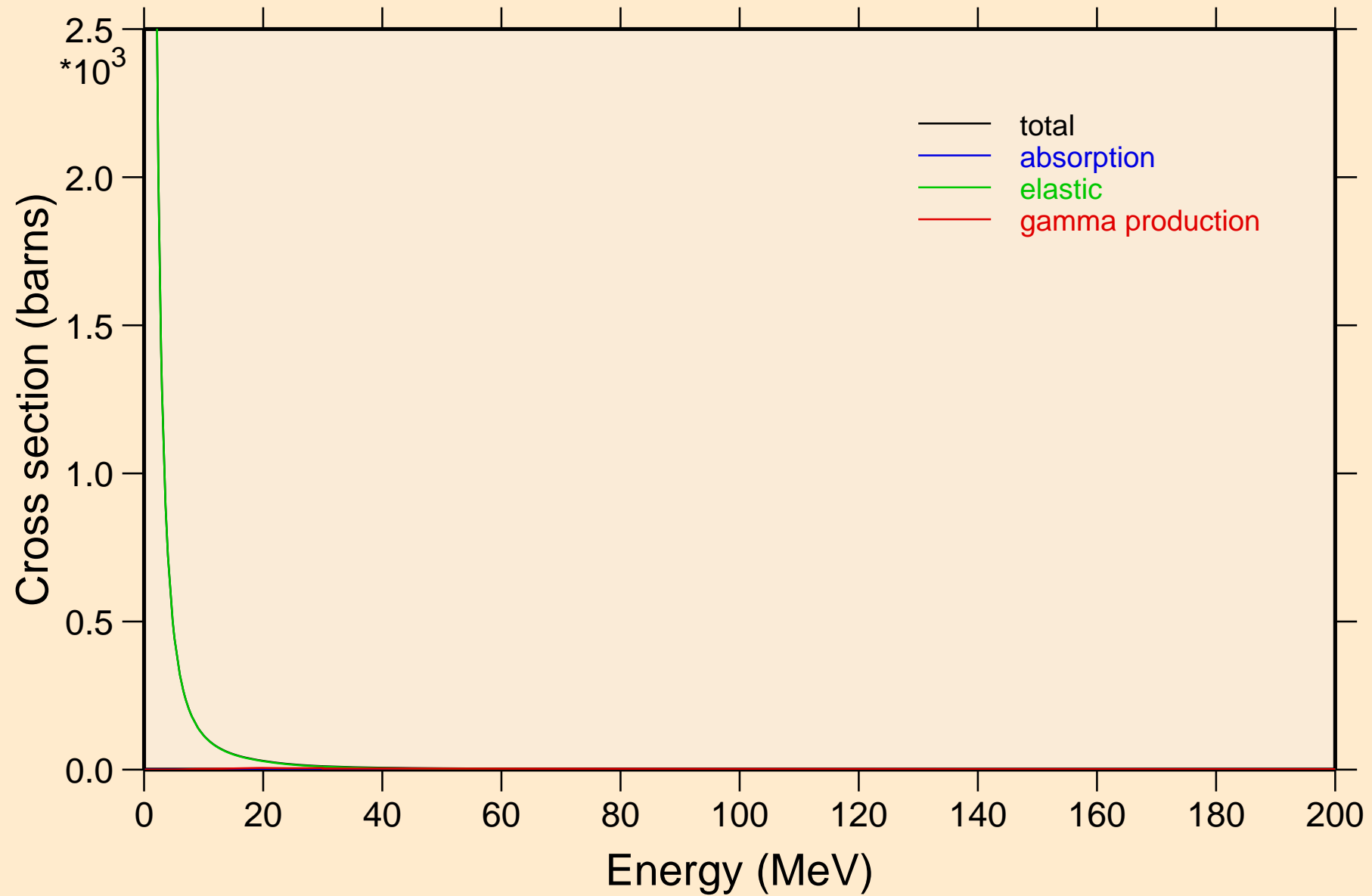

TC099 PROTON ACER TENDL-2021 LIBRARY; T=0.K

Heating

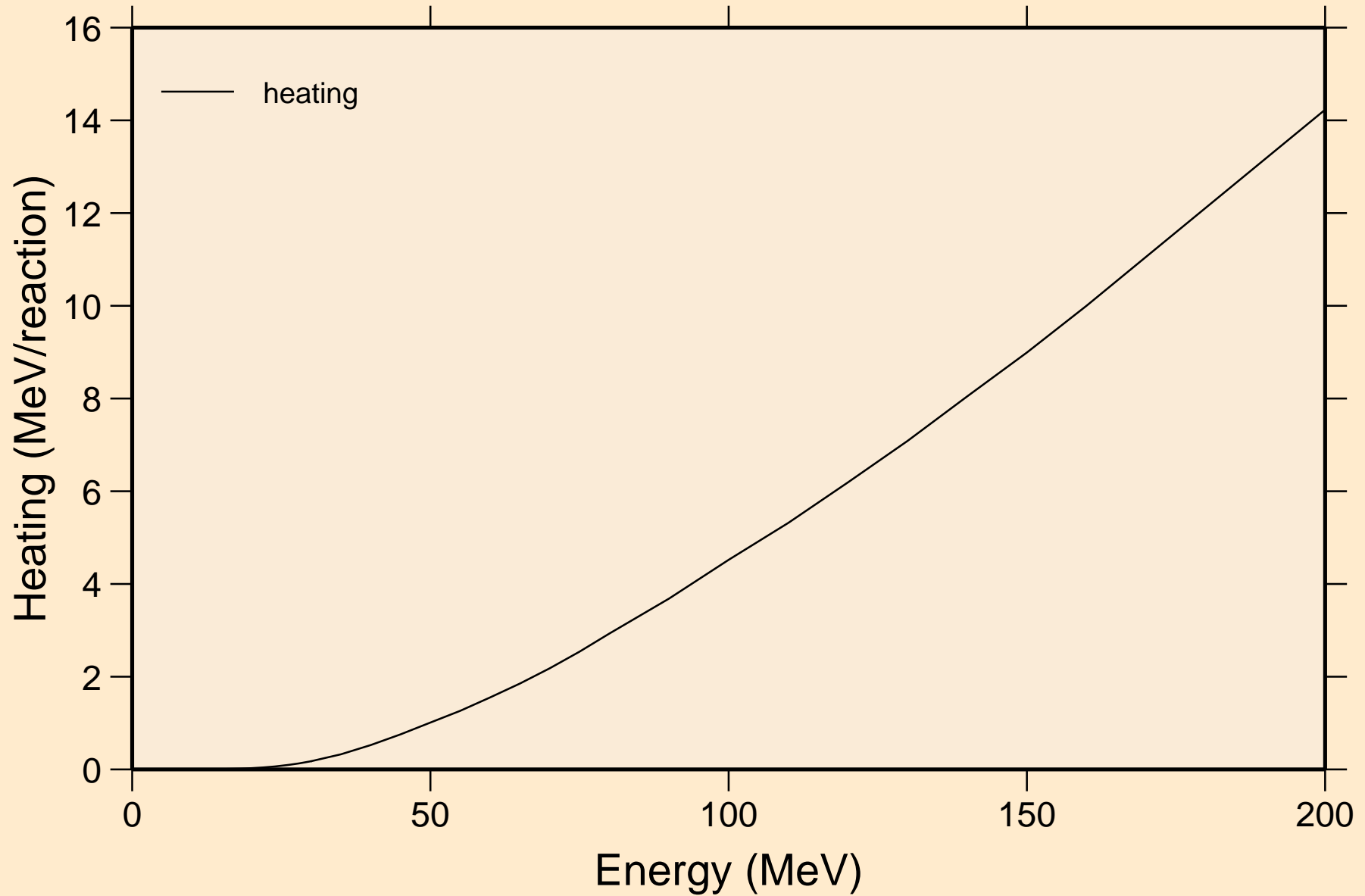

TC099 PROTON ACER TENDL-2021 LIBRARY; T=0.K  
Threshold reactions

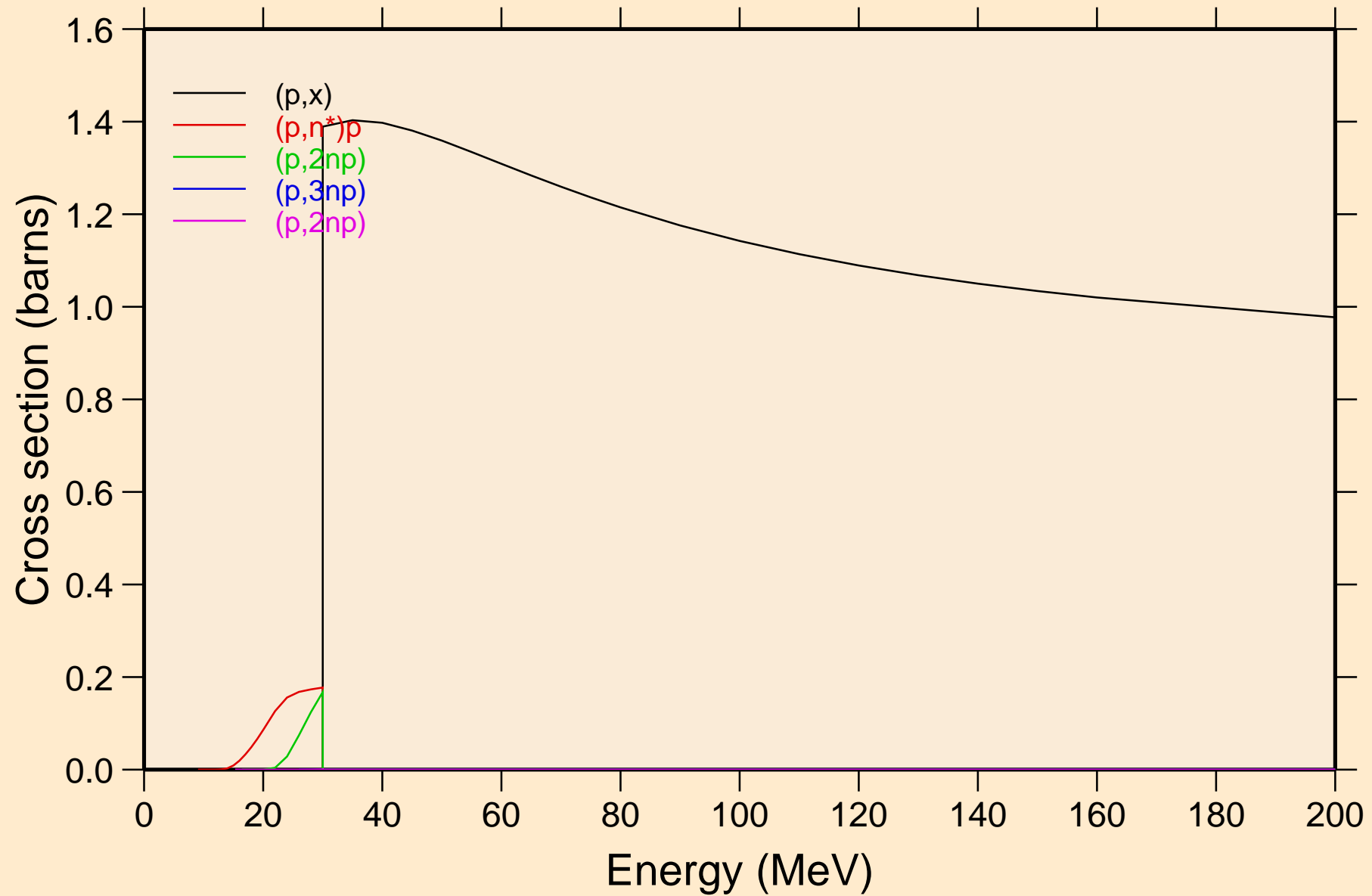

TC099 PROTON ACER TENDL-2021 LIBRARY; T=0.K  
Threshold reactions

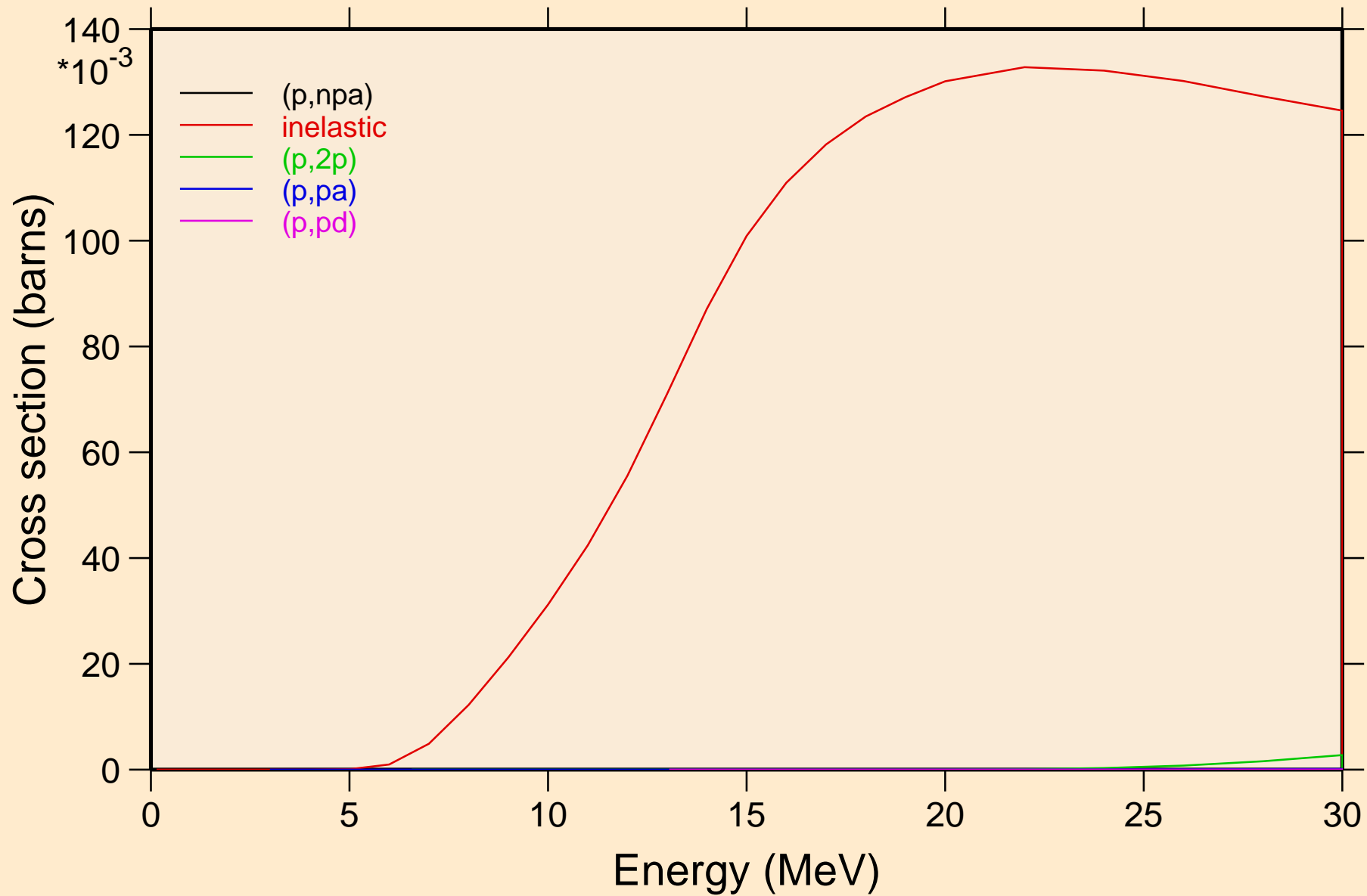

TC099 PROTON ACER TENDL-2021 LIBRARY; T=0.K  
Threshold reactions

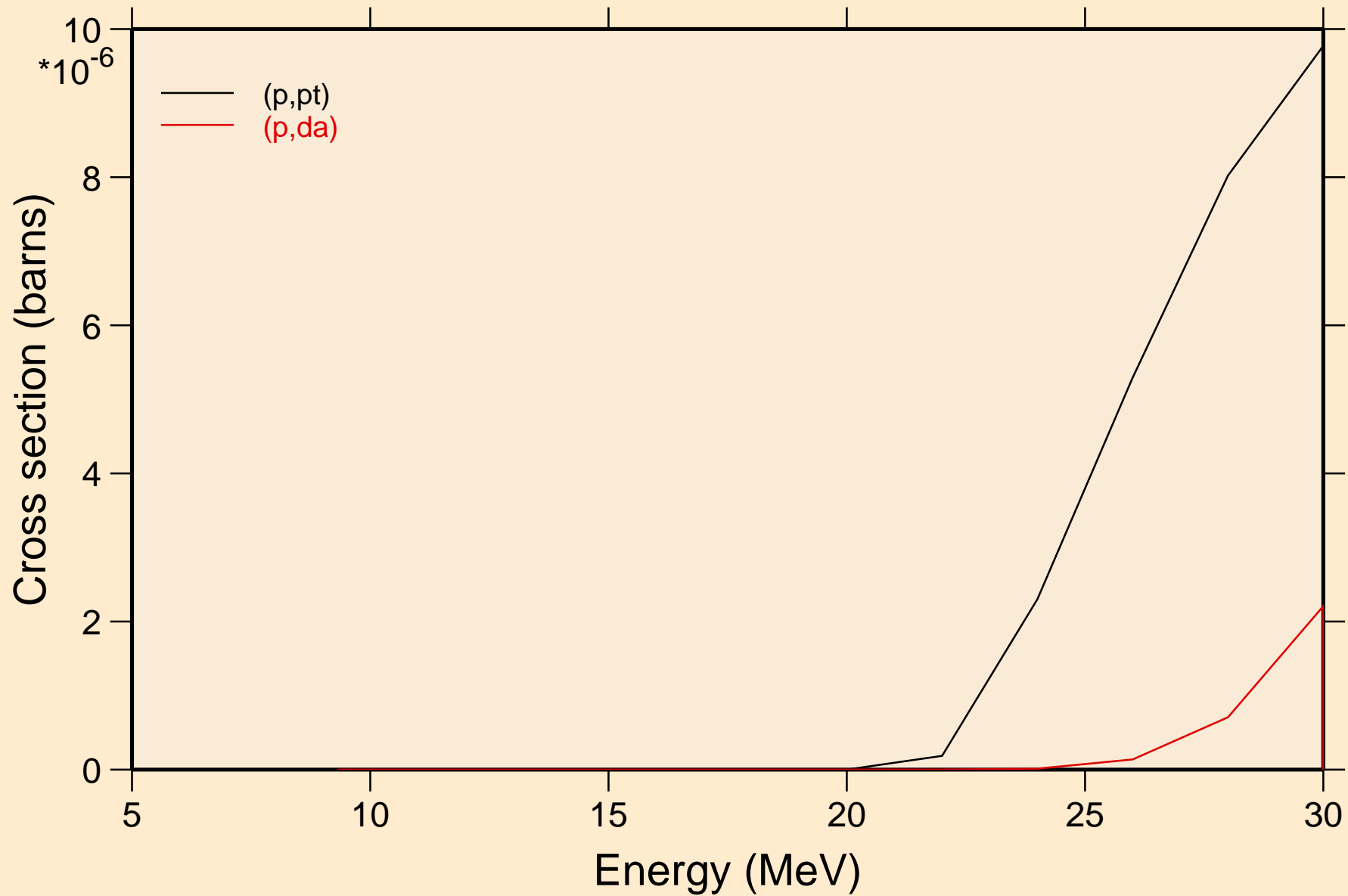

TC099 PROTON ACER TENDL-2021 LIBRARY; T=0.K  
angular distribution for elastic

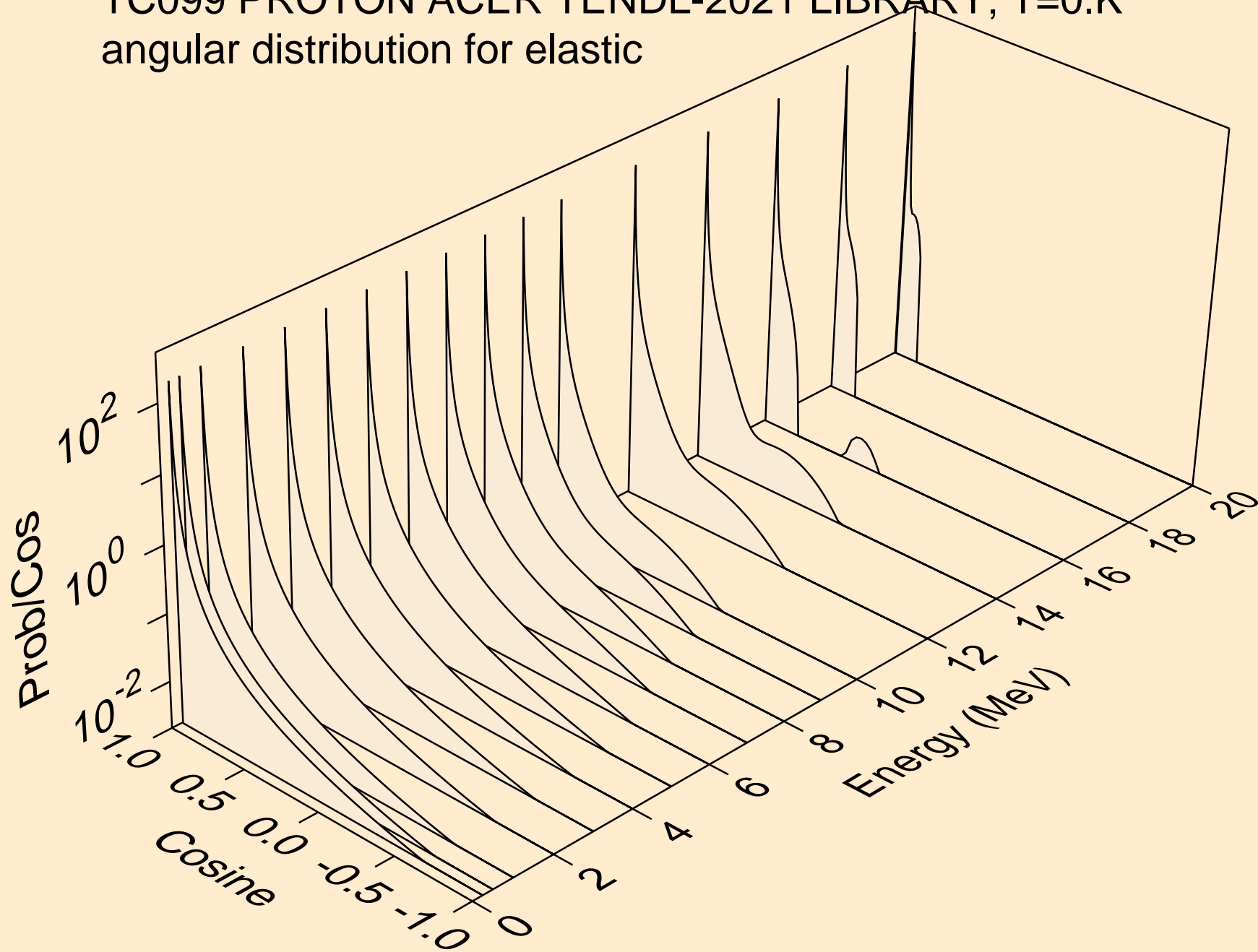



TC099 PROTON ACER TENDL-2021 LIBRARY; T=0.K  
angular distribution for elastic

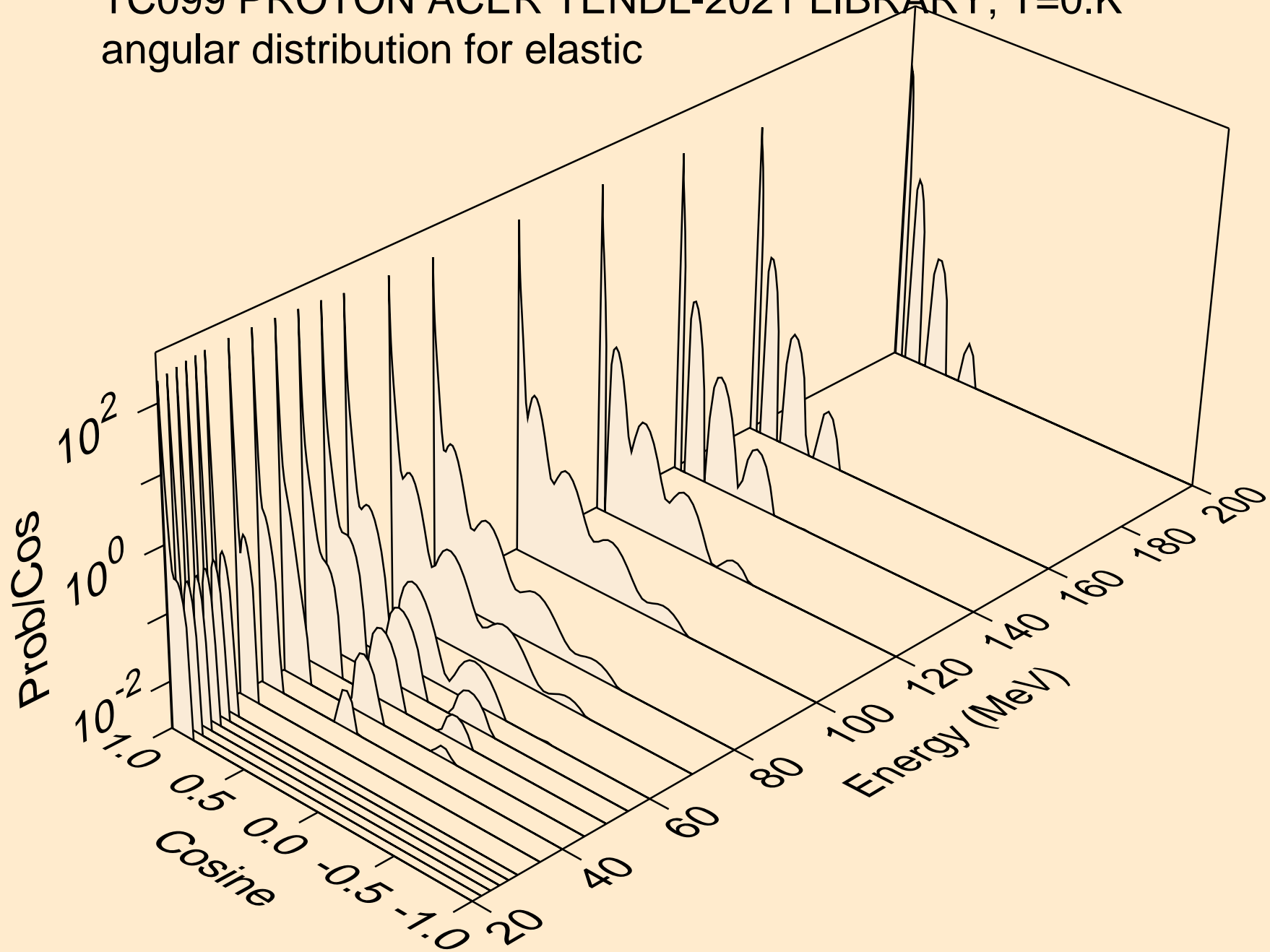

TC099 PROTON ACER TENDL-2021 LIBRARY; T=0.K  
Proton emission for (p,x)

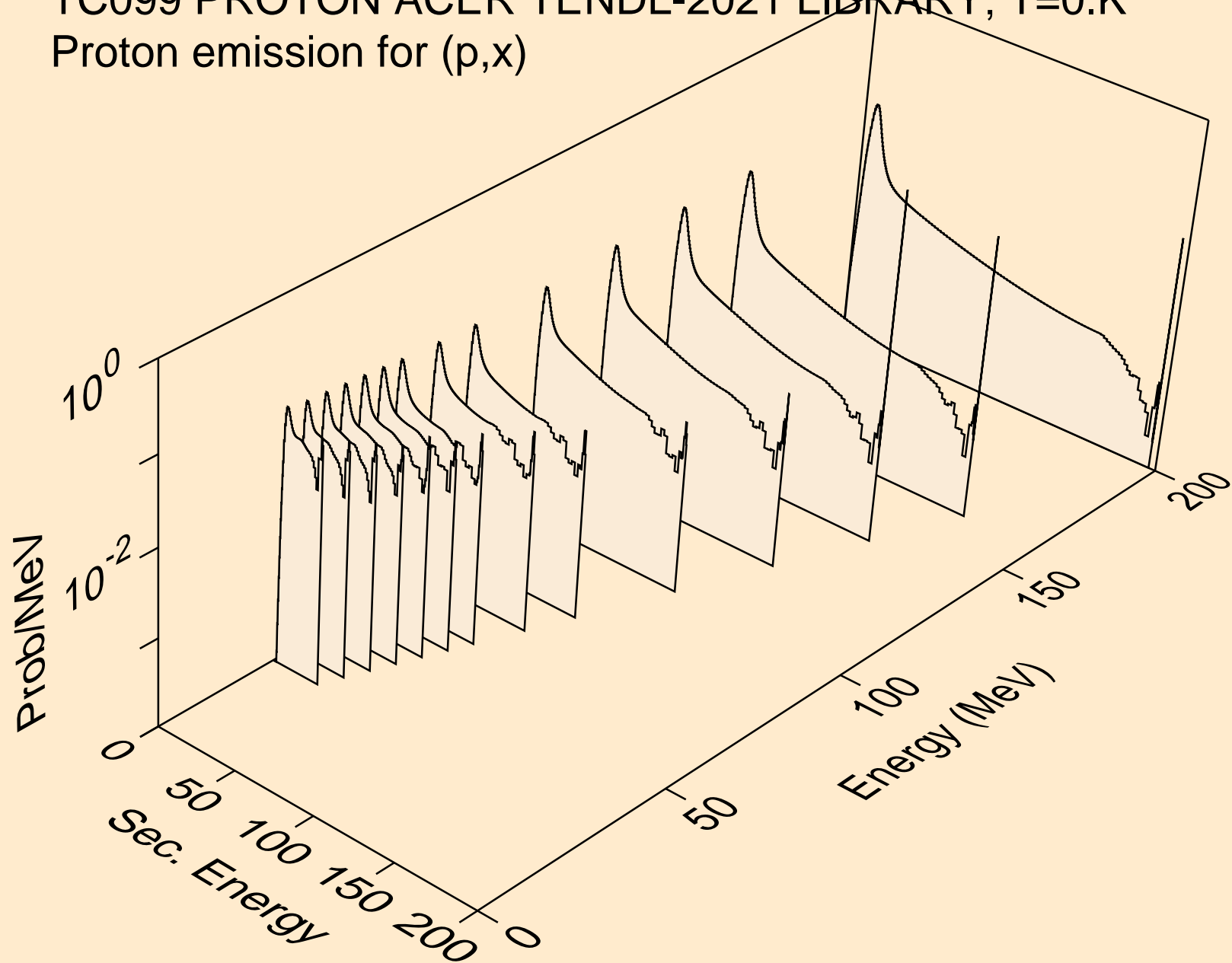

TC099 PROTON ACER TENDL-2021 LIBRARY; T=0.K  
Proton emission for (p,n\*)p

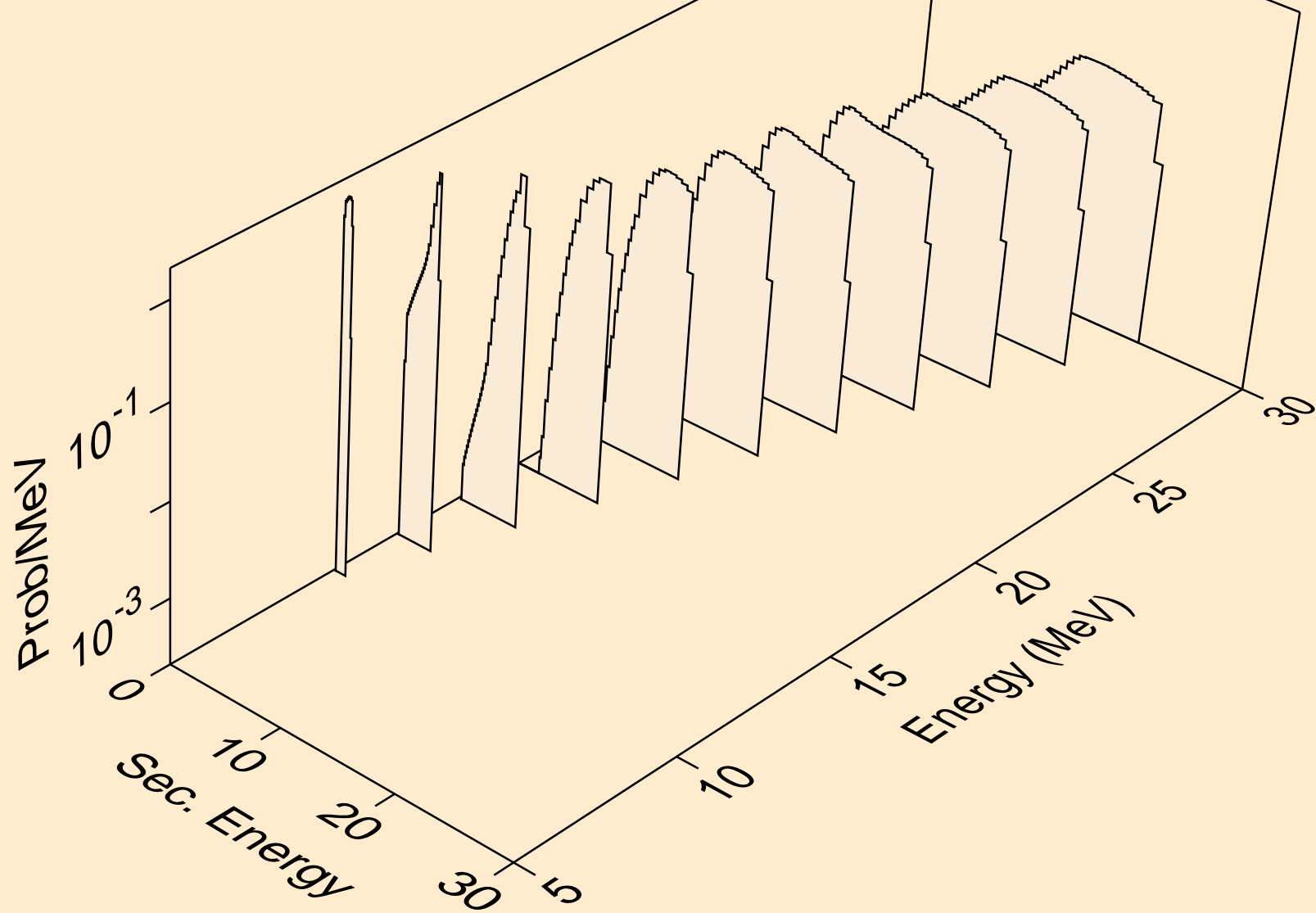

TC099 PROTON ACER TENDL-2021 LIBRARY; T=0.K  
Proton emission for (p,2np)

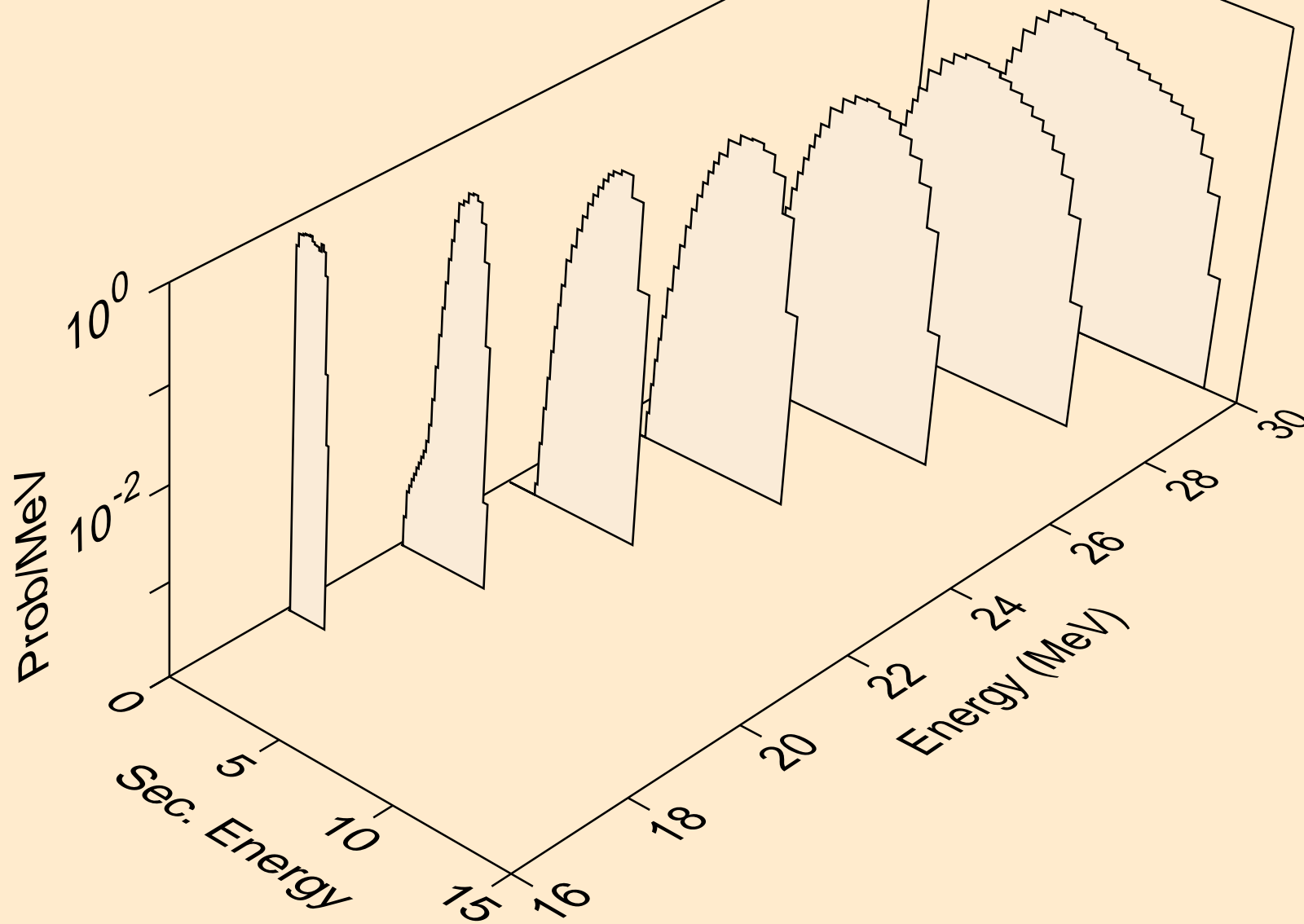

TC099 PROTON ACER TENDL-2021 LIBRARY; T=0.K  
Proton emission for (p,3np)

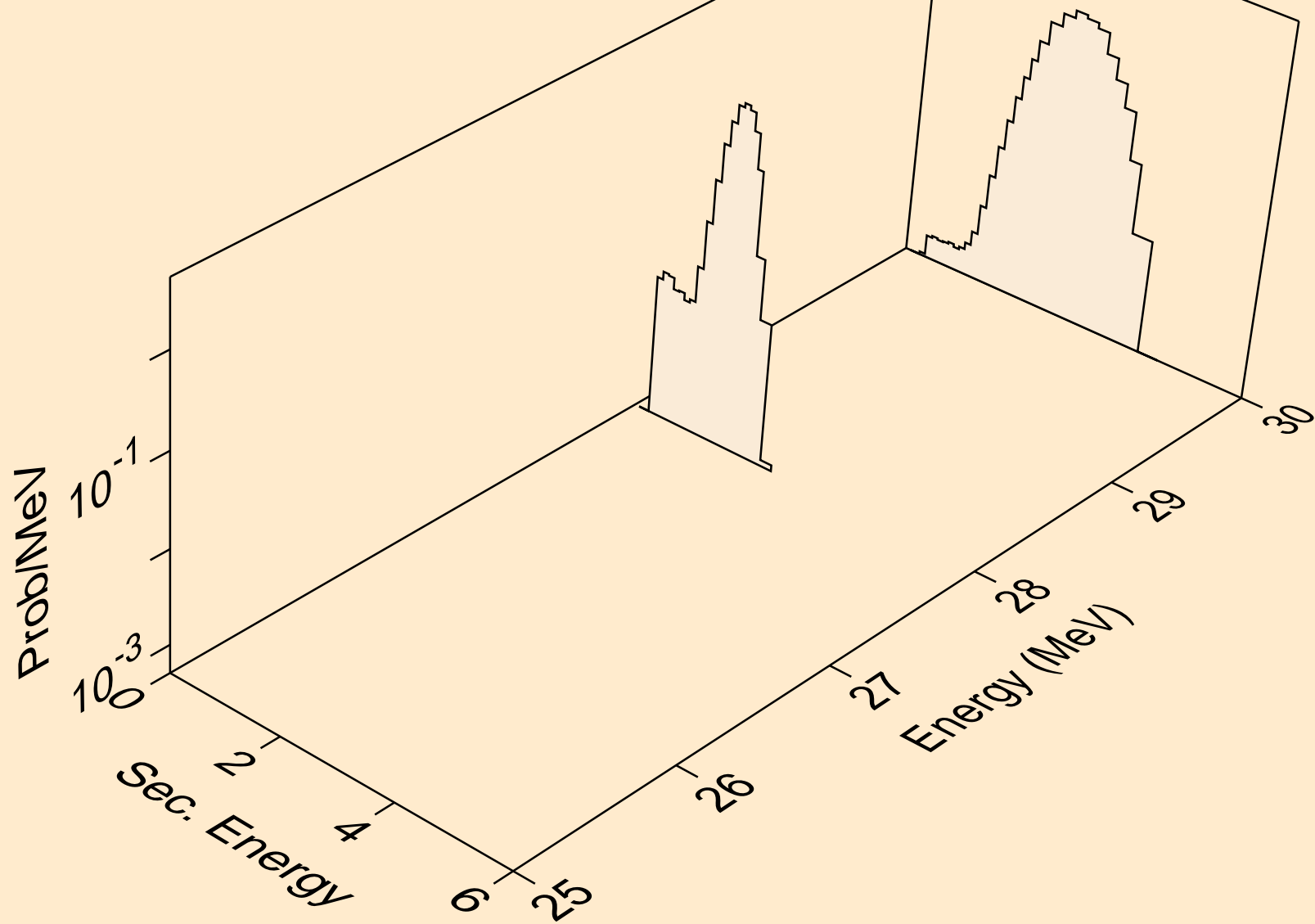

TC099 PROTON ACER TENDL-2021 LIBRARY; T=0.K  
Proton emission for (p,2np)

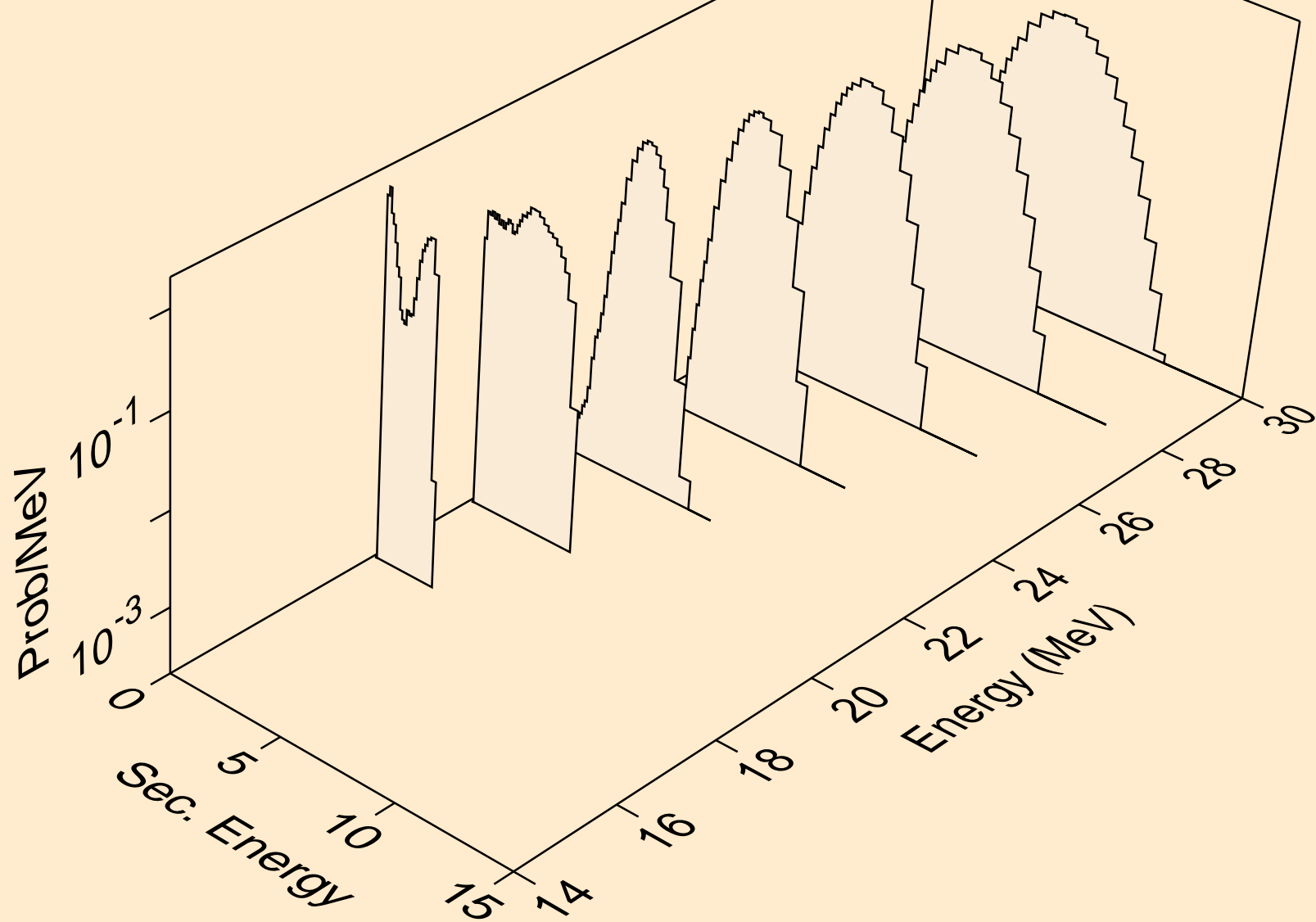

TC099 PROTON ACER TENDL-2021 LIBRARY; T=0.K  
Proton emission for (p,npa)

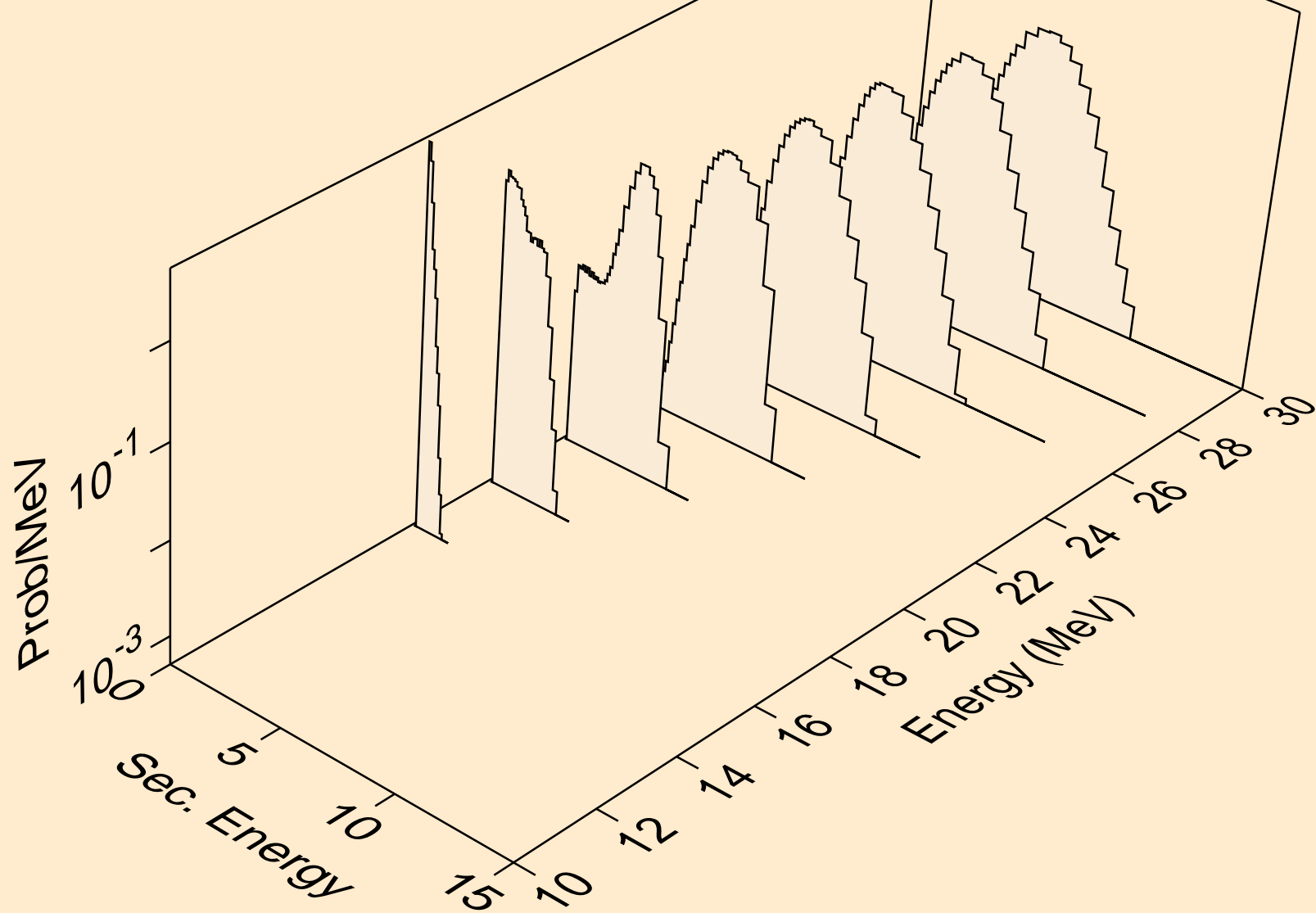

TC099 PROTON ACER TENDL-2021 LIBRARY; T=0.K  
Proton emission for inelastic

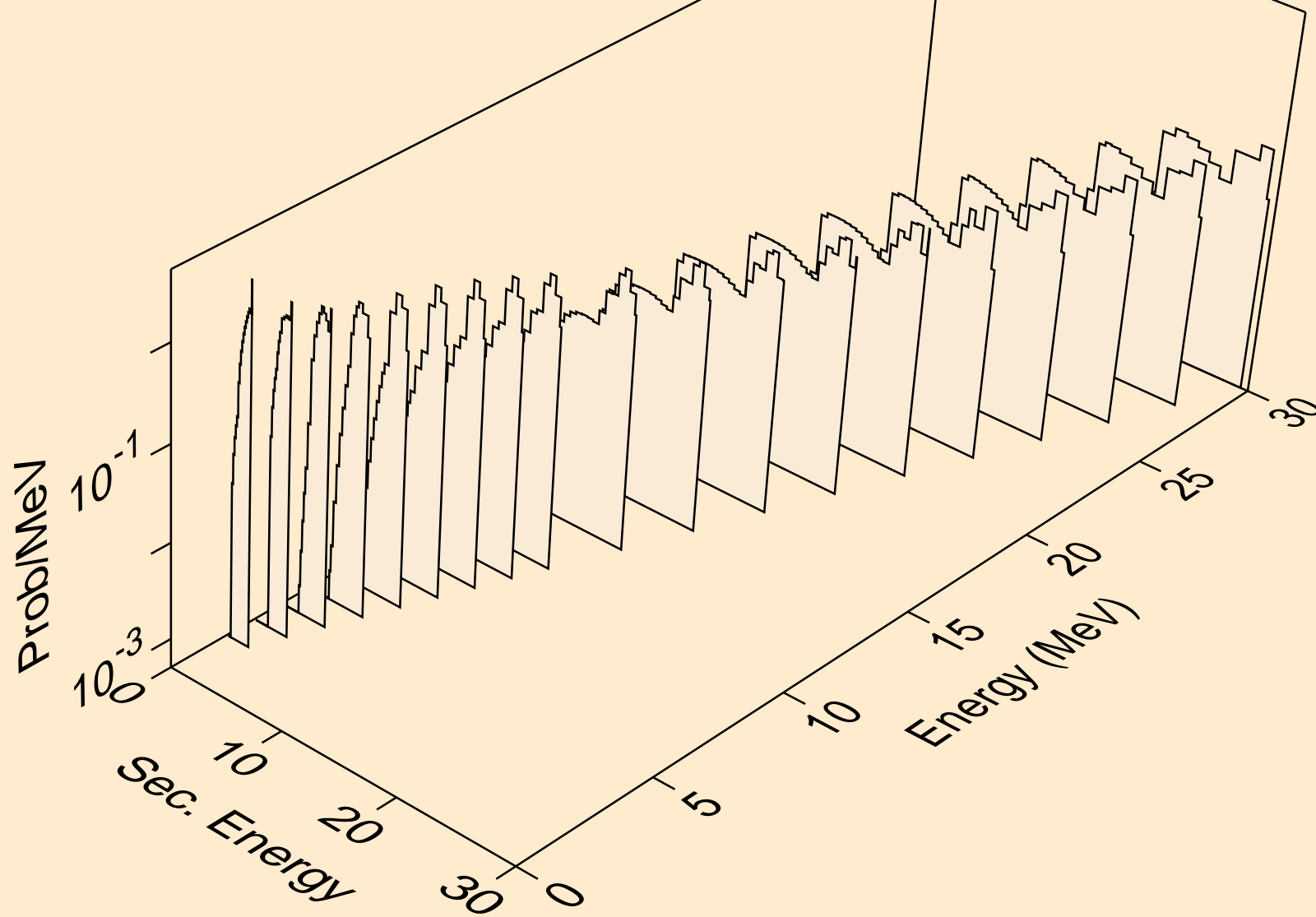



TC099 PROTON ACER TENDL-2021 LIBRARY; T=0.K  
Proton emission for (p,2p)

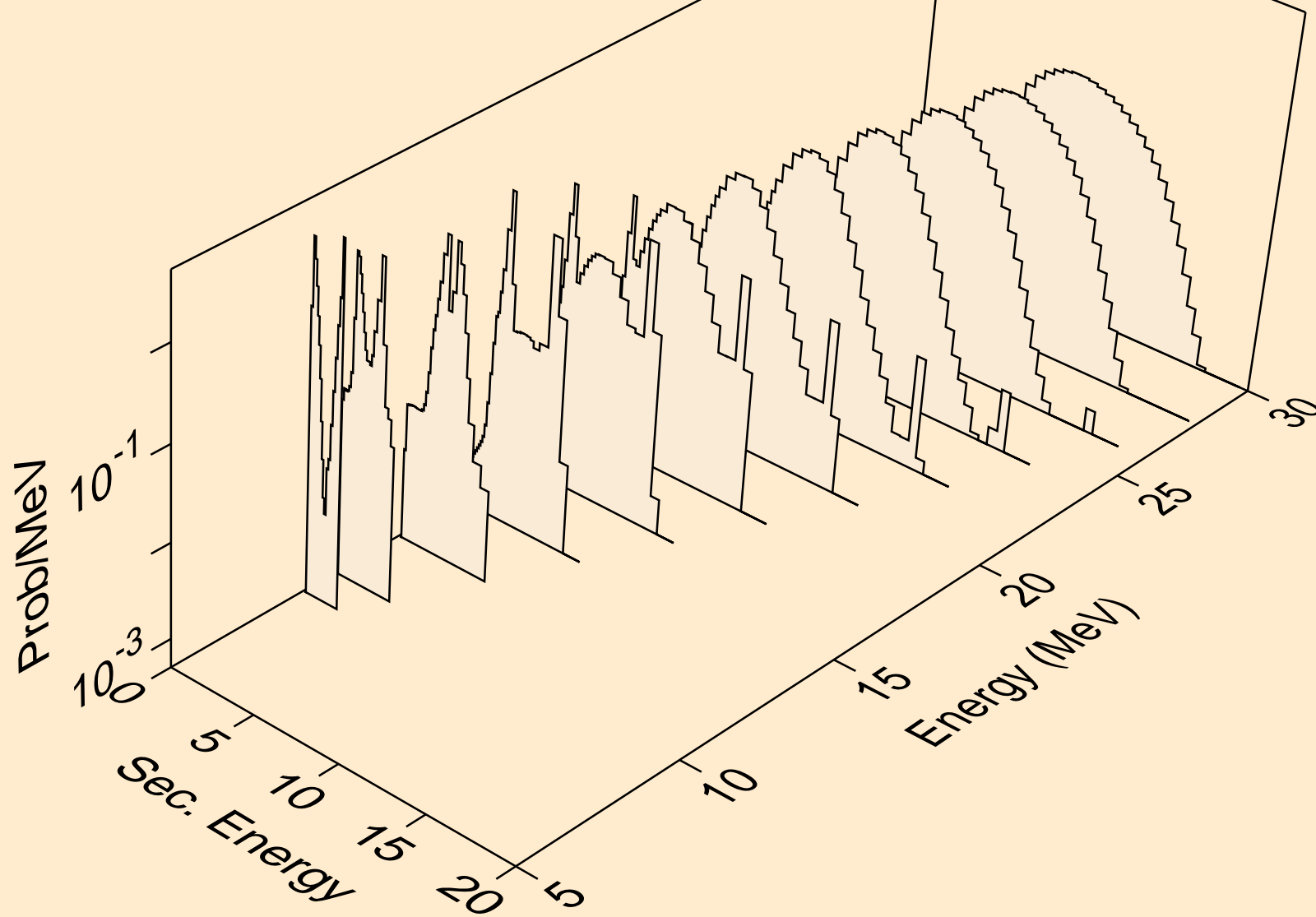

TC099 PROTON ACER TENDL-2021 LIBRARY; T=0.K  
Proton emission for (p,pa)

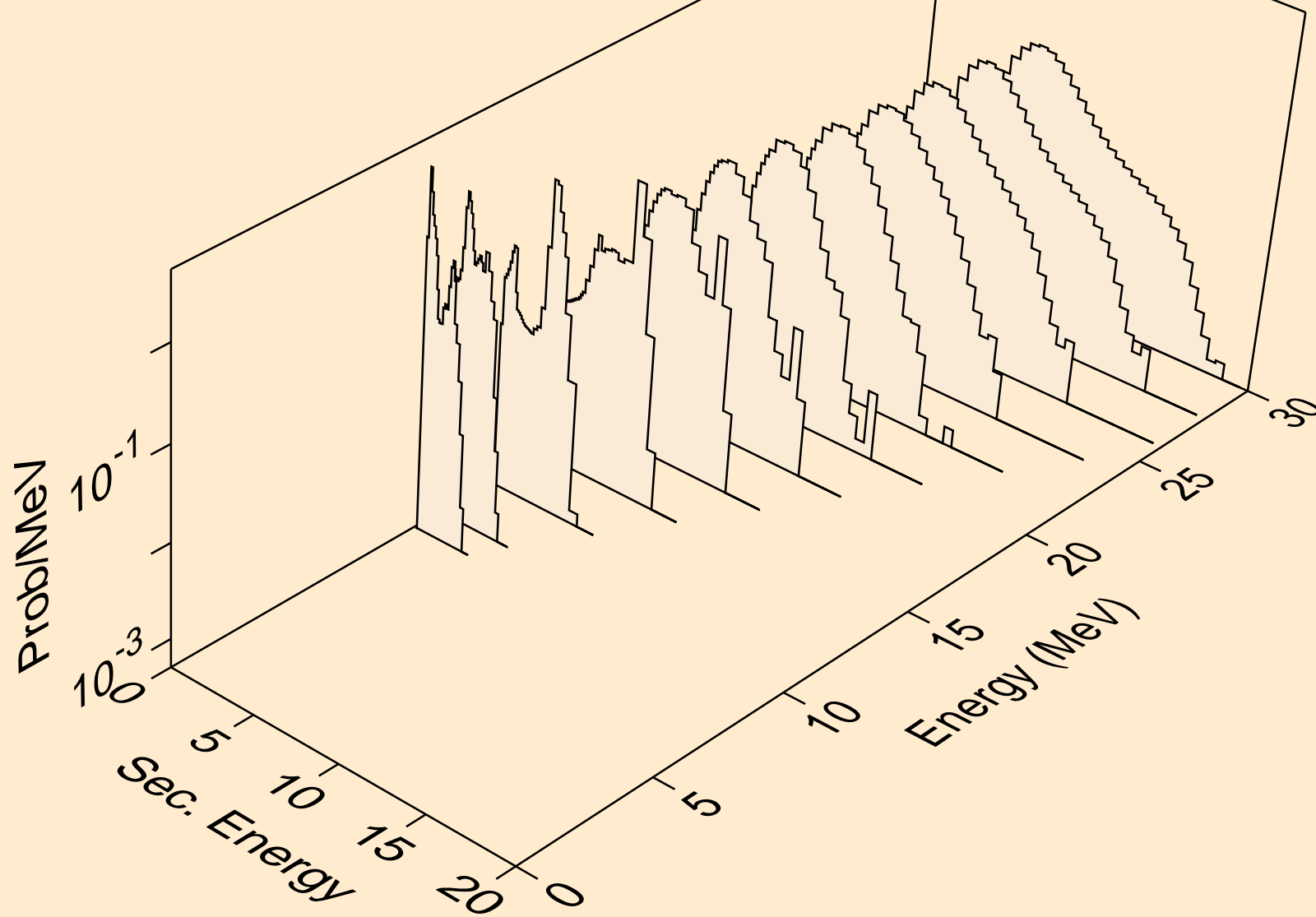

TC099 PROTON ACER TENDL-2021 LIBRARY; T=0.K  
Proton emission for (p,pd)

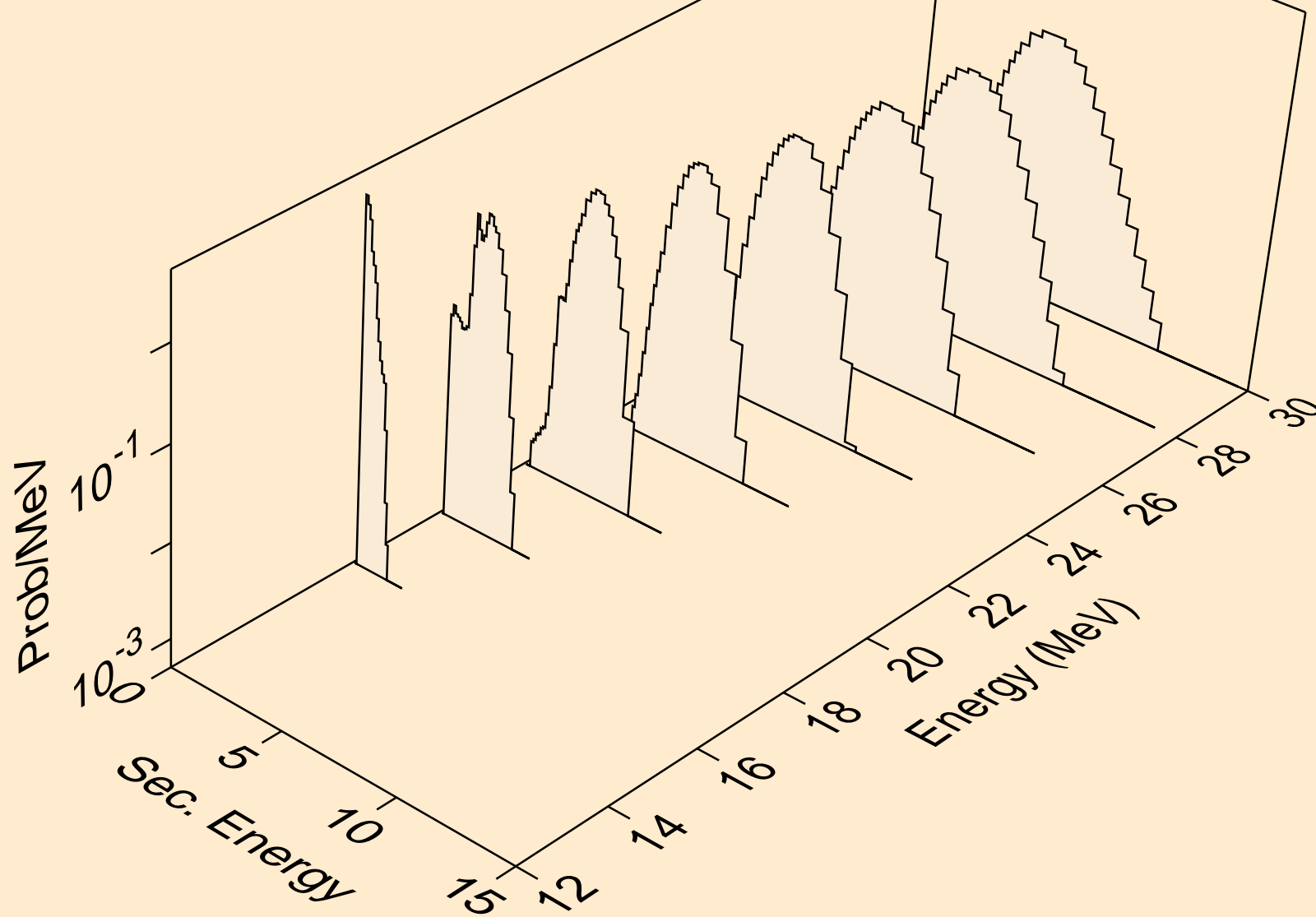

TC099 PROTON ACER TENDL-2021 LIBRARY; T=0.K  
Proton emission for (p,pt)

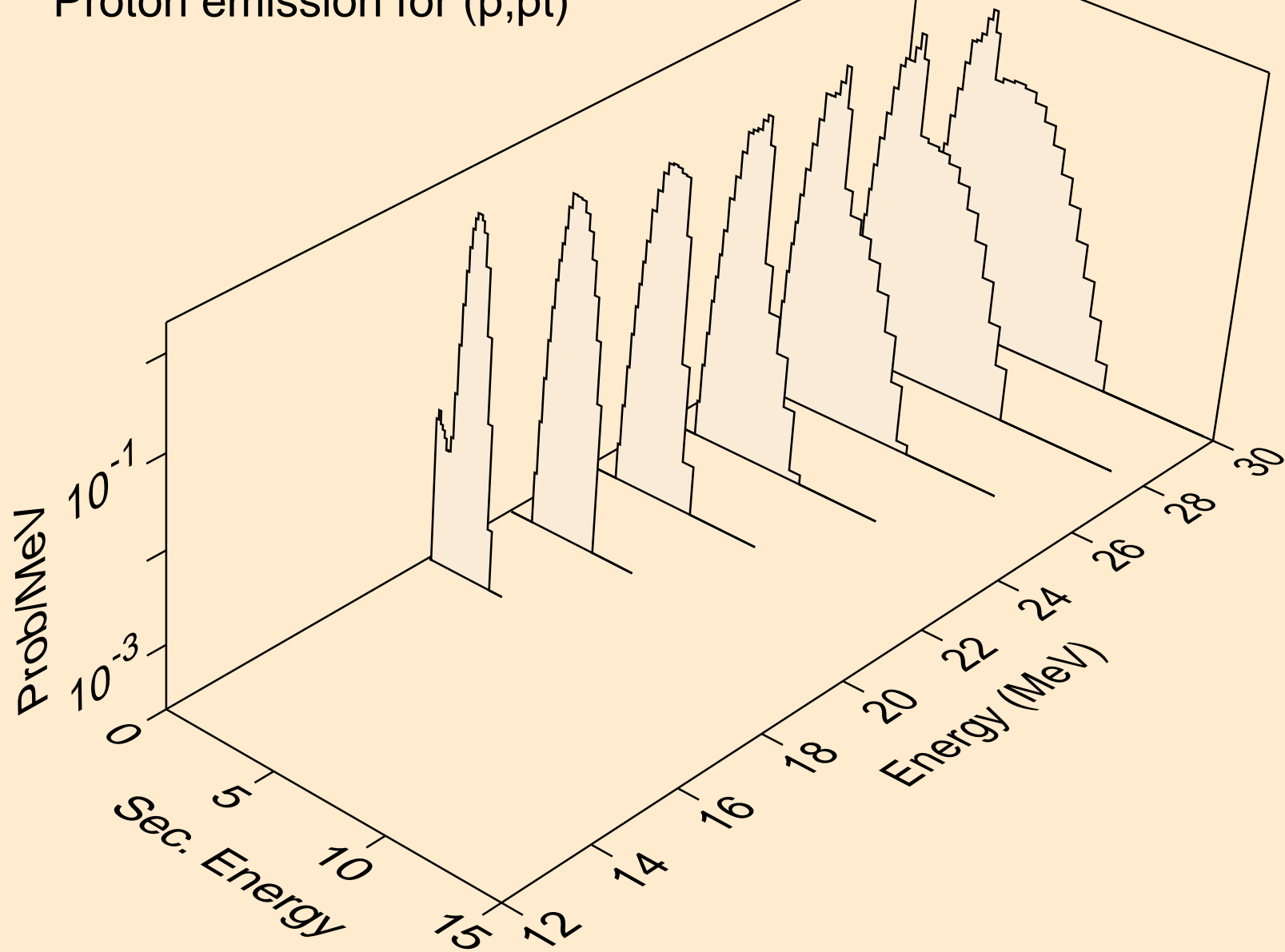

TC099 PROTON ACER TENDL-2021 LIBRARY; T=0.K  
Photon emission for (z,n)

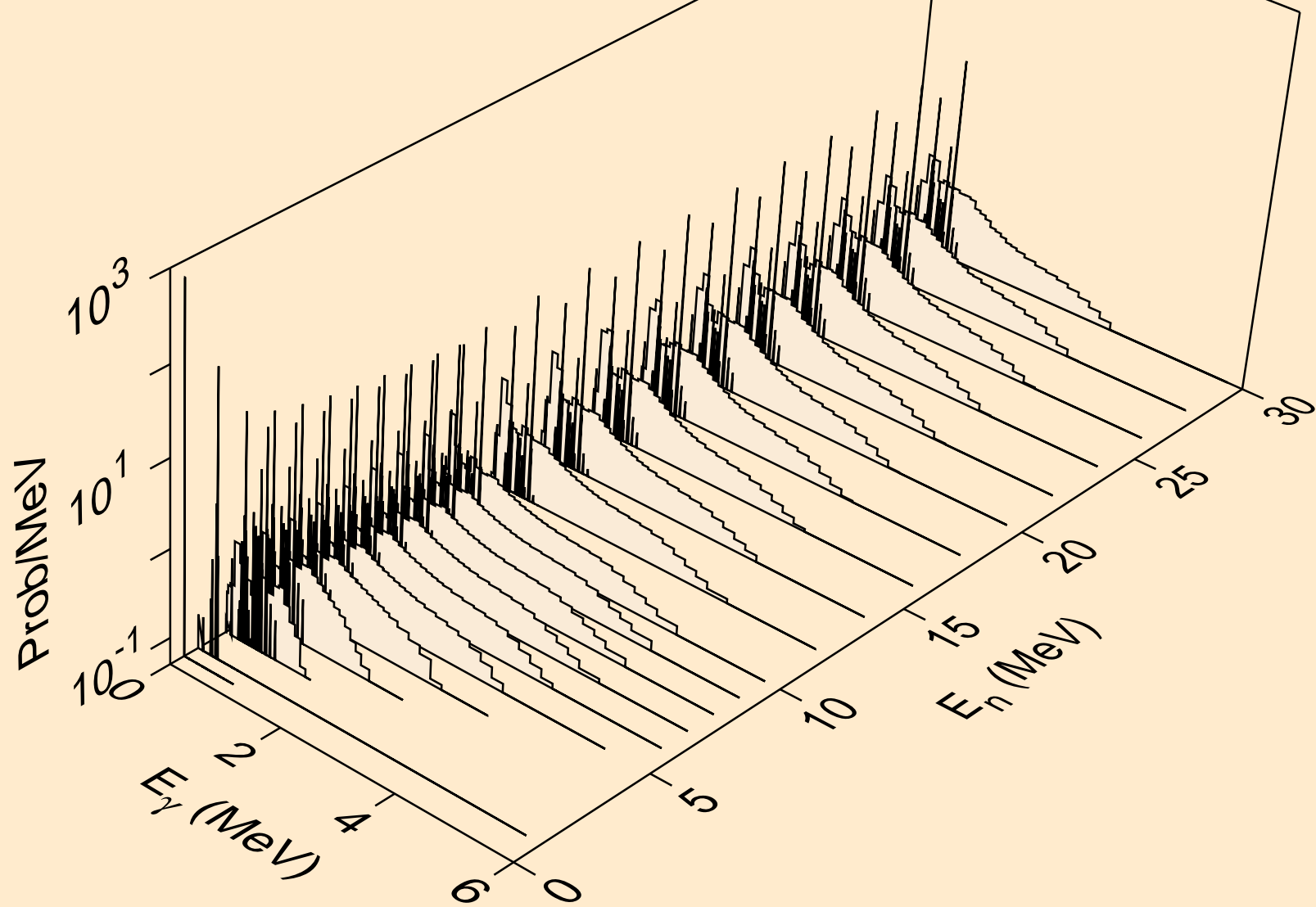

TC099 PROTON ACER TENDL-2021 LIBRARY; T=0.K  
Photon emission for (n,x)

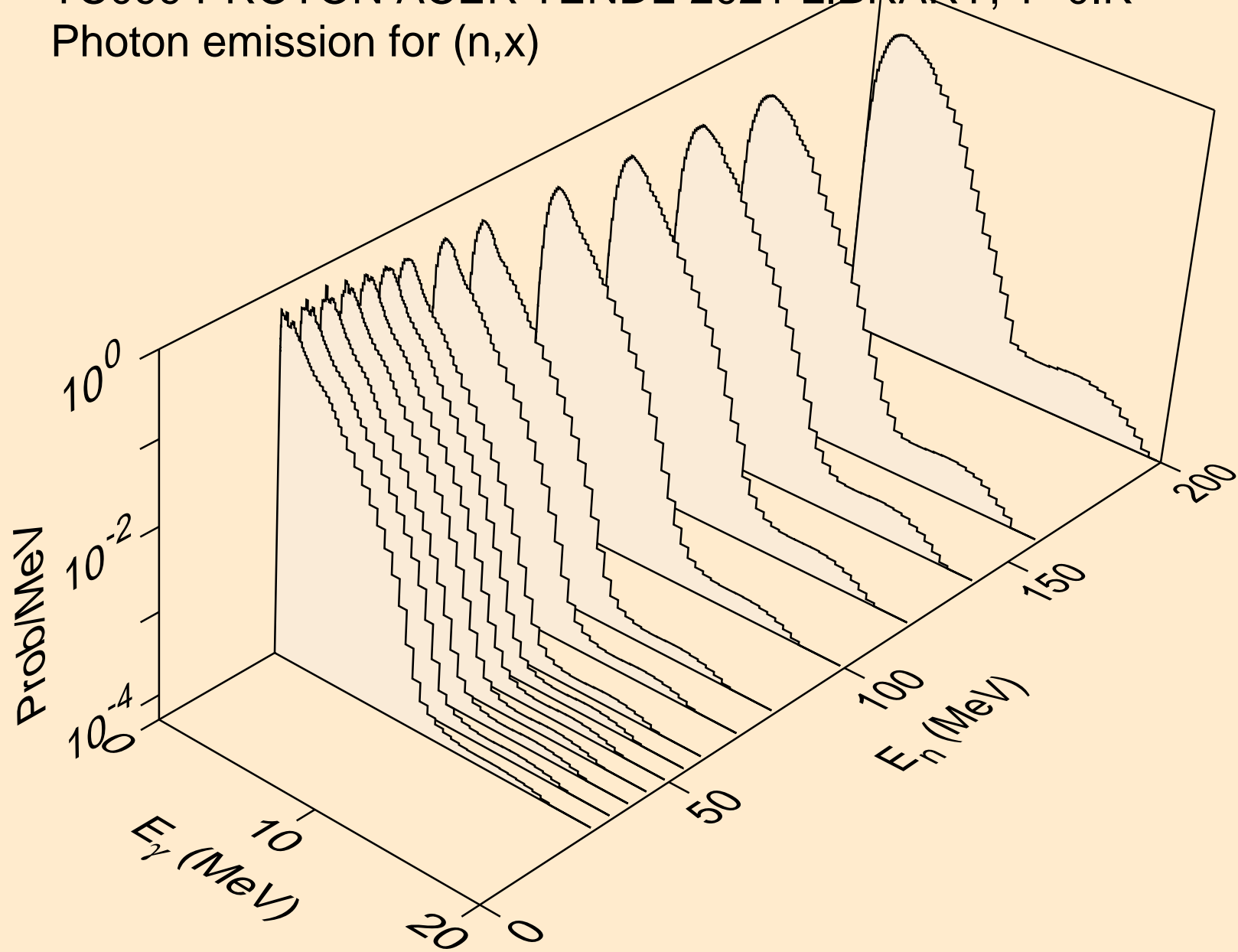

TC099 PROTON ACER TENDL-2021 LIBRARY; T=0.K  
Photon emission for (n,2nd)

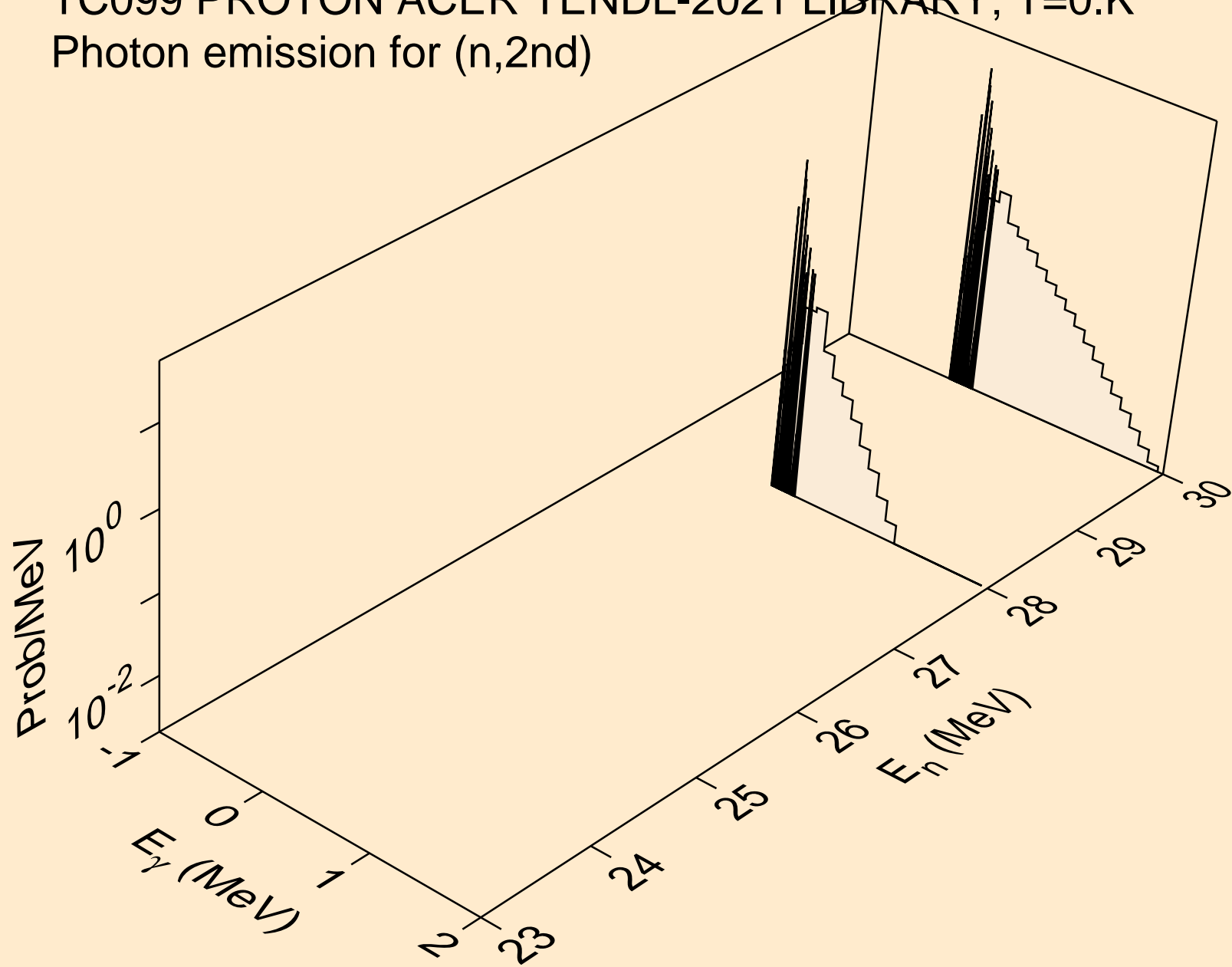

TC099 PROTON ACER TENDL-2021 LIBRARY; T=0.K  
Photon emission for (n,2n)

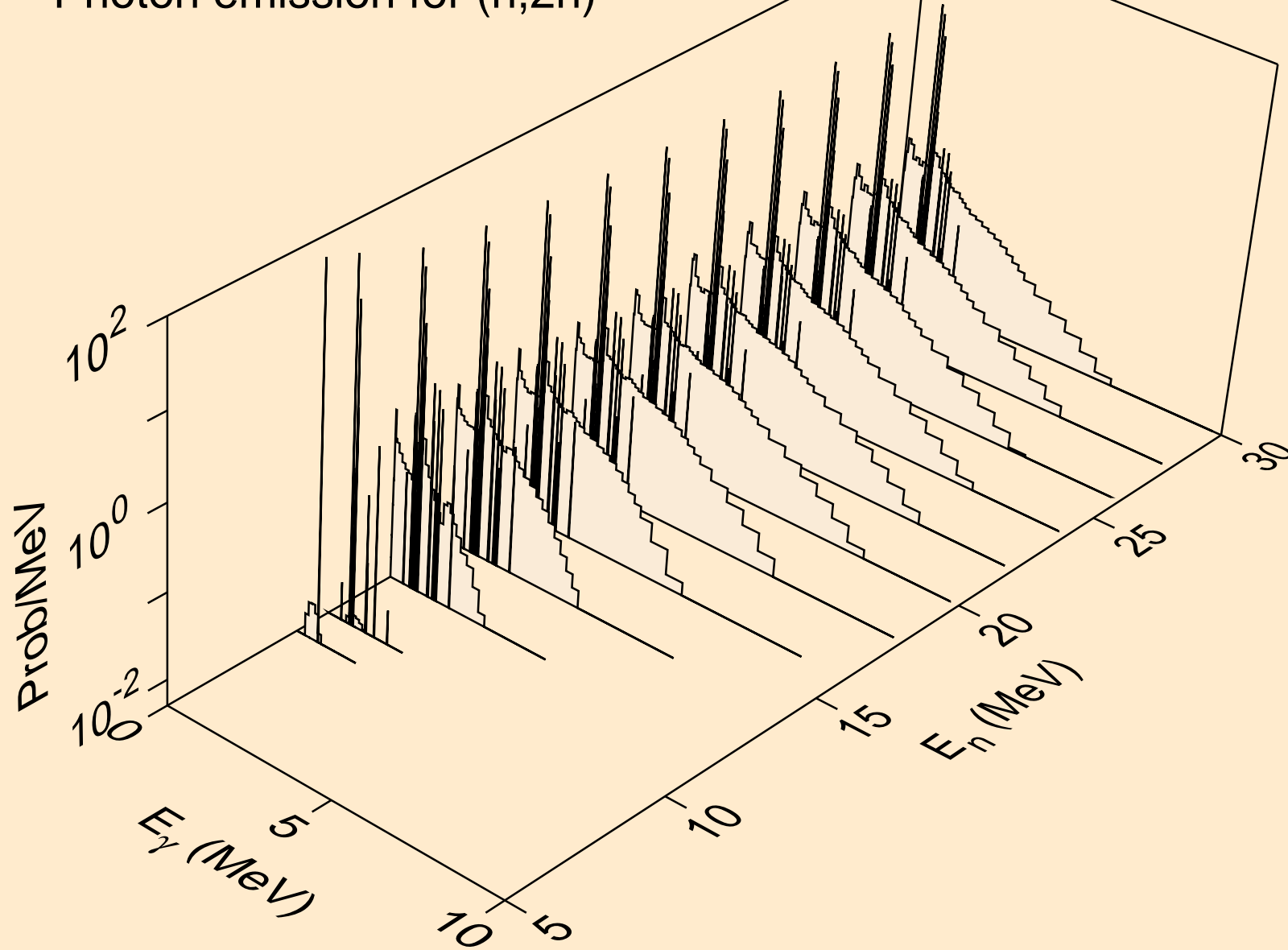



TC099 PROTON ACER TENDL-2021 LIBRARY; T=0.K  
Photon emission for (n,3n)

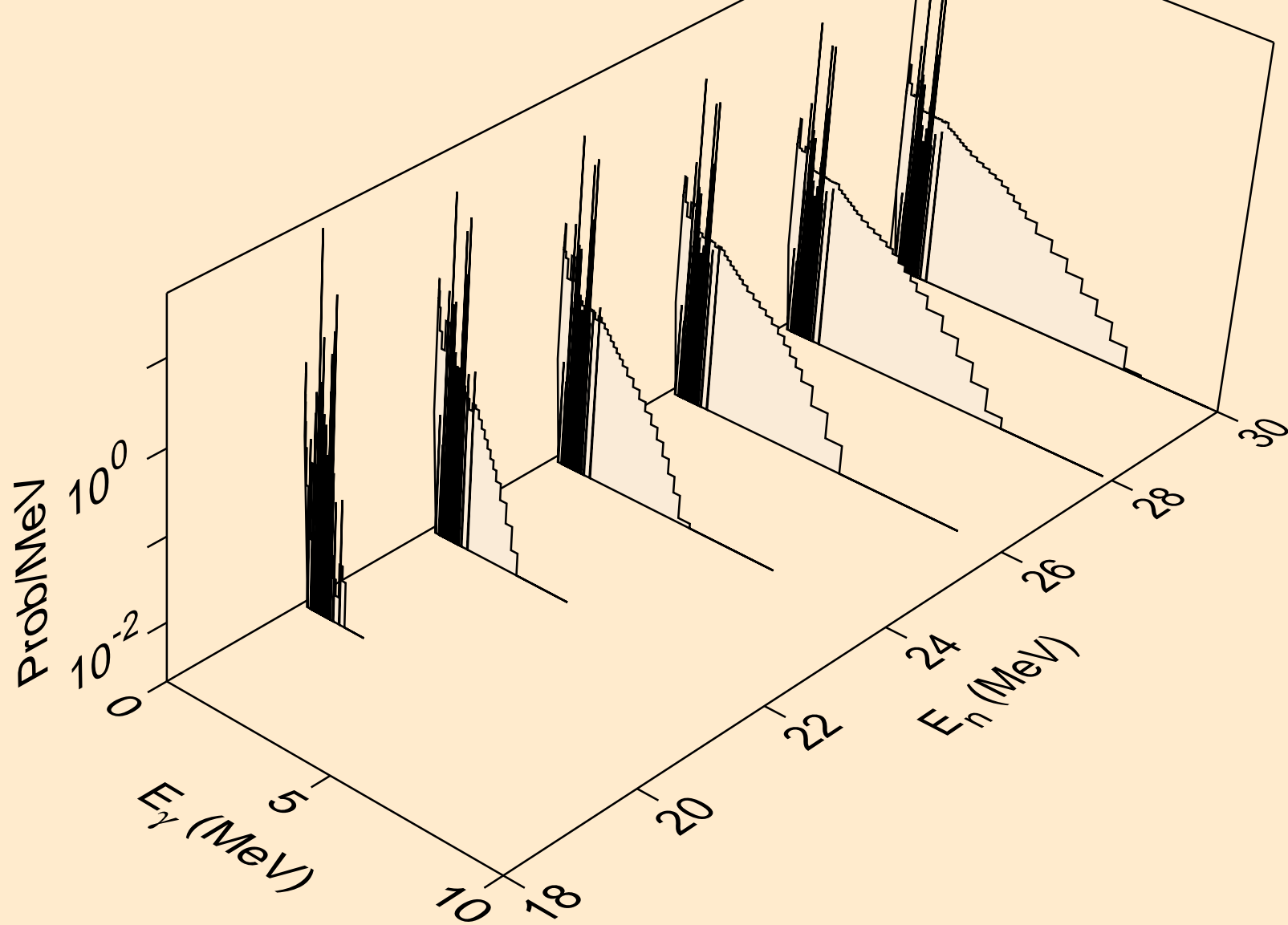

TC099 PROTON ACER TENDL-2021 LIBRARY; T=0.K  
Photon emission for (n,n\*)a

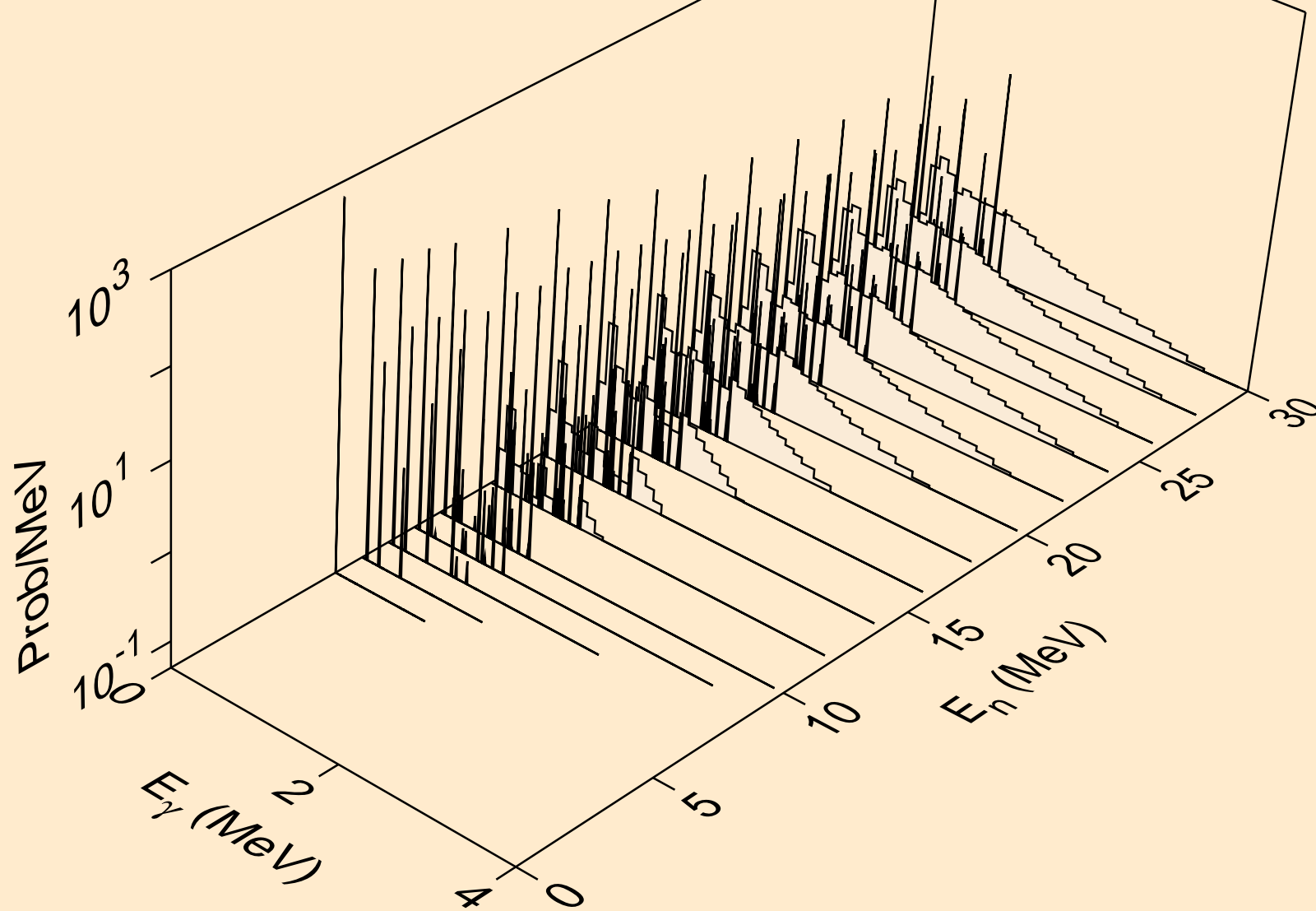

TC099 PROTON ACER TENDL-2021 LIBRARY; T=0.K  
Photon emission for (n,2n)a

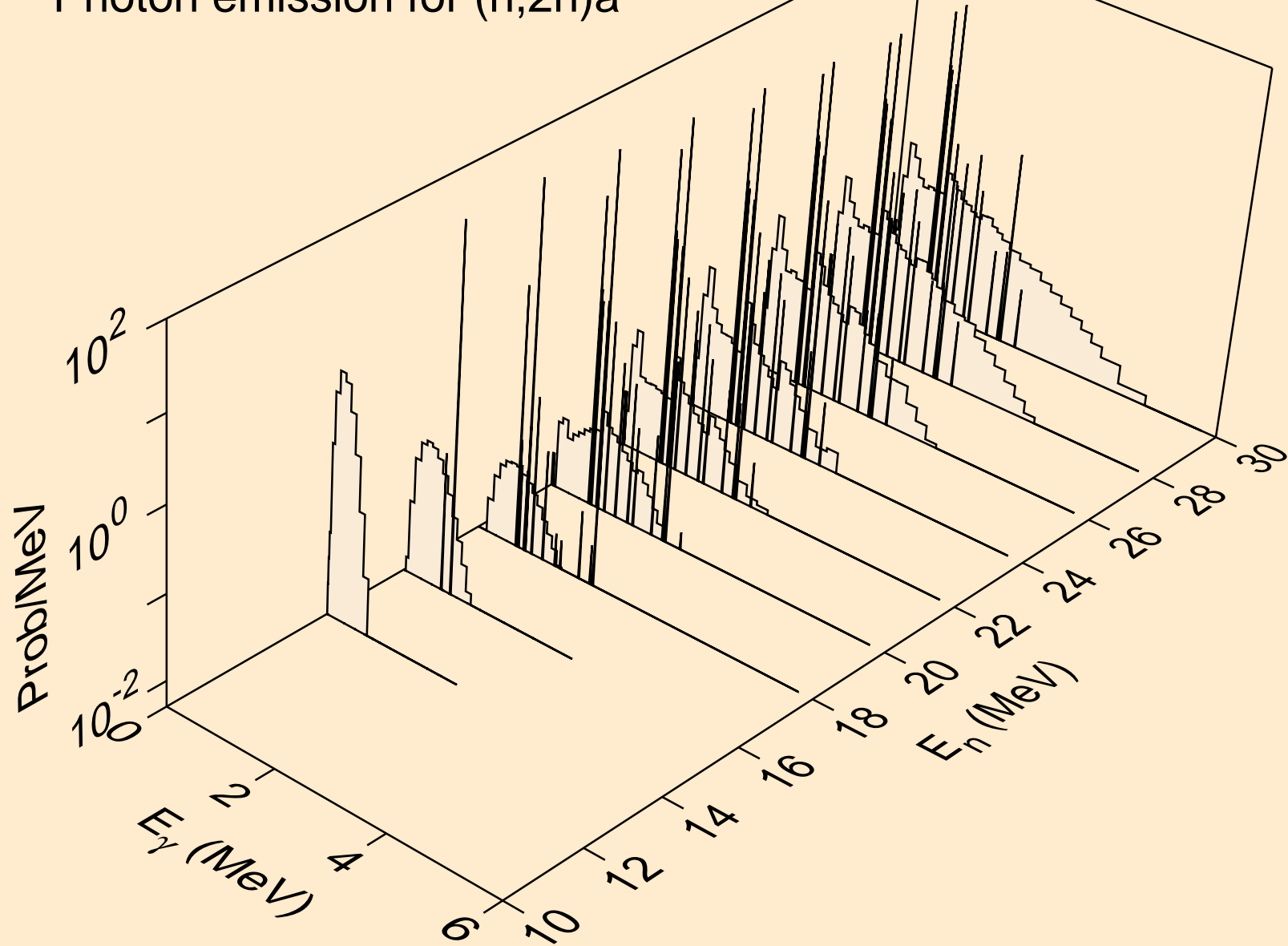

TC099 PROTON ACER TENDL-2021 LIBRARY; T=0.K  
Photon emission for (n,3n)a

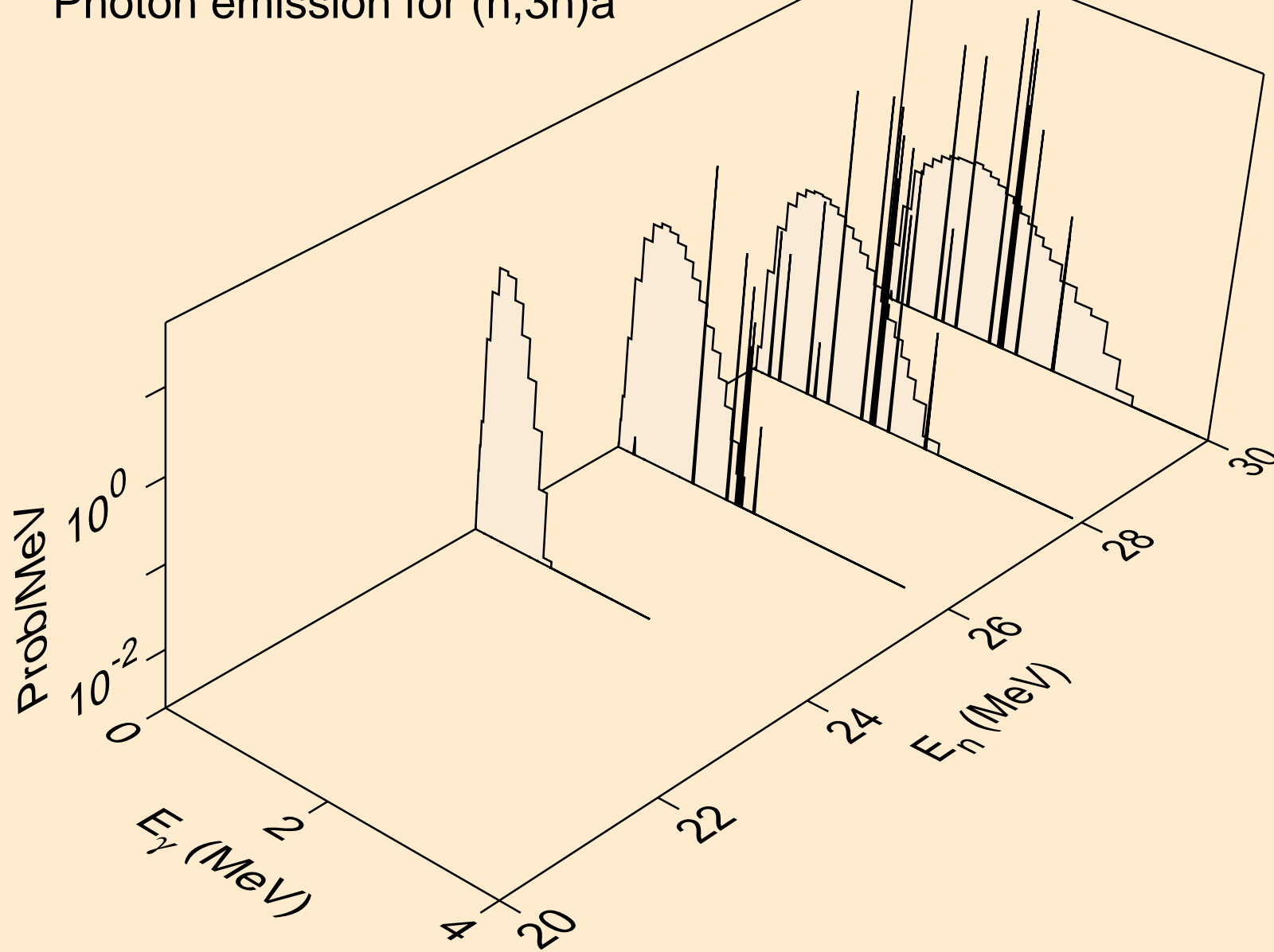

TC099 PROTON ACER TENDL-2021 LIBRARY; T=0.K  
Photon emission for (n,n\*)p

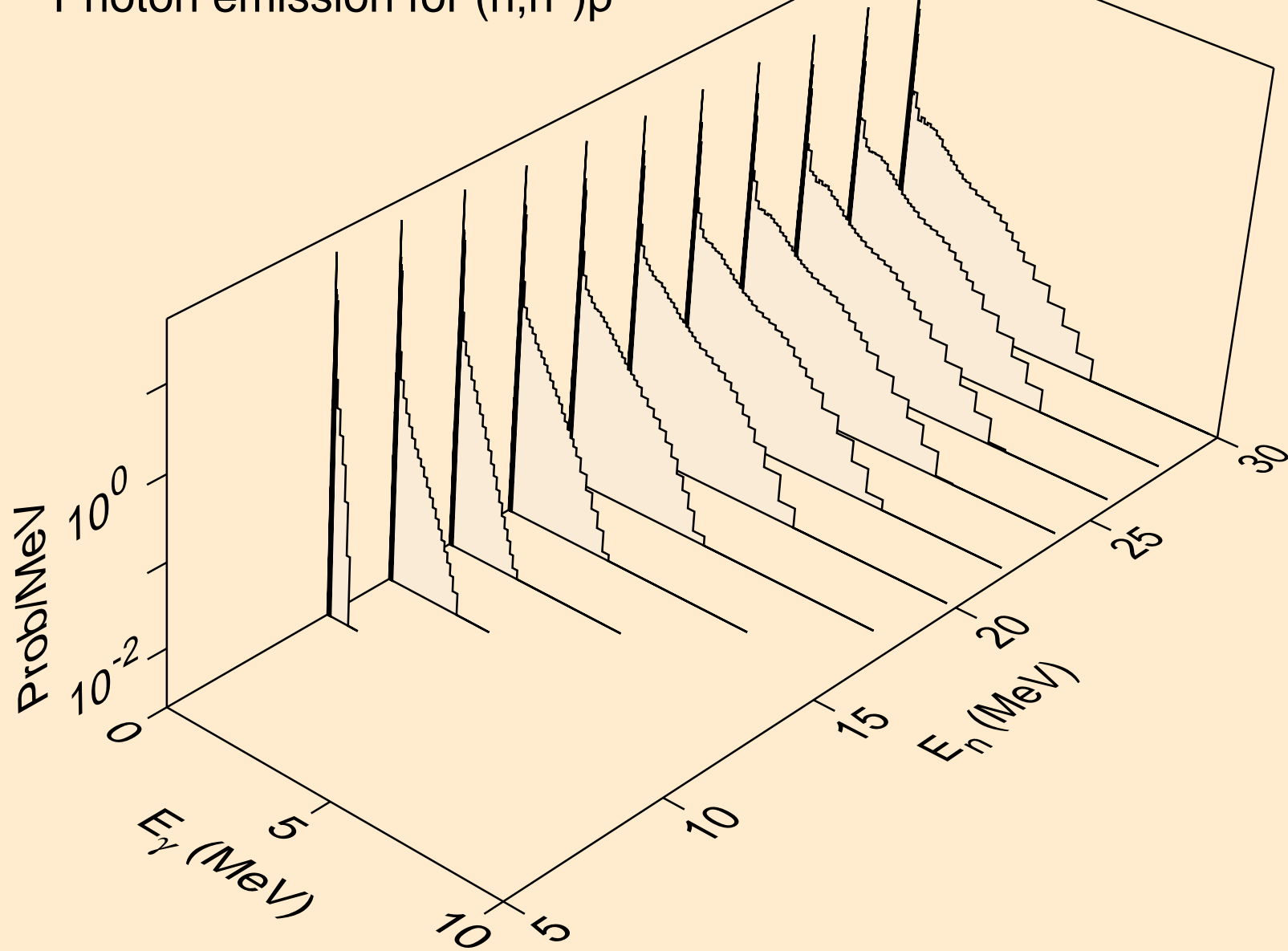

TC099 PROTON ACER TENDL-2021 LIBRARY; T=0.K  
Photon emission for (n,n\*)2a

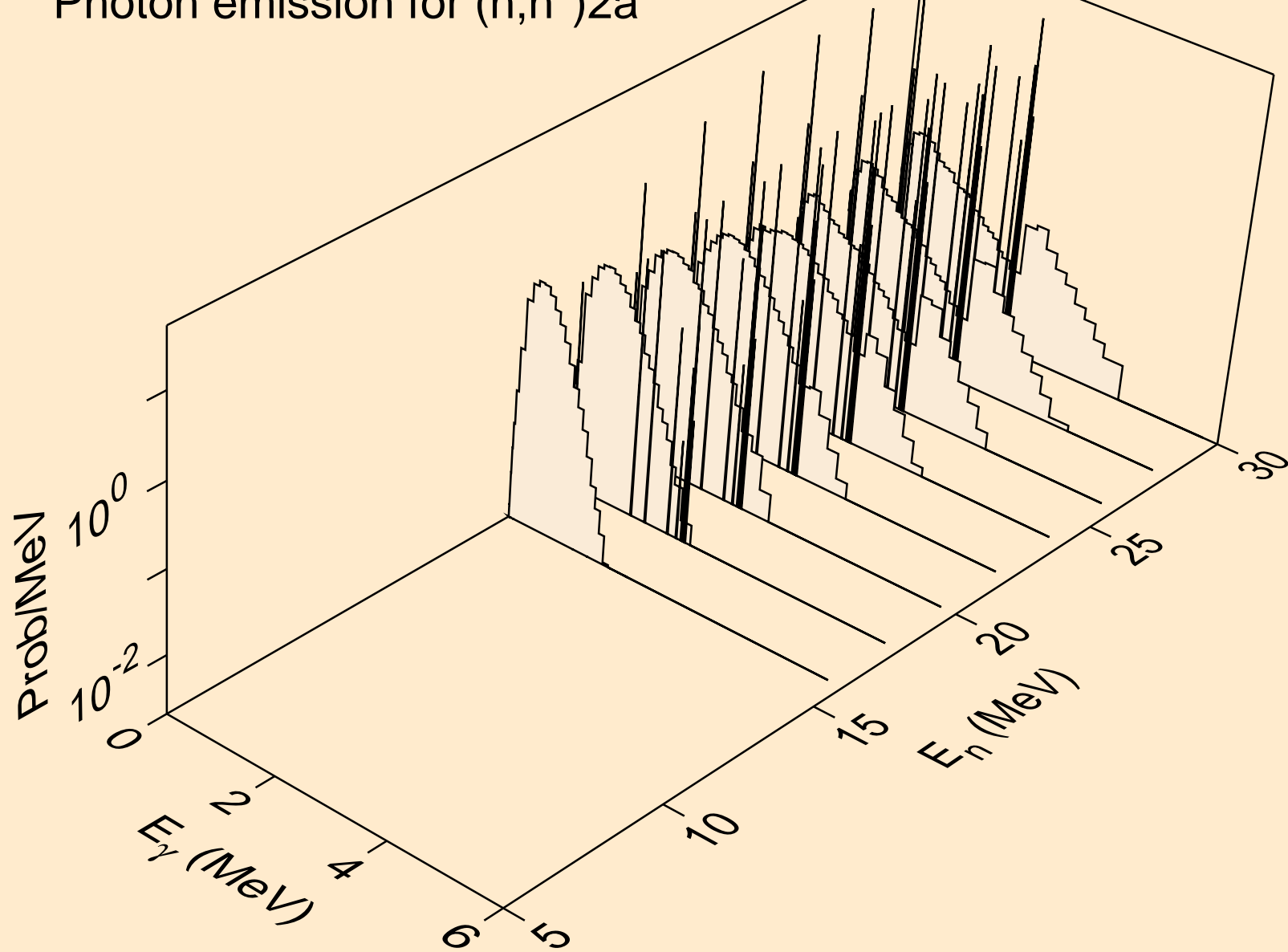

TC099 PROTON ACER TENDL-2021 LIBRARY; T=0.K  
Photon emission for (n,2n)2a

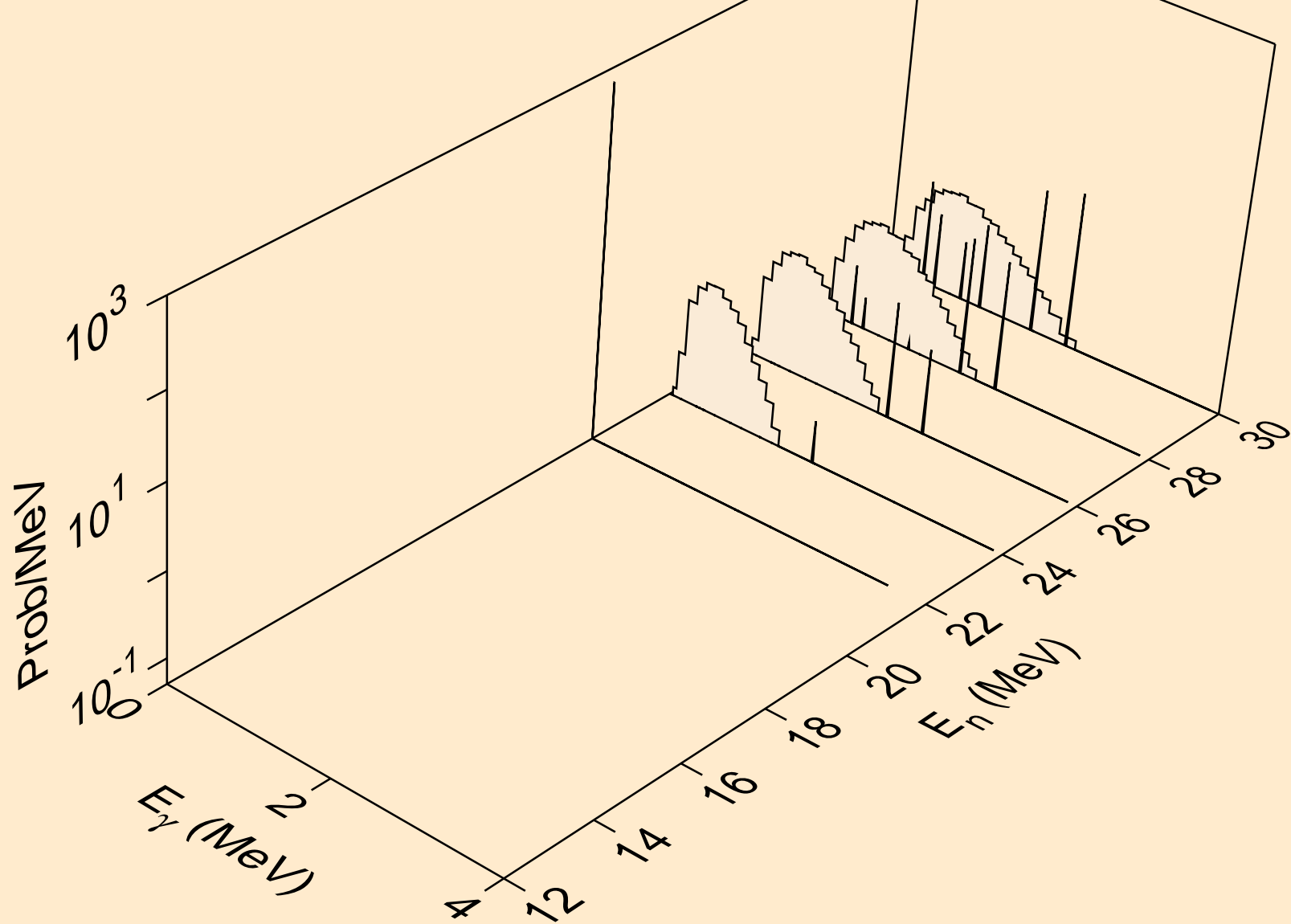

TC099 PROTON ACER TENDL-2021 LIBRARY; T=0.K  
Photon emission for (n,n\*)d

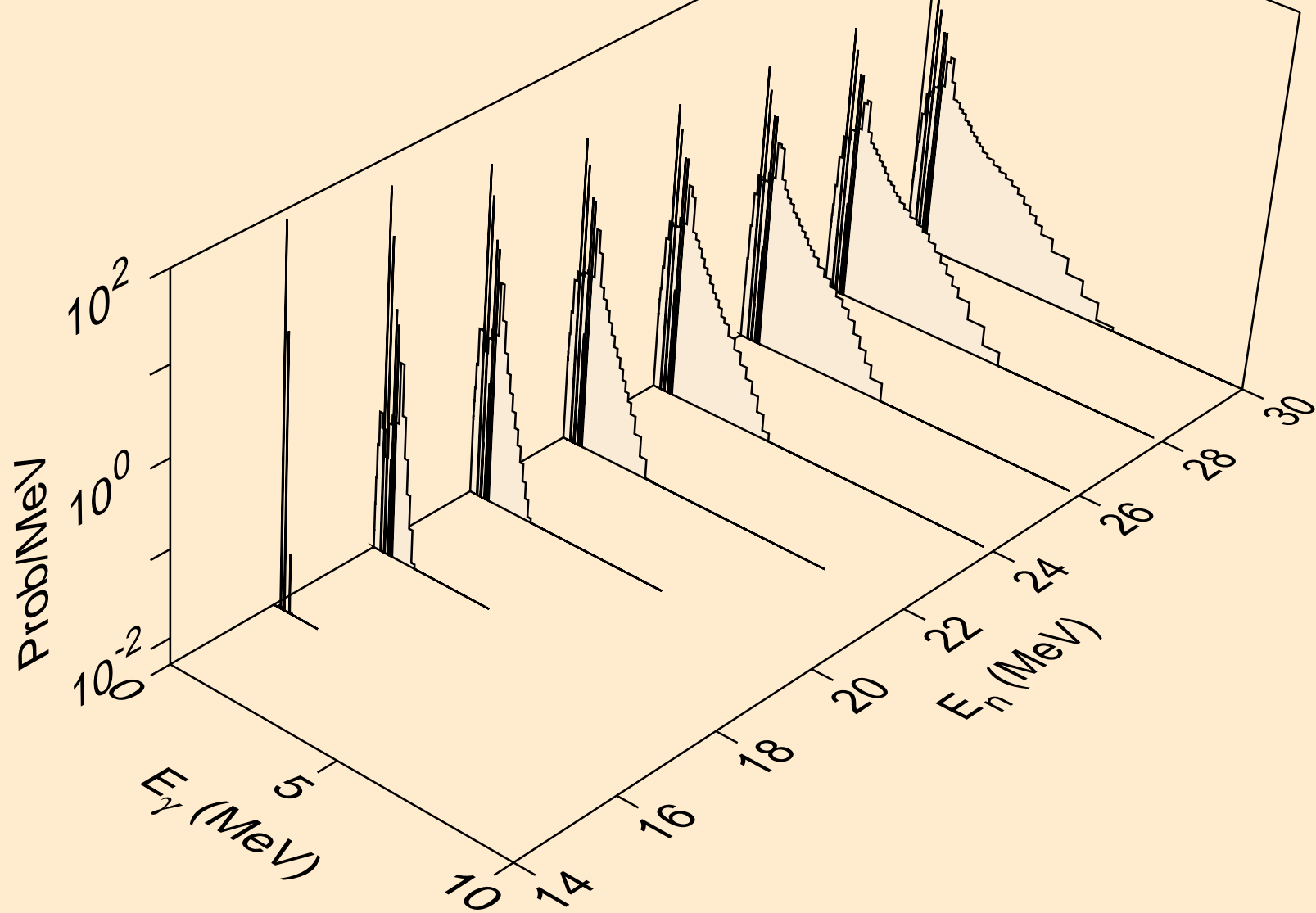



TC099 PROTON ACER TENDL-2021 LIBRARY; T=0.K  
Photon emission for (n,n\*)t

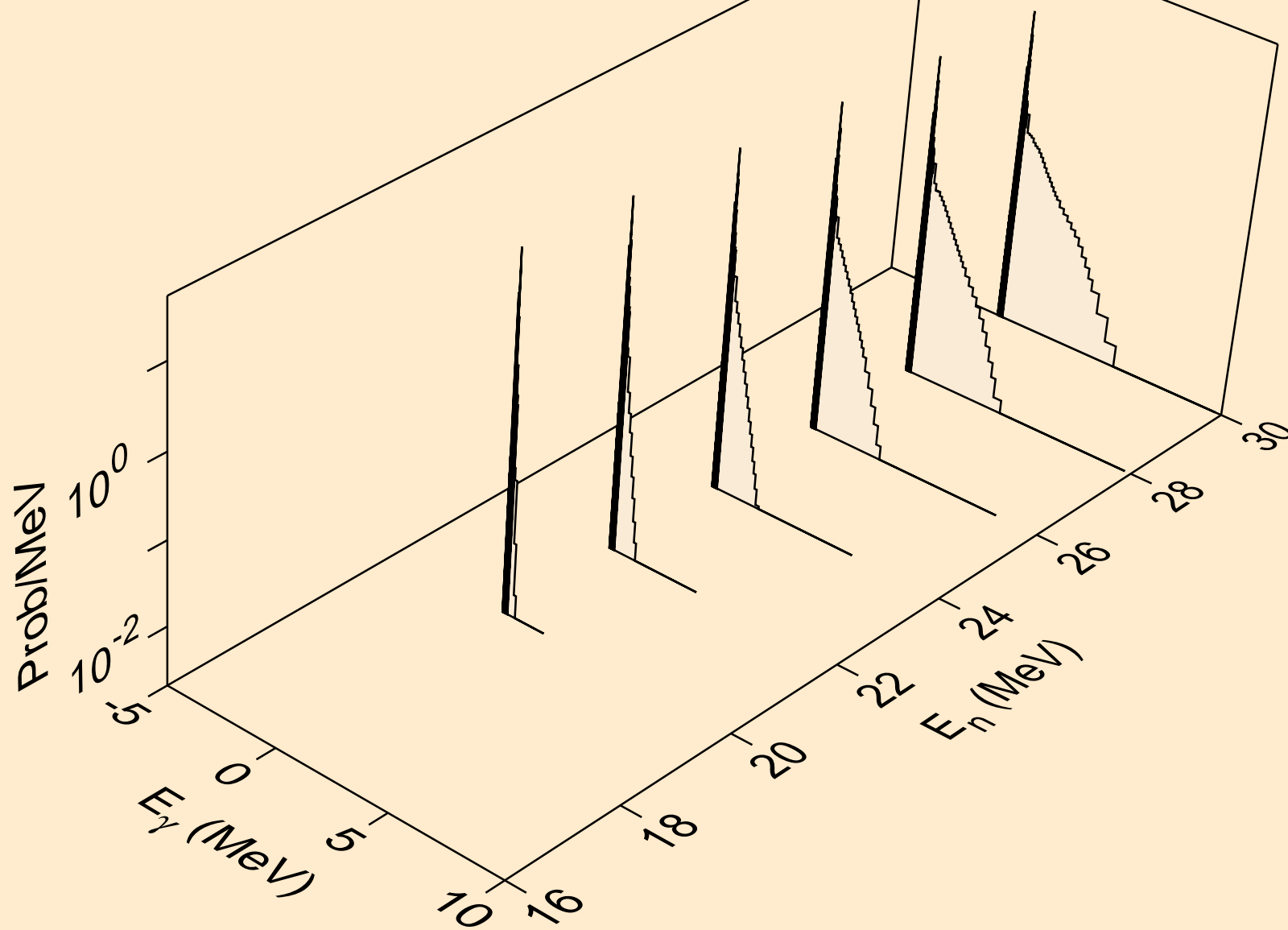

TC099 PROTON ACER TENDL-2021 LIBRARY; T=0.K  
Photon emission for (n,n\*)he3

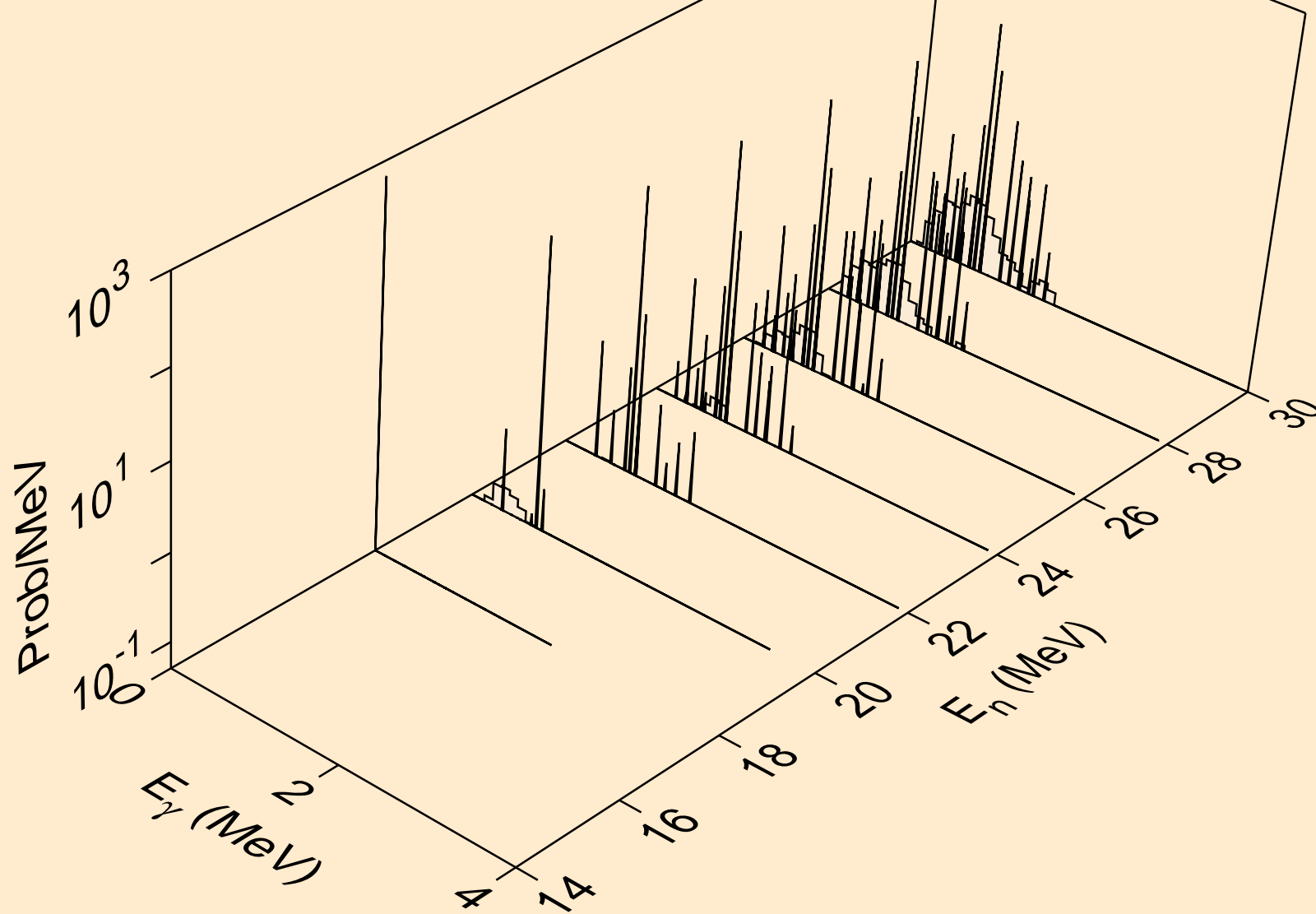

TC099 PROTON ACER TENDL-2021 LIBRARY; T=0.K  
Photon emission for (n,4n)

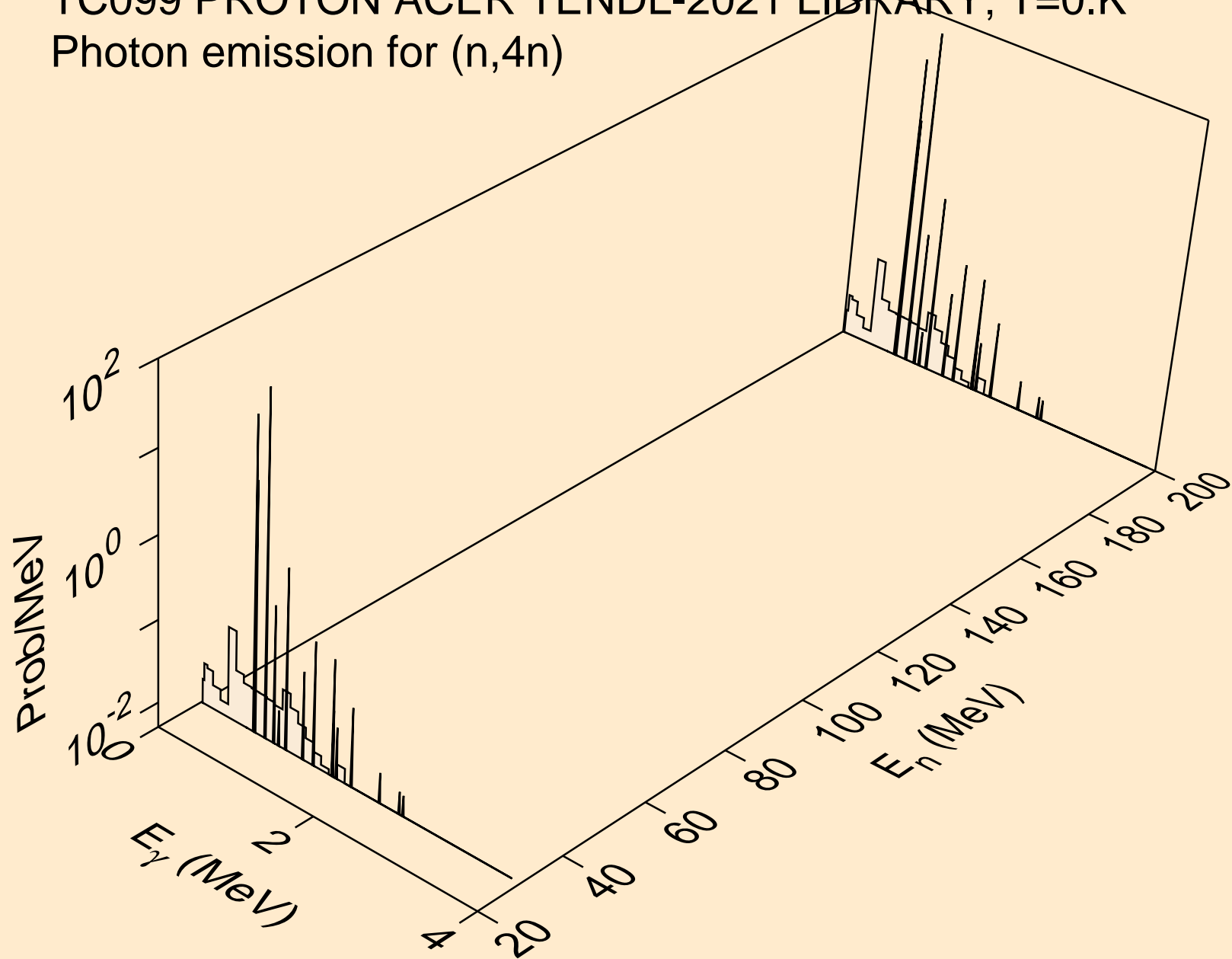

TC099 PROTON ACER TENDL-2021 LIBRARY; T=0.K  
Photon emission for (n,2np)

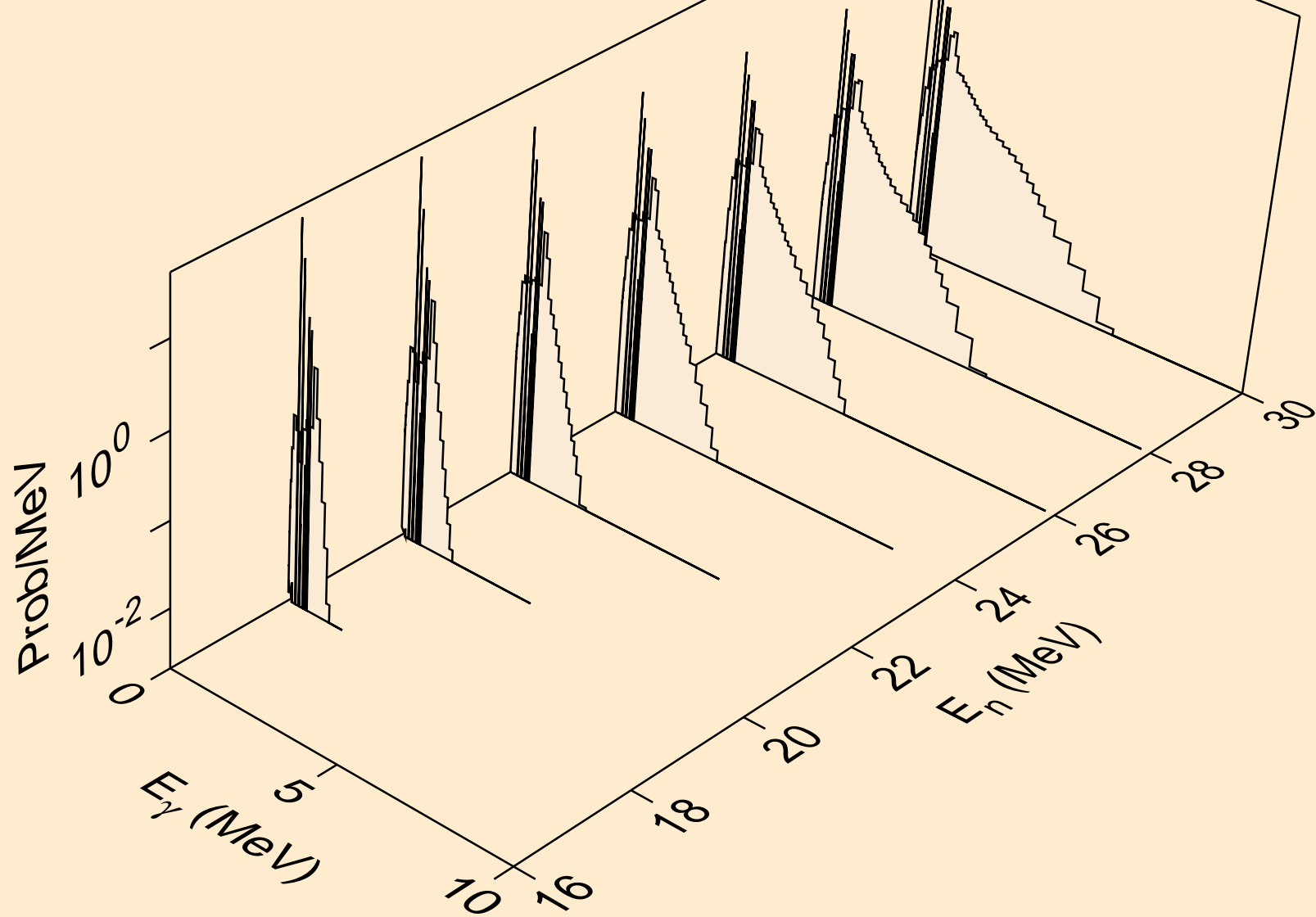

TC099 PROTON ACER TENDL-2021 LIBRARY; T=0.K  
Photon emission for (n,3np)

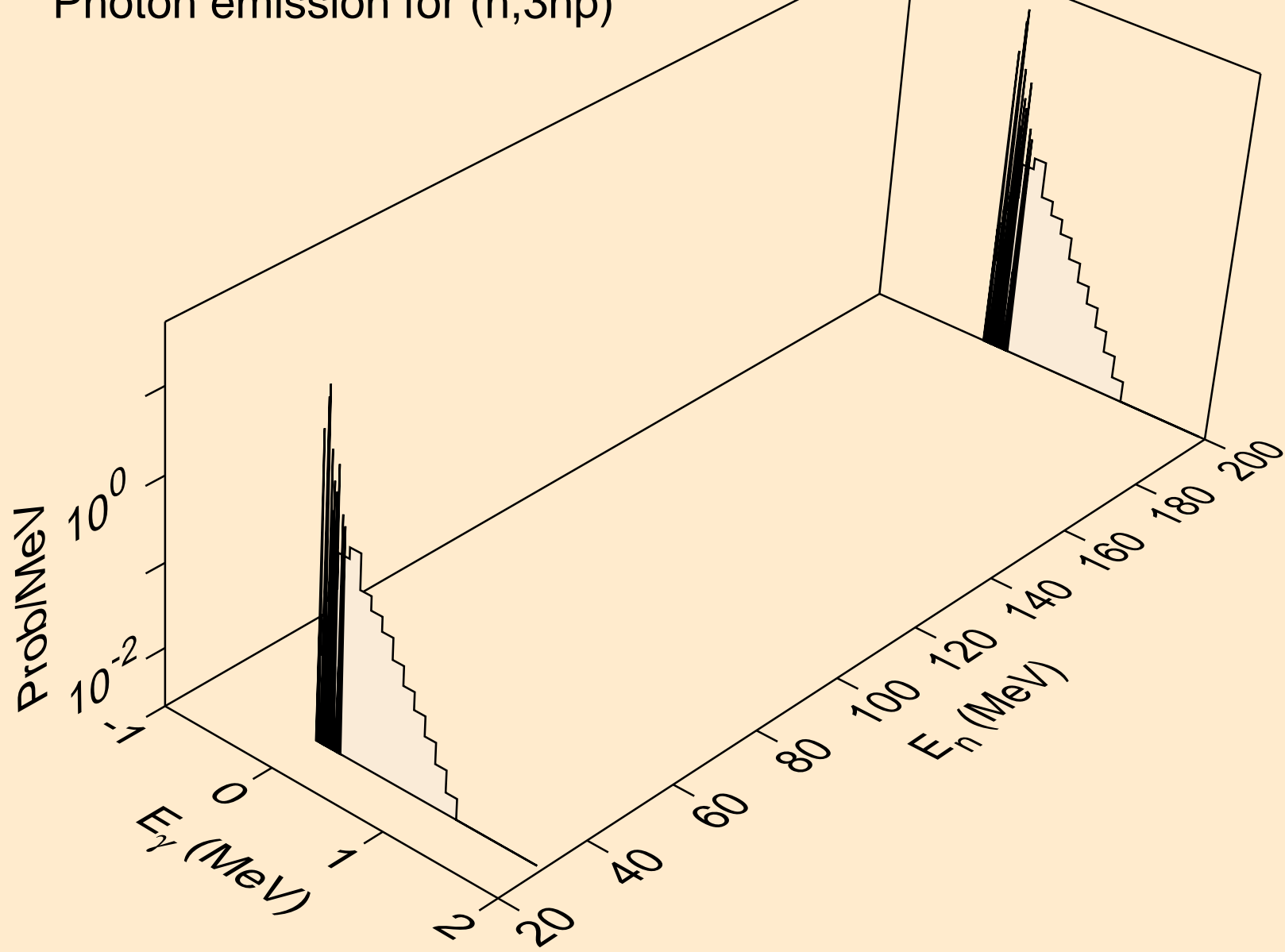

TC099 PROTON ACER TENDL-2021 LIBRARY; T=0.K  
Photon emission for (n,2np)

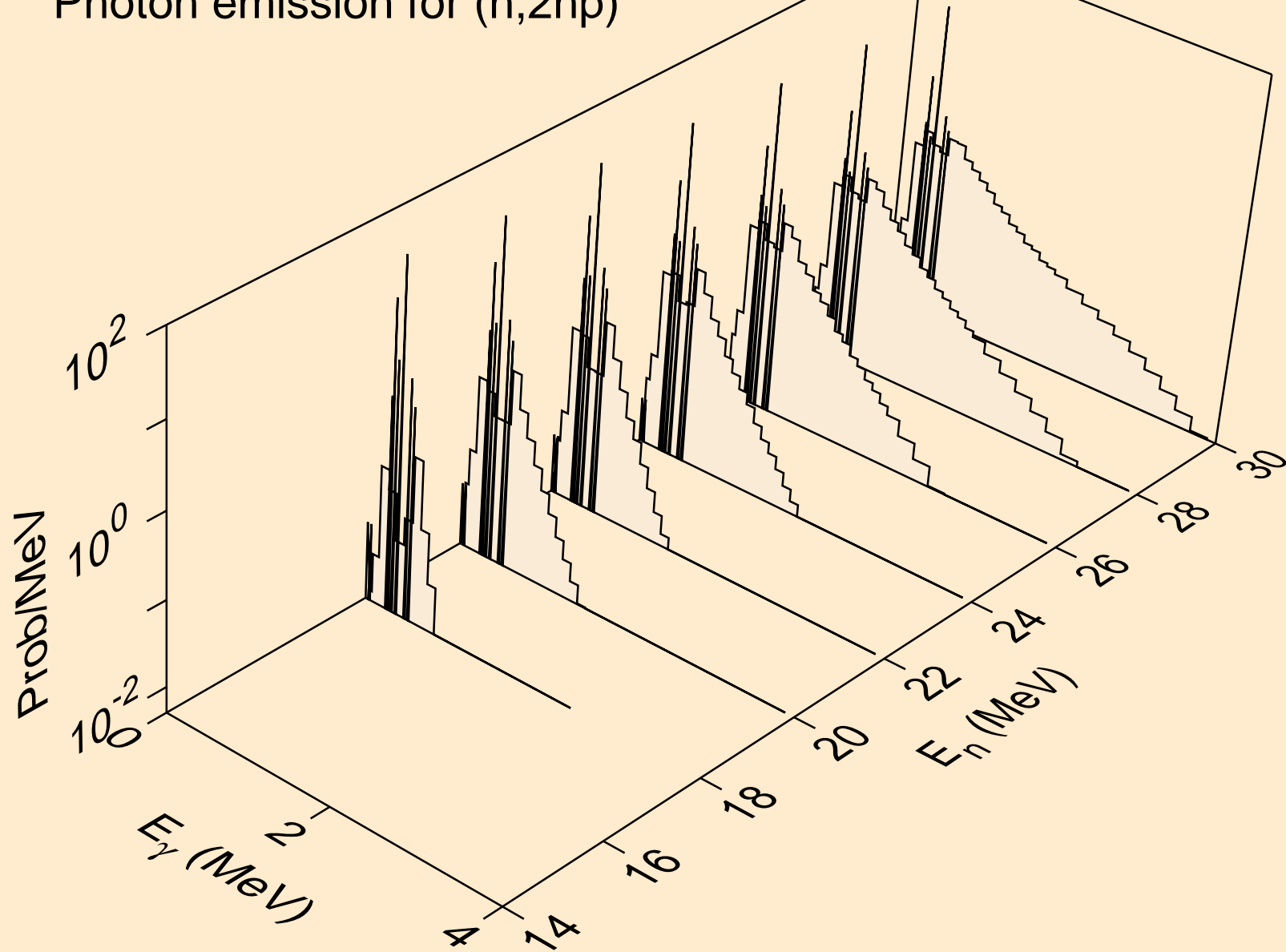

TC099 PROTON ACER TENDL-2021 LIBRARY; T=0.K  
Photon emission for (n,npa)

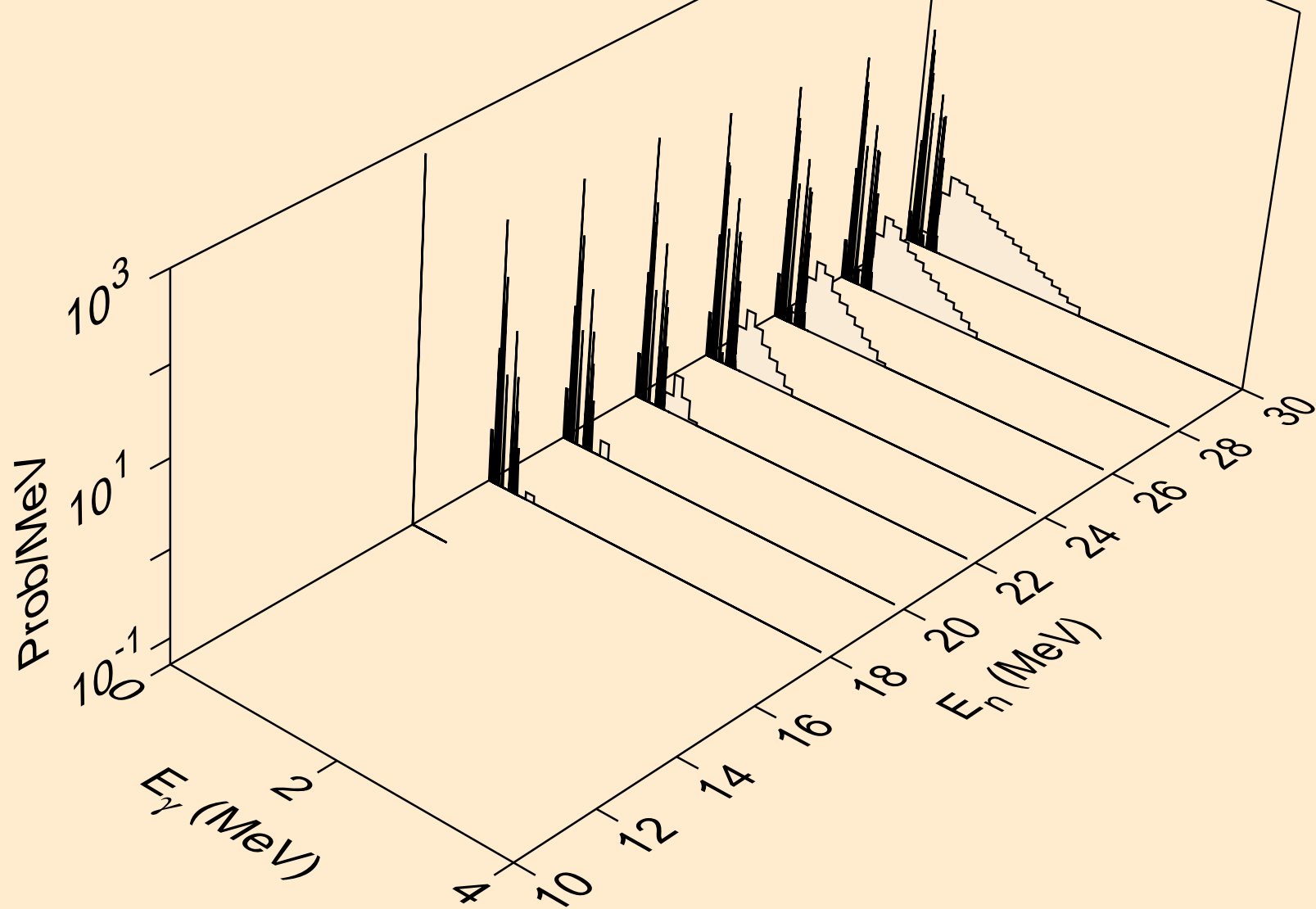

TC099 PROTON ACER TENDL-2021 LIBRARY; T=0.K  
Photon emission for (n,gma)

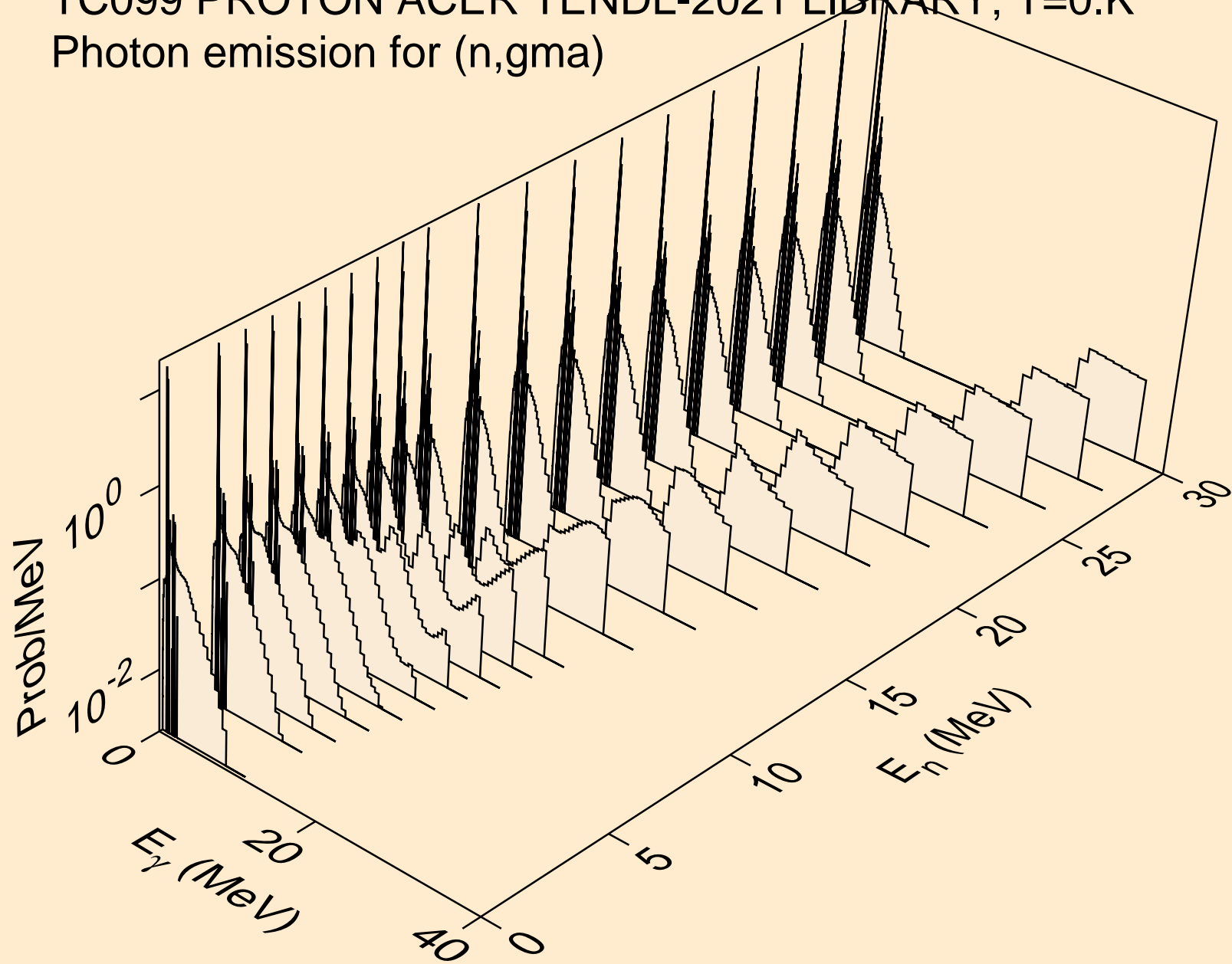



TC099 PROTON ACER TENDL-2021 LIBRARY; T=0.K  
Photon emission for inelastic

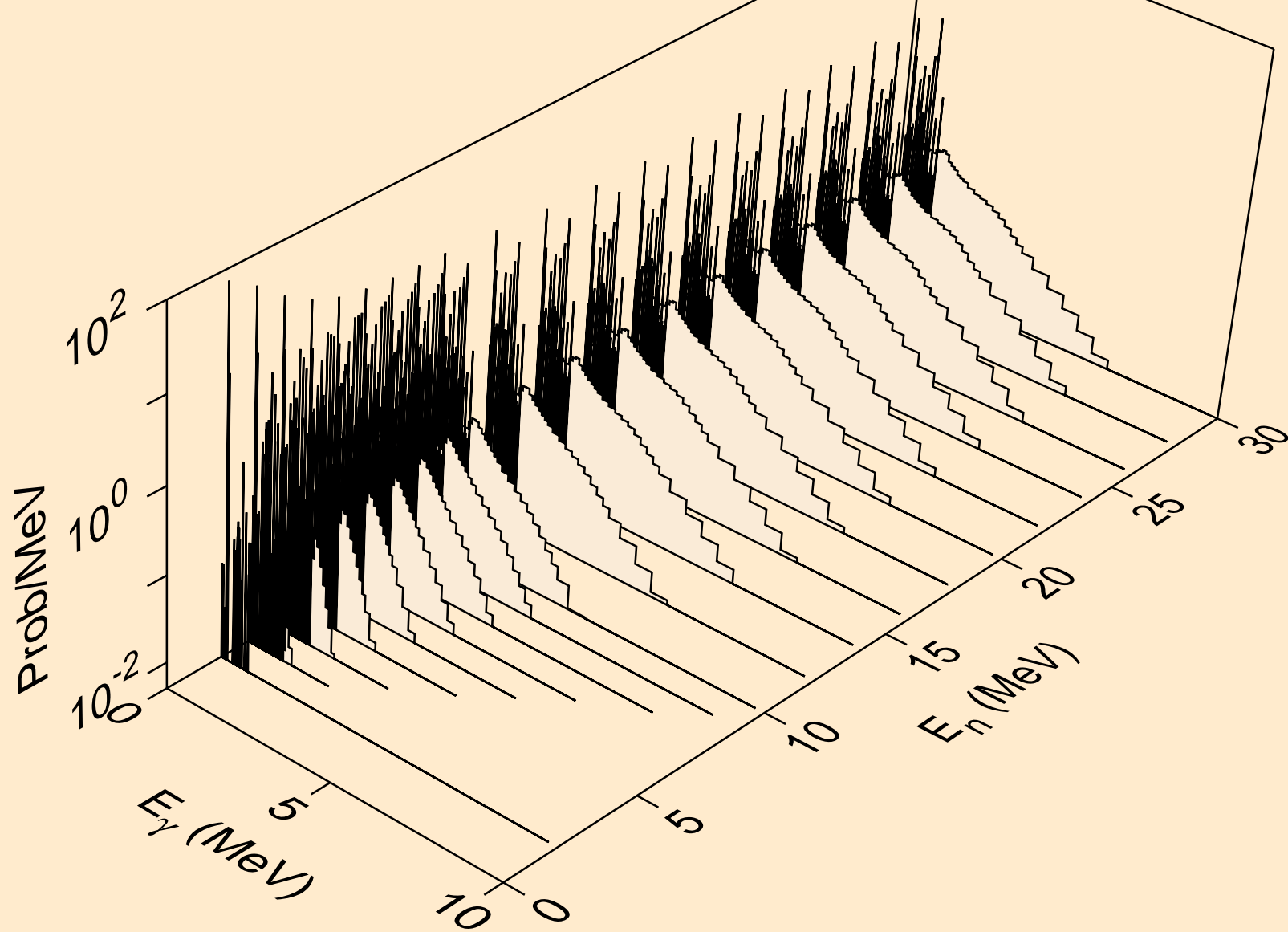

TC099 PROTON ACER TENDL-2021 LIBRARY; T=0.K  
Photon emission for (n,d)

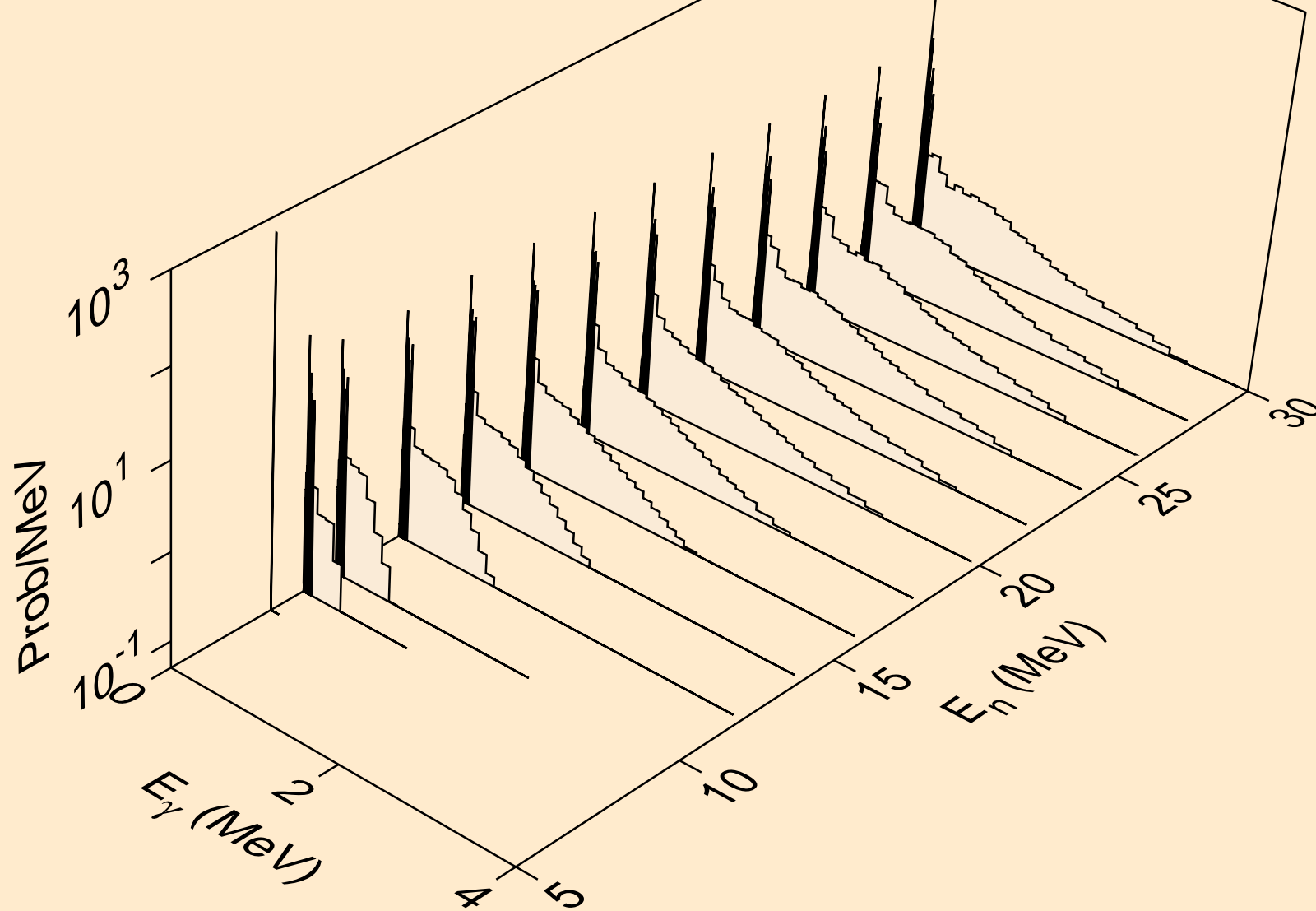

TC099 PROTON ACER TENDL-2021 LIBRARY; T=0.K  
Photon emission for (n,t)

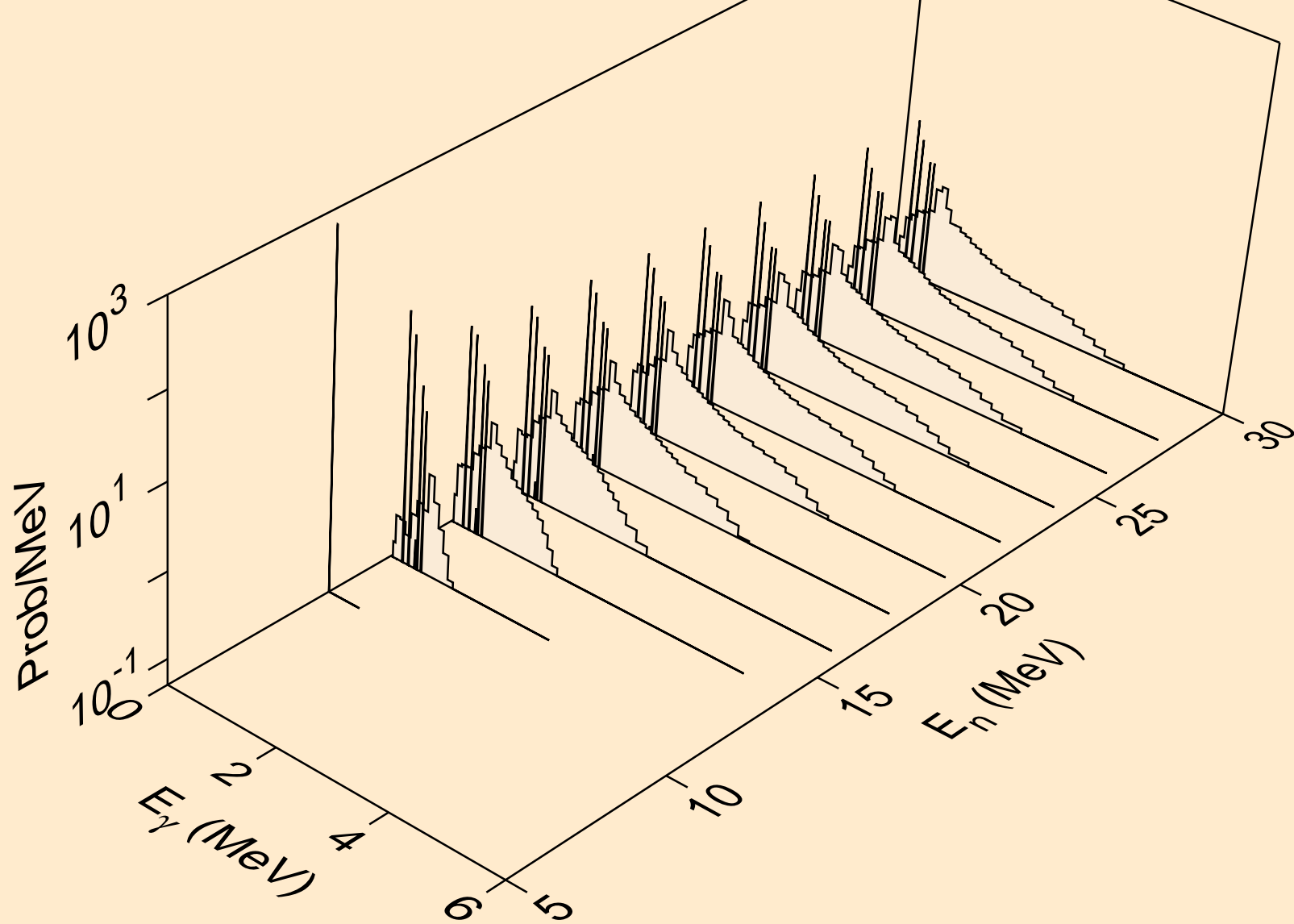

TC099 PROTON ACER TENDL-2021 LIBRARY; T=0.K  
Photon emission for (n,he3)

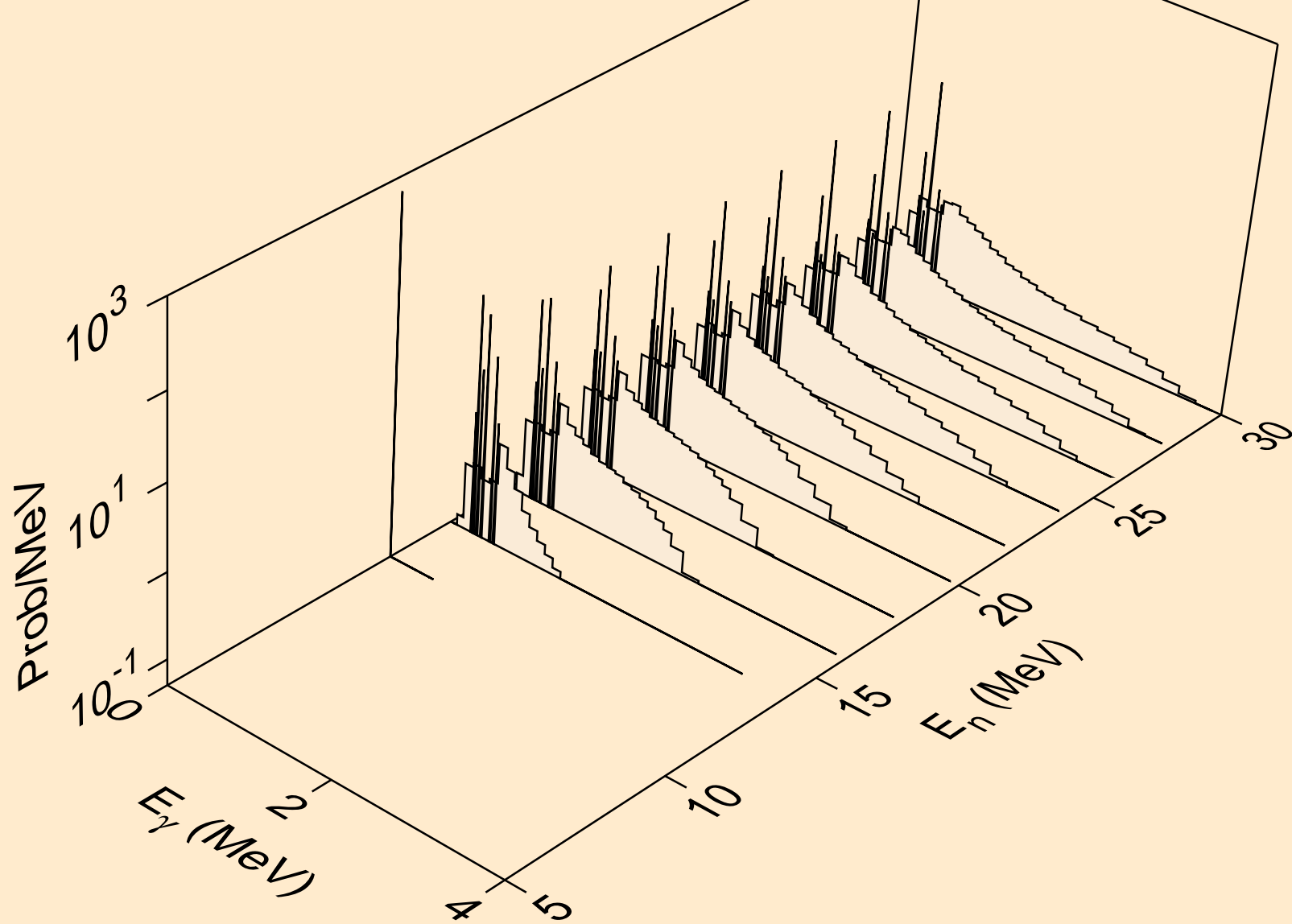

TC099 PROTON ACER TENDL-2021 LIBRARY; T=0.K  
Photon emission for (n,a)

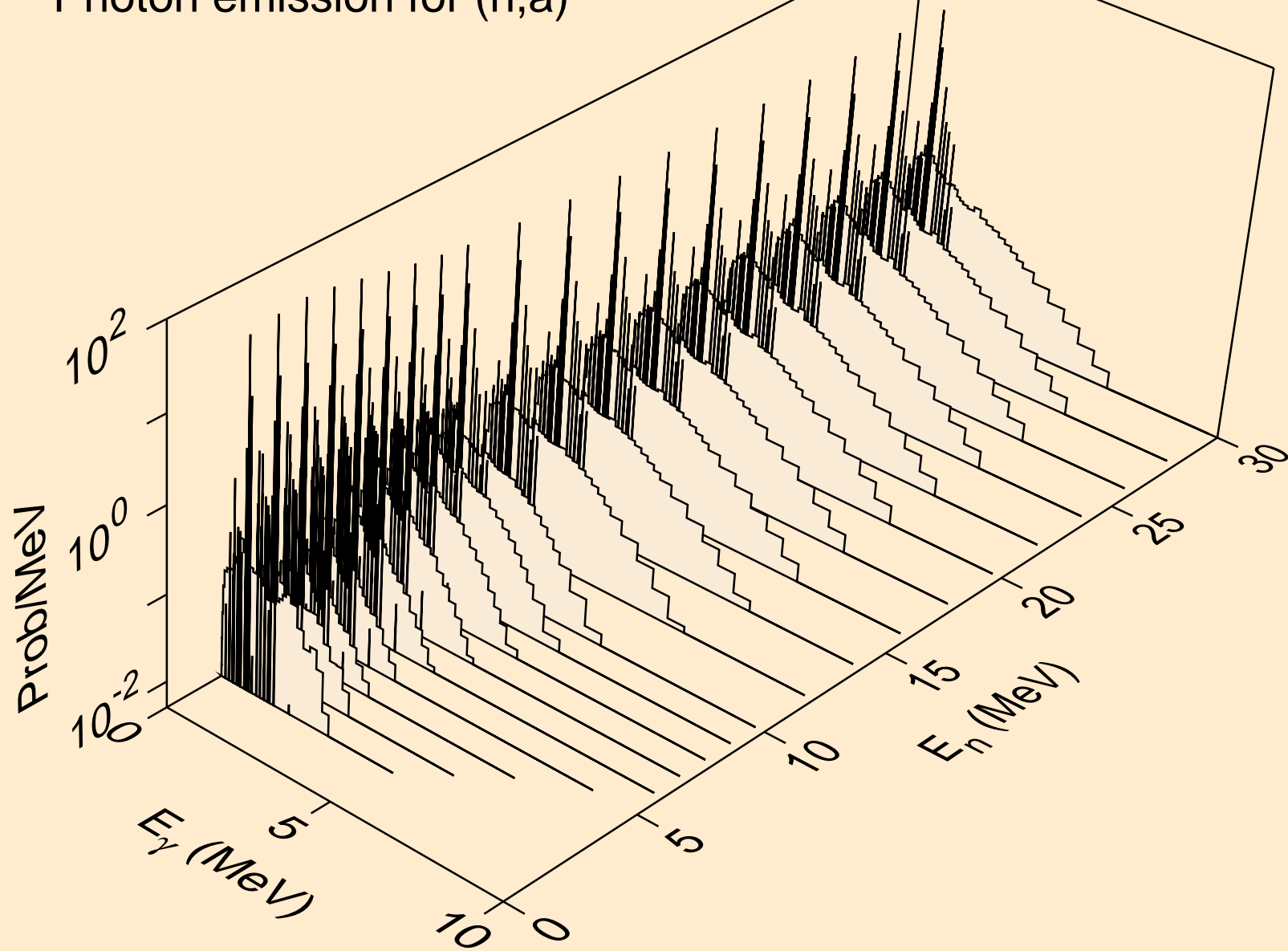

TC099 PROTON ACER TENDL-2021 LIBRARY; T=0.K  
Photon emission for (n,2a)

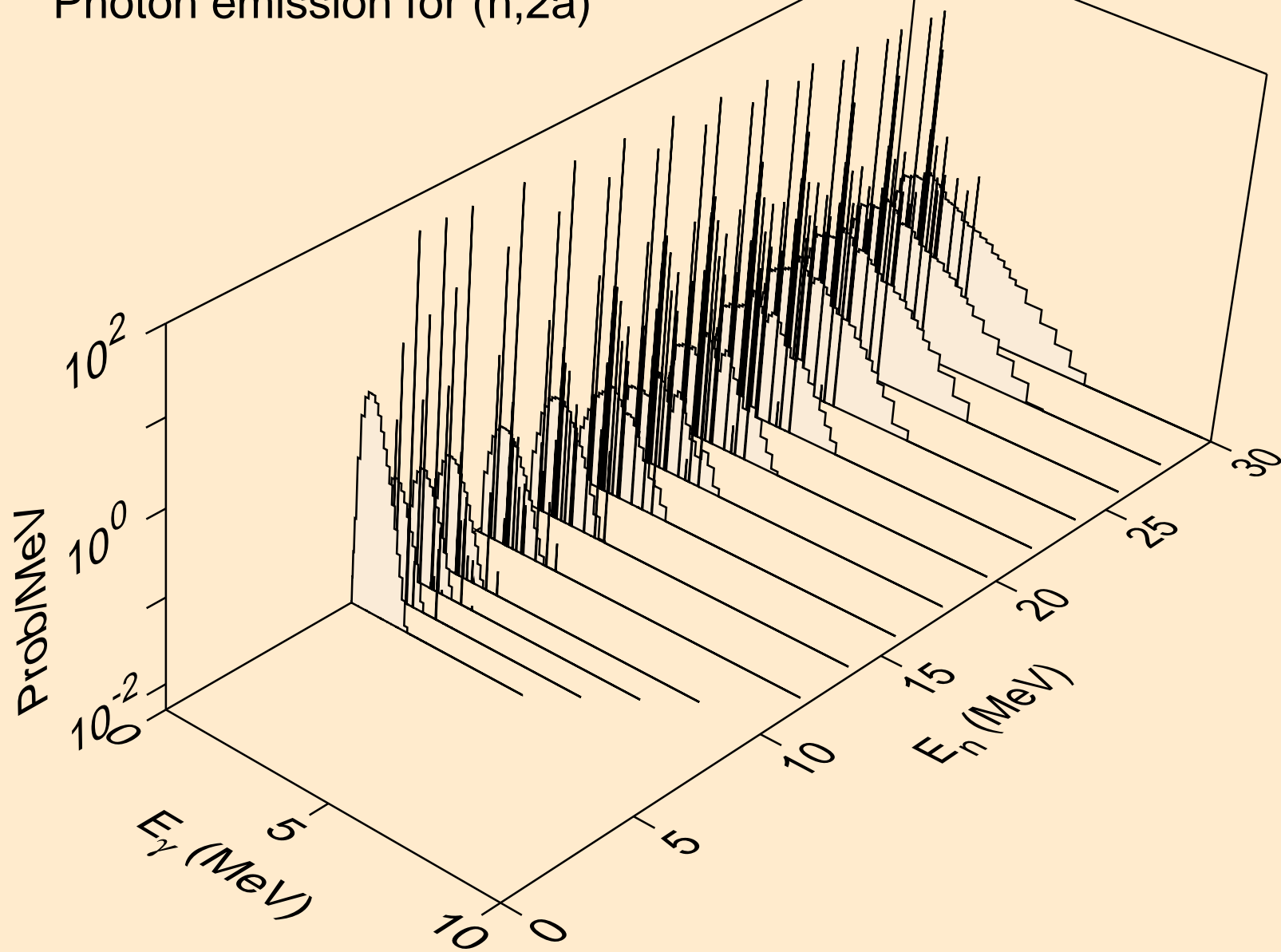

TC099 PROTON ACER TENDL-2021 LIBRARY; T=0.K  
Photon emission for (n,2p)

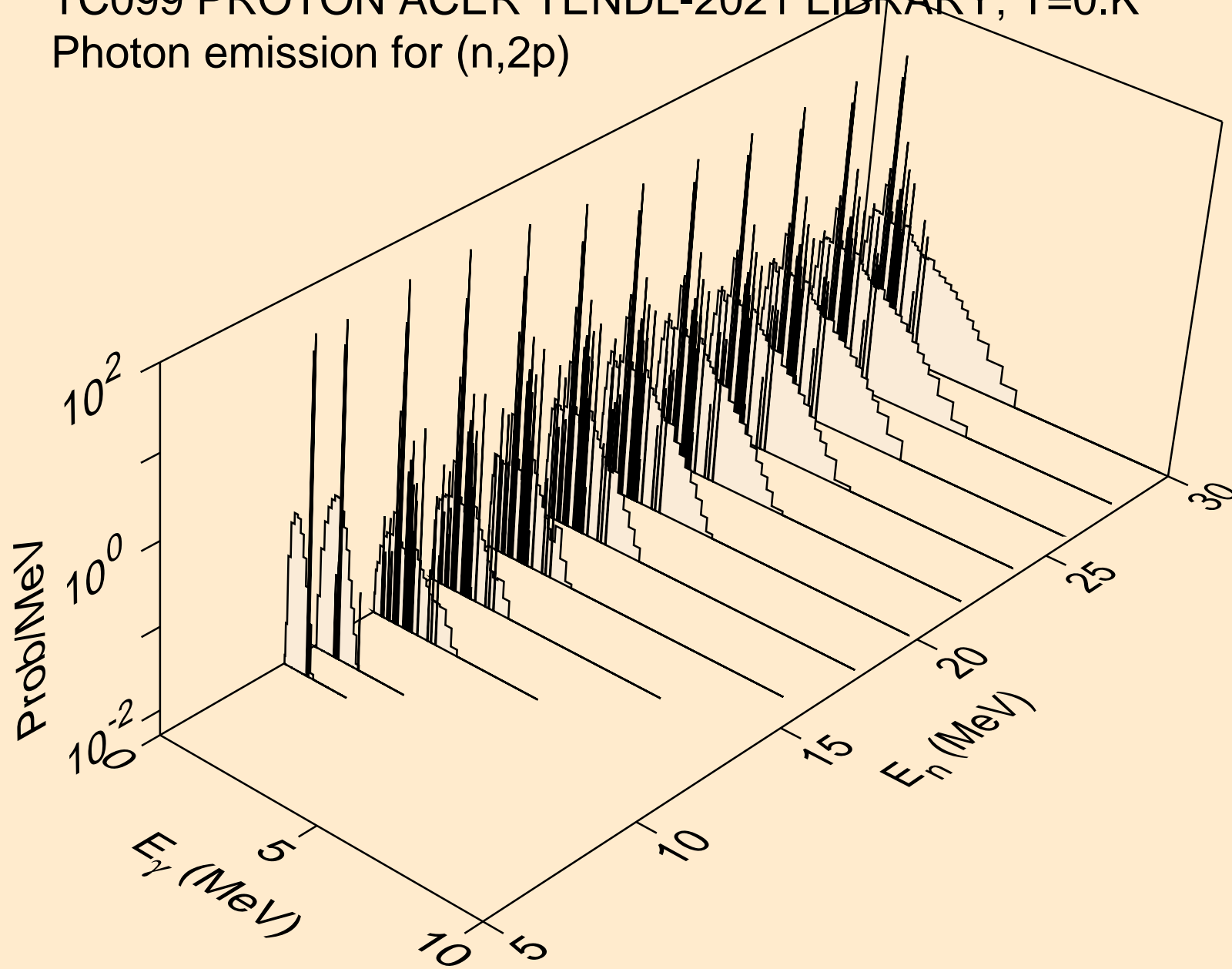

TC099 PROTON ACER TENDL-2021 LIBRARY; T=0.K  
Photon emission for (n,p $\alpha$ )

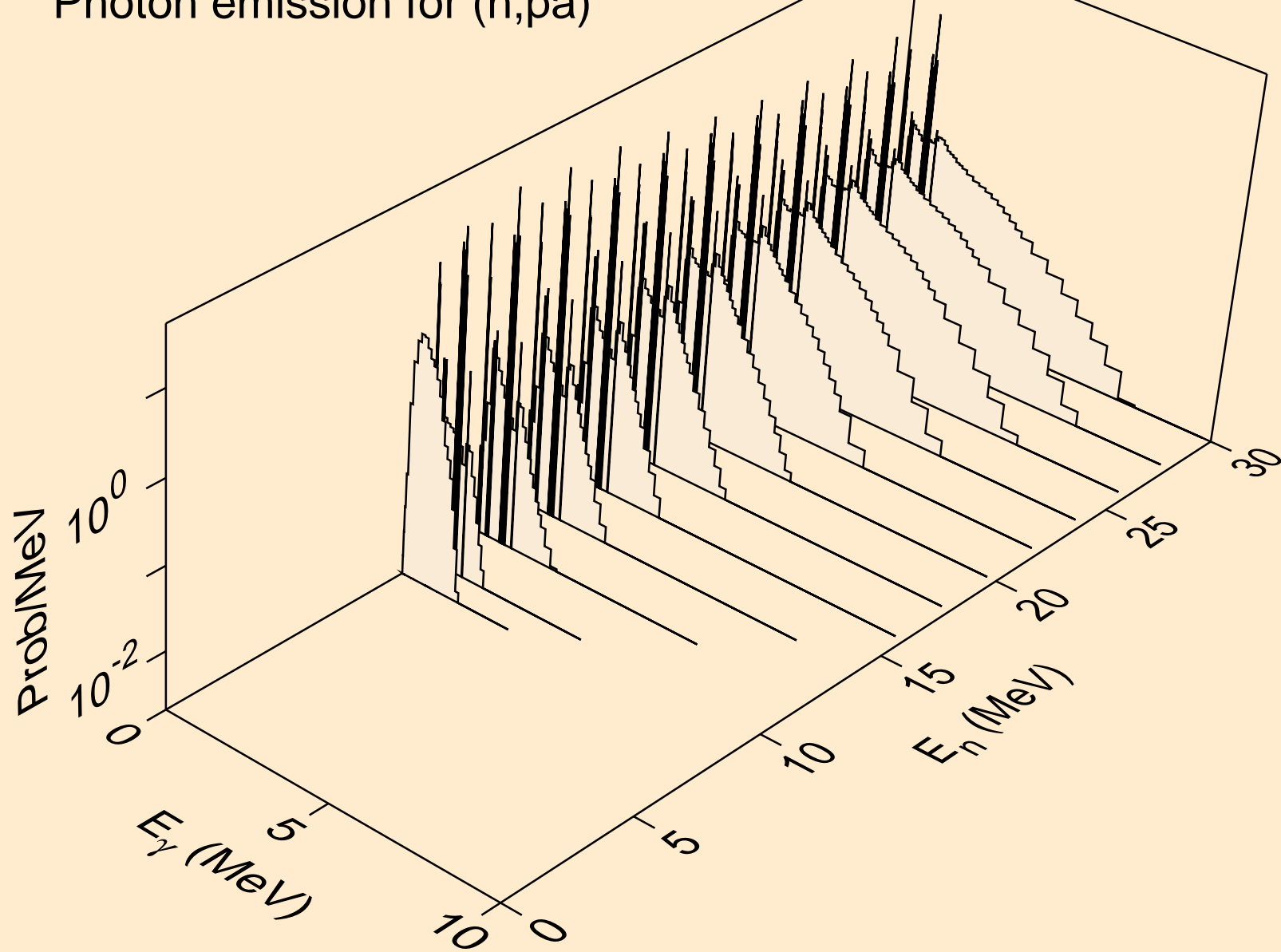



TC099 PROTON ACER TENDL-2021 LIBRARY; T=0.K  
Photon emission for (n,pd)

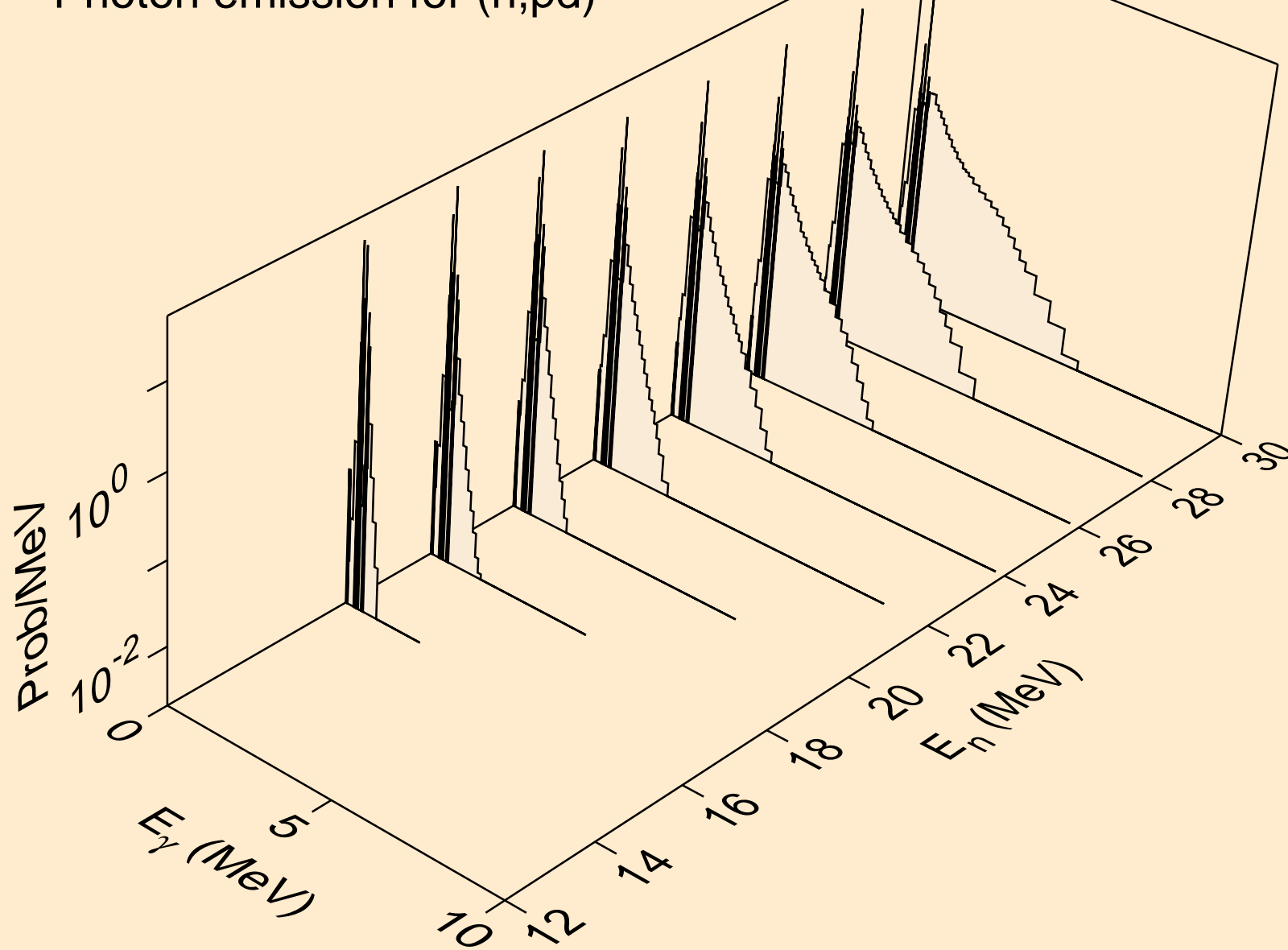

TC099 PROTON ACER TENDL-2021 LIBRARY; T=0.K  
Photon emission for (n,pt)

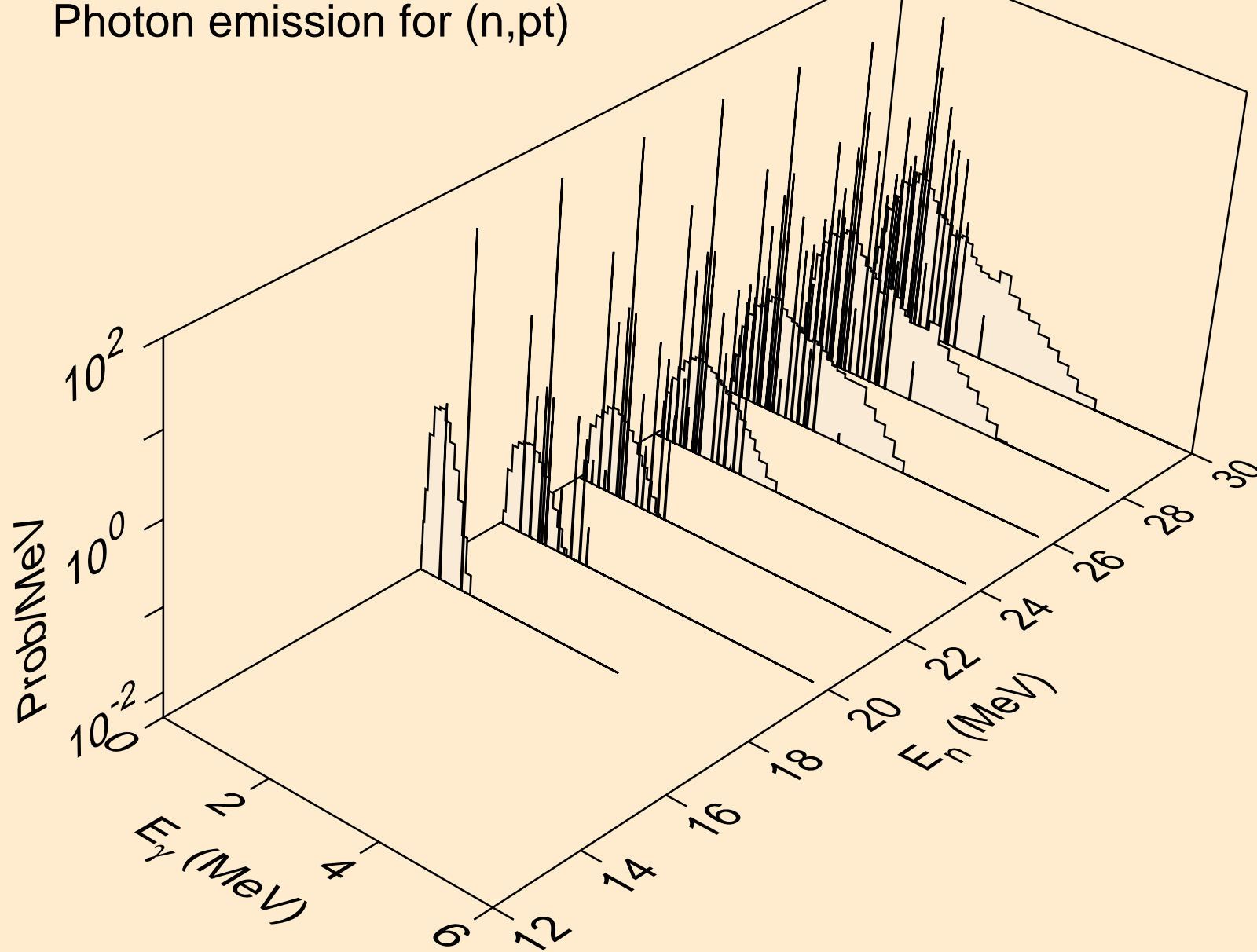

TC099 PROTON ACER TENDL-2021 LIBRARY; T=0.K  
Photon emission for (n,da)

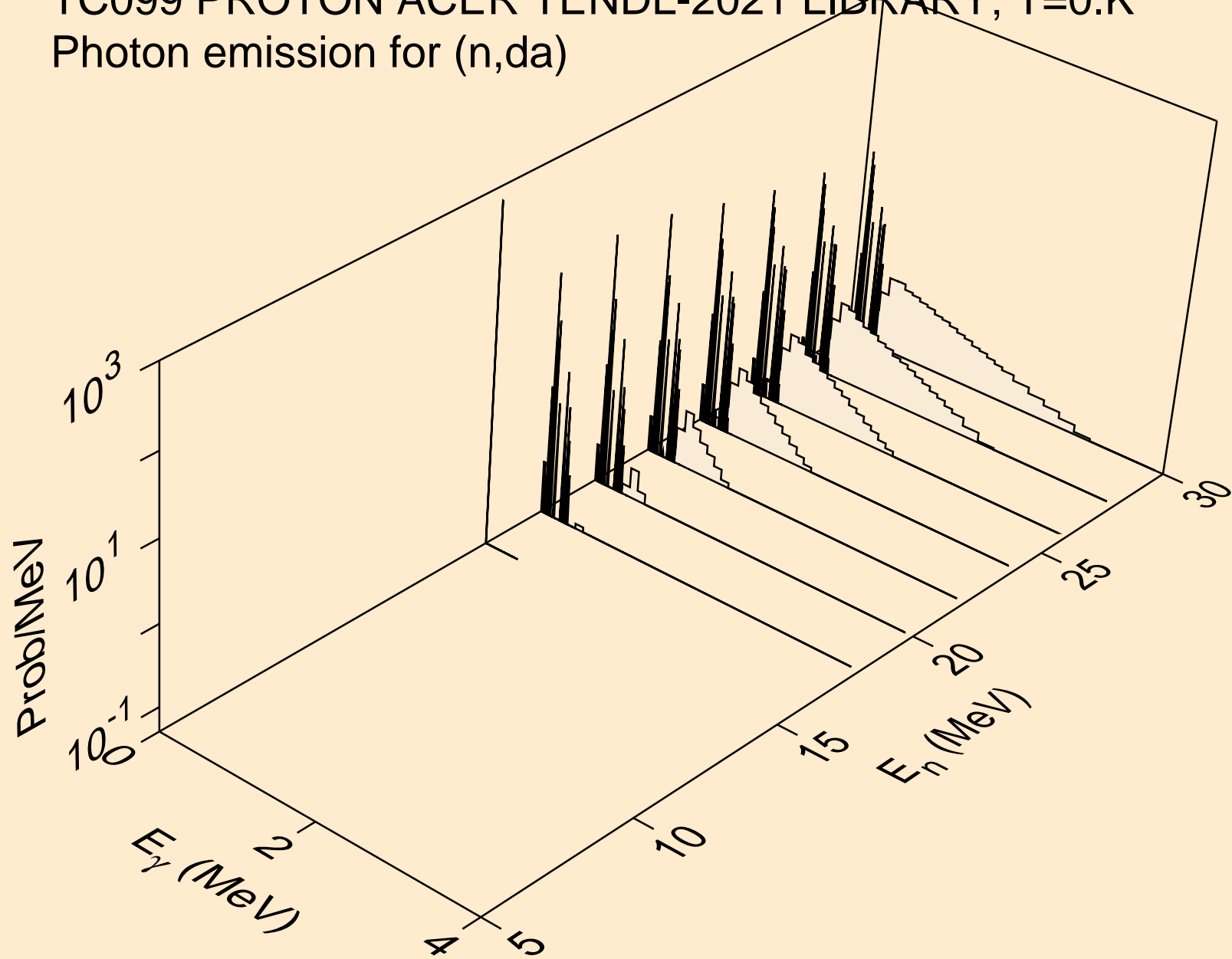

TC099 PROTON ACER TENDL-2021 LIBRARY; T=0.K  
Particle heating contributions

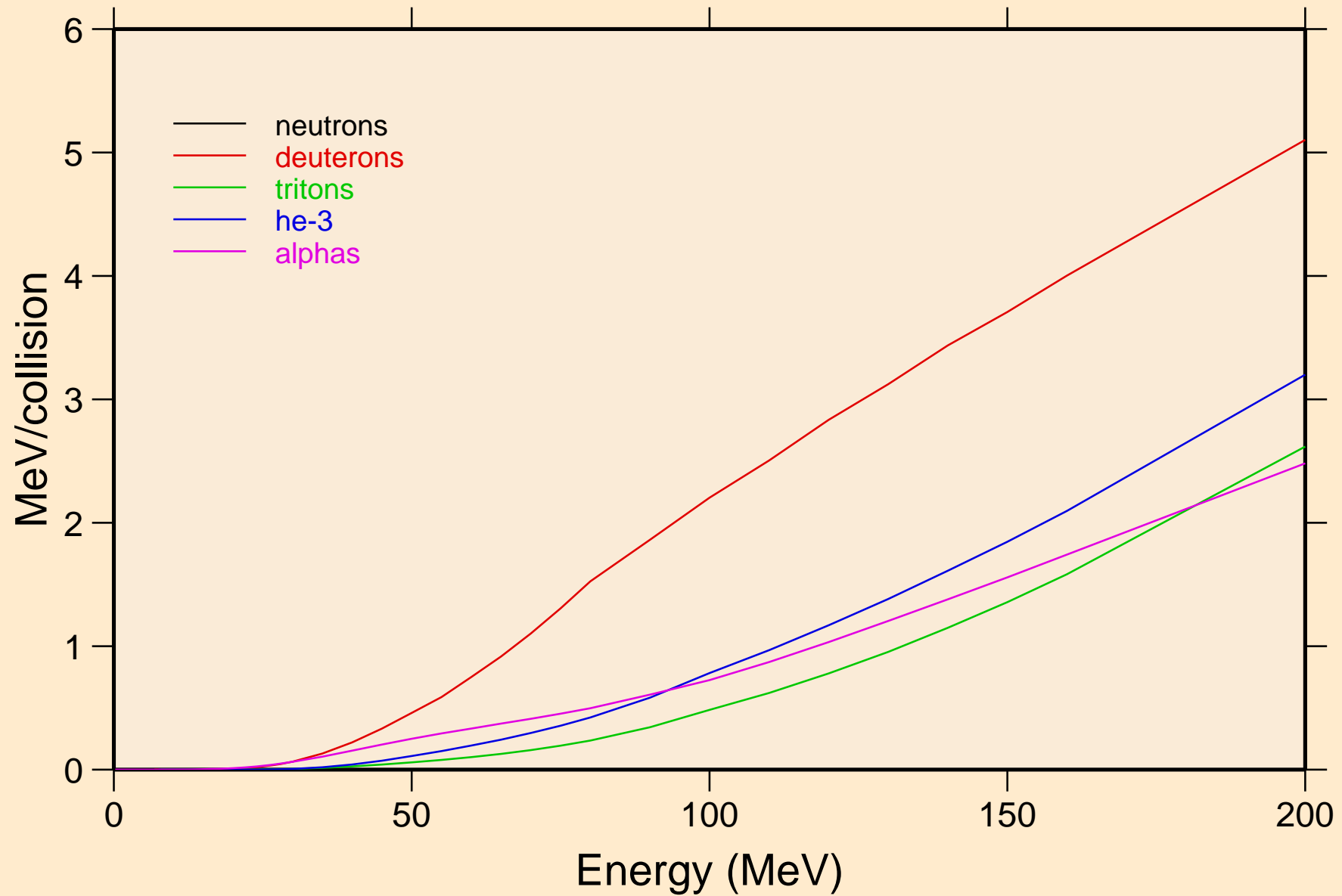

TC099 PROTON ACER TENDL-2021 LIBRARY; T=0.K  
Recoil Heating

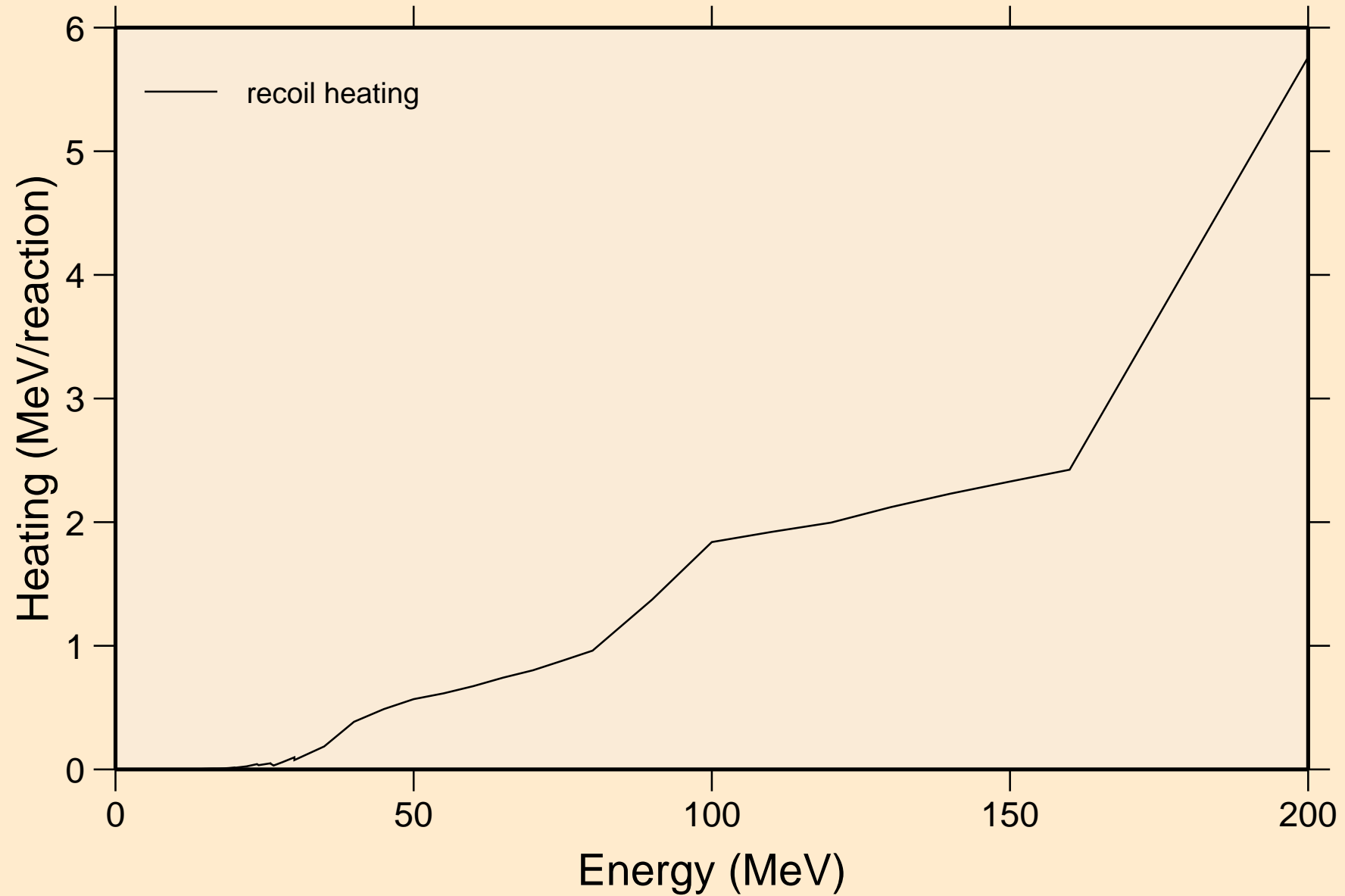

TC099 PROTON ACER TENDL-2021 LIBRARY; T=0.K  
Particle production cross sections

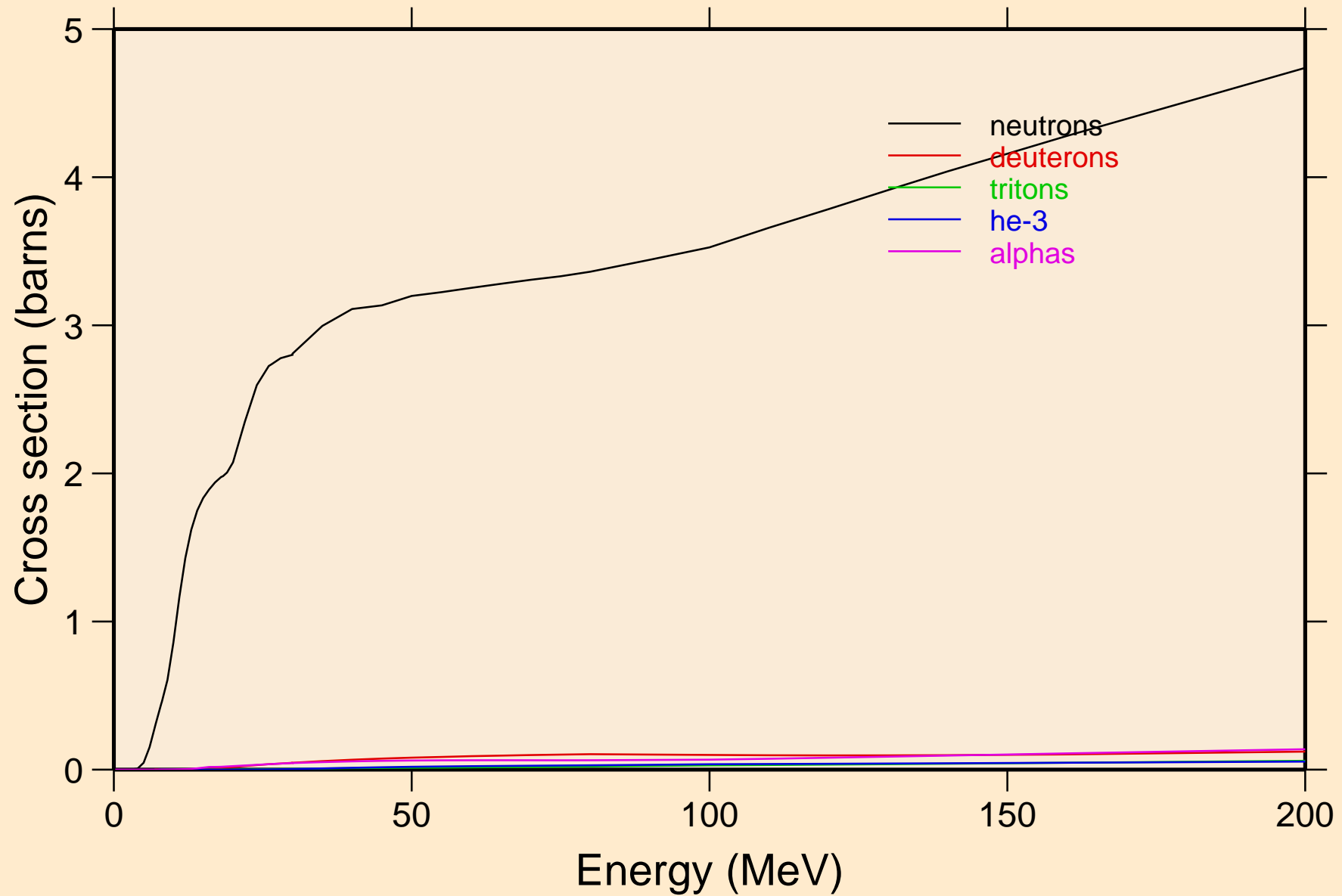

TC099 PROTON ACER TENDL-2021 LIBRARY; T=0.K  
neutrons from (p,n)

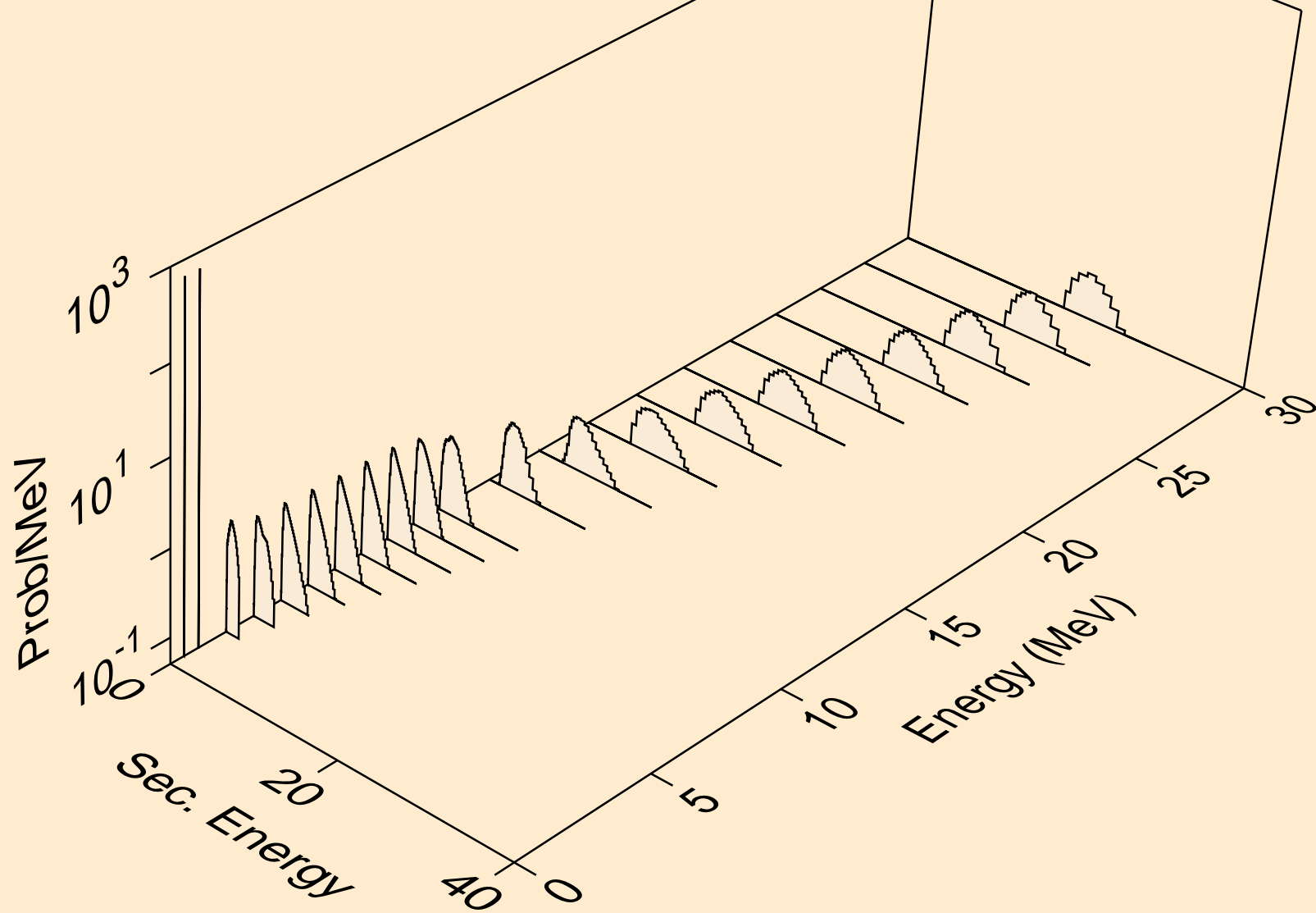

TC099 PROTON ACER TENDL-2021 LIBRARY; T=0.K  
neutrons from (p,x)

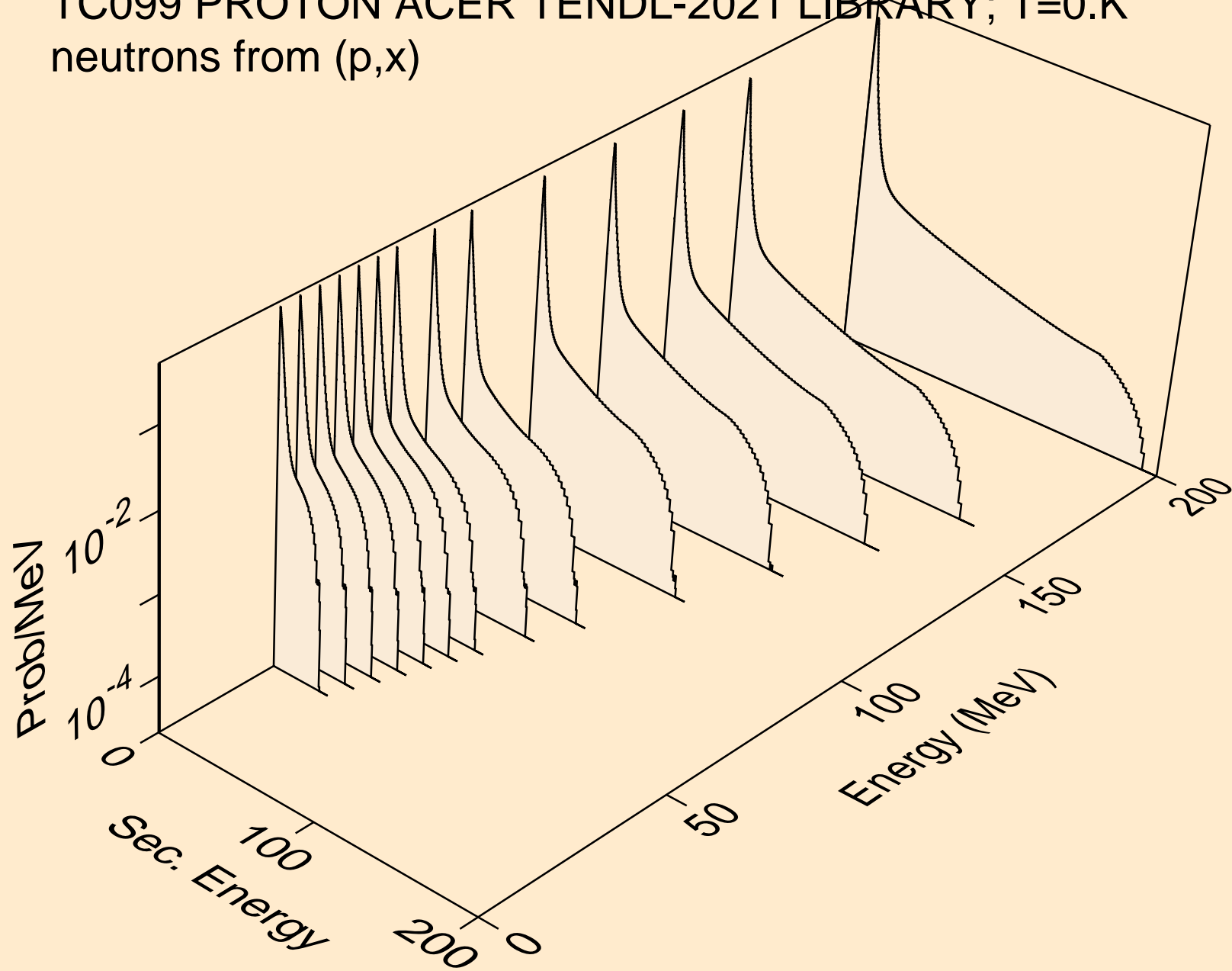



TC099 PROTON ACER TENDL-2021 LIBRARY; T=0.K  
neutrons from (p,2nd)

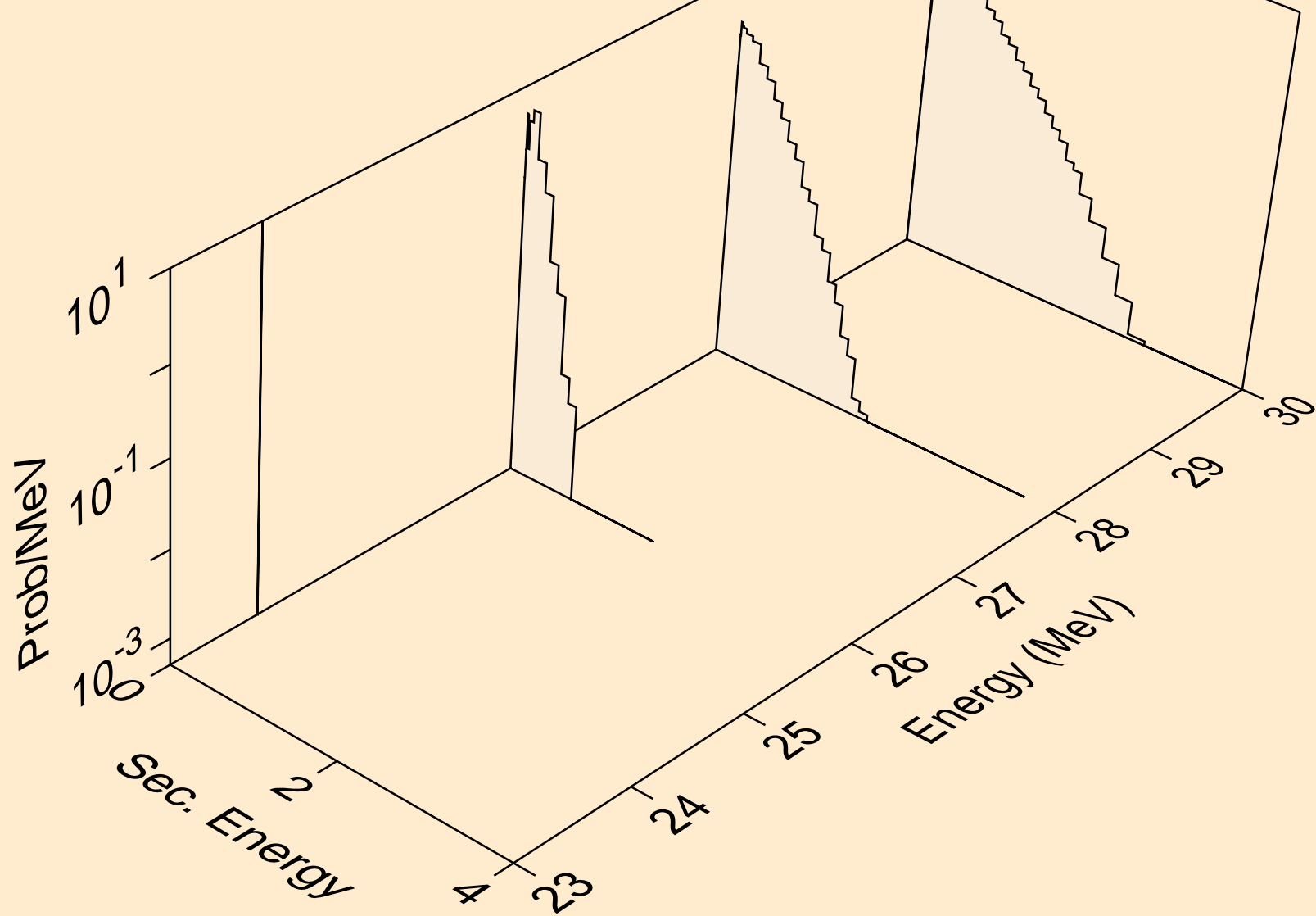

TC099 PROTON ACER TENDL-2021 LIBRARY; T=0.K  
neutrons from (p,2n)

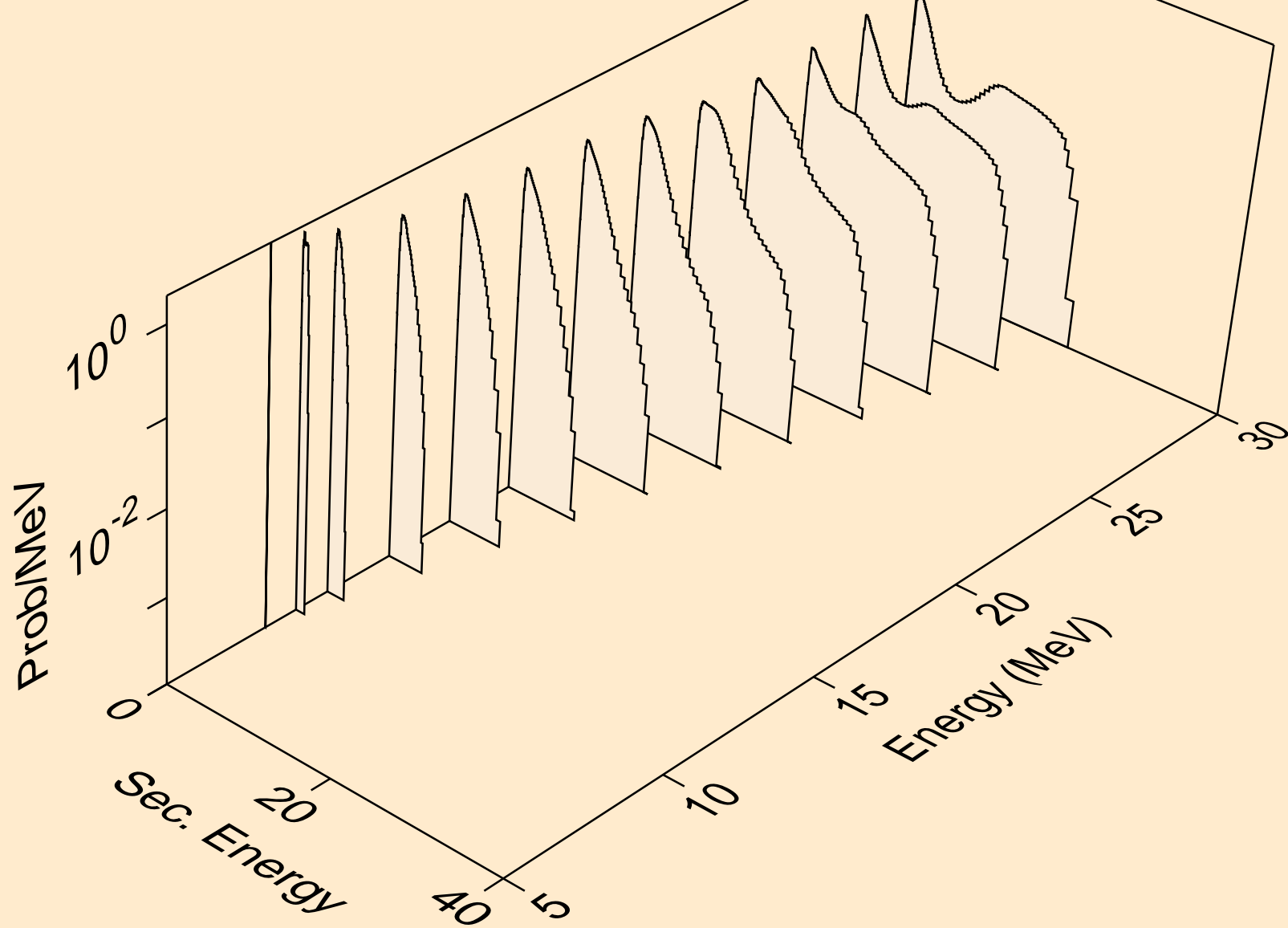

TC099 PROTON ACER TENDL-2021 LIBRARY; T=0.K  
neutrons from (p,3n)

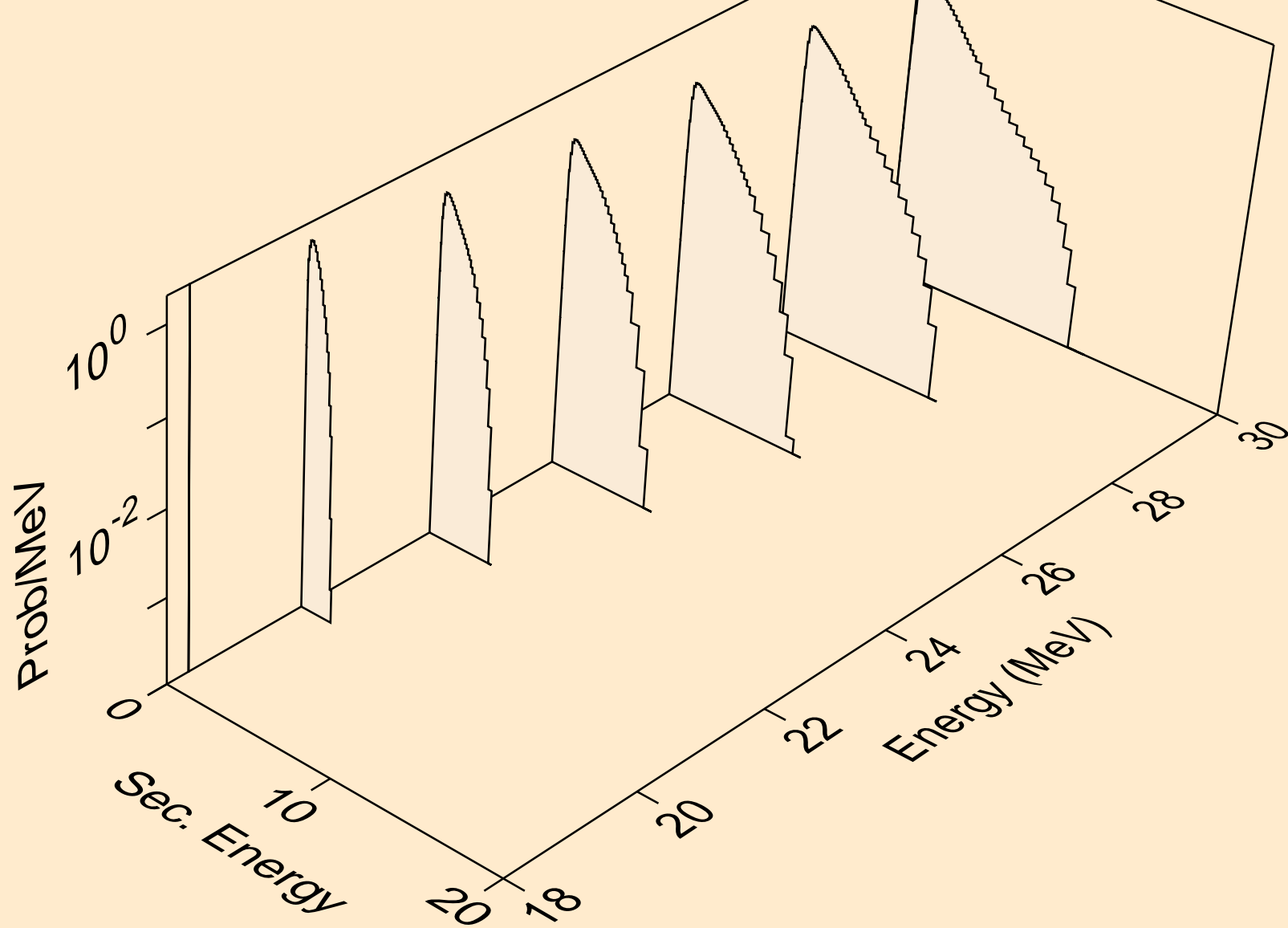

TC099 PROTON ACER TENDL-2021 LIBRARY; T=0.K  
neutrons from (p,n\*)a

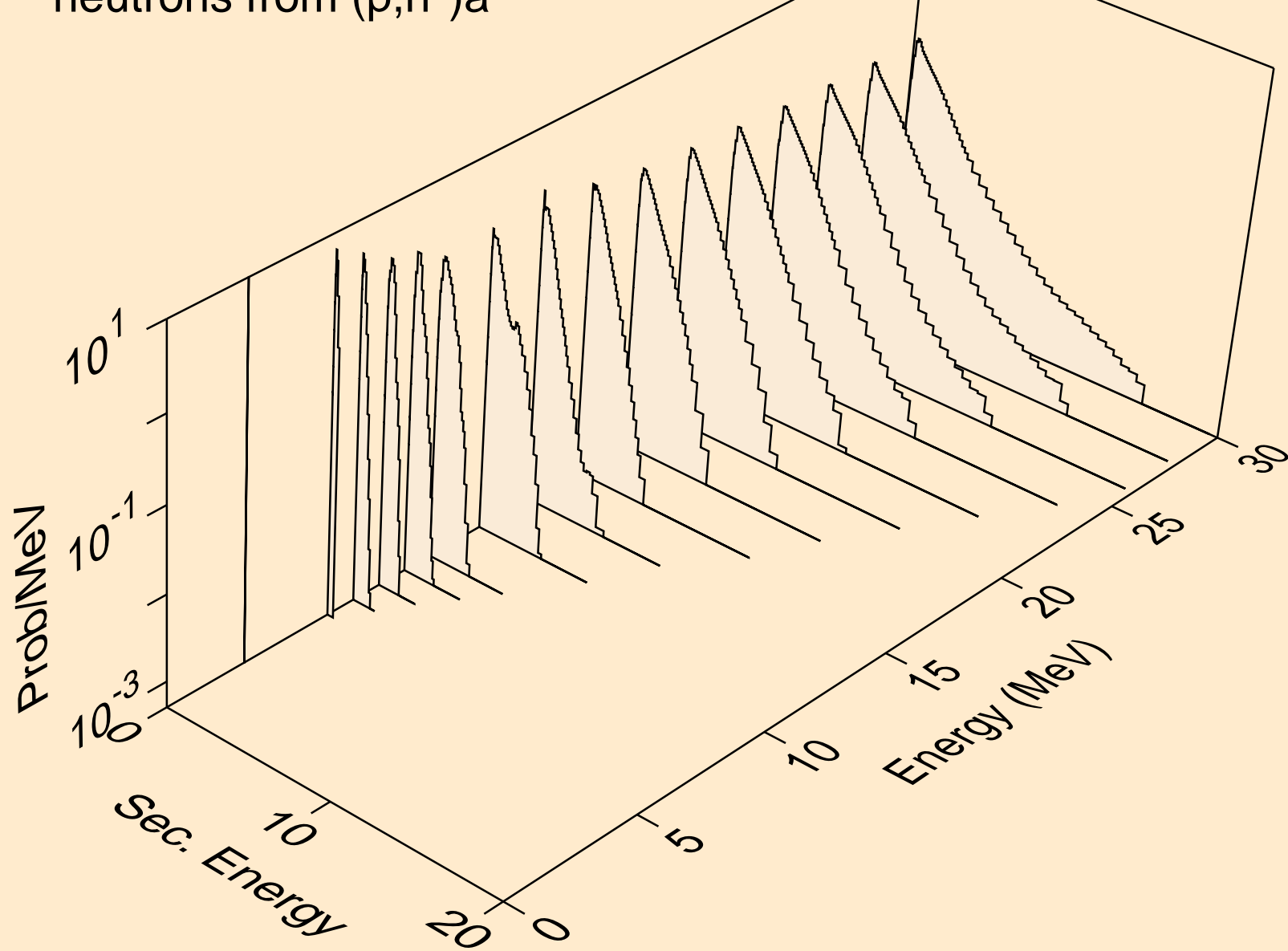

TC099 PROTON ACER TENDL-2021 LIBRARY; T=0.K  
neutrons from (p,2n)a

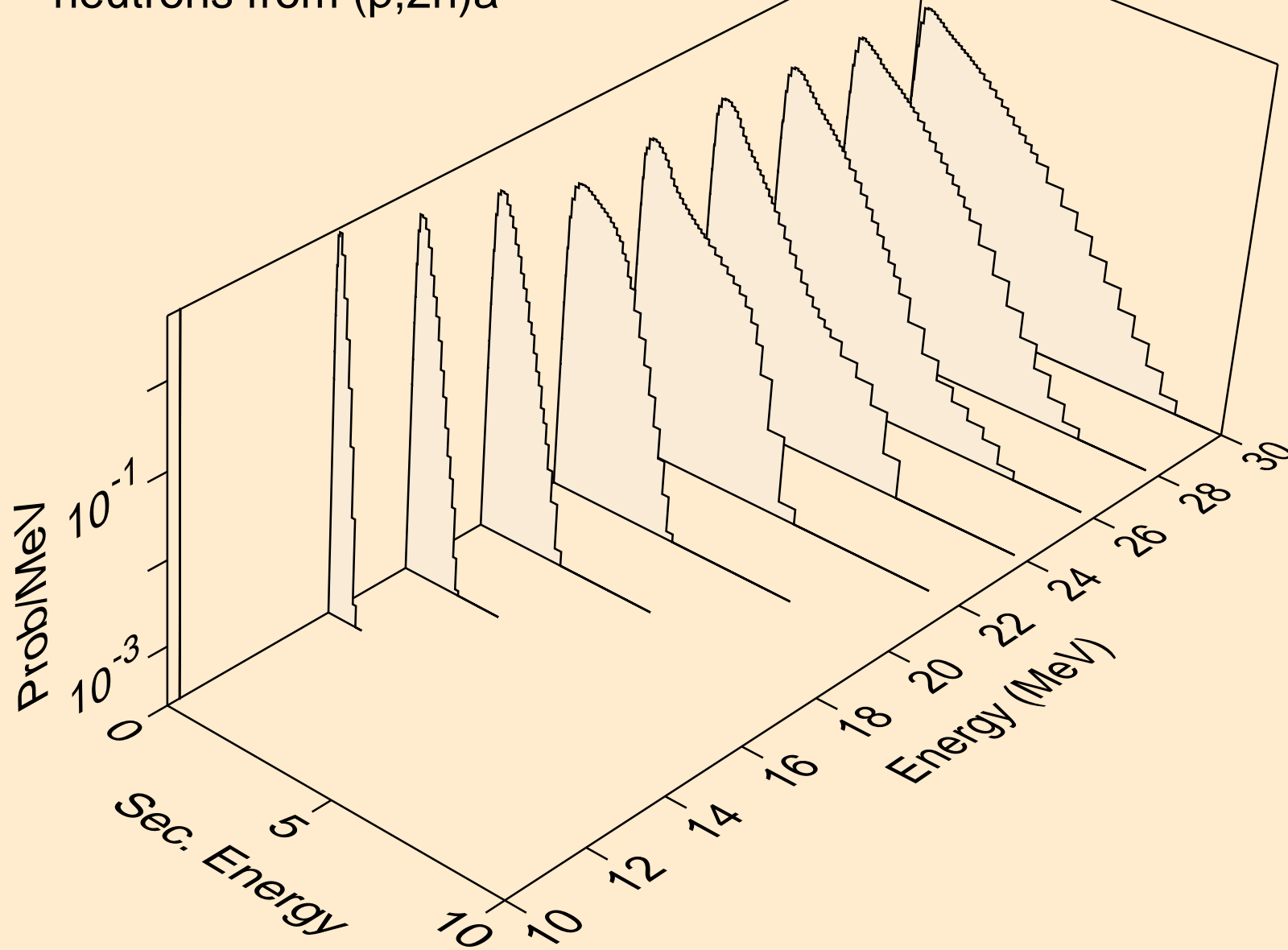

TC099 PROTON ACER TENDL-2021 LIBRARY; T=0.K  
neutrons from (p,3n)a

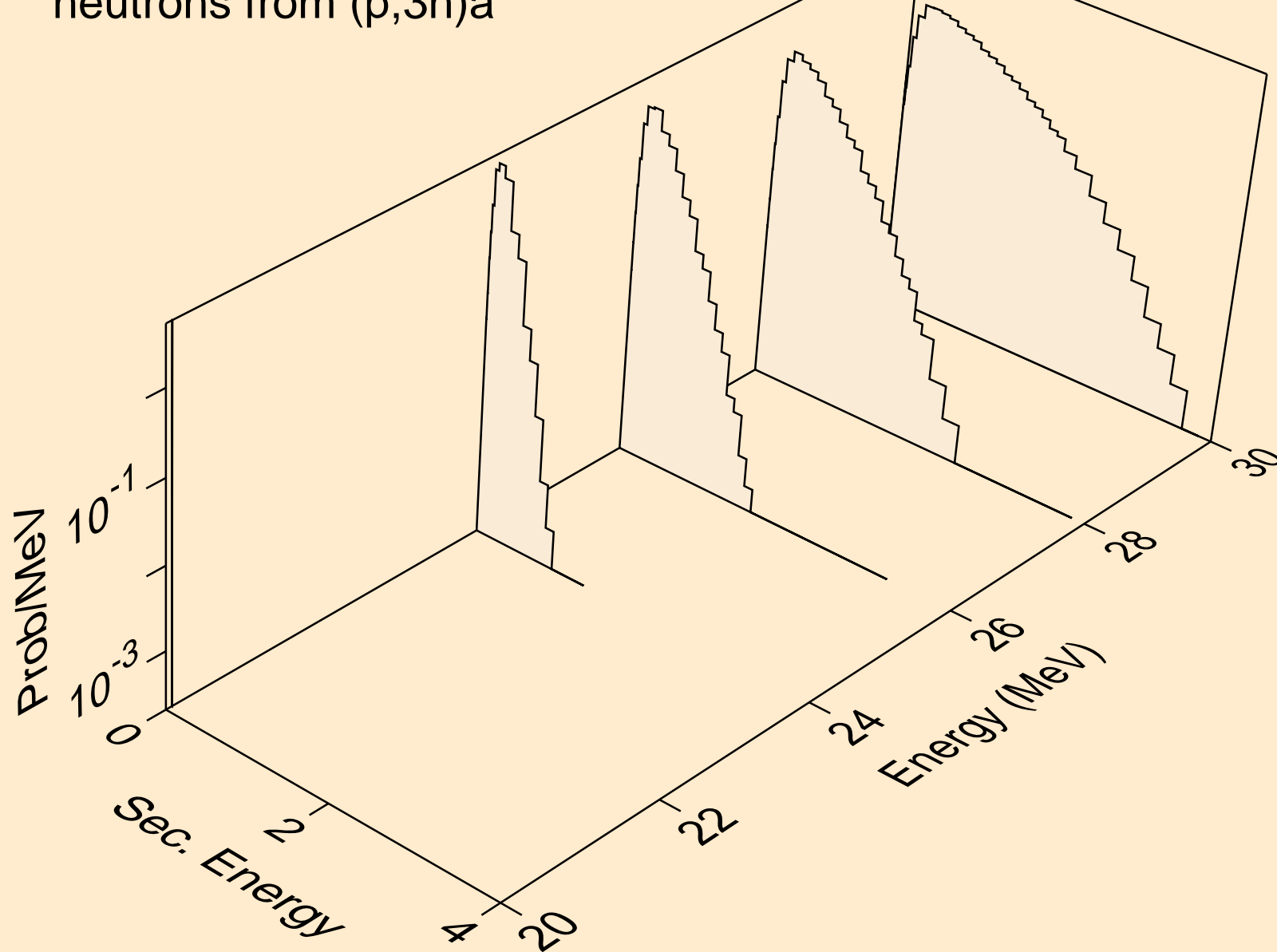

TC099 PROTON ACER TENDL-2021 LIBRARY; T=0.K  
neutrons from (p,n\*)p

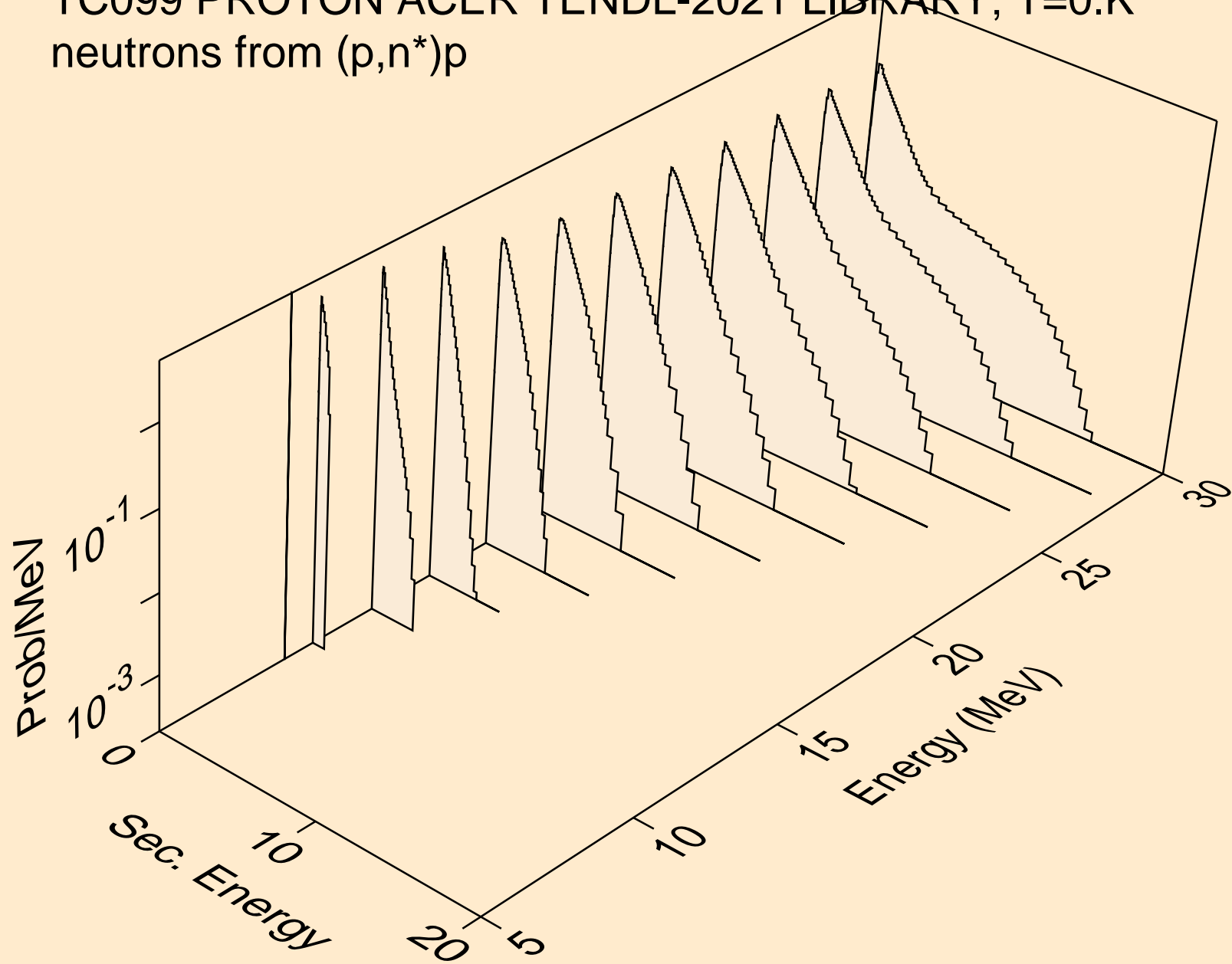

TC099 PROTON ACER TENDL-2021 LIBRARY; T=0.K  
neutrons from (p,n\*)2a

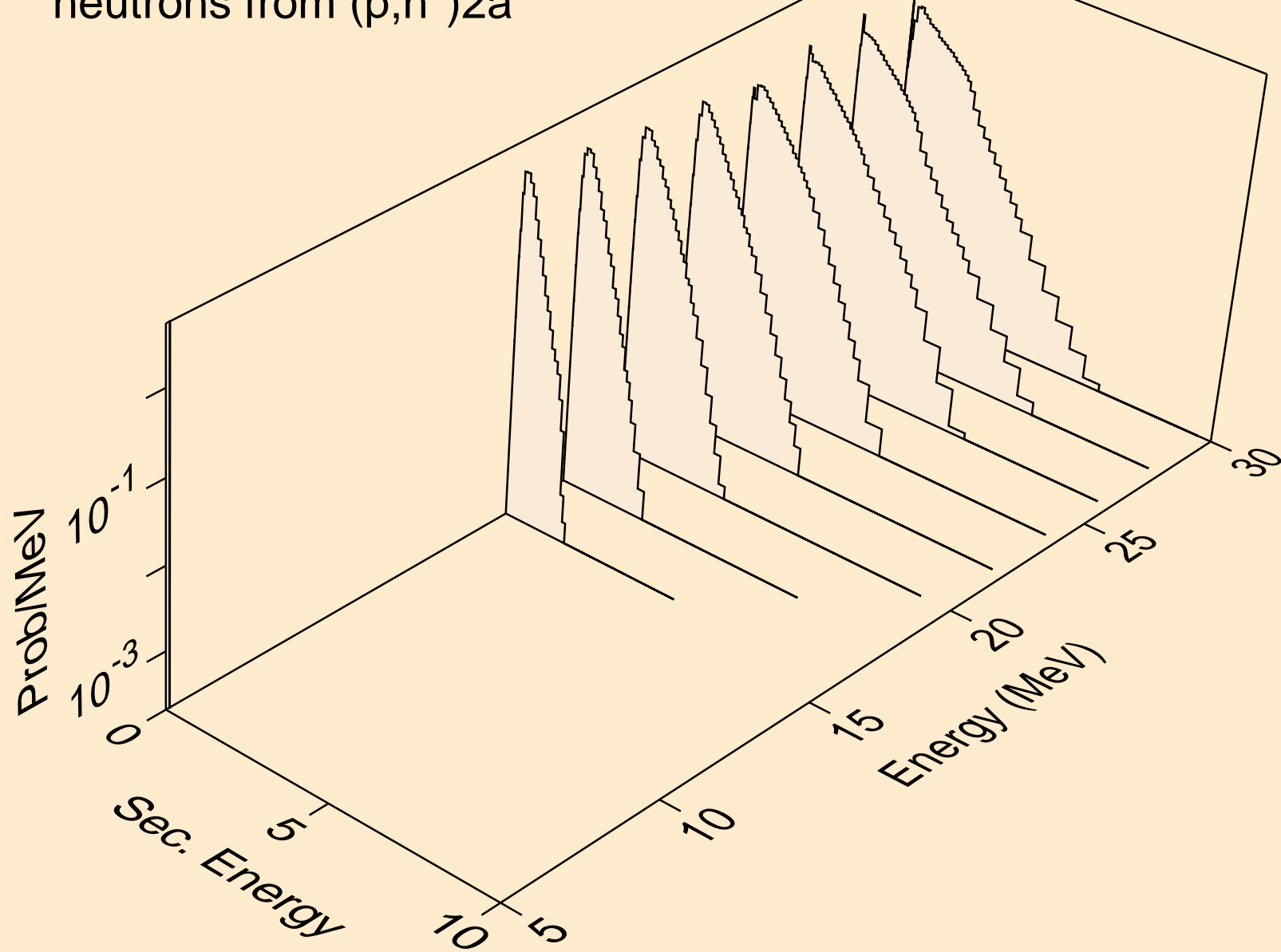



TC099 PROTON ACER TENDL-2021 LIBRARY; T=0.K  
neutrons from (p,2n)2a

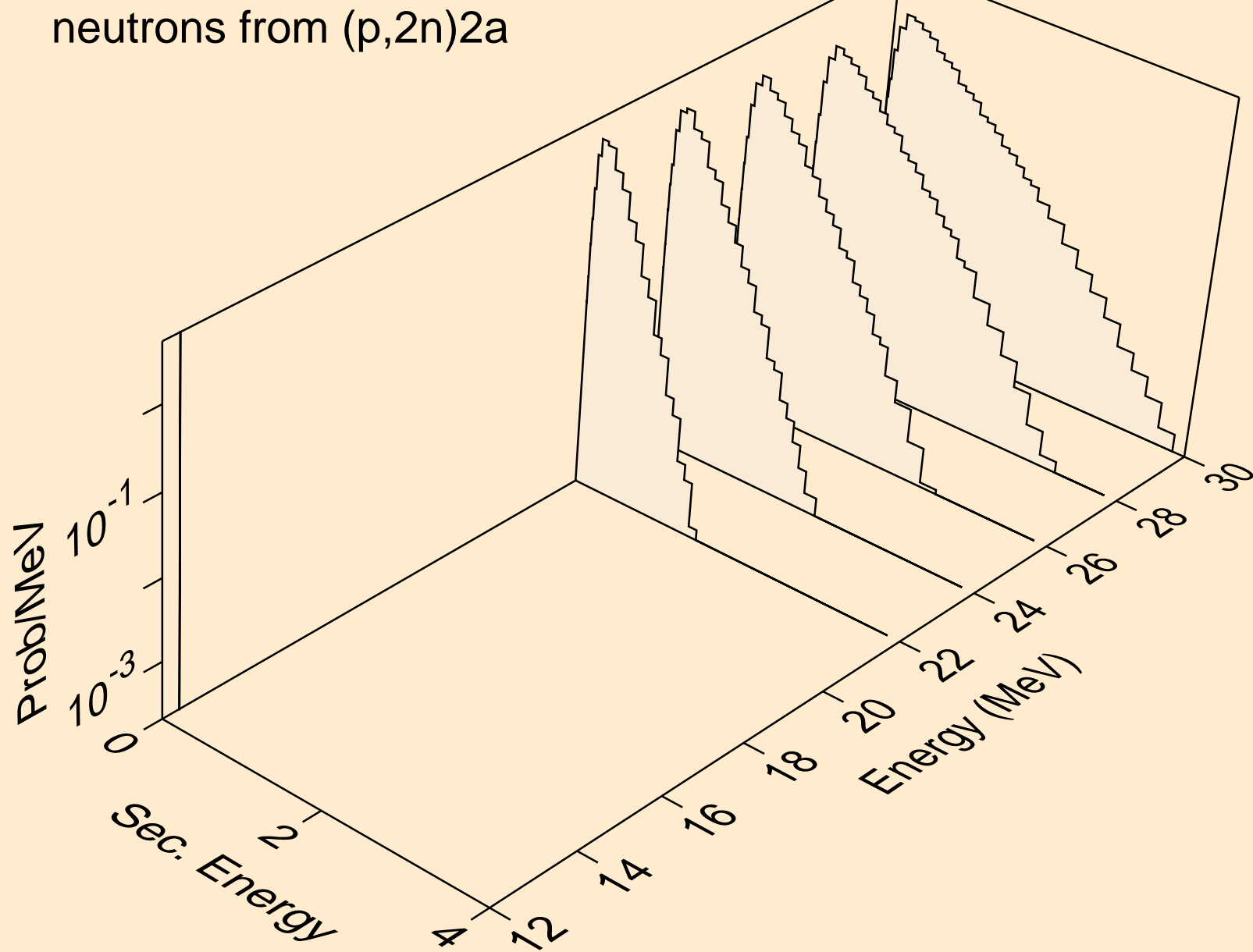

TC099 PROTON ACER TENDL-2021 LIBRARY; T=0.K  
neutrons from (p,n\*)d

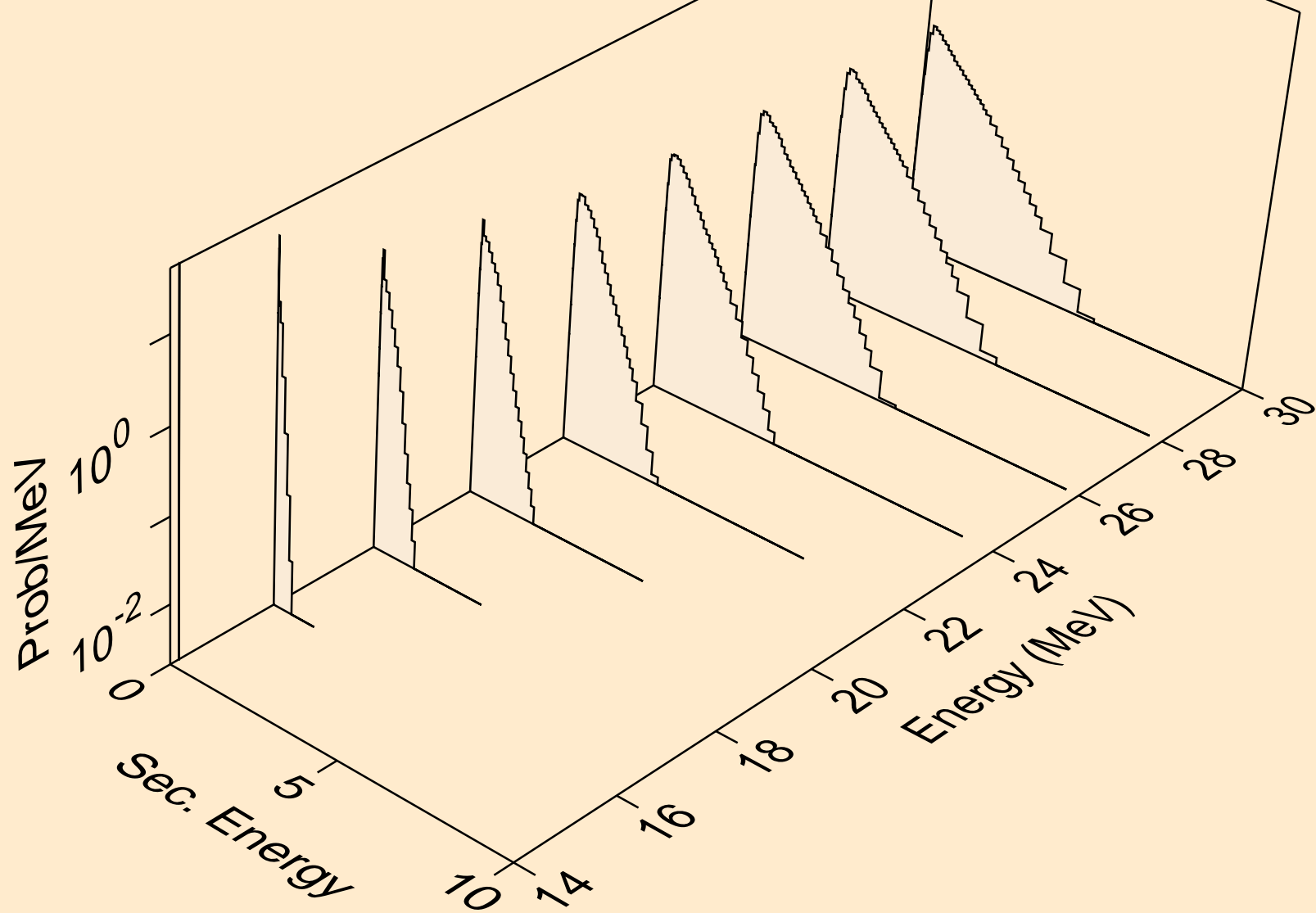

TC099 PROTON ACER TENDL-2021 LIBRARY; T=0.K  
neutrons from (p,n\*)t

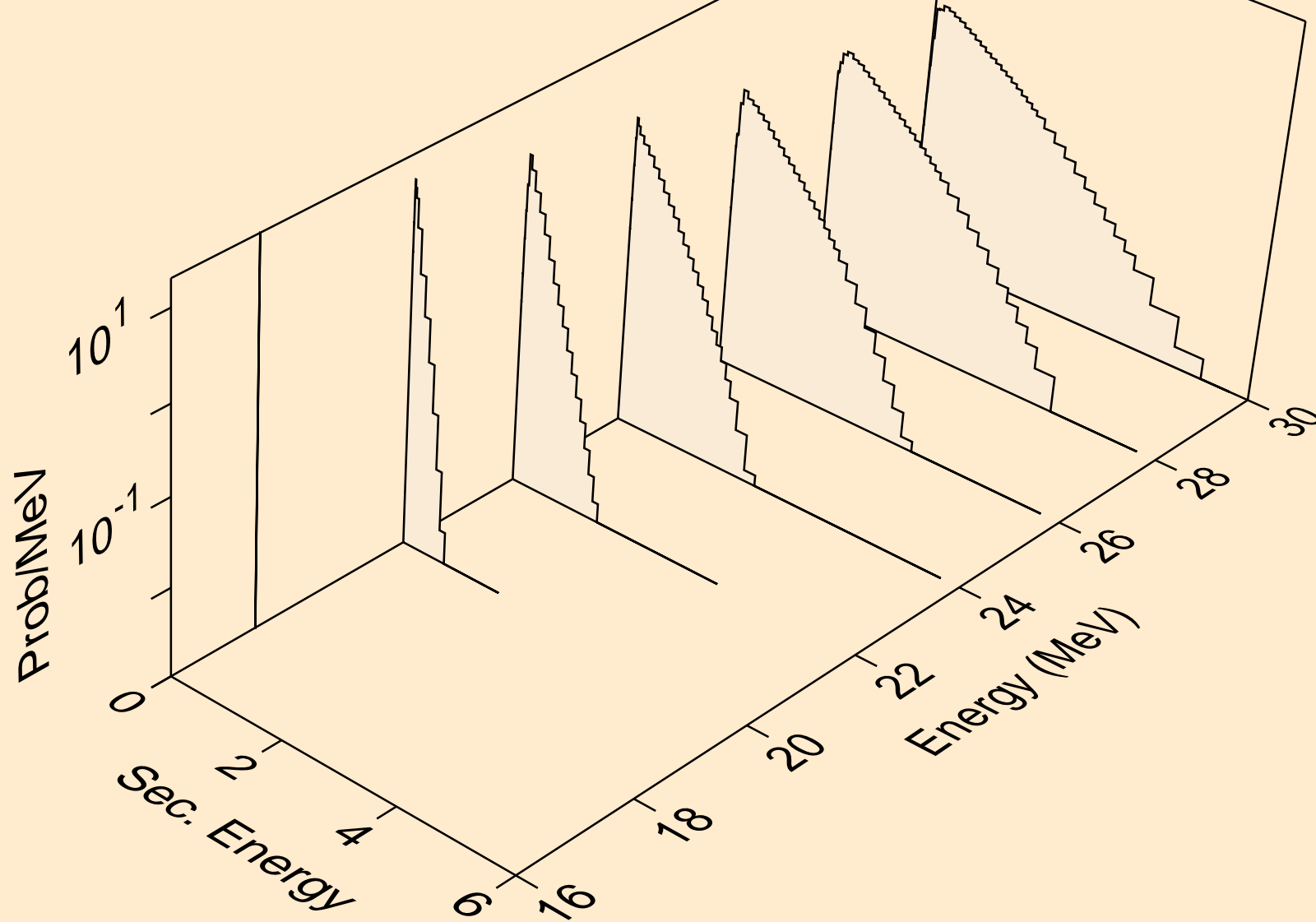

TC099 PROTON ACER TENDL-2021 LIBRARY; T=0.K  
neutrons from (p,n\*)he3

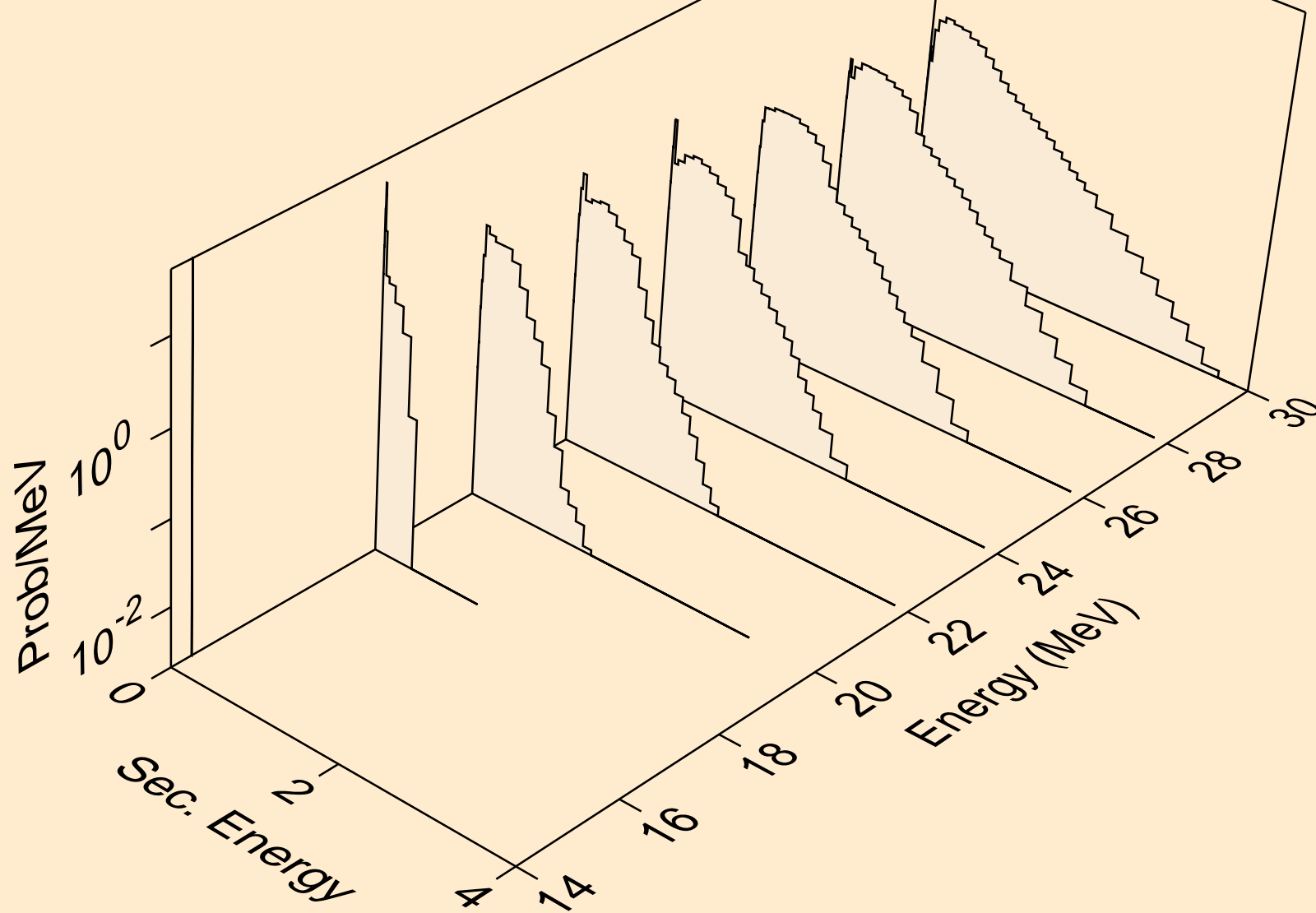

TC099 PROTON ACER TENDL-2021 LIBRARY; T=0.K  
neutrons from (p,4n)

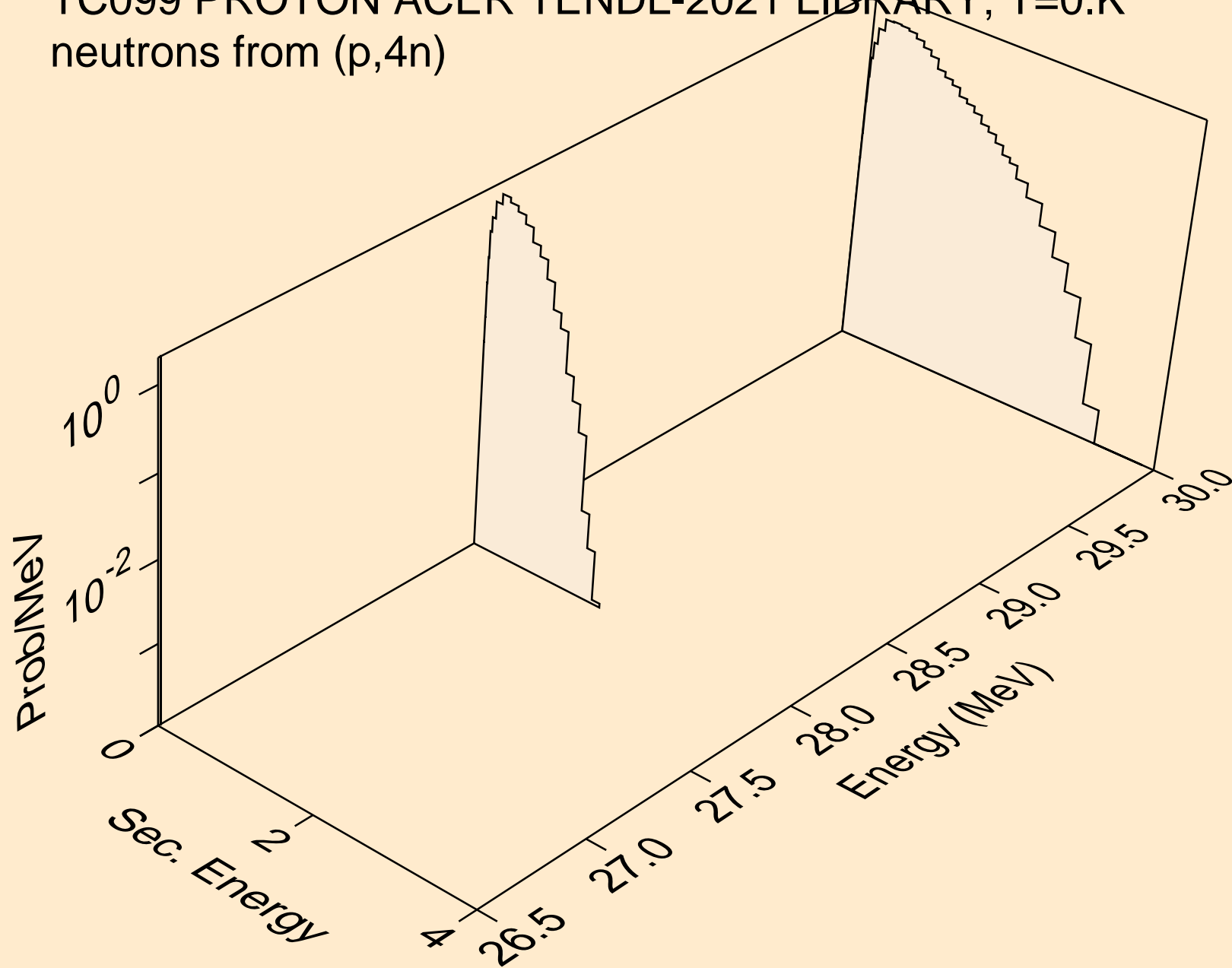

TC099 PROTON ACER TENDL-2021 LIBRARY; T=0.K  
neutrons from (p,2np)

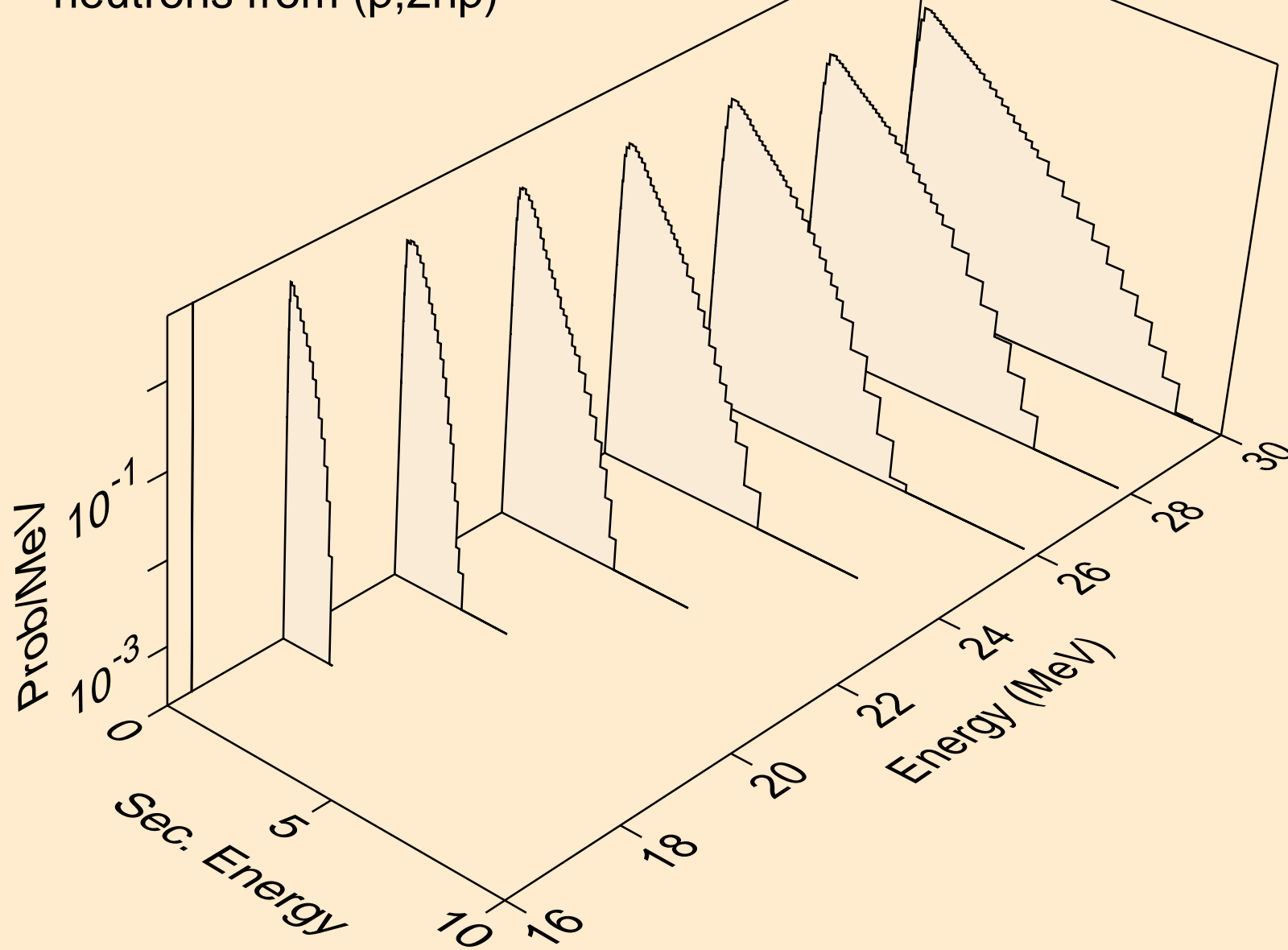

TC099 PROTON ACER TENDL-2021 LIBRARY; T=0.K  
neutrons from (p,3np)

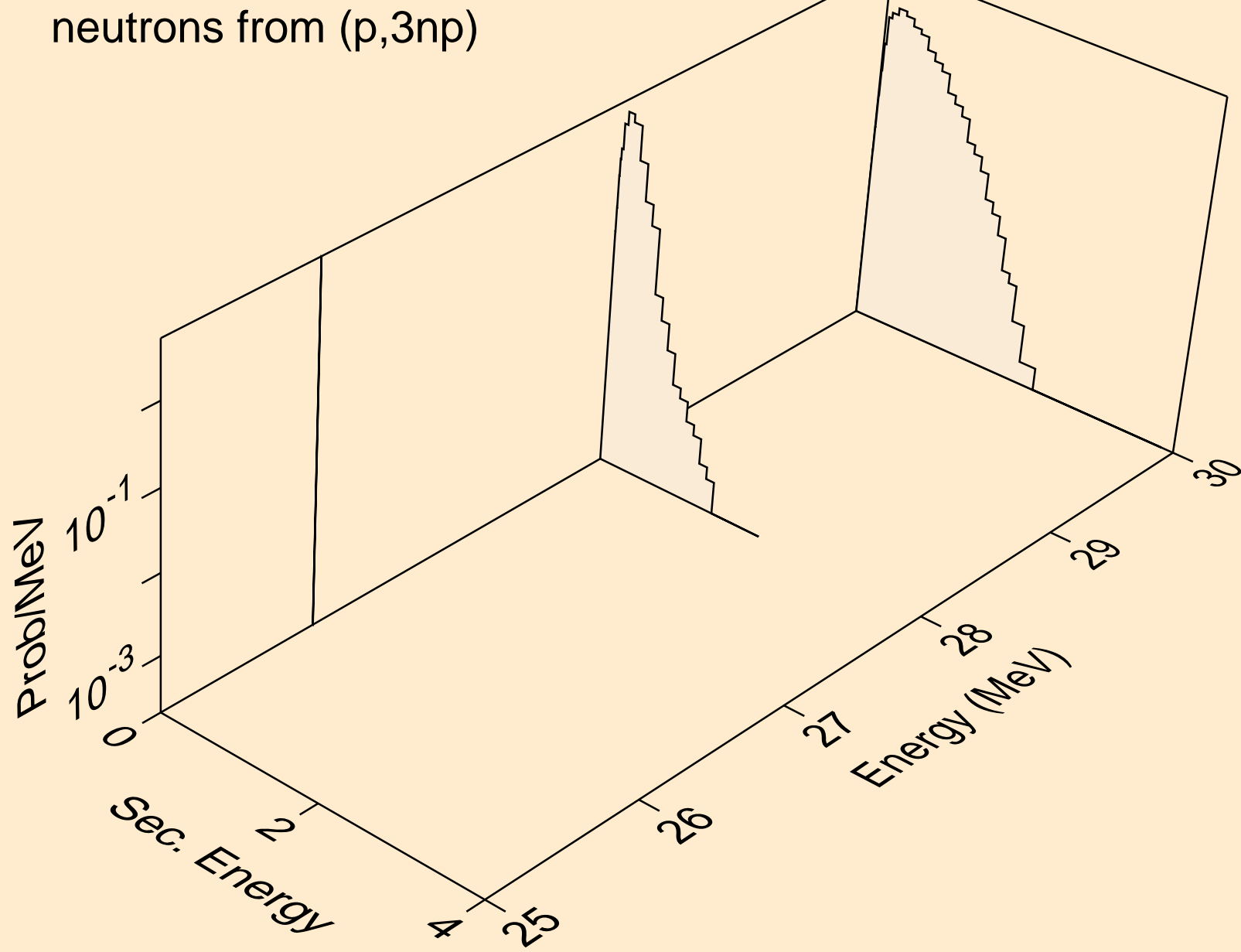

TC099 PROTON ACER TENDL-2021 LIBRARY; T=0.K  
neutrons from (p,2np)

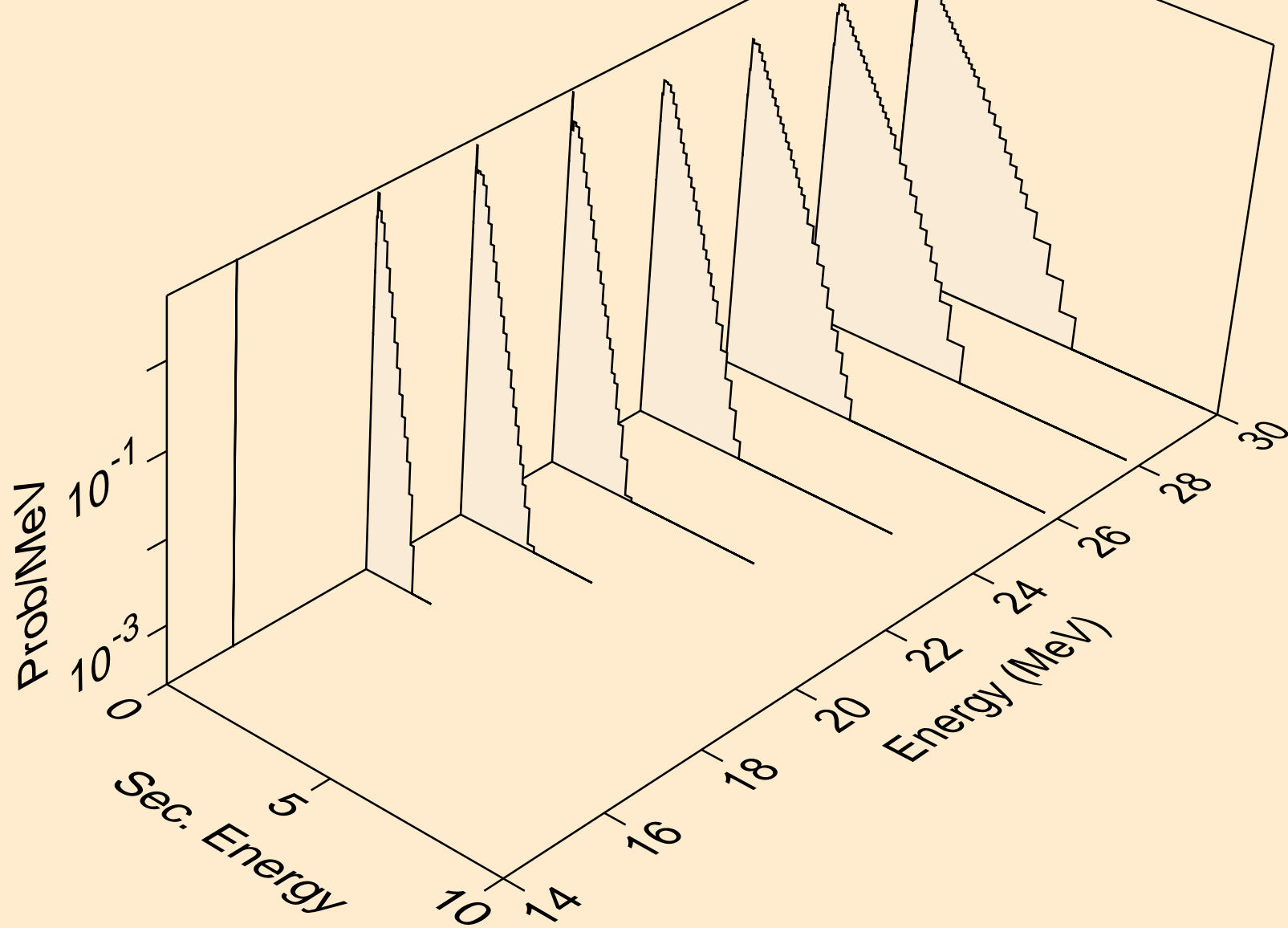



TC099 PROTON ACER TENDL-2021 LIBRARY; T=0.K  
neutrons from (p,npa)

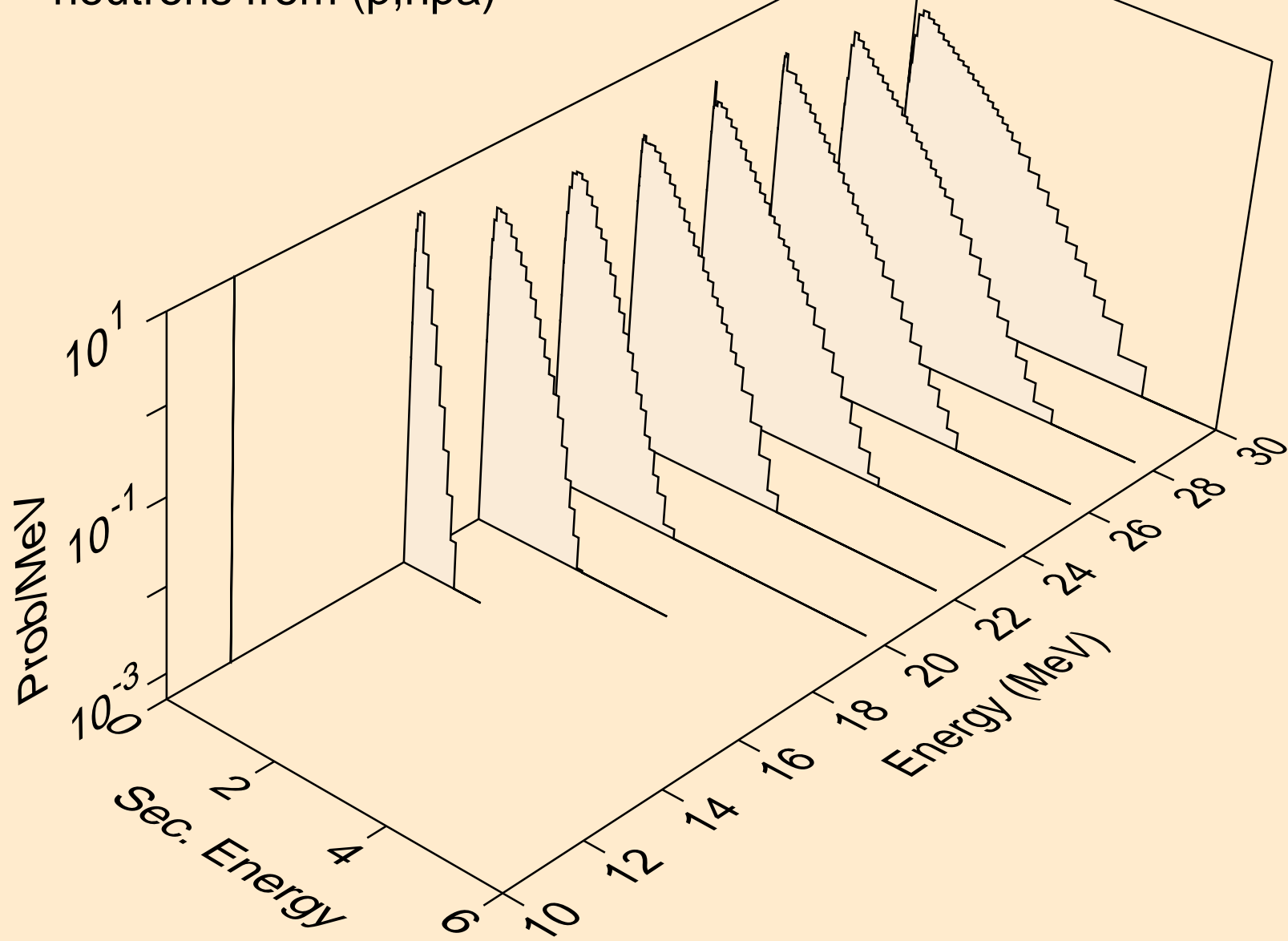

TC099 PROTON ACER TENDL-2021 LIBRARY; T=0.K  
deuterons from (p,x)

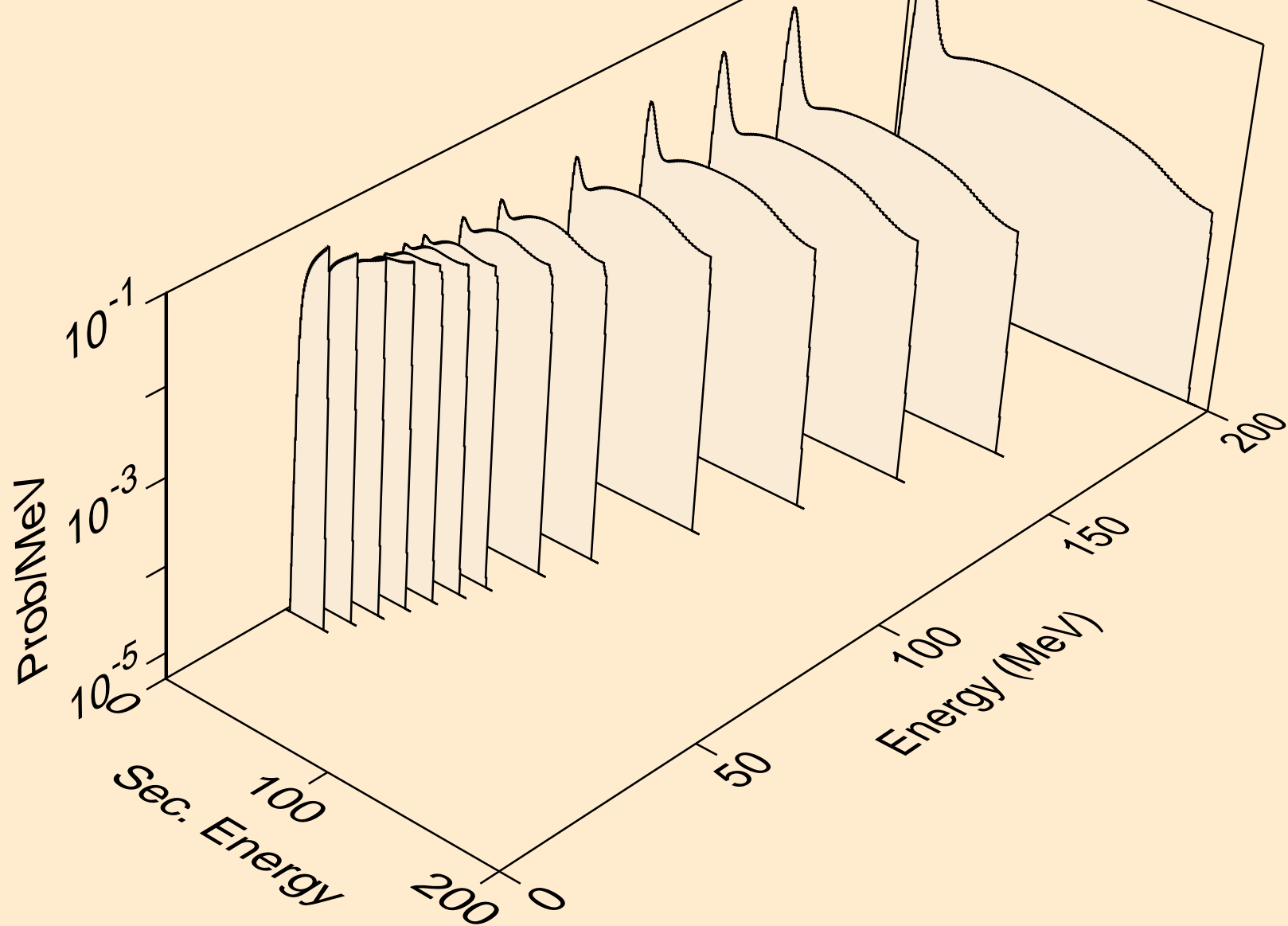

TC099 PROTON ACER TENDL-2021 LIBRARY; T=0.K  
deuterons from (p,2nd)

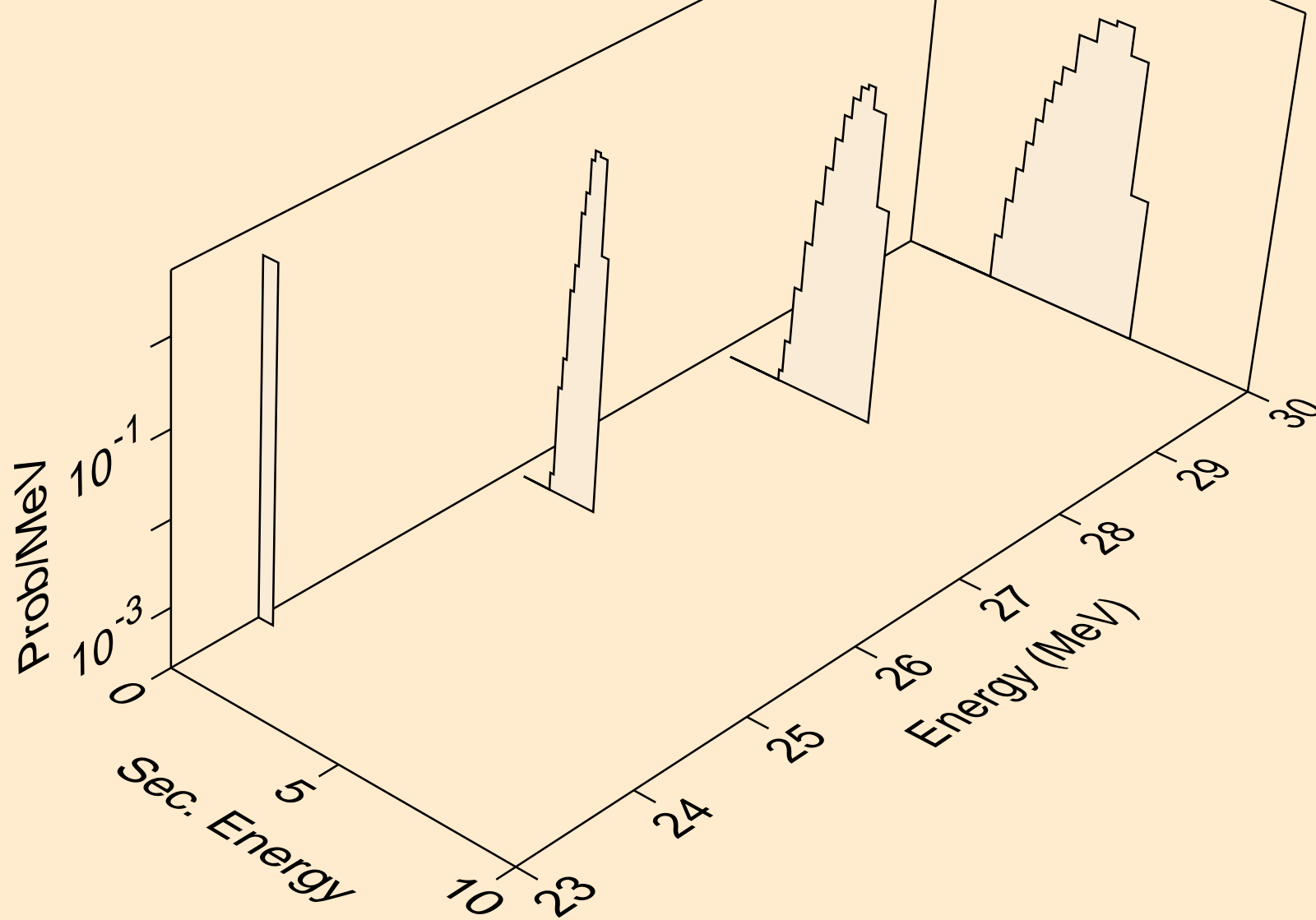

TC099 PROTON ACER TENDL-2021 LIBRARY; T=0.K  
deuterons from (p,n\*)d

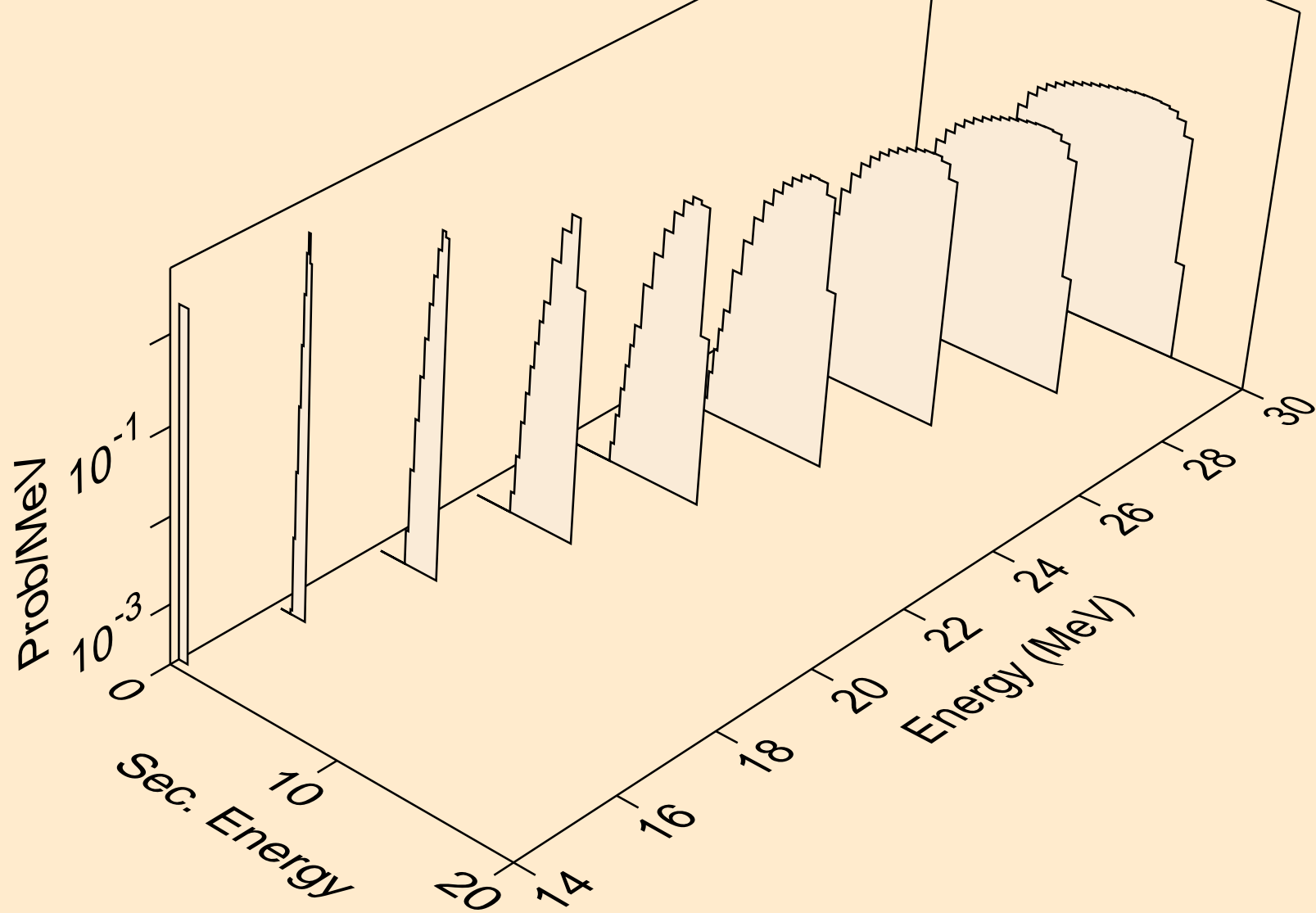

TC099 PROTON ACER TENDL-2021 LIBRARY; T=0.K  
deuterons from (p,d)

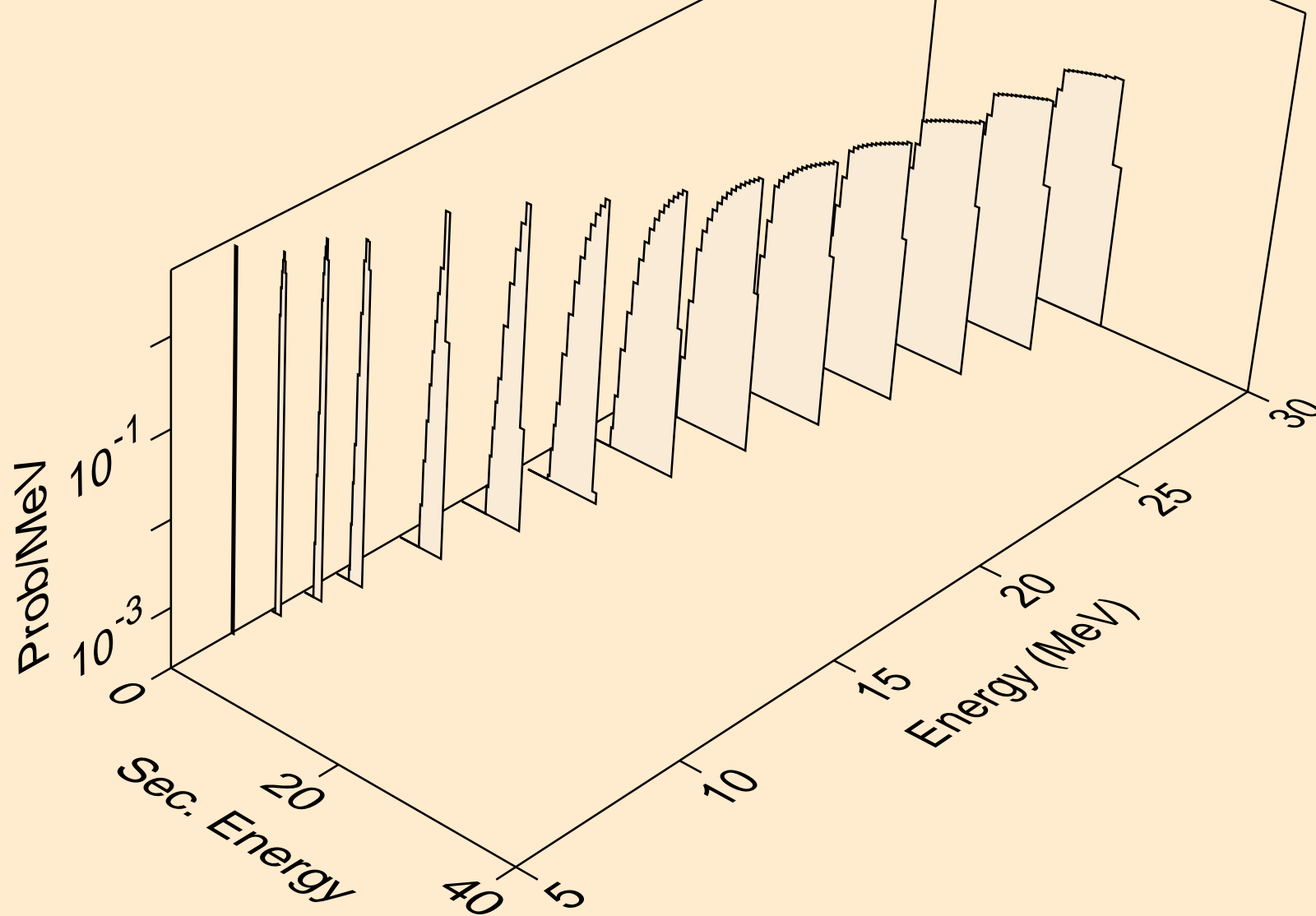

TC099 PROTON ACER TENDL-2021 LIBRARY; T=0.K  
deuterons from (p,pd)

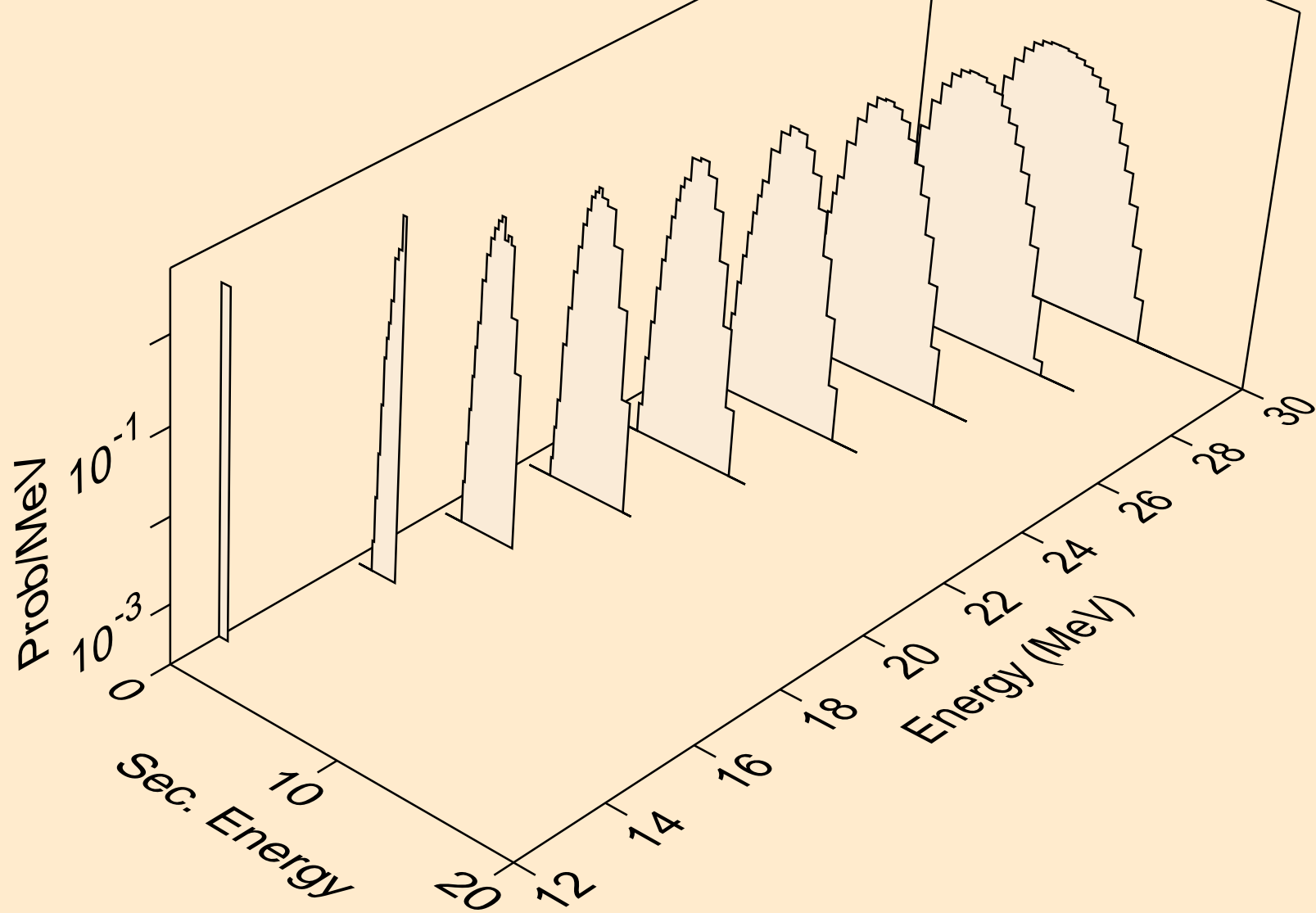

TC099 PROTON ACER TENDL-2021 LIBRARY; T=0.K  
deuterons from (p,da)

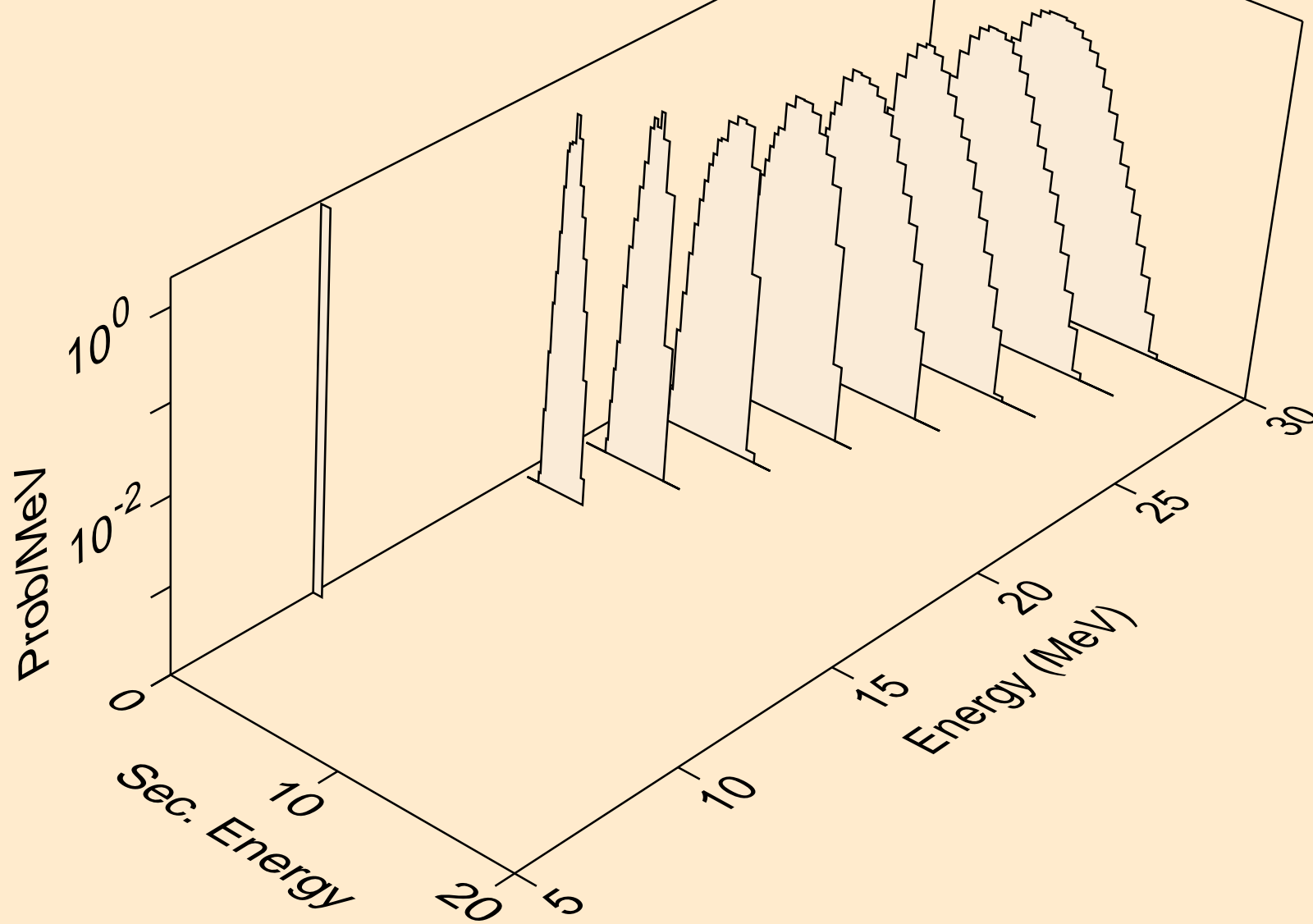

TC099 PROTON ACER TENDL-2021 LIBRARY; T=0.K  
tritons from (p,x)

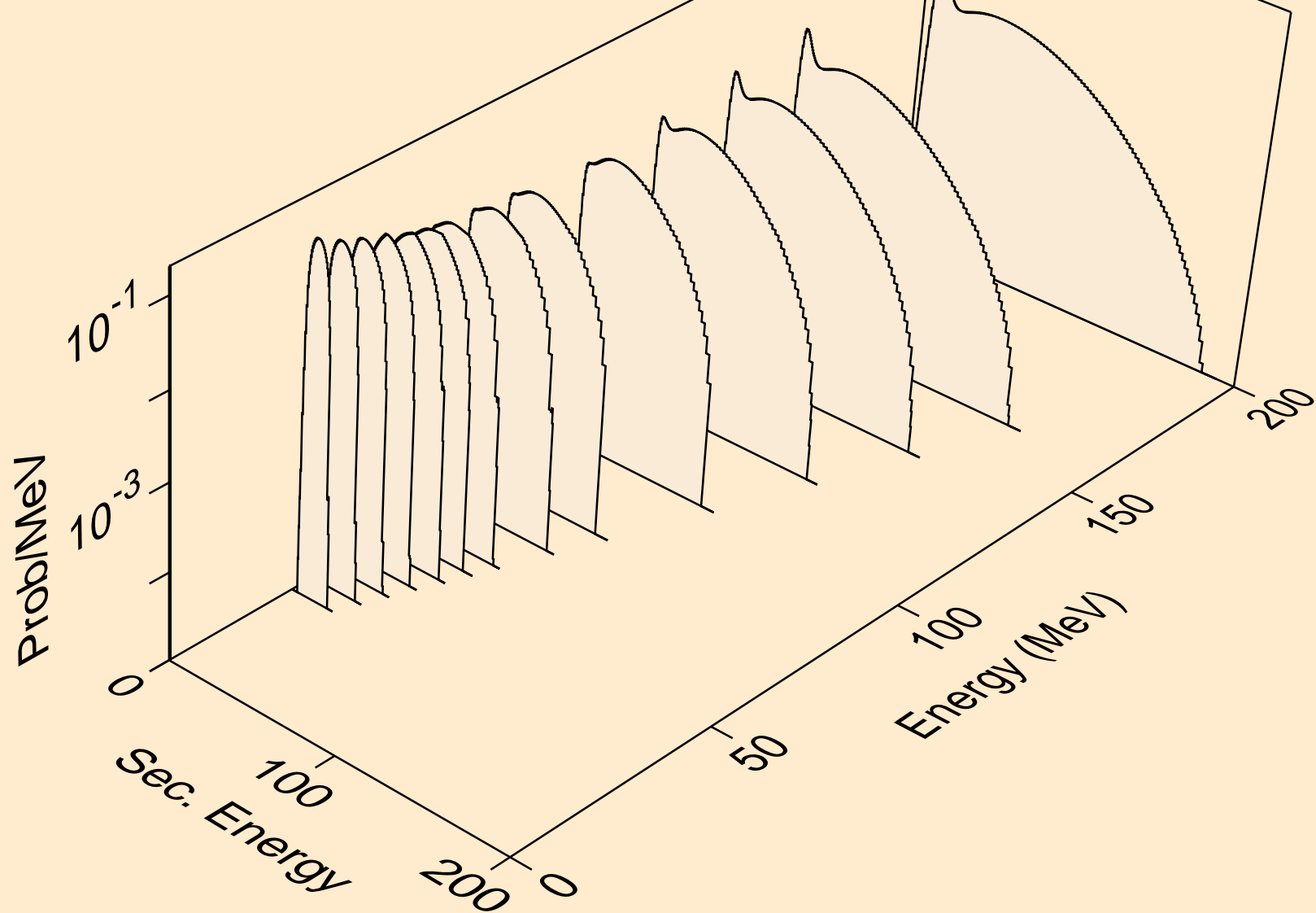



TC099 PROTON ACER TENDL-2021 LIBRARY; T=0.K  
tritons from (p,n\*)t

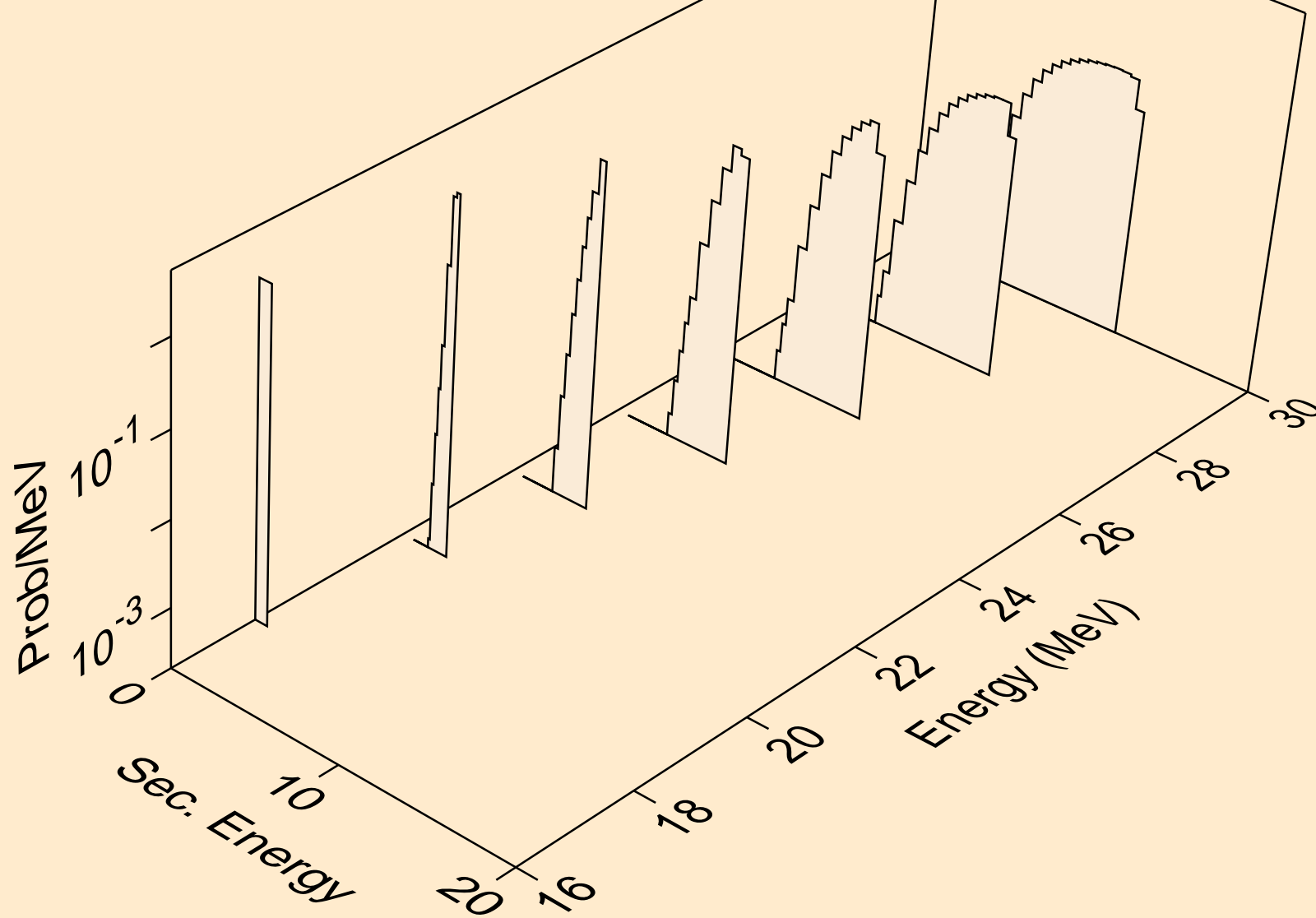

TC099 PROTON ACER TENDL-2021 LIBRARY; T=0.K  
tritons from (p,t)

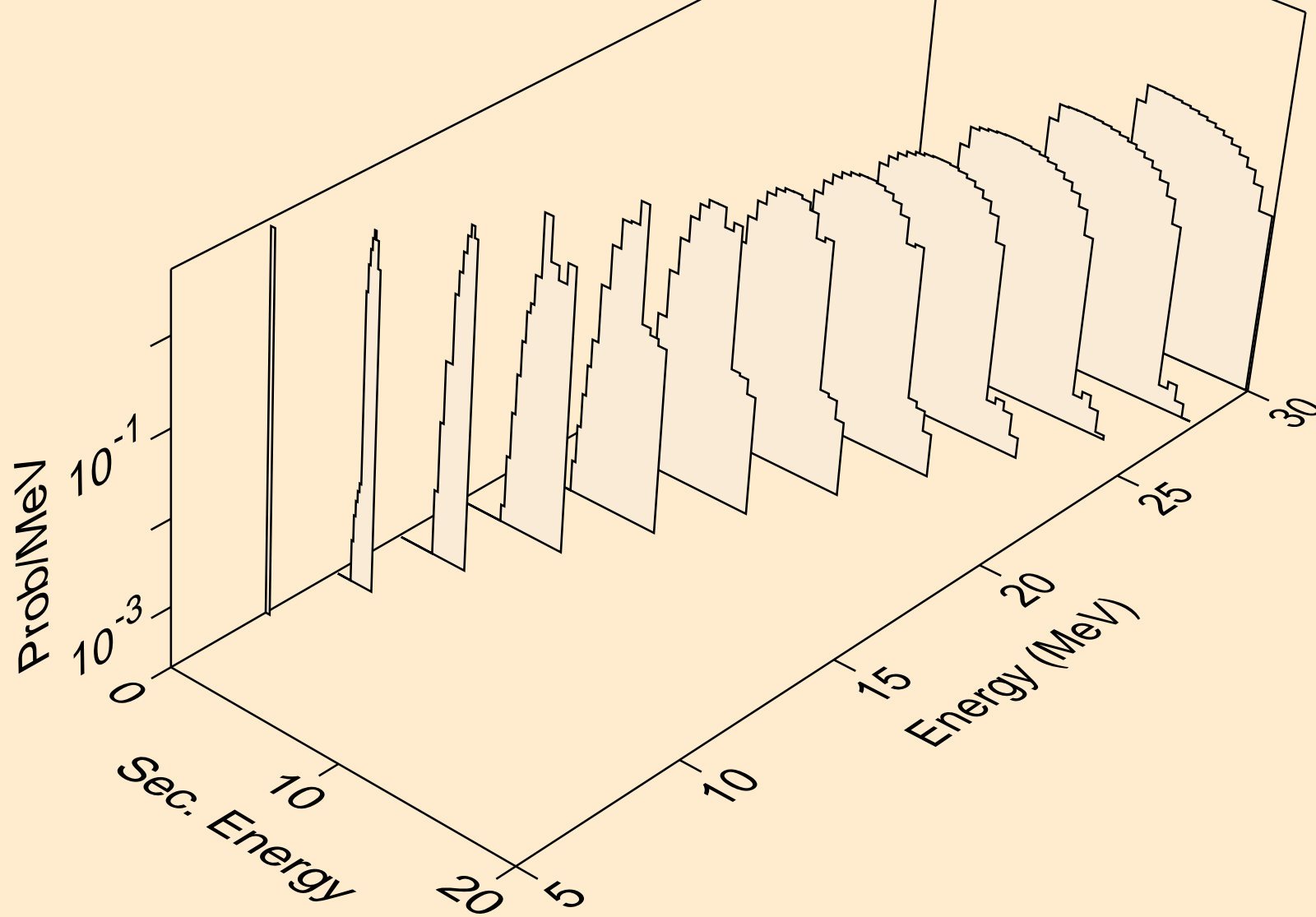

TC099 PROTON ACER TENDL-2021 LIBRARY; T=0.K  
tritons from (p,pt)

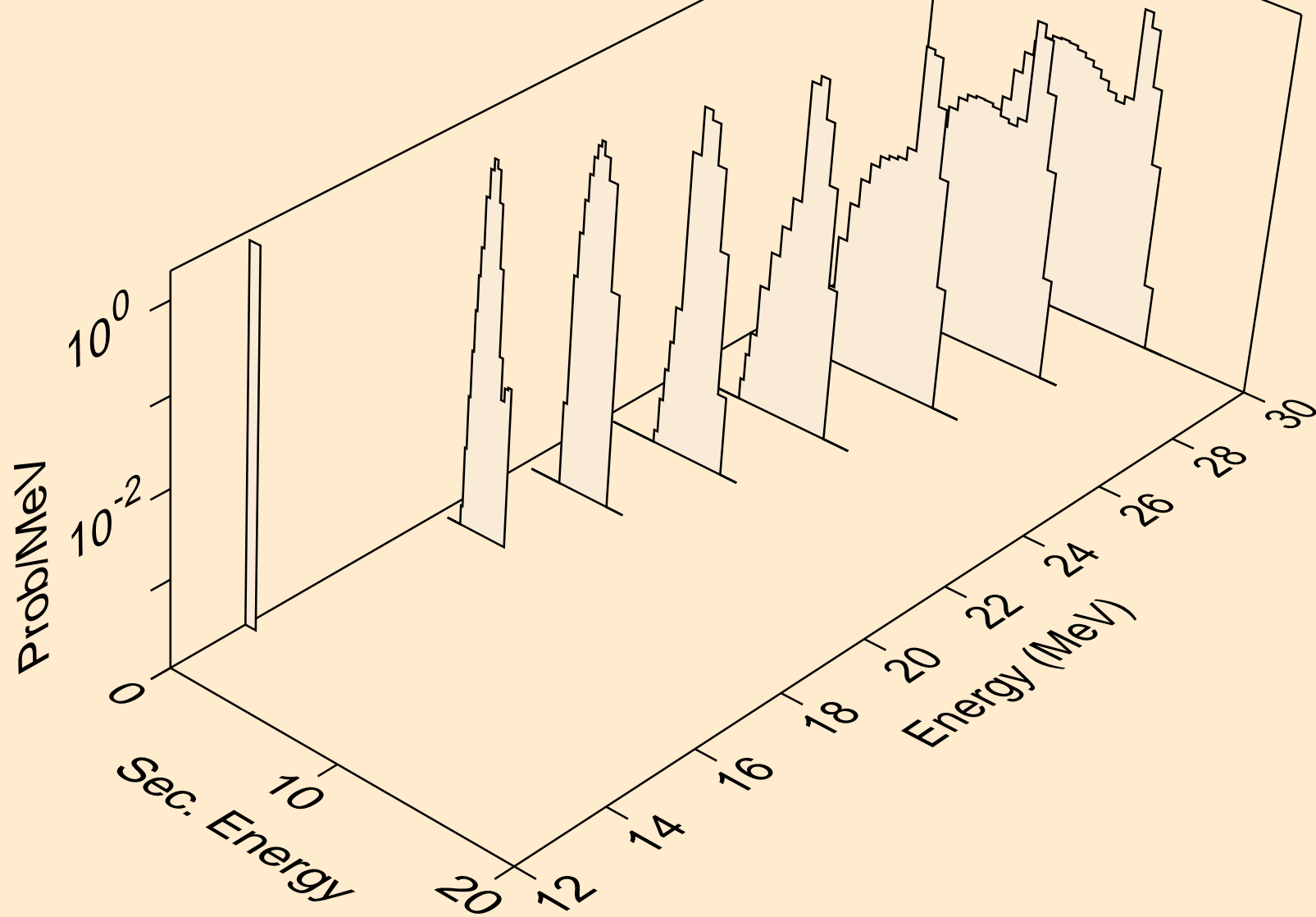

TC099 PROTON ACER TENDL-2021 LIBRARY; T=0.K  
he3s from (p,x)

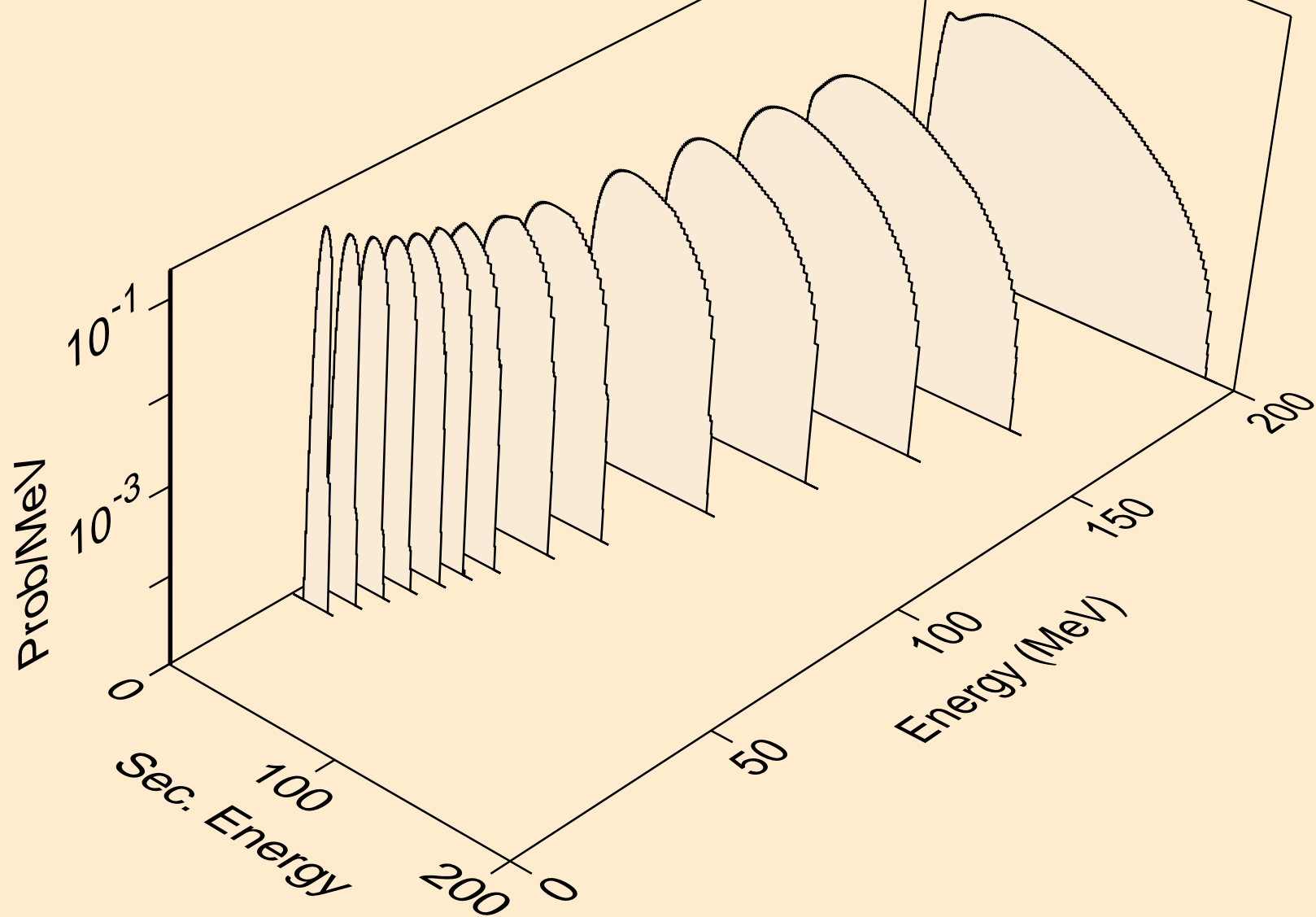

TC099 PROTON ACER TENDL-2021 LIBRARY; T=0.K  
he3s from (p,n\*)he3

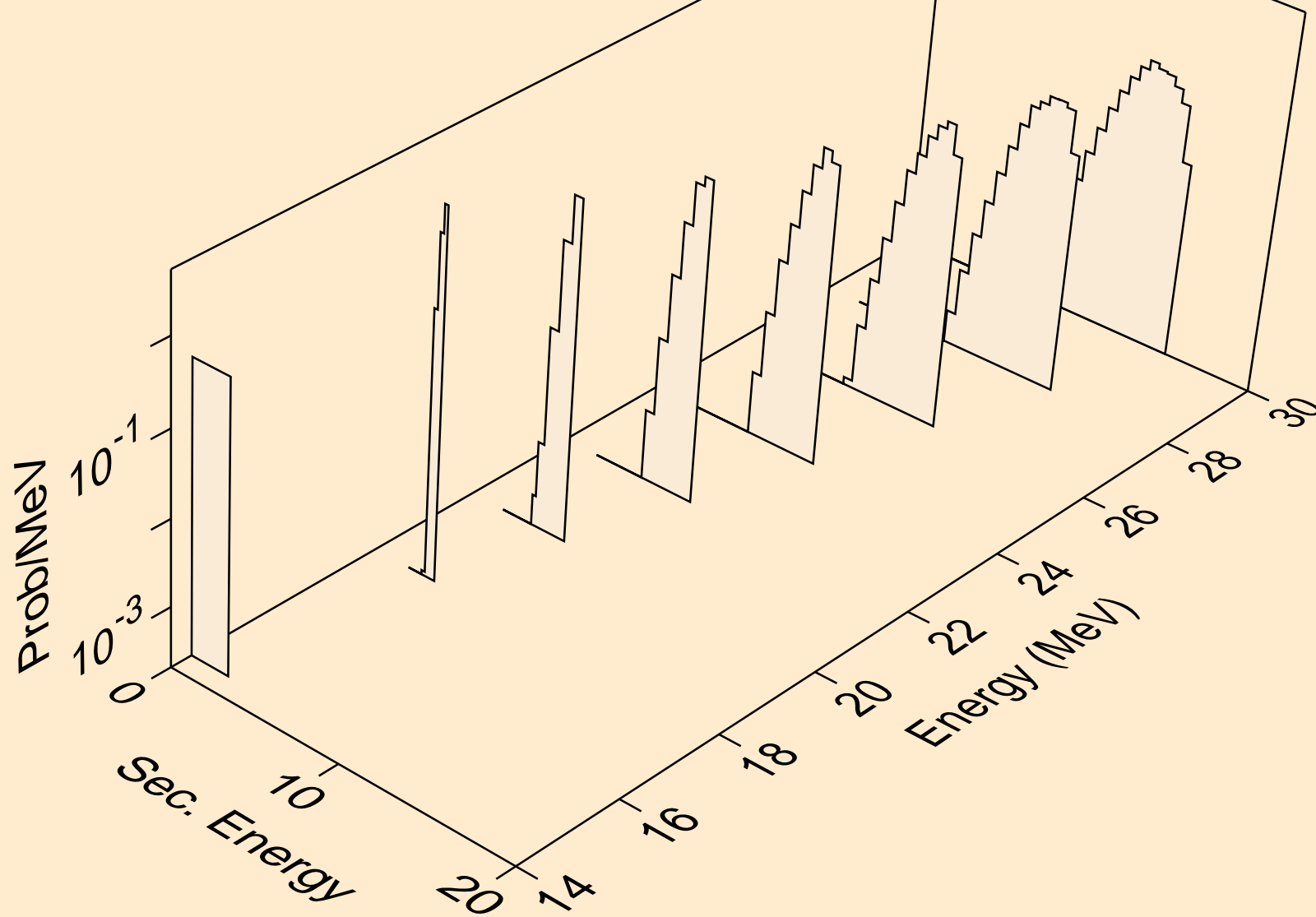

TC099 PROTON ACER TENDL-2021 LIBRARY; T=0.K  
he3s from (p,he3)

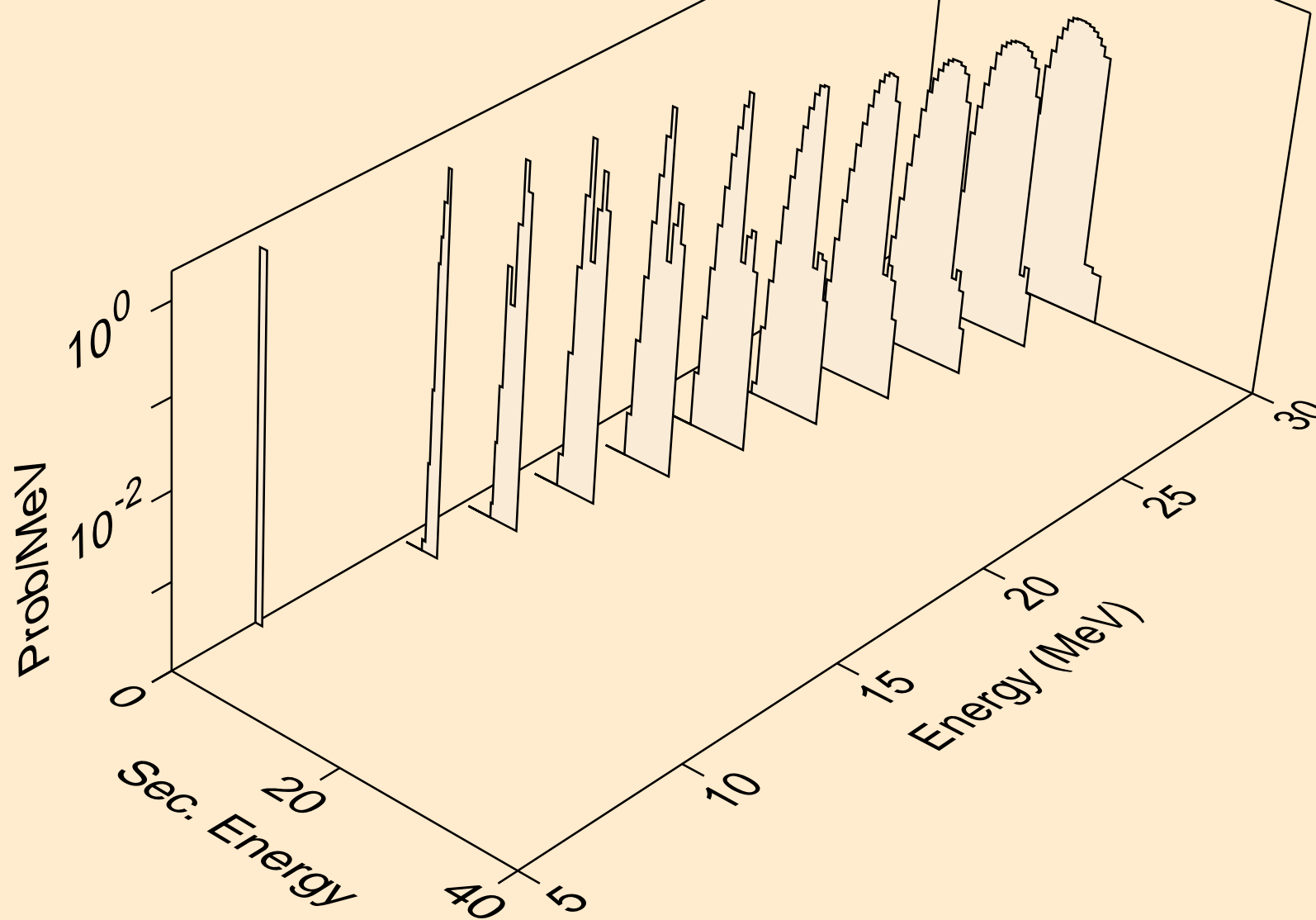

TC099 PROTON ACER TENDL-2021 LIBRARY; T=0.K  
alphas from (p,x)

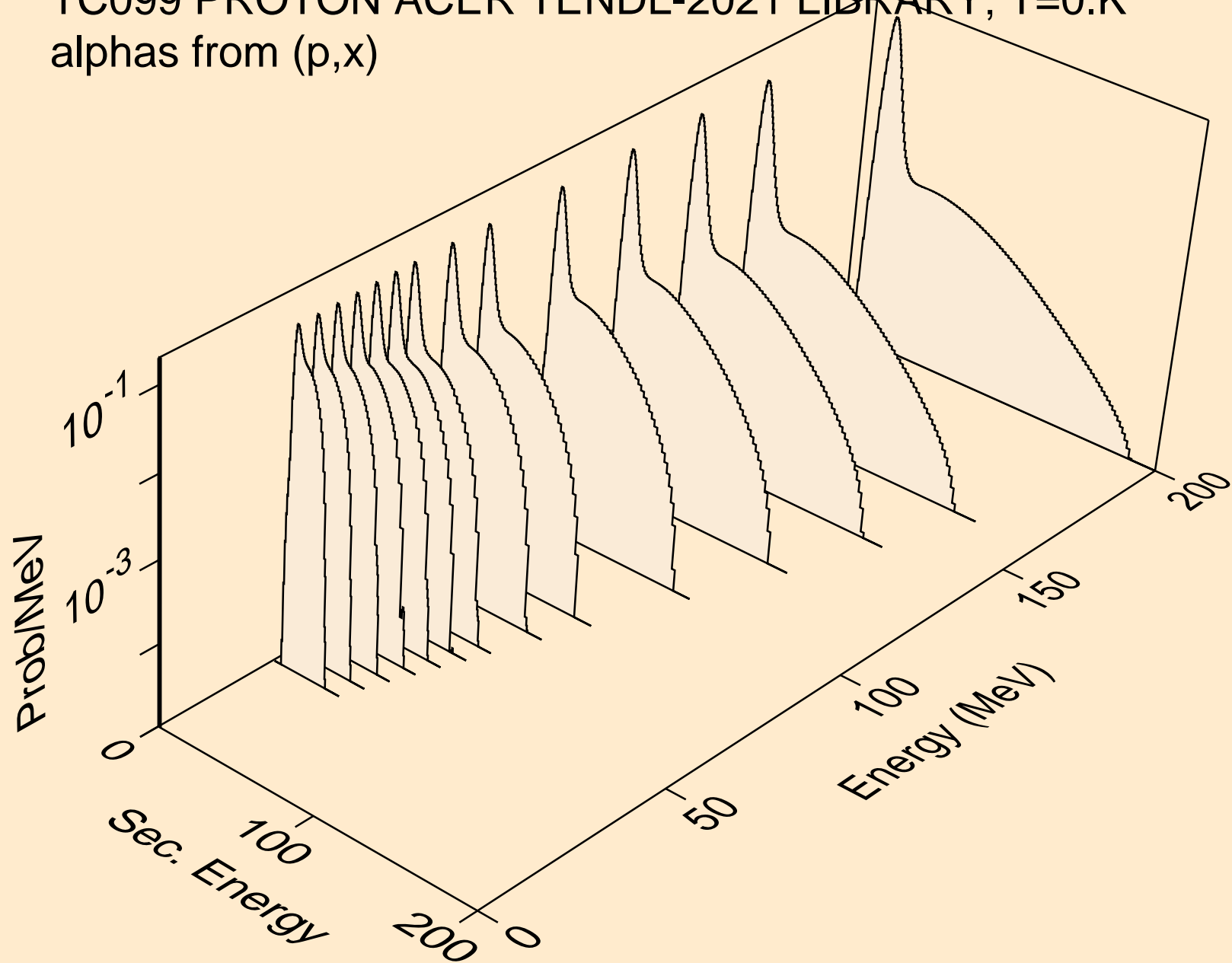

TC099 PROTON ACER TENDL-2021 LIBRARY; T=0.K  
alphas from (p,n\*)a

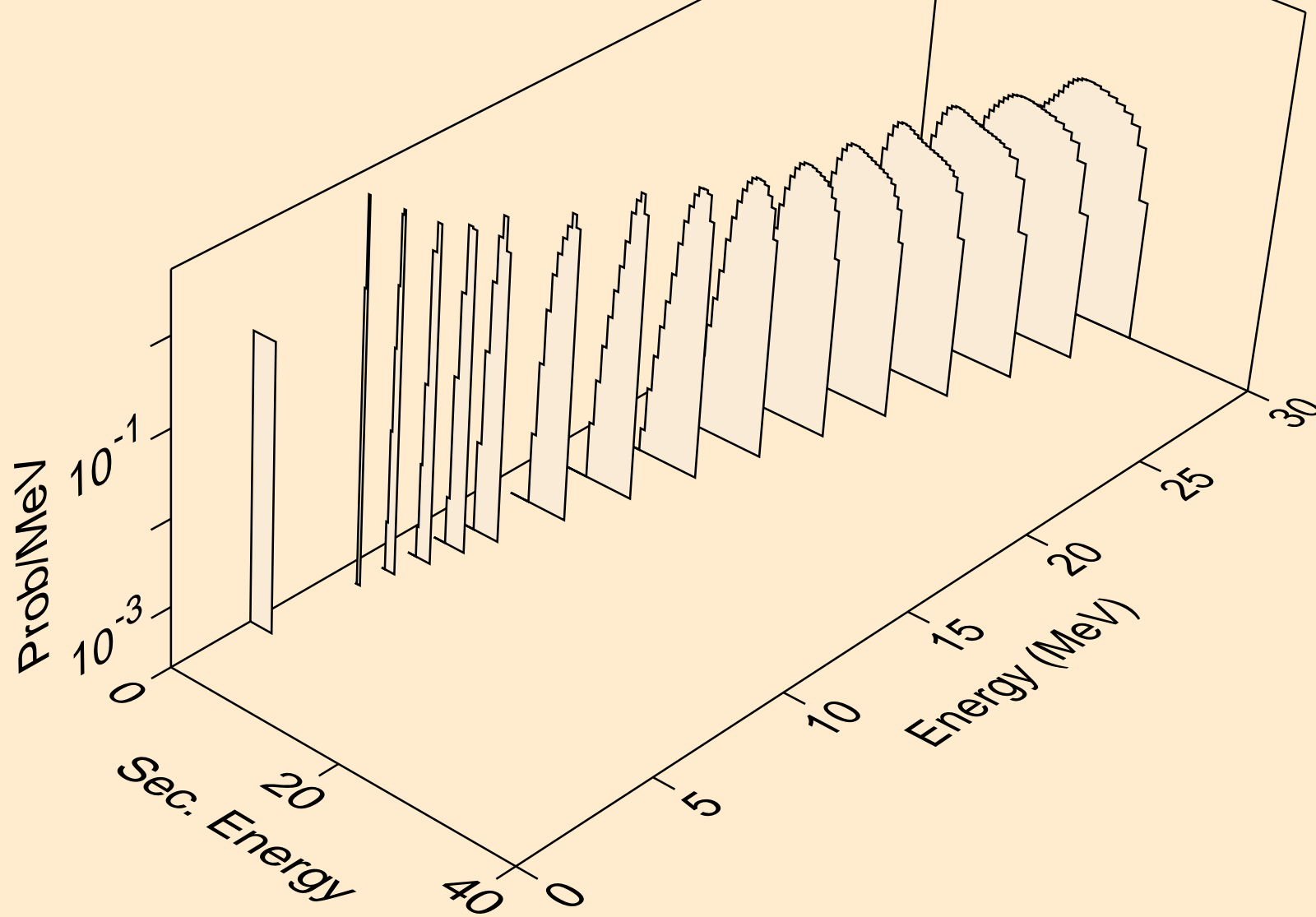



TC099 PROTON ACER TENDL-2021 LIBRARY; T=0.K  
alphas from (p,2n)a

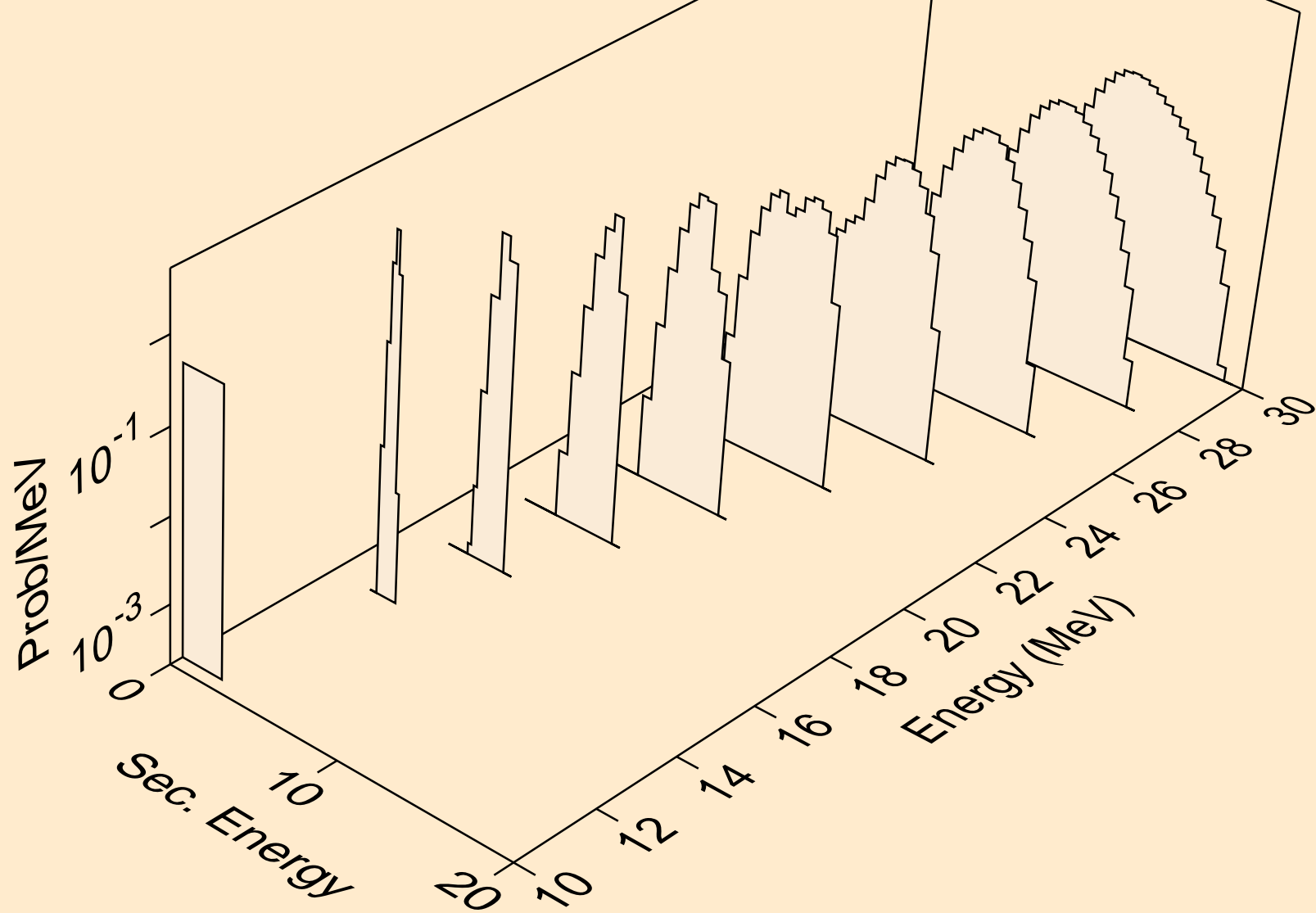

TC099 PROTON ACER TENDL-2021 LIBRARY; T=0.K  
alphas from (p,3n)a

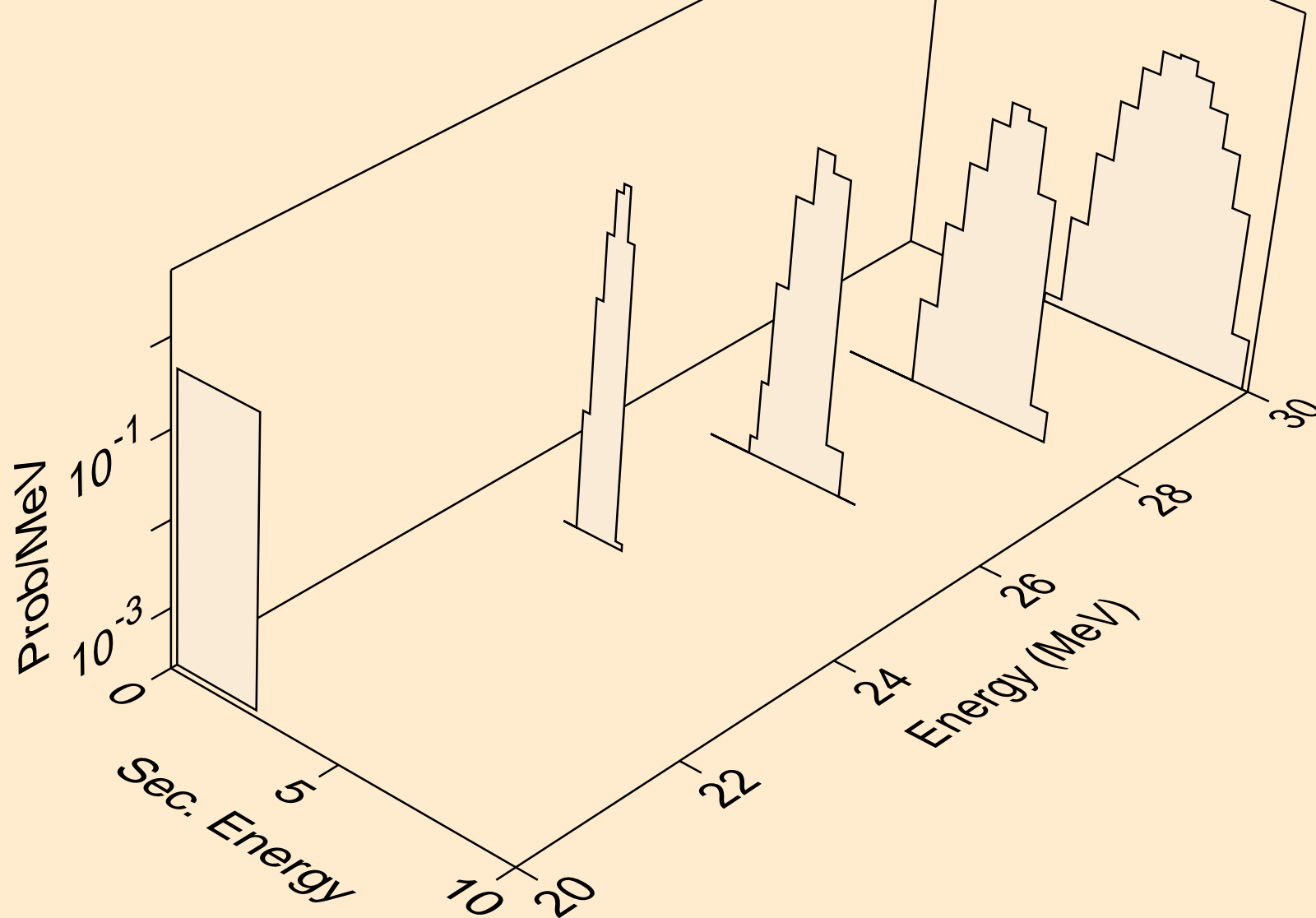

TC099 PROTON ACER TENDL-2021 LIBRARY; T=0.K  
alphas from (p,n\*)2a

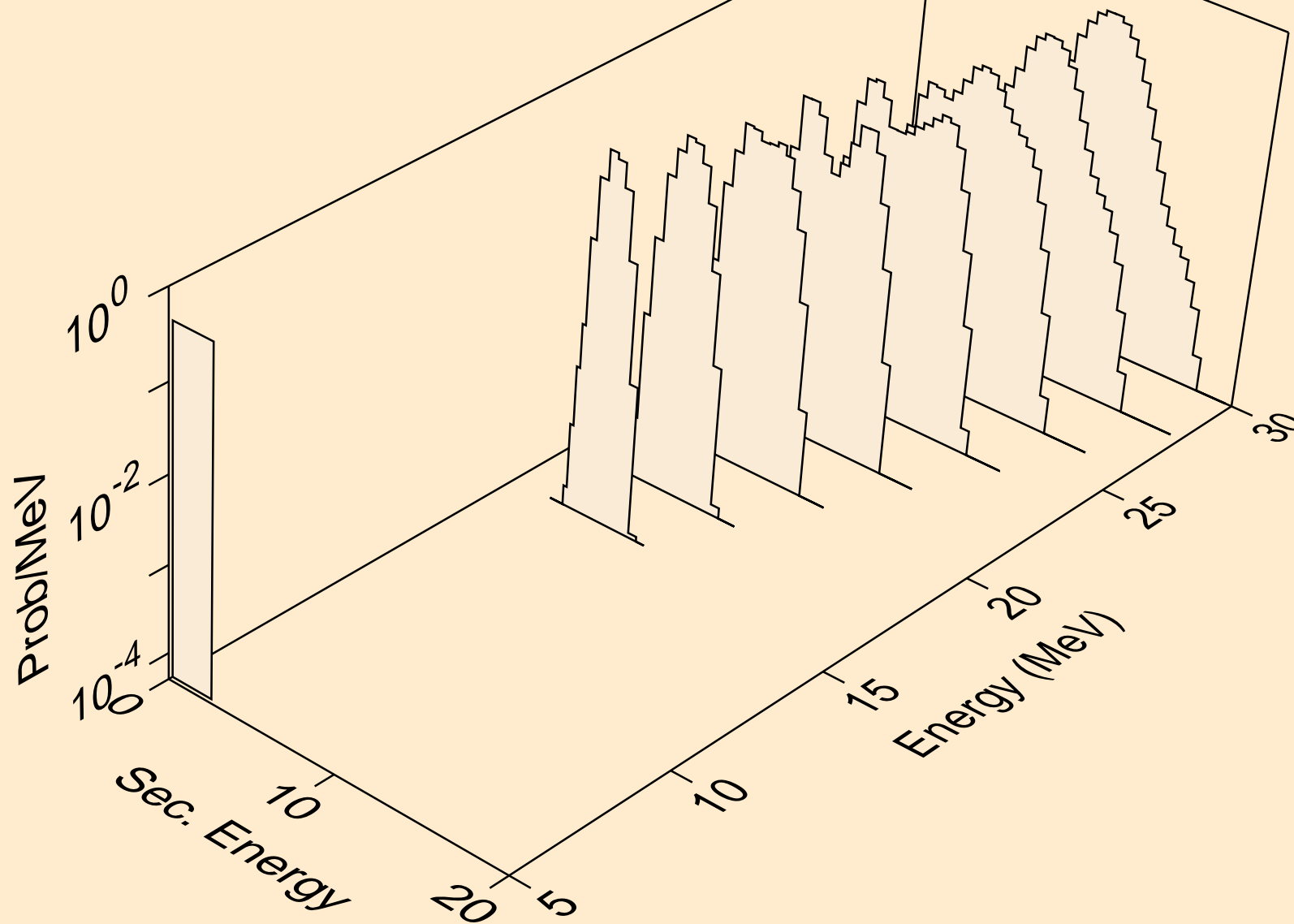

TC099 PROTON ACER TENDL-2021 LIBRARY; T=0.K  
alphas from (p,2n)2a

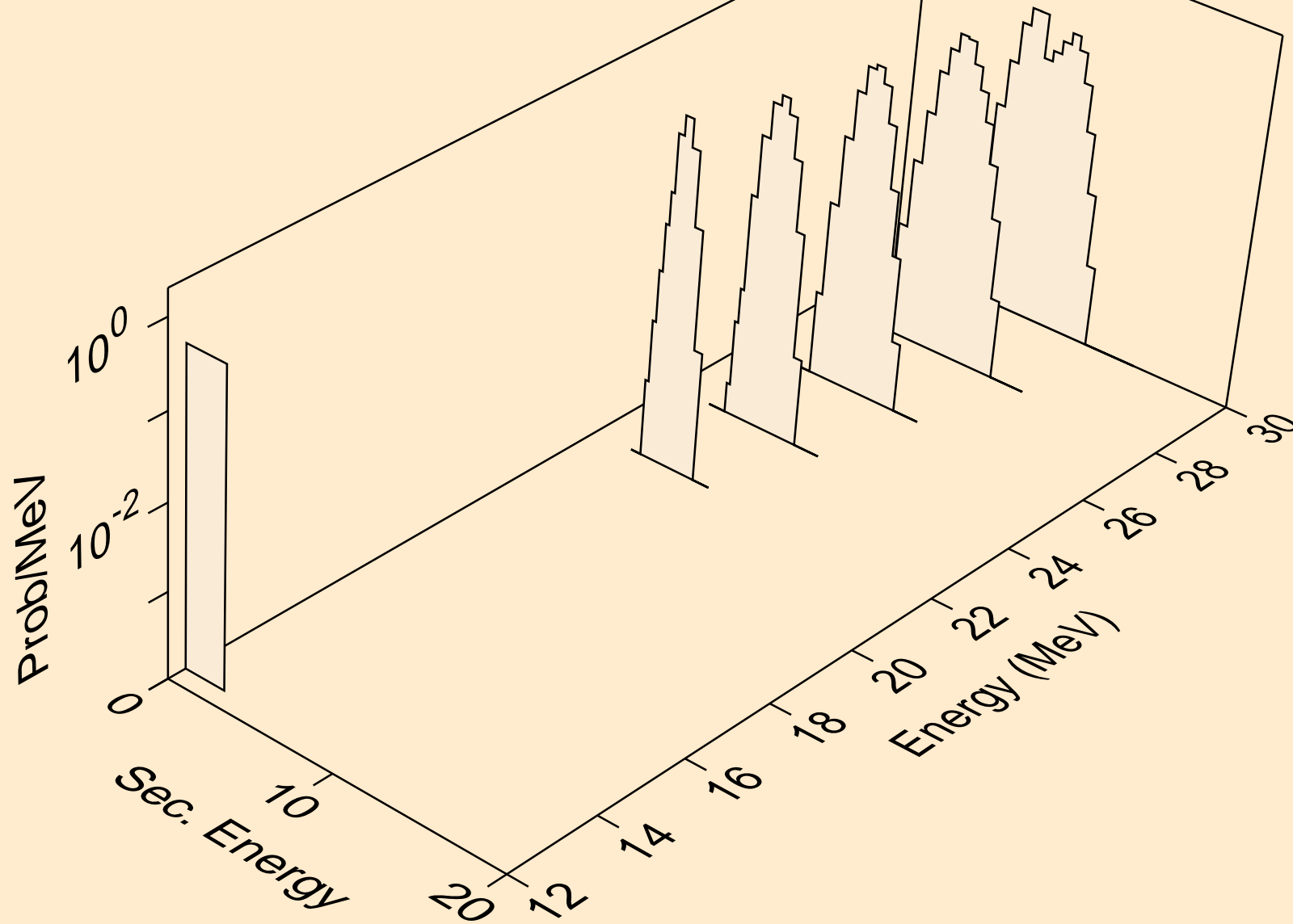

TC099 PROTON ACER TENDL-2021 LIBRARY; T=0.K  
alphas from (p,npa)

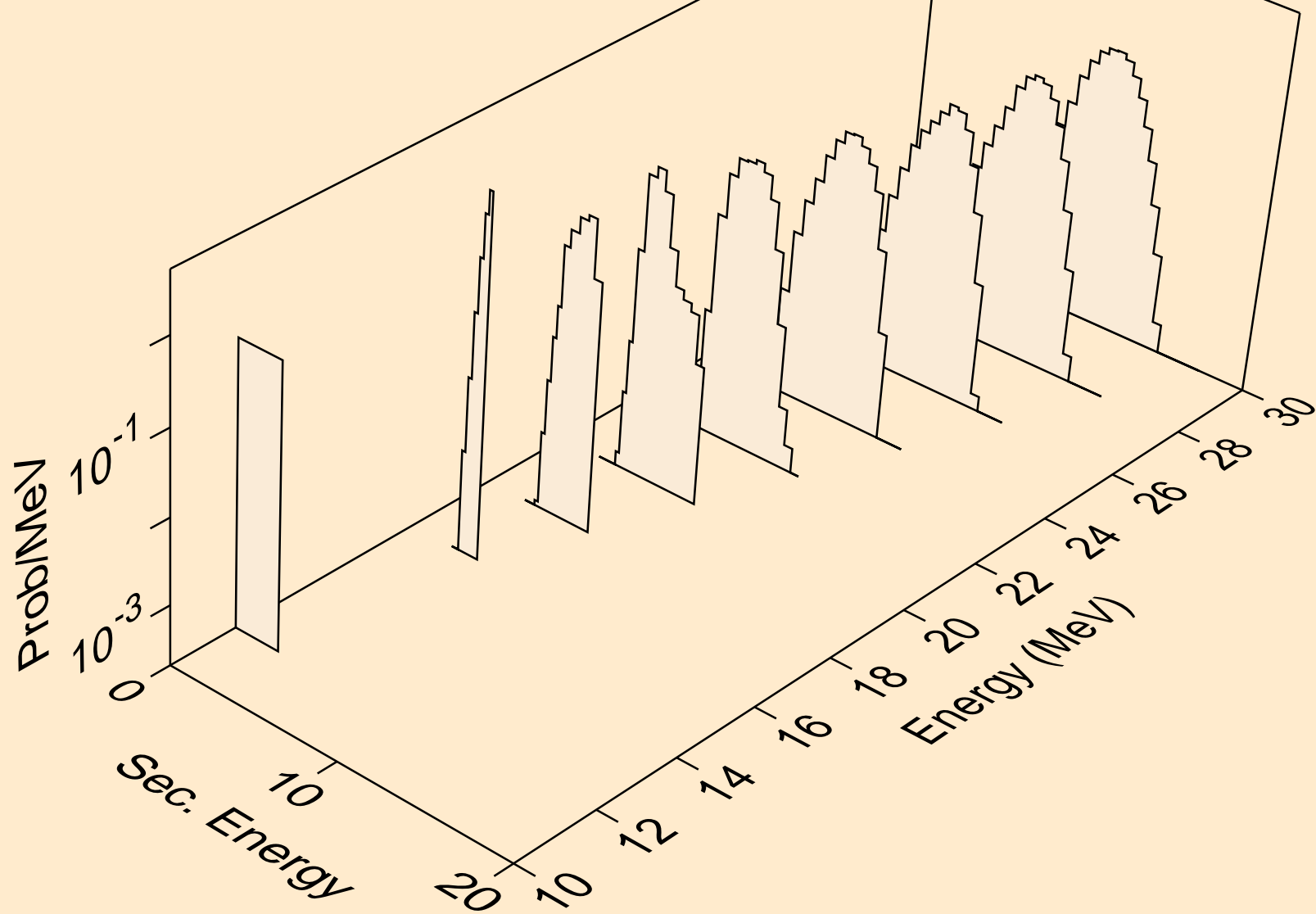

TC099 PROTON ACER TENDL-2021 LIBRARY; T=0.K  
alphas from (p,a)

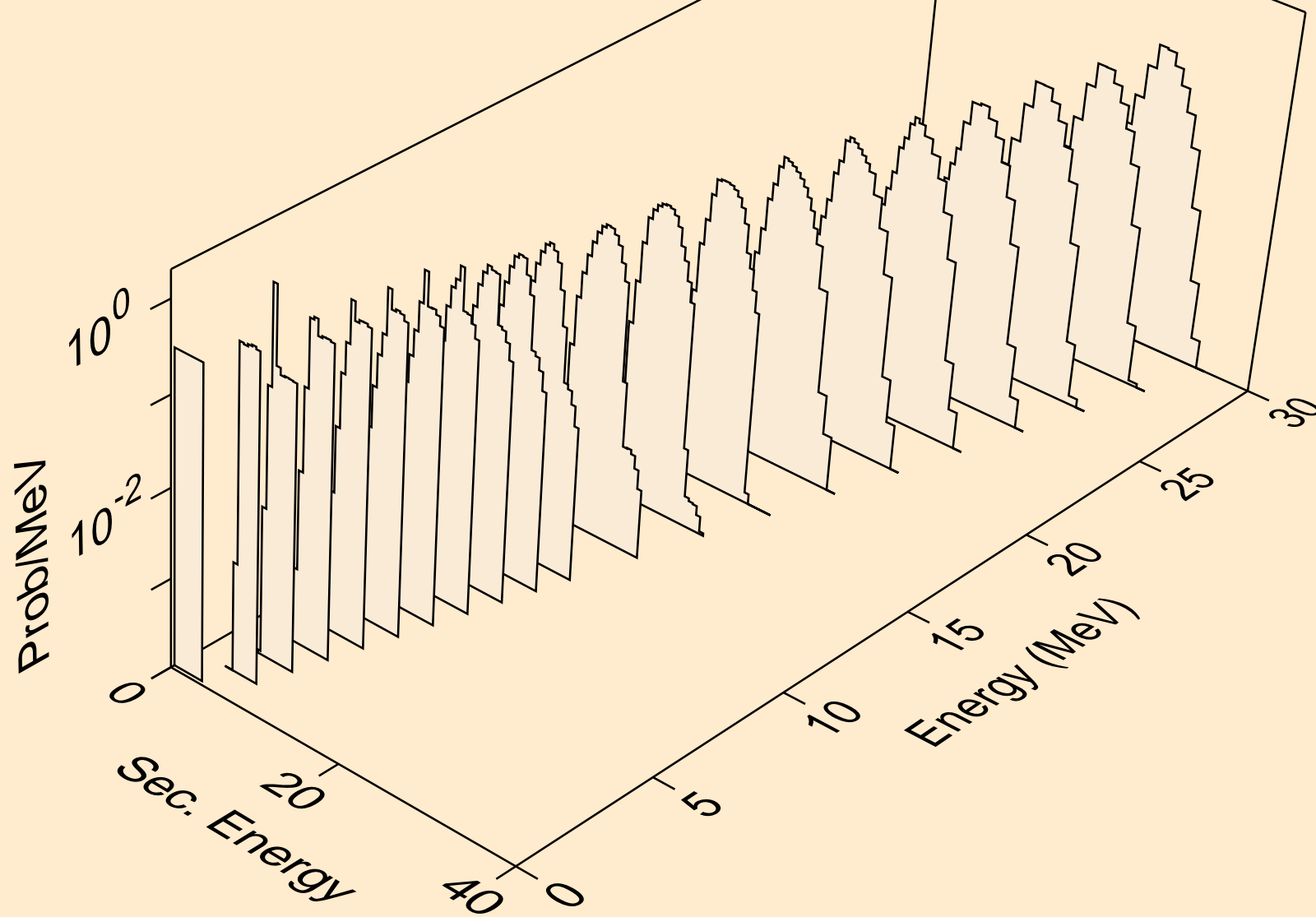

TC099 PROTON ACER TENDL-2021 LIBRARY; T=0.K  
alphas from (p,2a)

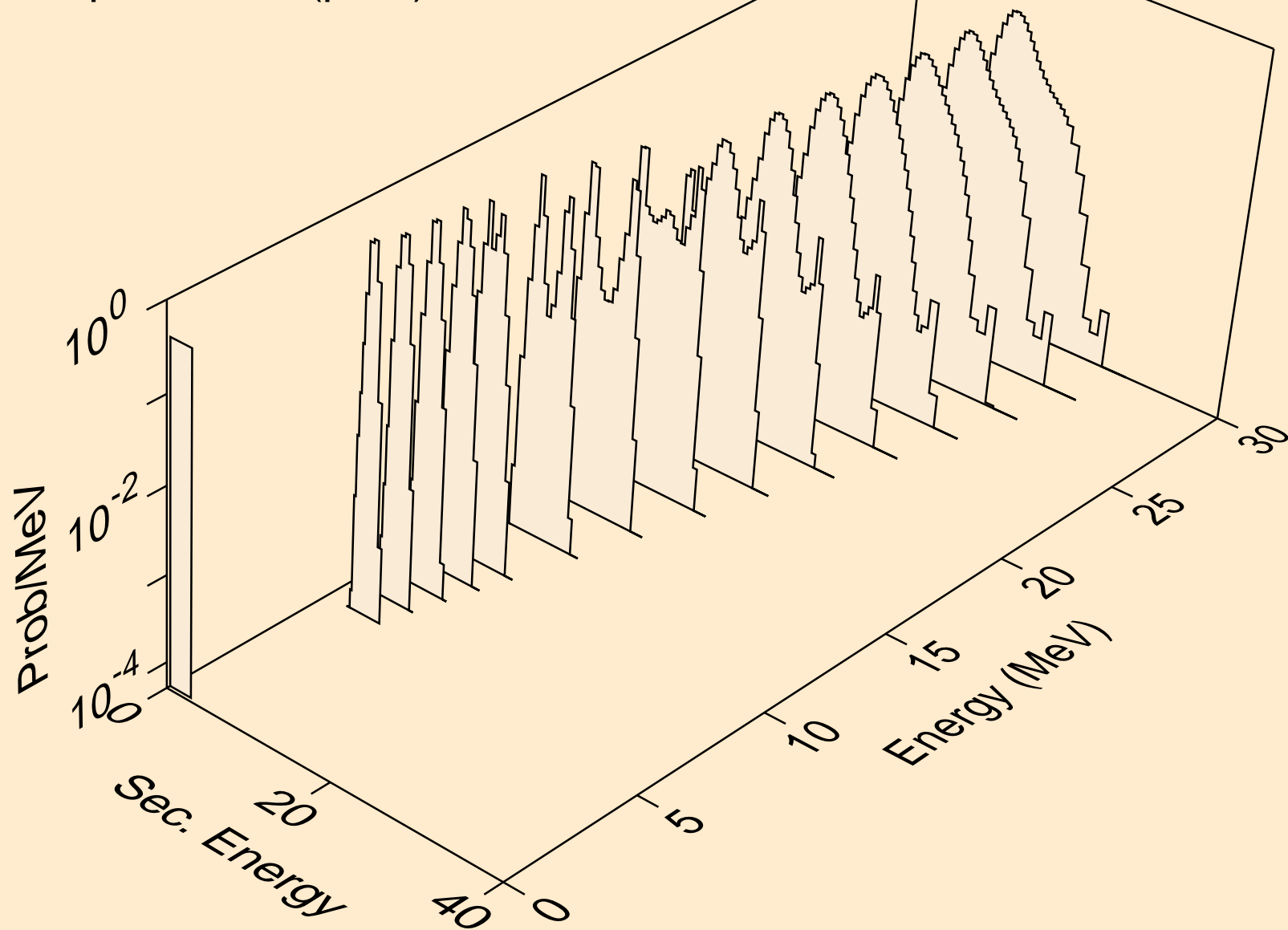

TC099 PROTON ACER TENDL-2021 LIBRARY; T=0.K  
alphas from (p,pa)

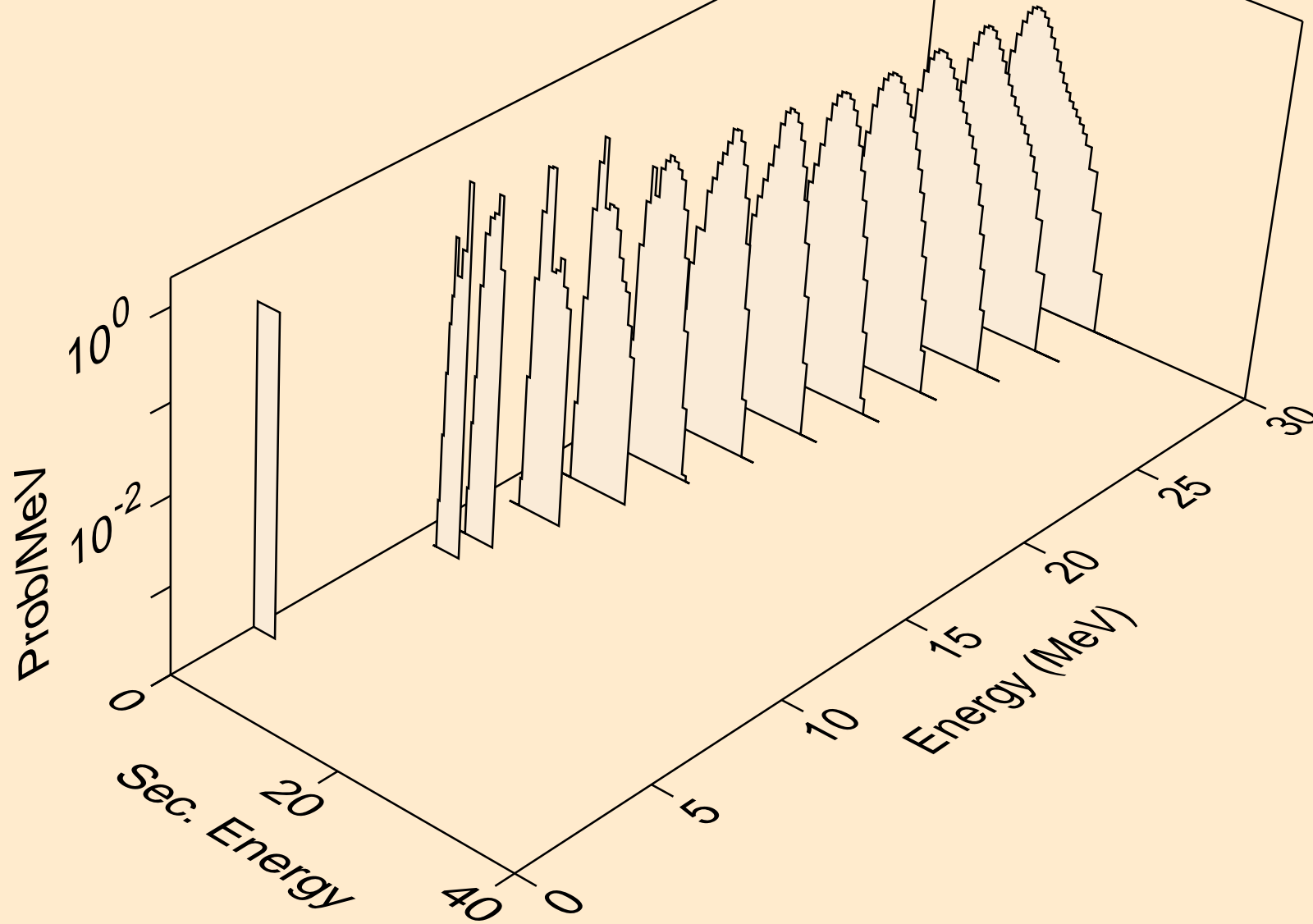



TC099 PROTON ACER TENDL-2021 LIBRARY; T=0.K  
alphas from (p,da)

