

TE126 PROTON ACER TENDL-2021 LIBRARY; T=0.K  
Principal cross sections

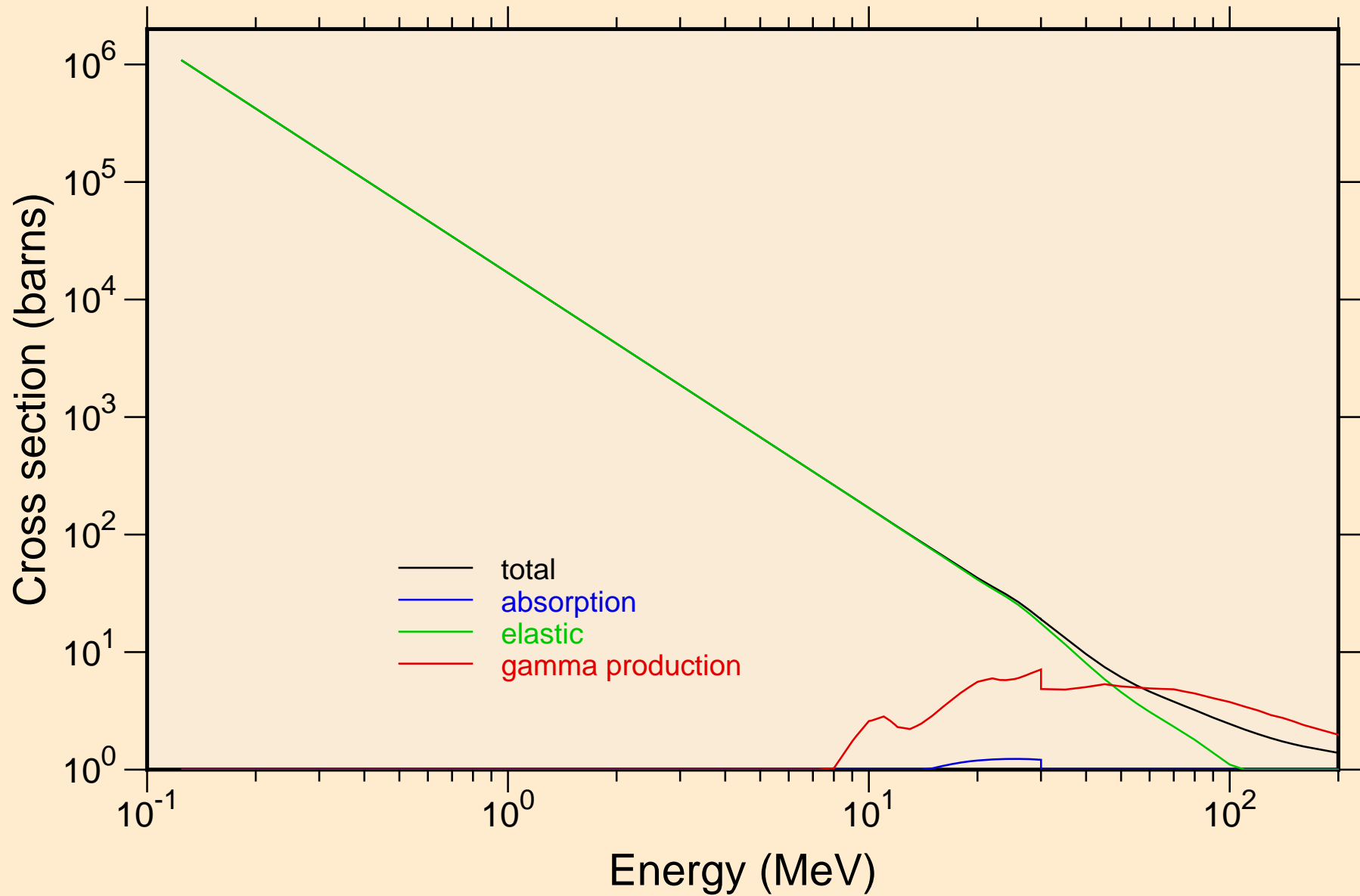

# TE126 PROTON ACER TENDL-2021 LIBRARY; T=0.K

## Heating

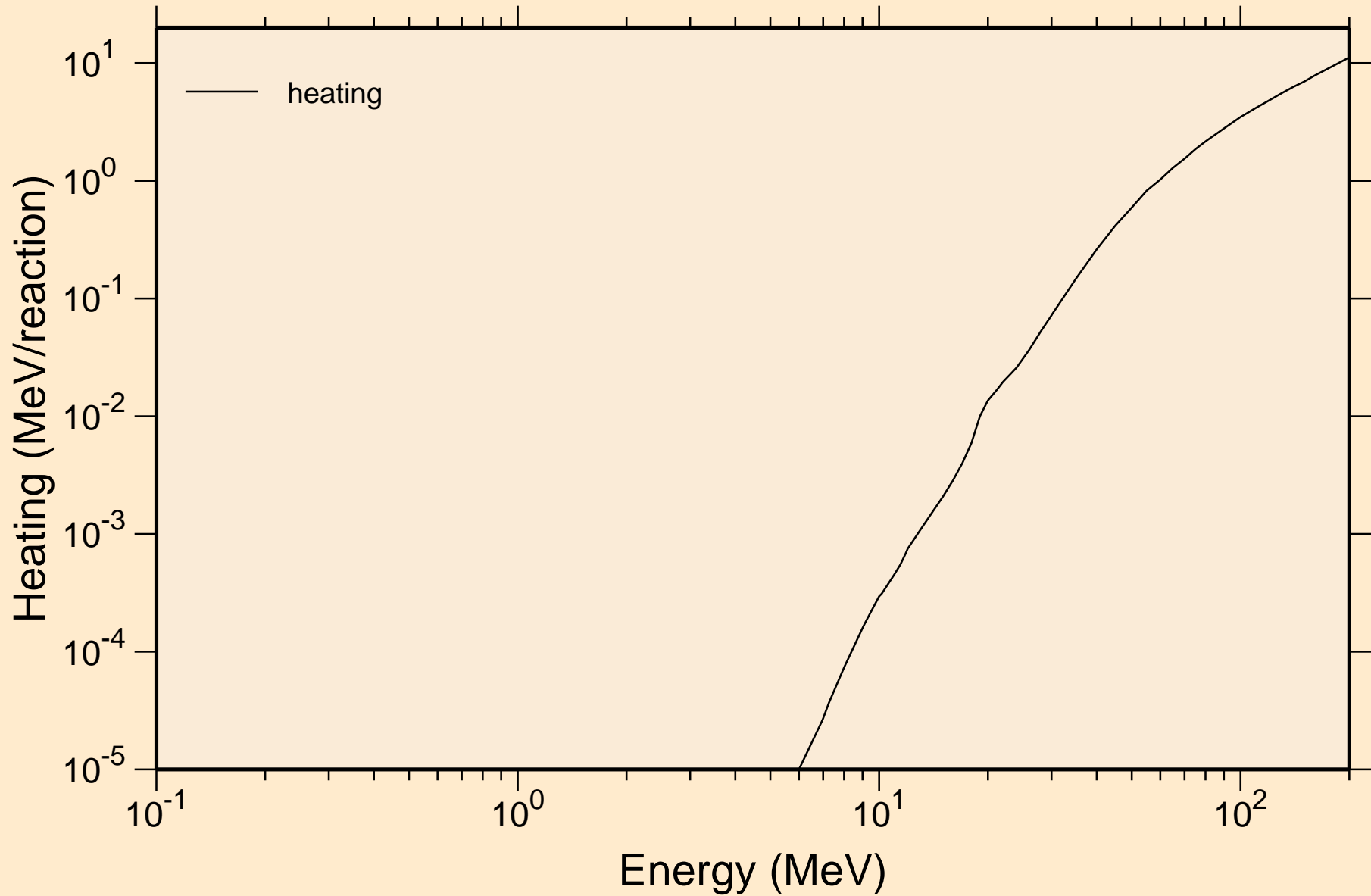

# TE126 PROTON ACER TENDL-2021 LIBRARY; T=0.K

## Principal cross sections

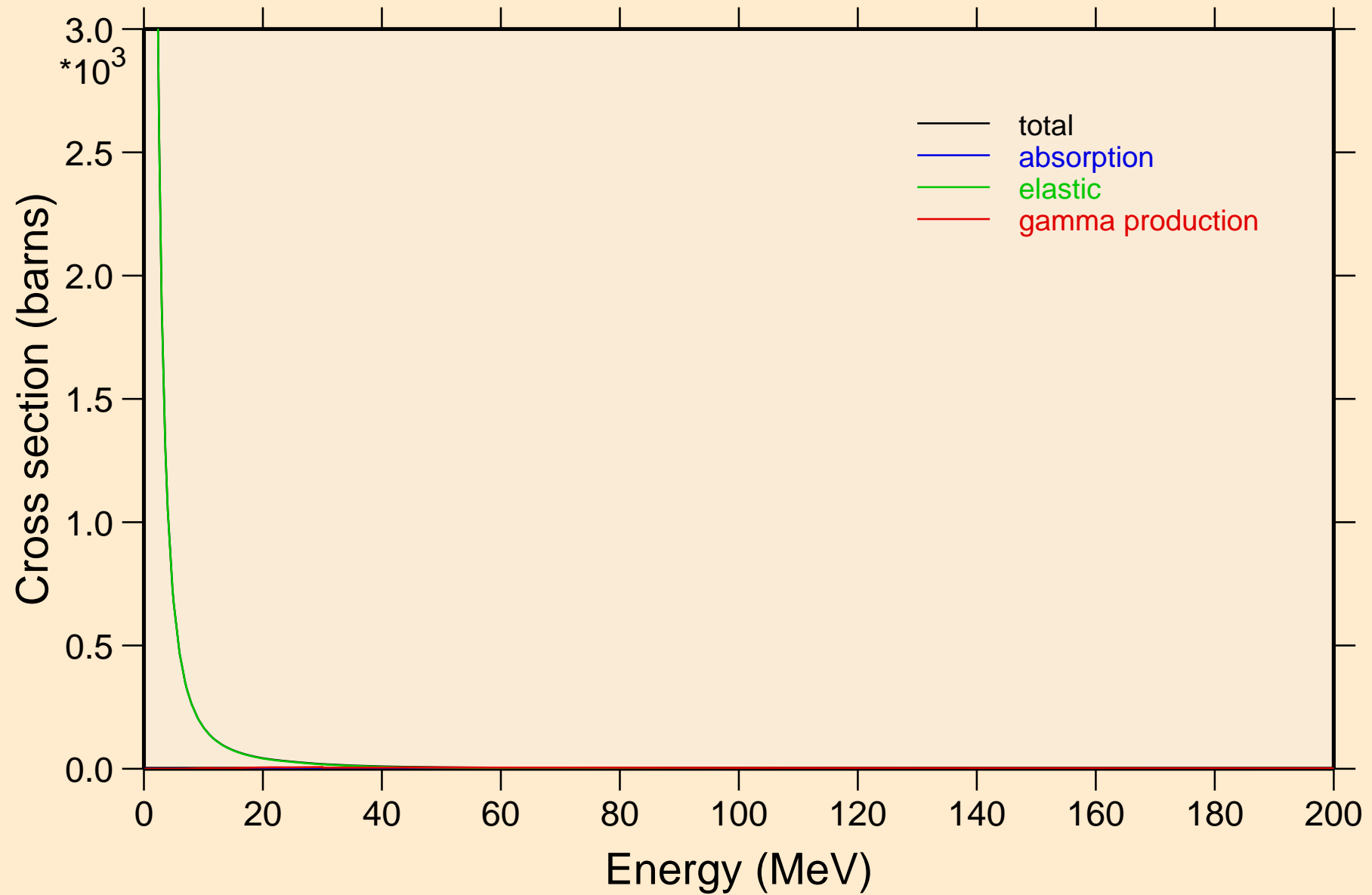

TE126 PROTON ACER TENDL-2021 LIBRARY; T=0.K

Heating

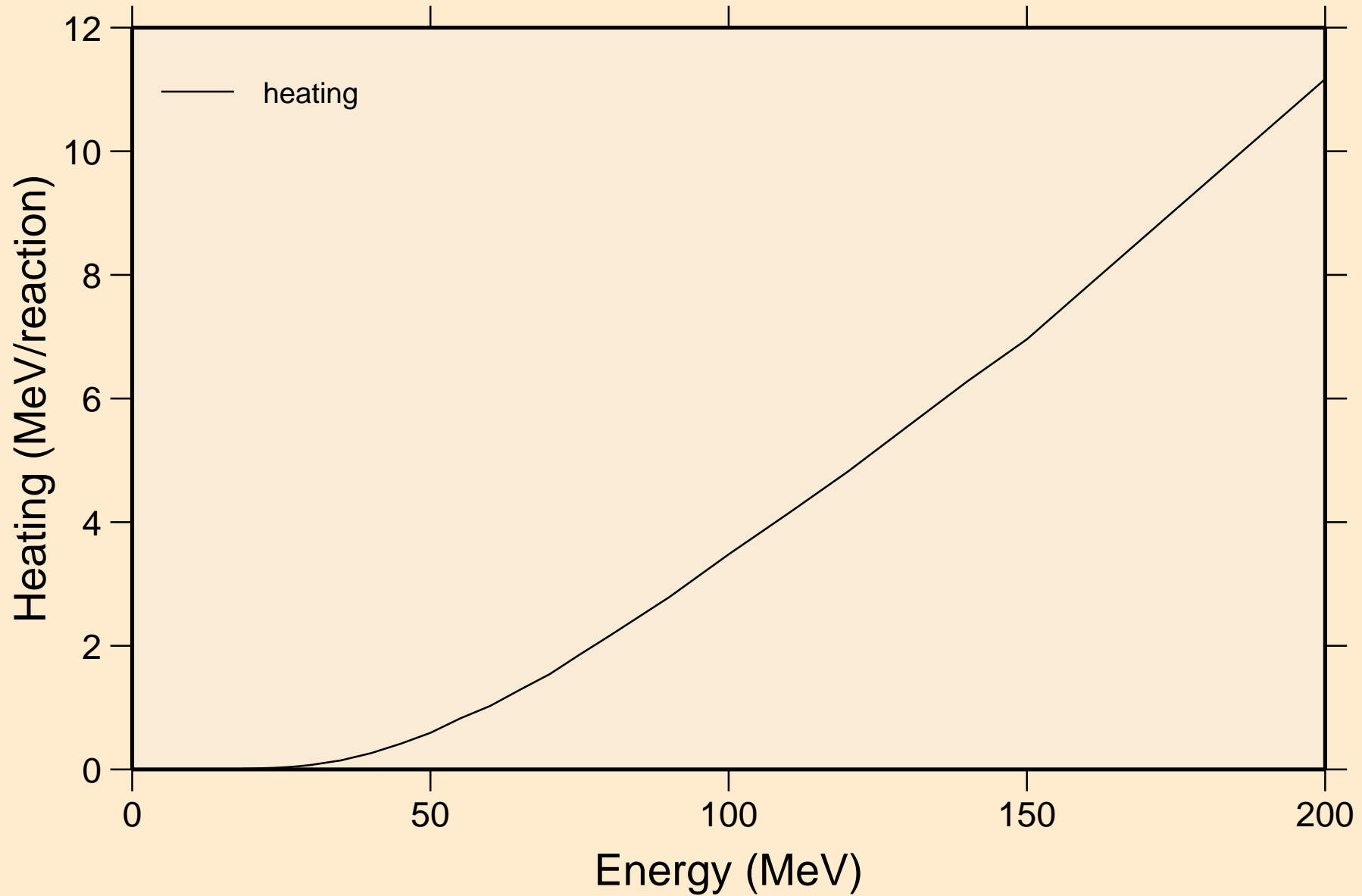

TE126 PROTON ACER TENDL-2021 LIBRARY; T=0.K  
Threshold reactions

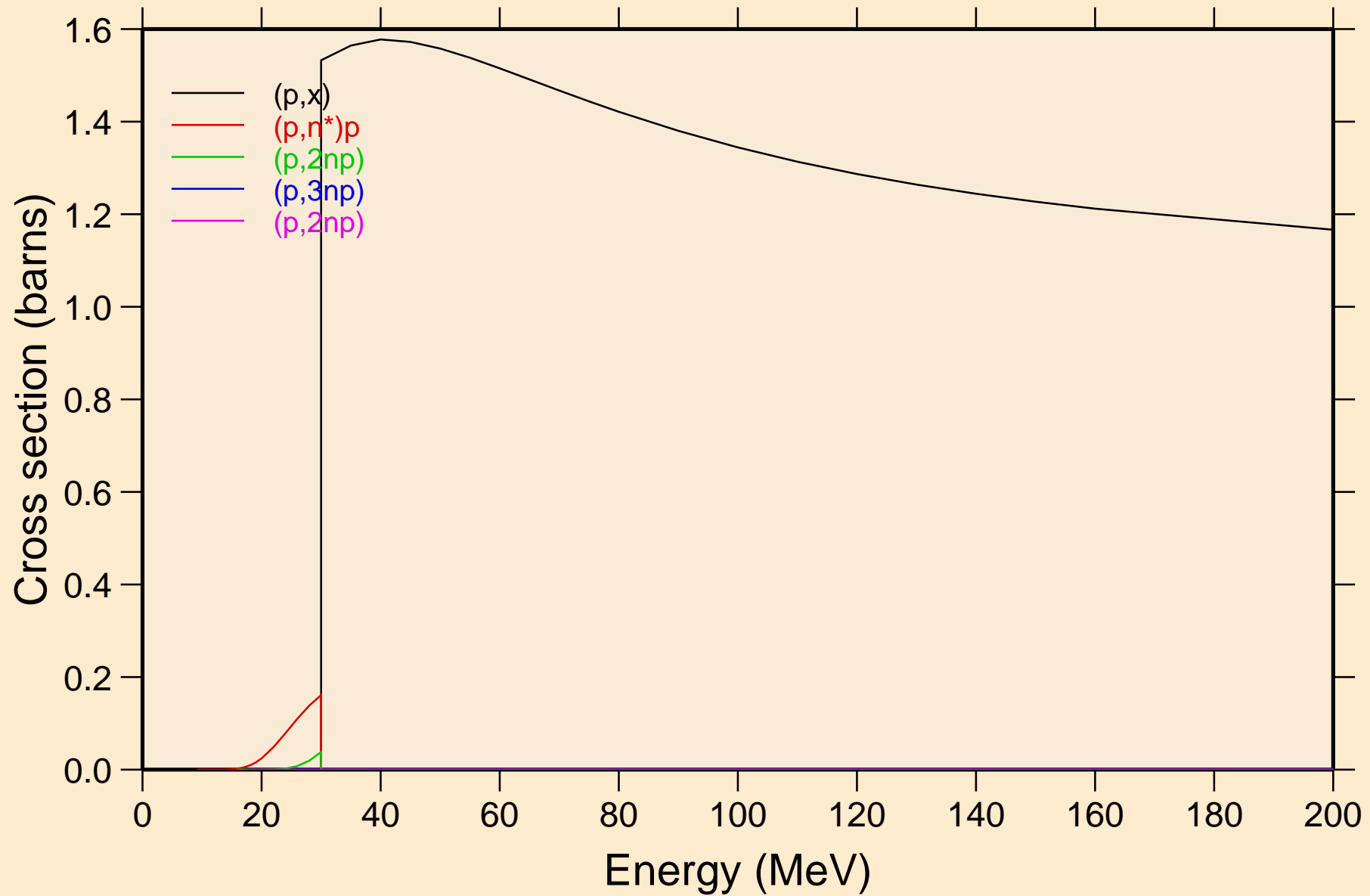

TE126 PROTON ACER TENDL-2021 LIBRARY; T=0.K  
Threshold reactions

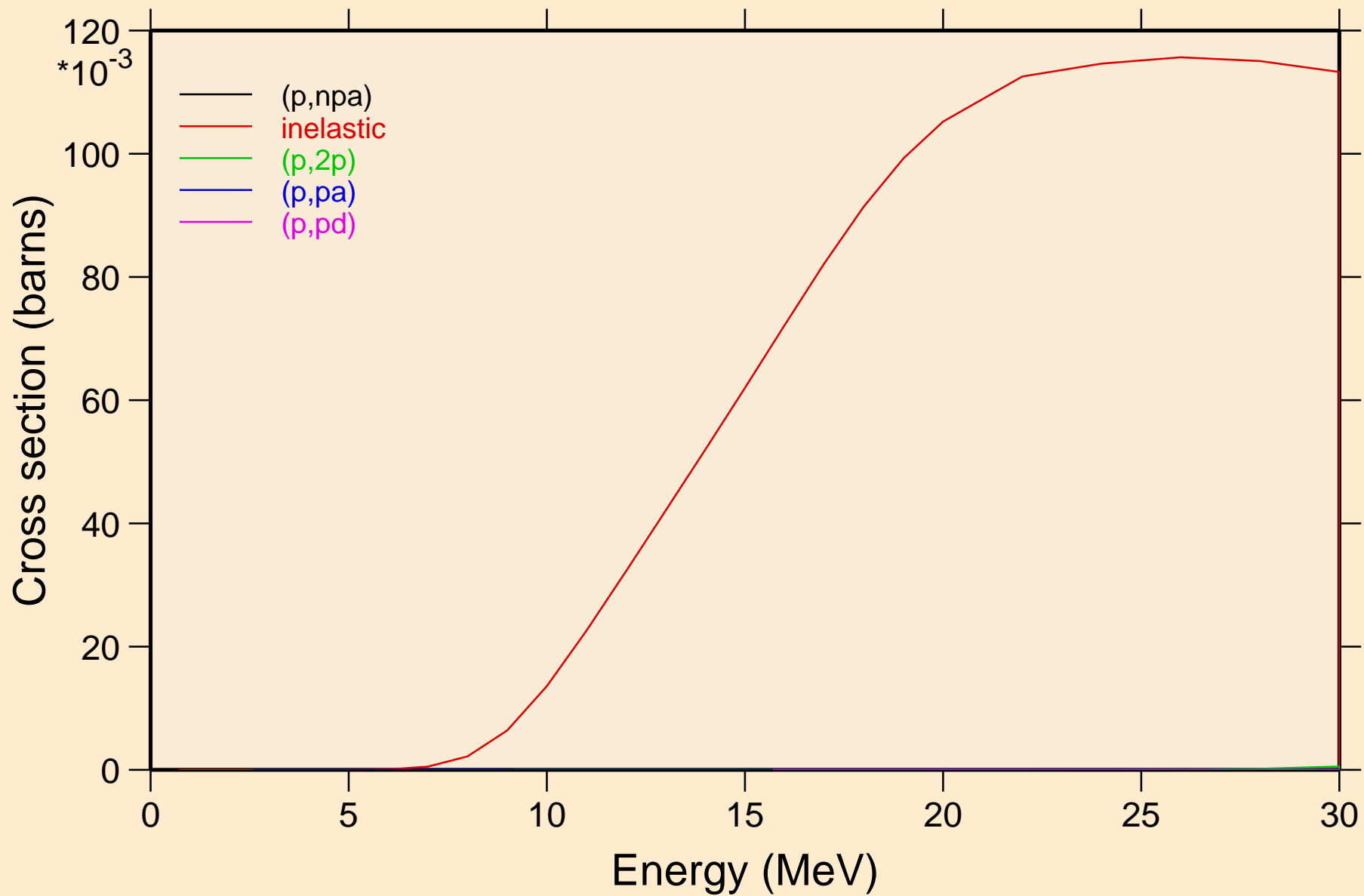

TE126 PROTON ACER TENDL-2021 LIBRARY; T=0.K  
Threshold reactions

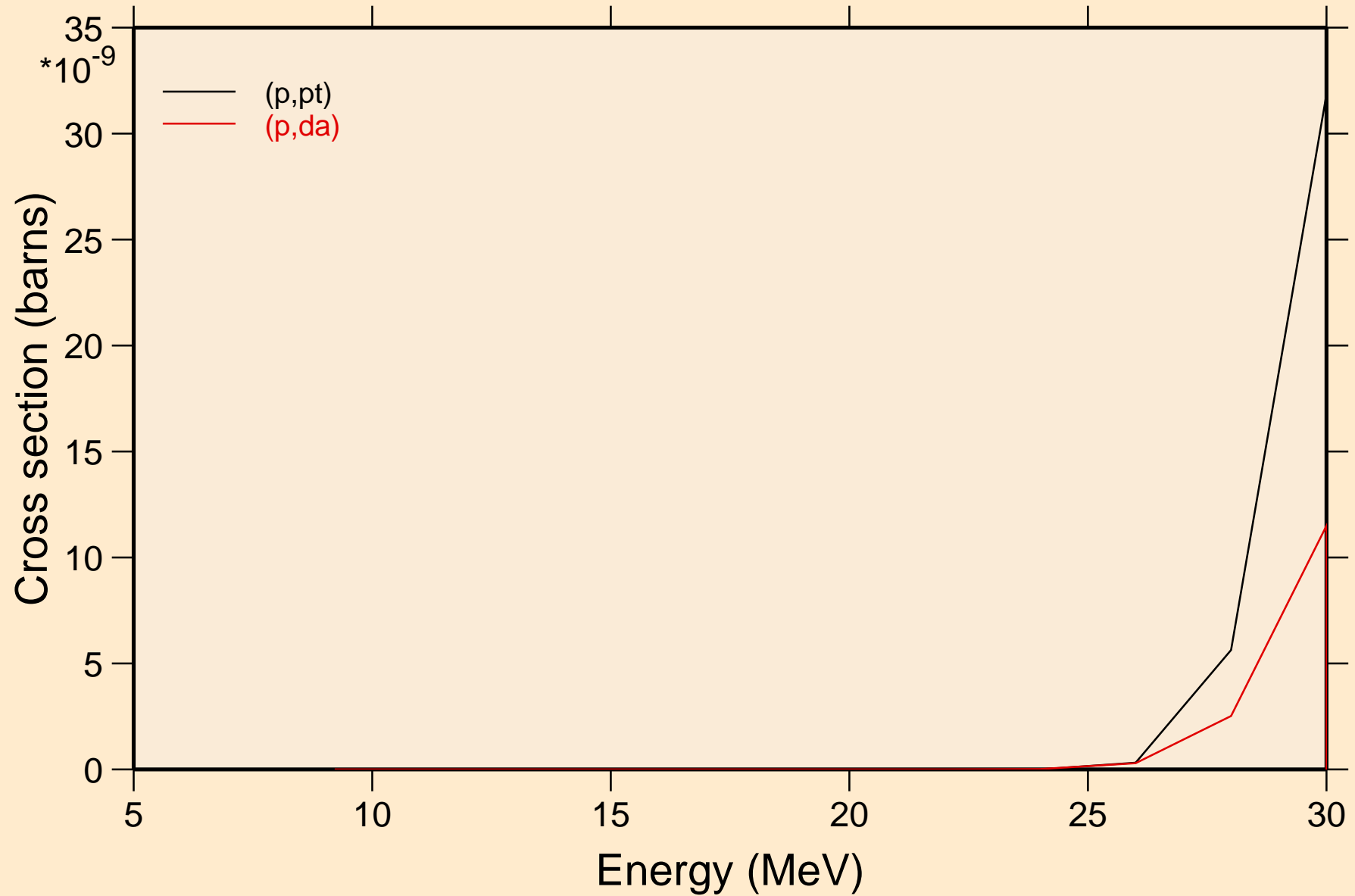

TE126 PROTON ACER TENDL-2021 LIBRARY; T=0.K  
angular distribution for elastic

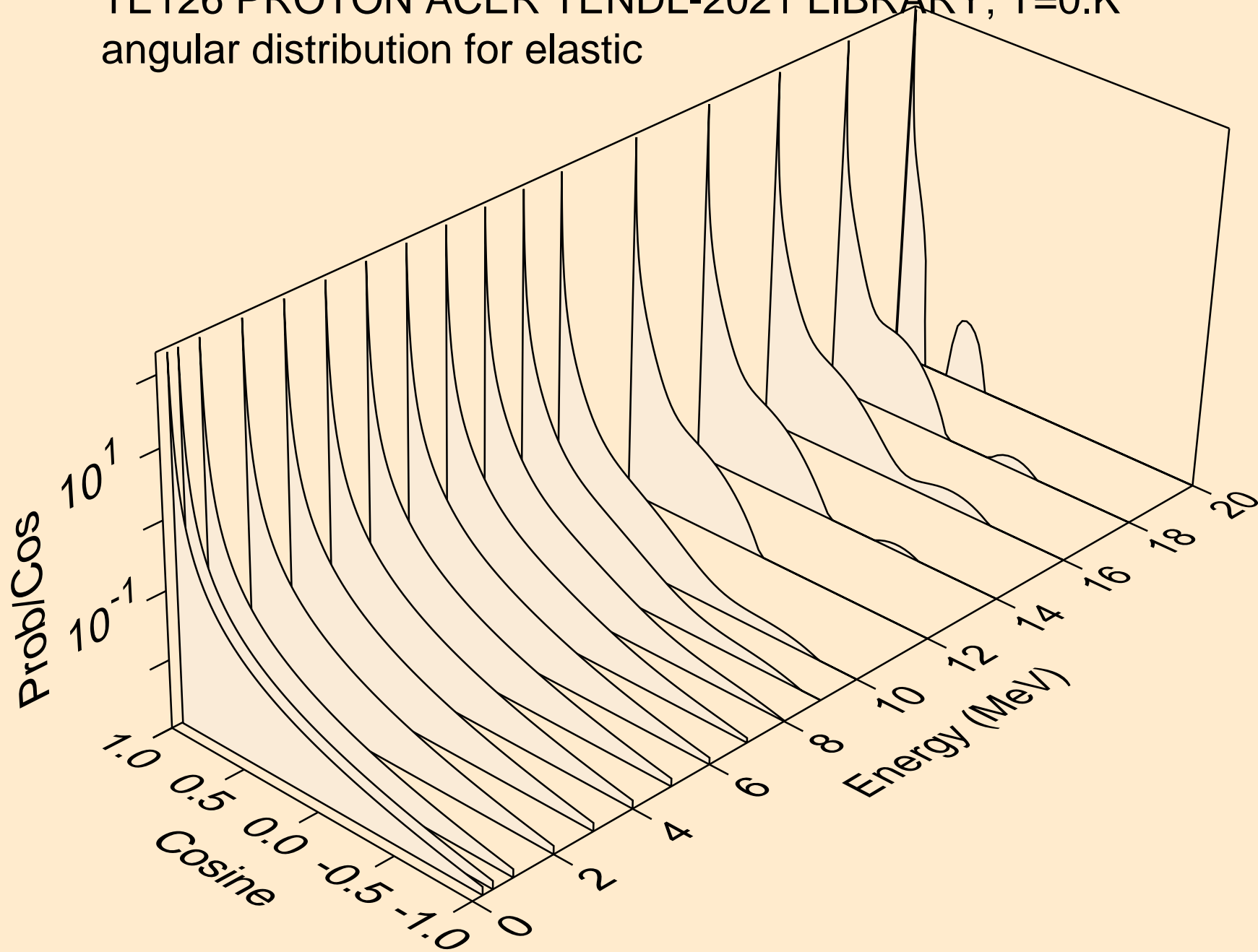



TE126 PROTON ACER TENDL-2021 LIBRARY; T=0.K  
angular distribution for elastic

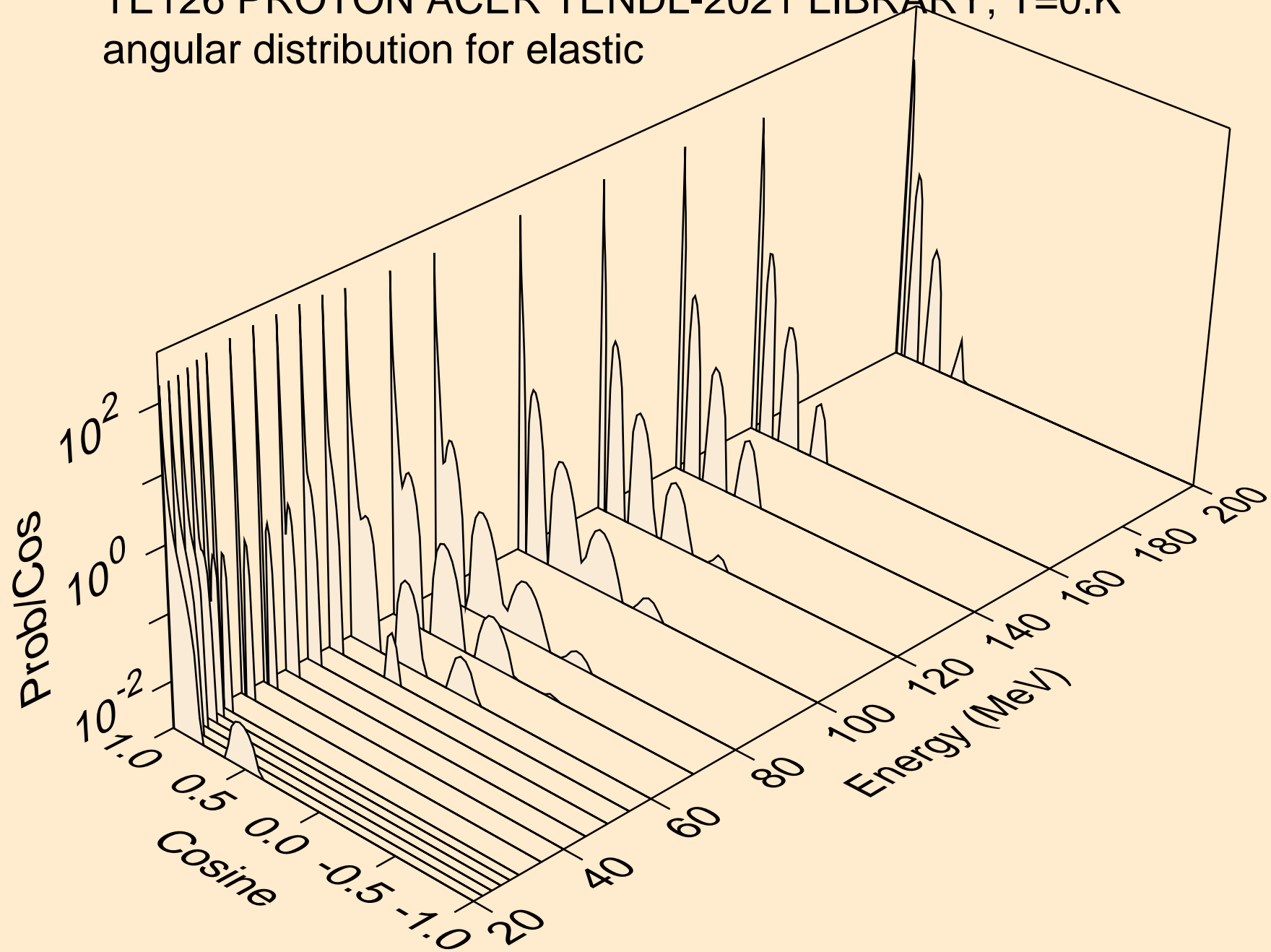

TE126 PROTON ACER TENDL-2021 LIBRARY; T=0.K  
Proton emission for (p,x)

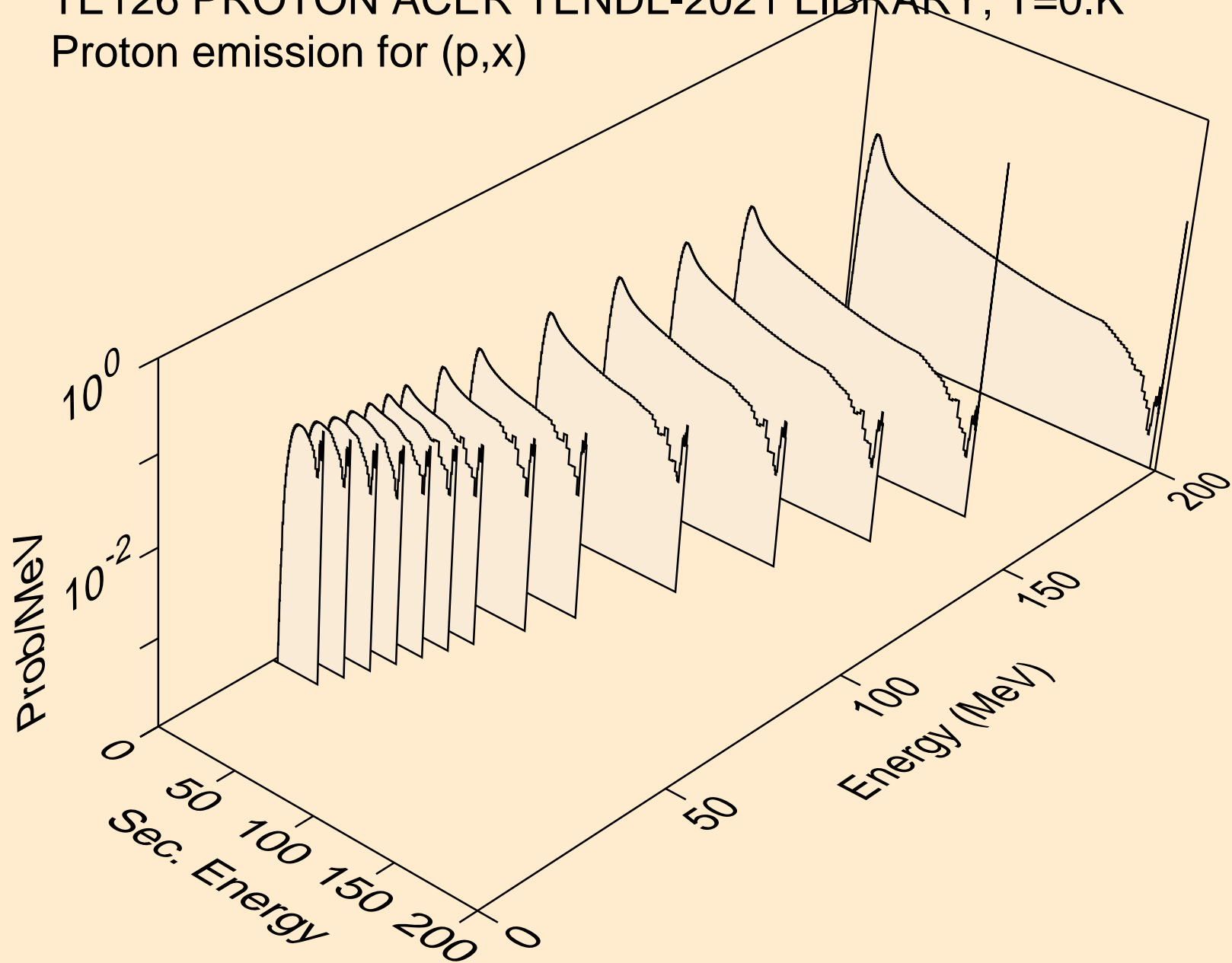

TE126 PROTON ACER TENDL-2021 LIBRARY; T=0.K  
Proton emission for (p,n\*)p

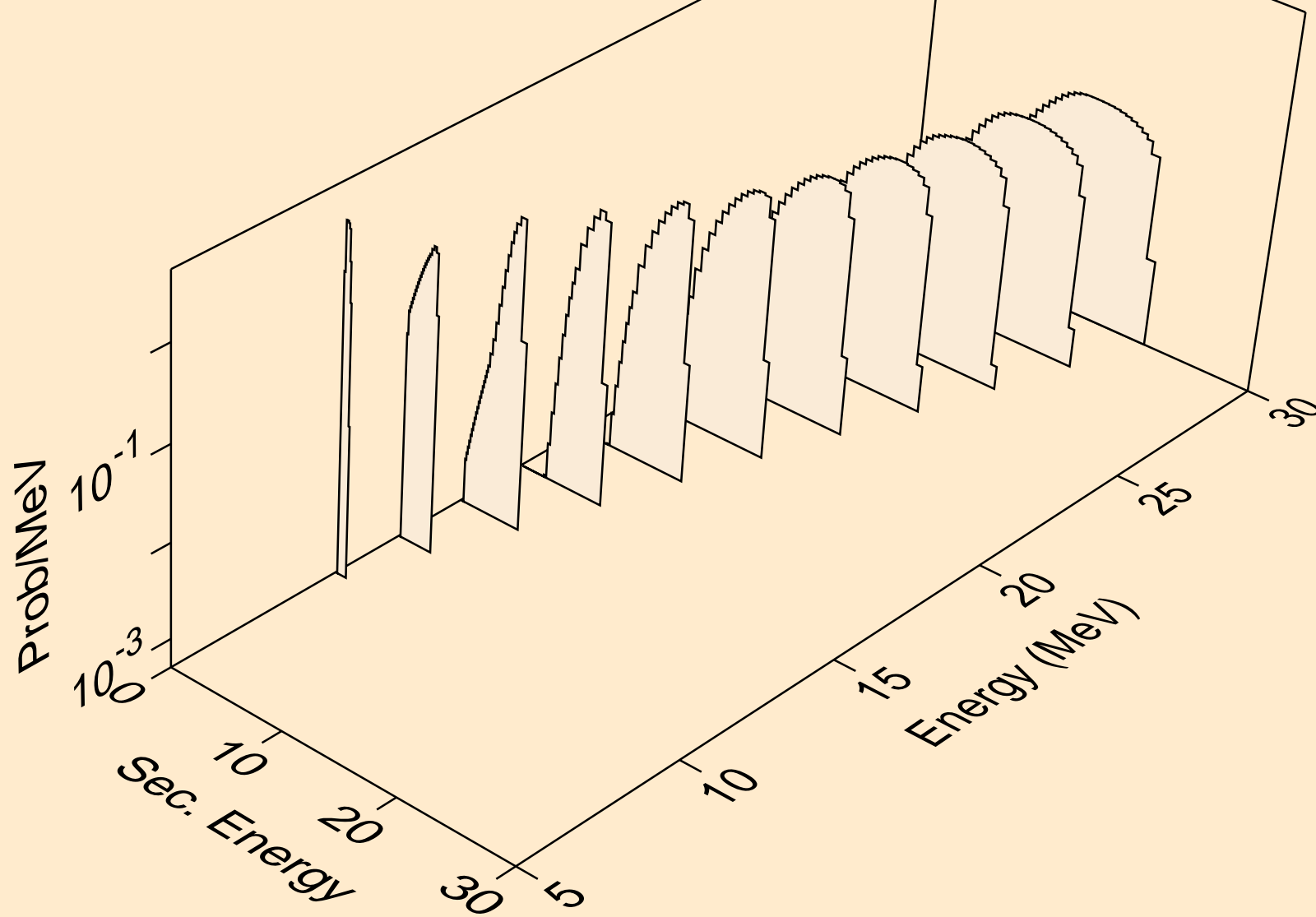

TE126 PROTON ACER TENDL-2021 LIBRARY; T=0.K  
Proton emission for (p,2np)

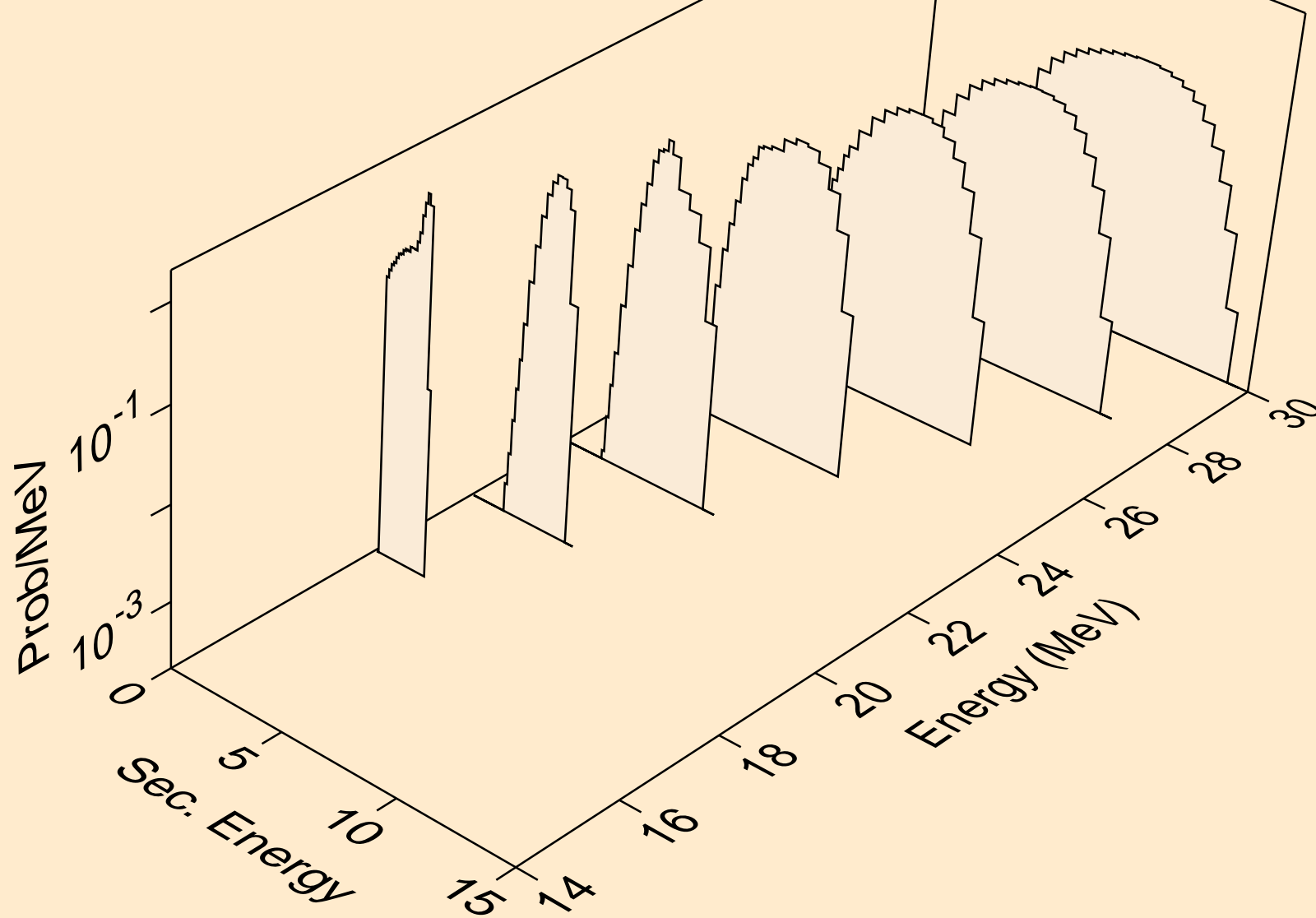

TE126 PROTON ACER TENDL-2021 LIBRARY; T=0.K  
Proton emission for (p,3np)

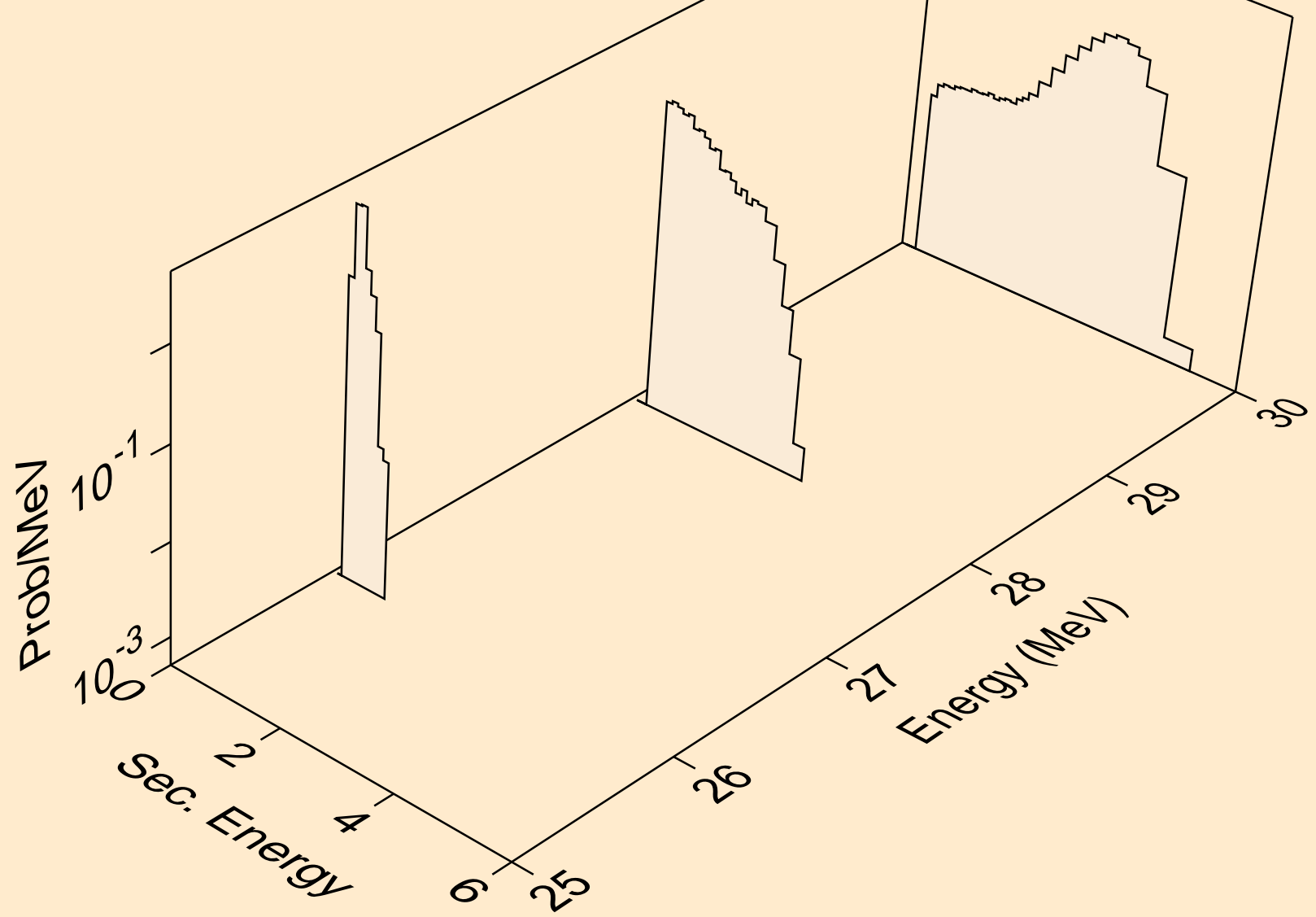

TE126 PROTON ACER TENDL-2021 LIBRARY; T=0.K  
Proton emission for (p,2np)

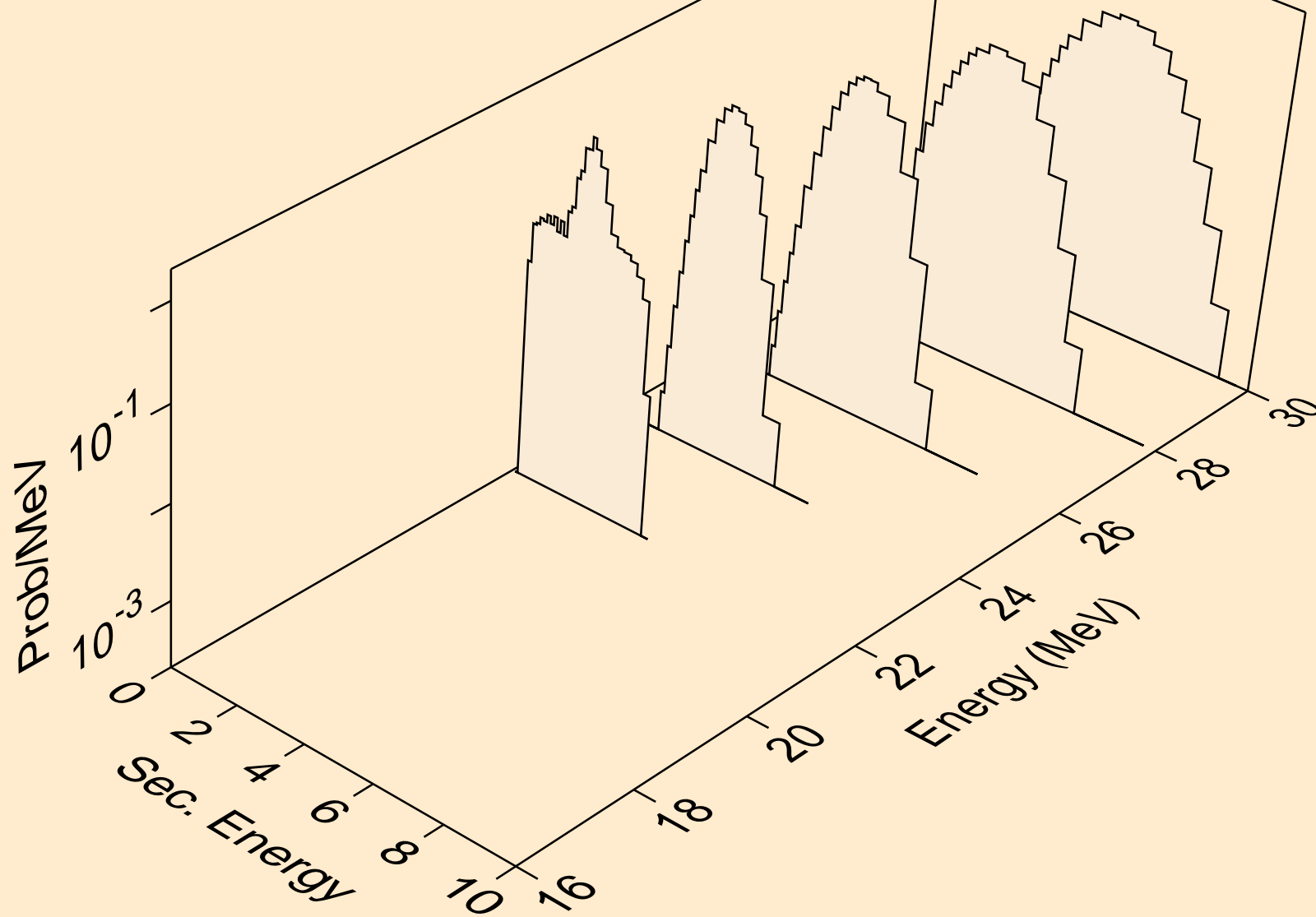

TE126 PROTON ACER TENDL-2021 LIBRARY; T=0.K  
Proton emission for (p,npa)

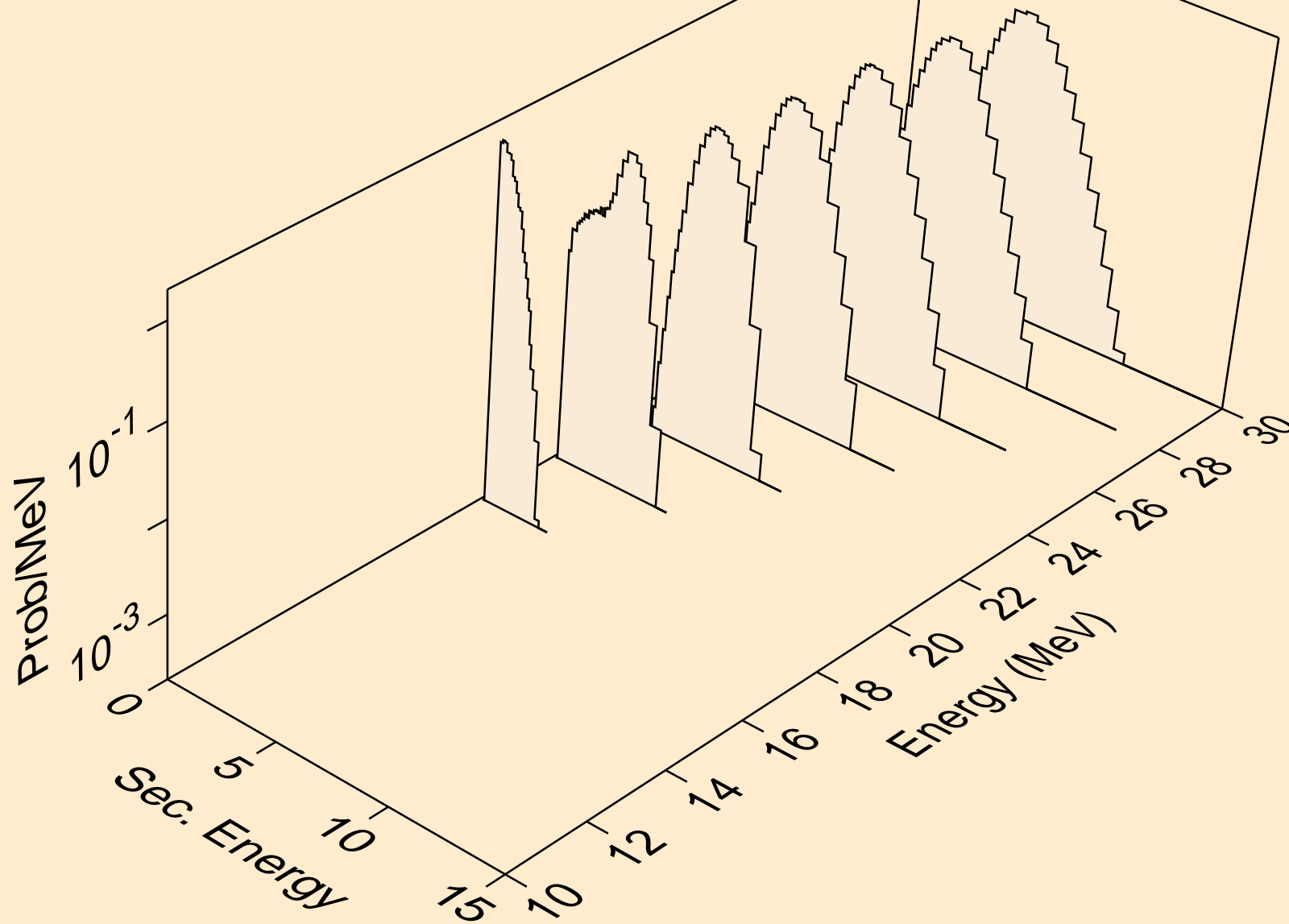

TE126 PROTON ACER TENDL-2021 LIBRARY; T=0.K  
Proton emission for inelastic

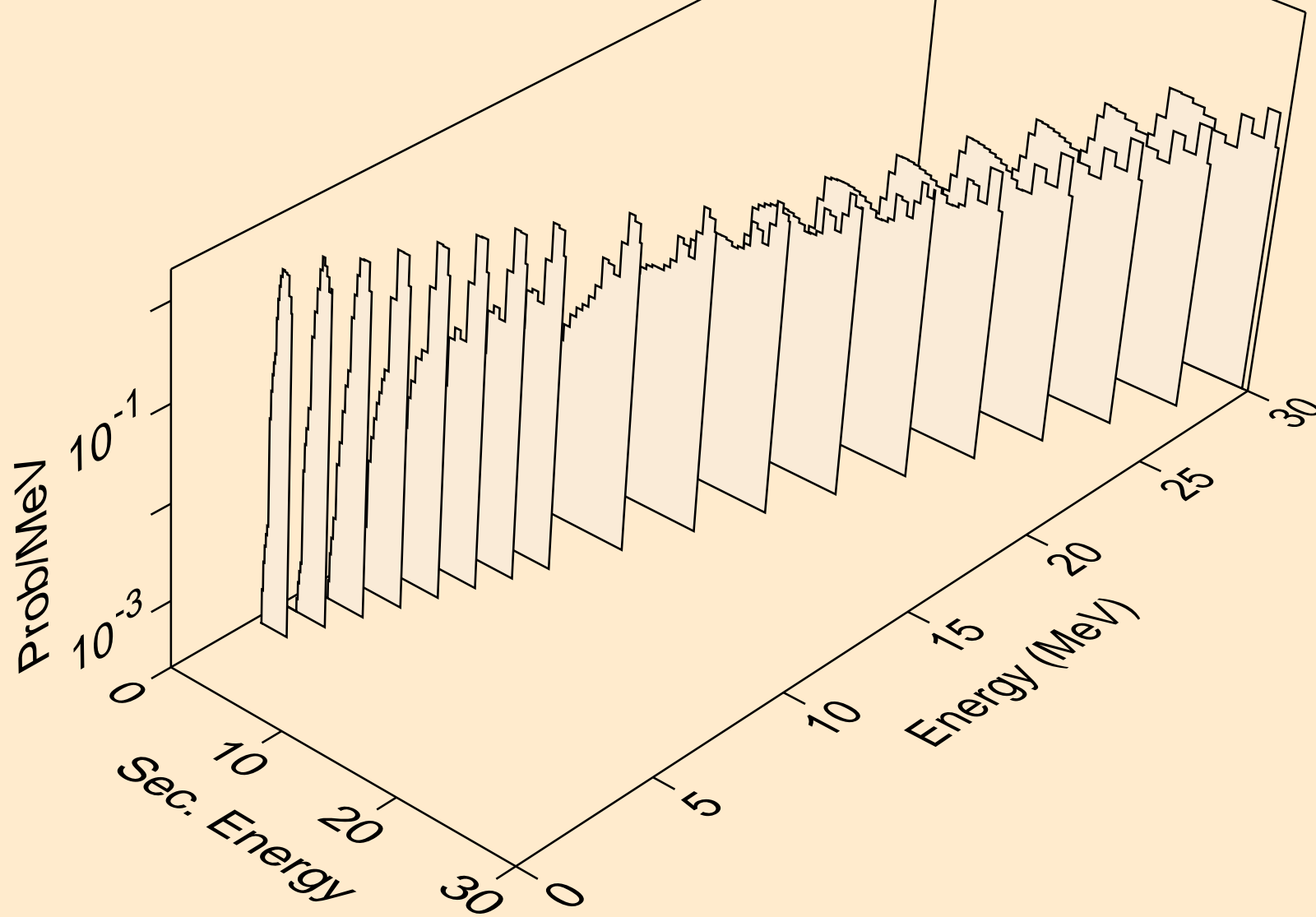



TE126 PROTON ACER TENDL-2021 LIBRARY; T=0.K  
Proton emission for (p,2p)

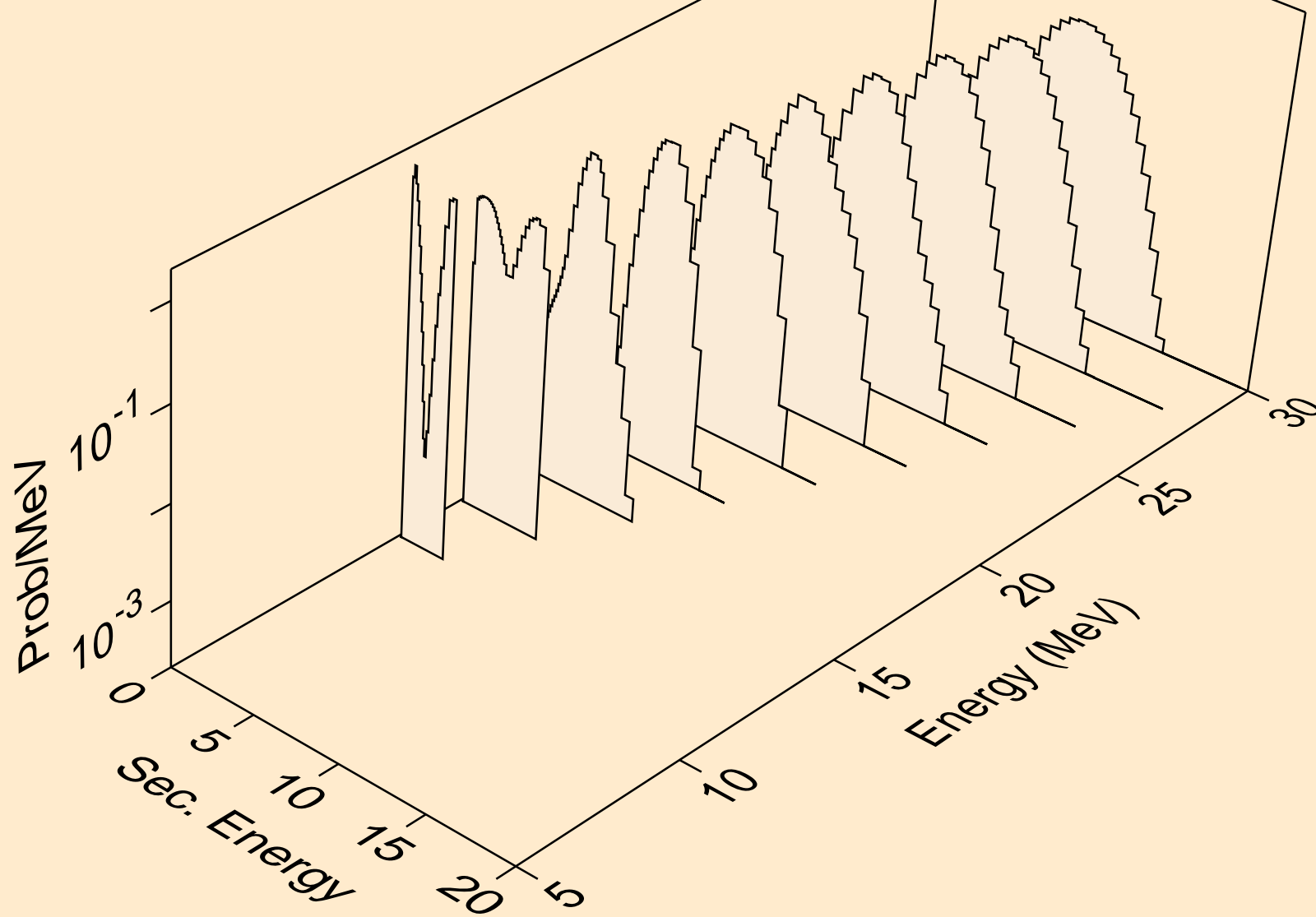

TE126 PROTON ACER TENDL-2021 LIBRARY; T=0.K  
Proton emission for (p,pa)

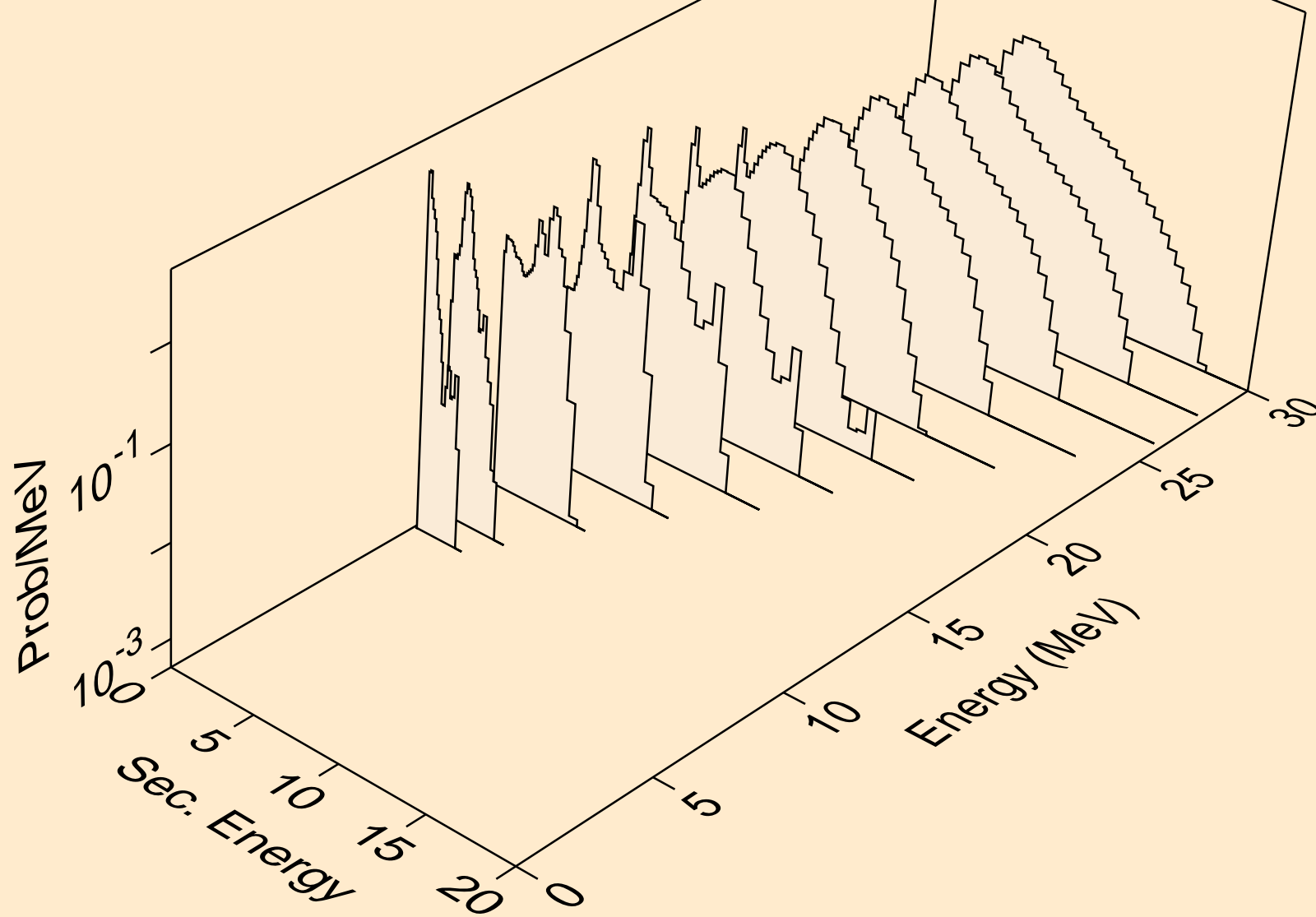

TE126 PROTON ACER TENDL-2021 LIBRARY; T=0.K  
Proton emission for (p,pd)

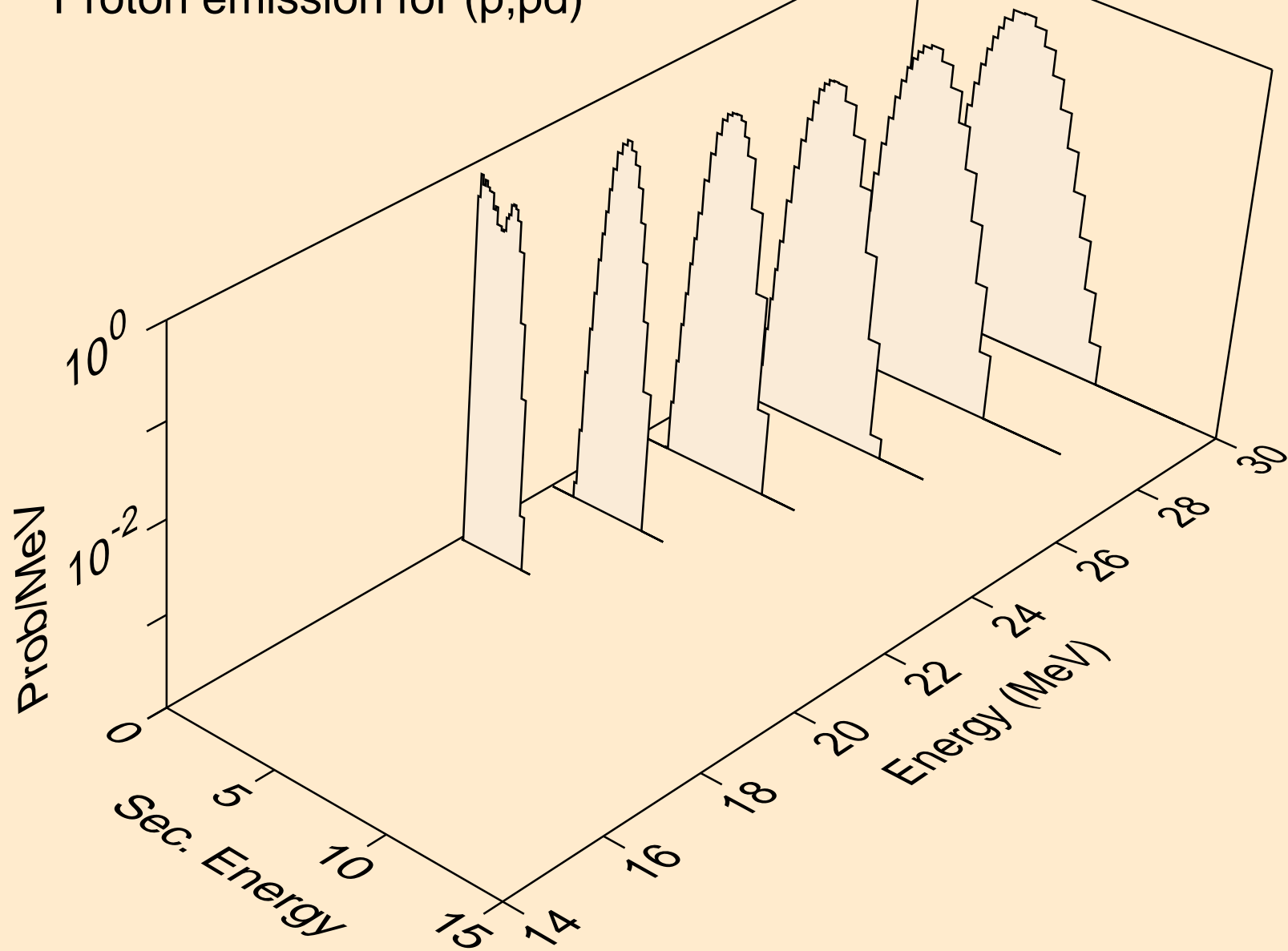

TE126 PROTON ACER TENDL-2021 LIBRARY; T=0.K  
Proton emission for (p,pt)

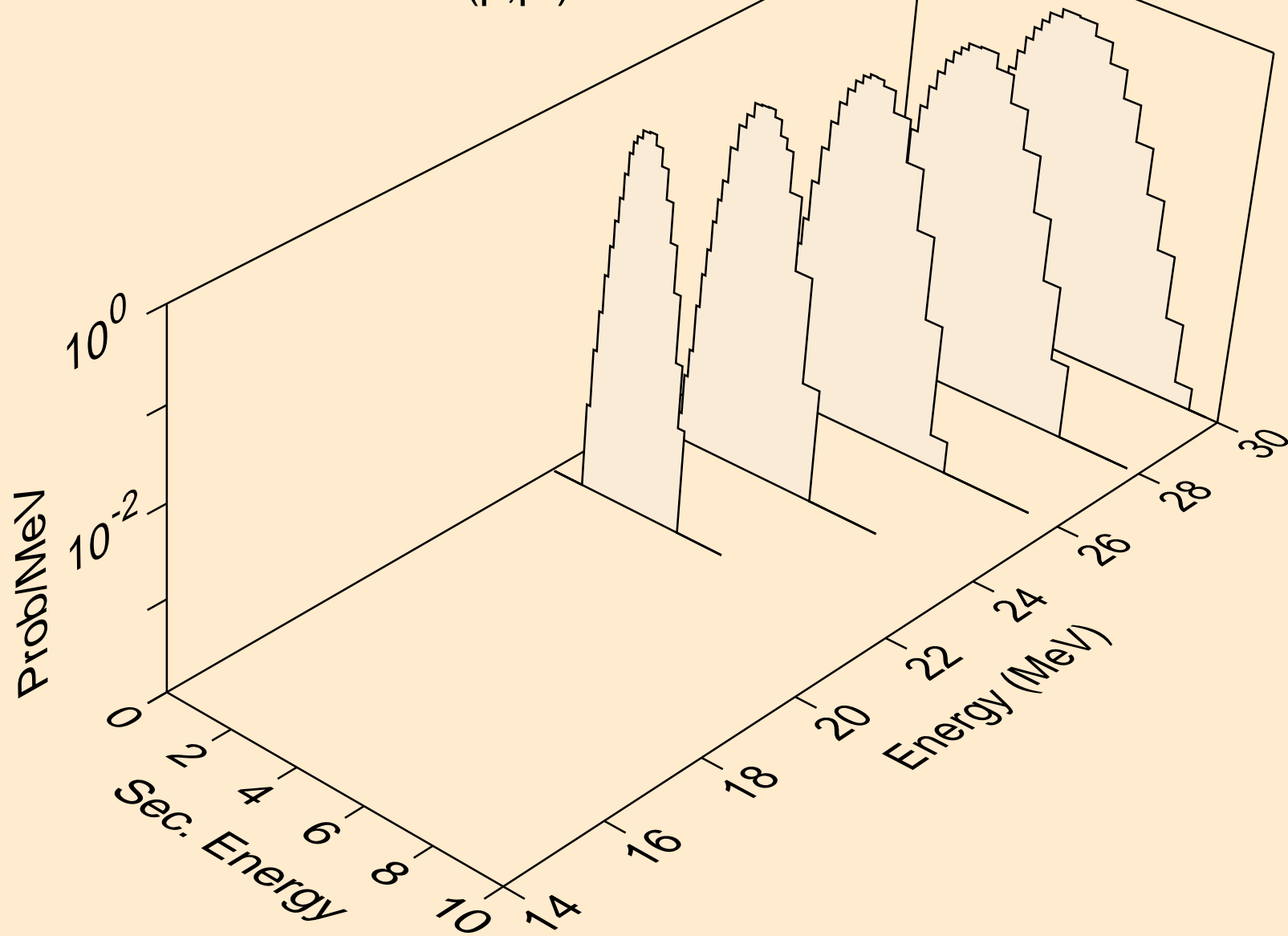

TE126 PROTON ACER TENDL-2021 LIBRARY; T=0.K  
Photon emission for (z,n)

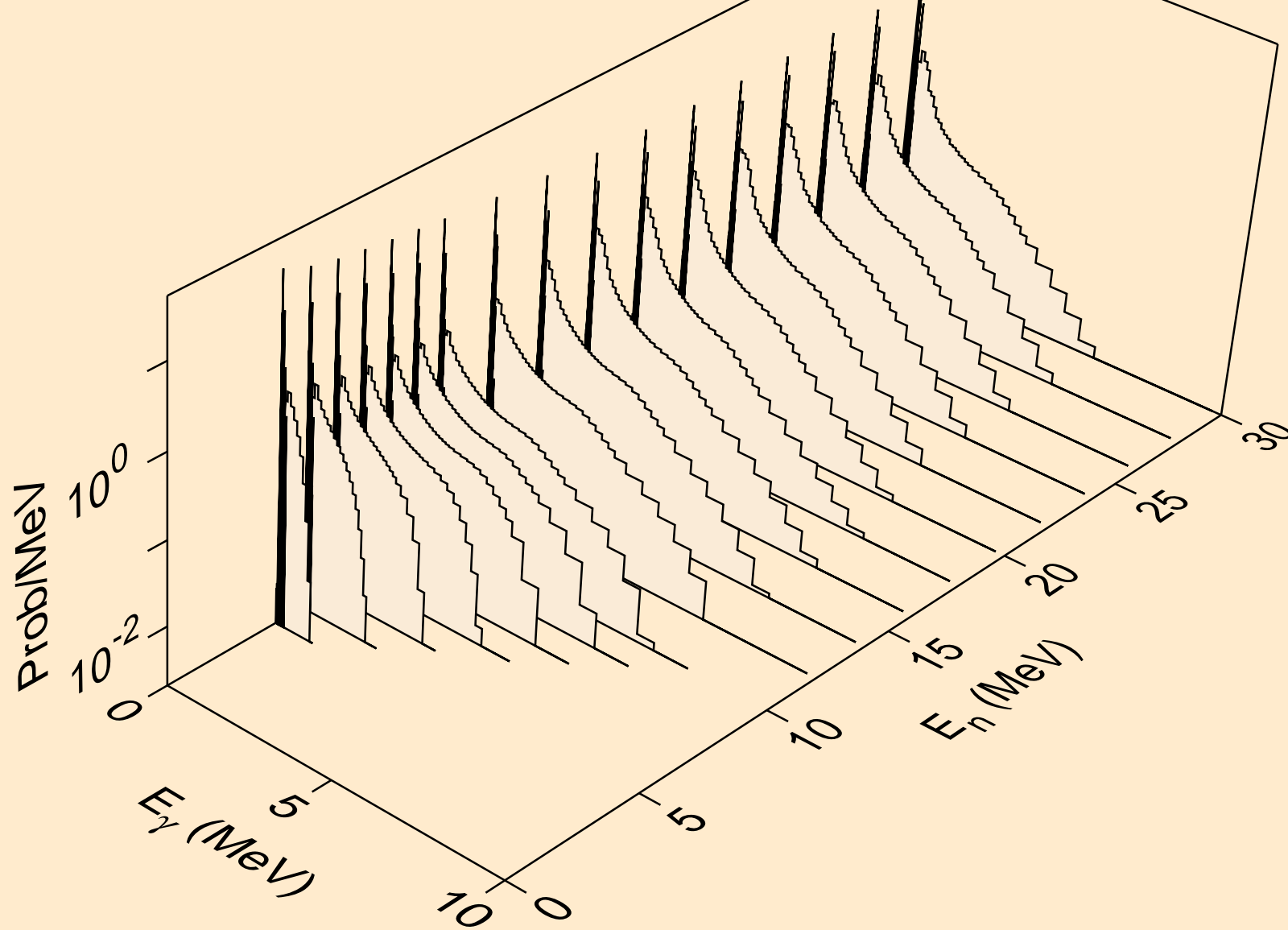

TE126 PROTON ACER TENDL-2021 LIBRARY; T=0.K  
Photon emission for (n,x)

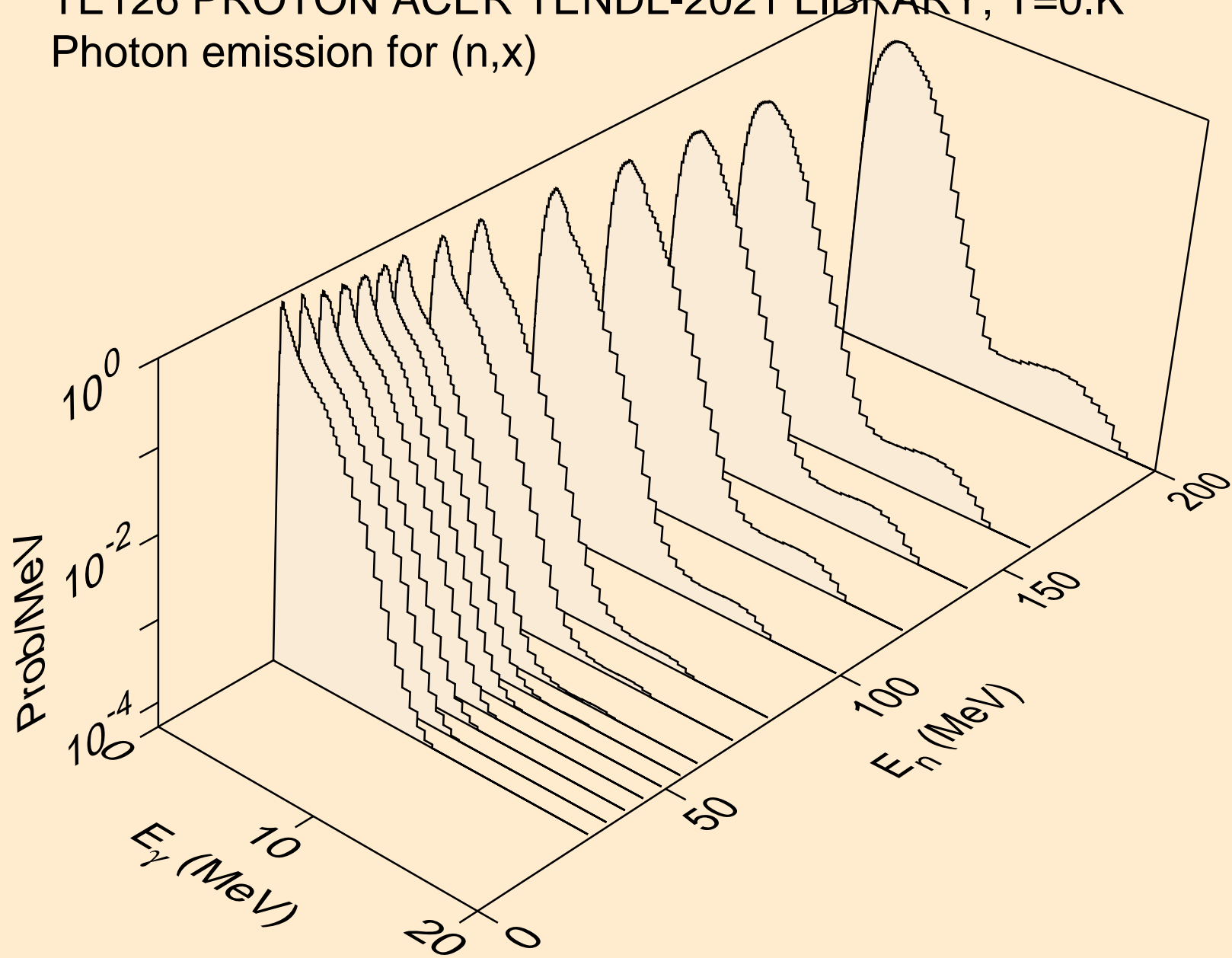

TE126 PROTON ACER TENDL-2021 LIBRARY; T=0.K  
Photon emission for (n,2nd)

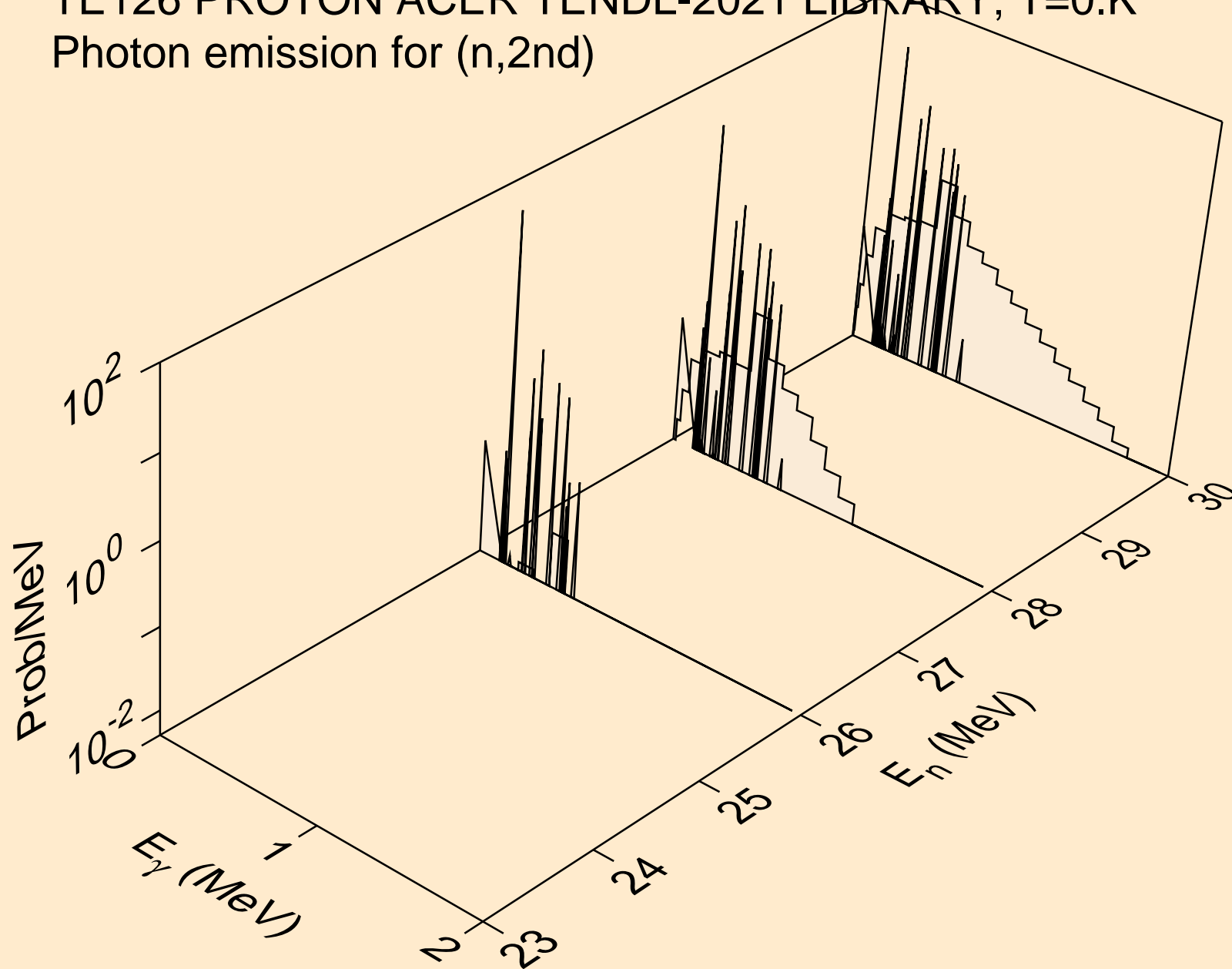

TE126 PROTON ACER TENDL-2021 LIBRARY; T=0.K  
Photon emission for (n,2n)

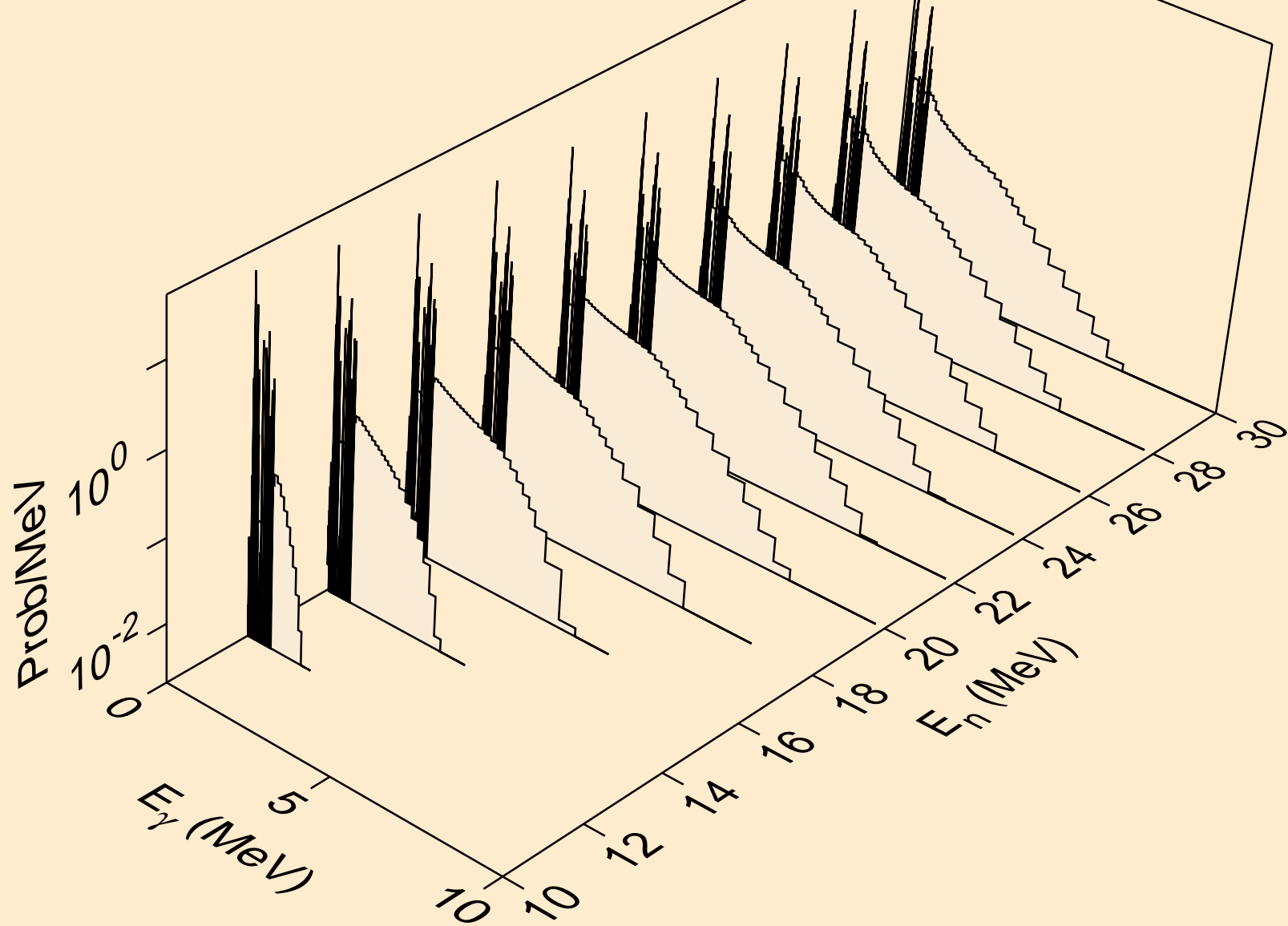



TE126 PROTON ACER TENDL-2021 LIBRARY; T=0.K  
Photon emission for (n,3n)

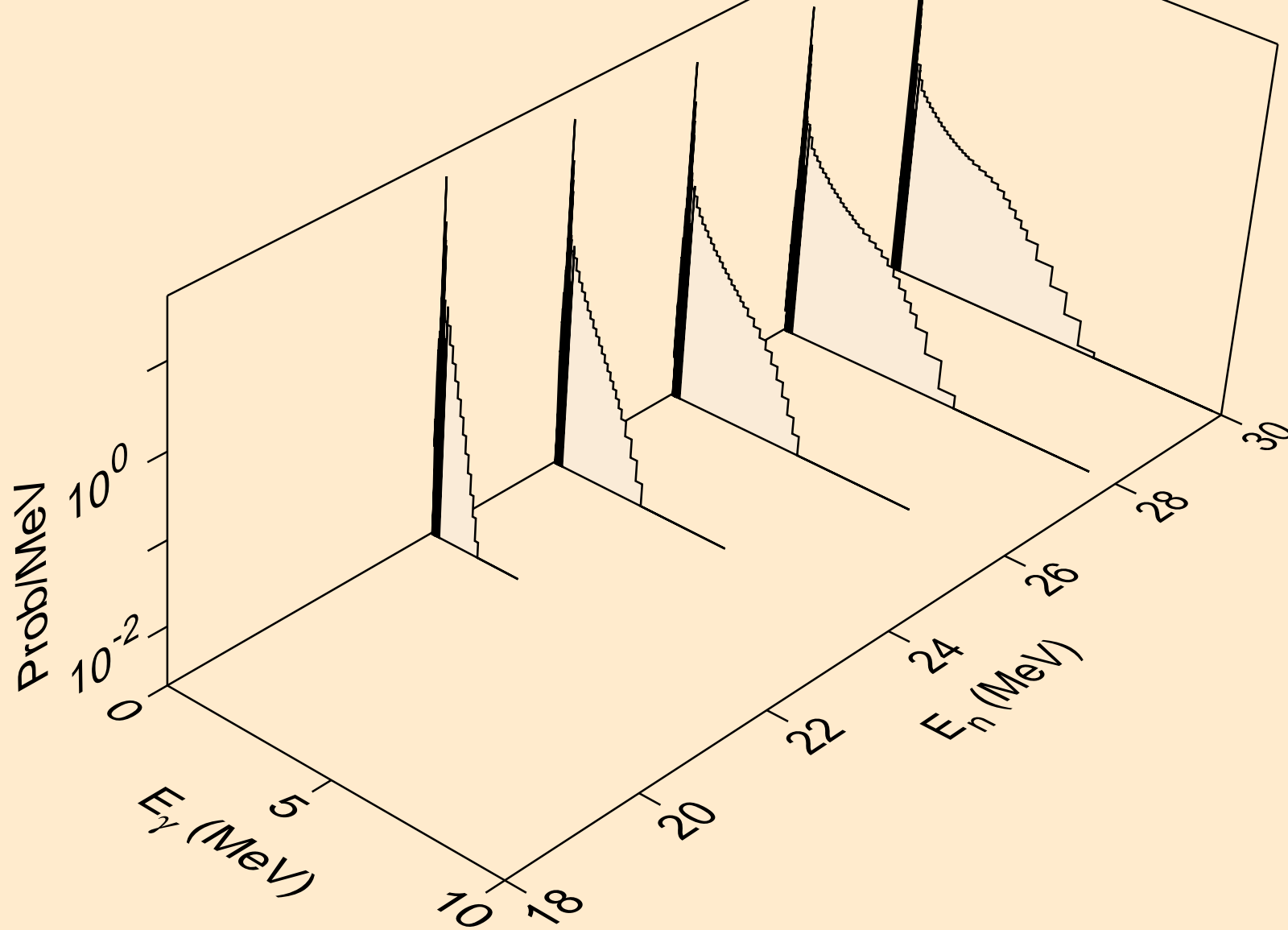

TE126 PROTON ACER TENDL-2021 LIBRARY; T=0.K  
Photon emission for (n,n\*)a

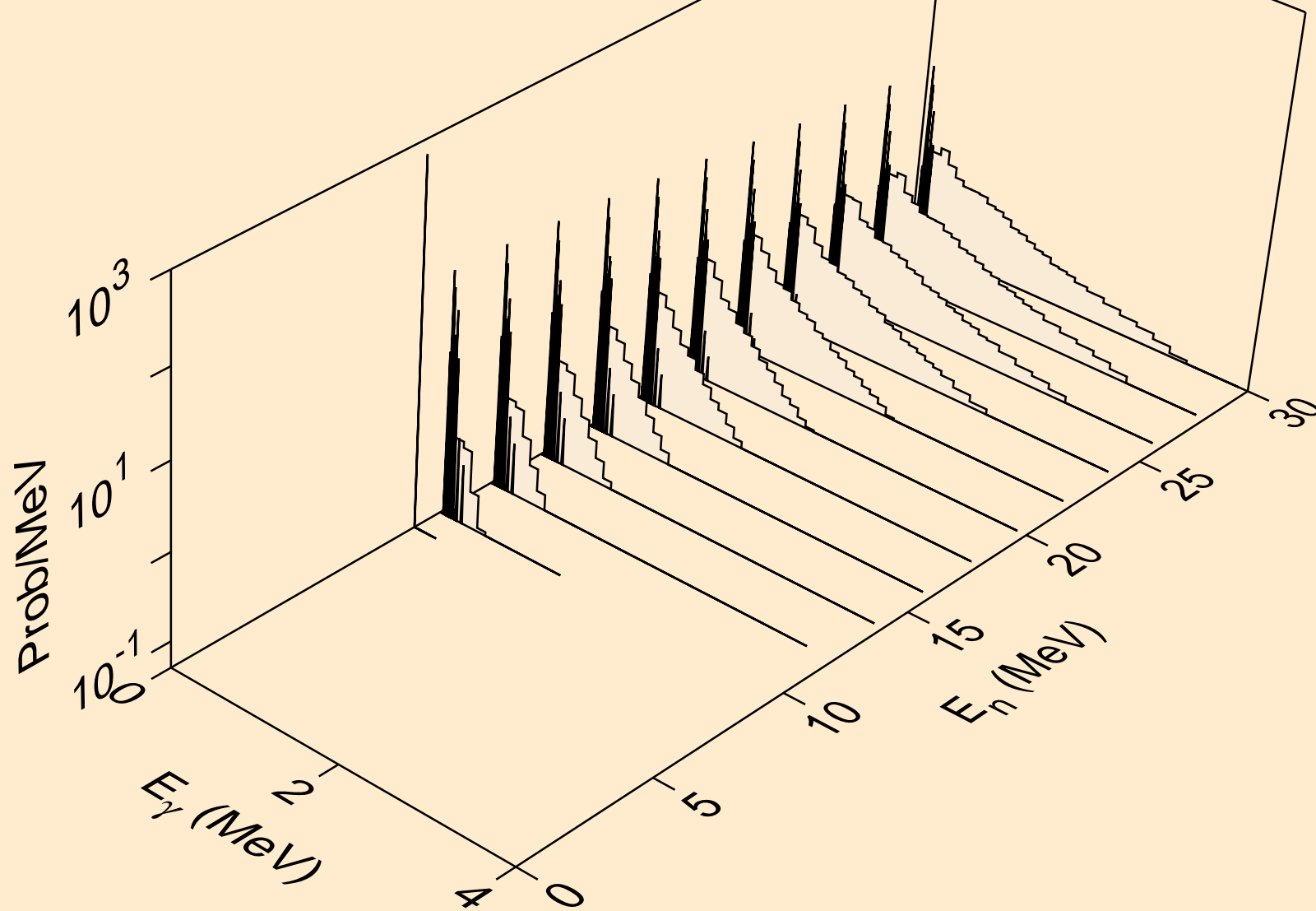

TE126 PROTON ACER TENDL-2021 LIBRARY; T=0.K  
Photon emission for (n,2n)a

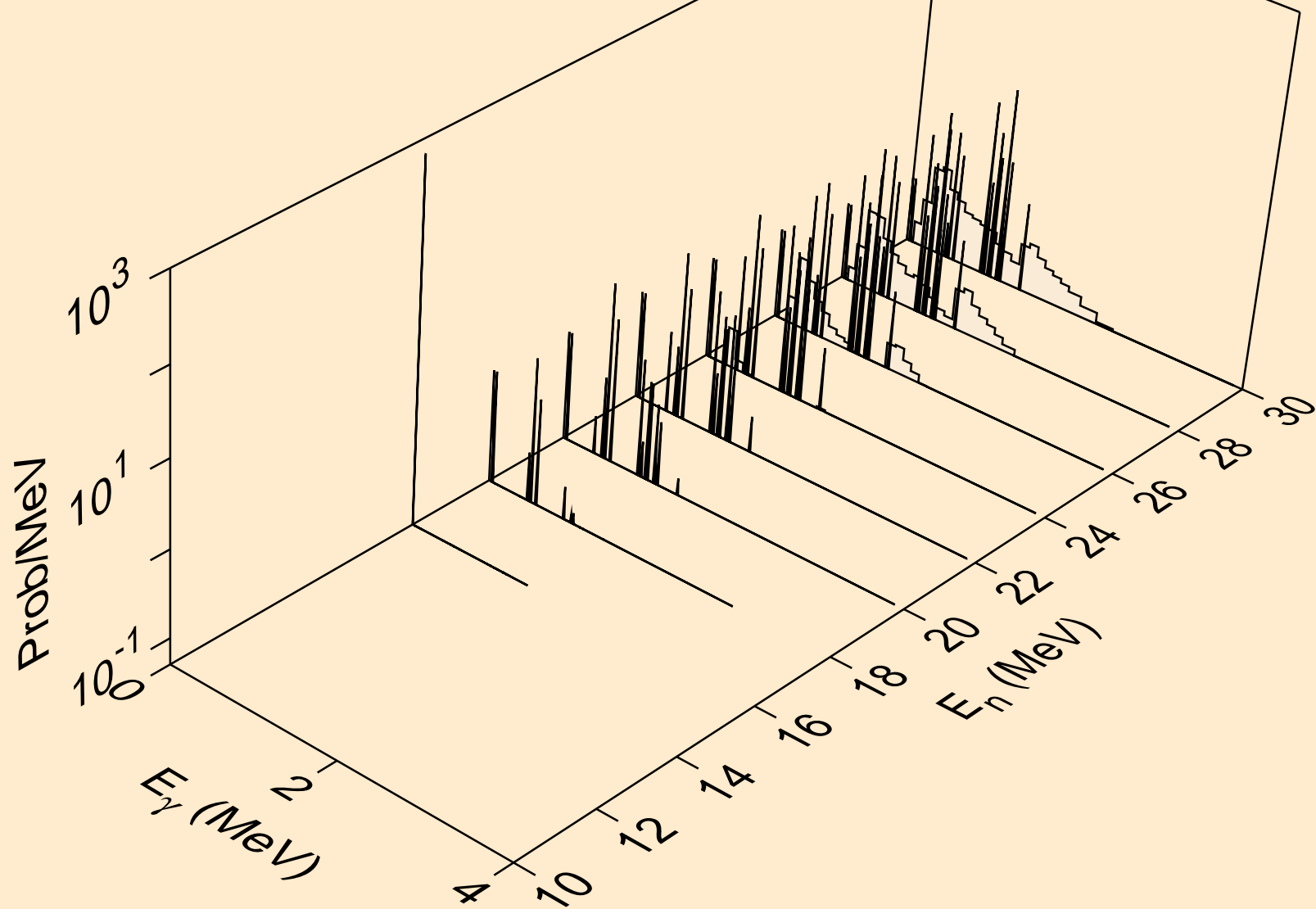

TE126 PROTON ACER TENDL-2021 LIBRARY; T=0.K  
Photon emission for (n,3n)a

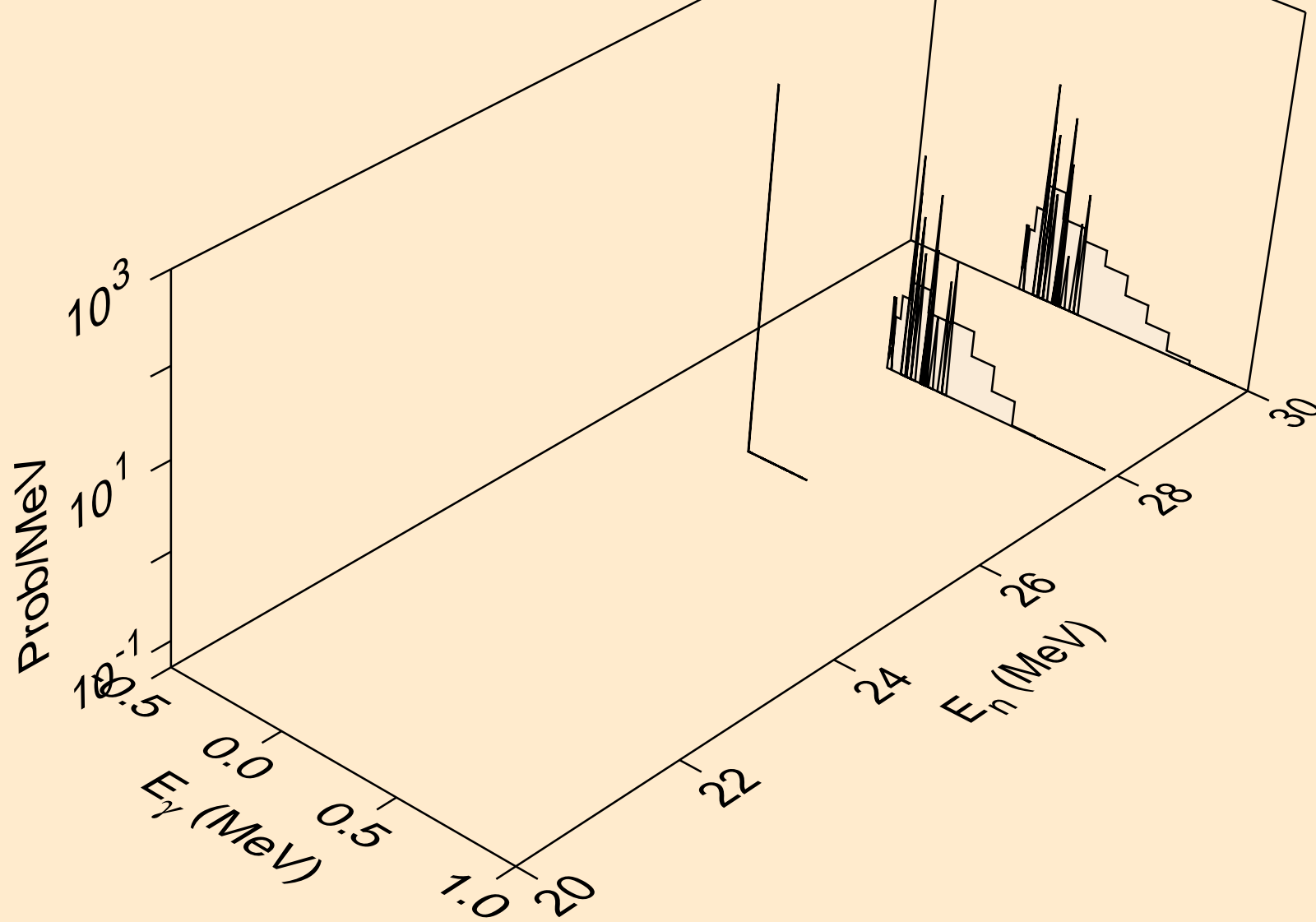

TE126 PROTON ACER TENDL-2021 LIBRARY; T=0.K  
Photon emission for (n,n\*)p

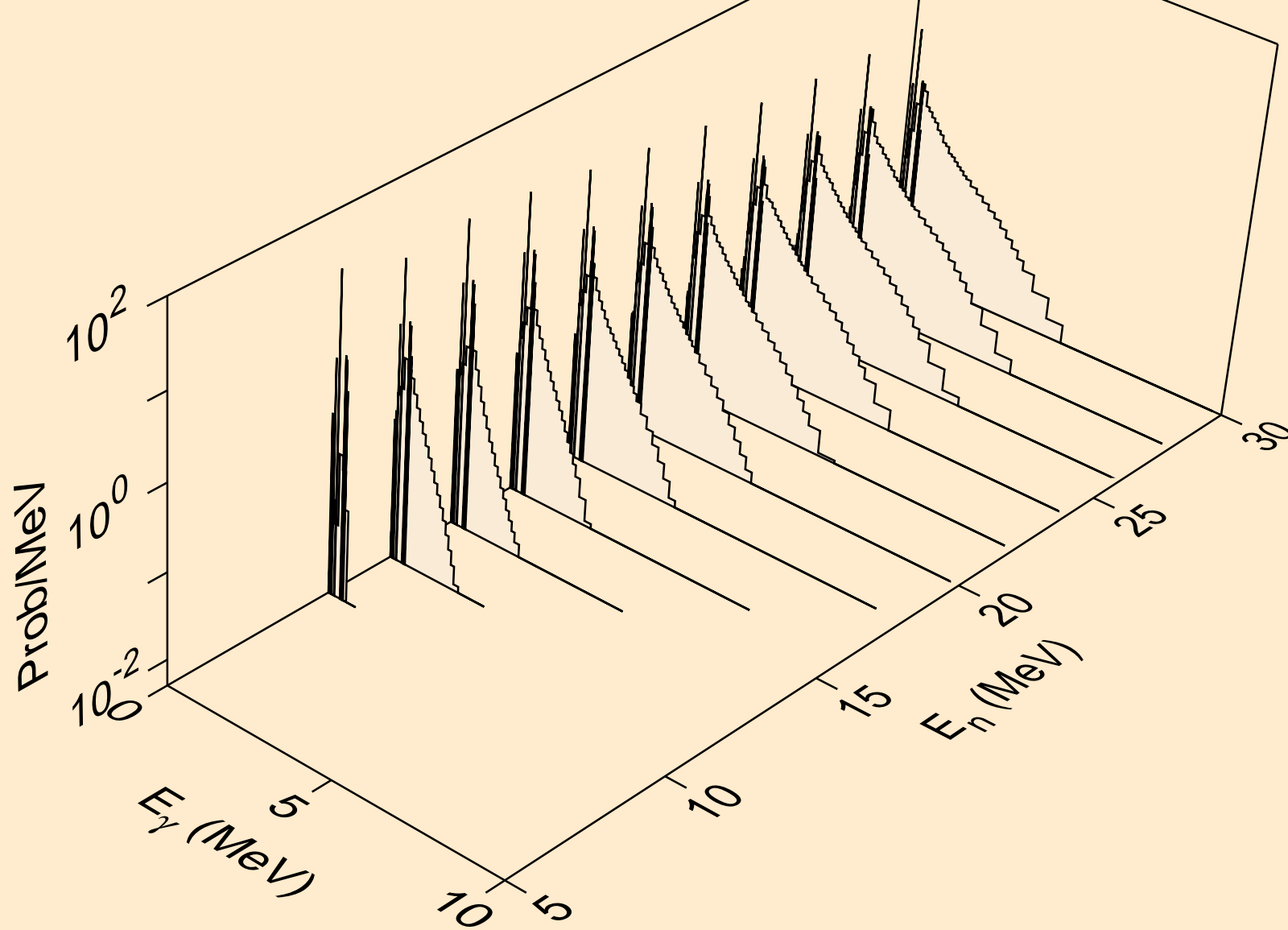

TE126 PROTON ACER TENDL-2021 LIBRARY; T=0.K  
Photon emission for (n,n\*)d

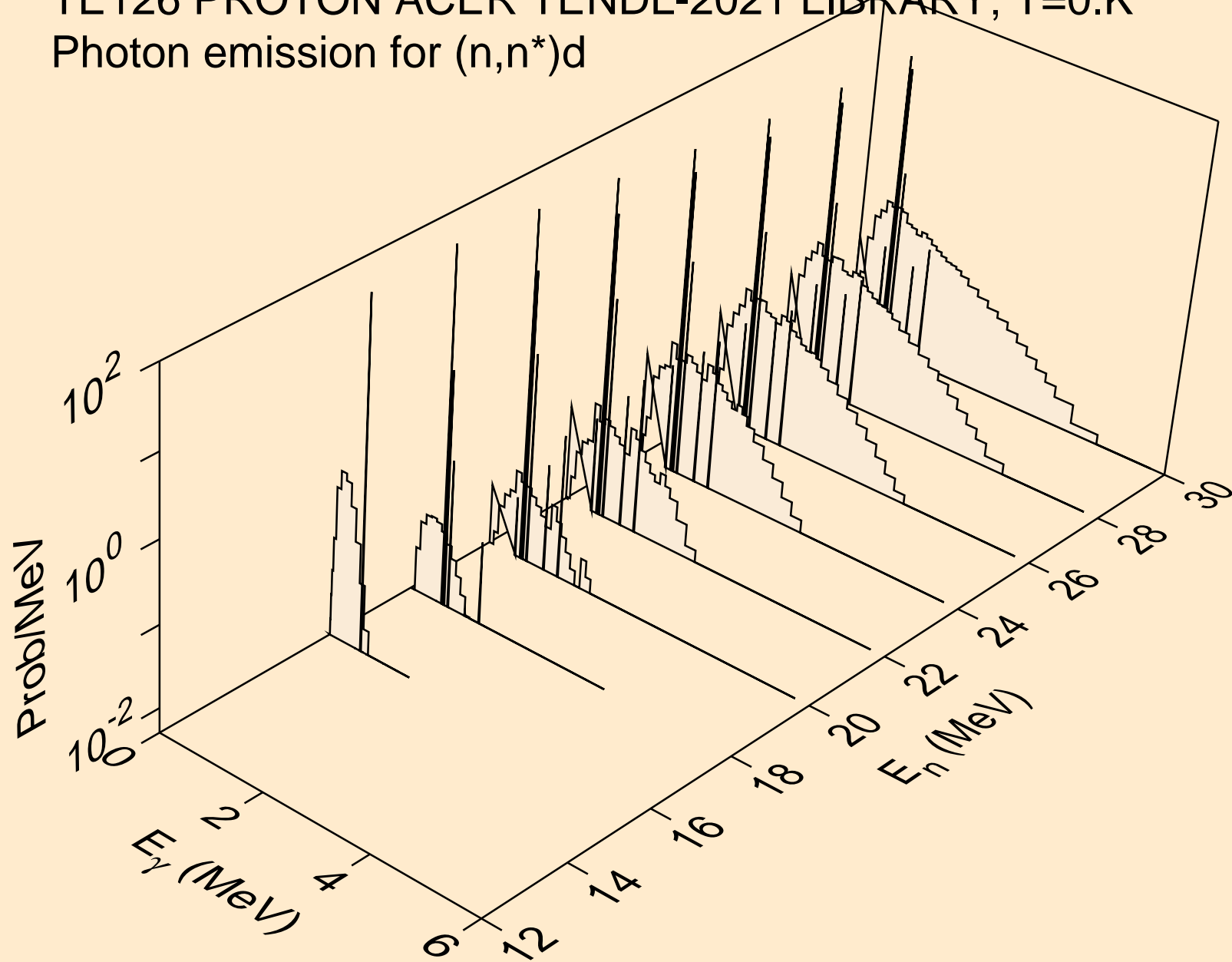

TE126 PROTON ACER TENDL-2021 LIBRARY; T=0.K  
Photon emission for (n,n\*)t

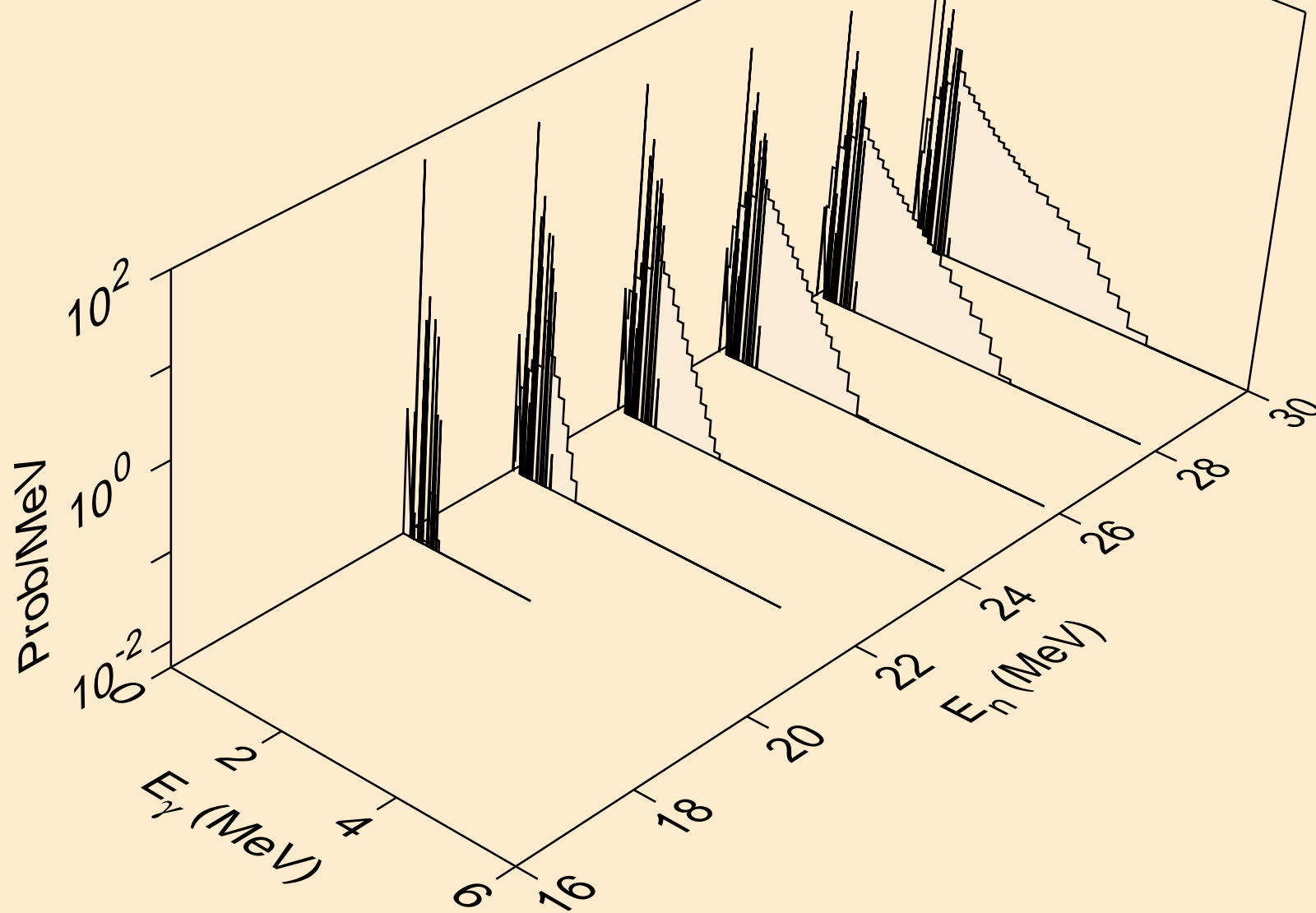

TE126 PROTON ACER TENDL-2021 LIBRARY; T=0.K  
Photon emission for (n,n\*)he3

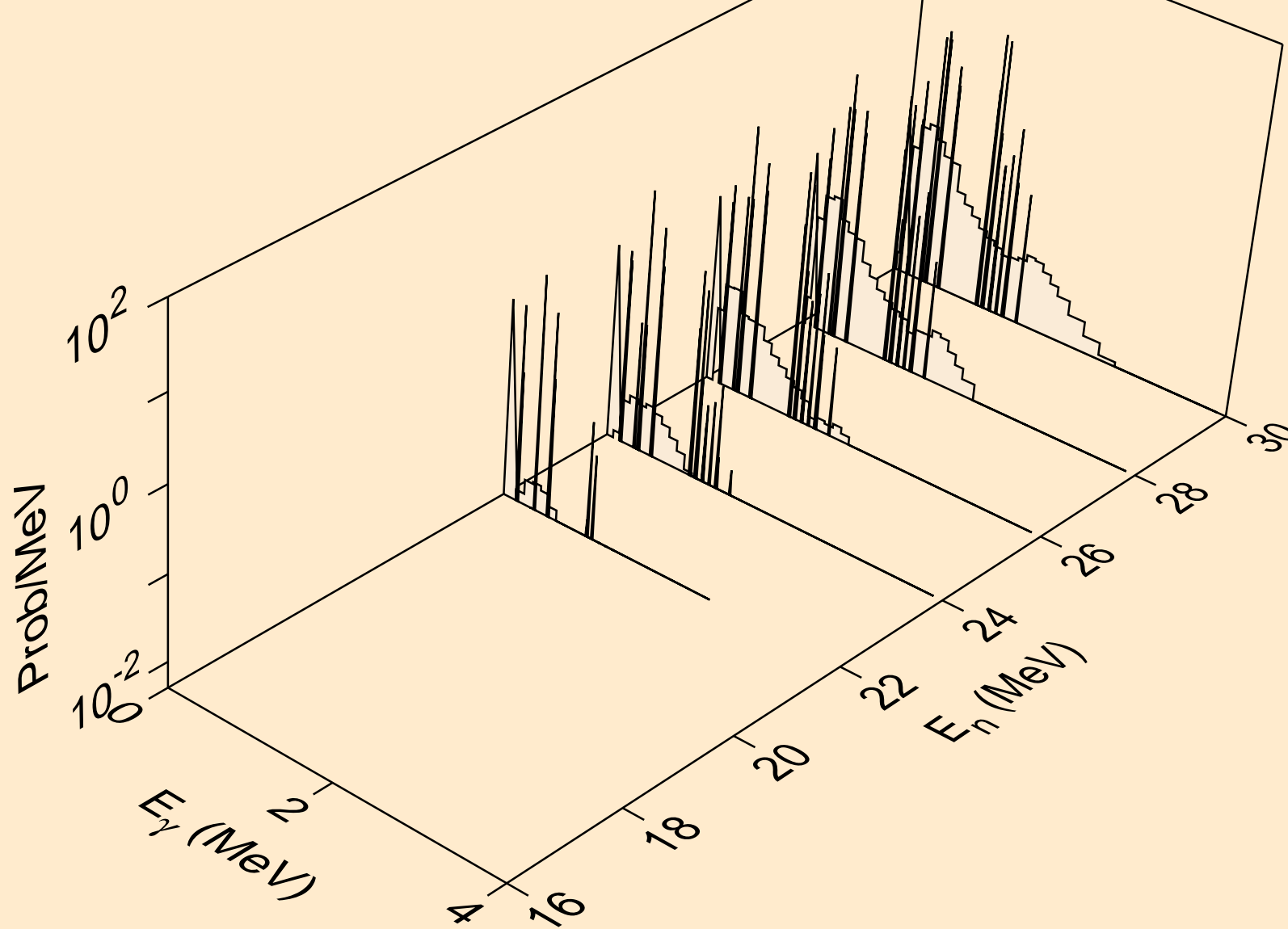



TE126 PROTON ACER TENDL-2021 LIBRARY; T=0.K  
Photon emission for (n,4n)

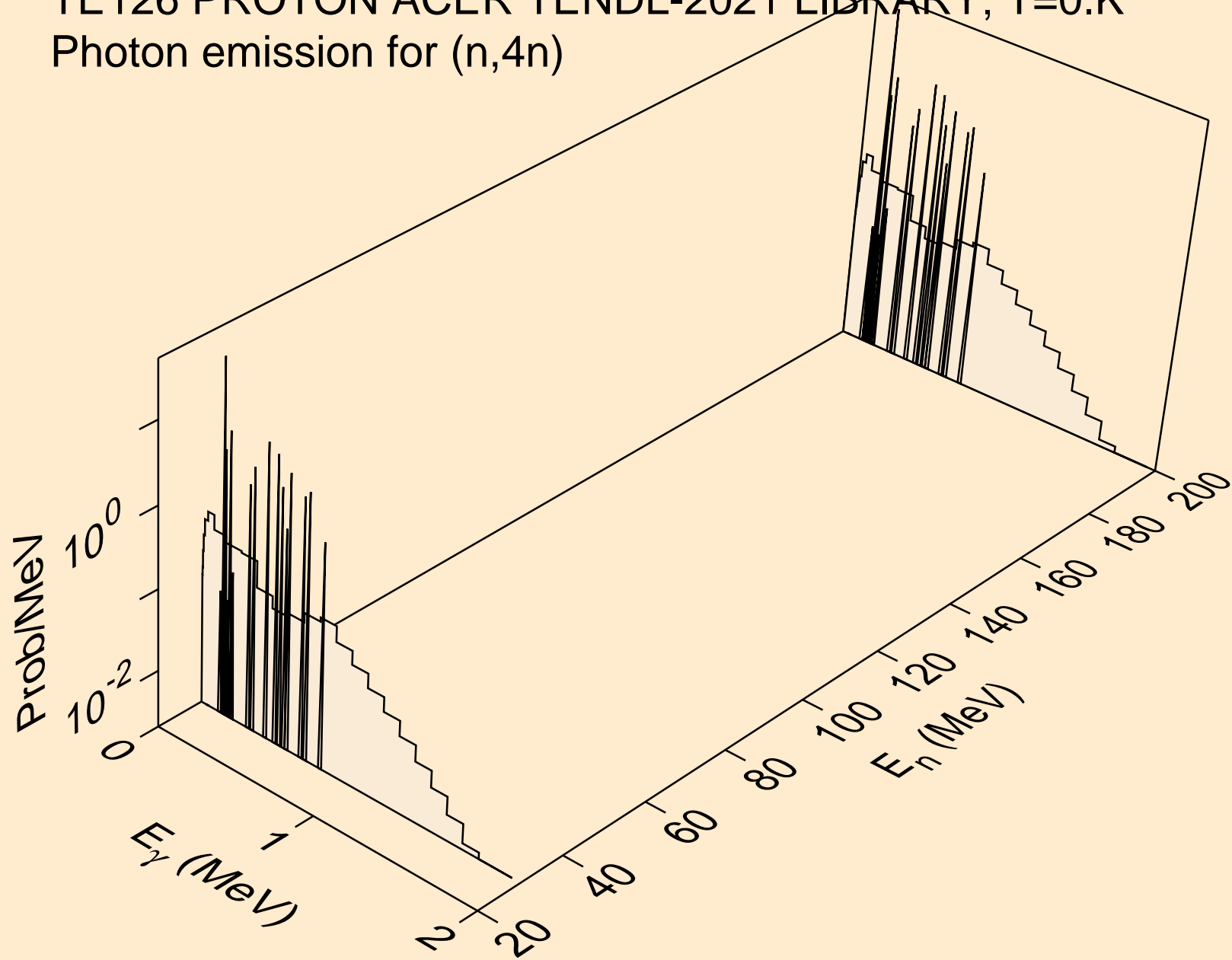

TE126 PROTON ACER TENDL-2021 LIBRARY; T=0.K  
Photon emission for (n,2np)

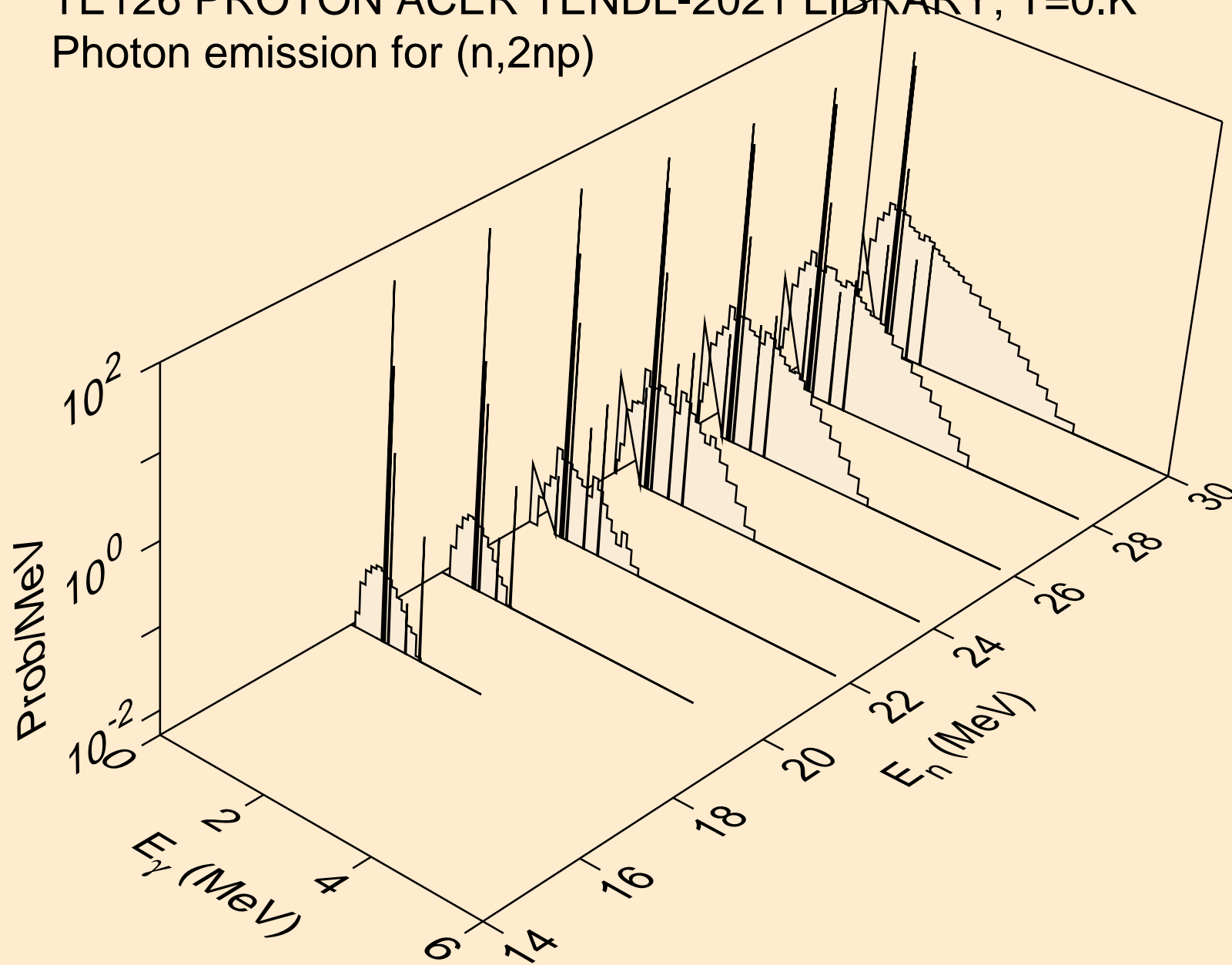

TE126 PROTON ACER TENDL-2021 LIBRARY; T=0.K  
Photon emission for (n,3np)

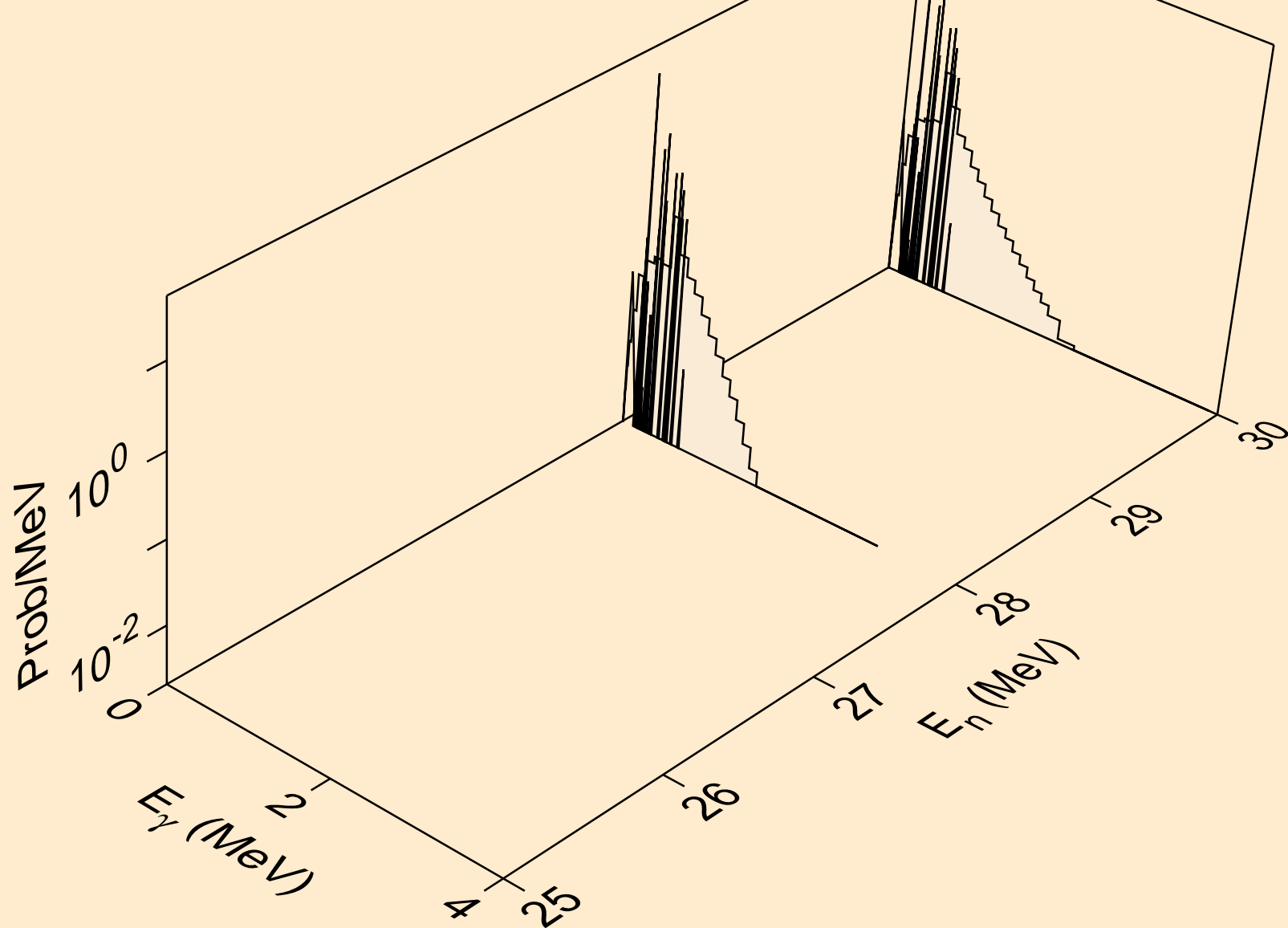

TE126 PROTON ACER TENDL-2021 LIBRARY; T=0.K  
Photon emission for (n,2np)

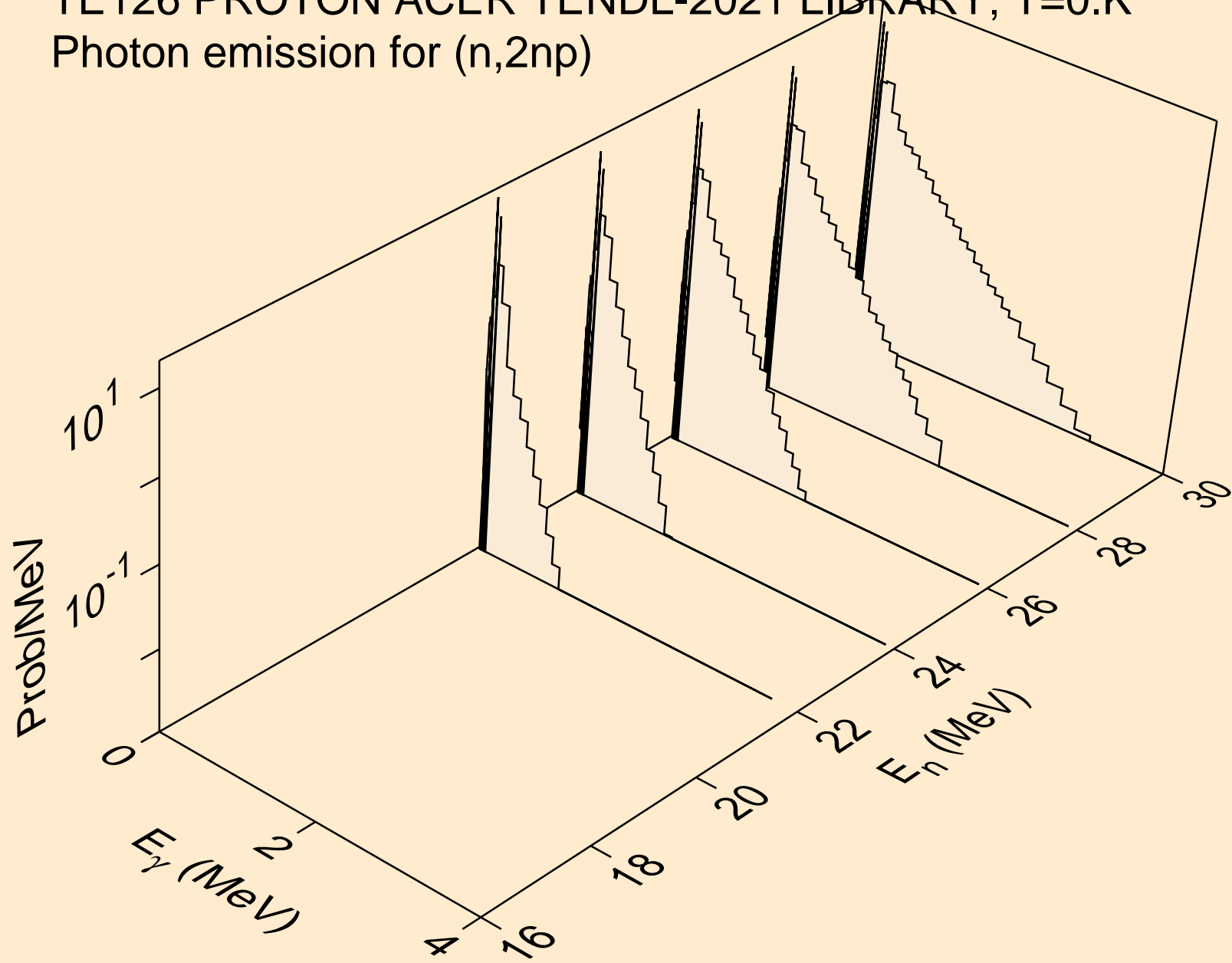

TE126 PROTON ACER TENDL-2021 LIBRARY; T=0.K  
Photon emission for (n,npa)

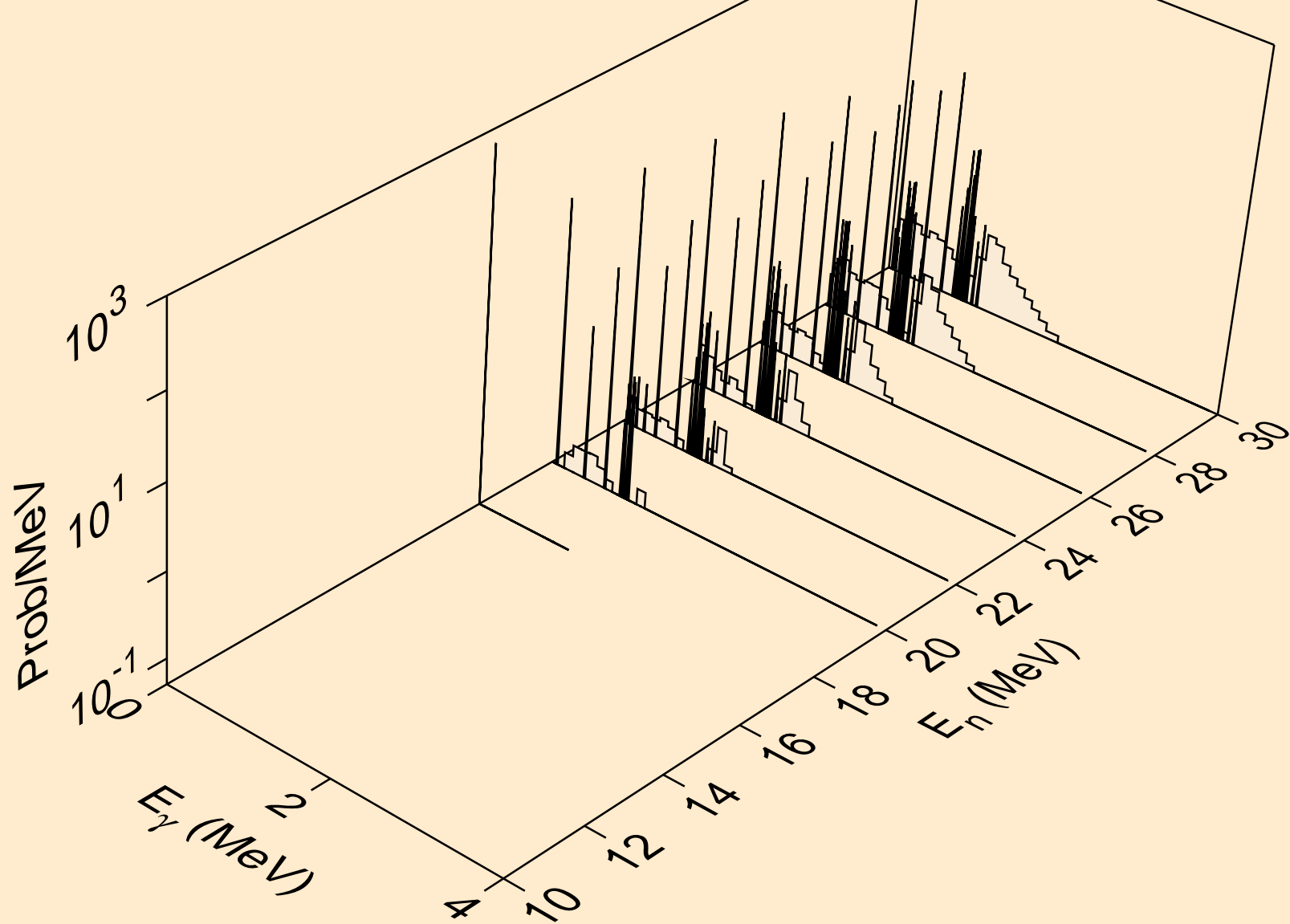

TE126 PROTON ACER TENDL-2021 LIBRARY; T=0.K  
Photon emission for (n,gma)

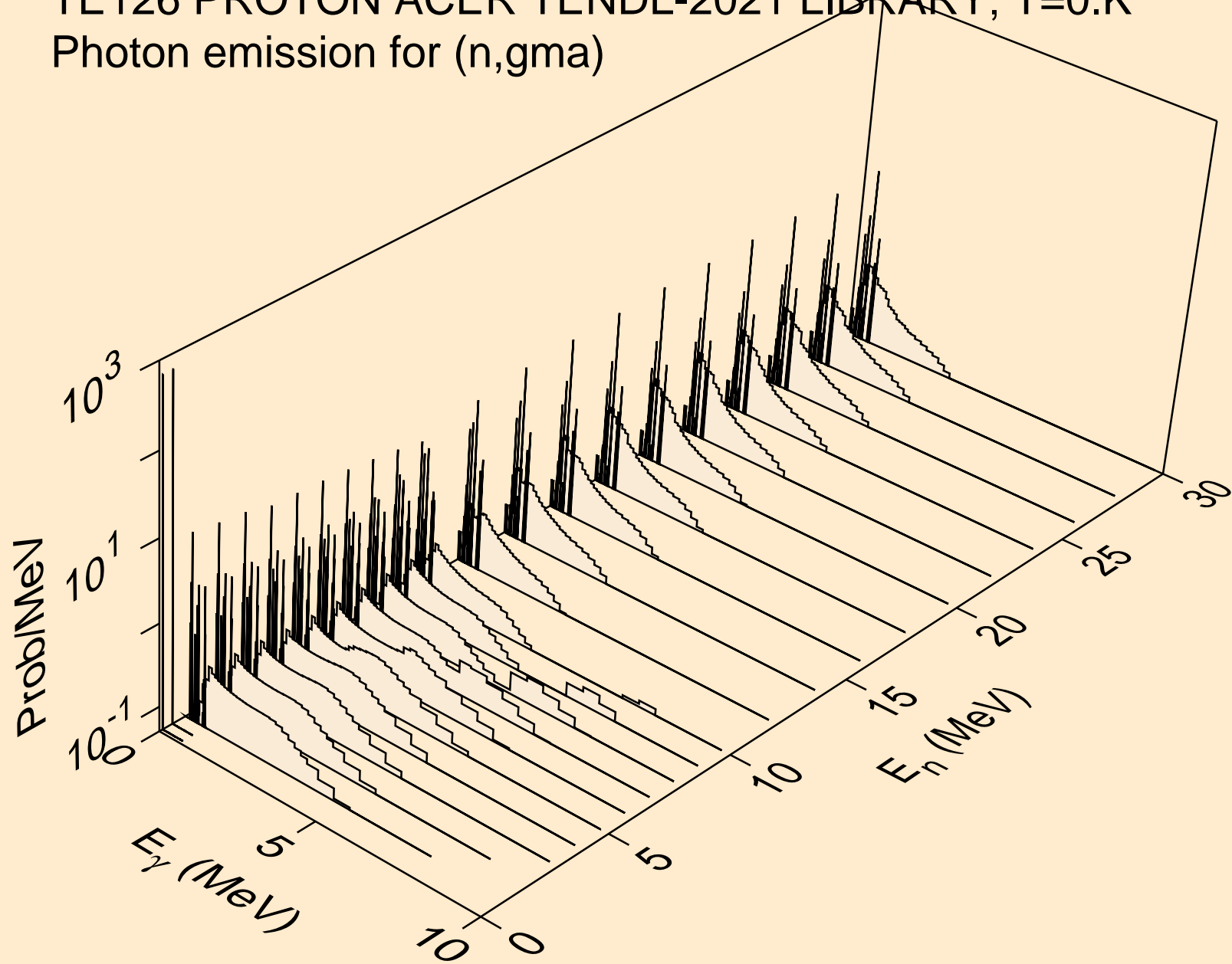

TE126 PROTON ACER TENDL-2021 LIBRARY; T=0.K  
Photon emission for inelastic

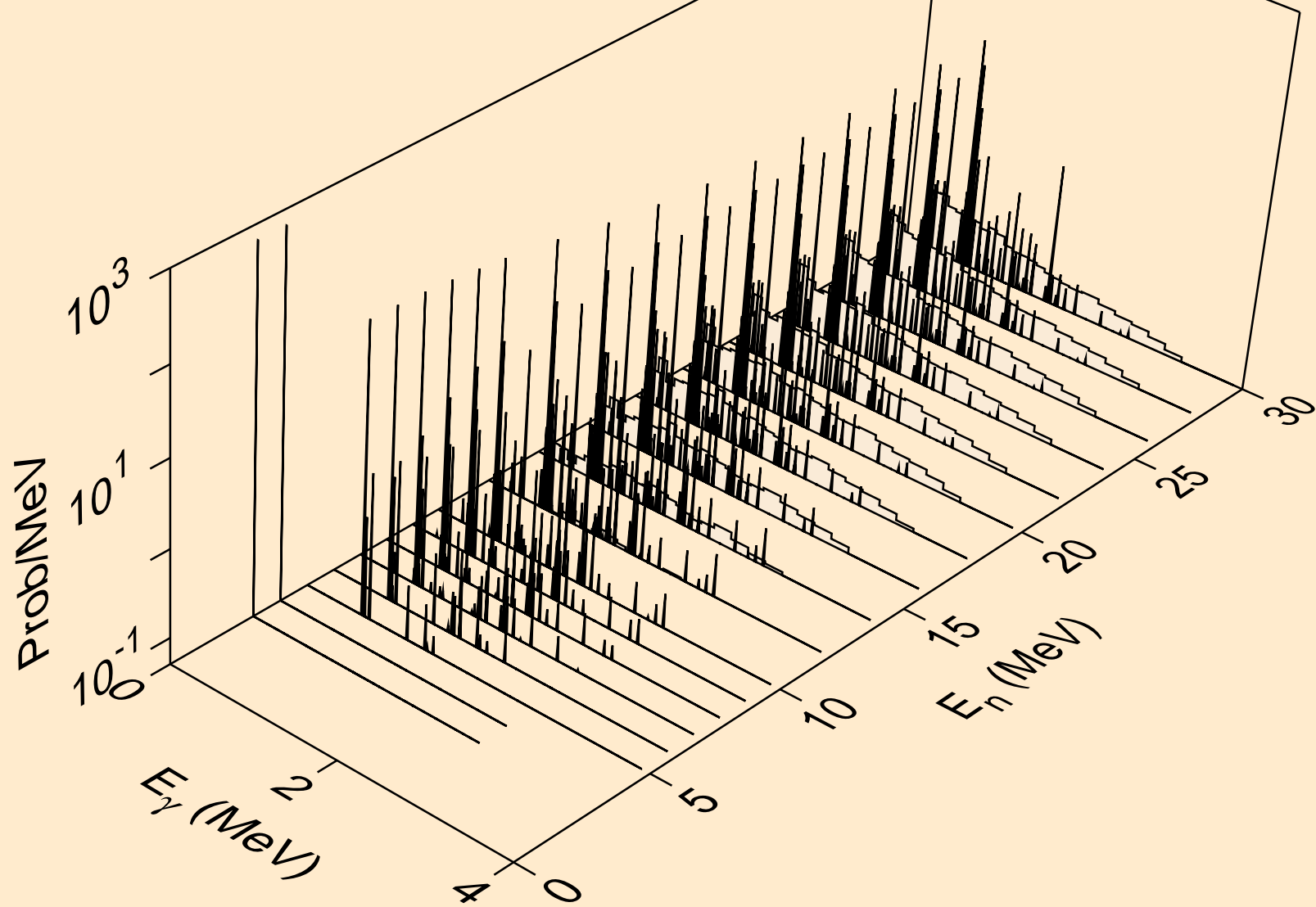

TE126 PROTON ACER TENDL-2021 LIBRARY; T=0.K  
Photon emission for (n,d)

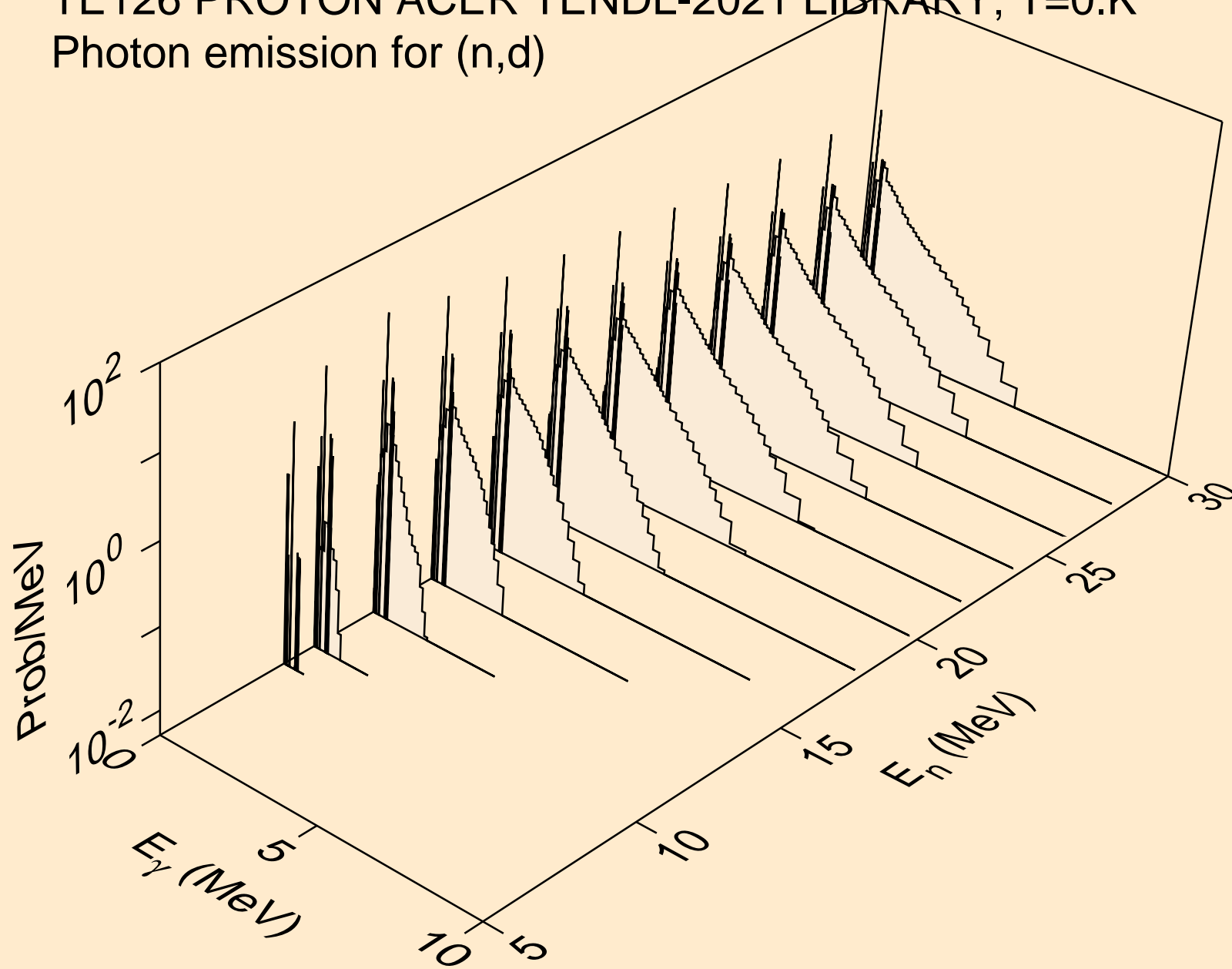



TE126 PROTON ACER TENDL-2021 LIBRARY; T=0.K  
Photon emission for (n,t)

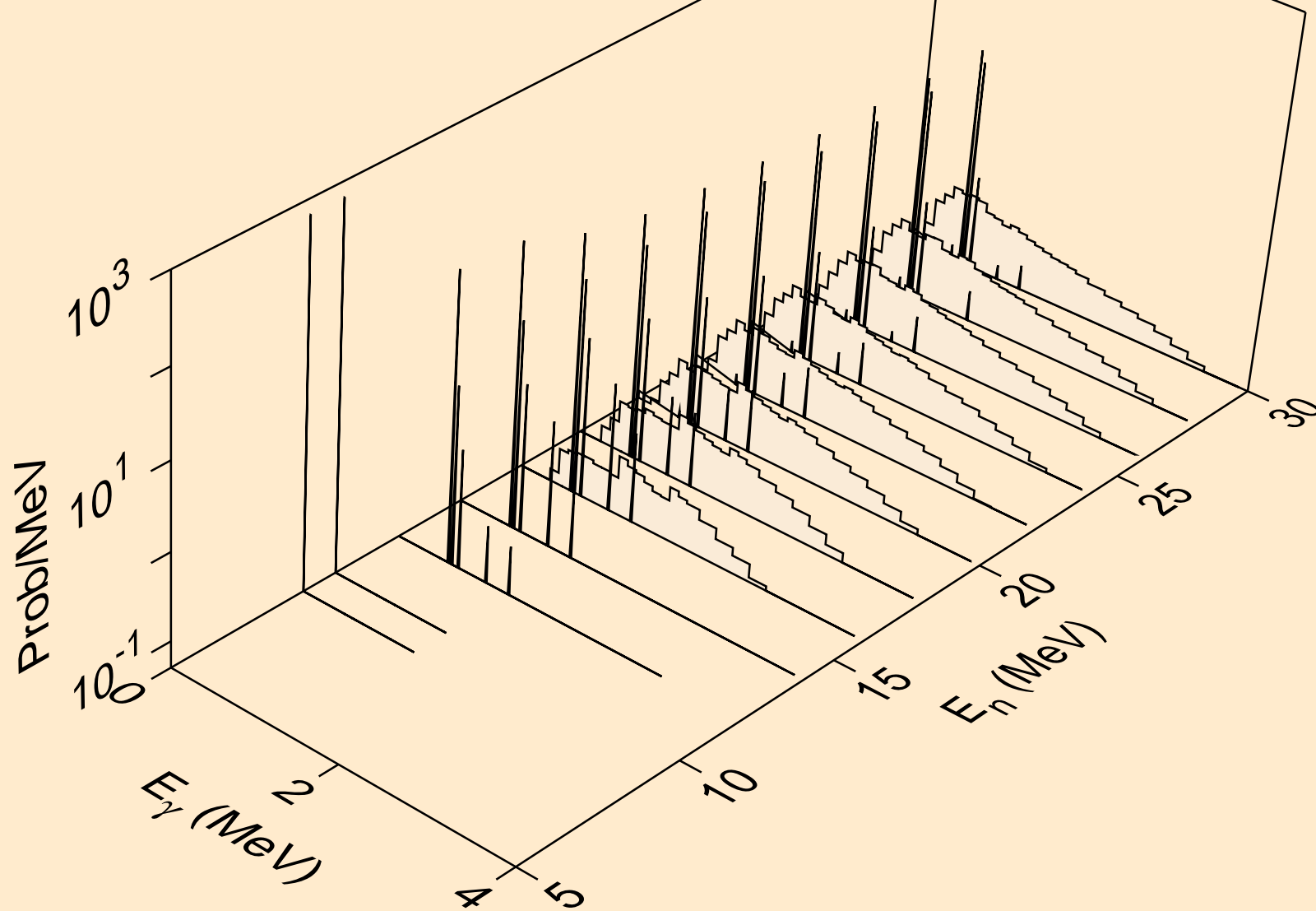

TE126 PROTON ACER TENDL-2021 LIBRARY; T=0.K  
Photon emission for (n,he3)

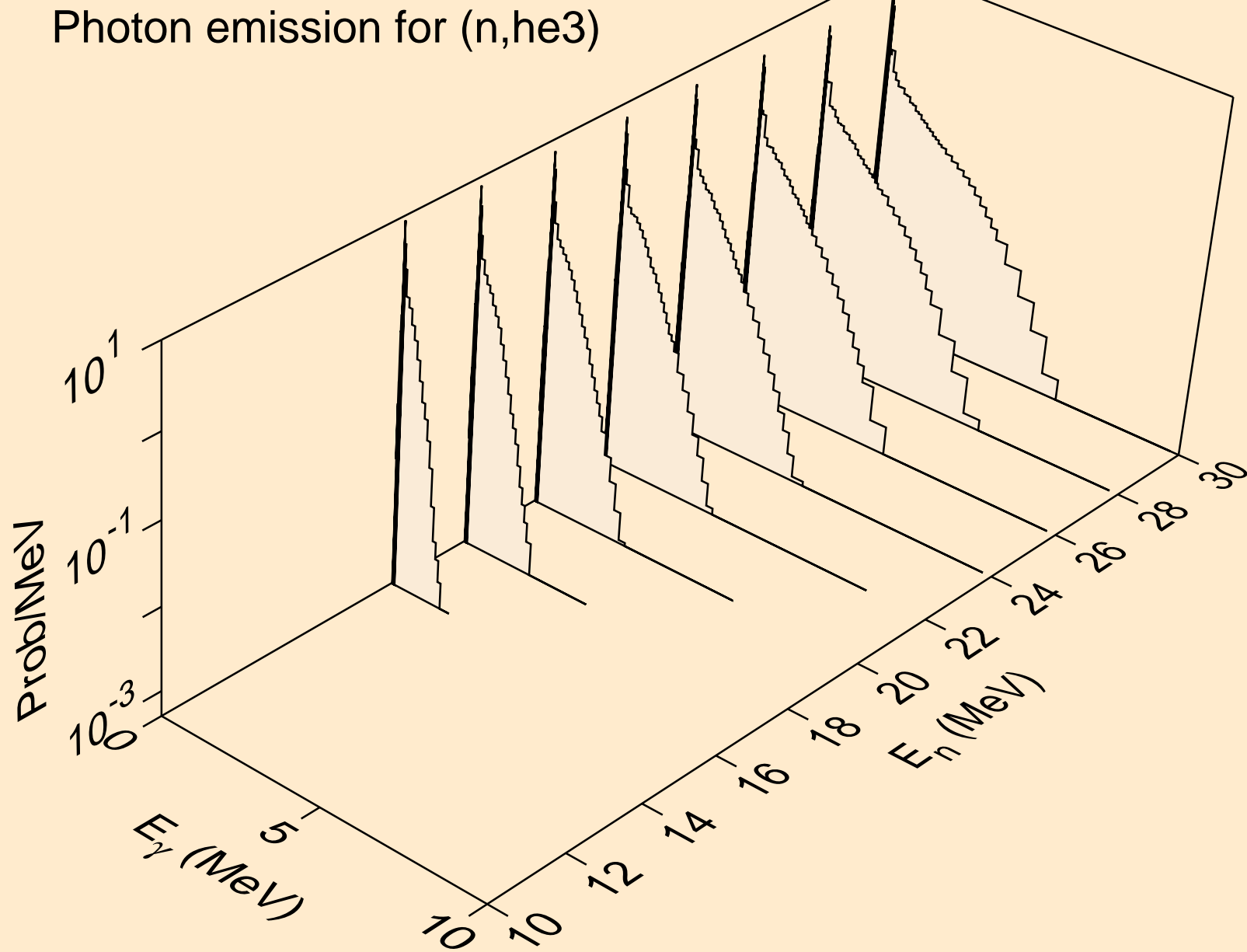

TE126 PROTON ACER TENDL-2021 LIBRARY; T=0.K  
Photon emission for (n,a)

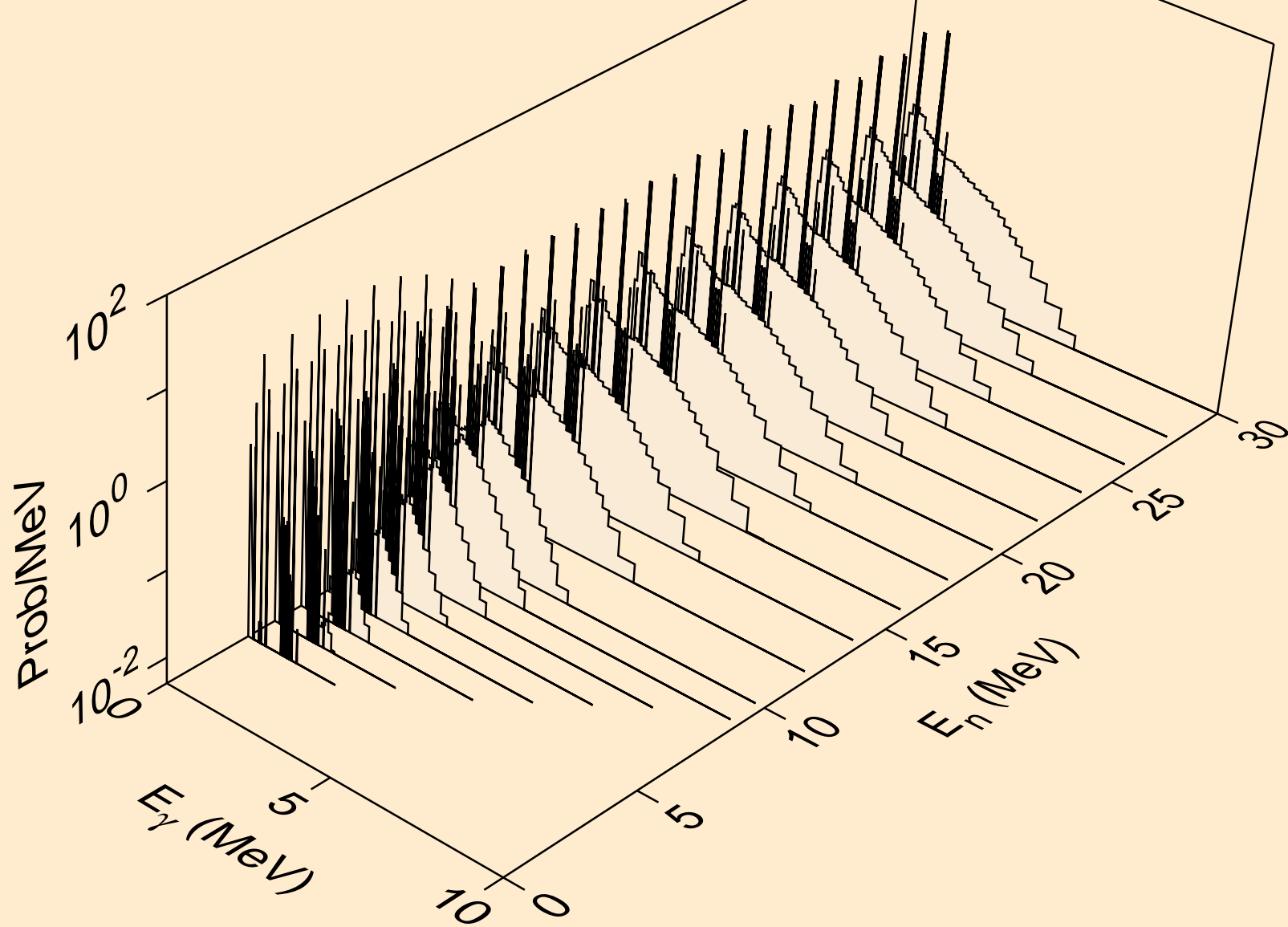

TE126 PROTON ACER TENDL-2021 LIBRARY; T=0.K  
Photon emission for (n,2a)

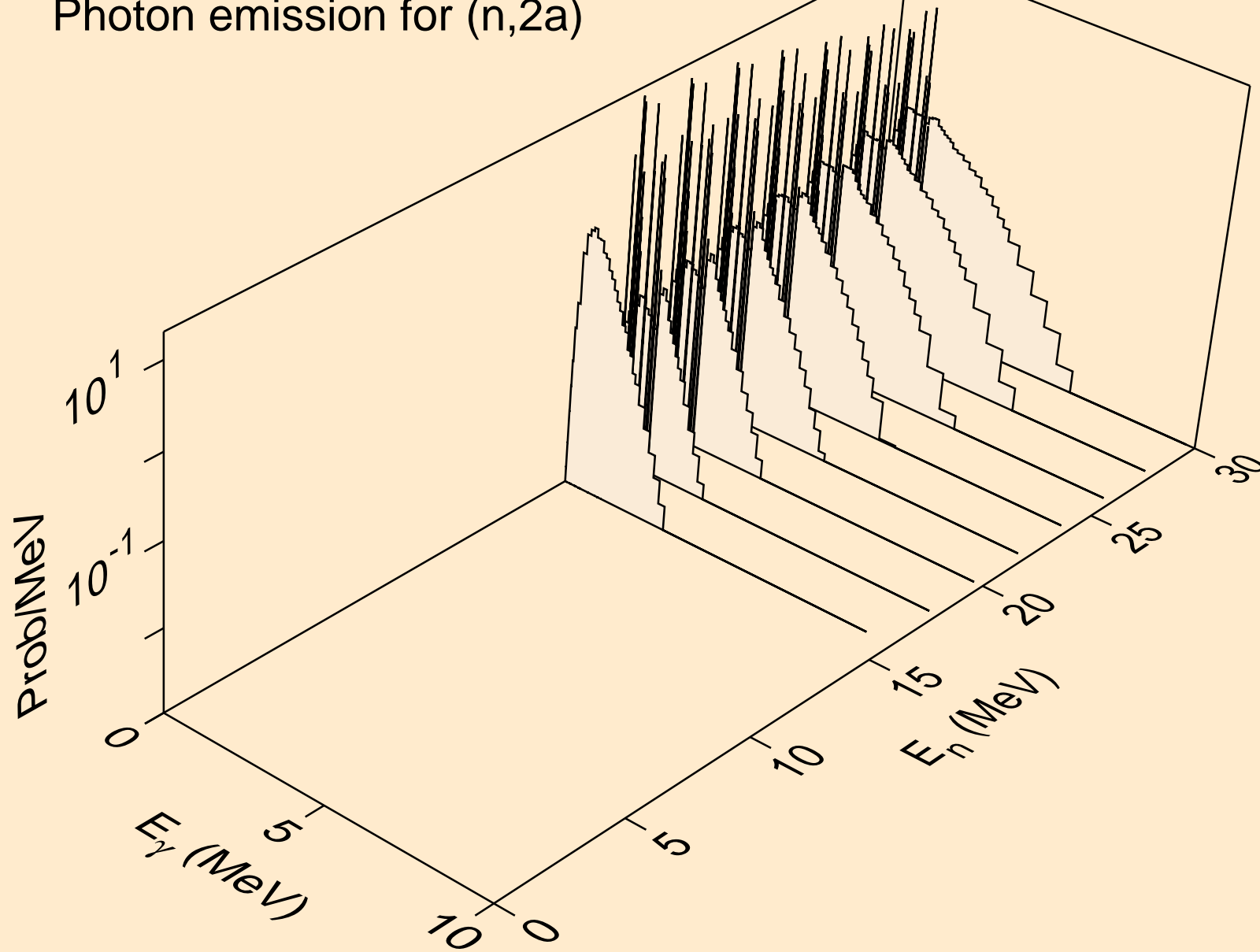

TE126 PROTON ACER TENDL-2021 LIBRARY; T=0.K  
Photon emission for (n,2p)

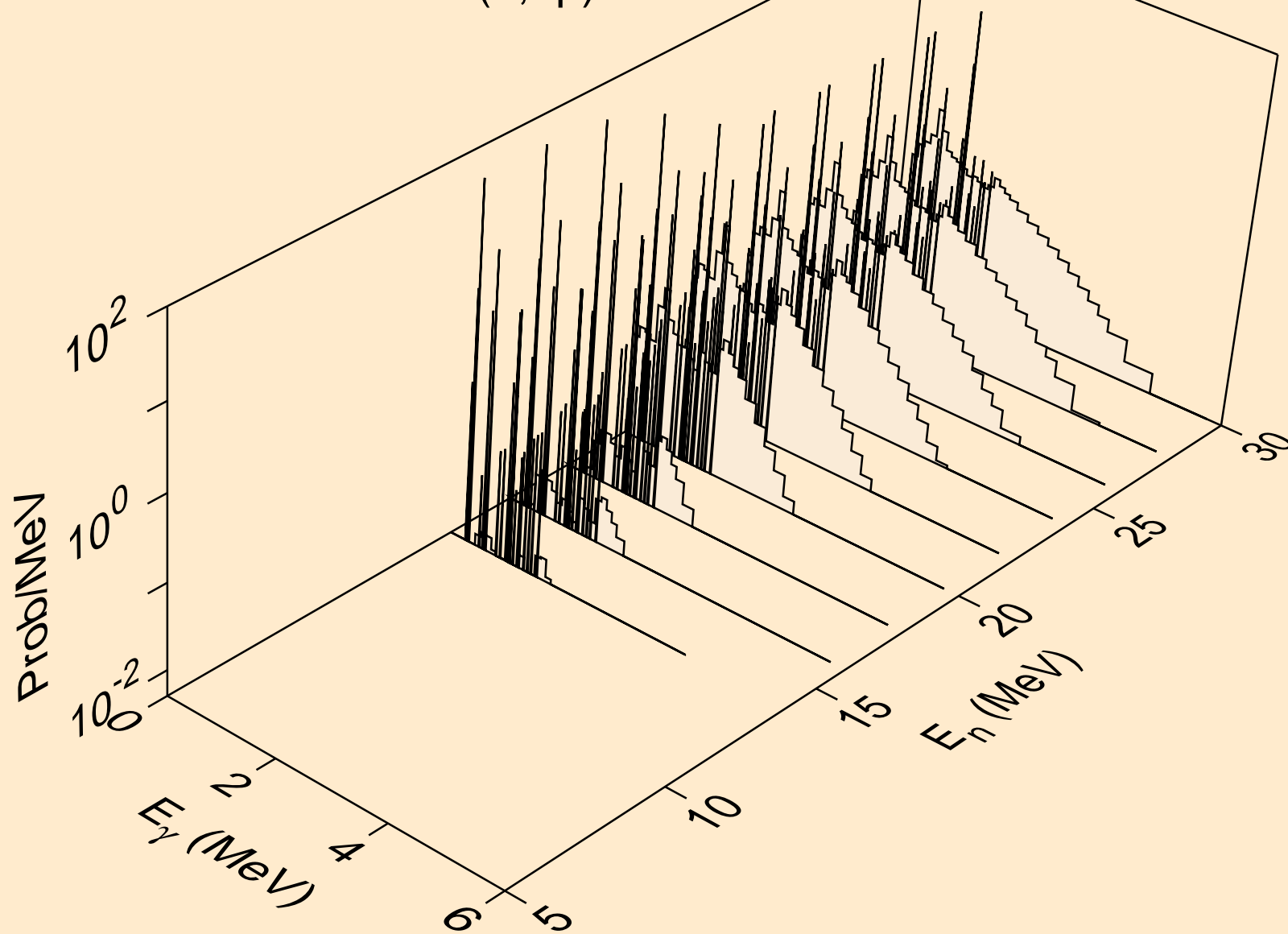

TE126 PROTON ACER TENDL-2021 LIBRARY; T=0.K  
Photon emission for (n,pa)

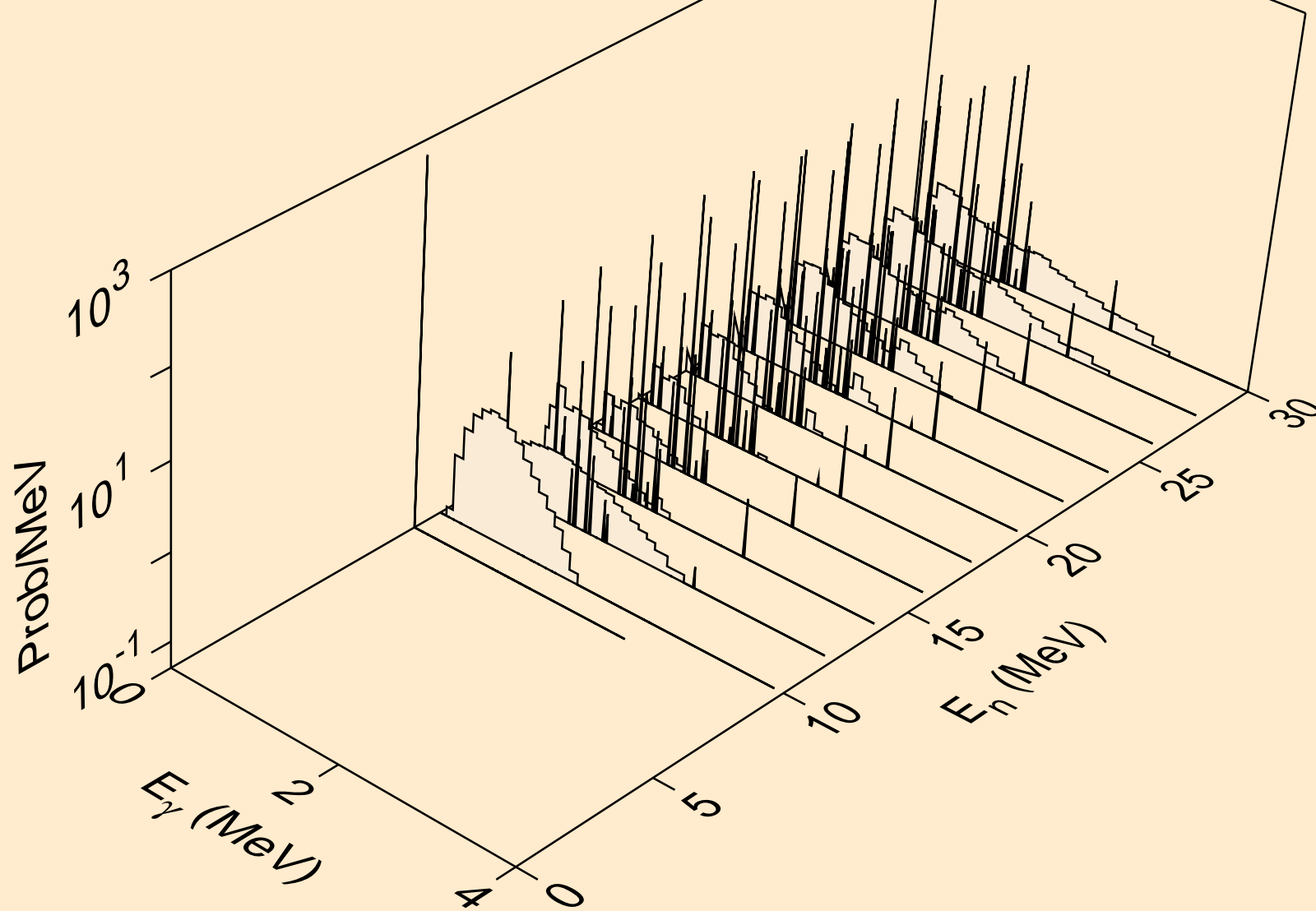

TE126 PROTON ACER TENDL-2021 LIBRARY; T=0.K  
Photon emission for (n,pd)

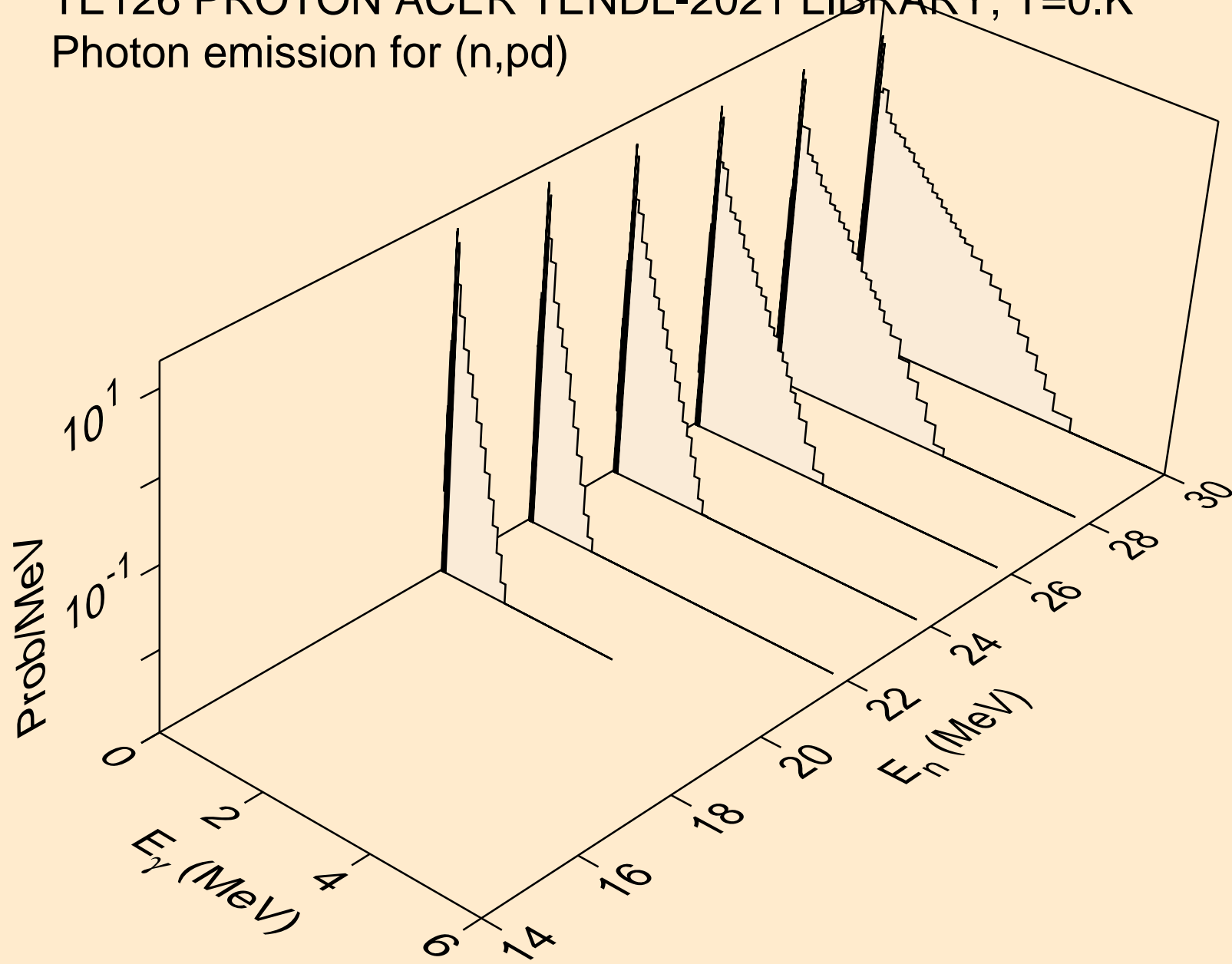

TE126 PROTON ACER TENDL-2021 LIBRARY; T=0.K  
Photon emission for (n,pt)

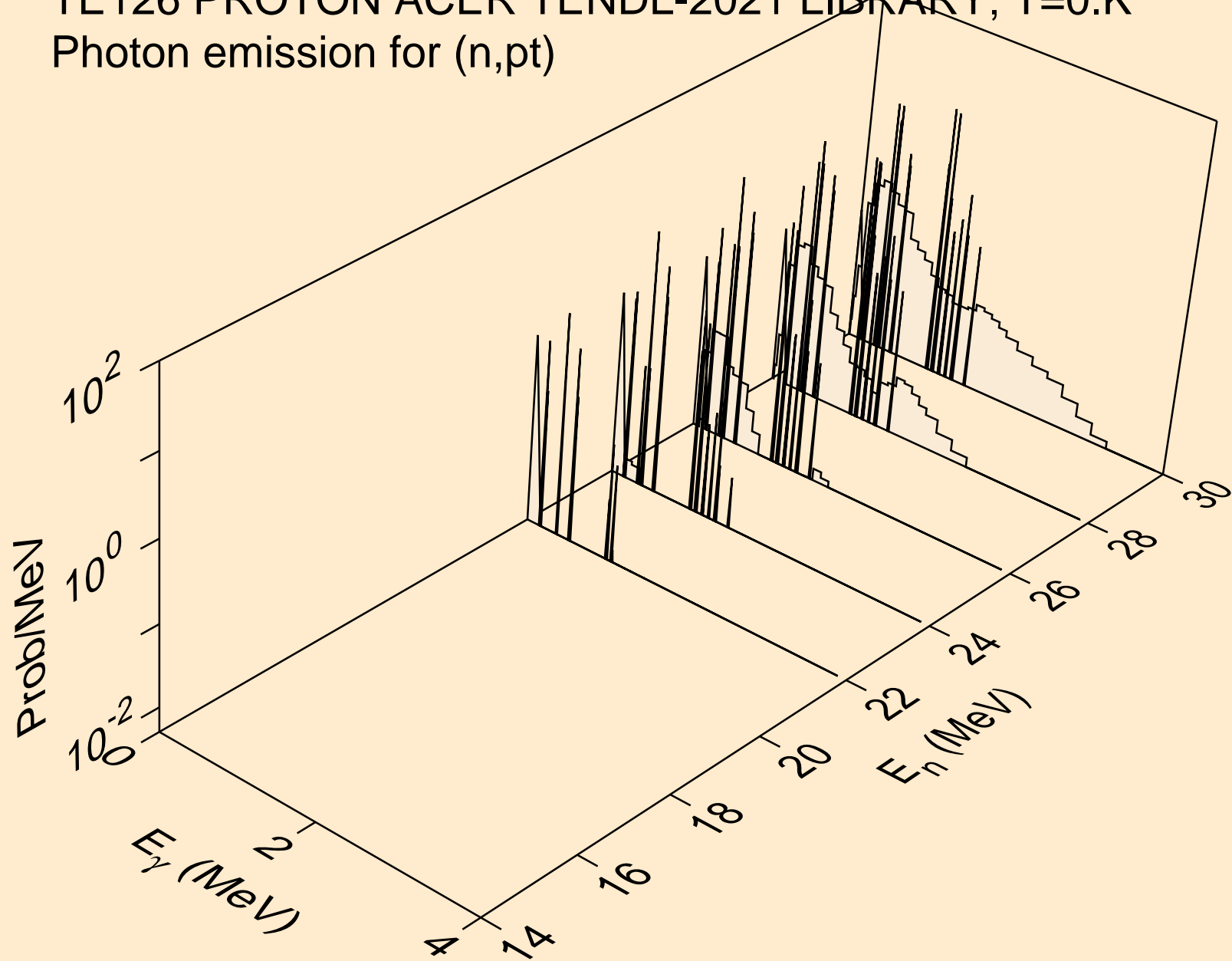



TE126 PROTON ACER TENDL-2021 LIBRARY; T=0.K  
Photon emission for (n,da)

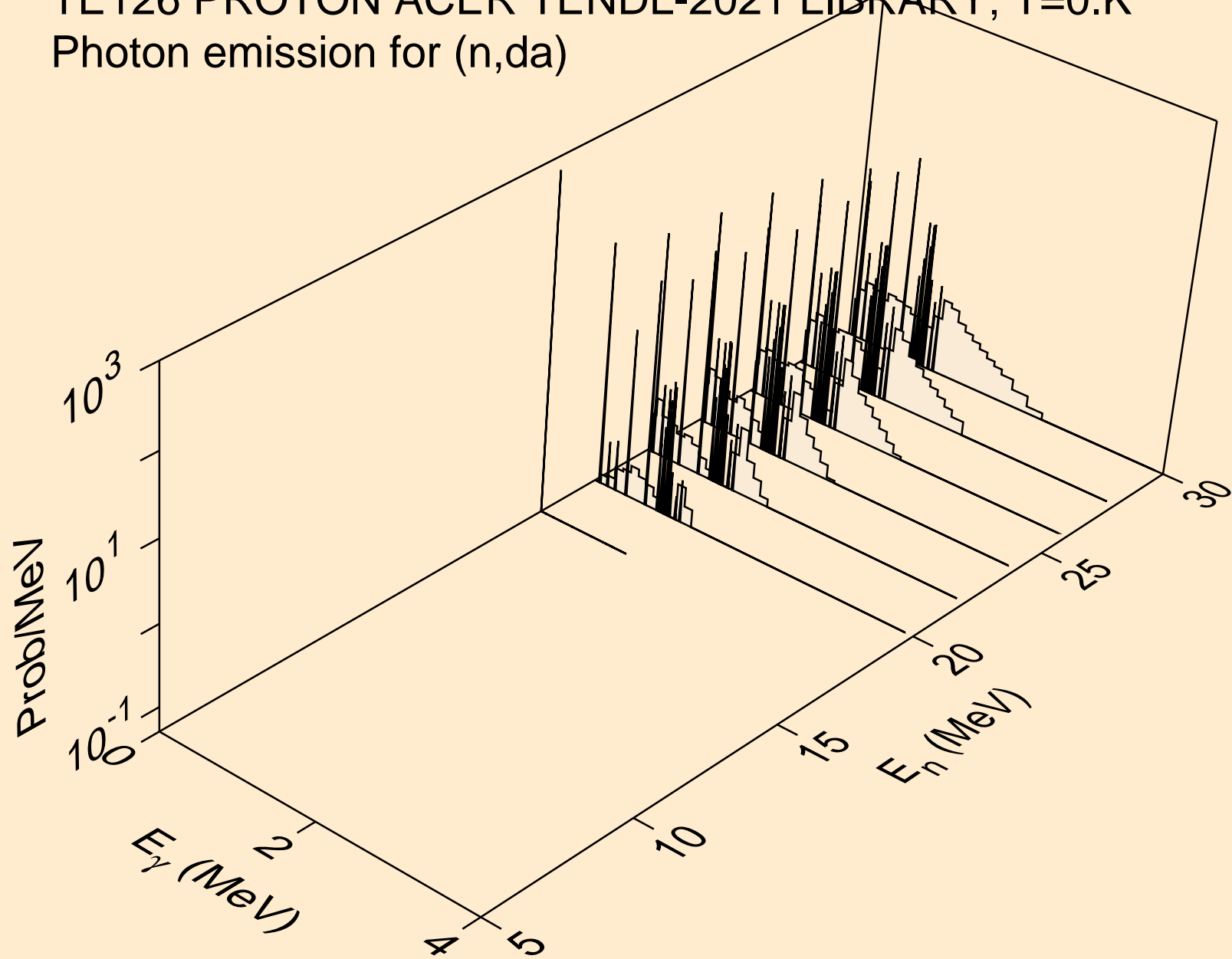

TE126 PROTON ACER TENDL-2021 LIBRARY; T=0.K  
Particle heating contributions

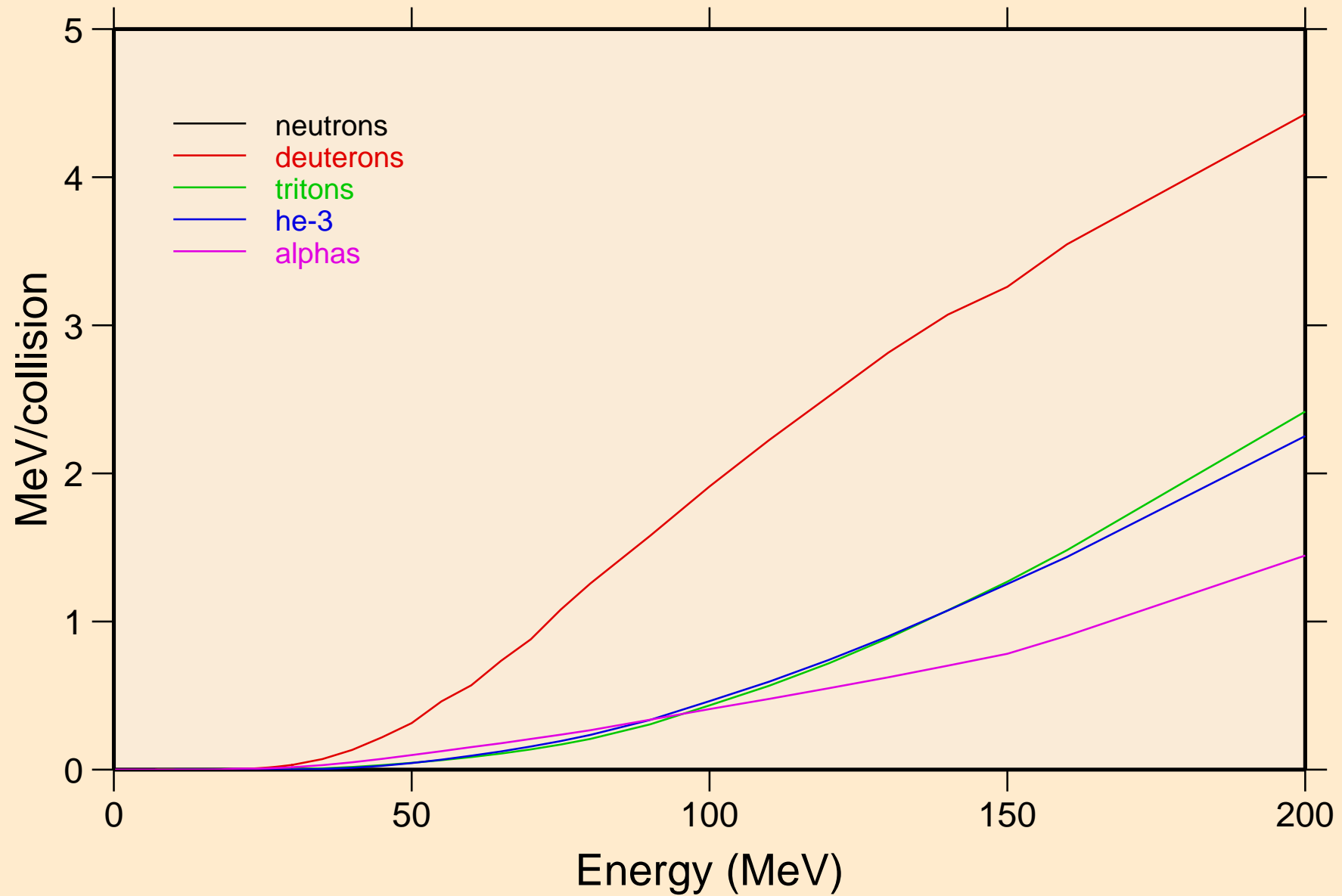

TE126 PROTON ACER TENDL-2021 LIBRARY; T=0.K  
Recoil Heating

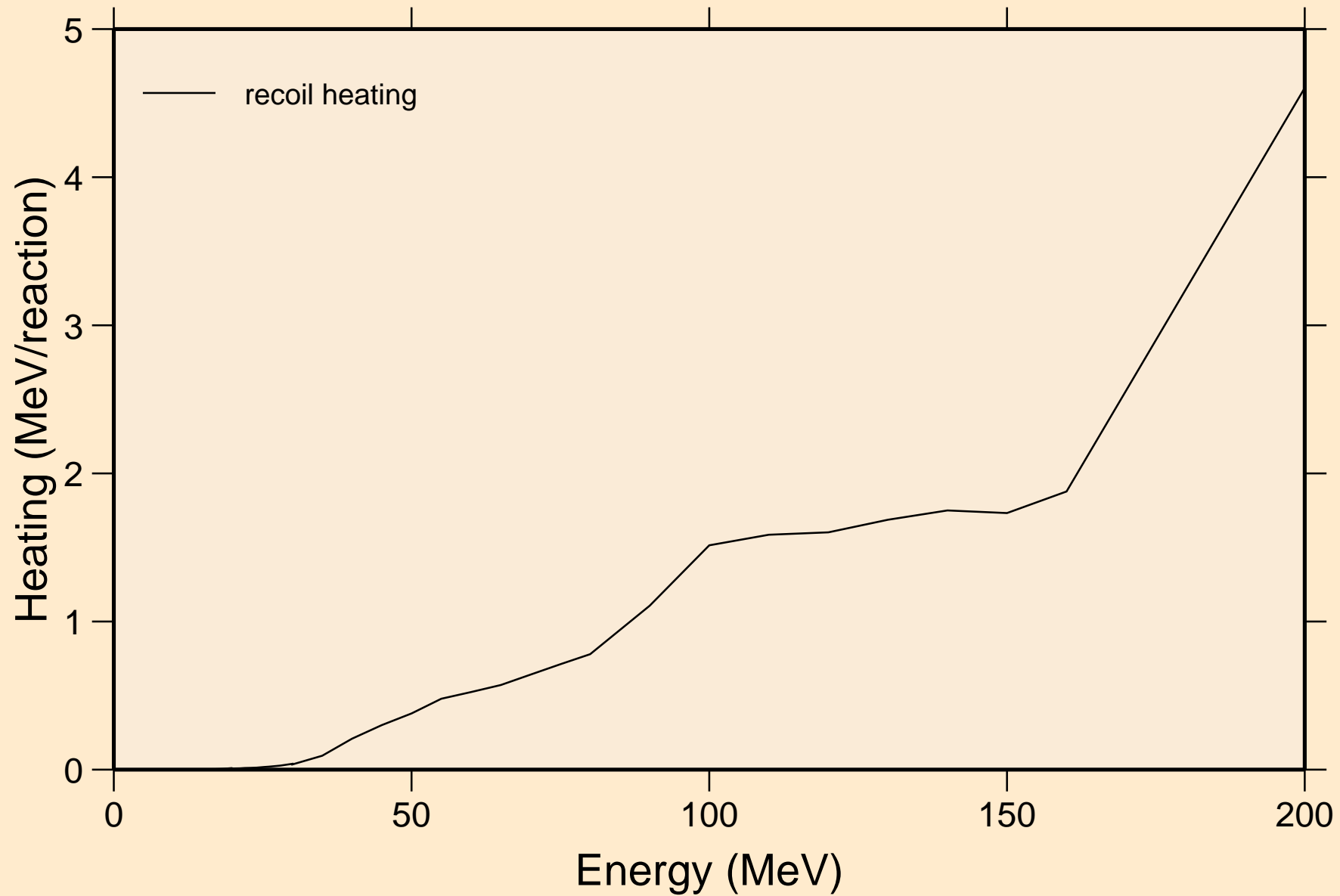

TE126 PROTON ACER TENDL-2021 LIBRARY; T=0.K  
Particle production cross sections

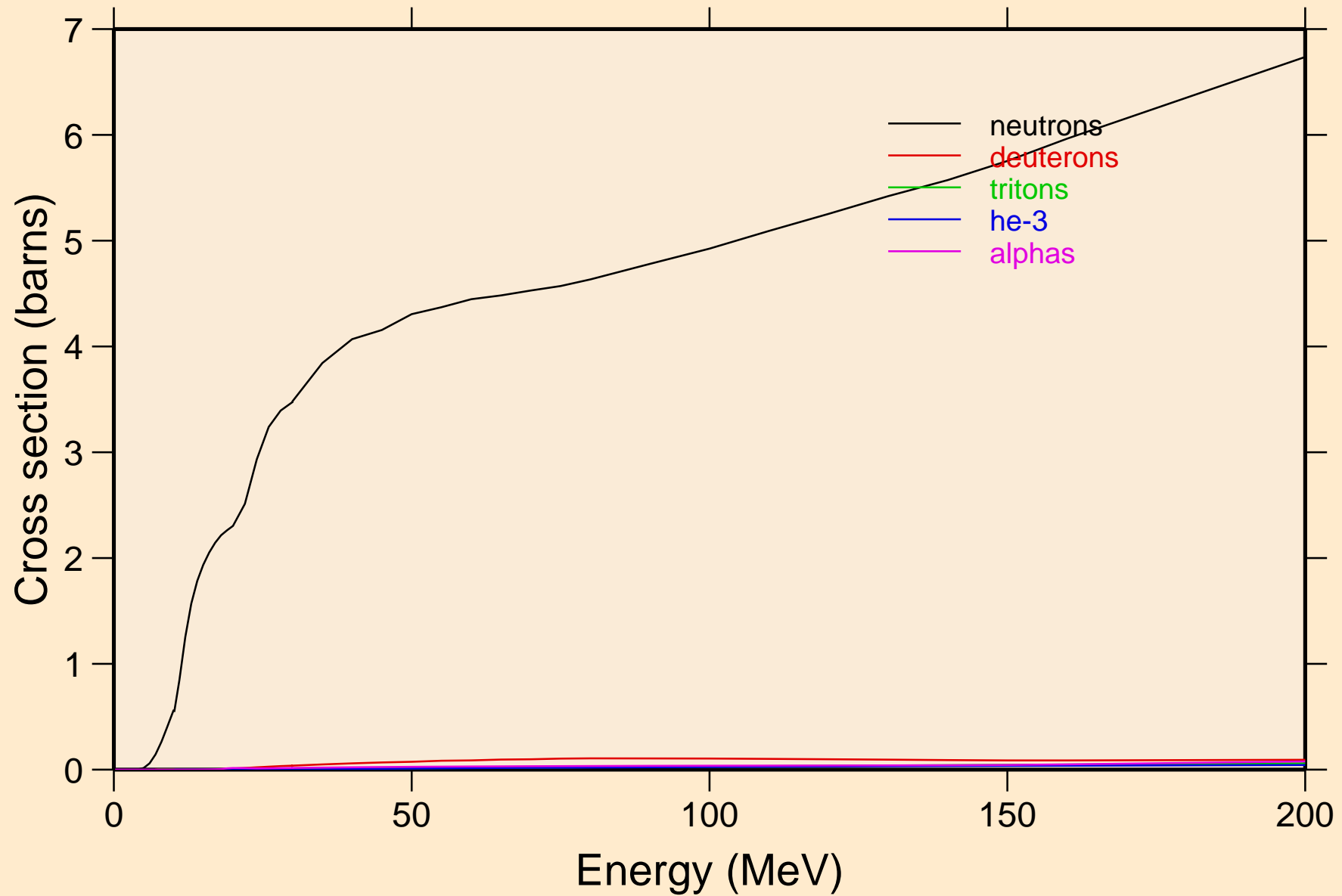

TE126 PROTON ACER TENDL-2021 LIBRARY; T=0.K  
neutrons from (p,n)

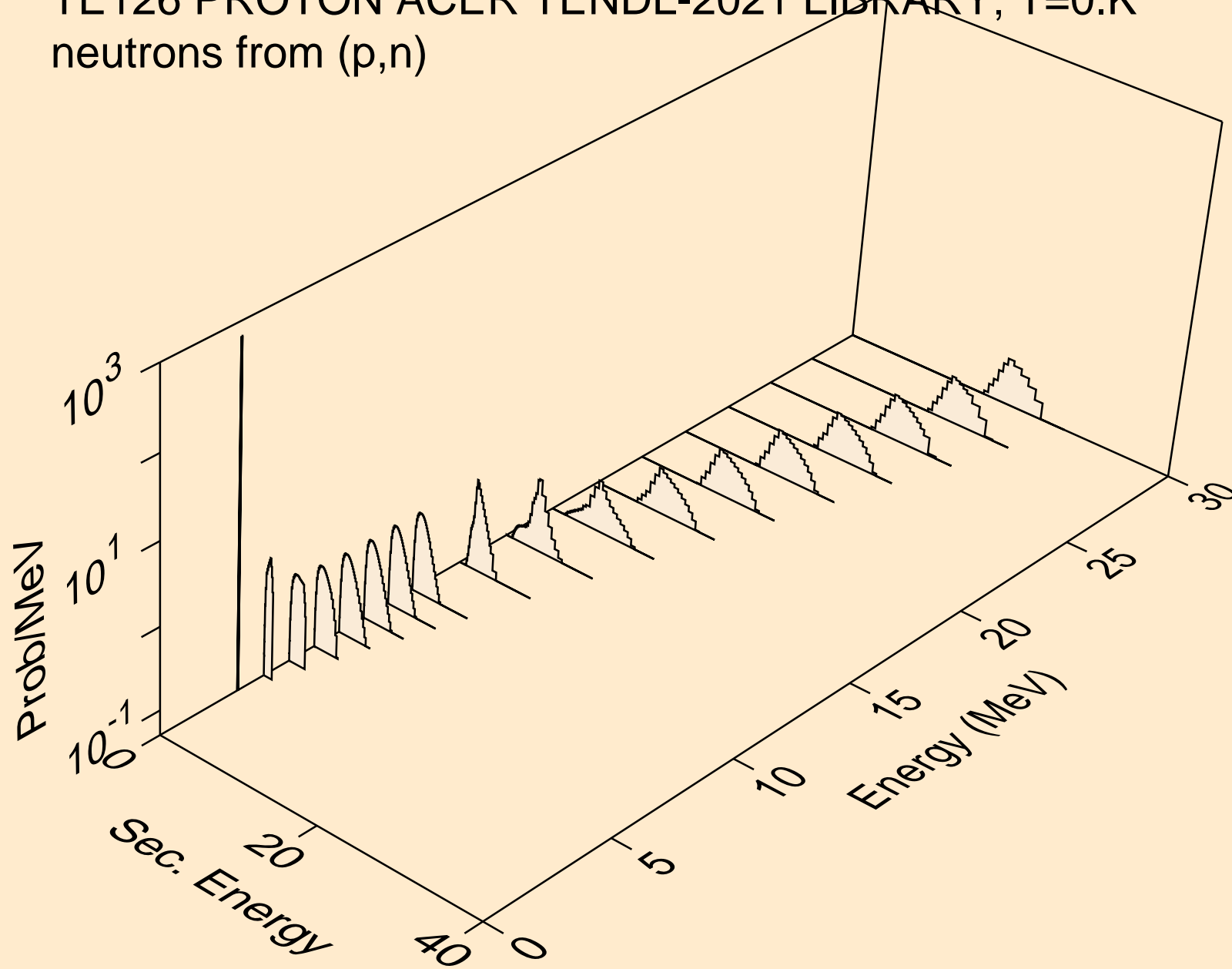

TE126 PROTON ACER TENDL-2021 LIBRARY; T=0.K  
neutrons from (p,x)

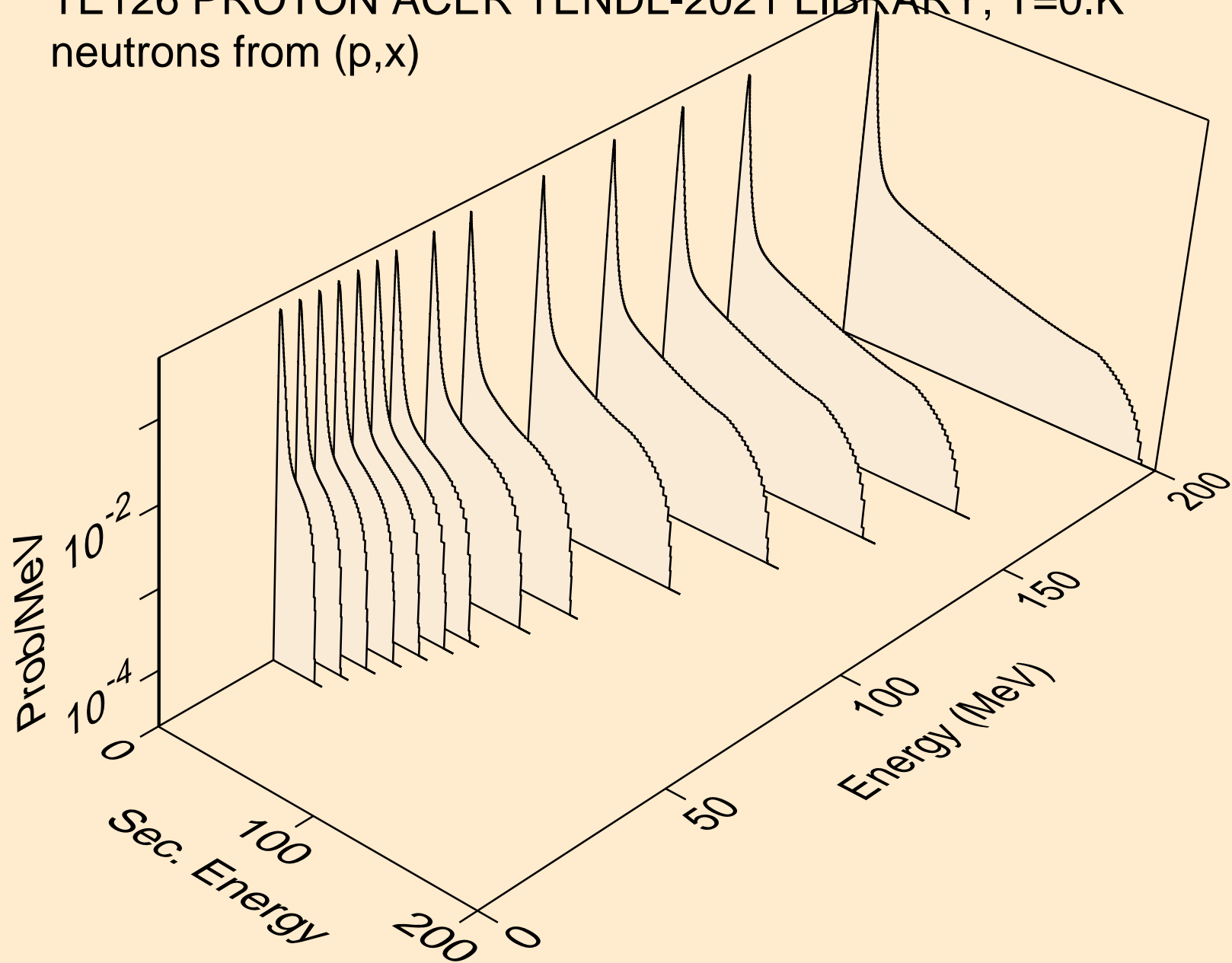

TE126 PROTON ACER TENDL-2021 LIBRARY; T=0.K  
neutrons from (p,2nd)

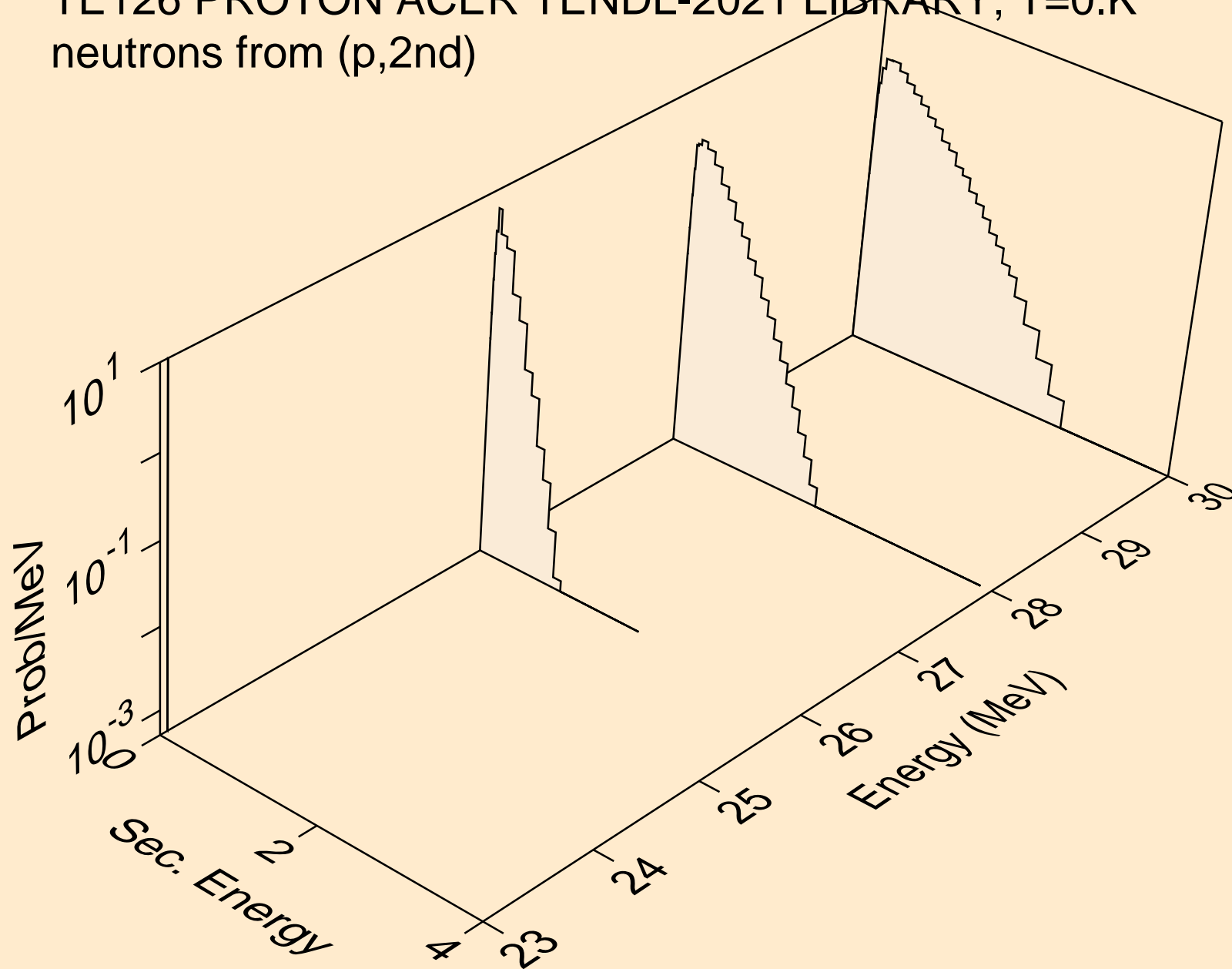

TE126 PROTON ACER TENDL-2021 LIBRARY; T=0.K  
neutrons from (p,2n)

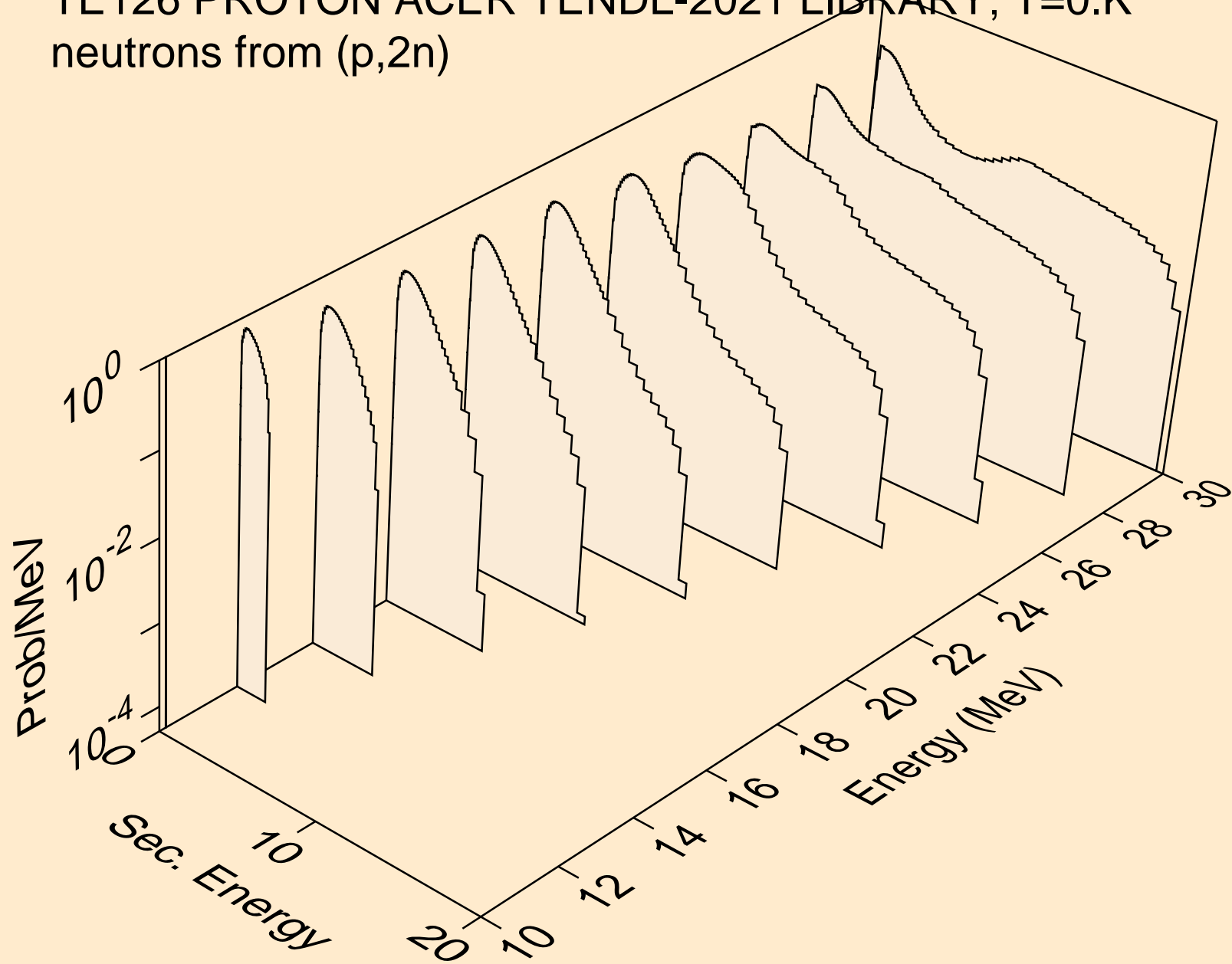



TE126 PROTON ACER TENDL-2021 LIBRARY; T=0.K  
neutrons from (p,3n)

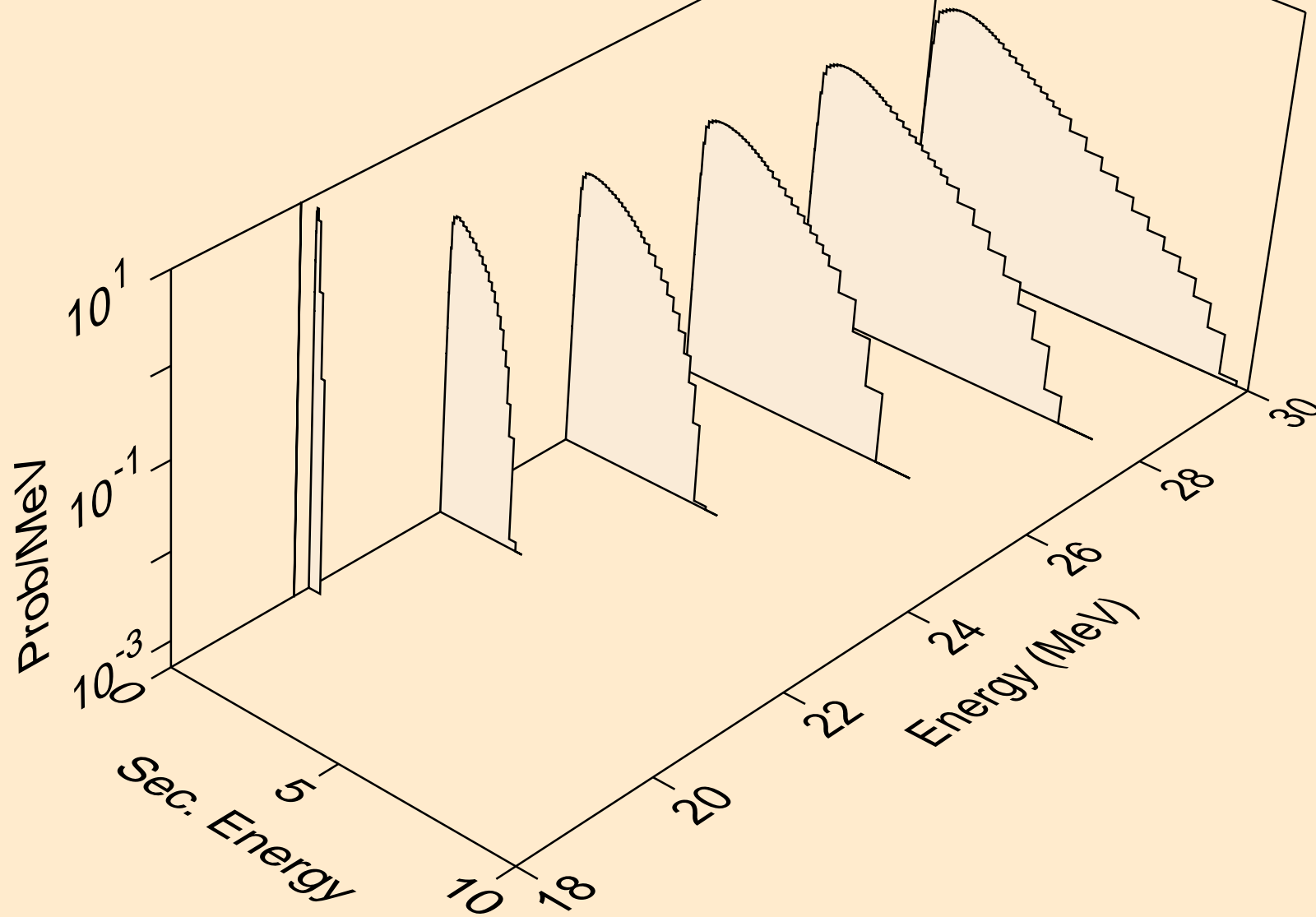

TE126 PROTON ACER TENDL-2021 LIBRARY; T=0.K  
neutrons from (p,n\*)a

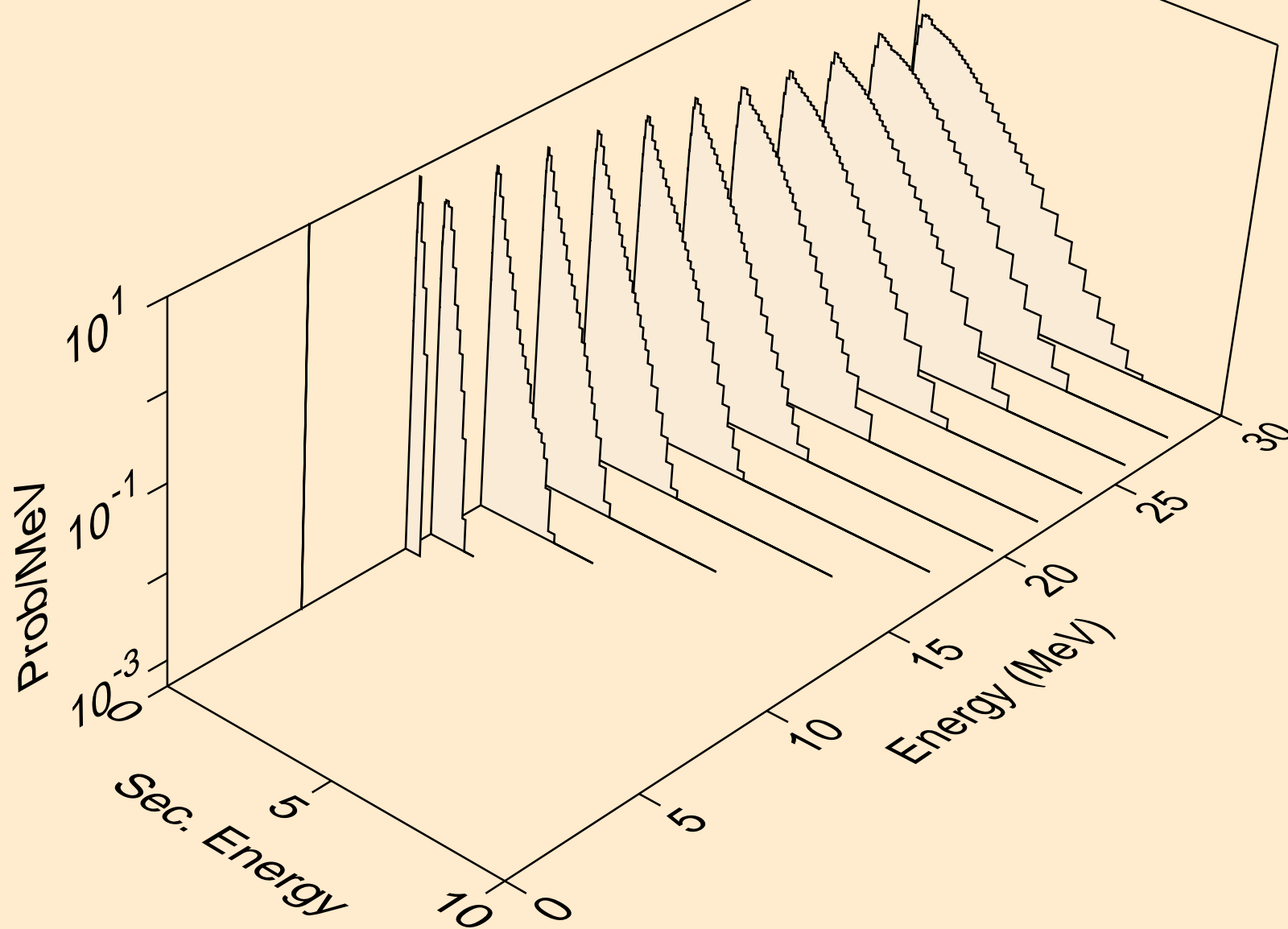

TE126 PROTON ACER TENDL-2021 LIBRARY; T=0.K  
neutrons from (p,2n)a

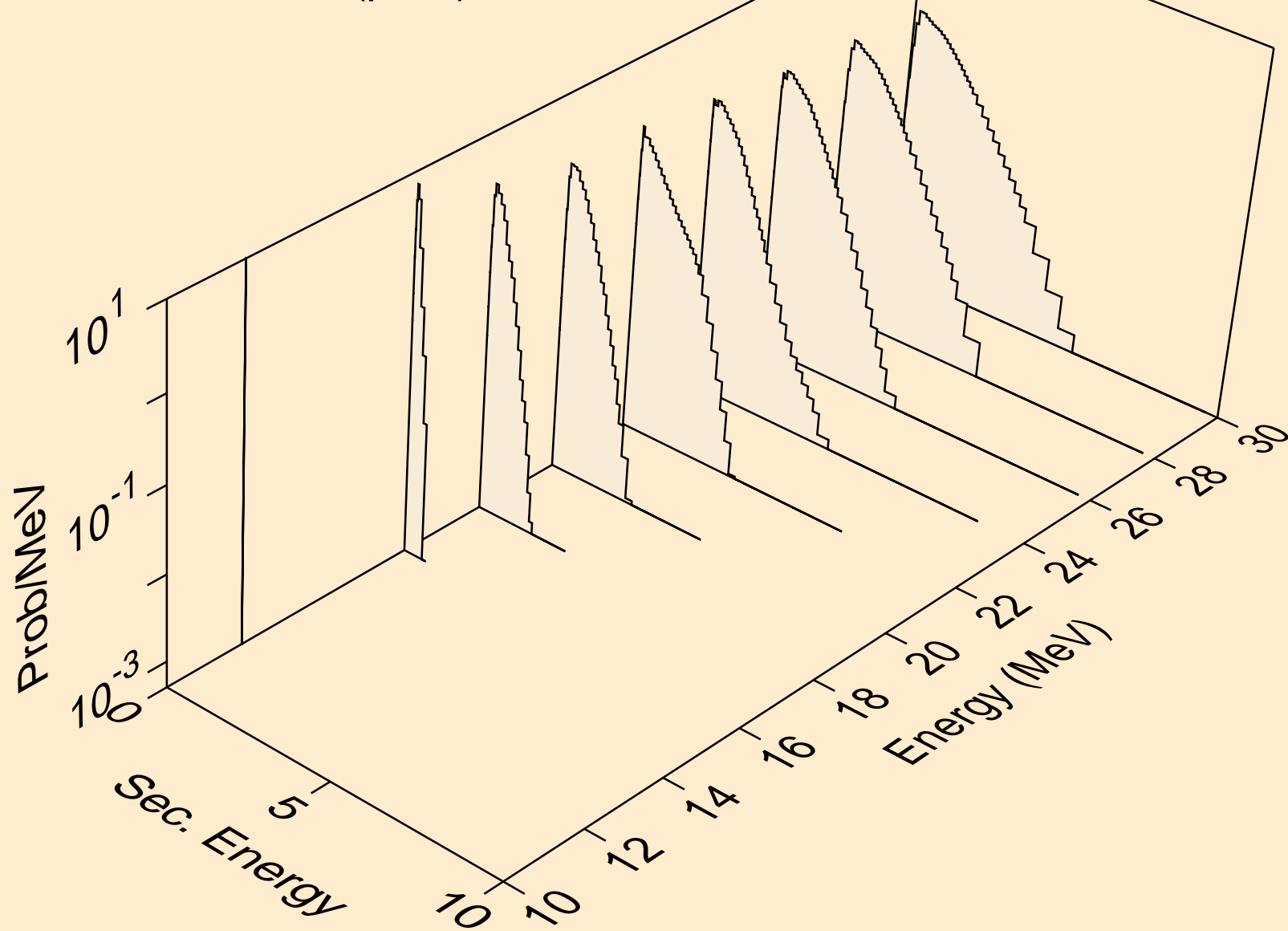

TE126 PROTON ACER TENDL-2021 LIBRARY; T=0.K  
neutrons from (p,3n)a

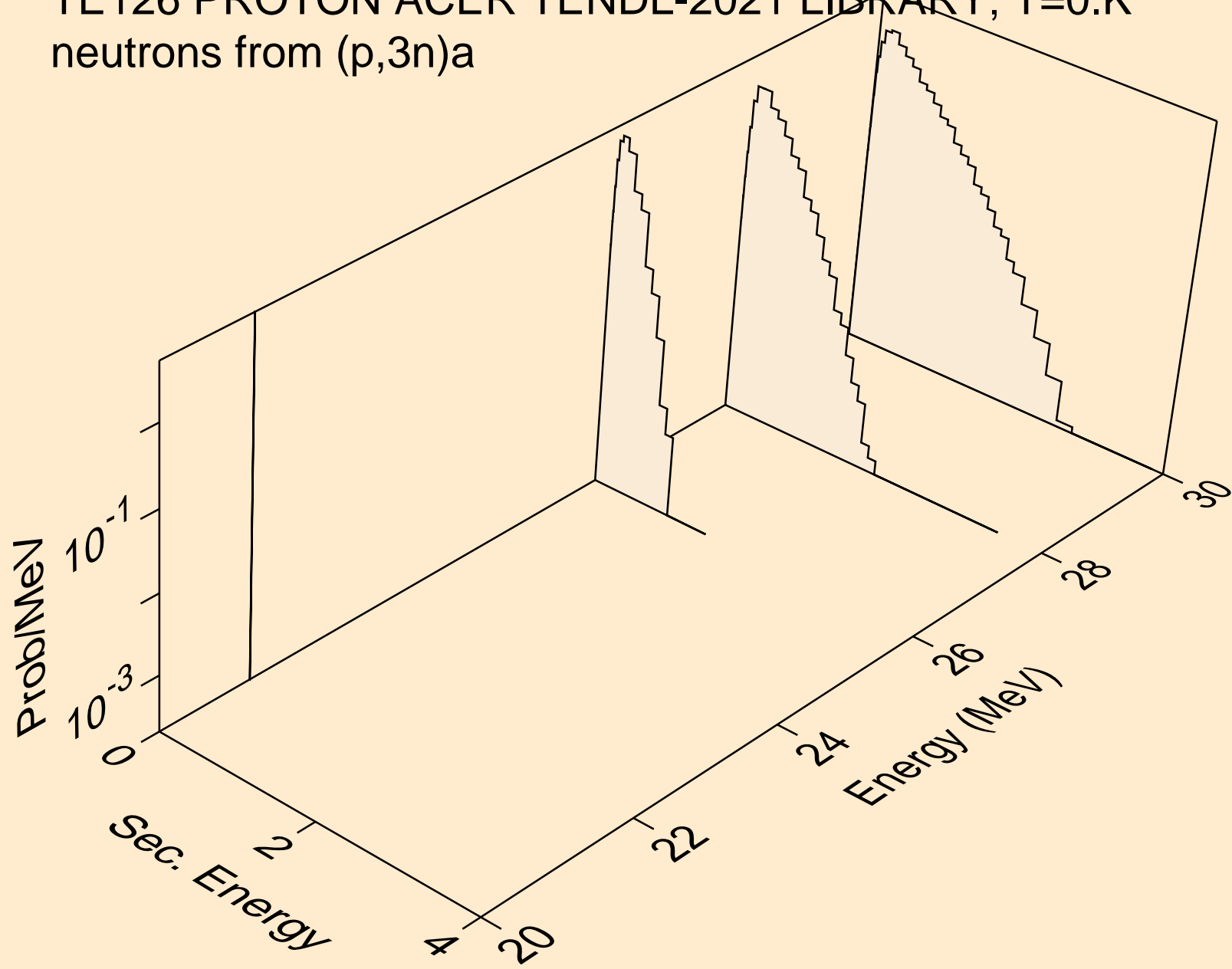

TE126 PROTON ACER TENDL-2021 LIBRARY; T=0.K  
neutrons from (p,n\*)p

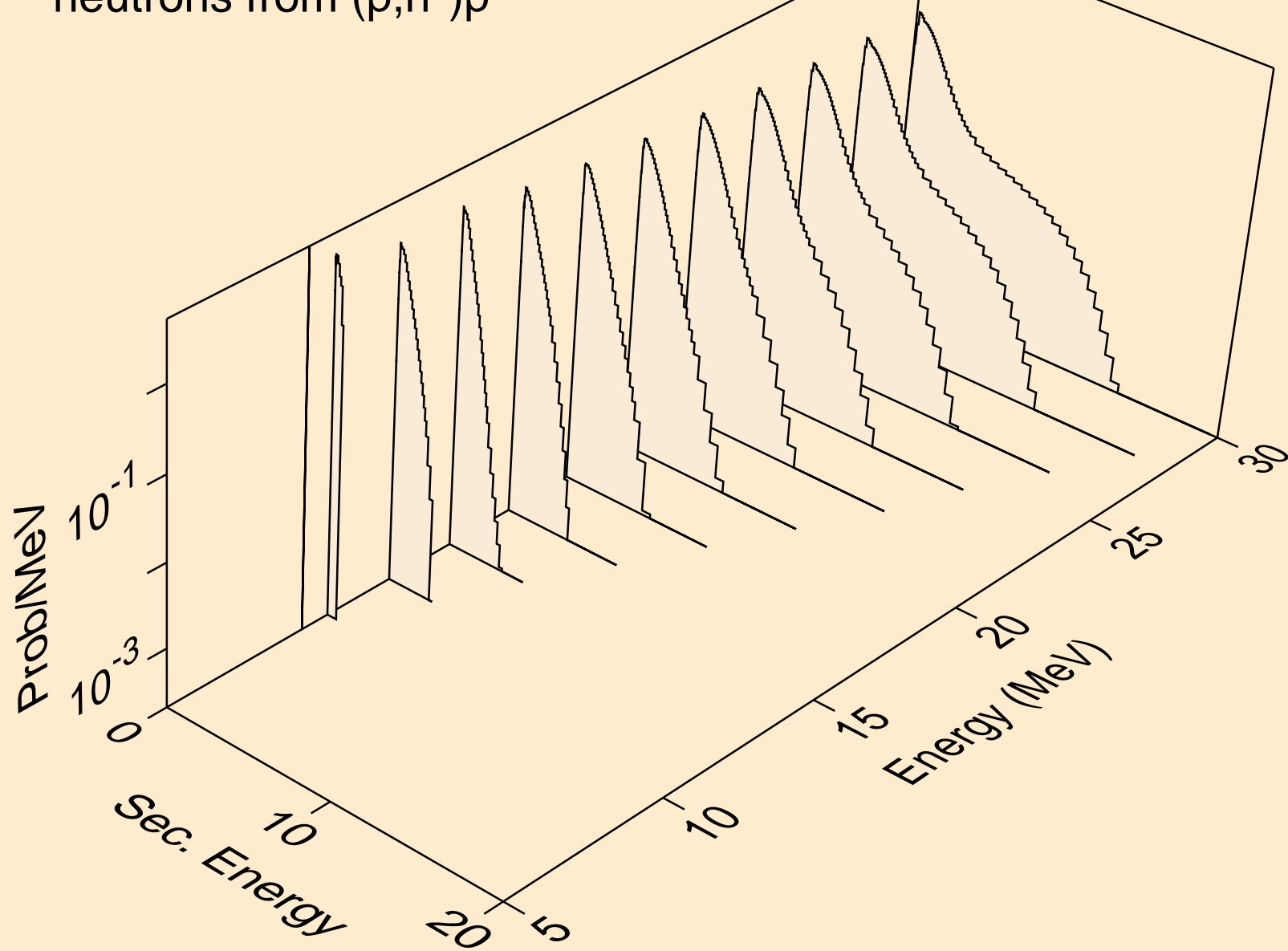

TE126 PROTON ACER TENDL-2021 LIBRARY; T=0.K  
neutrons from (p,n\*)d

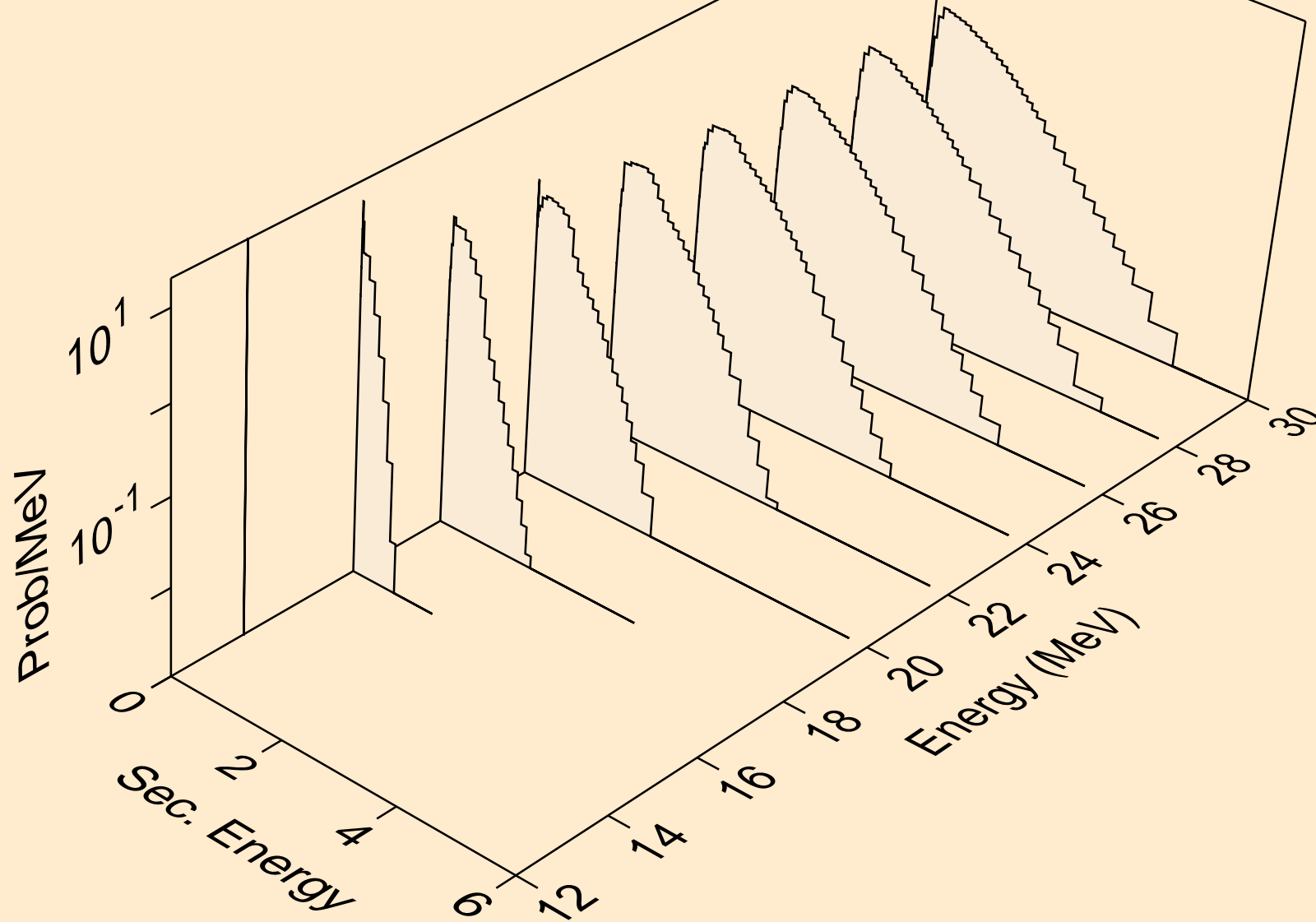

TE126 PROTON ACER TENDL-2021 LIBRARY; T=0.K  
neutrons from (p,n\*)t

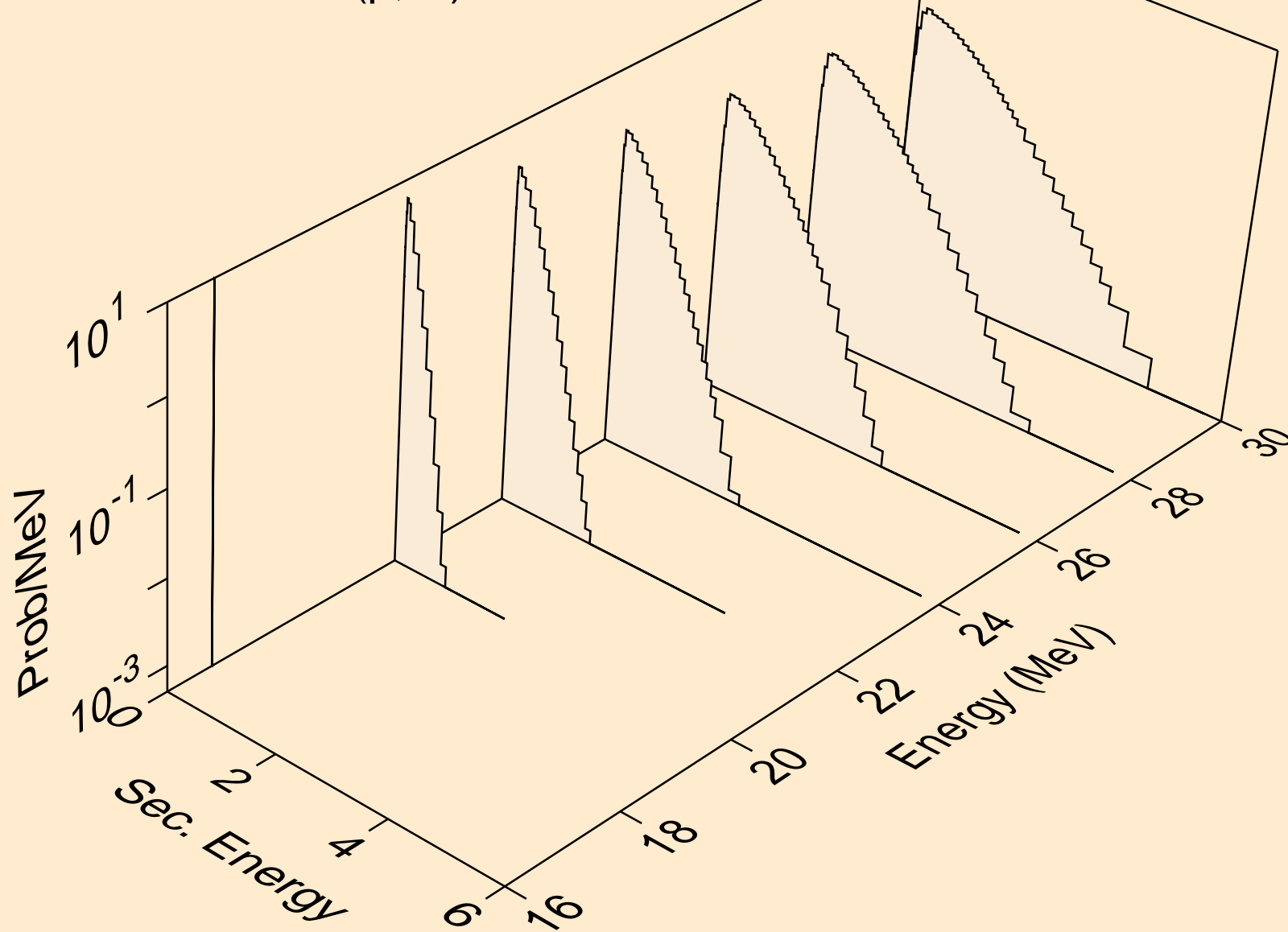

TE126 PROTON ACER TENDL-2021 LIBRARY; T=0.K  
neutrons from (p,n\*)he3

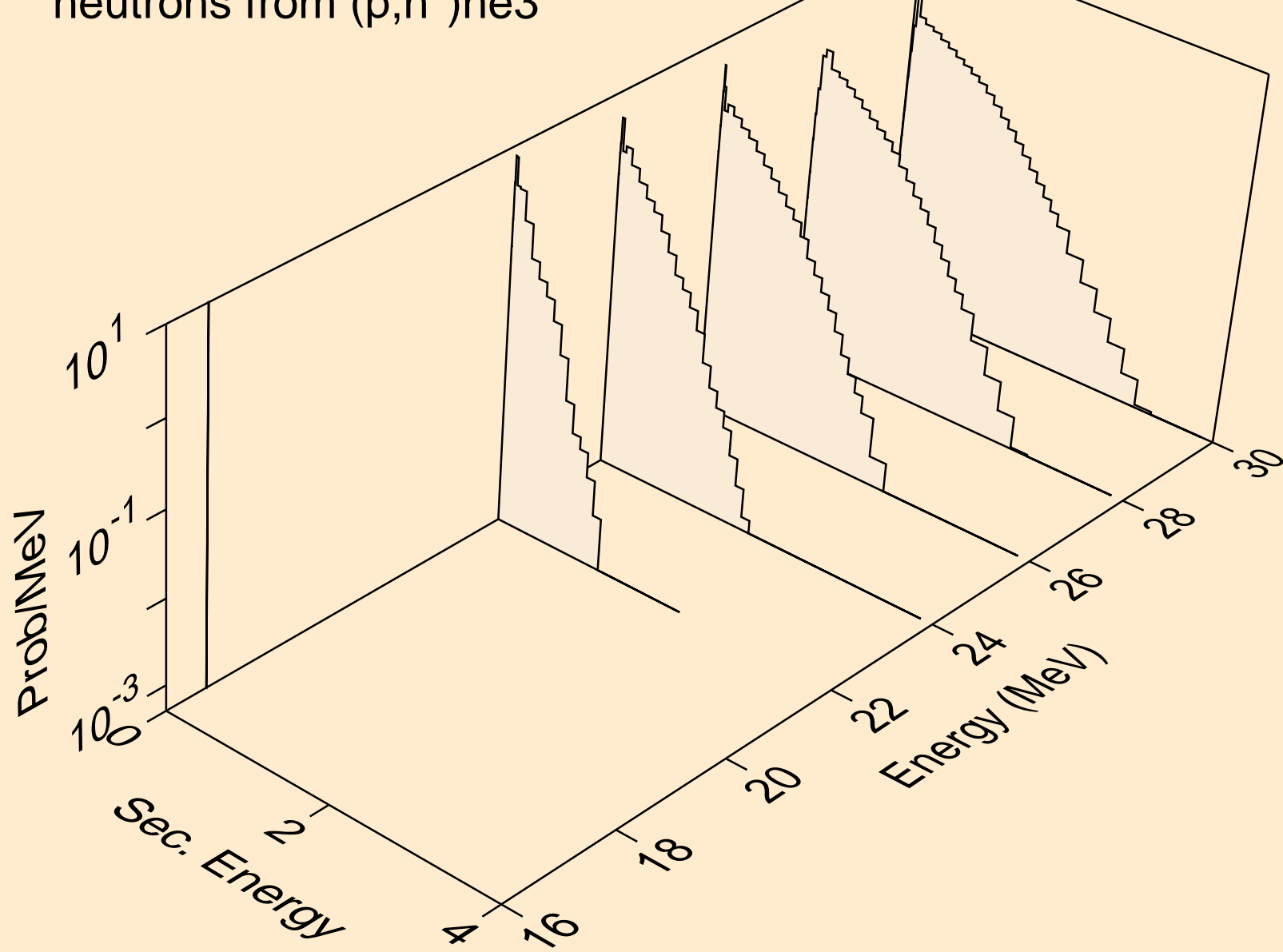



TE126 PROTON ACER TENDL-2021 LIBRARY; T=0.K  
neutrons from (p,4n)

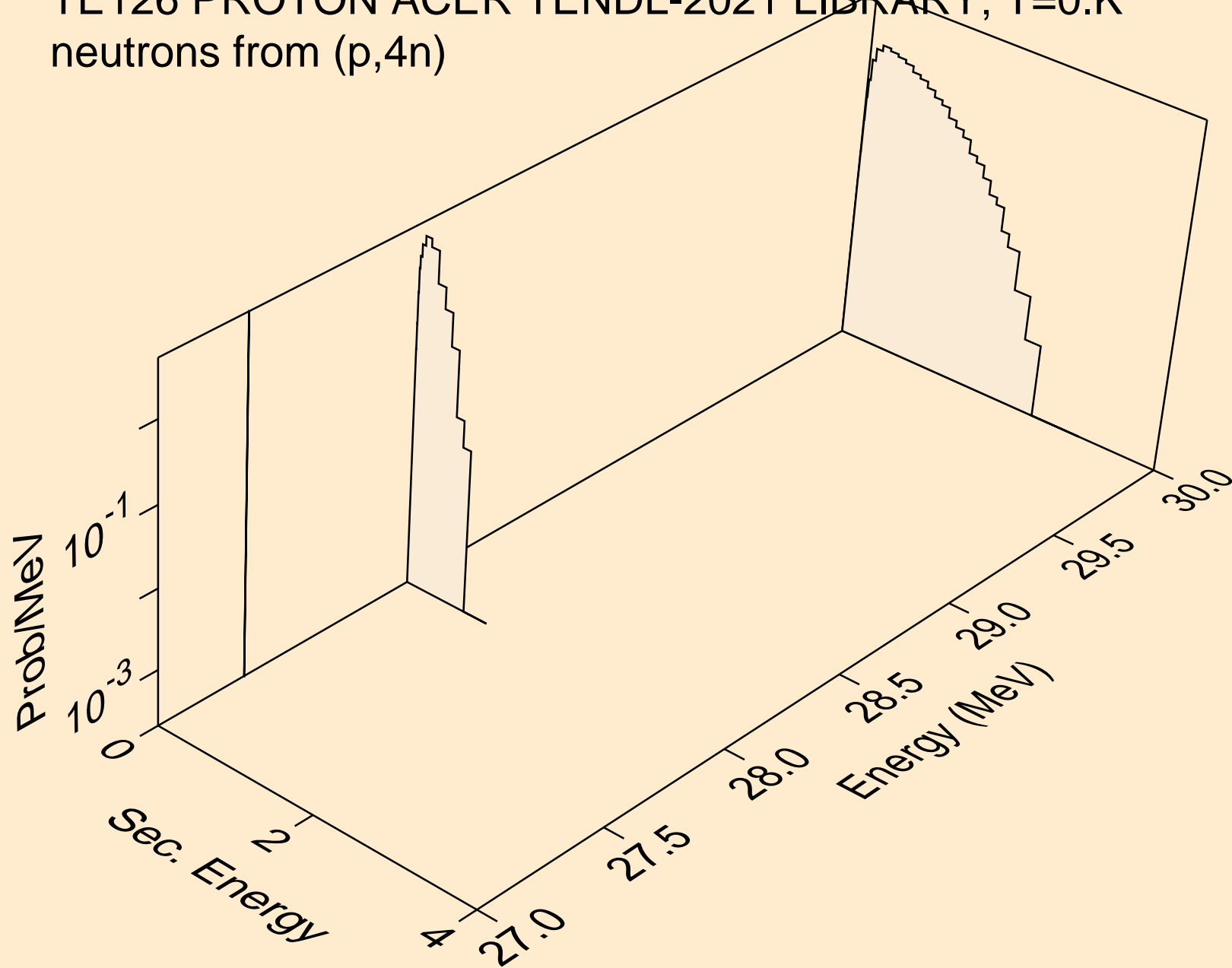

TE126 PROTON ACER TENDL-2021 LIBRARY; T=0.K  
neutrons from (p,2np)

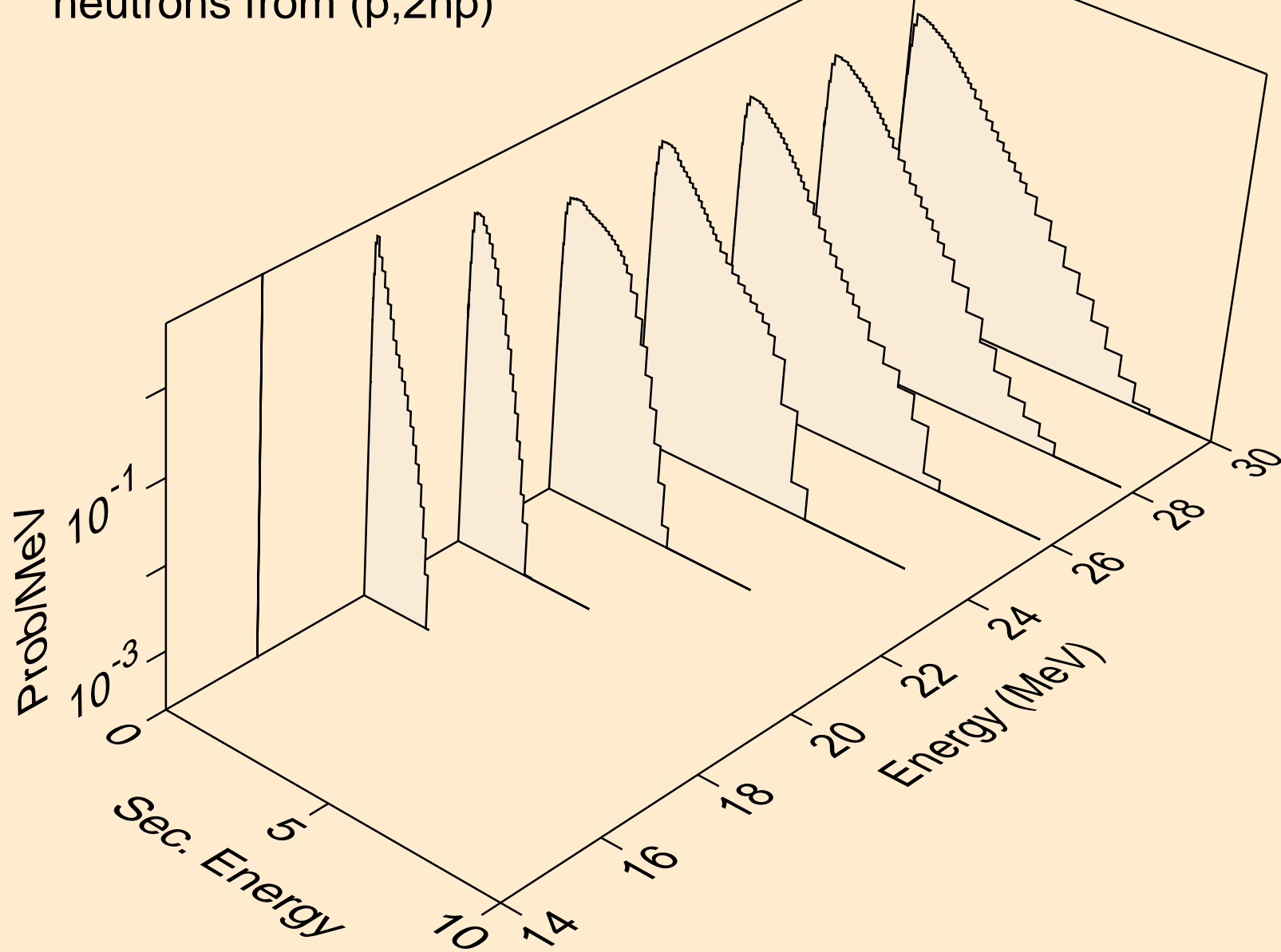

TE126 PROTON ACER TENDL-2021 LIBRARY; T=0.K  
neutrons from (p,3np)

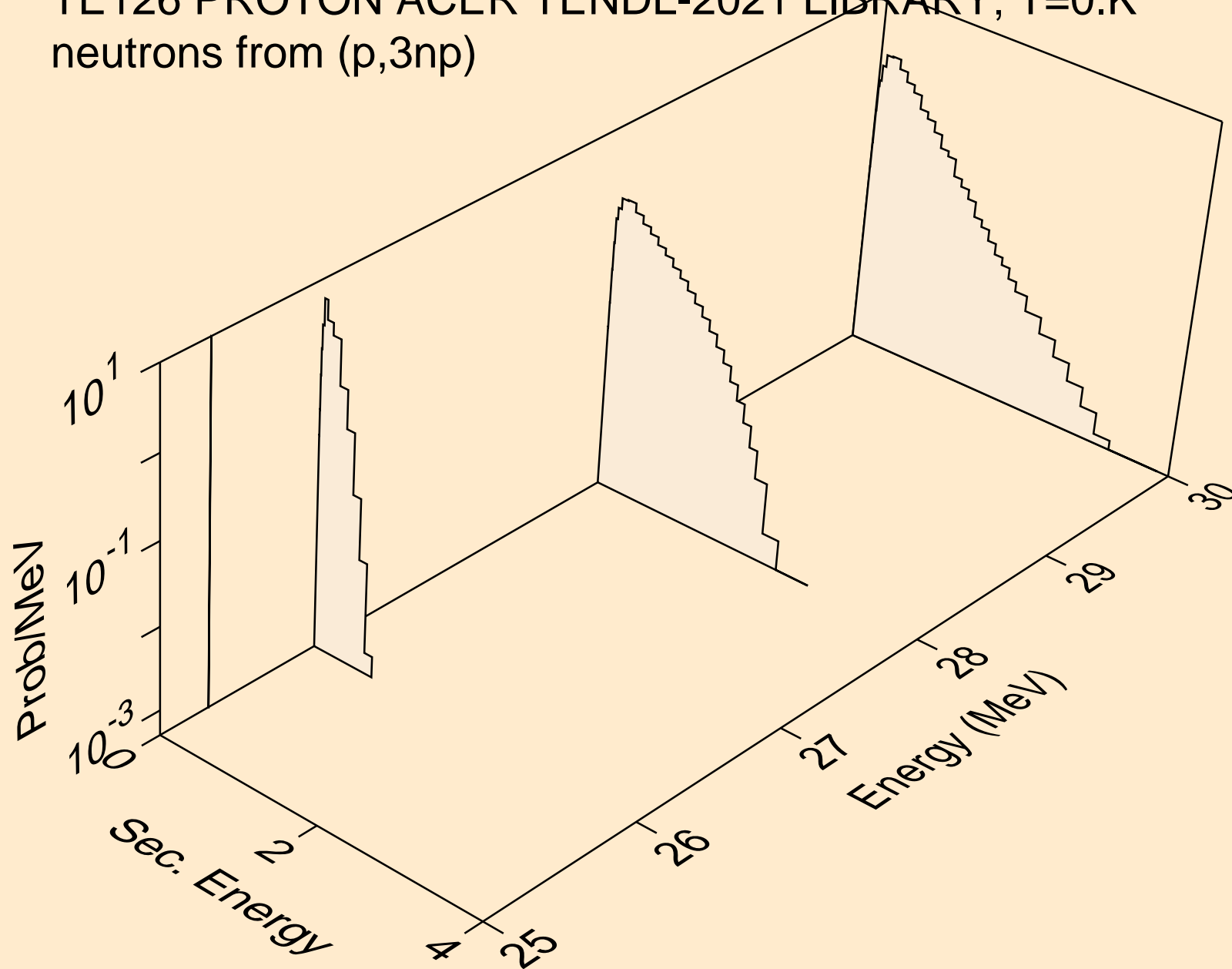

TE126 PROTON ACER TENDL-2021 LIBRARY; T=0.K  
neutrons from (p,2np)

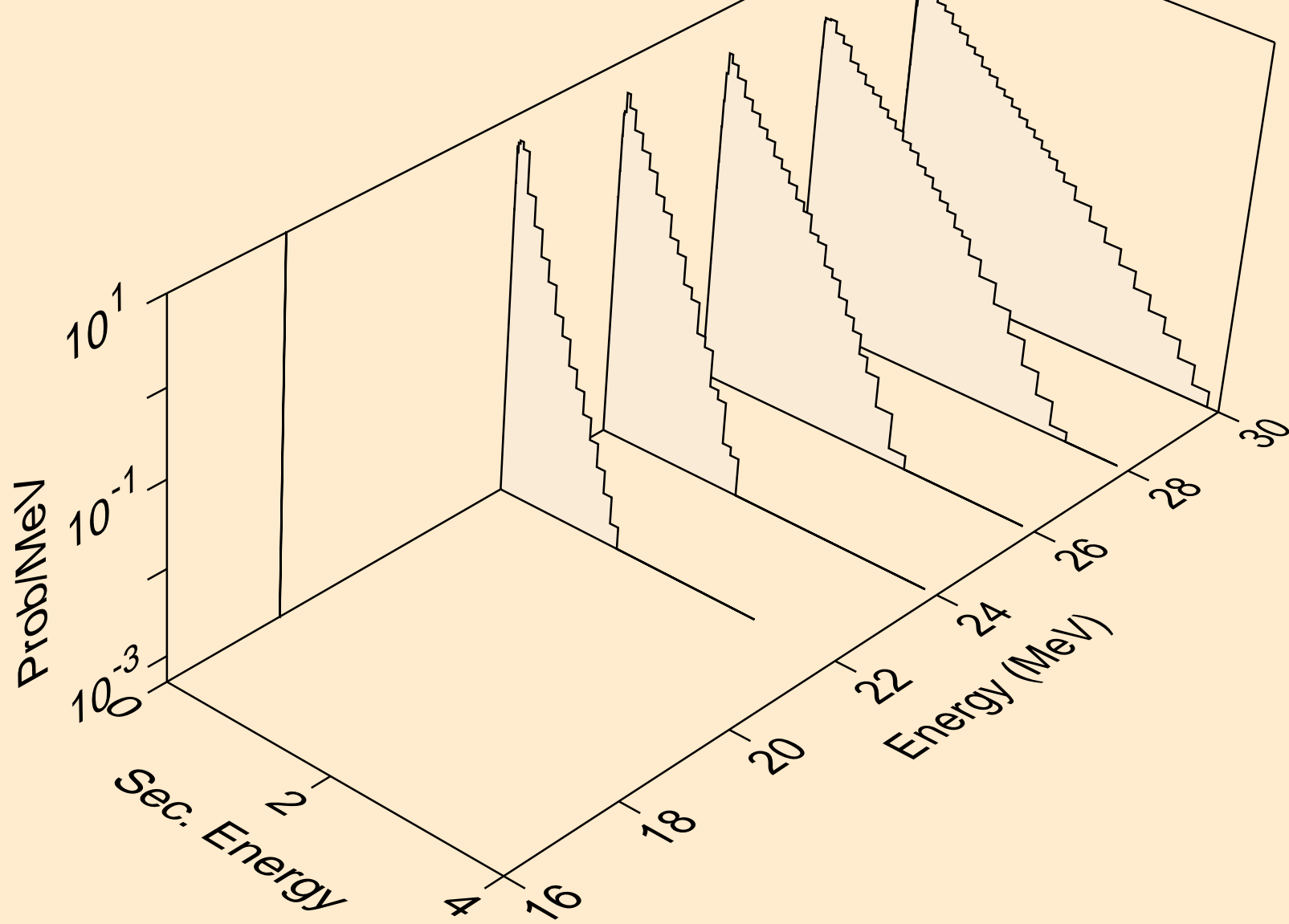

TE126 PROTON ACER TENDL-2021 LIBRARY; T=0.K  
neutrons from (p,npa)

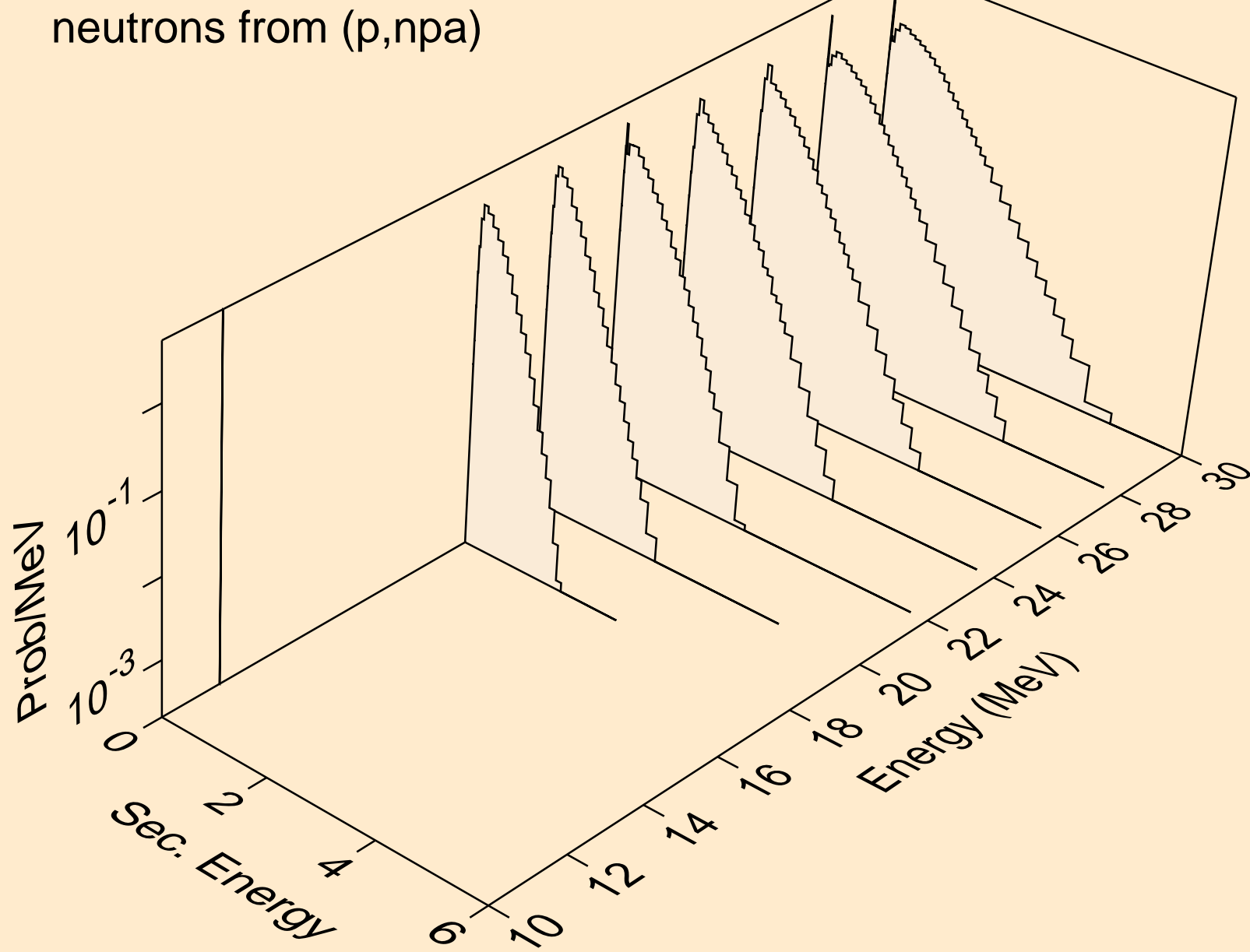

TE126 PROTON ACER TENDL-2021 LIBRARY; T=0.K  
deuterons from (p,x)

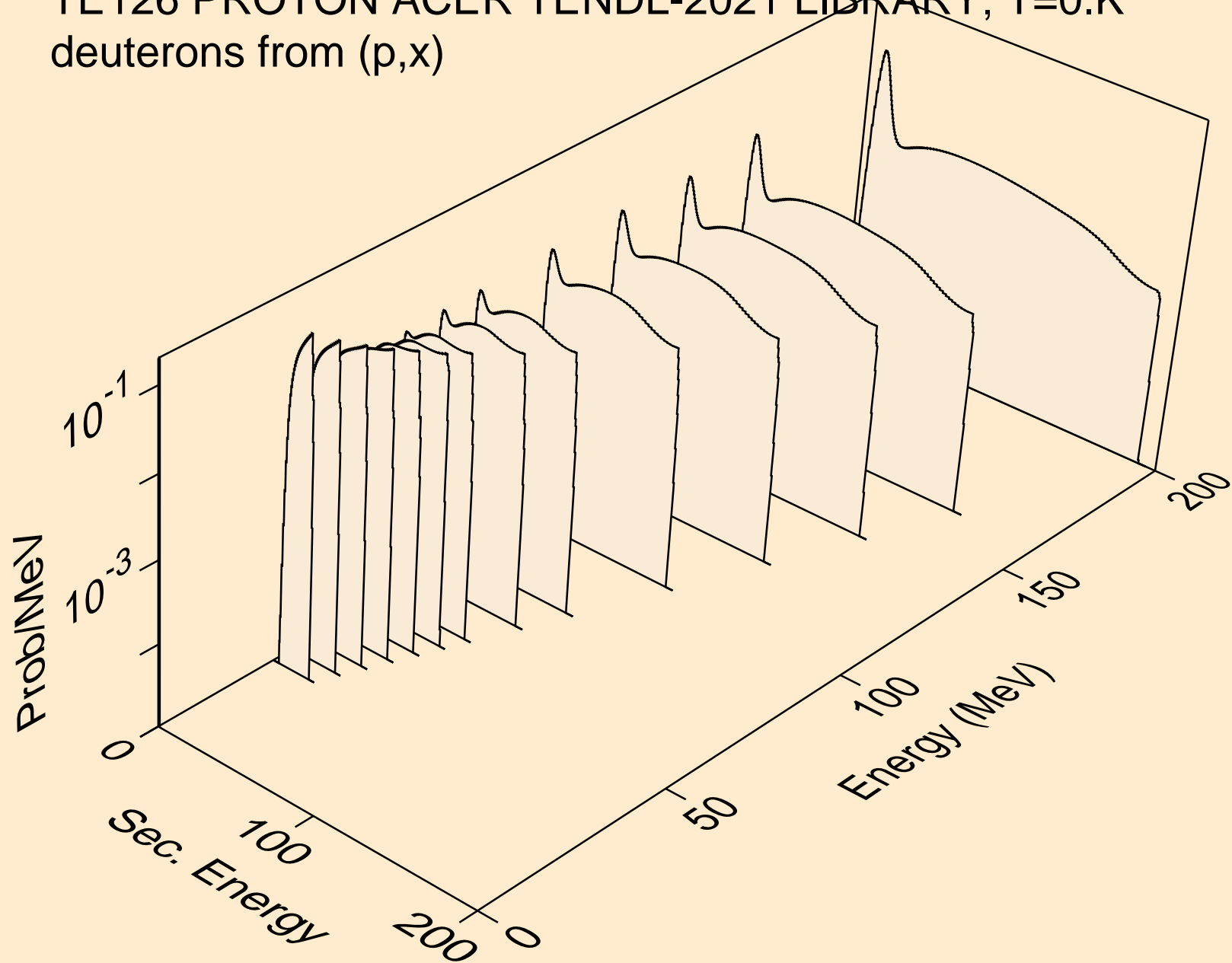

TE126 PROTON ACER TENDL-2021 LIBRARY; T=0.K  
deuterons from (p,2nd)

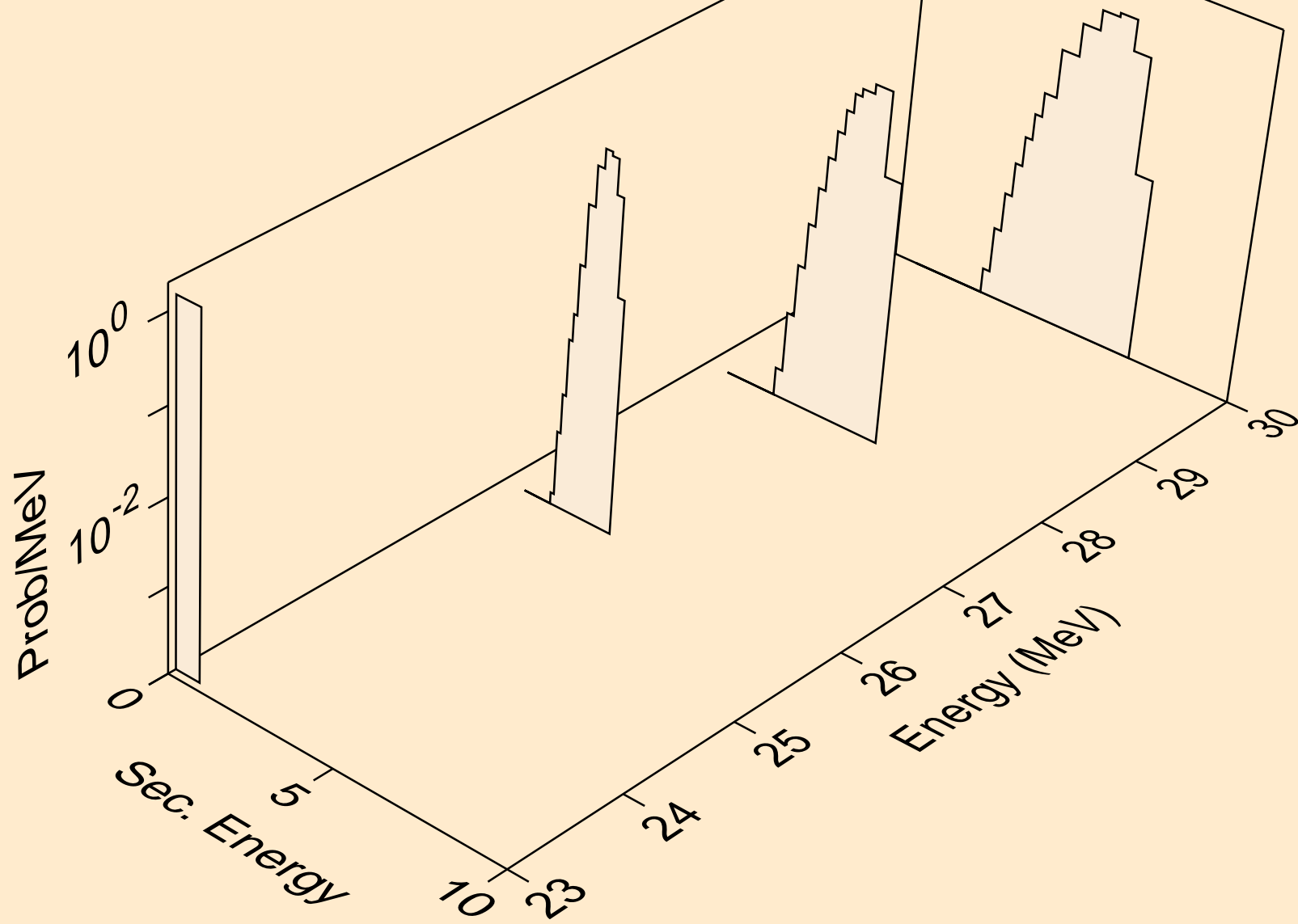

TE126 PROTON ACER TENDL-2021 LIBRARY; T=0.K  
deuterons from (p,n\*)d

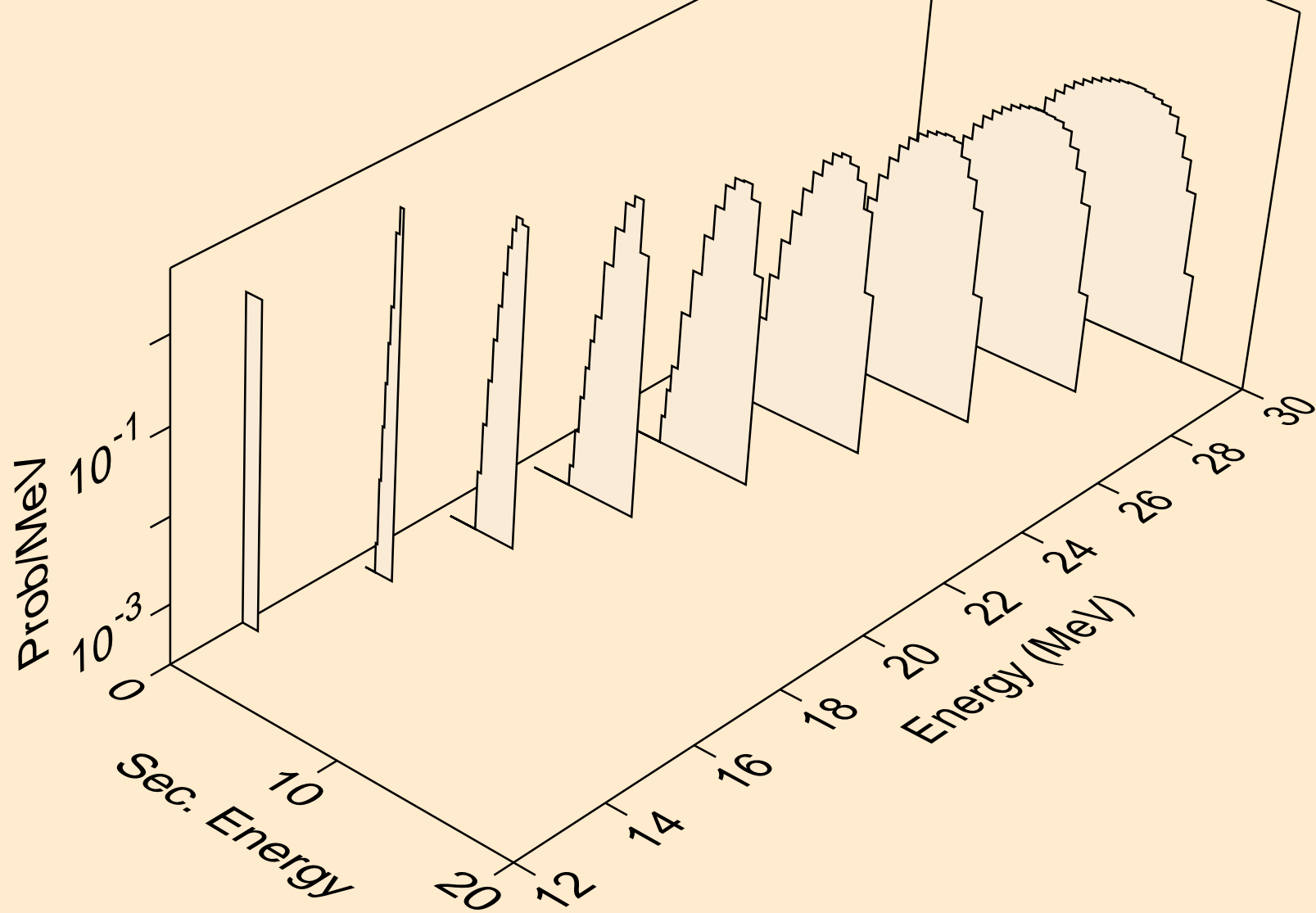



TE126 PROTON ACER TENDL-2021 LIBRARY; T=0.K  
deuterons from (p,d)

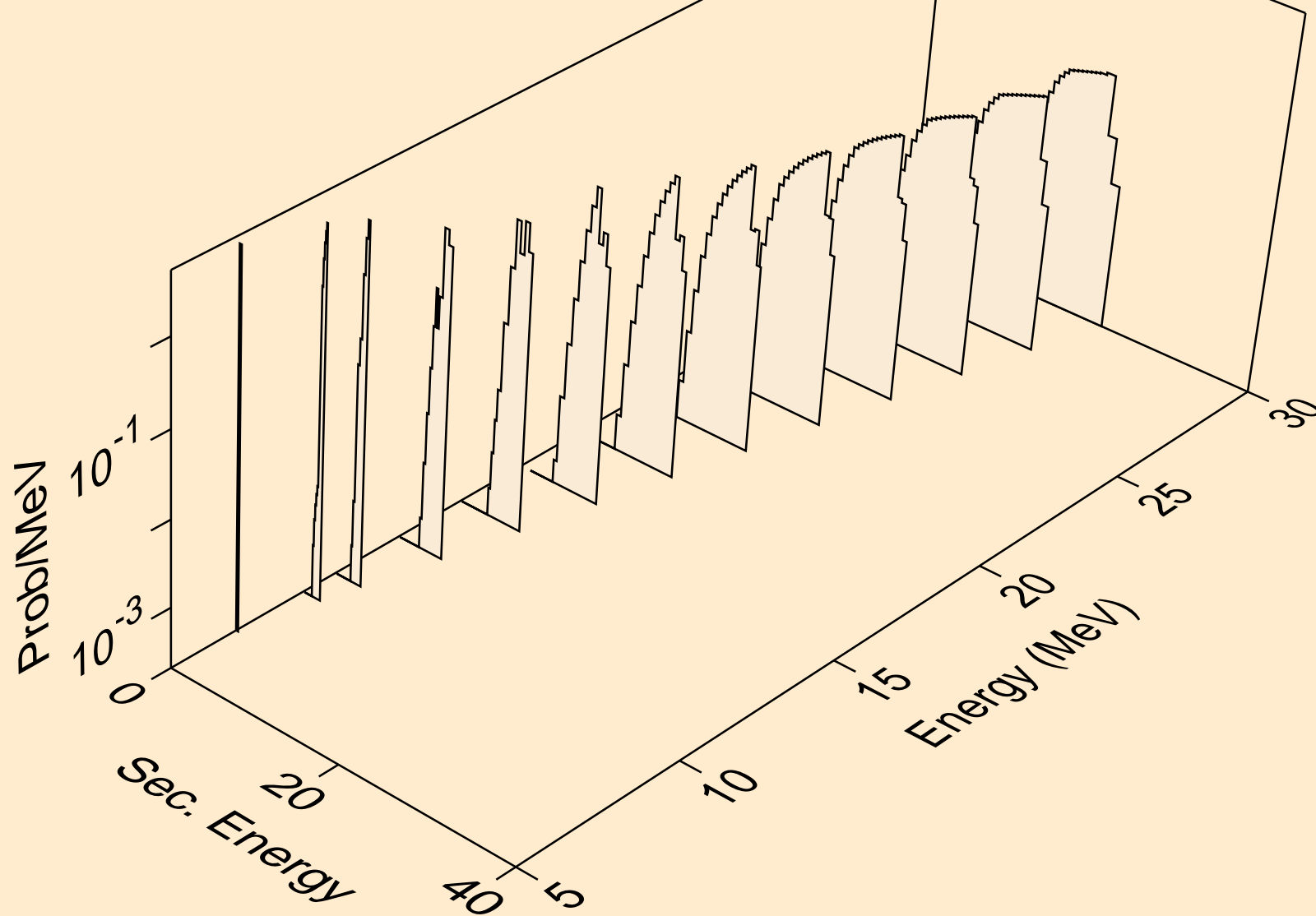

TE126 PROTON ACER TENDL-2021 LIBRARY; T=0.K  
deuterons from (p,pd)

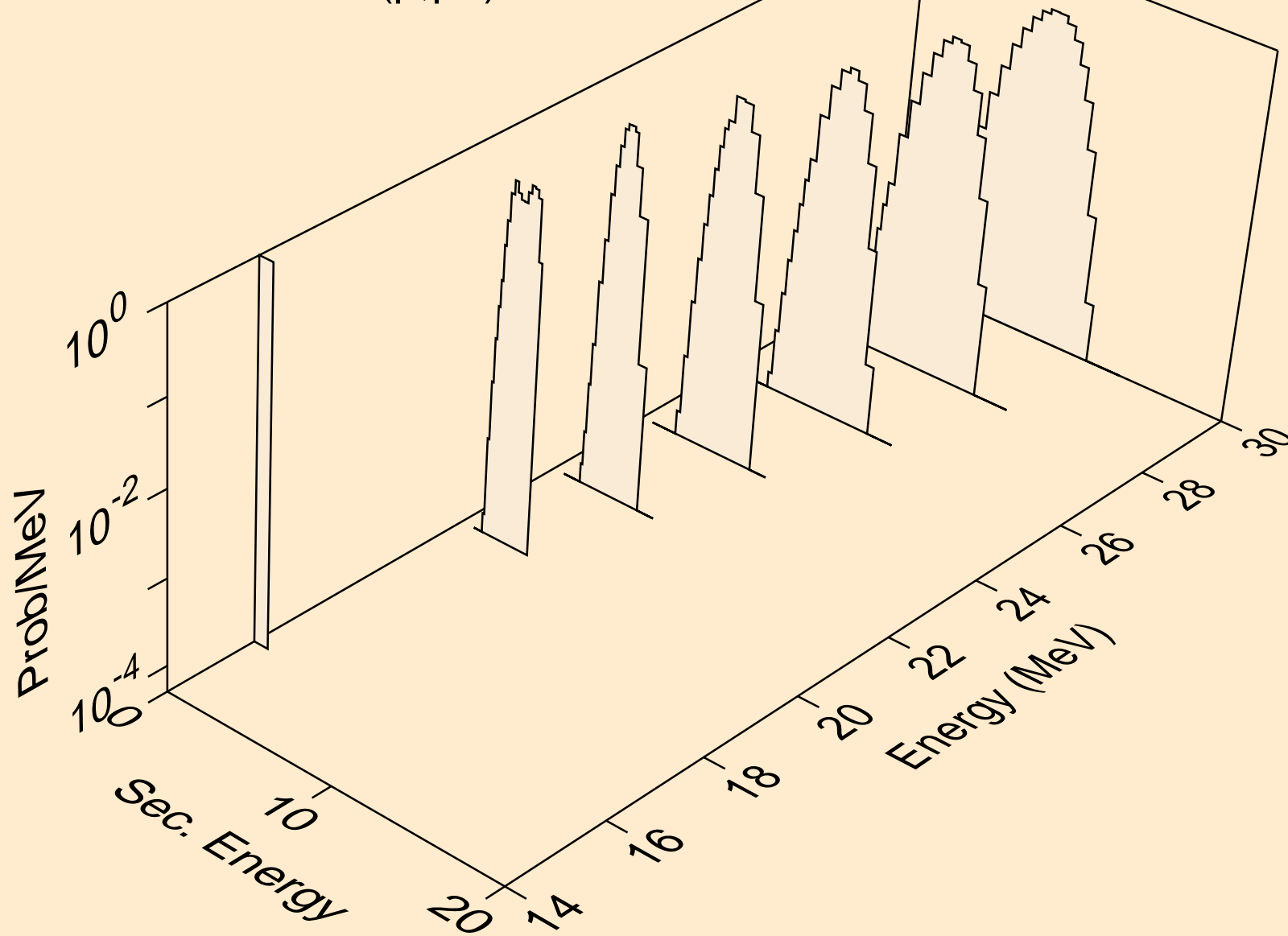

TE126 PROTON ACER TENDL-2021 LIBRARY; T=0.K  
deuterons from (p,da)

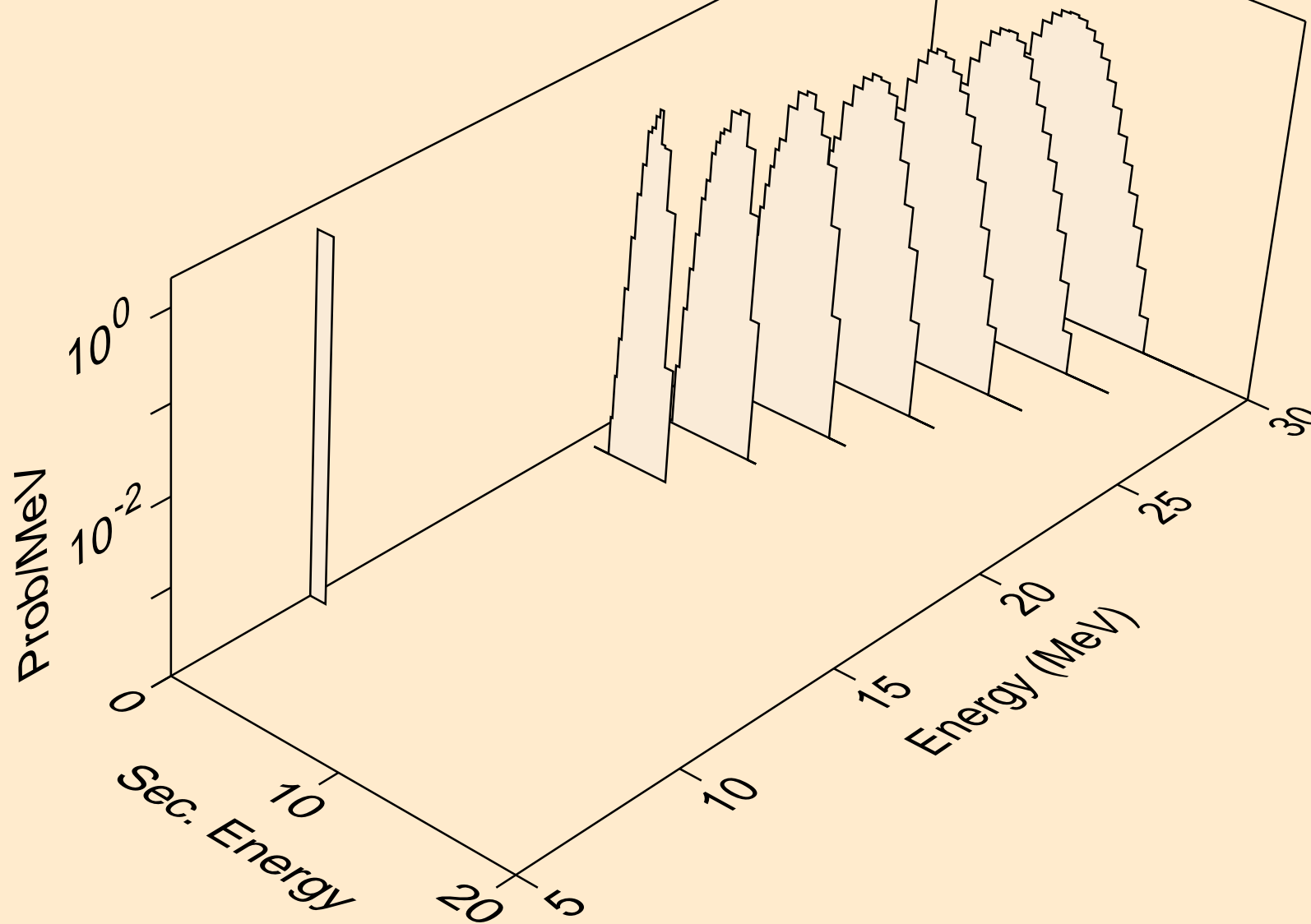

TE126 PROTON ACER TENDL-2021 LIBRARY; T=0.K  
tritons from (p,x)

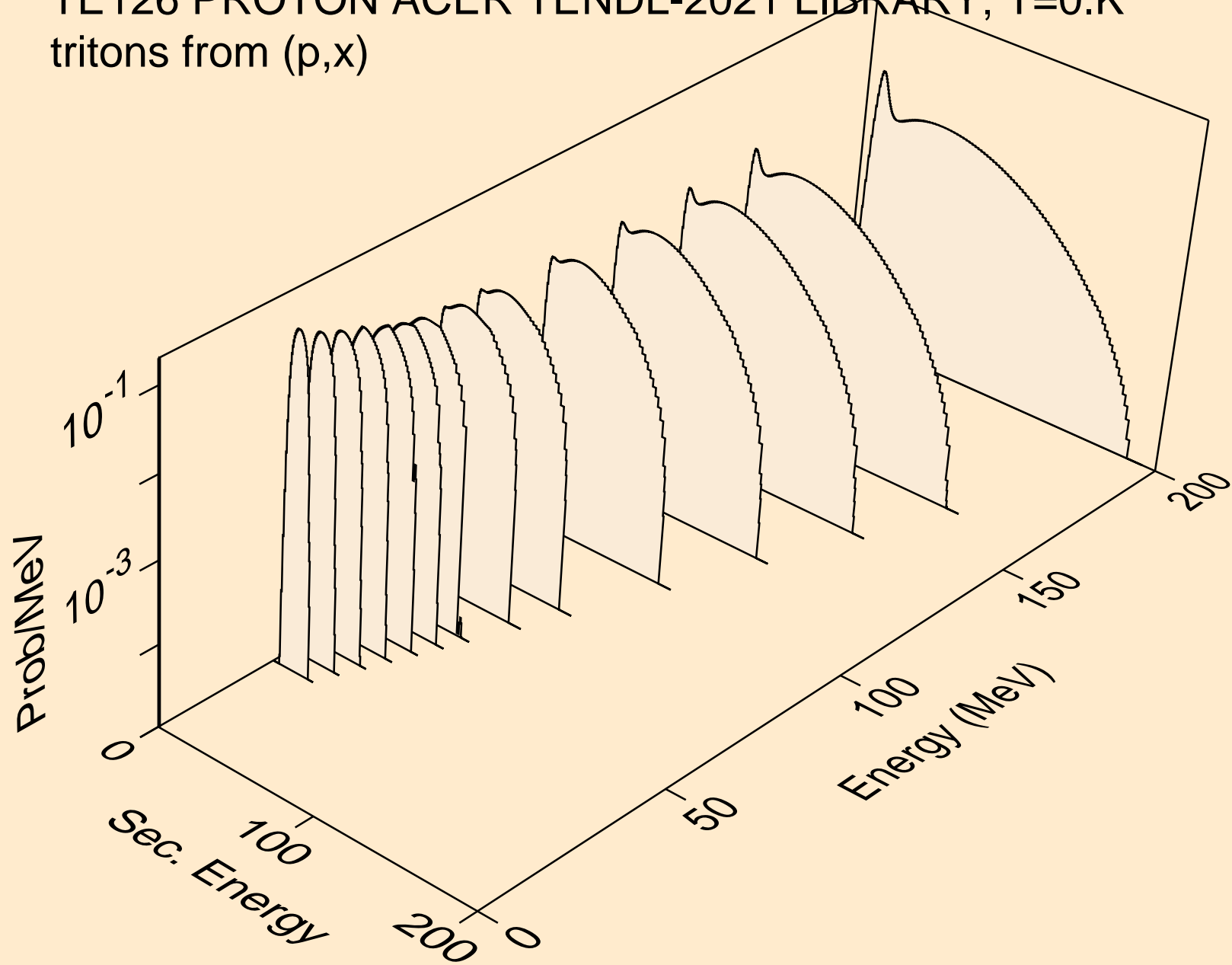

TE126 PROTON ACER TENDL-2021 LIBRARY; T=0.K  
tritons from (p,n\*)t

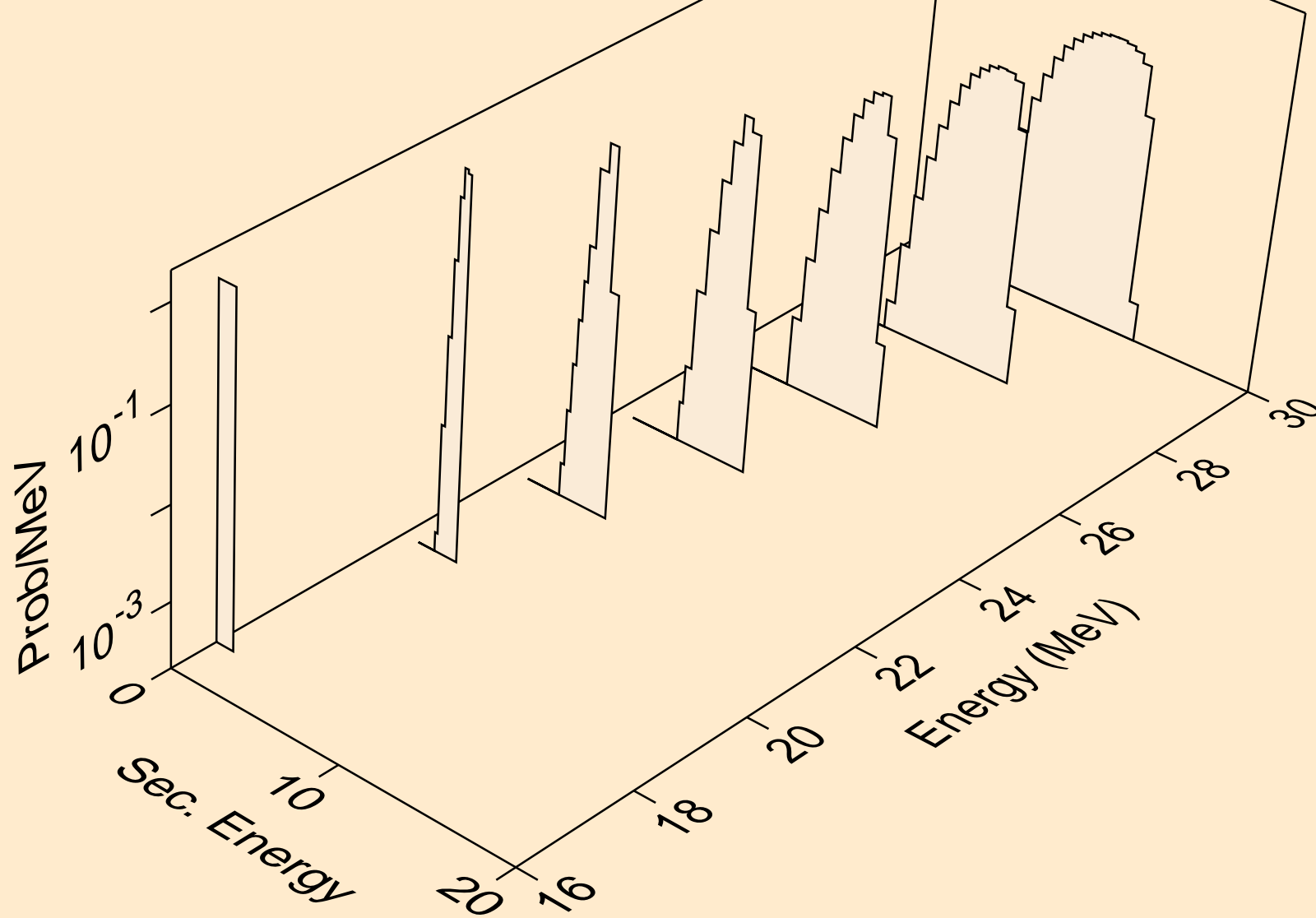

TE126 PROTON ACER TENDL-2021 LIBRARY; T=0.K  
tritons from (p,t)

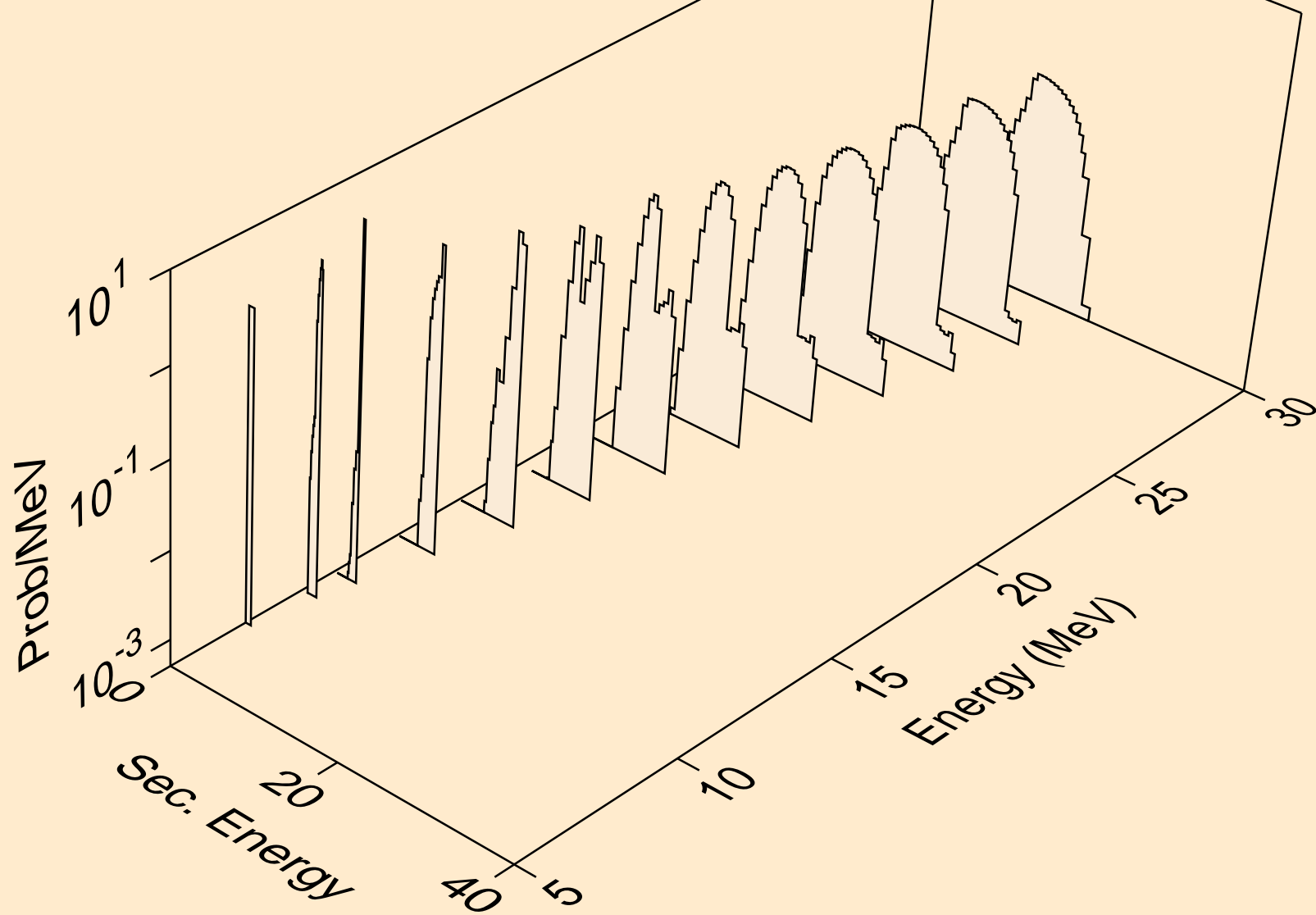

TE126 PROTON ACER TENDL-2021 LIBRARY; T=0.K  
tritons from (p,pt)

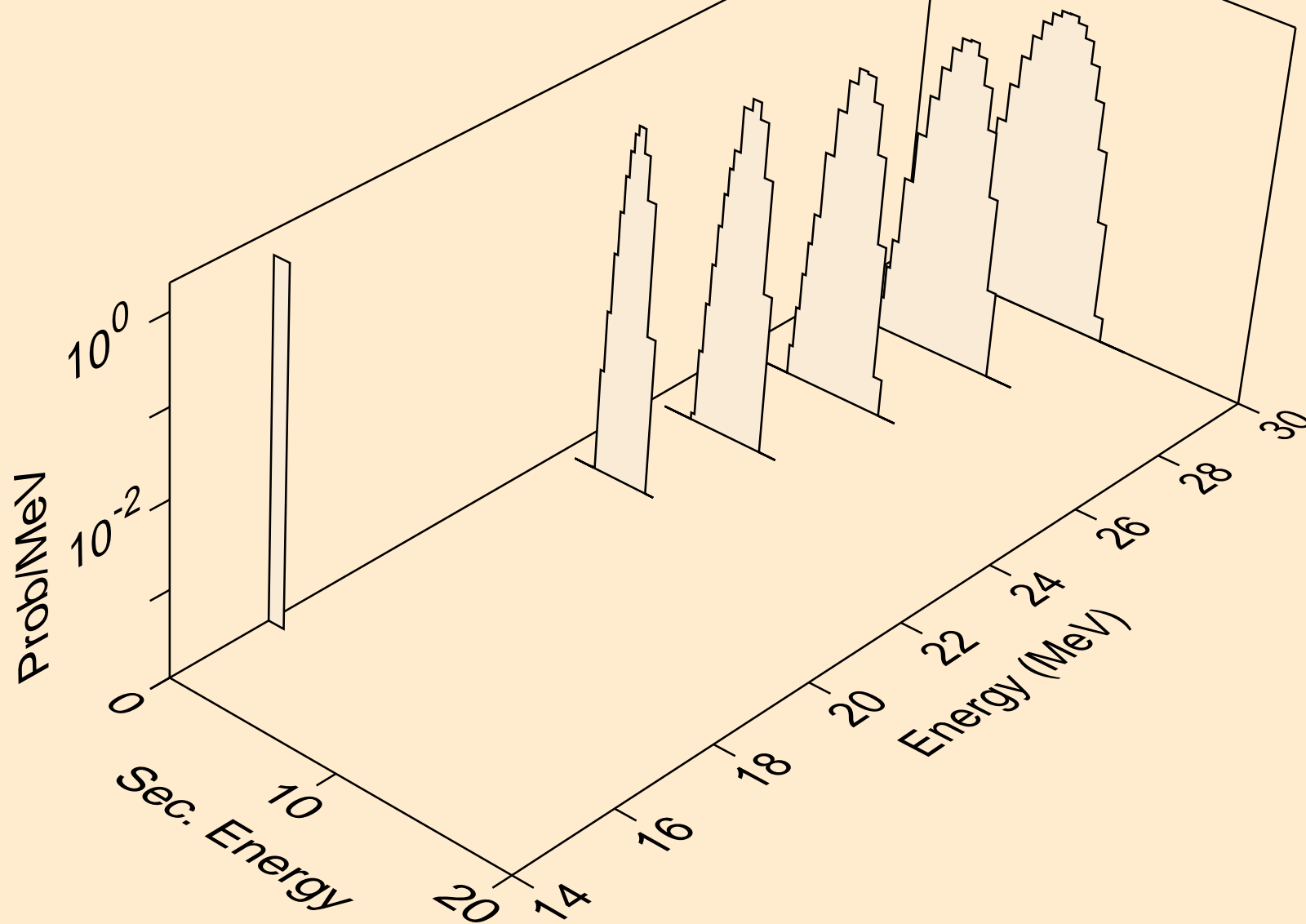

TE126 PROTON ACER TENDL-2021 LIBRARY; T=0.K  
he3s from (p,x)

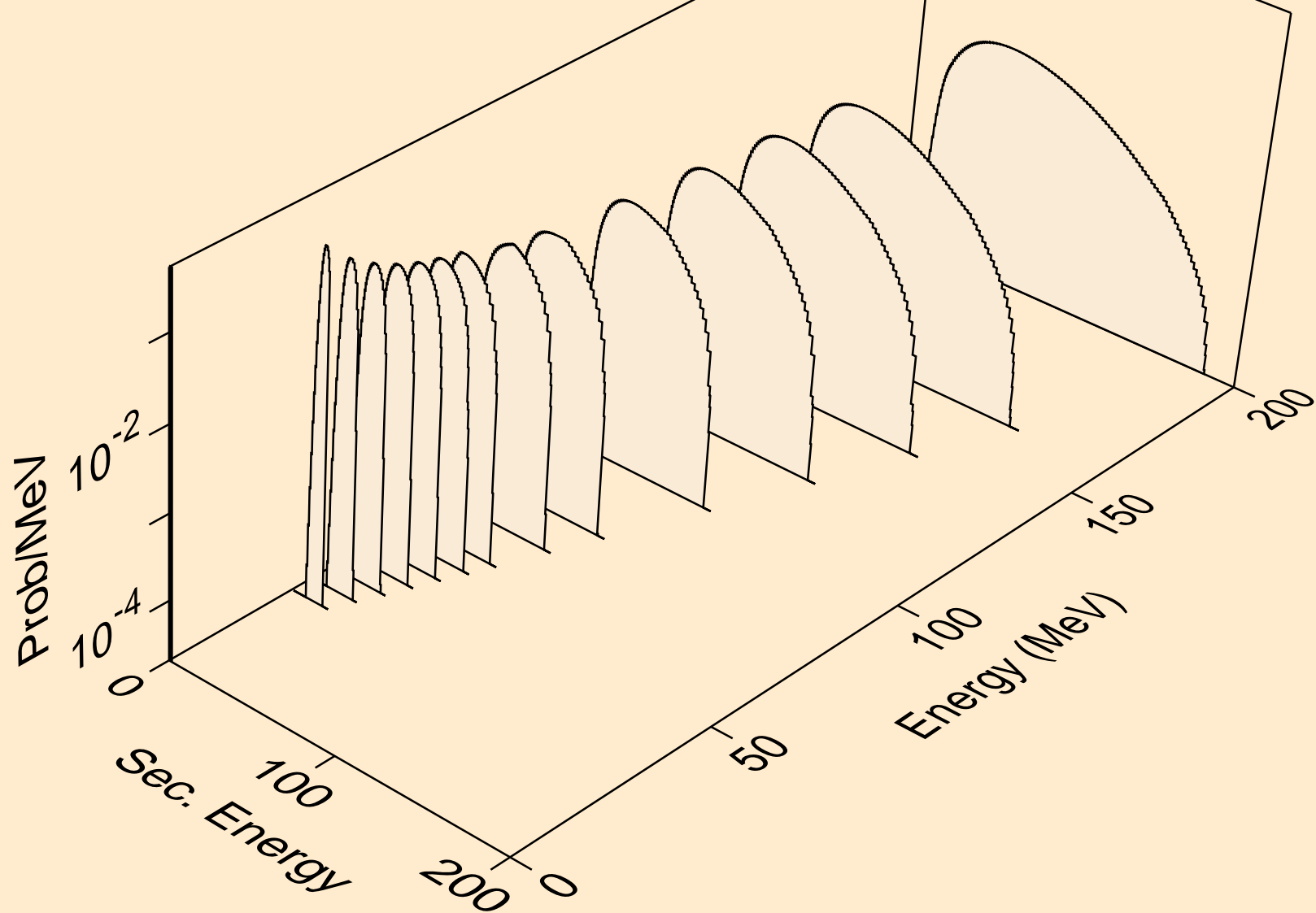



TE126 PROTON ACER TENDL-2021 LIBRARY; T=0.K  
he3s from (p,n\*)he3

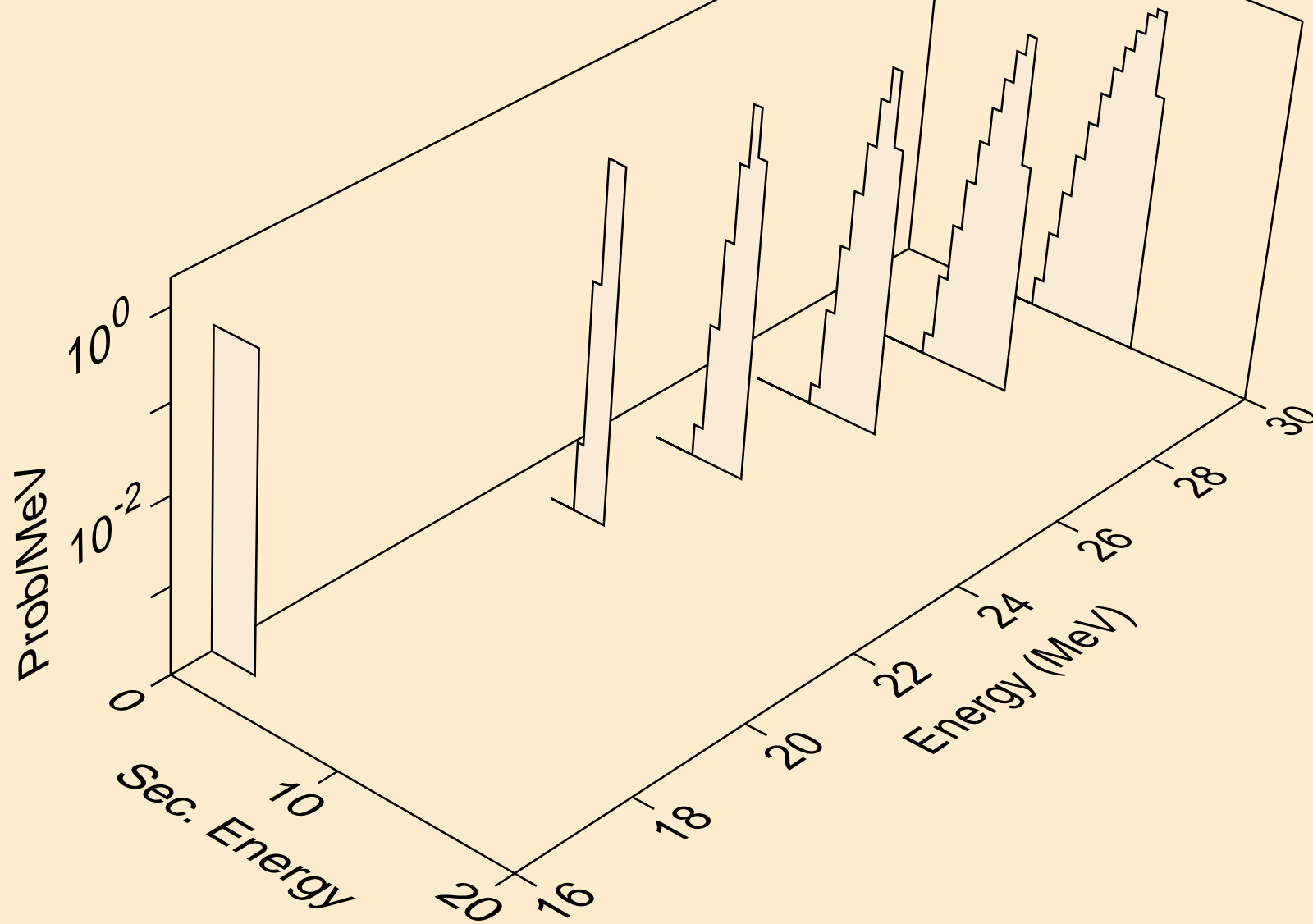

TE126 PROTON ACER TENDL-2021 LIBRARY; T=0.K  
he3s from (p,he3)

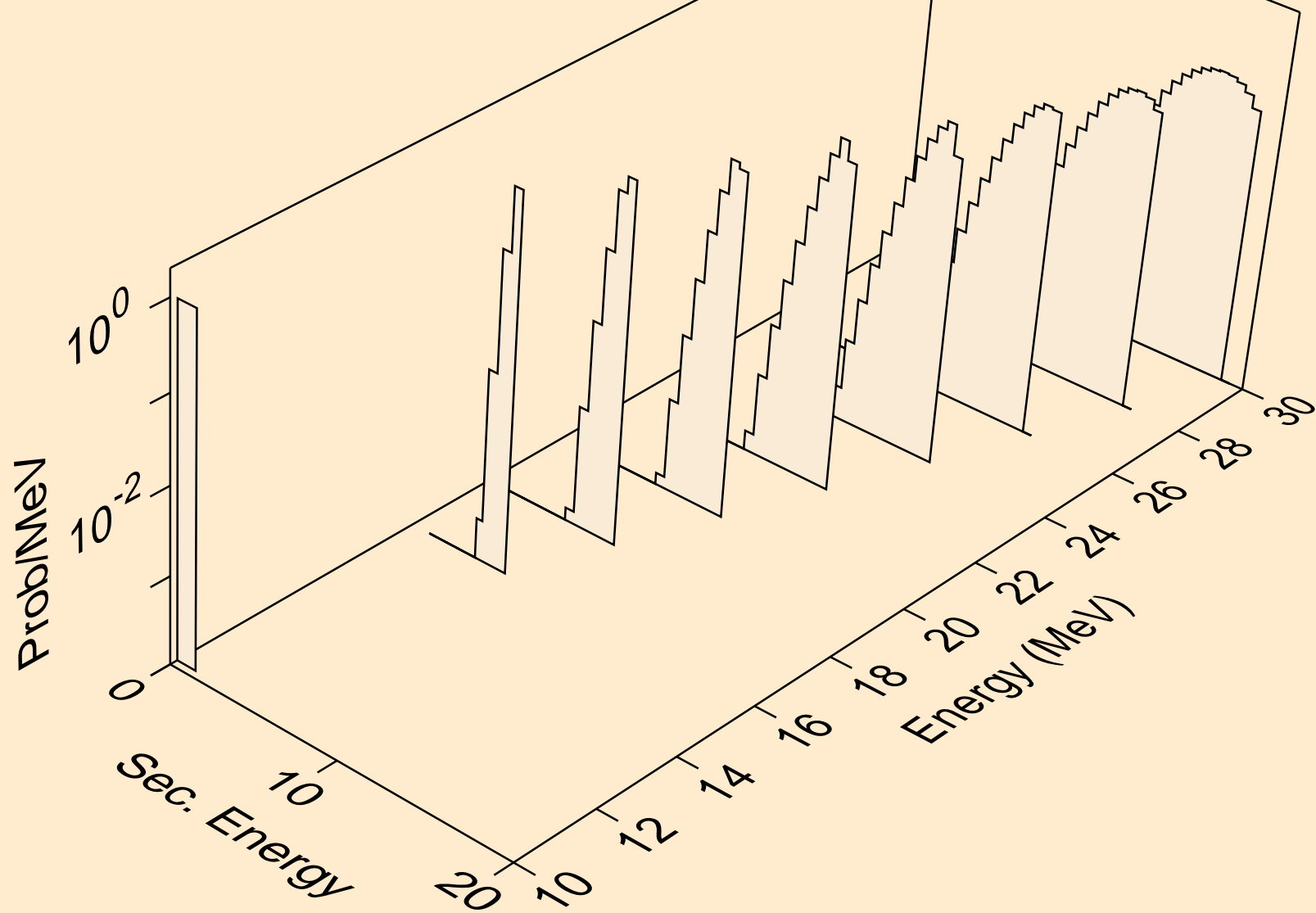

TE126 PROTON ACER TENDL-2021 LIBRARY; T=0.K  
alphas from (p,x)

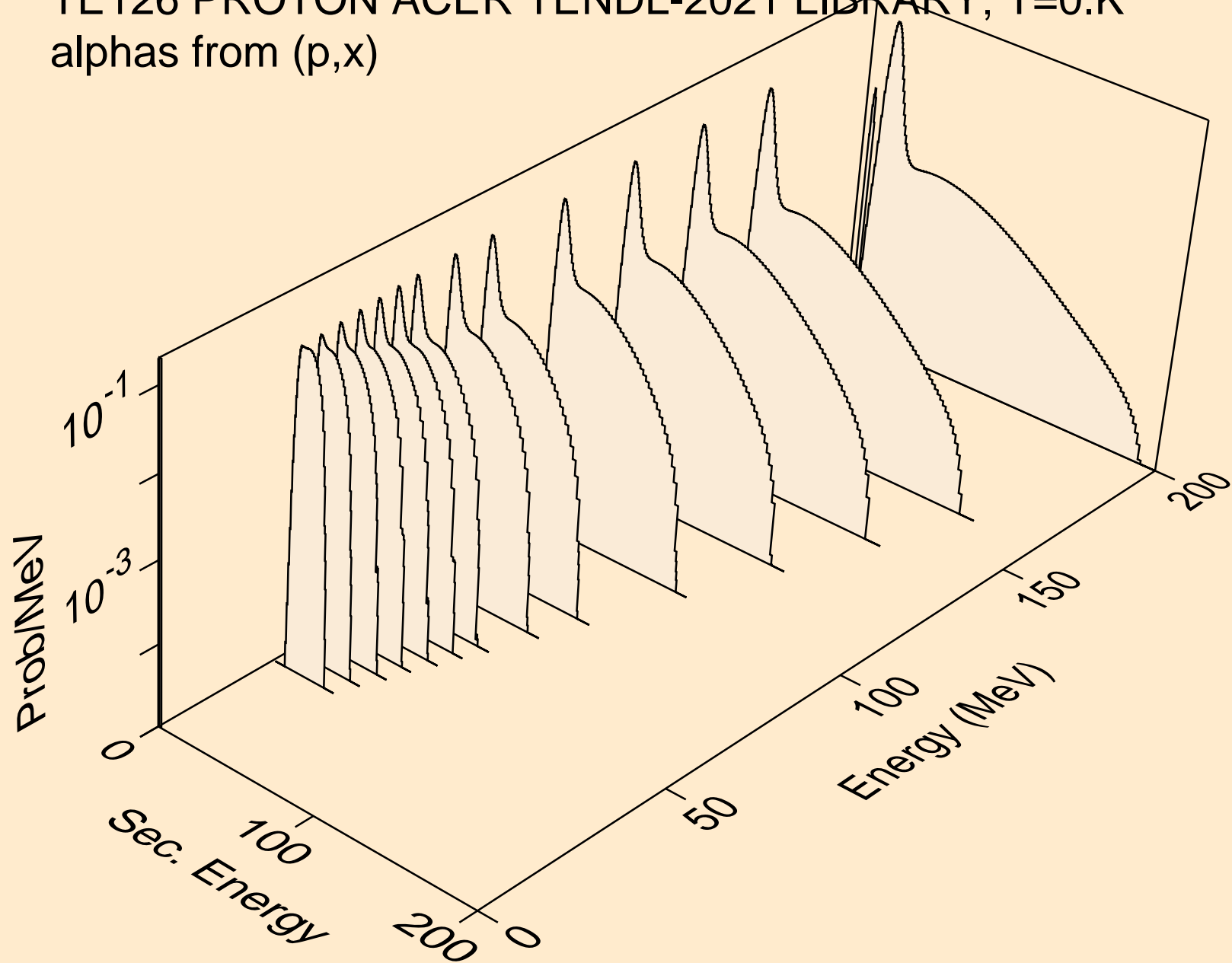

TE126 PROTON ACER TENDL-2021 LIBRARY; T=0.K  
alphas from (p,n\*)a

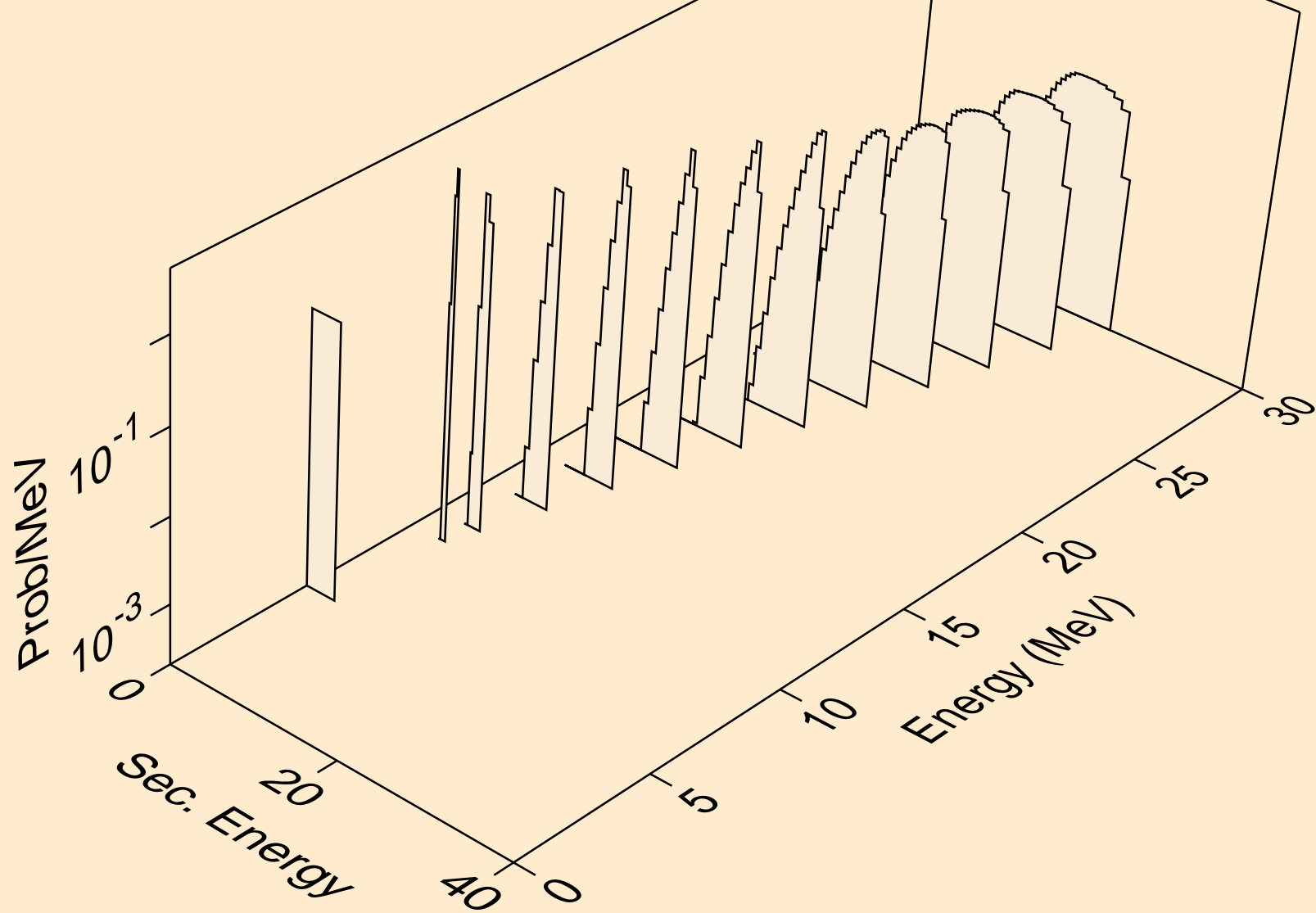

TE126 PROTON ACER TENDL-2021 LIBRARY; T=0.K  
alphas from (p,2n)a

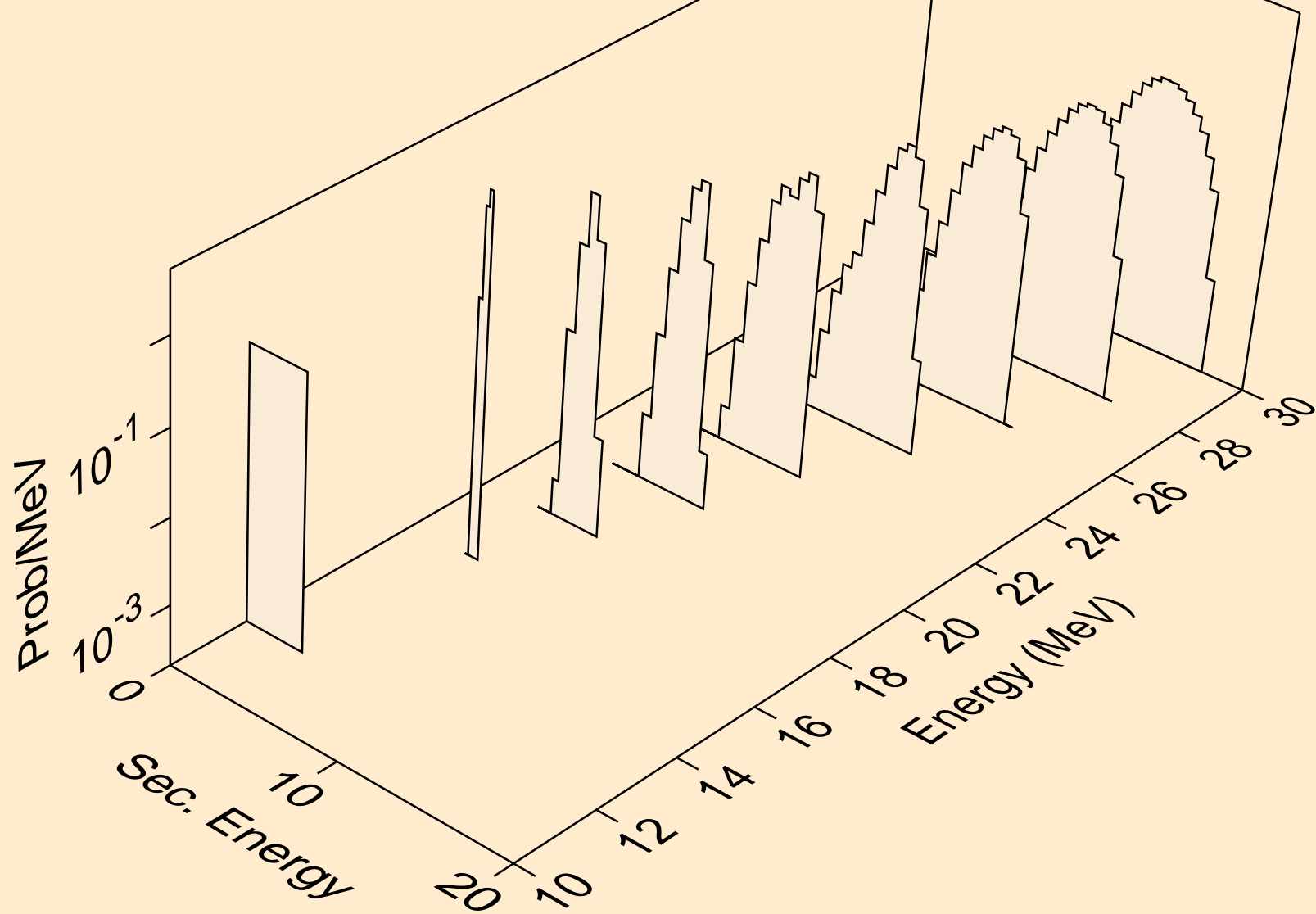

TE126 PROTON ACER TENDL-2021 LIBRARY; T=0.K  
alphas from (p,3n)a

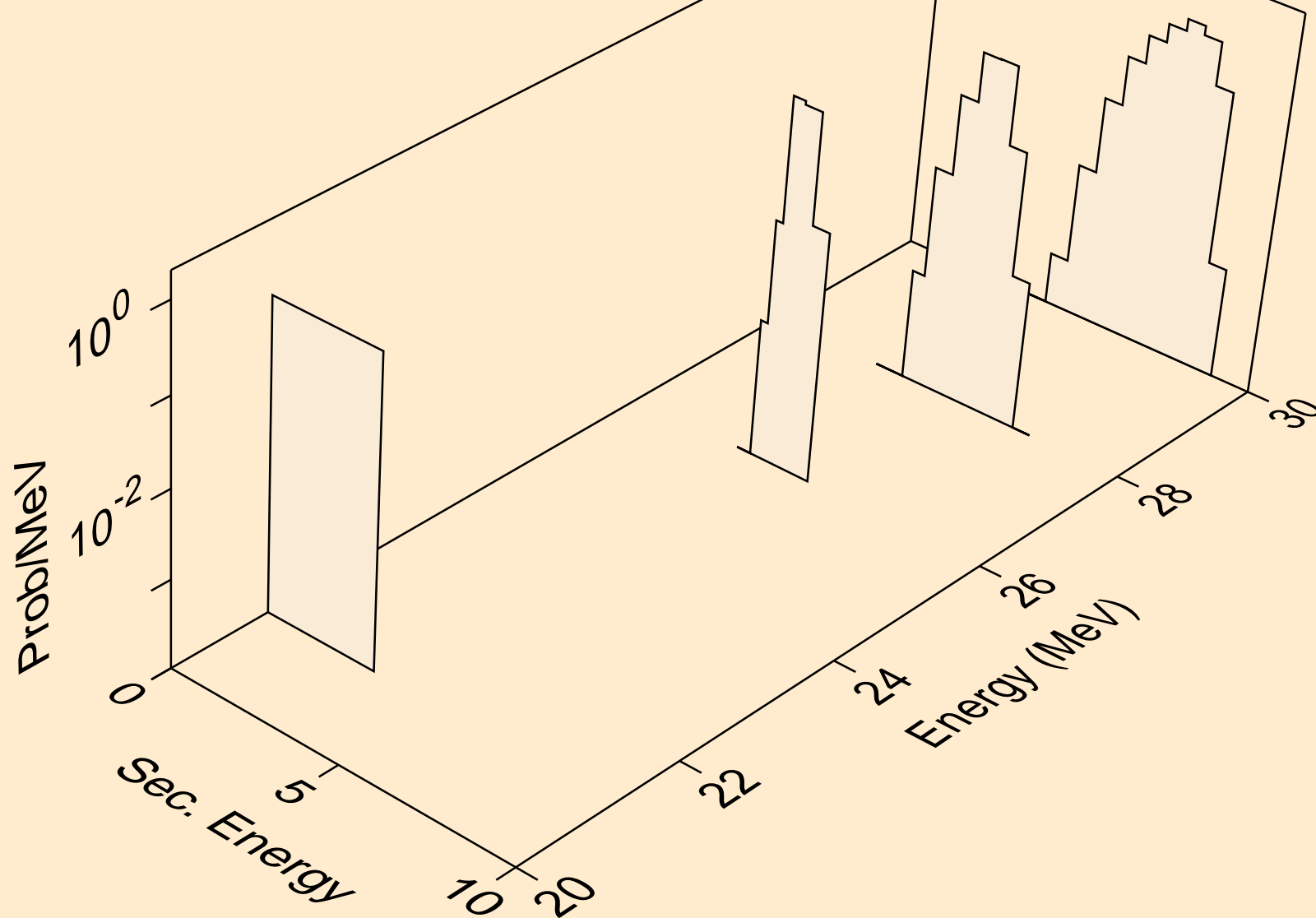

TE126 PROTON ACER TENDL-2021 LIBRARY; T=0.K  
alphas from (p,npa)

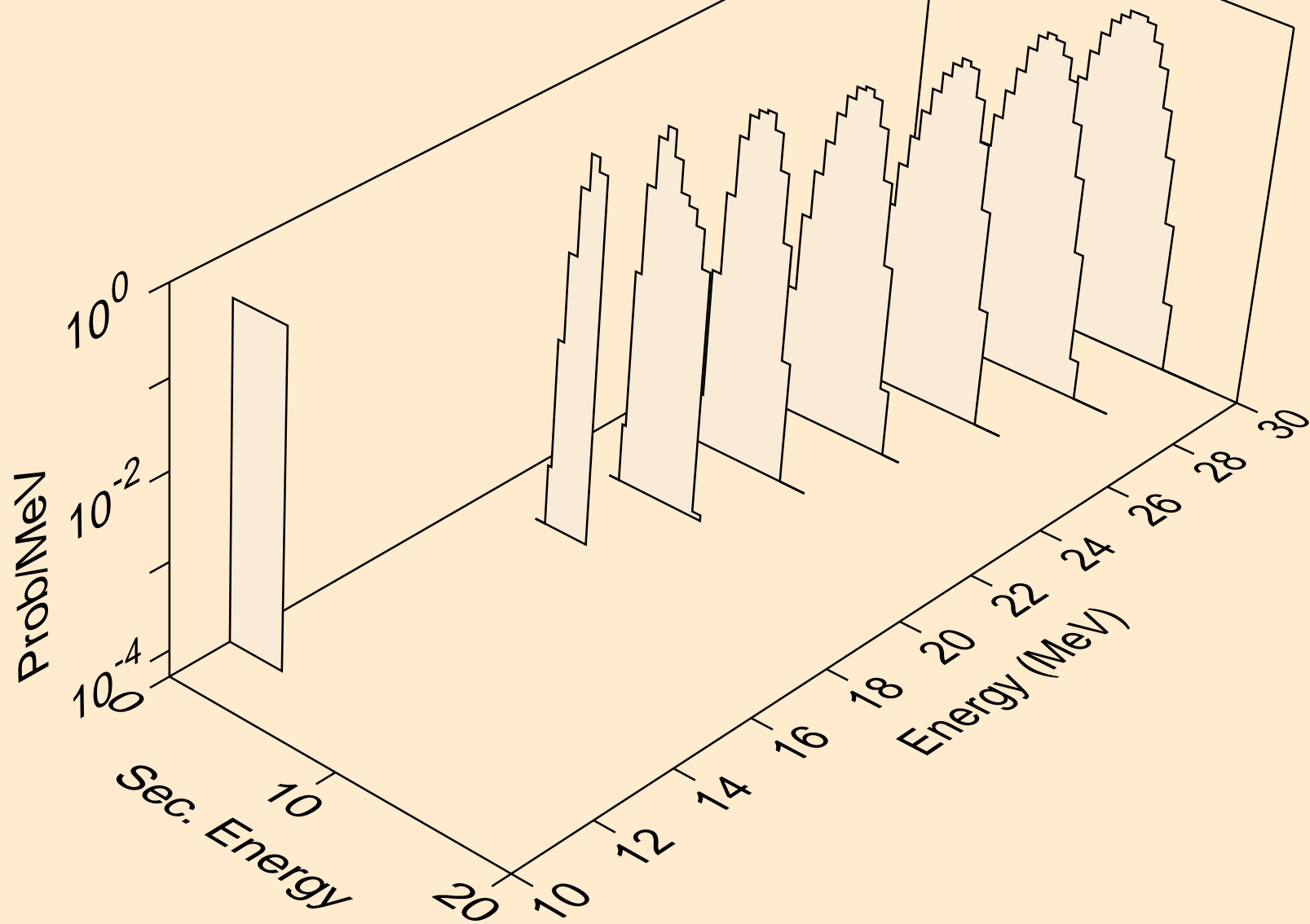

TE126 PROTON ACER TENDL-2021 LIBRARY; T=0.K  
alphas from (p,a)

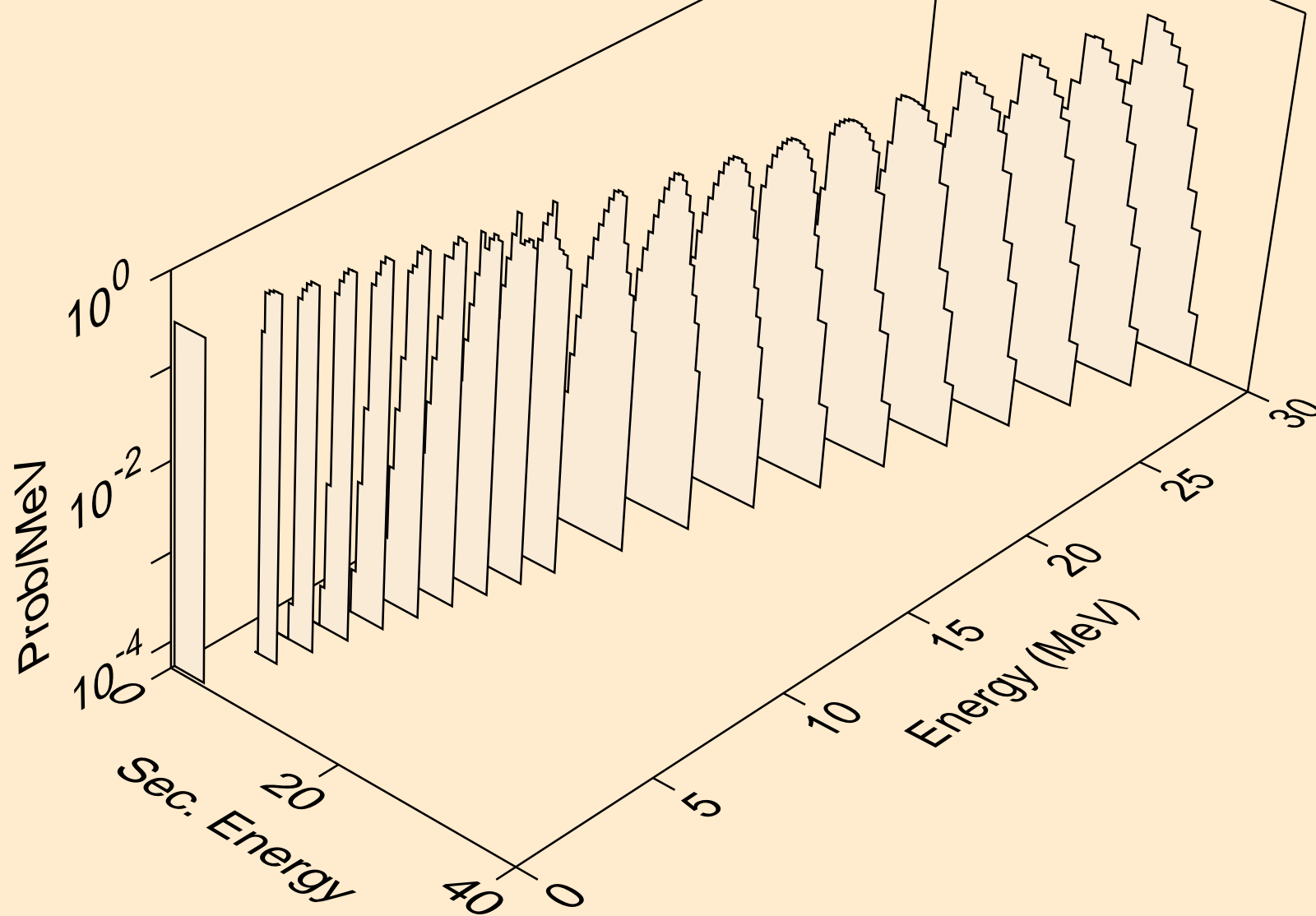



TE126 PROTON ACER TENDL-2021 LIBRARY; T=0.K  
alphas from (p,2a)

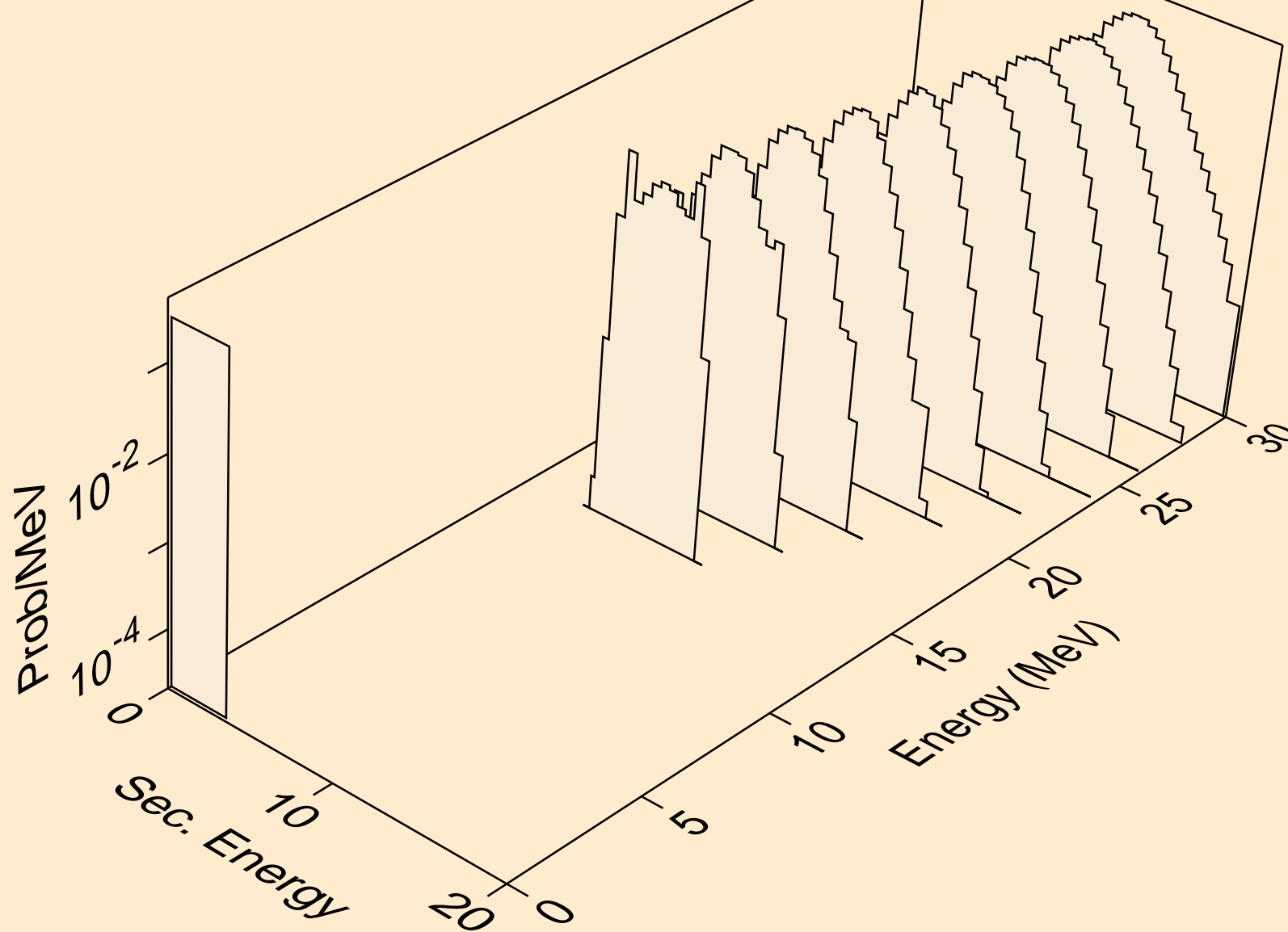

TE126 PROTON ACER TENDL-2021 LIBRARY; T=0.K  
alphas from (p,pa)

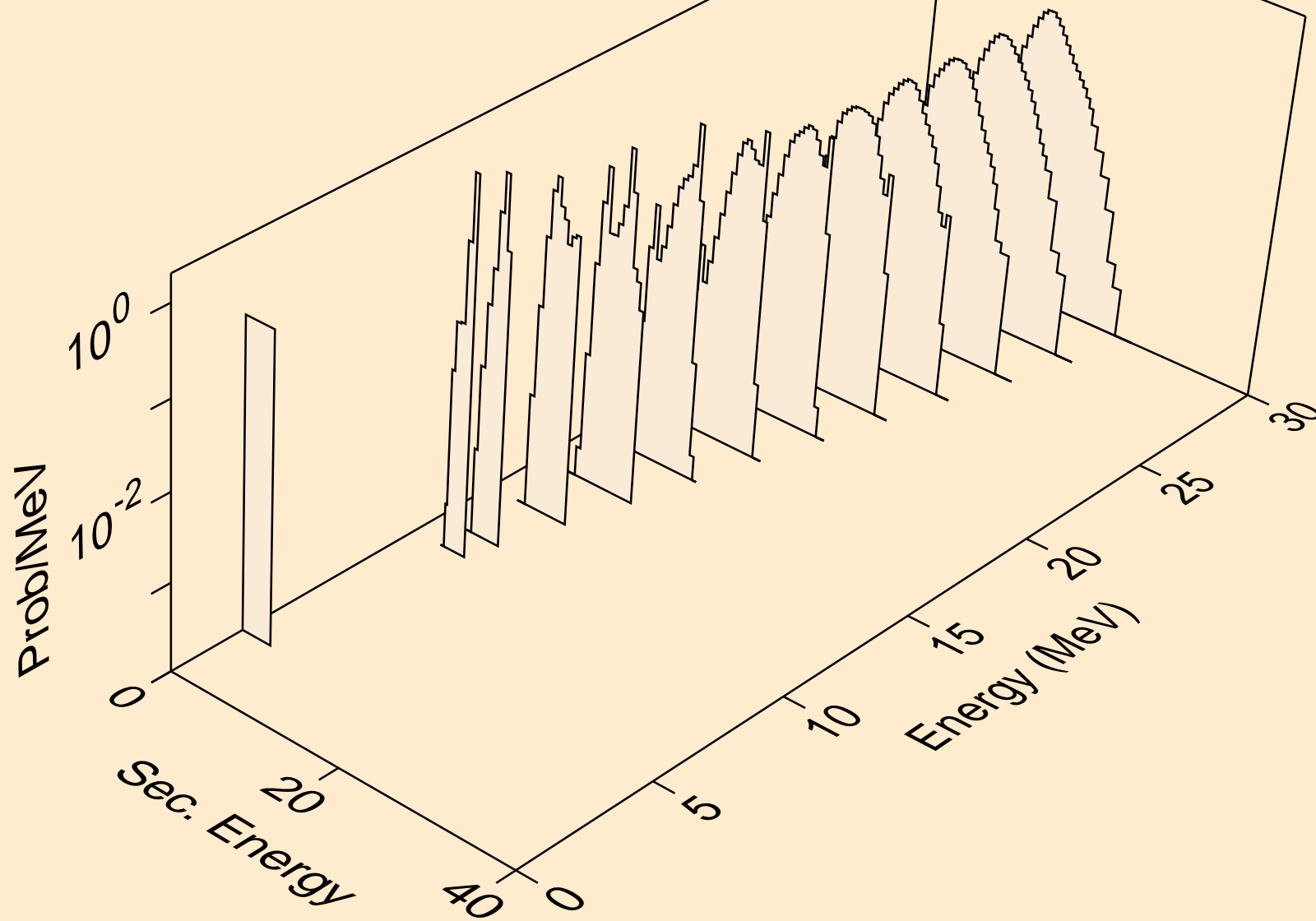

TE126 PROTON ACER TENDL-2021 LIBRARY; T=0.K  
alphas from (p,da)

