

TH232 PROTON ACER TENDL-2021 LIBRARY; T=0.K  
Principal cross sections

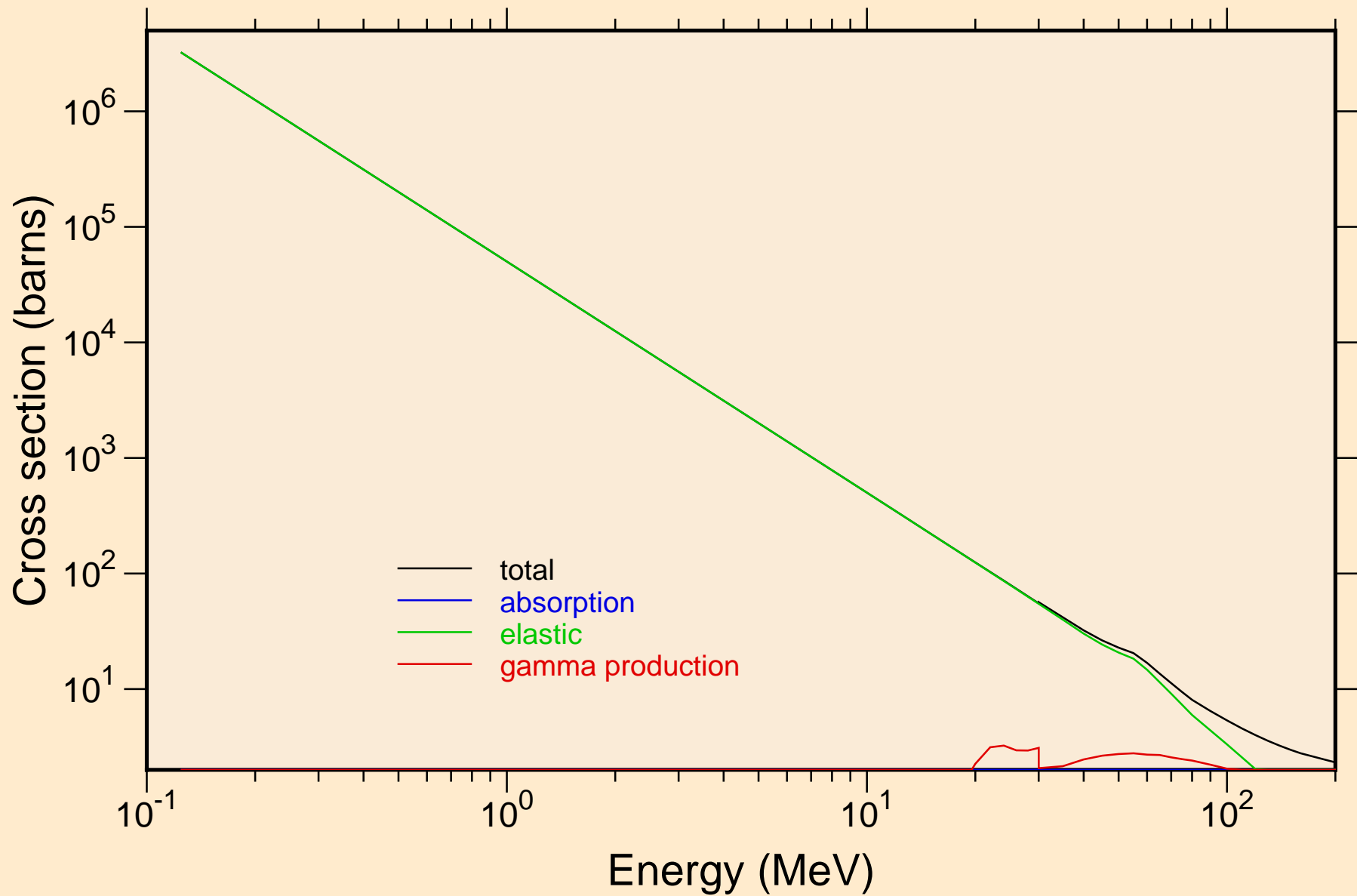

# TH232 PROTON ACER TENDL-2021 LIBRARY; T=0.K

## Heating

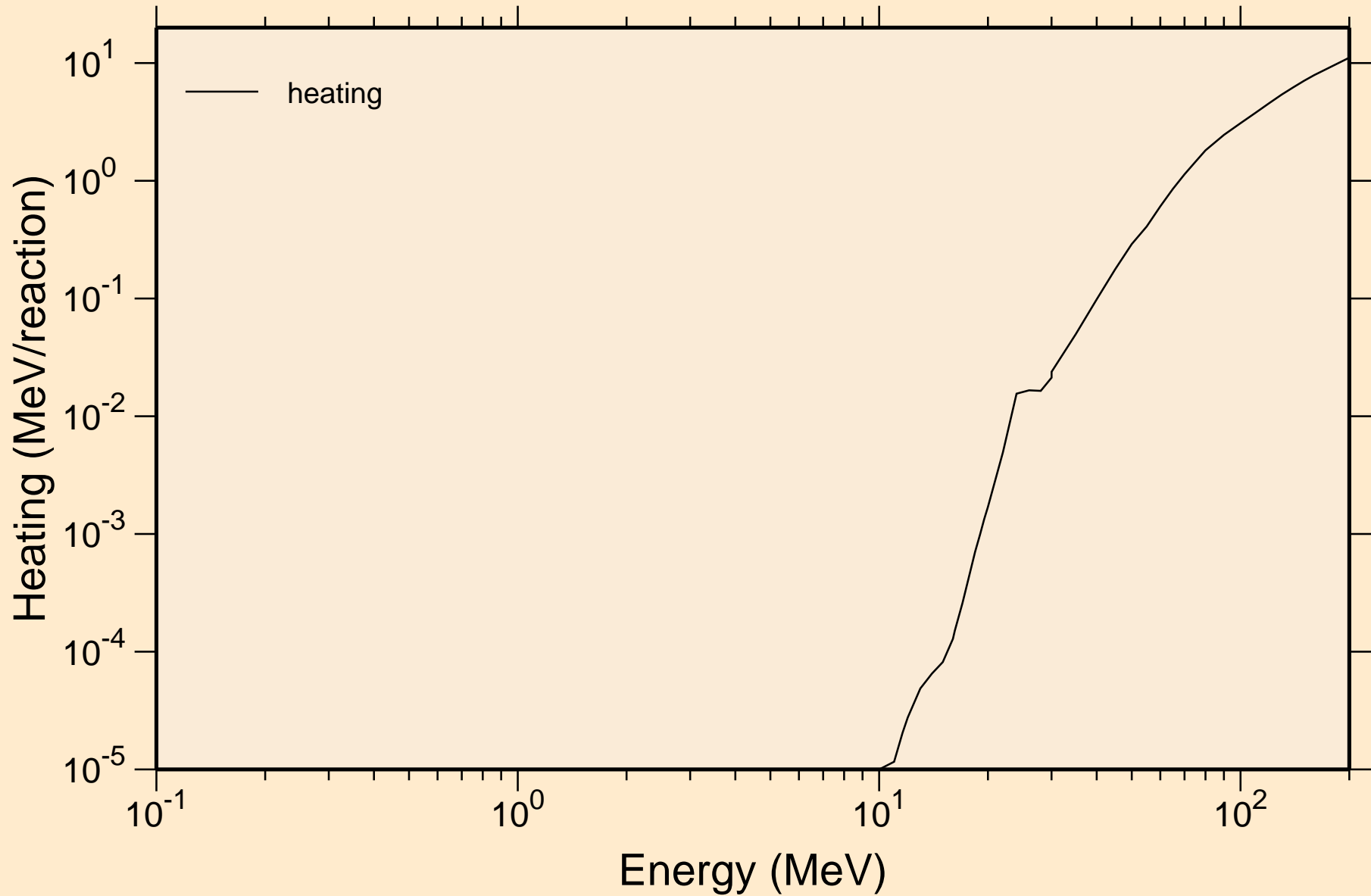

# TH232 PROTON ACER TENDL-2021 LIBRARY; T=0.K

## Principal cross sections

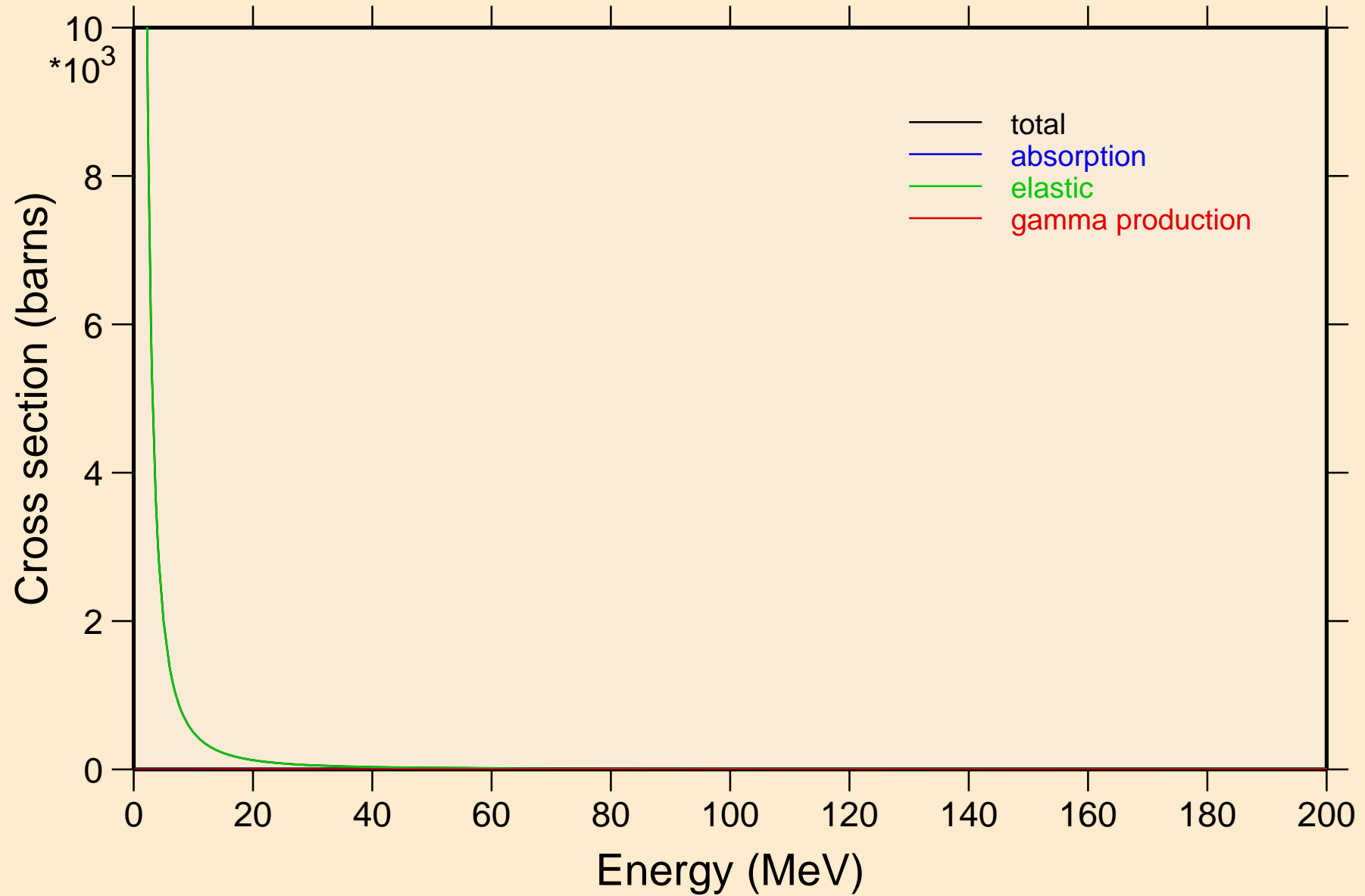

TH232 PROTON ACER TENDL-2021 LIBRARY; T=0.K

Heating

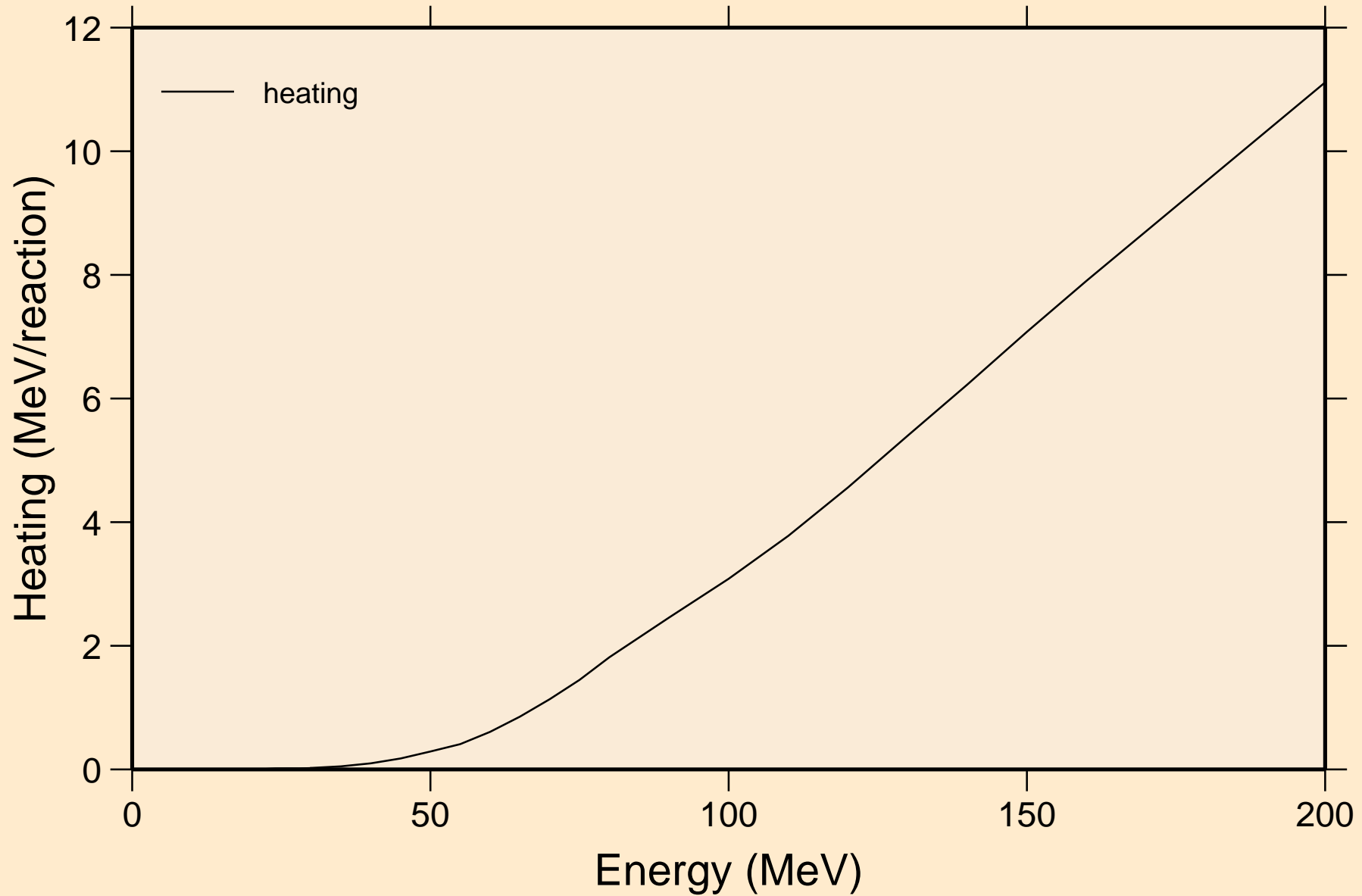

TH232 PROTON ACER TENDL-2021 LIBRARY; T=0.K  
Threshold reactions

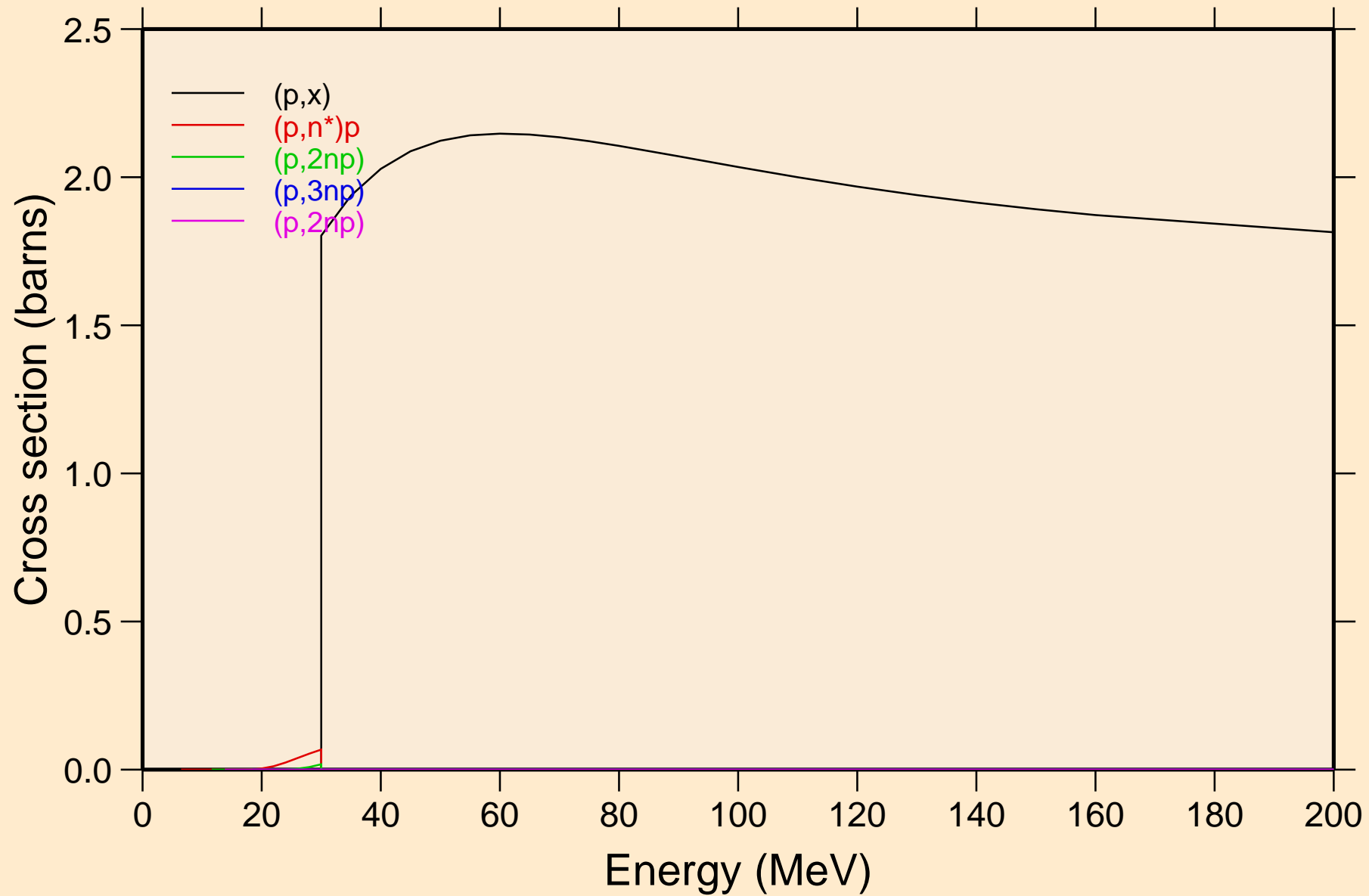

TH232 PROTON ACER TENDL-2021 LIBRARY; T=0.K  
Threshold reactions

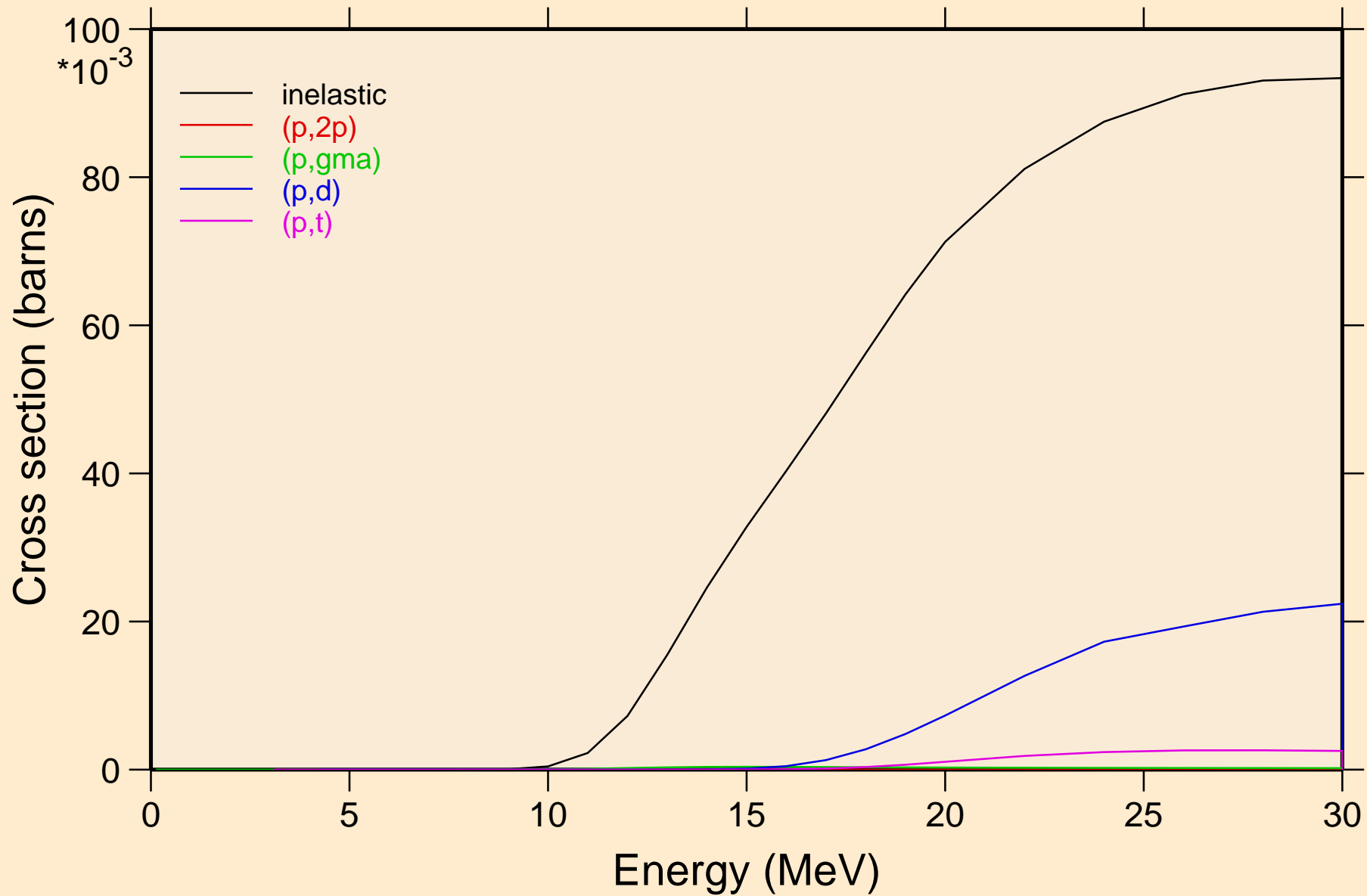

TH232 PROTON ACER TENDL-2021 LIBRARY; T=0.K  
Threshold reactions

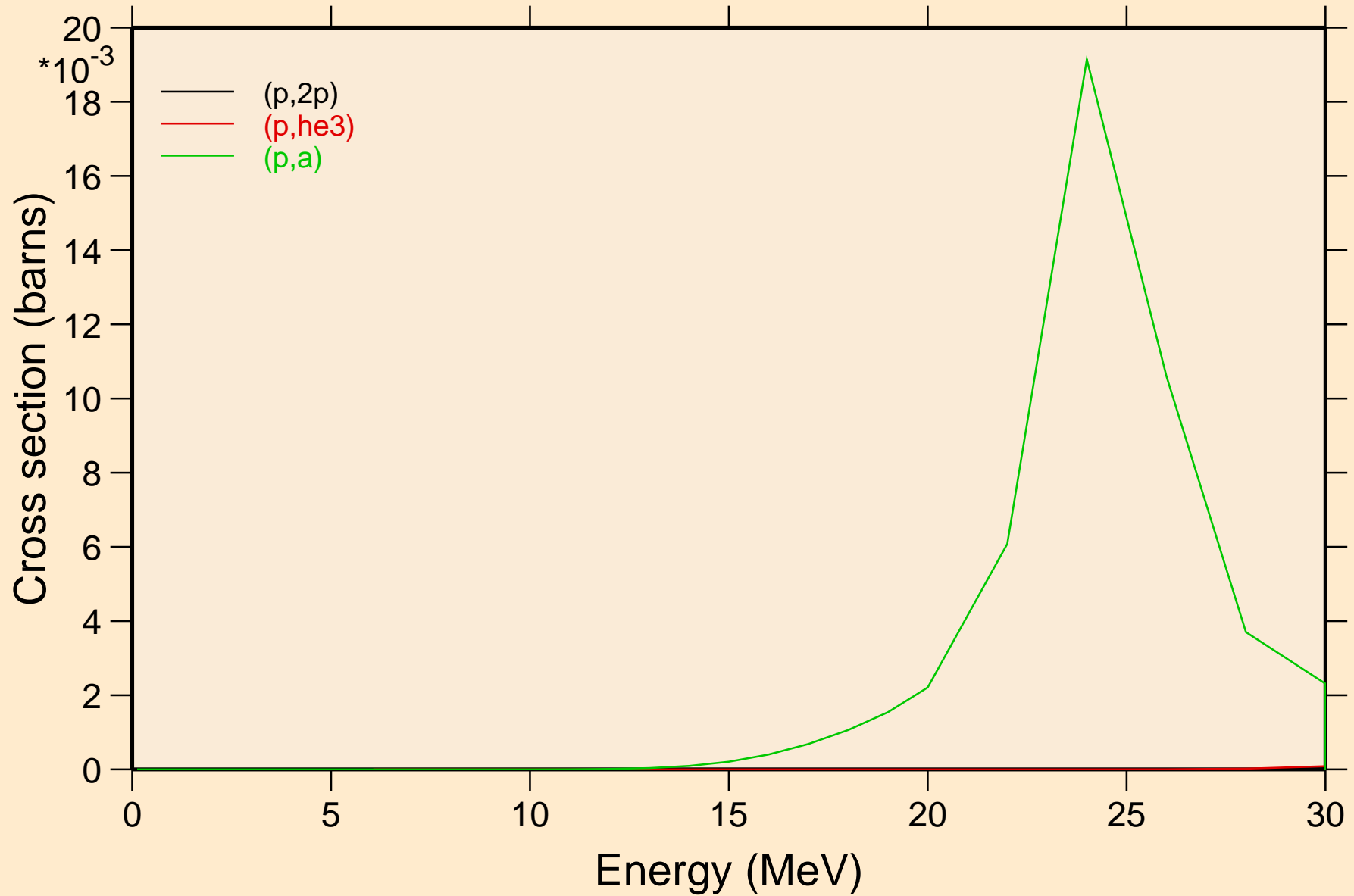

TH232 PROTON ACER TENDL-2021 LIBRARY; T=0.K  
Threshold reactions

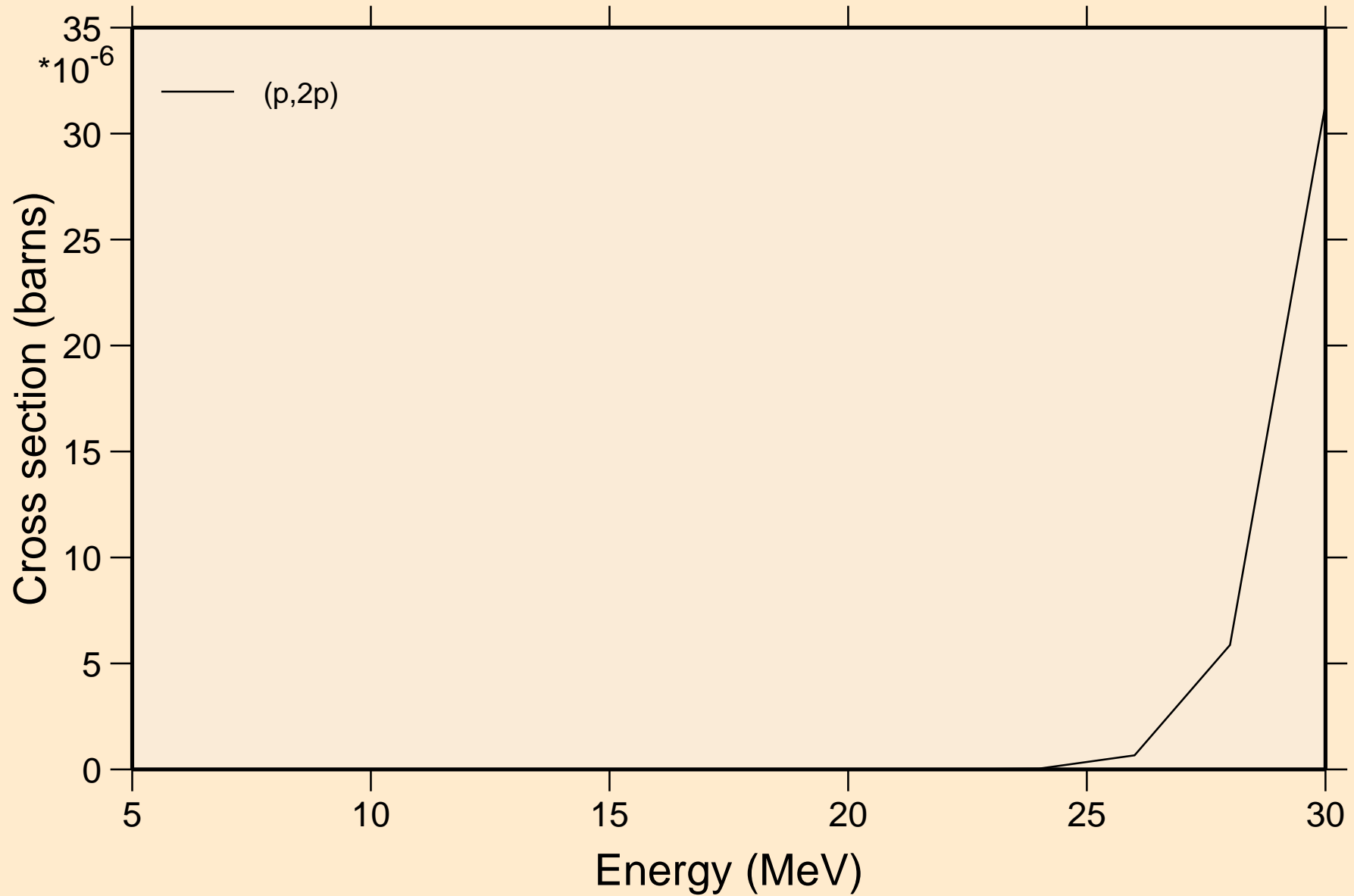



TH232 PROTON ACER TENDL-2021 LIBRARY; T=0.K  
angular distribution for elastic

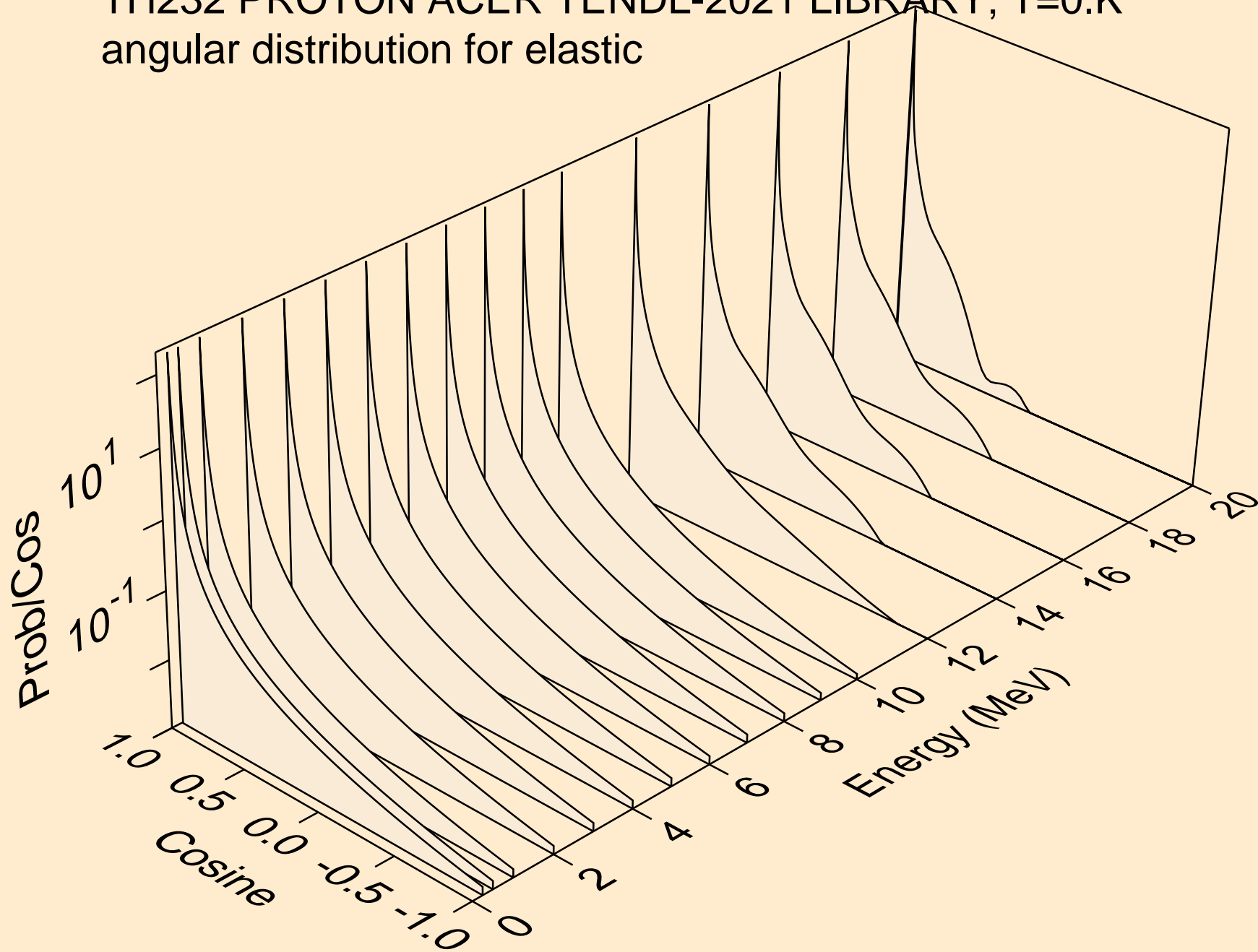

TH232 PROTON ACER TENDL-2021 LIBRARY; T=0.K  
angular distribution for elastic

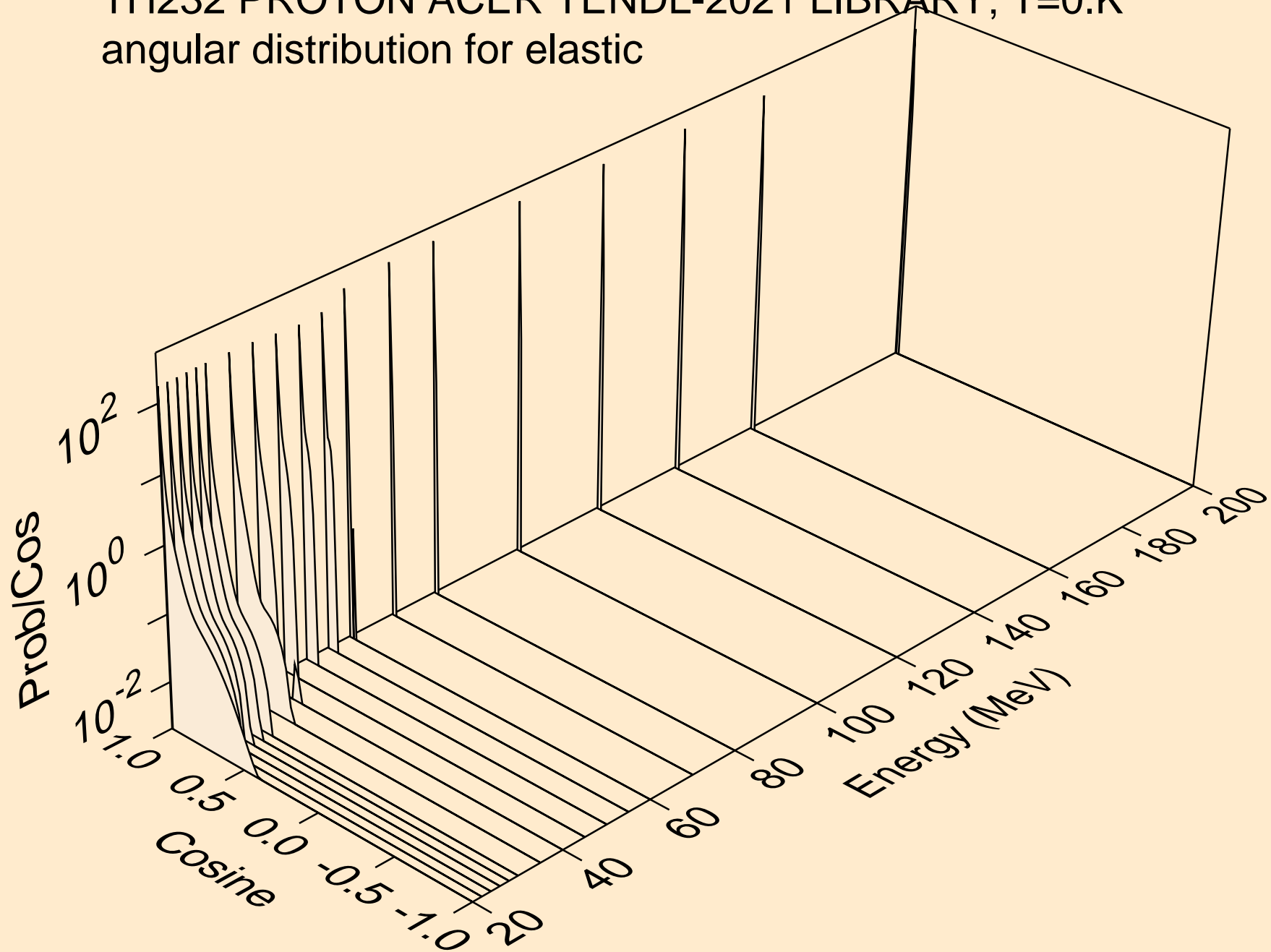

TH232 PROTON ACER TENDL-2021 LIBRARY; T=0.K  
Proton emission for (p,x)

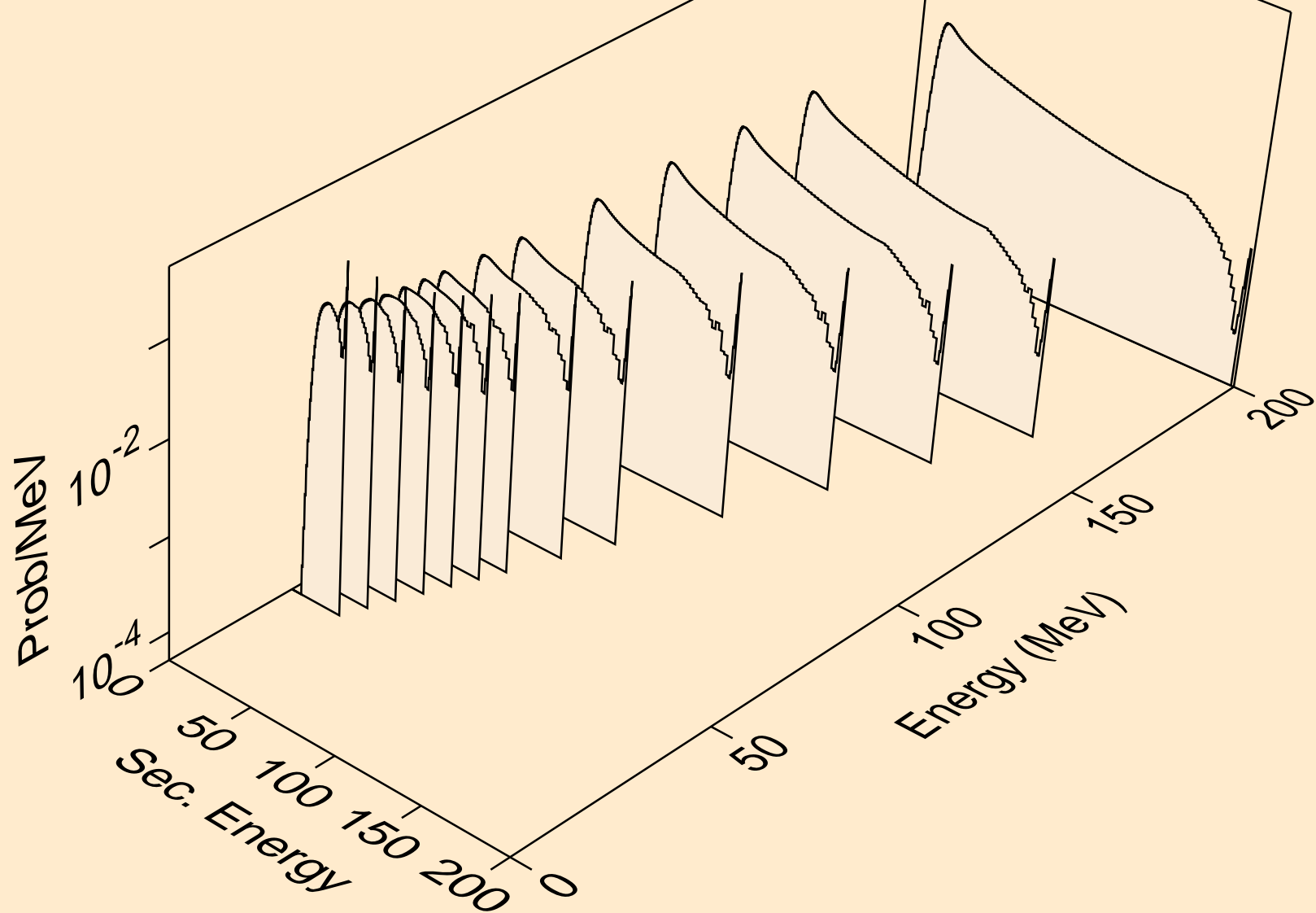

TH232 PROTON ACER TENDL-2021 LIBRARY; T=0.K  
Proton emission for (p,n\*)p

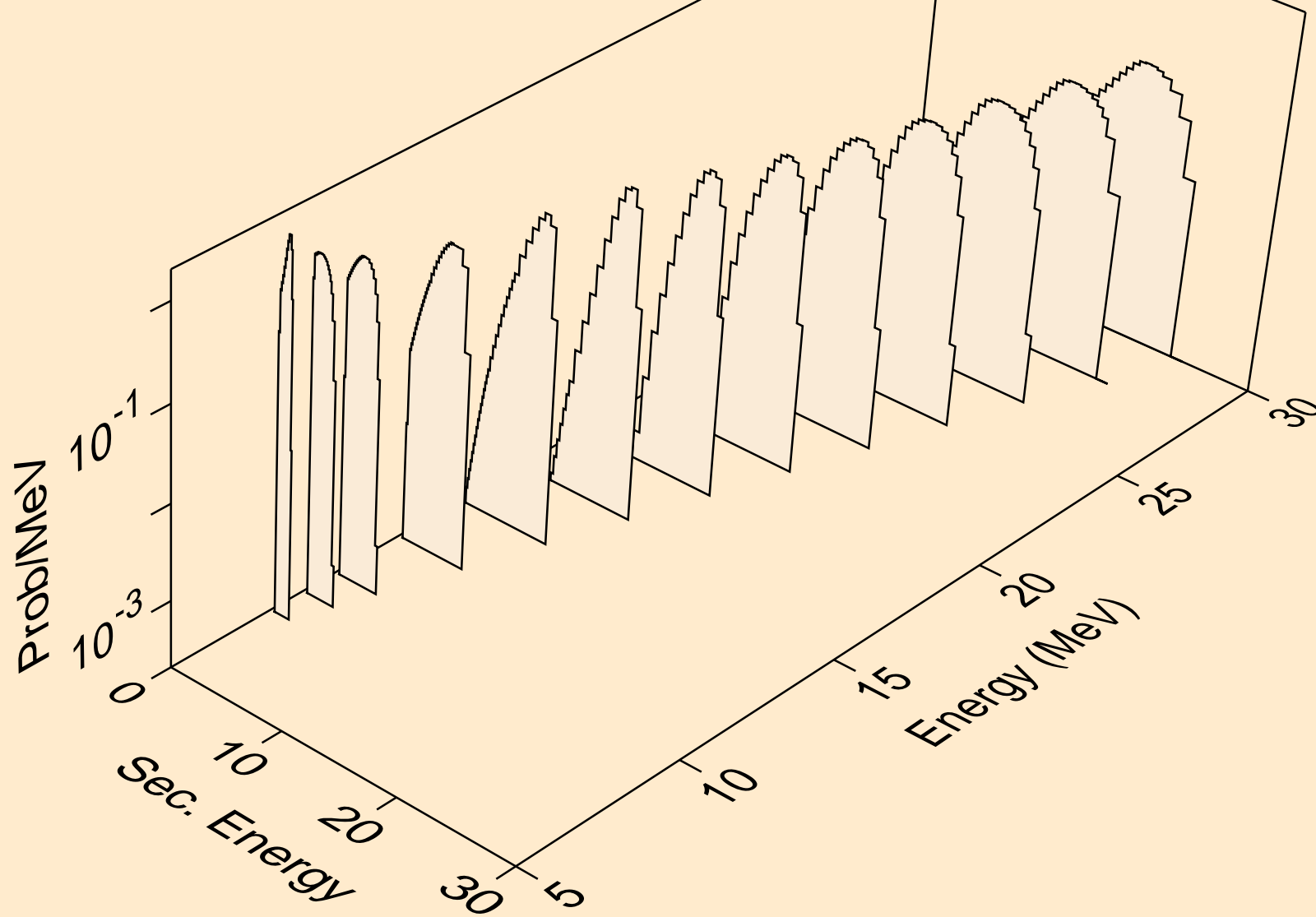

TH232 PROTON ACER TENDL-2021 LIBRARY; T=0.K  
Proton emission for (p,2np)

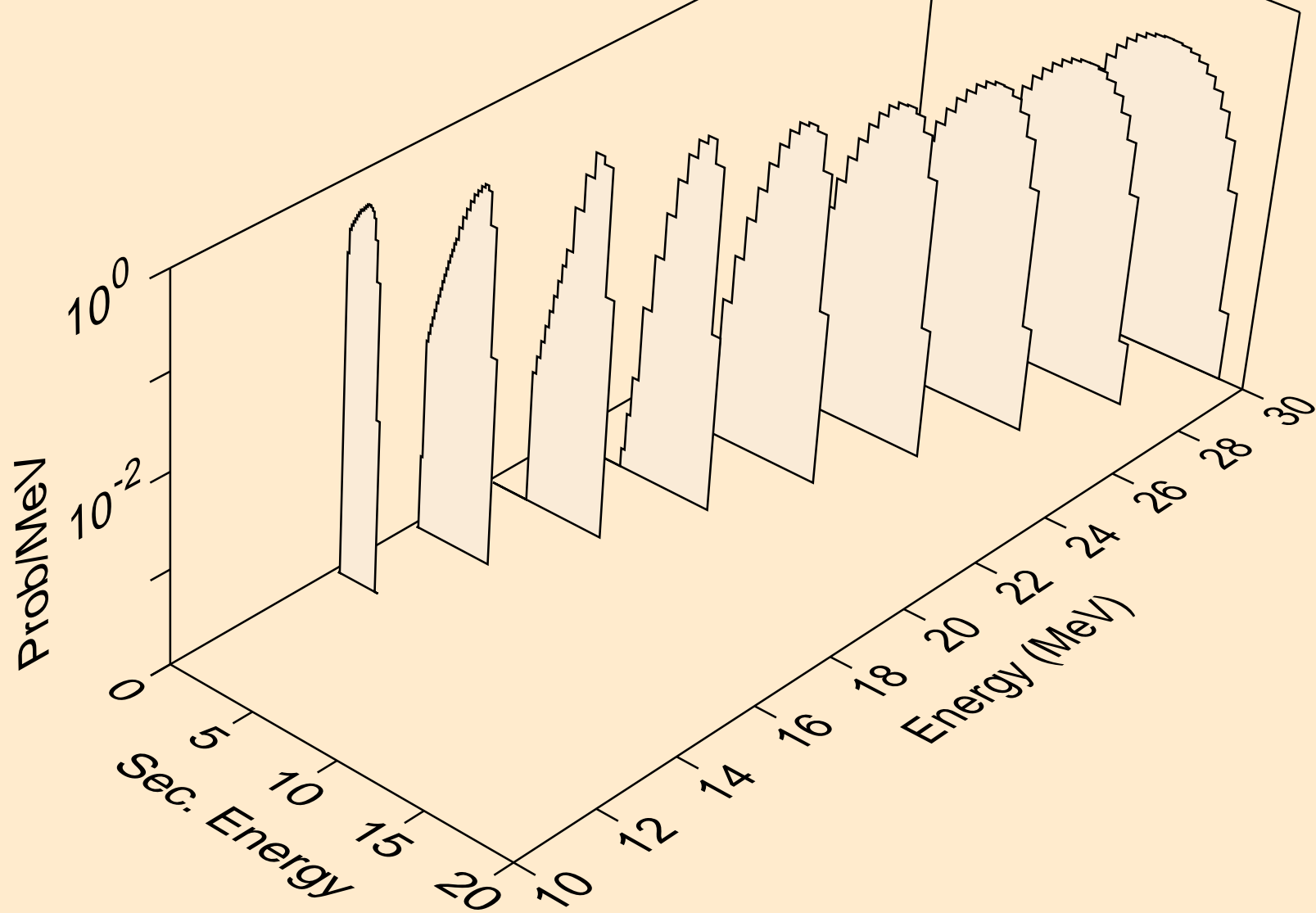

TH232 PROTON ACER TENDL-2021 LIBRARY; T=0.K  
Proton emission for (p,3np)

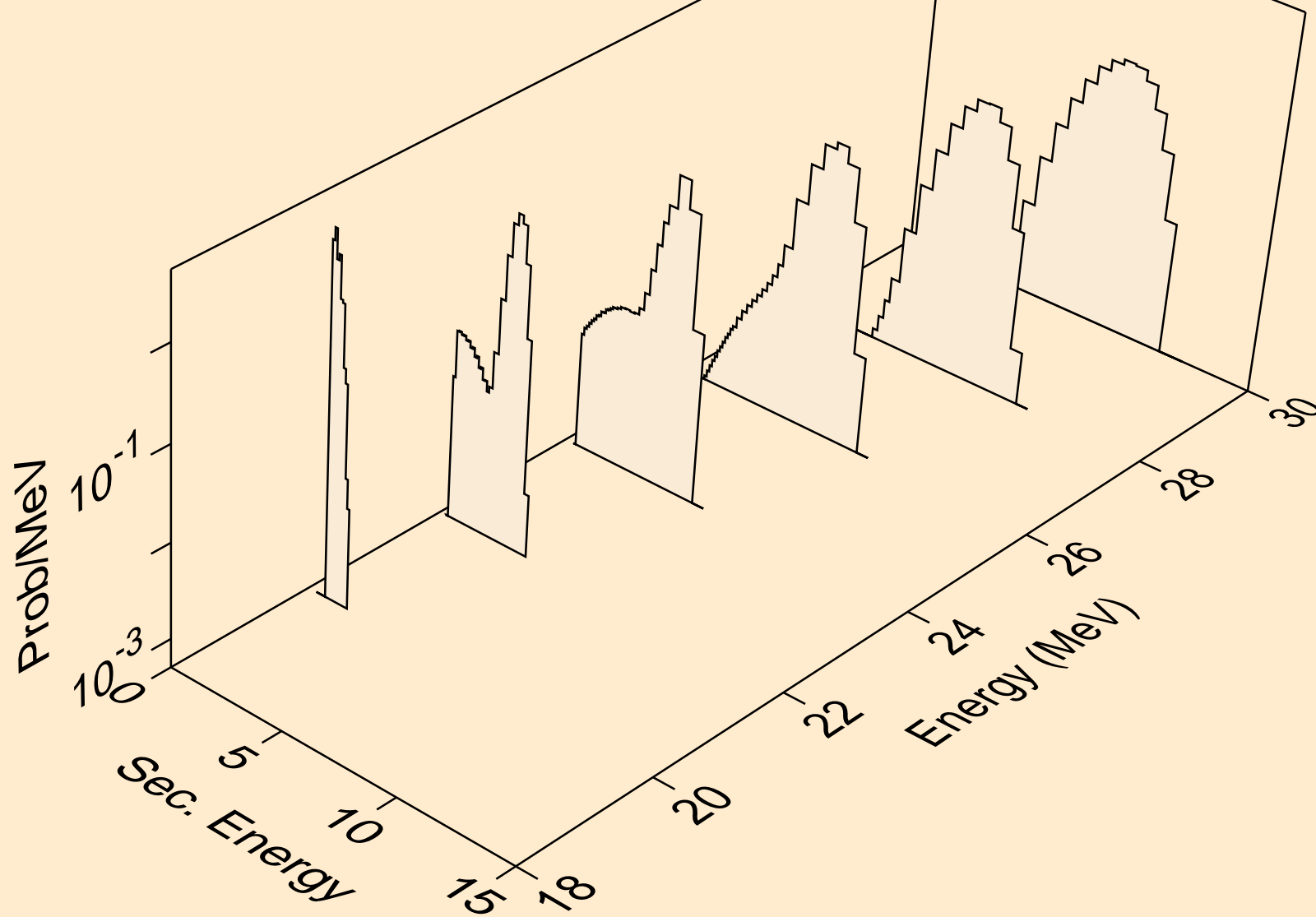

TH232 PROTON ACER TENDL-2021 LIBRARY; T=0.K  
Proton emission for (p,2np)

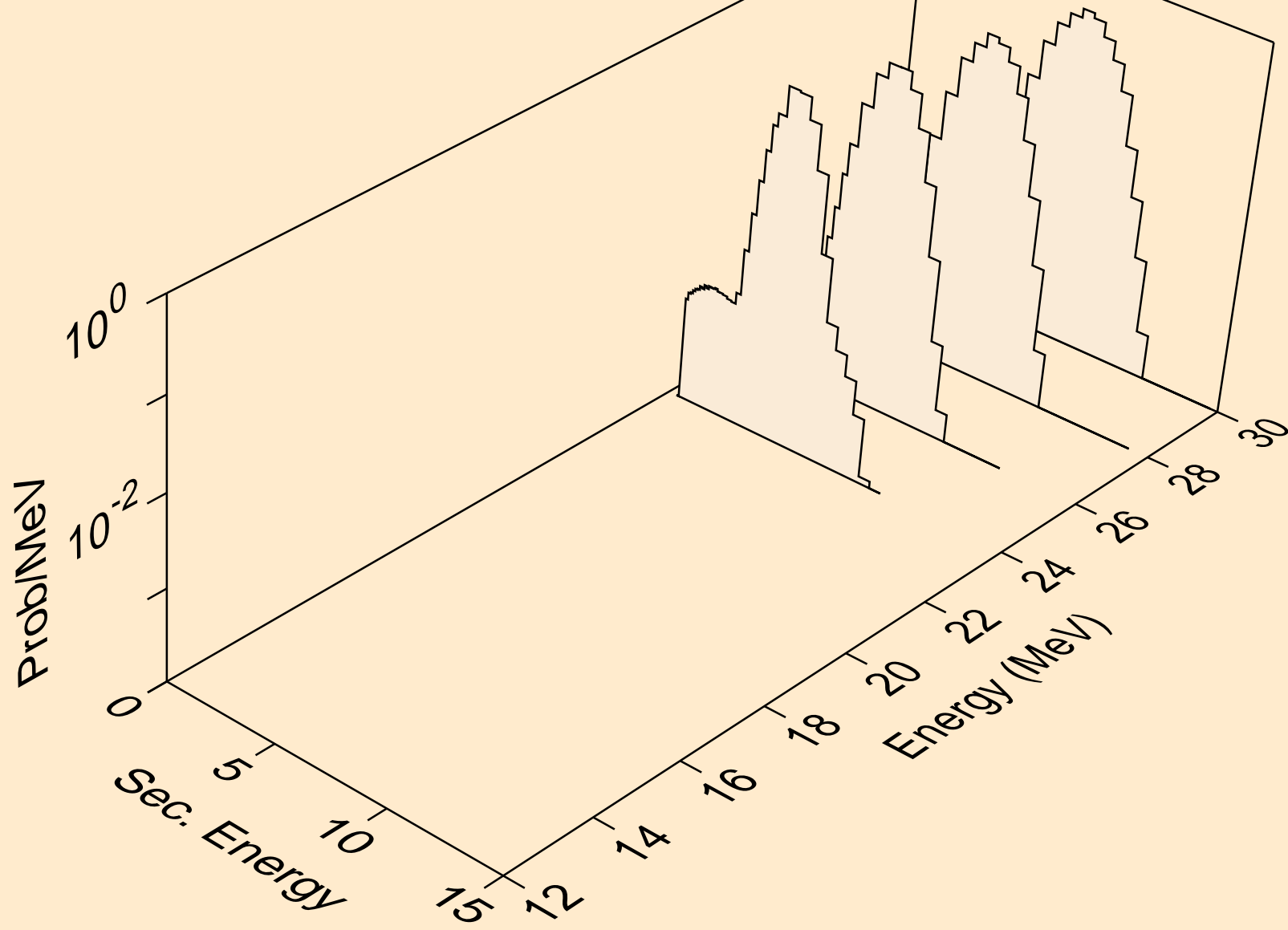

TH232 PROTON ACER TENDL-2021 LIBRARY; T=0.K  
Proton emission for inelastic

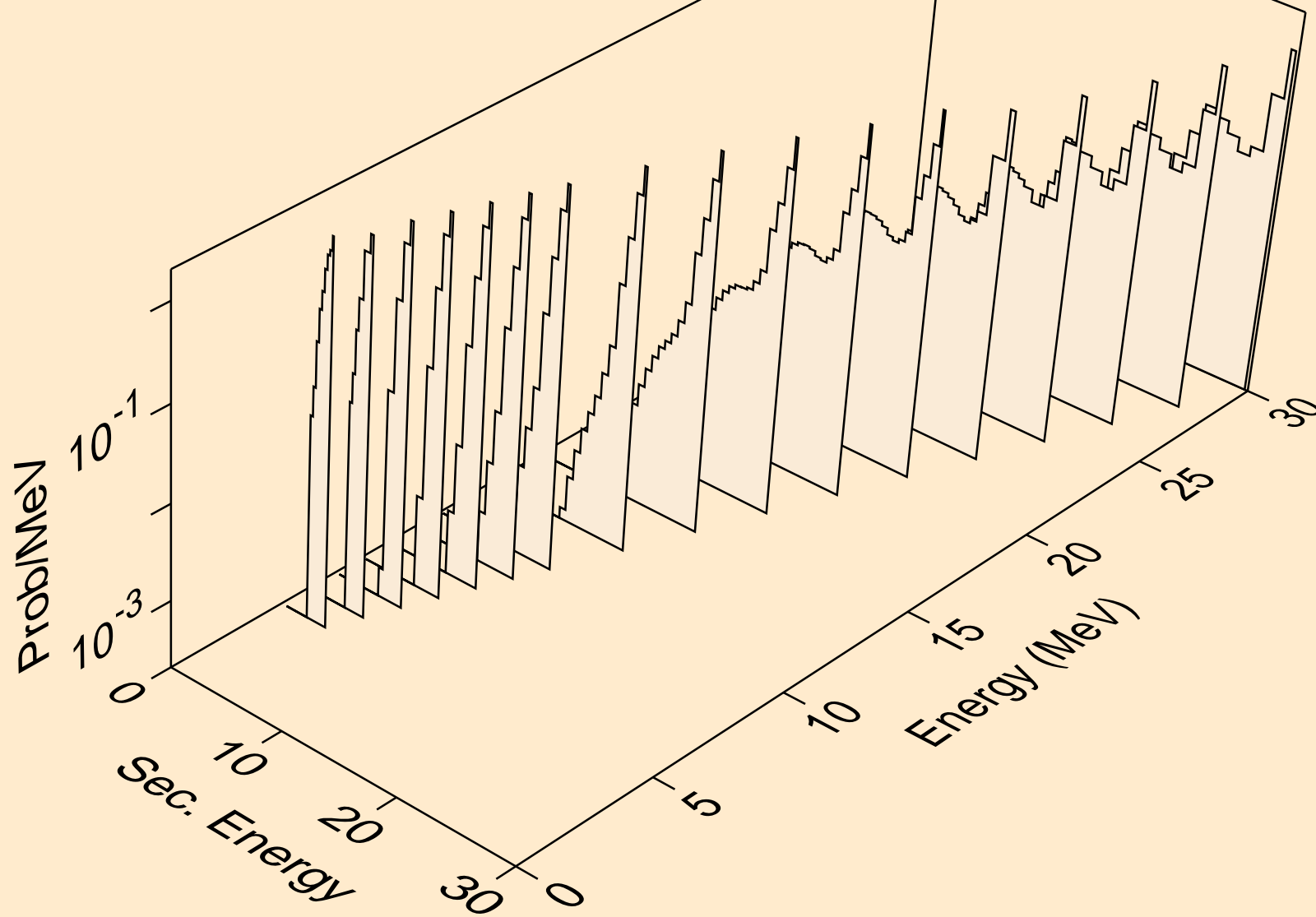



TH232 PROTON ACER TENDL-2021 LIBRARY; T=0.K  
Proton emission for (p,2p)

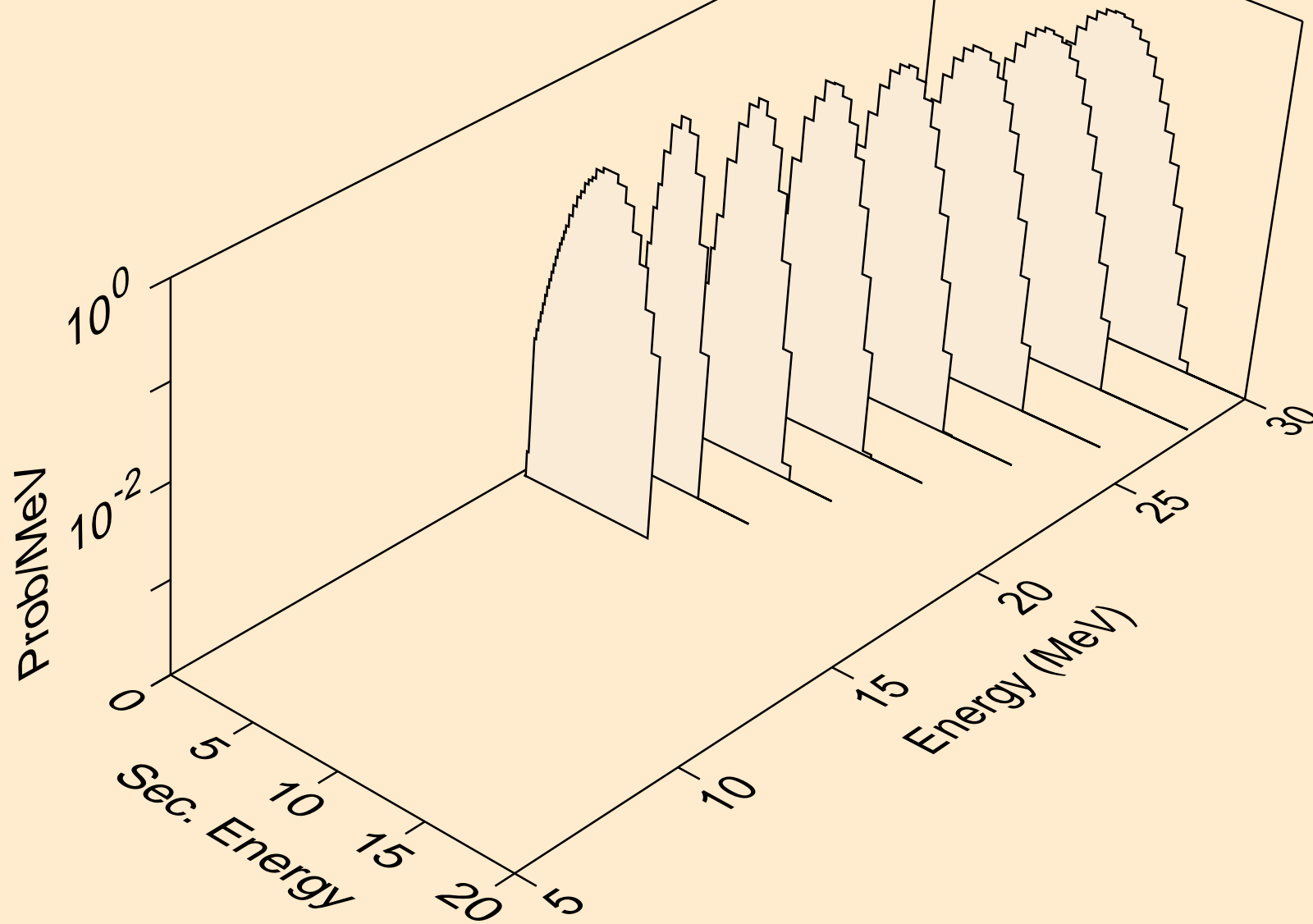

TH232 PROTON ACER TENDL-2021 LIBRARY; T=0.K  
Photon emission for (z,n)

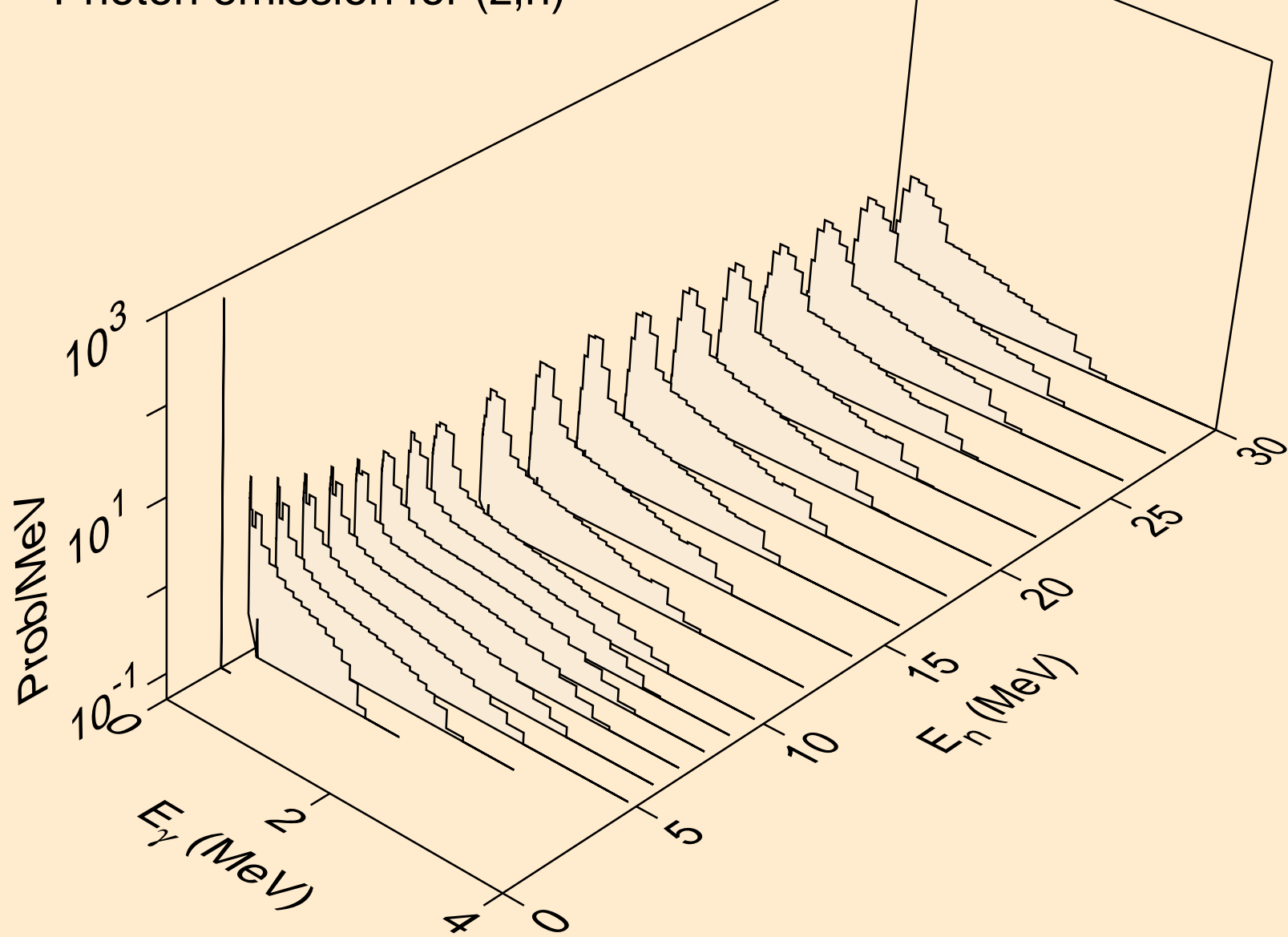

TH232 PROTON ACER TENDL-2021 LIBRARY; T=0.K  
Photon emission for (n,x)

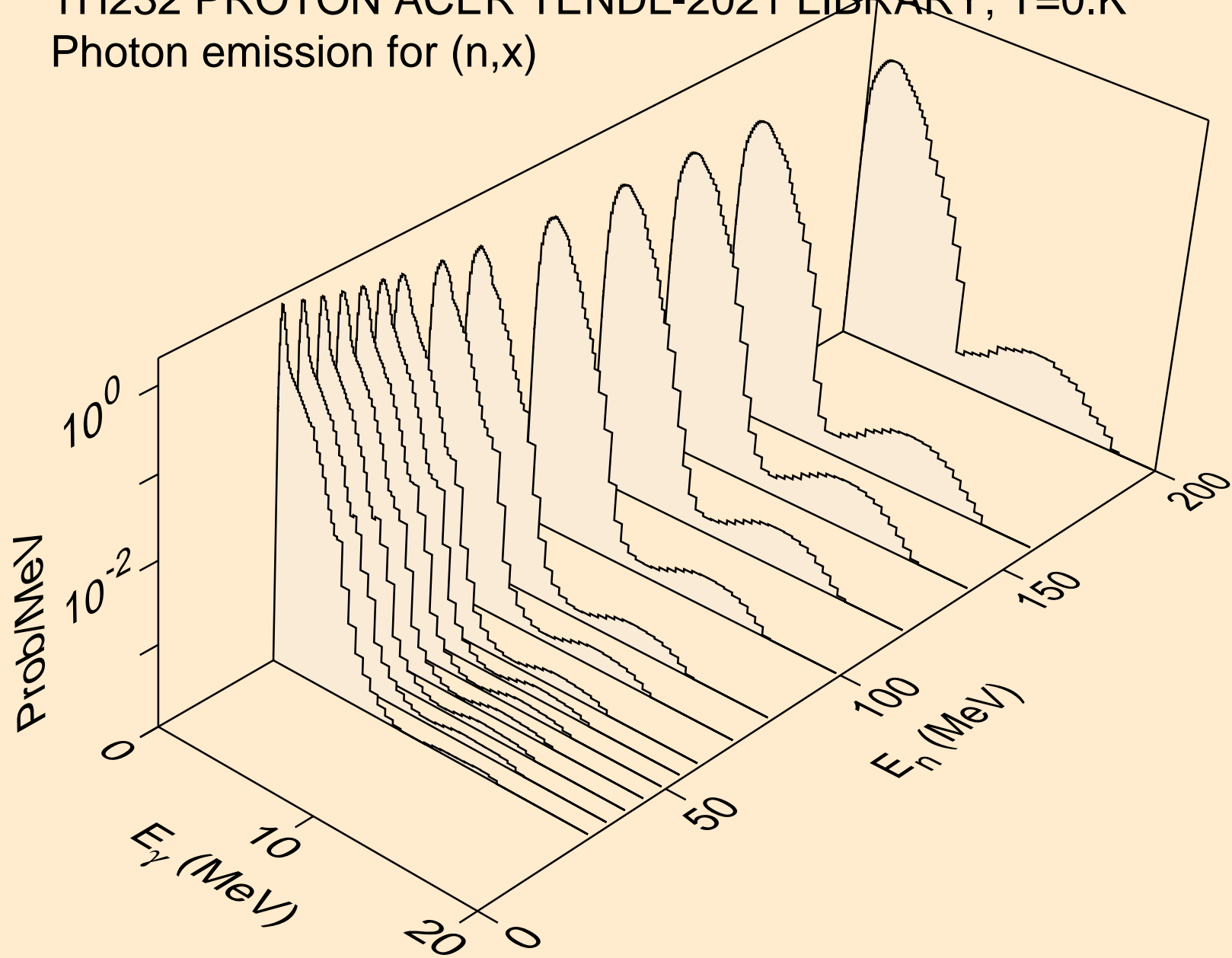

TH232 PROTON ACER TENDL-2021 LIBRARY; T=0.K  
Photon emission for (n,2nd)

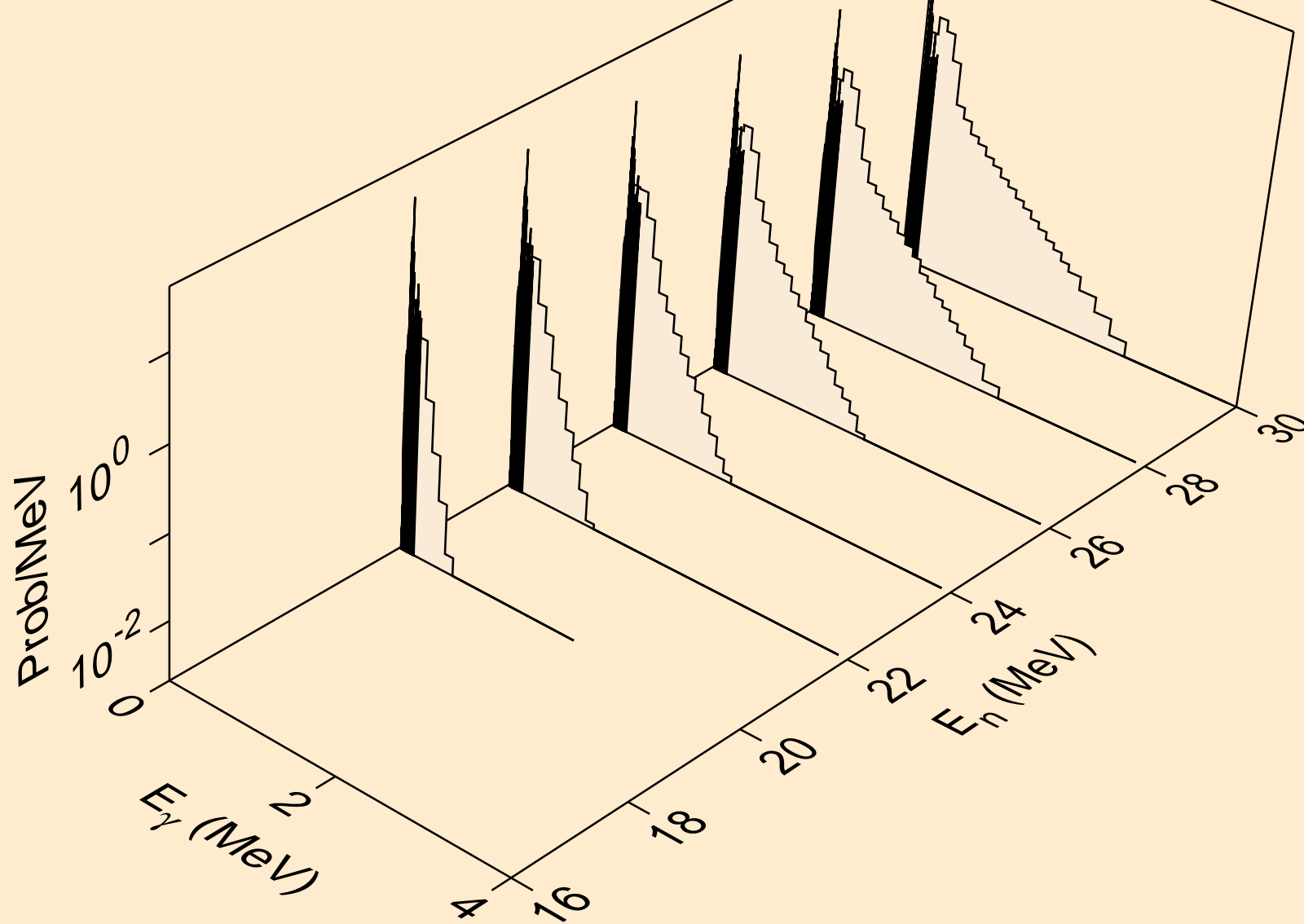

TH232 PROTON ACER TENDL-2021 LIBRARY; T=0.K  
Photon emission for (n,2n)

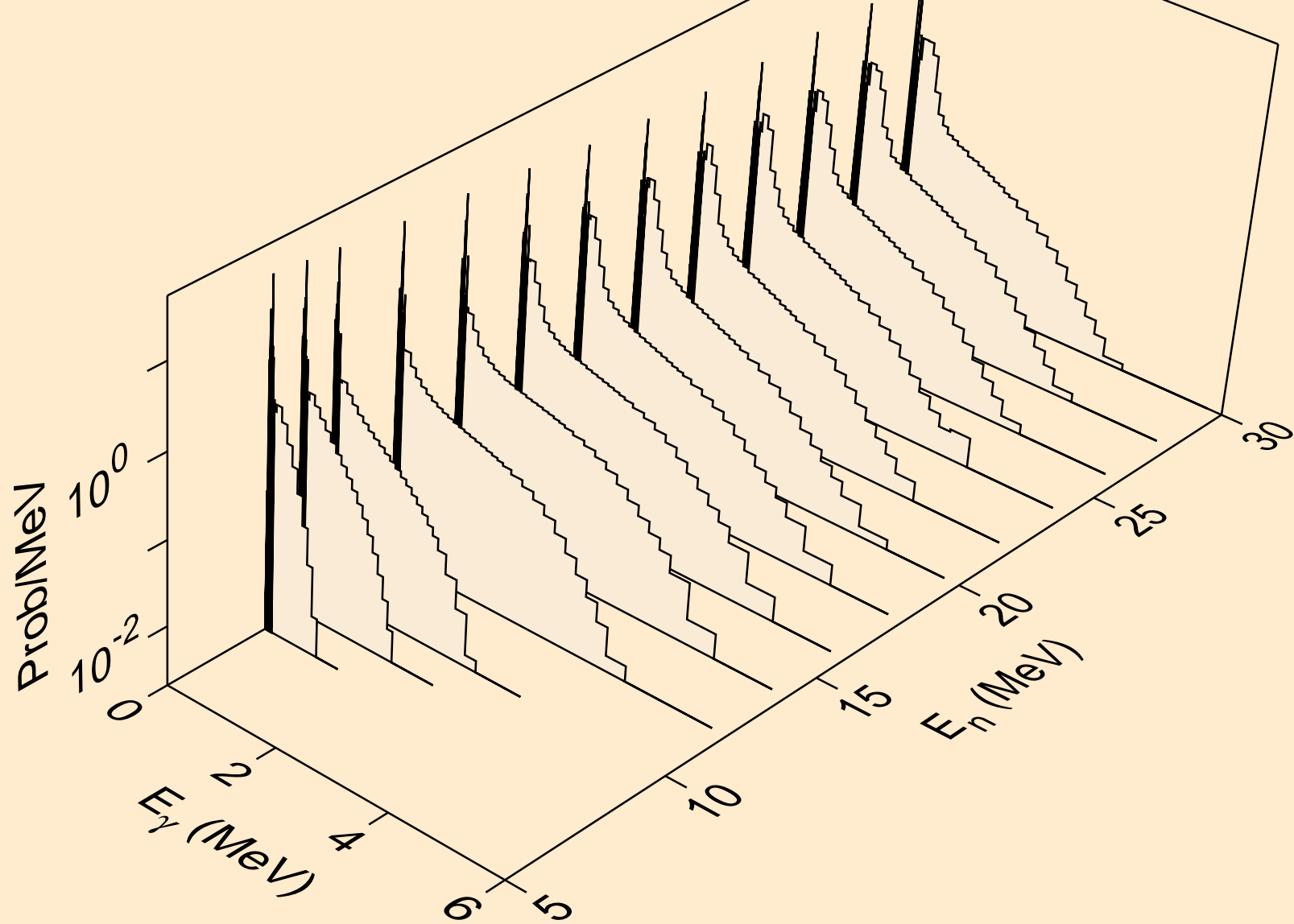

TH232 PROTON ACER TENDL-2021 LIBRARY; T=0.K  
Photon emission for (n,3n)

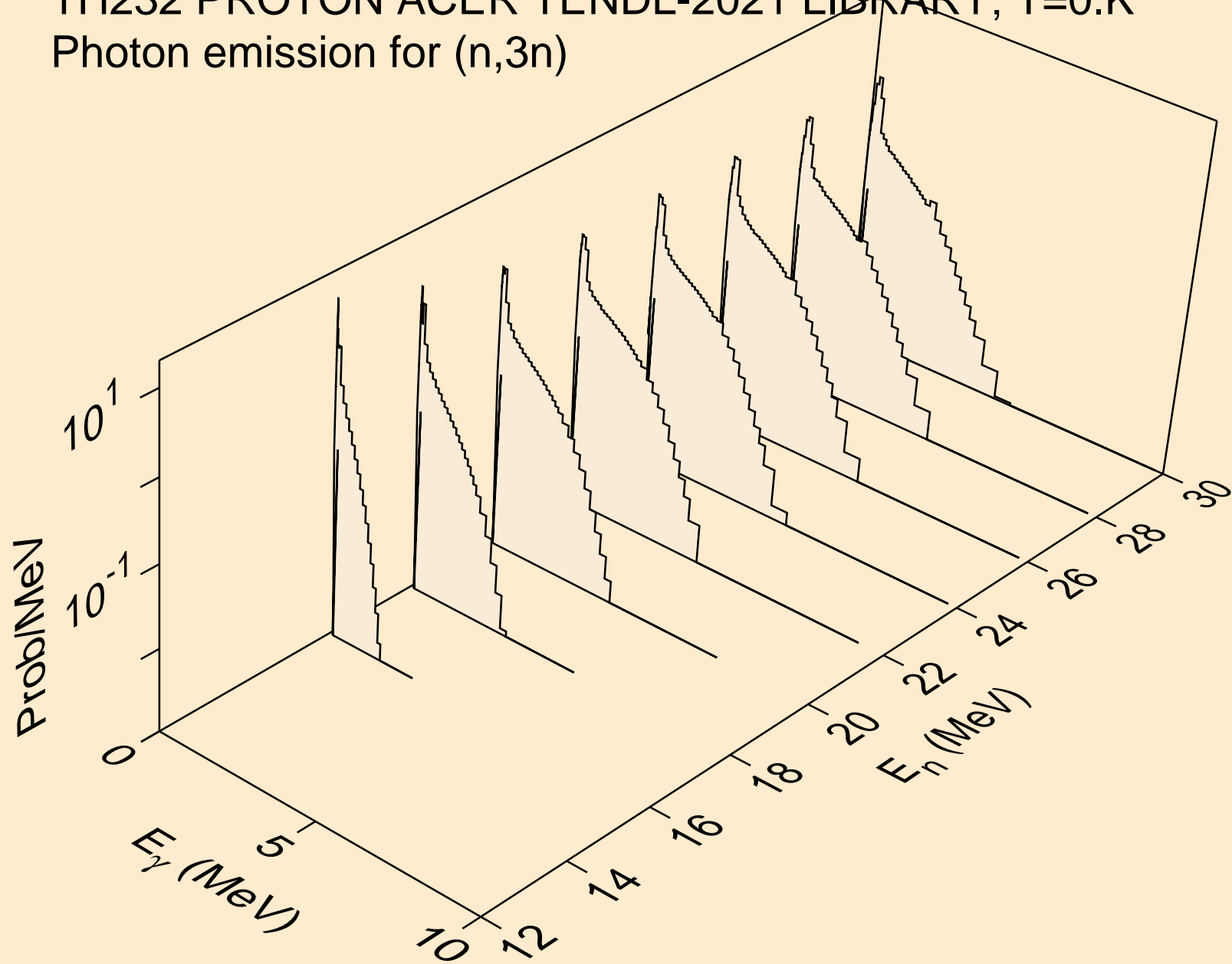

TH232 PROTON ACER TENDL-2021 LIBRARY; T=0.K  
Photon emission for (n,n\*)a

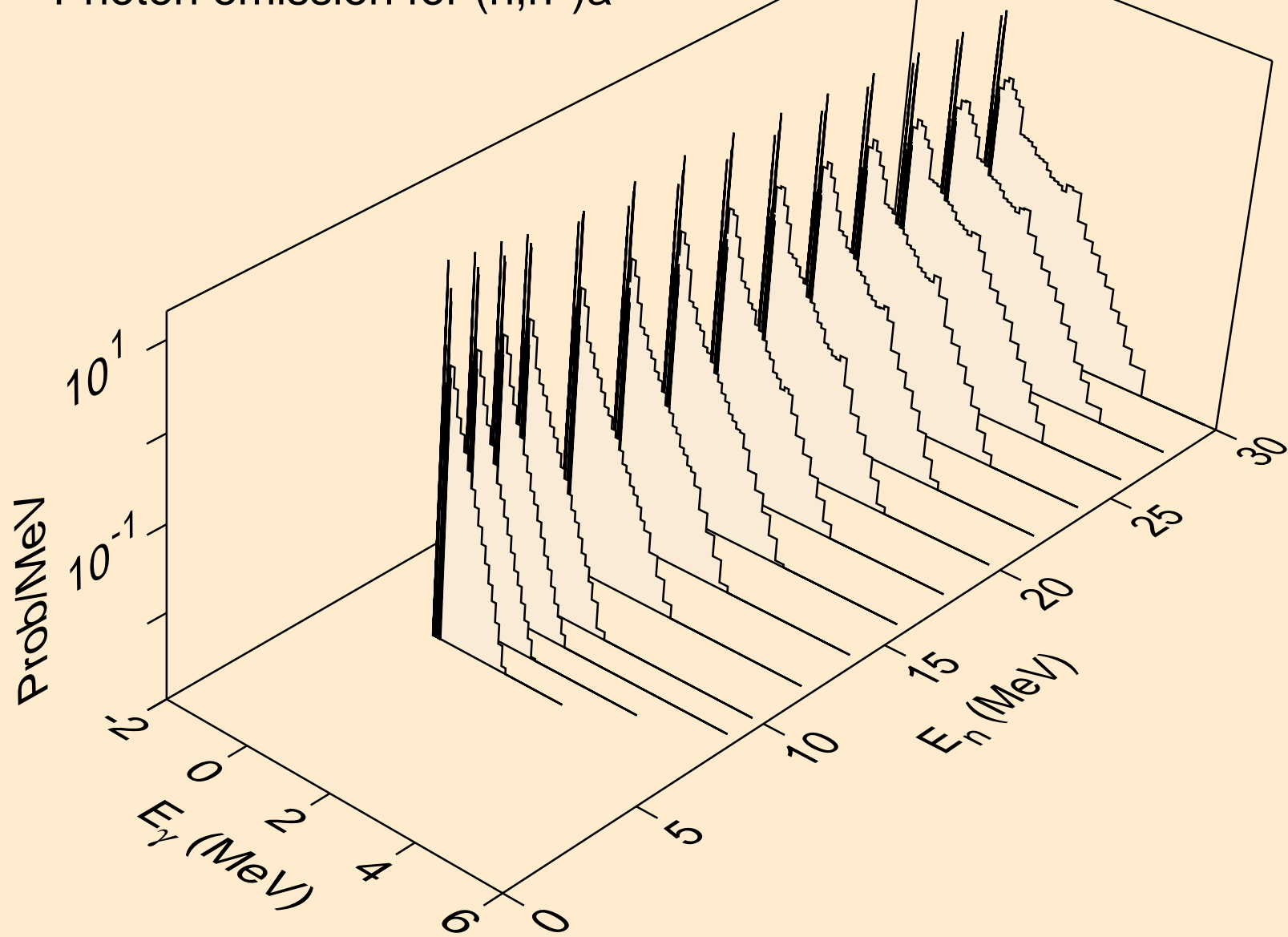

TH232 PROTON ACER TENDL-2021 LIBRARY; T=0.K  
Photon emission for (n,2n) $\alpha$

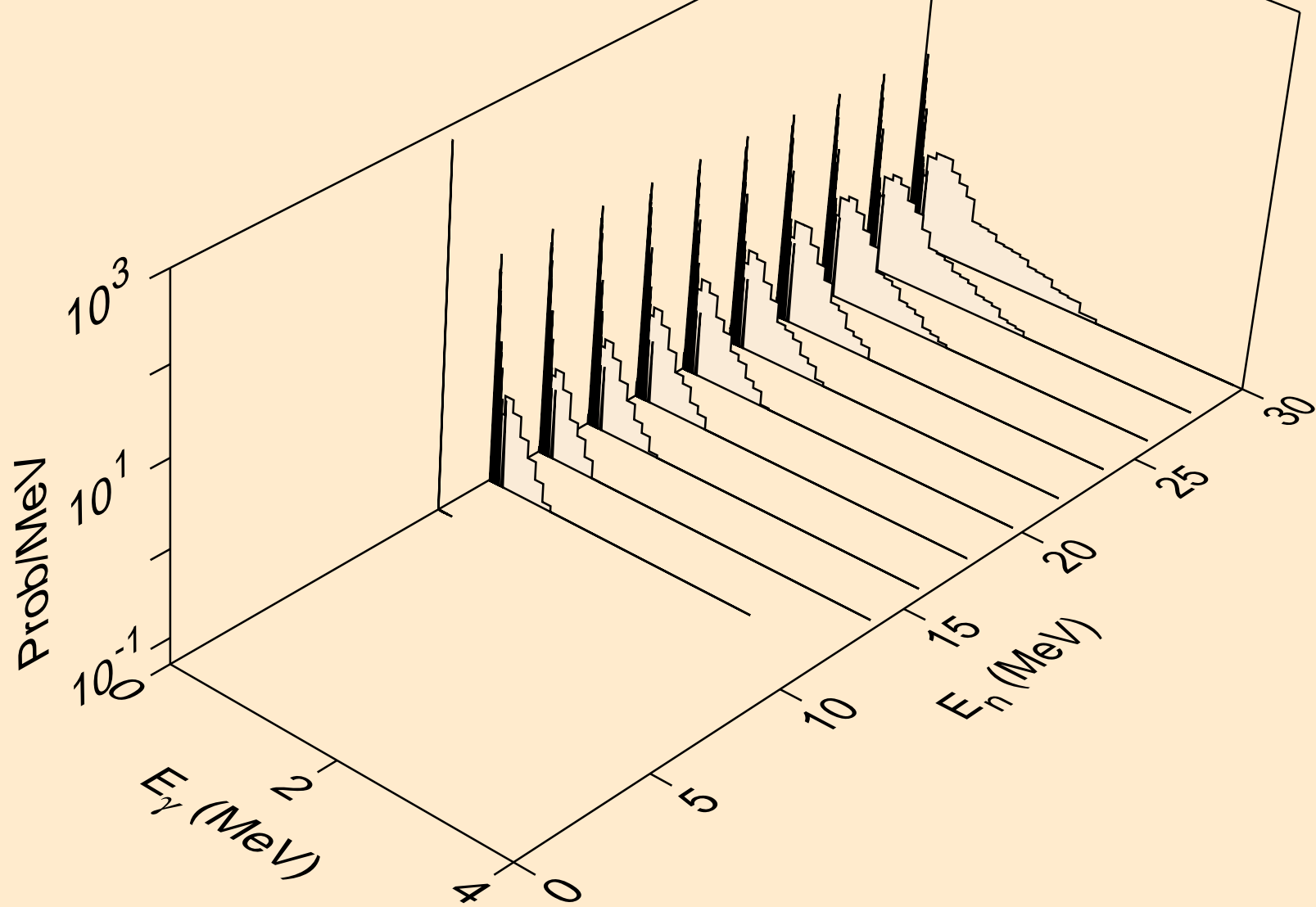



TH232 PROTON ACER TENDL-2021 LIBRARY; T=0.K  
Photon emission for (n,3n)a

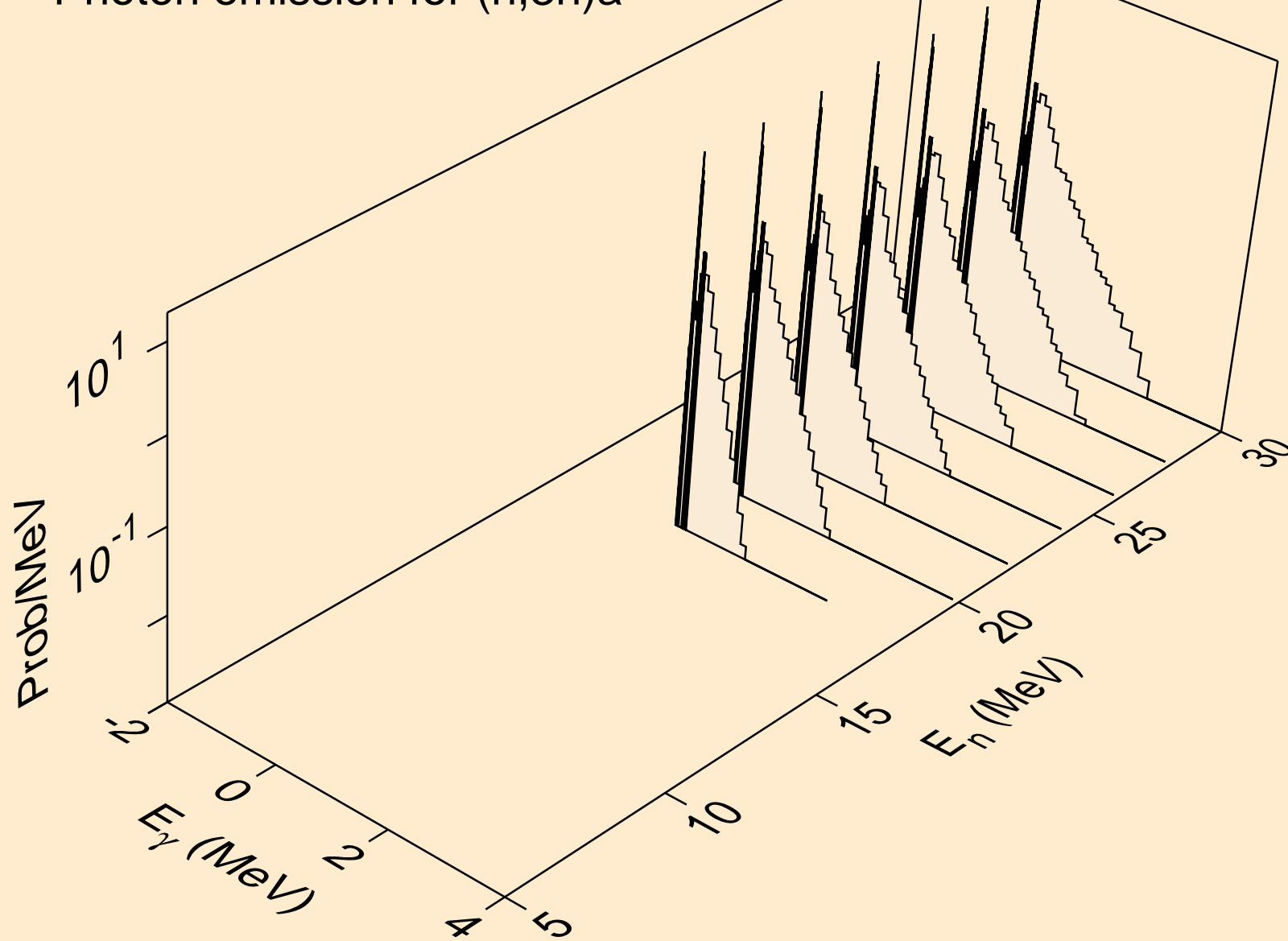

TH232 PROTON ACER TENDL-2021 LIBRARY; T=0.K  
Photon emission for (n,n\*)p

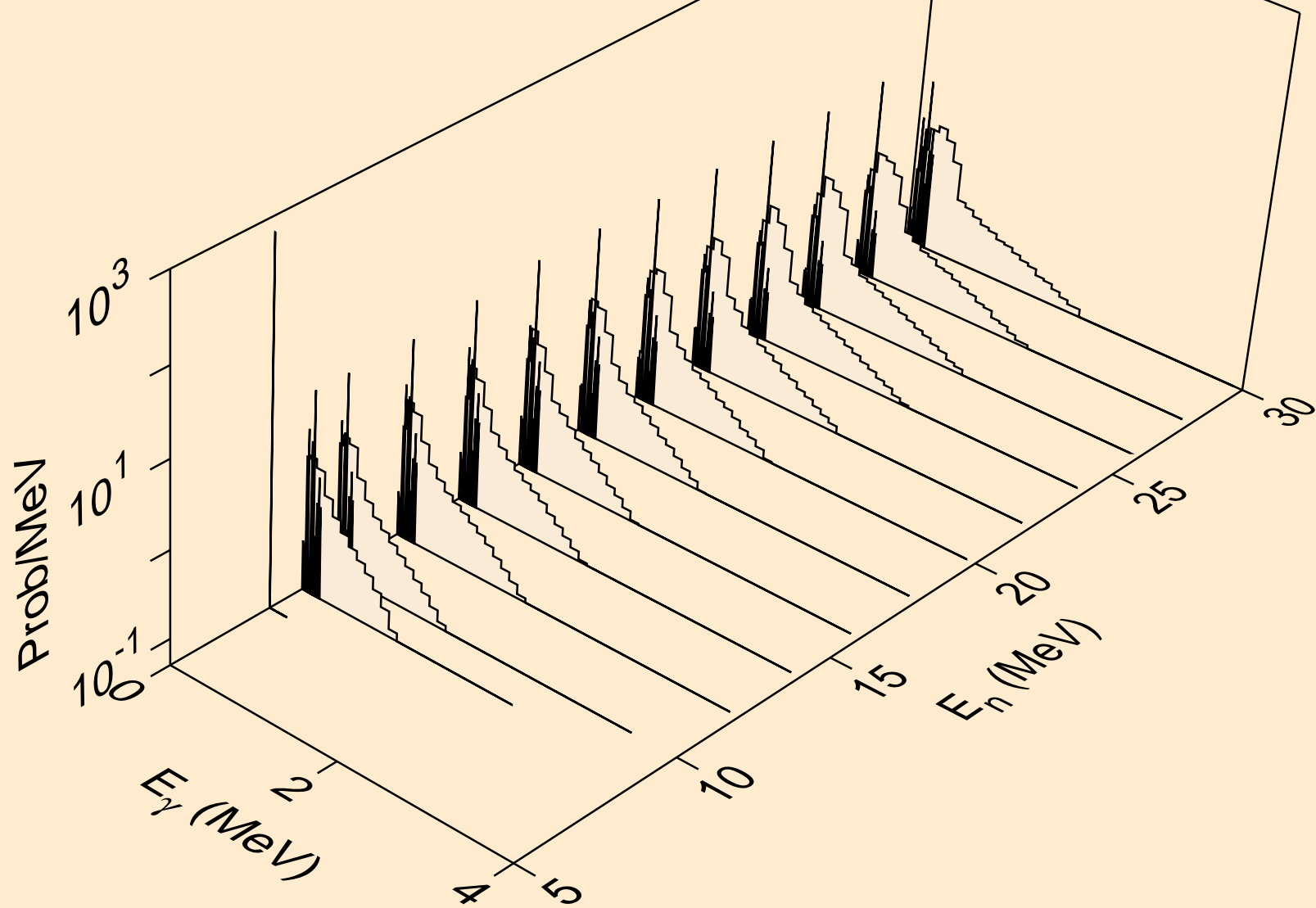

TH232 PROTON ACER TENDL-2021 LIBRARY; T=0.K  
Photon emission for (n,n\*)d

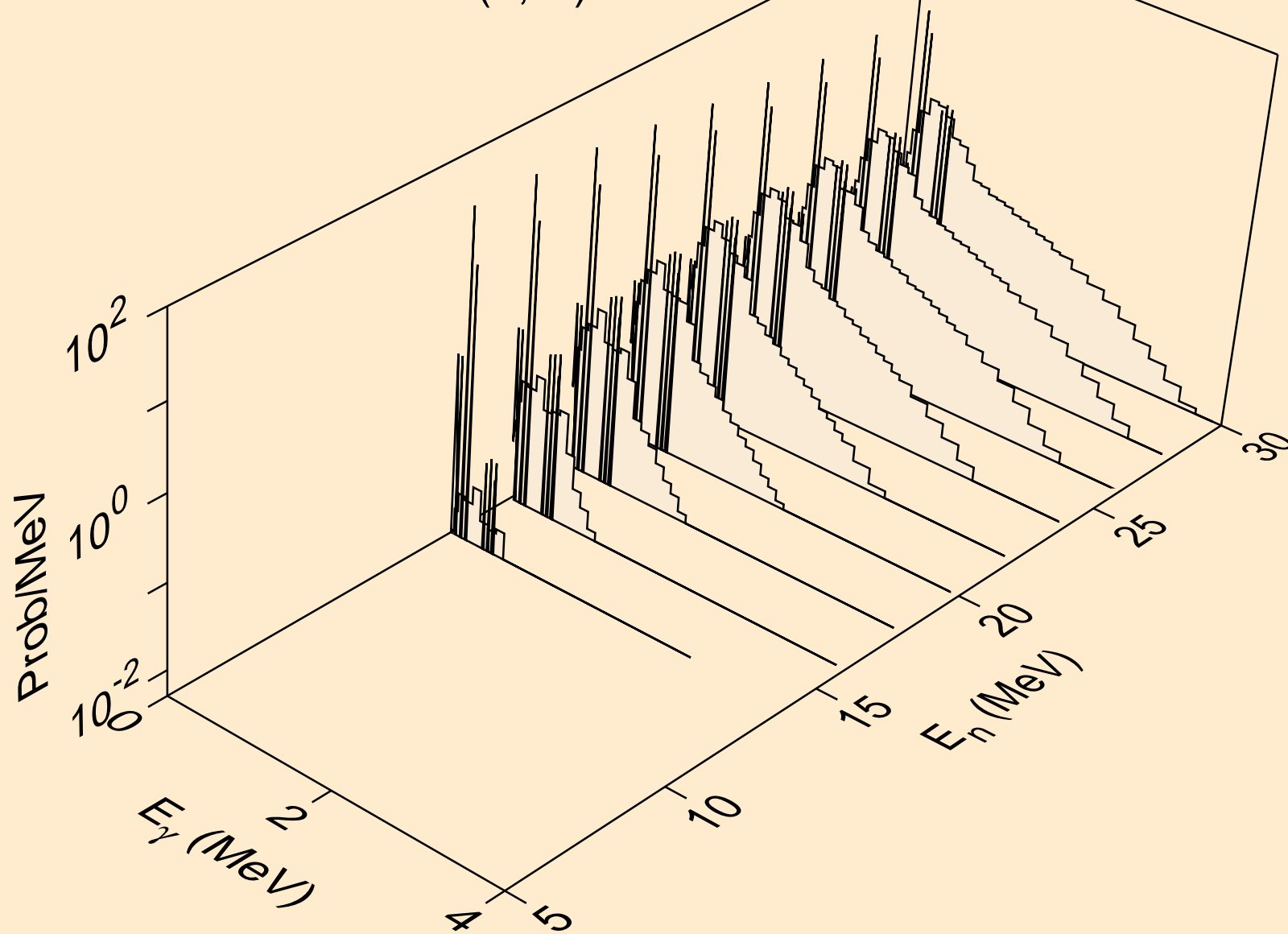

TH232 PROTON ACER TENDL-2021 LIBRARY; T=0.K  
Photon emission for (n,n\*)t

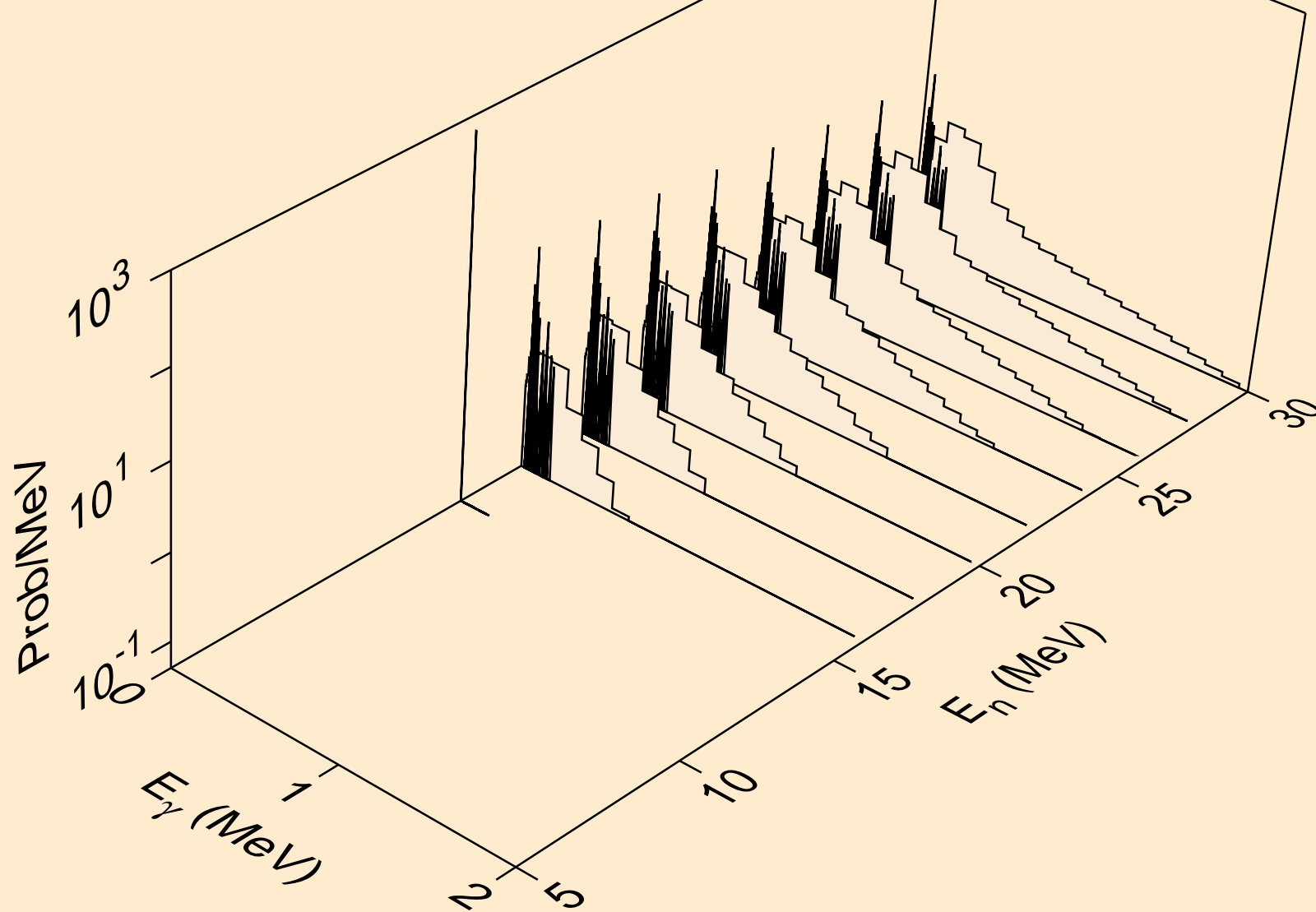

TH232 PROTON ACER TENDL-2021 LIBRARY; T=0.K  
Photon emission for (n,n\*)he3

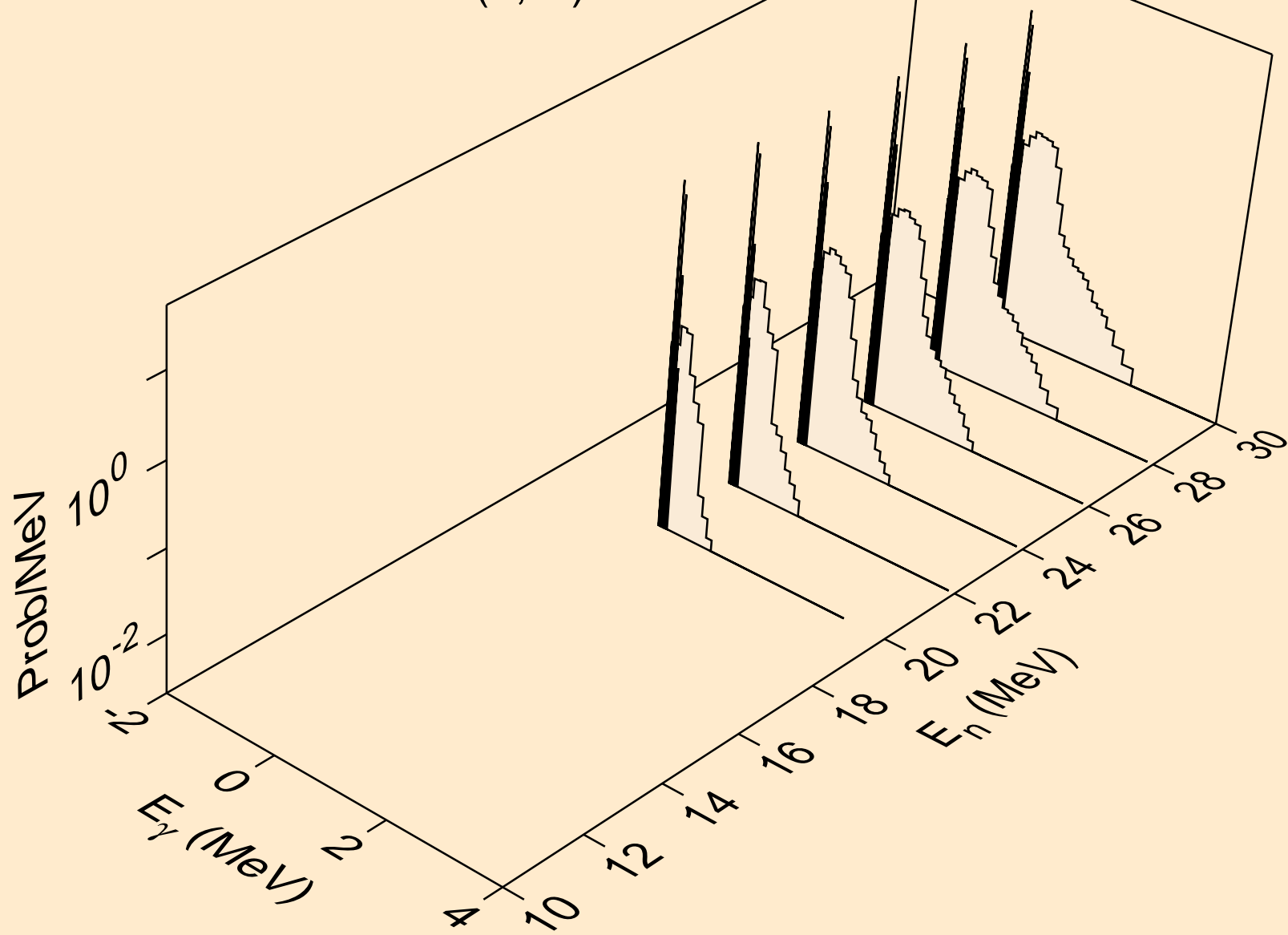

TH232 PROTON ACER TENDL-2021 LIBRARY; T=0.K  
Photon emission for (n,4n)

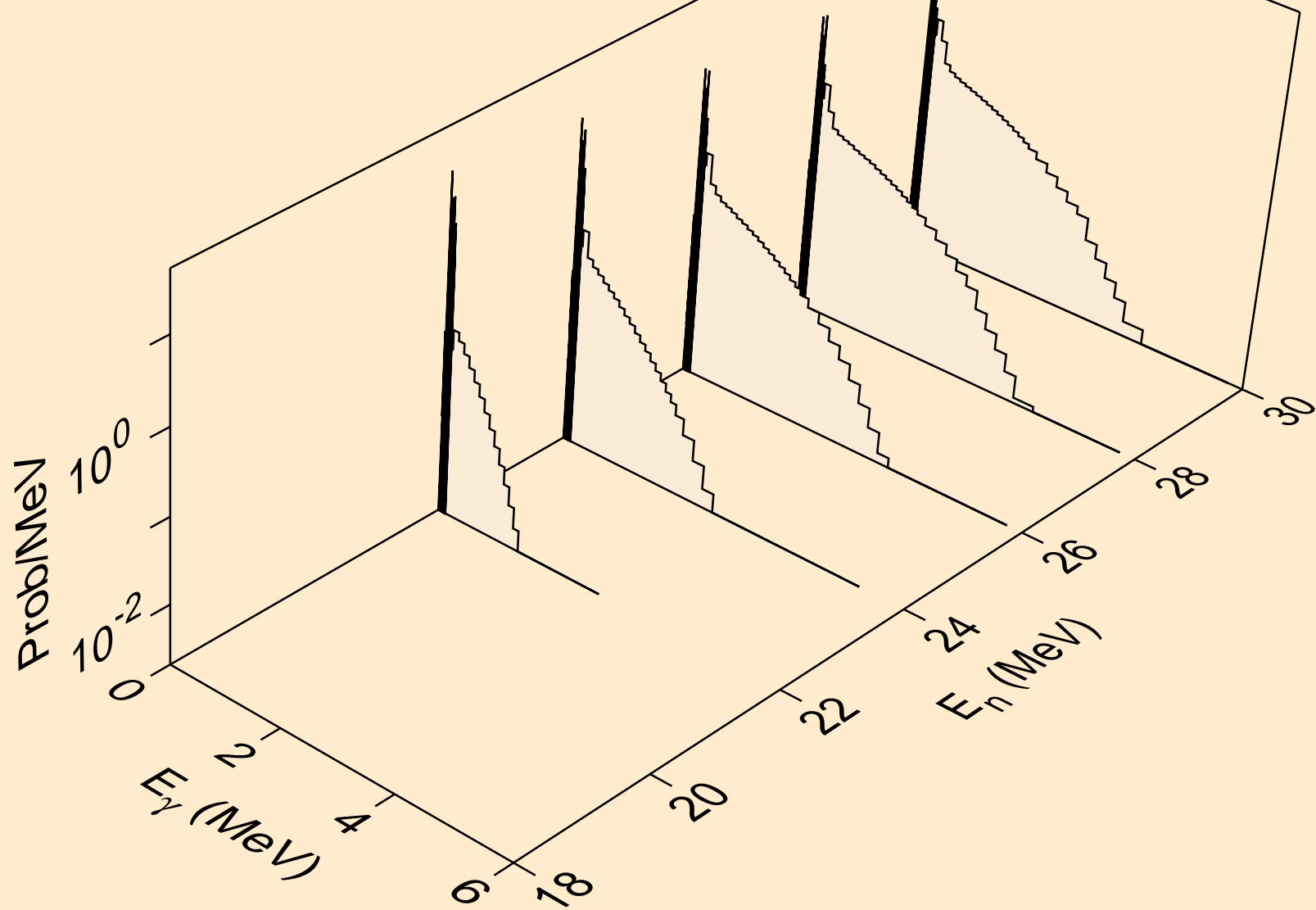

TH232 PROTON ACER TENDL-2021 LIBRARY; T=0.K  
Photon emission for (n,2np)

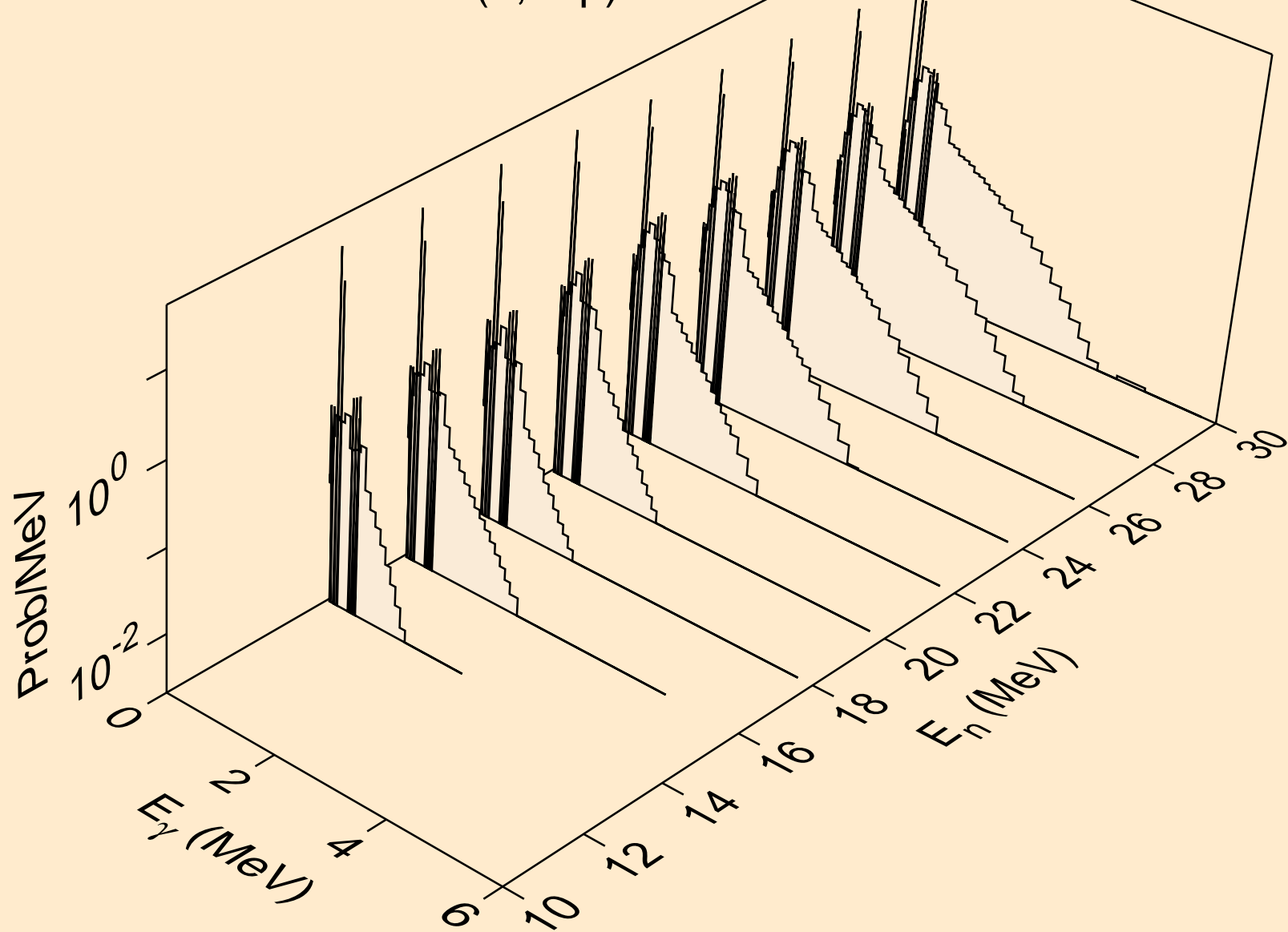

TH232 PROTON ACER TENDL-2021 LIBRARY; T=0.K  
Photon emission for (n,3np)

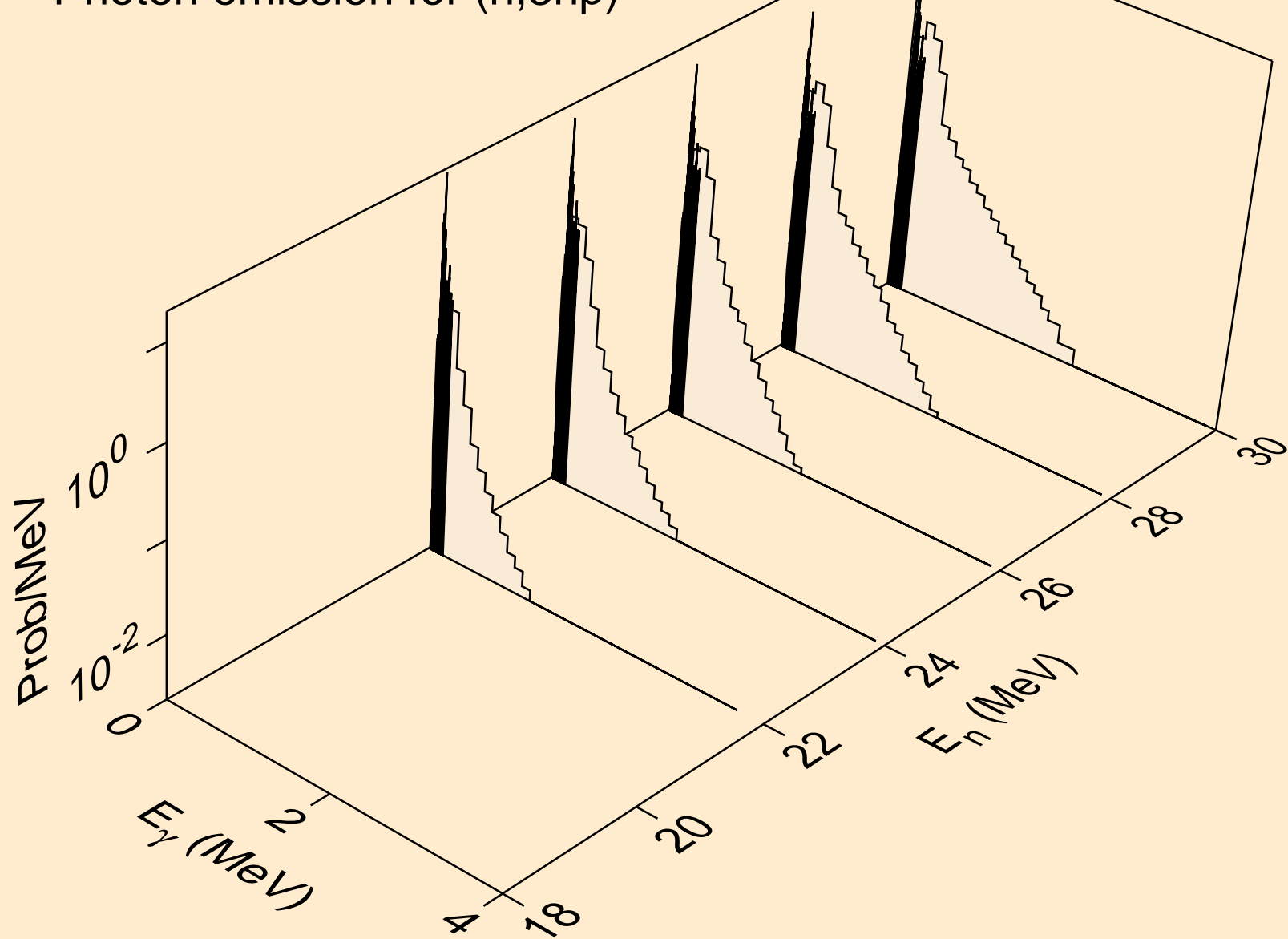



TH232 PROTON ACER TENDL-2021 LIBRARY; T=0.K  
Photon emission for (n,2np)

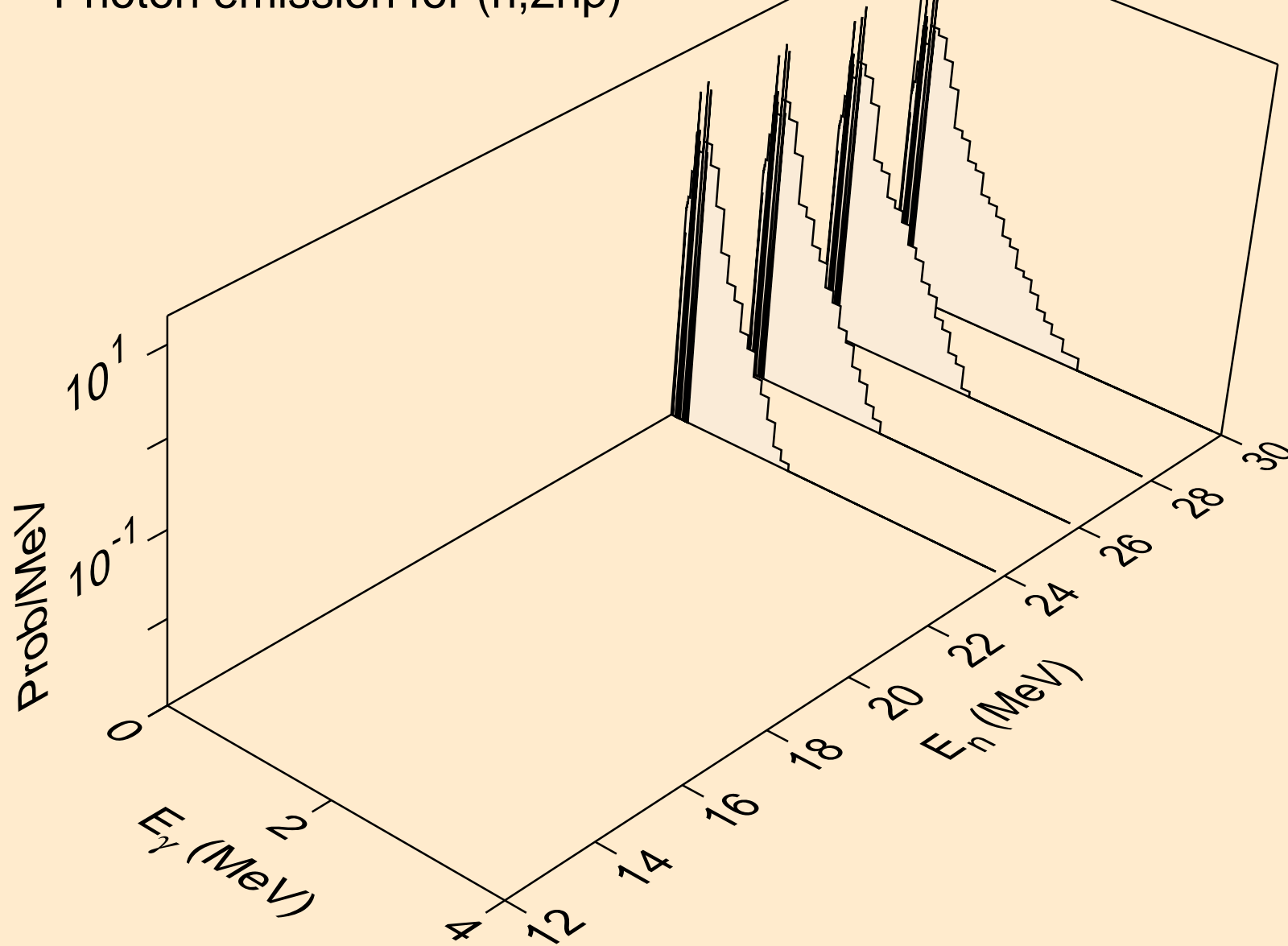

TH232 PROTON ACER TENDL-2021 LIBRARY; T=0.K  
Photon emission for (n,gma)

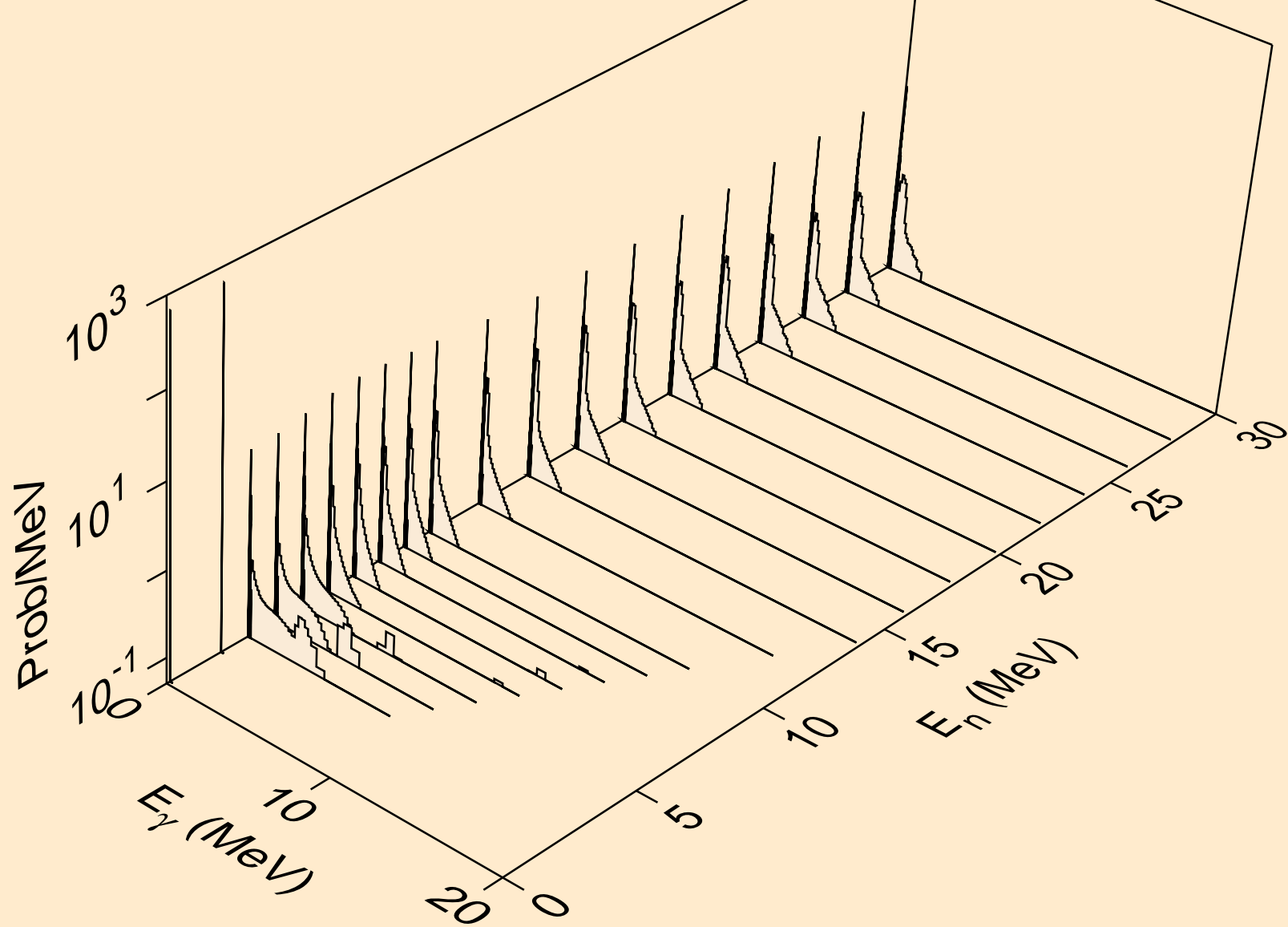

TH232 PROTON ACER TENDL-2021 LIBRARY; T=0.K  
Photon emission for inelastic

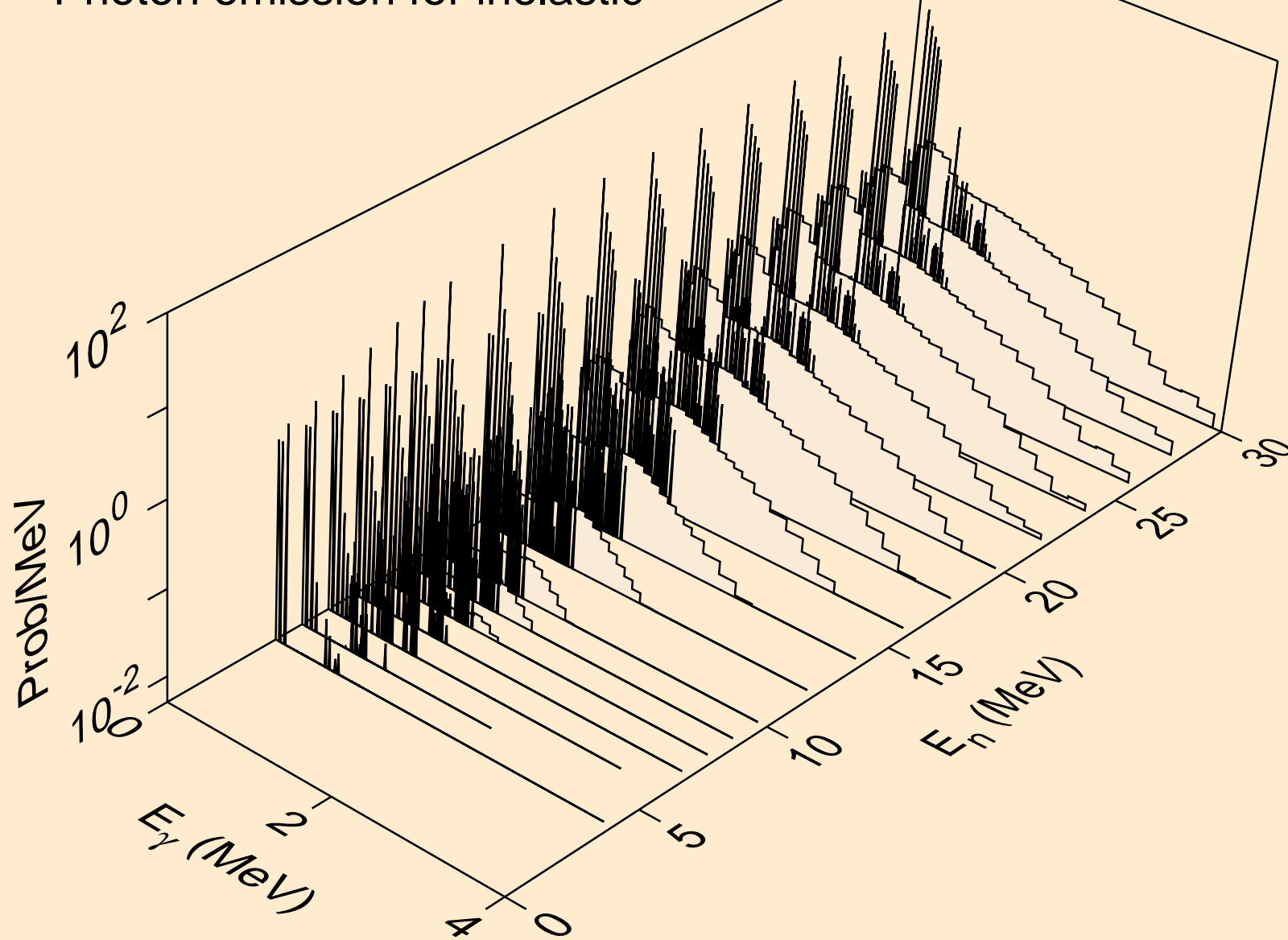

TH232 PROTON ACER TENDL-2021 LIBRARY; T=0.K  
Photon emission for (n,d)

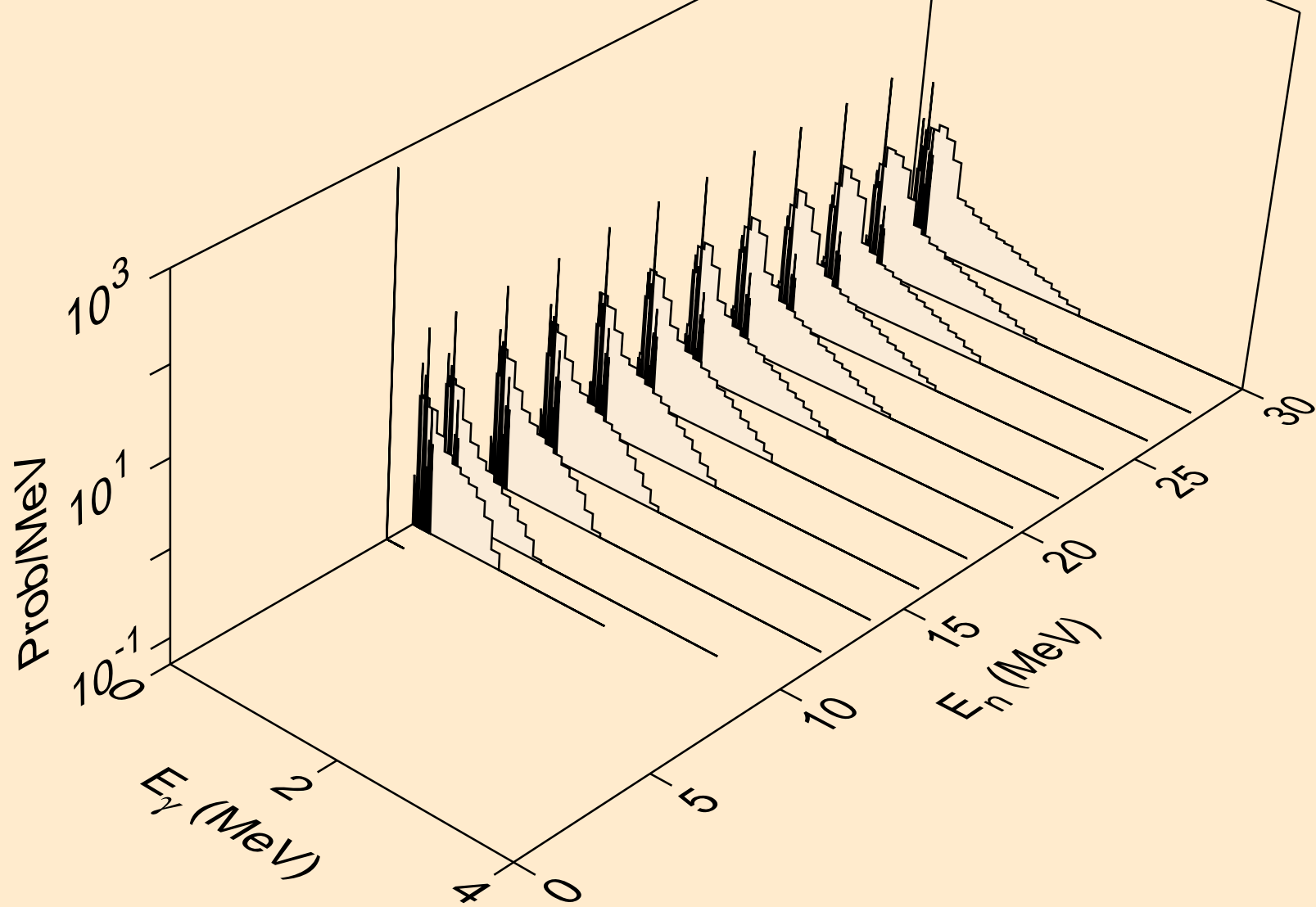

TH232 PROTON ACER TENDL-2021 LIBRARY; T=0.K  
Photon emission for (n,t)

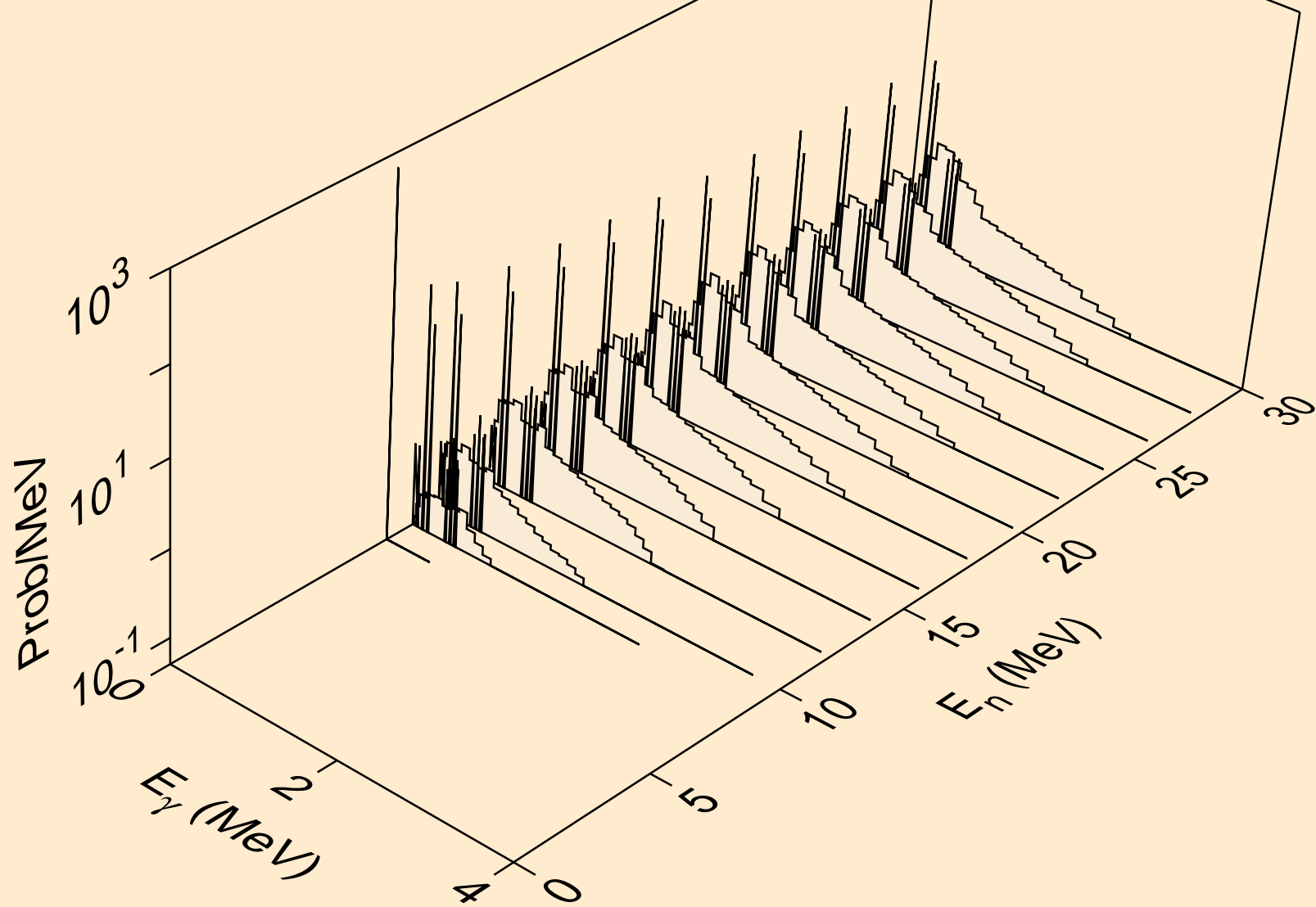

TH232 PROTON ACER TENDL-2021 LIBRARY; T=0.K  
Photon emission for (n,he3)

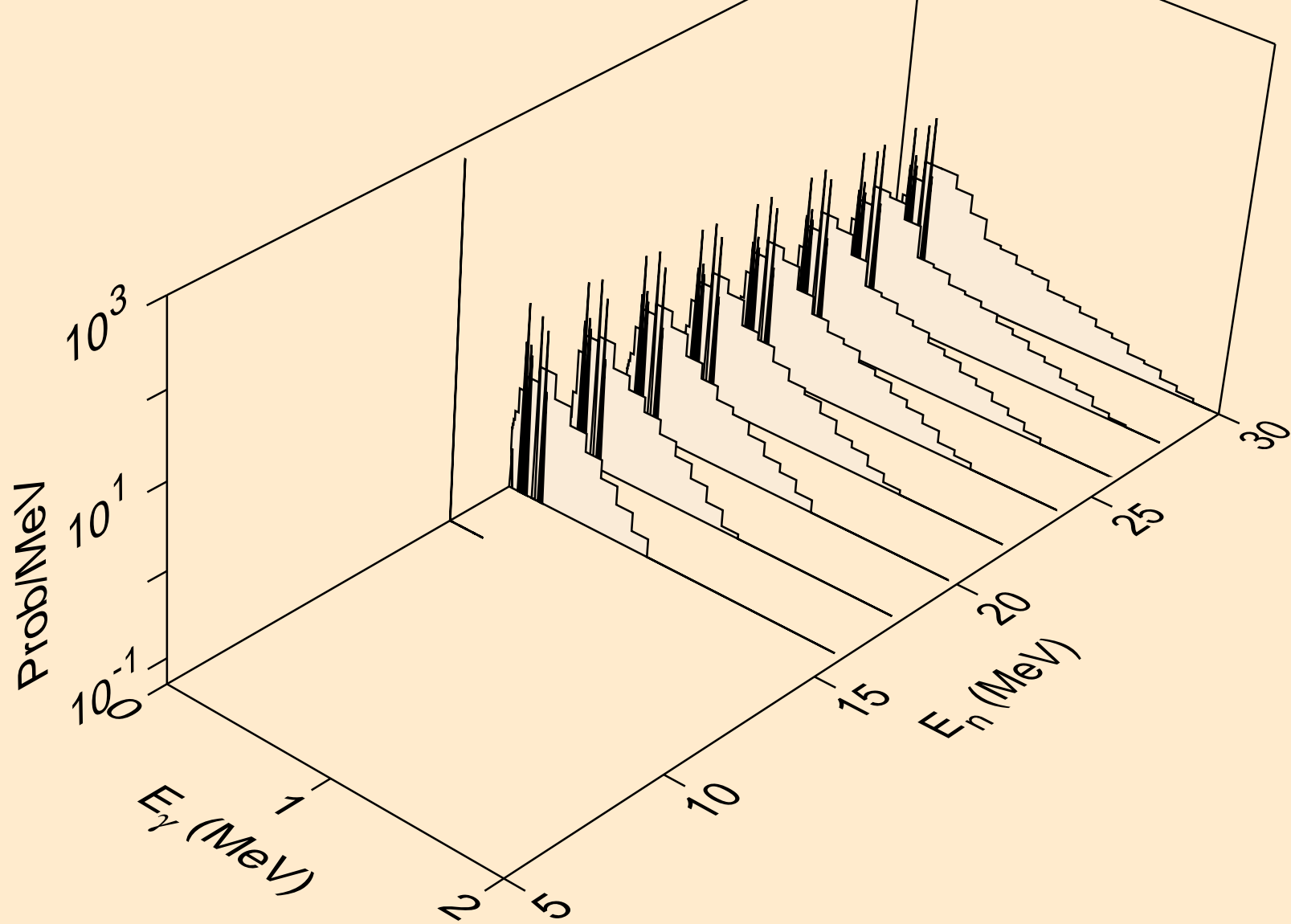

TH232 PROTON ACER TENDL-2021 LIBRARY; T=0.K  
Photon emission for (n,a)

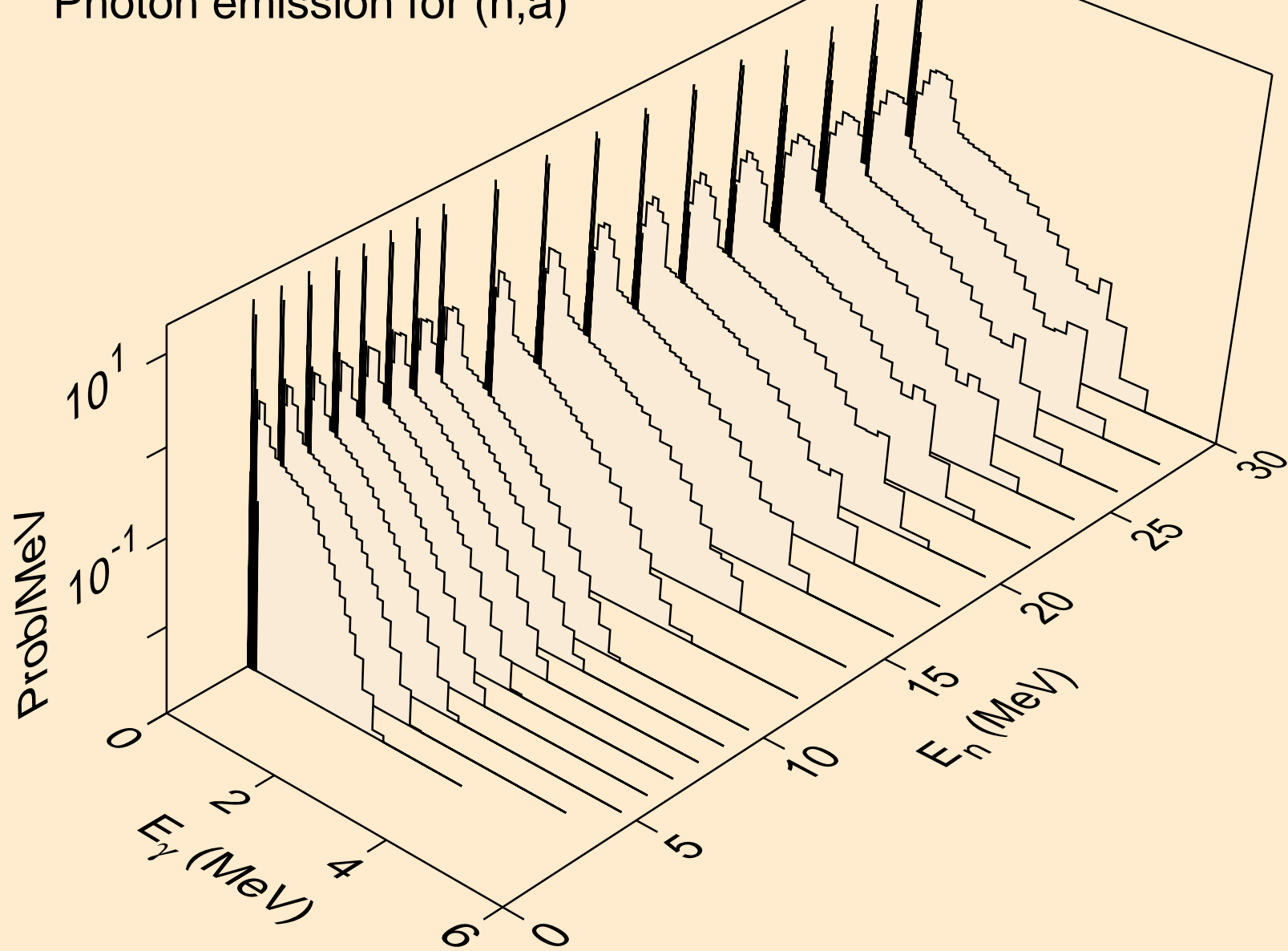

TH232 PROTON ACER TENDL-2021 LIBRARY; T=0.K  
Photon emission for (n,2p)

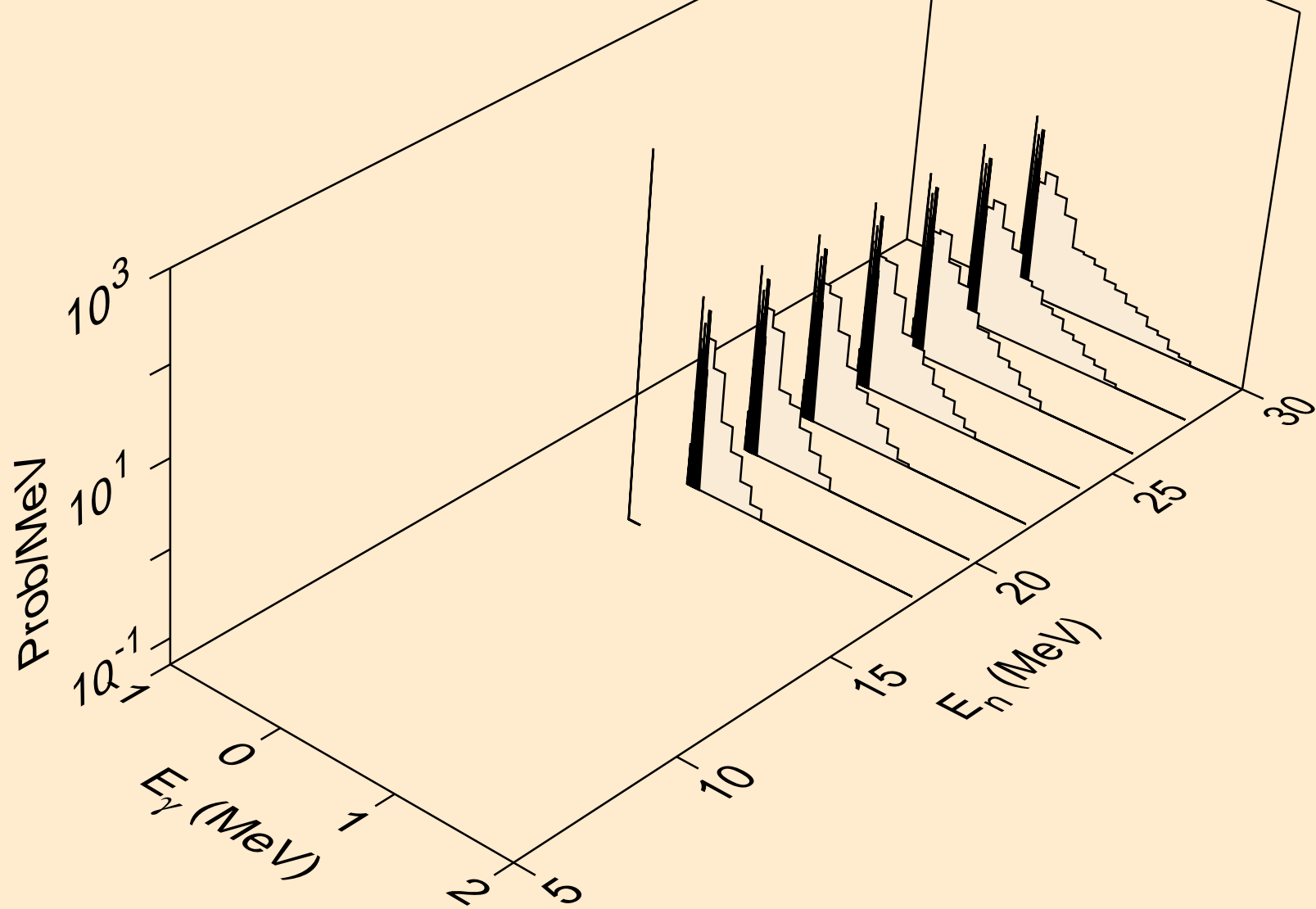



TH232 PROTON ACER TENDL-2021 LIBRARY; T=0.K  
Particle heating contributions

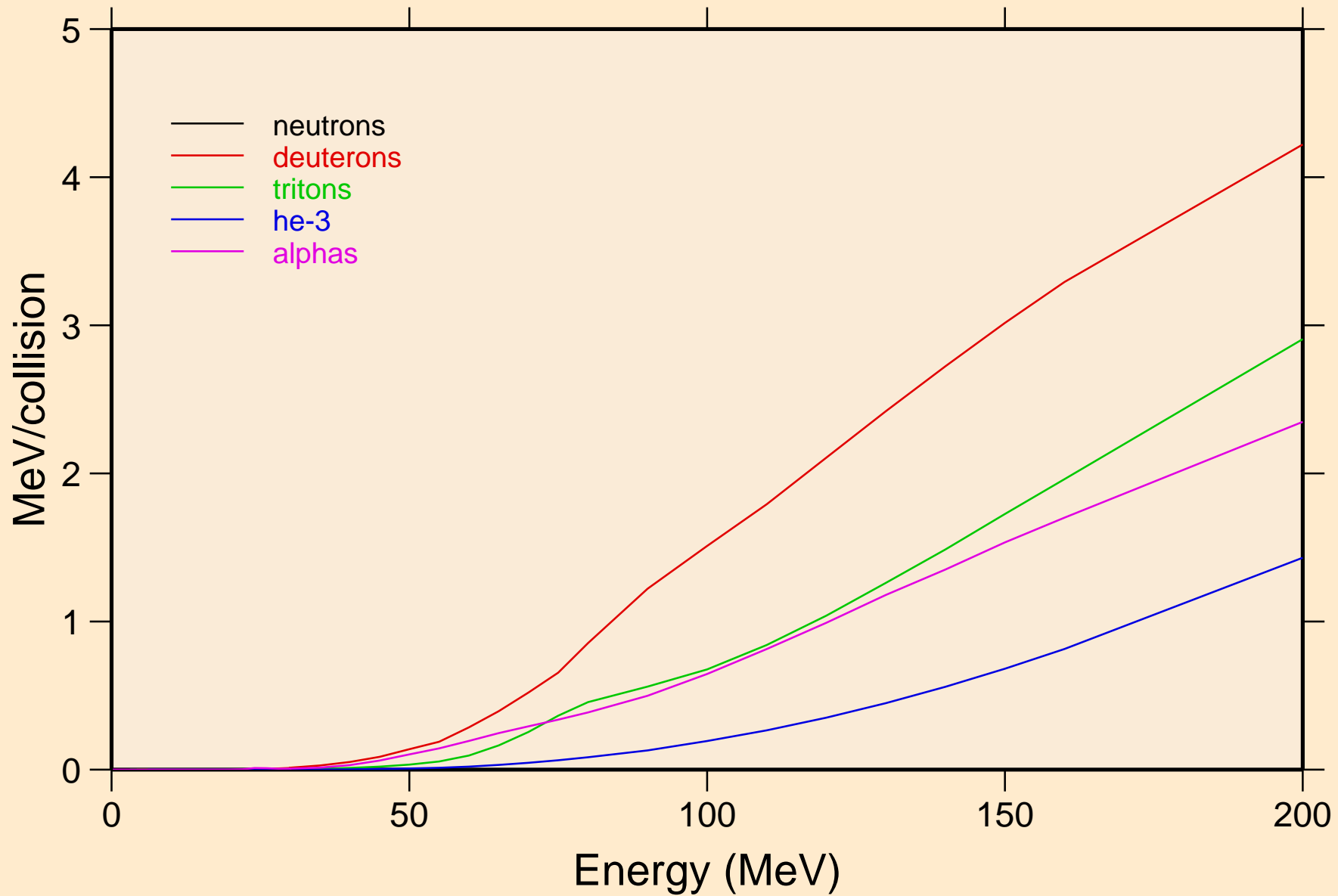

TH232 PROTON ACER TENDL-2021 LIBRARY; T=0.K  
Recoil Heating

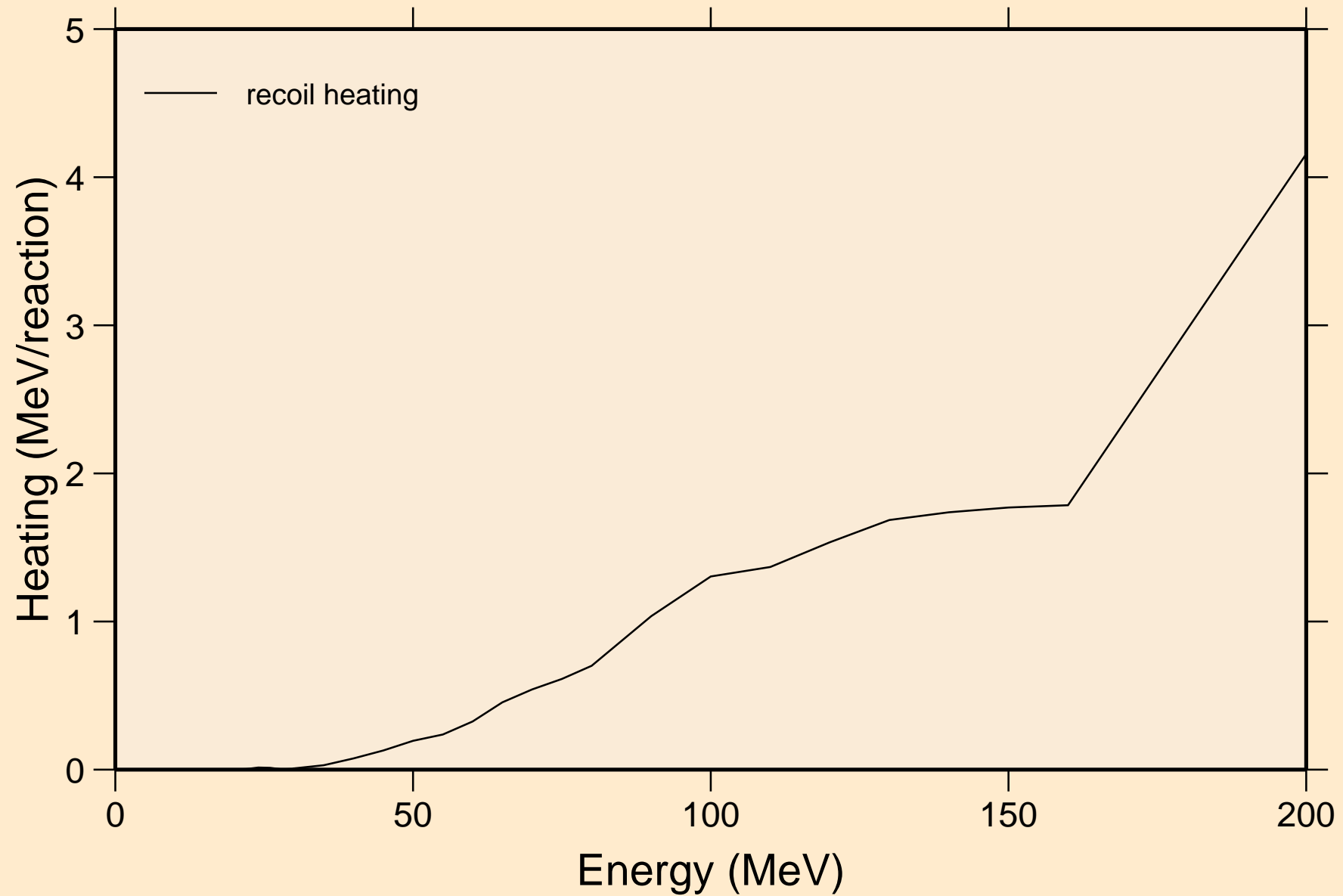

TH232 PROTON ACER TENDL-2021 LIBRARY; T=0.K  
Particle production cross sections

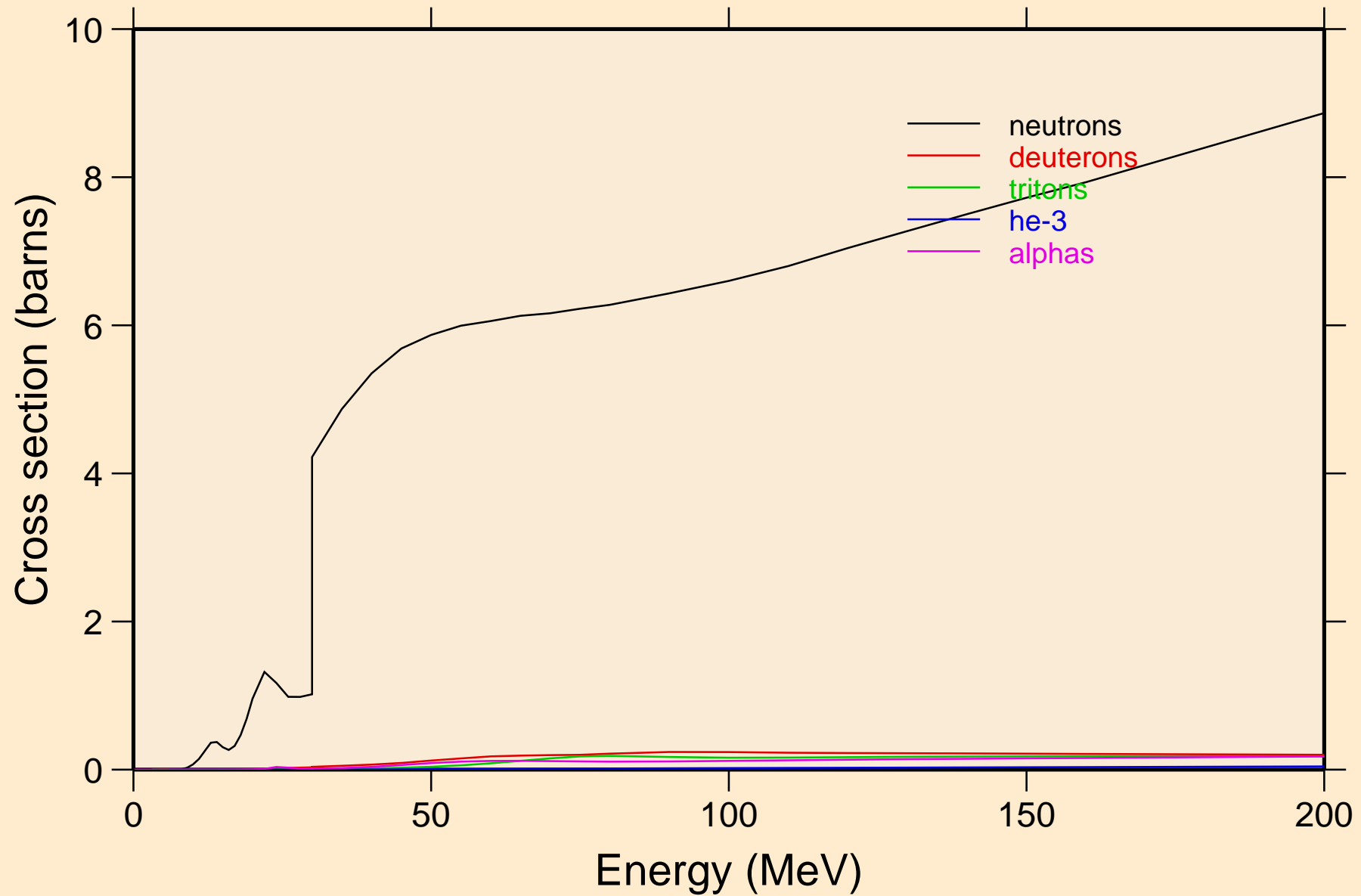

TH232 PROTON ACER TENDL-2021 LIBRARY; T=0.K  
neutrons from (p,n)

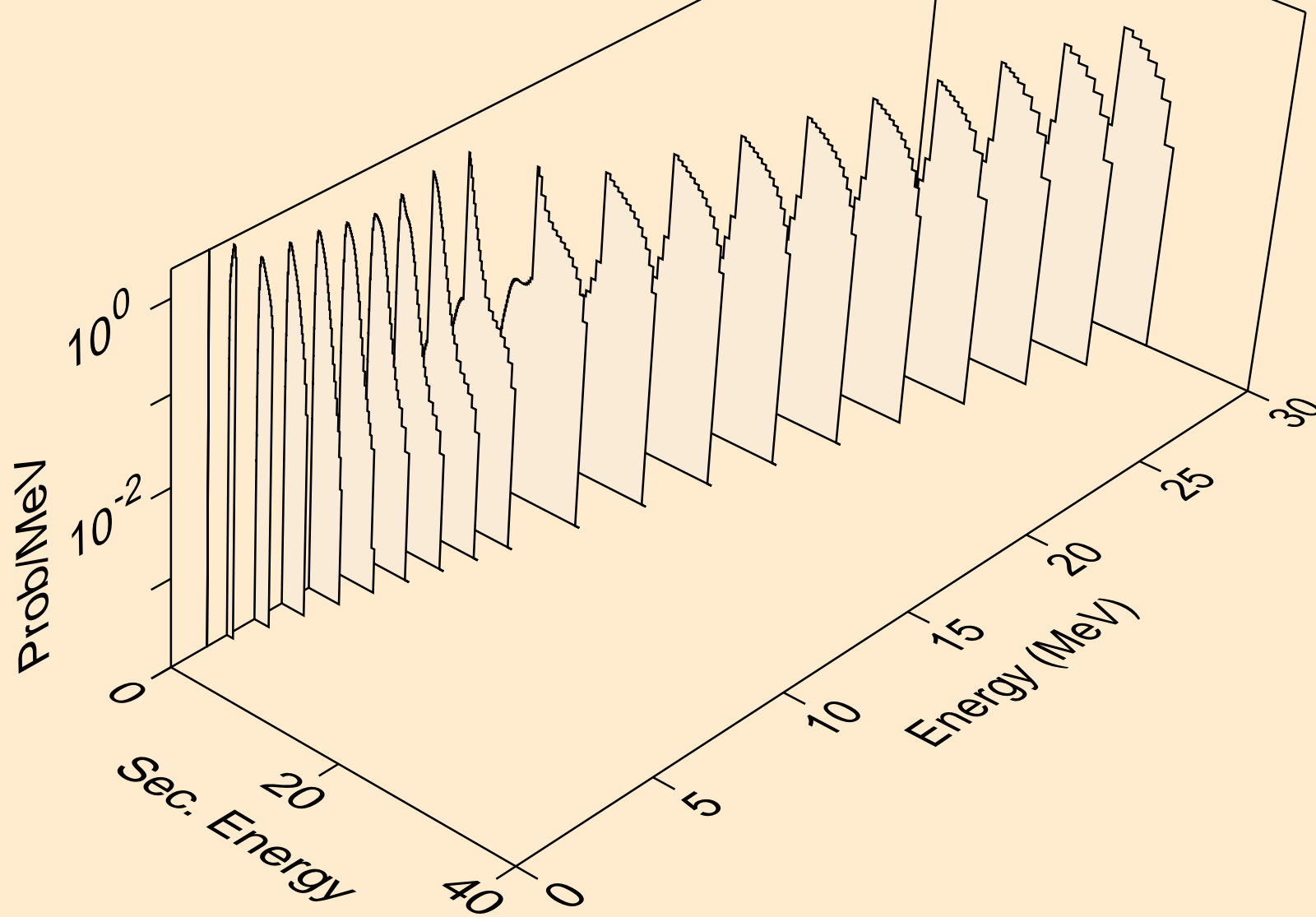

TH232 PROTON ACER TENDL-2021 LIBRARY; T=0.K  
neutrons from (p,x)

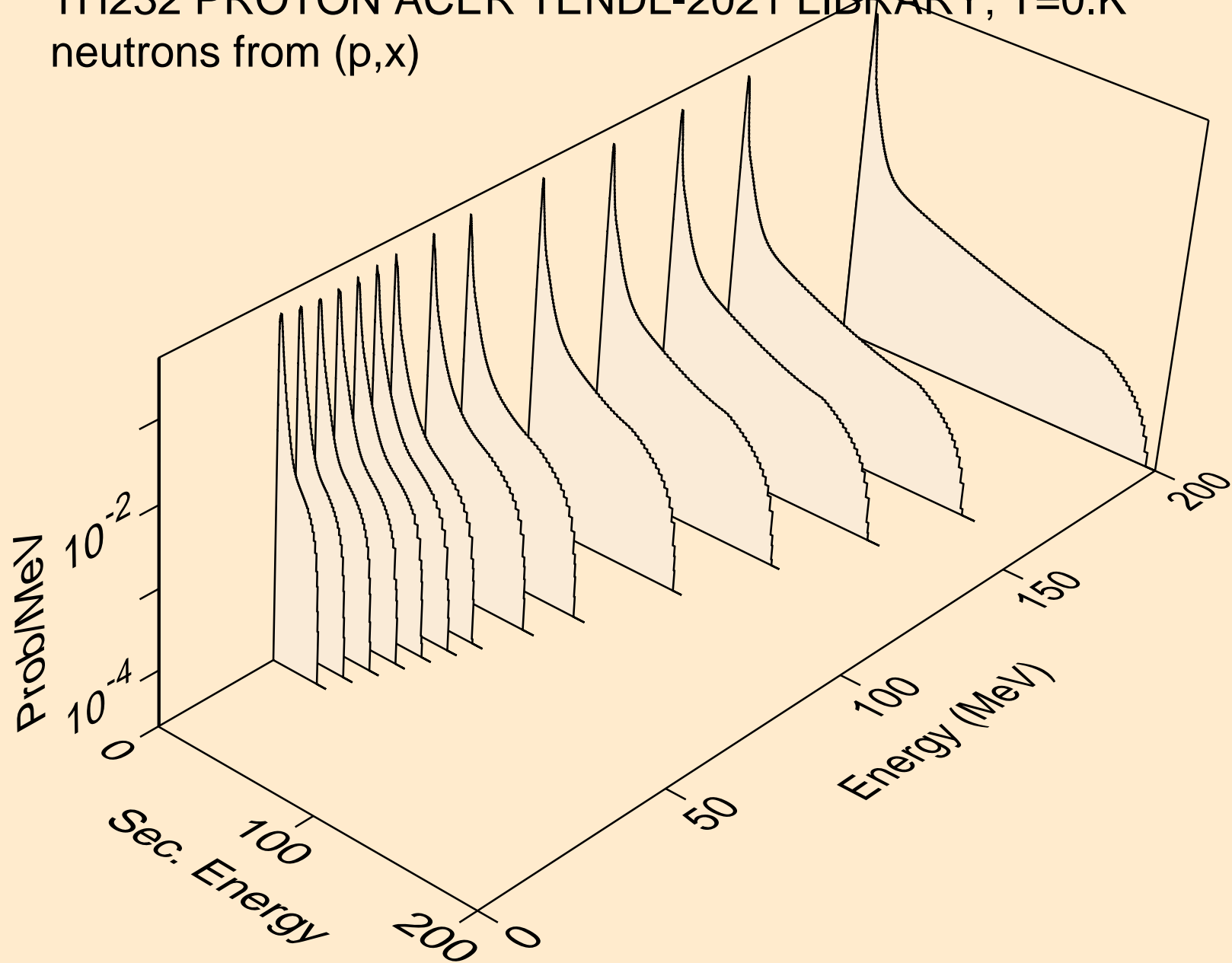

TH232 PROTON ACER TENDL-2021 LIBRARY; T=0.K  
neutrons from (p,2nd)

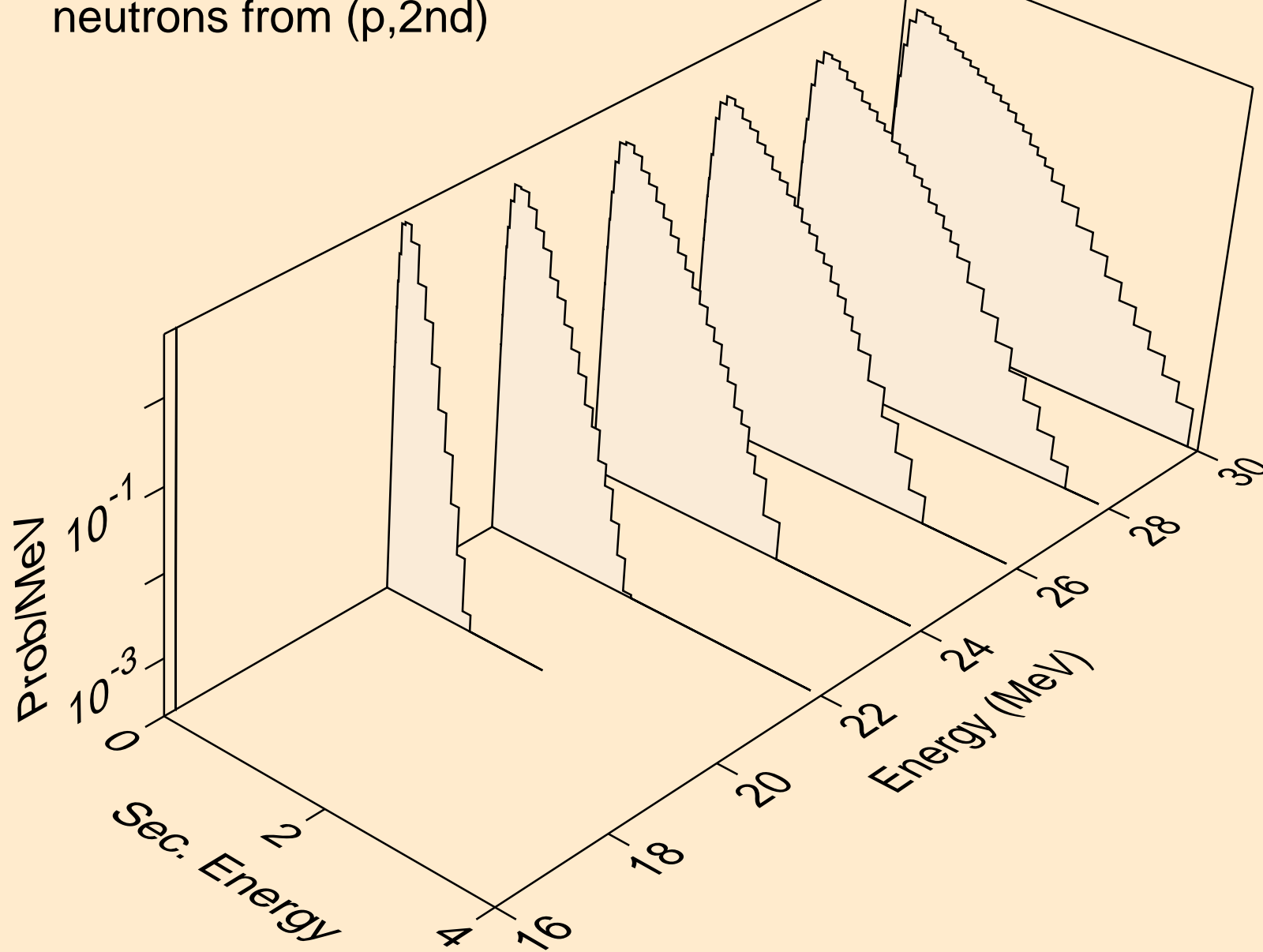

TH232 PROTON ACER TENDL-2021 LIBRARY; T=0.K  
neutrons from (p,2n)

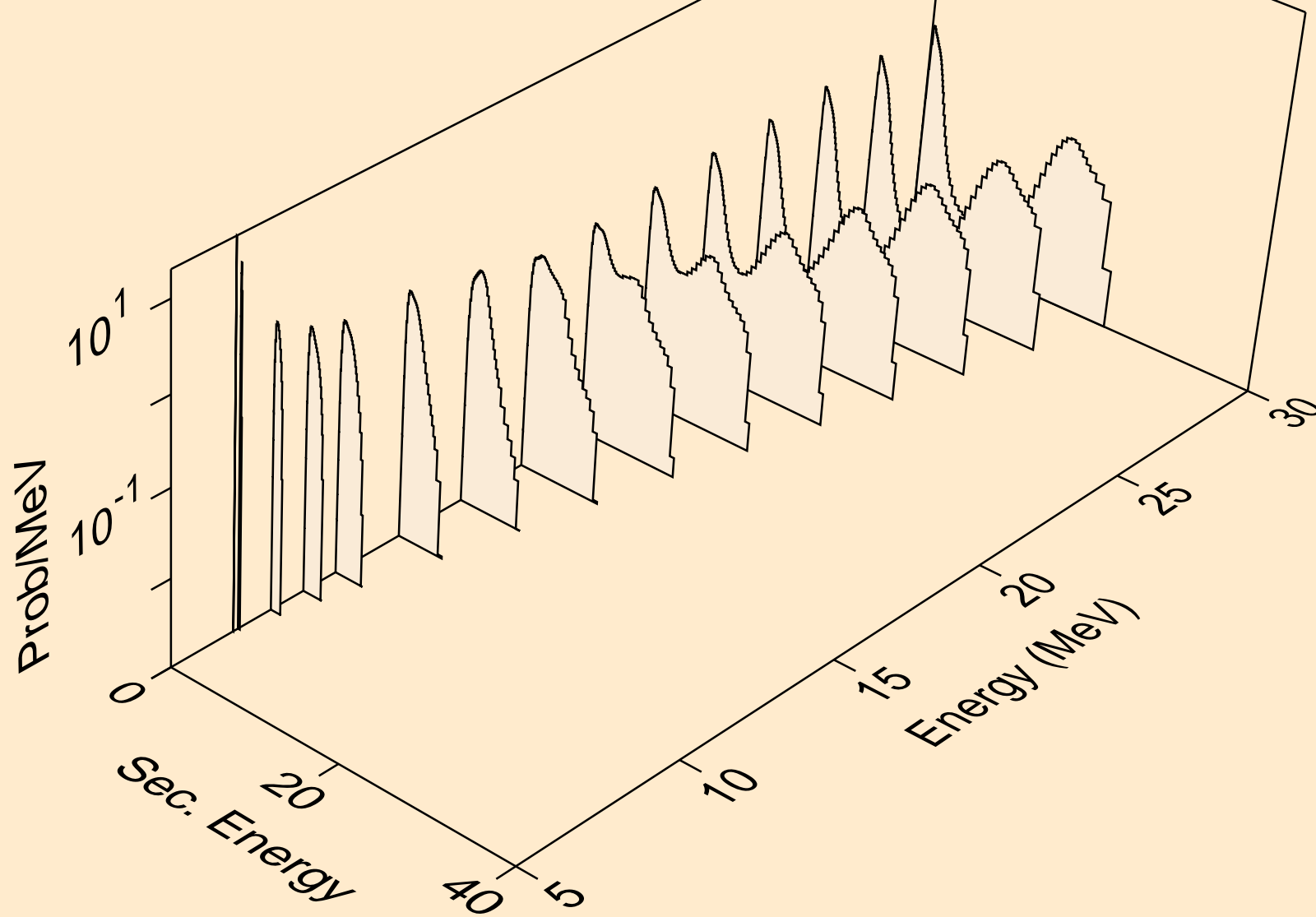

TH232 PROTON ACER TENDL-2021 LIBRARY; T=0.K  
neutrons from (p,3n)

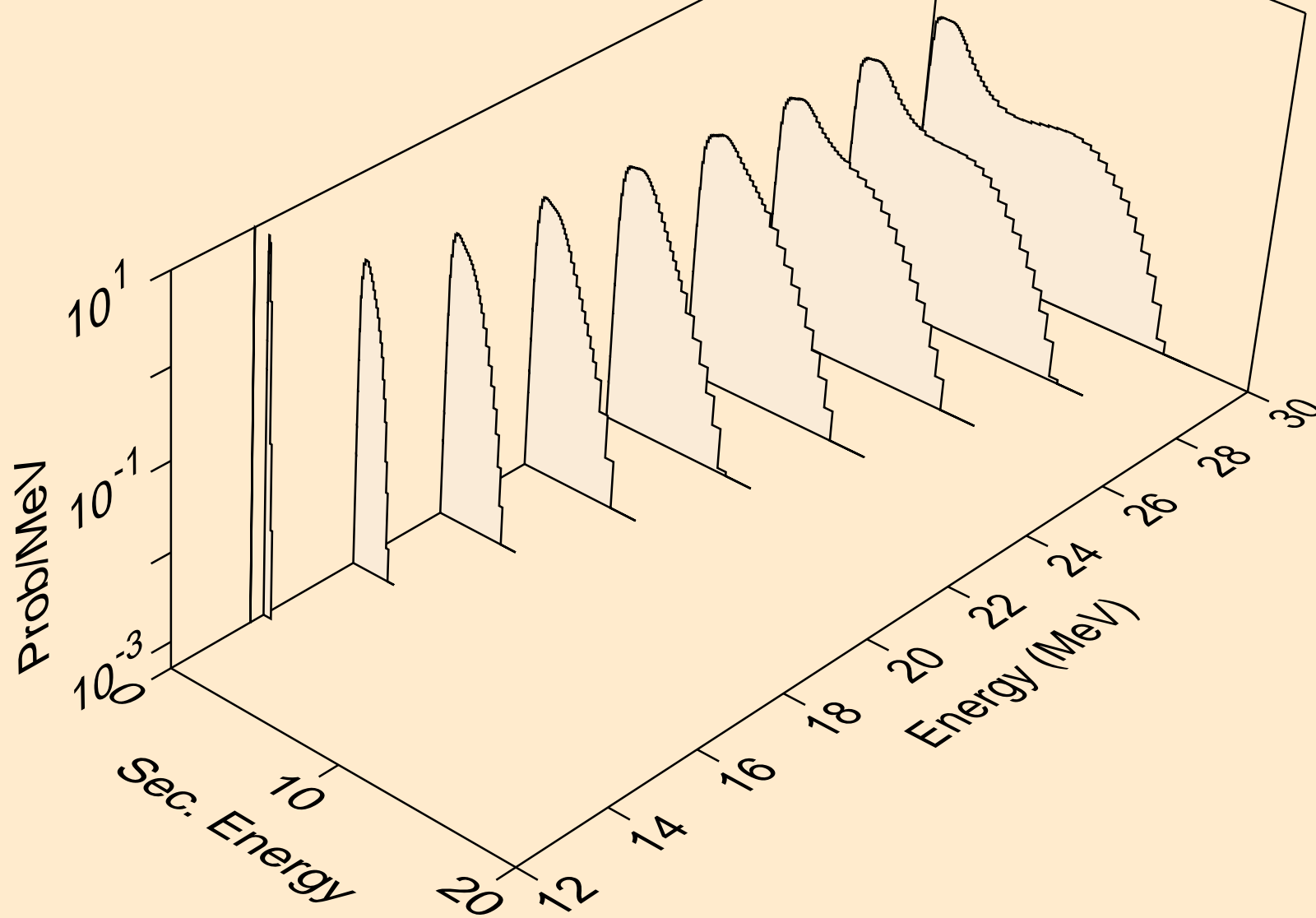



TH232 PROTON ACER TENDL-2021 LIBRARY; T=0.K  
neutrons from (p,n\*)a

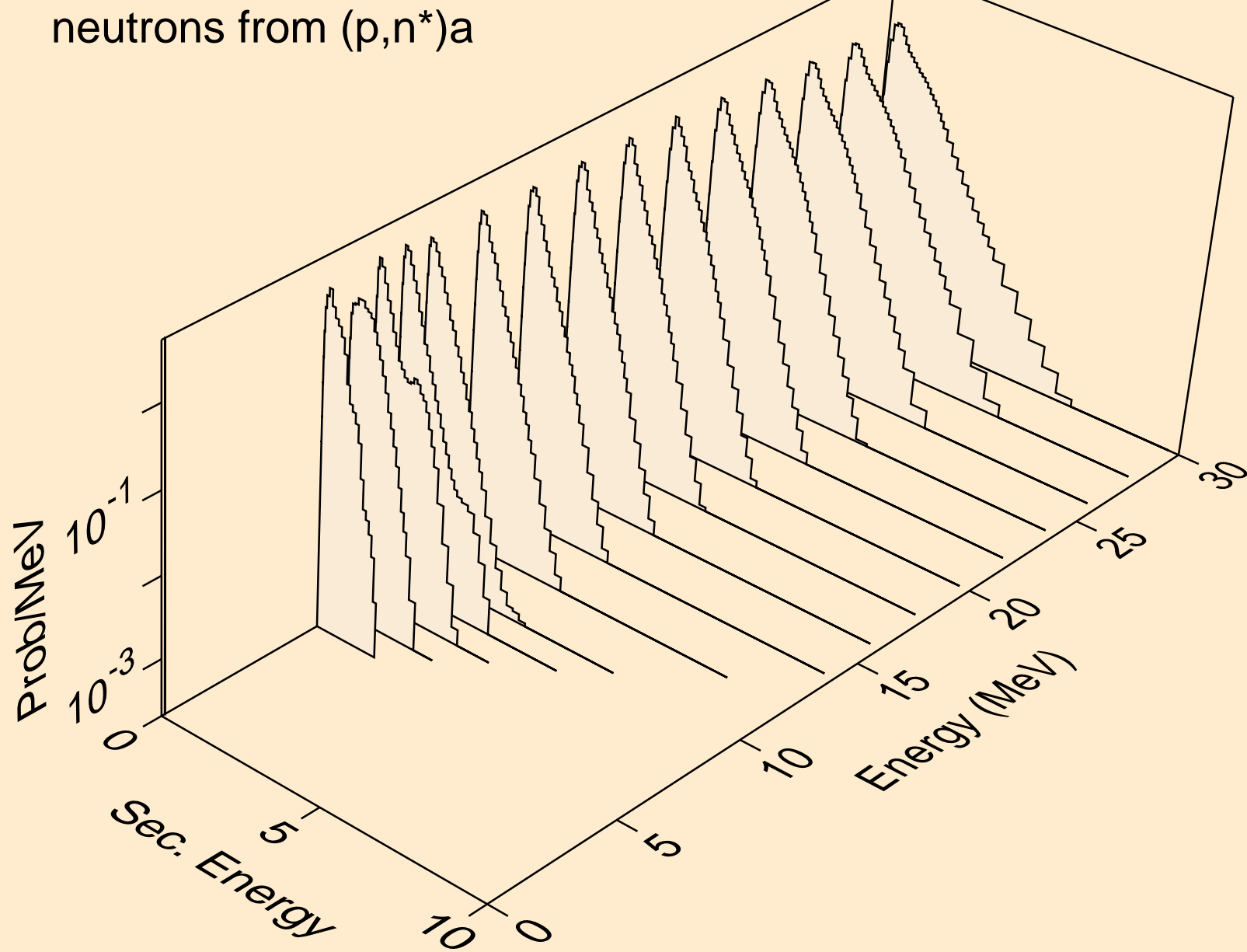

TH232 PROTON ACER TENDL-2021 LIBRARY; T=0.K  
neutrons from (p,2n)a

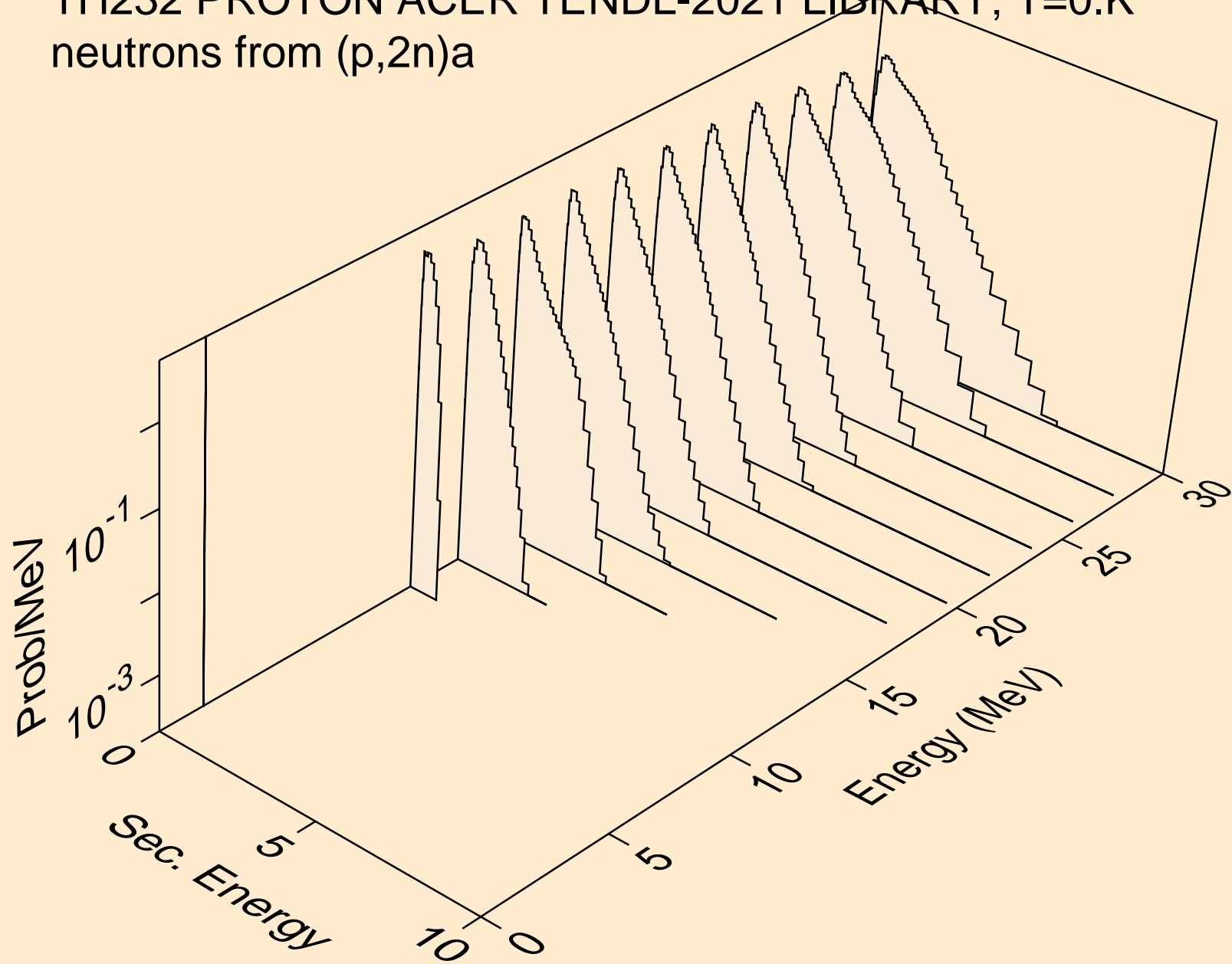

TH232 PROTON ACER TENDL-2021 LIBRARY; T=0.K  
neutrons from (p,3n)a

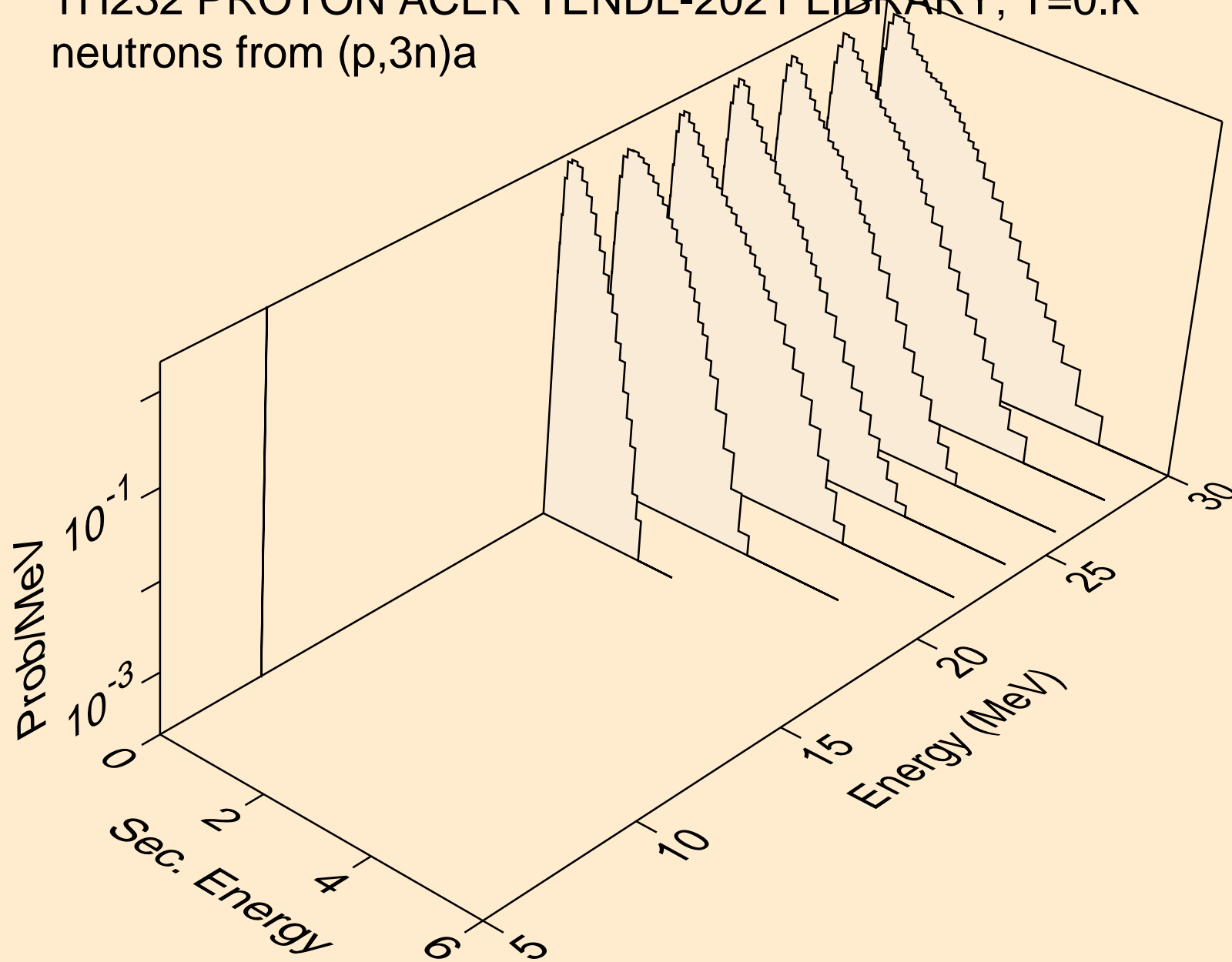

TH232 PROTON ACER TENDL-2021 LIBRARY; T=0.K  
neutrons from (p,n\*)p

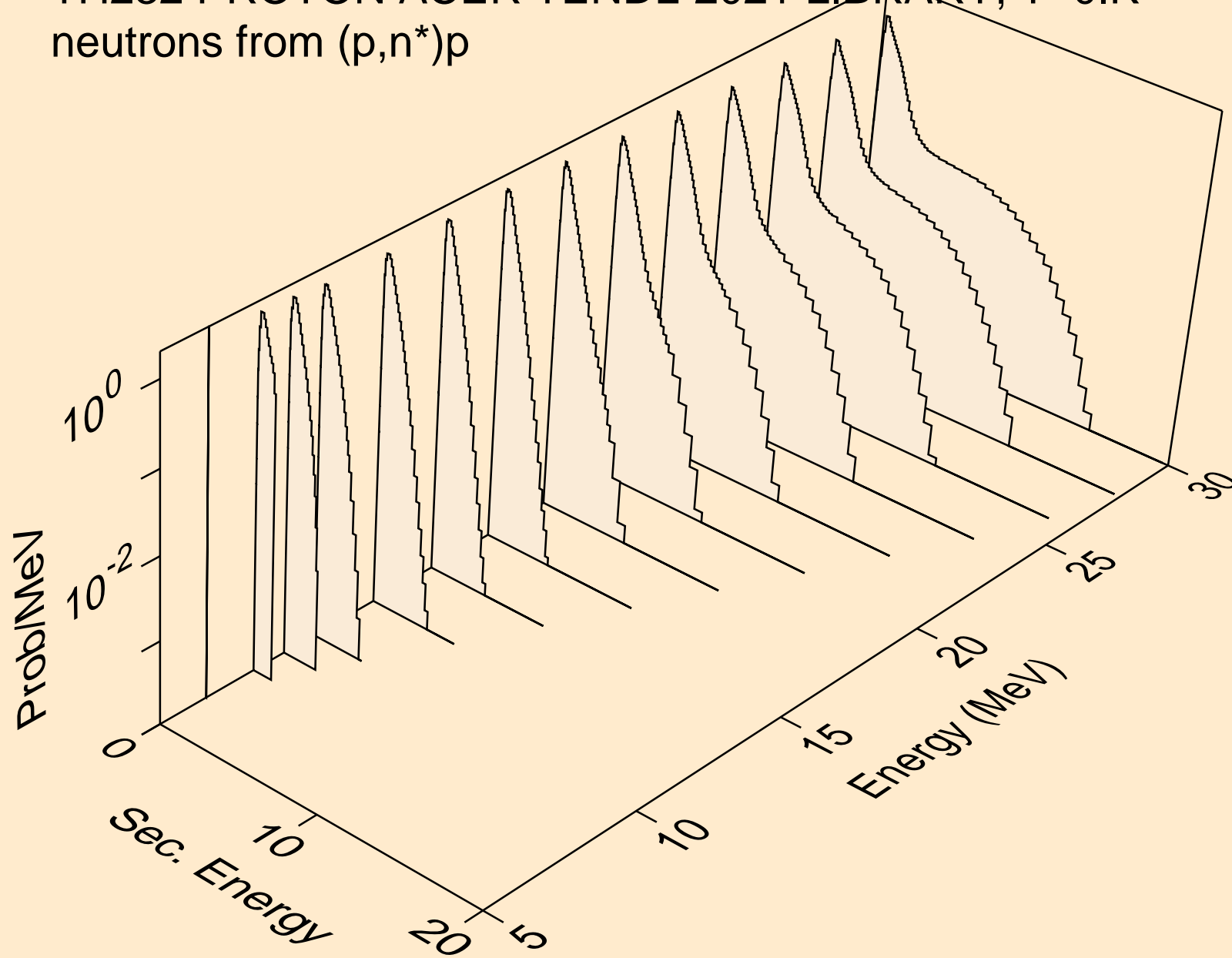

TH232 PROTON ACER TENDL-2021 LIBRARY; T=0.K  
neutrons from (p,n\*)d

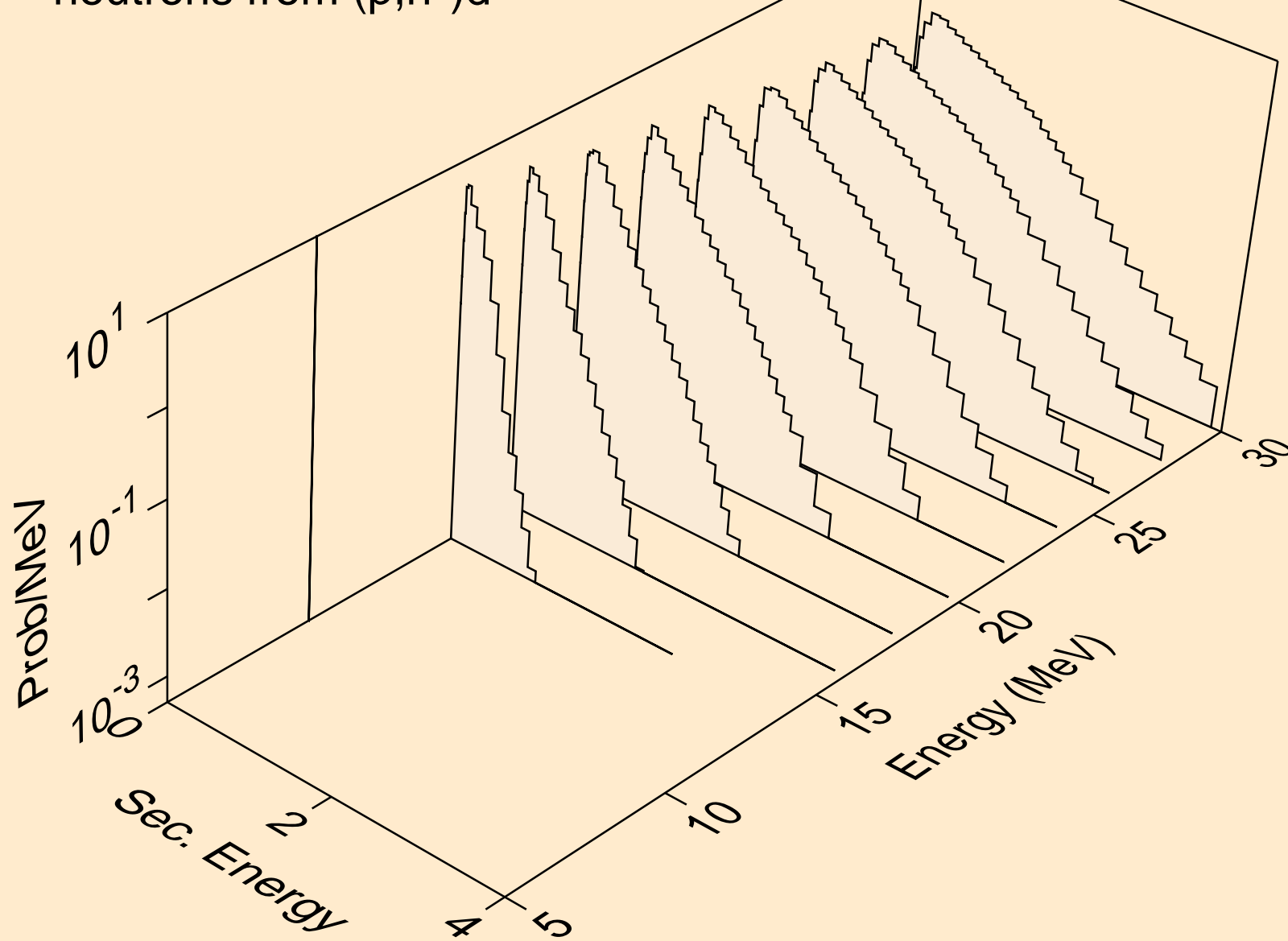

TH232 PROTON ACER TENDL-2021 LIBRARY; T=0.K  
neutrons from (p,n\*)t

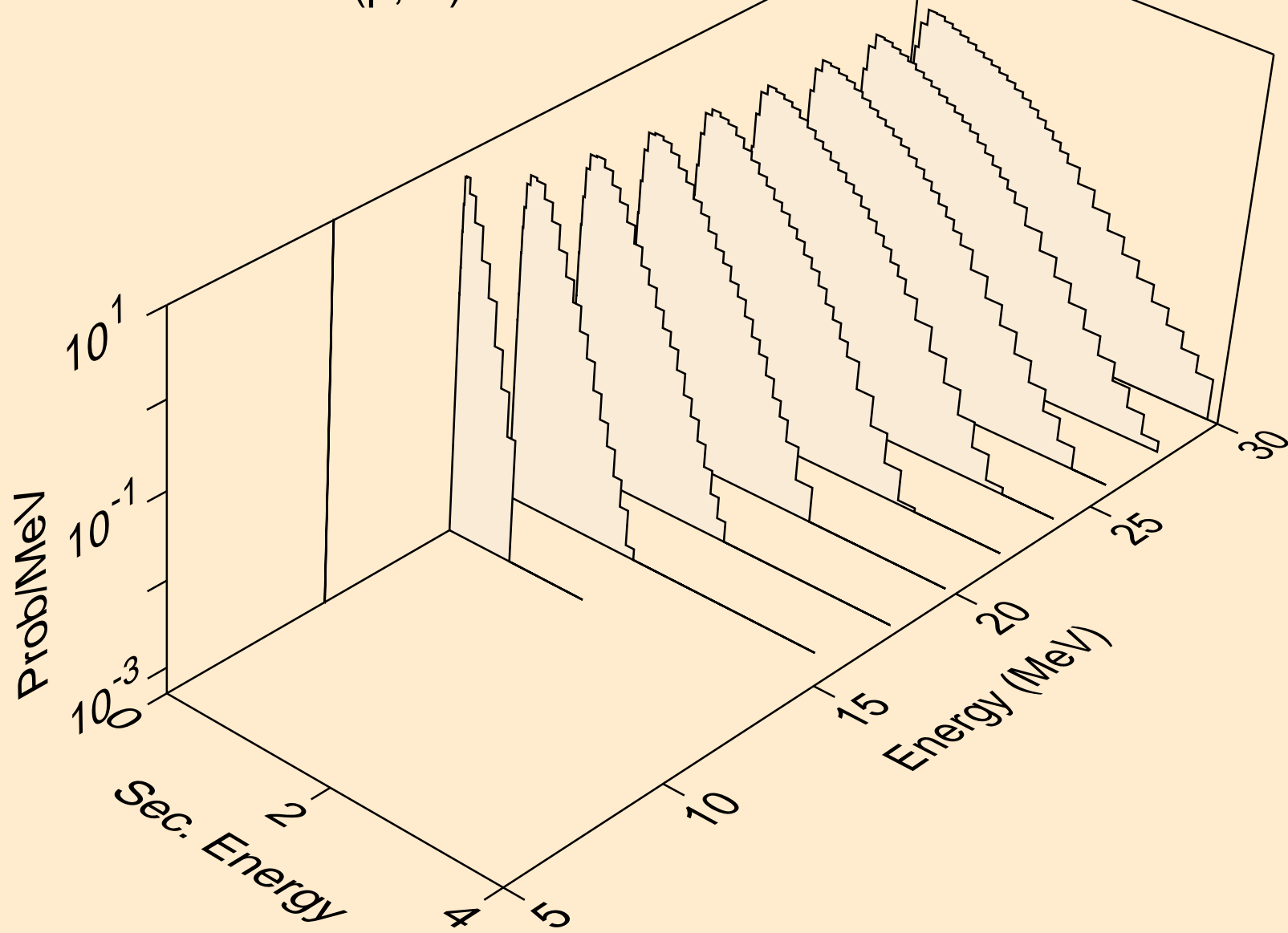

TH232 PROTON ACER TENDL-2021 LIBRARY; T=0.K  
neutrons from (p,n\*)he3

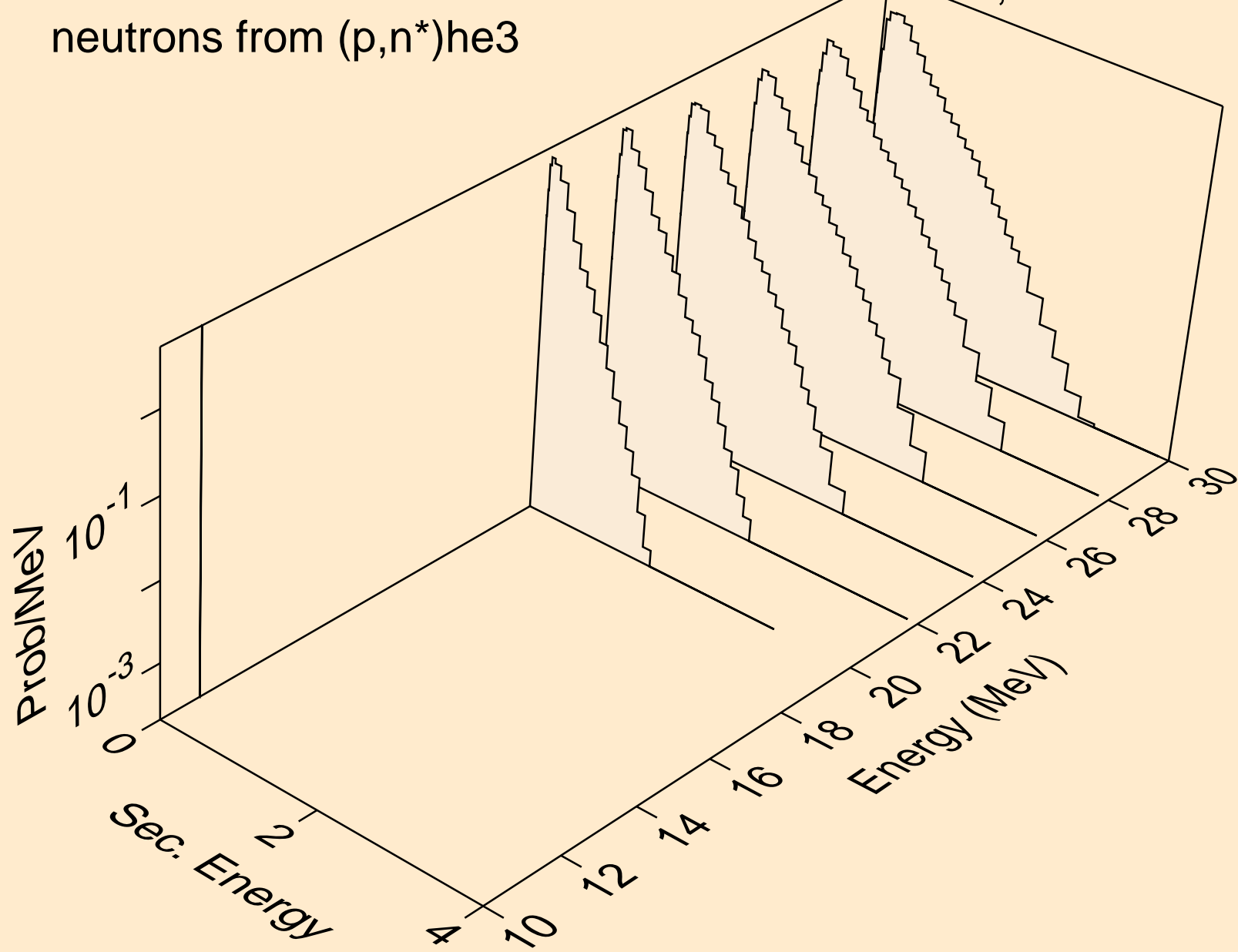

TH232 PROTON ACER TENDL-2021 LIBRARY; T=0.K  
neutrons from (p,4n)

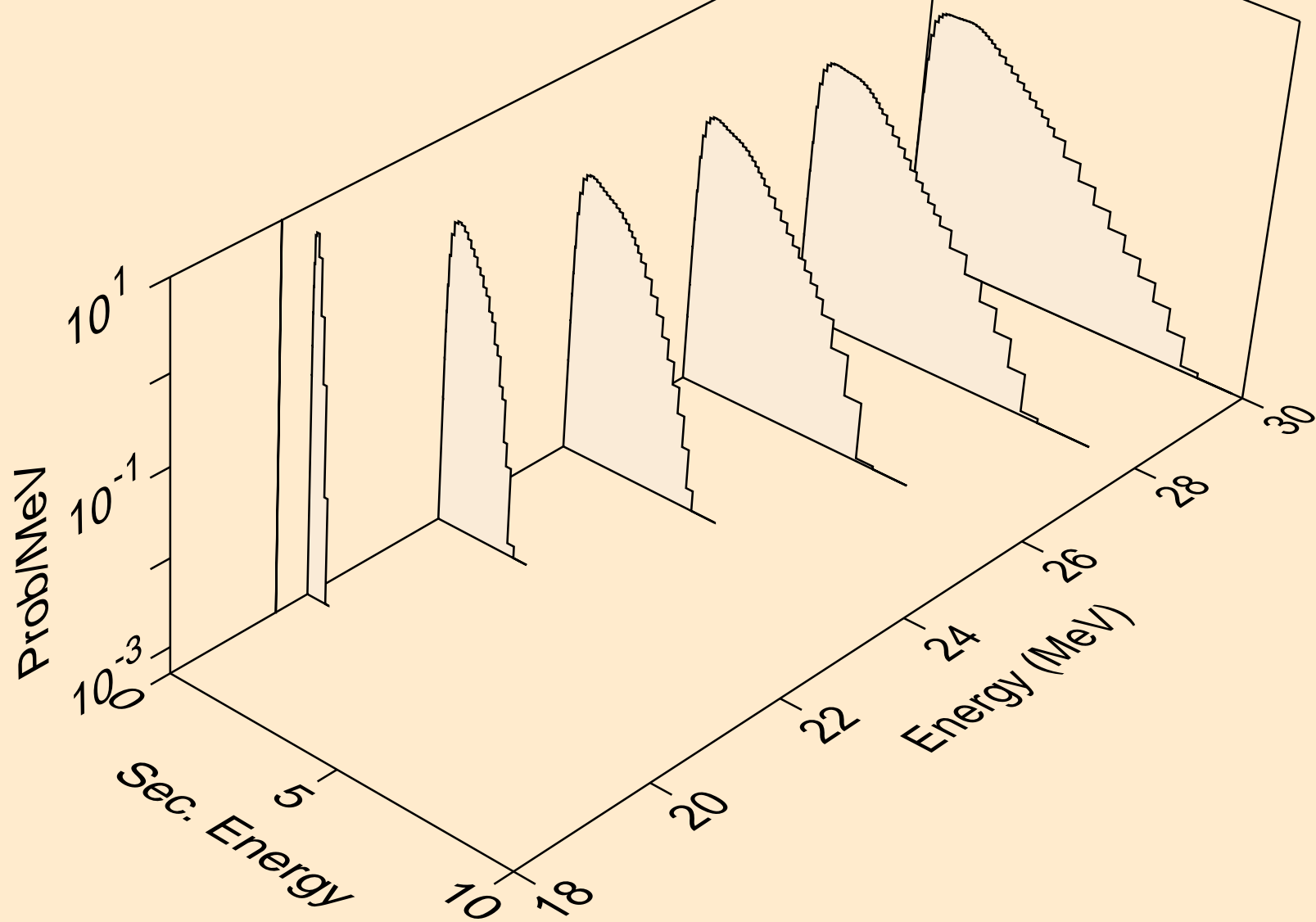



TH232 PROTON ACER TENDL-2021 LIBRARY; T=0.K  
neutrons from (p,2np)

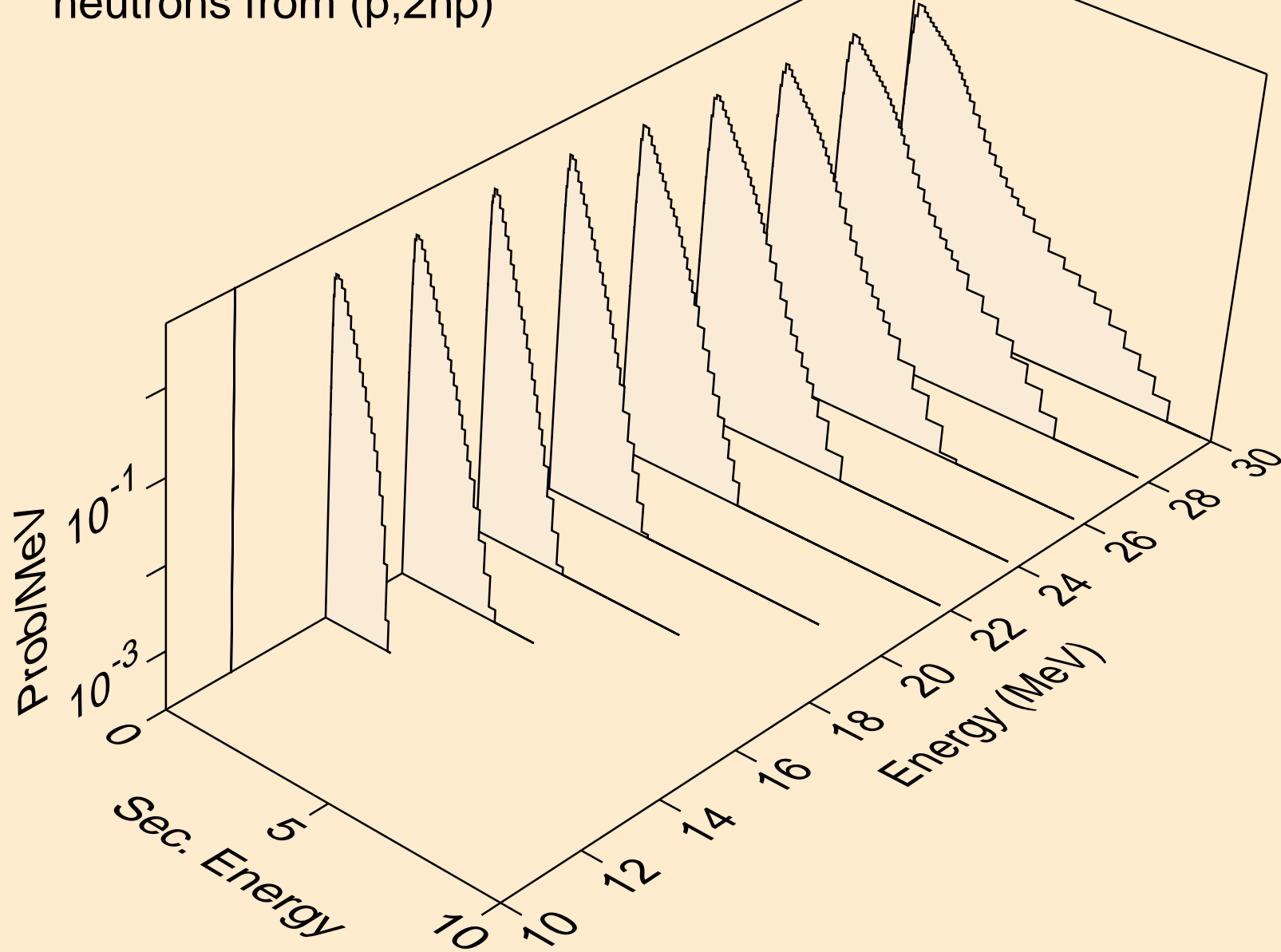

TH232 PROTON ACER TENDL-2021 LIBRARY; T=0.K  
neutrons from (p,3np)

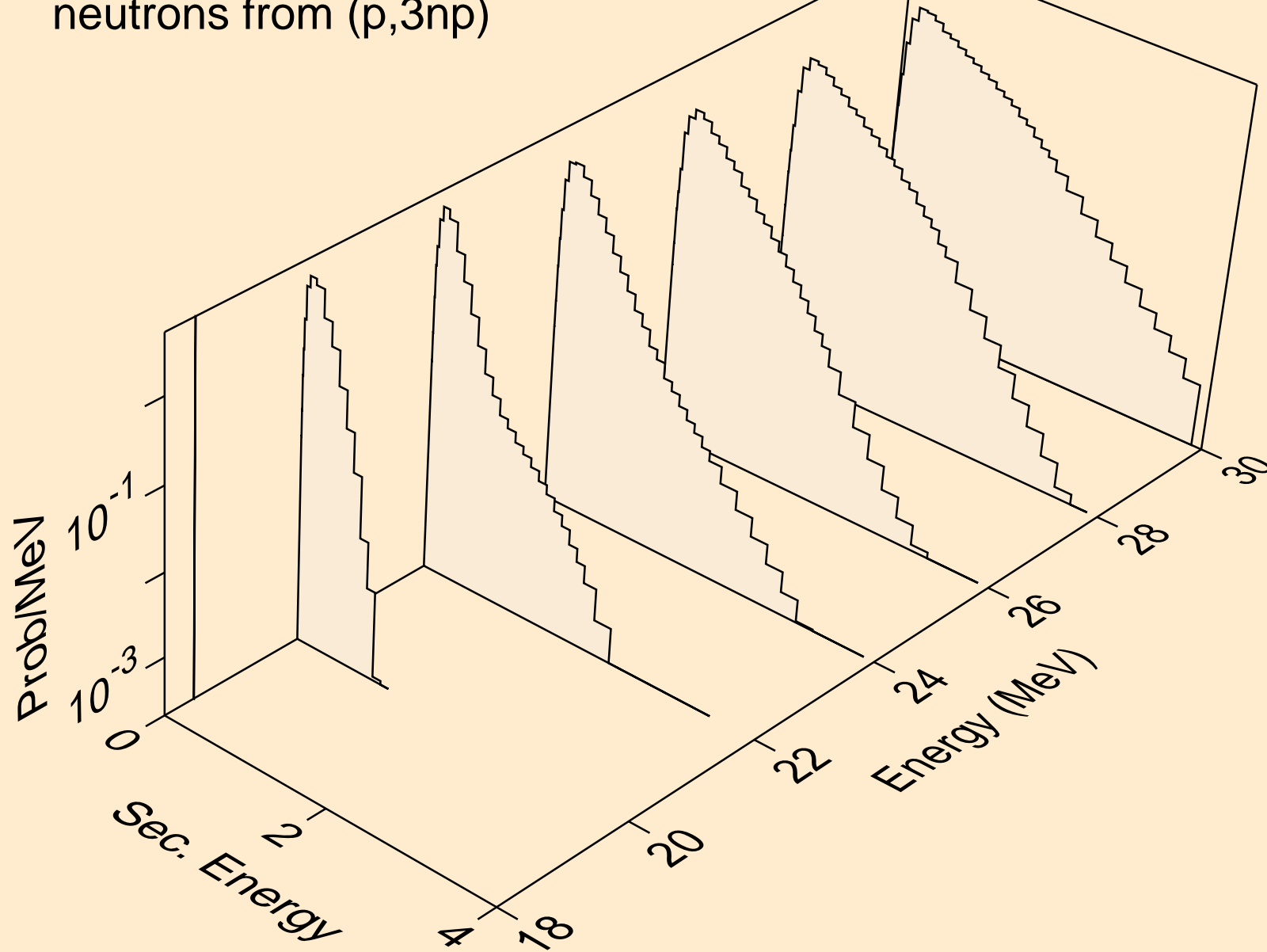

TH232 PROTON ACER TENDL-2021 LIBRARY; T=0.K  
neutrons from (p,2np)

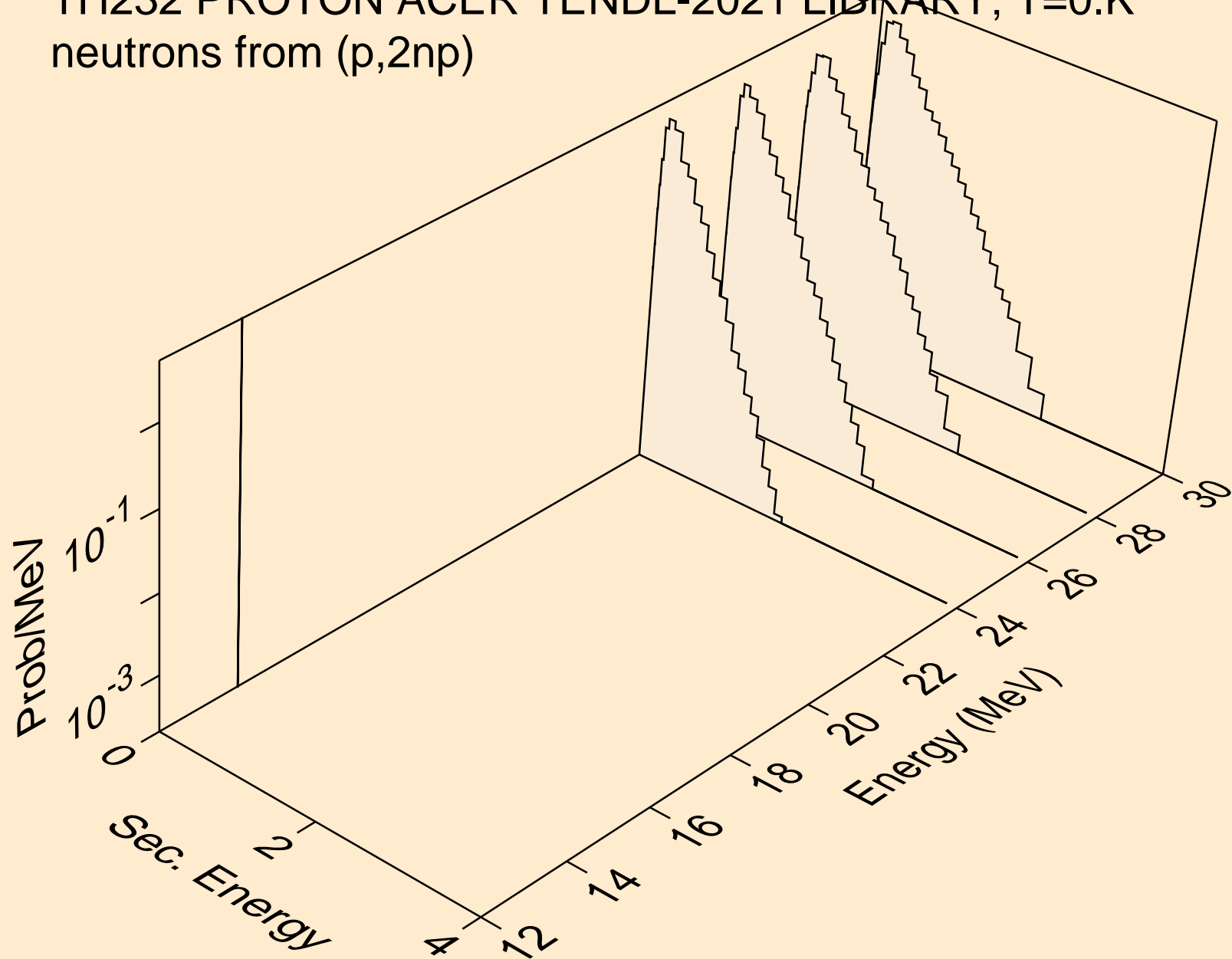

TH232 PROTON ACER TENDL-2021 LIBRARY; T=0.K  
deuterons from (p,x)

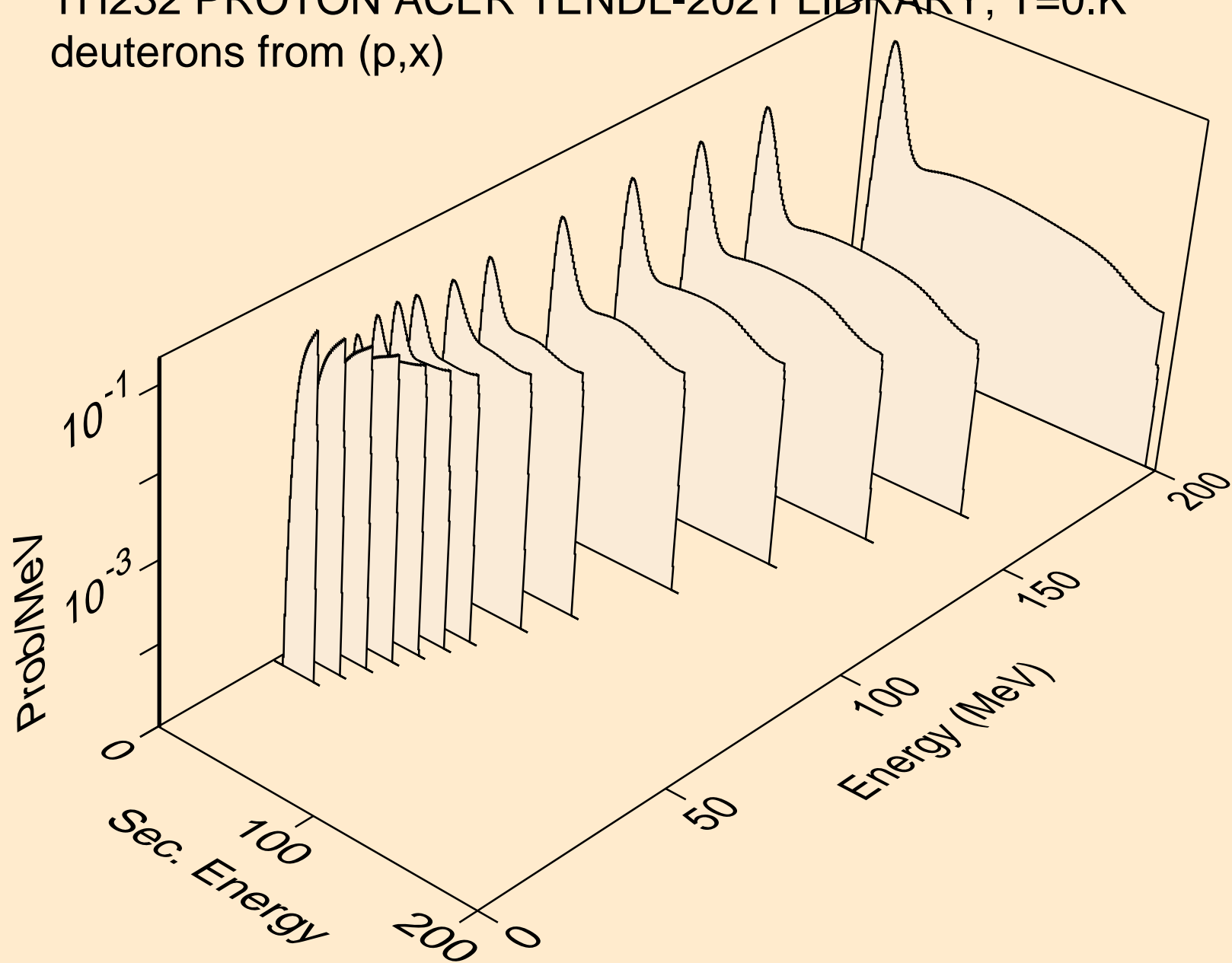

TH232 PROTON ACER TENDL-2021 LIBRARY; T=0.K  
deuterons from (p,2nd)

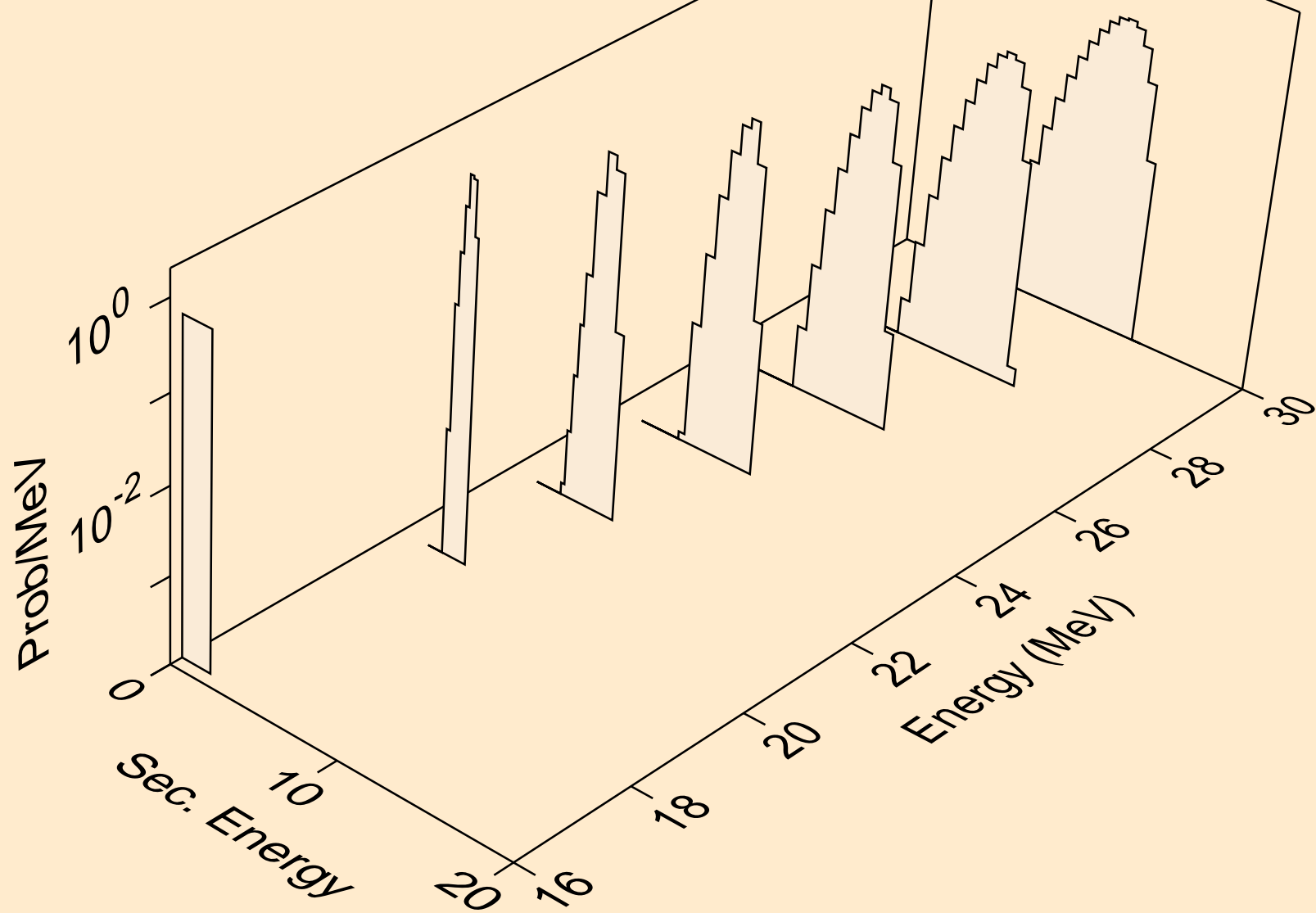

TH232 PROTON ACER TENDL-2021 LIBRARY; T=0.K  
deuterons from (p,n\*)d

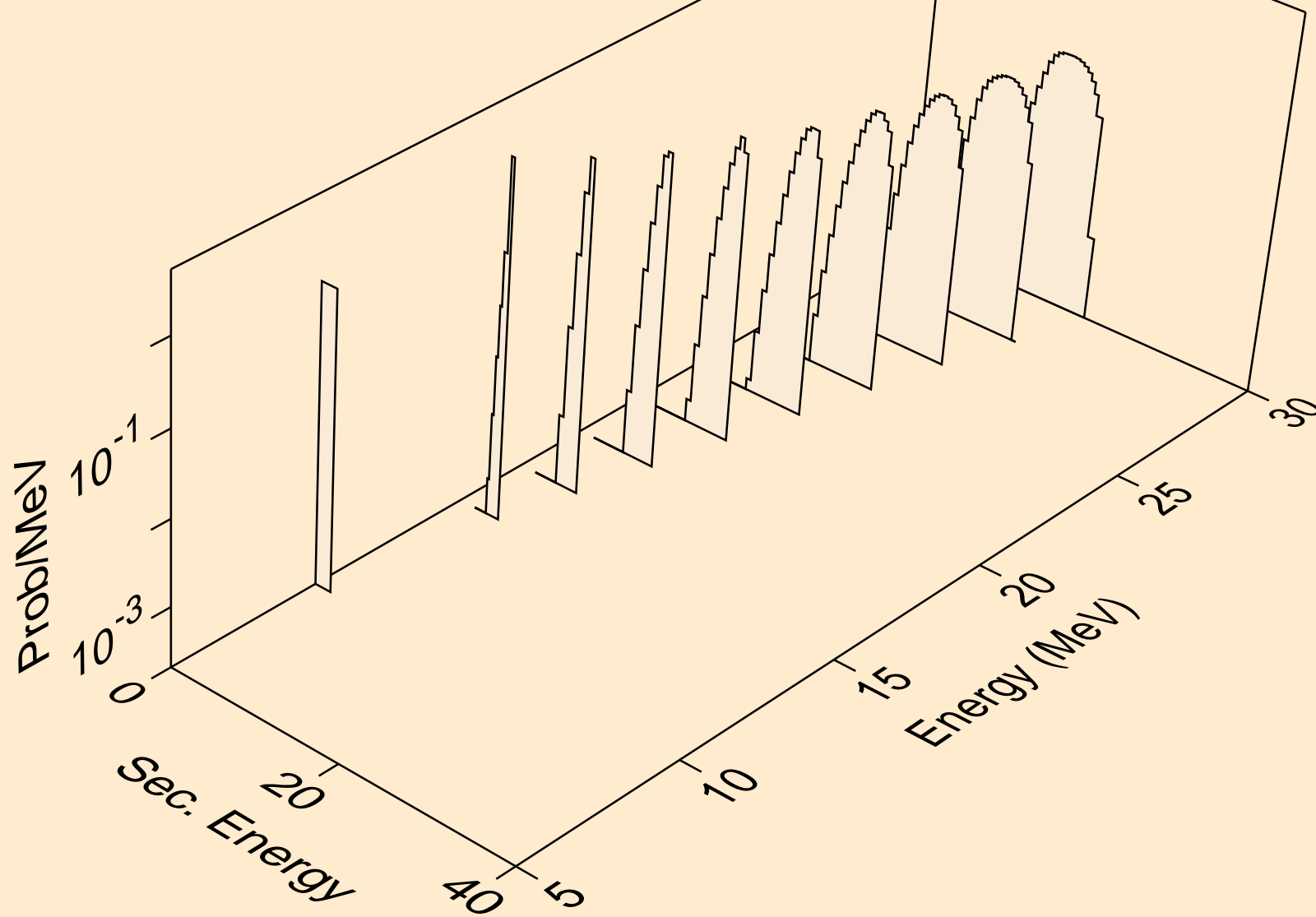

TH232 PROTON ACER TENDL-2021 LIBRARY; T=0.K  
deuterons from (p,d)

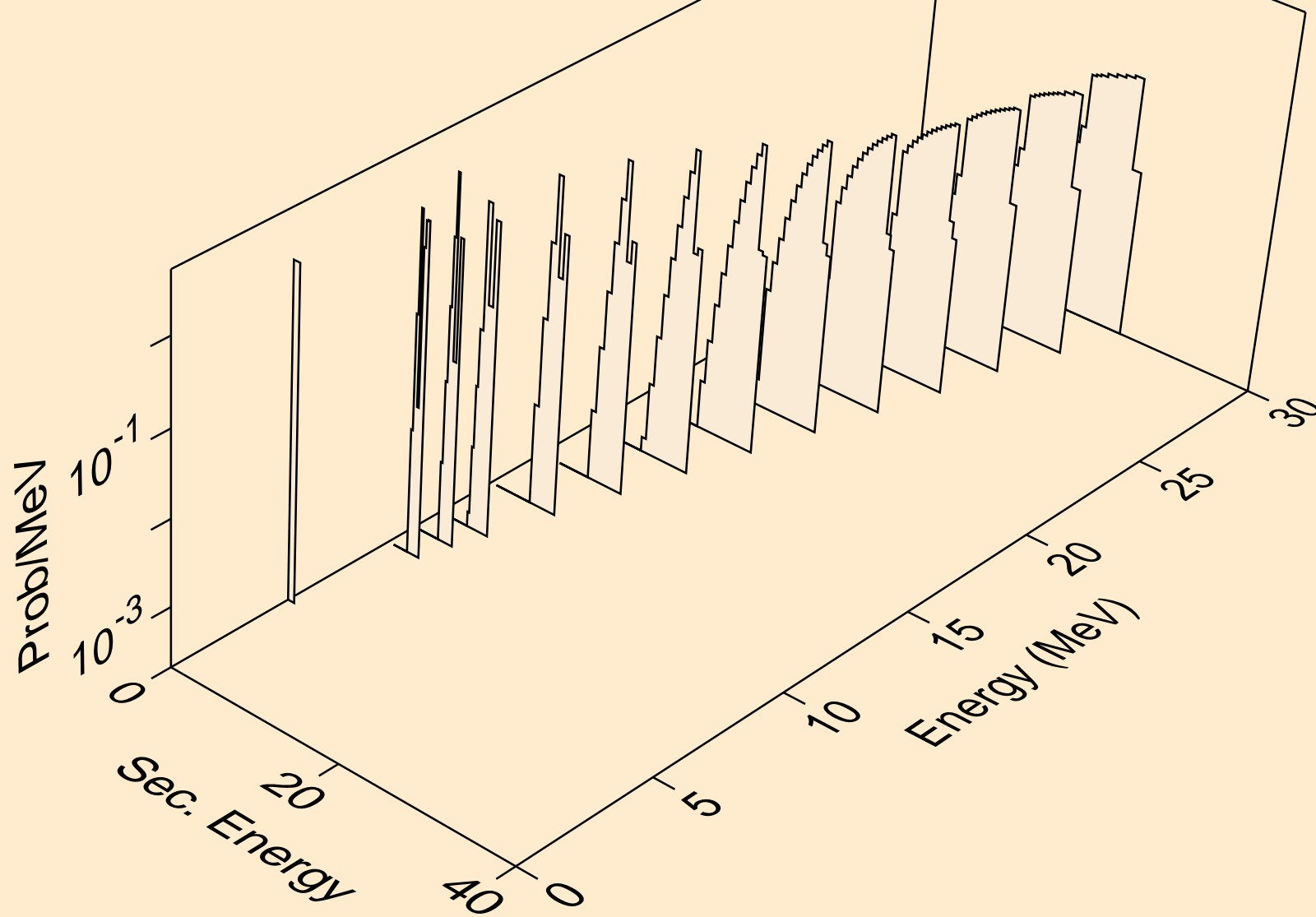

TH232 PROTON ACER TENDL-2021 LIBRARY; T=0.K  
tritons from (p,x)

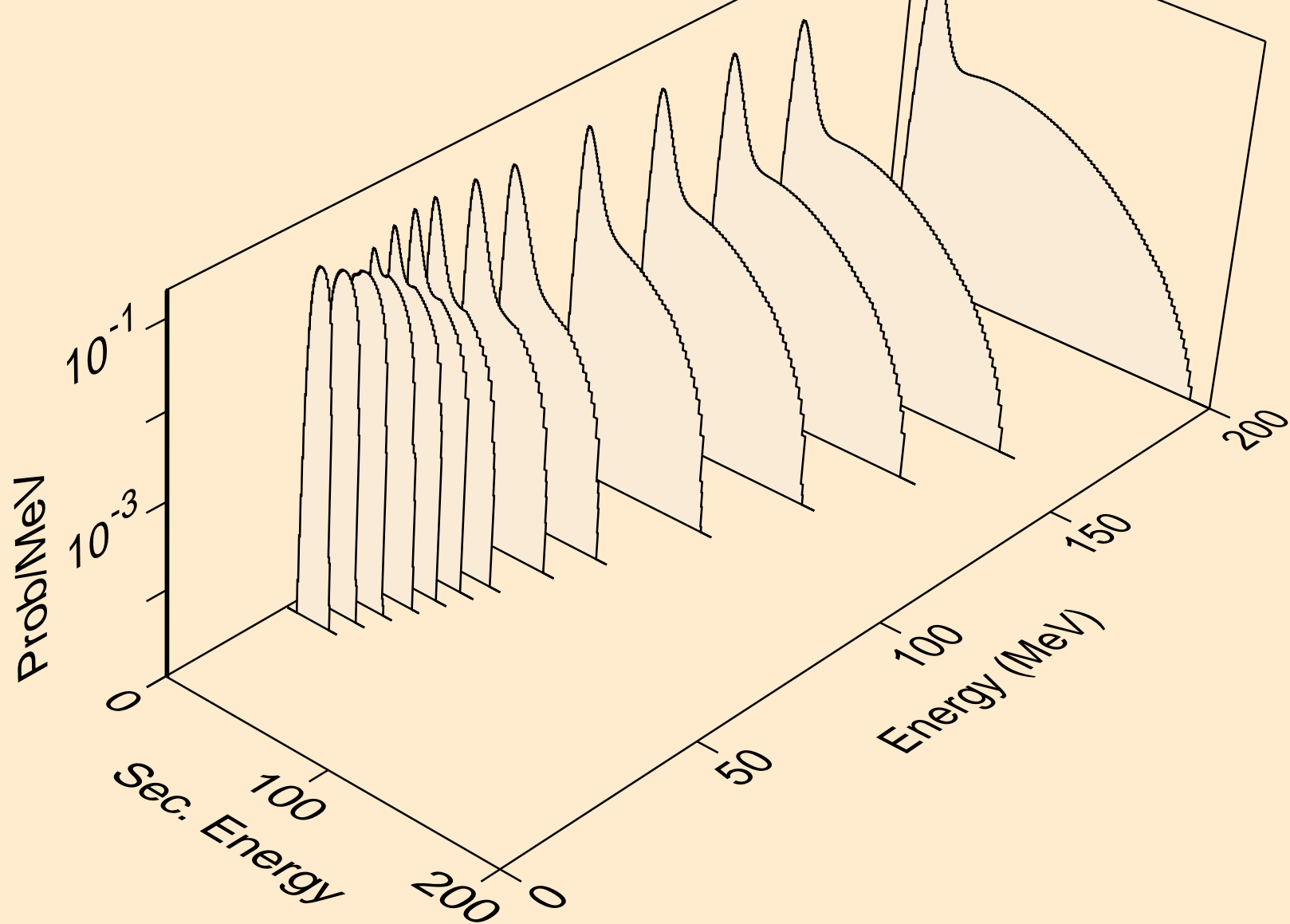



TH232 PROTON ACER TENDL-2021 LIBRARY; T=0.K  
tritons from (p,n\*)t

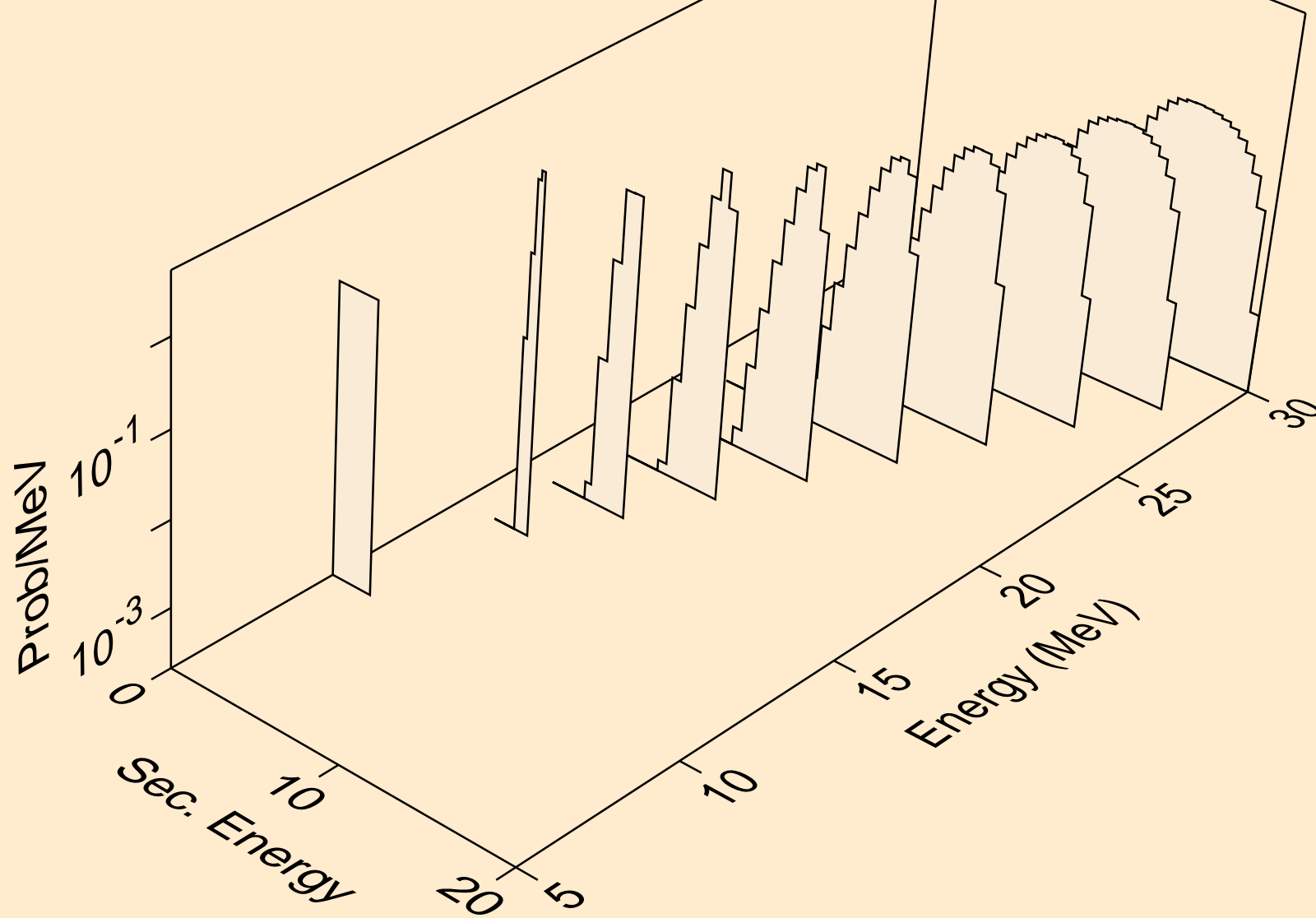

TH232 PROTON ACER TENDL-2021 LIBRARY; T=0.K  
tritons from (p,t)

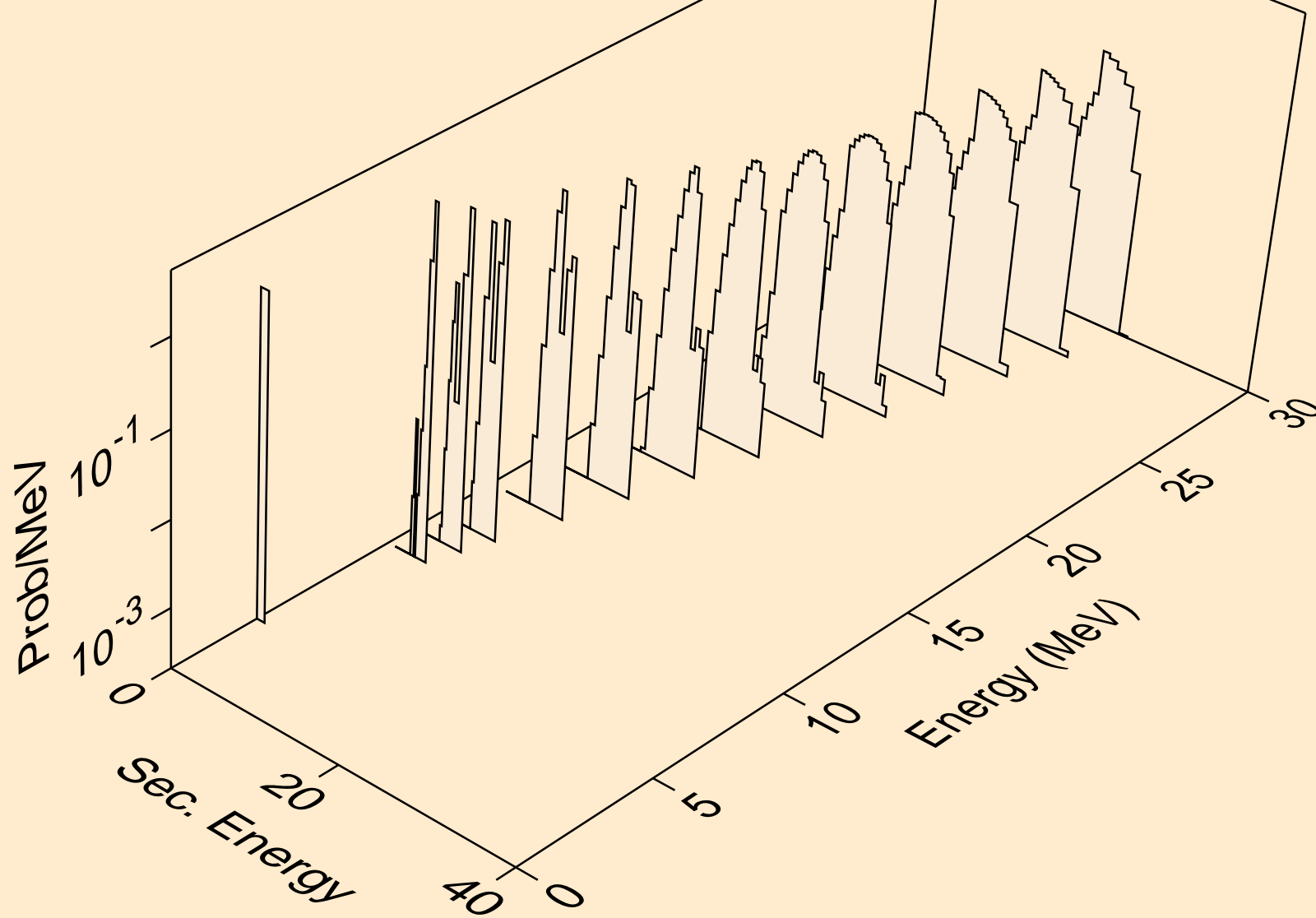

TH232 PROTON ACER TENDL-2021 LIBRARY; T=0.K  
he3s from (p,x)

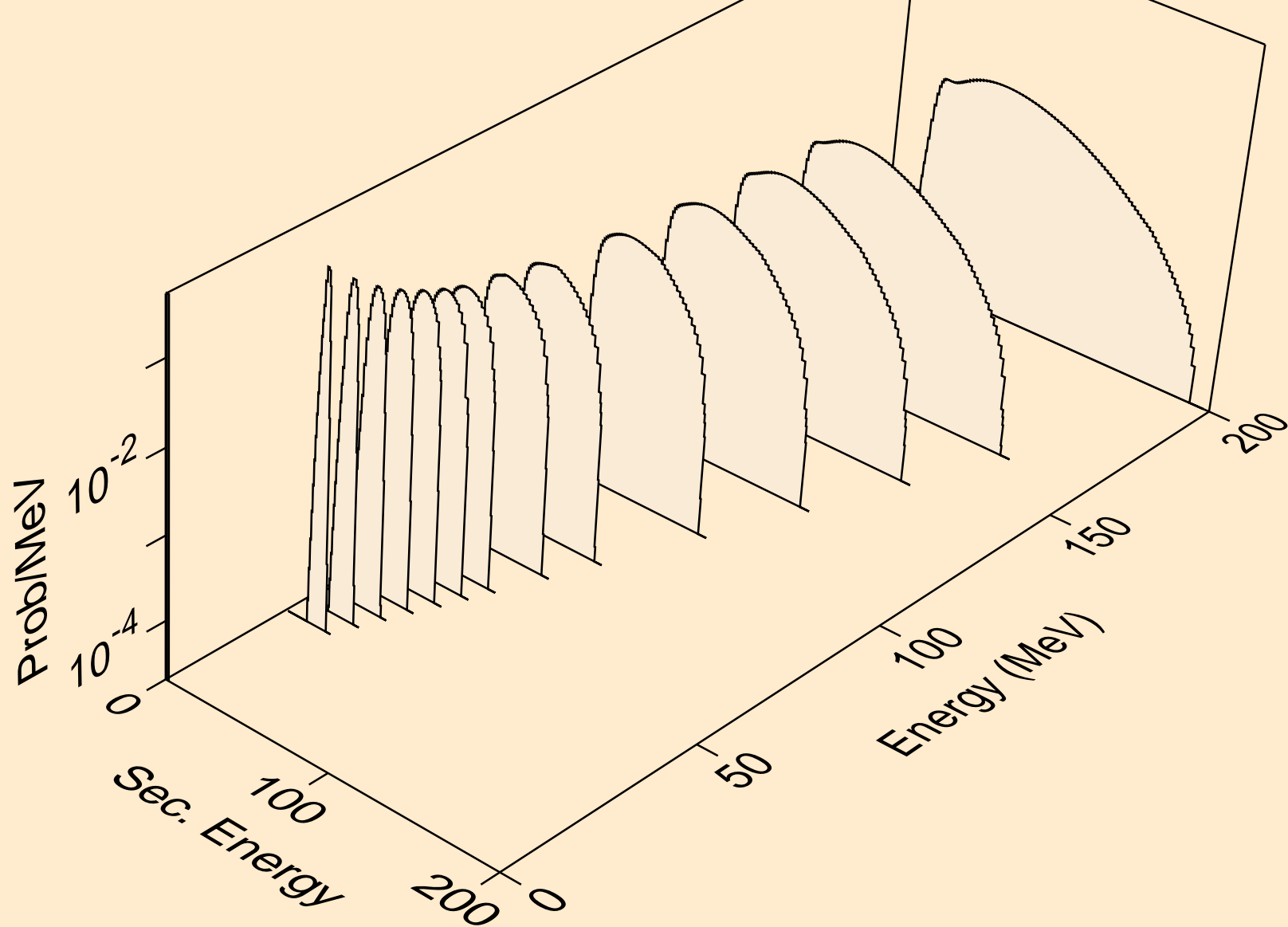

TH232 PROTON ACER TENDL-2021 LIBRARY; T=0.K  
he3s from (p,n\*)he3

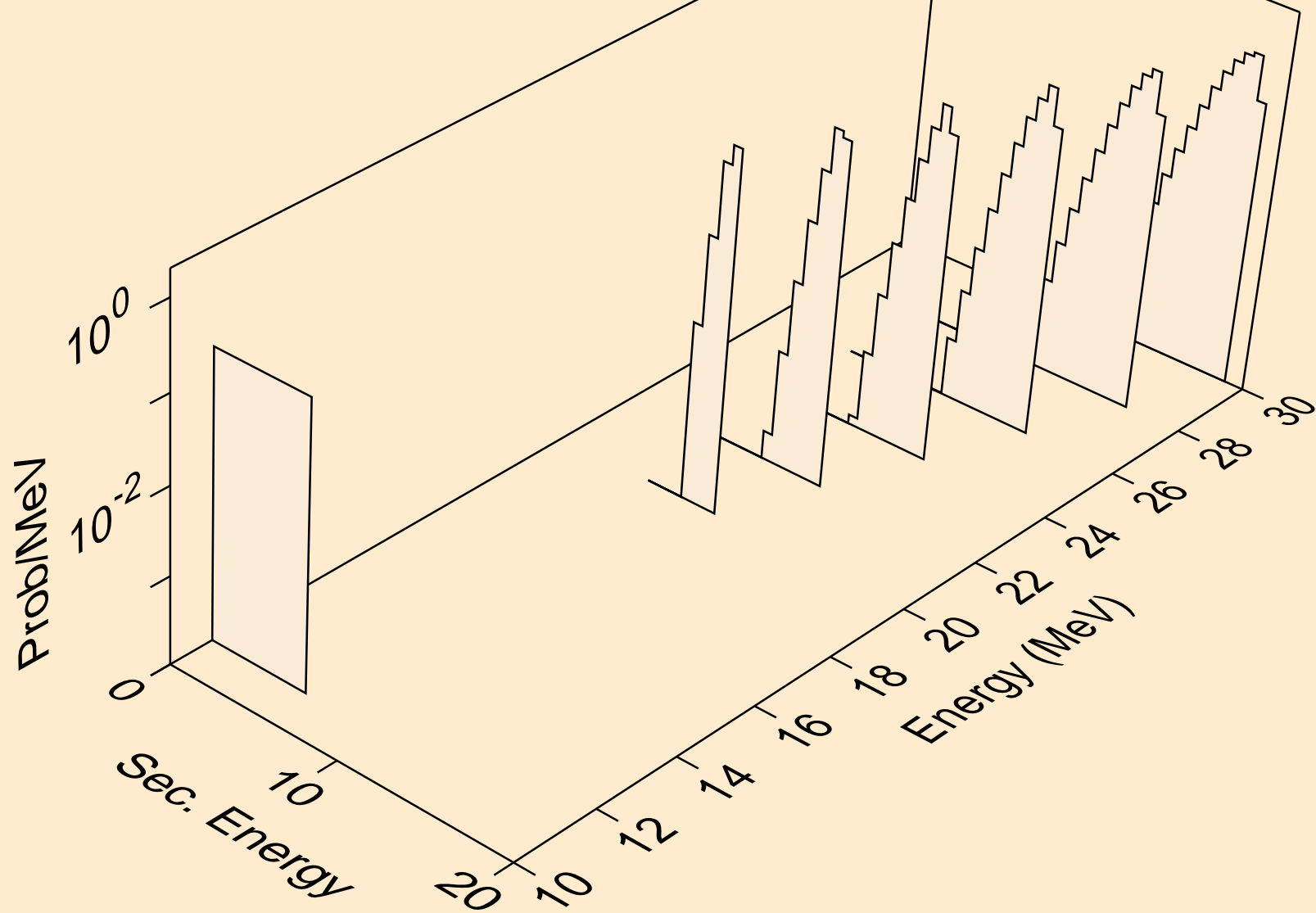

TH232 PROTON ACER TENDL-2021 LIBRARY; T=0.K  
he3s from (p,he3)

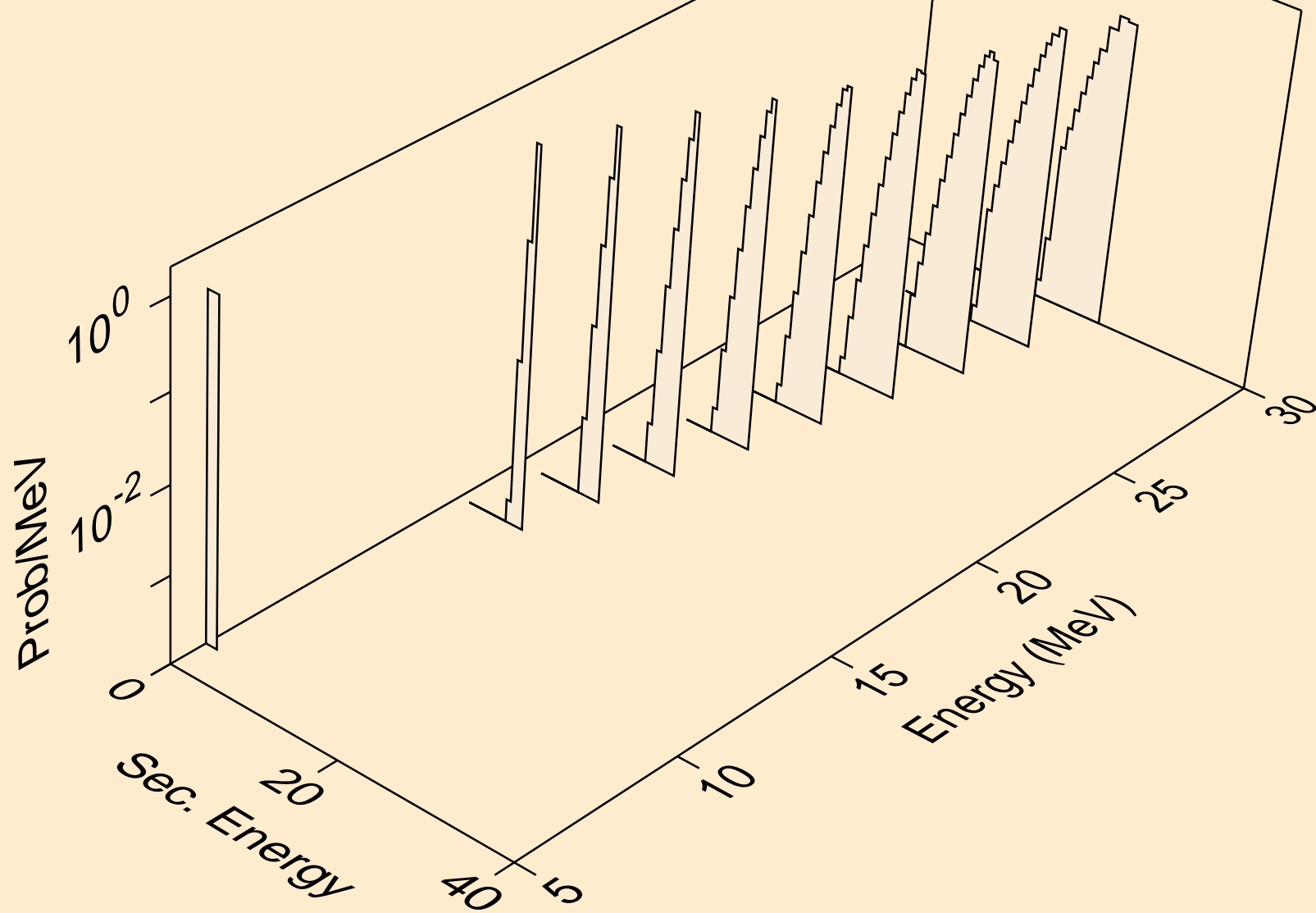

TH232 PROTON ACER TENDL-2021 LIBRARY; T=0.K  
alphas from (p,x)

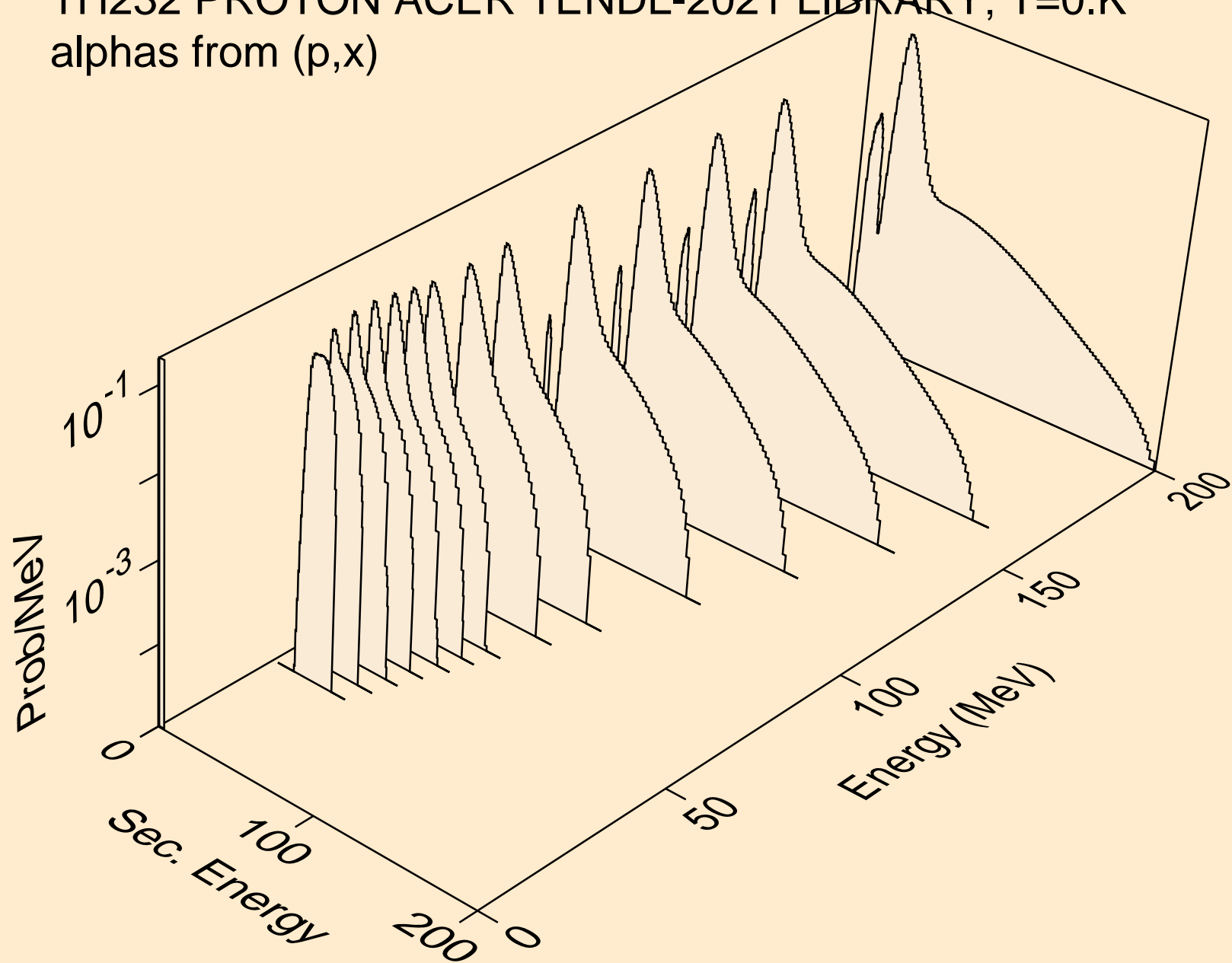

TH232 PROTON ACER TENDL-2021 LIBRARY; T=0.K  
alphas from (p,n\*)a

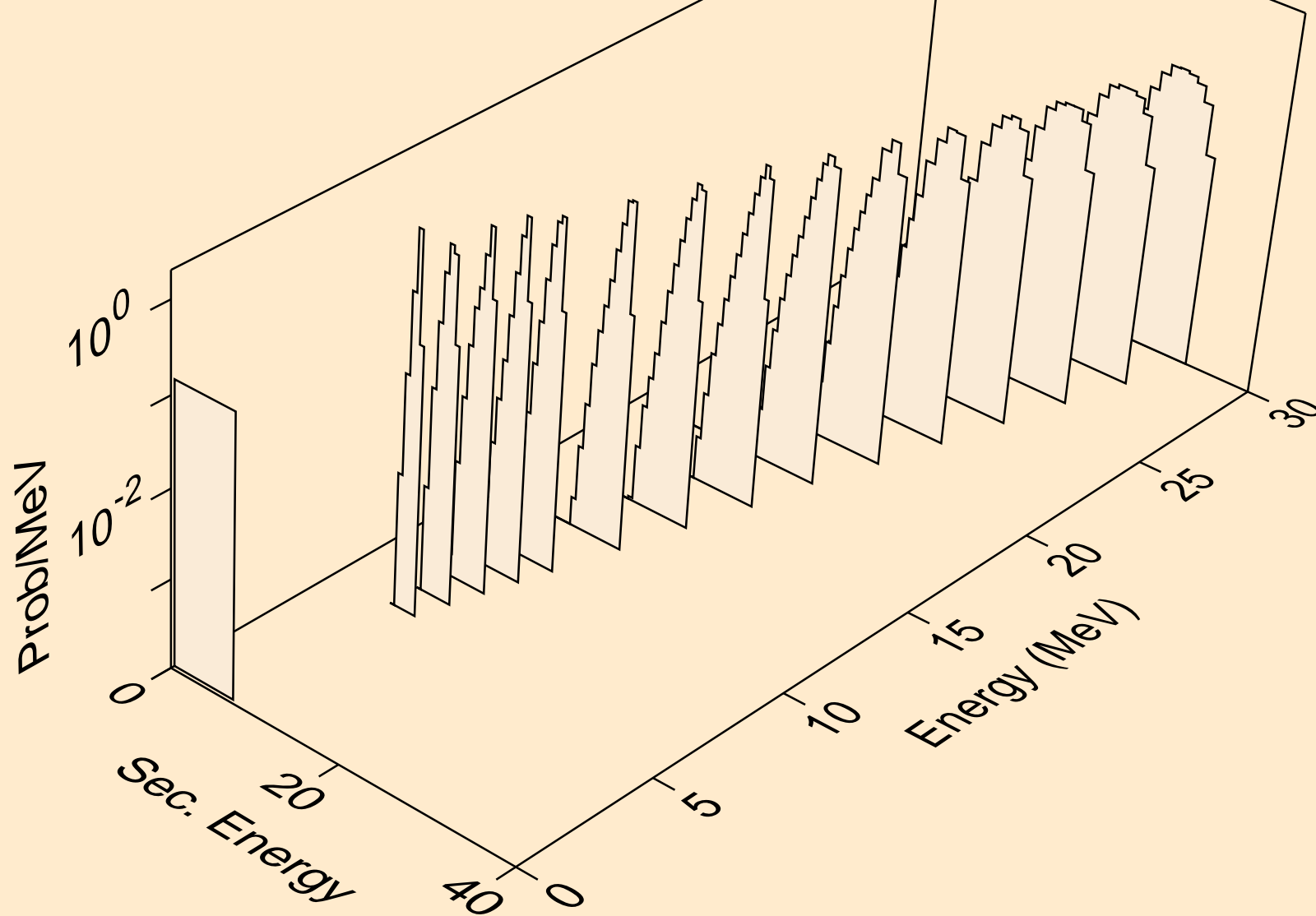

TH232 PROTON ACER TENDL-2021 LIBRARY; T=0.K  
alphas from (p,2n)a

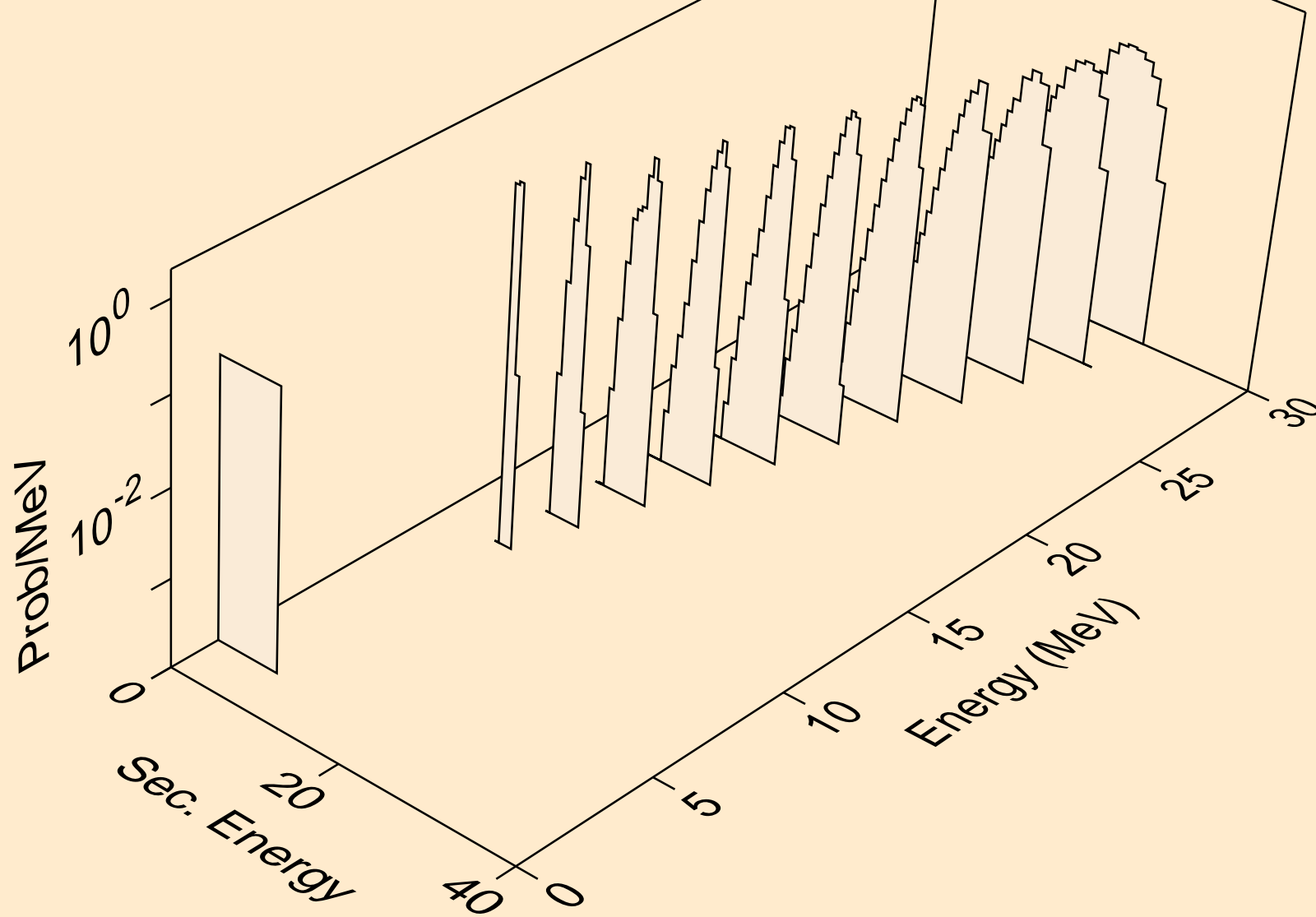



TH232 PROTON ACER TENDL-2021 LIBRARY; T=0.K  
alphas from (p,3n)a

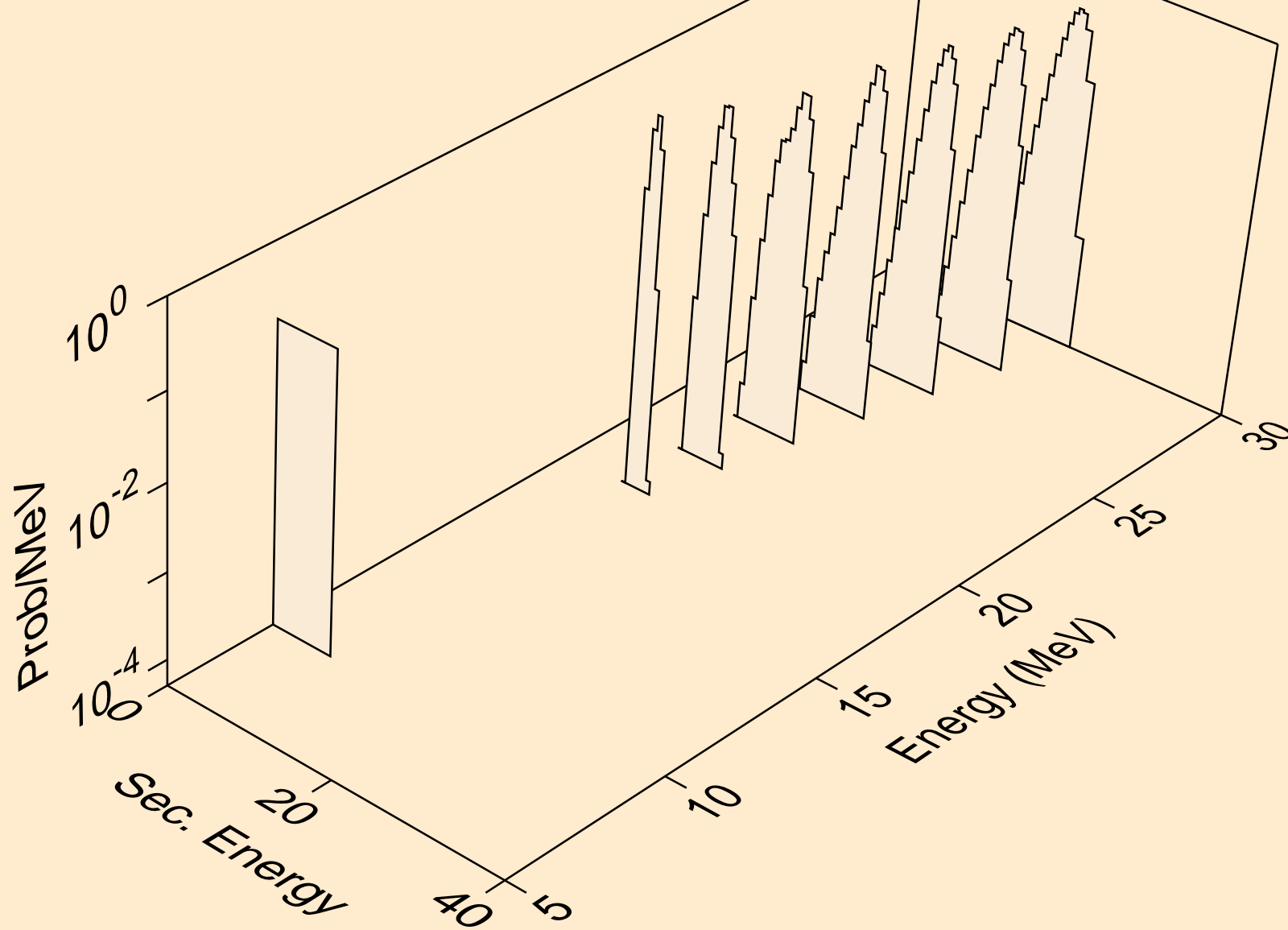

TH232 PROTON ACER TENDL-2021 LIBRARY; T=0.K  
alphas from (p,a)

