

TL186M PROTON ACER TENDL-2021 LIBRARY; T=0.K  
Principal cross sections

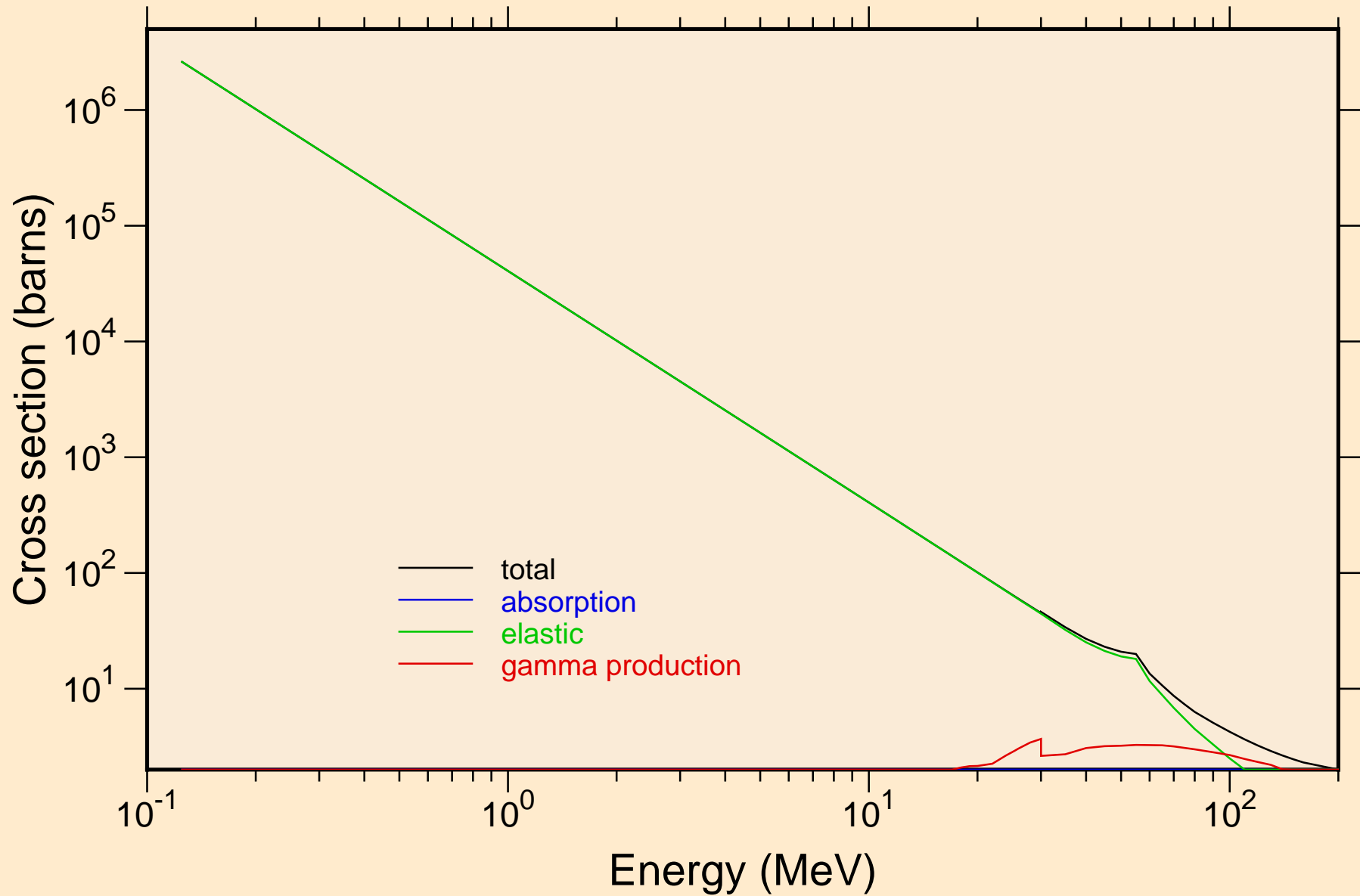

TL186M PROTON ACER TENDL-2021 LIBRARY; T=0.K  
Heating

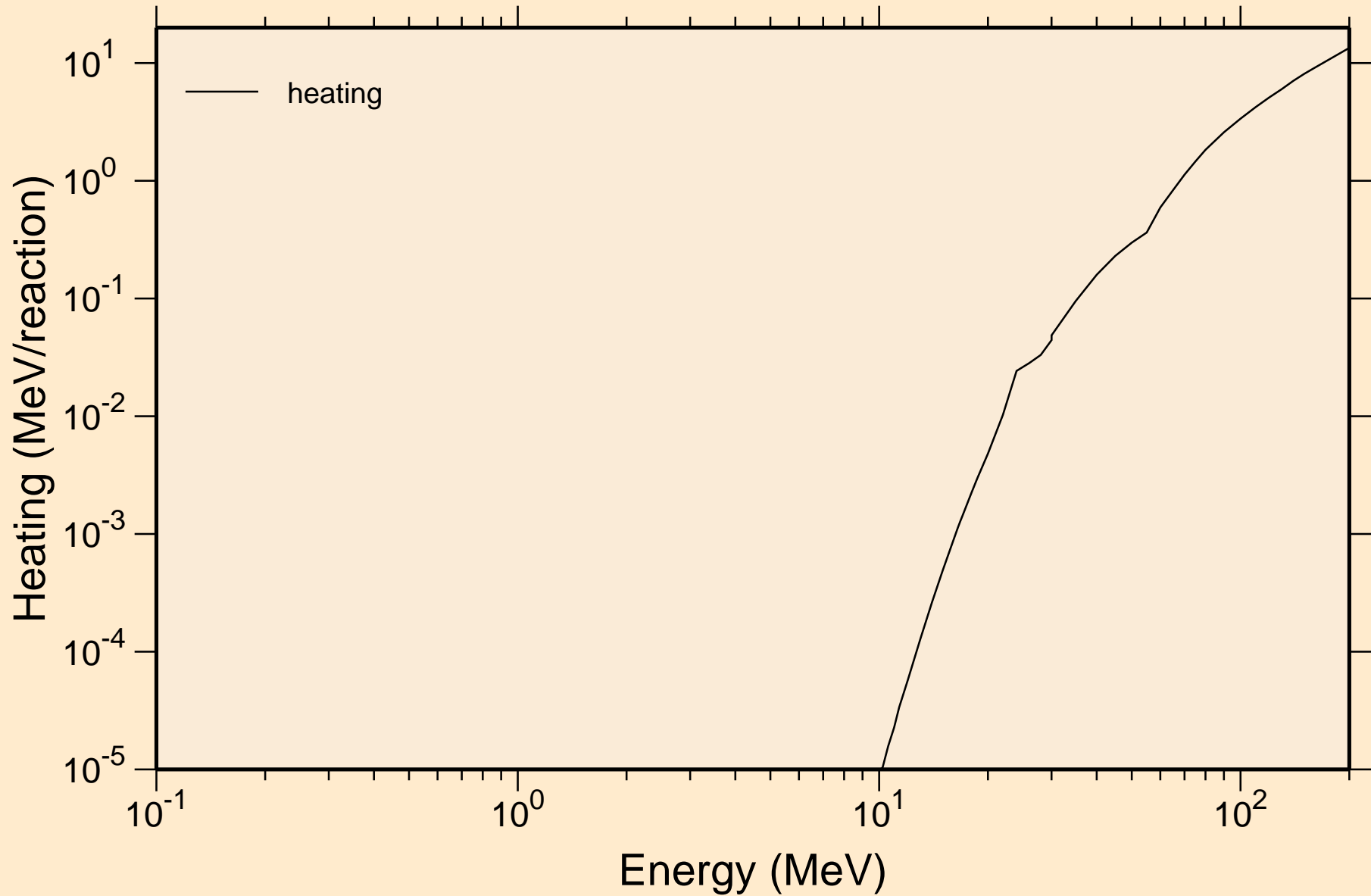

TL186M PROTON ACER TENDL-2021 LIBRARY; T=0.K  
Principal cross sections

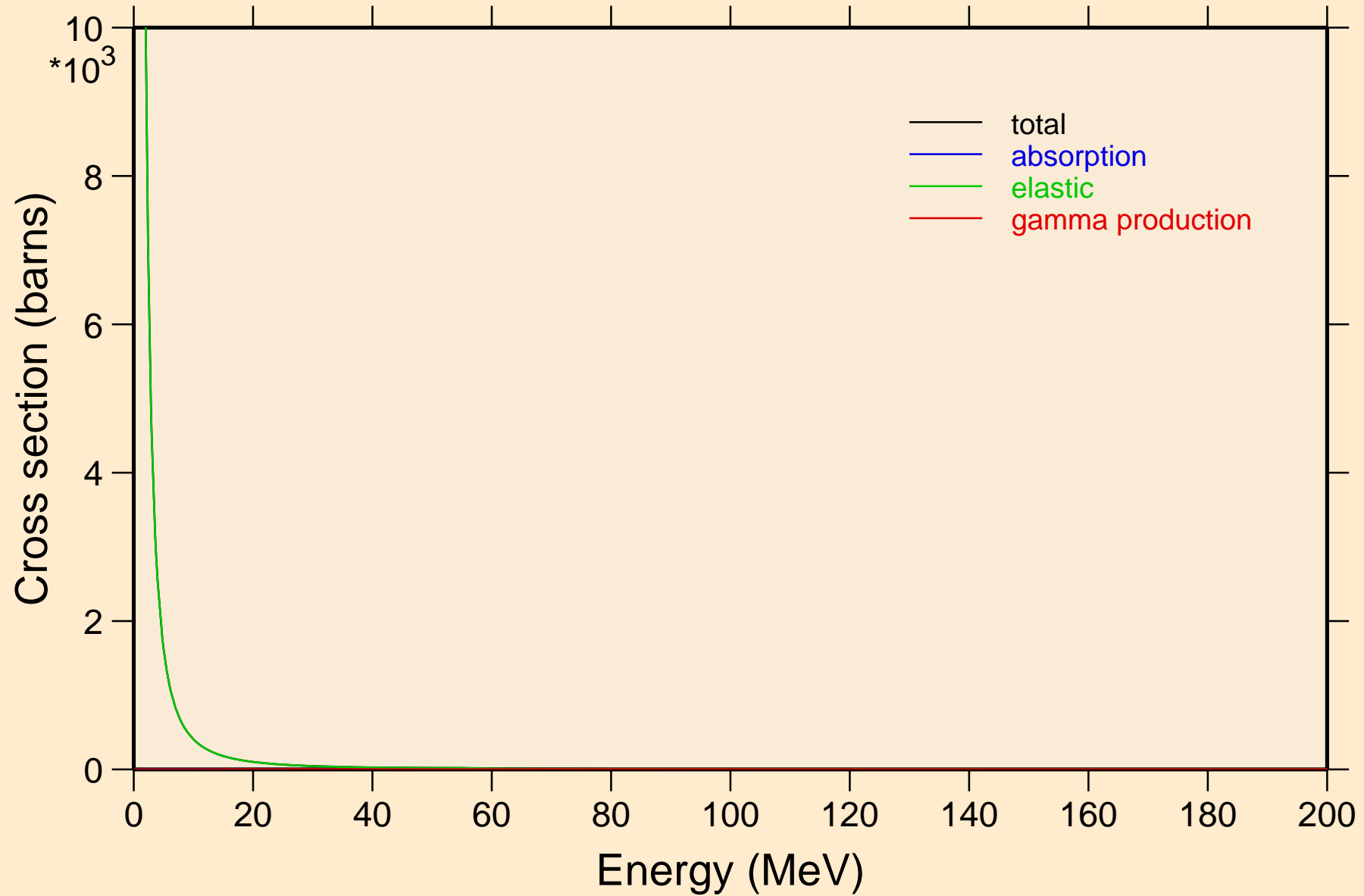

TL186M PROTON ACER TENDL-2021 LIBRARY; T=0.K

Heating

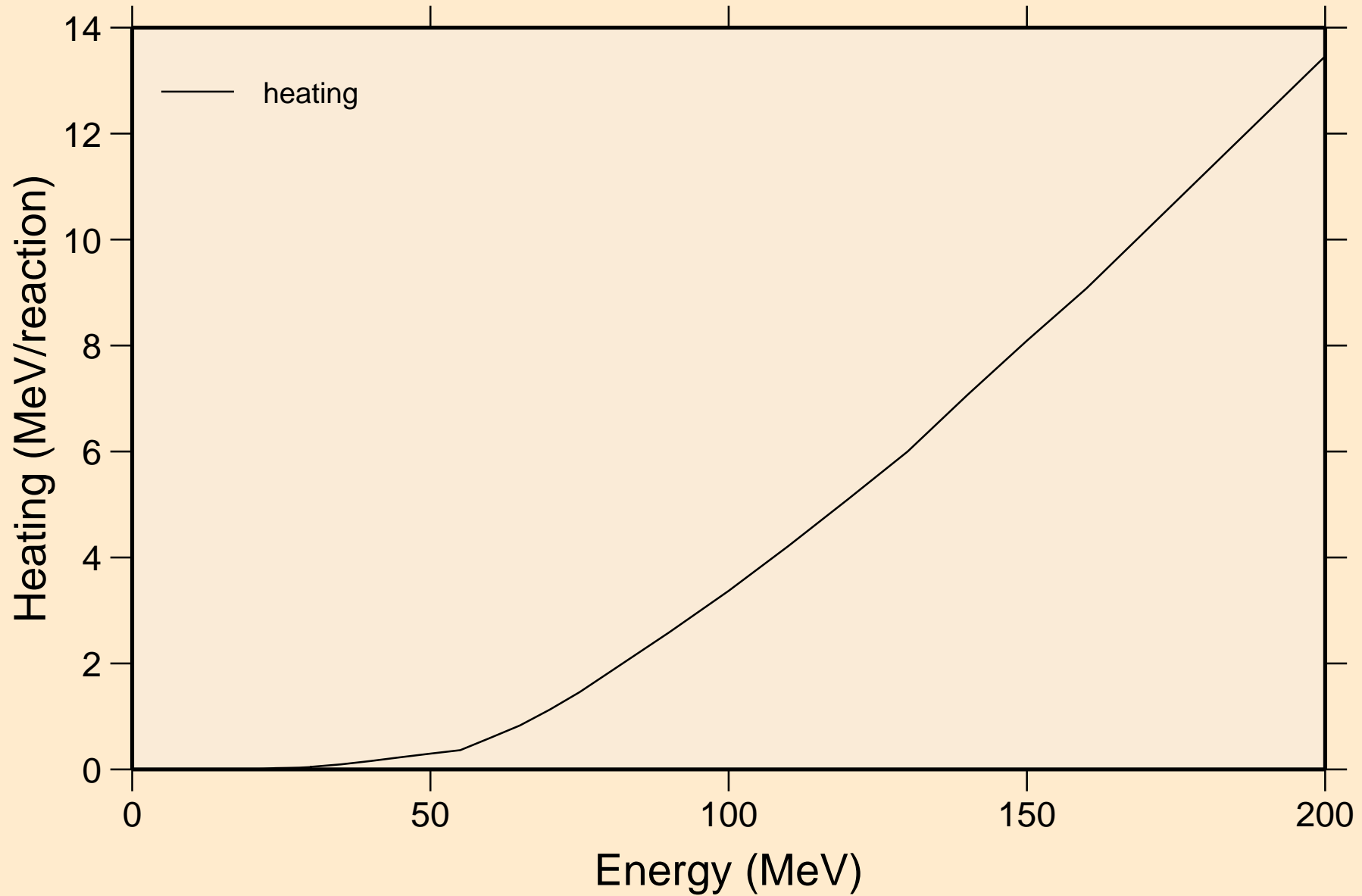

TL186M PROTON ACER TENDL-2021 LIBRARY; T=0.K  
Threshold reactions

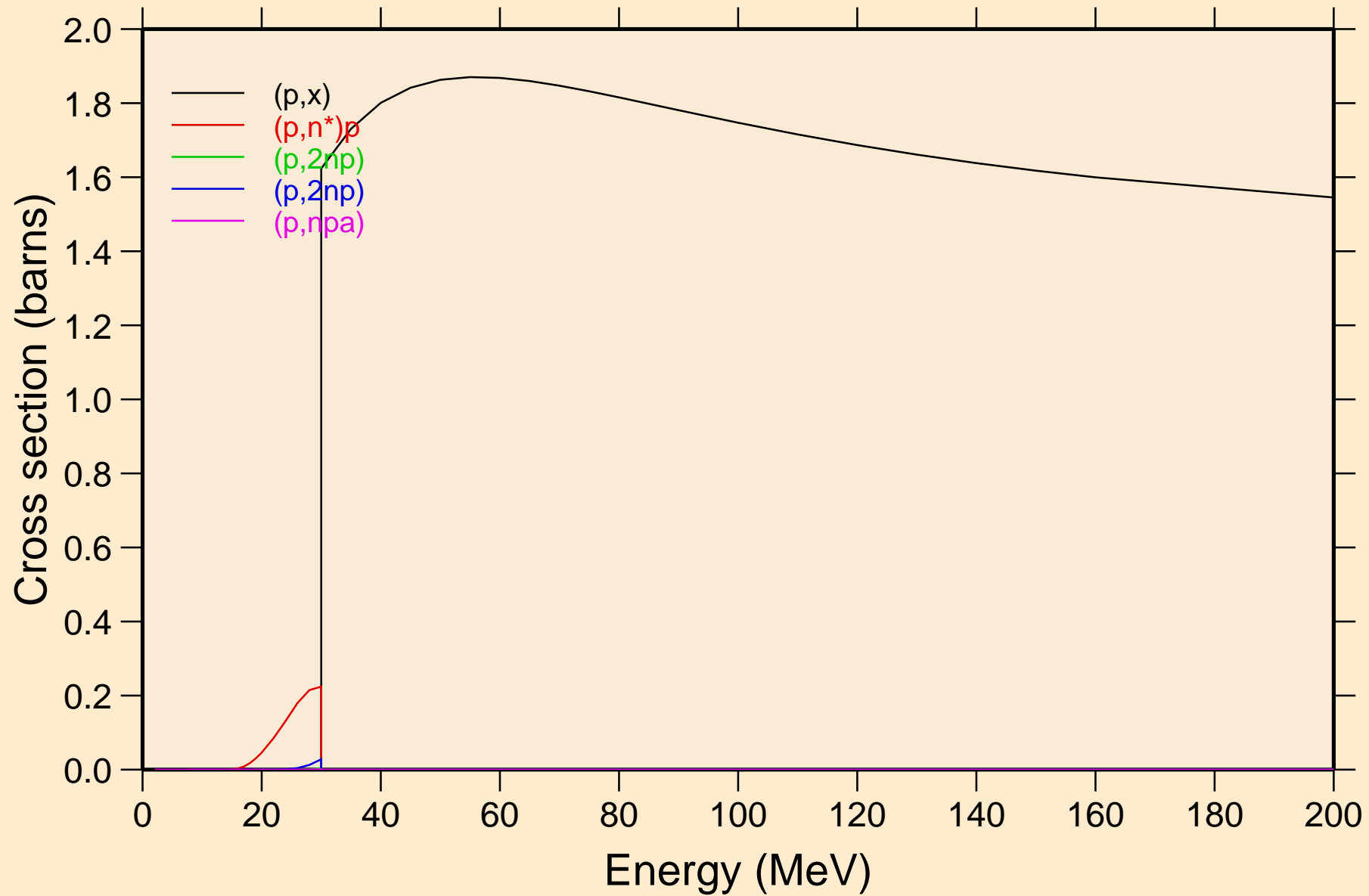

TL186M PROTON ACER TENDL-2021 LIBRARY; T=0.K  
Threshold reactions

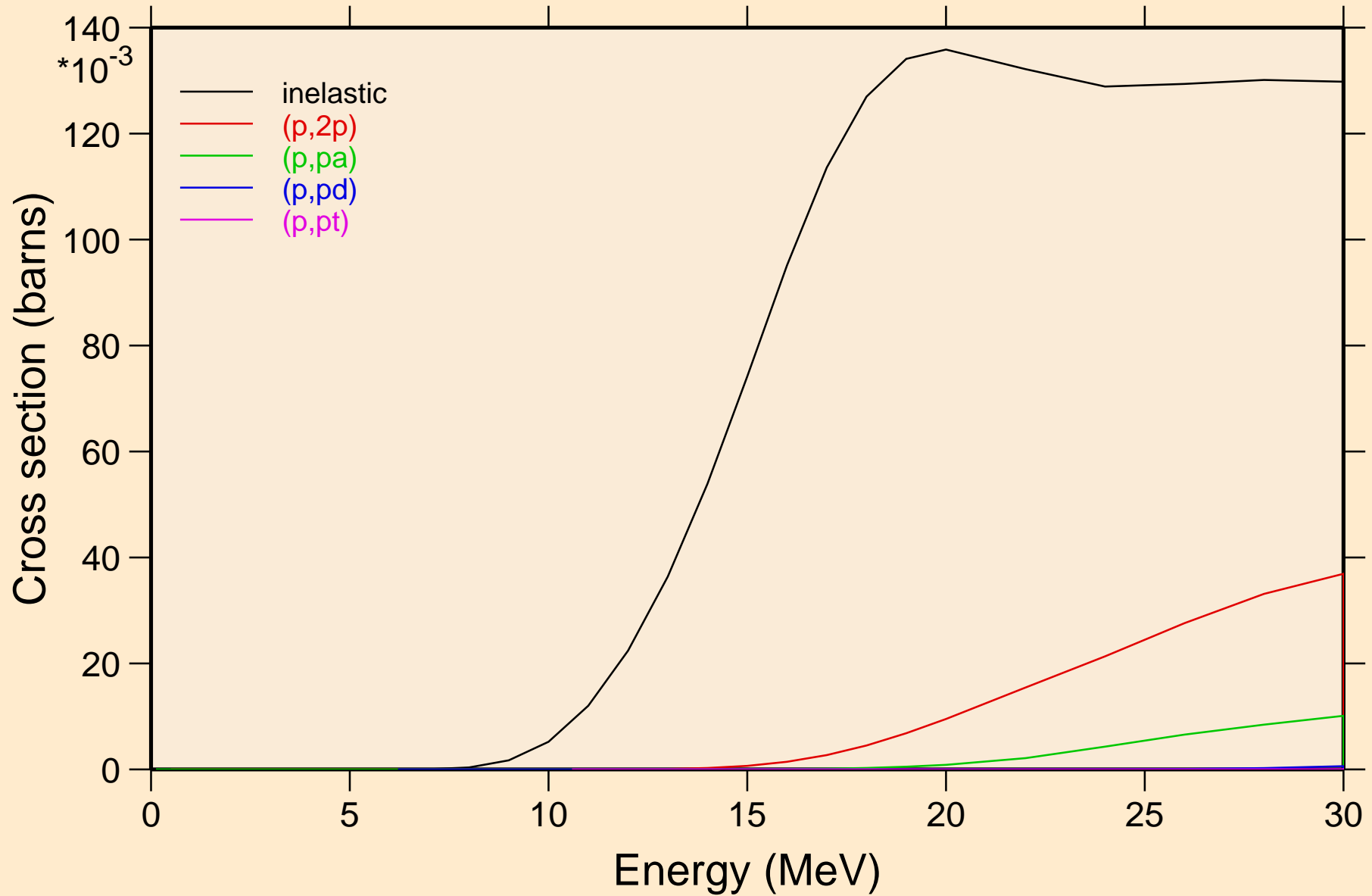

TL186M PROTON ACER TENDL-2021 LIBRARY; T=0.K  
Threshold reactions

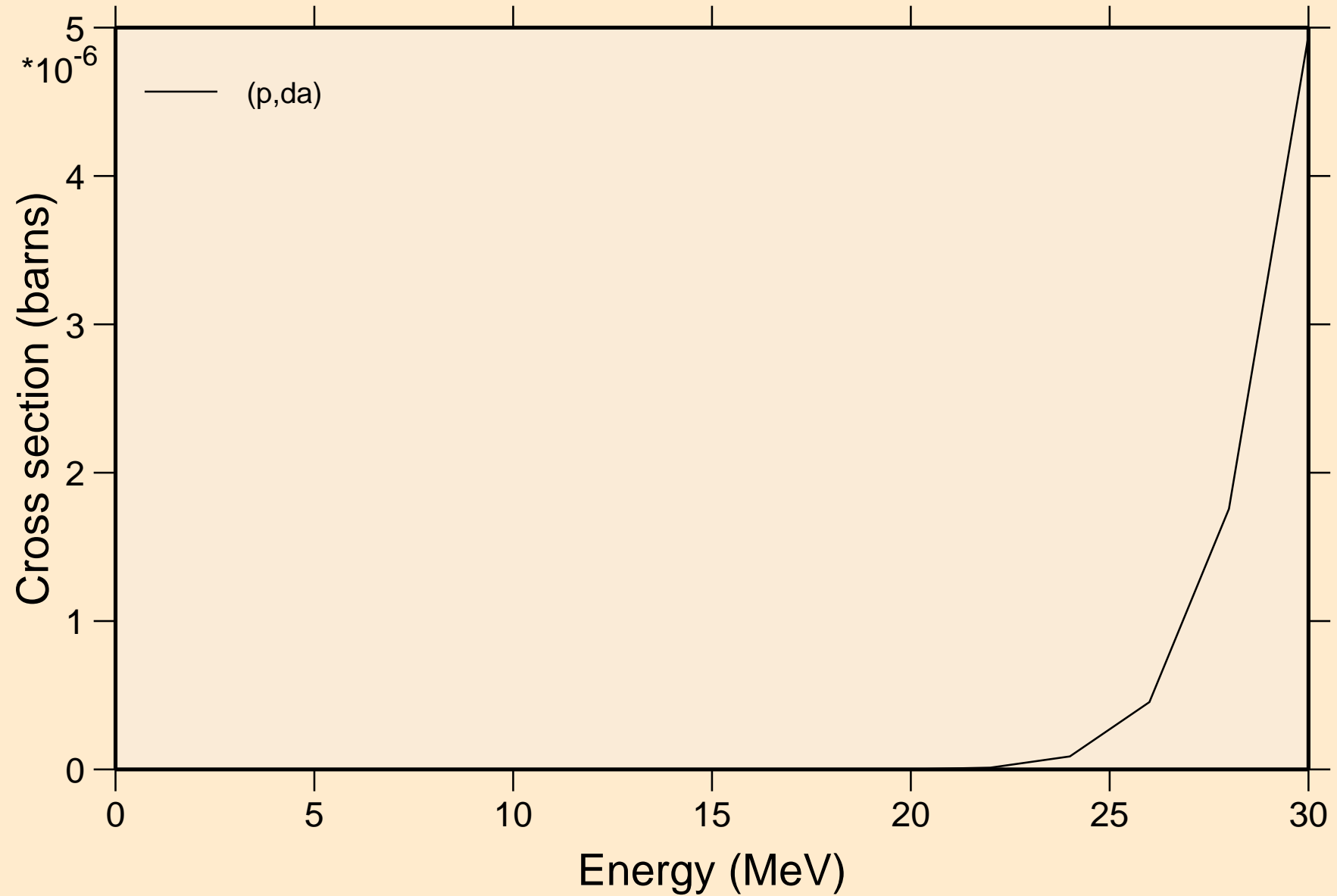

TL186M PROTON ACER TENDL-2021 LIBRARY; T=0.K  
angular distribution for elastic

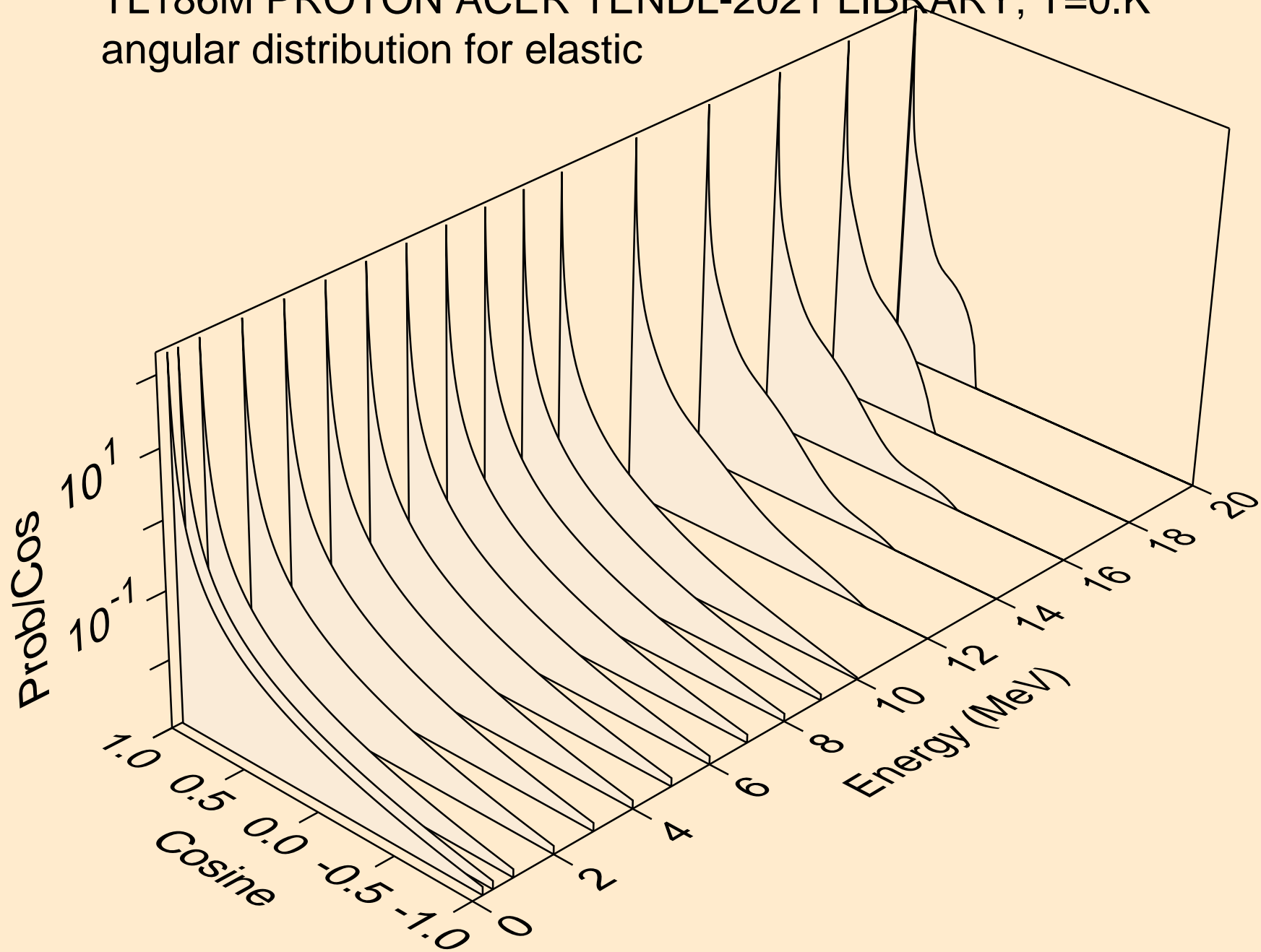



TL186M PROTON ACER TENDL-2021 LIBRARY; T=0.K  
angular distribution for elastic

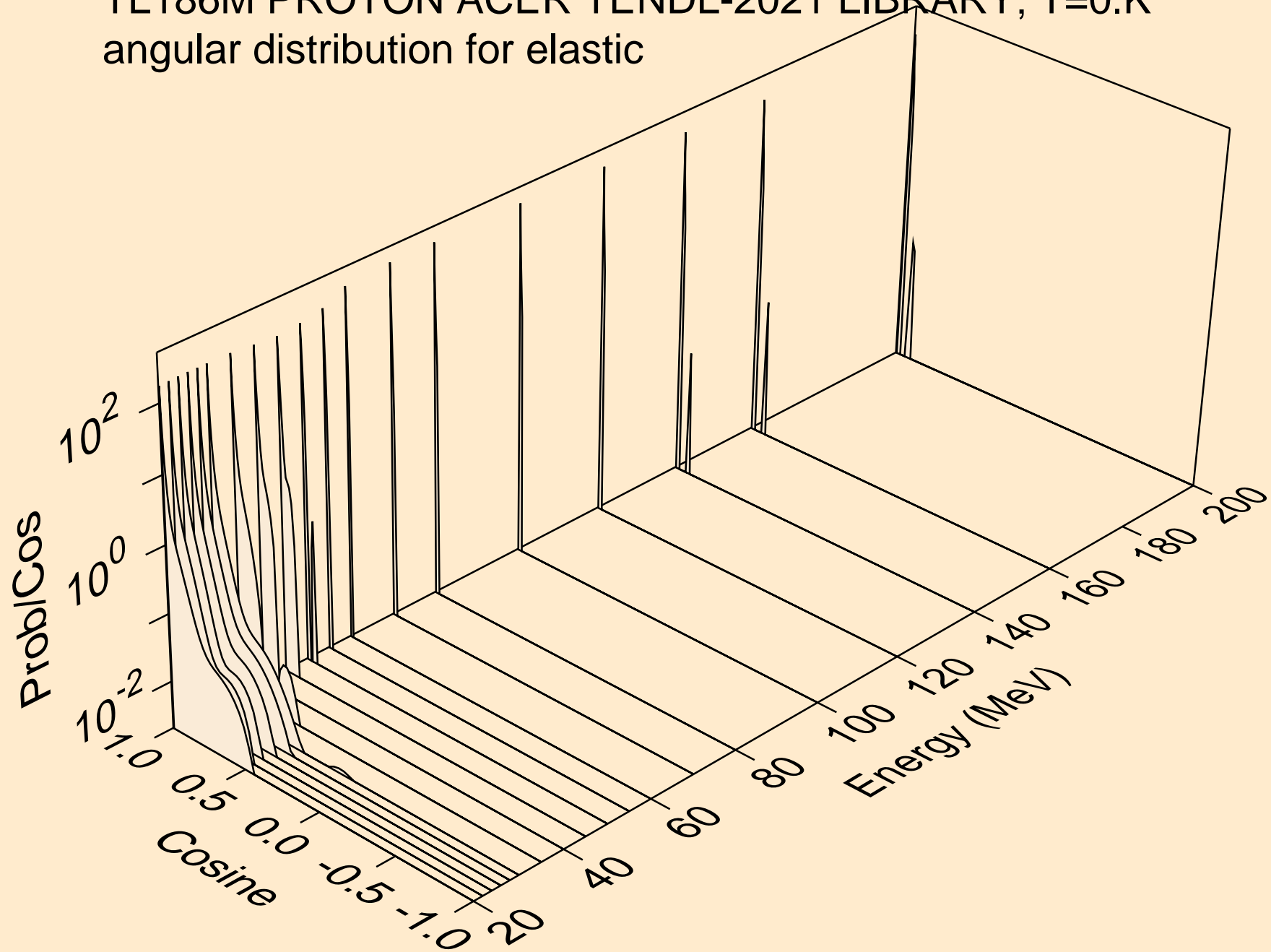

TL186M PROTON ACER TENDL-2021 LIBRARY; T=0.K  
Proton emission for (p,x)

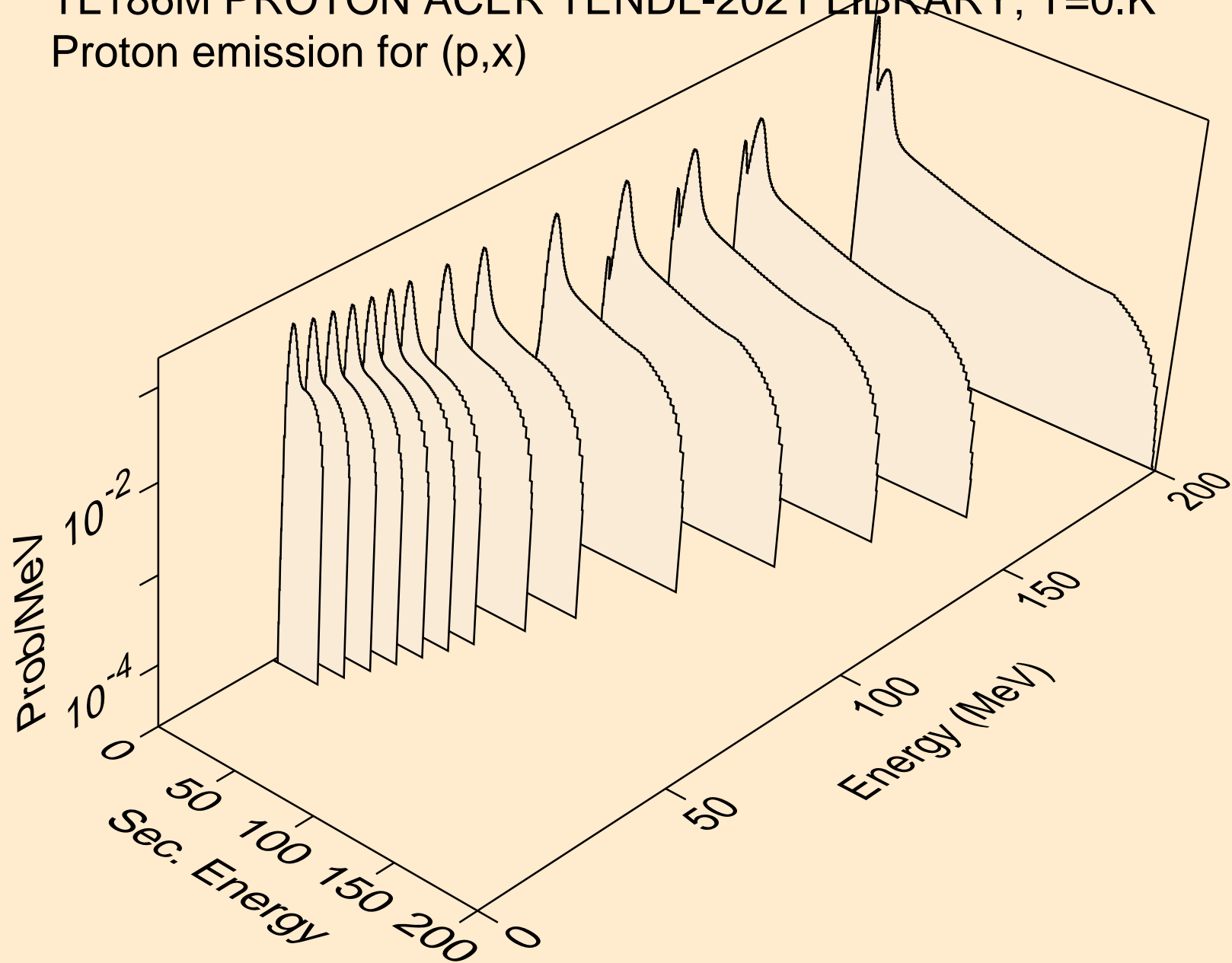

TL186M PROTON ACER TENDL-2021 LIBRARY; T=0.K  
Proton emission for (p,n\*)p

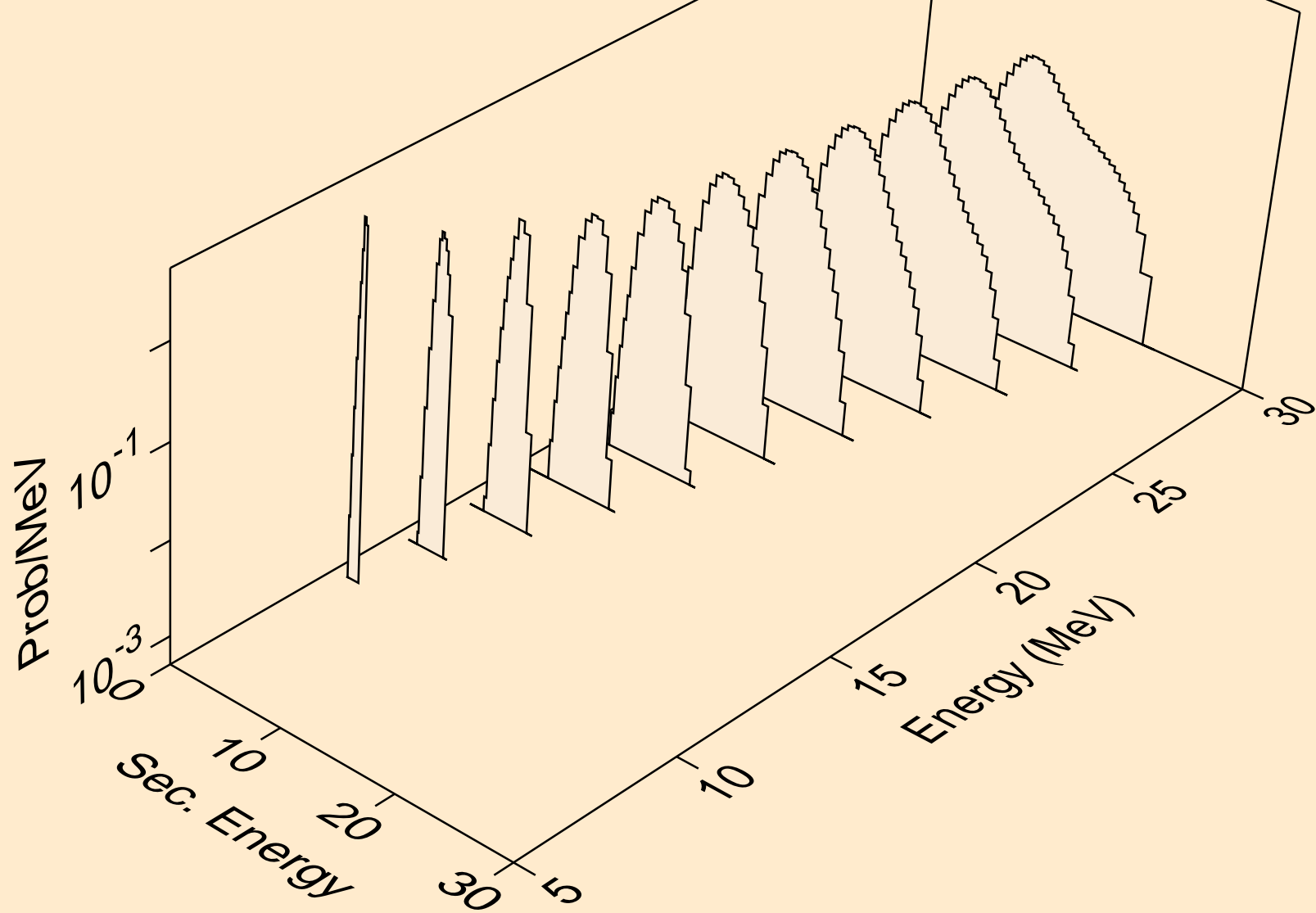

TL186M PROTON ACER TENDL-2021 LIBRARY; T=0.K  
Proton emission for (p,2np)

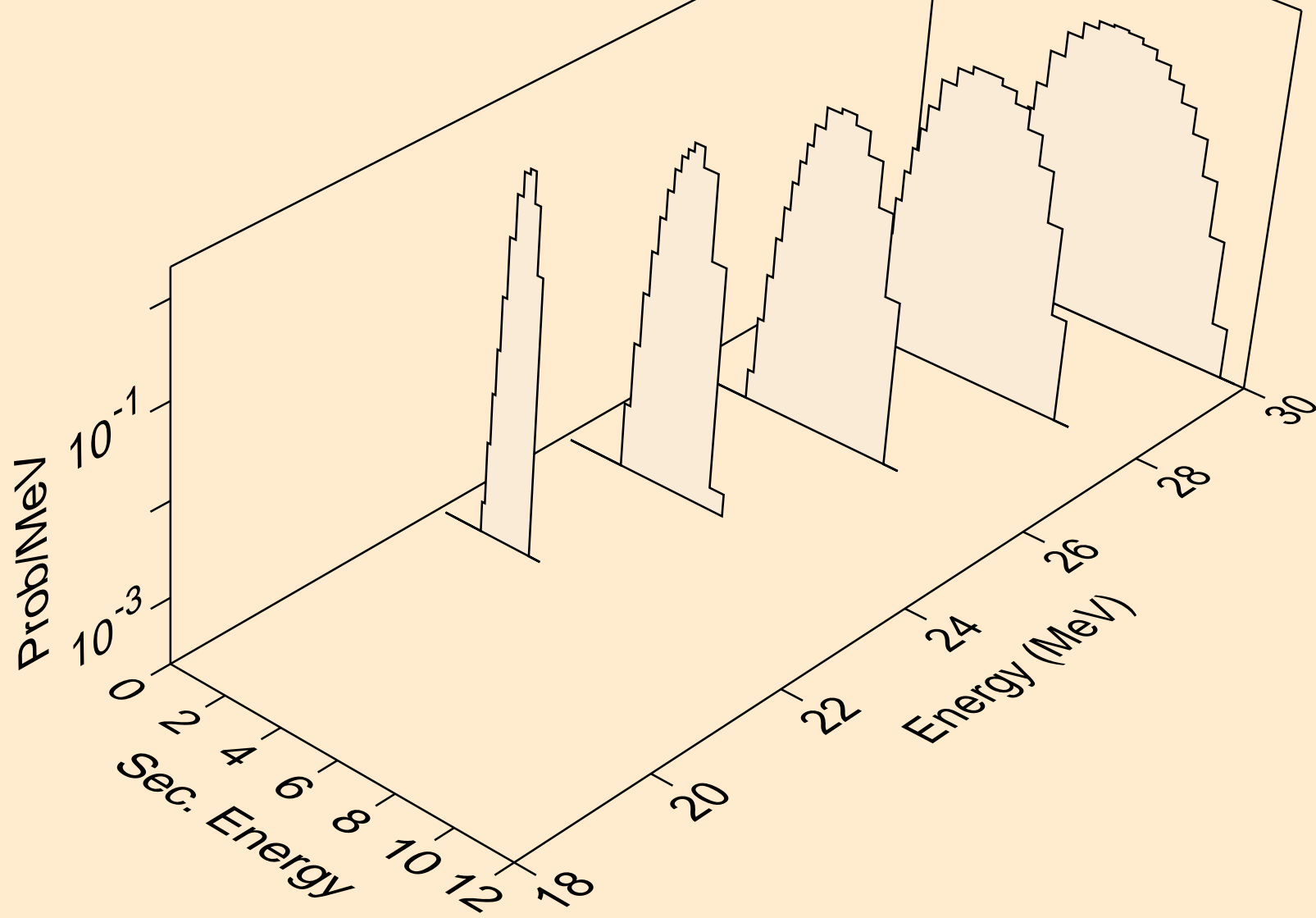

TL186M PROTON ACER TENDL-2021 LIBRARY; T=0.K  
Proton emission for (p,2np)

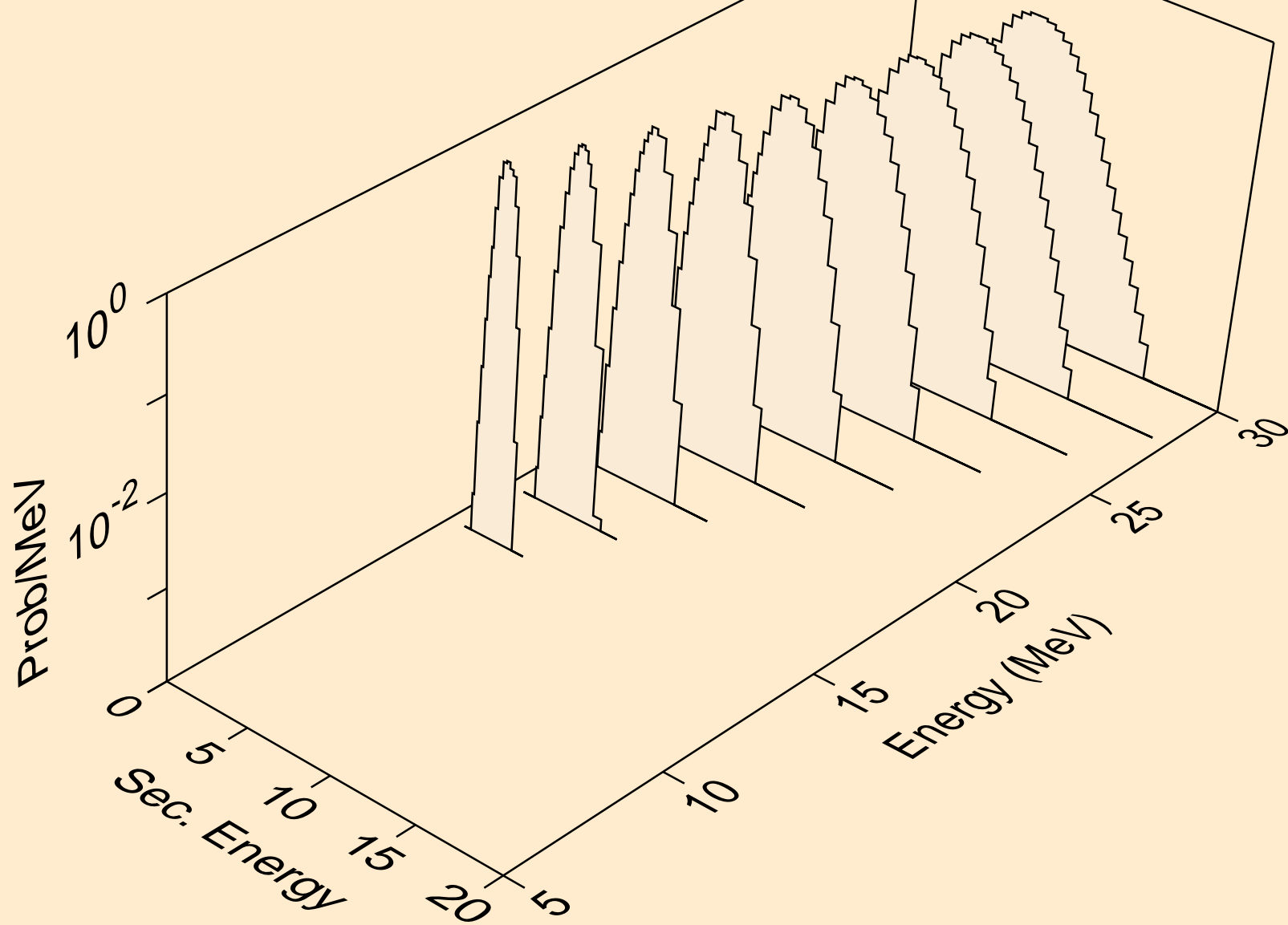

TL186M PROTON ACER TENDL-2021 LIBRARY; T=0.K  
Proton emission for (p,npa)

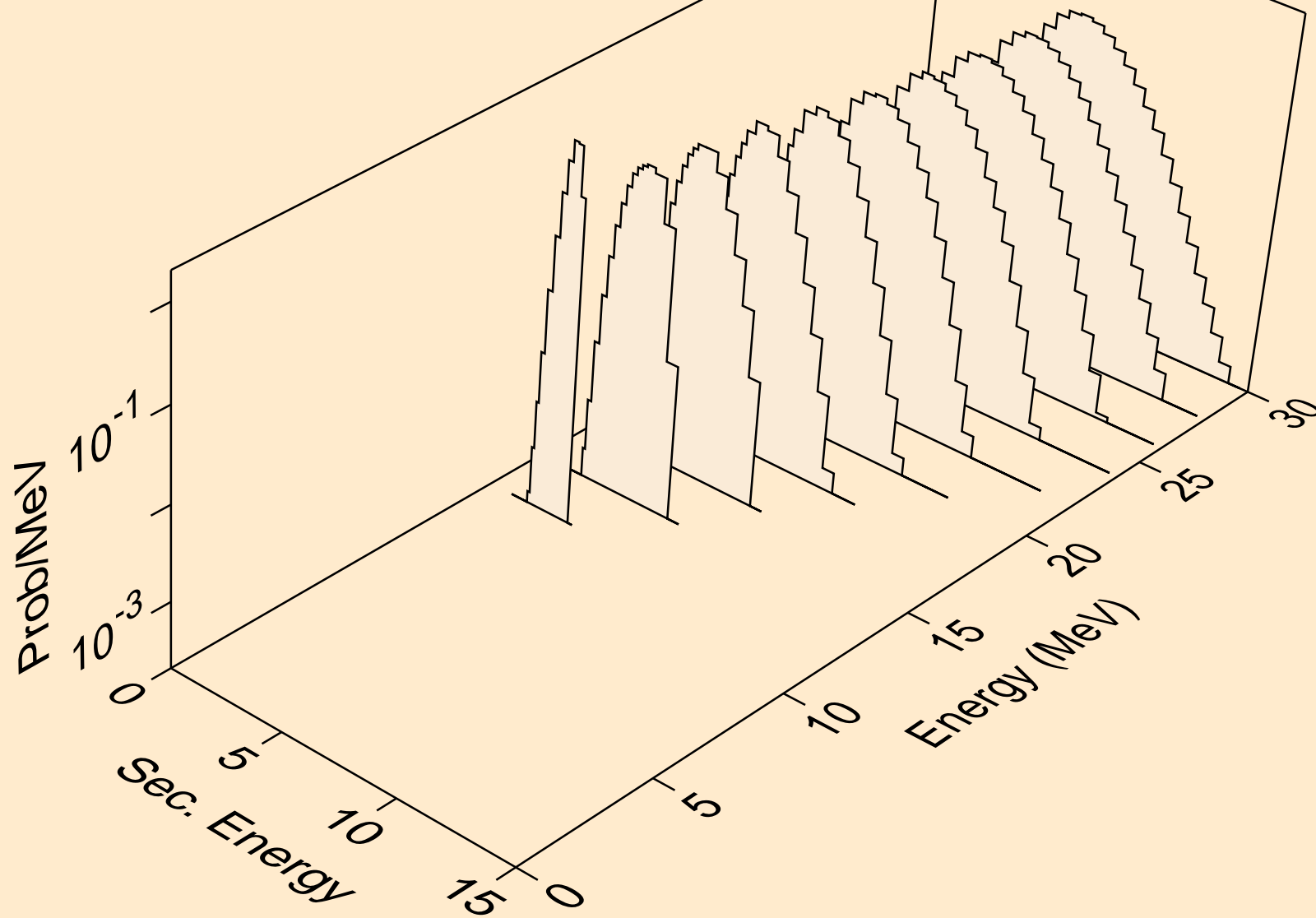

TL186M PROTON ACER TENDL-2021 LIBRARY; T=0.K  
Proton emission for inelastic

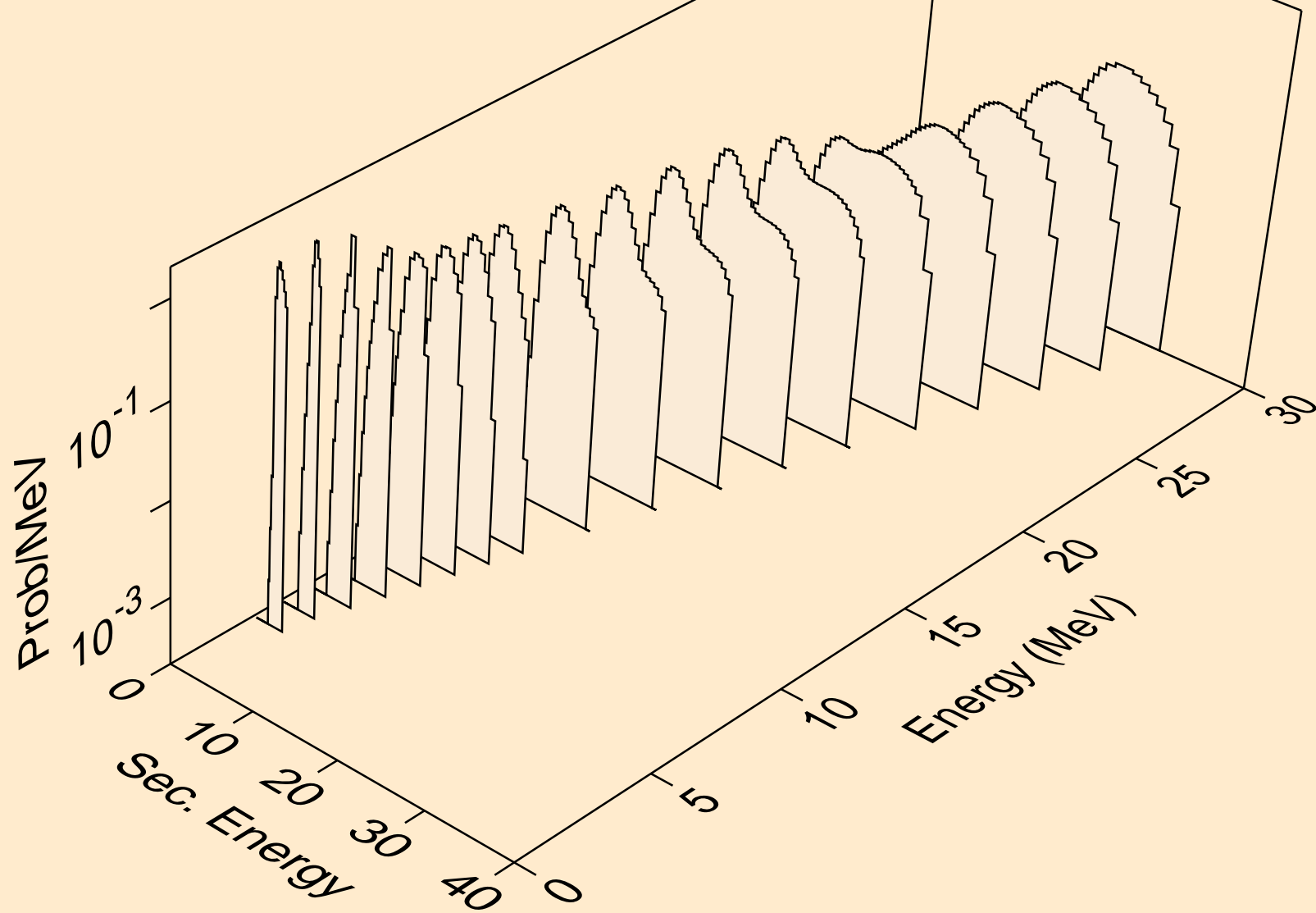

TL186M PROTON ACER TENDL-2021 LIBRARY; T=0.K  
Proton emission for (p,2p)

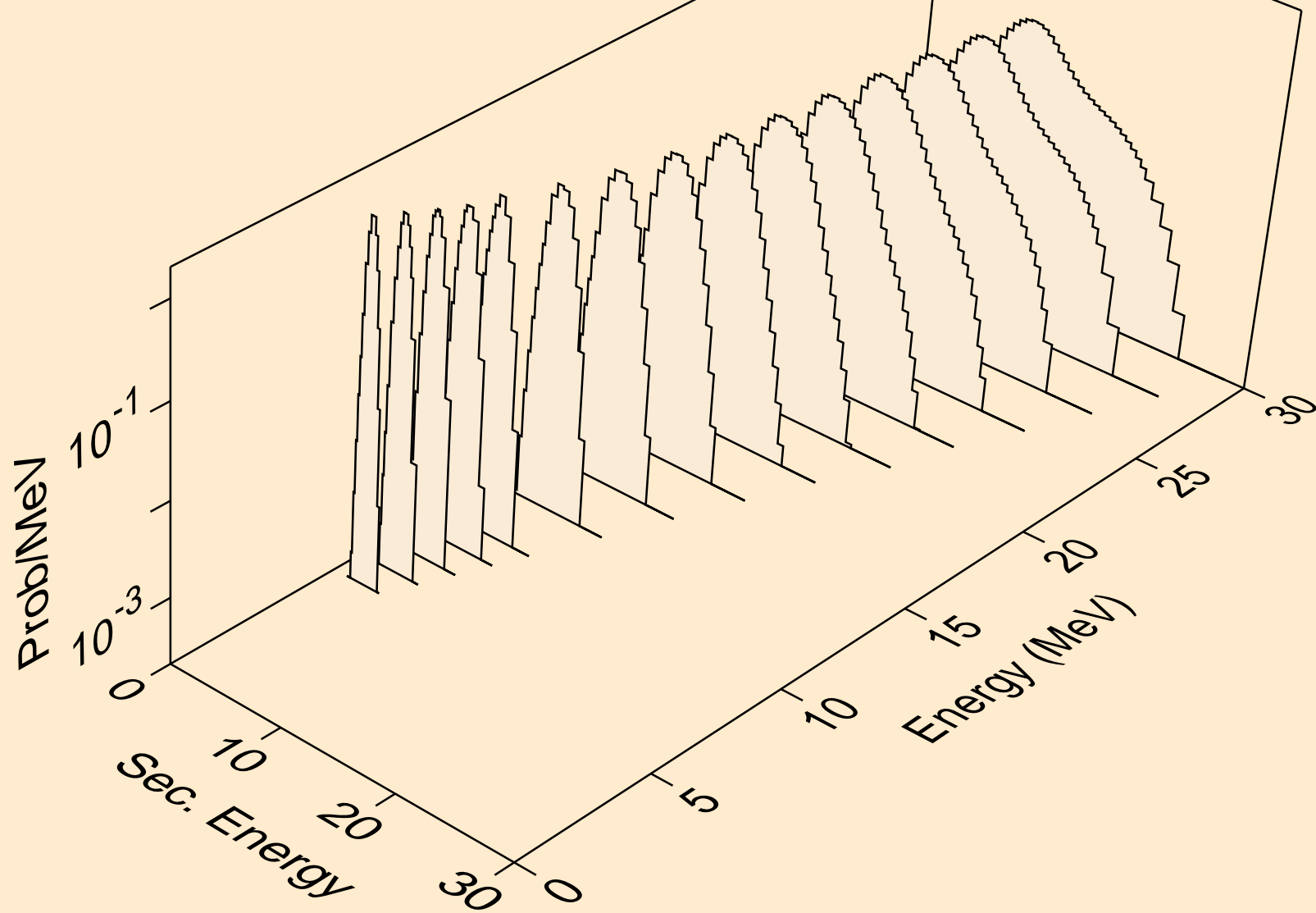



TL186M PROTON ACER TENDL-2021 LIBRARY; T=0.K  
Proton emission for (p,pa)

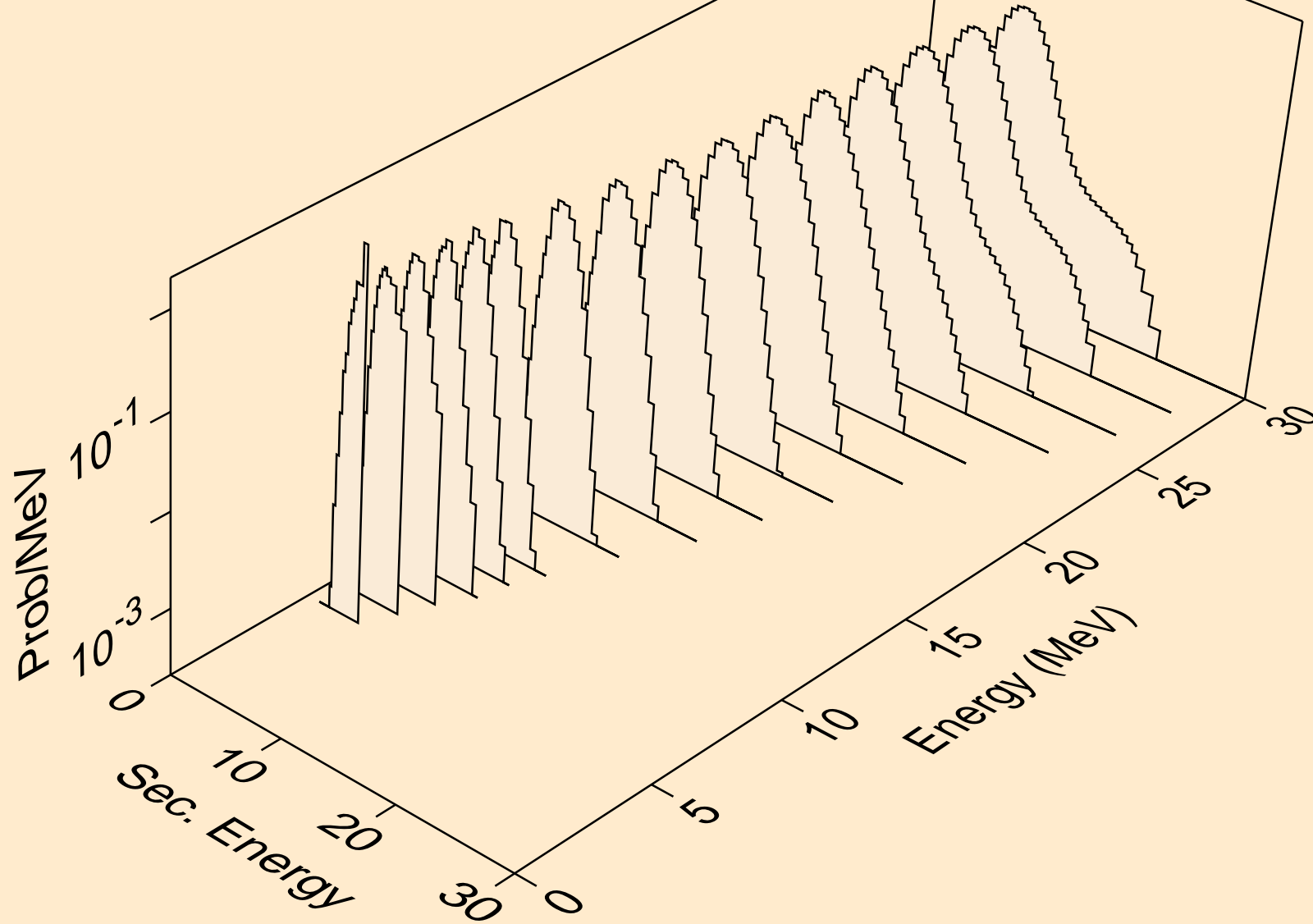

TL186M PROTON ACER TENDL-2021 LIBRARY; T=0.K  
Proton emission for (p,pd)

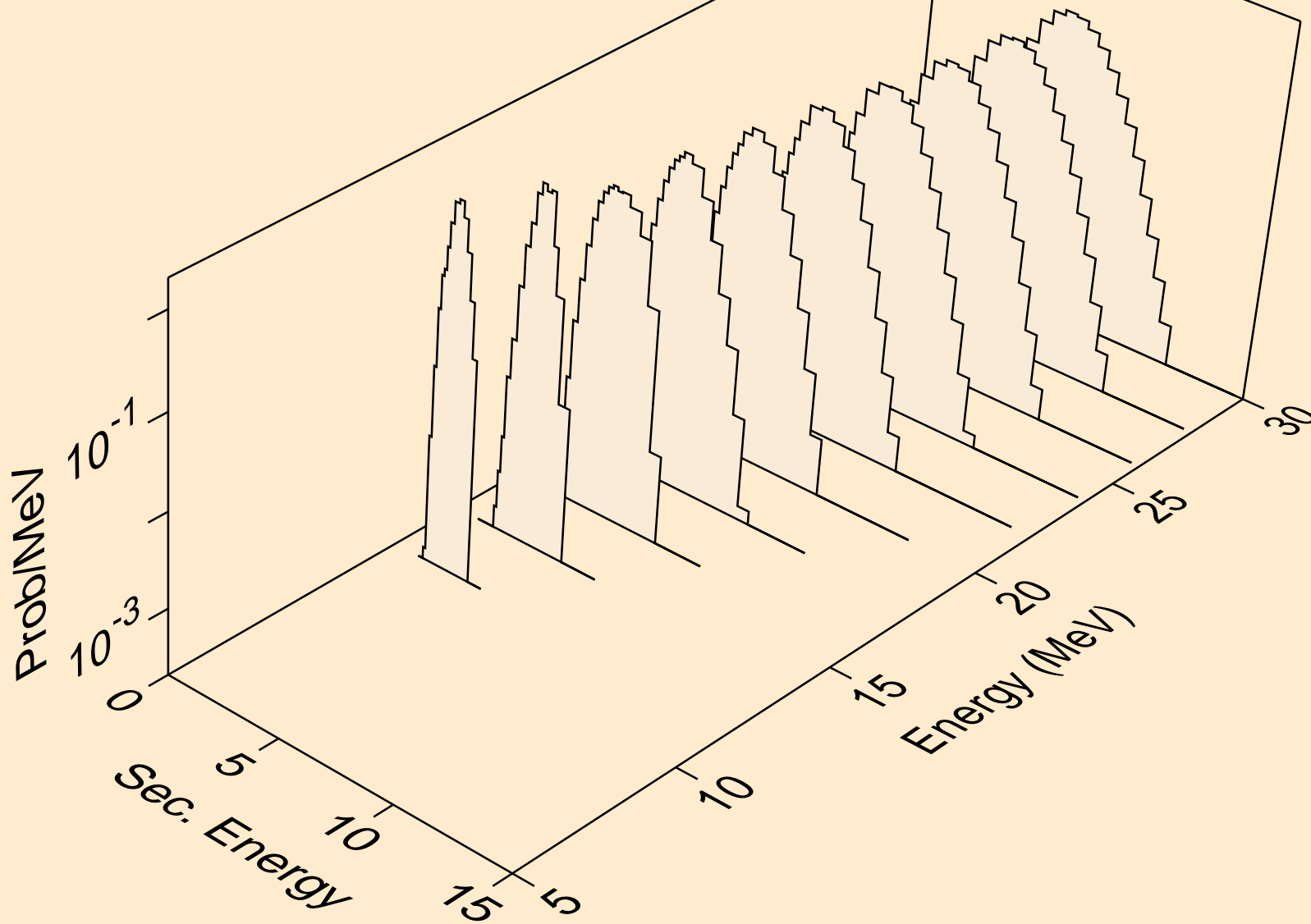

TL186M PROTON ACER TENDL-2021 LIBRARY; T=0.K  
Proton emission for (p,pt)

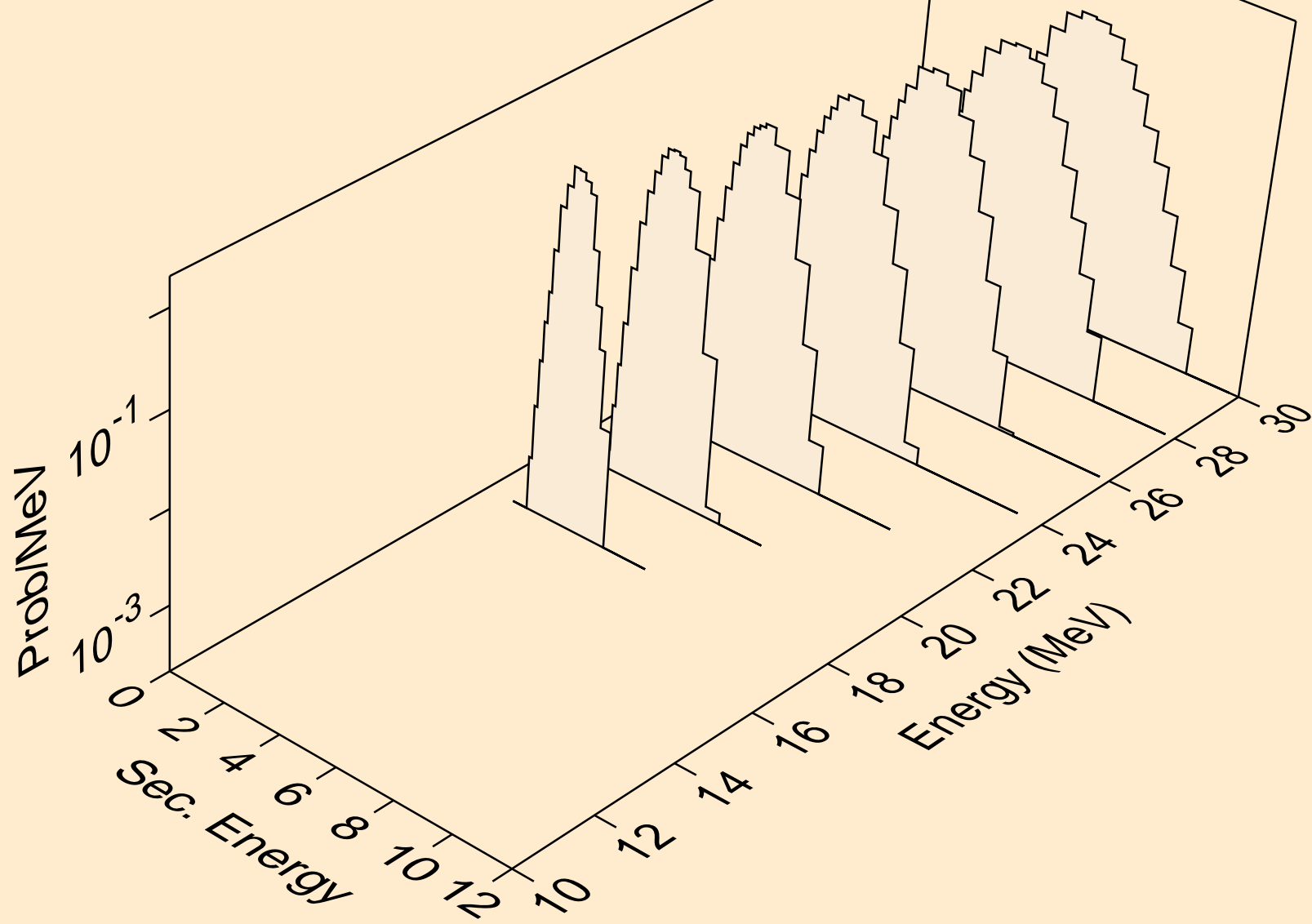

TL186M PROTON ACER TENDL-2021 LIBRARY; T=0.K  
Photon emission for (z,n)

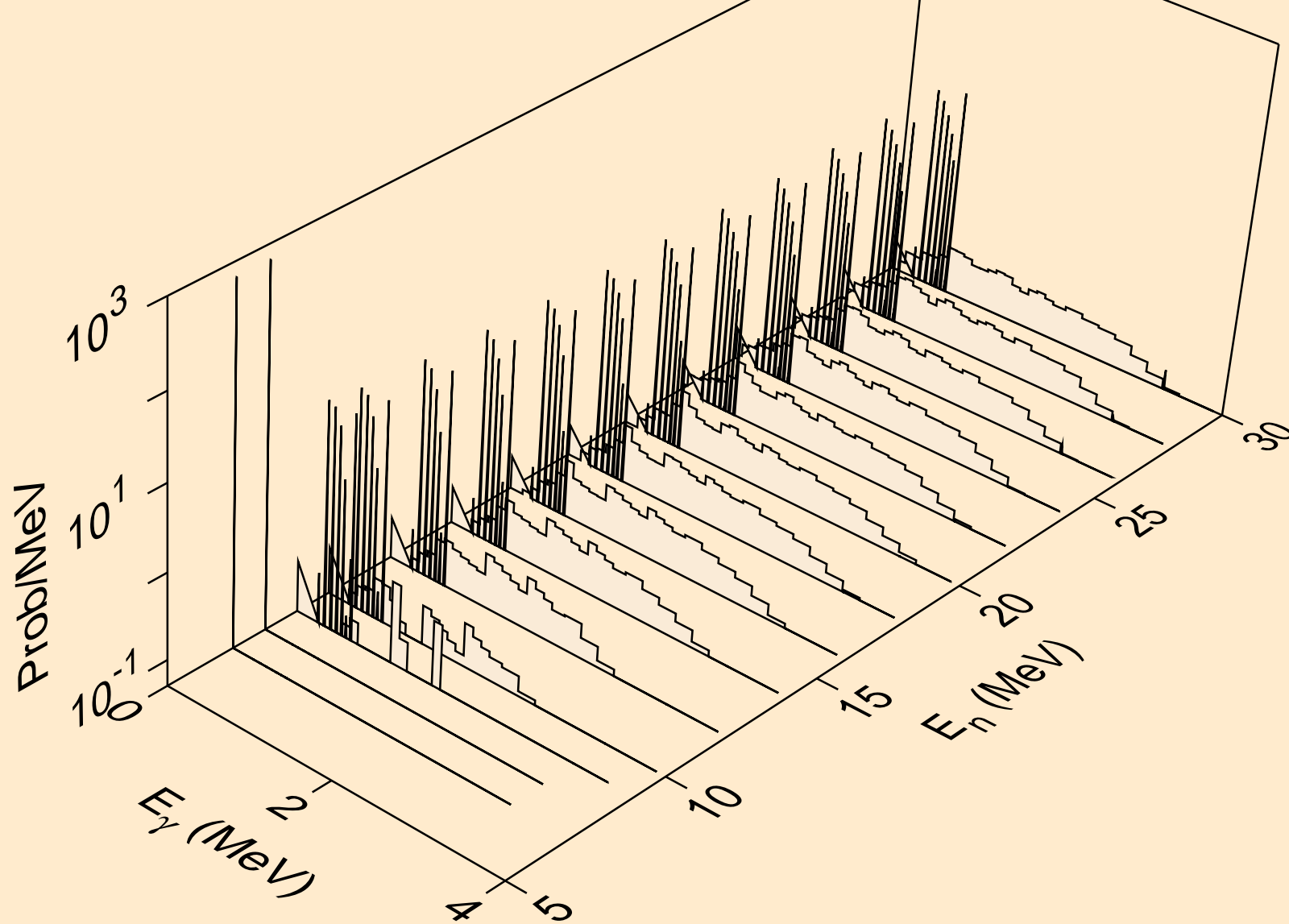

TL186M PROTON ACER TENDL-2021 LIBRARY; T=0.K  
Photon emission for (n,x)

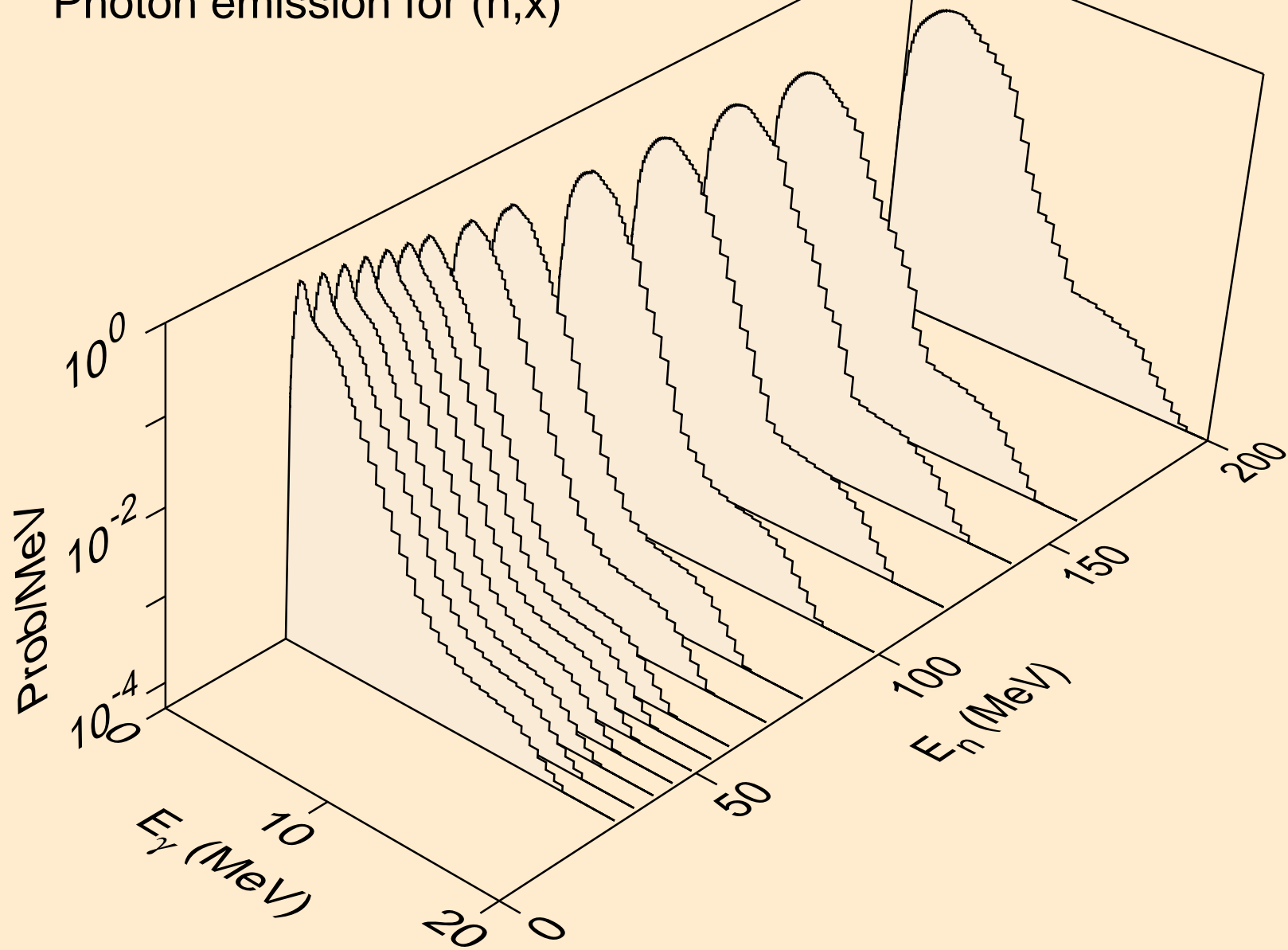

TL186M PROTON ACER TENDL-2021 LIBRARY; T=0.K  
Photon emission for (n,2n)

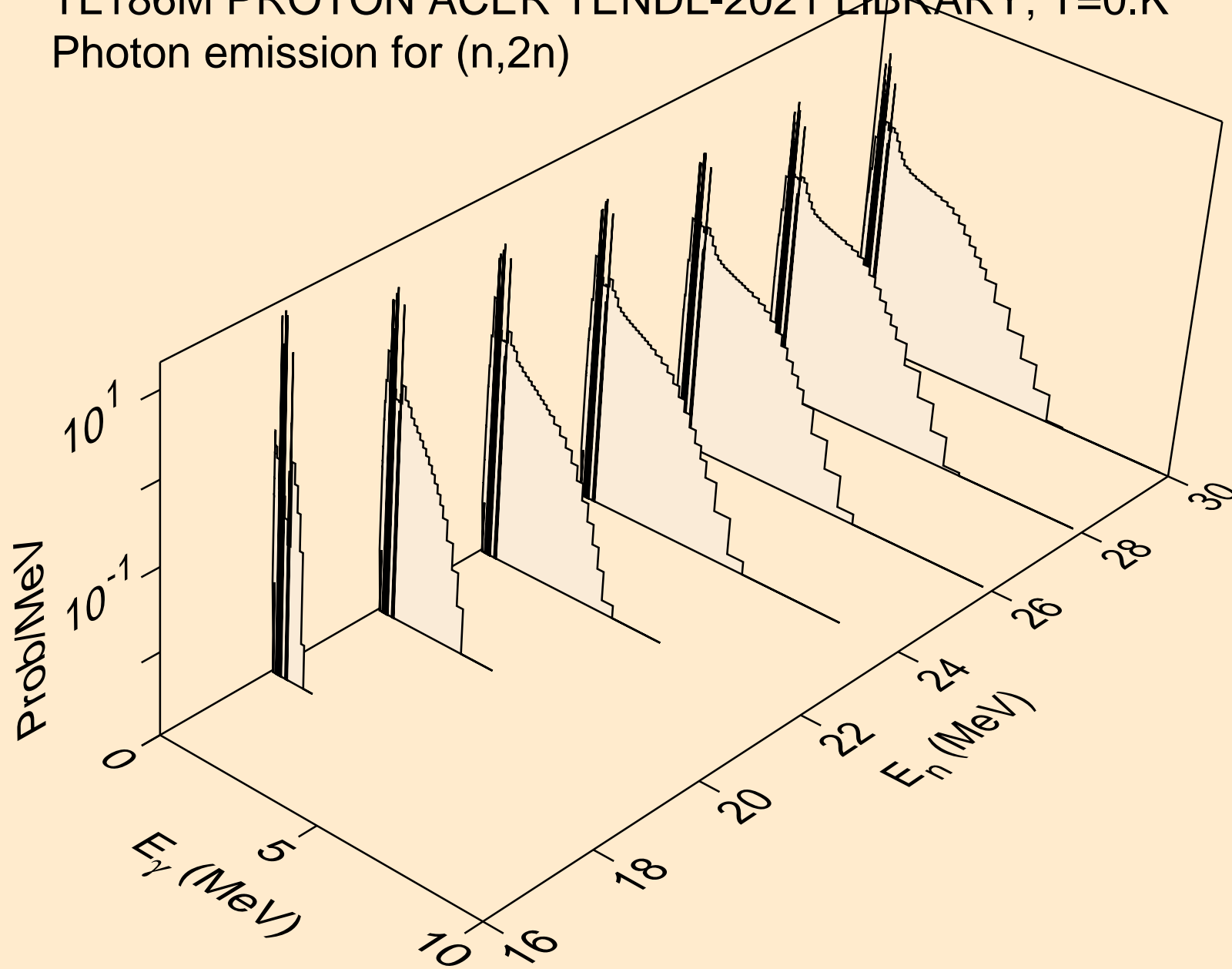

TL186M PROTON ACER TENDL-2021 LIBRARY; T=0.K  
Photon emission for (n,3n)

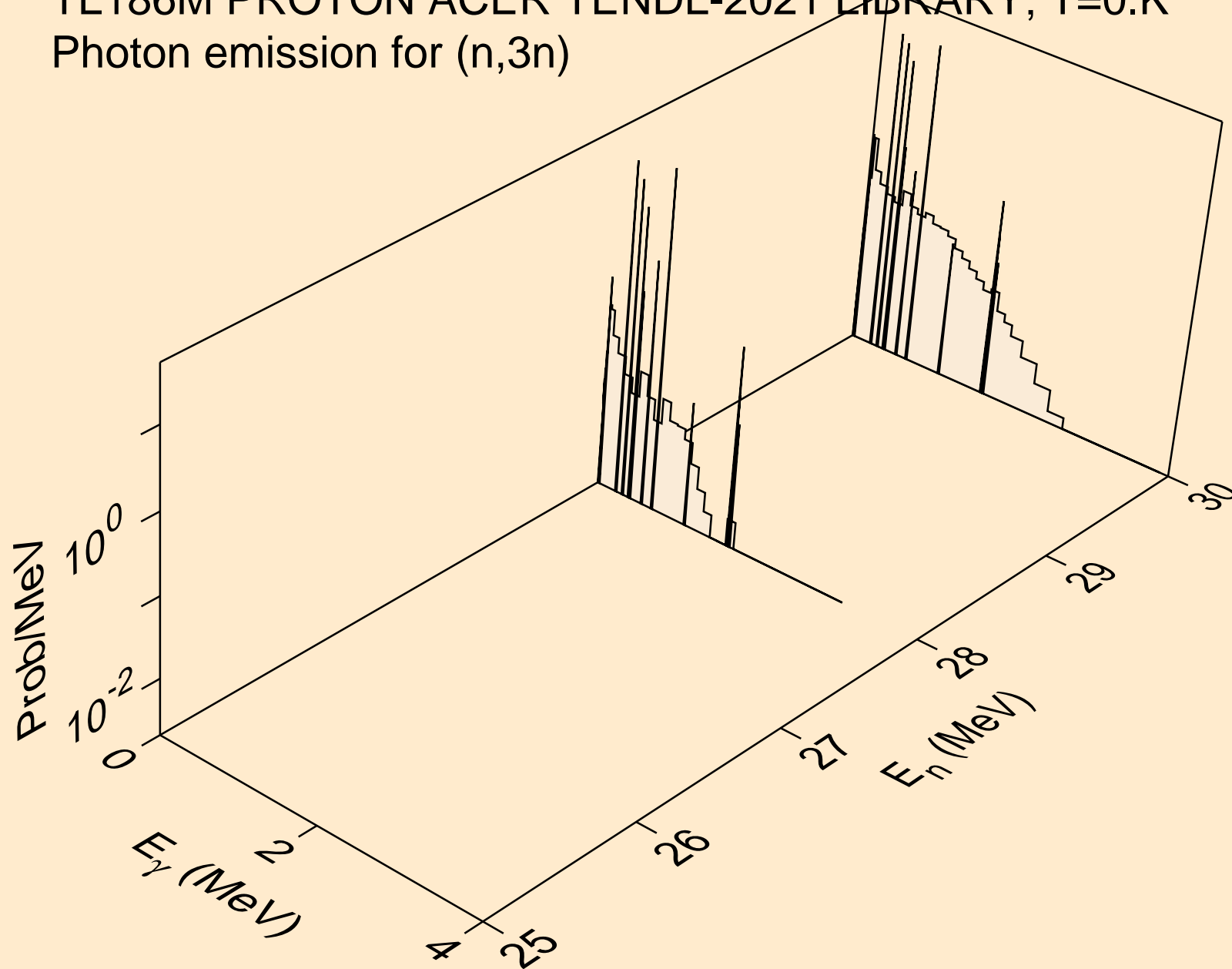

TL186M PROTON ACER TENDL-2021 LIBRARY; T=0.K  
Photon emission for (n,n\*)a

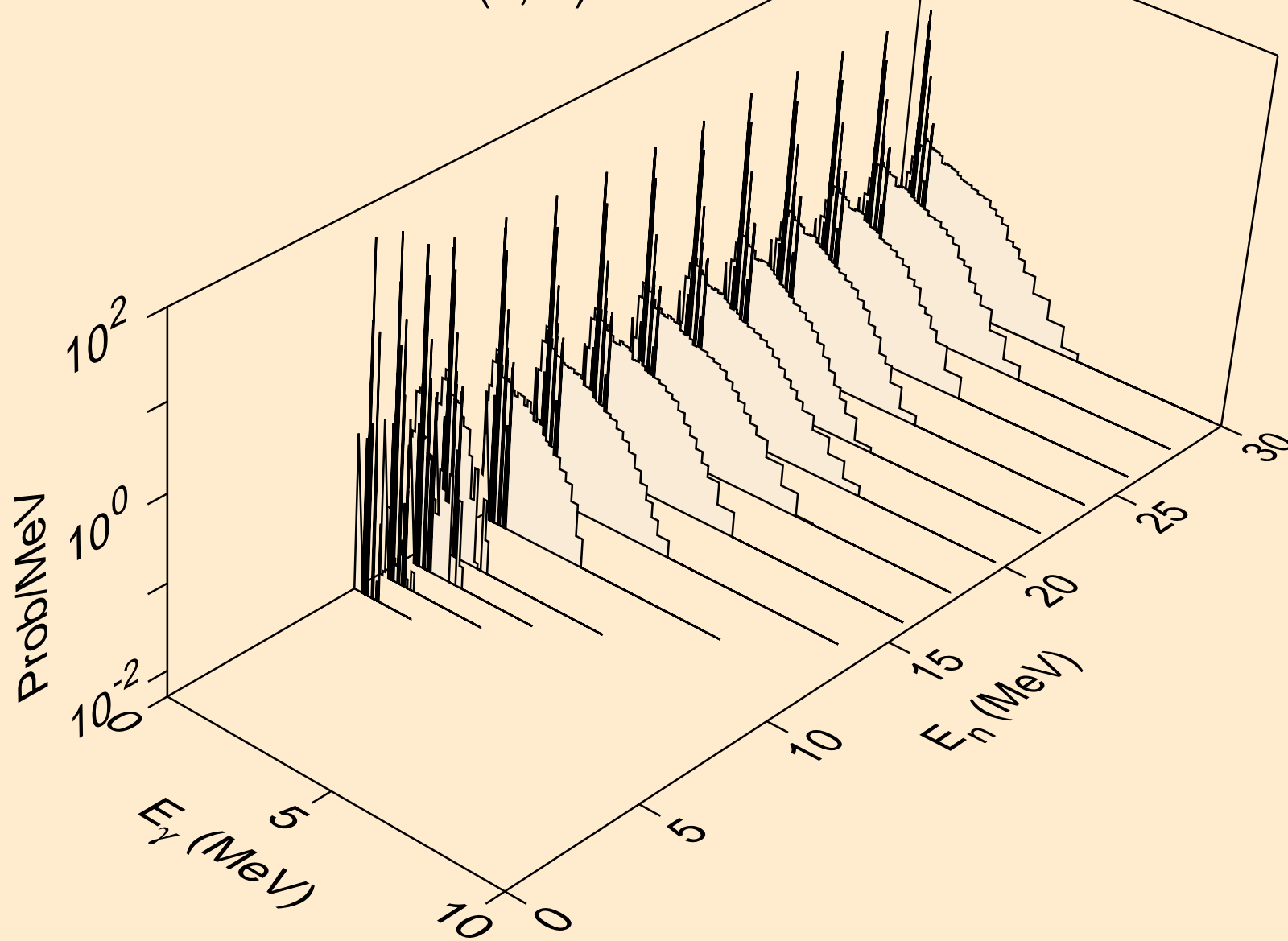



TL186M PROTON ACER TENDL-2021 LIBRARY; T=0.K  
Photon emission for (n,2n)a

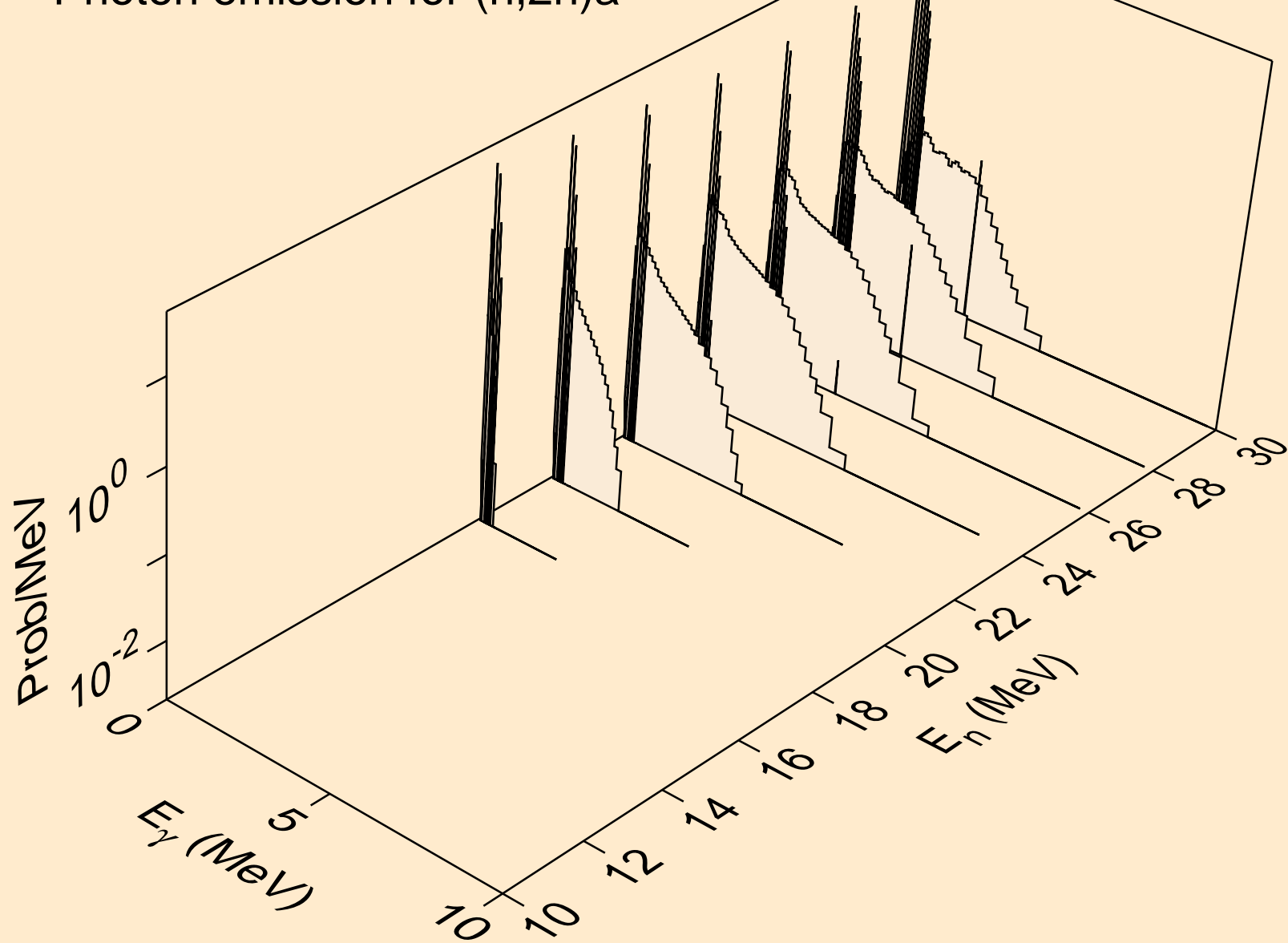

TL186M PROTON ACER TENDL-2021 LIBRARY; T=0.K  
Photon emission for (n,3n)a

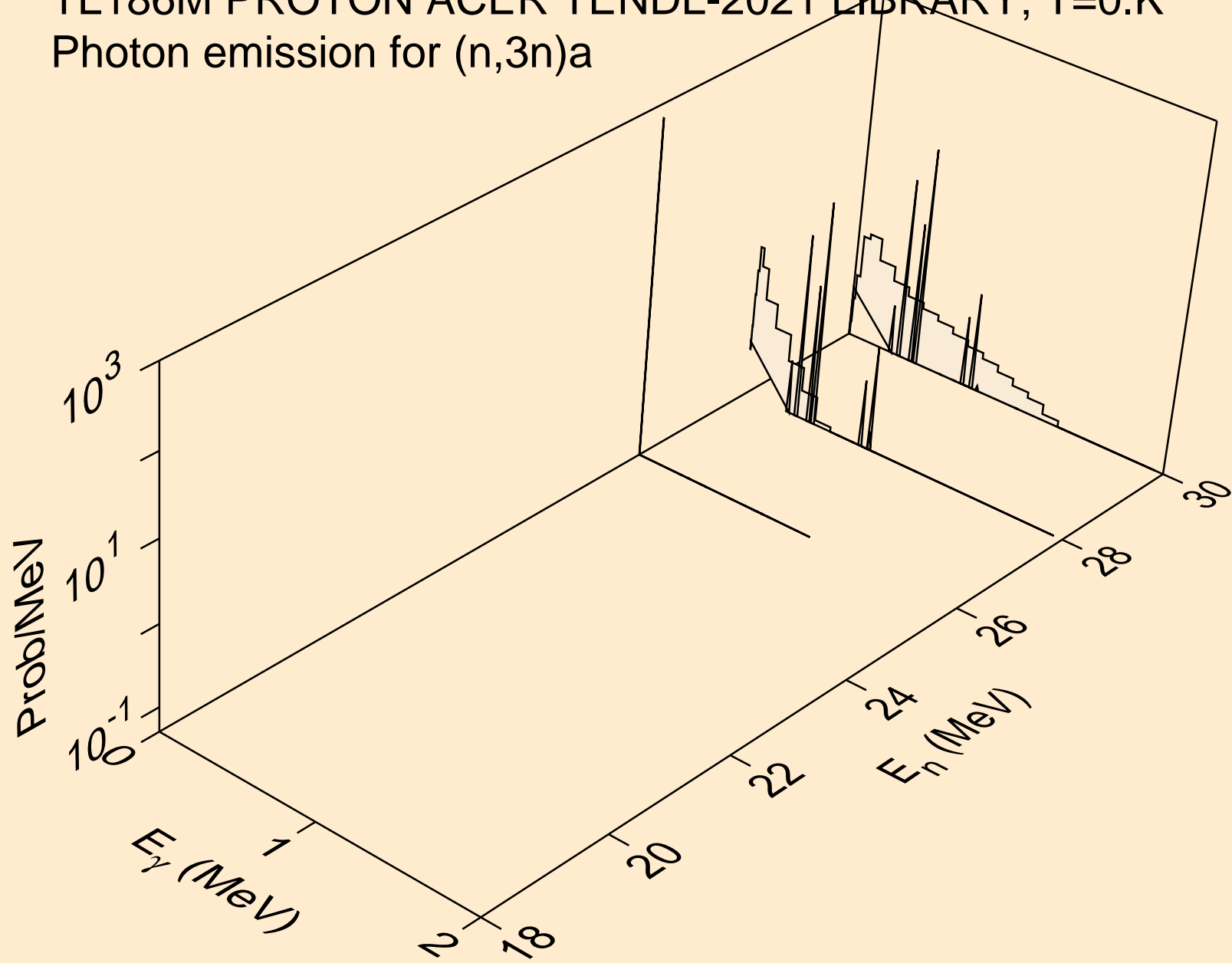

TL186M PROTON ACER TENDL-2021 LIBRARY; T=0.K  
Photon emission for (n,n\*)p

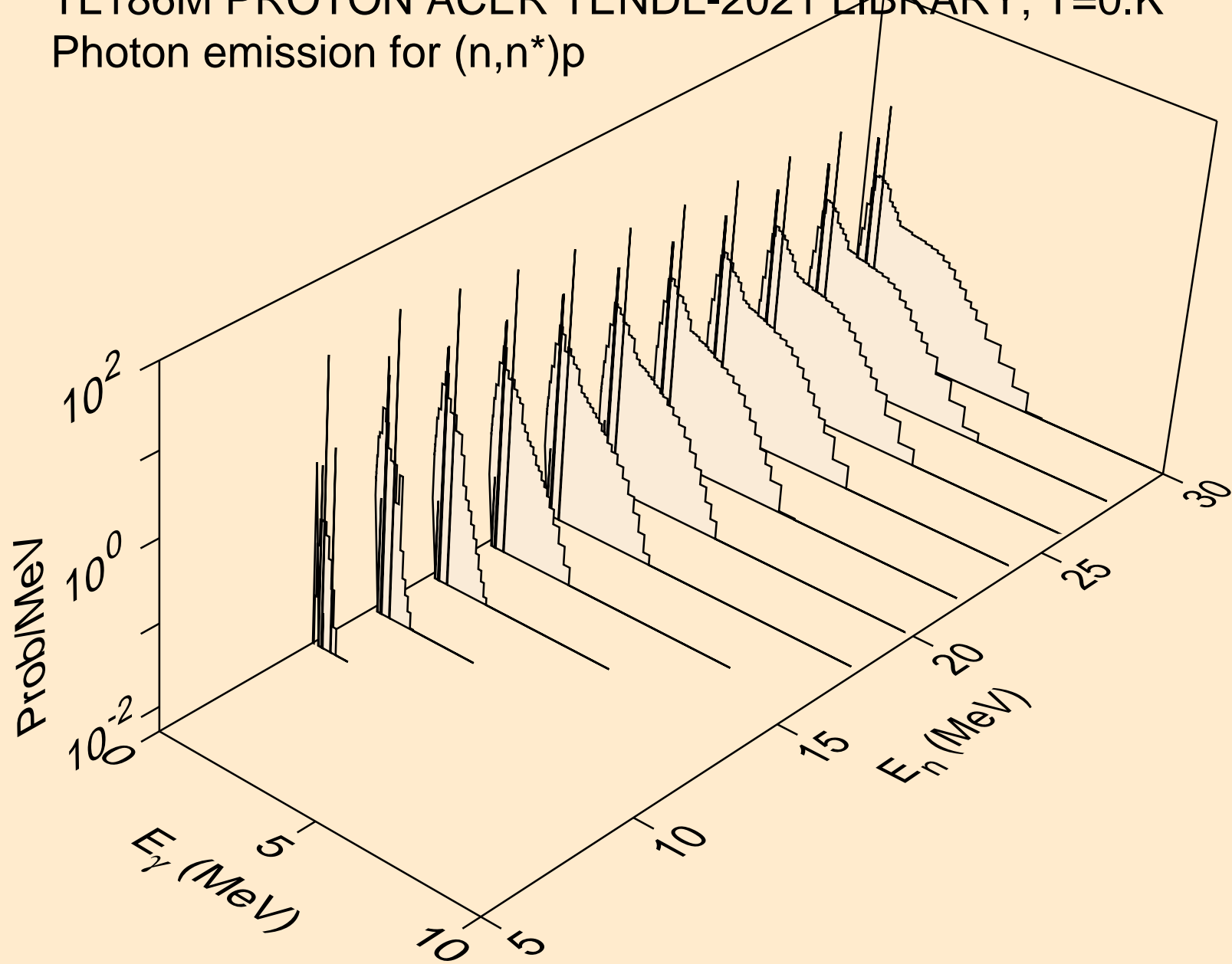

TL186M PROTON ACER TENDL-2021 LIBRARY; T=0.K  
Photon emission for (n,n\*)2a

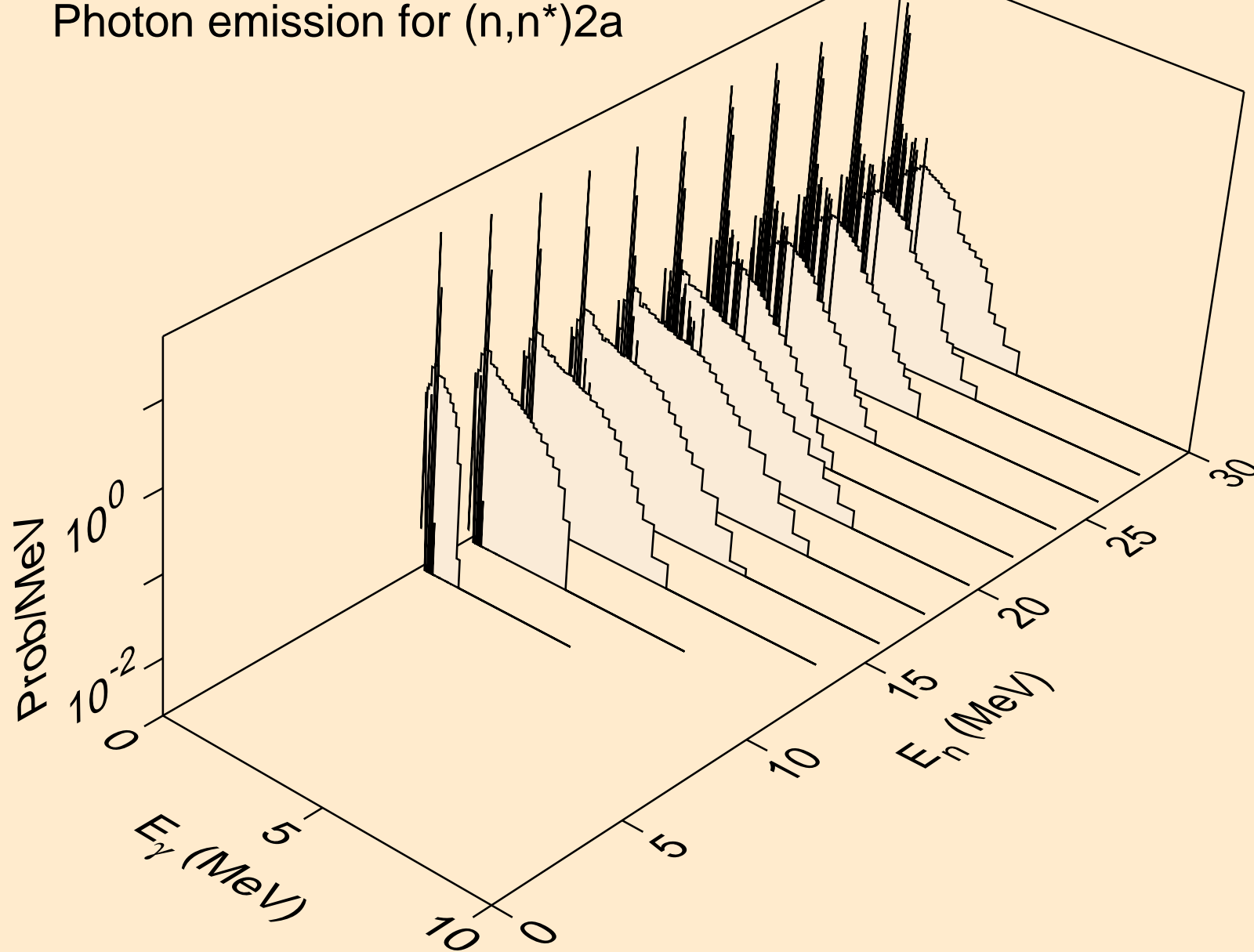

TL186M PROTON ACER TENDL-2021 LIBRARY; T=0.K  
Photon emission for (n,2n)2a

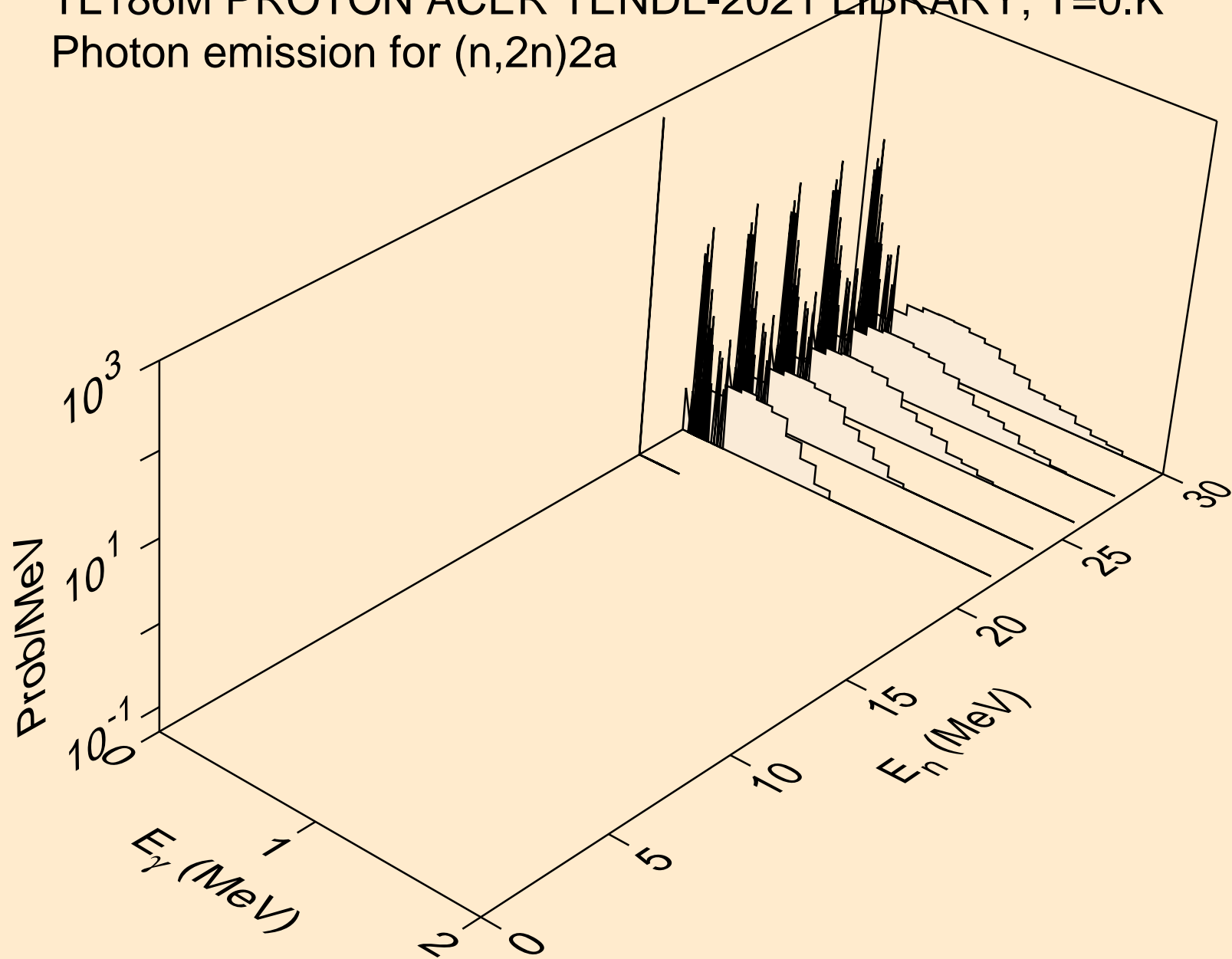

TL186M PROTON ACER TENDL-2021 LIBRARY; T=0.K  
Photon emission for (n,n\*)d

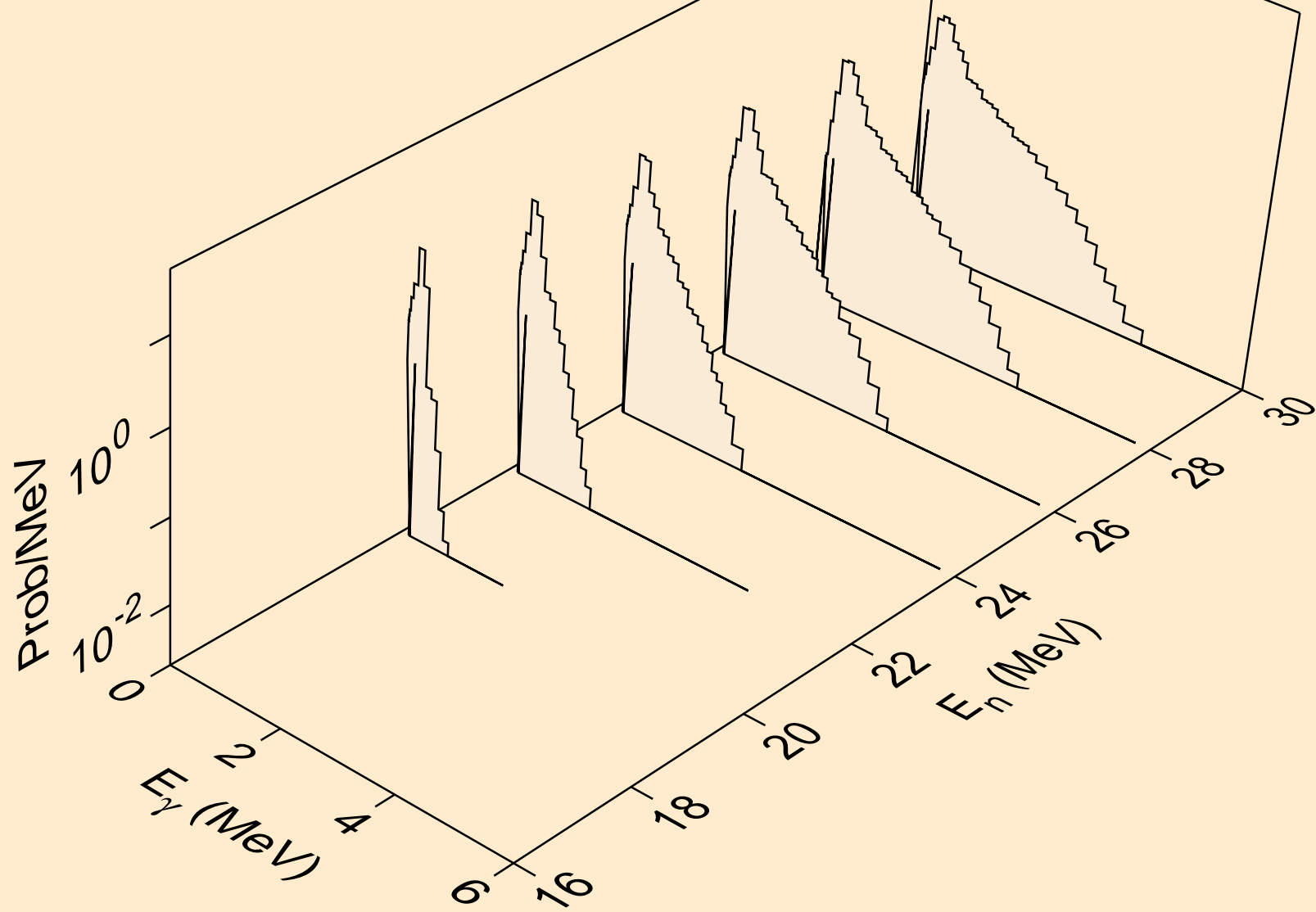

TL186M PROTON ACER TENDL-2021 LIBRARY; T=0.K  
Photon emission for (n,n\*)t

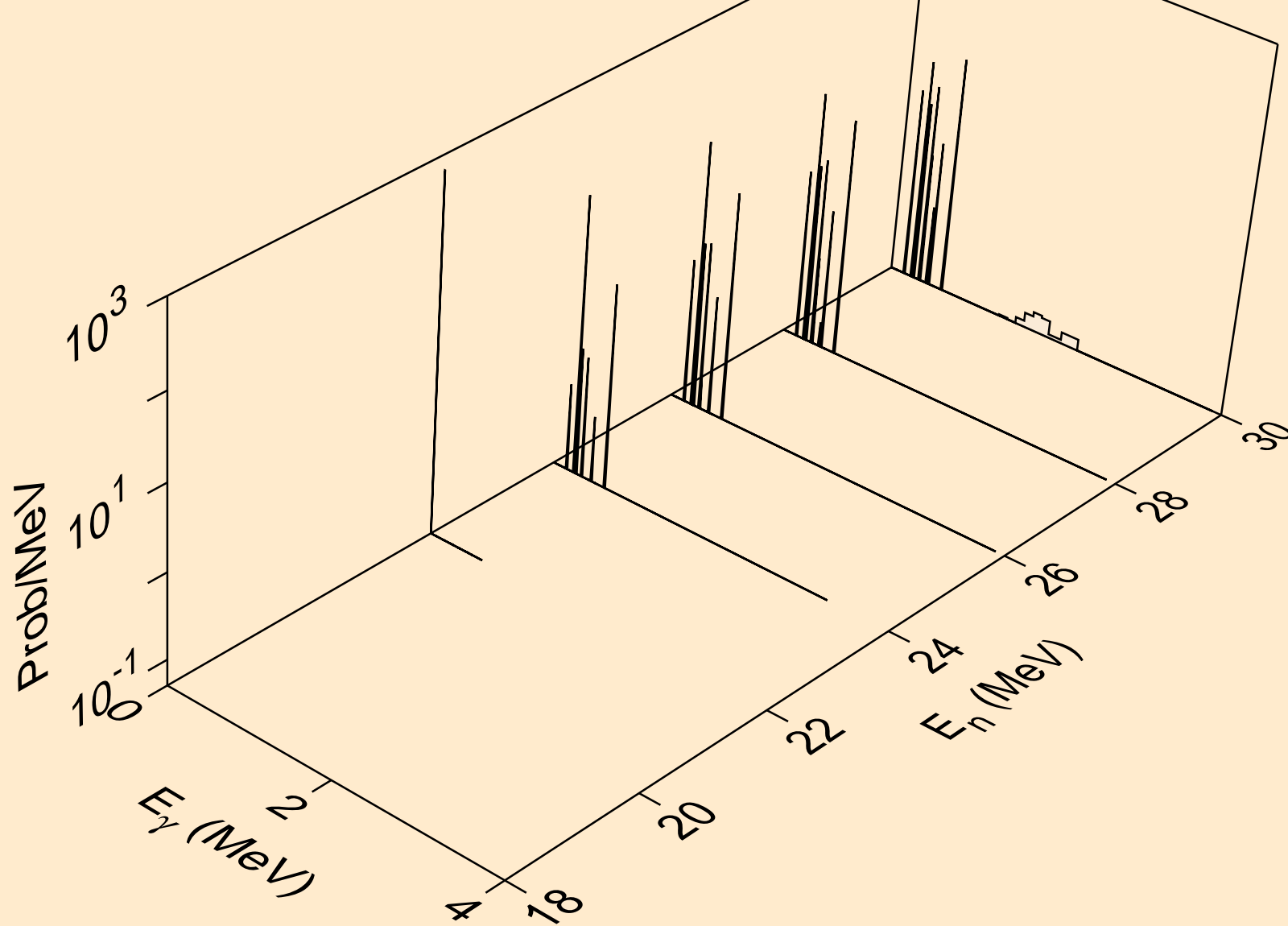

TL186M PROTON ACER TENDL-2021 LIBRARY; T=0.K  
Photon emission for (n,n\*)he3

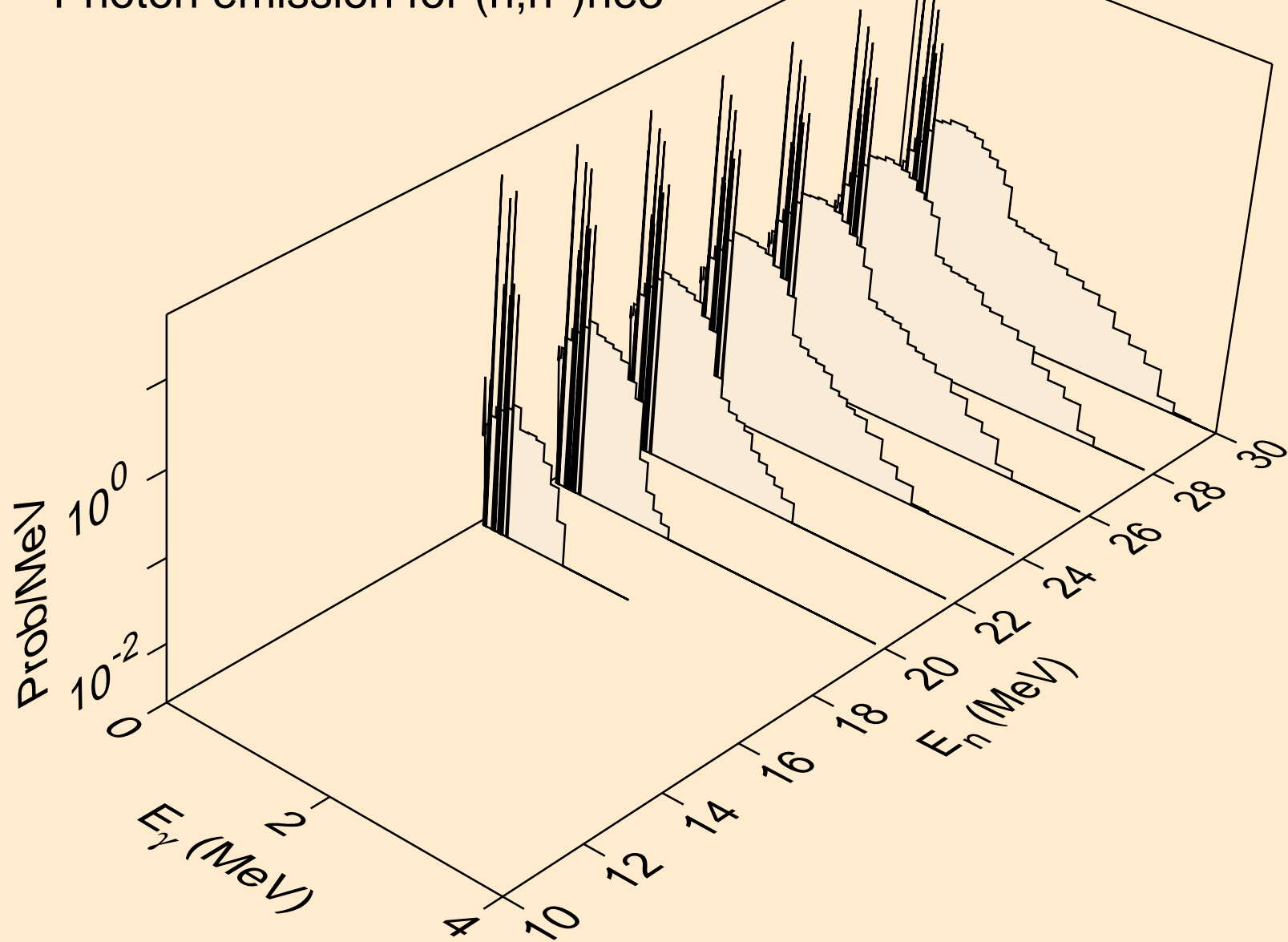



TL186M PROTON ACER TENDL-2021 LIBRARY; T=0.K  
Photon emission for (n,2np)

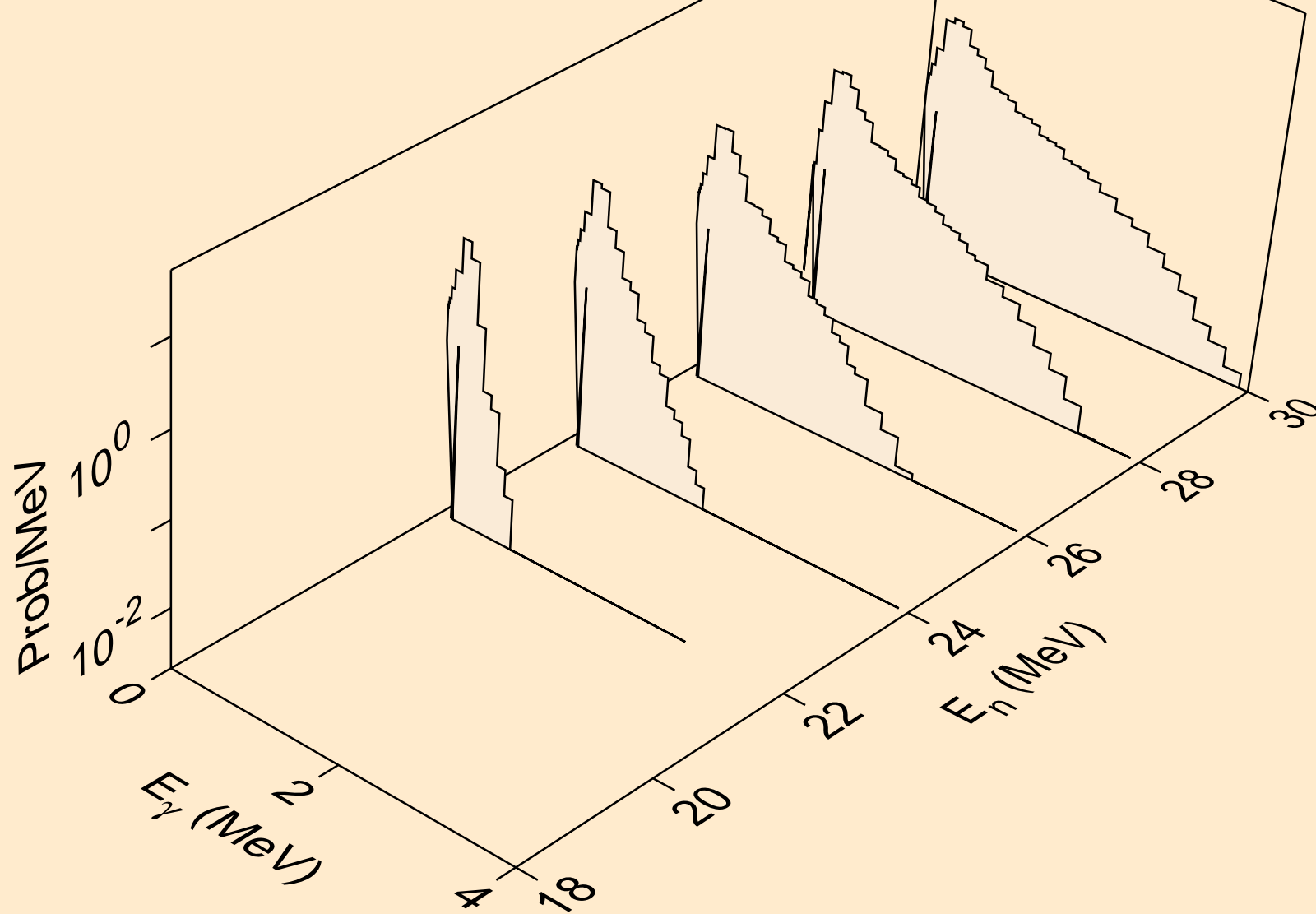

TL186M PROTON ACER TENDL-2021 LIBRARY; T=0.K  
Photon emission for (n,2np)

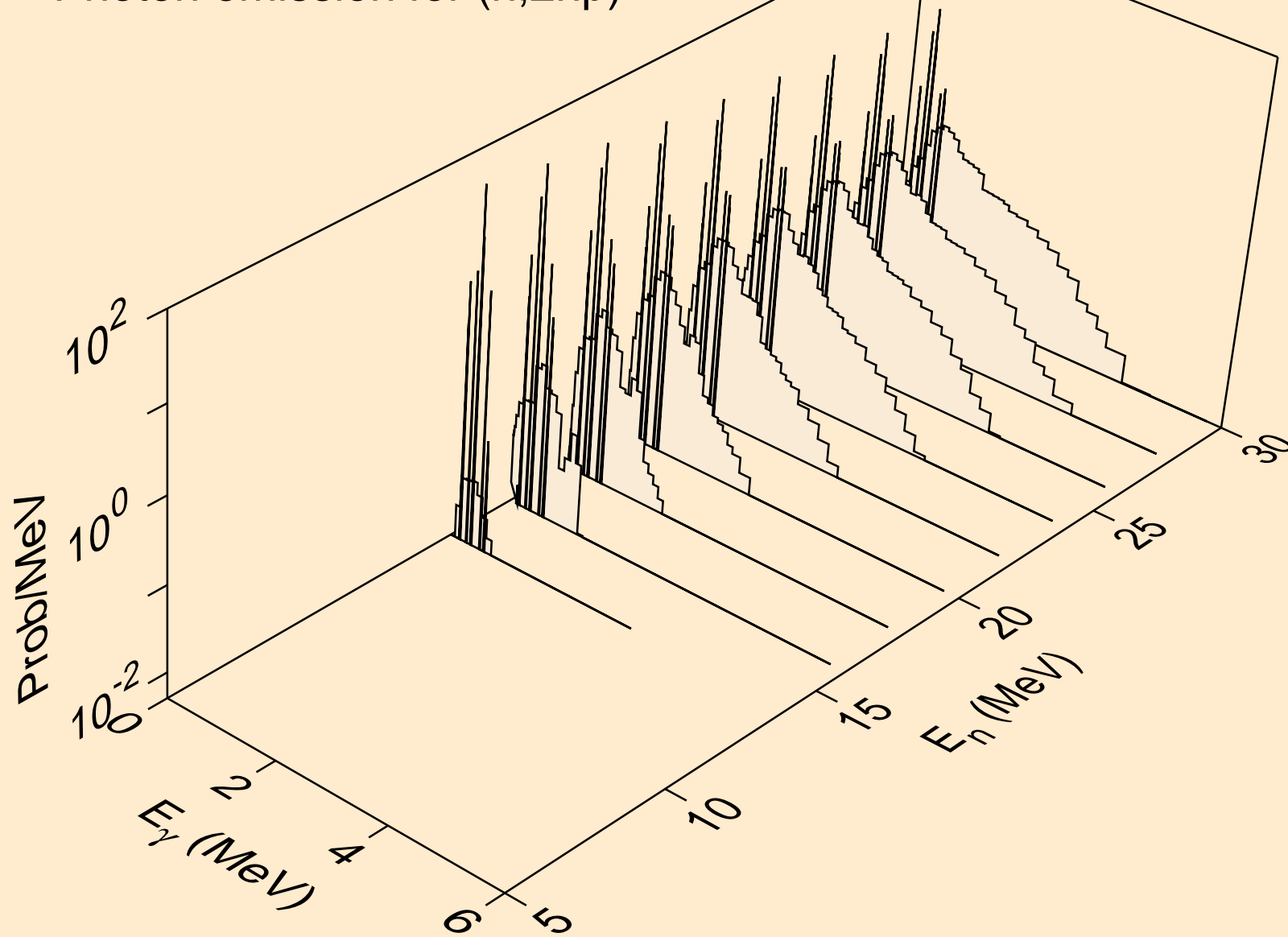

TL186M PROTON ACER TENDL-2021 LIBRARY; T=0.K  
Photon emission for (n,npa)

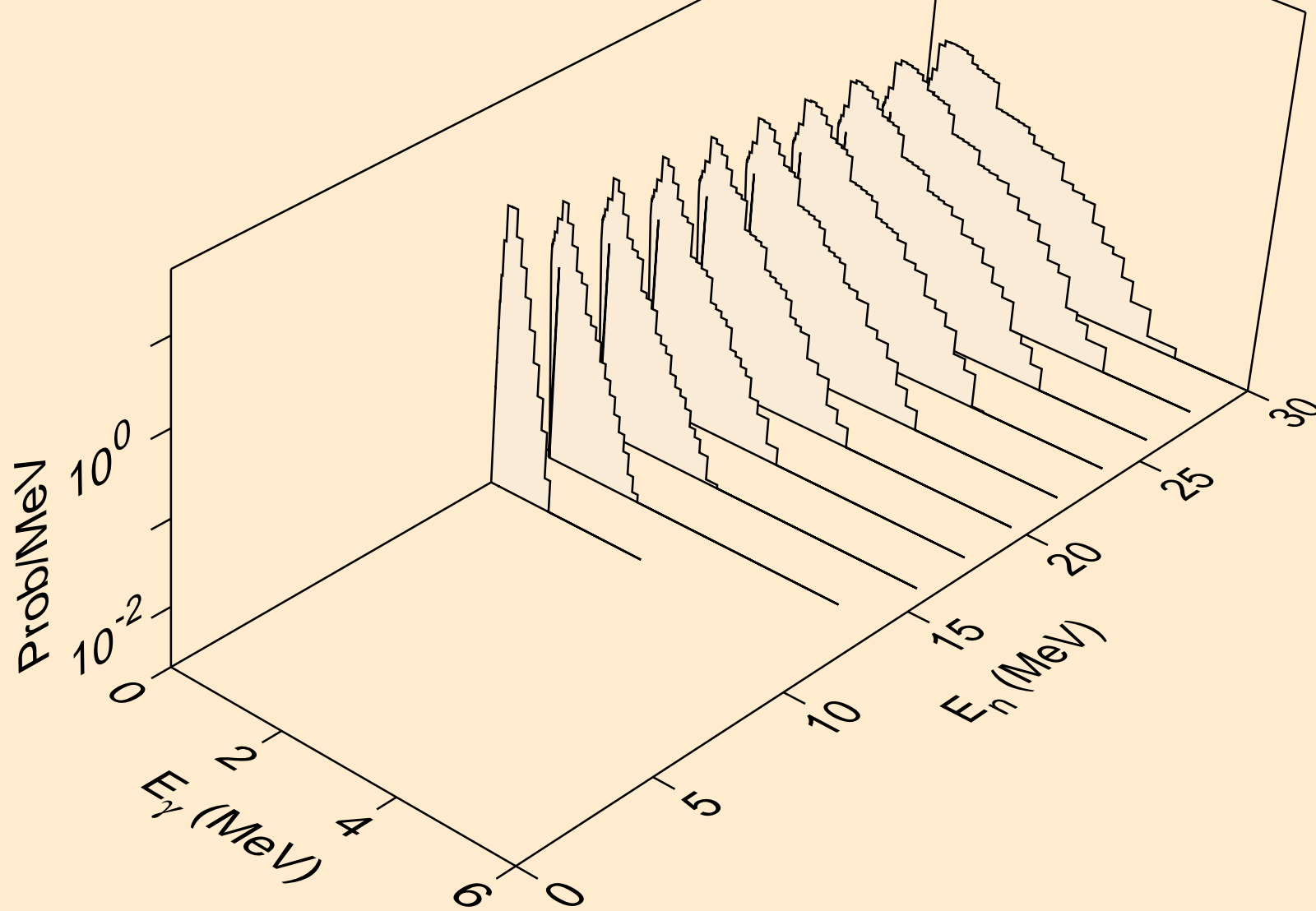

TL186M PROTON ACER TENDL-2021 LIBRARY; T=0.K  
Photon emission for (n,gma)

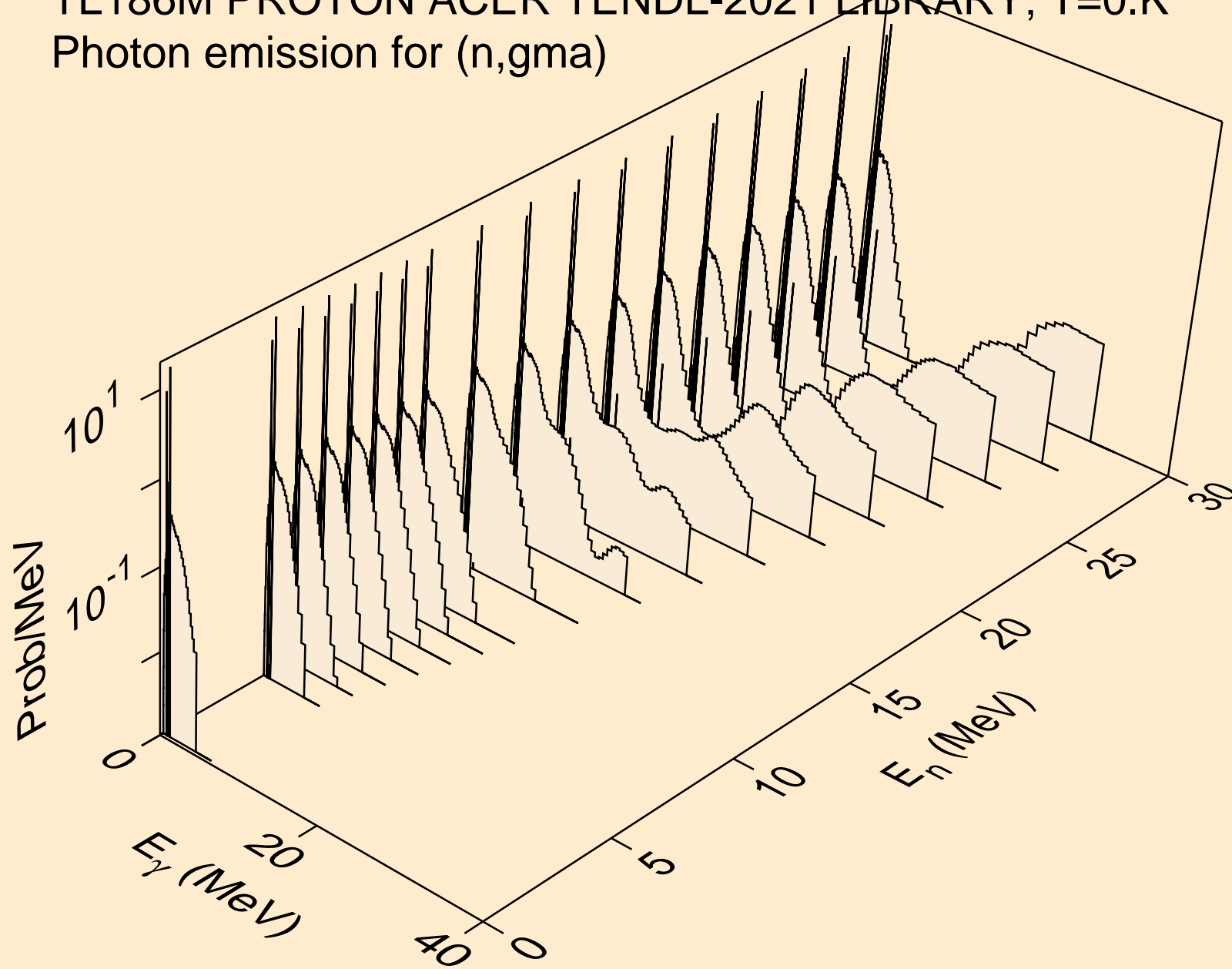

TL186M PROTON ACER TENDL-2021 LIBRARY; T=0.K  
Photon emission for inelastic

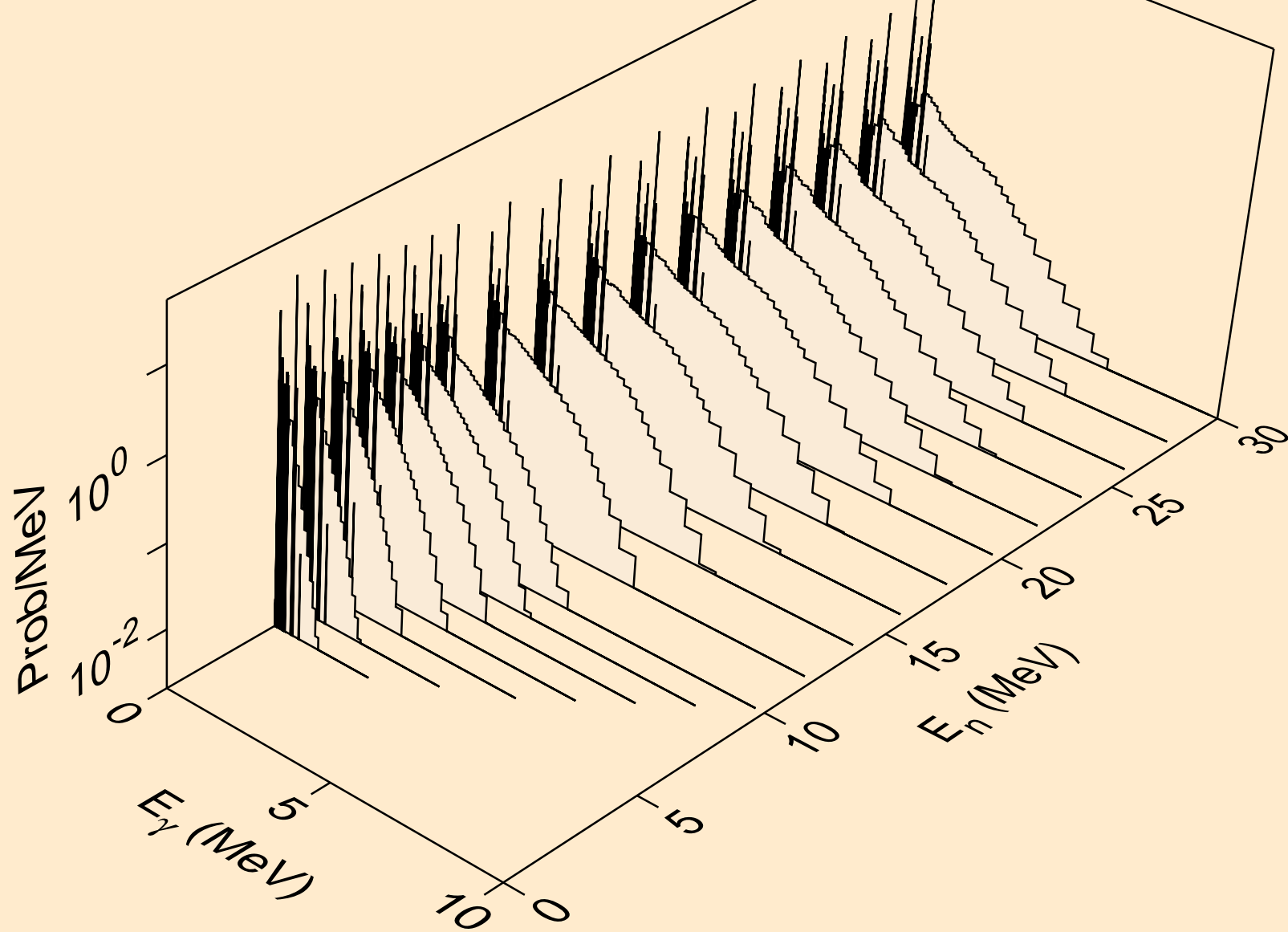

TL186M PROTON ACER TENDL-2021 LIBRARY; T=0.K  
Photon emission for (n,d)

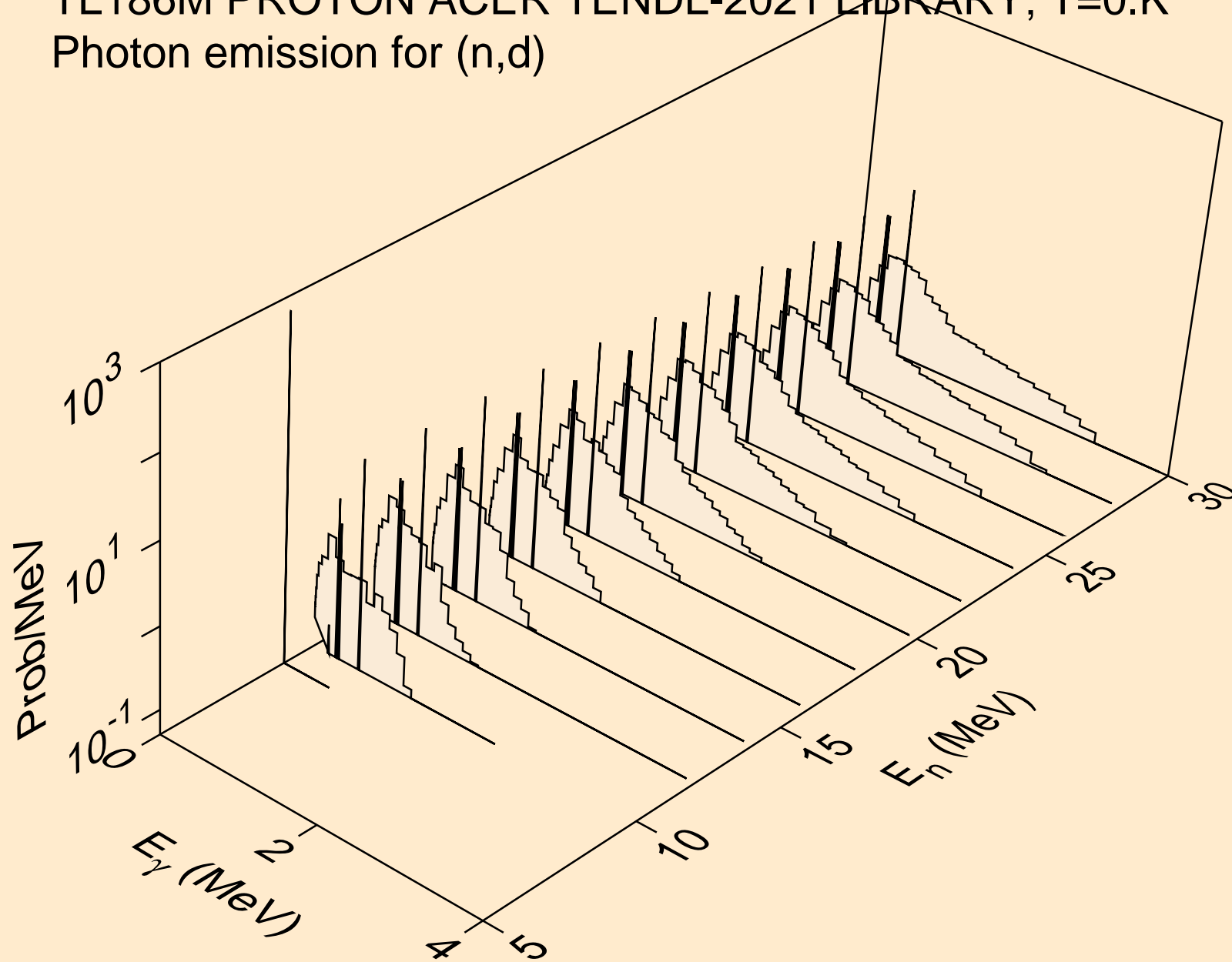

TL186M PROTON ACER TENDL-2021 LIBRARY; T=0.K  
Photon emission for (n,t)

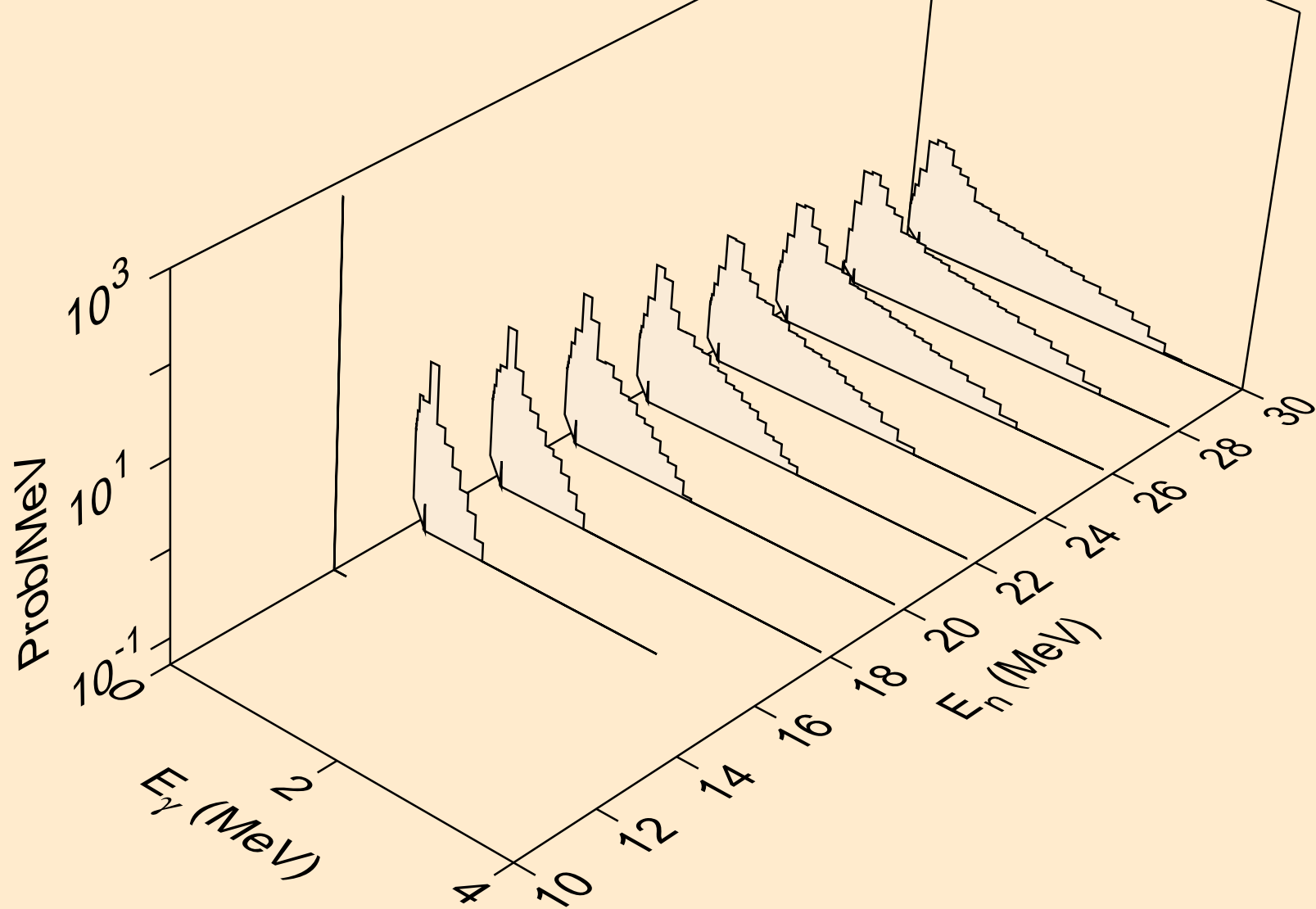

TL186M PROTON ACER TENDL-2021 LIBRARY; T=0.K  
Photon emission for (n,he3)

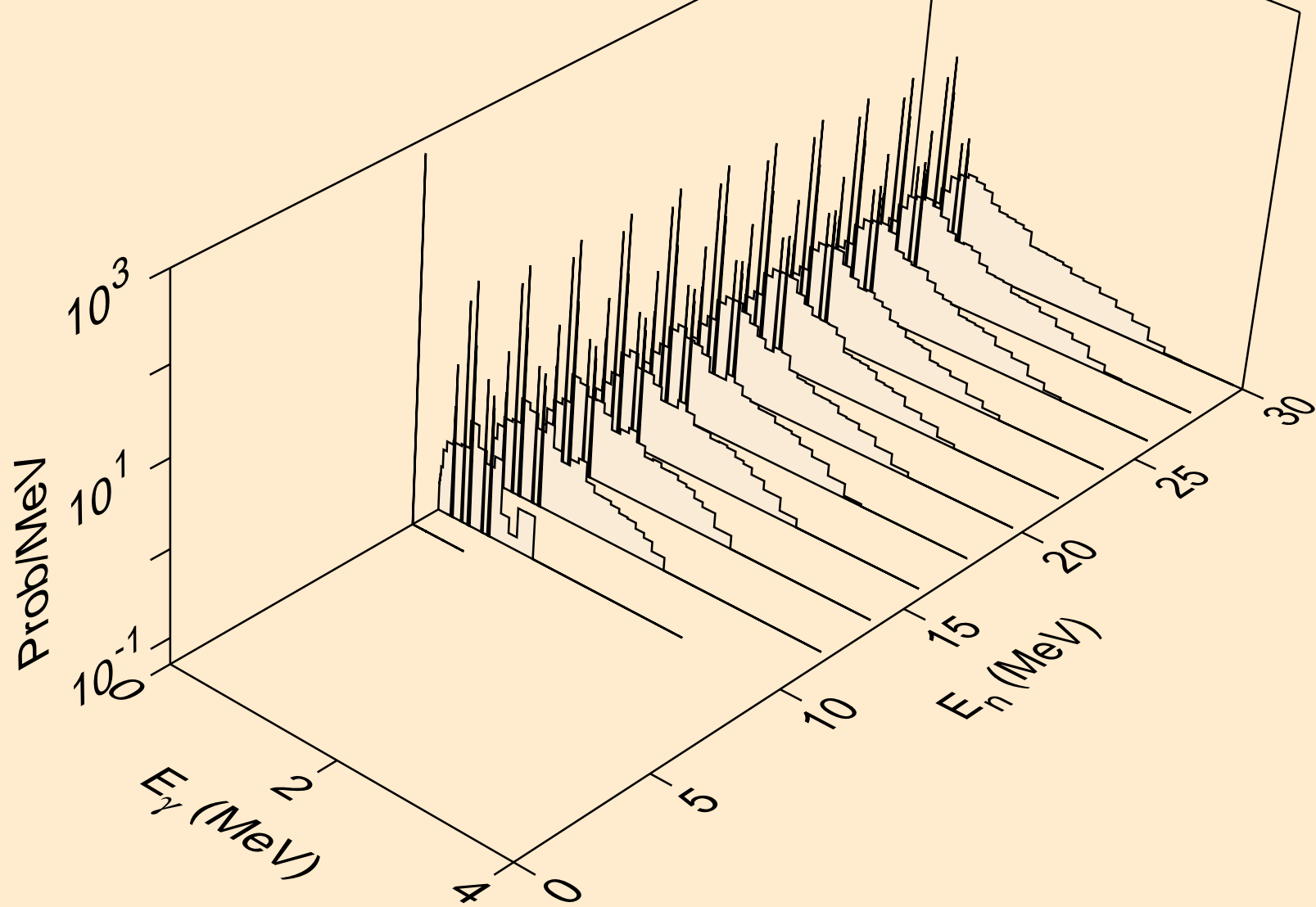



TL186M PROTON ACER TENDL-2021 LIBRARY; T=0.K  
Photon emission for (n,a)

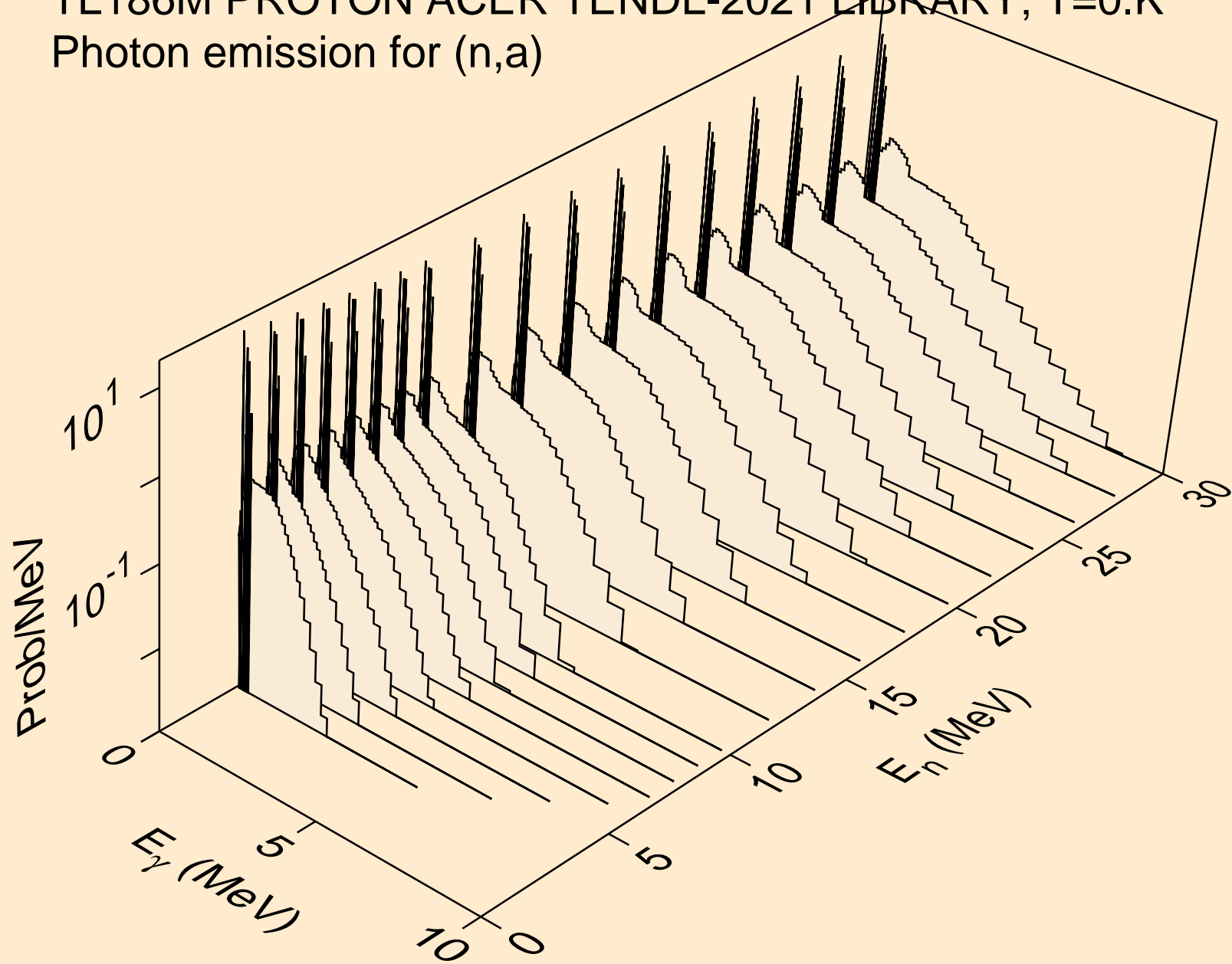

TL186M PROTON ACER TENDL-2021 LIBRARY; T=0.K  
Photon emission for (n,2a)

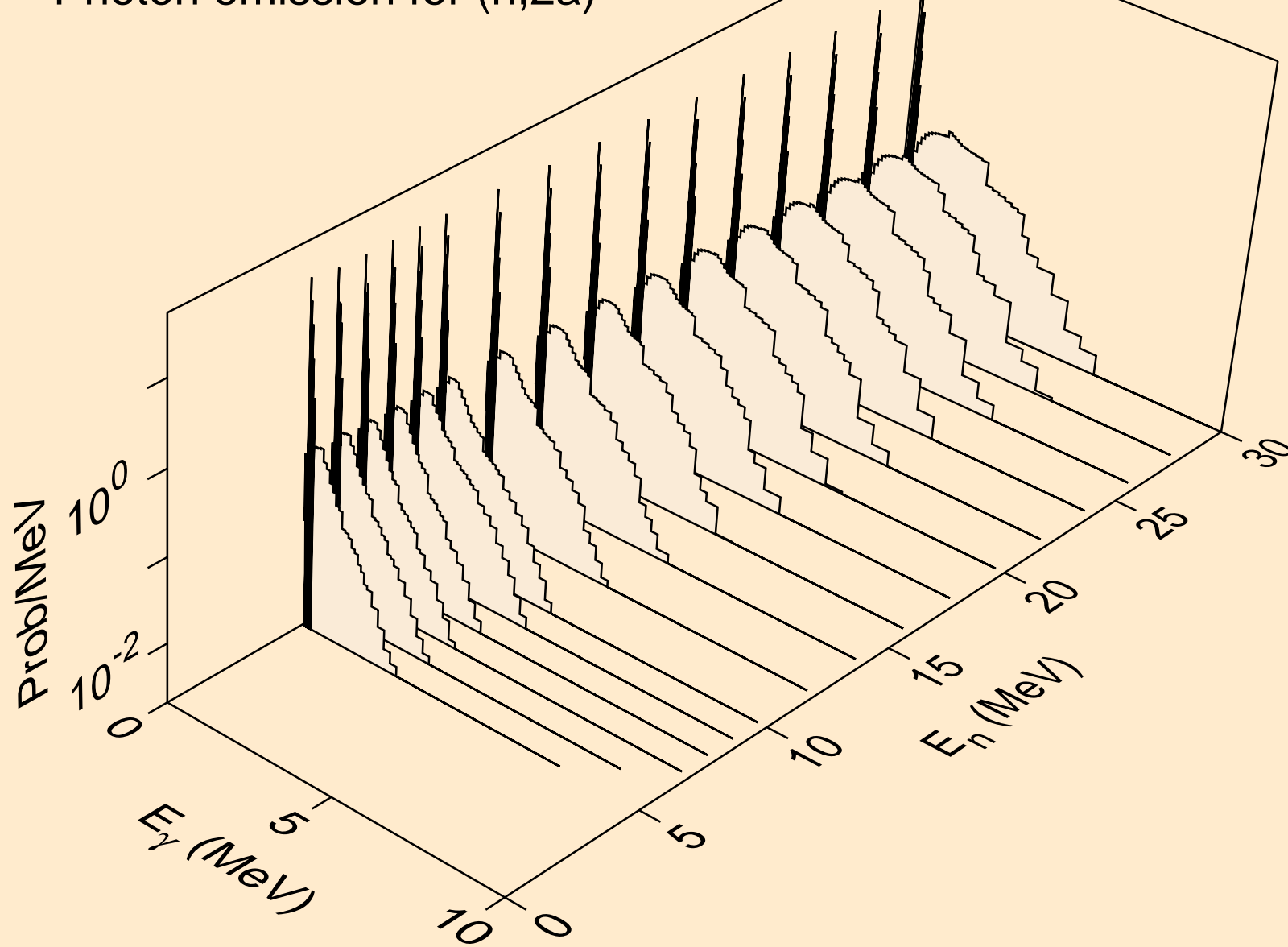

TL186M PROTON ACER TENDL-2021 LIBRARY; T=0.K  
Photon emission for (n,3a)

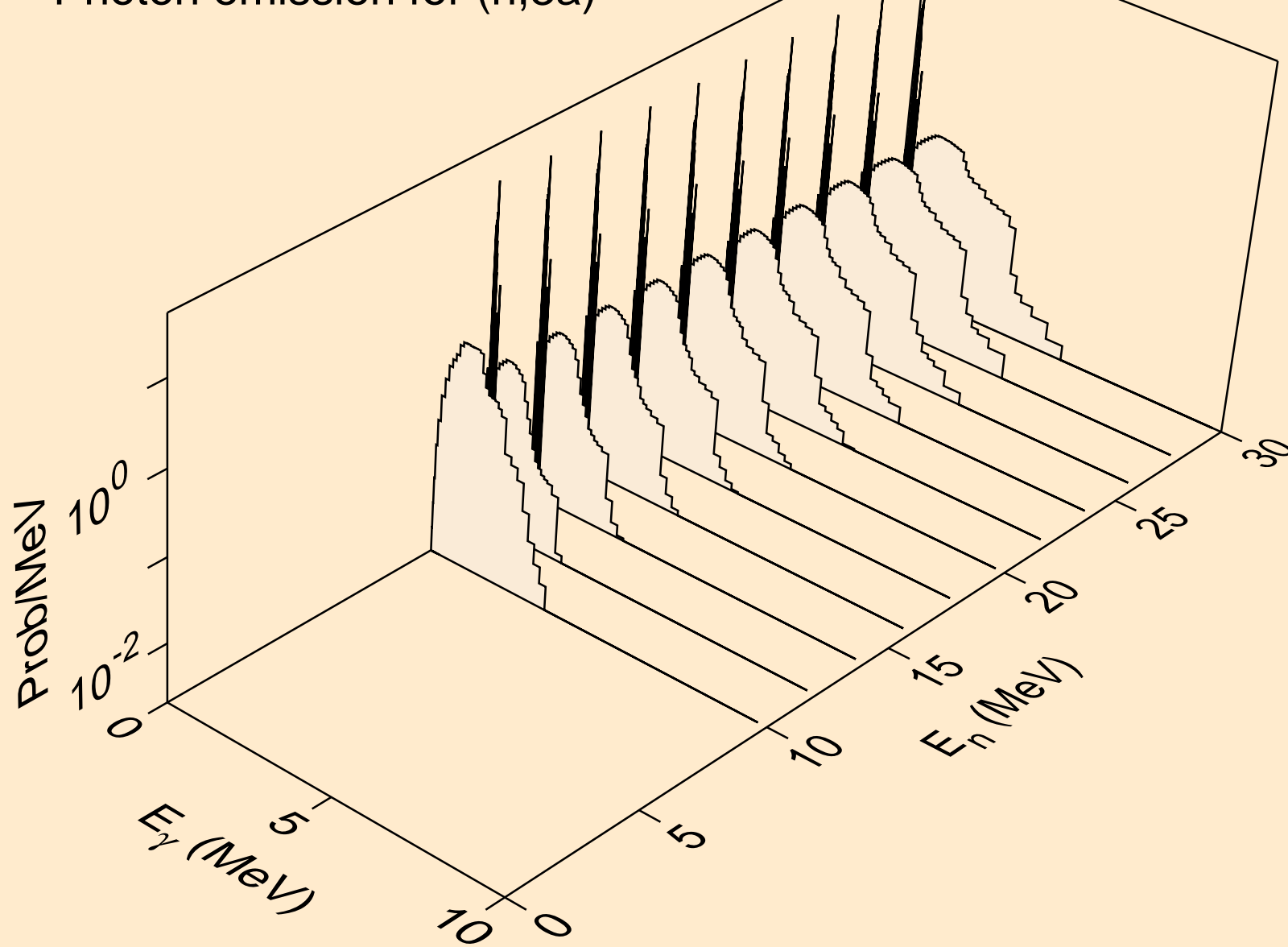

TL186M PROTON ACER TENDL-2021 LIBRARY; T=0.K  
Photon emission for (n,2p)

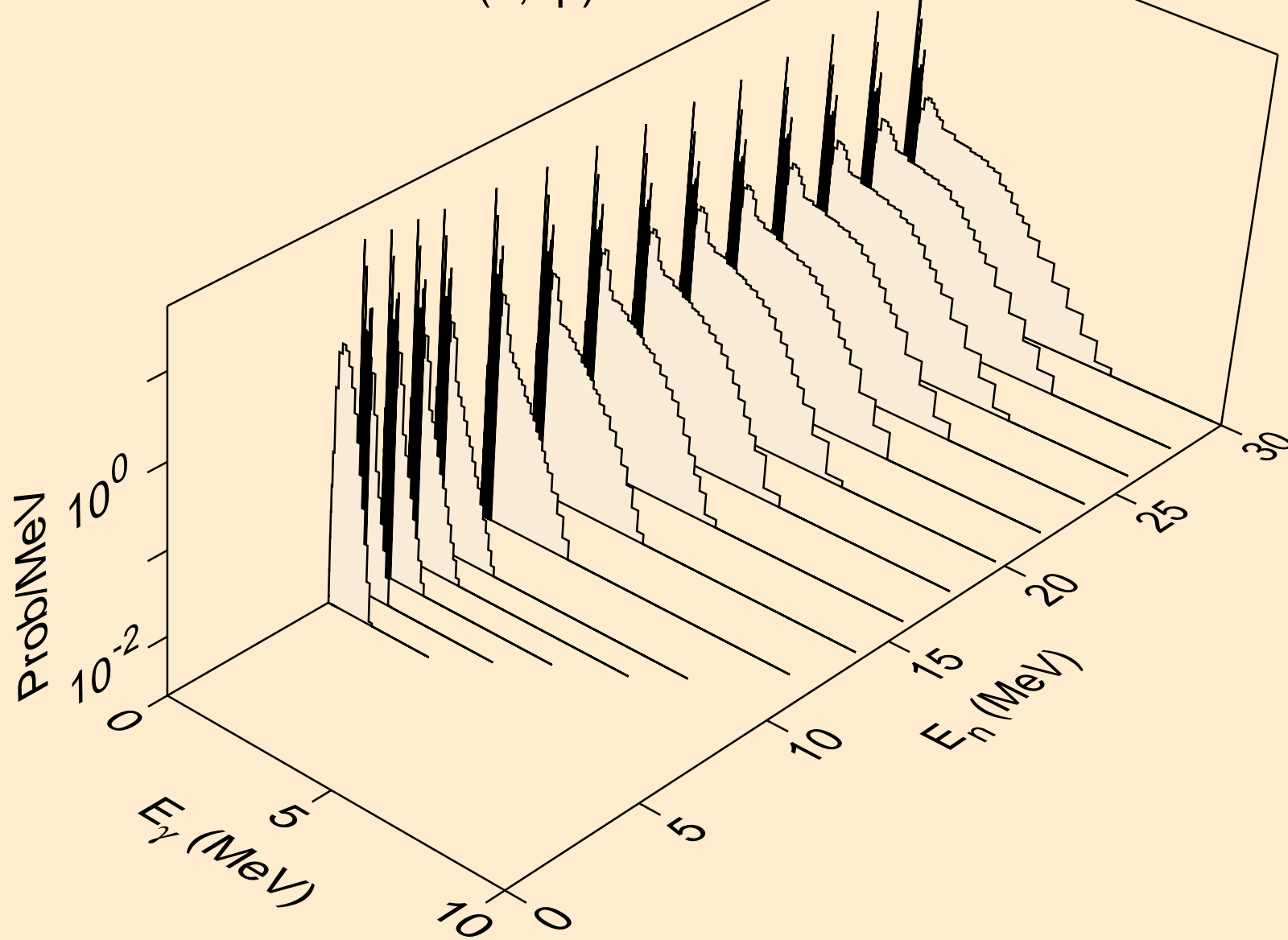

TL186M PROTON ACER TENDL-2021 LIBRARY; T=0.K  
Photon emission for (n,pa)

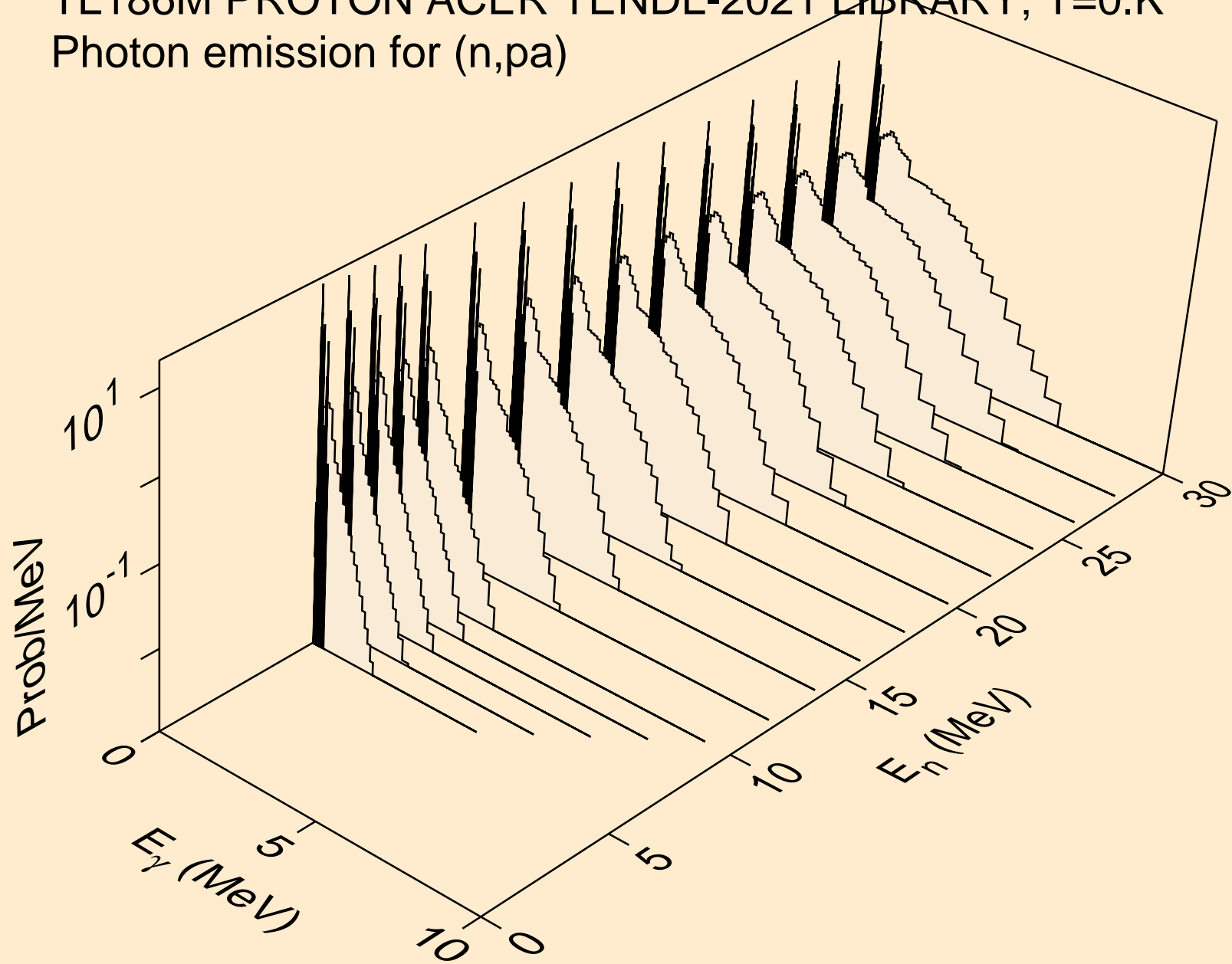

TL186M PROTON ACER TENDL-2021 LIBRARY; T=0.K  
Photon emission for (n,pd)

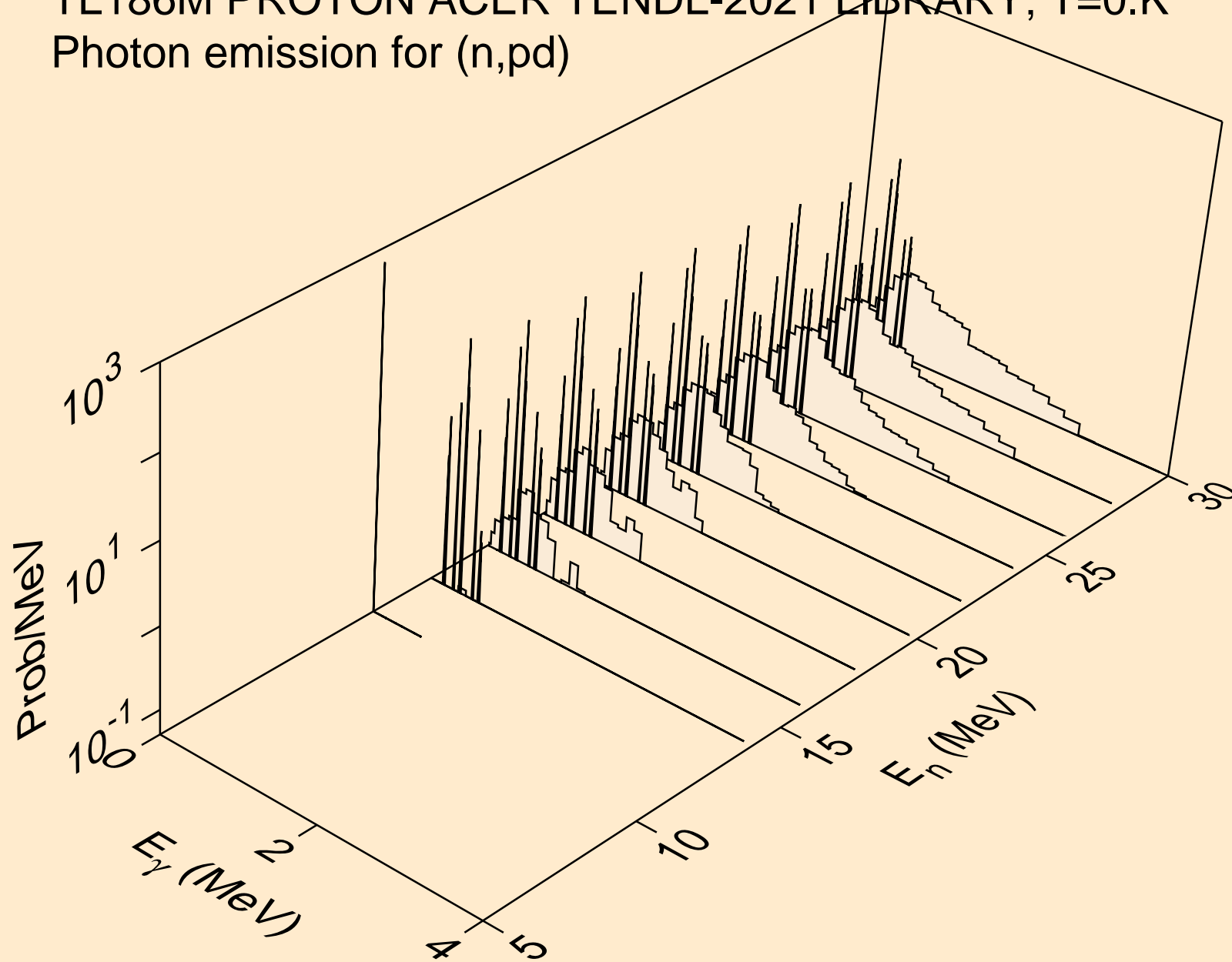

TL186M PROTON ACER TENDL-2021 LIBRARY; T=0.K  
Photon emission for (n,pt)

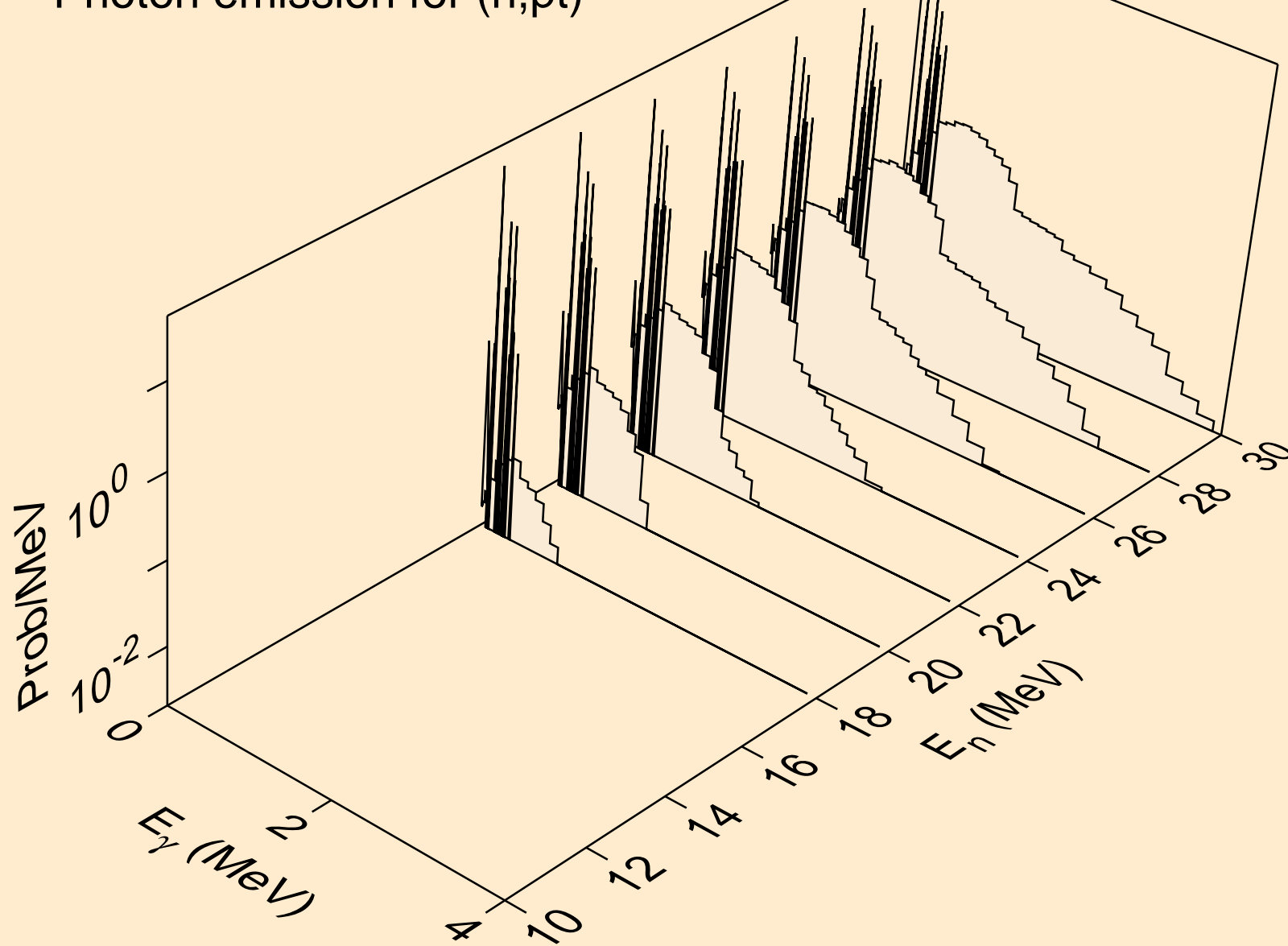

TL186M PROTON ACER TENDL-2021 LIBRARY; T=0.K  
Photon emission for (n,da)

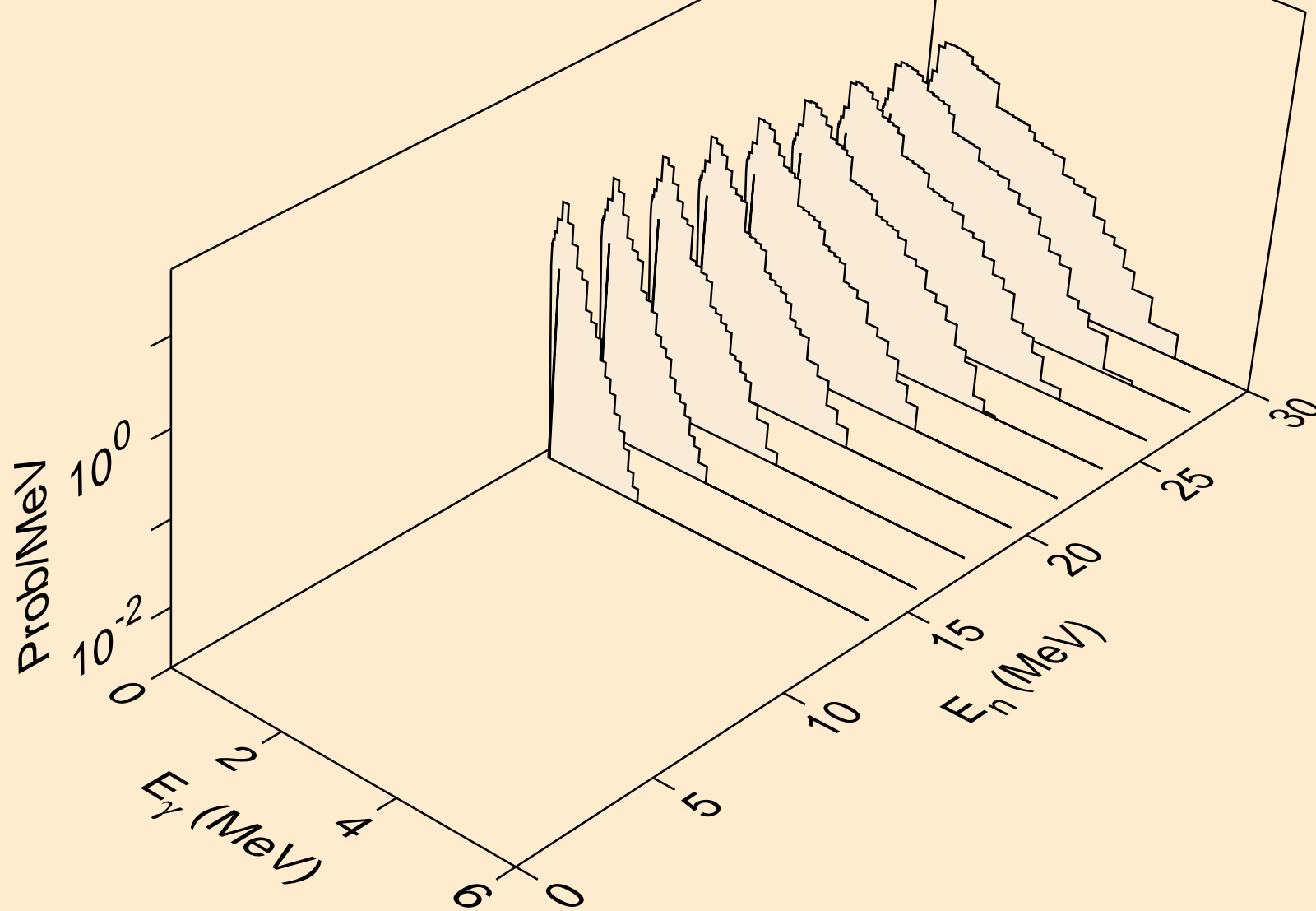



# TL186M PROTON ACER TENDL-2021 LIBRARY; T=0.K

## Particle heating contributions

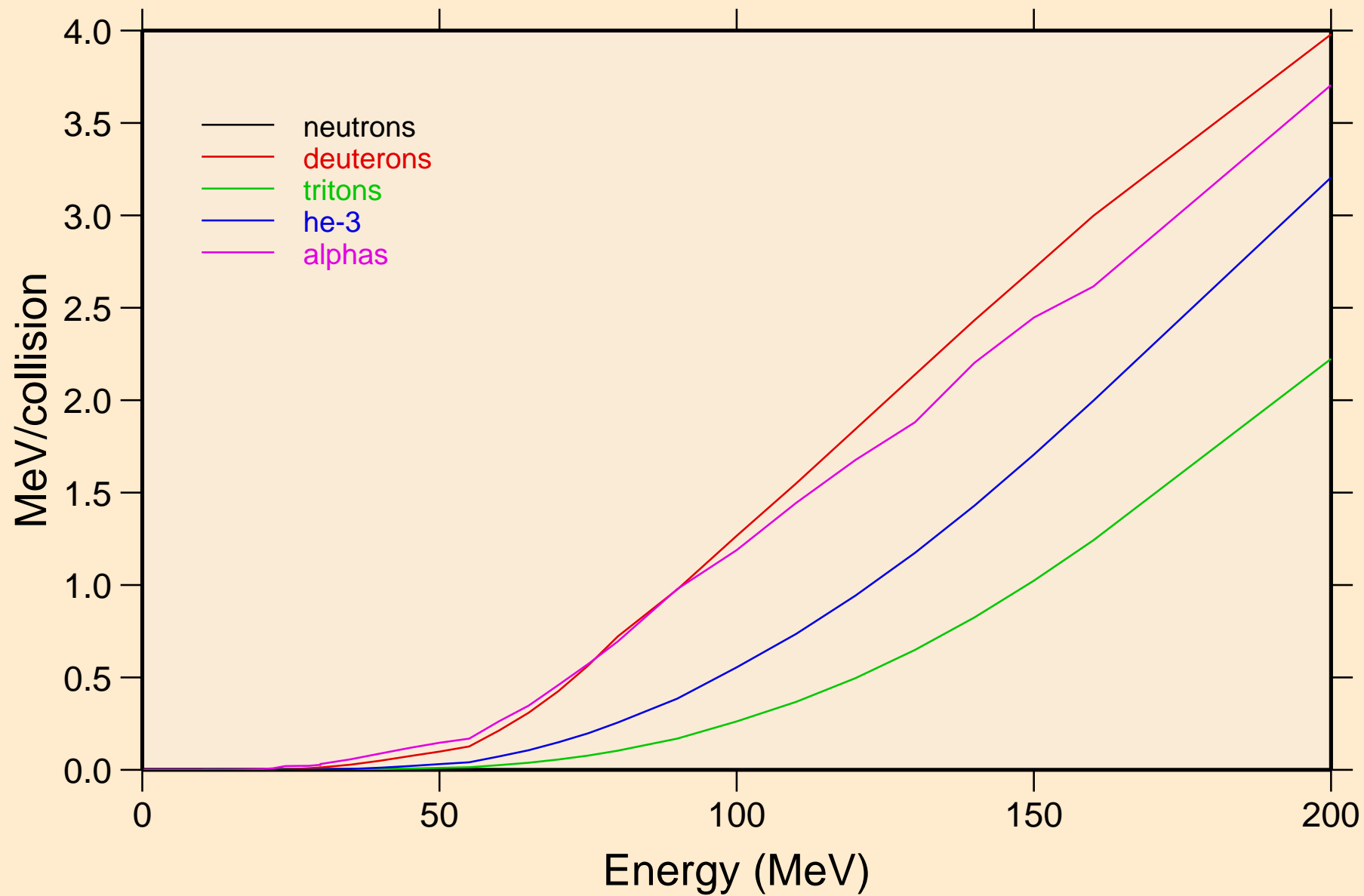

TL186M PROTON ACER TENDL-2021 LIBRARY; T=0.K  
Recoil Heating

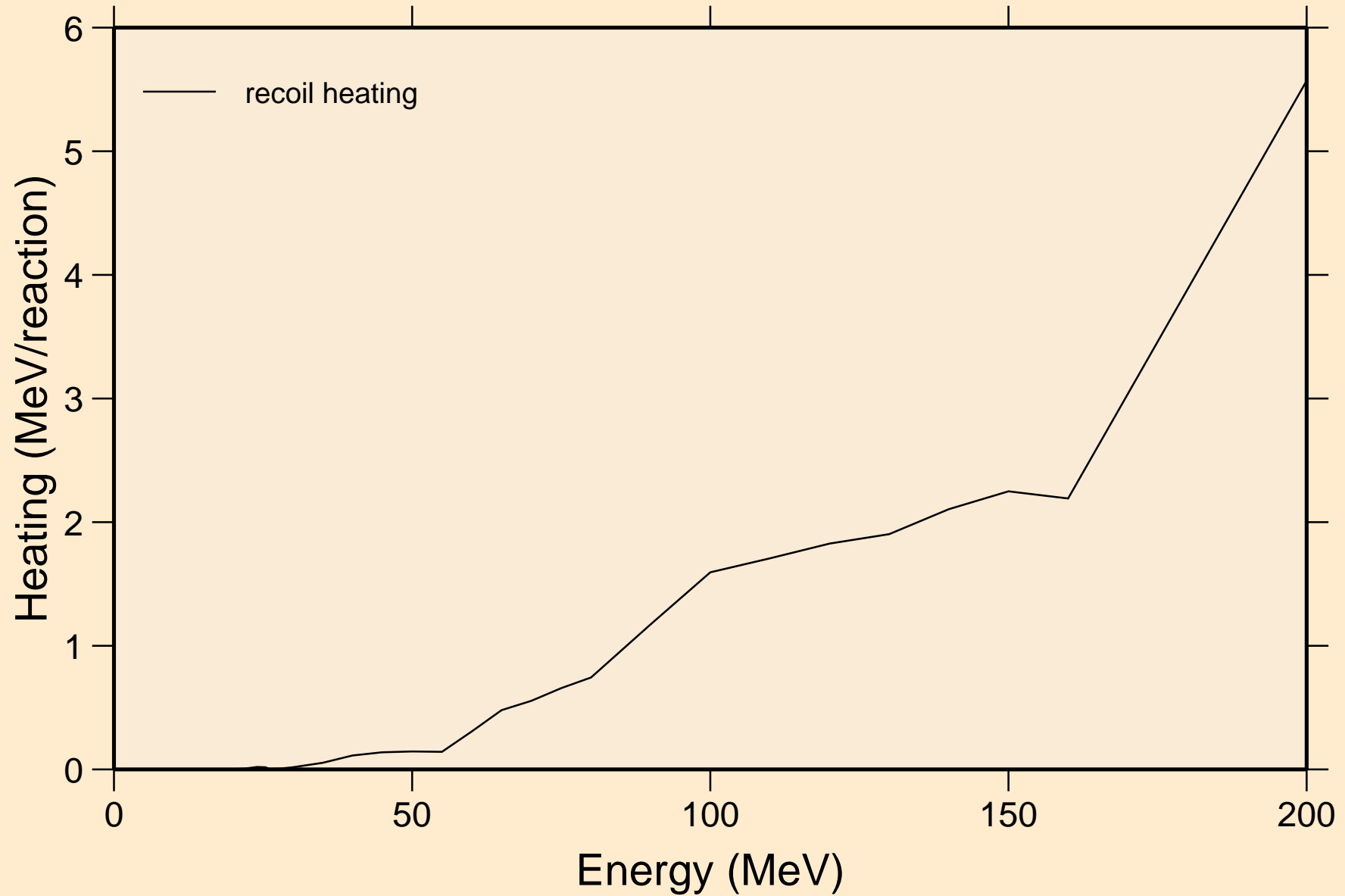

TL186M PROTON ACER TENDL-2021 LIBRARY; T=0.K  
Particle production cross sections

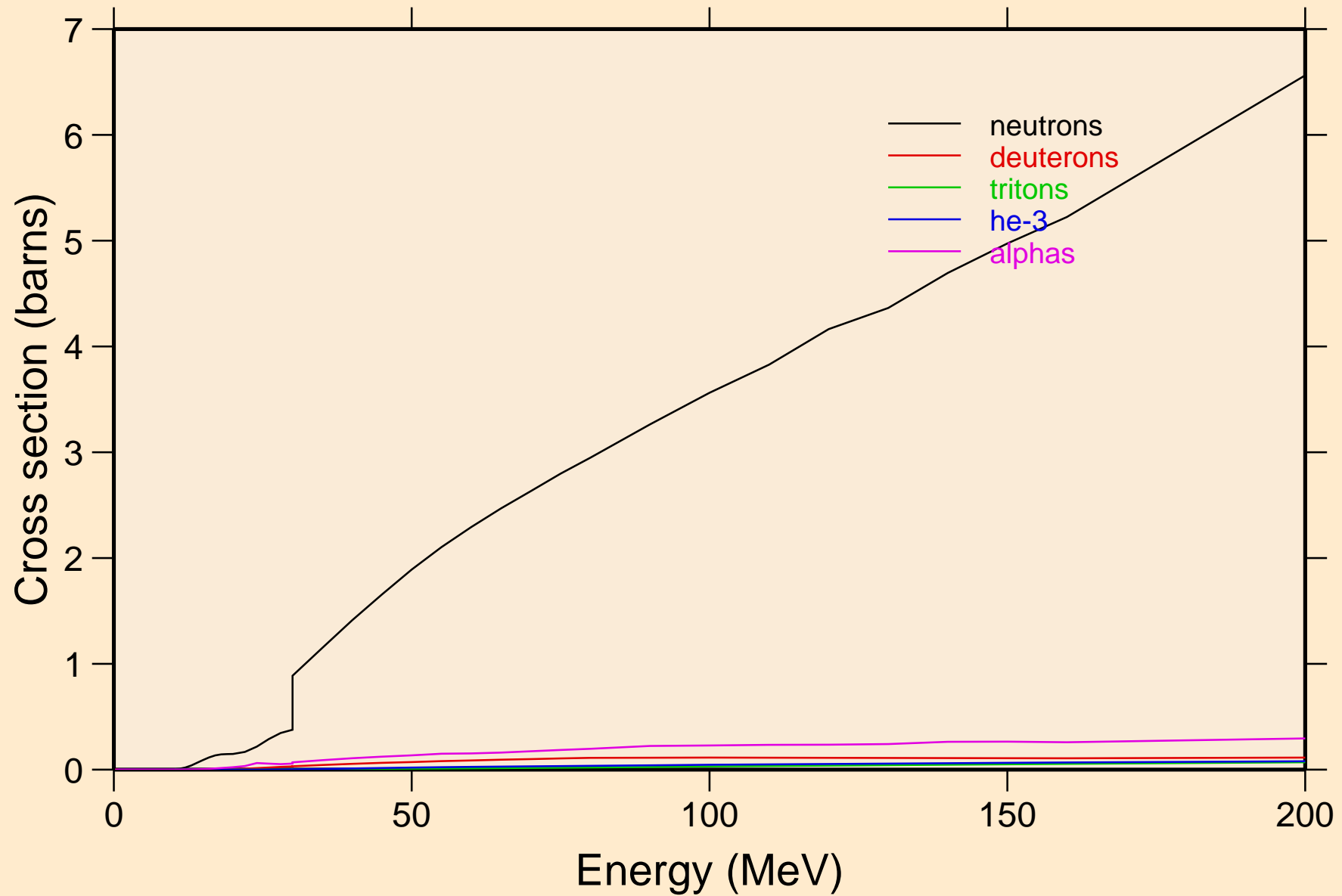

TL186M PROTON ACER TENDL-2021 LIBRARY; T=0.K  
neutrons from (p,n)

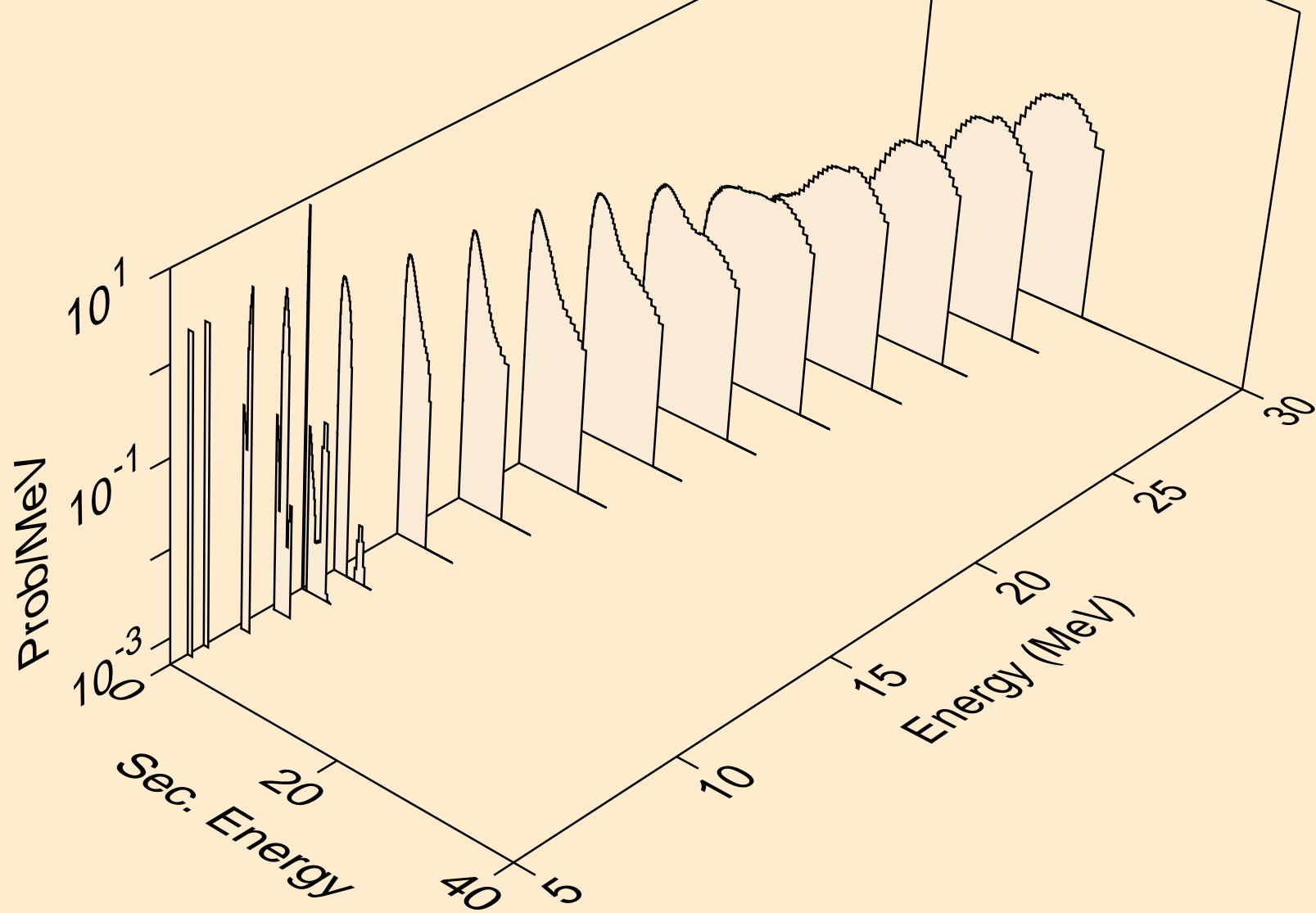

TL186M PROTON ACER TENDL-2021 LIBRARY; T=0.K  
neutrons from (p,x)

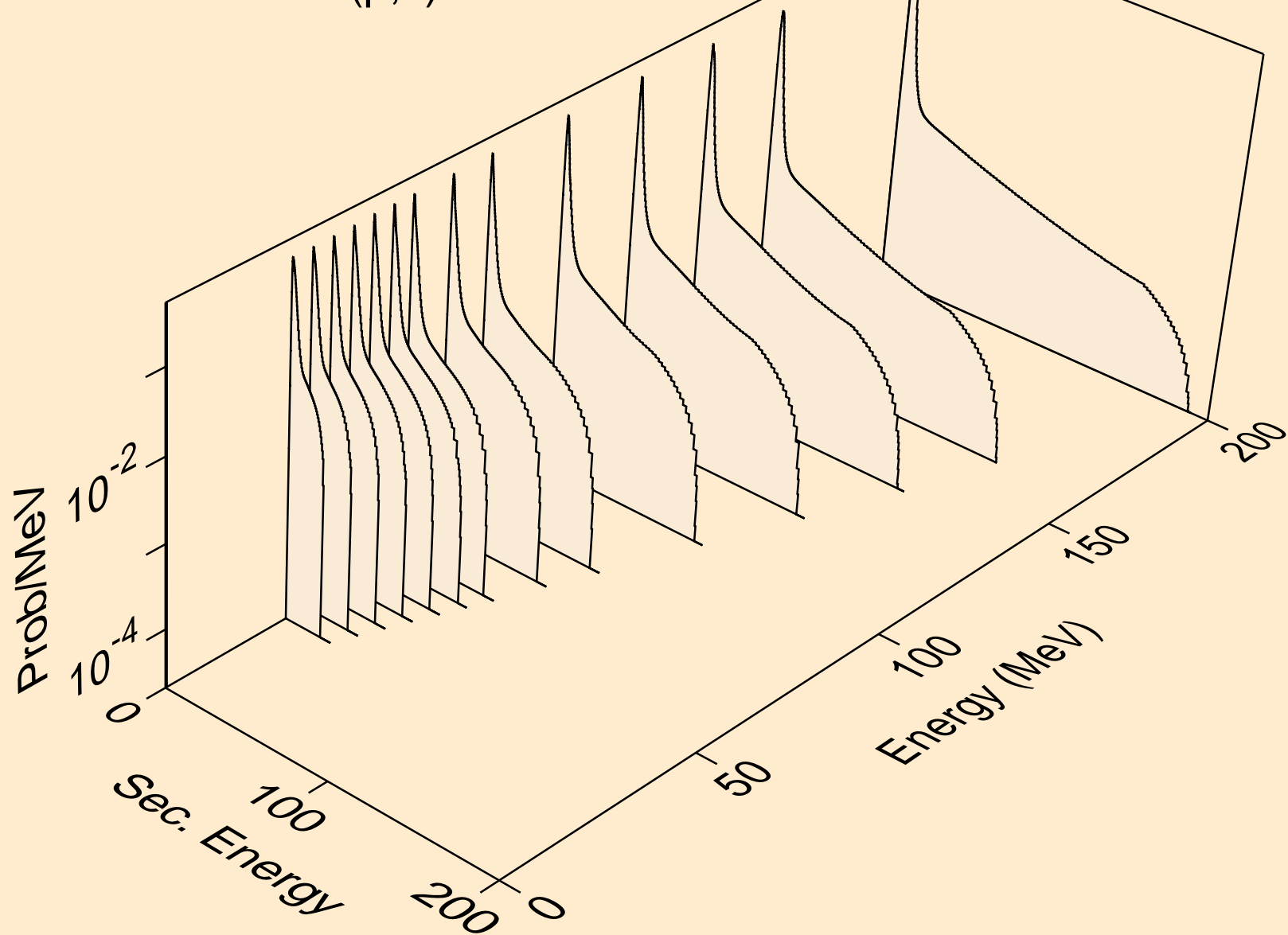

TL186M PROTON ACER TENDL-2021 LIBRARY; T=0.K  
neutrons from (p,2n)

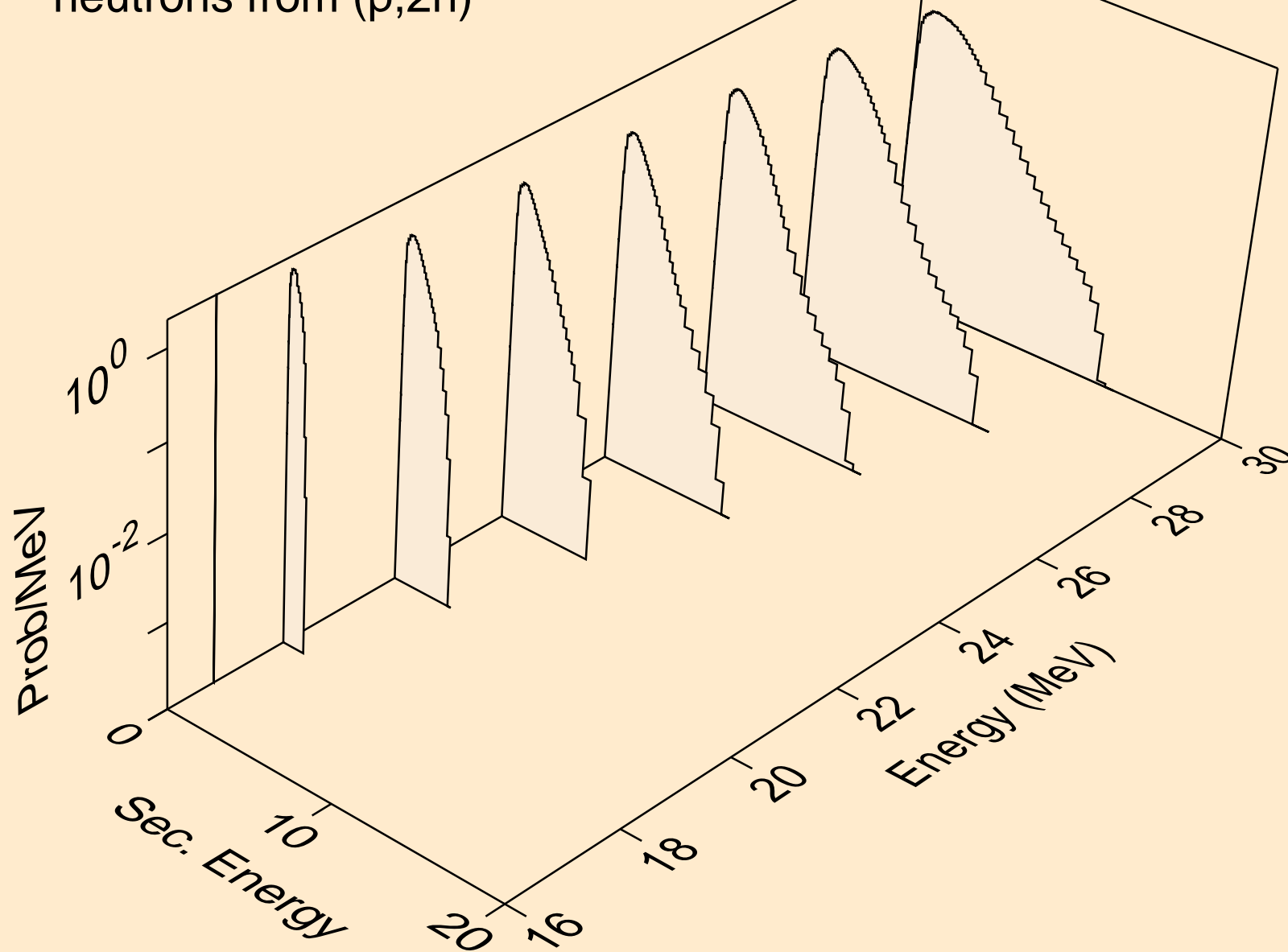

TL186M PROTON ACER TENDL-2021 LIBRARY; T=0.K  
neutrons from (p,3n)

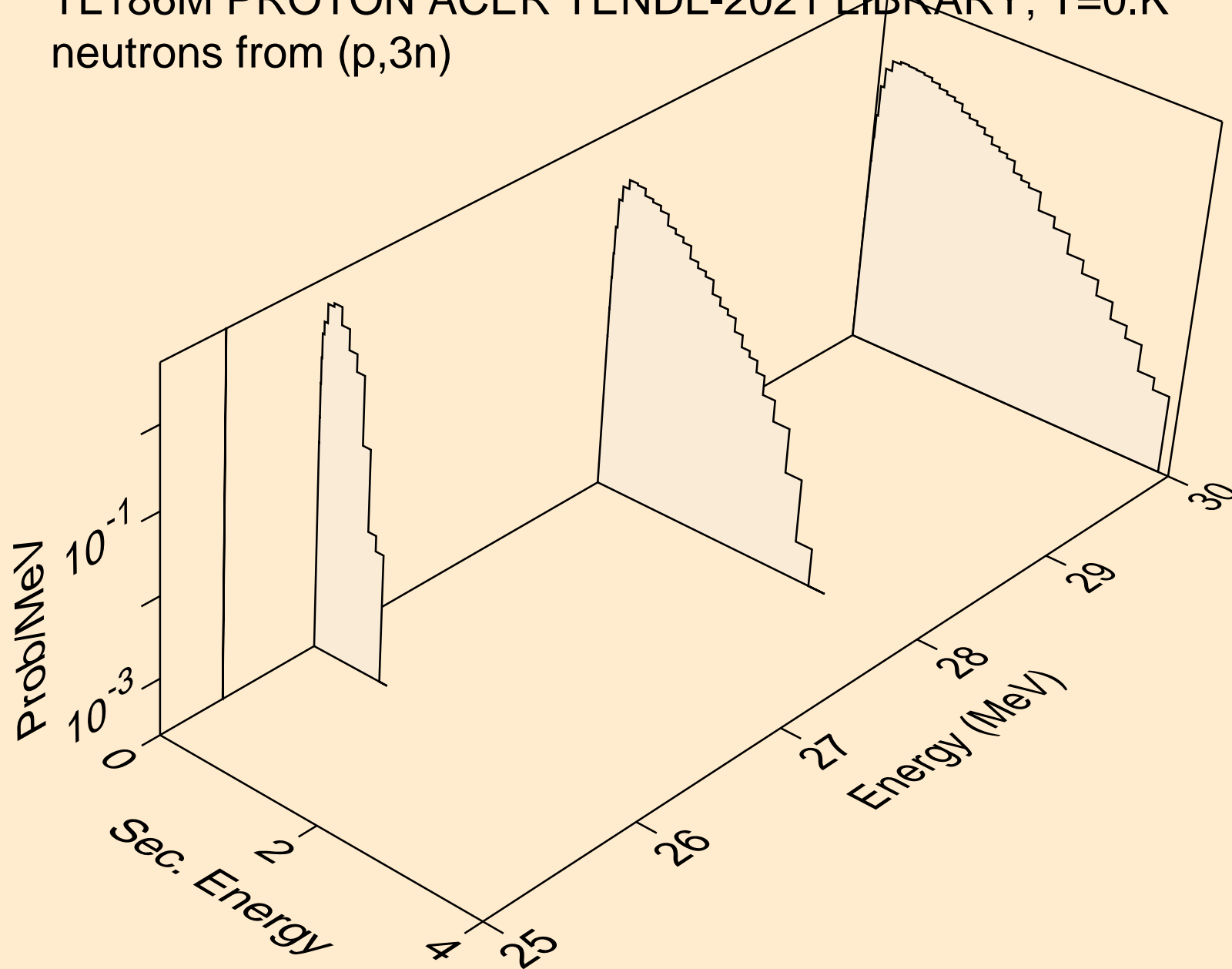

TL186M PROTON ACER TENDL-2021 LIBRARY; T=0.K  
neutrons from (p,n\*)a

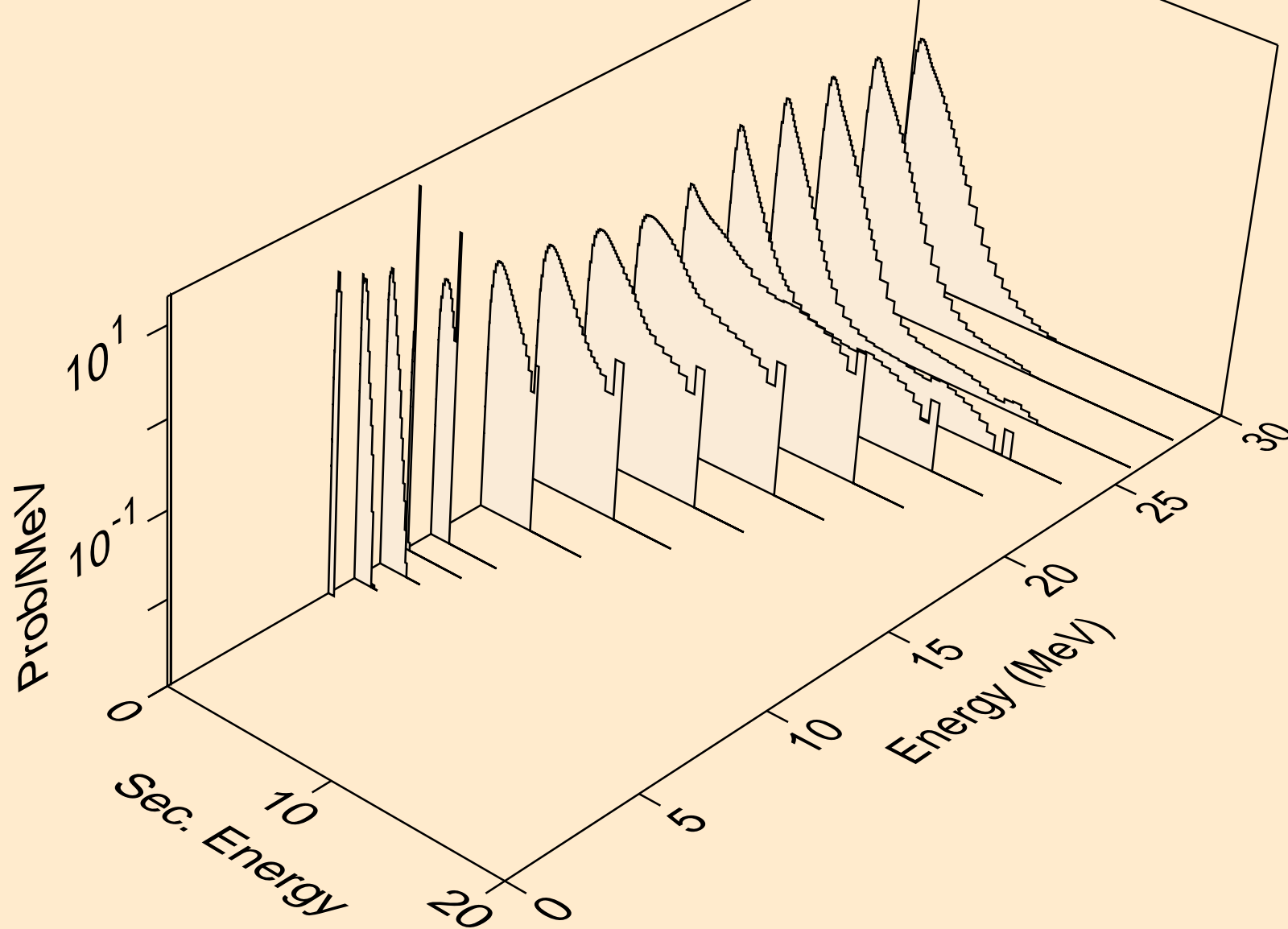



TL186M PROTON ACER TENDL-2021 LIBRARY; T=0.K  
neutrons from (p,2n)a

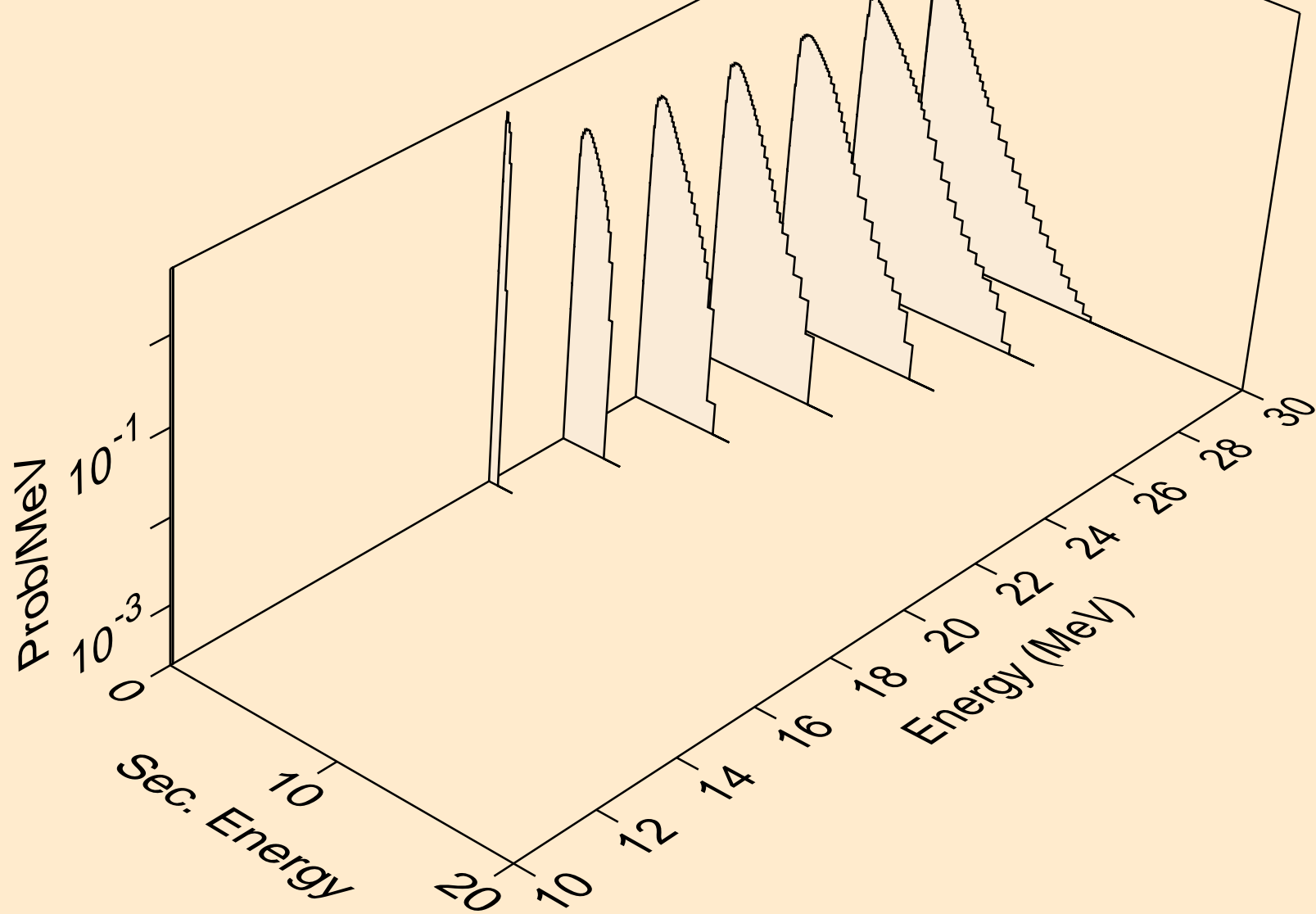

TL186M PROTON ACER TENDL-2021 LIBRARY; T=0.K  
neutrons from (p,3n)a

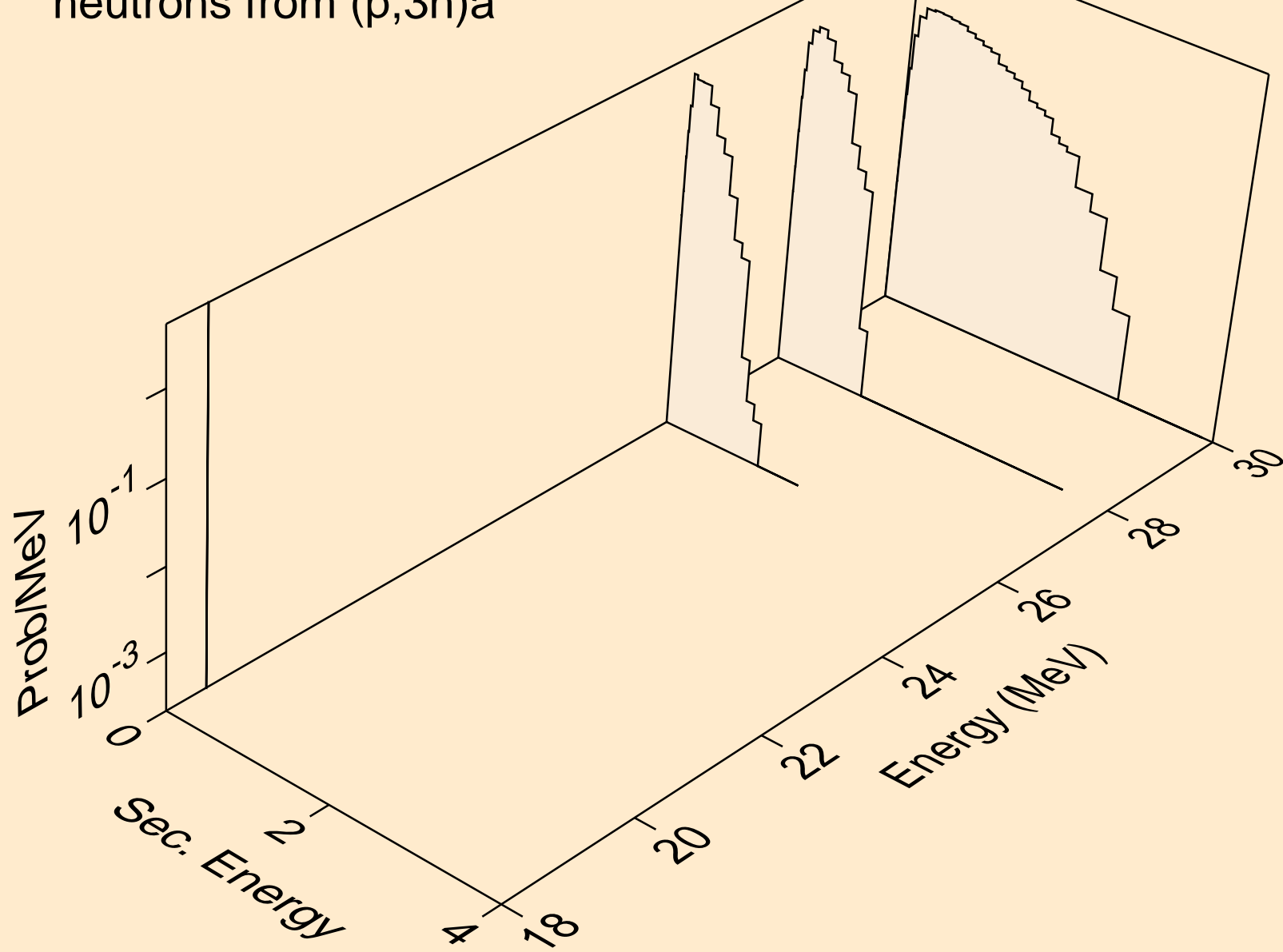

TL186M PROTON ACER TENDL-2021 LIBRARY; T=0.K  
neutrons from (p,n\*)p

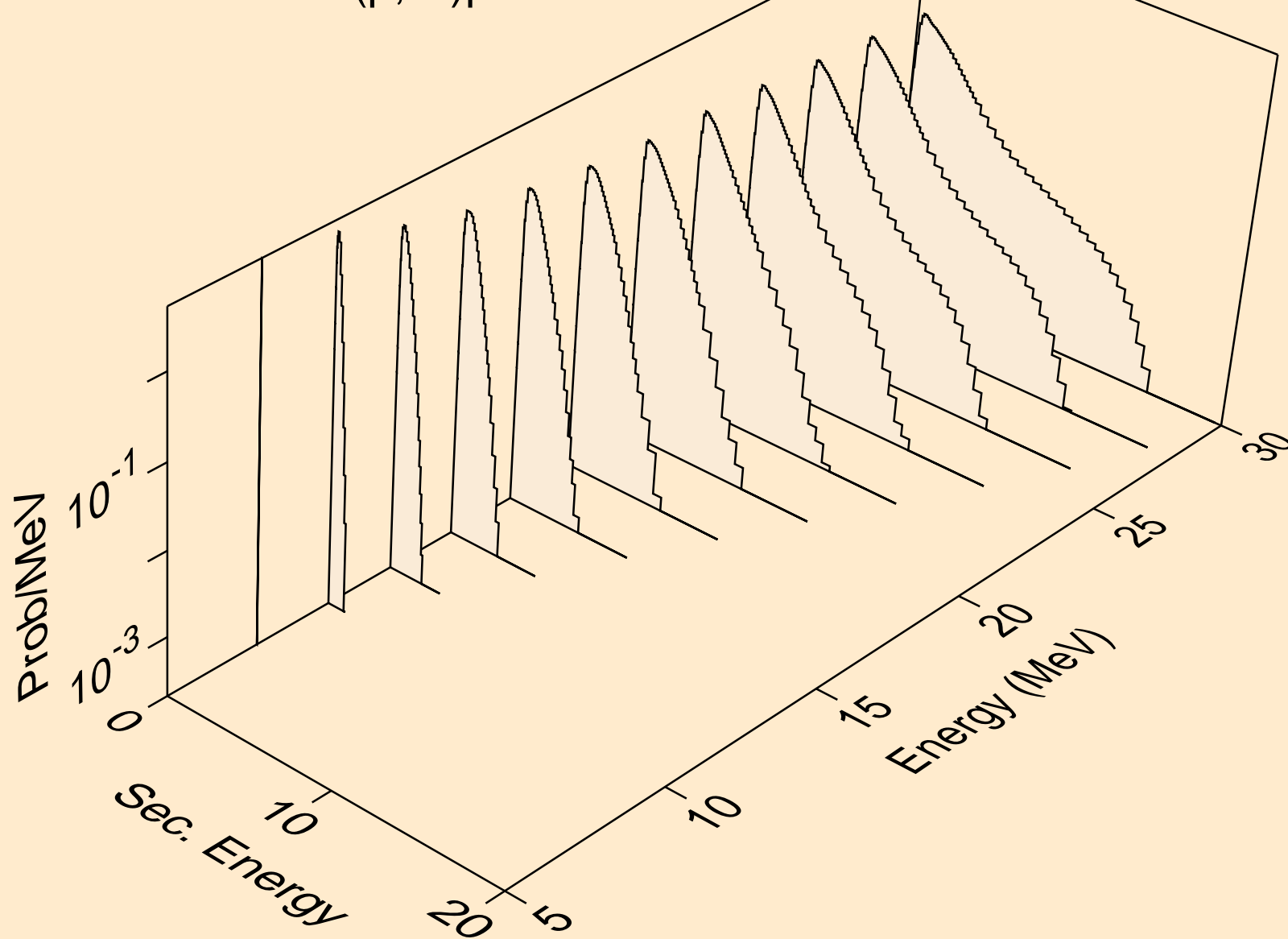

TL186M PROTON ACER TENDL-2021 LIBRARY; T=0.K  
neutrons from (p,n\*)2a

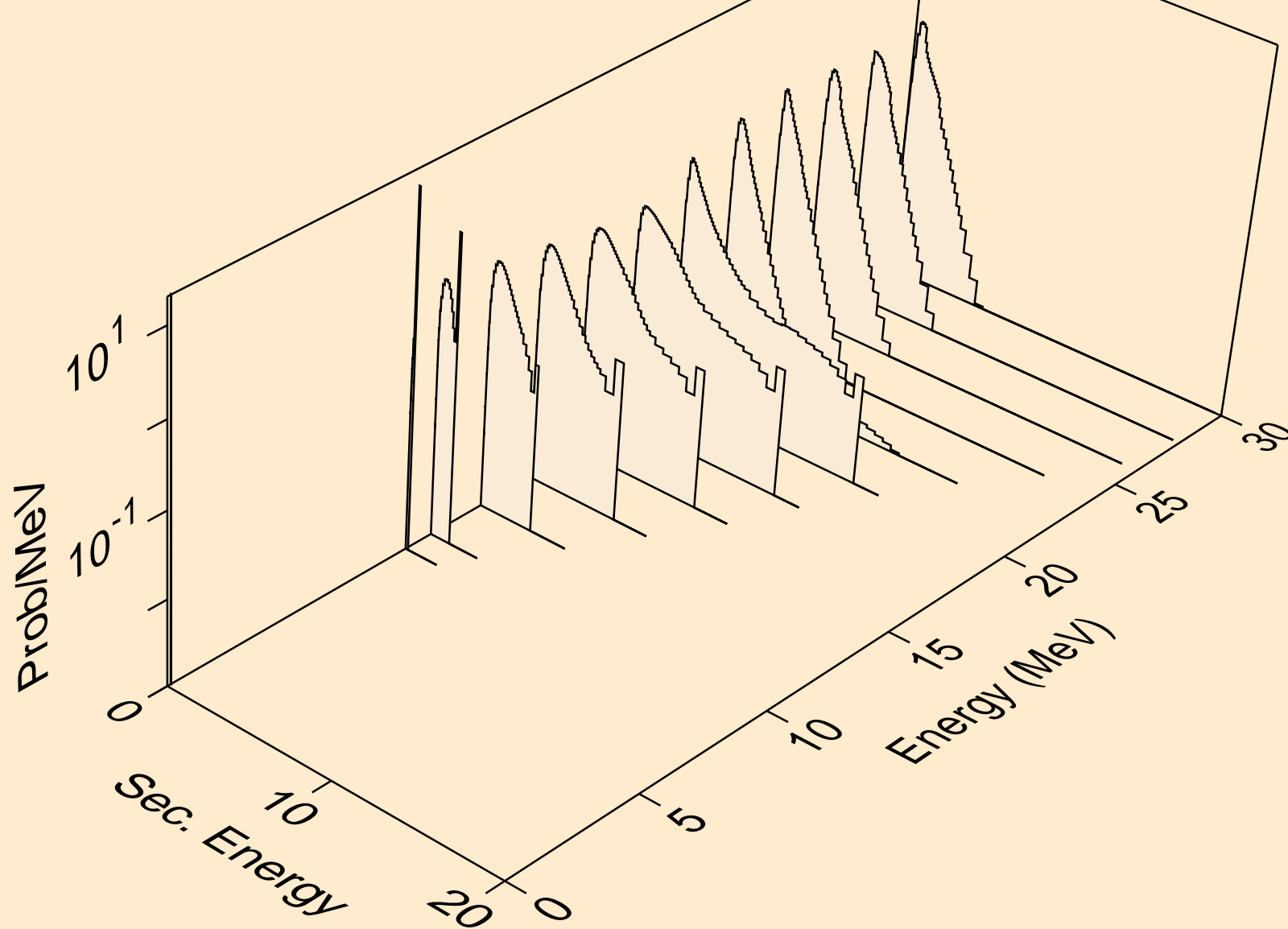

TL186M PROTON ACER TENDL-2021 LIBRARY; T=0.K  
neutrons from (p,2n)2a

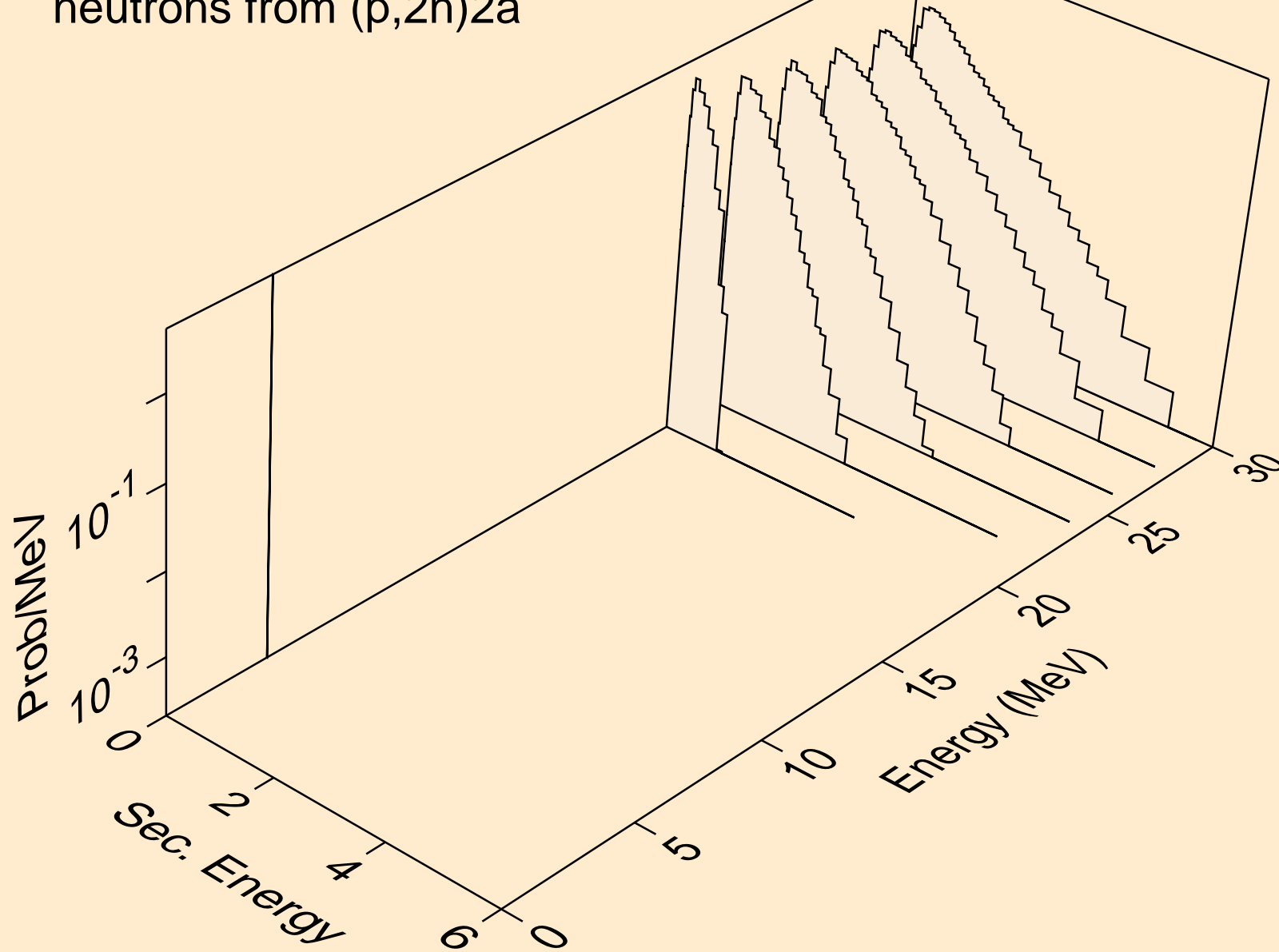

TL186M PROTON ACER TENDL-2021 LIBRARY; T=0.K  
neutrons from (p,n\*)d

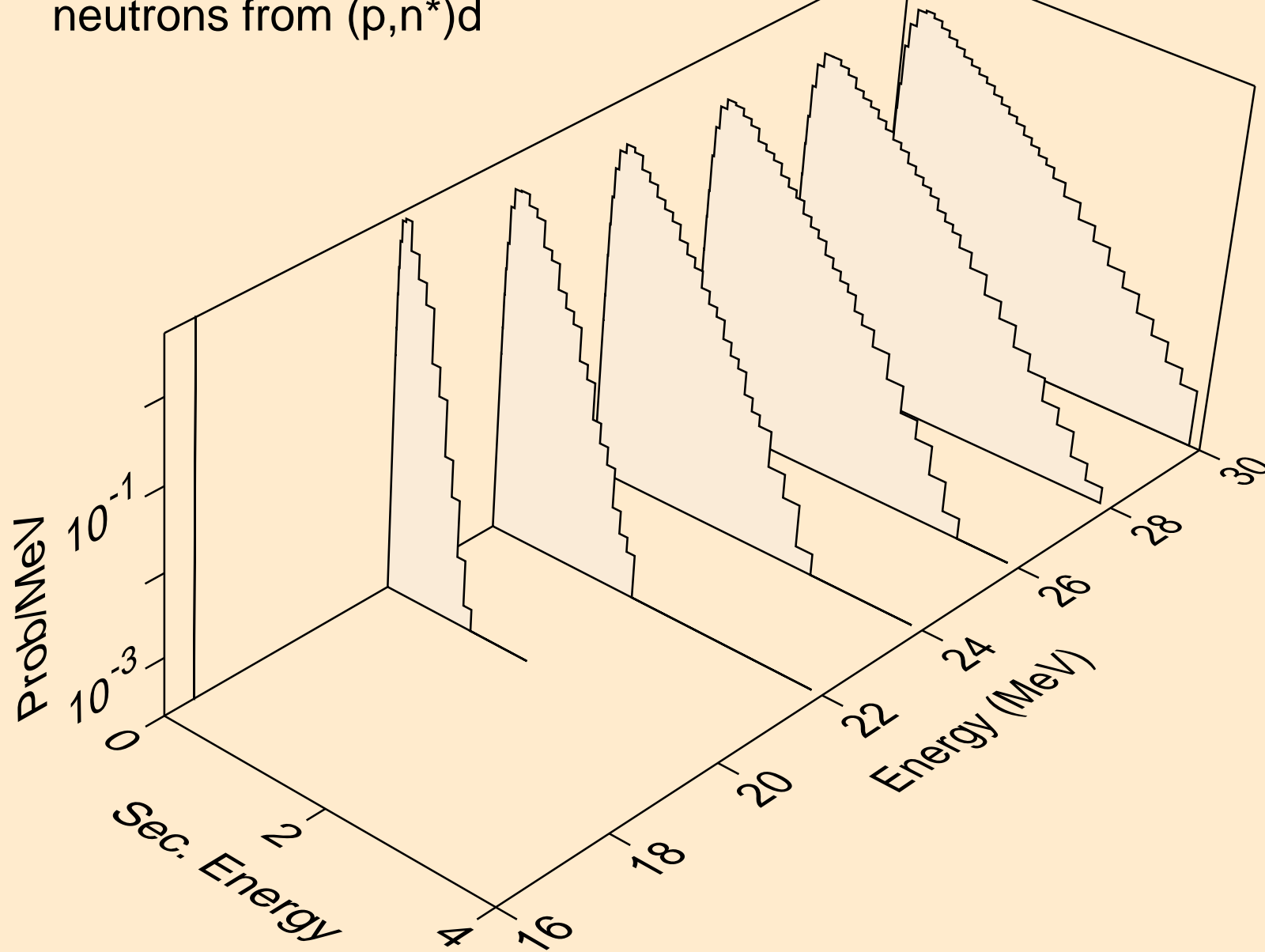

TL186M PROTON ACER TENDL-2021 LIBRARY; T=0.K  
neutrons from (p,n\*)t

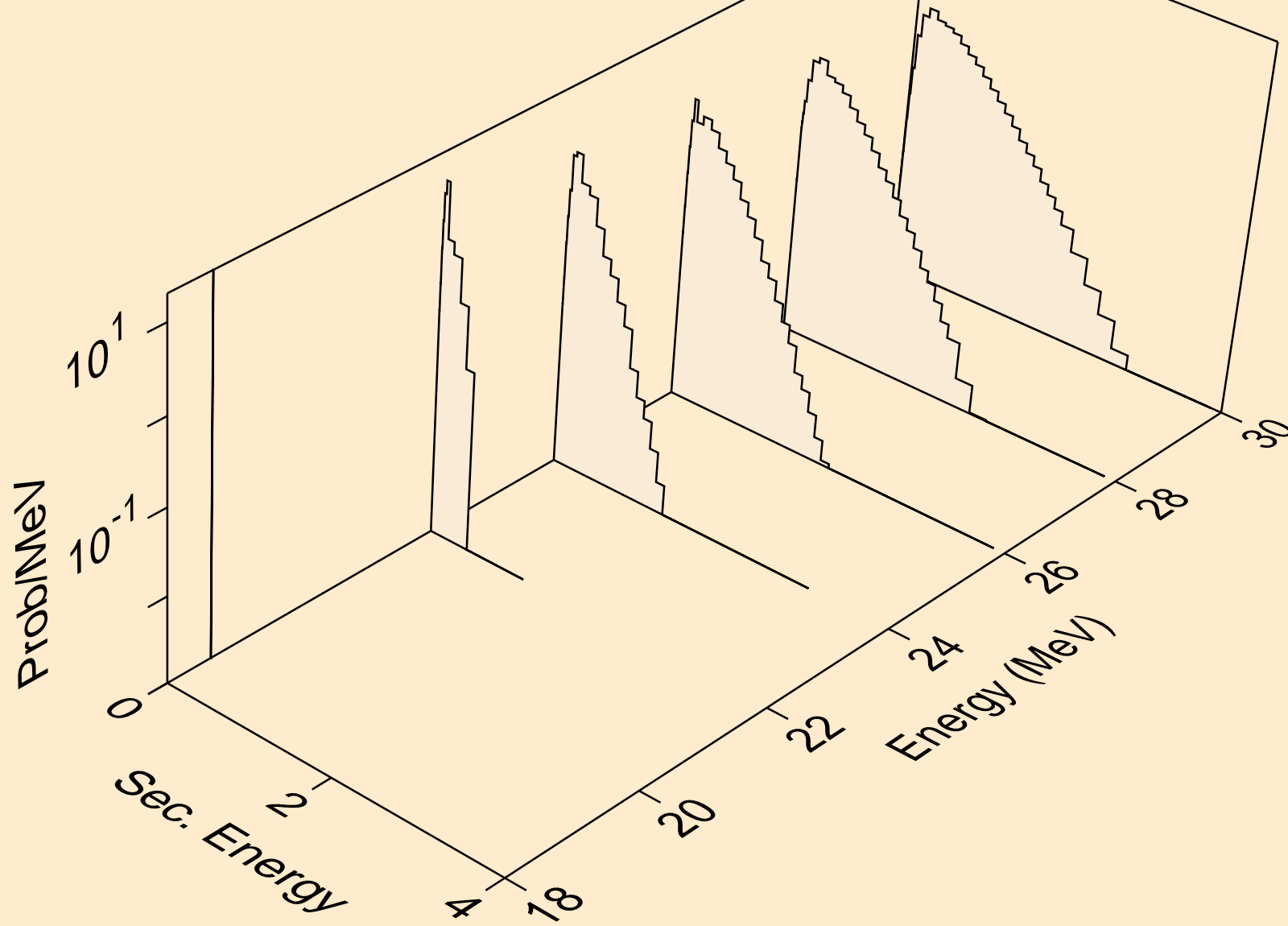

TL186M PROTON ACER TENDL-2021 LIBRARY; T=0.K  
neutrons from (p,n\*)he3

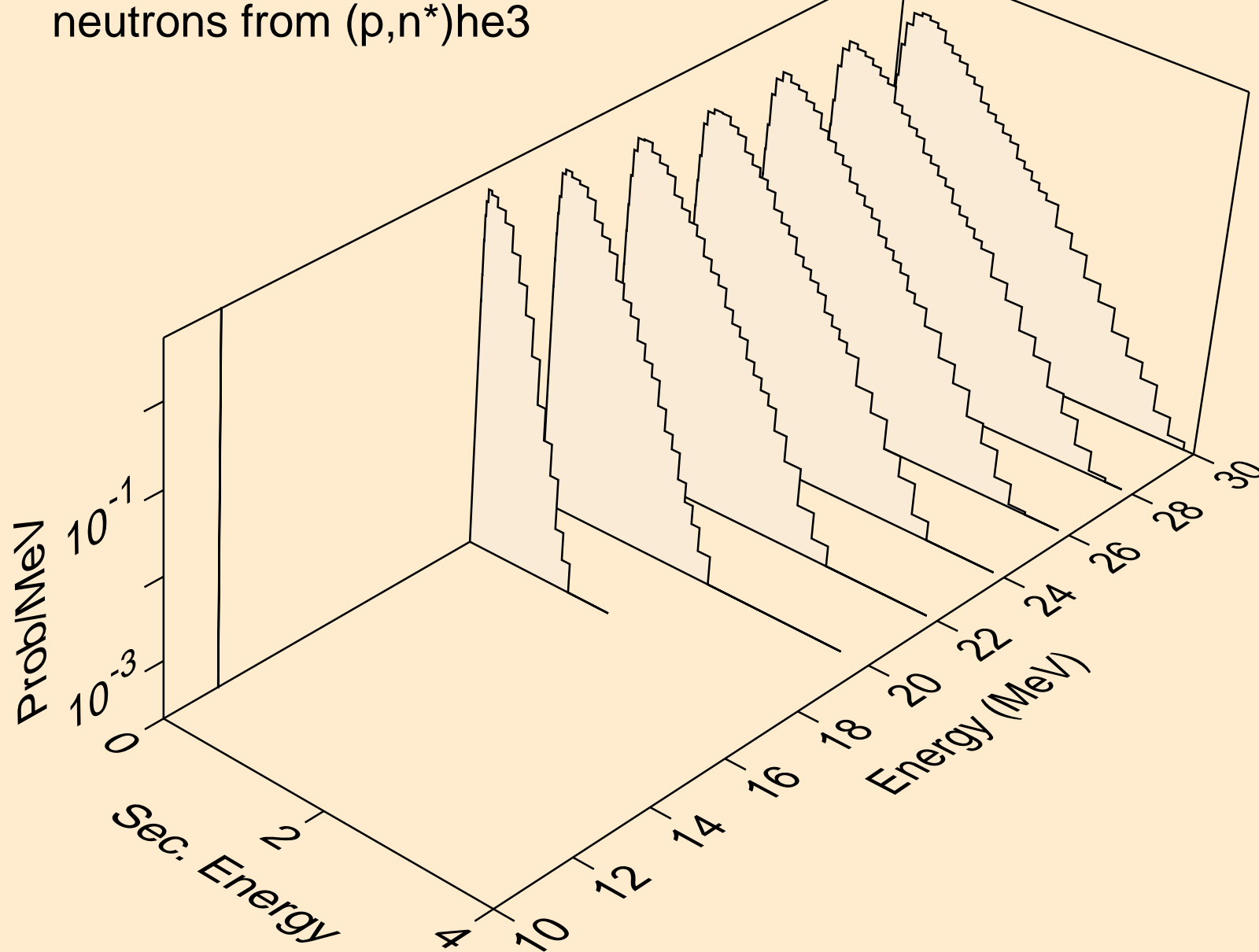



TL186M PROTON ACER TENDL-2021 LIBRARY; T=0.K  
neutrons from (p,2np)

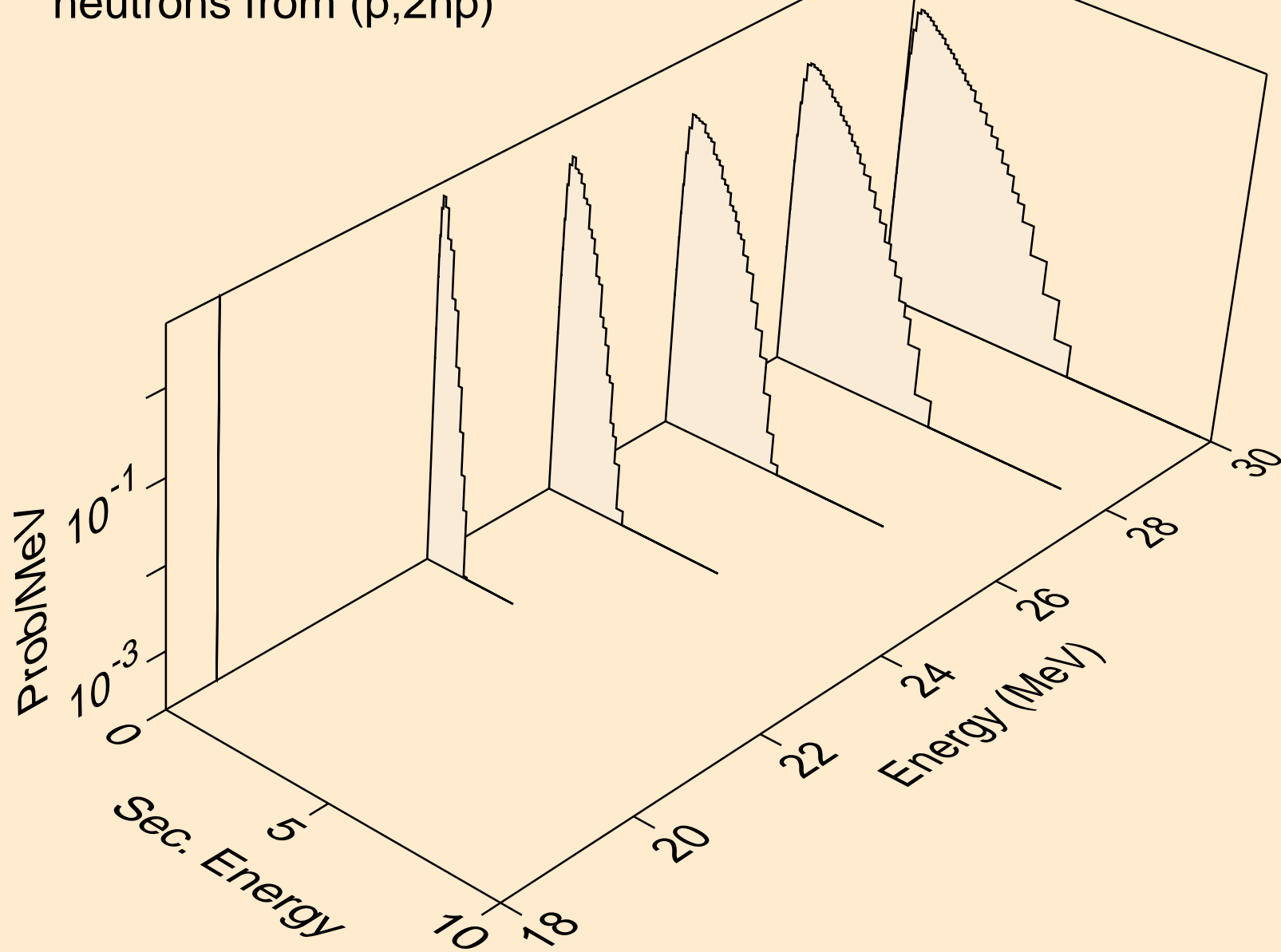

TL186M PROTON ACER TENDL-2021 LIBRARY; T=0.K  
neutrons from (p,2np)

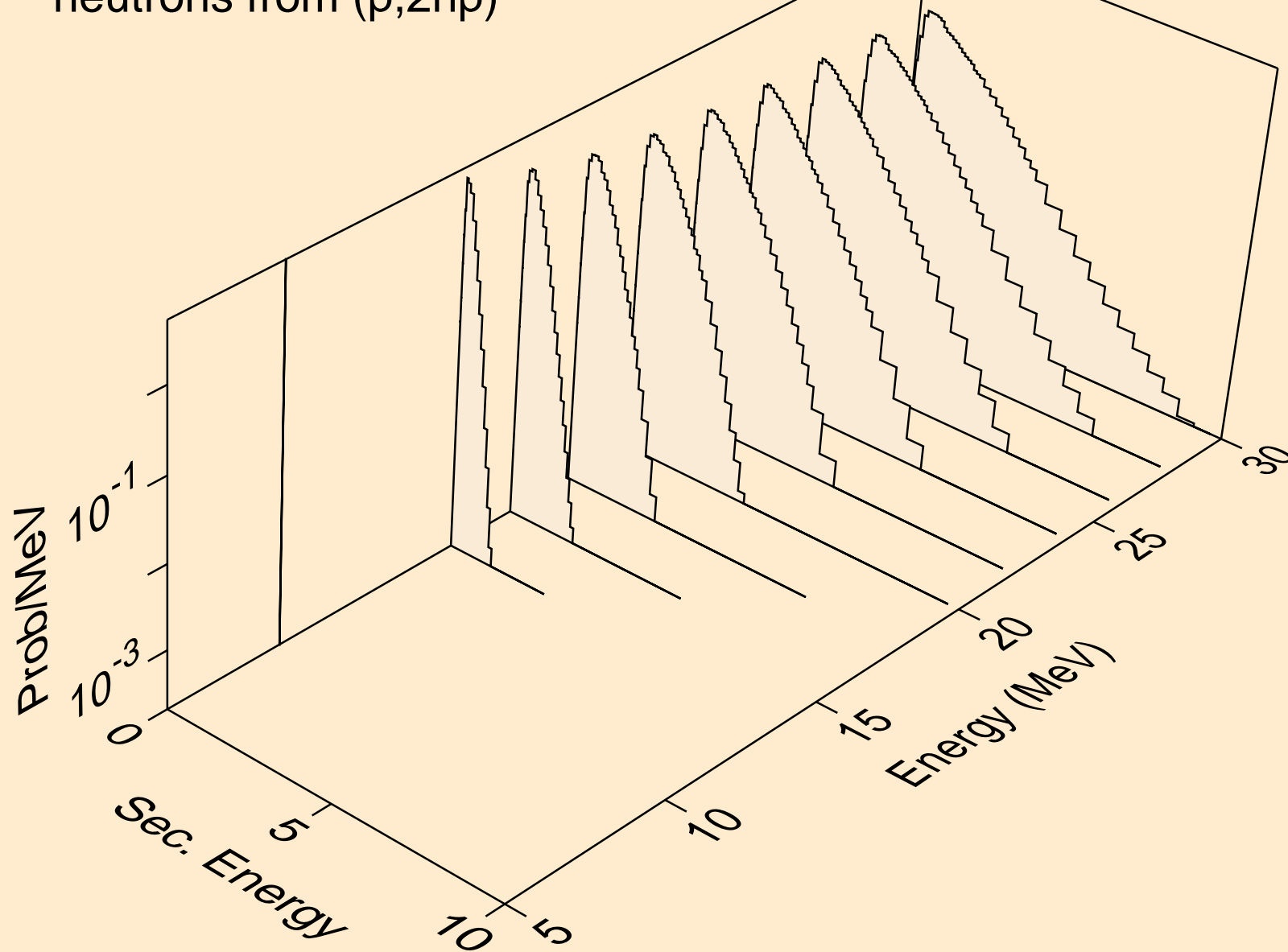

TL186M PROTON ACER TENDL-2021 LIBRARY; T=0.K  
neutrons from (p,npa)

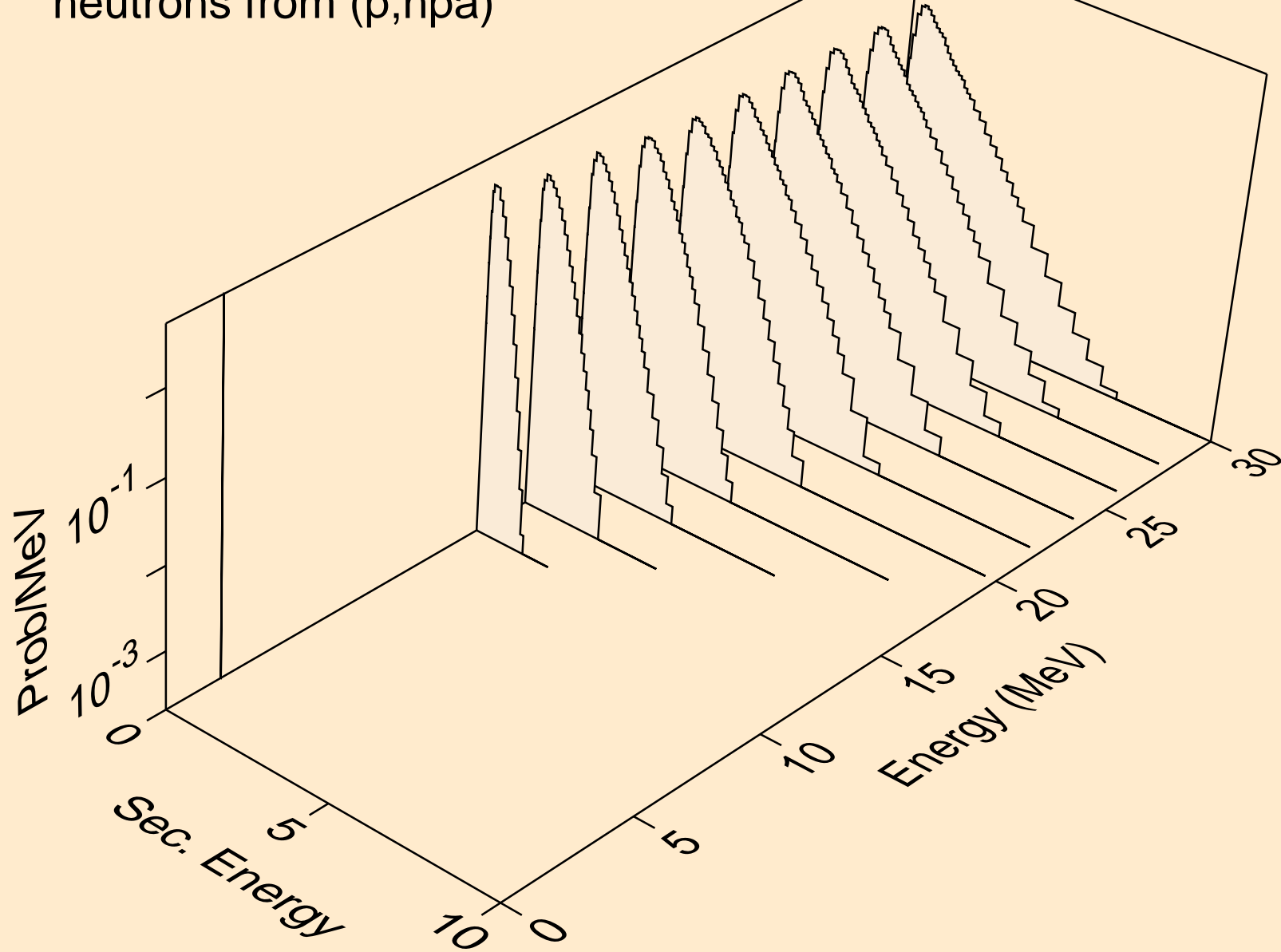

TL186M PROTON ACER TENDL-2021 LIBRARY; T=0.K  
deuterons from (p,x)

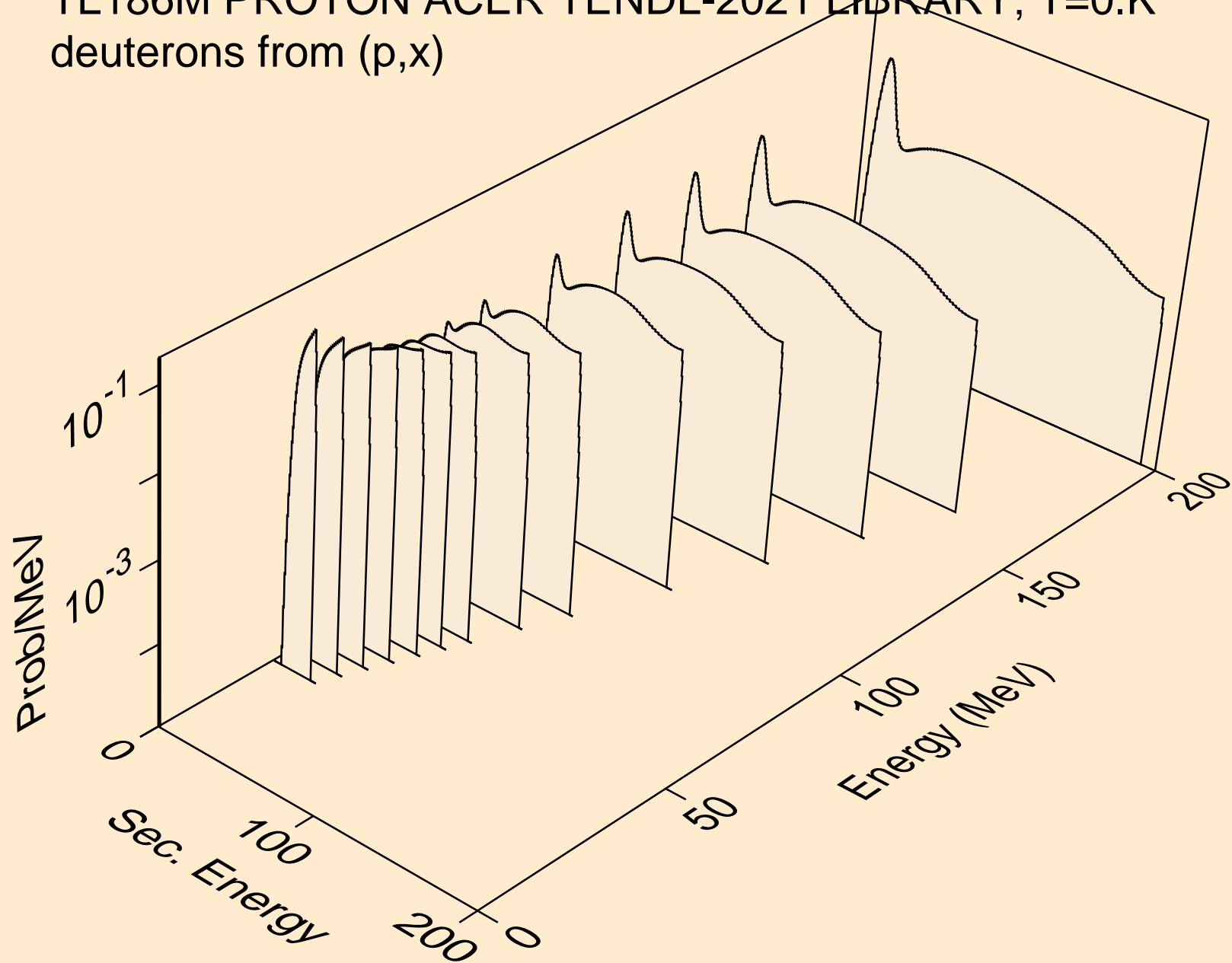

TL186M PROTON ACER TENDL-2021 LIBRARY; T=0.K  
deuterons from (p,n\*)d

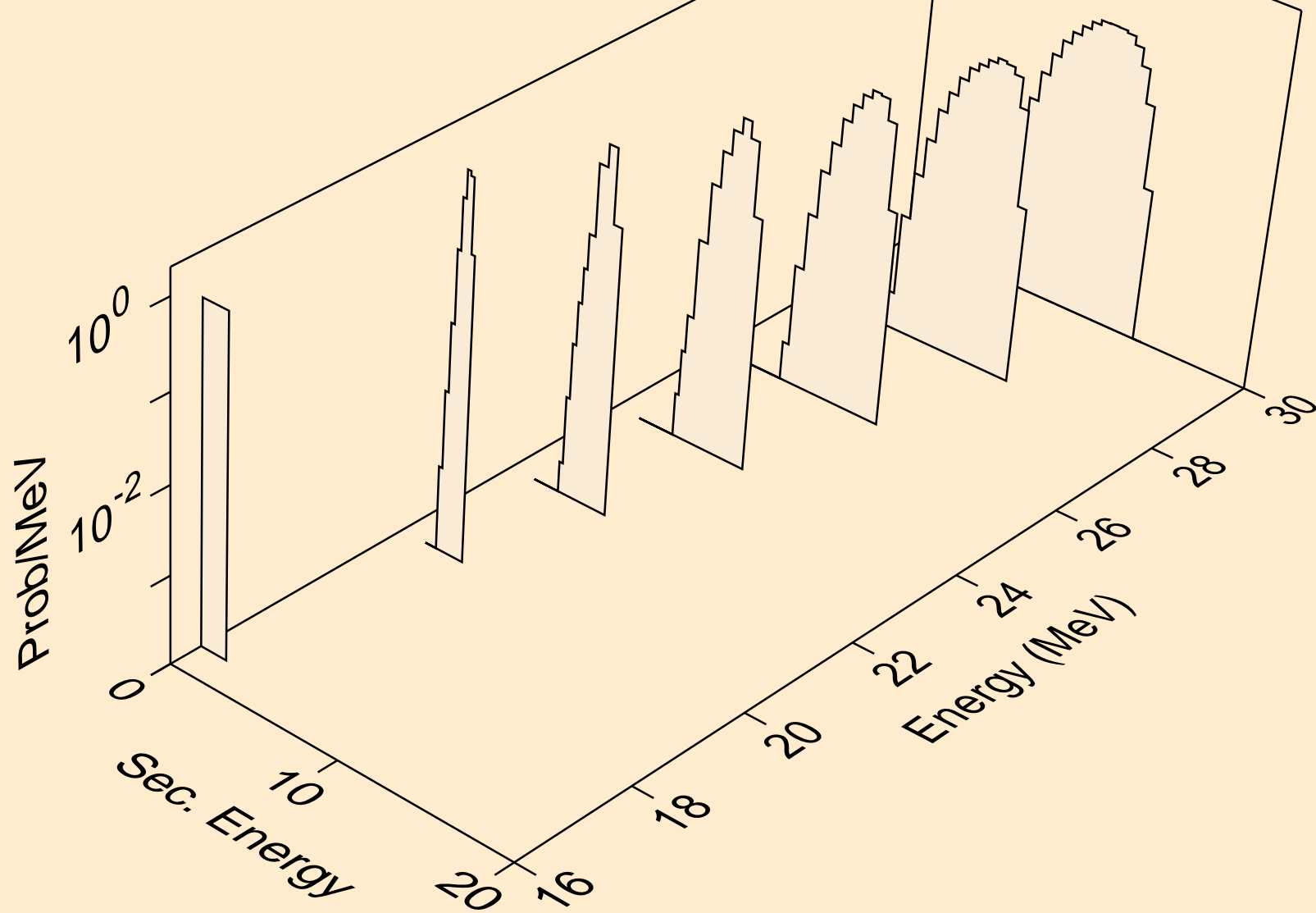

TL186M PROTON ACER TENDL-2021 LIBRARY; T=0.K  
deuterons from (p,d)

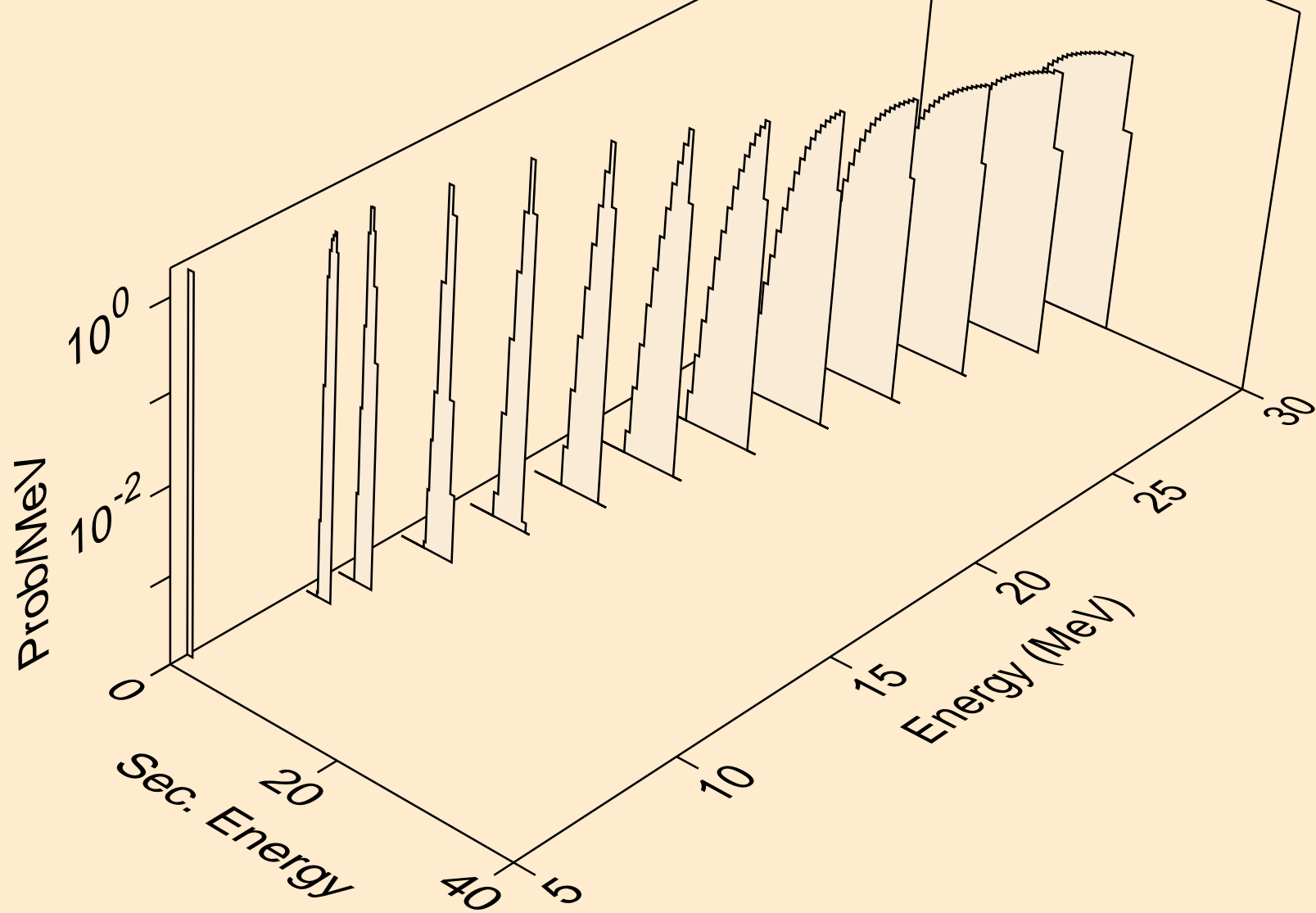

TL186M PROTON ACER TENDL-2021 LIBRARY; T=0.K  
deuterons from (p,pd)

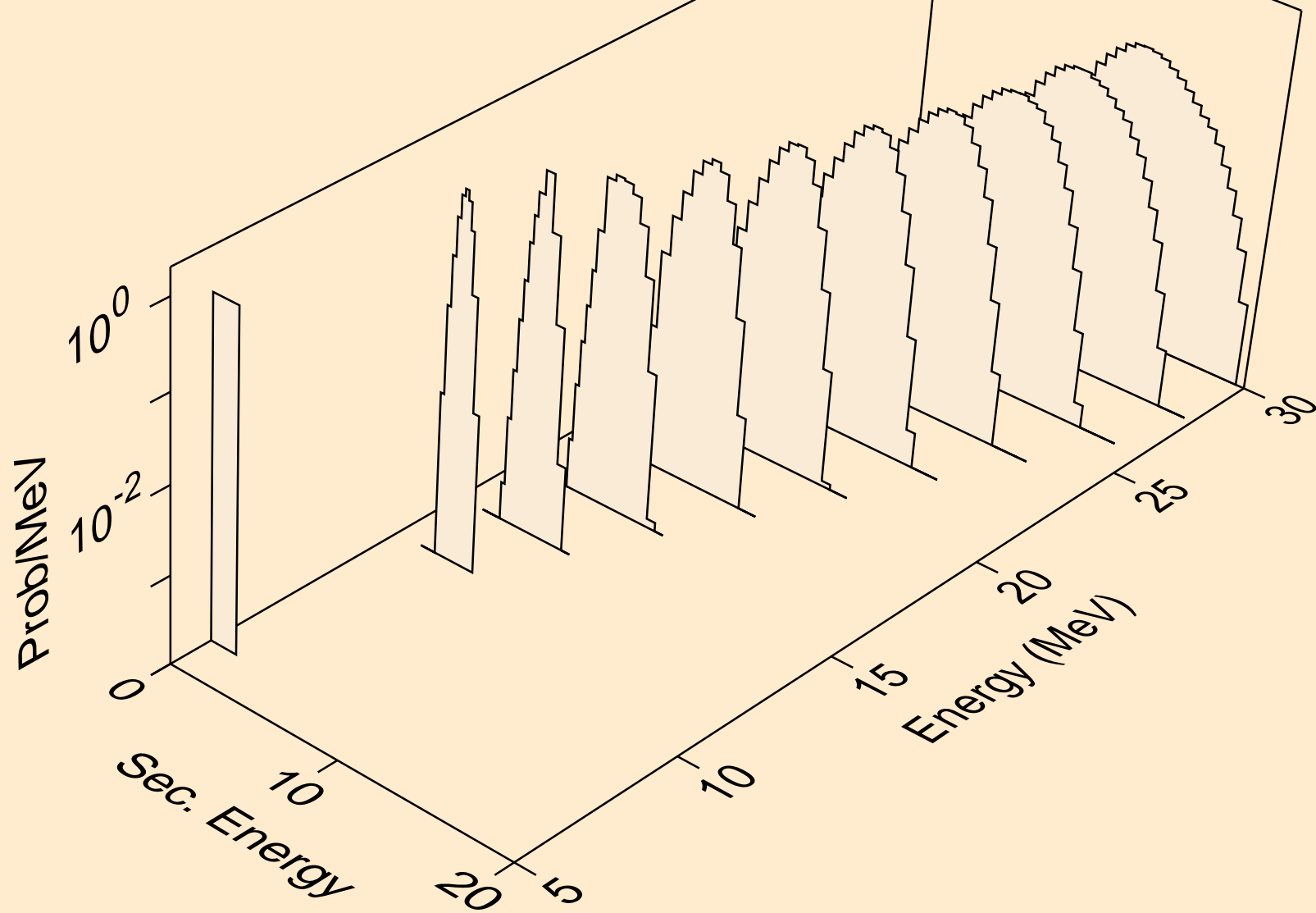

TL186M PROTON ACER TENDL-2021 LIBRARY; T=0.K  
deuterons from (p,da)

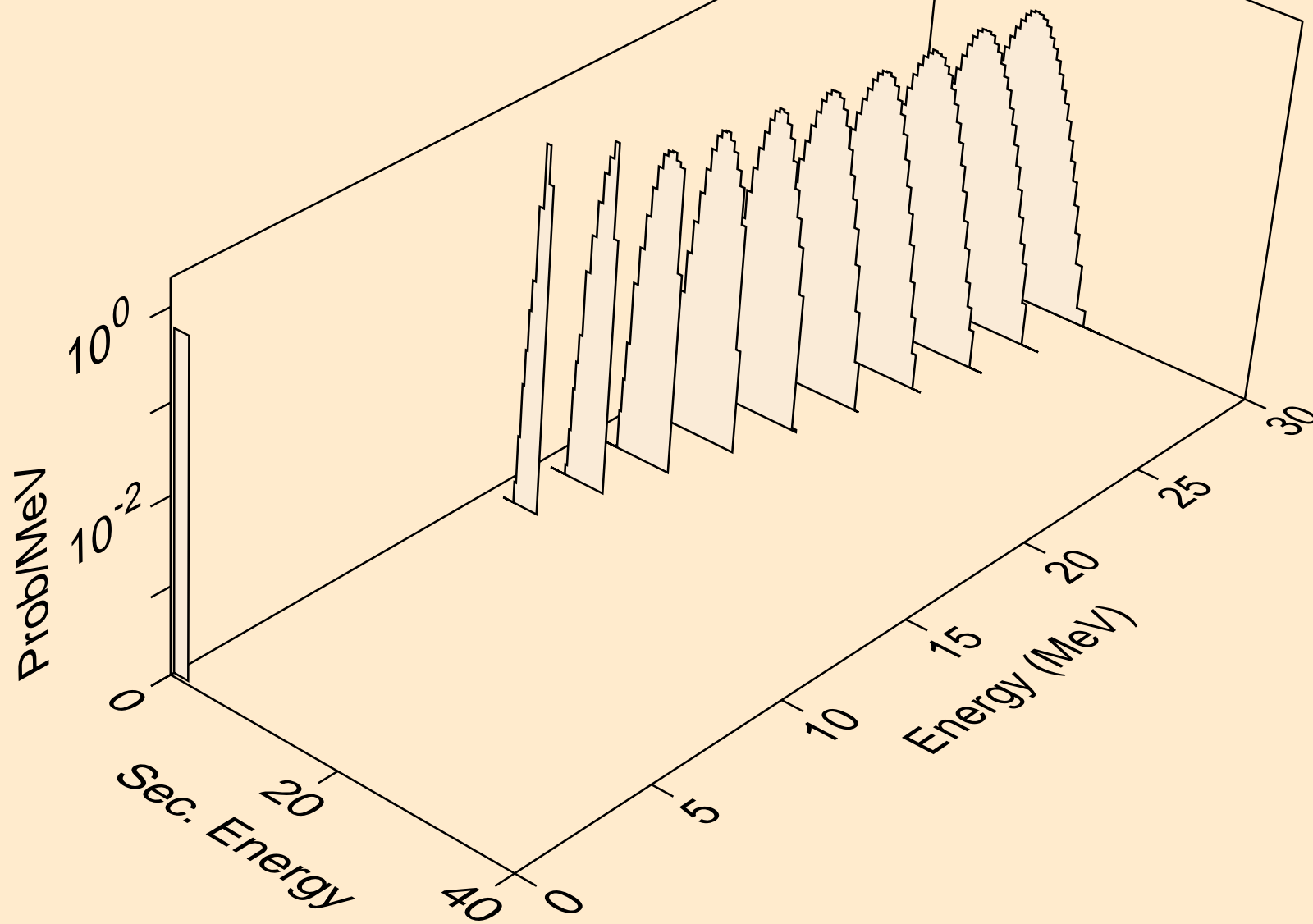



TL186M PROTON ACER TENDL-2021 LIBRARY; T=0.K  
tritons from (p,x)

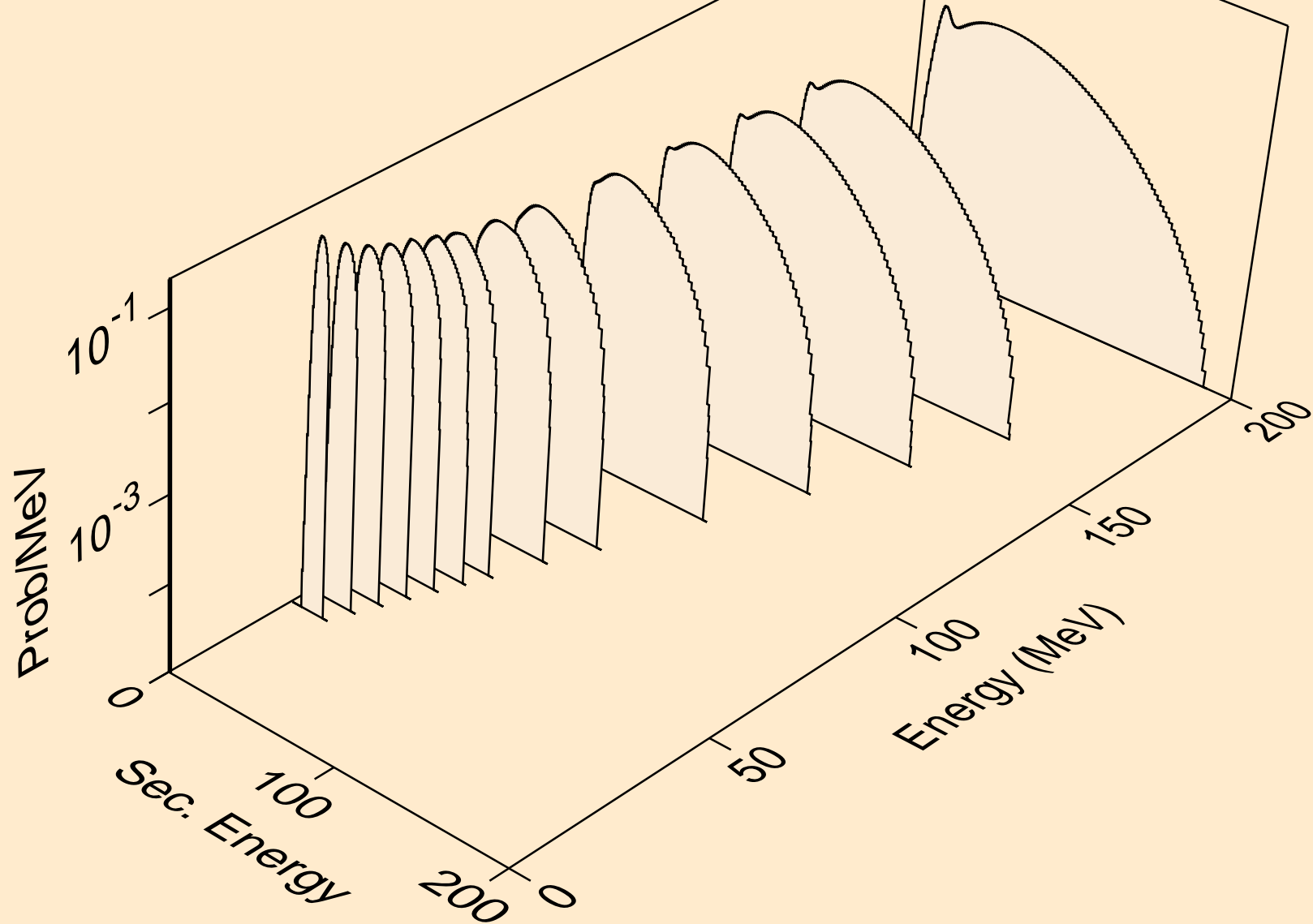

TL186M PROTON ACER TENDL-2021 LIBRARY; T=0.K  
tritons from (p,n\*)t

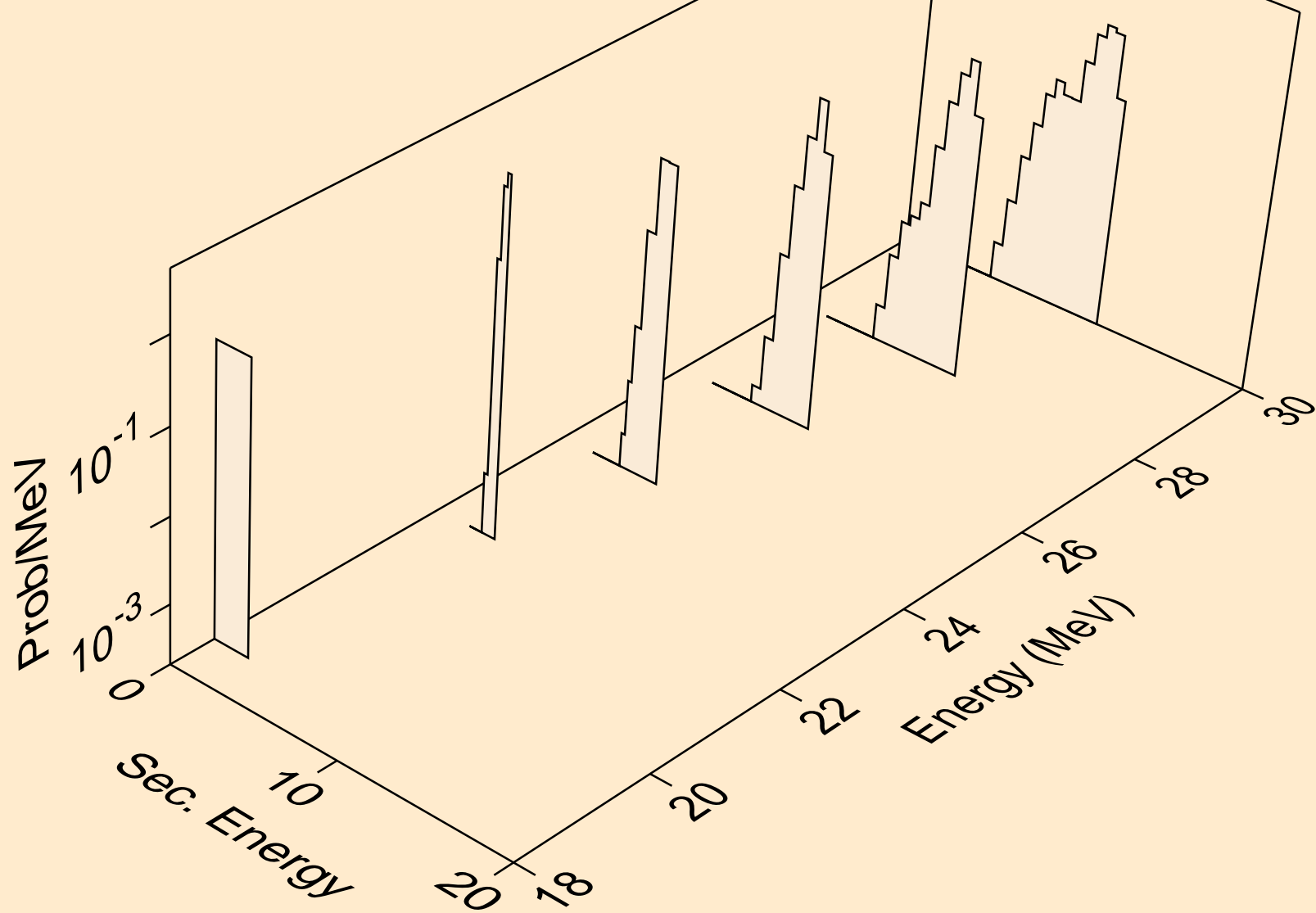

TL186M PROTON ACER TENDL-2021 LIBRARY; T=0.K  
tritons from (p,t)

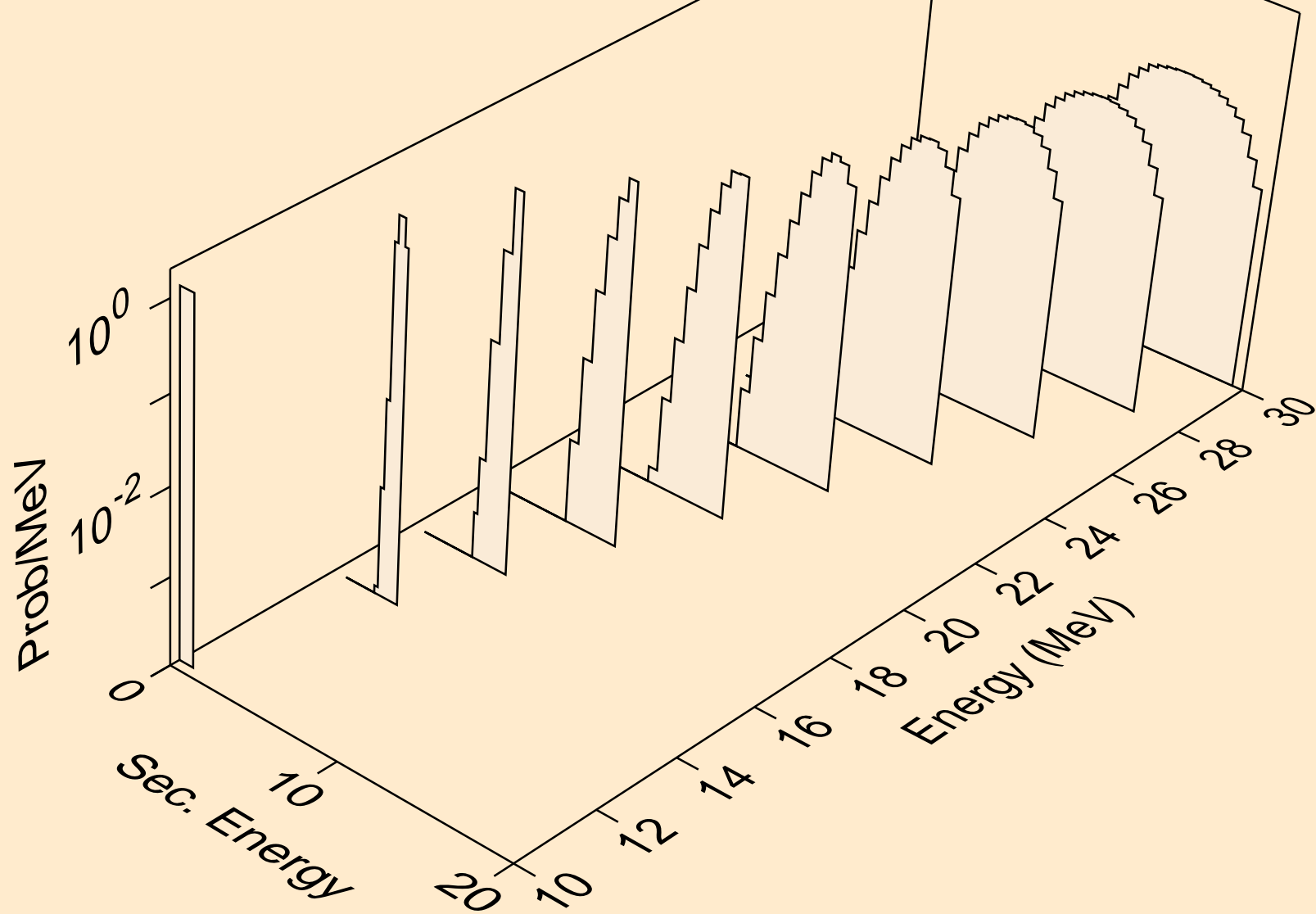

TL186M PROTON ACER TENDL-2021 LIBRARY; T=0.K  
tritons from (p,pt)

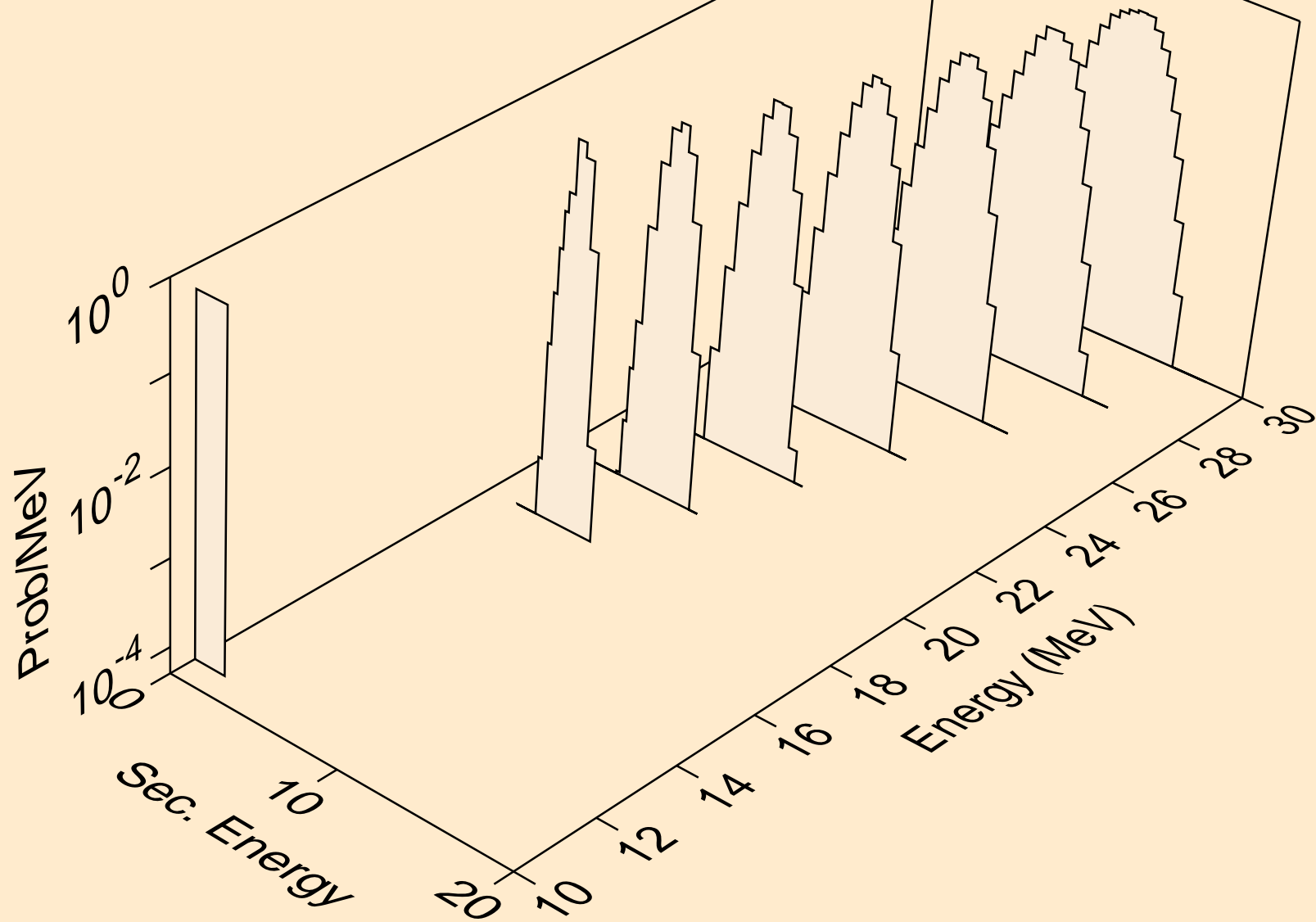

TL186M PROTON ACER TENDL-2021 LIBRARY; T=0.K  
he3s from (p,x)

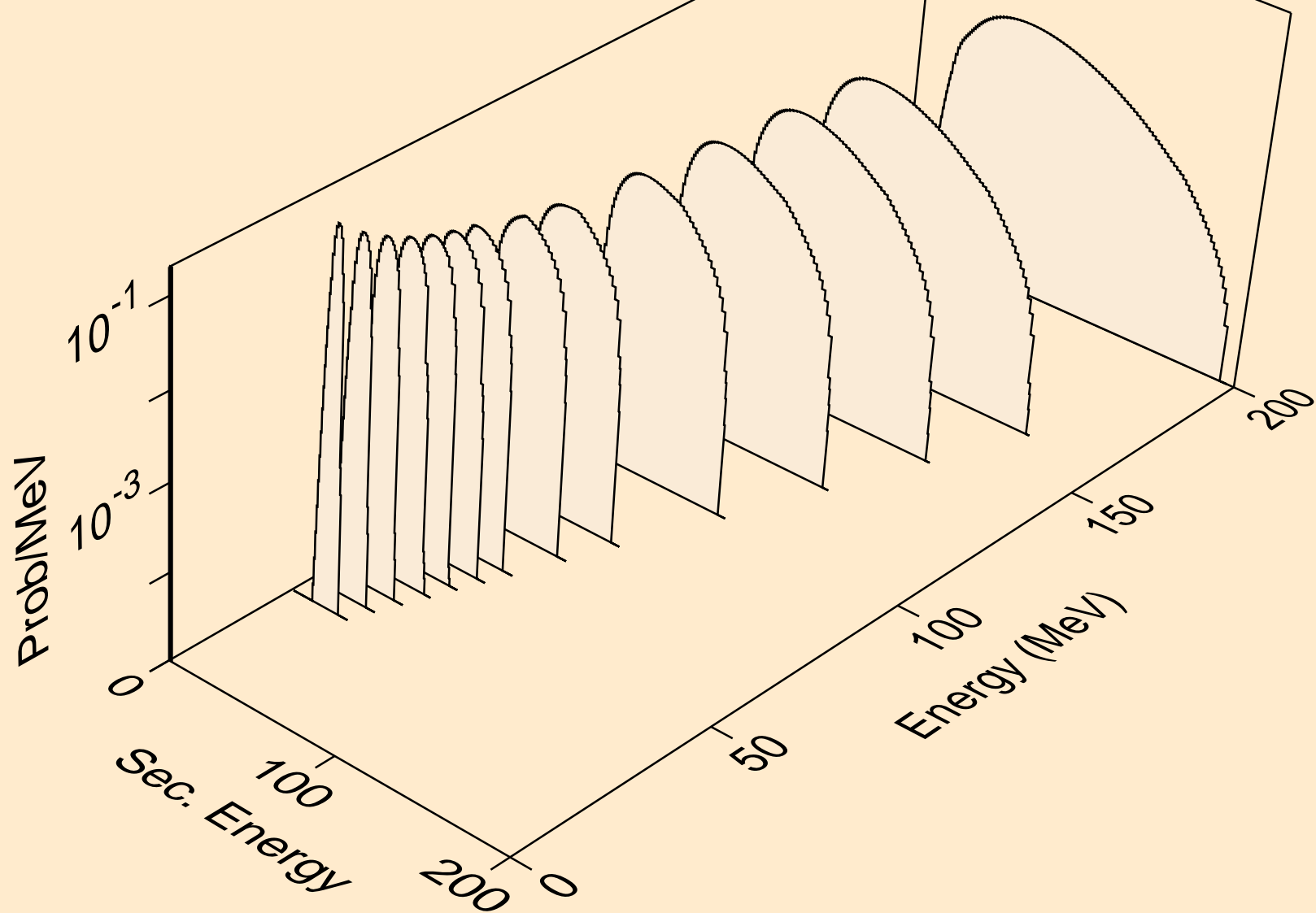

TL186M PROTON ACER TENDL-2021 LIBRARY; T=0.K  
he3s from (p,n\*)he3

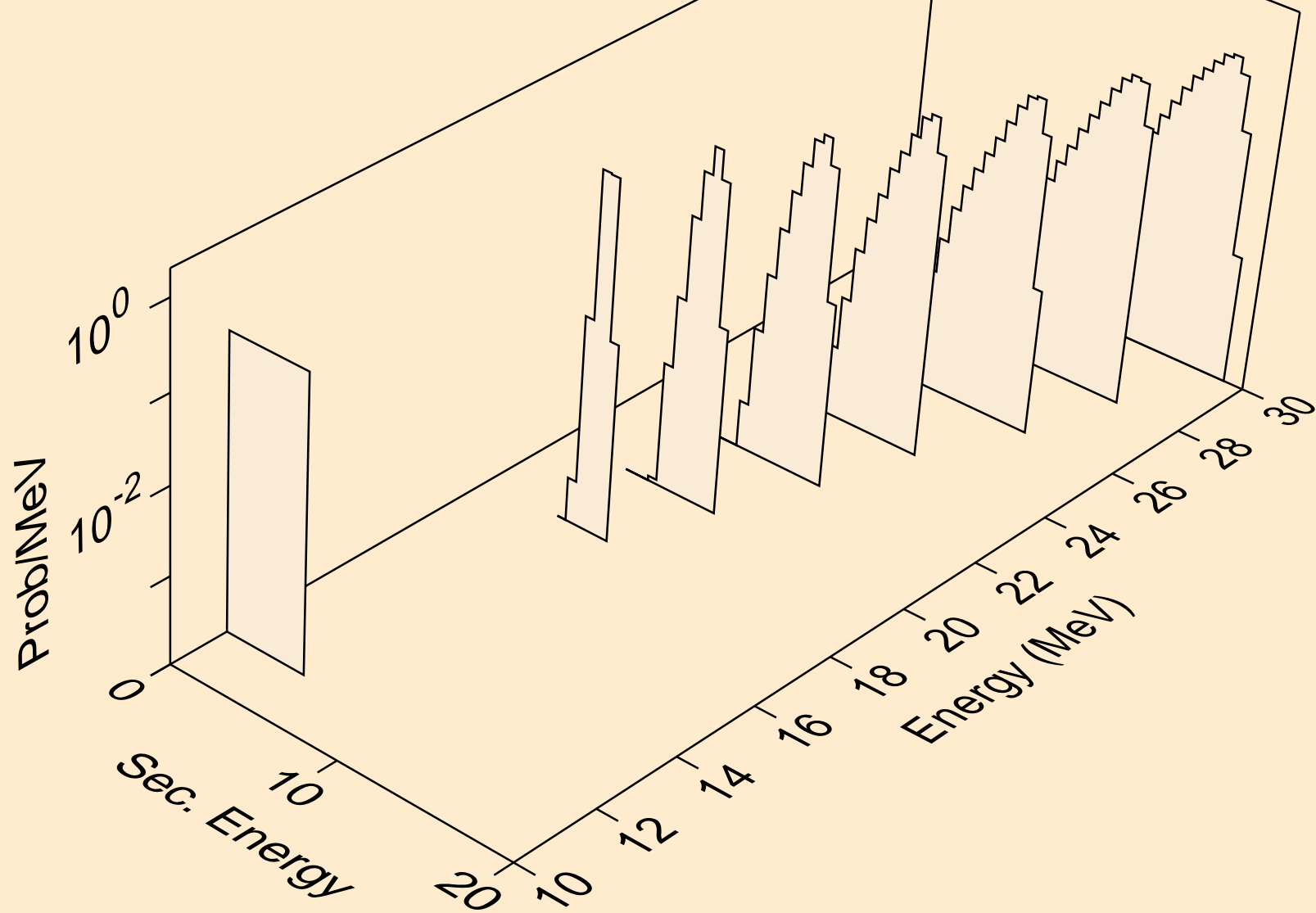

TL186M PROTON ACER TENDL-2021 LIBRARY; T=0.K  
he3s from (p,he3)

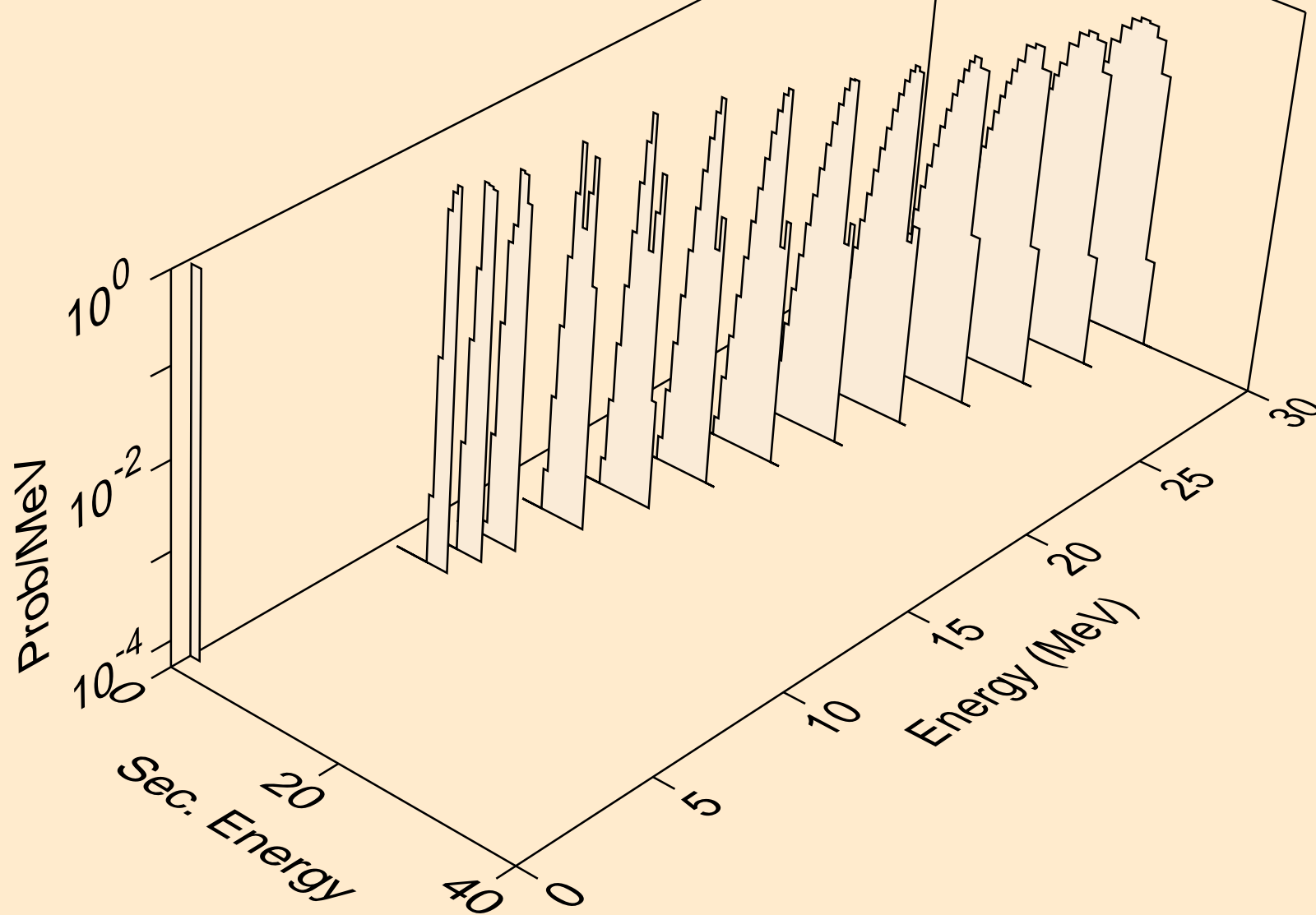

TL186M PROTON ACER TENDL-2021 LIBRARY; T=0.K  
alphas from (p,x)

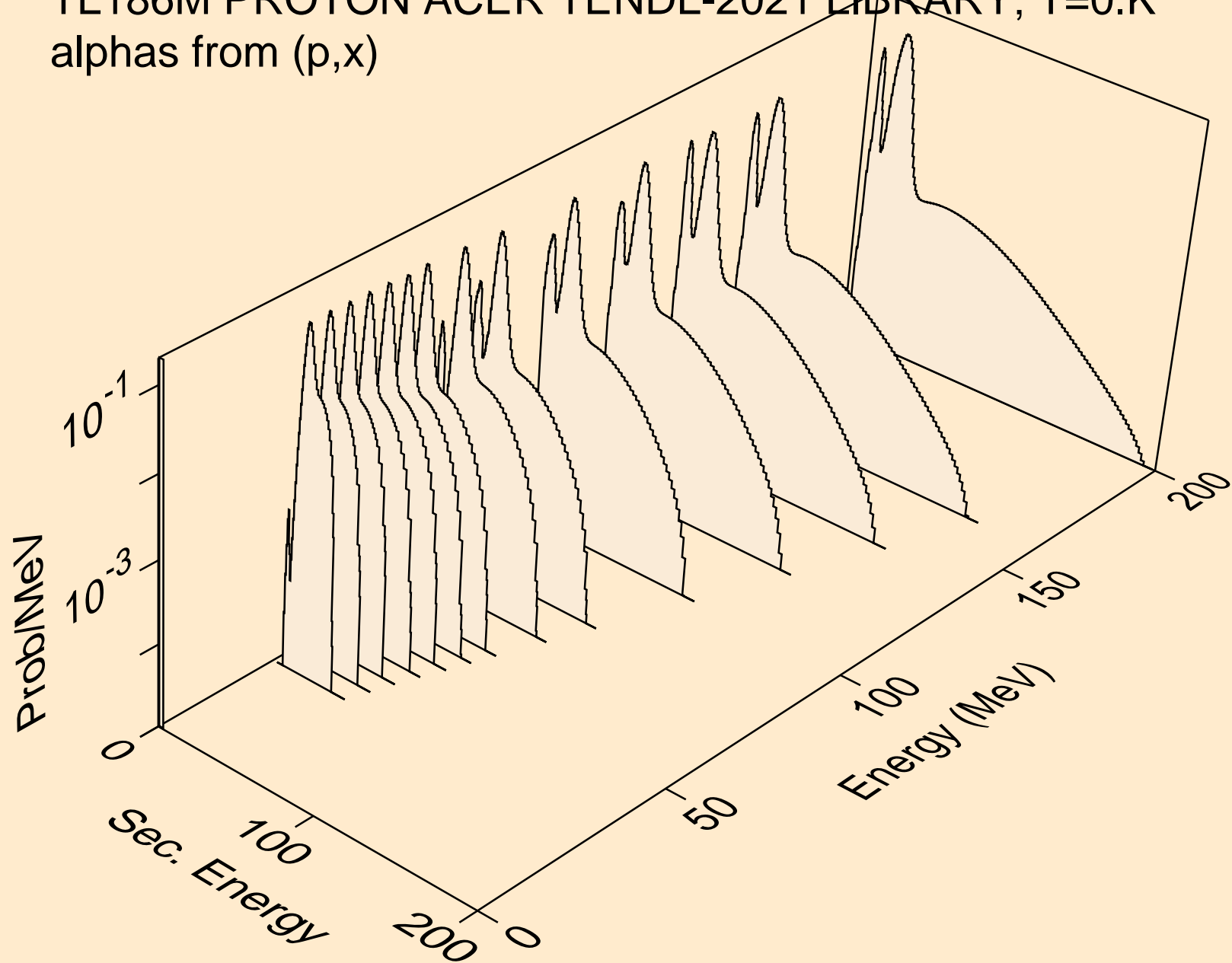



TL186M PROTON ACER TENDL-2021 LIBRARY; T=0.K  
alphas from (p,n\*)a

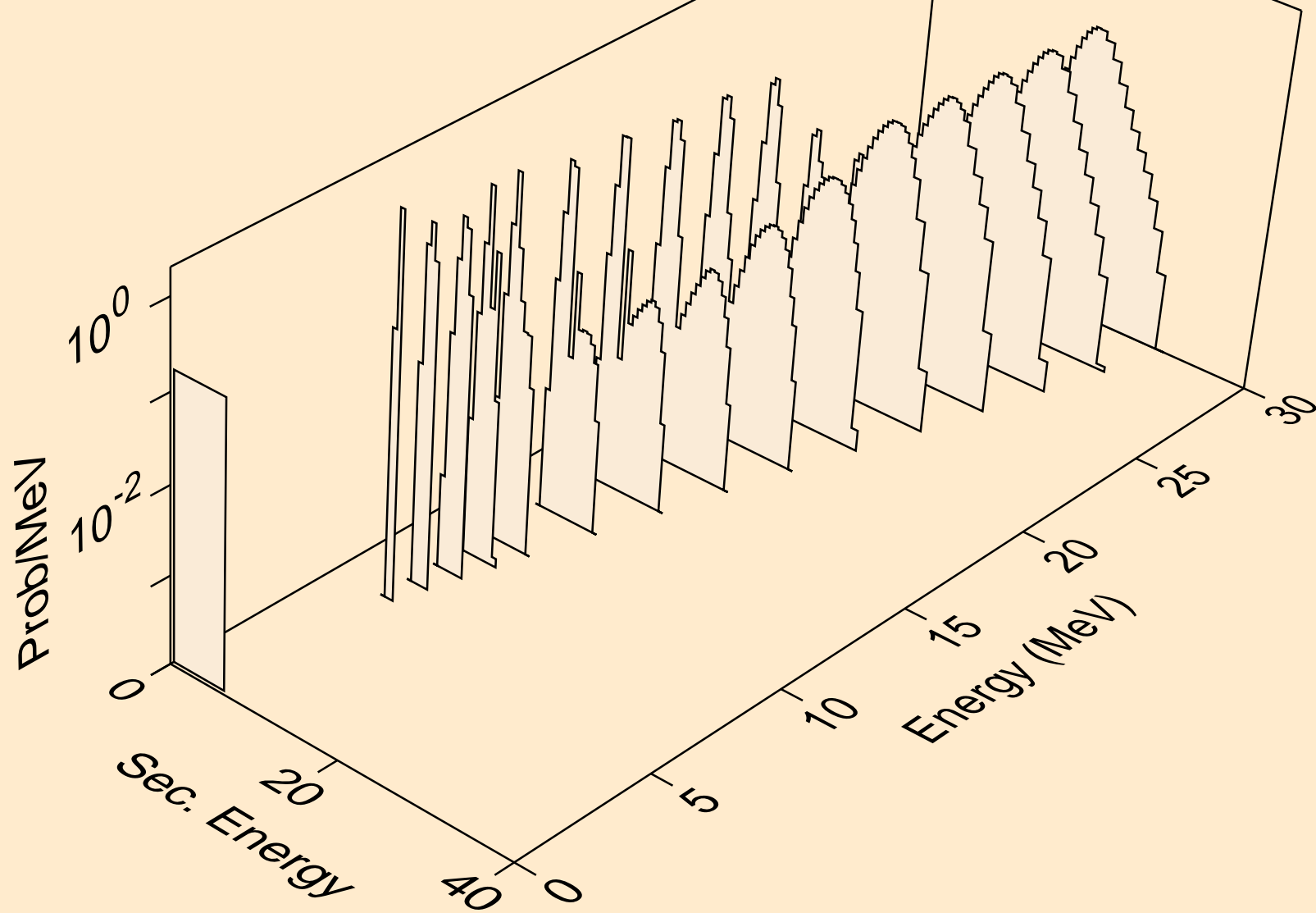

TL186M PROTON ACER TENDL-2021 LIBRARY; T=0.K  
alphas from (p,2n)a

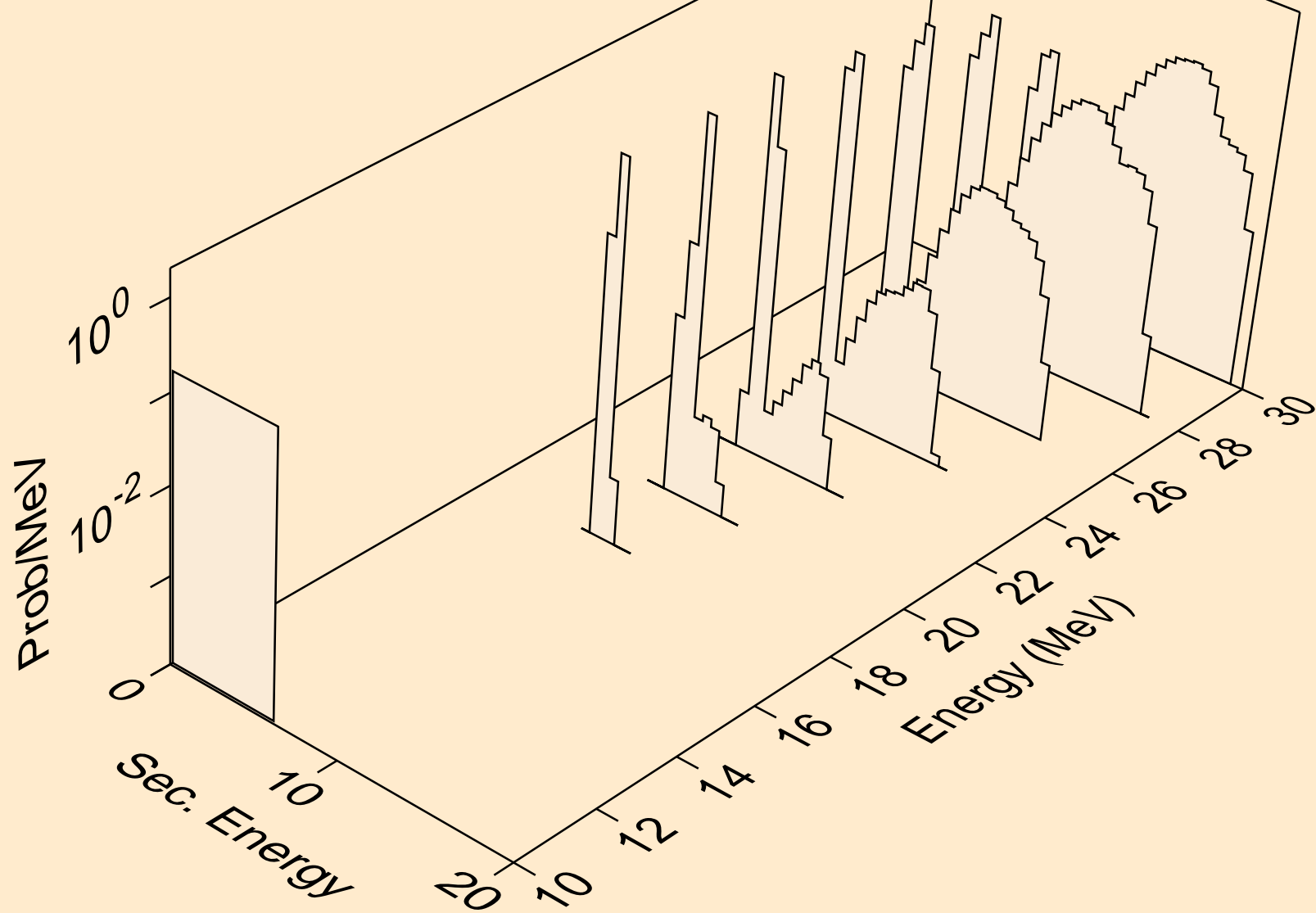

TL186M PROTON ACER TENDL-2021 LIBRARY; T=0.K  
alphas from (p,3n)a

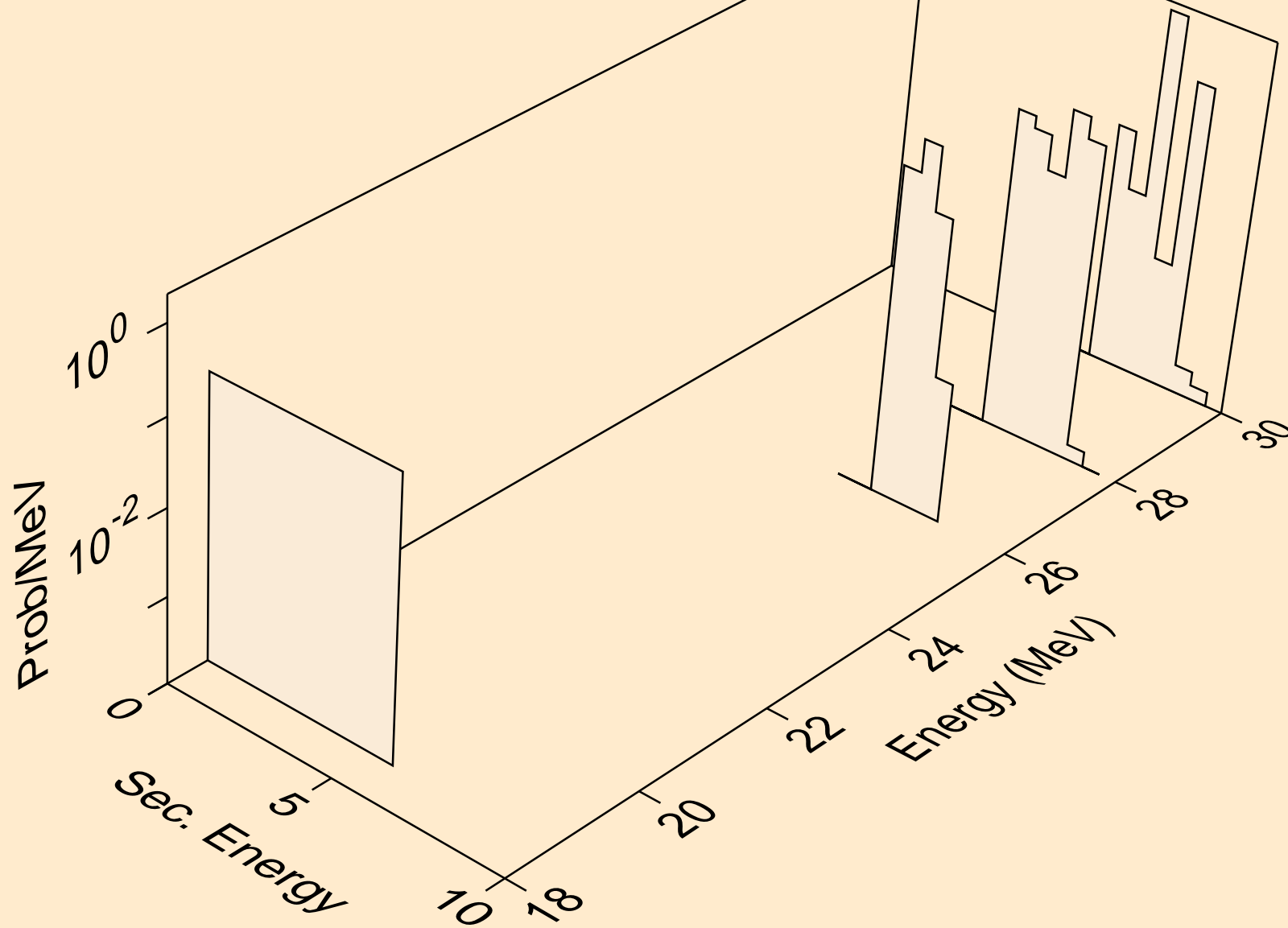

TL186M PROTON ACER TENDL-2021 LIBRARY; T=0.K  
alphas from (p,n\*)2a

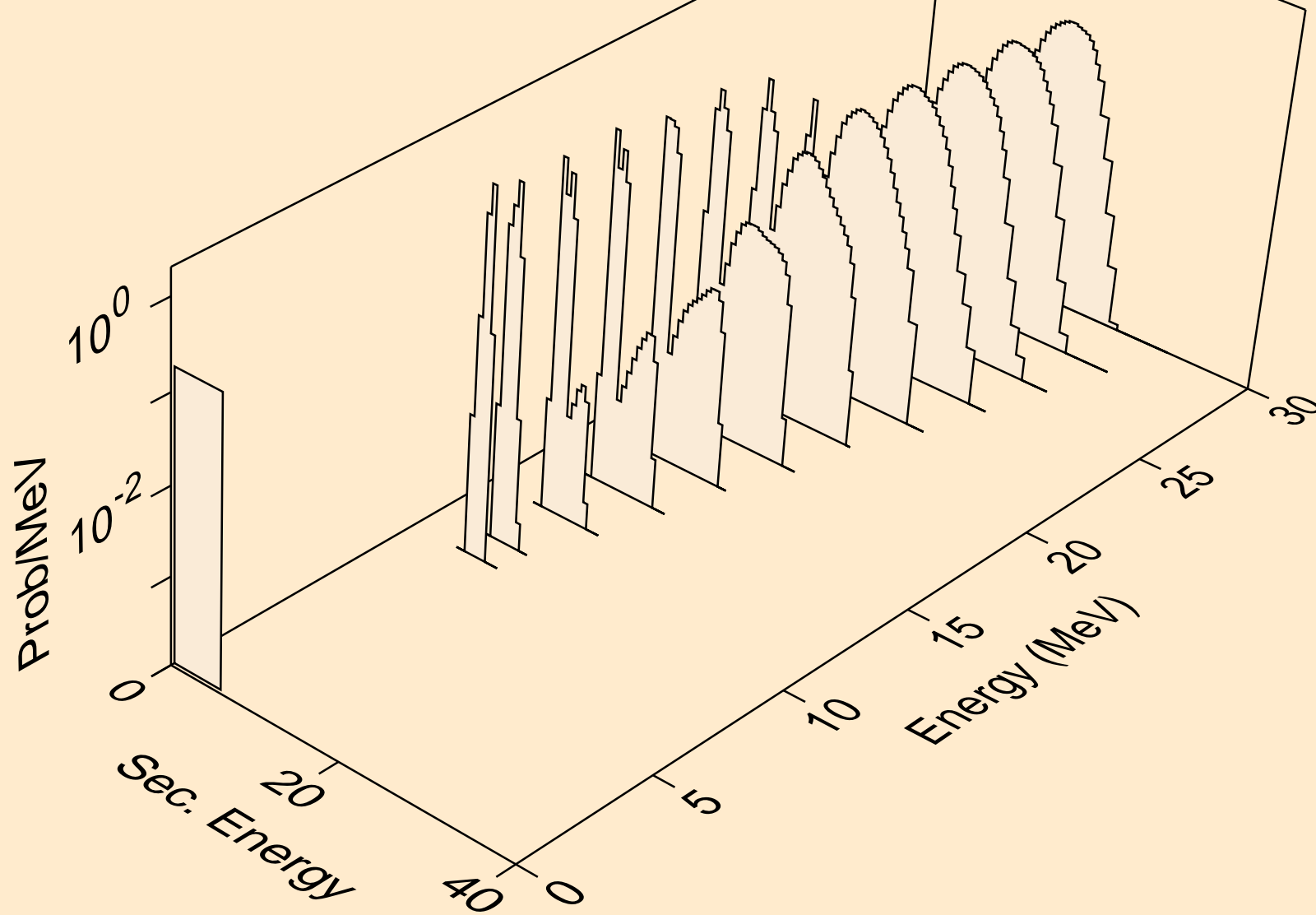

TL186M PROTON ACER TENDL-2021 LIBRARY; T=0.K  
alphas from (p,2n)2a

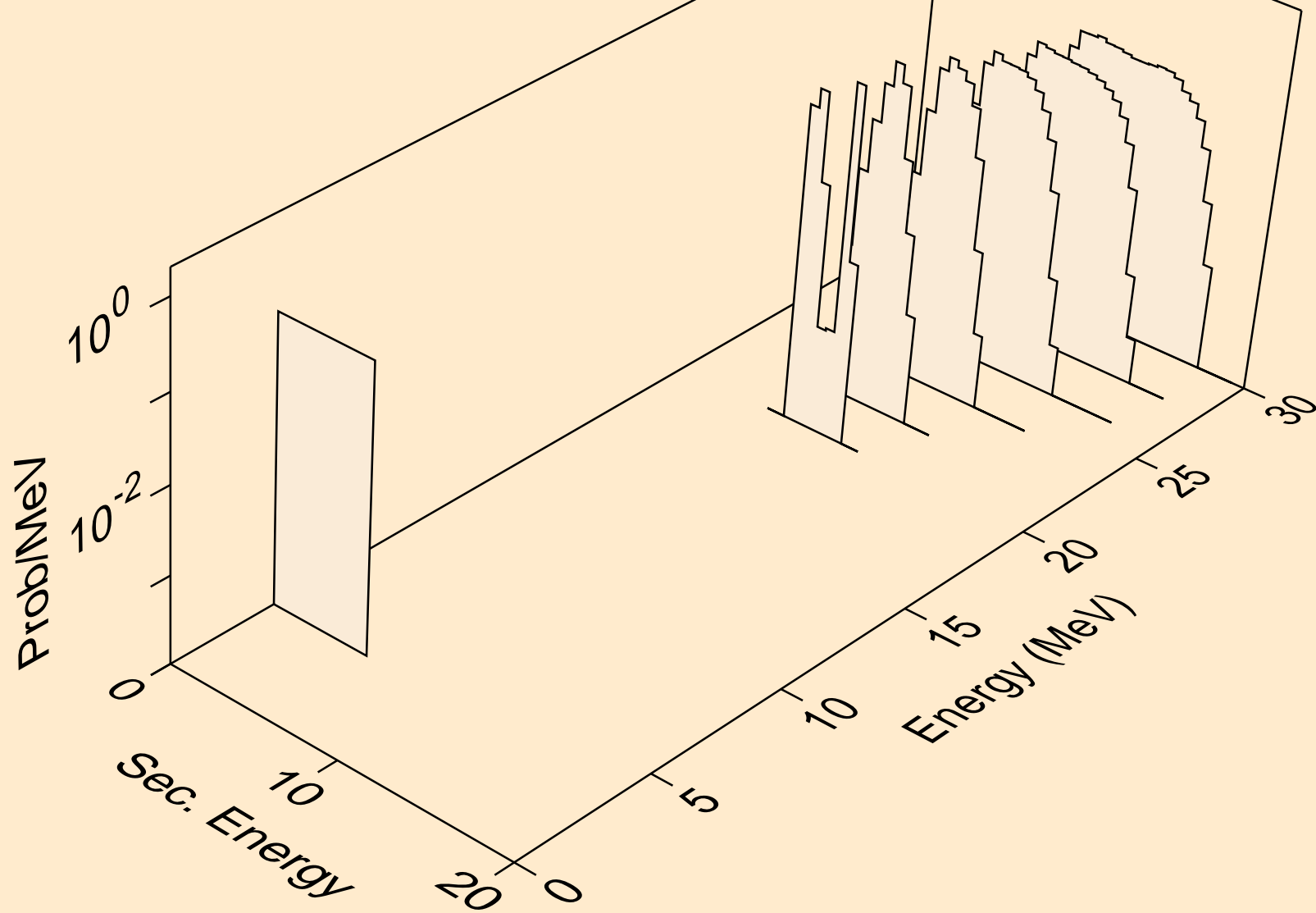

TL186M PROTON ACER TENDL-2021 LIBRARY; T=0.K  
alphas from (p,npa)

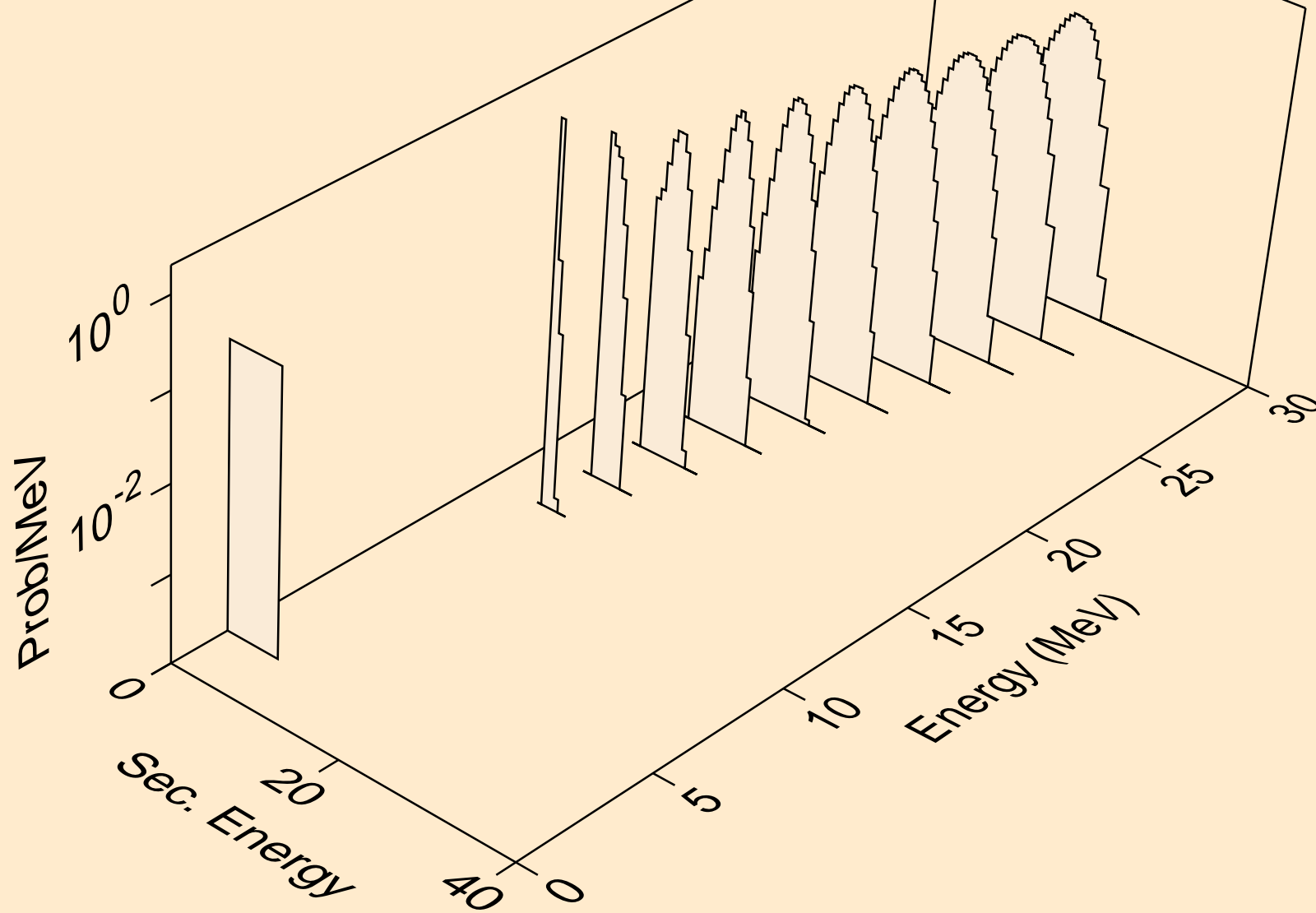

TL186M PROTON ACER TENDL-2021 LIBRARY; T=0.K  
alphas from (p,a)

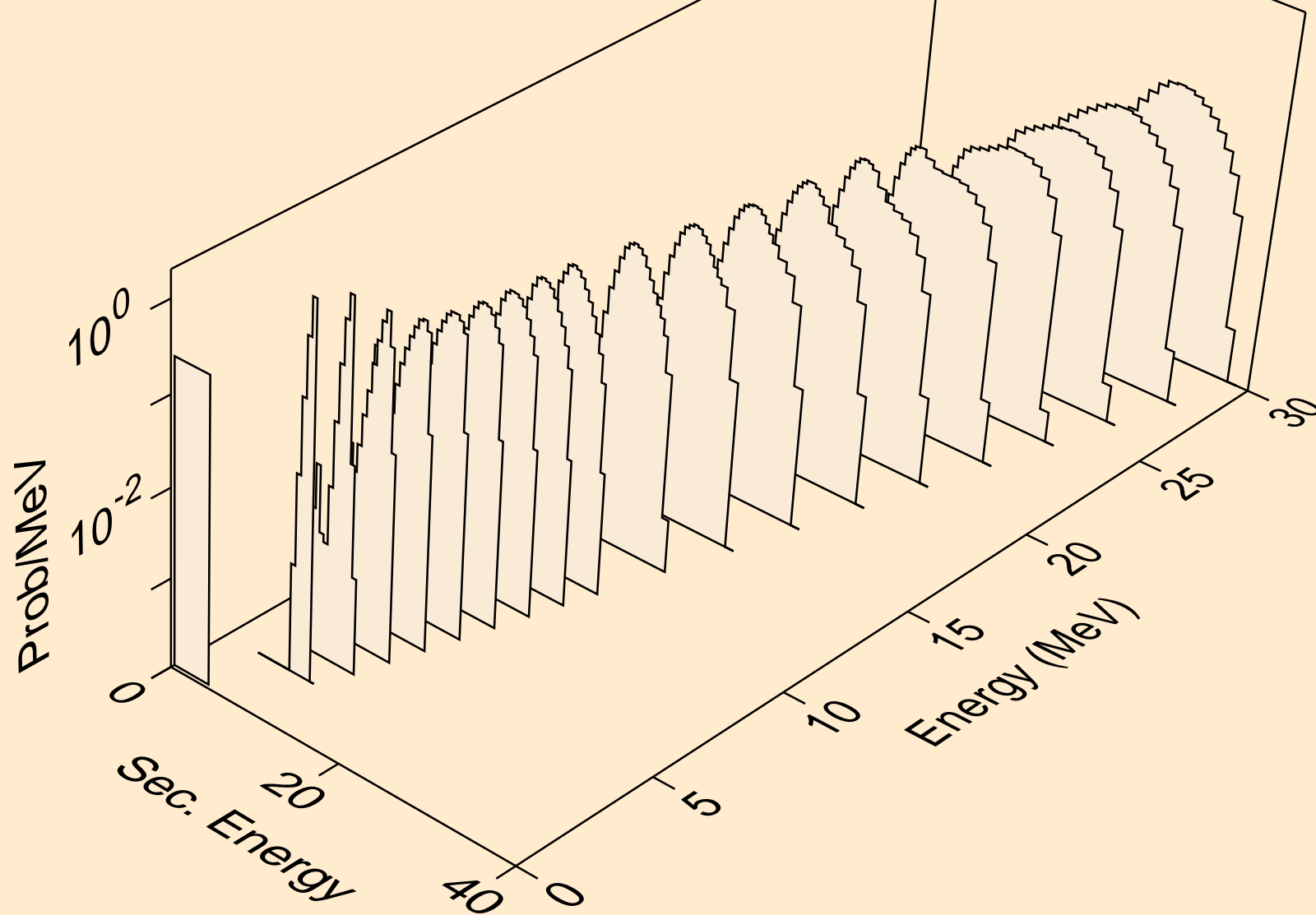

TL186M PROTON ACER TENDL-2021 LIBRARY; T=0.K  
alphas from (p,2a)

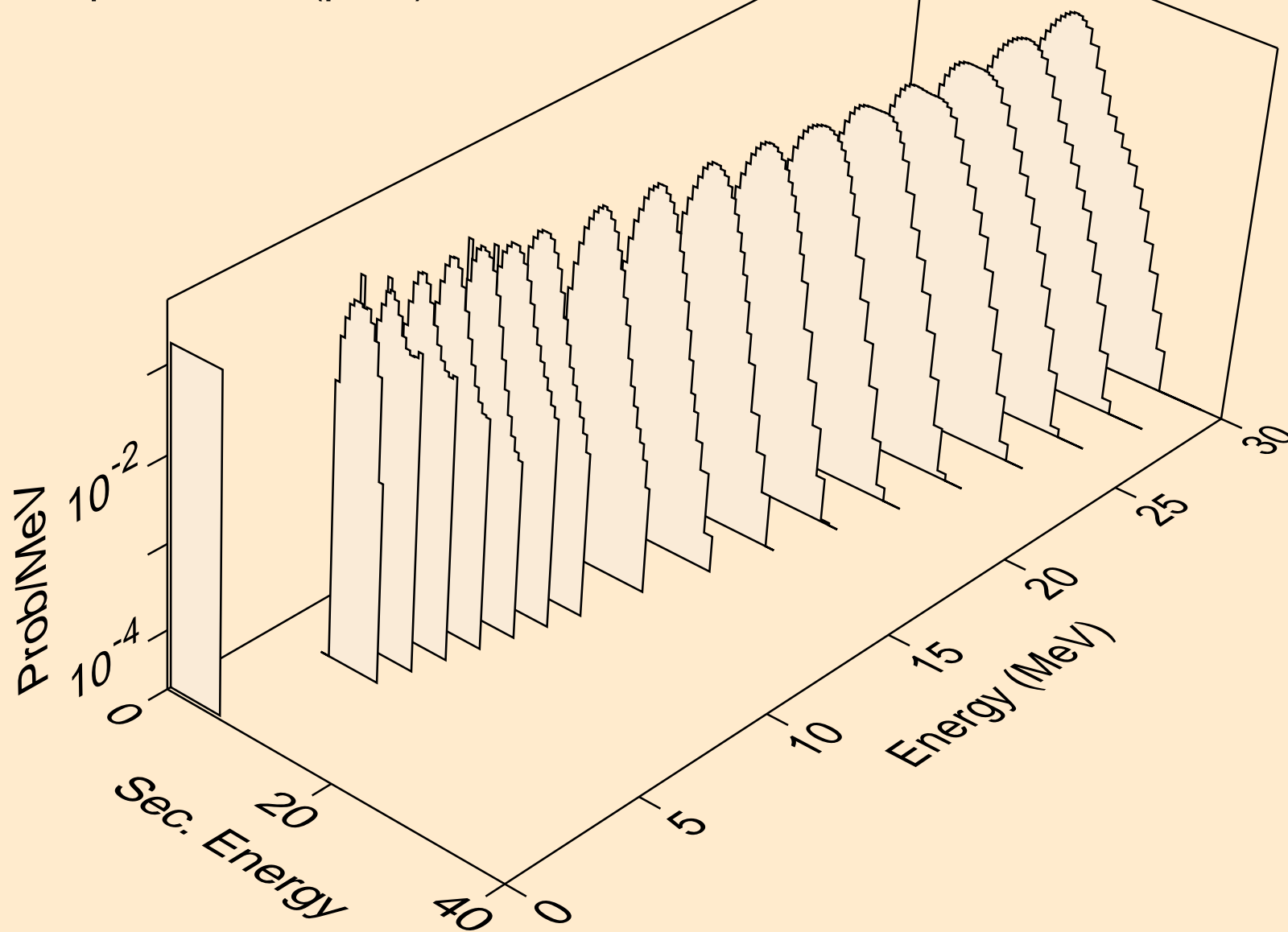



TL186M PROTON ACER TENDL-2021 LIBRARY; T=0.K  
alphas from (p,3a)

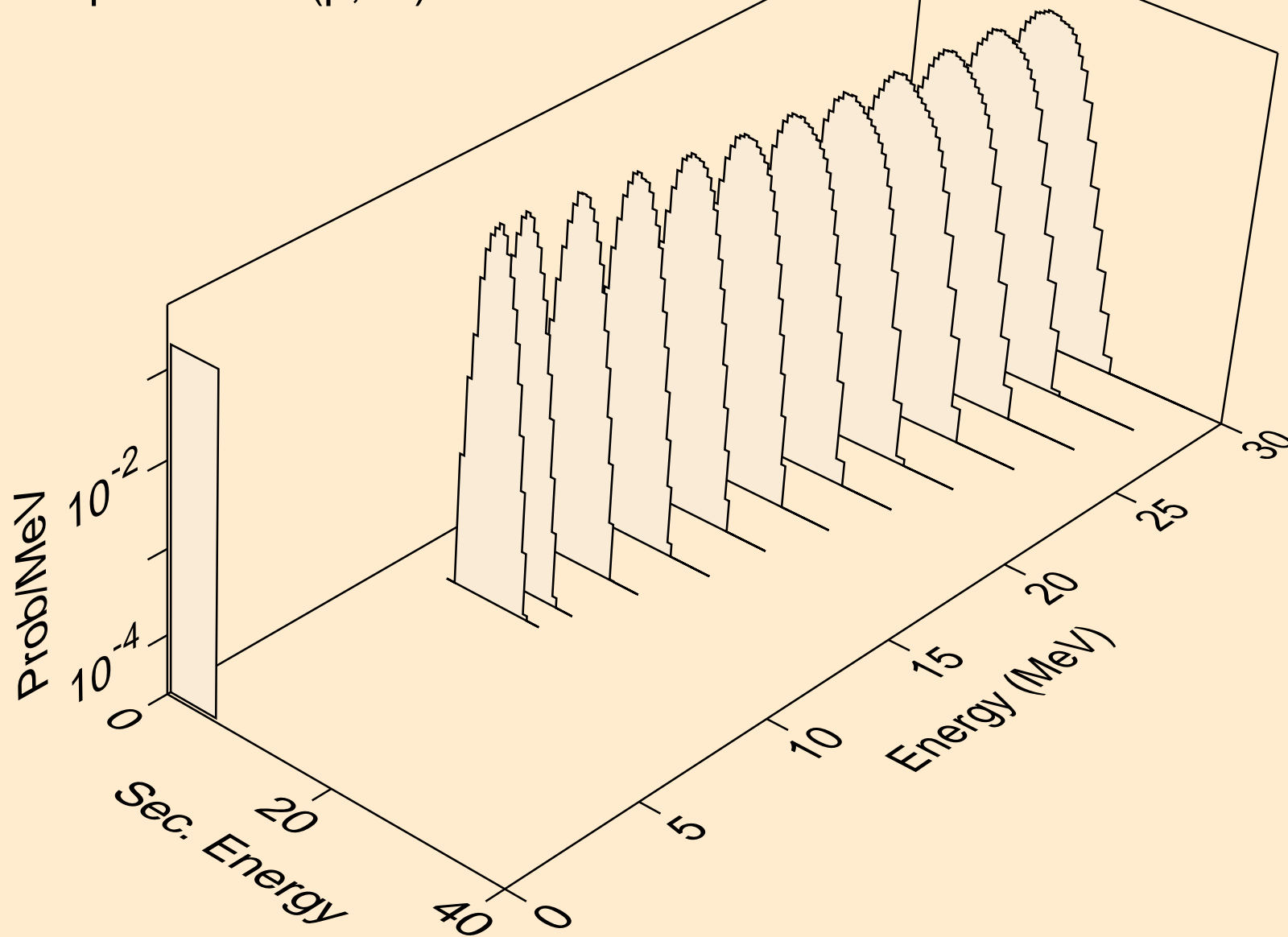

TL186M PROTON ACER TENDL-2021 LIBRARY; T=0.K  
alphas from (p,pa)

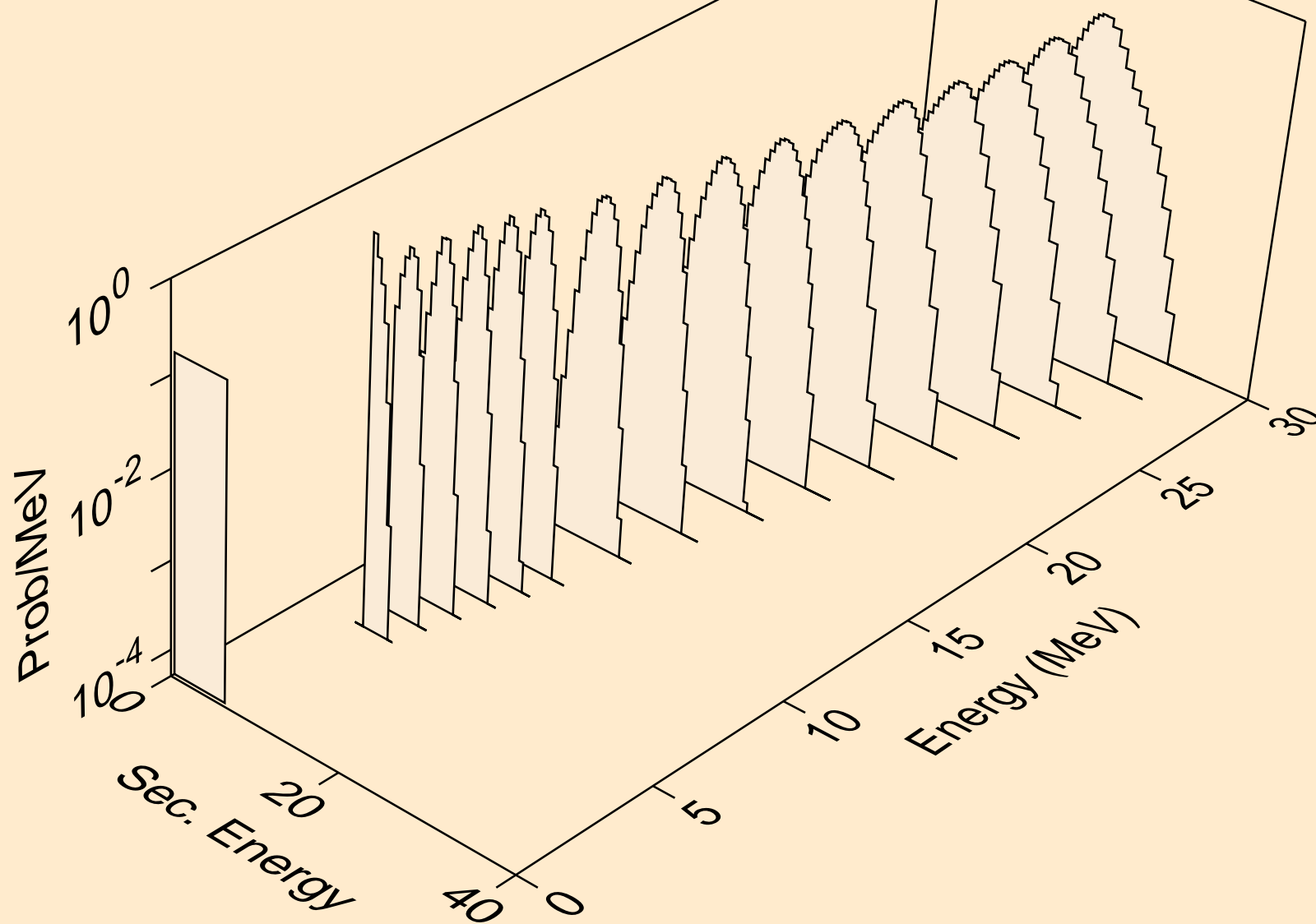

TL186M PROTON ACER TENDL-2021 LIBRARY; T=0.K  
alphas from (p,da)

