

# TL213 PROTON ACER TENDL-2021 LIBRARY; T=0.K

## Principal cross sections

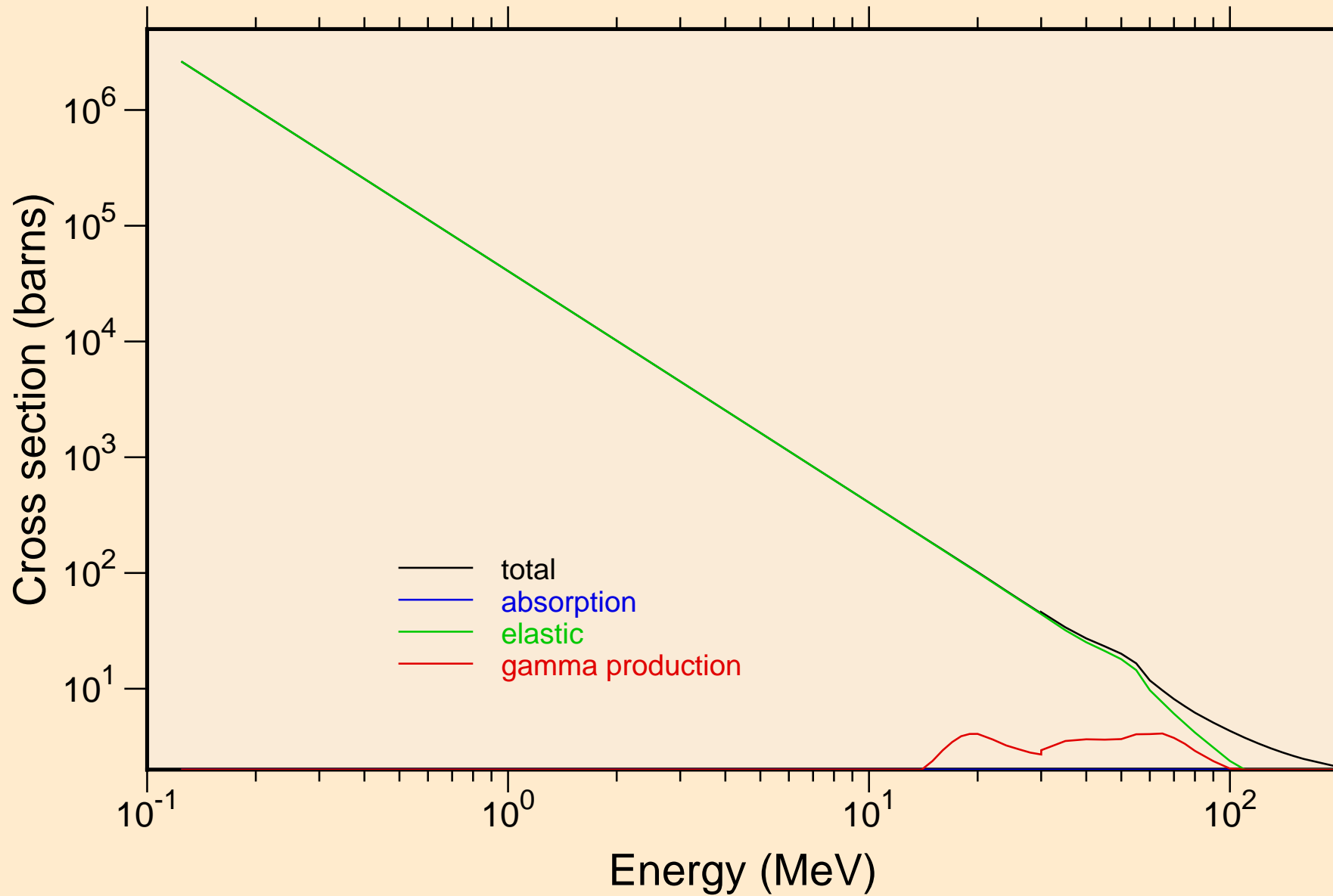

# TL213 PROTON ACER TENDL-2021 LIBRARY; T=0.K

## Heating

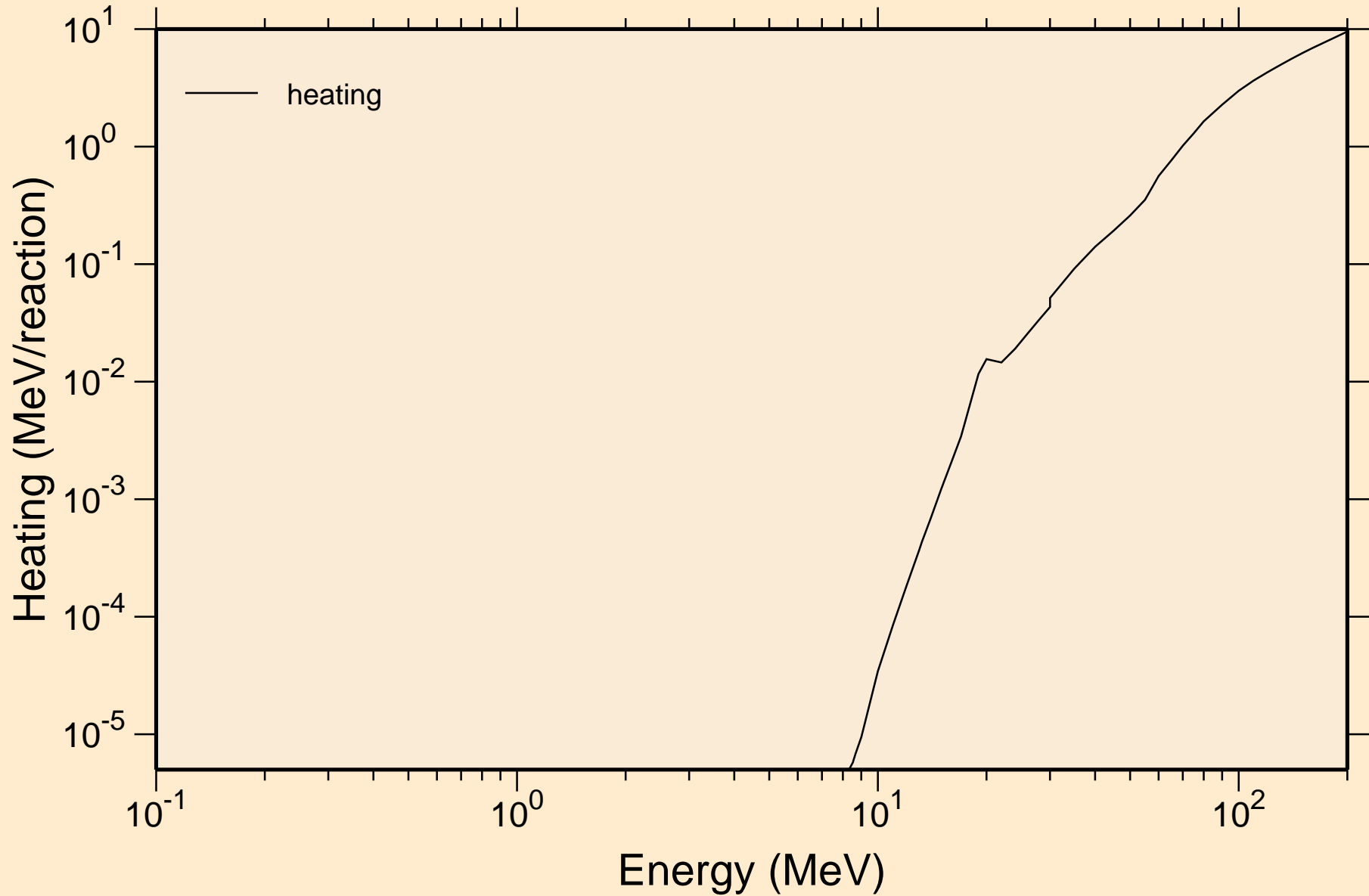

# TL213 PROTON ACER TENDL-2021 LIBRARY; T=0.K

## Principal cross sections

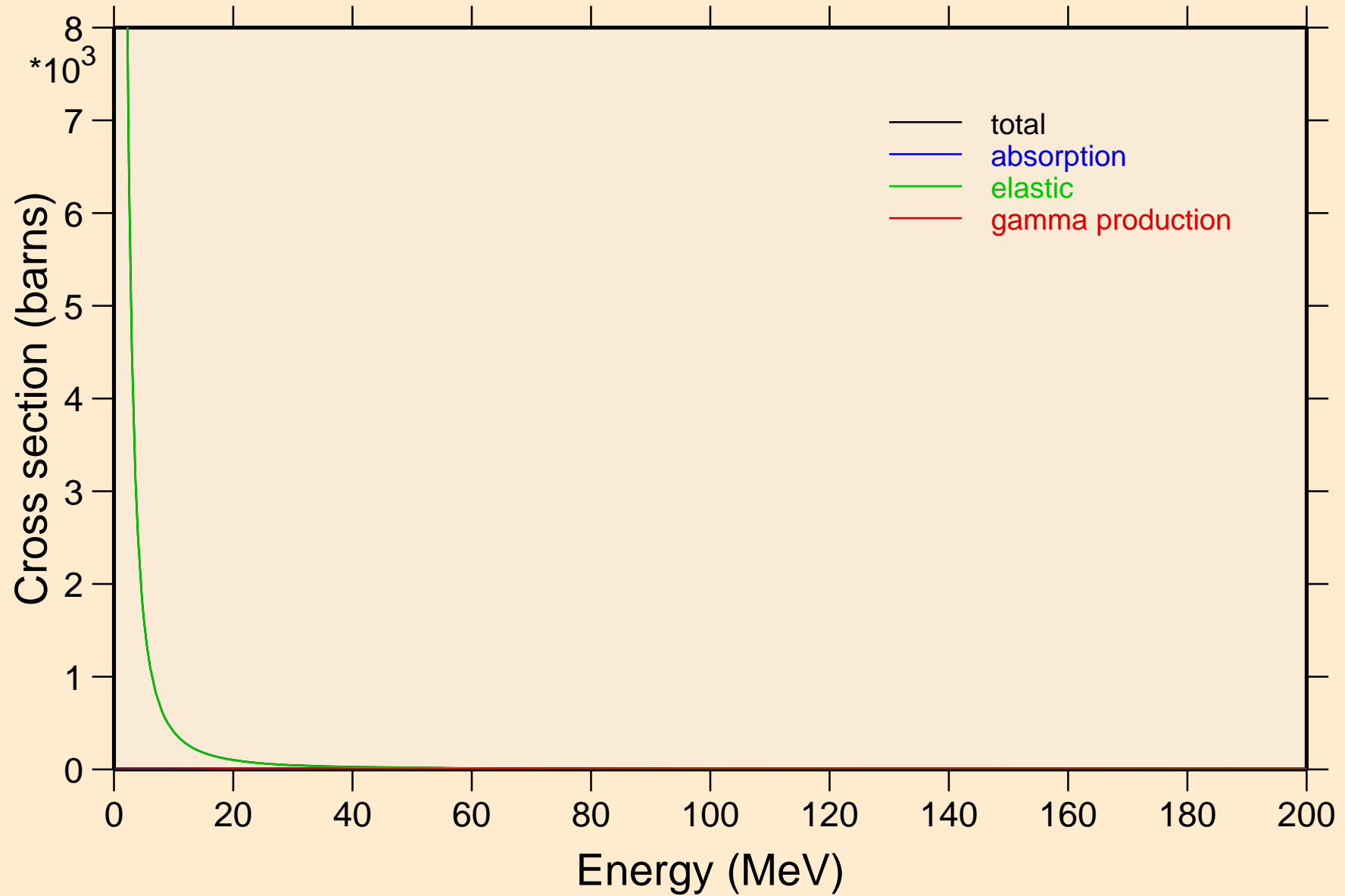

TL213 PROTON ACER TENDL-2021 LIBRARY; T=0.K

Heating

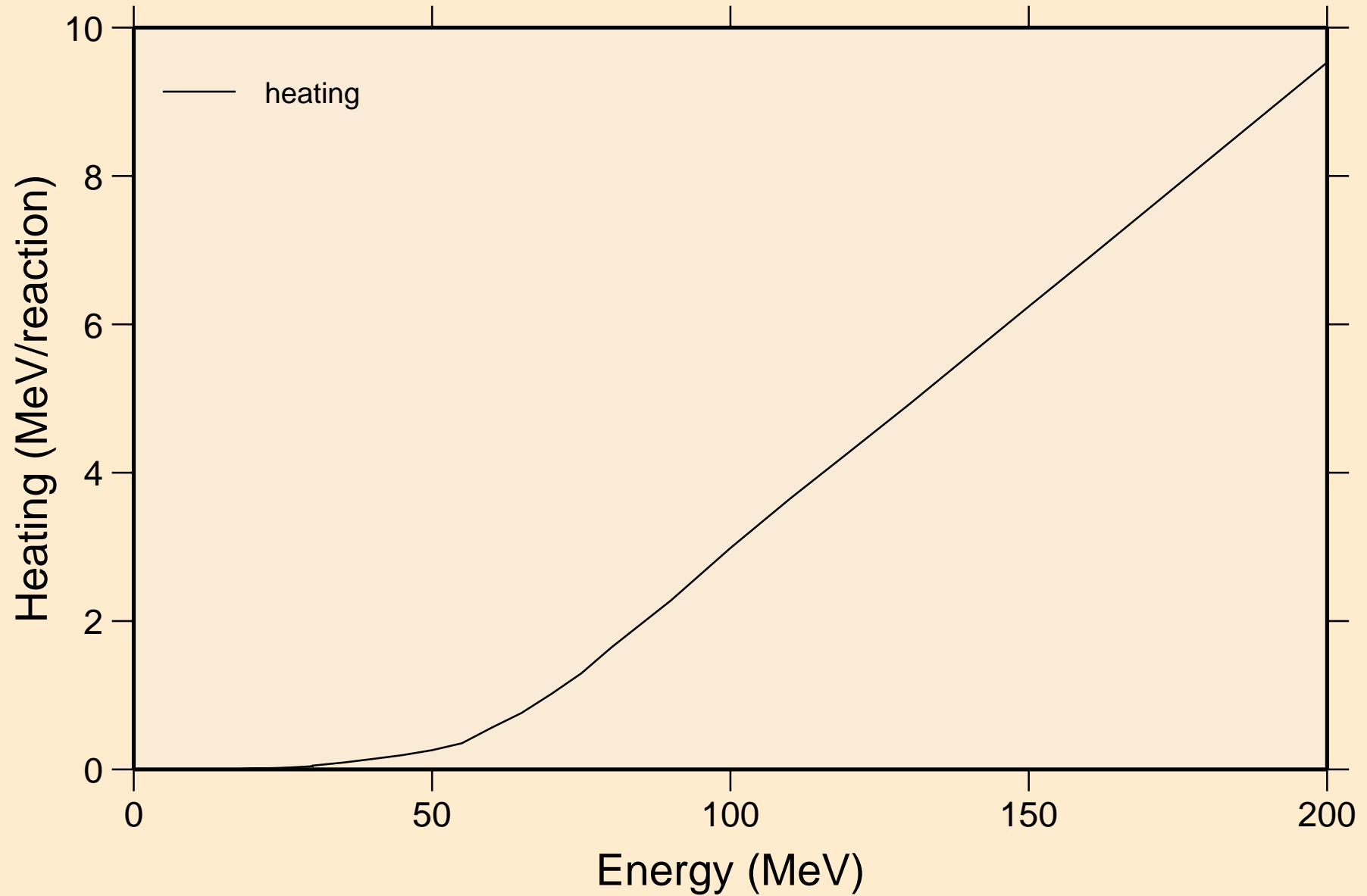

TL213 PROTON ACER TENDL-2021 LIBRARY; T=0.K  
Threshold reactions

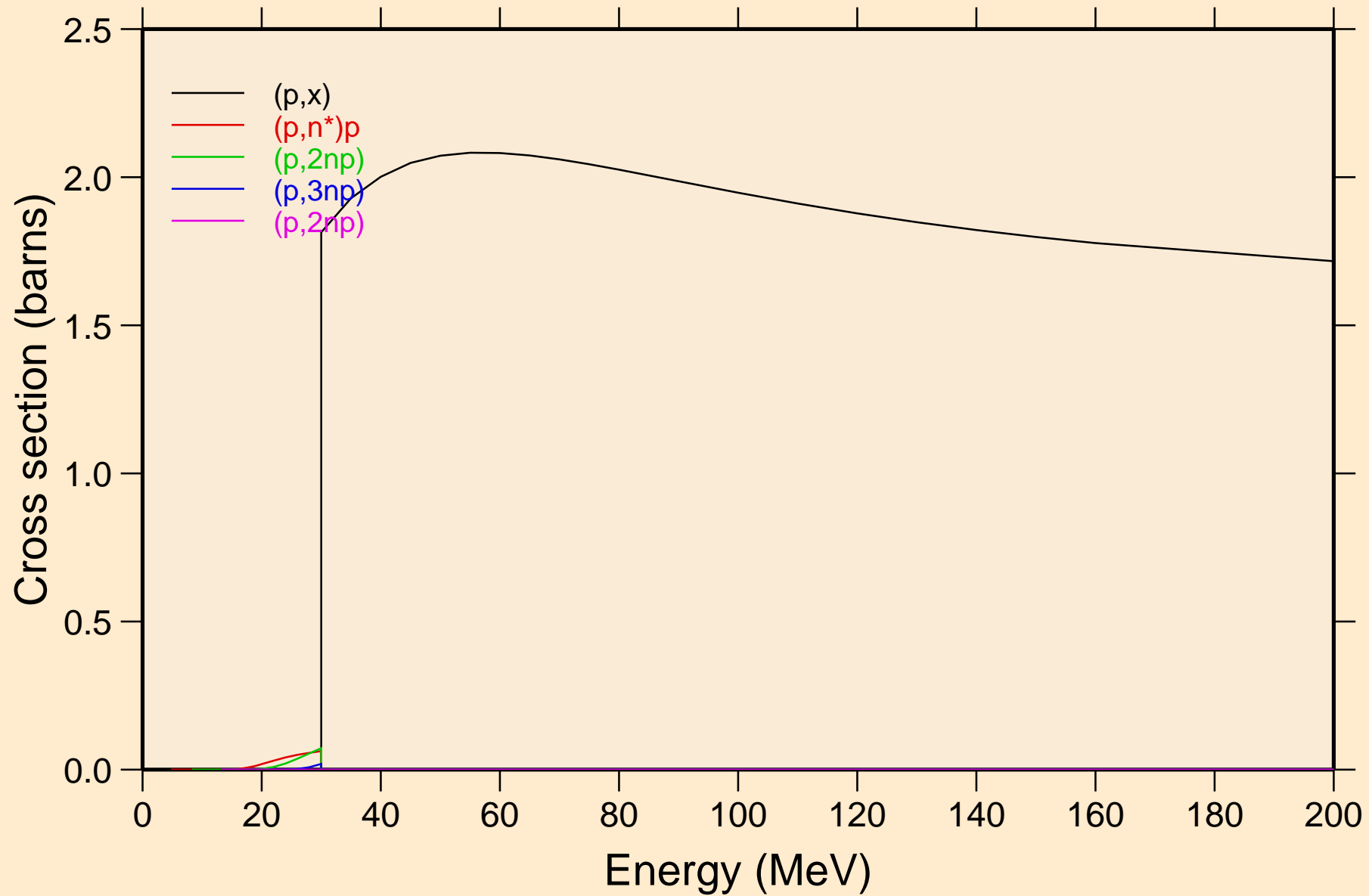

TL213 PROTON ACER TENDL-2021 LIBRARY; T=0.K  
Threshold reactions

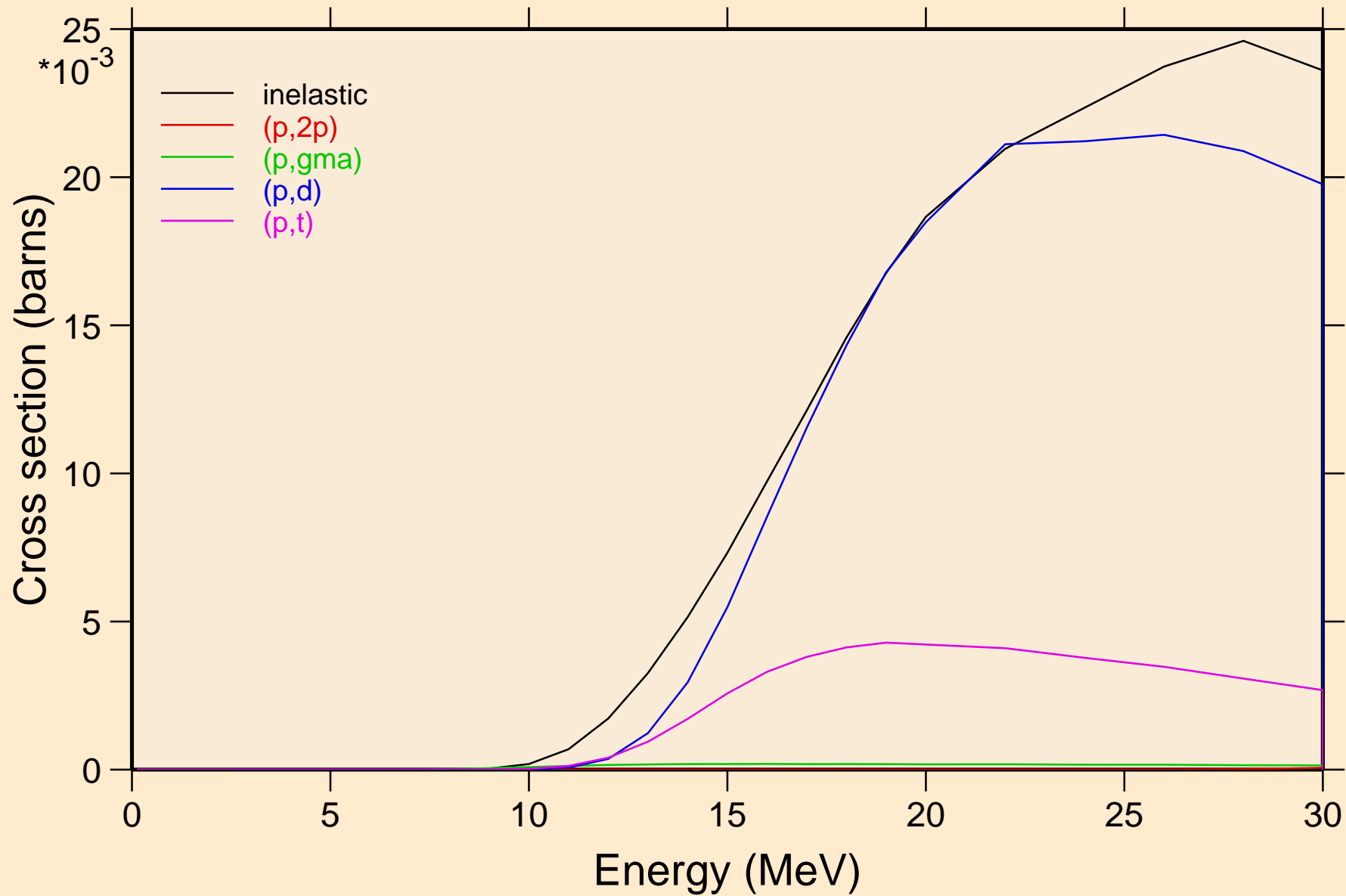

TL213 PROTON ACER TENDL-2021 LIBRARY; T=0.K  
Threshold reactions

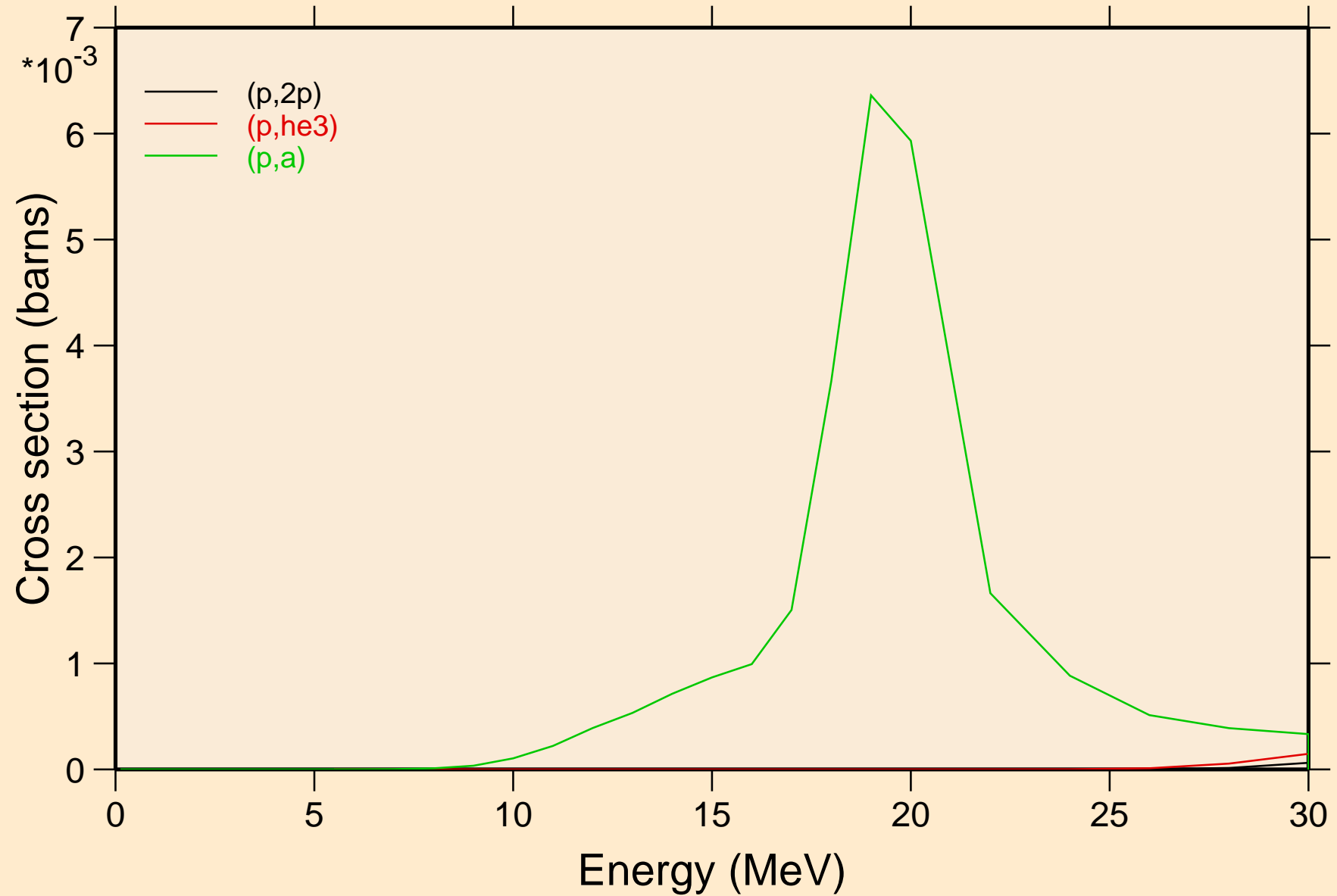

TL213 PROTON ACER TENDL-2021 LIBRARY; T=0.K  
Threshold reactions

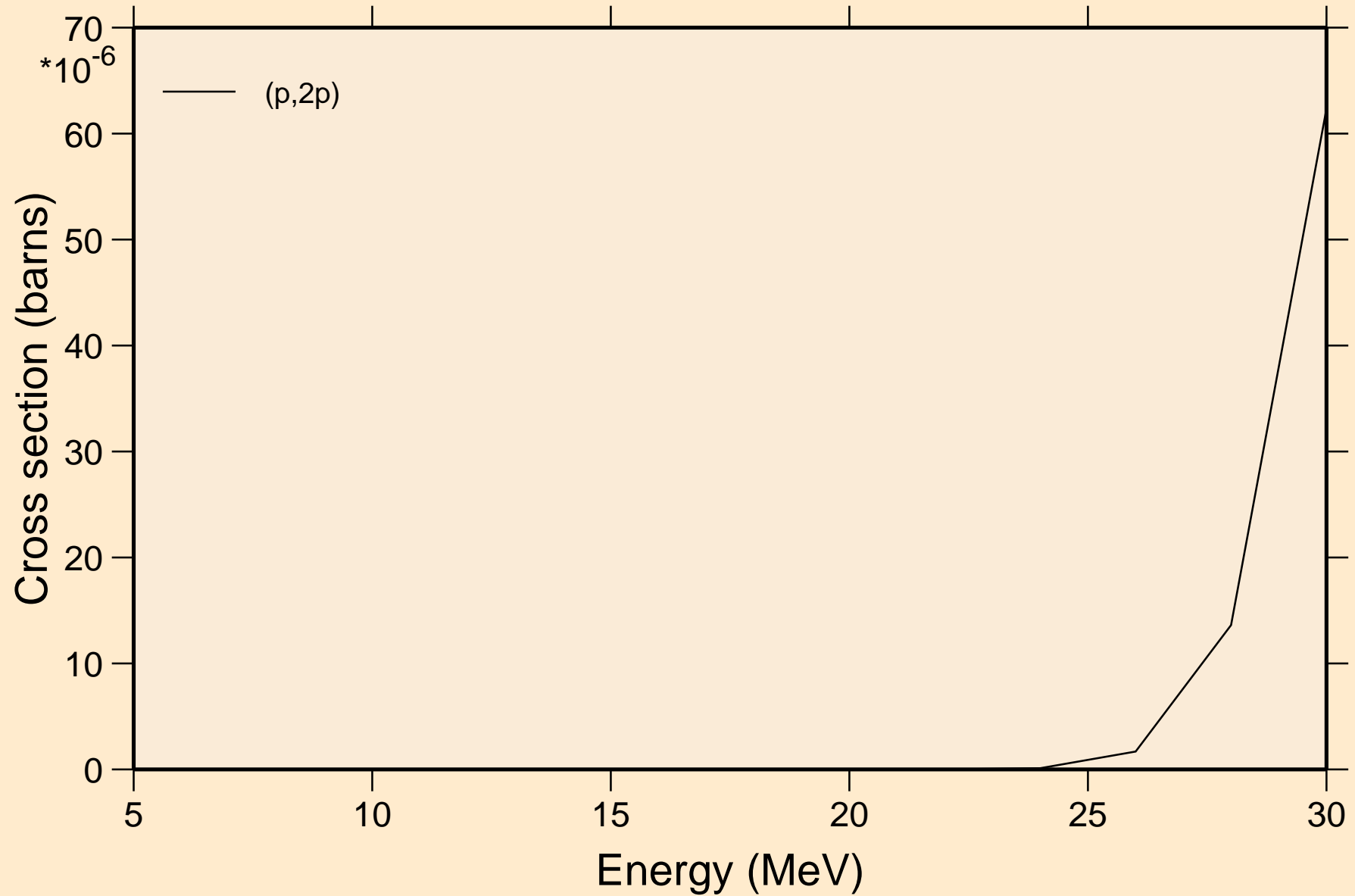



TL213 PROTON ACER TENDL-2021 LIBRARY; T=0.K  
angular distribution for elastic

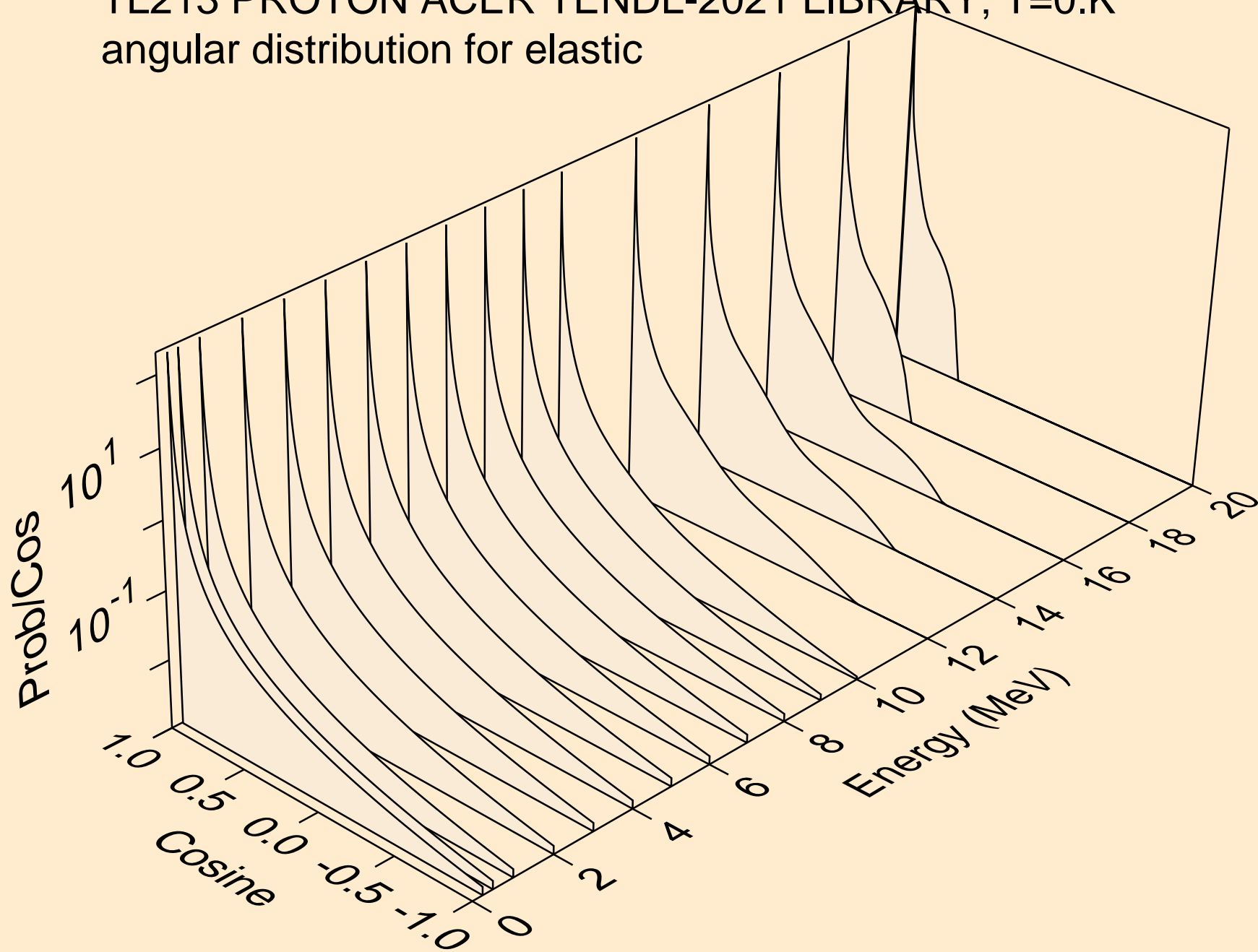

TL213 PROTON ACER TENDL-2021 LIBRARY; T=0.K  
angular distribution for elastic

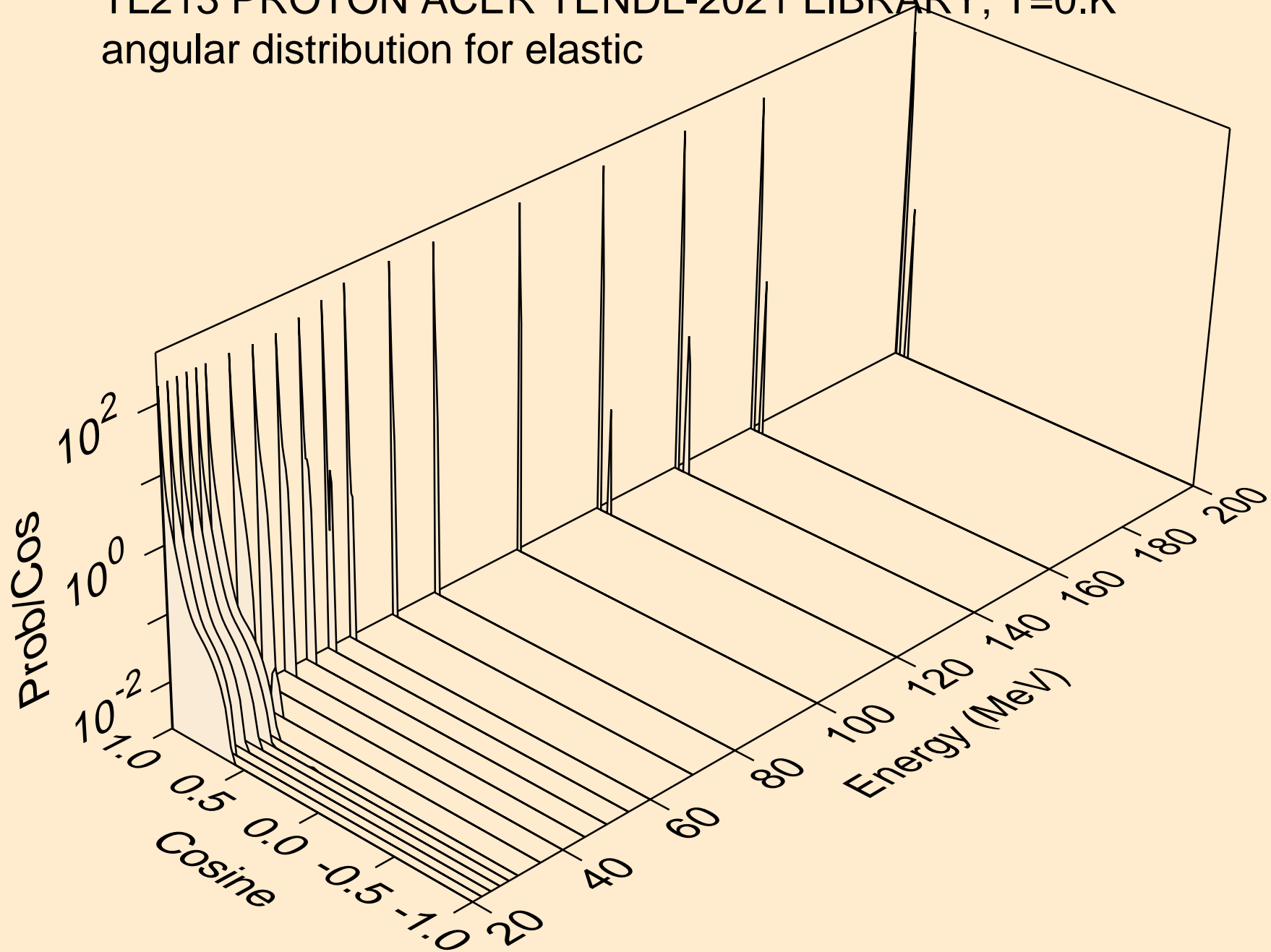

TL213 PROTON ACER TENDL-2021 LIBRARY; T=0.K  
Proton emission for (p,x)

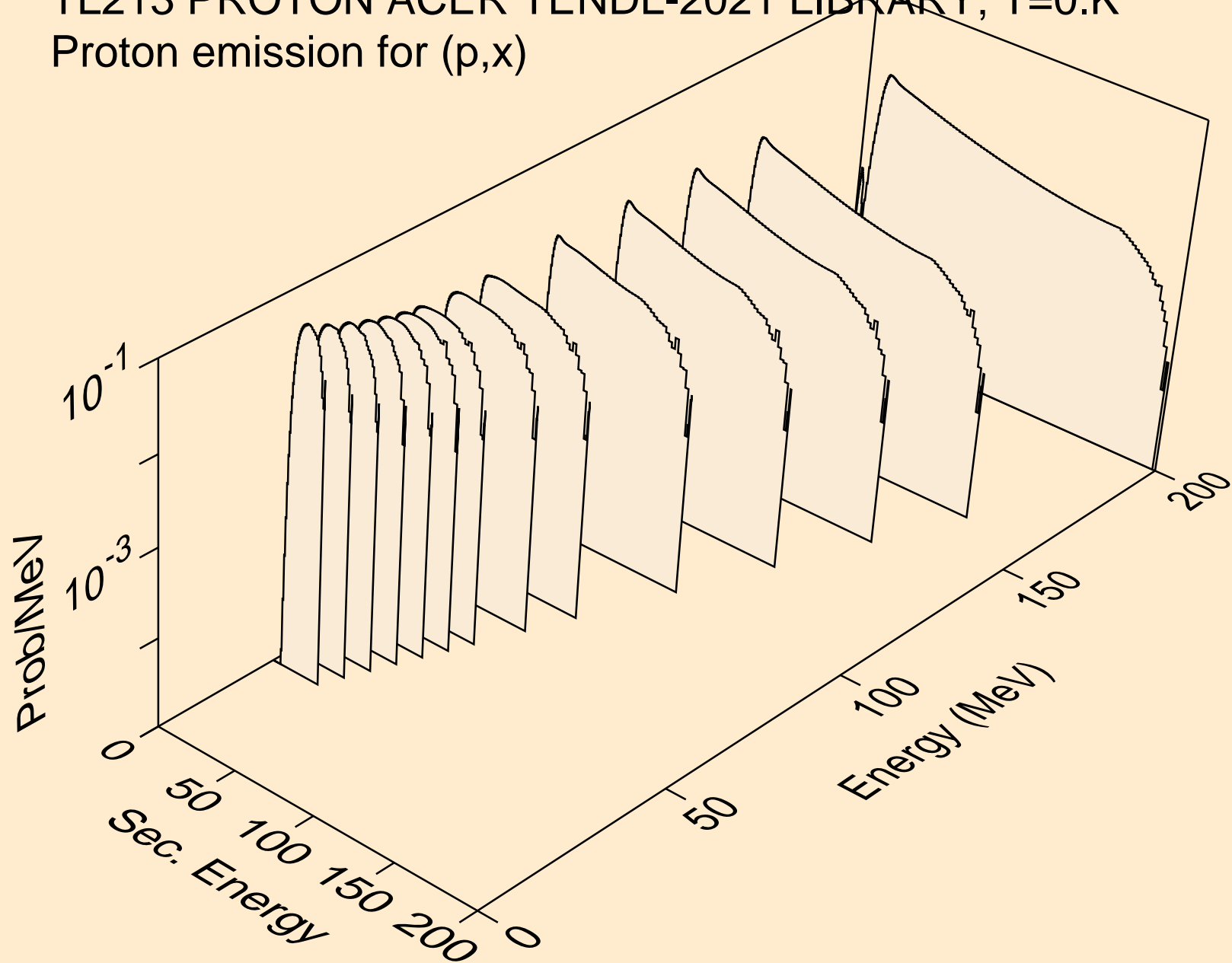

TL213 PROTON ACER TENDL-2021 LIBRARY; T=0.K  
Proton emission for (p,n\*)p

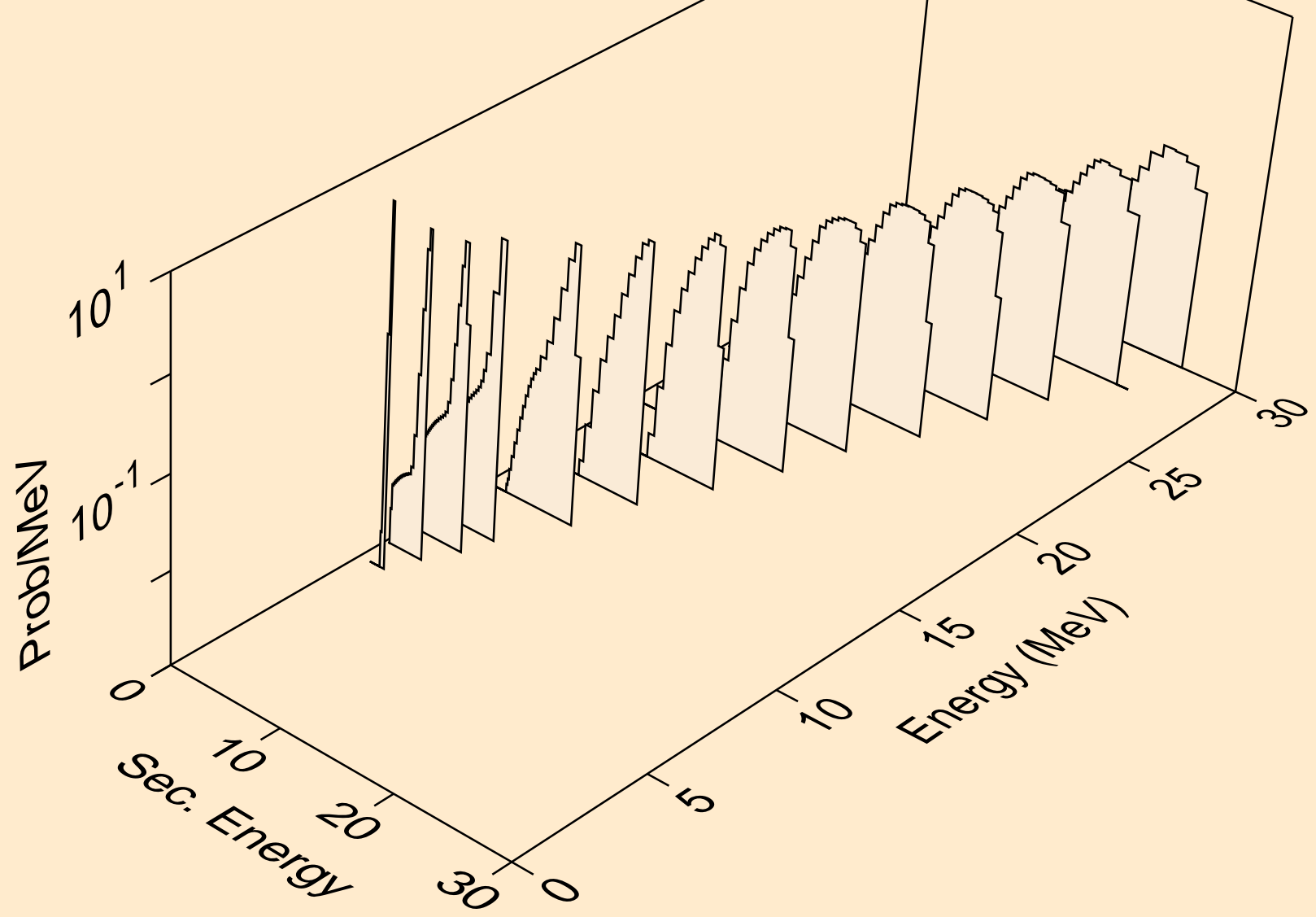

TL213 PROTON ACER TENDL-2021 LIBRARY; T=0.K  
Proton emission for (p,2np)

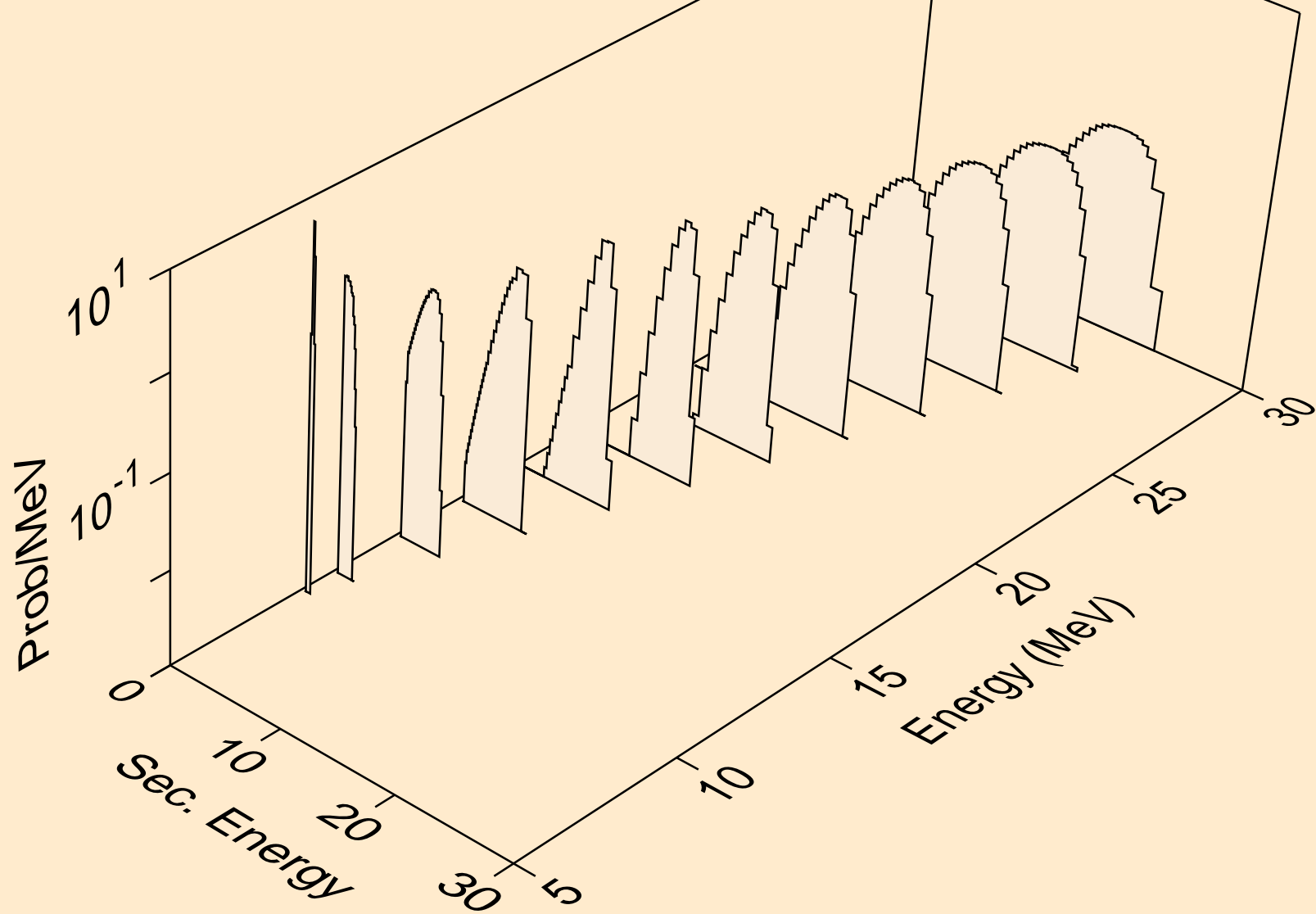

TL213 PROTON ACER TENDL-2021 LIBRARY; T=0.K  
Proton emission for (p,3np)

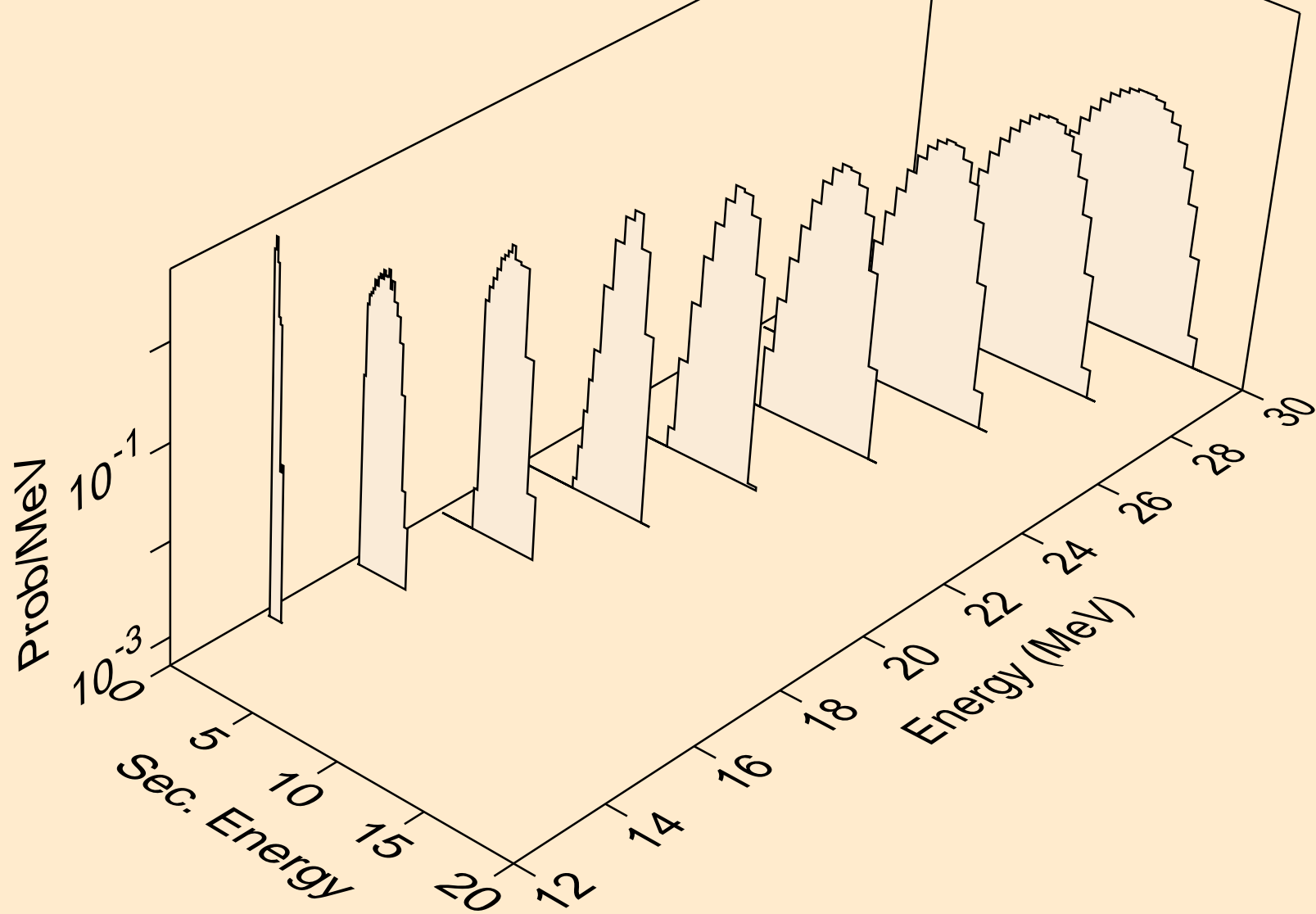

TL213 PROTON ACER TENDL-2021 LIBRARY; T=0.K  
Proton emission for (p,2np)

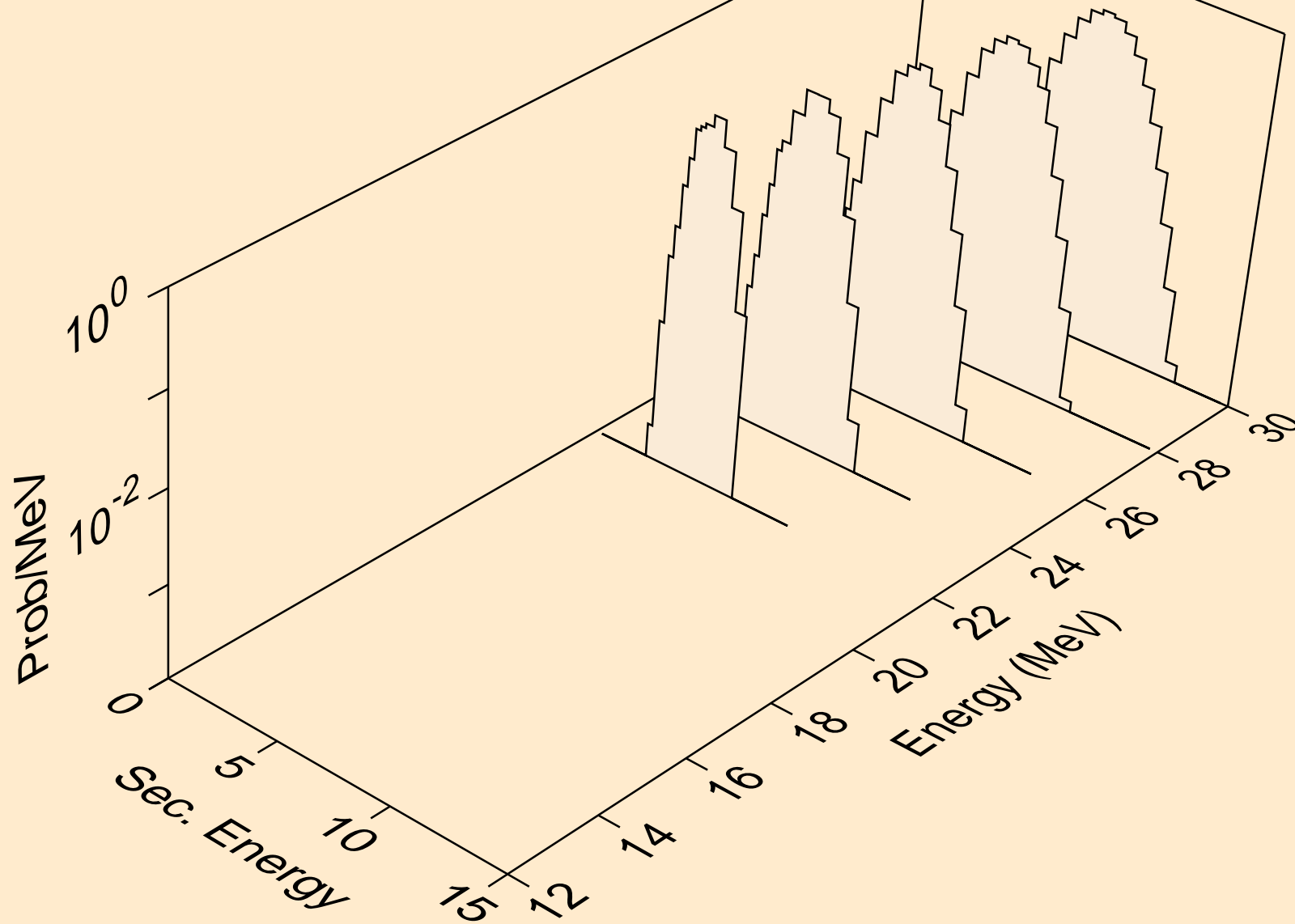

TL213 PROTON ACER TENDL-2021 LIBRARY; T=0.K  
Proton emission for inelastic

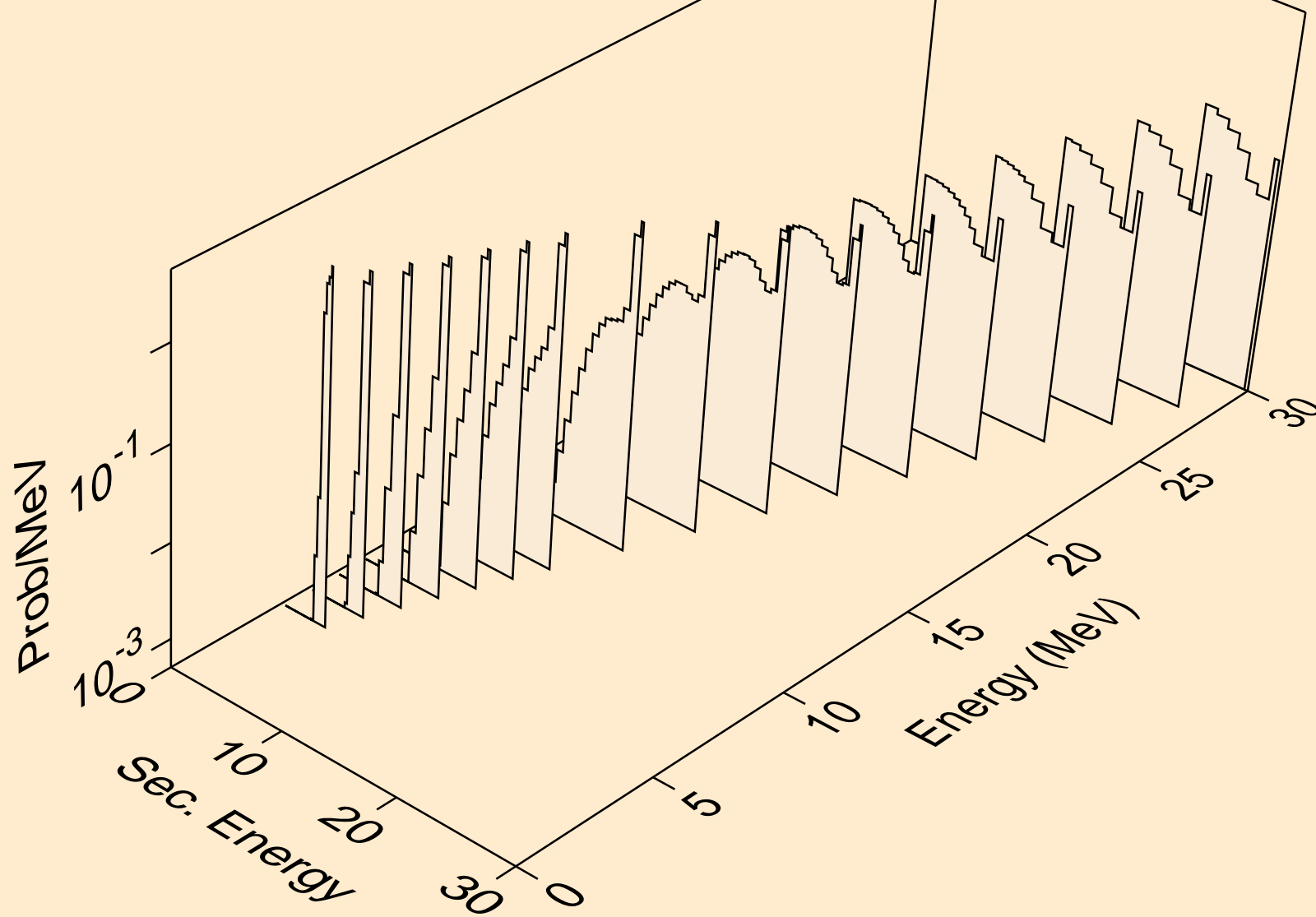



TL213 PROTON ACER TENDL-2021 LIBRARY; T=0.K  
Proton emission for (p,2p)

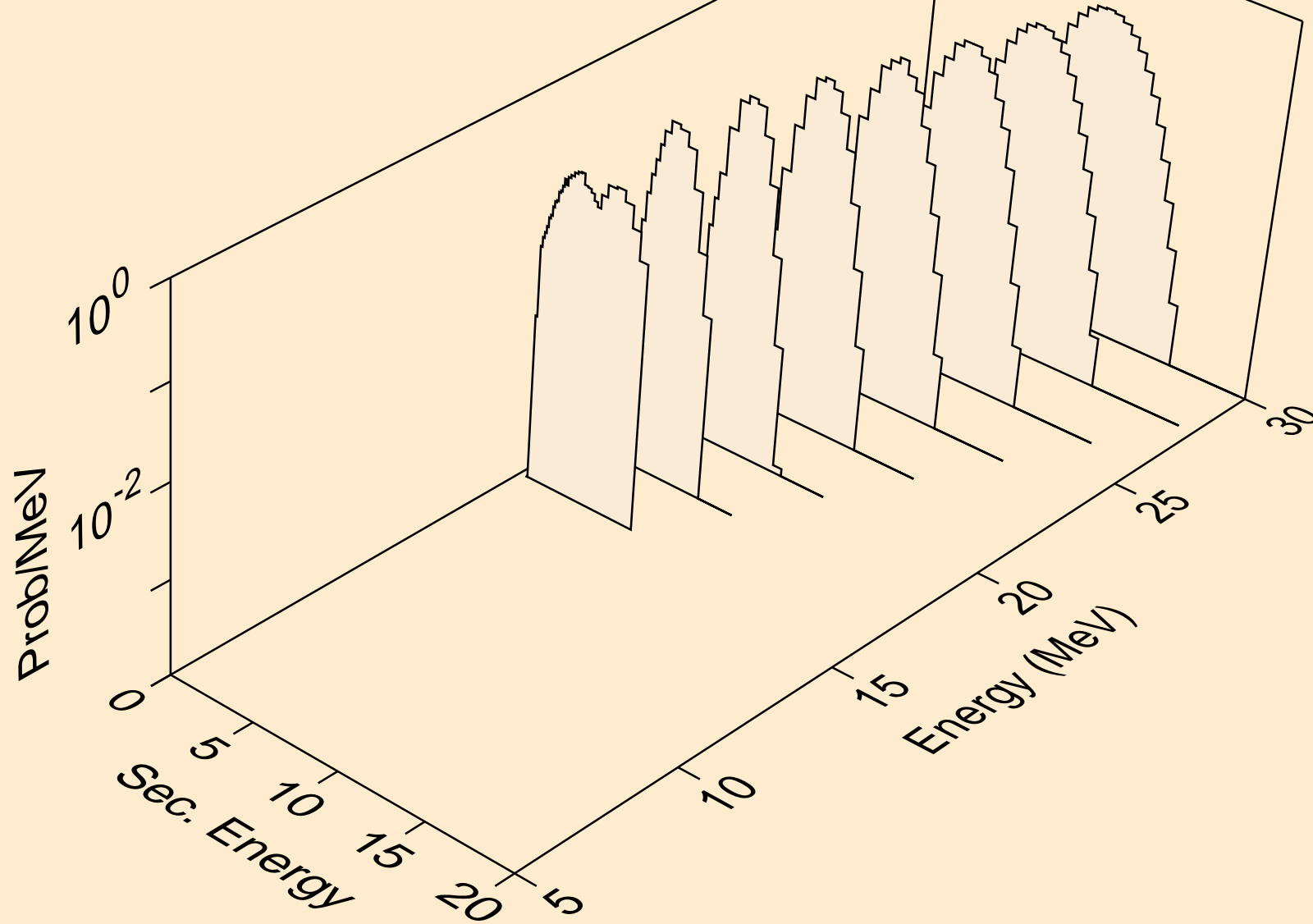

TL213 PROTON ACER TENDL-2021 LIBRARY; T=0.K  
Photon emission for (z,n)

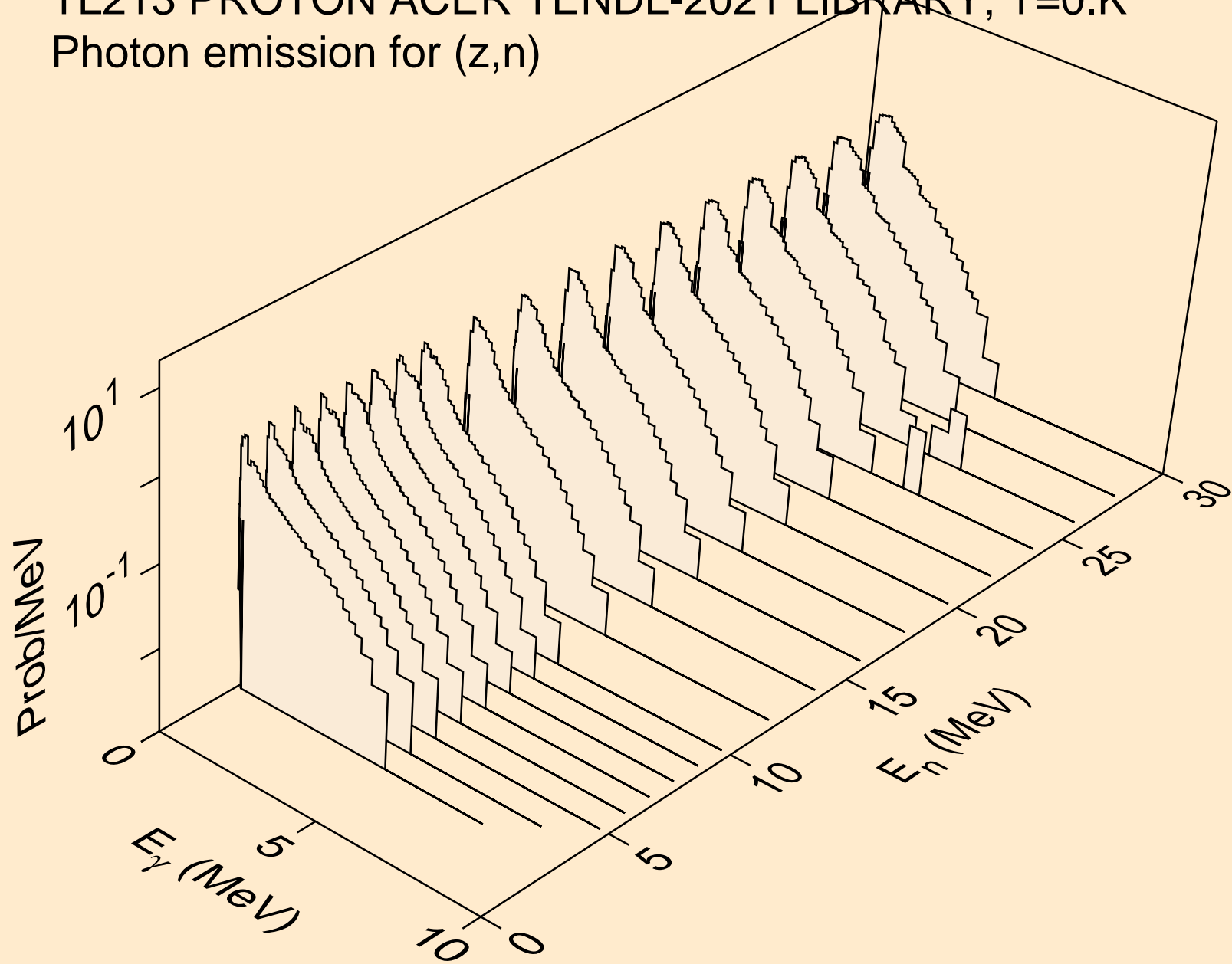

TL213 PROTON ACER TENDL-2021 LIBRARY; T=0.K  
Photon emission for (n,x)

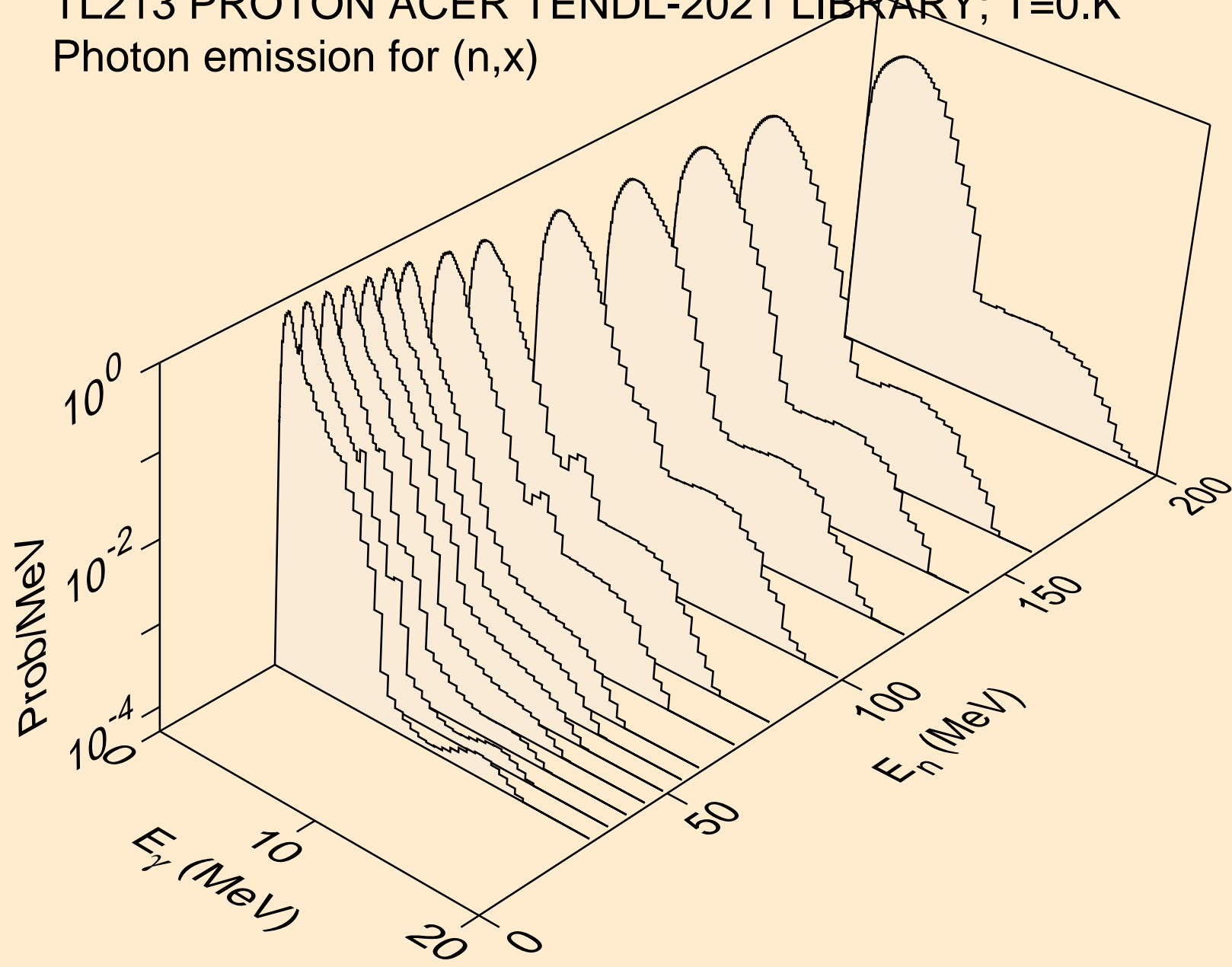

TL213 PROTON ACER TENDL-2021 LIBRARY; T=0.K  
Photon emission for (n,2nd)

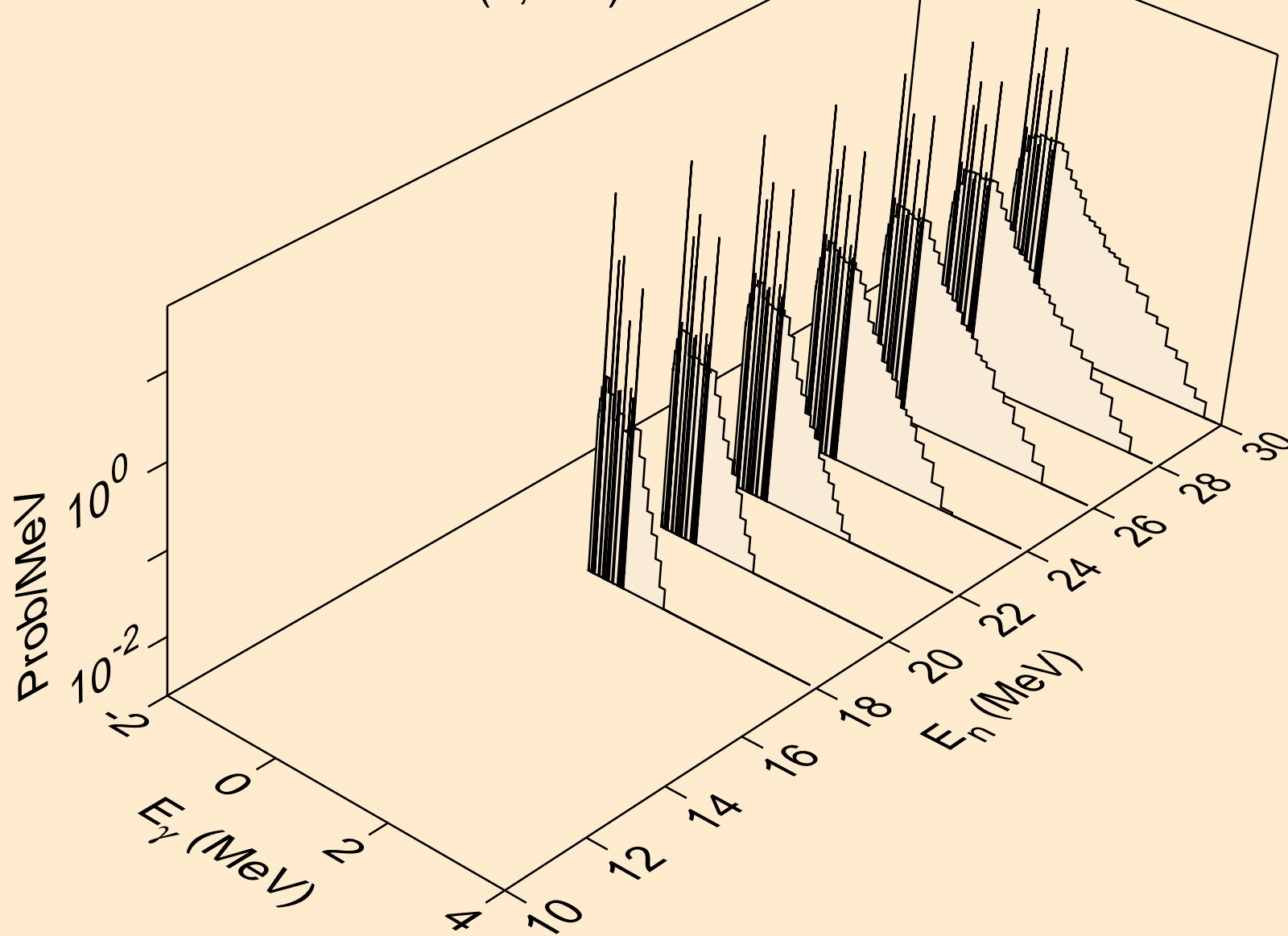

TL213 PROTON ACER TENDL-2021 LIBRARY; T=0.K  
Photon emission for (n,2n)

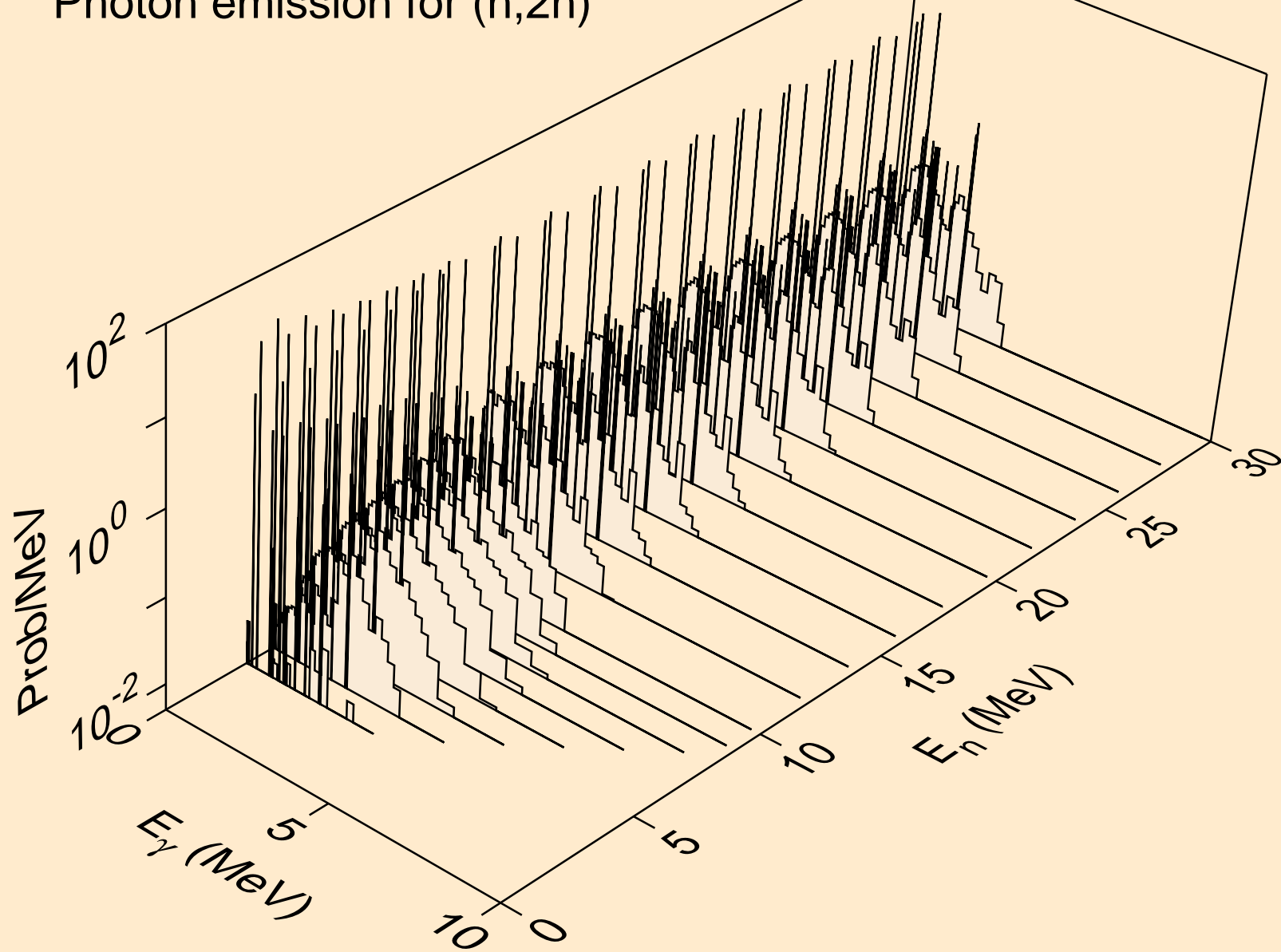

TL213 PROTON ACER TENDL-2021 LIBRARY; T=0.K  
Photon emission for (n,3n)

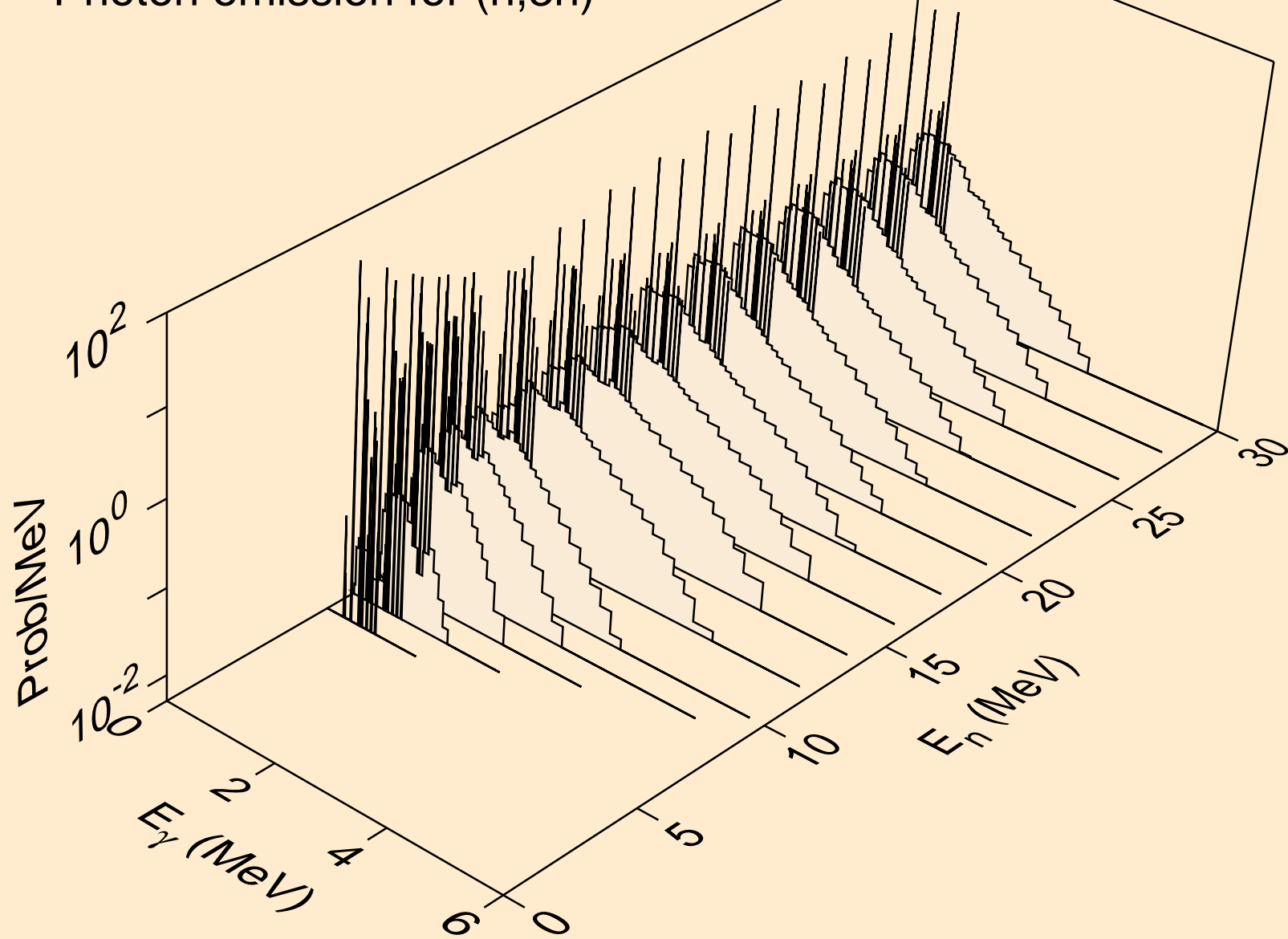

TL213 PROTON ACER TENDL-2021 LIBRARY; T=0.K  
Photon emission for (n,n\*)a

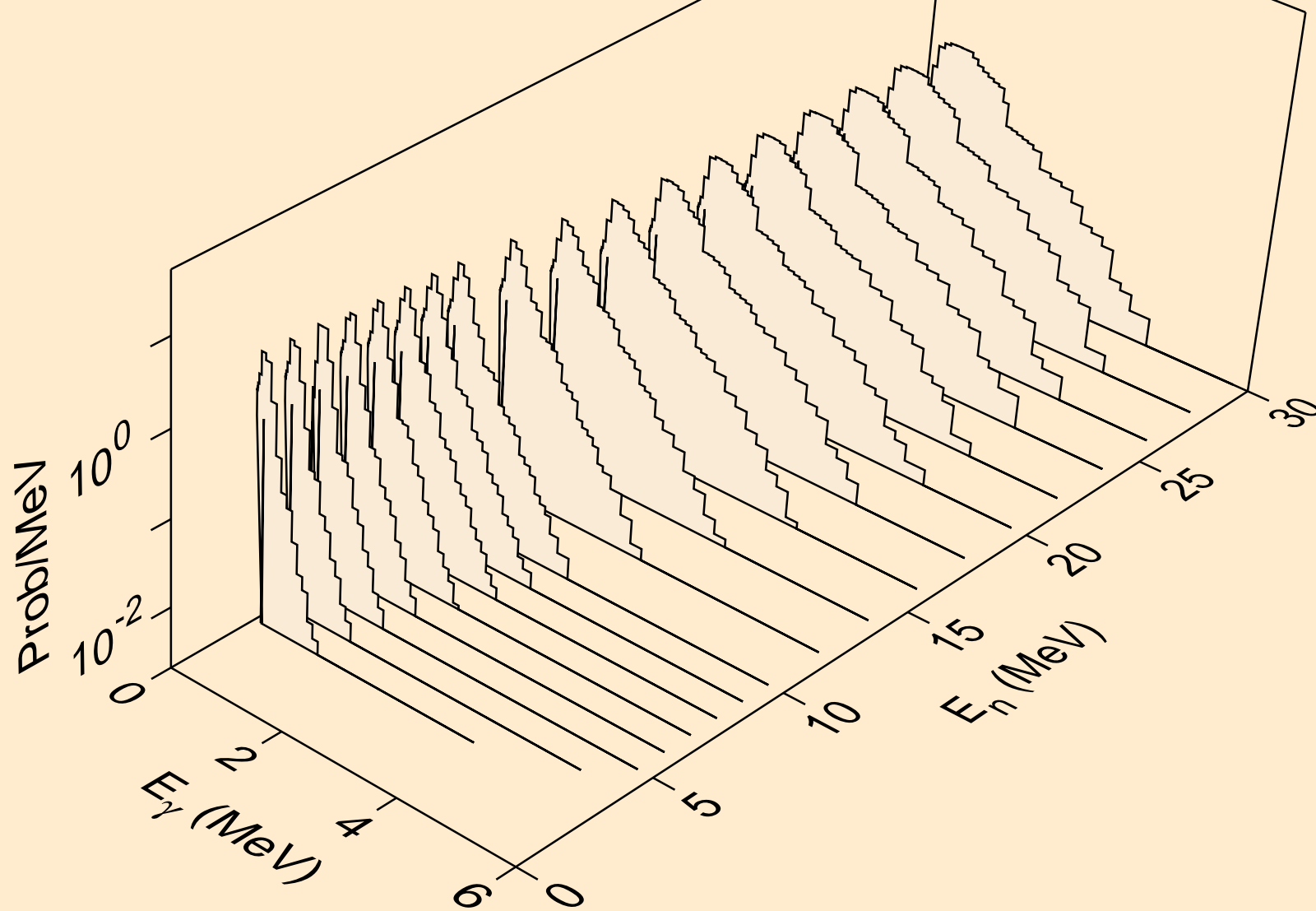

TL213 PROTON ACER TENDL-2021 LIBRARY; T=0.K  
Photon emission for (n,2n)a

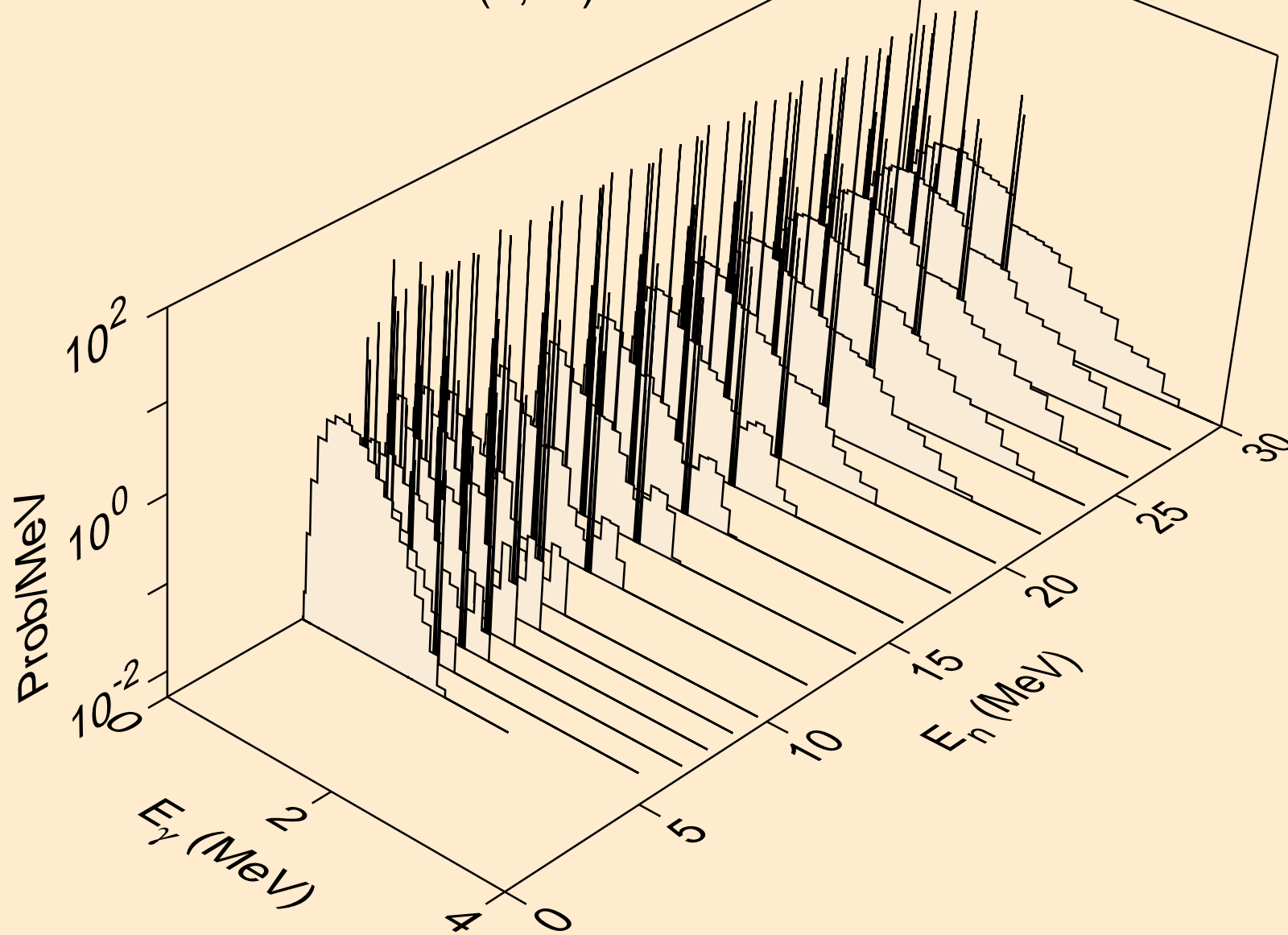



TL213 PROTON ACER TENDL-2021 LIBRARY; T=0.K  
Photon emission for (n,3n)a

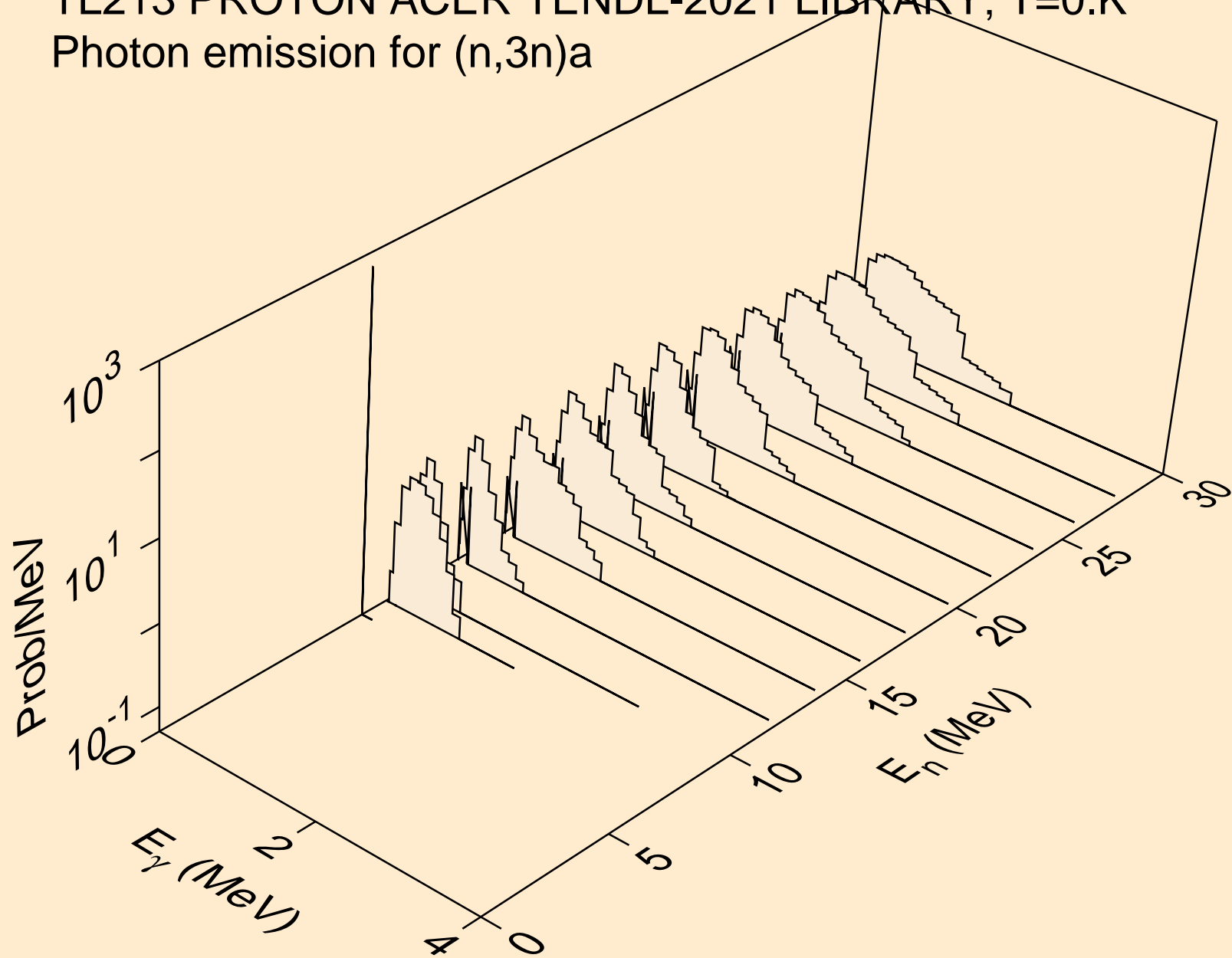

TL213 PROTON ACER TENDL-2021 LIBRARY; T=0.K  
Photon emission for (n,n\*)p

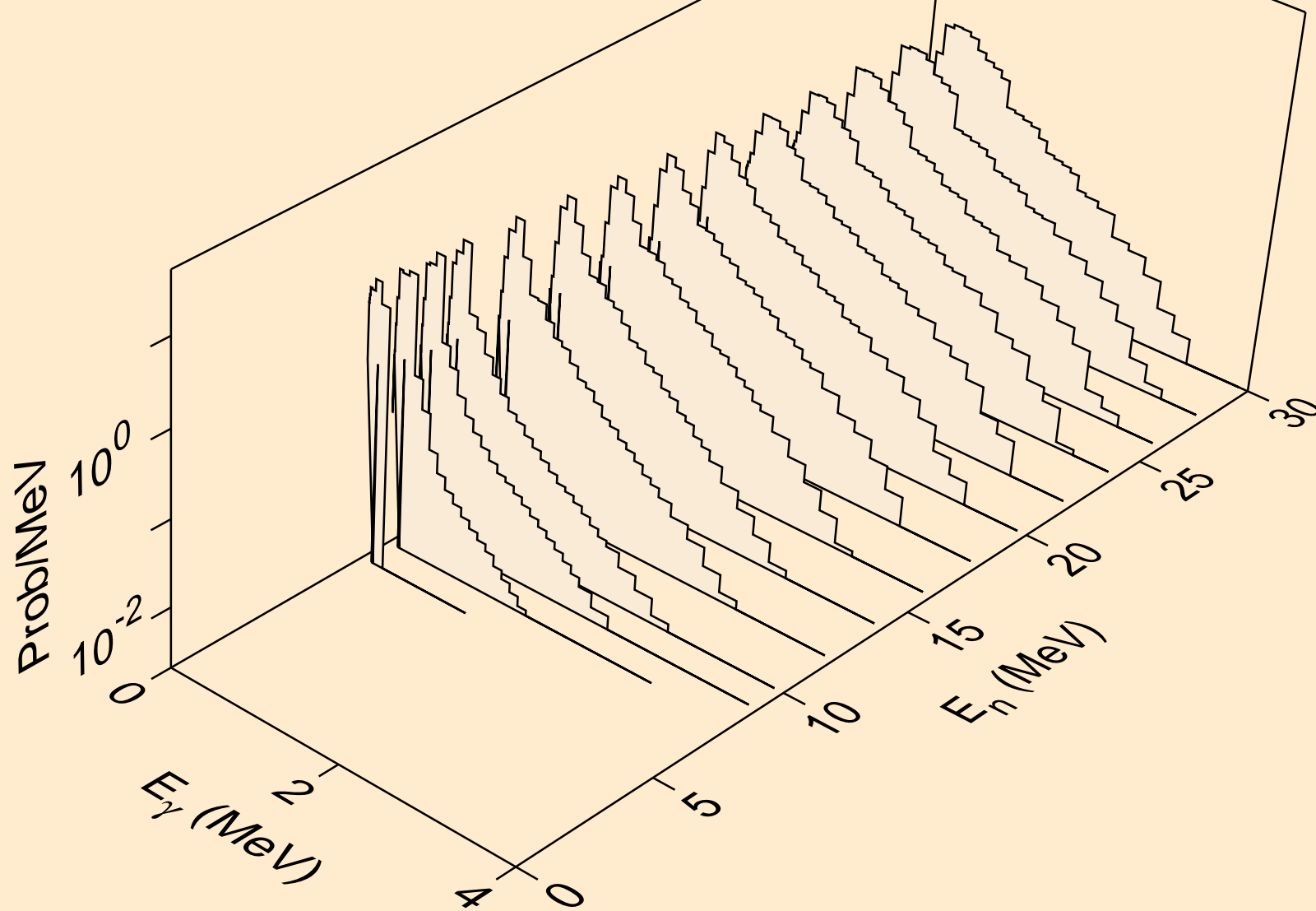

TL213 PROTON ACER TENDL-2021 LIBRARY; T=0.K  
Photon emission for (n,n\*)d

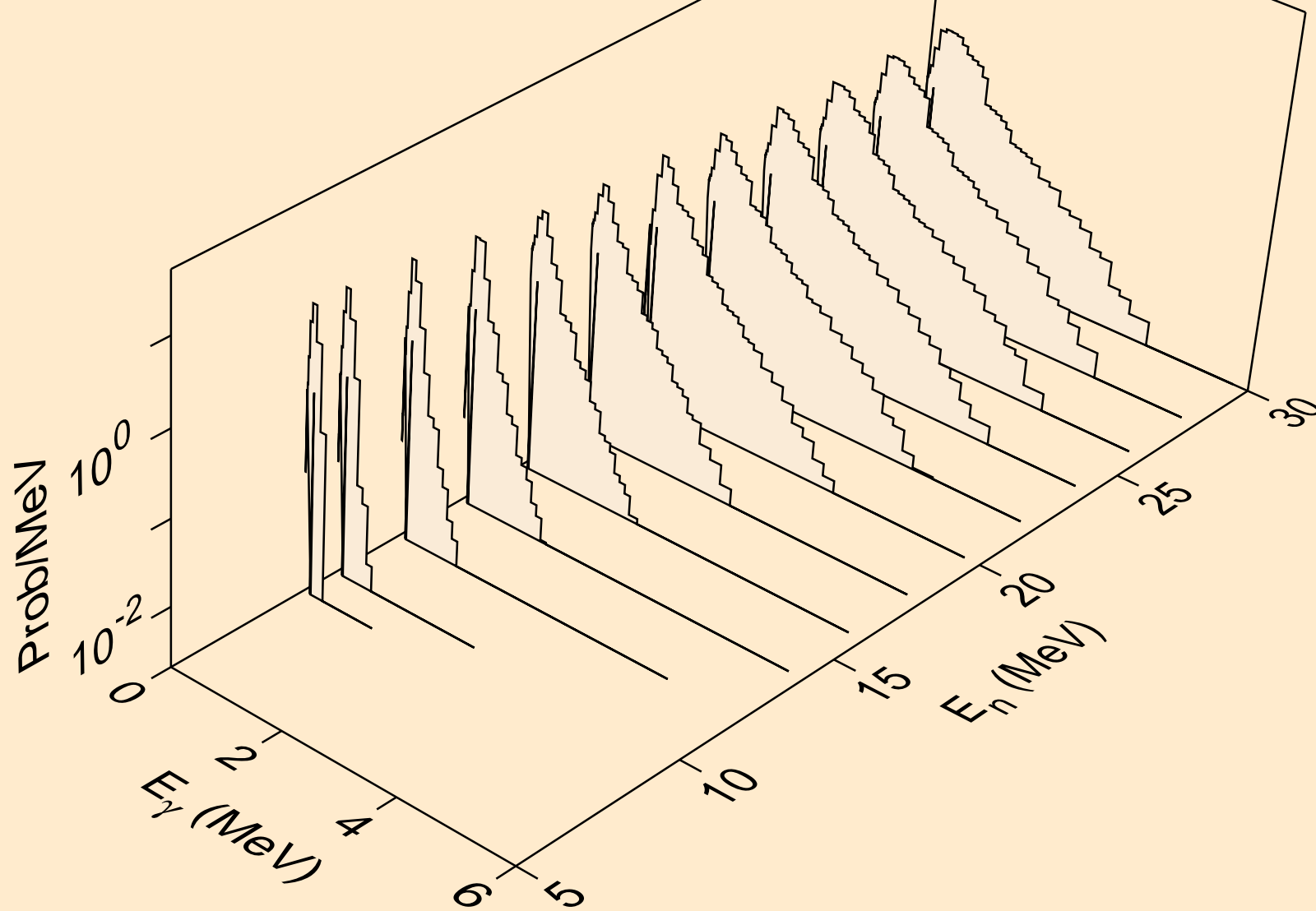

TL213 PROTON ACER TENDL-2021 LIBRARY; T=0.K  
Photon emission for (n,n\*)t

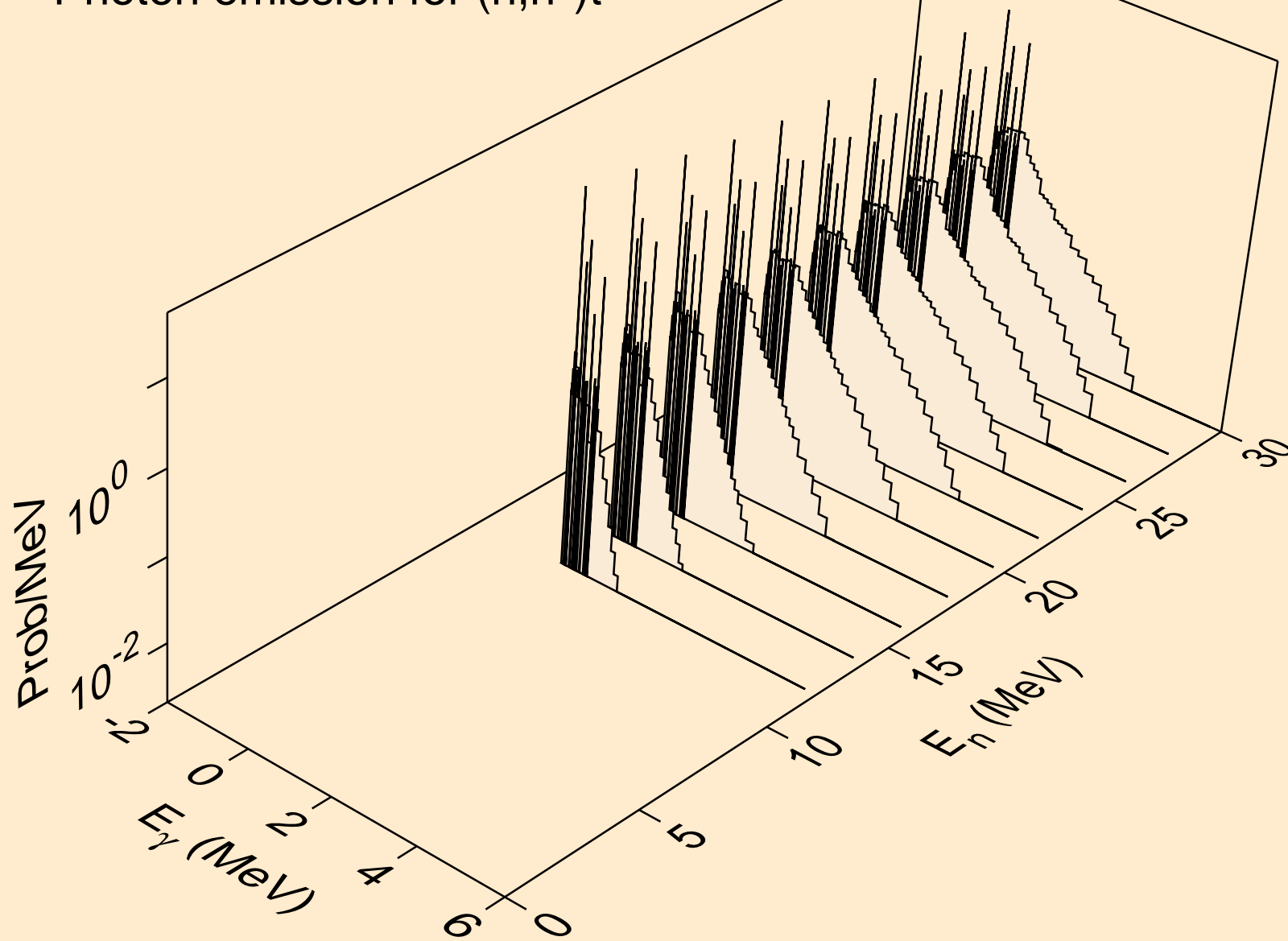

TL213 PROTON ACER TENDL-2021 LIBRARY; T=0.K  
Photon emission for (n,n\*)he3

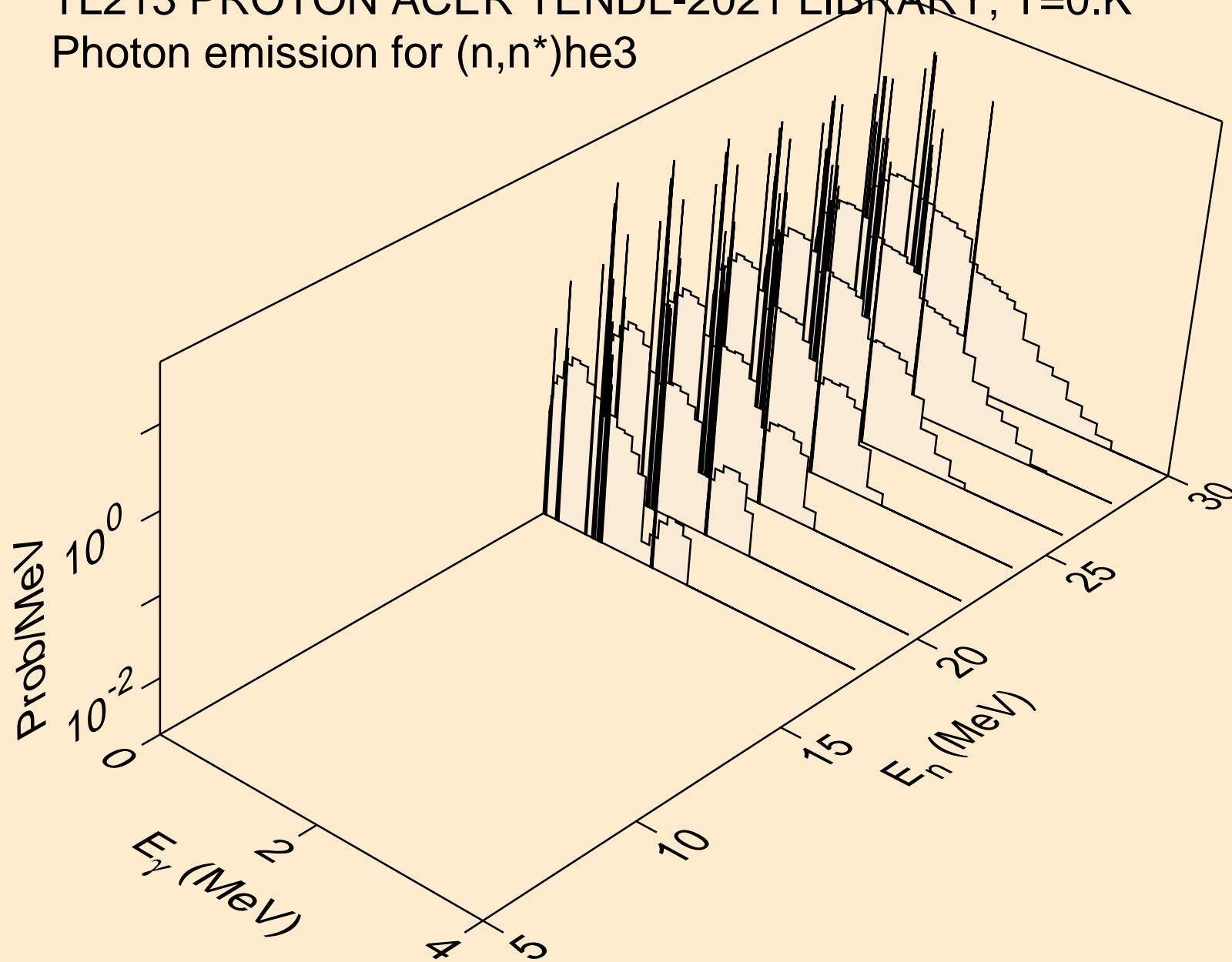

TL213 PROTON ACER TENDL-2021 LIBRARY; T=0.K  
Photon emission for (n,4n)

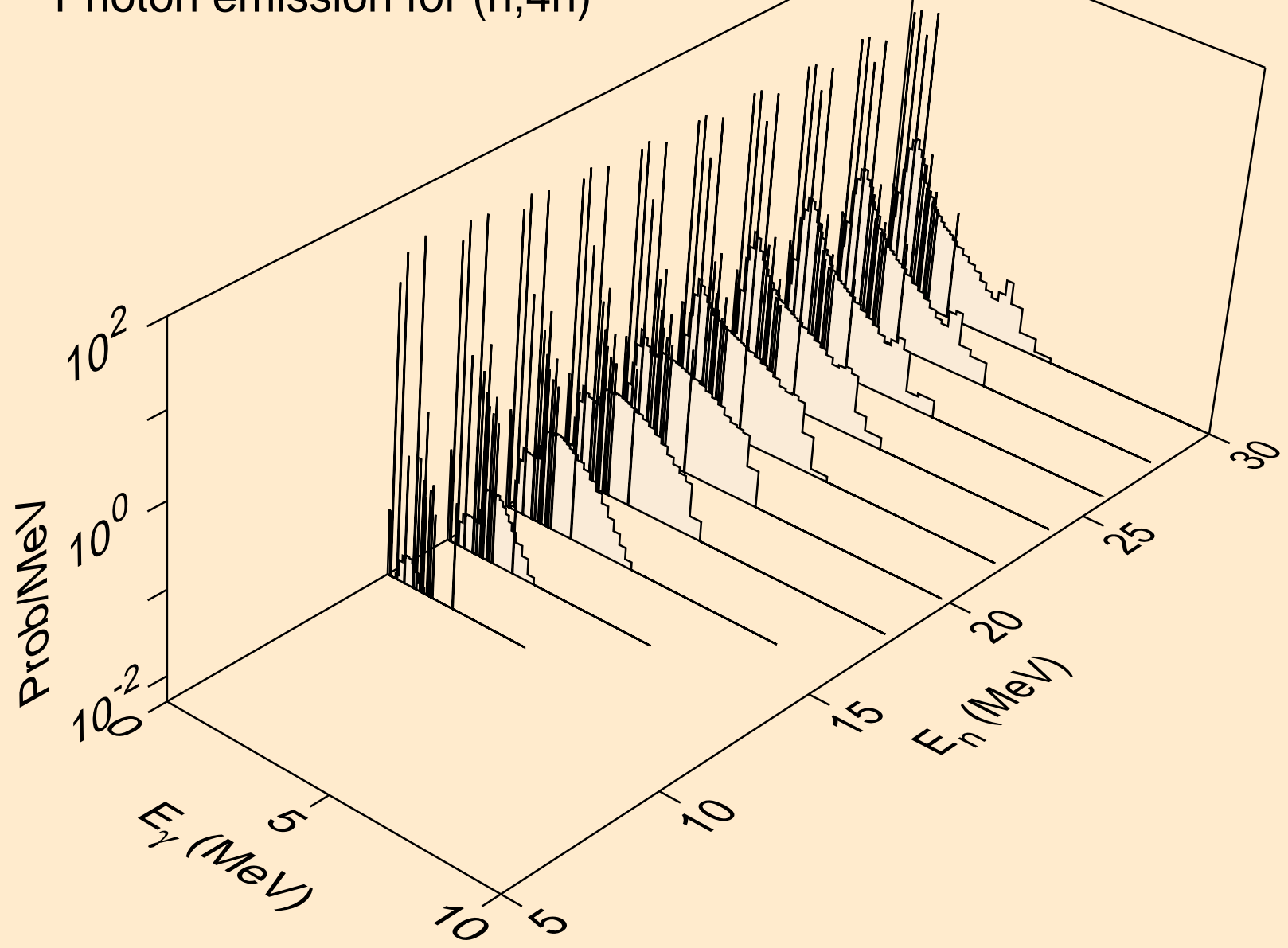

TL213 PROTON ACER TENDL-2021 LIBRARY; T=0.K  
Photon emission for (n,2np)

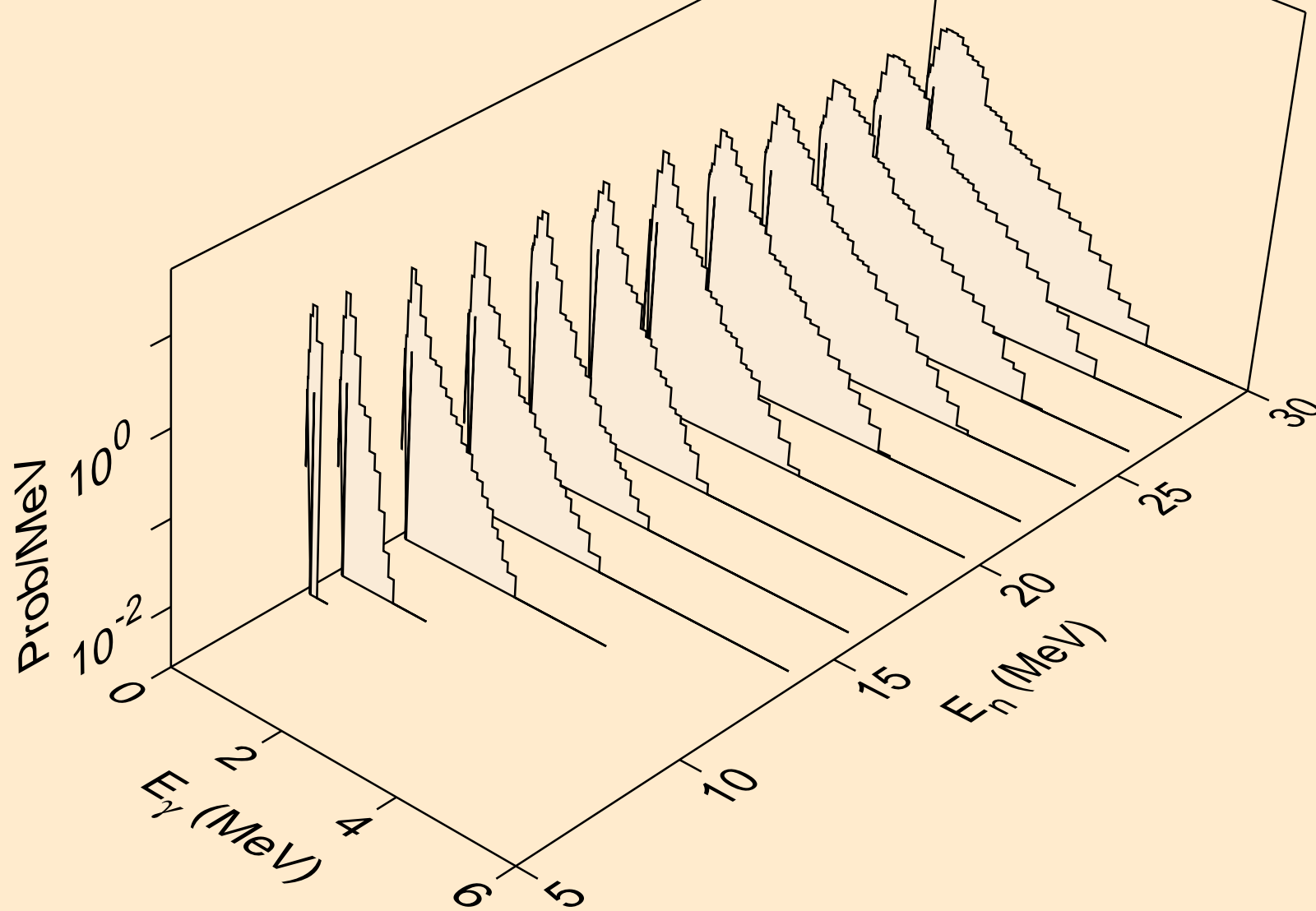

TL213 PROTON ACER TENDL-2021 LIBRARY; T=0.K  
Photon emission for (n,3np)

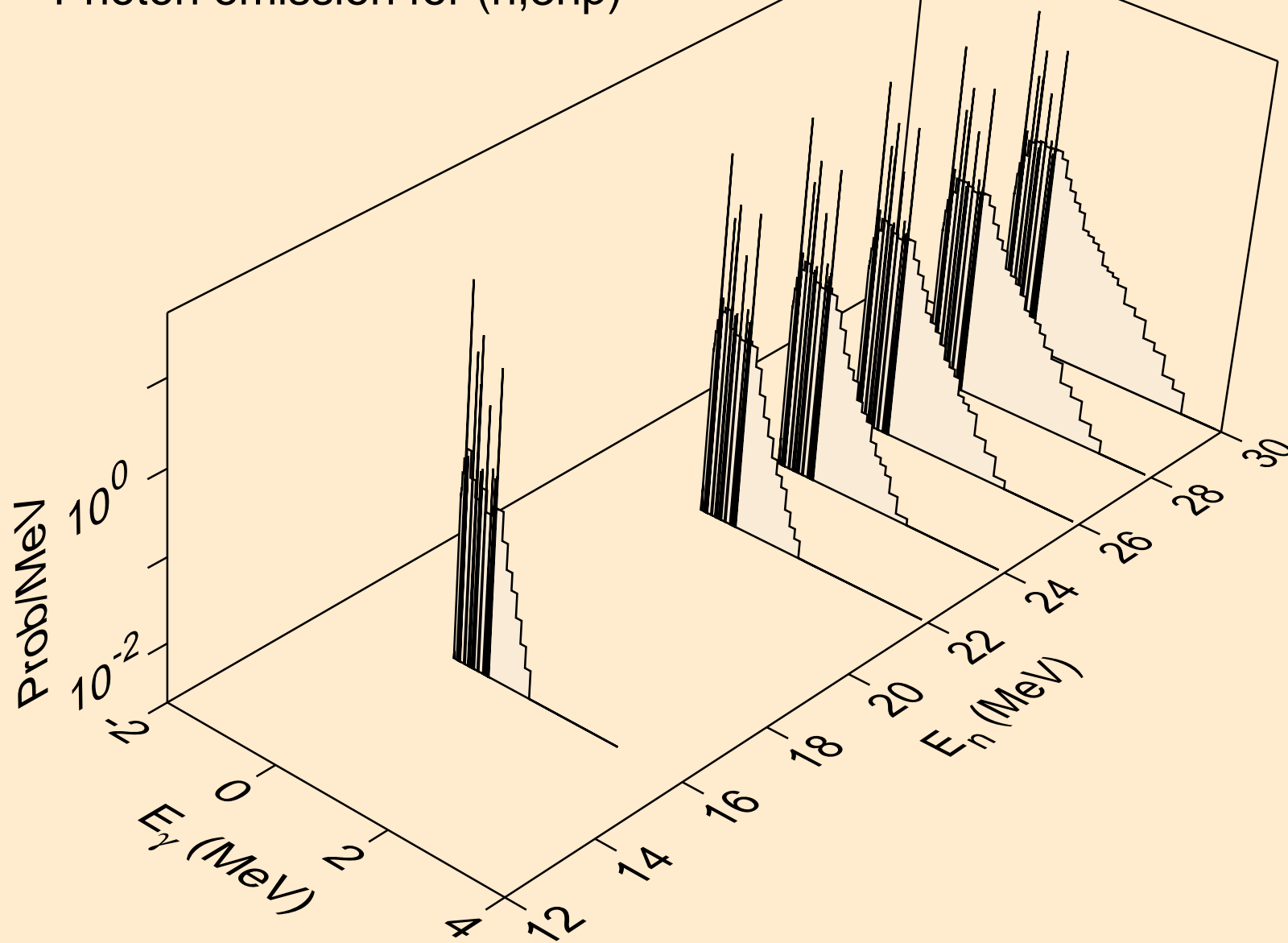



TL213 PROTON ACER TENDL-2021 LIBRARY; T=0.K  
Photon emission for (n,2np)

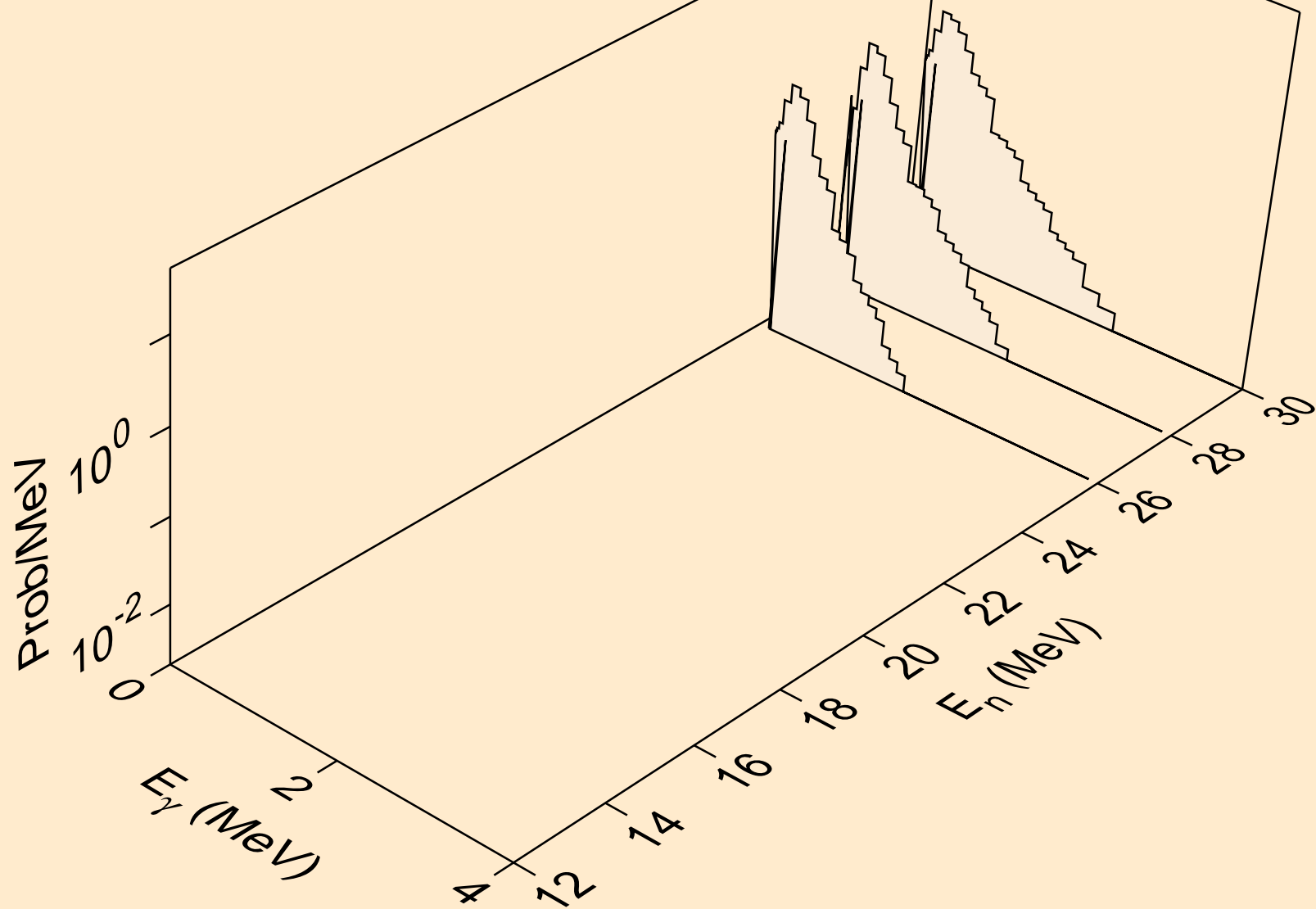

TL213 PROTON ACER TENDL-2021 LIBRARY; T=0.K  
Photon emission for (n,gma)

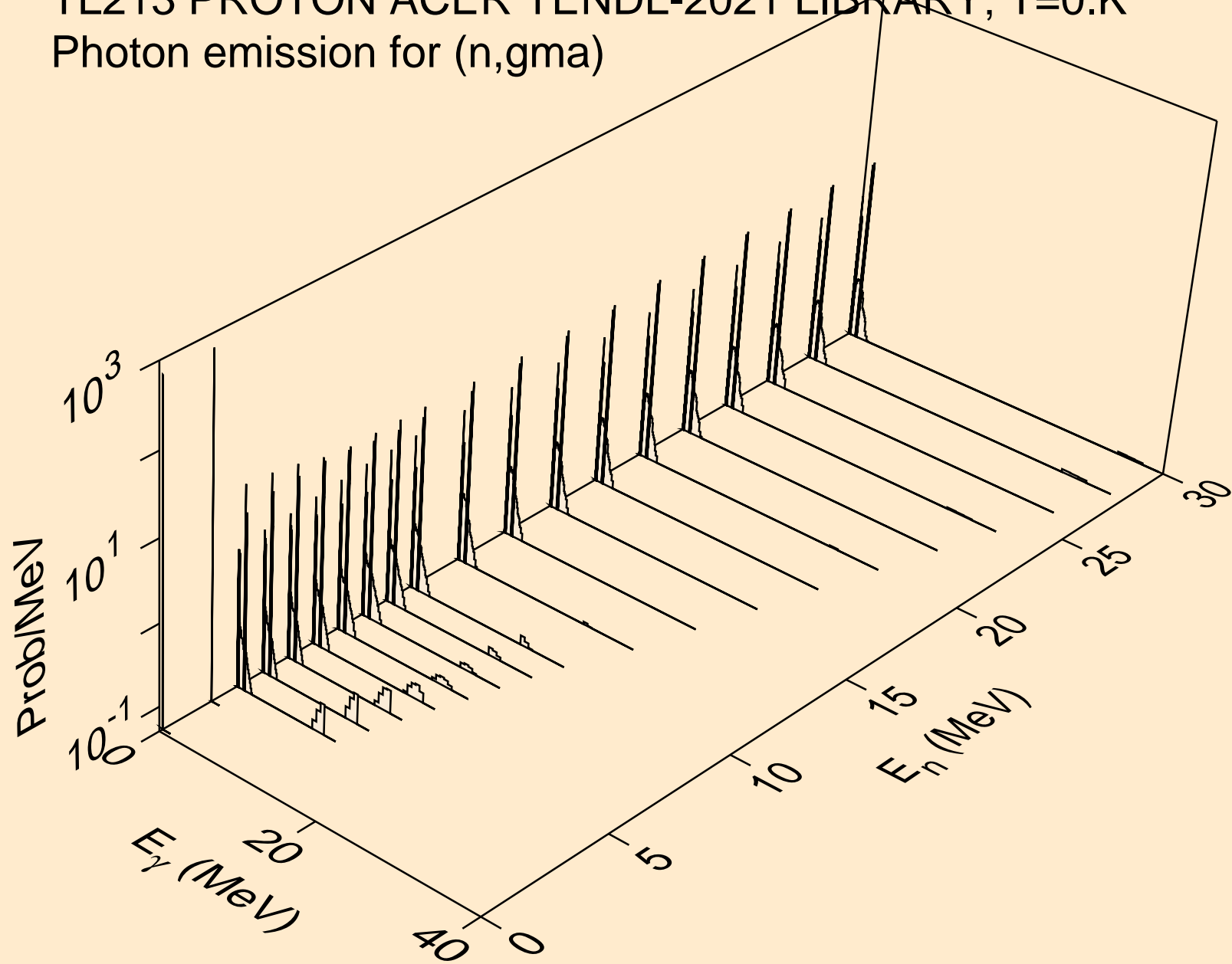

TL213 PROTON ACER TENDL-2021 LIBRARY; T=0.K  
Photon emission for inelastic

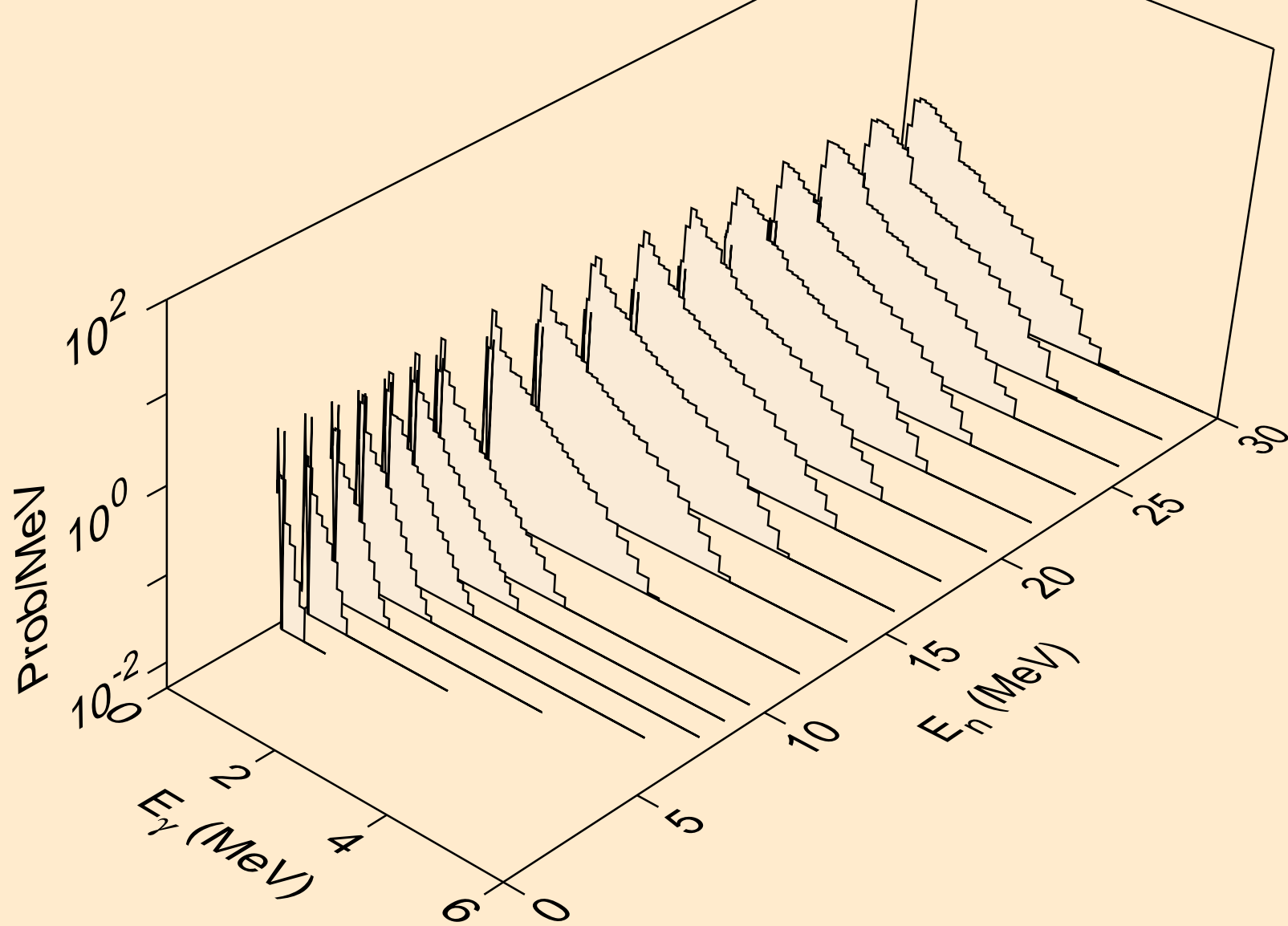

TL213 PROTON ACER TENDL-2021 LIBRARY; T=0.K  
Photon emission for (n,d)

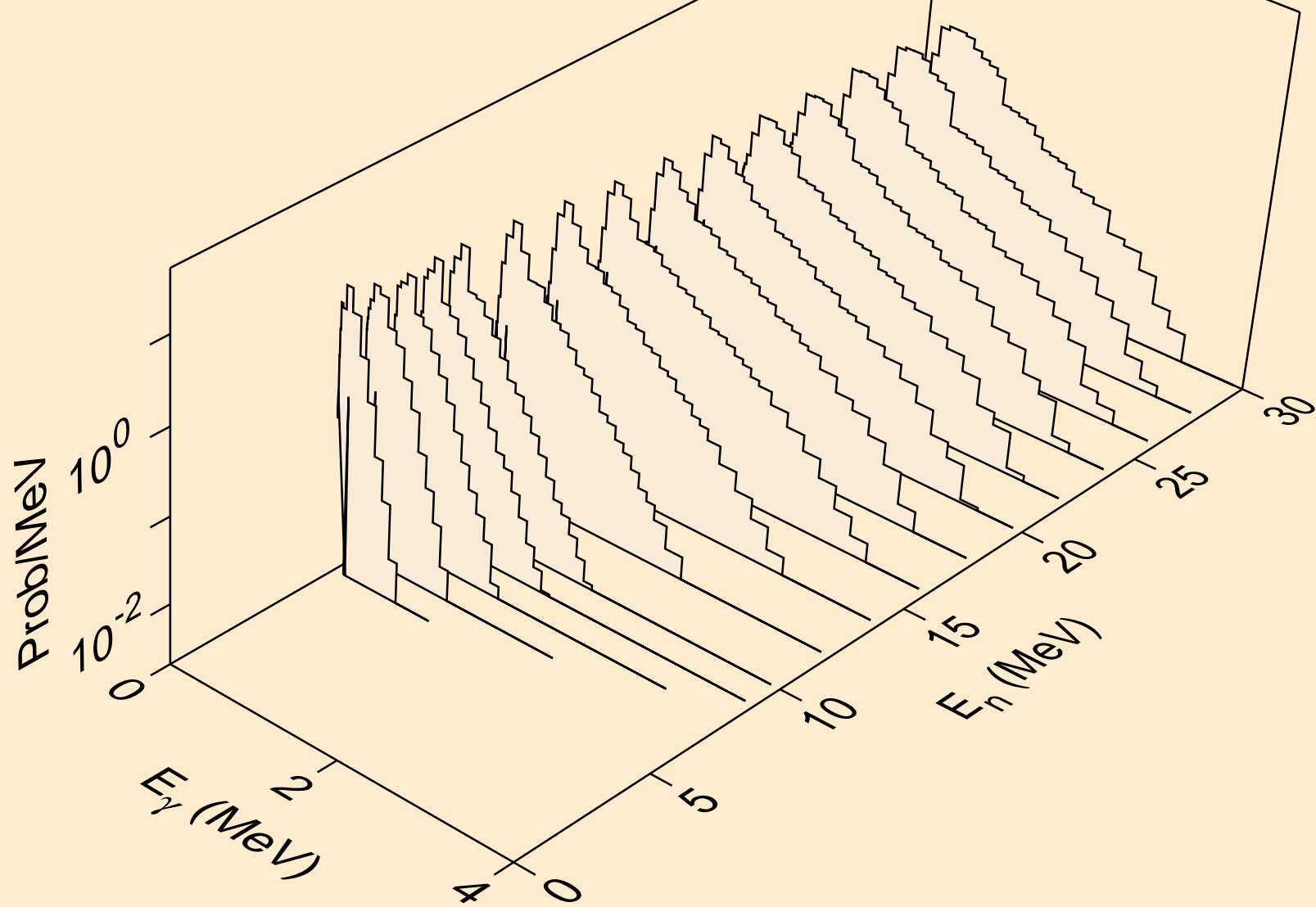

TL213 PROTON ACER TENDL-2021 LIBRARY; T=0.K  
Photon emission for (n,t)

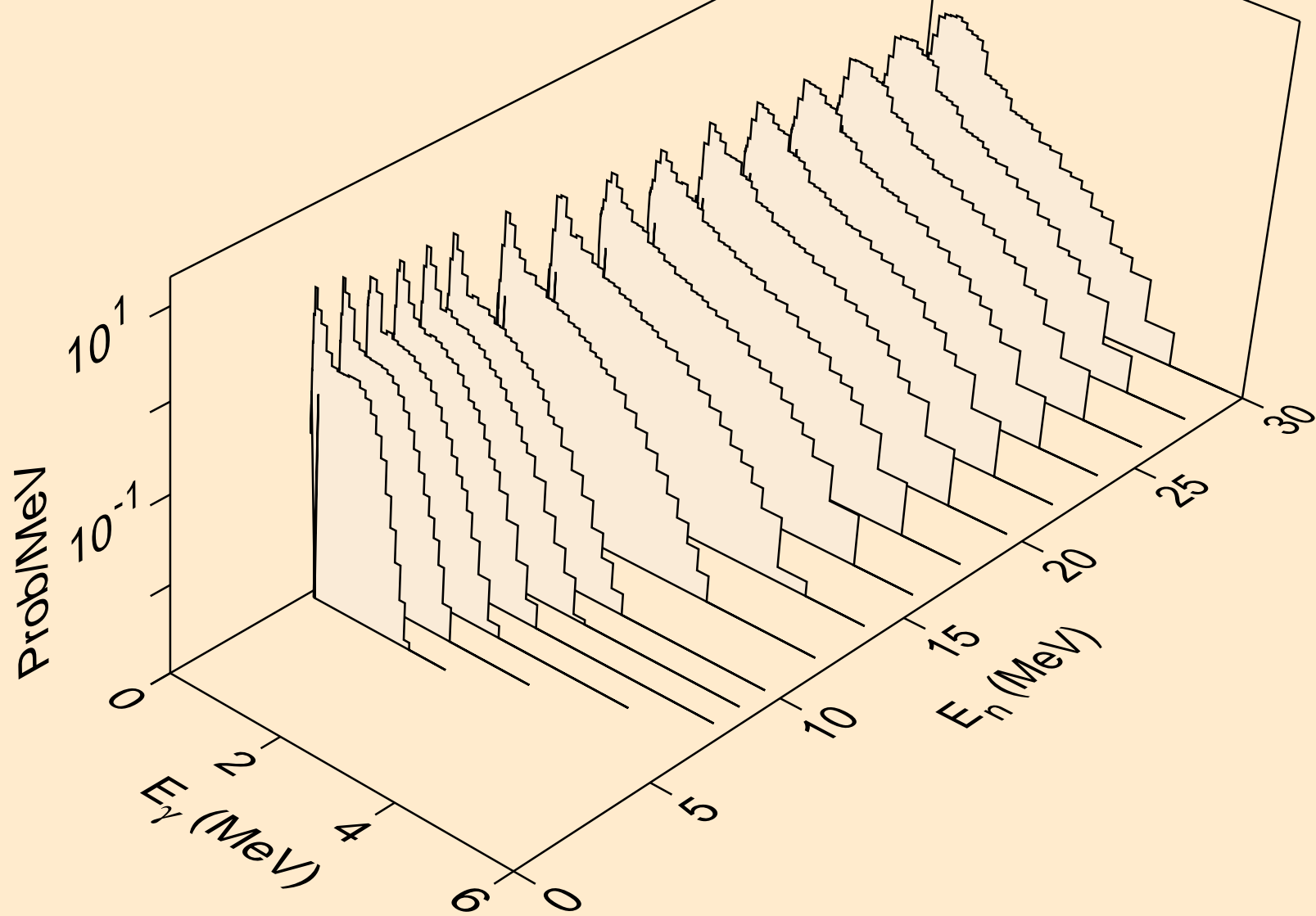

TL213 PROTON ACER TENDL-2021 LIBRARY; T=0.K  
Photon emission for (n,he3)

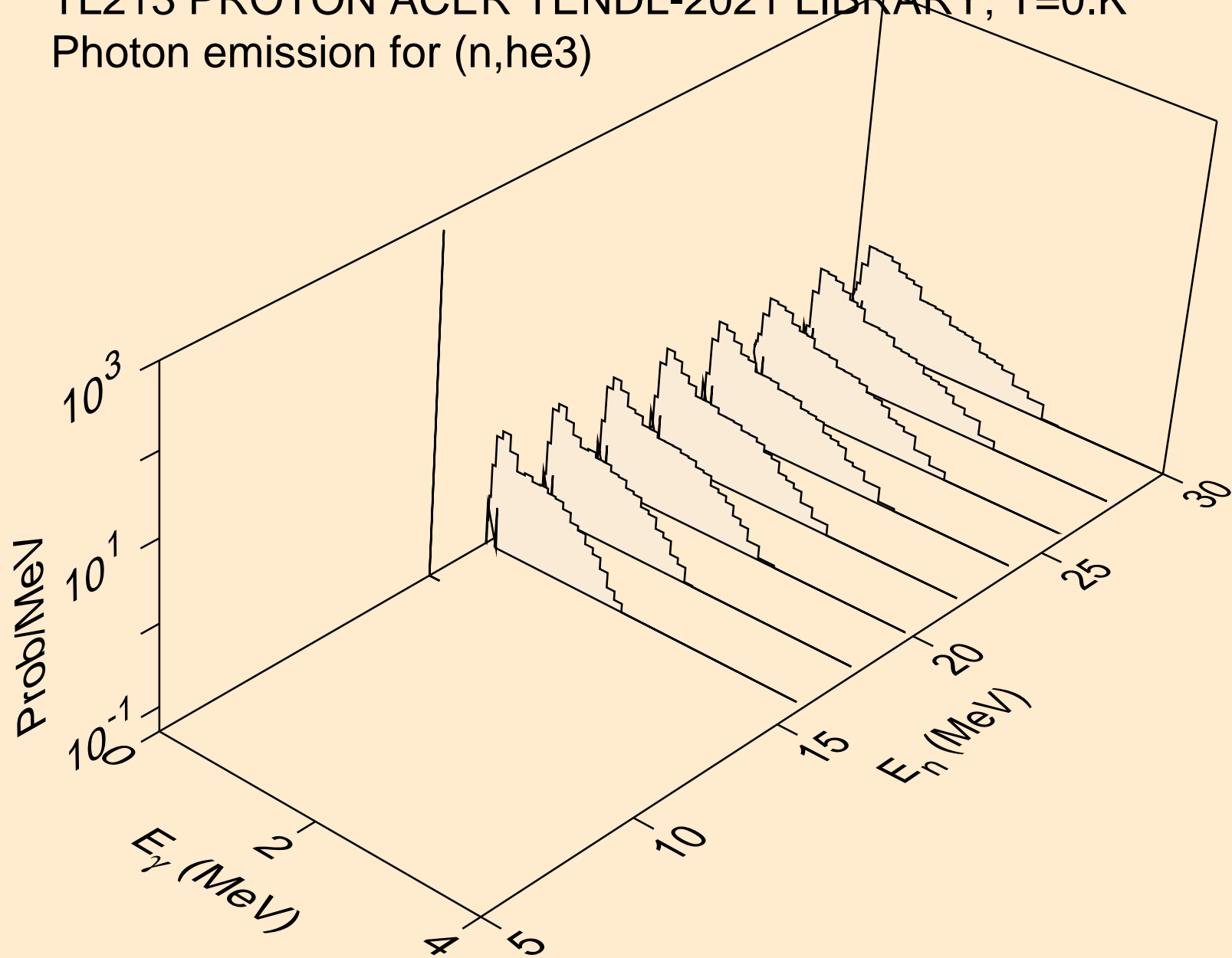

TL213 PROTON ACER TENDL-2021 LIBRARY; T=0.K  
Photon emission for (n,a)

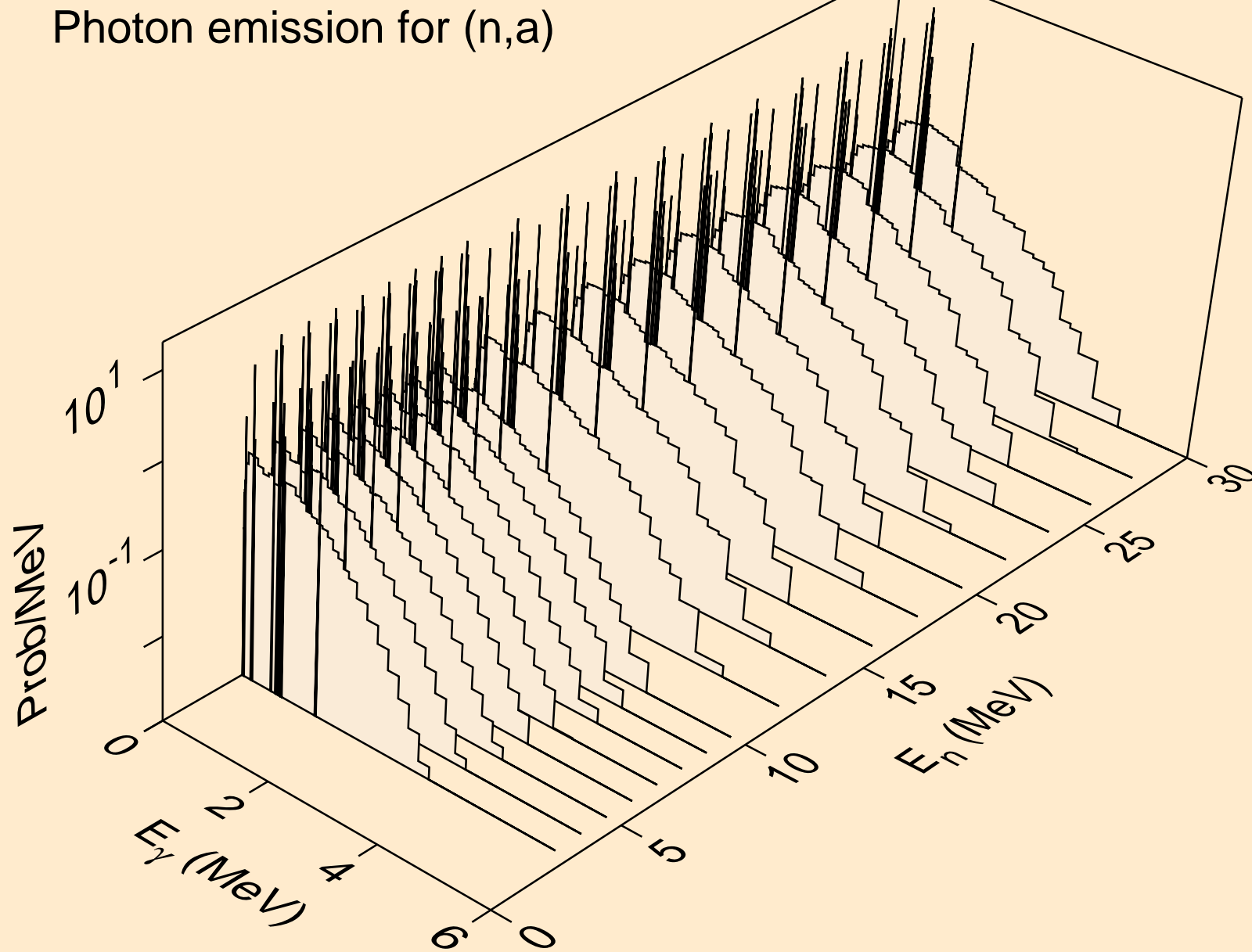

TL213 PROTON ACER TENDL-2021 LIBRARY; T=0.K  
Photon emission for (n,2p)

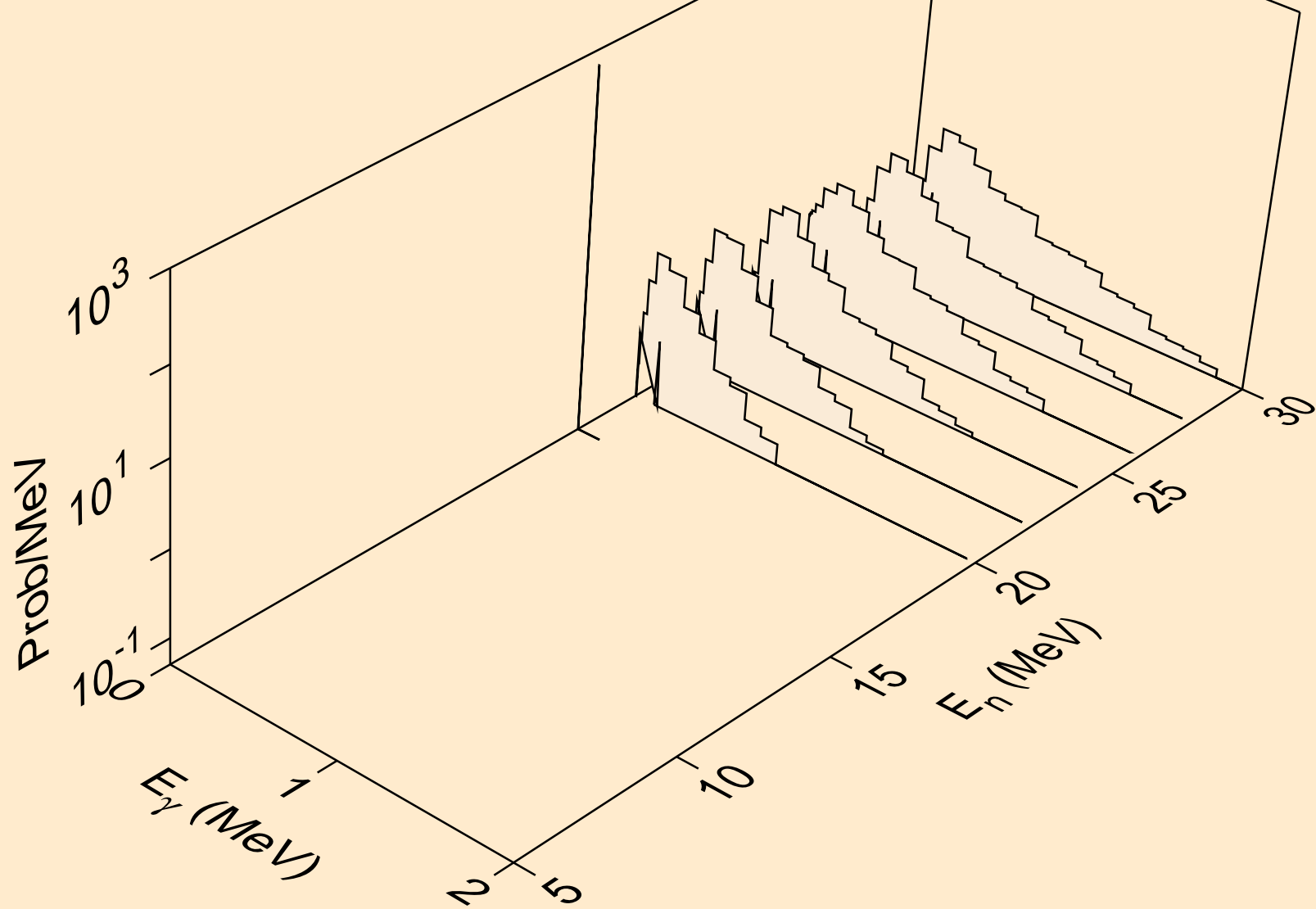



# TL213 PROTON ACER TENDL-2021 LIBRARY; T=0.K

## Particle heating contributions

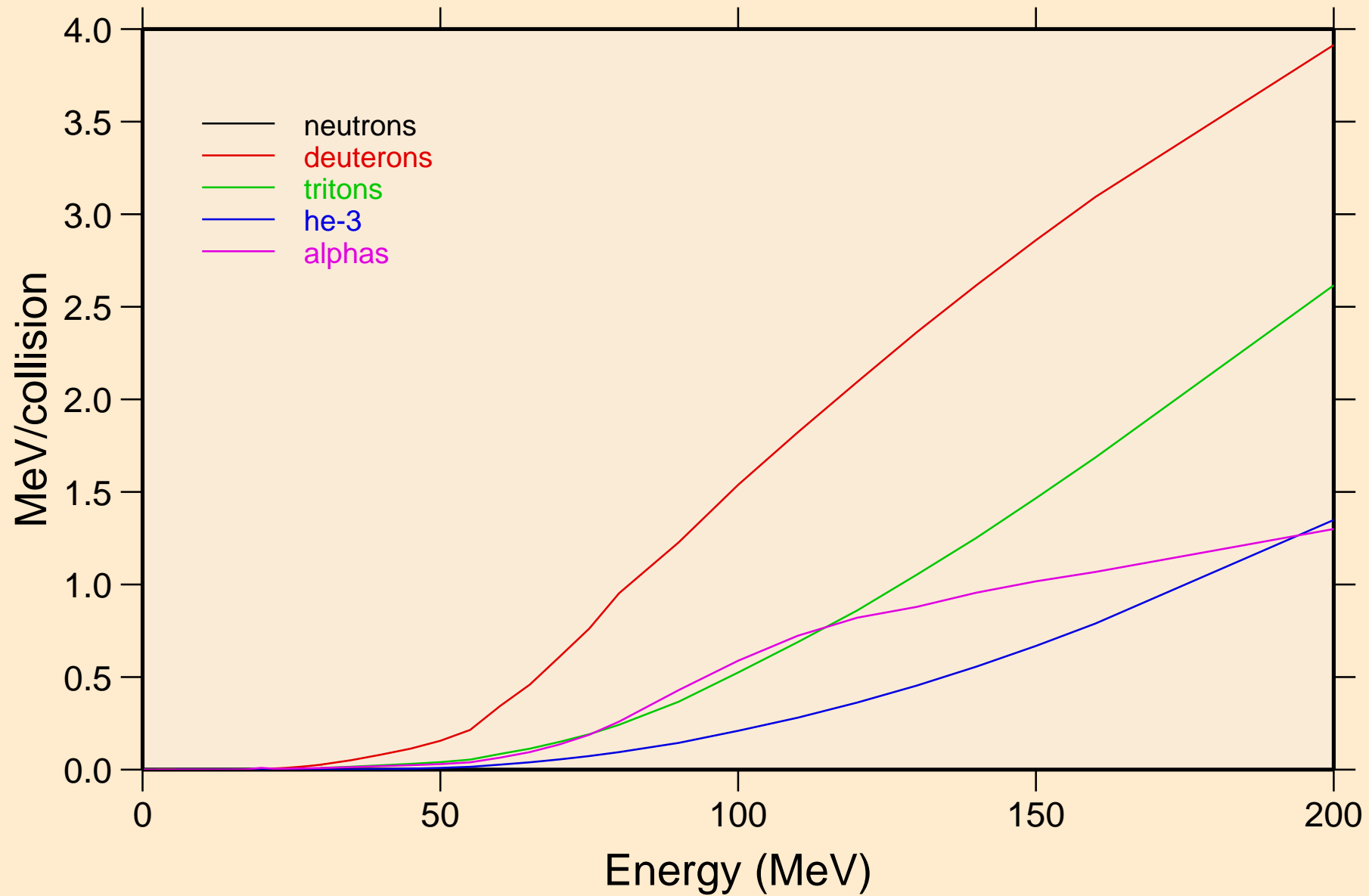

TL213 PROTON ACER TENDL-2021 LIBRARY; T=0.K  
Recoil Heating

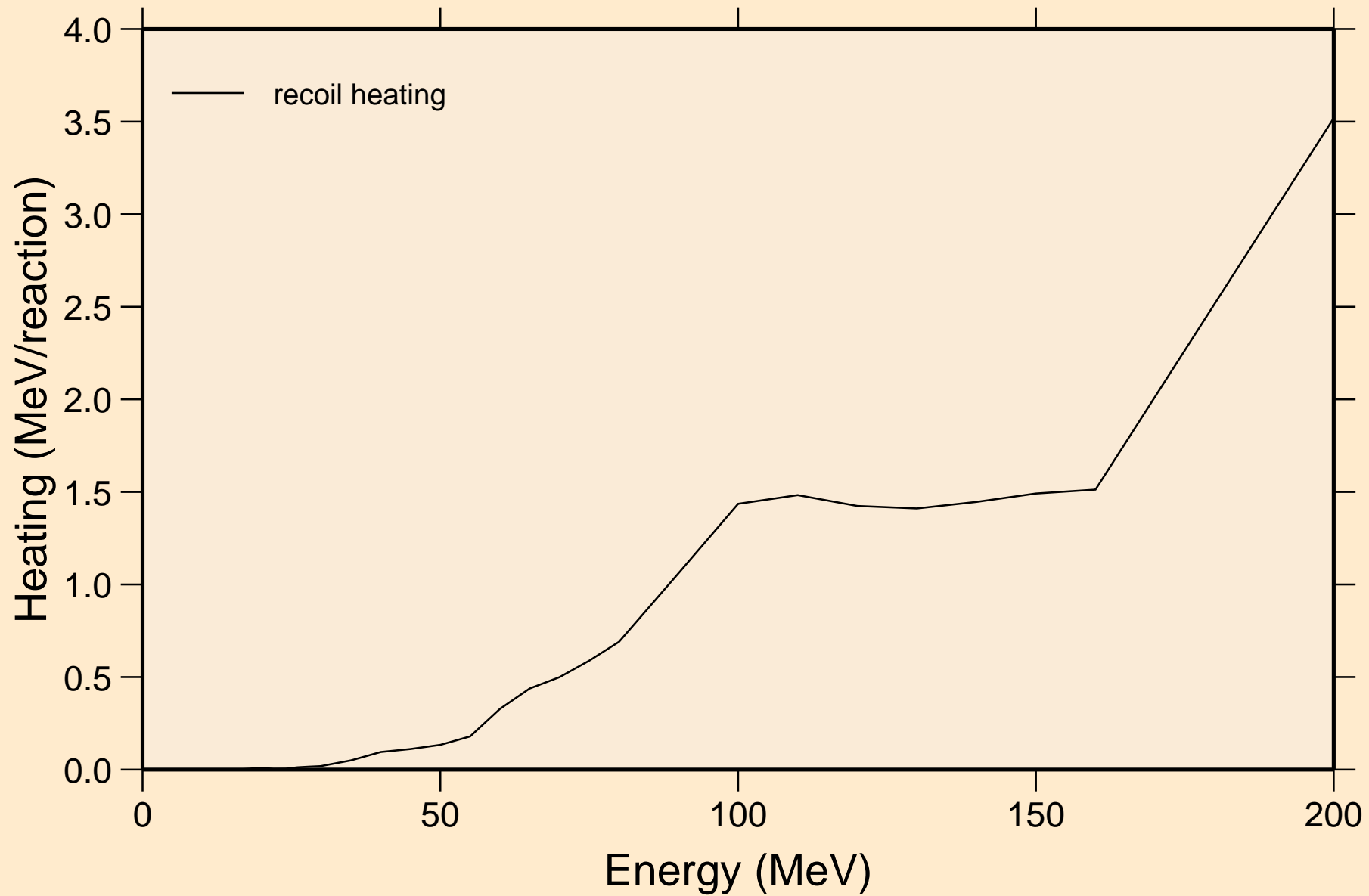

TL213 PROTON ACER TENDL-2021 LIBRARY; T=0.K  
Particle production cross sections

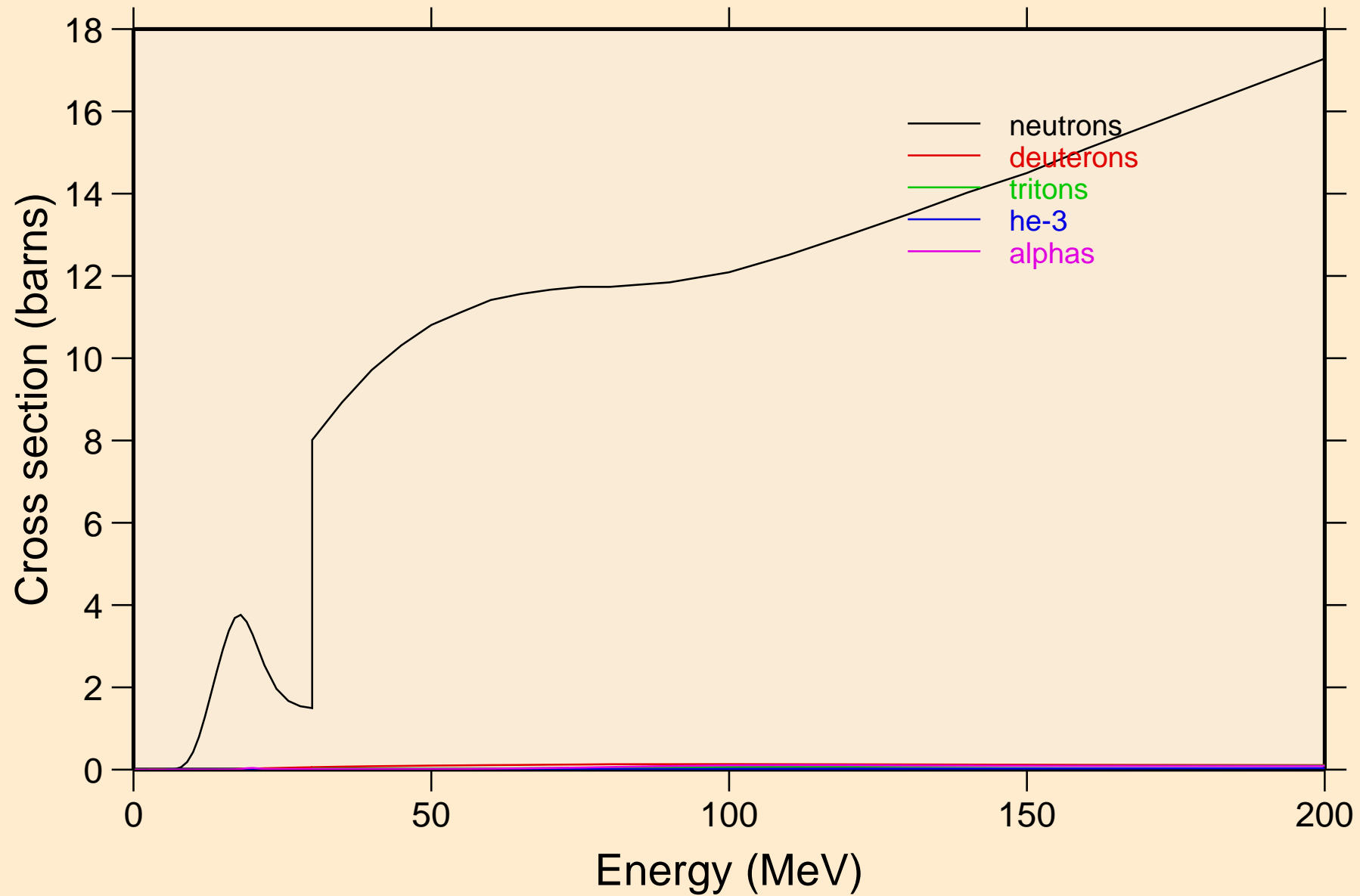

TL213 PROTON ACER TENDL-2021 LIBRARY; T=0.K  
neutrons from (p,n)

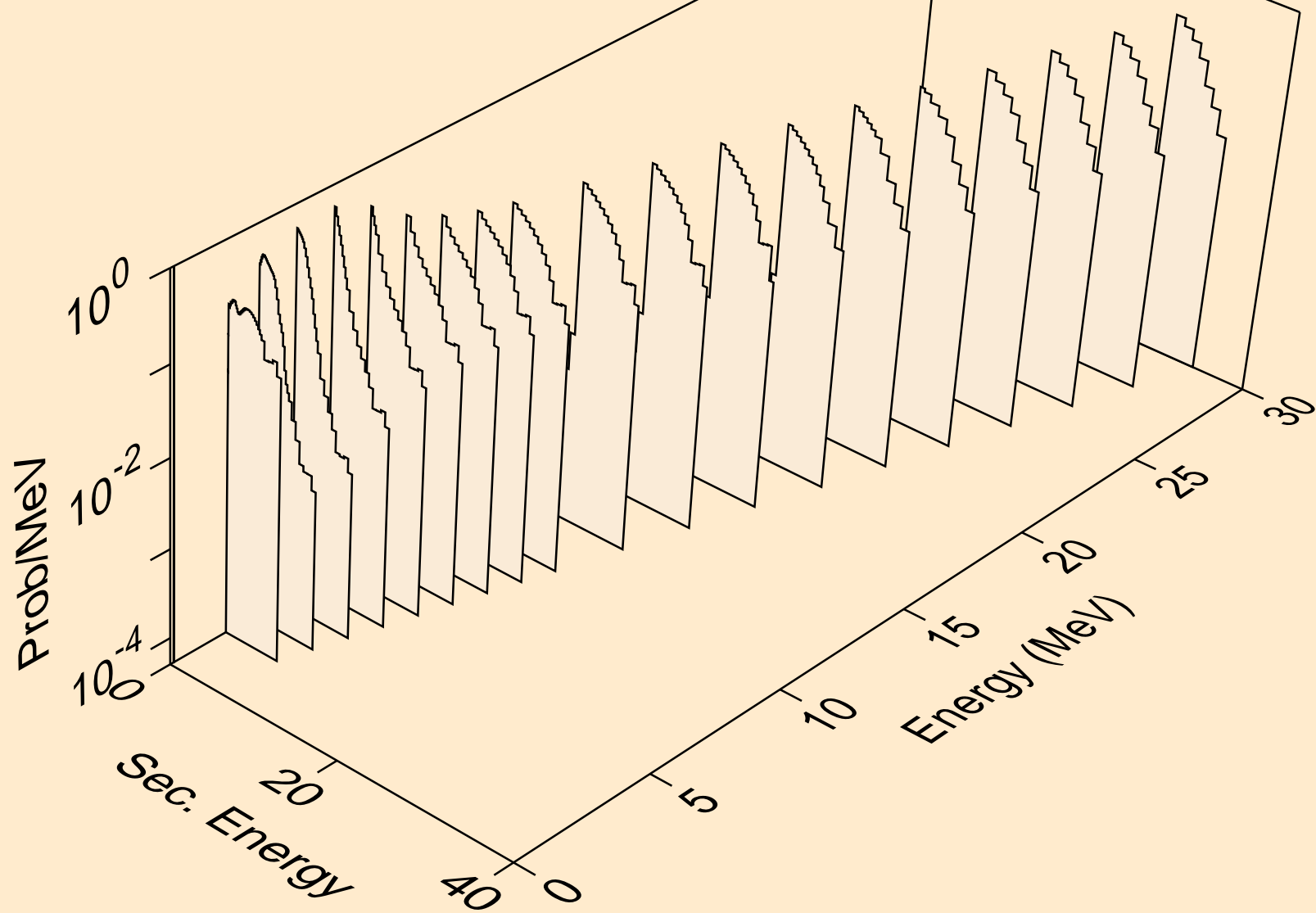

TL213 PROTON ACER TENDL-2021 LIBRARY; T=0.K  
neutrons from (p,x)

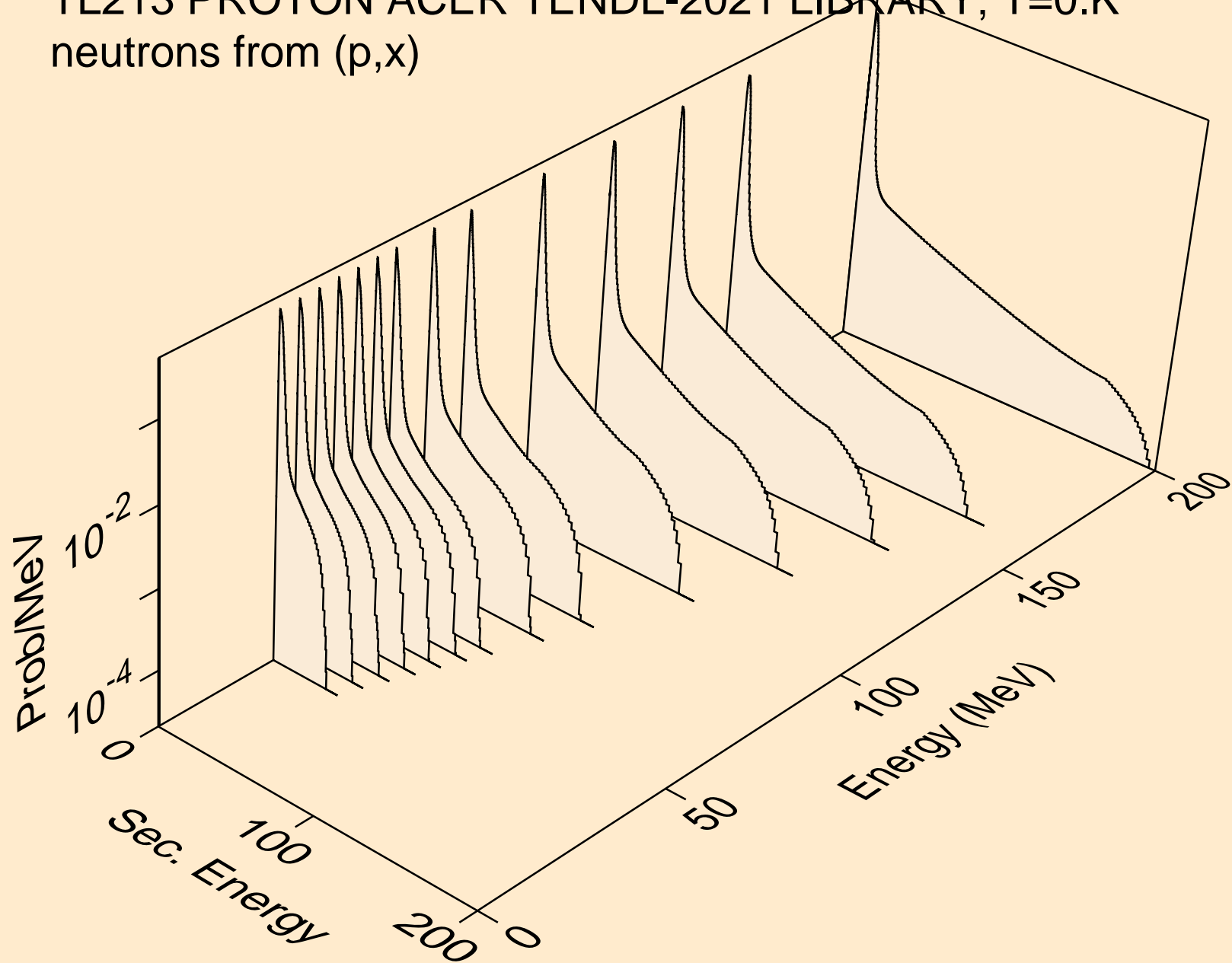

TL213 PROTON ACER TENDL-2021 LIBRARY; T=0.K  
neutrons from (p,2nd)

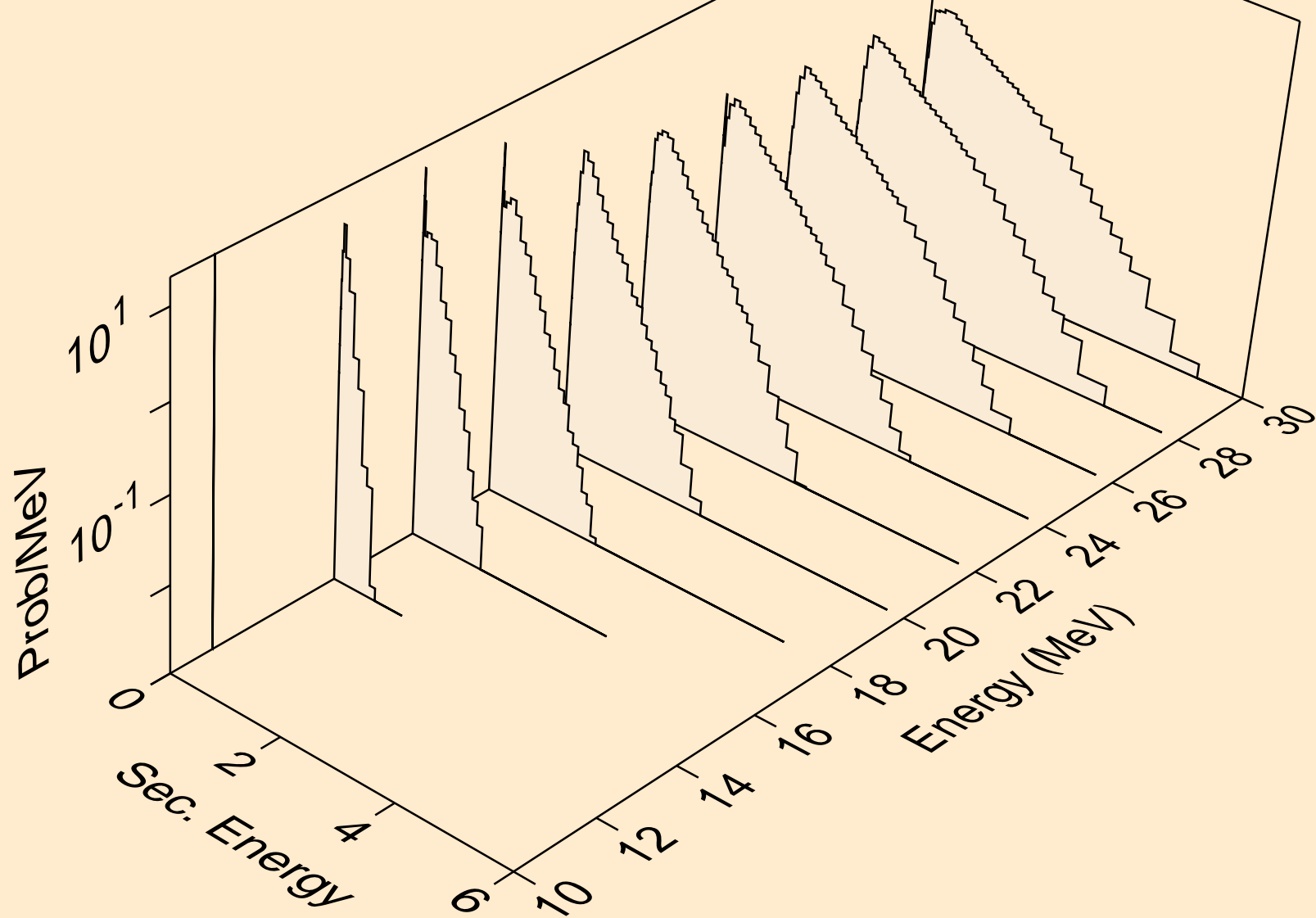

TL213 PROTON ACER TENDL-2021 LIBRARY; T=0.K  
neutrons from (p,2n)

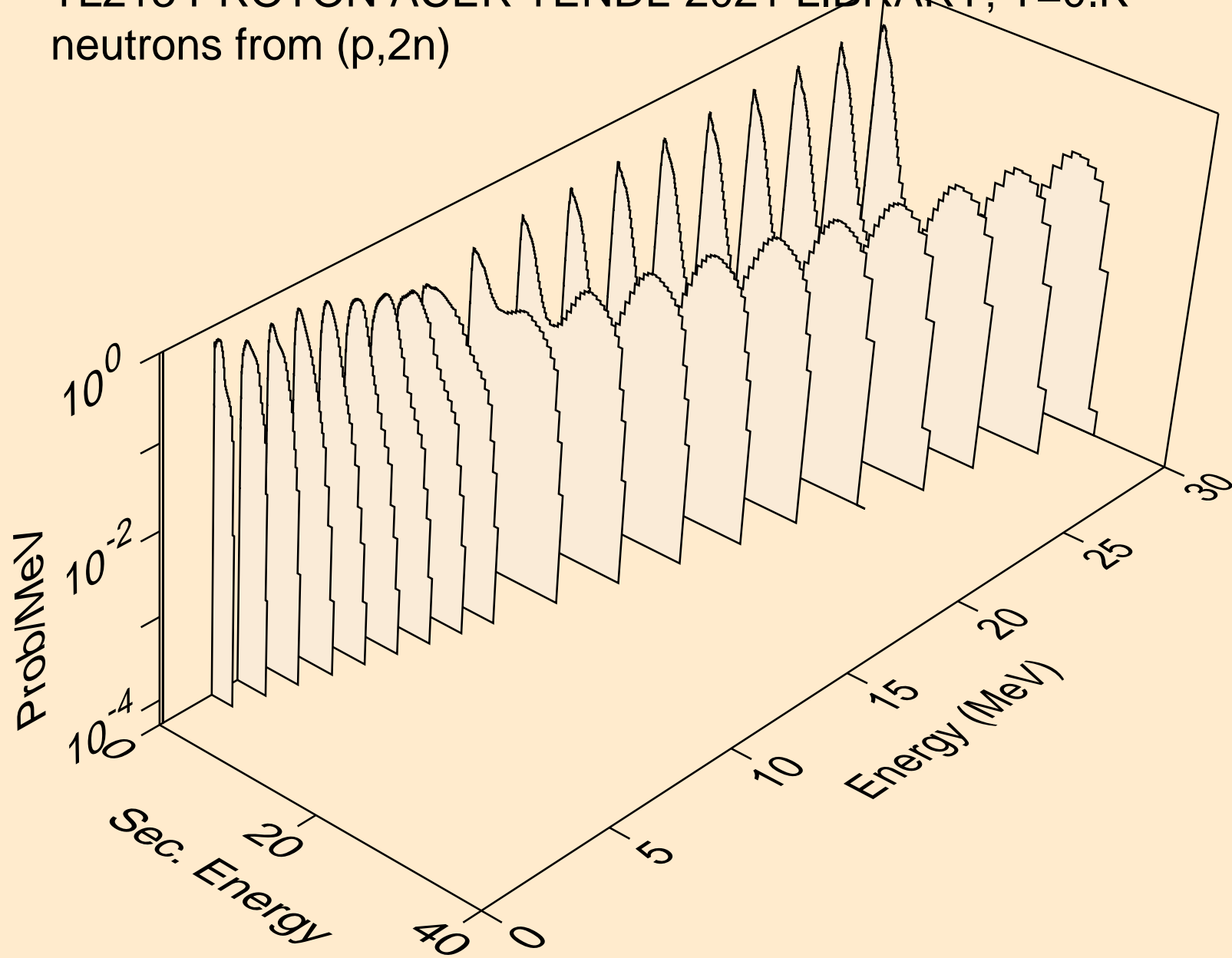

TL213 PROTON ACER TENDL-2021 LIBRARY; T=0.K  
neutrons from (p,3n)

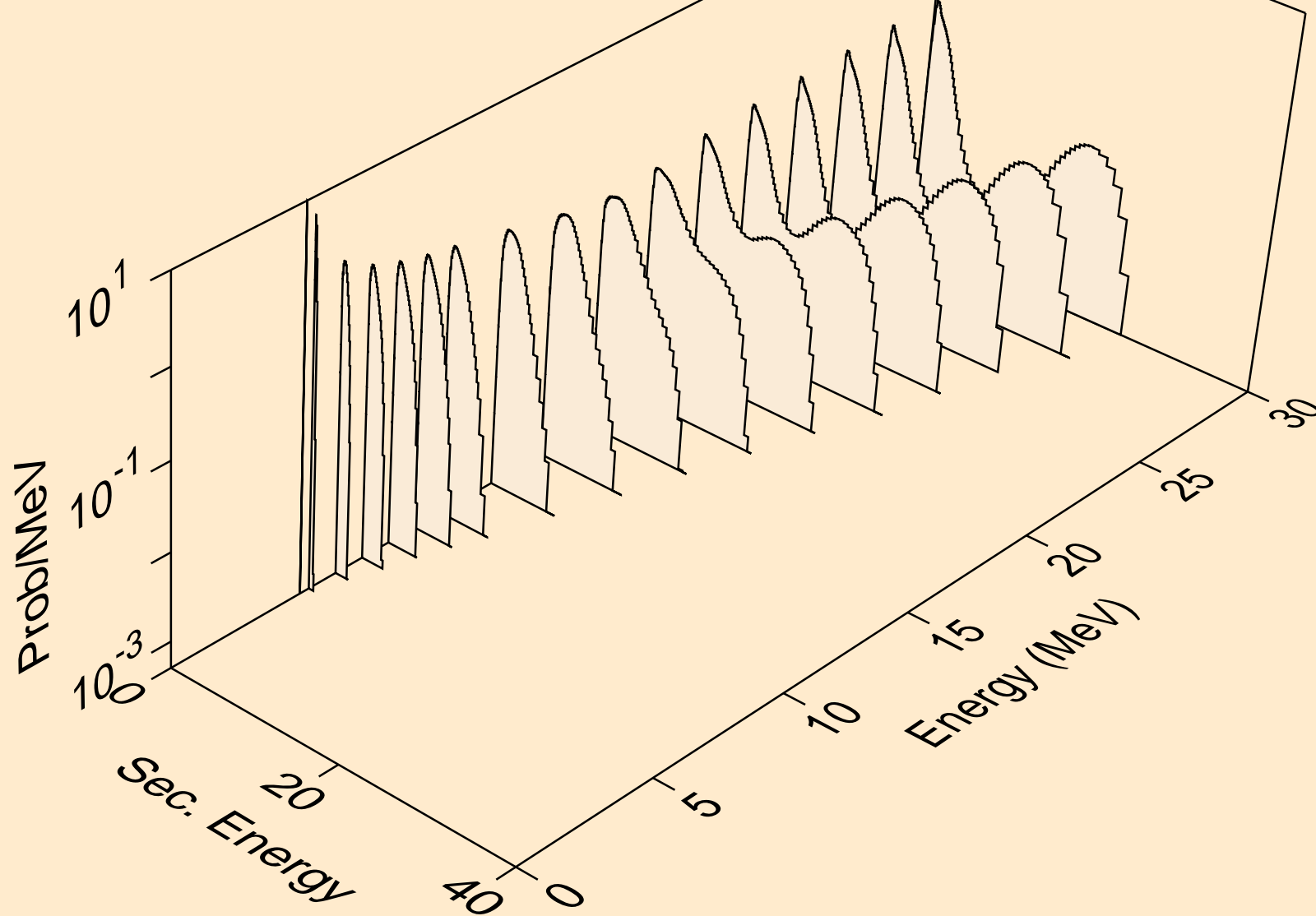



TL213 PROTON ACER TENDL-2021 LIBRARY; T=0.K  
neutrons from (p,n\*)a

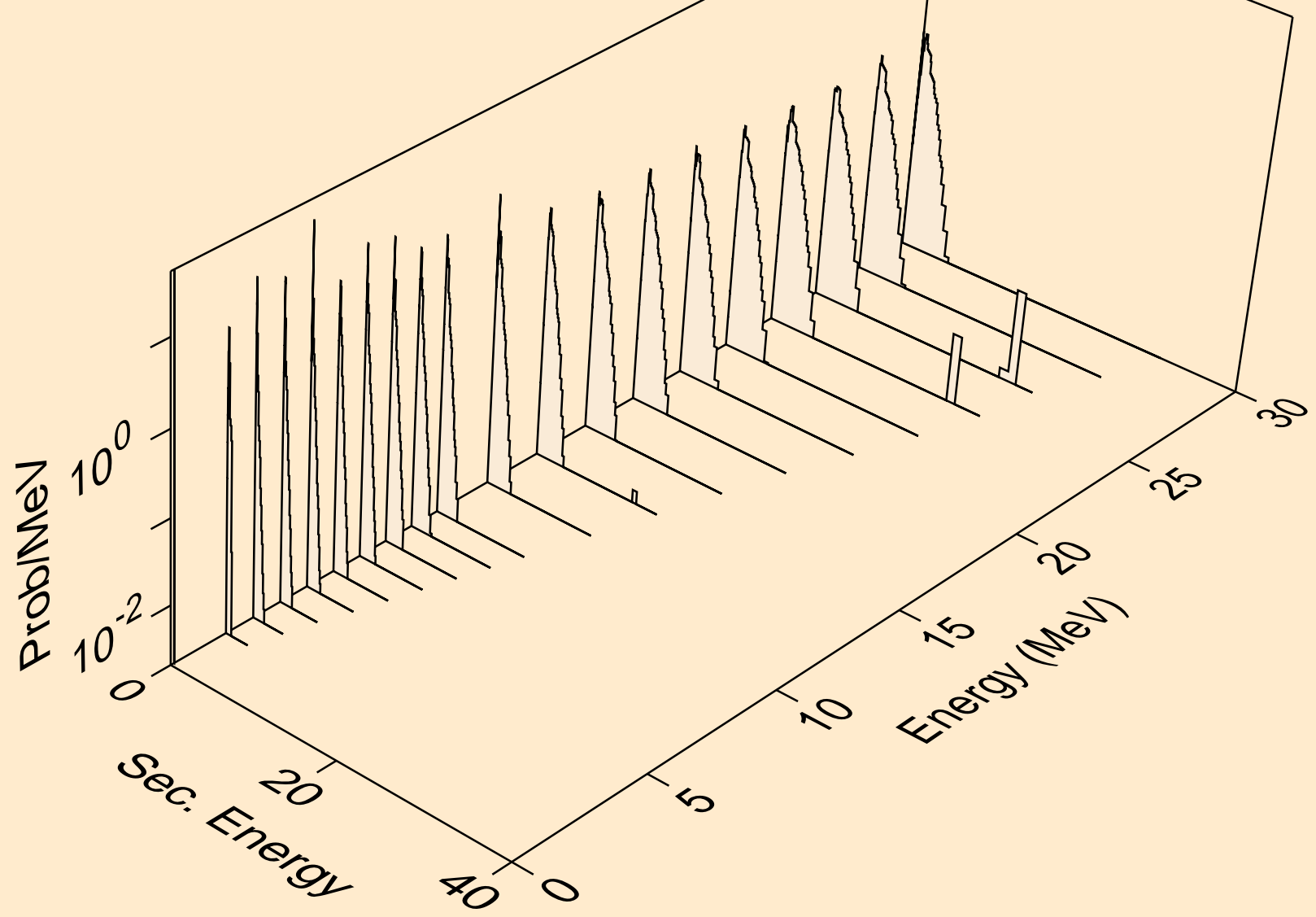

TL213 PROTON ACER TENDL-2021 LIBRARY; T=0.K  
neutrons from (p,2n)a

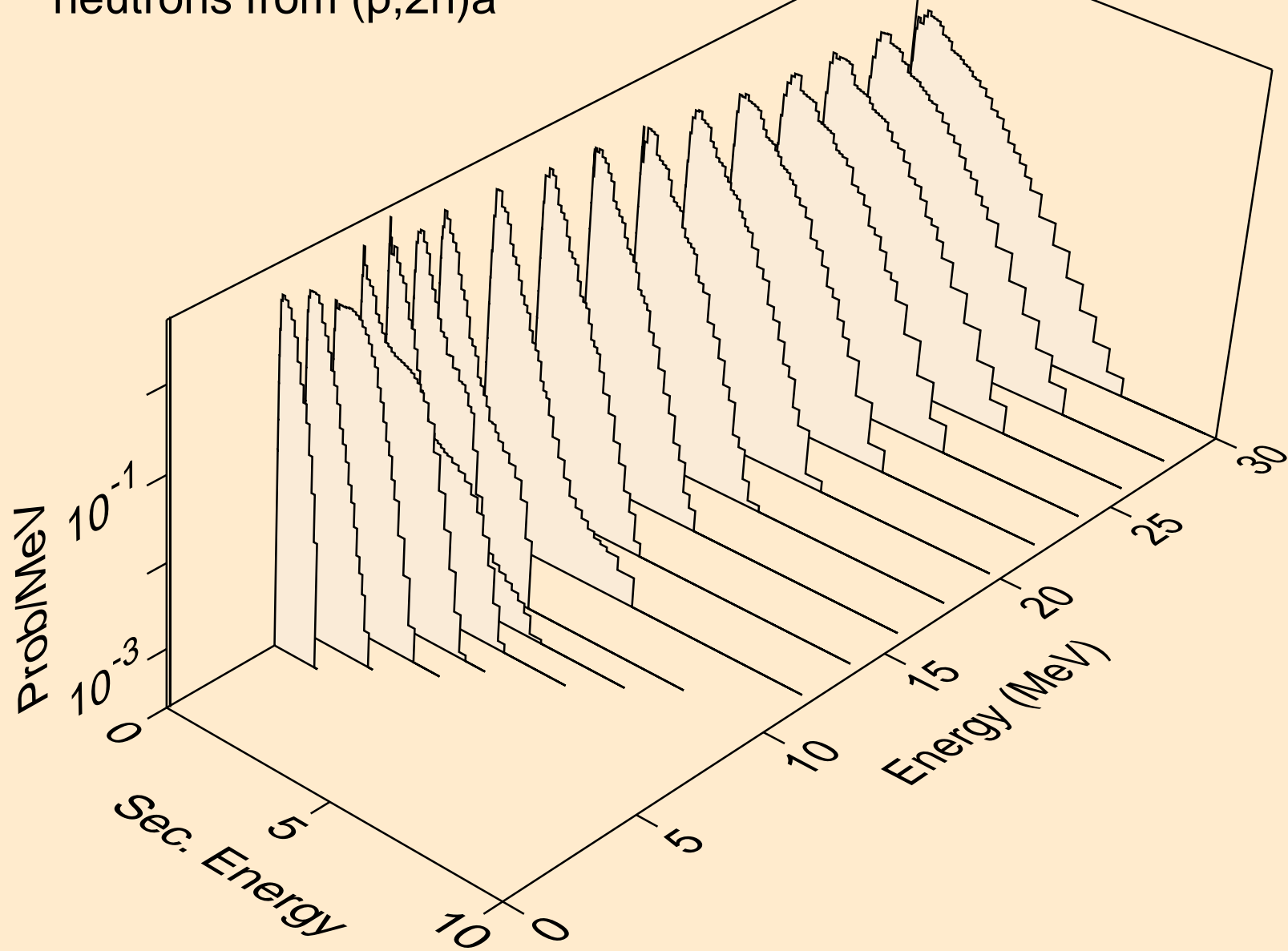

TL213 PROTON ACER TENDL-2021 LIBRARY; T=0.K  
neutrons from (p,3n)a

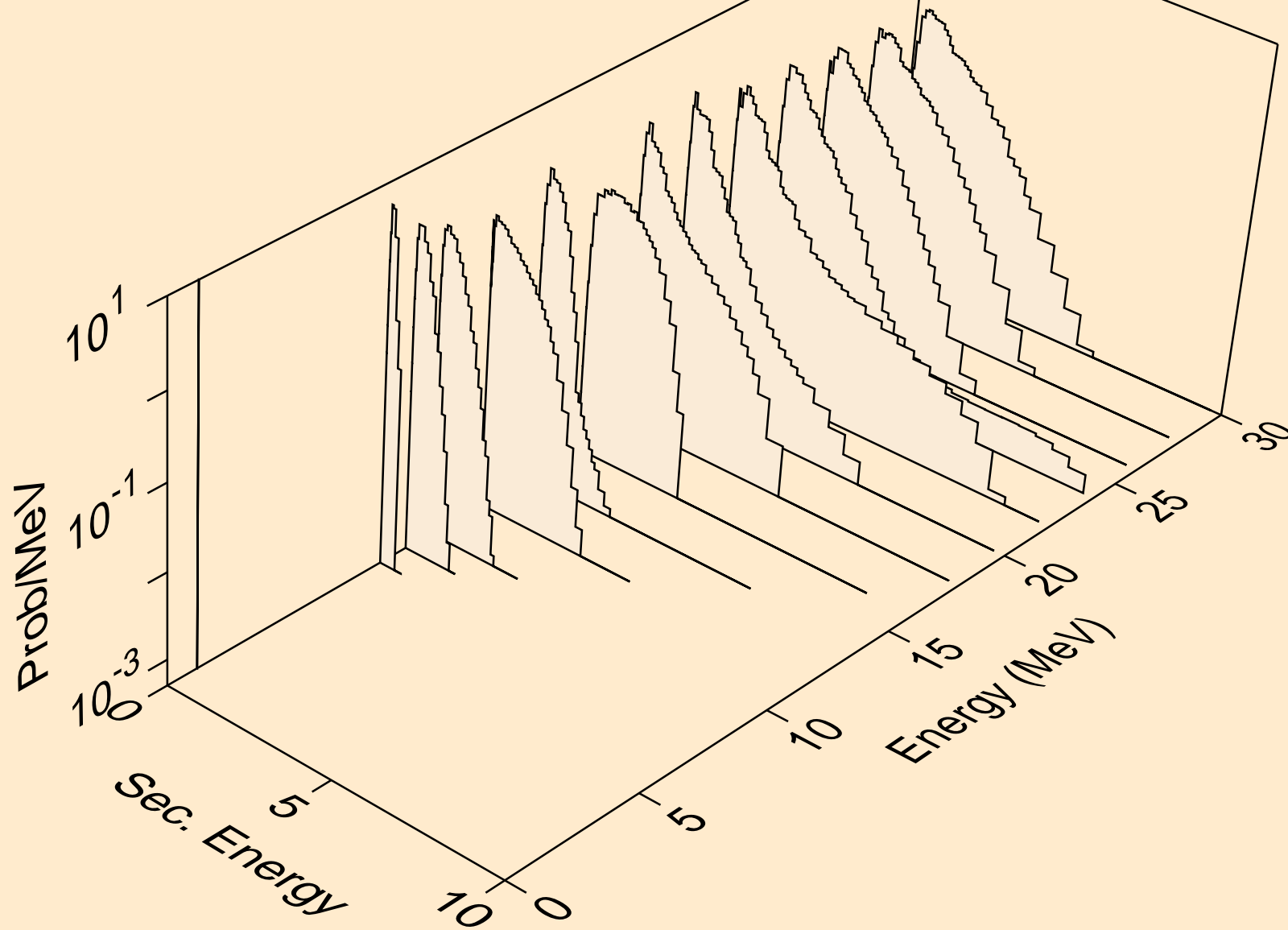

TL213 PROTON ACER TENDL-2021 LIBRARY; T=0.K  
neutrons from (p,n\*)p

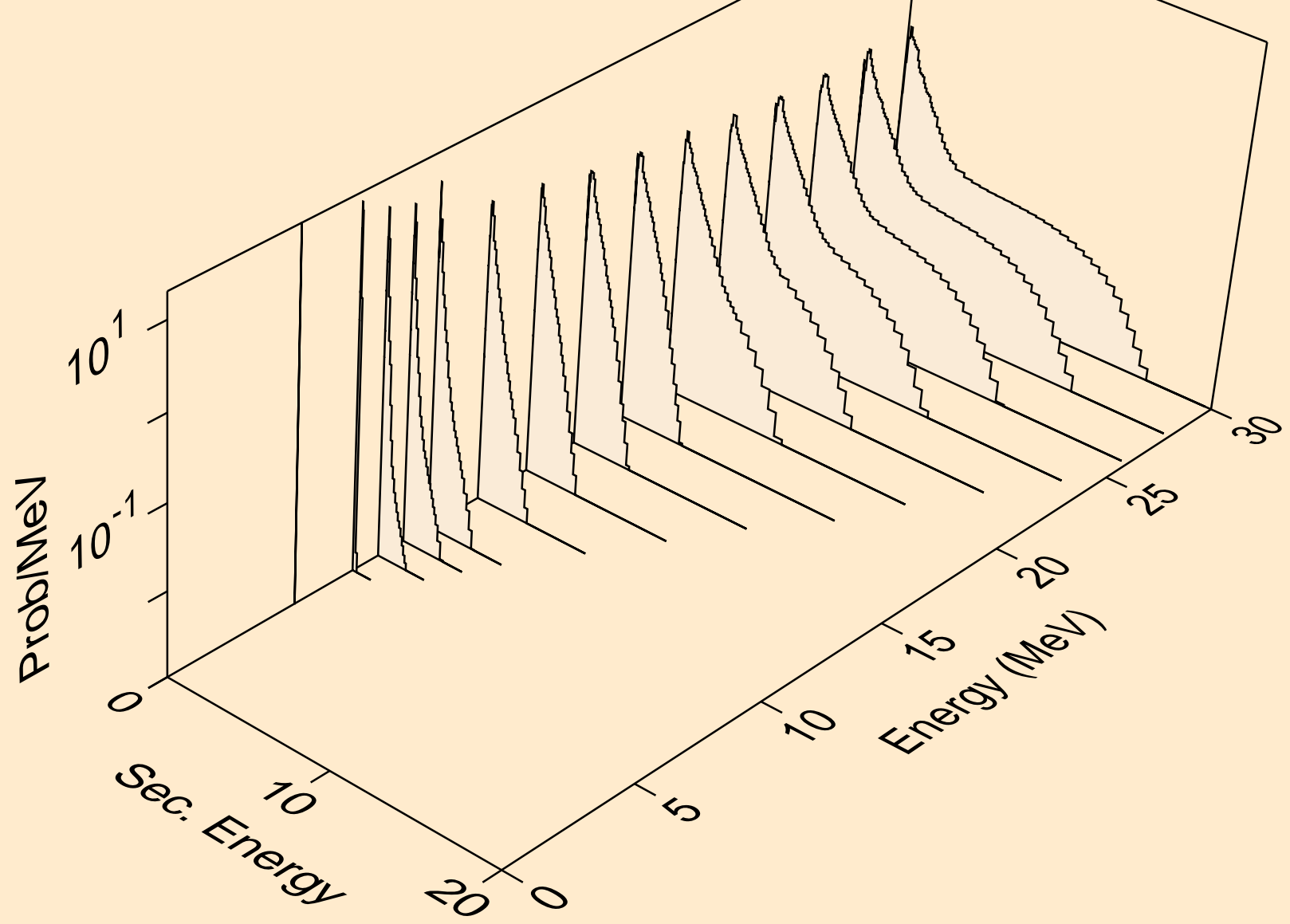

TL213 PROTON ACER TENDL-2021 LIBRARY; T=0.K  
neutrons from (p,n\*)d

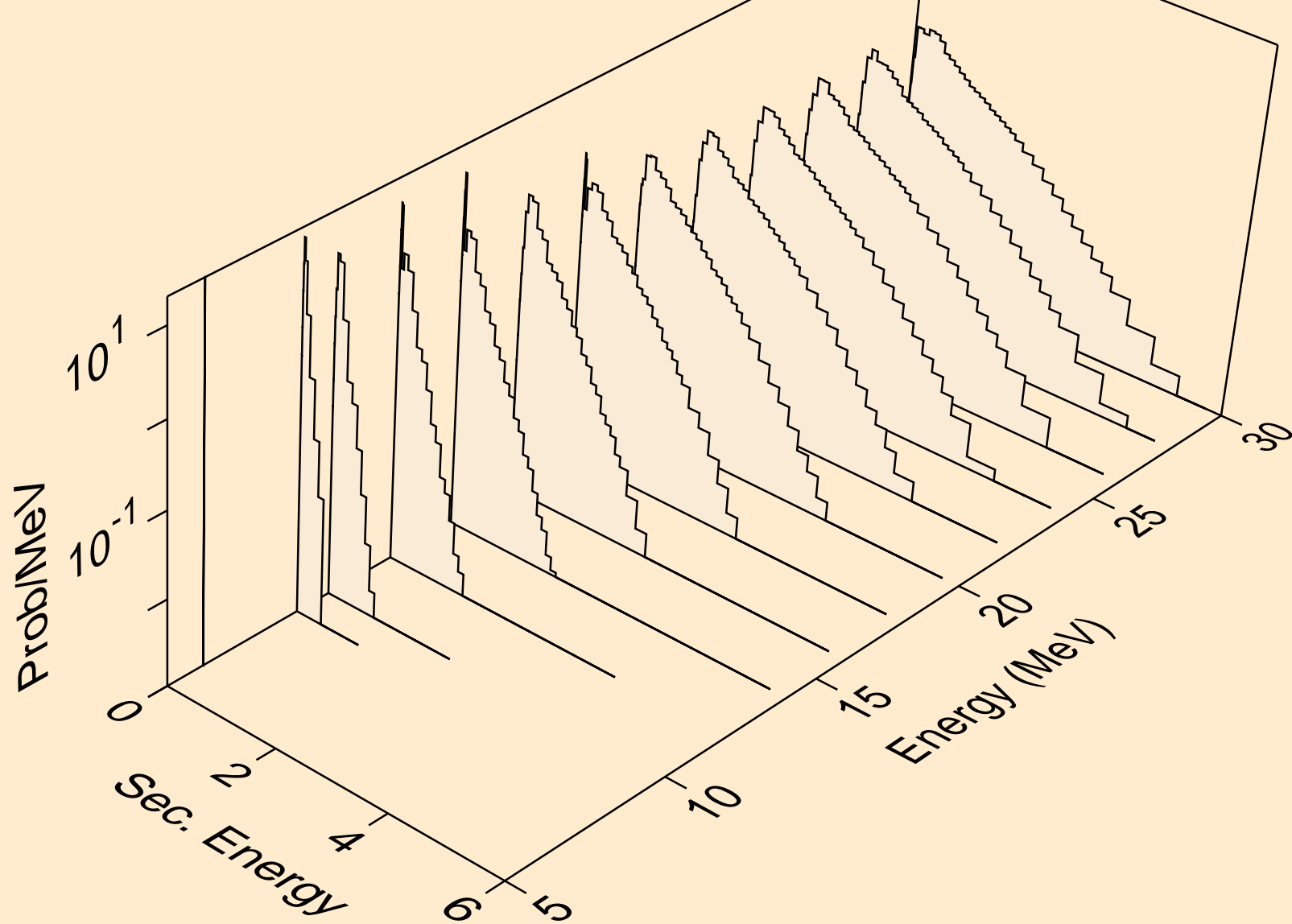

TL213 PROTON ACER TENDL-2021 LIBRARY; T=0.K  
neutrons from (p,n\*)t

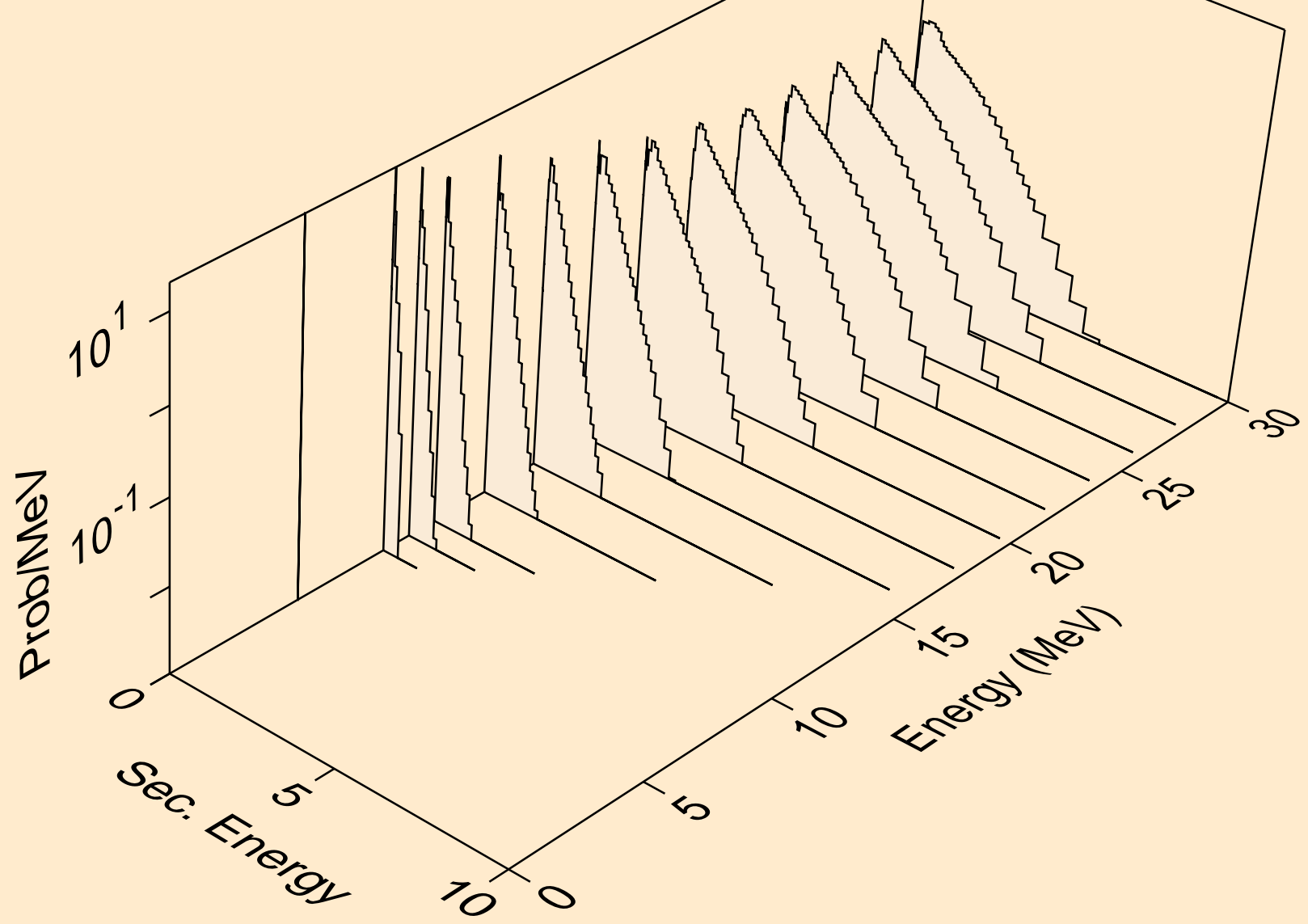

TL213 PROTON ACER TENDL-2021 LIBRARY; T=0.K  
neutrons from (p,n\*)he3

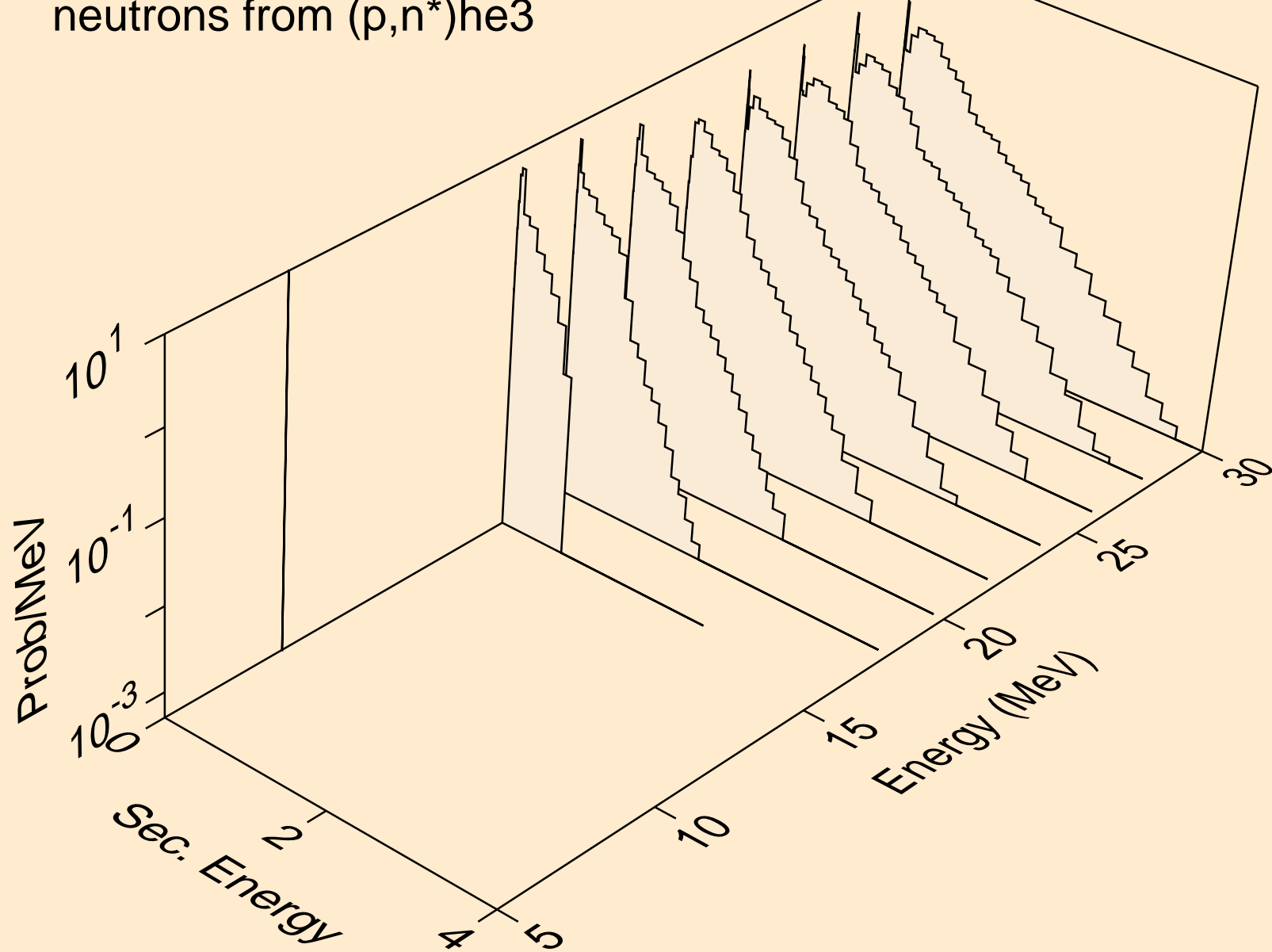

TL213 PROTON ACER TENDL-2021 LIBRARY; T=0.K  
neutrons from (p,4n)

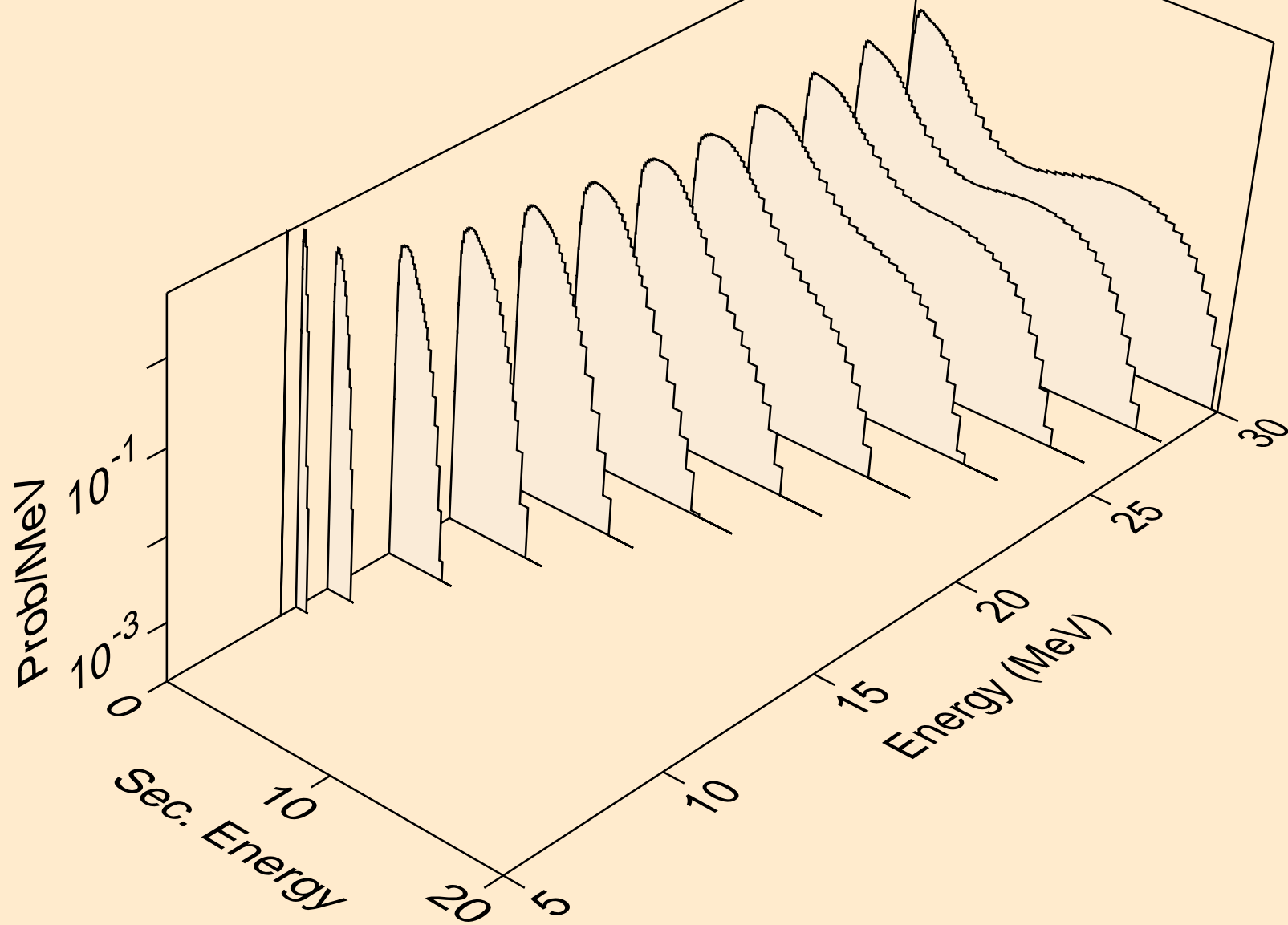



TL213 PROTON ACER TENDL-2021 LIBRARY; T=0.K  
neutrons from (p,2np)

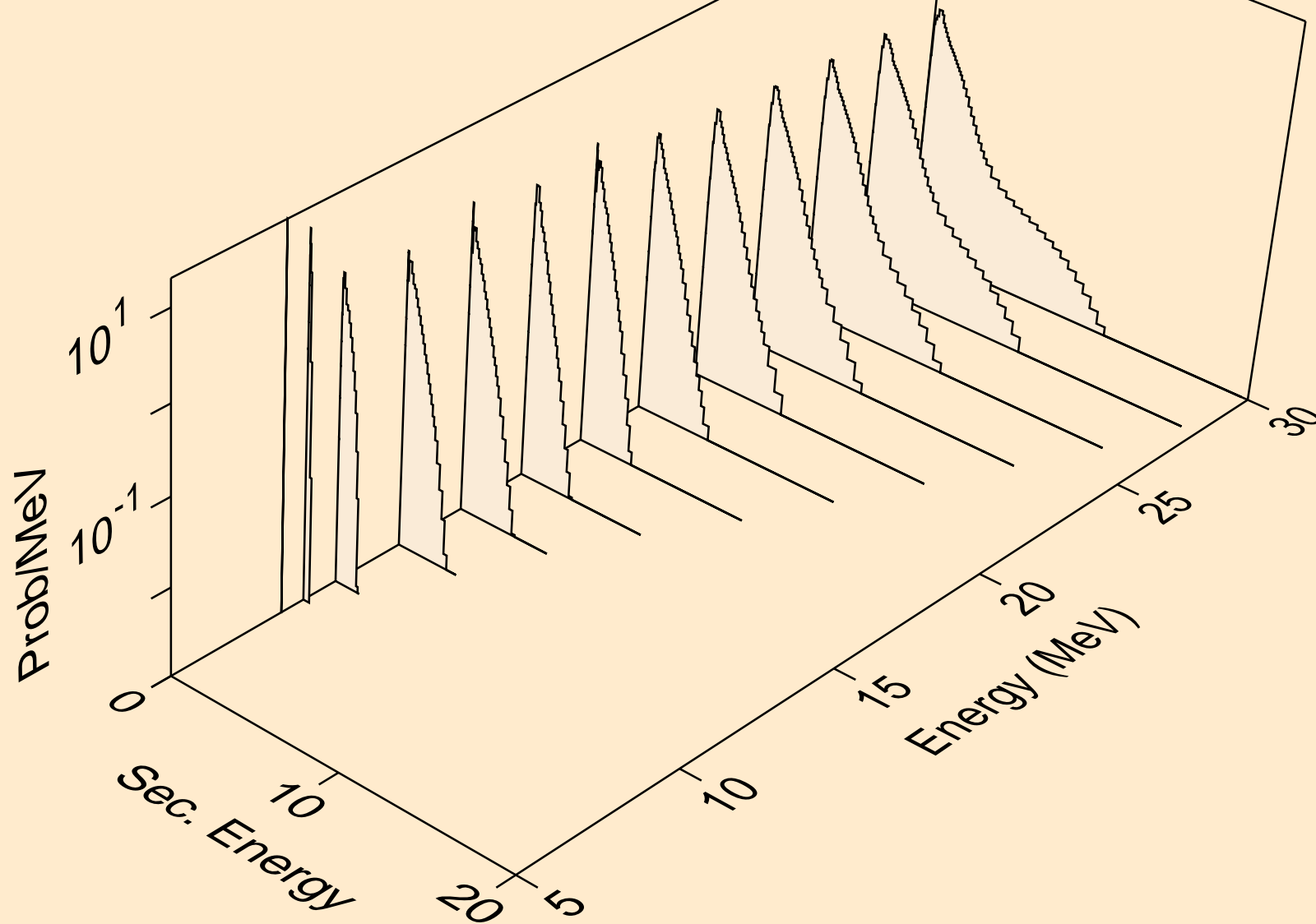

TL213 PROTON ACER TENDL-2021 LIBRARY; T=0.K  
neutrons from (p,3np)

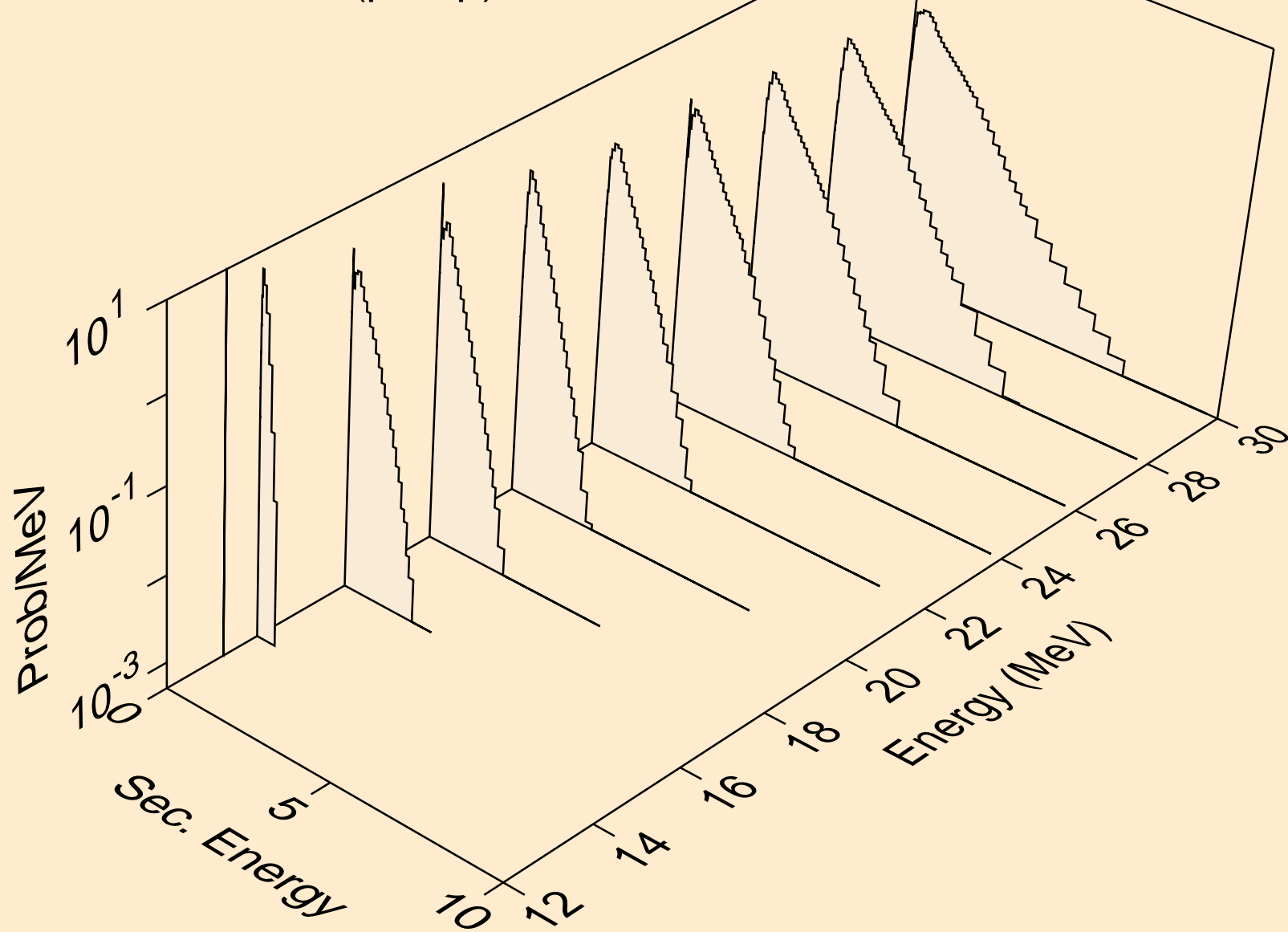

TL213 PROTON ACER TENDL-2021 LIBRARY; T=0.K  
neutrons from (p,2np)

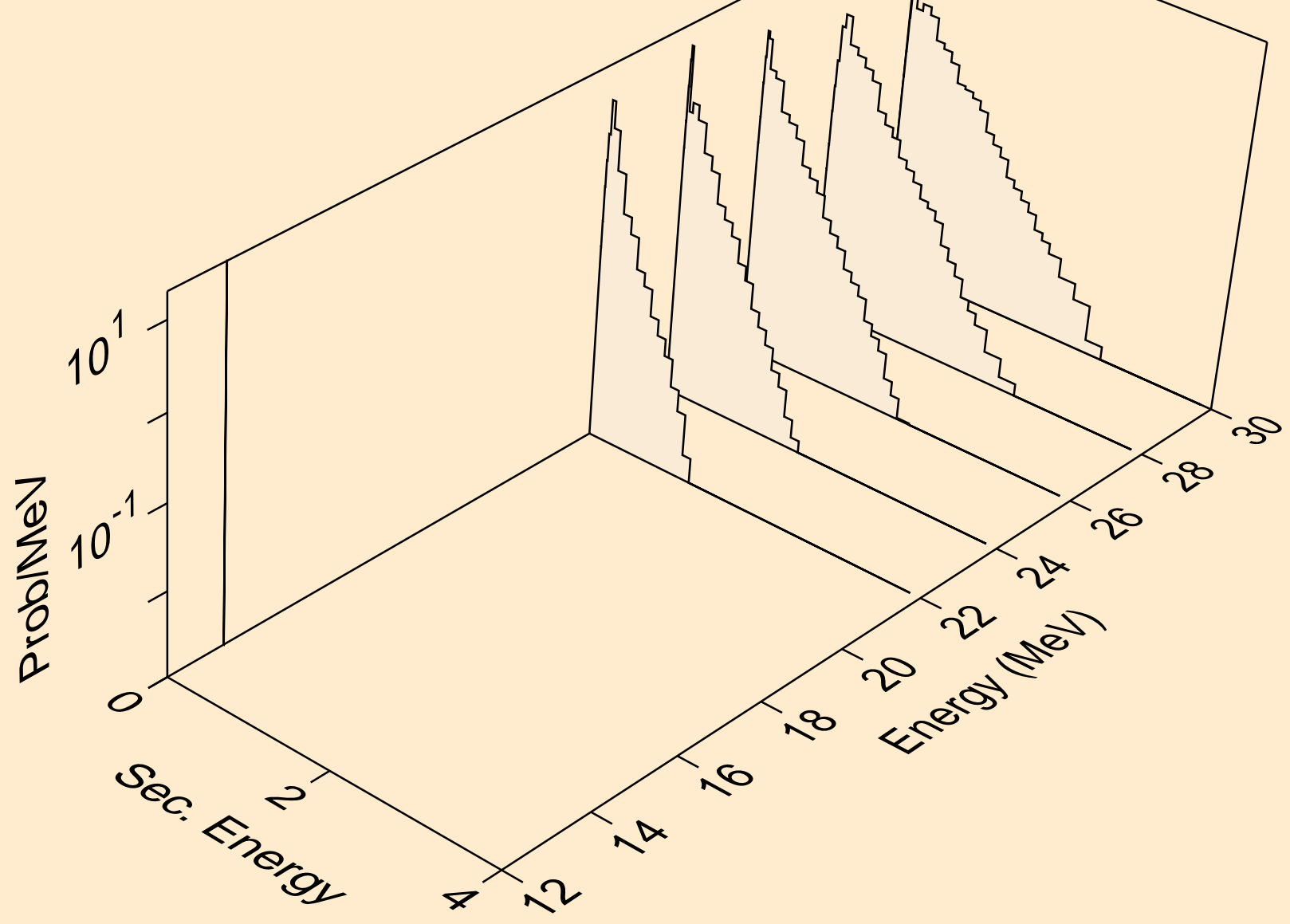

TL213 PROTON ACER TENDL-2021 LIBRARY; T=0.K  
deuterons from (p,x)

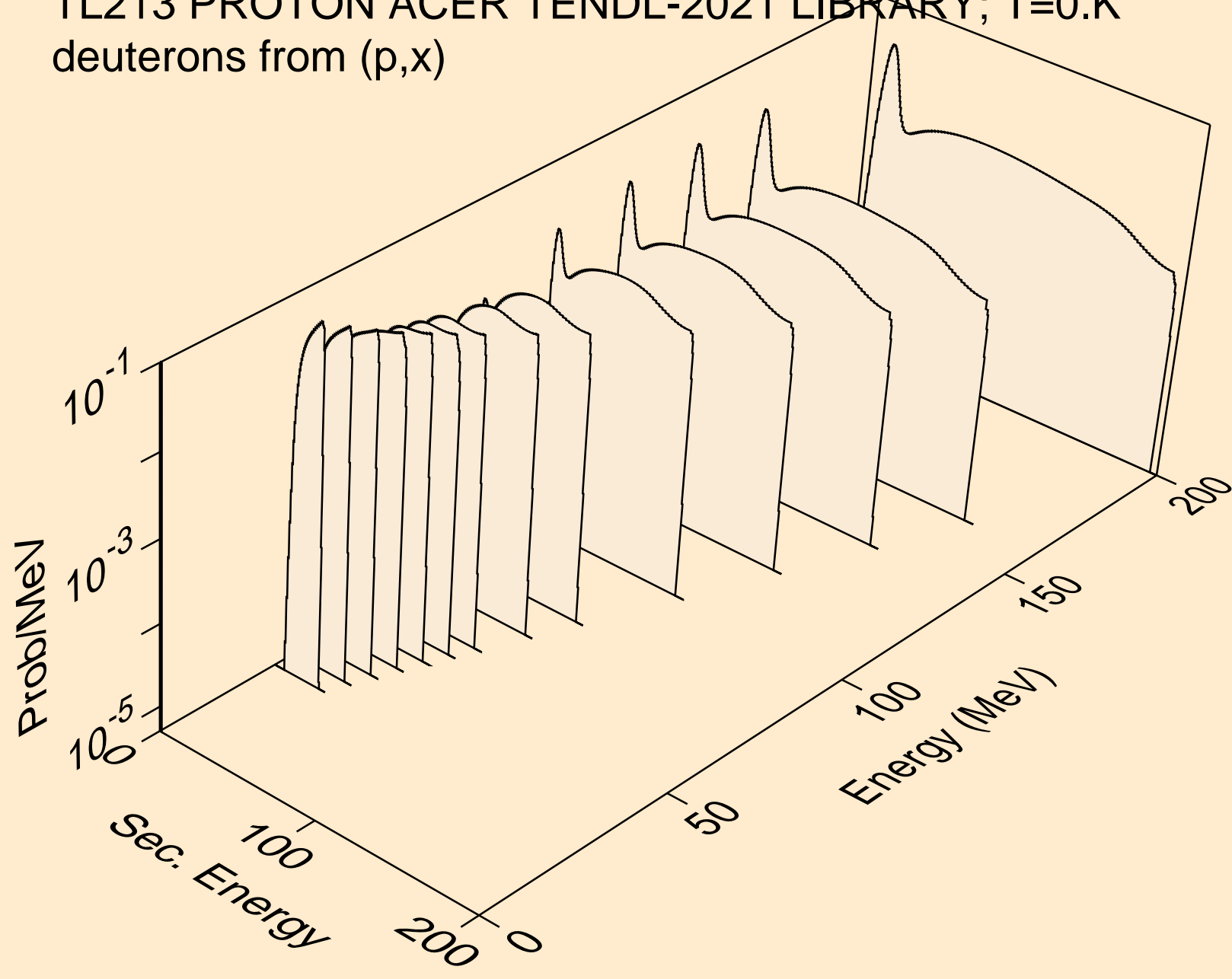

TL213 PROTON ACER TENDL-2021 LIBRARY; T=0.K  
deuterons from (p,2nd)

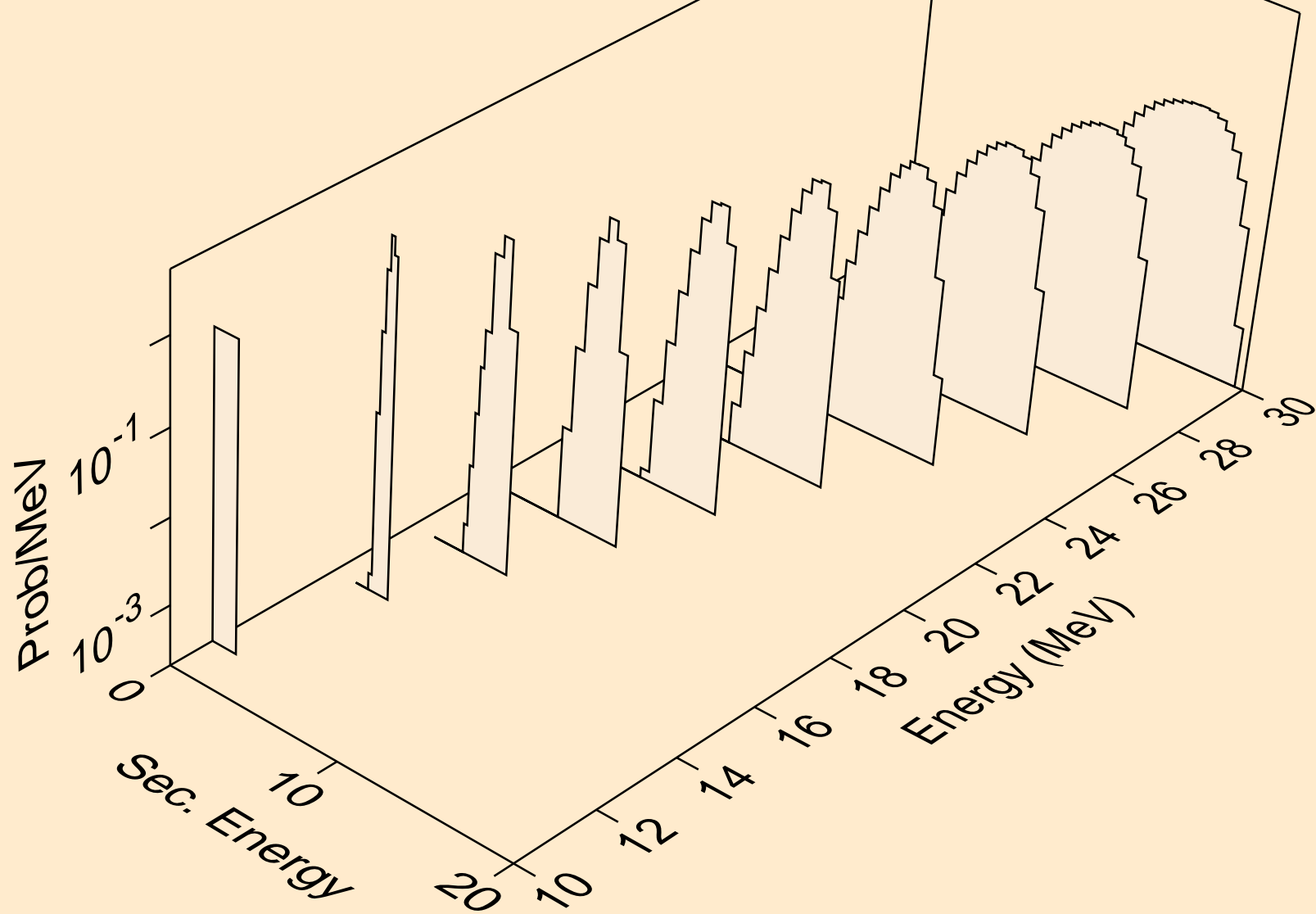

TL213 PROTON ACER TENDL-2021 LIBRARY; T=0.K  
deuterons from (p,n\*)d

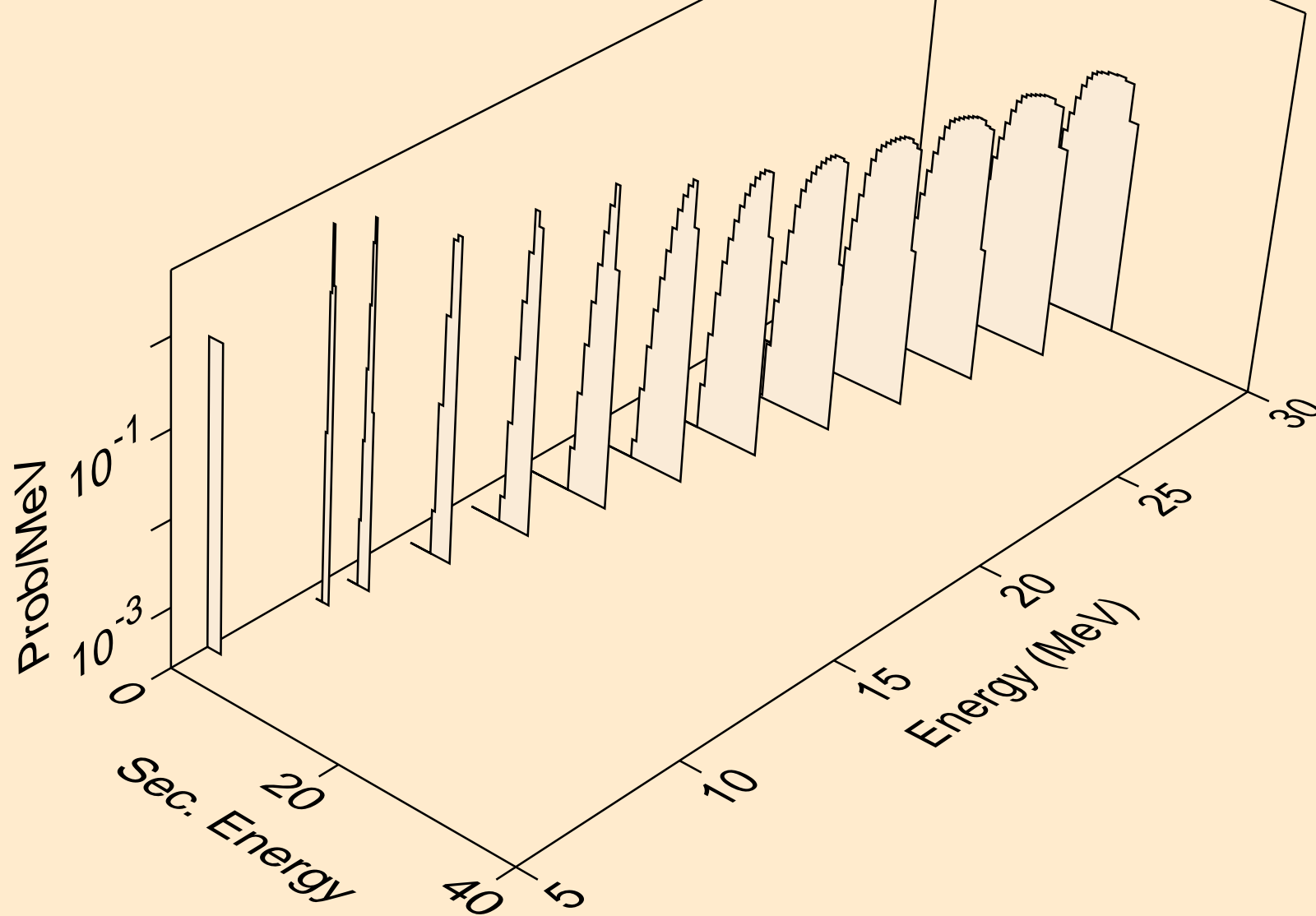

TL213 PROTON ACER TENDL-2021 LIBRARY; T=0.K  
deuterons from (p,d)

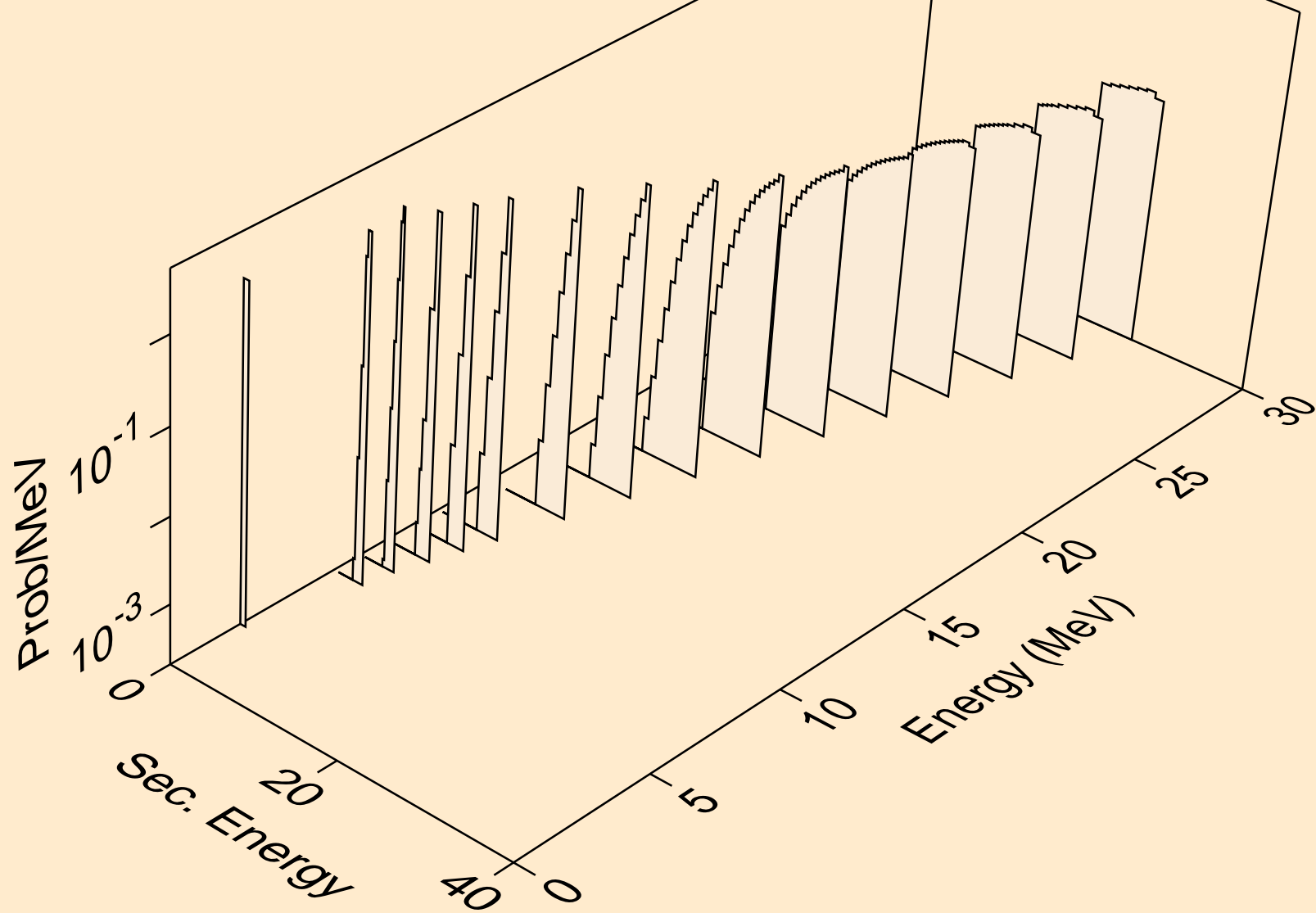

TL213 PROTON ACER TENDL-2021 LIBRARY; T=0.K  
tritons from (p,x)

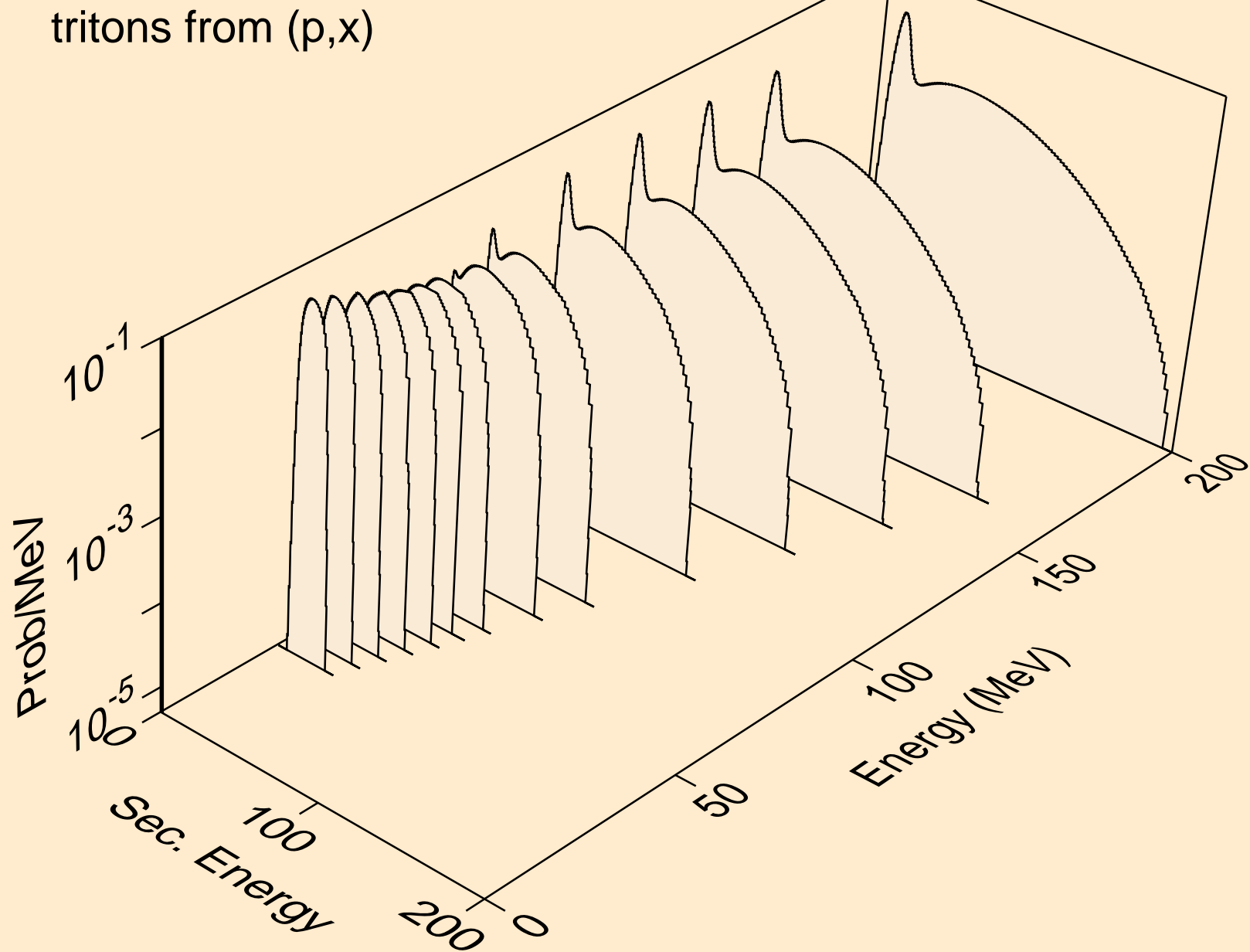



TL213 PROTON ACER TENDL-2021 LIBRARY; T=0.K  
tritons from (p,n\*)t

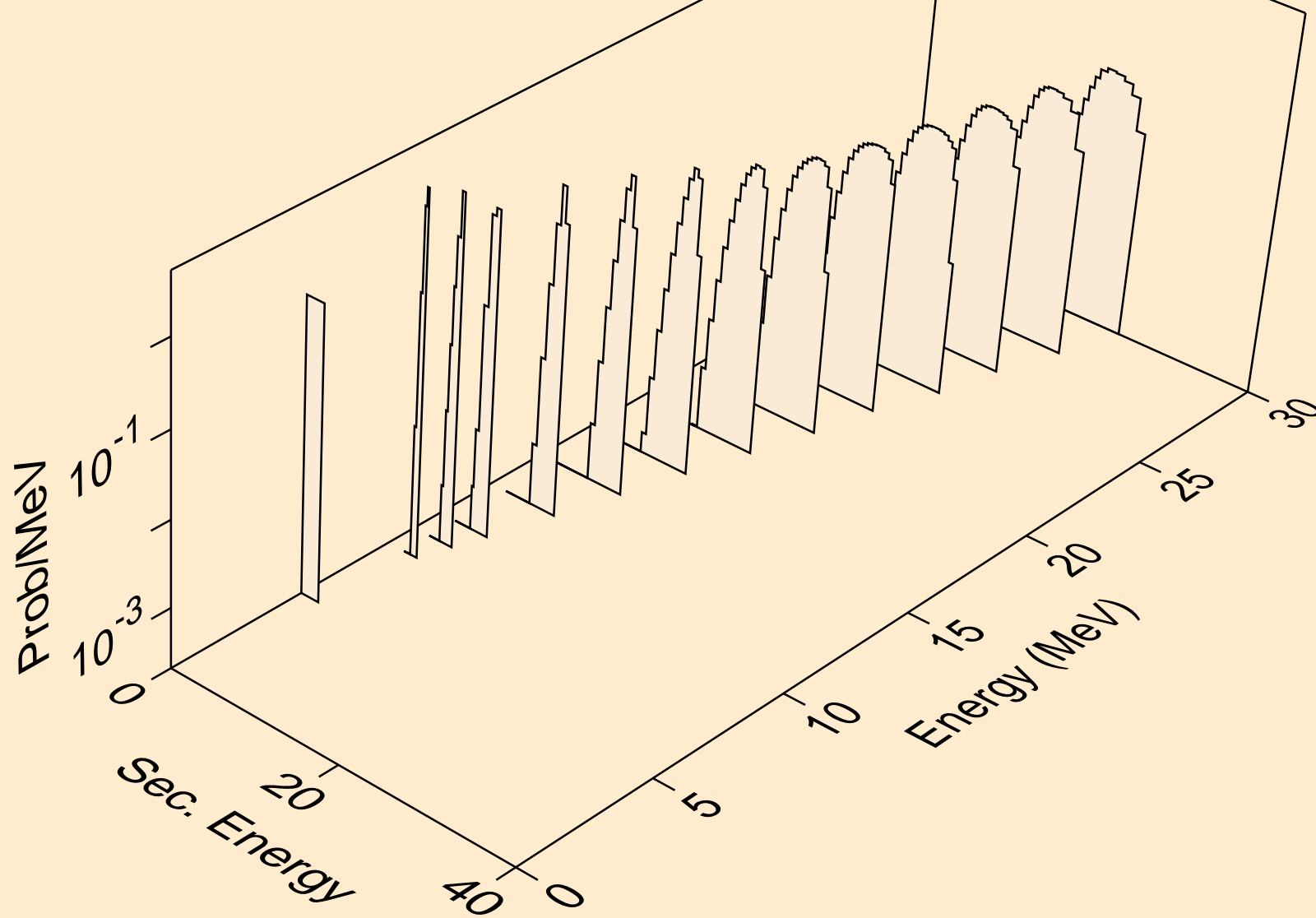

TL213 PROTON ACER TENDL-2021 LIBRARY; T=0.K  
tritons from (p,t)

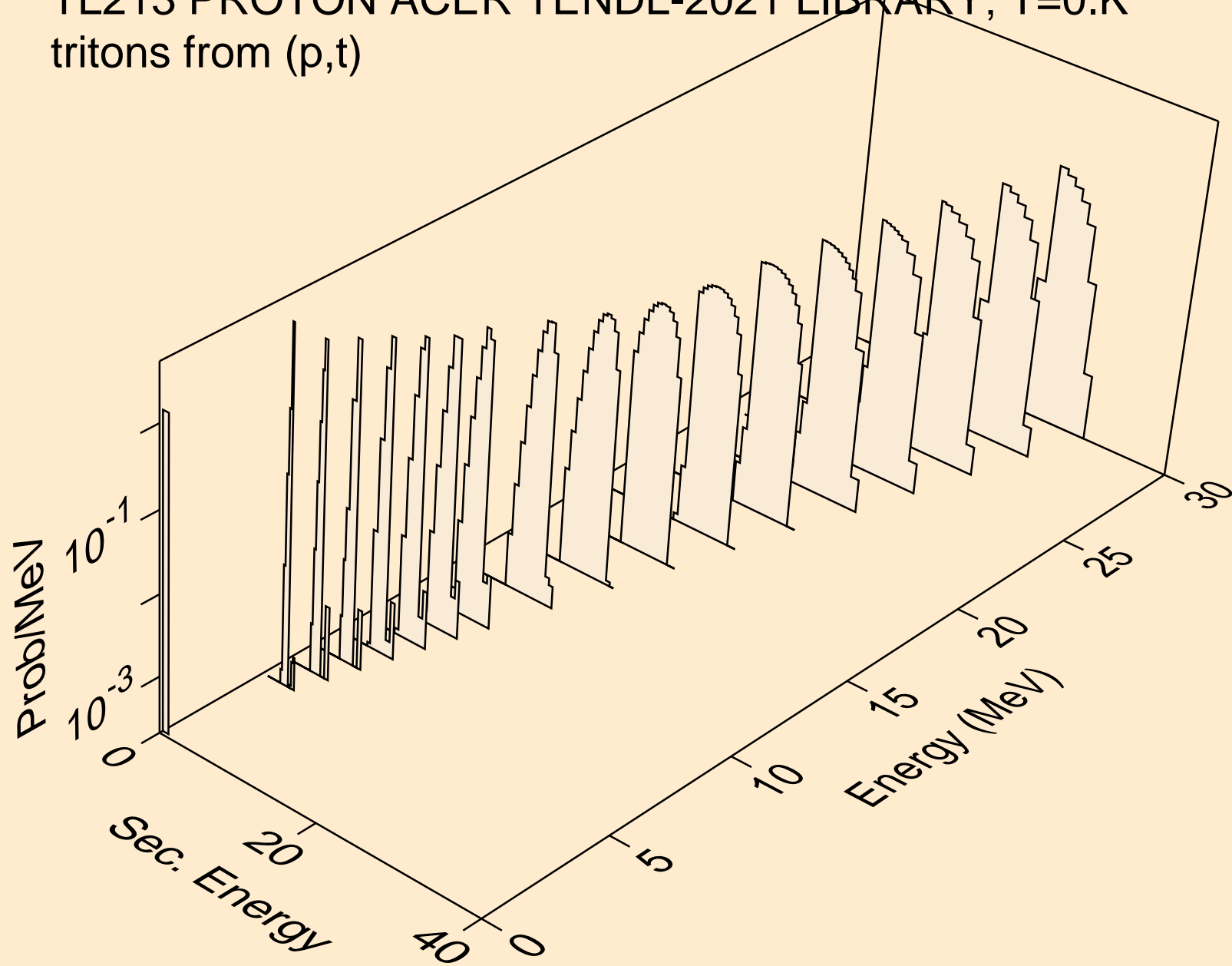

TL213 PROTON ACER TENDL-2021 LIBRARY; T=0.K  
he3s from (p,x)

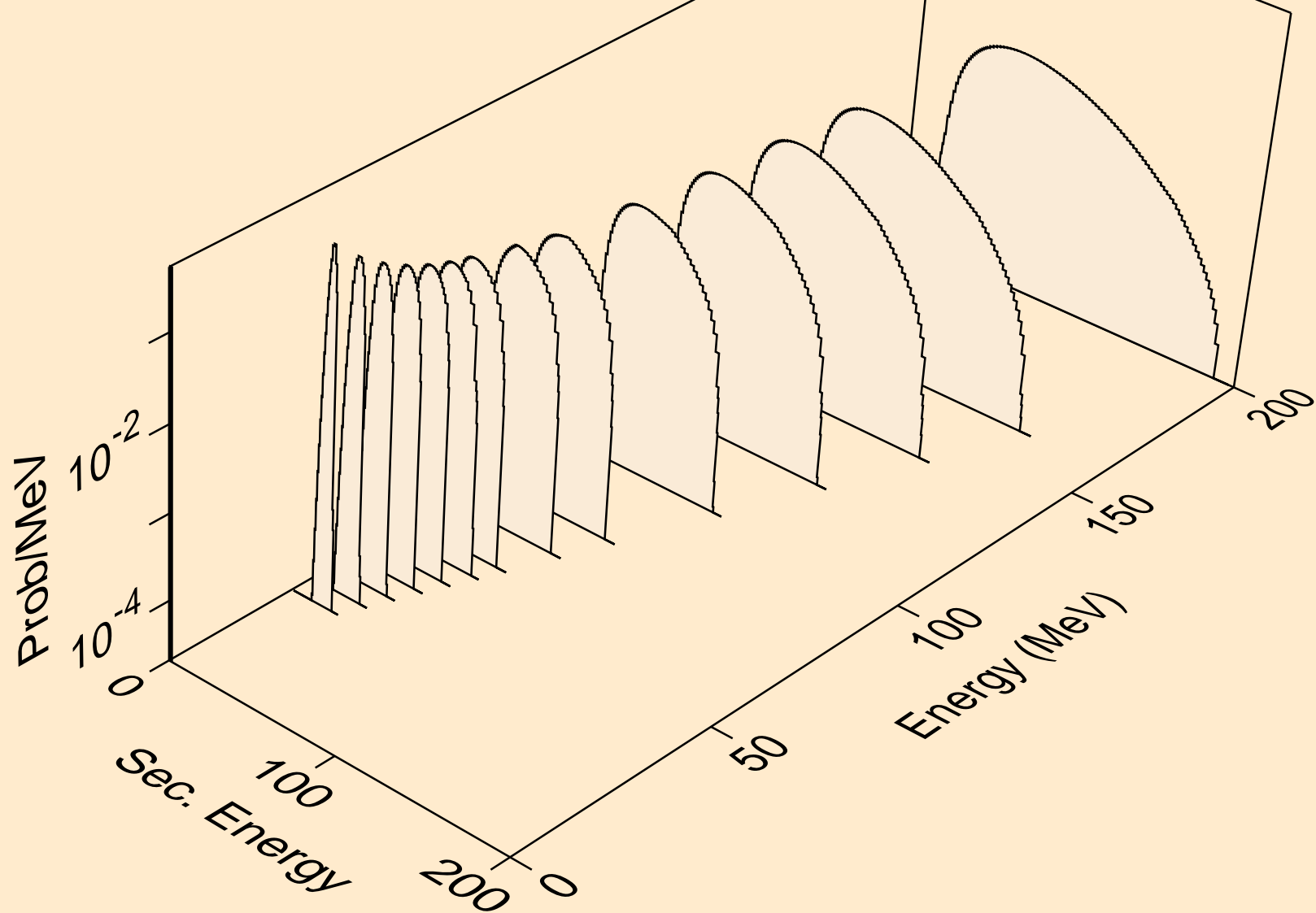

TL213 PROTON ACER TENDL-2021 LIBRARY; T=0.K  
he3s from (p,n\*)he3

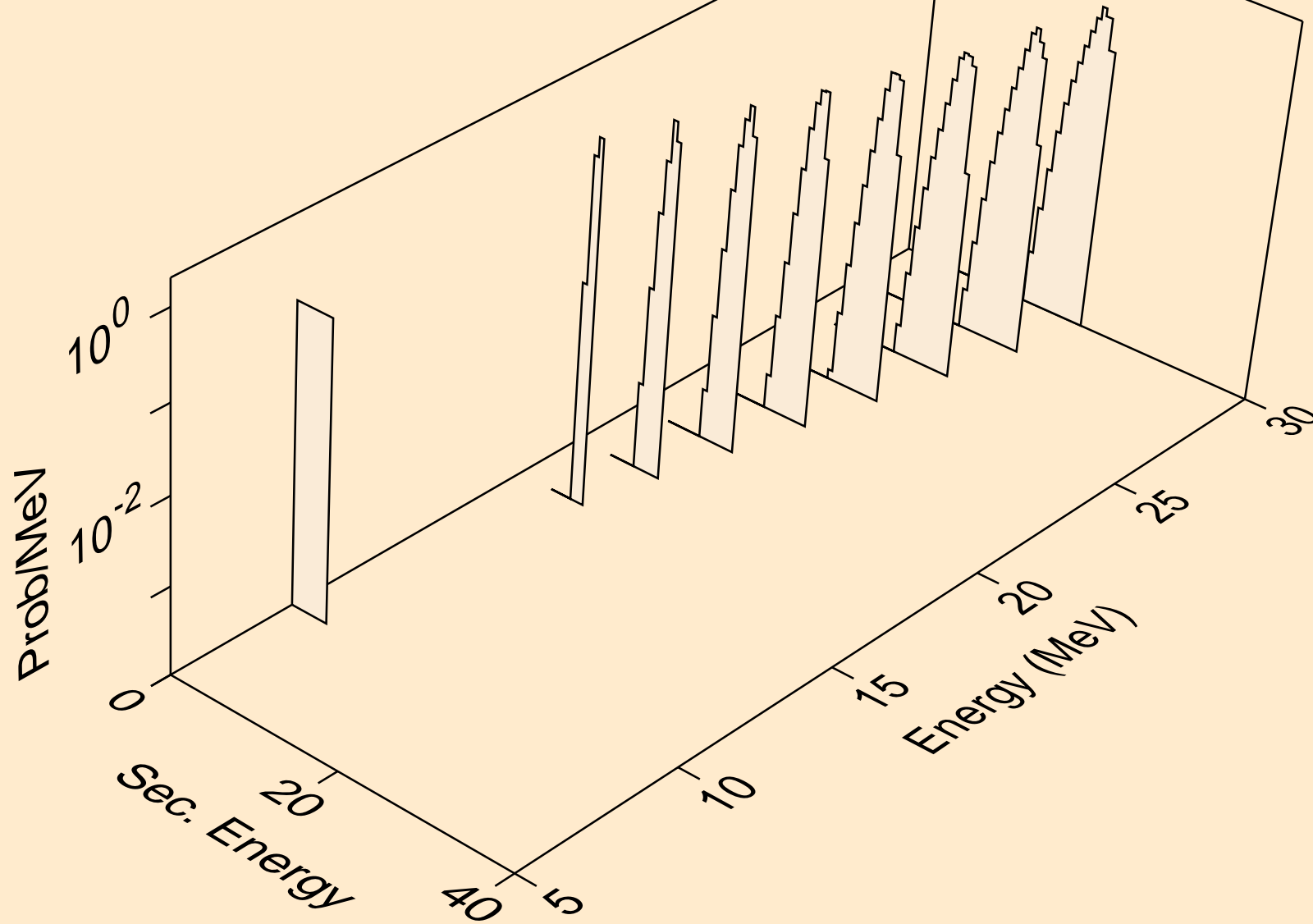

TL213 PROTON ACER TENDL-2021 LIBRARY; T=0.K  
he3s from (p,he3)

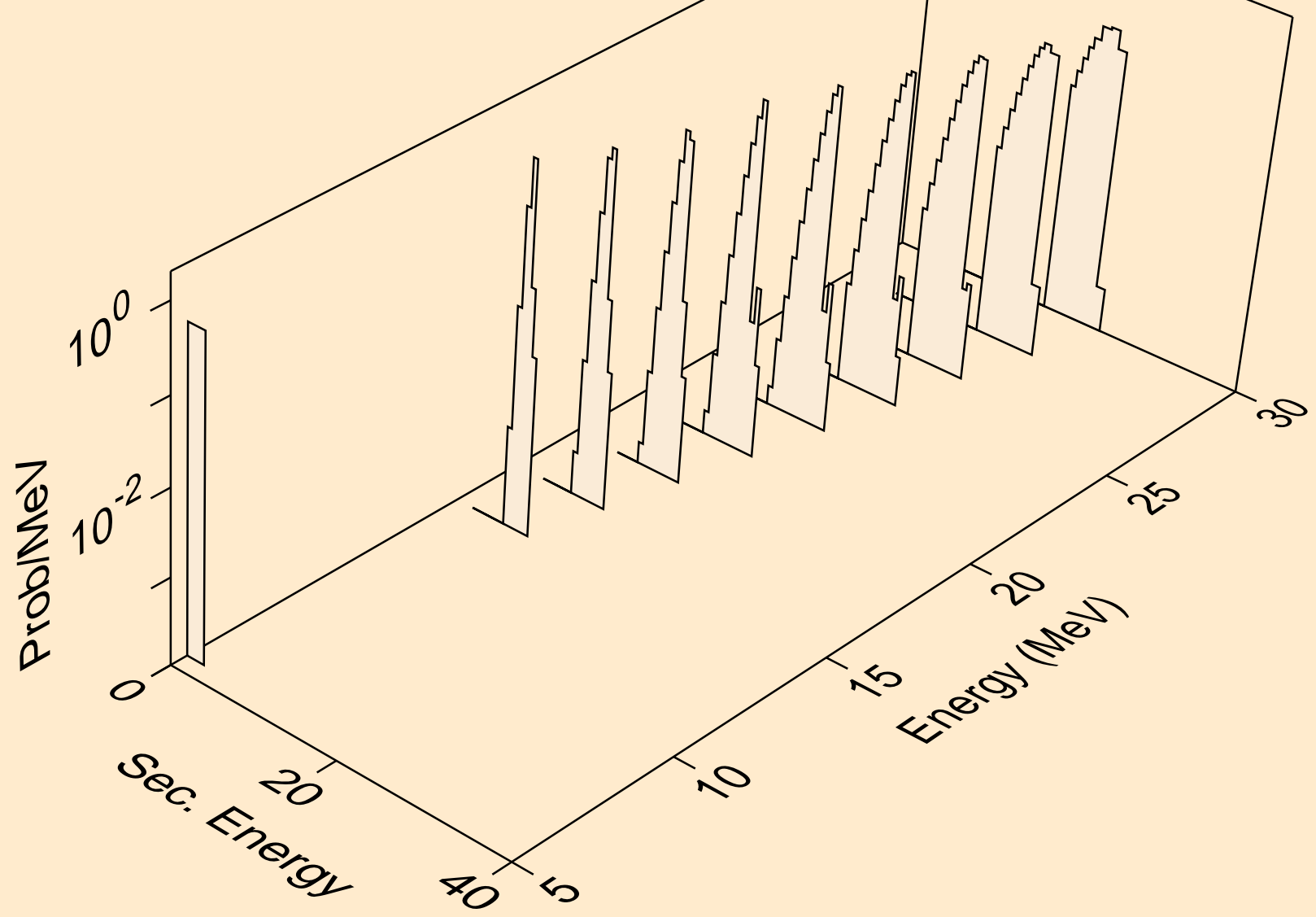

TL213 PROTON ACER TENDL-2021 LIBRARY; T=0.K  
alphas from (p,x)

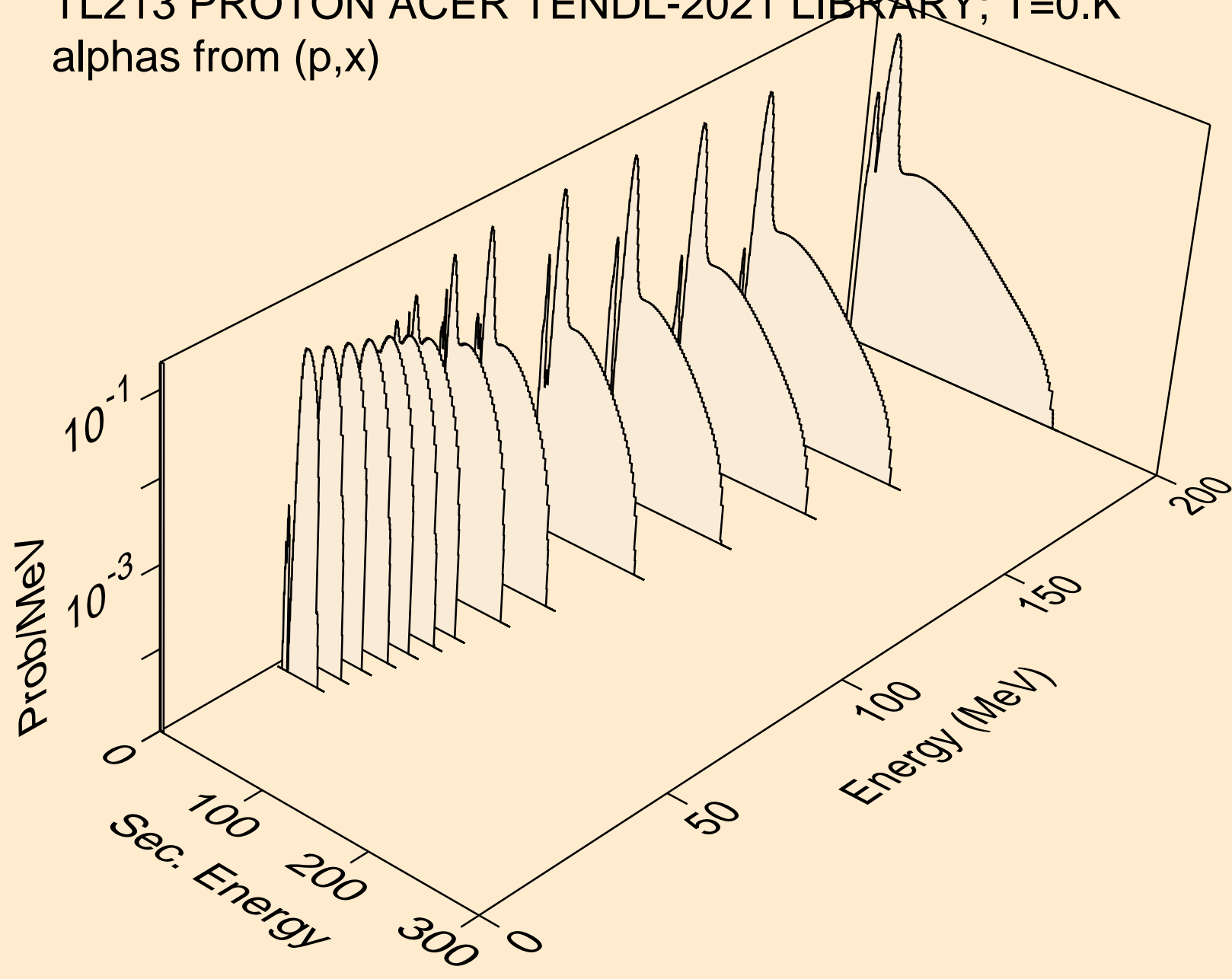

TL213 PROTON ACER TENDL-2021 LIBRARY; T=0.K  
alphas from (p,n\*)a

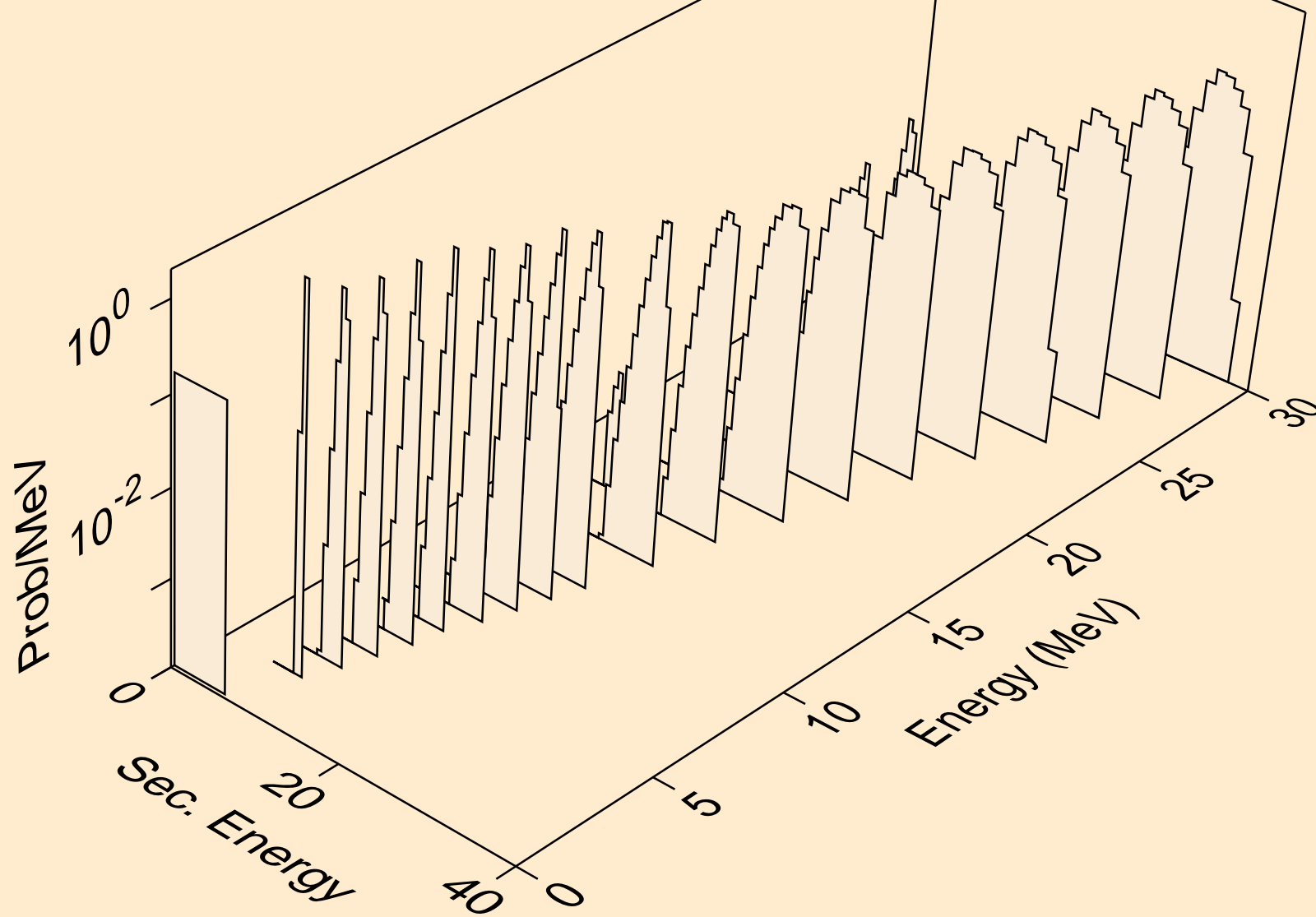

TL213 PROTON ACER TENDL-2021 LIBRARY; T=0.K  
alphas from (p,2n)a

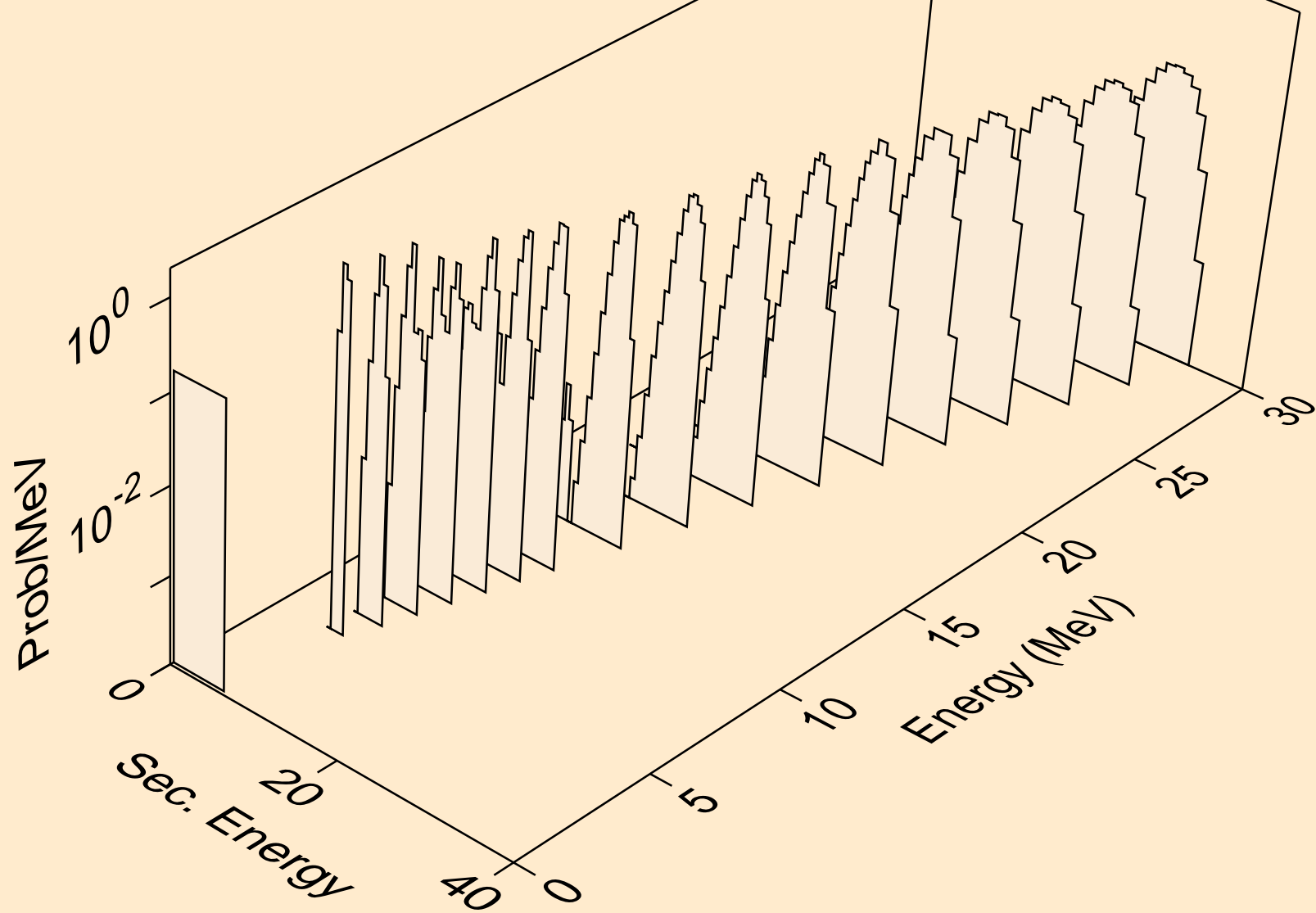



TL213 PROTON ACER TENDL-2021 LIBRARY; T=0.K  
alphas from (p,3n)a

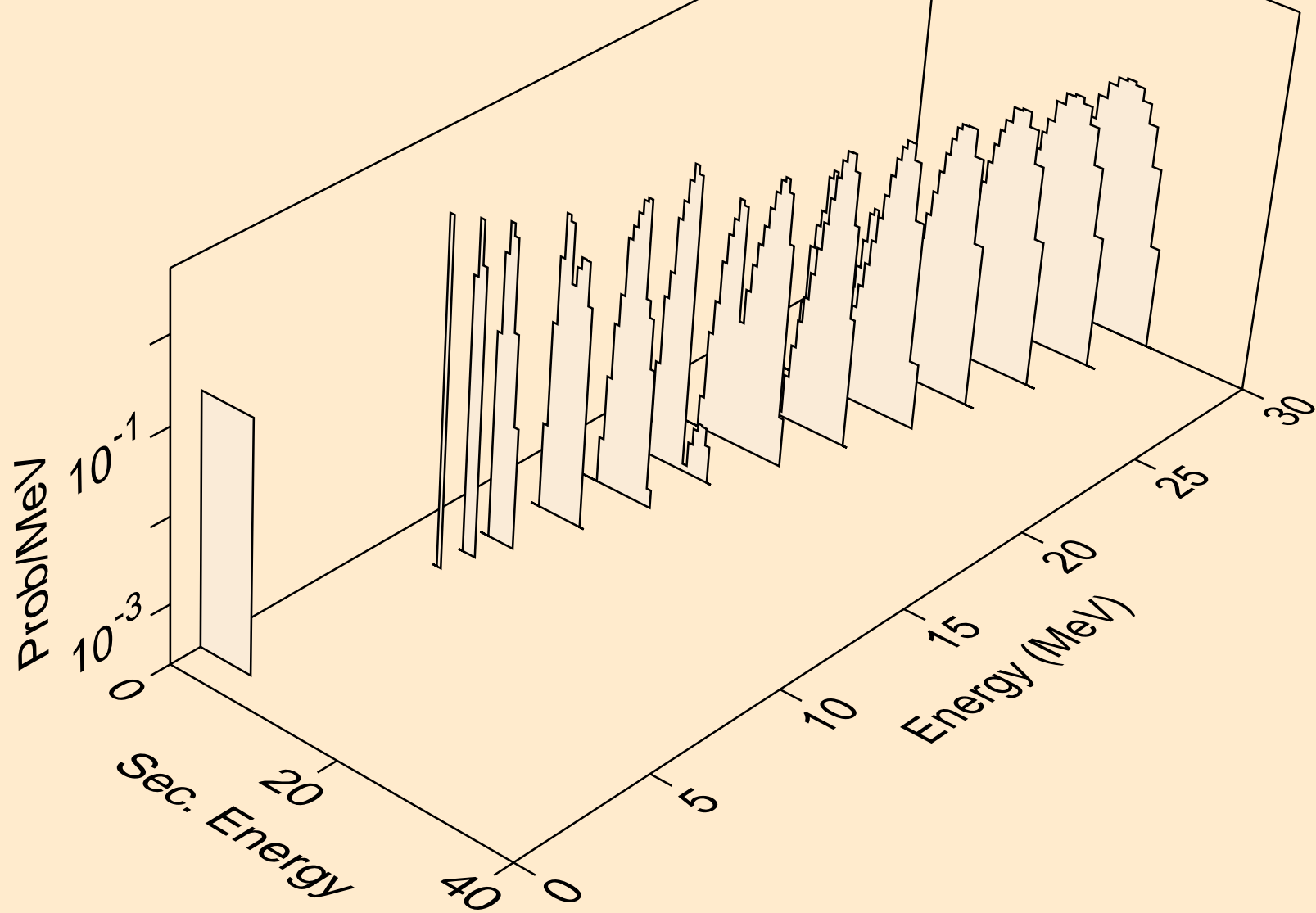

TL213 PROTON ACER TENDL-2021 LIBRARY; T=0.K  
alphas from (p,a)

