

# TM154 PROTON ACER TENDL-2021 LIBRARY; T=0.K

## Principal cross sections

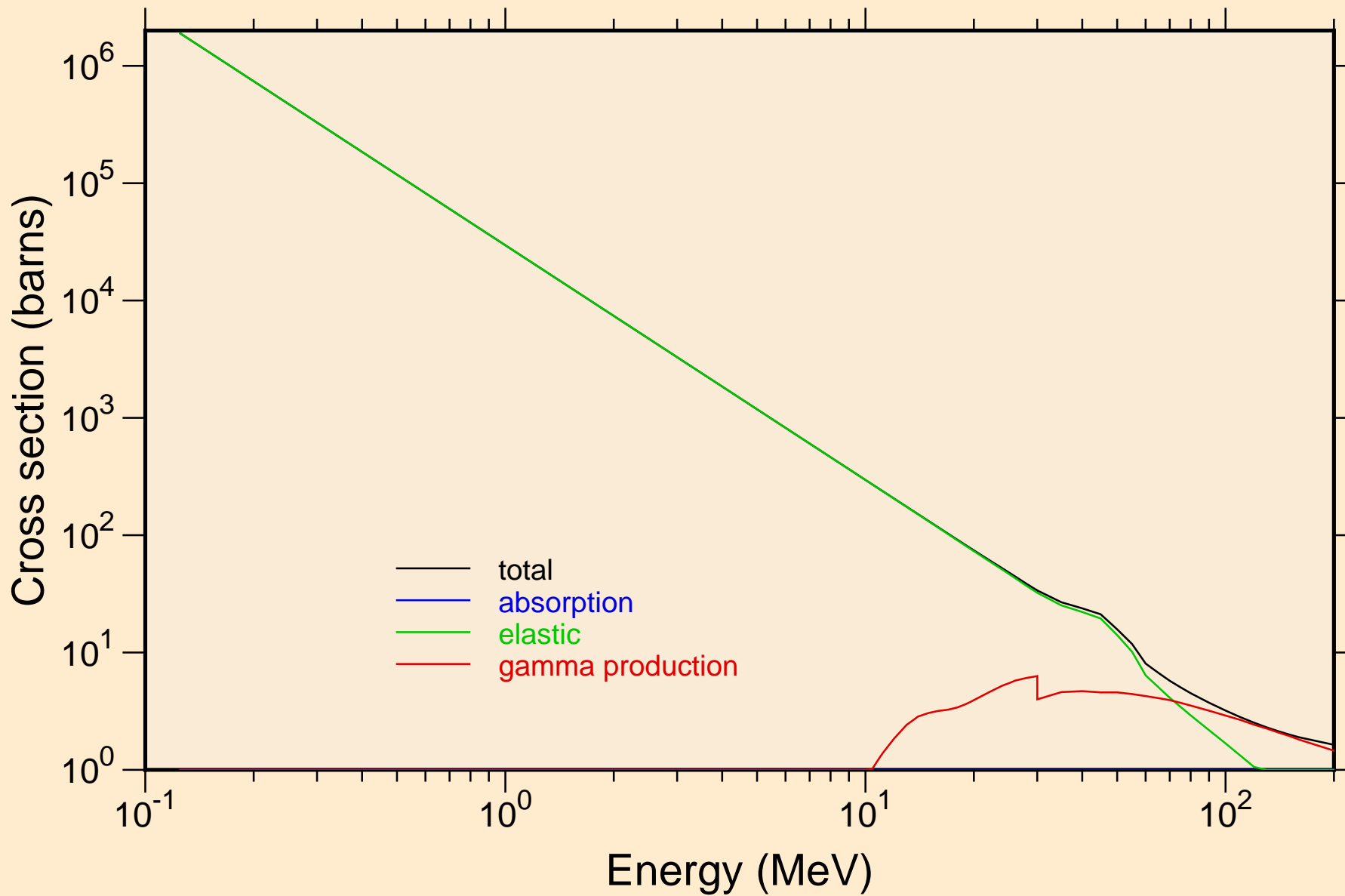

TM154 PROTON ACER TENDL-2021 LIBRARY; T=0.K  
Heating

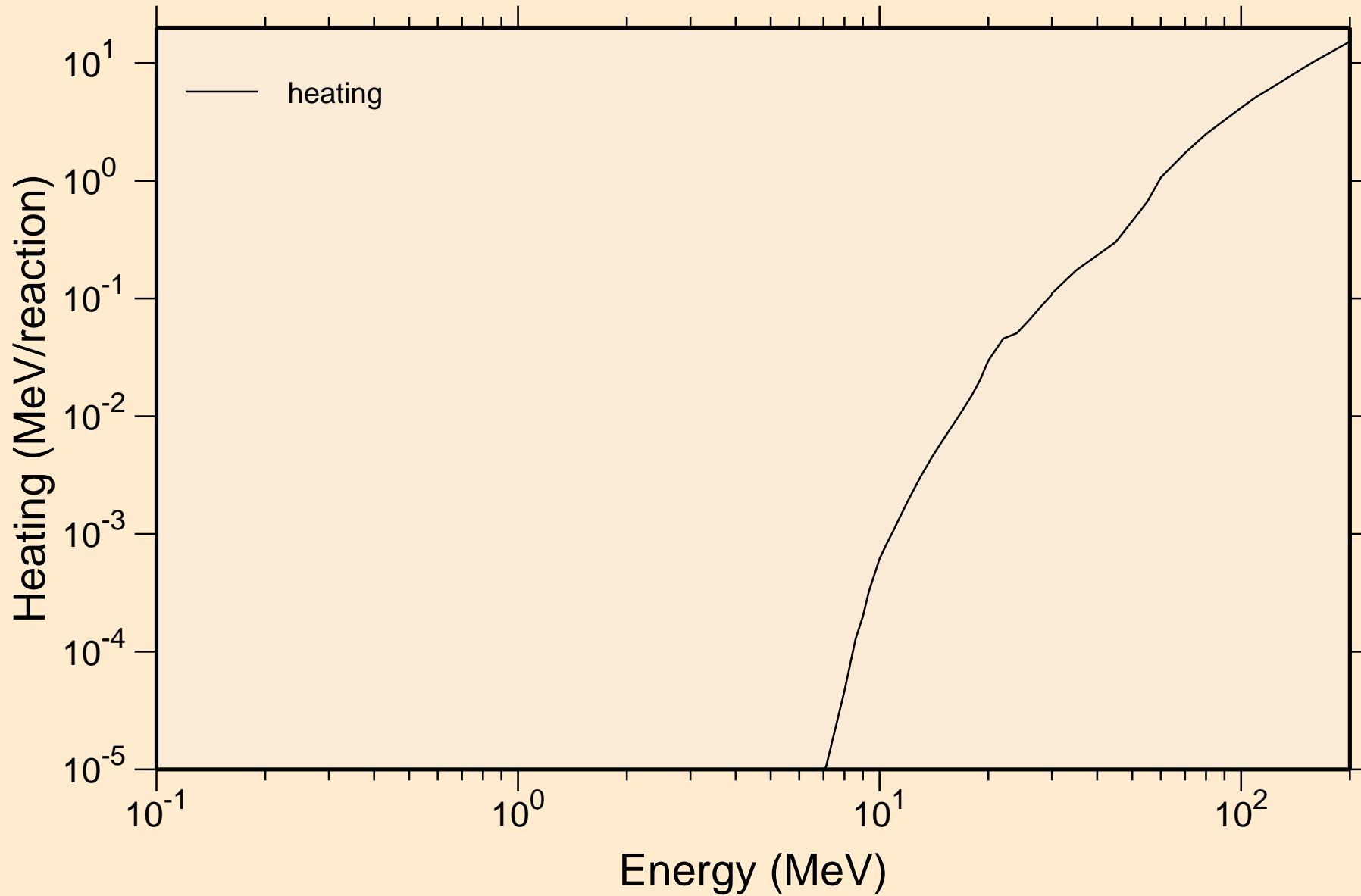

# TM154 PROTON ACER TENDL-2021 LIBRARY; T=0.K

## Principal cross sections

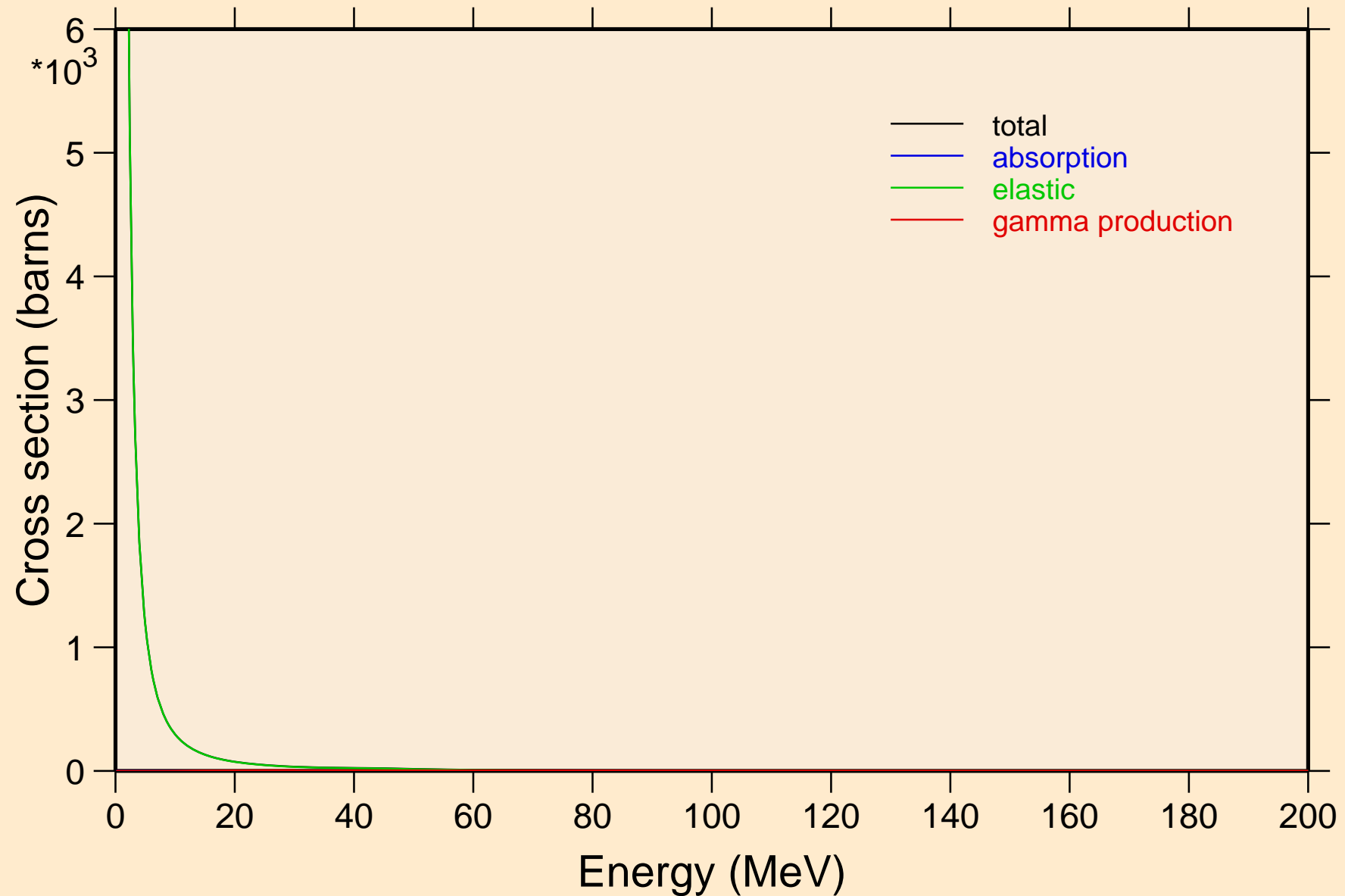

# TM154 PROTON ACER TENDL-2021 LIBRARY; T=0.K

## Heating

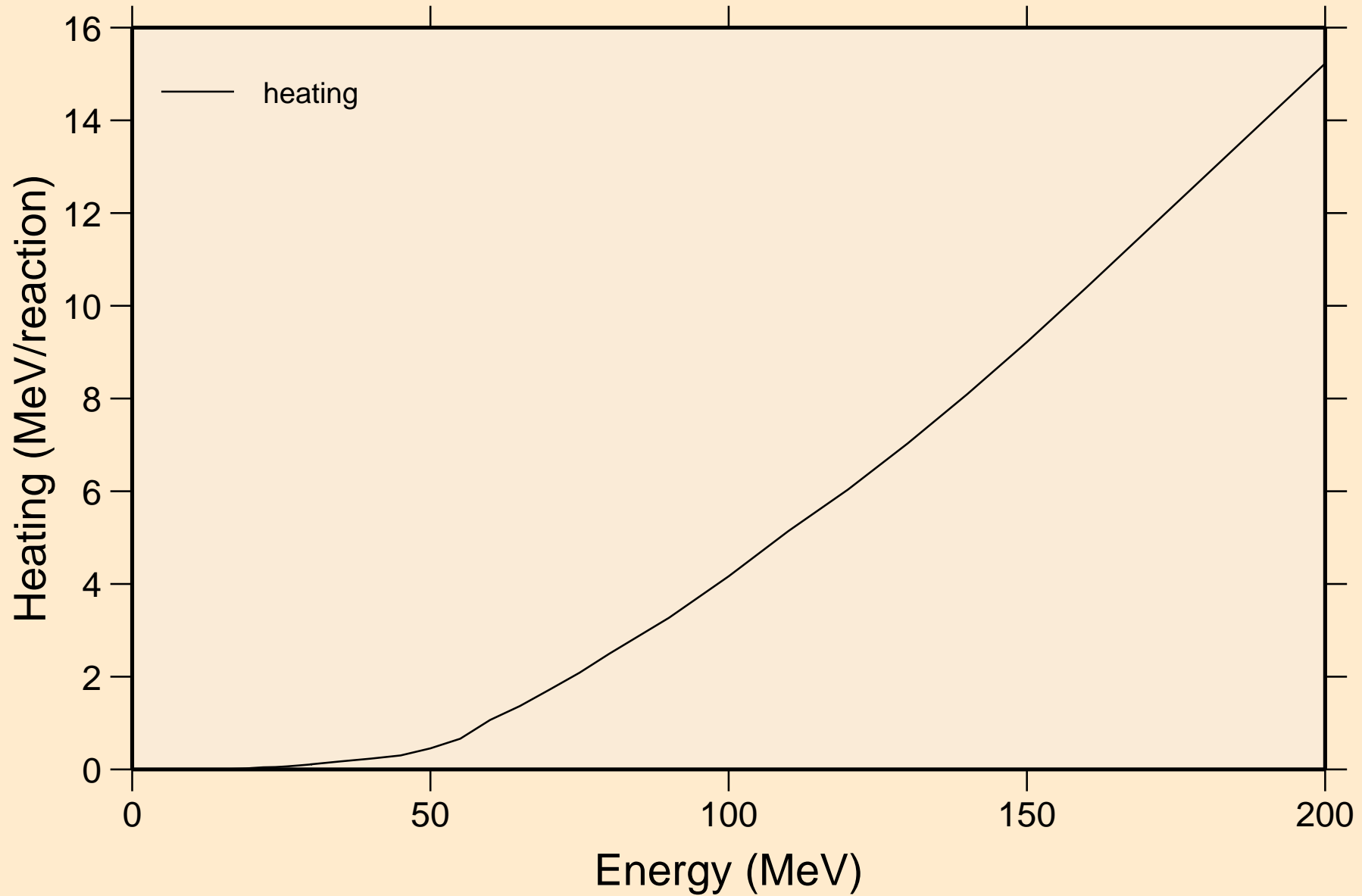

# TM154 PROTON ACER TENDL-2021 LIBRARY; T=0.K

## Threshold reactions

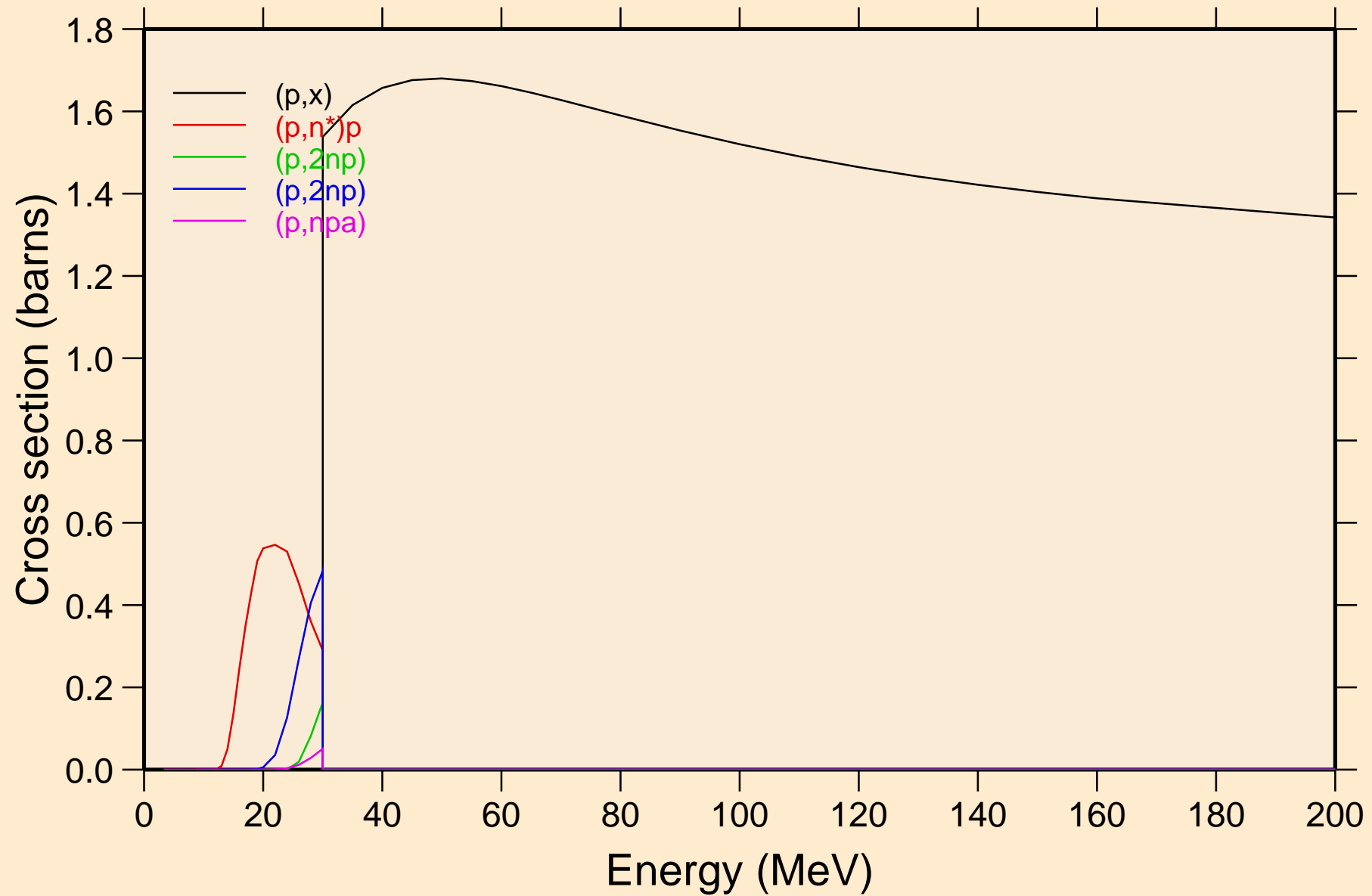

# TM154 PROTON ACER TENDL-2021 LIBRARY; T=0.K

## Threshold reactions

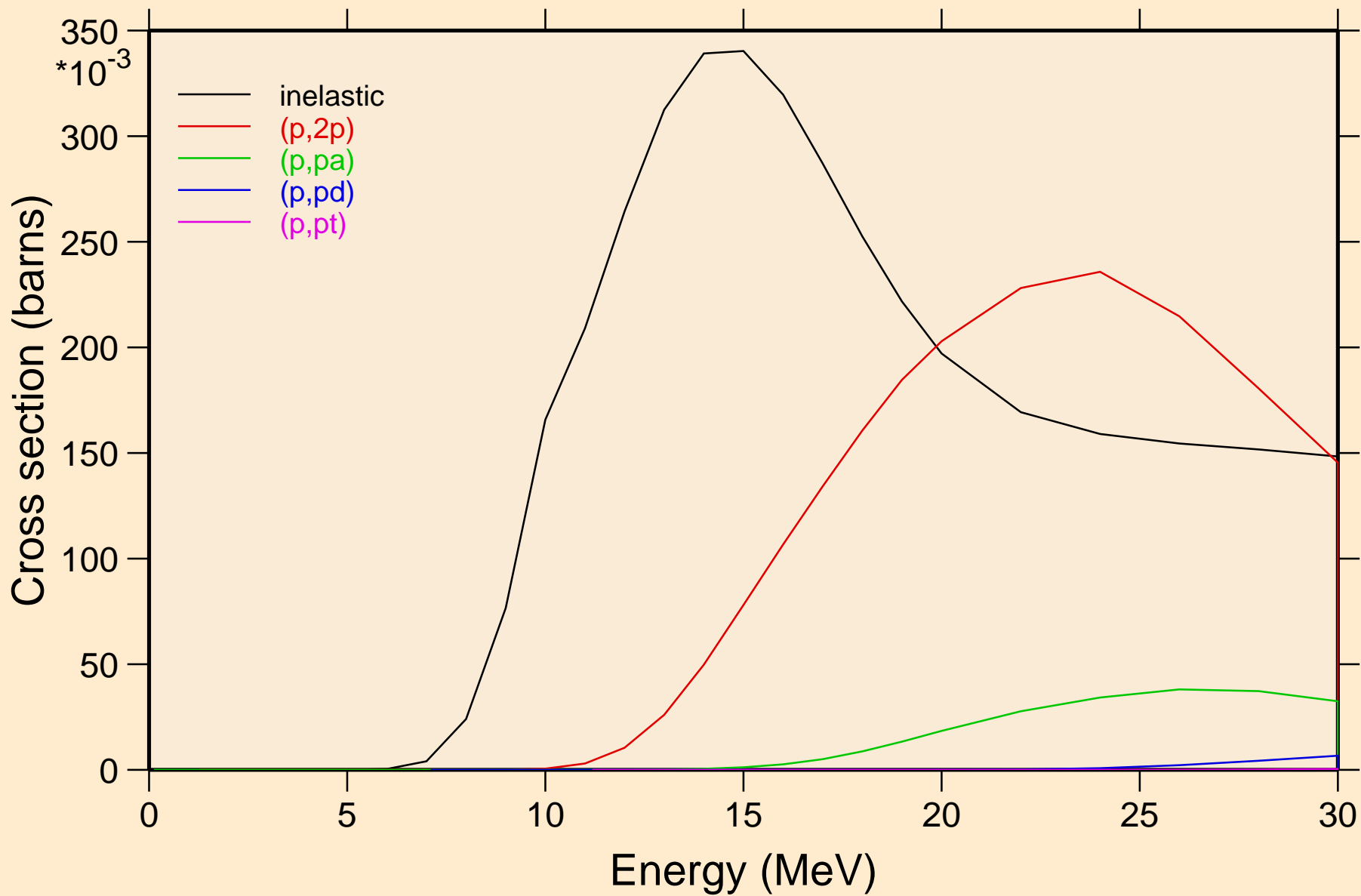

TM154 PROTON ACER TENDL-2021 LIBRARY; T=0.K  
Threshold reactions

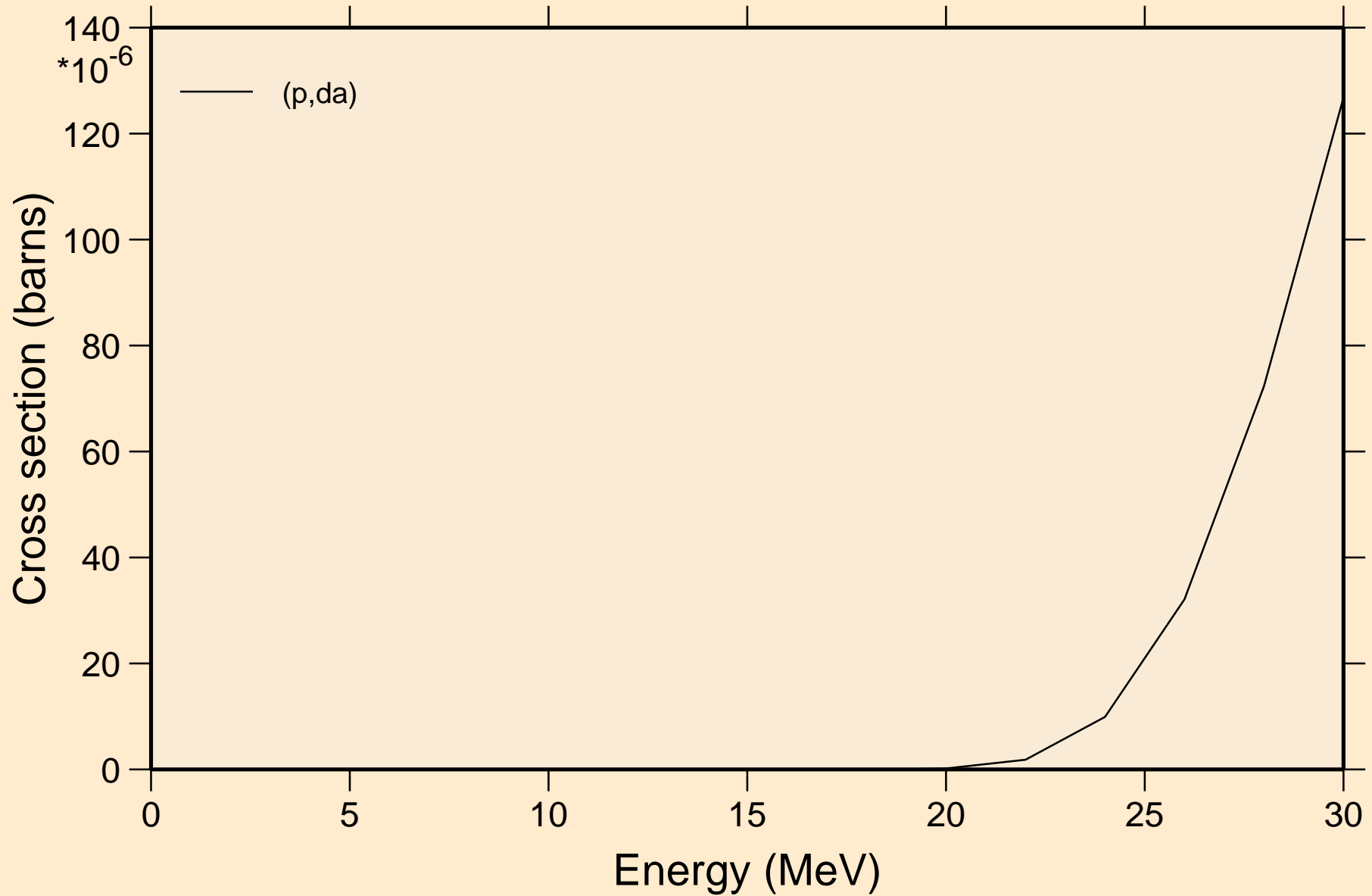

TM154 PROTON ACER TENDL-2021 LIBRARY; T=0.K  
angular distribution for elastic

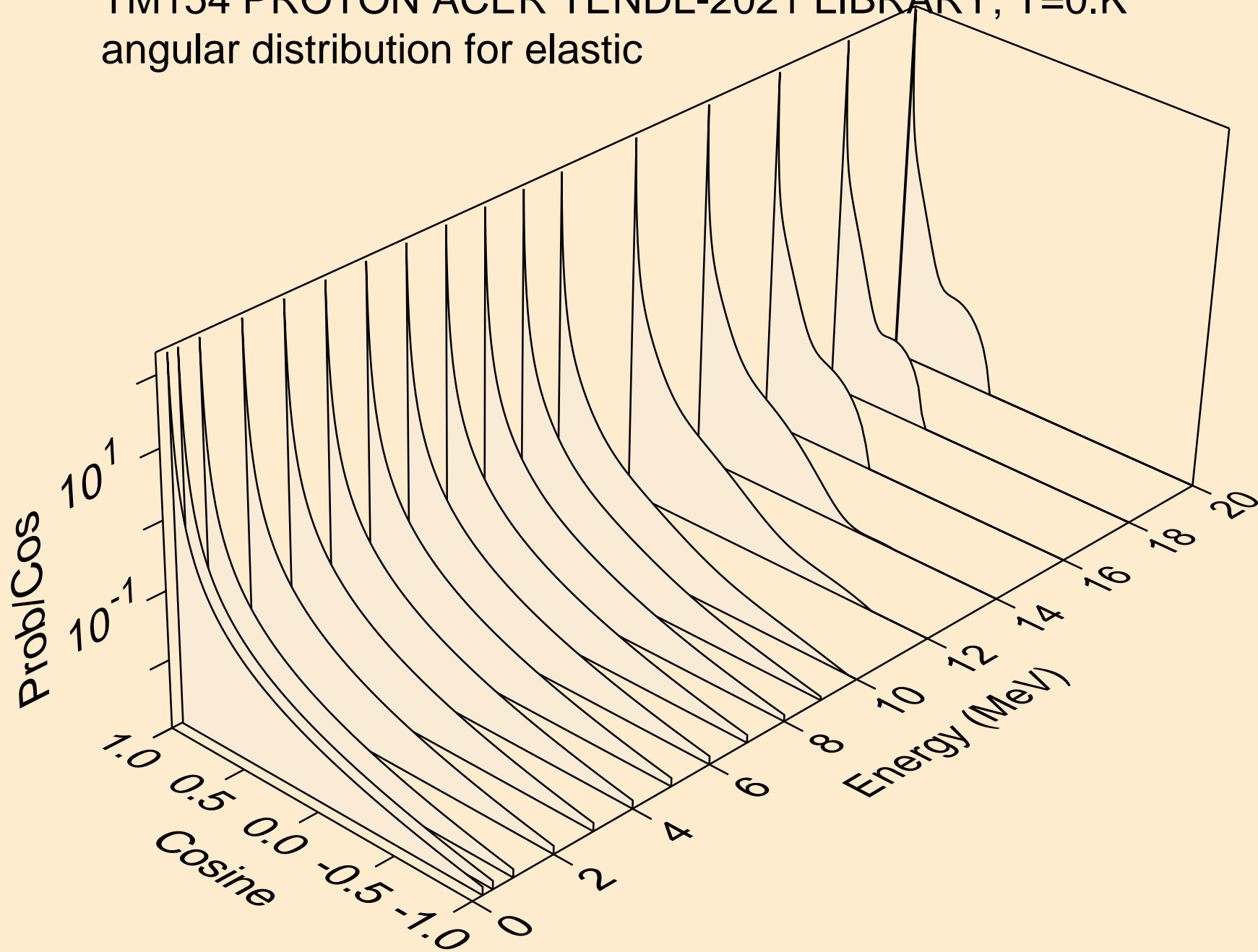



TM154 PROTON ACER TENDL-2021 LIBRARY; T=0.K  
angular distribution for elastic

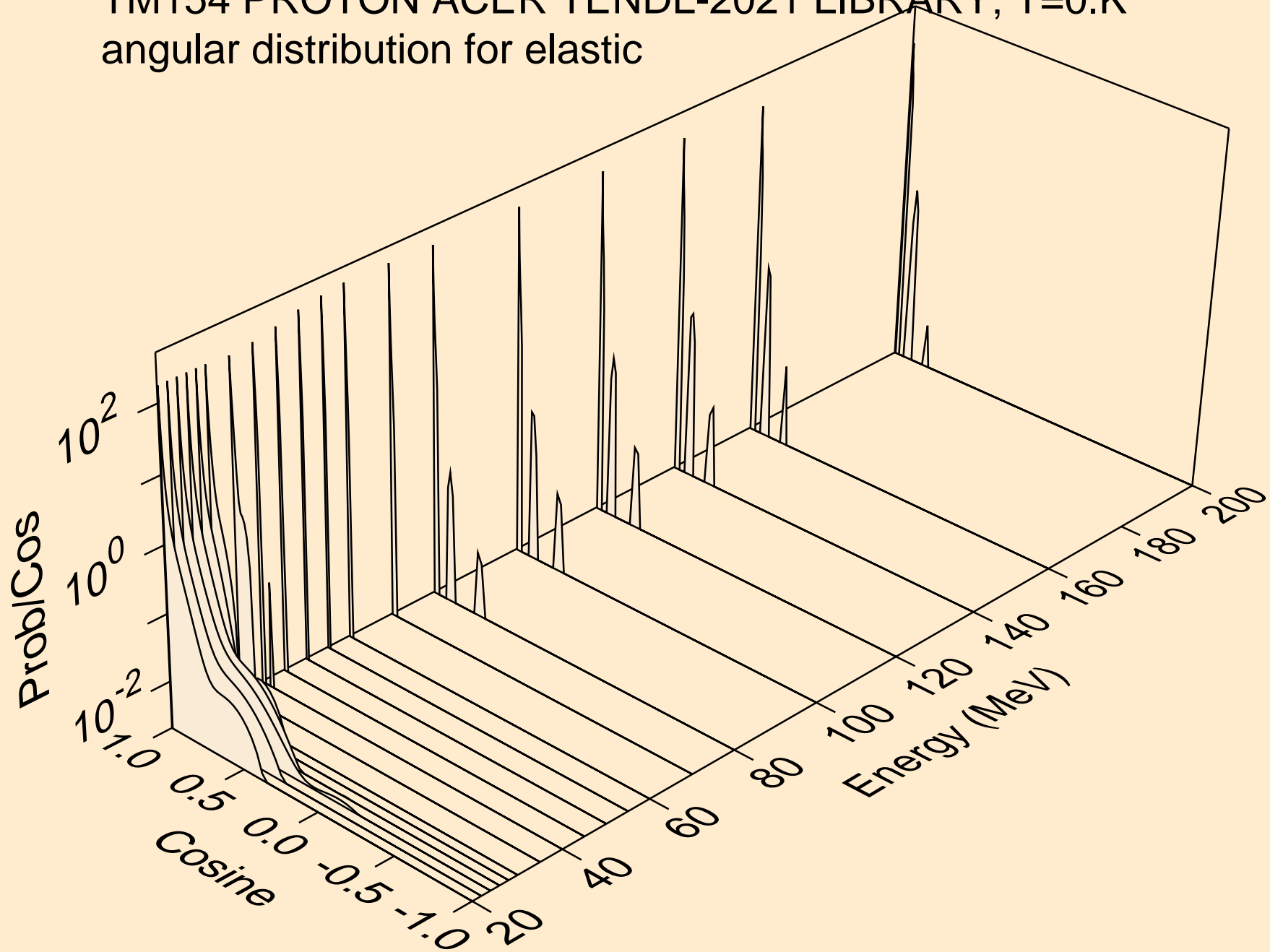

TM154 PROTON ACER TENDL-2021 LIBRARY; T=0.K  
Proton emission for (p,x)

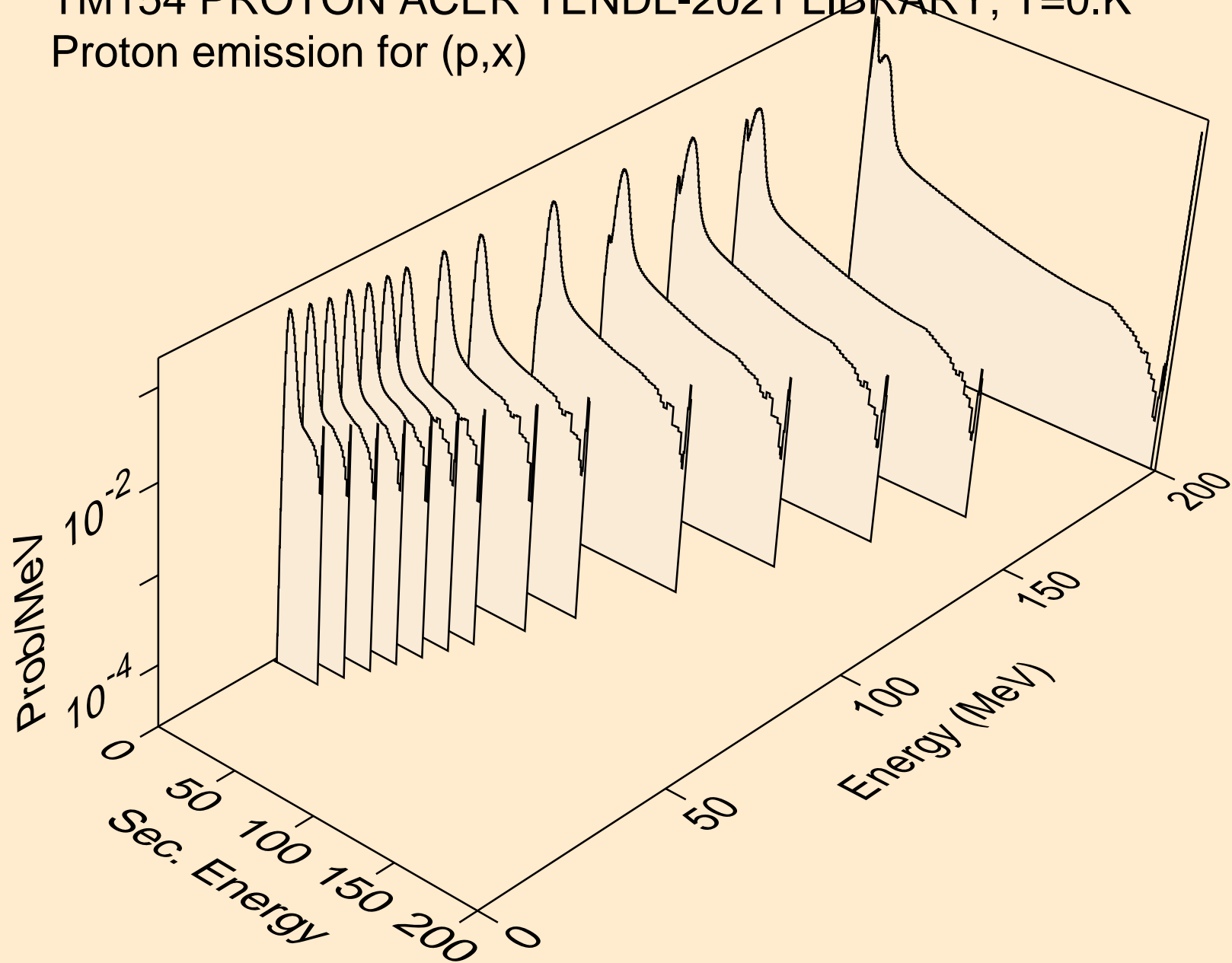

TM154 PROTON ACER TENDL-2021 LIBRARY; T=0.K  
Proton emission for (p,n\*)p

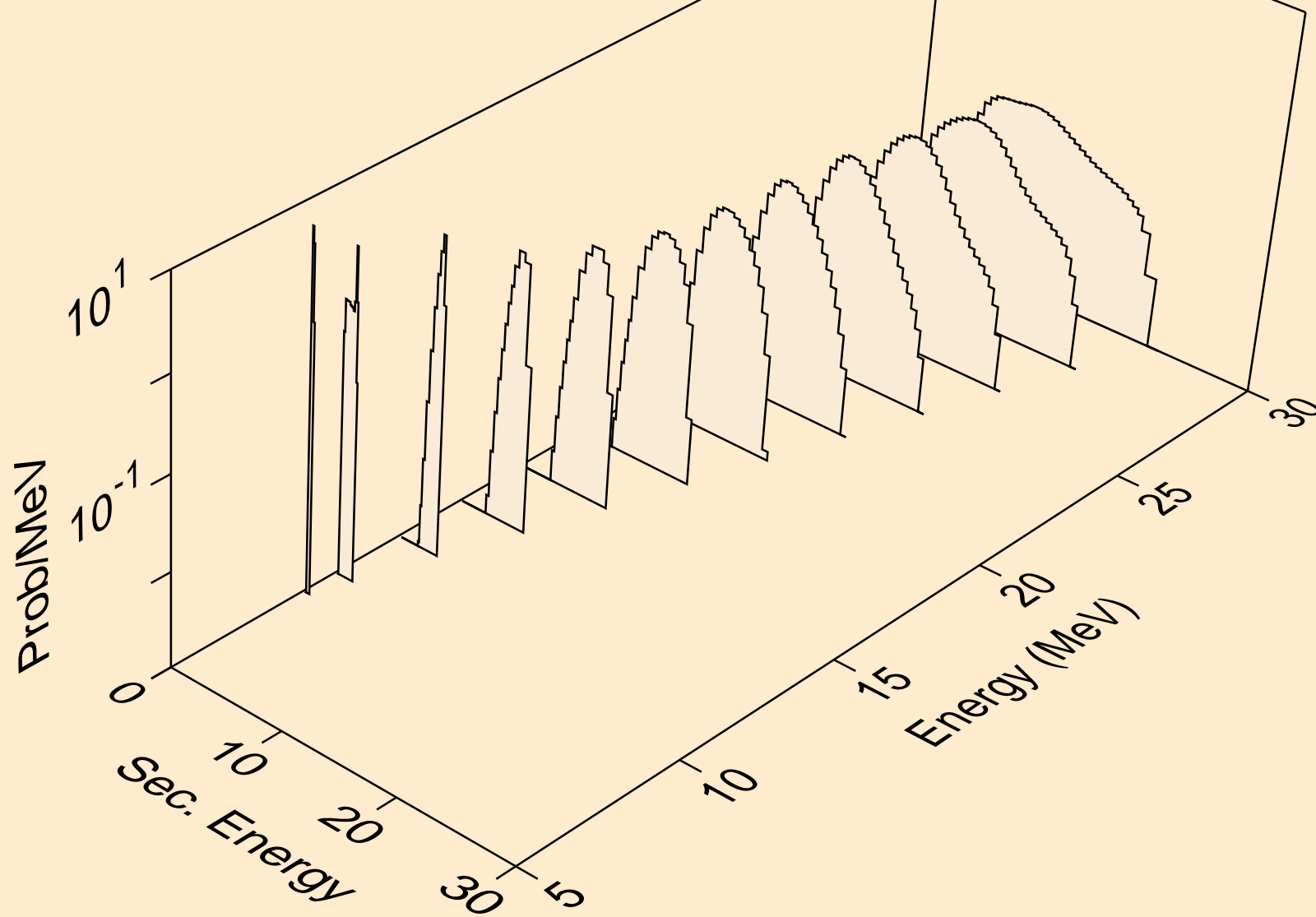

TM154 PROTON ACER TENDL-2021 LIBRARY; T=0.K  
Proton emission for (p,2np)

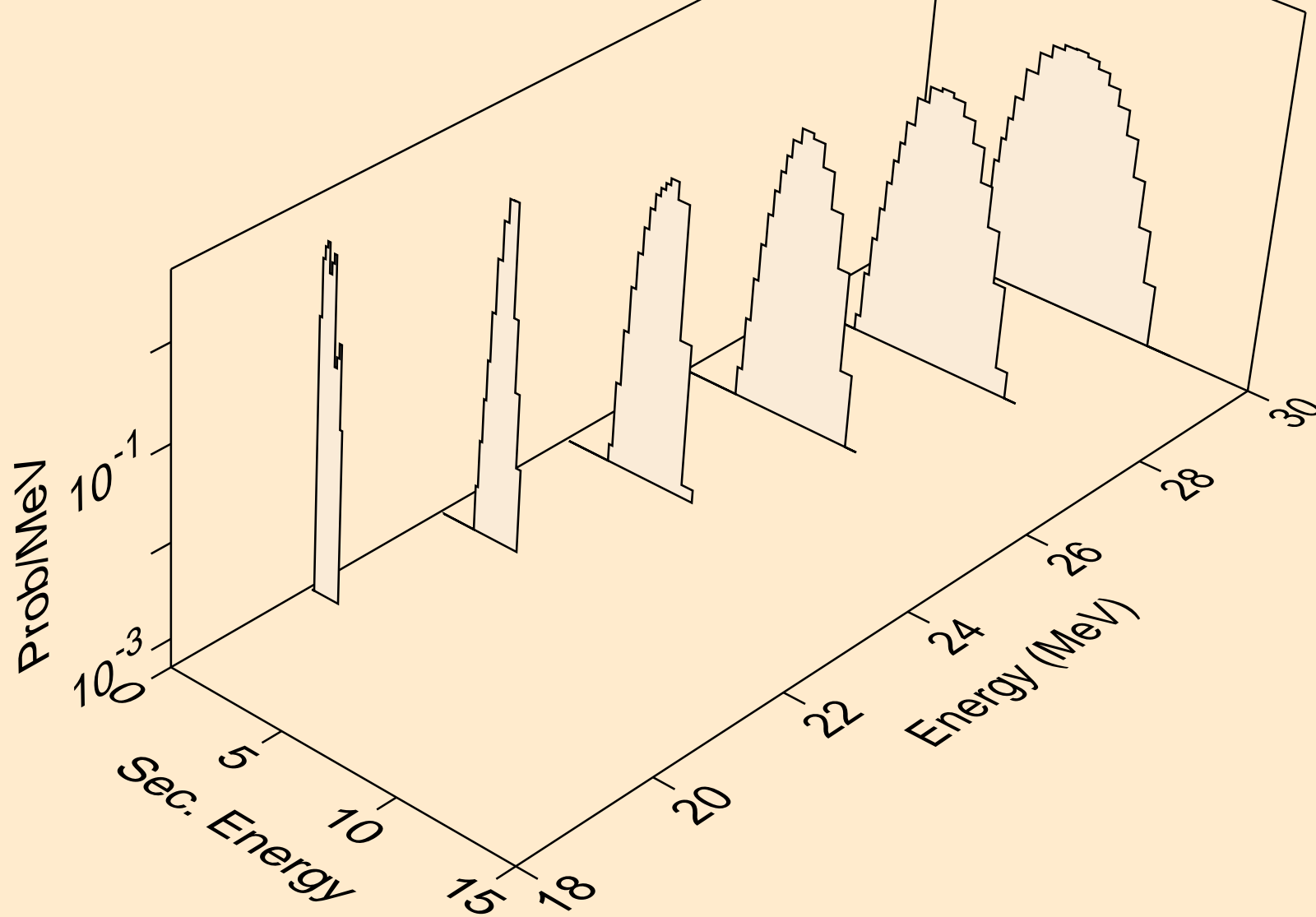

TM154 PROTON ACER TENDL-2021 LIBRARY; T=0.K  
Proton emission for (p,2np)

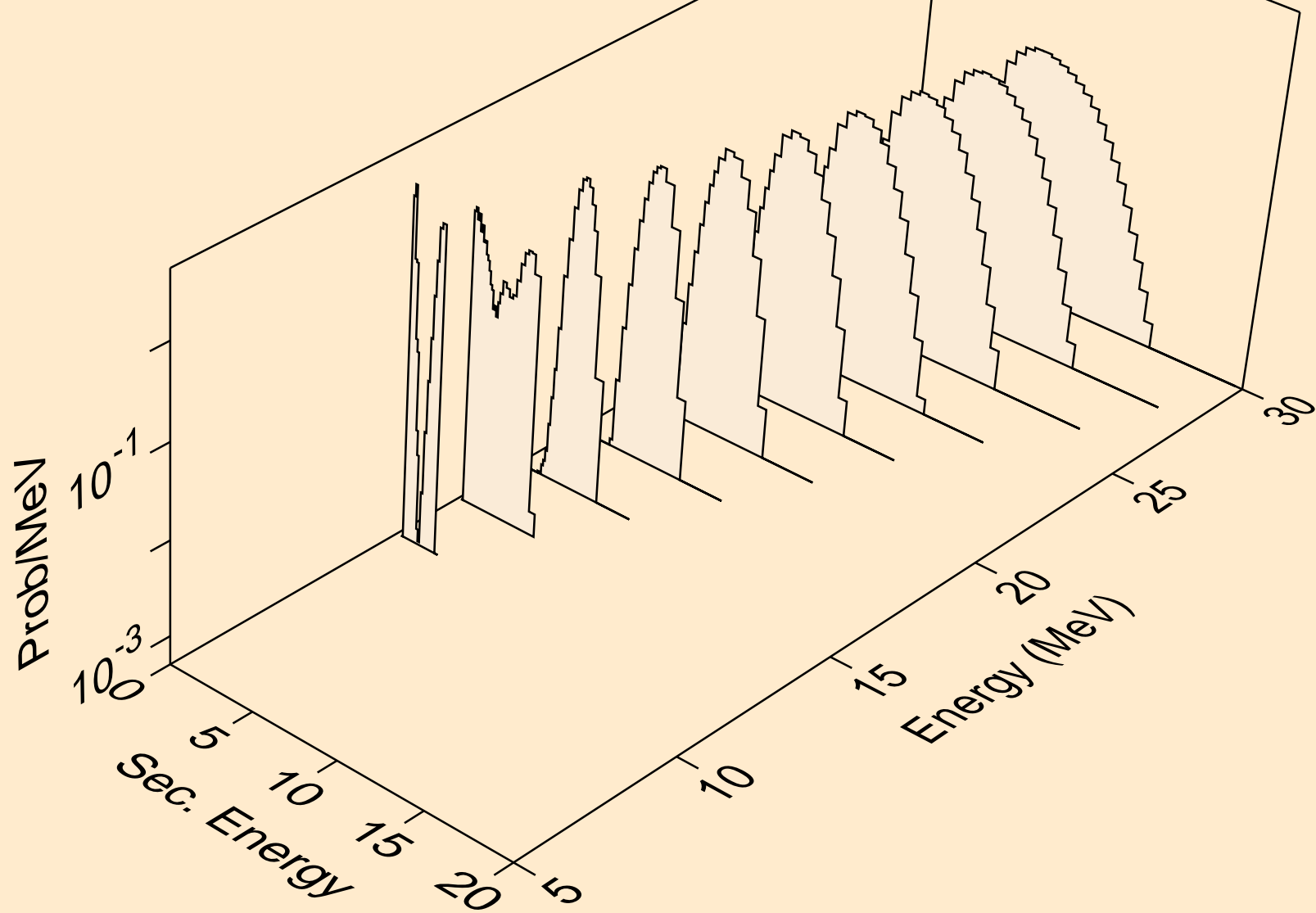

TM154 PROTON ACER TENDL-2021 LIBRARY; T=0.K  
Proton emission for (p,npa)

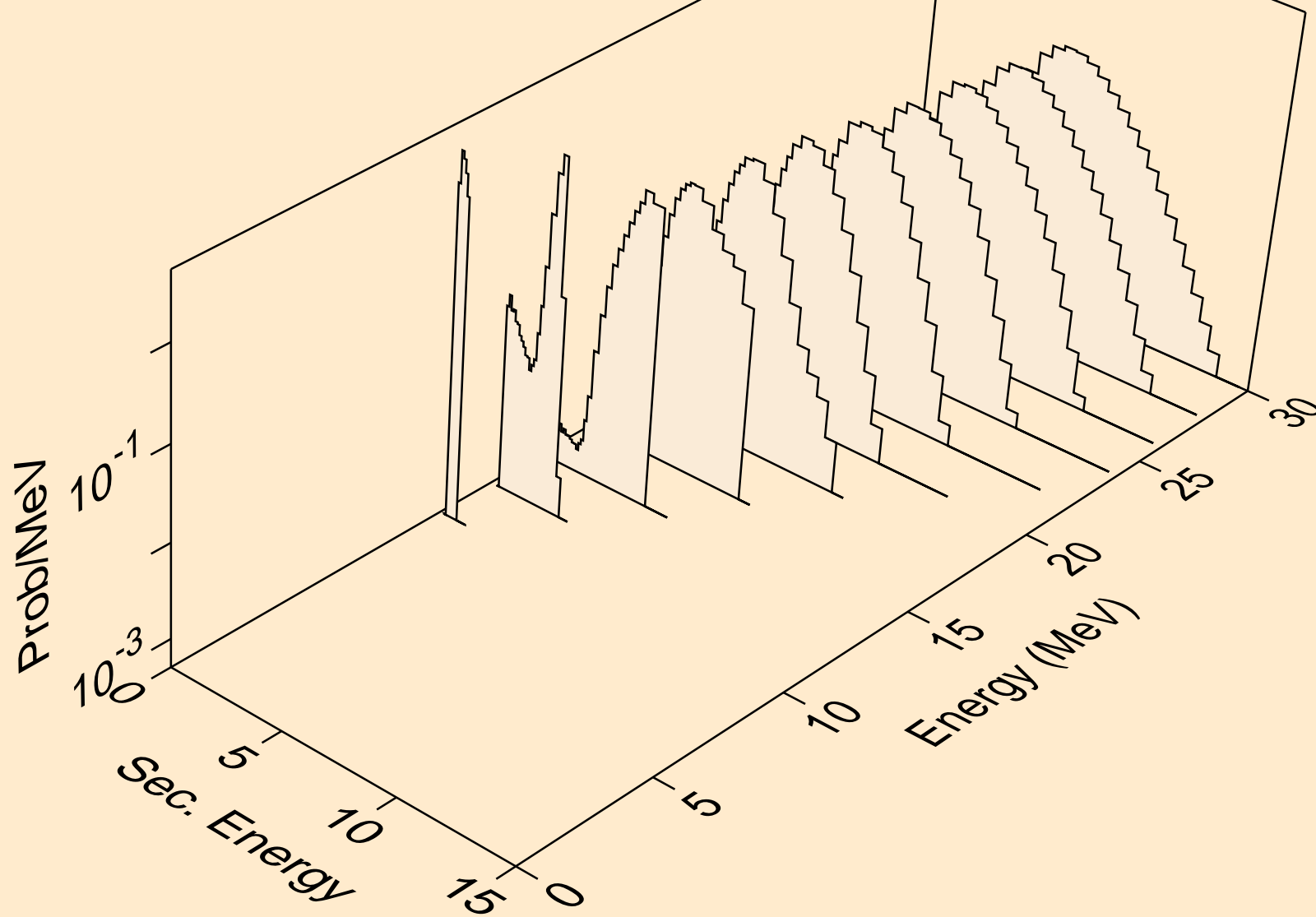

TM154 PROTON ACER TENDL-2021 LIBRARY; T=0.K  
Proton emission for inelastic

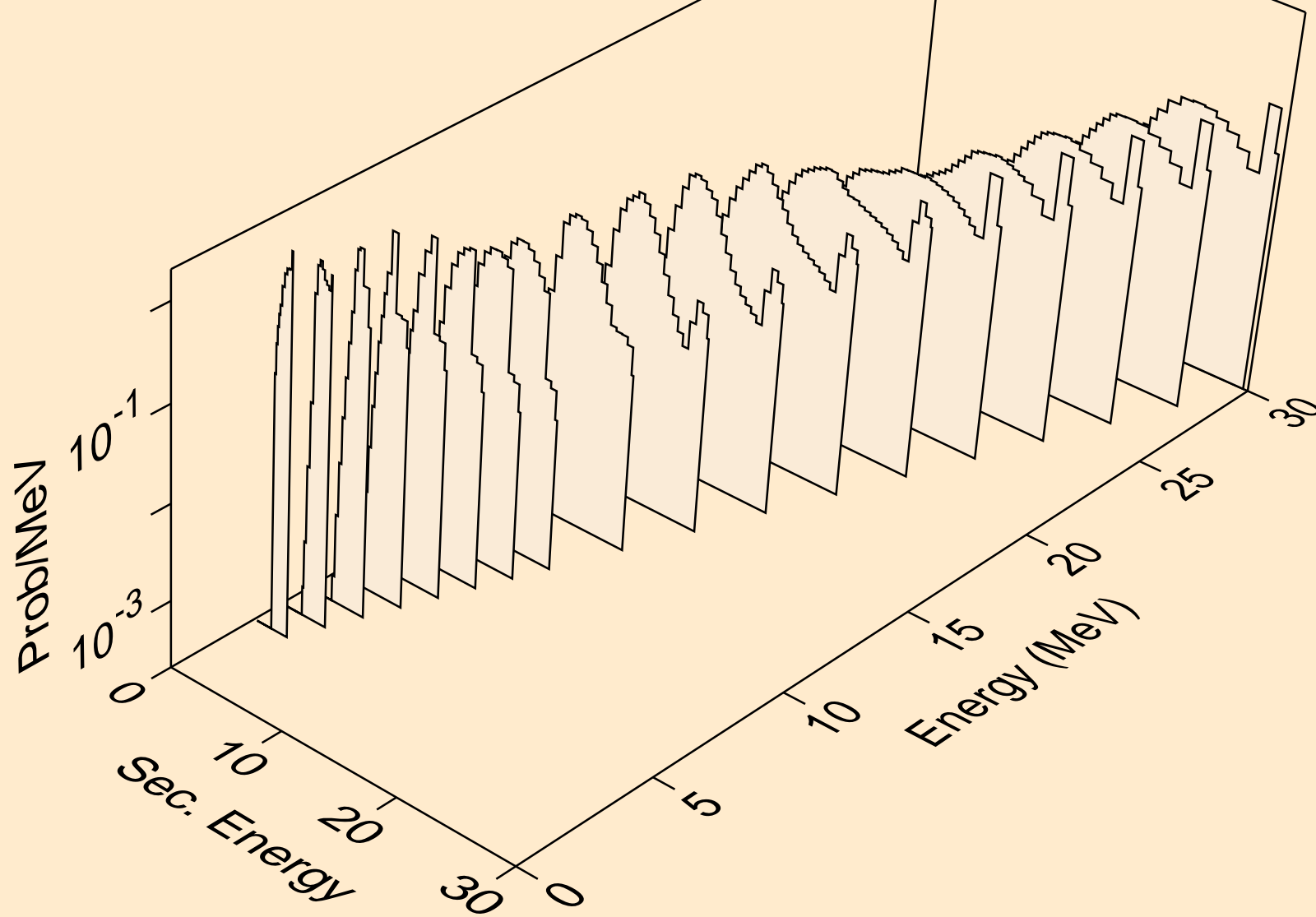

TM154 PROTON ACER TENDL-2021 LIBRARY; T=0.K  
Proton emission for (p,2p)

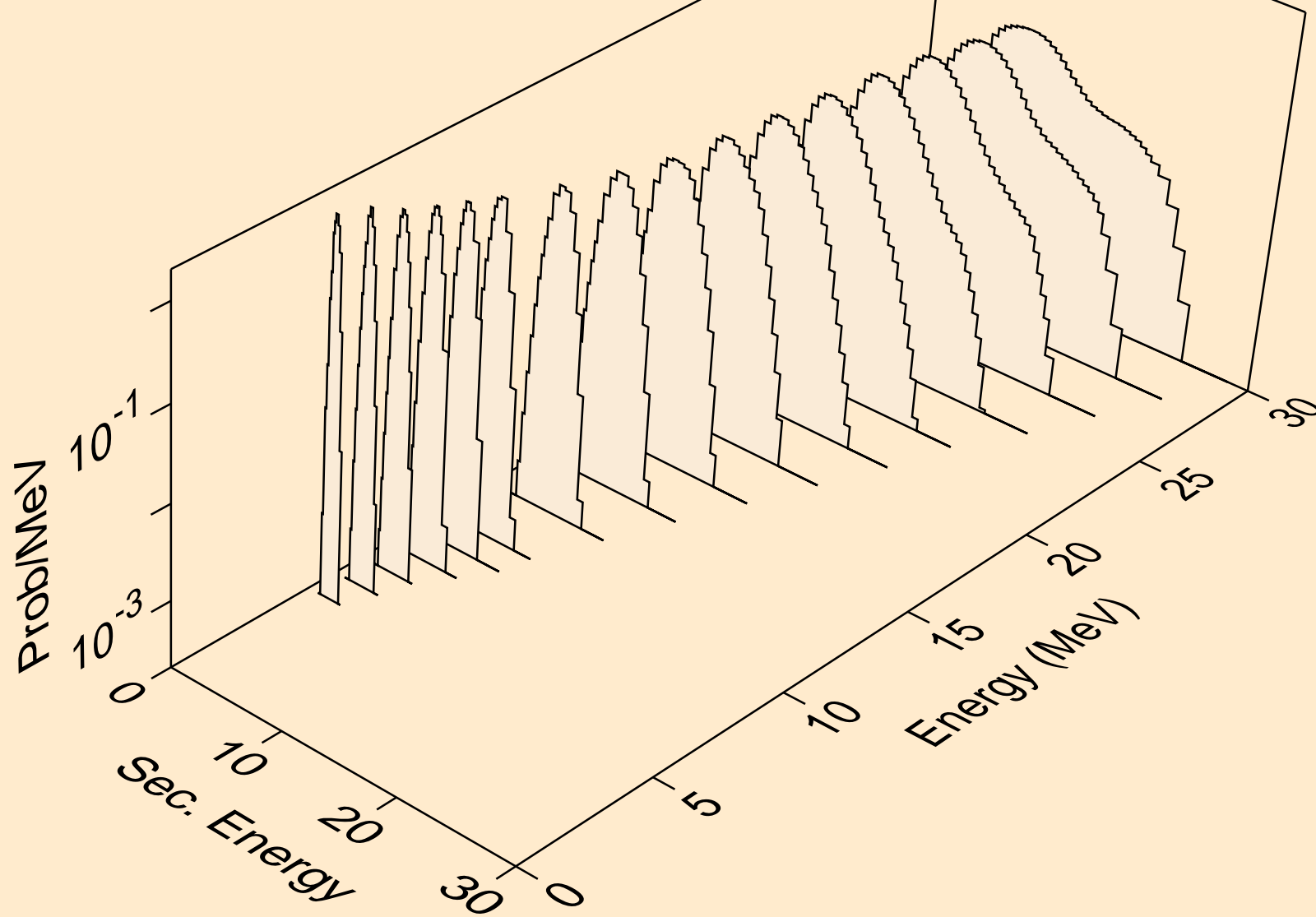



TM154 PROTON ACER TENDL-2021 LIBRARY; T=0.K  
Proton emission for (p,pa)

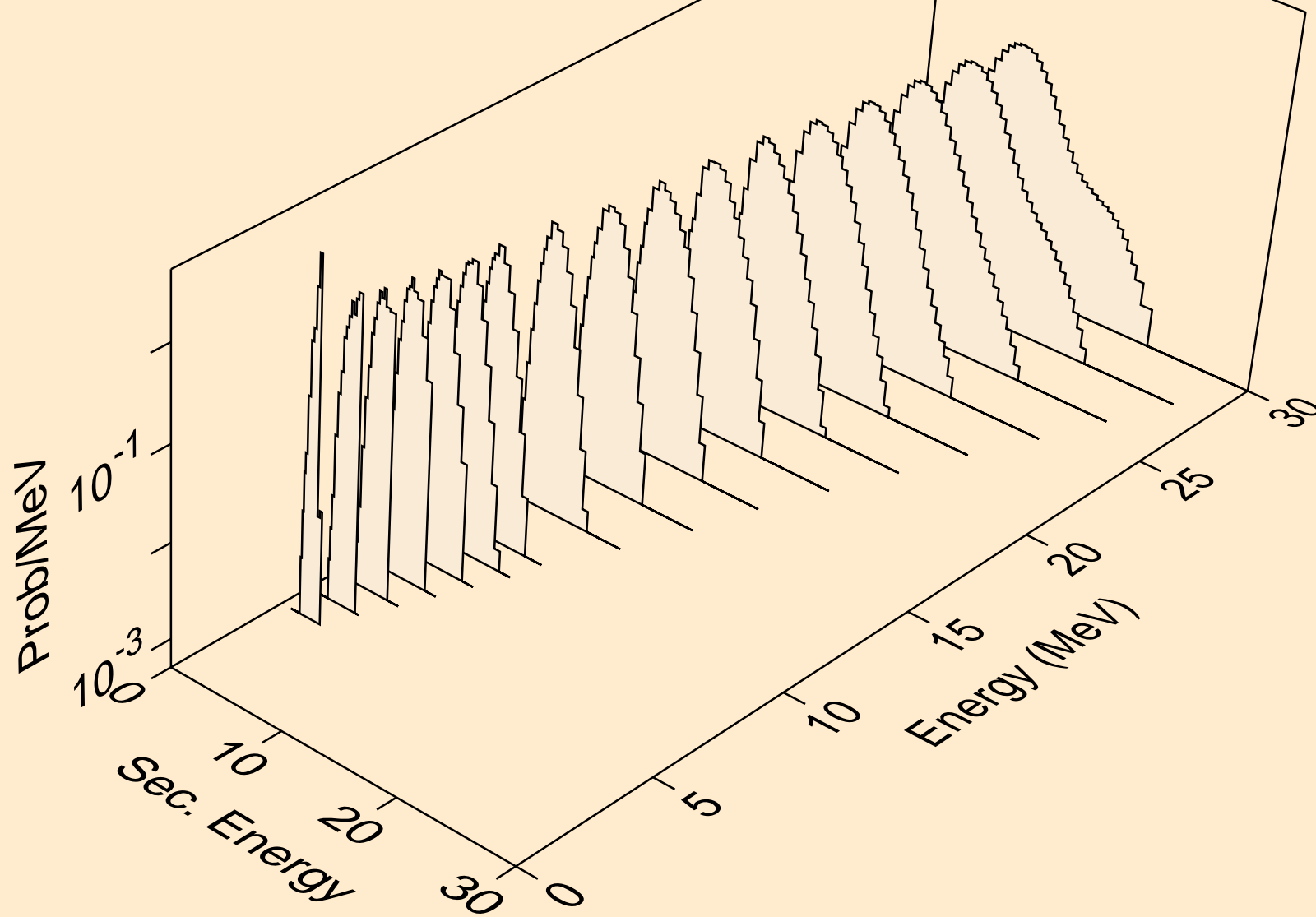

TM154 PROTON ACER TENDL-2021 LIBRARY; T=0.K  
Proton emission for (p,pd)

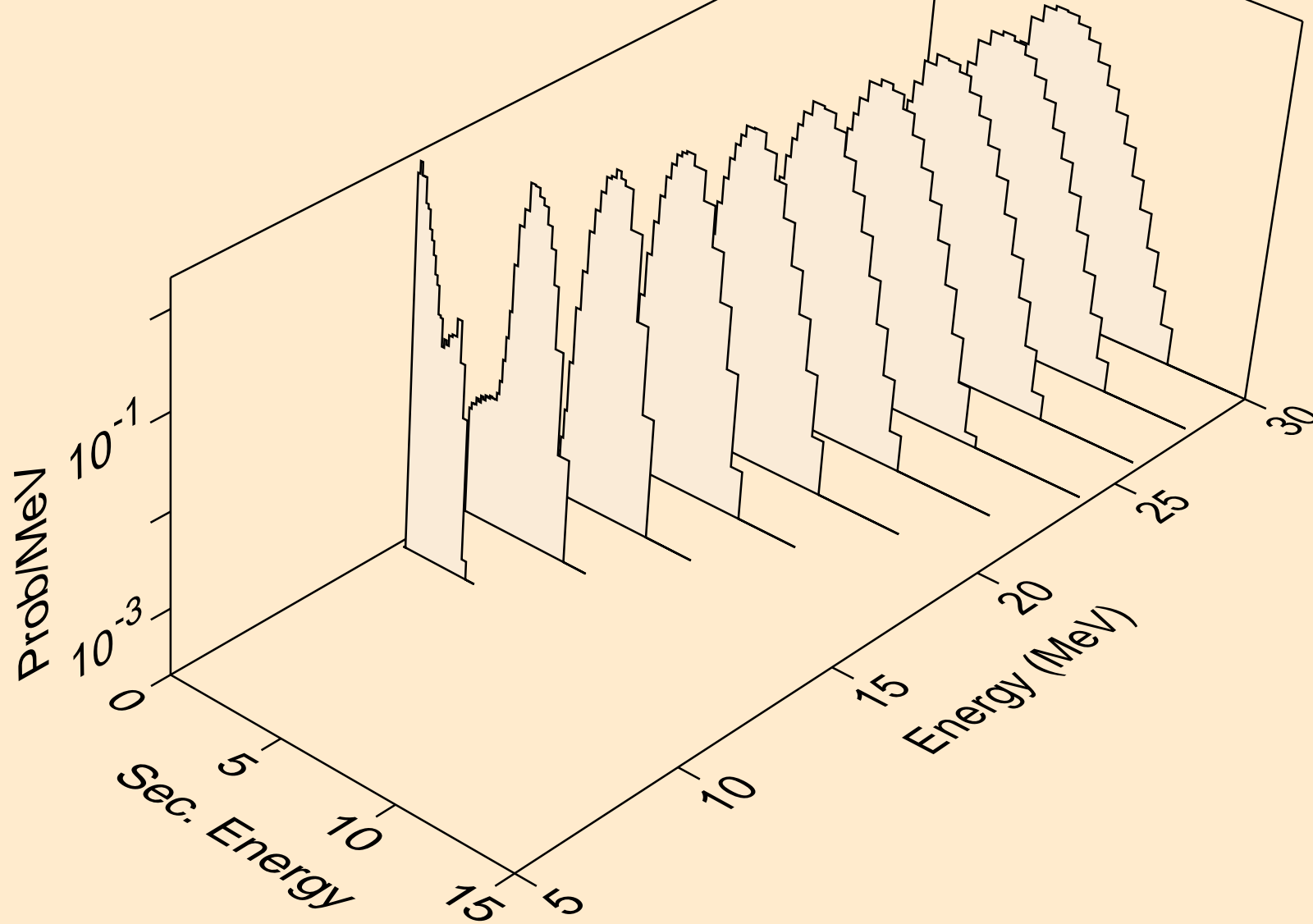

TM154 PROTON ACER TENDL-2021 LIBRARY; T=0.K  
Proton emission for (p,pt)

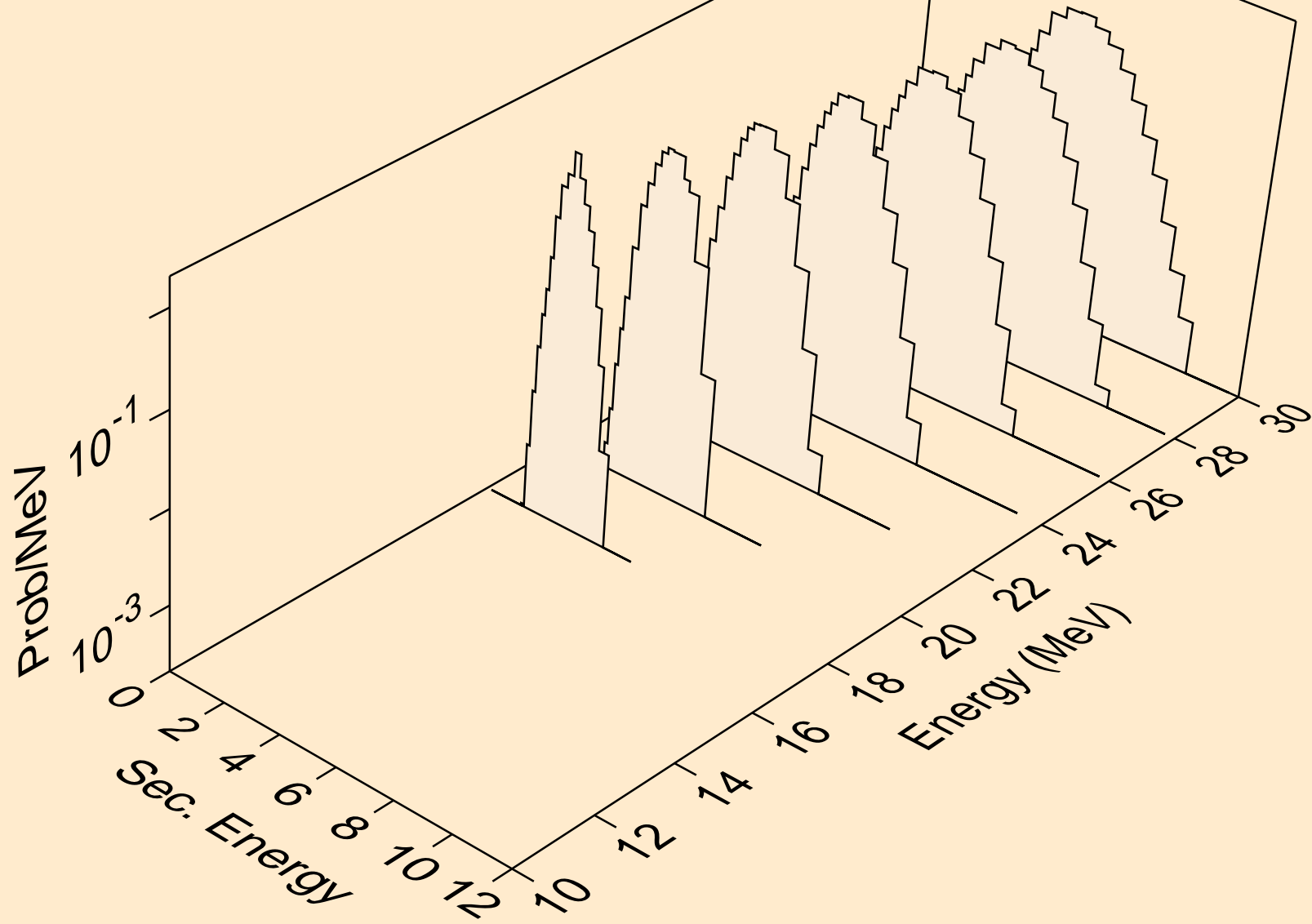

TM154 PROTON ACER TENDL-2021 LIBRARY; T=0.K  
Photon emission for (z,n)

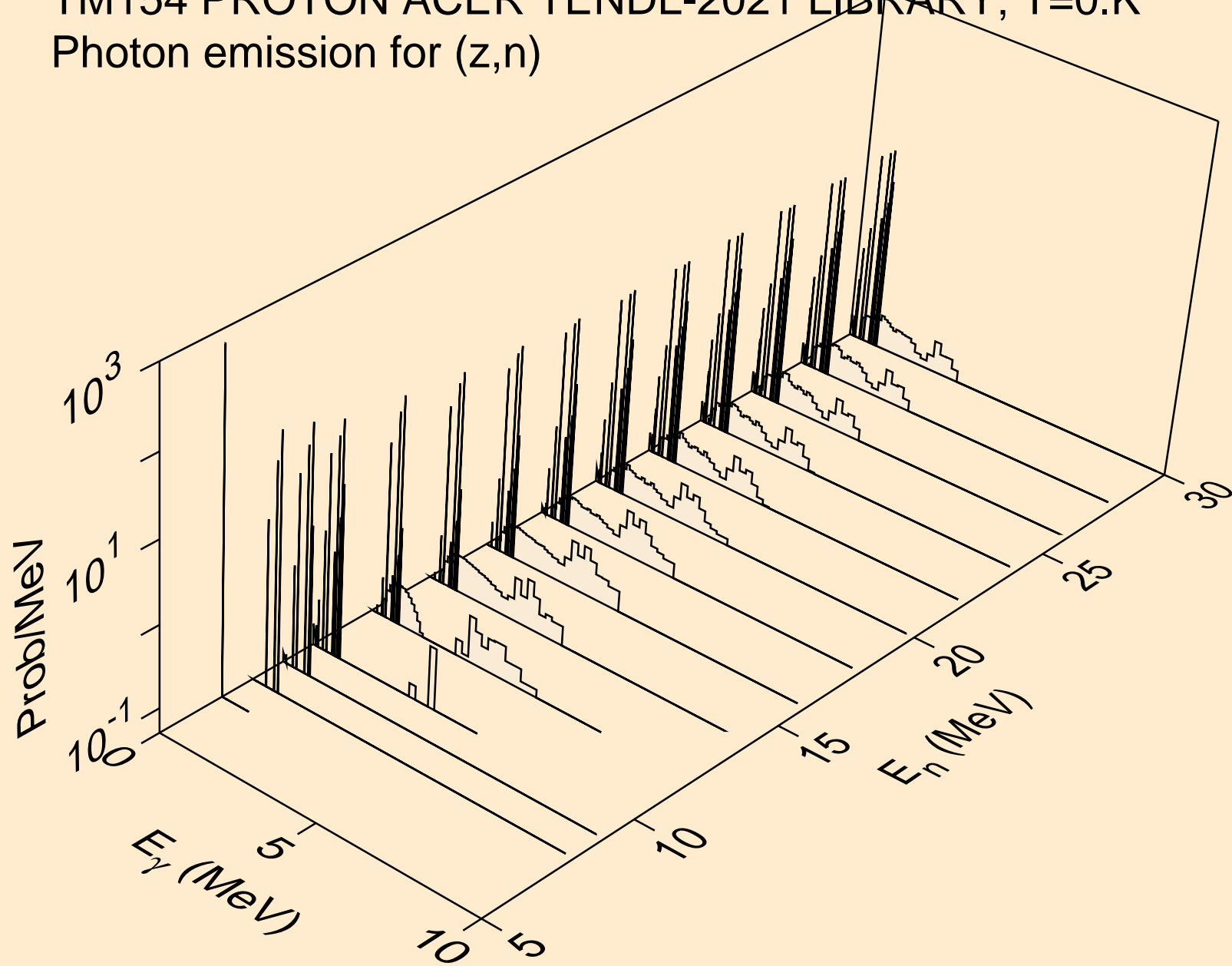

TM154 PROTON ACER TENDL-2021 LIBRARY; T=0.K  
Photon emission for (n,x)

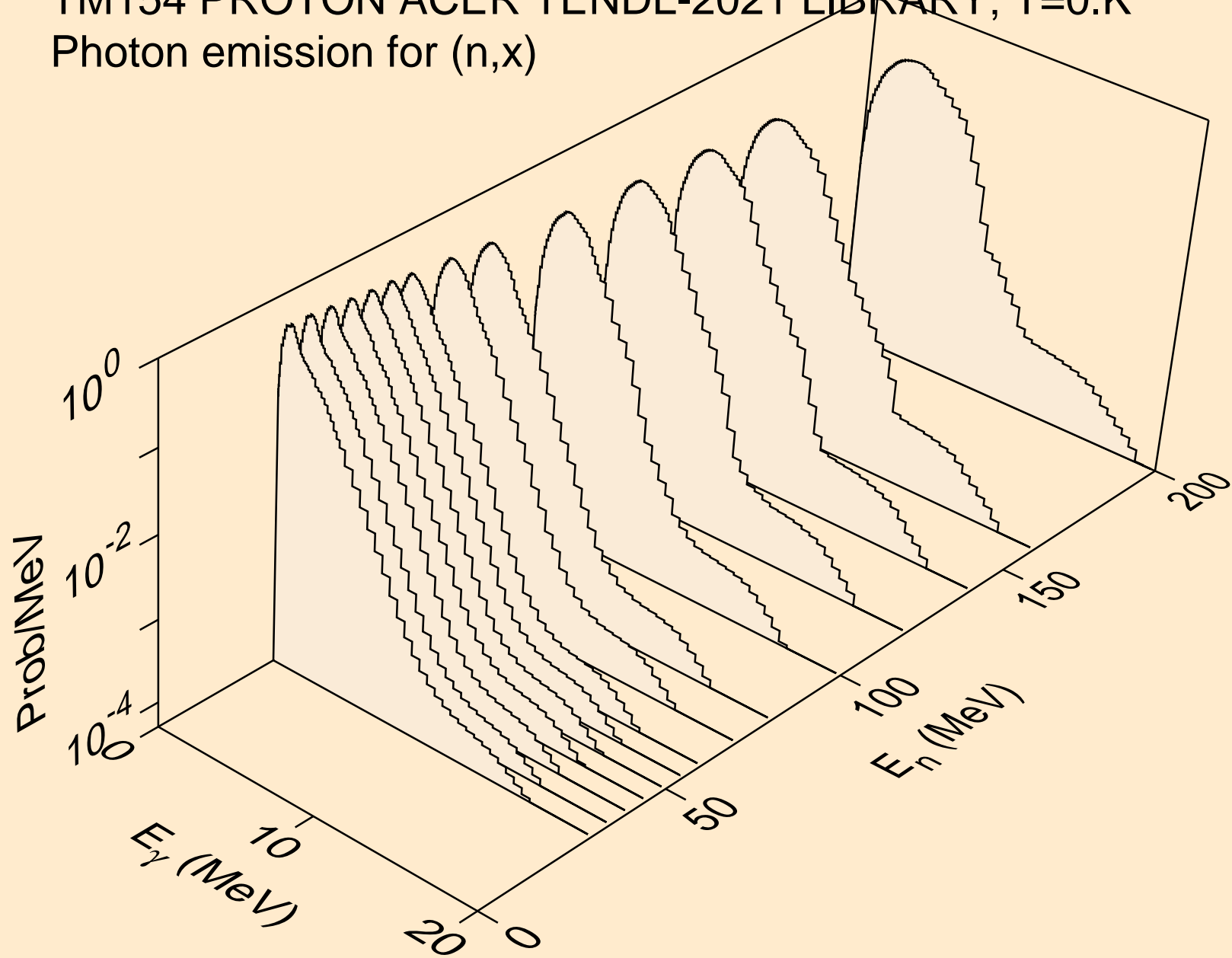

TM154 PROTON ACER TENDL-2021 LIBRARY; T=0.K  
Photon emission for (n,2n)

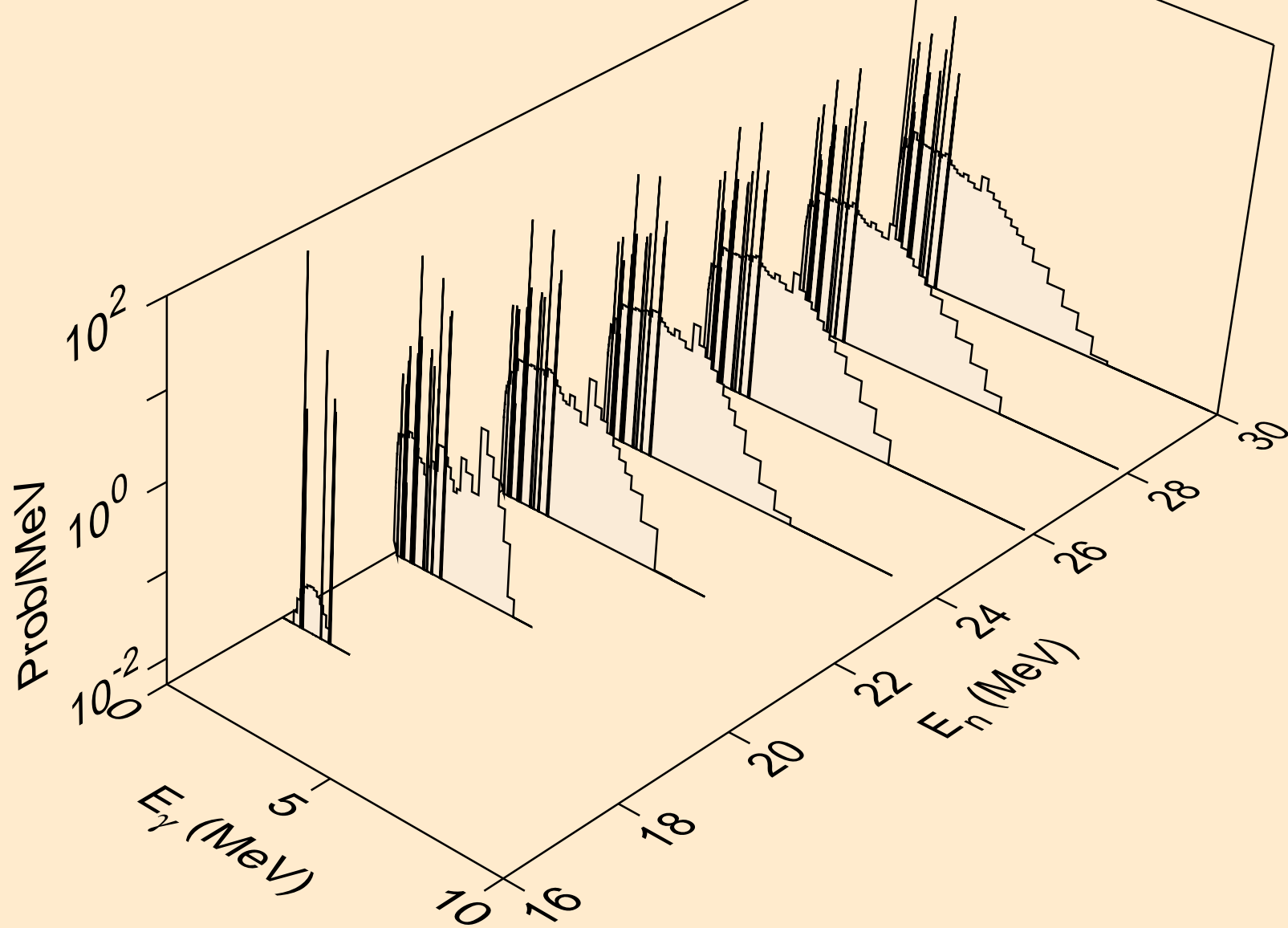

TM154 PROTON ACER TENDL-2021 LIBRARY; T=0.K  
Photon emission for (n,3n)

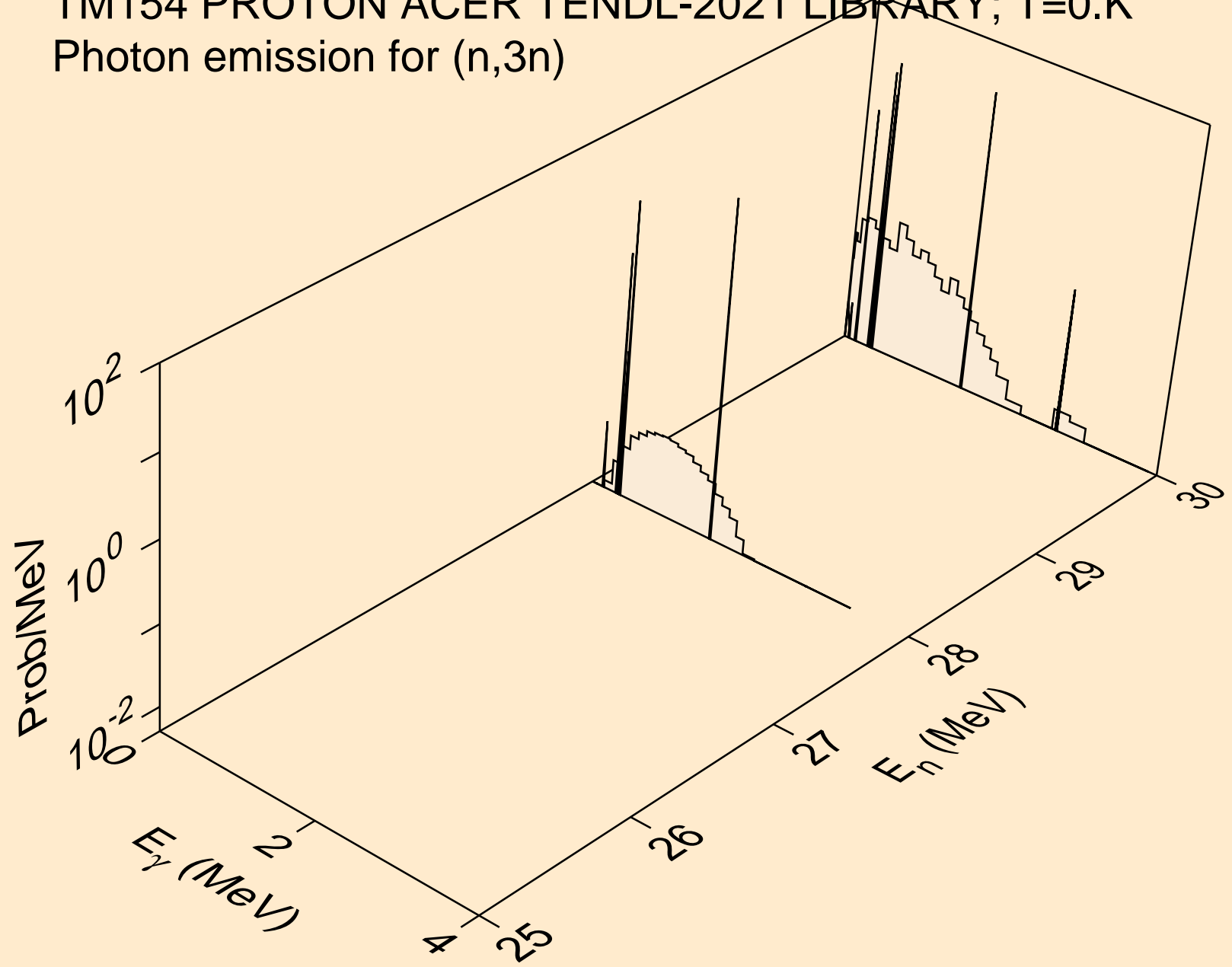

TM154 PROTON ACER TENDL-2021 LIBRARY; T=0.K  
Photon emission for (n,n\*)a

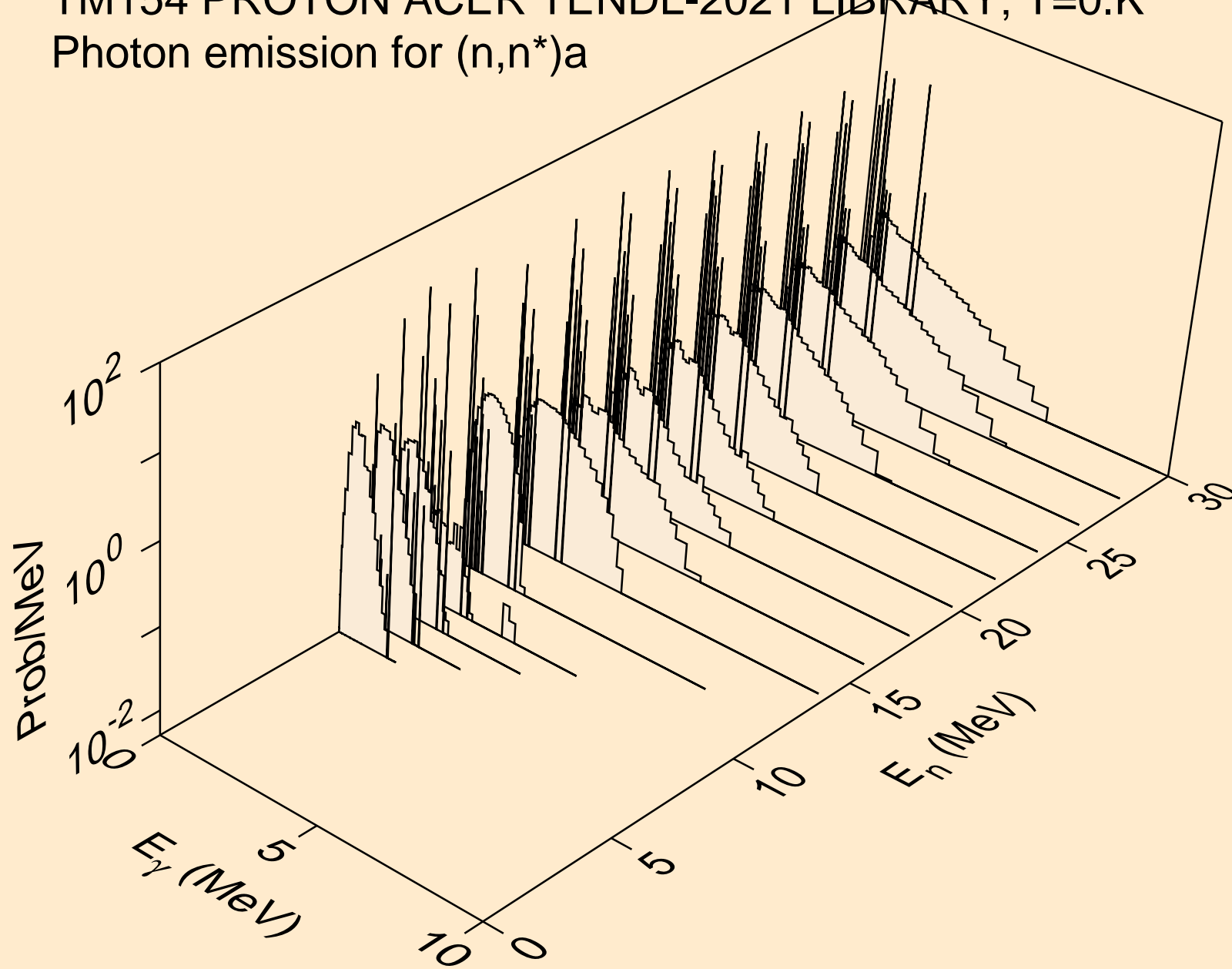



TM154 PROTON ACER TENDL-2021 LIBRARY; T=0.K  
Photon emission for (n,2n)a

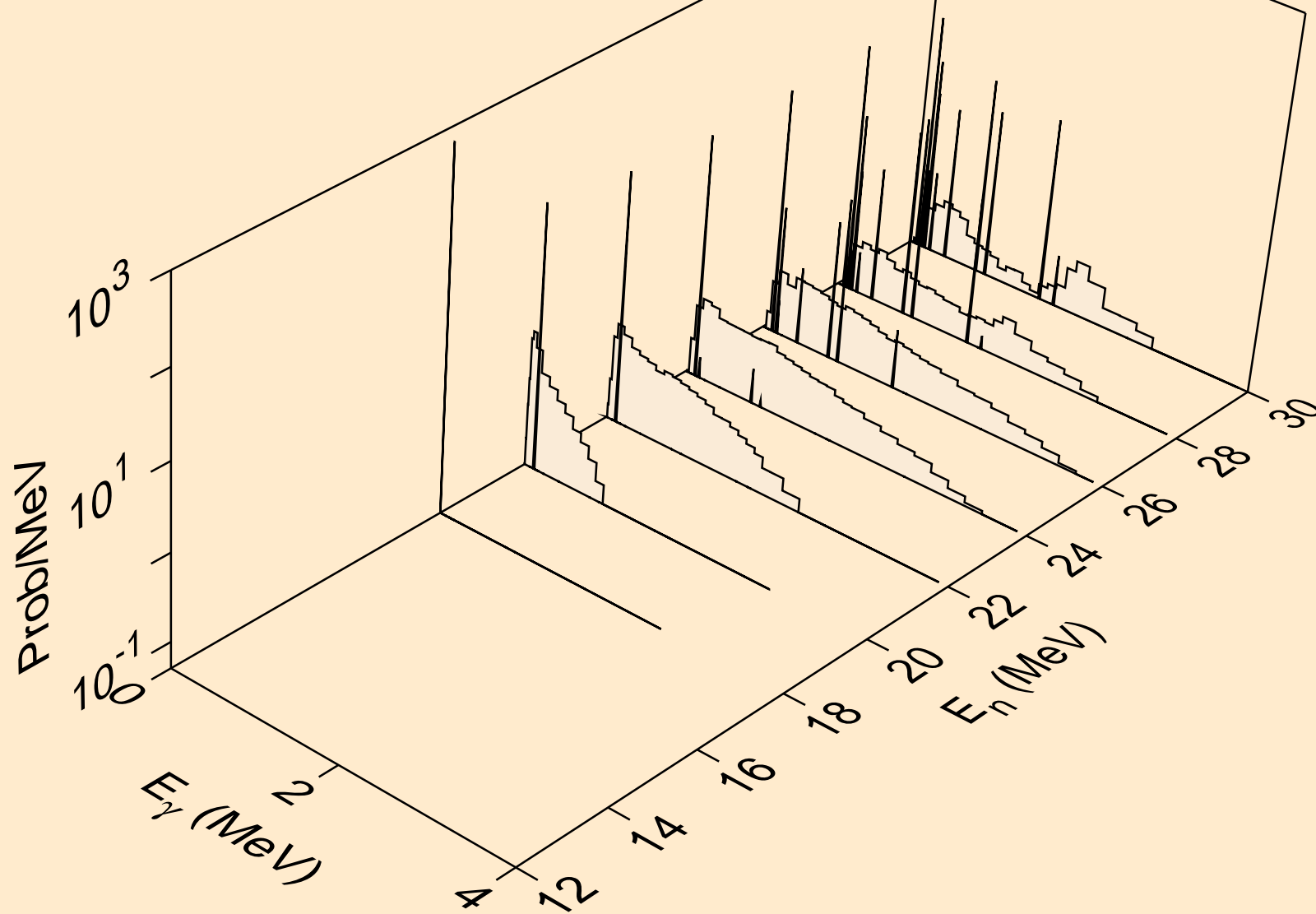

TM154 PROTON ACER TENDL-2021 LIBRARY; T=0.K  
Photon emission for (n,n\*)p

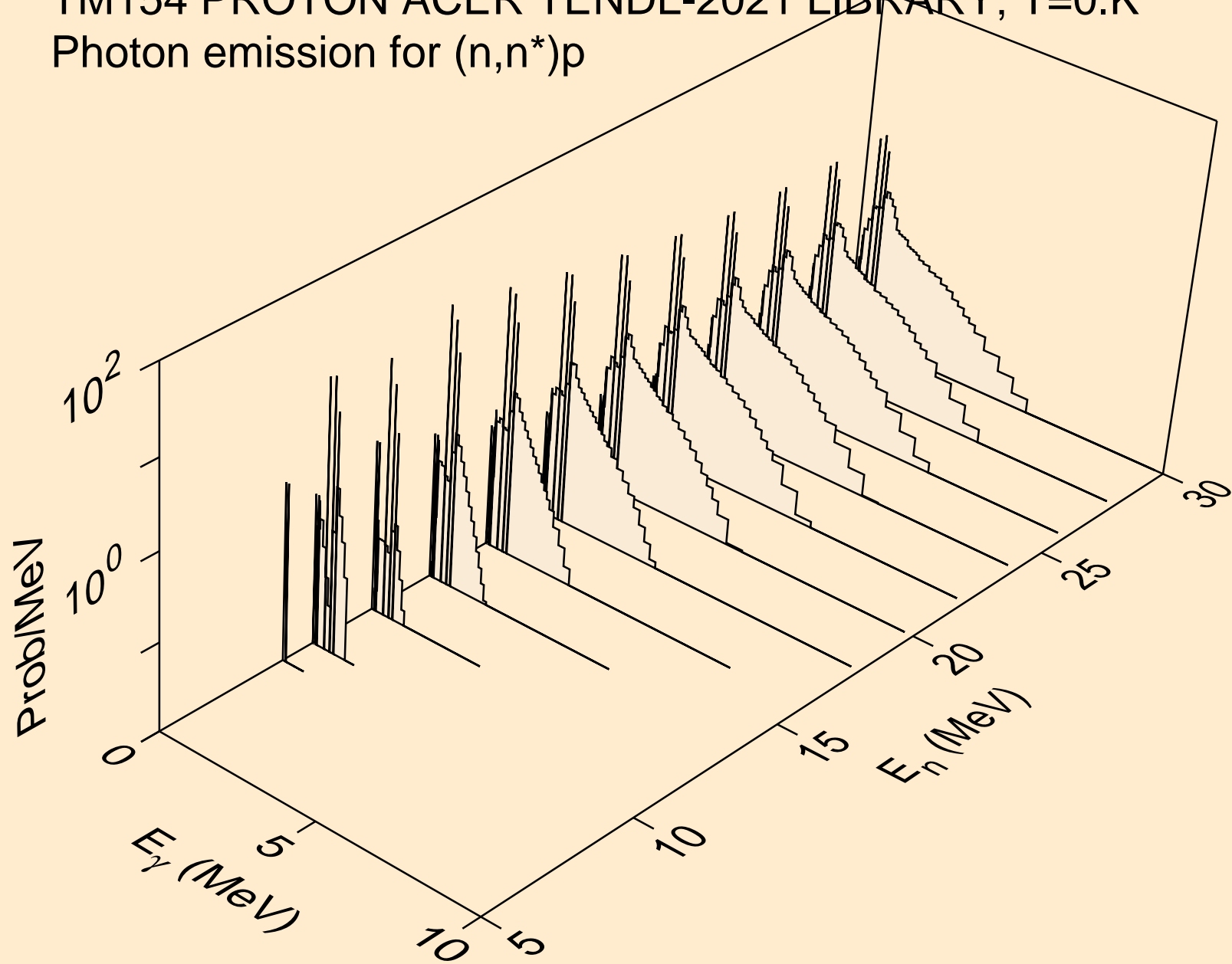

TM154 PROTON ACER TENDL-2021 LIBRARY; T=0.K  
Photon emission for (n,n\*)2a

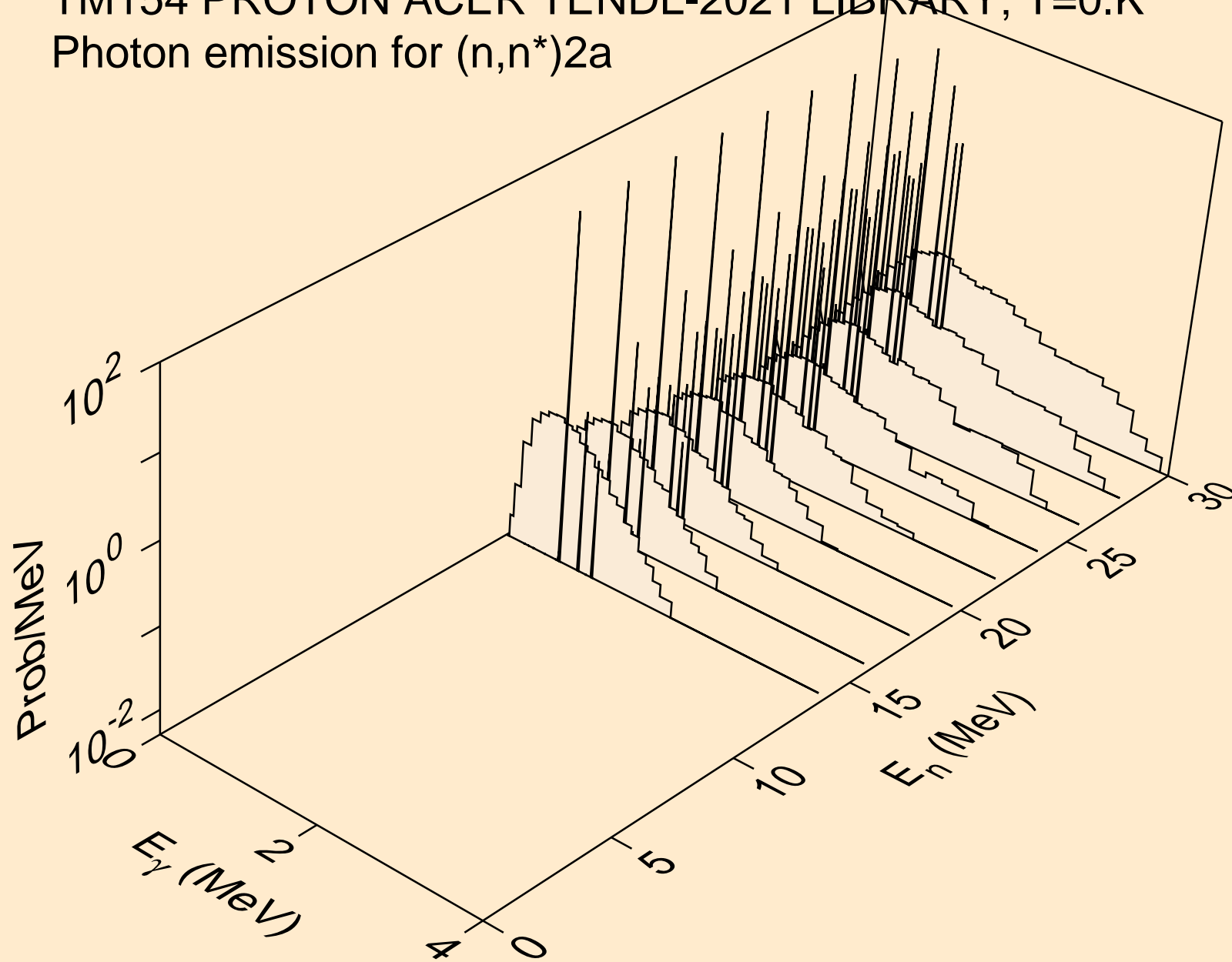

TM154 PROTON ACER TENDL-2021 LIBRARY; T=0.K  
Photon emission for (n,n\*)d

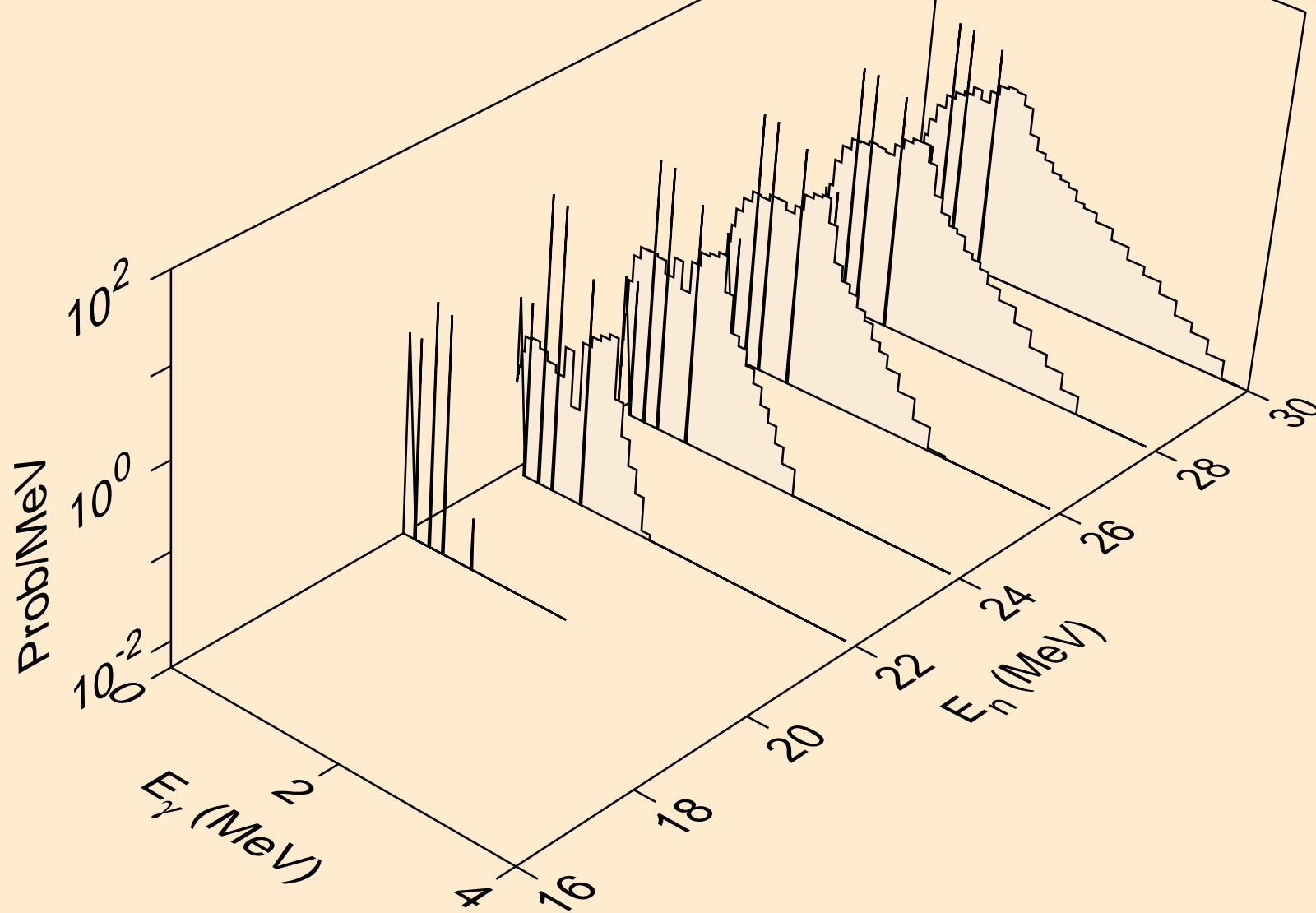

TM154 PROTON ACER TENDL-2021 LIBRARY; T=0.K  
Photon emission for (n,n\*)t

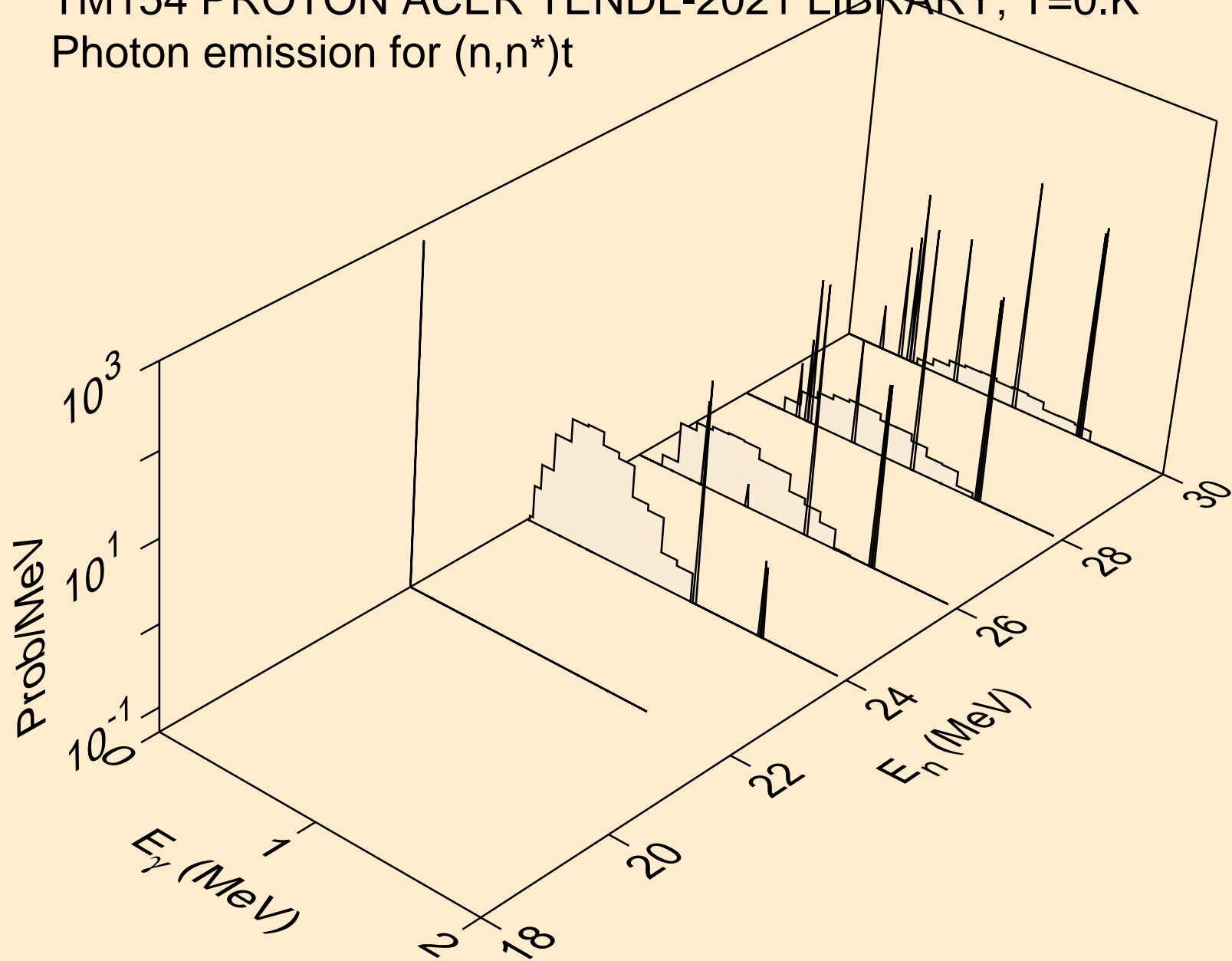

TM154 PROTON ACER TENDL-2021 LIBRARY; T=0.K  
Photon emission for (n,n\*)he3

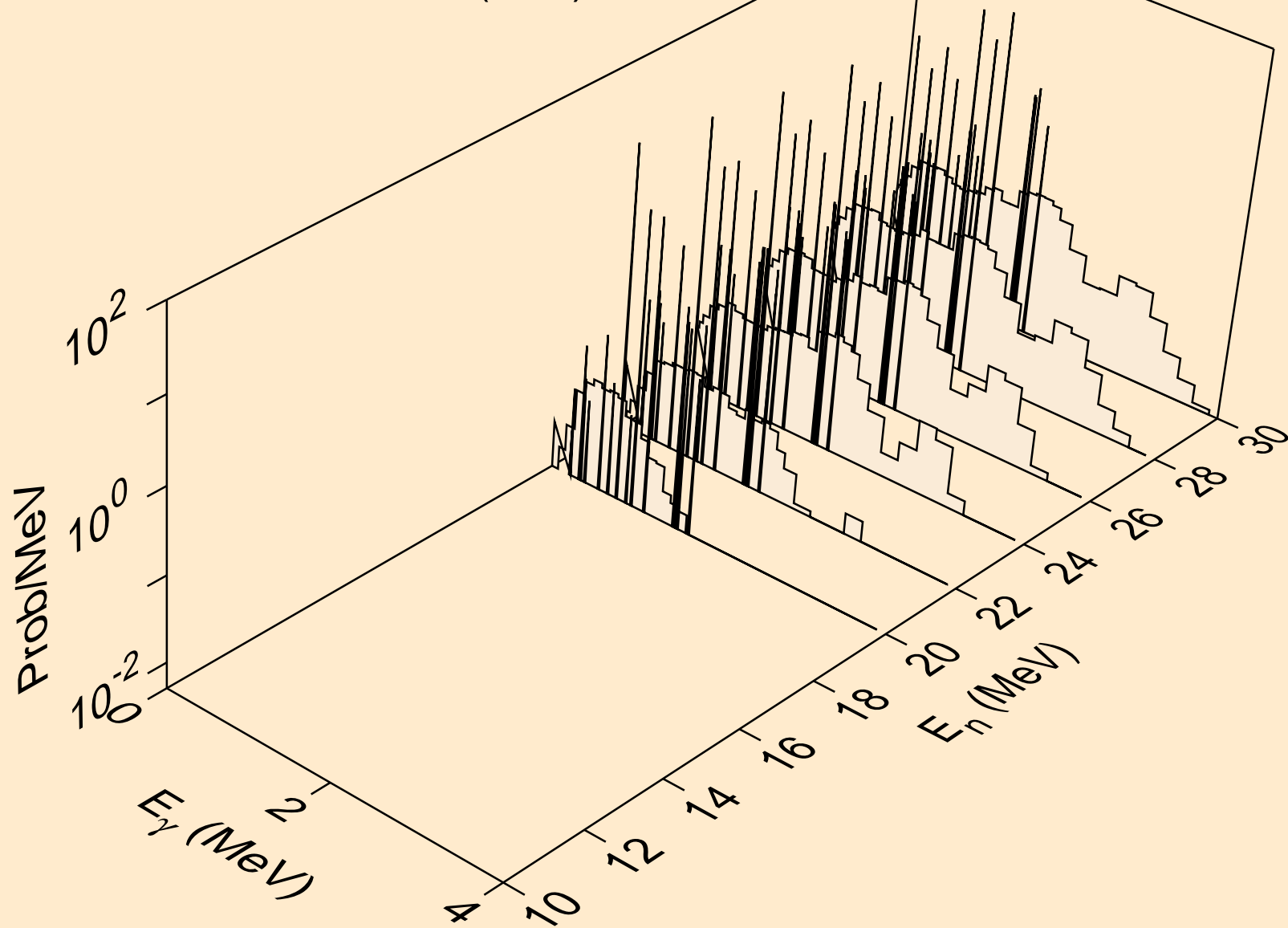

TM154 PROTON ACER TENDL-2021 LIBRARY; T=0.K  
Photon emission for (n,2np)

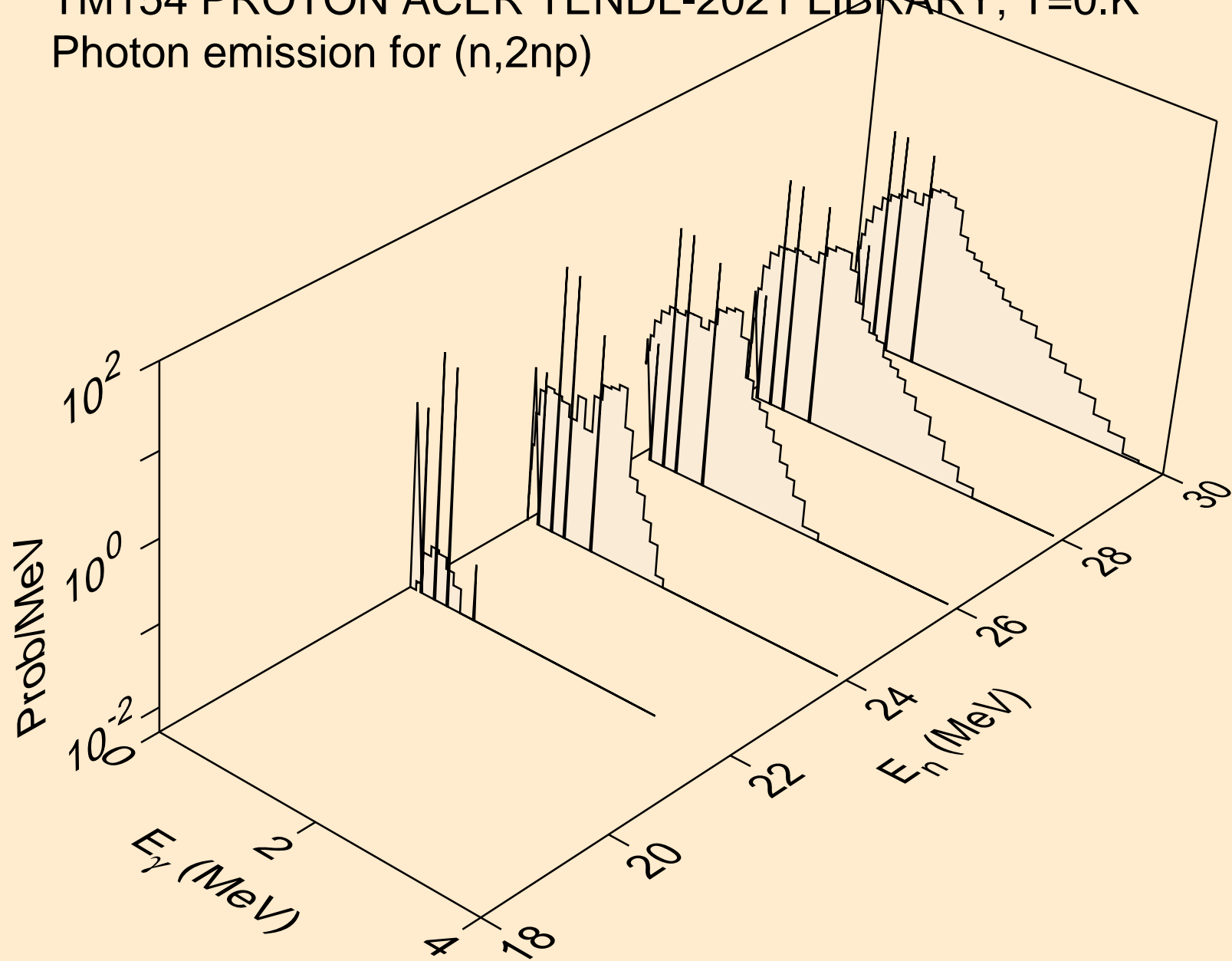

TM154 PROTON ACER TENDL-2021 LIBRARY; T=0.K  
Photon emission for (n,2np)

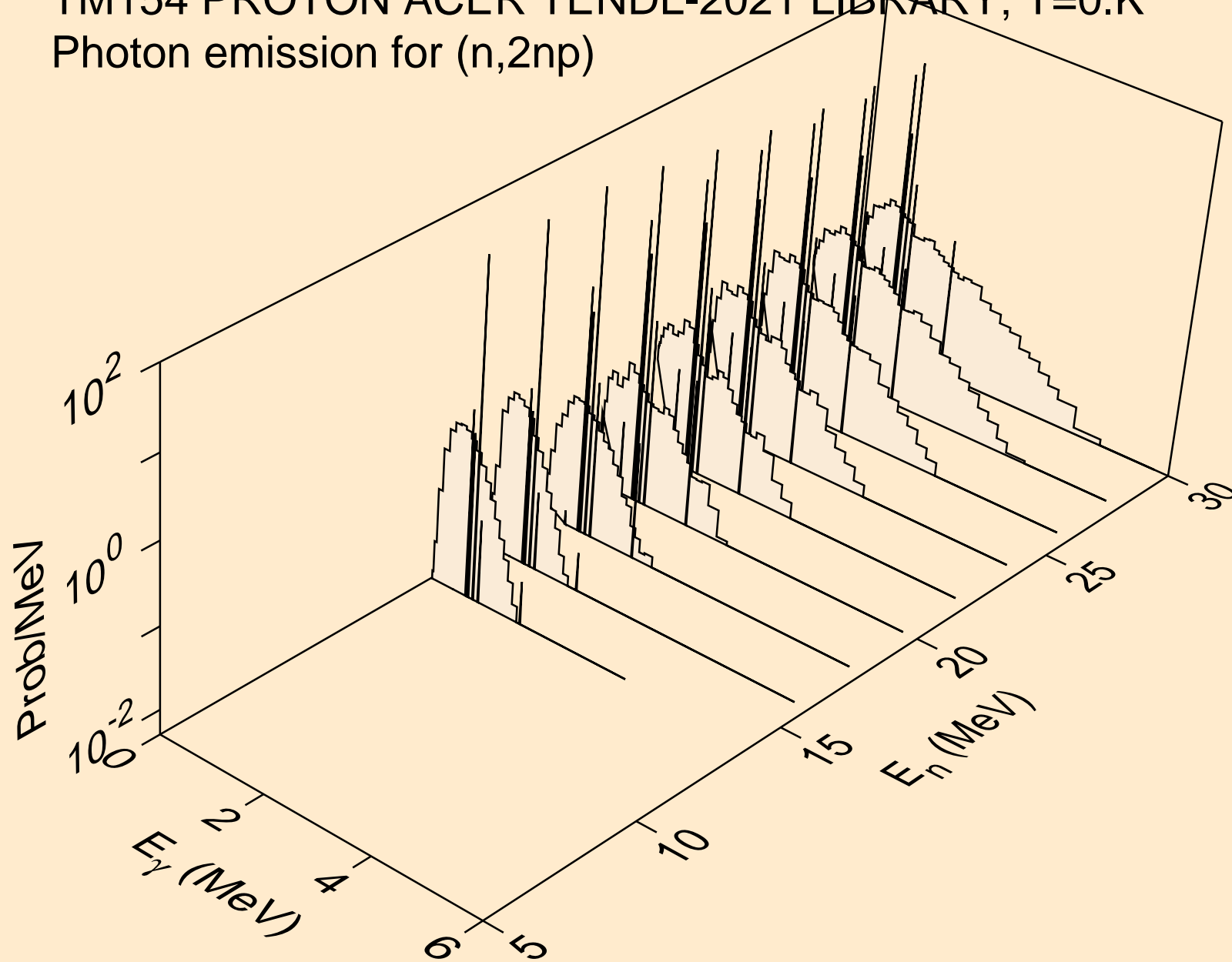



TM154 PROTON ACER TENDL-2021 LIBRARY; T=0.K  
Photon emission for (n,npa)

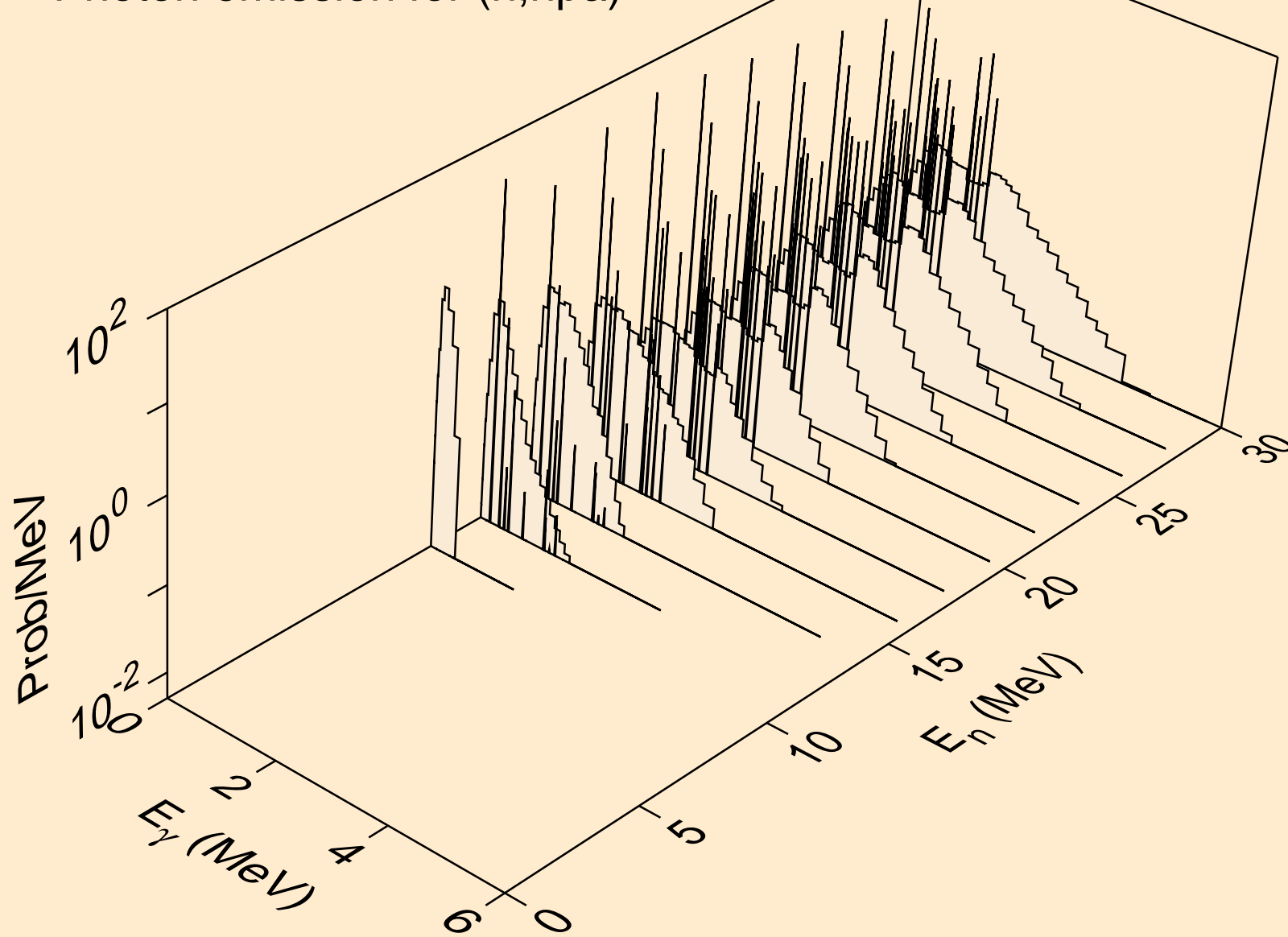

TM154 PROTON ACER TENDL-2021 LIBRARY; T=0.K  
Photon emission for (n,gma)

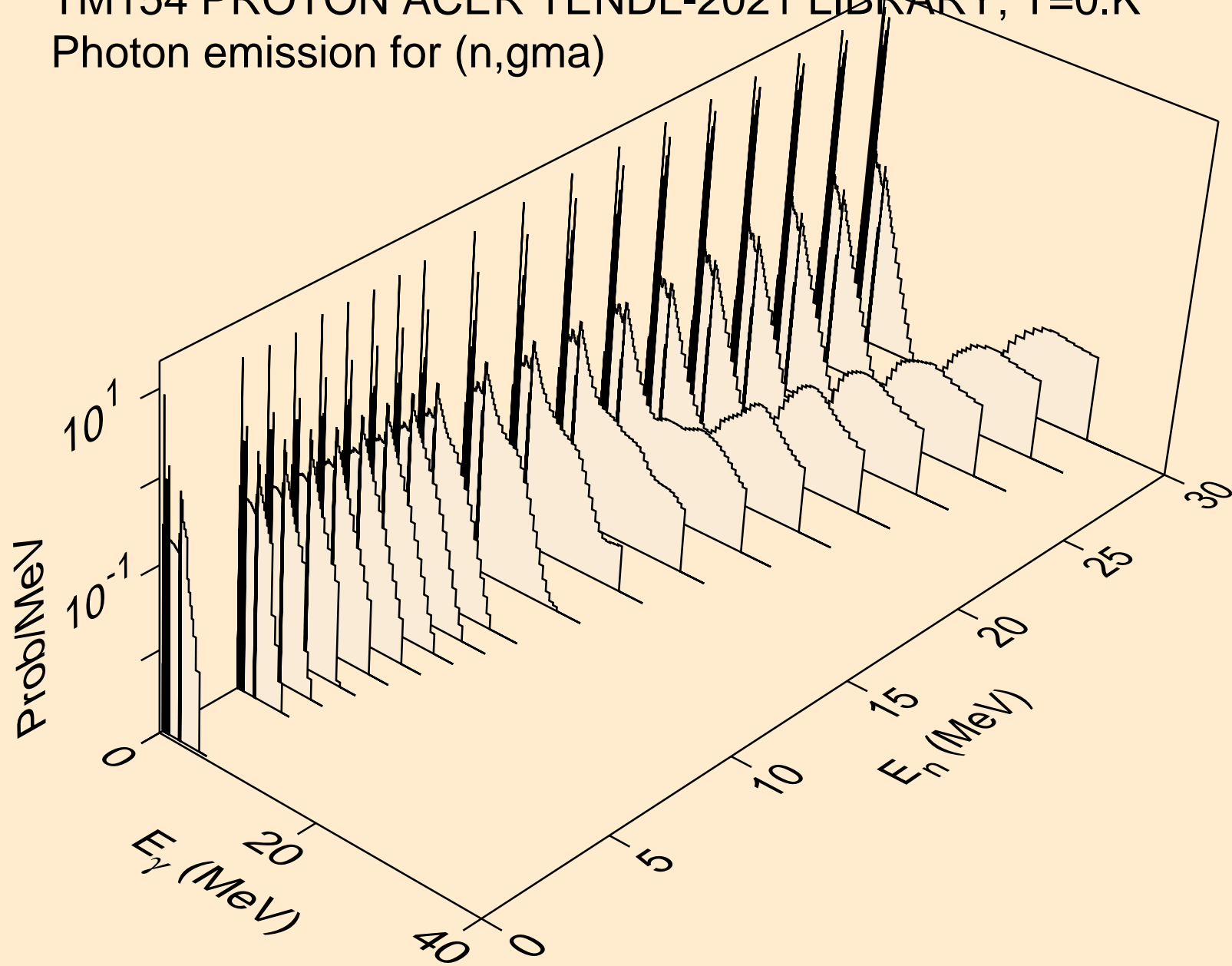

TM154 PROTON ACER TENDL-2021 LIBRARY; T=0.K  
Photon emission for inelastic

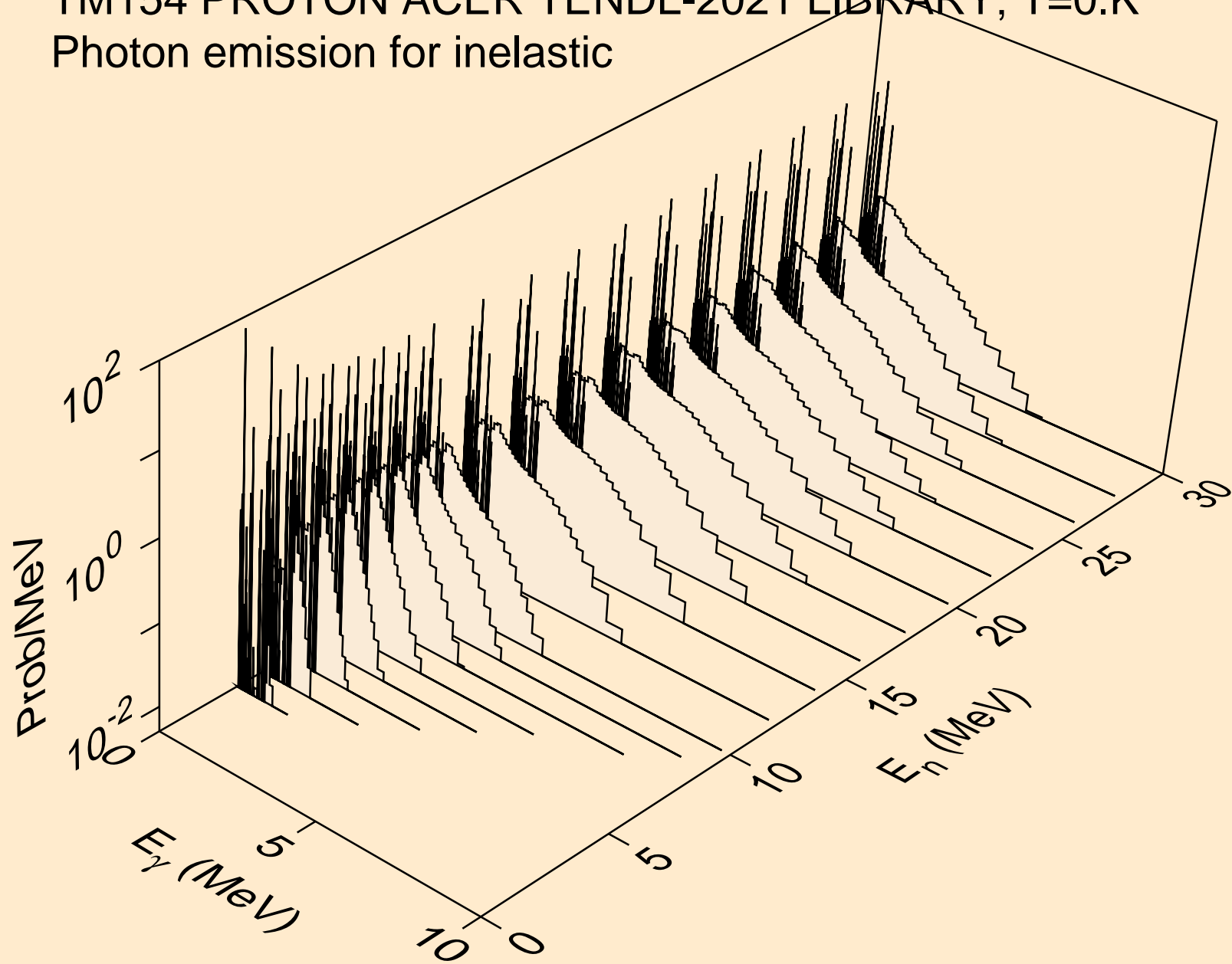

TM154 PROTON ACER TENDL-2021 LIBRARY; T=0.K  
Photon emission for (n,d)

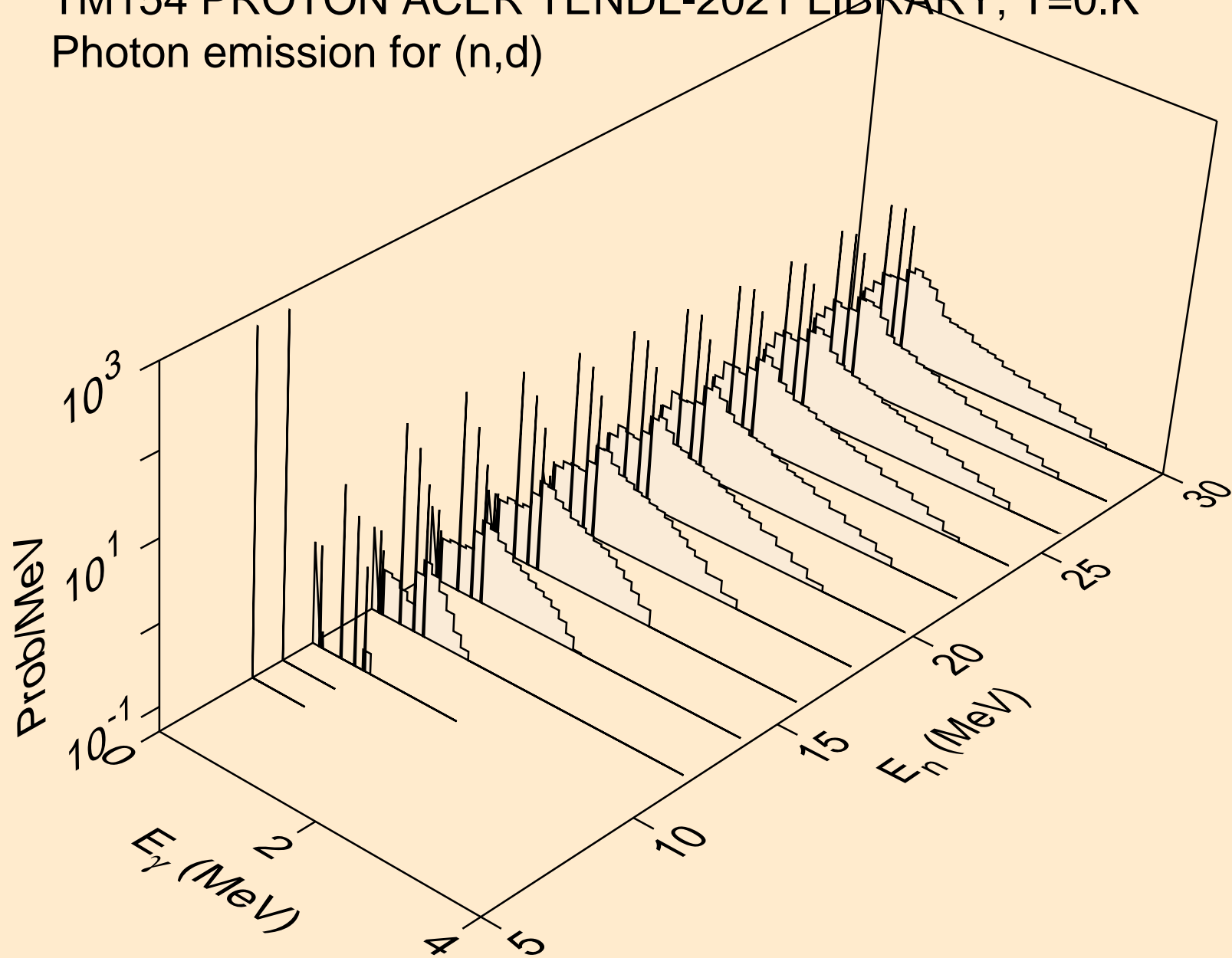

TM154 PROTON ACER TENDL-2021 LIBRARY; T=0.K  
Photon emission for (n,t)

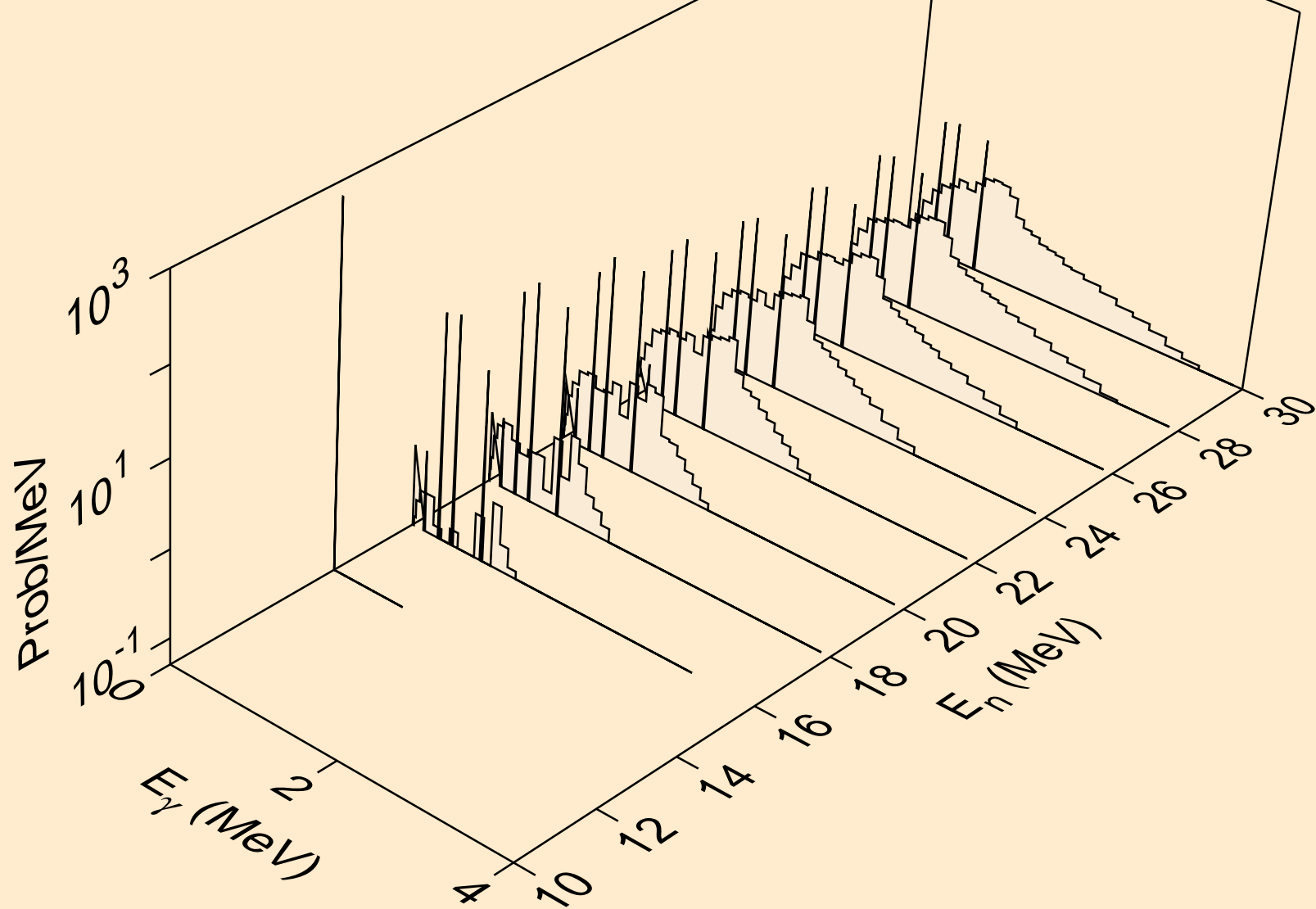

TM154 PROTON ACER TENDL-2021 LIBRARY; T=0.K  
Photon emission for (n,he3)

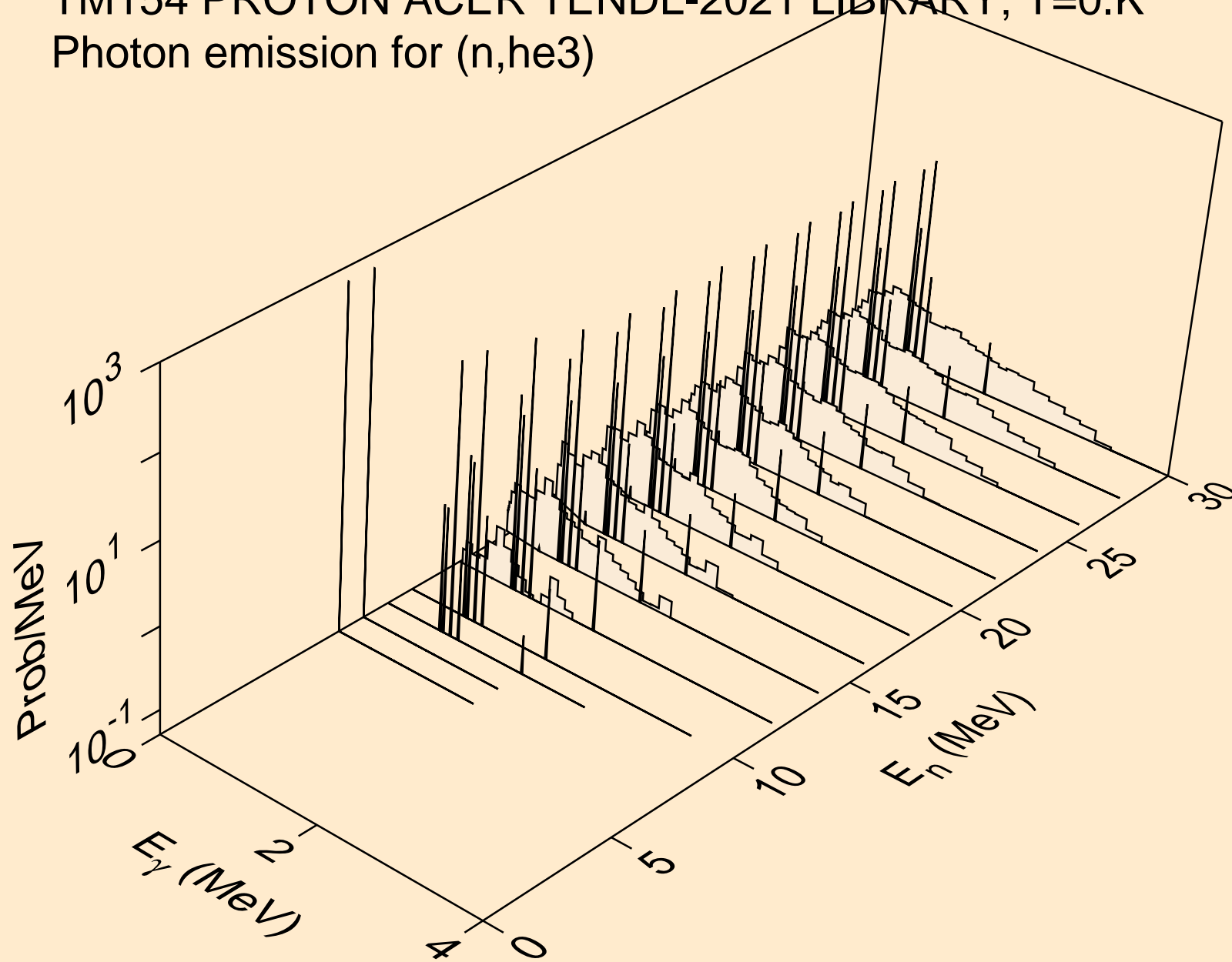

TM154 PROTON ACER TENDL-2021 LIBRARY; T=0.K  
Photon emission for (n,a)

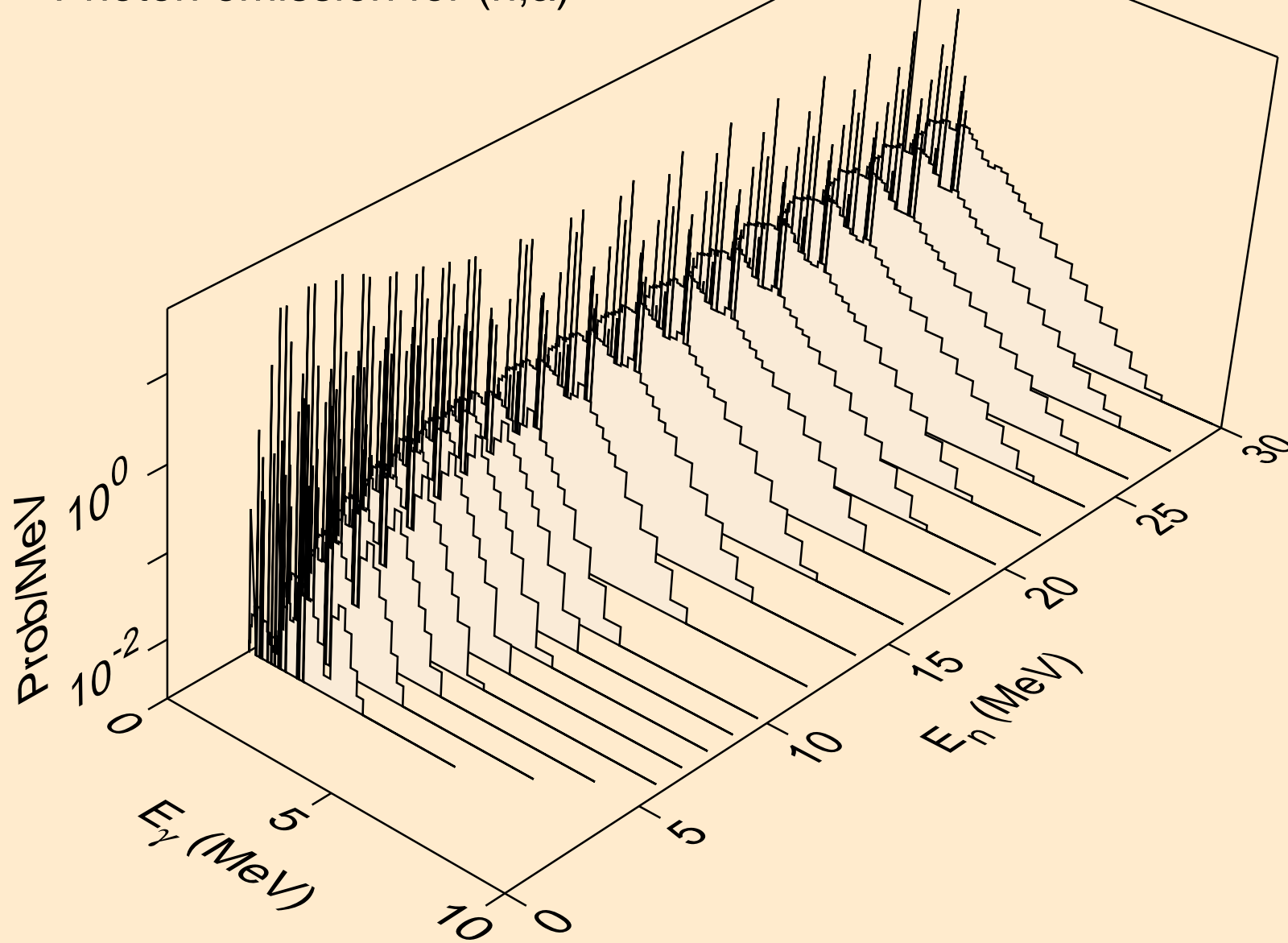

TM154 PROTON ACER TENDL-2021 LIBRARY; T=0.K  
Photon emission for (n,2a)

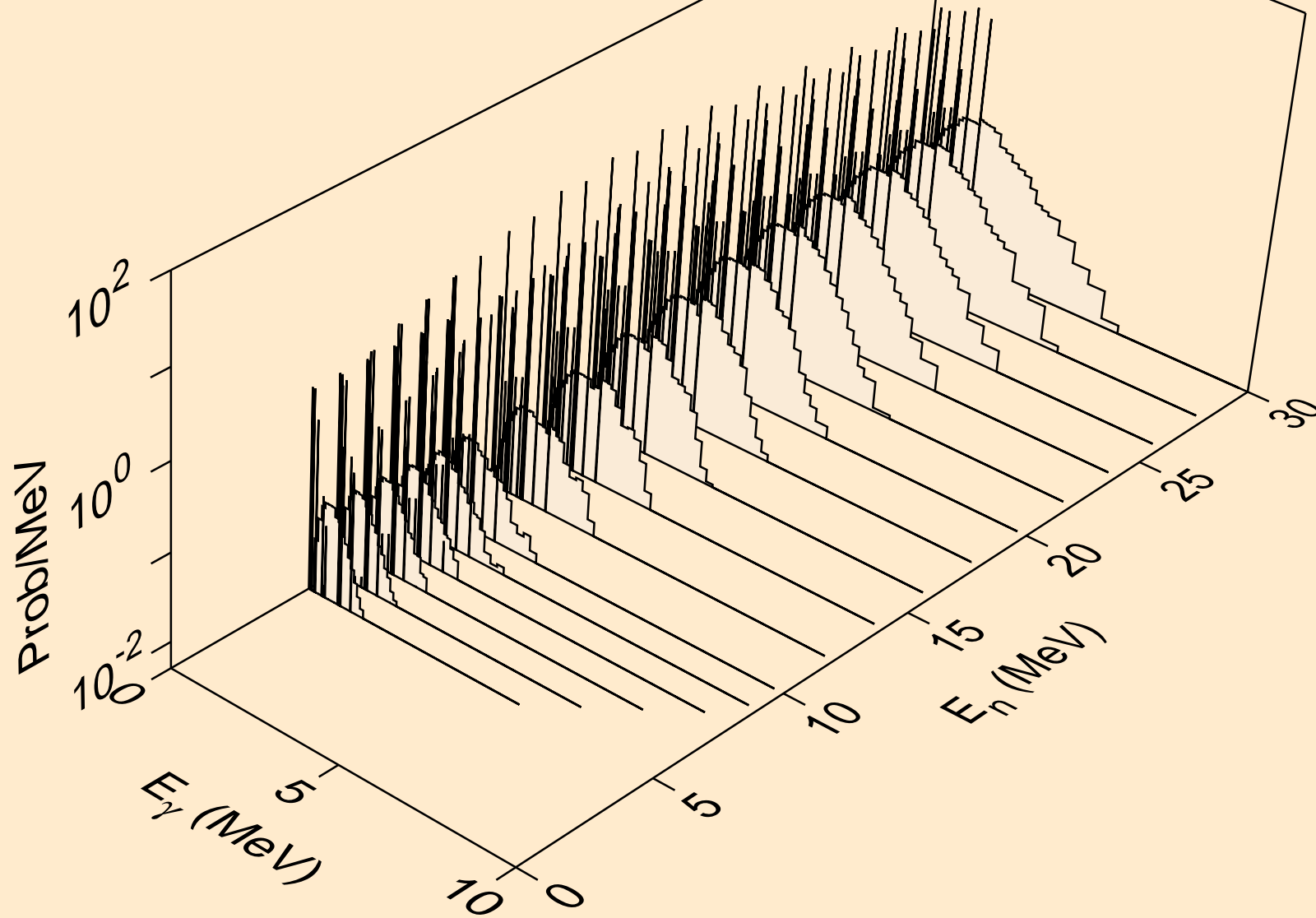



TM154 PROTON ACER TENDL-2021 LIBRARY; T=0.K  
Photon emission for (n,3a)

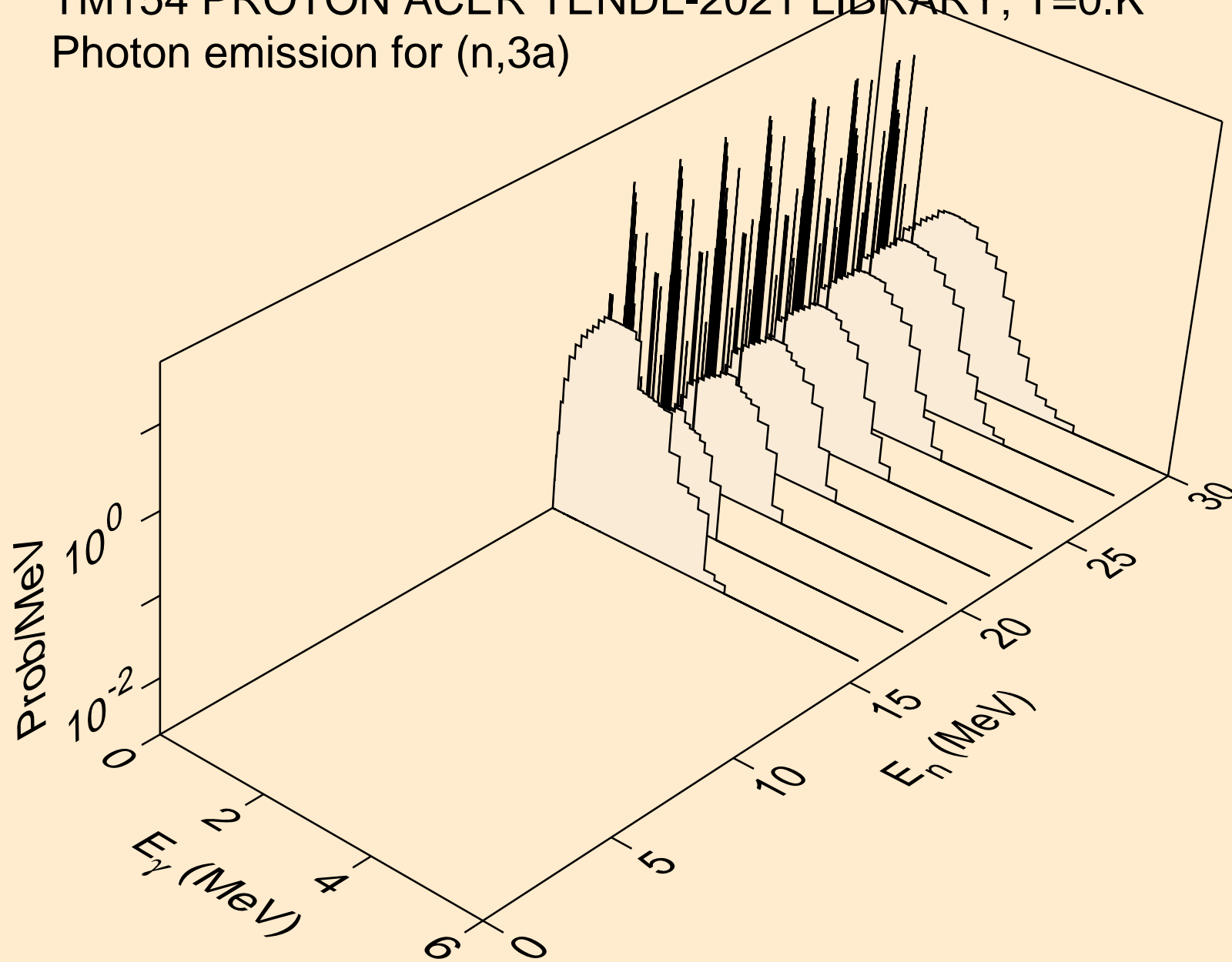

TM154 PROTON ACER TENDL-2021 LIBRARY; T=0.K  
Photon emission for (n,2p)

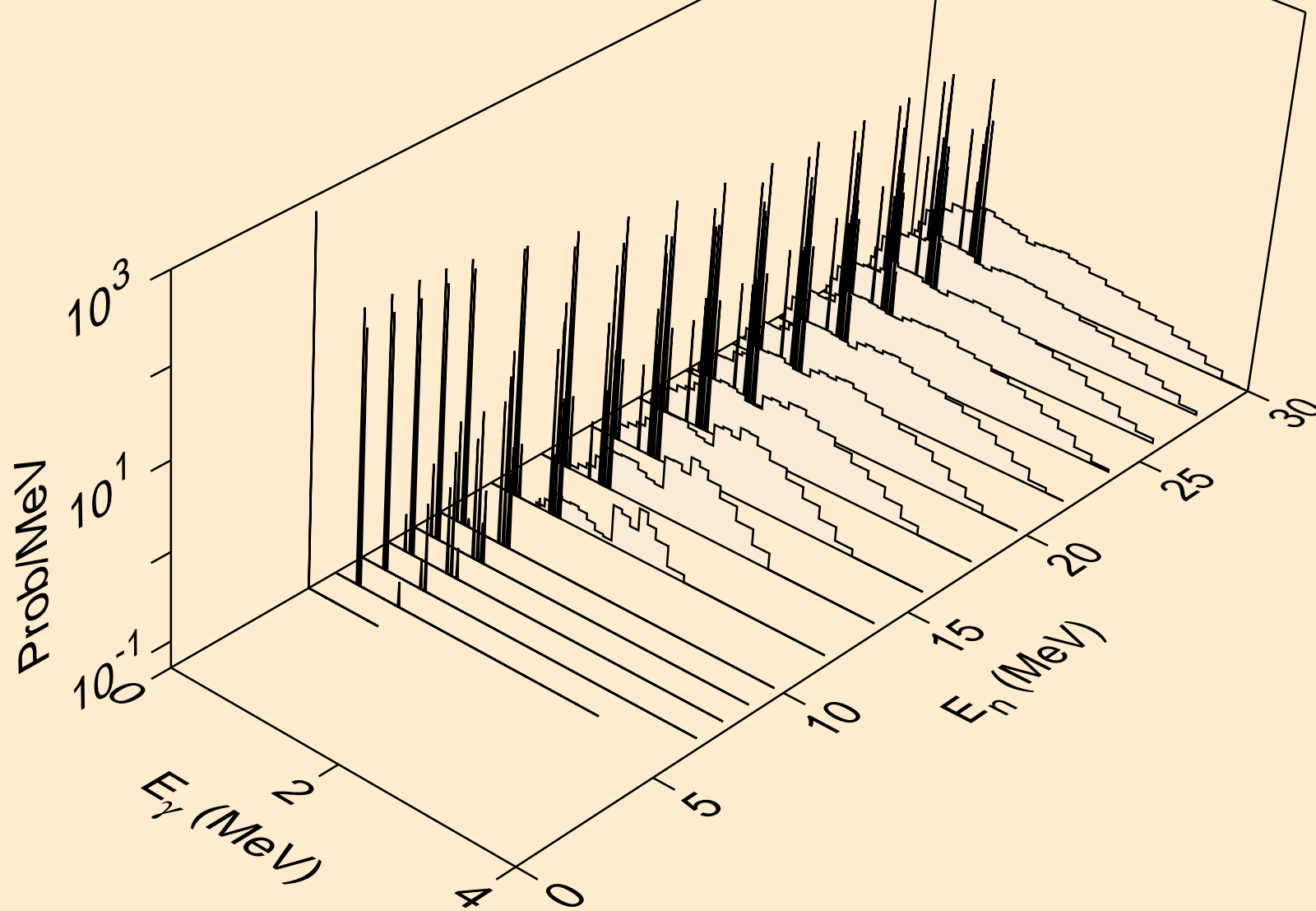

TM154 PROTON ACER TENDL-2021 LIBRARY; T=0.K  
Photon emission for (n,pa)

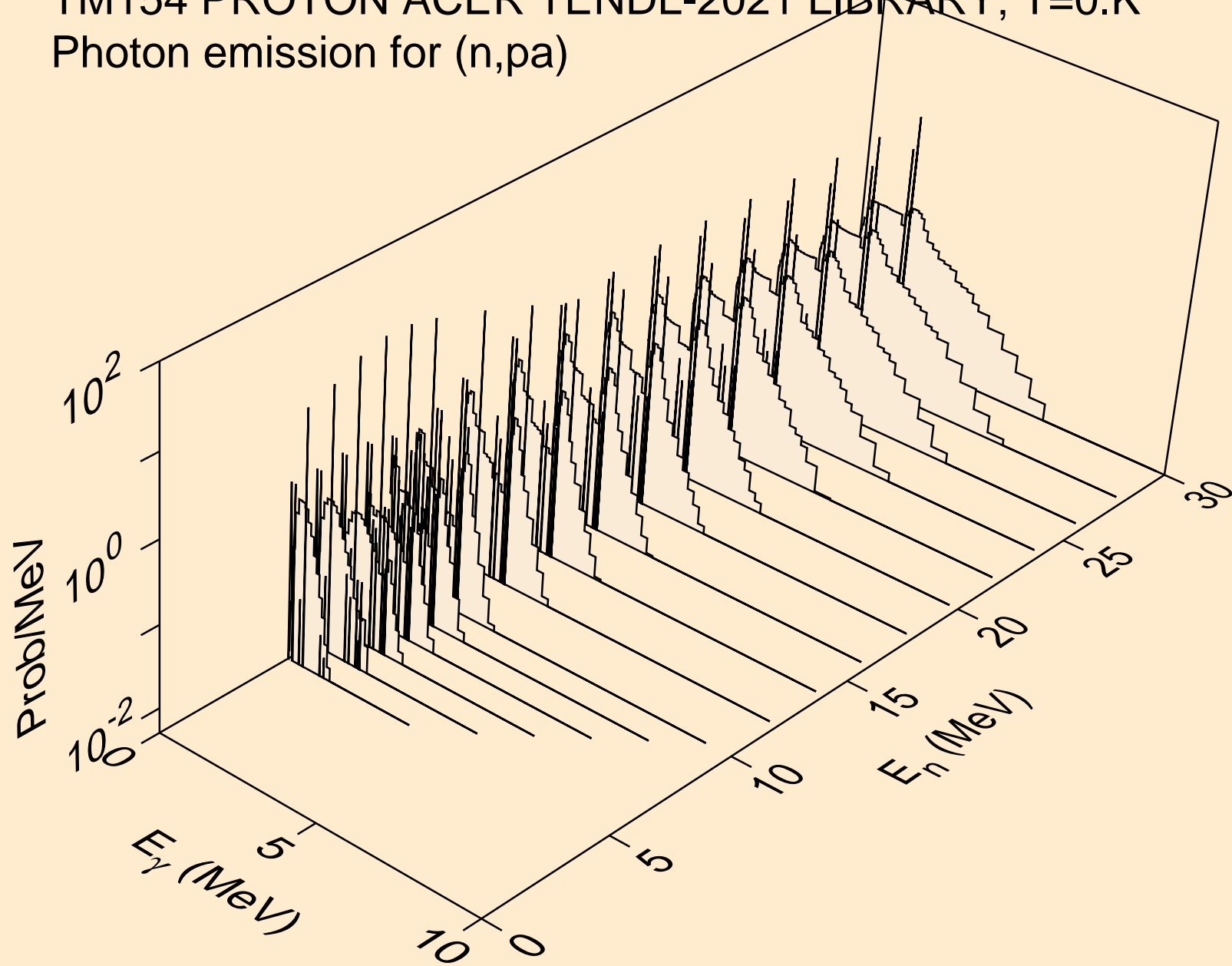

TM154 PROTON ACER TENDL-2021 LIBRARY; T=0.K  
Photon emission for (n,pd)

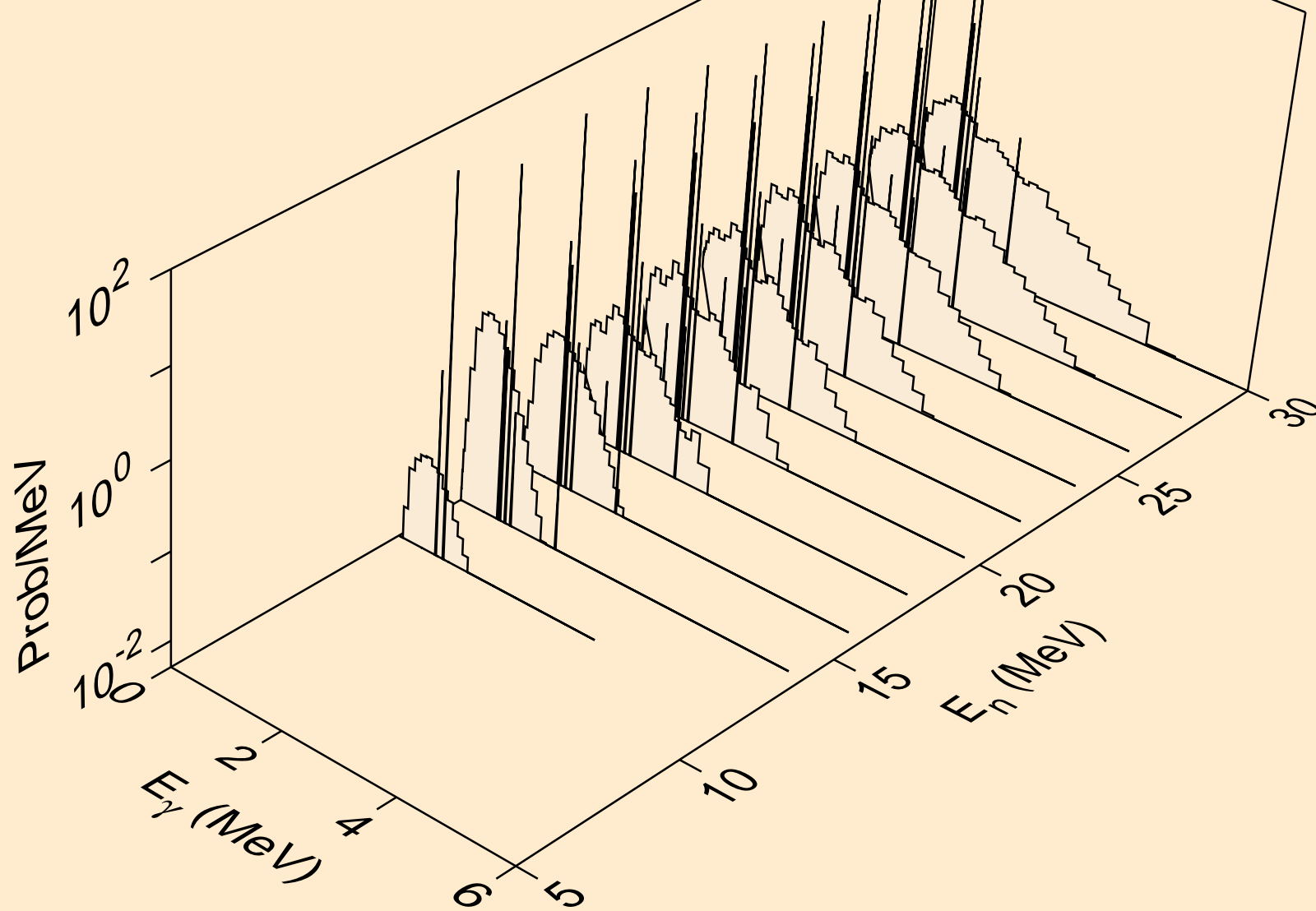

TM154 PROTON ACER TENDL-2021 LIBRARY; T=0.K  
Photon emission for (n,pt)

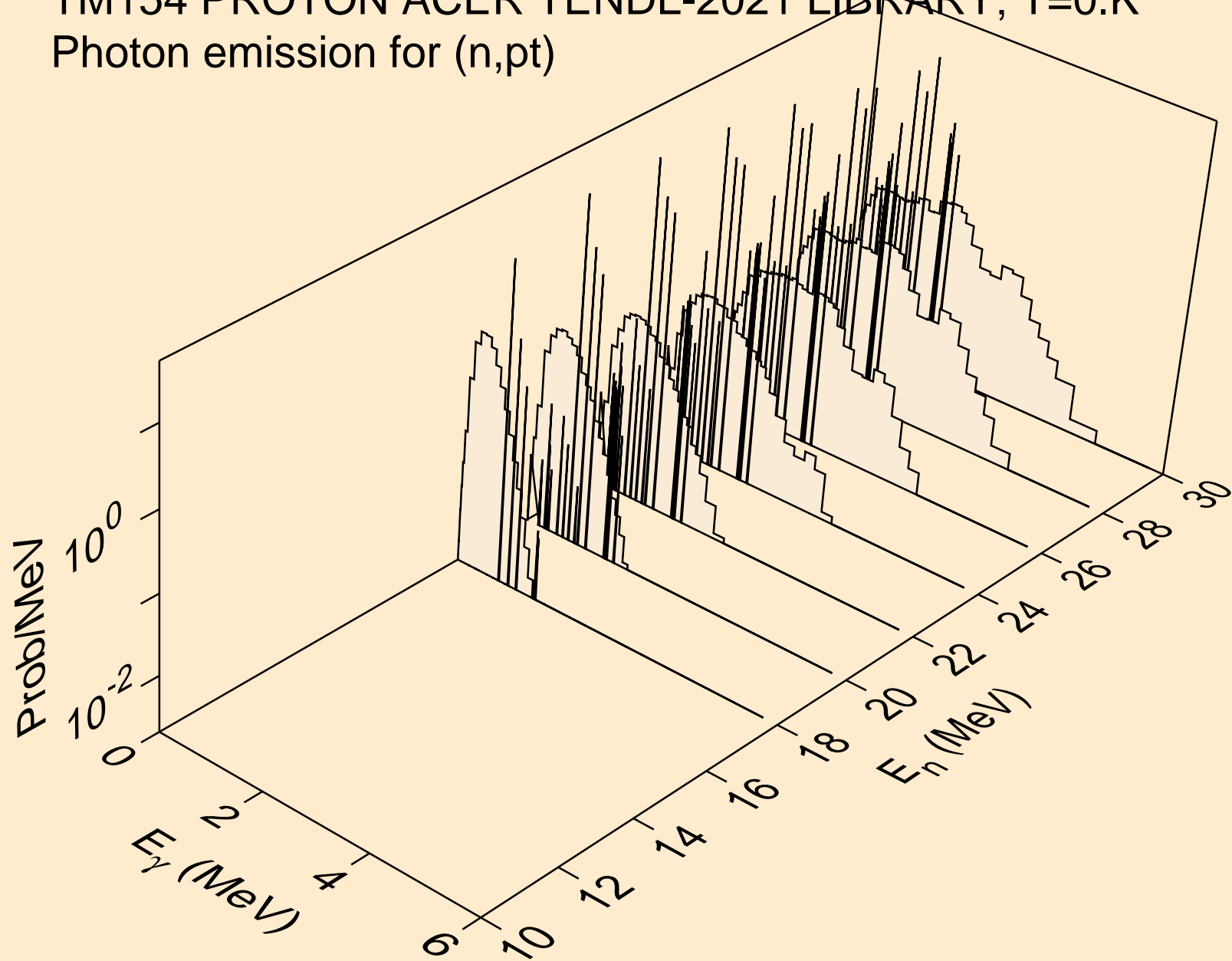

TM154 PROTON ACER TENDL-2021 LIBRARY; T=0.K  
Photon emission for (n,da)

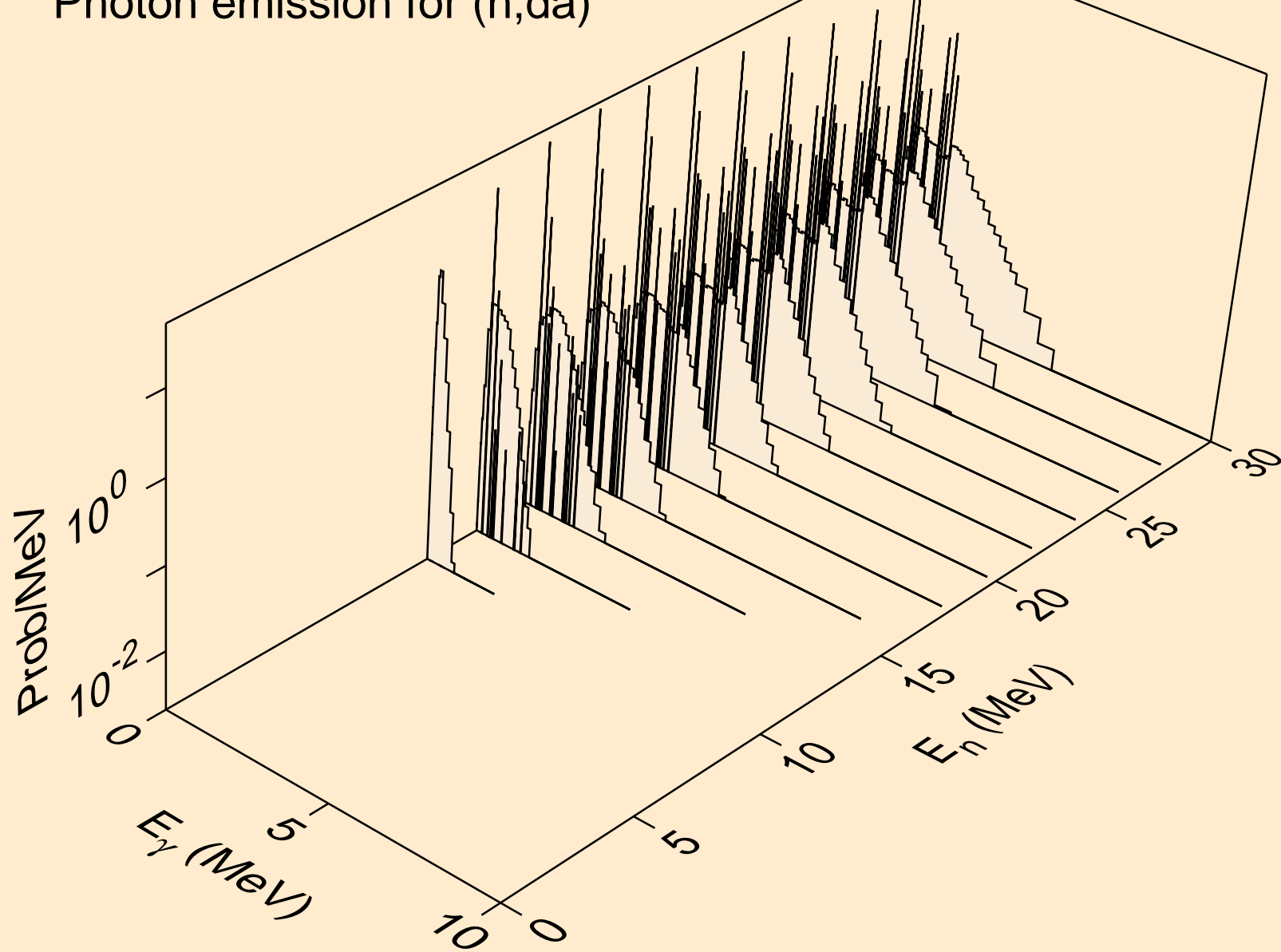

TM154 PROTON ACER TENDL-2021 LIBRARY; T=0.K  
Particle heating contributions

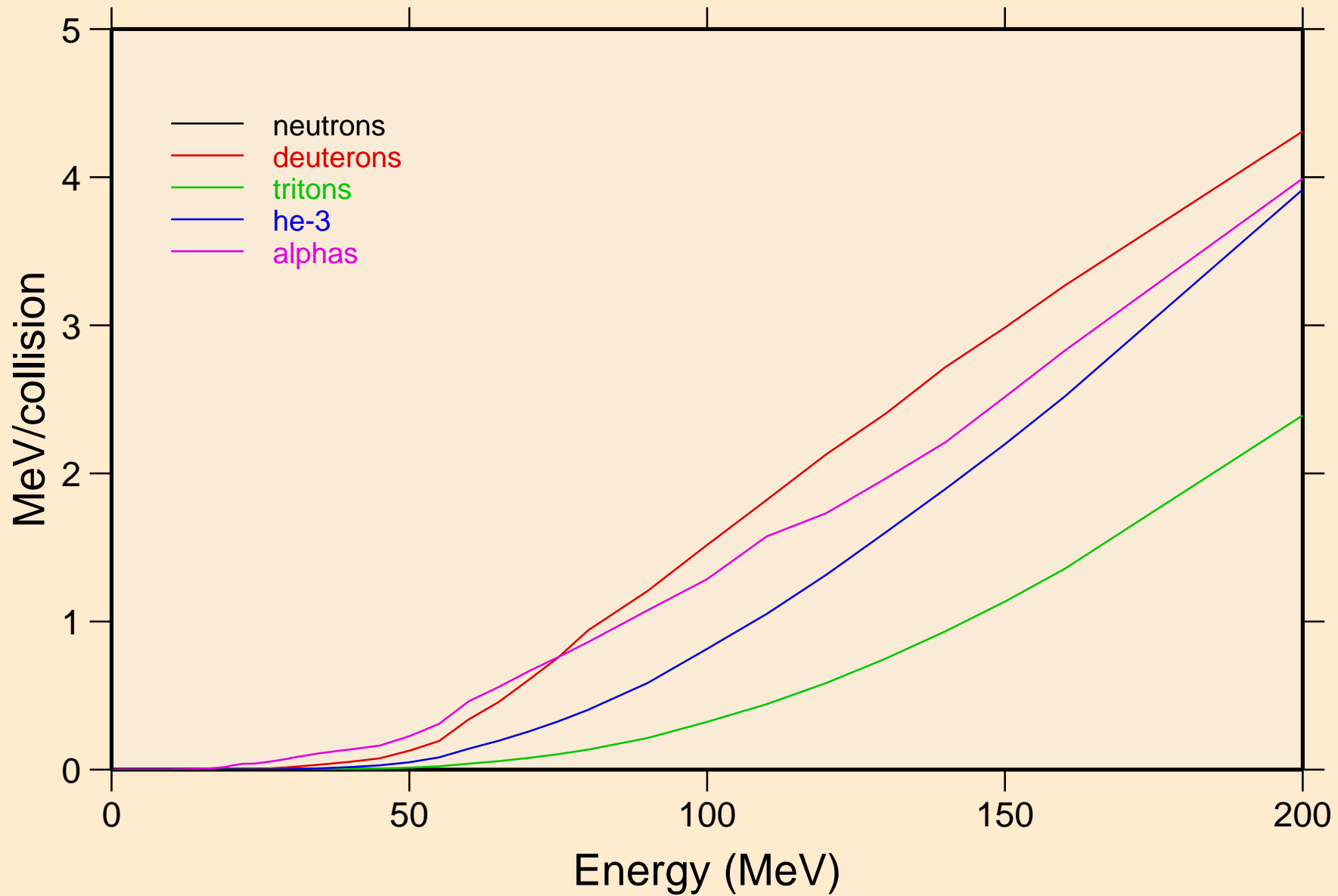

TM154 PROTON ACER TENDL-2021 LIBRARY; T=0.K  
Recoil Heating

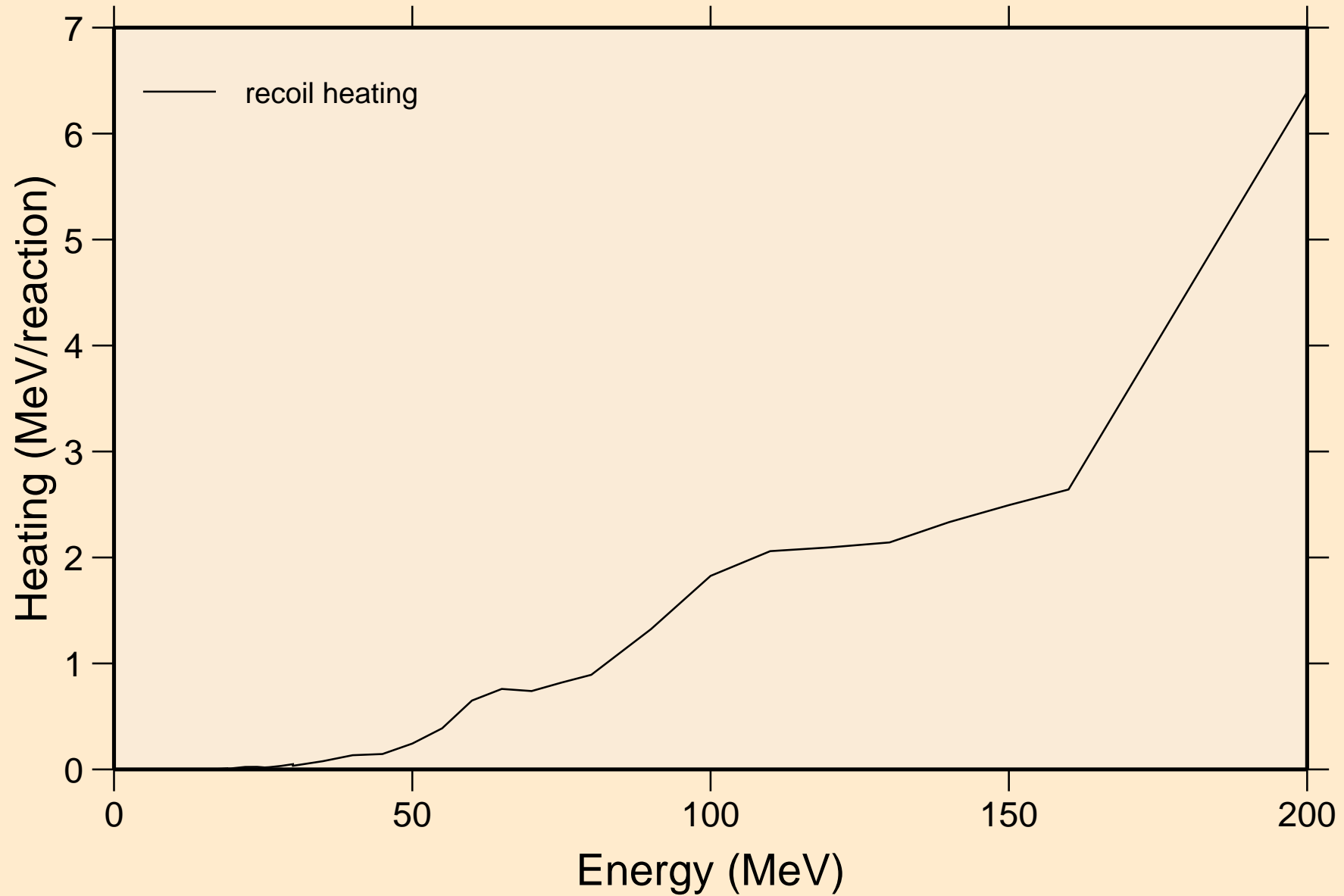



TM154 PROTON ACER TENDL-2021 LIBRARY; T=0.K  
Particle production cross sections

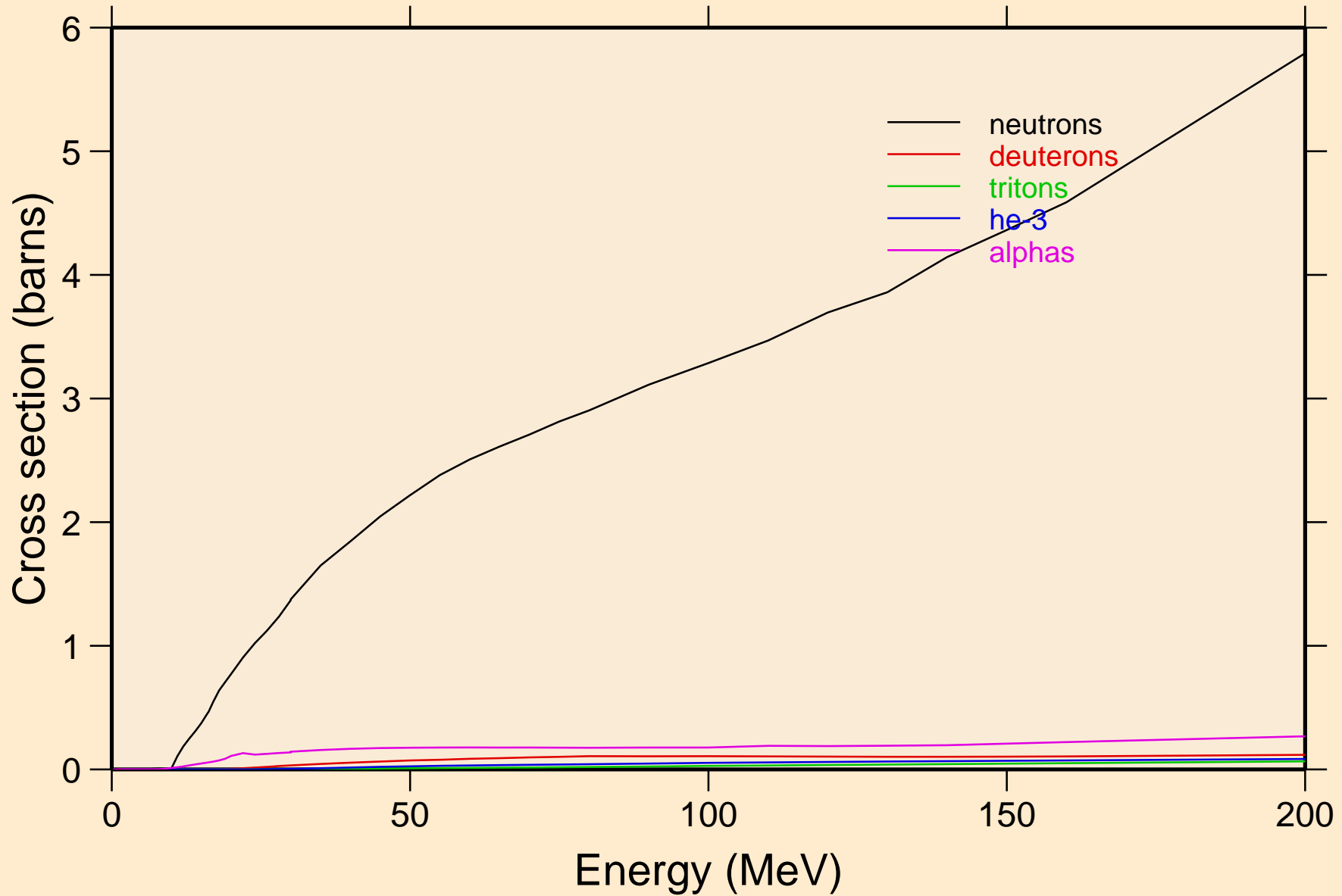

TM154 PROTON ACER TENDL-2021 LIBRARY; T=0.K  
neutrons from (p,n)

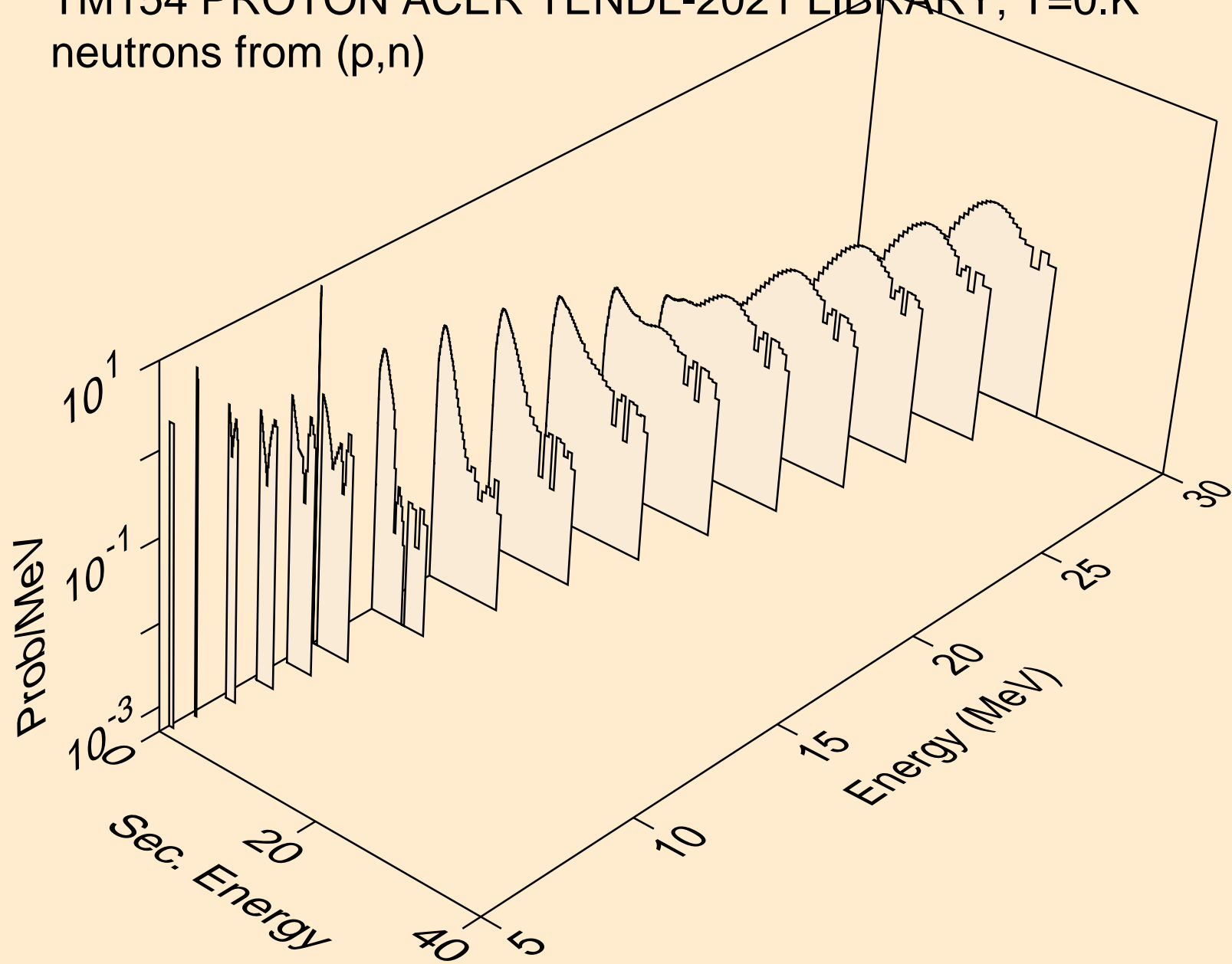

TM154 PROTON ACER TENDL-2021 LIBRARY; T=0.K  
neutrons from (p,x)

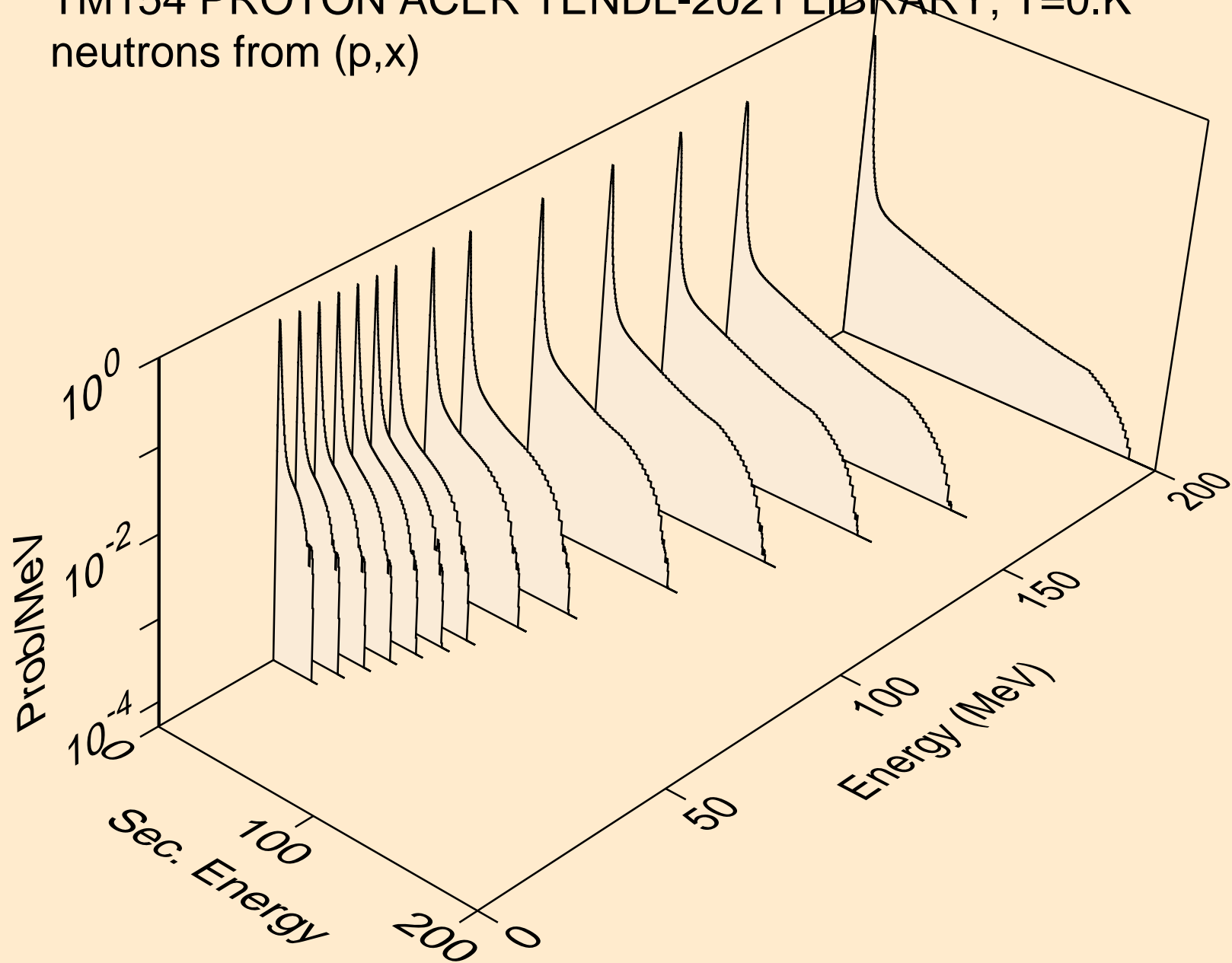

TM154 PROTON ACER TENDL-2021 LIBRARY; T=0.K  
neutrons from (p,2n)

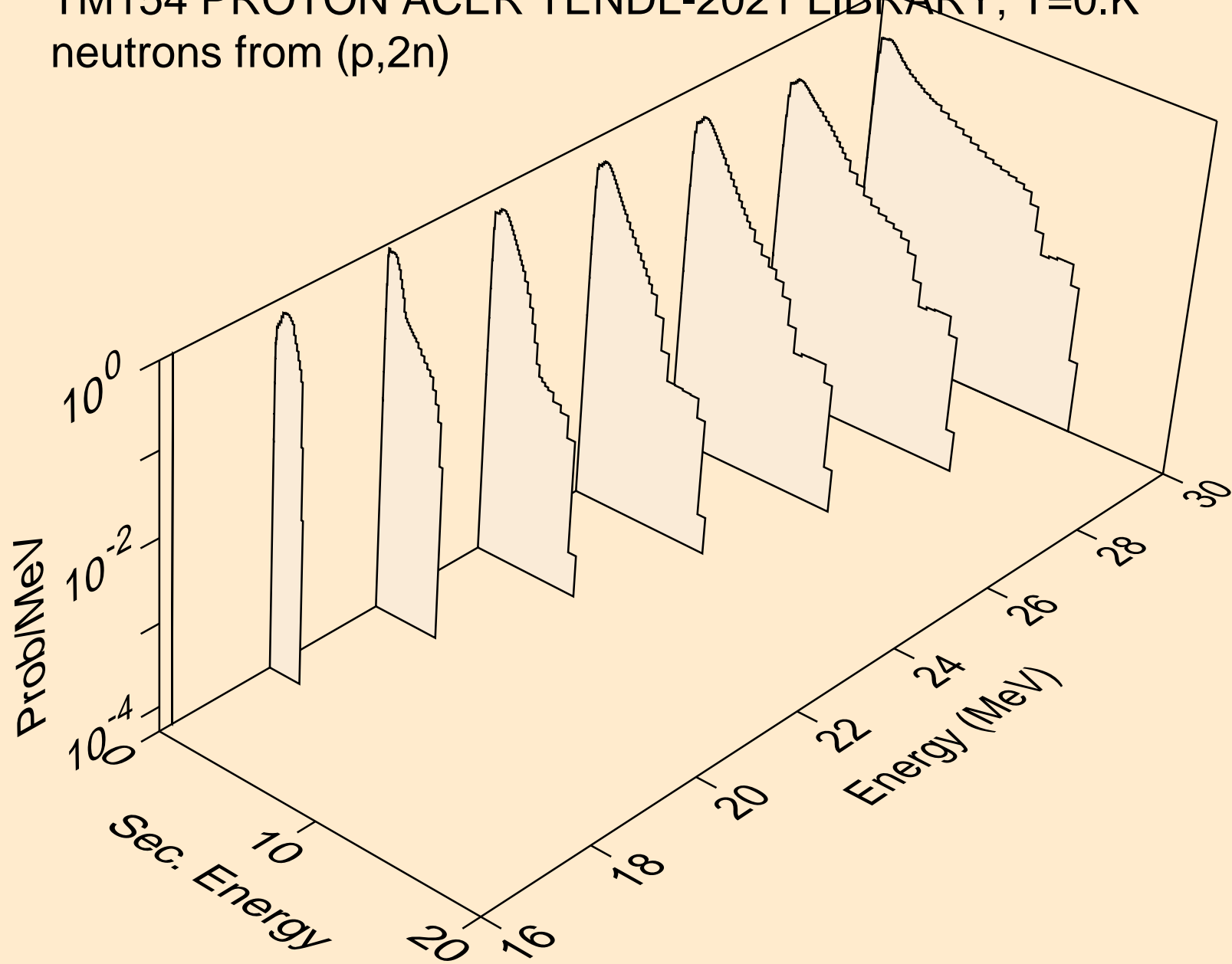

TM154 PROTON ACER TENDL-2021 LIBRARY; T=0.K  
neutrons from (p,3n)

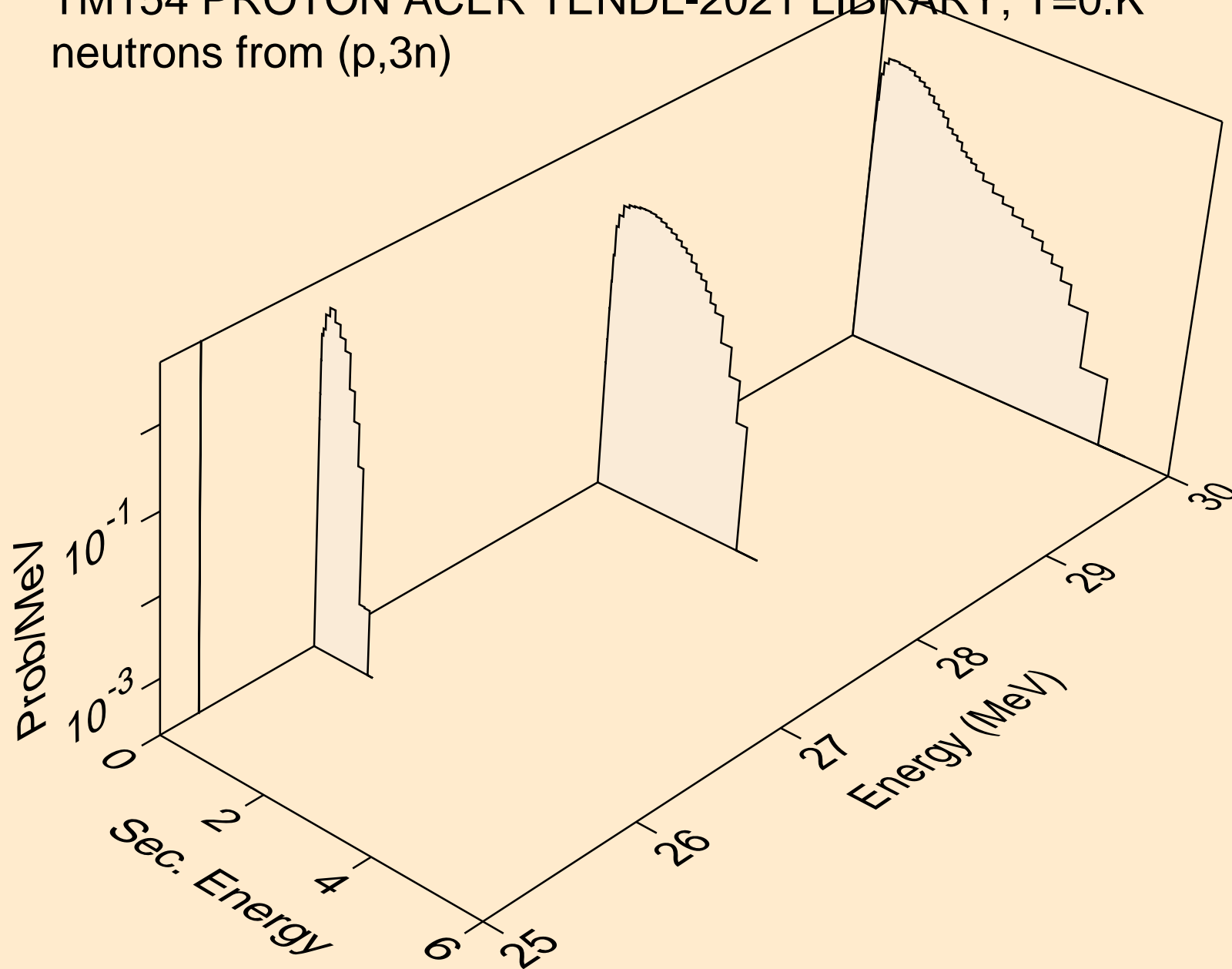

TM154 PROTON ACER TENDL-2021 LIBRARY; T=0.K  
neutrons from (p,n\*)a

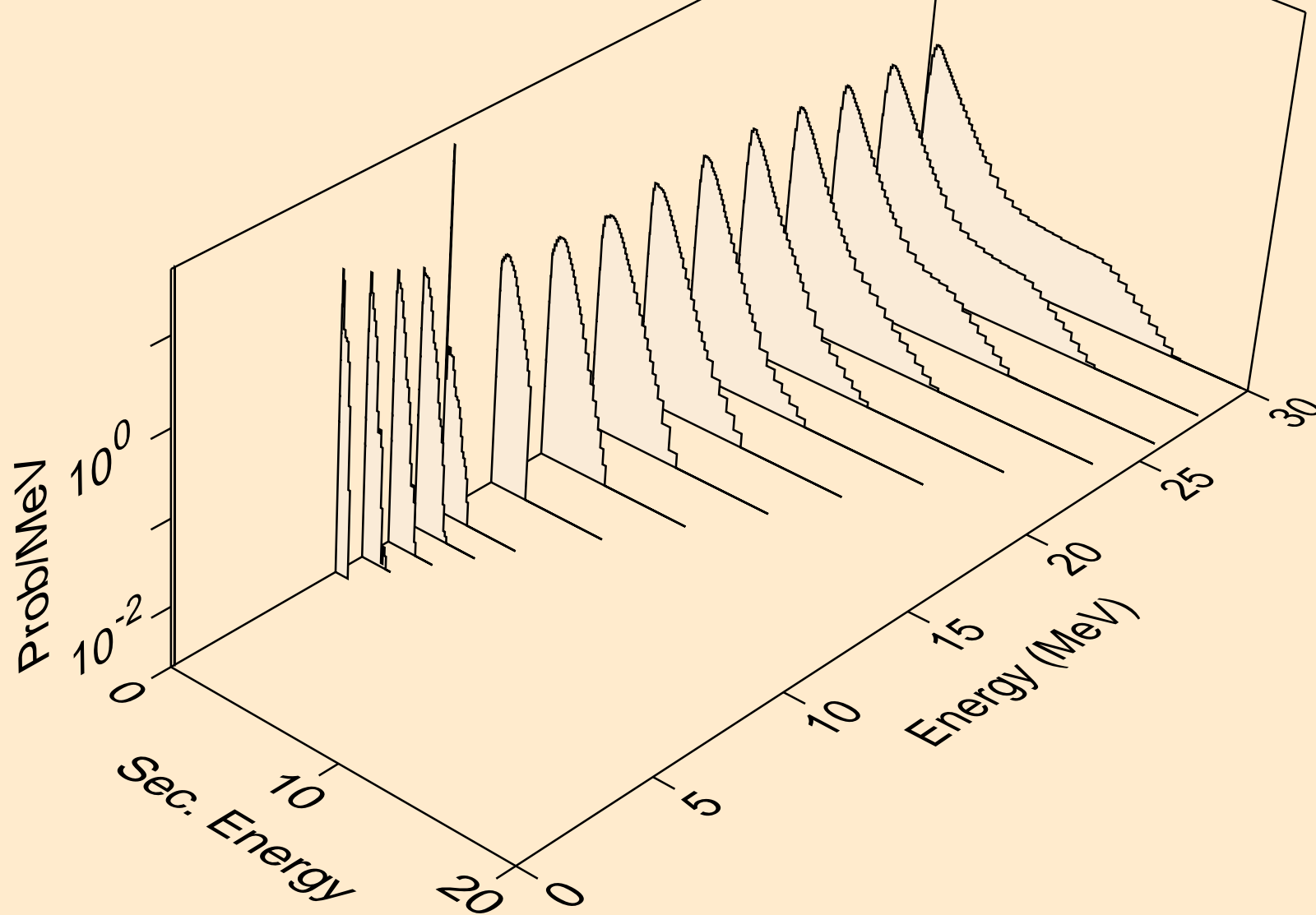

TM154 PROTON ACER TENDL-2021 LIBRARY; T=0.K  
neutrons from (p,2n)a

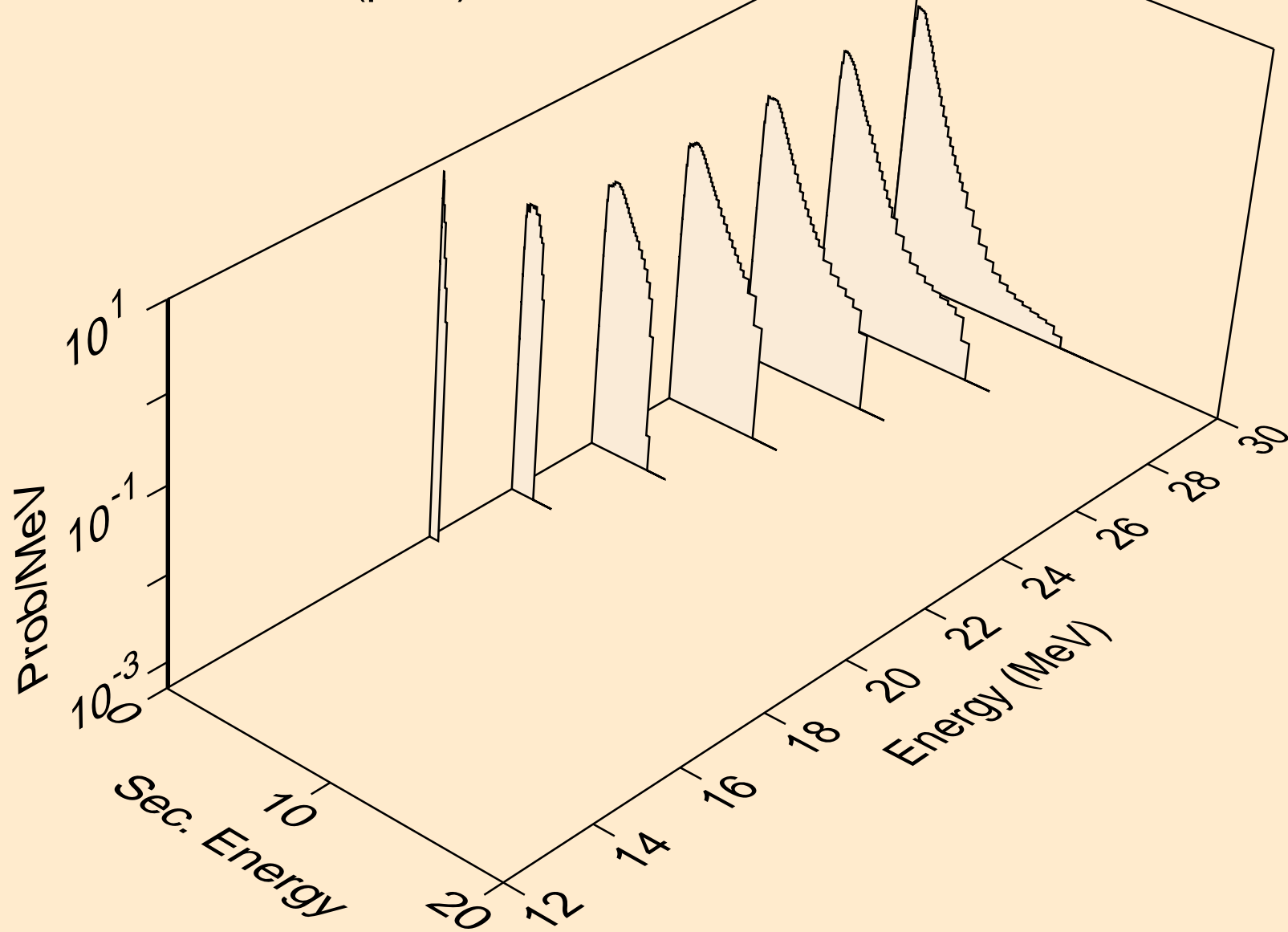

TM154 PROTON ACER TENDL-2021 LIBRARY; T=0.K  
neutrons from (p,n\*)p

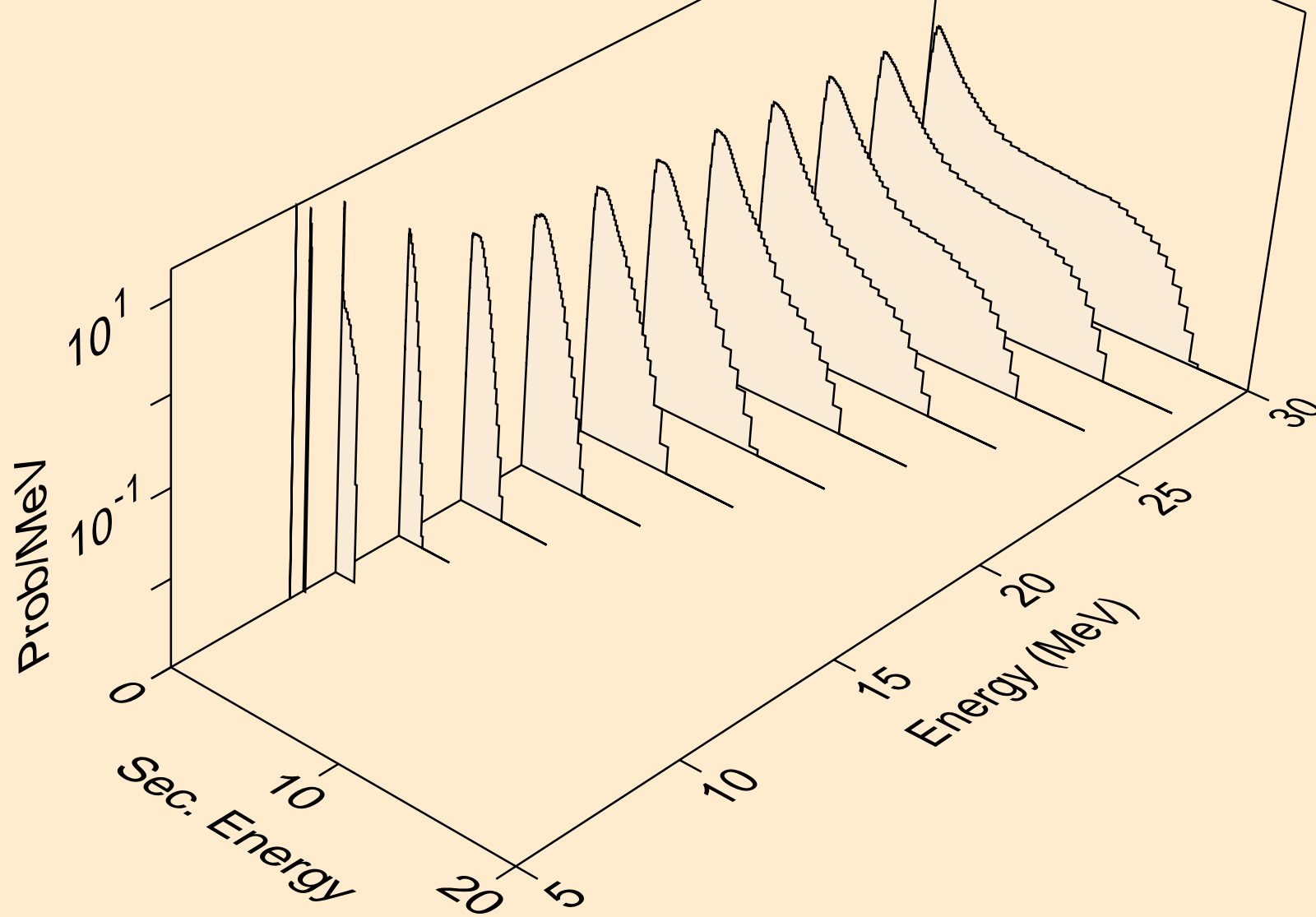



TM154 PROTON ACER TENDL-2021 LIBRARY; T=0.K  
neutrons from (p,n\*)2a

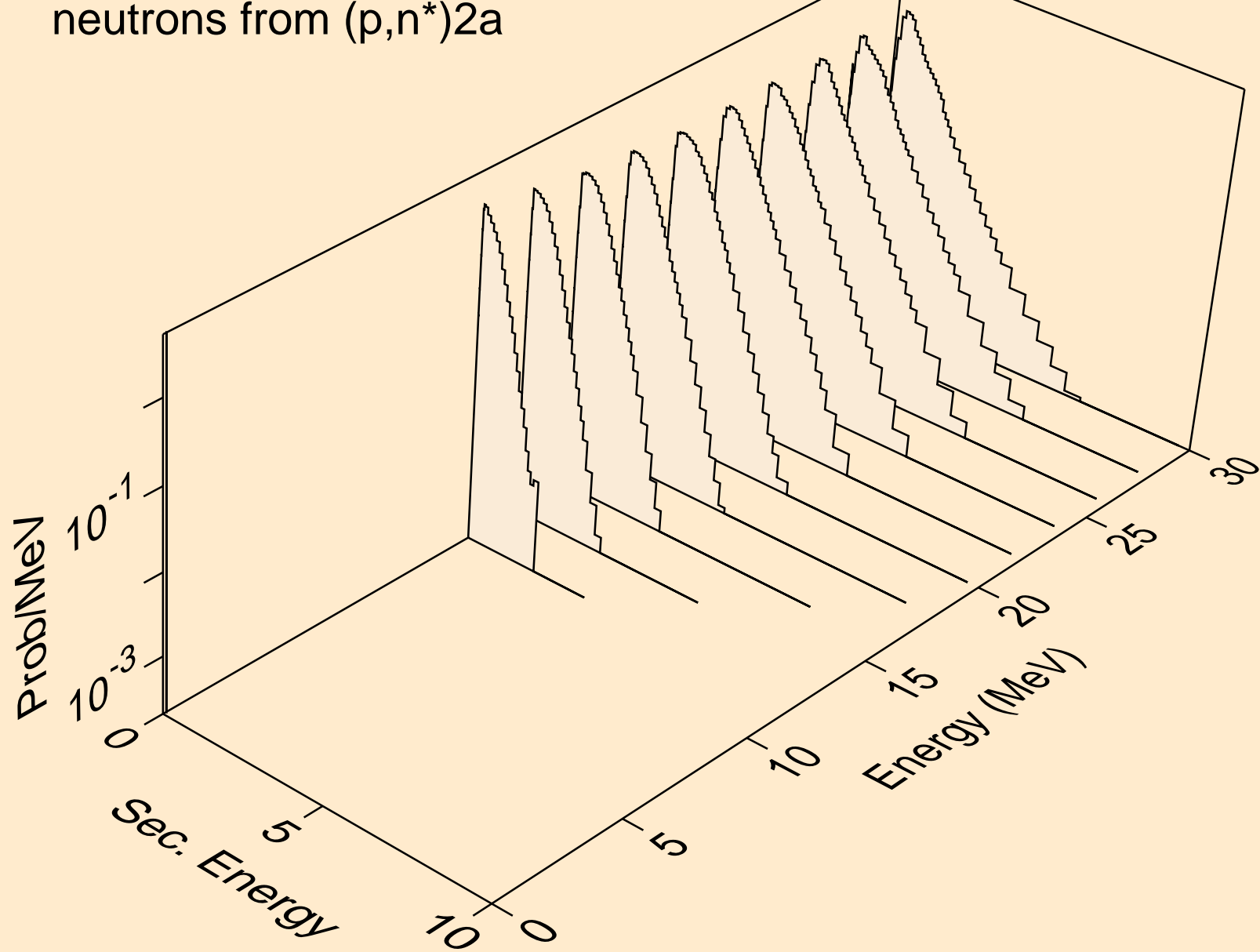

TM154 PROTON ACER TENDL-2021 LIBRARY; T=0.K  
neutrons from (p,n\*)d

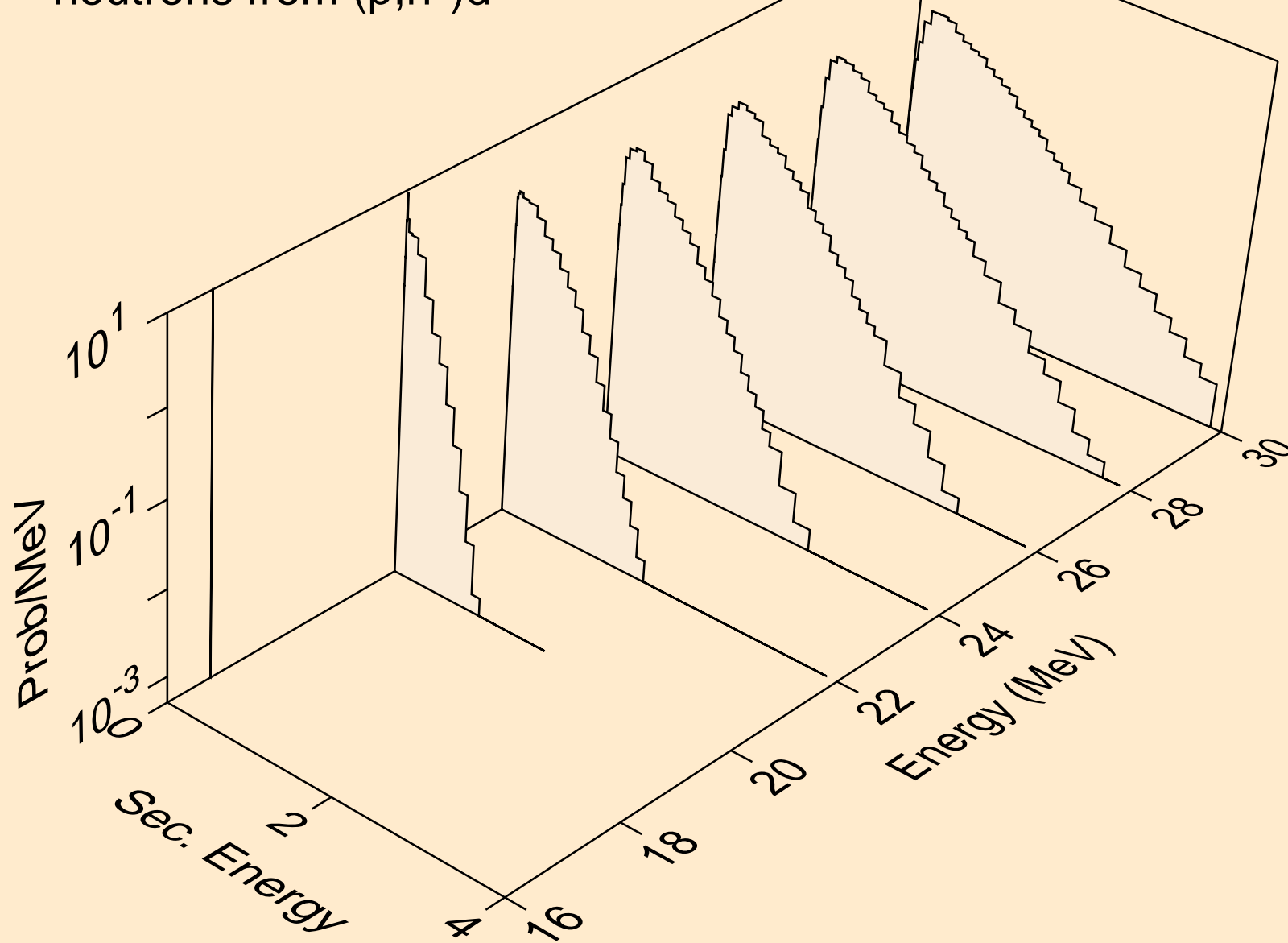

TM154 PROTON ACER TENDL-2021 LIBRARY; T=0.K  
neutrons from (p,n\*)t

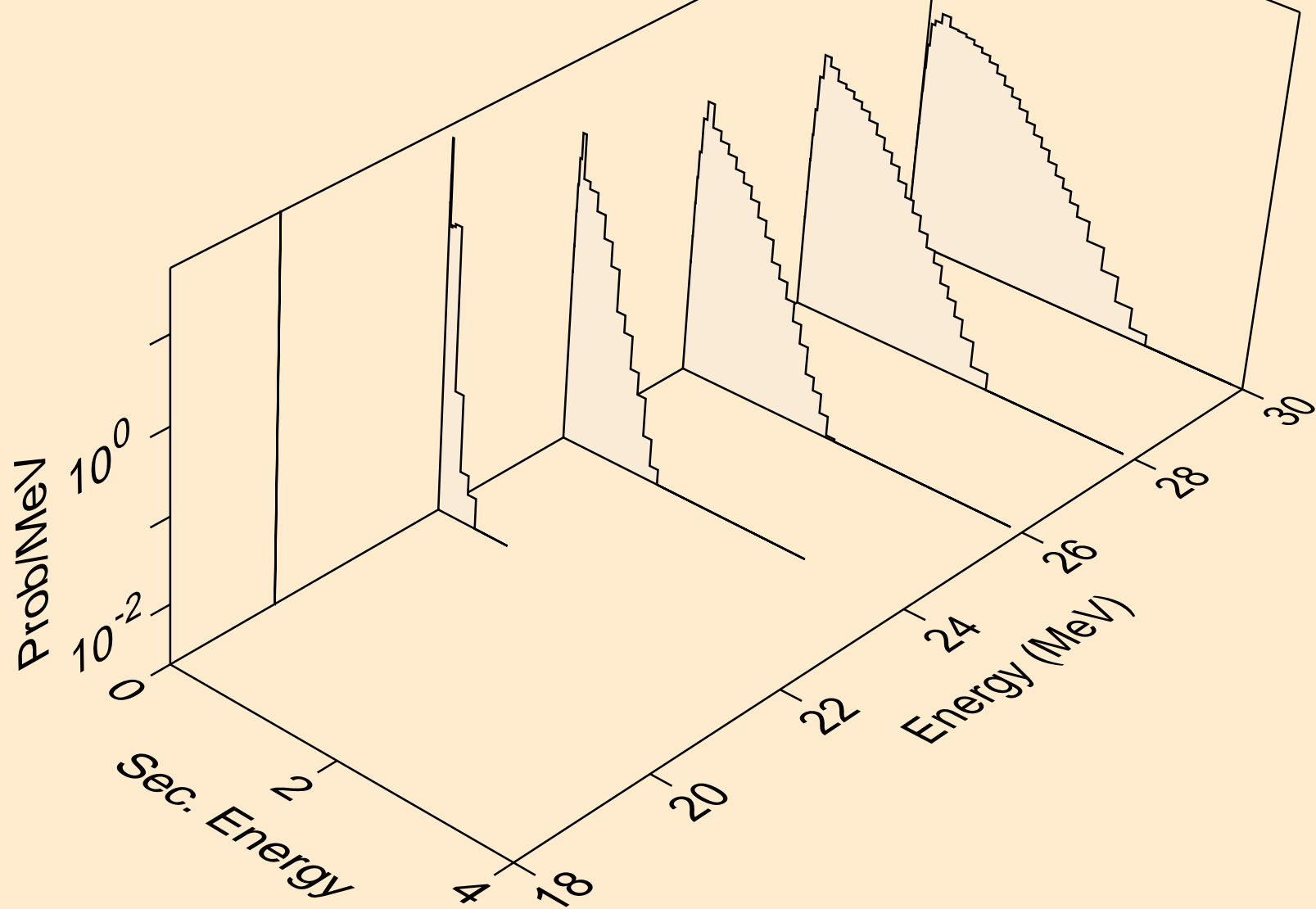

TM154 PROTON ACER TENDL-2021 LIBRARY; T=0.K  
neutrons from (p,n\*)he3

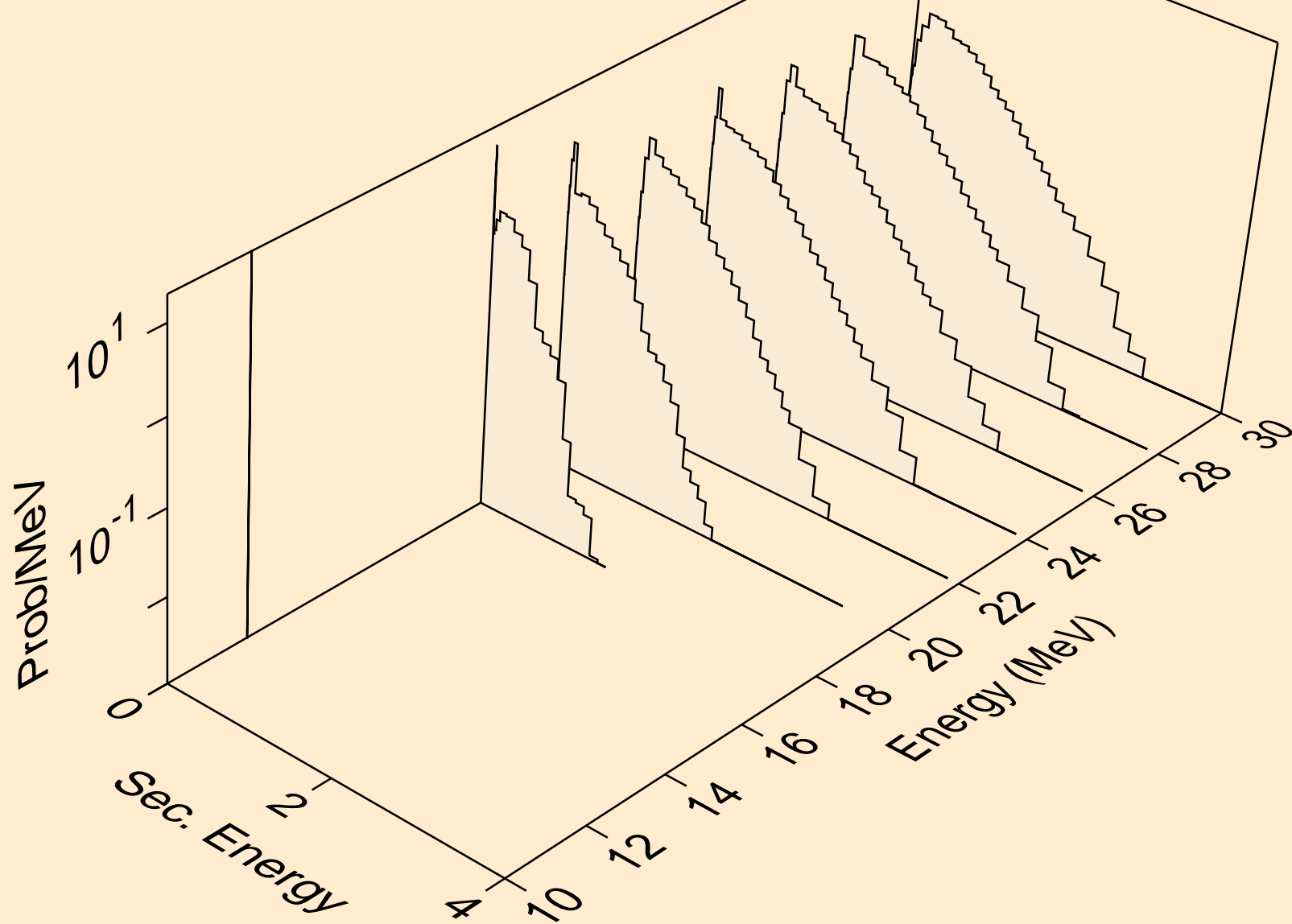

TM154 PROTON ACER TENDL-2021 LIBRARY; T=0.K  
neutrons from (p,2np)

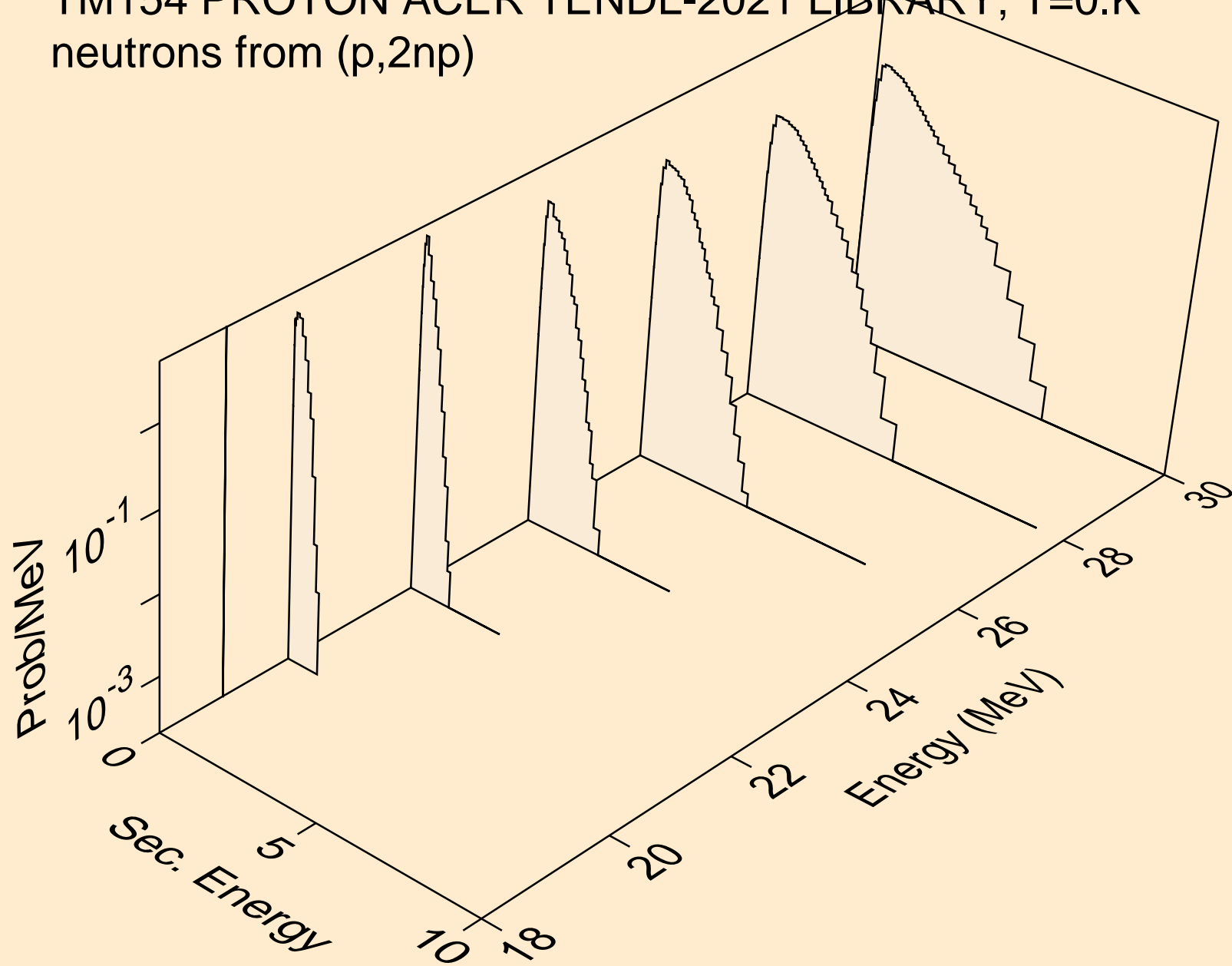

TM154 PROTON ACER TENDL-2021 LIBRARY; T=0.K  
neutrons from (p,2np)

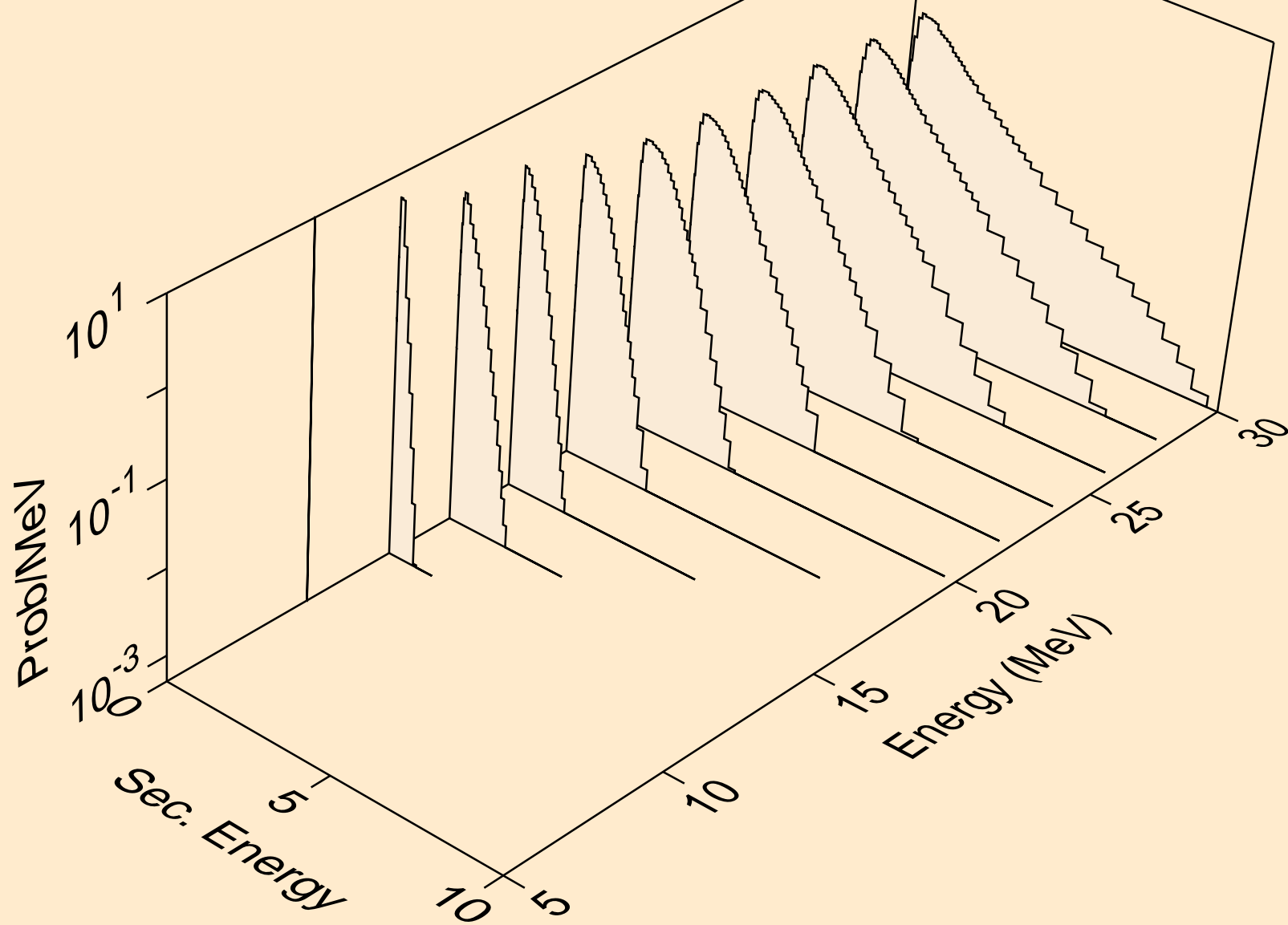

TM154 PROTON ACER TENDL-2021 LIBRARY; T=0.K  
neutrons from (p,npa)

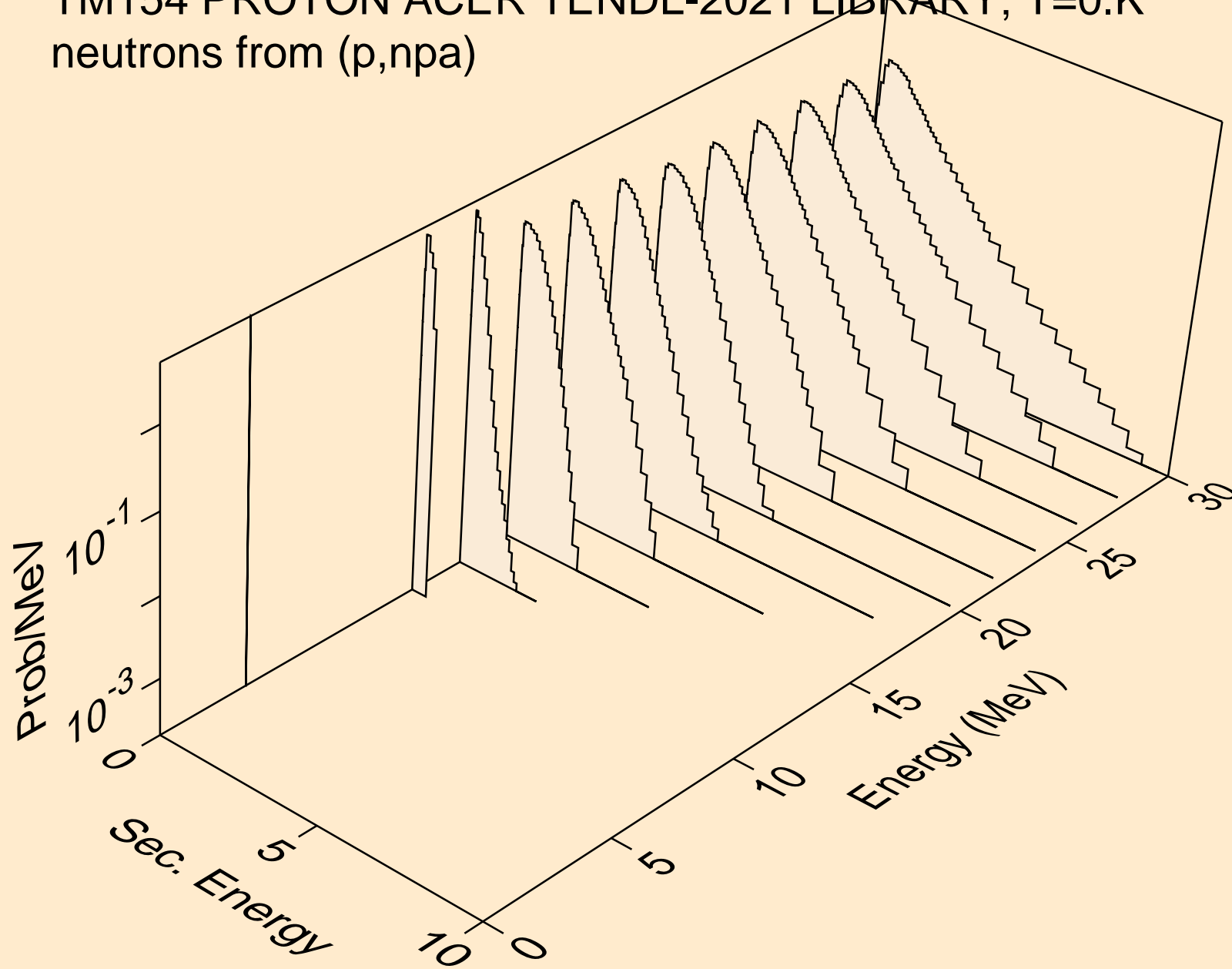

TM154 PROTON ACER TENDL-2021 LIBRARY; T=0.K  
deuterons from (p,x)

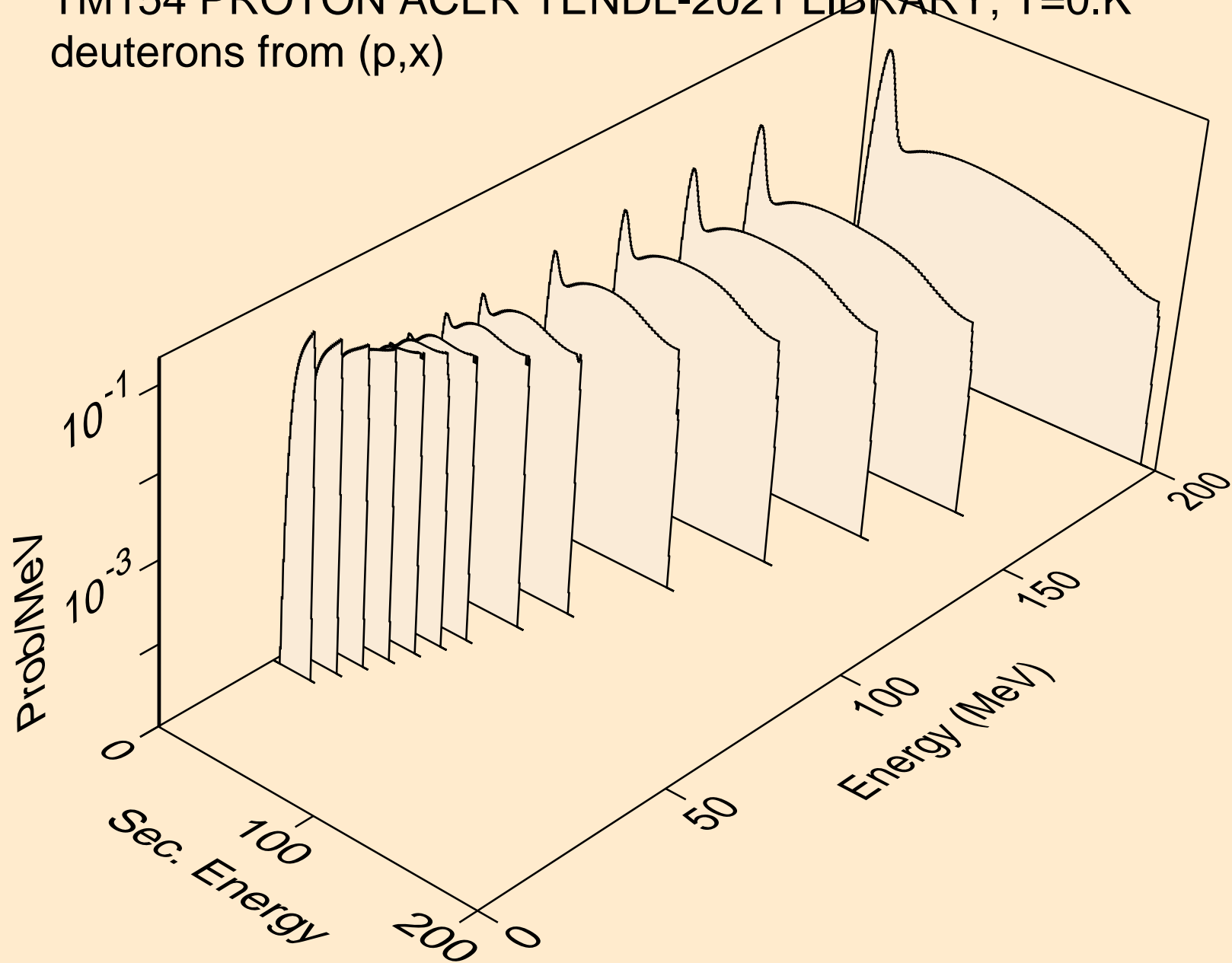



TM154 PROTON ACER TENDL-2021 LIBRARY; T=0.K  
deuterons from (p,n\*)d

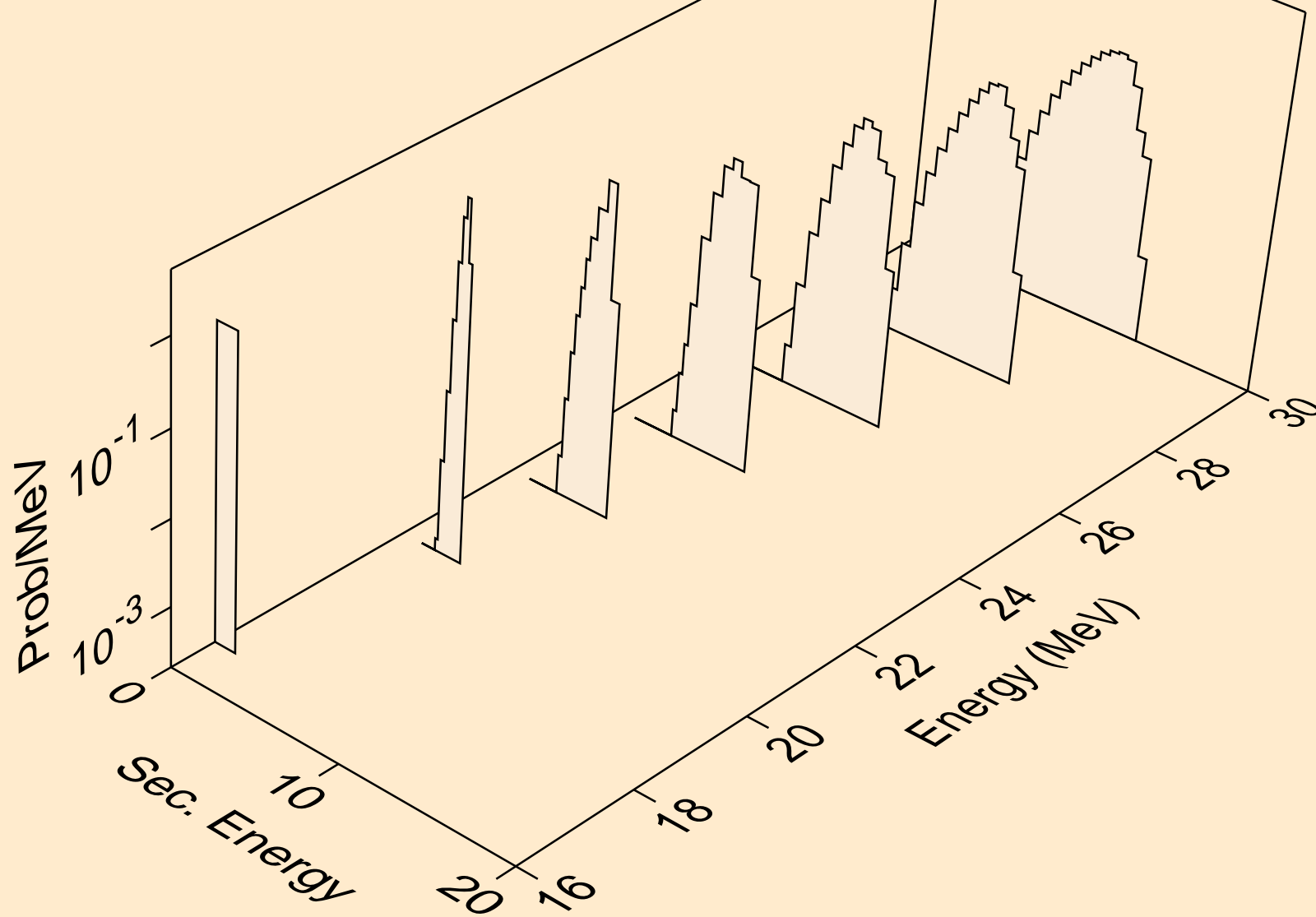

TM154 PROTON ACER TENDL-2021 LIBRARY; T=0.K  
deuterons from (p,d)

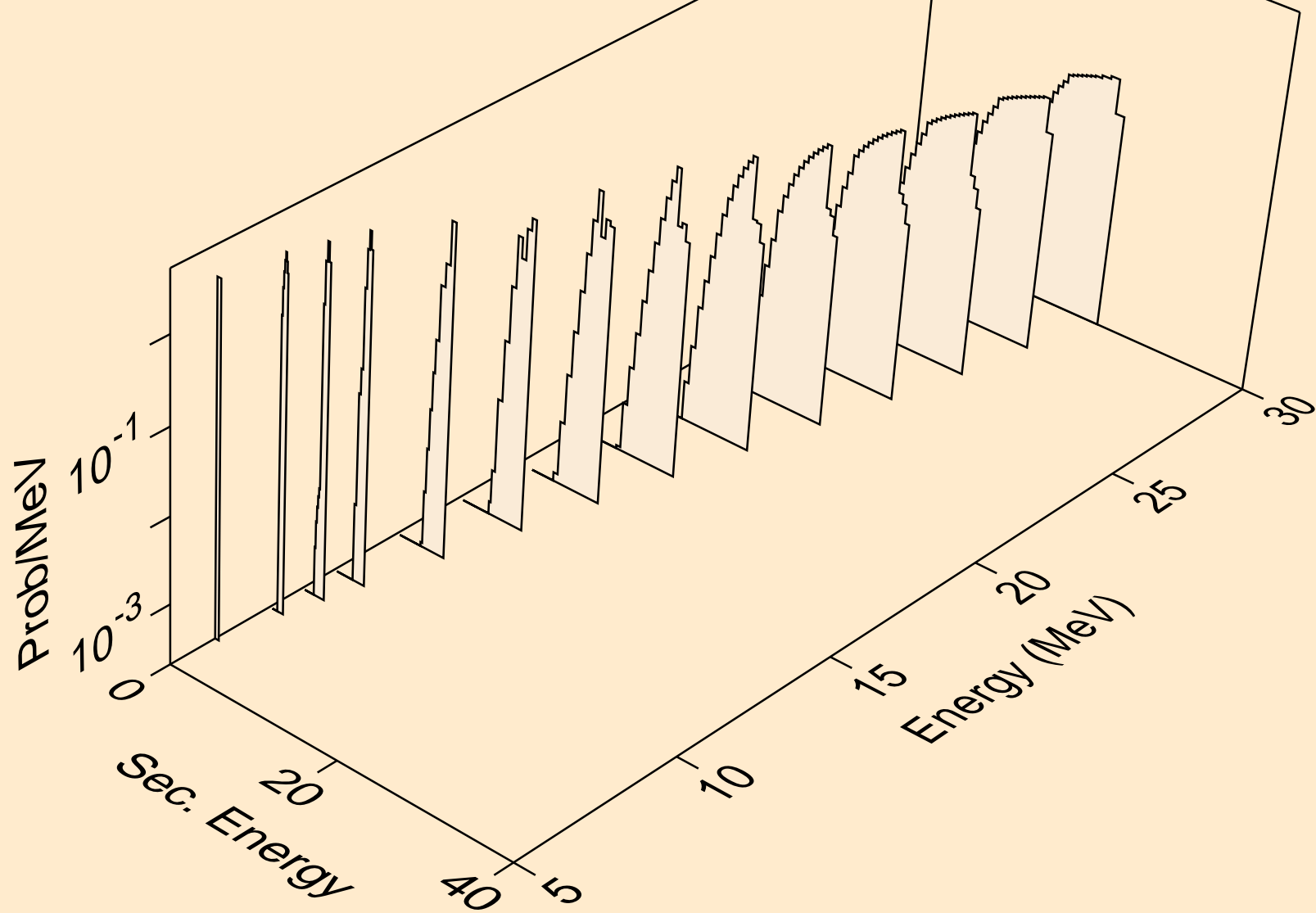

TM154 PROTON ACER TENDL-2021 LIBRARY; T=0.K  
deuterons from (p,pd)

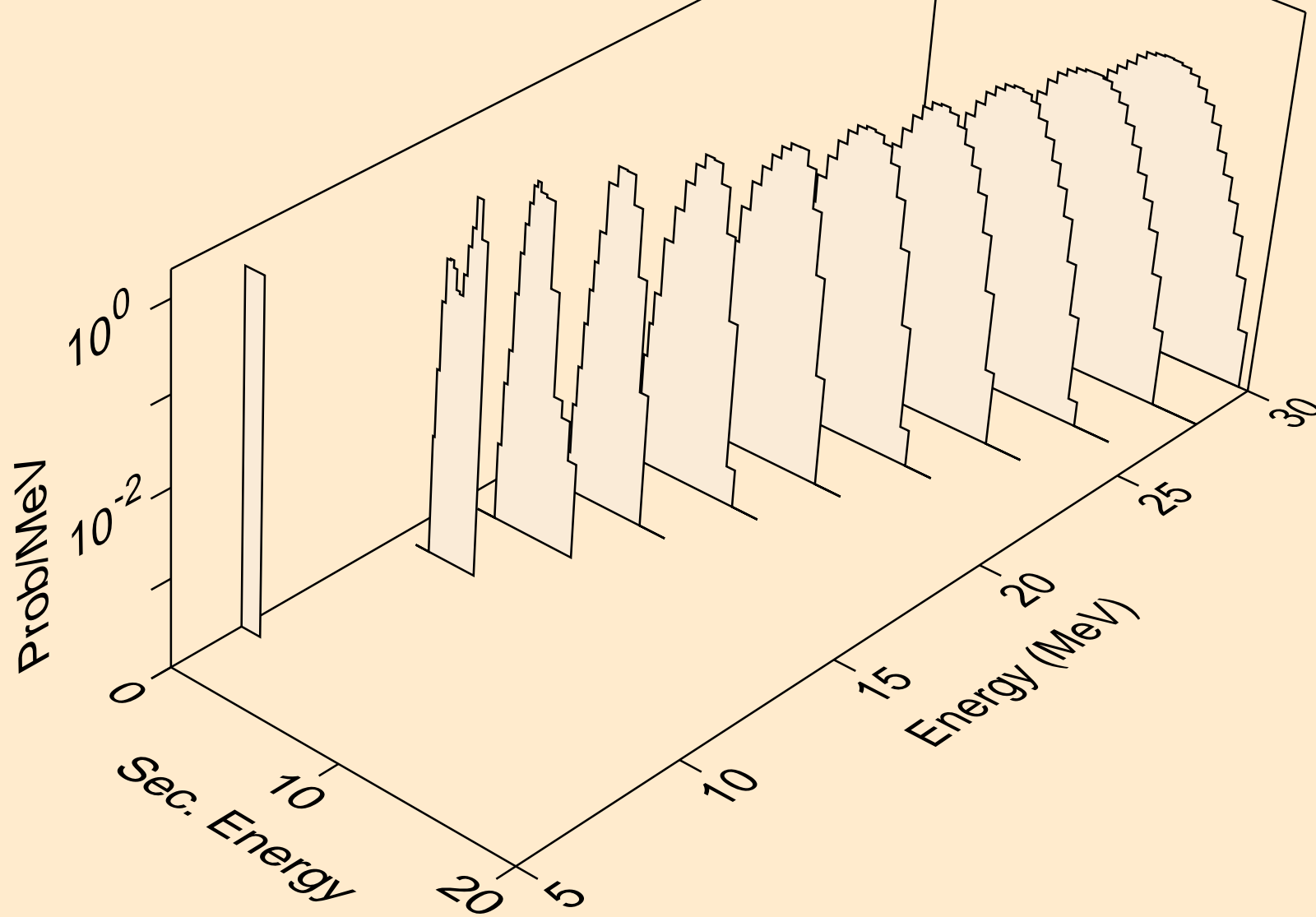

TM154 PROTON ACER TENDL-2021 LIBRARY; T=0.K  
deuterons from (p,da)

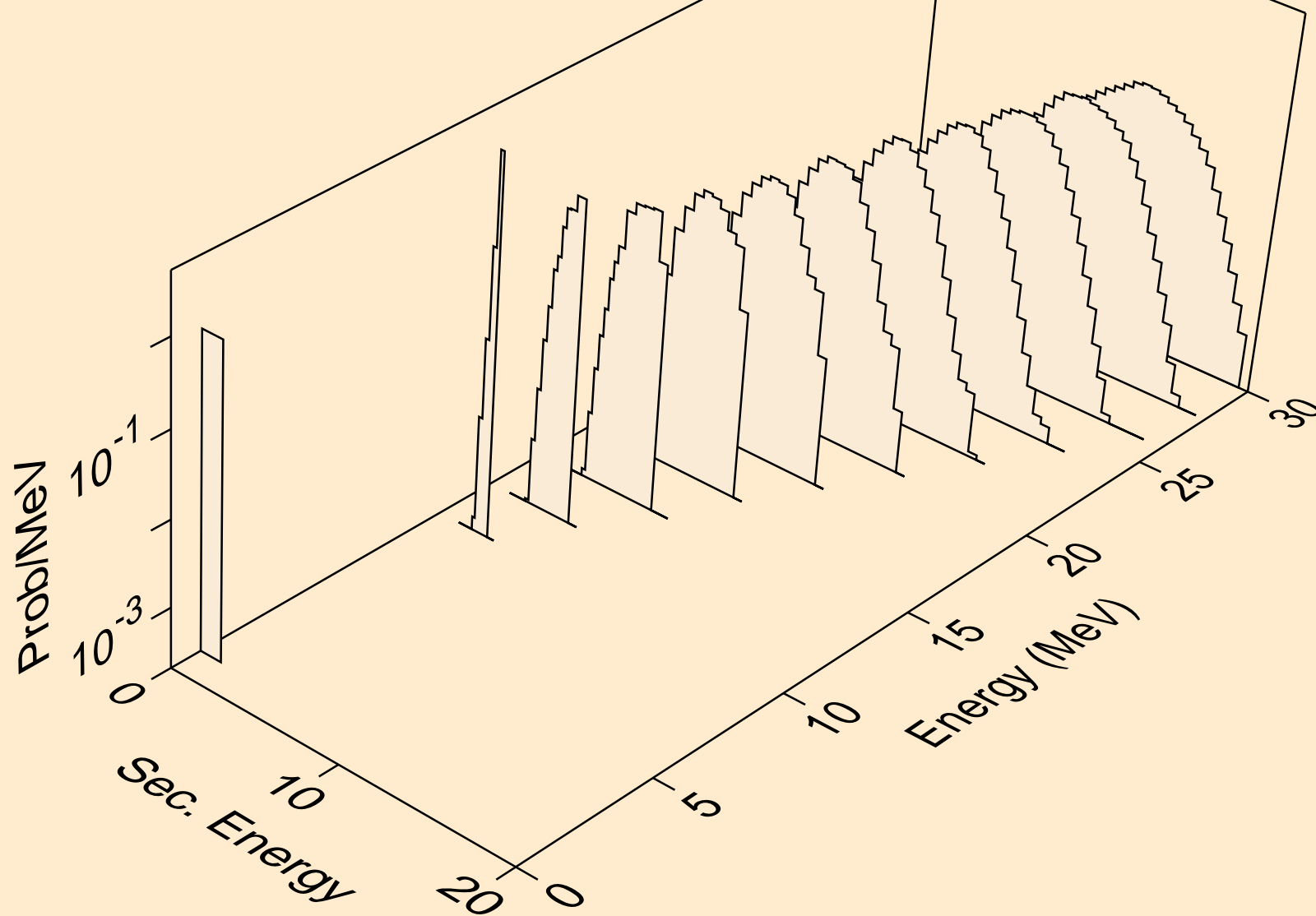

TM154 PROTON ACER TENDL-2021 LIBRARY; T=0.K  
tritons from (p,x)

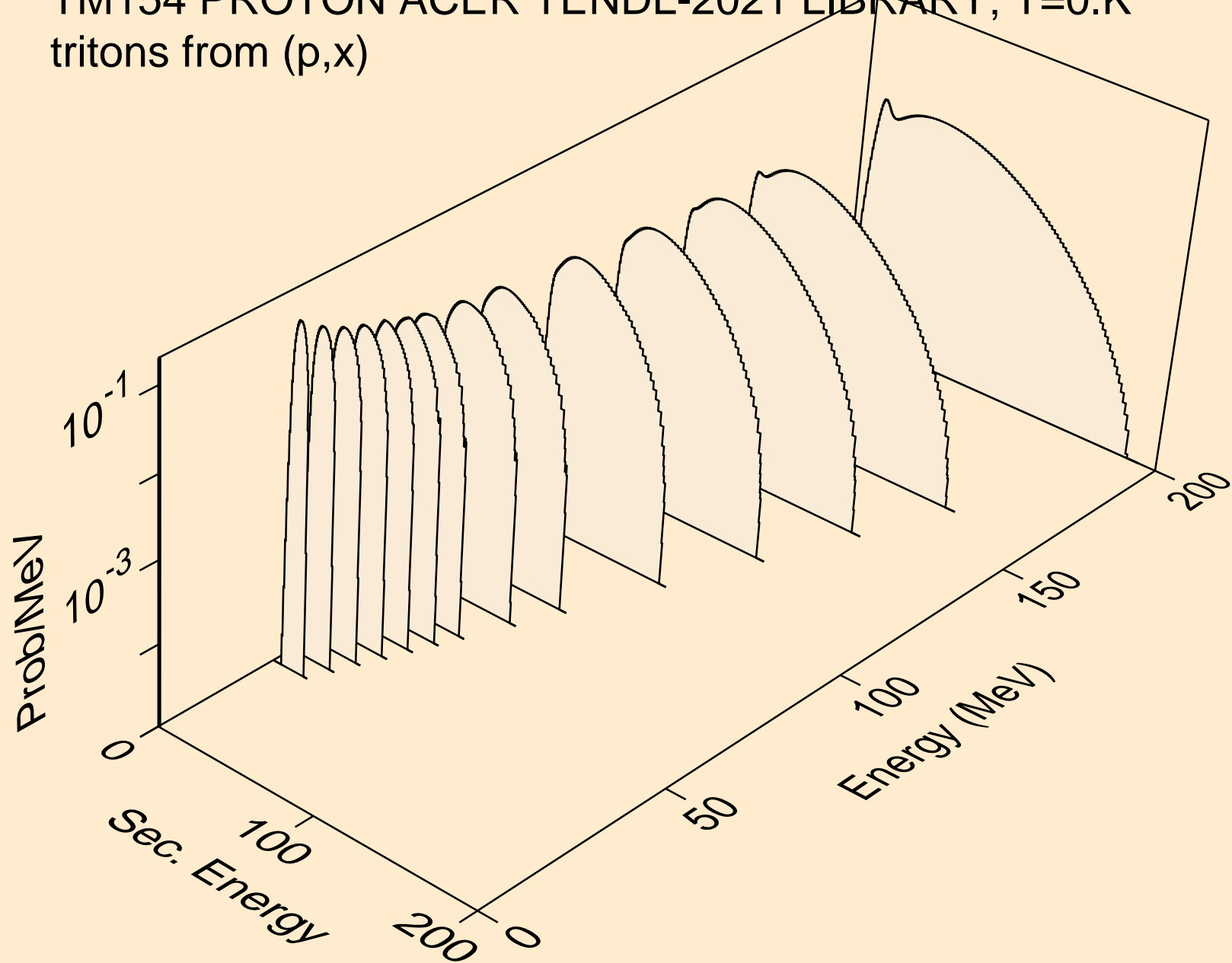

TM154 PROTON ACER TENDL-2021 LIBRARY; T=0.K  
tritons from (p,n\*)t

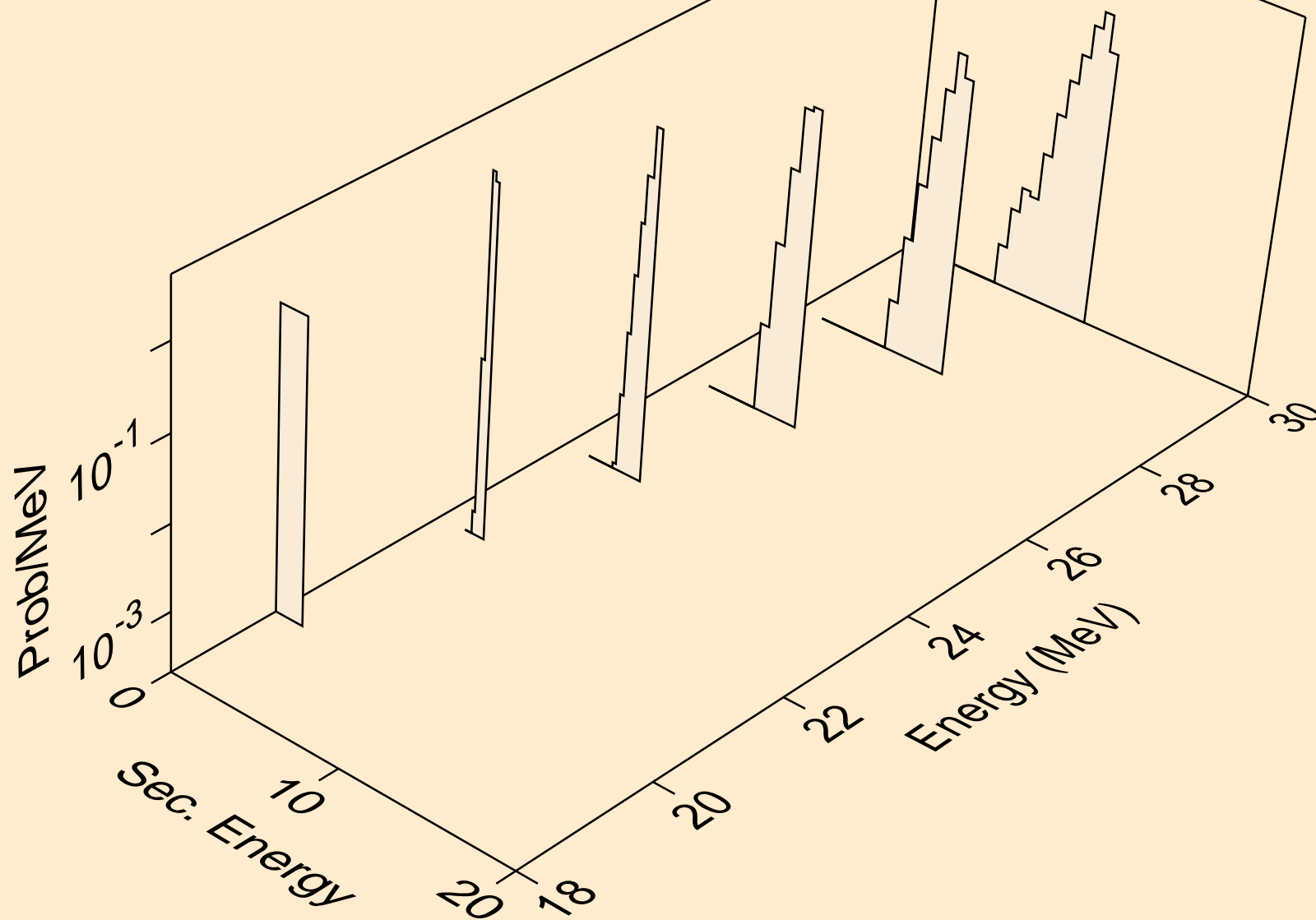

TM154 PROTON ACER TENDL-2021 LIBRARY; T=0.K  
tritons from (p,t)

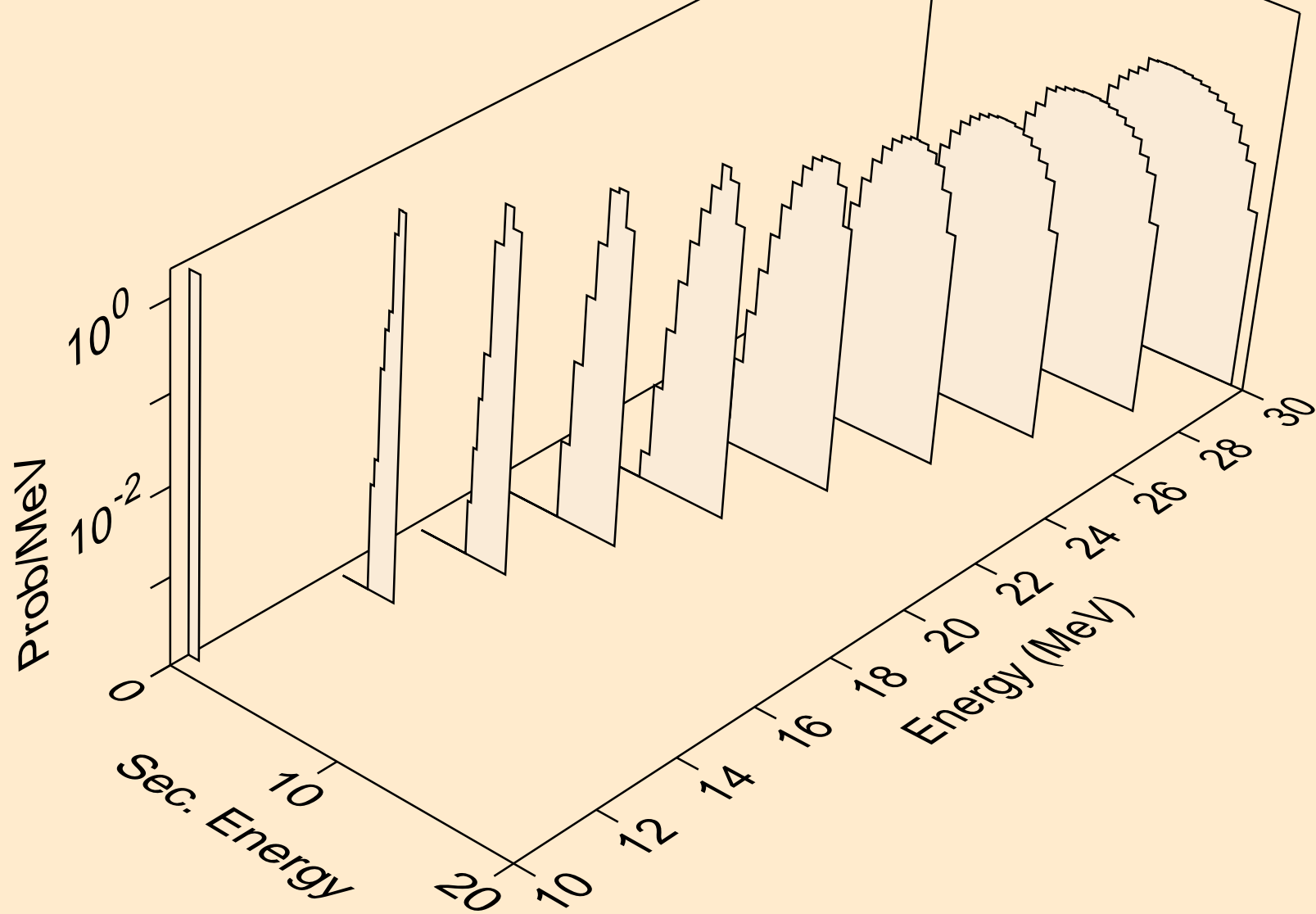

TM154 PROTON ACER TENDL-2021 LIBRARY; T=0.K  
tritons from (p,pt)

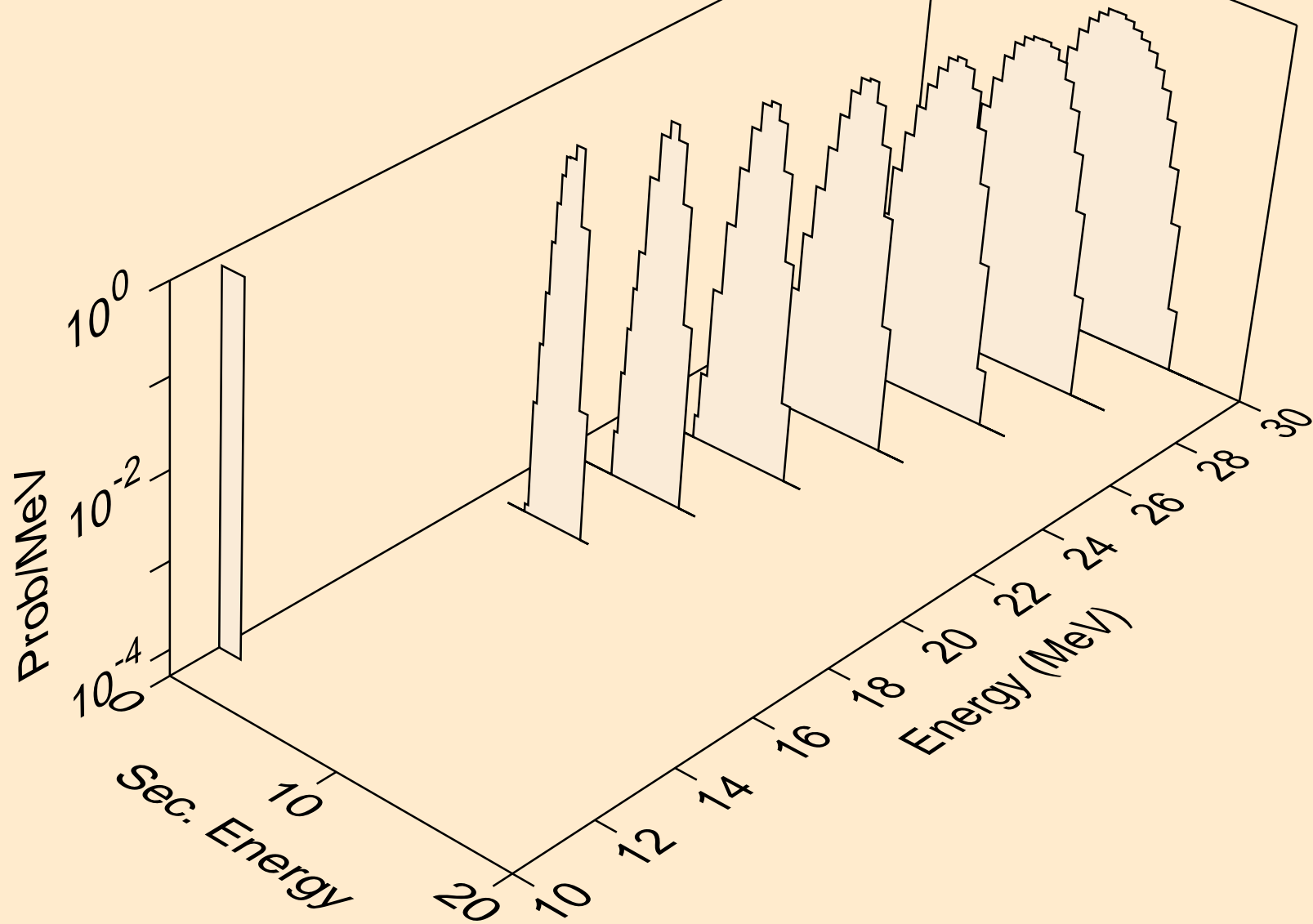



TM154 PROTON ACER TENDL-2021 LIBRARY; T=0.K  
he3s from (p,x)

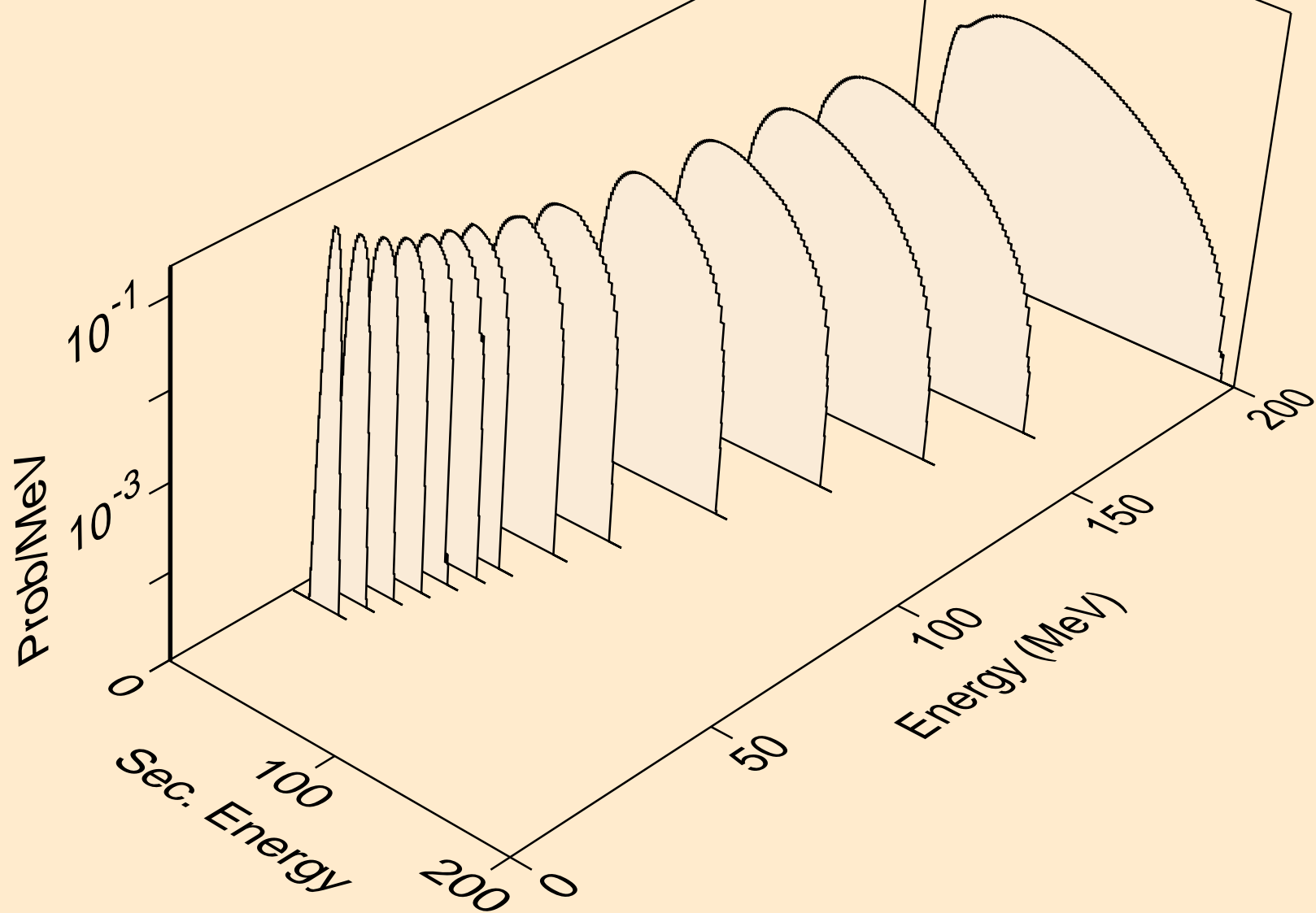

TM154 PROTON ACER TENDL-2021 LIBRARY; T=0.K  
he3s from (p,n\*)he3

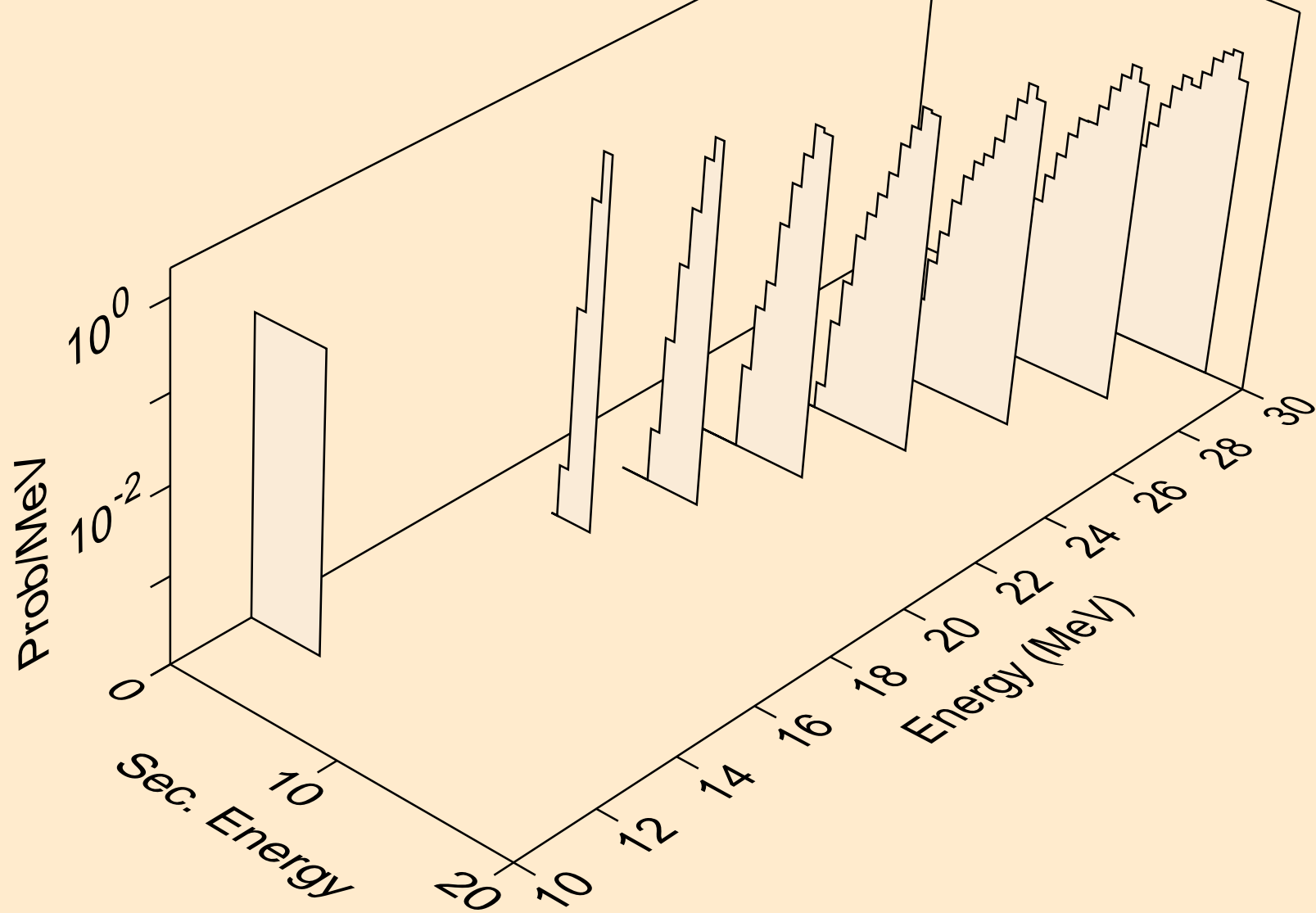

TM154 PROTON ACER TENDL-2021 LIBRARY; T=0.K  
he3s from (p,he3)

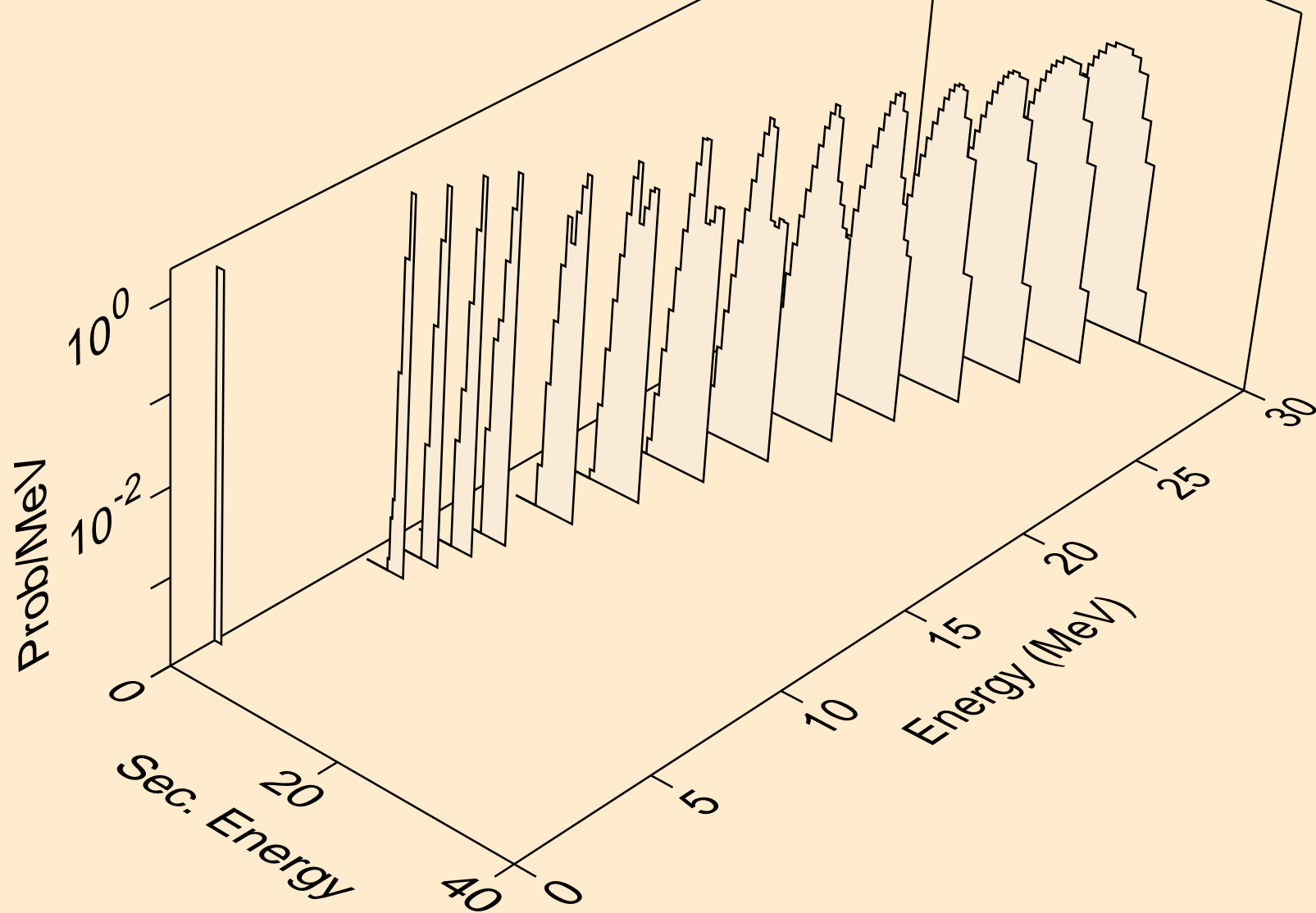

TM154 PROTON ACER TENDL-2021 LIBRARY; T=0.K  
alphas from (p,x)

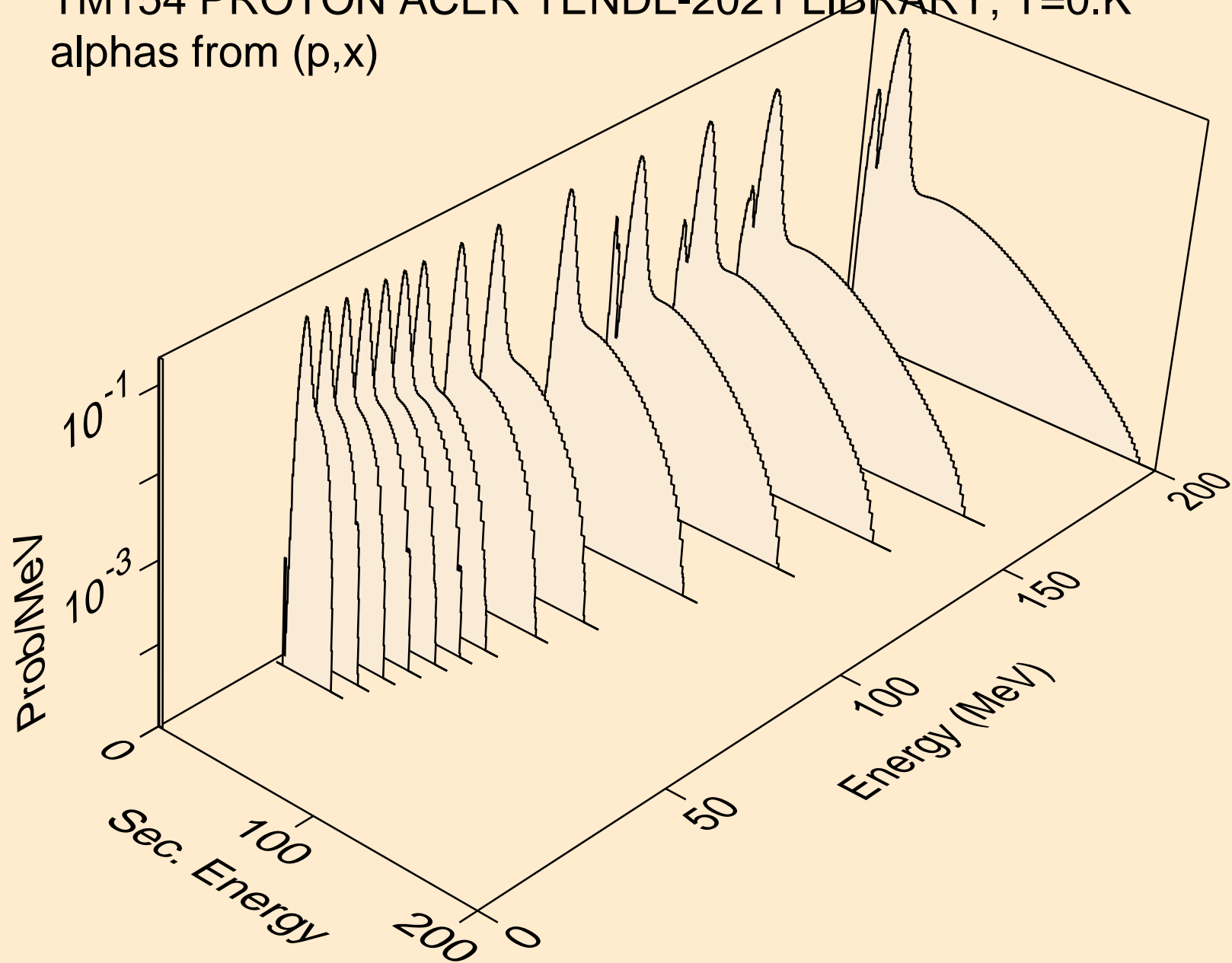

TM154 PROTON ACER TENDL-2021 LIBRARY; T=0.K  
alphas from (p,n\*)a

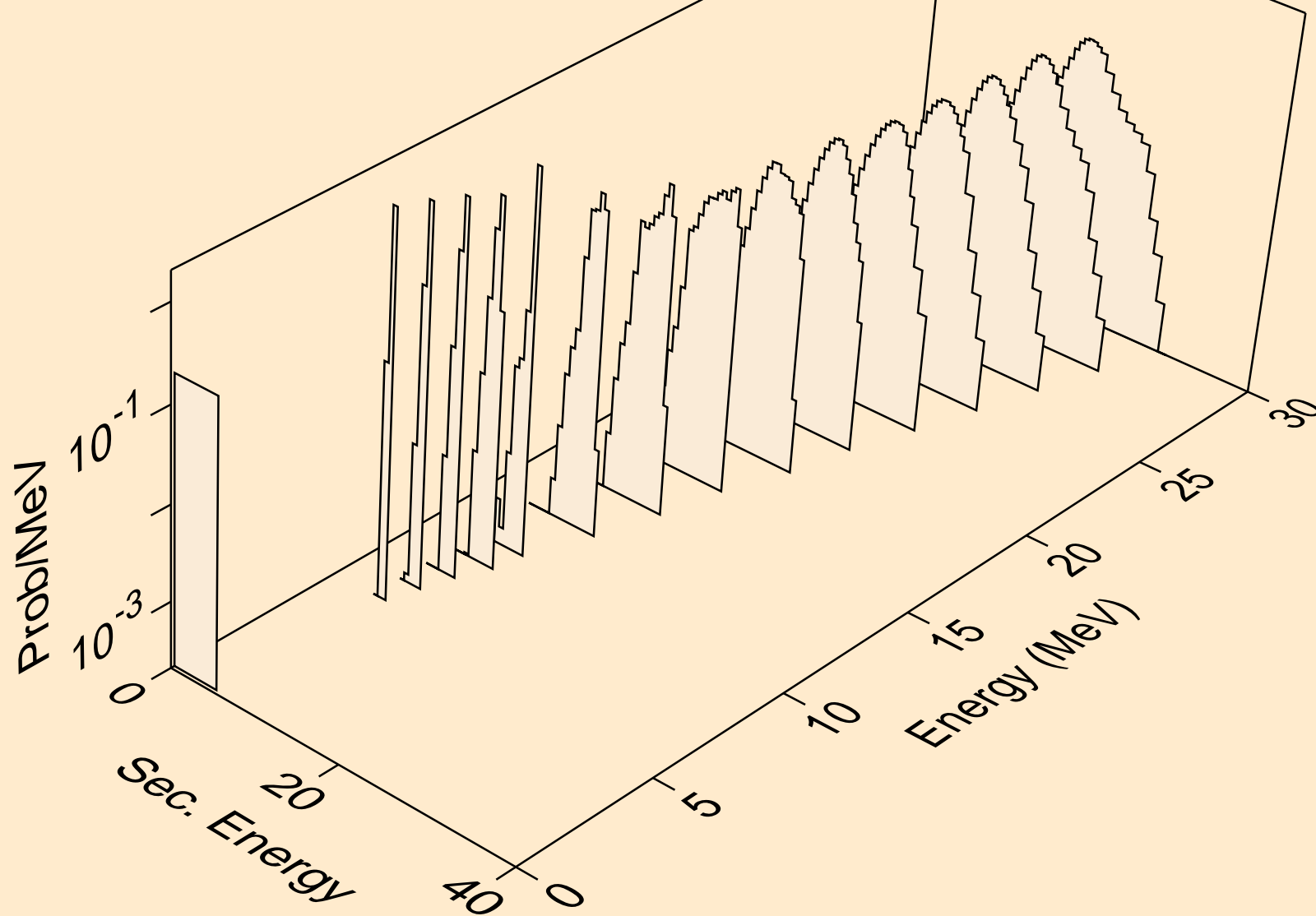

TM154 PROTON ACER TENDL-2021 LIBRARY; T=0.K  
alphas from (p,2n)a

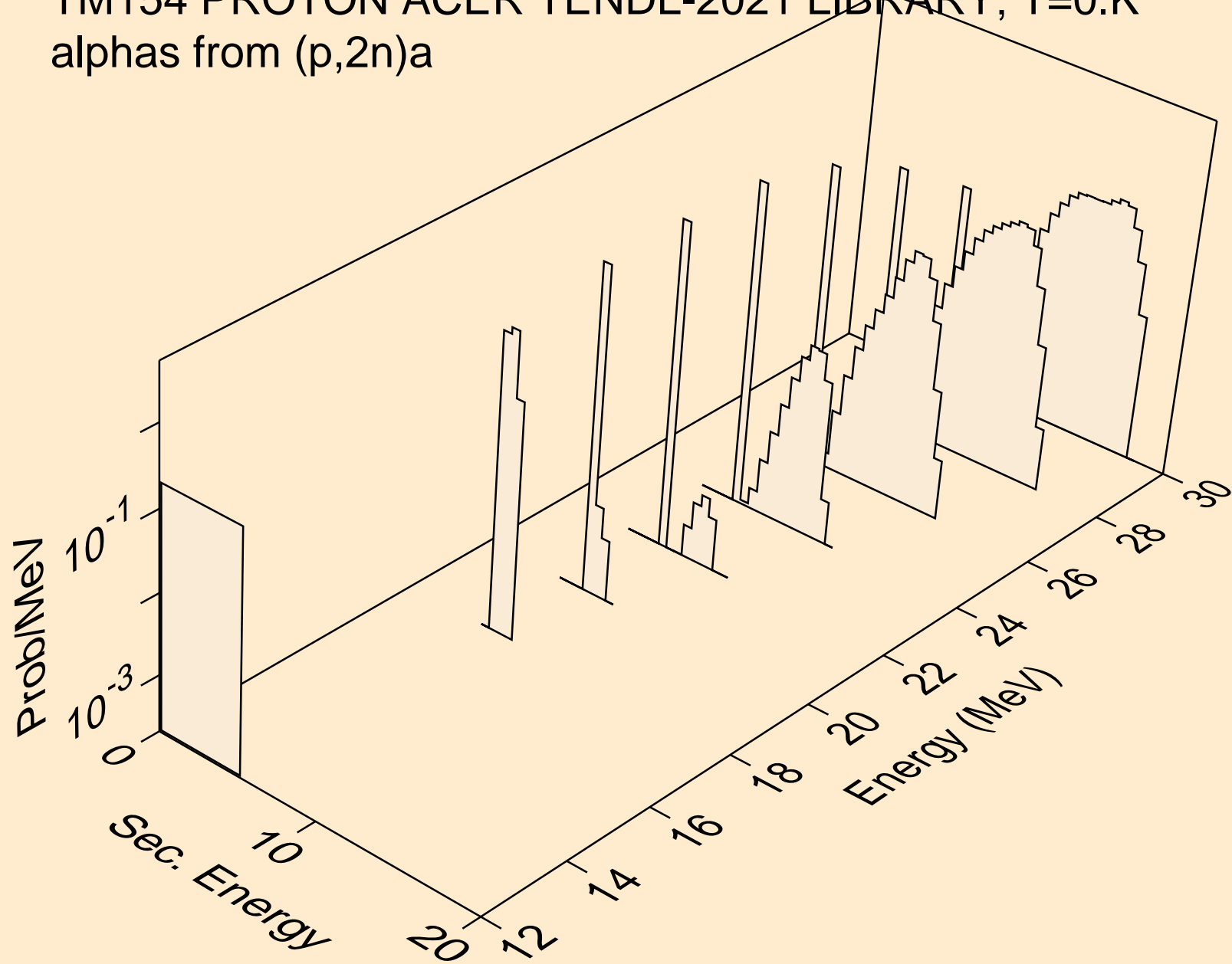

TM154 PROTON ACER TENDL-2021 LIBRARY; T=0.K  
alphas from (p,n\*)2a

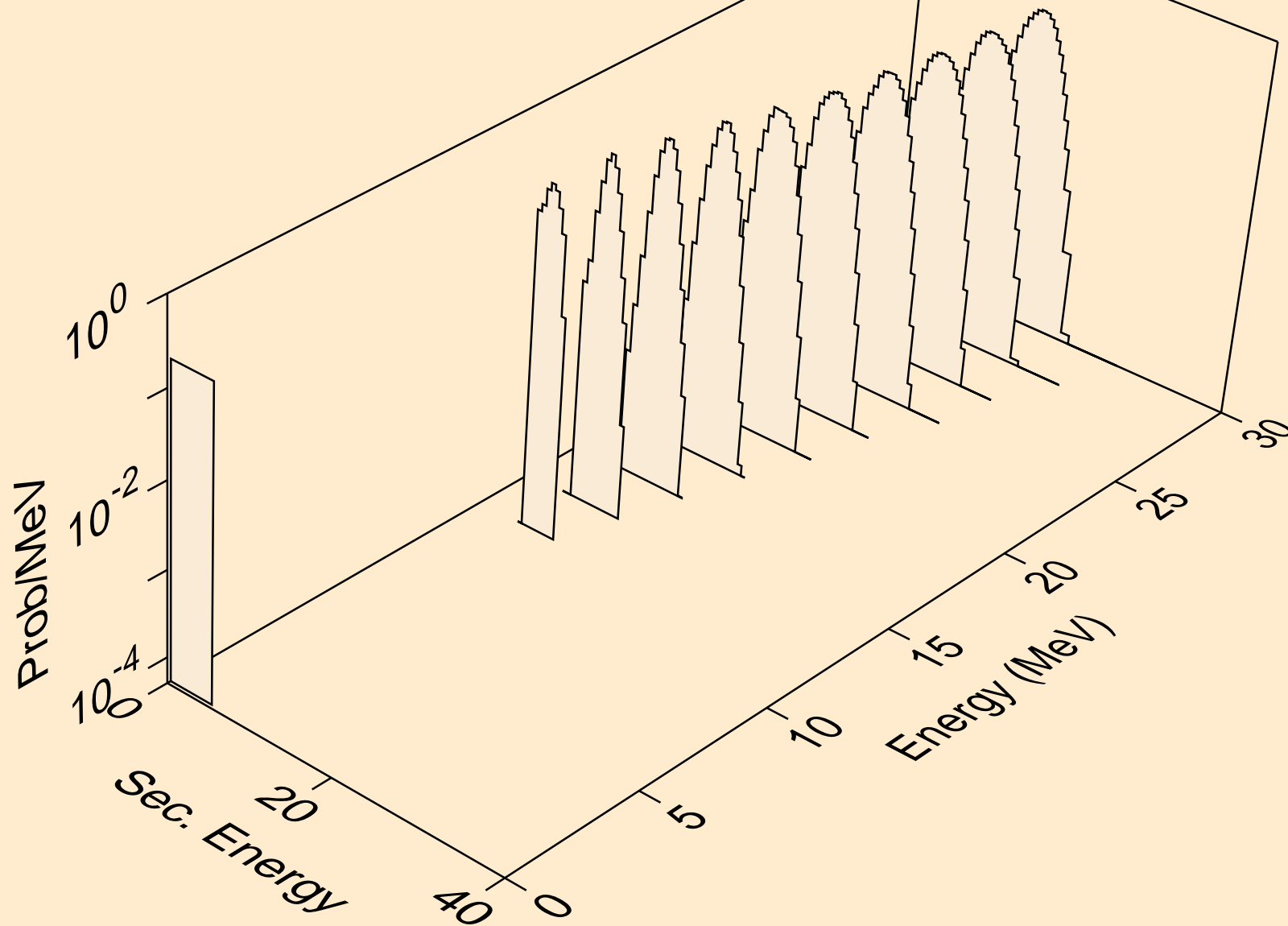

TM154 PROTON ACER TENDL-2021 LIBRARY; T=0.K  
alphas from (p,npa)

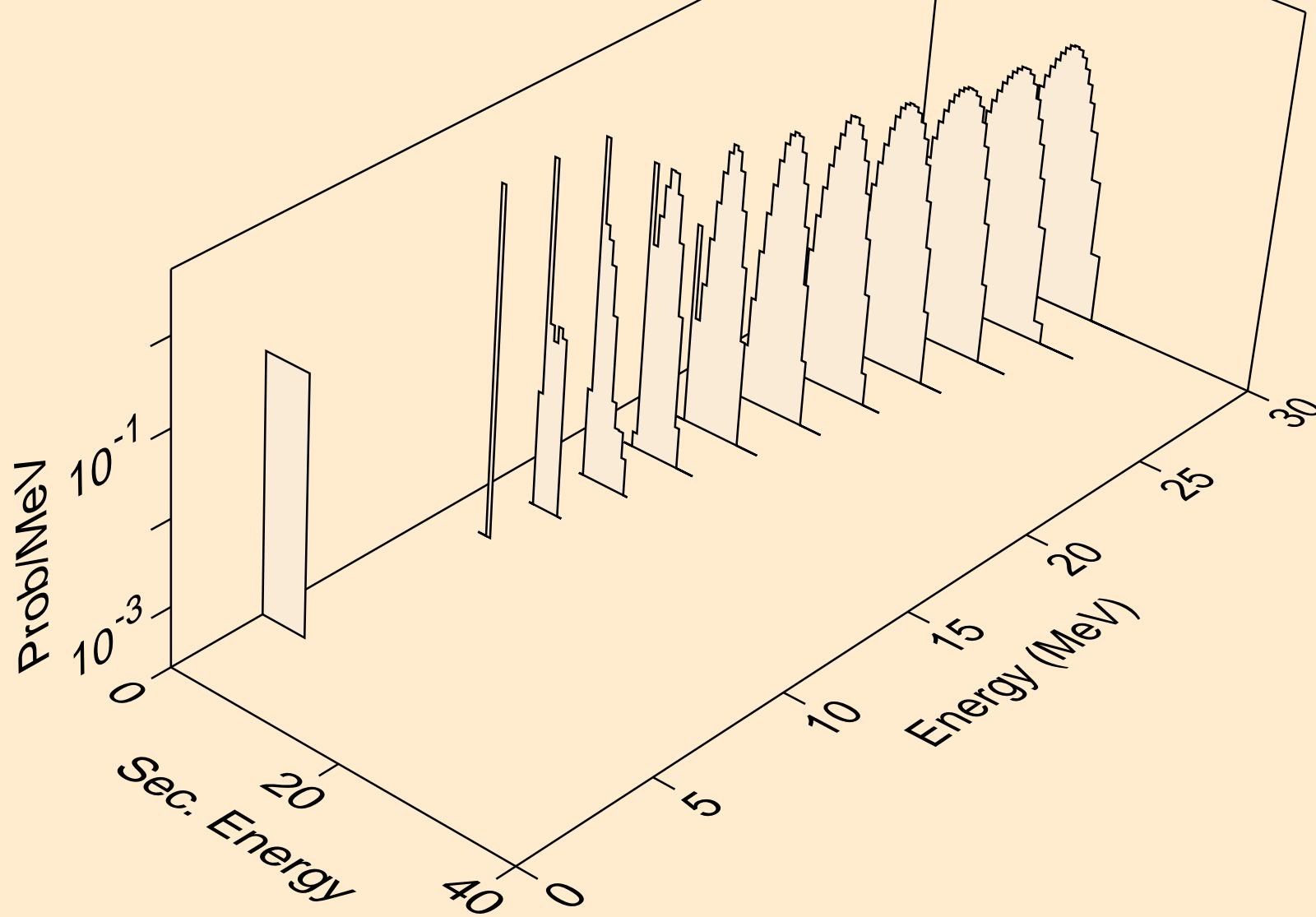



TM154 PROTON ACER TENDL-2021 LIBRARY; T=0.K  
alphas from (p,a)

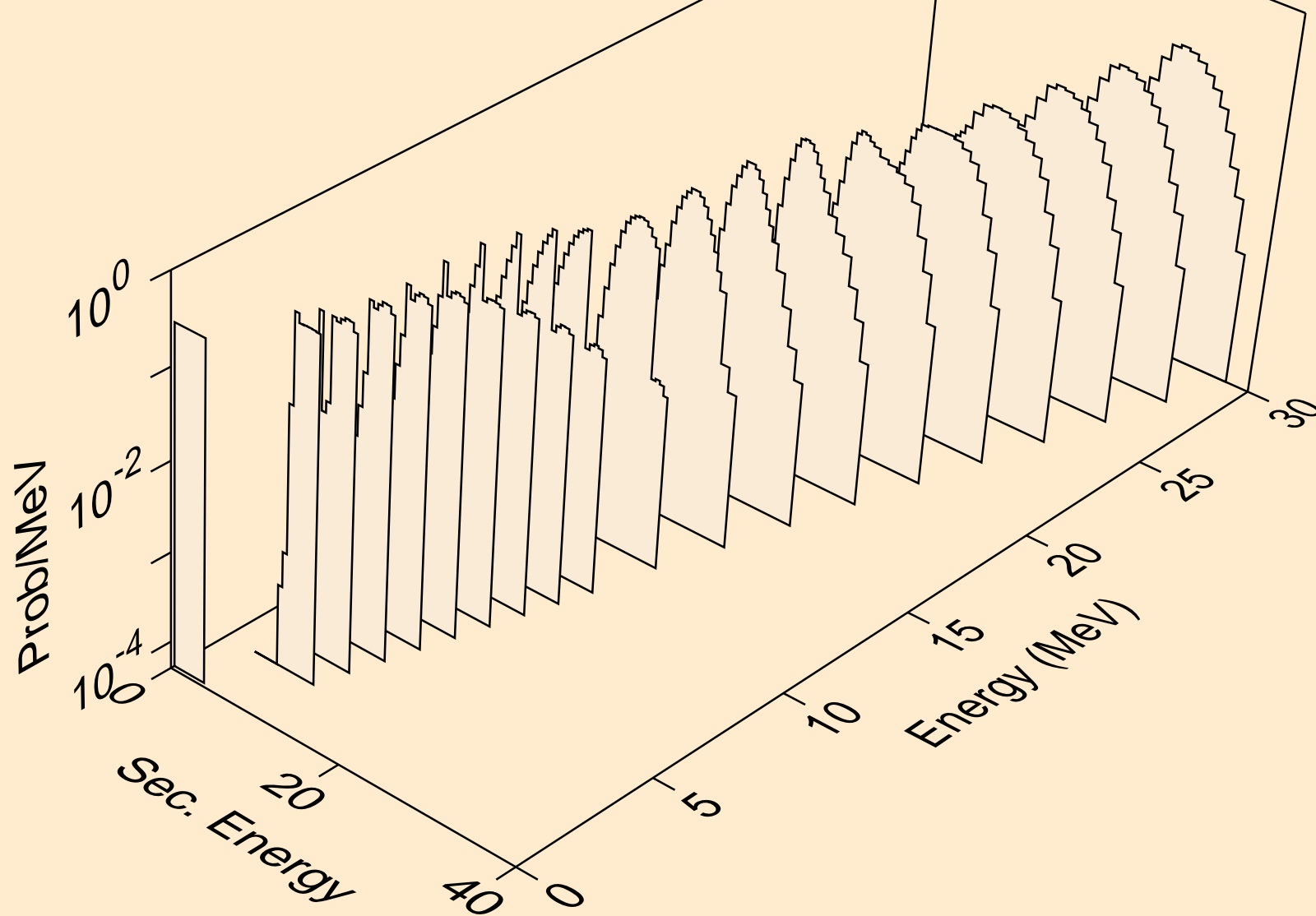

TM154 PROTON ACER TENDL-2021 LIBRARY; T=0.K  
alphas from (p,2a)

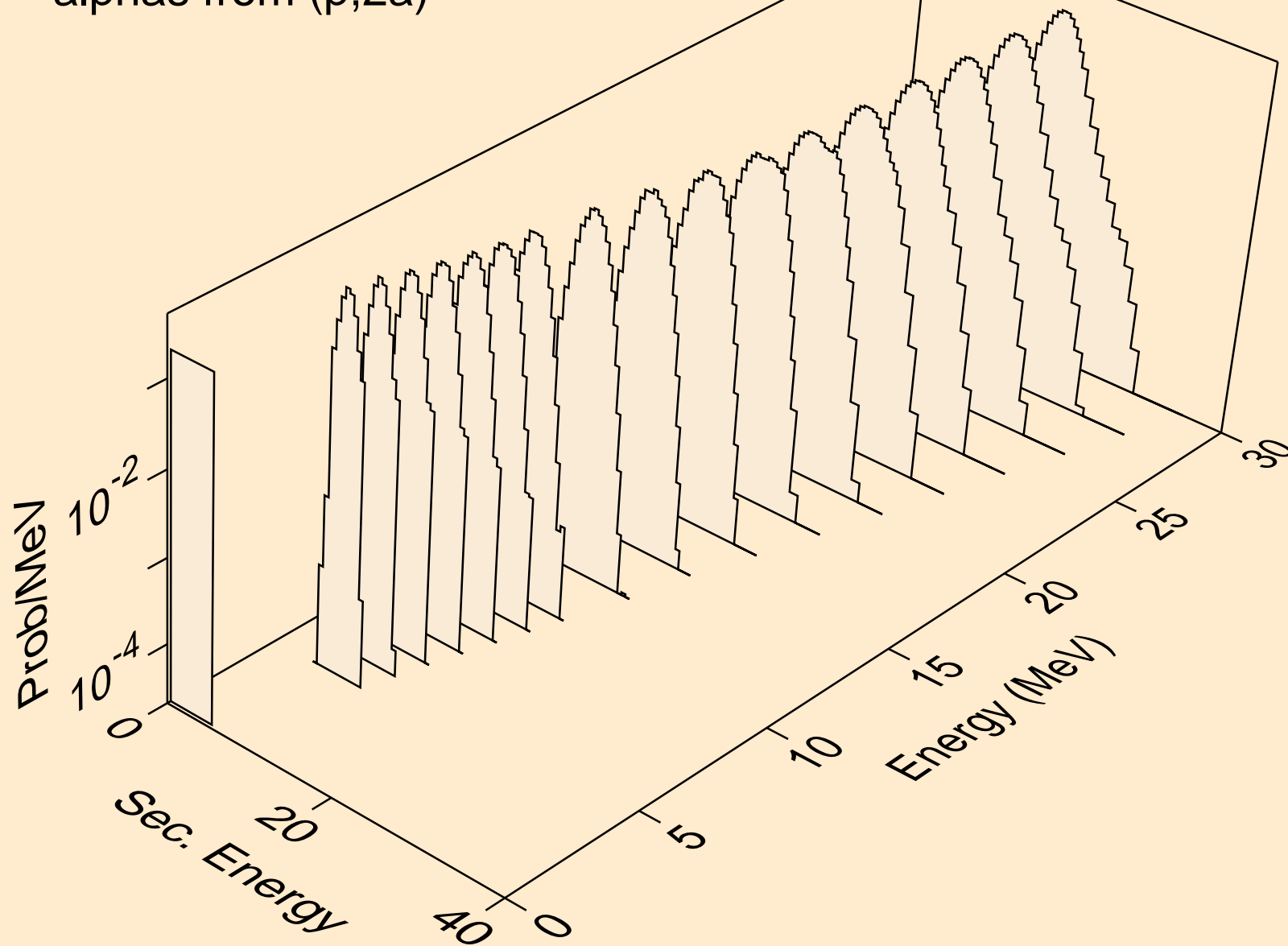

TM154 PROTON ACER TENDL-2021 LIBRARY; T=0.K  
alphas from (p,3a)

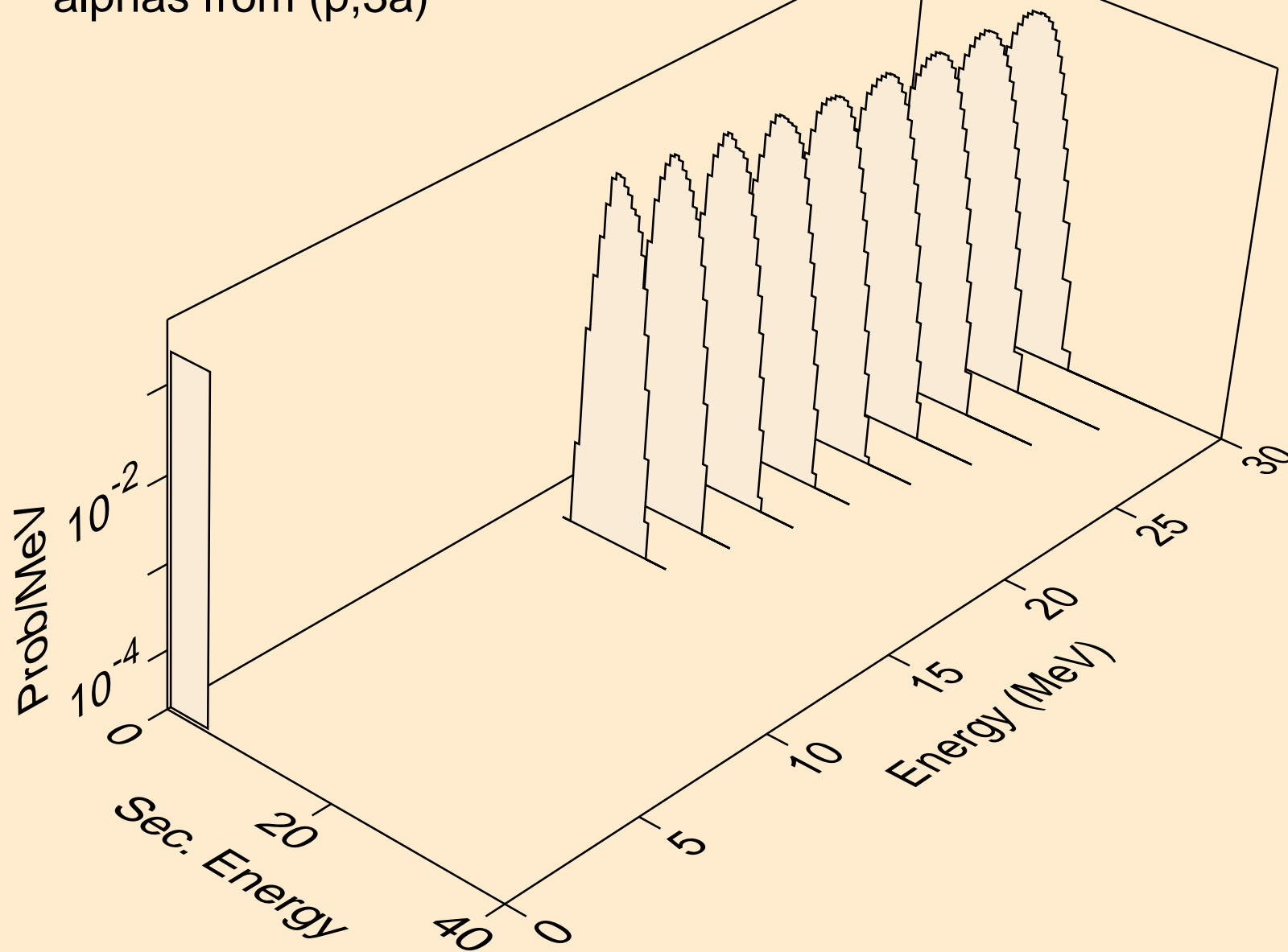

TM154 PROTON ACER TENDL-2021 LIBRARY; T=0.K  
alphas from (p,pa)

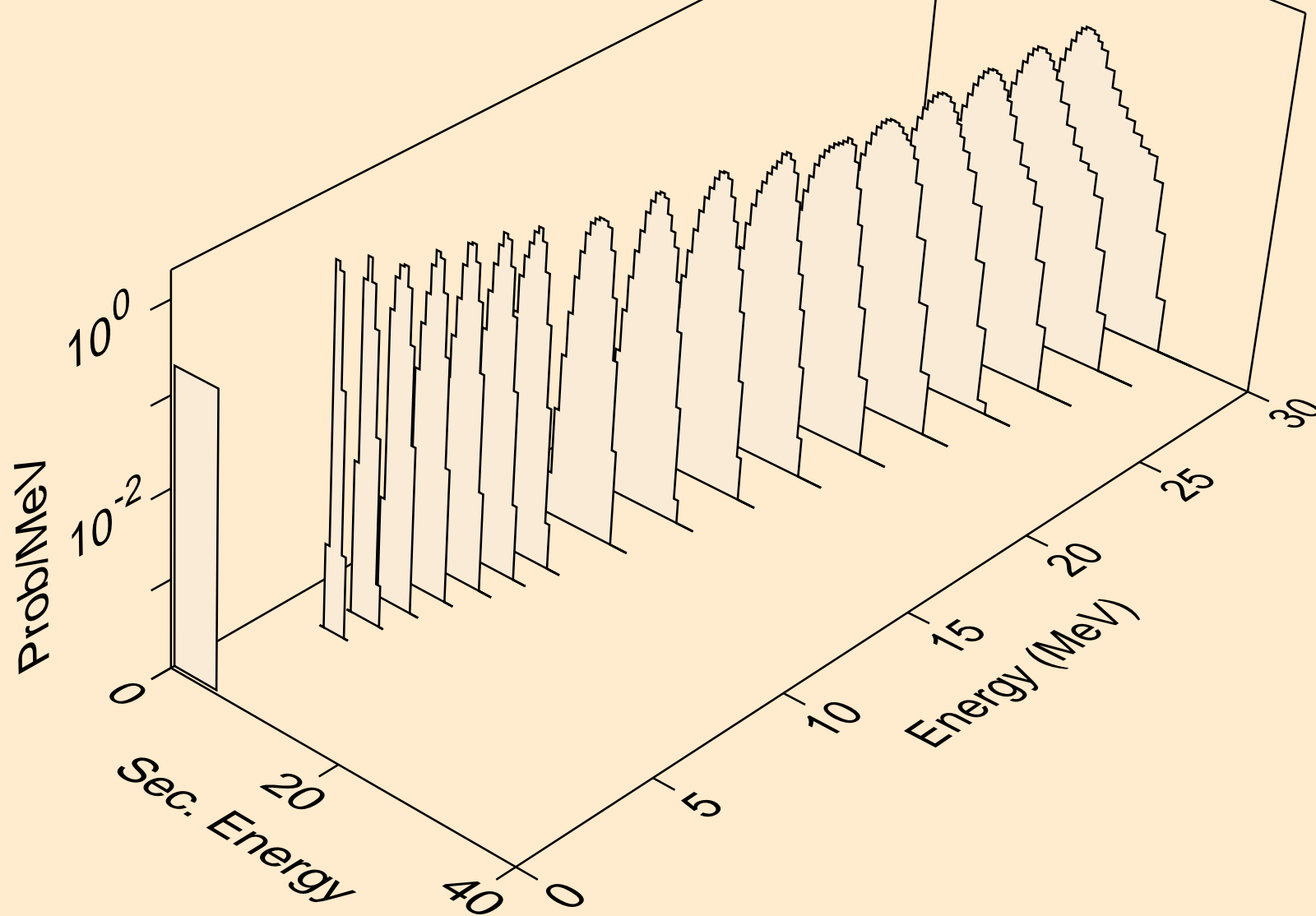

TM154 PROTON ACER TENDL-2021 LIBRARY; T=0.K  
alphas from (p,da)

